



Strathprints Institutional Repository

Zhang, Yonghao and Jiang, Hui-Rong (2016) A review on continuous-flow microfluidic PCR in droplets : advances, challenges and future. *Analytica Chimica Acta*, 914. pp. 7-16. ISSN 0003-2670 , <http://dx.doi.org/10.1016/j.aca.2016.02.006>

This version is available at <http://strathprints.strath.ac.uk/55532/>

Strathprints is designed to allow users to access the research output of the University of Strathclyde. Unless otherwise explicitly stated on the manuscript, Copyright © and Moral Rights for the papers on this site are retained by the individual authors and/or other copyright owners. Please check the manuscript for details of any other licences that may have been applied. You may not engage in further distribution of the material for any profitmaking activities or any commercial gain. You may freely distribute both the url (<http://strathprints.strath.ac.uk/>) and the content of this paper for research or private study, educational, or not-for-profit purposes without prior permission or charge.

Any correspondence concerning this service should be sent to Strathprints administrator: strathprints@strath.ac.uk



Review

A review on continuous-flow microfluidic PCR in droplets: Advances, challenges and future

Yonghao Zhang ^{a,*}, Hui-Rong Jiang ^b^a James Weir Fluids Laboratory, University of Strathclyde, Glasgow, UK^b Strathclyde Institute of Pharmacy and Biological Sciences, University of Strathclyde, Glasgow, UK

HIGHLIGHTS

- Reviewed recent important developments in continuous-flow microfluidic PCR in droplets.
- Discussion on the major challenges for system integration and automation, and potential solutions.
- A scientific speculation of future autonomous scientific discovery enabled by droplet intelligence.

GRAPHICAL ABSTRACT

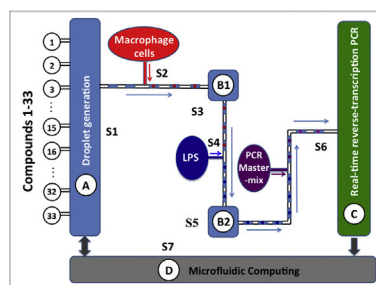

ARTICLE INFO

Article history:

Received 11 September 2015

Received in revised form

20 January 2016

Accepted 4 February 2016

Available online 13 February 2016

Keywords:

PCR

microfluidics

DNA amplification

microdroplet technology

droplet intelligence

ABSTRACT

Significant advances have been made in developing microfluidic polymerase chain reaction (PCR) devices in the last two decades. More recently, microfluidic microdroplet technology has been exploited to perform PCR in droplets because of its unique features. For example, it can prevent crossover contamination and PCR inhibition, is suitable for single-cell and single-molecule analyses, and has the potential for system integration and automation. This review will therefore focus on recent developments on droplet-based continuous-flow microfluidic PCR, and the major research challenges. This paper will also discuss a new way of on-chip flow control and a rational design simulation tool, which are required to underpin fully integrated and automated droplet-based microfluidic systems. We will conclude with a scientific speculation of future autonomous scientific discoveries enabled by microfluidic microdroplet technologies.

© 2016 The Authors. Published by Elsevier B.V. This is an open access article under the CC BY license (<http://creativecommons.org/licenses/by/4.0/>).

Contents

1. Introduction	8
2. Microfluidic PCR in droplets	8
2.1. Single-phase microfluidic PCR	8
2.2. Microfluidic PCR in droplets	8
3. Continuous-flow microfluidic PCR in droplets	9

* Corresponding author.

E-mail addresses: yonghao.zhang@strath.ac.uk (Y. Zhang), huirong.jiang@strath.ac.uk (H.-R. Jiang).

<http://dx.doi.org/10.1016/j.aca.2016.02.006>

0003-2670/© 2016 The Authors. Published by Elsevier B.V. This is an open access article under the CC BY license (<http://creativecommons.org/licenses/by/4.0/>).

3.1. Off-chip thermocycling	9
3.2. Continuous-flow microfluidic PCR in droplets with on-chip thermocycling	10
3.2.1. Continuous-flow microfluidic PCR in droplets	10
3.2.2. On-chip integration	10
3.3. Optofluidics: droplet heating and manipulation	12
3.4. Single-molecule and single-cell PCR	12
4. Integration and automation	13
4.1. Research challenges	13
4.2. Droplet intelligence/computing	14
4.3. Virtual design and experiment platform	14
5. Future: smart microfluidic platforms for autonomous scientific discovery	14
6. Conclusions	15
Acknowledgment	15
References	15

1. Introduction

Microfluidics has recently emerged as both a new technology and a scientific research field [1]. The early microfluidic device may be traced back to 1970s when the microfluidic gas chromatography was developed [2]. Since 1990s, microfluidics research and development have accelerated, and have already demonstrated the potential to revolutionise laboratory practice in chemistry and life sciences. The microfluidic technology, also often called Micro-Total-Analysis Systems (μ TAS), or Lab-on-a-Chip, can achieve common laboratory functions on a small chip which can expedite biological/chemical analyses, reduce the consumption of sample and reagents, and thus provide creative and ingenious solutions to chemical, pharmaceutical, healthcare and food industries [1].

The polymerase chain reaction (PCR) process was invented in 1984 by Kary Mullis, which has been used to amplify individual deoxyribonucleic acid (DNA) segments for functional analysis of genes in diseases. This simple chemical process has revolutionised clinical diagnoses, and medical, biological and forensic analyses [3]. The early microfluidic PCR device was reported in 1993, where the thermal cycles were performed in a continuous-single-phase-flow [4]. Since then, microfluidic PCR has been a research focus because of its importance in life sciences, and there are many review articles devoted on this subject e.g. Refs. [5–8]. However, recent research effort has been shifted to develop droplet-based microfluidic PCR as it can offer many advantages over single-phase operation and has the most promising potential for system integration and automation [9]. In addition, droplet-based microfluidics is ideal for single-cell and single-molecule analyses. However, some major research challenges need to be tackled in order to enable fully integrated, flexible and automated droplet-based microfluidic systems. Here, we will first review the recent progresses in exploiting on-chip microfluidic PCR in droplets, and then discuss how to develop integrated and automated droplet-based microfluidic systems. We will conclude with our scientific speculation of a future microfluidic system capable of autonomous scientific discovery without (or with minimal) human intervention.

2. Microfluidic PCR in droplets

2.1. Single-phase microfluidic PCR

Contrary to the conventional PCR devices, microfluidic PCR has small thermal mass, so thermal inertial effect may be negligible. In addition, the large surface-to-volume ratio of microfluidic PCR devices can ensure rapid heat transfer. Therefore, the time required for samples to achieve equilibrium temperatures in the

denaturation and annealing steps can be significantly reduced [10]. Because of rapid thermal response to the surrounding environment, the PCR mixtures are able to achieve more uniform temperatures that will help to enhance the yield. Mixing can be rapid even purely via diffusion, and consumption of expensive reagents is dramatically reduced. Furthermore, pre and post PCR steps including online sample handling, detection, mixing, and separation can be integrated into a single chip, which is essential for system integration and automation [11–13].

However, in single-phase microfluidic PCR devices, PCR mixture can be easily adsorbed at flow channel surfaces, which causes PCR inhibition and carryover contamination. The adsorption of biological/chemical particles on surface is also enhanced by large surface/volume ratio between channel surface area and sample volume, and low flow speed of PCR mixture adjacent to the surface. Therefore, PCR inhibition and carryover contamination become a serious problem for single-phase microfluidic PCR. Since PCR mixture moves much faster in channel centre than close to surface, the dwell times of PCR mixture in each thermal cycle are very different, leading to reduced yield and increased overall processing time. Furthermore, single-phase continuous-flow microfluidic PCR has the preference for amplifying short fragments and producing short chimerical molecules [14]. These problems may be amenable to microdroplet technology.

2.2. Microfluidic PCR in droplets

Discrete droplets have been exploited in the conventional PCR devices to provide a high throughput method for DNA sequencing [14,15]. Droplet-based microfluidics utilises small volume droplets as individual chemical reactors, which offer a well-controlled and highly reproducible reaction condition. It has great potential to transform the current practice in chemical and biological laboratories [16–18]. Massive parallelisation can be easily designed to enhance throughput. Rapid advances have been made in microdroplet technology to generate droplets on-demand, and to manipulate and detect droplets on-chip. Picolitre and even femtolitre droplets have been demonstrated to perform single-cell and single-molecule analyses [13]. The development of microdroplet technology in general and its applications can be referred to the recent review articles [15–20].

Since the very beginning, there has been strong research interest in developing microfluidics technology to perform PCR in droplets in order to benefit from its small discrete volumes and potential for automation [17]. Microdroplets provide an isolated environment for chemical reactions, so PCR mixtures will not be in direct contact with surface of flow channels. Surface adsorption of

biological/chemical particles can therefore be avoided, which prevents microfluidic PCR inhibition and carryover contamination. Although contamination may still occur during injection of PCR mixtures into droplets, it can be prevented by using techniques such as pico-injection method to add reagents to the droplets in a sequential order as reported by Eastburn et al. [21].

It is well known that conventional PCR has a limited capacity for amplifying larger DNA fragments and also suffers recombination between homologous gene fragments. In droplet-based microfluidic PCR, the template fragments are contained in the aqueous droplets, which encapsulate the target genes and are immersed in an immiscible oil carrier phase. Because droplets can be as small as femtolitre, they generally contain small amounts of template DNA molecules or even none, so recombination between homologous or partially homologous gene fragments during PCR process can be prevented. Consequently, the synthesis of short, chimeric products and other artifacts are avoided [14,17]. Therefore, PCR in droplets has promising applications in single-cell and single-molecule analyses, with the nucleic acids from one cell being amplified inside one droplet. Indeed, single-molecule resolution has been demonstrated in an on-chip well-based PCR device [22]. An additional benefit of the droplet based PCR is that multiplex assay will be more conveniently acquired in droplets. For example, Zhong et al. [23] demonstrated multiplexing real-time PCR in droplets to overcome multiplexing limit caused by the spectral overlap of the fluorophores in real-time PCR. The droplet-based PCR can also achieve high-throughput screening of transcription factor targets, ideal for exploration of genomic and cDNA libraries [9,24–31]. This technology will therefore greatly improve our understanding of disease pathophysiology and diagnosis.

Currently, there are two main approaches to performing microfluidic PCR in droplets: digital microfluidics e.g. Refs. [13,32], and continuous-flow microfluidics e.g. Ref. [7]. In contrast to continuous-flow microfluidics, one advantage of digital microfluidics is that most established chemistries and protocols can be directly used in small droplets. It often uses electrowetting and dielectrophoresis to generate droplets and manipulate their dynamical behaviour such as splitting and merging, e.g. see Fig. 1. It is convenient to automate the system with embedded electronic circuits. For example, Hua et al. [33] presented an automated digital microfluidic platform for multiplexed real-time PCR assays. A more recent example is the integrated digital microfluidics CMOS real-time PCR chip, which has the capability of real-time measurement at single-molecule level [34]. Furthermore, digital microfluidic platform can be configured flexibly and is not restricted to usually fixed PCR thermal cycles and inflexible dwell times often associated with continuous-flow systems. Until now, the digital microfluidics approach has therefore been commonly-used for performing microfluidic PCR in droplets [32,35,36]. However, digital microfluidics may be difficult to produce and handle a significant number of droplets on-chip in a sequential order during a short period of time, while the complementary continuous-flow approach has demonstrated its capability in this regard. For example, the continuous-flow microfluidic device developed by Pekin et al. [37] is able to generate millions droplets on-chip with well-mixed PCR mixture for quantitative and sensitive detection of rare mutations. The focus of this paper will therefore be on continuous-flow PCR in droplets.

3. Continuous-flow microfluidic PCR in droplets

Digital microfluidics usually performs its chemical and biological functions in stationary or semi-stationary droplets. By contrary, droplets are often *in motion* in continuous-flow droplet

microfluidics, which poses a challenge for precise flow control, droplet manipulation, and rapid detection. Consequently, this approach has made less headway towards system integration and automation than the digital microfluidics.

In comparison with the conventional continuous-flow microfluidic PCR devices working with a single aqueous phase, not only does the continuous-flow microfluidic PCR in droplets lead to an efficient PCR but also eliminates the PCR inhibition and carryover contamination. The thermal mass is further reduced while the thermal cycles are shortened. Because the volume of droplets can be as small as femtolitre, and PCR mixtures are confined in small droplets, any temperature change will be achieved uniformly. As PCR mixtures are now contained in droplets, they have the same dwell times, can thus be detected and subsequently sorted on chip conveniently. So PCR function may be more readily integrated into a highly automated lab-on-a-chip system. Each droplet containing samples and reagents usually moves through the designed microfluidic networks in a strict order, so that chemical and thermal conditions are reproducible for droplets. The repeatable equal conditions for interactions of all droplets with their environment contribute to an excellent stability of reaction conditions and ensure highest reproducibility, leading to homogeneous processes and products.

3.1. Off-chip thermocycling

For continuous-flow droplet-based microfluidic PCR, two types of thermocycling have been used: on-chip and off-chip. Off-chip thermal cycling is easy and efficient to deal with a large number of droplets simultaneously. For example, Eastburn et al. [38] reported a novel droplet microfluidic device which can perform ~50,000 single-cell reverse transcription PCR (RT-PCR) reactions in a single experiment to identify specific cells from a mixed human cell population, using cell type-specific staining and TaqMan RT-PCR probes. This work shows that droplet-based microfluidic system can significantly reduce labour, material consumption, and can dramatically increase throughput for characterising large, heterogeneous populations of cells at the transcriptional level.

Recently, Yang and his colleagues reported an innovative method of performing PCR in droplets [39]. The usual PCR thermal cycles were performed in agarose droplets, and the droplets were then cooled down to a temperature below 16 °C, so they became solid to make the follow-on analyses convenient [39]. This unique feature is also useful to maintain the monoclonality of each droplet for single copy genetic studies. Their droplet-based microfluidic platform was later refined and applied to single-cell analysis of rare pathogens, efficient RNA/cell encapsulation and RT-PCR at a single-cell level, and efficient screening of affinity ligands (aptamers) from a complex single-stranded DNA library [9,40,41]. With the multiplex single-cell PCR capability, their platform provides a way for ultra-high throughput and multi-parameter generic analysis of a large population of cells to reveal stochastic variation in biological systems.

However, in the above works, PCR thermal-cycling is performed off-chip which may become a concern for further system automation, which is important for future microfluidic technology to evolve out of laboratories and to be used by non-experts. In addition, labelling of individual droplets can be difficult during and after this off-chip thermal-cycling process, which is essential for system automation to deal with many individual droplets containing different PCR mixtures. Therefore, we will then discuss the most important and exciting recent developments in continuous-flow microfluidic PCR in droplets with on-chip thermocycling.

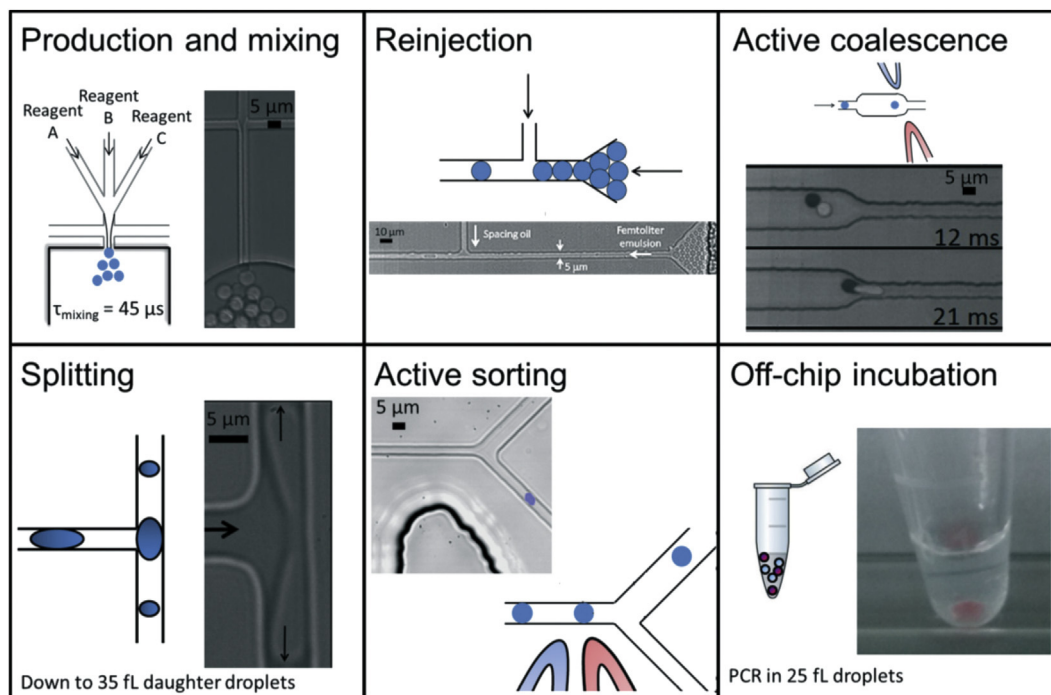

Fig. 1. An example of handling femtolitre droplets using digital microfluidics approach [13]. Reproduced from Ref. [13] with permission from The Royal Society of Chemistry.

3.2. Continuous-flow microfluidic PCR in droplets with on-chip thermocycling

Before microdroplet technology was introduced for droplet-based microfluidic PCR, immiscible liquids had been used to isolate the sample slugs from each other to mitigate some problems associated with single-phase flow PCR i.e. carryover contamination between successive samples, particle adsorption at the surface, and diffusional dilution of samples [42]. For example, Curcio and Roeraade [43] injected the samples/reagents in separate aqueous segments isolated by an immiscible organic liquid as the continuous flow phase. However, an intermediate cleaning process between two consecutive samples was needed to reduce carryover contamination between samples. Similarly, others also used a second phase flow to prevent sample contamination by separating the aqueous sample flows [44–46]. Another plug-based microfluidic device was demonstrated by Boedicker et al. [47], improved on the earlier work of Song, Rice and Ismagilov [48], which was a sophisticated example of integration of the droplet reactor device. To avoid PCR inhibition, it is important to prevent the direct interaction between PCR mixtures and device surfaces. However, the use of plugs/segments does not eliminate the adsorption problem even with a surface treatment [44]. Therefore early droplet-based microfluidic PCR devices emerged to tackle the contamination problem.

3.2.1. Continuous-flow microfluidic PCR in droplets

Nisisako, Torii and Higuchi [49] started to inject the aqueous phase into an immiscible oil phase to form droplets, where each droplet represents a transportable individual reaction volume which does not interact with its surrounding medium. This led to early droplet-based microfluidic PCR devices in which capillary tubes were often used. For example, Dorfman et al. [50] used 4.5-m-long PEA capillary with internal diameter of 800 μm , coiled around a cylinder, and performed 35 thermal cycles while the PCR mixture was encapsulated in 1 μL droplets. A similar design of

thermal cycles appeared more recently [51]. Hartung et al. [52] generated droplets within Teflon FEP tube and T-connectors, and integrated continuous reverse-transcription process, where the viruses were detected in very low concentration. Markey, Mohr and Day [53] also used T-junction to generate droplets, which was attached to PTFE tubing. The DNA amplification occurred in the PTFE tubing, which was coiled around the aluminium cylinder heaters. There were some different layouts of the devices reported in the literature. For example, Gonzalez et al. [54] presented a rotary PCR device and demonstrated robust detection of the low-copy transcript CLIC5 from 18 cells per microliter in cultured lymphoblasts. A closed-loop parallel-flow device was also reported [55].

An interesting approach to accomplish thermal cycles, very different from the above works, was reported by Ohashi et al. [56], in which the authors used the external magnet to drive aqueous droplets containing hydrophilic magnetic beads through different temperature zones in a flat-bottomed tray-type reaction chamber. Similarly, Okochi et al. [57] used magnetic force to control droplet motion in performing RT-PCR.

3.2.2. On-chip integration

Meanwhile, on-chip system integration of droplet-based continuous-flow microfluidic PCR started to emerge [58–61]. Mohr et al. [58,59] successfully developed and tested such a device, see Fig. 2. Their chip was mill-machined on a polycarbonate sheet, sealed with a 100 μm thick acetate foil. The number of thermal cycles was fixed at 32 and each cycle was 63 mm long. The dimensions of the overall device were 75 mm \times 74 mm \times 4 mm, and the droplets were generated in a T-junction with a uniform volume of 51 nL approximately. With an optical monitoring system, this device was able to perform quantitative real-time PCR measurements. The operation flow rates and temperature control were optimised by computational fluid dynamics simulations. A 60-base pairs fragment from the RNase P gene was successfully amplified.

Beer et al. [60,61] reduced the droplet size to picolitre and developed real-time measurement capability using fluorescence

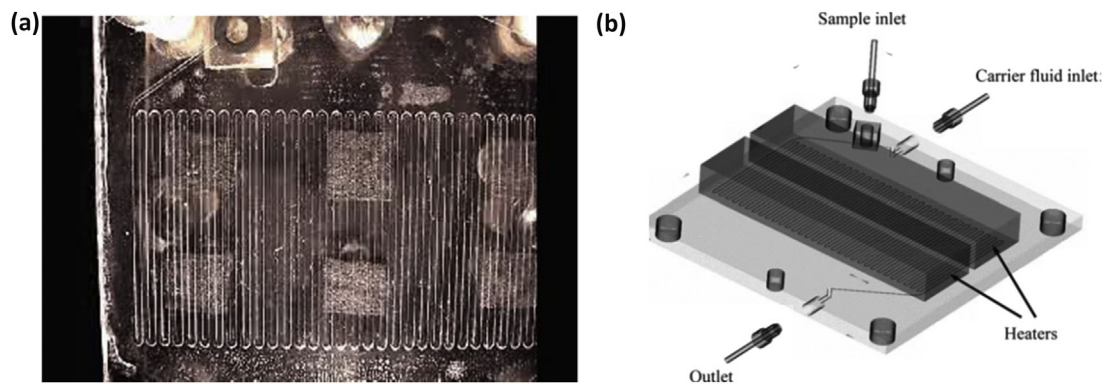

Fig. 2. (a) The continuous-flow droplet-based microfluidic PCR. (b) Layout of the PCR chip. Reproduced from Ref. [59] with permission of Springer.

for cDNA amplification. Similarly, this device benefits from the advantages of using aqueous droplets and immiscible oil-phase as the carrier fluid. This silicon based device has an off-chip valving system, which traps, stops and shunts the PCR mixture to perform thermal cycles within the microchannels. This platform requires only 18 thermal cycles for single-copy real-time detection, using Taqman-based FRET probes. It was used for RT-PCR to amplify cDNA from a complimentary RNA template. This work shows that droplet microfluidics provides a powerful tool for amplification of single-copy target nucleic acids from a complex environment. However, it is a well-based continuous-flow PCR device where the whole chip and fluids need to be heated up and cooled down for each thermal cycle. Therefore, the large thermal mass causes lengthy PCR process. This droplet microfluidic platform was later used for single transposition reactions [62]. Meanwhile, on-chip well-based PCR device can perform PCR thermocycling for many droplets simultaneously, which is particularly suitable for amplification of a large number of samples. For example, Bian et al. [22] reported the simultaneous and sensitive detection of pathogenic *Escherichia coli* O157 and *Listeria monocytogenes* with such a device. Wang et al. [63] compared the same device with the conventional quantitative real-time PCR and demonstrated its superior performance for its sensitive and efficient detection of lung cancer-related genes. Tao et al. [64] developed a similar device to amplify and sequence single recombinant viruses with high fidelity in picoliter droplets.

To enhance throughput, Kiss et al. [65] developed a continuous-flow microfluidic PCR device with a capability of generating millions of uniform droplets per hour, which was able to amplify 245-base pairs adenovirus product in droplets within 35 min at the starting template concentrations as low as 1 template molecule/167 droplets. In this device, a fluorescence monitoring system was used to collect data for the real-time measurements. Later, a very different radial design of continuous-flow PCR chip was reported by Schaerli et al. [66], which was used to amplify 85-base pairs of DNA in 17 min within 34 thermal cycles as shown in Fig. 3. The temperature gradient of the droplets were monitored and measured by adding fluorescence (rhodamine B) lifetime imaging to the aqueous PCR mixture. Wang and Burns [67] fabricated a glass-silicon chip to investigate the critical reagent concentration, which showed no volume loss of the droplets carrying PCR mixture even after 40 thermal cycles. The device was further refined to perform a two-step PCR with on-chip droplet generation, merging and mixing [68]. However, the generated droplets were relative large with volume of around 200 nL, so mixing by diffusion alone took about 10 min. Different mixing methods were therefore studied to expedite diffusion process to reduce mixing time to less than 1 s. A two-step thermal cycled bio-reaction - nest TaqMan PCR - was eventually successfully demonstrated, which was faster and more

sensitive than the regular one.

In order to develop an integrated platform to perform cell lysis, bio-reaction and PCR amplification on chip, magnetic force was exploited for droplet manipulation [59]. In this work, the magnetic beads were added in the droplets in addition to the cell samples so that the droplet dynamic behaviour may be manipulated through the magnetic force acting on the droplets by an applied external

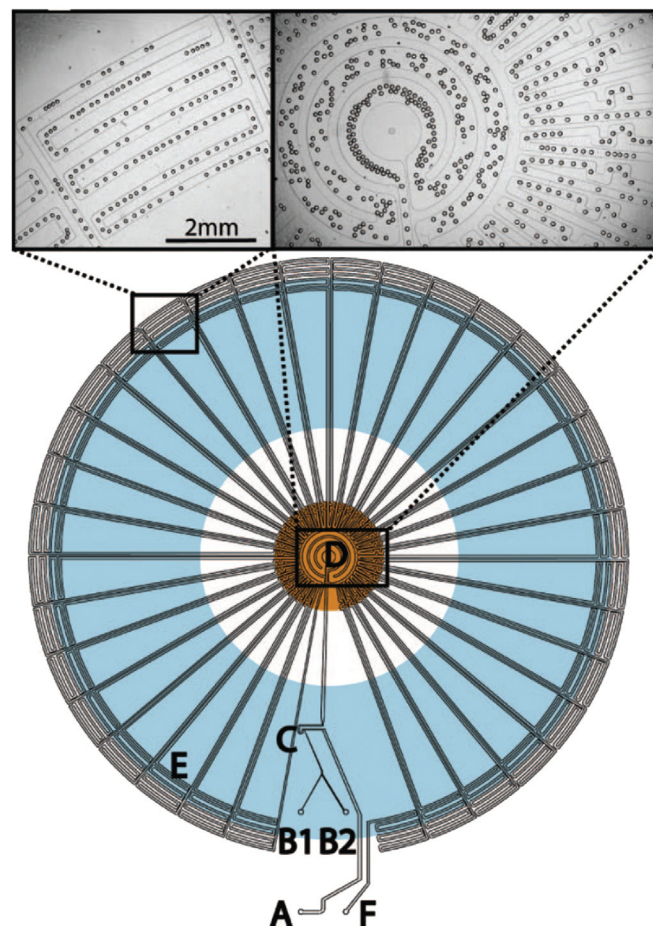

Fig. 3. The schematic diagram of the radial PCR device from Ref [66], where the inlet A is for oil injection and inlets B1 and B2 are for aqueous phase injection, and the droplets are generated at the T-junction C. The hot zone D is for denaturation, and the periphery E is for primer annealing and template extension. The final product after 34 thermal cycles is collected at the exit F. Reprinted with permission from Ref. [66]. Copyright (2009) American Chemical Society.

magnetic field. The cell lysis, cDNA synthesis, and amplification of genes were completed on-chip. As the applied force on droplet can be externally controlled, it provides additional flexibility in manipulation of droplets, which is essential for system automation and integration. Indeed such a highly automated continuous-flow PCR device was developed for real-time quantitative PCR in droplets [51]. The system architecture design can be found in Fig. 4, where a 'conveyor belt' concept was introduced to perform high-throughput PCR with the droplets containing PCR mixtures moving through a tubing coiled around the heaters continuously.

To reduce PCR thermocycling time and to enable rapid RT-PCR in droplets, wire-guide droplet manipulation technique was attempted in a continuous-flow system [69]. With the aid of computational fluid dynamics simulations, the authors found the optimal operating conditions and achieved 1–4 s for a 10 μ L droplet to complete each temperature changes leading to significant reduction of process times. Further time saving is expected if smaller droplets are to be used. The platform, which was simple and convenient to operate, was demonstrated by amplification of 160-base pairs gene sequence from 2009H1N1 influenza A. The total PCR process for 30 thermo-cycles took 510 s with 4 additional minutes for reverse transcription.

Different designs for on-chip thermal cycles have been tested as well. Oscillatory thermal cycling, which may reduce chip footprint and make microfluidic channel networks less complex in a continuous-flow microfluidic platform, was used for the first Nested-PCR for tyrosinase gene detection on chip as shown in Fig. 5 [70]. Bidirectional flow was also adopted to make thermo-cycling easy to implement in an interesting centrifugal microfluidic device for RT-PCR in droplets [71], where centrifugal force was used as driving power, exploiting density difference of the water and oil phases for droplet manipulation. The recent development of continuous-flow microfluidic devices that perform on-chip PCR in droplets is summarised in Table 1.

3.3. Optofluidics: droplet heating and manipulation

Instead of microheaters, the optofluidic heating method can provide additional flexibility for device configuration, thermocycling number and dwell times, which is essential for system integration and automation. It offers an alternative way to heat droplets as it can provide localised heat. For example, Kim et al. [72]

reported to use laser light to heat nanodroplets for real-time PCR, where the laser light provides not only the localised heating, but also temperature measurement and Taqman real-time readout in nanoliter droplets on a disposable plastic substrate. The selective heating scheme using an infrared laser appears ideal for PCR because it heats droplets only, resulting in fast thermal response. The authors reported to complete 40 cycles of PCR in just 370 s. No microheaters or microfluidic circuitry were deposited on the substrate, and PCR was performed in one droplet without affecting neighbouring droplets. This optofluidic technique was later extended to control droplet temperature for thermocycling [73].

In addition to providing localised heat, optofluidic heating method can also be used to manipulate droplet dynamical behaviour. The localised laser light heating generates a temperature gradient along the droplet interface, which leads to a thermocapillary force. This induced force is sufficiently large to actively manipulate droplet motion [74]. Therefore, optofluidic techniques may become a practical and convenient tool for flexible thermo-cycling and active manipulation of droplets, which may play a key role in an integrated and automated droplet-based microfluidic system.

3.4. Single-molecule and single-cell PCR

Since PCR process is able to generate millions of copies of a particular DNA sequence from a single copy, it has become the most promising tool for single-molecule analysis [75]. However, the standard PCR is difficult to be used for single-molecule analysis as it suffers from preference of amplifying short fragments and producing short chimeric molecules. By contrast, droplets have a dramatically reduced reaction volume ranging from femtolitre to nanolitre, so each droplet contains a small amount of template DNA molecules or even none of them. Meanwhile, a single template molecule in a droplet is able to produce saturating concentration of PCR product after a limited number of thermo-cycles, which can enhance fluorescence detection. For example, Leman et al. [13] showed that femtolitre droplets can be generated and manipulated on-chip, and demonstrated single-molecule amplification of 129-base pairs PCR product in 20 fL droplets. Small droplets thus provide an ideal environment for single-molecule analysis, which was one of the main driving forces underpinning droplet-based microfluidic PCR from the very beginning [22,39,41,61–64,66].

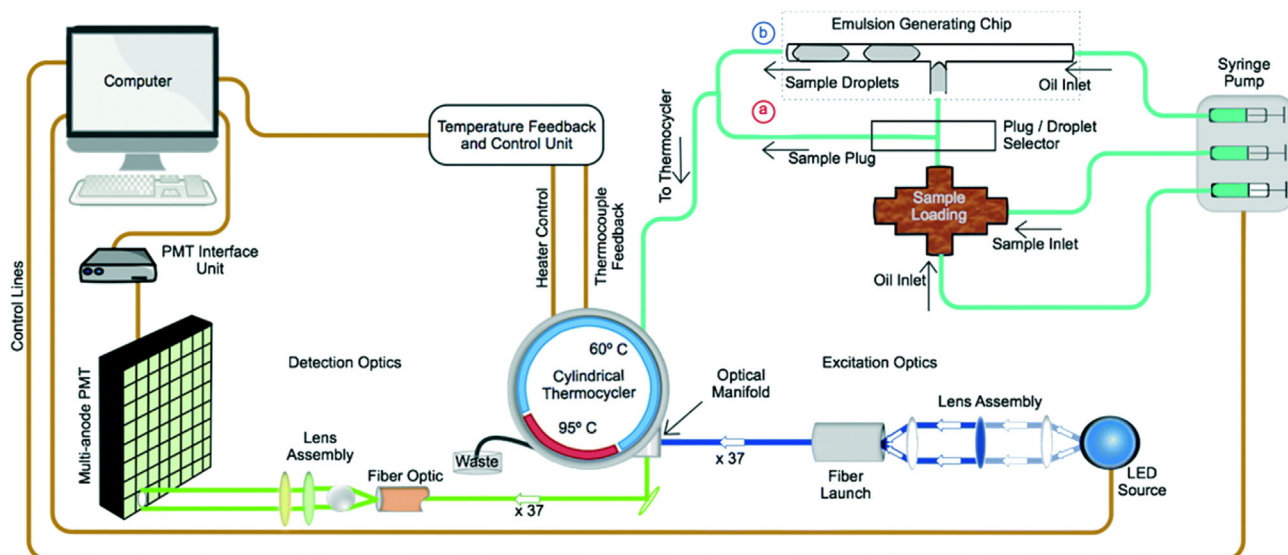

Fig. 4. The illustration of system architecture of the continuous-flow PCR device [51]. Reproduced from Ref. [51] with permission from The Royal Society of Chemistry.

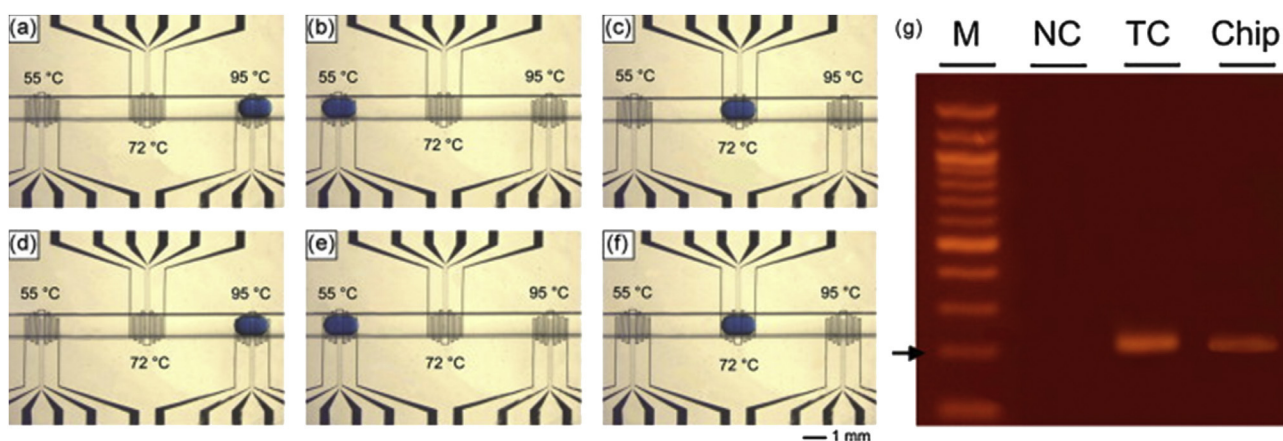

Fig. 5. The design of oscillatory thermal cycling from where the droplet moves through denaturation (a and d), annealing (b and e), and extension (c and f) regions. (g) Gel analysis of nested-PCR results for tyrosinase gene. The details can be found in Ref. [70]. Reprinted from Ref. [70], Copyright (2011), with permission from Elsevier.

4. Integration and automation

Although significant advances have been made in developing droplet-based continuous-flow microfluidic PCR devices, most of them were still focused on single PCR function. An ideal microfluidic system with implemented on-chip PCR function should be fully autonomous, easy for non-experts to use, and has complete protocol integration from sample collection to final analysis [76]. Ultimately, future droplet-based microfluidic system may be intelligent enough to perform autonomous scientific discovery itself [77].

To automate droplet-based microfluidic processes including PCR function on chip, three key steps are required to perform on-chip seamlessly, i.e. sample preparation (e.g. cell capturing, sorting, culturing, lysis, toxicity screening), thermo-cycling, and subsequent operations (e.g. detecting the concentration of intermediate product, hybridisation of the amplified DNA sequences). At present, these steps are often separate and may be off-chip as well. Although automated microfluidic PCR devices have been reported, where the PCR processes were not performed in droplets [78–80], progress towards an automated, sample-in & answer-out, and droplet-based continuous-flow microfluidic system has been slow due to the daunting research challenges associated with system design and operation.

4.1. Research challenges

One of these research challenges is that fast detection methods

are required to probe small volume droplets dynamically. Advances in single-molecule detection [81], fluorescence lifetime imaging [82], spectroscopy [83] could be used to interrogate droplets. However, this is out of scope of this review. More information about detection methods can be found in recent review papers e.g. Ref. [84].

Another major challenge is to control droplets' dynamical behaviour on-chip to realise their desired functions. In a droplet microfluidic system, each droplet usually moves through the designed microfluidic networks in a strictly pre-determined order, so that chemical and thermal conditions are reproducible for each droplet, leading to homogeneous processes and products. But this poses a research challenge to appropriately design a hierarchy of complex microfluidic channel network to achieve desired integration and automation, which requires precise control of individual droplets including generation on-demand, transport, splitting, merging and storage, although some flexibility can be introduced by using additional optical and/or electronic components for active droplet manipulation [32,77]. The commonly-used mechanical components including valves and pumps may be used to control flow on-chip and manipulate droplets. However, these moving components are difficult and expensive to fabricate and implement on-chip, and they are certainly becoming a major concern for robustness of the microfluidic systems. A new way of flow control on-chip without (or with minimal) moving parts is required to enable system integration and automation. Recently emerged concept of droplet intelligence/computing may be exploited for this purpose.

Table 1
Continuous-flow microfluidic systems with on-chip PCR in droplets.

Year	References	Features
2006	Mohr et al. [57], and later Mohr et al. [58]	On-chip droplet generation; on-line monitoring of fluorescence level within each droplet; numerical simulations carried out to optimise the design and operation conditions.
2007	Beer et al. [59], and later Beer et al. [60] & Heredia et al. [61]	Well-based; on-chip droplet generation; off-chip valve for flow control; on-line fluorescence detection
2008	Kiss et al. [62]	On-chip droplet generation at a rate of millions droplets per hour; on-chip sample injection and manipulation; on-line fluorescence detection within each droplet; single-molecule PCR.
2009	Schaerli et al. [63]	The temperatures of droplets were measured by fluorescence lifetime imaging inside the droplets; radial layout; on-chip droplet generation and manipulation; on-line fluorescence detection within each droplet
2011	Wang et al. [64], and later Wang et al. [65]	On-chip droplet generation, merging and mixing; no volume loss of droplets after 40 thermal cycles
2011	You et al. [66]	Wire-guide droplet manipulation; numerical simulations carried out to find optimised operating conditions
	Sciancalepore et al. [67]	Oscillatory thermal cycling
2013	Wang et al. [68]	Centrifugal microfluidic device; wireless temperature control; online fluorescence detection
2015	Bian et al. [22], Wang et al. [63]	Well-based; on-chip droplet generation
	Tao et al. [64]	Well-based; on-chip droplet generation, detection and sorting

4.2. Droplet intelligence/computing

Analogous to integrated electronic circuits, integrated microfluidic circuits (IMCs) utilise principles such as fluidic resistance and networks of microvalves to design computing functions, e.g., logic gates, counters, oscillator, timers [85]. Meanwhile, droplet-based microfluidics can also take advantage of the discrete nature of the droplets to enable more flexible devices for complex biological/chemical analysis. In this case a droplet represents a single “bit” of information as well as acting as a discrete chemical reactor. The size of droplets and their flow patterns may provide an additional basis for computing functions. So far, microfluidic devices have demonstrated simple logic operations, including AND, OR, NOT, NOR, NAND, and XNOR [86,87]. Droplet flows in microfluidic channel networks are able to encrypt and decrypt signals coded in the intervals between droplets [88]. Using microfluidic logic gates to convert a series of input signals into a parallel set of control actions has also been reported [89].

The microfluidic computing capabilities may be directly combined with biological and chemical functions in the same devices to design and guide autonomous experiments, free of (or with minimal) human intervention. Simple individual microfluidic computing functions have been reported in the literature but integration of these functions to achieve comprehensive flow control and communications between droplets, still needs imagination and ingenuity. Every implementation of droplet computing functions is bespoke, in contrast to equivalent Boolean circuits, and depends on collective dynamical behaviour of the droplets. However, the nonlinear dynamical behaviour of droplets is often non-intuitive and difficult to predict, so a rational design simulation tool is required to enable system design (to be discussed in Section 4.3).

To achieve combined computing and biological/chemical functions, multi-layer 3D structural hierarchies in microfluidic networks may be exploited with one layer for flow control and communication using droplet intelligence/computing functions and another layer for performing chemical/biological reactions in droplets. The individual droplets may be labelled so that they are not restricted to spatial order, which is easy for identification of droplets but complex to implement on-chip as an additional labelling and recognition module is required. Pre-determined order at the design stage or dynamically determined by droplet intelligence control will be complementary to labelling of every droplet. With necessary and appropriately integrated micro-electronic/optical sensors and actuators, microfluidic device combined with a droplet intelligence would be smart, self-regulating, and able to make logical decisions based on the experimental results in order to generate subsequent experiments. The device can be best used for optimising and creating enzymes, drug screening, complex protocol sequences, and optimisation of PCR conditions.

4.3. Virtual design and experiment platform

In developing highly automated and integrated systems, the major challenge is to monitor and control the biological and chemical processes in droplets in order to rapidly acquire information to make decisions for the follow-on experiments. These systems need to combine the additional reactions and preparation steps in the same device [90]. The complexity of integrated microfluidic processes, in addition to the often non-intuitive flow physics, makes system integration and automation even more difficult. A novel design simulation tool is urgently required to enable future automated and integrated microfluidic systems.

The present trial and error approach may work for demonstrating the concept of individual microfluidic components, but

becomes increasingly inappropriate for designing complex automated and integrated systems. Simply mimicking conventional and current systems at the macroscale may fail as flow physics and chemistry can be very different at the micro-scale. Even worse, the scaled-down microfluidic devices are often difficult and expensive to make due to a complex device structure involving many moving components. Therefore, we need to supplant the presently dominant empirical approaches – i.e. trial and error, and mimicking conventional systems – with a more strategic methodology based on state-of-the-art knowledge and techniques from across disciplinary boundaries. The resulting virtual design and experiment platform (VDEP) will be able to simulate and visualise how the chemical and biological processes behave in microfluidic devices, to facilitate the design of integrated systems to realise automated processing, optimise output, and to minimise the risk of runaway and other hazards. VDEP will predict the operational success of bio/chemical processing within a simulated virtual environment before the system is fabricated and tested. Not only does this expedite the system development cycle, but also will be able to achieve what is currently impossible for empirical approaches. It is the key to designing complex IMCs to achieve droplet intelligence/computing functions through simulation and visualisation of droplets' dynamic behaviour in complex microchannel networks. Development of such design simulation tool requires consorted effort from computational fluid dynamics, chemistry, biology, physics, software engineering, and high-performance computing. However, VDEP may enable future autonomous scientific discovery by exploiting microfluidic microdroplet technologies.

5. Future: smart microfluidic platforms for autonomous scientific discovery

Future smart microfluidic platform will have a major impact on artificial intelligence and biological computations. It is ideal for applications, e.g. directed evolution and closed loop synthesis, which need to react to feedback by redirecting the experiment. To conclude this paper, we will speculate an example of future smart droplet-based microfluidic platform for autonomous scientific discovery: evolutionary algorithms to achieve automated discovery of anti-inflammatory small-molecule combinations using an intelligent microfluidic device as illustrated in Fig. 6.

Recently, Small et al. [91] reported conventional multiple-objective evolutionary computing to design experiments to screen optimal compound combinations out of 33 compounds, targeting to inhibit signalling pathways leading to IL-1 β cytokine (a potent pro-inflammatory protein) production. IL-1 β activation pathways in immune macrophage cells are well-defined. Lipopolysaccharide (LPS), the major component of the outer membrane of Gram-negative bacteria, binds to Toll-like receptor expressed by macrophages. This will activate multiple proteins in the signalling networks, leading to IL-1 β production. Targeting these proteins provides an effective pharmacological modulation to IL-1 β production and may lead to therapy for IL-1 β mediated inflammatory diseases. To search for optimal reagent combinations in modulating IL-1 β signalling pathways from a dynamical chemical library of 33 compounds, the potential search space is about 9 billion. With an evolutionary computing strategy, the satisfied solutions were obtained with only 550 combinations, i.e. 550 rather than 9 billion experiments [91].

Evolutionary computing can be designed as a physical process in a microfluidic device, combined with its biological and chemical functions, which can efficiently search for these optimal compound combinations. This autonomous drug discovery process may include seven experimental steps in four modules as illustrated in Fig. 6. IMCs need to be created for logic operations in Module A to realise pair-wise combinations in each droplet for each generation

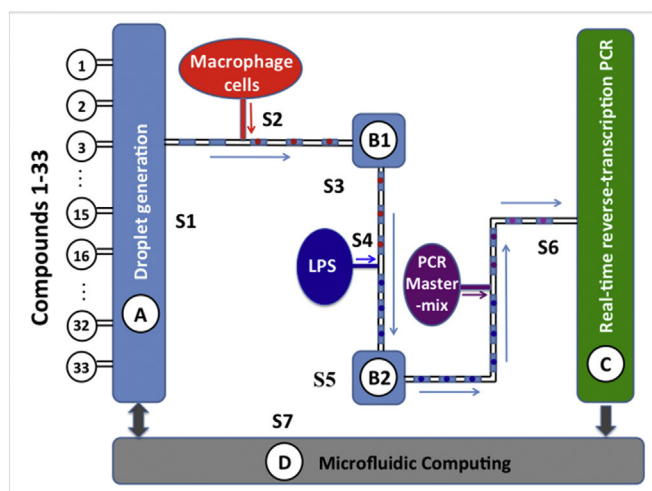

Fig. 6. The automated drug discovery microsystem. The experimental steps are: **S1:** A series of pair-wise combinations of the selected compounds with the same volume will be injected into uniform droplets sequentially, and the droplet generation order and its compounds will be recorded; **S2:** Each droplet will then be delivered in order to receive the same volume of macrophage cells, ensuring a uniform cell concentration in each droplet; **S3:** An incubation step (effect of compounds on macrophage cells) will occur for the droplets in Module B1 for a specific time, and the droplets will leave the on-chip incubator in the same sequential order; **S4:** LPS will then be injected into these droplets to activate macrophage cells; **S5:** Again, an incubation step is required in Module B2 before real-time RT-PCR starts; **S6:** PCR will quantify the production of IL-1 β mRNA in each droplet and provide fitness information to Module D (a compound combination with greater fitness, i.e. a lower level of IL-1 β mRNA, has better chance to be selected); **S7:** Consider sharing of individual compounds in all the droplets to recompute the fitness levels. An appropriate strategy, such as truncation selection [92], will be used to select the best compound combinations, and to generate the next generation compound combinations in S1 with an appropriate reproduction strategy such as the elitism and random combinations; **S1–S7:** the cycle will be repeated until an acceptable solution is found. For a small number of surviving compounds, say 5, pair-wise screening will then be performed together with a dose sensitivity study to obtain the optimal compound combination, which can be compared with conventional experimental results. **Module A:** to generate droplets in sequential order (each containing one combination of compounds), and to deliver them to receive macrophage cells; **Modules B1 & B2:** cell incubation; **Module C:** real-time RT-PCR for quantification of IL-1 β mRNA expression in each droplet i.e. fitness of the compound combination in each droplet, and represents the droplets containing the PCR Mastermix (one-step real-time RT-PCR reagents); **Module D:** to process the droplet generation information from Module A together with the fitness information from Module C to select compounds and recombine them, so Module A will be activated to form the new combinations for the next generation of experiments.

of experiments, and record the droplet generation order and its compounds. A timer circuit will be designed for cell incubation steps in Modules B1 & B2. The PCR module will have embedded micro-optical and micro-electronic components that detect fluorescence level in each thermal cycle to quantify IL-1 β mRNA production and transfer information to Module D. Module D is the “brain” of this device, using complex IMCs to convert the electric signals for IL-1 β mRNA production from the PCR module. Together with the droplets/compounds information from Module A, it recalculates the fitness of each droplet containing a combination of compounds to preserve diversity. In addition, it realises appropriate selection and reproduction strategies to generate the next generation of compound combinations through Module A, where integrated microelectronic components will be used as actuators and provide motive power. This example for automated drug discovery illustrates the potential of microfluidic microdroplet technology for future autonomous scientific discovery.

6. Conclusions

Continuous-flow droplet-based microfluidic PCR has made

headway at individual component level, and has demonstrated its great potential for high-throughput, single-cell and single-molecule analyses. However, highly integrated systems including pre and post PCR processes and other bio/chemical functions are still rare. Automation of integrated systems is even more challenging to develop. Emerging droplet intelligence/computing functions may provide a new way of achieving on-chip control of droplet dynamical behaviour to enable system automation. To design such intelligent automated and integrated systems, a powerful virtual design and experiment platform is required to supplant the present empirical design methodologies.

Acknowledgment

This work is financially supported by the UK's Engineering and Physical Sciences Research Council (EPSRC) under grants EP/M021475/1.

References

- [1] G.M. Whitesides, *Nature* 442 (2006) 368.
- [2] S.C. Terry, 1975, PhD thesis, Stanford University, USA.
- [3] J.M. Bartlett, D. Stirling, *Methods Mol. Biol.* 226 (2003) 3.
- [4] M.A. Northrup, M.T. Ching, R.M. White, R.T. Watson, *Transducers* 93 (1993) 924.
- [5] P.-A. Auroux, Y. Koc, A. deMello, A. Manz, P.J.R. Day, *Lab. Chip* 4 (2004) 534.
- [6] L. Chen, A. Manz, P.J.R. Day, *Lab. Chip* 7 (2007) 1413.
- [7] Y. Zhang, P. Ozdemir, *Anal. Chim. Acta* 638 (2009) 115.
- [8] J. Wu, R. Kodzius, W.B.W.J. Wen, *Microchim. Acta* 181 (2014) 1611.
- [9] Z. Zhu, G. Jenkins, W. Zhang, M. Zhang, Z. Guan, C.J. Yang, *Anal. Bioanal. Chem.* 403 (2012) 2127.
- [10] C.T. Wittwer, M.G. Hermann, in: M.A. Innis, D.H. Gelfand, J.J. Sninsky (Eds.), *PCR Applications: Protocols for Functional Genomics*, Academic, San Diego, 1999, pp. 211–229.
- [11] C.J. Easley, J.M. Karlinsey, J.M. Bienvenue, L.A. Legendre, M.G. Roper, S.H. Feldman, M.A. Hughes, E.L. Hewlett, T.J. Merkel, J.P. Ferrance, J.P. Landers, *Proc. Natl. Acad. Sci. U. S. A.* 103 (2006) 19272.
- [12] S.C.C. Shih, P.C. Gach, J. Sutarich, B.A. Simmons, P.D. Adams, S. Singh, A.K. Singh, *Lab. Chip* 15 (2015) 225.
- [13] M. Leman, F. Abouakil, A.D. Griffiths, P. Tabeling, *Lab. Chip* 15 (2015) 753.
- [14] V. Taly, B.T. Kelly, A.D. Griffiths, *Chem. Biol. Chem.* 8 (2007) 263.
- [15] B.T. Kelly, J.-C. Baret, V. Taly, A.D. Griffiths, *Chem. Commun.* (2007) 1773.
- [16] A. Günther, K.F. Jensen, *Lab. Chip* 6 (2006) 1487.
- [17] S.-Y. Teh, R. Lin, L.-H. Hung, A.P. Lee, *Lab. Chip* 8 (2008) 198.
- [18] A. Huebner, S. Sharma, M. Srisa-Art, F. Hoffelder, J.B. Edel, A.J. deMello, *Lab. Chip* 8 (2008) 1244.
- [19] P. Day, A. Manz, Y. Zhang (Eds.), *Microdroplet Technology and Microfluidics: Principles, Components and Emerging Applications*, Springer, USA, 2012.
- [20] E.Y. Basova, F. Foret, *Analyst* 140 (2015) 22.
- [21] D.J. Eastburn, A. Sciambi, A.R. Abate, *Plos One* 8 (2013) e62961.
- [22] X. Bian, F. Jing, G. Li, X. Fan, C. Jia, H. Zhou, Q. Jin, J. Zhao, *Biosens. Bioelectron.* 74 (2015) 770.
- [23] Q. Zhong, S. Bhattacharya, S. Kotsopoulos, J. Olson, V. Taly, A.D. Griffiths, D.R. Link, J.W. Larson, *Lab. Chip* 11 (2011) 2167.
- [24] D. Dressman, H. Yan, G. Traverso, K.W. Kinzler, B. Vogelstein, *Proc. Natl. Acad. Sci. U. S. A.* 100 (2003) 8817.
- [25] M. Margulies, M. Egholm, W.E. Altman, S. Attiya, J.S. Bader, L.A. Bembien, J. Berka, M.S. Braverman, Y.J. Chen, Z. Chen, S.B. Dewell, L. Du, J.M. Fierro, X.V. Gomes, B.C. Godwin, W. He, S. Helgesen, C.H. Ho, G.P. Irzyk, S.C. Jando, M.L. Alenquer, T.P. Jarvie, K.B. Jirave, J.B. Kim, J.R. Knight, J.R. Lanza, J.H. Leamon, S.M. Lefkowitz, M. Lei, J. Li, K.L. Lohman, H. Lu, V.B. Makhijani, K.E. McDade, M.P. McKenna, E.W. Myers, E. Nickerson, J.R. Nobile, R. Plant, B.P. Puc, M.T. Ronan, G.T. Roth, G.J. Sarkis, J.F. Simons, J.W. Simpson, M. Srinivasan, K.R. Tartaro, A. Tomasz, K.A. Vogt, G.A. Volkmer, S.H. Wang, Y. Wang, M.P. Weiner, P. Yu, R.F. Begley, J.M. Rothberg, *Nature* 437 (2005) 376.
- [26] J. Shendure, G.J. Porreca, N.B. Reppas, X. Lin, J.P. McCutcheon, A.M. Rosenbaum, M.D. Wang, K. Zhang, R.D. Mitra, G.M. Church, *Science* 309 (2005) 1728.
- [27] M. Li, F. Diehl, D. Dressman, B. Vogelstein, K.W. Kinzler, *Nat. Methods* 3 (2006) 95.
- [28] K. Zhang, J. Zhu, J. Shendure, G.J. Porreca, J.D. Aach, R.D. Mitra, G.M. Church, *Nat. Genet.* 38 (2006) 382.
- [29] J.G. Wetmur, M. Kumar, L. Zhang, C. Palomeque, S. Wallenstein, *J. Chem. Nucl. Acids Res.* 33 (2005) 2615.
- [30] T. Kojima, Y. Takei, M. Ohtsuka, Y. Kawarasaki, T. Yamane, H. Nakano, *Nucl. Acids Res.* 33 (2005) e150.
- [31] T. Beneyton, F. Coldren, J.-C. Baret, A.D. Griffiths, V. Taly, *Analyst* 139 (2014) 3314.
- [32] K. Perez-Toralla, D. Pekin, J.F. Bartolo, F. Garlan, P. Nizard, P. Laurent-Puig,

- J.C. Baret, V. Taly, *Med. Sci.* 31 (2015) 84.
- [33] Z. Hua, J.L. Rouse, A.E. Eckhardt, V. Srinivasan, V.K. Pamula, W.A. Schell, J.L. Benton, T.G. Mitchell, M.G. Pollack, *Anal. Chem.* 82 (2010) 2310.
- [34] H. Norian, R.M. Field, I. Kymissis, K.L. Shepard, *Lab. Chip* 14 (2014) 4076.
- [35] A.A. Morley, *Biomol. Detect. Quantif.* 1 (2014) 1.
- [36] E. Mazaika, J. Homsy, *Curr. Protoc. Hum. Genet.* 82 (2014), 7.24.1.
- [37] D. Pekin, Y. Skhiri, J.C. Baret, D. Le Corre, L. Mazutis, C.B. Salem, F. Millot, A. El Harrak, J.B. Hutchison, J.W. Larson, D.R. Link, P. Laurent-Puig, A.D. Griffiths, V. Taly, *Lab. Chip* 11 (2011) 2156.
- [38] D.J. Eastburn, A. Sciambi, A.R. Abate, *Anal. Chem.* 85 (2013) 8016.
- [39] X. Leng, W. Zhang, C. Wang, L. Cui, C.J. Yang, *Lab. Chip* 10 (2010) 2841.
- [40] H. Zhang, G. Jenkins, Y. Zou, Z. Zhu, C.J. Yang, *Anal. Chem.* 84 (2012) 3599.
- [41] W.Y. Zhang, W. Zhang, Z. Liu, C. Li, Z. Zhu, C.J. Yang, *Anal. Chem.* 84 (2012) 350.
- [42] S. Hardt, D. Dadic, F. Doffing, K.S. Drese, G. Münchow, O. Sörensen, *Nanotech* 1 (2004) 55.
- [43] M. Curcio, J. Roeraade, *Anal. Chem.* 75 (2003) 1.
- [44] N. Park, S. Kim, J.H. Hahn, *Anal. Chem.* 75 (2003) 6029.
- [45] P.J. Obeid, T.K. Christopoulos, H.J. Crabtree, C.J. Backhouse, *Anal. Chem.* 75 (2003) 288.
- [46] P.J. Obeid, T.K. Christopoulos, *Anal. Chim. Acta* 494 (2003) 1.
- [47] J.Q. Boedicker, L. Li, T.R. Kline, R.F. Ismagilov, *Lab. Chip* 8 (2008) 1265.
- [48] H. Song, J.D. Tice, R.F. Ismagilov, *Angew. Chem. Int. Ed.* 42 (2003) 767.
- [49] T. Nisisako, T. Torii, T. Higuchi, *Lab. Chip* 2 (2002) 24.
- [50] K.D. Dorfman, M. Chabert, J.-H. Codarbox, G. Rousseau, P. de Cremoux, J.-L. Viovy, *Anal. Chem.* 77 (2005) 3700.
- [51] A.C. Hatch, T. Ray, K. Lintecum, C. Youngbull, *Lab. Chip* 14 (2014) 562.
- [52] R. Hartung, A. Brösing, G. Sczcepankiewicz, U. Liebert, N. Häfner, M. Dürst, J. Felbel, D. Lassner, J.M. Köhler, *Biomed. Microdevices* 11 (2009) 685.
- [53] A.L. Markey, S. Mohr, P.J.R. Day, *Methods* 50 (2010) 277.
- [54] A. Gonzalez, R. Grimes, E.J. Walsh, T. Dalton, M. Davies, *Biomed. Microdevices* 9 (2007) 261.
- [55] C. Zhang, D. Xing, *Anal. Biochem.* 387 (2009) 102.
- [56] T. Ohashi, H. Kuyama, N. Hanafusa, Y. Togawa, *Biomed. Microdevices* 9 (2007) 695.
- [57] M. Okochi, H. Tsuchiya, F. Kumazawa, M. Shikida, H. Honda, J. Biosci. Bioeng. 109 (2010) 193.
- [58] S. Mohr, Y.-H. Zhang, A. Macaskill, P.J.R. Day, R.W. Barber, N.J. Goddard, D.R. Emerson, P.R. Fielden, June 2006. Proceedings of the 4th International Conference on Nanochannels, Microchannels and Minichannels, Limerick Ireland. p. Paper 96131.
- [59] S. Mohr, Y.-H. Zhang, A. Macaskill, P.J.R. Day, R.W. Barber, N.J. Goddard, D.R. Emerson, P.R. Fielden, *Microfluid. Nanofluid.* 3 (2007) 611.
- [60] N.R. Beer, B.J. Hindson, E.K. Wheeler, S.B. Hall, K.A. Rose, I.M. Kennedy, B.W. Colston, *Anal. Chem.* 79 (2007) 8471.
- [61] N.R. Beer, E.K. Wheeler, L. Lee-Houghton, N. Watkins, S. Nasarabadi, N. Hebert, P. Leung, D.W. Arnold, C.G. Bailey, B.W. Colston, *Anal. Chem.* 80 (2008) 1854.
- [62] N.J. Heredia, N.R. Beer, C.A. Hara, A.L. Hiddessen, C.G. Bailey, *Anal. Biochem.* 399 (2010) 78.
- [63] P. Wang, F. Jing, G. Li, Z. Wu, Z. Cheng, J. Zhang, H. Zhang, C. Jia, Q. Jin, H. Mao, J. Zhao, *Biosens. Bioelectron.* 74 (2015) 836.
- [64] Y. Tao, A. Rotem, H. Zhang, S.K. Cockrell, S.A. Koehler, C.B. Chang, L.W. Ung, P.G. Cantalupo, Y. Ren, J.S. Lin, A.B. Feldman, C.E. Wobus, J.M. Pipas, D.A. Weitz, *ChemBioChem* 16 (2015) 2167.
- [65] M.M. Kiss, L. Ortoleva-Donnelly, N.R. Beer, J. Warner, C.G. Bailey, B.W. Colston, J.M. Rothberg, D.R. Link, J.H. Leamon, *Anal. Chem.* 80 (2008) 8975.
- [66] Y. Schaerli, R.C. Wootton, T. Robinson, V. Stein, C. Dunsby, M.A.A. Neil, P.M.W. French, A.J. deMello, C. Abell, F. Hollfelder, *Anal. Chem.* 81 (2009) 302.
- [67] F. Wang, M.A. Burns, *Biomed. Microdevices* 11 (2009) 1071.
- [68] F. Wang, M.A. Burns, *Biomed. Microdevices* 12 (2010) 533.
- [69] D.J. You, P.L. Tran, H.-J. Kwon, D. Patel, J.-Y. Yoon, *Faraday Discuss.* 149 (2011) 159.
- [70] A.G. Sciancalepore, A. Polini, E. Mele, S. Girardo, R. Cingolani, D. Pisignano, *Biosens. Bioelectron.* 26 (2011) 2711.
- [71] G. Wang, H.-P. Ho, Q. Chen, A.K.-L. Yang, H.-C. Kwok, S.-Y. Wu, S.-K. Kong, Y.-W. Kwan, X. Zhang, *Lab. Chip* 13 (2013) 3698.
- [72] H. Kim, S. Dixit, C.J. Green, G.W. Faris, *Opt. Express* 17 (2009) 218.
- [73] K. Hettiarachchi, H. Kim, G.W. Faris, *Microfluid. Nanofluid.* 13 (2012) 967.
- [74] C.N. Baroud, J.-P. Delville, F. Gallaire, R. Wunnenburger, *Phys. Rev. E* 75 (2007) 046302.
- [75] A.J. Jeffreys, V. Wilson, R. Neumann, J. Keyte, *Nucl. Acids Res.* 16 (1988) 10953.
- [76] X. Niu, A.J. deMello, *Biochem. Soc. Trans.* 40 (2012) 615.
- [77] D. Waltz, B.G. Buchanan, *Science* 324 (2009) 43.
- [78] G.S. Lim, J.S. Chang, L. Zhang, R.G. Wu, Z.P. Wang, K.M. Cui, S. Wong, *Lab. Chip* 15 (2015) 4032.
- [79] G. Czilwik, T. Messinger, O. Strohmeier, S. Wadle, F. von Stetten, N. Paust, G. Roth, R. Zengerle, P. Saarinen, J. Niittymaki, K. McAllister, O. Sheils, J. O'Leary, D. Mark, *Lab. Chip* 15 (2015) 3749.
- [80] B.W. Shu, C.S. Zhang, D. Xing, *Lab. Chip* 15 (2015) 2597.
- [81] M. Srisa-Art, A.J. deMello, J. Edel, *J. Phys. Chem. B* 114 (2010) 15766.
- [82] X.C.I. Solvas, M. Srisa-Art, A.J. deMello, J.B. Edel, *Anal. Chem.* 82 (2010) 3950.
- [83] K.L.A. Chan, X. Niu, A.J. deMello, S.G. Kazarian, *Anal. Chem.* 83 (2011) 3606.
- [84] J. Wu, R. Kodzius, W. Cao, W. Wen, *Microchim. Acta* 181 (2014) 1611.
- [85] B. Mosadegh, T. Bersano-Begey, J.Y. Park, M.A. Burns, S. Takayama, *Lab. Chip* 11 (2011) 2813.
- [86] M. Prakash, N. Gershenfeld, *Science* 315 (2007) 832.
- [87] M.W. Toepke, V.V. Abhyankar, D.J. Beebe, *Lab. Chip* 7 (2007) 1449.
- [88] M.J. Fuerstman, P. Garstecki, G.M. Whitesides, *Science* 315 (2007) 828.
- [89] J.A. Weaver, J. Melin, D. Stark, S.R. Quake, M.A. Horowitz, *Nat. Phys.* 6 (2010) 218.
- [90] D. Janasek, J. Franzke, A. Manz, *Nature* 442 (2006) 374.
- [91] B.G. Small, B.W. McColl, R. Allmendinger, J. Pahle, G. Lopez-Castejon, N.J. Rothwell, J. Knowles, P. Mendes, D. Brough, D.B. Kell, *Nat. Chem. Biol.* 7 (2011) 902.
- [92] D.E. Goldberg, *The Design of Innovation: Lessons from and for Competent Genetic Algorithms*, Kluwer Academic Publishers, Boston, MA, 2002.



Yonghao Zhang is Weir Professor of Thermodynamics and Fluid Mechanics at University of Strathclyde, UK. He leads the James Weir Fluids Laboratory (<http://www.jwfl.org.uk>) to advance our understanding of fundamental flow physics and chemistry in micro/nano systems, with the aim of utilising these research advances to develop new technologies with capabilities beyond any currently conceived. After his PhD study in Mechanical Engineering at University of Aberdeen, UK, in 2001, he worked as a Scientist, then Senior Scientist at STFC Daresbury Laboratory, UK. In 2007, He joined University of Strathclyde as John Anderson Research Lecturer.



Dr Hui-Rong Jiang is currently a Senior Lecturer at the Institute for Pharmacy and Biomedical Sciences, University of Strathclyde, UK. Her research focuses on understanding the complex regulatory network of immune molecules during the development of autoimmune diseases such as multiple sclerosis, and uveoretinitis. She graduated from China Medical University and had her PhD and post-doctoral trainings at the Universities of Aberdeen, Cambridge, Manchester and Glasgow before joining University of Strathclyde in 2010.