

Digital Imaging and Communications in Medicine (DICOM)

Part 17: Explanatory Information

Published by

National Electrical Manufacturers Association

1300 N. 17th Street

Rosslyn, Virginia 22209 USA

© Copyright 2006 by the National Electrical Manufacturers Association. All rights including translation into other languages, reserved under the Universal Copyright Convention, the Berne Convention for the Protection of Literacy and Artistic Works, and the International and Pan American Copyright Conventions.

NOTICE AND DISCLAIMER

The information in this publication was considered technically sound by the consensus of persons engaged in the development and approval of the document at the time it was developed. Consensus does not necessarily mean that there is unanimous agreement among every person participating in the development of this document.

NEMA standards and guideline publications, of which the document contained herein is one, are developed through a voluntary consensus standards development process. This process brings together volunteers and/or seeks out the views of persons who have an interest in the topic covered by this publication. While NEMA administers the process and establishes rules to promote fairness in the development of consensus, it does not write the document and it does not independently test, evaluate, or verify the accuracy or completeness of any information or the soundness of any judgments contained in its standards and guideline publications.

NEMA disclaims liability for any personal injury, property, or other damages of any nature whatsoever, whether special, indirect, consequential, or compensatory, directly or indirectly resulting from the publication, use of, application, or reliance on this document. NEMA disclaims and makes no guaranty or warranty, expressed or implied, as to the accuracy or completeness of any information published herein, and disclaims and makes no warranty that the information in this document will fulfill any of your particular purposes or needs. NEMA does not undertake to guarantee the performance of any individual manufacturer or seller's products or services by virtue of this standard or guide.

In publishing and making this document available, NEMA is not undertaking to render professional or other services for or on behalf of any person or entity, nor is NEMA undertaking to perform any duty owed by any person or entity to someone else. Anyone using this document should rely on his or her own independent judgment or, as appropriate, seek the advice of a competent professional in determining the exercise of reasonable care in any given circumstances. Information and other standards on the topic covered by this publication may be available from other sources, which the user may wish to consult for additional views or information not covered by this publication.

NEMA has no power, nor does it undertake to police or enforce compliance with the contents of this document. NEMA does not certify, test, or inspect products, designs, or installations for safety or health purposes. Any certification or other statement of compliance with any health or safety-related information in this document shall not be attributable to NEMA and is solely the responsibility of the certifier or maker of the statement.

CONTENTS

NOTICE AND DISCLAIMER	2
CONTENTS	3
FOREWORD	9
1 Scope and field of application.....	11
2 Normative references	11
3 Definitions	11
4 Symbols and abbreviations	11
5 Conventions.....	11
Annex A Explanation of patient orientation (Normative)	13
Annex B Integration of Modality Worklist and Modality Performed Procedure Step in the Original DICOM Standard (Informative)	24
Annex C Waveforms (Informative)	27
C.1 DOMAIN OF APPLICATION.....	27
C.2 USE CASES.....	27
C.3 TIME SYNCHRONIZATION FRAME OF REFERENCE	28
C.4 WAVEFORM ACQUISITION MODEL	28
C.5 WAVEFORM INFORMATION MODEL.....	29
C.6 HARMONIZATION WITH HL7	30
C.6.1 HL7 Waveform Observation	30
C.6.2 Channel Definition	31
C.6.3 Timing.....	31
C.6.4 Waveform Data.....	31
C.6.5 Annotation	32
C.7 HARMONIZATION WITH SCP-ECG	32
Annex D SR Encoding Example (Informative)	33
Annex E Mammography CAD (Informative).....	40
E.1 MAMMOGRAPHY CAD SR CONTENT TREE STRUCTURE.....	40
E.2 MAMMOGRAPHY CAD SR OBSERVATION CONTEXT ENCODING	42
E.3 MAMMOGRAPHY CAD SR EXAMPLES.....	43
E.3.1....Example 1: Calcification and Mass Detection with No Findings.....	43
E.3.2....Example 2: Calcification and Mass Detection with Findings	45
E.3.3....Example 3: Calcification and Mass Detection, Temporal Differencing with Findings.....	59
E.4 CAD OPERATING POINT	71
E.5 Mammography CAD SR AND For Processing / For Presentation IMAGES	71
Annex F Chest CAD (Informative)	73
F.1 CHEST CAD SR CONTENT TREE STRUCTURE	73
F.2 CHEST CAD SR OBSERVATION CONTEXT ENCODING.....	74
F.3 CHEST CAD SR EXAMPLES	75
F.3.1 Example 1: Lung Nodule Detection with No Findings	75
F.3.2 Example 2: Lung Nodule Detection with Findings and Anatomy/Pathology Interpretation ..	76
F.3.3 Example 3: Lung Nodule Detection, Temporal Differencing with Findings	81
F.3.4 Example 4: Lung Nodule Detection in Chest Radiograph, Spatially Correlated with CT	84
Annex G Explanation of Grouping Criteria for Multi-frame Functional Group IODs (Informative).....	89

Annex H. Clinical Trial Identification Workflow Examples (Informative)	91
H.1 EXAMPLE USE-CASE	91
ANNEX I. Ultrasound Templates (Informative)	92
I.1 SR CONTENT TREE STRUCTURE	92
I.2 PROCEDURE SUMMARY	92
I.3 MULTIPLE FETUSES	92
I.4 EXPLICITLY SPECIFYING CALCULATION DEPENDENCIES	93
I.5 LINKING MEASUREMENTS TO IMAGES, COORDINATES	93
I.6 OB PATTERNS	94
I.7 SELECTED VALUE	96
I.8 OB-GYN EXAMPLES	97
Example 1: OB-GYN Root with Observation Context	97
Example 2: OB-GYN Patient Characteristics and Procedure Summary	98
Example 3: OB-GYN Multiple Fetus	99
Example 4: Biophysical Profile	100
Example 5: Biometry Ratios	100
Example 6: Biometry	100
Example 7: Amniotic Sac	102
Example 8: OB-GYN Ovaries	102
Example 9: OB-GYN Follicles	104
Example 10: Pelvis and Uterus	105
ANNEX J: HANDLING OF IDENTIFYING PARAMETERS (Informative)	106
J.1 PURPOSE OF THIS ANNEX	106
J.2 INTEGRATED ENVIRONMENT	106
J.2.1Modality Conforms to Modality Worklist and MPPS SOP Classes	107
J.2.2Modality Conforms only to the Modality Worklist SOP Class	107
J.2.3Modality Conforms only to the MPPS SOP Class	108
J.3 NON-INTEGRATED ENVIRONMENT	109
J.4 ONE MPPS IS CREATED IN RESPONSE TO TWO OR MORE REQUESTED PROCEDURES	109
J.4.1Choose or Create a Value for Study Instance UID and Accession Number	110
J.4.2Replicate the Image IOD	111
J.5 MPPS SOP INSTANCE CREATED BY ANOTHER SYSTEM (NOT THE MODALITY)	112
ANNEX K ULTRASOUND STAGED PROTOCOL DATA MANAGEMENT	113
K.1 PURPOSE OF THIS ANNEX	113
K.2 PREREQUISITES FOR SUPPORT	113
K.3 DEFINITION OF A STAGED PROTOCOL EXAM	113
K.4 ATTRIBUTES USED IN STAGED PROTOCOL EXAMS	114
K.5 GUIDELINES	115
K.5.1 STAGED PROTOCOL EXAM IDENTIFICATION	116
K.5.2 STAGE AND VIEW IDENTIFICATION	116
K.5.3 EXTRA-PROTOCOL IMAGE IDENTIFICATION	118
K.5.4 MULTIPLE IMAGES OF A STAGE-VIEW	119
K.5.5 WORKFLOW MANAGEMENT OF STAGED PROTOCOL IMAGES	119
Annex L Hemodynamics Report Structure (Informative)	123
ANNEX M Vascular Ultrasound Reports (Informative)	125
M.1 VASCULAR REPORT STRUCTURE	125
M.2 VASCULAR EXAMPLES	126
M.2.1 ...Example 1: Renal Vessels	126

M.2.2 ...Example 2: Carotids Extracranial.....	127
ANNEX N Echocardiography Procedure Reports (Informative)	129
N.1 CONTENT STRUCTURE	129
N.1 ECHO PATTERNS	129
N.2 MEASUREMENT TERMINOLOGY COMPOSITION.....	130
N.3 ILLUSTRATIVE MAPPING TO ASE CONCEPTS.....	131
N.3.1 Aorta	131
N.3.2 Aortic Valve	131
N.3.3 Left Ventricle - Linear	133
N.3.4 Left Ventricle Volumes and Ejection Fraction	135
N.3.5 Left Ventricle Output.....	136
N.3.6 Left Ventricular Outflow Tract.....	137
N.3.7 Left Ventricle Mass.....	138
N.3.8 Left Ventricle Miscellaneous.....	138
N.3.9 Mitral Valve.....	139
N.3.10 Pulmonary Vein	141
N.3.11 Left Atrium / Appendage.....	142
N.3.12 Right Ventricle	143
N.3.13 Pulmonic Valve / Pulmonic Artery	144
N.3.14 Tricuspid Valve.....	145
N.3.15 Right Atrium / Inferior Vena Cava.....	145
N.3.16 Congenital / Pediatric	147
N.4 ENCODING EXAMPLES	148
N.4.1 Example 1: Patient Characteristics	148
N.4.2 Example 2: LV Dimensions and Fractional Shortening.....	148
N.4.3 Example 3: Left Atrium / Aortic Root Ratio.....	149
N.4.4 Example 4: Pressures	149
N.4.5 Example 5: Cardiac Output	150
N.4.6 Example 6: Wall Scoring	150
N.5 IVUS REPORT	151
ANNEX O Registration (Informative)	153
O.1 SPATIAL REGISTRATION AND SPATIAL FIDUCIALS SOP CLASSES	153
O.2 FUNCTIONAL USE CASES	154
O.3 SYSTEM INTERACTION.....	154
O.4 OVERVIEW OF ENCODING	156
O.5 MATRIX REGISTRATION	157
O.6 SPATIAL FIDUCIALS	157
ANNEX P Transforms and Mappings (Informative).....	159
ANNEX Q Breast Imaging Report (Informative).....	162
Q.1 BREAST IMAGING REPORT CONTENT TREE STRUCTURE	162
Q.2 BREAST IMAGING REPORT EXAMPLES	166
Q.2.1 Example 1: Screening Mammogram with Negative Findings	166
Q.2.2 Example 2: Screening Mammogram with Negative Findings	167
Q.2.3 Example 3: Diagnostic Mammogram - Unilateral.....	169
Q.2.4 Example 4: Diagnostic Mammogram and Ultrasound - Unilateral	171
Annex R Configuration Use Cases (Informative).....	173
R.1 INSTALL A NEW MACHINE.....	173
R.1.1....Configure DHCP	173
R.1.2....Configure LDAP	174
R.1.3....Distributed update propagation.....	178
R.2 LEGACY COMPATIBILITY.....	179

R.3	OBTAIN CONFIGURATION OF OTHER DEVICES	179
R.3.1Find AE When Given Device Type	179
R.4	DEVICE STARTUP	180
R.5	SHUTDOWN.....	182
R.5.1Shutdown	182
R.5.2Online/Offline	182
R.6	TIME SYNCHRONIZATION	183
R.6.1High accuracy time synchronization	183
R.6.2Ordinary Time Synchronization.....	183
R.6.3Background	184
R.6.4SNTP restrictions	185
R.6.5Implementation Considerations	185
Annex S	Legacy Transition for Configuration Management (Informative).....	187
S.1	LEGACY ASSOCIATION REQUESTOR, CONFIGURATION MANAGED ASSOCIATION ACCEPTOR.....	187
S.1.1DHCP Server	187
S.1.2DNS Server	187
S.1.3LDAP Server	187
S.2	MANAGED ASSOCIATION REQUESTOR, LEGACY ASSOCIATION ACCEPTOR	187
S.2.1DHCP Server	187
S.2.2DNS Server	188
S.2.3LDAP Server	188
S.3	NO DDNS SUPPORT.....	188
S.4	PARTIALLY MANAGED DEVICES	188
S.5	ADDING THE FIRST MANAGED DEVICE TO A LEGACY NETWORK.....	188
S.5.1New Servers required	188
S.5.2NTP	188
S.5.3Documenting Managed and Unmanaged Nodes (DHCP, DNS, and LDAP).....	189
S.5.4Description of this device	190
S.6	SWITCHING A NODE FROM UNMANAGED TO MANAGED IN A MIXED NETWORK.....	190
S.6.1DHCP and DNS	190
S.6.2NTP	190
S.6.3Association Acceptors on This Node	190
S.6.4Association Requestors on Legacy Nodes	190
S.6.5Association Requestors on Managed Nodes.....	190
Annex T	Quantitative Analysis References (Informative).....	191
T.1	DEFINITION OF LEFT AND RIGHT IN THE CASE OF QUANTITATIVE ATERIAL ANALYSIS	191
T.2	DEFINITION OF DIAMETER SYMMETRY WITH ATERIAL PLAQUES.....	192
T.3	WALL MOTION REGIONS.....	193
T.3.1Landmark Based Wall Motion Regions.....	193
T.3.2Centerline Wall Motion Region	194
T.3.4Radial Based Wall Motion Region	196
T.4	QUANTITATIVE ARTERIAL ANALYSIS REFERENCE METHOD	197
T.4.1Computer Calculated Reference.....	197
T.4.2Interpolated Reference	197
T.4.3Mean Local Reference	197
T.5	POSITIONS IN DIAMETER GRAPHIC	197
Annex U	Ophthalmology Use Cases (Informative)	199
U.1	USE CASES.....	199
U.1.1	Routine N-spot exam.....	199
U.1.2	Routine N-spot exam with exceptions	199

U.1.3 Routine Fluorescein Exam	199
U.1.4 External examination	200
U.1.5 External examination with intention	200
U.1.6 External examination with drug application	200
U.1.7 Routine stereo camera examination	201
U.2 TYPICAL SEQUENCE OF EVENTS	201
Annex V Hanging Protocols (Informative)	203
V.1 Example Scenario	203
V.2 HANGING PROTOCOL INTERNAL PROCESS MODEL	206
V.3 CHEST X-RAY HANGING PROTOCOL EXAMPLE	208
V.3.1 Hanging Protocol Definition Module	209
V.3.2 Hanging Protocol Environment Module	210
V.3.3 Hanging Protocol Display Module	210
V.4 NEUROSURGERY PLANNING HANGING PROTOCOL EXAMPLE	211
V.4.1 Hanging Protocol Definition Module	212
V.4.2 Hanging Protocol Environment Module	213
V.4.3 Hanging Protocol Display Module	214
V.5 HANGING PROTOCOL QUERY EXAMPLE	226
V.6 DISPLAY SET PATIENT ORIENTATION EXAMPLE	230
Annex W Digital Signatures in Structured Reports Use Cases (Informative)	232
Annex X – Dictation-Based Reporting with Image References	234
X.1 BASIC DATA FLOWS	234
X.1.1 Dictation/Transcription Reporting	234
X.1.2 Reporting with Image References	235
X.1.3 Reporting with Annotated Images	236
X.2 TRANSCRIBED DIAGNOSTIC IMAGING SR INSTANCE CONTENT	236
X.2.1 SR Header Content	236
X.2.2 Transcribed Text Data Format	237
X.2.3 Image Reference Format	237
X.3 TRANSCRIBED DIAGNOSTIC IMAGING CDA INSTANCE CONTENT	238
X.3.1 CDA Header Content	238
X.3.2 Transcribed Text Content	239
X.3.3 Image References	239
X.3.4 Icons	240
X.3.5 Structured Entries	240
X.4.3 Using the WADO Reference for DICOM Network Protocol Retrievals	243
X.4 SIMULTANEOUS SR AND CDA INSTANCE CREATION	244
X.4.1 Equivalence	244
X.4.2 Document Cross-Reference	244
Annex Y – VOI LUT Functions (Informative)	245
Annex Z X-Ray Isocenter Reference Transformations (Informative)	247
Z.1 INTRODUCTION	247
Z.2 POSITIONER COORDINATE SYSTEM TRANSFORMATIONS	247
Z.3 TABLE COORDINATE SYSTEM TRANSFORMATIONS	247
Annex AA: Radiation Dose Reporting Use Cases (Informative)	249
AA.1 PURPOSE OF THIS ANNEX	249
AA.2 DEFINITIONS	249
AA.3 USE CASES	249
AA.3.1 Basic Dose Reporting	249
AA.3.2 Dose Reporting for Non-Digital Imaging	250

AA.3.3 Dose Reporting Post-Processing	251
AA.3.4 Dose Reporting Workflow Management	252
Annex BB: Printing (Informative).....	254
BB.1 EXAMPLE OF PRINT MANAGEMENT SCU SESSION (Informative).....	254
BB.1.1..Simple Example	254
BB.1.2..Advanced Example (Retired)	255
Annex CC: Storage Commitment (Informative)	256
CC.1 STORAGE COMMITMENT EXAMPLES (Informative)	256
CC.1.1 .Push Model Example	256
CC.1.2 .Pull Model Example (Retired)	256
CC.1.3 .Remote Storage of Data by the SCP	256
CC.1.4 .Storage Commitment in Conjunction with Use of Storage Media.....	257
Annex DD: Worklists (Informative).....	259
DD.1 EXAMPLES FOR THE USAGE OF THE MODALITY WORKLIST (Informative).....	259
DD.2 GENERAL PURPOSE WORKLIST EXAMPLE (INFORMATIVE)	260
DD.2.1 .Introduction	260
DD.2.2 .Transactions and message flow	261
Annex EE: Relevant Patient Information Query (Informative)	264
EE.1 RELEVANT PATIENT INFORMATION QUERY EXAMPLE (INFORMATIVE)	264
Annex FF CT/MR Cardiovascular Analysis Report Templates (Informative)	271
FF.2 TEMPLATE STRUCTURE	272
FF.3 REPORT EXAMPLE	274
Annex GG – JPIP Referenced Pixel Data Transfer Syntax Negotiation.....	277

FOREWORD

The American College of Radiology (ACR) and the National Electrical Manufacturers Association (NEMA) formed a joint committee to develop a standard for Digital Imaging and Communications in Medicine (DICOM). This DICOM Standard was developed according to the NEMA procedures.

This standard is developed in liaison with other standardization organizations including CEN TC251 in Europe, and JIRA and MEDIS-DC in Japan, with review also by other organizations including IEEE, HL7 and ANSI in the USA.

The DICOM Standard is structured as a multi-part document using the guidelines established in the following document:

- ISO/IEC Directives, 1989 Part 3 : Drafting and Presentation of International Standards.

This document is one part of the DICOM Standard, which consists of the following parts:

- PS 3.1: Introduction and Overview
- PS 3.2: Conformance
- PS 3.3: Information Object Definitions
- PS 3.4: Service Class Specifications
- PS 3.5: Data Structures and Encoding
- PS 3.6: Data Dictionary
- PS 3.7: Message Exchange
- PS 3.8: Network Communication Support for Message Exchange
- PS 3.9: Retired
- PS 3.10: Media Storage and File Format for Media Interchange
- PS 3.11: Media Storage Application Profiles
- PS 3.12: Formats and Physical Media
- PS 3.13: Retired
- PS 3.14: Grayscale Standard Display Function
- PS 3.15: Security and System Management Profiles
- PS 3.16: Content Mapping Resource
- PS 3.17: Explanatory Information
- PS 3.18: Web Access to DICOM Persistent Objects (WADO)

These parts are related but independent documents. Their development level and approval status may differ. Additional parts may be added to this multi-part standard. PS 3.1 should be used as the base reference for the current parts of this standard.

1 Scope and field of application

This part of the DICOM Standard contains explanatory information in the form of Normative and Informative Annexes.

2 Normative references

The following standards contain provisions that, through reference in this text, constitute provisions of this Standard. At the time of publication, the editions indicated were valid. All standards are subject to revision, and parties to agreements based on this Standard are encouraged to investigate the possibilities of applying the most recent editions of the standards indicated below.

3 Definitions

For the purposes of this Standard the following definitions apply.

4 Symbols and abbreviations

The following symbols and abbreviations are used in this Part of the Standard.

5 Conventions

Terms listed in Section 3 Definitions are capitalized throughout the document.

Annex A Explanation of patient orientation (Normative)

This Annex was formerly located in Annex E of PS 3.3 in the 2003 and earlier revisions of the standard.

This Annex provides an explanation of how to use the patient orientation data elements.

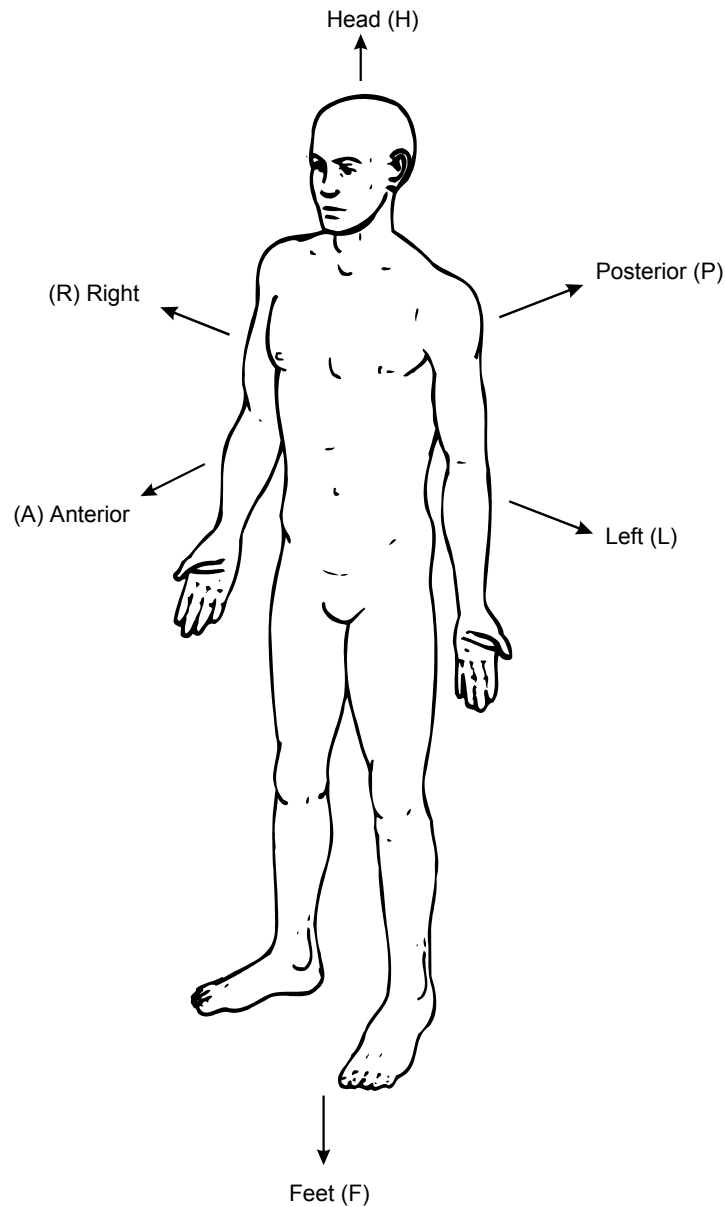

The standard anatomic position is standing erect with the palms facing anterior. This position is used to define a label for the direction of the fingers and toes (toward the Feet (F)) while the direction of the wrist and ankle is towards the Head (H). This labeling is retained despite changes in the position of the extremities. For bilaterally symmetric body parts, a laterality indicator (R or L) should be used.

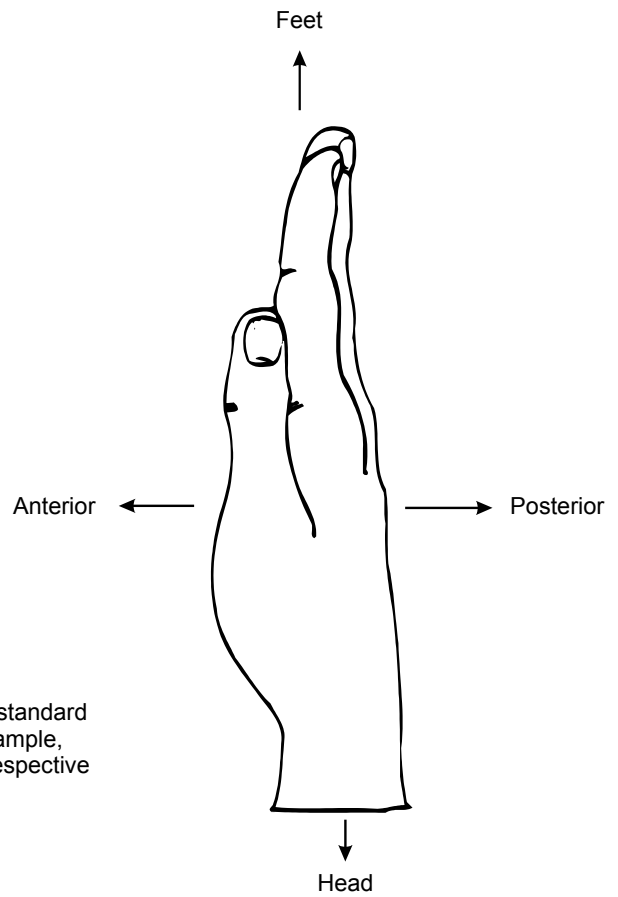
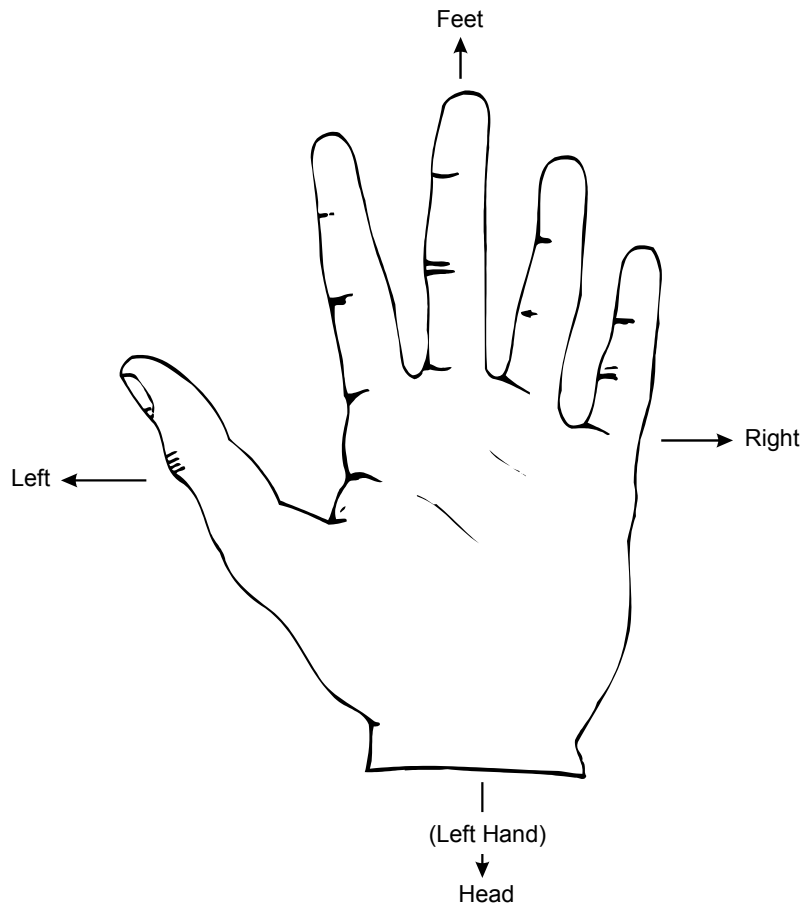

For the hands, the direction labels are based on the standard anatomic position. For the left hand illustrated for example, LEFT will always be in the direction of the thumb, irrespective of position changes.

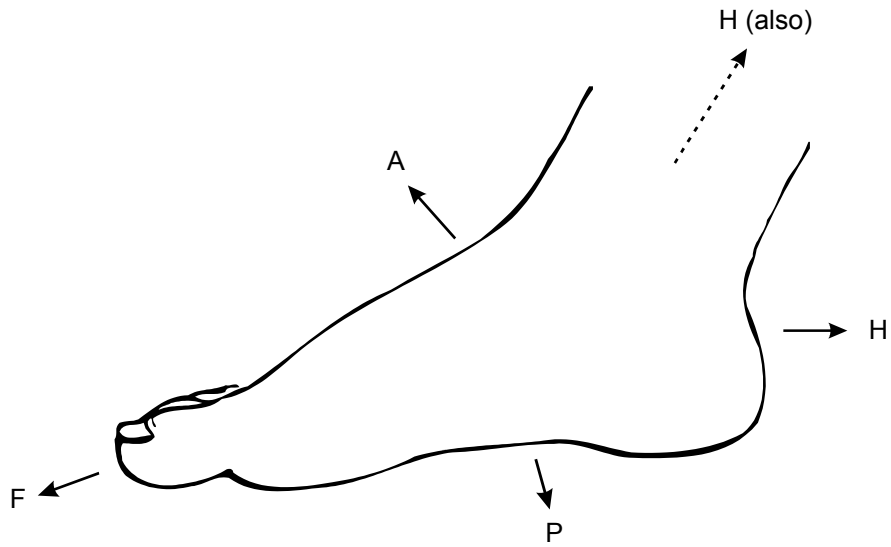

Right Foot

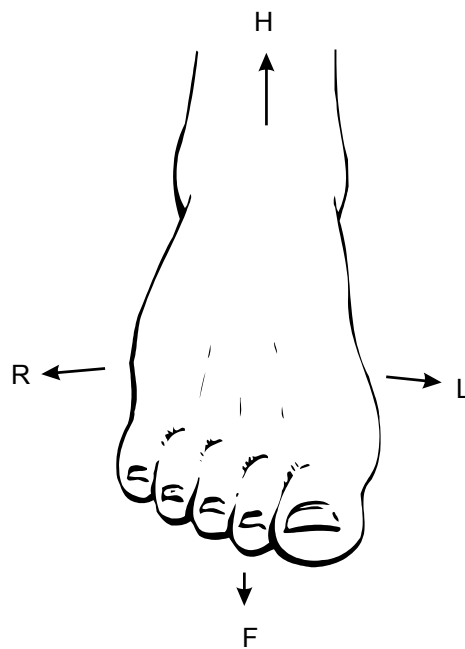

Right Foot - Anterior View

As for the hand, the direction labels are based on the foot in the standard anatomic position. For the right foot, for example, RIGHT will be in the direction of the 5th toe. This assignment will remain constant through movement or positioning of the extremity. This is also true of the HEAD and FOOT directions.

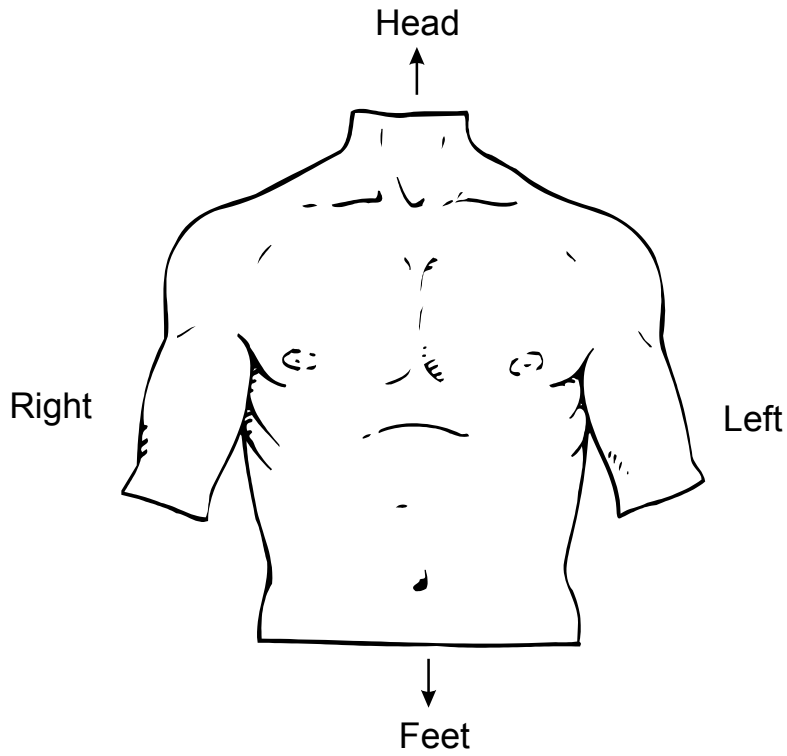

Viewing the Front of the Patient

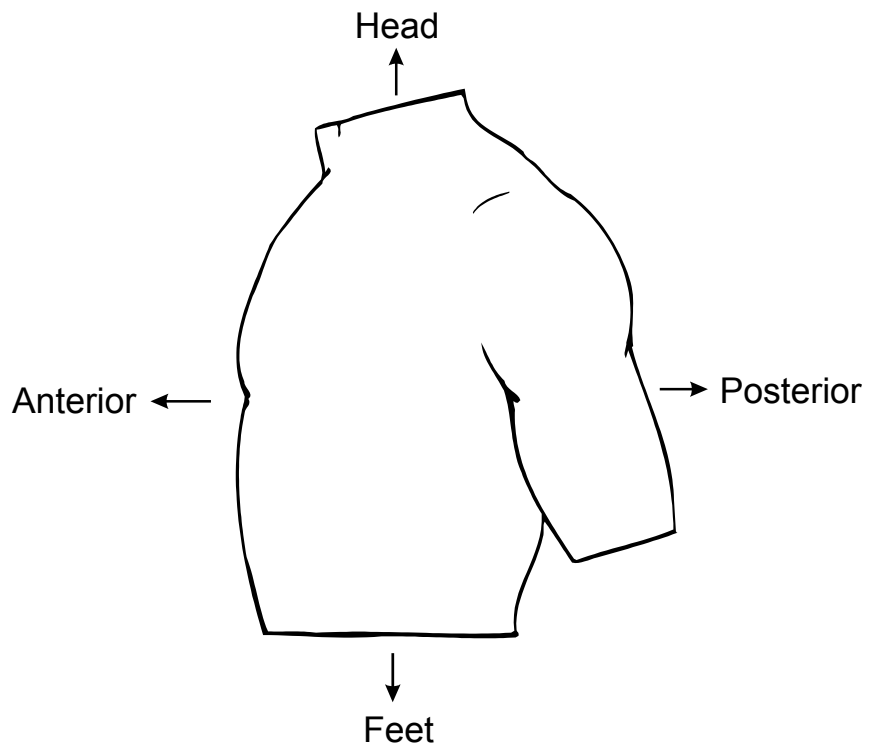

Anterior and left lateral views of the patient. In the view of the left side (bottom illustration) the left arm has been drawn posteriorly.

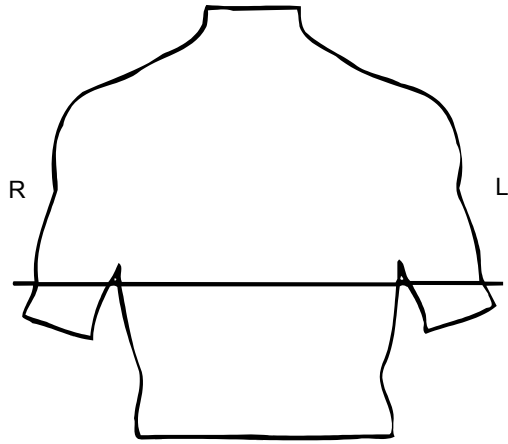

↑ Head
Transverse Plane
↓ Feet

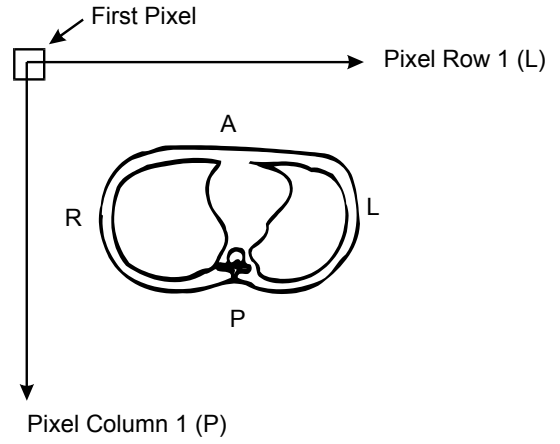

Note:
Bracketed letters along pixel directions
(e.g. [LP]) indicate the pixel row and
column directions.

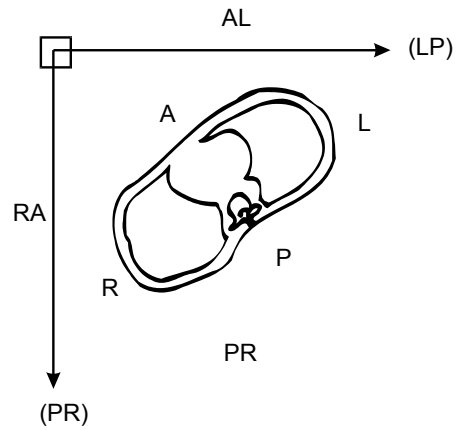

Transverse
with
oblique
patient

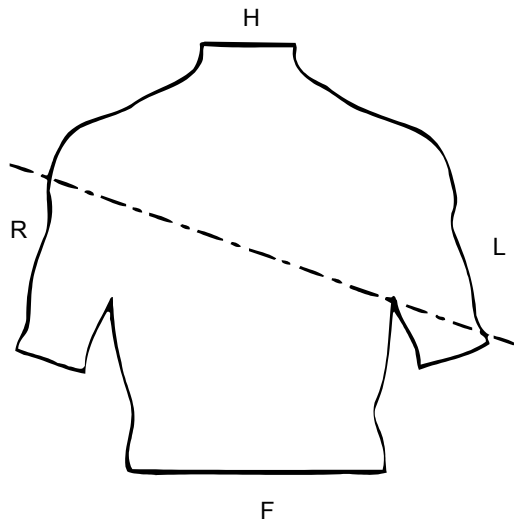

Oblique
transverse
plane

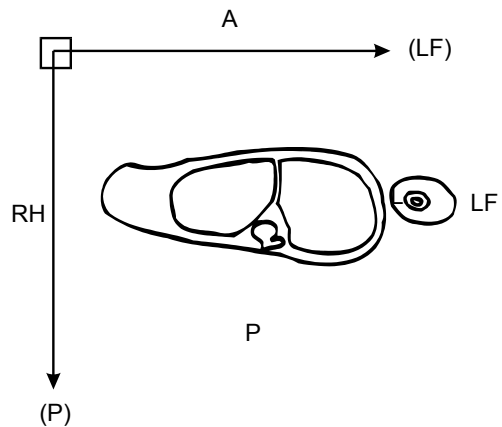

Since the major direction of the transverse plane is right-to-left (or anterior-to-posterior), the first letter of the combined direction will indicate this. For example, RH—moving right also moves towards the head.

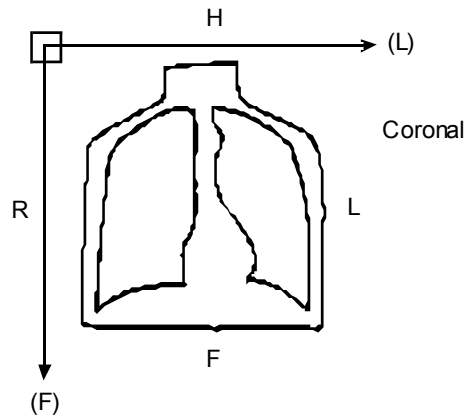
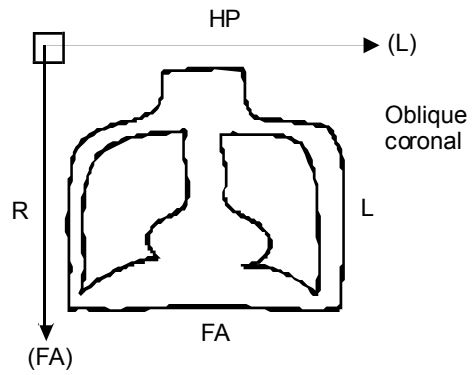
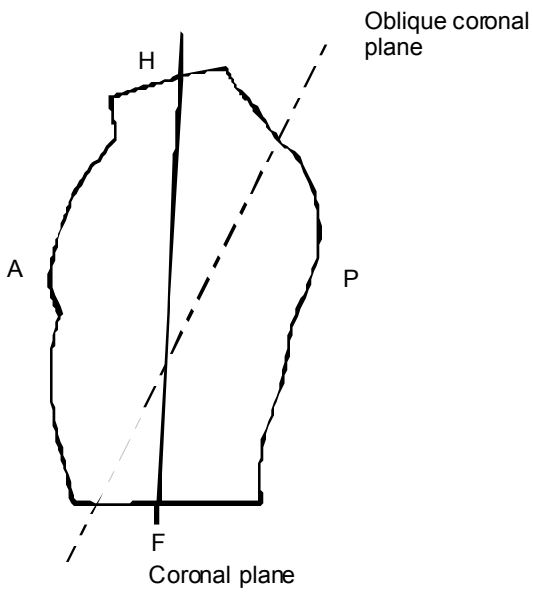
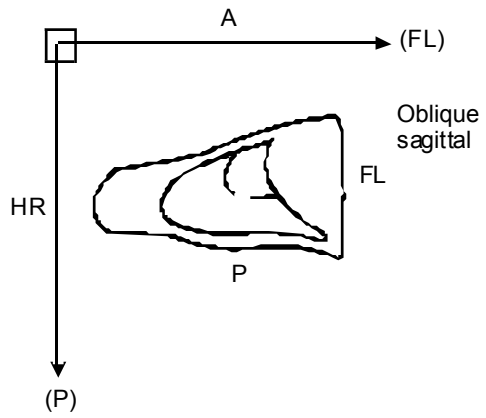
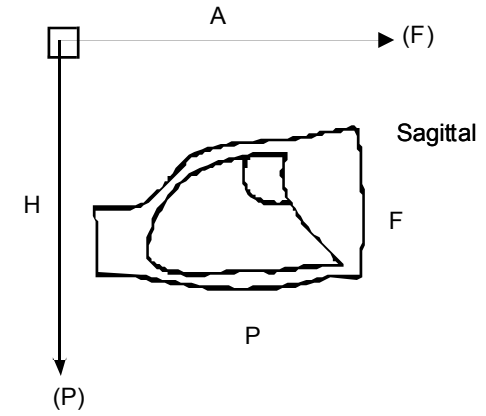
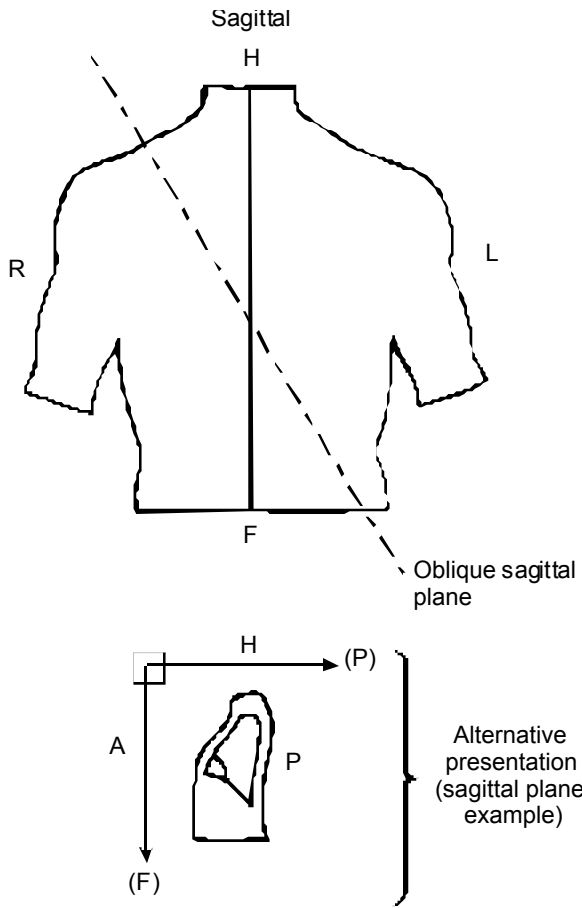

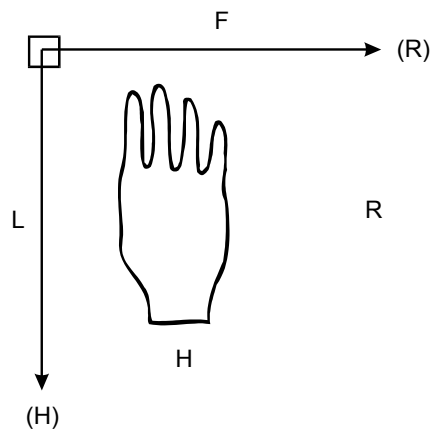
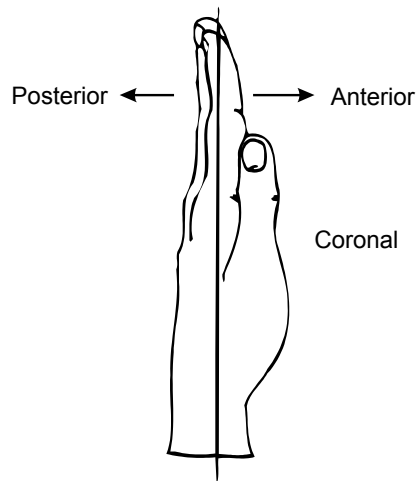
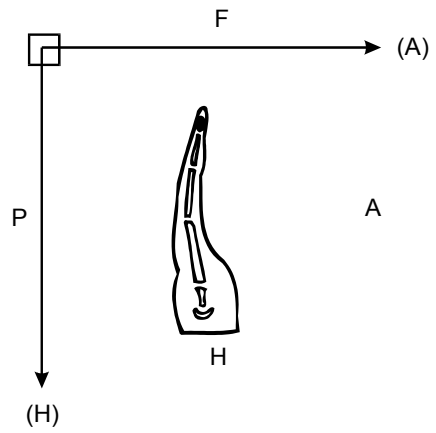
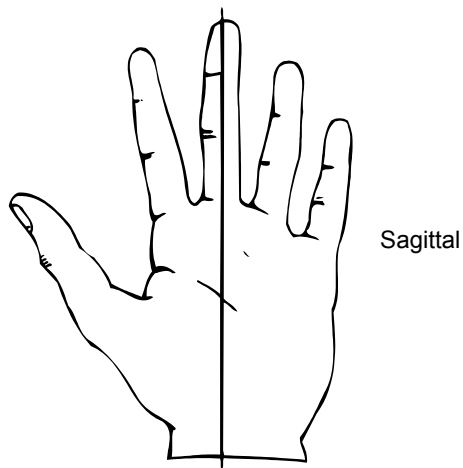
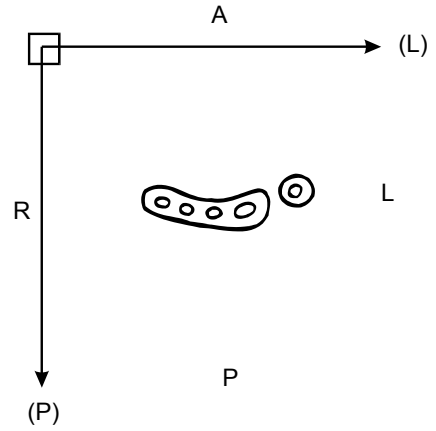
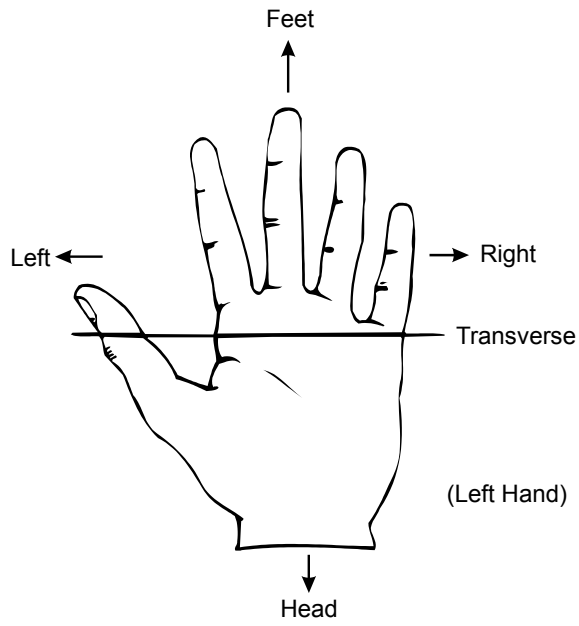

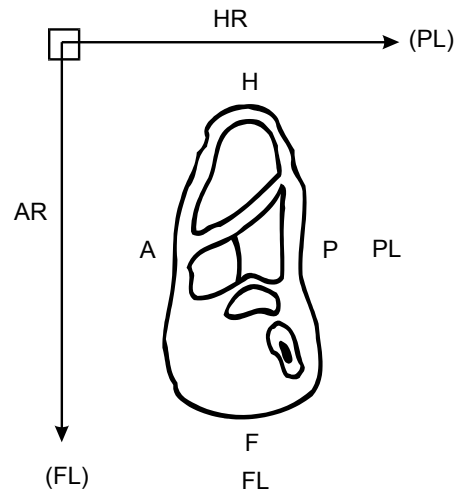
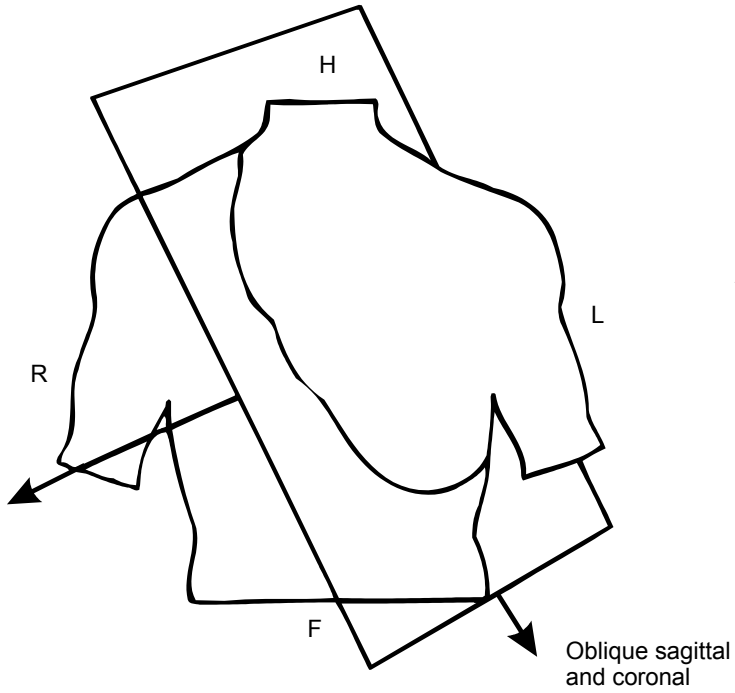

Combined tilt planes and possible labels are based on major plane directions.

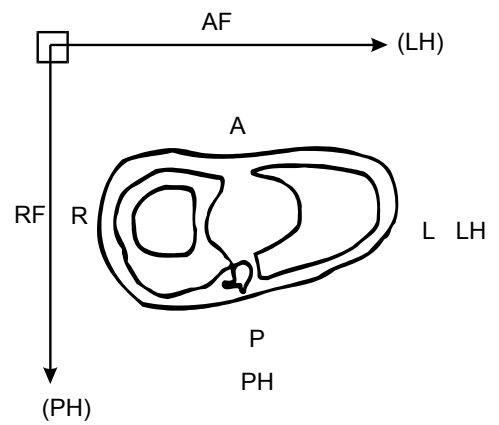
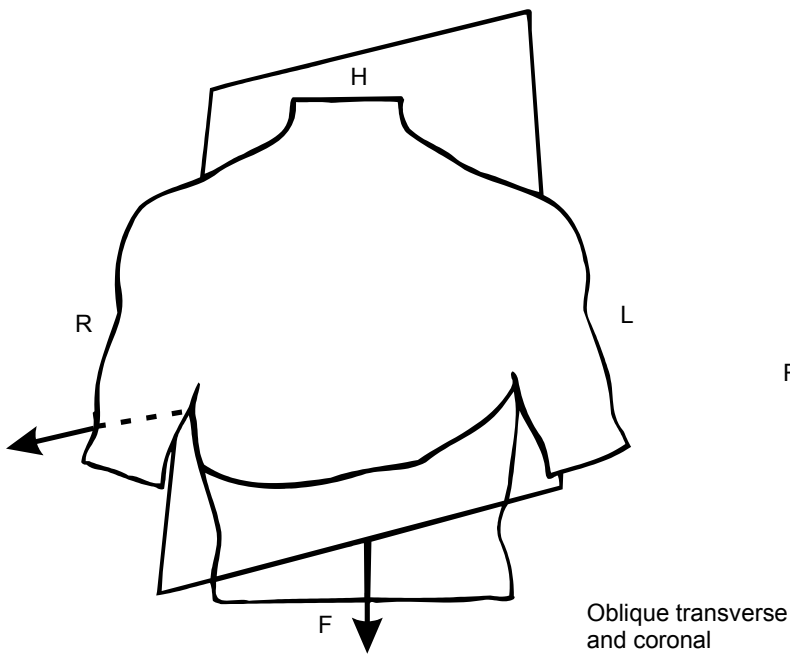

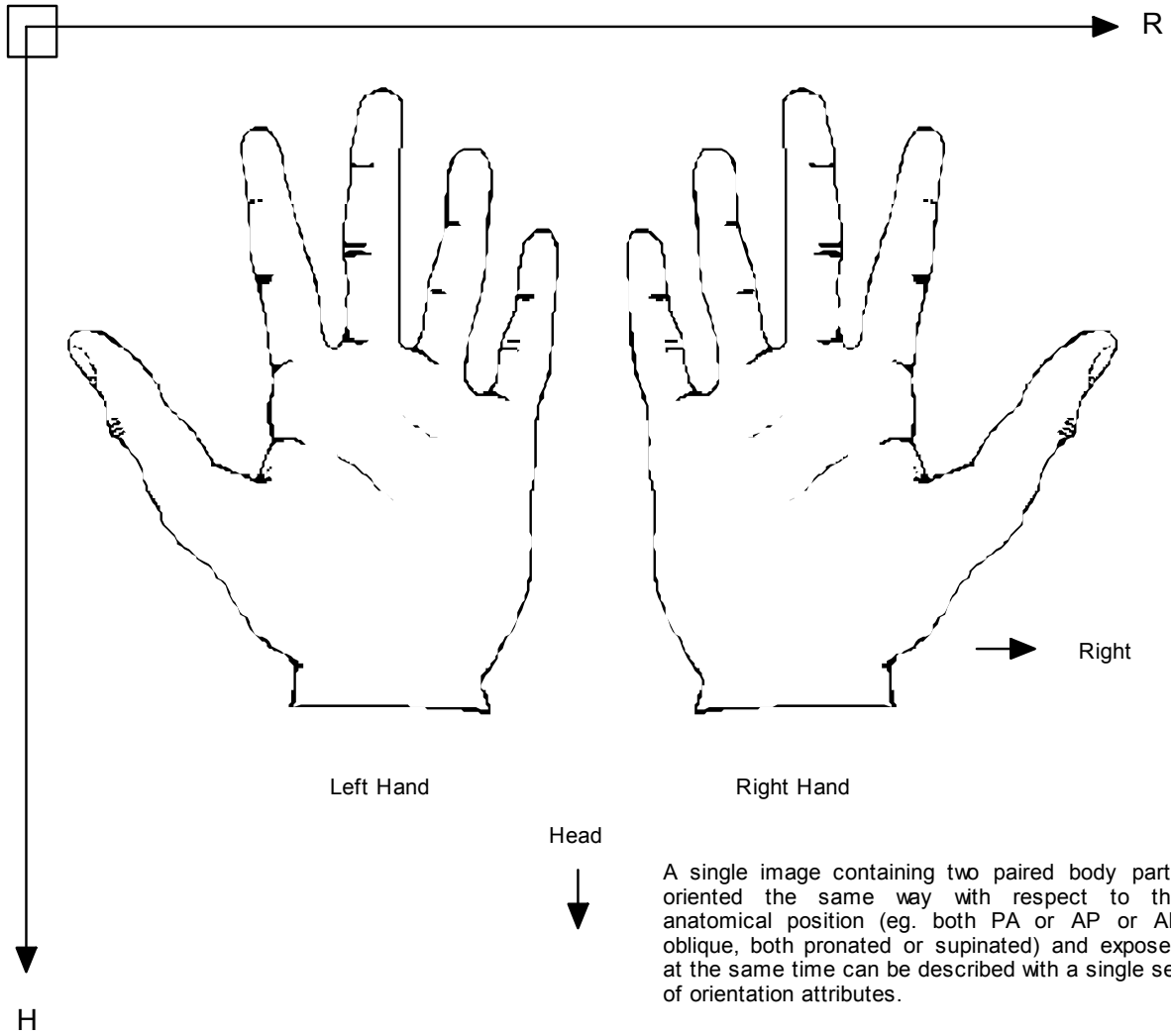

A single image containing two paired body parts oriented the same way with respect to the anatomical position (eg. both PA or AP or AP oblique, both pronated or supinated) and exposed at the same time can be described with a single set of orientation attributes.

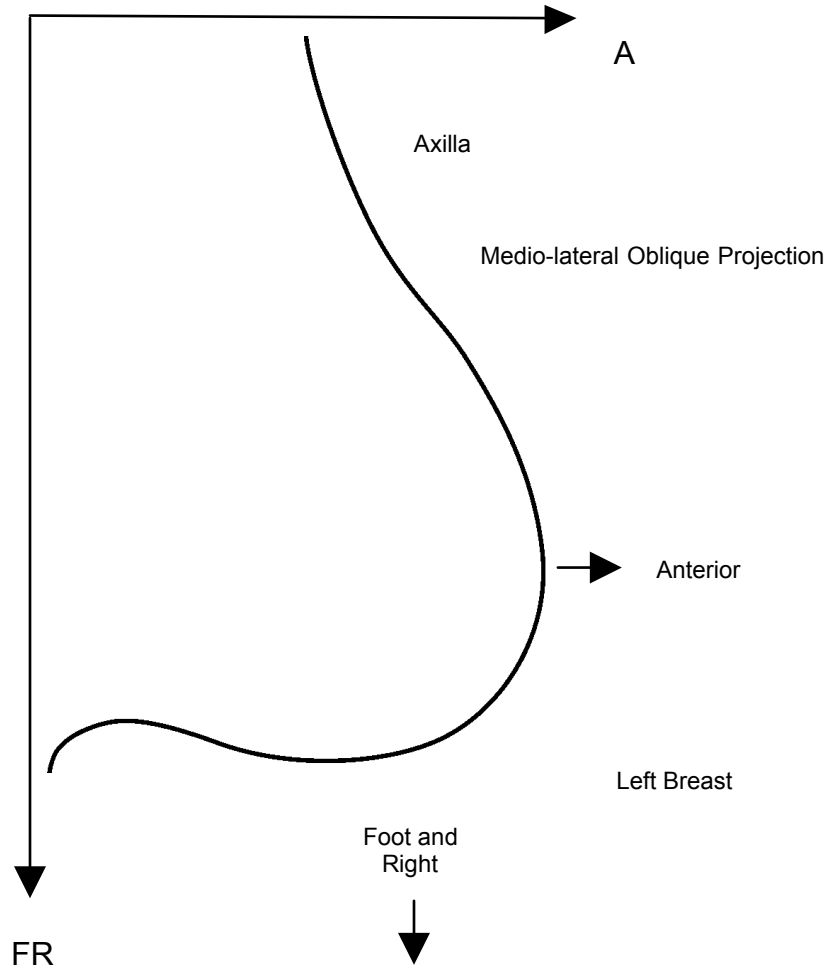

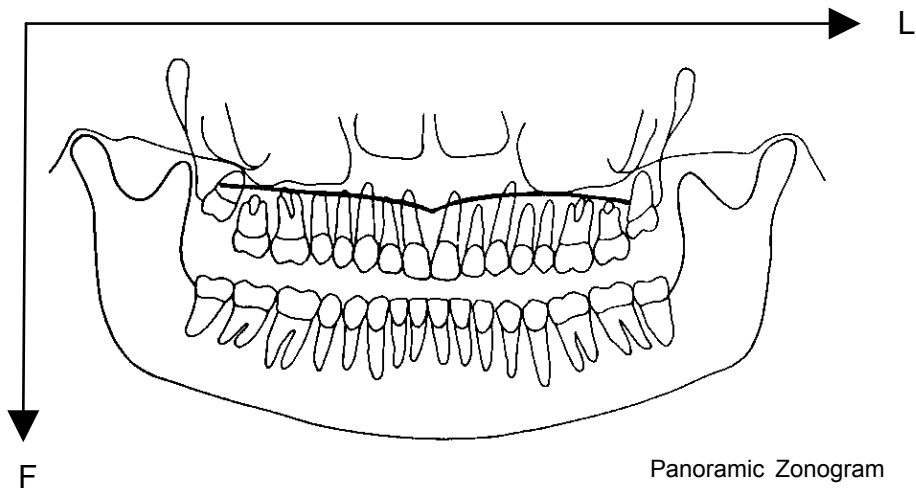
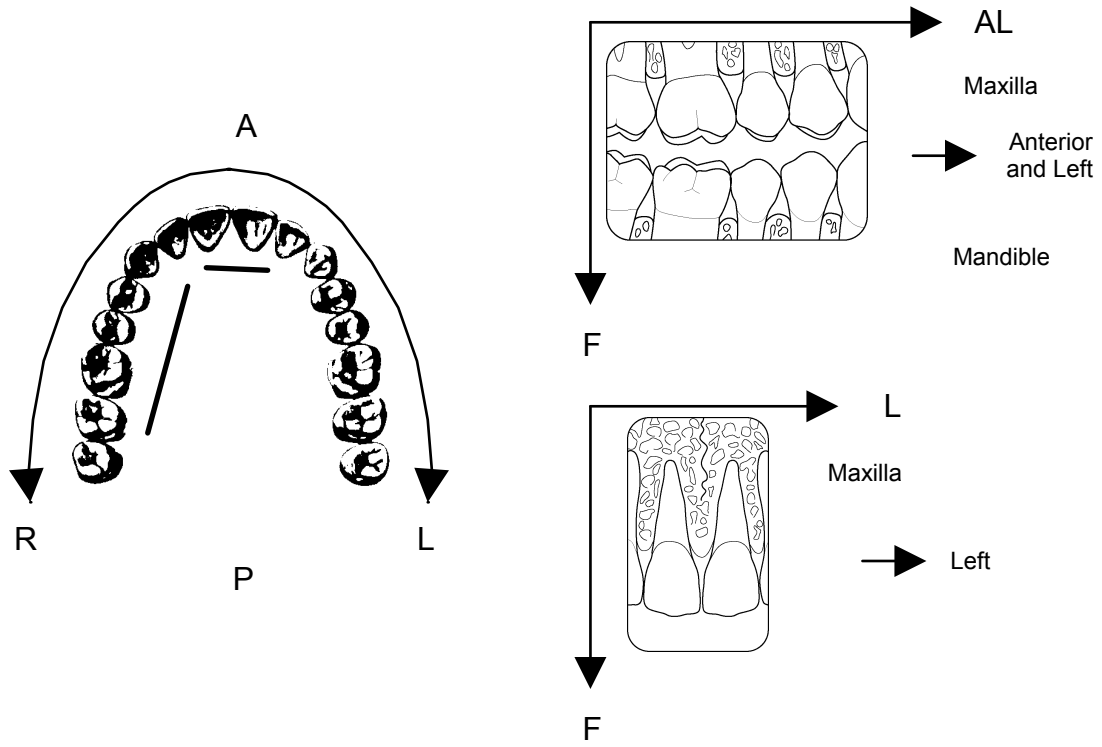

Annex B Integration of Modality Worklist and Modality Performed Procedure Step in the Original DICOM Standard (Informative)

This Annex was formerly located in Annex G of PS 3.3 in the 2003 and earlier revisions of the standard.

DICOM was published in 1993 and effectively addresses image communication for a number of modalities and Image Management functions for a significant part of the field of medical imaging. Since then, many additional medical imaging specialties have contributed to the extension of the DICOM Standard and developed additional Image Object Definitions. Furthermore, there have been discussions about the harmonization of the DICOM Real-World domain model with other standardization bodies. This effort has resulted in a number of extensions to the DICOM Standard. The integration of the Modality Worklist and Modality Performed Procedure Step address an important part of the domain area that was not included initially in the DICOM Standard. At the same time, the Modality Worklist and Modality Performed Procedure Step integration make steps in the direction of harmonization with other standardization bodies (CEN TC 251, HL7, etc.).

The purpose of this ANNEX is to show how the original DICOM Standard relates to the extension for Modality Worklist Management and Modality Performed Procedure Step. The two included figures outline the void filled by the Modality Worklist Management and Modality Performed Procedure Step specification, and the relationship between the original DICOM Data Model and the extended model.

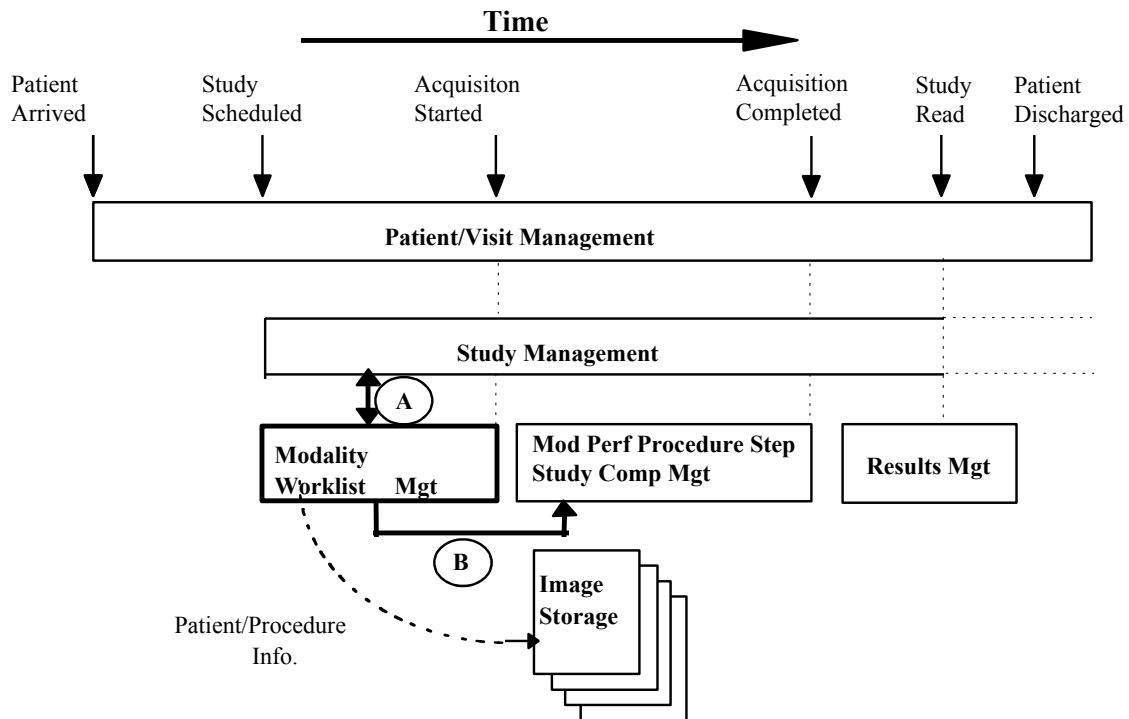

Figure B-1: Functional View - Modality Worklist and Modality Performed Procedure Step Management in the Context of DICOM Service Classes

The management of a patient starts when the patient enters a physical facility (e.g. a hospital, a clinic, an imaging center) or even before that time. The DICOM Patient Management SOP Class provides many of the functions that are of interest to imaging departments. Figure B-1 is an example where one presumes

that an order for a procedure has been issued for a patient. The order for an imaging procedure results in the creation of a Study Instance within the DICOM Study Management SOP Class. At the same time (A) the Modality Worklist Management SOP Class enables a modality operator to request the scheduling information for the ordered procedures. A worklist can be constructed based on the scheduling information. The handling of the requested imaging procedure in DICOM Study Management and in DICOM Worklist Management are closely related. The worklist also conveys patient/study demographic information that can be incorporated into the images.

Worklist Management is completed once the imaging procedure has started and the Scheduled Procedure Step has been removed from the Worklist, possibly in response to the Modality Performed Procedure Step (B). However, Study Management continues throughout all stages of the Study, including interpretation. The actual procedure performed (based on the request) and information about the images produced are conveyed by the DICOM Study Component SOP Class or the Modality Performed Procedure Step SOP Classes.

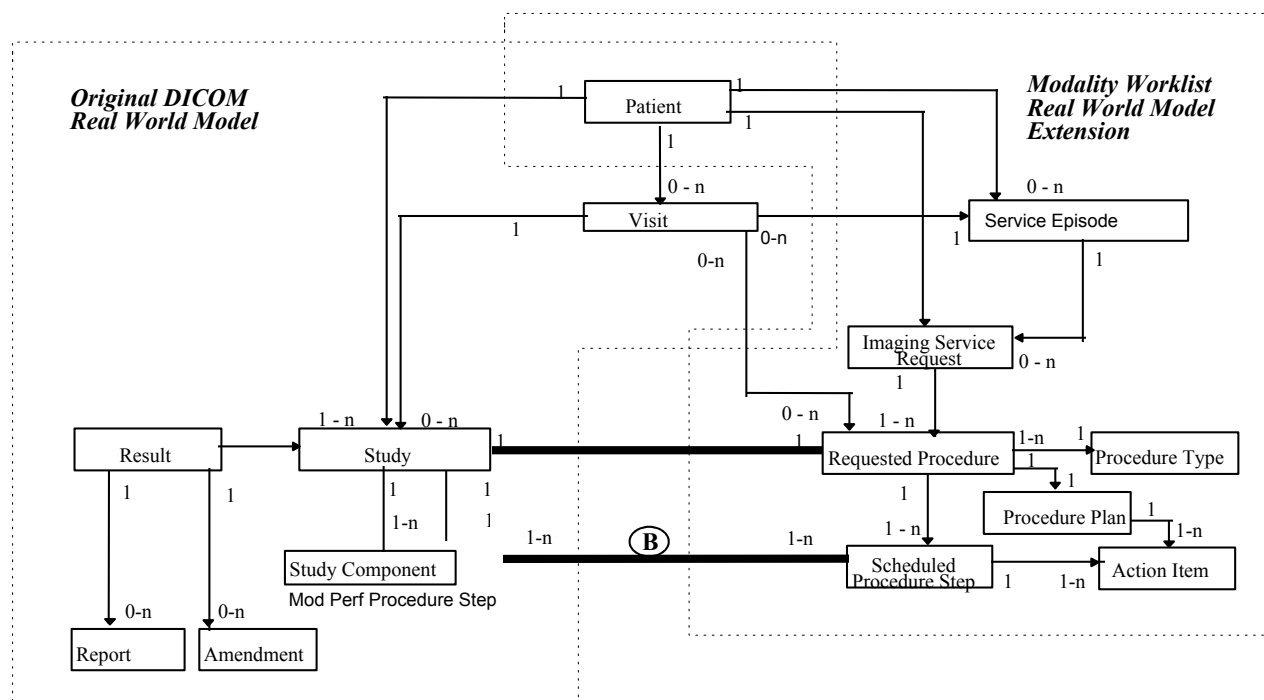

Figure B-2: Relationship of the Original Model and the Extensions for Modality Worklist and Modality Performed Procedure Step Management

Figure B-2 shows the relationship between the original DICOM Real-World model and the extensions of this Real-World model required to support the Modality Worklist and the Modality Performed Procedure Step. The new parts of the model add entities that are needed to request, schedule, and describe the performance of imaging procedures, concepts that were not supported in the original model. The entities required for representing the Worklist form a natural extension of the original DICOM Real-World model.

Common to both the original model and the extended model is the Patient entity. The Service Episode is an administrative concept that has been shown in the extended model in order to pave the way for future adaptation to a common model supported by other standardization groups including HL7, CEN TC 251 WG 3, CAP-IEC, etc. The Visit is in the original model but not shown in the extended model because it is a part of the Service Episode.

There is a 1 to 1 relationship between a Requested Procedure and the DICOM Study (A). A DICOM Study is the result of a single Requested Procedure. A Requested Procedure can result in only one Study.

A n:m relationship exists between a Scheduled Procedure Step and a Modality Performed Procedure Step (B). The concept of a Modality Performed Procedure Step is a superset of the Study Component concept contained in the original DICOM model. The Modality Performed Procedure Step SOP Classes provide a means to relate Modality Performed Procedure Steps to Scheduled Procedure Steps.

Annex C Waveforms (Informative)

This Annex was formerly located in Annex J of PS 3.3 in the 2003 and earlier revisions of the standard.

C.1 DOMAIN OF APPLICATION

Waveform acquisition is part of both the medical imaging environment and the general clinical environment. Because of its broad use, there has been significant previous and complementary work in waveform standardization of which the following are particularly important:

ASTM E31.16 - E1467 Specification for Transferring Digital Neurophysiological Data Between Independent Computer Systems

CEN TC251 PT5-007 - prENV1064 draft Standard Communications Protocol for Computer-Assisted Electrocardiography (SCP-ECG).

CEN TC251 PT5-021 - draft Vital Signs Information Representation Standard (VITAL)

HL7 Automated Data SIG - HL7 Version 2.3, Chapter 7.14-20

IEEE P1073 - draft Medical Information Bus Standard (MIB)

DICOM - NEMA PS3.3, Section A.10 Standalone Curve Information Object Definition

For DICOM, the domain of waveform standardization is waveform acquisition within the imaging context. It is specifically meant to address waveform acquisitions which will be analyzed with other data which is transferred and managed using the DICOM protocol. It allows the addition of waveform data to that context with minimal incremental cost. Further, it leverages the DICOM persistent object capability for maintaining referential relationships to other data collected in a multi-modality environment, including references necessary for multi-modality synchronization.

Waveform interchange in other clinical contexts may use different protocols more appropriate to those domains. In particular, HL7 may be used for transfer of waveform observations to general clinical information systems, and MIB may be used for real-time physiological monitoring and therapy.

The waveform information object definition in DICOM has been specifically harmonized at the semantic level with the HL7 waveform message format. The use of a common object model allows straightforward transcoding and interoperation between systems that use DICOM for waveform interchange and those that use HL7, and may be viewed as an example of common semantics implemented in the differing syntaxes of two messaging systems.

Note: HL7 allows transport of DICOM SOP Instances (information objects) encapsulated within HL7 messages. Since the DICOM and HL7 waveform semantics are harmonized, DICOM Waveform SOP Instances need not be transported as encapsulated data, as they can be transcoded to native HL7 Waveform Observation format.

C.2 USE CASES

The following are specific use case examples for waveforms in the imaging environment.

Case 1: Catheterization Laboratory - During a cardiac catheterization, several independent pieces of data acquisition equipment may be brought together for the exam. An electrocardiographic subsystem records surface ECG waveforms; an X-ray angiographic subsystem records motion images; a hemodynamic subsystem records intracardiac pressures from a sensor on the catheter. These subsystems send their acquired data by network to a repository. These data are assembled at an analytic workstation by retrieving from the repository. For a left ventriculographic procedure, the ECG is used by the physician to determine the time of maximum and minimum ventricular fill, and when coordinated with the angiographic

images, an accurate estimate of the ejection fraction can be calculated. For a valvuloplasty procedure, the hemodynamic waveforms are used to calculate the pre-intervention and post-intervention pressure gradients.

Case 2: Electrophysiology Laboratory - An electrophysiological exam will capture waveforms from multiple sensors on a catheter; the placement of the catheter in the heart is captured on an angiographic image. At an analytic workstation, the exact location of the sensors can thus be aligned with a model of the heart, and the relative timing of the arrival of the electrophysiological waves at different cardiac locations can be mapped.

Case 3: Stress Exam - A stress exam may involve the acquisition of both ECG waveforms and echocardiographic ultrasound images from portable equipment at different stages of the test. The waveforms and the echocardiograms are output on an interchange disk, which is then input and read at a review station. The physician analyzes both types of data to make a diagnosis of cardiac health.

C.3 TIME SYNCHRONIZATION FRAME OF REFERENCE

Synchronization of acquisition across multiple modalities in a single study (e.g., angiography and electrocardiography) requires either a shared trigger, or a shared clock. A Synchronization Module within the Frame of Reference Information Entity specifies the synchronization mechanism. A common temporal environment used by multiple equipment is identified by a shared Synchronization Frame of Reference UID. How this UID is determined and distributed to the participating equipment is outside the scope of the standard.

The method used for time synchronization of equipment clocks is implementation or site specific, and therefore outside the scope of this proposal. If required, standard time distribution protocols are available (e.g., NTP, IRIG, GPS).

*An informative description of time distribution methods can be found at:
<http://www.bancomm.com/cntpApp.htm>*

A second method of synchronizing acquisitions is to utilize a common reference channel (temporal fiducial), which is recorded in the data acquired from the several equipment units participating in a study, and/or which is used to trigger synchronized data acquisitions. For instance, the "X-ray on" pulse train which triggers the acquisition of frames for an X-ray angiographic SOP Instance can be recorded as a waveform channel in a simultaneously acquired hemodynamic waveform SOP Instance, and can be used to align the different object instances. Associated with this Supplement are proposed coded entry channel identifiers to specifically support this synchronization mechanism (DICOM Terminology Mapping Resource Context Group ID 3090).

C.4 WAVEFORM ACQUISITION MODEL

Figure C.4-1 shows a canonical model of waveform data acquisition. A patient is the subject of the study. There may be several sensors placed at different locations on or in the patient, and waveforms are measurements of some physical quality (metric) by those sensors (e.g., electrical voltage, pressure, gas concentration, or sound). The sensor is typically connected to an amplifier and filter, and its output is sampled at constant time intervals and digitized. In most cases, several signal channels are acquired synchronously. The measured signal usually originates in the anatomy of the patient, but an important special case is a signal which originates in the equipment, either as a stimulus, such as a cardiac pacing signal, as a therapy, such as a radio frequency signal used for ablation, or as a synchronization signal.

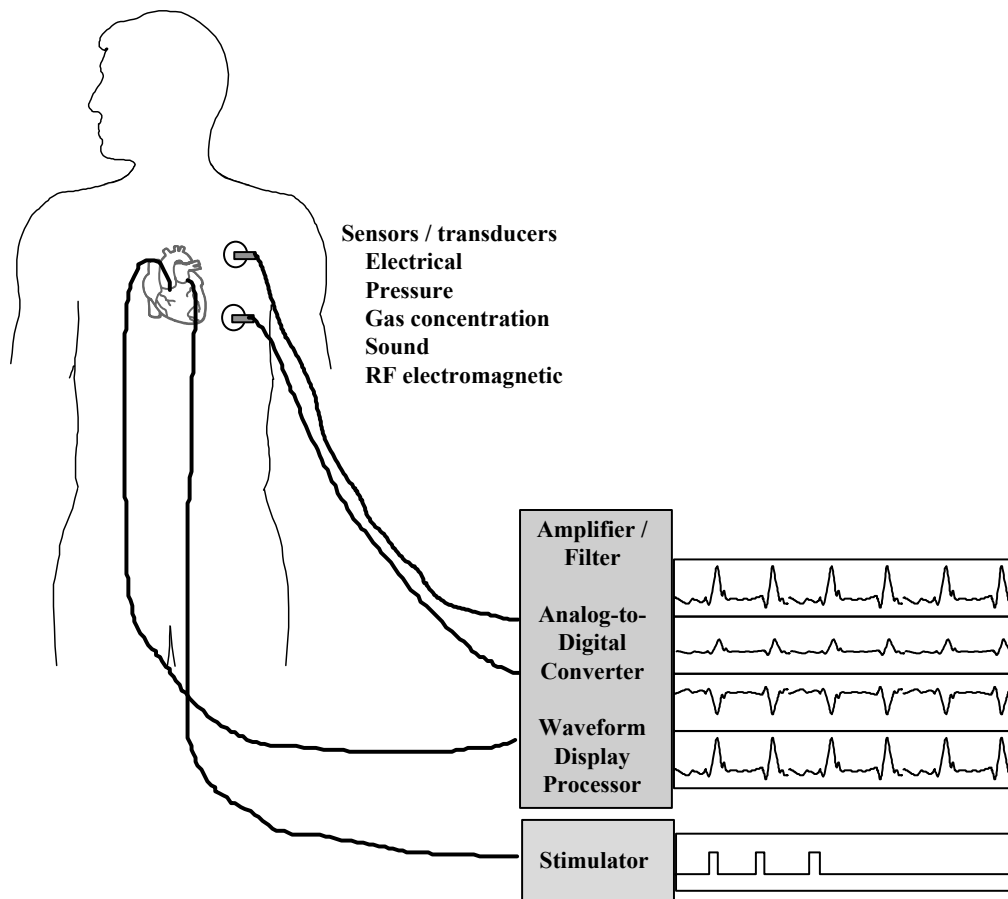

Figure C.4-1 - Waveform Acquisition Model

C.5 WAVEFORM INFORMATION MODEL

The part of the composite information object which carries the waveform data is the Waveform Information Entity (IE). The Waveform IE includes the technical parameters of waveform acquisition and the waveform samples.

The information model, or internal organizational structure, of the Waveform IE is shown in Figure C.5-1. A waveform information object includes data from a continuous time period during which signals were acquired. The object may contain several multiplex groups, each defined by digitization with the same clock whose frequency is defined for the group. Within each multiplex group there will be one or more channels, each with a full technical definition. Finally, each channel has its set of digital waveform samples.

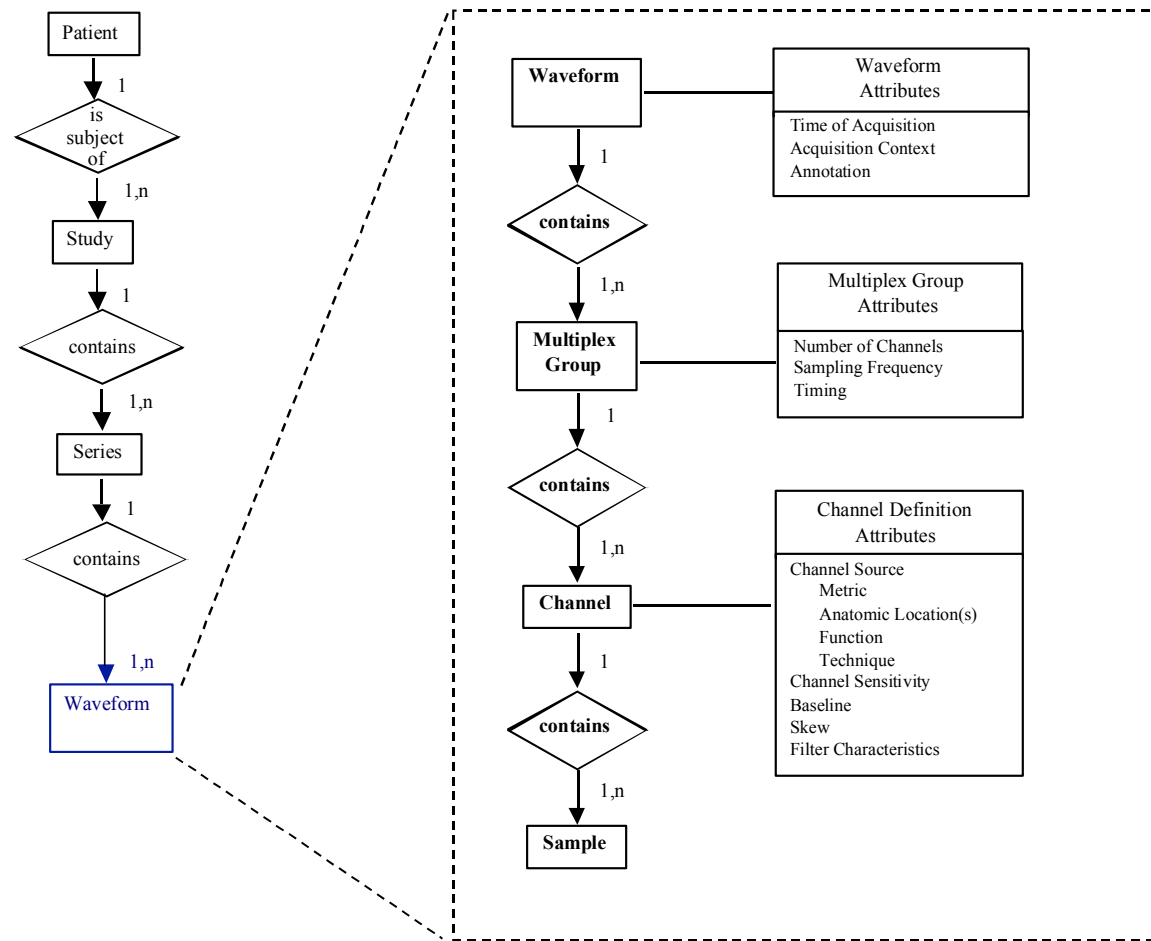

Figure C.5-1 DICOM Waveform Information Model

C.6 HARMONIZATION WITH HL7

This Waveform IE definition is harmonized with the HL7 waveform semantic constructs, including the channel definition attributes and the use of multiplex groups for synchronously acquired channels. The use of a common object model allows straightforward transcoding and interoperability between systems that use DICOM for waveform interchange and those that use HL7, and may be viewed as an example of common semantics implemented in the differing syntaxes of two messaging systems.

This section describes the congruence between the DICOM Waveform IE and the HL7 version 2.3 waveform message format (see HL7 version 2.3 Chapter 7, sections 7.14 – 7.20).

C.6.1 HL7 Waveform Observation

Waveforms in HL7 messages are sent in a set of OBX (Observation) Segments. Four subtypes of OBX segments are defined:

- The CHN subtype defines one channel in a CD (Channel Definition) Data Type
- The TIM subtype defines the start time of the waveform data in a TS (Time String) Data Type
- The WAV subtype carries the waveform data in an NA (Numeric Array) or MA (Multiplexed Array) Data Type (ASCII encoded samples, character delimited)
- The ANO subtype carries an annotation in a CE (Coded Entry) Data Type with a reference to a specific time within the waveform to which the annotation applies

Other segments of the HL7 message definition specify patient and study identification, whose harmonization with DICOM constructs is not defined in this Annex.

C.6.2 Channel Definition

The Waveform Module Channel Definition sequence attribute (003A,0200) is defined in harmonization with the HL7 Channel Definition (CD) Data Type, in accordance with the following Table. Each Item in the Channel Definition sequence attribute corresponds to an OBX Segment of subtype CHN.

**Table C.6-1
Correspondence Between DICOM and HL7 Channel Definition**

DICOM Attribute	HL7 CD Data Type Component
Waveform Channel Number (003A,0202)	Channel Identifier (number&name)
Channel Label (003A,0203)	
Channel Source Sequence (003A,0208)	Waveform Source
Channel Source Modifier Sequence (003A,0209)	
Channel Sensitivity (003A,0210)	Channel Sensitivity and Units
Channel Sensitivity Units Sequence (003A,0211)	
Channel Sensitivity Correction Factor (003A,0212)	Channel Calibration Parameters (correctionfactor&baseline×kew)
Channel Baseline (003A,0213)	
Channel Time Skew (003A,0214)	
[Group] Sampling Frequency (003A,001A)	Channel Sampling Frequency
Channel Minimum Value (5400,0110)	Minimum and Maximum Data Values (minimum&maximum)
Channel Maximum Value (5400,0112)	
Channel Offset (003A,0218)	not defined in HL7
Channel Status (003A,0205)	
Filter Low Frequency (003A,0220)	
Filter High Frequency (003A,0221)	
Notch Filter Frequency (003A,0222)	
Notch Filter Bandwidth (003A,0223)	

In the DICOM information object definition, the sampling frequency is defined for the multiplex group, while in HL7 it is defined for each channel, but is required to be identical for all multiplexed channels.

Note that in the HL7 syntax, Waveform Source is a string, rather than a coded entry as used in DICOM. This should be considered in any transcoding between the two formats.

C.6.3 Timing

In HL7, the exact start time for waveform data is sent in an OBX Segment of subtype TIM. The corresponding DICOM attributes, which must be combined to form the equivalent time string, are:

Acquisition Datetime	(0008,002A)
Multiplex Group Time Offset	(0018,1068)

C.6.4 Waveform Data

The DICOM binary encoding of data samples in the Waveform Data attribute (5400,1010) corresponds to the ASCII representation of data samples in the HL7 OBX Segment of subtype WAV. The same channel-

interleaved multiplexing used in the HL7 MA (Multiplexed Array) Data Type is used in the DICOM Waveform Data attribute.

Because of its binary representation, DICOM uses several data elements to specify the precise encoding, as listed in the following Table. There are no corresponding HL7 data elements, since HL7 uses explicit character-delimited ASCII encoding of data samples.

Number of Waveform Channels	(003A,0005)
Number of Waveform Samples	(003A,0010)
Waveform Bits Stored	(003A,021A)
Waveform Bits Allocated	(5400,1004)
Waveform Sample Interpretation	(5400,1006)
Waveform Padding Value	(5400,100A)

C.6.5 Annotation

In HL7, Waveform Annotation is sent in an OBX Segment of subtype ANO, using the CE (Coded Entry) Data Type CE. This corresponds precisely to the DICOM Annotation using Coded Entry Sequences. However, HL7 annotation ROI is to a single point only (time reference), while DICOM allows reference to ranges of samples delimited by time or by explicit sample position.

C.7 HARMONIZATION WITH SCP-ECG

The SCP-ECG standard is designed for recording routine resting electrocardiograms. Such ECGs are reviewed prior to cardiac imaging procedures, and a typical use case would be for SCP-ECG waveforms to be translated to DICOM for inclusion with the full cardiac imaging patient record.

SCP-ECG provides for either simultaneous or non-simultaneous recording of the channels, but does not provide a multiplexed data format (each channel is separately encoded). When translating to DICOM, each subset of simultaneously recorded channels may be encoded in a Waveform Sequence Item (multiplex group), and the delay to the recording of each multiplex group shall be encoded in the Multiplex Group Time Offset (0018,1068).

The electrode configuration of SCP-ECG Section 1 may be translated to the DICOM Acquisition Context (0040,0555) sequence items using DICOM Terminology Mapping Resource Template 3401 and Context Groups 3263 and 3264.

The lead identification of SCP-ECG Section 3, a term coded as an unsigned integer, may be translated to the DICOM Waveform Channel Source (003A,0208) coded sequence using Context Group 3001.

Pacemaker spike records of SCP-ECG Section 7 may be translated to items in the Waveform Annotations Sequence (0040,B020) with a code term from Context Group 3335. The annotation sequence item may record the spike amplitude in its Numeric Value and Measurement Units attributes.

Annex D SR Encoding Example (Informative)

This Annex was formerly located in Annex K of PS 3.3 in the 2003 and earlier revisions of the standard.

The following is a simple and non-comprehensive illustration of the encoding of the Informative SR Content Tree Example in PS 3.3.

SR Tree Depth	Nesting	Attribute	Tag	VR	VL (hex)	Value
		SOP Class UID	(0008,0016)	UI	001e	1.2.840.10008.5.1.4.1.1.88.33
		SOP Instance UID	(0008,0018)	UI	0012	1.2.3.4.5.6.7.300
		Study Date	(0008,0020)	DA	0008	19991029
		Content Date	(0008,0023)	DA	0008	19991029
		Study Time	(0008,0030)	TM	0006	154500
		Content Time	(0008,0033)	TM	0006	154510
		Accession Number	(0008,0050)	SH	0006	123456
		Modality	(0008,0060)	CS	0002	SR
		Manufacturer	(0008,0070)	LO	0004	WG6
		Referring Physician's Name	(0008,0090)	PN	0014	Luke^Will^^Dr.^M.D.
		Coding Scheme Identification Sequence	(0008,0110)	SQ	ffffff	
	%item					
		Coding Scheme Designator	(0008,0102)	SH	000e	99STElsewhere
		Coding Scheme UID	(0008,010C)	UI	0010	1.2.3.4.6.7.8.91
		Responsible Organization	(0008,0116)	ST	0034	Informatics Dept St Elsewhere Hosp Boston, MA 02390
	%enditem					
	%endseq					
		Referenced Performed Procedure Step Sequence	(0008,1111)	SQ	ffffff	
	%endseq					
		Patient's Name	(0010,0010)	PN	000e	Homer^Jane^^^
		Patient's ID	(0010,0020)	LO	0006	234567
		Patient's Birth Date	(0010,0030)	DA	0008	19991109
		Patient's Sex	(0010,0040)	CS	0002	F
		Study Instance UID	(0020,000D)	UI	0012	1.2.3.4.5.6.7.100
		Series Instance UID	(0020,000E)	UI	0012	1.2.3.4.5.6.7.200
		Study ID	(0020,0010)	SH	0006	345678
		Series Number	(0020,0011)	IS	0002	1
		Instance (formerly Image) Number	(0020,0013)	IS	0002	1
1		Value Type	(0040,a040)	CS	000a	CONTAINER
1		Concept Name Code Sequence	(0040,a043)	SQ	ffffff	
1	%item					
1	>	Code Value	(0008,0100)	SH	0006	333300
1	>	Coding Scheme Designator	(0008,0102)	SH	0006	LNdemo
1	>	Code Meaning	(0008,0104)	LO	000c	Chest X-Ray
1	%enditem					

	%endseq					
1		Continuity Of Content	(0040,a050)	CS	0008	SEPARATE
		Verifying Observer Sequence	(0040,a073)	SQ	ffffff	
	%item					
	>	Verifying Organization	(0040,a027)	LO	0004	WG6
	>	Verification DateTime	(0040,a030)	DT	000e	19991029154510
	>	Verifying Observer Name	(0040,a075)	PN	000e	Jones^Joe^^Dr^
	>	Verifying Observer Identification Code Sequence	(0040,a088)	SQ	ffffff	
	%item					
	>>	Code Value	(0008,0100)	SH	0006	369842
	>>	Coding Scheme Designator	(0008,0102)	SH	000e	99STElsewhere
	>>	Code Meaning	(0008,0104)	LO	0006	369842
	%enditem					
	%endseq					
	%enditem					
	%endseq					
		Referenced Request Sequence	(0040,a370)	SQ	ffffff	
	%item					
	>	Accession Number	(0008,0050)	SH	0006	123456
	>	Referenced Study Sequence	(0008,1110)	SQ	ffffff	
	%endseq					
	>	Study Instance UID	(0020,000D)	UI	0012	1.2.3.4.5.6.7.100
	>	Requested Procedure Description	(0032,1060)	LO	000a	Chest Xray
	>	Requested Procedure Code Sequence	(0032,1064)	SQ	ffffff	
	%item					
	>>	Code Value	(0008,0100)	SH	0006	369475
	>>	Coding Scheme Designator	(0008,0102)	SH	000e	99STElsewhere
	>>	Code Meaning	(0008,0104)	LO	000a	Chest XRay
	%enditem					
	%endseq					
	>	Requested Procedure ID	(0040,1001)	SH	0006	012340
	>	Placer Order Number/Imaging Service Request	(0040,2016)	LO	0	
	>	Filler Order Number/Imaging Service Request	(0040,2017)	LO	0	
	%enditem					
	%endseq					
		Performed Procedure Code Sequence	(0040,a372)	SQ	ffffff	
	%item					
	>	Code Value	(0008,0100)	SH	0006	369475
	>	Coding Scheme Designator	(0008,0102)	SH	000e	99STElsewhere
	>	Code Meaning	(0008,0104)	LO	000a	Chest XRay
	%enditem					
	%endseq					
		Current Requested Procedure Evidence Sequence	(0040,a375)	SQ	ffffff	

	%item					
	>	Referenced Series Sequence	(0008,1115)	SQ	ffffff	
	%item					
	>>	Referenced SOP Sequence	(0008,1199)	SQ	ffffff	
	%item					
	>>>	Referenced SOP Class UID	(0008,1150)	UI	0008	1.2.3.4
	>>>	Referenced SOP Instance UID	(0008,1155)	UI	000a	1.2.3.4.5
	%enditem					
	%endseq					
	>>	Series Instance UID	(0020,000E)	UI	0012	1.2.3.4.5.6.7.200
	%enditem					
	%endseq					
	>	Study Instance UID	(0020,000D)	UI	0012	1.2.3.4.5.6.7.100
	%enditem					
	%endseq					
		Completion Flag	(0040,a491)	CS	0008	COMPLETE
		Verification Flag	(0040,a493)	CS	0008	VERIFIED
1		Content Sequence	(0040,a730)	SQ	ffffff	
1.1	%item					
1.1	>	Relationship Type	(0040,a010)	CS	0010	HAS OBS CONTEXT
1.1	>	Value Type	(0040,a040)	CS	0006	PNAME
1.1	>	Concept Name Code Sequence	(0040,a043)	SQ	ffffff	
1.1	%item					
1.1	>>	Code Value	(0008,0100)	SH	0006	000555
1.1	>>	Coding Scheme Designator	(0008,0102)	SH	0006	LNdemo
1.1	>>	Code Meaning	(0008,0104)	LO	0012	Recording Observer
1.1	%enditem					
1.1	%endseq					
1.1	>	Person Name	(0040,a123)	PN	0010	Smith^John^^Dr^
1.1	%enditem					
1.2	%item					
1.2	>	Relationship Type	(0040,a010)	CS	0010	HAS OBS CONTEXT
1.2	>	Value Type	(0040,a040)	CS	0006	UIDREF
1.2	>	Concept Name Code Sequence	(0040,a043)	SQ	ffffff	
1.2	%item					
1.2	>>	Code Value	(0008,0100)	SH	0006	000599
1.2	>>	Coding Scheme Designator	(0008,0102)	SH	0006	LNdemo
1.2	>>	Code Meaning	(0008,0104)	LO	0036	Study Instance UID of Evidence Directly Examined by RO
1.2	%enditem					
1.2	%endseq					
1.2	>	UID	(0040,a124)	UI	0012	1.2.3.4.5.6.7.100
1.2	%enditem					
1.3	%item					
1.3	>	Relationship Type	(0040,a010)	CS	0010	HAS OBS CONTEXT
1.3	>	Value Type	(0040,a040)	CS	0006	PNAME

1.3	>	Concept Name Code Sequence	(0040,a043)	SQ	ffffff	
1.3	%item					
1.3	>>	Code Value	(0008,0100)	SH	0006	000579
1.3	>>	Coding Scheme Designator	(0008,0102)	SH	0006	LNdemo
1.3	>>	Code Meaning	(0008,0104)	LO	0020	Patient-Data-Acquisition Subject
1.3	%enditem					
1.3	%endseq					
1.3	>	Person Name	(0040,a123)	PN	000e	Homer^Jane^^^
1.3	%enditem					
1.4	%item					
1.4	>	Relationship Type	(0040,a010)	CS	0008	CONTAINS
1.4	>	Value Type	(0040,a040)	CS	0004	CODE
1.4	>	Concept Name Code Sequence	(0040,a043)	SQ	ffffff	
1.4	%item					
1.4	>>	Code Value	(0008,0100)	SH	0006	000444
1.4	>>	Coding Scheme Designator	(0008,0102)	SH	0006	LNdemo
1.4	>>	Code Meaning	(0008,0104)	LO	0008	Finding
1.4	%enditem					
1.4	%endseq					
1.4	>	Concept Code Sequence	(0040,a168)	SQ	ffffff	
1.4	%item					
1.4	>>	Code Value	(0008,0100)	SH	0006	000333
1.4	>>	Coding Scheme Designator	(0008,0102)	SH	000e	99STElsewhere
1.4	>>	Code Meaning	(0008,0104)	LO	0004	Mass
1.4	%enditem					
1.4	%endseq					
1.4	>	Content Sequence	(0040,a730)	SQ	ffffff	
1.4.1	%item					
1.4.1	>>	Relationship Type	(0040,a010)	CS	000e	HAS PROPERTIES
1.4.1	>>	Value Type	(0040,a040)	CS	0004	NUM
1.4.1	>>	Concept Name Code Sequence	(0040,a043)	SQ	ffffff	
1.4.1	%item					
1.4.1	>>>	Code Value	(0008,0100)	SH	0006	000222
1.4.1	>>>	Coding Scheme Designator	(0008,0102)	SH	0006	LNdemo
1.4.1	>>>	Code Meaning	(0008,0104)	LO	0008	Diameter
1.4.1	%enditem					
1.4.1	%endseq					
1.4.1	>>	Measured Value Sequence	(0040,a300)	SQ	ffffff	
1.4.1	%item					
1.4.1	>>>	Measurement Units Code Sequence	(0040,08ea)	SQ	ffffff	
1.4.1	%item					
1.4.1	>>>>	Code Value	(0008,0100)	SH	0006	000111
1.4.1	>>>>	Coding Scheme Designator	(0008,0102)	SH	0008	SNMdemo
1.4.1	>>>>	Code Meaning	(0008,0104)	LO	0002	cm
1.4.1	%enditem					
1.4.1	%endseq					
1.4.1	>>>	Numeric Value	(0040,a30a)	DS	0004	1.3

1.4.1	%enditem					
1.4.1	%endseq					
1.4.1	%enditem					
1.4.2	%item					
1.4.2	>>	Relationship Type	(0040,a010)	CS	000e	HAS PROPERTIES
1.4.2	>>	Value Type	(0040,a040)	CS	0004	CODE
1.4.2	>>	Concept Name Code Sequence	(0040,a043)	SQ	ffffff	
1.4.2	%item					
1.4.2	>>>	Code Value	(0008,0100)	SH	0006	111000
1.4.2	>>>	Coding Scheme Designator	(0008,0102)	SH	0008	SNMdemo
1.4.2	>>>	Code Meaning	(0008,0104)	LO	000c	Margination
1.4.2	%enditem					
1.4.2	%endseq					
1.4.2	>>	Concept Code Sequence	(0040,a168)	SQ	ffffff	
1.4.2	%item					
1.4.2	>>>	Code Value	(0008,0100)	SH	0006	222000
1.4.2	>>>	Coding Scheme Designator	(0008,0102)	SH	0008	SNMdemo
1.4.2	>>>	Code Meaning	(0008,0104)	LO	000c	Infiltrative
1.4.2	%enditem					
1.4.2	%endseq					
1.4.2	%enditem					
1.4	%endseq					
1.4	%enditem					
1.5	%item					
1.5	>	Referenced SOP Sequence	(0008,1199)	SQ	ffffff	
1.5	%item					
1.5	>>	Referenced SOP Class UID	(0008,1150)	UI	0008	1.2.3.4
1.5	>>	Referenced SOP Instance UID	(0008,1155)	UI	000a	1.2.3.4.5
1.5	%enditem					
1.5	%endseq					
1.5	>	Relationship Type	(0040,a010)	CS	0008	CONTAINS
1.5	>	Value Type	(0040,a040)	CS	0006	IMAGE
1.5	>	Concept Name Code Sequence	(0040,a043)	SQ	ffffff	
1.5	%item					
1.5	>>	Code Value	(0008,0100)	SH	0006	333000
1.5	>>	Coding Scheme Designator	(0008,0102)	SH	0008	SNMdemo
1.5	>>	Code Meaning	(0008,0104)	LO	0008	Baseline
1.5	%enditem					
1.5	%endseq					
1.5	%enditem					
1.6	%item					
1.6	>	Relationship Type	(0040,a010)	CS	0008	CONTAINS
1.6	>	Value Type	(0040,a040)	CS	000a	CONTAINER
1.6	>	Concept Name Code Sequence	(0040,a043)	SQ	ffffff	
1.6	%item					
1.6	>>	Code Value	(0008,0100)	SH	0006	555000
1.6	>>	Coding Scheme Designator	(0008,0102)	SH	0006	LNdemo
1.6	>>	Code Meaning	(0008,0104)	LO	000c	Conclusions
1.6	%enditem					

1.6	%endseq					
1.6		Continuity Of Content	(0040,a050)	CS	0008	SEPARATE
1.6	>	Content Sequence	(0040,a730)	SQ	ffffff	
1.6.1	%item					
1.6.1	>>	Relationship Type	(0040,a010)	CS	0008	CONTAINS
1.6.1	>>	Value Type	(0040,a040)	CS	0004	CODE
1.6.1	>>	Concept Name Code Sequence	(0040,a043)	SQ	ffffff	
1.6.1	%item					
1.6.1	>>>	Code Value	(0008,0100)	SH	0006	777000
1.6.1	>>>	Coding Scheme Designator	(0008,0102)	SH	0006	LNdemo
1.6.1	>>>	Code Meaning	(0008,0104)	LO	000a	Conclusion
1.6.1	%enditem					
1.6.1	%endseq					
1.6.1	>>	Concept Code Sequence	(0040,a168)	SQ	ffffff	
1.6.1	%item					
1.6.1	>>>	Code Value	(0008,0100)	SH	0006	888000
1.6.1	>>>	Coding Scheme Designator	(0008,0102)	SH	000e	99STElsewhere
1.6.1	>>>	Code Meaning	(0008,0104)	LO	0014	Probable malignancy
1.6.1	%enditem					
1.6.1	%endseq					
1.6.1	>>	Content Sequence	(0040,a730)	SQ	ffffff	
1.6.1.1	%item					
1.6.1.1	>>>	Relationship Type	(0040,a010)	CS	000e	INFERRED FROM
1.6.1.1	>>>	Referenced Content Item Identifier	(0040,db73)	UL	000c	0001,0004,0002
1.6.1.1	%enditem					
1.6.1.2	%item					
1.6.1.2	>>>	Relationship Type	(0040,a010)	CS	000e	INFERRED FROM
1.6.1.2	>>>	Referenced Content Item Identifier	(0040,db73)	UL	000c	0001,0007,0001
1.6.1.2	%enditem					
1.6.1	%endseq					
1.6.1	%enditem					
1.6	%endseq					
1.6	%enditem					
1.7	%item					
1.7	>	Relationship Type	(0040,a010)	CS	0008	CONTAINS
1.7	>	Value Type	(0040,a040)	CS	000a	CONTAINER
1.7	>	Concept Name Code Sequence	(0040,a043)	SQ	ffffff	
1.7	%item					
1.7	>>	Code Value	(0008,0100)	SH	0006	999000
1.7	>>	Coding Scheme Designator	(0008,0102)	SH	0006	LNdemo
1.7	>>	Code Meaning	(0008,0104)	LO	0018	Specific Image Findings
1.7	%enditem					
1.7	%endseq					
1.7		Continuity Of Content	(0040,a050)	CS	0008	SEPARATE
1.7	>	Content Sequence	(0040,a730)	SQ	ffffff	
1.7.1	%item					
1.7.1	>>	Relationship Type	(0040,a010)	CS	0008	CONTAINS

1.7.1	>>	Value Type	(0040,a040)	CS	0006	SCoord
1.7.1	>>	Concept Name Code Sequence	(0040,a043)	SQ	ffffff	
1.7.1	%item					
1.7.1	>>>	Code Value	(0008,0100)	SH	0006	333001
1.7.1	>>>	Coding Scheme Designator	(0008,0102)	SH	0008	SNMdemo
1.7.1	>>>	Code Meaning	(0008,0104)	LO	001e	Best illustration of findings
1.7.1	%enditem					
1.7.1	%endseq					
1.7.1	>>	Content Sequence	(0040,a730)	SQ	ffffff	
1.7.1.1	%item					
1.7.1.1	>>>	Referenced SOP Sequence	(0008,1199)	SQ	ffffff	
1.7.1.1	%item					
1.7.1.1	>>>>	Referenced SOP Class UID	(0008,1150)	UI	0008	1.2.3.4
1.7.1.1	>>>>	Referenced SOP Instance UID	(0008,1155)	UI	000a	1.2.3.4.6
1.7.1.1	%enditem					
1.7.1.1	%endseq					
1.7.1.1	>>>	Relationship Type	(0040,a010)	CS	000e	SELECTED FROM
1.7.1.1	>>>	Value Type	(0040,a040)	CS	0006	IMAGE
1.7.1.1	%enditem					
1.7.1	%endseq					
1.7.1	>>	Graphic Data	(0070,0022)	FL	0020	0,0,0,0,0,0,0
1.7.1	>>	Graphic Type	(0070,0023)	CS	0008	POLYLINE
1.7.1	%enditem					
1.7	%endseq					
1.7	%enditem					
1.8	%item					
1.8	>	Relationship Type	(0040,a010)	CS	0010	HAS CONCEPT MOD
1.8	>	Value Type	(0040,a040)	CS	0004	CODE
1.8	>	Concept Name Code Sequence	(0040,a043)	SQ	ffffff	
1.8	%item					
1.8	>>	Code Value	(0008,0100)	SH	0006	123456
1.8	>>	Coding Scheme Designator	(0008,0102)	SH	0006	LNdemo
1.8	>>	Code Meaning	(0008,0104)	LO	0006	Views
1.8	%enditem					
1.8	%endseq					
1.8	>	Concept Code Sequence	(0040,a168)	SQ	ffffff	
1.8	%item					
1.8	>>	Code Value	(0008,0100)	SH	0006	123457
1.8	>>	Coding Scheme Designator	(0008,0102)	SH	0006	LNdemo
1.8	>>	Code Meaning	(0008,0104)	LO	000e	PA and Lateral
1.8	%enditem					
1.8	%endseq					
1.8	%enditem					
1	%endseq					

Annex E Mammography CAD (Informative)

This Annex was formerly located in Annex L of PS 3.3 in the 2003 and earlier revisions of the standard.

E.1 MAMMOGRAPHY CAD SR CONTENT TREE STRUCTURE

The templates for the Mammography CAD SR IOD are defined in PS 3.16, Annex A, DCMR Templates. Relationships defined in the Mammography CAD SR IOD templates are by-value, unless otherwise stated. Content items referenced from another SR object instance, such as a prior Mammography CAD SR, are inserted by-value in the new SR object instance, with appropriate original source observation context. It is necessary to update Rendering Intent, and referenced content item identifiers for by-reference relationships, within content items paraphrased from another source.

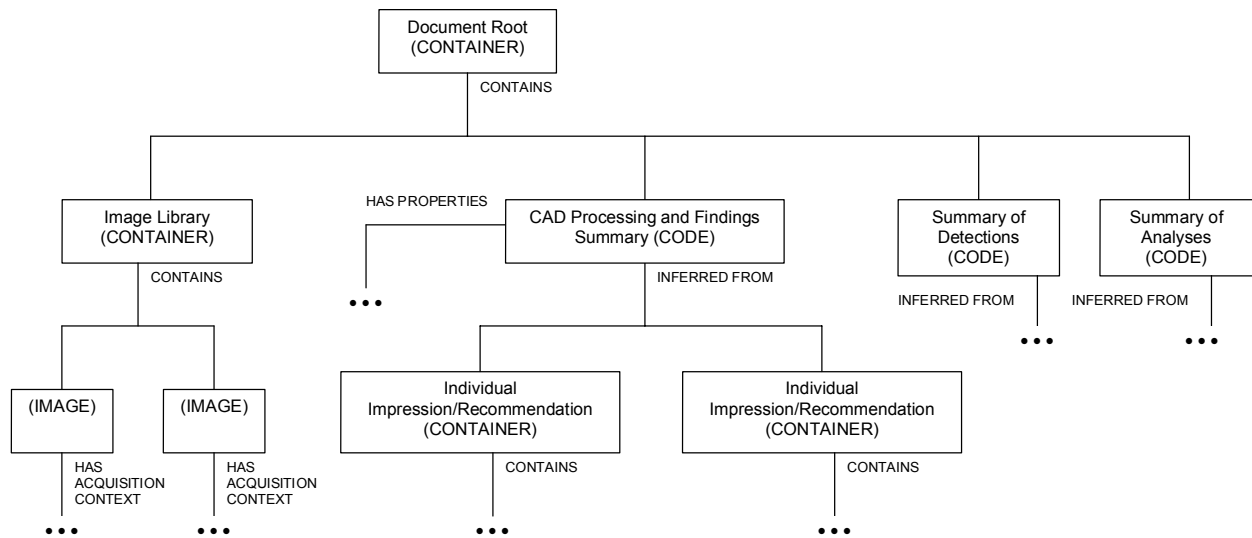

Figure E.1-1: Top Levels of Mammography CAD SR Content Tree

The Document Root, Image Library, Summaries of Detections and Analyses, and CAD Processing and Findings Summary sub-trees together form the content tree of the Mammography CAD SR IOD.

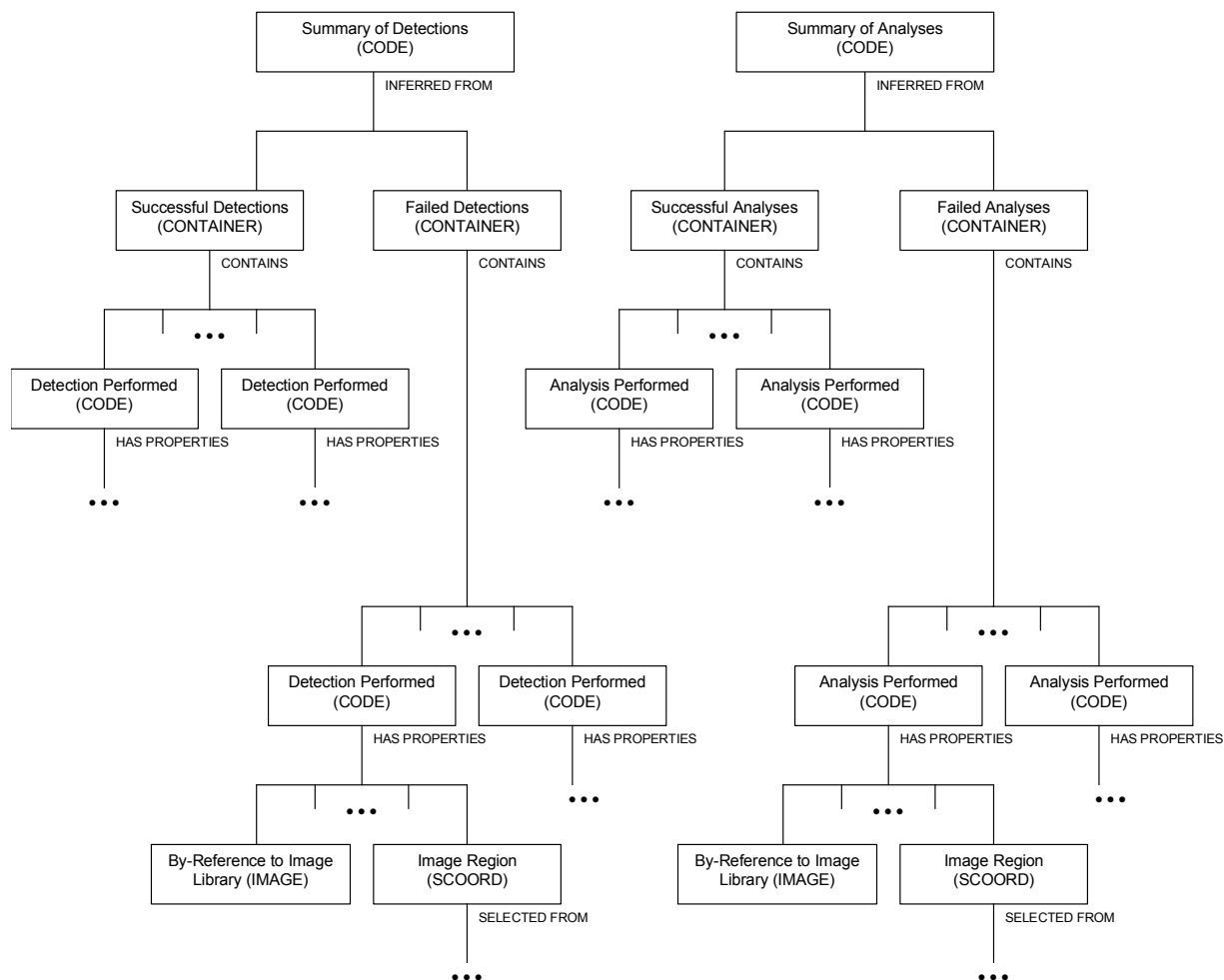

Figure E.1-2: Summary of Detections and Analyses Levels of Mammography CAD SR Content Tree

The Summary of Detections and Summary of Analyses sub-trees identify the algorithms used and the work done by the CAD device, and whether or not each process was performed on one or more entire images or selected regions of images. The findings of the detections and analyses are not encoded in the summary sub-trees, but rather in the CAD Processing and Findings Summary sub-tree. CAD processing may produce no findings, in which case the sub-trees of the CAD Processing and Findings Summary sub-tree are incompletely populated. This occurs in the following situations:

- All algorithms succeeded, but no findings resulted
- Some algorithms succeeded, some failed, but no findings resulted
- All algorithms failed

- Note 1: If the tree contains no Individual Impression/Recommendation nodes and all attempted detections and analyses succeeded then the mammography CAD device made no findings.
- Note 2: Detections and Analyses that are not attempted are not listed in the Summary of Detections and Summary of Analyses trees.
- Note 3: If the code value of the Summary of Detections or Summary of Analyses codes in TID 4000 is "Not Attempted" then no detail is provided as to which algorithms were not attempted.

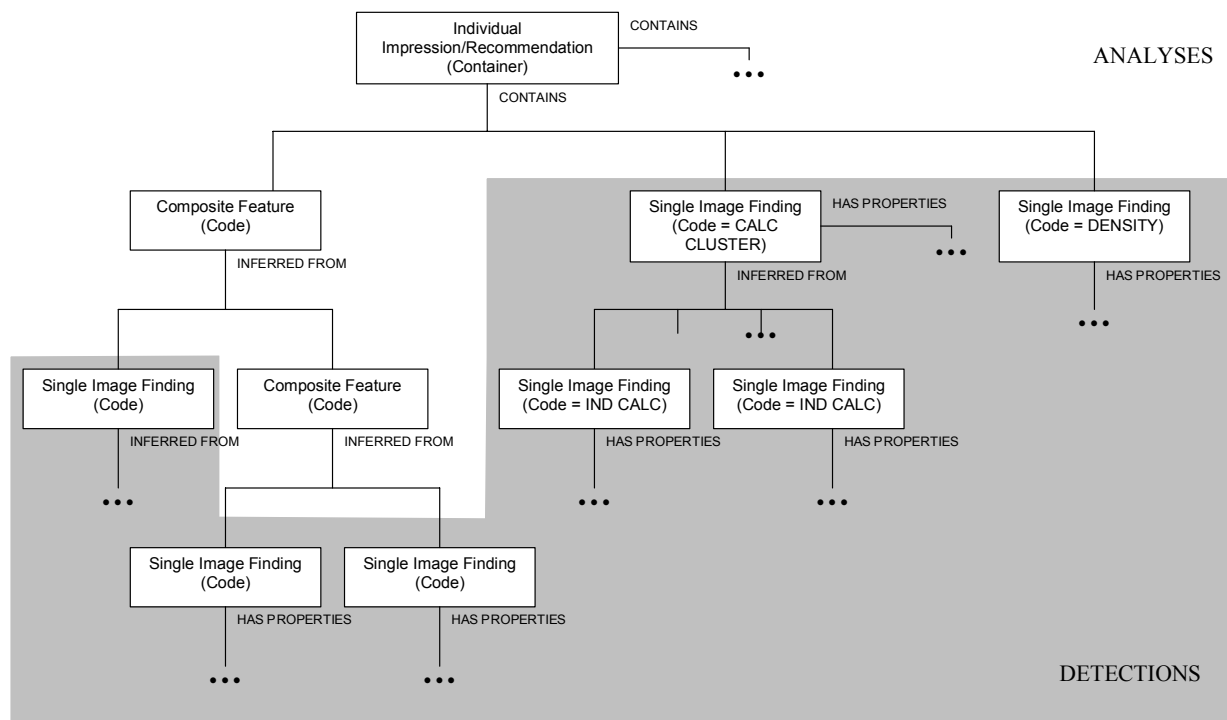

Figure E.1-3: Example of Individual Impression/Recommendation Levels of Mammography CAD SR Content Tree

The shaded area in Figure E.1-3 demarcates information resulting from Detection, whereas the unshaded area is information resulting from Analysis. This distinction is used in determining whether to place algorithm identification information in the Summary of Detections or Summary of Analyses sub-trees.

The clustering of calcifications within a single image is considered to be a Detection process which results in a Single Image Finding. The spatial correlation of a calcification cluster in two views, resulting in a Composite Feature, is considered Analysis. The clustering of calcifications in a single image is the only circumstance in which a Single Image Finding can result from the combination of other Single Image Findings, which must be Individual Calcifications.

Once a Single Image Finding or Composite Feature has been instantiated, it may be referenced by any number of Composite Features higher in the tree.

E.2 MAMMOGRAPHY CAD SR OBSERVATION CONTEXT ENCODING

- Any content item in the Content tree that has been inserted (i.e., duplicated) from another SR object instance has a HAS OBS CONTEXT relationship to one or more content items that describe the context of the SR object instance from which it originated. This mechanism may be used to combine reports (e.g., Mammography CAD 1, Mammography CAD 2, Human).
- By-reference relationships within Single Image Findings and Composite Features paraphrased from prior Mammography CAD SR objects need to be updated to properly reference Image Library Entries carried from the prior object to their new positions in the present object.

The Impression/Recommendation section of the SR Document Content tree of a Mammography CAD SR IOD may contain a mixture of current and prior single image findings and composite features. The content items from current and prior contexts are target content items that have a by-value INFERRED FROM relationship to a Composite Feature content item. Content items that come from a context other than the Initial Observation Context have a HAS OBS CONTEXT relationship to target content items that describe the context of the source document.

In Figure E.2-1, Composite Feature and Single Image Finding are current, and Single Image Finding (from Prior) is duplicated from a prior document.

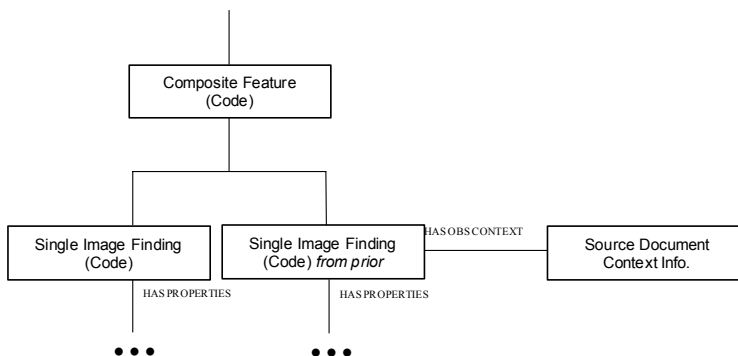

Figure E.2-1: Example of Use of Observation Context

E.3 MAMMOGRAPHY CAD SR EXAMPLES

The following is a simple and non-comprehensive illustration of an encoding of the Mammography CAD SR IOD for Mammography computer aided detection results. For brevity, some Mandatory content items are not included, such as several acquisition context content items for the images in the Image Library.

E.3.1 Example 1: Calcification and Mass Detection with No Findings

A mammography CAD device processes a typical screening mammography case, i.e., there are four films and no cancer. Mammography CAD runs both density and calcification detection successfully and finds nothing. The mammograms resemble:

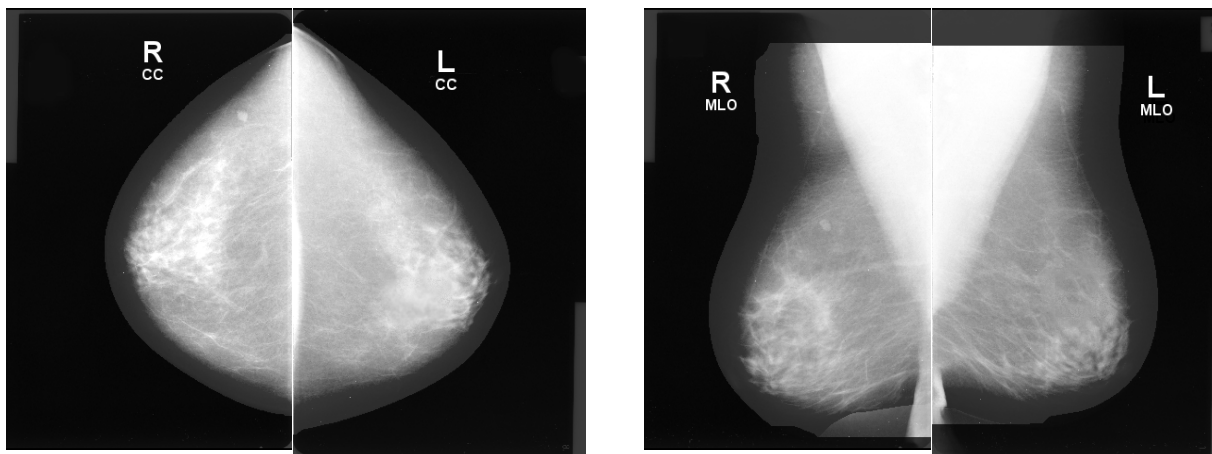

Figure E.3-1: Mammograms as Described in Example 1

The content tree structure would resemble:

Node	Code Meaning of Concept Name	Code Meaning or Example Value	TID
1	Mammography CAD Report		4000
1.1	Image Library		4000

Node	Code Meaning of Concept Name	Code Meaning or Example Value	TID
1.1.1		IMAGE 1	4020
1.1.1.1	Image Laterality	Right	4020
1.1.1.2	Image View	Cranio-caudal	4020
1.1.1.3	Study Date	19980101	4020
1.1.2		IMAGE 2	4020
1.1.2.1	Image Laterality	Left	4020
1.1.2.2	Image View	Cranio-caudal	4020
1.1.2.3	Study Date	19980101	4020
1.1.3		IMAGE 3	4020
1.1.3.1	Image Laterality	Right	4020
1.1.3.2	Image View	Medio-lateral oblique	4020
1.1.3.3	Study Date	19980101	4020
1.1.4		IMAGE 4	4020
1.1.4.1	Image Laterality	Left	4020
1.1.4.2	Image View	Medio-lateral oblique	4020
1.1.4.3	Study Date	19980101	4020
1.2	CAD Processing and Findings Summary	All algorithms succeeded; without findings	4001
1.3	Summary of Detections	Succeeded	4000
1.3.1	Successful Detections		4015
1.3.1.1	Detection Performed	Mammography breast density	4017
1.3.1.1.1	Algorithm Name	"Density Detector"	4019
1.3.1.1.2	Algorithm Version	"V3.7"	4019
1.3.1.1.3		Reference to node 1.1.1	4017
1.3.1.1.4		Reference to node 1.1.2	4017
1.3.1.1.5		Reference to node 1.1.3	4017
1.3.1.1.6		Reference to node 1.1.4	4017
1.3.1.2	Detection Performed	Individual Calcification	4017
1.3.1.2.1	Algorithm Name	"Calc Detector"	4019
1.3.1.2.2	Algorithm Version	"V2.4"	4019
1.3.1.2.3		Reference to node 1.1.1	4017

Node	Code Meaning of Concept Name	Code Meaning or Example Value	TID
1.3.1.2.4		Reference to node 1.1.2	4017
1.3.1.2.5		Reference to node 1.1.3	4017
1.3.1.2.6		Reference to node 1.1.4	4017
1.4	Summary of Analyses	Not Attempted	4000

E.3.2 Example 2: Calcification and Mass Detection with Findings

A mammography CAD device processes a screening mammography case with four films and a mass in the left breast. Mammography CAD runs both density and calcification detection successfully. It finds two densities in the LCC, one density in the LMLO, a cluster of two calcifications in the RCC and a cluster of 20 calcifications in the RMLO. It performs two clustering algorithms. One identifies individual calcifications and then clusters them, and the second simply detects calcification clusters. It performs mass correlation and combines one of the LCC densities and the LMLO density into a mass; the other LCC density is flagged Not for Presentation, therefore not intended for display to the end-user. The mammograms resemble:

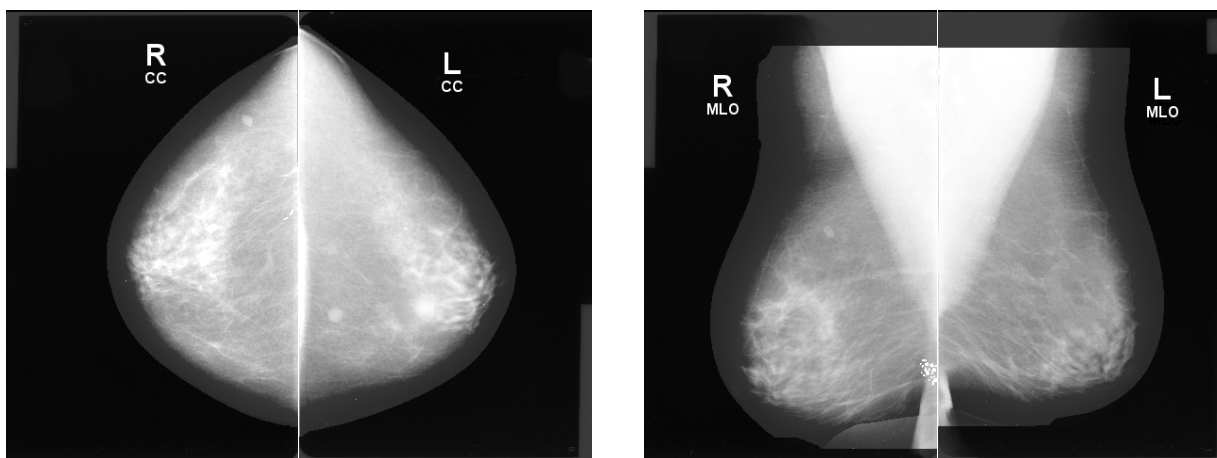

Figure E.3-2: Mammograms as Described in Example 2

The content tree structure in this example is complex. Structural illustrations of portions of the content tree are placed within the content tree table to show the relationships of data within the tree. Some content items are duplicated (and shown in boldface) to facilitate use of the diagrams.

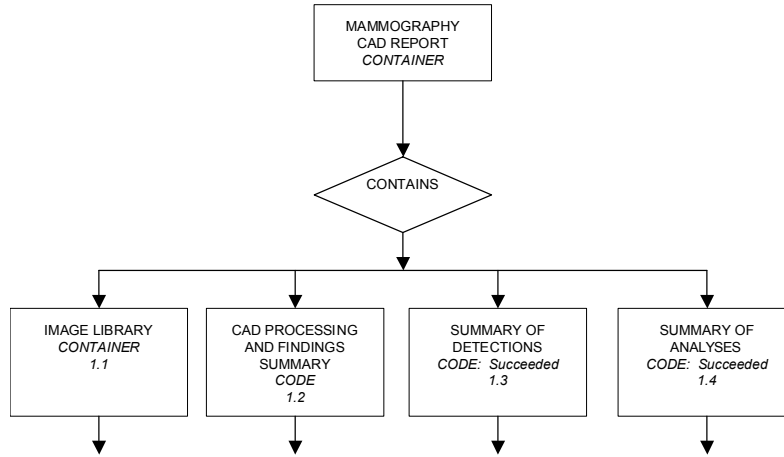

Figure E.3-3: Content Tree Root of Example 2 Content Tree

Node	Code Meaning of Concept Name	Code Meaning or Example Value	TID
1	Mammography CAD Report		4000
1.1	Image Library		4000
1.2	CAD Processing and Findings Summary	All algorithms succeeded; with findings	4001
1.3	Summary of Detections	Succeeded	4000
1.4	Summary of Analyses	Succeeded	4000

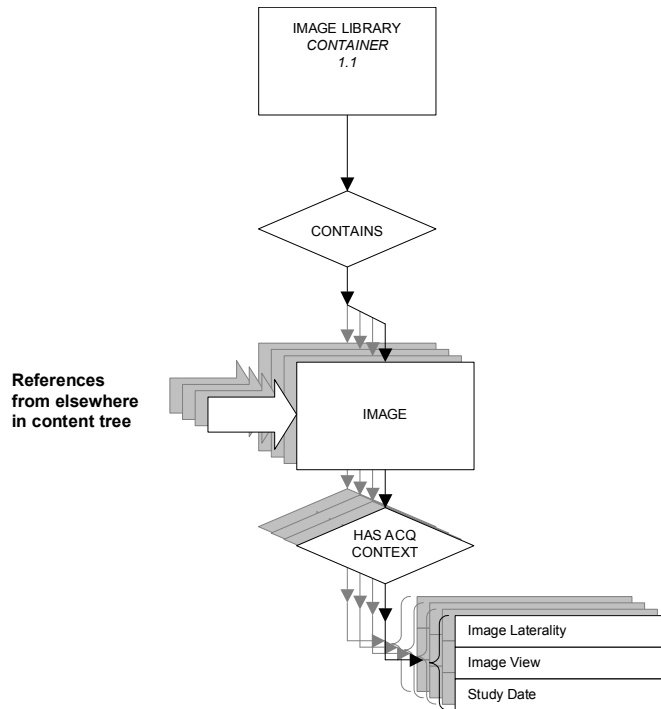

Figure E.3-4: Image Library Branch of Example 2 Content Tree

Node	Code Meaning of Concept Name	Code Meaning or Example Value	TID
1.1	Image Library		4000
1.1.1		IMAGE 1	4020
1.1.1.1	Image Laterality	Right	4020
1.1.1.2	Image View	Cranio-caudal	4020
1.1.1.3	Study Date	19990101	4020
1.1.2		IMAGE 2	4020
1.1.2.1	Image Laterality	Left	4020
1.1.2.2	Image View	Cranio-caudal	4020
1.1.2.3	Study Date	19990101	4020
1.1.3		IMAGE 3	4020
1.1.3.1	Image Laterality	Right	4020
1.1.3.2	Image View	Medio-lateral oblique	4020
1.1.3.3	Study Date	19990101	4020
1.1.4		IMAGE 4	4020
1.1.4.1	Image Laterality	Left	4020
1.1.4.2	Image View	Medio-lateral oblique	4020
1.1.4.3	Study Date	19990101	4020

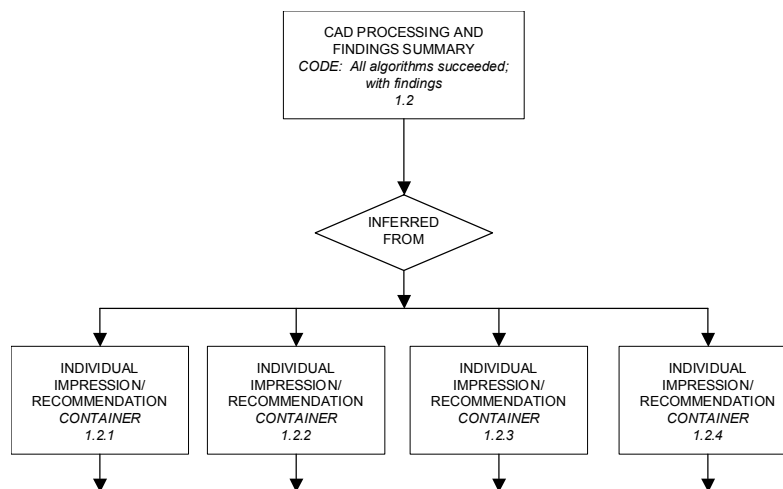

Figure E.3-5: CAD Processing and Findings Summary Bifurcation of Example 2 Content Tree

Node	Code Meaning of Concept Name	Code Meaning or Example Value	TID
1.2	CAD Processing and Findings Summary	All algorithms succeeded; with findings	4001
1.2.1	Individual Impression/Recommendation		4003

Node	Code Meaning of Concept Name	Code Meaning or Example Value	TID
1.2.2	Individual Impression/Recommendation		4003
1.2.3	Individual Impression/Recommendation		4003
1.2.4	Individual Impression/Recommendation		4003

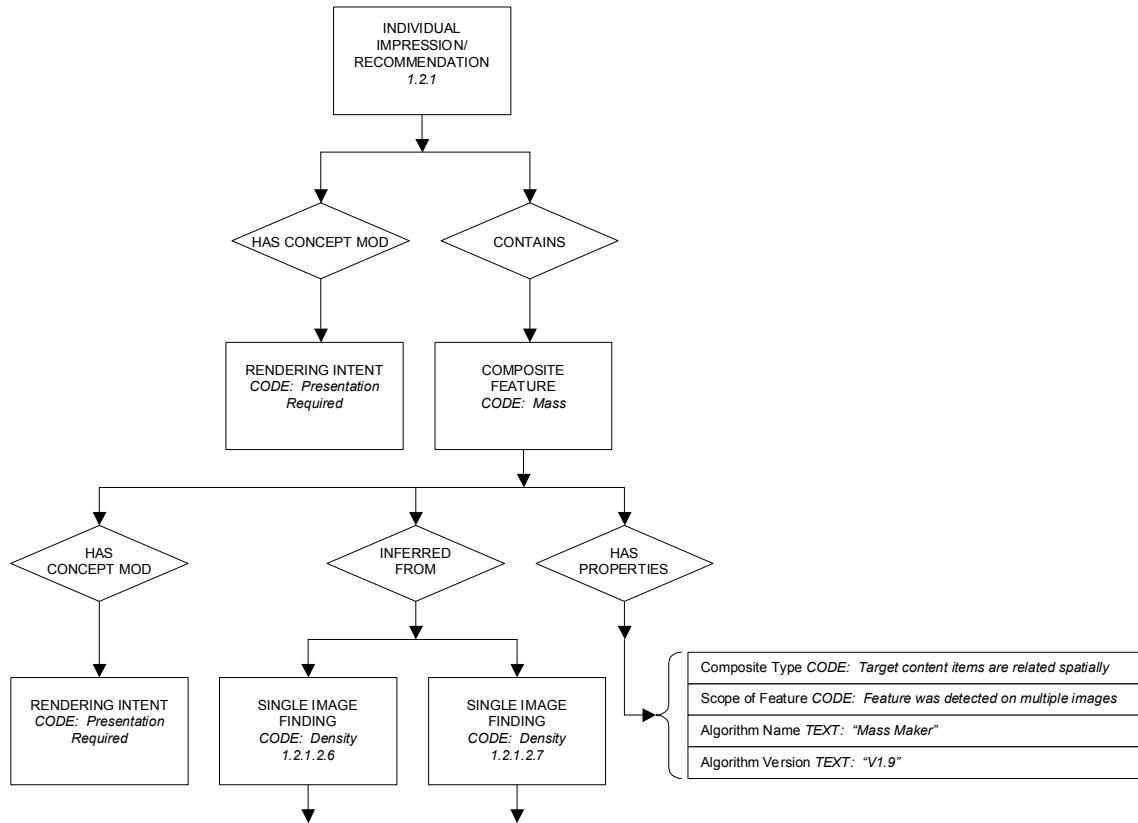

Figure E.3-6: Individual Impression/Recommendation 1.2.1 from Example 2 Content Tree

Node	Code Meaning of Concept Name	Code Meaning or Example Value	TID
1.2.1	Individual Impression/Recommendation		4003
1.2.1.1	Rendering Intent	Presentation Required	4003
1.2.1.2	Composite Feature	Mass	4004
1.2.1.2.1	Rendering Intent	Presentation Required	4004
1.2.1.2.2	Composite type	Target content items are related spatially	4005
1.2.1.2.3	Scope of Feature	Feature was detected on multiple images	4005
1.2.1.2.4	Algorithm Name	"Mass Maker"	4019
1.2.1.2.5	Algorithm Version	"V1.9"	4019

Node	Code Meaning of Concept Name	Code Meaning or Example Value	TID
1.2.1.2.6	Single Image Finding	Mammography breast density	4006
1.2.1.2.7	Single Image Finding	Mammography breast density	4006

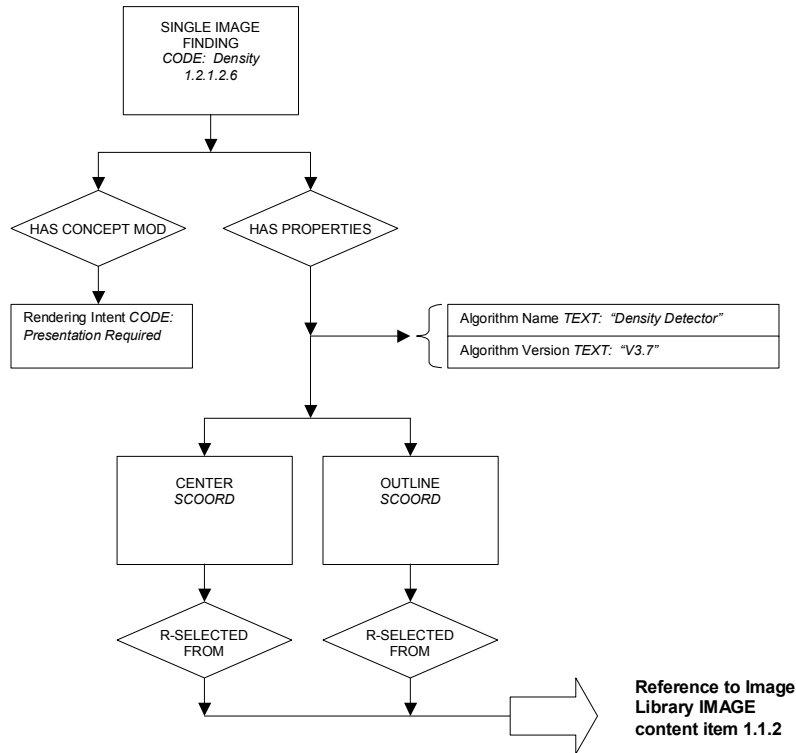

Figure E.3-7: Single Image Finding Density 1.2.1.2.6 from Example 2 Content Tree

Node	Code Meaning of Concept Name	Code Meaning or Example Value	TID
1.2.1.2.6	Single Image Finding	Mammography breast density	4006
1.2.1.2.6.1	Rendering Intent	Presentation Required	4006
1.2.1.2.6.2	Algorithm Name	"Density Detector"	4019
1.2.1.2.6.3	Algorithm Version	"V3.7"	4019
1.2.1.2.6.4	Center	POINT	4021
1.2.1.2.6.4.1		Reference to node 1.1.2	4021
1.2.1.2.6.5	Outline	SCOORD	4021
1.2.1.2.6.5.1		Reference to node 1.1.2	4021

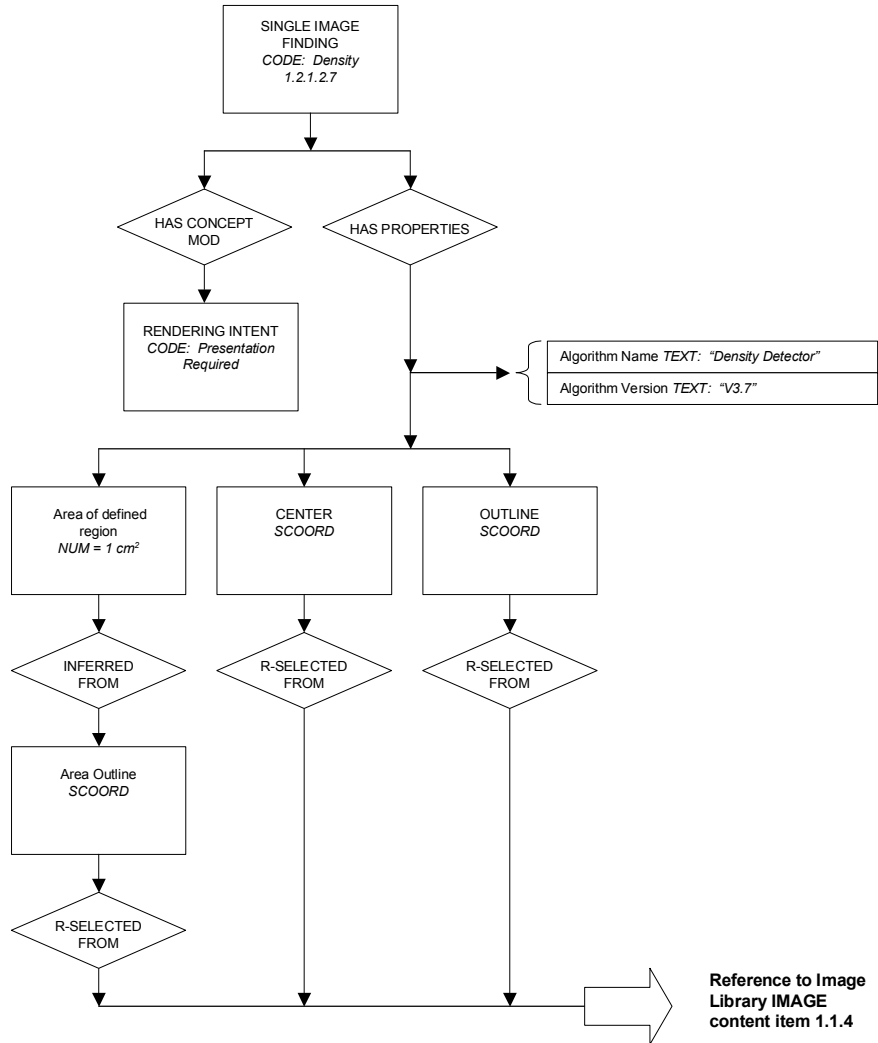

Figure E.3-8: Single Image Finding Density 1.2.1.2.7 from Example 2 Content Tree

Node	Code Meaning of Concept Name	Code Meaning or Example Value	TID
1.2.1.2.7	Single Image Finding	Mammography breast density	4006
1.2.1.2.7.1	Rendering Intent	Presentation Required	4006
1.2.1.2.7.2	Algorithm Name	"Density Detector"	4019
1.2.1.2.7.3	Algorithm Version	"V3.7"	4019
1.2.1.2.7.4	Center	POINT	4021
1.2.1.2.7.4.1		Reference to node 1.1.4	4021
1.2.1.2.7.5	Outline	SCOORD	4021
1.2.1.2.7.5.1		Reference to node 1.1.4	4021
1.2.1.2.7.6	Area of Defined Region	1 cm ²	1401
1.2.1.2.7.6.1	Area Outline	SCOORD	1401

Node	Code Meaning of Concept Name	Code Meaning or Example Value	TID
1.2.1.2.7.6.1.1		Reference to node 1.1.4	1401

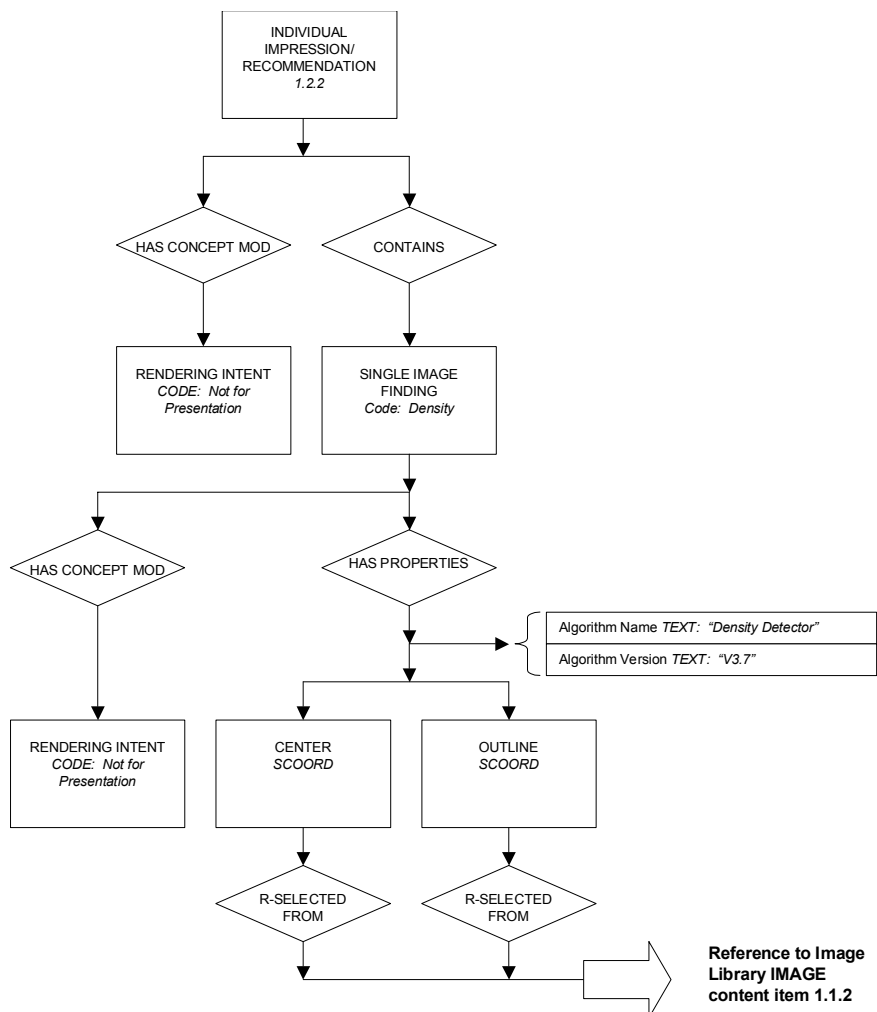

Figure E.3-9: Individual Impression/Recommendation 1.2.2 from Example 2 Content Tree

Node	Code Meaning of Concept Name	Code Meaning or Example Value	TID
1.2.2	Individual Impression/Recommendation		4003
1.2.2.1	Rendering Intent	Not for Presentation	4003
1.2.2.2	Single Image Finding	Mammography breast density	4006
1.2.2.2.1	Rendering Intent	Not for Presentation	4006
1.2.2.2.2	Algorithm Name	"Density Detector"	4019
1.2.2.2.3	Algorithm Version	"V3.7"	4019
1.2.2.2.4	Center	POINT	4021

Node	Code Meaning of Concept Name	Code Meaning or Example Value	TID
1.2.2.2.4.1		Reference to node 1.1.2	4021
1.2.2.2.5	Outline	SCOORD	4021
1.2.2.2.5.1		Reference to node 1.1.2	4021

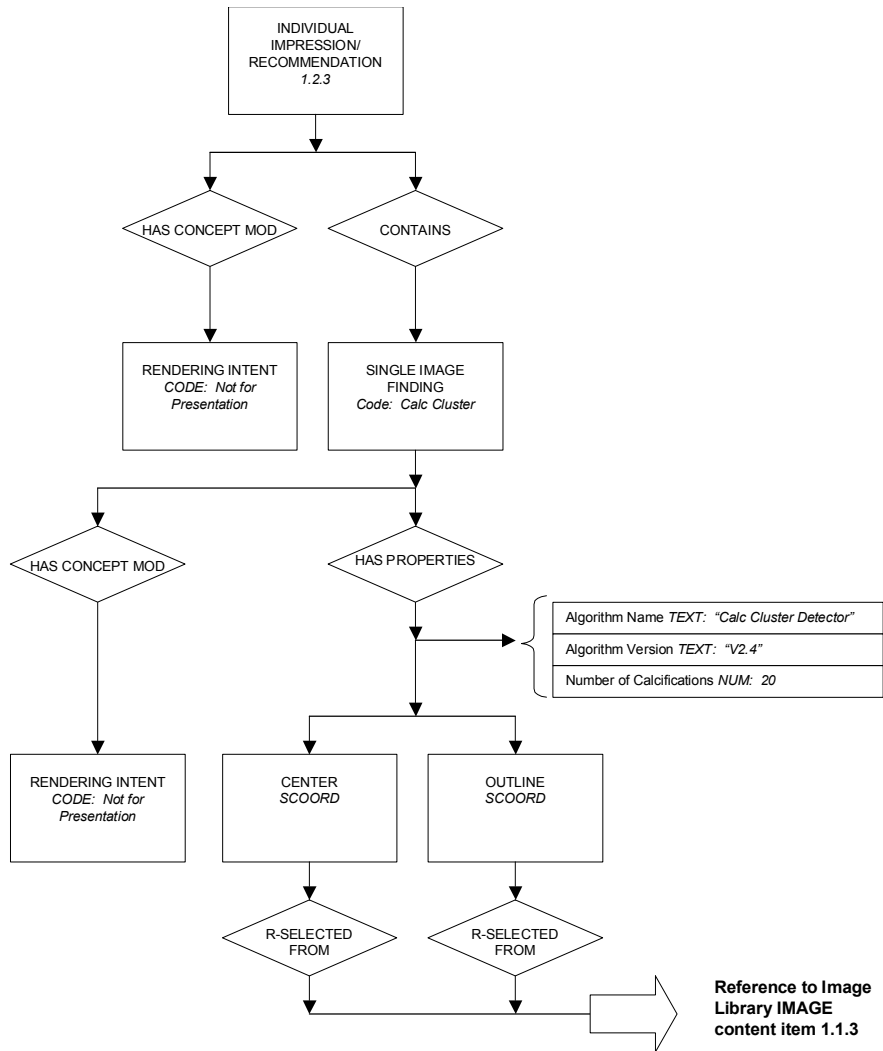

Figure E.3-10: Individual Impression/Recommendation 1.2.3 from Example 2 Content Tree

Node	Code Meaning of Concept Name	Code Meaning or Example Value	TID
1.2.3	Individual Impression/Recommendation		4003
1.2.3.1	Rendering Intent	Presentation Required	4003
1.2.3.2	Single Image Finding	Calcification Cluster	4006
1.2.3.2.1	Rendering Intent	Presentation Required	4006

Node	Code Meaning of Concept Name	Code Meaning or Example Value	TID
1.2.3.2.2	Algorithm Name	“Calc Cluster Detector”	4019
1.2.3.2.3	Algorithm Version	“V2.4”	4019
1.2.3.2.4	Center	POINT	4021
1.2.3.2.4.1		Reference to node 1.1.3	4021
1.2.3.2.5	Outline	SCOORD	4021
1.2.3.2.5.1		Reference to node 1.1.3	4021
1.2.3.2.6	Number of Calcifications	20	4010

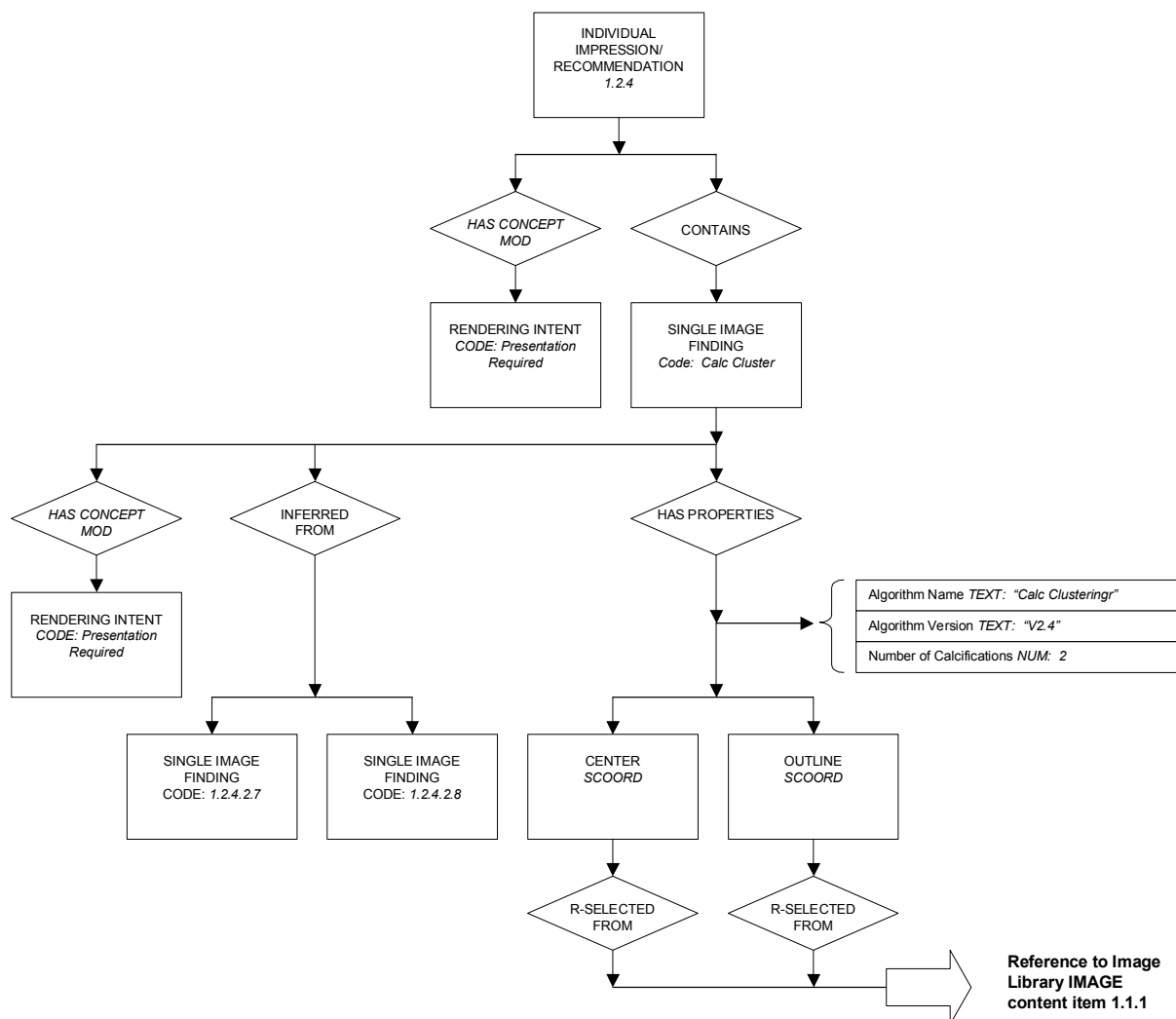

Figure E.3-11: Individual Impression/Recommendation 1.2.4 from Example 2 Content Tree

Node	Code Meaning of Concept Name	Code Meaning or Example Value	TID
------	------------------------------	-------------------------------	-----

Node	Code Meaning of Concept Name	Code Meaning or Example Value	TID
1.2.4	Individual Impression/Recommendation		4003
1.2.4.1	Rendering Intent	Presentation Required	4003
1.2.4.2	Single Image Finding	Calcification Cluster	4006
1.2.4.2.1	Rendering Intent	Presentation Required	4006
1.2.4.2.2	Algorithm Name	"Calc Clustering"	4019
1.2.4.2.3	Algorithm Version	"V2.4"	4019
1.2.4.2.4	Center	POINT	4021
1.2.4.2.4.1		Reference to node 1.1.1	4021
1.2.4.2.5	Outline	SCOORD	4021
1.2.4.2.5.1		Reference to node 1.1.1	4021
1.2.4.2.6	Number of Calcifications	2	4010

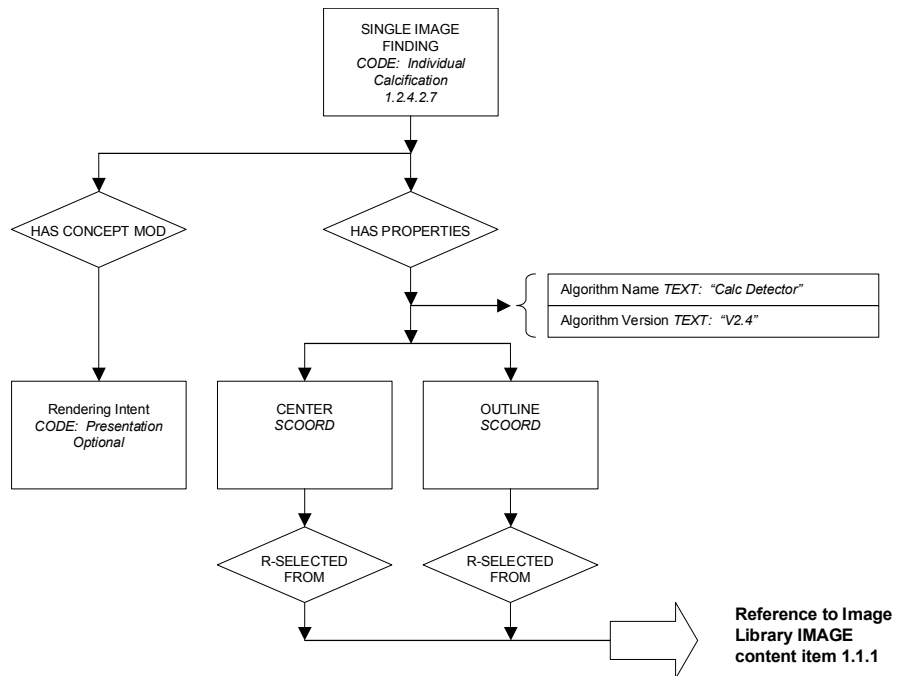

Figure E.3-12: Single Image Finding 1.2.4.2.7 from Example 2 Content Tree

Node	Code Meaning of Concept Name	Code Meaning or Example Value	TID
1.2.4.2.7	Single Image Finding	Individual Calcification	4006
1.2.4.2.7.1	Rendering Intent	Presentation Optional	4006
1.2.4.2.7.2	Algorithm Name	"Calc Detector"	4019
1.2.4.2.7.3	Algorithm Version	"V2.4"	4019

Node	Code Meaning of Concept Name	Code Meaning or Example Value	TID
1.2.4.2.7.4	Center	POINT	4021
1.2.4.2.7.4.1		Reference to node 1.1.1	4021
1.2.4.2.7.5	Outline	SCOORD	4021
1.2.4.2.7.5.1		Reference to node 1.1.1	4021

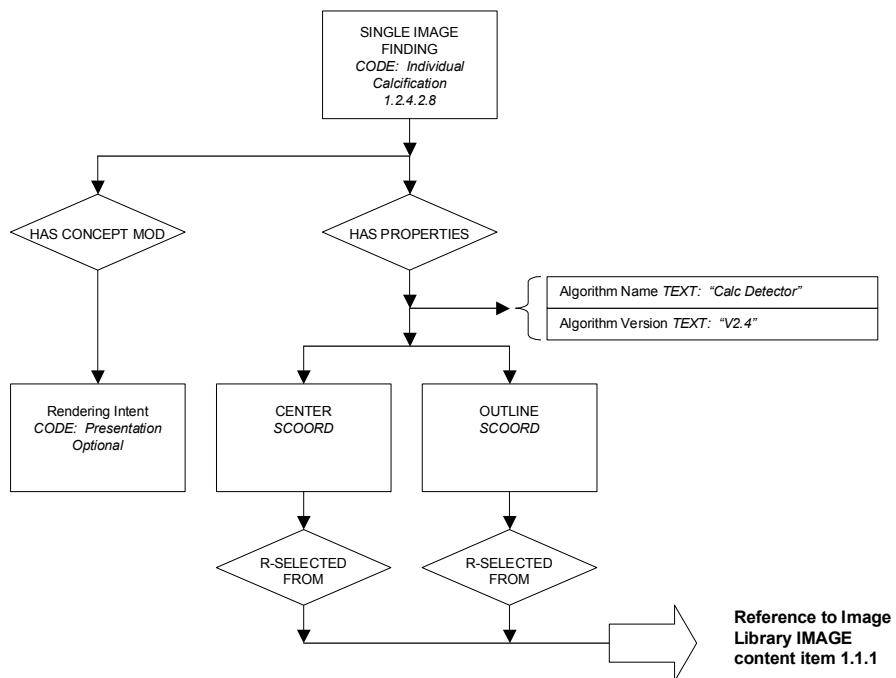

Figure E.3-13: Single Image Finding 1.2.4.2.8 from Example 2 Content Tree

Node	Code Meaning of Concept Name	Code Meaning or Example Value	TID
1.2.4.2.8	Single Image Finding	Individual Calcification	4006
1.2.4.2.8.1	Rendering Intent	Presentation Optional	4006
1.2.4.2.8.2	Algorithm Name	"Calc Detector"	4019
1.2.4.2.8.3	Algorithm Version	"V2.4"	4019
1.2.4.2.8.4	Center	POINT	4021
1.2.4.2.8.4.1		Reference to node 1.1.1	4021
1.2.4.2.8.5	Outline	SCOORD	4021
1.2.4.2.8.5.1		Reference to node 1.1.1	4021

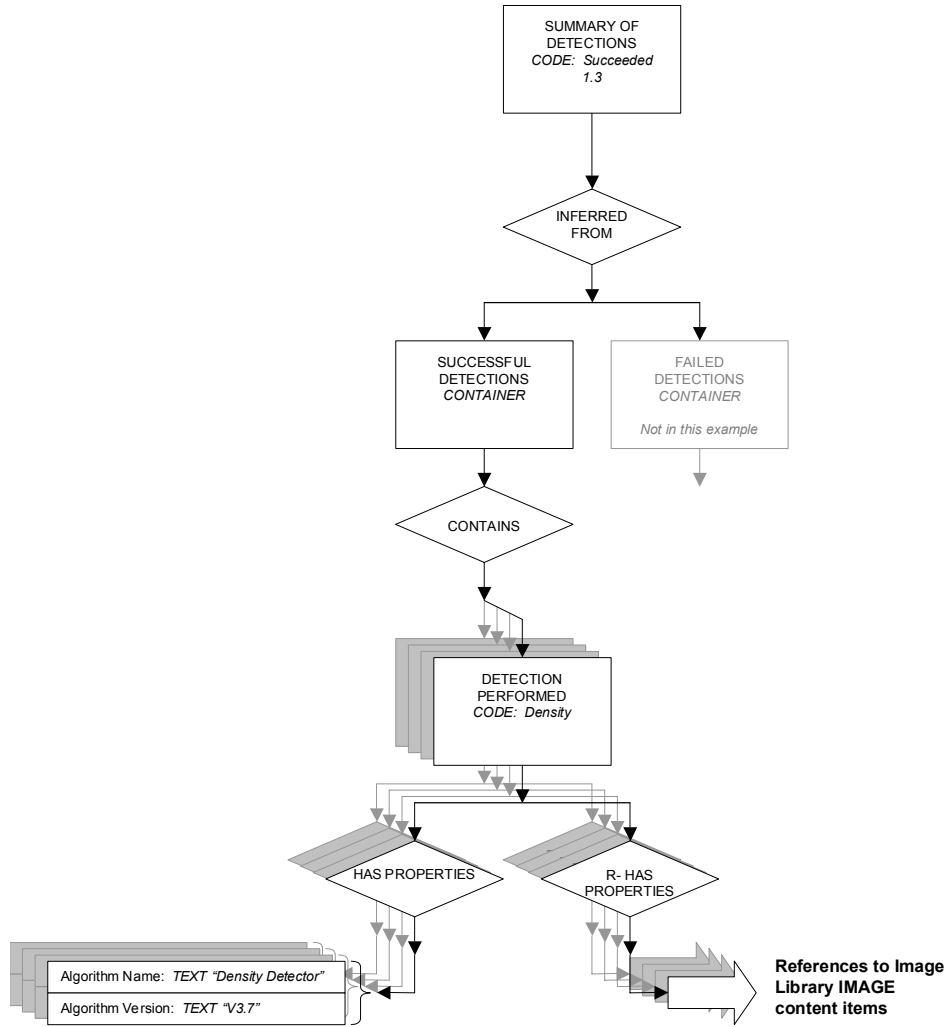

Figure E.3-14: Summary of Detections Branch of Example 2 Content Tree

Node	Code Meaning of Concept Name	Code Meaning or Example Value	TID
1.3	Summary of Detections	Succeeded	4000
1.3.1	Successful Detections		4015
1.3.1.1	Detection Performed	Mammography breast density	4017
1.3.1.1.1	Algorithm Name	"Density Detector"	4019
1.3.1.1.2	Algorithm Version	"V3.7"	4019
1.3.1.1.3		Reference to node 1.1.1	4017
1.3.1.1.4		Reference to node 1.1.2	4017
1.3.1.1.5		Reference to node 1.1.3	4017
1.3.1.1.6		Reference to node	4017

Node	Code Meaning of Concept Name	Code Meaning or Example Value	TID
		1.1.4	
1.3.1.2	Detection Performed	Individual Calcification	4017
1.3.1.2.1	Algorithm Name	"Calc Detector"	4019
1.3.1.2.2	Algorithm Version	"V2.4"	4019
1.3.1.2.3		Reference to node 1.1.1	4017
1.3.1.2.4		Reference to node 1.1.2	4017
1.3.1.2.5		Reference to node 1.1.3	4017
1.3.1.2.6		Reference to node 1.1.4	4017
1.3.1.3	Detection Performed	Calcification Cluster	4017
1.3.1.3.1	Algorithm Name	"Calc Clustering"	4019
1.3.1.3.2	Algorithm Version	"V2.4"	4019
1.3.1.3.3		Reference to node 1.1.1	4017
1.3.1.4	Detection Performed	Calcification Cluster	4017
1.3.1.4.1	Algorithm Name	"Calc Cluster Detector"	4019
1.3.1.4.2	Algorithm Version	"V2.4"	4019
1.3.1.4.3		Reference to node 1.1.1	4017
1.3.1.4.4		Reference to node 1.1.2	4017
1.3.1.4.5		Reference to node 1.1.3	4017
1.3.1.4.6		Reference to node 1.1.4	4017

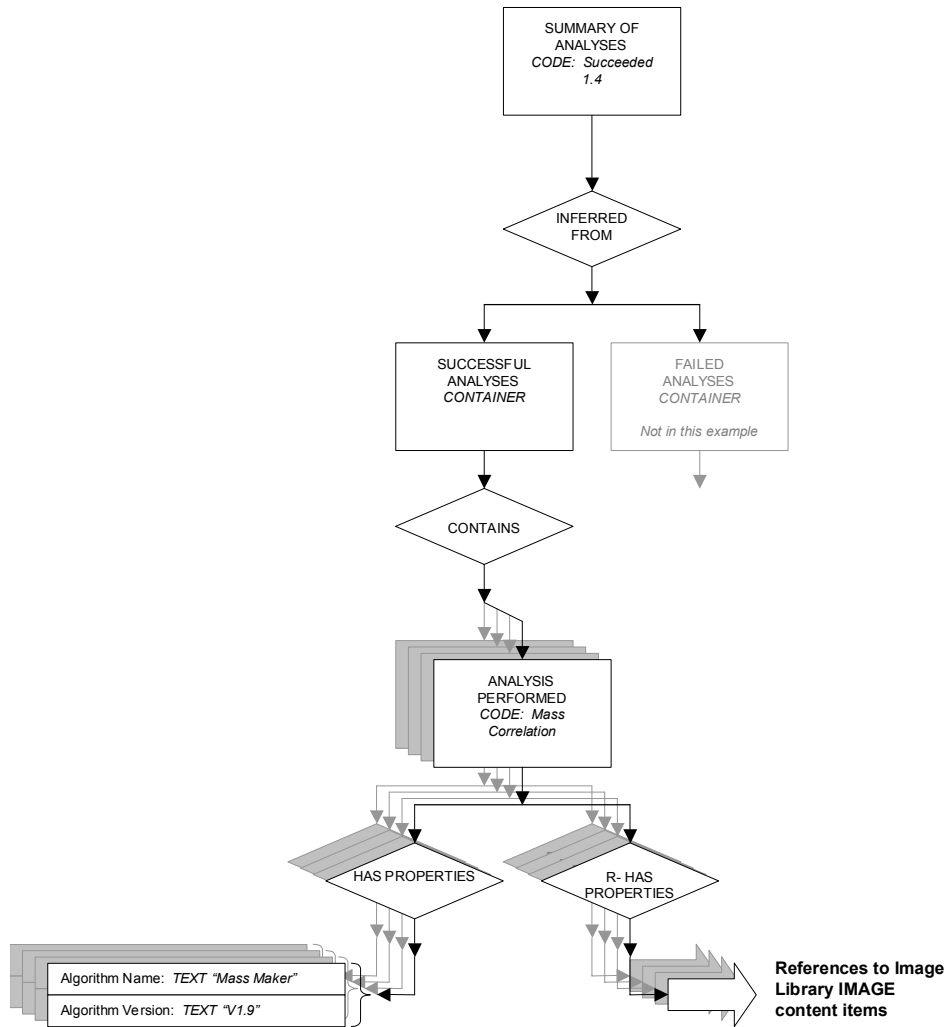

Figure E.3-15: Summary of Analyses Branch of Example 2 Content Tree

Node	Code Meaning of Concept Name	Code Meaning or Example Value	TID
1.4	Summary of Analyses	Succeeded	4000
1.4.1	Successful Analyses		4016
1.4.1.1	Analysis Performed	Mass Correlation	4018
1.4.1.1.1	Algorithm Name	"Mass Maker"	4019
1.4.1.1.2	Algorithm Version	"V1.9"	4019
1.4.1.1.3		Reference to node 1.1.2	4018
1.4.1.1.4		Reference to node 1.1.4	4018

E.3.3 Example 3: Calcification and Mass Detection, Temporal Differencing with Findings

The patient in Example 2 returns for another mammogram. A more comprehensive mammography CAD device processes the current mammogram; analyses are performed that determine some content items for Overall and Individual Impression/Recommendations. Portions of the prior mammography CAD report (Example 2) are incorporated into this report. In the current mammogram the number of calcifications in the RCC has increased, and the size of the mass in the left breast has increased from 1 to 4 cm².

PRIOR

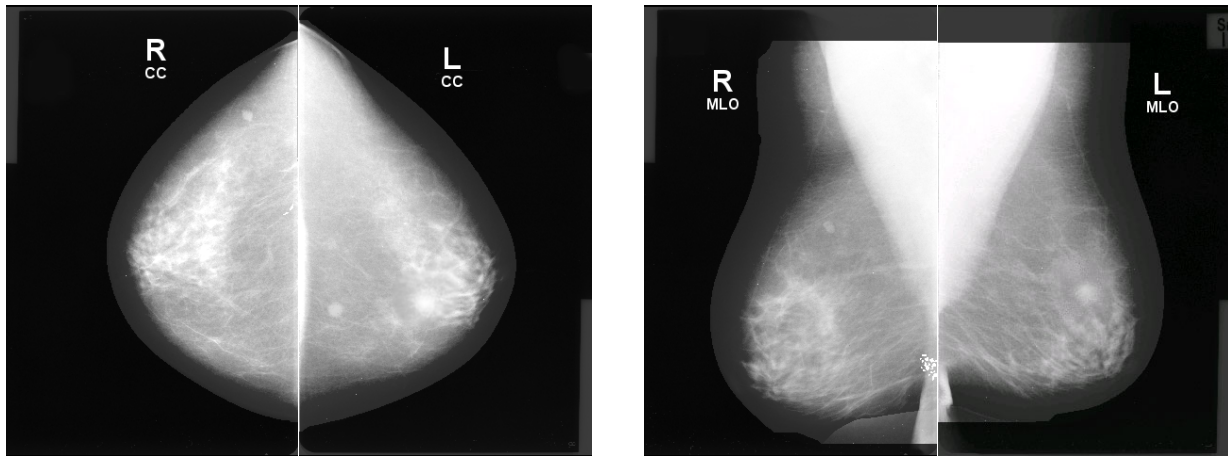

CURRENT

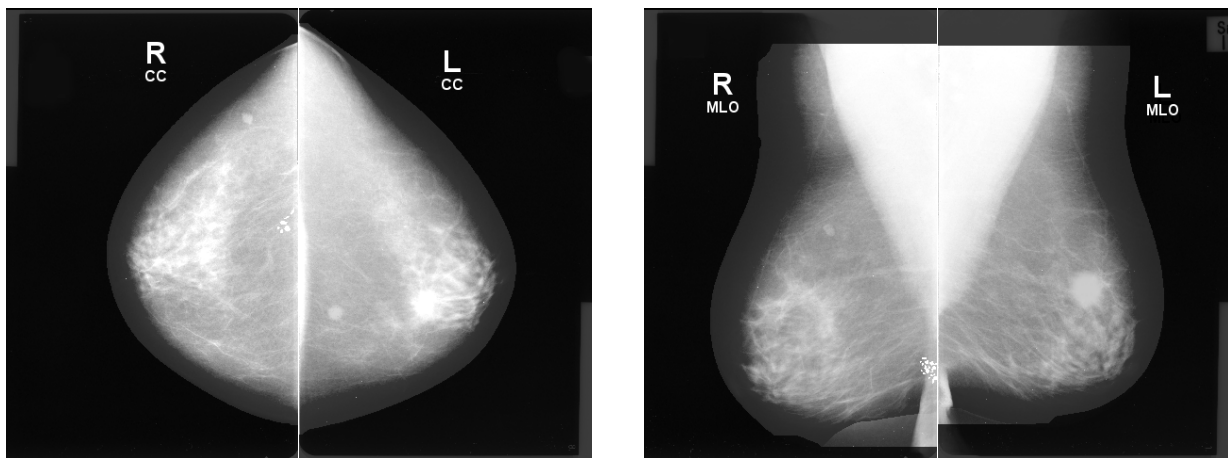

Figure E.3-16: Mammograms as Described in Example 3

Italicized entries (xxx) in the following table denote references to or by-value inclusion of content tree items reused from the prior Mammography CAD SR instance (Example 2).

Node	Code Meaning of Concept Name	Code Meaning or Example Value	TID
1	Mammography CAD Report		4000

While the Image Library contains references to content tree items reused from the prior Mammography CAD SR instance, the images are actually used in the mammography CAD analysis and are therefore not italicized as indicated above.

Node	Code Meaning of Concept Name	Code Meaning or Example Value	TID
1.1	Image Library		4000
1.1.1		IMAGE 1	4020
1.1.1.1	Image Laterality	Right	4020
1.1.1.2	Image View	Cranio-caudal	4020
1.1.1.3	Study Date	20000101	4020
1.1.2		IMAGE 2	4020
1.1.2.1	Image Laterality	Left	4020
1.1.2.2	Image View	Cranio-caudal	4020
1.1.2.3	Study Date	20000101	4020
1.1.3		IMAGE 3	4020
1.1.3.1	Image Laterality	Right	4020
1.1.3.2	Image View	Medio-lateral oblique	4020
1.1.3.3	Study Date	20000101	4020
1.1.4		IMAGE 4	4020
1.1.4.1	Image Laterality	Left	4020
1.1.4.2	Image View	Medio-lateral oblique	4020
1.1.4.3	Study Date	20000101	4020
1.1.5		IMAGE 5	4020
1.1.5.1	Image Laterality	Right	4020
1.1.5.2	Image View	Cranio-caudal	4020
1.1.5.3	Study Date	19990101	4020
1.1.6		IMAGE 6	4020
1.1.6.1	Image Laterality	Left	4020
1.1.6.2	Image View	Cranio-caudal	4020
1.1.6.3	Study Date	19990101	4020
1.1.7		IMAGE 7	4020
1.1.7.1	Image Laterality	Right	4020
1.1.7.2	Image View	Medio-lateral oblique	4020
1.1.7.3	Study Date	19990101	4020
1.1.8		IMAGE 8	4020
1.1.8.1	Image Laterality	Left	4020
1.1.8.2	Image View	Medio-lateral oblique	4020
1.1.8.3	Study Date	19990101	4020

Current year content:

Node	Code Meaning of Concept Name	Code Meaning or Example Value	TID
1.2	CAD Processing and Findings Summary	All algorithms succeeded; with findings	4001
1.2.1	Assessment Category	4 – Suspicious abnormality, biopsy should be considered	4002
1.2.2	Recommend Follow-up Interval	0 days	4002
1.2.3	Algorithm Name	“Mammogram Analyzer”	4019
1.2.4	Algorithm Version	“V1.0”	4019
1.2.5	Individual Impression/Recommendation		4003
1.2.5.1	Rendering Intent	Presentation Required	4003
1.2.5.2	Differential Diagnosis/Impression	Increase in size	4002
1.2.5.3	Impression Description	“Worrisome increase in size”	4002
1.2.5.4	Recommended Follow-up	Needle localization and biopsy	4002
1.2.5.5	Certainty of impression	84%	4002
1.2.5.6	Algorithm Name	“Lesion Analyzer”	4019
1.2.5.7	Algorithm Version	“V1.0”	4019
1.2.5.8	Composite Feature	Mass	4004
1.2.5.8.1	Rendering Intent	Presentation Required	4004
1.2.5.8.2	Composite type	Target content items are related temporally	4005
1.2.5.8.3	Scope of Feature	Feature was detected on multiple images	4005
1.2.5.8.4	Algorithm Name	“Temporal Change”	4019
1.2.5.8.5	Algorithm Version	“V0.1”	4019
1.2.5.8.6	Certainty of Feature	91%	4005
1.2.5.8.7	Probability of Cancer	84%	4005
1.2.5.8.8	Pathology	Invasivelobular carcinoma	4005
1.2.5.8.9	Difference in Size	3 cm ²	4005
1.2.5.8.9.1		Reference to node 1.2.5.8.13.7.6	4005
1.2.5.8.9.2		Reference to node 1.2.5.8.14.8.6	4005
1.2.5.8.10	Lesion Density	High density	4005
1.2.5.8.11	Shape	Lobular	4005
1.2.5.8.12	Margins	Microlobulated	4005

Node	Code Meaning of Concept Name	Code Meaning or Example Value	TID
1.2.5.8.13	Composite Feature	Mass	4004
1.2.5.8.13.1	Rendering Intent	Presentation Required	4004
1.2.5.8.13.2	Composite type	Target content items are related spatially	4005
1.2.5.8.13.3	Scope of Feature	Feature was detected on multiple images	4005
1.2.5.8.13.4	Algorithm Name	"Mass Maker"	4019
1.2.5.8.13.5	Algorithm Version	"V1.9"	4019
1.2.5.8.13.6	Single Image Finding	Mammography breast density	4006
1.2.5.8.13.6.1	Rendering Intent	Presentation Required	4006
1.2.5.8.13.6.2	Algorithm Name	"Density Detector"	4019
1.2.5.8.13.6.3	Algorithm Version	"V3.7"	4019
1.2.5.8.13.6.4	Center	POINT	4021
1.2.5.8.13.6.4.1		Reference to node 1.1.2	4021
1.2.5.8.13.6.5	Outline	SCOORD	4021
1.2.5.8.13.6.5.1		Reference to node 1.1.2	4021
1.2.5.8.13.7	Single Image Finding	Mammography breast density	4006
1.2.5.8.13.7.1	Rendering Intent	Presentation Required	4006
1.2.5.8.13.7.2	Algorithm Name	"Density Detector"	4019
1.2.5.8.13.7.3	Algorithm Version	"V3.7"	4019
1.2.5.8.13.7.4	Center	POINT	4021
1.2.5.8.13.7.4.1		Reference to node 1.1.4	4021
1.2.5.8.13.7.5	Outline	SCOORD	4021
1.2.5.8.13.7.5.1		Reference to node 1.1.4	4021
1.2.5.8.13.7.6	Area of Defined Region	4 cm ²	1401
1.2.5.8.13.7.6.1	Area Outline	SCOORD	1401
1.2.5.8.13.7.6. 1.1		Reference to node 1.1.4	1401

Included content from prior mammography CAD report (see Example 2, starting with node 1.2.1.2)

Node	Code Meaning of Concept Name	Code Meaning or Example Value	TID
1.2.5.8.14	Composite Feature	Mass	4004
1.2.5.8.14.1	Rendering Intent	Presentation Required	4004

Node	Code Meaning of Concept Name	Code Meaning or Example Value	TID
1.2.5.8.14.2	Composite type	Target content items are related spatially	4005
1.2.5.8.14.3	Scope of Feature	Feature was detected on multiple images	4005
1.2.5.8.14.4	Algorithm Name	"Mass Maker"	4019
1.2.5.8.14.5	Algorithm Version	"V1.9"	4019
1.2.5.8.14.6	[Observation Context content items]		4022
1.2.5.8.14.7	Single Image Finding	Mammography breast density	4006
1.2.5.8.14.7.1	Rendering Intent	Presentation Required	4006
1.2.5.8.14.7.2	Algorithm Name	"Density Detector"	4019
1.2.5.8.14.7.3	Algorithm Version	"V3.7"	4019
1.2.5.8.14.7.4	Center	POINT	4021
1.2.5.8.14.7.4.1		Reference to node 1.1.6	4021
1.2.5.8.14.7.5	Outline	SCOORD	4021
1.2.5.8.14.7.5.1		Reference to node 1.1.6	4021
1.2.5.8.14.8	Single Image Finding	Mammography breast density	4006
1.2.5.8.14.8.1	Rendering Intent	Presentation Required	4006
1.2.5.8.14.8.2	Algorithm Name	"Density Detector"	4019
1.2.5.8.14.8.3	Algorithm Version	"V3.7"	4019
1.2.5.8.14.8.4	Center	POINT	4021
1.2.5.8.14.8.4.1		Reference to node 1.1.8	4021
1.2.5.8.14.8.5	Outline	SCOORD	4021
1.2.5.8.14.8.5.1		Reference to node 1.1.8	4021
1.2.5.8.14.8.6	Area of Defined Region	1 cm ²	1401
1.2.5.8.14.8.6.1	Area Outline	SCOORD	1401
1.2.5.8.14.8.6.1.1		Reference to node 1.1.8	1401

More current year content:

Node	Code Meaning of Concept Name	Code Meaning or Example Value	TID
1.2.6	Individual Impression/Recommendation		4003
1.2.6.1	Rendering Intent	Not for Presentation	4003
1.2.6.2	Single Image Finding	Mammography breast density	4006

Node	Code Meaning of Concept Name	Code Meaning or Example Value	TID
1.2.6.2.1	Rendering Intent	Not for Presentation	4006
1.2.6.2.2	Algorithm Name	"Density Detector"	4019
1.2.6.2.3	Algorithm Version	"V3.7"	4019
1.2.6.2.4	Center	POINT	4021
1.2.6.2.4.1		Reference to node 1.1.2	4021
1.2.6.2.5	Outline	SCOORD	4021
1.2.6.2.5.1		Reference to node 1.1.2	4021
1.2.7	Individual Impression/Recommendation	INDIVIDUAL	4003
1.2.7.1	Rendering Intent	Presentation Required	4003
1.2.7.2	Single Image Finding	Calcification Cluster	4006
1.2.7.2.1	Rendering Intent	Presentation Required	4006
1.2.7.2.2	Algorithm Name	"Calc Cluster Detector"	4019
1.2.7.2.3	Algorithm Version	"V2.4"	4019
1.2.7.2.4	Center	POINT	4021
1.2.7.2.4.1		Reference to node 1.1.3	4021
1.2.7.2.5	Outline	SCOORD	4021
1.2.7.2.5.1		Reference to node 1.1.3	4021
1.2.7.2.6	Number of Calcifications	20	4010
1.2.8	Individual Impression/Recommendation		4003
1.2.8.1	Rendering Intent	Presentation Required	4003
1.2.8.2	Differential Diagnosis/Impression	Increase in number of calcifications	4002
1.2.8.3	Impression Description	"Calcification cluster has increased in size"	4002
1.2.8.4	Recommended Follow-up	Magnification views	4002
1.2.8.5	Certainty of impression	100%	4002
1.2.8.6	Algorithm Name	"Lesion Analyzer"	4019
1.2.8.7	Algorithm Version	"V1.0"	4019
1.2.8.8	Composite Feature	Calcification Cluster	4004
1.2.8.8.1	Rendering Intent	Presentation Required	4004
1.2.8.8.2	Composite type	Target content items are related temporally	4005
1.2.8.8.3	Scope of Feature	Feature was detected on multiple images	4005
1.2.8.8.4	Algorithm Name	"Lesion Analyzer"	4019

Node	Code Meaning of Concept Name	Code Meaning or Example Value	TID
1.2.8.8.5	Algorithm Version	"V1.0"	4019
1.2.8.8.6	Certainty of Feature	99%	4005
1.2.8.8.7	Probability of Cancer	54%	4005
1.2.8.8.8	Pathology	Intraductal carcinoma, low grade	4005
1.2.8.8.9	Difference in Number of calcifications	4	4005
1.2.8.8.9.1		Reference to node 1.2.8.8.12.6	4005
1.2.8.8.9.2		Reference to node 1.2.8.8.13.6	4005
1.2.8.8.10	Calcification type	Fine, linear, branching (casting)	4005
1.2.8.8.11	Calcification distribution	Grouped or clustered	4005
1.2.8.8.12	Single Image Finding	Calcification Cluster	4006
1.2.8.8.12.1	Rendering Intent	Presentation Required	4006
1.2.8.8.12.2	Algorithm Name	"Calc Clustering"	4019
1.2.8.8.12.3	Algorithm Version	"V2.4"	4019
1.2.8.8.12.4	Center	POINT	4021
1.2.8.8.12.4.1		Reference to node 1.1.1	4021
1.2.8.8.12.5	Outline	SCoord	4021
1.2.8.8.12.5.1		Reference to node 1.1.1	4021
1.2.8.8.12.6	Number of Calcifications	6	4010
1.2.8.8.12.7	Single Image Finding	Individual Calcification	4006
1.2.8.8.12.7.1	Rendering Intent	Presentation Optional	4006
1.2.8.8.12.7.2	Algorithm Name	"Calc Detector"	4019
1.2.8.8.12.7.3	Algorithm Version	"V2.4"	4019
1.2.8.8.12.7.4	Center	POINT	4021
1.2.8.8.12.7.4.1		Reference to node 1.1.1	4021
1.2.8.8.12.7.5	Outline	SCoord	4021
1.2.8.8.12.7.5.1		Reference to node 1.1.1	4021
1.2.8.8.12.8	Single Image Finding	Individual Calcification	4006
1.2.8.8.12.8.1	Rendering Intent	Presentation Optional	4006
1.2.8.8.12.8.2	Algorithm Name	"Calc Detector"	4019
1.2.8.8.12.8.3	Algorithm Version	"V2.4"	4019
1.2.8.8.12.8.4	Center	POINT	4021

Node	Code Meaning of Concept Name	Code Meaning or Example Value	TID
1.2.8.8.12.8.4.1		Reference to node 1.1.1	4021
1.2.8.8.12.8.5	Outline	SCOORD	4021
1.2.8.8.12.8.5.1		Reference to node 1.1.1	4021
1.2.8.8.12.9	Single Image Finding	Individual Calcification	4006
1.2.8.8.12.9.1	Rendering Intent	Presentation Optional	4006
1.2.8.8.12.9.2	Algorithm Name	"Calc Detector"	4019
1.2.8.8.12.9.3	Algorithm Version	"V2.4"	4019
1.2.8.8.12.9.4	Center	POINT	4021
1.2.8.8.12.9.4.1		Reference to node 1.1.1	4021
1.2.8.8.12.9.5	Outline	SCOORD	4021
1.2.8.8.12.9.5.1		Reference to node 1.1.1	4021
1.2.8.8.12.10	Single Image Finding	Individual Calcification	4006
1.2.8.8.12.10.1	Rendering Intent	Presentation Optional	4006
1.2.8.8.12.10.2	Algorithm Name	"Calc Detector"	4019
1.2.8.8.12.10.3	Algorithm Version	"V2.4"	4019
1.2.8.8.12.10.4	Center	POINT	4021
1.2.8.8.12.10.4.1		Reference to node 1.1.1	4021
1.2.8.8.12.10.5	Outline	SCOORD	4021
1.2.8.8.12.10.5.1		Reference to node 1.1.1	4021
1.2.8.8.12.11	Single Image Finding	Individual Calcification	4006
1.2.8.8.12.11.1	Rendering Intent	Presentation Optional	4006
1.2.8.8.12.11.2	Algorithm Name	"Calc Detector"	4019
1.2.8.8.12.11.3	Algorithm Version	"V2.4"	4019
1.2.8.8.12.11.4	Center	POINT	4021
1.2.8.8.12.11.4.1		Reference to node 1.1.1	4021
1.2.8.8.12.11.5	Outline	SCOORD	4021
1.2.8.8.12.11.5.1		Reference to node 1.1.1	4021
1.2.8.8.12.12	Single Image Finding	Individual Calcification	4006
1.2.8.8.12.12.1	Rendering Intent	Presentation Optional	4006
1.2.8.8.12.12.2	Algorithm Name	"Calc Detector"	4019

Node	Code Meaning of Concept Name	Code Meaning or Example Value	TID
1.2.8.8.12.12.3	Algorithm Version	"V2.4"	4019
1.2.8.8.12.12.4	Center	POINT	4021
1.2.8.8.12.12.4.1		Reference to node 1.1.1	4021
1.2.8.8.12.12.5	Outline	SCOORD	4021
1.2.8.8.12.12.5.1		Reference to node 1.1.1	4021

Included content from prior mammography CAD report (see Example 2, starting with node 1.2.4.2)

Node	Code Meaning of Concept Name	Code Meaning or Example Value	TID
1.2.8.8.13	Single Image Finding	Calcification Cluster	4006
1.2.8.8.13.1	Rendering Intent	Presentation Required	4006
1.2.8.8.13.2	Algorithm Name	"Calc Clustering"	4019
1.2.8.8.13.3	Algorithm Version	"V2.4"	4019
1.2.8.8.13.4	Center	POINT	4021
1.2.8.8.13.4.1		Reference to node 1.1.5	4021
1.2.8.8.13.5	Outline	SCOORD	4021
1.2.8.8.13.5.1		Reference to node 1.1.5	4021
1.2.8.8.13.6	Number of Calcifications	2	4010
1.2.8.8.13.7	[Observation Context content items]		4022
1.2.8.8.13.8	Single Image Finding	Individual Calcification	4006
1.2.8.8.13.8.1	Rendering Intent	Presentation Optional	4006
1.2.8.8.13.8.2	Algorithm Name	"Calc Detector"	4019
1.2.8.8.13.8.3	Algorithm Version	"V2.4"	4019
1.2.8.8.13.8.4	Center	POINT	4021
1.2.8.8.13.8.4.1		Reference to node 1.1.5	4021
1.2.8.8.13.8.5	Outline	SCOORD	4021
1.2.8.8.13.8.5.1		Reference to node 1.1.5	4021
1.2.8.8.13.9	Single Image Finding	Individual Calcification	4006
1.2.8.8.13.9.1	Rendering Intent	Presentation Optional	4006
1.2.8.8.13.9.2	Algorithm Name	"Calc Detector"	4019
1.2.8.8.13.9.3	Algorithm Version	"V2.4"	4019
1.2.8.8.13.9.4	Center	POINT	4021
1.2.8.8.13.9.4.1		Reference to node 1.1.5	4021

Node	Code Meaning of Concept Name	Code Meaning or Example Value	TID
1.2.8.8.13.9.4	Outline	SCOORD	4021
1.2.8.8.13.9.4.1		Reference to node 1.1.5	4021

More current year content:

Node	Code Meaning of Concept Name	Code Meaning or Example Value	TID
1.3	Summary of Detections	Succeeded	4000
1.3.1	Successful Detections		4015
1.3.1.1	Detection Performed	Mammography breast density	4017
1.3.1.1.1	Algorithm Name	"Density Detector"	4019
1.3.1.1.2	Algorithm Version	"V3.7"	4019
1.3.1.1.3		Reference to node 1.1.1	4017
1.3.1.1.4		Reference to node 1.1.2	4017
1.3.1.1.5		Reference to node 1.1.3	4017
1.3.1.1.6		Reference to node 1.1.4	4017
1.3.1.2	Detection Performed	Individual Calcification	4017
1.3.1.2.1	Algorithm Name	"Calc Detector"	4019
1.3.1.2.2	Algorithm Version	"V2.4"	4019
1.3.1.2.3		Reference to node 1.1.1	4017
1.3.1.2.4		Reference to node 1.1.2	4017
1.3.1.2.5		Reference to node 1.1.3	4017
1.3.1.2.6		Reference to node 1.1.4	4017
1.3.1.3	Detection Performed	Calcification Cluster	4017
1.3.1.3.1	Algorithm Name	"Calc Clustering"	4019
1.3.1.3.2	Algorithm Version	"V2.4"	4019
1.3.1.3.3		Reference to node 1.1.1	4017
1.3.1.4	Detection Performed	Calcification Cluster	4017
1.3.1.4.1	Algorithm Name	"Calc Cluster Detector"	4019

Node	Code Meaning of Concept Name	Code Meaning or Example Value	TID
1.3.1.4.2	Algorithm Version	"V2.4"	4019
1.3.1.4.3		Reference to node 1.1.1	4017
1.3.1.4.4		Reference to node 1.1.2	4017
1.3.1.4.5		Reference to node 1.1.3	4017
1.3.1.4.6		Reference to node 1.1.4	4017
1.4	Summary of Analyses	Succeeded	4000
1.4.1	Successful Analyses		4016
1.4.1.1	Analysis Performed	Mass Correlation	4018
1.4.1.1.1	Algorithm Name	"Mass Maker"	4019
1.4.1.1.2	Algorithm Version	"V1.9"	4019
1.4.1.1.3		Reference to node 1.1.2	4018
1.4.1.1.4		Reference to node 1.1.4	4018
1.4.1.2	Analysis Performed	Temporal Correlation	4018
1.4.1.2.1	Algorithm Name	"Temporal Change"	4019
1.4.1.2.2	Algorithm Version	"V0.1"	4019
1.4.1.2.3		Reference to node 1.1.2	4018
1.4.1.2.4		Reference to node 1.1.4	4018
1.4.1.2.5		Reference to node 1.1.6	4018
1.4.1.2.6		Reference to node 1.1.8	4018
1.4.1.3	Analysis Performed	Individual Impression / Recommendation Analysis	4018
1.4.1.3.1	Algorithm Name	"Lesion Analyzer"	4019
1.4.1.3.2	Algorithm Version	"V1.0"	4019
1.4.1.3.3		Reference to node 1.1.2	4018
1.4.1.3.4		Reference to node 1.1.4	4018
1.4.1.3.5		Reference to node 1.1.6	4018

Node	Code Meaning of Concept Name	Code Meaning or Example Value	TID
1.4.1.3.6		Reference to node 1.1.8	4018
1.4.1.4	Analysis Performed	Overall Impression / Recommendation Analysis	4018
1.4.1.4.1	Algorithm Name	"Mammogram Analyzer"	4019
1.4.1.4.2	Algorithm Version	"V1.0"	4019
1.4.1.4.3		Reference to node 1.1.2	4018
1.4.1.4.4		Reference to node 1.1.4	4018
1.4.1.4.5		Reference to node 1.1.6	4018
1.4.1.4.6		Reference to node 1.1.8	4018

E.4 CAD OPERATING POINT

Computer-aided detection algorithms often compute an internal “CAD score” for each Single Image Finding detected by the algorithm. In some implementations the algorithms then group the findings into “bins” as a function of their CAD score. The number of bins is a function of the algorithm and the manufacturer’s implementation, and must be one or more. The bins allow an application that is displaying CAD marks to provide a number of operating points on the Free-response Receiver-Operating Characteristic (FROC) curve for the algorithm, as illustrated in Figure E.4-1.

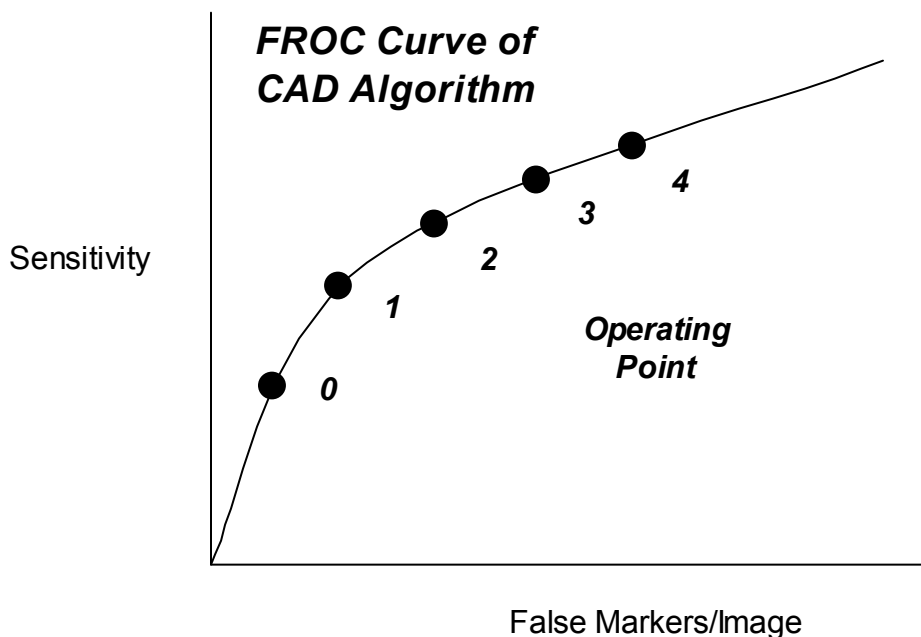

Figure E.4-1 - Free-response Receiver-Operating Characteristic (FROC) curve

This is accomplished by displaying all CAD marks of Rendering Intent “Presentation Required” or “Presentation Optional” according to the following rules:

- if the display application’s Operating Point is 0, only marks with a Rendering Intent = “Presentation Required” are displayed
- if the display application’s Operating Point is 1, then marks with a Rendering Intent = “Presentation Required” and marks with a Rendering Intent = “Presentation Optional” with a CAD Operating Point = 1 are displayed
- if the display application’s Operating Point is n, then marks with a Rendering Intent = “Presentation Required” and marks with a Rendering Intent = “Presentation Optional” with a CAD Operating Point $\leq n$ are displayed

E.5 Mammography CAD SR AND For Processing / For Presentation IMAGES

If a Mammography CAD SR Instance references Digital Mammography X-ray Image Storage – For Processing Instances, but a review workstation has access only to Digital Mammography X-Ray Image Storage – For Presentation Instances, the following steps are recommended in order to display such Mammography CAD SR content with Digital Mammography X-Ray Image – For Presentation Instances.

- In most scenarios, the Mammography CAD SR Instance is assigned to the same DICOM Patient and Study as the corresponding Digital Mammography “For Processing” and “For Presentation” image Instances.

- If a workstation has a Mammography CAD SR Instance, but does not have images for the same DICOM Patient and Study, the workstation may use the Patient and Study attributes of the Mammography CAD SR Instance in order to Query/Retrieve the Digital Mammography “For Presentation” images for that Patient and Study.
- Once a workstation has the Mammography CAD SR Instance and Digital Mammography “For Presentation” image Instances for the Patient and Study, the Source Image Sequence (0008,2112) attribute of each Digital Mammography “For Presentation” Instance will reference the corresponding Digital Mammography “For Processing” Instance. The workstation can match the referenced Digital Mammography “For Processing” Instance to a Digital Mammography “For Processing” Instance referenced in the Mammography CAD SR.
- The workstation should check for Spatial Locations Preserved (0028,135A) in the Source Image Sequence of each Digital Mammography “For Presentation” image Instance, to determine whether it is spatially equivalent to the corresponding Digital Mammography “For Processing” image Instance.
- If the value of Spatial Locations Preserved (0028,135A) is YES, then the CAD results should be displayed.
- If the value of Spatial Locations Preserved (0028,135A) is NO, then the CAD results should not be displayed.
- If Spatial Locations Preserved (0028,135A) is not present, whether or not the images are spatially equivalent is not known. If the workstation chooses to proceed with attempting to display CAD results, then compare the Image Library (see TID 4020) content item values of the Mammography CAD SR Instance to the associated attribute values in the corresponding Digital Mammography “For Presentation” image Instance. The content items (111044, DCM, “Patient Orientation Row”), (111043, DCM, “Patient Orientation Column”), (111025, DCM, “Horizontal Pixel Spacing”), and (111066, DCM, “Vertical Pixel Spacing”) may be used for this purpose. If the values do not match, the workstation needs to adjust the coordinates of the findings in the Mammography CAD SR content to match the spatial characteristics of the Digital Mammography “For Presentation” image Instance.

Annex F Chest CAD (Informative)

This Annex was formerly located in Annex M of PS 3.3 in the 2003 and earlier revisions of the standard.

F.1 CHEST CAD SR CONTENT TREE STRUCTURE

The templates for the Chest CAD SR IOD are defined in PS 3.16, Annex A, DCMR Templates. Relationships defined in the Chest CAD SR IOD templates are by-value, unless otherwise stated. Content items referenced from another SR object instance, such as a prior Chest CAD SR, are inserted by-value in the new SR object instance, with appropriate original source observation context. It is necessary to update Rendering Intent, and referenced content item identifiers for by-reference relationships, within content items paraphrased from another source.

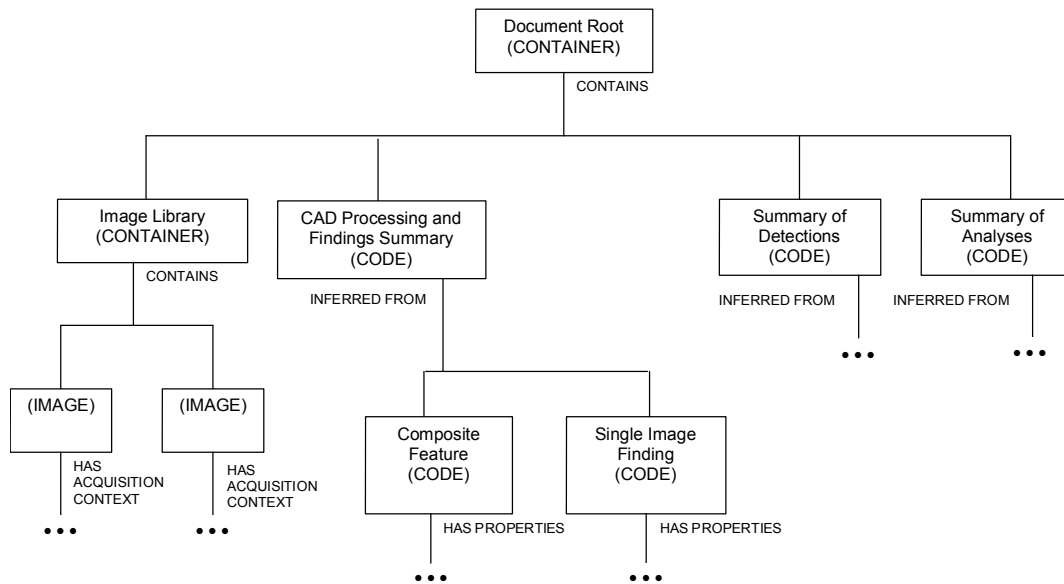

Figure F.1-1: Top Levels of Chest CAD SR Content Tree

The Document Root, Image Library, CAD Processing and Findings Summary, and Summaries of Detections and Analyses sub-trees together form the content tree of the Chest CAD SR IOD. See Annex E, Mammography CAD SR Content Tree Structure, for additional explanation of the Summaries of Detections and Analyses sub-trees.

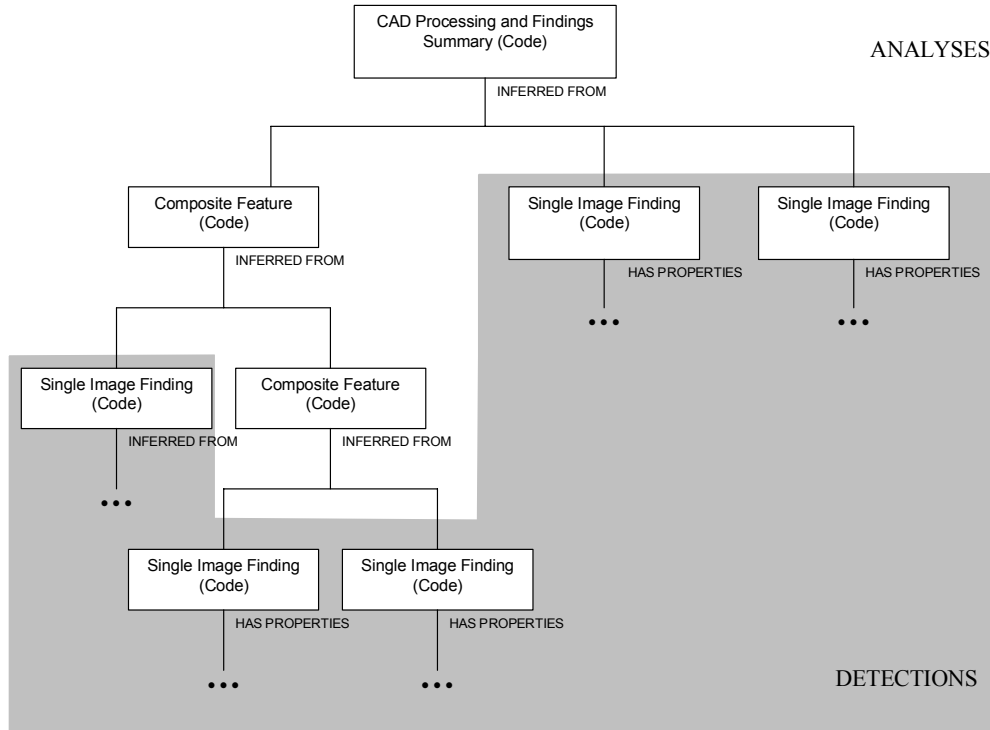

Figure F.1-2: Example of CAD Processing and Findings Summary sub-tree of Chest CAD SR Content Tree

The shaded area in Figure F.1-2 demarcates information resulting from Detection, whereas the unshaded area is information resulting from Analysis. This distinction is used in determining whether to place algorithm identification information in the Summary of Detections or Summary of Analyses sub-trees.

The identification of a lung nodule within a single image is considered to be a Detection, which results in a Single Image Finding. The temporal correlation of a lung nodule in two instances of the same view taken at different times, resulting in a Composite Feature, is considered Analysis.

Once a Single Image Finding or Composite Feature has been instantiated, it may be referenced by any number of Composite Features higher in the CAD Processing and Findings Summary sub-tree.

F.2 CHEST CAD SR OBSERVATION CONTEXT ENCODING

- Any content item in the Content tree that has been inserted (i.e., duplicated) from another SR object instance has a HAS OBS CONTEXT relationship to one or more content items that describe the context of the SR object instance from which it originated. This mechanism may be used to combine reports (e.g., Chest CAD SR 1, Chest CAD SR 2, Human).
- By-reference relationships within Single Image Findings and Composite Features paraphrased from prior Chest CAD SR objects need to be updated to properly reference Image Library Entries carried from the prior object to their new positions in the present object.

The CAD Processing and Findings Summary section of the SR Document Content tree of a Chest CAD SR IOD may contain a mixture of current and prior single image findings and composite features. The content items from current and prior contexts are target content items that have a by-value INFERRED FROM relationship to a Composite Feature content item. Content items that come from a context other than the Initial Observation Context have a HAS OBS CONTEXT relationship to target content items that describe the context of the source document.

In Figure F.2-1, Composite Feature and Single Image Finding are current, and Single Image Finding (from Prior) is duplicated from a prior document.

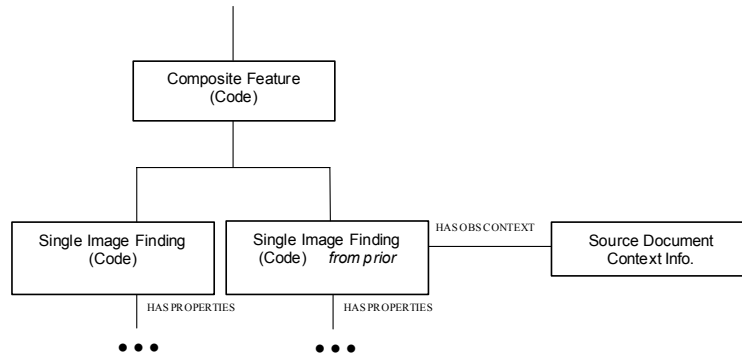

Figure F.2-1: Example of Use of Observation Context

F.3 CHEST CAD SR EXAMPLES

The following is a simple and non-comprehensive illustration of an encoding of the Chest CAD SR IOD for chest computer aided detection results. For brevity, some mandatory content items are not included, such as several acquisition context content items for the images in the Image Library.

F.3.1 Example 1: Lung Nodule Detection with No Findings

A chest CAD device processes a typical screening chest case, i.e., there is one image and no nodule findings. Chest CAD runs lung nodule detection successfully and finds nothing.

The chest radiograph resembles:

**PROJECTION
CHEST**



Figure F.3-1: Chest radiograph as Described in Example 1

The content tree structure would resemble:

Node	Code Meaning of Concept Name	Code Meaning or Example Value	TID
1	Chest CAD Report		4100
1.1	Image Library		4100
1.1.1		IMAGE 1	4020
1.1.1.1	Image View	Postero-anterior	4020
1.1.1.2	Study Date	19980101	4020

Node	Code Meaning of Concept Name	Code Meaning or Example Value	TID
1.2	CAD Processing and Findings Summary	All algorithms succeeded; without findings	4101
1.3	Summary of Detections	Succeeded	4100
1.3.1	Successful Detections		4015
1.3.1.1	Detection Performed	Nodule	4017
1.3.1.1.1	Algorithm Name	"Lung Nodule Detector"	4019
1.3.1.1.2	Algorithm Version	"V1.3"	4019
1.3.1.1.3		Reference to node 1.1.1	4017
1.4	Summary of Analyses	Not Attempted	4100

F.3.2 Example 2: Lung Nodule Detection with Findings and Anatomy/Pathology Interpretation

A chest CAD device processes a screening chest case with one image, and a lung nodule detected. The chest radiograph resembles:

**PROJECTION
CHEST**

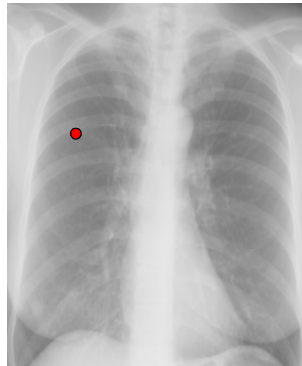

Figure F.3-2: Chest radiograph as Described in Example 2

The content tree structure in this example is complex. Structural illustrations of portions of the content tree are placed within the content tree table to show the relationships of data within the tree. Some content items are duplicated (and shown in boldface) to facilitate use of the diagrams.

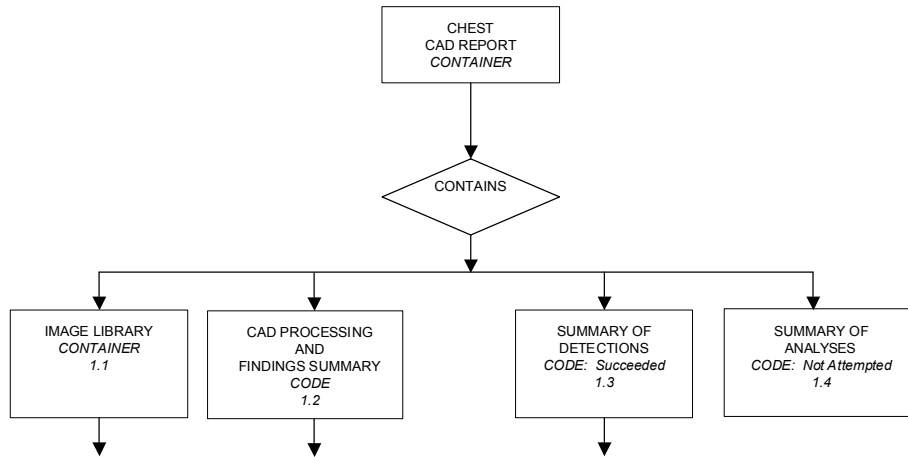

Figure F.3-3: Content Tree Root of Example 2 Content Tree

The content tree structure would resemble:

Node	Code Meaning of Concept Name	Code Meaning or Example Value	TID
1	Chest CAD Report		4100
1.1	Image Library		4100
1.2	CAD Processing and Findings Summary	All algorithms succeeded; with findings	4101
1.3	Summary of Detections	Succeeded	4100
1.4	Summary of Analyses	Not Attempted	4100

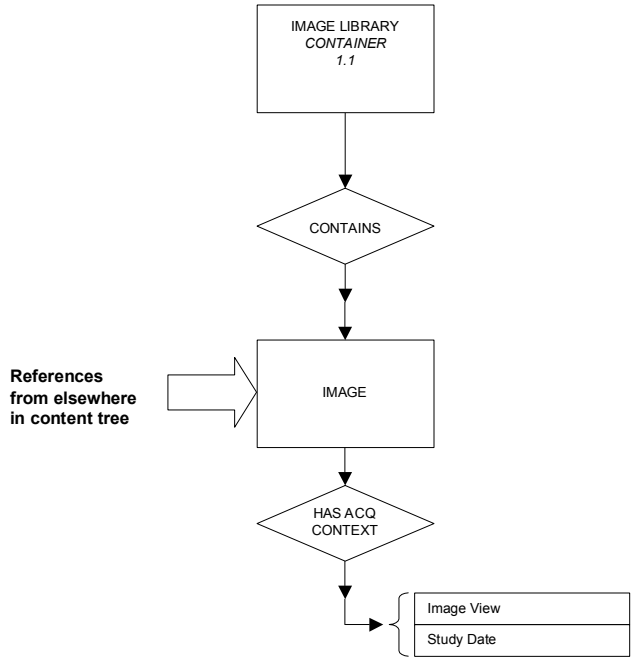

Figure F.3-4: Image Library Branch of Example 2 Content Tree

Node	Code Meaning of Concept Name	Code Meaning or Example Value	TID
1.1	Image Library		4100
1.1.1		IMAGE 1	4020
1.1.1.1	Image View	Postero-anterior	4020
1.1.1.2	Study Date	19990101	4020

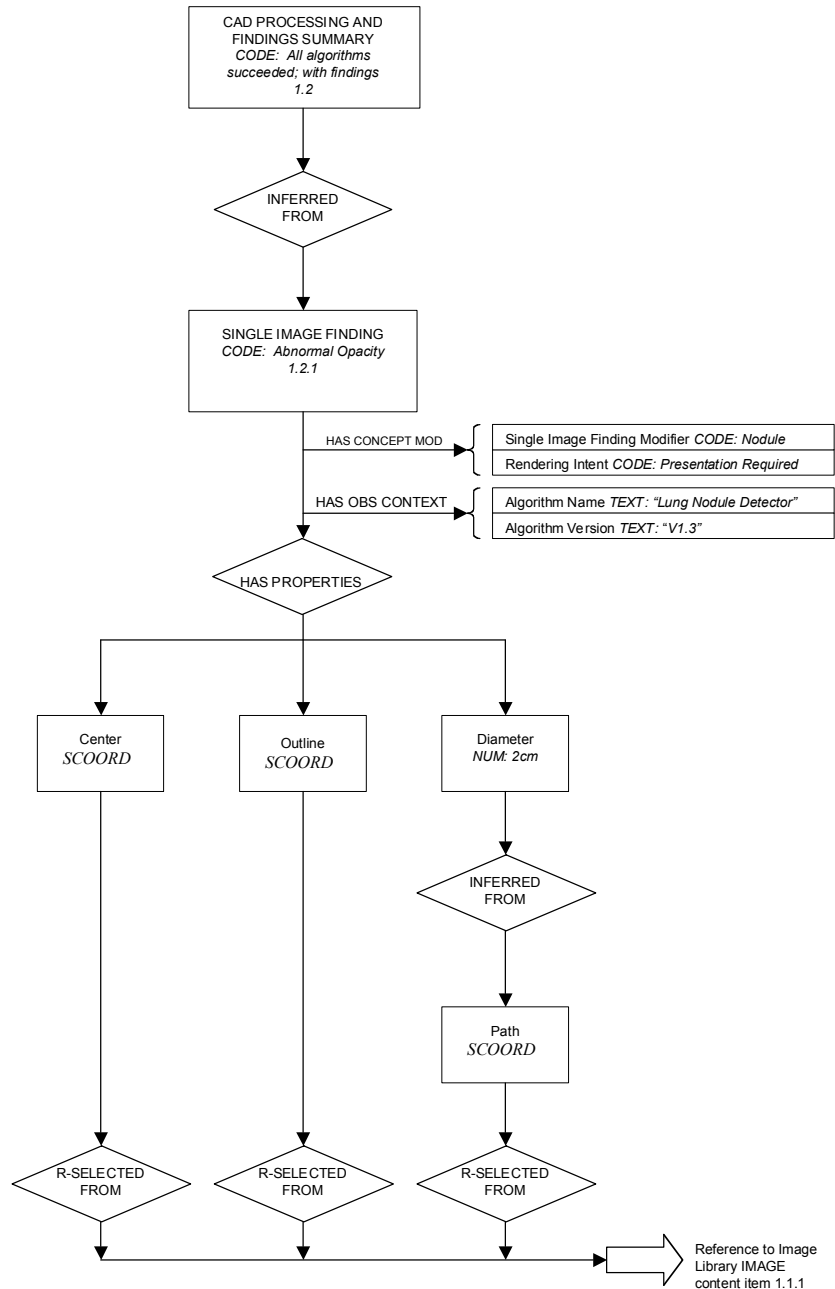

Figure F.3-5: CAD Processing and Findings Summary Portion of Example 2 Content Tree

Node	Code Meaning of Concept Name	Code Meaning or Example Value	TID
1.2	CAD Processing and Findings Summary	All algorithms succeeded; with findings	4101
1.2.1	Single Image Finding	Abnormal Opacity	4104
1.2.1.1	Single Image Finding Modifier	Nodule	4104
1.2.1.2	Rendering Intent	Presentation Required:...	4104

Node	Code Meaning of Concept Name	Code Meaning or Example Value	TID
1.2.1.3	Algorithm Name	"Lung Nodule Detector"	4019
1.2.1.4	Algorithm Version	"V1.3"	4019
1.2.1.5	Center	POINT	4107
1.2.1.5.1		Reference to Node 1.1.1	4107
1.2.1.6	Outline	POLYLINE	4107
1.2.1.6.1		Reference to Node 1.1.1	4107
1.2.1.7	Diameter	2 cm	1400
1.2.1.7.1	Path	POLYLINE	1400
1.2.1.7.1.1		Reference to Node 1.1.1	1400

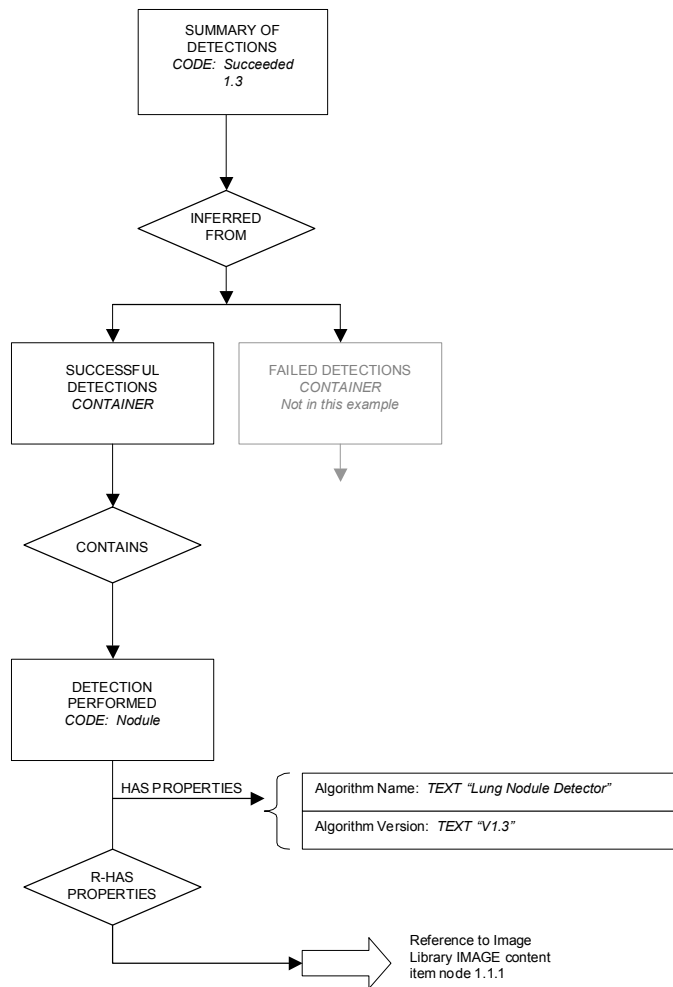

Figure F.3-6: Summary of Detections Portion of Example 2 Content Tree

Node	Code Meaning of Concept Name	Code Meaning or Example Value	TID
------	------------------------------	-------------------------------	-----

Node	Code Meaning of Concept Name	Code Meaning or Example Value	TID
1.3	Summary of Detections	Succeeded	4100
1.3.1	Successful Detections		4015
1.3.1.1	Detection Performed	Nodule	4017
1.3.1.1.1	Algorithm Name	"Lung Nodule Detector"	4019
1.3.1.1.2	Algorithm Version	"V1.3"	4019
1.3.1.1.3		Reference to node 1.1.1	4017

F.3.3 Example 3: Lung Nodule Detection, Temporal Differencing with Findings

The patient in Example 2 returns for another chest radiograph. A more comprehensive chest CAD device processes the current chest radiograph, and analyses are performed that determine some temporally related content items for Composite Features. Portions of the prior chest CAD report (Example 2) are incorporated into this report. In the current chest radiograph the lung nodule has increased in size.

**PRIOR
PROJECTION
CHEST**

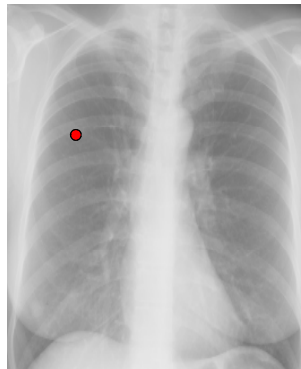

**CURRENT
PROJECTION
CHEST**

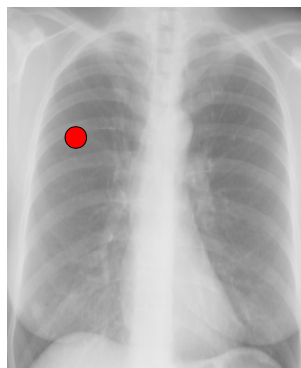

Figure F.3-8: Chest radiographs as Described in Example 3

Italicized entries (xxx) in the following table denote references to or by-value inclusion of content tree items reused from the prior Chest CAD SR instance (Example 2).

Node	Code Meaning of Concept Name	Code Meaning or Example Value	TID
------	------------------------------	-------------------------------	-----

Node	Code Meaning of Concept Name	Code Meaning or Example Value	TID
1	Chest CAD Report		4100

While the Image Library contains references to content tree items reused from the prior Chest CAD SR instance, the images are actually used in the chest CAD analysis and are therefore not italicized as indicated above.

Node	Code Meaning of Concept Name	Code Meaning or Example Value	TID
1.1	Image Library		4100
1.1.1		IMAGE 1	4020
1.1.1.1	Image View	Postero-anterior	4020
1.1.1.2	Study Date	20000101	4020
1.1.2		IMAGE 2	4020
1.1.2.1	Image View	Postero-anterior	4020
1.1.2.2	Study Date	19990101	4020

The CAD processing and findings consist of one composite feature, comprised of single image findings, one from each year. The temporal relationship allows a quantitative temporal difference to be calculated:

Node	Code Meaning of Concept Name	Code Meaning or Example Value	TID
1.2	CAD Processing and Findings Summary	All algorithms succeeded; with findings	4101
1.2.1	Composite Feature	Abnormal Opacity	4102
1.2.1.1	Composite Feature Modifier	Nodule	4102
1.2.1.2	Rendering Intent	Presentation Required: ...	4102
1.2.1.3	Algorithm Name	"Nodule Change"	4019
1.2.1.4	Algorithm Version	"V2.3"	4019
1.2.1.5	Composite Type	Target content items are related temporally	4103
1.2.1.6	Scope of Feature	Feature detected on multiple images	4103
1.2.1.7	Certainty of Feature	85%	4103
1.2.1.8	Difference in size	2 cm	4103
1.2.1.8.1		Reference to Node 1.2.1.9.8	4103
1.2.1.8.2		Reference to Node 1.2.1.10.8	4103
1.2.1.9	Single Image Finding	Abnormal Opacity	4104
1.2.1.9.1	Single Image Finding Modifier	Nodule	4104
1.2.1.9.2	Rendering Intent	Presentation Required: ...	4104

Node	Code Meaning of Concept Name	Code Meaning or Example Value	TID
1.2.1.9.3	Tracking Identifier	"Watchlist #1"	4108
1.2.1.9.4	Algorithm Name	"Lung Nodule Detector"	4019
1.2.1.9.5	Algorithm Version	"V1.3"	4019
1.2.1.9.6	Center	POINT	4107
1.2.1.9.6.1		Reference to Node 1.1.1	4107
1.2.1.9.7	Outline	POLYLINE	4107
1.2.1.9.7.1		Reference to Node 1.1.1	4107
1.2.1.9.8	Diameter	4 cm	1400
1.2.1.9.8.1	Path	POLYLINE	1400
1.2.1.9.8.1.1		Reference to Node 1.1.1	1400
<i>1.2.1.10</i>	Single Image Finding	Abnormal Opacity	4104
<i>1.2.1.10.1</i>	Single Image Finding Modifier	Nodule	4104
<i>1.2.1.10.2</i>	Rendering Intent	Presentation Required: ...	4104
<i>1.2.1.10.3</i>	[Observation Context content items]		4022
<i>1.2.1.10.4</i>	Algorithm Name	"Lung Nodule Detector"	4019
<i>1.2.1.10.5</i>	Algorithm Version	"V1.3"	4019
<i>1.2.1.10.6</i>	Center	POINT	4107
<i>1.2.1.10.6.1</i>		Reference to Node 1.1.2	4107
<i>1.2.1.10.7</i>	Outline	POLYLINE	4107
<i>1.2.1.10.7.1</i>		Reference to Node 1.1.2	4107
<i>1.2.1.10.8</i>	Diameter	2 cm	1400
<i>1.2.1.10.8.1</i>	Path	POLYLINE	1400
<i>1.2.1.10.8.1.1</i>		Reference to Node 1.1.2	1400
1.3	Summary of Detections	Succeeded	4100
1.3.1	Successful Detections		4015
1.3.1.1	Detection Performed	Nodule	4017
1.3.1.1.1	Algorithm Name	"Lung Nodule Detector"	4019
1.3.1.1.2	Algorithm Version	"V1.3"	4019
1.3.1.1.3		Reference to node 1.1.1	4017
1.4	Summary of Analyses	Succeeded	4100
1.4.1	Successful Analyses		4016
1.4.1.1	Analysis Performed	"Temporal correlation"	4018
1.4.1.1.1	Algorithm Name	"Nodule Change"	4019
1.4.1.1.2	Algorithm Version	"V2.3"	4019

Node	Code Meaning of Concept Name	Code Meaning or Example Value	TID
1.4.1.1.3		Reference to node 1.1.1	4018
1.4.1.1.4		Reference to node 1.1.2	4018

F.3.4 Example 4: Lung Nodule Detection in Chest Radiograph, Spatially Correlated with CT

The patient in Example 3 is called back for CT to confirm the Lung Nodule found in Example 3. The patient undergoes CT of the Thorax and the initial chest radiograph and CT slices are sent to a more comprehensive CAD device for processing. Findings are detected and analyses are performed that correlate findings from the two data sets. Portions of the prior CAD report (Example 3) are incorporated into this report.

**PROJECTION
CHEST
(PRIOR)**

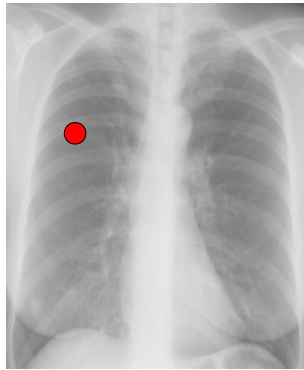

**CT SLICES
(CURRENT)**



Figure F.3-9: Chest radiograph and CT slice as described in Example 4

Italicized entries (xxx) in the following table denote references to or by-value inclusion of content tree items reused from the prior Chest CAD SR instance (Example 3).

Node	Code Meaning of Concept Name	Code Meaning of Example Value	TID
1	Chest CAD Report		4100
1.1	Language of Content Item and Descendants	English	1204
1.2	Image Library		4100
1.3	CAD Processing and Findings Summary	All algorithms succeeded; with findings	4101
1.4	Summary of Detections	Succeeded	4100
1.5	Summary of Analyses	Succeeded	4100

While the Image Library contains references to content tree items reused from the prior Chest CAD SR instance, the images are actually used in the CAD analysis and are therefore not italicized as indicated above.

Node	Code Meaning of Concept Name	Code Meaning of Example Value	TID
1.2	Image Library		4100
1.2.1		IMAGE 1	4020
1.2.1.1	Image View	Postero-anterior	4020
1.2.1.2	Study Date	20000101	4020

Most recent examination content:

Node	Code Meaning of Concept Name	Code Meaning of Example Value	TID
1.3	CAD Processing and Findings Summary	All algorithms succeeded; with findings	4101
1.3.1	Composite Feature	Abnormal opacity	4102

Node	Code Meaning of Concept Name	Code Meaning of Example Value	TID
1.3.1	Composite Feature	Abnormal opacity	4102
1.3.1.1	Composite Feature Modifier	Nodule	4102
1.3.1.2	Rendering Intent	Presentation Required: ...	4102
1.3.1.3	Tracking Identifier	"Watchlist #1"	4108
1.3.1.4	Algorithm Name	"Chest/CT Correlator"	4019
1.3.1.5	Algorithm Version	"V2.1"	4019
1.3.1.6	Composite type	Target content items are related spatially	4103
1.3.1.7	Scope of Feature	Feature detected on images from multiple modalities	4103
1.3.1.8	Diameter	4 cm	1400
1.3.1.8.1	Path		1400
1.3.1.8.1.1		IMAGE 3 [CT slice 104]	1400
1.3.1.9	Volume estimated from single 2D region	3.2 cm ³	1402
1.3.1.9.1	Perimeter Outline		1402
1.3.1.9.1.1		IMAGE 3 [CT slice 104]	1402
1.3.1.10	Size Descriptor	Small	4105
1.3.1.11	Border Shape	Lobulated	4105
1.3.1.12	Location in Chest	Mid lobe	4105
1.3.1.13	Laterality	Right	4105
1.3.1.14	Composite Feature	Abnormal opacity	4102
1.3.1.15	Single Image Finding	Abnormal opacity	4104

Node	Code Meaning of Concept Name	Code Meaning of Example Value	TID
1.3.1.14	Composite Feature	Abnormal opacity	4102
1.3.1.14.1	Composite Feature Modifier	Nodule	4102
1.3.1.14.2	Rendering Intent	Presentation Required: ...	4102
1.3.1.14.3	Tracking Identifier	"Nodule #1"	4108
1.3.1.14.4	Algorithm Name	"Nodule Builder"	4019
1.3.1.14.5	Algorithm Version	"V1.4"	4019
1.3.1.14.6	Composite type	Target content items are related spatially	4103
1.3.1.14.7	Scope of Feature	Feature detected on multiple images	4103
1.3.1.14.8	Diameter	4 cm	1400
1.3.1.14.9	Volume estimated from single 2D region	3.2 cm ³	1402
1.3.1.14.10	Single Image Finding	Abnormal opacity	4104
1.3.1.14.11	Single Image Finding	Abnormal opacity	4104
1.3.1.14.12	Single Image Finding	Abnormal opacity	4104

Node	Code Meaning of Concept Name	Code Meaning of Example Value	TID
1.3.1.14.10	Single Image Finding	Abnormal opacity	4104
1.3.1.14.10.1	Single Image Finding Modifier	Nodule	4104
1.3.1.14.10.2	Rendering Intent	Presentation Required: ...	4104
1.3.1.14.10.3	Tracking Identifier	"Detection #1"	4108
1.3.1.14.10.4	Algorithm Name	"CT Nodule Detector"	4019
1.3.1.14.10.5	Algorithm Version	"V2.5"	4019
1.3.1.14.10.6	Center	POINT	4107
1.3.1.14.10.6.1		IMAGE 2 [CT slice 103]	4107
1.3.1.14.10.7	Outline	POLYLINE	4107
1.3.1.14.10.7.1		IMAGE 2 [CT slice 103]	4107

Node	Code Meaning of Concept Name	Code Meaning of Example Value	TID
1.3.1.14.11	Single Image Finding	Abnormal opacity	4104
1.3.1.14.11.1	Single Image Finding Modifier	Nodule	4104
1.3.1.14.11.2	Rendering Intent	Presentation Required: ...	4104
1.3.1.14.11.3	Tracking Identifier	"Detection #2"	4108
1.3.1.14.11.4	Algorithm Name	"CT Nodule Detector"	4019
1.3.1.14.11.5	Algorithm Version	"V2.5"	4019
1.3.1.14.11.6	Center	POINT	4107
1.3.1.14.11.6.1		IMAGE 3 [CT slice 104]	4107

Node	Code Meaning of Concept Name	Code Meaning of Example Value	TID
1.3.1.14.11.7	Outline	POLYLINE	4107
1.3.1.14.11.7.1		IMAGE 3 [CT slice 104]	4107

Node	Code Meaning of Concept Name	Code Meaning of Example Value	TID
1.3.1.14.12	Single Image Finding	Abnormal opacity	4104
1.3.1.14.12.1	Single Image Finding Modifier	Nodule	4104
1.3.1.14.12.2	Rendering Intent	Presentation Required: ...	4104
1.3.1.14.12.3	Tracking Identifier	"Detection #3"	4108
1.3.1.14.12.4	Algorithm Name	"CT Nodule Detector"	4019
1.3.1.14.12.5	Algorithm Version	"V2.5"	4019
1.3.1.14.12.6	Center	POINT	4107
1.3.1.14.12.6.1		IMAGE 4 [CT slice 105]	4107
1.3.1.14.12.7	Outline	POLYLINE	4107
1.3.1.14.12.7.1		IMAGE 4 [CT slice 105]	4107

Node	Code Meaning of Concept Name	Code Meaning of Example Value	TID
1.3.1.15	Single Image Finding	Abnormal opacity	4104
1.3.1.15.1	Single Image Finding Modifier	Nodule	4104
1.3.1.15.2	Rendering Intent	Presentation Required: ...	4104
1.3.1.15.3	Tracking Identifier	"Watchlist #1"	4108
1.3.1.15.4	[Observation Context content items]		4022
1.3.1.15.5	Algorithm Name	"Lung Nodule Detector"	4019
1.3.1.15.6	Algorithm Version	"V1.3"	4019
1.3.1.15.7	Center	POINT	4107
1.3.1.15.7.1		Reference to node 1.2.1	4107
1.3.1.15.8	Outline	POLYLINE	4107
1.3.1.15.8.1		Reference to node 1.2.1	4107
1.3.1.15.9	Diameter	4 cm	1400
1.3.1.15.9.1	Path	POLYLINE	1400
1.3.1.15.9.1.1		Reference to Node 1.2.1	1400

Node	Code Meaning of Concept Name	Code Meaning of Example Value	TID
1.4	Summary of Detections	Succeeded	4100
1.4.1	Successful Detections		4015

Node	Code Meaning of Concept Name	Code Meaning of Example Value	TID
1.4.1.1	Detection Performed	Nodule	4017
1.4.1.1.1	Algorithm Name	"CT Nodule Detector"	4019
1.4.1.1.2	Algorithm Version	"V2.5"	4019
1.4.1.1.3		IMAGE 2 [CT slice 103]	4017
1.4.1.1.4		IMAGE 3 [CT slice 104]	4017
1.4.1.1.5		IMAGE 4 [CT slice 105]	4017
1.5	Summary of Analyses	Succeeded	4100
1.5.1	Successful Analyses		4016
1.5.1.1	Analysis Performed	"Spatial colocation analysis"	4018
1.5.1.1.1	Algorithm Name	"Chest/CT Correlator"	4019
1.5.1.1.2	Algorithm Version	"V2.1"	4019
1.5.1.1.3		Reference to node 1.2.1	4018
1.5.1.1.4		IMAGE 2 [CT slice 103]	4018
1.5.1.1.5		IMAGE 3 [CT slice 104]	4018
1.5.1.1.6		IMAGE 4 [CT slice 105]	4018
1.5.1.2	Analysis Performed	"Spatial colocation analysis"	4018
1.5.1.2.1	Algorithm Name	"Nodule Builder"	4019
1.5.1.2.2	Algorithm Version	"V1.4"	4019
1.5.1.2.3		IMAGE 2 [CT slice 103]	4018
1.5.1.2.4		IMAGE 3 [CT slice 104]	4018
1.5.1.2.5		IMAGE 4 [CT slice 105]	4018

Annex G Explanation of Grouping Criteria for Multi-frame Functional Group IODs (Informative)

This Annex was formerly located in Annex N of PS 3.3 in the 2003 and earlier revisions of the standard.

When considering how to group an attribute, one needs to consider first of all whether or not the values of an attribute are different per frame. The reasons to consider whether to allow an attribute to change include:

1. The more attributes that change, the more parsing a receiving application has to do in order to determine if the multi-frame object has frames the application should deal with. The more choices, the more complex the application becomes, potentially resulting in interoperability problems.
2. The frequency of change of an attribute must also be considered. If an attribute could be changed every frame then obviously it is not a very good candidate for making it fixed, since this would result in a multi-frame size of 1.
3. The number of applications that depend on frame level attribute grouping is another consideration. For example, one **might** imagine a pulse sequence being changed in a real-time acquisition, but the vast majority of acquisitions would leave this constant. Therefore, it was judged not too large a burden to force an acquisition device to start a new object when this happens. Obviously, this is a somewhat subjective decision, and one should take a close look at the attributes that are required to be fixed in this document.
4. The attributes from the image pixel module must not change in a multi-frame object due to legacy toolkits and implementations.
5. The potential frequency of change is dependent on the applications both now and likely during the life of this standard. The penalty for failure to allow an attribute to change is rather high since it will be hard/impossible to change later. Making an attribute variable that is static is more complex and could result in more header space usage depending on how it is grouped. Thus there is a trade-off of complexity and potentially header size with not being able to take advantage of the multi-frame organization for an application that requires changes per frame.

Once it is decided which attributes should be changed within a multi-frame object then one needs to consider the criteria for grouping attributes together:

1. Groupings should be designed so those attributes that are likely to vary together should be in the same sequence. The goal is to avoid the case where attributes that are mostly static have to be included in a sequence that is repeated for every frame.
2. Care should be taken so that we define a manageable number of grouping sequences. Too few sequences could result in many static attributes being repeated for each frame, when some other element in their sequence was varying, and too many sequences becomes unwieldy.
3. The groupings should be designed such that modality independent attributes are kept separate from those that are MR specific. This will presumably allow future working groups to reuse the more general groupings. It also should allow software that operates on multi-frame objects from multiple objects maximize code reuse.
4. Grouping related attributes together could convey some semantics of the overall contents of the multi-frame object to receiving applications. For instance, if a volumetric application finds the Plane Orientation Macro present in the Per-frame Functional Groups Sequence, it may decide to reject the object as inappropriate for volumetric calculations.

Specific notes on attribute grouping:

- Attributes not allowed to change: Image Pixel Module (due to legacy toolkit concerns); and Pulse Sequence Module attributes (normally do not change except in real-time – it is expected real time applications can handle the complexity and speed of starting new IODs when pulse sequence changes).
- Sequences not starting with the word “MR” could be applied to more modalities than just MR.
- All attributes that must be in a frame header were placed in the Frame Content Macro.
- Position and orientation are in separate sequences since they are changed independently.
- For real-time sequences there are contrast mechanisms that can be applied to base pulse sequences and are turned on and off by the operator depending on the anatomy being imaged and the time/contrast trade-off associated with these. Such modifiers include: IR, flow compensation, spoiled, MT, and T2 preparation... These probably are not changed in non-real-time scans. These are all kept in the MR Modifier Macro.

“Number of Averages” attributes is in its own sequence because real-time applications may start a new averaging process every time a slice position/orientation changes. Each subsequent frame will average with the preceding N frames where N is chosen based on motion and time. Each frame collected at a particular position/orientation will have a different number of averages, but all other attributes are likely to remain the same. This particular application drives this attribute being in its own group.

Annex H. Clinical Trial Identification Workflow Examples (Informative)

This Annex was formerly located in Annex O of PS 3.3 in the 2003 and earlier revisions of the standard.

The Clinical Trial Identification modules are optional. As such, there are several points in the workflow of clinical trial data at which the Clinical Trial Identification attributes may be added to the data. At the Clinical Trial Site, the attributes may be added at the scanner, a PACS system, a site workstation, or a workstation provided to the site by a Clinical Trial Coordinating Center. If not added at the site, the Clinical Trial Identification attributes may be added to the data after receipt by the Clinical Trial Coordinating Center. The addition of clinical trial attributes does not itself require changes to the SOP Instance UID. However, the clinical trial protocol or the process of de-identification may require such a change.

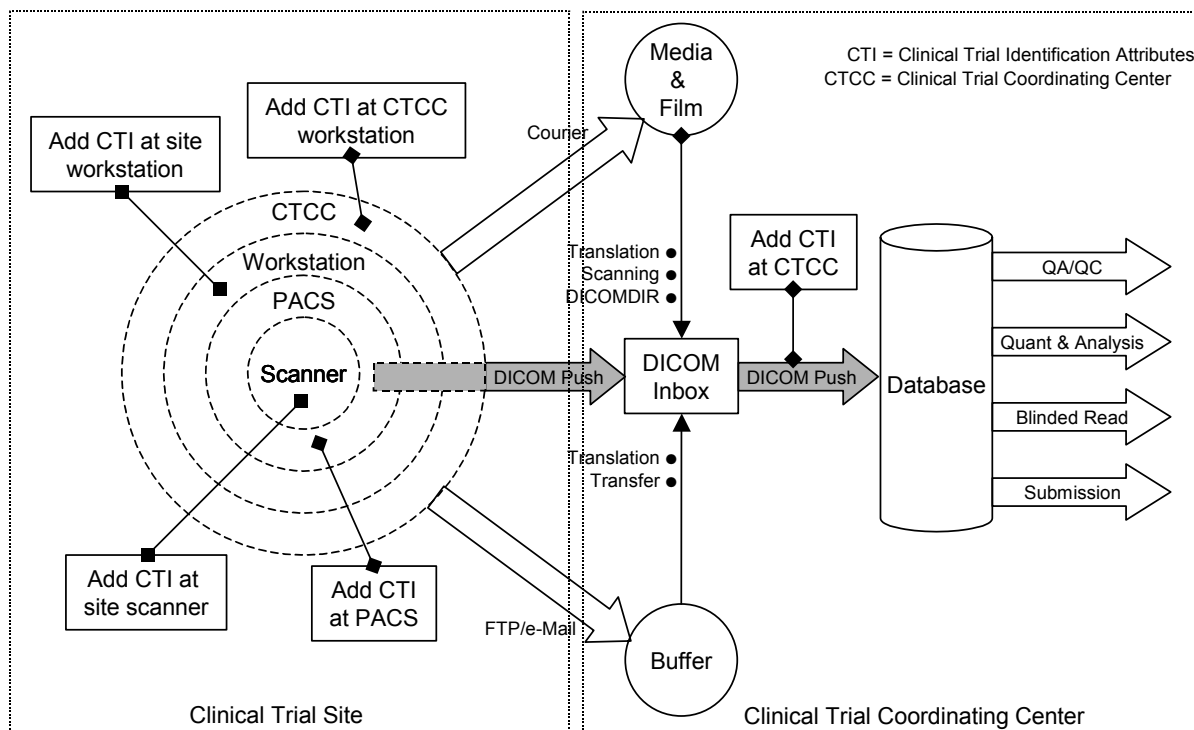

Figure H-1 – Workflow Diagram for Clinical Trials

H.1 EXAMPLE USE-CASE

Images are obtained for the purpose of comparing patients treated with placebo or the drug under test, then evaluated in a blinded manner by a team of radiologists at the Clinical Trial Coordinating Center (CTCC). The images are obtained at the clinical sites, collected by the CTCC, at which time their identifying attributes are removed and the Clinical Trial Identification (CTI) module is added. The de-identified images with the CTI information are then presented to the radiologists who make quantitative and/or qualitative assessments. The assessments, and in some cases the images, are returned to the sponsor for analysis, and later are contributed to the submission to the regulating authority.

ANNEX I. Ultrasound Templates (Informative)

I.1 SR CONTENT TREE STRUCTURE

The templates for ultrasound reports are defined in PS 3.16, Annex A, DCMR Templates. The following figure is an outline of the common elements of ultrasound structured reports.

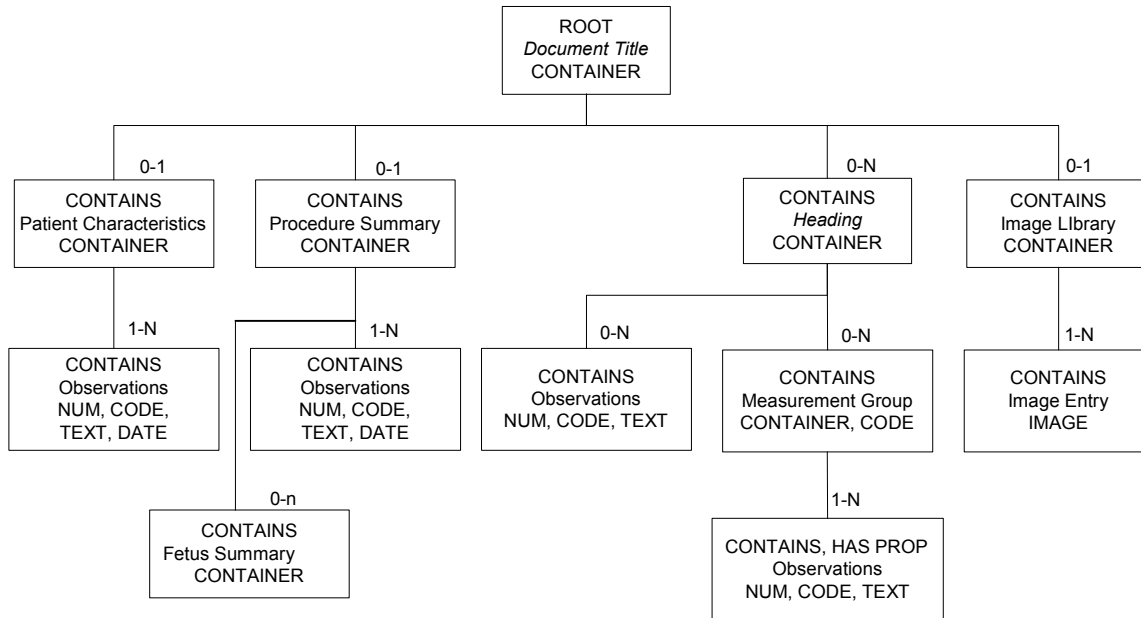

Figure I.1-1 Top Level Structure of Content Tree

The Patient Characteristics Section is for medical data of immediate relevance to administering the procedure and interpreting the results. This information may originate outside the procedure.

The Procedure Summary Section contains exam observations of immediate or primary significance. This is key information a physician typically expects to see first in the report.

Measurements typically reside in a measurement group container within a Section. Measurement groups share context such as anatomical location, protocol or type of analysis. The grouping may be specific to a product implementation or even to a user configuration. OB-GYN measurement groups have related measurements, averages and other derived results.

If present, the Image Library contains a list of images from which observations were derived. These are referenced from the observations with by-reference relationships.

I.2 PROCEDURE SUMMARY

The Procedure Summary Section contains the observations of most immediate interest. Observations in the procedure summary may have by-reference relationships to other content items.

I.3 MULTIPLE FETUSES

Where multiple fetuses exist, the observations specific to each fetus must reside under separate section headings. The section heading must specify the fetus observation context and designate so using Subject ID (121030,DCM, "Subject ID") and/or numerical designation (121037,DCM, "Fetus Number") as shown below. See TID 1008 Subject Context, Fetus.

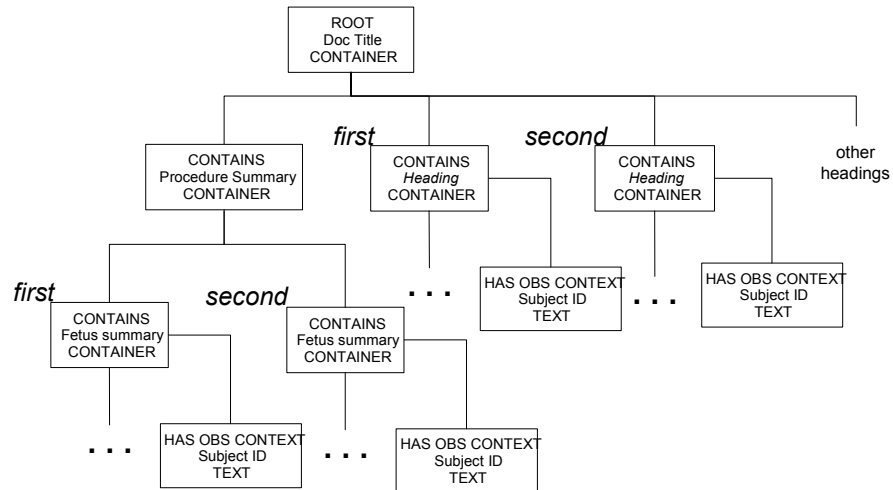

Figure I.3-1 Multiple Fetuses

I.4 EXPLICITLY SPECIFYING CALCULATION DEPENDENCIES

Reports may specify dependencies of a calculation on its dependent observations using by-reference relationships. This relationship must be present for the report reader to know the inputs of the derived value.

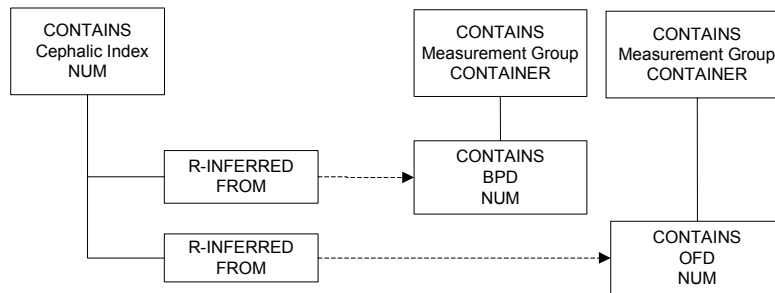

Figure I.4-1 Explicit Dependencies

I.5 LINKING MEASUREMENTS TO IMAGES, COORDINATES

Optionally, the relationship of an observation to its image and image coordinates can be encoded with by-reference content items as the following figure shows. For conciseness, the by-reference relationship points to the content item in the Image Library, rather than directly to the image.

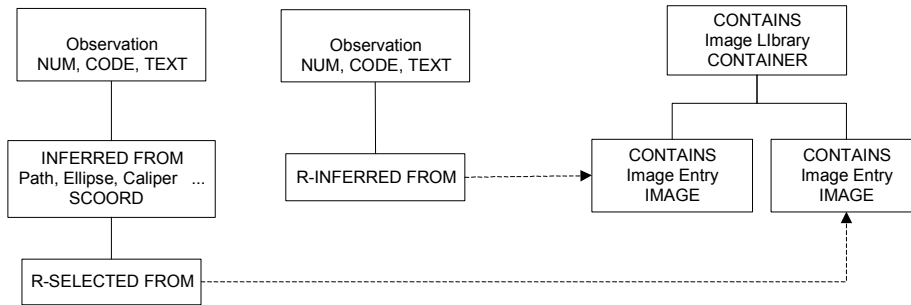

Figure I.5-1 Relationships to Images and Coordinates

R-INFERRED FROM relationships to IMAGE content items specify that the image supports the observation. A purpose of reference in an SCOORD content item may specify an analytic operation (performed on that image) that supports or produces the observation.

I.6 OB PATTERNS

A common OB-GYN pattern is that of several instances of one measurement type (e.g. BPD), the calculated average of those values, and derived values such as a gestational age calculated according to an equation or table. The measurements and calculations are all siblings in the measurement group. A child content item specifies the equation or table used to calculate the gestational age. All measurement types must relate to the same biometric type. For example, it is not allowed to mix a BPD and a Nuchal Fold Thickness measurement in the same biometry group.

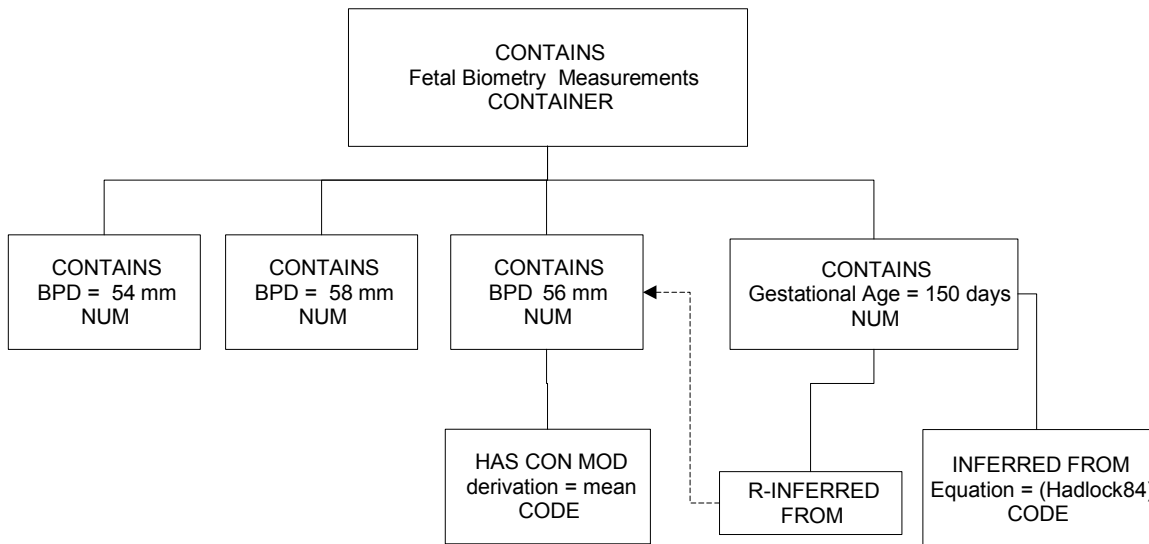

Figure I.6-1 OB Numeric Biometry Measurement group Example

The example above is a gestational age calculated from the measured value. The relationship is to an equation or table. The inferred from relationship identifies equation or table in the Concept Name. Codes from Context Group CID 12013 Gestational Age Equations and Tables identify the specific equation or table.

Another use case is the calculation of a growth parameter's relationship to that of a referenced distribution and a known or assumed gestational age. Context Group CID 12015 Fetal Growth Equations and Tables identify the growth table. The figure below shows the assignment of a percentile for the measured BPD, against the growth of a referenced population. The dependency relationship to the gestational age is a by-reference relationship to the established gestational age. Though the percentile

rank is derived from the BPD measurement, a by-reference relationship is not essential if one BPD has a concept modifier indicating that it is the mean or has selection status (see TID 300). A variation of this pattern is the use of Z-score instead of percentile rank. Not shown is the expression of the normal distribution mean, standard deviation, or confidence limits.

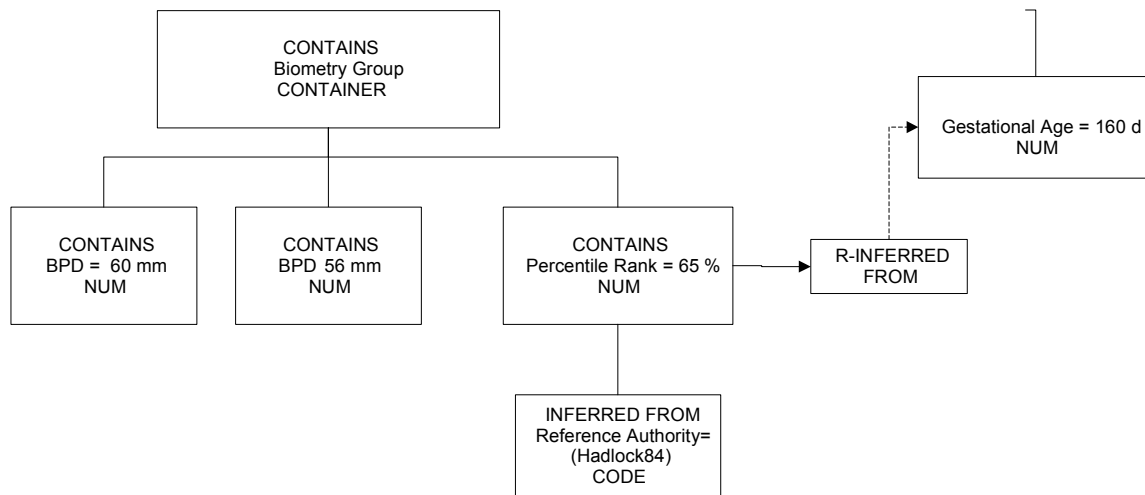

Figure I.6-2 Percentile Rank or Z-score Example

Estimated fetal weight (EFW) is a fetus summary item as shown below. It is calculated from one or more growth parameters (the inferred from relationships are not shown). The Equation or Table Template TID 315 allows specifying how the value was derived. Terms from Context Group CID 12014 specify the table or equation that yields the EFW from growth parameters.

“EFW percentile rank” is another summary term. By definition, this term depends upon the EFW and the population distribution of the ranking. A Reference Authority content item identifies the distribution. Context Group CID12016 is list of established reference authorities.

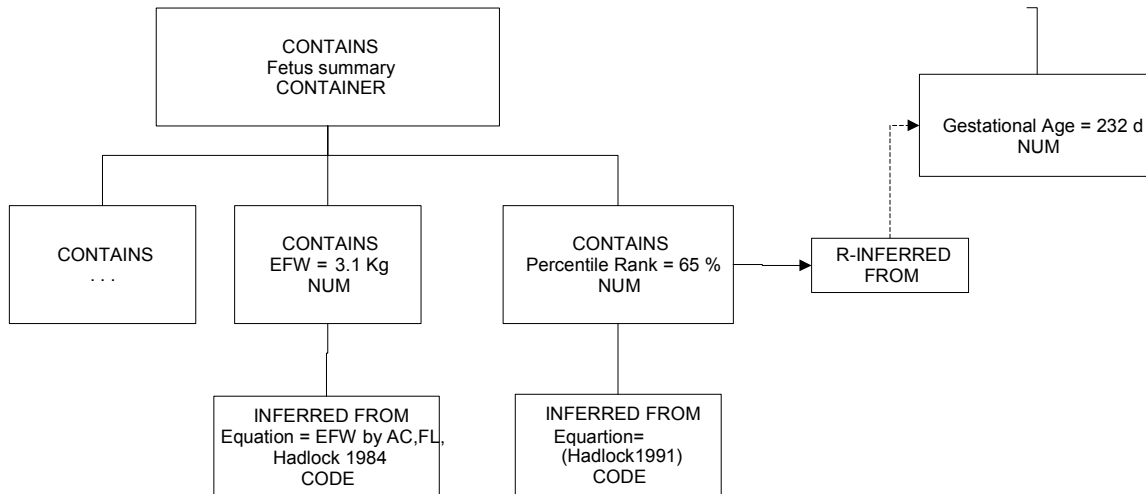

Figure I.6-3 Estimated Fetal Weight

I.7 SELECTED VALUE

When multiple observations of the same type exist, one of these may be the selected value. Typically, this value is the average of the others, or it may be the last entered, or user chosen. The Measurement Properties Template TID 310 provides a content item with concept name of (121404, DCM, "Selection Status") and a value set specified by DCID 224 Selection Method.

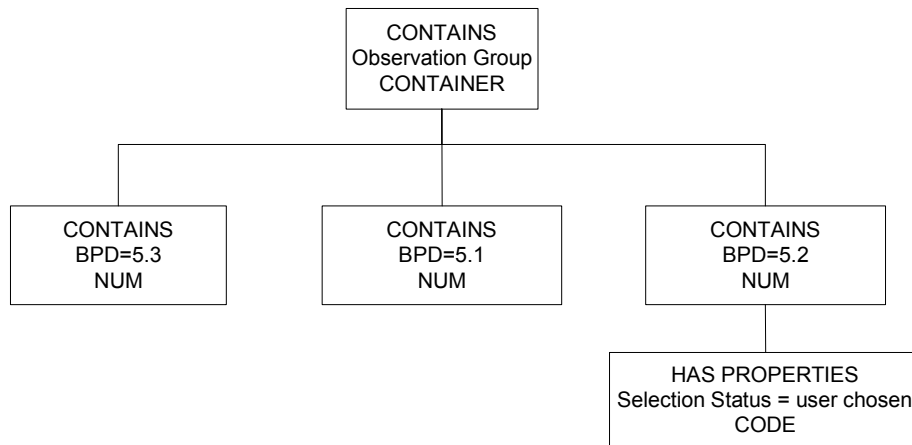

Figure I.7-1 Selected Value Example

There are multiple ways that a measurement may originate. The measurement value may result as an output of an image interactive, system tool. Alternatively, the user may directly enter the value, or the system may create a value automatically as the mean of multiple measurement instances. The Measurement Template TID 300 provides that a concept modifier of the numeric content item specify the derivation of the measurement. The concept name of the modifier is (121401, DCM, "Derivation"). CID 3627 Measurement Type provides concepts of appropriate measurement modifiers. The figure below illustrates such a case.

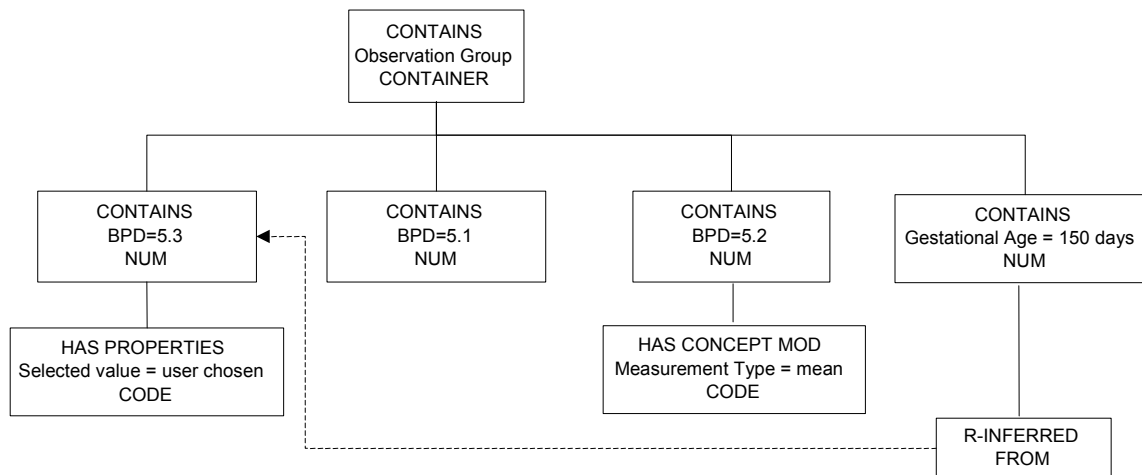

Figure I.7-2 Selected Value with Mean Example

I.8 OB-GYN EXAMPLES

The following are simple, non-comprehensive illustrations of report sections.

Example 1: OB-GYN Root with Observation Context

The following example shows the highest level of content items for a second or third trimester OB exam. Subsequent examples show details of section content,

Nest	Code Meaning of Concept Name	Code Meaning or Example Value	TID
1	OB-GYN Ultrasound Procedure Report		5000
1.1	Language of Content Item and Descendants	English	1204
1.2	Subject Name	Jane Doe	1007
1.3	Subject ID	123-45-6789	1007
1.4	Procedure Study Instance UID	1.2.842.111724.7678.32.34	1005
1.5	Procedure Study Component UID	1.2.842.111724.7678.55.34	1005
1.6	Procedure Accession Number	20011007-21	1005
1.7	Image Library		5000
1.7.1		IMAGE 1	5000
1.7.2		IMAGE 2	5000
1.7.n		IMAGE N	5000
1.8	Patient Characteristics		5001
1.8.n			5001
1.9	Summary		5002
1.9.n			5002
1.10	Fetal Biometry Ratios		5004
1.10.n			5004
1.11	Long Bones		5006
1.11.n			5006
1.12	Fetal Cranium		5007
1.12.n			5007
1.13	Biophysical Profile		5009

Nest	Code Meaning of Concept Name	Code Meaning or Example Value	TID
1.13.n			5009
1.14	Amniotic Sac		5010
1.14.n			5010

The following example shows the highest level of content items for a GYN exam. Subsequent examples show details of section content.

Nest	Code Meaning of Concept Name	Code Meaning or Example Value	TID
1	OB-GYN Ultrasound Procedure Report		5000
1.1	Subject Name	Jane Doe	1007
1.2	Subject ID	123-45-6789	1007
1.3	Image Library		5000
1.3.1		IMAGE 1	5000
1.3.2		IMAGE 2	5000
1.3.n		IMAGE N	5000
1.4	Patient Characteristics		5001
1.4.n			5001
1.5	Findings		5012
1.5.1	Findings Site	Ovary	5012
1.5.n			5012
1.6	Findings		5013
1.6.1	Findings Site	Ovarian Follicle	5013
1.6.2	Laterality	Left	5013
1.6.n			5013
1.7	Findings		5013
1.7.1	Findings Site	Ovarian Follicle	5013
1.7.2	Laterality	Right	5013
1.7.n			5013
1.8	Pelvis and Uterus		5015
1.8.n			5015

Example 2: OB-GYN Patient Characteristics and Procedure Summary

Nest	Code Meaning of Concept Name	Code Meaning or Example Value	TID
1	OB-GYN Ultrasound Procedure Report		5000
		5000
1.8	Patient Characteristics		5001
1.8.1	Gravida	5	5001
1.8.2	Para	3	5001
1.8.3	Aborta	2	5001
1.8.4	Ectopic Pregnancies	1	5001

Nest	Code Meaning of Concept Name	Code Meaning or Example Value	TID
1.9	Summary		5002
1.9.1	LMP	20010101	5002
1.9.2	EDD	20010914	5002
1.9.3	EDD from LMP	20010914	5002
1.9.4	EDD from average ultrasound age	20010907	5002
1.9.5	Gestational age by ovulation date	185 d	5002
1.9.6	Fetus Summary		5003
1.9.6.1	EFW	2222 g	300
1.9.6.1.1	+/-, range of measurement uncertainty	200 g	310
1.9.6.1.2	Equation	EFW by AC, BPD, Hadlock 1984	315
1.9.6.2	Comment	Enlarged cisterna magna	5003
1.9.6.3	Comment	Choroid plexus cyst	5003

Example 3: OB-GYN Multiple Fetus

Nest	Code Meaning of Concept Name	Code Meaning or Example Value	TID
1	OB-GYN Ultrasound Procedure Report		5000
1.n		5000
1.5	Summary		5002
1.5.1	EDD from LMP	20020325	5002
1.5.2	Fetus Summary		5003
1.5.2.1	Fetus ID	A	1008
1.5.2.2	EFW	1.6 Kg	300
1.5.2.2.1	Equation	EFW by AC, BPD, Hadlock 1984	315
1.5.2.2.2	+/-, range of measurement uncertainty	160g	310
1.5.2.3	Fetal Heart Rate	120 {H.B.}/min	300
1.5.3	Fetus Summary		5003
1.5.3.1	Fetus ID	B	1008
1.5.3.2	Comment	Choroid plexus cyst	5003
1.5.3.3	EFW	1.4 kg	300
1.5.3.3.1	Equation	EFW by AC, BPD, Hadlock 1984	315
1.5.3.3.2	+/-, range of measurement uncertainty	140 g	310
1.5.3.4	Fetal Heart Rate	135 {H.B.}/min	300
1.6	Biophysical Profile		5009
1.6.1	Fetus ID	A	1008
1.6.n	...		
1.7	Biophysical Profile		5009
1.7.1	Fetus ID	B	1008
1.7.n	...		

Example 4: Biophysical Profile

Nest	Code Meaning of Concept Name	Code Meaning or Example Value	TID
1	OB-GYN Ultrasound Procedure Report		5000
1.n		5000
1.9	Biophysical Profile		5009
1.9.1	Gross Body Movement	2 {0:2}	5009
1.9.2	Fetal Breathing	2 {0:2}	5009
1.9.3	Fetal Tone	2 {0:2}	5009
1.9.4	Fetal Heart Reactivity	2 {0:2}	5009
1.9.5	Amniotic Fluid Volume	2 {0:2}	5009
1.9.6	Biophysical Profile Sum Score	10 {0:10}	5009

Example 5: Biometry Ratios

Optionally, but not shown, the ratios may have by-reference, inferred-from relationships to the content items holding the numerator and denominator values.

Nest	Code Meaning of Concept Name	Code Meaning or Example Value	TID
1	OB-GYN Ultrasound Procedure Report		5000
1.n		5000
1.9	Fetal Biometry Ratios		5004
1.9.1	HC/AC	77%	5004
1.9.2	FL/AC	22 %	5004
1.9.2.1	Normal Range Lower Limit	20 %	312
1.9.2.2	Normal Range Upper Limit	24 %	312
1.9.2.3	Normal Range Authority	Hadlock, AJR 1983	312
1.9.3	FL/BPD	79 %	5004
1.9.3.1	Normal Range Lower Limit	71 %	312
1.9.3.2	Normal Range Upper Limit	81 %	312
1.9.3.3	Normal Range Authority	Hohler, Am J of Ob and Gyn 1981	312
1.9.4	Cephalic Index	82 %	5004
1.9.4.1	Normal Range Lower Limit	70 %	312
1.9.4.2	Normal Range Upper Limit	86 %	312
1.9.4.3	Normal Range Authority	Hadlock, AJR 1981	312

Example 6: Biometry

This example shows measurements and estimated gestational age.

Nest	Code Meaning of Concept Name	Code Meaning or Example Value	TID
1	OB-GYN Ultrasound Procedure Report		5000
1.n		5000

Nest	Code Meaning of Concept Name	Code Meaning or Example Value	TID
1.8	Fetal Biometry		5005
1.8.1	Biometry Group		5008
1.8.1.1	Biparietal Diameter	5.5 cm	300
1.8.1.2	Biparietal Diameter	5.3 cm	300
1.8.1.3	Biparietal Diameter	5.4 cm	300
1.8.1.3.1	Derivation	Mean	300
1.8.1.4	Gestational Age	190 d	5008
1.8.1.4.1	Equation	Jeanty, 1982	5008
1.8.1.4.2	5 th Percentile Value of population	131 d	5008
1.8.1.4.3	95 th Percentile Value of population	173 d	5008
1.8.2	Biometry Group		5008
1.8.2.1	Occipital-Frontal Diameter	18.1 cm	300
1.8.3	Biometry Group		5008
1.8.3.1	Head Circumference	34.3 cm	300
1.8.3.1.1	Derivation	Estimated	300
1.8.4	Biometry Group		5008
1.8.4.1	Abdominal Circumference	34.9 cm	300
1.8.4.2	Abdominal Circumference	34.3 cm	300
1.8.4.3	Abdominal Circumference	34.3 cm	300
1.8.4.4	Abdominal Circumference	34.5 cm	300
1.8.4.4.1	Derivation	Mean	300
1.8.4.5	Gestational Age	190 d	5008
1.8.4.5.1	Equation	Hadlock, 1984	5008
1.8.4.5.2	2 Sigma Lower Value of population	184 d	5008
1.8.4.5.3	2 Sigma Upper Value of population	196 d	5008
1.8.5	Biometry Group		5008
1.8.5.1	Femur Length	4.5 cm	300
1.8.5.n	...		300

This example shows measurements and with percentile ranking.

Nest	Code Meaning of Concept Name	Code Meaning or Example Value	TID
1	OB-GYN Ultrasound Procedure Report		5000
1.n		5000
1.8	Fetal Biometry		5005
1.8.1	Biometry Group		5008
1.8.1.1	Biparietal Diameter	5.5 cm	300
1.8.1.2	Biparietal Diameter	5.3 cm	300
1.8.1.3	Biparietal Diameter	5.4 cm	300
1.8.1.3.1	Derivation	Mean	300
1.8.1.4	Growth Percentile Rank	63 %	5008
1.8.1.4.1	Equation	BPD, Jeanty 1982	5008

Nest	Code Meaning of Concept Name	Code Meaning or Example Value	TID
1.8.2	Biometry Group		5008
1.8.2.n	...		300

Example 7: Amniotic Sac

Nest	Code Meaning of Concept Name	Code Meaning or Example Value	TID
1	OB-GYN Ultrasound Procedure Report		5000
1.n		5000
1.6	Findings		5010
1.6.1	Finding Site	Amniotic Sac	5010
1.6.2	Amniotic Fluid Index	11 cm	300
1.6.3	First Quadrant Diameter	10 cm	300
1.6.4	Second Quadrant Diameter	12 cm	300
1.6.5	Third Quadrant Diameter	11 cm	300
1.6.6	Fourth Quadrant Diameter	12 cm	300

Example 8: OB-GYN Ovaries

The content structure in the example below conforms to TID 5012. The example shows the volume derived from three perpendicular diameters.

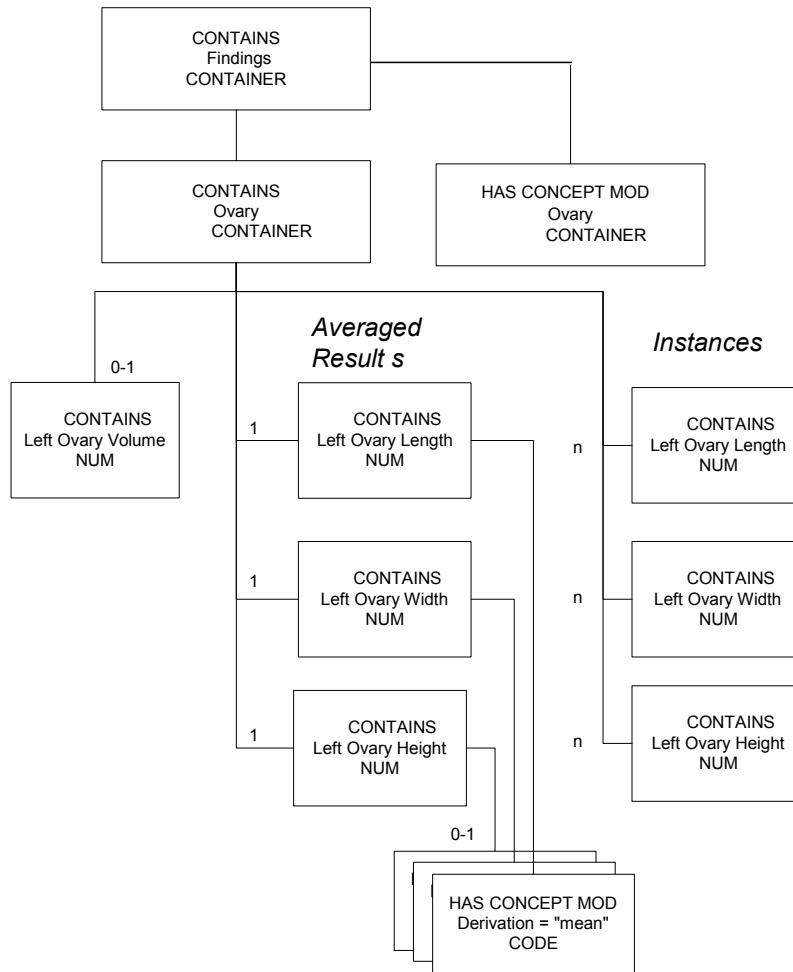

Figure I.8-1 Ovaries Example

Nest	Code Meaning of Concept Name	Code Meaning or Example Value	TID
1	OB-GYN Ultrasound Procedure Report		5000
1.n		5000
1.9	Findings		5012
1.9.1	Finding Site	Ovary	5012
1.9.2	Ovary		5016
1.9.2.1	Left Ovary Volume	6 cm ³	300
1.9.2.2	Left Ovary Length	3 cm	300
1.9.2.3	Left Ovary Length	3 cm	300
1.9.2.4	Left Ovary Length	3 cm	300
1.9.2.4.1	Derivation	Mean	300
1.9.2.5	Left Ovary Width	2 cm	300
1.9.2.5.1	Derivation	Mean	300
1.9.2.6	Left Ovary Height	2 cm	300
1.9.2.6.1	Derivation	Mean	300
1.9.3	Ovary		5016

Nest	Code Meaning of Concept Name	Code Meaning or Example Value	TID
1.9.3.1	Right Ovary Volume	7 cm3	300
1.9.3.2	...		300

Example 9: OB-GYN Follicles

The content structure in the example below conforms to TID 5013. It uses multiple measurements and derived averages for each of the perpendicular diameters.

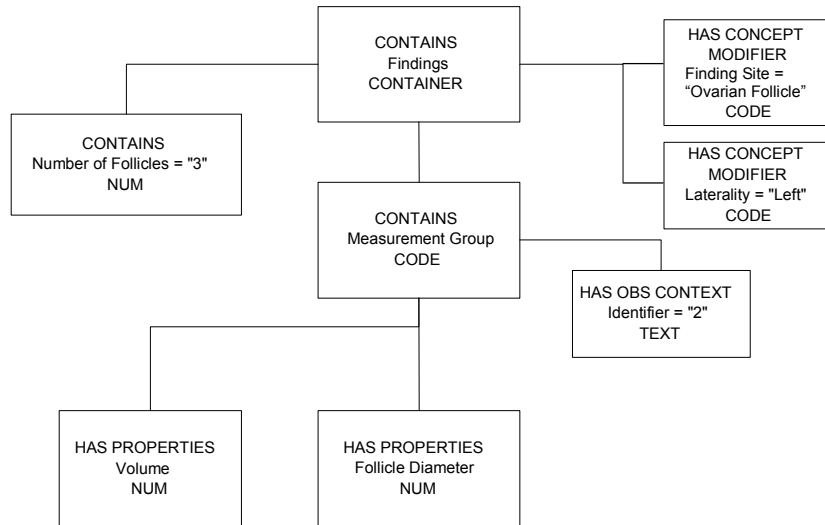

Figure I.8-2 Follicles Example

Nest	Code Meaning of Concept Name	Code Meaning or Example Value	TID
1	OB-GYN Ultrasound Procedure Report		5000
1.n		5000
1.8	Findings		5013
1.8.1	Finding Site	Ovarian Follicle	5013
1.8.2	Laterality	Right	5013
1.8.3	Number of follicles in right ovary	2	5013
1.8.4	Measurement Group		5014
1.8.4.1	Identifier	#1	5014
1.8.4.2	Volume	3 cm3	300
1.8.4.3	Follicle Diameter	15 mm	300
1.8.4.4	Follicle Diameter	13 mm	300
1.8.4.5	Follicle Diameter	14 mm	300
1.8.4.5.1	Derivation	Mean	300
1.8.5	Measurement Group		5014
1.8.5.1	Identifier	#2	5014
1.8.5.2	Volume	4 cm3	300
1.8.5.3	Follicle Diameter	18 mm	300
1.9	Findings		5013
1.9.1	Finding Site	Ovarian Follicle	5013

Nest	Code Meaning of Concept Name	Code Meaning or Example Value	TID
1.9.2	Laterality	Left	5013
1.9.3	Number of follicles in left ovary	1	5013
1.9.4	Follicle Measurement Group		5014
1.9.4.1	Identifier	#1	5014
1.9.4.2	Volume	3 cm ³	300
1.9.4.3	Follicle Diameter	15 mm	300

Example 10: Pelvis and Uterus

Nest	Code Meaning of Concept Name	Code Meaning or Example Value	TID
1	OB-GYN Ultrasound Procedure Report		5000
1.n		
1.9	Pelvis and Uterus		5015
1.9.1	Uterus		5016
1.9.1.1	Uterus Volume	136 cm ³	300
1.9.1.2	Uterus Length	9.5 cm	300
1.9.1.3	Uterus Width	5.9 cm	300
1.9.1.4	Uterus Height	4.2 cm	300
1.9.2	Endometrium Thickness	4 mm	5015
1.9.3	Cervix Length	5.3 cm	5015

ANNEX J: HANDLING OF IDENTIFYING PARAMETERS (Informative)

This Annex was formerly located in Annex M of PS 3.4 in the 2003 and earlier revisions of the standard.

J.1 PURPOSE OF THIS ANNEX

The DICOM Standard was published in 1993 and addresses medical images communication between medical modalities, workstations and other medical devices as well as data exchange between medical devices and the Information System (IS). DICOM defines SOP Instances with Patient, Visit and Study information managed by the Information System and allows to communicate the Attribute values of these objects.

Since the publication of the DICOM Standard great effort has been made to harmonize the Information Model of the DICOM Standard with the models of other relevant standards, especially with the HL7 model and the CEN TC 251 WG3 PT 022 model. The result of these effort is a better understanding of the various practical situations in hospitals and an adaptation of the model to these situations. In the discussion of models, the definition of Information Entities and their Identifying Parameters play a very important role.

The purpose of this Informative Annex is to show which identifying parameters may be included in Image SOP Instances and their related Modality Performed Procedure Step (MPPS) SOP Instance. Different scenarios are elucidated to describe varying levels of integration of the Modality with the Information System, as well as situations in which a connection is temporarily unavailable.

Note: In this Annex, "Image SOP Instance" is used as a collective term for all Composite Image Storage SOP Instances.

The scenarios described here are informative and do not constitute a normative section of the DICOM Standard.

J.2 INTEGRATED ENVIRONMENT

"Integrated" means in this context that the Acquisition Modality is connected to an Information System or Systems that may be an SCP of the Modality Worklist SOP Class or an SCP of the Modality Performed Procedure Step SOP Class or both. In the following description only the behavior of "Modalities" is mentioned, it goes without saying that the IS must conform to the same SOP Classes.

The Modality receives identifying parameters by querying the Modality Worklist SCP and generates other Attribute values during image generation. It is desirable that these identifying parameters be included in the Image SOP Instances as well as in the MPPS object in a consistent manner. In the case of a Modality that is integrated but unable to receive or send identifying parameters, e.g. link down, emergency case, the Modality may behave as if it were not integrated.

The Study Instance UID is a crucial Attribute that is used to relate Image SOP Instances (whose Study is identified by their Study Instance UID), the Modality PPS SOP Instance which contains it as a reference, and the actual or conceptual Requested Procedure (i.e. Study) and related Imaging Service Request in the IS. An IS that manages an actual or conceptual Detached Study Management entity is expected to be able to relate this Study Instance UID to the SOP Instance UID of the Detached Study Management SOP Instance, whether or not the Study Instance UID is provided by the IS or generated by the modality.

For a detailed description of an integrated environment see the IHE Radiology Technical Framework. This document can be obtained at:

<http://www.ihe.net/>

J.2.1 Modality Conforms to Modality Worklist and MPPS SOP Classes

The modality may:

- N-CREATE a MPPS SOP Instance and include its SOP Instance UID in the Image SOP Instances within the Referenced Performed Procedure Step Sequence Attribute.
- Copy the following Attribute values from the Modality Worklist information into the Image SOP Instances and into the related MPPS SOP Instance:
 - Study Instance UID
 - Referenced Study Sequence
 - Accession Number
 - Requested Procedure ID
 - Scheduled Procedure Step ID
 - Scheduled Procedure Step Description
 - Scheduled Protocol Code Sequence
- Create the following Attribute value and include it into the Image SOP Instances and the related MPPS SOP Instance:
 - Performed Procedure Step ID
- Include the following Attribute values that may be generated during image acquisition, if supported, into the Image SOP Instances and the related MPPS SOP Instance:
 - Performed Procedure Step Start Date
 - Performed Procedure Step Start Time
 - Performed Procedure Step Description
 - Study ID

J.2.2 Modality Conforms only to the Modality Worklist SOP Class

The modality may:

- In the absence of the ability to N-CREATE a MPPS SOP Instance, generate a MPPS SOP Instance UID and include it into the Referenced Performed Procedure Step Sequence Attribute of the Image SOP Instances. A system that later N-CREATES a MPPS SOP Instance may use this UID extracted from the related Image SOP Instances.
- Copy the following Attribute values from the Modality Worklist information into the Image SOP Instances:
 - Study Instance UID
 - Referenced Study Sequence
 - Accession Number
 - Requested Procedure ID
 - Scheduled Procedure Step ID
 - Scheduled Procedure Step Description
 - Scheduled Protocol Code Sequence
- Create the following Attribute value and include it into the Image SOP Instances:

- Performed Procedure Step ID

A system that later N-CREATES a MPPS SOP Instance may use this Attribute value extracted from the related Image SOP Instances.

- Include the following Attribute values that may be generated during image acquisition, if supported, into the Image SOP Instances:
 - Performed Procedure Step Start Date
 - Performed Procedure Step Start Time
 - Performed Procedure Step Description
 - Study ID

A system that later N-CREATES a MPPS SOP Instance may use these Attribute values extracted from the related Image SOP Instances.

J.2.3 Modality Conforms only to the MPPS SOP Class

The modality may:

- N-CREATE a MPPS SOP Instance and include its SOP Instance UID in the Image SOP Instances within the Referenced Performed Procedure Step Sequence Attribute.
- Create the following Attribute values and include them in the Image SOP Instances and the related MPPS SOP Instance:
 - Study Instance UID (see also section J.6)
 - Performed Procedure Step ID
- Copy the following Attribute values, if available to the Modality, into the Image SOP Instances and into the related MPPS SOP Instance:
 - Accession Number
 - Patient ID
 - Patient's Name
 - Patient's Birth Date
 - Patient's Sex

If sufficient identifying information is included, it will allow the Image SOP Instances and the MPPS SOP Instance to be later related to the Requested Procedure and the actual or conceptual Detached Study Management entity.

- Include the following Attribute values that may be generated during image acquisition, if supported, into the Image SOP Instances and the related MPPS SOP Instance:
 - Performed Procedure Step Start Date
 - Performed Procedure Step Start Time
 - Performed Procedure Step Description
 - Study ID

J.3 NON-INTEGRATED ENVIRONMENT

"Non-Integrated" means in this context that the Acquisition Modality is not connected to an Information System Systems, does not receive Attribute values from an SCP of the Modality Worklist SOP Class, and cannot create a Performed Procedure Step SOP Instance.

The modality may:

- In the absence of the ability to N-CREATE a MPPS SOP Instance, generate a MPPS SOP Instance UID and include it into the Referenced Performed Procedure Step Sequence Attribute of the Image SOP Instances. A system that later N-CREATES a MPPS SOP Instance may use this UID extracted from the related Image SOP Instances.

- Create the following Attribute values and include them in the Image SOP Instances:

- Study Instance UID (see also section J.6)
- Performed Procedure Step ID

A system that later N-CREATES a MPPS SOP Instance may use these Attribute values extracted from the related Image SOP Instances.

- Copy the following Attribute values, if available to the Modality, into the Image SOP Instances:

- Accession Number
- Patient ID
- Patient's Name
- Patient's Birth Date
- Patient's Sex

If sufficient identifying information is be included, it will allow the Image SOP Instances to be later related to the Requested Procedure and the actual or conceptual Detached Study Management entity.

- Include the following Attribute values that may be generated during image acquisition, if supported, into the Image SOP Instances:

- Performed Procedure Step Start Date
- Performed Procedure Step Start Time
- Performed Procedure Step Description
- Study ID

A system that later N-CREATES a MPPS SOP Instance may use these Attribute values extracted from the related Image SOP Instances.

J.4 ONE MPPS IS CREATED IN RESPONSE TO TWO OR MORE REQUESTED PROCEDURES

In the MPPS SOP Instance, all the specific Attributes of a Scheduled Procedure Step or Steps are included in the Scheduled Step Attributes Sequence. In the Image SOP Instances, these Attributes may be included in the Request Attributes Sequence. This is an optional Sequence in order not to change the definition of existing SOP Classes by adding new required Attributes or changing the meaning of existing Attributes.

Both Sequences may have more than one Item if more than one Requested Procedure results in a single Performed Procedure Step.

Because of the definitions of existing Attributes in existing Image SOP Classes, the following solutions are a compromise. The first one chooses or creates a value for the single valued Attributes Study Instance UID and Accession Number. The second one completely replicates the Image data with different values for the Attributes Study Instance UID and Accession Number.

J.4.1 Choose or Create a Value for Study Instance UID and Accession Number

The modality may:

- In the Image SOP Instances:
 - create a Request Attributes Sequence containing two or more Items each containing the following Attributes:
 - Requested Procedure ID
 - Scheduled Procedure Step ID
 - Scheduled Procedure Step Description
 - Scheduled Protocol Code Sequence
 - create a Referenced Study Sequence containing two or more Items sufficient to contain the Study SOP Instance UID values from the Modality Worklist for both Requested Procedures
 - select one value from the Modality Worklist or generate a new value for:
 - Study Instance UID (see also J.6)
 - select one value from the Modality Worklist or generate a new value or assign an empty value for:
 - Accession Number
- In the MPPS SOP Instance:
 - create a Scheduled Step Attributes Sequence containing two or more Items each containing the following Attributes:
 - Study Instance UID
 - Referenced Study Sequence
 - Accession Number
 - Requested Procedure ID
 - Scheduled Procedure Step ID
 - Scheduled Procedure Step Description
 - Scheduled Protocol Code Sequence
 - include the following Attribute value that may be generated during image acquisition, if supported:
 - Procedure Code Sequence
- In both the Image SOP Instances and the MPPS SOP Instance
 - create a Performed Procedure Step ID
 - include the following Attribute values that may be generated during image acquisition, if supported:
 - Performed Procedure Step Start Date
 - Performed Procedure Step Start Time
 - Performed Procedure Step Description
 - Study ID

J.4.2 Replicate the Image IOD

An alternative method is to replicate the entire Image SOP Instance with a new SOP Instance UID, and assign each Image IOD it's own identifying Attributes. In this case, each of the Study Instance UID and the Accession Number values can be used in their own Image SOP Instance.

Both Image SOP Instances may reference a single MPPS SOP Instance (via the MPPS SOP Instance UID in the Referenced Performed Procedure Step Sequence).

Each individual Image SOP Instance may reference it's own related Study SOP Instance, if it exists (via the Referenced Study Sequence). This Study SOP Instance has a one to one relationship with the corresponding Requested Procedure.

If an MPPS SOP Instance is created, it may reference both related Study SOP Instances.

The modality may:

- For all Series in the MPPS, replicate the entire Series of Images using new Series Instance UIDs
- Create replicated Image SOP Instances with different SOP Instance UIDs that use the new Series Instance UIDs, for each of the two or more Requested Procedures
- In each of the Image SOP Instances, using values from the corresponding Requested Procedure:
 - create a Request Attributes Sequence containing an Item containing the following Attributes:
 - Requested Procedure ID
 - Scheduled Procedure Step ID
 - Scheduled Procedure Step Description
 - Scheduled Protocol Code Sequence
 - copy from the Modality Worklist:
 - Study Instance UID
 - Accession Number
 - create a Referenced Study Sequence containing an Item containing the following Attribute:
 - Study SOP Instance in the Referenced Study Sequence from the Worklist
- In the MPPS SOP Instance (if supported):
 - create a Scheduled Step Attributes Sequence containing two or more Items each containing the following Attributes:
 - Study Instance UID
 - Referenced Study Sequence
 - Accession Number
 - Requested Procedure ID
 - Scheduled Procedure Step ID
 - Scheduled Procedure Step Description
 - Scheduled Protocol Code Sequence
 - include the following Attribute value that may be generated during image acquisition, if supported:
 - Procedure Code Sequence
- In both the Image SOP Instances and the MPPS SOP Instance (if supported):
 - create a Performed Procedure Step ID

- Include the following Attribute values that may be generated during image acquisition, if supported:
 - Performed Procedure Step Start Date
 - Performed Procedure Step Start Time
 - Performed Procedure Step Description
 - Study ID

J.5 MPPS SOP INSTANCE CREATED BY ANOTHER SYSTEM (NOT THE MODALITY)

If for some reason the Modality was unable to create the MPPS SOP Instance, another system may wish to perform this service. This system must make sure that the created PPS SOP Instance is consistent with the related Image SOP Instances.

Depending on the availability and correctness of values for the Attributes in the Image SOP Instances, these values may be copied into the MPPS SOP Instance, or they may have to be coerced, e.g. if they are not consistent with corresponding values available from the IS.

For example, if the MPPS SOP Instance UID is already available in the Image SOP Instance (in the Referenced Performed Procedure Step Sequence), it may be utilized to N-CREATE the MPPS SOP Instance. If not available, a new MPPS SOP Instance UID may be generated and used to N-CREATE the MPPS SOP Instance. In this case there may be no MPPS SOP Instance UID in the Referenced Performed Procedure Step Sequence in the corresponding Image SOP Instances. An update of the Image SOP Instances will restore the consistency, but this is not required.

ANNEX K ULTRASOUND STAGED PROTOCOL DATA MANAGEMENT (INFORMATIVE)

K.1 PURPOSE OF THIS ANNEX

The purpose of this annex is to enhance consistency and interoperability among creators and consumers of Ultrasound images within Staged Protocol Exams. An ultrasound “Staged Protocol Exam” is an exam that acquires a set of images under specified conditions during time intervals called “Stages”. An example of such an exam is a cardiac stress-echo Staged Protocol.

This informative annex describes the use of ultrasound Staged Protocol attributes within the following DICOM Services: Ultrasound Image, Ultrasound Multi-frame Image, and Key Object Selection Storage, Modality Worklist, and Modality Performed Procedure Step Services.

K.2 PREREQUISITES FOR SUPPORT

The support of ultrasound Staged Protocol Data Management requires support for the Ultrasound Image SOP Class or Ultrasound Multi-frame Image SOP Class as appropriate for the nature of the Protocol. By supporting some optional Elements of these SOP Classes, Staged-Protocols can be managed. Support of Key Object Selection allows control of the order of View and Stage presentation. Support of Modality Worklist Management and Modality Performed Procedure Step allow control over specific workflow use cases as described in this Annex.

K.3 DEFINITION OF A STAGED PROTOCOL EXAM

A “Staged Protocol Exam” acquires images in two or more distinct time intervals called “Stages” with a consistent set of images called “Views” acquired during each Stage of the exam. A View is of a particular cross section of the anatomy acquired with a specific ultrasound transducer position and orientation. During the acquisition of a Staged Protocol Exam, the modality may also acquire non-Protocol images at one or more Protocol Stages.

A common real-world example of an ultrasound Staged Protocol exam is a cardiac stress-echo ultrasound exam. Images are acquired in distinct time intervals (Stages) of different levels of stress and Views as shown in Figure K.3-1. Typically, stress is induced by means of patient exercise or medication. Typical Stages for such an exam are baseline, mid-stress, peak-stress, and recovery. During the baseline Stage the patient is at rest, prior to inducing stress through medication or exercise. At mid-stress Stage the heart is under a moderate level of stress. During peak-stress Stage the patient’s heart experiences maximum stress appropriate for the patient’s condition. Finally, during the recovery Stage, the heart recovers because the source of stress is absent.

At each Stage an equivalent set of Views is acquired. Examples of typical Views are parasternal long axis and parasternal short axis. Examination of wall motion between the corresponding Views of different Stages may reveal ischemia of one or more regions (“segments”) of the myocardium. Figure K.3-1 illustrates the typical results of a cardiac stress-echo ultrasound exam.

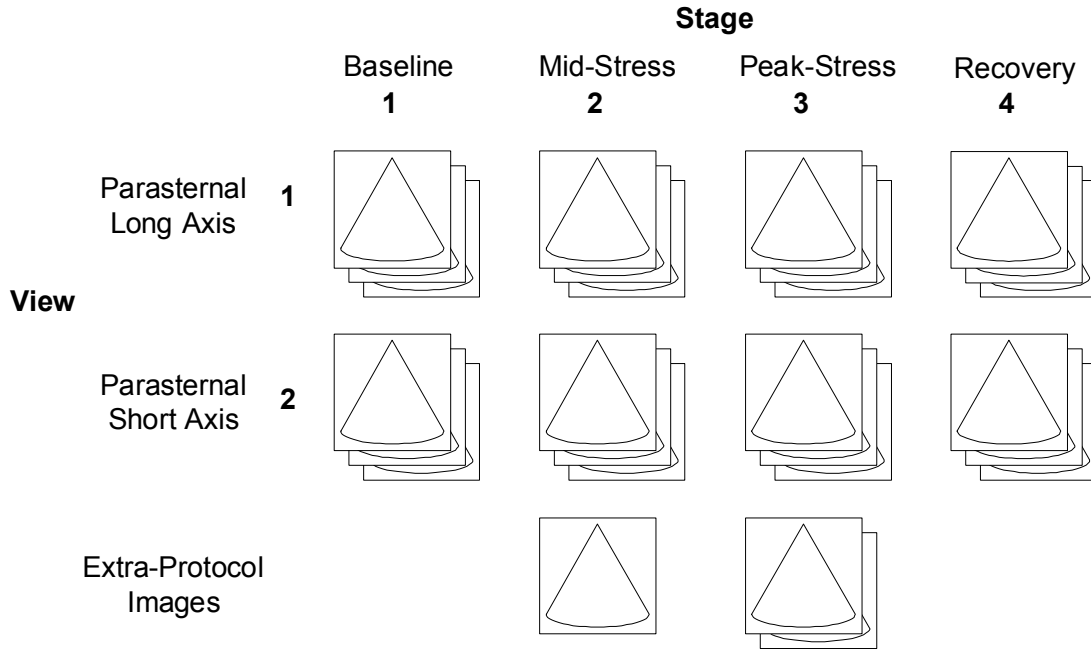

**Figure K.3-1
Cardiac Stress-Echo Staged Protocol US Exam**

K.4 ATTRIBUTES USED IN STAGED PROTOCOL EXAMS

The DICOM standard includes a number of attributes of significance to Staged Protocol Exams. This Annex explains how scheduling and acquisition systems may use these attributes to convey Staged Protocol related information.

Table K.4-1 lists all the attributes relevant to convey Staged Protocol related information. (see PS 3.3 for details about these attributes).

**Table K.4-1
Attributes THAT convey Staged Protocol Related Information**

Modality Worklist (TAG) [Return Key Type]	US Image and US MULTI-FRAME IOD (TAG) [TyPe]	MPPS IOD (tag) [SCU/SCP Type]
----	----	Scheduled Step Attributes Sequence (0040,0270) [1/1] (b)
Study Instance UID (0020,000D) [1]	Study Instance UID (0020,000D) [1]	>Study Instance UID (0020,000D) [1/1]
----	Request Attributes Sequence (0040,0275) [3] (a,b)	----
Scheduled Procedure Step Sequence (0040,0100) >Scheduled Procedure Step Description (0040,0007) [1C]	>Scheduled Procedure Step Description (0040,0007) [3]	>Scheduled Procedure Step Description (0040,0007) [2/2]
Scheduled Procedure Step Sequence (0040,0100) >Scheduled Protocol Code Sequence (0040,0008) [1C]	>Scheduled Protocol Code Sequence (0040,0008) [3]	>Scheduled Protocol Code Sequence (0040,0008) [2/2]
----	Performed Procedure Step	Performed Procedure Step

	Description (0040,0254) [3]	Description (0040,0254) [2/2]
----	Protocol Name (0018,1030) [3]	Performed Series Sequence (0040,0340) >Protocol Name (0018,1030) [1/1]
----	Performed Protocol Code Sequence (0040,0260) [3]	Performed Protocol Code Sequence (0040,0260) [1/1]
----	Number of Stages (0008,2124) [2C]	----
----	Number of Views In Stage (0008,212A) [2C]	----
----	Stage Name (0008,2120) [3]	----
----	Stage Number (0008,2122) [3]	----
----	Stage Code Sequence (0040,000A) [3]	----
----	View Name (0008,2127) [3]	----
----	View Number (0008,2128) [3]	----
----	Number of Event Timers (0008,2129) [3]	----
----	Event Elapsed Time(s) (0008,2130) [3]	----
----	Event Timer Name(s) (0008,2132) [3]	----
----	Transducer Position Sequence (0008,2240) [3]	----
----	> Transducer Position Modifier Sequence (0008,2242) [3]	----
----	Transducer Orientation Sequence (0008,2244) [3]	----
----	> Transducer Orientation Modifier Sequence (0008,2246) [3]	----

(a) Recommended if the Modality conforms as a SCU to the Modality Worklist SOP Class and Modality Performed Procedure Step

(b) Sequence may have one or more Items

K.5 GUIDELINES

This annex provides guidelines for implementation of the following aspects of Staged Protocol exams:

1. Identification of a Staged Protocol exam
2. Identification of Stages and Views within a Staged Protocol exam
3. Identification of extra-Protocol images within a Staged Protocol exam
4. Acquisition of multiple images of a View during a Stage, and identification of the preferred image for that Stage
5. Workflow management of Staged Protocol images

K.5.1 STAGED PROTOCOL EXAM IDENTIFICATION

The attributes Number of Stages (0008,2124) and Number of Views in Stage (0008,212A) are each Type 2C with the condition “Required if this image was acquired in a Staged Protocol.” These two attributes will be present with values in image SOP Instances if the exam meets the definition of a Staged Protocol Exam stated in Section K.3. This includes both the Protocol View images as well as any extra-Protocol images acquired during the Protocol Stages.

The attributes Protocol Name (0018,1030) and Performed Protocol Code Sequence (0040,0260) identify the Protocol of a Staged Protocol Exam, but the mere presence of one or both of these attributes does not in itself identify the acquisition as a Staged Protocol Exam. If both Protocol Name and Performed Protocol Code Sequence attributes are present, the Protocol Name value takes precedence over the Performed Protocol Code Sequence Code Meaning value as a display label for the Protocol, since the Protocol Name would convey the institutional preference better than the standardized code meaning.

K.5.2 STAGE AND VIEW IDENTIFICATION

Display devices usually include capabilities that aid in the organization and presentation of images acquired as part of the Staged Protocol. These capabilities allow a clinician to display images of a given View acquired during different Stages of the Protocol side by side for comparison. A View is a particular combination of the transducer position and orientation at the time of image acquisition. Images are acquired at the same View in different Protocol Stages for the purpose of comparison. For these features to work properly, the display device must be able to determine the Stage and View of each image in an unambiguous fashion.

There are three possible mechanisms for conveying Stage and View identification in the image SOP Instances:

- “Numbers” (Stage Number (0008,2122) and View Number (0008,2128)) which number Stages and Views, starting with one.
- “Names” (Stage Name (0008,2120) and View Name (0008,2127)) which specify textual names for each Stage and View, respectively.
- One or more “code sequences” (Stage Code Sequence (0040,000A) for Stage identification, and Transducer Position Code Sequence (0008,2240) and Transducer Orientation Code Sequence (0008,2244) for View identification) which give identification “codes” to the Stage and View respectively.

View Number (0008,2128) and View Name (0008,2127) enable correlating the Views amongst the different Stages. The value set for Stage Name (0008,2120) and View Name are undefined. Therefore, this Annex recommends that the creator always send Stage Number (0008,2122) and View Number (0008,2128) to identify the Stage and View. Stages and Views are numbered sequentially and suggest a display sequence. There is a one-to-one correspondence between the number and the name for the images in the staged protocol. Names or code sequences allow the display device to label Stages and Views for the clinical user.

Table K.5-1 provides an example of the Staged Protocol relevant attributes in images acquired during a typical cardiac stress-echo ultrasound exam.

**Table K.5-1
Staged Protocol Image attributes example**

BASELINE STAGE – VIEW 1	MID-STRESS Stage – VIEW 1	MID-STRESS Stage – VIEW 2
Study Instance UID : “1.2.840....123.1”	Study Instance UID : “1.2.840....123.1”	Study Instance UID : “1.2.840....123.1”
Request Attributes Sequence:	Request Attributes Sequence:	Request Attributes Sequence:
>Scheduled Procedure Step Description : “Exercise stress echocardiography”	>Scheduled Procedure Step Description : “Exercise stress echocardiography”	>Scheduled Procedure Step Description : “Exercise stress echocardiography”

>Scheduled Protocol Code Sequence:	>Scheduled Protocol Code Sequence:	>Scheduled Protocol Code Sequence:
>>Code Value: "P5-B3050"	>>Code Value: "P5-B3050"	>>Code Value: "P5-B3050"
>>Coding Scheme Designator: "SNM3"	>>Coding Scheme Designator: "SNM3"	>>Coding Scheme Designator: "SNM3"
>>Code Meaning: "Exercise stress echocardiography"	>>Code Meaning: "Exercise stress echocardiography"	>>Code Meaning: "Exercise stress echocardiography"
Performed Procedure Step Description: "Exercise stress echocardiography"	Performed Procedure Step Description: "Exercise stress echocardiography"	Performed Procedure Step Description: "Exercise stress echocardiography"
Protocol Name: "EXERCISE STRESS-ECHO"	Protocol Name: "EXERCISE STRESS-ECHO"	Protocol Name: "EXERCISE STRESS-ECHO"
Performed Protocol Code Sequence:	Performed Protocol Code Sequence:	Performed Protocol Code Sequence:
>Code Value: "P5-B3050"	>Code Value: "P5-B3050"	>Code Value: "P5-B3050"
>Coding Scheme Designator: "SNM3"	>Coding Scheme Designator: "SNM3"	>Coding Scheme Designator: "SNM3"
>Code Meaning: "Exercise stress echocardiography"	>Code Meaning: "Exercise stress echocardiography"	>Code Meaning: "Exercise stress echocardiography"
Number of Stages: "4"	Number of Stages: "4"	Number of Stages: "4"
Number of Views In Stage: "2"	Number of Views In Stage: "2"	Number of Views In Stage: "2"
Stage Name: "BASELINE"	Stage Name: "MID-STRESS"	Stage Name: "MID-STRESS"
Stage Number : "1"	Stage Number : "2"	Stage Number : "2"
Stage Code Sequence:	Stage Code Sequence:	Stage Code Sequence:
>Code Value: "P5-01202"	>Code Value: "P5-01203"	>Code Value: "P5-01203"
>Coding Scheme Designator: "SNM3"	>Coding Scheme Designator: "SNM3"	>Coding Scheme Designator: "SNM3"
>Code Meaning: "Pre -stress image acquisition"	>Code Meaning: "Mid-stress image acquisition"	>Code Meaning: "Mid-stress image acquisition"
View Name: "Para-sternal long axis"	View Name: "Para-sternal long axis"	View Name: "Para-sternal short axis"
View Number : "1"	View Number : "1"	View Number : "2"
----	Number of Event Timers: "1"	Number of Event Timers: "1"
----	Event Elapsed Time(s): "10000" (ms)	Event Elapsed Time(s): "25000" (ms)
----	Event Elapsed Timer Name(s): "Time Since Exercise Halted"	Event Elapsed Timer Name(s): "Time Since Exercise Halted"
Transducer Position Sequence:	Transducer Position Sequence:	Transducer Position Sequence:
>Code Value: "T-D3136"	>Code Value: "T-D3136"	>Code Value: "T-D3136"
>Coding Scheme Designator: "SNM3"	>Coding Scheme Designator: "SNM3"	>Coding Scheme Designator: "SNM3"
>Code Meaning: "Parasternal"	>Code Meaning: "Parasternal"	>Code Meaning: "Parasternal"
Transducer Orientation Sequence:	Transducer Orientation Sequence:	Transducer Orientation Sequence:
>Code Value: "G-A185"	>Code Value: "G-A185"	>Code Value: "G-A186"
>Coding Scheme Designator:	>Coding Scheme Designator:	>Coding Scheme Designator:

"SNM3"	"SNM3"	"SNM3"
>Code Meaning: "Long axis"	>Code Meaning: "Long axis"	>Code Meaning: "Short axis"

K.5.3 EXTRA-PROTOCOL IMAGE IDENTIFICATION

At any Stage of a Staged Protocol exam, the operator may acquire images that are not part of the Protocol. These images are so-called "extra-Protocol images". Information regarding the performed Protocol is still included because such images are acquired in the same Procedure Step as the Protocol images. The Stage number and optionally other Stage identification attributes (Stage Name and/or Stage Code Sequence) should still be conveyed in extra-Protocol images. However, the View number should be omitted to signify that the image is not one of the standard Views in the Protocol. Other View identifying information, such as name or code sequences, may indicate the image location.

Table K.5-2
COMPARISON OF Protocol AND EXTRA-PROTOCOL Image attributes example

MID-STRESS Stage – VIEW 1 Protocol Image	MID-STRESS Stage Extra-Protocol Image
Study Instance UID : "1.2.840....123.1"	Study Instance UID : "1.2.840....123.1"
Request Attributes Sequence: >Scheduled Procedure Step Description : " Exercise stress echocardiography protocol"	Request Attributes Sequence: >Scheduled Procedure Step Description : " Exercise stress echocardiography protocol"
>Scheduled Protocol Code Sequence:	>Scheduled Protocol Code Sequence:
>>Code Value: " P5-B3050"	>>Code Value: " P5-B3050"
>>Coding Scheme Designator: "SNM3"	>>Coding Scheme Designator: "SNM3"
>>Code Meaning:" Exercise stress echocardiography"	>>Code Meaning:" Exercise stress echocardiography"
Performed Procedure Step Description: "Exercise stress echocardiography"	Performed Procedure Step Description: "Exercise stress echocardiography"
Protocol Name: "EXERCISE STRESS-ECHO"	Protocol Name: "EXERCISE STRESS-ECHO"
Performed Protocol Code Sequence:	Performed Protocol Code Sequence:
>Code Value: "P5-B3050"	>Code Value: "P5-B3050"
>Coding Scheme Designator: "SNM3"	>Coding Scheme Designator: "SNM3"
>Code Meaning:" Exercise stress echocardiography"	>Code Meaning:" Exercise stress echocardiography"
Number of Stages: "4"	Number of Stages: "4"
Number of Views In Stage: "2"	Number of Views In Stage: "2"
Stage Name: "MID-STRESS"	Stage Name: "MID-STRESS"
Stage Number : "2"	Stage Number : "2"
Stage Code Sequence:	Stage Code Sequence:
>Code Value: "P5-01203"	>Code Value: "P5-01203"

>Coding Scheme Designator: "SNM3"	>Coding Scheme Designator: "SNM3"
>Code Meaning:" Mid-stress image acquisition"	>Code Meaning:" Mid-stress image acquisition"
View Name: "Para-sternal long axis"	----
View Number : "1"	----
Transducer Position Sequence:	----
>Code Value: "T-D3136"	----
>Coding Scheme Designator: "SNM3"	----
>Code Meaning: "Parasternal"	----
Transducer Orientation Sequence:	----
>Code Value: "G-A185"	----
>Coding Scheme Designator: "SNM3"	----
>Code Meaning: "Long axis"	----

K.5.4 MULTIPLE IMAGES OF A STAGE-VIEW

Ultrasound systems often acquire multiple images at a particular stage and view. If one image is difficult to interpret or does not fully portray the ventricle wall, the physician may choose to view an alternate. In some cases, the user may identify the preferred image. The Key Object Selection Document can identify the preferred image for any or all of the Stage-Views. This specific usage of the Key Object Selection Document has a Document Title of (113013, DCM, "Best In Set") and Document Title Modifier of (113017, DCM, "Stage-View").

K.5.5 WORKFLOW MANAGEMENT OF STAGED PROTOCOL IMAGES

K.5.5.1 Uninterrupted Exams – SINGLE MPPS

Modality Performed Procedure Step (MPPS) is the basic organizational unit of Staged Protocol Exams. It is recommended that a single MPPS instance encompass the entire acquisition of an ultrasound Staged Protocol Exam if possible.

There are no semantics assigned to the use of Series within a Staged Protocol Exam other than the DICOM requirements as to the relationship between Series and Modality Performed Procedure Steps. In particular, all of the following scenarios are possible:

1. one Series for all images in the MPPS
2. separate Series for Protocol View images and extra-Protocol images in the MPPS
3. separate Series for images of each Stage within the MPPS
4. more than one Series for the images acquired in a single Protocol Stage.

There is no recommendation on the organization of images into Series because clinical events make such recommendations impractical. Figure K.5.5-1 shows a possible sequence of interactions for a protocol performed as a single MPPS.

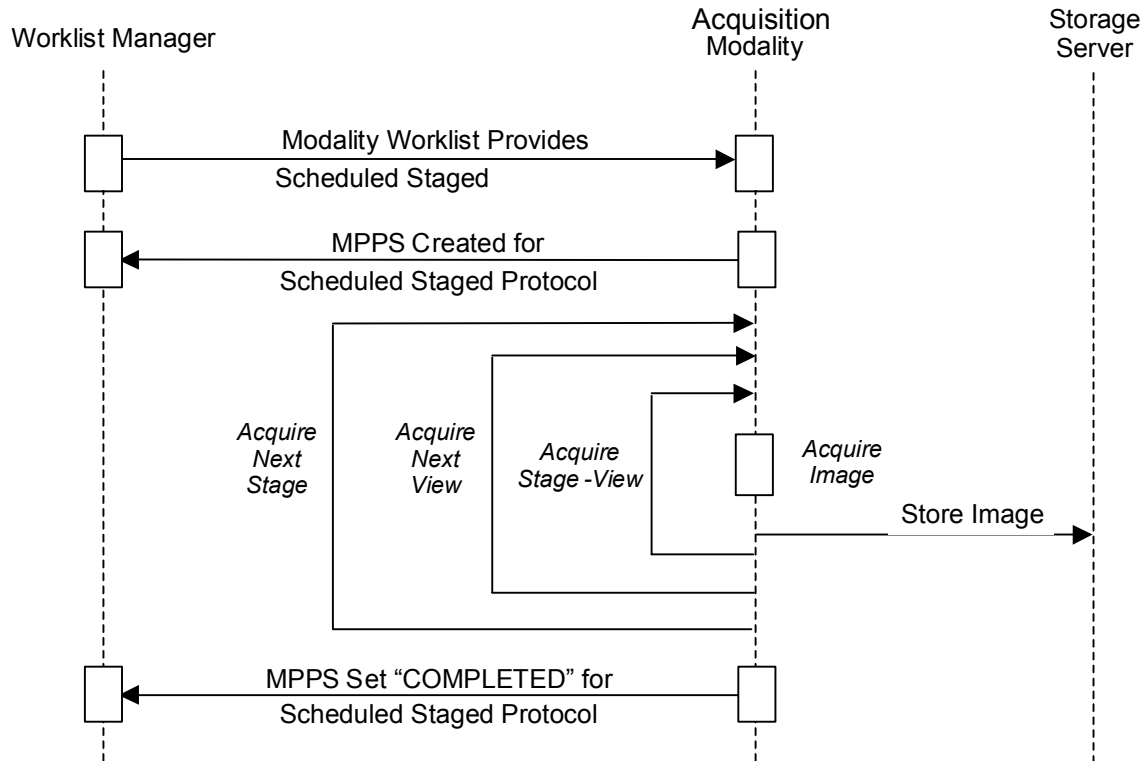

Figure K.5.5-1 Example of Uninterrupted Staged-Protocol Exam WORKFLOW

K.5.5.2 Interrupted Exams – MULTIPLE MPPS

A special case arises when the acquisition during a Protocol Stage is halted for some reason. For example, such a situation can occur if signs of patient distress are observed, such as angina in a cardiac stress exam. These criteria are part of the normal exam Protocol, and as long as the conditions defined for the Protocol are met the MPPS status is set to COMPLETED. Only if the exam terminates before meeting the minimum acquisition requirements of the selected Protocol would MPPS status be set to DISCONTINUED. It is recommended that the reason for discontinuation should be conveyed in the Modality Procedure Step Discontinuation Reason Code Sequence (0040,0281). Staged Protocols generally include criteria for ending the exam, such as when a target time duration is reached or if signs of patient distress are observed.

If a Protocol Stage is to be acquired at a later time with the intention of using an earlier completed Protocol Stage of a halted Staged Protocol then a new Scheduled Procedure Step may or may not be created for this additional acquisition. Workflow management recommendations vary depending on whether the care institution decides to create a new Scheduled Procedure Step or not.

Follow-up Stages must use View Numbers, Names, and Code Sequences identical to those in the prior Stages to enable automatically correlating images of the original and follow-up Stages.

K.5.5.2.1 UNSCHEDULED FOLLOW-UP STAGES

Follow-up Stages require a separate MPPS. Since follow-up stages are part of the same Requested Procedure and Scheduled Procedure Step, all acquired image SOP Instances and generated MPPS instances specify the same Study Instance UID. If the Study Instance UID is different, systems will have difficulty associating related images. This creates a significant problem if Modality Worklist is not supported. Therefore systems should assign the same Study Instance UID for follow-up Stages even if Modality Worklist is not supported. Figure K.5.5-2 shows a possible interaction sequence for this scenario.

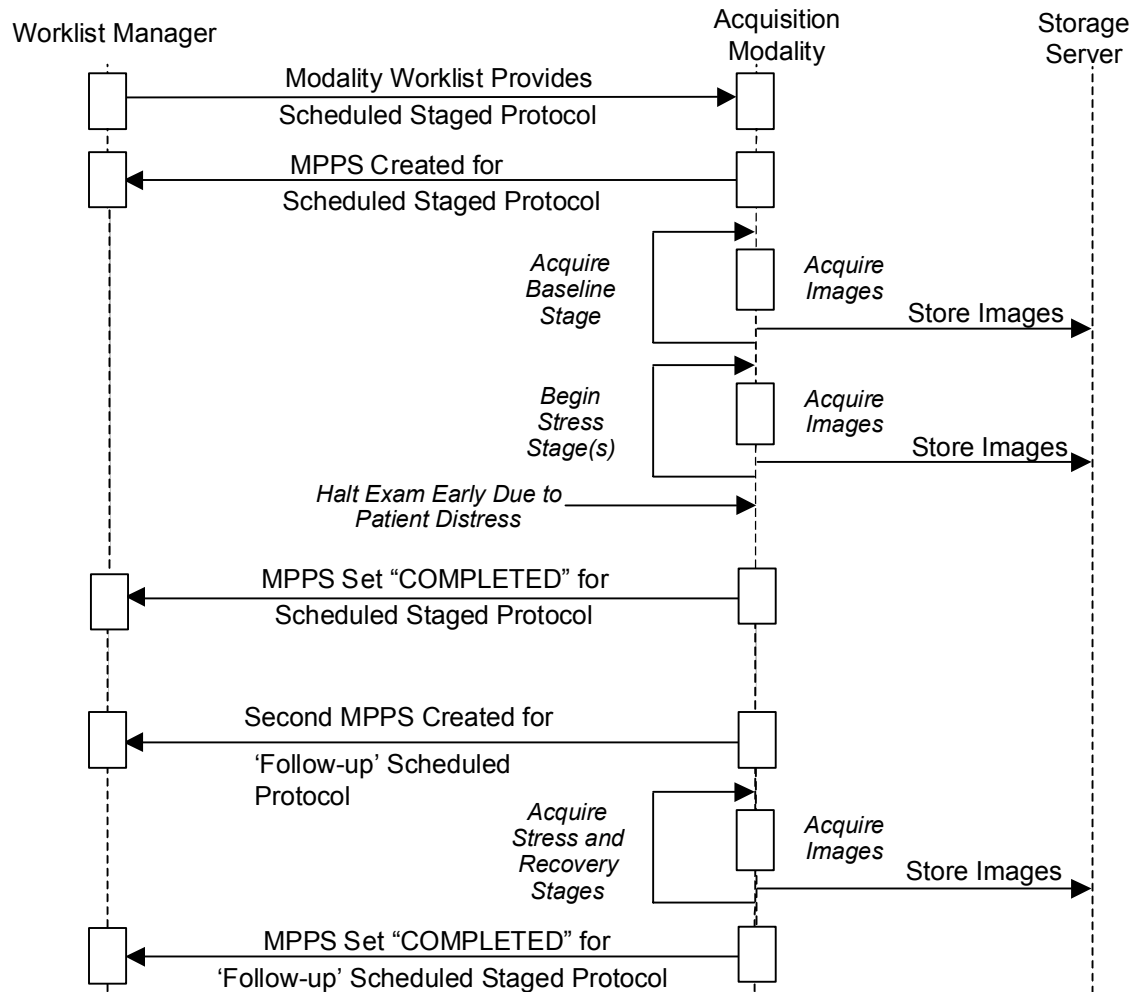

Figure K.5.5-2 Example Staged-Protocol Exam with Unscheduled Follow-up Stages

K.5.5.2.2 Scheduled Follow-up Stages

In some cases a new Scheduled Procedure Step is created to acquire follow-up Stages. For example, a drug induced stress-echo exam may be scheduled because an earlier exercise induced stress-echo exam had to be halted due to patient discomfort. In such cases it would be redundant to reacquire earlier Stages such as the rest Stage of a cardiac stress-echo ultrasound exam. One MPPS contains the Image instances of the original Stage and a separate MPSS contains the follow-up instances.

If Scheduled and Performed Procedure Steps for Staged Protocol Exam data use the same Study Instance UID, workstations can associate images from the original and follow-up Stages. Figure K.5.5-3 shows a possible interaction sequence for this scenario.

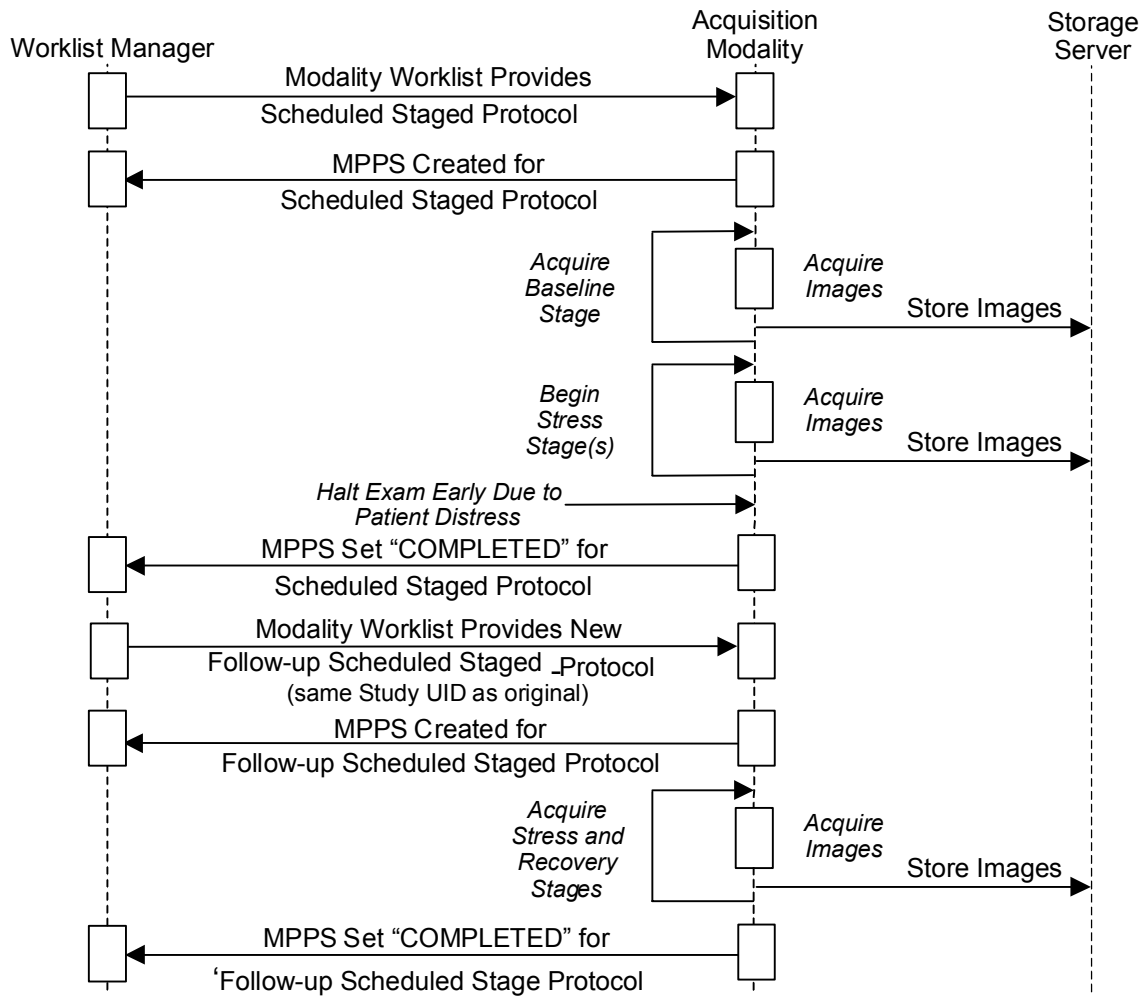

Figure K.5.5-3 Example Staged-Protocol Exam with Scheduled Follow-up Stages

Annex L Hemodynamics Report Structure (Informative)

The Hemodynamics Report is based on TID 3500. The report contains one or more measurement containers, each corresponding to a phase of the cath procedure. Within each container may be one or more sub-containers, each associated with a single measurement set. A measurement set consists of measurements from a single anatomic location. The resulting hierarchical structure is depicted in Figure L-1.

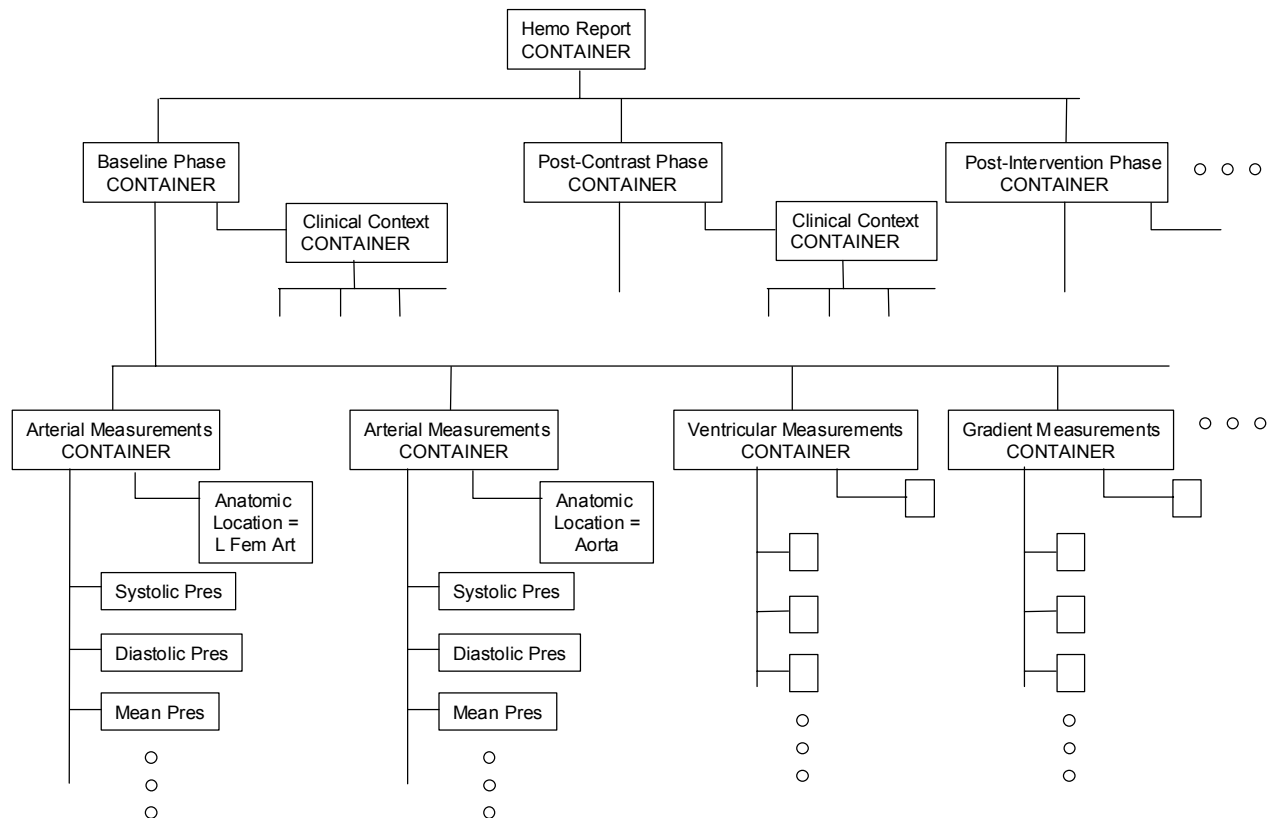

Figure L-1 Hemodynamics Report Structure

The container for each phase has an optional subsidiary container for Clinical Context with a parent-child relationship of has-acquisition-context. This Clinical Context container allows the recording of pertinent patient state information that may be essential to understanding the measurements made during that procedure phase. It should be noted that any such patient state information is necessarily only a summary; a more complete clinical picture may be obtained by review of the cath procedure log.

The lowest level containers for the measurement sets are specialized by the class of anatomic location - arterial, venous, atrial, ventricular - for the particular measurements appropriate to that type of location. These containers explicitly identify the anatomic location with a has-acquisition-context relationship. Since such measurement sets are typically measured on the same source (e.g., pressure waveform), the

container may also have a has-acquisition-context relationship with a source DICOM waveform SOP Instance.

The "atomic" level of measurements within the measurement set containers includes three types of data. First is the *specific measurement data* acquired from waveforms related to the site. Second is *general measurement data* that may include any hemodynamic, patient vital sign, or blood chemistry data. Third, *derived data* are produced from a combination of other data using a mathematical formula or table, and may provide reference to the equation.

ANNEX M Vascular Ultrasound Reports (Informative)

M.1 VASCULAR REPORT STRUCTURE

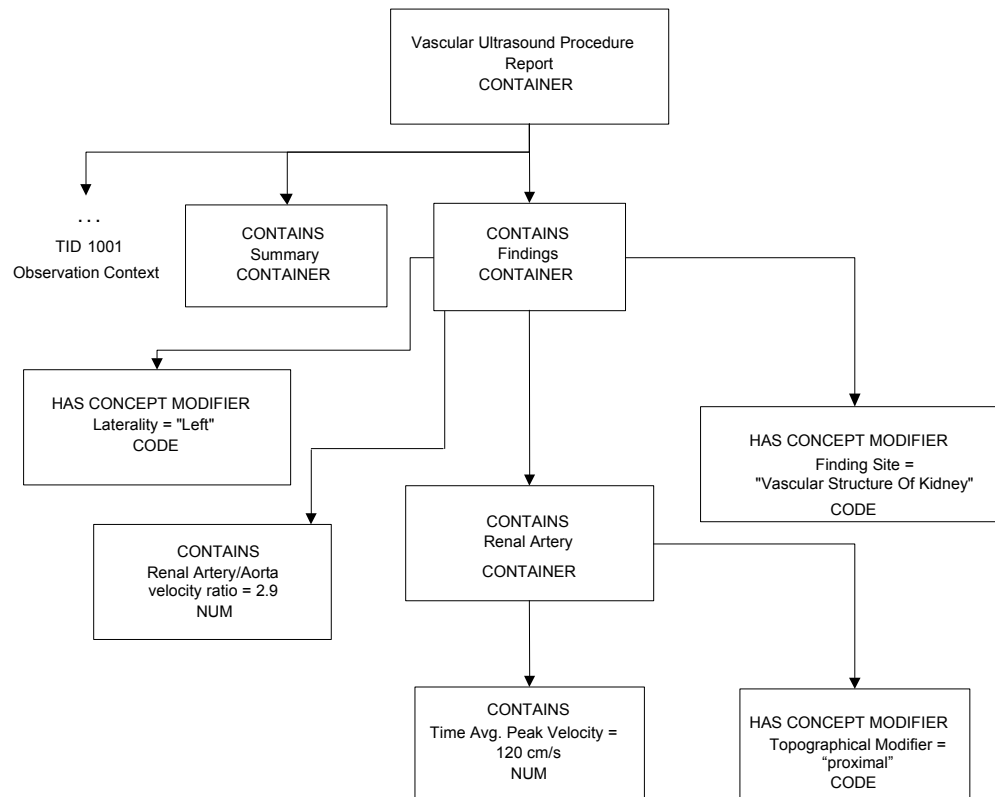

Figure M.2-1 Vascular Numeric Measurement Example

The vascular procedure report partitions numeric measurements into section headings by anatomic region and by laterality. A laterality concept modifier of the section heading concept name specifies whether laterality is left or right. Therefore, laterally paired anatomy sections may appear two times, once for each laterality. Findings of unpaired anatomy, are separately contained in a separate “unilateral” section container. Therefore, in vascular ultrasound, laterality is always expressed at the section heading level with one of three states: left, right, or unilateral (unpaired). There is no provision for anatomy of unknown laterality other than as a TEXT content item in the summary.

Note that expressing laterality at the heading level differs from OB-GYN Pelvic and fetal vasculature which expresses laterality as concept modifiers of the anatomic containers.

Section Heading Concept Name	Section Heading Laterality
------------------------------	----------------------------

Cerebral Vessels	Left, Right or Unilateral
Artery of Neck	Left, Right
Artery of Lower Extremity	Left, Right
Vein of Lower Extremity	Left, Right
Artery of Upper Extremity	Left, Right
Vein of Upper Extremity	Left, Right
Vascular Structure of Kidney	Left, Right
Artery of Abdomen	Left, Right or Unilateral
Vein of Abdomen	Left, Right or Unilateral

The common vascular pattern is a battery of measurements and calculations repeatedly applied to various anatomic locations. The anatomic location is the acquisition context of the measurement group. For example, a measurement group may have a measurement source of Common Iliac Artery with several measurement instances and measurement types such as mean velocity, peak systolic velocity, acceleration time, etc.

There are distinct anatomic concepts to modify the base anatomy concept. The modification expression is a content item with a modifier concept name and value selected from a Context Group as the table shows below.

Anatomic Modifier Concept Name	Context Group	Usage
(G-C171, SRT, "Laterality")	CID 244 Laterality	Distinguishes laterality
(G-A1F8, SRT, "Topographical Modifier")	CID 12116 Vessel Segment Modifiers	Distinguishes the location along a segment: prox, mid, distal, ...
(125101, DCM, "Vessel Branch")	CID 12117 Vessel Branch Modifiers	Distinguishes between one of multiple branches: inferior, middle

M.2 VASCULAR EXAMPLES

The following are simple, non-comprehensive illustrations of significant report sections.

M.2.1 Example 1: Renal Vessels

Nest	Code Meaning of Concept Name	Code Meaning or Example Value	TID
1	Vascular Ultrasound Procedure Report		5100
1.1	Language of Content Item and Descendants	English	1204
1.2	Subject Name	John Doe	1007
1.3	Subject ID	123-45-9876	1007
1.4	Procedure Study Instance UID	1.2.842.111724.7678.12.33	1005
1.5	Procedure Study Component UID	1.2.842.111724.7678.55.33	1005
1.6	Procedure Accession Number	20011007-21	1005
1.7	Patient Characteristics		5101
1.7.n	...		5101
1.8	Summary		5102
1.8.n	...		5102

Nest	Code Meaning of Concept Name	Code Meaning or Example Value	TID
1.9	Findings		5103
1.9.1	Finding Site	Vascular Structure Of Kidney	5103
1.9.2	Laterality	Right	5103
1.9.3	Renal Artery		5104
1.9.3.1	Topographical Modifier	Origin	5104
1.9.3.2	Peak Systolic Velocity	420 cm/s	300
1.9.3.3	End Diastolic Velocity	120 cm/s	300
1.9.3.4	Resistive Index	3.7	300
1.9.3.5	Pulsatility Index	0.7	300
1.9.3.6	Systolic to Diastolic Velocity Ratio	3.5	300
1.9.4	Renal Artery		5104
1.9.4.1	Topographical Modifier	Proximal	5104
1.9.4.n	<i>. . . other measurements</i>		300
1.9.5	Renal Artery		5104
1.9.5.1	Topographical Modifier	Middle	5104
1.9.5.n	<i>. . . other measurements</i>		300
1.9.6	Renal Artery		5104
1.9.6.1	Topographical Modifier	Distal	5104
1.9.6.n	<i>. . . other measurements</i>		300
1.9.7	Renal Vein		5104
1.9.7.1	Topographical Modifier	Middle	5104
1.9.7.2	Peak Systolic Velocity	120 cm/s	300
1.9.7.n	<i>. . . other measurements</i>		300
1.9.8	Renal Artery/Aorta Velocity Ratio	2.9	5103
1.9.n	<i>other renal vessels</i>		5104
1.10	Findings		5103
1.10.1	Finding Site	Vascular Structure of Kidney	5103
1.10.2	Laterality	Left	5103
	...		5104

M.2.2 Example 2: Carotids Extracranial

Nest	Code Meaning of Concept Name	Code Meaning or Example Value	TID
1	Vascular Ultrasound Procedure Report		5100
1.n		5100
1.10	Findings		5103
1.10.1	Findings Site	Artery of neck	5103
1.10.2	Laterality	Right	5103
1.10.3	Common Carotid Artery		5104
1.10.3.1	Topographical Modifier	Proximal	5104

Nest	Code Meaning of Concept Name	Code Meaning or Example Value	TID
1.10.3.2	Peak Systolic Velocity	80 cm/s	300
1.10.3.3	Peak Systolic Velocity	88 cm/s	300
1.10.3.4	Peak Systolic Velocity	84 cm/s	300
1.10.3.4.1	Derivation	Mean	300
1.10.4	Common Carotid Artery		5104
1.10.4.1	Topographical Modifier	Middle	5104
1.10.4.2	Peak Systolic Velocity	180 cm/s	300
1.10.5	Common Carotid Artery		5104
1.10.5.1	Topographical Modifier	Distal	5104
1.10.5.2	Peak Systolic Velocity	180 cm/s	300
1.10.6	Carotid bulb		5104
1.10.6.1	Peak Systolic Velocity	190 cm/s	300
1.10.7	Internal Carotid Artery		5104
1.10.7.1	Topographical Modifier	Proximal	5104
1.10.7.2	Peak Systolic Velocity	180 cm/s	300
1.10.8	Internal Carotid Artery		5104
1.10.8.1	Topographical Modifier	Distal	5104
1.10.8.2	Peak Systolic Velocity	180 cm/s	300
1.10.9	ICA/CCA velocity ratio	1.5	5103
1.10.n		300
1.11	Findings		5103
1.11.1	Finding Site	Artery of neck	5103
1.11.2	Laterality	Left	5103
		

ANNEX N Echocardiography Procedure Reports (Informative)

N.1 CONTENT STRUCTURE

The templates for ultrasound reports are defined in PS 3.16. The following figure is an outline of the echocardiography report.

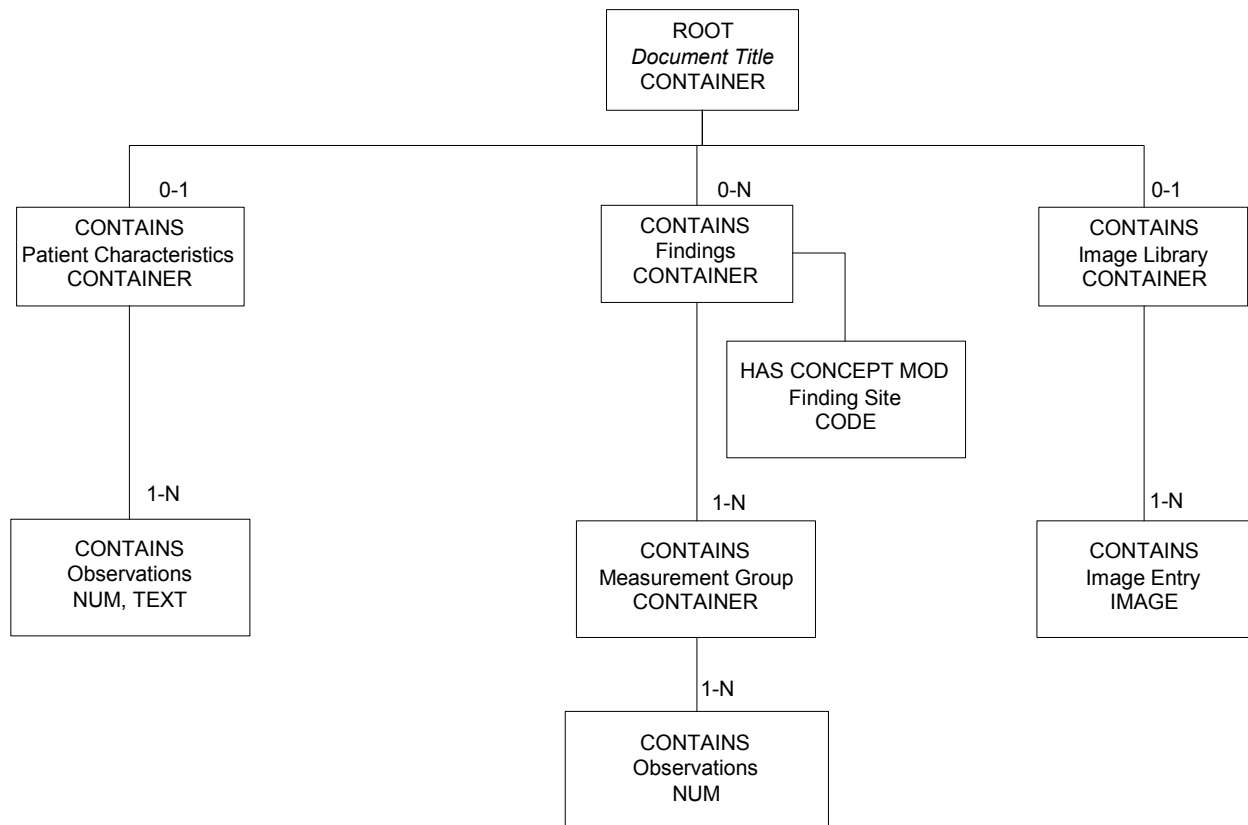

Figure N.1-1 Top Level Structure of Content

N.1 ECHO PATTERNS

The common echocardiography measurement pattern is a group of measurements obtained in the context of a protocol. The figure below shows the pattern.

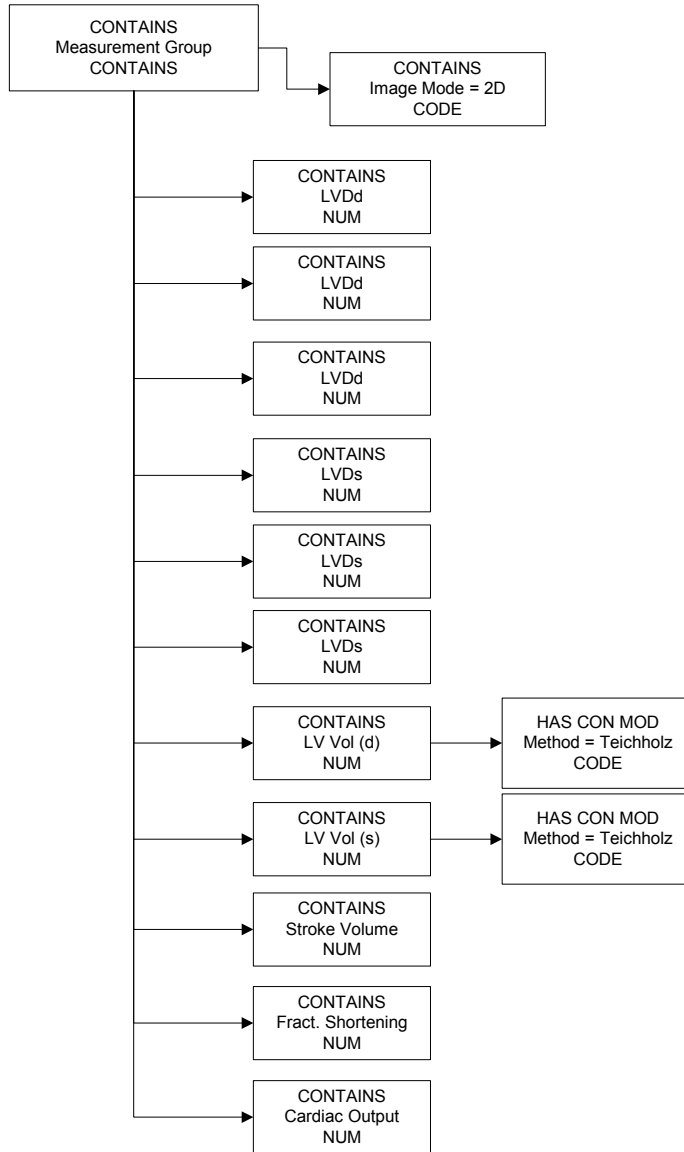

Figure N.1-2 Echocardiography Measurement Group Example

N.2 MEASUREMENT TERMINOLOGY COMPOSITION

DICOM identifies echocardiography observations with various degrees of pre- and post-coordination. The concept name of the base content item typically specifies both anatomy and property for commonly used terms, or purely a property. Pure property concepts require an anatomic site concept modifier. Pure property concepts such as those in CID 12222 Orifice Flow Properties and CID 12239 Cardiac Output Properties use concept modifiers shown below.

Concept Name of Modifier	Value Set
(G-C036, SRT, "Measurement Method")	CID 12227 Echo Measurement Method
(G-C0E3, SRT, "Finding Site")	CID 12236 Echo Anatomic Sites
(G-A1F8, SRT, "Topographical Modifier")	CID 12237 Echo Anatomic Site Modifiers
(G-C048, SRT, "Flow Direction")	CID 12221 Flow Direction

(R-4089A, SRT, "Respiratory Cycle Point")	CID 12234 Respiration State
(R-4089A, SRT, "Cardiac Cycle Point")	CID 12233 Cardiac Phase
(121401, DCM, "Derivation")	CID 3627 Measurement Type

Further qualification specifies the image mode and the image plane using HAS ACQ CONTEXT with the value sets shown below.

Concept Name	Value Set
(G-0373, SRT, "Image Mode")	CID 12224 Ultrasound Image Modes
(111031, DCM, "Image View")	CID 12226 Echocardiography Image View

N.3 ILLUSTRATIVE MAPPING TO ASE CONCEPTS

The content of this section provides recommendations on how to express the concepts from draft ASE guidelines with measurement type concept names and concept name modifiers.

The leftmost column is the name of the ASE concept. The Base Measurement Concept Name is the concept name of the numeric measurement content item. The modifiers column specifies a set of modifiers for the base measurement concept name. Each modifier consists of a modifier concept name (e.g. method or mode) and its value (e.g. Continuity). Where no Concept Modifier appears, the base concept matches the ASE concept.

N.3.1 Aorta

Name of ASE Concept	Base Measurement Concept Name	Concept or Acquisition Context Modifiers
Aortic Root Diameter	(18015-8, LN, "Aortic Root Diameter")	
Ascending Aortic Diameter	(18012-5, LN, "Ascending Aortic Diameter")	
Aortic Arch Diameter	(18011-7, LN, "Aortic Arch Diameter")	
Descending Aortic Diameter	(18013-3, LN, "Descending Aortic Diameter")	

N.3.2 Aortic Valve

Name of ASE Concept	Base Measurement Concept Name	Concept or Acquisition Context Modifiers
Aortic Valve Cusp Separation	(17996-0, LN, "Aortic Valve Cusp Separation")	
Aortic Valve Systolic Peak Velocity	(11726-7, LN, "Peak Velocity")	(G-C048, SRT, "Direction of Flow") = (R-42047, SRT, "Antegrade Flow")
Aortic Valve Systolic Velocity Time Integral	(20354-7, LN, "Velocity Time")	(G-C048, SRT, "Direction of Flow") = (R-42047, SRT, "Antegrade Flow")

Name of ASE Concept	Base Measurement Concept Name	Concept or Acquisition Context Modifiers
	Integral")	
Aortic Valve Systolic Area	(G-038E, SRT, "Cardiovascular Orifice Area")	(G-C048, SRT, "Direction of Flow") = (R-42047, SRT, "Antegrade Flow")
Aortic Valve Planimetered Systolic Area	(G-038E, SRT, "Cardiovascular Orifice Area")	(G-C048, SRT, "Direction of Flow") = (R-42047, SRT, "Antegrade Flow") (G-C036, SRT, "Measurement Method") = (125220, DCM, "Planimetry")
Aortic Valve Systolic Area by Continuity	(G-038E, SRT, "Cardiovascular Orifice Area")	(G-C048, SRT, "Direction of Flow") = (R-42047, SRT, "Antegrade Flow") (G-C036, SRT, "Measurement Method") = (125212, DCM, "Continuity Equation")
Aortic Valve Systolic Area by Continuity of Peak Velocity	(G-038E, SRT, "Cardiovascular Orifice Area")	(G-C048, SRT, "Direction of Flow") = (R-42047, SRT, "Antegrade Flow") (G-C036, SRT, "Measurement Method") = (125214, DCM, "Continuity Equation Peak Velocity")
Aortic Valve Systolic Area by Continuity of Mean Velocity	(G-038E, SRT, "Cardiovascular Orifice Area")	(G-C048, SRT, "Direction of Flow") = (R-42047, SRT, "Antegrade Flow") (G-C036, SRT, "Measurement Method") = (125213, DCM, "Continuity Equation by Mean Velocity")
Aortic Valve Systolic Area by Continuity of VTI	(G-038E, SRT, "Cardiovascular Orifice Area")	(G-C048, SRT, "Direction of Flow") = (R-42047, SRT, "Antegrade Flow") (G-C036, SRT, "Measurement Method") = (1252125, DCM, "Continuity Equation by Velocity Time Integral")
Aortic Valve Systolic Peak Instantaneous Gradient	(20247-3 LN, "Peak Gradient")	(G-C048, SRT, "Direction of Flow") = (R-42047, SRT, "Antegrade Flow")
Aortic Valve Systolic Mean Gradient	(20256-4, LN, "Mean Gradient")	(G-C048, SRT, "Direction of Flow") = (R-42047, SRT, "Antegrade Flow")
Aortic Annulus Systolic Diameter	(G-038F, SRT, "Cardiovascular Orifice Diameter")	(G-C0E3, SRT, "Finding Site") = (T-35410, SRT, "Aortic Valve Ring") (G-C048, SRT, "Direction of Flow") = (R-42047, SRT, "Antegrade Flow")
Aortic Valve Regurgitant Diastolic Deceleration Slope	(20216-8, LN, "Deceleration Slope")	(G-C048, SRT, "Direction of Flow") = (R-42E61, SRT, "Regurgitant Flow")
Aortic Valve Regurgitant Diastolic Deceleration Time	(20217-6, LN, "Deceleration Time")	(G-C048, SRT, "Direction of Flow") = (R-42E61, SRT, "Regurgitant Flow")
Aortic Valve Regurgitant Diastolic Pressure Half-time	(20280-4, LN, "Pressure Half-Time")	(G-C048, SRT, "Direction of Flow") = (R-42E61, SRT, "Regurgitant Flow")
Aortic Insufficiency, End-Diastolic Pressure Gradient	(20247-3, LN, "Peak Gradient")	(G-C048, SRT, "Direction of Flow") = (R-42E61, SRT, "Regurgitant Flow")
Aortic Insufficiency, End Diastolic Velocity	(11653-3, LN, "End Diastolic Velocity")	(G-C048, SRT, "Direction of Flow") = (R-42E61, SRT, "Regurgitant Flow")

Note: Aortic Valve measurements appear in TID 5202 which specifies the Finding Site to be Aortic Valve with the concept modifier (G-C0E3, SRT, "Finding Site") = (T-35400, SRT, "Aortic Valve"). Therefore, the Finding Site modifier does not appear in the right column.

N.3.3 Left Ventricle - Linear

Name of ASE Concept	Base Measurement Concept Name	Concept or Acquisition Context Modifiers
Left Ventricle Internal End Diastolic Dimension	(29436-3, LN "Left Ventricle Internal End Diastolic Dimension")	
Left Ventricle Internal Systolic Dimension	(29438-9, LN, "Left Ventricle Internal Systolic Dimension")	
Left Ventricle Diastolic Major Axis	(18077-8, LN, "Left Ventricle Diastolic Major Axis")	
Left Ventricle Systolic Major Axis	(18076-0, LN, "Left Ventricle Systolic Major Axis")	
Left Ventricular Fractional Shortening	(18051-3, LN, "Left Ventricular Fractional Shortening")	
Interventricular Septum Diastolic Thickness	(18154-5, LN, "Interventricular Septum Diastolic Thickness")	
Interventricular Septum Systolic Thickness	(18158-6, LN, "Interventricular Septum Systolic Thickness")	
Interventricular Septum % Thickening	(18054-7, LN, "Interventricular Septum % Thickening")	
Left Ventricle Posterior Wall Diastolic Thickness	(18152-9, LN, "Left Ventricle Posterior Wall Diastolic Thickness")	
Left Ventricle Posterior Wall Systolic Thickness	(18156-0, LN, "Left Ventricle Posterior Wall Systolic Thickness")	
Left Ventricle Posterior Wall % Thickening	(18053-9, LN, "Left Ventricle Posterior Wall % Thickening")	
Interventricular Septum to Posterior Wall Thickness ratio	(18155-2, LN, "Interventricular Septum to Posterior Wall Thickness Ratio")	
Left Ventricular Internal End Diastolic Dimension by 2-D	(29436-3, LN, "Left Ventricle Internal	(G-0373, SRT, "Image Mode") = (G-03A2, SRT, "2D mode")

Name of ASE Concept	Base Measurement Concept Name	Concept or Acquisition Context Modifiers
	End Diastolic Dimension")	
Left Ventricular Internal Systolic Dimension by 2-D	(29438-9, LN, "Left Ventricle Internal Systolic Dimension")	(G-0373, SRT, "Image Mode") = (G-03A2, SRT, "2D mode")
Left Ventricular Fractional Shortening by 2-D	(18051-3, LN, "Left Ventricular Fractional Shortening")	(G-0373, SRT, "Image Mode") = (G-03A2, SRT, "2D mode")
Interventricular Septum Diastolic Thickness by 2-D	(18154-5, LN, "Interventricular Septum Diastolic Thickness")	(G-0373, SRT, "Image Mode") = (G-03A2, SRT, "2D mode")
Interventricular Septum Systolic Thickness by 2-D	(18158-6, LN, "Interventricular Septum Systolic Thickness")	(G-0373, SRT, "Image Mode") = (G-03A2, SRT, "2D mode")
Interventricular Septum % Thickening by 2-D	(18054-7, LN, "Interventricular Septum % Thickening")	(G-0373, SRT, "Image Mode") = (G-03A2, SRT, "2D mode")
Left Ventricular Posterior Wall Diastolic Thickness by 2-D	(18152-9, LN, "Left Ventricle Posterior Wall Diastolic Thickness")	(G-0373, SRT, "Image Mode") = (G-03A2, SRT, "2D mode")
Left Ventricle Posterior Wall Systolic Thickness by 2-D	(18156-0, LN, "Left Ventricle Posterior Wall Systolic Thickness")	(G-0373, SRT, "Image Mode") = (G-03A2, SRT, "2D mode")
Left Ventricle Posterior Wall % Thickening by 2-D	(18053-9, LN, "Left Ventricle Posterior Wall % Thickening")	G-0373, SRT, "Image Mode") = (G-03A2, SRT, "2D mode")
Interventricular Septum/ Left Ventricular Posterior Wall Diastolic Thickness Ratio by 2-D	(18155-2, LN, "Interventricular Septum to Posterior Wall Thickness Ratio")	(G-0373, SRT, "Image Mode") = (G-03A2, SRT, "2D mode")
Left Ventricular Internal End Diastolic Dimension by M-Mode	(29436-3, LN, "Left Ventricle Internal End Diastolic Dimension")	(G-0373, SRT, "Image Mode") = (G-0394, SRT, "M mode")
Left Ventricular Internal Systolic Dimension by M-Mode	(29438-9, LN, "Left Ventricle Internal Systolic Dimension")	(G-0373, SRT, "Image Mode") = (G-0394, SRT, "M mode")
Left Ventricular Systolic Fractional Shortening by M-Mode	(18051-3, LN, "Left Ventricular Fractional Shortening")	(G-0373, SRT, "Image Mode") = (G-0394, SRT, "M mode")
Interventricular Septum Diastolic Thickness by M-Mode	(18154-5, LN, "Interventricular	(G-0373, SRT, "Image Mode") = (G-0394, SRT, "M mode")

Name of ASE Concept	Base Measurement Concept Name	Concept or Acquisition Context Modifiers
	Septum Diastolic Thickness")	
Interventricular Septum Systolic Thickness by M-Mode	(18158-6, LN, "Interventricular Septum Systolic Thickness")	(G-0373, SRT, "Image Mode") = (G-0394, SRT, "M mode")
Interventricular Septum % Thickening by M-Mode	(18054-7, LN, "Interventricular Septum % Thickening")	G-0373, SRT, "Image Mode") = (G-0394, SRT, "M mode")
Left Ventricular Posterior Wall Diastolic Thickness by M-Mode	(18152-9, LN, "Left Ventricle Posterior Wall Diastolic Thickness")	(G-0373, SRT, "Image Mode") = (G-0394, SRT, "M mode")
Left Ventricle Posterior Wall Systolic Thickness by M-Mode	(18156-0, LN, "Left Ventricle Posterior Wall Systolic Thickness")	(G-0373, SRT, "Image Mode") = (G-0394, SRT, "M mode")
Left Ventricle Posterior Wall % Thickening by M-Mode	(18053-9, LN, "Left Ventricle Posterior Wall % Thickening")	(G-0373, SRT, "Image Mode") = (G-0394, SRT, "M mode")
Interventricular Septum to Left Ventricular Posterior Wall Ratio by M-Mode	(18155-2, LN, "Interventricular Septum to Posterior Wall Thickness Ratio")	(G-0373, SRT, "Image Mode") = (G-0394, SRT, "M mode")

N.3.4 Left Ventricle Volumes and Ejection Fraction

Name of ASE Concept	Base Measurement Concept Name	Concept or Acquisition Context Modifiers
Left Ventricular End Diastolic Volume	(18026-5, LN, "Left Ventricular End Diastolic Volume")	
Left Ventricular End Diastolic Volume by Teichholz Method	(18026-5, LN, "Left Ventricular End Diastolic Volume")	(G-C036, SRT, "Measurement Method") = (125209, DCM, "Teichholz")
Left Ventricular End Diastolic Volume by 2-D Single Plane by Method of Disks (4-Chamber)	(18026-5, LN, "Left Ventricular End Diastolic Volume")	(111031, DCM, "Image View") = (G-A19C, SRT, "Apical Four Chamber") (G-C036, SRT, "Measurement Method") = (125208, DCM, "Method of Disks, Single Plane")
Left Ventricular End Diastolic Volume by 2-D Biplane by Method of Disks	(18026-5, LN, "Left Ventricular End Diastolic Volume")	(G-C036, SRT, "Measurement Method") = (125207, DCM, "Method of Disks, Biplane")
Left Ventricular End Systolic Volume	(18148-7, LN, "Left Ventricular End Systolic Volume")	
Left Ventricular End Systolic Volume by Teichholz Method	(18148-7, LN, "Left Ventricular End	(G-C036, SRT, "Measurement Method") = (125209, DCM, "Teichholz")

Name of ASE Concept	Base Measurement Concept Name	Concept or Acquisition Context Modifiers
	Systolic Volume")	
Left Ventricular End Systolic Volume by 2D Single Plane by Method of Disks (4-Chamber)	(18148-7, LN, "Left Ventricular End Systolic Volume")	(111031, DCM, "Image View") = (G-A19C, SRT, "Apical Four Chamber") (G-C036, SRT, "Measurement Method") = (125208, DCM, "Method of Disks, Single Plane")
Left Ventricular End Systolic Volume by 2-D Biplane by Method of Disks	(18148-7, LN, "Left Ventricular End Systolic Volume")	(G-C036, SRT, "Measurement Method") = (125207, DCM, "Method of Disks, Biplane")
Left Ventricular EF	(18043-0, LN, "Left Ventricular Ejection Fraction")	
Left Ventricular EF by Teichholz Method	(18043-0, LN, "Left Ventricular Ejection Fraction")	(G-C036, SRT, "Measurement Method") = (125209, DCM, "Teichholz")
Left Ventricular EF by 2D Single Plane by Method of Disks (4-Chamber)	(18043-0, LN, "Left Ventricular Ejection Fraction")	(111031, DCM, "Image View") = (G-A19C, SRT, "Apical Four Chamber") (G-C036, SRT, "Measurement Method") = (125208, DCM, "Method Of Disks, Single Plane")
Left Ventricular EF by 2-D Biplane by Method of Disks	(18043-0, LN, "Left Ventricular Ejection Fraction")	(G-C036, SRT, "Measurement Method") = (1252087, DCM, "Method of Disks, Biplane")

N.3.5 Left Ventricle Output

Name of ASE Concept	Base Measurement Concept Name	Concept or Acquisition Context Modifiers
Left Ventricular Stroke Volume	(F-32120, SRT, "Stroke Volume")	
Left Ventricular Stroke Volume by Doppler Volume Flow	(F-32120, SRT, "Stroke Volume")	(G-C036, SRT, "Measurement Method") = (125219, DCM, "Doppler Volume Flow") (G-C0E3, SRT, "Finding Site") = (T-32650, SNM3, "Left Ventricle Outflow Tract")
Left Ventricular Stroke Volume by Teichholz Method	(F-32120, SRT, "Stroke Volume")	(G-C036, SRT, "Measurement Method") = (125209, DCM, "Teichholz")
Left Ventricular Stroke Volume by 2-D Single Plane by Method of Disks (4-Chamber)	(F-32120, SRT, "Stroke Volume")	(1110321 DCM, "Image View") = (G-A19C, SRT, "Apical Four Chamber") (G-C036, SRT, "Measurement Method") = (125208, DCM, "Method of Disks, Single Plane")
Left Ventricular Stroke Volume by 2-D Biplane by Method of Disks	(F-32120, SRT, "Stroke Volume")	(G-C036, SRT, "Measurement Method") = (125207, DCM, "Method of Disks, Biplane")
Left Ventricular Cardiac Output	(F-32100, SRT, "Cardiac Output")	
Left Ventricular Cardiac Output by Doppler Volume Outflow	(F-32100, SRT, "Cardiac Output")	(G-C036, SRT, "Measurement Method") = (125219, DCM, "Doppler Volume Flow") (G-C0E3, SRT, "Finding Site") = (T-32650, SNM3,

Name of ASE Concept	Base Measurement Concept Name	Concept or Acquisition Context Modifiers
		"Left Ventricle Outflow Tract")
Left Ventricular Cardiac Output by Teichholz Method	(F-32100, SRT, "Cardiac Output")	(G-C036, SRT, "Measurement Method") = (125209, DCM, "Teichholz")
Left Ventricular Cardiac Output by 2-D Single Plane by Method of Disks (4-Chamber)	(F-32100, SRT, "Cardiac Output")	(111031, DCM, "Image View") = (G-A19C, SRT, "Apical Four Chamber") (G-C036, SRT, "Measurement Method") = (125208, DCM, "Method of Disks, Single Plane")
Left Ventricular Cardiac Output by 2-D Biplane by Method of Disks	(F-32100, SRT, "Cardiac Output")	(G-C036, SRT, "Measurement Method") = (125207, DCM, "Method of Disks, Biplane")
Left Ventricular Cardiac Index	(F-32110, SRT, "Cardiac Index")	
Left Ventricular Cardiac Index by Doppler Volume Flow	(F-32110, SRT, "Cardiac Index")	(G-C036, SRT, "Measurement Method") = (125219, DCM, "Doppler Volume Flow")
Left Ventricular Cardiac Index by Teichholz Method	(F-32110, SRT, "Cardiac Index")	(G-C036, SRT, "Measurement Method") = (125209, DCM, "Teichholz")
Left Ventricular Cardiac Index by 2-D Single Plane by Method of Disks (4-Chamber)	(F-32110, SRT, "Cardiac Index")	(111031, DCM, "Image View") = (G-A19C, SRT, "Apical Four Chamber") (G-C036, SRT, "Measurement Method") = (125208, DCM, "Method Of Disks, Single Plane")
Left Ventricular Cardiac Index by 2-D Biplane by Method of Disks	(F-32110, SRT, "Cardiac Index")	(G-C036, SRT, "Measurement Method") = (125207, DCM, "Method of Disks, Biplane")

Note: Measurements in the Left Ventricle section have context of Left Ventricle and do not require a Finding Site modifier (G-C0E3, SRT, "Finding Site") = (T-35400, SRT, "Left Ventricle") to specify the site. The Finding Site modifier appears for more specificity.

N.3.6 Left Ventricular Outflow Tract

Name of ASE Concept	Base Measurement Concept Name	Concept or Acquisition Context Modifiers
Left Ventricular Outflow Tract Systolic Diameter	(G-038F, SRT, "Cardiovascular Orifice Diameter")	(G-C0E3, SRT, "Finding Site") = (T-32650, SRT, "Left Ventricular Outflow Tract")
Left Ventricular Outflow Tract Systolic Cross Sectional Area	(G-038E, SRT, "Cardiovascular Orifice Area")	(G-C0E3, SRT, "Finding Site") = (T-32650, SRT, "Left Ventricular Outflow Tract")
Left Ventricular Outflow Tract Systolic Peak Velocity	(11726-7, LN, "Peak Velocity")	(G-C0E3, SRT, "Finding Site") = (T-32650, SRT, "Left Ventricular Outflow Tract")
Left Ventricular Outflow Tract Systolic Peak Instantaneous Gradient	(20247-3, LN, "Peak Gradient")	(G-C0E3, SRT, "Finding Site") = (T-32650, SRT, "Left Ventricular Outflow Tract")
Left Ventricular Outflow Tract Systolic Mean Velocity	(20352-1, LN, "Mean Velocity")	(G-C0E3, SRT, "Finding Site") = (T-32650, SRT, "Left Ventricular Outflow Tract")
Left Ventricular Outflow Tract Systolic Mean Gradient	(20256-4, LN, "Mean Gradient")	(G-C0E3, SRT, "Finding Site") = (T-32650, SRT, "Left Ventricular Outflow Tract")

Name of ASE Concept	Base Measurement Concept Name	Concept or Acquisition Context Modifiers
Left Ventricular Outflow Tract Systolic Velocity Time Integral	(20354-7, LN, "Velocity Time Integral")	(G-C0E3, SRT, "Finding Site") = (T-32650, SRT, "Left Ventricular Outflow Tract")

N.3.7 Left Ventricle Mass

Name of ASE Concept	Base Measurement Concept Name	Concept or Acquisition Context Modifiers
Left Ventricle Mass	(18087-7, LN, "Left Ventricle Mass")	
Left Ventricular Mass by 2-D Method of Disks, Single Plane (4-Chamber)	(18087-7, LN, "Left Ventricle Mass")	(G-0373, SRT, "Image Mode") = (G-03A2, SRT, "2D mode") (G-C036, SRT, "Measurement Method") = (125208, DCM, "Method Of Disks, single plane")
Left Ventricular Mass by 2-D Biplane by Method of Disks	(18087-7, LN, "Left Ventricle Mass")	(G-0373, SRT, "Image Mode") = (G-03A2, SRT, "2D mode") (G-C036, SRT, "Measurement Method") = (1252087, DCM, "Method of disks, biplane")
Left Ventricular Mass by M-Mode	(18087-7, LN, "Left Ventricle Mass")	(G-0373, SRT, "Image Mode") = (G-0394, SRT, "M mode")

N.3.8 Left Ventricle Miscellaneous

Name of ASE Concept	Base Measurement Concept Name	Concept or Acquisition Context Modifiers
Left Ventricular Isovolumic Relaxation Time	(18071-1, LN, "Left Ventricular Isovolumic Relaxation Time")	
Left Ventricular Isovolumic Contraction Time	(G-037E, SRT, "Left Ventricular Isovolumic Contraction Time")	
Left Ventricular Peak Early Diastolic Tissue Velocity at the Medial Mitral Annulus	(G-037A, SRT, "Left Ventricular Peak Early Diastolic Tissue Velocity")	(G-C0E3, SRT, "Finding Site") = (G-0391, SRT, "Medial Mitral Annulus")
Left Ventricular Peak Early Diastolic Tissue Velocity at the Lateral Mitral Annulus	(G-037A, SRT, "Left Ventricular Peak Early Diastolic Tissue Velocity")	(G-C0E3, SRT, "Finding Site") = (G-0392, SRT, "Lateral Mitral Annulus")
Ratio of Mitral Valve E-Wave Peak Velocity to Left Ventricular Peak Early Diastolic Tissue Velocity at the Medial Mitral Annulus	(G-037B, SRT, "Ratio of MV Peak Velocity to LV Peak Tissue Velocity E-Wave")	(G-C0E3, SRT, "Finding Site") = (G-0391, SRT, "Medial Mitral Annulus")
Ratio of Mitral Valve E-Wave Peak Velocity to Left Ventricular Peak Early Diastolic Tissue Velocity at the Lateral Mitral Annulus	(G-037B, SRT, "Ratio of MV Peak Velocity to LV Peak Tissue Velocity E-Wave")	(G-C0E3, SRT, "Finding Site") = (G-0392, SRT, "Lateral Mitral Annulus")

Name of ASE Concept	Base Measurement Concept Name	Concept or Acquisition Context Modifiers
Velocity at the Lateral Mitral Annulus	Tissue Velocity E-Wave")	
Left Ventricular Peak Diastolic Tissue Velocity at the Medial Mitral Annulus During Atrial Systole	(G-037C, SRT, "LV Peak Diastolic Tissue Velocity During Atrial Systole")	(G-C0E3, SRT, "Finding Site") = (G-0391, SRT, "Medial Mitral Annulus")
Left Ventricular Peak Diastolic Tissue Velocity at the Lateral Mitral Annulus During Atrial Systole	(G-037C, SRT, "LV Peak Diastolic Tissue Velocity During Atrial Systole")	(G-C0E3, SRT, "Finding Site") = (G-0392, SRT, "Lateral Mitral Annulus")
Left Ventricular Peak Systolic Tissue Velocity at the Medial Mitral Annulus	(G-037D, SRT, "Left Ventricular Peak Systolic Tissue Velocity")	(G-C0E3, SRT, "Finding Site") = (G-0391, SRT, "Medial Mitral Annulus")
Left Ventricular Peak Systolic Tissue Velocity at the Lateral Mitral Annulus	(G-037D, SRT, "Left Ventricular Peak Systolic Tissue Velocity")	(G-C0E3, SRT, "Finding Site") = (G-0392, SRT, "Lateral Mitral Annulus")

N.3.9 Mitral Valve

Name of ASE Concept	Base Measurement Concept Name	Concept or Acquisition Context Modifiers
Mitral Valve Area	(G-038E, SRT, "Cardiovascular Orifice Area")	(G-C048, SRT, "Direction of Flow") = (R-42047, SRT, "Antegrade Flow")
Mitral Valve Area by Continuity	(G-038E, SRT, "Cardiovascular Orifice Area")	(G-C048, SRT, "Direction of Flow") = (R-42047, SRT, "Antegrade Flow") (G-C036, SRT, "Measurement Method") = (125212, DCM, "Continuity Equation")
Mitral Valve Area by Planimetry	(G-038E, SRT, "Cardiovascular Orifice Area")	(G-C048, SRT, "Direction of Flow") = (R-42047, SRT, "Antegrade Flow") (G-C036, SRT, "Measurement Method") = (125220, DCM, "Planimetry")
Mitral Valve Area by Pressure Half-time	(G-038E, SRT, "Cardiovascular Orifice Area")	(G-C048, SRT, "Direction of Flow") = (R-42047, SRT, "Antegrade Flow") (G-C036, SRT, "Measurement Method") = (125210, DCM, "Area by PHT")
Mitral Valve Area by Proximal Isovelocity Surface Area	(G-038E, SRT, "Cardiovascular Orifice Area")	(G-C048, SRT, "Direction of Flow") = (R-42047, SRT, "Antegrade Flow") (G-C036, SRT, "Measurement Method") = (125216, DCM, "Proximal Isovelocity Surface Area")
Mitral Valve Pressure Half-time	(20280-4, LN, "Pressure Half-Time")	(G-C048, SRT, "Direction of Flow") = (R-42047, SRT, "Antegrade Flow")
Mitral Valve A-Wave Peak	(17978-8, LN, "Mitral	

Name of ASE Concept	Base Measurement Concept Name	Concept or Acquisition Context Modifiers
Velocity	Valve A-Wave Peak Velocity")	
Mitral Valve E-Wave Peak Velocity	(18037-2, LN, "Mitral Valve E-Wave Peak Velocity")	
Mitral Valve E to A Ratio	(18038-0, LN, "Mitral Valve E to A Ratio")	
Mitral Valve E-Wave Deceleration Time	(G-0384, SRT, "Mitral Valve E-Wave Deceleration Time")	
Mitral Valve E-F Slope by M-Mode	(18040-6, LN, "Mitral Valve E-F Slope by M-Mode")	
Mitral Valve Velocity Time Integral	(20354-7, LN, "Velocity Time Integral")	(G-C048, SRT, "Direction of Flow") = (R-42047, SRT, "Antegrade Flow")
Mitral Valve Diastolic Peak Instantaneous Gradient	(20247-3, LN, "Peak Gradient")	(G-C048, SRT, "Direction of Flow") = (R-42047, SRT, "Antegrade Flow")
Mitral Valve Diastolic Mean Gradient	(20256-4, LN, "Mean Gradient")	(G-C048, SRT, "Direction of Flow") = (R-42047, SRT, "Antegrade Flow")
Mitral Valve Annulus Diastolic Velocity Time Integral	(20354-7, LN, "Velocity Time Integral")	(G-C0E3, SRT, "Finding Site") = (T-35313, SRT, "Mitral Annulus") (G-C048, SRT, "Direction of Flow") = (R-42047, SRT, "Antegrade Flow")
Mitral Valve Annulus Diastolic Diameter	(G-038F, SRT, "Cardiovascular Orifice Diameter")	(G-C0E3, SRT, "Finding Site") = (T-35313, SRT, "Mitral Annulus") (G-C048, SRT, "Direction of Flow") = (R-42047, SRT, "Antegrade Flow")
Mitral Regurgitant Peak Velocity	(11726-7, LN, "Peak Velocity")	(G-C048, SRT, "Direction of Flow") = (R-42E61, SRT, "Regurgitant Flow")
Mitral Valve Effective Regurgitant Orifice by Proximal Isovelocity Surface Area Method	(G-038E, SRT, "Cardiovascular Orifice Area")	(G-C048, SRT, "Direction of Flow") = (R-42E61, SRT, "Regurgitant Flow") G-C036, SRT, "Measurement Method") = (125216, DCM, "Proximal Isovelocity Surface Area")
Mitral Valve Regurgitant Volume by Proximal Isovelocity Surface Area Method	(33878-0, LN, "Volume Flow")	(G-C0E3, SRT, "Finding Site") = (T-35313, SRT, "Mitral Annulus") (G-C048, SRT, "Direction of Flow") = (R-42E61, SRT, "Regurgitant Flow") (G-C036, SRT, "Measurement Method") = (125216, DCM, "Proximal Isovelocity Surface Area")
Mitral Valve Regurgitant Fraction	(G-0390, SRT, "Regurgitant Fraction")	
Mitral Valve Regurgitant Fraction by PISA	(G-0390, SRT, "Regurgitant Fraction")	(G-C036, SRT, "Measurement Method") = (125216, DCM, "Proximal Isovelocity Surface Area")
Mitral Valve Regurgitant Fraction by Mitral Annular Flow	(G-0390, SRT, "Regurgitant Fraction")	(G-C0E3, SRT, "Finding Site") = (T-35313, SRT, "Mitral Annulus") (G-C036, SRT, "Measurement Method") = (125219, DCM, "Proximal Isovelocity Surface Area")

Name of ASE Concept	Base Measurement Concept Name	Concept or Acquisition Context Modifiers
		DCM, "Doppler Volume Flow")
Mitral Regurgitation Peak Gradient	(20247-3, LN, "Peak Gradient")	(G-C048, SRT, "Direction of Flow") = (R-42E61, SRT, "Regurgitant Flow")
Left Ventricular dP/dt derived from Mitral Regurgitation velocity	(18035-6, LN, "Mitral Regurgitation dP/dt derived from Mitral Regurgitation velocity")	

Note: Mitral Valve measurements appear in TID 5202 which specifies the Finding Site to be Mitral Valve with the concept modifier (G-C0E3, SRT, "Finding Site") = (T-35300, SRT, "Mitral Valve"). Therefore, the Finding Site modifier does not appear in the right column.

N.3.10 Pulmonary Vein

Name of ASE Concept	Base Measurement Concept Name	Concept or Acquisition Context Modifiers
Pulmonary Vein Systolic Peak Velocity	(29450-4, LN, "Pulmonary Vein Systolic Peak Velocity")	
Pulmonary Vein Diastolic Peak Velocity	(29451-2, LN, "Pulmonary Vein Diastolic Peak Velocity")	
Pulmonary Vein Systolic to Diastolic Ratio	(29452-0, LN, "Pulmonary Vein Systolic to Diastolic Ratio")	
Pulmonary Vein Atrial Contraction Reversal Peak Velocity	(29453-8, LN, "Pulmonary Vein Atrial Contraction Reversal Peak Velocity")	
Right Upper Pulmonary Vein Peak Systolic Velocity	(29450-4, LN, "Pulmonary Vein Systolic Peak Velocity")	(G-A1F8G-A1F8, SRT, "Topographical Modifier") = (R-404A0, SRT, "Right Upper Segment")
Right Upper Pulmonary Vein Diastolic Peak Velocity	(29451-2, LN, "Pulmonary Vein Diastolic Peak Velocity")	(G-A1F8G-A1F8, SRT, "Topographical Modifier") = (R-404A0, SRT, "Right Upper Segment")
Right Upper Pulmonary Vein Systolic to Diastolic Velocity Ratio	(29452-0, LN, "Pulmonary Vein Systolic to Diastolic Ratio")	(G-A1F8, SRT, "Anatomic Site Modifier") = (R-404A0, SRT, "Right Upper Segment")
Right Lower Pulmonary Vein Peak Systolic Velocity	(29450-4, LN, "Pulmonary Vein Systolic Peak Velocity")	(G-A1F8, SRT, "Topographical Modifier") = (R-4049E, SRT, "Right Lower Segment")

Name of ASE Concept	Base Measurement Concept Name	Concept or Acquisition Context Modifiers
Right Lower Pulmonary Vein Diastolic Peak Velocity	(29451-2, LN, "Pulmonary Vein Diastolic Peak Velocity")	(G-A1F8, SRT, "Topographical Modifier") = (R-4049E, SRT, "Right Lower Segment")
Right Lower Pulmonary Vein Systolic to Diastolic Velocity Ratio	(29452-0, LN, "Pulmonary Vein Systolic to Diastolic Ratio")	(G-A1F8, SRT, "Topographical Modifier") = (R-4049E, SRT, "Right Lower Segment")
Left Upper Pulmonary Vein Peak Systolic Velocity	(29450-4, LN, "Pulmonary Vein Systolic Peak Velocity")	(G-A1F8, SRT, "Topographical Modifier") = (R-40491, SRT, "Left Upper Segment")
Left Upper Pulmonary Vein Velocity Peak Diastolic	(29451-2, LN, "Pulmonary Vein Diastolic Peak Velocity")	(G-A1F8, SRT, "Topographical Modifier") = (R-40491, SRT, "Left Upper Segment")
Left Upper Pulmonary Vein Systolic to Diastolic Velocity Ratio	(29452-0, LN, "Pulmonary Vein Systolic to Diastolic Ratio")	(G-A1F8, SRT, "Topographical Modifier") = (R-40491, SRT, "Left Upper Segment")
Left Lower Pulmonary Vein Peak Systolic Velocity	(29450-4, LN, "Pulmonary Vein Systolic Peak Velocity")	(G-A1F8, SRT, "Topographical Modifier") = (R-4214B, SRT, "Left Lower Segment")
Left Lower Pulmonary Vein Diastolic Peak Velocity	(29451-2, LN, "Pulmonary Vein Diastolic Peak Velocity")	(G-A1F8, SRT, "Topographical Modifier") = (R-4214B, SRT, "Left Lower Segment")
Left Lower Pulmonary Vein Systolic to Diastolic Velocity Ratio	(29452-0, LN, "Pulmonary Vein Systolic to Diastolic Ratio")	(G-A1F8, SRT, "Topographical Modifier") = (R-4214B, SRT, "Left Lower Segment")

N.3.11 Left Atrium / Appendage

Name of ASE Concept	Base Measurement Concept Name	Concept or Acquisition Context Modifiers
Left Atrium Antero-posterior Systolic Dimension	(29469-4, LN, "Left Atrium Antero-posterior Systolic Dimension")	
Left Atrial Antero-posterior Systolic Dimension by M-Mode	(29469-4, LN, "Left Atrium Antero-posterior Systolic Dimension")	(G-0373, SRT, "Image Mode") = (G-0394, SRT, "M mode")
Left Atrial Antero-posterior Systolic Dimension by 2-D	(29469-4, LN, "Left Atrium Antero-posterior Systolic Dimension")	(G-0373, SRT, "Image Mode") = (G-03A2, SRT, "2D mode")
Left Atrium to Aortic Root Ratio	(17985-3, LN, "Left	

Name of ASE Concept	Base Measurement Concept Name	Concept or Acquisition Context Modifiers
	Atrium to Aortic Root Ratio")	
Left Atrial Appendage Peak Velocity	(29486-8, LN, "Left Atrial Appendage Peak Velocity")	
Left Atrium Systolic Area	(17977-0, LN, "Left Atrium Systolic Area")	
Left Atrium Systolic Volume	(G-0383, SRT, "Left Atrium Systolic Volume")	

N.3.12 Right Ventricle

Name of ASE Concept	Base Measurement Concept Name	Concept or Acquisition Context Modifiers
Right Ventricular Internal Diastolic Dimension by M-Mode	(20304-2, LN, "Right Ventricular Internal Diastolic Dimension")	(G-0373, SRT, "Image Mode") = (G-0394, SRT, "M mode")
Right Ventricular Internal Diastolic Dimension by 2-D	(20304-2, LN, "Right Ventricular Internal Diastolic Dimension")	(G-0373, SRT, "Image Mode") = (G-03A2, SRT, "2D mode")
Right Ventricular Outflow Tract Systolic Peak Velocity	(11726-7, LN, "Peak Velocity")	(G-C0E3, SRT, "Finding Site") = (T-32550, SRT, "Right Ventricular Outflow Tract")
Right Ventricular Outflow Tract Systolic Velocity Time Integral	(20354-7, LN, "Velocity Time Integral")	(G-C0E3, SRT, "Finding Site") = (T-32550, SRT, "Right Ventricular Outflow Tract")
Right Ventricular Outflow Systolic Diameter by 2-D	(G-038F, SRT, "Cardiovascular Orifice Diameter")	(G-C0E3, SRT, "Finding Site") = (T-32550, SRT, "Right Ventricular Outflow Tract") (G-0373, SRT, "Image Mode") = (G-03A2, SRT, "2D mode")
Right Ventricular Outflow Tract Systolic Peak Instantaneous Gradient	(20247-3, LN, "Peak Gradient")	(G-C0E3, SRT, "Finding Site") = (T-32550, SRT, "Right Ventricular Outflow Tract")
Right Ventricular Outflow Tract Systolic Mean Gradient	(20256-4, LN, "Mean Gradient")	(G-C0E3, SRT, "Finding Site") = (T-32550, SRT, "Right Ventricular Outflow Tract")
Right Ventricular Stroke Volume by Doppler Volume Outflow	(F-32120, SRT, "Stroke Volume")	(G-C036, SRT, "Measurement Method") = (125219, DCM, "Doppler Volume Flow") (G-C0E3, SRT, "Finding Site") = (T-32550, SRT, "Right Ventricular Outflow Tract")
Right Ventricular Outflow Tract Area	(G-038E, SRT, "Cardiovascular Orifice Area")	(G-C0E3, SRT, "Finding Site") = (T-32550, SRT, "Right Ventricular Outflow Tract")
Right Ventricular Outflow Tract Mean Velocity	(20352-1, LN, "Mean Velocity")	(G-C0E3, SRT, "Finding Site") = (T-32550, SRT, "Right Ventricular Outflow Tract")
Right Ventricle Anterior Wall	(18153-7, LN, "Right Ventricle Anterior	

Name of ASE Concept	Base Measurement Concept Name	Concept or Acquisition Context Modifiers
Diastolic Thickness	Wall Diastolic Thickness")	
Right Ventricular Anterior Wall Systolic Thickness	(18157-8, LN, "Right Ventricular Anterior Wall Systolic Thickness")	
Right Ventricular Peak Systolic Pressure	(G-0380, SRT, "Right Ventricular Peak Systolic Pressure")	

N.3.13 Pulmonic Valve / Pulmonic Artery

Name of ASE Concept	Base Measurement Concept Name	Concept or Acquisition Context Modifiers
Main Pulmonary Artery Diameter	(18020-8, LN, "Main Pulmonary Artery Diameter")	
Main Pulmonary Artery Velocity	(G-038A, SRT, "Main Pulmonary Artery Velocity")	
Right Pulmonary Artery Diameter	(18021-6, LN, "Right Pulmonary Artery Diameter")	
Left Pulmonary Artery Diameter	(18019-0, LN, "Left Pulmonary Artery Diameter")	
Pulmonic Valve Systolic Peak Instantaneous Gradient	(20247-3, LN, "Peak Gradient")	(G-C048, SRT, "Direction of Flow") = (R-42047, SRT, "Antegrade Flow")
Pulmonic Valve Systolic Mean Gradient	(20256-4, LN, "Mean Gradient")	(G-C048, SRT, "Direction of Flow") = (R-42047, SRT, "Antegrade Flow")
Pulmonic Valve Systolic Peak Velocity	(20354-7, LN, 11726-7, LN, "Peak Velocity")	(G-C048, SRT, "Direction of Flow") = (R-42047, SRT, "Antegrade Flow")
Pulmonic Valve Systolic Velocity Time Integral	(20354-7, LN, "Velocity Time Integral")	(G-C048, SRT, "Direction of Flow") = (R-42047, SRT, "Antegrade Flow")
Pulmonic Valve Area by Continuity	(18096-8, LN, "Pulmonic valve Area by Continuity")	
Pulmonic Valve Acceleration Time	(20168-1, LN, "Acceleration Time")	(G-C048, SRT, "Direction of Flow") = (R-42E61, SRT, "Regurgitant Flow")
Pulmonic Valve Regurgitant End Diastolic Velocity	(11653-3, LN, "End Diastolic Velocity")	(G-C048, SRT, "Direction of Flow") = (R-42E61, SRT, "Regurgitant Flow")
Pulmonic Valve Regurgitant Diastolic Peak Velocity	(11726-7, LN, "Peak Velocity")	(G-C048, SRT, "Direction of Flow") = (R-42E61, SRT, "Regurgitant Flow")

Note: Pulmonic Valve measurements appear in TID 5202 which specifies the Finding Site to be Pulmonic Valve with the concept modifier (G-C0E3, SRT, "Finding Site") = (T-35100, SRT, "Pulmonic Valve"). Therefore, this Finding Site concept modifier does not appear in the right column.

N.3.14 Tricuspid Valve

Name of ASE Concept	Base Measurement Concept Name	Concept or Acquisition Context Modifiers
Tricuspid Valve Mean Diastolic Velocity	(20352-1, LN, "Mean Velocity")	(G-C048, SRT, "Direction of Flow") = (R-42047, SRT, "Antegrade Flow")
Tricuspid Valve E Wave Peak Velocity	(18031-5, LN, "Tricuspid Valve E Wave Peak Velocity")	
Tricuspid Valve A Wave Peak Velocity	(18030-7, LN, "Tricuspid Valve A Wave Peak Velocity")	
Tricuspid Valve Diastolic Velocity Time Integral	(20354-7, LN, "Velocity Time Integral")	(G-C048, SRT, "Direction of Flow") = (R-42047, SRT, "Antegrade Flow")
Tricuspid Valve Peak Diastolic Gradient	(20247-3, LN, Peak Gradient")	(G-C048, SRT, "Direction of Flow") = (R-42047, SRT, "Antegrade Flow")
Tricuspid Valve Mean Diastolic Gradient	(20256-4, LN, Mean Gradient")	(G-C048, SRT, "Direction of Flow") = (R-42047, SRT, "Antegrade Flow")
Tricuspid Valve Annulus Diastolic Diameter	(G-038F, SRT, Cardiovascular Orifice Diameter")	(G-C0E3, SRT, "Finding Site") = (T-35111, SRT, "Tricuspid Annulus") (G-C048, SRT, "Direction of Flow") = (R-42047, SRT, "Antegrade Flow")
Tricuspid Valve Regurgitant Peak Velocity	(11726-7, LN, "Peak Velocity")	(G-C048, SRT, "Direction of Flow") = (R-42E61, SRT, "Regurgitant Flow")
Tricuspid Regurgitation Peak Pressure Gradient	(20247-3, LN, "Peak Gradient")	(G-C048, SRT, "Direction of Flow") = (R-42E61, SRT, "Regurgitant Flow")
Tricuspid Regurgitation Velocity Time Integral	(20354-7, LN, "Velocity Time Integral")	(G-C048, SRT, "Direction of Flow") = (R-42E61, SRT, "Regurgitant Flow")
Tricuspid Valve Deceleration Time	(20217-6, LN, "Deceleration Time")	(G-C048, SRT, "Direction of Flow") = (R-42047, SRT, "Antegrade Flow")

Note: TRICUSPID Valve measurements appear in TID 5202 which specifies the Finding Site to be Tricuspid Valve with the concept modifier (G-C0E3, SRT, "Finding Site") = (T-35100, SRT, "Tricuspid Valve"). Therefore, the Finding Site modifier does not appear in the right column.

N.3.15 Right Atrium / Inferior Vena Cava

Name of ASE Concept	Base Measurement Concept Name	Concept or Acquisition Context Modifiers
Right Atrium Systolic Pressure	(18070-3, LN, "Right Atrium Systolic Pressure")	
Right Atrium Systolic Area	(17988-7, LN, "Right	

Name of ASE Concept	Base Measurement Concept Name	Concept or Acquisition Context Modifiers
	Atrium Systolic Area")	
Inferior Vena Cava Diameter	(18006-7, LN, "Inferior Vena Cava Diameter")	
Inferior Vena Cava Diameter at Inspiration	(18006-7, LN, "Inferior Vena Cava Diameter")	(R-40899, SRT, "Respiratory Cycle Point") = (F-20010, SRT, "During Inspiration")
Inferior Vena Cava Diameter at Expiration	(18006-7, LN, "Inferior Vena Cava Diameter")	(R-40899, SRT, "Respiratory Cycle Point") = (F-20020, SRT, "During Expiration")
Inferior Vena Cava % Collapse	(18050-5, LN, "Inferior Vena Cava % Collapse")	
Hepatic Vein Systolic Peak Velocity	(29471-0, LN, "Hepatic Vein Systolic Peak Velocity")	
Hepatic Vein Diastolic Peak Velocity	(29472-8, LN, "Hepatic Vein Diastolic Peak Velocity")	
Hepatic Vein Systolic to Diastolic Ratio	(29473-6, LN, "Hepatic Vein Systolic to Diastolic Ratio")	
Hepatic Vein Atrial Contraction Reversal Peak Velocity	(29474-4, LN, "Hepatic Vein Atrial Contraction Reversal Peak Velocity")	
Hepatic Vein Peak Systolic Velocity at Inspiration	(29471-0, LN, "Hepatic Vein Systolic Peak Velocity")	(R-40899, SRT, "Respiratory Cycle Point") = (F-20010, SRT, "During Inspiration")
Hepatic Vein Peak Diastolic Velocity at Inspiration	(29472-8, LN, "Hepatic Vein Diastolic Peak Velocity")	(R-40899, SRT, "Respiratory Cycle Point") = (F-20010, SRT, "During Inspiration")
Hepatic Vein Systolic to Diastolic Ratio at Inspiration	(29473-6, LN, "Hepatic Vein Systolic to Diastolic Ratio")	(R-40899, SRT, "Respiratory Cycle Point") = (F-20010, SRT, "During Inspiration")
Hepatic Vein Peak Atrial Contraction Reversal Velocity at Inspiration	(29474-4, LN, "Hepatic Vein Atrial Contraction Reversal Peak Velocity")	(R-40899, SRT, "Respiratory Cycle Point") = (F-20010, SRT, "During Inspiration")
Hepatic Vein Peak Systolic Velocity at Expiration	(29471-0, LN, "Hepatic Vein Systolic Peak Velocity")	(R-40899, SRT, "Respiratory Cycle Point") = (F-20020, SRT, "During Expiration")
Hepatic Vein Peak Diastolic	(29472-8, LN,	(R-40899, SRT, "Respiratory Cycle Point") = (F-

Name of ASE Concept	Base Measurement Concept Name	Concept or Acquisition Context Modifiers
Velocity at Expiration	"Hepatic Vein Diastolic Peak Velocity")	20020, SRT, "During Expiration")
Hepatic Vein Systolic to Diastolic Ratio at Expiration	(29473-6, LN, "Hepatic Vein Systolic to Diastolic Ratio")	(R-40899, SRT, "Respiratory Cycle Point") = (F-20020, SRT, "During Expiration")
Hepatic Vein Peak Atrial Contraction Reversal Velocity at Expiration	(29474-4, LN, "Hepatic Vein Atrial Contraction Reversal Peak Velocity")	(R-40899, SRT, "Respiratory Cycle Point") = (F-20020, SRT, "During Expiration")

N.3.16 Congenital / Pediatric

Name of ASE Concept	Base Measurement Concept Name	Concept or Acquisition Context Modifiers
Thoracic Aorta Coarctation Systolic Peak Velocity	(29460-3, LN, "Thoracic Aorta Coarctation Systolic Peak Velocity")	
Thoracic Aorta Coarctation Systolic Peak Instantaneous Gradient	(20256-4, LN, "Mean Gradient")	(G-C0E3, SRT, "Finding Site") = (D4-32030, SRT, "Thoracic Aortic Coarctation")
Thoracic Aorta Coarctation Systolic Mean Gradient	(17995-2, LN, "Thoracic Aorta Coarctation Systolic Peak Instantaneous Gradient")	
Ventricular Septal Defect Diameter	(G-038F, SRT, "Cardiovascular Orifice Diameter")	(G-C0E3, SRT, "Finding Site") = (D4-31150, SRT, "Ventricular Septal Defect")
Ventricular Septal Defect Systolic Peak Instantaneous Gradient	(20247-3, LN, "Peak Gradient")	(G-C0E3, SRT, "Finding Site") = (D4-31150, SRT, "Ventricular Septal Defect")
Ventricular Septal Defect Systolic Mean Gradient	(20256-4, LN, "Mean Gradient")	(G-C0E3, SRT, "Finding Site") = (D4-31150, SRT, "Ventricular Septal Defect")
Ventricular Septum Defect Systolic Peak Velocity	(11726-7, LN, "Peak Velocity")	(G-C0E3, SRT, "Finding Site") = (D4-31150, SRT, "Ventricular Septal Defect")
Atrial Septal Defect Diameter	(G-038F, SRT, "Cardiovascular Orifice Diameter")	(G-C0E3, SRT, "Finding Site") = (D4-31220, SRT, "Atrial Septal Defect")
Pulmonary-to-Systemic Shunt Flow Ratio	(29462-9, LN, "Pulmonary-to-Systemic Shunt Flow Ratio")	
Pulmonary-to-Systemic Shunt Flow Ratio by Doppler Volume Flow	(29462-9, LN, "Pulmonary-to-Systemic Shunt Flow Ratio")	(G-C036, SRT, "Measurement Method") = (125219, DCM, "Doppler Volume Flow")

N.4 ENCODING EXAMPLES

N.4.1 Example 1: Patient Characteristics

Nest	Code Meaning of Concept Name	Code Meaning or Example Value	TID
	Adult Echocardiography Procedure Report		5200
>
>	Patient Characteristics		5201
>>	Subject Age	39 years	5201
>>	Subject Sex	M	5201
>>	Patient Height	167 cm	300
>>	Patient Weight	72.6 kg	300
>>	Body Surface Area	1.82 m2	300
>>>	Body Surface Area Formula	Code: 122240	5201

N.4.2 Example 2: LV Dimensions and Fractional Shortening

Nest	Code Meaning of Concept Name	Code Meaning or Example Value	TID
	Adult Echocardiography Procedure Report		5200
>
>	Findings		5202
>>	Finding Site	Left Ventricle	5202
>>	Measurement Group		5202
>>	Acquisition Protocol	2D Dimensions	5202
>>>	Heart Rate	45 bpm	300
>>>	Left Ventricle Internal End Diastolic Dimension	5.09 cm	300
>>>>	Image Mode	2d	5203
>>>	Left Ventricle Internal End Diastolic Dimension	5.34 cm	300
>>>>	Image Mode	2d	5203
>>>	Left Ventricle Internal End Diastolic Dimension	5.22 cm	300
>>>>	Image Mode	2d	5203
>>>>	Derivation	Mean	300
>>>	Left Ventricle Internal Systolic Dimension	5.09 cm	300
>>>>	Image Mode	2d	5203
>>>	Left Ventricle Internal Systolic Dimension	5.34 cm	300
>>>>	Image Mode	2d	5203
>>>	Left Ventricle Internal Systolic Dimension	5.22 cm	300
>>>>	Image Mode	2d	5203
>>>>	Derivation	Mean	300
>>>	Interventricular Septum Diastolic Thickness	1.20 cm	300
>>>	Interventricular Septum Diastolic Thickness	1.20 cm	300
>>>>	Derivation	Mean	300
>>>	Left Ventricle Internal Systolic Dimension	5.09 cm	300

Nest	Code Meaning of Concept Name	Code Meaning or Example Value	TID
>>>	Left Ventricle Internal Systolic Dimension	5.30 cm	300
>>>>	Derivation	Mean	300
>>>	Left Ventricular Fractional Shortening	54.8%	300
>>>

N.4.3 Example 3: Left Atrium / Aortic Root Ratio

Nest	Code Meaning of Concept Name	Code Meaning or Example Value	TID
	Adult Echocardiography Procedure Report		5200
>
>	Findings		5202
>>	Finding Site	Left Atrium	5202
>>	Measurement Group		5202
>>>	Acquisition Protocol	2D Dimensions	5202
>>>	Left Atrium Antero-posterior Systolic Dimension	3.45 cm	5202
>>>	Left Atrium Antero-posterior Systolic Dimension	3.45 cm	5202
>>>>	Derivation	Mean	5202
>>>	Left Atrium to Aortic Root Ratio	1.35	5202
>	Findings		5202
>>	Finding Site	Aorta	5202
>>	Measurement Group		5202
>>	Acquisition Protocol	2D Dimensions	5202
>>>	Aortic Root Diameter	2.55 cm	5202
>>>

N.4.4 Example 4: Pressures

Nest	Code Meaning of Concept Name	Code Meaning or Example Value	TID
	Adult Echocardiography Procedure Report		5200
>
>	Findings		5202
>>	Finding Site	Right Atrium	5202
>>	Measurement Group		5202
>>>	Acquisition Protocol	Pressure Predictions	5202
>>>	Right Atrium Systolic Pressure	10 mmHg	5202
>>>>	Derivation	User estimate	5202
>>	Finding Site	Right Ventricle	5202
>>	Measurement Group		5202
>>>	Acquisition Protocol	Pressure Predictions	5202
>>>	Right Ventricular Peak Systolic Pressure	49.3 mmHg	5202

N.4.5 Example 5: Cardiac Output

Nest	Code Meaning of Concept Name	Code Meaning or Example Value	TID
	Adult Echocardiography Procedure Report		5200
>
>	Findings		5202
>>	Finding Site	Left Ventricle	5202
>>	Measurement Group		5202
>>	Image Mode	2D	5202
>>>	Heart Rate	89 bpm	5202
>>>	Left Ventricular End Diastolic Volume	38.914 ml	5202
>>>>	Measurement Method	Teichholz	5202
>>>	Left Ventricular End Systolic Volume	12.304 ml	5202
>>>>	Measurement Method	Teichholz	5202
...
>>>	Stroke Volume	26.6 ml	5202
>>>>	Anatomic Site	Left Ventricle	5202
>>>	Stroke Index	13.49 ml/m ²	5202
>>>>	Anatomic Site	Left Ventricle	5202
>>>	Cardiac Output	2.37 l/min	5202
>>>>	Anatomic Site	Left Ventricle	5202
>>>	Cardiac Index	1.20 l/min/m ²	5202
>>>>	Anatomic Site	Left Ventricle	5202
>>>>	Index	BSA	5202
>>>	Left Ventricular Ejection Fraction	68.4 %	5202
>>>

N.4.6 Example 6: Wall Scoring

Nest	Code Meaning of Concept Name	Code Meaning or Example Value	TID
	Adult Echocardiography Procedure Report		5200
>
>	Findings		5204
>>	Procedure Reported	Echocardiography for Determining Ventricular Contraction	5204
>>	Stage	Pre-stress image acquisition	5204
>>	LV Wall Motion Score Index	1.0	5204
>>>	Assessment Scale	5 Point Segment Finding Scale	5204
>>	Findings		5204

Nest	Code Meaning of Concept Name	Code Meaning or Example Value	TID
>>>	Wall Segment	Basal anterior	5204
>>>>	Wall motion finding	Normal	5204
>>>	Wall Segment	Basal anteroseptal	5204
>>>>	Wall motion finding	Normal	5204
>>>	Wall Segment	Basal inferoseptal	5204
>>>>	Wall motion finding	Akinetic	5204
...	... remaining segments ...		5204
>	Wall Motion Analysis		5204
>>	Stage	Peak-stress image acquisition	5204
>>	LV Wall Motion Score Index	1.23	5204
>>>	Assessment Scale	5 Point Segment Finding Scale	5204
>>	Findings		5204
>>>	Wall Segment	Basal anterior	5204
>>>>	Score	Hypokinesis	5204
>>>	Wall Segment	Basal anteroseptal	5204
>>>>	Score	Akinetic	5204
>>>>	Morphology	Scar / Thinning	5204
>>>	Wall Segment	Basal inferoseptal	5204
>>>>	Score	Normal	5204
...	... remaining segments ...		5204

N.5 IVUS REPORT

The IVUS Report contains one or more vessel containers, each corresponding to the vessel (arterial location) being imaged. Each vessel is associated with one or more IVUS image pullbacks (Ultrasound Multi-frame Images), acquired during a phase of a catheterization procedure. Each vessel may contain one or more sub-containers, each associated with a single lesion. Each lesion container includes a set of IVUS measurements and qualitative assessments. The resulting hierarchical structure is depicted in Figure N.5-1.

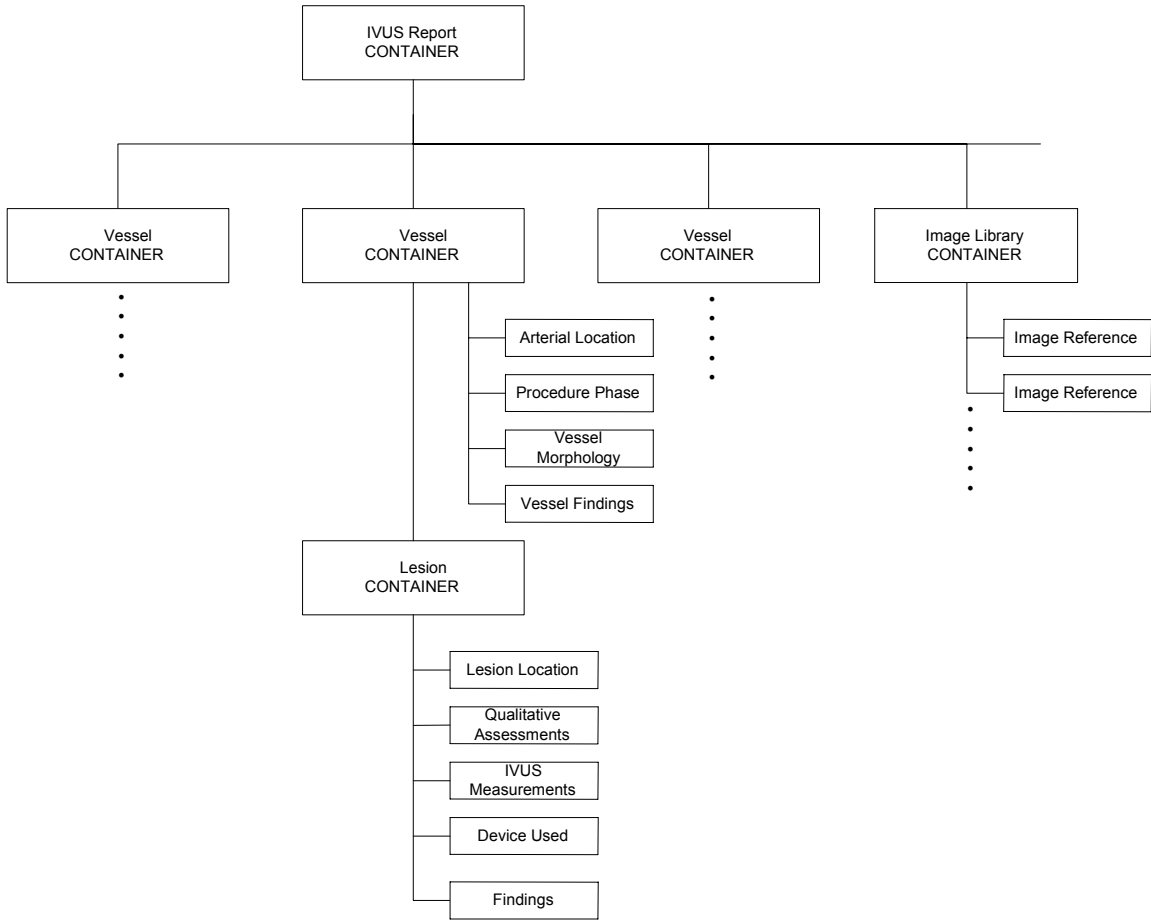

Figure N.5-1: IVUS Report Structure

ANNEX O Registration (Informative)

O.1 SPATIAL REGISTRATION AND SPATIAL FIDUCIALS SOP CLASSES

These SOP Classes allow describing spatial relationships between sets of referenced images. Each instance can describe any number of registrations created during the course of the work in the current procedural context, as shown in Figure O.1-1. It may also reference prior registration instances that contribute to the creation of the registrations in the instance.

The Spatial Registration instance specifies a transformation from its own local Reference Coordinate System to that of the referenced image sets or atlas. The Reference Coordinate System is a Frame of Reference described by the DICOM Frame of Reference Module. The chosen Frame of Reference of the Registration SOP Instance may be the same as the Referenced SOP Instances. In this case, the Frame of Reference UID (0020,0052) is the same, as shown by Registration A in the figure. The registration information is a sequence of spatial transformation matrices. Images may have no DICOM Frame of Reference in which case the registration is to that single image. A special case is an atlas. An atlas has a Frame of Reference UID defined by DICOM.

The Spatial Fiducials SOP Class stores spatial fiducials as implicit registration information. It is otherwise similar to Spatial Registration.

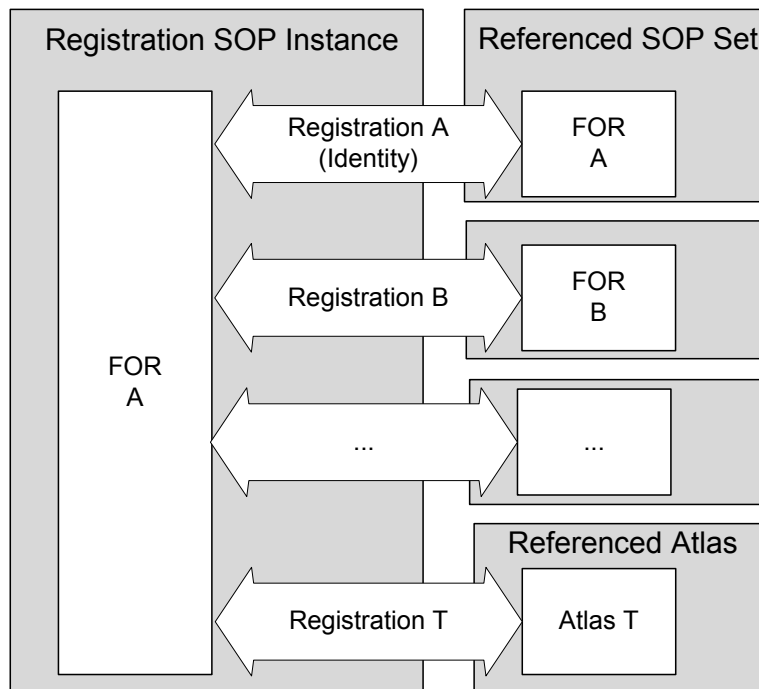

Figure O.1-1 Registration of Image SOP Instances

O.2 FUNCTIONAL USE CASES

Multi-Modality Fusion: A workstation or modality performs a registration of images from independent acquisition modalities—PET, CT, MR, NM, and US—from multiple series. The workstation stores the registration data for subsequent visualization and image processing. Such visualization may include side-by-side synchronized display, or overlay (fusion) of one modality image on the display of another. The processes for such fusion are beyond the scope of the Standard. The workstation may also create and store a ready-for-display fused image, which references both the source image instances and the registration instance that describes their alignment.

Prior Study Fusion: Using post processing or a manual process, a workstation creates a spatial object registration of the current Study's Series from prior Studies for comparative evaluation.

Atlas Mapping: A workstation or a CAD device specifies fiducials of anatomical features in the brain such as the anterior commissure, posterior commissure, and points that define the hemispheric fissure plane. The system stores this information in the Spatial Fiducials SOP Instance. Subsequent retrieval of the fiducials enables a device or workstation to register the patient images to a functional or anatomical atlas, presenting the atlas information as overlays.

CAD: A CAD device creates fiducials of features during the course of the analysis. It stores the locations of the fiducials for future analysis in another imaging procedure. In the subsequent CAD procedure, the CAD device performs a new analysis on the new data set. As before, it creates comparable fiducials, which it may store in a Spatial Fiducials SOP Instance. The CAD device then performs additional analysis by registering the images of the current exam to the prior exam. It does so by correlating the fiducials of the prior and current exam. The CAD device may store the registration in Registration SOP Instance.

Adaptive Radiotherapy: A CT Scan is taken to account for variations in patient position prior to radiation therapy. A workstation performs the registration of the most recent image data to the prior data, corrects the plan, and stores the registration and revised plan.

Image Stitching: An acquisition device captures multiple images, e.g. DX images down a limb. A user identifies fiducials on each of the images. The system stores these in one or more Fiducial SOP Instances. Then the images are "stitched" together algorithmically by means that utilize the Fiducial SOP Instances as input. The result is a single image and optionally a Registration SOP Instance that indicates how the original images can be transformed to a location on the final image.

O.3 SYSTEM INTERACTION

Figure O.3-1 shows the system interaction of storage operations for a registration of MR and CT using the Spatial Registration SOP Class. The Image Plane Module attributes of the CT Series specify the spatial mapping to the RCS of its DICOM Frame of Reference.

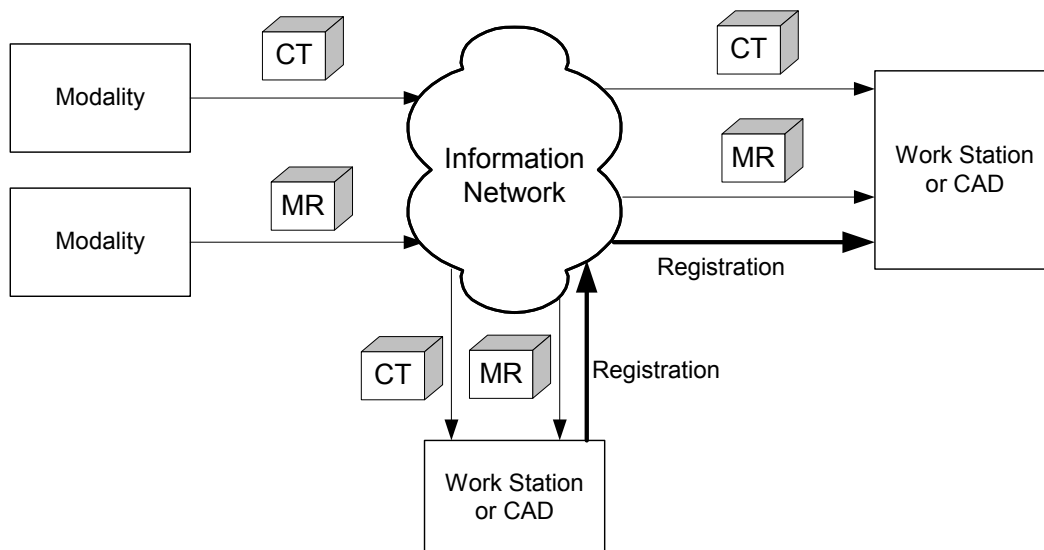

Figure O.3-1 Stored Registration System Interaction

The receiver of the Registration SOP Instance may use the spatial transformation to display or process the referenced image data in a common coordinate system. This enables interactive display in 3D during interpretation or planning, tissue classification, quantification, or Computer Aided Detection. Figure O.3-2 shows a typical interaction scenario.

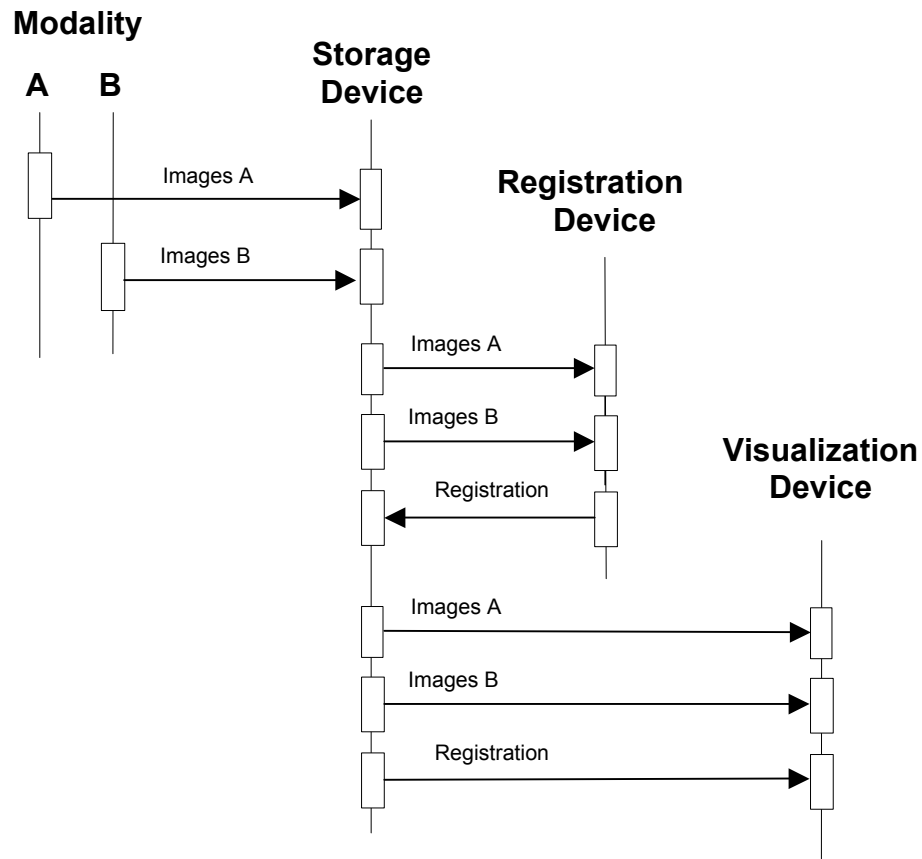

Figure O.3-2 Interaction Scenario

In the case of coupled acquisition modalities, one acquisition device may know the spatial relationship of its image data relative to the other. The acquisition device may use the Registration SOP Class to specify the relationship of modality B images to modality A images as shown below in Figure O.3-3. In the most direct case, the data of both modalities are in the same DICOM Frame of Reference for each SOP Class Instance.

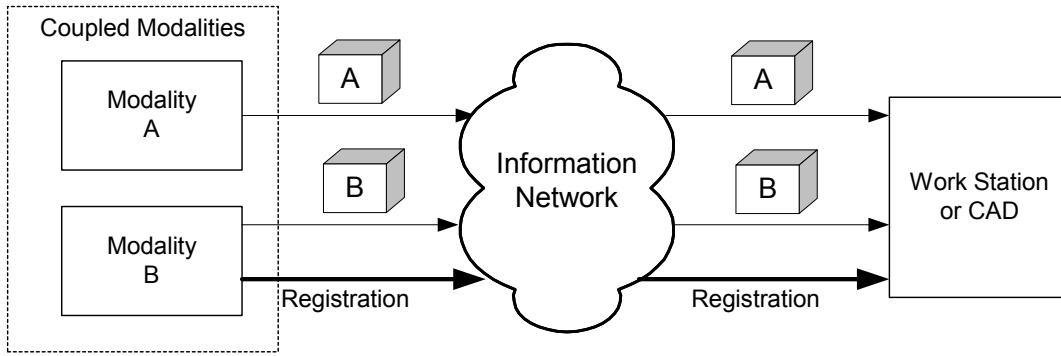

Figure O.3-3 Coupled Modalities

A Spatial Registration instance consists of one or more instances of a Registration. Each Registration specifies a transformation from the RCS of the Referenced Image Set, to the RCS of this Spatial Registration instance (see PS 3.3) identified by the Frame of Reference UID (0020,0052).

O.4 OVERVIEW OF ENCODING

Figure O.4-1 shows an information model of a Spatial Registration to illustrate the relationship of the attributes to the objects of the model. The DICOM attributes that describe each object are adjacent to the object.

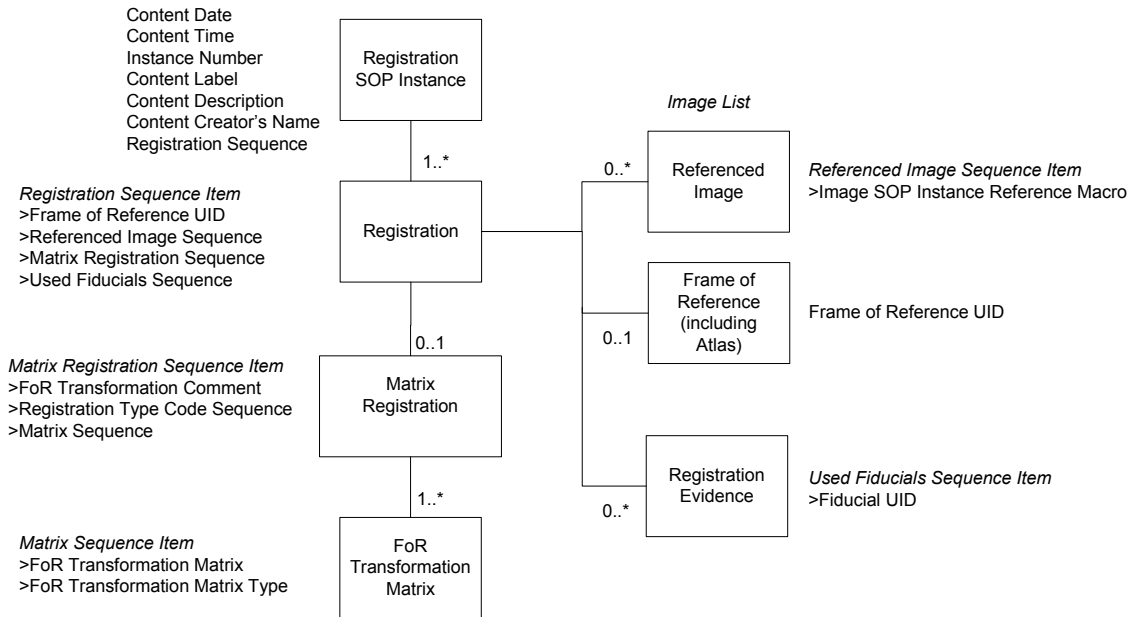

Figure O.4-1 Spatial Registration Encoding

Figure O.4-2 shows a Spatial Fiducials information model to illustrate the relationship of the attributes to the objects of the model. The DICOM attributes that describe each object are adjacent to the object.

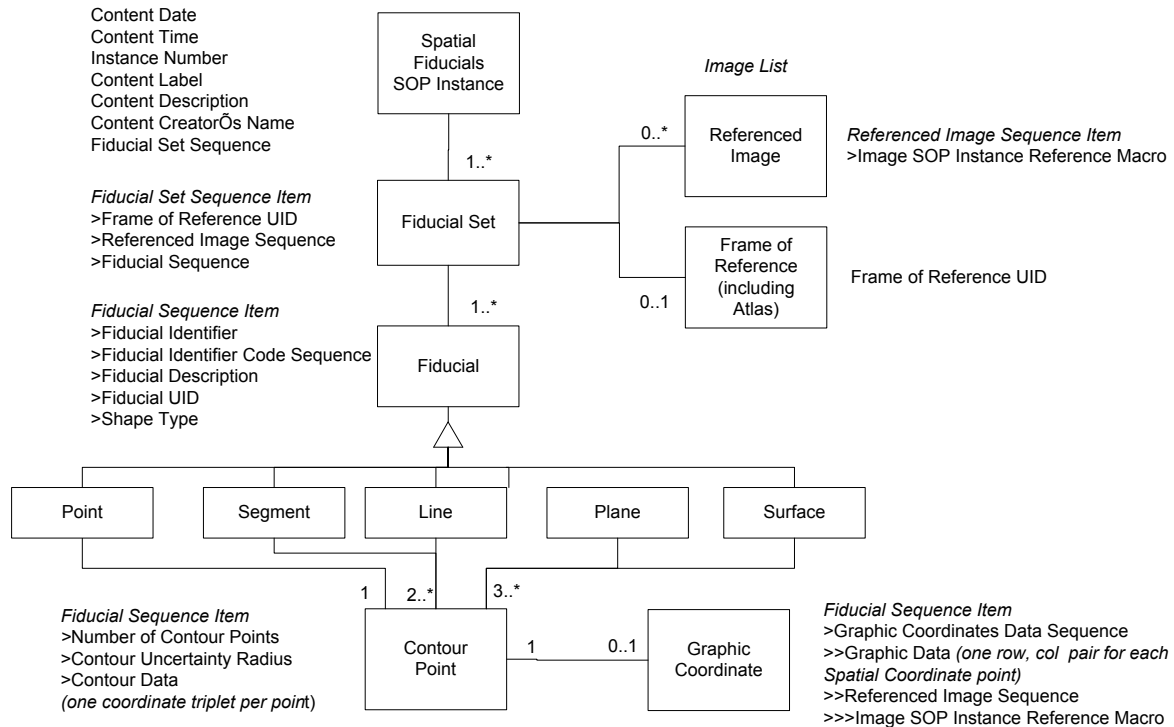

Figure O.4-2 Spatial Fiducials Encoding

O.5 MATRIX REGISTRATION

A 4x4 homogeneous transformation matrix describes spatial rotation, translation, scale changes and affine transformations that register referenced images to the Registration IE's RCS. These steps are expressible in a single matrix, or as a sequence of multiple independent rotations, translations, or scaling, each expressed in a separate matrix. Normally, registrations are rigid body, involving only rotation and translation. Changes in scale or affine transformations occur in atlas registration or to correct minor mismatches.

O.6 SPATIAL FIDUCIALS

Fiducials are image-derived reference markers of location, orientation, or scale. These may be labeled points or collections of points in a data volume that specify a shape. Most commonly, fiducials are individual points.

Correlated fiducials of separate image sets may serve as inputs to a registration process to estimate the spatial registration between similar objects in the images. The correlation may, or may not, be expressed in the fiducial identifiers. A fiducial identifier may be an arbitrary number or text string to uniquely identify each fiducial from others in the set. In this case, fiducial correlation relies on operator recognition and control.

Alternatively, coded concepts may identify the acquired fiducials so that systems can automatically correlate them. Examples of such coded concepts are points of a stereotactic frame, prosthesis points, or well-resolved anatomical landmarks such as bicuspid tips. Such codes could be established and used locally by a department, over a wider area by a society or research study coordinator, or from a standardized set.

The table below shows each case of identifier encoding. A and B represent two independent registrations: one to some image set A, and the other to image set B.

	Fiducial Identifier (0070,0310)	Fiducial Identifier Code Sequence
--	---------------------------------	-----------------------------------

		(0070,0311)
Uncorrelated	A: 1, 2, 3 B: 4, 5, 6	A: (1, 99_A_CSD, <i>label A1</i>) ... B: (4, 99_B_CSD, <i>label B4</i>) ...
Correlated	A: 1, 2, 3 ... B: 1, 2, 3 ...	A: (1, 99_MY_CSD, <i>label 1</i>) ... B: (1, 99_MY_CSD, <i>label 1</i>)...

Fiducials may be a point or some other shape. For example, three or more arbitrarily chosen points might designate the inter-hemispheric plane for the registration of head images. Many arbitrarily chosen points may identify a surface such as the inside of the skull.

A fiducial also has a Fiducial UID. This UID identifies the creation of the fiducial and allows other SOP Instances to reference the fiducial assignment.

ANNEX P
Transforms and Mappings
(Informative)

The Homogenous Transform Matrix is of the following form.

$$\begin{bmatrix} M_{11} & M_{12} & M_{13} & T_x \\ M_{21} & M_{22} & M_{23} & T_y \\ M_{31} & M_{32} & M_{33} & T_z \\ 0 & 0 & 0 & 1 \end{bmatrix}$$

This matrix requires the bottom row to be [0 0 0 1].

The matrix can be of type: RIGID, RIGID_SCALE and AFFINE. These different types represent different conditions on the allowable values for the matrix elements.

RIGID:

This transform requires the matrix obey orthonormal transformation properties:

$$\sum_{i=1}^3 M_{ij} M_{ik} = \delta_{jk} \text{ for all combinations of } j = 1,2,3 \text{ and } k = 1,2,3 \text{ where } \delta = 1 \text{ for } i = j \text{ and zero otherwise.}$$

The expansion into non-matrix equations is:

$$M_{11} M_{11} + M_{21} M_{21} + M_{31} M_{31} = 1 \text{ where } j = 1, k = 1$$

$$M_{11} M_{12} + M_{21} M_{22} + M_{31} M_{32} = 0 \text{ where } j = 1, k = 2$$

$$M_{11} M_{13} + M_{21} M_{23} + M_{31} M_{33} = 0 \text{ where } j = 1, k = 3$$

$$M_{12} M_{11} + M_{22} M_{21} + M_{32} M_{31} = 0 \text{ where } j = 2, k = 1$$

$$M_{12} M_{12} + M_{22} M_{22} + M_{32} M_{32} = 1 \text{ where } j = 2, k = 2$$

$$M_{12} M_{13} + M_{22} M_{23} + M_{32} M_{33} = 0 \text{ where } j = 2, k = 3$$

$$M_{13} M_{11} + M_{23} M_{21} + M_{33} M_{31} = 0 \text{ where } j = 3, k = 1$$

$$M_{13} M_{12} + M_{23} M_{22} + M_{33} M_{32} = 0 \text{ where } j = 3, k = 2$$

$$M_{13} M_{13} + M_{23} M_{23} + M_{33} M_{33} = 1 \text{ where } j = 3, k = 3$$

The Frame of Reference Transformation Matrix ${}^A M_B$ describes how to transform a point $({}^B x, {}^B y, {}^B z)$ with respect to RCS_B into $({}^A x, {}^A y, {}^A z)$ with respect to RCS_A .

$$\begin{bmatrix} {}^A X \\ {}^A Y \\ {}^A Z \\ 1 \end{bmatrix} = \begin{bmatrix} M_{11} & M_{12} & M_{13} & T_1 \\ M_{21} & M_{22} & M_{23} & T_2 \\ M_{31} & M_{32} & M_{33} & T_3 \\ 0 & 0 & 0 & 1 \end{bmatrix} \begin{bmatrix} {}^B X \\ {}^B Y \\ {}^B Z \\ 1 \end{bmatrix}$$

The matrix above consists of two parts: a rotation and translation as shown below;

$$\text{Rotation: } \begin{bmatrix} M_{11} & M_{12} & M_{13} & 0 \\ M_{21} & M_{22} & M_{23} & 0 \\ M_{31} & M_{32} & M_{33} & 0 \\ 0 & 0 & 0 & 1 \end{bmatrix} \quad \text{Translation: } \begin{bmatrix} 1 & 0 & 0 & T_1 \\ 0 & 1 & 0 & T_2 \\ 0 & 0 & 1 & T_3 \\ 0 & 0 & 0 & 1 \end{bmatrix}$$

The first column $[M_{11}, M_{21}, M_{31}]$ are the direction cosines (projection) of the X-axis of RCS_B with respect to RCS_A . The second column $[M_{12}, M_{22}, M_{32}]$ are the direction cosines (projection) of the Y-axis of RCS_B with respect to RCS_A . The third column $[M_{13}, M_{23}, M_{33}]$ are the direction cosines (projection) of the Z-axis of RCS_B with respect to RCS_A . The fourth column $[T_1, T_2, T_3]$ is the origin of RCS_B with respect to RCS_A .

There are three degrees of freedom representing rotation, and three degrees of freedom representing translation, giving a total of six degrees of freedom.

RIGID_SCALE

The following constraint applies:

$$\sum_{i=1}^3 M_{ij} M_{ik} = \delta_{jk} S_j^2 \quad \text{for all combinations of } j = 1, 2, 3 \text{ and } k = 1, 2, 3 \text{ where } \delta = 1 \text{ for } i=j \text{ and zero otherwise.}$$

The expansion into non-matrix equations is:

$$M_{11} M_{11} + M_{21} M_{21} + M_{31} M_{31} = S_1^2 \quad \text{where } j = 1, k = 1$$

$$M_{11} M_{12} + M_{21} M_{22} + M_{31} M_{32} = 0 \quad \text{where } j = 1, k = 2$$

$$M_{11} M_{13} + M_{21} M_{23} + M_{31} M_{33} = 0 \quad \text{where } j = 1, k = 3$$

$$M_{12} M_{11} + M_{22} M_{21} + M_{32} M_{31} = 0 \quad \text{where } j = 2, k = 1$$

$$M_{12} M_{12} + M_{22} M_{22} + M_{32} M_{32} = S_2^2 \quad \text{where } j = 2, k = 2$$

$$M_{12} M_{13} + M_{22} M_{23} + M_{32} M_{33} = 0 \quad \text{where } j = 2, k = 3$$

$$M_{13} M_{11} + M_{23} M_{21} + M_{33} M_{31} = 0 \quad \text{where } j = 3, k = 1$$

$$M_{13} M_{12} + M_{23} M_{22} + M_{33} M_{32} = 0 \quad \text{where } j = 3, k = 2$$

$$M_{13} M_{13} + M_{23} M_{23} + M_{33} M_{33} = S_3^2 \quad \text{where } j = 3, k = 3$$

The above equations show a simple way of extracting the spatial scaling parameters S_j from a given matrix. The units of S_j^2 is the RCS unit dimension of one millimeter.

This type can be considered a simple extension of the type RIGID. The RIGID_SCALE is easily created by pre-multiplying a RIGID matrix by a diagonal scaling matrix as follows:

$$M_{RBWS} = \begin{bmatrix} S_1 & 0 & 0 & 0 \\ 0 & S_2 & 0 & 0 \\ 0 & 0 & S_3 & 0 \\ 0 & 0 & 0 & 1 \end{bmatrix} * M_{RB}$$

where M_{RBWS} is a matrix of type RIGID_SCALE and M_{RB} is a matrix of type RIGID.

AFFINE:

No constraints apply to this matrix, so it contains twelve degrees of freedom. This type of Frame of Reference Transformation Matrix allows shearing in addition to rotation, translation and scaling.

For a RIGID type of Frame of Reference Transformation Matrix, the inverse is easily computed using the following formula (inverse of an orthonormal matrix):

$$annex. ({}^A\mathbf{M}_B)^{-1} = \begin{bmatrix} M_{11} & M_{12} & M_{13} & T_x \\ M_{21} & M_{22} & M_{23} & T_y \\ M_{31} & M_{32} & M_{33} & T_z \\ 0 & 0 & 0 & 1 \end{bmatrix}^{-1} = \begin{bmatrix} M_{11} & M_{21} & M_{31} & M_{11}T_x + M_{21}T_y + M_{31}T_z \\ M_{12} & M_{22} & M_{32} & M_{12}T_x + M_{22}T_y + M_{32}T_z \\ M_{13} & M_{23} & M_{33} & M_{13}T_x + M_{23}T_y + M_{33}T_z \\ 0 & 0 & 0 & 1 \end{bmatrix}$$

For RIGID_SCALE and AFFINE types of Registration Matrices, the inverse cannot be calculated using the above equation, and must be calculated using a conventional matrix inverse operation.

ANNEX Q Breast Imaging Report (Informative)

Q.1 BREAST IMAGING REPORT CONTENT TREE STRUCTURE

The templates for the Breast Imaging Report are defined in PS 3.16. Relationships defined in the Breast Imaging Report templates are by-value. This template structure may be conveyed using the Enhanced SR SOP Class or the Basic Text SR SOP Class.

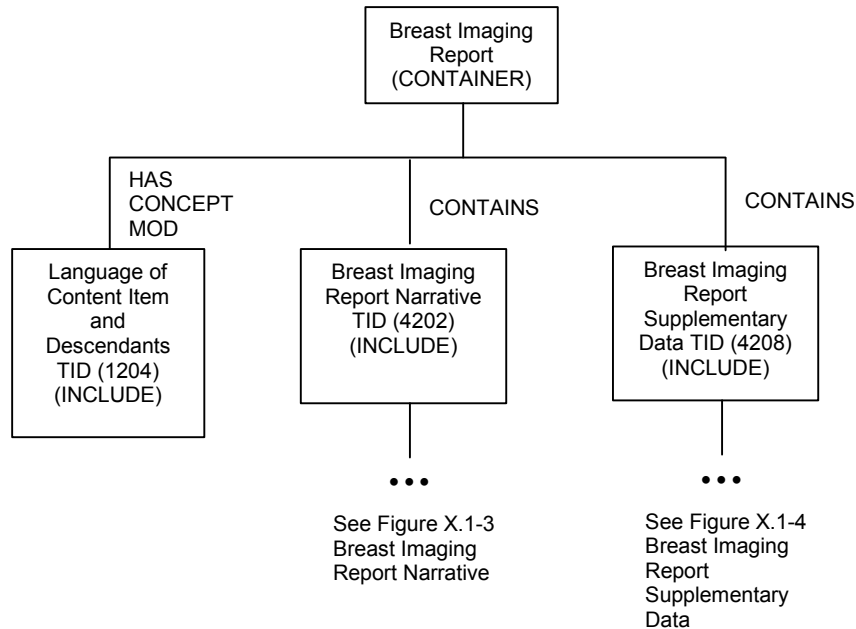

Figure Q.1-1: Top Level of Breast Imaging Report Content Tree

As shown in Figure Q.1-1, the Breast Imaging Report Narrative and Breast Imaging Report Supplementary Data sub-trees together form the content tree of the Breast Imaging Report.

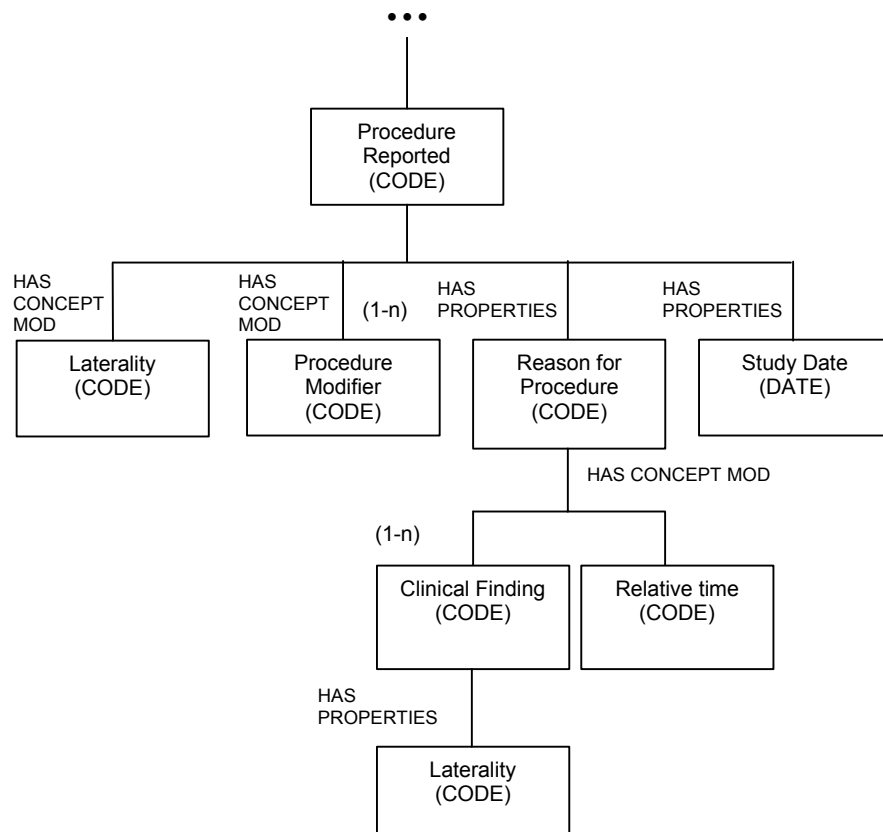

Figure Q.1-2: Breast Imaging Procedure Reported Content Tree

The Breast Imaging Procedure Reported sub-tree is a mandatory child of the Supplementary Data content item, to describe all of the procedures to which the report applies using coded terminology. It may also be used as a sub-tree of sections within the Supplementary Data sub-tree, for the instance in which a report covers more than one procedure, but different sections of the Supplementary Data record the evidence of a subset of the procedures.

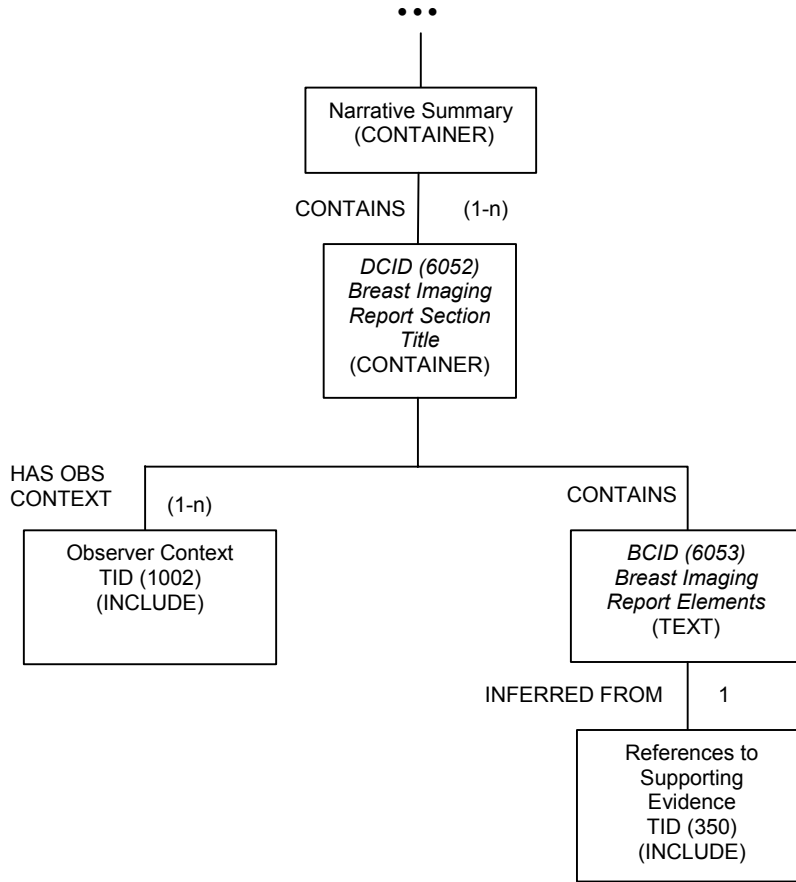

Figure Q.1-3: Breast Imaging Report Narrative Content Tree

An instance of the Breast Imaging Report Narrative sub-tree contains one or more text-based report sections, with a name chosen from CID 6052, Breast Imaging Report Section Title. Within a report section, one or more observers may be identified. This sub-tree is intended to contain the report text as it was created, presented to, and signed off by the verifying observer. It is not intended to convey the exact rendering of the report, such as formatting or visual organization. Report text may reference one or more image or other composite objects on which the interpretation was based.

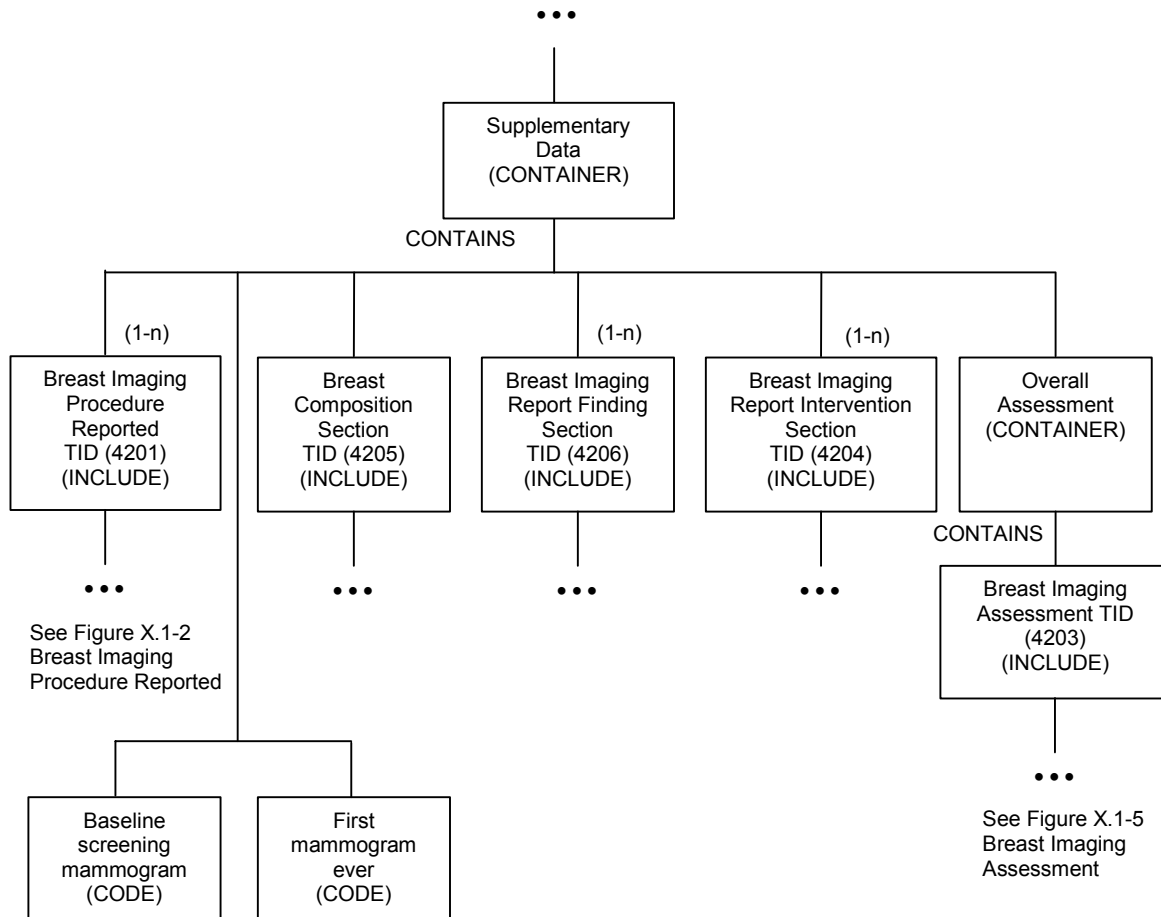

Figure Q.1-4: Breast Imaging Report Supplementary Data Content Tree

An instance of the Breast Imaging Report Supplementary Data sub-tree contains one or more of: Breast Imaging Procedure Reported, Breast Composition Section, Breast Imaging Report Finding Section, Breast Imaging Report Intervention Section, Overall Assessment. This sub-tree is intended to contain the supporting evidence for the Breast Imaging Report Narrative sub-tree, using coded terminology and numeric data.

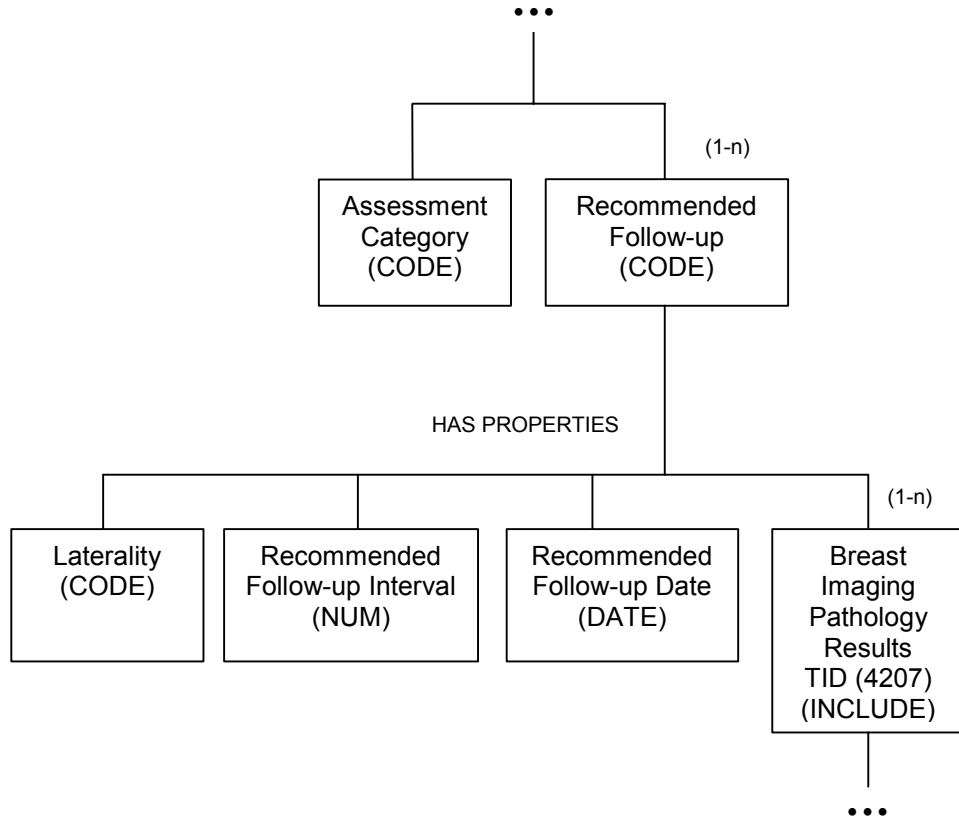

Figure Q.1-5: Breast Imaging Assessment Content Tree

The Breast Imaging Assessment sub-tree may be instantiated as the content of an Overall Assessment section of a report (see Figure Q.1-4), or as part of a Findings section of a report (see TID 4206). Reports may provide an individual assessment for each Finding, and then an overall assessment based on an aggregate of the individual assessments.

Q.2 BREAST IMAGING REPORT EXAMPLES

The following are simple illustrations of encoding Mammography procedure based Breast Imaging Reports.

Q.2.1 Example 1: Screening Mammogram with Negative Findings

A screening mammography case, i.e., there are typically four films and no suspicious abnormalities. The result is a negative mammogram with basic reporting. This example illustrates a report encoded as narrative text only:

Report Sample:

```
Procedure reported
Film screen mammography, both breasts.
Reason for procedure
Screening
Findings
```

Comparison was made to exam from 11/14/2001. The breasts are heterogeneously dense. This may lower the sensitivity of mammography. No significant masses, calcifications, or other abnormalities are present. There is no significant change from the prior exam.

Impressions

BI-RADS® Category 1: Negative. Recommend normal interval follow-up in 12 months

TABLE Q.2-1: Breast Image Report Content for Example 1

Node	Code Meaning of Concept Name	Code Meaning or Example Value	TID/CID
1	Breast Imaging Report		4200
1.1	Language of Content Item and Descendants	English	1204
1.2	Narrative Summary		4202
1.2.1	Procedure reported		4202/6052
1.2.1.1	Procedure reported	Film screen mammography, both breasts.	4202/6053
1.2.2	Reason for procedure		4202/6052
1.2.2.1	Reason for procedure	Screening	4202/6053
1.2.3	Findings		4202/6052
1.2.3.1	Finding	Comparison was made to exam from 11/14/2001. The breasts are heterogeneously dense. This may lower the sensitivity of mammography. No significant masses, calcifications, or other abnormalities are present. There is no significant change from the prior exam.	4202/6053
1.2.4	Impressions		4202/6052
1.2.4.1	Impression	BI-RADS® Category 1: Negative. Recommend normal interval follow-up in 12 months.	4202/6053

Q.2.2 Example 2: Screening Mammogram with Negative Findings

A screening mammography case, i.e., there are typically four films and no suspicious abnormalities. The result is a negative mammogram with basic reporting. This example illustrates a report encoded as narrative text with minimal supplementary data, and follows BI-RADS® and MQSA:

Report Sample:

Procedure reported
Film screen mammography, both breasts.
Reason for procedure
Screening
Comparison to previous exams

Comparison was made to exam from 11/14/2001.
Breast composition
The breasts are heterogeneously dense. This may lower the sensitivity of mammography.
Findings
No significant masses, calcifications, or other abnormalities are present. There is no significant change from the prior exam.
Impressions
BI-RADS® Category 1: Negative. Recommend normal interval follow-up in 12 months.
Overall Assessment
Negative

TABLE Q.2-2: Breast Imaging Report Content for Example 2

Node	Code Meaning of Concept Name	Code Meaning or Example Value	TID/CID
1	Breast Imaging Report		4200
1.1	Language of Content Item and Descendants	English	1204
1.2	Narrative Summary		4202
1.2.1	Procedure reported		4202/6052
1.2.1.1	Procedure reported	Film screen mammography, both breasts.	4202/6053
1.2.2	Reason for procedure		4202/6052
1.2.2.1	Reason for procedure	Screening	4202/6053
1.2.3	Comparison to previous exams		4202/6052
1.2.3.1	Comparison to previous exams	Comparison was made to exam from 11/14/2001.	4202/6053
1.2.4	Breast composition		4202/6052
1.2.4.1	Breast composition	The breasts are heterogeneously dense. This may lower the sensitivity of mammography.	4202/6053
1.2.5	Findings		4202/6052
1.2.5.1	Finding	No significant masses, calcifications, or other abnormalities are present. There is no significant change from the prior exam.	4202/6053
1.2.6	Impressions		4202/6052
1.2.6.1	Impression	BI-RADS® Category 1: Negative. Recommend normal interval follow-up in 12 months.	4202/6053
1.2.7	Overall Assessment		4202/6052
1.2.7.1	Overall Assessment	Negative	4202/6053

Node	Code Meaning of Concept Name	Code Meaning or Example Value	TID/CID
1.3	Supplementary Data		4208
1.3.1	Procedure reported	Film Screen Mammography	4201/6050
1.3.1.1	Laterality	Both breasts	4201/6022
1.3.1.2	Reason for procedure	Screening	4201/6051
1.3.2	Breast composition		4205
1.3.2.1	Breast composition	Heterogeneously dense	4205/6000
1.3.2.1.1	Laterality	Both breasts	4205/6022
1.3.3	Overall Assessment		4208
1.3.3.1	Assessment Category	1 – Negative	4203/6026
1.3.3.2	Recommended Follow-up	Normal interval follow-up	4203/6028

Q.2.3 Example 3: Diagnostic Mammogram - Unilateral

A diagnostic mammogram was prompted by a clinical finding. The result is a probably benign finding with a short interval follow-up of the left breast. This report provides the narrative text with more extensive supplementary data.

Report Sample:

<p>Procedure reported</p> <p>Film screen mammography, left breast.</p> <p>Reason for procedure</p> <p>Non-bloody discharge left breast.</p> <p>Breast composition</p> <p>The breast is almost entirely fat.</p> <p>Findings</p> <p>Film screen mammograms were performed. There are heterogeneous calcifications regionally distributed in the 1 o'clock upper outer quadrant, anterior region of the left breast. There is an increase in the number of calcifications from the prior exam.</p> <p>Impressions</p> <p>BI-RADS® Category 3: Probably Benign Finding. Short interval follow-up of the left breast is recommended in 6 months.</p>
--

Table Q.2-3: Breast Imaging Report Content for Example 3

Node	Code Meaning of Concept Name	Code Meaning or Example Value	TID/CID
1	Breast Imaging Report		4200
1.1	Language of Content Item and Descendants	English	1204
1.2	Narrative Summary		4202
1.2.1	Procedure reported		4202/6052
1.2.1.1	Procedure reported	Film screen mammography, left breast.	4202/6053

Node	Code Meaning of Concept Name	Code Meaning or Example Value	TID/CID
1.2.2	Reason for procedure		4202/6052
1.2.2.1	Reason for procedure	Non-bloody discharge left breast.	4202/6053
1.2.3	Breast composition		4202/6052
1.2.3.1	Breast composition	The breast is almost entirely fat.	4202/6053
1.2.4	Findings		4202/6052
1.2.4.1	Finding	Film screen mammograms were performed. There are heterogeneous calcifications regionally distributed in the 1 o'clock upper outer quadrant, anterior region of the left breast. There is an increase in the number of calcifications from the prior exam.	4202/6053
1.2.5	Impressions		4202/6052
1.2.5.1	Impression	BI-RADS® Category 3: Probably Benign Finding. Short interval follow-up of the left breast is recommended in 6 months.	4202/6053
1.3	Supplementary Data		4208
1.3.1	Procedure reported	Film Screen Mammography	4201/6050
1.3.1.1	Laterality	Left breast	4201/6022
1.3.1.2	Reason for procedure	Clinical Finding	4201/6051
1.3.1.2.1	Clinical Finding	Non-bloody discharge	4201/6055
1.3.1.2.1.1	Laterality	Left breast	4201/6022
1.3.2	Breast composition		4205
1.3.2.1	Breast composition	Almost entirely fat	4205/6000
1.3.2.1.1	Laterality	Left breast	4205/6022
1.3.3	Findings		4206
1.3.3.1	Finding	Calcification of breast	4206/6054
1.3.3.1.1	Assessment Category	3 – Probably Benign Finding – short interval follow-up	4203/6026
1.3.3.1.2	Recommended Follow-up	Follow-up at short interval (1-11 months)	4203/6028
1.3.3.1.2.1	Laterality	Left breast	4203/6022
1.3.3.1.2.2	Recommended Follow-up Interval	6 months	4203/6046
1.3.3.1.3	Clockface or region	1 o'clock position	4206/6018
1.3.3.1.4	Quadrant location	Upper outer quadrant of breast	4206/6020
1.3.3.1.5	Depth	Anterior	4206/6024
1.3.3.1.6	Calcification Type	Heterogeneous calcification	4206/6010
1.3.3.1.7	Calcification Distribution	Regional calcification distribution	4206/6012
1.3.3.1.8	Change since last mammogram	Increase in number of calcifications	4206/6002

Q.2.4 Example 4: Diagnostic Mammogram and Ultrasound - Unilateral

Following a screening mammogram, the patient was asked to return for additional imaging and an ultrasound on the breast, for further evaluation of a mammographic mass. This example demonstrates a report on multiple breast imaging procedures. This report provides the narrative text with some supplementary data.

Report Sample:

Procedure reported
Film screen mammography, left breast; Ultrasound procedure, left breast.
Reason for procedure
Additional evaluation requested at current screening.
Comparison to previous exams
Comparison was made to exam from 11/14/2001.
Findings
Film Screen Mammography: A lobular mass with obscured margins is present measuring 7mm in the upper outer quadrant.
Findings
Ultrasound demonstrates a simple cyst.
Impressions
BI-RADS® Category 2: Benign, no evidence of malignancy. Normal interval follow-up of both breasts is recommended in 12 months.
Overall Assessment
Benign

Table Q.2-4: Breast Imaging Report Content for Example 4

Node	Code Meaning of Concept Name	Code Meaning or Example Value	TID/CID
1	Breast Imaging Report		4200
1.1	Language of Content Item and Descendants	English	1204
1.2	Narrative Summary		4202
1.2.1	Procedure reported		4202/6052
1.2.1.1	Procedure reported	Film screen mammography, left breast; Ultrasound procedure, left breast.	4202/6053
1.2.2	Reason for procedure		4202/6052
1.2.2.1	Reason for procedure	Additional evaluation requested at current screening.	4202/6053
1.2.3	Comparison to previous exams		4202/6052
1.2.3.1	Comparison to previous exams	Comparison was made to exam from 11/14/2001.	4202/6053

Node	Code Meaning of Concept Name	Code Meaning or Example Value	TID/CID
1.2.4	Findings		4202/6052
1.2.4.1	Finding	Film Screen Mammography: A lobular mass with obscured margins is present measuring 7mm in the upper outer quadrant.	4202/6053
1.2.5	Findings		4202/6052
1.2.5.1	Finding	Ultrasound demonstrates a simple cyst.	4202/6053
1.2.6	Impressions		4202/6052
1.2.6.1	Impression	BI-RADS® Category 2: Benign, no evidence of malignancy. Normal interval follow-up of both breasts is recommended in 12 months.	4202/6053
1.2.7	Overall Assessment		4202/6052
1.2.7.1	Overall Assessment	Benign	4202/6053
1.3	Supplementary Data		4208
1.3.1	Procedure reported	Film Screen Mammography	4201/6050
1.3.1.1	Laterality	Left breast	4201/6022
1.3.1.2	Reason for procedure	Additional evaluation requested at current screening	4201/6051
1.3.2	Procedure reported	Ultrasound procedure	4201/6050
1.3.2.1	Laterality	Left breast	4201/6022
1.3.2.2	Reason for procedure	Additional evaluation requested at current screening	4201/6051
1.3.3	Findings		4206
1.3.3.1	Procedure reported	Film Screen Mammography	4201/6050
1.3.3.1.1	Laterality	Left breast	4201/6022
1.3.3.1.2	Reason for procedure	Additional evaluation requested at current screening	4201/6051
1.3.3.2	Finding	Mammographic breast mass	4206/6054
1.3.3.2.1	Quadrant location	Upper outer quadrant of breast	4206/6020
1.3.3.2.2	Diameter	7 mm	1400/7470
1.3.3.2.3	Shape	Lobular	4206/6004
1.3.3.2.4	Margins	Obscured lesion	4206/6006
1.3.4	Findings		4206
1.3.4.1	Procedure reported	Ultrasound procedure	4201/6050
1.3.4.1.1	Laterality	Left breast	4201/6022
1.3.4.1.2	Reason for procedure	Additional evaluation requested at current screening	4201/6051
1.3.4.2	Finding	Simple cyst of breast	4206/6054
1.3.5	Overall Assessment		4208
1.3.5.1	Assessment Category	2 – Benign Finding	4203/6026

Annex R Configuration Use Cases (Informative)

The following use cases are the basis for the decisions made in defining the Configuration Management Profiles specified in PS 3.15. Where possible specific protocols that are commonly used in IT system management are specifically identified.

R.1 INSTALL A NEW MACHINE

When a new machine is added there need to be new entries made for:

- a. TCP/IP parameters
- b. DICOM Application Entity related Parameters

The service staff effort needed for either of these should be minimal. To the extent feasible these parameters should be generated and installed automatically.

The need for some sort of ID is common to most of the use cases, so it is assumed that each machine has sufficient non-volatile storage to at least remember its own name for later use.

Updates may be made directly to the configuration databases or made via the machine being configured. A common procedure for large networks is for the initial network design to assign these parameters and create the initial databases during the complete initial network design. Updates can be made later as new devices are installed.

One step that specifically needs automation is the allocation of AE-titles. These must be unique. Their assignment has been a problem with manual procedures. Possibilities include:

- a. Fully automatic allocation of AE-titles as requested. This interacts with the need for AE title stability in some use cases. The automatic process should permit AE-titles to be persistently associated with particular devices and application entities. The automatic process should permit the assignment of AE titles that comply with particular internal structuring rules.
- b. Assisted manual allocation, where the service staff proposes AE-titles (perhaps based on examining the list of present AE-titles) and the system accepts them as unique or rejects them when non-unique.

These AE-titles can then be associated with the other application entity related information. This complete set of information needs to be provided for later uses.

The local setup may also involve searches for other AE's on the network. For example, it is likely that a search will be made for archives and printers. These searches might be by SOP class or device type. This is related to vendor specific application setup procedures which are outside the scope of DICOM.

R.1.1 Configure DHCP

The network may have been designed in advance and the configuration specified in advance. It should be possible to pre-configure the configuration servers prior to other hardware installation. This should not preclude later updates or later configuration at specific devices.

The DHCP servers have a database that is manually maintained defining the relationship between machine parameters and IP parameters. This defines:

- a. Hardware MAC addresses that are to be allocated specific fixed IP information.
- b. Client machine names that are to be allocated specific fixed IP information.
- c. Hardware MAC addresses and address ranges that are to be allocated dynamically assigned IP addresses and IP information.

- d. Client machine name patterns that are to be allocated dynamically assigned IP addresses and IP information.

The IP information that is provided will be a specific IP address together with other information. The present recommendation is to provide all of the following information when available.

The manual configuration of DHCP is often assisted by automated user interface tools that are outside the scope of DICOM. Some people utilize the DHCP database as a documentation tool for documenting the assignment of IP addresses that are preset on equipment. This does not interfere with DHCP operation and can make a gradual transition from equipment presets to DHCP assignments easier. It also helps avoid accidental re-use of IP addresses that are already manually assigned. However, DHCP does not verify that these entries are in fact correct.

R.1.2 Configure LDAP

There are several ways that the LDAP configuration information can be obtained.

- a. A complete installation may be pre-designed and the full configuration loaded into the LDAP server, with the installation attribute set to false. Then as systems are installed, they acquire their own configurations from the LDAP server. The site administration can set the installation attribute to true when appropriate.
- b. When the LDAP server permits network clients to update the configuration, they can be individually installed and configured. Then after each device is configured, that device uploads its own configuration to the LDAP server.
- c. When the LDAP server does not permit network clients to update configurations, they can be individually installed and configured. Then, instead of uploading their own configuration, they create a standard format file with their configuration objects. This file is then manually added to the LDAP server (complying with local security procedures) and any conflicts resolved manually.

R.1.2.1 Pre-configure

The network may have been designed in advance and the configuration specified in advance. It should be possible to pre-configure the configuration servers prior to other hardware installation. This should not preclude later updates or later configuration at specific devices.

LDAP defines a standard file exchange format for transmitting LDAP database subsets in an ASCII format. This file exchange format can be created by a variety of network configuration tools. There are also systems that use XML tools to create database subsets that can be loaded into LDAP servers. It is out of scope to specify these tools in any detail. The use case simply requires that such tools be available.

When the LDAP database is preconfigured using these tools, it is the responsibility of the tools to ensure that the resulting database entries have unique names. The unique name requirement is common to any LDAP database and not just to DICOM AE-titles. Consequently, most tools have mechanisms to ensure that the database updates that they create do have unique names.

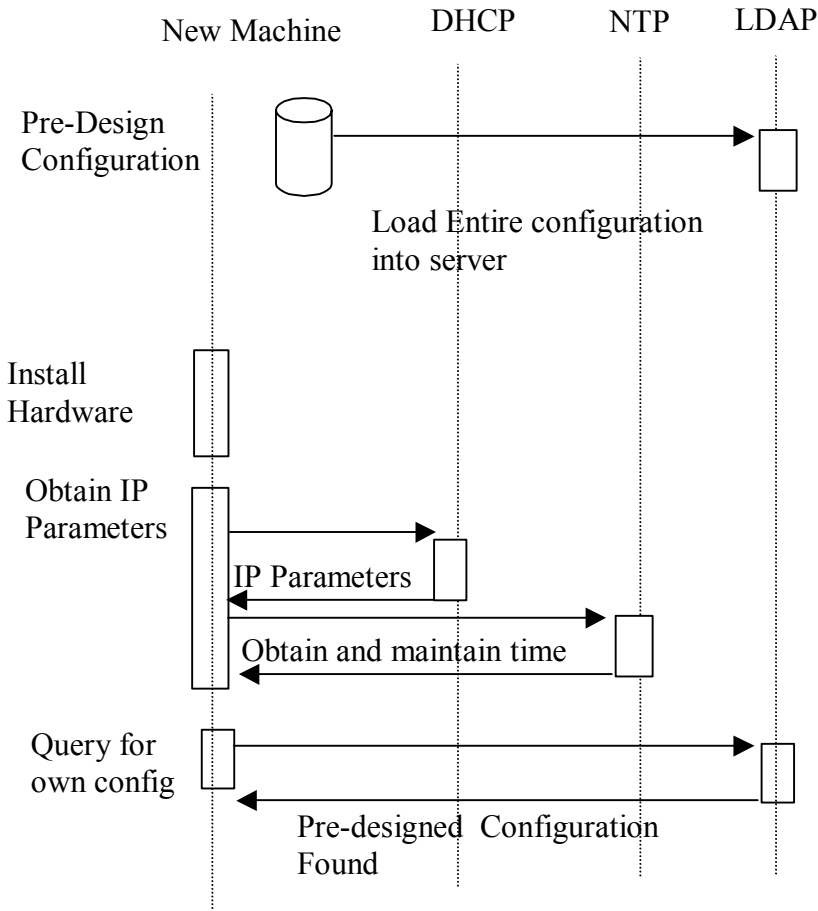

Figure R.1-1 System Installation with Pre-configured Configuration

At an appropriate time, the installed attribute is set on the device objects in the LDAP configuration.

R.1.2.2 Updating configuration during installation

The “unconfigured” device startup begins with use of the pre-configured services from DHCP, DNS, and NTP. It then performs device configuration and updates the LDAP database. This description assumes that the device has been given permission to update the LDAP database directly.

- a. DHCP is used to obtain IP related parameters. The DHCP request can indicate a desired machine name that DHCP can associate with a configuration saved at the DHCP server. DHCP does not guarantee that the desired machine name will be granted because it might already be in use, but this mechanism is often used to maintain specific machine configurations. The DHCP will also update the DNS server (using the DDNS mechanisms) with the assigned IP address and hostname information.

Legacy note: A machine with preconfigured IP addresses, DNS servers, and NTP servers may skip this step. As an operational and documentation convenience, the DHCP server database may contain the description of this preconfigured machine.

- b. The list of NTP servers is used to initiate the NTP process for obtaining and maintaining the correct time. This is an ongoing process that continues for the duration of device activity. See Time Synchronization below.
- c. The list of DNS servers is used to obtain the address of the DNS servers at this site. Then the DNS servers are queried to get the list of LDAP servers. This utilizes a relatively new addition to the DNS

capabilities that permit querying DNS to obtain servers within a domain that provide a particular service.

- d. The LDAP servers are queried to find the server that provides DICOM configuration services, and then obtain a description for the device matching the assigned machine name. This description includes device specific configuration information and a list of Network AEs. For the unconfigured device there will be no configuration found.

Note: These first four steps are the same as a normal startup (described below).

- e. Through a device specific process it determines its internal AE structure. During initial device installation it is likely that the LDAP database lacks information regarding the device. Using some vendor specific mechanism, e.g. service procedures, the device configuration is obtained. This device configuration includes all the information that will be stored in the LDAP database. The fields for "device name" and "AE Title" are tentative at this point.
- f. Each of the Network AE objects is created by means of the LDAP object creation process. It is at this point that LDAP determines whether the AE Title is in fact unique among all AE Titles. If the title is unique, the creation succeeds. If there is a conflict, the creation fails and "name already in use" is given as a reason.

LDAP uses propose/create as an atomic operation for creating unique items. The LDAP approach permits unique titles that comply with algorithms for structured names, check digits, etc. DICOM does not require structured names, but they are a commonplace requirement for other LDAP users. It may take multiple attempts to find an unused name.

This multiple probe behavior can be a problem if "unconfigured device" is a common occurrence and name collisions are common. Name collisions can be minimized at the expense of name structure by selecting names such as "AExxxxxxxxxxxx" where "xxxxxxxxxxxx" is a truly randomly selected number. The odds of collision are then exceedingly small, and a unique name will be found within one or two probes.

- g. The device object is created. The device information is updated to reflect the actual AE titles of the AE objects. As with AE objects, there is the potential for device name collisions.
- h. The network connection objects are created as subordinates to the device object.
- i. The AE objects are updated to reflect the names of the network connection objects.

The "unconfigured device" now has a saved configuration. The LDAP database reflects its present configuration.

In the following example, the new system needs two AE-titles. During its installation another machine is also being installed and takes one of the two AE-titles that the first machine expected to use. The new system then claims another different AE-title that does not conflict.

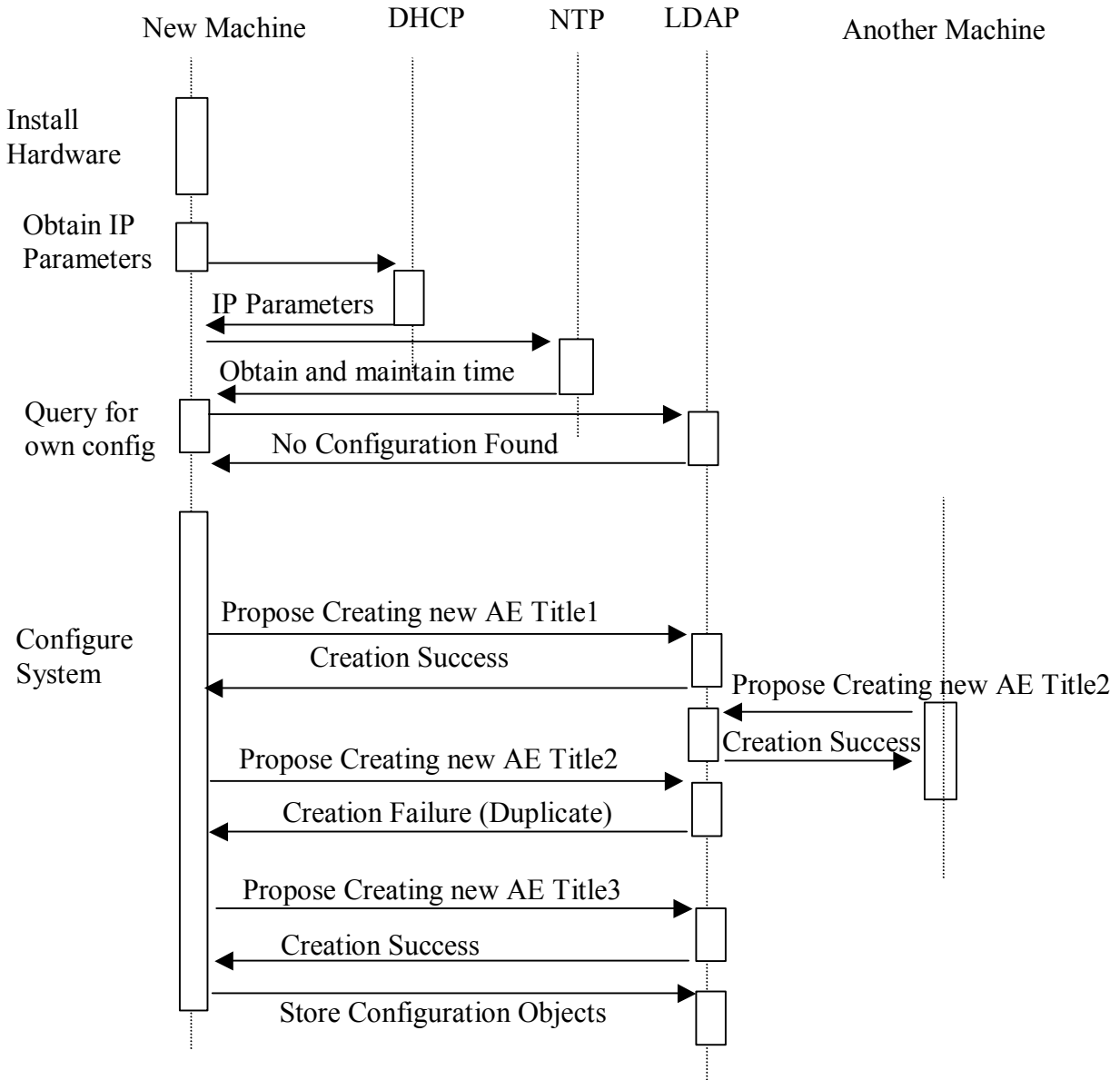

Figure R.1-2 – Configuring a System when network LDAP updates are permitted

R.1.2.3 Configure Client then update Server

Much of the initial startup is the same for restarting a configured device and for configuring a client first and then updating the server. The difference is two-fold.

The AE-title uniqueness must be established manually, and the configuration information saved at the client onto a file that can then be provided to the LDAP server. There is a risk that the manually assigned AE-title is not unique, but this can be managed and is easier than the present entirely manual process for assigning AE-titles.

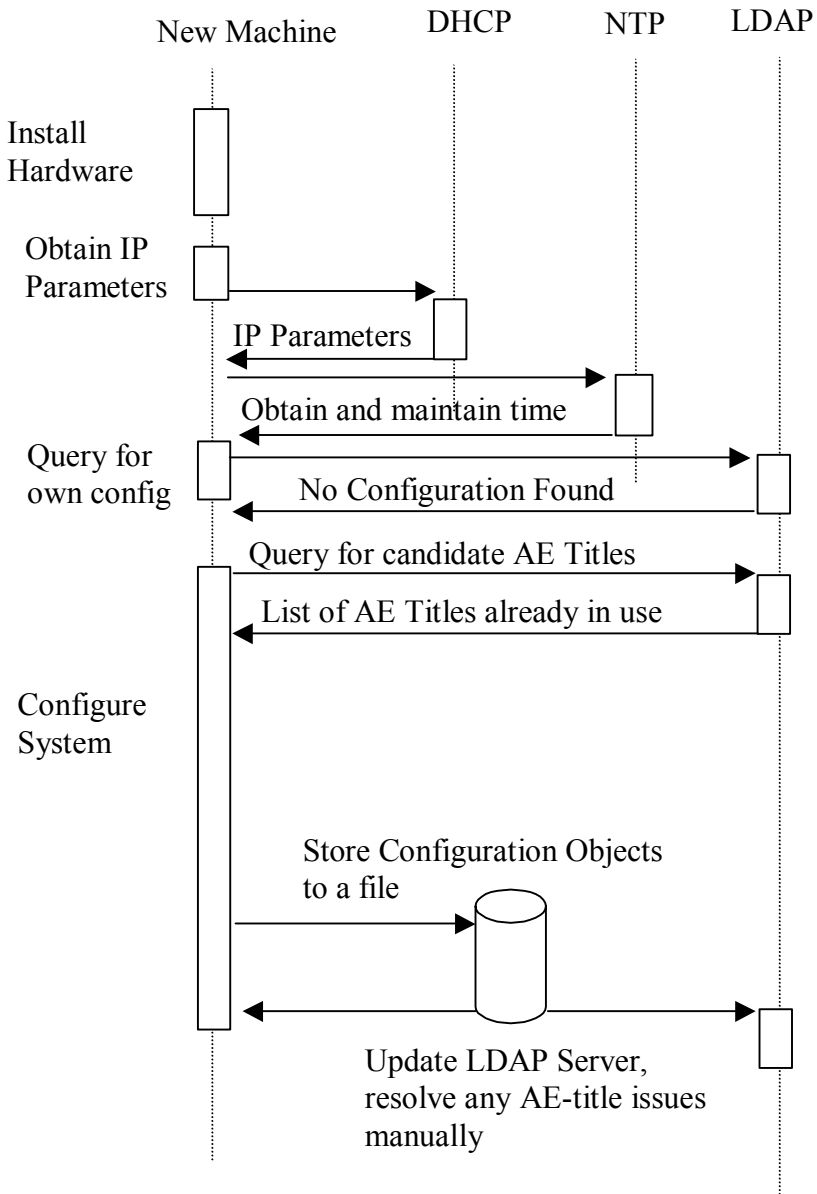

Figure R.1-3 Configuring a system when LDAP network updates are not permitted

R.1.3 Distributed update propagation

The larger enterprise networks require prompt database responses and reliable responses during network disruptions. This implies the use of a distributed or federated database. These have update propagation issues. There is not a requirement for a complete and accurate view of the DICOM network at all times. There is a requirement that local subsets of the network maintain an accurate local view. E.g., each hospital in a large hospital chain may tolerate occasional disconnections or problems in viewing the network information in other hospitals in that chain, but they require that their own internal network be reliably and accurately described.

LDAP supports a variety of federation and distribution schemes. It specifically states that it is designed and appropriate for federated situations where distribution of updates between federated servers may be slow. It is specifically designed for situations where database updates are infrequent and database queries dominate.

R.2 LEGACY COMPATIBILITY

Legacy devices utilize some internal method for obtaining the IP addresses, port numbers, and AE-titles of the other devices. For legacy compatibility, a managed node must be controlled so that the IP addresses, port numbers, and AE-titles do not change. This affects DHCP because it is DHCP that assigns IP addresses. The LDAP database design must preserve port number and AE-title so that once the device is configured these do not change.

DHCP was designed to deal with some common legacy issues:

- a. Documenting legacy devices that do not utilize DHCP. Most DHCP servers can document a legacy device with a DHCP entry that describes the device. This avoids IP address conflicts. Since this is a manual process, there still remains the potential for errors. The DHCP server configuration is used to reserve the addresses and document how they are used.

This documented entry approach is also used for complex multi-homed servers. These are often manually configured and kept with fixed configurations.

- b. Specifying fixed IP addresses for DHCP clients. Many servers have clients that are not able to use DNS to obtain server IP addresses. These servers may also utilize DHCP for startup configuration. The DHCP servers must support the use of fixed IP allocations so that the servers are always assigned the same IP address. This avoids disrupting access by the server's legacy clients.

This usage is quite common because it gives the IT administrators the centralized control that they need without disrupting operations. It is a frequent transitional stage for machines on networks that are transitioning to full DHCP operation.

There are two legacy-related issues with time configuration:

- a. The NTP system operates in UTC. The device users probably want to operate in local time. This introduces additional internal software requirements to configure local time. DHCP will provide this information if that option is configured into the DHCP server.
- b. Device clock setting must be documented correctly. Some systems set the battery-powered clock to local time; others use UTC. Incorrect settings will introduce very large time transient problems during startup. Eventually NTP clients do resolve the huge mismatch between battery clock and NTP clock, but the device may already be in medical use by the time this problem is resolved. The resulting time discontinuity can then pose problems. The magnitude of this problem depends on the particular NTP client implementation.

R.3 OBTAIN CONFIGURATION OF OTHER DEVICES

Managed devices can utilize the LDAP database during their own installation to establish configuration parameters such as the AE-title of destination devices. They may also utilize the LDAP database to obtain this information at run time prior to association negotiation.

R.3.1 Find AE When Given Device Type

The LDAP server supports simple relational queries. This query can be phrased:

```
Return devices where  
DeviceType == <device type>
```

Then, for each of those devices, query

*Return Network AE where
[ApplicationCluster == name]*

The result will be the Network AE entries that match those two criteria. The first criteria selects the device type match. There are LDAP scoping controls that determine whether the queries search the entire enterprise or just this server. LDAP does not support complex queries, transactions, constraints, nesting, etc. LDAP cannot provide the hostnames for these Network AEs as part of a single query. Instead, the returned Network AEs will include the names of the network connections for each Network AE. Then the application would need to issue LDAP reads using the DN of the NetworkConnection objects to obtain the hostnames.

R.4 DEVICE STARTUP

Normal startup of an already configured device will obtain IP information and DICOM information from the servers.

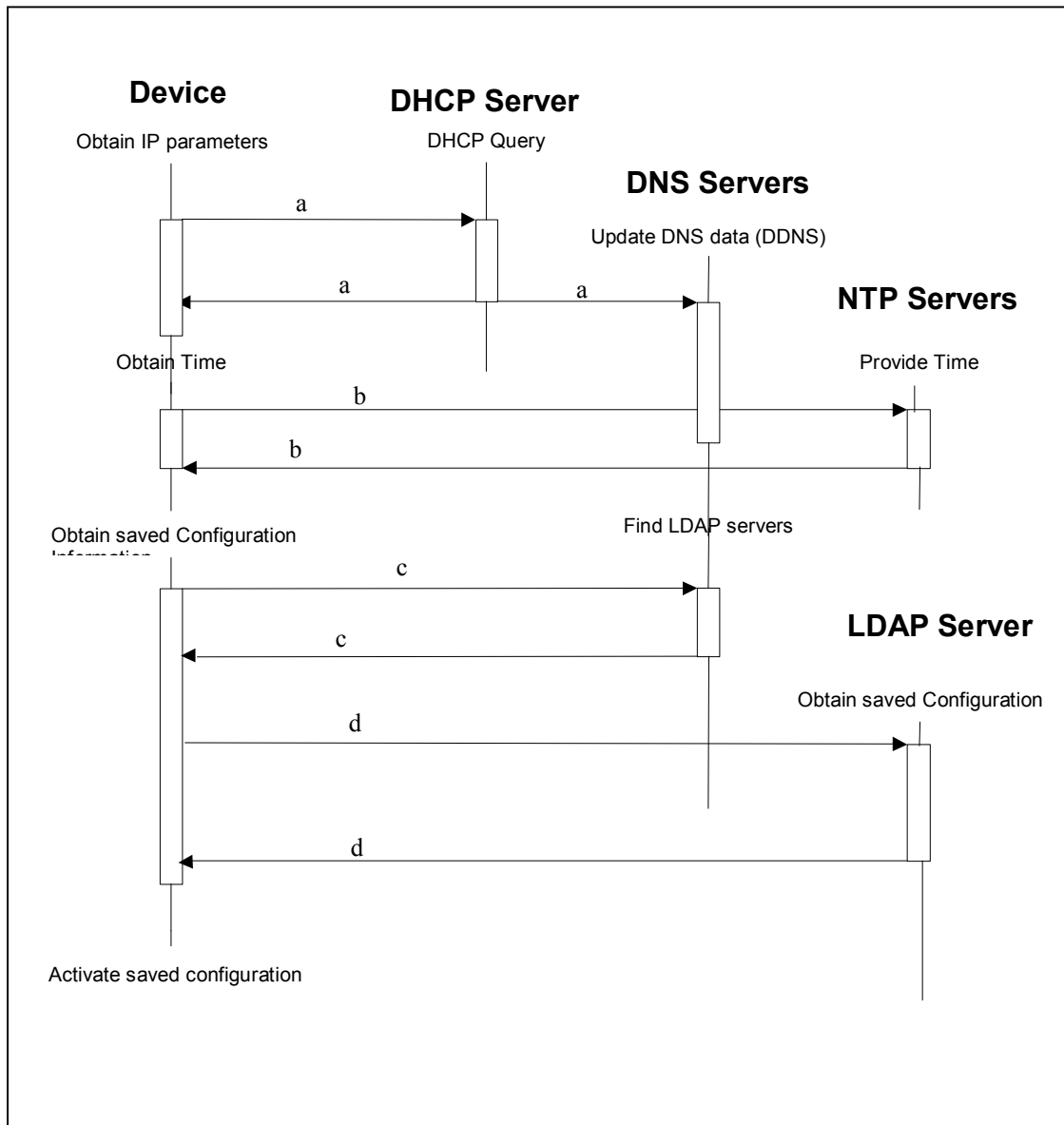

Figure R.4-1 Configured Device Startup (Normal Startup)

The device startup sequence is:

- a. DHCP is used to obtain IP related parameters. The DHCP request can indicate a desired machine name that DHCP can associate with a configuration saved at the DHCP server. DHCP does not guarantee that the desired machine name will be granted because it might already be in use, but this mechanism is often used to maintain specific machine configurations. The DHCP will also update the DNS server (using the DDNS mechanisms) with the assigned IP address and hostname information.

Legacy note: A machine with preconfigured IP addresses, DNS servers, and NTP servers may skip this step. As an operational and documentation convenience, the DHCP server database may contain the description of this preconfigured machine.

- b. The list of NTP servers is used to initiate the NTP process for obtaining and maintaining the correct time. This is an ongoing process that continues for the duration of device activity. See Time Synchronization below.

- c. The list of DNS servers is used to obtain the list of LDAP servers. This utilizes a relatively new addition to the DNS capabilities that permit querying DNS to obtain servers within a domain that provide a particular service.
- d. The "nearest" LDAP server is queried to obtain a description for the device matching the assigned machine name. This description includes device specific configuration information and a list of Network AEs.

Note: A partially managed node may reach this point and discover that there is no description for that device in the LDAP database. During installation (as described above) this may then proceed into device configuration. Partially managed devices may utilize an internal configuration mechanism.

- e. The AE descriptions are obtained from the LDAP server. Key information in the AE description is the assigned AE-title. The AE descriptions probably include vendor unique information in either the vendor text field or vendor extensions to the AE object. The details of this information are vendor unique. DICOM is defining a mandatory minimum capability because this will be a common need for vendors that offer dynamically configurable devices.

The AE description may be present even for devices that do not support dynamic configuration. If the device has been configured with an AE-title and description that is intended to be fixed, then a description should be present in the LDAP database. The device can confirm that the description matches its stored configuration. The presence of the AE-title in the description will prevent later network activities from inadvertently re-using the same AE-title for another purpose.

The degree of configurability may also vary. Many simple devices may only permit dynamic configuration of the IP address and AE-title, with all other configuration requiring local service modifications.

- f. The device performs whatever internal operations are involved to configure itself to match the device description and AE descriptions.

At this point, the device is ready for regular operation, the DNS servers will correctly report its IP address when requested, and the LDAP server has a correct description of the device, Network AEs, and network connections.

R.5 SHUTDOWN

R.5.1 Shutdown

The lease timeouts eventually release the IP address at DHCP, which can then update DNS to indicate that the host is down. Clients that utilize the hostname information in the LDAP database will initially experience reports of connection failure; and then after DNS is updated, they will get errors indicating the device is down when they attempt to use it. Clients that use the IP entry directly will experience reports of connection failure.

R.5.2 Online/Offline

A device may be deliberately placed offline in the LDAP database to indicate that it is unavailable and will remain unavailable for an extended period of time. This may be utilized during system installation so that preconfigured systems can be marked as offline until the system installation is complete. It can also be used for systems that are down for extended maintenance or upgrades. It may be useful for equipment that is on mobile vans and only present for certain days.

For this purpose a separate Installed attribute has been given to devices, Network AE's, and Network Connections so that it can be manually managed.

R.6 TIME SYNCHRONIZATION

Medical device time requirements primarily deal with synchronization of machines on a local network or campus. There are very few requirements for accurate time (synchronized with an international reference clock). DICOM time users are usually concerned with:

local time synchronization between machines

local time base stability. This means controlling the discontinuities in the local time and its first derivative. There is also an upper bound on time base stability errors that results from the synchronization error limits.

international time synchronization with the UTC master clocks

Other master clocks and time references (e.g. sidereal time) are not relevant to medical users.

R.6.1 High accuracy time synchronization

High accuracy time synchronization is needed for devices like cardiology equipment. The measurements taken on various different machines are recorded with synchronization modules specifying the precise time base for measurements such as waveforms and multi-frame images. These are later used to synchronize data for analysis and display.

Typical requirements are:

Local synchronization

Synchronized to within approximately 10 millisecond. This corresponds to a few percent of a typical heartbeat. Under some circumstances, the requirements may be stricter than this.

Time base stability

During the measurement period there should be no discontinuities greater than a few milliseconds. The time base rate should be within 0.01% of standard time rate.

International Time Synchronization

There are no special extra requirements. Note however that time base stability conflicts with time synchronization when UTC time jumps (e.g. leap seconds).

R.6.2 Ordinary Time Synchronization

Ordinary medical equipment uses time synchronization to perform functions that were previously performed manually, e.g. recordkeeping and scheduling. These were typically done using watches and clocks, with resultant stability and synchronization errors measured in seconds or longer. The most stringent time synchronization requirements for networked medical equipment derive from some of the security protocols and their record keeping.

Ordinary requirements are:

Local synchronization

Synchronized to within approximately 500 milliseconds. Some security systems have problems when the synchronization error exceeds 1 second.

Time base stability

Large drift errors may cause problems. Typical clock drift errors approximately 1 second/day are unlikely to cause problems. Large discontinuities are permissible if rare or during startup. Time may run backwards, but only during rare large discontinuities.

International Time Synchronization

Some sites require synchronization to within a few seconds of UTC. Others have no requirement.

R.6.3 Background

R.6.3.1 Unsynchronized Time

The local system time of a computer is usually provided by two distinct components.

- a. There is a battery-powered clock that is used to establish an initial time estimate when the machine is turned on. These clocks are typically very inaccurate. Local and international synchronization errors are often 5-10 minutes. In some cases, the battery clock is incorrect by hours or days.
- b. The ongoing system time is provided by a software function and a pulse source. The pulse source "ticks" at some rate between 1-1000Hz. It has a nominal tick rate that is used by the system software. For every tick the system software increments the current time estimate appropriately. E.g., for a system with a 100Hz tick, the system time increments 10ms each tick.

This lacks any external synchronization and is subject to substantial initial error in the time estimate and to errors due to systematic and random drift in the tick source. The tick sources are typically low cost quartz crystal based, with a systematic error up to approximately 10^{-5} in the actual versus nominal tick rate and with a variation due to temperature, pressure, etc. up to approximately 10^{-5} . This corresponds to drifts on the order of 10 seconds per day.

R.6.3.2 Network Synchronized Time

There is a well established Internet protocol (NTP) for maintaining time synchronization that should be used by DICOM. It operates in several ways.

The most common is for the computer to become an NTP client of one or more NTP servers. As a client it uses occasional ping-pong NTP messages to:

- a. Estimate the network delays. These estimates are updated during each NTP update cycle.
- b. Obtain a time estimate from the server. Each estimate includes the server's own statistical characteristics and accuracy assessment of the estimate.
- c. Use the time estimates from the servers, the network delay estimates, and the time estimates from the local system clock, to obtain a new NTP time estimate. This typically uses modern statistical methods and filtering to perform optimal estimation.
- d. Use the resulting time estimate to
 1. Adjust the system time, and
 2. Update drift and statistical characteristics of the local clock.

The local applications do not normally communicate with the NTP client software. They normally continue to use the system clock services. The NTP client software adjusts the system clock. The NTP standard defines a nominal system clock service as having two adjustable parameters:

- a. The clock frequency. In the example above, the nominal clock was 100Hz, with a nominal increment of 10 milliseconds. Long term measurement may indicate that the actual clock is slightly faster and the NTP client can adjust the clock increment to be 9.98 milliseconds.
- b. The clock phase. This adjustment permits jump adjustments, and is the fixed time offset between the internal clock and the estimated UTC.

The experience with NTP in the field is that NTP clients on the same LAN as their NTP server will maintain synchronization to within approximately 100 microseconds. NTP clients on the North American Internet and utilizing multiple NTP servers will maintain synchronization to within approximately 10 milliseconds.

There are low cost devices with only limited time synchronization needs. NTP has been updated to include SNTP for these devices. SNTP eliminates the estimation of network delays and eliminates the statistical methods for optimal time estimation. It assumes that the network delays are nil and that each NTP server time estimate received is completely accurate. This reduces the development and hardware

costs for these devices. The computer processing costs for NTP are insignificant for a PC, but may be burdensome for very small devices. The SNTP synchronization errors are only a few milliseconds in a LAN environment. They are very topology sensitive and errors may become huge in a WAN environment.

Most NTP servers are in turn NTP clients to multiple superior servers and peers. NTP is designed to accommodate a hierarchy of server/clients that distributes time information from a few international standard clocks out through layers of servers.

R.6.3.3 External Clocks

The NTP implementations anticipate the use of three major kinds of external clock sources:

External NTP servers

Many ISPs and government agencies offer access to NTP servers that are in turn synchronized with the international standard clocks. This access is usually offered on a restricted basis.

External clock broadcasts

The US, Canada, Germany, and others offer radio broadcasts of time signals that may be used by local receivers attached to an NTP server. The US and Russia broadcast time signals from satellites, e.g. GPS. Some mobile telephone services broadcast time signals. These signals are synchronized with the international standard clocks. GPS time signals are popular worldwide time sources. Their primary problem is difficulties with proper antenna location and receiver cost. Most of the popular low cost consumer GPS systems save money by sacrificing the clock accuracy.

External pulse sources

For extremely high accuracy synchronization, atomic clocks can be attached to NTP servers. These clocks do not provide a time estimate, but they provide a pulse signal that is known to be extremely accurate. The optimal estimation logic can use this in combination with other external sources to achieve sub microsecond synchronization to a reference clock even when the devices are separated by the earth's diameter.

The details regarding selecting an external clock source and appropriate use of the clock source are outside the scope of the NTP protocol. They are often discussed and documented in conjunction with the NTP protocol and many such interfaces are included in the reference implementation of NTP.

R.6.4 SNTP restrictions

In theory, servers can be SNTP servers and NTP servers can be SNTP clients of other servers. This is very strongly discouraged. The SNTP errors can be substantial, and the clients of a server using SNTP will not have the statistical information needed to assess the magnitude of these errors. It is feasible for SNTP clients to use NTP servers. The SNTP protocol packets are identical to the NTP protocol packets. SNTP differs in that some of the statistical information fields are filled with nominal SNTP values instead of having actual measured values.

R.6.5 Implementation Considerations

There are several public reference implementations of NTP server and client software available. These are in widespread use and have been ported to many platforms (including Unix, Windows, and Macintosh). There are also proprietary and built-in NTP services for some platforms (e.g. Windows 2000). The public reference implementations include sample interfaces to many kinds of external clock sources.

There are significant performance considerations in the selection of locations for servers and clients. Devices that need high accuracy synchronization should probably be all on the same LAN together with an NTP server on that LAN.

Real time operating system (RTOS) implementations may have greater difficulties. The reference NTP implementations have been ported to several RTOSs. There were difficulties with the implementations of

the internal system clock on the RTOS. The dual frequency/phase adjustment requirements may require the clock functions to be rewritten. The reference implementations also require access to a separate high resolution interval timer (with sub microsecond accuracy and precision). This is a standard CPU feature for modern workstation processors, but may be missing on low end processors.

An RTOS implementation with only ordinary synchronization requirements might choose to write their own SNTP only implementation rather than use the reference NTP implementation. The SNTP client is very simple. It may be based on the reference implementation or written from scratch. The operating system support needed for accurate adjustment is optional for SNTP clients. The only requirement is the time base stability requirement, which usually implies the ability to specify fractional seconds when setting the time.

The conflict between the user desire to use local time and the NTP use of UTC must be resolved in the device. DHCP offers the ability to obtain the offset between local time and UTC dynamically, provided the DHCP server supports this option. There remain issues such as service procedures, startup in the absence of DHCP, etc.

The differences between local time, UTC, summer time, etc. are a common source of confusion and errors setting the battery clock. The NTP algorithms will eventually resolve these errors, but the final convergence on correct time may be significantly delayed. The device might be ready for medical use before these errors are resolved.

Annex S Legacy Transition for Configuration Management (Informative)

There will usually be a period of time where a network will have some applications that utilize the configuration management protocols coexisting with applications that are only manually configured. The transition issues arise when a legacy Association Requestor interacts with a managed Association Acceptor or when a managed Association Requestor interacts with a legacy Association Acceptor. Some of these issues also arise when the Association Requestor and Association Acceptor support different configuration management profiles. These are discussed below and some general recommendations made for techniques that simplify the transition to a fully configuration managed network.

S.1 LEGACY ASSOCIATION REQUESTOR, CONFIGURATION MANAGED ASSOCIATION ACCEPTOR

The legacy Association Requestor requires that the IP address of the Association Acceptor not change dynamically because it lacks the ability to utilize DNS to obtain the current IP address of the Association Acceptor. The legacy Association Requestor also requires that the AE-title of the Association Acceptor be provided manually.

S.1.1 DHCP Server

The DHCP server should be configurable with a database of hostname, IP, and MAC address relationships. The DHCP server can be configured to provide the same IP address every time that a particular machine requests an IP address. This is a common requirement for Association Acceptors that obtain IP addresses from DHCP. The Association Acceptor may be identified by either the hardware MAC address or the hostname requested by the Association Acceptor.

The IP address can be permanently assigned as a static IP address so that legacy Association Requestor can be configured to use that IP address while managed Association Requestor can utilize the DNS services to obtain its IP address.

S.1.2 DNS Server

No specific actions are needed, although see below for the potential that the DHCP server does not perform DDNS updates.

S.1.3 LDAP Server

Although the managed Association Acceptor may obtain information from the LDAP server, the legacy Association Requestor will not. This means that the legacy mechanisms for establishing AE-Titles and related information on the Association Requestor will need to be coordinated manually. Most LDAP products have suitable GUI mechanisms for examining and updating the LDAP database. These are not specified by this standard.

An LDAP entry for the Association Requestor should be manually created, although this may be a very abbreviated entry. It is needed so that the AE-Title mechanisms can maintain unique AE-titles. There must be entries created for each of the AEs on the legacy Association Requestor.

The legacy Association Requestor will need to be configured based on manual examination of the LDAP information for the server and using the legacy procedures for that Association Requestor.

S.2 MANAGED ASSOCIATION REQUESTOR, LEGACY ASSOCIATION ACCEPTOR

S.2.1 DHCP Server

The DHCP server may need to be configured with a pre-assigned IP address for the Association Requestor if the legacy Association Acceptor restricts access by IP addresses. Otherwise no special actions are needed.

S.2.2 DNS Server

The legacy Association Acceptor hostname and IP address should be manually placed into the DNS database.

S.2.3 LDAP Server

The LDAP server should be configured with a full description of the legacy Association Acceptor, even though the Association Acceptor itself cannot provide this information. This will need to be done manually, most likely using GUI tools. The legacy Association Acceptor will need to be manually configured to match the AE-Titles and other configuration information.

S.3 NO DDNS SUPPORT

In the event that the DHCP server or DNS server do not support or permit DDNS updates, then the DNS server database will need to be manually configured. Also, because these updates are not occurring, all of the machines should have fixed pre-assigned IP addresses. This is not strictly necessary for clients, since they will not have incoming DICOM connections, but may be needed for other reasons. In practice maintaining this file is very similar to the maintenance of the older hostname files. There is still a significant administrative gain because only the DNS and DHCP configuration files need to be maintained, instead of maintaining files on each of the servers and clients

S.4 PARTIALLY MANAGED DEVICES

It is likely that some devices will support only some of the system management profiles. A typical example of such partial support is a node that supports:

- a. DHCP Client,
- b. DNS Client, and
- c. NTP Client

Configurations like this are common because many operating system platforms provide complete tools for implementing these clients. The support for LDAP Client requires application support and is often released on a different cycle than the operating system support. These devices will still have their DICOM application manually configured, but will utilize the DHCP, DNS, and NTP services.

S.5 ADDING THE FIRST MANAGED DEVICE TO A LEGACY NETWORK

The addition of the first fully managed device to a legacy network requires both server setup and device setup.

S.5.1 New Servers required

The managed node requires that servers be installed or assigned to provide the following actors:

- a. DHCP Server
- b. DNS Server
- c. NTP Server
- d. LDAP Server

These may be existing servers that need only administrative additions, they may be existing hardware that has new software added, and these may be one or multiple different systems. DHCP, DNS, and NTP services are provided by a very wide variety of equipment.

S.5.2 NTP

The NTP server location relative to this device should be reviewed to be sure that it meets the timing requirements of the device. If it is an NTP client with a time accuracy requirement of approximately 1 second, almost any NTP server location will be acceptable. For SNTP clients and devices with high time accuracy requirements, it is possible that an additional NTP server or network topology adjustment may be needed.

If the NTP server is using secured time information, certificates or passwords may need to be exchanged.

S.5.3 Documenting Managed and Unmanaged Nodes (DHCP, DNS, and LDAP)

S.5.3.1 DHCP Documentation

There are advantages to documenting the unmanaged nodes in the DHCP database. This is not critical for operations, but it helps avoid administrative errors. Most DHCP servers support the definition of pre-allocated static IP addresses. The unmanaged nodes can be documented by including entries for static IP addresses for the unmanaged nodes. These nodes will not be using the DHCP server initially, but having their entries in the DHCP database helps reduce errors and simplifies gradual transitions. The DHCP database can be used to document the manually assigned IP addresses in a way that avoids unintentional duplication.

The managed node must be documented in the DHCP database. The NTP and DNS server locations must be specified.

If this device is an association acceptor it probably should be assigned a fixed IP address. Many legacy devices cannot operate properly when communicating with devices that have dynamically assigned IP addresses. The legacy device does not utilize the DNS system, so the DDNS updates that maintain the changing IP address are not available. So most managed nodes that are association acceptors must be assigned a static IP address. The DHCP system still provides the IP address to the device during the boot process, but it is configured to always provide the same IP address every time. The legacy systems are configured to use that IP address.

S.5.3.2 DNS Documentation

Most DNS servers have a database for hostname to IP relationships that is similar to the DHCP database. The unmanaged devices that will be used by the managed node must have entries in this database so that machine IP addresses can be found. It is often convenient to document all of the hostnames and IP addresses for the network into the DNS database. This is a fairly routine administrative task and can be done for the entire network and maintained manually as devices are added, moved, or removed. There are many administrative tools that expect DNS information about all network devices, and this makes that information available.

If DDNS updates are being used, the manually maintained portion of the DNS database must be adjusted to avoid conflicts.

There must be DNS entries provided for every device that will be used by the managed node.

S.5.3.3 LDAP Documentation

The LDAP database should be configured to include device descriptions for this managed device, and there should be descriptions for the other devices that this device will communicate with. The first portion is used by this device during its startup configuration process. The second portion is used by this device to find the services that it will use.

The basic structural components of the DICOM information must be present on the LDAP server so that this device can find the DICOM root and its own entry. It is a good idea to fully populate the AE-title registry so that as managed devices are added there are no AE-title conflicts.

S.5.3.4 Descriptions of other devices

This device needs to be able to find the association acceptors (usually SCPs) that it will use during normal operation. These may need to be manually configured into the LDAP server. Their descriptions can be highly incomplete if these other devices are not managed devices. Only enough information is needed to meet the needs of this device. If this device is manually configured and makes no LDAP queries to find services, then none of the other device descriptions are needed.

There are some advantages to manually maintaining the LDAP database for unmanaged devices. This can document the manually assigned AE Titles. The service and network connection information can be very useful during network planning and troubleshooting. The database can also be useful during service

operations on unmanaged devices as a documentation aid. The decision whether to use the LDAP database as a documentation aid often depends upon the features provided with the LDAP server. If it has good tools for manually updating the LDAP database and good tools for querying and reporting, it is often a good investment to create a manually maintained LDAP database.

S.5.4 Description of this device

This device needs its own LDAP entry. This is used during the system startup process. The LDAP server updates must be performed.

S.6 SWITCHING A NODE FROM UNMANAGED TO MANAGED IN A MIXED NETWORK

During the transition period devices will be switched from unmanaged to managed. This may be done in stages, with the LDAP client transition being done at a different time than the DHCP, DNS, and NTP client. This section describes a switch that changes a device from completely unmanaged to a fully managed device. The device itself may be completely replaced or simply have a software upgrade. Details of how the device is switched are not important.

S.6.1 DHCP and DNS

If the device was documented as part of an initial full network documentation process, the entries in the DHCP and DNS databases need to be checked. If the entry is missing, wrong, or incomplete, it must be corrected in the DHCP and DNS databases. If the entries are correct, then no changes are needed to those servers. The device can simply start using the servers. The only synchronization requirement is that the DHCP and DNS servers be updated before the device, so these can be scheduled as convenient.

If the device is going to be dynamically assigned an IP address by the DHCP server, then the DNS server database should be updated to reflect that DDNS is now going to be used for this device. This update should not be made ahead of time. It should be made when the device is updated.

S.6.2 NTP

The NTP server location relative to this device should be reviewed to be sure that it meets the timing requirements of the device. If it is an NTP client with a time accuracy requirement of approximately 1 second, almost any NTP server location will be acceptable. For SNTP clients and devices with high time accuracy requirements, it is possible that an additional NTP server or network topology adjustment may be needed.

If the NTP server is using secured time information, certificates or passwords may need to be exchanged.

S.6.3 Association Acceptors on This Node

The association acceptors may be able to simply utilize the configuration information from the LDAP database, but it is likely that further configuration will be needed. Unmanaged nodes probably have only a minimal configuration in the database.

S.6.4 Association Requestors on Legacy Nodes

These will probably remain unchanged. The IP address must be pre-allocated if there are legacy nodes that cannot support DHCP.

S.6.5 Association Requestors on Managed Nodes

If the previous configuration had already been described in the LDAP database, the managed nodes can continue to use the LDAP database. The updated and more detailed entry describing the now managed association acceptor will be used.

Annex T Quantitative Analysis References (Informative)

T.1 DEFINITION OF LEFT AND RIGHT IN THE CASE OF QUANTITATIVE ATERIAL ANALYSIS

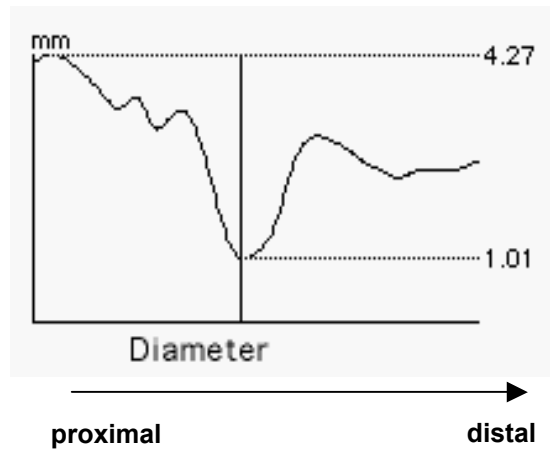
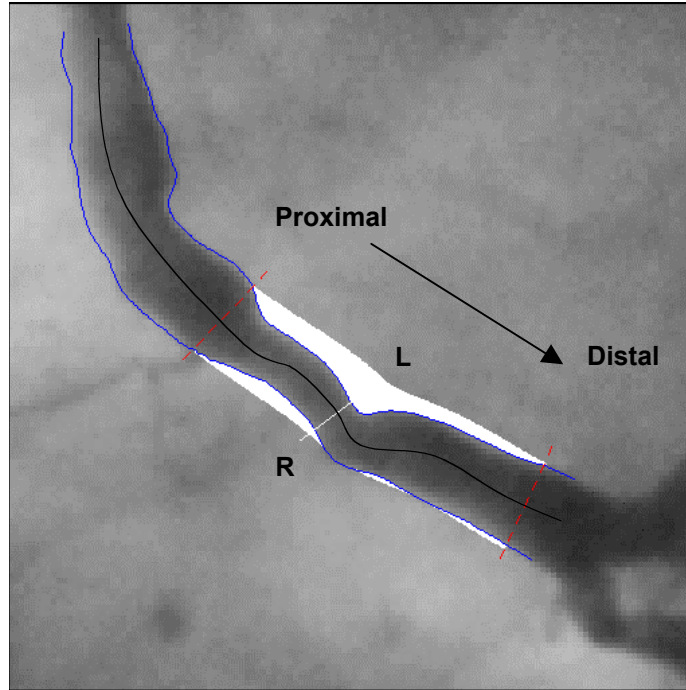

T.2 DEFINITION OF DIAMETER SYMMETRY WITH ATERIAL PLAQUES

The Diameter Symmetry of a Stenosis is a parameter determining the symmetry in arterial plaque distribution.

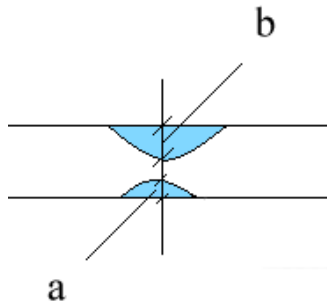

The Symmetry Index is defined by: $\frac{a}{b}$ where **a** is smaller or equal to than **b**. **a** and **b** are measured in the reconstructed artery at the position of the minimal luminal diameter.

Possible values of symmetry range from 0 to 1, where 0 indicates complete asymmetry and 1 indicates complete symmetry.

Reference: Quantitative coronary arteriography; physiological aspects, page 102-103 in: Reiber and Serruys, Quantitative coronary arteriography, 1991

T.3 WALL MOTION REGIONS

T.3.1 Landmark Based Wall Motion Regions

Landmark based Wall Motion

Contribution of Regions to global Ejection Fraction (CREF)

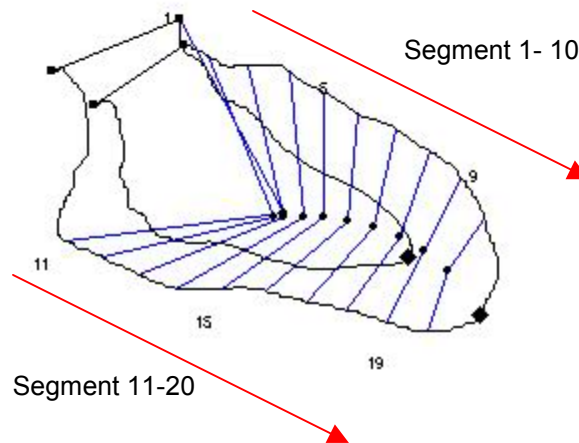
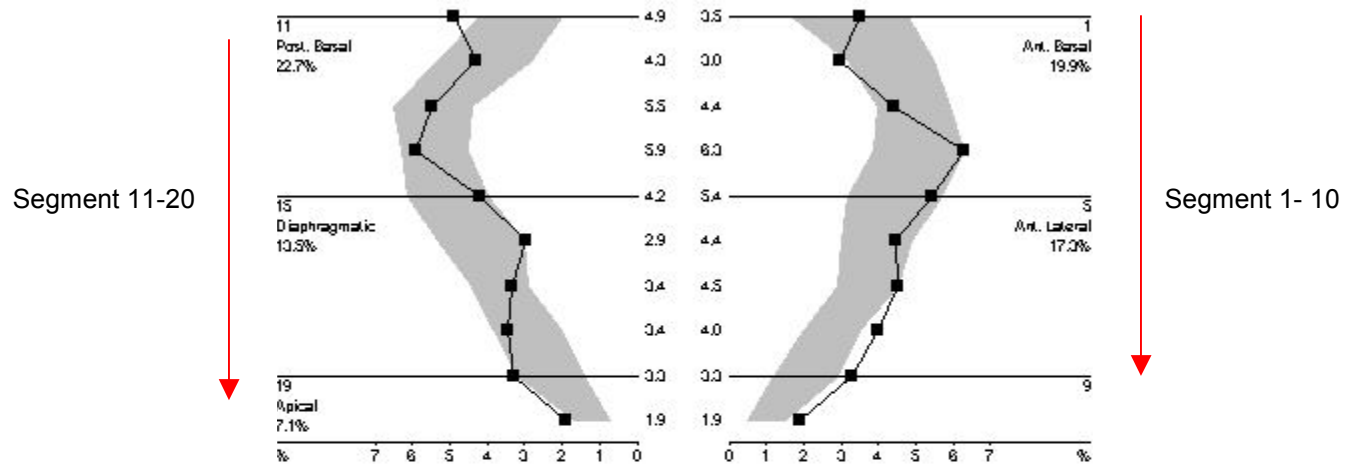

To compare the quantitative results with those provided by the usual visual interpretation, the left ventricular boundary is divided into 5 anatomical regions, denoted:

1. Anterobasal
2. Anterolateral
3. Posterobasal
4. Diaphragmatic
5. Apical

T.3.2 Centerline Wall Motion Region

Example of Centerline Wall Motion Template usage.

Centerline Wall Motion

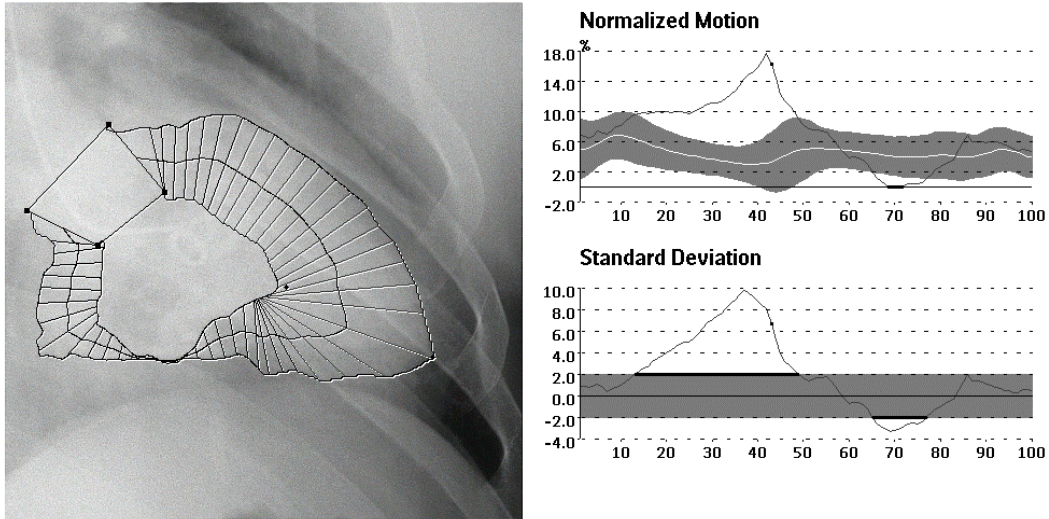

Extent (+/- 2 sdev)	Length	LAD		Length	RCA	
		Start	End		Start	End
Hypokinetic	11	66	76	66	76	
Hyperkinetic	35	14	48	24	48	
Akinetic	3	69	71	3	69	71

Territorial (+/- 2 sdev)	Type	Severity	Opp. Type	Opp. Severity
LAD	Hyper	6.6	Hypo	3.1
RCA	Hypo	2.6	Hyper	7.6
Mult. LAD	Hyper	7.1	Hypo	2.9
Mult. RCA	Hypo	2.9	Hyper	7.1

Node	Code Meaning of Concept Name	Code Meaning or Example Value	TID
X.X	Findings		
X.X.1	Procedure Reported	Centerline Wall Motion Analysis	3208
X.X.2	Contour Realignment	Center of Gravity	3208
X.X.3	Normalized Chord Length	5.0 %	300
X.X.4	Normalized Chord Length	5.1 %	300
X.X.5	Normalized Chord Length	5.3 %	300
...
X.X.102	Normalized Chord Length	4.5 %	300
X.X.103	Threshold Value	2	3208
X.X.104	Abnormal Region		3208

Node	Code Meaning of Concept Name	Code Meaning or Example Value	TID
X.X.104.1	Cardiac Wall Motion	Hypokinetic	3208
X.X.104.2	Circumferential Extend	LAD Region	3208
X.X.104.3	First Chord of Abnormal Region	66	3208
X.X.104.4	Last Chord of Abnormal Region	76	3208
X.X.104.5	Cardiac Wall Motion	Hypokinetic	3208
X.X.104.6	Circumferential Extend	RCA Region	3208
X.X.104.7	First Chord of Abnormal Region	66	3208
X.X.104.8	Last Chord of Abnormal Region	76	3208
X.X.104.9	Cardiac Wall Motion	Hyperkinetic	3208
X.X.104.10	Circumferential Extend	LAD Region	3208
X.X.104.11	First Chord of Abnormal Region	14	3208
X.X.104.12	Last Chord of Abnormal Region	48	3208
X.X.104.13	Cardiac Wall Motion	Hyperkinetic	3208
X.X.104.14	Circumferential Extend	RCA Region	3208
X.X.104.15	First Chord of Abnormal Region	25	3208
X.X.104.16	Last Chord of Abnormal Region	48	3208
X.X.104.17	Cardiac Wall Motion	Akinetic	3208
X.X.104.18	Circumferential Extend	LAD Region	3208
X.X.104.19	First Chord of Abnormal Region	69	3208
X.X.104.20	Last Chord of Abnormal Region	71	3208
X.X.104.21	Cardiac Wall Motion	Akinetic	3208
X.X.104.22	Circumferential Extend	RCA Region	3208
X.X.104.23	First Chord of Abnormal Region	69	3208
X.X.104.24	Last Chord of Abnormal Region	71	3208
X.X.105	Regional Abnormal Wall Motion		3208
X.X.105.1	Finding Site	Single LAD Region in RAO Projection	3208
X.X.105.2	Territory Region Severity	6.6	300
X.X.105.2.1	Cardiac Wall Motion	Hypokinetic	300
X.X.105.3	Opposite Region Severity	3.1	300
X.X.105.3.1	Cardiac Wall Motion	Hyperkinetic	300
X.X.105.4	Finding Site	Single RCA Region in RAO Projection	3208
X.X.105.5	Territory Region Severity	2.6	300
X.X.105.5.1	Cardiac Wall Motion	Hyperkinetic	300
X.X.105.6	Opposite Region Severity	7.6	300
X.X.105.6.1	Cardiac Wall Motion	Hypokinetic	300
X.X.105.7	Finding Site	Multiple LAD Region in RAO Projection	3208
X.X.105.8	Territory Region Severity	7.1	300

Node	Code Meaning of Concept Name	Code Meaning or Example Value	TID
X.X.105.8.1	Cardiac Wall Motion	Hyperkinetic	300
X.X.105.9	Opposite Region Severity	2.9	300
X.X.105.9.1	Cardiac Wall Motion	Hyperkinetic	300
X.X.105.10	Finding Site	Multiple RCA in Region RAO Projection	3208
X.X.105.11	Territory Region Severity	2.9	300
X.X.105.11.1	Cardiac Wall Motion	Hypokinetic	300
X.X.105.12	Opposite Region Severity	7.1	300
X.X.105.12.1	Cardiac Wall Motion	Hyperkinetic	300
X.X.106	3208

T.3.4 Radial Based Wall Motion Region

Radial Based Wall Motion

Mean Motion

- 1.Antero-basal : 33 %
- 2.Antero-lateral : 39 %
- 3.Apical : 17 %
- 4.Diaphragmatic : 26 %
- 5.Postero-basal : 30 %

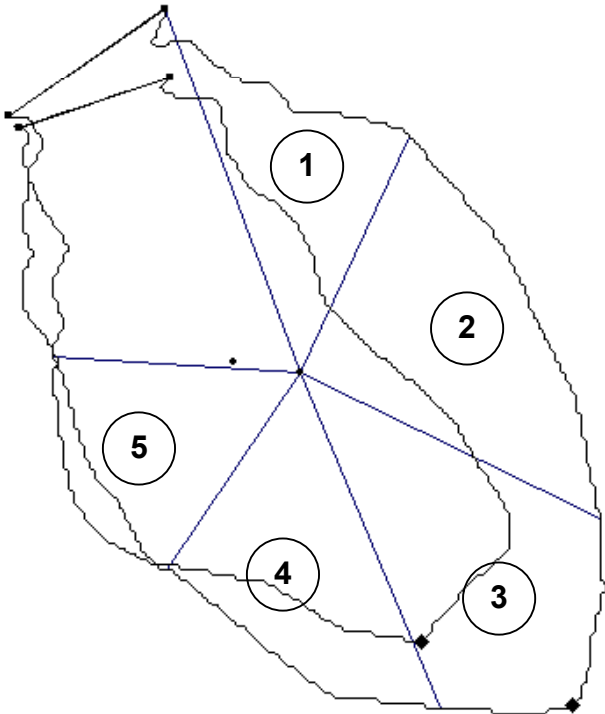

T.4 QUANTITATIVE ARTERIAL ANALYSIS REFERENCE METHOD

Defined Terms:

1. Computer Calculated Reference
2. Interpolated Local Reference
3. Mean Local Reference

T.4.1 Computer Calculated Reference

The computer-defined obstruction analysis calculates the reconstruction diameter based on the diameters outside the stenotic segment. This method is completely automated and user independent. The reconstructed diameter represents the diameters of the artery had the obstruction not been present.

The proximal and distal borders of the stenotic segment are automatically calculated.

The difference between the detected contour and the reconstructed contour inside the reconstructed diameter contour is considered to be the plaque.

Based on the reconstruction diameter at the Minimum Luminal Diameter (MLD) position a reference diameter for the obstruction is defined.

T.4.2 Interpolated Reference

The interpolated reference obstruction analysis calculates a reconstruction diameter for each position in the analyzed artery. This reconstructed diameter represents the diameters of the artery when no disease would be present. The reconstruction diameter is a line fitted through at least two user-defined reference markers by linear interpolation.

By default two references are used at the positions of the reference markers are automatically positioned at 5% and 95% of the artery length.

To calculate a percentage diameter stenosis the reference diameter for the obstruction is defined as the reconstructed diameter at the position of the MLD.

In cases where the proximal and distal part of the analyzed artery have a stable diameter during the treatment and long-term follow-up, this method will produce a stable reference diameter for all positions in the artery.

T.4.3 Mean Local Reference

In case of mean local reference obstruction the reference diameter will be an average of the diameters at the position of one or more the reference markers.

This method is particularly appropriate for the analysis of bifurcated arteries.

T.5 POSITIONS IN DIAMETER GRAPHIC

A vessel segment length as seen in the image is not always indicated as the same X-axis difference in the graph.

The X-axis of the graph is based on pixel positions on the midline and these points are not necessarily equidistant. This is caused by the fact that vessels do not only run perfectly horizontally or vertically, but also at angles.

When a vessel midline is covering a number of pixel positions perfectly horizontal or vertical, it will cover less space in mm compared to a vessel that covers the same number of pixel positions under an angle. When a segment runs perfectly horizontal or vertical, the segment length is equal to the amount of

midline pixel points times the pixel separation (each point of the midline is separated exactly the pixel spacing in mm) and the points on the X-axis also represent exactly one pixel space. This is not the case when the vessel runs under an angle. For example an artery that is positioned at a 45 angle, the distance between two points on the midline is 0.7 times the pixel spacing.

As example, the artery consists of 10 elements ($n = 10$); each has a length of 1mm(pixel size). If the MLD was exactly in the center of the artery you would expect the length from 0 to the MLD would be 5 sub segments long, thus 5 mm. This is true if the artery runs horizontal or vertically (assumed aspect ratio is 1).

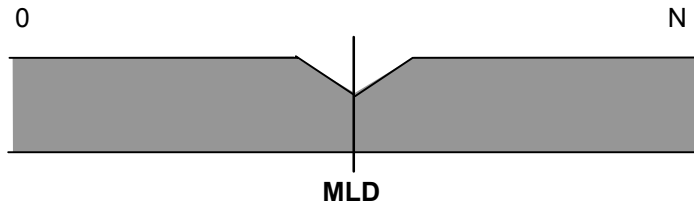

If the artery is positioned in a 45° angle then the length of each element is $\sqrt{2}$ times the pixel size compared to the previous example. Thus the length depends on the angle of the artery.

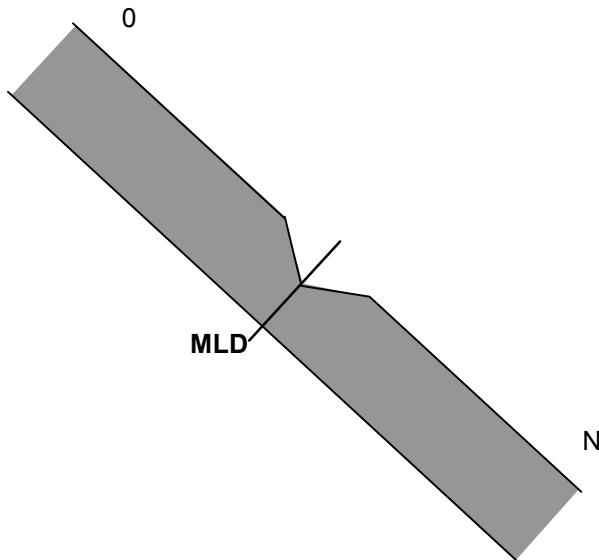

Annex U Ophthalmology Use Cases (Informative)

U.1 USE CASES

The following use cases are examples of how the DICOM Ophthalmology Photography objects may be used. These use cases utilize the term “picture” or “pictures” to avoid using the DICOM terminology of frame, instance or image. In the use cases, the series means DICOM Series.

U.1.1 Routine N-spot exam

An N-spot retinal photography exam means that “N” predefined locations on the retina are examined.

A routine N-spot retinal photography exam is ordered for both eyes. There is nothing unusual observed during the exam, so N pictures are taken of each retina. This healthcare facility also specifies that in an N-spot exam a routine external picture is captured of both eyes, that the current intraocular pressure (IOP) is measured, and that the current refractive state is measured.

The resulting study contains:

- a. 2N pictures of the retina and one external picture. Each retinal picture is labeled in the acquisition information to indicate its position in the local N-spot definition. The series is not labeled, each picture is labeled OS or OD as appropriate.

Note: DICOM uses L, R, and B in the Image Laterality Attribute (0020,0062). The actual encodings will be L, R, or B. Ophthalmic equipment can convert this to OS, OD, and OU before display.

- a. In the acquisition information of every picture, the IOP and refractive state information is replicated.
- b. Since there are no stereo pictures taken, there is no Stereometric Relationship IOD instance created.

The pictures may or may not be in the same Series.

U.1.2 Routine N-spot exam with exceptions

A routine N-spot retinal photography exam is ordered for both eyes. During the exam a lesion is observed in the right eye. The lesion spans several spots, so an additional wide angle view is taken that captures the complete lesion. Additional narrow angle views of the lesion are captured in stereo. After completing the N-spot exam, several slit lamp pictures are taken to further detail the lesion outline.

The resulting study contains:

- a. 2N pictures of the retina and one external picture, one additional wide angle picture of the abnormal retina, 2M additional pictures for the stereo detail of the abnormal retina, and several slit lamp pictures of the abnormal eye. The different lenses and lighting parameters are documented in the acquisition information for each picture.
- b. One instance of a Stereometric Relationship IOD, indicating which of the stereo detail pictures above should be used as stereo pairs.

The pictures may or may not be in the same Series.

U.1.3 Routine Fluorescein Exam

A routine fluorescein exam is ordered for one eye. The procedure includes:

- a. Routine stereo N-spot pictures of both eyes, routine external picture, and current IOP.
- b. Reference stereo picture of each eye using filtered lighting
- c. Fluorescein injection
- d. Capture of 20 stereo pairs with about 0.7 seconds between pictures in a pair and 3-5 seconds between pairs.

- e. Stereo pair capture of each eye at increasing intervals for the next 10 minutes, taking a total of 8 pairs for each eye.

The result is a study with:

- a. The usual 2N+1 pictures from the N-spot exam
- b. Four pictures taken with filtered lighting (documented in acquisition information) that constitute a stereo pair for each eye.
- c. 40 pictures (20 pairs) for one eye of near term fluorescein. These include the acquisition information, lighting context, and time stamp.
- d. 32 pictures (8 pairs for each eye) of long term fluorescein. These include acquisition information, lighting context, and time stamp.
- e. One Stereometric Relationship IOD, indicating which of the above OP instances should be used as stereo pairs.

The pictures of a) through d) may or may not be in the same series.

U.1.4 External examination

The patient presents with a generic eye complaint. Visual examination reveals a possible abrasion. The general appearance of the eyes is documented with a wide angle shot, followed by several detailed pictures of the ocular surface. A topical stain is applied to reveal details of the surface lesion, followed by several additional pictures. Due to the nature of the examination, no basic ophthalmic measurements were taken.

The result is a study with one or more series that contains:

- a. One overall external picture of both eyes
- b. Several close-up pictures of the injured eye
- c. Several close-up pictures of the injured eye after topical stain. These pictures have the additional stain information conveyed in the acquisition information for these pictures.

U.1.5 External examination with intention

The patient is suspected of a nervous system injury. A series of external pictures are taken with the patient given instructions to follow a light with his eyes. For each picture the location of the light is indicated by the patient intent information, (e.g. above, below, patient left, patient right).

The result is a study with one or more series that contains:

- a. Individual pictures with each picture using the patient intent field to indicate the intended direction.

U.1.6 External examination with drug application

Patient is suspected of myasthenia gravis. Both eyes are imaged in normal situation. Then after Tensilon® (edrophonium chloride) injection a series of pictures is taken. The time, amount, and method of Tensilon® (edrophonium chloride) administration is captured in the acquisition information. The time stamps of the pictures are used in conjunction with the behavior of the eyelids to assess the state of the disease.

Note: Tensilon® is a registered trademark of Roche Laboratories

The result is a study with one or more series that contains:

- a. Multiple reference pictures prior to test
- b. Pictures with acquisition information to document drug administration time.

U.1.7 Routine stereo camera examination

A stereo optic disk examination is ordered for a patient with glaucoma. For this examination, the IOP does not need to be measured. The procedure includes:

- a. Mydriasis using agent at time t
- b. N stereo pictures (camera pictures right and left stereo picture simultaneously) of the optic disk region at the time $t+s$

The result is a study with:

- a. N right and N left stereo pictures. These include acquisition information, lighting context, agent and time stamps.
- b. One Stereometric Relationship SOP Instance, indicating that the above OP images should be used as stereo pairs.

U.2 TYPICAL SEQUENCE OF EVENTS

The following shows the proposed sequence of events using individual images that are captured for later stereo viewing, with the stereo viewing relationships captured in the stereometric relationship instance.

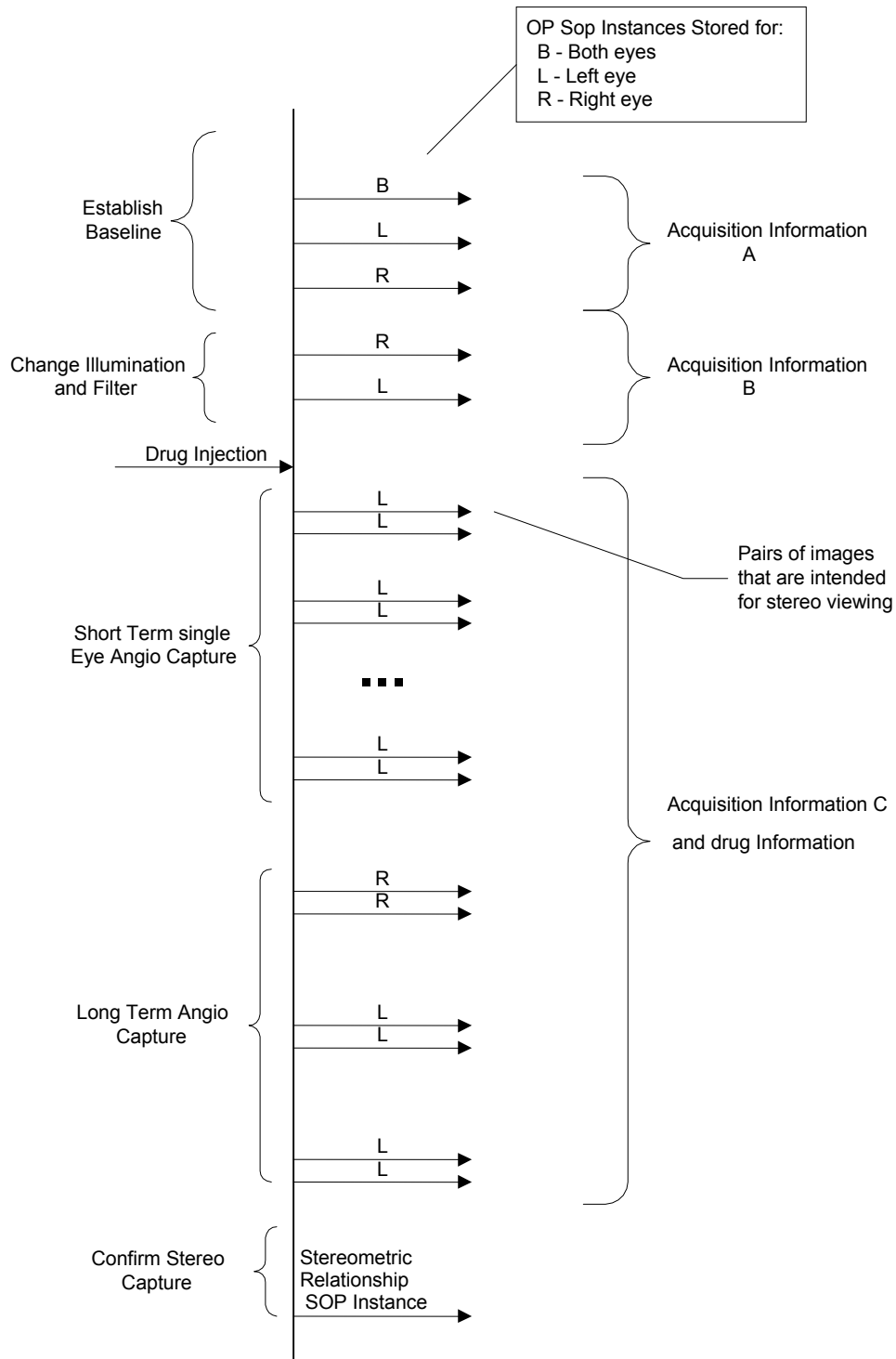

The instances captured are all time stamped so that the fluorescein progress can be measured accurately. The acquisition and equipment information captures the different setups that are in use:

- Acquisition information A** is the ordinary illumination and planned lenses for the examination.
- Acquisition information B** is the filtered illumination, filtered viewing, and lenses appropriate for the fluorescein examination.
- Acquisition information C** indicates no change to the equipment settings, but once the injection is made, the subsequent images include the drug, method, dose, and time of delivery.

Annex V Hanging Protocols (Informative)

The Hanging Protocol Composite IOD contains information about user viewing preferences, related to image display station (workstation) capabilities. The associated Service Classes support the storage (C-STORE), query (C-FIND) and retrieve (C-MOVE) of Hanging Protocol Instances between servers and workstations. The goal is for users to be able to conveniently define their preferred methods of presentation and interaction for different types of viewing circumstances once, and then to automatically layout image sets according to the users' preferences on workstations of similar capability.

The primary expectation is to facilitate the automatic and consistent hanging of images according to definitions provided by the users, sites or vendors of the workstations by providing the capability to:

- Save defined Hanging Protocols
- Search for Hanging Protocols by name, level (single user, user group, site, manufacturer), user identification code, modality, anatomy, and laterality.
- Allow automatic hanging of image sets to occur for all studies on workstations with sufficiently compatible capabilities by matching against user or site defined Hanging Protocols. This includes supporting automatic hanging when the user reads from different locations, or on different but similar workstation types.

How relevant image sets (e.g., from the current and prior studies) are obtained is not defined by the Hanging Protocol IOD or Service Classes.

Conformance with the DICOM Grayscale Standard Display Function and the DICOM Softcopy Presentation States in conjunction with the Hanging Protocol IOD allows the complete picture of what the users see, and how they interact with it, to be defined, stored and reproduced as similarly as possible, independent of workstation type. Further, it is anticipated that implementors will make it easy for users to point to a graphical representation of what they want (such as 4x1 versus 12x1 format with a horizontal alternator scroll mechanism) and select it.

V.1 Example Scenario

User A sits down at workstation X, with two 1024x1280 resolution screens (Figure V.1-1) that recently has been installed and hence has no user specific Hanging Protocols defined. The user brings up the list of studies to be read and selects the first study, a chest CT, together with the relevant prior studies. The workstation queries the Hanging Protocol Query SCP for instances of the Hanging Protocol Storage SOP Class. It finds none for this specific user, but matches a site specific Hanging Protocol Instance, which was set up when the workstation was installed at the site. It applies the site Hanging Protocol Instance, and the user reads the current study in comparison to the prior studies.

The user decides to customize the viewing style, and uses the viewing application to define what type of Hanging Protocol is preferred (layout style, interaction style) by pointing and clicking on graphical representations of the choices. The user chooses a 3-column by 4-row tiled presentation with a "vertical alternator" interaction, and a default scroll amount of one row of images. The user places the current study on the left screen, and the prior study on the right screen. The user requests the application to save this Hanging Protocol, which causes the new Hanging Protocol Instance to be stored to the Hanging Protocol Storage SCP.

When the same user comes back the next day to read chest CT studies at workstation X and a study is selected, the application queries the Hanging Protocol Query SCP to determine which Hanging Protocol Instances best match the scenario of this user on this workstation for this study. The best match returned by the SCP in response to the query is with the user ID matching his userid, the study type matched to the study type(s) of the image set selected for viewing, and the screen types matching the workstation in use.

A list of matches is produced, with the Hanging Protocol Instance that the user defined yesterday for chest CT matching the best, and the current CT study is automatically displayed on the left screen with that Hanging Protocol. Alternative next best matches are available to the user via the application interface's pull-down menu list of all closely matching Hanging Protocol Instances.

Because this Hanging Protocol defines an additional image set, the prior year's chest CT study for the same patient is displayed next to the current study, on the right screen.

The next week, the same user reads chest CTs at a different site in the same enterprise on a similar type workstation, workstation Y, from a different vendor. The workstation has a single 2048x2560 screen (Figure V.1-1). This workstation queries the Hanging Protocol Query SCP, and retrieves matching Hanging Protocol Instances, choosing as the best match the Hanging Protocol Instance used on workstation X before by user A. This Hanging Protocol is automatically applied to display the chest CT study. The current chest CT study is displayed on the left half of the 2048x2560 screen, and the prior chest CT study is displayed on the right half of the screen, with 3 columns and 8 rows each, maintaining the same vertical alternator layout. The sequence of communications between the workstations and the SCP is depicted in Figure V.1-2.

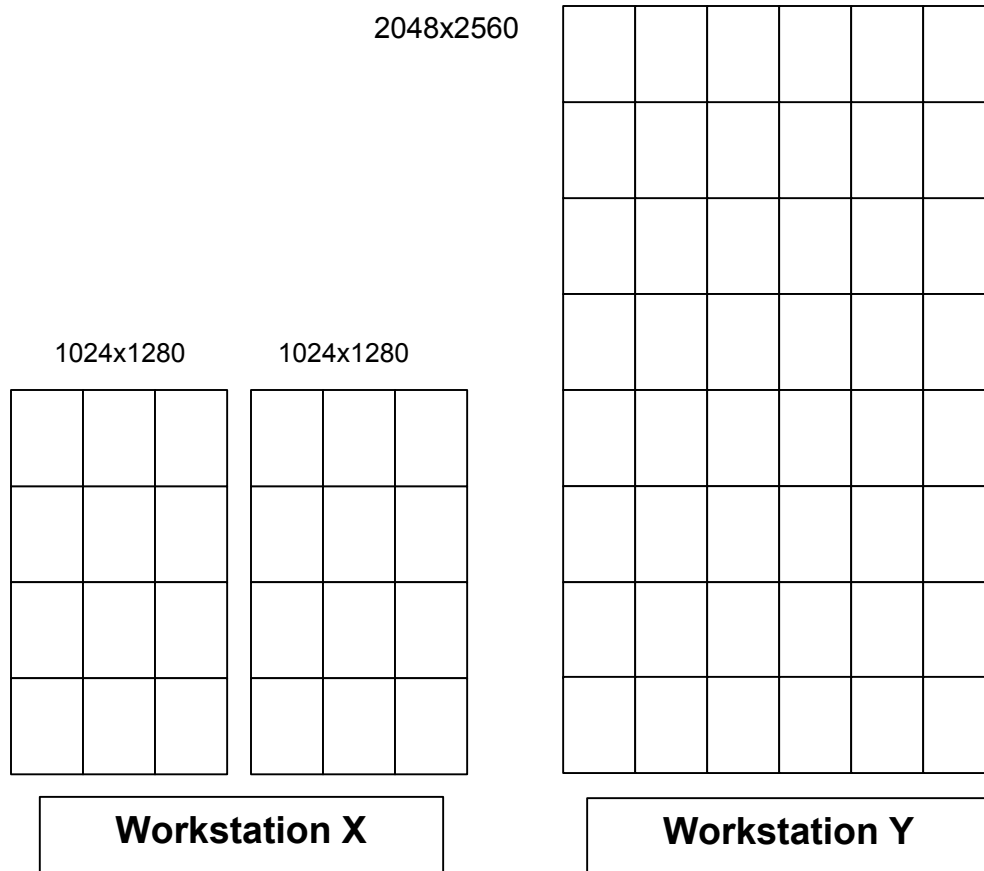

Figure V.1-1. Spatial layout of screens for workstations in Example Scenario.

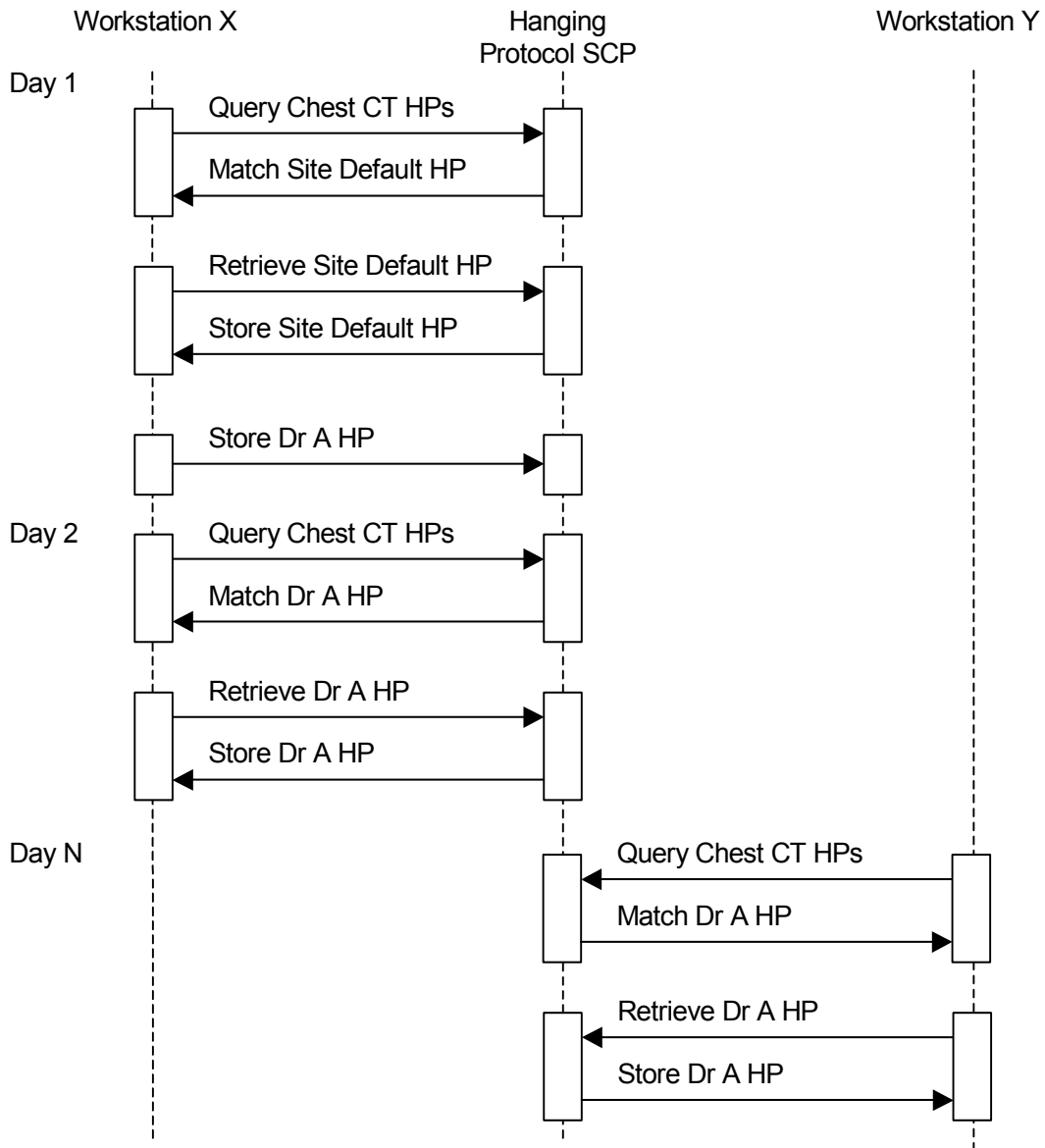

Figure V.1-2. **Sequence diagram for Example Scenario**

V.2 HANGING PROTOCOL INTERNAL PROCESS MODEL

The overall process flow of Hanging Protocols can be seen in Figure V.2-1, and consists of three main steps: selection, processing, and layout. The selection is defined in the ***Hanging Protocol Definition Module***. The processing and layout are defined in the ***Hanging Protocol Display Module***. The first process step, the selection of sets of images that need to be available from DICOM image objects, is defined by the Image Sets Sequence of the ***Hanging Protocol Definition Module***. This is a N:M mapping, with multiple image sets potentially drawing from the same image objects.

The second part of the process flow consists of the filtering, reformatting, sorting, and presentation intent operations that map the Image Sets into their final form, the Display Sets. This is defined in the ***Hanging Protocol Display Module***. This is a 1:M relationship, as multiple Display Sets may draw their images from the same Image Set. The filtering operation allows for selecting a subset of the Image Set and is defined by the Hanging Protocol Display Module Filter Operations Sequence. Reformatting allows operations such as multiplanar reformatting to resample images from a volume (Reformatting Operation Type, Reformatting Thickness, Reformatting Interval, Reformatting Operation Initial View Direction, 3D Rendering Type). The Hanging Protocol Display Module Sorting Operations Sequence allows for ordering of the images. Default presentation intent (a subset of the Presentation State operations such as intensity window default setting) is defined by the Hanging Protocol Display Module presentation intent attributes. The Display Sets are containers holding the final sets of images after all operations have occurred. These sets contain the images ready for rendering to locations on the screen(s).

The rendering of a Display Set to the screen is determined by the layout information in the Image Boxes Sequence within a Display Sets Sequence Item in the Hanging Protocol Display Module. A Display Set is mapped to a single Image Boxes Sequence. This is generally a single Image Box (rectangular area on screen), but may be an ordered set of image boxes. The mapping to an ordered set of image boxes is a special case to allow the images to flow in an ordered sequence through multiple locations on the screen (e.g., newspaper columns). Display Environment Spatial Position specifies rectangular locations on the screen where the images from the Display Sets will be rendered. The type of interaction to be used is defined by the Image Boxes Sequence Item attributes. A vertically scrolling alternator could be specified by having Image Box Layout Type equal TILED and Image Box Scroll Direction equal VERTICAL.

An example of this processing is shown in Figure V.2-2. The figure is based on the Neurosurgery Planning Hanging Protocol Example contained in this Annex, and corresponds to the display sets for Display Set Presentation Group #1 (CT only display of current CT study).

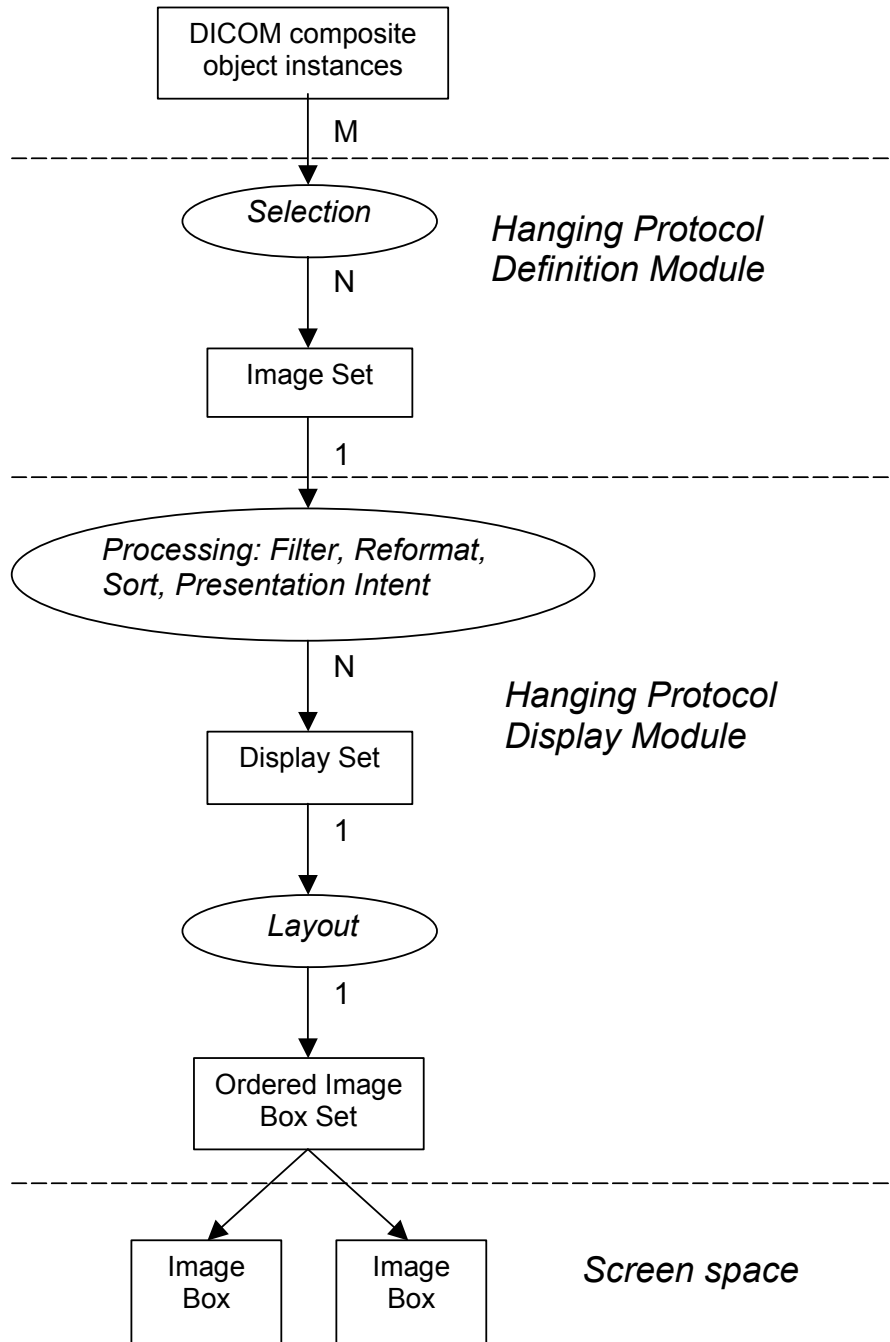

Figure V.2-1 Hanging Protocol Internal Process Model

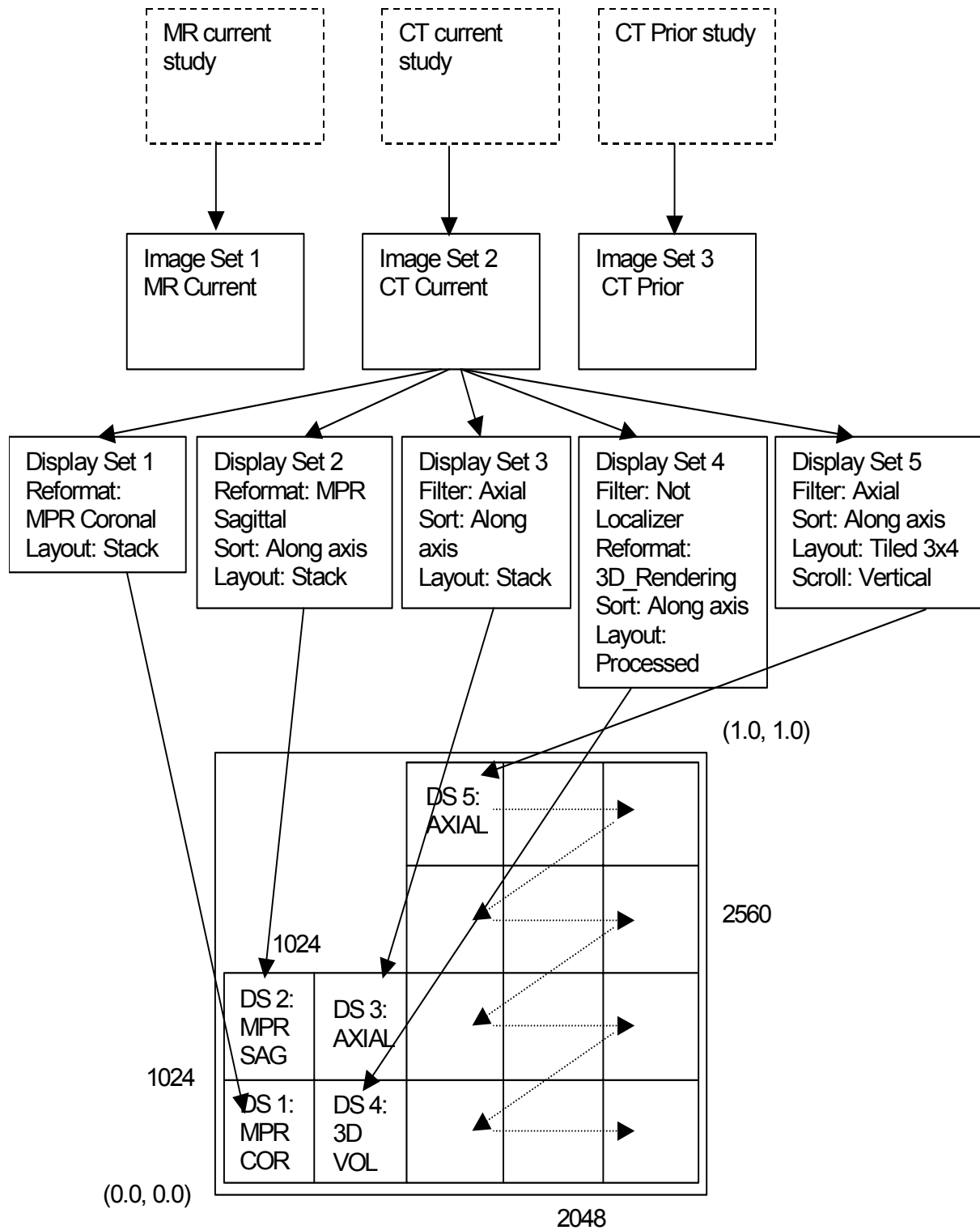

Figure V.2-2 Example Process Flow

V.3 CHEST X-RAY HANGING PROTOCOL EXAMPLE

Goal: A Hanging Protocol for Chest X-ray, PA & Lateral (LL, RL) views, current & prior, with the following layout:

Screen 1		Screen 2	
Display Set 1, 1 Image Box: Prior Lateral	Display Set 2, 1 Image Box: Prior PA	Display Set 3, 1 Image Box: Current PA	Display Set 4, 1 Image Box: Current Lateral

The Hanging Protocol Definition does not specify a specific modality, but rather a specific anatomy (Chest). The Image Sets Sequence provides more detail, in that it specifies the modalities in addition to the anatomy for each image set.

V.3.1 Hanging Protocol Definition Module

Hanging Protocol Name: "Chest X-ray"

Hanging Protocol Description: "Current and Prior Chest PA and Lateral"

Hanging Protocol Level: "SITE"

Hanging Protocol Creator: "Senior Radiologist"

Hanging Protocol Creation Datetime: "20020823133455"

Hanging Protocol Definition Sequence:

- Item 1:
- Anatomic Region Sequence:
 - Item 1: (T-D3000, SNM3, "Chest")
- Laterality: *zero length*
- Procedure Code Sequence: *zero length*
- Reason for Requested Procedure Code Sequence: *zero length*

Number of Priors Referenced: 1

Image Sets Sequence:

- Item 1:
- Image Set Selector Sequence:
 - Item 1:
 - Image Set Selector Usage Flag: "NO_MATCH"
 - Selector Attribute: (0008,2218) [Anatomic Region Sequence]
 - Selector Attribute VR: "SQ"
 - Selector Code Sequence Value:
 - Item 1: (T-D3000, SNM3, "Chest")
 - Selector Value Number: 1
 - Item 2:
 - Image Set Selector Usage Flag: "NO_MATCH"
 - Selector Attribute: (0008,0060) [Modality]
 - Selector Attribute VR: "CS"
 - Selector CS Value: "CR\DX"
 - Selector Value Number: 1
- Time Based Image Sets Sequence:
 - Item 1:
 - Image Set Number: 1
 - Image Set Selector Category: "RELATIVE_TIME"
 - Relative Time: 0\0
 - Relative Time Units: "MINUTES"
 - Image Set Label: "Current Chest X-ray"

- Item 2:
- Image Set Number: 2
- Image Set Selector Category: "ABSTRACT_PRIOR"
- Abstract Prior Value: 1\1
- Image Set Label: "Prior Chest X-ray"

Hanging Protocol User Identification Code Sequence: *zero length*

Hanging Protocol User Group Name: "ABC Hospital"

V.3.2 Hanging Protocol Environment Module

Number of Screens: 2

Nominal Screen Definition Sequence:

- Item 1:
 - Number of Vertical Pixels: 2560
 - Number of Horizontal Pixels: 2048
 - Display Environment Spatial Position: 0.0\1.0\0.5\0.0, representing (0,1), (0.5,0)
 - Screen Minimum Grayscale Bit Depth: 8
 - Application Maximum Repaint Time: 100
- Item 2:
 - Number of Vertical Pixels: 2560
 - Number of Horizontal Pixels: 2048
 - Display Environment Spatial Position: 0.5\1.0\1.0\0.0, representing (0.5,1), (1,0)
 - Screen Minimum Grayscale Bit Depth: 8
 - Application Maximum Repaint Time: 100

V.3.3 Hanging Protocol Display Module

Display Sets Sequence:

- Item 1:
 - Display Set Number: 1
 - Display Set Presentation Group: 1
 - Image Set Number: 2
 - Image Boxes Sequence:
 - Item 1:
 - Image Box Number: 1
 - Display Environment Spatial Position: 0.0\1.0\0.25\0.0, representing (0,1), (0.25,0)
 - Image Box Layout Type: "SINGLE"
 - Filter Operations Sequence:
 - Item 1:
 - Selector Attribute: (0018,5101) [View Position]
 - Selector Attribute VR: "CS"
 - Selector CS Value: "RL\LL"
 - Selector Value Number: 1
 - Filter-by Operator: "MEMBER_OF"
 - Sorting Operations Sequence: *zero length*
 - Display Set Patient Orientation: "A\F"
 - Show Image True Size Flag: "NO"
 - Show Graphic Annotation Flag: "NO"
- Item 2:
 - Display Set Number: 2
 - Display Set Presentation Group: 1
 - Image Set Number: 2
 - Image Boxes Sequence:
 - Item 1:
 - Image Box Number: 1
 - Display Environment Spatial Position: 0.25\1.0\0.5\0.0, representing (0.25,1), (0.5,0)
 - Image Box Layout Type: "SINGLE"
 - Filter Operations Sequence:
 - Item 1:

- Selector Attribute: (0018,5101) [View Position]
 - Selector Attribute VR: "CS"
 - Selector CS Value: "PA"
 - Selector Value Number: 1
 - Filter-by Operator: "MEMBER_OF"
 - Sorting Operations Sequence: *zero length*
 - Display Set Patient Orientation: "R\F"
 - Show Image True Size Flag: "NO"
 - Show Graphic Annotation Flag: "NO"
 - Item 3:
 - Display Set Number: 3
 - Display Set Presentation Group: 1
 - Image Set Number: 1
 - Image Boxes Sequence:
 - Item 1:
 - Image Box Number: 1
 - Display Environment Spatial Position: 0.5\1.0\0.75\1.0, representing (0.5,1), (0.75,0)
 - Image Box Layout Type: "SINGLE"
 - Filter Operations Sequence:
 - Item 1:
 - Selector Attribute: (0018,5101) [View Position]
 - Selector Attribute VR: "CS"
 - Selector CS Value: "PA"
 - Selector Value Number: 1
 - Filter-by Operator: "MEMBER_OF"
 - Sorting Operations Sequence: *zero length*
 - Display Set Patient Orientation: "R\F"
 - Show Image True Size Flag: "NO"
 - Show Graphic Annotation Flag: "NO"
 - Item 4:
 - Display Set Number: 4
 - Display Set Presentation Group: 1
 - Image Set Number: 1
 - Image Boxes Sequence:
 - Item 1:
 - Image Box Number: 1
 - Display Environment Spatial Position: 0.75\1.0\1.0\0.0, representing (0.75,1), (1,0)
 - Image Box Layout Type: "SINGLE"
 - Filter Operations Sequence:
 - Item 1:
 - Selector Attribute: (0018,5101) [View Position]
 - Selector Attribute VR: "CS"
 - Selector CS Value: "RL\LL"
 - Selector Value Number: 1
 - Filter-by Operator: "MEMBER_OF"
 - Sorting Operations Sequence: *zero length*
 - Display Set Patient Orientation: "A\F"
 - Show Image True Size Flag: "NO"
 - Show Graphic Annotation Flag: "NO"
- Partial Data Display Handling: "MAINTAIN_LAYOUT"

V.4 NEUROSURGERY PLANNING HANGING PROTOCOL EXAMPLE

Goal: A Hanging Protocol for MR & CT of Head, for a neurosurgery plan. 1Kx1K screen on left shows orthogonal MPR slices through the acquisition volume, and in one presentation group has a 3D interactive volume rendering in the lower right quadrant. In all display sets the 1Kx1K screen is split into

4 512x512 quadrants. The 2560x2048 screen has a 4 row by 3 column tiled display area. There are 4 temporal presentation groups: CT_{new}, MR, combined CT_{new} and MR, combined CT_{new} and CT_{old}.

Display Environment Spatial Position attribute values for image boxes are represented in terms of ratios in pixel space [(0/3072, 512/2560), (512/3072,0/2560)] rather than (0.0,0.0), (1.0,1.0) space, for ease of understanding the example.

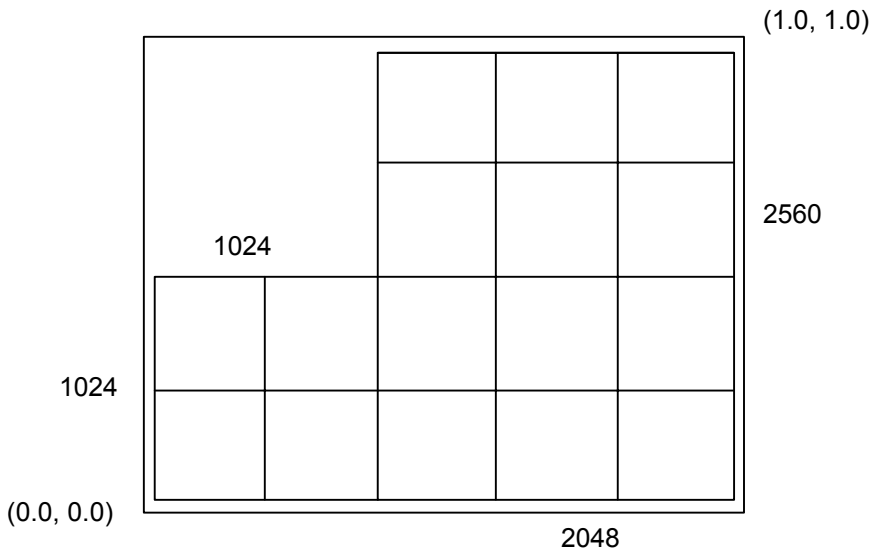

V.4.1 Hanging Protocol Definition Module

Hanging Protocol Name: "NeurosurgeryPlan"

Hanging Protocol Description: "Neurosurgery planning, requiring MR and CT of head"

Hanging Protocol Level: "SITE"

Hanging Protocol Creator: "Smith^Joseph"

Hanging Protocol Creation Datetime: "20020101104200"

Hanging Protocol Definition Sequence:

- Item 1:
 - Modality: "MR"
 - Anatomic Region Sequence:
 - Item 1: (T-D1100, SNM3, "Head")
 - Laterality: *zero length*
 - Procedure Code Sequence:
 - Item 1: (98765, 99Local, 1.5, "NeuroSurgery Plan Local5")
 - Reason for Requested Procedure Code Sequence:
 - Item 1: (I67.1, I10, "Cerebral aneurysm")
- Item 2:
 - Modality: "CT"
 - Anatomic Region Sequence:
 - Item 1: (T-D1100, SNM3, "Head")
 - Laterality: *zero length*
 - Procedure Code Sequence:
 - Item 1: (98765, 99Local, 1.5, "NeuroSurgery Plan Local5")
 - Reason for Requested Procedure Code Sequence:
 - Item 1: (I67.1, I10, "Cerebral aneurysm")

Number of Priors Referenced: 1

Image Sets Sequence:

- Item 1:
 - Image Set Selector Sequence:
 - Item 1:
 - Image Set Selector Usage Flag: "NO_MATCH"

- Selector Attribute: (0018,0015) [Body Part Examined]
- Selector Attribute VR: "CS"
- Selector CS Value: "HEAD"
- Selector Value Number: 1
- Item 2:
- Image Set Selector Usage Flag: "NO_MATCH"
- Selector Attribute: (0008,0060) [Modality]
- Selector Attribute VR: "CS"
- Selector CS Value: "MR"
- Selector Value Number: 1
- Time Based Image Sets Sequence:
 - Item 1:
 - Image Set Number: 1
 - Image Set Selector Category: "RELATIVE_TIME"
 - Relative Time: 0\0
 - Relative Time Units: "MINUTES"
 - Image Set Label: "Current MR Head"
- Item 2:
- Image Set Selector Sequence:
 - Item 1:
 - Image Set Selector Usage Flag: "NO_MATCH"
 - Selector Attribute: (0018,0015) [Body Part Examined]
 - Selector Attribute VR: "CS"
 - Selector CS Value: "HEAD"
 - Selector Value Number: 1
 - Item 2:
 - Image Set Selector Usage Flag: "NO_MATCH"
 - Selector Attribute: (0008,0060) [Modality]
 - Selector Attribute VR: "CS"
 - Selector CS Value: "CT"
 - Selector Value Number: 1
- Time Based Image Sets Sequence:
 - Item 1:
 - Image Set Number: 2
 - Image Set Selector Category: "RELATIVE_TIME"
 - Relative Time: 0\0
 - Relative Time Units: "MINUTES"
 - Image Set Label: "Current CT Head"
 - Item 2:
 - Image Set Number: 3
 - Image Set Selector Category: "ABSTRACT_PRIOR"
 - Abstract Prior Value: 1\1
 - Image Set Label: "Prior CT Head"

Hanging Protocol User Identification Code Sequence: *zero length*

Hanging Protocol User Group Name: "ABC Hospital"

V.4.2 Hanging Protocol Environment Module

Number of Screens: 2

Nominal Screen Definition Sequence:

- Item 1:
- Number of Vertical Pixels: 1024
- Number of Horizontal Pixels: 1024
- Display Environment Spatial Position: 0.0\0.28\0.33\0.0, representing (0.0, 0.28), (0.33, 0.0)
- Screen Minimum Color Bit Depth: 8
- Application Maximum Repaint Time: 70
- Item 2:
- Number of Vertical Pixels: 2560
- Number of Horizontal Pixels: 2048

- Image Boxes Sequence:
 - Item 1: [upper left quadrant of 1024x1024]
 - Image Box Number: 1
 - Display Environment Spatial Position: (0/3072, 1024/2560), (512/3072, 512/2560)
 - Image Box Layout Type: "STACK"
- Filter Operations Sequence:
 - Item 1:
 - Filter-by Category: "IMAGE_PLANE"
 - Selector Attribute VR: "CS"
 - Selector CS Value: "AXIAL"
 - Filter-by Operator: "MEMBER_OF"
- Sorting Operations Sequence:
 - Item 1:
 - Sort-by Category: "ALONG_AXIS"
 - Sorting Direction: "INCREASING"
- Reformatting Operation Type: "MPR"
- Reformatting Thickness: 5
- Reformatting Interval: 5
- Reformatting Operation Initial View Direction: "SAGITTAL"
- Display Set Patient Orientation: "PIF"
- VOI Type: BRAIN
- Item 3:
- Display Set Number: 3
- Display Set Presentation Group: 1
- Image Set Number: 2
- Image Boxes Sequence:
 - Item 1: [upper right quadrant of 1024x1024]
 - Image Box Number: 1
 - Display Environment Spatial Position: (512/3072, 1024/2560), (1024/3072, 512/2560)
 - Image Box Layout Type: "STACK"
- Filter Operations Sequence:
 - Item 1:
 - Filter-by Category: "IMAGE_PLANE"
 - Selector Attribute VR: "CS"
 - Selector CS Value: "AXIAL"
 - Filter-by Operator: "MEMBER_OF"
- Sorting Operations Sequence:
 - Item 1:
 - Sort-by Category: "ALONG_AXIS"
 - Sorting Direction: "INCREASING"
- Display Set Patient Orientation: "LIP"
- VOI Type: BRAIN
- Show Graphic Annotation Flag: "YES"
- Item 4:
- Display Set Number: 4
- Display Set Presentation Group: 1
- Image Set Number: 2
- Image Boxes Sequence:
 - Item 1: [lower right quadrant of 1024x1024]
 - Image Box Number: 1
 - Display Environment Spatial Position: (512/3072, 512/2560), (1024/3072, 0/2560)
 - Image Box Layout Type: "PROCESSED"
- Filter Operations Sequence:
 - Item 1:
 - Selector Attribute: (0008,0008) [Image Type]
 - Selector Attribute VR: "CS"
 - Selector CS Value: "LOCALIZER "
 - Selector Value Number: 3

- Filter-by Operator: "NOT_MEMBER_OF"
- Sorting Operations Sequence: *zero length*
- Reformatting Operation Type: "3D_RENDERING"
- Reformatting Operation Initial View Direction: "CORONAL"
- 3D Rendering Type: "VOLUME"
- Display Set Patient Orientation: "XIF"
- Show Graphic Annotation Flag: "NO"
- Item 5:
- Display Set Number: 5
- Display Set Presentation Group: 1
- Image Set Number: 2
- Image Boxes Sequence:
 - Item 1: [entire 2048x2560 space]
 - Image Box Number: 1
 - Display Environment Spatial Position: (1024/3072, 2560/2560), (3072/3072, 0/2560)
 - Image Box Layout Type: "TILED"
 - Image Box Tile Horizontal Dimension: 3
 - Image Box Tile Vertical Dimension: 4
 - Image Box Scroll Direction: "VERTICAL"
 - Image Box Small Scroll Type: "ROW_COLUMN"
 - Image Box Small Scroll Amount: 1
 - Image Box Large Scroll Type: "PAGE"
 - Image Box Large Scroll Amount: 1
- Filter Operations Sequence:
 - Item 1:
 - Filter-by Category: "IMAGE_PLANE"
 - Selector Attribute VR: "CS"
 - Selector CS Value: "AXIAL"
 - Filter-by Operator: "MEMBER_OF"
- Sorting Operations Sequence:
 - Item 1:
 - Sort-by Category: "ALONG_AXIS"
 - Sorting Direction: "INCREASING"
- Display Set Patient Orientation: "LIP"
- VOI Type: BRAIN
- Show Graphic Annotation Flag: "YES"

[Group #2 is MR only display]

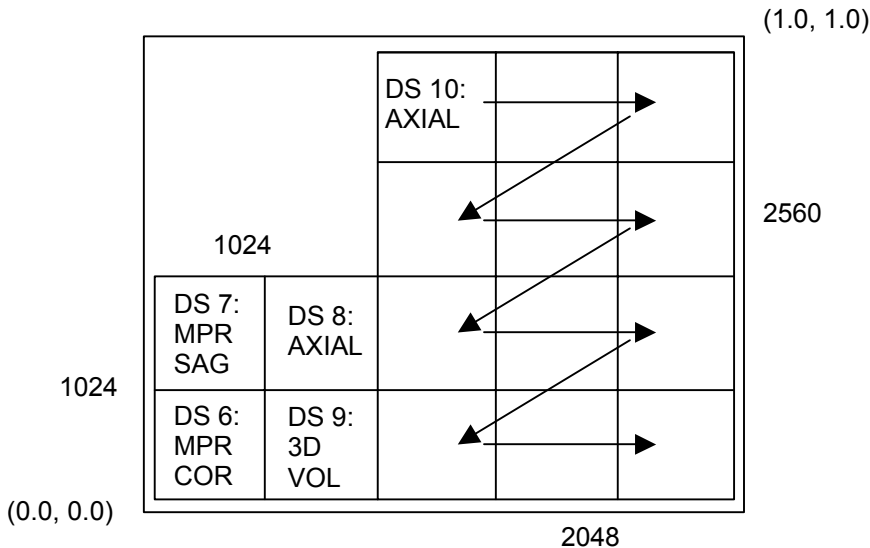

- Item 6:
- Display Set Number: 6
- Display Set Presentation Group: 2
- Image Set Number: 1
- Image Boxes Sequence:
 - Item 1: [lower left quadrant of 1024x1024]
 - Image Box Number: 1
 - Display Environment Spatial Position: (0/3072, 512/2560), (512/3072,0/2560)
 - Image Box Layout Type: "STACK"
- Filter Operations Sequence:
 - Item 1:
 - Filter-by Category: "IMAGE_PLANE"
 - Selector Attribute VR: "CS"
 - Selector CS Value: "AXIAL"
 - Filter-by Operator: "MEMBER_OF"
- Sorting Operations Sequence:
 - Item 1:
 - Sort-by Category: "ALONG_AXIS"
 - Sorting Direction: "INCREASING"
- Reformatting Operation Type: "MPR"
- Reformatting Thickness: 5
- Reformatting Interval: 5
- Reformatting Operation Initial View Direction: "CORONAL"
- Display Set Patient Orientation: "P\F"
- Display Set Presentation Group Description: "MR only"
- Item 7:
- Display Set Number: 7
- Display Set Presentation Group: 2
- Image Set Number: 1
- Image Boxes Sequence:
 - Item 1: [upper left quadrant of 1024x1024]
 - Image Box Number: 1
 - Display Environment Spatial Position: (0/3072, 1024/2560), (512/3072, 512/2560)
 - Image Box Layout Type: "STACK"
- Filter Operations Sequence:
 - Item 1:
 - Filter-by Category: "IMAGE_PLANE"
 - Selector Attribute VR: "CS"
 - Selector CS Value: "AXIAL"
 - Filter-by Operator: "MEMBER_OF"
- Sorting Operations Sequence:
 - Item 1:
 - Sort-by Category: "ALONG_AXIS"
 - Sorting Direction: "INCREASING"
- Reformatting Operation Type: "MPR"
- Reformatting Thickness: 5
- Reformatting Interval: 5
- Reformatting Operation Initial View Direction: "SAGITTAL"
- Display Set Patient Orientation: "P\F"
- Item 8:
- Display Set Number: 8
- Display Set Presentation Group: 2
- Image Set Number: 1
- Image Boxes Sequence:
 - Item 1: [upper right quadrant of 1024x1024]
 - Image Box Number: 1
 - Display Environment Spatial Position: (512/3072, 1024/2560), (1024/3072, 512/2560)
 - Image Box Layout Type: "STACK"

- Filter Operations Sequence:
 - Item 1:
 - Filter-by Category: "IMAGE_PLANE"
 - Selector Attribute VR: "CS"
 - Selector CS Value: "AXIAL"
 - Filter-by Operator: "MEMBER_OF"
- Sorting Operations Sequence:
 - Item 1:
 - Sort-by Category: "ALONG_AXIS"
 - Sorting Direction: "INCREASING"
- Display Set Patient Orientation: "L\|P"
- Item 9:
- Display Set Number: 9
- Display Set Presentation Group: 2
- Image Set Number: 1
- Image Boxes Sequence:
 - Item 1: [lower right quadrant of 1024x1024]
 - Image Box Number: 1
 - Display Environment Spatial Position: (512/3072, 512/2560), (1024/3072, 0/2560)
 - Image Box Layout Type: "PROCESSED"
- Filter Operations Sequence: *zero length*
- Sorting Operations Sequence: *zero length*
- Reformatting Operation Type: "3D_RENDERING"
- Reformatting Operation Initial View Direction: "CORONAL"
- 3D Rendering Type: "VOLUME"
- Display Set Patient Orientation: "X\|F"
- Item 10:
- Display Set Number: 10
- Display Set Presentation Group: 2
- Image Set Number: 1
- Image Boxes Sequence:
 - Item 1: [entire 2048x2560 space]
 - Image Box Number: 1
 - Display Environment Spatial Position: (1024/3072, 2560/2560), (3072/3072, 0/2560)
 - Image Box Layout Type: "TILED"
 - Image Box Tile Horizontal Dimension: 3
 - Image Box Tile Vertical Dimension: 4
 - Image Box Scroll Direction: "VERTICAL"
 - Image Box Small Scroll Type: "ROW_COLUMN"
 - Image Box Small Scroll Amount: 1
 - Image Box Large Scroll Type: "PAGE"
 - Image Box Large Scroll Amount: 1
- Filter Operations Sequence:
 - Item 1:
 - Filter-by Category: "IMAGE_PLANE"
 - Selector Attribute VR: "CS"
 - Selector CS Value: "AXIAL"
 - Filter-by Operator: "MEMBER_OF"
- Sorting Operations Sequence:
 - Item 1:
 - Sort-by Category: "ALONG_AXIS"
 - Sorting Direction: "INCREASING"
- Display Set Patient Orientation: "L\|P"

[Group #3 is combined MR & CT]

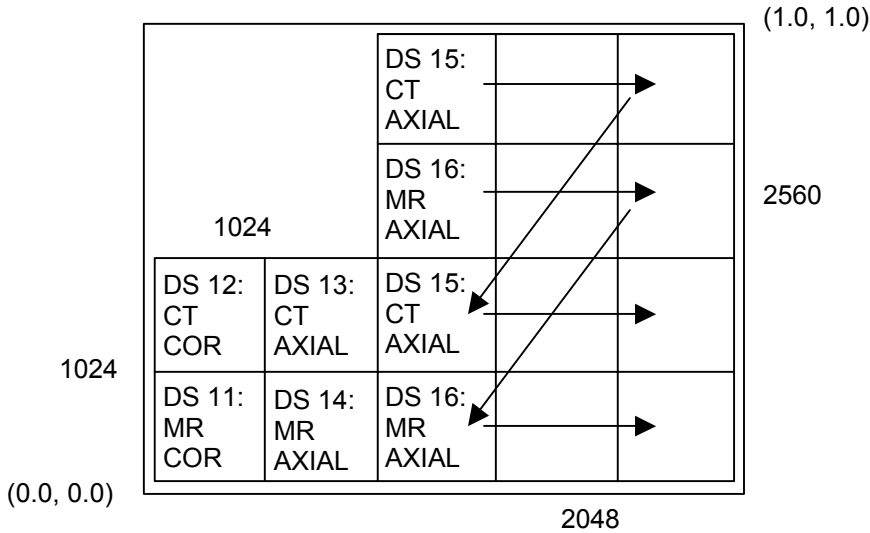

- Item 11: [MR coronal]
- Display Set Number: 11
- Display Set Presentation Group: 3
- Image Set Number: 1
- Image Boxes Sequence:
 - Item 1: [lower left quadrant of 1024x1024]
 - Image Box Number: 1
 - Display Environment Spatial Position: (0/3072, 512/2560), (512/3072,0/2560)
 - Image Box Layout Type: "STACK"
- Filter Operations Sequence:
 - Item 1:
 - Filter-by Category: "IMAGE_PLANE"
 - Selector Attribute VR: "CS"
 - Selector CS Value: "AXIAL"
 - Filter-by Operator: "MEMBER_OF"
- Sorting Operations Sequence:
 - Item 1:
 - Sort-by Category: "ALONG_AXIS"
 - Sorting Direction: "INCREASING"
- Reformatting Operation Type: "MPR"
- Reformatting Thickness: 5
- Reformatting Interval: 5
- Reformatting Operation Initial View Direction: "CORONAL"
- Display Set Patient Orientation: "L\F"
- Show Graphic Annotation Flag: "NO"
- Display Set Presentation Group Description: "MR & CT combined"
- Item 12: [CT coronal]
- Display Set Number: 12
- Display Set Presentation Group: 3
- Image Set Number: 2
- Image Boxes Sequence:
 - Item 1: [upper left quadrant of 1024x1024]
 - Image Box Number: 1
 - Display Environment Spatial Position: (0/3072, 1024/2560), (512/3072, 512/2560)
 - Image Box Layout Type: "STACK"
- Filter Operations Sequence:
 - Item 1:
 - Filter-by Category: "IMAGE_PLANE"

- Selector Attribute VR: "CS"
 - Selector CS Value: "AXIAL"
 - Filter-by Operator: "MEMBER_OF"
- Sorting Operations Sequence:
 - Item 1:
 - Sort-by Category: "ALONG_AXIS"
 - Sorting Direction: "INCREASING"
- Reformatting Operation Type: "MPR"
- Reformatting Thickness: 5
- Reformatting Interval: 5
- Reformatting Operation Initial View Direction: "CORONAL"
- Display Set Patient Orientation: "L\F"
- VOI Type: BRAIN
- Show Graphic Annotation Flag: "NO"
- Item 13: [CT axial]
- Display Set Number: 13
- Display Set Presentation Group: 3
- Image Set Number: 2
- Image Boxes Sequence:
 - Item 1: [upper right quadrant of 1024x1024]
 - Image Box Number: 1
 - Display Environment Spatial Position: (512/3072, 1024/2560), (1024/3072, 512/2560)
 - Image Box Layout Type: "STACK"
- Filter Operations Sequence:
 - Item 1:
 - Filter-by Category: "IMAGE_PLANE"
 - Selector Attribute VR: "CS"
 - Selector CS Value: "AXIAL"
 - Filter-by Operator: "MEMBER_OF"
- Sorting Operations Sequence:
 - Item 1:
 - Sort-by Category: "ALONG_AXIS"
 - Sorting Direction: "INCREASING"
- Display Set Patient Orientation: "L\F"
- VOI Type: BRAIN
- Show Graphic Annotation Flag: "YES"
- Item 14: [MR axial]
- Display Set Number: 14
- Display Set Presentation Group: 3
- Image Set Number: 1
- Image Boxes Sequence:
 - Item 1: [lower right quadrant of 1024x1024]
 - Image Box Number: 1
 - Display Environment Spatial Position: (512/3072, 512/2560), (1024/3072, 0/2560)
 - Image Box Layout Type: "STACK"
- Filter Operations Sequence:
 - Item 1:
 - Filter-by Category: "IMAGE_PLANE"
 - Selector Attribute VR: "CS"
 - Selector CS Value: "AXIAL"
 - Filter-by Operator: "MEMBER_OF"
- Sorting Operations Sequence:
 - Item 1:
 - Sort-by Category: "ALONG_AXIS"
 - Sorting Direction: "INCREASING"
- Display Set Patient Orientation: "L\F"
- Show Graphic Annotation Flag: "NO"

- Item 15: [CT two part scrolled, rows 1 & 3]
- Display Set Number: 15
- Display Set Presentation Group: 3
- Image Set Number: 2
- Image Boxes Sequence:
 - Item 1: [row 1 (top row) of 2048x2560 space]
 - Image Box Number: 1
 - Display Environment Spatial Position: (1024/3072, 2048/2560), (3072/3072, 1536/2560)
 - Image Box Layout Type: "TILED"
 - Image Box Tile Horizontal Dimension: 3
 - Image Box Tile Vertical Dimension: 1
 - Image Box Scroll Direction: "HORIZONTAL"
 - Image Box Small Scroll Type: "IMAGE"
 - Image Box Small Scroll Amount: 1
 - Image Box Large Scroll Type: "ROW_COLUMN"
 - Image Box Large Scroll Amount: 1
 - Item 2: [row 3 of 2048x2560 space]
 - Image Box Number: 2
 - Display Environment Spatial Position: (1024/3072, 1024/2560), (3072/3072, 512/2560)
 - Image Box Layout Type: "TILED"
 - Image Box Tile Horizontal Dimension: 3
 - Image Box Tile Vertical Dimension: 1
 - Image Box Scroll Direction: "HORIZONTAL"
 - Image Box Small Scroll Type: "IMAGE"
 - Image Box Small Scroll Amount: 1
 - Image Box Large Scroll Type: "ROW_COLUMN"
 - Image Box Large Scroll Amount: 1
- Filter Operations Sequence:
 - Item 1:
 - Filter-by Category: "IMAGE_PLANE"
 - Selector Attribute VR: "CS"
 - Selector CS Value: "AXIAL"
 - Filter-by Operator: "MEMBER_OF"
- Sorting Operations Sequence:
 - Item 1:
 - Sort-by Category: "ALONG_AXIS"
 - Sorting Direction: "INCREASING"
- Display Set Patient Orientation: "L\&P"
- VOI Type: BRAIN
- Show Graphic Annotation Flag: "YES"

- Item 16: [MR two part scrolled, rows 2 & 4]
- Display Set Number: 16
- Display Set Presentation Group: 3
- Image Set Number: 1
- Image Boxes Sequence:
 - Item 1: [row 2 of 2048x2560 space]
 - Image Box Number: 1
 - Display Environment Spatial Position: (1024/3072, 1536/2560), (3072/3072, 1024/2560)
 - Image Box Layout Type: "TILED"
 - Image Box Tile Horizontal Dimension: 3
 - Image Box Tile Vertical Dimension: 1
 - Image Box Scroll Direction: "HORIZONTAL"
 - Image Box Small Scroll Type: "IMAGE"
 - Image Box Small Scroll Amount: 1
 - Image Box Large Scroll Type: "ROW_COLUMN"
 - Image Box Large Scroll Amount: 1
 - Item 2: [row 4 (bottom row) of 2048x2560 space]

- Image Box Number: 2
- Display Environment Spatial Position: (1024/3072, 512/2560), (3072/3072, 0/2560)
- Image Box Layout Type: "TILED"
- Image Box Tile Horizontal Dimension: 3
- Image Box Tile Vertical Dimension: 1
- Image Box Scroll Direction: "HORIZONTAL"
- Image Box Small Scroll Type: "IMAGE"
- Image Box Small Scroll Amount: 1
- Image Box Large Scroll Type: "ROW_COLUMN"
- Image Box Large Scroll Amount: 1
- Filter Operations Sequence:
 - Item 1:
 - Filter-by Category: "IMAGE_PLANE"
 - Selector Attribute VR: "CS"
 - Selector CS Value: "AXIAL"
 - Filter-by Operator: "MEMBER_OF"
- Sorting Operations Sequence:
 - Item 1:
 - Sort-by Category: "ALONG_AXIS"
 - Sorting Direction: "INCREASING"
- Display Set Patient Orientation: "L\|P"
- Show Graphic Annotation Flag: "NO"

[Group #4 is combined CT new & CT old]

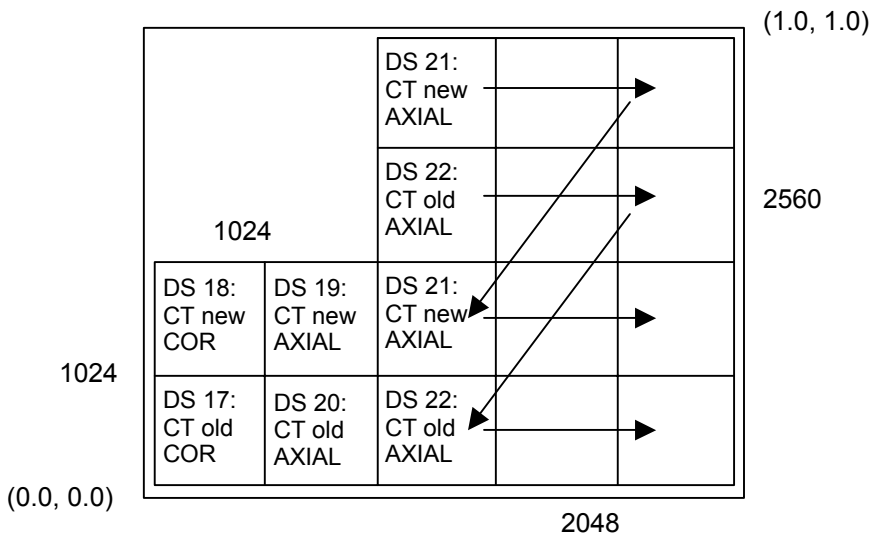

- Item 17: [CT old coronal]
- Display Set Number: 17
- Display Set Presentation Group: 4
- Image Set Number: 3
- Image Boxes Sequence:
 - Item 1: [lower left quadrant of 1024x1024]
 - Image Box Number: 1
 - Display Environment Spatial Position: (0/3072, 512/2560), (512/3072,0/2560)
 - Image Box Layout Type: "STACK"
- Filter Operations Sequence:
 - Item 1:
 - Filter-by Category: "IMAGE_PLANE"
 - Selector Attribute VR: "CS"
 - Selector CS Value: "AXIAL"

- Filter-by Operator: "MEMBER_OF"
- Sorting Operations Sequence:
 - Item 1:
 - Sort-by Category: "ALONG_AXIS"
 - Sorting Direction: "INCREASING"
- Reformatting Operation Type: "MPR"
- Reformatting Thickness: 5
- Reformatting Interval: 5
- Reformatting Operation Initial View Direction: "CORONAL"
- Display Set Patient Orientation: "L\F"
- VOI Type: BRAIN
- Display Set Presentation Group Description: "CT old & CT new combined"
- Item 18: [CT new coronal]
- Display Set Number: 18
- Display Set Presentation Group: 4
- Image Set Number: 2
- Image Boxes Sequence:
 - Item 1: [upper left quadrant of 1024x1024]
 - Image Box Number: 1
 - Display Environment Spatial Position: (0/3072, 1024/2560), (512/3072, 512/2560)
 - Image Box Layout Type: "STACK"
- Filter Operations Sequence:
 - Item 1:
 - Filter-by Category: "IMAGE_PLANE"
 - Selector Attribute VR: "CS"
 - Selector CS Value: "AXIAL"
 - Filter-by Operator: "MEMBER_OF"
- Sorting Operations Sequence:
 - Item 1:
 - Sort-by Category: "ALONG_AXIS"
 - Sorting Direction: "INCREASING"
- Reformatting Operation Type: "MPR"
- Reformatting Thickness: 5
- Reformatting Interval: 5
- Reformatting Operation Initial View Direction: "CORONAL"
- Display Set Patient Orientation: "L\F"
- VOI Type: BRAIN
- Item 19: [CT new axial]
- Display Set Number: 19
- Display Set Presentation Group: 4
- Image Set Number: 2
- Image Boxes Sequence:
 - Item 1: [upper right quadrant of 1024x1024]
 - Image Box Number: 1
 - Display Environment Spatial Position: (512/3072, 1024/2560), (1024/3072, 512/2560)
 - Image Box Layout Type: "STACK"
- Filter Operations Sequence:
 - Item 1:
 - Filter-by Category: "IMAGE_PLANE"
 - Selector Attribute VR: "CS"
 - Selector CS Value: "AXIAL"
 - Filter-by Operator: "MEMBER_OF"
- Sorting Operations Sequence:
 - Item 1:
 - Sort-by Category: "ALONG_AXIS"
 - Sorting Direction: "INCREASING"
- Display Set Patient Orientation: "L\F"
- VOI Type: BRAIN

- Show Graphic Annotation Flag: "YES"
- Item 20: [CT old axial]
- Display Set Number: 20
- Display Set Presentation Group: 4
- Image Set Number: 3
- Image Boxes Sequence:
 - Item 1: [lower right quadrant of 1024x1024]
 - Image Box Number: 1
 - Display Environment Spatial Position: (512/3072, 512/2560), (1024/3072, 0/2560)
 - Image Box Layout Type: "STACK"
- Filter Operations Sequence:
 - Item 1:
 - Filter-by Category: "IMAGE_PLANE"
 - Selector Attribute VR: "CS"
 - Selector CS Value: "AXIAL"
 - Filter-by Operator: "MEMBER_OF"
- Sorting Operations Sequence:
 - Item 1:
 - Sort-by Category: "ALONG_AXIS"
 - Sorting Direction: "INCREASING"
- Display Set Patient Orientation: "L\|P"
- VOI Type: BRAIN
- Show Graphic Annotation Flag: "YES"

- Item 21: [CT new two part scrolled, rows 1 & 3]
- Display Set Number: 21
- Display Set Presentation Group: 4
- Image Set Number: 2
- Image Boxes Sequence:
 - Item 1: [row 1 (top row) of 2048x2560 space]
 - Image Box Number: 1
 - Display Environment Spatial Position: (1024/3072, 2048/2560), (3072/3072, 1536/2560)
 - Image Box Layout Type: "TILED"
 - Image Box Tile Horizontal Dimension: 3
 - Image Box Tile Vertical Dimension: 1
 - Image Box Scroll Direction: "HORIZONTAL"
 - Image Box Small Scroll Type: "IMAGE"
 - Image Box Small Scroll Amount: 1
 - Image Box Large Scroll Type: "ROW_COLUMN"
 - Image Box Large Scroll Amount: 1
 - Item 2: [row 3 of 2048x2560 space]
 - Image Box Number: 2
 - Display Environment Spatial Position: (1024/3072, 1024/2560), (3072/3072, 512/2560)
 - Image Box Layout Type: "TILED"
 - Image Box Tile Horizontal Dimension: 3
 - Image Box Tile Vertical Dimension: 1
 - Image Box Scroll Direction: "HORIZONTAL"
 - Image Box Small Scroll Type: "IMAGE"
 - Image Box Small Scroll Amount: 1
 - Image Box Large Scroll Type: "ROW_COLUMN"
 - Image Box Large Scroll Amount: 1
- Filter Operations Sequence:
 - Item 1:
 - Filter-by Category: "IMAGE_PLANE"
 - Selector Attribute VR: "CS"
 - Selector CS Value: "AXIAL"
 - Filter-by Operator: "MEMBER_OF"
- Sorting Operations Sequence:

- Item 1:
- Sort-by Category: "ALONG_AXIS"
- Sorting Direction: "INCREASING"
- Display Set Patient Orientation: "L\P"
- VOI Type: BRAIN
- Show Graphic Annotation Flag: "YES"

- Item 22: [CT old two part scrolled, rows 2 & 4]
- Display Set Number: 22
- Display Set Presentation Group: 4
- Image Set Number: 3
- Image Boxes Sequence:
 - Item 1: [row 2 of 2048x2560 space]
 - Image Box Number: 1
 - Display Environment Spatial Position: (1024/3072, 1536/2560), (3072/3072, 1024/2560)
 - Image Box Layout Type: "TILED"
 - Image Box Tile Horizontal Dimension: 3
 - Image Box Tile Vertical Dimension: 1
 - Image Box Scroll Direction: "HORIZONTAL"
 - Image Box Small Scroll Type: "IMAGE"
 - Image Box Small Scroll Amount: 1
 - Image Box Large Scroll Type: "ROW_COLUMN"
 - Image Box Large Scroll Amount: 1
 - Item 2: [row 4 (bottom row) of 2048x2560 space]
 - Image Box Number: 2
 - Display Environment Spatial Position: (1024/3072, 512/2560), (3072/3072, 0/2560)
 - Image Box Layout Type: "TILED"
 - Image Box Tile Horizontal Dimension: 3
 - Image Box Tile Vertical Dimension: 1
 - Image Box Scroll Direction: "HORIZONTAL"
 - Image Box Small Scroll Type: "IMAGE"
 - Image Box Small Scroll Amount: 1
 - Image Box Large Scroll Type: "ROW_COLUMN"
 - Image Box Large Scroll Amount: 1
- Filter Operations Sequence:
 - Item 1:
 - Filter-by Category: "IMAGE_PLANE"
 - Selector Attribute VR: "CS"
 - Selector CS Value: "AXIAL"
 - Filter-by Operator: "MEMBER_OF"
- Sorting Operations Sequence:
 - Item 1:
 - Sort-by Category: "ALONG_AXIS"
 - Sorting Direction: "INCREASING"
- Display Set Patient Orientation: "L\P"
- VOI Type: BRAIN
- Show Graphic Annotation Flag: "YES"

Partial Data Display Handling: "MAINTAIN_LAYOUT"

[Link up (synchronize) the MR and CT tiled scroll panes in Display Sets 15 and 16, and the CT new and CT old tiled scroll panes in Display Sets 21 and 22]

Synchronized Scrolling Sequence:

- Item 1:
- Display Set Scrolling Group: 15\16
- Item 2:
- Display Set Scrolling Group: 21\22

V.5 HANGING PROTOCOL QUERY EXAMPLE

The following is an example of a general C-FIND Request for the Hanging Protocol Information Model – FIND SOP Class that is searching for all Chest related Hanging Protocols for the purpose of reading projection Chest X-ray. The user is at a workstation that has two 2Kx2.5K screens.

C-FIND Request:

Nesting	Attribute	Tag	VR	VL (hex)	Value
	Affected SOP Class UID	(0000,0002)	UI	0018	1.2.840.10008.5.1.4.38.2
	Command Field	(0000,0100)	US	0002	0020H [C-FIND-RQ]
	Message ID	(0000,0110)	US	0002	0010H
	Priority	(0000,0700)	US	0002	0000H [MEDIUM]
	Data Set Type	(0000,0800)	US	0002	0102H
	SOP Class UID	(0008,0016)	UI	0000	
	SOP Instance UID	(0008,0018)	UI	0000	
	Hanging Protocol Name	(0072,0002)	SH	0000	
	Hanging Protocol Description	(0072,0004)	LO	0000	
	Hanging Protocol Level	(0072,0006)	CS	0000	
	Hanging Protocol Creator	(0072,0008)	LO	0000	
	Hanging Protocol Creation Datetime	(0072,000A)	DT	0000	
	Hanging Protocol Definition Sequence	(0072,000C)	SQ	ffffff	
%item					
>	Modality	(0008,0060)	CS	0000	
>	Anatomic Region Sequence	(0008,2218)	SQ	ffffff	
%item					
>>	Code Value	(0008,0100)	SH	0008	T-D3000
>>	Coding Scheme Designator	(0008,0102)	SH	0004	SNM3
>>	Code Meaning	(0008,0104)	LO	0006	Chest
%enditem					
%endseq					
>	Procedure Code Sequence	(0008,1032)	SQ	0000	
>	Laterality	(0020,0060)	CS	0000	
>	Reason for Requested Procedure Code Sequence	(0040,100A)	SQ	0000	
%enditem					
%endseq					
	Hanging Protocol User Identification Code Sequence	(0072,000E)	SQ	0000	
	Number of Priors Referenced	(0072,0014)	US	0000	
	Number of Screens	(0072,0100)	US	0000	
	Nominal Screen Definition Sequence	(0072,0102)	SQ	0000	

The following is an example of a set of C-FIND Responses for the Hanging Protocol Information Model – FIND SOP Class, answering the C-FIND Request listed above. There are a few matches for this general query. The application needs to select the best choice among the matches, which is the second response. The first response is for Chest CT, and the third response does not match the user's workstation environment as well as does the second.

C-FIND Response #1:

Nesting	Attribute	Tag	VR	VL (hex)	Value
	Affected SOP Class UID	(0000,0002)	UI	0018	1.2.840.10008.5.1.4.38.2
	Command Field	(0000,0100)	US	0002	8020H [C-FIND-RSP]
	Message ID Being Responded To	(0000,0120)	US	0002	0010H
	Data Set Type	(0000,0800)	US	0002	0102H
	Status	(0000,0900)	US	0002	FF00H [Pending]
	SOP Class UID	(0008,0016)	UI	0018	1.2.840.10008.5.1.4.38.1
	SOP Instance UID	(0008,0018)	UI	0024	1.2.840.10008.5.1.4.1.1.76392.999.2
	Hanging Protocol Name	(0072,0002)	SH	000a	CT 1 prior
	Hanging Protocol Description	(0072,0004)	LO	0038	Dual screen layout for current and single prior chest CT
	Hanging Protocol Level	(0072,0006)	CS	000c	SINGLE_USER
	Hanging Protocol Creator	(0072,0008)	LO	0008	Dr. Chan
	Hanging Protocol Creation Datetime	(0072,000A)	DT	000c	200408210718
	Hanging Protocol Definition Sequence	(0072,000C)	SQ	ffffff	
%item					
>	Modality	(0008,0060)	CS	0002	CT
>	Anatomic Region Sequence	(0008,2218)	SQ	ffffff	
%item					
>>	Code Value	(0008,0100)	SH	0008	T-D3000
>>	Coding Scheme Designator	(0008,0102)	SH	0004	SNM3
>>	Code Meaning	(0008,0104)	LO	0006	Chest
%enditem					
%endseq					
>	Procedure Code Sequence	(0008,1032)	SQ	0000	
>	Laterality	(0020,0060)	CS	0000	
>	Reason for Requested Procedure Code Sequence	(0040,100A)	SQ	0000	
%enditem					
%endseq					
	Hanging Protocol User Identification Code Sequence	(0072,000E)	SQ	0000	
%item					
>	Code Value	(0008,0100)	SH	000a	58489749P
>	Coding Scheme Designator	(0008,0102)	SH	0008	HOSP_ID
>	Code Meaning	(0008,0104)	LO	000e	Susan H. Chan
%enditem					
%endseq					
	Number of Priors Referenced	(0072,0014)	US	0002	1
	Number of Screens	(0072,0100)	US	0002	2
	Nominal Screen Definition Sequence	(0072,0102)	SQ	0000	

C-FIND Response #2:

Nesting	Attribute	Tag	VR	VL (hex)	Value
	Affected SOP Class UID	(0000,0002)	UI	0018	1.2.840.10008.5.1.4.38.2
	Command Field	(0000,0100)	US	0002	8020H [C-FIND-RSP]
	Message ID Being Responded To	(0000,0120)	US	0002	0010H
	Data Set Type	(0000,0800)	US	0002	0102H
	Status	(0000,0900)	US	0002	FF00H [Pending]
	SOP Class UID	(0008,0016)	UI	0018	1.2.840.10008.5.1.4.38.1
	SOP Instance UID	(0008,0018)	UI	0020	1.2.840.123456.20030822.223344.1
	Hanging Protocol Name	(0072,0002)	SH	000c	Chest X-ray
	Hanging Protocol Description	(0072,0004)	LO	0026	Current and Prior Chest PA and Lateral
	Hanging Protocol Level	(0072,0006)	CS	0004	SITE
	Hanging Protocol Creator	(0072,0008)	LO	0012	Senior Radiologist
	Hanging Protocol Creation Datetime	(0072,000A)	DT	000e	20020823133455
	Hanging Protocol Definition Sequence	(0072,000C)	SQ	ffffff	
%item					
>	Modality	(0008,0060)	CS	0000	
>	Anatomic Region Sequence	(0008,2218)	SQ	ffffff	
%item					
>>	Code Value	(0008,0100)	SH	0008	T-D3000
>>	Coding Scheme Designator	(0008,0102)	SH	0004	SNM3
>>	Code Meaning	(0008,0104)	LO	0006	Chest
%enditem					
%endseq					
>	Procedure Code Sequence	(0008,1032)	SQ	0000	
>	Laterality	(0020,0060)	CS	0000	
>	Reason for Requested Procedure Code Sequence	(0040,100A)	SQ	0000	
%enditem					
%endseq					
	Hanging Protocol User Identification Code Sequence	(0072,000E)	SQ	0000	
	Number of Priors Referenced	(0072,0014)	US	0002	1
	Number of Screens	(0072,0100)	US	0002	0002H
	Nominal Screen Definition Sequence	(0072,0102)	SQ	ffffff	
%item					
>	Number of Vertical Pixels	(0072,0104)	US	0002	2560
>	Number of Horizontal Pixels	(0072,0106)	US	0002	2048
>	Display Environment Spatial Position	(0072,0108)	FD	0020	0.0\1.0\0.5\0.0
>	Screen Minimum Grayscale Bit Depth	(0072,010A)	US	0002	0008H
>	Application Maximum Repaint Time	(0072,010E)	US	0002	0064H
%enditem					
%item					
>	Number of Vertical Pixels	(0072,0104)	US	0002	2560
>	Number of Horizontal Pixels	(0072,0106)	US	0002	2048
>	Display Environment Spatial Position	(0072,0108)	FD	0020	0.5\1.0\1.0\0.0
>	Screen Minimum Grayscale Bit Depth	(0072,010A)	US	0002	0008H

Nesting	Attribute	Tag	VR	VL (hex)	Value
>	Application Maximum Repaint Time	(0072,010E)	US	0004	0064H
%enditem					
%endseq					

C-FIND Response #3:

Nesting	Attribute	Tag	VR	VL (hex)	Value
	Affected SOP Class UID	(0000,0002)	UI	0018	1.2.840.10008.5.1.4.38.2
	Command Field	(0000,0100)	US	0002	8020H [C-FIND-RSP]
	Message ID Being Responded To	(0000,0120)	US	0002	0010H
	Data Set Type	(0000,0800)	US	0002	0102H
	Status	(0000,0900)	US	0002	FF00H [Pending]
	SOP Class UID	(0008,0016)	UI	0018	1.2.840.10008.5.1.4.38.1
	SOP Instance UID	(0008,0018)	UI	002a	1.2.840.113986.2.664566.21121125.85669.967
	Hanging Protocol Name	(0072,0002)	SH	0010	Chest X-ray_LGon
	Hanging Protocol Description	(0072,0004)	LO	003e	Prior and Current Lateral of Chest X-ray for two screen system
	Hanging Protocol Level	(0072,0006)	CS	000c	SINGLE_USER
	Hanging Protocol Creator	(0072,0008)	LO	0012	Dr. Leia Gonzales
	Hanging Protocol Creation Datetime	(0072,000A)	DT	000e	20030822101100
	Hanging Protocol Definition Sequence	(0072,000C)	SQ	ffffff	
%item					
>	Modality	(0008,0060)	CS	0002	DX
>	Anatomic Region Sequence	(0008,2218)	SQ	ffffff	
%item					
>>	Code Value	(0008,0100)	SH	0008	T-D3000
>>	Coding Scheme Designator	(0008,0102)	SH	0004	SNM3
>>	Code Meaning	(0008,0104)	LO	0006	Chest
%enditem					
%endseq					
>	Procedure Code Sequence	(0008,1032)	SQ	0000	
>	Laterality	(0020,0060)	CS	0000	
>	Reason for Requested Procedure Code Sequence	(0040,100A)	SQ	0000	
%enditem					
%endseq					
	Hanging Protocol User Identification Code Sequence	(0072,000E)	SQ	0000	
%item					
>	Code Value	(0008,0100)	SH	0004	Lgon
>	Coding Scheme Designator	(0008,0102)	SH	0008	99Local
>	Coding Scheme Version	(0008,0103)	SH	0004	v40a
>	Code Meaning	(0008,0104)	LO	000c	log-in name
%enditem					

Nesting	Attribute	Tag	VR	VL (hex)	Value
%endseq					
	Number of Priors Referenced	(0072,0014)	US	0002	1
	Number of Screens	(0072,0100)	US	0002	0002H
	Nominal Screen Definition Sequence	(0072,0102)	SQ	ffffff	
%item					
>	Number of Vertical Pixels	(0072,0104)	US	0002	1280
>	Number of Horizontal Pixels	(0072,0106)	US	0002	1024
>	Display Environment Spatial Position	(0072,0108)	FD	0020	0.0\1.0\0.5\0.0
>	Screen Minimum Grayscale Bit Depth	(0072,010A)	US	0002	0008H
>	Application Maximum Repaint Time	(0072,010E)	US	0004	0064H
%enditem					
%item					
>	Number of Vertical Pixels	(0072,0104)	US	0002	1280
>	Number of Horizontal Pixels	(0072,0106)	US	0002	1024
>	Display Environment Spatial Position	(0072,0108)	FD	0020	0.5\1.0\1.0\0.0
>	Screen Minimum Grayscale Bit Depth	(0072,010A)	US	0002	0008H
>	Application Maximum Repaint Time	(0072,010E)	US	0004	0064H
%enditem					
%endseq					

C-FIND Response #4:

Nesting	Attribute	Tag	VR	VL (hex)	Value
	Affected SOP Class UID	(0000,0002)	UI	0018	1.2.840.10008.5.1.4.38.2.
	Command Field	(0000,0100)	US	0002	8020H [C-FIND-RSP]
	Message ID Being Responded To	(0000,0120)	US	0002	0010H
	Data Set Type	(0000,0800)	US	0002	0101H
	Status	(0000,0900)	US	0002	0000H [Success]

V.6 DISPLAY SET PATIENT ORIENTATION EXAMPLE

For Display Set Patient Orientation (0072,0700) with value "A\F", the application interpreting the Hanging Protocol will arrange sagittal images oriented with the patient's anterior toward the right side of the image box, and the patient's foot will be toward the bottom of the image box. An incoming sagittal MRI image as shown in Figure V.6-1 will require a horizontal flip before display in the image box.

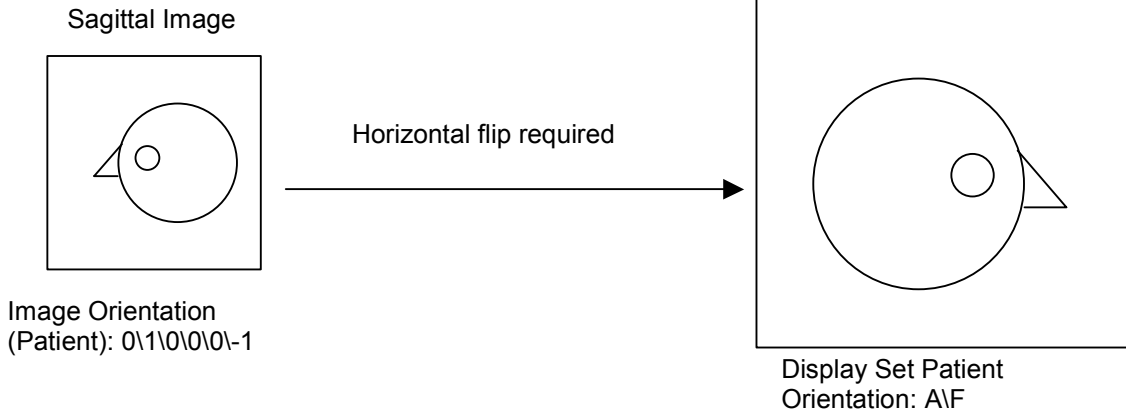

Figure V.6-1 Display Set Patient Orientation Example

Annex W Digital Signatures in Structured Reports Use Cases (Informative)

The scenarios in which Digital Signatures would be used in DICOM Structured Reports include, but are not limited to the following.

Case 1: Human Signed Report and Automatically Signed Evidence.

- a. The archive, after receiving an MPPS complete and determining that it has the complete set of objects created during an acquisition procedure step, creates a signed Key Object Selection Document Instance with secure references to all of the DICOM composite objects that constitute the exam. The Document would include a Digital Signature according to the Basic SR Digital Signatures Secure Use Profile with the Digital Signature Purpose Code Sequence (0400,0401) of (14,ASTM-sigpurpose,"Source Signature"). It would set the Key Object Selection Document Title of that Instance to (113035,DCM, "Signed Complete Acquisition Content"). Note that the objects that are referenced in the MPPS may or may not have Digital Signatures. By creating the Key Object Selection Document Instance, the archive can in effect add the equivalent of Digital Signatures to the set of objects.
- b. A post-processing system generates additional evidence objects, such as measurements or CAD reports, referring to objects in the exam. This post-processing system may or may not include Digital Signatures in the evidence objects, and may or may not be included as secure references in a signed Key Object Selection Document.
- c. Working at a reporting station, a report author gathers evidences from a variety of sources, including those referenced by the Key Object Selection Document Instance and the additional evidence objects generated by the post-processing system, and incorporates his or her own observations and conclusions into one or more reports.
- d. It is desired that all evidence references from a DICOM SR be secure. The application creating the SR may either:
 1. create secure references by copying a verified Digital Signature from the referenced object or by generating a MAC code directly from the referenced object,
 2. make a secure reference to a signed Key Object Selection Document that in turn securely references the SOP Instances, or
 3. copy the secure reference information from a trusted Key Object Selection Document to avoid the overhead of recalculating the MAC codes or revalidating the reference Digital Signatures.
- e. When the author completes a DICOM SR, the system, using the author's X.509 Digital Signature Certificate generates a Digital Signature with the Digital Signature Purpose Code Sequence (0400,0401) of (1,ASTM-sigpurpose,"Author Signature") for the report.
- f. The author's supervisor reviews the DICOM SR. If the supervisor approves of the report, the system sets the Verification Flag to "VERIFIED" and adds a Digital Signature with the Digital Signature Purpose Code Sequence (0400,0401) of (5,ASTM-sigpurpose,"Verification Signature") or (6,ASTM-sigpurpose,"Validation Signature") using the supervisor's X.509 certificate.
- g. At some later time, someone who is reading the DICOM SR SOP Instance wishes to verify its authenticity. The system would verify that the Author Signature, as well as any Verification or Validation Signature present are intact (i.e., that the signed data has not been altered based on the recorded Digital Signatures, and that the X.509 Certificates were valid at the time that the report was created).
- h. If the report reader wishes to inspect DICOM source materials referenced in a DICOM SR, the system can insure that the materials have not been altered since the report was written by verifying the Referenced Digital Signatures or the Referenced SOP Instance MAC that the report creator generated from the referenced materials.

Case 2: Cross Enterprise Document Exchange

- a. An application sends by any means a set of DICOM composite objects to an entity outside of the institutional environment (e.g. for review by a third party).
- b. The application creates a signed Key Object Selection Document Instance with a Key Object Selection Document Title of (113031,DCM, "Signed Manifest") referencing the set of DICOM Data Objects that it sent outside the institutional environment, and sends that SR to the external entity as a shipping manifest.
- c. The external entity may utilize the Key Object Selection SR SOP Instance to confirm that it received all of the referenced objects intact (i.e., without alterations). Because the signed Key Object Selection Instance must use secure references, it can verify that the objects have not been modified.

Annex X – Dictation-Based Reporting with Image References

This Annex describes a use of Key Object Selection (KO) and Grayscale Softcopy Presentation State (GSPS) SOP Instances, in conjunction with a typical dictation/transcription process for creating an imaging clinical report. The result is a clinical report as a Basic Text Structured Report (SR) SOP Instance that includes annotated image references (see section X.2). This report may also (or alternatively) be encoded as an HL7 Clinical Document Architecture (CDA) document (see section X.3).

Similar but more complex processes that include, for instance, numeric measurements and Enhanced or Comprehensive SR, are not addressed by this Annex. This Annex also does not specifically address the special issues associated with reporting across multiple studies (e.g., the “grouped procedures” case).

X.1 BASIC DATA FLOWS

X.1.1 Dictation/Transcription Reporting

During the softcopy reading of an imaging study, the physician dictates the report, which is sent to a transcription service or is processed by a voice recognition system. The transcribed dictation arrives at the report management system (typically a RIS) by some mechanism not specified here. The report management system enables the reporting physician to correct, verify, and “sign” the transcribed report. See Figure X.1-1. This data flow applies to reports stored in a proprietary format, reports stored as DICOM Basic Text SR SOP Instances, or reports stored as HL7 CDA instances.

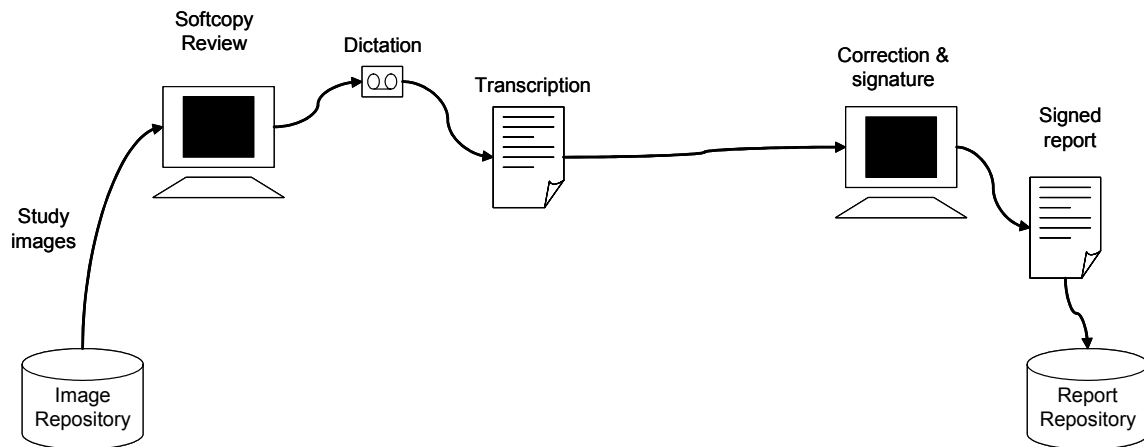

Figure X.1-1 Dictation/Transcription Reporting Data Flow

The report management system has flexibility in encoding the report title. For example, it could be any of the following:

- the generic title “Diagnostic Imaging Report”,
- a report title associated with the department (e.g., “Radiology Report”),
- a report title associated with the imaging modality or procedure (e.g., “Ultrasound Report”), or
- a report title pre-coordinated with the modality and body part (e.g., “CT Chest Report”).

There are LOINC codes associated with each of these types of titles, if a coded title is used on the report (see PS3.16 CID 7000).

The transcribed dictation may be either a single text stream, or a series of text sections each with a title. Division of reports into a limited number of canonically named sections may be done by the transcriptionist, or automated division of typical free text reports may be possible with voice recognition or a natural language processing algorithm.

For an electronically stored report, the signing function may or may not involve a cryptographic digital signature; any such cryptographic signature is beyond the scope of this description.

X.1.2 Reporting with Image References

To augment the basic dictation/transcription reporting use case, it is desired to select significant images to be attached (by reference) to the report. During the softcopy reading, the physician may select images from those displayed on his workstation (e.g., by a point-and-click function through the user interface). The selection of images is conveyed to the image repository (PACS) through a DICOM Key Object Selection (KO) document. When the report management system receives the transcribed dictation, it queries the image repository for any KO documents, and appends the image references from the KO to the transcription. In this process step, the report management system does not need to access the referenced images; it only needs to copy the references into the draft report. The correction and signature function potentially allows the physician to retrieve and view the referenced images, correct and change text, and to delete individual image references. See Figure X.1-2.

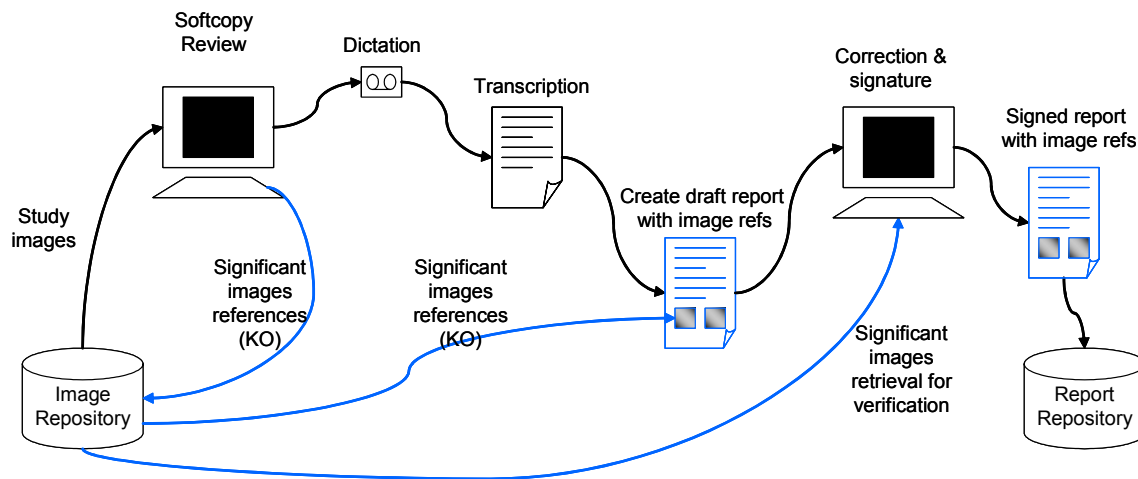

Figure X.1-2 Reporting Data Flow with Image References

The transcribed dictation must have associated with it sufficient key attributes for the report management system to query for the appropriate KO documents in the image repository (e.g., Study ID, or Accession Number).

Each KO document in this process includes a specific title “For Report Attachment”, a single optional descriptive text field, plus a list of image references using the SR Image Content Item format. The report management system may need to retrieve all KO documents of the study to find those with this title, since the image repository might not support the object title as a query return key.

Multiple KO instances may be created for a study report, e.g., to facilitate associating different descriptive text (included in the KO document) with different images or image sets. All KOs with the title “For Report Attachment” in the study are to be attached to the dictated report by copying their content into the draft report (see sections X.2 and X.3). (There may also be KOs with other titles, such as “For Teaching”, that are not to be attached to the report.)

The nature of the image reference links will differ depending on the format of the report. A DICOM SR format report will use DICOM native references, and other formats may use a hyperlink to the referenced images using the Web Access to DICOM Persistent Objects (WADO) service (see PS3.18).

X.1.3 Reporting with Annotated Images

The KO also allows the referencing of a Grayscale Softcopy Presentation State (GSPS) instance for each selected image. A GSPS instance can be created by the workstation for annotation (“electronic grease pencil”) of the selected image, as well as to set the window width/window level, rotation/flip, and/or display area selection of the image attached to the report. The created GSPS instances are transferred to the image repository (PACS) and are referenced in the KO document.

As with image references, the report management system may include the GSPS instance references in the report. When the report is subsequently displayed, the reader may retrieve the referenced images together with the referenced GSPS, so that the image is displayed with the annotations and other GSPS display controls. See Figure X.1-3.

Note that the GSPS display controls can also be included in WADO hyperlinks and invoked from non-DICOM display stations.

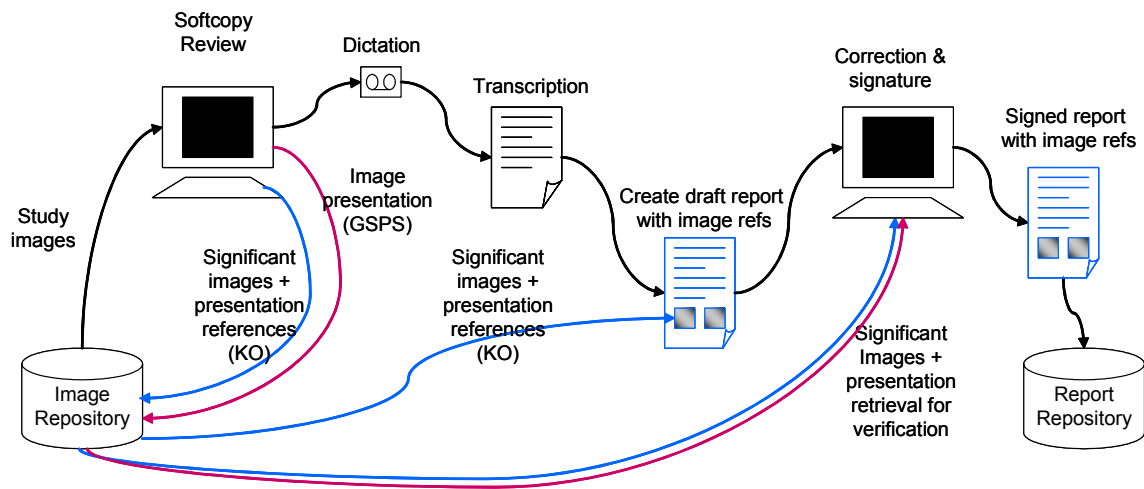

Figure X.1-3 Reporting Data Flow with Image and Presentation/Annotation References

X.2 TRANSCRIBED DIAGNOSTIC IMAGING SR INSTANCE CONTENT

This section describes the use of transcribed dictation and Key Object Selection (KO) instances to produce a DICOM Basic Text SR instance. A specific SR Template, TID 2005 (see PS3.16), is defined to support transcribed diagnostic imaging reports created using this data flow.

X.2.1 SR Header Content

The attributes of the Patient and Study Modules will be identical to those of the Study being reported. The following information is encoded in the SR Document General Module:

- Identity of the dictating physician (observer context) in the Author Sequence
- Identity of the transcriptionist or transcribing device (voice recognition) in the Participant Sequence
- Identity of the report signing physician in the Verifying Observer Sequence
- Identity of the institution owning the report in the Custodial Organization Sequence

- Linkages to the order and requested procedures in the Referenced Request Sequence
- A list of all images in the study in the Current Requested Procedure Evidence Sequence (from MPPS SOP Instances of the Study, or from query of the image repository)
- A list of all images not in the study, but also attached to the report as referenced significant images, in the Pertinent Other Evidence Sequence

X.2.2 Transcribed Text Data Format

The transcribed dictation is used to populate one or more section containers in the content tree of the SR Instance. If the transcription consists of a single undifferentiated text stream, it will typically be encoded using a single CONTAINER content item with Concept Name "Findings", and the text encoded as the value in a subsidiary TEXT content item with Concept Name "Finding". When the transcription is differentiated into multiple sections with captions, e.g., using the concepts in CID 7001 (see PS3.16), each section may be encoded in a separate CONTAINER, with the concept from CID 7001 as the container Concept Name, and the corresponding term from CID 7002 as the Concept Name for a subsidiary TEXT content item. See Figure X.2-1.

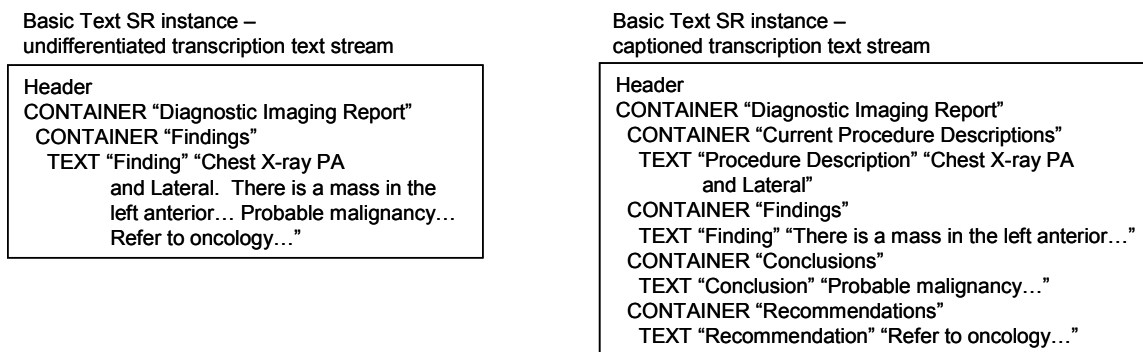

Figure X.2-1 Transcribed Text Content Tree

X.2.3 Image Reference Format

The content items from each associated KO object will be included in the SR in a separate CONTAINER with Concept Name (121180, DCM, "Key Images"). The text item "Key Object Description" and all image reference items shall be copied from the KO content tree to the corresponding SR container. See Figure X.2-2.

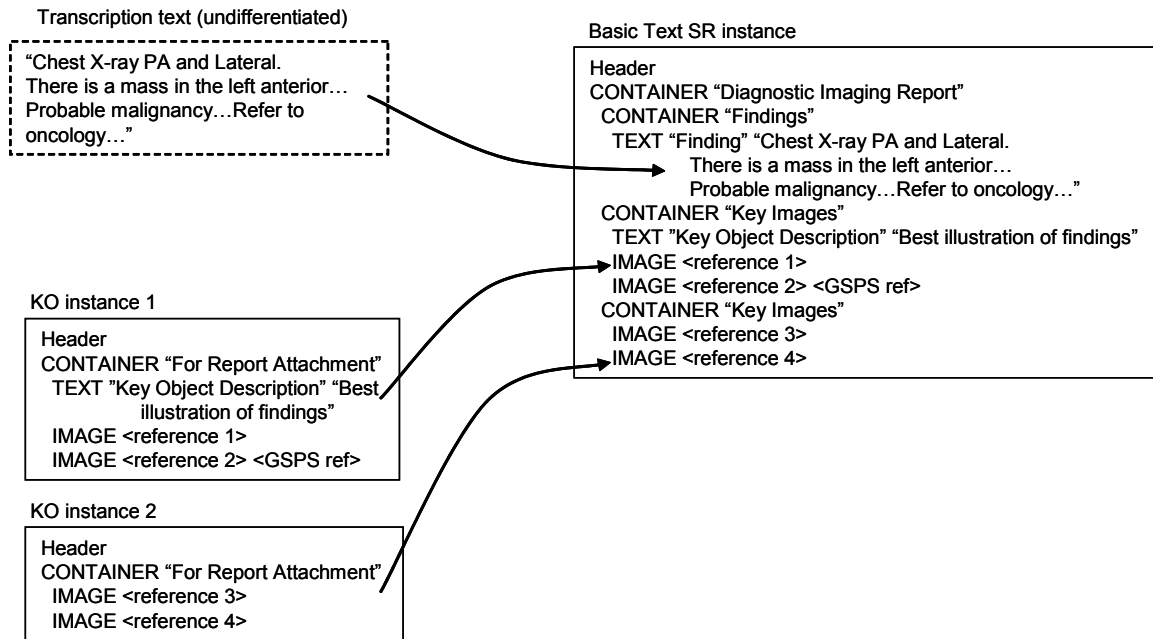

Figure X.2-2 Inputs to SR Basic Text Object Content Tree

The KO and SR IMAGE content item format allows the encoding of an icon (image thumbnail) with the image reference, as well as a reference to a GSPS instance controlling image presentation. Whether or not to include icons or GSPS references is an implementation decision of the softcopy review station that creates the KO; the IMAGE content item as a whole may be simply copied by the report management system from the KO to the Basic Text SR instance.

The intended process is that all KOs "For Report Attachment" are to be automatically included in the draft report. Therefore, the correction and signature function of the report management system should allow the physician to delete image references that were included, perhaps unintentionally, by the automatic process.

X.3 TRANSCRIBED DIAGNOSTIC IMAGING CDA INSTANCE CONTENT

This section describes the use of transcribed dictation and Key Object Selection (KO) documents to produce an HL7 Clinical Document Architecture (CDA) Release 2 document.

Note: While this section describes encoding as CDA Release 2, notes are provided about encoding issues for CDA Release 1.

X.3.1 CDA Header Content

The header of the CDA instance includes:

- Identity of the patient ("recordTarget" participation)
- Identity of the requested procedure ("documentationOf" act relationship)
- Identity of the dictating physician ("author" participation)
- Identity of the transcriptionist ("dataEnterer" participation)
- Identity of the report signing physician ("legalAuthenticator" participation)
- Identity of the institution owning the report ("custodian" participation)

- Identity of the request/order (“inFulfillmentOf” act relationship)

Note: The markup components in CDA Release 1 use different names.

X.3.2 Transcribed Text Content

Each transcription section can be encoded in a Section in the CDA document. The Section.Code and/or Section.Title can be derived from the corresponding transcription section title, if any. Although the transcription text can be encoded in the Section.Text without further markup, it is recommended that it be enclosed in <paragraph> tags.

X.3.3 Image References

Images are referenced using hypertext links in the narrative text. These links in CDA are not considered part of the attested content.

- Notes:
1. The primary use case for this Annex is the dictation/transcription reporting model. In the historical context of that model, the images (film sheets) are usually not considered part of the attested content of the report, although they are part of the complete exam record. I.e., the report is clinically complete without the images, and the referenced images are not formally part of the report. Therefore, this Annex discusses only the use of image references, not images embedded in the report.
 2. Being part of the attested content would require the images to be displayed every time the report is displayed – i.e., they are integral to understanding the report. If the images are attested, they must also be encapsulated with the CDA package. I.e., the CDA document itself is only one part of the interchanged package; the referenced images must also always be sent with the CDA document. If the images are for reference only and not attested, the Image Content Item may be transformed to a simple hypertext link; it is then the responsibility of CDA document receiver to follow or not follow the hyperlink. Moreover, as the industry moves toward ubiquitous network access to a distributed electronic healthcare record, there will be less need to prepackage the referenced images with the report.

In the current use case, there will be one or more KO instances with image references. Each KO instance can be transformed to a Section in the CDA document with a Section.Title “Key Images”, and a Section.Code of 121180 from the DICOM Controlled Terminology (see PS3.16). If the KO includes a TEXT content item, it can be transformed to <paragraph> data in that Section.Text of the CDA document. Each IMAGE content item can be transformed to a link item using the <linkHtml> markup.

Within the <linkHtml> markup, the value of the href attribute is the DICOM object reference as a Web Access to Persistent DICOM Objects (WADO) specified URI (see Table X.3-1).

- Notes:
1. When a DICOM object reference is included in an HL7 CDA document, it is presumed the recipient would not be a DICOM application; it would have access only to general Internet network protocols (and not the DICOM upper layer protocol), and would not be configured with the means to display a native DICOM image. Therefore, the recommended encoding of a DICOM Object Reference in the CDA narrative block <linkHtml> uses WADO for access by the HTTP/HTTPS network protocol (see PS3.18), using one of the formats broadly supported in Web browsers (image/jpeg or video/mpeg) as the requested content type.
 2. In CDA Release 1, the markup tag for hyperlinks is <link_html> within the scope of a <link> tag.

Table X.3-1 WADO Reference in an HL7 CDA <linkHtml>

WADO Component	Source
<scheme>://<authority>/<path>	Configuration setting, used by the conversion process, identifying the WADO server
?requestType=WADO	Fixed
&studyUID=<uid>	Study Instance UID for referenced image obtained from the Current Requested Procedure Evidence Sequence or the Pertinent Other Evidence Sequence in the KO Instance
&seriesUID=<uid>	Series Instance UID for referenced image obtained from the

	Current Requested Procedure Evidence Sequence or the Pertinent Other Evidence Sequence in the KO Instance
&objectUID=<uid>	Referenced SOP Instance UID from IMAGE content item
&frameNumber=<list>	Referenced Frame Number from IMAGE content item (if present)
&presentationUID=<uid>	Referenced SOP Instance UID from Referenced SOP Sequence within IMAGE content item
&presentationSeriesUID=<uid>	Series Instance UID for referenced presentation state obtained from the Current Requested Procedure Evidence Sequence or the Pertinent Other Evidence Sequence in the KO Instance
&contentType=video/mpeg	Present if Referenced SOP Class UID from IMAGE content item is for a multi-frame image IOD

- Notes:
1. Literal strings are in normal typeface, while *<italic typeface within angle brackets>* indicates values to be copied from the identified source.
 2. The default contentType for single frame images is image/jpeg, which does not need to be specified as a WADO component. However, the default contentType for multiple frame images is application/dicom, which needs to be overridden with the specific request for video/mpeg.
 3. There is not yet a standard mechanism for minimizing the potential for staleness of the *<scheme>://<authority>/<path>* component.

X.3.4 Icons

If the IMAGE content item includes an Icon Image Sequence, the report creation process may embed the icon in the Section.Text narrative. The Icon Image Sequence Pixel Data is converted into an image file, e.g., in JPEG or GIF format, and base64 encoded. The file is encoded in an ObservationMedia entry in the CDA instance, and a <renderMultimedia> tag reference to the entry is encoded in the Section.Text adjacent to the <linkHtml> of the image reference.

X.3.5 Structured Entries

The Current Requested Procedure Evidence Sequence (0040,A375) of the KO instance lists all the SOP Instances referenced in the IMAGE content items in their hierarchical Study/Series/Instance context. It is recommended that this list be transcoded to CDA Entries in a Section with Section.Title "DICOM Object Catalog" and a Section.Code of 121181 from the DICOM Controlled Terminology (see PS3.16).

- Notes:
1. Structured Entries are not defined in CDA Release 1.
 2. Since the image hypertext links in the Section narrative may refer to both an image and a softcopy presentation state, as well as possibly being constrained to specific frame numbers, in general there is not a simple mapping from the <linkHtml> to an entry. Therefore it is not expected that there would be ID reference links between the <linkHtml> and related entries.

The purpose of the Structured Entries is to allow DICOM-aware applications to access the referenced images in their hierarchical context.

The encoding of the DICOM Object References in CDA Entries is shown in Figure X.3-1 and Tables X.3-2 through X.3-6. All of the mandatory data elements for the Entries are available in the Current Requested Procedure Evidence Sequence; optional elements (e.g., instance datetimes) may also be included if known by the encoding application.

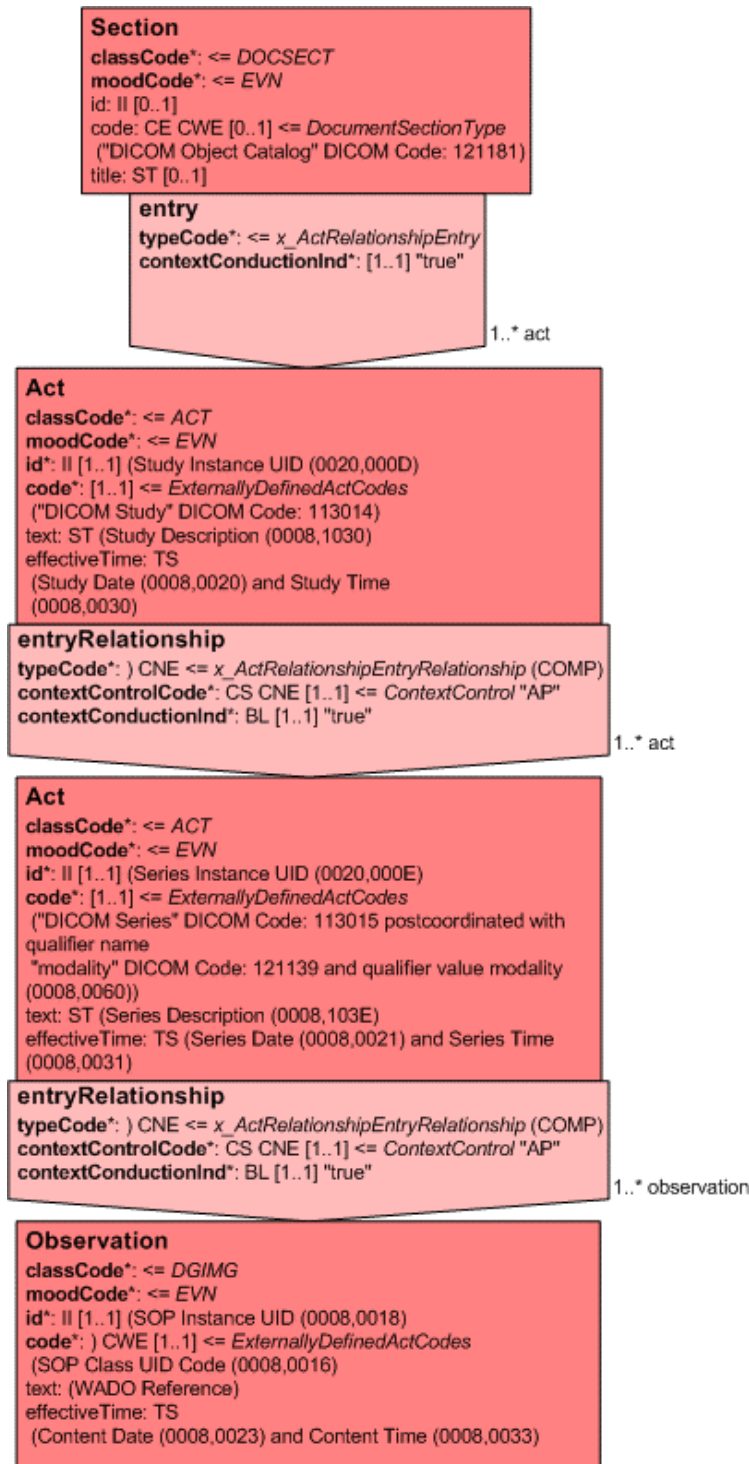

Figure X.3-1 CDA Section with DICOM Object References

Note: The format of Figure X.3-1 follows the conventions of HL7 v3 Reference Information Model diagrams.

Table X.3-2 DICOM Study Reference in an HL7 v3 Act (CDA Act Entry)

Attribute	Data Type	Multiplicity	Value
-----------	-----------	--------------	-------

classCode	CS	1..1	ACT
moodCode	CS	1..1	EVN
id	II	1..1	<Study Instance UID (0020,000D) as root property with no extension property>
code	CD	1..1	<113014 as code property, 1.2.840.10008.2.16.4 as codeSystem property, DCM as codeSystemName property, "DICOM Study" as displayName property>
text	ST	0..1	<Study Description (0008,1030)>
effectiveTime	TS	0..1	<Study Date (0008,0020) and Study Time (0008,0030)>

Table X.3-3 DICOM Series Reference in an HL7 v3 Act (CDA Act Entry)

Attribute	Data Type	Multiplicity	Value
classCode	CS	1..1	ACT
moodCode	CS	1..1	EVN
id	II	1..1	<Series Instance UID (0020,000E) as root property with no extension property>
code	CD	0..1	<113015 as code property, 1.2.840.10008.2.16.4 as codeSystem property, DCM as codeSystemName property, "DICOM Series" as displayName property, Modality as qualifier property (see text and Table X.3-4)>
text	ST	0..1	<Series Description (0008,103E)>
effectiveTime	TS	0..1	<Series Date (0008,0021) and Series Time (0008,0031)>

The code for the Act representing a Series uses a qualifier property to indicate the modality. The qualifier property is a list of coded name/value pairs. For this use, only a single list entry is used, as described in Table X.3-4.

Table X.3-4 Modality Qualifier for the Series Act.Code

Property	Data Type	Value
name	CV	<121139 as code property, 1.2.840.10008.2.16.4 as codeSystem property, DCM as codeSystemName property, "Modality" as displayName property>
value	CD	<Modality (0008,0060) as code property, 1.2.840.10008.2.16.4 as codeSystem property, DCM as codeSystemName property, Modality code meaning (from PS3.16) as displayName property>

Table X.3-5 DICOM Composite Object Reference in an HL7 v3 Act (CDA Observation Entry)

Attribute	Data Type	Multiplicity	Value
-----------	-----------	--------------	-------

classCode	CS	1..1	DGIMG
moodCode	CS	1..1	EVN
id	II	1..1	<SOP Instance UID (0008,0018) as root property with no extension property>
code	CD	1..1	<SOP Class UID (0008,0016) as code property, 1.2.840.10008.2.6.1 as codeSystem property, DCMUID as codeSystemName property, SOP Class UID Name (from PS3.6) as displayName property>
text	ED	0..1	<application/DICOM as mediaType property, WADO reference (see Table X.3-6) as reference property>
effectiveTime	TS	0..1	<Content Date (0008,0023) and Content Time (0008,0033)>

- Notes:
1. The DGIMG class is used to reference all DICOM Composite Instances, not just diagnostic images.
 2. The Observation.Text reference property may alternatively use a DICOM protocol based URI, rather than WADO, should such a URI be defined.

Table X.3-6 WADO Reference in an HL7 DGIMG Observation.Text

WADO Component	Source
<scheme>://<authority>/<path>	Configuration setting, used by the conversion process, identifying the WADO server
?requestType=WADO	Fixed
&studyUID=<uid>	Study Instance UID for referenced instance
&seriesUID=<uid>	Series Instance UID for referenced instance
&objectUID=<uid>	SOP Instance UID for referenced instance
&contentType=application/DICOM	Fixed

X.4.3 Using the WADO Reference for DICOM Network Protocol Retrievals

An application that receives a CDA with image references, and is capable of using the full services of DICOM upper layer protocol directly, can use the WADO parameters in either the linkHtml or in the DGIMG Observation.Text to retrieve the object using the DICOM network services. Such an application would need to be pre-configured with the hostname/IP address, TCP port, and AE Title of the DICOM object server (C-MOVE or C-GET SCP); this network address is not part of the WADO string. (Note that pre-configuration of this network address is typical for DICOM applications, and is facilitated by the LDAP-based DICOM Application Configuration Management Profile; see PS3.15.)

The application would open a Query/Retrieve Service Association with the configured server, and send a C-MOVE or C-GET command using the study, series, and object instance UIDs identified in the WADO query parameters. Such an application might also reasonably query the server for related objects, such as Grayscale Softcopy Presentation State.

- Note:
- When using the C-GET service, the retrieving application needs to specify and negotiate the SOP Class of the retrieved objects when it opens the Association. This information is not available in the linkHtml WADO reference; however, it is available in the DGIMG Observation.Code. It may also be obtained from the configured server using a C-FIND query on a prior Association.

X.4 SIMULTANEOUS SR AND CDA INSTANCE CREATION

The report may be created as both an SR instance and a CDA instance. In this case, the two instances are equivalent, and can cross-reference each other.

X.4.1 Equivalence

The CDA Document shall contain clinical content equivalent to the SR Document.

Note: The HL7 CDA standard specifically addresses transformation of documents from a non-CDA format. The requirement in the CDA specification is: "A proper transformation must ensure that the human readable clinical content of the report is not impacted."

There is no requirement that the transform or transcoding between DICOM SR and HL7 CDA be reversible. In particular, some attributes of the DICOM Patient, Study, and Series IEs have no corresponding standard encoding in the HL7 CDA Header, and vice versa. Such data elements, if transcoded, may need to be encoded in "local markup" (in HL7 CDA) or private data elements (in DICOM SR) in an implementation-dependent manner; and some such data elements may not be transcoded at all. It is a responsibility of the transforming application to ensure clinical equivalence.

Many attributes of the SR Document General Module can be transcoded to CDA Header participations or related acts.

X.4.2 Document Cross-Reference

Due to the inherent differences between DICOM SR and HL7 CDA, a transcoded document will have a different UID than the source document. However, the SR Document may reference the CDA Document as equivalent using the Equivalent CDA Document Sequence (0040,A090) attribute, and the CDA Document may reference the SR Document with a relatedDocument act relationship.

Since the ParentDocument target of the relatedDocument relationship is constrained to be a simple DOCCLIN act, it is recommended that the reference to the DICOM SR be encoded per Table X.3-4, without explicit identification of the Study and Series Instance UIDs, and with classCode DOCCLIN (rather than DGIMG).

- Notes:
1. The Study and Series Instance UIDs would be encoded in the WADO reference in the Act.Text ED data type.
 2. CDA Release 1 does not provide a standard for the relatedDocument relationship to another document.

Annex Y – VOI LUT Functions (Informative)

Digital projection X-ray images typically have a very high dynamic range due to the digital detector's performance. In order to display these images, various Values Of Interest (VOI) transformations can be applied to the images to facilitate diagnostic interpretation. The original description of the DICOM grayscale pipeline assumed that either the parameters of a linear LUT (window center and width) are used, or a static non-linear LUT is applied (VOI LUT).

Normally, a display application interprets the window center and width as parameters of a function following a linear law (see figure Y-1).

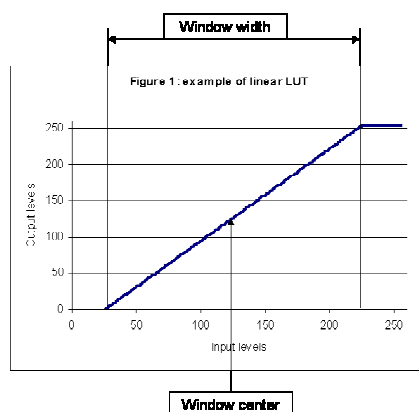

Figure Y-1.

A VOI LUT sequence can be provided to describe a non-linear LUT as a table of values, with the limitation that the parameters of this LUT cannot be adjusted subsequently, unless the application provides the ability to scale the output of the LUT (and there is no way in DICOM to save such a change unless a new scaled LUT is built), or to fit a curve to the LUT data, which may then be difficult to parameterize or adjust, or be a poor fit.

Digital X-ray applications all have their counterpart in conventional film/screen X-ray and a critical requirement for such applications is to have an image “look” close to the film/screen applications. In the film/screen world the image dynamics are mainly driven by the H-D curve of the film that is the plot of the resulting optical density (OD) of the film with respect to the logarithm of the exposure. The typical appearance of an H-D curve is illustrated in figure Y-2.

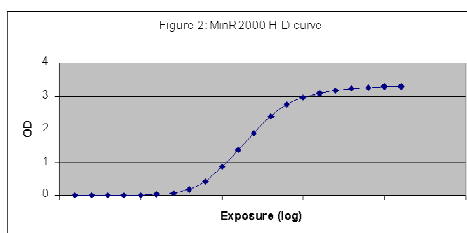

Figure Y-2.

In digital applications, a straightforward way to mock up a film-like look would be to use a VOI LUT that has a similar shape to an H-D curve, namely a toe, a linear part and a shoulder instead of a linear ramp.

While such a curve could be encoded as data within a VOI LUT, DICOM defines an alternative for interpreting the existing window center and width parameters, as the parameters of a non-linear function.

Figure Y-3 illustrates the shape of a typical sigmoid as well as the graphical interpretation of the two LUT parameters window center and window width. This figure corresponds to the equation definition in PS 3.3 for the VOI LUT Function (0028,1056) is SIGMOID.

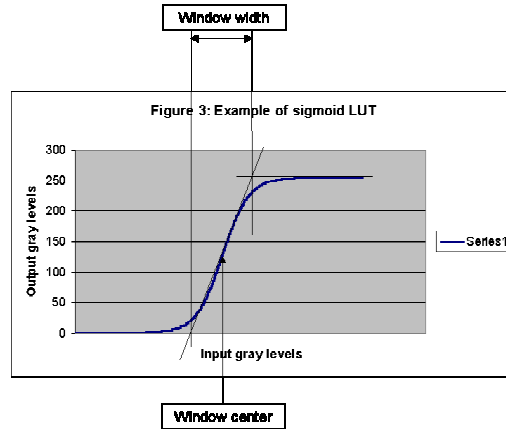

Figure Y-3.

If a receiving display application does not support the SIGMOID VOI LUT Function, then it can successfully apply the same window center and window width parameters to a linear ramp and achieve acceptable results, specifically a similar perceived contrast but without the roll-off at the shoulder and toe.

A receiving display application that does support such a function is then able to allow the user to adjust the window center and window width with a more acceptable resulting appearance.

Annex Z X-Ray Isocenter Reference Transformations (Informative)

Z.1 INTRODUCTION

The Isocenter Reference System Attributes describe the 3D geometry of the X-Ray equipment composed by the X-Ray positioner and the X-Ray table.

These attributes define three coordinate systems in the 3D space:

- Isocenter coordinate system
- Positioner coordinate system
- Table coordinate system

The Isocenter Reference System attributes describe the relationship between the 3D coordinates of a point in the table coordinate system and the 3D coordinates of such point in the positioner coordinate system (both systems moving in the equipment), by using the Isocenter coordinate system that is fixed in the equipment.

Z.2 POSITIONER COORDINATE SYSTEM TRANSFORMATIONS

Any point of the Positioner coordinate system (P_{xp} , P_{yp} , P_{zp}) can be expressed in the Isocenter coordinate system (P_x , P_y , P_z) by applying the following transformation:

$$(P_x, P_y, P_z)^T = (R_2 \cdot R_1)^T \cdot (R_3^T \cdot (P_{xp}, P_{yp}, P_{zp})^T)$$

And inversely, any point of the Isocenter coordinate system (P_x , P_y , P_z) can be expressed in the Positioner coordinate system (P_{xp} , P_{yp} , P_{zp}) by applying the following transformation:

$$(P_{xp}, P_{yp}, P_{zp})^T = R_3 \cdot ((R_2 \cdot R_1) \cdot (P_x, P_y, P_z)^T)$$

Where R_1 , R_2 and R_3 are defined as follows:

$$R_1 = \begin{pmatrix} \cos(Ap_1) & \sin(Ap_1) & 0 \\ -\sin(Ap_1) & \cos(Ap_1) & 0 \\ 0 & 0 & 1 \end{pmatrix}$$

$$R_2 = \begin{pmatrix} 1 & 0 & 0 \\ 0 & \cos(Ap_2) & -\sin(Ap_2) \\ 0 & \sin(Ap_2) & \cos(Ap_2) \end{pmatrix}$$

$$R_3 = \begin{pmatrix} \cos(Ap_3) & 0 & -\sin(Ap_3) \\ 0 & 1 & 0 \\ \sin(Ap_3) & 0 & \cos(Ap_3) \end{pmatrix}$$

Z.3 TABLE COORDINATE SYSTEM TRANSFORMATIONS

Any point of the table coordinate system (P_{xt} , P_{yt} , P_{zt}) (see Figure Z-1) can be expressed in the Isocenter Reference coordinate system (P_x , P_y , P_z) by applying the following transformation:

$$(P_x, P_y, P_z)^T = (R_3 \cdot R_2 \cdot R_1)^T \cdot (P_{xt}, P_{yt}, P_{zt})^T + (T_x, T_y, T_z)^T$$

And inversely, any point of the Isocenter coordinate system (P_x , P_y , P_z) can be expressed in the table coordinate system (P_{xt} , P_{yt} , P_{zt}) by applying the following transformation:

$$(P_{X_t}, P_{Y_t}, P_{Z_t})^T = (R_3 \cdot R_2 \cdot R_1) \cdot ((P_X, P_Y, P_Z)^T - (T_X, T_Y, T_Z)^T)$$

Where R_1 , R_2 and R_3 are defined as follows:

$$R_1 = \begin{pmatrix} \cos(At_1) & 0 & -\sin(At_1) \\ 0 & 1 & 0 \\ \sin(At_1) & 0 & \cos(At_1) \end{pmatrix}$$

$$R_2 = \begin{pmatrix} 1 & 0 & 0 \\ 0 & \cos(At_2) & \sin(At_2) \\ 0 & -\sin(At_2) & \cos(At_2) \end{pmatrix}$$

$$R_3 = \begin{pmatrix} \cos(At_3) & -\sin(At_3) & 0 \\ \sin(At_3) & \cos(At_3) & 0 \\ 0 & 0 & 1 \end{pmatrix}$$

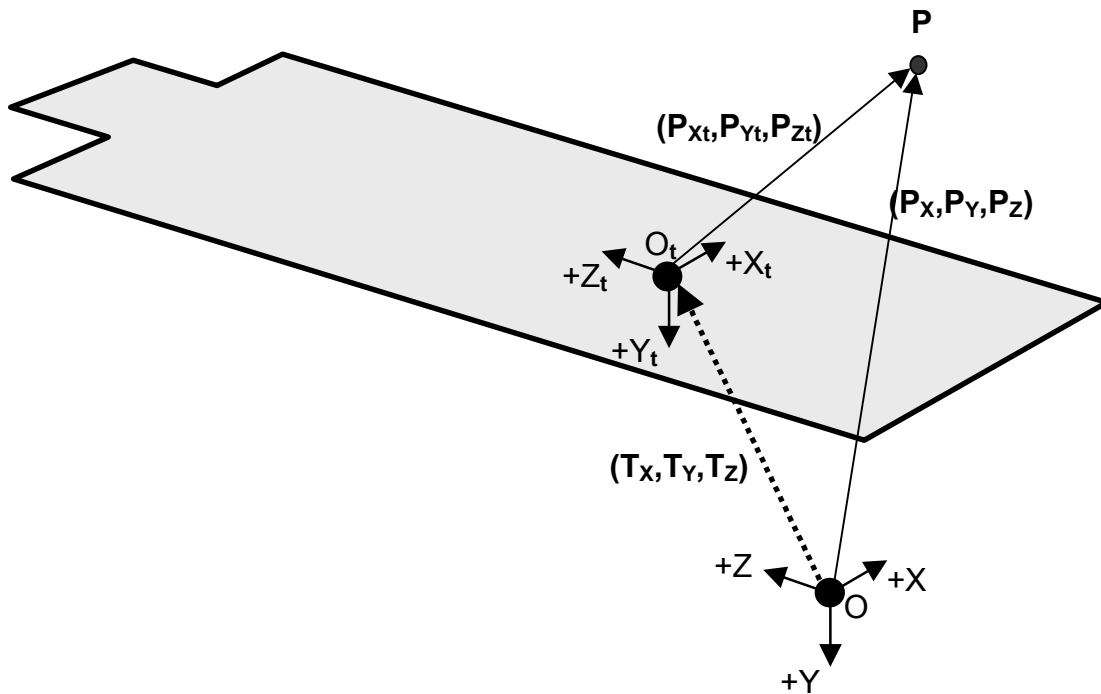

Figure Z-1
Coordinates of a Point "P" in the Isocenter and Table coordinate systems

Annex AA: Radiation Dose Reporting Use Cases (Informative)

AA.1 PURPOSE OF THIS ANNEX

This Annex describes the use of the X-Ray Radiation Dose SR Object. Multiple systems contributing to patient care during a visit may expose the patient to irradiation during diagnostic and/ or interventional procedures. Each of those equipments may record the dose in an X-Ray Dose Reporting information object. Radiation safety information reporting systems may take advantage of this information and create dose reports for a visit, parts of a procedure performed or accumulation for the patient in total, if information is completely available in a structured content.

AA.2 DEFINITIONS

Irradiation Event

An irradiation event is the occurrence of radiation being applied to a patient in single continuous time-frame between the start (release) and the stop (cease) of the irradiation. The irradiation event is the “smallest” information entity to be recorded in the realm of Radiation Dose reporting. Individual Irradiation Events are described by a set of accompanying physical parameters that are sufficient to understand the “quality” of irradiation that is being applied. This set of parameters may be different for the various types of equipment that are able to create irradiation events. Any on-off switching of the irradiation source during the event is not treated as separate events, rather the event includes the time between start and stop of irradiation as triggered by the user. E.g., a pulsed fluoro X-Ray acquisition is treated as a single irradiation event.

Irradiation events include all exposures performed on X-Ray equipment, independent of whether a DICOM Image Object is being created. That is why an irradiation event needs to be described with sufficient attributes to exchange the physical nature of irradiation applied.

Accumulated Dose Values

Accumulated Dose Values describe the integrated results of performing multiple irradiation events. The scope of accumulation is typically a study or a performed procedure step.

AA.3 USE CASES

The following use cases illustrate the information flow between participating roles and the possible capabilities of the equipment that is performing in those roles. Each case will include a use case diagram and denote the integration requirements. The diagrams will denote actors (persons in role or other systems involved in the process of data handling and/or storage). Furthermore, in certain cases it is assumed that the equipment (e.g. Acquisition Modality) is capable of displaying the contents of any dose reports it creates.

These use cases are only examples of possible uses for the Dose Report, and are by no means exhaustive.

AA.3.1 Basic Dose Reporting

This is the basic use case for electronic dose reporting. See Figure AA.3-1

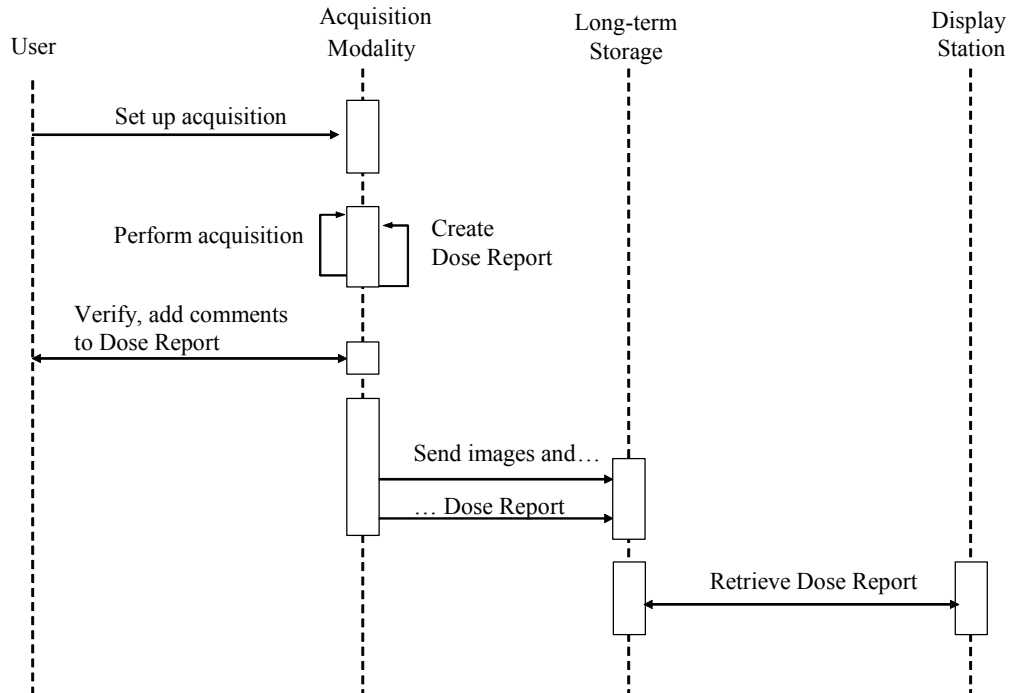

Figure AA.3-1 Basic Dose Reporting

In this use case the user sets up the Acquisition Modality, and performs the study. The Modality captures the irradiation event exposure information, and encodes it together with the accumulated values in a Dose Report. The Modality may allow the user to review the dose report, and to add comments. The acquired images and Dose Report are sent to a Long-Term Storage system (e.g., PACS) that is capable of storing Dose Report objects.

A Display Station may retrieve the Dose Report from the Storage system, and display it. Because the X-Ray Radiation Dose SR object is a proper subset of the Enhanced SR object, the Display Station may render it using the same functionality as used for displaying any Enhanced SR object.

AA.3.2 Dose Reporting for Non-Digital Imaging

The Dose Report may also be used for image acquisitions using non-digital Acquisition Modalities. See Figure AA.3-2.

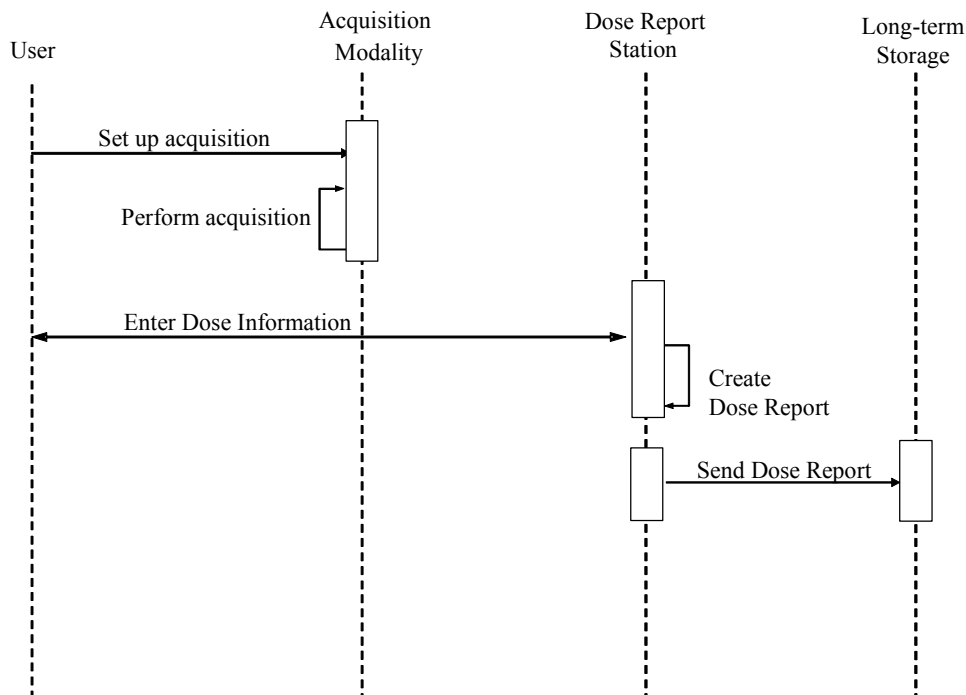

Figure AA.3-2 Dose Reporting for Non-Digital Imaging

In this use case the user may manually enter the irradiation event exposure information into a Dose Reporting Station, possibly transcribing it from a dosimeter read-out display. The station encodes the data in a Dose Report and sends it to a Storage system. The same Dose Reporting Station may be used to support several acquisition modalities.

This case may be useful in film-only radiography environments, or in mixed film and digital environments, where the DICOM X-Ray Radiation Dose SR Object provides a standard format for recording and storing irradiation events.

Note that in a non-PACS environment, the Dose Reports may be sent to a Long-Term Storage function built into a Radiation Safety workstation or information system.

AA.3.3 Dose Reporting Post-Processing

A specialized Radiation Safety workstation may contribute to the process of dose reporting in terms of more elaborate calculations or graphical dose data displays, or by aggregating dose data over multiple studies. See Figure AA.3-3. The Radiation Safety workstation may or may not be integrated with the Long-Term Storage function in a single system; such application entity architectural decisions are outside the scope of DICOM, but DICOM services and information objects do facilitate a variety of possible architectures.

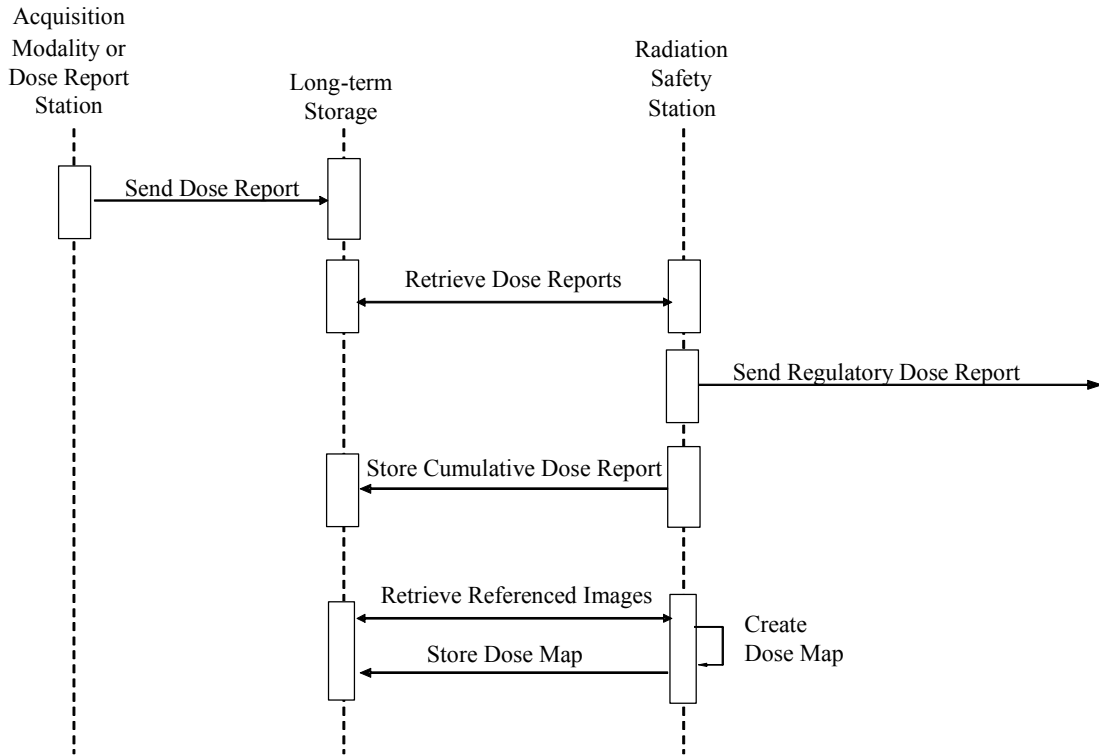

Figure AA.3-3 Dose Reporting Post-Processing

The Radiation Safety workstation may be able to create specific reports to respond to dose registry requirements, as established by local regulatory authorities. These reports would generally not be in DICOM format, but would be generated from the data in DICOM X-Ray Radiation Dose SR objects.

The Radiation Safety workstation may also be used to generate more elaborate reports on patient applied dose. The workstation may retrieve the Dose Reports for multiple procedures performed on a particular patient. A report of the cumulative dose for a specified time period, or for a visit/admission, may be generated, encoded as a DICOM Dose Report, and stored in the Long-Term Storage system. Any such further reports will be stored in addition to the “basic report”.

Note that such cumulative Dose Reports may describe irradiation events that are also documented in other Dose Reports. The assignment of a UID to each irradiation event allows the application to identify unique irradiation events that may be reported in multiple objects. The structure of the X-Ray Radiation Dose SR object also allows a cumulative report to reference the contributing report objects using the Predecessor Documents Sequence (0040,A360) attribute.

An advanced application may be able to use the Dose Report data, potentially supplemented by the data in the image objects referenced in the Dose Report, to create a Dose Map that visualizes applied dose. Such a Dose Map may be sent to the Long-Term Storage system using an appropriate object format.

Other purposes of the Radiation Safety workstation may include statistical analyses over all Dose Report Objects in order to gain information for educational or quality control purposes. This may include searches for Reports performed in certain time ranges, or with specific equipment, or using certain protocols.

AA.3.4 Dose Reporting Workflow Management

The dose reporting workflow may be managed using the same DICOM services used for managing the imaging workflow. These services include Modality Worklist (MWL) and Performed Procedure Step (MPPS), and General Purpose Worklist (GP-WL), Scheduled Procedure Step (GP-SPS), and Performed Procedure Step (GP-PPS) services.

In particular, a Dose Report produced for an Acquisition Modality Performed Procedure Step can be identified in the MPPS Referenced Non-Image Composite SOP Instance Sequence (0040,0220). Dose Report post-processing tasks may be scheduled and monitored using the GP-WL, GP-SPS, and GP-PPS services.

Annex BB: Printing (Informative)

BB.1 EXAMPLE OF PRINT MANAGEMENT SCU SESSION (Informative)

BB.1.1 Simple Example

This example of a Print Management SCU Session is provided for informational purposes only. It illustrates the use of one of the Basic Print Management Meta SOP Classes.

A-ASSOCIATE

N-GET (PRINTER SOP Instance)

N-CREATE (Film Session SOP Instance)

for (each film of film session)

{

N-CREATE (Film Box SOP Instance)

for (each image of film)

{

N-SET (Image Box SOP Instance which encapsulates a PREFORMATTED IMAGE SOP Instance)

}

if (no collation)

{

N-ACTION (PRINT, Film Box SOP Instance)

N-DELETE (Film Box SOP Instance)

}

}

if (collation)

{

N-ACTION (PRINT, Film Session SOP Instance)

N-DELETE (Film Session SOP Instance)

}

N-EVENT-REPORT (PRINTER SOP Instance)

A-RELEASE

BB.1.2 Advanced Example (Retired)

This section was previously defined in DICOM. It is now retired. See PS 3.4-1998.

Annex CC: Storage Commitment (Informative)

CC.1 STORAGE COMMITMENT EXAMPLES (Informative)

This Section and its sub-sections contain examples of ways in which the Storage Commitment Service Class could be used. This is not meant to be an exhaustive set of scenarios but rather a set of examples.

CC.1.1 Push Model Example

Figure CC.1-1 is an example of the use of the Storage Commitment Push Model SOP Class.

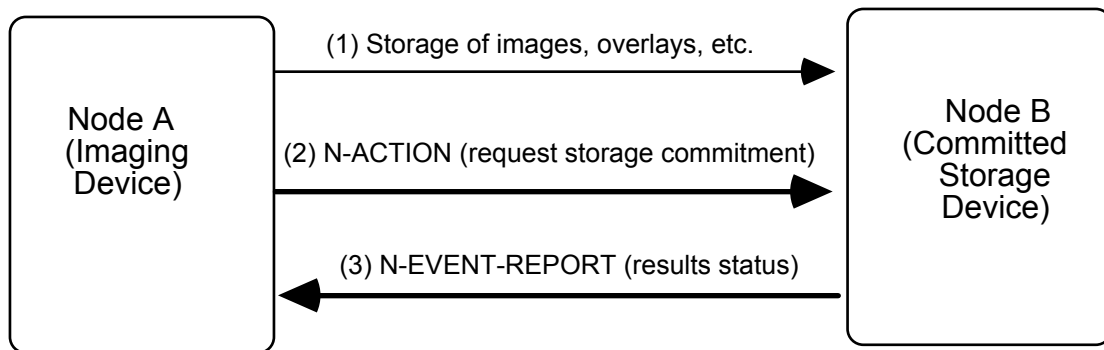

Figure CC.1-1
EXAMPLE OF STORAGE COMMITMENT PUSH MODEL SOP CLASS

Node A (an SCU) uses the services of the Storage Service Class to transmit one or more SOP Instances to Node B (1). Node A then issues an N-ACTION to Node B (an SCP) containing a list of references to SOP Instances, requesting that the SCP take responsibility for storage commitment of the SOP Instances (2). If the SCP has determined that all SOP Instances exist and that it has successfully completed storage commitment for the set of SOP Instances, it issues an N-EVENT-REPORT with the status successful (3) and a list of the stored SOP Instances. Node A now knows that Node B has accepted the commitment to store the SOP Instances. Node A might decide that it is now appropriate for it to delete its copies of the SOP Instances. The N-EVENT-REPORT may or may not occur on the same Association as the N-ACTION.

If the SCP determines that committed storage can for some reason not be provided for one or more SOP Instances referenced by the N-ACTION request, then instead of reporting success it would issue an N-EVENT-REPORT with a status of completed - failures exists. With the EVENT-REPORT it would include a list of the SOP Instances that were successfully stored and also a list of the SOP Instances for which storage failed.

CC.1.2 Pull Model Example (Retired)

A Pull Model was defined in earlier versions, but has been retired. See PS 3.4-2001.

CC.1.3 Remote Storage of Data by the SCP

Figure CC.1-3 explains the use of the Retrieve AE Title. Using the push model a set of SOP Instances will be transferred from the SCU to the SCP. The SCP may decide to store the data locally or,

alternatively, may decide to store the data at a remote location. This example illustrates how to handle the latter case.

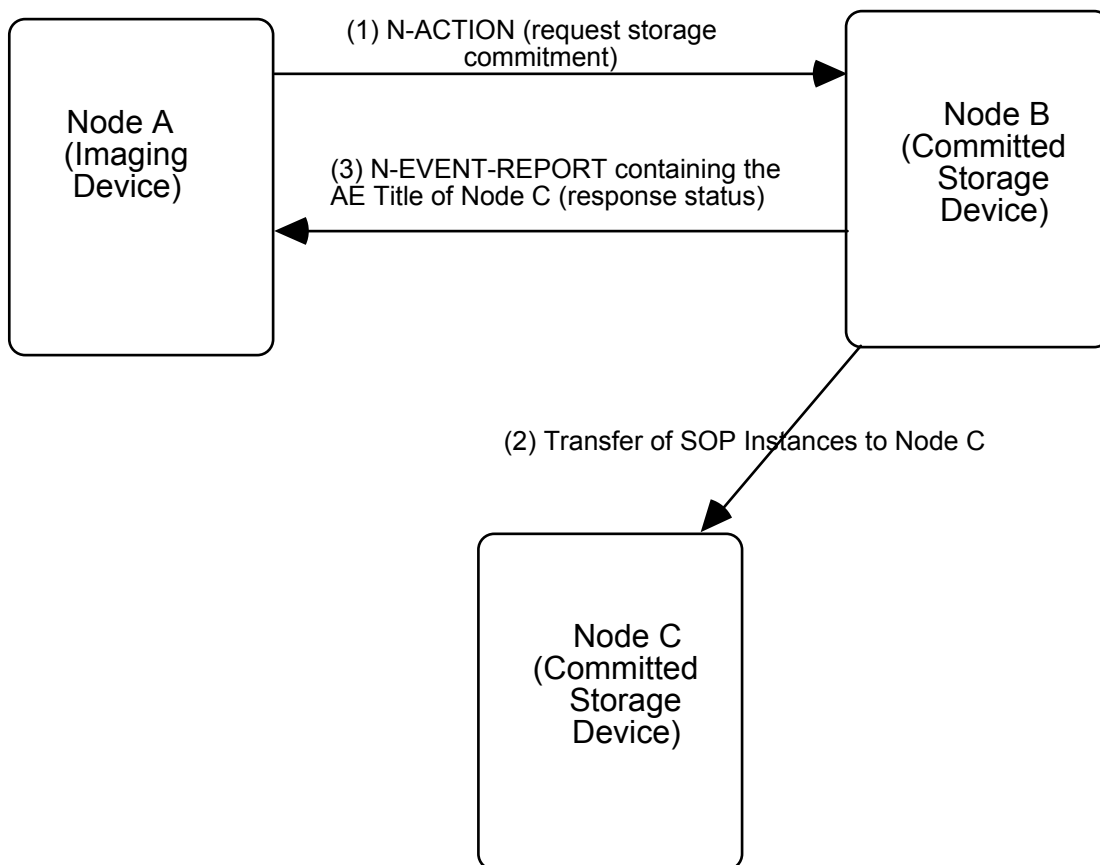

Figure CC.1-3
EXAMPLE OF REMOTE STORAGE OF SOP INSTANCES

Node A, an SCU of the Storage Commitment Push Model SOP Class, informs Node B, an SCP of the corresponding SOP Class, of its wish for storage commitment by issuing an N-ACTION containing a list of references to SOP Instances (1). The SOP Instances will already have been transferred from Node A to Node B (Push Model) (2). If the SCP has determined that storage commitment has been achieved for all SOP Instances at Node C specified in the original Storage Commitment Request (from Node A), it issues an N-EVENT-REPORT (3) like in the previous examples. However, to inform the SCU about the address of the location at which the data will be stored, the SCP includes in the N-EVENT-REPORT the Application Entity Title of Node C.

The Retrieve AE Title can be included in the N-EVENT-REPORT at two different levels. If all the SOP Instances in question were stored at Node C, a single Retrieve AE Title could be used for the whole data set. However, the SCP could also choose not to store all the SOP Instances at the same location. In this case the Retrieve AE Title Attribute must be provided at the level of each single SOP Instance in the Referenced SOP Instance Sequence.

This example also applies to the situation where the SCP decides to store the SOP Instances on Storage Media. Instead of providing the Retrieve AE Title, the SCP will then provide a pair of Storage Media File-Set ID and UID.

CC.1.4 Storage Commitment in Conjunction with Use of Storage Media

Figure CC.1-4 is an example of how to use the Push Model with Storage Media to perform the actual transfer of the SOP Instances.

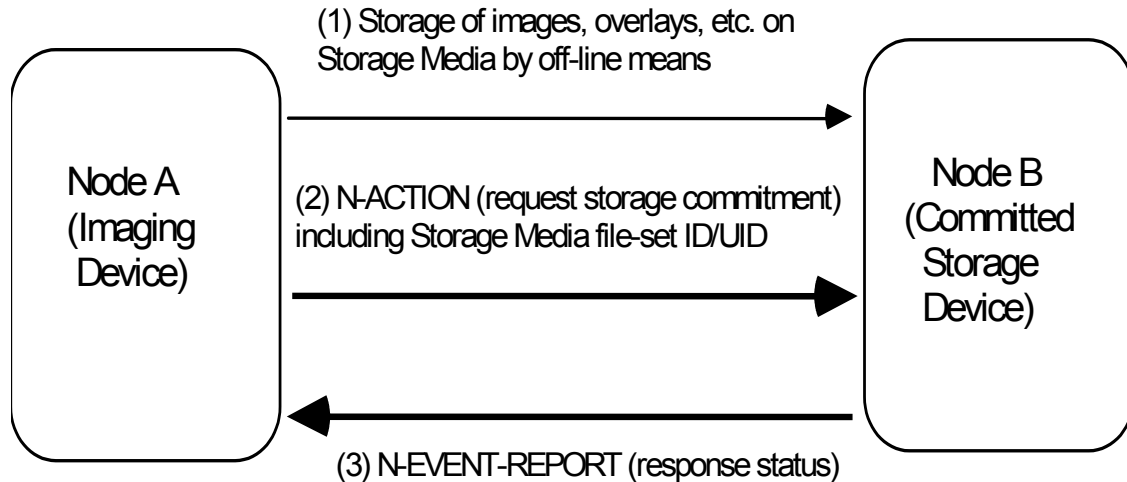

Figure CC.1-4
EXAMPLE OF STORAGE COMMITMENT IN CONJUNCTION WITH STORAGE MEDIA

Node A (an SCU) starts out by transferring the SOP Instances for which committed storage is required to Node B (an SCP) by off-line means on some kind of Storage Media (1). When the data is believed to have arrived at Node B, Node A can issue an N-ACTION to Node B containing a list of references to the SOP Instances contained on the Storage Media, requesting that the SCP perform storage commitment of these SOP Instances (2). If the SCP has determined that all the referenced SOP Instances exist (they may already have been loaded into the system or they may still reside on the Storage Media) and that it has successfully completed storage commitment for the SOP Instances, it issues an N-EVENT-REPORT with the status successful (3) and a list of the stored SOP Instances like in the previous examples.

If the Storage Media has not yet arrived or if the SCP determines that committed storage can for some other reason not be provided for one or more SOP Instances referenced by the N-ACTION request it would issue an N-EVENT-REPORT with a status of completed - failures exists. With the EVENT-REPORT it would include a list of the SOP Instances that were successfully stored and also a list of the SOP Instances for which storage failed. The SCP is not required to wait for the Storage Media to arrive (however it may chose to wait) but is free to reject the Storage Commitment request immediately. If so, the SCU may decide to reissue another N-ACTION at a later point in time.

Annex DD: Worklists (Informative)

DD.1 EXAMPLES FOR THE USAGE OF THE MODALITY WORKLIST (Informative)

These typical examples of Modality Worklists are provided for informational purposes only.

- A Worklist consisting of Scheduled Procedure Step entities that have been scheduled for a certain time period (e.g. "August 9, 1995"), and for a certain Scheduled Station AE title (namely the modality, where the Scheduled Procedure Step is going to be performed). See Figure DD.7-1.
- A Worklist consisting of the Scheduled Procedure Step entities that have been scheduled for a certain time period (e.g. "August 9, 1995"), and for a certain Modality type (e.g. CT machines). This is a scenario, where scheduling is related to a pool of modality resources, and not for a single resource.
- A Worklist consisting of the Scheduled Procedure Step entities that have been scheduled for a certain time period (e.g. "August 9, 1995"), and for a certain Scheduled Performing Physician. This is a scenario, where scheduling is related to human resources and not for equipment resources.
- A Worklist consisting of a single Scheduled Procedure Step entity that has been scheduled for a specific Patient. In this scenario, the selection of the Scheduled Procedure Step was done beforehand at the modality. The rationale to retrieve this specific worklist is to convey the most accurate and up-to-date information from the IS, right before the Procedure Step is performed.

The Modality Worklist SOP Class User may retrieve additional Attributes. This may be achieved by Services outside the scope of the Modality Worklist SOP Class.

Additional Attributes may be retrieved using N-GET services on the appropriate Service Class Providers, e.g. on the Detached Patient Management Service Class to retrieve additional patient Attributes.

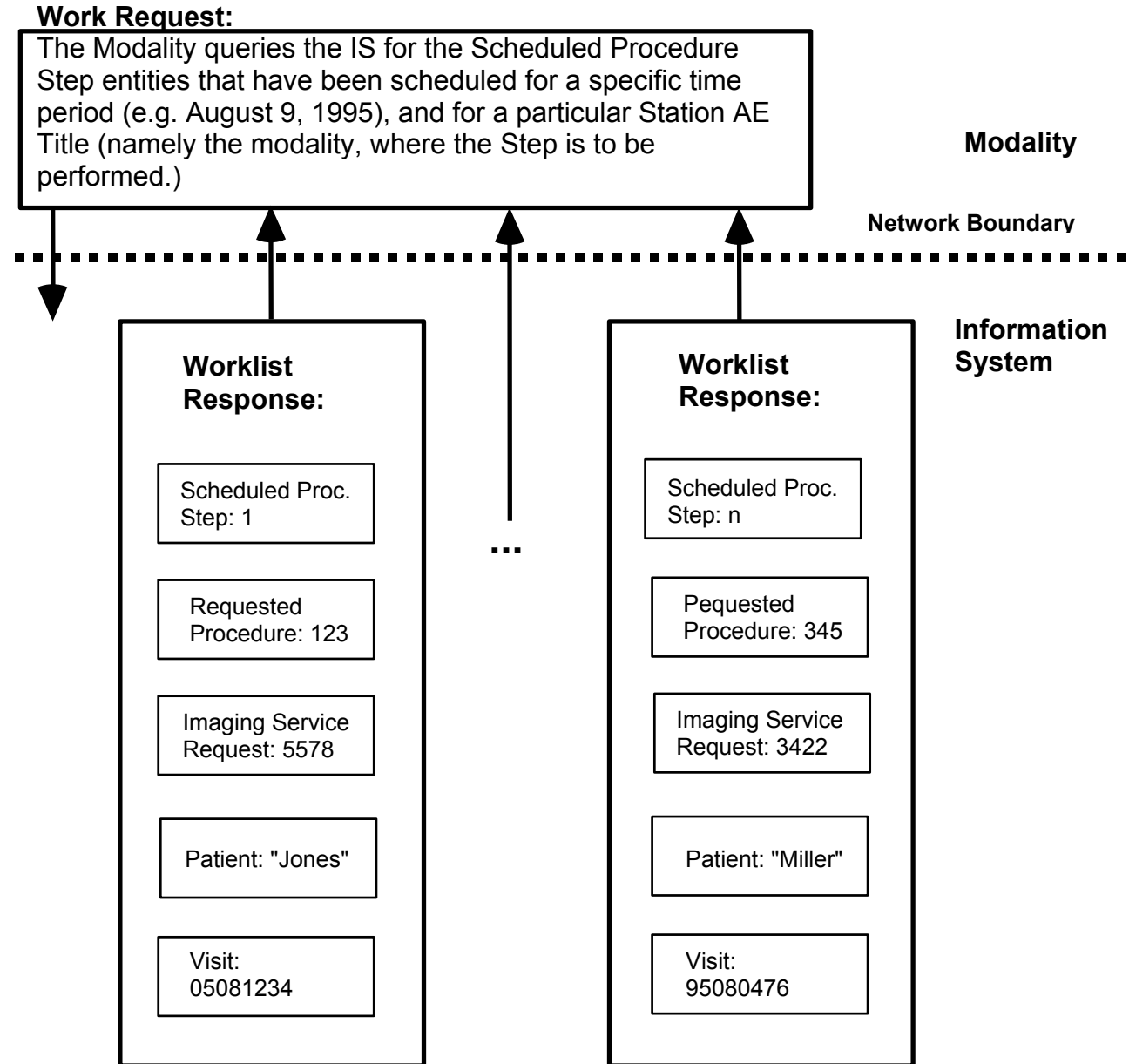

Figure DD.1-1
MODALITY WORKLIST MESSAGE FLOW EXAMPLE

DD.2 GENERAL PURPOSE WORKLIST EXAMPLE (INFORMATIVE)

DD.2.1 Introduction

This section provides an example of message sequencing when using the General Purpose Worklist SOP Classes. This section is not intended to provide an exhaustive set of use cases but rather an informative example. There are other valid message sequences that could be used to obtain an equivalent outcome and there are other valid combinations of actors that could be involved in the workflow management.

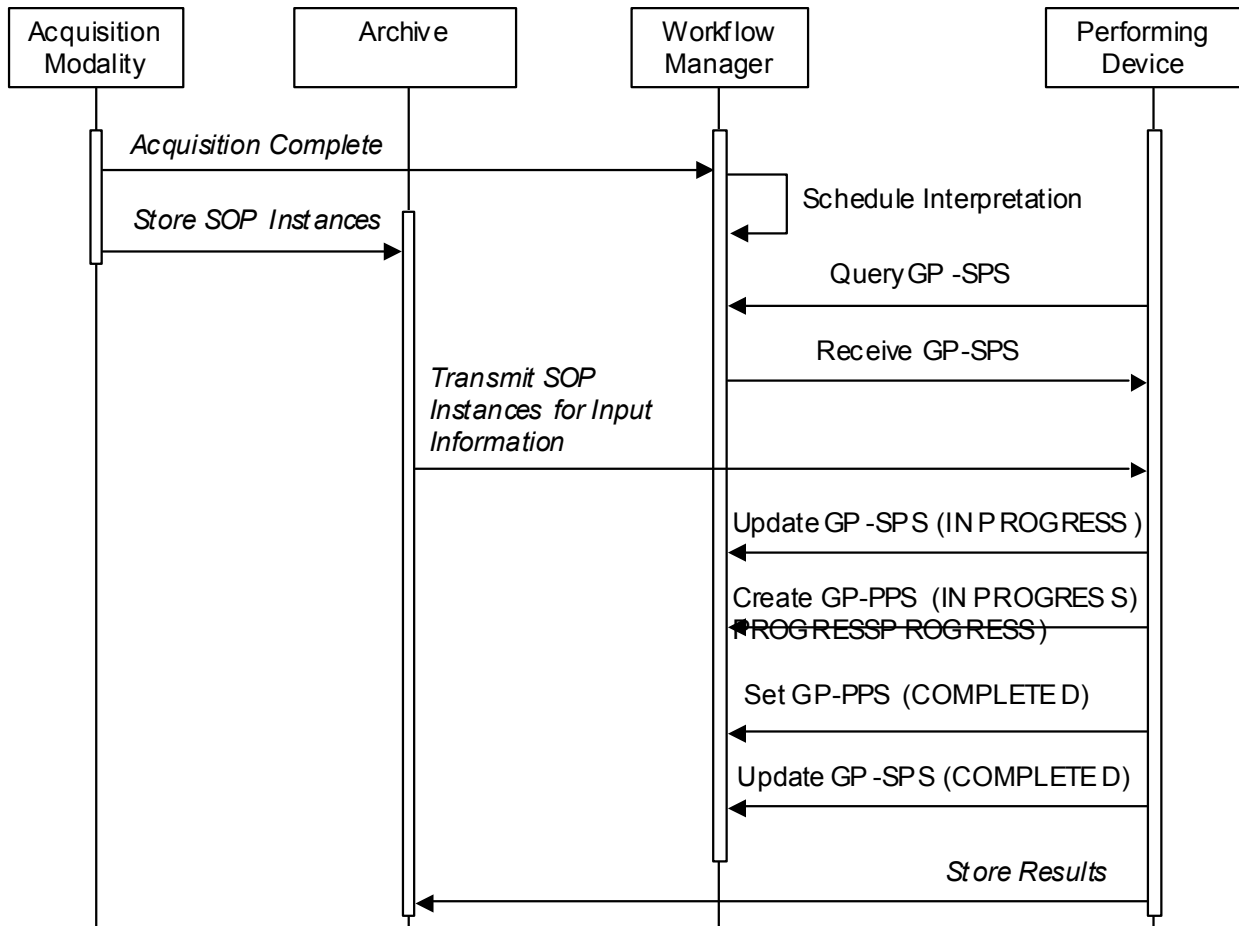

Figure DD.2-1 Example of General Purpose Worklist Message Sequencing

Figure DD.2-1 illustrates a message sequence example in the case where a General Purpose Scheduled Procedure Step (GP-SPS) is performed using a single General Purpose Performed Procedure Step (GP-PPS) that completes normally. Further examples could be constructed for discontinued, unscheduled, group, cooperative and other use cases but are not considered in this informative section. Italic text in Figure DD.8-1 denote messages outside the scope of General Purpose Worklist that will typically be conveyed using other DICOM Services such as Storage, Storage Commitment and Query/Retrieve.

The Actors shown in Figure DD.2-1 are:

Acquisition Modality: Acquires the images that are input for the General Purpose steps

Archive: Stores SOP Instances (images, structured reports, etc)

Workflow Manager: Manages worklists and tracks performance of procedures

Performing Device: Performs the tasks specified by the worklist and creates results

DD.2.2 Transactions and message flow

In Figure DD.2-1 the following transactions and messages are shown.

DD.2.2.1 Acquisition Complete

The Acquisition Modality reports that the acquisition is complete. This message would typically be conveyed using the Modality Performed Procedure Step SOP Class. Upon receiving this message the

Workflow Manager can update its worklist of General Purpose Scheduled Procedure Steps to indicate that input is available and to identify these composite SOP instances.

DD.2.2.2 Store SOP Instances

The Acquisition Modality stores SOP Instances to the Archive. This message would typically be conveyed using the Storage and Storage Commitment Service Classes. This message could equally be transmitted prior to the Acquisition Complete message.

DD.2.2.3 Query GP-SPS

The Performing Device queries the Workflow Manager for General Purpose Scheduled Procedure Steps (GP-SPS) matching its search criteria. For example, all worklist items with General Purpose Scheduled Procedure Step Status (0040,4001) of "SCHEDULED", Input Availability Flag (0040,4020) of "COMPLETE" and Scheduled Human Performers Sequence (0040,4034) of the currently active user. This message is conveyed using the C-FIND request primitive of the General Purpose Worklist SOP Class.

DD.2.2.4 Receive GP-SPS

The Performing Device receives the set of General Purpose Scheduled Procedure Steps (GP-SPS) resulting from the Query GP-SPS message. The Receive GP-SPS message is conveyed via one or more C-FIND response primitives of the General Purpose Worklist SOP Class, each response with status pending containing the requested attributes of a single GP-SPS worklist item.

DD.2.2.5 Transmit SOP Instances to be Used

The Archive transmits the SOP Instances to be used as input information during the task to the Performing Device. This message would typically be conveyed using the Storage Service Class which could be initiated by the Performing Device via the Query/Retrieve Service Class based on information contained in the GP-SPS, or could also be initiated by the Archive or Workflow Manager in order to ensure the necessary SOP Instances are available before use.

DD.2.2.6 Update GP-SPS (IN PROGRESS)

The Performing Device updates a General Purpose Scheduled Procedure Step (GP-SPS) managed by the Workflow Manager to have the status IN PROGRESS upon starting work on the item. The SOP Instance UID of the GP-SPS will normally have been obtained via the Receive GP-SPS message as a worklist item. This message is conveyed using the N-ACTION primitive of the General Purpose Scheduled Procedure Step SOP Class with an action type "Request GP-SPS Status Modification". This message allows the Workflow Manager to update its worklist and permits other Performing Devices to detect that the GP-SPS is already being worked on.

DD.2.2.7 Create GP-PPS (IN PROGRESS)

The Performing Device creates a new General Purpose Performed Procedure Step (GP-PPS) instance on the Workflow Manager upon starting work on a General Purpose Scheduled Procedure Step (GP-SPS). This message is conveyed using the N-CREATE primitive of the General Purpose Performed Procedure Step SOP Class. Upon creation, the GP-PPS must have a GP-PPS Status of IN PROGRESS, should contain references to the related GP-SPS and have values for any other attributes known when starting the GP-PPS.

DD.2.2.8 Set GP-PPS (COMPLETED)

The Performing Device sets the GP-PPS Status to COMPLETED upon completion of the performed step and includes details of the performed step and references to any results (results are themselves conveyed by the Store Results message). This message is conveyed using the N-SET primitive of the General Purpose Performed Procedure Step SOP Class. Upon completion, all mandatory attributes of the GP-PPS must have been assigned a value.

DD.2.2.9 Update GP-SPS (COMPLETED)

The Performing Device updates the GP-SPS Status to COMPLETED upon completion of the scheduled step. This message is conveyed using the N-ACTION primitive of the General Purpose Scheduled Procedure Step SOP Class with an action type "Request GP-SPS Status Modification". This message

informs the Workflow Manager that the GP-SPS is now complete and that further GP-PPS will not be created.

DD.2.2.10 Store Results

The Performing Device stores any generated results to the Archive. This message would typically be conveyed using the Storage and Storage Commitment Service Classes and may contain Structured Reports, Images or other relevant Composite SOP Instances. This message could equally be transmitted prior to the Set GP-PPS (COMPLETED) message. References to the results are associated with the GP-PPS in the Set GP-PPS (COMPLETED) message.

Annex EE: Relevant Patient Information Query (Informative)

EE.1 RELEVANT PATIENT INFORMATION QUERY EXAMPLE (INFORMATIVE)

The following is a simple and non-comprehensive example of a C-FIND Request for the Relevant Patient Information Query Service Class, specifically for the Breast Imaging Relevant Patient Information Query SOP Class, requesting a specific Patient ID, and requiring that any matching response be structured in the form of TID 9000 Relevant Patient Information for Breast Imaging.

C-FIND Request:

SR Tree Depth	Nesting	Attribute	Tag	VR	VL (hex)	Value
		Affected SOP Class UID	(0000,0002)	UI	0018	1.2.840.10008.5.1.4.37.2
		Command Field	(0000,0100)	US	0002	0020H [C-FIND-RQ]
		Message ID	(0000,0110)	US	0002	0010H
		Priority	(0000,0700)	US	0002	0000H [MEDIUM]
		Data Set Type	(0000,0800)	US	0002	0102H
		Patient's Name	(0010,0010)	PN	0000	
		Patient ID	(0010,0020)	LO	0008	MR975311
		Patient's Birth Date	(0010,0030)	DA	0000	
		Patient's Sex	(0010,0040)	CS	0000	
		Observation DateTime	(0040,A032)	DT	0000	
1		Value Type	(0040,A040)	CS	0000	
1		Concept Name Code Sequence	(0040,A043)	SQ	0000	
		Content Template Sequence	(0040,A504)	SQ	ffffff	
	%item					
	>	Mapping Resource	(0008,0105)	CS	0004	DCMR
	>	Template Identifier	(0040,DB00)	CS	0004	9000
	%enditem					
	%endseq					
1		Content Sequence	(0040,A730)	SQ	0000	

The following is a simple and non-comprehensive example of a C-FIND Response for the Relevant Patient Information Query Service Class, answering the C-FIND Request listed above, and structured in the form of TID 9000 Relevant Patient Information for Breast Imaging as required by the Affected SOP Class.

C-FIND Response #1:

SR Tree Depth	Nesting	Attribute	Tag	VR	VL (hex)	Value
		Affected SOP Class UID	(0000,0002)	UI	0018	1.2.840.10008.5.1.4.37.2
		Command Field	(0000,0100)	US	0002	8020H [C-FIND-RSP]
		Message ID Being Responded To	(0000,0120)	US	0002	0010H
		Data Set Type	(0000,0800)	US	0002	0102H

SR Tree Depth	Nesting	Attribute	Tag	VR	VL (hex)	Value
		Status	(0000,0900)	US	0002	FF00H [Pending]
		Patient's Name	(0010,0010)	PN	0008	Doe^Jane
		Patient ID	(0010,0020)	LO	0008	MR975311
		Patient's Birth Date	(0010,0030)	DA	0008	19541106
		Patient's Sex	(0010,0040)	CS	0002	F
		Observation DateTime	(0040,A032)	DT	000E	20021114124623
1		Value Type	(0040,A040)	CS	000A	CONTAINER
1		Concept Name Code Sequence	(0040,A043)	SQ	ffffff	
1	%item					
1	>	Code Value	(0008,0100)	SH	0006	111511
1	>	Coding Scheme Designator	(0008,0102)	SH	0004	DCM
1	>	Code Meaning	(0008,0104)	LO	0030	Relevant Patient Information for Breast Imaging
1	%enditem					
1	%endseq					
		Content Template Sequence	(0040,A504)	SQ	ffffff	
	%item					
	>	Mapping Resource	(0008,0105)	CS	0004	DCMR
	>	Template Identifier	(0040,DB00)	CS	0004	9000
	%enditem					
	%endseq					
1		Content Sequence	(0040,A730)	SQ	ffffff	
1.1	%item					
1.1	>	Relationship Type	(0040,A010)	CS	0010	HAS CONCEPT MOD
1.1	>	Value Type	(0040,A040)	CS	0004	CODE
1.1	>	Concept Name Code Sequence	(0040,A043)	SQ	ffffff	
1.1	%item					
1.1	>>	Code Value	(0008,0100)	SH	0006	121049
1.1	>>	Coding Scheme Designator	(0008,0102)	SH	0004	DCM
1.1	>>	Code Meaning	(0008,0104)	LO	0018	Language of Content Item and Descendants
1.1	%enditem					
1.1	%endseq					
1.1	>	Concept Code Sequence	(0040,A168)	SQ	ffffff	
1.1	%item					
1.1	>>	Code Value	(0008,0100)	SH	0002	en
1.1	>>	Coding Scheme Designator	(0008,0102)	SH	0008	RFC3066
1.1	>>	Code Meaning	(0008,0104)	LO	0008	English
1.1	%enditem					
1.1	%endseq					
1.1	%enditem					
1.2	%item					
1.2	>	Relationship Type	(0040,A010)	CS	0008	CONTAINS
1.2	>	Value Type	(0040,A040)	CS	0004	NUM
1.2	>	Concept Name Code Sequence	(0040,A043)	SQ	ffffff	
1.2	%item					

SR Tree Depth	Nesting	Attribute	Tag	VR	VL (hex)	Value
1.2	>>	Code Value	(0008,0100)	SH	0006	121033
1.2	>>	Coding Scheme Designator	(0008,0102)	SH	0004	DCM
1.2	>>	Code Meaning	(0008,0104)	LO	000C	Subject Age
1.2	%enditem					
1.2	%endseq					
1.2	>	Measured Value Sequence	(0040,A300)	SQ	ffffff	
1.2	%item					
1.2	>>	Measurement Units Code Sequence	(0040,08EA)	SQ	ffffff	
1.2	%item					
1.2	>>>	Code Value	(0008,0100)	SH	0002	a
1.2	>>>	Coding Scheme Designator	(0008,0102)	SH	0004	UCUM
1.2	>>>	Coding Scheme Version	(0008,0103)	SH	0004	1.4
1.2	>>>	Code Meaning	(0008,0104)	LO	0004	Year
1.2	%enditem					
1.2	%endseq					
1.2	>>	Numeric Value	(0040,A30A)	DS	0002	48
1.2	%enditem					
1.2	%endseq					
1.2	%enditem					
1.3	%item					
1.3	>	Relationship Type	(0040,A010)	CS	0008	CONTAINS
1.3	>	Value Type	(0040,A040)	CS	000A	CONTAINER
1.3	>	Concept Name Code Sequence	(0040,A043)	SQ	ffffff	
1.3	%item					
1.3	>>	Code Value	(0008,0100)	SH	0008	R-20767
1.3	>>	Coding Scheme Designator	(0008,0102)	SH	0004	SRT
1.3	>>	Code Meaning	(0008,0104)	LO	0016	Gynecological History
1.3	%enditem					
1.3	%endseq					
1.3	>	Continuity of Content	(0040,A050)	CS	0008	SEPARATE
1.3	>	Content Sequence	(0040,A730)	SQ	ffffff	
1.3.1	%item					
1.3.1	>>	Relationship Type	(0040,A010)	CS	0008	CONTAINS
1.3.1	>>	Value Type	(0040,A040)	CS	0004	NUM
1.3.1	>>	Concept Name Code Sequence	(0040,A043)	SQ	ffffff	
1.3.1	%item					
1.3.1	>>>	Code Value	(0008,0100)	SH	0006	111519
1.3.1	>>>	Coding Scheme Designator	(0008,0102)	SH	0004	DCM
1.3.1	>>>	Code Meaning	(0008,0104)	LO	0020	Age at First Full Term Pregnancy
1.3.1	%enditem					
1.3.1	%endseq					
1.3.1	>>	Measured Value Sequence	(0040,A300)	SQ	ffffff	
1.3.1	%item					
1.3.1	>>>	Measurement Units Code Sequence	(0040,08EA)	SQ	ffffff	
1.3.1	%item					
1.3.1	>>>>	Code Value	(0008,0100)	SH	0002	a

SR Tree Depth	Nesting	Attribute	Tag	VR	VL (hex)	Value
1.3.1	>>>>	Coding Scheme Designator	(0008,0102)	SH	0004	UCUM
1.3.1	>>>>	Coding Scheme Version	(0008,0103)	SH	0004	1.4
1.3.1	>>>>	Code Meaning	(0008,0104)	LO	0004	Year
1.3.1	%enditem					
1.3.1	%endseq					
1.3.1	>>>	Numeric Value	(0040,A30A)	DS	0002	28
1.3.1	%enditem					
1.3.1	%endseq					
1.3.1	%enditem					
1.3.2	%item					
1.3.2	>>	Relationship Type	(0040,A010)	CS	0008	CONTAINS
1.3.2	>>	Value Type	(0040,A040)	CS	0004	NUM
1.3.2	>>	Concept Name Code Sequence	(0040,A043)	SQ	ffffff	
1.3.2	%item					
1.3.2	>>>	Code Value	(0008,0100)	SH	0008	11977-6
1.3.2	>>>	Coding Scheme Designator	(0008,0102)	SH	0002	LN
1.3.2	>>>	Code Meaning	(0008,0104)	LO	0004	Para
1.3.2	%enditem					
1.3.2	%endseq					
1.3.2	>>	Measured Value Sequence	(0040,A300)	SQ	ffffff	
1.3.2	%item					
1.3.2	>>>	Measurement Units Code Sequence	(0040,08EA)	SQ	ffffff	
1.3.2	%item					
1.3.2	>>>>	Code Value	(0008,0100)	SH	0002	1
1.3.2	>>>>	Coding Scheme Designator	(0008,0102)	SH	0004	UCUM
1.3.2	>>>>	Coding Scheme Version	(0008,0103)	SH	0004	1.4
1.3.2	>>>>	Code Meaning	(0008,0104)	LO	0006	Unity
1.3.2	%enditem					
1.3.2	%endseq					
1.3.2	>>>	Numeric Value	(0040,A30A)	DS	0002	2
1.3.2	%enditem					
1.3.2	%endseq					
1.3.2	%enditem					
1.3	%endseq					
1.3	%enditem					
1.4	%item					
1.4	>	Relationship Type	(0040,A010)	CS	0008	CONTAINS
1.4	>	Value Type	(0040,A040)	CS	000A	CONTAINER
1.4	>	Concept Name Code Sequence	(0040,A043)	SQ	ffffff	
1.4	%item					
1.4	>>	Code Value	(0008,0100)	SH	0006	111513
1.4	>>	Coding Scheme Designator	(0008,0102)	SH	0004	DCM
1.4	>>	Code Meaning	(0008,0104)	LO	001C	Relevant Previous Procedures
1.4	%enditem					
1.4	%endseq					
1.4	>	Continuity of Content	(0040,A050)	CS	0008	SEPARATE

SR Tree Depth	Nesting	Attribute	Tag	VR	VL (hex)	Value
1.4	>	Content Sequence	(0040,A730)	SQ	ffffff	
1.4.1	%item					
1.4.1	>>	Relationship Type	(0040,A010)	CS	0008	CONTAINS
1.4.1	>>	Value Type	(0040,A040)	CS	0004	CODE
1.4.1	>>	Concept Name Code Sequence	(0040,A043)	SQ	ffffff	
1.4.1	%item					
1.4.1	>>>	Code Value	(0008,0100)	SH	0006	111531
1.4.1	>>>	Coding Scheme Designator	(0008,0102)	SH	0004	DCM
1.4.1	>>>	Code Meaning	(0008,0104)	LO	0012	Previous Procedure
1.4.1	%enditem					
1.4.1	%endseq					
1.4.1	>>	Concept Code Sequence	(0040,A168)	SQ	ffffff	
1.4.1	%item					
1.4.1	>>>	Code Value	(0008,0100)	SH	0008	P1-48142
1.4.1	>>>	Coding Scheme Designator	(0008,0102)	SH	0004	SRT
1.4.1	>>>	Code Meaning	(0008,0104)	LO	0010	Cyst aspiration
1.4.1	%enditem					
1.4.1	%endseq					
1.4.1	>>	Content Sequence	(0040,A730)	SQ	ffffff	
1.4.1.1	%item					
1.4.1.1	>>>	Relationship Type	(0040,A010)	CS	000E	HAS PROPERTIES
1.4.1.1	>>>	Value Type	(0040,A040)	CS	0004	CODE
1.4.1.1	>>>	Concept Name Code Sequence	(0040,A043)	SQ	ffffff	
1.4.1.1	%item					
1.4.1.1	>>>>	Code Value	(0008,0100)	SH	0006	G-C171
1.4.1.1	>>>>	Coding Scheme Designator	(0008,0102)	SH	0004	SRT
1.4.1.1	>>>>	Code Meaning	(0008,0104)	LO	000A	Laterality
1.4.1.1	%enditem					
1.4.1.1	%endseq					
1.4.1.1	>>>	Concept Code Sequence	(0040,A168)	SQ	ffffff	
1.4.1.1	%item					
1.4.1.1	>>>>	Code Value	(0008,0100)	SH	0008	T-04030
1.4.1.1	>>>>	Coding Scheme Designator	(0008,0102)	SH	0004	SNM3
1.4.1.1	>>>>	Code Meaning	(0008,0104)	LO	000C	Left breast
1.4.1.1	%enditem					
1.4.1.1	%endseq					
1.4.1.1	%enditem					
1.4.1.2	%item					
1.4.1.2	>>>	Relationship Type	(0040,A010)	CS	000E	HAS PROPERTIES
1.4.1.2	>>>	Value Type	(0040,A040)	CS	0004	DATETIME
1.4.1.2	>>>	Concept Name Code Sequence	(0040,A043)	SQ	ffffff	
1.4.1.2	%item					
1.4.1.2	>>>>	Code Value	(0008,0100)	SH	0006	122146
1.4.1.2	>>>>	Coding Scheme Designator	(0008,0102)	SH	0004	DCM
1.4.1.2	>>>>	Code Meaning	(0008,0104)	LO	0012	Procedure Datetime
1.4.1.2	%enditem					
1.4.1.2	%endseq					

SR Tree Depth	Nesting	Attribute	Tag	VR	VL (hex)	Value
1.4.1.2	>>>	DateTime	(0040,A120)	DT	0008	19990825
1.4.1.2	%enditem					
1.4.1	%endseq					
1.4.1	%enditem					
1.4	%endseq					
1.4	%enditem					
1.5	%item					
1.5	>	Relationship Type	(0040,A010)	CS	0008	CONTAINS
1.5	>	Value Type	(0040,A040)	CS	000A	CONTAINER
1.5	>	Concept Name Code Sequence	(0040,A043)	SQ	ffffff	
1.5	%item					
1.5	>>	Code Value	(0008,0100)	SH	0006	111515
1.5	>>	Coding Scheme Designator	(0008,0102)	SH	0004	DCM
1.5	>>	Code Meaning	(0008,0104)	LO	0016	Relevant Risk Factors
1.5	%enditem					
1.5	%endseq					
1.5	>	Continuity of Content	(0040,A050)	CS	0008	SEPARATE
1.5	>	Content Sequence	(0040,A730)	SQ	ffffff	
1.5.1	%item					
1.5.1	>>	Relationship Type	(0040,A010)	CS	0008	CONTAINS
1.5.1	>>	Value Type	(0040,A040)	CS	0004	CODE
1.5.1	>>	Concept Name Code Sequence	(0040,A043)	SQ	ffffff	
1.5.1	%item					
1.5.1	>>>	Code Value	(0008,0100)	SH	0008	F-01500
1.5.1	>>>	Coding Scheme Designator	(0008,0102)	SH	0004	SRT
1.5.1	>>>	Code Meaning	(0008,0104)	LO	000C	Risk factor
1.5.1	%enditem					
1.5.1	%endseq					
1.5.1	>>	Concept Code Sequence	(0040,A168)	SQ	ffffff	
1.5.1	%item					
1.5.1	>>>	Code Value	(0008,0100)	SH	0006	111559
1.5.1	>>>	Coding Scheme Designator	(0008,0102)	SH	0004	DCM
1.5.1	>>>	Code Meaning	(0008,0104)	LO	0024	Weak family history of breast cancer
1.5.1	%enditem					
1.5.1	%endseq					
1.5.1	>>	Content Sequence	(0040,A730)	SQ	ffffff	
1.5.1.1	%item					
1.5.1.1	>>>	Relationship Type	(0040,A010)	CS	000E	INFERRED FROM
1.5.1.1	>>>	Value Type	(0040,A040)	CS	0004	CODE
1.5.1.1	>>>	Concept Name Code Sequence	(0040,A043)	SQ	ffffff	
1.5.1.1	%item					
1.5.1.1	>>>>	Code Value	(0008,0100)	SH	0006	111537
1.5.1.1	>>>>	Coding Scheme Designator	(0008,0102)	SH	0004	DCM
1.5.1.1	>>>>	Code Meaning	(0008,0104)	LO	001E	Family Member with Risk Factor
1.5.1.1	%enditem					

SR Tree Depth	Nesting	Attribute	Tag	VR	VL (hex)	Value
1.5.1.1	%endseq					
1.5.1.1	>>>	Concept Code Sequence	(0040,A168)	SQ	ffffff	
1.5.1.1	%item					
1.5.1.1	>>>>	Code Value	(0008,0100)	SH	0008	S-101A1
1.5.1.1	>>>>	Coding Scheme Designator	(0008,0102)	SH	0004	SRT
1.5.1.1	>>>>	Code Meaning	(0008,0104)	LO	0004	Aunt
1.5.1.1	%enditem					
1.5.1.1	%endseq					
1.5.1.1	%enditem					
1.5.1	%endseq					
1.5.1	%enditem					
1.5	%endseq					
1.5	%enditem					
1	%endseq					

C-FIND Response #2:

SR Tree Depth	Nesting	Attribute	Tag	VR	VL (hex)	Value
		Affected SOP Class UID	(0000,0002)	UI	0018	1.2.840.10008.5.1.4.37.2
		Command Field	(0000,0100)	US	0002	8020H [C-FIND-RSP]
		Message ID Being Responded To	(0000,0120)	US	0002	0010H
		Data Set Type	(0000,0800)	US	0002	0101H
		Status	(0000,0900)	US	0002	0000H [Success]

Annex FF CT/MR Cardiovascular Analysis Report Templates (Informative)

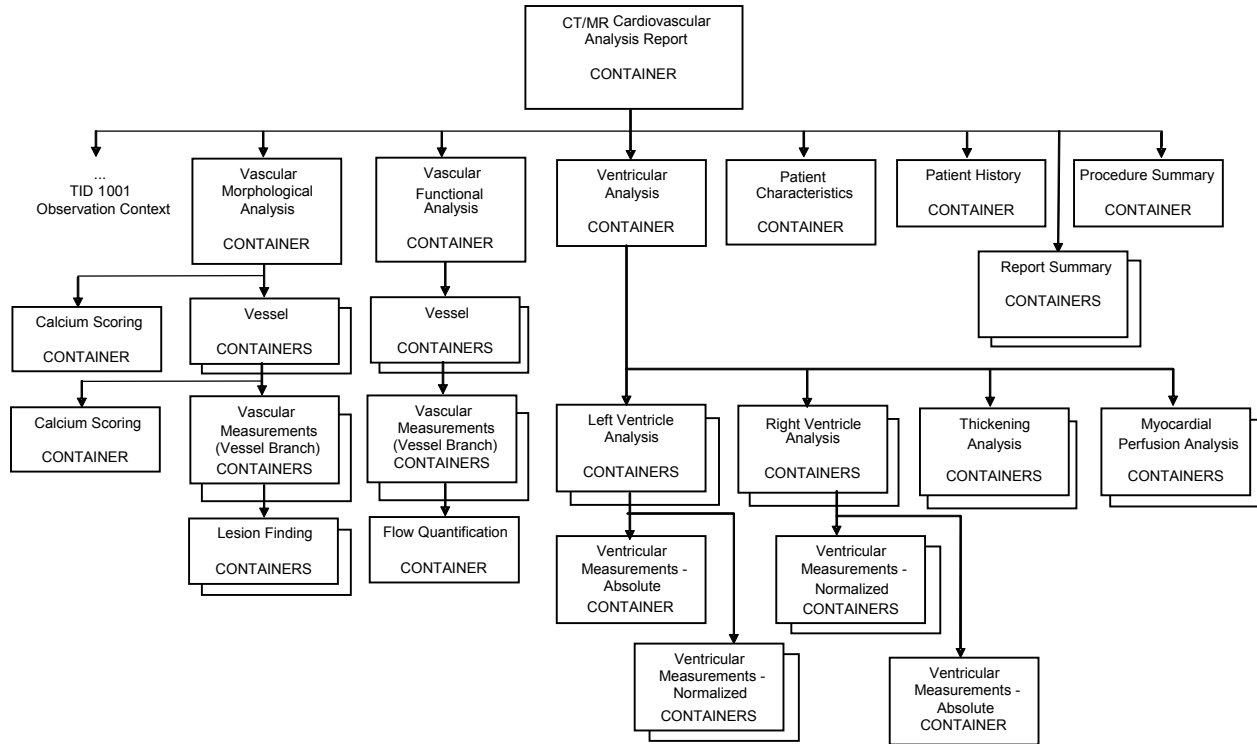
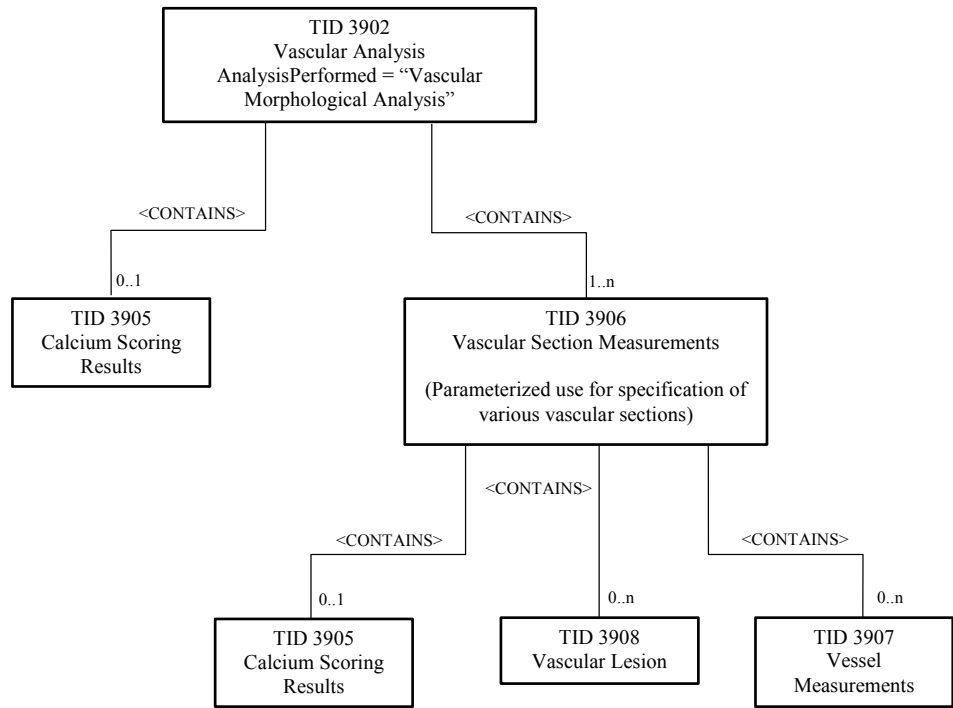
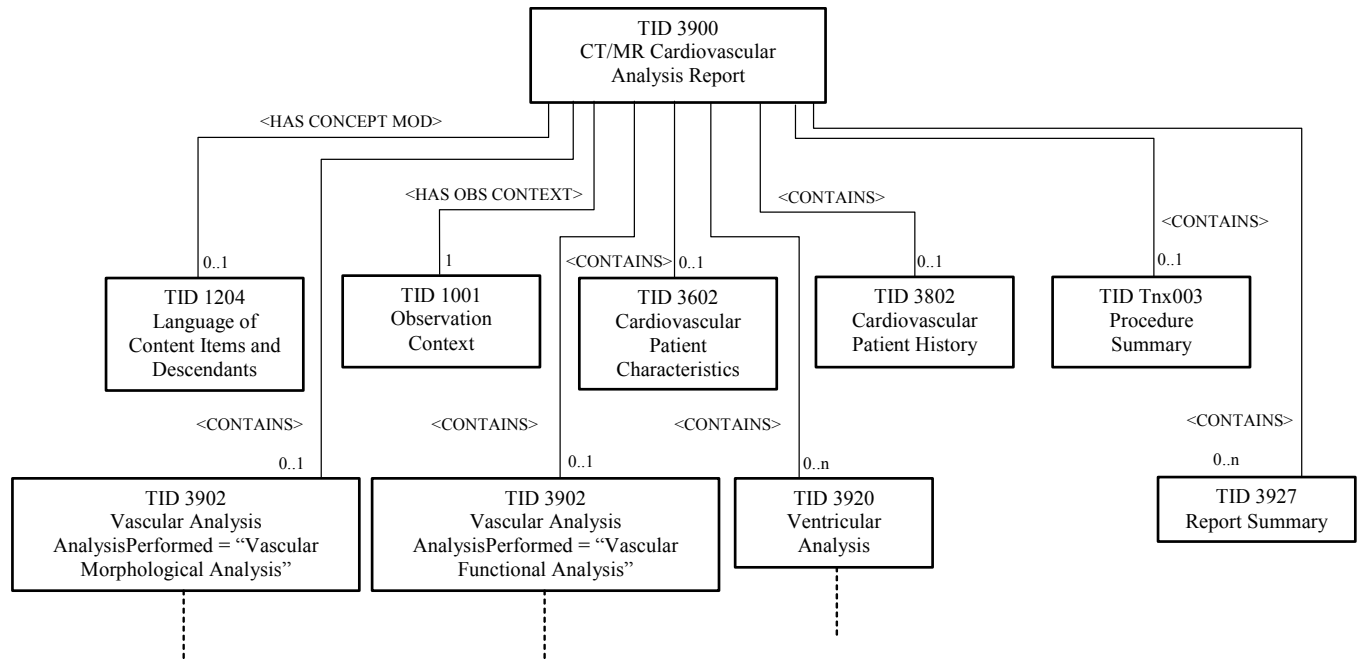
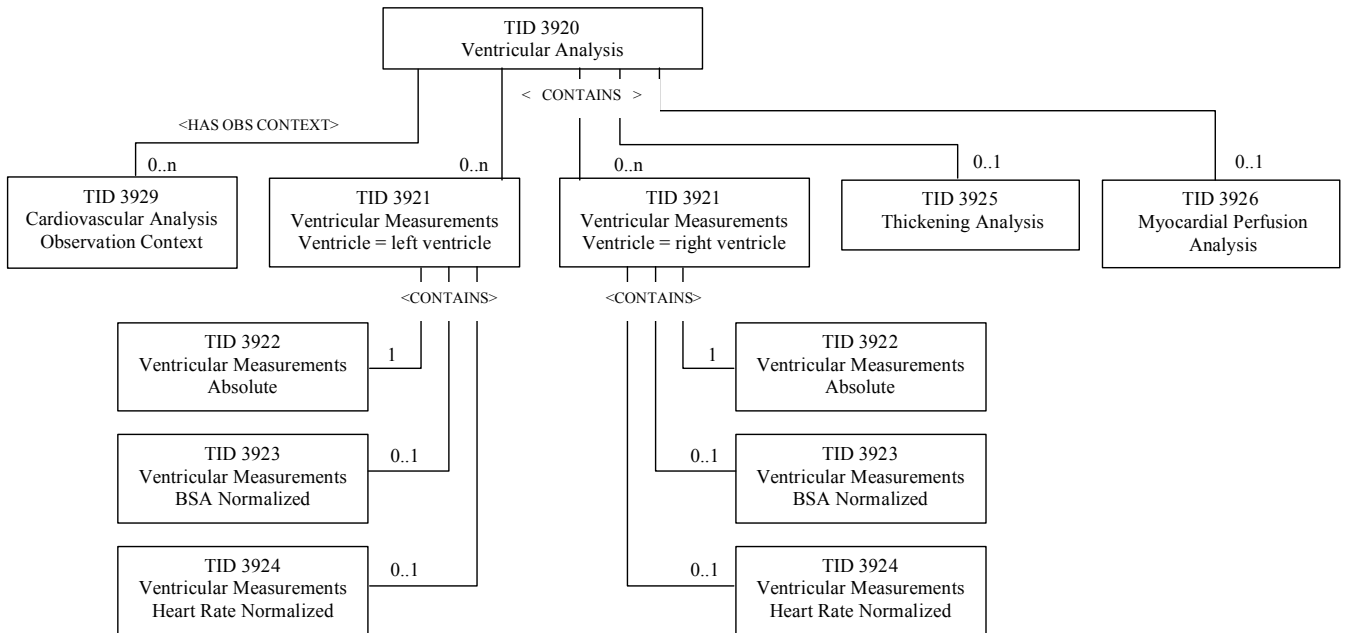
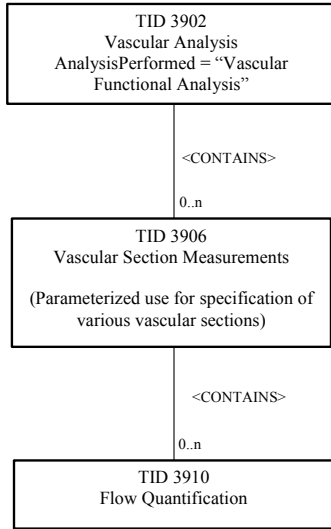
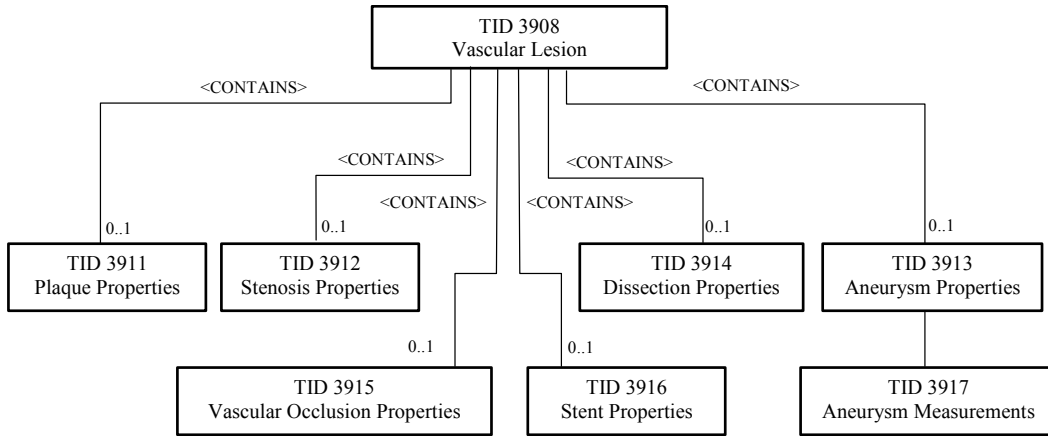

Figure FF.1-1 Top Level Structure of Content Tree

FF.2 TEMPLATE STRUCTURE







FF.3 REPORT EXAMPLE

The following is a simple, non-comprehensive illustration of a report for a morphological examination with stenosis findings.

Cardiovascular Analysis Report – Vascular MRI

Observer: John Doe

Procedure Description
Abdominal aorta-iliac angiography procedure

Vascular Morphological Analysis

Anatomic Region = Abdominal Artery, Left
Left Gastric Artery
Findings:
Vessel Lumen Diameter: 2 mm
Vessel Lumen Cross Sectional Area: 3.4 mm²
Lesion Finding #1
Best illustration of finding [<hyperlink to Image with ROI highlighted>](#)
Associated Morphology: Stenosis
Stenosis type: Vasculitis
Shape: Eccentric
Minimum Vessel Lumen Diameter: 1 mm
Maximum Vessel Lumen Diameter: 1.5 mm
Mean Vessel Lumen Diameter: 1.2 mm
Minimum Vessel Lumen Cross-sectional Area: 1 mm²
Maximum Vessel Lumen Cross-sectional Area: 3 mm²
Stenotic Lesion Length: 5 mm
Minimum Lumen Area Stenosis: 45 %
Maximum Lumen Area Stenosis: 75 %
Mean Lumen Area Stenosis: 60%

Figure FF.3-1 Presentation of Report Example #1

Table FF.3-1 Example #1 Report Encoding

Nest	Code Meaning of Concept Name	Code Meaning or Example Value	TID
1	CT/MR Cardiovascular Analysis Report		3900
1.1	Procedure Reported	Vascular MRI	3900
1.2	Observer Name	John Doe	1001
1.3	Language of Content Items and Descendents	English	1204
1.4	Procedure Summary		3901
1.4.1	Current Procedure Description	Abdominal aorta-iliac angiography procedure	3901
1.5	Findings		3902
1.5.1	Analysis Performed	Vascular Morphological Analysis	3902
1.5.2	Artery of Abdomen		3906
1.5.2.1	Laterality	Left	3906
1.5.2.2	Findings		3906
1.5.2.3.1	Finding Site	Gastric Artery	3906
1.5.2.3.2	Vessel Lumen Diameter	2 mm	3907
1.5.2.3.3	Vessel Lumen Cross Sectional Area	3.4 mm ²	3907
1.5.2.3.4	Lesion Finding		3908
1.5.2.3.4.1	Identifier	1	3908
1.5.2.3.4.2	Best Illustration of Findings (SCOORD)	<ROI specification>	3909
1.5.2.3.4.2.1		<Image reference>	3909
1.5.2.3.4.3	Associated Morphology	Stenosis	3908
1.5.2.3.4.4	Type	Vasculitis	3912
1.5.2.3.4.5	Shape	Eccentric	3912
1.5.2.3.4.6	Vessel Lumen Diameter	1 mm	3912
1.5.2.3.4.6.1	Qualifier Value	Minimum	3912
1.5.2.3.4.7	Vessel Lumen Diameter	1.5 mm	3912
1.5.2.3.4.7.1	Qualifier Value	Maximum	3912
1.5.2.3.4.8	Vessel Lumen Diameter	1.2 mm	3912
1.5.2.3.4.8.1	Qualifier Value	Mean	3912
1.5.2.3.4.9	Vessel Lumen Cross-sectional Area	1 mm ²	3912
1.5.2.3.4.9.1	Qualifier Value	Minimum	3912
1.5.2.3.4.10	Vessel Lumen Cross-sectional Area	3 mm ²	3912
1.5.2.3.4.10.1	Qualifier Value	Maximum	3912
1.5.2.3.3.11	Stenotic Lesion Length	5 mm	3912
1.5.2.3.4.12	Lumen Area Stenosis	45 %	3912

Nest	Code Meaning of Concept Name	Code Meaning or Example Value	TID
1.5.2.3.4.12.1	Qualifier Value	Minimum	3912
1.5.2.3.4.13	Lumen Area Stenosis	75 %	3912
1.5.2.3.4.13.1	Qualifier Value	Maximum	3912
1.5.2.3.4.14	Lumen Area Stenosis	60 %	3912
1.5.2.3.4.14.1	Qualifier	Mean	3912

Annex GG – JPIP Referenced Pixel Data Transfer Syntax Negotiation

The JPIP Referenced Pixel Data transfer syntaxes allow transfer of image objects with a reference to a non-DICOM network service that provides the pixel data rather than encoding the pixel data in (7FE0,0010).

The use cases for this extension to the standard relate to an application's desire to gain access to a portion of DICOM pixel data without the need to wait for reception of all the pixel data. Examples are:

1) Stack Navigation of a large CT Study.

In this case, it is desirable to quickly scroll through this large set of data at a lower resolution and once the anatomy of interest is located the full resolution data is presented. Initially lower resolution images are requested from the server for the purpose of stack navigation. Once a specific image is identified the system requests the rest of the detail from the server.

2) Large Single Image Navigation

In cases such as microscopy, very large images may be generated. It is undesirable to wait for the complete pixel data to be loaded when only a small portion of the specific image is of interest. Additionally, this large image may exceed the display capabilities thus resulting in a decimation of the image when displayed. A lower resolution image (i.e. one that matches the resolution of the display) is all that is required, as additional data cannot be fully rendered. Once an area of interest is determined, the application can pan and zoom to this area and request additional detail to fill the screen resolution.

3) Thumbnails

It is desirable to generate thumbnail representations for a study. This has been accomplished through various means, many of which require the client to receive the complete pixel data from the server to generate the thumbnail image. This uses significant network bandwidth.

The thumbnails can be considered low-resolution representations of the image. The application can request a low-resolution representation of the image for use as a thumbnail.

4) Display by Dimension

Multi-frame images may encode multiple dimensions. It is desirable for an application to access only the specific frames of interest in a particular dimension without the need to receive the complete pixel data set. By using the multi-dimensional description, applications using the JPIP protocol may request frames of the multi-frame image.

The association negotiation between the initiator and acceptor controls when this method of transfer is used. An acceptor can potentially accept both the JPIP Referenced Pixel Data transfer syntax and a non-JPIP transfer syntax on different presentation contexts. When an acceptor accepts both of these transfer syntaxes, the initiator chooses the presentation context.

Examples:

For the following cases:

- AE1 requests images from AE2
- AE1 implements a C-MOVE SCU, as well as a C-STORE SCP. AE2 implements a C-MOVE SCP, as well as a C-STORE SCU

Case 1:

- AE1 and AE2 both support both a JPIP Referenced Pixel Data Transfer Syntax and a non-JPIP Transfer Syntax
- AE1 makes a C-MOVE request to AE2
- AE2 proposes two presentation contexts to AE1, one for with a JPIP Referenced Pixel Data Transfer Syntax, and the other with a non-JPIP Transfer Syntax
- AE1 accepts both presentation contexts
- AE2 may choose either presentation context to send the object
- AE1 must be able to either receive the pixel data in the C-STORE message, or to be able to obtain it from the provider URL

Case 2:

- AE1 supports only the JPIP Referenced Pixel Data Transfer Syntax
- AE2 supports both a JPIP Referenced Pixel Data Transfer Syntax and a non-JPIP Transfer Syntax
- AE1 makes a C-MOVE request to AE2
- AE2 proposes to AE1 either
 - two presentation contexts, one for with a JPIP Referenced Pixel Data Transfer Syntax, and the other with a non-JPIP Transfer Syntax, or
 - a single presentation context with both a JPIP Referenced Pixel Data Transfer Syntax and a non-JPIP Transfer Syntax
- AE1 accepts only the presentation context with the JPIP Referenced Pixel Data Transfer Syntax, or only the JPIP Referenced Pixel Data Transfer Syntax within the single presentation context proposed
- AE2 sends the object with the JPIP Referenced Pixel Data Transfer Syntax
- AE1 must be able to either retrieve the pixel data from the provider URL

For the following cases:

- AE1 requests images from AE2
- AE1 implements a C-GET SCU. AE2 implements a C-GET SCP

Case 3:

- AE1 and AE2 both support both a JPIP Referenced Pixel Data Transfer Syntax and a non-JPIP Transfer Syntax
- In addition to the C-GET presentation context, AE2 proposes to AE1 two presentation contexts for storage sub-operations, one for with a JPIP Referenced Pixel Data Transfer Syntax, and the other with a non-JPIP Transfer Syntax
- AE2 accepts both storage presentation contexts
- AE1 makes a C-GET request to AE2
- AE2 may choose either presentation context to send the object

- AE1 must be able to either receive the pixel data in the C-STORE message, or to be able to obtain it from the provider URL

Case 4:

- AE1 supports only the JPIP Referenced Pixel Data Transfer Syntax
- AE2 supports both a JPIP Referenced Pixel Data Transfer Syntax and a non-JPIPTransfer Syntax
- In addition to the C-GET presentation context, AE2 proposes to AE1 a single presentation context for storage sub-operations with a JPIP Referenced Pixel Data Transfer Syntax
- AE2 accepts the storage presentation context
- AE1 makes a C-GET request to AE2
- AE2 sends the object with the JPIP Referenced Pixel Data Transfer Syntax
- AE1 must be able to either retrieve the pixel data from the provider URL