



TECHNISCHE
UNIVERSITÄT
WIEN

DIPLOMARBEIT

Analytic Combinatorics and Bijections for Directed Lattice Paths

ausgeführt am

Institut für
Diskrete Mathematik und Geometrie
Fakultät für Mathematik und Geoinformation
TU Wien

unter der Anleitung von

Dipl.-Ing. Dr.techn. Michael Wallner MSc

durch

Florian Schager BSc

Matrikelnummer: 11819578

Hervicusgasse 4/3/20

1120 Wien

Wien, am 14. Februar 2024

Kurzfassung

Die zentralen mathematischen Objekte in der Analyse von Gitternetzpfaden sind die erzeugenden Funktionen. Wir führen sie zunächst als formale Potenzreihen ein, deren algebraische Struktur unmittelbar die Struktur der zugrundeliegenden kombinatorischen Klassen widerspiegelt. Der logische erste Schritt zur Analyse einer beliebigen Familie von Gitternetzpfaden liegt in der Herleitung ihrer erzeugenden Funktion. Nach der Identifizierung einer formalen Spezifikation dieser Familie, in Form grundlegender mengentheoretischer Konstruktionen, liefert die sogenannte symbolische Methode eine Funktionalgleichung für die erzeugende Funktion. Darauf aufbauend, liefert uns schließlich die sogenannte *kernel method* ein leistungsfähiges Werkzeug zur Lösung solcher, oftmals scheinbar unterbestimmten, Gleichungen. Sobald wir die erzeugende Funktion endlich in der Hand haben, schreiten wir in drei mögliche Richtungen voran. Erstens ist es in einfachen Fällen möglich, durch eine Kombination von Newtons verallgemeinertem binomischem Lehrsatz mit der Lagrangeschen Inversionsformel, eine geschlossene Formel für die entsprechende Zählsequenz zu erhalten. Zweitens gewährt eine Untersuchung der Lage und des Typs der dominanten Singularitäten der erzeugenden Funktion tiefe Einblicke in die asymptotischen Wachstumsraten ihrer Koeffizienten, selbst wenn eine geschlossene Formel nicht mehr in Reichweite ist. Schließlich verwenden wir die erzeugenden Funktionen, um mit Hilfe der On-Line Encyclopedia of Integer Sequences (OEIS) Verbindungen zu verwandten kombinatorischen Strukturen zu entdecken, welche dieselbe Zählsequenz aufweisen. Die Gleichheit dieser Sequenzen garantiert zwar die Existenz eines kombinatorischen Isomorphismus, allerdings ist die tatsächliche Konstruktion einer solchen Bijektion oft alles andere als offensichtlich.

Abstract

The central mathematical objects of lattice path combinatorics are generating functions. Initially, we introduce them as formal power series, whose algebraic structure directly reflects the structure of combinatorial classes. Hence, the logical first step for analyzing any family of lattice paths lies in the derivation of its generating function. After identifying a formal specification of this family in terms of basic set-theoretic constructions, the *symbolic method* provides us with a functional equation satisfied by our generating function. Next, the so-called *kernel method* serves as a powerful tool to solve this often seemingly underdetermined functional equation. Once the generating function has been derived, we may continue in three possible directions. Firstly, in simple cases, it is possible to obtain a closed-form expression for the corresponding counting sequence via a combination of Newton's generalized binomial theorem and Lagrange's inversion formula. Secondly, an investigation into the nature and location of the complex singularities of the generating function provides vital insights into the asymptotic growth rates of their coefficients, even if a closed-form formula is no longer feasible. Finally, we use the generating functions in conjunction with the On-Line Encyclopedia of Integer Sequences (OEIS) to discover connections to related combinatorial structures and construct explicit bijections between them. While the equality of the counting sequences guarantees the existence of such a function, the actual construction is often far from obvious.

Preface

Historical developments and motivation

The topic of lattice path combinatorics is a rich and active field of research. Its origins can be traced back as early as 1878, when the earliest known drawing of a lattice path is used by Whitworth¹ [31] to help picture a combinatorial problem. He uses a two-dimensional lattice path with steps in $\mathcal{S} = \{(1, 0), (0, 1)\}$ to solve a counting problem involving urns containing m black and n white balls, where the number of white balls drawn must never exceed the number of black balls. Today this problem is commonly known as Bertrand's ballot problem, as Bertrand² rediscovered the result nine years later in 1887 and published his answer in the *Comptes Rendus de l'Academie des Sciences*: The probability is simply $(m - n + 1)/(m + 1)$, provided that $m \geq n$. However, it was not until the start of the second half of the 20th century, when the study of lattice path combinatorics really took off. Around this time the first papers appeared to study lattice path enumeration for the sake of counting lattice paths, see for example Bizley's work on the number of minimal lattice paths from $(0, 0)$ to (km, kn) having just t contacts with the line $my = nx$ [7]. After this the scientific interest for this field has been steadily growing. In fact, Humphreys studied the counting sequence of the number of papers, pertaining to lattice path enumeration, published by decade, noting that the number of such papers more than doubled each decade from 1960 to 2010. For more details and a deep dive into the history of lattice path enumeration, the author recommends her thorough survey [16].

Consequently, it is fair to say that the study of lattice path combinatorics has emancipated itself from its parental roots in probability and statistics. Today, its applications reach far into fields like cryptanalysis, crystallography and sphere packing [21]. Furthermore, lattice paths can be used to encode a variety of combinatorial objects, such as trees, maps, permutations, polyominoes, Young tableaux, queues and many, many more [8].

Goals and contributions

Goals. Firstly, the necessary groundwork for the analysis of directed lattice paths shall be thoroughly presented, with all necessary derivations made explicit. This includes a detailed treatment of the central *kernel method*, as well as the process of *singularity analysis*. Secondly, the general formulae and techniques are then applied to specific classes of lattice paths, in particular, *basketball walks* and directed lattice paths with *catastrophes*. Wherever possible, we make lateral connections to different combinatorial objects explicit, by constructing vivid bijections between them.

¹William Allen Whitworth (1840–1905)

²Joseph Louis François Bertrand (1822–1900)

Contributions. In Chapter 2, we collect the often scattered properties of the kernel method, along with their theoretical underpinnings, in the concise Proposition 2.1.4. In Chapter 3, we augment the article by Banderier, Krattenthaler, Krinik, D. Kruchinin, V. Kruchinin, Nguyen and Wallner [2] with a novel, combinatorial derivation of a generating function (Proposition 3.1.5) and correct several typos in the paper. In Chapter 4, we expand on the work by Banderier and Wallner [3], by contrasting their model of catastrophes with a similar alternative suggested in the paper. In this context, we provide multiple new bijections between related families of lattice paths arising from this alternative model in Section 4.1 and prove a general result pertaining to the asymptotic growth rates of the number of k -Motzkin excursions with alternative catastrophes (Theorem 4.2.11). Finally, in Chapter 5, we link the theory of lattice path combinatorics to the field of counting animals via a novel bijective procedure (Theorem 5.1.16) mapping Motzkin excursions with alternative catastrophes to the class of stacked directed animals, introduced by Bousquet-Mélou and Rechnitzer in [10].

Thesis structure

In Chapter 1 we provide the necessary framework with the basics of combinatorial structures and complex analysis, along with a perspective on the historical developments of this field. In Chapter 2 we study directed lattice paths and give a thorough introduction to the kernel method, essential for deriving their generating functions. In Chapter 3 we specialize the general formulae derived in the previous chapter to a subclass of directed lattice paths, called *basketball walks*, after the evolution of the score of a basketball game before the introduction of the 3-point rule. Next, in Chapter 4 we study an extension of the theory of directed lattice paths, where we allow additional steps, so-called *catastrophes* that reset the lattice path back to the x -axis. We compare and contrast two different models of catastrophes in terms of their generating functions and the asymptotic growth rates of the respective counting sequences. Finally, in Chapter 5 we provide bijections between lattice paths with catastrophes and directed animals.

Acknowledgements

First and foremost I want to thank my supervisor, Michael Wallner, for introducing me to the field of lattice path combinatorics and for passing on his contagious excitement for the topic. Not only did he have a fitting answer to all of my questions, but he was also able to point me in exciting new directions with his questions to me. Furthermore, he ensured a high standard of quality with detailed corrections right to the end.

Next, I would also like to thank my colleagues Fabian Zehetgruber and Paul Winkler, whose helpful comments have noticeably improved this thesis.

Last but not least, I would like to thank my family for actively supporting and believing in me throughout my studies.

Eidesstattliche Erklärung

Ich erkläre an Eides statt, dass ich die vorliegende Diplomarbeit selbstständig und ohne fremde Hilfe verfasst, andere als die angegebenen Quellen und Hilfsmittel nicht benutzt bzw. die wörtlich oder sinngemäß entnommenen Stellen als solche kenntlich gemacht habe.

Wien, am 14. Februar 2024

Florian Schager

Contents

1	Introduction	1
1.1	Lattice paths	1
1.2	Formal power series	6
1.3	Combinatorial structures	7
1.4	Complex analysis	13
2	Directed lattice paths and the kernel method	19
2.1	Kernel method	20
2.2	Generating functions	28
2.3	Singularity analysis	39
3	Basketball walks	51
3.1	Generating functions	51
3.2	Closed-form expressions for coefficients	57
3.3	Asymptotic number of basketball walks	62
4	Lattice paths with catastrophes	65
4.1	Generating functions	65
4.1.1	Dyck walks	68
4.1.2	Motzkin walks	72
4.1.3	2-Motzkin walks	74
4.2	Asymptotic number of lattice paths	75
5	Links to other combinatorial problems	89
5.1	Stacked directed animals	89
5.1.1	Generating functions	95
5.1.2	Bijection to Motzkin excursions with alternative catastrophes	99
	List of Figures	105
	List of Tables	107
	Bibliography	109

Definition 1.1.2 (Euclidean lattice). The *Euclidean lattice* consists of the vertices \mathbb{Z}^d . The edges are defined indirectly via the step set $\mathcal{S} \subset \mathbb{Z}^d$. Two vertices $v, w \in \mathbb{Z}^d$ are connected by an edge $(v, w) \in E$ iff¹ $w - v \in \mathcal{S}$. An n -step lattice path on the Euclidean lattice from $s \in \mathbb{Z}^d$ to $t \in \mathbb{Z}^d$ is consequently equivalently characterized by a sequence $\omega = (\omega_0, \dots, \omega_n)$ of elements in \mathbb{Z}^d such that

- $\omega_0 = s, \omega_n = t$ and
- $\omega_{i+1} - \omega_i \in \mathcal{S}$ for $i = 0, \dots, n - 1$.

A fascinating part of lattice path combinatorics is the fact that despite their easily accessible definitions, most of their properties still remain unproven or unknown. Hence, most step sets of lattice paths analyzed in this thesis satisfy further restrictions.

Definition 1.1.3 (Directed paths). *Directed paths* are lattice paths on the two-dimensional Euclidean lattice with a fixed direction of increase which we choose to be the positive horizontal axis. This is described by the allowed steps: If $(i, j) \in \mathcal{S}$, then $i > 0$. This implies that the geometric realization of the path always lives in the right half-plane $\mathbb{Z}_+ \times \mathbb{Z}$. Further, for any given step set \mathcal{S} we commonly distinguish four subclasses of directed paths.

- *Walks/paths* are directed paths that
 - are **not** constrained to stay above the x -axis,
 - may end at any altitude.
- *Bridges* are directed paths
 - that are **not** constrained to stay above the x -axis,
 - whose endpoint ω_n lies on the x -axis.
- *Meanders* are directed paths
 - are constrained to stay above the x -axis,
 - may end at any altitude.
- *Excursions* are directed paths
 - that are constrained to stay above the x -axis,
 - whose endpoint ω_n lies on the x -axis.

Definition 1.1.4 (Simple paths). We call a family of directed paths or a set of steps *simple*, if the step set satisfies $\mathcal{S} = \{(1, b_1), \dots, (1, b_k)\}$ with $b_i \in \mathbb{Z}$. In this case, we shorten the notation to $\mathcal{S} = \{b_1, \dots, b_k\}$.

Since the steps in simple paths are always of the form $(1, b)$, simple paths are essentially one-dimensional objects. This stands in contrast to step sets including generic steps of the form (x, y) , where we do need the whole two-dimensional plane to represent such paths. This reduction in dimensionality allows us to understand simple lattice paths in much greater detail. In many applications, step sets may be augmented with a system of weights.

¹“iff” is Paul Halmos’ convenient abbreviation for “if and only if”.

Definition 1.1.5 (System of weights). For a given step set \mathcal{S} we define the respective *system of weights* as $\Pi = \{p_s \mid s \in \mathcal{S}\}$, where $p_s > 0$ is the weight associated to step $s \in \mathcal{S}$. The *weight* of a lattice path is then defined as the product of the weights of its individual steps. Some useful choices are:

- $\forall s \in \mathcal{S}: p_s = 1$, representing combinatorial paths in the standard sense.
- $\forall s \in \mathcal{S}: p_s \in \mathbb{N}$, representing paths with colored steps, for example, $p_s = 2$ means that the associated step has two possible colors.
- $\sum_{s \in \mathcal{S}} p_s = 1$, representing a probabilistic model of paths, where step s is chosen with probability p_s .

With this definition, a central concept in the analysis of linear recurrences can be adapted to the theory of lattice paths.

Definition 1.1.6 (Characteristic polynomial). The *characteristic polynomial* or *jump polynomial* of a simple step set $\mathcal{S} \subset \mathbb{Z}$ is defined as the Laurent polynomial

$$P(u) = \sum_{s \in \mathcal{S}} p_s u^s,$$

where $p_s > 0$ is the weight associated to the step $s \in \mathcal{S}$. If we define $c = -\min(\mathcal{S})$ and $d = \max(\mathcal{S})$ as the two extremal vertical amplitudes of any jump, it is often convenient to rewrite the jump polynomial to

$$P(u) = \sum_{k=-c}^d p_k u^k,$$

with the convention that $p_k = 0$ if $k \notin \mathcal{S}$.

The field of lattice path enumeration allows for countless connections to other areas of combinatorics. In particular, plane trees are closely related to lattice paths. Any plane tree can be traversed starting from the root, proceeding depth-first and left-to-right, and backtracking upwards once a subtree has been completely traversed. This order is known as a *preorder* or *prefix order*, since a node is preferentially visited before its children. Given a tree, the listing of the outdegrees of nodes in prefix order is called the preorder degree sequence. Note that a plane tree can be uniquely determined by its preorder degree sequence. For the example tree depicted in Figure 1.2a, the preorder degree sequence reads

$$\sigma = (3, 1, 2, 0, 0, 1, 0, 2, 0, 0).$$

This degree sequence can then be interpreted as a word over a finite alphabet. Each value j for the outdegree of a node is represented by a symbol f_j . Then, after adding parentheses, the word can be interpreted as a functional term, where f_j represents a function of arity j . In our example this yields the functional term

$$f_3(f_1(f_2(f_0, f_0)), f_1(f_0), f_2(f_0, f_0)).$$

Such codes are known as *Lukasiewicz codes* after the polish logician² with the same name. Finally, we make the connection to lattice paths by associating any symbol f_j to the simple step $(1, j - 1)$. Then, by starting at the origin and adding steps according to the preorder degree sequence we get a lattice path, associated with a simple step set $\mathcal{S} \subset \{-1, 0, 1, 2, \dots\}$, also known as a *Lukasiewicz walk*. Further, since every tree satisfies $|E| = |V| - 1$, the lattice path never crosses below the x -axis except at the very last step; see Figure 1.2b. Thus, by omitting the last step we get a correspondence between plane trees with $n + 1$ nodes and Lukasiewicz excursions of length n [14, p. 74–75].

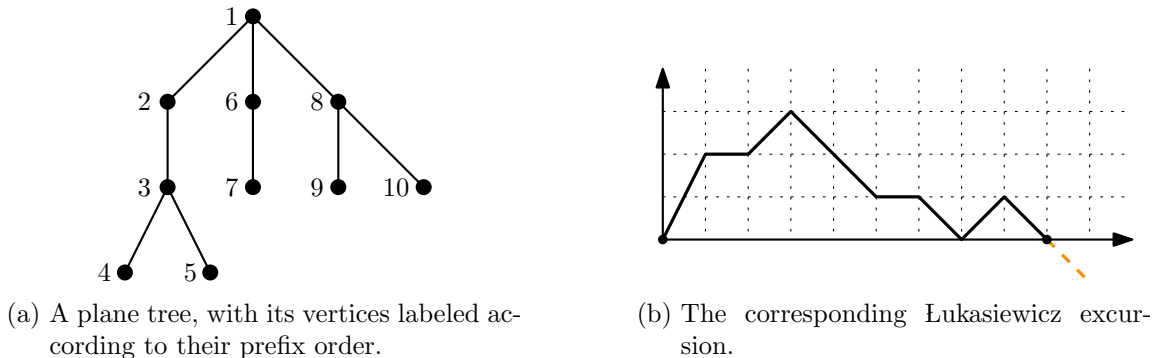

Figure 1.2: The bijection between plane trees and Lukasiewicz excursions.

In particular, binary trees are associated in this way to the possibly most famous example of a family of directed lattice paths, named after the German mathematician Dyck³.

Definition 1.1.7 (Dyck walks). *Dyck walks* are lattice paths associated with the simple step set $\mathcal{S} = \{-1, 1\}$. Throughout this thesis we will denote these steps with $\mathbf{NE} := (1, 1)$ and $\mathbf{SE} := (1, -1)$.

We now present an elementary counting argument to derive the number of Dyck excursions of length $2n$.

Example 1.1.8 (André’s reflection principle). The formula for the number d_{2n} of Dyck excursions consisting of $2n$ steps can be derived using a counting argument that is now referred to as André’s reflection principle, even though André himself never employed the method [25]. The idea is the following: We count lattice paths consisting of n \mathbf{NE} -steps and n \mathbf{SE} -steps and then subtract the number of such paths that are not Dyck paths.

A lattice path consisting of n \mathbf{NE} -steps and n \mathbf{SE} -steps can be uniquely identified by the position of the \mathbf{NE} -steps, which yields $\binom{2n}{n}$ possible such lattice paths. Hence, the number of Dyck bridges of length $2n$ is given by $\binom{2n}{n}$. Now we subtract all paths that go below the x -axis at some point.

Let p be a lattice path with n \mathbf{NE} -steps and n \mathbf{SE} -steps that is not a Dyck path. Then pick the first step that lies beneath the x -axis and change all \mathbf{NE} -steps occurring afterwards into \mathbf{SE} -steps and vice-versa. These reflected paths must all end at $(2n, -2)$ since we reflect

²Jan Lukasiewicz (1878–1956)

³Walther Franz Anton von Dyck (1856–1934)

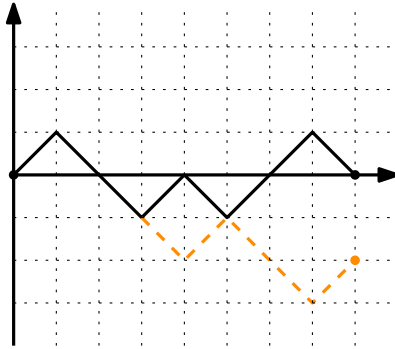

Figure 1.3: A Dyck excursion reflected after the first step that crosses below the x -axis.

the path after the point when it hits $y = -1$ for the first time; see Figure 1.3. This means that one net **NE**-step gets flipped to one net **SE**-step. The number of paths consisting of $(n - 1)$ **NE**-steps and $(n + 1)$ **SE**-steps can be counted via $\binom{2n}{n-1}$. By subtracting these unwanted reflected paths we see that the number of Dyck excursions with $2n$ steps satisfies

$$d_{2n} = \binom{2n}{n} - \binom{2n}{n-1} = \binom{2n}{n} - \frac{n}{n+1} \binom{2n}{n} = \frac{1}{n+1} \binom{2n}{n}.$$

In addition, if we interpret a **NE**-step as a vote for candidate A and a **SE**-step as a vote for candidate B we see that we rederived the solution to Bertrand's ballot problem for the special case that the total number of votes for candidate A equals the number of votes for candidate B . \triangle

As the prime example of lattice path enumeration, it is perhaps not surprising that the enumeration of Dyck paths is intimately connected to the most ubiquitous sequence in combinatorics: the Catalan numbers. They are named after the Belgian mathematician Catalan⁴, who was the first to obtain today's standard formulae

$$C_n = \frac{(2n)!}{n!(n+1)!} = \binom{2n}{n} - \binom{2n}{n-1} = \frac{1}{n+1} \binom{2n}{n}.$$

The origins of the sequence, however, reach back even further than this. They first appeared in the works of the Mongolian astronomer and mathematician Minggatu⁵. In his book *Quick Methods for Accurate Values of Circle Segments* [23], he already obtained the recurrence formula

$$C_1 = 1, \quad C_2 = 2, \quad C_{n+1} = \sum_{k=0}^n (-1)^k \binom{n+1-k}{k+1} C_{n-k}.$$

In European mathematical circles, Euler⁶ was the first one to obtain a closed formula

$$C_{n-2} = \frac{2 \cdot 6 \cdot 10 \cdots (4n-10)}{2 \cdot 3 \cdot 4 \cdot (n-1)} \quad (1.1)$$

⁴Eugène Charles Catalan (1814–1894)

⁵Sharabiin Myangat (1692–1763)

⁶Leonhard Euler (1707–1783)

for the Catalan numbers in 1751. A complete proof of this formula, however, was not achieved until 1759 with substantial assistance by Goldbach⁷ and Segner⁸, the latter of which provided the final missing piece with the recurrence relation

$$C_{n+1} = \sum_{k=0}^n C_k C_{n-k}. \quad (1.2)$$

The study of this sequence then really kicked off with the French School between 1838 and 1843, as Liouville⁹ used his large mailing list of mathematicians to communicate the problem of deriving Euler’s product formula (1.1) from Segner’s recurrence (1.2) to “various geometers”, among them the aforementioned Catalan. This fascinating digression into the history of mathematics and many more details can be found in Appendix B of the monograph on the Catalan numbers [28], contributed by Igor Pak.

For more combinatorial interpretations, the monograph [28] from Richard Stanley lists 214 different kinds of combinatorial objects counted by the Catalan numbers, some of which will reappear at various points throughout this thesis.

1.2 Formal power series

As generating functions of counting sequences are the central mathematical object of combinatorial analysis, we need to introduce a few basic concepts about polynomial rings from algebra.

Definition 1.2.1 (Formal power series [30, Definition 1.8]). Let R be a ring with unity. The ring of *formal power series* $R[[z]]$ consists of all formal sums of the form

$$\sum_{n \geq 0} a_n z^n = a_0 + a_1 z + a_2 z^2 + \dots,$$

with coefficients $a_n \in R$. The sum of two formal power series $\sum_{n \geq 0} a_n z^n, \sum_{n \geq 0} b_n z^n$ is defined by

$$\sum_{n \geq 0} a_n z^n + \sum_{n \geq 0} b_n z^n = \sum_{n \geq 0} (a_n + b_n) z^n$$

and their product by

$$\sum_{n \geq 0} a_n z^n \cdot \sum_{n \geq 0} b_n z^n = \sum_{n \geq 0} \left(\sum_{k=0}^n a_k b_{n-k} \right) z^n.$$

Definition 1.2.2 (Formal topology [14, p. 731]). We define the valuation of a non-zero formal power series $f(z) = \sum_{n=0}^{\infty} f_n z^n$ as the smallest $r \in \mathbb{N}$ such that $f_r \neq 0$ and denote it by $\text{val}(f)$. Further, we set $\text{val}(0) = \infty$. Then, one defines a metric on $R[[z]]$ via

$$d(f, g) = 2^{-\text{val}(f-g)}.$$

With this distance, the space of all formal power series becomes a complete metric space.

⁷Christian Goldbach (1690–1754)

⁸Johann Andreas von Segner (1704–1777)

⁹Joseph Liouville (1809–1882)

The formal topology is a useful tool to analyze the convergence of some combinatorial constructions that go beyond a finite number of arithmetic operations.

Example 1.2.3. Let $f \in R[[z]]$ be a formal power series with $f_0 = 0$. Then, the infinite sum $Q(f) := \sum_{k=0}^{\infty} f^k$ converges in the formal topology. Let $Q_n(f) = \sum_{k=0}^n f^k$ be the partial sum terminating at index n . We notice that $\text{val}(f^k) \geq k$ and thus we have

$$d(Q_n, Q_m) = 2^{-(\min(n,m)+1)}.$$

Hence, $(Q_n)_{n \in \mathbb{N}}$ is a Cauchy sequence and consequently converges. \triangle

1.3 Combinatorial structures

A generating function is a clothesline on which we hang up a sequence of numbers for display. What that means is this: suppose we have a problem whose answer is a sequence of numbers, a_0, a_1, a_2, \dots . We want to ‘know’ what the sequence is. What kind of an answer might we expect?

HERBERT WILF [32, p. 1]

In this section we introduce the notion of a combinatorial class, together with the powerful symbolic method, based on Chapter I of [14]. Many general set-theoretic constructions are built directly in terms of simpler classes by means of a collection of elementary combinatorial constructions, namely the operations of union, Cartesian product, sequence, set, multiset and cycle. The symbolic method then provides a dictionary translating these set-theoretic operations into algebraic operations on generating functions. Hence, the task of constructing a generating function of a combinatorial structure reduces to the identification of a formal specification in terms of basic constructions. After this, the translation into generating functions becomes a purely mechanical process.

The fundamental object studied by symbolic enumeration methods is the *combinatorial class*. It serves as a model of sets of discrete objects, like words, trees, graphs, permutations or lattice paths.

Definition 1.3.1 (Combinatorial class). A *combinatorial class* \mathcal{A} , or simply a *class*, is a finite or denumerable set on which a size function is defined, satisfying the following conditions:

1. The size of an element is a non-negative integer.
2. The number of elements of any given size is finite.

The size of an element $\alpha \in \mathcal{A}$ is denoted by $|\alpha|$, or $|\alpha|_{\mathcal{A}}$ and we define

$$\mathcal{A}_n := \{ \alpha \in \mathcal{A} : |\alpha| = n \}.$$

We denote the cardinality of these subsets by $a_n := \text{card}(\mathcal{A}_n)$ and call $(a_n)_{n \in \mathbb{N}}$ the *counting sequence* of \mathcal{A} . Further, we define two elementary combinatorial classes:

- The *neutral class* \mathcal{E} consists of a single object of size 0.

- The *atomic class* \mathcal{Z} consists of a single object of size 1.

They form the basis from which all combinatorial structures are constructed.

Example 1.3.2 (Number of Dyck walks). Consider the set $\mathcal{W}_{\mathcal{D}}$ of unconstrained Dyck walks. Since there two possible steps available at every point on the lattice path, the number of Dyck walks of length n satisfies $w_n = 2^n$. \triangle

Next, for combinatorial enumeration purposes, it proves convenient to identify combinatorial classes that are merely variants of each other.

Definition 1.3.3 (Combinatorial isomorphism). Two combinatorial classes \mathcal{A} and \mathcal{B} are said to be *combinatorially isomorphic*, iff their counting sequences are identical. In this case, we also write $\mathcal{A} \cong \mathcal{B}$. This condition is equivalent to the existence of a bijection from \mathcal{A} to \mathcal{B} that preserves size. Hence, one also says that \mathcal{A} and \mathcal{B} are *bijectionally equivalent*.

Next we introduce the central mathematical object of combinatorial analysis.

Definition 1.3.4 (Ordinary generating function). The *ordinary generating function (OGF)* of a sequence $(a_n)_{n \in \mathbb{N}}$ is the formal power series

$$A(z) = \sum_{n=0}^{\infty} a_n z^n.$$

The OGF of a combinatorial class \mathcal{A} is the generating function for the counting sequence $a_n = \text{card}(\mathcal{A}_n), n \geq 0$. Equivalently, the combinatorial form

$$A(z) = \sum_{\alpha \in \mathcal{A}} z^{|\alpha|},$$

is employed. We say the variable z marks the size in the generating function. Further, we introduce the coefficient extraction operator $[z^n] : R[[z]] \rightarrow \mathbb{C}$, defined via

$$[z^n] \left(\sum_{n \geq 0} f_n z^n \right) = f_n.$$

Example 1.3.5 (Generating function of Dyck walks). The OGF corresponding to unrestricted Dyck walks considered in Example 1.3.2 henceforth satisfies

$$W_{\mathcal{D}}(z) = \sum_{n=0}^{\infty} 2^n z^n = \frac{1}{1-2z}.$$

Note that at this point $\frac{1}{1-2z}$ is just a shorthand notation for the corresponding formal power series and we are not yet concerned with its analytic properties like convergence. \triangle

The symbolic method for describing set-theoretic construction closely resembles the description of formal languages by means of grammars. Specifically, it is based on so-called *admissible constructions* that permit direct translations into generating functions.

In lattice path combinatorics we are often interested in precise quantitative information on probabilistic properties of parameters defined for combinatorial objects. In this case, ordinary generating functions are no longer sufficient to keep track of the additional information gained by the introduction of these parameters. Hence, just like the formal variable z marks the size of a combinatorial object, we will introduce an additional formal variable for each of the new parameters to fulfill just this role.

Definition 1.3.6 (Multivariate generating function). Let \mathcal{A} be a combinatorial class equipped with a (multidimensional) *parameter* $\chi = (\chi_1, \dots, \chi_d) : \mathcal{A} \rightarrow \mathbb{N}^d$. Let $\mathbf{u} = (u_1, \dots, u_d)$ denote a vector of d formal variables and let $\mathbf{k} = (k_1, \dots, k_d) \in \mathbb{N}^d$ denote an integer-valued vector of parameters. We make use of the multi-index convention and introduce the shorthand notation $\mathbf{u}^{\mathbf{k}}$ for the multipower

$$\mathbf{u}^{\mathbf{k}} := u_1^{k_1} u_2^{k_2} \cdots u_d^{k_d}.$$

The counting sequence of \mathcal{A} with respect to size and the parameter χ is then defined by

$$a_{n,\mathbf{k}} = |\{ \alpha \in \mathcal{A}_n \mid \chi_1(\alpha) = k_1, \dots, \chi_d(\alpha) = k_d \}|.$$

Further, the *multivariate generating function (MGF)* of the sequence $(a_{n,\mathbf{k}})_{n \in \mathbb{N}, \mathbf{k} \in \mathbb{N}^d}$ is defined as the formal power series

$$A(z, \mathbf{u}) = \sum_{n, \mathbf{k}} a_{n,\mathbf{k}} \mathbf{u}^{\mathbf{k}} z^n.$$

One also says that $A(z, \mathbf{u})$ is the MGF of the combinatorial class \mathcal{A} , with the formal variable u_j marking the parameter χ_j and z marking size. This function can formally be interpreted as a formal power series in z with coefficients in $\mathbb{Q}[\mathbf{u}]$. In addition, one easily recovers the ordinary generating function of the combinatorial class \mathcal{A} by setting $A(z) = A(z, \mathbf{1})$.

Remark 1.3.7. In most cases pertaining to lattice path combinatorics it suffices to consider a single scalar parameter χ , usually encoding the final height of a lattice path. This way, we obtain a *bivariate generating function (BGF)*

$$A(z, u) = \sum_{n, k=0}^{\infty} a_{n,k} u^k z^n,$$

with z marking the length of the path and u marking the final height (or an alternative parameter).

Definition 1.3.8 (Admissible construction). Let $\Phi : \mathcal{C}^k \rightarrow \mathcal{C}$ for a family of combinatorial classes \mathcal{C} . We call Φ an *admissible construction* if the counting sequence for $\mathcal{A} = \Phi(\mathcal{B}_1, \dots, \mathcal{B}_k)$ depends only on the counting sequences for $\mathcal{B}_1, \dots, \mathcal{B}_k$. Then there exists a well-defined operator Ψ such that $A(x) = \Psi(B_1(x), \dots, B_k(x))$.

We now give a quick overview of all the basic constructions commonly used within the symbolic framework and how they are translated into the language of generating functions.

Definition 1.3.9 (Basic constructions). Here we introduce formally the basic constructions that form the core of a specification language for combinatorial structures. Let \mathcal{B} and \mathcal{C} be two combinatorial classes. For the combinatorial sum we assume \mathcal{B} and \mathcal{C} to be disjoint.

- Combinatorial sum (disjoint union) $\mathcal{A} = \mathcal{B} + \mathcal{C}$:

$$\mathcal{A} := \mathcal{B} \cup \mathcal{C}, \quad |\alpha|_{\mathcal{A}} = \begin{cases} |\alpha|_{\mathcal{B}} & \text{if } \alpha \in \mathcal{B} \\ |\alpha|_{\mathcal{C}} & \text{if } \alpha \in \mathcal{C} \end{cases}.$$

- Cartesian product $\mathcal{A} = \mathcal{B} \times \mathcal{C}$:

$$\mathcal{A} := \{ \alpha = (\beta, \gamma) \mid \beta \in \mathcal{B}, \gamma \in \mathcal{C} \}, \quad |(\beta, \gamma)|_{\mathcal{A}} = |\beta|_{\mathcal{B}} + |\gamma|_{\mathcal{C}}.$$

- Sequence construction $\mathcal{A} = \text{SEQ}(\mathcal{B})$:

$$\mathcal{A} := \{ (\beta_1, \dots, \beta_n) \mid n \geq 0, \beta_j \in \mathcal{B} \}, \quad |(\beta_1, \dots, \beta_n)|_{\mathcal{A}} = \sum_{k=1}^n |\beta_k|_{\mathcal{B}}.$$

- Cycle construction $\mathcal{A} = \text{CYC}(\mathcal{B})$:

$$\mathcal{A} := (\text{SEQ}(\mathcal{B}) \setminus \{\varepsilon\}) / S,$$

where S is the equivalence relation between sequences defined by

$$(\alpha_1, \dots, \alpha_r) S (\beta_1, \dots, \beta_r)$$

iff there exists a circular shift τ such that for all j : $\alpha_j = \beta_{\tau(j)}$. The size function carries over from $\text{SEQ}(\mathcal{B})$.

- Multiset construction $\mathcal{A} = \text{MSET}(\mathcal{B})$:

$$\mathcal{A} := \text{SEQ}(\mathcal{B}) / R,$$

where R is the equivalence relation between sequences defined by

$$(\alpha_1, \dots, \alpha_r) R (\beta_1, \dots, \beta_r)$$

iff there exists an arbitrary permutation σ such that for all j : $\alpha_j = \beta_{\sigma(j)}$. The size function carries over from $\text{SEQ}(\mathcal{B})$.

- Powerset construction $\mathcal{A} = \text{PSET}(\mathcal{B})$:

$$\mathcal{A} := \{ B \mid B \subset \mathcal{B} \}.$$

As $\text{PSET}(\mathcal{B}) \subset \text{MSET}(\mathcal{B})$, the size function carries over from $\text{SEQ}(\mathcal{B})$ as well.

Theorem 1.3.10 (Basic admissibility [14, Theorem I.1, p. 27]). The constructions of union, Cartesian product, sequence, powerset, multiset and cycle are all admissible. The associated operators are as follows:

$$\begin{aligned}
 \text{Combinatorial sum: } \mathcal{A} = \mathcal{B} + \mathcal{C} &\implies A(z) = B(z) + C(z), \\
 \text{Cartesian product: } \mathcal{A} = \mathcal{B} \times \mathcal{C} &\implies A(z) = B(z) \cdot C(z), \\
 \text{Sequence: } \mathcal{A} = \text{SEQ}(\mathcal{B}) &\implies A(z) = (1 - B(z))^{-1}, \\
 \text{Powerset: } \mathcal{A} = \text{PSET}(\mathcal{B}) &\implies A(z) = \exp\left(\sum_{k=1}^{\infty} \frac{(-1)^{k-1}}{k} B(z^k)\right), \\
 \text{Multiset: } \mathcal{A} = \text{MSET}(\mathcal{B}) &\implies A(z) = \exp\left(\sum_{k=1}^{\infty} \frac{1}{k} B(z^k)\right), \\
 \text{Cycle: } \mathcal{A} = \text{CYC}(\mathcal{B}) &\implies A(z) = \sum_{k=1}^{\infty} \frac{\phi(k)}{k} \log \frac{1}{1 - B(z^k)},
 \end{aligned}$$

where ϕ denotes Euler's totient function. For the sequence, powerset, multiset and cycle translations, it is assumed that $b_0 = 0$.

Proof. We will provide the proof regarding the sequence construction as an example. The admissibility of this construction follows from the admissibility of the union and product constructions. One has

$$\mathcal{A} = \{\varepsilon\} + \mathcal{B} + (\mathcal{B} \times \mathcal{B}) + \dots,$$

which implies

$$A(z) = 1 + B(z) + B(z)^2 + \dots = \frac{1}{1 - B(z)},$$

where the final equality is to be interpreted as convergence in the formal topology, which we have shown in Example 1.2.3. For a thorough treatment of these combinatorial constructions, the author recommends the treatise in [14, Section I.2] by Flajolet and Sedgewick. \square

Example 1.3.11 (Counting sequence of Dyck excursions [14, pp. 318–321]). In Example 1.1.8 we already derived the counting sequence of Dyck excursions to be $d_{2n} = \frac{1}{n+1} \binom{2n}{n}$, also known as the Catalan numbers. Now we will present an alternative way to derive this result, using the symbolic method:

Let \mathcal{D} denote the combinatorial class of Dyck excursions, let $\omega_0 \in \mathcal{D}$ be an arbitrary Dyck excursion and let $D(z)$ be the corresponding generating function. We now partition ω_0 into two (possibly empty) shorter Dyck excursions via a technique called a first passage decomposition. If ω is not the empty path, there exists a second point of contact x_0 with the x -axis. Now we decompose ω into the path ω_1 starting from the origin and ending at x_0 and the (possibly empty) path ω_2 from x_0 to the endpoint of ω . Since the first passage ω_1 is non-empty, we can describe it as a sequence of an initial **NE**-step, a (possibly empty) Dyck excursion starting and ending at altitude one, and a final **SE**-step back down to the x -axis. Hence, the formal symbolic specification for the class of Dyck excursions \mathcal{D} reads

$$\mathcal{D} = \mathcal{E} \cup (\mathcal{Z}_{\text{NE}} \times \mathcal{D} \times \mathcal{Z}_{\text{SE}}) \times \mathcal{D}.$$

Using the translation schemes of Theorem 1.3.10 we obtain the functional equation

$$D(z) = 1 + z^2 D(z)^2.$$

This quadratic equation admits the two possible solutions

$$D_{\pm}(z) = \frac{1 \pm \sqrt{1 - 4z^2}}{2z^2}.$$

An expansion of the square root term around zero shows that only $D_-(z)$ admits a power series expansion around zero, with $D_+(z)$ possessing a polar singularity at zero. Hence, we conclude

$$\begin{aligned} D(z) &= \sum_{n=0}^{\infty} d_n z^n = \frac{1 - \sqrt{1 - 4z^2}}{2z^2} \\ &= 1 + z^2 + 2z^4 + 5z^6 + 14z^8 + 42z^{10} + 132z^{12} + 429z^{14} + \mathcal{O}(z^{16}). \end{aligned}$$

In order to extract the coefficients of $D(z)$, we use the double factorial notation $n!!$ to denote the product of all positive integers up to n that have the same parity as n . Then, using Newton's generalized binomial theorem 1.4.9, we rederive the formula

$$\begin{aligned} d_{2n} &= [z^{2n}] \left(\frac{1 - \sqrt{1 - 4z^2}}{2z^2} \right) = -\frac{1}{2} [z^{2n+2}] \left(\sum_{k \geq 0} \binom{\frac{1}{2}}{k} (-4z)^{2k} \right) \\ &= (-1)^n \frac{1}{2} \frac{(1/2) \cdot (-1/2) \cdot (-3/2) \cdots (-(2n-1)/2)}{(n+1)!} 4^{n+1} \\ &= \frac{1}{4} \cdot \frac{1}{2^n} \cdot \frac{(2n-1)!!}{(n+1)!} \cdot 4^{n+1} = \frac{1}{4^n} \cdot \frac{(2n)!}{(n+1)!n!} \cdot 4^n = \frac{1}{n+1} \binom{2n}{n}. \quad \triangle \end{aligned}$$

In simple cases like this it is possible to get a closed-form expression for the counting sequence. With increasing complexity in the combinatorial structures, the challenge of finding closed-form expressions decreases in feasibility, and thus results pertaining the asymptotic growth rates of coefficients gain in importance. To compare the growth rates of sequences, we use the classic Landau (or Big O) notation, invented by the German mathematicians Bachmann¹⁰ and Landau¹¹.

Definition 1.3.12 (Asymptotic notation). Let S be a set equipped with a neighborhood topology \mathcal{N} and let $s_0 \in S$. Further, two functions $\phi, g: S \setminus \{s_0\} \rightarrow \mathbb{C}$ are given. Then we write

- $f(s) = \mathcal{O}(g(s))$, if $|f(s)| \leq C \cdot |g(s)|$ for all $s \neq s_0$ in a neighborhood $V \in \mathcal{N}(s_0)$,
- $f(s) \sim g(s)$, if $\lim_{s \rightarrow s_0} f(s)/g(s) = 1$ and
- $f(s) = o(g(s))$, if $\lim_{s \rightarrow s_0} f(s)/g(s) = 0$.

¹⁰Paul Gustav Heinrich Bachmann (1837–1920)

¹¹Edmund Georg Hermann Landau (1877–1938)

1.4 Complex analysis

Combinatorialists use recurrence, generating functions, and such transformations as the Vandermonde convolution; others, to my horror, use contour integrals, differential equations, and other resources of mathematical analysis.

JOHN RIORDAN [26, Preface]

So far we have introduced generating functions as purely formal objects and demonstrated how its algebraic structure directly reflects the structure of combinatorial classes. However, to uncover the true power of this central concept in lattice path enumeration, we need to examine it in the light of analysis. Hence, in this section we will introduce the basic concepts and theorems that form the framework of this complex-analytic examination. Unless otherwise stated, the definitions and theorems introduced in this section can be found in the book [17] by Jänich.

Definition 1.4.1 (Analytic function). A function $f(z)$ defined over a region Ω is *analytic* at a point $z_0 \in \Omega$ iff, for z in some open disc centered at z_0 and contained in Ω , it is representable by a convergent power series expansion

$$f(z) = \sum_{n=0}^{\infty} c_n (z - z_0)^n.$$

A function is analytic in a region Ω iff it is analytic at every point of Ω .

Definition 1.4.2 (Holomorphic function). A function $f: \Omega \rightarrow \mathbb{C}$, defined on an open set $\Omega \subset \mathbb{C}$ is complex differentiable at $z_0 \in \Omega$ iff the limit

$$f'(z_0) := \lim_{z \rightarrow z_0} \frac{f(z) - f(z_0)}{z - z_0}$$

exists. The function f is called *holomorphic* in Ω iff it is complex differentiable at every point of Ω .

An important property of holomorphic functions is that not a lot of information about them is necessary in order to uniquely characterize them, as the following theorem demonstrates.

Theorem 1.4.3 (Identity theorem [17, Satz 12]). Let G be a region in \mathbb{C} and $f, g: G \rightarrow \mathbb{C}$ be two holomorphic functions. Let $D := \{z \in G \mid f(z) = g(z)\}$ have an accumulation point in G . Then it holds that $f \equiv g$ on G .

Further, it should be noted that the notions of analyticity and holomorphy are equivalent. One direction of this equivalence can be demonstrated via Cauchy's¹² coefficient formula.

Theorem 1.4.4 (Cauchy's coefficient formula [17, Satz 3]). Let $f: U \rightarrow \mathbb{C}$ be a holomorphic function and let $z_0 \in U$. Then there exists exactly one power series $\sum_{n=0}^{\infty} c_n (z - z_0)^n$

¹²Augustin-Louis Cauchy (1789–1857)

with positive radius of convergence that represents f in a neighborhood of z_0 . Further, the coefficients c_n are given via

$$c_n = \frac{1}{2\pi i} \int_{|z-z_0|=r} \frac{f(z)}{(z-z_0)^{n+1}} dz,$$

with $r > 0$ sufficiently small such that $\{z : |z - z_0| \leq r\} \subset U$. The power series converges for every open disk fully contained in U and represents the function $f(z)$. In particular, this shows that every holomorphic function is also analytic.

Even though all the series expansions at 0 of the generating functions we study in this thesis will not contain any terms with negative exponents, the theory of power series alone cannot yet suffice, if we want to derive asymptotic results about the growth of the series coefficients. In Section 2.3 we will present an introduction into singularity analysis, where we will show how the location and nature of a generating functions dominant singularity determines the asymptotic growth of its corresponding counting sequence. The simplest case to analyze is a generating function with exactly one simple pole on its radius of convergence. If we want to observe the behavior of the function around this polar singularity, a Laurent¹³ series expansion is the method of choice.

Definition 1.4.5 (Laurent series). Let $z_0 \in \mathbb{C}$. A *Laurent series* around z_0 is a series of the form

$$\sum_{n=-\infty}^{\infty} c_n (z - z_0)^n,$$

consisting of the *principal part* $\sum_{n=1}^{\infty} c_{-n} (z - z_0)^{-n}$ and the *Taylor part* $\sum_{n=0}^{\infty} c_n (z - z_0)^n$ of the Laurent series. For the principal part we introduce the convenient notation

$$\{u^{<0}\} \left(\sum_{n=-\infty}^{\infty} c_n (z - z_0)^n \right) := \sum_{n=1}^{\infty} c_{-n} (z - z_0)^{-n}.$$

A Laurent series converges iff both subseries converge. In this case, the limit is defined as the sum of the limits of the two subseries. Let $1/r$ be the radius of convergence of $\sum_{n=1}^{\infty} c_{-n} (z - z_0)^{-n}$ and R be the radius of convergence of the Taylor part. Then, the Laurent series converges on the open annulus $\{z : r < |z| < R\}$ and for all $r < \rho_1 < \rho_2 < R$ it converges uniformly on $\{z : \rho_1 < |z| < \rho_2\}$.

As power series correspond to local expansions of holomorphic functions, Laurent series are similarly local expansions of meromorphic function.

Definition 1.4.6 (Meromorphic function). A function $h(z)$ is *meromorphic* at z_0 iff, for z in a neighborhood of z_0 with $z \neq z_0$ it can be represented as a quotient $f(z)/g(z)$ of two analytic functions. In that case, it admits near z_0 a Laurent series expansion of the form

$$h(z) = \sum_{n \geq n_0} h_n (z - z_0)^n.$$

If $h_{n_0} \neq 0$ and $n_0 \leq -1$, then $h(z)$ is said to have a pole of order n_0 at $z = z_0$. A function is meromorphic in a region iff it is meromorphic at every point of the region.

¹³Pierre Alphonse Laurent (1813–1854)

Cauchy's coefficient formula can then be extended to Laurent series.

Theorem 1.4.7 (Laurent coefficient formula [17, Satz 16]). Let $f(z) = \sum_{n=-\infty}^{\infty} c_n z^n$ be a convergent Laurent series on an open annulus

$$\{z : r < |z| < R\}.$$

Then the coefficients c_n are given via

$$c_n = \frac{1}{2\pi i} \int_{|z|=\rho} \frac{f(z)}{z^{n+1}} dz$$

for all $n \in \mathbb{Z}$ and $r < \rho < R$.

Finally, the theory of coefficient extraction using contour integrals culminates in the famous residue theorem named after Cauchy.

Theorem 1.4.8 (Cauchy's residue theorem [14, Theorem IV.3, p. 234]). Let $h(z)$ be meromorphic in the region Ω , let $S \subset \Omega$ be the set of isolated singularities of $h(z)$ and let γ be a positively oriented simple loop in Ω along which $h(z)$ is analytic. Then it holds that

$$\frac{1}{2\pi i} \int_{\gamma} h(z) dz = \sum_{s \in S} \text{Res}_{z=s} h(z),$$

with

$$\text{Res}_{z=s} h(z) := \frac{1}{2\pi i} \int_{|z-s|=\varepsilon} h(z) dz = [z^{-1}]h(z).$$

The cornerstone on which we will build the important theorems of singularity analysis is Newton's generalized binomial theorem that generalizes the classical binomial theorem to arbitrary complex exponents.

Theorem 1.4.9 (Newton's generalized binomial theorem). We extend the definition of the binomial coefficient to

$$\binom{\alpha}{n} = \frac{\alpha \cdot (\alpha - 1) \cdots (\alpha - n + 1)}{n!}$$

for any $\alpha \in \mathbb{C}$ and $n \in \mathbb{N}$. Then, there holds a generalized version of the binomial theorem, stating

$$(1+z)^\alpha = \sum_{n=0}^{\infty} \binom{\alpha}{n} z^n.$$

Further, we will need a complex version of a well known result in real analysis.

Theorem 1.4.10 (Implicit function theorem [14, Appendix B.5]). Let $F(z, u)$ be bivariate analytic in two complex variables (z, u) near $(0, 0)$ in the sense that it admits a convergent power series in a polydisk

$$F(z, u) = \sum_{n, k \geq 0} f_{n, k} z^n u^k, \quad |z| < R, \quad |u| < S.$$

Further, assume that $F(0, 0) = 0$ and $\frac{\partial F}{\partial u}(0, 0) \neq 0$. Then there exists a unique function $f(z)$ analytic in a neighborhood of zero such that $f(0) = 0$ and

$$F(z, f(z)) = 0, \quad |z| < \rho.$$

We close this synopsis over the complex-analytic methods used throughout this thesis with an important algebraic elimination technique. In many cases, generating functions are only accessible as solutions to algebraic equations. For higher degrees this means that closed-form solutions are often infeasible, if not straight-up impossible. Say we derived a formula for a generating function like $E(z) = -\frac{u_1(z)u_2(z)}{z}$, with $u_1(z), u_2(z)$ being solutions of an algebraic equation $K(z, u)$. Can we derive an algebraic equation satisfied by $F(z)$?

This question can be positively answered with the help of *resultants*, as they provide a way to eliminate auxiliary quantities from systems of polynomial equations.

Definition 1.4.11 (Resultant [14, p. 739]). Consider a field of coefficients \mathbb{K} and two polynomials

$$P(x) = \sum_{j=0}^{\ell} a_j x^{\ell-j}, \quad Q(x) = \sum_{k=0}^m b_k x^{m-k},$$

in $\mathbb{K}[X]$. We define their *resultant* with respect to the variable x as the determinant of order $(\ell + m)$,

$$\mathbf{R}(P(x), Q(x), x) = \det \begin{pmatrix} a_0 & a_1 & a_2 & \cdots & 0 & 0 \\ 0 & a_0 & a_1 & \cdots & 0 & 0 \\ \vdots & \vdots & \vdots & \ddots & \vdots & \vdots \\ 0 & 0 & 0 & \cdots & a_{\ell-1} & a_{\ell} \\ b_0 & b_1 & b_2 & \cdots & 0 & 0 \\ 0 & b_0 & b_1 & \cdots & \vdots & \vdots \\ \vdots & \vdots & \vdots & \ddots & \vdots & \vdots \\ 0 & 0 & 0 & \cdots & b_{m-1} & b_m \end{pmatrix},$$

also called the *Sylvester determinant*. By its definition, the resultant is a polynomial in the coefficients of P and Q .

Proposition 1.4.12 ([14, pp. 739-740]). Let $\mathbf{R} = \mathbf{R}(P(x), Q(x), x)$ be the resultant of $P(x), Q(x) \in \mathbb{K}[x]$ and let $\overline{\mathbb{K}}$ be the algebraic closure of \mathbb{K} . Then the following statements hold:

- If $P(x)$ and $Q(x)$ have a common root in $\overline{\mathbb{K}}$, then $\mathbf{R}(P(x), Q(x), x) = 0$.
- If $\mathbf{R}(P(x), Q(x), x) = 0$, then either $a_0 = b_0 = 0$, or else $P(x)$ and $Q(x)$ have a common root in $\overline{\mathbb{K}}$.

Proof. We only prove the relevant direction for the thesis here. In particular, we only need to know that all common roots of $P(x)$ and $Q(x)$ can be found as zeroes of the resultants. Let ξ be a common root of $P(x)$ and $Q(x)$. Then $w = (\xi^{l+m-1}, \dots, \xi, 1)$ solves

the homogenous linear system $S \cdot w = 0$, since

$$S \cdot \begin{pmatrix} \xi^{l+m-1} \\ \vdots \\ \xi \\ 1 \end{pmatrix} = \begin{pmatrix} \xi^{m-1}P(\xi) \\ \vdots \\ P(\xi) \\ \xi^{l-1}Q(\xi) \\ \vdots \\ Q(\xi) \end{pmatrix}.$$

This implies that $\ker(S) \neq \{0\}$ and hence $\mathbf{R}(P(x), Q(x), x) = \det(S) = 0$. The other direction can be found for example in [22, V. 10]. \square

Remark 1.4.13 (Elimination of auxiliary variables [14, p. 740]). Given a system of polynomial equations

$$P_j(z, y_1, \dots, y_m) = 0, \quad j = 1, \dots, m,$$

defining an algebraic curve we can systematically eliminate one of the auxiliary variables y_i until we are left with a single equation in z . We start by taking resultants with P_m and eliminate all occurrences of the variable y_m from the first $m - 1$ equations by replacing P_j with $\mathbf{R}(P_j, P_m, y_m)$. Then, we repeat this process until all auxiliary variables have been eliminated and we are left with a single polynomial equation over z . The resulting polynomial is in general not minimal, in fact, the complexity of elimination is exponential in the resulting degree, in the worst-case. Hence, additional polynomial factorization techniques are required, when dealing with a large system of equations.

Example 1.4.14. Consider again the function $E(z)$ defined via

$$E(z) = -\frac{u_1(z)u_2(z)}{z}$$

and let $K(z, u) = z(1 + u + u^3 + u^4)$. In this case, the system of polynomial equations can be defined as

$$\begin{aligned} P_1(E, z, u_1, u_2) &:= zE + u_1(z)u_2(z), \\ P_2(E, z, u_1, u_2) &:= K(z, u_1), \\ P_3(E, z, u_1, u_2) &:= K(z, u_2). \end{aligned}$$

We begin by eliminating u_2 :

$$Q(E, z, u_1) := \mathbf{R}(P_1, P_3, u_2) = -z(E^4z^4 - E^3u_1z^3 - E^2u_1^2z - Eu_1^3z + u_1^4).$$

Next, we eliminate u_1 and obtain the desired polynomial equation in E and z :

$$\begin{aligned} P(E, z) := \mathbf{R}(Q, P_2, u_1) &= z^8(zE + 1)^4(E^4z^4 + E^3z^3 + 2E^3z^2 + E^2 + zE + 2E + 1) \\ &\quad (E^4z^4 - 2E^3z^3 - E^3z^2 + 3E^2z^2 + 2E^2z - 2zE - E + 1)^2. \quad \triangle \end{aligned}$$

2 Directed lattice paths and the kernel method

This chapter is devoted to the analysis of the four basic types of simple lattice paths; see Table 2.1. We begin in Section 2.1 with providing a thorough treatment, including its historical developments, of the central technique in the theory of lattice path enumeration: the *kernel method*. Following up, in Section 2.2 we apply this method to derive general formulae for the generating functions of the four basic types for arbitrary simple step sets. The first two sections are mainly based on the seminal article *Basic analytic combinatorics of directed lattice paths* by Banderier and Flajolet [1]. Further, in Section 2.3 we present an introduction into the theory of singularity analysis and their application for determining the asymptotic behavior of the counting sequences for directed lattice paths. For this part we follow closely the clear presentation in the definite treatment on the topic: The monograph *Analytic Combinatorics* by Flajolet and Sedgewick [14].

	ending anywhere	ending at 0
unconstrained (on \mathbb{Z})	 walk/path (\mathcal{W}) $W(z) = \frac{1}{1-zP(1)}$	 bridge (\mathcal{B}) $B(z) = z \sum_{i=1}^c \frac{u_i'(z)}{u_i(z)}$
constrained (on \mathbb{Z}_+)	 meander (\mathcal{M}) $M(z) = \frac{1}{1-zP(1)} \prod_{i=1}^c (1 - u_i(z))$	 excursion (\mathcal{E}) $E(z) = \frac{(-1)^{c-1}}{p_{-c}z} \prod_{i=1}^c u_i(z)$

Table 2.1: The four types of directed paths: walks, bridges, meanders and excursions and the corresponding generating functions [1, Fig. 1].

Definition 2.0.1 (Common families of lattice paths). In this definition we give an overview over all the families of lattice paths used in this thesis. We state the specific simple

step set and the corresponding kernel equation, which will be defined in the next section, respectively.

- *Dyck walks*: The step set is given by $\mathcal{D} := \{-1, 1\}$ and the kernel equation reads

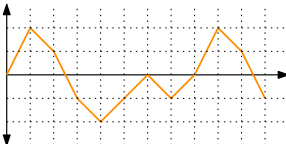
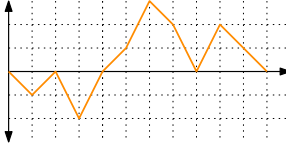
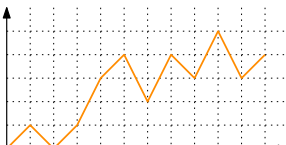
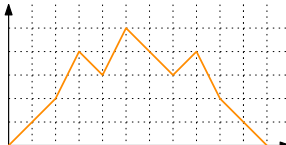
$$K(z, u) = u - z(1 + u^2).$$

- *Motzkin walks*: The step set is given by $\mathcal{M} := \{-1, 0, 1\}$ and the kernel equation reads

$$K(z, u) = u - z(1 + u + u^2).$$

- *k-Motzkin walks*: The step multiset is given by $\mathcal{M}_k := \{-1, \underbrace{0, \dots, 0}_{k \text{ times}}, 1\}$ and the kernel equation reads

$$K(z, u) = u - z(1 + ku + u^2).$$

They are commonly interpreted as lattice paths with k different colors for the horizontal step. Hence, we model them as simple lattice paths with a horizontal step of weight $p_0 = k$.

- *Basketball walks*: The step set is given by $\mathcal{B} := \{-2, -1, 1, 2\}$ and the kernel equation reads

$$K(z, u) = u^2 - z(1 + u + u^3 + u^4).$$

Throughout this thesis, we will use the following notation rules for generating functions:

1. $W(z), B(z), M(z)$ and $E(z)$ denote the generating functions for walks, bridges, meanders and excursions, respectively.
2. The subscript encodes the corresponding step set.
3. Additional extensions, like catastrophes, will be noted in the superscript.

For example, $M_{\mathcal{D}}^{\text{cat}}(z, u)$ will denote the bivariate generating function of Dyck meanders with catastrophes.

2.1 Kernel method

To derive most of these general formulae for the generating functions, the technique of choice will be the so-called *kernel method*. As Banderier and Flajolet note in [1, p. 55], this method has been part of the folklore of combinatorialists for some time. It deals with a functional equation of the form

$$K(z, u)F(z, u) = A(z, u) + B(z, u)G(z),$$

with $F(z, u)$ and $G(z)$ being the unknown functions. The core idea is now to solve the *kernel equation* $K(z, u) = 0$ for u . In its simplest form, the equation admits exactly one *small branch* $u_1(z)$ that is characterized by the property that $\lim_{z \rightarrow 0} u_1(z) = 0$. In that case, a single substitution does the job, and we get

$$G(z) = -\frac{A(z, u_1(z))}{B(z, u_1(z))}, \quad F(z, u) = \frac{1}{K(z, u)} \left(A(z, u) - \frac{B(z, u) \cdot A(z, u_1(z))}{B(z, u_1(z))} \right).$$

Example 2.1.1 (Origin of the kernel method). One of the first known applications of this technique appears in Knuth’s *The Art of Computer Programming* [18, Answer to Exercise 2.2.1.4, pp. 536–537], where he counts permutations obtainable via admissible sequences of operations on stacks. The two operations on a stack are to move an element from the input into the stack and to move an element from the stack into the output. We note that this counting problem is equivalent to counting the number of Dyck meanders, as the number of removals from the stack may never exceed the number of insertions. The special case that the total number of insertions equals the total number of removals then fits neatly into the long list of objects counted by the Catalan numbers, as we have shown in 1.1.8. To address the general case, Knuth introduces a new technique that we now call the kernel method.

Let $g_{n,k}$ be the number of admissible sequences of stack operations of length n , with k more insertions than removals and define the bivariate generating function $G(z, u) := \sum_{n,k=0}^{\infty} g_{n,k} u^k z^n$. By partitioning these sequences based on whether their last operation is an insertion or a removal, we see that the counting sequence satisfies, for $n, m \geq 0$,

$$g_{n+1,m} = g_{n,m-1} + g_{n,m+1}, \quad g_{0,m} = \delta_{0,m}, \quad g_{n,-1} := 0,$$

where $\delta_{0,m}$ denotes the Kronecker¹ symbol defined via

$$\delta_{i,j} = \begin{cases} 1, & i = j, \\ 0, & i \neq j. \end{cases}$$

We multiply the recurrence relation with $z^n u^k$ and sum over n and k . This yields the functional equation

$$\frac{1}{z}(G(z, u) - 1) = u \cdot G(z, u) + \frac{1}{u}(G(z, u) - G(z, 0)).$$

Rearranging the terms of this equation and multiplying to get rid of the denominators, the kernel structure of this equation becomes apparent, as

$$\underbrace{(z(u^2 + 1) - u)}_{=:K(z,u)} G(z, u) = zG(z, 0) - u. \tag{2.1}$$

We are now looking to find an expression for $G(z, 0)$ such that $G(z, u)$ admits a power series expansion in z and u at $(z, u) = (0, 0)$. The most straightforward ansatz is to set the kernel $K(z, u) = 0$. Solving this equation for u yields two conjugated solutions

$$u_1(z) = \frac{1 - \sqrt{1 - 4z^2}}{2z}, \quad v_1(z) = \frac{1 + \sqrt{1 - 4z^2}}{2z}.$$

Plugging them into the functional equation (2.1) we get the two candidate solutions $u_1(z)/z$ and $u_2(z)/z$ for $G(z, 0)$. By expanding

$$\sqrt{1 - 4z^2} = 1 - 2z^2 + \mathcal{O}(z^4)$$

¹Leopold Kronecker (1823–1891)

we see that only $u_1(z)/z$ admits a proper power series expansion at $z = 0$. Hence, only $G(z, 0) = u_1(z)/z$ conforms with the fact that $G(z, 0)$ is a generating function of a combinatorial class. Further, we observe that

$$u_1(z) + u_2(z) = \frac{1}{z}, \quad u_1(z) \cdot u_2(z) = 1.$$

Thus, together with $G(z, 0) = u_1(z)/z$, we find

$$G(z, u) = \frac{zu_1(z) - u}{z(u^2 + 1) - u} = \frac{zu_1(z) - u}{z(1 - u_1(z) \cdot u)(1 - u_2(z) \cdot u)} = \frac{u_1(z)}{z(1 - u_1(z) \cdot u)},$$

which can then be used in conjunction with the expansion

$$u_1(z) = \sum_{n=0}^{\infty} \frac{1}{2n+1} \binom{2n+1}{n} z^{2n+1}$$

to determine the general solution

$$\begin{aligned} g_{2n,2k} &= \frac{2k+1}{2n+1} \binom{2n+1}{n-k} = \binom{2n}{n-k} - \binom{2n}{n-k-1}, \\ g_{2n+1,2k+1} &= \binom{2k+2}{2n+2} = \binom{2n+1}{n-m} - \binom{2n+1}{n-k-1}. \end{aligned} \quad \triangle$$

Further developments pertaining the kernel method can be found in the article by Bousquet-Mélou and Petkovšek [9], concerned with the subject of multi-dimensional walks, linear recurrences and kernels. Let us now provide a formal definition for the kernel equation and analyze a few basic properties regarding its solutions.

Definition 2.1.2 (Kernel equation). Let $\mathcal{S} = \{s_1, \dots, s_m\}$ be a simple step set with a corresponding system of weights $\Pi = \{p_s \mid s \in \mathcal{S}\}$ and let $c = -\min_j s_j$ and $d = \max_j s_j$ be the two extreme vertical amplitudes of any jump. Throughout this section we will assume $c, d > 0$, as well as $p_s > 0$, for $s \in \mathcal{S}$. Further, let

$$P(u) = \sum_{k=-c}^d p_k u^k$$

be the matching jump polynomial. Then we define the *kernel equation* for (\mathcal{S}, Π) as

$$K(z, u) := 1 - zP(u) = 0,$$

where $K(z, u)$, or equivalently $u^c - z(u^c P(u)) = 0$ (as an entire function without negative powers) is called the *kernel*. The kernel equation then defines the so-called *characteristic curve* of the family of lattice paths with step set \mathcal{S} .

Before we proceed with analyzing the most important properties of this characteristic curve, we interject a useful little lemma for Laurent series with non-negative coefficients.

Lemma 2.1.3 (Strong triangle inequality). Let $Q(z)$ be an aperiodic Laurent series with non-negative coefficients that is not a monomial. Then, by the strong form of the triangle inequality it holds that

$$|Q(z)| < Q(|z|) \quad \text{for all } z \in \mathbb{C} \setminus \mathbb{R}_{\geq 0}.$$

Proof. Firstly we note that

$$|Q(z)| = \left| \sum_{n \geq 0} q_n z^n \right| \leq \sum_{n \geq 0} |q_n z^n| = \sum_{n \geq 0} q_n |z|^n = Q(|z|).$$

The strict version of this inequality clearly holds for any z such that $z/|z|$ is not a root of unity since no two summands can be collinear in this case. Now assume that $(z/|z|)^k = 1$ and suppose that $|Q(z)| = Q(|z|)$. Hence the equality condition of the triangle inequality tells us that all summands must be collinear, i.e. there must be an $i < k$ with $q_n = 0$ for all $n \in \mathbb{N} : n \not\equiv i \pmod k$. However, that would imply

$$Q(z) = z^i \sum_{n \in \mathbb{N}} q_{kn+j} z^{kn} = z^i H(z^k),$$

contradicting the aperiodicity of $Q(z)$. \square

In the following proposition we collect a handful of useful results from [1] by Banderier and Flajolet pertaining the kernel equation.

Proposition 2.1.4 (Properties of the characteristic curve). Let $K(z, u)$ be the kernel equation corresponding to a simple step set $\mathcal{S} = \{s_1, \dots, s_m\}$ augmented with a system of weights $\Pi = \{p_s \mid s \in \mathcal{S}\}$ and let $c = -\min_j s_j$ and $d = \max_j s_j$ denote the two extremal vertical amplitudes of any jump. Further, let $\omega_c = \exp(2\pi i/c)$ and $\omega_d = \exp(2\pi i/d)$ denote the respective roots of unity. Then, the following statements hold:

1. The kernel equation $K(z, u) = 0$ defines $c+d$ branches of a single algebraic curve. Of these branches, there are c distinct *small roots* u_1, \dots, u_c , conjugated to each other at zero, satisfying

$$u_j(z) \sim \omega_c^{j-1} (p_{-c})^{1/c} z^{1/c} \quad \text{as } z \rightarrow 0.$$

More precisely, this means that there exists a function A analytic at zero, such that, in a neighborhood of zero, one has

$$u_j(z) = \omega_c^{j-1} z^{1/c} A\left(\omega_c^{j-1} z^{1/c}\right), \quad j = 1, \dots, c.$$

The remaining d distinct *large roots* are conjugated to each other at ∞ and satisfy

$$v_k(z) \sim \omega_d^{1-k} (p_d)^{-1/d} z^{-1/d} \quad \text{as } z \rightarrow 0.$$

More precisely, there exists an analytic function B , such that, in a neighborhood of zero, one has

$$v_k(z) = \omega_d^{1-k} z^{-1/d} B\left(\omega_d^{1-k} z^{1/d}\right), \quad k = 1, \dots, d.$$

In summary, the u_j and v_k organize themselves into two cycles of c and d elements; see Figure 2.1 for an example. For determinacy, one restricts attention to the complex plane slit along the negative real axis, which allows us to talk freely of the individual branches in the sequel.

2. The characteristic polynomial $P(u)$ admits a unique positive minimum at a real number $\tau > 0$, called the *structural constant*. This value then defines the *structural radius* $\rho := 1/P(\tau)$.

3. There is a *dominant small root* $u_1(z)$ and a *dominant large root* $v_1(z)$, determined by the reality conditions

$$u_1(z) \sim \gamma z^{1/c}, \quad v_1(z) \sim \delta z^{-1/d}, \quad (z \rightarrow 0^+)$$

with $\gamma := (p_{-c})^{1/c}, \delta := (p_d)^{-1/d} \in \mathbb{R}_{>0}$, such that, for $|z| < \rho$, $i = 2, \dots, c$ and $j = 2, \dots, d$, one has

$$|u_i(z)| < u_1(|z|) < v_1(|z|) < |v_j(z)|.$$

Further, on the circle of convergence $|z| = \rho$ we have

$$|u_i(z)| < u_1(\rho) = v_1(\rho) < |v_j(z)|.$$

4. The dominant small root $u_1(z)$ and the dominant large root $v_1(z)$ are conjugated to each other at their dominant singularity occuring at the structural radius ρ :

$$u_1(z) \sim \tau + \sum_{n=1}^{\infty} a_n (\rho - z)^{n/2}, \quad v_1(z) \sim \tau + \sum_{n=1}^{\infty} (-1)^n a_n (\rho - z)^{n/2}.$$

5. The product

$$Y_1(z) := \prod_{i=2}^c u_i(z)$$

of the non-dominant small roots, as well as the product

$$\bar{Y}_1(z, u) := \prod_{j=2}^d \frac{1}{u - v_j(z)}$$

of the non-dominant large roots, is analytic in the closed disk including the structural radius $|z| \leq \rho$.

Proof.

1. As the characteristic equation is a polynomial of degree $c + d$ (in its entire form) it generically admits $c + d$ roots that constitute the branches of a single algebraic curve. We will now provide an argument from [2, Proposition 6.9, p. 104] that shows this conjugation principle for small roots. The case of large roots can then be handled analogously. The kernel equation yields

$$u = X(p_{-c} + p_{-c+1}u + \dots + p_{d-1}u^{c+d-1} + p_d u^{c+d})^{1/c}$$

with $X = \omega_c^j z^{1/c}$ for $j = 0, \dots, c - 1$. In this form, we see that the Lagrange inversion formula (Theorem 3.2.1) guarantees a unique power series solution $u(X)$ to this equation. Substituting $X = \omega_c^j z^{1/c}$ into this power series yields the claim.

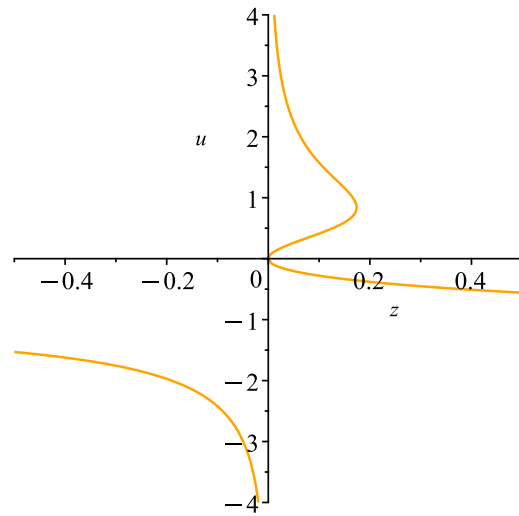
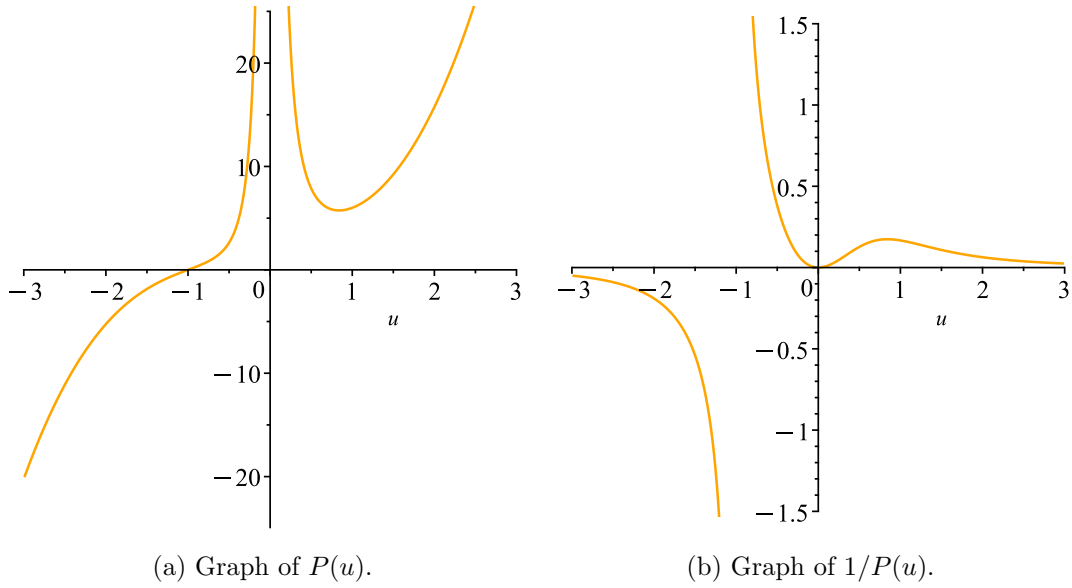

(c) Graph of the two small branches u_1, u_2 of order $\pm z^{1/2}$ and the only real large branch v_1 of order $z^{-1/3}$ of the characteristic curve.

Figure 2.1: Graphs of $P(u) = u^{-2} + u^{-1} + 1 + u + u^2 + u^3$, the inverse $1/P(u)$ and the three real branches of the characteristic curve $1 - zP(u)$ associated with the set of jumps $\mathcal{S} = \{-2, -1, 0, 1, 2, 3\}$ [1, Figure 3].

2. Since we assumed all weights to be positive, we have

$$P''(u) = \sum_{k=-c}^d k(k-1)p_k u^{k-2} > 0$$

for $u > 0$. As $\lim_{u \rightarrow 0} P(u) = \lim_{u \rightarrow +\infty} P(u) = \infty$ it must admit a unique real, positive minimum attained at some $\tau > 0$.

3. The proof given here follows the lines of [1, Lemma 2, pp. 59–60]. As $P(\tau)$ is the unique positive minimum of $P(u)$, it follows immediately that $1/P(u)$ is monotonically increasing for $u \in [0, \tau]$. Hence, there exists a unique function $u^+(z) : [0, \rho] \rightarrow [0, \tau]$ satisfying

$$z = \frac{1}{P(u^+(z))} \quad \text{for } z \in [0, \rho].$$

Due to the reality condition on $u_1(z)$ we see that this positive solution $u^+(z)$ must coincide with the branch $u_1(z)$ of the characteristic curve for $z \rightarrow 0^+$. Further, the implicit function theorem 1.4.10 guarantees the analyticity of $u^+(z)$ in the interval $(0, \rho)$ and with the identity theorem 1.4.3 we obtain $u^+ \equiv u_1$ in $(0, \rho)$. Next, we use the fact that $P(u)$ is an aperiodic Laurent polynomial with positive coefficients, which according to Lemma 2.1.3 leads to the strict inequality

$$|P(r \cdot \exp(i\theta))| < P(r) \quad \text{for all } \theta \not\equiv 0 \pmod{2\pi}. \quad (2.2)$$

Let $x \leq \rho$ be a real positive number and fix $z = x$. Then, let w be an arbitrary solution of the kernel equation $1 - xP(w) = 0$ that is at most τ in modulus and **not** equal to $u_1(x)$. Hence $w \notin \mathbb{R}_{>0}$ and by (2.2) one has

$$x = \frac{1}{P(u_1(x))} = \frac{1}{P(w)} > \frac{1}{P(|w|)},$$

implying $|w| < u_1(x)$, since $1/P(u)$ monotonically increases in the interval $[0, \tau]$. Further, by construction all non-dominant small branches are majorized by τ for $x \rightarrow 0^+$. Thus, they must satisfy $|u_i(x)| < u_1(x)$ for x sufficiently close to zero. By continuity of the modulus of any branch the domination property cannot cease to hold on $(0, \rho)$, as otherwise that would imply $u_1(x)$ reaches τ for some $x < \rho$, yielding a clear contradiction. Then, for $x = \rho$ we can apply (2.2) again to see that the strict domination must continue to hold at ρ . Similar arguments can then be used to demonstrate $|v_j(z)| > v_1(|z|)$ for $|z| < \rho$. Finally, we observe $|u_1(z)| < |v_1(z)|$, except for $z = \rho$, closing our chain of inequalities.

4. A part of the proof to [1, Theorem 3] gives insight into the conjugation principle for the dominant small and large root. We start by considering the kernel equation

$$z = \frac{1}{P(u)}$$

at the structural constant τ . By construction one has $P'(\tau) = 0$ and $P''(\tau) > 0$. Then, the local expansion at $u = \tau$ reads²

$$z = \rho - \frac{\rho^2}{2} P''(\tau)(u - \tau)^2 + \mathcal{O}((u - \tau)^3).$$

Solving above equation for u yields two local solutions

$$\begin{aligned} u_1(z) &= \tau - \sqrt{2 \frac{P(\tau)}{P''(\tau)}} \sqrt{1 - z/\rho} + \mathcal{O}(1 - z/\rho), \\ v_1(z) &= \tau + \sqrt{2 \frac{P(\tau)}{P''(\tau)}} \sqrt{1 - z/\rho} + \mathcal{O}(1 - z/\rho), \end{aligned} \quad z \rightarrow \rho^-,$$

corresponding to the dominant small root u_1 and the dominant large root v_1 . In order to expand this informal discussion into a full proof, we refer to the theory of Newton-Puiseux expansions presented in Theorem 2.1.5.

5. See [1, Theorem 3, p. 61–64] and [1, Theorem 6, pp. 72–75]. □

These properties are vindicated by the classical theory of Newton-Puiseux expansions. For completeness sake, we will state and prove this fundamental result in the elementary theory of algebraic curves that determines constructively all the possible behaviors of solutions of polynomial equations.

Theorem 2.1.5 (Newton-Puiseux theorem [14, Theorem VII.7, p. 498]). Let $f(z)$ be a branch of an algebraic function $P(z, f(z)) = 0$. In a circular neighborhood of a singularity ζ , slit along a ray emanating from ζ , the function $f(z)$ admits a fractional series expansion, called a *Puiseux series*, that is locally convergent and of the form

$$f(z) = \sum_{k \geq k_0} c_k (z - \zeta)^{k/\kappa},$$

for a fixed determination of $(z - \zeta)^{1/\kappa}$, where $k_0 \in \mathbb{Z}$ and $\kappa \in \mathbb{N}_{\geq 1}$.

Proof. Let $P(z, y)$ be an irreducible polynomial of degree d in y with

$$P(z, y) = p_0(z)y^d + p_1(z)y^{d-1} + \cdots + p_d(z).$$

For each z there are exactly d distinct values for y such that $P(z, y) = 0$ except for two cases:

- Firstly, if $p_0(z_0) = 0$, then there is a reduction in the degree of y and hence a reduction in the number of finite y -solutions for that particular value.
- Secondly, $P(z_0, y)$ may have a multiple root in y and some of the values of y will coalesce.

²The formula in the proof of [1, Theorem 3, p. 62] is missing the factor ρ^2 .

Hence, we define the exceptional set $\Xi[P]$ of P as

$$\Xi[P] := \{ z \mid p_0(z) = 0 \vee \exists y : P(z, y) = \partial_y P(z, y) = 0 \}.$$

For each $z \notin \Xi[P]$ the implicit function theorem 1.4.10 guarantees that each of the solutions y_j lifts into a locally analytic function $y_j(z)$. The exceptional set thus provides a set of possible candidates for the singularities of an algebraic function. Any $y(z)$, analytic at the origin, satisfying $P(z, y) = 0$, can be analytically continued along any simple path emanating from the origin that does not cross any point of $\Xi[P]$. Consider an exceptional point at the origin and assume that $P(0, y)$ has k equal roots y_1, \dots, y_k at $y = 0$. Consider a punctured disk $|z| < r$ that does not include any other exceptional point relative to P . Continue $y_1(z)$ analytically along a curve starting from an arbitrary value z in the interior of $(0, r)$, encircling the origin and returning to z . By permanence of analytic relations $y_1(z)$ will be taken into another root. Repeat this process until one has obtained a collection of roots $y_1(z) = y_1^{(0)}(z), y_1^{(1)}(z), \dots, y_1^{(\kappa)}(z) = y_1(z)$. In this case, $y_1(t^\kappa)$ is an analytic function in t except possibly at zero where it is continuous and has value zero. By general principles (Morera's theorem) it is in fact analytic at zero. This implies the existence of a convergent power series expansion at zero:

$$y_1(t^\kappa) = \sum_{n=1}^{\infty} c_n t^n.$$

Each determination of $z^{1/\kappa}$ yields one of the branches of the multivalued analytic function:

$$y_1^{(j)}(z) = \sum_{n=1}^{\infty} c_n \omega^n z^{n/\kappa}, \quad j = 0, \dots, \kappa - 1,$$

with $\omega = \exp(2\pi i/\kappa)$. If $\kappa = k$, then the cycle accounts for all the roots which tend to zero. Otherwise, we repeat the process with another root and, in this fashion, eventually exhaust all roots that tend to zero. Thus, all the k roots that have value zero at $z = 0$ are grouped into cycles of size $\kappa_1, \dots, \kappa_\ell$. Finally, values of y at infinity are brought to zero by means of the change of variables $y = 1/u$, leading to negative exponents in the expansion of y . \square

2.2 Generating functions

The aim of this section is to present the derivations of the generating functions depicted in Table 2.1 in a manner that is easily accessible. Hence, we will present the proofs in the seminal work [1] by Banderier and Flajolet with all necessary calculations being made explicit. We begin with the easiest class of lattice paths to analyze. Walks or paths are lattice paths not confined to the upper-right quadrant that may end anywhere. Hence they are only restricted by their step set.

Theorem 2.2.1 (Generating function of walks [1, Theorem 1, p. 45]). The bivariate generating function of directed paths (z marking size and u marking final altitude) relative to a simple step set \mathcal{S} with characteristic polynomial $P(u)$ is a rational function. It is given by

$$W(z, u) = \frac{1}{1 - zP(u)}.$$

Proof. Let $w_n(u) = [z^n]W(z, u)$ count the number of paths ending at altitude k after a total of n steps. By decomposing a path before its very last step, we find the recursive description

$$w_0(u) = 1, \quad w_1(u) = P(u), \quad w_{n+1}(u) = w_n(u) \cdot P(u).$$

Hence, we have $w_n(u) = P(u)^n$ for all n . Therefore it holds that

$$W(z, u) = \sum_{n=0}^{\infty} z^n w_n(u) = \sum_{n=0}^{\infty} z^n P(u)^n = \frac{1}{1 - zP(u)},$$

converging for $|z| < 1/P(|u|)$. □

Next, we want to determine the generating function of walks ending at a particular altitude k , and in particular, the generating function of bridges. In this proof we will initiate the demonstration on how the complex-analytic framework proves crucially useful to the theory of lattice path enumeration.

Theorem 2.2.2 (Generating function of bridges and walks ending at altitude k [1, Theorem 1, p. 45]). Let

$$P(u) = \sum_{k=-c}^d p_k u^k$$

be the characteristic polynomial of a simple set of jumps. The generating function of bridges is an algebraic function given by

$$B(z) = z \sum_{j=1}^c \frac{u'_j(z)}{u_j(z)} = z \frac{d}{dz} \log(u_1(z) \cdots u_c(z)),$$

where $u_1(z), \dots, u_c(z)$ are the small branches of the characteristic curve. Generally, the generating function $W_k(z)$ of paths ending at altitude k for $-\infty < k < c$ is given by,

$$W_k(z) = z \sum_{j=1}^c \frac{u'_j(z)}{u_j(z)^{k+1}} = -\frac{z}{k} \frac{d}{dz} \left(\sum_{j=1}^c u_j(z)^{-k} \right)$$

and for $-d < k < \infty$,

$$W_k(z) = -z \sum_{\ell=1}^d \frac{v'_\ell(z)}{v_\ell(z)^{k+1}} = \frac{z}{k} \left(\sum_{\ell=1}^d v_\ell(z)^{-k} \right), \tag{2.3}$$

where v_1, \dots, v_d are the large branches of the characteristic curve.

Proof. As the number of bridges is trivially upper-bounded by the number of walks, we see that the radius of convergence of $B(z)$ is at least $1/P(1)$. Further, in Proposition 2.1.4 we observed that the jump polynomial $P(u)$ is a convex function for $u > 0$ and that

$$\lim_{u \rightarrow 0} \frac{1}{P(u)} = \lim_{u \rightarrow \infty} \frac{1}{P(u)} = 0.$$

Hence, $1/P(u)$ attains its unique positive maximum at τ and we can find an interval such that for all $u \in [\alpha, \beta]$ it holds that $r := \frac{1}{2P(\tau)} < \frac{1}{P(u)}$. Then, for $|z| < r$, one finds

$$|z \cdot P(u)| \leq |z|P(|u|) \leq 1.$$

Thus we observe that $W(z, u)$ is analytic in

$$\{z : |z| < r\} \times \{u : \alpha < |u| < \beta\}.$$

Now choose z sufficiently small such that all large branches lie outside and all small branches remain inside the circle $|u| \leq (\alpha + \beta)/2$. Note that due to

$$W(z, u) = \frac{1}{1 - zP(u)} = \frac{u^c}{-zp_d \prod_{i=1}^{c+d} (u - u_i(z))} = \mathcal{O}(u^c), \quad u \rightarrow 0,$$

we see that $W(z, u)/u$ does not possess a singularity at $u = 0$ for any fixed $z \neq 0$. Then, applying Cauchy's coefficient formula to $W(z, u)$ as a Laurent series in u yields

$$B(z) = [u^0]W(z, u) = \frac{1}{2\pi i} \int_{|u|=(\alpha+\beta)/2} W(z, u) \frac{du}{u} = \sum_{j=1}^c \text{Res}_{u=u_j(z)} \left(\frac{1}{u(1 - zP(u))} \right).$$

To calculate the residue, we factor the characteristic curve

$$u^c(1 - zP(u)) = -zp_d \prod_{i=1}^{c+d} (u - u_i(z)).$$

Since the small branches only contribute simple poles, we obtain

$$\text{Res}_{u=u_j(z)} \left(\frac{1}{u(1 - zP(u))} \right) = -\frac{u_j(z)^{c-1}}{p_d z} \frac{1}{\prod_{i \neq j} (u_j(z) - u_i(z))}.$$

Next, we recognize that

$$\begin{aligned} \prod_{i \neq j} (u_j(z) - u_i(z)) &= \sum_{k=1}^{c+d} \prod_{i \neq k} (u_j(z) - u_i(z)) = \frac{\partial}{\partial u} \left(\prod_{i=1}^{c+d} (u - u_i(z)) \right) \Big|_{u=u_j(z)} \\ &= \frac{1}{p_d} \frac{\partial}{\partial u} \left(u^c P(u) - \frac{u^c}{z} \right) \Big|_{u=u_j(z)} \\ &= \frac{1}{p_d} \left(cu_j(z)^{c-1} P(u_j(z)) + u_j(z)^c P'(u_j(z)) - u_j(z)^{c-1} \frac{c}{z} \right). \end{aligned}$$

Using the kernel equation we further simplify

$$\begin{aligned} \prod_{i \neq j} (u_j(z) - u_i(z)) &= \frac{1}{p_d} \left(u_j(z)^c P'(u_j(z)) - \frac{cu_j(z)^{c-1}}{z} (1 - zP(u_j(z))) \right) \\ &= \frac{1}{p_d} u_j(z)^c P'(u_j(z)). \end{aligned}$$

Thus, our residue works out to be

$$\operatorname{Res}_{u=u_j(z)} \left(\frac{1}{u(1-zP(u))} \right) = -\frac{1}{zu_j(z)P'(u_j(z))}.$$

Differentiating the characteristic equation we can further simplify

$$0 = \frac{d}{dz}(1 - zP(u(z))) = -P(u(z)) - zP'(u(z))u'(z) \iff P'(u(z)) = -\frac{1}{z^2u'(z)}.$$

This finally yields

$$B(z) = \sum_{j=1}^c \operatorname{Res}_{u=u_j(z)} \left(\frac{1}{u(1-zP(u))} \right) = z \sum_{j=1}^c \frac{u'_j(z)}{u_j(z)}.$$

The same procedure is applicable to

$$W_k(z) = [u^k]W(z, u) = \frac{1}{2\pi i} \int_{|u|=(\alpha+\beta)/2} W(z, u) \frac{du}{u^{k+1}},$$

where the additional factor u^{-k} can simply be treated as a constant in the residue calculation as long as $k < c$. For $k \geq c$, Cauchy's residue theorem would need to account the additional polar singularity at zero, messing up our formula. For that reason, when $k > -d$, the residue calculation is completed by performing a change of variables; in this case, the large branches contribute. We note that $W(z, u)$ satisfies

$$W(z, u) = \frac{1}{1-zP(u)} = \frac{u^c}{-zp_d \prod_{i=1}^{c+d} (u - u_i(z))} = \mathcal{O}(u^{-d}), \quad u \rightarrow \infty.$$

Hence, applying Cauchy's residue theorem for $k > -d$ to $\overline{W}(z, u) := W(z, 1/u)$ and performing an analogous residue calculation yields

$$\begin{aligned} W_k(z) &= [u^{-k}]\overline{W}(z, u) = \frac{1}{2\pi i} \int_{|u|=2/(\alpha+\beta)} \overline{W}(z, u) \cdot u^{k+1} du \\ &= \sum_{\ell=1}^d \operatorname{Res}_{u=v_\ell(z)^{-1}} \left(\frac{u^{k+1}}{1-zP(u^{-1})} \right) \\ &= \sum_{\ell=1}^d \frac{v'_\ell(z)}{v_\ell(z)^{k+1}}, \end{aligned}$$

as $\overline{W}(z, u) \cdot u^{k+1}$ does not possess a singularity at $u = 0$. This argument shows the formulae to be valid in a small neighborhood of the origin, which then implies the identities between the formal Laurent series a posteriori. The algebraic character of $B(z)$ and the $W_k(z)$ finally results from the well-known fact that algebraic functions are closed under sums, products and multiplicative inverses. \square

Corollary 2.2.3 (Dyck bridges). The generating function $B_{\mathcal{D}}(z) = \sum_{n=0}^{\infty} b_n z^n$ for Dyck bridges satisfies

$$B_{\mathcal{D}}(z) = \frac{1}{\sqrt{1-4z^2}} = \sum_{n=0}^{\infty} \binom{2n}{n} z^{2n}.$$

Its coefficients b_n are also known as the central binomial numbers, see OEIS A000984³.

Proof. The characteristic polynomial of Dyck bridges is given by $P(u) = 1/u + u$ and hence the kernel equation reads

$$K(z, u) = 1 - z \left(\frac{1}{u} + u \right) = 0.$$

There exists one small and one large branch of the characteristic curve:

$$u_1(z) = \frac{1 - \sqrt{1-4z^2}}{2z} \underset{z \rightarrow 0}{\sim} z, \quad u_2(z) = \frac{1 + \sqrt{1-4z^2}}{2z} \underset{z \rightarrow 0}{\sim} \frac{1}{z},$$

since

$$\sqrt{1-4z^2} = \sum_{n \geq 0} \binom{1/2}{n} (-4)^n z^{2n} = 1 - 2z^2 + \mathcal{O}(z^4).$$

After applying Theorem 2.2.2 we get

$$\begin{aligned} B_{\mathcal{D}}(z) &= z \frac{u_1'(z)}{u_1(z)} = \frac{1}{\sqrt{1-4z^2}} \\ &= 1 + 2z^2 + 6z^4 + 20z^6 + 70z^8 + 252z^{10} + 924z^{12} + 3432z^{14} + \mathcal{O}(z^{16}). \end{aligned}$$

Using Newton's generalized binomial theorem 1.4.9 we extract

$$\begin{aligned} [z^n] \frac{1}{\sqrt{1-4z}} &= [z^n] \left(\sum_{k \geq 0} \binom{-1/2}{k} (-4z)^k \right) = \frac{(-1/2) \cdot (-3/2) \cdots (-(2n-1)/2)}{n!} (-4)^n \\ &= 2^n \frac{(2n-1)!!}{n!} = 2^n \frac{(2n)!}{n!(2n)!!} = \binom{2n}{n} = [t^n](1+t^2)^n. \end{aligned}$$

The coefficients are called the central binomial numbers and are closely related to the Catalan numbers. This result can be explained very easily: In order to uniquely characterize a Dyck bridge consisting of n **NE**-steps and n **SE**-steps, we simply need to choose the positions of the **NE**-steps (or equivalently of the **SE**-steps). For this, there are $\binom{2n}{n}$ possibilities. \square

Corollary 2.2.4 (Motzkin bridges). The generating function $B_{\mathcal{M}}(z) = \sum_{n=0}^{\infty} b_n z^n$ for Motzkin bridges satisfies

$$B_{\mathcal{M}}(z) = \frac{1}{\sqrt{1-2z-3z^2}} = 1 + z + 3z^2 + 7z^3 + 19z^4 + 51z^5 + 141z^6 + 393z^7 + \mathcal{O}(z^8)$$

and its coefficients $b_n = [u^n](1+u+u^2)^n$ are also known as the central trinomial numbers; see OEIS A002426.

³Such references are links to the web-page by N. J. A. Sloane dedicated to the corresponding sequence in the On-Line Encyclopedia of Integer Sequences, <https://oeis.org>.

Proof. The characteristic curve of Motzkin paths reads $u - z - zu - zu^2 = 0$. Solving this quadratic function for u yields the two branches

$$u_1(z) = \frac{1}{2z} \left(1 - z - \sqrt{1 - 2z - 3z^2} \right), \quad u_2(z) = \frac{1}{2z} \left(1 - z + \sqrt{1 - 2z - 3z^2} \right).$$

Due to $\sqrt{1 - 2z - 3z^2} = 1 - z + \mathcal{O}(z^2)$, we conclude that $u_1(z)$ is the only small branch of the characteristic curve. Now we may apply Theorem 2.2.2 to obtain the generating function

$$B_{\mathcal{M}}(z) = z \frac{u_1'(z)}{u_1(z)} = z \frac{1 - z - \sqrt{1 - 2z - 3z^2}}{2z^2 \sqrt{1 - 2z - 3z^2}} \frac{2z}{1 - z - \sqrt{1 - 2z - 3z^2}} = \frac{1}{\sqrt{1 - 2z - 3z^2}}.$$

Further, recalling that the generating function for bridges is simply the coefficient of u^0 in the generating function of all walks $W_{\mathcal{M}}(z, u)$, we see that

$$b_n = [z^n u^0] W(z, u) = [z^n u^0] \frac{1}{1 - z(1/u + 1 + u)} = [u^n](1 + u + u^2)^n. \quad \square$$

Theorem 2.2.5 (Generating function of meanders and excursions [1, Theorem 2, p. 49]). The bivariate generating function of meanders (z marking size and u marking final altitude) relative to a simple step set \mathcal{S} with characteristic polynomial $P(u)$, is an algebraic function. It is given by

$$M(z, u) = \frac{\prod_{j=1}^c (u - u_j(z))}{u^c (1 - zP(u))} = -\frac{1}{pdz} \prod_{\ell=1}^d \frac{1}{u - v_{\ell}(z)}. \quad (2.4)$$

In particular, the generating function of excursions, $E(z) = M(z, 0)$ satisfies

$$E(z) = \frac{(-1)^{c-1}}{p-cz} \prod_{j=1}^c u_j(z) = \frac{(-1)^{d-1}}{pdz} \prod_{\ell=1}^d \frac{1}{v_{\ell}(z)}. \quad (2.5)$$

Proof. Let $m_{n,k}$ be the number of meanders of size n that end at altitude k . By the combinatorial origin of the problem, $M(z, u) = \sum_{n,k \in \mathbb{N}} m_{n,k} u^k z^n$ is bivariate analytic for $|u| \leq 1$ and $z < 1/P(1)$. Decomposing a path based on the last step added yields the recurrence

$$m_0(u) = 1, \quad m_{n+1}(u) = P(u)m_n(u) - \{u^{<0}\}P(u)m_n(u).$$

Multiplying both sides by z^{n+1} and summing over n then leads to the fundamental functional equation defining meanders:

$$\begin{aligned} \sum_{n \geq 0} m_{n+1}(u) z^{n+1} &= zP(u) \sum_{n \geq 0} m_n(u) z^n - z\{u^{<0}\}P(u) \sum_{n \geq 0} z^n m_n(u) \\ \iff M(z, u) - 1 &= zP(u)M(z, u) - z\{u^{<0}\}(P(u)M(z, u)). \end{aligned} \quad (2.6)$$

Since the characteristic polynomial $P(u)$ involves only a finite number of negative powers it can be rewritten to

$$M(z, u)(1 - zP(u)) = 1 - z \sum_{k=0}^{c-1} r_k(u) M_k(z).$$

The Laurent polynomials $r_k(u)$ are immediately computable from $P(u)$ via

$$r_k(u) := \{u^{<0}\}(u^k P(u)) = \sum_{j=-c}^{-k-1} p_j u^{j+k}.$$

For instance, if $P(u) = p_{-2}u^{-2} + p_{-1}u^{-1} + \mathcal{O}(1)$, one has

$$r_0(u) = \frac{p_{-2}}{u^2} + \frac{p_{-1}}{u}, \quad r_1(u) = \frac{p_{-2}}{u}.$$

The fundamental functional equation (2.6) appears to be grossly underdetermined with one unknown bivariate generating function and c unknown ordinary generating functions involved. Luckily, the kernel method comes to the rescue. In order to substitute the small branches into the functional equation we choose $|z| < 1/P(1)$ sufficiently small such that

- all small branches are distinct and
- all small branches satisfy $|u_i(z)| \leq 1$.

Under these conditions it is analytically legitimate to substitute any small branch of the characteristic equation in the fundamental functional equation in (2.6) to reduce the number of unknowns. The substitution yields the following system of c equations for the c unknown functions M_0, \dots, M_{c-1} :

$$z \cdot \underbrace{\begin{pmatrix} u_1(z)^c r_0(u_1(z)) & \cdots & u_1(z)^c r_{c-1}(u_1(z)) \\ \vdots & \ddots & \vdots \\ u_c(z)^c r_0(u_c(z)) & \cdots & u_c(z)^c r_{c-1}(u_c(z)) \end{pmatrix}}_{:=A} \begin{pmatrix} M_0(z) \\ \vdots \\ M_{c-1}(z) \end{pmatrix} = \begin{pmatrix} u_1(z)^c \\ \vdots \\ u_c(z)^c \end{pmatrix}.$$

If we expand the Laurent polynomials $r_k(u)$ in the matrix A we get a clearer picture of its structure, as

$$A = \begin{pmatrix} p_{-c} + p_{-c+1}u_1(z) + \cdots + p_{-2}u_1(z)^{c-2} + p_{-1}u_1(z)^{c-1} & \cdots & p_{-c}u_1(z)^{c-1} \\ \vdots & \ddots & \vdots \\ p_{-c} + p_{-c+1}u_c(z) + \cdots + p_{-2}u_c(z)^{c-2} + p_{-1}u_c(z)^{c-1} & \cdots & p_{-c}u_c(z)^{c-1} \end{pmatrix}.$$

In this form, we can see that the matrix A can be transformed into a Vandermonde matrix by iteratively adding $-p_{-c+(j-k)}/p_{-c}$ times the j -th column to the k -th column, starting from the rightmost column. Since the determinant is invariant under these elementary column operations and we have chosen z such that all small branches are distinct, we find that

$$\det(A) = p_{-c}^c \prod_{1 \leq i < j \leq c} (u_j(z) - u_i(z)) \neq 0.$$

Thus, the system is non-singular and admits a unique solution. To avoid further determinantal calculation, we make use of a cute observation by Bousquet-Mélou, introduced in [9], and define

$$N(z, u) = u^c - z \sum_{k=0}^{c-1} u^c r_k(u) M_k(z). \quad (2.7)$$

We observe that the roots of $N(z, u)$ are precisely u_1, \dots, u_c and the leading monomial of $N(z, u)$ is u^c , hence we obtain the alternative expression of

$$N(z, u) = \prod_{j=1}^c (u - u_j(z)). \quad (2.8)$$

Now we compare the constant terms in both equations. Due to (2.8) the constant term of $N(z, u)$ equals $\prod_{j=1}^c (-u_j(z))$. On the other hand, (2.7) implies that the constant term equals $-zp_{-c}M_0(z)$. Hence, we find that $M_0(z)$ satisfies

$$M_0(z) = \frac{(-1)^{c-1}}{zp_{-c}} \prod_{j=1}^c u_j(z)$$

and finally we get

$$M(z, u) = \frac{N(z, u)}{u^c(1 - zP(u))}. \quad \square$$

Corollary 2.2.6 (Generating function for walks with non-negative final altitude [1, p. 51]). Let $W^+(z, u) = \sum_{k,n=0}^{\infty} w_{n,k} z^n u^k$ denote the bivariate generating function of paths, whose intermediate steps may be negative, but that end at a non-negative final altitude $k \geq 0$. Then $W^+(z)$ satisfies

$$W^+(z, u) = z \sum_{\ell=1}^d \frac{v'_\ell(z)}{u - v_\ell(z)} = 1 + z \frac{d}{dz} (\log M(z, u)),$$

where v_1, \dots, v_d are the large branches of the characteristic curve.

Proof. We start with the formula (2.3) for the generating function for walks ending at altitude $-d < k < \infty$ and derive

$$\begin{aligned} W^+(z, u) &= \sum_{k=0}^{\infty} W_k(z) u^k = -z \sum_{k=0}^{\infty} \left(\sum_{\ell=1}^d \frac{v'_\ell(z)}{v_\ell(z)^{k+1}} \right) u^k \\ &= -z \sum_{\ell=1}^d \left(\frac{v'_\ell(z)}{v_\ell(z)} \sum_{k=0}^{\infty} \frac{u^k}{v_\ell(z)^k} \right) = -z \sum_{\ell=1}^d \frac{v'_\ell(z)}{v_\ell(z)} \frac{1}{1 - u/v_\ell(z)} \\ &= z \sum_{\ell=1}^d \frac{v'_\ell(z)}{u - v_\ell(z)}. \end{aligned}$$

Further, using formula (2.4), we note that

$$\begin{aligned} \frac{d}{dz} M(z, u) &= \left(\frac{1}{p_d z^2} - \frac{1}{p_d z} \sum_{\ell=1}^d \frac{v'_\ell(z)}{u - v_\ell(z)} \right) \prod_{\ell=1}^d \frac{1}{u - v_\ell(z)} \\ &= -\frac{1}{z} \left(1 - \sum_{\ell=1}^d \frac{v'_\ell(z)}{u - v_\ell(z)} \right) M(z, u) \end{aligned}$$

and thus

$$1 + z \frac{d}{dz} (\log M(z, u)) = z \sum_{j=1}^d \frac{v'_j(z)}{u - v_j(z)}. \quad \square$$

Corollary 2.2.7. [1, Corollary 3, p. 51] The generating function of meanders terminating at altitude k is given by

$$M_k(z) = \frac{1}{p_d z} \sum_{\ell=1}^d \xi_\ell^d(z) v_\ell^{-k-1}(z), \quad \xi_\ell^d(z) := \prod_{\substack{j=1 \\ j \neq \ell}}^d \frac{1}{v_\ell(z) - v_j(z)}.$$

Proof. Since $M(z, u)$ is a rational function in u with a simple product expression in terms of the large branches in (2.4), its expansion with respect to u is accessible via a partial fraction decomposition. Starting with the generating function

$$M(z, u) = -\frac{1}{p_d z} \prod_{\ell=1}^d \frac{1}{u - v_\ell(z)}$$

from (2.4), we claim the following partial fraction decomposition via induction over d :

$$\prod_{\ell=1}^d \frac{1}{u - v_\ell(z)} = \sum_{\ell=1}^d \frac{\xi_\ell^d(z)}{u - v_\ell(z)}.$$

A single partial fraction decomposition shows the claim to be true for $d = 2$, as

$$\frac{1}{(u - v_1(z))(u - v_2(z))} = \frac{1}{v_1(z) - v_2(z)} \cdot \frac{1}{u - v_1(z)} + \frac{1}{v_2(z) - v_1(z)} \cdot \frac{1}{u - v_2(z)}.$$

For the induction step, let the claimed formula hold for d . Then we have

$$\begin{aligned} \prod_{\ell=1}^{d+1} \frac{1}{u - v_\ell(z)} &= \left(\sum_{\ell=1}^d \frac{\xi_\ell^d(z)}{u - v_\ell(z)} \right) \frac{1}{u - v_{d+1}(z)} \\ &= \sum_{\ell=1}^d \xi_\ell^d(z) \left(\frac{1}{v_\ell(z) - v_{d+1}(z)} \frac{1}{u - v_\ell(z)} + \frac{1}{v_{d+1}(z) - v_\ell(z)} \frac{1}{u - v_{d+1}(z)} \right) \\ &= \sum_{\ell=1}^d \left(\frac{\xi_\ell^{d+1}(z)}{u - v_\ell(z)} + \frac{\xi_\ell^d(z)}{v_{d+1}(z) - v_\ell(z)} \cdot \frac{1}{u - v_{d+1}(z)} \right). \end{aligned}$$

Now we apply the induction hypothesis a second time with $v_{d+1}(z)$ replacing u and obtain

$$\begin{aligned} \prod_{\ell=1}^{d+1} \frac{1}{u - v_\ell(z)} &= \sum_{\ell=1}^d \left(\frac{\xi_\ell^{d+1}(z)}{u - v_\ell(z)} + \frac{\xi_\ell^d(z)}{v_{d+1}(z) - v_\ell(z)} \cdot \frac{1}{u - v_{d+1}(z)} \right) \\ &= \left(\sum_{\ell=1}^d \frac{\xi_\ell^{d+1}(z)}{u - v_\ell(z)} \right) + \left(\prod_{\ell=1}^d \frac{1}{v_{d+1}(z) - v_\ell(z)} \right) \frac{1}{u - v_{d+1}(z)} \\ &= \sum_{\ell=1}^{d+1} \frac{\xi_\ell^{d+1}(z)}{u - v_\ell(z)}. \end{aligned}$$

Finally, we extract the coefficient of u^k in this newly derived expression:

$$\begin{aligned} M_k(z) &= [u^k]M(z, u) = -\frac{1}{pdz}[u^k] \left(\sum_{\ell=1}^d \frac{\xi_\ell^d(z)}{u - v_\ell} \right) = \frac{1}{pdz} \sum_{\ell=1}^d \xi_\ell^d(z)[u^k] \left(\frac{1}{v_\ell(1 - \frac{u}{v_\ell})} \right) \\ &= \frac{1}{pdz} \sum_{\ell=1}^d \xi_\ell^d(z)v_\ell^{-k-1}(z). \quad \square \end{aligned}$$

Corollary 2.2.8 (Dyck meanders). The bivariate generating function $M_{\mathcal{D}}(z, u)$ for Dyck meanders satisfies

$$M_{\mathcal{D}}(z, u) = \frac{1 - 2zu - \sqrt{1 - 4z^2}}{2z(z(1 + u^2) - u)}.$$

Further, the generating function $M_{\mathcal{D}}(z, 1) = \sum_{n=0}^{\infty} m_n z^n$ of meanders ending at any altitude satisfies

$$M_{\mathcal{D}}(z, 1) = \frac{1 - 2z - \sqrt{1 - 4z^2}}{4z^2 - 2z} = 1 + z + 2z^2 + 3z^3 + 6z^4 + 10z^5 + 20z^6 + 35z^7 + \mathcal{O}(z^8).$$

and its coefficients $m_n = \binom{n}{\lfloor n/2 \rfloor}$ correspond to OEIS A001405. Even further, the generating functions

$$G_{\mathcal{D}}(z) = \sum_{n=0}^{\infty} m_{2n} z^n, \quad U_{\mathcal{D}}(z) = \sum_{n=0}^{\infty} m_{2n+1} z^n$$

of even and odd meanders, respectively, satisfy

$$G_{\mathcal{D}}(z) = \frac{1}{\sqrt{1 - 4z^2}}, \quad U_{\mathcal{D}}(z) = \frac{1}{2z} \left(\frac{1}{\sqrt{1 - 4z^2}} - 1 \right).$$

Proof. The kernel equation for Dyck walks reads $1 - z(\frac{1}{u} + u) = 0$. Solving this equation for u yields the unique small branch

$$u_1 = \frac{1 - \sqrt{1 - 4z^2}}{2z}.$$

Applying Theorem 2.2.5 we find the generating function for Dyck meanders to be

$$M_{\mathcal{D}}(z, u) = \frac{u - u_1(z)}{u(1 - zP(u))} = \frac{1 - 2zu - \sqrt{1 - 4z^2}}{2z(z(1 + u^2) - u)}.$$

Setting $u = 1$ then yields

$$M_{\mathcal{D}}(z, 1) = \frac{1 - 2z - \sqrt{1 - 4z^2}}{4z^2 - 2z}.$$

To obtain the generating function for meanders of even length, we apply a last passage decomposition. Let ω_0 be an arbitrary meander of even length. Hence, it must end at an even altitude. Now we split ω_0 every time it leaves altitude $2k$ for a last time. That means, ω_0 is composed of a Dyck excursion, followed by a sequence of subpaths, starting at altitude k and ending at $k + 2$ without returning to altitude k at any point after the start.

Each of these subpaths can thus be described as a **NE**-step up to altitude $k + 1$, followed by an excursion and finally another **NE**-step up to altitude $k + 2$. Considering that the variable z counts twice the length of a meander (or equivalently the number of **NE**-steps of a meander) the generating function for one of these subpaths reads $z(uD(z))^2$. Thus, we obtain the generating function

$$G(z, u) = \frac{D(z)}{1 - z(uD(z))^2}.$$

Setting $u = 1$ yields

$$G(z, 1) = \frac{D(z)}{1 - zD(z)^2} = \frac{D(z)}{2 - D(z)} = \frac{1 - \sqrt{1 - 4z}}{\sqrt{1 - 4z} - (1 - 4z)} = \frac{1}{\sqrt{1 - 4z}} = \sum_{n=0}^{\infty} \binom{2n}{n} z^n.$$

Further, a last passage decomposition on Dyck meanders of odd length splits ω_0 into a Dyck excursion, followed by the last **NE**-step to leave from altitude 0 and a final Dyck meander of even length. This translates to the formula

$$U(z, u) = uD(z)G(z, u).$$

Setting $u = 1$ yields

$$U(z, 1) = \frac{D(z)}{\sqrt{1 - 4z}} = \frac{1}{2z} \left(\frac{1}{\sqrt{1 - 4z}} - 1 \right) = \sum_{n=0}^{\infty} \frac{1}{2} \binom{2n+2}{n+1} z^n = \sum_{n=0}^{\infty} \binom{2n+1}{n} z^n. \quad \square$$

Corollary 2.2.9 (Motzkin meanders). The bivariate generating function $M_{\mathcal{M}}(z, u)$ for Motzkin meanders satisfies

$$M_{\mathcal{M}}(z, u) = \frac{2z(u+1) - 1 + \sqrt{1 - 2z - 3z^2}}{2z(u - z(u^2 + u + 1))}.$$

Further, the generating function $M_{\mathcal{M}}(z, 1)$ of meanders ending at any altitude satisfies

$$\begin{aligned} M_{\mathcal{M}}(z, 1) &= \frac{1 - 3z - \sqrt{1 - 2z - 3z^2}}{6z^2 - 2z} \\ &= 1 + 2z + 5z^2 + 13z^3 + 35z^4 + 96z^5 + 267z^6 + 750z^7 + \mathcal{O}(z^8). \end{aligned}$$

This counting sequence corresponds to [OEIS A005773](#), which tells us that it also counts the number of directed animals of size n . We will explore this connection further in the last chapter of this thesis.

Proof. Solving the kernel equation

$$1 - z(1 + u + u^2) = 0$$

for the Motzkin family of directed lattice paths yields the unique small branch

$$u_1(z) = \frac{1 - z - \sqrt{1 - 2z - 3z^2}}{2z}.$$

Now, all that remains is to plug $u_1(z)$ into Equation (2.4) and we obtain

$$M_{\mathcal{M}}(z, u) = \frac{u - u_1(z)}{u(1 - zP(u))} = \frac{2z(u + 1) - 1 + \sqrt{1 - 2z - 3z^2}}{2z(u - z(u^2 + u + 1))}.$$

Setting $u = 1$ then yields

$$M_{\mathcal{M}}(z, 1) = \frac{1 - 3z - \sqrt{1 - 2z - 3z^2}}{6z^2 - 2z}. \quad \square$$

We conclude this section with the two short applications of the formula (2.5) for the generating function of excursions. In particular, after Example 1.1.8 and Example 1.3.11, we now give a third distinct derivation of the fact that the number of Dyck excursions of length $2n$ equals the n -th Catalan number C_n .

Corollary 2.2.10 (Dyck excursions). The generating function $E_{\mathcal{D}}(z)$ for Dyck excursions satisfies

$$E_{\mathcal{D}}(z) = \frac{u_1(z)}{z} = \frac{1 - \sqrt{1 - 4z^2}}{2z^2} = \sum_{n=0}^{\infty} \frac{1}{n+1} \binom{2n}{n} z^{2n}.$$

Corollary 2.2.11 (Motzkin excursions). The generating function $E_{\mathcal{M}}(z, 1)$ for Motzkin excursions satisfies

$$\begin{aligned} E_{\mathcal{M}}(z, 1) &= \frac{u_1(z)}{z} = \frac{1 - z - \sqrt{1 - 2z - 3z^2}}{2z^2} \\ &= 1 + z + 2z^2 + 4z^3 + 9z^4 + 21z^5 + 51z^6 + 127z^7 + \mathcal{O}(z^8) \end{aligned}$$

and its coefficients are known as the *Motzkin numbers*; see OEIS A001006

2.3 Singularity analysis

First Principle of Coefficient Asymptotics. The location of a function's singularities dictates the exponential growth (A^n) of its coefficients.

Second Principle of Coefficient Asymptotics. The nature of a function's singularities determines the associate subexponential factor ($\theta(n)$).

PHILIPPE FLAJOLET and ROBERT SEDGEWICK [14, p. 227]

In this section, we present a concise introduction to the general approach to the analysis of coefficients of generating functions. We will base our exposition on the excellent presentation on this topic by Flajolet and Sedgewick in [14, Chapter VI].

Through the lens of complex analysis a generating function becomes a geometric transformation of the complex plane. While this transformation is very regular at the origin, when we move away from it, singularities start to appear that distort this smooth picture. As it turns out, the nature and the location of a function's singularities hold the key for determining the asymptotic growth rates of the coefficients. Precisely, the method of singularity analysis applies to functions, whose singular expansion involves fractional powers and

logarithms. In order not to clutter the important conceptual points with tedious technical details, we will restrict our attention to only fractional powers and give notice whenever the results may be generalized to so-called “algebraic-logarithmic” singularities. The process relies on two central ingredients:

1. A catalogue of asymptotic expansions for coefficients of the standard functions that occur in such singular expansions.
2. Transfer theorems, which allow us to extract the asymptotic order of coefficients of error terms in singular expansions.

Before we introduce the catalogue known as the *standard function scale*, let us return to the basics for a second. Remember the Newton expansion

$$(1 - z)^{-\alpha} = \sum_{n=0}^{\infty} \binom{n + \alpha - 1}{n} z^n.$$

For $\alpha = r \in \mathbb{Z}_{\geq 1}$ this quickly leads to the asymptotic formula

$$[z^n](1 - z)^{-r} = \frac{(n + 1)(n + 2) \cdots (n + r - 1)}{(r - 1)!} = \frac{n^{r-1}}{(r - 1)!} \left(1 + \mathcal{O}\left(\frac{1}{n}\right) \right).$$

The standard function scale will generalize this result to arbitrary complex α with the help of special contours of integration, known as *Hankel contours*. The motivation behind them is to come very close to the singularities, but to steer away at the last moment, thus capturing the essential asymptotic information contained in the functions’ singularities.

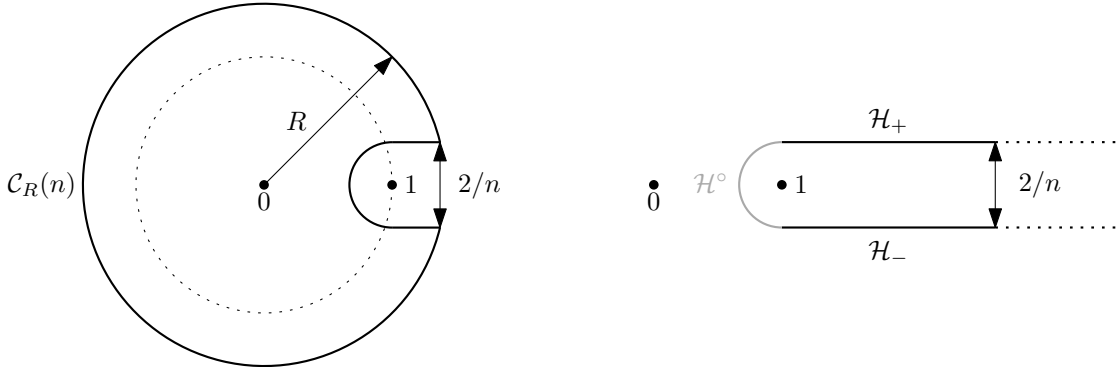

Figure 2.2: The contours $\mathcal{C}_{\mathcal{R}}(n)$ and $\mathcal{H}(n)$ used for estimating the coefficients of functions from the standard function scale [14, Figure VI.2, p. 381].

Theorem 2.3.1 (Standard function scale [14, Theorem VI.1, p. 381]). Let α be an arbitrary complex number in $\mathbb{C} \setminus \mathbb{Z}_{\leq 0}$. The coefficient of z^n in $f(z) = (1 - z)^{-\alpha}$ admits for large n a complete asymptotic expansion in descending powers of n :

$$[z^n]f(z) \sim \frac{n^{\alpha-1}}{\Gamma(\alpha)} \left(1 + \sum_{k=1}^{\infty} \frac{e_k}{n^k} \right),$$

where e_k is a polynomial in α of degree $2k$. In particular:

$$[z^n]f(z) \sim \frac{n^{\alpha-1}}{\Gamma(\alpha)} \left(1 + \frac{\alpha(\alpha-1)}{2n} + \frac{\alpha(\alpha-1)(\alpha-2)(3\alpha-1)}{24n^2} + \frac{\alpha^2(\alpha-1)^2(\alpha-2)(\alpha-3)}{48n^3} + \mathcal{O}\left(\frac{1}{n^4}\right) \right).$$

The quantity e_k is a polynomial in α that is divisible by $\alpha(\alpha-1)\cdots(\alpha-k)$, in accordance with the fact that the asymptotic expansion terminates when $\alpha \in \mathbb{Z}_{\geq 0}$. The formula is even valid (but not very meaningful) for $\alpha \in \mathbb{Z}_{\leq 0}$, as $1/\Gamma(\alpha) = 0$ and the coefficients $[z^n](1-z)^{-\alpha}$ are zero for $n > -\alpha$.

Proof. We start by applying Cauchy's coefficient formula, with a sufficiently small contour \mathcal{C}_0 encircling the origin, to obtain

$$f_n = \frac{1}{2\pi i} \int_{\mathcal{C}_0} (1-z)^{-\alpha} \frac{dz}{z^{n+1}}.$$

We now deform \mathcal{C}_0 to a large circle with radius $R > 1$ that does not cross the half-line $[1, \infty[$. More precisely, the new contour $\mathcal{C}_R(n)$ consists of the following parts (see Figure 2.2):

1. $\mathcal{C}_R^\circ(n) := \{z \in \mathbb{C} : |z| = R\} \setminus \{z \in \mathbb{C} : (\Im(z) < 1/n) \wedge (\Re(z) > 0)\}$
2. $\mathcal{H}_R^+(n) := \{z \in \mathbb{C} : z = x + i/n, x \in [1, R]\}$
3. $\mathcal{H}_R^-(n) := \{z \in \mathbb{C} : z = x - i/n, x \in [1, R]\}$
4. $\mathcal{H}^\circ(n) := \{z \in \mathbb{C} : z = 1 - (1/n) \cdot \exp(i\varphi), \varphi \in [-\pi/2, \pi/2]\}$

As R tends to infinity the integrand along $\mathcal{C}_R^\circ(n)$ decreases as $\mathcal{O}(R^{-n-1-\alpha})$. Hence the limit process produces the Hankel contour $\mathcal{H}(n)$ consisting of

1. $\mathcal{H}^+(n) := \{z \in \mathbb{C} : z = x + i/n, x \geq 1\}$
2. $\mathcal{H}^-(n) := \{z \in \mathbb{C} : z = x - i/n, x \geq 1\}$
3. $\mathcal{H}^\circ(n) := \{z \in \mathbb{C} : z = 1 - (1/n) \cdot \exp(i\varphi), \varphi \in [-\pi/2, \pi/2]\}$

We apply a change of variables by introducing $z = 1 + t/n$. This leads to

$$f_n = \frac{n^{\alpha-1}}{2\pi i} \int_{\mathcal{H}(n)} (-t)^{-\alpha} \left(1 + \frac{t}{n}\right)^{-n-1} dt.$$

Next we calculate the asymptotic estimate

$$\begin{aligned} \left(1 + \frac{t}{n}\right)^{-n-1} &= \exp\left(- (n+1) \log\left(1 + \frac{t}{n}\right)\right) \\ &= \exp(-t) \left(1 + \frac{t^2 - 2t}{2n} + \frac{3t^4 - 20t^3 + 24t^2}{24n^2} + \mathcal{O}\left(\frac{1}{n^3}\right)\right). \end{aligned} \tag{2.9}$$

Hence, we can see that the integrand converges pointwise to $\exp(-t)$ and even uniformly in any bounded domain. Applying Hankel's formula for the Gamma function [14, Theorem B.1, p. 745] yields

$$\frac{1}{\Gamma(\alpha)} = \frac{1}{2\pi i} \int_{\mathcal{H}(n)} (-t)^{-\alpha} \exp(-t) dt.$$

Hence, it only remains to argue that integration and limit can be interchanged. For that purpose we split the contour at the half-line $\Re(z) = \log^2(n)$. Firstly, we establish that the part corresponding to $\Re(z) \geq \log^2(n)$ is indeed negligible in the scale of the problem. After substituting $u = t + \log^2 n$ and observing

$$\begin{aligned} \exp(\log^2 n) \left(1 + \frac{u + \log^2 n}{n}\right)^{-n-1} &= \exp\left(\log^2 n - (n+1) \log\left(1 + \frac{u + \log^2 n}{n}\right)\right) \\ &= \exp\left(\log^2 n - (n+1) \left(\frac{u + \log^2 n}{n} + \mathcal{O}\left(\frac{\log^4 n}{n^2}\right)\right)\right) \\ &= \exp\left(-u + \mathcal{O}\left(\frac{\log^4 n}{n}\right)\right) \\ &\xrightarrow{n \rightarrow \infty} \exp(-u), \end{aligned}$$

we may apply the dominated convergence theorem. This yields, for $\alpha < 0$,

$$\begin{aligned} &\lim_{n \rightarrow \infty} \left| \exp(\log^2 n) \log^{2\alpha} n \int_{\log^2 n}^{\infty} (-t)^{-\alpha} \left(1 + \frac{t}{n}\right)^{-n-1} dt \right| \\ &\leq \lim_{n \rightarrow \infty} \left(\int_0^{\infty} u^{-\alpha} \exp(\log^2 n) \left(1 + \frac{u + \log^2 n}{n}\right)^{-n-1} du \right) \\ &= \int_0^{\infty} u^{-\alpha} \exp(-u) du = \Gamma(1 - \alpha) < \infty. \end{aligned}$$

For $\alpha \geq 0$, we have

$$\begin{aligned} &\lim_{n \rightarrow \infty} \left| \exp(\log^2 n) \int_{\log^2 n}^{\infty} (-t)^{-\alpha} \left(1 + \frac{t}{n}\right)^{-n-1} dt \right| \\ &\leq \lim_{n \rightarrow \infty} \left(\int_0^{\infty} \exp(\log^2 n) \left(1 + \frac{u + \log^2 n}{n}\right)^{-n-1} du \right) \\ &= \int_0^{\infty} \exp(-u) du = 1 < \infty. \end{aligned}$$

Finally, we observe that

$$\exp(-\log^2 n) = o(\exp(-k \log n)) = o(n^{-k})$$

for any fixed k . Further, $f_n(t)$ converges uniformly to $(-t)^{-\alpha} \exp(-t)$ for $|t| \leq \log^2(n)$ and

thus we have the asymptotic estimate

$$\begin{aligned} f_n &= \frac{n^{\alpha-1}}{2\pi i} \left(\int_{\mathcal{H}(n)_{<\log^2 n}} (-t)^{-\alpha} \left(1 + \frac{t}{n}\right)^{-n-1} dt + \int_{\mathcal{H}(n)_{\geq\log^2 n}} (-t)^{-\alpha} \left(1 + \frac{t}{n}\right)^{-n-1} dt \right) \\ &= \frac{n^{\alpha-1}}{2\pi i} \left(\left(1 + \mathcal{O}\left(\frac{\log^2 n}{n}\right)\right) \left(\int_{\mathcal{H}(n)_{<\log^2 n}} (-t)^{-\alpha} \exp(-t) dt \right) + o\left(n^{-k} \log^{2|\alpha|} n\right) \right) \\ &\xrightarrow{n \rightarrow \infty} \frac{n^{\alpha-1}}{\Gamma(\alpha)} \left(1 + \mathcal{O}\left(\frac{\log^2 n}{n}\right)\right). \end{aligned}$$

Now we can use a terminating form of the asymptotic expansion in (2.9) to develop an expansion to any predetermined order. This is possible because $t/n = \mathcal{O}((\log^2 n)/n)$ is small. To simplify the expansion we make use of the property of the Gamma function that

$$\frac{1}{\Gamma(\alpha - k)} = \frac{1}{\Gamma(\alpha)} (\alpha - 1) \cdots (\alpha - k).$$

We develop it as an example up to $\mathcal{O}(n^{-2})$:

$$\begin{aligned} f_n &\sim \frac{n^{\alpha-1}}{2\pi i} \int_{\mathcal{H}} (-t)^{-\alpha} \exp(-t) \left(1 + \frac{t^2 - 2t}{2n}\right) dt \\ &= \frac{n^{\alpha-1}}{\Gamma(\alpha)} \left(1 + \frac{1}{2n}(\alpha - 1)(\alpha - 2) + \frac{1}{n}(\alpha - 1)\right) \\ &= \frac{n^{\alpha-1}}{\Gamma(\alpha)} \left(1 + \frac{\alpha(\alpha - 1)}{2n}\right). \quad \square \end{aligned}$$

As indicated in the beginning of the section, the standard function scale can be extended to a wider class of functions. We state the corresponding result here without proof and refer the inclined reader to [13] for a thorough treatment.

Theorem 2.3.2 (Standard function scale, logarithms [14, Theorem VI.2, p. 385]). Let $\alpha \in \mathbb{C} \setminus \mathbb{Z}_{\leq 0}$. Then, the coefficient of z^n in the function

$$f(z) = (1 - z)^{-\alpha} \left(\frac{1}{z} \log \frac{1}{1 - z}\right)^\beta$$

admits for large n a full asymptotic expansion in descending powers of $\log n$ with

$$f_n = [z^n]f(z) \sim \frac{n^{\alpha-1}}{\Gamma(\alpha)} (\log n)^\beta \left(1 + \frac{C_1}{\log n} + \frac{C_2}{\log^2 n} + \cdots\right),$$

where

$$C_k = \binom{\beta}{k} \Gamma(\alpha) \left(\frac{d^k}{ds^k} \frac{1}{\Gamma(s)}\right) \Big|_{s=\alpha}.$$

In Table 2.2 we illustrate the asymptotic form of coefficients of the most commonly encountered functions belonging to the standard function scale.

A technical aid to establish the transfer theorems necessary to bound the perturbation in the asymptotics of the coefficients, introduced by error terms in the singular expansions, is the concept of a Δ -domain.

Function	Coefficients
$(1 - z)^{3/2}$	$\frac{1}{\sqrt{\pi n^5}} \left(\frac{3}{4} + \frac{45}{32n} + \frac{1155}{512n^2} + \mathcal{O}\left(\frac{1}{n^3}\right) \right)$
$(1 - z)$	(0)
$(1 - z)^{1/2}$	$-\frac{1}{\sqrt{\pi n^3}} \left(\frac{1}{2} + \frac{3}{16n} + \frac{25}{256n^2} + \mathcal{O}\left(\frac{1}{n^3}\right) \right)$
1	(0)
$(1 - z)^{-1/2}$	$\frac{1}{\sqrt{\pi n}} \left(1 - \frac{1}{8n} + \frac{1}{128n^2} + \frac{5}{1024n^3} + \mathcal{O}\left(\frac{1}{n^4}\right) \right)$
$(1 - z)^{-1}$	1
$(1 - z)^{-3/2}$	$\sqrt{\frac{n}{\pi}} \left(2 + \frac{3}{4n} - \frac{7}{64n^2} + \mathcal{O}\left(\frac{1}{n^3}\right) \right)$
$(1 - z)^{-2}$	$n + 1$
$(1 - z)^{-3}$	$\frac{n^2}{2} + \frac{3n}{2} + 1$

Table 2.2: Table of commonly encountered functions within the standard function scale [14, Figure VI.5, p. 388].

Definition 2.3.3 (Δ -domain). Given two numbers ϕ, R with $R > 1$ and $0 < \phi < \frac{\pi}{2}$, the open Δ -domain $\Delta(\phi, R)$ at one is defined as

$$\Delta(\phi, R) = \{ z : |z| < R, z \neq 1, |\arg(z - 1)| > \phi \}.$$

For a complex number $\zeta \neq 0$, a Δ -domain at ζ is the image by the mapping $z \mapsto \zeta z$ of a Δ -domain at 1. A function is Δ -analytic if it is analytic in some Δ -domain.

Theorem 2.3.4 (\mathcal{O} -Transfer [14, Theorem VI.3, p. 390]). Let $\alpha \in \mathbb{R}$ be an arbitrary real number and let $f(z)$ be a function that is Δ -analytic. Assume that $f(z)$ satisfies in the intersection of a neighborhood of one with its Δ -domain the condition

$$f(z) = \mathcal{O}\left((1 - z)^{-\alpha}\right).$$

Then it holds that $[z^n]f(z) = \mathcal{O}(n^{\alpha-1})$.

Proof. Assume that f is analytic in the domain $\Delta(\phi, R)$, let $1 < r < R$ and $\phi < \theta < \pi/2$. Then we define the contour $\gamma = \gamma_1 \cup \gamma_2 \cup \gamma_3 \cup \gamma_4$ (see Figure 2.3) through

$$\begin{aligned} \gamma_1 &= \{ z : |z - 1| = 1/n, |\arg(z - 1)| \geq \theta \}, \\ \gamma_2 &= \{ z : 1/n \leq |z - 1|, |z| \leq r, \arg(z - 1) = \theta \}, \\ \gamma_3 &= \{ z : |z| = r, |\arg(z - 1)| = \theta \}, \\ \gamma_4 &= \{ z : 1/n \leq |z - 1|, |z| \leq r, \arg(z - 1) = -\theta \}. \end{aligned}$$

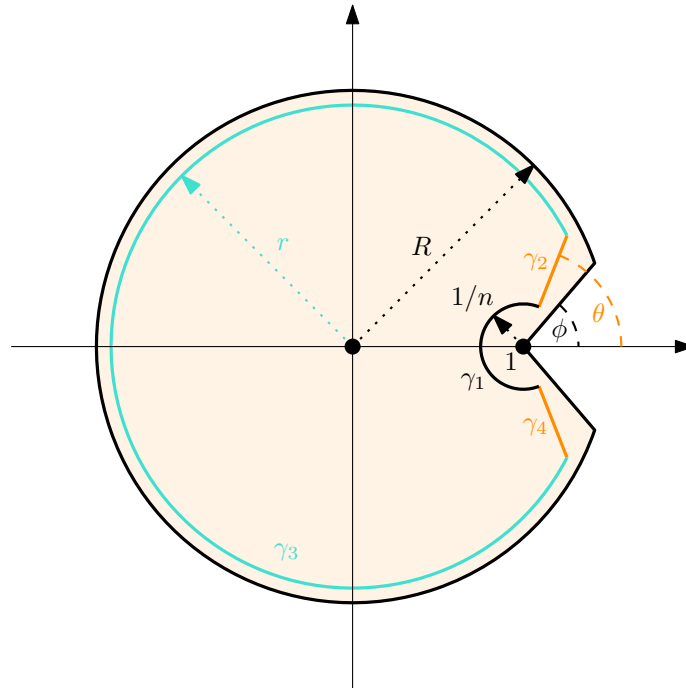

Figure 2.3: The integration contour γ in the domain $\Delta(\phi, R)$.

Under these assumption, the contour γ lies entirely inside the domain of analyticity of f . Now we apply Cauchy's coefficient formula to obtain

$$f_n = [z^n]f(z) = \frac{1}{2\pi i} \int_{\gamma} f(z) \frac{dz}{z^{n+1}}.$$

Next, we proceed by bounding the absolute value of the integral along each of the four partial contours separately. For that purpose we define

$$f_n^{(j)} = \frac{1}{2\pi i} \int_{\gamma_j} f(z) \frac{dz}{z^{n+1}}.$$

By assumption, there exists a $K > 0$ such that $|f(z)| < K \cdot |1 - z|^{-\alpha}$ in the intersection of a neighborhood of one with $\Delta(\phi, R)$.

1. We start by considering the inner circle γ_1 . Since the integrand is bounded by $K \cdot n^{\alpha}$ we obtain the simple estimate $|f_n^{(1)}| \leq K \cdot n^{\alpha-1}$.
2. Next, we bound the rectilinear parts along γ_2 and γ_4 . Setting $\omega = \exp(i\theta)$ and performing the change of variable $z = 1 + \omega t/n$, we find

$$|f_n^{(2)}| \leq \frac{n}{2\pi} \int_1^{\infty} K \cdot \left(\frac{t}{n}\right)^{-\alpha} \left|1 + \frac{\omega t}{n}\right|^{-n-1} dt.$$

From the relation

$$\left|1 + \frac{\omega t}{n}\right| \geq 1 + \Re\left(\frac{\omega t}{n}\right) = 1 + \frac{t}{n} \cos \theta,$$

there results the inequality

$$|f_n^{(2)}| \leq \frac{K \cdot n^{\alpha-1}}{2\pi} J_n, \quad \text{with} \quad J_n = \int_1^\infty t^{-\alpha} \left(1 + \frac{t \cos \theta}{n}\right)^{-n-1} dt.$$

For any given α , the integrals J_n are all bounded above by some constant since they admit the limit

$$J_n \xrightarrow{n \rightarrow \infty} \int_1^\infty t^{-\alpha} \exp(-t \cos \theta) dt < \infty,$$

where the condition $0 < \theta < \pi/2$ ensures convergence of the integral. Thus, we obtain the bound

$$|f_n^{(2)}| = \mathcal{O}(n^{\alpha-1})$$

and similar arguments show the same bound for $f_n^{(4)}$.

3. Finally we consider the contribution from the integral along the outer circle γ_3 . There the integrand remains bounded while z^{-n} is of order $\mathcal{O}(r^{-n})$. Hence, $f_n^{(3)}$ is exponentially small and negligible in the scale of the problem.

In summary, each of the four integrals of the split contour are bounded by $\mathcal{O}(n^{\alpha-1})$ and thus the statement of the theorem follows. \square

As we indicated at the start of this section, this theorem even holds for a larger class of functions, which the theorem below captures.

Theorem 2.3.5 (\mathcal{O} -Transfer, logarithms [14, Theorem VI.3, p. 390]). Let $\alpha, \beta \in \mathbb{R}$ be arbitrary real numbers and let $f(z)$ be a function that is Δ -analytic. Assume that $f(z)$ satisfies in the intersection of a neighborhood of one with its Δ -domain the condition

$$f(z) = \mathcal{O} \left((1-z)^{-\alpha} \left(\log \frac{1}{1-z} \right)^\beta \right).$$

Then it holds that $[z^n]f(z) = \mathcal{O}(n^{\alpha-1}(\log n)^\beta)$.

A similar proof also shows another variant of the Transfer Theorem.

Theorem 2.3.6 (o -Transfer, logarithms [14, Theorem VI.3, p. 390]). Let $\alpha, \beta \in \mathbb{R}$ be arbitrary real numbers and let $f(z)$ be a function that is Δ -analytic. Assume that $f(z)$ satisfies in the intersection of a neighborhood of one with its Δ -domain the condition

$$f(z) = o \left((1-z)^{-\alpha} \left(\log \frac{1}{1-z} \right)^\beta \right)$$

Then it holds that $[z^n]f(z) = o(n^{\alpha-1}(\log n)^\beta)$.

An immediately corollary of the \mathcal{O} - and the o -transfer combined is the transfer of asymptotic equivalence from singular forms to coefficients.

Corollary 2.3.7 (\sim -Transfer [14, Corollary VI.1, p. 392]). Assume that $f(z)$ is Δ -analytic and

$$f(z) \sim (1 - z)^{-\alpha}$$

for $z \rightarrow 1, z \in \Delta_1$ with $\alpha \notin \mathbb{Z}_{\leq 0}$. Then, the coefficients of f satisfy

$$[z^n]f(z) \sim \frac{n^{\alpha-1}}{\Gamma(\alpha)}.$$

Proof. It suffices to observe that, with $g(z) = (1 - z)^{-\alpha}$, one has

$$f(z) \sim g(z) \iff f(z) = g(z) + o(g(z)).$$

Then we apply the \mathcal{O} -Transfer Theorem 2.3.4 to the first term and the o -Transfer Theorem 2.3.6 to the remainder, yielding the claim. \square

We summarize these findings in the following proposition, which describes a procedural approach for applying singularity analysis to a function with a single dominant singularity.

Proposition 2.3.8 (Process of singularity analysis [14, Figure VI.7, p. 394]). Let $f(z)$ be a function, analytic at zero, whose coefficients are to be analyzed.

1. Determine the dominant singularity ρ of $f(z)$ and check that $f(z)$ has no other singularities on its circle of convergence.
2. Establish that $f(z)$ is analytic in a Δ -domain Δ_ρ around ρ .
3. Analyze the function $f(z)$ as $z \rightarrow \rho$ in Δ_ρ and determine a singular expansion of the form

$$f(z) = \sigma(z/\rho) + \mathcal{O}(\tau(z/\rho)) \quad \text{with} \quad \tau(z) = o(\sigma(z)), \quad \text{as } z \rightarrow \rho.$$

In order to proceed to the next step, the functions σ and τ should belong to the standard scale of functions.

4. Translate the main term $\sigma(z)$ using the standard function scale (Theorem 2.3.1), transfer the error term using the Transfer Theorem 2.3.4 and conclude that

$$[z^n]f(z) = \rho^{-n}\sigma_n + \mathcal{O}(\rho^{-n}\tau_n),$$

where $\sigma_n = [z^n]\sigma(z)$ and $\tau_n = [z^n]\tau(z)$.

As a first application of the process of singularity analysis we derive the asymptotic behavior of the most famous sequence in combinatorics, the Catalan numbers.

Corollary 2.3.9. The Catalan numbers satisfy the following asymptotic expansion:

$$C_n = \frac{1}{n+1} \binom{2n}{n} = \frac{4^n}{\sqrt{\pi n^3}} \left(1 + \mathcal{O}\left(\frac{1}{n}\right) \right).$$

Proof. Due to Example 1.3.11 we know the generating function of the Catalan numbers to be

$$C(z) = \sum_{n=0}^{\infty} \frac{1}{n+1} \binom{2n}{n} z^n = \frac{1 - \sqrt{1-4z}}{2z}.$$

Due to its simple form, we immediately recognize its dominant singularity at $\rho = 1/4$. Using the functional equation $C(z) - C^2(z) - 1 = 0$ we can now derive an asymptotic expansion at the singularity. Substituting $z = 1/4 - Z$ and $C(z) = 2 + Y$ we shift the singularity to zero and eliminate the constant term in the expansion. The functional equation now reads

$$Q(Z, Y) = -\frac{1}{4}Y^2 + 4Z + 4ZY + ZY^2.$$

The theory of Puiseux expansions now gives us a priori the existence of solutions of the type

$$Y = cZ^\alpha(1 + o(1))$$

for some $c \neq 0, \alpha \in \mathbb{Q}$. Plugging this asymptotic estimate into our functional equation yields

$$Q(Z, Y) \sim -\frac{c^2}{4}Z^{2\alpha} + 4Z + 4cZ^{1+\alpha} + cZ^{1+2\alpha}.$$

To satisfy this equation identically, two exponents need to coincide and the corresponding monomials need to cancel each other. This is only possible for $2\alpha = 1$ and $c^2 = 16$. Hence, $Q(Z, Y) = 0$ is asymptotically consistent with

$$Y \sim 4Z^{1/2}, \quad Y \sim -4Z^{1/2},$$

corresponding to the two branches of the algebraic equation. Reversing the substitutions we thus obtain the asymptotic expansion

$$C(z) = 2 - 2\sqrt{1-4z} + \mathcal{O}(1-4z).$$

This process can be iterated upon subtracting dominant terms to obtain a complete asymptotic expansion. For that we take the ansatz $Y \sim -4Z^{1/2} + cZ$. Plugging this asymptotic estimate into $Q(Z, Y)$ we obtain

$$\begin{aligned} Q(Z, Y) &\sim -\frac{1}{4} \left(-4Z^{1/2} + cZ\right)^2 + 4Z + 4Z \left(-4Z^{1/2} + cZ\right) + Z \left(-4Z^{1/2} + cZ\right)^2 \\ &= -\frac{1}{4} \left(16Z + c^2Z^2 - 8cZ^{3/2}\right) + 4Z - 16Z^{3/2} + 4cZ^2 + Z \left(16Z + c^2Z^2 - 8cZ^{3/2}\right) \\ &= (2c - 16)Z^{3/2} - \left(\frac{c^2}{4} + 4c + 16\right)Z^2 - 8cZ^{5/2} + c^2Z^3. \end{aligned}$$

This then immediately yields $c = 8$. One more:

$$Y \sim -4Z^{1/2} + 8Z + cZ^{3/2}.$$

We get

$$Q(Z, Y) \sim (2c + 32)Z^2 + \mathcal{O}\left(Z^{3/2}\right).$$

Finally, we get $c = -16$ and

$$C(z) = 2 - 2\sqrt{1-4z} + 2(1-4z) - 2(1-4z)^{3/2} + \mathcal{O}((1-4z)^2).$$

Define $\sigma(u) = 2 - 2\sqrt{1-u} + 2(1-u) - 2(1-u)^{3/2} + 2(1-u)^2$ and $\tau(u) = (1-u)^{5/2}$. Now that we have expanded $C(z)$ into the form

$$C(z) = \sigma(4z) + \mathcal{O}(\tau(4z)),$$

we can start translating via the standard function scale (Theorem 2.3.1):

$$\begin{aligned} \sigma_n &= [z^n]\sigma(z) = -2[z^n]\left(\sqrt{1-4z} + (1-4z)^{3/2}\right) \\ &\sim -2\frac{n^{-3/2}}{\Gamma(-1/2)}\left(1 + \sum_{k \geq 0} \frac{e_k\left(-\frac{1}{2}\right)}{n^k}\right) - 2\frac{n^{-5/2}}{\Gamma(-3/2)}\left(1 + \sum_{k \geq 0} \frac{e_k\left(-\frac{3}{2}\right)}{n^k}\right) \\ &= \frac{1}{\sqrt{\pi n^3}}\left(1 + \frac{3}{8n} + \mathcal{O}\left(\frac{1}{n^2}\right)\right) - \frac{3}{2\sqrt{\pi n^5}}\left(1 + \mathcal{O}\left(\frac{1}{n}\right)\right). \\ &= \frac{1}{\sqrt{\pi n^3}}\left(1 - \frac{9}{8n} + \mathcal{O}\left(\frac{1}{n^2}\right)\right). \end{aligned}$$

Similarly, we have

$$\tau_n = [z^n]\tau(z) \sim \frac{n^{-7/2}}{\Gamma(-3/2)}\left(1 + \sum_{k \geq 0} \frac{e_k}{n^k}\right) = \mathcal{O}\left(\frac{3}{4\sqrt{\pi n^7}}\right).$$

After translating the error via the Transfer Theorem 2.3.4, we thus get

$$[z^n]D(z) = 4^n \sigma_n + 4^n \cdot \mathcal{O}(\tau_n) = \frac{4^n}{\sqrt{\pi n^3}}\left(1 - \frac{9}{8n} + \mathcal{O}\left(\frac{1}{n^2}\right)\right). \quad \square$$

We conclude this section with a helpful tool for the identification of dominant singularities, which was originally formulated by Giulio Vivanti in 1893 and proved by Alfred Pringsheim in 1894. The proof of the so-called Pringsheim Theorem is based on the following lemma, which guarantees the existence of a singular point on the circle of convergence.

Lemma 2.3.10 (Existence of singular points [24, p. 234]). On the boundary of the disk of convergence of a power series $f(z) = \sum_{n=0}^{\infty} f_n(z-z_0)^n$ there is always at least one singular point of f .

Proof. Let the radius of convergence be bounded and let $B := B_R(z_0)$ be the disk of convergence. Assume that there are no singular points of f on B . For every $w \in \partial B$ there is a disc $B_r(w)$ of positive radius $r(w)$ and a holomorphic function g in $B_r(w)$ such that

f and g coincide in $B \cap B_r(w)$. Choose a finite cover $B_r(w_1) \cup \dots \cup B_r(w_n) \supseteq \partial B$ of the compact boundary of the disk. There exists an $\tilde{R} > R$ such that

$$\tilde{B} := B_{\tilde{R}}(z_0) \subseteq B \cup B_r(w_1) \cup \dots \cup B_r(w_n).$$

Let g_j be holomorphic in $B_r(w_j)$ with

$$f|(B \cap B_r(w_j)) = g|(B \cap B_r(w_j)).$$

Now we define $\tilde{f}: \tilde{B} \rightarrow \mathbb{C}$ as an extension of f . If $z \in \tilde{B} \setminus B$, choose a disk $B_r(w_j) \ni z$ and set $\tilde{f}(z) = g_j(z)$. This function is well-defined, because for $B_r(w_j) \cap B_r(w_k) \neq \emptyset$ there is also

$$D := B_r(w_j) \cap B_r(w_k) \cap B \neq \emptyset.$$

By definition both g_j and g_k must coincide with f in D and due to the Identity Theorem 1.4.3 they must also coincide in $B_r(w_j) \cap B_r(w_k)$. Now \tilde{f} is a holomorphic function in \tilde{B} coinciding with f in B with a larger radius of convergence than f contradicting our assumption. \square

Theorem 2.3.11 (Pringsheim's theorem [24, p. 235]). Let $f(z) = \sum_{n=0}^{\infty} f_n z^n$ be a power series with positive finite radius of convergence R and suppose that all but finitely many of its coefficients f_n are non-negative real numbers. Then $z = R$ is a singularity of $f(z)$.

Proof. Without loss of generality we assume $R = 1$. Suppose f were not singular at $z = 1$. Then its Taylor series centered at $1/2$ would be holomorphic at one. Hence, by Lemma 2.3.10 its radius of convergence would be $r > 1/2$. Further, for every ζ with $|\zeta| = 1/2$ we have:

$$\left| \frac{1}{n!} f^{(n)}(\zeta) \right| = \frac{1}{n!} \frac{d^n}{d\zeta^n} \left| \sum_{k=0}^{\infty} a_k \zeta^k \right| = \left| \sum_{k=n}^{\infty} \binom{k}{n} a_k \zeta^{k-n} \right| \leq \sum_{k=n}^{\infty} \binom{k}{n} a_k \left(\frac{1}{2} \right)^{k-n} = \frac{1}{n!} f^{(n)} \left(\frac{1}{2} \right).$$

Hence, for every ζ with $|\zeta| = 1/2$ the radius of convergence of the Taylor series centered at ζ would be at least $r > 1/2$. As a result there would be no singular point of f on $\partial \mathbb{E}$ contradicting the previous Lemma 2.3.10. \square

3 Basketball walks

This chapter is based on and extends the work by Banderier, Krattenthaler, Krinik, D. Kruchinin, V. Kruchinin, Nguyen and Wallner in [2]. In this article, the authors investigate a wide class of lattice paths with symmetric step sets $\{-h, \dots, -1, 1, \dots, h\}$. For $h = 1$, this corresponds to the classical Dyck paths and $h = 2$ yields the eponymous basketball walks, which will be the main focus of this chapter. We derive their generating functions, as well as closed form formulae for the coefficients of the counting sequences and their corresponding asymptotic growth rates. In addition, we present a novel combinatorial derivation of a generating function (Proposition 3.1.5) that was previously only accessible via contour integrals and residue calculations. Further, we will correct some typos in the original paper, which will be highlighted with a footnote.

Definition 3.0.1. *Basketball walks* are simple lattice paths constructed from the step set $\{-2, -1, 1, 2\}$. The name refers to the evolution of the score during a basketball game before the introduction of the 3-point rule. *Positive basketball walks* are basketball meanders staying strictly above the x -axis, possibly touching it at the first or last step.

3.1 Generating functions

Let $G_{j,n,k}$ be the number of positive basketball walks starting at $(0, j)$ and ending at (n, k) for $j, k \geq 0$ and define

$$G_j(z, u) := \sum_{n,k=0}^{\infty} G_{j,n,k} z^n u^k = \sum_{n=0}^{\infty} g_{j,n}(u) z^n = \sum_{k=0}^{\infty} G_{j,k}(z) u^k.$$

We note that this bivariate generating function is analytic for $|z| < 1/P(1)$ and $|u| \leq 1$. Further, the characteristic polynomial is given by

$$P(u) = u^{-2} + u^{-1} + u + u^2$$

and thus the kernel equation

$$K(z, u) = u^2 - z(1 + u + u^3 + u^4) \tag{3.1}$$

admits two small roots, $u_1(z)$ and $u_2(z)$, as well as two large roots, $v_1(z)$ and $v_2(z)$.

Remark 3.1.1 (Time reversal). Due to the symmetry of the step set, we observe that mirroring a basketball walk across the y -axis yields another valid basketball walk. Hence, we have the *time reversal* equality

$$G_{j,k}(z) = G_{k,j}(z). \tag{3.2}$$

Equipped with those basic properties we are now ready to apply the kernel method to yet another lattice path enumeration problem.

Lemma 3.1.2 ([2, pp. 88-89]). Let $u_1(z)$ and $u_2(z)$ be the small roots of the kernel equation (3.1). Then, for $j > 0$, we have

$$G_{j,1}(z) = -\frac{u_1 u_2 (u_1^j - u_2^j)}{z(u_1 - u_2)}, \quad (3.3)$$

$$G_{j,2}(z) = \frac{u_1 u_2 (u_1^j - u_2^j) + u_1^{j+1} - u_2^{j+1}}{z(u_1 - u_2)} = \frac{u_1^{j+1} - u_2^{j+1}}{z(u_1 - u_2)} - G_{j,1}(z), \quad (3.4)$$

$$G_j(z, u) = \frac{u^j - z(G_{j,1}(z) + G_{j,2}(z) + G_{j,1}(z)/u)}{1 - zP(u)}. \quad (3.5)$$

Proof. To derive a functional equation for the generating function of all positive basketball walks starting at $(0, j)$, we split them before their last step. A positive basketball walk is then either the single initial point at altitude j , or a positive basketball walk followed by a step not reaching altitude 0 or below. This leads to the functional equation

$$(1 - zP(u))G_j(z, u) = u^j - z \left(G_{j,1}(z) + G_{j,2}(z) + \frac{G_{j,1}(z)}{u} \right), \quad j > 0, \quad (3.6)$$

which already implies (3.5). To solve for the remaining unknowns $G_{j,1}$ and $G_{j,2}$ we substitute the small roots $u_1(z)$ and $u_2(z)$ of the kernel equation into (3.6) and get the linear system

$$\begin{aligned} u_1^j(z) &= z \left(G_{j,1}(z) + G_{j,2}(z) + \frac{G_{j,1}(z)}{u_1(z)} \right), \\ u_2^j(z) &= z \left(G_{j,1}(z) + G_{j,2}(z) + \frac{G_{j,1}(z)}{u_2(z)} \right). \end{aligned}$$

Solving this system for $j > 0$ immediately yields the formulae (3.3) and (3.4). \square

Theorem 3.1.3 ([2, Proposition 6.3]). Let $u_1(z)$ and $u_2(z)$ be the small roots of the kernel equation. Then, for $k \geq j > 0$, we have¹

$$G_{0,k}(z) = \frac{u_1^{k+1}(z) - u_2^{k+1}(z)}{u_1(z) - u_2(z)}, \quad (3.7)$$

$$G_{j,k}(z) = -\frac{u_1(z)u_2(z)}{z} \sum_{i=1}^j G_{0,j-i}(z) \cdot G_{0,k-i}(z). \quad (3.8)$$

Proof. Since positive basketball walks must stay strictly above the x -axis, the first step of a walk can only go up. Thus, removing this first step and shifting the origin, we have

$$G_{0,k}(z) = z(G_{1,k}(z) + G_{2,k}(z)).$$

¹The formula in [2, Proposition 6.3] incorrectly includes the summand corresponding to $i = 0$.

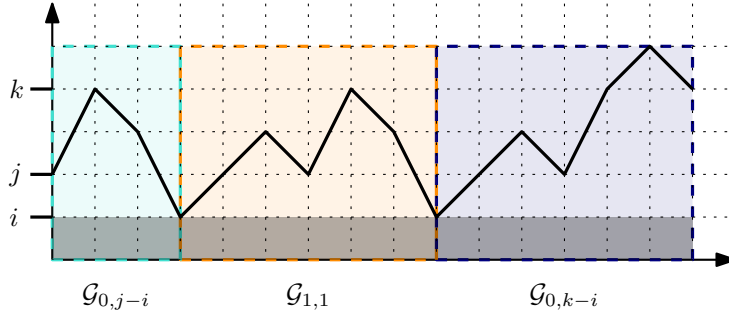

Figure 3.1: The decomposition of a basketball walk counted by $G_{j,k}(z)$.

We can rewrite this equation using the time reversal equation (3.2) to obtain

$$G_{0,k}(z) = z(G_{k,1}(z) + G_{k,2}(z)).$$

In this form, plugging in the formulae (3.3) and (3.4) derived in the preceding lemma instantly yields

$$G_{0,k}(z) = \frac{u_1^{k+1}(z) - u_2^{k+1}(z)}{u_1(z) - u_2(z)}.$$

To derive the formula for $G_{j,k}(z)$ for general $j > 0$ we make use of a first passage decomposition with respect to the minimal altitude of the walk. By time reversal, we have $G_{0,m}(z)$ as the generating function for basketball walks starting at $(0, m)$, staying strictly above the x -axis, but ending on the x -axis. Furthermore, we recognize

$$E(z) = G_{1,1}(z) = -\frac{u_1(z)u_2(z)}{z}$$

as the generating function of basketball excursions. Note that in contrast to the positive basketball walks counted by $G_{0,0}(z)$, basketball excursions are allowed to touch the x -axis at any point. Positive basketball walks starting from height j and ending at height k can then be decomposed into three parts; see Figure 3.1:

1. The walk starts at altitude j and continues until it hits the lowest altitude of the entire walk i for the first time. This part is counted by $G_{0,j-i}(z)$.
2. The second part then continues to the last time the path reaches altitude i . Consequently, this part is counted by $E(z)$.
3. The last part runs from altitude i to altitude k without ever returning to altitude i . By time reversal, this part is counted by $G_{0,k-i}(z)$.

Summing over all possible values for i then yields (3.8). □

Example 3.1.4 ([2, p. 92]). We use the general formula (3.7) to compute explicit expressions for $G_{0,1}(z)$ and $G_{0,2}(z)$. By substituting $k = 1, 2$ we get

$$\begin{aligned} G_{0,1}(z) &= u_1(z) + u_2(z), \\ G_{0,2}(z) &= u_1(z)^2 + u_1(z)u_2(z) + u_2(z)^2. \end{aligned}$$

We defer the remaining mechanical calculations to our favorite computer algebra system and see that

$$\begin{aligned} G_{0,1}(z) &= -\frac{1}{2} + \frac{1}{2} \sqrt{\frac{2 - 3z - 2\sqrt{1 - 4z}}{z}} \\ &= z + z^2 + 3z^3 + 7z^4 + 22z^5 + 65z^6 + 213z^7 + \mathcal{O}(z^8). \end{aligned}$$

This corresponds to the sequence OEIS A166135. Furthermore $G_{0,1}(z)$ is uniquely determined as the only solution having a power series expansion with non-negative coefficients at $z_0 = 0$ of

$$zu^4 + 2zu^3 + (3z - 1)u^2 + (2z - 1)u + z = 0.$$

For $G_{0,2}(z)$, the computer tells us that

$$\begin{aligned} G_{0,2}(z) &= \frac{3 - \sqrt{1 - 4z} - \sqrt{2 + 12z + 2\sqrt{1 - 4z}}}{4z} \\ &= z + z^2 + 4z^3 + 9z^4 + 31z^5 + 91z^6 + 309z^7 + \mathcal{O}(z^8). \end{aligned}$$

This corresponds to the sequence OEIS A111160. Furthermore, $G_{0,2}(z)$ is uniquely determined as the only solution of

$$z^3u^4 - 3z^2u^3 - (z^2 - 3z)u^2 + (z - 1)u + z = 0,$$

having a power series expansion with non-negative coefficients at $z_0 = 0$. △

Proposition 3.1.5 ([2, Proposition 6.4]). Let $G_{j,k}(z)$ be the generating function for positive basketball walks starting at altitude $j > 0$ and ending at altitude $k > 0$. Then²

$$G_{j,k}(z) = W_{j-k}(z) - G_{0,j}(z)W_{-k}(z) - zG_{1,1}(z)G_{0,j-1}(z)W_{-k-1}(z), \quad (3.9)$$

where

$$W_i(z) = z \left(\frac{u'_1}{u_1^{i+1}} + \frac{u'_2}{u_2^{i+1}} \right)$$

is the generating function of unconstrained walks starting at the origin and ending at altitude i derived in Theorem 2.2.1.

We will present two proofs of this proposition. The first one, introduced in [2], uses contour integrals and a residue calculation. Our new, second proof, will present a combinatorial argument that does not require any complex analysis.

Proof. In Lemma 3.1.2 we derived the formula

$$G_j(z, u) = \frac{u^j - z \left(G_{j,1}(z) + G_{j,2}(z) + \frac{G_{j,1}(z)}{u} \right)}{1 - zP(u)}$$

for the bivariate generating function of positive basketball walks starting at $(0, j)$. To obtain an expression for $G_{j,k}(z)$ we extract the coefficient of u^k in the left-hand side of this

²The formula in [2, Proposition 6.4] contains some typos, as some signs are incorrectly flipped.

equation. After simplifying the numerator using equations (3.3), (3.4) and (3.7), together with the linearity of the coefficient extraction operator, we are left with

$$G_{j,k}(z) = [u^k] \frac{u^j}{1 - zP(u)} - G_{0,j}(z) \cdot [u^k] \frac{1}{1 - zP(u)} - zG_{1,1}(z)G_{0,j-1}(z) \cdot [u^k] \frac{u^{-1}}{1 - zP(u)}.$$

Next we can recognize $W(z, u) = \frac{1}{1 - zP(u)}$. Together with the time reversal identity $W_\ell = W_{-\ell}$, we obtain the formula

$$G_{j,k}(z) = W_{j-k} - \frac{u_1^{j+1} - u_2^{j+1}}{u_1 - u_2} W_{-k} + \frac{u_1 u_2 (u_1^j - u_2^j)}{u_1 - u_2} W_{-k-1}.$$

Now it only remains to derive the desired expression for W_ℓ . For this we apply Cauchy's coefficient formula with a curve γ encircling the origin, shrunk sufficiently such that only the small roots remain inside. Cauchy's residue theorem then yields

$$\begin{aligned} W_\ell(z) &= [u^\ell] \frac{1}{1 - zP(u)} = \frac{1}{2\pi i} \int_\gamma \frac{du}{u^{\ell+1}(1 - zP(u))} \\ &= \text{Res}_{u=u_1(z)} \left(\frac{1}{u^{\ell+1}(1 - zP(u))} \right) + \text{Res}_{u=u_2(z)} \left(\frac{1}{u^{\ell+1}(1 - zP(u))} \right). \end{aligned}$$

To calculate these residues, we make use of the identities $1/z = P(u_i(z))$, as well as $zP'(u_i(z)) = -P(u_i(z))/u_i'(z)$, which are immediate consequences of the kernel equation and its derivative. With that in mind we compute

$$\begin{aligned} \text{Res}_{u=u_i(z)} \left(\frac{1}{u^{\ell+1}(1 - zP(u))} \right) &= \left(u_i(z)^{\ell+1} \left(\frac{d}{du} (1 - zP(u)) \right) \Big|_{u=u_i(z)} \right)^{-1} \\ &= \frac{1}{u_i(z)^{\ell+1} zP'(u_i(z))} \\ &= \frac{u_i'(z)}{u_i(z)^{\ell+1} P(u_i(z))} = z \frac{u_i'(z)}{u_i(z)^{\ell+1}}. \quad \square \end{aligned}$$

Another way to prove this result without needing to dive into complex analysis is to use the symbolic method to translate equation (3.9) into a specification for the class of general basketball walks.

Proof. First, we isolate $W_{j-k}(z)$ from equation (3.9) and substitute $j = k + \ell$ to obtain

$$W_\ell(z) = G_{k,k+\ell}(z) + W_{-k}(z)G_{0,k+\ell}(z) + W_{-k-1}(z)zG_{1,1}(z)G_{0,k+\ell-1}(z).$$

To prove this formula using the symbolic method we thus need to show that any basketball walk starting from $(0, 0)$ and ending at altitude ℓ falls into one of three categories:

1. $G_{k,k+\ell}(z)$: A walk that never touches nor crosses altitude $-k$.
2. $W_{-k}(z) \cdot G_{0,k+\ell}(z)$: A walk to altitude $-k$, followed by a walk from altitude $-k$ to altitude ℓ that never returns to altitude $-k$.

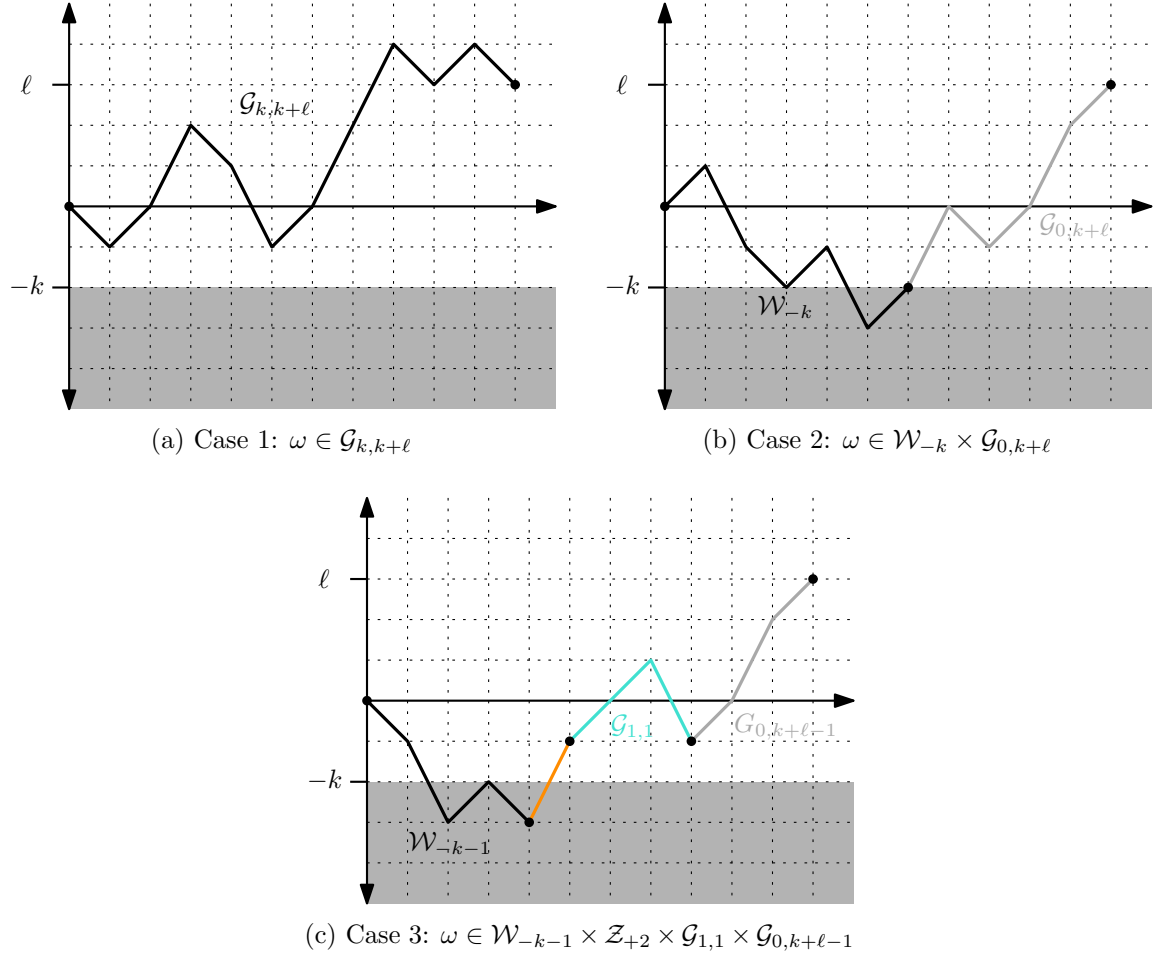

Figure 3.2: The three possible decompositions of a basketball walk ending at altitude ℓ .

3. $W_{-k-1}(z) \cdot z \cdot G_{1,1}(z) \cdot G_{0,k+\ell-1}(z)$: A walk to altitude $-k - 1$, followed by a step to altitude $-k + 1$, then an excursion at altitude $-k + 1$, until it ends with a walk from altitude $-k + 1$ to altitude ℓ that never returns to altitude $-k + 1$.

We argue this with a modified last passage decomposition of $W_\ell(z)$. We define the last traversal of an altitude j as the last step that either leaves from altitude j or crosses from altitude $j - 1$ to $j + 1$. Let ω be an arbitrary basketball walk ending at altitude ℓ . We split ω at its last traversal of altitude $-k$. If this traversal does not exist, then ω falls into the first category. Otherwise, if the last traversal of altitude $-k$ leaves from altitude $-k$, ω falls into the second category. Finally, in the case that the last traversal crosses over altitude $-k$ we need to be a little more delicate. Since the final part is forced to start with a $+2$ step, we cannot simply describe it as a positive basketball walk from altitude 0 to altitude $k + \ell + 1$. Hence, we need to split off the first $+2$ step. Now the remaining part is still not yet a positive basketball walk, as it still may return to the line $y = -k + 1$. Hence, we apply a second last passage decomposition to partition the remaining part into an excursion at altitude $(-k + 1)$, followed by a walk from altitude $-k + 1$ to altitude ℓ

that never returns to altitude $-k + 1$. For a visual representation of these three cases, we refer to Figure 3.2. \square

3.2 Closed-form expressions for coefficients

In this section we will present closed form expressions for the coefficients of $G_{0,1}(z)$, $G_{0,2}(z)$ and $G_{1,1}(z)$. To derive these formulae we will make use of a variant of the classical Lagrange inversion formula.

Theorem 3.2.1 (Lagrange inversion formula [14, Appendix A.6., p. 732]). Let $F(z)$ be a formal power series which satisfies $F(z) = z\phi(F(z))$, where $\phi(z)$ is a power series with $\phi(0) \neq 0$. Then, for any Laurent series $H(z) = \sum_{n \geq a} H_n z^n$ and for all non-zero integers n , we have

$$[z^n]H(F(z)) = \frac{1}{n}[z^{n-1}]H'(z)\phi^n(z).$$

Lemma 3.2.2 (Variant of Lagrange inversion formula [2, Lemma 6.1]). Let $F(z)$ and $H(z)$ be two formal power series satisfying the equations

$$F(z) = z\phi(F(z)), \quad H(z) = z\psi(H(z)),$$

where $\phi(z)$ and $\psi(z)$ are formal power series such that $\phi(0) \neq 0$ and $\psi(0) \neq 0$. Then,

$$[z^n]H(F(z)) = \frac{1}{n} \sum_{k=1}^n \left([z^{k-1}]\psi^k(z) \right) \left([z^{n-k}]\phi^n(z) \right).$$

Proof. The classical Lagrange inversion formula of Theorem 3.2.1 yields

$$[z^n]H(F(z)) = \frac{1}{n}[z^{n-1}]H'(z)\phi^n(z).$$

Applying the Cauchy product formula allows us to apply Lagrange's inversion formula a second time:

$$\begin{aligned} [z^n]H(F(z)) &= \frac{1}{n} \sum_{k=0}^{n-1} \left([z^k]H'(z) \right) \left([z^{n-1-k}]\phi^n(z) \right) \\ &= \frac{1}{n} \sum_{k=1}^n \left(k[z^k]H(z) \right) \left([z^{n-k}]\phi^n(z) \right) \\ &= \frac{1}{n} \sum_{k=1}^n \left([z^{k-1}]\psi^k(z) \right) \left([z^{n-k}]\phi^n(z) \right). \end{aligned} \quad \square$$

Proposition 3.2.3 (Closed-form expression for the coefficients of $G_{0,1}(z)$ [2, Proposition 6.5]). The number of basketball walks $G_{0,n,1}$ of length n from the origin to altitude one and never returning to the x -axis equals

$$G_{0,n,1} = \frac{1}{n} \sum_{k=1}^n (-1)^{k-1} \binom{2k-2}{k-1} \binom{2n}{n-k} = \frac{1}{n} \sum_{i=0}^n \binom{n}{i} \binom{n}{2n+1-3i}.$$

Proof. In Example 3.1.4 we derived the functional equation

$$zG_{0,1}^4(z) + 2zG_{0,1}^3(z) + (3z - 1)G_{0,1}^2(z) + (2z - 1)G_{0,1}(z) + z = 0.$$

We rewrite the equation to

$$z(1 + G_{0,1}(z) + G_{0,1}^2(z))^2 - G_{0,1}(z) - G_{0,1}^2(z) = 0.$$

Comparing with the functional equation $C(z) = 1 + zC(z)^2$ for the Catalan numbers yields the striking identity

$$G_{0,1}(z) + G_{0,1}^2(z) = C(z) - 1.$$

Define $H(z)$ implicitly as the functional inverse of $H + H^2$. Then we have

$$G_{0,1}(z) = H(C(z) - 1).$$

Since $H(z) = z/(1 + H)$ and $\tilde{C}(z) := C(z) - 1$ satisfies $\tilde{C}(z) = z(1 + \tilde{C}(z))^2$ we can apply Lemma 3.2.2 and obtain

$$\begin{aligned} [z^n]G_{0,1}(z) &= \frac{1}{n} \sum_{k=1}^n \left([z^{k-1}] \frac{1}{(1+z)^k} \right) \left([z^{n-k}] (1+z)^{2n} \right) \\ &= \frac{1}{n} \sum_{k=1}^n \binom{-k}{k-1} \binom{2n}{n-k} \\ &= \frac{1}{n} \sum_{k=1}^n (-1)^{k-1} \binom{2k-2}{k-1} \binom{2n}{n-k}. \end{aligned}$$

The alternative expression without the $(-1)^{k-1}$ factors comes from the Lagrange inversion formula for u_1 applied to the equation $G_{0,1}(z) = u_1(z) + u_2(z)$, using the fact that

$$u_1(z)^2 = zu_1(z)^2P(u_1(z))$$

in conjunction with the conjugation property of the small roots. By the properties of the kernel method 2.1.4 we know that $u_1(z)$ admits an expansion of the form

$$u_1(z) = \sum_{n=0}^{\infty} a_n z^{n/2}.$$

In order to apply Lagrange's inversion formula to $u_1(z)$ we thus define

$$U(x) := u_1(x^2) = \sum_{n=0}^{\infty} a_n x^n$$

Thus, U is a power series in x and satisfies the equation

$$U(x) = x\sqrt{U(x)^2P(U(x))}.$$

This leads to

$$\begin{aligned}
 [z^n]G_{0,1}(z) &= [z^n](u_1(z) + u_2(z)) = 2[x^{2n}]U(x) \\
 &= \frac{1}{n}[t^{2n-1}](t^2P(t))^n \\
 &= \frac{1}{n}[t^{2n-1}]((1+t)(1+t^3))^n \\
 &= \frac{1}{n} \sum_{k=0}^n \binom{n}{k} \binom{n}{2n+1-3k}.
 \end{aligned}$$

The last closed-form expression can also be explained indirectly via counting the number of unrestricted basketball walks from altitude zero to altitude one in n steps. We simply extract the coefficient of $[u^1]$ in the generating function $W(z, u)$ and obtain

$$[u^1 z^n]W(z, u) = [u^1]P(u)^n = [u^1] \left(\frac{(1+u^3)(1+u)}{u^2} \right)^n = \sum_{k=0}^n \binom{n}{k} \binom{n}{2n+1-3k}.$$

Now we establish a 1-to- n correspondence between walks of length n counted by $G_{0,1}(z)$ and those counted by $W_{0,1}(z)$. Each walk ω counted by $G_{0,1}(z)$ can be decomposed into $\omega = \omega_\ell B \omega_r$ with B being any point in the walk. Now we obtain a new unconstrained walk by $\omega' = B \omega_r \omega_\ell$. If ω is of length n there are n choices for B . Finally we remark that all new walks obtained in this way are in fact different walks. This is due to the fact that there are no walks from altitude zero to altitude one, which are formed as concatenation of several copies of one and the same walk. Conversely, given a walk τ of length n counted by $W_{0,1}(z)$, we decompose τ into $\tau = \tau_\ell B \tau_r$ with B being the right-most lowest point of τ . Then, $\tau' = B \tau_r \tau_\ell$ is a walk of length n counted by $G_{0,1}(z)$. \square

Proposition 3.2.4 (Closed-form expression for the coefficients of $G_{0,2}(z)$ [2, Proposition 6.6]). The number $G_{0,n,2}$ of basketball walks of length n from the origin to altitude two and never returning to the x -axis equals

$$G_{0,n,2} = \frac{1}{2n+1} \sum_{k=0}^{n+1} (-1)^{n+k+1} \binom{2n+1}{n+k} \binom{n+2k-1}{k}.$$

Proof. The idea of the proof is the build up a chain of dependencies between the actual series of interest, $G_{0,2}(z)$, and several auxiliary series, so that repeated application of Lagrange inversion formula can be applied to provide an explicit expression for the coefficients of the series of interest. As the first auxiliary series we define $F(z)$ by

$$-\frac{1}{F(z)} = G_{0,2}(z) - \frac{1}{z}.$$

Substituting $F(z)$ into the functional equation

$$z^3 G_{0,2}^4(z) - 3z^2 G_{0,2}^3(z) - (z^2 - 3z) G_{0,2}^2(z) + (z-1) G_{0,2}(z) + z = 0$$

yields

$$(F^3(z) - zF(z))(1 + F(z)) + z^2 = 0.$$

We rewrite this equation further to

$$\left(F^2(z) - \frac{z}{2}\right)^2 = \frac{z^2(1 - 3F(z))}{4(1 + F(z))}.$$

Next, we take the square root on both sides. The sign is decided by observing the first terms in the counting sequence associated with $G_{0,2}(z)$ and concluding $F^2(z) = z^2 + \mathcal{O}(z^3)$. Hence, we have

$$F^2(z) - \frac{z}{2} = -\frac{z}{2} \sqrt{\frac{1 - 3F(z)}{1 + F(z)}}.$$

We define

$$B(z) = \frac{1}{2} \left(1 - \sqrt{\frac{1 - 3z}{1 + z}}\right)$$

and finally obtain an equation suitable for the application of Lagrange inversion formula:

$$F(z) = z \frac{B(F(z))}{F(z)}.$$

Hence, for $n \geq 1$ we have

$$[z^n]G_{0,2}(z) = -[z^n] \frac{1}{F(z)} = \frac{1}{n} [z^{n-1}] z^{-2} \left(\frac{B(z)}{z}\right)^n = \frac{1}{n} [z^{2n+1}] B^n(z).$$

To proceed, we derive an equation amenable to Lagrange's inversion formula for $B(z)$. Firstly, we note that $B(z)$ solves the quadratic equation

$$(z + 1)B^2(z) - (z + 1)B(z) + z = 0,$$

which can be rewritten to

$$B(z) = z \left(\frac{1}{1 - B(z)} - B(z)\right) = z\phi(B(z)).$$

Now, we apply Lagrange's inversion formula again with $H(z) = z^n$ and obtain

$$\begin{aligned} [z^n]G_{0,2}(z) &= \frac{1}{n} [z^{2n+1}] B^n(z) = \frac{1}{n(2n+1)} [z^{2n}] \left(nz^{n-1} \left(\frac{1}{1-z} - z\right)^{2n+1}\right) \\ &= \frac{1}{2n+1} [z^{n+1}] \left(\frac{1}{1-z} - z\right)^{2n+1}. \end{aligned}$$

Finally, all that remains is to apply Newton's generalized binomial theorem to calculate

$$\begin{aligned}
 [z^n]G_{0,2}(z) &= \frac{1}{2n+1} [z^{n+1}] \sum_{k=0}^{2n+1} (-1)^{k+1} \binom{2n+1}{k} z^{2n+1-k} \left(\frac{1}{1-z}\right)^k \\
 &= \frac{1}{2n+1} [z^{n+1}] \sum_{\ell=0}^{\infty} \sum_{k=0}^{2n+1} (-1)^{k+1} \binom{2n+1}{k} \binom{k+\ell-1}{\ell} z^{2n+1-k+\ell} \\
 &= \frac{1}{2n+1} \sum_{k=n}^{2n+1} (-1)^{k+1} \binom{2n+1}{k} \binom{2k-n-1}{k-n} \\
 &= \frac{1}{2n+1} \sum_{k=0}^{n+1} (-1)^{n+k+1} \binom{2n+1}{k+n} \binom{2k-1}{k}. \quad \square
 \end{aligned}$$

Proposition 3.2.5 (Closed-form expression for the coefficients of $G_{1,1}(z)$ [2, Proposition 6.7]). The number $G_{1,n,1}$ of basketball excursions of length n (allowed to return to altitude 0 anywhere) is given by

$$G_{1,n,1} = \frac{1}{n+1} \sum_{k=0}^n (-1)^{n+k} \binom{2n+2}{n-k} \binom{n+2k+1}{k} = \frac{1}{n+1} \sum_{i=0}^{\lfloor n/2 \rfloor} \binom{2n+2}{i} \binom{n-i-1}{n-2i}.$$

Proof. By Theorem 2.2.5 we know the generating function for excursions to be

$$E(z) = -\frac{u_1(z)u_2(z)}{z}.$$

Further, we can generate an algebraic equation satisfied by $E(z)$ via computer algebra:

$$z^4 E^4 - (2z^3 + z^2) E^3 + (3z^2 + 2z) E^2 - (2z + 1) E + 1 = 0.$$

We rewrite this equation in order to be amenable to Lagrange's inversion formula:

$$zE(z) = z \left(\frac{1}{1-zE(z)} - zE(z) \right)^2 = z\phi(zE(z)).$$

Hence we have

$$\begin{aligned}
 [z^n]E(z) &= \frac{1}{n+1} [z^n] \left(\frac{1}{1-z} - z \right)^{2n+2} \\
 &= \frac{1}{n+1} [z^n] \sum_{k=0}^{2n+2} \binom{2n+2}{k} (-z)^k \left(\frac{1}{1-z}\right)^{2n+2-k} \\
 &= \frac{1}{n+1} \sum_{k=0}^n (-1)^{n-k} \binom{2n+2}{n-k} [z^k] \left(\frac{1}{1-z}\right)^{n+k+2} \\
 &= \frac{1}{n+1} \sum_{k=0}^n (-1)^{n+k} \binom{2n+2}{n-k} \binom{n+2k+1}{k}.
 \end{aligned}$$

The second expression can be derived by rewriting $\phi(z) = \left(1 + \frac{z^2}{1-z}\right)^2$. □

3.3 Asymptotic number of basketball walks

In this section we analyze the asymptotic behavior of the exactly enumerated sequences from the previous sections.

Theorem 3.3.1 (Asymptotics of $[z^n]G_{0,1}(z)$ and $[z^n]G_{0,2}(z)$ [2, Theorem 6.3]). Let $G_{0,1}(z)$ and $G_{0,2}(z)$ be the generating functions for positive basketball walks starting at the origin and ending at altitude one, respectively, at two. Then, as $n \rightarrow \infty$ the coefficients are asymptotically equal to

$$\begin{aligned} [z^n]G_{0,1}(z) &= \frac{1}{\sqrt{5\pi}} \frac{4^n}{\sqrt{n^3}} \left(1 - \frac{81}{200n} + \mathcal{O}\left(\frac{1}{n^2}\right) \right), \\ [z^n]G_{0,2}(z) &= \frac{5 + \sqrt{5}}{10\sqrt{\pi}} \frac{4^n}{\sqrt{n^3}} \left(1 - \frac{201 + 24\sqrt{5}}{200n} + \mathcal{O}\left(\frac{1}{n^2}\right) \right), \end{aligned}$$

with $C_1 := \frac{1}{\sqrt{5\pi}} \approx 0.25231$ and $C_2 := \frac{5+\sqrt{5}}{10\sqrt{\pi}} \approx 0.40825$.

Proof. In Example 3.1.4 we derived the expressions

$$\begin{aligned} G_{0,1}(z) &= -\frac{1}{2} + \frac{1}{2} \sqrt{\frac{2 - 3z - 2\sqrt{1-4z}}{z}}, \\ G_{0,2}(z) &= \frac{3 - \sqrt{1-4z} - \sqrt{2 + 12z + 2\sqrt{1-4z}}}{4z}. \end{aligned}$$

The dominant singularity of both of these functions is at $\rho_0 = 1/4$. Computing the Puiseux series at ρ_0 yields

$$\begin{aligned} G_{0,1}(z) &= -\frac{1 - \sqrt{5}}{2} - \frac{2}{\sqrt{5}}(1-4z)^{1/2} + \frac{6}{5\sqrt{5}}(1-4z) - \frac{26}{25\sqrt{5}}(1-4z)^{3/2} + \mathcal{O}((1-4z)^2), \\ G_{0,2}(z) &= \left(3 - \sqrt{5}\right) - \frac{5 + \sqrt{5}}{5}(1-4z)^{1/2} + \frac{75 - 17\sqrt{5}}{25}(1-4z) \\ &\quad - \frac{125 + 33\sqrt{5}}{125}(1-4z)^{3/2} + \mathcal{O}((1-4z)^2). \end{aligned}$$

Applying the standard function scale (Theorem 2.3.1) in conjunction with the Transfer Theorem 2.3.4 we obtain

$$\begin{aligned} [z^n]G_{0,1}(z) &= \frac{4^n}{\sqrt{5\pi n^3}} \left(1 + \frac{3}{8n} + \mathcal{O}\left(\frac{1}{n^2}\right) \right) - \frac{26}{25\sqrt{5}} \frac{4^n}{\sqrt{\pi n^5}} \left(\frac{3}{4} + \mathcal{O}\left(\frac{1}{n}\right) \right) + \mathcal{O}\left(\frac{4^n}{\sqrt{n^7}}\right) \\ &= \frac{4^n}{\sqrt{5\pi n^3}} \left(1 - \frac{81}{200n} + \mathcal{O}\left(\frac{1}{n^2}\right) \right), \end{aligned}$$

as well as

$$\begin{aligned}
 [z^n]G_{0,2}(z) &= \frac{5 + \sqrt{5}}{10} \frac{4^n}{\sqrt{\pi n^3}} \left(1 + \frac{3}{8n} + \mathcal{O}\left(\frac{1}{n^2}\right) \right) \\
 &\quad - \frac{125 + 33\sqrt{5}}{125} \frac{4^n}{\sqrt{\pi n^5}} \left(\frac{3}{4} + \mathcal{O}\left(\frac{1}{n}\right) \right) + \mathcal{O}\left(\frac{4^n}{\sqrt{n^7}}\right) \\
 &= \frac{5 + \sqrt{5}}{10\sqrt{\pi}} \frac{4^n}{\sqrt{n^3}} \left(1 - \frac{201 + 24\sqrt{5}}{200n} + \mathcal{O}\left(\frac{1}{n^2}\right) \right). \quad \square
 \end{aligned}$$

In addition to the asymptotic results presented in [2], we present the asymptotic growth rate of the number of basketball excursions and compare them to the previously derived asymptotics in Table 3.1.

Theorem 3.3.2 (Asymptotics of $[z^n]G_{1,1}(z)$). Let $G_{1,1}(z)$ be the generating function for positive basketball walks starting and ending at altitude one, also known as basketball excursions. Then, as $n \rightarrow \infty$ the coefficients are asymptotically equal to

$$[z^n]G_{1,1}(z) = \frac{6\sqrt{5} - 10}{5\sqrt{\pi}} \frac{4^n}{\sqrt{n^3}} \left(1 - \frac{381 - 48\sqrt{5}}{200n} + \mathcal{O}\left(\frac{1}{n^2}\right) \right)$$

with $C := \frac{6\sqrt{5} - 10}{5\sqrt{\pi}} \approx 0.38550$.

Proof. In Proposition 3.2.5 we derived the algebraic equation

$$P(z, E) := z^4 E^4 - (2z^3 + z^2)E^3 + (3z^2 + 2z)E^2 - (2z + 1)E + 1 = 0$$

for the generating function $G_{1,1}(z)$. The candidates for its singular points are found within the exceptional set

$$\Xi[P] := \{ z \mid \mathbf{R}(P(z, E), \partial_E P(z, E), E) = 0 \},$$

where $\mathbf{R}(z)$ is the resultant defined in Definition 1.4.11. Solving the equation $\mathbf{R}(z) = 0$ yields again $\rho = 1/4$ as the unique dominant singularity. Now we can let our favorite computer algebra system compute the Puiseux expansion

$$\begin{aligned}
 G_{1,1}(z) &= 6 - 2\sqrt{5} + \frac{20 - 12\sqrt{5}}{5} \sqrt{1 - 4z} + \frac{250 - 94\sqrt{5}}{25} (1 - 4z) \\
 &\quad + \frac{1000 - 536\sqrt{5}}{125} (1 - 4z)^{3/2} + \mathcal{O}((1 - 4z)^2).
 \end{aligned}$$

We determine the correct branch of the Puiseux expansion by guessing and checking the asymptotic approximations against the actual values of the counting sequence. Applying the standard function scale (Theorem 2.3.1) in conjunction with the Transfer Theorem

2.3.4 we finally obtain

$$\begin{aligned}
 [z^n]G_{1,1}(z) &= \frac{6\sqrt{5}-10}{5} \frac{4^n}{\sqrt{\pi n^3}} \left(1 + \frac{3}{8n} + \mathcal{O}\left(\frac{1}{n^2}\right)\right) \\
 &+ \frac{1000-536\sqrt{5}}{125} \frac{4^n}{\sqrt{\pi n^5}} \left(\frac{3}{4} + \mathcal{O}\left(\frac{1}{n}\right)\right) + \mathcal{O}\left(\frac{4^n}{\sqrt{n^5}}\right) \\
 &= \frac{6\sqrt{5}-10}{5\sqrt{\pi}} \frac{4^n}{\sqrt{n^3}} \left(1 + \frac{48\sqrt{5}-381}{200n} + \mathcal{O}\left(\frac{1}{n^2}\right)\right). \quad \square
 \end{aligned}$$

	OEIS	First terms	Growth rate
$G_{0,1}(z)$	A166135	$z + z^2 + 3z^3 + 7z^4 + 22z^5 + 65z^6$	$\approx 0.25231 \cdot 4^n \cdot n^{-3/2}$
$G_{1,1}(z)$	A187430	$1 + 2z^2 + 2z^3 + 11z^4 + 24z^5 + 93z^6$	$\approx 0.38550 \cdot 4^n \cdot n^{-3/2}$
$G_{0,2}(z)$	A111160	$z + z^2 + 4z^3 + 9z^4 + 31z^5 + 91z^6$	$\approx 0.40825 \cdot 4^n \cdot n^{-3/2}$

Table 3.1: Table of coefficients of different basketball walks.

4 Lattice paths with catastrophes

This chapter is rooted in the paper from Banderier and Wallner [3], where the authors study directed lattice paths, augmented with so-called *catastrophes*, as a model for queues with resets. Already in 2005 Krinik et al. [19] used Dyck meanders with catastrophes as a model for the classical single server queueing system with a finite capacity $M/M/1/H$, with a constant catastrophe rate γ . This allowed them to introduce a new method to determine the transient probability functions of classical queueing theory systems using lattice path combinatorics. Further, queues with catastrophes also arise as simple, natural models of the evolution of stock markets [27], or under the name of *random walks with resetting* in the field of probability theory and statistical mechanics [20]. Since the differing requirements of the diverse applications often call for adaptations to the simple model of queues with resets, we will compare and contrast two different versions of catastrophes in this chapter. As a baseline, Banderier and Wallner, in their article [3], introduce them as follows:

Definition 4.0.1 (Catastrophe). Consider a simple path with a finite step set \mathcal{S} . A *catastrophe* is a step of the form $(1, -s)$, with $-s \notin \mathcal{S}$ and $s > 0$, allowed only at altitude s , that takes the path immediately down to the x -axis. We denote the weight of a catastrophe with q . Note that, with this definition catastrophes can never coincide with regular jumps.

However, it might also make sense to allow catastrophes, even when they would coincide with regular jumps, as well as catastrophes at height zero. This conveniently leads to a model that is easier to handle, simplifying some of the more tedious calculations. To distinguish these two models we will refer to catastrophes of the second kind as *alternative catastrophes*.

Definition 4.0.2. An *alternative catastrophe* is a step of the form $(1, -s)$, with $s \geq 0$ and weight q , allowed only at altitude s , that takes the path immediately down to the x -axis.

4.1 Generating functions

We now start by providing a general formula for the generating function of meanders with (alternative) catastrophes. The structure of the general formula does not change for similar models of catastrophes and thus only slight modifications are necessary to encompass the differences in the two models.

Theorem 4.1.1 (Generating function for meanders and excursions with catastrophes [3, Theorem 2.1]). Let $c_{n,k}$ be the number of meanders with catastrophes of length n ending at altitude k , relative to a simple step set \mathcal{S} , with characteristic polynomial $P(u) = \sum_{k=-c}^d p_k u^k$. Further, let u_1, \dots, u_c denote the small roots and v_1, \dots, v_d the large roots of

the kernel equation. Then the generating function

$$C(z, u) = \sum_{n,k=0}^{\infty} c_{n,k} u^k z^n$$

is algebraic and satisfies

$$C(z, u) = D(z) \cdot M(z, u) = \frac{1}{1 - Q(z)} \cdot \frac{\prod_{i=1}^c (u - u_i(z))}{u^c (1 - zP(u))},$$

where $D(z)$ denotes the generating function of excursions ending with a catastrophe and $Q(z)$ counts the number of excursions with exactly one catastrophe occurring as the last step of the path. In addition, the generating functions for meanders with catastrophes ending at altitude k satisfy

$$C_k(z) = D(z) \cdot M_k(z) = \frac{1}{1 - Q(z)} \cdot \frac{1}{p_d z} \sum_{\ell=1}^d v_{\ell}^{-k-1} \prod_{\substack{1 \leq j \leq d, \\ j \neq \ell}} \frac{1}{v_j - v_{\ell}}, \quad \text{for } k \geq 0.$$

The generating function $Q(z)$ in both cases depends on the model of catastrophes:

$$Q^{\text{cat}}(z) = qz \left(M(z) - E(z) - \sum_{\substack{s>0, \\ -s \in \mathcal{S}}} M_s(z) \right), \quad Q^{\text{alt}}(z) = qz \cdot M(z).$$

Proof. Begin by taking an arbitrary meander with catastrophes of length n . We decompose the path into a final meander without any catastrophes, counted by $M(z, u)$, and a possibly empty initial part counted by $D(z)$. The expression for the generating function $M(z, u)$ of the final meander has already been derived in Theorem 2.2.5. The initial part can then be further decomposed into a sequence of excursions containing exactly one catastrophe as their respective last step. The decomposition is illustrated in Figure 4.1. Since each of the individual excursions are counted by $Q(z)$, we thus have $D(z) = 1/(1 - Q(z))$. Finally, to describe $Q(z)$ we note that each of these individual excursions is simply a meander without any catastrophes, followed by a final catastrophe. In the case of regular catastrophes, we now need to subtract all heights from which by definition no catastrophe can occur, and we get

$$Q^{\text{cat}}(z) = qz \left(M(z) - E(z) - \sum_{\substack{s>0, \\ -s \in \mathcal{S}}} M_s(z) \right),$$

with q denoting the weight of a catastrophe. In the model of alternative catastrophes, catastrophes may occur at any altitude and thus we have

$$Q^{\text{alt}}(z) = qz \cdot M(z).$$

For the generating function of meanders with catastrophes ending at a fixed altitude k , it suffices to replace the bivariate generating function for meanders $M(z, u)$ with the generating function $M_k(z)$ of meanders ending at altitude k . The expression for $M_k(z)$ has been derived in Corollary 2.2.7. \square

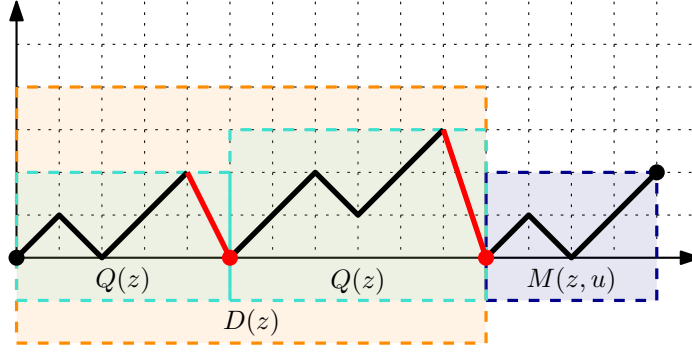

Figure 4.1: The decomposition of a meander with catastrophes.

If we let go of the negative image of a catastrophe that pushes the path down to zero and adopt the more neutral point of view as a reset to zero, it makes also sense to look at walks and bridges with resets to zero.

Definition 4.1.2 (Resets to zero). Consider a simple path with a finite step set J . A *reset to zero* is a step of the form $(1, -s)$, with $-s \notin \mathcal{S}$, allowed only at altitude s , that resets the path to the x -axis. An *alternative reset to zero* is a step of the form $(1, -s)$, for any $s \in \mathbb{Z}$, allowed only at altitude s , that resets the path to the x -axis.

Together with Theorem 2.2.1 and Theorem 2.2.2 we derive an almost analogous result for the generating function of unconstrained walks and bridges with resets to zero.

Theorem 4.1.3 (Generating function of walks and bridges with resets to zero). Let $r_{n,k}$ be the number of walks with resets to zero of length n from altitude 0 to altitude k . Then the generating function $R(z, u)$ is algebraic and satisfies

$$R(z, u) = D(z) \cdot W(z, u) = \frac{1}{1 - Q(z)} \cdot \frac{1}{1 - zP(u)},$$

with $Q(z)$ depending on the model of resets to zero:

$$Q^{\text{cat}}(z) = qz \left(W(z) - W_0(z) - \sum_{\substack{s>0, \\ -s \in \mathcal{S}}} W_s(z) \right), \quad Q^{\text{alt}}(z) = qz \cdot W(z).$$

In addition, the generating functions for walks with resets to zero, ending at altitude k satisfy

$$R_k(z) = D(z)W_k(z) = \frac{1}{1 - Q(z)} \cdot \begin{cases} z \sum_{j=1}^c \frac{u_j'(z)}{u_j(z)^{k+1}}, & \text{for } -\infty < k < c, \\ -z \sum_{j=1}^c \frac{v_j'(z)}{v_j(z)^{k+1}}, & \text{for } -d < k < +\infty. \end{cases}$$

Proof. Again, any arbitrary walk can be decomposed into a final walk without any resets to zero, which we count via $W(z, u)$ and a possibly empty initial part counted by $D(z)$. The

formula for the generating function of walks $W(z, u)$ comes from Theorem 2.2.1. The initial part now consists of a sequence of walks ending with a catastrophe, instead of meanders. Hence, we simply replace all generating functions for meanders with their corresponding counterparts for walks and we obtain the claimed formulae. For the generating function of walks ending at a fixed altitude k , we refer to Theorem 2.2.2. \square

Example 4.1.4 (Generating function for Dyck bridges with resets to zero). According to Theorem 4.1.3 we have

$$B_{\mathcal{D}}^{\text{cat}}(z) = \frac{W_0(z)}{1 - z(W(z) - W_0(z) - W_1(z) - W_{-1}(z))}.$$

With the help of a computer algebra system we calculate

$$\begin{aligned} B_{\mathcal{D}}^{\text{cat}}(z) &= -\frac{(2z-1)\left(1 + \sqrt{1-4z^2}\right)^2}{(4z^3 - 4z^2 - 4z + 2)\sqrt{1-4z^2} + 8z^4 + 12z^3 - 8z^2 - 4z + 2} \\ &= -\frac{2z(2z-1)v_1(z)^2}{(4z^3 - 4z^2 - 4z + 2)v_1(z) + 4z^3 + 4z^2 - 2z} \\ &= 1 + 2z^2 + 2z^3 + 8z^4 + 14z^5 + 40z^6 + 84z^7 + \mathcal{O}(z^8). \end{aligned}$$

This sequence was not contained in the OEIS before writing this thesis, but it can now be found at OEIS A369316. Further, $B_{\mathcal{D}}^{\text{cat}}(z)$ can be characterized as the only solution, having a power series expansion with non-negative coefficients at zero, of the quadratic equation

$$(4z^3 + 4z^2 - 1)B^2 + 2z(2z + 1)B + 2z + 1.$$

For comparison, the generating function of Dyck bridges with alternative resets to zero satisfies

$$\begin{aligned} B_{\mathcal{D}}^{\text{alt}}(z) &= \frac{W_0(z)}{1 - zW(z)} = \frac{\sqrt{1-4z^2}}{(1-3z)(1+2z)} \\ &= 1 + z + 5z^2 + 11z^3 + 39z^4 + 105z^5 + 335z^6 + 965z^7 + \mathcal{O}(z^8). \end{aligned}$$

This sequence was not contained in the OEIS before writing this thesis, but it can now be found at OEIS A369982. \triangle

In the following subsections we present a number of different step sets paired with alternative catastrophes. We derive their generating functions and provide bijections with various combinatorial objects that originate from the OEIS entries corresponding to the respective counting sequences.

4.1.1 Dyck walks

We start with the classical example in lattice path enumeration, the family of Dyck walks corresponding to the simple step set $\mathcal{D} = \{-1, 1\}$.

Example 4.1.5. Let $M_{\mathcal{D}}^{\text{alt}}(z, 1)$ denote the generating function of Dyck meanders with alternative catastrophes. According to Theorem 4.1.1 we have

$$M_{\mathcal{D}}^{\text{alt}}(z, 1) = D(z)M(z, 1) = D(z)\frac{1 - u_1(z)}{1 - zP(1)} = \frac{1 - u_1(z)}{(1 - Q^{\text{alt}}(z))(1 - 2z)},$$

with $u_1(z) = \frac{1 - \sqrt{1 - 4z^2}}{2z}$ being the solution to the kernel equation $1 - z(u^{-1} + u) = 0$. Plugging in the formula for the generating function $M(z, 1)$, derived in Theorem 2.2.5, then yields

$$Q^{\text{alt}}(z) = zM(z, 1) = z\frac{1 - u_1(z)}{1 - zP(1)} = z\frac{1 - \frac{1 - \sqrt{1 - 4z^2}}{2z}}{1 - 2z}.$$

With the help of our favorite computer algebra system we finally arrive at

$$\begin{aligned} M_{\mathcal{D}}^{\text{alt}}(z, 1) &= \frac{1 - u_1(z)}{(1 - Q^{\text{alt}}(z))(1 - 2z)} = \frac{1 - u_1(z)}{1 + (u_1(z) - 3)z} \\ &= 1 + 2z + 5z^2 + 12z^3 + 30z^4 + 74z^5 + 185z^6 + 460z^7 + \mathcal{O}(z^8). \end{aligned}$$

This sequence corresponds to OEIS A054341. For the generating function of Dyck meanders with regular catastrophes, we need to compute

$$Q^{\text{cat}}(z) = z(M(z) - E(z) - M_1(z))$$

instead. The formulae

$$M(z) = \frac{1 - u_1(z)}{1 - zP(1)}, \quad E(z) = \frac{u_1(z)}{z}$$

are already known from Theorem 2.2.5 and the remaining unknown $M_1(z)$ can be determined using a simple last passage decomposition. Let ω_M be an arbitrary meander ending at altitude 1. Split ω_M into two parts by cutting at the point when it leaves the x -axis for the last time. The first part is then simply an excursion counted by $E(z)$. The final part is also an excursion, if we discard the first up-step. This decomposition shows that $M_1(z) = zE(z)^2$. The remaining calculations remain in the hands of our favorite computer algebra system, which returns

$$\begin{aligned} M_{\mathcal{D}}^{\text{cat}}(z, 1) &= \frac{z(u_1(z) - 1)}{z^2 + (z^2 + z - 1)u_1(z)} \\ &= 1 + z + 2z^2 + 4z^3 + 8z^4 + 17z^5 + 35z^6 + 75z^7 + \mathcal{O}(z^8). \end{aligned}$$

This sequence corresponds to OEIS A274115. △

Now we follow these results up with two simple bijections to related classes of lattice paths listed in the respective OEIS entries.

Theorem 4.1.6. The set of Dyck meanders with alternative catastrophes of length n is in bijection with the set of 2-Motzkin excursions of length n , with no **E**-steps at positive heights $h > 0$.

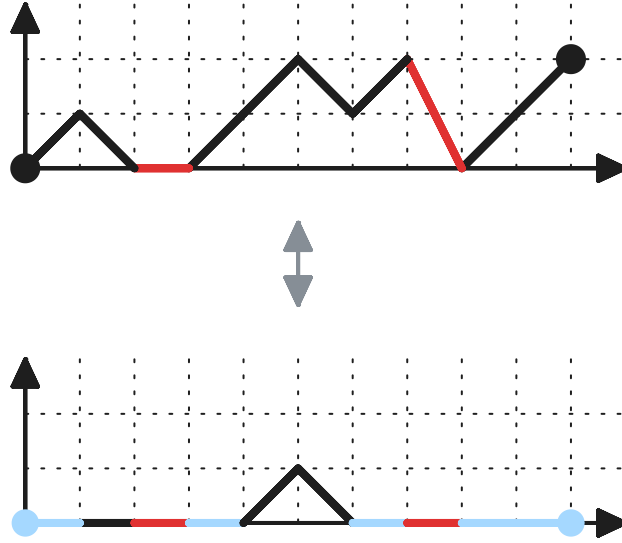

Figure 4.2: Bijection between Dyck meanders with alternative catastrophes and 2-Motzkin excursions with no **E**-steps at positive height.

Proof. Let $\omega_{\mathcal{M}}$ be an arbitrary 2-Motzkin excursion. Start by transforming every blue **E**-step in $\omega_{\mathcal{M}}$ into a **NE**-step. The **NE**-step and **SE**-steps in $\omega_{\mathcal{M}}$ remain unchanged. Finally, transform every red **E**-step in $\omega_{\mathcal{M}}$ into a catastrophe. This process clearly yields a valid Dyck meander with alternative catastrophes, since the height at each point may only increase in this procedure and alternative catastrophes may occur at any height.

For the inverse mapping we consider an arbitrary Dyck meander $\omega_{\mathcal{D}}$ with alternative catastrophes. Clearly, every catastrophe in $\omega_{\mathcal{D}}$ needs to map to a **E**-step and every **SE**-step needs to remain unchanged. Hence, it only remains to determine, which **NE**-steps get mapped to a blue **E**-step and which **NE**-steps stay unchanged. For that, we first split $\omega_{\mathcal{D}}$ into a sequence of meanders without catastrophes, with a catastrophe separating them, and a final meander without any catastrophes at the end. Then, for each meander in the sequence, we apply a last passage decomposition and turn the last **NE**-step to leave altitude $i = 0, \dots, k - 1$ into a blue **E**-step, where k is the final height of the meander. This procedure ensures that all **E**-steps occur only at height 0. For an illustration of this procedure we refer to Figure 4.2. \square

Theorem 4.1.7. The set of Dyck meanders with alternative catastrophes of length n is bijectively equivalent to the set of Dyck excursions with symmetric arches of length $2(n + 1)$. In addition, the set of Dyck excursions with alternative catastrophes is bijectively equivalent to the set of Dyck excursions with symmetric arches of length $2(n + 1)$, where the midpoint of the last arch happens to be at height one.

Proof. Consider an arbitrary Dyck meander $\omega_{\mathcal{M}}$ with alternative catastrophes of length n . We will now construct a Dyck excursion $\omega_{\mathcal{E}}$ with symmetric arches of length $2(n + 1)$. In any case we have to draw the first obligatory **NE**-step in $\omega_{\mathcal{E}}$. After that we will identify

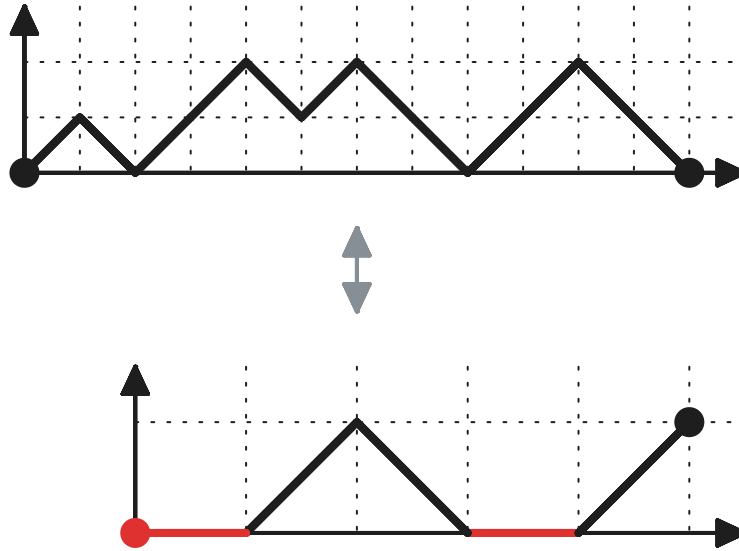

Figure 4.3: Bijection between Dyck meanders with alternative catastrophes of length n and Dyck excursions with symmetric arches of length $2(n+1)$.

every step in ω_M with the first half of each symmetric arch of ω_E . Further, we identify every catastrophe in ω_M with the first **NE**-step at the start of a new arch. In particular, if ω_M starts with a catastrophe, this translates to ω_E starting with the minimal arch of size two, immediately succeeded by the next arch. Then, after drawing the first **NE**-step of the arch, every regular step between two catastrophes gets mapped to the first half of the symmetric arch. The inverse is easily constructed by reading these steps backwards; see Figure 4.3 \square

For further bijections, Baril and Kirgizov [5, Theorem 1] have also constructed a bijection between the set of Dyck meanders of length n with catastrophes and the set of Dyck excursions of length $2n$ having no occurrence of the patterns **NE-NE-NE** and **SE-NE-SE** at height $h > 0$, highlighting the diverse connections between different families of lattice paths. To conclude this subsection, we present the counting sequences of Dyck excursions with (alternative) catastrophes.

Example 4.1.8. Let $E_{\mathcal{D}}^{\text{alt}}(z)$ denote the generating function of Dyck excursions with alternative catastrophes. According to Theorem 4.1.1 we have

$$E_{\mathcal{D}}^{\text{alt}}(z) = D(z)M_0(z) = \frac{E(z)}{1 - Q(z)} = \frac{u_1(z)}{z \left(1 - z \frac{1 - u_1(z)}{1 - 2z}\right)} = \frac{u_1(z)(1 - 2z)}{z(1 + z(u_1(z) - 3))}.$$

Extracting the first few coefficients then gives

$$E_{\mathcal{D}}^{\text{alt}}(z) = 1 + z + 3z^2 + 6z^3 + 16z^4 + 37z^5 + 95z^6 + 230z^7 + \mathcal{O}(z^8).$$

This sequence was not contained in the OEIS before writing this thesis, but it can now be found at [OEIS A369432](https://oeis.org/A369432). For comparison, the generating function of Dyck excursion with

catastrophes satisfies

$$E_{\mathcal{D}}^{\text{cat}}(z) = \frac{(2z-1)u_1(z)}{z^2 + (z^2+z-1)u_1(z)} = 1 + z^2 + z^3 + 3z^4 + 5z^5 + 12z^6 + 23z^7 + \mathcal{O}(z^8).$$

This sequence corresponds to OEIS A224747. △

4.1.2 Motzkin walks

We recall Motzkin walks to be directed lattice paths with the simple step set $\mathcal{M} = \{-1, 0, 1\}$. If we use k different colors for the horizontal step, we call the resulting lattice paths k -Motzkin walks. Let us start now with the enumeration of Motzkin meanders with (alternative) catastrophes.

Example 4.1.9. Let $M_{\mathcal{M}}^{\text{alt}}(z, 1)$ denote the generating function of Motzkin meanders with alternative catastrophes. According to Theorem 4.1.1 we have

$$M_{\mathcal{M}}^{\text{alt}}(z, 1) = \frac{M(z, 1)}{(1 - zM(z, 1))} = \frac{1 - u_1(z)}{\left(1 - z \frac{1 - u_1(z)}{1 - 3z}\right)(1 - 3z)} = \frac{1 - u_1(z)}{1 + (u_1(z) - 4)z},$$

with $u_1(z) = \frac{1 - z - \sqrt{1 - 2z - 3z^2}}{2z}$ being the only small solution to the kernel equation

$$u - z(1 + u + u^2) = 0.$$

Furthermore, we can extract the first coefficients to see

$$M_{\mathcal{M}}^{\text{alt}}(z, 1) = 1 + 3z + 10z^2 + 34z^3 + 117z^4 + 405z^5 + 1407z^6 + 4899z^7 + \mathcal{O}(z^8).$$

This sequence corresponds to OEIS A059738. For comparison, the generating function of Motzkin meanders with catastrophes satisfies

$$\begin{aligned} M_{\mathcal{M}}^{\text{cat}}(z) &= \frac{u_1(z) - 1}{u_1(z)^2(3z - 1) + (2z - 1)u_1(z) + 4z - 1} \\ &= 1 + 2z + 5z^2 + 14z^3 + 41z^4 + 123z^5 + 374z^6 + 1147z^7 + \mathcal{O}(z^8). \end{aligned}$$

This sequence corresponds to OEIS A054391, which appears as a interpolation between the famous Catalan and Motzkin numbers. △

Again, we follow these results up with bijections to related families of lattice paths listed in OEIS A059738.

Theorem 4.1.10. The set of Motzkin meanders with alternative catastrophes of length n is bijectively equivalent to the set of 3-Motzkin excursions of length n , with no **E**-steps at positive height $h > 0$.

Proof. The proof follows the arguments in Theorem 4.1.7 almost word for word and the procedure is illustrated in Figure 4.4. Let ω_E denote an arbitrary 3-Motzkin excursion. Simply transform every blue **E**-step in ω_E to a **NE**-step. Each **NE**-step, black **E**-step and **SE**-step stays unchanged. Finally, we map every red **E**-step to a catastrophe.

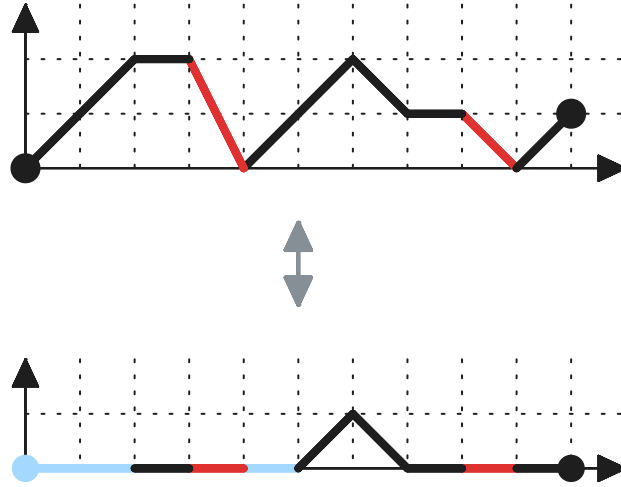

Figure 4.4: Bijection between Motzkin meanders with alternative catastrophes and 3-Motzkin excursions with no **E**-steps at positive heights.

Hence, for the inverse mapping, it only remains to determine, which **NE**-steps get mapped to a blue **E**-step and which **NE**-steps stay unchanged. For that, we first split $\omega_{\mathcal{D}}$ into a sequence of meanders without catastrophes, with a catastrophe separating them, and a final meander without any catastrophes at the end. Then, for each meander in the sequence, we apply a last passage decomposition and turn the last **NE**-step to leave altitude $i = 0, \dots, k - 1$ into a blue **E**-step, where k is the final height of the meander. This procedure ensures that all **E**-steps occur only at height zero. \square

Theorem 4.1.11. The set of Motzkin meanders with alternative catastrophes of length $n - 1$, starting with a catastrophe, is bijectively equivalent to the set of Motzkin excursions with symmetric arches of length $2n$, with **E**-steps **only** at positive heights $h > 0$.

Proof. Let ω_M be a Motzkin meander of length $n - 1$ with alternative catastrophes. We now construct a Motzkin excursion ω_E with symmetric arches of length $2n$. We start by drawing the first obligatory **NE**-step of ω_E and continue adding the steps of ω_M to ω_E until the first catastrophe occurs. Each catastrophe signals the start of a new symmetric arch. Thus, we complete the current arch by mirroring all previous steps, before we map the catastrophe to the first **NE**-step of the new arch. Now we iterate this process until all arches have been drawn. To construct the inverse mapping we simply take the first halves of each symmetric arch and replace the first **NE**-step each with an alternative catastrophe, except for the first arch, where the alternative catastrophe is omitted. This procedure is illustrated in Figure 4.5. \square

Further, for the set \mathcal{M}_n of Motzkin meanders of length n with catastrophes, Baril and Kirgizov [5, Theorem 3] construct a bijection to the set \mathcal{B}_{n+1} of Dyck excursions of length $2n + 2$ avoiding the patterns **NE-NE-NE** at height $h \geq 2$.

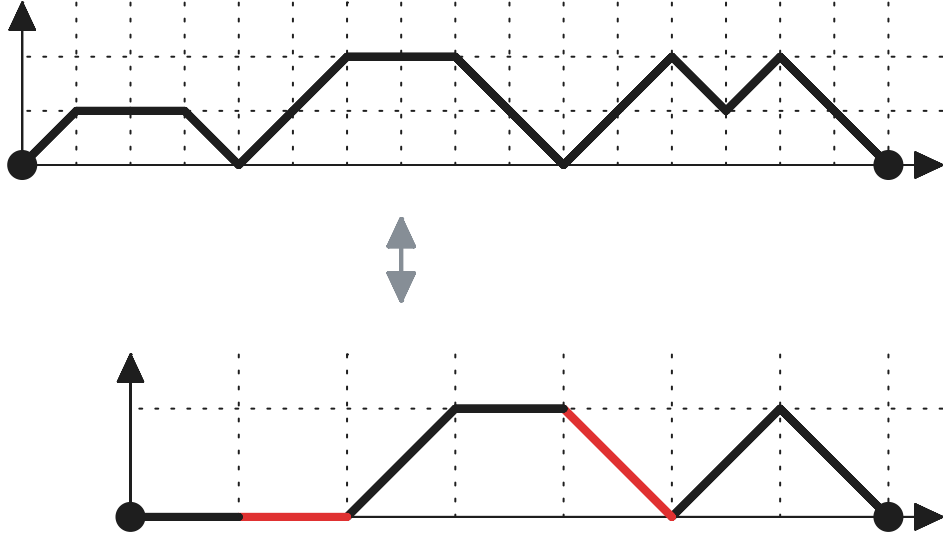

Figure 4.5: Bijection between Motzkin meanders with alternative catastrophes and Motzkin excursions with symmetric arches.

Example 4.1.12. Let $E_{\mathcal{M}}^{\text{alt}}(z)$ denote the generating function of Motzkin excursions with alternative catastrophes. According to Theorem 4.1.1 we have

$$E_{\mathcal{M}}^{\text{alt}}(z) = D(z)M_0(z) = \frac{E(z)}{1 - Q(z)} = \frac{u_1(z)}{z \left(1 - z \frac{1 - u_1(z)}{1 - 3z}\right)} = \frac{u_1(z)(1 - 3z)}{z(1 + (u_1(z) - 4)z)}.$$

Extracting the first few coefficients yields

$$E_{\mathcal{M}}^{\text{alt}}(z) = 1 + 2z + 6z^2 + 19z^3 + 63z^4 + 213z^5 + 729z^6 + 2513z^7 + \mathcal{O}(z^8).$$

This sequence corresponds to OEIS A059712. For comparison, the generating function of Motzkin excursions with catastrophes satisfies

$$\begin{aligned} E_{\mathcal{M}}^{\text{cat}}(z) &= \frac{3uz - u}{(3u^2 + 2u + 4)z^2 + (-u^2 - u - 1)z} \\ &= 1 + z + 2z^2 + 5z^3 + 14z^4 + 41z^5 + 123z^6 + 374z^7 + \mathcal{O}(z^8). \end{aligned}$$

This sequence corresponds to OEIS A073525. △

4.1.3 2-Motzkin walks

Example 4.1.13. Let $M_{\mathcal{M}_2}^{\text{alt}}(z)$ denote the generating function for 2-Motzkin meanders with alternative catastrophes. According to Theorem 4.1.1 we have

$$M_{\mathcal{M}_2}^{\text{alt}} = D(z)M(z) = \frac{M(z)}{1 - Q(z)} = \frac{1 - u_1(z)}{\left(1 - z \frac{1 - u_1(z)}{1 - 4z}\right)(1 - 4z)} = \frac{1 - u_1(z)}{1 + (u_1(z) - 5)z},$$

with $u_1(z) = \frac{1-2z-\sqrt{1-4z}}{2z}$ being the solution to the kernel equation

$$u - z(u^2 + 2u + 1) = 0.$$

Extracting the first few coefficients yields

$$M_{\mathcal{M}_2}^{\text{alt}}(z) = 1 + 4z + 17z^2 + 74z^3 + 326z^4 + 1446z^5 + 6441z^6 + 28770z^7 + \mathcal{O}(z^8).$$

This sequence corresponds to OEIS A049027, which appears as a row sum of a generalized Pascal's triangle. For comparison, the generating function of 2-Motzkin meanders with catastrophes satisfies

$$\begin{aligned} M_{\mathcal{M}_2}^{\text{cat}}(z) &= \frac{u_1(z) - 1}{u_1(z)^2(1-4z) + (1-3z)u_1(z) + 5z - 1} \\ &= 1 + 3z + 10z^2 + 36z^3 + 136z^4 + 529z^5 + 2095z^6 + 8393z^7 + \mathcal{O}(z^8). \end{aligned}$$

This sequence was not contained in the OEIS before writing this thesis, but it can now be found at OEIS A369436. \triangle

Example 4.1.14. Let $E_{\mathcal{M}_2}^{\text{alt}}(z)$ denote the generating function of 2-Motzkin excursions with alternative catastrophes. According to Theorem 4.1.1 we have

$$E_{\mathcal{M}_2}^{\text{alt}}(z) = D(z)M_0(z) = \frac{E(z)}{1-Q(z)} = \frac{u_1(z)}{z\left(1 - z\frac{1-u_1(z)}{1-4z}\right)} = \frac{u_1(z)(1-4z)}{z(1+(u_1(z)-5)z)}.$$

Extracting the first few coefficients yields

$$E_{\mathcal{M}_2}^{\text{alt}}(z) = 1 + 3z + 11z^2 + 44z^3 + 184z^4 + 789z^5 + 3435z^6 + 15100z^7 + \mathcal{O}(z^8).$$

This sequence corresponds to OEIS A059714. For comparison, the generating function of 2-Motzkin excursions with catastrophes satisfies

$$\begin{aligned} E_{\mathcal{M}_2}^{\text{cat}}(z) &= \frac{4u_1(z)z - u_1(z)}{(4u_1(z)^2 + 3u_1(z) + 5)z^2 + (-u_1(z)^2 - u_1(z) - 1)z} \\ &= 1 + 2z + 5z^2 + 15z^3 + 51z^4 + 187z^5 + 716z^6 + 2811z^7 + \mathcal{O}(z^8). \end{aligned}$$

This sequence corresponds to OEIS A073525. \triangle

All of these enumeration results are summarized in Table 4.1 and Table 4.2 below.

4.2 Asymptotic number of lattice paths

In this section we work out the asymptotic behavior of the sequences derived in the previous sections. To derive asymptotics of coefficients of generating functions, singularity analysis is the way to go. A central theme in this process is the search for singularities of the function. In the easiest case, there is exactly one singularity on the radius of convergence. However, when considering periodic step sets, we have to deal with the periodically distributed

	OEIS	First terms
Dyck excursions	A224747	$1 + 0z + z^2 + z^3 + 3z^4 + 5z^5$
Dyck meanders	A274115	$1 + z + 2z^2 + 4z^3 + 8z^4 + 17z^5$
Motzkin excursions	A054391	$1 + z + 2z^2 + 5z^3 + 14z^4 + 41z^5$
Motzkin meanders	A054391	$1 + 2z + 5z^2 + 14z^3 + 41z^4 + 123z^5$
2-Motzkin excursions	A073525	$1 + 2z + 5z^2 + 15z^3 + 51z^4 + 187z^5$
2-Motzkin meanders	A369436	$1 + 3z + 10z^2 + 36z^3 + 136z^4 + 529z^5$

Table 4.1: Table of lattice paths with catastrophes.

	OEIS	First terms
Dyck excursions	A369432	$1 + z + 3z^2 + 6z^3 + 16z^4 + 37z^5$
Dyck meanders	A054341	$1 + 2z + 5z^2 + 12z^3 + 30z^4 + 74z^5$
Motzkin excursions	A059712	$1 + 2z + 6z^2 + 19z^3 + 63z^4 + 213z^5$
Motzkin meanders	A059738	$1 + 3z + 10z^2 + 34z^3 + 117z^4 + 405z^5$
2-Motzkin excursions	A059714	$1 + 3z + 11z^2 + 44z^3 + 184z^4 + 789z^5$
2-Motzkin meanders	A049027	$1 + 4z + 17z^2 + 74z^3 + 326z^4 + 1446z^5$

Table 4.2: Table of lattice paths with alternative catastrophes.

singularities on the circle of convergence. In this case, all of these singularities need to be handled with care, as cancellations might occur. In this thesis, however, we will not delve into these technical details and restrict ourselves to the analysis of aperiodic step sets. For a full treatment on how to deduce the asymptotics of walks having periodic jump polynomials from the results on aperiodic ones, we refer to [4, Lemma 8.7 and Theorem 8.8] from Banderier and Wallner.

Definition 4.2.1 (Periodic support). We say that a function $F(z)$ has periodic support of period p or for short $F(z)$ is p -periodic if there exists an integer b and a function $H(z)$ such that

$$F(z) = z^b H(z^p).$$

The largest such p is called the *period* of F and is denoted by $\text{per}(F)$. If this holds only for $p = 1$, the function is said to be *aperiodic*. A simple walk defined by the set of jumps \mathcal{S} is said to have period p if the characteristic polynomial $P(u) = \sum_{s \in \mathcal{S}} p_s u^s$ has period p . In this case, the period can also be defined via

$$\text{per}(P) = \text{gcd}(b_2 - b_1, \dots, b_m - b_1).$$

Further, a simple walk is said to be *reduced*, if the greatest common divisor of the jumps is equal to one. Note that aperiodic walks are by their definition automatically reduced.

These periodicities play a crucial role in the process of singularity analysis, as they contribute additional singularities periodically distributed on the disk of convergence.

Example 4.2.2. The generating function for Dyck excursions $E_{\mathcal{D}}(z) = \frac{1 - \sqrt{1 - 4z^2}}{2z^2}$ is periodic with period $\text{per}(E_{\mathcal{D}}) = 2$. This corresponds to the fact there are no Dyck excursions of odd length; see Figure 4.6. \triangle

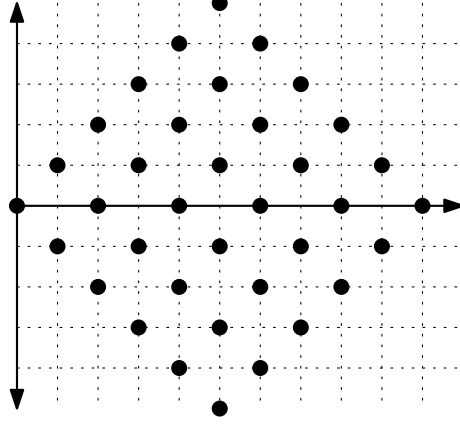

Figure 4.6: All vertices accessible from the origin by Dyck excursions of length 10.

As a first step towards deriving the asymptotics of meanders and excursions with catastrophes, we start by analyzing the function $D(z) = 1/(1 - Q(z))$, since it is a crucial building block in all of the generating functions. For that we need to find its singularities. They are either zeroes of $1 - Q(z)$ or singularities of $Q(z)$. Since

$$Q(z) = qz \left(M(z) - E(z) - \sum_{\substack{s>0, \\ -s \in \mathcal{S}}} M_s(z) \right)$$

we have to analyze the singularities of the components $M(z)$, $E(z)$ and $M_s(z)$. For that, the results of [1, Theorem 3, Theorem 4] show that the components $M(z)$, $M_s(z)$ and $E(z)$ have exactly one dominant singularity. However, there is a caveat: Even if we already know the radii of convergence $\rho_M, \rho_E, \rho_{M_s}$ of $M(z)$, $E(z)$, $M_s(z)$, respectively, it is a priori not granted that $Q(z)$ does not have a larger radius of convergence, since some cancellations could occur. Therefore we need to look at the asymptotics of their coefficients and argue that they make such cancellations impossible. The asymptotics depend on a quantity called the drift of a walk.

Definition 4.2.3 (Drift). Let $P(u)$ be the characteristic polynomial of a simple step set. Then we define the *drift* of the corresponding walk to be $\delta := P'(1)$. The drift models the expected change in height per step, if we use the probabilistic model of weights.

Firstly we note that, as long as no cancellations occur, the dominant singularity will be at ρ_M , as the coefficients of $M(z)$ dominate the coefficients of the functions $E(z)$ and $M_s(z)$. For a positive drift $\delta > 0$, the results in [1, Theorem 3, Theorem 4] show that

$$M(z) \sim C \cdot P(1)^n \gg D_s \cdot P(\tau)^n \sim E(z), M_s(z).$$

Hence, the dominant singularity at $\rho_M = 1/P(1)$ cannot be cancelled by the other functions. For $\delta \leq 0$ the growth rates of the coefficients are all of the same exponential order $P(\tau)^n$. In particular, the coefficients for all $M_s(z)$, $s > 0$ are of the same order. Since \mathcal{S} is finite, $Q(z)$ is by definition the sum of an infinite number of $M_s(z)$, and consequently, its coefficients cannot have a lower exponential growth rate. Thus the dominant singularity has to remain at $\rho_M = 1/P(\tau)$. Therefore the radius of convergence of $Q(z)$ is given by $\rho_Q = \rho_M$. We now determine the radius of convergence ρ_D of $D(z)$.

Lemma 4.2.4 (Radius of convergence of $D(z)$ [3, Lemma 4.2]). Let $P(u)$ be an aperiodic characteristic polynomial and let $\rho = 1/P(\tau)$ be the structural radius defined in Proposition 2.1.4. Further, consider the set

$$\mathcal{Z} := \{z \in \mathbb{C} \mid 1 - Q(z) = 0, |z| \leq \rho\}.$$

The set is either empty, or it contains exactly one real positive element, in which case we denote it with ρ_0 . In any case, the generating function $D(z)$ of excursions ending with a catastrophe possesses exactly one dominant singularity on its radius of convergence ρ_D . The sign of the drift $\delta := P'(1)$ of the walk then dictates the location ρ_D :

- If $\delta \geq 0$, we have $\rho_D = \rho_0 < 1/P(1) \leq \rho$.
- If $\delta < 0$, it also depends on the value $Q(\rho)$:

$$\begin{cases} Q(\rho) > 1 & \iff \rho_D = \rho_0 < \rho, \\ Q(\rho) = 1 & \iff \rho_D = \rho_0 = \rho, \\ Q(\rho) < 1 & \iff \rho_D = \rho \text{ and } \mathcal{Z} \text{ is empty.} \end{cases}$$

Proof. Due to its combinatorial origin, $D(z) = (1 - Q(z))^{-1}$ is a power series with positive coefficients. Hence, Pringsheim's theorem applies, which tells us that there exists a singularity on the intersection of its radius of convergence with the positive real axis. This singularity has to be either a singularity of $Q(z)$ or the smallest positive zero of $1 - Q(z)$. In both cases, it must be the only dominant singularity. In the first case, let ρ_Q denote the dominant singularity of $Q(z)$. In this case, the argument above shows that ρ_Q must coincide with the unique dominant singularity of $M(z)$ and thus we have $\rho_Q = \rho_M = \rho$.

In the second case, let ρ_0 be the smallest positive zero of $1 - Q(z)$. Now the aperiodicity of $Q(z)$, together with the fact that all its coefficients are positive implies that

$$\forall z \in \mathbb{C}: (|z| = \rho_0, z \neq \rho_0) \implies |Q(z)| < Q(|z|) = 1$$

and therefore the only dominant singularity has to lie on the positive real axis. Now we will determine the location of the dominant singularity. This will depend on the sign of the drift $\delta := P'(1)$:

- For a positive drift $\delta \geq 0$ we observe that the prefactor $(1 - zP(1))^{-1}$ in

$$M(z) = \frac{\prod_{j=1}^c (1 - u_j(z))}{1 - zP(1)}$$

possesses a simple pole at $z = 1/P(1)$. We show now that this pole cannot be cancelled by the factors $(1 - u_j(z))$. First we want to evaluate u_1 at the structural constant τ . By the definition of the structural radius and the kernel equation, one has

$$P(\tau) = \frac{1}{\rho} = P(u_1(\rho))$$

As $P(u)$ is injective on the interval $(0, \tau]$, this implies $u_1(\rho) = \tau$. Next, since $P'(1) \geq 0$ we observe that $\tau \leq 1$. Further, u_1 is monotonically increasing in $[0, \rho]$, so we have

$$u_1(1/P(1)) < u_1(\rho) = \tau \leq 1.$$

Finally, all other small roots are dominated by u_1 and hence cannot reach one either. Thus, the pole at $z = 1/P(1)$ of the prefactor is in fact also a pole of $M(z)$ and we have

$$\lim_{z \rightarrow (1/P(1))^-} Q(z) = +\infty.$$

However, this pole cannot be the dominant singularity of $D(z) = (1 - Q(z))^{-1}$, since by the continuity of $Q(z)$, together with $Q(0) = 0$, there must be a solution ρ_0 of $1 - Q(z) = 0$ with

$$0 < \rho_0 < \frac{1}{P(1)} \leq \rho.$$

- In the case of a negative drift $\delta < 0$, the pole in the prefactor does cancel out with $1 - u_1(z)$. This is due to the kernel equation for u_1 , which yields

$$P(u_1(1/P(1))) = P(1),$$

and the fact that for $u \in [0, \tau]$, with $\tau > 1$, the function $1/P(u)$ is continuously increasing. Thus the kernel equation admits a unique positive solution, which coincides with the principal small branch $u_1(z)$. Hence, we have that $|Q(z)|$ is bounded for $|z| < \rho$. Since $u_1(z)$ has a square root singularity at $|z| = \rho$ we also have $\rho_Q = \rho$. Now we only need to compare whether ρ_0 or ρ_Q yields the smaller singularity. Finally, since $Q(z)$ is monotonically increasing on the real axis, it suffices to compare its value at its maximum $Q(\rho)$. \square

The above considerations about periodicity are only necessary when the dominant asymptotics come from the singularity ρ_Q . When $\rho_0 < \rho$, we have a unique dominant simple pole originating from $M(z)$ and the possibly periodic functions $E(z)$ and $M_s(z)$ cannot contribute additional dominant singularities. This polar behavior occurs for Dyck paths, as we will see in Corollary 4.2.8.

Further, the results from Theorem 4.2.5 also hold for the generating function of excursions ending with alternative catastrophes with $Q(z) = zM(z)$, since the now missing components $E(z)$ and $M_s(z)$ do not contribute relevant singularities in the proof. The following theorems about the asymptotics of meanders and excursions are thus stated with a generic function $Q(z)$ and hold both for catastrophes and alternative catastrophes.

Theorem 4.2.5 (Asymptotics of excursions ending with a catastrophe [3, Theorem 4.3]). Let d_n be the number of excursions ending with a(n alternative) catastrophe. Their asymptotics depend on the structural radius $\rho = 1/P(\tau)$ and the possible polar singularity ρ_0 of $Q(z)$:

$$d_n = \begin{cases} \frac{\rho_0^{-n}}{\rho_0 Q'(\rho_0)} + \mathcal{O}(P(1)^n) & \text{if } \rho_0 < \rho \text{ and } \delta > 0, \\ \frac{\rho_0^{-n}}{\rho_0 Q'(\rho_0)} + \mathcal{O}(n^{-3/2} \rho^{-n}) & \text{if } \rho_0 < \rho \text{ and } \delta \leq 0, \\ \frac{\rho^{-n}}{\eta \sqrt{\pi n}} (1 + \mathcal{O}(1/n)) & \text{if } \rho_0 = \rho, \\ \frac{D(\rho)^2 \eta \rho^{-n}}{2\sqrt{\pi n^3}} (1 + \mathcal{O}(1/n)) & \text{if } \mathcal{Z} \text{ is empty,} \end{cases}$$

where η is given by the Puiseux expansion of

$$Q(z) = Q(\rho) - \eta \sqrt{1 - z/\rho} + \mathcal{O}(1 - z/\rho)$$

for $z \rightarrow \rho$. The last two cases occur only when $\delta < 0$.

Proof.

1. We start with the case $\rho_0 < \rho$. Expanding the denominator for $z \rightarrow \rho_0$ yields

$$1 - Q(z) = \underbrace{(1 - Q(\rho_0))}_{=0} + \rho_0 Q'(\rho_0) (1 - z/\rho_0) + \mathcal{O}\left((1 - z/\rho_0)^2\right).$$

Next, an elementary coefficient extraction gives

$$[z^n] \frac{1}{\rho_0 Q'(\rho_0)} (1 - z/\rho_0)^{-1} = \frac{\rho_0^{-n}}{\rho_0 Q'(\rho_0)}.$$

We now continue the asymptotic analysis by subtracting the simple pole. For $\delta \leq 0$ we observe that $|Q(z)|$ is bounded for $|z| < \rho$ and monotonically increasing on the real axis. This implies that ρ_0 is the only zero of $1 - Q(z)$ with $|z| < \rho$. Hence, the new dominant singularity must occur at the structural radius ρ , where the dominant small root becomes singular. The new square-root singularity at ρ thus contributes a summand of the type $n^{-3/2} \rho^{-n}$ to the asymptotic growth rate of d_n .

For $\delta > 0$ the new dominant singularity instead happens to be a simple pole at $1/P(1) < \rho$ and thus we have

$$d_n = \frac{\rho_0^{-n}}{\rho_0 Q'(\rho_0)} + \mathcal{O}(P(1)^n).$$

2. In the case that $\rho_0 = \rho$, the branching point of $u_1(z)$ leads to a square root behavior in the Puiseux expansion of $Q(z)$ for $z \rightarrow \rho$:

$$1 - Q(z) = \underbrace{(1 - Q(\rho_0))}_{=0} + \eta \sqrt{1 - z/\rho} + \mathcal{O}(1 - z/\rho).$$

Substituting $D(z) = (1 - Q(z))^{-1}$ then yields

$$D(z) = \frac{1}{\eta\sqrt{1-z/\rho} + \mathcal{O}(1-z/\rho)} = \frac{1}{\eta\sqrt{1-z/\rho}} \left(1 + \mathcal{O}\left(\sqrt{1-z/\rho}\right)\right).$$

Finally, singularity analysis gives us

$$d_n = [z^n] \frac{1}{\eta\sqrt{1-z/\rho}} \left(1 + \mathcal{O}\left(\sqrt{1-z/\rho}\right)\right) = \frac{\rho^{-n}}{\eta\sqrt{\pi n}} \left(1 + \mathcal{O}\left(\frac{1}{n}\right)\right).$$

3. In the case that \mathcal{Z} is empty, the constant term does not vanish. Instead we expand the right-hand side into a geometric series:

$$\begin{aligned} D(z) &= \left(1 - \left(Q(\rho) - \eta\sqrt{1-z/\rho} + \mathcal{O}(1-z/\rho_0)\right)\right)^{-1} \\ &= \sum_{k=0}^{\infty} \left(Q(\rho) - \eta\sqrt{1-z/\rho} + \mathcal{O}(1-z/\rho_0)\right)^k \\ &= \sum_{k=0}^{\infty} Q(\rho)^k - \left(\sum_{k=1}^{\infty} kQ(\rho)^{k-1}\right) \eta\sqrt{1-z/\rho} + \mathcal{O}(1-z/\rho) \\ &= D(\rho) - \eta D^2(\rho) \sqrt{1-z/\rho} + \mathcal{O}(1-z/\rho). \end{aligned}$$

Applying singularity analysis then yields

$$\begin{aligned} d_n &= [z^n] D(\rho) - \eta D^2(\rho) \sqrt{1-z/\rho} + \mathcal{O}(1-z/\rho) \\ &= \frac{D(\rho)^2 \eta \rho^{-n}}{2\sqrt{\pi n^3}} \left(1 + \mathcal{O}\left(\frac{1}{n}\right)\right). \end{aligned} \quad \square$$

Theorem 4.2.6 (Asymptotics of excursions with catastrophes [3, Theorem 4.4]). The number of excursions with (alternative) catastrophes e_n is asymptotically equal to

$$e_n = \begin{cases} \frac{E(\rho_0)}{\rho_0 \cdot Q'(\rho_0)} \rho_0^{-n} + \mathcal{O}(P(1)^n) & \text{if } \rho_0 < \rho \text{ and } \delta > 0, \\ \frac{E(\rho_0)}{\rho_0 \cdot Q'(\rho_0)} \rho_0^{-n} + \mathcal{O}(n^{-3/2} \rho^{-n}) & \text{if } \rho_0 < \rho \text{ and } \delta \leq 0, \\ \frac{E(\rho)}{\eta} \frac{\rho^{-n}}{\sqrt{\pi n}} (1 + \mathcal{O}(1/n)) & \text{if } \rho_0 = \rho, \\ \frac{C_0(\rho)}{2} \frac{\rho^{-n}}{\sqrt{\pi n^3}} \left(\frac{1}{\tau} \sqrt{2 \frac{P(\tau)}{P''(\tau)}} + \eta D(\rho)\right) (1 + \mathcal{O}(1/n)) & \text{if } \mathcal{Z} \text{ is empty.} \end{cases}$$

Proof. Since the generating function $C_0(z)$ of excursions with (alternative) catastrophes satisfies $C_0(z) = D(z)E(z)$, the dominant singularity is either a simple pole of $D(z)$ at ρ_0 , or a square root singularity at the structural radius $\rho = 1/P(\tau)$. Note that the cases $\rho_0 = \rho$ and $\mathcal{Z} = \emptyset$ are only possible for $\delta < 0$. In the case of $\rho_0 < \rho$ we have

$$\frac{E(z)}{1-Q(z)} = \frac{E(\rho_0) + \mathcal{O}(1-z/\rho_0)}{\rho Q'(\rho_0) (1-z/\rho_0) + \mathcal{O}\left((1-z/\rho_0)^2\right)} = \frac{E(\rho_0)}{\rho Q'(\rho_0)} (1-z/\rho_0)^{-1} + \mathcal{O}(1).$$

Applying singularity analysis then yields

$$e_n = \frac{E(\rho_0)\rho_0^{-n}}{\rho_0 Q'(\rho_0)} + \mathcal{O}(\rho^n).$$

In the case of $\rho_0 = \rho$ we have analogously to the proof of Theorem 4.2.5 that

$$C_0(z) = \frac{E(\rho_0)}{\eta\sqrt{1-z/\rho}} \left(1 + \mathcal{O}\left(\sqrt{1-z/\rho}\right)\right).$$

The process of singularity analysis then gives

$$e_n = \frac{E(\rho)}{\eta} \frac{\rho^{-n}}{\sqrt{\pi n}} \left(1 + \mathcal{O}\left(\frac{1}{n}\right)\right).$$

In the final case that \mathcal{Z} is empty, the results in the proof of [1, Theorem 3] give us the asymptotic expansion

$$\begin{aligned} E(z) &= E(\rho) - \frac{(-1)^{c-1}}{p-c\rho} \prod_{j=2}^c u_j(\rho) \sqrt{2 \frac{P(\tau)}{P''(\tau)}} \sqrt{1-z/\rho} + \mathcal{O}(1-z/\rho) \\ &= E(\rho) - \frac{E(\rho)}{u_1(\rho)} \sqrt{2 \frac{P(\tau)}{P''(\tau)}} \sqrt{1-z/\rho} + \mathcal{O}(1-z/\rho). \end{aligned}$$

Combined with the results from Theorem 4.2.5 and the fact that $u_1(\rho) = \tau$ we thus have

$$C_0(z) = \frac{E(z)}{1-Q(z)} = \frac{E(\rho) - \frac{E(\rho)}{\tau} \sqrt{2 \frac{P(\tau)}{P''(\tau)}} \sqrt{1-z/\rho} + \mathcal{O}(1-z/\rho)}{(1-Q(\rho_0)) + \eta\sqrt{1-z/\rho} + \mathcal{O}(1-z/\rho)}.$$

Like in the previous theorem, we develop the denominator into a geometric series and obtain

$$\begin{aligned} C_0(z) &= \frac{E(\rho)}{1-Q(\rho)} - \left(\frac{\frac{E(\rho)}{\tau} \sqrt{2 \frac{P(\tau)}{P''(\tau)}}}{1-Q(\rho)} + \eta \frac{E(\rho)}{(1-Q(\rho))^2} \sqrt{1-z/\rho} + \mathcal{O}(1-z/\rho) \right) \\ &= C_0(\rho) - C_0(\rho) \left(\frac{1}{\tau} \sqrt{2 \frac{P(\tau)}{P''(\tau)}} + \eta D(\rho) \right) \sqrt{1-z/\rho} + \mathcal{O}(1-z/\rho). \end{aligned}$$

Now the results follow from the standard function scale (Theorem 2.3.1) and the Transfer Theorem 2.3.4. \square

Theorem 4.2.7 (Asymptotics of meanders with catastrophes [3, Theorem 4.5]). The number of meanders with catastrophes m_n is asymptotically equal to

$$e_n = \begin{cases} \frac{M(\rho_0)}{\rho_0 \cdot Q'(\rho_0)} \rho_0^{-n} + \mathcal{O}(P(1)^n) & \text{if } \rho_0 < \rho \text{ and } \delta > 0, \\ \frac{M(\rho_0)}{\rho_0 \cdot Q'(\rho_0)} \rho_0^{-n} + \mathcal{O}(n^{-3/2} \rho^{-n}) & \text{if } \rho_0 < \rho \text{ and } \delta \leq 0, \\ \frac{M(\rho)}{\eta} \frac{\rho^{-n}}{\sqrt{\pi n}} (1 + \mathcal{O}(1/n)) & \text{if } \rho_0 = \rho, \\ \frac{C(\rho,1)}{2} \frac{\rho^{-n}}{\sqrt{\pi n^3}} \left(\frac{1}{\tau-1} \sqrt{2 \frac{P(\tau)}{P''(\tau)}} + \eta D(\rho) \right) (1 + \mathcal{O}(1/n)) & \text{if } \mathcal{Z} \text{ is empty.} \end{cases} \quad (4.1)$$

Note that the only difference to Theorem 4.2.6 is the appearance of $M(z)$ instead of $E(z)$, and a factor $1/(\tau - 1)$ instead of $1/\tau$ in the first term, when \mathcal{Z} is empty.

Proof. The first three cases can be handled completely analogously to Theorem 4.2.6. For the final case we again rely on results from [1, Theorem 4]. From there we have the asymptotic expansion

$$\begin{aligned} M(z) &= M(\rho) + \sqrt{2 \frac{P(\tau)^3}{P''(\tau)} \frac{\prod_{j=2}^c (1 - u_j(\rho))}{P(\tau) - P(1)}} \sqrt{1 - z/\rho} + \mathcal{O}(1 - z/\rho) \\ &= M(\rho) + \sqrt{2 \frac{P(\tau)^3}{P''(\tau)} \frac{M(\rho)(1 - \rho P(1))}{(1 - u_1(\rho))(P(\tau) - P(1))}} \sqrt{1 - z/\rho} + \mathcal{O}(1 - z/\rho) \\ &= M(\rho) - \sqrt{2 \frac{P(\tau)}{P''(\tau)} \frac{M(\rho)}{\tau - 1}} \sqrt{1 - z/\rho} + \mathcal{O}(1 - z/\rho). \end{aligned}$$

The remaining calculations follow the line of the previous theorems. \square

Let us now apply the theorems to derive the asymptotics of the families of lattice paths with alternative catastrophes considered in the previous section.

Corollary 4.2.8. The generating functions $M_{\mathcal{D}}^{\text{alt}}(z, 1)$ and $E_{\mathcal{D}}^{\text{alt}}(z)$ of Dyck meanders and excursions with alternative catastrophes, respectively, admit the following asymptotic expansions:

$$\begin{aligned} [z^n]M_{\mathcal{D}}^{\text{alt}}(z, 1) &= \frac{3}{4} \left(\frac{5}{2}\right)^n + \sqrt{\frac{2}{\pi}} \frac{2^n}{\sqrt{n^3}} \left(1 + \mathcal{O}\left(\frac{1}{n}\right)\right), \\ [z^n]E_{\mathcal{D}}^{\text{alt}}(z) &= \frac{3}{8} \left(\frac{5}{2}\right)^n + \sqrt{\frac{2}{\pi}} \frac{2^n}{\sqrt{n^3}} \left(1 + \mathcal{O}\left(\frac{1}{n}\right)\right). \end{aligned}$$

In particular, this implies that asymptotically every second Dyck meander with alternative catastrophes turns out to be an excursion. For Dyck walks with catastrophes, this probability works out to be $e_n/m_n \approx 0.31767$ [3, Corollary 4.9].

Proof. Recall the generating function of Dyck meanders with alternative catastrophes

$$M_{\mathcal{D}}^{\text{alt}}(z, 1) = \frac{M_{\mathcal{D}}(z, 1)}{1 - zM_{\mathcal{D}}(z, 1)} = \frac{1 - u_1(z)}{1 + (u_1(z) - 3)z}.$$

Due to the symmetric step set of Dyck paths we have $\delta = 0$. Hence we already know that the dominant singularity has to be a simple pole at a point $\rho_0 < \rho$. In fact, by setting the denominator zero we have $\rho_0 = 2/5 < 1/2$. Plugging these numbers into (4.1) we obtain

$$\frac{M_{\mathcal{D}}(\rho_0, 1)}{\rho_0 \cdot Q'_{\mathcal{D}}(\rho)} = \frac{5/2}{2/5 \cdot 25/3} = \frac{3}{4}.$$

Hence, we have

$$[z^n]M_{\mathcal{D}}^{\text{alt}}(z, 1) = \frac{3}{4} \left(\frac{5}{2}\right)^n + \mathcal{O}\left(\frac{2^n}{\sqrt{n^3}}\right).$$

However, to get the full asymptotic expansion we need to dig deeper. We subtract the simple pole in order to expand the function at the branching point $\rho = 1/2$. This gives

$$G(z) := M_{\mathcal{D}}^{\text{alt}}(z, 1) + \frac{3}{10} \left(z - \frac{2}{5} \right)^{-1} = 1 - 2\sqrt{2}\sqrt{1-2z} + 7(1-2z) + \mathcal{O}(1-2z)^{3/2}.$$

Now we apply the standard function scale (Theorem 2.3.1) to $\sigma(u) = 1 - 2\sqrt{2}\sqrt{1-u} + 7(1-u)$ and obtain

$$\sigma_n = [u^n]\sigma(u) = \frac{2\sqrt{2}}{\sqrt{\pi n^3}} \left(\frac{1}{2} + \mathcal{O}\left(\frac{1}{n}\right) \right).$$

After translating the error $\tau(u) = (1-u)^{3/2}$ using the Transfer Theorem 2.3.4 we finally get

$$[z^n]G(z) = \frac{2^{n+1/2}}{\sqrt{\pi n^3}} \left(1 + \mathcal{O}\left(\frac{1}{n}\right) \right) + \mathcal{O}\left(\frac{2^n}{\sqrt{n^5}}\right) = \frac{2^{n+1/2}}{\sqrt{\pi n^3}} \left(1 + \mathcal{O}\left(\frac{1}{n}\right) \right). \quad \square$$

For the asymptotic behavior of Dyck excursions with alternative catastrophes we first recall their generating function to be

$$E_{\mathcal{D}}^{\text{alt}}(z) = \frac{E_{\mathcal{D}}(z)}{1 - zM_{\mathcal{D}}(z, 1)} = \frac{u_1(z)(1-2z)}{z(1+(u-3)z)}.$$

We already observed that the dominant singularity is a simple pole at $\rho_0 = 2/5$. Now we can compute

$$\frac{E_{\mathcal{D}}(\rho_0)}{\rho_0 Q'_{\mathcal{D}}(\rho_0)} = \frac{5/4}{2/5 \cdot 25/3} = \frac{3}{8}.$$

and continue by subtracting the pole in order to get to the asymptotic behavior at the square root singularity at $\rho = 1/2$. At $\rho = 1/2$ we develop

$$G(z) := E_{\mathcal{D}}^{\text{alt}}(z) + \frac{3}{20} \left(z - \frac{2}{5} \right)^{-1}$$

into a Puiseux series with critical exponent $\alpha = 1/2$:

$$G(z) = 3 - 2\sqrt{2}(1-2z)^{1/2} + 13(1-2z) + \mathcal{O}((1-2z)^{3/2}).$$

Translating this expansion to coefficient asymptotics using the standard function scale (Theorem 2.3.1) and the Transfer Theorem 2.3.4 yields the claimed result.

Corollary 4.2.9. The generating functions $M_{\mathcal{M}}^{\text{alt}}(z, 1)$ and $E_{\mathcal{M}}^{\text{alt}}(z)$ of Motzkin meanders and excursions with alternative catastrophes, respectively, admit the following asymptotic expansions:

$$\begin{aligned} [z^n]M_{\mathcal{M}}^{\text{alt}}(z, 1) &= \frac{3}{4} \left(\frac{7}{2} \right)^n + \sqrt{\frac{27}{4\pi}} \frac{3^n}{\sqrt{n^3}} \left(1 + \mathcal{O}\left(\frac{1}{n}\right) \right), \\ [z^n]E_{\mathcal{M}}^{\text{alt}}(z) &= \frac{3}{8} \left(\frac{7}{2} \right)^n + \sqrt{\frac{27}{4\pi}} \frac{3^n}{\sqrt{n^3}} \left(1 + \mathcal{O}\left(\frac{1}{n}\right) \right). \end{aligned}$$

In particular, this implies that asymptotically every second Motzkin meander with alternative catastrophes turns out to be an excursion.

Proof. Since we are still dealing with symmetric step sizes, the dominant singularity is still guaranteed to be a simple pole. In this case, we find $\rho_0 = 2/7$. An application of Theorem 4.2.6 together with some computer algebra yields

$$[z^n]M_{\mathcal{M}}^{\text{alt}}(z, 1) = \frac{3}{4} \left(\frac{7}{2}\right)^n + \mathcal{O}\left(\frac{P(1)^n}{\sqrt{n^3}}\right).$$

We continue by subtracting the pole in order to get to the asymptotic behavior at the square root singularity at $\rho = 1/3$. At $\rho = 1/3$ we develop

$$G(z) := M_{\mathcal{M}}^{\text{alt}}(z, 1) + \frac{3}{14} \left(z - \frac{2}{7}\right)^{-1}$$

into a Puiseux series with critical exponent $\alpha = 1/3$:

$$G(z) = \frac{9}{2} - 3\sqrt{3}(1-3z)^{1/2} + 27(1-3z) + \mathcal{O}((1-3z)^{3/2}).$$

Translating this expansion to coefficient asymptotics using the standard function scale (Theorem 2.3.1) and the Transfer Theorem 2.3.4 yields the claimed result.

For excursions, an application of Theorem 4.2.6 yields

$$[z^n]E_{\mathcal{M}}^{\text{alt}}(z) = \frac{3}{8} \left(\frac{7}{2}\right)^n + o(K^n)$$

for some $K < 7/2$. Now we can continue by subtracting the pole in order to get to the asymptotic behavior at the square root singularity at $\rho = 1/3$. At $\rho = 1/3$ we develop

$$G(z) := E_{\mathcal{M}}^{\text{alt}}(z) + \frac{3}{28} \left(z - \frac{2}{7}\right)^{-1}$$

into a Puiseux series with critical exponent $\alpha = 1/3$:

$$G(z) = \frac{9}{4} - 3\sqrt{3}(1-3z)^{1/2} + \frac{45}{4}(1-3z) + \mathcal{O}((1-3z)^{3/2}).$$

Translating this expansion to coefficient asymptotics using the standard function scale (Theorem 2.3.1) and the Transfer Theorem 2.3.4 yields the claimed result. \square

There appears to be a pattern pertaining the asymptotic growth rates of k -Motzkin walks (with Dyck walks appearing as 0-Motzkin walks) and the results for 2-Motzkin walks continue to fall in line with it.

Corollary 4.2.10. The generating functions $M_{\mathcal{M}_2}^{\text{alt}}(z, 1)$ and $E_{\mathcal{M}_2}^{\text{alt}}(z)$ of 2-Motzkin meanders and excursions with alternative catastrophes, respectively, admit the following asymptotic expansions:

$$\begin{aligned} [z^n]M_{\mathcal{M}_2}^{\text{alt}}(z, 1) &= \frac{3}{4} \left(\frac{9}{2}\right)^n + \frac{4}{\sqrt{\pi}} \frac{4^n}{\sqrt{n^3}} \left(1 + \mathcal{O}\left(\frac{1}{n}\right)\right), \\ [z^n]E_{\mathcal{M}_2}^{\text{alt}}(z) &= \frac{3}{8} \left(\frac{9}{2}\right)^n + \frac{4}{\sqrt{\pi}} \frac{4^n}{\sqrt{n^3}} \left(1 + \mathcal{O}\left(\frac{1}{n}\right)\right). \end{aligned}$$

In particular, this implies that asymptotically every second 2-Motzkin meander with alternative catastrophes turns out to be an excursion.

	Meanders	Excursions	Ratio
Dyck	$\sim 3/4 \cdot (5/2)^n$	$\sim 3/8 \cdot (5/2)^n$	1/2
Motzkin	$\sim 3/4 \cdot (7/2)^n$	$\sim 3/8 \cdot (7/2)^n$	1/2
2-Motzkin	$\sim 3/4 \cdot (9/2)^n$	$\sim 3/8 \cdot (9/2)^n$	1/2

Table 4.3: Table of asymptotic growth rates of lattice paths with alternative catastrophes.

As the proof uses exactly the same methods used in the previous corollaries, we will not repeat it here. Instead, we conclude this section by proving that this pattern, illustrated in Table 4.3, can in fact be generalized to k -Motzkin walks for arbitrary positive integers k .

Theorem 4.2.11. The generating functions $M_{\mathcal{M}_k}^{\text{alt}}(z)$ and $E_{\mathcal{M}_k}^{\text{alt}}(z)$ of k -Motzkin excursions and meanders with alternative catastrophes, respectively, satisfy

$$[z^n]M_{\mathcal{M}_k}^{\text{alt}}(z) \sim \frac{3}{4} \left(\frac{2k+5}{2} \right)^n,$$

$$[z^n]E_{\mathcal{M}_k}^{\text{alt}}(z) \sim \frac{3}{8} \left(\frac{2k+5}{2} \right)^n.$$

In particular, this implies that asymptotically, every second k -Motzkin meander with alternative catastrophes is in fact an excursion.

Proof. We start with the asymptotic growth rate of $[z^n]E_{\mathcal{M}_k}^{\text{alt}}(z)$. According to Theorem 4.1.1, we have

$$E_{\mathcal{M}_k}^{\text{alt}}(z) = \frac{E(z)}{1-Q(z)} = \frac{1}{1-z\frac{1-u_1(z)}{1-P(1)z}} \frac{u_1(z)}{z}.$$

In order to determine the exponential growth rate of $[z^n]E_{\mathcal{M}_k}^{\text{alt}}(z)$, we need to localize its dominant singularity. By solving the quadratic kernel equation, one finds a square root singularity at $\rho = 1/(k+2)$. However, as it turns out there always exists a smaller, polar singularity $\rho_0 < \rho$. This is vindicated by the fact that the drift of our step set is zero. Hence, the dominant singularity can always be found as a zero of the denominator

$$g(z) := 1 - P(1)z - z(1 - u_1(z)).$$

To find the zero, we use the kernel equation to observe

$$P\left(\frac{1}{2}\right) = \frac{2k+5}{2} = P\left(u_1\left(\frac{2}{2k+5}\right)\right).$$

In particular, since $P(u)$ is injective on the interval $(0, \tau)$, with $\tau = 1$, this implies $u_1(2/(2k+5)) = 1/2$ and therefore

$$g\left(\frac{2}{2k+5}\right) = 1 - \frac{2(k+2)}{2k+5} - \frac{1}{2k+5} = 0.$$

Hence $E_{\mathcal{M}_k}^{\text{alt}}(z)$ has a polar singularity at $\rho_0 := 2/(2k+5)$ and, according to Theorem 4.2.6, admits the asymptotic expansion

$$[z^n]E_{\mathcal{M}_k}^{\text{alt}}(z) \sim \frac{E(\rho_0)}{\rho_0 Q'(\rho_0)} \left(\frac{2k+5}{2} \right)^n.$$

To determine the constant factor, we firstly note that

$$E(\rho_0) = \frac{u_1(\rho_0)}{\rho_0} = \frac{1}{2\rho_0}.$$

Secondly, we calculate

$$\begin{aligned} Q'(\rho_0) &= \frac{1 - u_1(\rho_0)}{1 - P(1)\rho_0} + \frac{P(1)\rho_0(1 - u_1(\rho_0))}{(1 - P(1)\rho_0)^2} - \frac{\rho_0}{1 - P(1)\rho_0} u_1'(\rho_0) \\ &= M(\rho_0) + \frac{(k+2)/(2k+5)}{(1 - (2k+2)/(2k+5))^2} - \frac{2/(2k+5)}{1/(2k+5)} u_1'(\rho_0) \\ &= M(\rho_0) + (2k+4) \frac{1}{\rho_0} - 2u_1'(\rho_0). \end{aligned}$$

To compute $M(\rho_0)$, we note that

$$\frac{M(\rho_0)}{E(\rho_0)} = \frac{1 - u_1(\rho_0)}{u_1(\rho_0)} \cdot \frac{\rho_0}{1 - P(1)\rho_0} = \frac{2/(2k+5)}{1 - 2(k+2)/(2k+5)} = 2$$

and therefore $M(\rho_0) = 1/\rho_0$. Hence, it only remains to determine $u_1'(\rho_0)$. For that, we use the derivative of the kernel equation, which yields

$$u_1'(\rho_0) = -\frac{P(u_1(\rho_0))}{\rho_0 P'(u_1(\rho_0))} = \frac{1}{\rho_0^2(u_1(\rho_0)^{-2} - 1)} = \frac{1}{3\rho_0^2}.$$

This implies

$$Q'(\rho_0) = \frac{2k+5}{\rho_0} - \frac{2}{3\rho_0^2} = \frac{4}{3\rho_0^2}$$

and finally we obtain

$$\frac{E(\rho_0)}{\rho_0 Q'(\rho_0)} = \frac{1}{2\rho^2} \cdot \frac{3\rho^2}{4} = \frac{3}{8}.$$

The constant factor for the asymptotic growth of $[z^n]M_{\mathcal{M}_k}^{\text{alt}}(z)$ is then, according to Theorem 4.2.7, given by

$$\frac{M(\rho_0)}{\rho_0 Q'(\rho_0)} = 2 \frac{E(\rho_0)}{\rho_0 Q'(\rho_0)} = \frac{3}{4}. \quad \square$$

5 Links to other combinatorial problems

[...] a property, which is translated by an equality $|A| = |B|$, is understood better, when one constructs a bijection between the two sets A and B , than when one calculates the coefficients of a polynomial whose variables have no particular meaning.

CLAUDE BERGE [6, p. 10], translated in [14, p. 94]

5.1 Stacked directed animals

This section gives an introduction into the theory of counting animals, including the quite lengthy definition of stacked directed animals, together with their generating functions and corresponding asymptotic behavior. The presentation of these results follows the excellent article by Bousquet-Mélou and Rechnitzer [10]. Once we have established the necessary groundwork to understand these combinatorial objects, we will present a novel bijective procedure in Subsection 5.1.2, linking this subclass of polyominoes to the class of Motzkin excursions with alternative catastrophes.

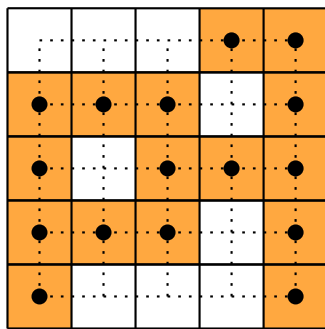

(a) Polyomino with square cells and the corresponding lattice animal on the square lattice.

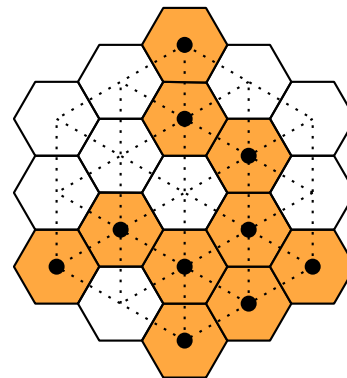

(b) Polyomino with hexagonal cells and the corresponding lattice animal on the triangular lattice.

Figure 5.1: Polyominoes and matching lattice animals with square and hexagonal cells.

The motivation behind the enumeration of such lattice animals or polyominoes can be found in the study of branched polymers [15] and percolation [11]. However, even though these combinatorial objects have been studied for more than 40 years, exact enumeration results for general polyominoes are still rare. Thus, one of the main research directions focuses on the investigation of large subclasses of polyominoes that are exactly enumerable.

This is also the motivating force behind the class of stacked directed animals that we will define in this section.

Definition 5.1.1 (Lattice animals). A *polyomino* of area n is a connected union of n cells on a lattice. The corresponding *lattice animal* then lives on the dual lattice obtained by taking the center of each cell.

The polyominoes we care about in this section have square or hexagonal cells, as illustrated in Figure 5.1. We start now with the definition of a subclass of polyominoes that has already been exactly enumerated by Dhar in [12].

Definition 5.1.2 (Directed animals). A *directed animal* on the square grid is a lattice animal, where one vertex has been designated the *source* and all other vertices are connected to the source via a directed path consisting only of **N**- and **E**-steps, and visiting only vertices belonging to the animal. On the triangular grid, one similarly defines the three possible directions of increase to be **NW**, **N**, and **NE**.

The easiest description for the class of stacked directed animals, however, does not build directly upon the above definition. Instead, it defines them indirectly via a one-to-one correspondence to a natural class of heaps of dimers, which are a powerful tool in the enumeration of directed animals. These heaps are simple combinatorial structures first introduced by Viennot [29]. This new approach greatly simplifies the derivation of the corresponding generating function and also serves as an intermediary step for our bijection to Motzkin excursions with alternative catastrophes.

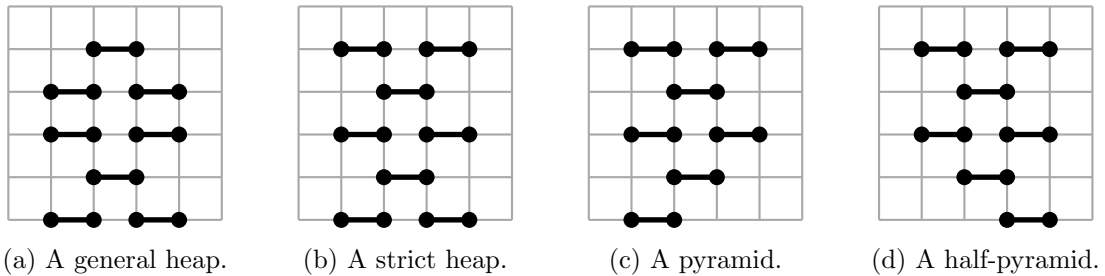

Figure 5.2: Heaps of dimers.

Definition 5.1.3 (Heaps of dimers). A *dimer* consists of two adjacent vertices on a lattice. A *heap of dimers* is obtained by dropping a finite number of dimers towards a horizontal axis, where each dimer falls until it either touches the horizontal axis or another dimer. The *width* of a heap is the number of non-empty columns. The dimers that touch the x -axis are called *minimal*. A heap is called

- *strict*, if no dimer has another dimer directly above it;
- *connected*, if its orthogonal projection on the horizontal axis is connected;
- a *pyramid*, if it has only one minimal dimer;

- a *half-pyramid*, if its only minimal dimer lies in the rightmost non-empty column.

The *right width* of a pyramid is the number of non-empty columns to the right of the minimal dimer with the *left width* being defined symmetrically. Note that pyramids and half-pyramids are always connected. These definitions are illustrated in Figure 5.2.

Now we will describe a construction from [10, p. 240] that maps directed animals on the square lattice to strict pyramids of dimers, as well as directed animals on the triangular lattice to general pyramids of dimers.

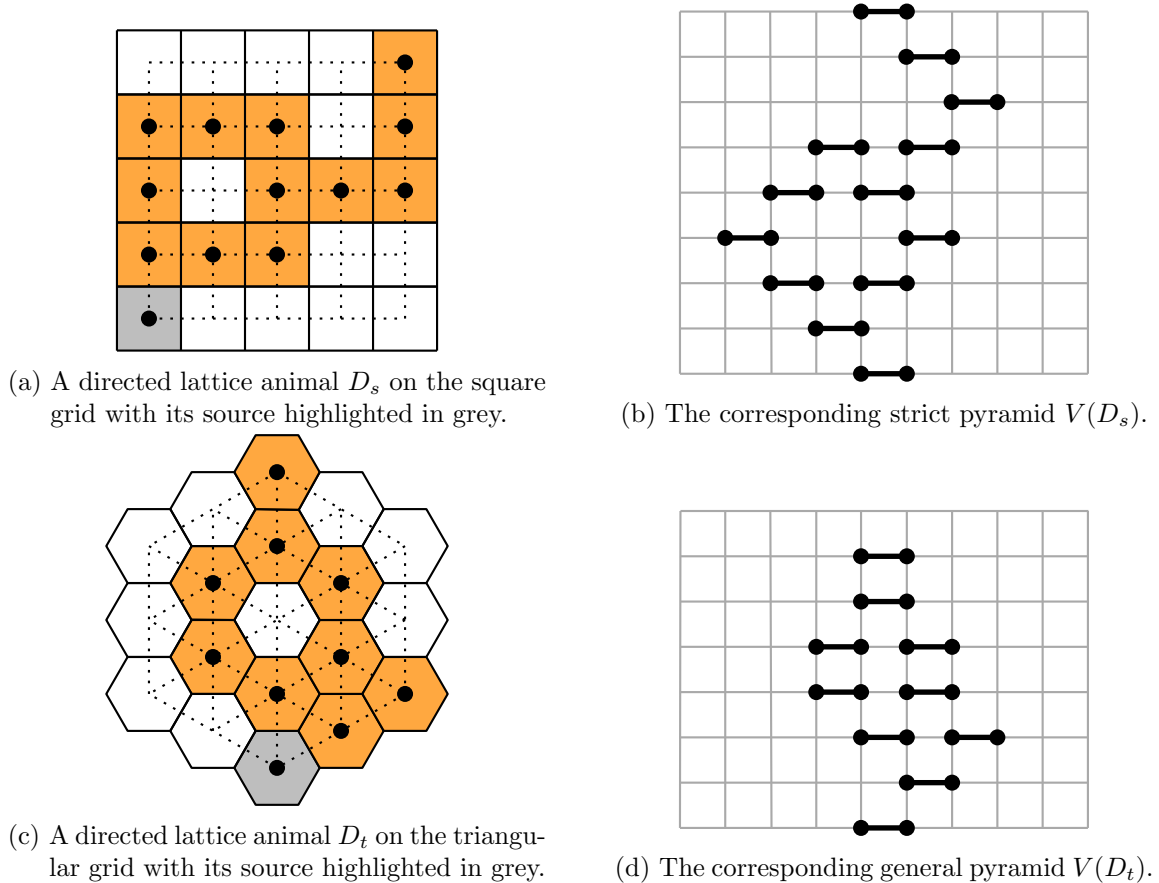

Figure 5.3: Constructing the strict (general) pyramid from a directed lattice animal on the square (triangular) grid.

Definition 5.1.4 (Mapping from directed animals to heaps). Let \mathcal{D}_A denote the class of directed lattice animals on the square (triangular) lattice, let \mathcal{P} denote the class of strict (general) pyramids and let $D \in \mathcal{D}_A$ be a directed lattice animal. We now define a mapping $V: \mathcal{D}_A \rightarrow \mathcal{P}$ as follows:

1. Rotate D by 45° degrees counter-clockwise, if D is an animal on the square grid.
2. Replace each individual cell in D by a dimer.

This results in a pyramid $V(D)$ with the source of the lattice animal being the only minimal dimer; see Figure 5.3.

Remark 5.1.5. It was observed by Viennot in [29] that this mapping induces a bijection between directed animals on the square (triangular) lattice and strict (general) pyramids of dimers and we denote the inverse mapping by \bar{V} . This can be easily verified by recalling that any vertex in D lies on a directed path consisting only of \mathbf{N} and \mathbf{E} steps from the source, visiting only other vertices in D . Hence, the corresponding dimer in $V(D)$ lies on a directed path of dimers lying diagonally to the left or the right above each other. In the case of directed animals on the triangular lattice, the additional possible direction translates to dimers lying directly above each other. As the next definition will show, it only takes a small adaptation to extend this mapping to general lattice animals.

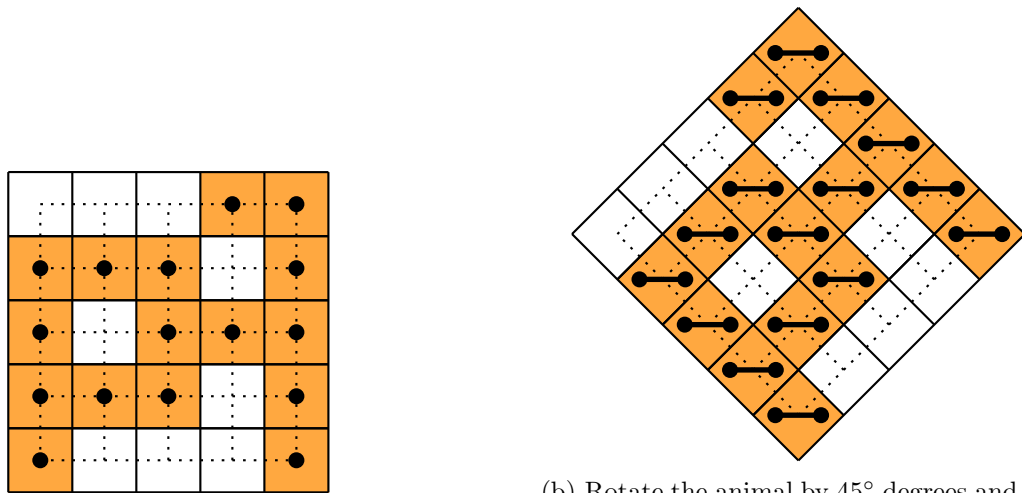

(a) A lattice animal on the square grid.

(b) Rotate the animal by 45° degrees and replace each cell by a dimer.

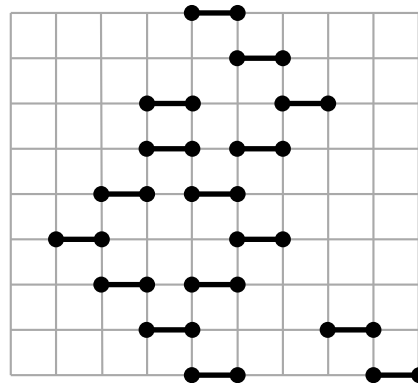

(c) Let the dimers fall.

Figure 5.4: Constructing the connected heap $V(A)$ from an animal A on the square grid.

Definition 5.1.6 (Mapping from lattice animals to heaps). Let \mathcal{A} denote the class of lattice animals on the square (triangular) lattice, \mathcal{H} the class of connected heaps and let $A \in \mathcal{A}$ be a directed lattice animal. We now define a mapping $V : \mathcal{A} \rightarrow \mathcal{H}$ as follows:

1. Rotate A by 45° degrees counter-clockwise, if A is an animal on the square grid.
2. Replace each individual cell in A by a dimer.
3. Let the dimers fall.

We call the resulting heap $V(A)$; see Figure 5.4 for an example of this procedure.

Thus, V maps lattice animals to connected heaps and in the case of triangular lattice animals, the following construction will show that the mapping is even surjective.

Definition 5.1.7 (Multi-directed animals). Let H be an arbitrary connected heap. We now construct an extension of \bar{V} to connected heaps via induction over the number of minimal dimers k of H :

- For $k = 1$, the heap H reduces to a simple pyramid and thus, according to Remark 5.1.5, $\bar{V}(H)$ is already well-defined.
- If instead H has $k > 1$ minimal dimers, we push the $(k - 1)$ leftmost pyramids upwards, producing a connected heap H' with $k - 1$ minimal dimers, placed far above the remaining pyramid P_k . Now recursively replace H' by $\bar{V}(H')$ and P_k by $\bar{V}(P_k)$.
- Finalize the construction by pushing $\bar{V}(H')$ downwards until it connects to $\bar{V}(P_k)$.

We define $\bar{V}(H)$ as the resulting animal and call the class of triangular lattice animals obtainable in this way *triangular multi-directed animals*. The case of square lattice animals is a bit more delicate, since V does not necessarily map them to strict heaps, as illustrated in Figure 5.4. However, the converse is still valid: If we apply \bar{V} to a strict heap H , we obtain a square lattice animal. This is guaranteed by the fact that \bar{V} maps strict pyramids to directed square animals. Hence, we restrict the above procedure to strict, connected heaps to obtain the class of *square multi-directed animals*; see Figure 5.5.

We will now finally define the class of stacked directed animals as a subclass of multi-directed animals that is easier to enumerate.

Definition 5.1.8 (Stacked directed animals). Take a connected heap H with k minimal dimers. Let us denote by P_1, P_2, \dots, P_k , from left to right, the corresponding pyramidal factors of H from the construction in Definition 5.1.7. Let us call *stacked pyramids* the connected heaps such that for $2 \leq i \leq k$, the horizontal projection of P_i intersects the horizontal projection of P_{i-1} . Then, *stacked directed animals* are defined as the image of the set of stacked pyramids under \bar{V} . We define the *right width* of a stacked pyramid to be the right width of its rightmost pyramidal factor.

These lattice animals are easier to enumerate due to their recursive description. This description translates easily into algebraic equations for their generating functions, and will also prove to be vital for the construction of our correspondence to the set of Motzkin excursions with alternative catastrophes.

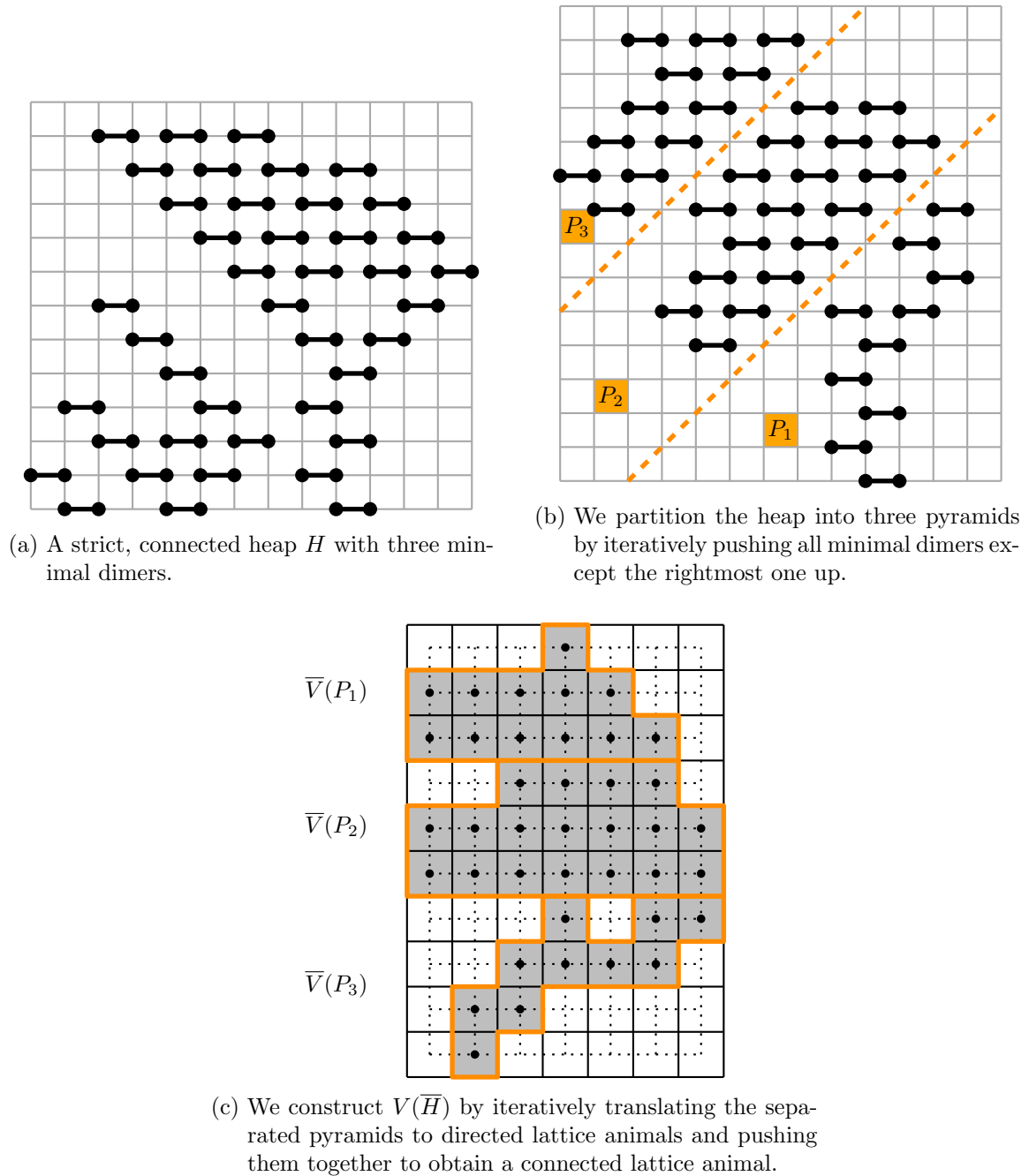

Figure 5.5: Constructing the square lattice animal $\overline{V}(H)$ from a strict, connected heap H .

5.1.1 Generating functions

Theorem 5.1.9 (Generating functions of directed animals [10, Proposition 1]). The generating functions $Q_s(z)$ and $Q_t(z)$ for strict and general half-pyramids, respectively, are given by

$$Q_s(z) = \frac{1 - z - \sqrt{(1+z)(1-3z)}}{2z},$$

$$Q_t(z) = Q_s\left(\frac{z}{1-z}\right) = \frac{1 - 2z - \sqrt{1-4z}}{2z}.$$

The generating function for strict and general pyramids, with z counting their number of dimers and u counting their right width is

$$P(z, u) = \frac{Q(z)}{1 - uQ(z)} \quad (5.1)$$

with Q denoting the respective generating function for strict or general half-pyramids. In particular, the generating functions $P_s(z, 1)$ and $P_t(z, 1)$ for directed animals on the square and the triangular lattice, respectively, are given by

$$P_s(z, 1) = \frac{1}{2} \left(\sqrt{\frac{1+z}{1-3z}} - 1 \right),$$

$$P_t(z, 1) = P_s\left(\frac{z}{1-z}, 1\right) = \frac{1}{2} \left(\frac{1}{\sqrt{1-4z}} - 1 \right).$$

Proof. The factorization of strict half-pyramids, depicted in Figure 5.6a, directly yields the functional equation $Q_s(z) = z + Q_s(z) + Q_s(z)^2$. Solving this quadratic equation yields

$$Q_s(z) = \frac{1 - z - \sqrt{(1+z)(1-3z)}}{2z},$$

which we recognize as the generating function of the Motzkin numbers; see OEIS A001006.

For the generating function of general heaps we simply note that a general heap can be built from a strict heap by replacing each dimer with $k \geq 1$ dimers lying on top of each other. This expansion operation does not change the right width and thus preserves the property of being a half-pyramid. This immediately gives

$$Q_t(z) = Q_s\left(\frac{z}{1-z}\right) = \frac{1 - 2z - \sqrt{1-4z}}{2z},$$

which again corresponds to the generating function of a famous combinatorial sequence: the Catalan numbers, see OEIS A000108.

The factorization of pyramids shown in Figure 5.6b leads us to the functional equation $P(z, u) = Q(z)(1 + uP(z, u))$, where we observe that the half-pyramids involved do not contribute to the right width of the pyramid. Further, the factorization is also valid for general pyramids, if we exchange strict half-pyramids for general half-pyramids.

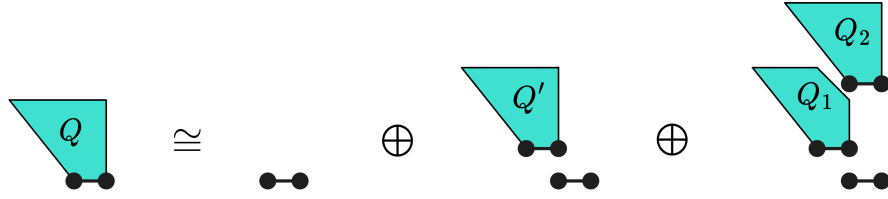

(a) The factorization of strict half-pyramids.

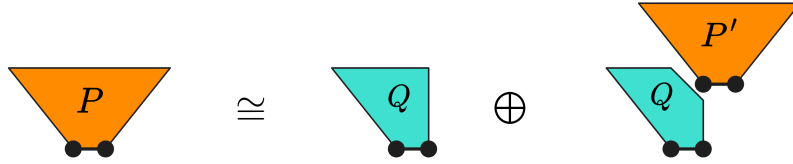

(b) The factorization of strict pyramids.

Figure 5.6: The factorizations of strict half-pyramids and pyramids.

For strict pyramids we thus obtain

$$\begin{aligned}
 P_s(z, 1) &= \frac{1 - z - \sqrt{-3z^2 - 2z + 1}}{2z + z - 1 + \sqrt{-3z^2 - 2z + 1}} \\
 &= \frac{(z - 1 + \sqrt{-3z^2 - 2z + 1})(-3z + 1 + \sqrt{-3z^2 - 2z + 1})}{4z(3z - 1)} \\
 &= \frac{1}{2} \left(\sqrt{\frac{1+z}{1-3z}} - 1 \right) \\
 &= z + 2z^2 + 5z^3 + 13z^4 + 35z^5 + 96z^6 + 267z^7 + \mathcal{O}(z^8).
 \end{aligned}$$

The counting sequence corresponds to OEIS A005773 shifted by one unit. In Corollary 2.2.9 we already observed this sequence to count the number of Motzkin meanders. Hence, the class of strict pyramids of size $n + 1$ corresponds not only to the class of directed animals of size $n + 1$, but also to the class of Motzkin meanders of length n . \square

Corollary 5.1.10 (Asymptotics of directed animals [10, Proposition 1]). The number of n -celled directed animals on the square and the triangular lattice, respectively, is asymptotically equal to

$$s_n = \frac{1}{\sqrt{3\pi}} \frac{3^n}{\sqrt{n}} \left(1 + \mathcal{O}\left(\frac{1}{n}\right) \right), \quad t_n = \frac{1}{\sqrt{4\pi}} \frac{4^n}{\sqrt{n}} \left(1 + \mathcal{O}\left(\frac{1}{n}\right) \right).$$

Their average width is asymptotically equal to $6\sqrt{3\pi n}$ and $16\sqrt{\pi n}$, respectively.

Proof. The dominant singularity of $P_s(z, 1)$ is a square root singularity at $\rho = 1/3$, leading to the asymptotic expansion

$$s_n = \frac{1}{\sqrt{3\pi}} \frac{3^n}{\sqrt{n}} \left(1 + \mathcal{O}\left(\frac{1}{n}\right) \right).$$

To calculate the average right width, we differentiate (5.1) with respect to u and apply singularity analysis to the function $\frac{1}{P(z,1)} \left(\frac{\partial}{\partial u} P(z, u) \right) \Big|_{u=1}$. By symmetry, the average width is then simply twice the average right width plus one. For general pyramids we have

$$P_t(z, 1) = P_s \left(\frac{z}{1-z}, 1 \right) = \frac{1}{2} \left(\frac{1}{\sqrt{1-4z}} - 1 \right),$$

and thus a simple application of the standard function scale (Theorem 2.3.1) combined with the Transfer Theorem 2.3.4 gives the desired result. \square

Theorem 5.1.11 (Generating functions of stacked directed animals [10, Proposition 2]). Let $Q(z)$ denote the generating function for strict and general half-pyramids, respectively. Let $P(z, u)$ denote the bivariate generating function for strict and general pyramids, respectively, with u counting the right width of the pyramid. Then, the generating function for square and triangular stacked directed animals, respectively, with z enumerating the number of dimers, u the right width and t the number of minimal dimers, is given by

$$S(z, u, t) = \frac{tP(z, u)}{1 - tP(z, 1)^2} = \frac{tQ(1-Q)^2}{(1-uQ)((1-Q)^2 - tQ^2)}.$$

In particular, the generating function for square and triangular stacked directed animals, respectively, is given by

$$S_s(z) = \frac{(1-z)(1-3z) - (1-4z)\sqrt{(1-3z)(1+z)}}{2z(2-7z)},$$

$$S_t(z) = S_s \left(\frac{z}{1-z} \right) = \frac{(1-3z)(1-4z) - (1-5z)\sqrt{1-4z}}{2z(2-9z)}.$$

Proof. Let H be an arbitrary stacked pyramid. Either it has only one minimal piece and is thus a single pyramid, or it is the product of a pyramid P with a stacked pyramid H' placed above P . The number of ways that P can be placed below H' equals the right width of H' . Further, by definition the right width of P determines the right width of H . Translating this construction into the language of generating functions yields

$$S(z, u, t) = tP(z, u) \left(1 + \frac{\partial S}{\partial u}(z, 1, t) \right).$$

To compute the derivative $\frac{\partial S}{\partial u}(z, 1, t)$, we differentiate the equation with respect to u and set u to 1:

$$\frac{\partial S}{\partial u}(z, 1, t) = t \frac{\partial P}{\partial u}(z, 1) \left(1 + \frac{\partial S}{\partial u}(z, 1, t) \right).$$

Further, differentiating Equation (5.1) lets us calculate

$$\frac{\partial P}{\partial u}(z, u) = \frac{Q(z)^2}{(1 - uQ(z))^2} = P(z, u)^2.$$

Hence, we obtain

$$S(z, u, t) = tP(z, u) \left(1 + \frac{t \frac{\partial P}{\partial u}(z, 1)}{1 - t \frac{\partial P}{\partial u}(z, 1)} \right) = \frac{tP(z, u)}{1 - tP(z, 1)^2}. \quad \square$$

Another standard application of the process of singularity analysis yields the asymptotic growth rates of stacked directed animals.

Corollary 5.1.12 (Asymptotics of stacked directed animals [10, Proposition 2]). The number of n -celled stacked directed animals on the square and triangular lattice, respectively, is asymptotically equal to

$$s_n = \frac{3}{28} \left(\frac{7}{2} \right)^n \left(1 + \mathcal{O} \left(\frac{1}{n} \right) \right), \quad t_n = \frac{1}{12} \left(\frac{9}{2} \right)^n \left(1 + \mathcal{O} \left(\frac{1}{n} \right) \right).$$

The number of minimal dimers in the corresponding stacked pyramids, which is a lower bound on their width, is asymptotically equal to $\frac{3}{28}n$ and $\frac{1}{12}n$, respectively. The width is trivially bounded above by n .

Theorem 5.1.13. The generating function of stacked directed animals of size $n + 1$ on the square lattice coincides with the generating function of Motzkin paths with alternative catastrophes of length n .

Proof. Let $E_{\mathcal{M}}(z)$ be the generating function of Motzkin excursions and $Q_s(z)$ be the generating function of strict half-pyramids. Then, Theorem 5.1.9 shows that

$$Q_s(z) = zE_{\mathcal{M}}(z). \quad (5.2)$$

Furthermore, for the bivariate generating function of strict pyramids $P_s(z, u)$, with u marking the right width of the pyramid we have

$$P_s(z, u) = \frac{Q_s(z)}{1 - uQ_s(z)} = \frac{zE_{\mathcal{M}}(z)}{1 - uzE_{\mathcal{M}}(z)}.$$

This generating function also has a lattice path interpretation. Let ω be a Motzkin excursion, with catastrophes only at altitude zero and let u count the number of catastrophes in ω . We split ω before each catastrophe. This partitions ω into a Motzkin excursion without catastrophes, counted by $E_{\mathcal{M}}(z)$, followed by a possibly empty sequence of Motzkin excursions without catastrophes, each preceded by a catastrophe, counted by $uz \cdot E_{\mathcal{M}}(z)$. Hence, their generating function $F(z, u)$ satisfies

$$F(z, u) = \frac{E_{\mathcal{M}}(z)}{1 - uzE_{\mathcal{M}}(z)} = \frac{P_s(z, u)}{z}. \quad (5.3)$$

Further, the generating function for stacked directed animals reads

$$S(z, 1, 1) = \frac{P(z, 1)}{1 - P(z, 1)^2} = \frac{\frac{Q_s(z)}{1 - Q_s(z)}}{1 - \frac{Q_s(z)^2}{(1 - Q_s(z))^2}} = \frac{Q_s(z)}{1 - Q_s(z) - \frac{Q_s(z)^2}{1 - Q_s(z)}} = \frac{Q_s(z)}{1 - \frac{Q_s(z)}{1 - Q_s(z)}}. \quad (5.4)$$

Next, we observe that the generating function of Motzkin meanders satisfies

$$M_{\mathcal{M}}(z) = \frac{E_{\mathcal{M}}(z)}{1 - zE_{\mathcal{M}}(z)}. \quad (5.5)$$

To wit, consider a last passage decomposition of a Motzkin meander ω . This splits ω into an initial excursion, counted by $E_{\mathcal{M}}(z)$, followed by a sequence of paths going from altitude i to altitude $i + 1$, while staying above the line $y = i$, counted by $zE_{\mathcal{M}}(z)$. Finally, combining (5.4), (5.2) and (5.5), we obtain

$$S(z, 1, 1) = \frac{Q_s(z)}{1 - \frac{Q_s(z)}{1 - Q_s(z)}} = \frac{zE_{\mathcal{M}}(z)}{1 - z\frac{E_{\mathcal{M}}(z)}{1 - zE_{\mathcal{M}}(z)}} = \frac{zE_{\mathcal{M}}(z)}{1 - zM_{\mathcal{M}}(z)} = zM_{\mathcal{M}}(z). \quad \square$$

In the following subsection we will present a bijective interpretation of this result.

5.1.2 Bijection to Motzkin excursions with alternative catastrophes

Lemma 5.1.14. The set of strict half-pyramids of size $n + 1$ is in bijection with the set of Motzkin excursions of length n .

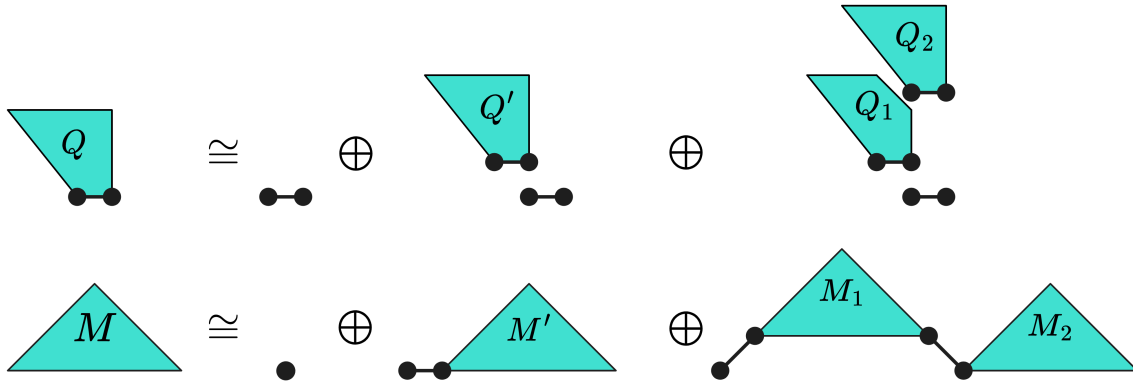

Figure 5.7: The factorizations of half-pyramids and Motzkin excursions.

Proof. We already observed in (5.2) that strict half-pyramids are counted by the Motzkin numbers. Now we will make the combinatorial origin of this connection explicit, by recursively constructing a bijection ω between these combinatorial classes. The recursive descriptions of both classes are pictured in Figure 5.7.

Let Q be a strict half-pyramid. It is either just a minimal dimer, or it consists of multiple dimers. In the first case, we set $\omega(Q)$ to be the empty path. In the latter case, we further

distinguish whether there is more than one dimer in the rightmost column of the half-pyramids. If there is just one, then Q is just the product of its minimal dimer and a half-pyramid Q' lying above the minimal dimer on its left side. In this case, we define $\omega(Q) := \mathbf{E}\omega(Q')$. Otherwise, we push the lowest non-minimal dimer of the rightmost column upwards to obtain a factorization into the minimal dimer and two half-pyramids Q_1 and Q_2 . This leads to the recursive rule $\omega(Q) := \mathbf{NE}\omega(Q_1)\mathbf{SE}\omega(Q_2)$.

For the inverse direction, let M be a Motzkin excursion. It is either just the empty walk or it consists of at least one step. In the first case, we set $\omega^{-1}(M)$ to be a single dimer. In the latter case, we further distinguish by the first step in M . If $M = \mathbf{E}M'$, we place a single dimer on the x -axis and recursively build $\omega^{-1}(M')$ diagonally right above the minimal dimer. If otherwise M starts with a \mathbf{NE} -step, we identify the first \mathbf{SE} -step that returns to the x -axis and partition $M = \mathbf{NE}M_1\mathbf{SE}M_2$. Here we again start by placing a dimer on the x -axis and recursively building $\omega^{-1}(M_1)$ diagonally left above it. Once the construction of $\omega^{-1}(M_1)$ is complete, we place $\omega^{-1}(M_2)$ in the same column as the minimal dimer, diagonally right above $\omega^{-1}(M_1)$. \square

Lemma 5.1.15. The set of strict pyramids of size $n + 1$ is in bijection with the set of 2-Motzkin excursions of length n (with black and red \mathbf{E} -steps), such that no red \mathbf{E} -step occurs at positive height $h > 0$. Equivalently, we could describe it as the set of Motzkin excursions of length n with catastrophes only occurring at height $h = 0$.

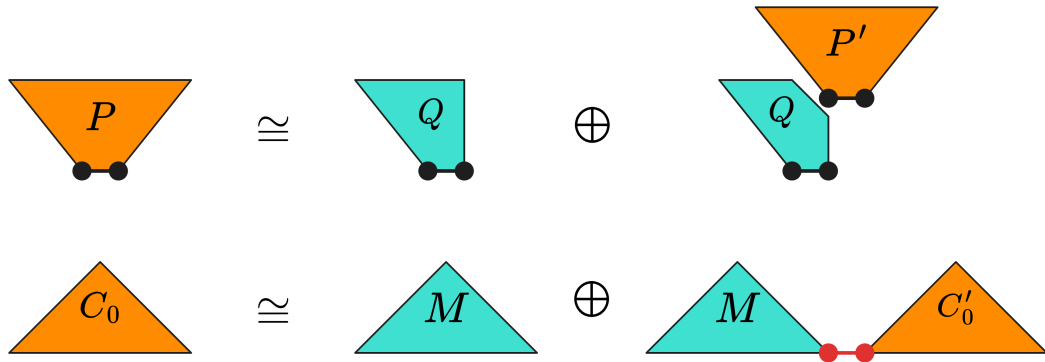

Figure 5.8: The factorizations of strict pyramids and Motzkin excursions with only horizontal catastrophes.

Proof. We already observed in (5.3) that the generating functions of these two combinatorial classes coincide. Now we present a combinatorial argument for this fact, by constructing an explicit bijection ω . Let P be a strict pyramid. It either has zero right width and is thus a half-pyramid, or there exists a dimer exactly one step to the right of the minimal dimer at some height $h > 0$. In the first case, we already know how to construct $\omega(P)$ from Lemma 5.1.14. In the second case, we partition P into a lower half-pyramid Q and an upper

pyramid P , by pushing the lowest non-minimal dimer in the column of the minimal dimer upwards; see Figure 5.8. In this case we apply the recursive rule $\omega(P) = \omega(Q)\mathbf{E}\omega(P')$.

For the reverse direction, consider a 2-Motzkin excursion M with no red \mathbf{E} -steps at positive height $h > 0$. If it has no red \mathbf{E} -step, it is simply a regular Motzkin excursion and Lemma 5.1.14 applies. In the other case, we recursively split it at the first red \mathbf{E} -step into an initial Motzkin excursion, followed by a red \mathbf{E} -step and a final 2-Motzkin excursion and apply Lemma 5.1.14 to the first part. \square

Theorem 5.1.16. The set of Motzkin excursions with alternative catastrophes of length n is in bijection with the set of stacked directed animals of size $n + 1$ on the square grid. Furthermore, the set of 2-Motzkin excursions (with black and blue \mathbf{E} -steps) with alternative catastrophes of length n is in bijection with the set of stacked directed animals of size $n + 1$ on the triangular grid.

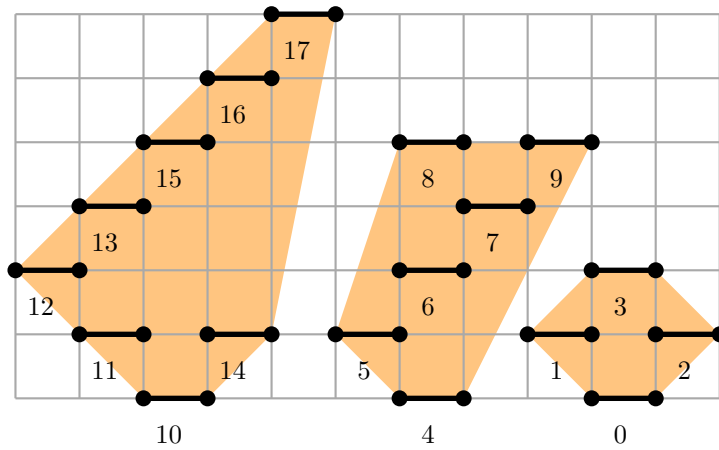

(a) Stacked directed animal of size 18.

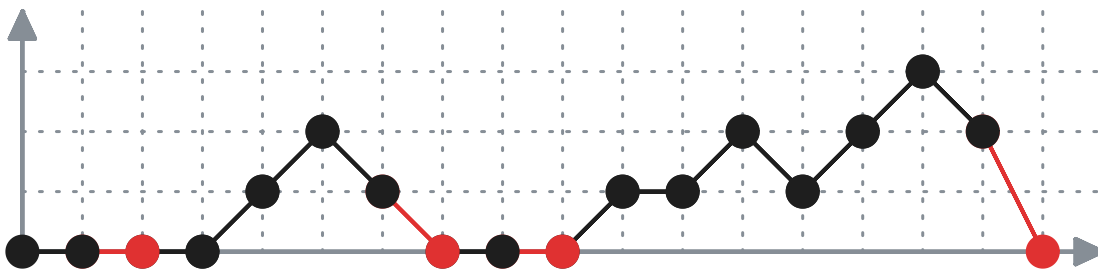

(b) Motzkin excursion with alternative catastrophes of length 17.

Figure 5.9: A stacked directed animal and their corresponding Motzkin excursion with alternative catastrophes. The dimers are numbered according to the order of their corresponding steps in the lattice path.

Proof. Let H be the connected heap of dimers representing a stacked directed animal on the square grid and denote with P_1, P_2, \dots, P_k the corresponding pyramidal factors of H .

We start our translation into lattice paths with the rightmost pyramid P_k . If $k = 1$, we simply apply Lemma 5.1.15 to translate H into a Motzkin excursion with catastrophes only occurring at height $h = 0$. Otherwise, if $k > 1$, after we have drawn P_k , the so far unused catastrophes from heights $h > 0$ will now encode the position where P_k is placed below P_{k-1} . Recall that the number of ways that P_k can be placed equals the right width of P_{k-1} . We will now define the distance between the two pyramids as the horizontal distance between the leftmost dimer of P_k and the minimal dimer of P_{k-1} . Let us denote this distance with ℓ , which will correspond to the height of the following catastrophe. We now make the first ℓ recursive factorizations of P_{k-1} explicit. This yields ℓ half-pyramids $Q_{k-1,1}, \dots, Q_{k-1,\ell}$ stacked diagonally to the right on top of each other and a final pyramid P'_{k-1} above them as illustrated in Figure 5.10. Note that the minimal dimer of P'_{k-1} is the first dimer whose horizontal projection intersects with the horizontal projection of P_k , thus connecting the pyramids. Now we need to deviate from the construction presented in Lemma 5.1.15, as we need to introduce ℓ additional **NE**-steps in order to offset the height lost with the new catastrophe. Hence, the start of each of the half-pyramids Q_i will be marked with a **NE**-step instead of with a horizontal catastrophe, like in Lemma 5.1.15. In particular, this means that the start of a new pyramid is always marked with an additional **NE**-step. This additional step is important, as otherwise each pyramid consisting of m dimers would be translated to a lattice path of length $m - 1$, and the final length of the lattice path would depend on the number of pyramids. The half-pyramids themselves are then simply translated according to the recursion rules from Lemma 5.1.14. Note that these rules remain legitimate on altitude $i > 0$, as they do not involve horizontal catastrophes, which may only happen at height 0. Thus, the last half-pyramid $Q_{k-1,\ell}$ before P'_{k-1} will be represented by a Motzkin excursion starting and ending at height ℓ . After that, a catastrophe from height ℓ will usher in the start of the image of P'_{k-1} , which can now again be drawn according to the rules of Lemma 5.1.15, as it no longer starts at a positive height. This procedure, illustrated in Figure 5.10, can now be iterated over all pyramidal factors of H to obtain the final lattice path image of H .

For the inverse mapping, let M be a Motzkin excursion with alternative catastrophes. If M does not contain any non-horizontal catastrophes, we may simply apply Lemma 5.1.15 to translate M to a single pyramid. Otherwise, we split M at every non-horizontal catastrophe. This yields a set of excursions E_1, E_2, \dots, E_k , with $k > 1$, each having exactly one non-horizontal catastrophe at their very end. Consider the first of these excursions E_1 , which will correspond to the rightmost pyramid P_k of H and the start of the next pyramid P_{k-1} . To recover P_k , it suffices to apply the procedure described in Lemma 5.1.15. However, this alone does not yet tell us, at which point we need to start drawing P_{k-1} . For that we need to look ahead to the non-horizontal catastrophe, which signals the end of E_1 . The start of P_{k-1} then corresponds to the last time E_1 leaves altitude zero before its final catastrophe, which can be intuitively described as the first **NE**-step visible from the viewpoint of the next catastrophe. The next question we need to answer is where to place the minimal dimer of P_{k-1} . For this we start at the horizontal projection of the leftmost dimer of P_k and move $\ell + 1$ units to the left, where ℓ is the height of the catastrophe at the end of E_1 . This is where we place the minimal dimer of P_{k-1} and start building the first half-pyramid $Q_{k-1,1}$. Similarly, the last time E_1 leaves altitude one marks the start of the next half-pyramid $Q_{k-1,i+1}$. The minimal dimer of $Q_{k-1,i+1}$ needs to be placed diagonally

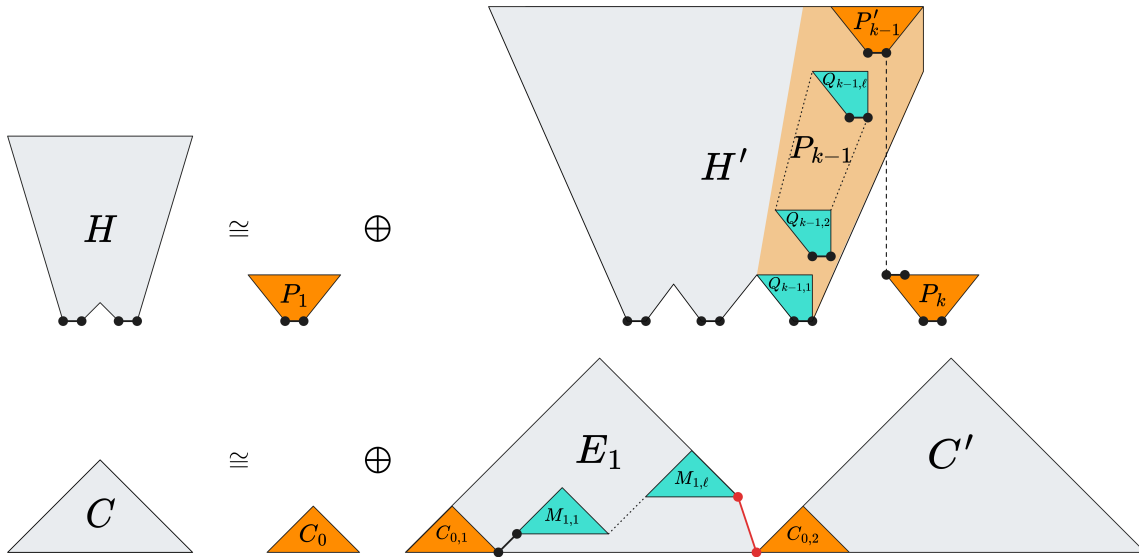

Figure 5.10: The recursive constructions of stacked pyramids and Motzkin excursions with alternative catastrophes.

right above the highest dimer in the rightmost column of $Q_{k-1,i}$. Now we can iterate this process until we hit the catastrophe, which marks the start of the pyramid P'_{k-1} . Now the process repeats, as we draw P'_{k-1} until we reach the first **NE**-step visible from the next non-horizontal catastrophe; see Figure 5.9 for an example of this correspondence.

In the case of stacked directed animals on the triangular grid, we are now working with general pyramids. We reduce this case to strict pyramids by simply inserting a blue **E**-step for every dimer lying directly above another dimer. \square

List of Figures

1.1	Examples of lattices.	1
1.2	Łukasiewicz correspondence.	4
1.3	The reflection principle.	5
2.1	Graphs of the characteristic curve.	25
2.2	The contours $\mathcal{C}_{\mathcal{R}}(n)$ and $\mathcal{H}(n)$	40
2.3	The integration contour γ in the domain $\Delta(\phi, R)$	45
3.1	The decomposition of a basketball walk counted by $G_{j,k}(z)$	53
3.2	Decompositions of a basketball walk ending at altitude ℓ	56
4.1	The decomposition of a meander with catastrophes.	67
4.2	Bijection involving Dyck meanders with alternative catastrophes.	70
4.3	Bijection involving Dyck meanders with alternative catastrophes.	71
4.4	Bijection involving Motzkin meanders with alternative catastrophes.	73
4.5	Bijection involving Motzkin meanders with alternative catastrophes.	74
4.6	All vertices accessible from the origin by Dyck excursions of length 10.	77
5.1	Polyominoes and matching lattice animals.	89
5.2	Heaps of dimers.	90
5.3	Constructing pyramids from directed lattice animals.	91
5.4	Constructing a connected heap from a square lattice animal.	92
5.5	Constructing a square lattice animal from a strict, connected heap.	94
5.6	The factorizations of strict half-pyramids and pyramids.	96
5.7	The factorizations of half-pyramids and Motzkin excursions.	99
5.8	The factorization of Motzkin excursions with only horizontal catastrophes.	100
5.9	Bijection involving stacked directed animals.	101
5.10	Recursive construction of stacked pyramids.	103

List of Tables

- 2.1 The four types of directed paths. 19
- 2.2 Table of standard function scale. 44

- 3.1 Table of coefficients of different basketball walks. 64

- 4.1 Table of lattice paths with catastrophes. 76
- 4.2 Table of lattice paths with alternative catastrophes. 76
- 4.3 Asymptotics of lattice paths with alternative catastrophes. 86

Bibliography

- [1] Cyril Banderier and Philippe Flajolet. Basic analytic combinatorics of directed lattice paths. *Theoret. Comput. Sci.*, 281(1-2):37–80, 2002.
- [2] Cyril Banderier, Christian Krattenthaler, Alan Krinik, Dmitry Kruchinin, Vladimir Kruchinin, David Nguyen, and Michael Wallner. Explicit formulas for enumeration of lattice paths: basketball and the kernel method. In *Lattice Path Combinatorics and Applications*, pages 78–118. Springer, 2019.
- [3] Cyril Banderier and Michael Wallner. Lattice paths with catastrophes. *Discrete Math. Theor. Comput. Sci.*, 19(1), 2017.
- [4] Cyril Banderier and Michael Wallner. The kernel method for lattice paths below a line of rational slope. In *Lattice Path Combinatorics and Applications*, pages 119–154. Springer, 2019.
- [5] Jean-Luc Baril and Sergey Kirgizov. Bijections from Dyck and Motzkin meanders with catastrophes to pattern avoiding Dyck paths. *Discrete Math. Lett.*, 7:5–10, 2021.
- [6] Claude Berge. *Principes de combinatoire*. Dunod, 1968.
- [7] Michael Terence Lewis Bizley. Derivation of a new formula for the number of minimal lattice paths from $(0, 0)$ to (km, kn) having just t contacts with the line $my = nx$ and having no points above this line; and a proof of Grossman’s formula for the number of paths which may touch but do not rise above this line. *J. Inst. Actuar.*, 80(1):55–62, 1954.
- [8] Mireille Bousquet-Mélou and Marni Mishna. Walks with small steps in the quarter plane. *Contemp. Math.*, 520:1–40, 2010.
- [9] Mireille Bousquet-Mélou and Marko Petkovšek. Linear recurrences with constant coefficients: the multivariate case. *Discrete Math.*, 225(1-3):51–75, 2000.
- [10] Mireille Bousquet-Mélou and Andrew Rechnitzer. Lattice animals and heaps of dimers. *Discrete Math.*, 258(1-3):235–274, 2002.
- [11] Andrew R. Conway and Anthony J. Guttmann. On two-dimensional percolation. *J. Phys. A: Math. and Gen.*, 28(4):891–904, 1995.
- [12] Deepak Dhar. Equivalence of the two-dimensional directed-site animal problem to Baxter’s hard-square lattice-gas model. *Phys. Rev. Lett.*, 49(14):959–962, 1982.
- [13] Philippe Flajolet and Andrew Odlyzko. Singularity analysis of generating functions. *SIAM J. Discrete Math.*, 3(2):216–240, 1990.

- [14] Philippe Flajolet and Robert Sedgewick. *Analytic combinatorics*. Cambridge University press, 2009.
- [15] S. Flesia, D.S. Gaunt, C.E. Soteros, and S.G. Whittington. Statistics of collapsing lattice animals. *J. Phys. A: Math. and Gen.*, 27(17):5831–5846, 1994.
- [16] Katherine Humphreys. A history and a survey of lattice path enumeration. *J. Statist. Plann. Inference*, 140(8):2237–2254, 2010.
- [17] Klaus Jänich. *Funktionentheorie. Eine Einführung. Sechste Auflage*. Springer, 2004.
- [18] Donald E. Knuth. *The Art of Computer Programming. Vol. 1; Fundamental algorithms*. Addison-Wesley, third edition, 1997.
- [19] Alan Krinik, Gerardo Rubino, Daniel Marcus, Randall J Swift, Hassan Kasfy, and Holly Lam. Dual processes to solve single server systems. *J. Statist. Plann. Inference*, 135(1):121–147, 2005.
- [20] Lukasz Kusmierz, Satya N. Majumdar, Sanjib Sabhapandit, and Grégory Schehr. First order transition for the optimal search time of Lévy flights with resetting. *Phys. Rev. Lett.*, 113:220602, 2014.
- [21] Marie-Louise Lackner and Michael Wallner. An invitation to analytic combinatorics and lattice path counting. In *Lecture note of the 2015 ALEA in Europe Young Researchers’ Workshop*, 2015.
- [22] Serge Lang. *Linear Algebra*. Addison-Wesley, 1966.
- [23] Sharabiin Myangat. *Quick Methods for Accurate Values of Circle Segments*.
- [24] Reinhold Remmert. *Theory of complex functions*, volume 122. Springer Science & Business Media, 1991.
- [25] Marc Renault. Lost (and found) in translation: André’s actual method and its application to the generalized ballot problem. *Amer. Math. Monthly*, 115(4):358–363, 2008.
- [26] John Riordan. *Combinatorial Identities*. Wiley, 1968.
- [27] Wim Schoutens. *Lévy Processes in Finance: Pricing Financial Derivatives*. John Wiley & Sons, 2003.
- [28] Richard P. Stanley. *Catalan numbers*. Cambridge University Press, 2015.
- [29] Gérard Viennot. Problèmes combinatoires posés par la physique statistique. *Astérisque*, 121–122:225–246, 1985.
- [30] Michael Wallner. Lattice path combinatorics. Master’s thesis, TU Wien, 2013.
- [31] William A. Whitworth. Arrangements of m things of one sort and n things of another sort, under certain conditions of priority. *Messenger Math.*, 8:105–114, 1878.
- [32] Herbert S. Wilf. *generatingfunctionology*. CRC Press, 2005.