

HYBRID DIAGNOSIS IN THE HYDRAULIC DOMAIN

Torsten Hesse* Benno Stein*

* *Department of Mathematics and Computer Science / Knowledge-based Systems
University of Paderborn, D-33100 Paderborn, Germany
email: art@uni-paderborn.de, stein@uni-paderborn.de*

Abstract: Within the scope of the research project INSAFA¹ we study the diagnosis of fluidic systems. A core objective is the automatic generation of tailored diagnosis systems for a class of hydraulic systems. Clearly, such an automatically generated diagnosis system cannot be intended to detect very particular faults, but it shall provide a reasonable support with respect to standard faults.

The variable structure, but also the various sources of faults and the presence of multiple faults result in a diagnostic process which is difficult, even for an expert in that field.

Our pursued objectives along with the properties of the fluidic domain suggest that a diagnosis concept should rather be model-based than heuristic. However, previous research showed that a purely model-based approach is not capable of getting a grip on the diagnosis problem. The approach presented here combines graph-theoretical investigations with model-based as well as heuristic diagnosis concepts.

Keywords: diagnosis, hydraulic systems, graph theory

1. INTRODUCTION

Hydraulic circuits consist of several types of hydraulic building blocks: (i) cylinders, which transform hydraulic energy into mechanical energy, (ii) various forms of valves, which control flow and pressure of the hydraulic medium, and (iii) service components such as pumps, tanks, and pipes, which provide and distribute the necessary pressure p and flow Q .

Like other technical systems hydraulic circuits can break down. Given this case typical symptoms are observed at the cylinder, whose piston may extend too slowly or may drift. The cause for such a misbehavior can lie in a defect control valve, or in the cylinder load that is too high, or in other things. Diagnosing a hydraulic circuit means to identify the component or, as the case may be, the set of components that are defect and that are responsible for the observed misbehavior.

A core objective of our work is the automatic generation of tailored diagnosis systems for a *class* of hydraulic circuits rather than the development of a single diagnosis system for one circuit. An automatically generated diagnosis system cannot be expected to detect very particular faults, but

it can provide a reasonable support with respect to standard faults.

To each hydraulic building block a physical behavior description can be stated. Along with a circuit's topology the local behavior descriptions define the behavior of the entire circuit. Hence a fundamental requirement for a model-based diagnosis procedure is fulfilled (de Kleer and Williams, 1987; de Kleer and Williams, 1989): Given the structure of hydraulic circuit, e.g. in the form of a drawing, its behavior can be predicted up to a sufficient precision. Model-based diagnosis compares predicted behavior to observed behavior (cf. Figure 1).

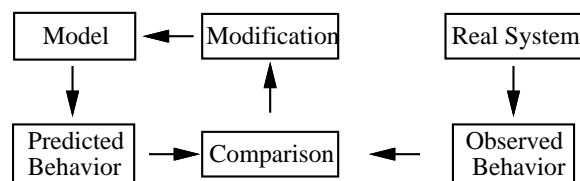

Figure 1. The idea behind model-based diagnosis.

A well known representative for this procedure is the General Diagnostic Engine, GDE (Forbus and de Kleer, 1993; Stefik, 1995). Diagnosis by means of GDE is based on assumptions relating the components' behavior status and the violation of these assumptions.

¹ In the INSAFA project, which is supported by the BMBF, a new generation of sensor/actor systems shall be developed.

Especially in connection with hydraulic circuits two problems come along when applying the GDE diagnosis procedure: (i) Long paths of interaction between components result in a large number of diagnosis candidates, which in turn result in a large number of measurements to be carried out. (ii) Hydraulic circuits are dynamic systems with a feedback structure; as a consequence, simple cause-effect chains, which form the base for GDE's reasoning process on violated assumptions, do not exist.

This paper proposes a hybrid diagnosis strategy for hydraulic circuits that shall overcome the problems of a purely model-based approach. The following subsection outlines the approach.

1.1 Overview of the Diagnosis Approach

Key concepts of the proposed diagnosis approach are: (i) a topological circuit analysis to reduce the diagnosis complexity, (ii) a rule instantiation step to make expert knowledge applicable for a concrete circuit C , and (iii) a heuristic diagnosis loop to find the defect components in C . The following paragraphs illustrate both the roles and the interplay of the three concepts; Figure 2 provides for a pictorial overview.

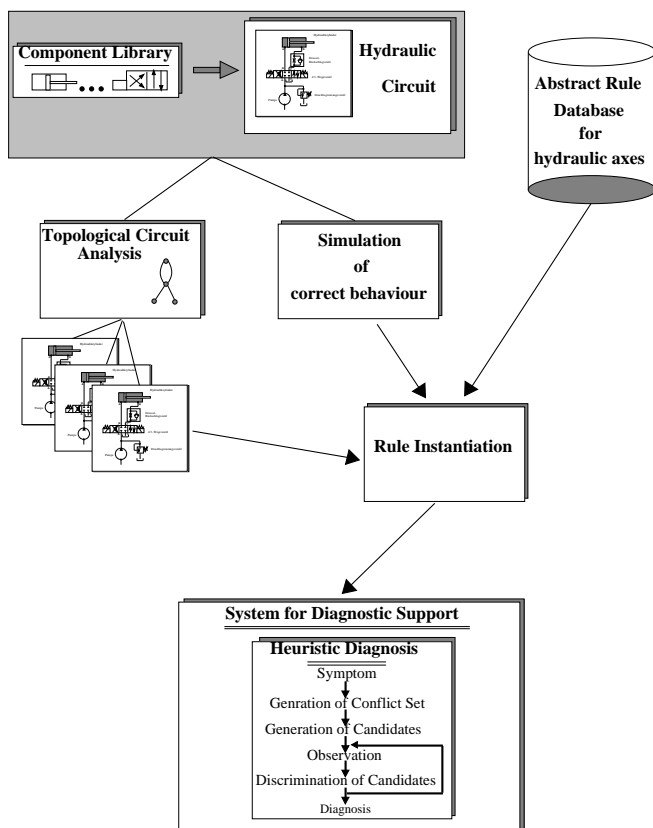

Figure 2. Overview of the diagnosis approach.

As in Davis (Davis, 1984) already mentioned, a hierarchical structuring of the diagnosis process is a must when investigating large systems. Figure 3 shows a midrange-sized hydraulic system. Given this system, how can a diagnosis process become organized hierarchically?

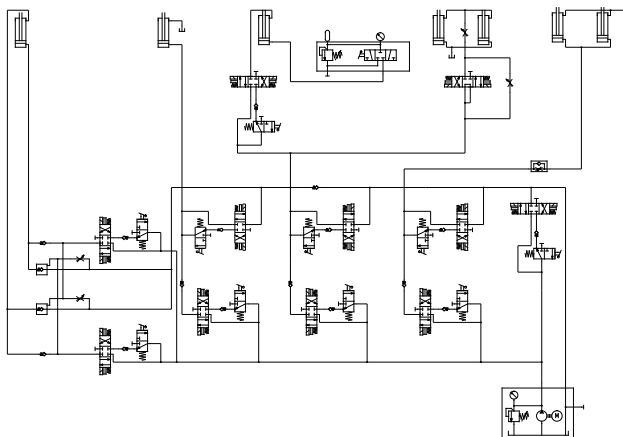

Figure 3. Hydraulic circuit.

Clearly, an expert starts at some macro level when investigating this circuit. More precisely, instead “envisoning” the circuit behavior at the bottommost, i.e. at the component level, he looks at the circuit’s function level. Taken this view, a circuit consists of blocks, so-called *hydraulic axes*, each of which providing a particular function. A clamping device, a press, or a bending device are representatives for such functions.

Thus, in a first step, a hydraulic circuit is decomposed into its hydraulic axes. The diagnosis process then can be focused onto a single axis according to the following working hypothesis: If symptoms are observed only at a single hydraulic axis, then the defect component(s) must be amongst the components of this axis. If symptoms are observed at several axes, the axes’ coupling type will give further answers with respect to defect components. We have developed algorithms that perform such a topological analysis; section 2 elaborates on this.

A single hydraulic axis provides always one working unit section, consisting of at least one cylinder, and one control unit section, consisting of different types of valves. Moreover, there is knowledge in the form of *abstract rules* that link observations made at the working unit section to hypotheses regarding the control unit section. Example:

$$\text{Velocity}(\text{Cylinder}) \text{ is Low} \rightarrow \neg \text{OK}(\text{Control_Valve}) \vee \neg \text{OK}(\text{Switching_Valve})$$

Rules of this kind have been acquired within discussions with domain experts. Of course these rules cannot be applied in an ad-hoc manner; they must be adapted, filled, and refined with respect to a given circuit. E.g., the above

abstract rule may become instantiated in the following way:

$$\text{Velocity}(\text{CD } 250\text{F}) \leq 0.1 \rightarrow \\ \neg \text{OK}(4\text{WRT } 16) \vee \neg \text{OK}(4\text{WE } 6)$$

Note that the instantiation does not only require a mapping from abstract components onto real components but also the simulation of the circuit's correct behavior. Section 3 goes into rule instantiation details.

Within the heuristic diagnosis loop the instantiated rules are used to generate conflict sets, to reason about diagnosis candidates, and to isolate a single diagnosis candidate by means of additional measurements. Section 4 describes the procedure.

2. TOPOLOGICAL ANALYSIS

If a hydraulic circuit is decomposed into its hydraulic axes, the diagnosis process can focus on isolated axes, which leads to a substantial reduction of the diagnosis complexity. In order to realize such a top down strategy, hydraulic axes must be detected as such. Figure 4 shows a few examples for hydraulic axes that have been cut free from a large circuit.

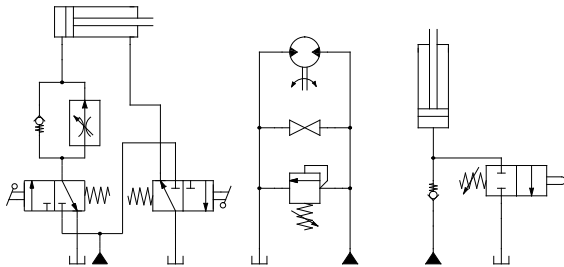

Figure 4. Examples for hydraulic axes.

From an engineering standpoint, a hydraulic axis A both represents and fulfills a subfunction f of an entire hydraulic plant. A defines the connections and the interplay among those working, control, and supply elements that realize f .

Although this definition leaves a scope of interpretation—e.g., regarding the components which actually must be counted to an axis and which not, it conveys a useful idea of what we are looking for within the topological analysis process.

The analysis procedure that we have developed is comprised of the following steps:

- (1) *Graph-theoretical Formulation.* Starting point is an abstraction from a circuit C onto a simplified graph data structure $G_h(C)$. As subsection 2.1 shows, this

data structure also forms the basis for a precise definition of the couplings between axes.

- (2) *Preprocessing.* To reduce G_h 's complexity—but, in first place, to make axes identification possible at all, G_h is simplified by means of merging, deletion, and condensation rules.
- (3) *Axes Identification.* Identifying a hydraulic axis means to search for a set of nodes in the hydraulic graph whose counterpart in the circuit realizes a particular function. Among others, each such set must contain at least one working element and one supply element.
- (4) *Coupling Type Determination.* The type of coupling between hydraulic axes can only be determined, if all components of a circuit have been assigned to at least one axis. In most cases, coupling type determination requires the comparison of supply paths between the axes' working elements.

The remainder of this section further elaborates on the analysis procedure; a detailed description can be found in (Stein and Schulz, 1998).

2.1 Graph-theoretical Formulation of Hydraulic Concepts

The topological analysis as pursued here is a matter of graph theory, and, in the following, we will fall back on some basic graph-theoretical terms such as *multigraph*, *path*, or *connected component*.²

A related *hydraulic graph* $G_h(C)$ of a circuit C is a multigraph $\langle V_C, E_C, g_C \rangle$ whose elements are defined as follows. (i) V_C is a set of points, and there is a bijective mapping from the set of non-pipe components in C onto V_C . (ii) E_C is a set of edges, and there is a bijective mapping from the set of pipe components in C onto E_C . (iii) $g : E_C \rightarrow 2^{V_C}$ is a function that maps an $e \in E_C$ onto $(v_i, v_j) \in 2^{V_C}$, if and only if there is a pipe between the components associated with v_i, v_j , and if e is associated with this pipe.³

Figure 5 depicts a circuit and its related hydraulic graph.

To accomplish complex manufacturing or manipulation tasks, several hydraulic axes are coupled and play together. Its in the nature of things that the level of such a coupling can vary, from rather loosely coupled axes to axes that strongly depend on each other. Note that in order to determine those components of a circuit belonging to an

² We use these definitions in a standard way as specified in (Cormen *et al.*, 1990; Jungnickel, 1990), and (McHugh, 1990).

³ We need multigraphs instead of graphs since components of a hydraulic system may be connected in parallel.

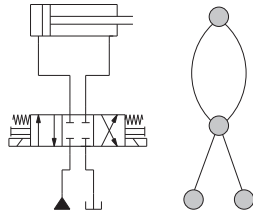

Figure 5. Circuit and its related hydraulic graph.

axis A , all couplings between A and other axes must be identified as such.

In particular we distinguish between informational, parallel, series, and sequential couplings; graph theory provides a proper means to define these couplings—Example:

Given is a hydraulic circuit C containing two sub-circuits A , B , which realize two different hydraulic axes. Let $G_h(A) := \langle V_A, E_A, g_A \rangle$ and $G_h(B) := \langle V_B, E_B, g_B \rangle$ denote the related hydraulic graphs of A and B respectively. Moreover, let $V'_A := V_A - (V_A \cap V_B)$, $V'_B := V_B - (V_A \cap V_B)$, and let $P_{w,s}$ be the set of all those paths from the working element w to a supply element s that use no edge associated with a control line. Then A and B are coupled in parallel if $\exists v_x \in V_X, X \in \{A, B\}$ such that the following conditions hold:

- (i) v_x is associated with a control element.
- (ii) $\forall p \in P_{w,s} \cap V'_x, p = (v_1, \dots, v_n) : \exists i \in \{1, \dots, k\}$ with $v_x = v_i$.

Figure 6 gives an example.

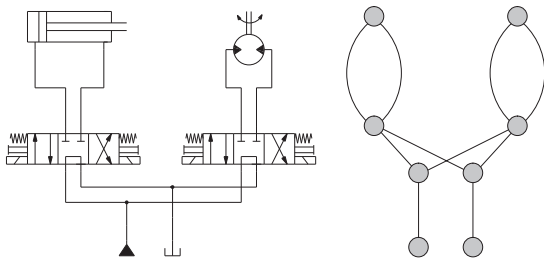

Figure 6. Circuit containing hydraulic axes coupled in parallel.

From an engineering point of view the definition states that each of the axes A and B is controlled by its own control element.

2.2 Preprocessing of Hydraulic Graphs

Within the preprocessing step, a circuit's hydraulic graph G_h is reduced in order to make axes identification possible. Loosely speaking, G_h is "stripped" from components that do not form a hydraulic axis backbone. Figure 7 gives an illustration.

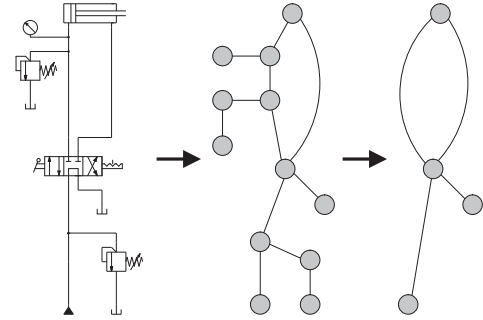

Figure 7. The effect of preprocessing.

Depending on the circuit in hand, a preprocessing may comprise the repeated application of up to 10 condensation rules, among others the following:

- **Control Path Deletion.** Control paths establish no isolation characteristic for hydraulic axes. They can be found (and removed) easily in G_h .
- **Dead Branch Deletion.** In this connection a dead branch is a subgraph whose nodes are not associated with control or working elements and whose connectivity is 1. Figure 8 shows two examples.

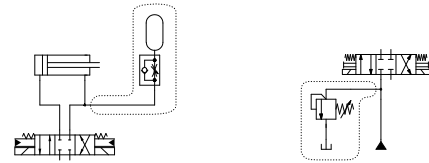

Figure 8. Two examples for a dead branch.

- **Particular Component Deletion.** There exist non-auxiliary components, whose corresponding nodes can be removed from G_h without a sophisticated investigation. The check valve is an example for such a component.
- **Loop Resolution.** A circuit may contain cyclic structures and components connected in parallel. These structures are not necessary for detection purposes if they neither contain nor control a working element. Figure 9 gives a few examples.

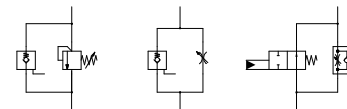

Figure 9. Examples for loops that can be cut.

Note that the valve in the rightmost circuit merely provides for an auxiliary function; in its context of use it cannot control a working element.

2.3 Identification of Axes and Coupling Types

Both the identification of axes and coupling types is straightforward if the preprocessing step has been carried out in a powerful and smart way. To identify hydraulic axes, all paths between the supply elements and the working elements of a circuit must be investigated. Hence a shortest-path problem must be solved for each supply element. Each run of a shortest-path algorithm labels the edges in the form of a directed tree, encoding the successor relationship between two nodes (cf. Figure 10).

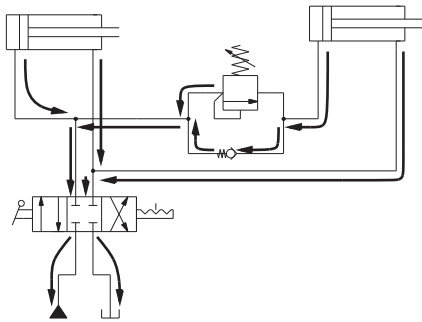

Figure 10. Successor information after a shortest-path run.

Note that all components that lie on the same path in the directed tree belong to the same hydraulic axis. Since hydraulic graphs are multigraphs there must exist two different paths from a working element to a supply element. A second path can be found by simply deleting one edge incident to the working element and then applying the shortest-path algorithm again.

Each hydraulic axis is also connected with a tank, and the components lying on the path between the tank and the working element are also count to the hydraulic axis. Hence we apply the path search algorithm in the same way for tanks as we did for the supply elements.

3. RULE INSTANTIATION

Since our approach shall not be restricted to a single hydraulic system, knowledge about cause-effect relationships must be formulated in some generic manner. In particular, the diagnosis knowledge here is encoded in the form of *abstract* heuristics and hypotheses. These rules, which exist to every hydraulic component class (cylinders, valves, pumps, etc.), have to be checked in order to establish correct component behavior.

The premises of the rules either refer to abstract parameter values of a component class, or they define comparisons between expected and observed values.

The rules' conclusions either reference further possibly defective components of a class, or they point to a conclusion of an additional rule, which in turn has to be checked.

Figure 11, for example, shows the structure of a rule graph of the class `Control_Valve`. This rule must be instantiated for every control valve of the circuit under investigation. I. e., the instantiation process realizes a casting from some abstract valve class `Control_Valve` onto those valves of the current circuit that are actually used as control valves.

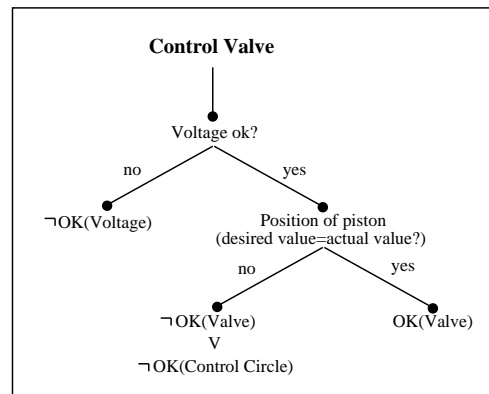

Figure 11. Rule graph of the class `Control_Valve`.

Values for the abstract physical parameters and the expected values of these rules must be filled after having performed a simulation run of the correct behavior of the system.

The following figures show an isolated hydraulic axis (figure 12) along with two rule graphs, which have been instantiated for the axis's valves.

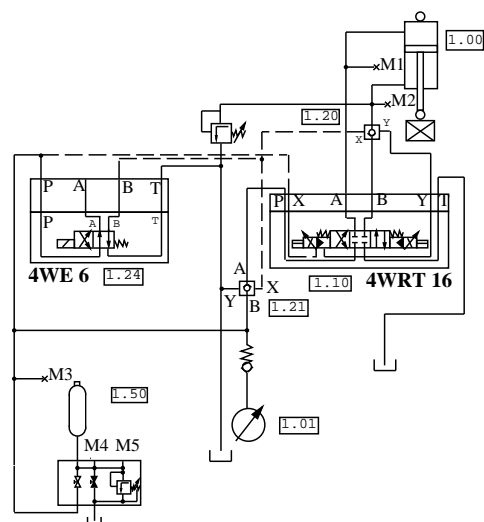

Figure 12. Hydraulic Axis.

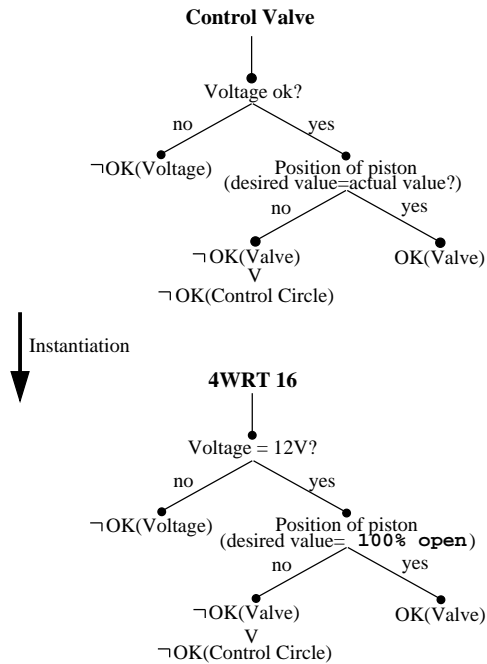

Figure 13. Instantiation of the proportional valve's rules.

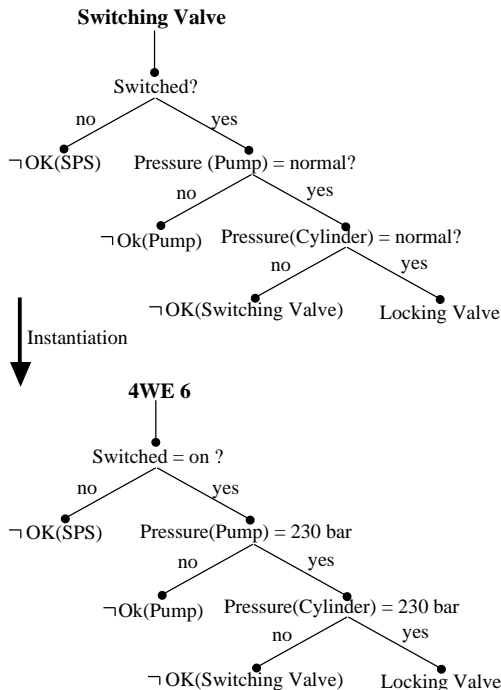

Figure 14. Instantiation of the switching valve's rules.

4. HEURISTIC DIAGNOSIS

The heuristic diagnosis is based on the empirical knowledge of the engineer, which is encoded in rules (see the previous section) and the probability of faults. Together with the results of the topological analysis and the simulation, these rules are used to propose and to interpret ob-

servations. As well as that, the rules are also exploited to choose and to discriminate amongst diagnosis candidates.

Every symptom possesses several causal relations to other components, that is to say, the faulty behavior of these components can explain the observed symptom. The components of these causal relations together form a *conflict set* S_o , which says that at least one component in S_o must be defective in order to explain the observed symptom.

Theoretically every power set of a n-element conflict set represents a diagnosis candidate, but more than two simultaneously defective components are very improbable in practice. So we limit our diagnoses to one- and two-element sets, which together form the candidate set.

Algorithm: Heuristic Diagnosis

- (1) *Symptom Observation on Fluidic Axis.*
It is in the nature of things that symptoms of misbehavior are usually observed on a cylinder of a fluidic axis.
- (2) *Generation of Conflict Set.*
Every component which is in causal relation to the observed symptom will become an element in the conflict set, according to the expert rules. Figure 15 depicts causal relationships for the symptom "Velocity of cylinder = 0"; the components are arranged with respect to their fault probability.

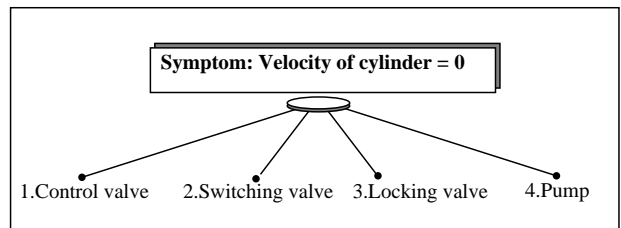

Figure 15. Causal relations.

- (3) *Candidate Composition.*
Based on the conflict set all two- and one-element subsets are constructed.
- (4) *Observation.*
By means of the instantiated rules, both fault probabilities and the effort estimations of further observations are computed.
- (5) *Candidate Discrimination.*
The search space is discriminated by the observation and the heuristic rules. In particular, there is an estimation function, which sums up the fault probability of a component and the proportion between the cost and the benefit of an observation.
- (6) *Raw Diagnosis.*
In the case of that there are raw diagnoses and further heuristics in the set of instantiated rules, new observations will be proposed (continue with (4)).

Remarks. A strategy to cut down the candidate set is the deployment of meta knowledge, which is available for many hydraulic systems. For example, when given parallel coupled axes, the hypothesis can be established that similar symptoms must be observed at all axes. In case of the confirmation of this hypothesis, the candidate set is restricted to those subsets which contain only components of the intersection of the coupled axes.

5. STATE OF THE REALIZATION

A large part of the outlined concepts has been realized and tested. In particular, the algorithms for the topological analysis were evaluated with our circuit library, which contains more than 150 circuits at the moment. More than 95% of the hydraulic axes in these circuits are identified correctly by the algorithms. In connection with the rather sophisticated hydraulic simulation job, we fall back on a simulation tool that has been developed in our working group over the past years (Kleine Büning *et al.*, 1995). However, the power of the heuristic diagnosis loop was evaluated only exemplarily by now.

Current research concentrates onto the coupling of the different modules towards an integrated diagnosis tool. In this connection the automatic utilization of simulation results within the process of rule instantiation establishes one challenge.

The outlined approach strives at the generation of diagnosis systems for a *class* of hydraulic systems, and, of course, there is a price to pay with respect to both the quality of the diagnosis and the efficiency of the diagnosis process. Nevertheless, we suppose that future experiments will justify a large part of the presented concepts.

References

- Cormen, Thomas H., Charles E. Leiserson and Ronald L. Rivest (1990). *Introduction to Algorithms*. The MIT Press, Cambridge, Massachusetts.
- Davis, Randall (1984). Diagnostic Reasoning Based on Structure and Behavior. *Artificial Intelligence* **24**, 347–410.
- de Kleer, Johan and Brian C. Williams (1987). Diagnosing Multiple Faults. *Artificial Intelligence* **32**, 97–130.
- de Kleer, Johan and Brian C. Williams (1989). Diagnoses with Behavioral Models. In: *Proc. of 11th IJCAI*. pp. 1324–1330.
- Forbus, Kenneth D. and Johan de Kleer (1993). *Building Problem Solvers*. MIT Press, Cambridge, MA.
- Jungnickel, Dieter (1990). *Graphen, Netzwerke und Algorithmen*. BI Wissenschaftsverlag, Wien.
- Kleine Büning, Hans, Daniel Curatolo, Marcus Hoffmann, Ralf Lemmen, Michael Suermann and Benno Stein (1995). ARTDECO – Entwurfsunterstützung in der Hydraulik. *KI 5/95*.
- McHugh, J. (1990). *Algorithmic Graph Theory*. Prentice Hall.
- Stefik, Mark (1995). *Introduction to Knowledge Systems*. Morgan Kaufmann Publishers, Inc. pp. 670–771.
- Stein, Benno and André Schulz (1998). Topological Analysis of Hydraulic Systems. Technical Report tr-ri-98-197. University of Paderborn, Department of Mathematics and Computer Science.
- Winston, Patrick Henry (1984). *Artificial Intelligence*. 2 ed.. Addison Wesley. pp. 192–203.