

AQY 1

User Guide

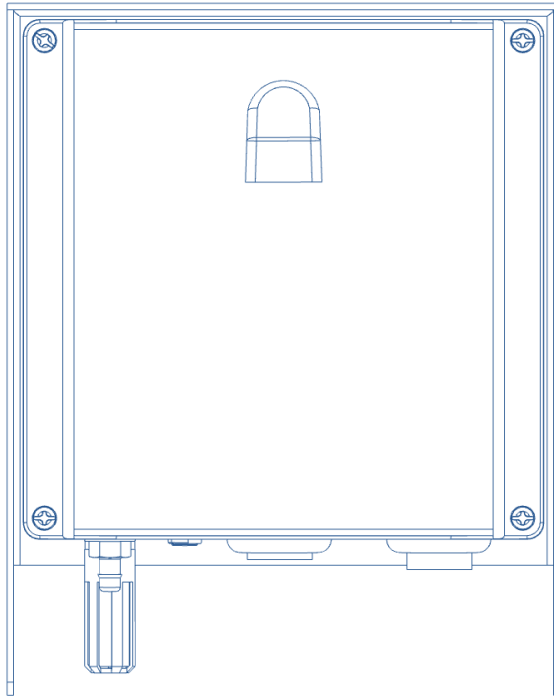

Ozone



Particulate Matter
 $PM_{2.5}$



Nitrogen
Dioxide



Temperature
Humidity & Dew Point

User Guide Revision History

Date	Revision	Description of changes
Jun 2018	1	First release.
Oct 2018	2	PM ₁₀ removed.
Apr 2019	3	Troubleshooting updated with: Status errors, replacing SD card.
Feb 2020	4	Power supply options and connection changed, new mounting bracket design, new sensor module image, sensor module retaining screw added. Updated the setting of PM _{2.5} sensor parameters after sensor replacement. Updated USB status messages to reflect changes to Connect/Cloud v1.17.0.

Contents

- User Guide Revision History 2**
- In the box 4**
- External features 4**
- How your AQY 1 works 5**
- Powering up your AQY 1 6**
 - Power requirements 6
- SIM card installation 7**
- Mounting your AQY 1 8**
- Connecting to your AQY 1 9**
 - Data Security 9
 - Aeroqual Connect (via Direct WIFI)..... 10
 - Aeroqual Cloud (via network WIFI / modem) 11
- Your AQY 1 data 14**
 - Manage data 14
- Looking after your AQY 1 15**
- Calibration of your AQY 1..... 16**
 - Standard operating procedure..... 16
 - Annual maintenance 21
- Specifications 29**
- Dimensions 30**
- Troubleshooting 34**
 - Resetting your AQY 1 34
 - USB status messages..... 35
 - Replacing the USB stick..... 36
 - Replacing the SD card 36
- The Legal Stuff..... 39**
 - Copyright..... 39
 - Terms and Conditions 39
 - Statements of Compliance 40
- For your notes 41**

In the box

The AQY comes with:

- 12 Vdc IP rated power supply connector and mating plug
- AQY 1 mounting bracket and screws
- Cable ties for securing power cable/modem
- USB stick with reset files and user guide
- User Guide

External features

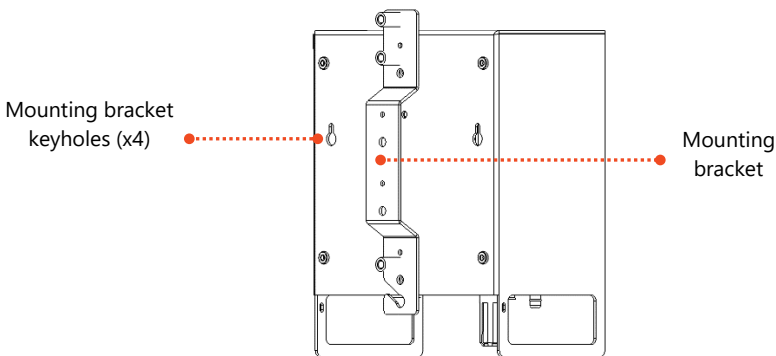
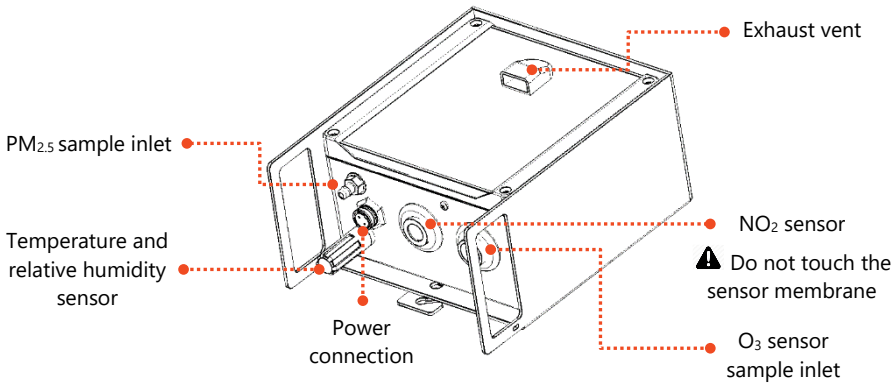

How your AQY 1 works

The AQY 1 does all measurement on the instrument; there is no correction of the data on the cloud. We believe this ensures the integrity of the data and helps to maintain confidence in the measurement. It is also in keeping with the IoT trend for increased 'processing at the edge'.

Fans of our ozone sensors will be pleased to know that we're still using our patented world class GSS ozone sensor. Outside of the AQM and AQS products, the GSS ozone sensor still performs extremely well in the AQY 1 as various independent evaluations have shown.

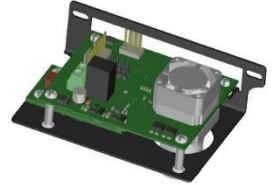

The NO₂ measurement is also unique. We're using our selective ozone sensor to correct for ozone interference on the electrochemical NO₂ sensor (a technique patented by Aeroqual). What this means is that the AQY 1 delivers a real NO₂ measurement rather than an approximation of NO₂ as delivered by all other devices that use an electrochemical NO₂ sensor. This is because all electrochemical NO₂ sensors are cross sensitive to ozone, and all electrochemical ozone sensors are cross sensitive to NO₂. Because we use a GSS ozone sensor which is highly selective to ozone, it allows us to use this technique to provide a highly accurate NO₂ measurement. The algorithm is embedded in the device itself and occurs in real-time.

The PM_{2.5} measurement is delivered by an optical particle counter which uses a well-known light scattering method to size and count particles and then convert them to a mass fraction. In humid conditions light scattering is susceptible to humidity artefacts which over-report particulate levels due to 'fogging' where the particles are encapsulated by moisture and appear larger to the sensor than they actually are. We correct for this effect by way of a humidity correction algorithm.



Find out more about Aeroqual's technology:

<https://www.aeroqual.com/company/our-technology>

Powering up your AQY 1

⚠ Before powering up your AQY 1

- If you have a modem fitted, please insert the SIM card before first powering up. This will ensure the AQY 1 automatically connects to Aeroqual Cloud at start up. See SIM card installation on page 7.
- If you do not have a modem and/or SIM card, when the unit powers up you can connect to the AQY 1 using WIFI. See Aeroqual Connect (via Direct WIFI) on page 10.

Connect the power supply to your mains power socket – for power supply options see **Power requirements** below.

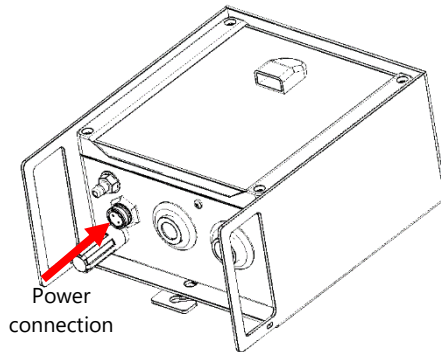

A green light should flash for 60 seconds then will stay on. After 60 seconds you should hear the internal fan switching on, then on and off every seconds. This indicates successful power on.

Power requirements

The AQY ships with an IP rated power connection and mating plug for wiring to a user supplied 12 Vdc, 24 W power supply, recommended specs are (11-32 Vdc range max, 150 mVp-p ripple and noise max).

An optional 12 Vdc plug pack (90 to 260 Vac input) 24 W (rated for -10 C to 40°C), 5 m cable and socket is available as a kit (P/N: **AQY 1 MAP Kit**) – some assembly required.

The AQY 1 can be powered by solar electricity if the supply output delivers 12VDC / 24W / 2A.

SIM card installation

⚠ Insert the SIM card before first powering up. This will ensure the AQY 1 automatically connects to Aeroqual Cloud at start up. If the AQY 1 does not appear in Aeroqual Cloud after powering up, see Connect your AQY 1 to Aeroqual Cloud via modem on page 12.

The standard modem takes a Micro SIM (12 x 15mm).

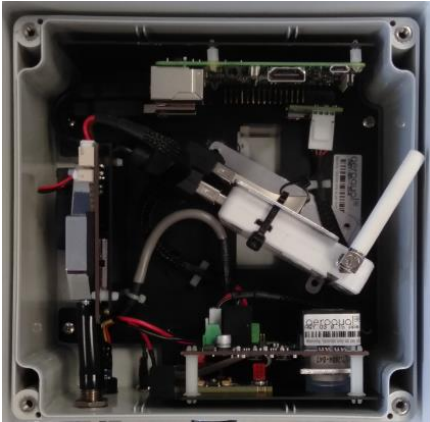

1 Remove the front cover.

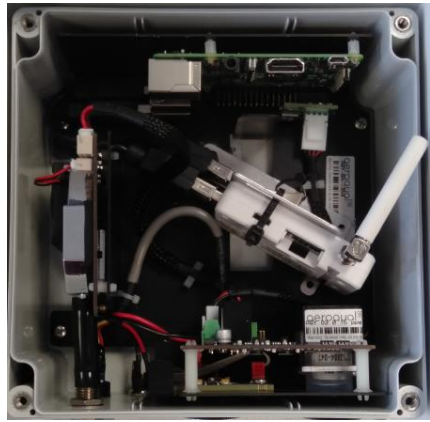

2 Remove the SIM card cover (the retaining screw is removed in the factory). Slide the cover up to remove it.

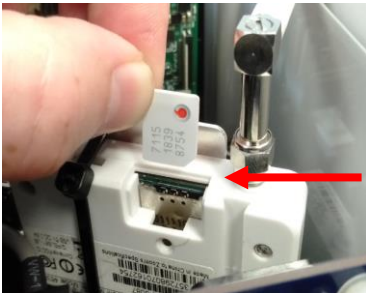

micro SIM

Micro SIM installation orientation

3 Orientate and push in the Micro SIM with the connector face facing up and bevelled corner on the right as shown above.



4 Rotate the aerial back to the vertical position. When replacing the front cover ensure the vent is at the top with the opening facing down.

Mounting your AQY 1

The AQY 1 is weatherproof (IP33), no further shelter is required. It comes with a mounting bracket for mounting to a wall or pole. The backplate of the AQY 1 has “key-holes” to allow the bracket to be used vertically or horizontally, or you can fix the bracket using the M3 screw mount points. The DC side of the power adaptor has a 5 m cable to allow connection to an indoor mains power socket.

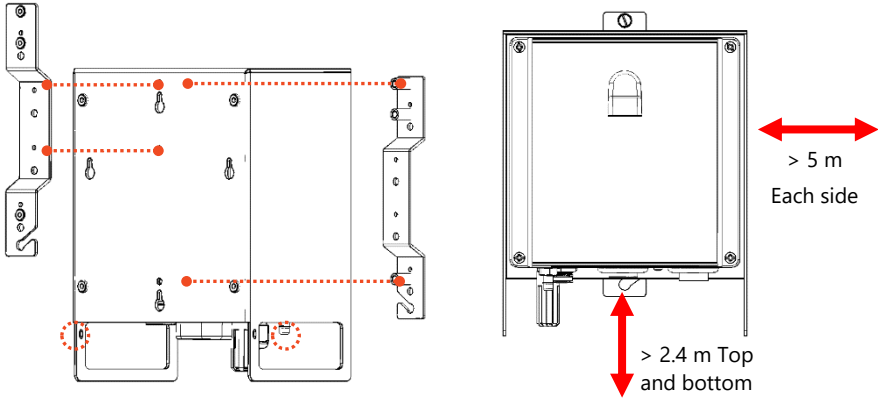

- Cable tie points to secure power cable
- M3 screw bracket mount points

Installation Clearances

- Choose a location with good airflow.
- Secure the power cable using cable ties.
- Install away from specific point sources e.g. kitchen vents, A/C units.



Installation examples

Connecting to your AQY 1

There are two ways to connect to your AQY 1:

- **Aeroqual Connect** for initial set up and when access to the internet is limited.
- **Aeroqual Cloud** for remote access, visibility of all your AQY 1 stations, and remote technical support from Aeroqual Care.

Aeroqual highly recommends every AQY 1 is connected to Aeroqual Cloud for the best user experience, additional data features, and Aeroqual Care.

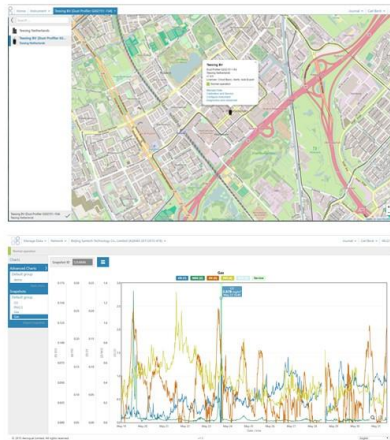
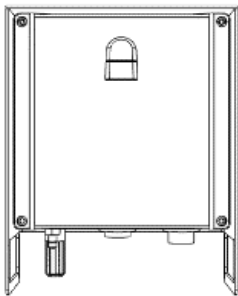

Data Security

The data belongs to you. We look after it in the same way that a bank looks after your money. Who you let access your data is entirely up to you – our job is to carry out your instructions.

If you do choose to store data with us, then here are some of the security assurances we provide:

- We use only ISO 27001 approved data centres
- Infrastructure is monitored and protected 24/7
- Data is accessed via a secure website with 256-bit SSL encryption
- User defined passwords

Aeroqual Connect (via Direct WIFI)

No internet connection is required for Aeroqual Connect. Aeroqual Connect is always running on the AQY 1 and can be accessed via an internet browser on any device, there is no software to install.

1. Connect your AQY 1 to Aeroqual Connect via Direct WIFI

After a few minutes of power on, you should see a new Wi-Fi network in your device's list of Wi-Fi networks. The Wi-Fi name (SSID) will match your AQY 1 serial number, connect to this network using the password below.

- Wi-Fi SSID: **AQY-AA000**
- Password: **Aeroqual**

2. Access your AQY 1 on Aeroqual Connect

After connecting your AQY 1 to your device, open an internet browser window and enter **10.10.0.1** in the address bar. You should see the Aeroqual Connect login screen. Log in with the default user name and password provided.

- Username: **administrator**
- Password: **aqmadmin**

After logging in to Aeroqual Connect, you will be presented with a screen with three 'apps'; Manage Data, Configure Instrument and Administration. You are now accessing your AQY 1 in "Access point" mode.

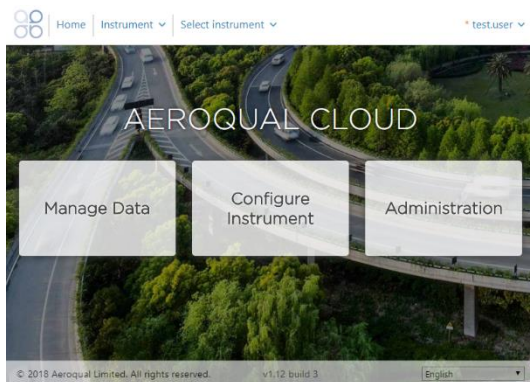

After logging in go to the Administration app and create a new user and secure password, then delete the default username and password.

Click on the **Manage Data** app to immediately see your data. In access point mode you can view and download data and make changes to the AQY 1 settings. The Wi-Fi range is approximately 10 meters. Data is automatically saved on-board the AQY 1 and can be accessed and downloaded over the direct Wi-Fi connection.

Aeroqual Cloud (via network WIFI / modem)

Data from your AQY 1 can be viewed or downloaded by you or your authorised users, remotely from anywhere in the world using Aeroqual Cloud.

1. Connect your AQY 1 to Aeroqual Cloud via a WIFI network

NOTE: If you haven't already done so you will need to first connect to your AQY 1 via Aeroqual Connect.

To use Aeroqual Cloud you need to connect to it through either an internet connected WIFI network, or by using the AQY 1 modem.

Open Aeroqual Connect as per step 2 in the previous section. Click on the **Configure Instrument** app to modify the connection settings.

⚠ In the next step the access point will be disabled, take extra care entering the SSID and password, or you may need to reset the AQY 1 – see Resetting your AQY 1 on page 34.

Change the WIFI mode from "Access Point" to "Client", type in the name of your internet connected WIFI network SSID, then type in your internet connected WIFI network password and click save. Your device will lose contact with the AQY 1 and the AQY 1 will connect to the internet.

The screenshot shows the 'Configure Instrument' app interface for an AQY-128 (AQY-AA128) instrument. The 'Communications' tab is selected, and the 'WIFI mode' is set to 'Client'. The 'WIFI SSID' is 'MyWIFINetwork' and the 'WIFI password' is 'MyWIFIPassword'. The 'WIFI IP address' is '192.168.0.15'. The 'Legacy' tab shows 'COM 1' as the communications port. The 'System' tab shows the instrument name 'AQY-128', software version '1.10.6509', and time zone '(UTC+12:00) Auckland'. The 'Sensors' tab shows active sensors: O3, GSE O3, cNO2, PM2.5, cPM2.5, PM10, cPM10, TEMP, RH, DP, LAT, and LONG. The 'Settings' sidebar on the left includes 'Alerts', 'Sensor List', 'Data Filters', and 'About'. The 'Offline' status is indicated at the top left, with a last contact date of 23 November 2017. The 'Save changes?' button at the bottom right has 'Cancel' and 'Save' options.

2. Connect your AQY 1 to Aeroqual Cloud via modem

The AQY 1 modem supplied is 3/3.5/4G cellular modem configured to work with most cellular networks. When the network SIM card is installed in the modem prior to powering on it should detect the correct access point name (APN).

NOTE: 4G is only available in the US.

If your AQY 1 does not become available in your Aeroqual Cloud after inserting your SIM card and powering on, then you may need to change the Access Point Name (**APN**) which may be unique to your chosen cellular provider.

1. To change the APN you will need to access you AQY 1 through Aeroqual Connect. To do this refer to Aeroqual Connect (via Direct WIFI) on page 10.
2. Once logged in open **Configure Instrument**. Under the "Communications" column you will need to change the "Cellular APN" to match that of your cellular provider. The default is "internet". A list of cellular providers APNs is available at the following website: <http://wiki.apnchanger.org>.

The screenshot shows the 'Configure Instrument' interface for an AQY-BA instrument. The 'Communications' tab is selected, and the 'Cellular APN' field is highlighted with a red box. The interface is divided into several sections: System, Sensors, Communications, External Sensors, and Legacy. The 'System' section includes fields for Serial number (AQY-BA), Name (AQY-BA), Instrument type (AQY1), Software version (1.16.0), Time zone (UTC+00:00 Dublin, 1), Summer time adjusted (checked), Location, Default averaging period (1 hour), Service time-out (24 hours), and Maximum SMS alerts per month (50). The 'Sensors' section includes Aeromass Sensor Port (COM 1), Poll interval (Every 5 seconds), Poll time-out (1.5 seconds), and Active Sensors (NO2, O3, PM2.5 raw, PM10 raw, RH, DP). The 'Communications' section includes Remote config interval (Every minute), Remote config server (Production server), VPN Server (Production), Offline reboot interval (24 hours), Ethernet mode (Direct (DHCP server)), Ethernet IP address (10.10.1.1), WiFi mode (Access point), WiFi SSID (Aeroqual AQM), WiFi password (Aeroqual), WiFi IP address (10.10.0.1), Cellular APN (internet), and VPN IP Address (10.9.1.176). The 'External Sensors' section includes External Sensors Activation (Add new driver ...) and Legacy (ACQM ID (1), Communications port (COM 2), Auto data report enabled). The footer shows '© 2019 aeroqual. All rights reserved.' and 'v1.17 build 2'.

3. Access your AQY 1 on Aeroqual Cloud

Go to <https://cloud.aeroqual.com>. Enter the username and password provided by Aeroqual. For assistance email technical@aeroqual.com.

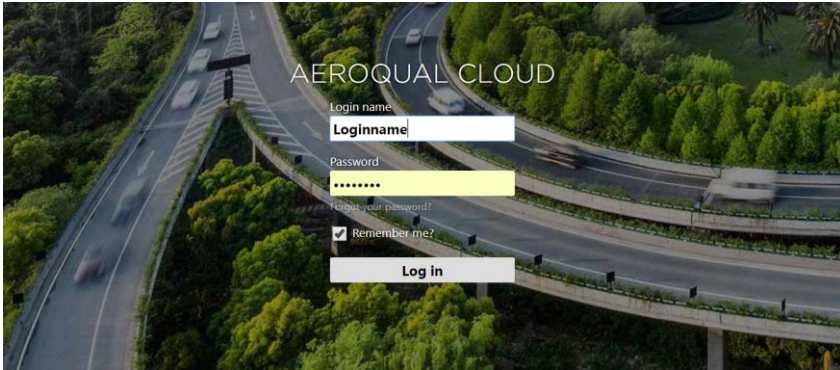

After logging in to Aeroqual Cloud, you will be presented with a screen with three “apps”; Manage Data, Configure Instrument and Administration. You can now access your AQY 1 through Aeroqual Cloud from anywhere in the world.

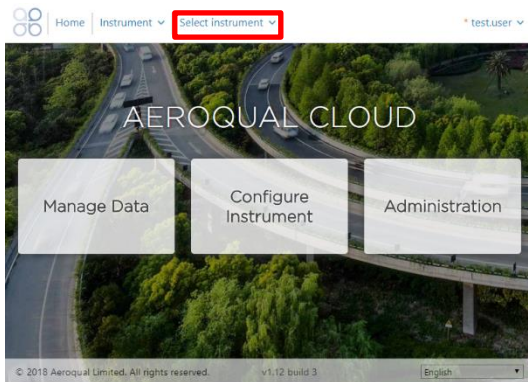

Click on **Select Instrument**. If your AQY 1 has successfully connected, you'll see “Normal Operation” reported in the banner at the top of the screen. If there is a connection error then check your APN as per the steps under Aeroqual Cloud (via network WIFI / modem) on page 11.

NOTE: If you have more than one instrument connected to Aeroqual Cloud, enter the Serial Number (AQY-AA000) of the AQY 1 you want to access.

If you have Administrator privileges then you can create other users (in the Administrator App) and these users can log on and download data from the AQY 1 also. You can view and download data using the Cloud Manage Data app.

Your AQY 1 data

Once you are connected to your AQY 1 you can start viewing your data! Data can be viewed and managed in either Aeroqual Connect or Aeroqual Cloud under "Manage Data".

Manage data

Under "Manage Data", you can view your data in *Charts*, *Advanced Charts*, *Table* format, or use *Download Data* to see your data in a .csv file. For other features such as *Auto Export* and *Manual Sync*, please contact technical@aeroqual.com.

All data captured on the instrument is retained from the first measurement. Under *Charts*, adjust the **From** and **To** date range and **Averaging period** as required.

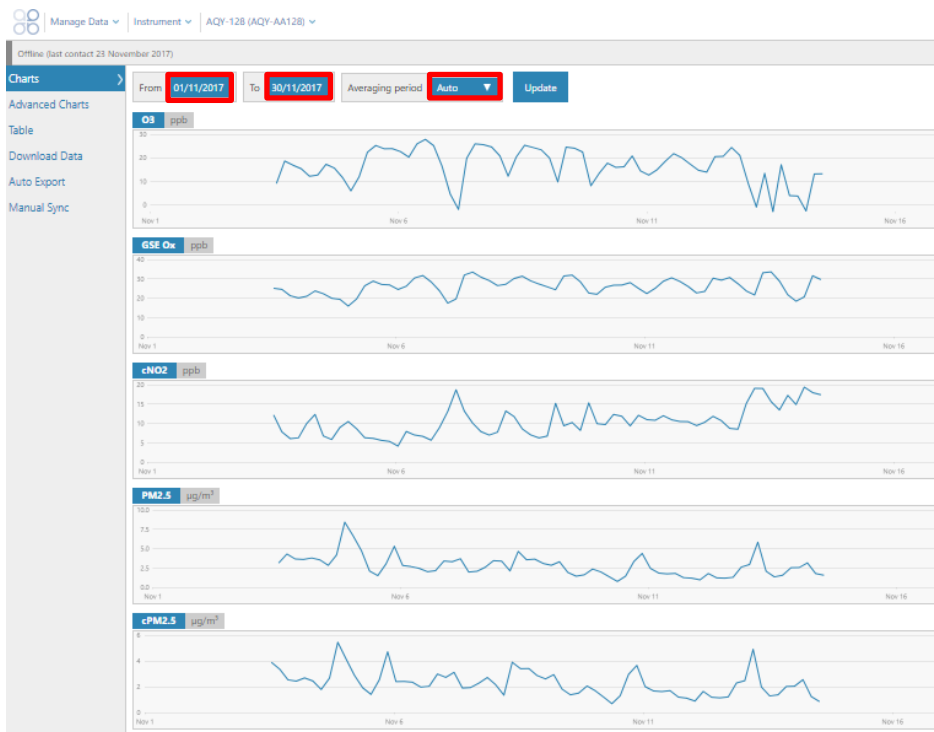

Looking after your AQY 1

The sensors supplied with your AQY 1 are intended to provide trouble free operation during the useful life of its sensors subject to geographical location.

WHO annual average PM₁₀ (ug/m³)	Example Cities	Useful AQY 1 life (months)*
0 - 50	Sydney, Los Angeles, London, Hong Kong, Berlin, Singapore, Sao Paulo, Tokyo, Moscow	10 - 14
51 - 100	Seoul, Bangkok, Istanbul, Shanghai, Johannesburg	8 – 12
101 – 150	Beijing, Medina, Kuwait, Lagos	6 – 10
151 - 200	Delhi, Mumbai,	4 – 8

*Useful life means the time from installation until the point when the sensor can no longer be remotely calibrated.

Calibration of your AQY 1

For most users, simply turning on the AQY 1 is enough. Data will start flowing. The AQY 1 comes factory calibrated and will report measured air quality parameters accurately.

For some users, with high data quality objectives, calibration against a 'reference' station is the best way to ensure highest correlation between AQY 1 and reference. To perform a co-location calibration see the next section.

This section describes how to perform a calibration of an Aeroqual AQY 1 using the method of co-location with a regulatory monitoring station. The AQY 1 contains both gas (O₃, NO₂) and particulate matter (PM_{2.5}) sensors.

Calibration via co-location provides a robust method of calibration that works for all measurements.

AQY 1 calibration is recommended when inter-comparability with regulatory monitoring data is required. It is often performed before and after deployment for project-based work or at regular intervals in long term monitoring projects.

In summary, the method compares data (usually hourly averaged) from the AQY 1 with the regulatory data and uses linear regression to calculate new slope and intercepts. These are then input into the AQY 1 via the Calibration and Service app in Aeroqual Cloud or Aeroqual Connect.

Standard operating procedure

1. Regulatory monitoring station selection

The regulatory station is a key element of the method. It should meet the following criteria:

- The station collects air quality data for all pollutants of interest (NO₂, O₃, PM_{2.5}) and the data is available at 1 hour (or more frequent) average values.
- The station has a secure and safe structure to mount the AQY 1 (e.g. roof railings).
- There is mains power available for the AQY 1 at the station.
- The pollutant concentrations (O₃, NO₂ and PM_{2.5}) are expected to be reasonably high at the regulatory site for at least some of the days during the co-location. Ideally, there should be some hourly averaged values for O₃ > 60 ppb, NO₂ > 40 ppb and PM_{2.5} > 50 ug/m³.

- If multiple stations are available, select the station that has environmental characteristics that are most similar to the project monitoring site of the AQY 1.

2. AQY 1 installation.

- a) Install the AQY 1 on the regulatory station at a position as close as possible and a similar height to station gas and PM inlets.
- b) Connect power.
- c) If you are using Aeroqual Cloud confirm the AQY 1 is connected to Aeroqual Cloud and data is being logged
- d) If you are not using Aeroqual Cloud connect to the AQY 1 via Aeroqual Connect and confirm data is logging correctly.
- e) Confirm the date-time stamp of the AQY 1 matches the regulatory station.

NOTE: If multiple AQY 1 units are being calibrated, consider using an external 3G WIFI router to connect all AQY 1s to Aeroqual Cloud to save data costs.

3. Co-location interval

- a) Leave the AQY 1 to run for a minimum of 3 days to collect enough data for a valid comparison. If pollutant data is low it is recommended that the co-location interval is extended. If the regulatory PM_{2.5} hourly averaged data is noisy you may need to use 24 hour averaged data and therefore you will need to co-locate for a considerably longer time, perhaps 2 weeks.
- b) If meteorological conditions are unusual during the co-location such as the presence of fog, storms or wildfires you should extend the colocation interval.

NOTE: The longer you can leave the AQY 1 at the co-location site the better as more data will be collected, improving the accuracy of the calibration.

4. Data preparation

Download the AQY 1 data and Reference data and prepare the data for comparison by checking the following:

- a) Make sure the date-time stamp for the reference station and the AQY 1 match each other. If not, make the required changes to align the AQY 1 data to the reference data.
- b) Make sure the reference data and AQY 1 data are using the same units of measurement.
- c) Check the reference data and remove any invalid data such as daily calibrations or maintenance.

- d) Remove invalid data from the AQY 1 data such as the warm up period (first 4-6 hours of operation), any spikes or lost data from power on/off issues.
- e) You should have a pair of data sets which have the same number of data and are correctly synchronised.

NOTE: The AQY 1 uses calibration parameters *gain* and *offset* which are applied to the instrument readings to produce an accurate concentration. The form of the equation on the instrument is:

$$[\text{gas}] = \text{gain} * (\text{reading} - \text{offset})$$

5. PM_{2.5} calibration

- a) Plot AQY 1 PM_{2.5} (y-axis) versus the regulatory PM_{2.5} (x-axis).
- b) Calculate the *slope* and *intercept* from a linear least squares fit to the data.
- c) Calculate the new AQY 1 *gain* and *offset* using the equations below:

$$\text{New gain} = \text{old gain} / \text{slope}$$

$$\text{New offset} = \text{old offset} + (\text{intercept} / \text{old gain})$$

6. O₃ calibration

- a) Plot AQY 1 O₃ (y-axis) versus the regulatory O₃ (x-axis).
- b) Calculate the *slope* and *intercept* from a linear least squares fit to the data.
- c) Calculate the new AQY 1 *gain* and *offset* using the equations below:

$$\text{New gain} = \text{old gain} / \text{slope}$$

$$\text{New offset} = \text{old offset} + (\text{intercept} / \text{old gain})$$

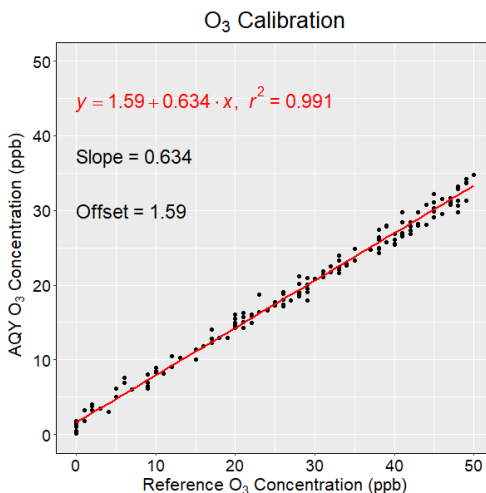

Figure 1: Example scatterplot of ozone data showing linear regression line with slope and intercept.

7. NO₂ calibration

AQY 1 NO₂ calibration requires a more complex approach. The AQY 1 NO₂ measurement uses two sensors to calculate the NO₂ concentration, a GSE Ox sensor and a GSS O₃ sensor. The NO₂ is calculated from the difference between the Ox and O₃ sensors according to the equation $[NO_2] = [Ox] - 1.1 * [O_3]$. Hence the Ox and O₃ sensor calibrations form part of the overall NO₂ calibration and the sequence is important. Since Ox sensor data is not reported by the AQY 1 it must first be determined by back-calculation. The process to follow is outlined below:

- a) Back-calculate AQY 1 Ox using the equation:
$$AQY\ 1\ Ox = AQY\ 1\ NO_2 + (1.1 * AQY\ 1\ O_3)$$
- b) Calculate a new gain and offset for Ox using a linear least squares fit of AQY 1 Ox vs Ref (NO₂ + O₃)
- c) Create calibrated AQY 1 Ox and O₃ data (Ox_{calibrated} and O_{3calibrated}) using the results of 7(b) and 6(c)
- d) Calculate an AQY 1 NO_{2new} dataset using these calibrated Ox and O₃ data where
$$NO_{2new} = Ox_{calibrated} - 1.1 * O_{3calibrated}$$
- e) Undertake a linear least squares fit of NO_{2new} to the reference NO₂ to get *slope* and *intercept* for AQY 1 NO₂.
- f) Calculate the new AQY 1 NO₂ gain and offset using the equations below:

$$New\ gain = old\ gain / slope$$

$$New\ offset = old\ offset + (intercept / old\ gain)$$

NOTE: Contact Aeroqual customer support if you would like Aeroqual to undertake the NO₂ calibration calculation for you. The first calibration is provided free of charge for Aeroqual Care customers.

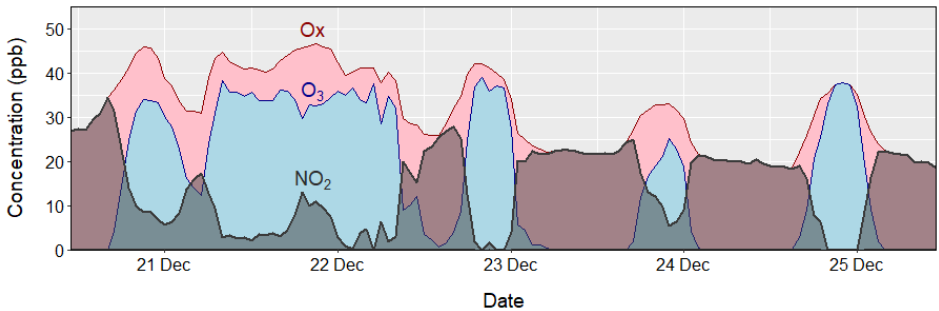

Figure 2: Example time series plot of ozone, Ox and nitrogen dioxide showing that NO₂ is the difference between Ox and O₃.

8. Upload new gain and offsets to the instruments.

The new gains and offsets can be uploaded to the instrument setting either remotely via Aeroqual Cloud or onsite through Aeroqual Connect. Enter the Calibration and Service app, click on "Manual Entry" and enter the new parameters in the Calibration parameters table.

9. Calibration validation.

Once the new gain and offsets are uploaded to the instrument, the calibration can be validated by continuing to run the AQY 1 at the regulatory station and collect 2-3 days of data. Plot the scatterplots described in e.g. 5(a) and confirm the slope and intercept of the linear regression line for each pollutant is close to 1 and 0, respectively. If they are significantly different, please recheck your calculations in sections 5 to 7. If no errors are observed it's possible the instrument has drifted and you may need to repeat the calibration process.

Annual maintenance

1. Replacing the PM_{2.5} Sensor



1 Disconnect the power supply at the bottom of the AQY 1 unit.

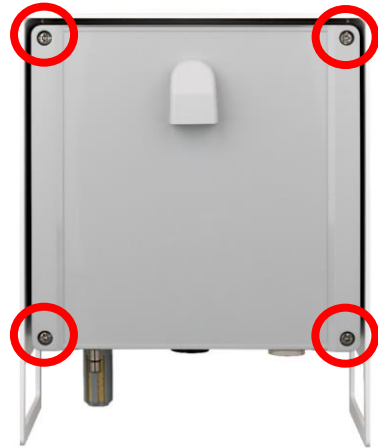

2 Loosen all 4 screws (they will not come out of the casing)



3 Unscrew the modem/USB mounting bracket.

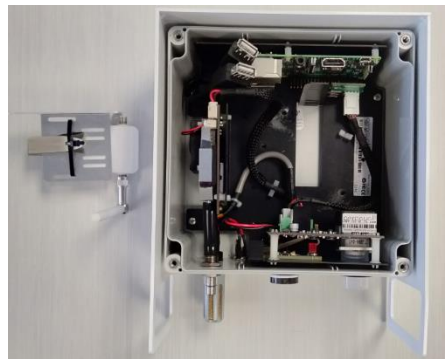

4 Disconnect the USB connections and remove the entire bracket with USB backup and modem attached.



5 Disconnect white connector at the top of the PM sensor.

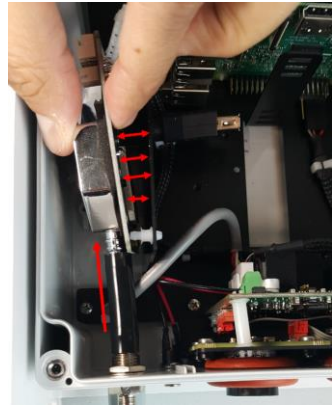

6 Separate the PM sensor from the metal bracket by disconnecting the white spacers. Pull the sensor out of the sample tube (wiggling or rotating may be required).



7 Insert the new PM sensor into the sample tube. Connect using the white spacers back to the metal bracket. Connect the white connector at the top of the new sensor.

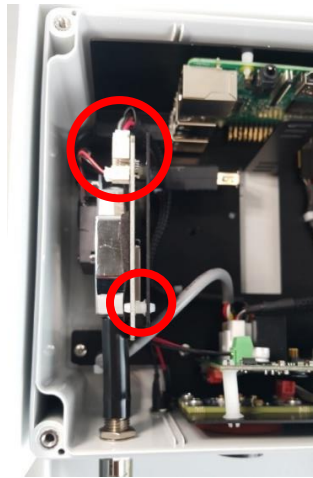

NOTE: If you are only changing the PM sensor then you still need to program the calibration parameters for this sensor, refer to section 3 Setting the PM2.5 sensor calibration parameters.

2. Replacing NO₂ and O₃ combined sensor cartridge

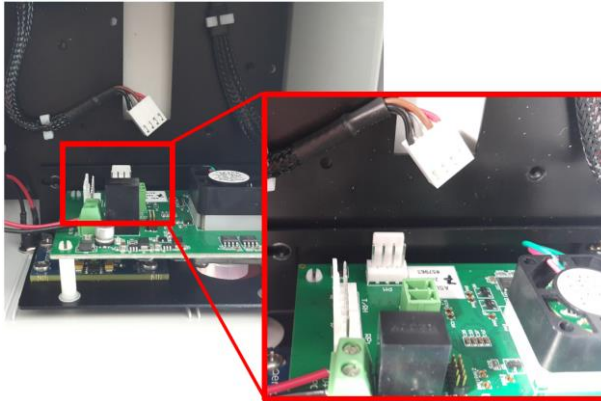

❶ Disconnect the 3 white data connections from the O₃/NO₂ sensor module. The connections are labelled PM, T/RH and RPi.

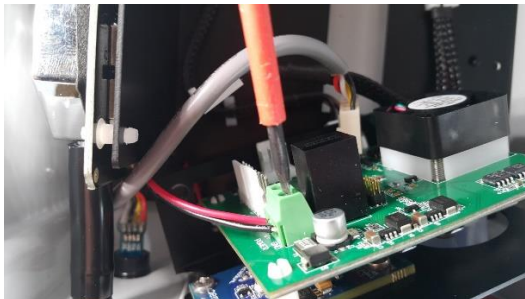

❷ Unscrew the positive and negative power supply cables from the O₃/NO₂ sensor module.

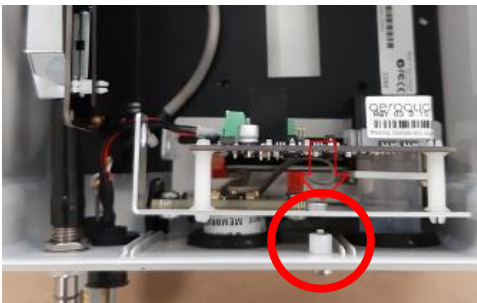

❸ Unscrew the entire sensor module, 1 screw underneath and two on the backplate. The sensor module can now be removed by gently pulling it vertically to free the sensors from their grommets.



④ Never directly touch the exposed NO₂ sensor at the bottom. If for any reason the sensor becomes disconnected from your replacement sensor assembly only grip the sides of the sensor when reconnecting.



⑤ Connect the positive and negative power supply cables to the replacement O₃/NO₂ sensor module. Ensure you double check the polarity

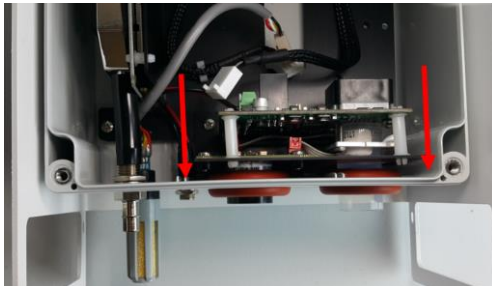

⑥ Align the NO₂ and O₃ sensors with the appropriate holes in the base and place the sensor module in position.

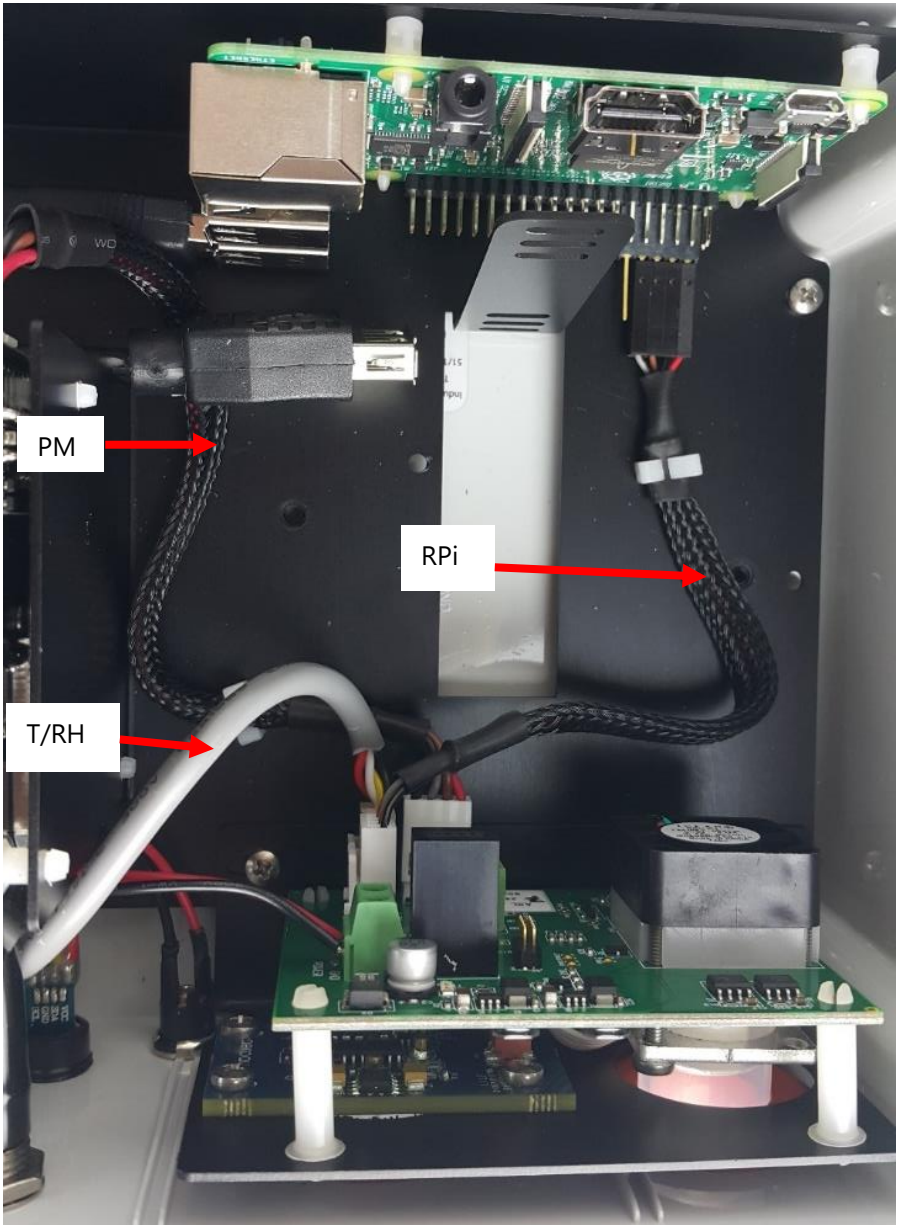

7 Re-attach the sensor board securing the bottom screw then the backplate screws. Ensure you connect the data connections to the correct terminals on the sensor board.



8 Reconnect the USB backup and Modem to their USB cables and screw the bracket back onto the backplate.



9 Replace the front cover ensuring the front vent is at the top with the opening pointing down, then reconnect the power supply.

3. Setting the PM_{2.5} sensor calibration parameters

After replacing the PM_{2.5} sensor the sensor calibration parameters need to be checked and reset.

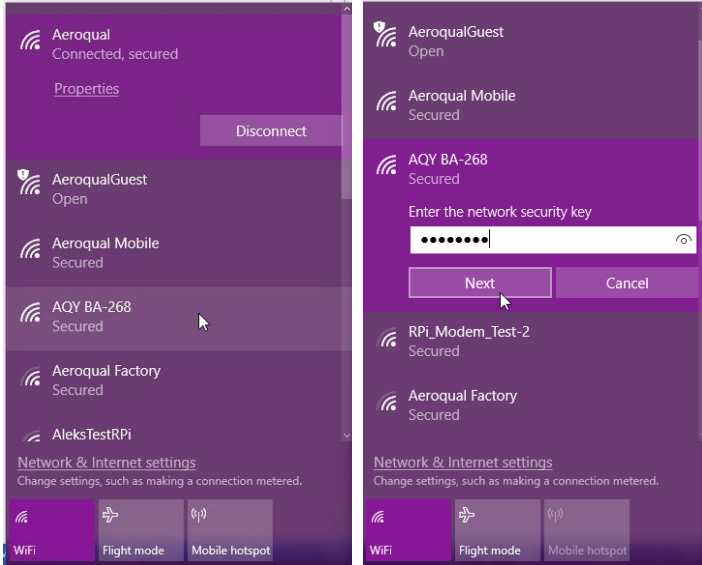

1 Connect to the instrument's access point or alternatively view the unit on Aeroqual Cloud.

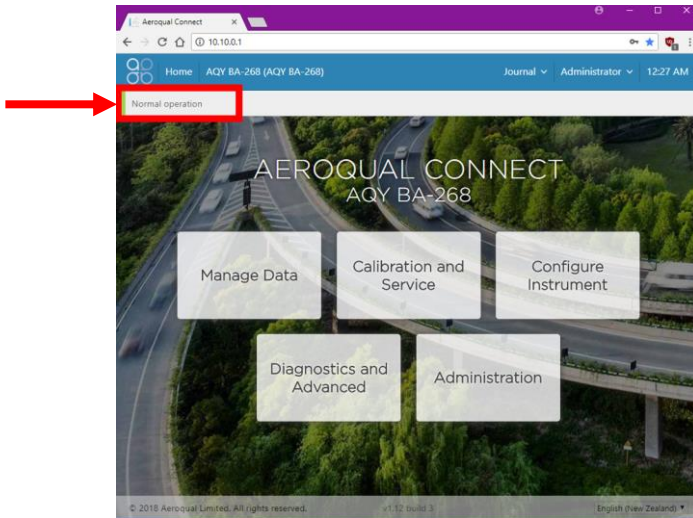

2 Ensure that the instrument is in **Normal operation** and not displaying an error message. If an error is displayed return to step 5 of section 1 Replacing the PM_{2.5} Sensor, and ensure the connections are correct.

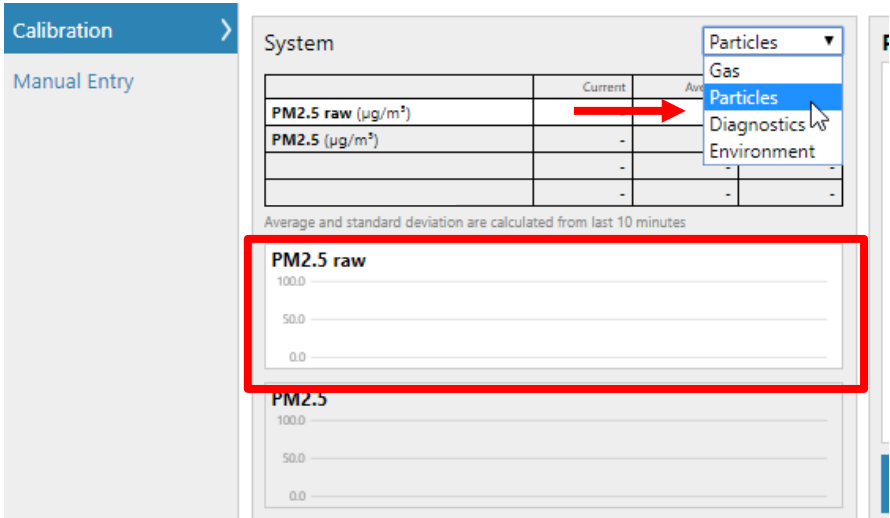

- ③ Select Calibration and Service and toggle the drop-down selection to “Particles”

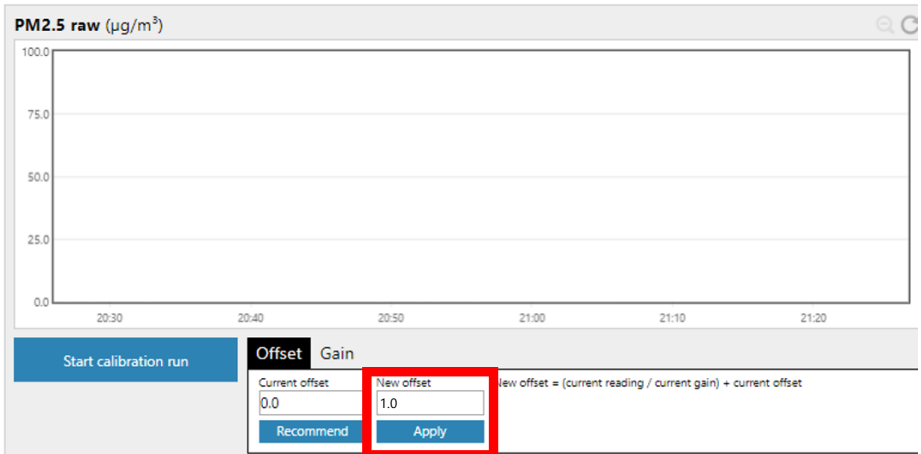

- ④ Select the “PM2.5 raw” channel, check the New offset is set to 0.0 and the New gain is set to 1.0, then press apply. Select Gain and input then apply the gain for the “PM2.5 raw” channel. Do not adjust these parameters on the other particle channels.

Specifications

PARTICLE SENSING	SIZES	RANGE	ACCURACY	LOWER DETECTABLE LIMIT (2 σ)
Laser scattering	PM _{2.5}	0 to 1000 $\mu\text{g}/\text{m}^3$	$\pm(10 \mu\text{g}/\text{m}^3 + 5\%$ of reading)	1 $\mu\text{g}/\text{m}^3$

GAS SENSING	RANGE	RESOLUTION	NOISE	LOWER DETECTION LIMIT	PRECISION	LINEARITY (% OF FS)	DRIFT 24 HOUR
			ZERO; SPAN % OF READING				ZERO; SPAN % OF FS
Ozone (O ₃)	0-200 ppb	0.1 Ppb	1 ppb; 2 %	1 ppb	4 % of reading or 4 ppb	3 %	2 ppb; 1 %
Nitrogen Dioxide (NO ₂)	0-500 ppb	0.1 ppb	2 ppb; 4 %	2 ppb	8 % of reading or 8 ppb	6 %	< 4 ppb; 1 %

SYSTEM SPECIFICATIONS	
Control System	Single board computer, 1.2 GHz quad-core, 1 GB SDRAM, 16 GB SDHC Storage, Debian Operating System
Communications	Standard: WIFI, 3/3.5/4G cellular modem (4G US networks only)
Software	<p>Aeroqual Connect: instrument operating system</p> <p>Aeroqual Cloud: instrument monitoring, management and technical support via secure cloud servers, accessed via web browser (IE, Firefox, Chrome, Safari).</p> <ul style="list-style-type: none"> • Cloud standard features; configuration, calibration, diagnostics, remote technical support. • Cloud optional features; text (SMS) and email alerts, 3rd party sensor measurements, full data visualization with charts, wind and pollution roses, data reporting with auto data export via FTP and API, full instrument event journal capture.
Data logging	Unlimited Aeroqual Cloud data storage, 32 GB Memory stick backup.
Averaging period	1 min, 5 min, 10 min, 15 min, 20 min, 30 min, 1 hr, 2 hr, 4 hr, 8 hr, 12 hr, 24 hr
Power system	User Supplied: 12 Vdc, 24 W recommended (11-32 Vdc range max, 150 mVp-p ripple and noise max) Optional: 12 Vdc plug pack (90 to 260 Vac input) 24 W (rated for -10 C to 40°C), 5 m cable
Enclosure	Weather proof IP33 with solar shield
PM Sampling System	Inlet: 4 cm anti-static inlet Sampling: 5 Vdc fan
Gas Sampling System	Inlet: Teflon, stainless steel Sampling: 5 Vdc fan
Dimensions	215 H x 170 W x 125 D mm (including solar shield armour & mounting brackets)
Weight	< 1 kg
Environmental operating range	-10 °C to +40 °C
Mounting	Mounting bracket included for pole, tripod or wall
Life expectancy	System: 5 years Sensors: ~12 months based on 0-50 $\mu\text{g}/\text{m}^3$ annual average PM ₁₀
Other measurements	Temperature: -40 °C to 125 °C; Relative Humidity: 0 to 100%; Dew Point: -30 °C to 50 °C

Dimensions

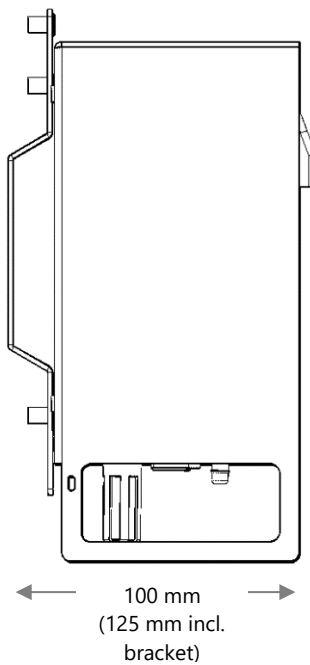
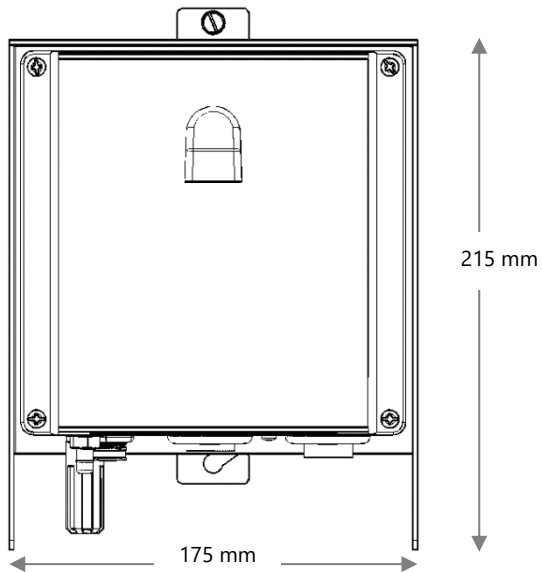

Off-grid solar solution

This section provides guidance for the construction of an off-grid power source for the AQY 1.

This guidance applies to an AQY 1 using a modem utilising maximum power consumption configuration. The off-grid configurations considered is:

- A solar panel array with battery bank

Key photovoltaic (PV) system elements include:

- Solar panels - convert sunlight into electric energy
- Deep cycle batteries - store power produced by solar panels and provide power to instruments
- Charge controllers - protect batteries from overcharging and optimize the battery charging function
- Wires and cables - connect the electrical components

Supporting structures include:

- Panel mounting – supporting framework for the solar panels
- Battery enclosure – protects batteries and charging circuitry from environmental elements

Designing a PV system

The off-grid PV system must keep up with regular power demands and infrequent peak periods. Keys to the design of such a system are:

- a) Computing power demands of the instruments,
- b) Evaluating how many batteries are needed to ensure operation

Power requirements

The first thing to know before designing a PV system is the power requirement of your system. You need to consider the following points:

- The PV system will connect directly to the 12 Vdc input on the AQY 1.
- AQY 1 with a modem consumes 5.4 W
- A regulated 12 Vdc input ($\pm 2.5\%$) with < 150 mV (pk-pk) ripple is required for the AQY

Compute amp-hours per day

To compute amp-hours per day:

- Current Drawn is 0.43 amps peak. AQY1 runs for 24hours a day.
- C (amp hours) = $0.43 * 24$ hours = 10.32 amp hours.
- It is also necessary to apply a loss factor for the batteries (20 % is a conservative guide).

Determine the size of the battery bank

Batteries are needed to provide power to the system during the night and through periods with overcast skies. The size of the bank will vary with latitude and according to your climate. For this reason alone engaging a local expert is strongly advisable. You also need to consider that the batteries should never be fully discharged, as they can be damaged.

- It isn't good to run a battery all the way down to zero during each charge cycle. For example, if you want to use a lead acid battery for many cycles you shouldn't run it past 80 % of its charge, leaving 20 % left in the battery. This not only extends the number of cycles you get, but lets the battery degrade by 20 % before you start getting less run time than the design calls for

$$C' = C/0.8 \text{ (80 \% depth of discharge or DOD)}$$

$$C' = 10.32/0.8 = 12.9 \text{ AH}$$

- Step 3: For lead acid batteries the rated capacity (i.e. the number of AH stamped on the side of the battery) is typically given for a 20 hour discharge rate. If you are discharging at a slow rate you will get the rated number of amp-hours out of them. However, at high discharge rates the capacity falls steeply. A rule of thumb is that for a 1 hour discharge rate (i.e. drawing 10 amps from a 10 amp hour battery, or 1 C) you will only get half of the rated capacity (or 5 amp-hours from a 10 amp-hour battery). Charts that detail this effect for different discharge rate can be used for greater accuracy. For example the data sheets listed in <https://www.powerstream.com/BB.htm>

Determine the number of solar panels

- Solar panels must be sized according to the amp-hours per day for your system, and the efficiency of the panel. The number of sun hours per day determines the number of panels, and is location dependant. To find out the solar insolation (given in kWh/m²/day) for your location you can use reference websites such as:
http://www.apricus.com/html/solar_collector_insolation.htm#.XJnBu5gzbjZ

System output and charge controller

- A charge controller regulates the power transfer from the PV array to the batteries, which prevents overcharging. In addition, it prevents the batteries from discharging into the solar array. Some charge controllers also monitor the temperature of the batteries to prevent overheating. Charge controllers may offer remote power monitoring and can show the overall operating efficiency of the system.

Worked example of a PV system designed to handle 1 day or 3 day operation without solar charging

- a) AQY1 Load is $0.45 \times 12 = 5.4 \text{ W}$
- b) The AQY1 will run for 24hrs a day. $5.4 \text{ W} \times 24 \text{ h} = 129.6 \text{ Wh}$
- c) We are running on 12 V. $129.6 \text{ Wh} / 12 \text{ V} = 10.8 \text{ Ah}$ per day.
- d) The system will have to run for max. 1 day without the sun.
 $10.8 \text{ Ah} \times 1 \text{ day} = 10.8 \text{ Ah}$
The system will have to run for max. 3 days without the sun.
 $10.8 \text{ Ah} \times 3 \text{ day} = 32.4 \text{ Ah}$
- e) We will use lead acid batteries.

1 Day Calculation: Lead acid charge should not go below 50 % (Peukart effect).

$$10.8 \text{ Ah} / 50 \% = \mathbf{21.6 \text{ Ah}}$$
 battery capacity needed.

3 Day Calculation: Lead Acid charge should not go below 50% (Peukart effect).

$$32.4 \text{ Ah} / 50 \% = \mathbf{64.8 \text{ Ah}}$$
 battery capacity needed.

Troubleshooting

Resetting your AQY 1

If you don't see the "Normal Operation" status after 10 minutes when first connecting, or you have incorrectly entered your network details, follow these instructions to reset your AQY 1 back to factory settings.

The AQY 1 will return to Access Point mode, which will broadcast a WI-FI network with SSID called "Aeroqual AQM", password is "Aeroqual".

The USB stick that came with your AQY 1 has a file in the root directory called **.resetnetwork.aqm** (note the "dot" at the beginning). You can create this file on a FAT32 encoded USB stick by creating a new .txt document and naming it **.resetnetwork.aqm** (the file extension must be **.aqm**, not **.aqm.txt**).

To reset your AQY 1 remove the lid and plug the USB stick into the USB ports as shown in the image below – if you have a modem fitted you will need to unplug the modem to use the USB connection. After several minutes, the computer will reset. Depending on the version of Aeroqual Connect you are using, the SSID name will appear as the monitor **"serial number"** or as **"Aeroqual AQM"**, the reset WIFI password will be **"Aeroqual"**.

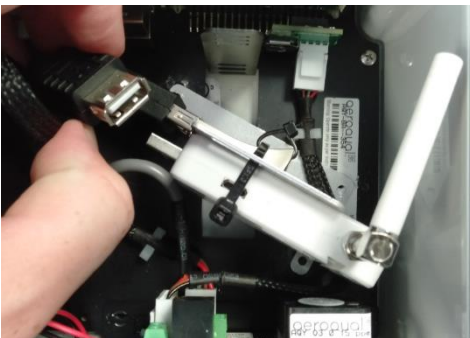

USB status messages

The following messages apply to factory shipped Connect version 1.14.0 and above. Upgrading to version 1.14.0 does NOT provide this functionality.

Notification banner messages

Message	Used In	Details
Normal Operation	Cloud & Connect	USB drive connected and there is connection to the Cloud server.

Journal messages

Message	Details
USB storage drive successfully initiated	When the system can use the connected USB drive.
System resources critically low!	When database size in volatile memory reaches maximum limit. Reboot will happen when it is detected.

Replacing the USB stick

⚠ The USB stick provided with the AQY has been specifically selected for its performance and reliability. Always consult with Aeroqual before replacing the USB, selecting an inferior USB stick may compromise operation of your AQY.

If you have consulted with Aeroqual and a replacement USB stick is required, then below is a link to the only USB stick we have tested:

<https://www.samsung.com/nz/memory-storage/usb-3-1-flash-drive-bar-silver/MUF-32BE3APC/>

Replacing the SD card

Tools Required: Phillips Screwdriver (small), Anti Magnetic Tweezers

Parts Required: 1 x AIC MSD01 (Imaged with Connect)

Time Taken: 5-10 minutes

Remove the front cover of the AQY, the SD card is located on the top right hand side of the Raspberry Pi and indicated on the image below.

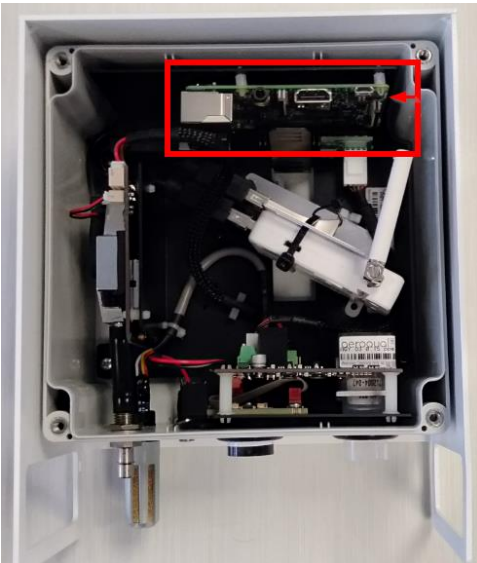

Disconnect the modem/USB backup bracket and remove.

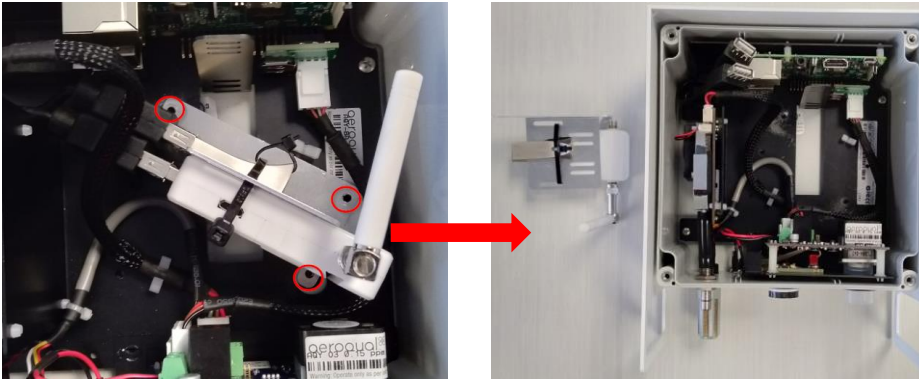

The raspberry Pi in the AQY V1 can be pulled down to separate the connectors and provide access to the SD card.

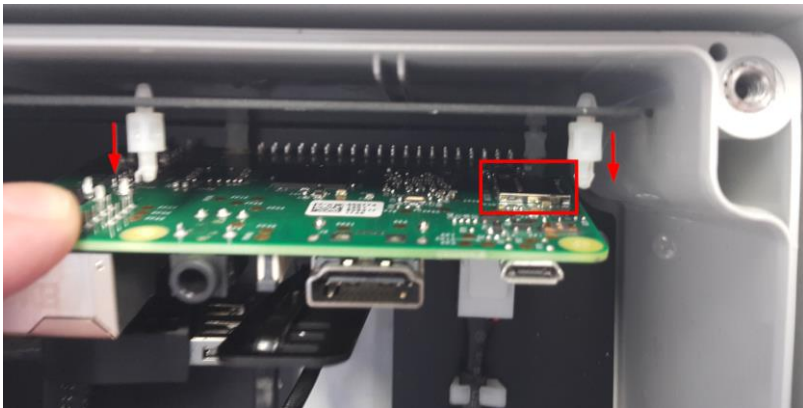

Reverse the steps to fit the new Micro SD Card.

After fitting the new SD card you will need to do the following:

- Transfer the calibration. If you are fitting an SD card provided with a "SPARE" serial number, then you will need to connect the unit to the internet and contact Aeroqual to correctly set the serial number of the unit.
- Apply calibration parameters from the old SD card to the new SD card.

Updating the calibration parameters

The replacement SD card will be supplied with a unique serial number. Both the old serial number and new serial number will have entries in Cloud:

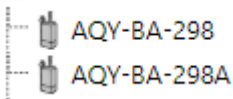

First navigate to the "Manual Entry" section of the "Calibration and Service" app for the original serial number and record the calibration parameters:

Calibration		Calibration parameters										
Manual Entry	>	NO2 ppb	Ox ppb	O3 ppb	O3 raw ppb	PM2.5 raw µg/m ³	PM2.5 µg/m ³	PM10 raw µg/m ³	PM10 µg/m ³	TEMP °C	RH %	DP °C
Gain		1.000	1.000	1.000	1.000	1.578	1.000	1.578	1.000	1.000	1.000	1.000
Offset		0.0	0.0	0.0	0.0	0.0	0.0	0.0	0.0	0.00	0.0	0.0
a		1.100		2.550								
b				1.870								

Update the parameters in the same location on the new serial number:

Calibration		Calibration parameters										
Manual Entry	>	NO2 ppb	Ox ppb	O3 ppb	O3 raw ppb	PM2.5 raw µg/m ³	PM2.5 µg/m ³	PM10 raw µg/m ³	PM10 µg/m ³	TEMP °C	RH %	DP °C
Gain		1.000	1.000	1.000	1.000	1.000	1.000	1.000	1.000	1.000	1.000	1.000
Offset		0.0	0.0	0.0	0.0	0.0	0.0	0.0	0.0	0.00	0.0	0.0
a		1.100		2.550								
b				1.870								

For all other technical issues contact technical@aeroqual.com

The Legal Stuff

Copyright

Copyright Aeroqual Limited. All rights reserved. Reproduction, transfer, distribution or storage of part or all of the contents of this document in any form without the prior written permission of Aeroqual Limited is prohibited.

"Aeroqual" and "Aeroqual Limited – Making the Invisible Visible" are registered trademarks of Aeroqual Limited. Other product and company names mentioned herein may also be trademarks or trade names.

Aeroqual operates a policy of continuous development. Aeroqual reserves the right to make changes and improvements to any of the products described in this document without prior notice.

Under no circumstances shall Aeroqual be responsible for any loss of data or income or any special, incidental, consequential or indirect damages howsoever caused.

The contents of this document are provided "as is". Except as required by applicable law, no warranties of any kind, either express or implied, including, but not limited to, the implied warranties of merchantability and fitness for a particular purpose, are made in relation to the accuracy, reliability or contents of this document.

Aeroqual reserves the right to revise this document or withdraw it at any time without prior notice. The availability of particular products may vary by region. Please check with the Aeroqual dealer nearest to you.

Terms and Conditions

This product is warranted according to Aeroqual Ltd's Terms of Trade. For further warranty information, please refer to the standard Product Warranty Policy as published on the Aeroqual website at www.aeroqual.com.

Statements of Compliance

- The Aeroqual AQY 1 complies with EN 61326-1:2013
- The Aeroqual AQY 1 complies with FCC 47 CFR Part 15.105 and 109.
Operation is subject to the following two conditions: (1) these devices may not cause harmful interference, and (2) these devices must accept any interference received, including interference that may cause undesired operation.

NOTE: This equipment has been tested and found to comply with the limits for a Class B digital device, pursuant to Part 15 of the FCC Rules. These limits are designed to provide reasonable protection against harmful interference in a residential installation. This equipment generates, uses and can radiate radio frequency energy and, if not installed and used in accordance with the instructions, may cause harmful interference to radio communications. However, there is no guarantee that interference will not occur in a particular installation. If this equipment does cause harmful interference to radio or television reception, which can be determined by turning the equipment off and on, the user is encouraged to try to correct the interference by one or more of the following measures:

- Reorient or relocate the receiving antenna.
- Increase the separation between the equipment and receiver.
- Connect the equipment into an outlet on a circuit different from that to which the receiver is connected.
- Consult the dealer or an experienced radio/TV technician for help.

We hope you enjoy using your AQY 1 as much as we enjoyed making it!

For your notes

For your notes

For your notes

Just a handful of customers who chose Aeroqual



aeroqual[®]

Aeroqual Limited

460 Rosebank Road, Avondale, Auckland 1026, New Zealand
t +64 9 623 3013 | f +64 9 623 3012 | e sales@aeroqual.com

aeroqual.com