

MACHINE PERCEPTION OF THREE-DIMENSIONAL SOLIDS

by

LAWRENCE GILMAN ROBERTS

S.B., Massachusetts Institute of Technology  
(1961)

M.S., Massachusetts Institute of Technology  
(1961)

SUBMITTED IN PARTIAL FULFILLMENT OF THE  
REQUIREMENTS FOR THE DEGREE OF  
DOCTOR OF PHILOSOPHY

at the

MASSACHUSETTS INSTITUTE OF TECHNOLOGY  
June, 1963

Signature of Author \_\_\_\_\_

Certified by \_\_\_\_\_ Thesis Supervisor

Accepted by \_\_\_\_\_  
Chairman, Departmental Committee on Graduate Students

## MACHINE PERCEPTION OF THREE-DIMENSIONAL SOLIDS

by

LAWRENCE GILMAN ROBERTS

Submitted to the Department of Electrical Engineering on May 10, 1963, in partial fulfillment of the requirements for the degree of Doctor of Philosophy.

## ABSTRACT

In order to make it possible for a computer to construct and display a three-dimensional array of solid objects from a single two-dimensional photograph, the rules and assumptions of depth perception have been carefully analyzed and mechanized. It is assumed that a photograph is a perspective projection of a set of objects which can be constructed from transformations of known three-dimensional models, and that the objects are supported by other visible objects or by a ground plane. These assumptions enable a computer to obtain a reasonable, three-dimensional description from the edge information in a photograph by means of a topological, mathematical process.

A computer program has been written which can process a photograph into a line drawing, transform the line drawing into a three-dimensional representation, and finally, display the three-dimensional structure with all the hidden lines removed, from any point of view. The 2-D to 3-D construction and 3-D to 2-D display processes are sufficiently general to handle most collections of planar-surfaced objects and provide a valuable starting point for future investigation of computer-aided three-dimensional systems.

Thesis Supervisor: Peter Elias

Title: Head, Department of Electrical Engineering

### ACKNOWLEDGEMENT

I am indebted to Professor P. Elias for his valuable suggestions and criticisms in his capacity of Thesis Supervisor. His advice as well as that of Professors Claude Shannon, Murray Eden, and Thomas Stockham has been very helpful in encouraging and guiding this work. I also wish to thank Ivan Sutherland for his help and list structure subroutines, Leonard Hantman, who programmed the major part of the 3-D display process, and the M.I.T. Lincoln Laboratory staff for their cooperation in the use of the TX-2 computer.

## TABLE OF CONTENTS

	<u>Page</u>
Abstract	2
Acknowledgement	3
Table of Contents	4
List of Figures	6
List of Pictures	7
I. INTRODUCTION	8
II. BACKGROUND	10
Pattern Recognition by Computer	10
Psychophysical Theory	11
III. DEPTH PERCEPTION	14
Transformation of Real World	14
Objects Observed	17
Model Identification	19
Depth Information	22
IV. PICTURE INPUT AND REDUCTION TO LINES	25
V. CONSTRUCTION OF THREE-DIMENSIONAL OBJECTS FROM LINE DRAWING	37
Polygon Recognition	38
Model Matching	43
Compound Object Construction	46
Ground Plane Construction	51

TABLE OF CONTENTS (continued)		<u>Page</u>
VI.	THREE-DIMENSIONAL DISPLAY	58
	Storage Structure	58
	Display Generation	60
	Hidden Line Elimination	62
	Display Construction	69
VII.	CONCLUSION	72
	APPENDIX A	75
	Homogeneous Coordinates	75
	APPENDIX B	78
	Similarity Test	78
	Error	80
	BIBLIOGRAPHY	81
	BIOGRAPHY	82

## LIST OF FIGURES

		<u>Page</u>
Figure 1	Camera Transformation	15
Figure 2	Exterior Angles	39
Figure 3	Complete Convex Polygons	41
Figure 4	Compound Object Construction	50
Figure 5	List Structure Formation	61

## LIST OF PICTURES

		<u>Page</u>
Pictures 1A-1D	Picture to Line Drawing. Initial Steps.	35
Pictures 1E-1H	Picture to Line Drawing. Final Steps	36
Pictures 2A-2D	Single Model: Reduction of Photo- graph to line drawing and display of 3-D construction from another viewpoint.	54
Pictures 3A-3D	Multiple Objects: Reduction of photo- graph to line drawing and 3-D con- struction, involving ground plane determination of depth.	55
Pictures 4A-4D	Compound Object Construction: Proces- sing of picture 1 to obtain 3-D description of compound object.	56
Pictures 4E-4H	Compound Object Construction: Rotated views of object obtained in picture 4D.	57
Pictures 5A-5D	3-D Displays: Pictures constructed with 3-D display program.	70
Pictures 5E-5H	3-D Displays: Pictures made with 3-D display program showing hidden line elimination.	71

## CHAPTER I

### INTRODUCTION

The problem of machine recognition of pictorial data has long been a challenging goal, but has seldom been attempted with anything more complex than alphabetic characters. Many people have felt that research on character recognition would be a first step, leading the way to a more general pattern recognition system. However, the multitudinous attempts at character recognition, including my own, have not led very far. The reason, I feel, is that the study of abstract, two-dimensional forms leads us away from, not toward, the techniques necessary for the recognition of three-dimensional objects. The perception of solid objects is a process which can be based on the properties of three-dimensional transformations and the laws of nature. By carefully utilizing these properties, a procedure has been developed which can not only identify objects, but also determines their orientation and position in space.

Three main processes have been developed and programmed in this thesis. The input process produces a line drawing from a photograph. Then, the 3-D construction program produces a three-dimensional



object list from the line drawing. When this is completed, the 3-D display program can produce a two-dimensional projection of the objects from any point of view. Of these processes, the input program is the most restrictive, while the 2-D to 3-D program and 3-D to 2-D program are capable of handling almost any array of planar-surfaced objects.

In order to implement the three-dimensional processing of pictures, perspective effects must be considered. For this reason, a four-dimensional, homogeneous system of coordinates will be used. In this system a single  $4 \times 4$  matrix can modify a position vector by a linear transform, a translation, and a perspective transformation. Although many books discuss this homogeneous system of coordinates, their presentations are either incomplete or too involved for our purposes.<sup>1</sup> Therefore, the system is explained in Appendix A. Without the notational simplicity provided by using homogeneous transformations, most of the following analysis would not have been accomplished.

## CHAPTER II

### BACKGROUND

#### PATTERN RECOGNITION BY COMPUTER

There have been numerous attempts to recognize simple patterns by machine. There is the work with perceptron-type nets of threshold elements which divide the set of all input patterns into a number of classes by correlating a set of adaptive weights with some functions of multiple input cells. For this type of system there may not be many output classes and the transformations of the patterns must be minimal or nonexistent. Because of these restrictions, the patterns worked on so far have been those which, although complex, are not subject to much transformation such as characters and spoken digits. My paper on character recognition is typical and gives the other references.<sup>2</sup> This type of system would be of no value for multiple object recognition except perhaps for finding the lines originally.

In the work by Selfridge and Doyle, a more useful set of tests is made on the input while the output processing is similar to the perceptron-type machine.<sup>3</sup> That is, computation routines are developed to extract the useful information from the input and their outputs are weighted to determine the most likely output class. Here again a small

set of outputs is expected and characters were the patterns tested. One problem with both of these methods is that they were intended for specific groups of abstract patterns such as characters and not for the well-defined geometry of photographs. They are better suited for looking at my resultant list structure of objects and deciding if a group of objects is a chair or a table.

The closest any researcher has come to the problem I propose is Leo Hodes in his work on processing line drawings.<sup>4</sup> His main result was to produce a list of lines and vertices by following out lines. Then he suggested a few simple tests which might be made on this list to find triangles, etc. Although his main purpose was to study abstract line patterns, he did describe a working line follower which was of value to me in this part of my effort.

As far as machine depth perception, the only work I know of is on binocular images. Julesz has reported a procedure which shifts the binocular pictures to find the areas at different depths.<sup>5</sup> This procedure uses only texture, not edges, to develop the depth information and shows that the binocular information alone is sufficient for depth perception. This work is similar in goal but completely different in procedure from mine. Other work in machine photograph processing has mainly been in the field of information reduction for bandwidth compression and my paper in this area summarizes this work.<sup>6</sup>

#### PSYCHOPHYSICAL THEORY

There has been a large volume of psychophysical research on human depth perception and shape recognition. From all this I have

tried to isolate the ideas and theories which are used to explain our monocular perception of a three-dimensional world. It will be apparent, however, that the work of Gibson is dominant in my mind, since his book is both clear and complete.<sup>7</sup>

Of all the monocular depth cues perhaps the most written about is that of known object size. Ittelson reports experiments where only one object could be seen, thus eliminating other depth cues.<sup>8</sup> Although the assumed size of objects such as playing cards tended to vary, the subjects would judge the depth reasonably well for normal-sized cards and proportionately shorter for jumbo cards. Thus he, for one, showed that the size of familiar objects is a good relative depth cue and fair for absolute depth. Gibson points out, however, that this type of distance perception is rarely used in the everyday world since we look at arrays of objects rather than single objects and can use more general depth cues.

Gibson's favorite cue is that of texture gradient. This is the effect of perspective on the grain or fine structure of large surfaces. As these surfaces recede, the apparent grain becomes finer. Another gradient cue is the illumination variation which puts curved surfaces in relief. This shows us the surface depth variations.

The final depth cues are those of aerial perspective or blur with depth, and the angular upward position of objects toward the horizon which is a depth measure in most outdoor scenes.

Recognition of forms, shapes and objects is often discussed from the Gestalt point of view where shadowy forms and plane geometry figures are the forms to be recognized. Attneave and Arnoult spend many pages

explaining random shape generation, and the useful procedures for analyzing them.<sup>9</sup> They discuss contour following, differentiating pictures, and some of the simple measures of shape complexity. If they were discussing character recognition, it might be reasonable to use these tools; however, they say they are investigating "natural forms."

This preoccupation with the abstract projected form is strongly attacked by Gibson. He feels that the visual world of objects and surfaces should be studied rather than the visual field on the retina. A perspective transformation does not reduce a solid object to a shadowy form. Rather, it defines the set of shapes which go with a single perception.

Perspective variations in a cube were tested by Langdon in an experiment on 3-D solids.<sup>10</sup> He found that perspective plays only a minor part in the perception of the size and depth and that the subjects always saw a cube, even when it was badly distorted by the perspective transform. The fact that the depth is not determined from the object perspective is interesting since it agrees with my results covered later on. The continual perception of a cube even when transformed is consistent with Gibson's idea that shape perception is and must be invariant under perspective transformation. My idea of models also follows from this, since each model represents an invariant percept, and can be identified with any projection of itself.

### CHAPTER III

### DEPTH PERCEPTION

The perception of depth in a monocular picture is based completely upon the assumptions of the observer. Some of the assumptions are about the nature of the real world and some are based on the observer's familiarity with the objects. Without these assumptions the picture is just another two-dimensional image whereas with them, the human is rarely confused about the depth relationships represented in the picture. Since humans agree so closely on their depth impressions, it is fair to assume that their major assumptions are the same and are therefore subject to identification and analysis. The following is therefore an attempt to set down some of the likely assumptions and derive what depth information can be obtained if they were used.

#### TRANSFORMATION OF REAL WORLD

The first assumption is that the picture is a view of the real world recorded by a camera or comparable device and therefore that the image is a perspective transformation of a three-dimensional field. This transformation is a projection of each point in the viewing space, toward a focal point, onto a plane. The transformation will be represented with a homogeneous,  $4 \times 4$ , transformation matrix,  $P$ , such that the

points in the real world are transformed into points on the photograph. (See Appendix A for an explanation of homogeneous coordinates.) The transformation depends on the camera used, the enlargement-printing process and, of course, the coordinate system the real world is referred to. Let us fix the real world coordinates by assuming that the focal plane is the  $x=0$  plane and the focal point is at  $x=f$ ,  $y=0$ ,  $z=0$ . In order that the picture not be a reflection, we choose the focal plane in front of the camera. Then the objects seen will be in the  $-x$  half space. Thus, the focal plane is really the plane of the print, not the negative. Figure 1 shows this arrangement.

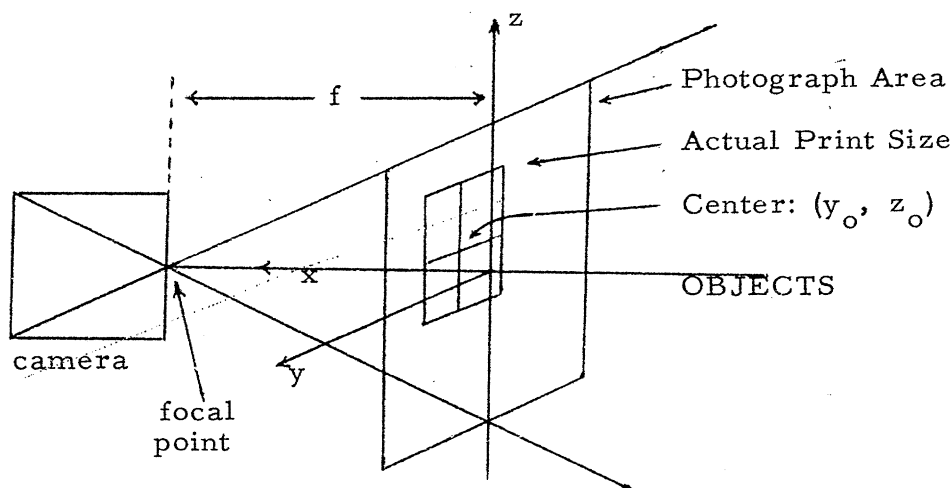

Figure 1: Camera Transformation

A particular camera will have some focal distance  $f$ . We will consider the square on the focal plane which was enlarged to create the print. The center of this square will be at some coordinates  $y_0, z_0$ , and the size of the square from the center to an edge will be some

distance  $S$ . The actual size to which the square is enlarged is unimportant since we will measure the print with a normalized system having the origin at the center and the edges at  $y, z = \pm 1$ . Normally, the whole film area is printed, and in this case  $y_0 = z_0 = 0$  and  $S$  is equal to half the film size. For standard cameras without special lenses the ratio of focal distance to film size is usually the same since this corresponds to a fixed viewing angle. Thus, the ratio  $S/f$  is fairly constant at about  $1/4$ . In any case, the ratio is known if the camera is known and could be supplied with the photo.

It is not necessary to know the variables  $y_0, z_0, f,$  and  $S$  since they can be computed from the picture given other assumptions later on. However, for the sake of simplicity we will assume  $S/f$  is known and that  $y_0 = z_0 = 0$ . The numerical values of  $S$  and  $f$  alone are not necessary since this just affects the scale of the real world. Thus, we can assume  $S = 1$  and with  $r = S/f$  obtain a simple transformation  $P$ .

$$P = \begin{bmatrix} 1 & & & -r \\ & 1 & & \\ & & 1 & \\ & & & 1 \end{bmatrix}$$

If  $\bar{v}$  is a point in real space, then  $\bar{v}P$  is a point in a perspective space such that its  $Y$  and  $Z$  coordinates are the original point's projection on the picture plane. The  $X$  coordinate of  $\bar{v}P$  is also obtained and will be useful for hidden line computation during display of 3-D objects.



Thus, a transformation from the real world to a picture has been described and to go the other way one simply uses the inverse transformation,  $P^{-1}$ . Of course, the  $x$  component of the real world points will not be known in this case.

#### OBJECTS OBSERVED

We will further assume that the three-dimensional field observed consists of a set of solid objects which occupy a definite region of space. Since we realize it is usually possible to pick out the lines which define the boundaries of the objects and their surfaces, we will assume this has been accomplished and the picture has been reduced to a line drawing. Because the objects are solid we do not expect to see the boundaries which are hidden from the focal point by another solid.

Secondly, we will assume that the objects seen could be constructed out of parts with which we are familiar. That is, either the whole object is a transformation of a preconceived model, or else it can be broken into parts which are. The models could be anything from a cube to a human body, the only requirement being that we have a complete description of the three-dimensional structure of each model.

The transformation from the model to the real world object will be a suitably restricted homogeneous transformation matrix,  $R$ . We must allow an arbitrary rotation and translation of the model in order to position it properly in space. We would also like to allow three degrees of freedom for size change of the model so that a cube model can represent any parallelepiped. So far we have allowed nine degrees of freedom. The

4x4 matrix  $R$  can allow 15 degrees of freedom since it has 16 elements and the total scale of the matrix is arbitrary in the homogeneous coordinate system. The last six degrees of freedom represent skew and perspective deformations. Skew deformations are size changes in the  $x$ ,  $y$ , and  $z$  directions after the model has been rotated, and will change the sides of a cube to parallelograms. A perspective deformation is most easily visualized as a compression of one end of the model. Objects which have been deformed in either way are not usually considered to be simple instances of the model. Furthermore, objects which are deformed in these ways could be constructed from smaller parts so it is not necessary to allow skew and perspective deformations.

We cannot allow perspective deformation and still obtain a unique transform  $R$  from the picture, therefore, we require the top three elements in the last column of  $R$  to be zero. Skew variations can be allowed if we maintain very high accuracy in our computations, so our derivation will allow them, but later on they will be eliminated.

Now,  $R$  transforms a model into an object and  $P$  transforms the object onto the picture so that if:

$$H = RP$$

then  $H$  transforms the model points into picture points. Therefore, in order to identify a group of points and lines in the picture with a particular model, we must find out if there exists any transformation  $H$  which will take the model's points and lines into those of the picture. If such a model and transform are found then it can be said that the object

represented in the picture could be that model under the transformation

$$R = HP^{-1}.$$

#### MODEL IDENTIFICATION

Let us say we are given a picture of a parallelepiped and it has been reduced to a line drawing. We can then find the interior polygons which correspond to the surfaces of the object. There will normally be three quadrilaterals visible. These polygons all come together at one point and it can be used for a reference point. Looking through our list of models we find that a cube and perhaps other models have three quadrilaterals about one point. Therefore, we can pick a point in the cube model which has the proper polygons around it, pick a polygon from both the cube and the picture as starting points, and proceed to list topologically equivalent point pairs. When we have finished we have a list of seven three-dimensional points from the model and a corresponding list of seven two-dimensional points from the picture. By adding a homogeneous coordinate  $w = 1$  to each point vector we obtain a  $4 \times 7$  matrix of model points,  $A$ , and a  $3 \times 7$  matrix of picture points,  $B$ .

Now by means of the similarity test derived in Appendix B, we obtain the best transform  $H$  which will take  $A$  into  $B$ . We also obtain a mean square error which indicates if the model chosen really can fit the picture or not. We can then choose the model which causes the least error. For the parallelepiped, the cube model should fit with very little error. The transform obtained is a  $3 \times 4$  since no depth data accompanied the picture points. Now, since we know  $P$  and thus  $P^{-1}$  we can start

to obtain  $R$ , the real space transform of the model. Since we have required that the three perspective components of  $R$  should be zero, we can specify the top three components of  $R$  in the first column as  $(-1/r)$  times the corresponding elements of the last column of  $H$ .

$$R = HP^{-1}$$

$$H = \begin{bmatrix} y_1 & z_1 & w_1 \\ y_2 & z_2 & w_2 \\ y_3 & z_3 & w_3 \\ y_4 & z_4 & w_4 \end{bmatrix} \quad P^{-1} = \begin{bmatrix} 1 & & & r \\ & 1 & & \\ & & 1 & \\ & & & 1 \end{bmatrix}$$

$$R_o = \begin{bmatrix} -w_1/r & y_1 & z_1 & 0 \\ -w_2/r & y_2 & z_2 & 0 \\ -w_3/r & y_3 & z_3 & 0 \\ 0 & y_4 & z_4 & w_4 \end{bmatrix}$$

The lower left element of  $R$  still is not known since it is the  $x$  position of the whole object and if an object grows in size as it moves away from us, it can maintain the same projection on the focal plane. Thus, this depth value must be found some other way. For the time being we can call it zero and label the matrix  $R_o$ .

At this point, by assuming that an object in a picture is a transformation of a known model and by utilizing our knowledge of perspective

geometry, we have been able to find the model and transformation which best represent the object. We know the precise orientation and position of the object except for one depth variable. We also know all the dimensions of the object relative to its total size. We also should know the skew deformation of the object since we have obtained eleven variables. However, compression or expansion in the  $x$  direction produces only a slight change in the picture due to the perspective, since we are looking along the  $x$  axis. Thus, the determination of the  $x$  skew can easily be in error. This problem of skew error in derived transformations was not realized until the computer program implementing these ideas began to produce distorted transformations of models. Even though the program could match every point in the picture with model points within one part in 4000, the  $x$  skew of the transformation might be off by a factor of two. Thus, it is rather clear that the  $x$  skew is not really obtainable from a picture, even though it can be derived mathematically.

If  $x$  skew deformations of the model must be restricted, it is logical to eliminate all skew variations for consistency. To restrict skew it is necessary to ask that the top three rows of  $R$  be orthogonal. Since the introduction of this requirement into the similarity test requires solving second order equations, it is simplest to modify  $R$  after it has been computed. Thus, the top three rows of  $R$  are forced to be orthogonal by modifying the first column which is the one with the worst error. This means that the focal ratio,  $r$ , and  $w_1, w_2, w_3$ , are not needed for the computation of the model transformation. Now in fact,  $r$  may be computed from the ratio of the new first column to the  $w_j$ .

Thus, by assuming that the objects seen in a picture are non-deformed transformations of known models, we can find the model and transformation without knowing the camera characteristics. Even if the picture is an orthogonal projection, as is almost the case with long telephoto lenses, we can compute the proper transformation. This would be impossible if we did not eliminate skew since  $r$ ,  $w_1$ ,  $w_2$ , and  $w_3$  would all be zero. Thus, the process accounts for but does not depend on perspective information.

The information required to obtain a transformation is obtained from the points in the line drawing. These points have two dimensions each and we need to determine eight degrees of freedom in the transformation. Therefore, at least four points from the picture must be used. These points cannot all lie in the same plane of the object or the equations will be degenerate. If more than four points are available, the mean square error will indicate whether they are consistent with the model and therefore help in the selection of the proper model.

#### DEPTH INFORMATION

After the matrix  $R_0$  is obtained for an object or object part, it is still necessary to obtain the  $x$  translation or depth. Here we must resort to another assumption. There are several possibilities which I have chosen to ignore. If we were to assume that we know the models so well that we knew their size, this would fix their depth also. Or, if we wished to interpret shadows, this might determine the depth if shadows existed. The fact that one object is partly in front of another supplies depth information, but only in the form of inequalities. Lastly, the various gradients, intensity, blur, and texture, might be useful to determine

the depth gradients of each surface, but this information has already been found through the use of models. All of these cues may be useful to humans, but each one is restricted in its generality and only useful in special cases.

The one depth perception concept which is suitably general, and sufficiently accurate to position all objects properly, is the use of a support theorem. We assume that each object must be supported somehow, either by another object or by a ground plane. This assumption allows us to project each object back in the  $x$  direction until it hits the ground plane or another object. While it is being projected back, it must be expanded so as to maintain the same image on the focal plane. The slope of the ground plane can be determined by examining each object for parallel planes sloping so as to go under the focal point and as parallel to the  $z=0$  plane as possible. When such a plane is found we only know its slope not its distance from the origin. However, this single variable can be arbitrarily set since it only affects the total scale of the picture. Actually, it can be guessed rather accurately for the majority of pictures just by assuming or knowing the distance the camera was held from the ground and the focal ratio,  $r$ . Since  $r$  may be computed, we could assume the camera was held five feet above the floor, and now we can state the dimensions of each object in feet.

For compound objects, we know the pieces should fit together, so their relative depths are determined and the compound object can then be treated as one object and projected onto the ground plane. The whole

procedure is relatively simple so long as the ground plane is really planar. If the ground curves, this could be taken care of by computing the curvature from the slopes of several objects. If there are breaks in the floor's slope such as walls, the breaks will be seen as lines and walls treated as objects. Thus, the support assumption enables us to properly place all the objects in space.

To review the depth perception assumptions and results, we assumed that the picture was in fact a perspective view of the real world, that the objects shown in the picture could be described by means of one or more transformations of known models, and that all objects were supported by others or by a ground plane. The transformations allowed were restricted to rotation, translation, and size changes. Then, from a single picture, each object which has four or more points showing can be described in terms of the models and positioned in a three-dimensional space. The scale of this space in feet can even be determined if the distance of the camera from the floor can be supplied. The whole representation in three dimensions should be accurate except for a simplification of hidden details and occasional problems due to the assumptions breaking down. However, humans have the same problems.



## CHAPTER IV

### PICTURE INPUT AND REDUCTION TO LINES

Pictures are presently being entered into the computer by means of a facsimile scanner although many types of optical scanners would be suitable. The facsimile scanner, however, was already connected to the computer for some of my previous experiments.<sup>6</sup> A 4x5 photographic print is placed on the drum of the scanner and the computer made ready. Then, during each rotation of the drum, a photomultiplier output scans a line of the picture. An analog-to-digital converter samples the photomultiplier output at about 600 cps and sends the computer ten-bit digital intensity values. Thus, in about three minutes a 256x256 raster of intensity samples can be read into the computer. Each sample is compressed to eight bits in the computer so the storage of one picture requires about half a million bits of memory. Thus, four pictures can be stored in the TX-2 memory. Pictures 1A and 1B are examples of a picture before and after computer sampling.

When the scanning is completed, the picture is processed with a local differential operator to produce a new raster which has the appearance of a line drawing. The choice of a differential operator is very critical and many variations were tried. Three main criteria can be used to judge such an operation. The edges produced should be as sharp

as possible, the background should produce as little noise as possible, and the intensity of the lines produced should correspond closely to a human's ability to perceive the edge in the original picture. Edge sharpness depends upon the number of samples used by the differential operator. Background noise seems to be reduced by using operators symmetric in  $x$  and  $y$ . In order to make equally apparent edges have equal derivatives, the intensity values of the picture can be subjected to a gamma change so as to make intensity differences proportional to a human's ability to perceive them. According to psychophysical theory, the square root of the intensities should be used in order to achieve the desired effect.<sup>11</sup>

Therefore, after a picture is read in, a differential picture is created according to the functions:

$$y_{i,j} = \sqrt{x_{i,j}}$$

$$z_{i,j} = \sqrt{(y_{i,j} - y_{i+1,j+1})^2 + (y_{i+1,j} - y_{i,j+1})^2}$$

where  $x_{i,j}$  is the initial intensity value,  $z_{i,j}$  is the computed derivative value, and  $i$  and  $j$  are the coordinates in the two dimensions. The resulting  $z$  values indicate the probability of a line through that cell. Even though the square root operation involved takes more time than several simpler operations which were tried, the extra line sharpness and background noise reduction obtained are well worth the additional time. Picture 1C is an example of the result of this differentiation.

After obtaining the differential picture the problem is to determine a set of lines and end points which correlate well with the raster. It is no simple chore to obtain a list of lines and their end points from a half-million-bit array of data. A simple procedure might be to choose a clip level and start tracing out lines which correspond to a string of adjacent cells in the raster, all of whose values are above the clip level. The hoplessness of this procedure is easily seen when one looks at typical pictures and considers them as a three-dimensional surface where the  $z$  values are used as the height. Even a very clean input picture when viewed in this way, looks like a bumpy, hilly, landscape, with a broken-down stone wall representing the lines, and where some hills are higher than the top of other stone walls. If we imagine the clip level as a flood over this landscape, there is no water level which covers all the hills and yet does not submerge some stone walls. In fact, even by adjusting the water level to be optimal for a particular area, a line will look like stepping stones in a rock-strewn brook rather than a smooth dam. Thus, it can be seen that the problem of mapping the walls is not a simple one.

The procedure I have developed for finding the lines from the differential picture makes mistakes in complex pictures and is a complex special-purpose program demonstrating very few general concepts. However, it does manage to produce accurate line drawings from a sufficient group of pictures so that the transformation techniques can be tested on data from real photographs. The description of this procedure will, therefore, be rather general in nature.

The over-all concept utilized was to look at local features first and build up to the determination of long lines in a series of steps. There are two reasons for this procedure. First, at each step the complexity of the processing goes up since more data is being considered, but at the same time the number of features to process is being reduced at each step. Thus, the total time to process the picture is much less than if a one-step process were used. Such a one-step process was tried by Leo Hodes in an attempt to find the lines in black and white line drawings.<sup>3</sup> For each possible line a correlation with the raster was made and then the line position was corrected and recorrelated. This type of procedure becomes more and more time consuming as the raster size, line length and accuracy required increase, whereas a multi-step process need not consume additional time.

The second reason for a multi-step process is that the initial local feature extraction can take into consideration the local noise level and thus detect lines which an over-all clip level would miss.

The first step of the process looks for points in the differential picture which seem to be on a line. The maximum sample in each 4x4 square of raster points is considered as a possibility if its value exceeds a small threshold. This threshold is low enough to include all the lines and much of the noise but it does eliminate further processing of smooth areas of the picture. Its value has been determined by experiment to be about one-tenth of the maximum intensity in the original picture. After a point has been chosen in this way, four correlations are performed to find the direction of a line through the point which best fits the data. Four

lines of five samples length with slopes of 0, 1,  $\infty$ , -1 are correlated with the data around the point and the ratio of the best to the worst fit taken. If the ratio is greater than a second threshold (about 3) then the point and the best direction are recorded. In this way a set of feature points is obtained along with approximate line directions through them. The procedure can be considered to be a ridge detector which locates points along each ridge with limits on the height and width of the ridge. The number of feature points obtained is usually between 100 and 1000. Picture 1D shows a short line at each feature point pointing in the recorded direction.

After the feature points are found, the next step is to connect lines between neighboring points. The line directions of the points are used to limit cross connections between adjacent lines. Specifically, a pair of points are connected together if they are in touching 4x4 squares, and if the line's direction will be within  $\pm 23^\circ$  of the direction recorded for either point. Any points left unconnected are eliminated, thus filtering out most of those created by noise. The result is a preliminary line drawing composed of many short lines. There are two major problems with this line structure; sections of a long line may be missing, and sections can be filled in later but the interconnections make it hard to trace a line. They are most obvious at corners but also appear along a line as extra width. Refer to picture 1E for a more graphic illustration. To reduce these small networks of lines to a single line or neat corner, two reduction techniques are used. Their important property is that they

do not change the over-all connectivity and topology of the line structure. First, the longest side of each triangle is deleted. A triangle is defined here as any three lines in a loop. This cleans out most of the unwanted lines, however, there are a few quadrilaterals left. Therefore, each group of four lines connected in a loop is compressed along its shortest diagonal. That is the two closest, non-adjacent points are merged. There may still be a few pentagons left but most of the networks have been reduced. The last step in smoothing out the line structure is to remove all small tails or spurs which are unconnected at one end and connect to more than one line at the other end. These smoothing operations are all on short lines so no major features are changed. They do, however, limit the resolution of the input system to about four to eight samples out of 256. This restriction is on resolving short, close lines, not on the accuracy of longer lines. The result of smoothing picture 1E appears in picture 1F.

Now that a structural outline of the lines in the picture has been obtained, longer lines can be fitted to sections, missing segments filled in and extra segments removed. The segments along the path of a true straight line may weave in and out but each point was obtained by the ridge detection technique and is accurate to about one sample width if it was caused by the edge. A sequence of singly connected points with no intersections will most likely be caused by the same edge or sequence of edges. By a least mean square error line fitting routine, a straight line can be put through the points and result in a very high accuracy line. Curve segments could also be fitted to the points if this were desired, the

main additional problem being the choice of the type of curve to try, circle, parabolic, cubic, etc. It becomes more and more obvious as one considers fitting curves to the picture edges that it is advantageous to have a set of points already determined, through which to put a curve, instead of having to correlate various curves with the picture data.

To fit a straight line to a sequence of points, a sequential least mean square error fitting routine is used. The problem is to find the best coefficients (a, b, c) for the line equation:

$$ax + by = c$$

The data is supplied sequentially in the form of points (x, y) and it is desirable to recompute as little as possible each time a point is added. However, upon each addition of a point, the coefficients (a, b, c) and the new mean square error, E, should be available. It is sufficient to keep a history of five numbers, the cumulative sums:

$$\Sigma x, \quad \Sigma y, \quad \Sigma xy, \quad \Sigma x^2, \quad \Sigma y^2$$

and the number of entries made, n. Then after each addition of a new point (x, y) the coefficients are computed as follows:

$$\begin{aligned} a &= \frac{\Sigma x \Sigma y^2 - \Sigma y \Sigma xy}{\Sigma y^2 - \Sigma xy} \\ b &= \frac{\Sigma y \Sigma x^2 - \Sigma x \Sigma xy}{\Sigma x^2 - \Sigma xy} \\ c &= \frac{\Sigma x^2 \Sigma y^2 - \Sigma xy^2}{\Sigma x^2 - \Sigma xy} \\ E &= \frac{c(nc - a \Sigma x - b \Sigma y)}{n(a^2 + b^2)} \end{aligned}$$

Since these equations represent the mean square best reduction of the unnormalized error,  $E(a^2 + b^2)$ , they do not always produce the least mean square distance error as represented by  $E$ . However, the solution is much easier than the complete form and just as good in almost all cases.

The procedure for fitting a line to a series of connected points, starts by choosing any small line segment as a starting place, and moving in one direction until a point is reached with other than two line segments attached or until the mean square error exceeds a threshold. When the error threshold is reached a bend in the true lines has probably been passed, so the procedure is to back up until the angle between the little line segments and the computed line has decreased by a factor of two. Usually this condition will occur at the bend sought for, since on the other side of the bend the angles must be negative. This procedure works very well and needs no threshold adjustment because of the back-up procedure.

After the line has been finished in one direction from the starting point, the other direction is investigated in the same manner, still modifying the same computed line. The method of using cumulative sums as the only history for the line computation allows points to be subtracted out during backup, eliminating the need for large tables of past history. Also, the procedure is fairly independent of the starting point since during the second direction's backup the start point can be passed, thus creating a line totally to one side of the start point. This will occur when a break point appears just after the start point and as it is passed in the forward direction the error does not build up to threshold.



Thus, the line fitting procedure replaces groups of small line segments with longer, more accurate lines. The ends of these new lines are at the intersections of several lines, at break points as detected by the error criteria, or are free and unconnected. Each time a long line is computed the points at its ends are moved onto the line since the line is more accurate than the points. If several long lines meet at a point, the point's coordinates are computed to be the intersection point of the two longest non-parallel lines. Thus, the points become as accurate as the lines connected to them. A special case may come up due to the incomplete removal of a network of small lines. Two lines may be constructed between the same end points and they must be merged and the lines connected to these false intersections reprocessed into one line if possible.

When all the lines have been fitted to the small segments, the representation of the picture consists of a set of lines and end points mapping the edges in the picture. There still may be sections of lines missing and extra segments near intersections. Picture 1G shows the result at this point. Now line filling and merging is done to complete the line drawing. Each line is considered for modification. If the line is of significant length, the nearest points to both ends of the line and which are within about three raster units of the extended line, are considered as possibilities for new end points. A new line is correlated with the differential picture between an end point and the new point and if the average value along the line is greater than a threshold, the line is put in.

When a line is very short, it is not extended but considered for merging or elimination. If the line's end points both connect to one other line, then the end points are merged, otherwise the line is deleted. After extending, merging or deleting the proper lines, the whole line structure is again processed with the mean square line fitting program in order to eliminate extra joints which may have been created. The resulting line drawing is the finished version as shown in picture 1H.

The entire picture to line drawing processes is not optimal but works for simple pictures. It has several useful parts, the differentiation, the feature point extraction and the mean square line fitting being the best parts. I hope in the future to recombine these sections to produce a more general system.

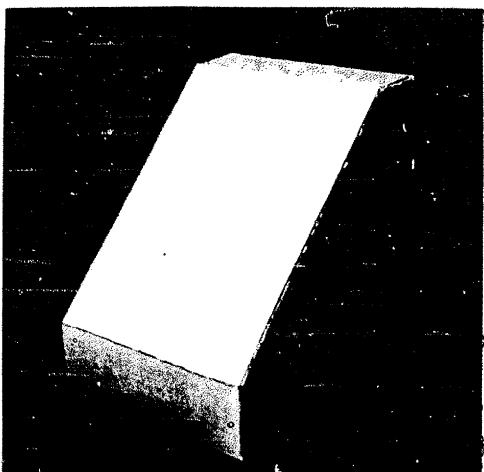

A. Original Picture

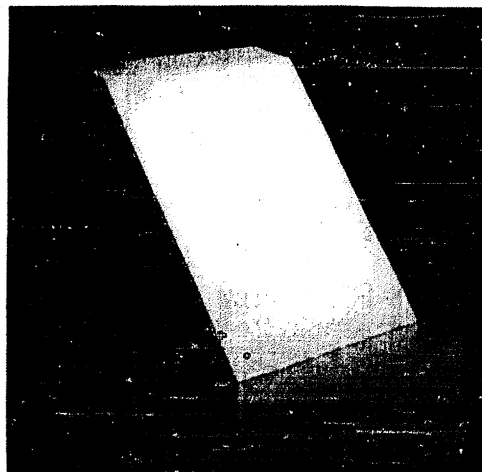

B. Computer Display of Picture  
(Reflected by mistake)



C. Differentiated Picture

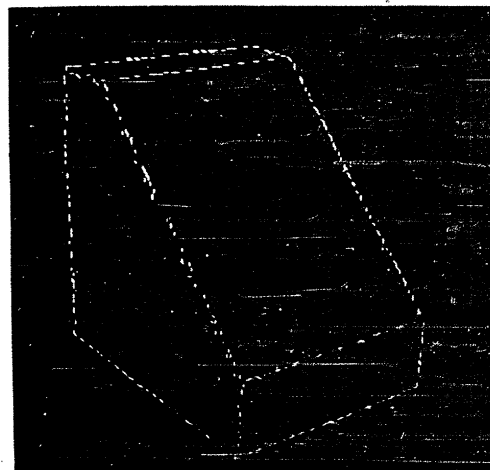

D. Feature Points Selected

Pictures 1A - 1D:

Picture to Line Drawing.  
Initial Steps.

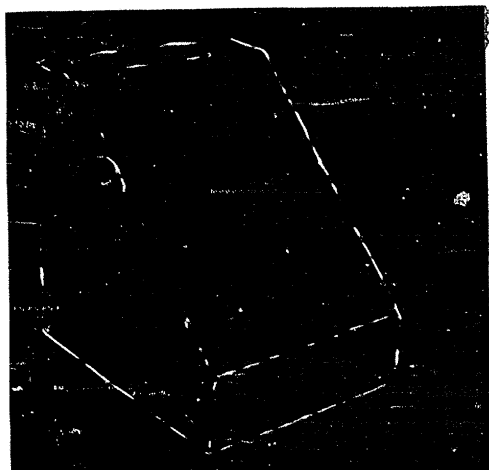

E. Connected Feature Points

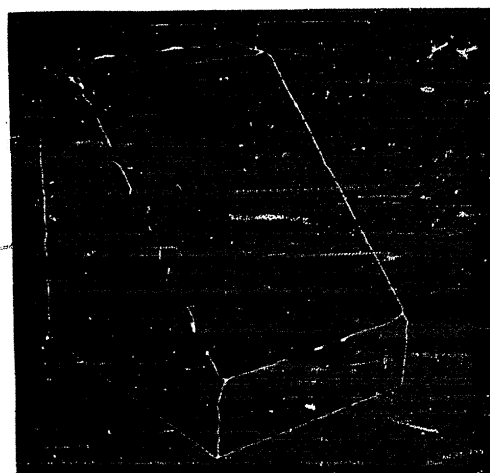

F. After Complexity Reduction

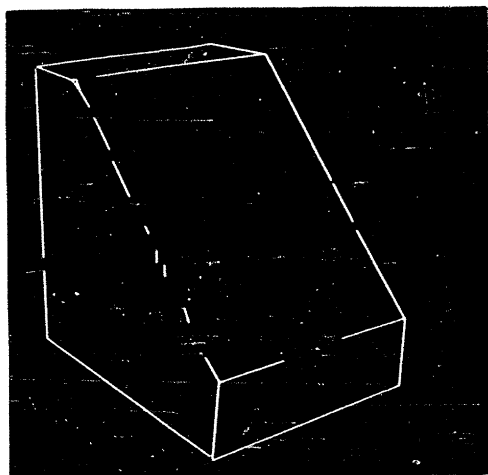

G. After Initial Line Fitting

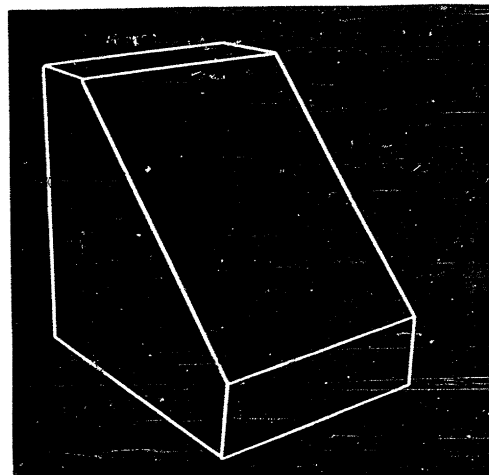

H. Final Line Drawing

Pictures 1E - 1H:

Picture to Line Drawing.  
Final Steps.

CHAPTER V  
CONSTRUCTION OF THREE-DIMENSIONAL OBJECTS  
FROM LINE DRAWING

The program described in this chapter starts with a planar line drawing and produces a three-dimensional description of the objects shown in the drawing in terms of models and their transformations. The line drawing may be one generated by the picture input process or some other computer program such as the 3-D display program (Chapter VI). The main restriction on the lines is that they should be a perspective projection of the surface boundaries of a set of three-dimensional objects with planar surfaces. Any line drawing produced by the 3-D display program is acceptable as an input to this program and since this program's output is an input to the display program, the two programs can be used to check each other. The models used for construction can be any set of three-dimensional building blocks which seem useful so long as all their surfaces are planar. Since the models can be put together such that their joint lines disappear, almost any complex object can be constructed with a very few models. There are only three models presently used in the program: a cube, a wedge, and a hexagonal prism. Figure 5, in the next chapter, illustrates these models.

Chapter III describes the general procedure used for this 2-D to 3-D transformation, whereas we now wish to develop the specific mathematics and techniques used in the program.

#### POLYGON RECOGNITION

The line drawing which is produced by the 3-D display program is just a list of end point pairs, one pair for each line. This type of input is specially processed to put it in the form wanted. Each line is assigned to a line block in a line list and each point to a point block. Each point indicates which lines are connected to it and each line block points to its end points. Thus, for each end point pair in the input list, a line block is created and the point list searched for point values close to the end points. If the points already exist, the line is just tied into them, otherwise a new point block is created. Upon the completion of this phase each point is checked against all lines to see if it lies on a line and is not connected to the line. If this occurs, the line is broken in two and both new ends tied to the point. The list format produced is a good form for topology processing and is the same format as that produced by the picture input program.

The first problem is to find the polygons described by the lines. In order to be able to trace the polygons easily, the lines tied to each point are ordered by their angle of exit. This allows us to start with any line, choose an adjacent line at one end point and continue around the polygon to the first line, without ever getting off the polygon. This procedure can be made to go clockwise or counter-clockwise around polygons and

thus record two polygons for each line. A list of polygon blocks is prepared, each tied to the lines which compose it. The lines also point to their two polygons. As each polygon is produced, the exterior angle at each vertex is computed and the sum of these angles kept for the polygon. These angles are computed in semicircles so they are between +1 and -1. The sum will therefore be +2, if the polygon was hollow on its inside, but if the polygon was really an exterior boundary of an object, the "hollow" part is outside and the sum will be -2. Figure 2 shows the polygons of a cube projection and their exterior angles.

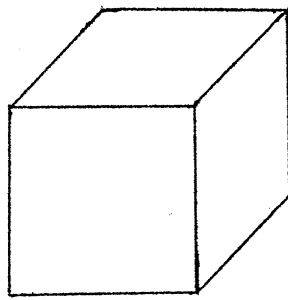

A. Complete Cube

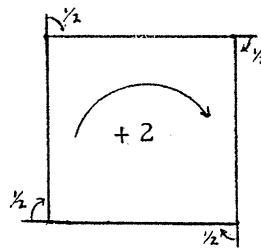

B. Interior Polygon

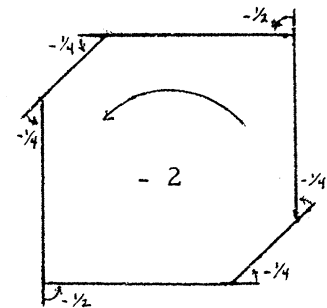

C. Exterior Boundary

Figure 2: Exterior Angles. The exterior boundary of an object is separated from the normal polygons by the sum of the exterior angles taking the unconnected direction as the inside. The direction of travel and the sum of the exterior angles appear in the center of B and C. Angles are in semicircles.

It may not be apparent that exterior boundaries are difficult to separate from the real polygons, but as the computer traces a polygon it has no concept of inside, it just traces a closed path with all connecting lines on one side of the boundary. It must expect some negative angles because the polygon may be concave. Thus, the sum of the exterior angles is necessary if the computer is going to separate exterior boundaries from real polygons.

Some further information is obtained as the polygon is traced out and this is the number of sides of the polygon, the number of negative angles encountered, and the number of near zero exterior angles. One or more negative angles indicate that the polygon is concave while the zero angles indicate collinear joints which most likely were produced by another object partially hidden behind this one. Thus, a first guess at the number of sides the surface really has, is the number of lines minus the number of zero angles. The polygon is then marked as complete and convex if there are no negative angles; it is not an exterior boundary; and it does not include a point where a zero angle was observed on another polygon. The last condition eliminates from initial consideration, polygons which are most likely partially hidden by another object. Figure 3 shows an example where each complete and convex polygon is labeled with its first guess number of sides.

The reason concave polygons are not considered at first is that the models presently being used in the program are all convex. However, if a model with concave polygons is included, the appropriate concave



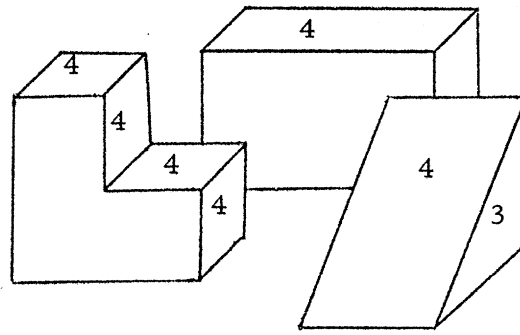

Figure 3: Complete Convex Polygons. The polygon selection procedure would select the numbered polygons as complete and convex. The number indicates the probable number of sides. A polygon is incomplete if one of its points is a collinear joint of another polygon.

polygons from the line drawing should be considered. In this connection, the rule being applied here is that both the number of positive angles and the number of negative angles of a polygon are invariant under any perspective transformation. Thus, the only polygons which need be considered at this point are those which have the same number of plus and minus angles as some model surface. With the models included in the present program, the acceptable polygons are further restricted to have 3, 4, or 6 sides.

A comment on incomplete polygons may be useful at this point. A perfect projection of solid objects with visible width and no two-dimensional markings is being assumed for the input. Since such projections are completely composed of surface boundary projections, they will never contain any points connected to only one line, unless the points are on the boundaries of the picture. If a special external boundary square is

included, there will be no incomplete polygons as is assumed. The 3-D display program will always generate acceptable input, but the picture input process could miss lines, generate false lines, or include two-dimensional markings. These cases could be taken care of by further checking of the picture and other techniques but at present this task was ignored. The program eliminates such problems by deleting all lines not connected in a closed polygon. Also any isolated polygon is considered to be a two-dimensional marking and is deleted. Thus, all letters except B are deleted as well as most other simple two-dimensional markings. When the process is completed, these markings could be transferred to the appropriate surface, if desired, but this was not done.

One further computation is performed on each polygon even though it is only used to order the investigation of the polygons. The area of each polygon is found as the program moves clockwise around the points,  $(x_j, y_j)$ .

$$A = 1 / 2 \sum (x_{j+1} y_j - x_j y_{j+1})$$

This procedure, which is really summing the signed areas of the triangles formed by each line and the origin, is very simple and works for any shape polygon. If the motion is counter-clockwise instead of clockwise as is the case for external boundaries, the area will come out negative. This formula for the area of a polygon was derived by the author since no suitable formulation could be found easily.

## MODEL MATCHING

The first tool used to match the polygon structure to the models is topology. Basically, we wish to find points in the line drawing which fit a transformation of some model. The polygon structure is used to find a suitable model with a set of topologically equivalent points. Then the mean square error technique is used to find out if the point positions are related by a simple transformation or not. Topology matching proceeds in four steps. First, each point is examined to see if it is completely surrounded by approved polygons. When such a point is found, the number of polygons of each type is counted. At present, since the only approved polygons are those with 3, 4, or 6 sides, three counts are obtained. A list of triads corresponding to distinct points on the models is maintained so that a quick search will indicate which model points are surrounded by the same polygon structure as the picture point. For example, if a point has three quadrilaterals around it, the list will specify a particular point on the cube model. The other points on the cube need not be listed because they are all similar to each other. Once a model point has been chosen the program cycles around the picture and model points to line up the order of the polygons. If the orders cannot be matched, other listed model points are tested; however, if they are matched, a list of equivalent point pairs is constructed.

The computation of the optimal transformation matrix from the point pairs is presented in Appendix B. Besides producing the transformation, the procedure generates the mean square error. A threshold is placed on this error to eliminate models which fit the picture topologically, but

do not fit exactly without being deformed. Models having acceptably small error can now be transformed to produce the lines and points which were not part of the fitted area. The points are checked against the picture to make sure they do not fall outside the object's external boundary. If a point does exceed this boundary, the model must be discarded since it would produce new lines not in the picture. Models which pass this test, however, could represent at least part of the object, and are accepted. If a transformed model accounts for all of the lines connected together in a region, the transform and model are used to represent that object; however, if some lines are left, the procedure described under object construction must be used.

The examination of all points surrounded by polygons is only the first step of the topology matching. After all the points are tested, lines are examined for approved polygons on both sides. A second list of model information is searched for any models with such a pair of adjoining polygons. When a line and model are found, the polygons are aligned and a list of point pairs produced. From here on the transformation procedure is the same as before.

The third step, after all lines have been examined, is to test each remaining approved polygon. The polygon must have a line attached to one vertex. The model information lists each distinct model, polygon, and vertex for each type of polygon and the point pair list is easily prepared. The fourth step, if necessary, is to take each point with three lines out of it and test these four points against each distinct vertex and

line orientation in each model. This test is a last resort because there are so many model possibilities and in every case a transformation can be found which makes the mean square error zero. Only finding a point outside the boundary can eliminate these cases.

The four steps are ideal for the cube model since the number of points found decrease by one with each step. Almost any visible piece of a cube will be processed with the maximum number of points possible. Even though this is not true for all models, the four steps are a good approximation to a comprehensive topology search. Topology tests and matching are very difficult to implement on a computer, even with the aid of a good list structure. Computer languages seem to be far superior at numerical and symbolic manipulation than the decision loaded searching associated with topology. The inherent limitations of the serial processing of a line structure without some global picture of what you are looking at, make specific tests such as the four steps, far easier to achieve than any general procedure. Even to accomplish these steps without continual searching and backtracking, the list structure must be organized in a very special manner. At each vertex the connecting lines are ordered by angle of exit in a counter-clockwise ring. Thus, any time the program arrives on one line it can easily exit on an adjacent line. Further, the lines in each polygon are ordered in a clockwise ring, with the end points of each line and the two polygons of the line specifically related. This is important because upon arrival at an end point of a line the program can immediately identify the right and left polygons and proceed around either

one. Both the model structure and the line drawing are organized in this way. The definition of clockwise and counter-clockwise in a three-dimensional model structure is not obvious, but for compatibility with the projections of a solid model, all such orderings are made while looking in from the outside.

#### COMPOUND OBJECT CONSTRUCTION

A compound object is a single solid object which is not a transformation of a single model, but must be formed by piecing together several models. Whenever two models are fitted together such that they have a frontal plane in common, the 3-D display program will eliminate any piece of line which touches both models and is in that plane. Since these joint lines do not reflect any surface discontinuity, it is expected that they will also be missing in the line drawing input. If joint lines happen to appear in the input, the resultant structure will most likely be the same as if they were missing, therefore the display will not include them. As models are found which fit a part of an object, their lines are projected back onto the drawing and the joint lines found. Thus, the complex unapproved polygons are cut up by these joint lines into smaller polygons until each piece is approved. The following rules are for deleting an accepted model from an object and reforming the picture to make ready for the next model identification. The expression "T joint" refers to a vertex at which two collinear lines and one other line, the "stem", meet. During the process parts of the drawing are deleted but these changes are never allowed to modify the external boundary polygon since it must be used to test new

models. The concept of a "visible" model line or point refers to the points and lines on the frontal surfaces of the model.

1. Each visible point of the transformed model is projected on the drawing.
  - a. Any new point pairs found by model and picture points being close, are used to recompute the transformation for better accuracy.
  - b. If a model point falls on a picture line, the line is cut in two and the point inserted.
2. All the model lines and points are added to the picture if they are not already there. Any picture point which lies on a model line, but not on either end, is separated from the model line structure. Thus, a picture line ending in a T joint stem, may be extended to its proper end point and the collinear T joint lines unified into one line. Joint lines are those visible model lines which were not in the picture and which divide a picture polygon.
3. Each visible model point in the picture which does not connect to any non-model lines is now marked "used". Also, all points on polygons with more than two "used" points are marked "used". The joining polygon between parts is the polygon including the joint line which was not divided by the joint, and all the points on such a polygon must be unmarked. Now all "used" points are

deleted along with their attached lines and polygons. Also, any line in a joining polygon which is the stem of a T joint at both ends, should be deleted.

4. All remaining model lines should be marked as unnecessary. If all lines left connected to them are unnecessary or if no lines are left connected, then the object has been finished.

Each time a model is stripped off an object in this way its transform and model name are saved as part of an object block. For each model, a point which was connected to the remainder of the object is remembered, so that the depth relations between the parts may be computed. When an object is finished, there exists a string of points connecting them. An object transformation is set up to position the depth of the whole object and so the first model can be assumed to have the correct depth. Then each model whose point connects to the first has its transformation modified so that the points have the same depth. Then the models connected to those are updated and so on.

To correct a transformation  $R_o$  when a known point  $\bar{v}$  should be equal to a point  $\bar{p} = \bar{q} R_o$ , the new lower left element,  $x$ , of  $R_o$  is computed as follows:

$$x = \frac{q_4 v_1 w - p_1 v_4}{q_4 (v_4 - r v_1)}$$



Here,  $w$  is the present lower right element of  $R_o$  and the new  $w' = w + r \times$ . Note that the focal ratio,  $r$ , for the picture must be known at this point. However, the accuracy of  $r$  will not affect the accuracy of positioning the parts with respect to each other.

Eclipsed objects, or objects partially hidden from view by other objects, are automatically taken care of by the construction rules. One case however, needs further attention. When an object is so well hidden that a dimension cannot be determined, this dimension must be estimated. An example of this case would be when only the top of a building is visible over another. The first assumption we make is that the object is supported by the ground plane. But a second assumption is needed to place the object, and the program assumes that the hidden object just touches the object in front. This is not a very good assumption, but there are no good assumptions.

Figure 4 illustrates the construction of a compound object. The original line drawing appears in A1 and includes a compound object and a partially hidden object. Since there are no points surrounded by acceptable polygons, we must look for a line with good polygons on both sides. There is only one such line to which a model can be fitted and this is in the upper object. Both the cube and wedge models fit this object, however, the cube is always tested first to avoid splitting cubes into wedges. The lines of the cube model are then projected onto the line drawing as in A2, and the transformed model is entered into the 3-D structure as displayed in A3. After a model has been identified, the "used" points and lines are deleted, thus producing the line drawing in B1. Now

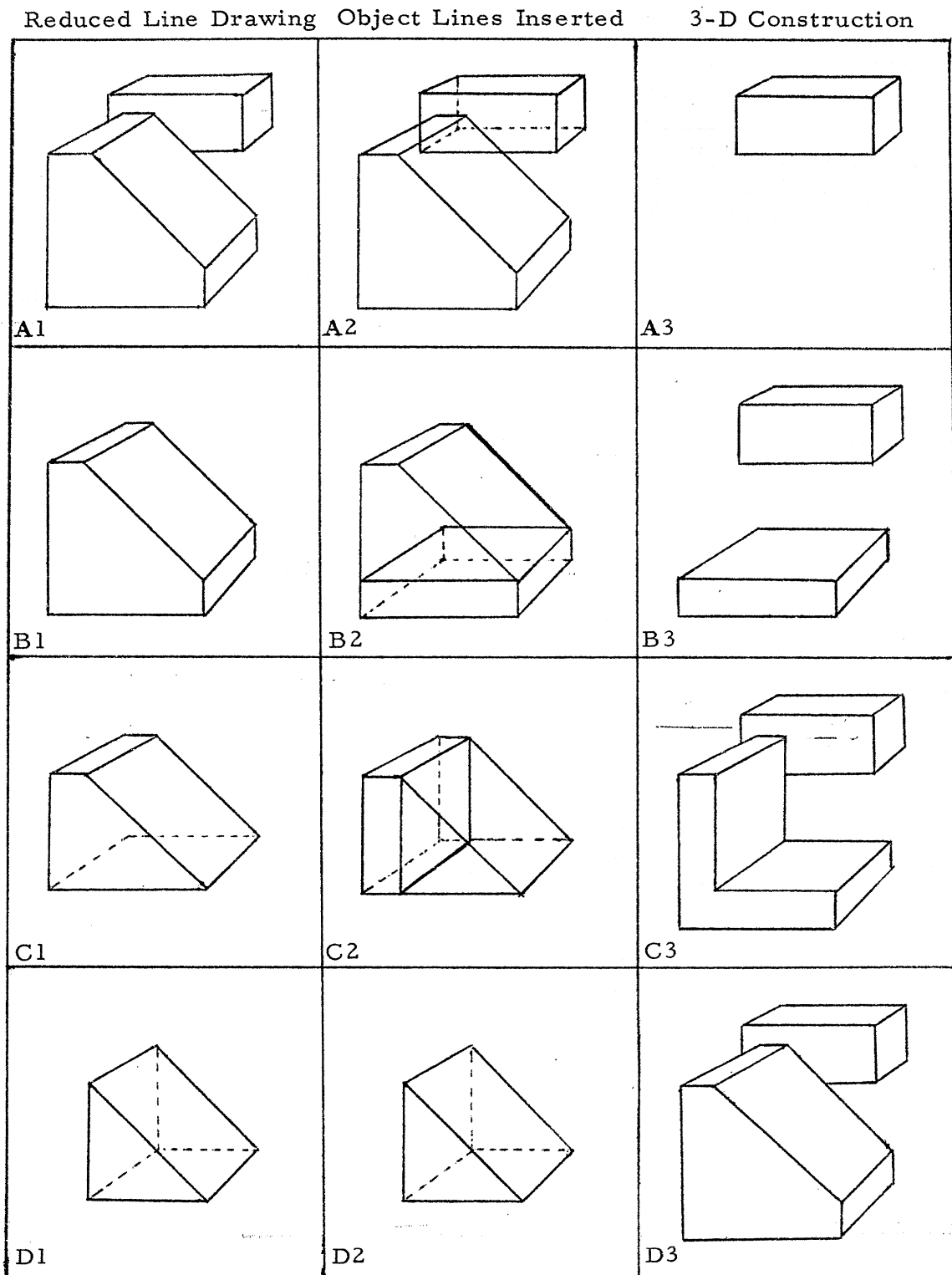

Figure 4:

Compound Object Construction: Original Line drawing in A1 is processed to obtain 3-D figure in D3 by sequential recognition and deletion of four models in steps A, B, C, and D.

a new search for fitting models is made. The lower right quadrilateral and the bottom line adjoining it are found to fit a cube model resulting in B2 and B3. Next, a cube is fitted at the left, in C1, producing C2 and C3. Finally, just a wedge is left in D1 and since all the back lines have already been determined, D2 appears the same. When this model is added to the 3-D structure, the result is a complete description of the objects and can be displayed as in D3 or from any other point of view.

#### GROUND PLANE ASSUMPTION

When all the objects in the picture have been constructed, they still need their object transformations adjusted for depth. If an object consisted of a single model, the transformation listed is  $R_0$ . If the object was compound, an identity matrix was set down as the object transform and the model transforms all relate to it. In both cases each object has one free variable related to depth and size. The support theory would place each object on top of another or on a ground plane. In order to simplify the present program the ground plane is the only support assumed. However, the addition of object support will not be very difficult.

Finding the ground plane is the most difficult part of the depth computation. Each object could be examined for possible support planes and all objects compared for a common plane. An object could be supported by anything from three points to a full plane in contact with the ground. To simplify this chore, it was assumed that the picture was upright and each object had a full plane in contact with the ground. A simple test of the slope of each plane of an object is used to determine if

that plane is the bottom. This test merely asks that the bottom is not visible, that it faces the downward  $z$  direction, and that the tilts in the  $y$  and  $x$  directions are moderate. The best such plane is chosen from each object and all are expected to agree. The slope of this plane is the only information available from the incomplete transformations, so the distance of the plane below the origin or focal point must be assumed. This distance just sets the numerical scale of all distances so it might as well be unity. Thus, a ground plane is determined and all the object bottoms are now made to lie in this plane.

With each model surface is stored its plane equation vector for the use of a 3-D display program. The dot product of this vector with any position vector is zero if the position is on the surface, and positive if the position is inside the solid. These plane vectors should be transformed by  $R^{-1}$  to become plane vectors of the transformed model. If the plane vector of an object plane is transformed by  $R_0^{-1}$  it has the correct slope but not necessarily the correct length. In other words, its first three components are correct. These are used to find the ground plane. Now with the ground plane distance equal to one we must find the depth  $x$  for each  $R$ . The lower right component of  $R_0$  we will call  $w$  and the same component in the final  $R$ ,  $w'$ . We first set  $x_1 = -w/2r$  and  $w_1 = w/2$  to obtain  $R_1$ . If we transform the plane vector by  $R_0^{-1}$  and  $R_1^{-1}$  we obtain  $\bar{v}_0$  and  $\bar{v}_1$ . Normalizing these vectors so that the sum of the squares of the first three components is one, we obtain normalized fourth components  $p_0$  and  $p_1$ . The plane vector for  $R$  has a fourth component which is a linear combination of

$p_0$  and  $p_1$ . Setting this combination equal to one and solving for the depth,  $x$ , we obtain:

$$x = \frac{w (p_0 - 1)}{r (1 + p_1 - 2p_0)}$$

$$w' = w + rx$$

Here again the focal ratio,  $r$ , is needed and this time if  $r$  is zero, the computation of  $x$  blows up. This just reflects the fact that an infinite projection has infinite depths; however, it restricts  $r$  to be non-zero for this procedure.

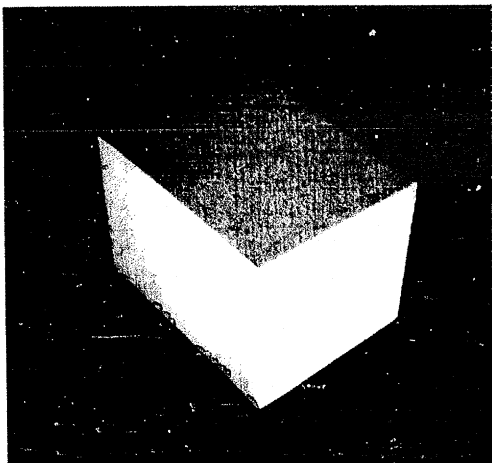

A. Original Picture

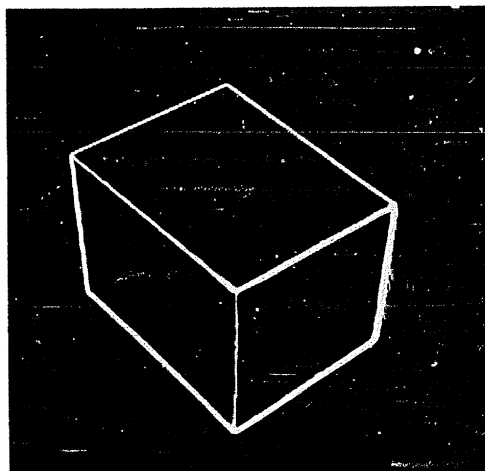

B. Differentiated Picture

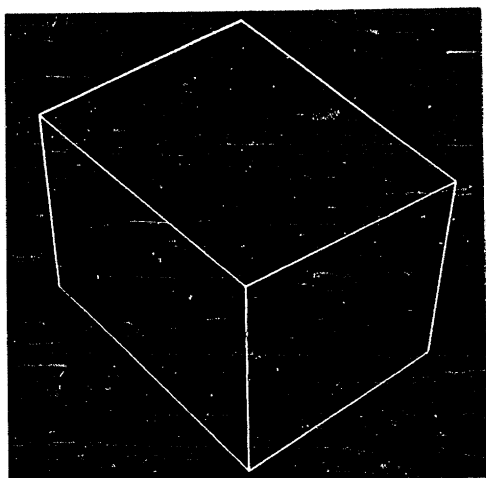

C. Line Drawing

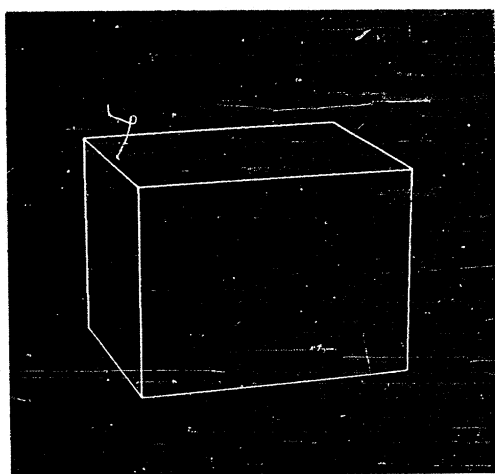

D. Rotated View

Pictures 2A - 2D:

Single Model: Reduction of photograph to line drawing and display of 3-D construction from another viewpoint.

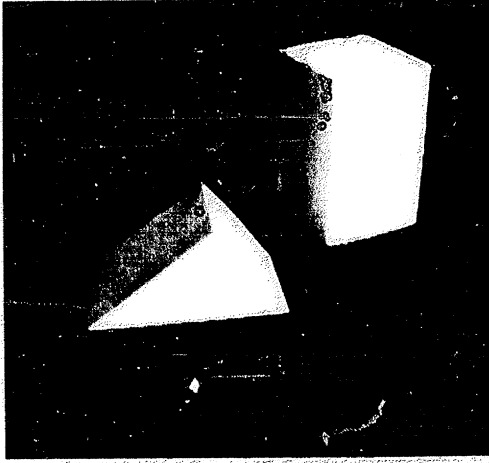

A. Original Picture

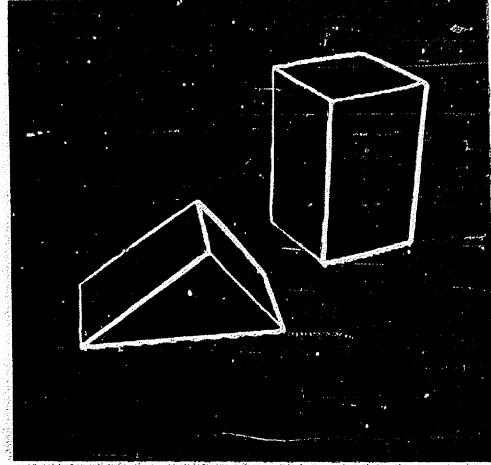

B. Differentiated Picture

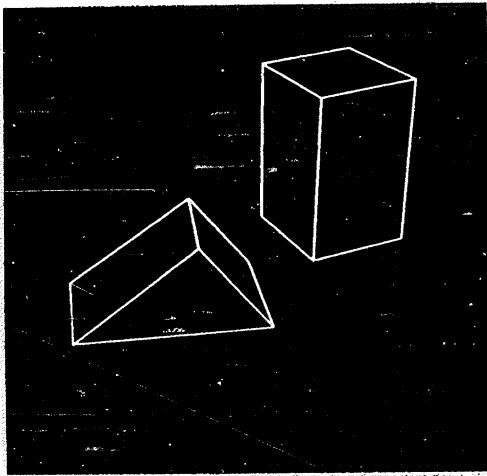

C. Line Drawing

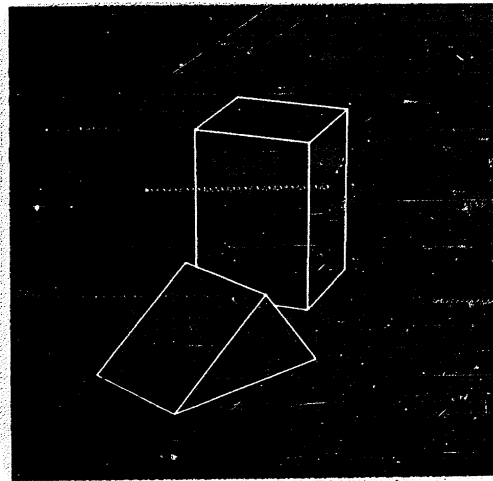

D. Rotated View

Pictures 3A - 3D:

Multiple Objects: Reduction of photograph to line drawing and 3-D construction, involving ground plane determination of depth.

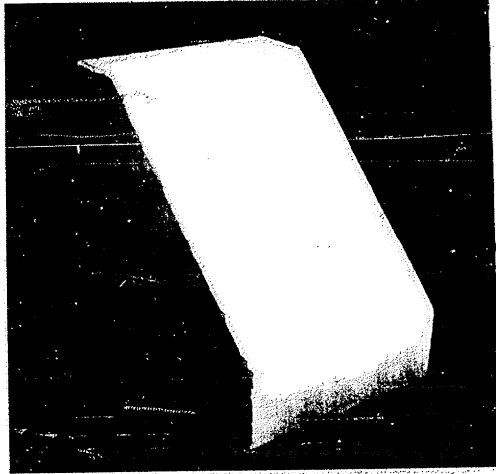

A. Original Picture

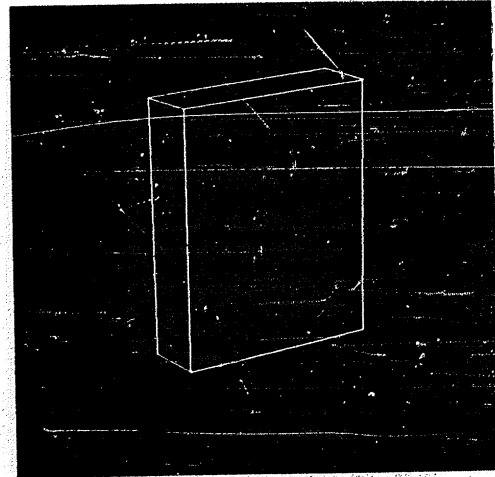

B. First Construction Model

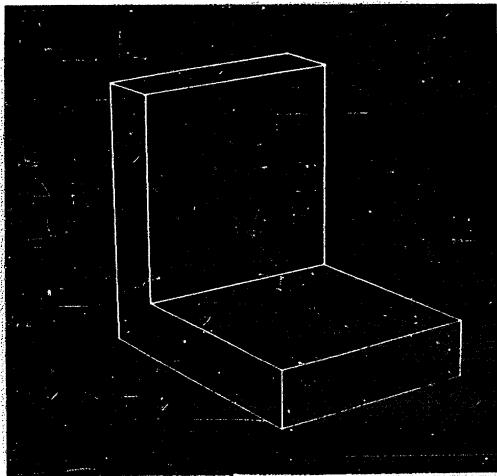

C. Two Construction Models

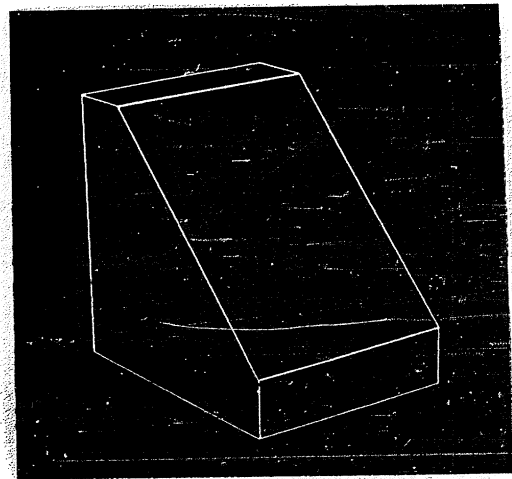

D. Complete 3-D Object

Pictures 4A - 4D:

Compound Object Construction: Processing of picture 1 to obtain 3-D description of compound object.



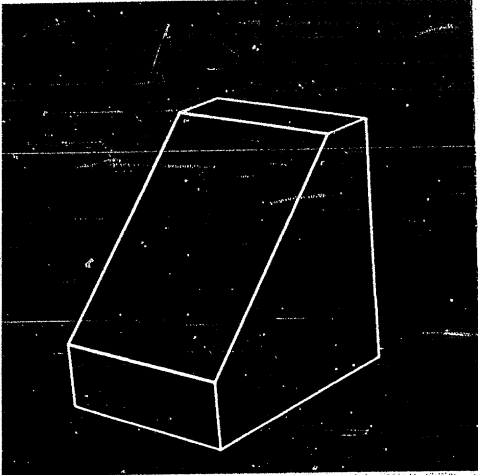

E. Rotated View

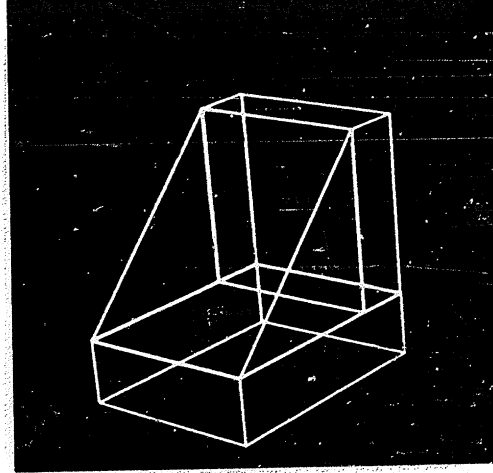

F. All Lines of A

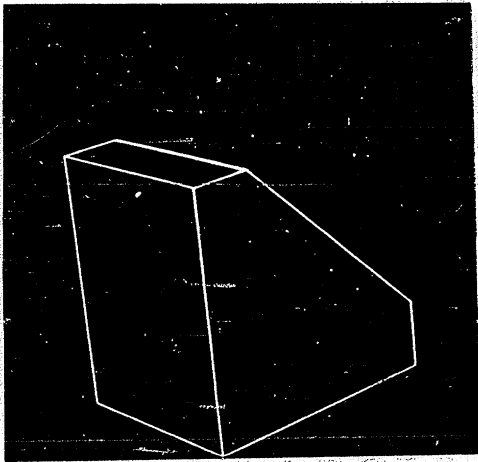

G. Second Rotated View

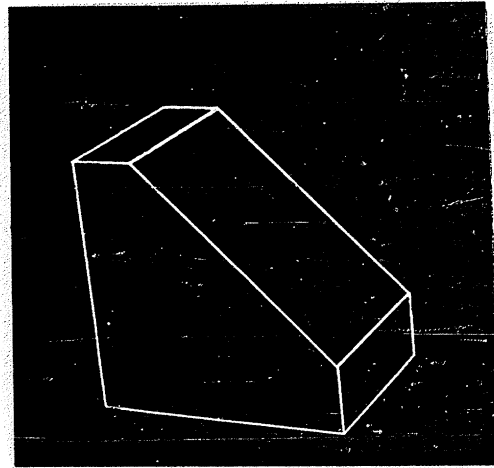

H. Third Rotated View

Pictures 4E - 4H:

Compound Object Construction: Rotated views of object obtained in picture 4D

## CHAPTER VI

### THREE-DIMENSIONAL DISPLAY

After a list of three-dimensional objects has been obtained in some manner, it should be possible to display them from any point of view. The sections of objects behind other objects should not be seen, nor should the back lines and construction lines of individual objects. The 3-D display program will do all this and more. It allows macro-like instances of objects so that a single object construction can be used many times with different transformations. It allows structures of models to be built up by the use of the knobs, push buttons, and light pen. Any object can be duplicated, deleted, or transformed. These extras make possible the construction of test cases for the 2-D to 3-D program to process. However, the most significant feature of this program is the mathematical technique which makes possible the hidden line removal.

#### STORAGE STRUCTURE

A good method of storing three-dimensional data is extremely important. The structure used is the basis for both the display program and the 3-D construction process. Therefore, the data necessary for hidden line removal must be quickly available and at the same time the topological structure must be suitable for model matching.

The list structure used is a list of tied blocks connected in rings. Ring list structures were developed for the TX-2 Computer by Sutherland for his Sketchpad system.<sup>12</sup> Sketchpad allows a user to draw two-dimensional line drawings on the computer display with the aid of the light pen, knobs, and push buttons. An extension of this work to three dimensions is currently being completed by Johnson.<sup>13</sup> These two systems use ring list structure and in order to be compatible with them, the same format is used in the 3-D display program. However, the exact block form used is different because of the different data requirements. In the ring structure, a block of registers is used for each item and contains pairs of ties to other blocks. Each pair of ties is part of a ring which allows the program to move from block to block around the ring in either direction.

The basis of all three-dimensional forms is the set of models. Each model block is tied to lists of its points, lines, and surfaces. The point blocks are tied to the lines connected to them and include a four component position vector. Since a homogeneous vector can be normalized without changing the point, each component of the vector can be represented by a fixed point, 36-bit number. The line blocks are tied to two point blocks and two surface blocks since two planes determine a line. The surface blocks are tied to a ring of lines representing the surface polygon and also include a plane vector. This detailed structure is only needed for models since the objects are to be composed out of transformations of models. The models are always in the list structure and must be referred to by instances in order to be

displayed. An instance is an intermediate block between a picture and either a model or another picture. Each instance includes a  $4 \times 4$  transformation matrix and also the inverse of this matrix. The picture blocks may be referred to by any number of instances and have as their parts any number of instances. Thus, each picture represents an object or a collection of objects and is composed out of transformations of other pictures or models by means of instances. One picture is the current picture being displayed, and it has only one instance containing the picture transformation. Figure 5 shows a possible structure leading from the models to the current picture. The instances have been compressed to ties with matrices on them for simplicity.

#### DISPLAY GENERATION

In order to display the picture represented by the current storage pattern, a recursive procedure is used, starting with the current picture. Each picture block has a temporary storage area to store the effective transformation and its inverse at that picture level. One recursion involves taking the transformation at one picture level, pre-multiplying by the matrix of one of instances the picture refers to, and placing that transformation in the picture block referred to by the instance. The inverse matrices are carried along also, but post multiplication must be used for them. If the instance refers to a model, the matrices obtained are put in a transform block along with the model name. Each time a model is reached, the process backs up to the last picture block and proceeds to the next instance, or if all instances have been processed, it backs up to the preceding picture block. In this way

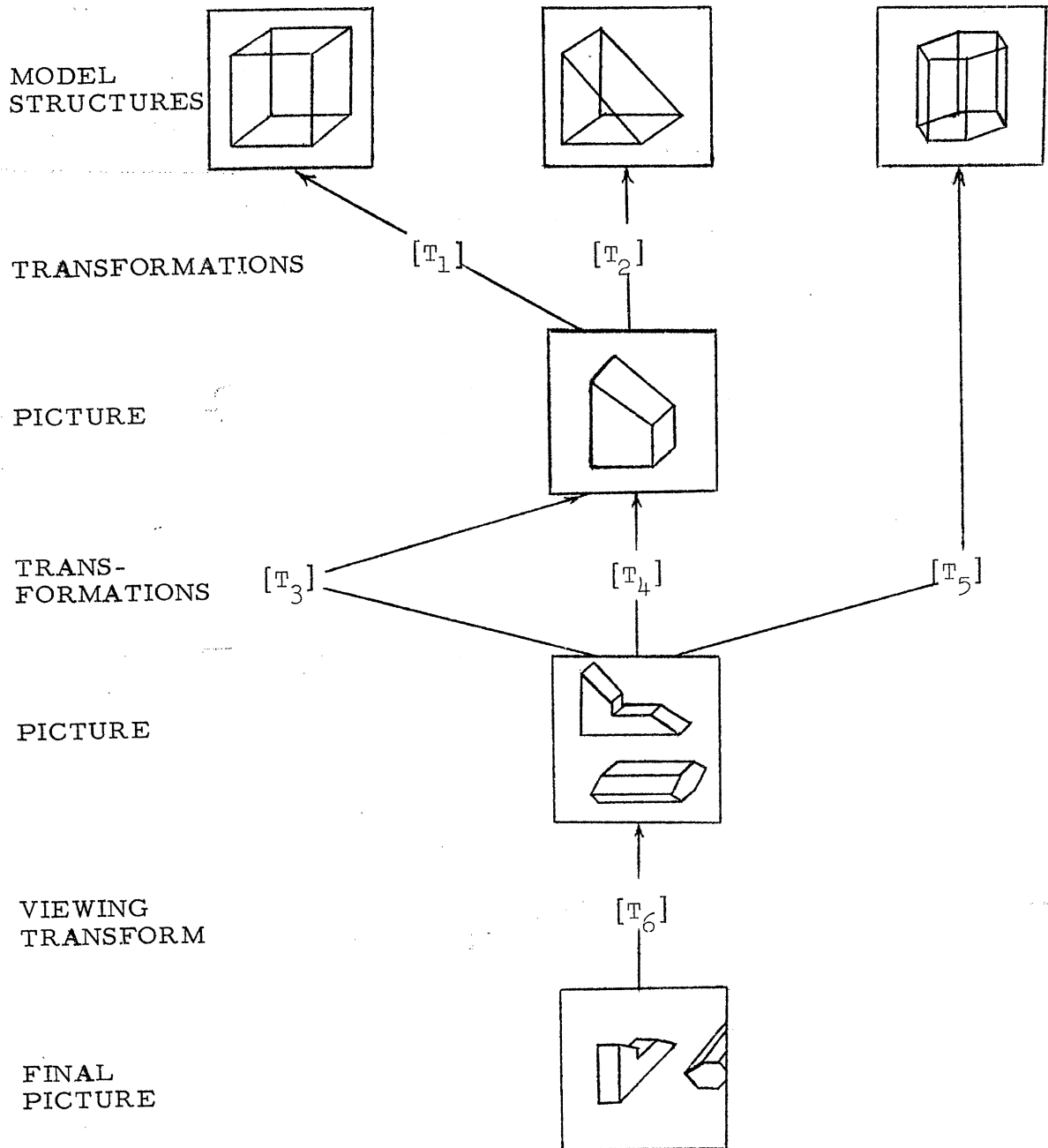

Figure 5:

List Structure Formation: Representation of list structure formation of compound pictures. Each "PICTURE" is composed of transformed versions of models and other pictures. There may be as many levels of pictures as necessary.

a list of transform blocks is obtained. Each transform block is now processed by tying to it a list of point-pair blocks obtained by transforming the end points of each line in the selected model. Each position vector is postmultiplied by the transformation in the transform block to obtain the new position vector. Also, the plane vectors of the model are transformed by the inverse matrix and collected as the columns of a volume matrix.

Thus, a list of transform blocks are obtained, each of which has a volume matrix and a list of point pairs. The point pairs represent all the lines in the display and can now be processed to eliminate the hidden lines. The scope coordinates of a point are obtained from the four component position vector  $\bar{v}$  as follows:

$$x = v_2 / v_4$$

$$y = v_3 / v_4$$

#### HIDDEN LINE ELIMINATION

Three steps are required to prepare a line for display. First, it is trimmed off at the edges of the scope. Next, the back lines of each model are deleted. Third, the sections of each line which are hidden by other models are removed. It is the third part which is difficult and time consuming. As far as I know, no one has ever devised a procedure before for determining hidden line segments. One can imagine brute force methods such as calculating all the line intersections on the focal plane and then computing which lines were in which polygons and tracing

out the frontal lines. But, procedures such as this are hard to make complete for all cases, and the processing time could be fantastic. Therefore, a new mathematical method was conceived which utilizes volume inequality matrices to find out whether a point is inside or outside a volume. This test can then be extended by linear inequality solutions to tell which segment of a line is behind a volume. This is why the inverse transformations, plane vectors, and volume matrices are needed. Since they are available, they can be used to advantage in the first two steps.

The volume matrix,  $V$ , of a model is a  $4 \times n$  matrix with the  $n$  plane vectors as columns. In the homogeneous coordinate system, a dot product of a position vector and a plane vector produces a measure of the distance of the point from the plane. The plane vectors of the models have had their signs adjusted so that the dot products will be negative if the point is outside the solid and positive if the point is inside. Thus, when a position vector,  $\bar{v}$ , is postmultiplied by a volume matrix, the resulting vector,  $\bar{v}V$ , being a collection of dot products, will have at least one negative term if the point is outside the volume. If any terms are zero, the point is on the model's surface, and if all are positive, the point is inside. For this test to work, the models must be convex. This is a small restriction since the objects constructed with the models need not be convex.

$$(\bar{v}V \geq 0) \Rightarrow \bar{v} \text{ inside volume } V$$

In the expression above the inequality sign means that all components of the vector should be non-negative. Expressions and formulations of inequality matrices have been used in the field of linear programming to express the interior region of convex polyhedral cones where the general problem to be solved was to optimize a function in such a region. However, literature in this field does not seem to cover the geometrical type of problem we are concerned with.

A volume matrix can be used for the first step of the line reduction; the elimination of lines off the scope. As well as cutting off lines at the scope edge it is desired to cut off lines in front of the focal plane. Thus, a volume matrix can be designed which has planes at  $y = \pm 1$ ,  $z = \pm 1$  and  $x = 0$ . These planes form a semi-infinite box, and we wish to find the section of each line which is inside the box. First, we will define the volume matrix,  $V_o$ .

$$V_o = \begin{bmatrix} 0 & 0 & 0 & 0 & -1 \\ 1 & -1 & 0 & 0 & 0 \\ 0 & 0 & 1 & -1 & 0 \\ 1 & 1 & 1 & 1 & 0 \end{bmatrix}$$

The set of all lines is the list of point-pair blocks. We will want to use a line equation of the form:

$$\bar{v} = \bar{s} + t\bar{d} \quad , \quad 0 \leq t \leq 1$$

where  $t$  is a running variable, moving the position  $\bar{v}$  from  $\bar{s}$  to  $\bar{s} + \bar{d}$ . A point-pair block has two points,  $\bar{s}$  and  $\bar{r}$ . If the fourth component of



these vectors is made to agree by normalizing one vector, the difference vector,  $\bar{d} = \bar{r} - \bar{s}$ , can be formed. With this line representation we can proceed to find the values of the variable  $t$  for which the following inequalities are true.

$$\bar{s} V_o + t \bar{d} V_o \geq 0$$

This set of inequalities requires the line to be inside  $V_o$  and we can solve for the minimum and maximum  $t$ .

If we define:  $\bar{p} = \bar{s} V_o$  ,  $\bar{q} = \bar{d} V_o$

Then for all  $j$ :  $p_j + t q_j \geq 0$

For  $q_j > 0$   $t \geq -p_j / q_j$

For  $q_j < 0$   $t \leq -p_j / q_j$

From these relations it is fairly obvious that we can obtain a minimum and maximum value for  $t$  and thus define the segment of line inside the volume. This segment then replaces the old point pair.

The second step of the line elimination is the removal of all the lines hidden by their own volume. Although this would be done automatically if we went right onto the third step and included the line's own volume among all the others, it is faster to eliminate the back lines ahead of time. The volume matrix associated with a line contains the plane vectors of the model, and two of these planes intersect to form the line. In each point-pair block we keep track of which columns of  $V$  are the line's plane vectors. The first component of a plane vector

is the  $\bar{x}$  component and will be negative if the plane faces toward the observer. Thus, the second step is very simple; a line should be deleted if both of the  $x$  components of its plane vectors are positive.

The third method of eliminating a line is to see if it is hidden by some other volume. For this test, each remaining line is tested against every volume matrix except its own. The procedure is similar to that of step one except that a two variable inequality solution must be found this time. The segment of line found is the part to be deleted, and this may be an end, the center, or the complete line.

A volume matrix produces inequalities which tell if a point is in the volume. In step one we used a point with one degree of freedom,  $t$ , along a line. Now the line may be behind the volume so a second degree of freedom must be used to move the point forward, through the volume. If a point on the line is moved forward in  $x$  in this transformed space, it will have to move through the volume, if it is hidden. The variable point will thus be represented as before with a variable  $t$  along the line, but also with a variable  $\alpha$ , in the  $\bar{x} = [1, 0, 0, 0]$  direction.

$$\text{Variable point:} \quad \bar{v} = \bar{s} + t \bar{d} + \alpha \bar{x}$$

$$\text{Inequalities:} \quad \bar{v} V > 0$$

$$\text{Thus:} \quad \bar{s} V + t \bar{d} V + \alpha \bar{x} V \geq 0$$

Now,  $\bar{x} V$  is just the top row of  $V$  which we can call  $\bar{w}$ , and  $\bar{s} V$  and  $\bar{d} V$  can be computed as before.

Define:  $\bar{p} = \bar{s} V$  ,  $\bar{q} = \bar{d} V$  ,  $\bar{w} = \bar{x} V$

Thus, for all j:  $p_j + t q_j + \alpha w_j \geq 0$

Where:  $0 \geq \alpha \geq 1$  ,  $0 \geq t \geq 1$

These inequalities must be solved for the minimum and maximum  $t$  for any non-negative  $\alpha$ . A few simple tests allow the removal of equations which are always satisfied or the termination of the test if an equation will never be satisfied.

Ignore equation:

a.  $(q_j > 0) \wedge (p_j \geq 0) \wedge (p_j + w_j \geq 0)$

b.  $(q_j < 0) \wedge (p_j > 0) \wedge (p_j + q_j \geq 0) \wedge (p_j + q_j + w_j \geq 0)$

Quit, leave line:

c.  $(q_j > 0) \wedge (p_j < 0) \wedge (p_j + q_j \leq 0) \wedge (p_j + q_j + w_j \leq 0)$

d.  $(q_j < 0) \wedge (p_j \leq 0) \wedge (p_j + w_j \leq 0)$

These tests speed up the process considerably since only a few planes of each volume are really involved in the determination of  $t$ . To solve the remaining equations, many methods are possible and a very simple one was chosen. Each inequality is considered as an equality and all intersections between these quantities are found. Also, the intersections of these equalities with the boundaries,  $\alpha = 0, 1$  and  $t = 0, 1$ , are found. Each intersection results in a pair  $(\alpha, t)$  and these pairs are tested in the inequalities. Any pair satisfying all inequalities and the boundary conditions is used to compute a minimum and maximum  $t$ .

Because the actual minimum and maximum  $t$  must occur at intersections, this is a complete solution. It is also fairly fast since there are usually very few equations. If no pair will satisfy all the inequalities, then the line is not hidden by the volume and is left intact. Otherwise, the section of line corresponding to the solution area, between min and max  $t$ , is deleted.

One case of interest can be modified during this process. We want to eliminate joint lines between touching, tangent objects. A joint line, when processed with the touching solid, is detectable since the inequality caused by the plane through the line will have  $q_j = p_j = 0$ . If this occurs, the solution space is limited to  $\alpha = 0$ . Thus, the joint line can have a proper solution and will be eliminated. However, this also occurs for joints between objects where the planes are not tangent. We want these lines and must act to preserve them. Therefore, whenever  $q_j = p_j = 0$ , we make a special test to find out if either of the planes through the line from its own volume, are parallel to the plane being tested. We also ask that the tangent planes face the same direction. If parallel planes facing the same way are not found, the line under consideration is kept intact and the rest of the test skipped.

This completes the testing of one line with one volume. The line is then tested against the other volumes. The final result of the complete hidden line removal is a modified list of point pairs. These lines are then displayed. The complete process tends to be time consuming for complicated displays, but the time does not seem to go up as the square of the number of objects as might be expected. This is because objects

far away from the line being processed are quickly disposed of by conditions (c) and (d). Thus, the time consumed is on the order of one second per object for displays of up to thirty objects. It is not necessary to do the complete hidden line removal, though, if a faster moving display is required. The complete process can be reserved until the desired view is obtained.

### DISPLAY CONSTRUCTION

Besides being able to display the list structure, the display program has provisions for modifying the list. The picture transformation in the first instance, can always be changed by a rotation about each of three axes, a translation in three directions, or a size change. All transformation changes are obtained through the use of four shaft encoder knobs on the computer console. The function of these knobs is selected by means of push buttons. Besides being able to modify the picture transformation, the light pen can be used to point out any instance transformation for modification. The pen is pointed at the object to be modified and a level register indicates which instance level of the object to modify. This method is somewhat crude but does allow any instance to be modified. The transformation changes allowable for objects include rotation, translation, three size components, three skew components, and an over-all size factor. Beyond these transformation controls, any object can be deleted or duplicated. New instances of models can be generated and instances made of present pictures. These controls allow the construction of any list structure possible or the modification of any existing structure. Thus, test pictures may be generated to facilitate the testing of this program and the 3-D construction program.

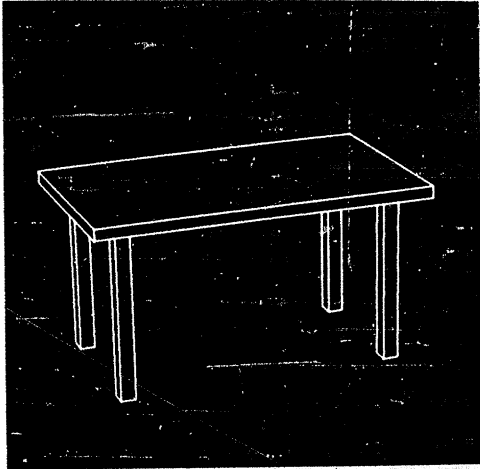

A. Table

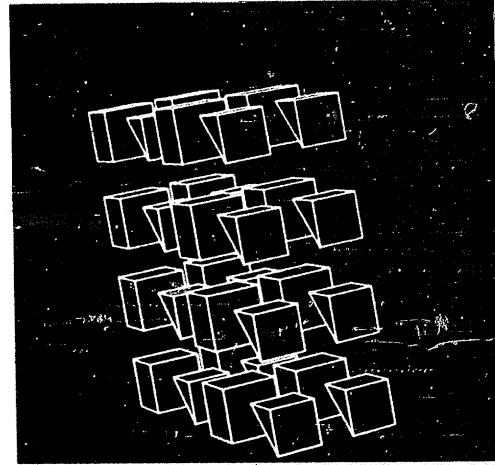

B. Array Made with instances

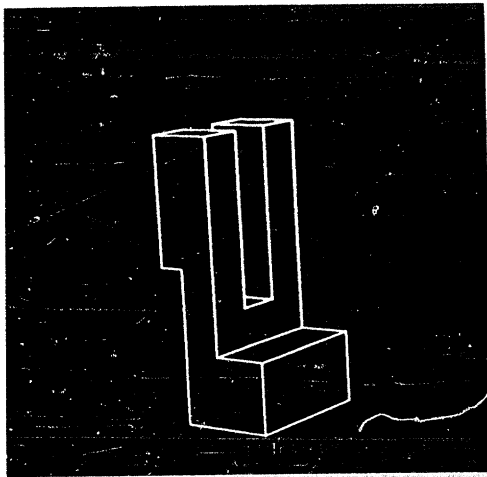

C. Compound Object

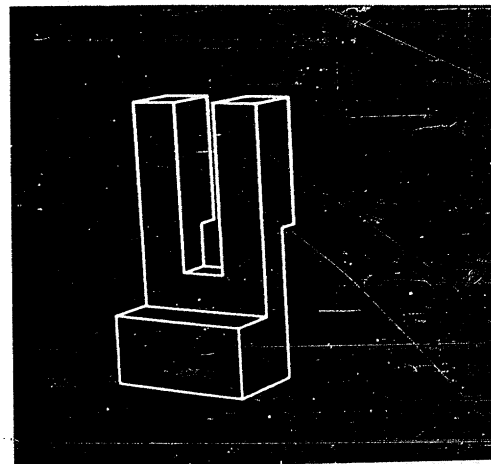

D. Rotated View of Object

Pictures 5A - 5D:

3-D Displays: Pictures constructed with 3-D display program.

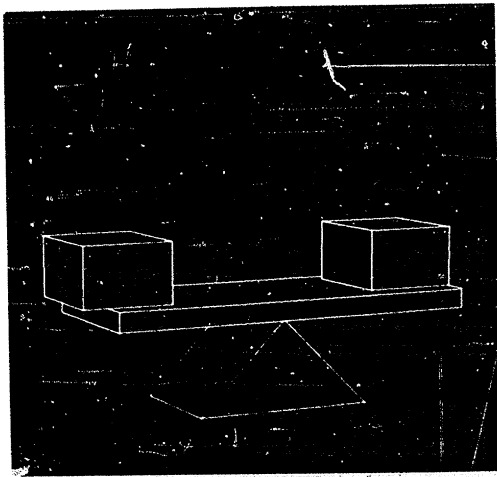

E. See-Saw

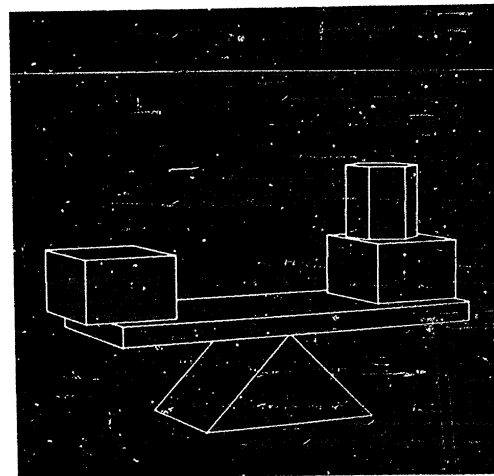

F. With Hexagonal Prism

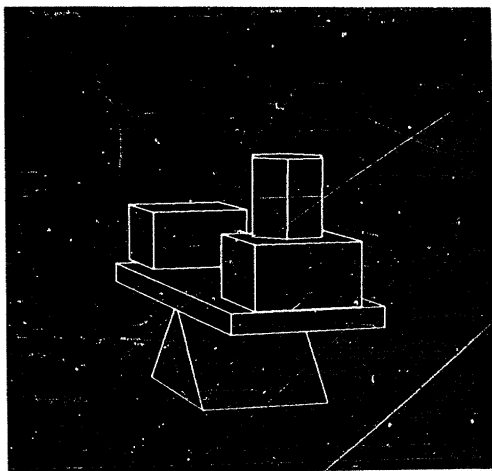

G. Second View

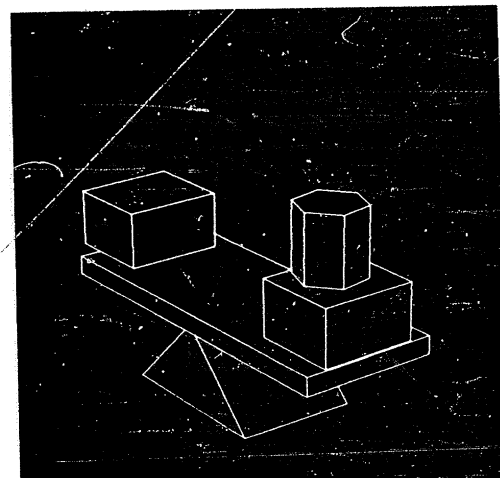

H. Balanced ?

Pictures 5E - 5H:

3-D Displays: Pictures made with 3-D display program showing hidden line elimination.

## CHAPTER VII

## CONCLUSION

In the past, research in the pattern recognition field has been limited to the identification of two-dimensional shapes, mainly because it was thought that any three-dimensional analysis would be more difficult. The idea seems to have been that the 2-D work would pave the road for future 3-D work. Progress, however, has been slow and it may well be that the study of three-dimensional projections is an easier step. The human visual field is the result of a projective transformation and the shapes perceived are independent of this transform. Thus, it makes sense to utilize this transformation, since our goal is to recognize the same similarity classes which humans do.

The mathematics necessary to go from a photograph to an object list has been described. A set of transforms is found which takes a set of models into the shapes observed. The models are then the invariant shapes which we perceive as the same object from any point of view. Individually or in specific groups, they could be given names.

The process of creating an object list from a picture is mainly mathematical, based on the natural laws of the space around us. It is based on the assumptions of model construction and object support and shows the theoretical implications of these concepts. Four or more



points on an object must be seen in order to find the correct model and its transformation. Further, the depth relationships between objects depend on the focal ratio which can either be assumed as a camera constant, or calculated from the picture if the data is accurate enough. If the focal ratio used is wrong, the effect will be a contraction or expansion of the depth dimension. When both the focal ratio and the distance from the camera to the ground are known, the exact size of each object can be calculated.

The 2-D to 3-D and 3-D to 2-D programs are completely general as long as the assumptions of model construction and support are not violated. The display program can handle any structure made up of transformations of models. The construction program will always produce a 3-D structure which projects to the given line drawing except that it will eliminate any 2-D markings, isolated polygons, and superfluous joint lines. Any drawing produced by the 3-D display program will be correctly reconstructed into the 3-D structure if the objects are properly supported and sufficiently visible.

The programs are all written for the TX-2 computer at Lincoln Laboratory<sup>+</sup>. The TX-2 is ideal for this type of work because of its large memory for picture storage, and its special input-output equipment. During the course of developing these programs I designed a vector-drawing display for the computer which can draw line and circle segments.

---

+ Operated with support from the U.S. Army, Navy and Air Force.

This scope enables the computer to continuously display a line drawing and still spend most of its time computing new data. Thus, it is possible to display rotating objects and have them move fairly smoothly.

The input program has about 5000 instructions and uses over 40,000 registers of data storage for its pictures and lists. It takes about one minute to process a picture into a line drawing of which half is for differentiation. The 3-D construction and display programs are each about 3000 instructions and use from 5000 to 40,000 registers of data storage depending upon the number of objects. Both construction and display take about one second per object. All told, a rotated view of the objects in a photograph might be obtained in two minutes.

I foresee at least two uses for this type of picture handling system. First, it could be used for an information reduction system to aid in the transmission of pictorial information. However, the necessity of an ultra high speed computer will probably limit this use. Second, the computer programs will be useful input-output tools for future investigations of three-dimensional processes. The biggest benefit of this investigation, however, is an increased understanding of the possible processes of visual perception.

## APPENDIX A

## HOMOGENEOUS COORDINATES

In a homogeneous coordinate system a fourth coordinate, or scale factor, is used in such a way that the total scale of a vector is unimportant. That is:

$$k\bar{v} \equiv \bar{v}$$

I am using  $\equiv$  to indicate that the same point is represented even though the individual components may not be equal. The above form is achieved by defining the point's coordinates, X, Y, Z, in terms of the homogeneous components x, y, z, w as below.

$$X = x/w \quad Y = y/w \quad Z = z/w$$

When new points are introduced into the system, w may be assigned to any non-zero value and the above equations used to find x, y and z. When points are to be displayed, the above equations are used to find X, Y, and Z. An added advantage for a fixed point computer is gained by using a homogeneous system in that w may always be chosen so as to keep the numbers normalized.

A plane is represented by l, m, n, p such that on the plane:

$$lx + my + nz + pw = 0$$

I have chosen to represent points by row vectors, therefore, to transform a set of points,  $\bar{v}_i$ , each is post multiplied by a 4x4 matrix H.

$$\bar{v}_i' = \bar{v}_i H$$

The advantage of homogeneous coordinates is that a single transform,  $H$ , can accomplish a full projective transformation. Normally, it is convenient to separate the various functions provided by a transform until they are needed and then multiply them together. Below is a breakdown of a transform,  $H$ , consisting of a rotation by a standard  $3 \times 3$   $R$  matrix, a translation by a vector  $\bar{v} = (x, y, z, w)$ , a perspective transform from a focal point at  $f$  on the  $x$  axis, a translation after perspective to a center  $(y_0, z_0)$ , and a total picture scale factor  $S$ . This sequence might represent the transform made by taking a picture with an arbitrary camera orientation and making an enlargement of a section. The transform would take the real space points  $X, Y, Z$  into a  $Y', Z'$  on the print. An  $X'$  will be formed which can be used for eliminating object overlap.

$$H = \begin{bmatrix} & & & 0 \\ [R] & & & 0 \\ & & & 0 \\ 0 & 0 & 0 & 1 \end{bmatrix} \begin{bmatrix} w & & & \\ & w & & \\ & & w & \\ x & y & z & w \end{bmatrix} \begin{bmatrix} f & & & -1 \\ & f & & \\ & & f & \\ & & & f \end{bmatrix} \begin{bmatrix} 1 & & & \\ & 1 & & \\ & & 1 & \\ & & & 1 \end{bmatrix} \begin{bmatrix} 1 & & & \\ & 1 & & \\ & & 1 & \\ & & & S \end{bmatrix}$$

Rotation                  Translation                  Perspective                  Translation                  Scale

It should be noted that a set of points,  $\bar{v}_i$ , can be written as the successive rows of a matrix  $V$  and transformed by one matrix equation.

$$V' = VH$$

Also, a plane equation can be expressed as a scalar product in terms of  $\bar{n} = (l, m, n, p)$ .

$$\bar{v} \cdot \bar{n} = 0$$

A plane normal,  $\bar{n}$ , can be transformed along with the points of a space.

$$\bar{v}' = \bar{v}H \qquad \bar{n}' = \bar{n}(H^{-1})^T$$

$$\bar{v}' \cdot \bar{n}' = 0$$

And, of course, if the transform is orthogonal:  $(H^{-1})^T = H$

## APPENDIX B

## SIMILARITY TEST

We are given a matrix  $A$  of  $n$  points  $(x, y, z, w)$  from a model and want to find a transform  $H$ , so as to most nearly fit  $n$  points  $(y, z, w)$  in a matrix  $B$ . Thus, we hope for:

$$AH \approx B$$

However, we cannot write an equality sign above without introducing a diagonal scale matrix  $D$  which will allow the  $w_i$  values of  $AH$  to differ from the  $w_i$  of  $B$ .

$$AH = DB$$

We now have 12 unknowns in  $H$  ( $3 \times 4$ ) and  $n$  unknowns in  $D$  ( $n \times n$ ). Matrix  $A$  is  $4 \times n$  and matrix  $B$  is  $3 \times n$ , creating  $3n$  equations. Therefore,  $n \geq 6$  should produce a complete solution. We will use a minimum square error technique to solve the equations. Thus, we wish to minimize the squared error in each equation. We will use  $A'$  to indicate the transpose of  $A$ .

$$\frac{\partial}{\partial h_{jm}} \left[ \sum_i \sum_k \left( \sum_j a_{ij} h_{jk} - d_i b_{ik} \right)^2 \right] = 0$$

$$\sum_j h_{jm} \sum_i a_{ij} a_{ij} = \sum_i d_i a_{ij} b_{im}$$

$$\text{or} \quad A'AH = A'DB$$

$$\text{Thus:} \quad \underline{H = (A'A)^{-1} A'DB}$$

Now we must find D.

$$\frac{\partial}{\partial d_\ell} \left[ \sum_i^n \sum_k^3 \left( \sum_j^4 a_{ij} h_{jk} - d_i b_{ik} \right)^2 \right] = 0$$

$$\sum_j^4 a_{\ell j} \sum_k^3 h_{jk} b_{\ell k} = d_\ell \sum_k^3 b_{\ell k}^2$$

Thus, the diagonal terms of  $AHB'$  equal those of  $DBB'$ .

Substituting for H from above and making the definition:

$$G = A(A'A)^{-1}A' - I$$

we obtain a matrix,  $GDBB'$ , which has zero diagonal terms.

Define:  $Q = BB'$

If we now multiply the terms of G by those of  $Q'$ , term by term, we get a new  $n \times n$  matrix S.

$$S_{ij} = g_{ij} q_{ji}$$

Define:  $\bar{d} = d_1 \dots \dots \dots d_n$

Now the vector  $\bar{d}$  or diagonal terms of D can be found by solving:

$$S\bar{d} = 0$$

This equation requires S to be singular with degeneracy at least one. If the degeneracy is one, the problem is solved since the common

scale factor of D and H is unimportant. A degeneracy more than one means that too few equations were used ( $n < 6$ ) or that the picture had no perspective. However, by assuming a value of unity for each undefined  $d_j$ , an accurate, but not complete solution, can be found.

When D is found, H can be found.

$$H = (A'A)^{-1}A'DB$$

It should be noted that for  $n = 4$ ,  $A^{-1}$  will probably exist and in this case the best solution obtainable is one with no perspective.

$$H = A^{-1}B$$

If solutions without perspective are expected, the matrix D is unnecessary and the ordinary minimum square error solution holds.

$$H = (A'A)^{-1}A'B$$

#### ERROR

An error criteria can be found to indicate the mismatch of model and picture. An error matrix E is found:

$$E = AH - DB \quad \text{or} \quad \underline{E = GDB}$$

Now if the sum of the squares of the components of E is taken, this number can be used to indicate the error magnitude. If one row of E contributes the main error, this point of B probably should not be mapped to the model A.



## BIBLIOGRAPHY

1. Somerville, D.M.Y., Analytical Geometry of Three Dimensions, Cambridge University Press, 1959.
2. Roberts, L.G., "Pattern Recognition With An Adaptive Network," IRE International Convention Record, Pt. 2, pp. 66-70, 1960.
3. Selfridge, O.G., and U. Neisser, "Pattern Recognition by Machine," Scientific American, Vol. 203, No. 3, pp 60-68, August, 1960.
4. Hodes, L., Machine Processing of Line Drawings," Lincoln Laboratory, MIT, Lexington, Mass., Group Report 54G0028, March, 1961.
5. Julesz, B., "Toward the Automation of Binocular Depth Perception," Proceedings of the I.F.I.P. Congress, Munich, 1962.
6. Roberts, L.G., "Picture Coding Using Pseudo-Random Noise," IRE Trans. on Information Theory, Vol. IT-8, No. 2, pp 145-154, February, 1962.
7. Gibson, J.J., The Perception of the Visual World, H. Mifflin Company, Boston, Mass., 1950.
8. Ittelson, W.H., "Size As a Cue to Distance," American J. Psychology, Vol. 64, pp 54-67, 1951.
9. Attneave, F. and Arnoult, "The Quantitative Study of Shape and Pattern Perception," Psychological Bull., Vol. 53, p 452, 1956.
10. Langdon, J., "The Perception of 3-D Solids," Quar. J. Exp. Psychology, Vol. 7, 1955.
11. Stevens, S.S., "The Psychophysiology of Vision," in Sensory Communication, W. Rosenblith, Editor, MIT Press, Cambridge, and John Wiley and Sons, New York, N.Y., p. 13, 1961.
12. Sutherland, I.E., Sketchpad, A Man-Machine Graphical Communication System, Ph.D. Thesis, Massachusetts Institute of Technology, Electrical Engineering Department, Cambridge, Mass., February, 1963.
13. Johnson, T., Sketchpad III, 3-D, Graphical, Communication with a Digital Computer, Masters Thesis, Massachusetts Institute of Technology, Mechanical Engineering Department, Cambridge, Mass., June, 1963.

## BIOGRAPHY

Lawrence Gilman Roberts was born in Westport, Connecticut, on December 21, 1937. He received the S.B. and S.M. degrees from the Massachusetts Institute of Technology, Cambridge, in 1961.

From 1959 to 1961 he was employed by Research Laboratory of Electronics, M.I.T., as a Research Assistant in the fields of information theory and artificial intelligence. During the summers of this period he worked at Lincoln Laboratory, M.I.T., engaged in digital computer research. In addition to work on pattern recognition, data processing and circuit simulation, he wrote the compiler for the Laboratory's TX-2 computer. At present, while completing his doctoral studies at M.I.T., he is a Staff Associate at Lincoln Laboratory.

Mr. Roberts is a member of Sigma Xi.