

TRAMPER

An autonomous crawler for long-term benthic oxygen flux studies in remote deep sea ecosystems

F. Wenzhoefer, J. Lemburg,
M. Hofbauer, S. Lehmenhecker

HGF-MPG Group for Deep Sea Ecology and Technology
Alfred-Wegener-Institute Helmholtz Center for Polar and
Marine Research
D-27570 Bremerhaven, Germany
frank.wenzhoefer@awi.de

P. Faerber

Max Planck Institute for Marine Microbiology
D-28359 Bremen, Germany

Abstract — TRAMPER is an autonomous benthic crawler equipped with oxygen sensors to perform long-term flux time series measurements at abyssal depth. The crawler is developed within the HGF-Alliance ROBEX. TRAMPER has five main subsystems: the titanium frame with the flotation, the caterpillar drive system, recovery and communication systems, energy and electronics and a multi-optode profiler as the scientific payload. A lithium-ion battery pack provides the energy to run an oxygen profiling system performing consecutive measurements (>52 cycles) along its transecting moving on the seafloor. This new generation of optode-based oxygen monitoring system allows using 18 oxygen optodes and is able to perform in situ calibrations. A video-guided launching system is used to deploy the crawler at the seafloor. At the seafloor the pre-programmed mission scenario is performed consisting of consecutive sleeping, moving and measurement cycles. The aim is to cover a seasonal cycle of settling organic matter on the seafloor and to resolve the impact on the benthic community respiration activity.

Keywords — Deep Sea; Crawler; In Situ Measurement

I. INTRODUCTION

The benthic crawler TRAMPER (Fig. 1) is a fully autonomous robotic platform, which is capable to record sediment oxygen distributions over a full annual cycle with translocation between consecutive measurements. During its mission the crawler, equipped with a multi-optode-profiler, is pre-programmed to perform multiple sets of vertical oxygen profiles across the sediment-water interface along a defined transect.

Oxygen is a key molecule in earth ecology and global element cycles. Produced by photosynthesis, oxygen is the ultimate electron acceptor for organic matter mineralization and thus directly connected to the carbon cycle. A lot of our knowledge on oxygen exchange and carbon mineralization at the vast ocean floor originates from high-resolution studies of oxygen distributions and fluxes at the sediment-water interface and in the top layer of marine sediments. These studies allow determining the amount of organic material that escapes

mineralization and is retained in the sediment record - with strongest implications for O₂ and CO₂ levels in the global ocean and, ultimately, the atmosphere. Despite the fact that several studies demonstrated strong spatial and temporal heterogeneities of oxygen distributions and fluxes at the seafloor, our understanding is still based on relatively few “snapshot” measurements. Additionally measurements in the Arctic are usually limited to the ice-free summer periods. Long-term investigations, covering the entire seasonal cycle, are rare, especially in the deep sea [1]. This limits our knowledge on the dynamic range of seafloor remineralization processes.



Fig. 1. TRAMPER at 4150m depth in the Pacific Ocean.

Polar regions play a central role for the global climate. To investigate the consequences climate change and the decline in sea ice has on Arctic ecosystems, is one of the most important challenges for Earth Sciences. Rapidly changing physical and chemical conditions, as observed and projected for the future, will affect the ecosystem functioning including productivity, remineralisation, and energy flow between ecosystem compartments. At the HAUSGARTEN deep-sea observatory

(FRAM Strait at about 79° N), studies on the pelagic-benthic coupling are performed, to investigate how benthic life is governed by the food supply from surface waters. The use of new underwater technologies will thereby enhance our capabilities to improve our knowledge on the effects of climate change on the Arctic ecosystem.

II. FRAM

The open-ocean infrastructure FRAM (FRontiers in Arctic marine Monitoring) is an ocean observing system [2] installed in the gateway between the North Atlantic and the Central Arctic, representing a highly climate-sensitive and rapidly changing region of the Earth system [3]. It serves as national and international tasks towards a better understanding of the effects of change in ocean circulation, water mass properties and sea-ice retreat on Arctic marine ecosystems and their main functions and services. FRAM implements existing and next-generation sensors and observatory platforms, allowing synchronous observation of relevant ocean variables, as well as the study of physical, chemical and biological processes in the water column and at the seafloor.

Enabling the detection of expected changes in abiotic and biotic parameters in a transition zone between the northern North Atlantic and the central Arctic Ocean, the Alfred Wegener Institute established the deep-sea observatory HAUSGARTEN in the eastern Fram Strait in 1999, now being integrated also into FRAM. HAUSGARTEN observatory displays 21 permanent stations covering a water depth range of 300 to 5500 m water depth [4]. The central HAUSGARTEN station at about 79° N, 04° E in the eastern Fram Strait (approx. 2500 m water depth) serves as an experimental area for unique biological experiments at the deep seafloor, simulating various scenarios in changing environmental settings. Repeated sampling and the deployment of moorings and different free-falling systems, which act as observation platforms, has taken place since the beginning. At regular intervals, a Remotely Operated Vehicle (ROV) is used for targeted sampling, the positioning and servicing of autonomous measuring instruments and the performance of in situ experiments. A 3000 m depth-rated Autonomous Underwater Vehicle (AUV) extends the sensing and sampling programs.

The global cycles of a variety of materials fundamental to life and the state of the atmosphere depend to a significant extent on arctic marine processes. The past decades has seen remarkable changes in the Arctic, of which we do not know whether these represent temporary perturbations, long-term trends, or a new equilibrium. The decrease of sea-ice extent and sea-ice thickness in the past decade is statistically significant. These alterations will directly affect food-web structures and ecosystem functioning. Time-series studies at the HAUSGARTEN observatory provide insights into processes and dynamics within an arctic marine ecosystem and act as a baseline for further investigations of ongoing changes in the Fram Strait.

III. BENTHIC CRAWLER TRAMPER

Tramper is a fully autonomous benthic crawler capable to perform long-term benthic flux time series measurements at abyssal depth developed at the Alfred-Wegener-Institute Helmholtz Center for Polar and Marine Research (AWI). Specifically it is designed to improve our understanding on benthic carbon mineralization rates in the Arctic. Much of the design was driven by the requirement of a modular design of the main components, and payload as well as full autonomy for a 12-month deployment. The basic crawler design was developed within the Crawler Design Team of the HGF-Alliance ROBEX [5], and is based on the crawler Wally [6]. A common design of the main crawler frame and caterpillar propulsion was identified where modular systems for docking and scientific payloads can be added depending on the different scientific question [7].

A. Mechanical Design

TRAMPER is a 1.5m long, 1.3m wide, 1.2m tall crawler, and weighs 653kg in air and has approx. 20kg negative buoyancy in seawater. All components are depth-rated to 6000m. The general assembly of TRAMPER comprises of a titanium frame that connects two caterpillar drives and the syntactic foam as the flotation device (Fig.2). The frame also carries in its center a battery cylinder and a drop-weight system. The scientific payload is located on the front of the crawler. All subsystems are detachable from the load carrying structure and all connectors and openings of the pressure housings face to the rear for ease of access.

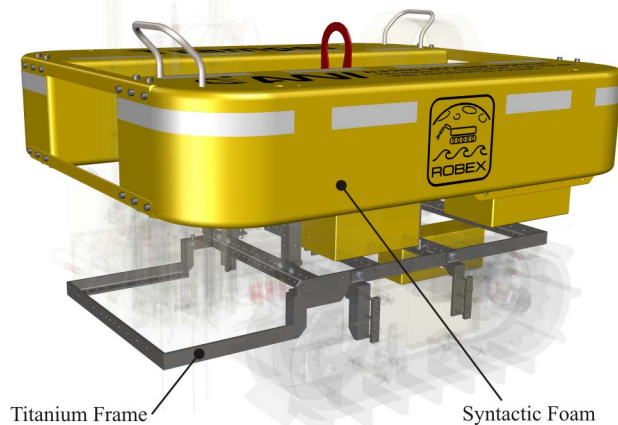

Fig. 2. Titanium frame and syntactic foam flotation device.

The drive system has two modified excavator caterpillar tracks that are each powered by a brushless direct current motor with a high reduction angled gear head (Fig. 3). The motors and gears are mounted in a fluid filled detachable housing. All structural components and track sprockets are made of polyethylen to enhance the systems buoyancy and corrosion resistance.

Because TRAMPERS one year missions strive for a temporal, not spacial distribution of the measurements, the motors gear reduction is chosen to 1:256 to enable high torque

instead of speed. The maximum velocity of TRAMPER on the seafloor is 13 m min^{-1} . The mechanical design of the tracks features tight gaps between track and structure to avoid intrusion of pebbles that might jam the sprockets.

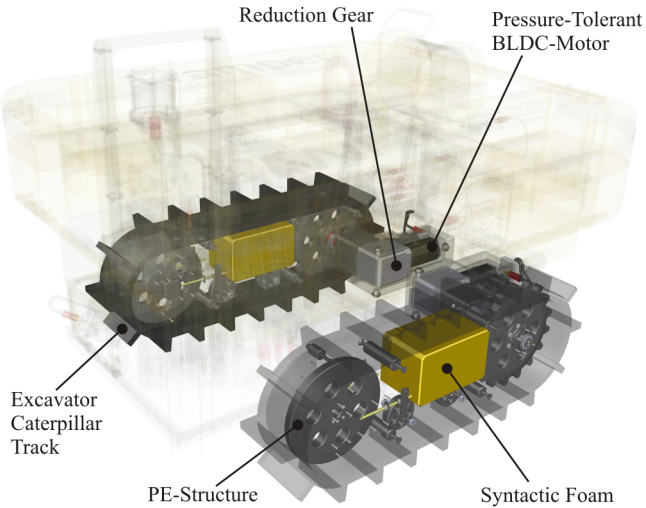

Fig. 3. Drive system.

The recovery of TRAMPER after completing the mission is initiated by an acoustic release command from the research vessel. The drop-weight system (Fig. 4) then releases 100 kg steel plates and ejects a pop-up buoy that uncoils a 11m long rope. The upper 5m of the rope is a floating line that is connected to a 2,5t load carrying dyneema rope.

After dropping the weight Trumper ascends with $0,45 \text{ m s}^{-1}$ to the surface, where it starts broadcasting its position to Argos satellites and in the vicinity on the VHF band

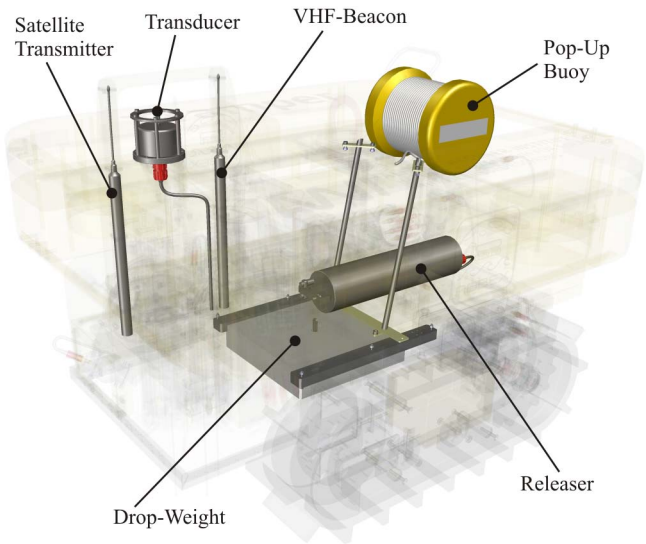

Fig. 4. Drop-weight and communication systems.

B. Electronics

TRAMPERS electronics are powered by a 32.4V lithium-ion primary cell battery pack (Devologic, Germany) with

5.7kWh capacity (Fig. 5). This energy storage powers the drive tracks and the measurement electronics. There is no redundancy in the energy storage system, because of design-space and weight restrictions.

The maximum energy consumption of the drive system is $0,8 \text{ Wh/m}$ at its top speed of 13 m s^{-1} and its most efficient speed is 4 m s^{-1} with $0,3 \text{ Wh/m}$. The highest energy drain is caused by the lights, which are therefore only switched on shortly for photos and object recognition

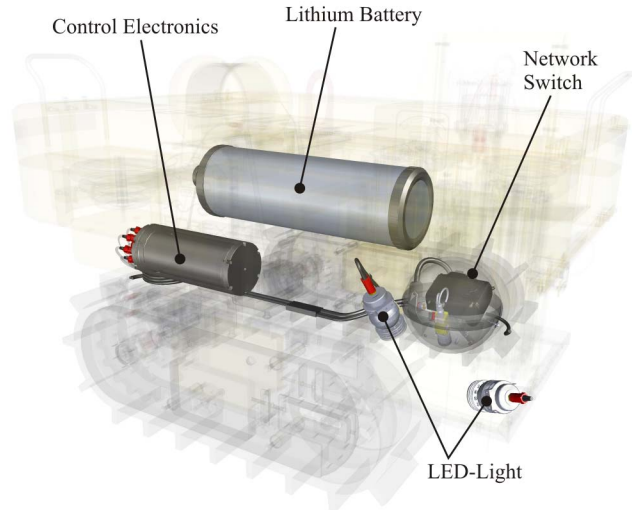

Fig. 5. Energy storage and electronics.

TRAMPERS control electronic comprises of three separate modules, the main, track and fieldbus controller:

1. Main Controller

The Main controller consists of an Atmel micro computer that controls the overall operation of the mission. It interprets a user created script. This text based script contains all required instructions for drive control and measurement operations. An electronic compass controls the pre-programmed direction during the autonomous mission at the seafloor. During work breaks (sleeping mode) the main controller switches all TRAMPER modules in a power saving mode in order to manage the energy supply for the entire mission. For communications with higher level controllers and for test and parameter settings on board interfaces are available.

1. Track Controller

The Track Controller consists of an ARM-9 microcomputer with an embedded Linux operating system. It controls and monitors the connected brushless track motors via a CAN bus. The track controller also has an integrated web server that allows the manual control using a standard web browser. Driving control with a joystick is also possible.

2. Fieldbus Controller

The Fieldbus Controller consists of a PIC micro controller to manage the connected actuators and sensors of the oxygen profiler via an RS485 bus. It can be programmed by the user with a special Windows application to adapt the different

measurement procedures. For future measurement tasks, the bus system can be expanded with additional units.

C. Scientific Payload

The main scientific payload of TRAMPER is a multi-optode-profiler system to monitor sediment oxygen distributions year-round (Fig 6 & 7). It performs repetitive oxygen profiles with a maximum resolution of 100 μ m and a length of up to 25 cm. Eighteen Piccolo2 OEM oxygen modules (PyroScience, Germany) installed in a pressure housing are used for life time-based optical determination of oxygen. Bare fibre oxygen sensors (OSB430; PyroScience, Germany) are connected to these modules and are housed in 6mm pushrods ending in 0,9mm syringe needles serving as a protection for the fibers while being inserted into the sediment.

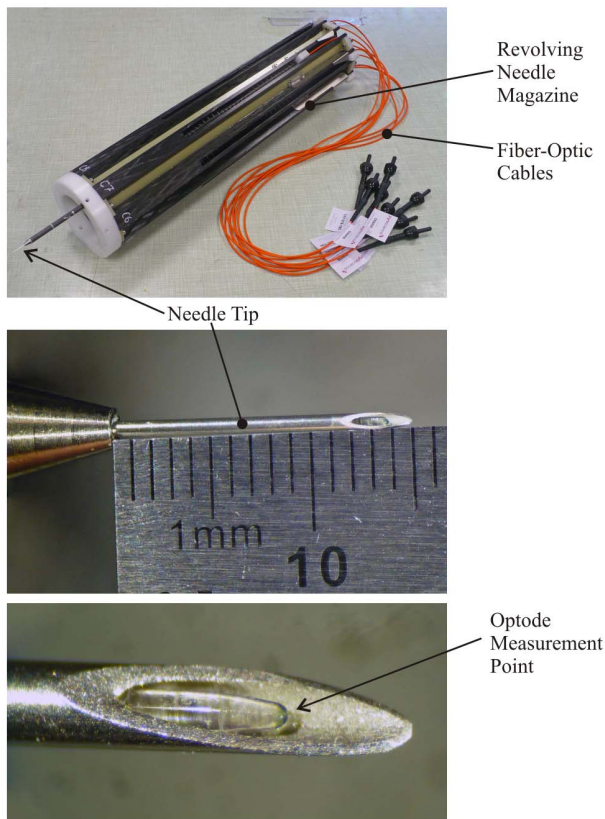

Fig. 6. Revolving needle magazine, a needle and the tip of the fibre-optode.

All needles are stored in three independently revolving magazines that are rotated by pressure tolerant electric motors. Before use the needle tips are retracted within protecting chambers that can also be flushed with a fluid of known oxygen concentration for calibration purposes. The calibration fluid (max. 4,5L) is stored in an oxygen tight bag and transported by a three-channel peristaltic pump. This in situ calibration-system provides the zero point calibration whilst an additional reference oxygen optode (Aanderaa, Norway) provides the oxygen concentration of the surrounding water column. This in situ two-point calibration is a way to validate the stability of the sensor signal and to ensure long-term accuracy.

For each oxygen profile measurement, three needles are coupled to a vertically moving sledge by a spring loaded, zero-play snap-hook connection that acts as an overload protection. If one or more of the needles hit an obstacle in the sediment the connection disengages the needle before it breaks. After the measurement of the remaining needles the disengaged needle snaps back in when it reaches the upper end stop. A pressure-tolerant motor positions the sledge via a self-cleaning spindle-drive.

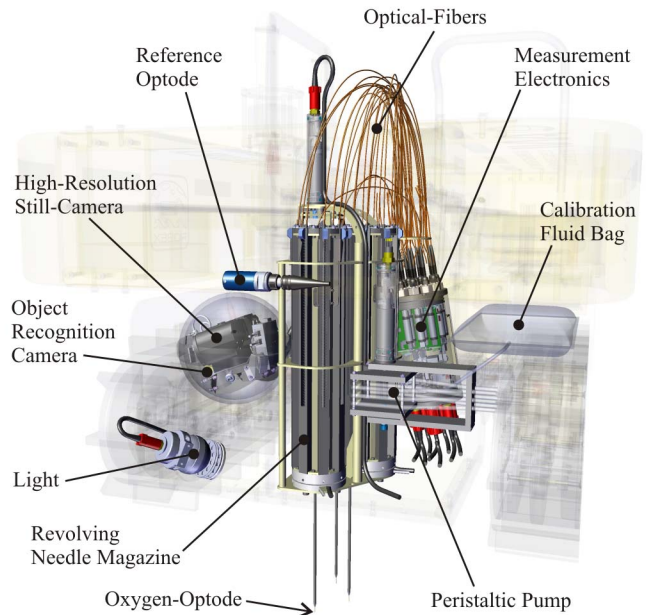

Fig. 7. The scientific payload of Tramper.

On the starboard side next to the O₂-Profiler are two LED-Lights (DeepSea Power & Light Sphere 3150) and a glass-sphere mounted. This pressure housing contains a high resolution DSLR camera (Nikon D300S with 24mm lens) that documents the measurement site prior and after taking the oxygen profile and an object recognition camera (Cognex In-Sight micro 1020) to check the sediment for obstacles that endanger the fragile optode needles.

Pressure-tolerant motors that are coordinated by the custom-built modular control system 'MPI-Modular' drive the mechanical movement of the revolving magazines and the profiling of the needles. Its low-power electronics also receive and save the measurements raw data in two physically redundant solid-state storage units.

D. System Deployment

A video-guided launching system is used to deploy the crawler at the seafloor. It is based on an already existing Ocean Floor Observation System (OFOS) that comprises of a sturdy frame with a Fibre-Optic-Telemetry, a camera and light. A mechanical adapter complements this OFOS system with a telemetry-triggered quick-release hook to a launching system. The connection between TRAMPER and the Launcher is rigid to allow a winch speed of 0,7m s⁻¹ despite the nearly buoyant TRAMPER and its high water resistance mounted beneath the heavy Launcher.

Prior to the deployment the Launcher is temporarily placed on legs on deck of the ship to allow the attachment of TRAMPER, which is moved below the launcher on a wheeled carriage (Fig. 8). This way the whole system can be assembled and tested safely on a moving vessel prior to the deployment.



Fig. 9. TRAMPER preparation on deck.

The descent of the crawler can be monitored by video-observation. An altimeter reading can additionally be monitored when approaching the seafloor. At a height of 1 – 2m above seafloor TRAMPER is released via a quick release (Fig. 9). Shortly after release TRAMPER (Fig. 10) reaches its terminal velocity and therefore could also be deployed as free fall instrument from higher altitudes. Nevertheless all previously conducted deployments have been performed with the launcher system to allow a more precise placement of TRAMPER on the seafloor.

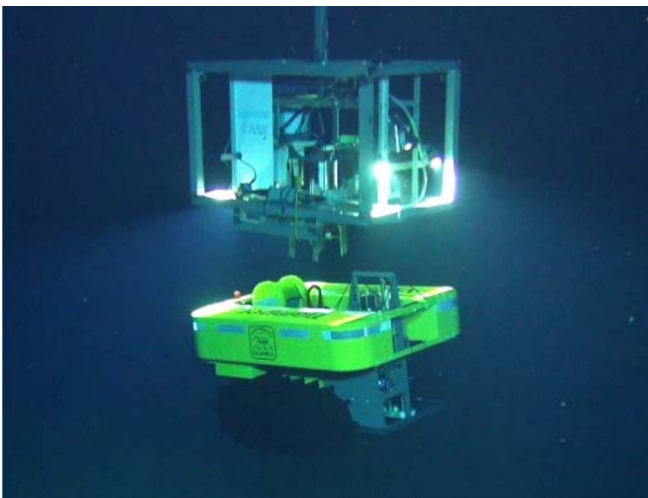

Fig. 9. Launching Trampler to the seafloor.

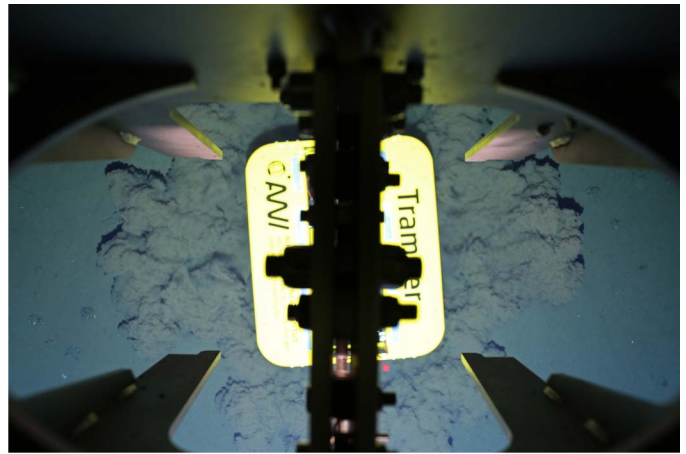

Fig. 10. Touchdown of Trampler seen from the OFOS launching system.

IV. SEASONAL STUDIES IN REMOTE DEEP-SEA SYSTEMS

A typical mission starts with the video-guided deployment of the crawler at the seafloor. After an initial waiting period a sequence of compass guided driving instructions, oxygen measurements and photographs are performed. All these actions are software controlled by a user definable script, created with a standard text editor and stored in a plain text file. The command interpreter of the Trampler will execute this linear sequence of instructions. The weekly mission plan consist of:

- Trampler moves the defined distance and direction to the measuring position
- Turn lights on, take a photo
- Check the sediment under the O₂-Profiler, if there are obstacles such as stones or shells
- If the ground is disturbed drive further and check again. Lights off.
- Start O₂-Profiler and wait until the measurement is completed
- Turn lights on, take a second picture, turn lights off
- Waiting for the next measurement cycle in sleep mode

During its mission at the seafloor the pre-programmed mission scenario is performed consisting of consecutive sleeping, moving and measurement cycles (Fig. 12) [7]. When active TRAMPER starts with a movement of 15m at 14m min⁻¹ to avoid sediment resuspension. At the new spot an obstacle avoidance camera system takes a photo, which is internally analyzed. In case of identified objects Trampler moves on for another 2 m to select another measurement spot. This procedure can be repeated for a maximum of 3-times. Then or when the seafloor is free obstacles a high-resolution photo is taken to document the seafloor area before the profiling starts. During the measuring cycle 3 optical oxygen sensors are moved vertically in steps of 100 μm across the sediment-water interface for a total distance of 25 cm. At each position the

sensors equilibrated for 5 sec before the signal is internally stored. After completing the vertical profile the sensors are moved back to the start position and a second high-resolution photo is taken. Afterwards Trampler is sleeping for 164 hours (roughly 7 days) before the next cycle is started (Fig. 13). This operation cycle is in total repeated for at least 52-time to cover a full seasonal cycle. The aim is to cover a seasonal cycle of settling organic matter on the seafloor and to resolve the impact on the benthic community respiration activity (Fig. 13).

A first test of TRAMPER was performed during the RV Sonne expedition So 242-2 to the Equatorial Pacific in 2015. At 4150m TRAMPER was able to transit over the seafloor at the pre-programmed distance steps but revealed some problems with oxygen measurements. This test results lead to modifications to the profiling system. A second full short mission test was conducted in July 2016 at the HAUSGRTEN observatory at 1500m during RV Polarstern cruise PS 99.2. Trampler performed 7 profiling and 3 calibration cycles and moved 123m. This short test deployment verified the entire mission operation. Thus at the end of this cruise TRAMPER was deployed for its first long-term mission at the central HAUSGARTEN site in July 2016. The crawler will stay in the Arctic deep-sea at 2500m for more than one year and will be recovered during the ROBEX Demonstration mission cruise with RV Polarstern PS108 in August 2017 [7].

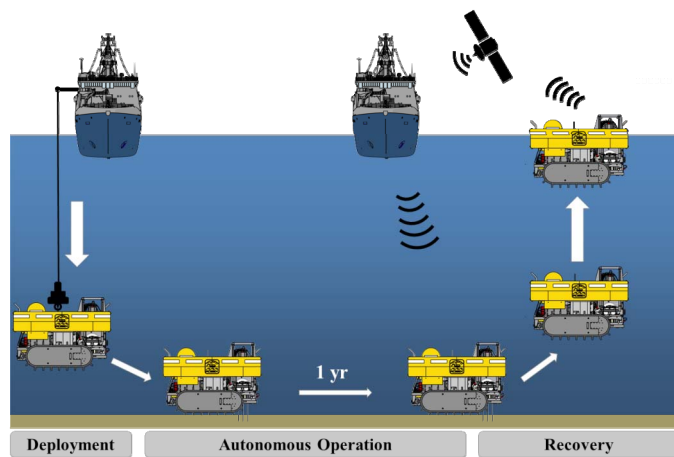

Fig. 12. TRAMPER mission with video-guided deployment, consecutive movements and measurements, and acoustic release.

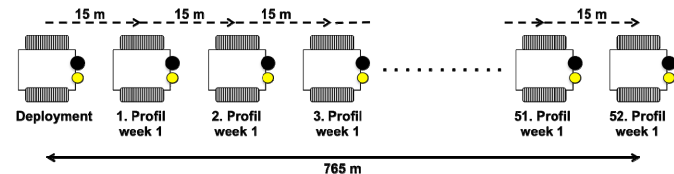

Fig. 13. TRAMPER autonomous long-term mission to study the benthic oxygen consumption over a seasonal cycle.

V. FUTURE DEVELOPMENTS

Future developments in autonomous crawler technology at the AWI for long-term benthic ecosystems studies at FRAM include additional scientific payloads for benthic community studies. This includes systems to measure the benthic oxygen uptake, as benthic chambers and eddy correlation, as well as sampling devices for multiple sediment recovery and storage during a long-term mission. A second-generation crawler system is in conceptual development, which will provide more capacity for standardized, modular payload systems. The new design emphasizes easy reconfiguration, increased reliability by redundancy of crucial subsystems and efficient transportation.

ACKNOWLEDGMENT

The project is supported through HGF-Alliance ROBEX - Robotic Exploration of Extreme Environments (HA-304), the long-term observatory FRAM (AWI), the EU-FP7 project SenseOCEAN (Grant 614141), and the Max Planck Society and Helmholtz Association.

REFERENCES

- [1] Smith KL, Huffard CL, Sherman AD, Ruhl HA (2016) Decadal Change in Sediment Community Oxygen Consumption in the Abyssal Northeast Pacific. *Aquat. Geochem.* In press, DOI 10.1007/s10498-016-9293-3.
- [2] FRAM (Frontiers in Arctic Marine Monitoring) - Arctic long-term observatory. <https://www.awi.de/en/expedition/observatories/oceanfram.html>.
- [3] Soltwedel, T., Schauer, U., Boebel, O., Nöthig, E.-M., Bracher, A., Metfies, K., Schewe, I., Klages, M., Boetius, A. (2013): FRAM - Frontiers in Arctic marine Monitoring: Permanent Observations in a Gateway to the Arctic Ocean. *OCEANS - Bergen, 2013 MTS/IEEE*. doi:10.1109/OCEANS.Bergen.2013.6608008.
- [4] Soltwedel, T., Bauerfeind, E., Bergmann, M., Bracher, A., Budaeva, N., Busch, K., Cherkasheva, A., Fahl, K., Lalande, C., Metfies, K., Nöthig, E.-M., Meyer, K., Quéric, N.-V., Schewe, I., Wlodarska-Kowalczyk, M., Klages, M. (2015). Natural variability or anthropogenically-induced variation? Insights from 15 years of multidisciplinary observations at the arctic marine LTER site HAUSGARTEN. *Ecological Indicators*, 65: 89-102, doi.org/10.1016/j.ecolind.201510.001.
- [5] ROBEX - Robotic Exploration of Extreme Environments, <http://www.robex-allianz.de/en/>
- [6] Purser, A., Thomsen, L., Barnes, C., Best, M., Chapman, R., Hofbauer, M., Menzel, M. and Wagner, H. (2013) Temporal and spatial benthic data collection via an internet operated Deep Sea Crawler. *Methods in Oceanography* 5 (2013) 1-18
- [7] Wenzhoefer F, Wulff T, Floegel S, Sommer S, Waldmann C (2016) ROBEX - Innovative robotic technologies for ocean observations, a deep-sea demonstration mission. *OCEANS16/IEEE - Monterey, USA, 2013*.