

4G/5G SPECTRUM SHARING

Efficient 5G Deployment to Serve Enhanced Mobile Broadband and Internet of Things Applications

Lei Wan, Zhiheng Guo, Yong Wu, Wenping Bi, Jinhong Yuan, Maged Elkaslan, and Lajos Hanzo

The fifth-generation (5G) has been developed for supporting diverse services, such as enhanced mobile broadband (eMBB), massive machine-type communication (mMTC) and ultrareliable low-latency communication (URLLC). The latter two constitute Internet of Things (IoT) enablers. The new spectrum released for 5G deployments are primarily above 3 GHz and, unfortunately, has a relatively high path loss, which limits the coverage, especially for the uplink (UL). The high propagation loss, the limited number of UL slots in a time-division duplexing (TDD) frame, and the limited user power gravely restrict the UL coverage, but this is where bandwidth is available. Moreover, the stringent requirements of eMBB and IoT applications lead to grave 5G challenges, e.g., site planning, ensuring seamless coverage, adapting the TDD downlink (DL)/UL slot ratio and the frame structure for maintaining a low bit error rate as well as low latency, and so on. This article addresses some of those challenges with the aid of a unified spectrum-sharing mechanism, and by means of a UL/DL

decoupling solution based on fourth-generation (4G)/5G frequency sharing. The key concept relies on accommodating the UL resources in a long-term evolution (LTE) frequency-division duplexing (FDD) frequency band as a supplemental UL (SUL) carrier in addition to the new radio (NR) operation in the TDD band above 3 GHz. With the advent of this concept, the conflicting requirements of high-transmission efficiency, large coverage area, and low latency can be beneficially balanced. We demonstrate that the unified 5G spectrum-exploitation mechanism is capable of seamlessly supporting compelling IoT and eMBB services.

5G Research Progress Introduction

The 5G concept, known as *International Mobile Telecommunications (IMT)-2020*, was developed by the International Telecommunication Union (ITU) in 2012. Diverse 5G use cases have been envisioned, spanning from eMBB to mMTC, as well as URLLC [1]–[4]. The latter two use cases compose major components of the IoT. Accordingly, the 5G radio interface must have very diverse capabilities, including a 20-Gb/s peak data rate, a 100-Mb/s user rate, a velocity of up to 500 km/h, less than a

Digital Object Identifier 10.1109/MVT.2018.2865830

Date of publication: 20 September 2018

4-ms latency, and a 100-fold improved network energy efficiency to enable the seamless delivery of large amounts of data for eMBB. Additionally, it also has to be capable of supporting a 1,000,000/km²-connection density, low power consumption for mMTC, and at least 99.999% reliability within a 1-ms latency for URLLC. Vehicular communications, which are referred to as *vehicle to everything (V2X)*, also constitute a compelling 5G application. V2X communications defined in the 3rd Generation Partnership Project (3GPP) include vehicle to network, vehicle to vehicle, vehicle to infrastructure, and vehicle to pedestrian, all complemented by the integrated cellular interface and the direct-link interface [15].

In the 3GPP, 5G NR relies on a common air interface that aims to address such diverse requirements. The first version of NR specifications was frozen in December 2017; however, regional regulators invested considerable effort in 5G spectrum planning for the first wave of 5G NR deployments, including the C-band (3–5 GHz) and millimeter wave (mm-wave) bands near 26 and 39 GHz. The mm-wave bands have very large available bandwidths and usually adopt TDD for exploiting the channel reciprocity to support both multiple input, multiple output (MIMO) techniques and asymmetric DL/UL resource allocation. However, those high-frequency bands also experience high propagation loss and are typically configured to have a small number of UL transmission slots in a 10-ms time frame due to the heavy DL traffic load, which results in limited UL coverage. Hence, a high infrastructure cost is imposed by the dense base station (BS) deployment required for continuous coverage. Additionally, the limited UL coverage also hampers both the low latency of URLLC and the massive connection requirements of mMTC, especially in light of cost efficiency. Several challenging issues, such as large coverage and low latency, must be tackled to support robust vehicular communications, especially for autonomous driving applications. As will be discussed in subsequent sections, critical challenges are experienced by the TDD wide-band operation above 3 GHz for efficiently delivering 5G services in a wide coverage area.

An innovative air-interface design is expected to efficiently support 5G NR, eMBB, and IoT services. Given that the majority of operators are expected to deploy 5G as an oversailing layer on top of their existing LTE network using an FDD below 3 GHz, there is ample opportunity to share the low-frequency band with some of the 5G NR users or devices as a complementary band to the TDD band above 3 GHz. LTE/NR frequency sharing, also known as *DL/UL decoupling* was consequently proposed during the standardization of the 3GPP and was accepted in Release 15. The concept of LTE/NR frequency sharing detailed in the “NR/LTE Frequency Sharing: Addressing Deployment Challenges” section, is to employ a portion of the existing LTE frequency band (most

of them are below 2 GHz and are allocated as paired spectrums) into NR operation in addition to the new, unpaired NR bands above 3 GHz. Since the lower-frequency bands experience a lower propagation loss, by exploiting this concept, the coverage can be substantially extended, and the challenges involved in 5G deployments can also be conveniently circumvented. The frequency-sharing mechanisms can also be used jointly with previous studies [5]–[7] for further enhancing the coverage for frequency bands above 3 GHz. This article focuses on the standardization progress of the first version of NR, thus it does not include the mMTC portion. However, it is clear that most IoT applications (low power wide area, mMTC, and even URLLC) need large, continuous UL coverage. In this sense, LTE/NR UL sharing will indeed benefit diverse IoT applications.

5G Spectrum and Challenges

5G Candidate Spectrum

The IMT spectrum identified in the 2015 and 2019 ITU’s World Radiocommunication Conferences, which are below 6 and above 24 GHz, respectively, are applicable for 5G deployments. The 3GPP defines frequency bands for the 5G NR interface according to guidance both from the ITU and from the regional regulators, with prioritization given according to the operators’ commercial 5G plan. In [8], three frequency ranges are identified for 5G deployments for both eMBB and IoT applications, including the new frequency ranges of 3–5 GHz and 24–40 GHz, respectively, as well as the existing LTE bands below 3 GHz.

As shown in Figure 1, generally, a triple-layer concept can be applied to the spectral resources based on different service requirements. Particularly important for mMTC and URLLC applications, an “oversailing layer” below 2 GHz is expected to remain the essential layer for extending the 5G mobile broadband coverage both to wide areas and to deep indoor environments. On the other hand, the coverage and capacity layer spanning from 2 to 6 GHz can be used for striking a compromise between capacity and coverage. However, compared to the range below 2 GHz, these bands suffer from a higher penetration loss and propagation attenuation. The superdata layer above 6 GHz can be invoked for use cases requiring extremely high data rates but relaxed coverage. Given this triple-layer concept, the eMBB, mMTC, and URLLC services that require different coverage and rate capability can be accommodated in the appropriate layer. However, a service-based, single-layer operation would complicate the 5G deployments, and it is inefficient in delivering services that simultaneously require both good coverage and high data rates as well as low latency, and so on. To accommodate these diverse

services, the employment of joint, multiple spectral layers becomes a must for a meritorious 5G network.

Coverage Analyses for the 5G Spectrum

Let us define the coverage of a communication link as the maximum tolerable power attenuation (in dB) of an electromagnetic wave, as it propagates from the transmitter (Tx) to the receiver (Rx), while still guaranteeing the transmission rate target, which is given by

$$C_{\text{coverage}} = P_{RE} + G_{\text{Ant}}^{\text{TX}} + G_{\text{Ant}}^{\text{RX}} - N_{RE} - I_m - N_F - \gamma - L_{\text{CL}}^{\text{TX}} - L_{\text{CL}}^{\text{RX}} - L_{pe} - L_{SF} - L_f, \quad (1)$$

where P_{RE} is the transmission power per subcarrier, γ denotes the Rx sensitivity, $G_{\text{Ant}}^{\text{TX}}$ and $G_{\text{Ant}}^{\text{RX}}$ are the Tx and Rx antenna gains, respectively, and N_{RE} and N_F denote the thermal noise and the noise figure of each subcarrier, respectively. Furthermore, $L_{\text{CL}}^{\text{TX}}$ and $L_{\text{CL}}^{\text{RX}}$ are the cable loss

at the Tx and Rx side, respectively, while L_{pe} , L_{SF} , I_m , and L_f represent the penetration loss, shadowing loss, interference margin, and propagation loss difference due to the subcarrier frequency offset with respect to the reference frequency, respectively.

According to (1), the coverage is affected by numerous factors, including the transmission power, propagation loss, and Rx sensitivity. Since the propagation loss varies with the frequency, the coverage differs substantially within different frequency bands. Therefore, the provision of a good performance in all frequency bands remains a key challenge for 5G deployments. Furthermore, due to the limited UL transmission power and higher path loss in NR than in LTE, the UL coverage is typically the bottleneck in 5G deployments.

In Figure 2, we demonstrate the coverage performance of the 3.5-GHz TDD band and compare it to that of the 1.8-GHz FDD band. A portion of the parameters assumed for this comparison are shown in Figure 2, while the rest are given in Table 1. In the link budget, the UL coverage is calculated when the UL data rate is set to 1 Mb/s for supporting typical UL video traffic. In contrast, the DL coverage is usually limited by the physical DL control channel (PDCCH) quantified in terms of the block error rate of the primary PDCCH. The UL coverage and DL coverage are balanced over the 1.8-GHz FDD band with the aid of four transmit and four receive antennas. For the 3.5-GHz TDD band using the

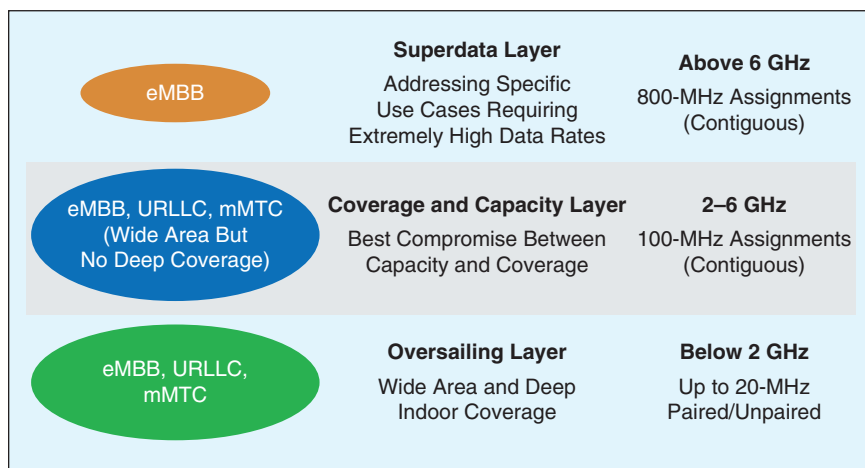

FIGURE 1 A multilayer approach for 5G scenarios.

TABLE 1 The parameters assumed in the link budgets.

Parameters	1.8 GHz with 4T4R		3.5 GHz with 4T4R		3.5 GHz with 64T64R	
	PDCCH	PUSCH	PDCCH	PUSCH	PDCCH	PUSCH
Tx antenna gain $G_{\text{Ant}}^{\text{TX}}$ (dBi)	17	0	17	0	8.7	0
Tx cable loss $L_{\text{CL}}^{\text{TX}}$ (dB)	2	0	0	0	2	0
Rx antenna gain $G_{\text{Ant}}^{\text{RX}}$ (dBi)	0	18	0	18	0	8.7
Rx cable loss $L_{\text{CL}}^{\text{RX}}$ (dBm)	0	2	0	0	0	2
Penetration loss L_{pe} (dB)	21	21	26	26	26	26
Rx sensitivity γ (dBm)	-129.44	-134.3	-129.44	-134.3	-141.02	-141.23
Shadowing loss L_{SF} (dB)	9	9	9	9	9	9
Propagation loss due to frequency L_f (dB)	0	0	5.78	5.78	5.78	5.78
Interference margin I_m (dB)	14	3	14	3	7	2
Thermal noise per subcarrier N_{RE} (dBm)	-132.24	-132.24	-129.23	-129.23	-129.23	-129.23
Noise figure N_F (dB)	7	2.3	7	3.5	7	3.5

PDCCH: physical DL control channel; PUSCH: physical UL-shared channel.

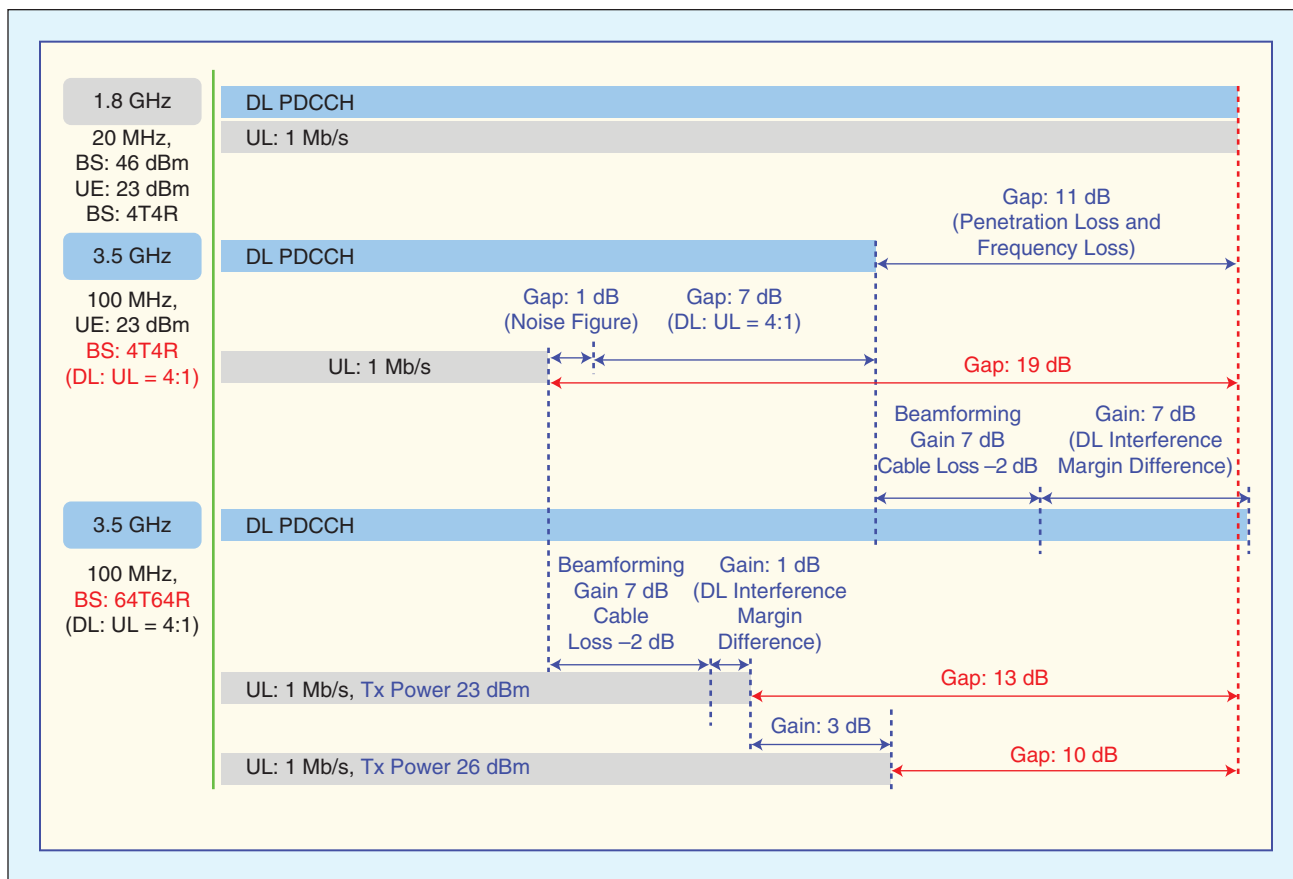

FIGURE 2 The link budgets for different frequency bands in which 1 Mb/s throughput is assumed. Note that the BS transmitting power spectral density remains the same for 1.8 GHz and 3.5 GHz. Note: The BS transmitting power spectral density remains the same for 1.8 GHz and 3.5 GHz. UE: user equipment.

same transmit and receive antennas as that of 1.8-GHz scenario, in excess of a 10-dB coverage gap is observed. This is mainly due to the large propagation loss, the penetration loss, and the limited number of UL transmission slots in a frame of the 3.5-GHz TDD band. By comparison, for the 3.5-GHz TDD band using 64 transmit and 64 receive antennas, a similar DL coverage performance can be achieved to that of 1.8 GHz, because of the beamforming gain provided by massive MIMOs (mMIMOs) and the DL interference margin difference. Simply put, since mMIMOs also reduce the intercell interference, they reduce the DL interference margin. However, the UL coverage is poorer compared to the DL of 3.5 GHz, even when mMIMOs are employed, because the UL power-spectral density of the 3.5-GHz TDD band is lower than that of the 1.8-GHz FDD band at the same maximum device transmission power. This is partly due to having less UL slots in a TDD frame than in an FDD frame, which means that more frequency resources per slot should be allocated for a given UL throughput of, for instance, 1 Mb/s. Therefore, how best to improve the UL coverage is indeed an important issue for 5G deployments.

5G Spectrum Duplexing and DL/UL Asymmetry

Duplexing is another key factor affecting the performance of 5G networks in terms of their wide-area coverage. 5G NR supports multiple duplex modes, including static TDD, FDD, and flexible duplexing. In the 3GPP, the same frame structures and resource allocation mechanisms are invoked for both FDD and TDD. It is expected that early 5G deployments are very likely to start from the new TDD spectral bands (e.g., 3.5 GHz). Therefore, in this section we will discuss both static and dynamic 5G TDD networks.

For static TDD, the UL/DL traffic ratio is usually decided by the statistical UL/DL traffic load ratio among multiple operators in a specific country or region. As discussed in [9], the DL traffic constitutes a large portion of the entire teletraffic. With the popularity of video streaming increasing, it is likely that the proportion of DL content will grow even further in the future, so it is presumed that more resources should be allocated to the DL. Therefore, a smaller proportion of the resources is left for the UL, which will further affect the UL coverage performance. On the other hand, for LTE FDD bands, the same bandwidth is allocated to both the UL and DL,

which means that the UL spectrum is underutilized and will even be severe in the future.

Dynamic TDD mechanisms have been specified from the 3GPP's Release 12 and beyond, especially for the hot spots in which the TDD DL/UL ratio can be adapted based on the actual traffic. However, it has not yet been deployed in practical systems due to its severe intercarrier and intracarrier interference.

5G Deployment Challenges

In this section, we discuss a few challenging issues that must be considered in 5G deployments, particularly for the TDD mode and in higher-frequency bands.

5G Band Selection: Wide-Band Spectrum Availability Versus Coverage

The availability of the bands below 3 GHz remains limited for 5G NR in the near future, and the lower bands fail to support high data rates because of their limited bandwidth. On the other hand, the wider NR bands above 3 GHz experience increased propagation losses, leading to limited coverage. Therefore, independent usage of the spectrum below and above 3 GHz fails to strike a compelling tradeoff between a high data rate and large coverage.

TDD DL/UL Ratio: Spectrum Utilization Efficiency Versus DL/UL Coverage Balance

As discussed, the NR TDD operation is usually configured for a limited number of UL transmission slots (e.g., DL: UL = 4:1) in a frame because of the heavy DL traffic load, even though more slots should be allocated to the UL for improving the UL coverage. This can increase the UL data rates, when the bandwidth cannot be further increased due to the maximum transmission power constraint. While the DL spectral efficiency is usually higher than that of the UL, having more UL slots would further reduce the spectral utilization efficiency. Therefore, there is a clear tradeoff between the UL coverage and spectral utilization efficiency.

TDD DL/UL Switching Period: Transmission Efficiency Versus Latency

For the TDD operation, frequent DL/UL switching is required for low-latency DL and UL transmission. However, a certain guard period (GP) is needed at each DL/UL switching point (e.g., 130 μ s is used in time-division LTE networks) for avoiding serious blocking of the UL Rx because of the strong DL interference emanating from other cells. Frequent DL/UL switching would lead to a high-idle time (14.3% versus 2.8% for a 1-ms and 5-ms switch period, respectively), which is undesirable in efficient eMBS services.

Site Planning: Seamless Coverage Versus Deployment Investment

For early 5G NR deployment, cosite installation with the existing LTE networks would be cost-effective and convenient. However, due to the higher propagation loss above 3 GHz, one has to introduce denser cells and new sites; otherwise, 5G NR cannot attain the same seamless UL coverage as that of LTE. To circumvent this challenge, a new LTE/NR frequency-sharing concept was accepted by the 3GPP, which will be elaborated on in the next section.

NR/LTE Frequency Sharing: Addressing Deployment Challenges

The concept of NR/LTE frequency sharing is to exploit the extra resources in the existing LTE frequency band for 5G NR operation as a complement to the new 5G wide-band spectrum. For example, as shown in Figure 3, the C-band (frequency ranges of 3–5 GHz) TDD carrier can be paired with the UL part of a FDD band overlapped with LTE (e.g., 1.8 GHz). In other words, a UL carrier within the lower frequency FDD band is coupled with a TDD carrier in the higher frequency band for NR users. Then, an NR user has two UL carriers and one DL carrier in the same serving cell. By contrast, only one DL carrier and one UL carrier are invoked for a traditional serving cell. With the advent of this concept, the cell-edge NR users can employ either the lower-frequency FDD band carrier (UL part) or the higher-frequency TDD band carrier to transmit their UL data. In this case, since the UL propagation loss on the lower-frequency band is much lower than that of the higher-frequency TDD band, the coverage performance of NR users can be substantially extended and a high-UL data rate is guaranteed even if this user is relatively far from the BS. On the other hand, the cell-center users can rely on the higher-frequency TDD band to take advantage of its higher bandwidth.

Typically, it is not necessary to allocate the low-frequency FDD band for the DL of NR, since, as discussed in the "5G Spectrum and Challenges" section, the DL coverage in the C-band is good. The low-frequency FDD band is then employed in NR only for the UL. In the 3GPP, the UL-only carrier frequency is referred to as the *SUL frequency* from an NR perspective. Given the concept of NR/LTE frequency sharing, the four challenging issues

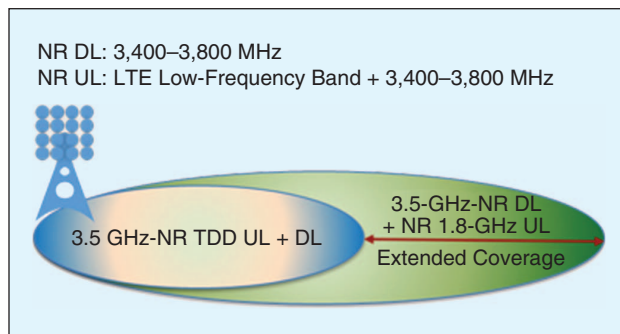

FIGURE 3 The NR LTE UL spectrum sharing that extends 5G coverage at higher frequencies (e.g., 3.5 GHz).

described in the “5G Spectrum and Challenges” section can be dealt with appropriately.

The Balance Between Wide-Band Spectrum Availability and Coverage Quality

With the advent of NR/LTE frequency sharing, the spectrum availability versus coverage tradeoff can be well balanced. In this case, the 5G NR DL traffic is scheduled on the higher TDD bands, and a high-DL/UL teletraffic ratio facilitates the efficient exploitation of the large bandwidth. The DL coverage quality remains similar to that of LTE with the aid of mMIMO and multiple beamforming (e.g., three-dimensional beamforming [7]). Additionally, the 5G NR UL traffic can be supported by either a low-frequency SUL carrier or a high-frequency TDD carrier. The cell-edge users rely on lower-frequency bands for ensuring that their spectral efficiency can be maintained at the same level as that of LTE, and their UL scheduling opportunities can be increased compared to that in the high-frequency TDD-only system. Consequently, both higher data rates and large coverage are achieved.

The Balance Between Spectrum-Utilization Efficiency and DL/UL Coverage

NR/LTE frequency sharing is instrumental in striking a compelling tradeoff between high-spectrum exploitation efficiency and wider DL/UL coverage. For the high-frequency TDD carrier, the DL/UL time slot (TS) ratio configuration only has to take into account the long-term DL/UL traffic statistics for guaranteeing the DL spectrum exploitation efficiency (typically 4:1). The cell-edge users and IoT devices may opt for the SUL carrier philosophy for their UL transmission. In this case, the high-DL/UL TS ratio on the TDD carrier does not impose any detrimental effects on IoT services. Moreover, the lower propagation loss of the lower band is helpful for improving the spectrum efficiency. As a result, given a certain packet size, the requirements imposed on the scheduled bandwidth, or the user equipment’s (UE’s) transmit power are reduced on the lower band compared to that on the higher band.

Let us now observe the UL user throughputs of various UL channel allocations in the 3.5-GHz band, the joint 3.5-GHz and 0.8-GHz bands,

and the joint 3.5-GHz and 1.8-GHz bands, as shown in Figure 4. An orthogonal frequency-division multiplexing (OFDM) waveform is adopted for both the LTE DL as well as for the 5G NR, DL, and UL, while the LTE UL adopts the single-carrier frequency division multiple-access waveform based on similar frequency-domain subcarrier mapping as that of the OFDM waveform. The UE’s maximum total transmission power for all cases is 23 dBm and the DL/UL TS ratio of the 3.5-GHz TDD system is 4:1. The channel bandwidths of the 3.5-GHz, 0.8-GHz, and 1.8-GHz scenarios are 100 MHz, 10 MHz, and 20 MHz, respectively. In Figure 4, the UL throughput of the cell-edge UEs relying on the SUL is substantially improved compared to that of the UEs operating without SUL, which is a joint benefit of the additional bandwidth, the lower propagation loss, and the continuous UL resource of the SUL. Additionally, the UL throughput of UEs relying on the SUL at 0.8 GHz is better than that of the UEs with an SUL at 1.8 GHz at lower throughput, but it is lower than that of UEs with an SUL at 1.8 GHz at higher throughput. The reason for this trend is that when the UL throughput is low, the UEs are usually power limited and the propagation loss is minimal at lesser frequencies, hence the throughput of the SUL at 0.8 GHz is better than at 1.8 GHz. By contrast, when the throughput is high, the UL transmission power is not an issue and it is the bandwidth that becomes the bottleneck; therefore,

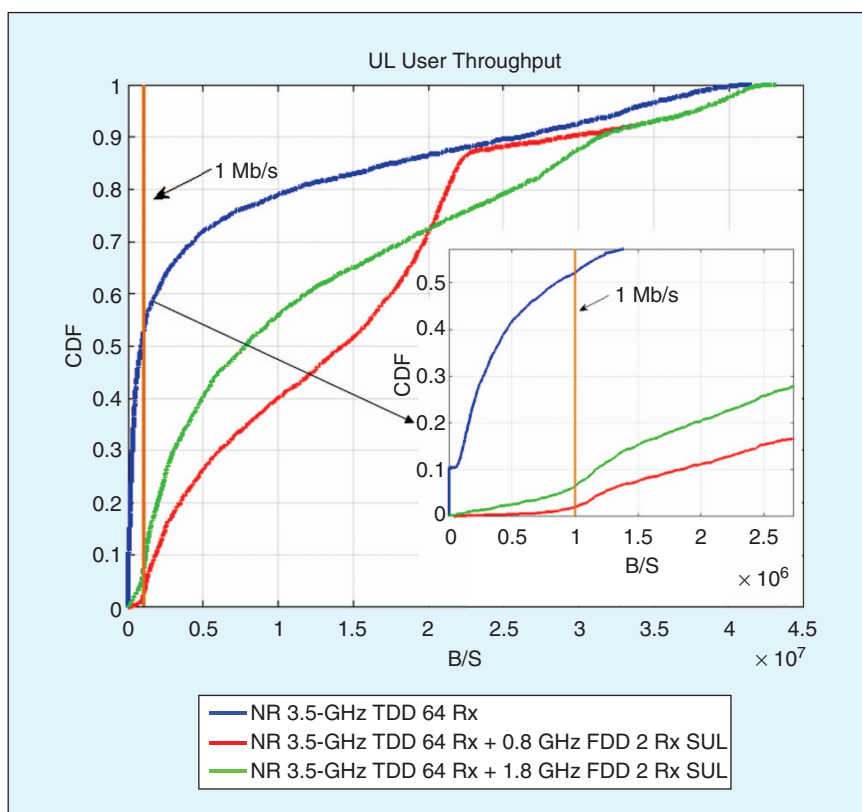

FIGURE 4 The UL user-throughput comparison. CDF: cumulative distribution function.

the throughput of the SUL at 1.8 GHz within a 20-MHz bandwidth outperforms that which is at 0.8 GHz with 10-MHz bandwidth. As a result, with the arrival of the NR/LTE frequency-sharing concept, the spectrum-exploitation efficiency and DL/UL coverage can be beneficially balanced.

The Balance Between Transmission Efficiency and Latency

Low latency is a critical requirement for URLLC services. In a 5G NR design, a self-contained TDD frame structure [10] is proposed in which both the DL and the UL can be included in each subframe/slot. As mentioned previously, frequent DL/UL switching may help reduce the UL latency, but it also introduces a nonnegligible overhead, which is inefficient for both of the eMBB and URLLC services in a unified system. Under the NR/LTE frequency-sharing concept, the URLLC devices can be scheduled at the SUL carrier for the UL data or control messages, which means that UL resources always exist whenever a UL message arrives. Thus, the latency due to the discontinuous UL resources of the TDD carrier is beneficially reduced, and, simultaneously, the overhead caused by the frequent DL/UL switching on the higher-frequency TDD band can also be avoided.

Figure 5 shows both the latency and the overhead comparison of various TDD frame structures. For the “TDD carrier-only” system associated with a 5-ms switch period, the round-trip time (RTT) cannot be tolerated

by the URLLC services because of the long feedback latency. If a self-contained TDD time frame is applied in the TDD carrier-only system having a 1-ms switch period, although the RTT is reduced, the overhead increases dramatically because of the frequent DL/UL switching. For the proposed NR/LTE frequency-sharing concept, the SUL can provide timely UL feedback without frequent DL/UL switching, which beneficially reduces the RTT without any extra overhead. Therefore, the transmission efficiency and latency become well balanced.

The Balance Between Seamless Coverage and Deployment Investment

Seamless coverage is highly desirable for the 5G NR to provide a uniform user experience. Again, it is difficult for the 5G NR to achieve seamless coverage in the case of cosite deployment with LTE by only using the frequency band above 3 GHz. With the start of the NR/LTE frequency sharing, the 5G NR UL becomes capable of exploiting the precious, limited spectrum resources in the lower-frequency bands that the operators have been using for LTE. The NR UL coverage can then be improved to a level similar to that of LTE. This implies that the seamless NR coverage can be supported in a cosite NR/LTE deployment.

Mobility Improvement

With the increase of NR/LTE frequency sharing, seamless NR coverage is achieved and the mobility-related

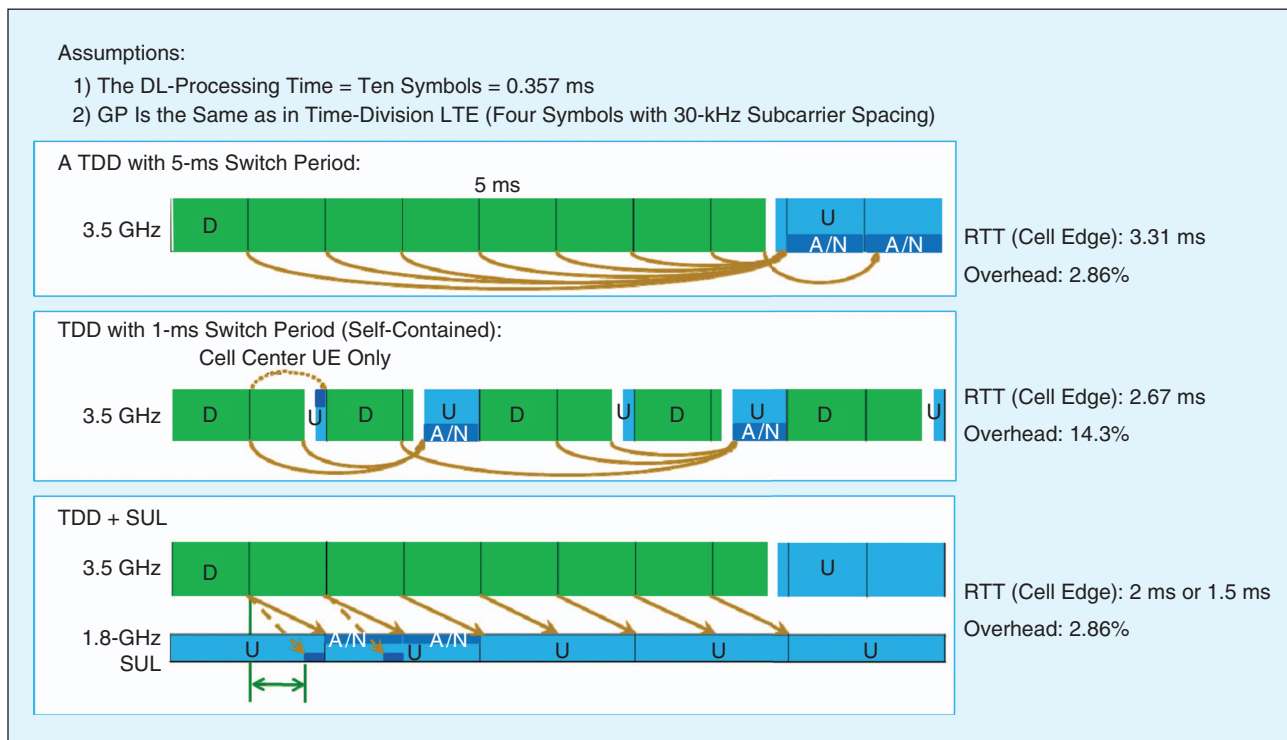

FIGURE 5 The latency comparison of different TDD frame structures.

user experience is also improved. As illustrated in the cosite deployment example of Figure 6(a), due to the limited UL coverage, the radius of the 5G C-band cells is much smaller than that of the LTE 1.8-GHz cells. When a UE moves to the boundary of the cells, inter-radio access technology (RAT) handovers will occur. Note that each inter-RAT handover will impose interruptions in excess of 100 ms, which is much higher than that of the intra-RAT handover. Since the development of the NR/LTE spectrum-sharing concept, the SUL carrier beneficially extends the coverage of 5G cells. As shown in Figure 6(b), with the help of SULs, the coverage range of 5G cells and LTE cells becomes similar. Then, inter-RAT handovers will occur much less frequently because handovers are only encountered when the UE goes beyond the boundary of the area contiguously covered by multiple 5G NR cells. Thus, the probability of the inter-RAT handovers is significantly reduced; consequently, the UE's mobility-related experience is markedly improved with the help of NR/LTE spectrum-sharing mechanisms.

Unified Support for the IoT and eMBB

NR/LTE frequency sharing also provides unified support for diverse IoT and eMBB services, including the following aspects:

- 1) In a 5G NR operation, a cell can include both a TDD carrier and an SUL carrier.
- 2) A unified eMBB and IoT TDD DL/UL frame structure configuration can be used by a high-frequency TDD carrier. The eMBB-optimized configuration imposes no detrimental impact on low-latency IoT devices because a pair of ULs are available for transmission, and the teletraffic of the low-latency IoT devices can be offloaded to an SUL carrier. Moreover, the unified eMBB and IoT TDD DL/UL ratio eliminates the potential network synchronization or intercarrier synchronization problems of multiple operators.

- 3) A unified site planning can be arranged for a 5G NR deployment in harmony with the existing LTE networks to meet the diverse requirements of both eMBB and IoT services.

Technical Enablers of NR/LTE Frequency Sharing

To enable NR/LTE spectrum sharing, the relevant NR/LTE coexistence mechanisms have been specified in the 3GPP's Release 15. In this section, some key mechanisms, including efficient spectrum-sharing management, frequency sensing, and UL frequency selection, as well as service-oriented dynamic scheduling, are introduced.

Efficient NR/LTE Frequency-Sharing Management

As for the NR/LTE frequency sharing, the specific resource-sharing philosophy is of particular concern [11]. Based on the statistical spectral-activity results of practical LTE networks, the UL resources in the paired spectrum are typically underutilized. This offers opportunities for exploiting the idle LTE UL resources for the UL transmission of the 5G NR. According to the 3GPP specification ratified for LTE FDD bands, there is a provision for feedback information in all of the UL subframes. It is therefore important to reserve UL feedback resources in all of the subframes of legacy LTE UEs for improving the network's performance.

As shown in Figure 7(a), frequency division multiplexing between LTE and NR is recommended either in a semistatic or in a dynamic manner. Semistatic sharing is suitable for multiple vendors' deployment, because it requires that no frequent scheduling information is exchanged between the LTE and NR equipment, while dynamic sharing is more suitable for the deployment of NR and LTE equipment from the same vendor and it typically achieves a higher spectral efficiency. In addition, the NR/LTE frequency sharing will cause little burden on interoperator cooperation. On one side, almost all of the operators who have a 5G NR deployment plan today also

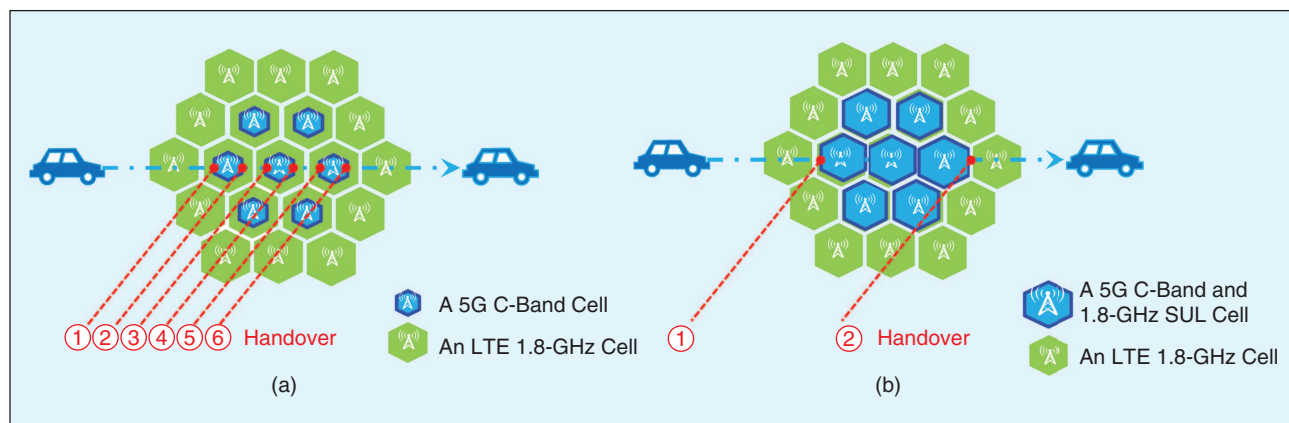

FIGURE 6 The seamless coverages by cosite NR/LTE deployments. (a) The UL over only higher-frequency bands and (b) the UL over both C- and lower-frequency bands.

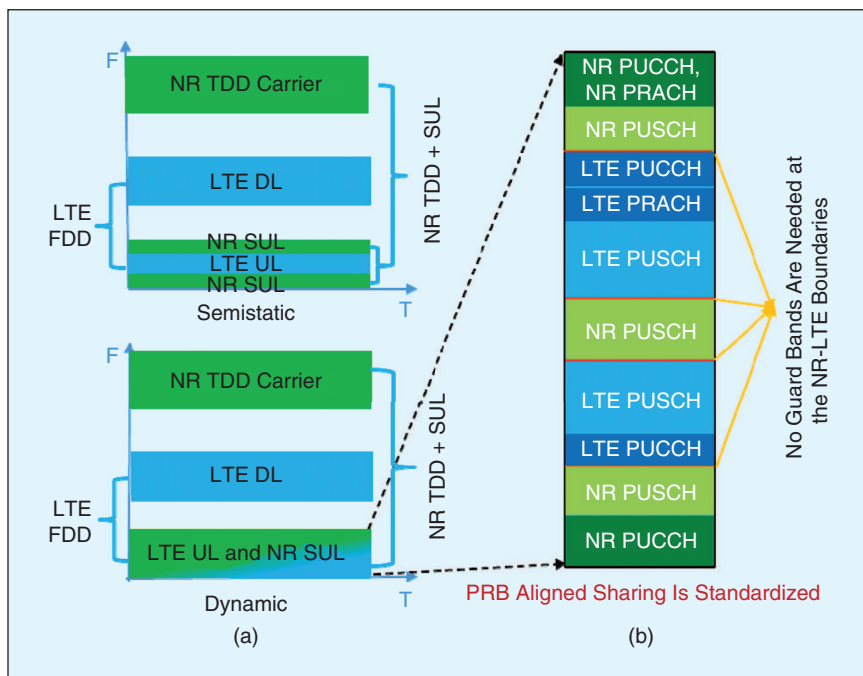

FIGURE 7 (a) The NR/LTE frequency division multiplexing sharing: semistatic or dynamic. (b) PRB aligned sharing between NR and LTE. PRB: physical resource block; PUCCH: physical UL control channel; PRACH: physical random access channel; PUSCH: physical UL-shared channel.

have existing LTE networks at low-frequency bands and there is no need for interoperator cooperation. On the other side, if LTE and 5G NR belong to different operators, it is difficult for LTE UL and 5G NR SUL to conduct the dynamic TDM carrier sharing. Static or semistatic frequency-domain reservations for 5G NR SULs carriers, which can relax the tight interoperator coordination requirement significantly, can be used.

To make full use of the spectral resources, it is expected that the LTE and NR UEs are scheduled in orthogonal frequency resources without any extra overhead at the boundaries between the frequency resources allocated to LTE and NR. Accordingly, as shown in Figure 7(b), the subcarrier spacing (SCS) of NR SUL can be configured in the same way as in LTE. The NR SUL scheduling granularity is designed to be aligned with the physical resource block boundary of LTE, otherwise wasteful guard bands would be needed.

In NR, different SCSs are specified for different frequency ranges, while only a 15-kHz SCS is defined in LTE. To coexist with LTE, the SCS of the SUL carrier is recommended to be 15 kHz, which is likely to be different from that of the new TDD band for NR, e.g., a 30-kHz SCS for 3.5-GHz TDD bands. As a consequence of different SCSs on the SUL and on the TDD carrier, the parameters, including the lengths of OFDM symbols and slots on the two carriers, are different. The 3GPP's Release 15 defined the corresponding mechanisms for supporting

efficient scheduling, and the feedback for ULs and DLs.

Moreover, for the LTE UL carrier, there is a half-SCS (7.5-kHz) shift of the subcarriers to reduce the impact of the dc leakage to the discrete Fourier transform-spread-OFDM waveform. Hence, a 7.5-kHz shift is also required for the SUL bands, otherwise, the subcarriers of LTE and NR would not be orthogonal [12]. The LTE frequency bands will also be "refarmed" for NR in the future; in this case, the 7.5-kHz shift should also be introduced for the LTE refarmed bands to support its coexistence with the narrow-band IoT and enhanced MTC.

The UE implementation design of the SUL and TDD UL transmission, a potential prototype design of which is shown in Figure 8, is another important issue. To facilitate prompt UL carrier switching, the 7.5-kHz subcarrier shift of the SUL carrier can be more beneficially carried out in the digital domain.

This is because if the frequency shift is implemented in the RF domain, a much longer retuning time would be imposed between the LTE UL and NR SUL [14].

Single-UL Transmission

Another challenge for NR/LTE UL frequency sharing is the deleterious interference. Simultaneous UL transmissions on the 1.8-GHz SUL band and the 3.5-GHz TDD band will impose serious in-device intermodulation interference, which may degrade the 1.8-GHz DL reception quality. The 3GPP's Release 15 has specified that NR/LTE UL sharing is only allowed to select a single UL carrier to transmit at any instant in a UE. Additionally, prompt carrier switching between an SUL and TDD carrier is supported if a sounding reference signal is needed at a TDD carrier for the specific cell-edge UEs, which are scheduled on the SUL carrier. The standard UE architecture design has already supported individual RF chains for the SUL band and TDD band, which support prompt UL carrier switching and is very convenient for scheduling.

Frequency Sensing and UL Frequency Selection

For a 5G NR system with a combined TDD carrier and SUL carrier, frequency sensing is required for the UL frequency selection and random access [11].

When determining the initial access, it is best for cell-edge users to transmit the random access preamble on the SUL carrier, while the cell-center users may be better

served by selecting the higher-frequency TDD carrier for random access. Therefore, during the initial access, each UE compares its DL reference signal received power (RSRP) measurement on the TDD carrier to the RSRP threshold configured by the network to select the UL carrier for random access. If the RSRP is lower than the threshold, the UE is classified as a cell-edge UE and will request random access on the SUL carrier, while if the RSRP is higher than the threshold, the UE is treated as a cell-center UE and will select the TDD carrier for random access.

Service-Oriented Dynamic Scheduling

5G NR provides a unified air interface for the flexible support of various services. Additionally, to support the various services with appropriate system configurations, scheduling and resource allocation relying on quality-of-service (QoS) awareness is encouraged. The 3GPP's Release 15 defines three slice types for the so-called 5G new core, including eMBB, URLLC, and mMTC, with each slice type configured to meet a specified set of QoS parameters. The QoS of each slice type can be passed down from the core network to the radio-access network; then, based on the QoS requirements, the BS can perform either QoS-prioritized scheduling or service-oriented scheduling. Such a service-oriented scheduling mechanism can work together with the UL carrier selection in the previously mentioned NR/LTE UL sharing. For example, the URLLC service can automatically select the SUL carrier from the outset without the need for comparing the RSRP to the appropriately configured threshold.

Independent Configuration of SUL and Non-SUL

To support a pair of UL carriers in a serving cell, various specific configurations are needed. In the standardization, some of the parameters, such as the random-access-related configurations, data transmission bandwidth, transmission power settings, DL-to-UL scheduling timing, and so on, are configured for the SUL and non-SUL (TDD carrier) independently. Given these carefully specified configurations, the SUL and non-SUL can seamlessly work together to improve system performance.

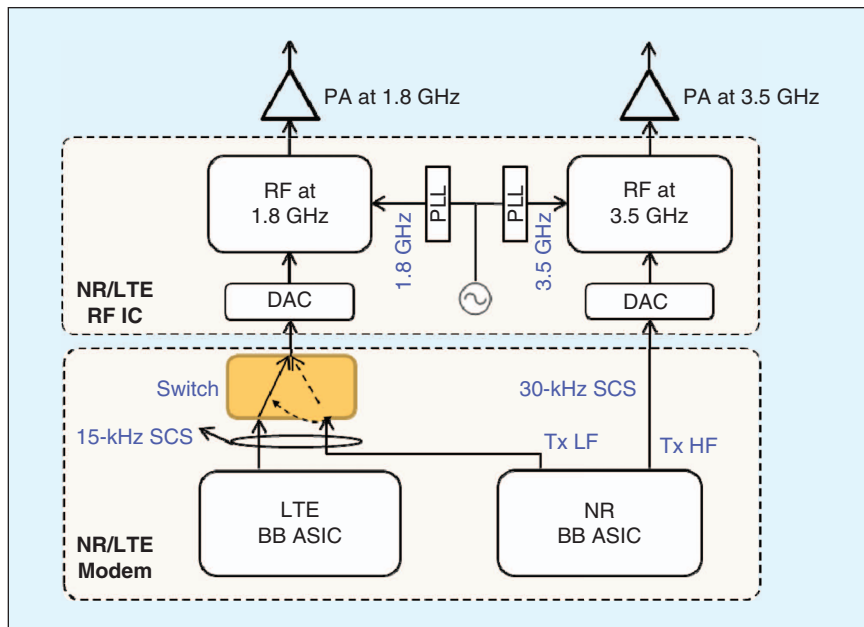

FIGURE 8 The joint NR/LTE UE architecture [14]. PA: power amplifier; DAC: digital-to-analog converter; IC: integrated circuit; PLL: phase-locked loop; HF: high frequency; LF: low frequency; BB ASIC: base-band application-specific integrated circuit; RF: radio frequency.

Standardization of NR/LTE Frequency Sharing

The 3GPP's Standardization Progress on NR/LTE Coexistence

On 21 December 2017, the first version of nonstand-alone (NSA) 5G was declared to be frozen and the NR/LTE coexistence is one of the important features on the completed list. The completed technology components include the spectrum to be used for stand-alone (SA) NR and for the NSA NR/LTE dual-connectivity mode, as well as for hybrid automatic repeat request feedback, power control, UL-scheduling mechanisms, and so on. In the following section, we will mainly discuss the NR/LTE coexistence band combinations specified in the 3GPP's Release 15.

NR/LTE Coexistence Band Combination Definition

As shown in Table 2, [3] GPP Release 15 has defined a number of bands for SUL and for the corresponding SUL and TDD band combinations conceived for NR, SA, and NSA deployment, respectively [13].

In the "5G NR New Bands" column of Table 2, typical examples of the frequency bands specified for the NR operation are given. The frequency bands include the C-band frequencies spanning from 3.3 to 5 GHz, and the mm-wave band having frequencies of approximately 26 and 38 GHz. The SUL bands spanning from 700 MHz to 2 GHz are also specified, as shown in the "5G NR New bands" column of Table 2. As described previously, when SUL is used, there are two UL carriers in a serving cell. Then, the frequency band combinations for the two UL

carriers in a serving cell are defined in the column of “5G NR Band Combinations.” To make the band combination definitions more clear, consider SUL_n78-n80 of Table 2: in a serving cell, the non-SUL carrier is on band n78 and the SUL carrier is on band n80. Another example is DC_1-SUL_n78-n84, in which “DC” means that the dual-connectivity-aided UE is configured with both LTE and NR. The LTE cell is on LTE band 1 and the NR cell is on band n78, with an additional SUL carrier on band n84. Since the NR SUL band n84 overlaps with LTE band 1, the LTE UL carrier and the NR SUL carrier share the same frequency resources.

Summary and Future Work

This article introduced an innovative spectrum-exploitation mechanism, e.g., the NR/LTE spectrum-sharing philosophy, for efficient 5G deployment to serve both eMBB and IoT applications. This solution eminently balances the various conflicting requirements, such as DL/UL traffic asymmetry, DL/UL coverage imbalance, transmission efficiency versus latency, and so on. The proposed spectrum sharing between LTE and NR also allows operators to retain their LTE investment without refarming the LTE band to NR, given that the spared LTE UL resources can be used as a 5G NR SUL carrier paired with a wide-band TDD carrier above 3 GHz.

As for future work, first, it is expected that more spectrum combinations can be introduced; for example, the SUL carrier can be paired with the DL-only band to form an independent cell. Another promising technique of NR/LTE coexistence is to combine the SUL carrier with the mm-wave band to improve both the UL coverage and the mobility, while simultaneously reducing the number of

mm-wave BSs required for providing seamless coverage. In this case, the SUL Rx and the mm-wave transceiver may be deployed at noncollocated BSs. There are several challenges for the noncollocated scenario, such as the provision of power control, UL synchronization, UL access-point switching, and so on. Other evolving scenarios may include multiple SUL carriers being paired with higher-frequency bands within the same cell. The strategies of traffic and user allocation among multiple SUL and UL carriers also have to be studied. The evolution of NR/LTE frequency sharing can also aim for supporting IoT services at a low latency in a large coverage area, in addition to supporting eMBB operation.

Acknowledgment

This work was funded, in part, by the Australia Research Council Discovery Project DP160104566 and Linkage Project LP 0100708, the EPSRC projects EP/Noo4558/1, EP/PO34284/1, as well as the European Research Council’s Advanced Fellow Grant QuantCom, and the EPSRC project EP/N029666/1.

Author Information



Lei Wan (wan.lei@huawei.com) is currently a senior expert of wireless research and standards at Huawei Technologies Co., Ltd., Beijing, China, responsible for long-term evolution advanced research and the 3rd Generation Partnership Project radio-access networks. Her research interests include FDD and TDD harmonization, network topology evolution as CoMP and HetNet, traffic adaptive system design, interference coordination and the evaluation methodology.

TABLE 2 The 5G NR new bands and band combination definitions.

5G NR New Bands			5G NR Band Combinations	
			Stand-Alone	Nonstand-Alone
Band Number	Frequency	Duplex	Band Number	Band Number
n77	3.3–4.2 GHz	TDD	SUL_n78-n80	DC_1-SUL_n78-n84
n78	3.3–3.8 GHz	TDD	SUL_n78-n81	DC_3-SUL_n78-n80
n79	4.4–5 GHz	TDD	SUL_n78-n82	DC_3-SUL_n78-n82
n80	1,710–1,785 MHz	SUL	SUL_n78-n83	DC_8-SUL_n78-n81
n81	880–915 MHz	SUL	SUL_n78-n84	DC_20-SUL_n78-82
n82	832–862 MHz	SUL	For example: SUL_n78-n80 means band combination of NR band n78 and band n80 (SUL) for NR operation.	DC_28-SUL_n78-n83
n83	703–748 MHz	SUL		For example: DC_1-SUL_n78-n84 means NR/LTE dual connectivity between LTE band 1 and NR bands n81 (SUL) and n78, including NR/LTE coexistence with UL sharing.
n84	1,920–1,980 MHz	SUL		
n257	26.5–29.5 GHz	TDD		
n258	24.25–27.5 GHz	TDD		
n260	37–40 GHz	TDD		



Zhiheng Guo (guozhiheng@huawei.com) received his B.E. and Ph.D. degrees from Beijing University of Posts and Telecommunications, China, in 2002 and 2007, respectively. From 2007 to 2014, he was a research engineer with Ericsson Research.

In 2014, he joined Huawei Technologies Co., Ltd., as a senior researcher. He is currently a principle researcher with Huawei Technologies Co., Ltd., Beijing, China. His research interests include long-term evolution/new radio coexistence, multiuser access, and the cross-link interference management of flexible duplexes.



Yong Wu (wuyong@huawei.com) received his B.S. and Ph.D. degrees in electronics engineering from Dalian University of Technology, China, in 2003, and Tsinghua University, Beijing, China, in 2008, respectively. He is currently with Huawei Technologies, Co., Ltd., Beijing, China. His research interests include multiple antenna processing, interference suppression, and system-level modeling and evaluation of wireless communications.

His research interests include multiple antenna processing, interference suppression, and system-level modeling and evaluation of wireless communications.



Wenping Bi (biwenping@huawei.com) received his B.E. and Ph.D. degrees in electronic engineering from Tsinghua University, Beijing, China, in 2012 and 2017, respectively. He is currently with Huawei Technologies Co., Ltd., Beijing, China. His research interests include wireless communications, full-duplex communications, and interference cancellation.

Jinhong Yuan (j.yuan@unsw.edu.au) received his B.E. and Ph.D. degrees in electronics engineering from the Beijing Institute of Technology, China, in 1991 and 1997, respectively. From 1997 to 1999, he was a research fellow with the School of Electrical Engineering, University of Sydney, Australia. In 2000, he joined the School of Electrical Engineering and Telecommunications, University of New South Wales, Sydney, Australia, where he is currently an associate editor of *IEEE Transactions on Wireless Communications*. His research interests include error-control coding and information theory, communication theory, and wireless communications. He is a Fellow of the IEEE.



Maged ElKashlan (maged.elkashlan@qmul.ac.uk) received his Ph.D. degree in electrical engineering from the University of British Columbia, Canada, in 2006. He joined the School of Electronic Engineering and Computer Science at Queen Mary University of London, United Kingdom, as an assistant professor in 2011. He currently serves as an editor of *IEEE Transactions on Wireless Communications*, *IEEE Transactions on Vehicular Technology*, and *IEEE Communications Letters*. His research interests include millimeter-wave

communications, energy harvesting, cognitive radio, and wireless security.



Lajos Hanzo (lh@ecs.soton.ac.uk) received his degree in electronics in 1976 and his Ph.D. degree in 1983. He was awarded an honorary doctorate by the Technical University of Budapest in 2009 and by the University of Edinburgh, United

Kingdom, in 2015. In 2016, he was admitted to the Hungarian Academy of Science. Since 1986, he has been with the School of Electronics and Computer Science, University of Southampton, United Kingdom, where he serves as chair of telecommunications. Currently, he is directing an academic research team that is working on a range of research projects in the field of wireless multimedia communications. He is a Fellow of the IEEE.

References

- [1] *IMT Vision Framework and Overall Objectives of the Future Development of IMT for 2020 and Beyond*, ITU-RM.2083, 2015.
- [2] J. G. Andrews, S. Buzzi, W. Choi, S. V. Hanly, A. Lozano, A. C. Soong, and J. C. Zhang, "What will 5G be?" *IEEE J. Sel. Areas Commun.*, vol. 32, no. 6, pp. 1065–1082, 2014.
- [3] *Minimum Requirements Related to Technical Performance for IMT-2020 Radio Interface(s)*, ITU-RM.2040, 2017.
- [4] 3GPP. (2016, Dec.). Study on scenarios and requirements for next generation access technologies. 3rd Generation Partnership Project. Sophia Antipolis, France. TR 38.913v14.1.0. [Online]. Available: http://www.3gpp.org/ftp/Specs/archive/38_series/38.913/
- [5] C. Bockelmann, C. Pratas, N. Nikopour, H. Au, K. Svensson, T. Stefanovic, and C. Dekorsy, "Massive machine-type communications in 5G: Physical and MAC-layer solutions," *IEEE Commun. Mag.*, vol. 54, no. 9, pp. 59–65, 2016.
- [6] M. Chen, Y. Miao, Y. Hao, and K. Hwang, "Narrow band Internet of Things," *IEEE Access*, vol. 5, pp. 20,557–20,577, Sept. 2017.
- [7] G. Liu, G. Hou, X. Jin, J. Wang, F. Wang, Q. Hao, Y. Huang, X. Wang, X. Xiao, A. Deng, "3-D-MIMO with massive antennas paves the way to 5G enhanced mobile broadband: From system design to field trials," *IEEE J. Sel. Areas Commun.*, vol. 35, no. 6, pp. 1222–1233, 2017.
- [8] NTT DOCOMO. (2017, June). WF on band specific UE channel bandwidth. 3rd Generation Partnership Project. Sophia Antipolis, France. Rep. RAN4-NR#2. [Online]. Available: <https://portal.3gpp.org/ngppapp/CreateTdoc.aspx?mode=view&contributionId=805939>
- [9] *IMT Traffic Estimates for the Years 2020 to 2030*, ITU-RM.2370-0, 2015.
- [10] Q. Wang, Z. Zhao, Y. Guo, X. Gong, M. Schubert, M. Schellmann, and W. Xu, "Enhancing OFDM by pulse shaping for self-contained TDD transmission in 5G," in *Proc. IEEE 83rd Vehicular Technology Conf. (VTC Spring)*, 2016, pp. 1–5.
- [11] Huawei and HiSilicon. (2017, June). Overview of NR UL for LTE NR coexistence. 3rd Generation Partnership Project. Sophia Antipolis, France. Rep. RAN1#89. [Online]. Available: <https://portal.3gpp.org/ngppapp/CreateTdoc.aspx?mode=view&contributionId=783916>
- [12] Huawei and HiSilicon. (2017, May). Consideration on subcarrier mapping for LTE NR coexistence. 3rd Generation Partnership Project. Sophia Antipolis, France. Rep. RAN1#89. [Online]. Available: <https://portal.3gpp.org/ngppapp/CreateTdoc.aspx?mode=view&contributionId=783917>
- [13] 3GPP. (2017, Sept.). User equipment (UE) radio transmission and reception. 3rd Generation Partnership Project. Sophia Antipolis, France. Rep. TS 36.101 V15.0.0. [Online]. Available: http://www.3gpp.org/ftp/Specs/archive/36_series/36.101/
- [14] HiSilicon and Huawei, "R1-1712166 Discussion on scenario 2 for LTE NR dc with UL sharing from UE perspective," 3rd Generation Partnership Project, Sophia Antipolis, France, Rep. TSG-RAN WG1 Meeting 90, 2017.
- [15] 5G Americas. (2016, Oct.). V2X cellular solutions. 5G Americas. Bellevue, WA. [Online]. Available: http://www.5gamericas.org/files/2914/7769/1296/5GA_V2X_Report_FINAL_for_upload.pdf