

Tableau Desktop and Web Authoring Help

Last Updated 11/11/2024
© 2024 Salesforce, Inc.



Contents

Tableau Desktop and Web Authoring Release Notes	1
Related resources	2
Get Started	3
Build a Basic View to Explore Your Data	3
Connect to your data	3
About the Data pane	4
Build the view	5
Different ways to start building a view	6
Build a view from scratch	7
Drill into the data	10
Increase the level of detail with small multiples	11
Filter the view to focus your exploration	13
Use the Marks card to add depth to your analysis	15
More resources	17
Tableau Desktop and Tableau Desktop Public Edition Feature Comparison	17
Who should use Tableau Desktop Public Edition?	17
Who should use Tableau Desktop?	18
Comparison guide	18
Tour the Tableau Environment	19
Start Page	20
Connect	20
Open	21
Discover	23
Data Source Page	24
Left pane	25

Canvas	25
Refreshing your data source	25
Data grid	26
Metadata grid	27
The Tableau Workspace	27
Workspace area	27
Tableau Toolbar Button Reference	28
Show and Hide the Side Bar (Data pane)	33
Status Bar Information	35
Work with Data Fields in the Data Pane	37
Areas of the Data pane	37
Columns become measure and dimension fields in the view	40
Fields that Tableau automatically creates	41
Measure Names and Measure Values	41
Count of Table	42
Number of Records (before version 2020.2)	42
Latitude and Longitude (generated)	42
Perform common tasks in the Data pane	42
Change data fields to fit your needs	44
Relational versus cube data	44
Navigate Data Sources in the Data Pane	45
Navigate Between the Start Page and Workspace	47
Apply Advanced Analysis to a View (Analytics Pane)	48
Add an analytics object to the view	49
Delete an analytics object from the view	51
Edit an analytics object in the view	51
Analytics object definitions	52

Constant Line	52
Average Line	52
Median with Quartiles	53
Box Plot	53
Totals	54
Average with 95% CI	54
Median with 95% CI	55
Trend Line	55
Forecast	55
Custom Reference Line	56
Custom Reference Band	56
Custom Distribution Band	56
Custom Box Plot	56
Shelves and Cards Reference	57
Options for starting a view	57
Columns and Rows shelves	58
Hide rows and columns	60
Marks card	62
Filters shelf	64
Pages shelf	68
Jump to a specific page	70
Manually advance through the pages	71
Automatically advance through pages	72
Show the Page history	72
Pages on dashboards (Tableau Desktop only)	74
Additional Shelves, Legends, Cards, and Controls	74
Parts of the View	76

The View area	76
Headers	77
Axes	80
Panes	82
Cells	82
Marks	83
Tooltips	84
Tooltip command buttons for exploring data in a viz	85
Disable tooltip commands	86
Body text and markup in tooltips	86
Action links	86
Titles	86
Show and hide titles in worksheets	86
Show and hide titles in dashboards	87
Show and hide titles in stories	88
Captions	88
Field Labels	89
Legends	91
Measure values and color legends	91
Workbooks and Sheets	95
About sheets	95
Create new worksheets, dashboards, or stories	96
More ways to create new worksheets	96
More ways to create new dashboards	96
More ways to create new stories	97
Undo, redo, or clear sheets	97
Duplicate a sheet	98

Duplicate as Crosstab	98
Rename sheets	98
See the underlying data in a sheet	98
Delete sheets	99
Create or Open Workbooks	99
Create or open a workbook	99
Open a workbook that has an unsupported data connection on the Mac	99
Open a published workbook from the server	100
Navigate and Organize Sheets	102
Options for navigating, viewing, and organizing sheets	102
Navigate with sheet tabs	102
Show thumbnails with the filmstrip	103
Manage many sheets with sheet sorter	104
Sheet commands	104
Reorganizing the Workspace	105
Rearranging Cards	106
Showing and Hiding Parts of the Workspace	106
Presentation Mode	107
Tableau File Types and Folders	108
Changing the Repository Location	109
Language and Locale	109
Set a language	109
Set a locale	110
Day of the Week Sorting	111
Visual Cues and Icons in Tableau Desktop	111
Data sources in the Data pane	111
Fields in the Data Pane	112

Fields on Shelves	114
Fields on the Marks card	116
Sheets in the Dashboards and Worksheets pane	116
Fields in the Calculation editor	117
Tableau Concepts	117
Structure Data for Analysis	118
How structure impacts analysis	118
Data Structure	118
What is a row?	118
What is a field or column?	120
Categorizing fields	121
Binning & Histograms	122
Distributions and outliers	123
Data Types	125
Pivot and Unpivot Data	126
Wide data	126
Tall data	129
Normalization	132
Join Types	134
"Tidy" Data	135
Find Good Data Sets	135
The reality of data sets	135
What makes a good data set	135
1. A good data set has the elements you need for your purposes	136
2. A good data set is disaggregated (raw) data	137
3. A good data set has dimensions and measures	138
Dimensions and Measures	139

Discrete and Continuous	140
4. A good data set has metadata or a data dictionary	141
5. A good data set is one you can use	142
Relabel your data	143
Relabel to make fake data	144
Re-alias to make the data easier to use	144
Re-alias with the CASE function	144
Tips when looking for data sets	145
Places to look for data	146
Dimensions and Measures, Blue and Green	147
About data field roles and types	147
Blue versus green fields	147
Possible combinations of fields in Tableau	147
Examples of continuous and discrete fields used in a view	148
Dimension fields in the view	149
How dimensions affect the level of detail in the view	151
Notes	152
Measure fields in the view	153
How continuous and discrete fields change the view	155
Continuous fields produce axes	155
Discrete fields create headers	156
Discrete versus continuous fields on filters	156
Discrete versus continuous fields on color	157
Data Types	157
Data type icons in Tableau	157
Change the data type for a field in the Data Source page	158
Change the data type for a field in the Data pane	159

Change the data type for a field in the view	159
Mixed data types in data from files	160
Tableau's Order of Operations	161
About the order of operations (aka query pipeline)	162
Example 1: Convert a Dimension Filter to a Context Filter	163
Example 2: Convert a Table Calculation to a FIXED Level of Detail Expression	166
Data Aggregation in Tableau	171
Change the Aggregation of a Measure in the View	171
Aggregating Dimensions	172
List of Predefined Aggregations in Tableau	175
Set the Default Aggregation for a Measure	178
How to Disaggregate Data	180
Example: Scatter Plots, Aggregation, and Granularity	181
Start building the scatter plot	181
Use dimensions to add detail	182
Try adding more fields to the rows and columns shelves	184
Try disaggregating the data	186
The Bookshop data set	187
Download the files	188
About the data set	188
Data Dictionary	189
If you build your own data source	189
Bookshop Libraries	190
Data Dictionary	190
Explore	192
Sign in to Tableau Server or Tableau Cloud	193
Sign in from Tableau Desktop	194

- Tableau Server 194
- Tableau Cloud 195
- Automatically keep Tableau Desktop connected to Tableau Server or Online 196
 - Switch servers, switch sites 197
 - Sign out or clear all saved connections 198
- Switch user accounts from Tableau Desktop (Kerberos authentication only) 198
- Sign in with another user account in a browser 199
- Sign in to a specific site in a browser (Tableau Server only) 200
- Choose the Right Chart Type for Your Data 201
 - Change over time 202
 - Related topics 202
 - What kind of question does this chart answer? 202
 - More inspiration 203
 - Correlation 203
 - Related topics 204
 - What types of question can this chart answer? 204
 - Magnitude 205
 - Related topics 205
 - What types of question can this chart answer? 205
 - Deviation 206
 - Related topics 206
 - What types of question can this chart answer? 207
 - Distribution 207
 - Related topics 208
 - What types of question can this chart answer? 208
 - Ranking 209
 - Related topics 209

What types of question can this chart answer?	209
Part-to-Whole	210
Related topics	210
What types of question can this chart answer?	211
Spatial	211
Related topics	212
What types of question can this chart answer?	212
Flow	212
Related topics	213
What types of question can this chart answer?	213
Related resources	213
Tableau Workbook Performance Checklist	214
General tips	214
Data source and structure	215
Related topics and resources	216
Building views and dashboards	216
Related topics and resources	217
Filtering	217
Calculations	218
Related topics and resources	218
Other Suggestions	218
Related topics and resources	218
Connect to and Prepare Data	219
Connect to Your Data	219
Tableau Desktop	219
Tableau Server and Tableau Cloud web authoring	220
Tableau Server	220

Tableau Cloud	221
Request a new connector	221
Supported Connectors	221
Excel	221
Make the connection and set up the data source	222
Microsoft Excel data source example	222
Get more data	223
Set Excel table options	223
Use Data Interpreter to clean your data	223
About .tde and .hyper files	224
Changes to the way values are computed	224
See also	224
Tips for Working with Your Data	224
Pivot data in crosstab format	225
Remove pre-aggregated data	226
Remove or exclude introductory text	227
Flatten hierarchical headers to a single row	228
Make sure there are no blank cells	229
Remove blank rows	229
Add missing headers	230
Text File	230
Make the connection and set up the data source	230
Text file data source example	231
Optional settings	231
Get more data	232
Clean your data with Data Interpreter	232
Set text file options	232

Review the data, pivot, split, and create calculations	233
Examine the data source structure and perform management tasks	233
Connect live or use an extract	233
Add data source filters	234
Best practices	234
Collect files in a single directory	234
Text file column width and size considerations	234
About .ttde and .hhyper files	234
See also	234
Microsoft Access	235
Before you begin	235
Driver required	235
Make the connection and set up the data source	235
See also	236
JSON File	236
Make the connection and set up the data source	236
JSON file data source example	237
Select schema levels	237
Detect new fields	239
Change schema levels	239
Union JSON files	239
How dimension folders are organized for hierarchical JSON files	239
Why measures are calculated in hierarchical JSON files	240
Tips for working with JSON data	241
About .ttde and .hhyper files	242
See also	242
PDF File	242

- Make the connection and scan your document for tables 242
 - PDF file data source example 244
- Get more data 245
- Set table options 246
- Use Data Interpreter to clean your data 246
- Union tables in your .pdf files 246
- Tips for working with .pdf files 247
- About .ttde and .hhyper files 252
- See also 253
- Spatial File 253
 - Before you connect 253
 - Make the connection and set up the data source 254
 - Spatial file data source example 254
 - Work with the Geometry column 254
 - About .ttde and .hhyper files in Tableau Desktop 255
 - See also 255
- Statistical File 255
 - Make the connection and set up the data source 255
 - Statistical file data source example 256
 - R data file object and format support 257
 - Change the character encoding for a statistical file 257
 - Create the TDC file 258
 - Sample TDC file sets the source-charset value 258
 - About .ttde and .hhyper files 259
 - See also 259
 - User-defined Encodings Supported by the Statistical File Connector 259
 - Single-byte user-defined encodings 259

Multi-byte user-defined encodings	265
Unicode user-defined encodings	266
Single-byte encodings that can't be mapped to SAS encodings	267
Multi-byte encodings that can't be mapped to SAS encodings	269
Other Files	270
Tableau Data Extract data source example	271
See also	271
Connect to Data by Using Tableau Server or Tableau Cloud	271
Connect from Tableau Desktop	272
Sign in on a Mac	274
Connect to published data sources while web authoring	274
Add more data to an existing view	275
Create a workbook with a published data source	275
Action Vector	275
Before you begin	275
Driver required	276
Make the connection and set up the data source	276
See also	277
Alibaba AnalyticDB for MySQL	277
Before you begin	277
Driver required	277
Make the connection and set up the data source	277
Sign in on a Mac	278
See also	278
Alibaba Data Lake Analytics	278
Before you begin	279
Driver required	279

Make the connection and set up the data source	279
Sign in on a Mac	280
See also	280
Alibaba MaxCompute	280
Before you begin	280
Driver required	280
Make the connection and set up the data source	280
Sign in on a Mac	281
See also	281
Amazon Athena	282
Before you begin	282
Driver required	282
Make the connection and set up the data source	282
Customize JDBC connections	283
See also	283
Amazon Aurora for MySQL	283
Before you begin	284
Driver required	284
Make the connection and set up the data source	284
Sign in on a Mac	285
See also	285
Amazon EMR Hadoop Hive	285
Before you begin	285
Driver required	286
Make the connection and set up the data source	287
Sign in on a Mac	288
Work with Hadoop Hive data	288

Work with date/time data	288
NULL value returned	288
High latency limitation	288
See also	288
Amazon Redshift	289
Before you begin	289
Driver required	289
Make the connection and set up the data source	289
Customize the connection using driver parameters	290
Sign in on a Mac	291
See also	291
Amazon S3	291
Before you begin	291
Permissions	291
Recommendations	292
Make the connection and set up the data source	292
Set up the data source	292
Union your data	292
Known issues and limitations	292
Authentication known issues and limitations	293
Publishing known issues and limitations	293
Union known issues and limitations	293
File type known issues and limitations	293
Additional Parquet file known issues and imitations	293
See also	294
Anaplan	294
Before you begin	294

- Make the connection and set up the data source 295
- Date range selections can impact performance 296
- Groom your data 296
- Refresh your data 297
- See also 298
- Apache Drill 298
 - Before you begin 298
 - Driver required 298
 - Make the connection and set up the data source 298
 - Sign in on a Mac 299
 - See also 299
- Azure Data Lake Storage Gen2 299
 - Before you begin 300
 - Recommendation 300
 - Setup a custom OAuth Client to use your company's IT policies 300
 - Make the connection and set up the data source 300
 - About Azure storage accounts 301
 - See also 301
- Azure SQL Database 302
 - Before you begin 302
 - Make the connection and set up the data source 303
 - Sign in on a Mac 304
 - See also 304
- Azure SQL Synapse Analytics 304
 - Before you begin 305
 - Driver required 305
 - Make the connection and set up the data source 306

Sign in on a Mac	307
See also	307
Box	308
Before you begin	308
Make the connection and set up the data source	308
Use Data Interpreter to clean your data	308
Adding Tableau to your Box account	308
Limitations and known issues	309
Known issues	309
See also	309
Cloudera Hadoop	309
Before you begin	309
Driver required	310
Make the connection and set up the data source	311
Sign in on a Mac	312
Work with Hadoop Hive data	312
Work with date/time data	312
NULL value returned	312
High latency limitation	312
See also	313
Databricks	313
Before you begin	313
Driver required	313
Make the connection and set up the data source	313
Sign in on a Mac	314
Databricks best practices and troubleshooting	315
See also	315

- Denodo 315
 - Before you begin 315
 - Driver required 315
 - Update 20170515 of Denodo 6.0 required 316
 - Make the connection and set up the data source 316
 - See also 317
- Dremio Connector by Dremio 317
 - Before you begin 317
 - Driver required 317
 - Make the connection and set up the data source 317
 - Sign in on a Mac 318
 - See also 318
- Dropbox 318
 - Before you begin 319
 - Make the connection and set up the data source 319
 - Use Data Interpreter to clean your data 319
 - Troubleshoot Dropbox issues 319
 - Connections to multiple accounts 319
 - Web authoring with Internet Explorer 11 and Edge 320
 - See also 320
- Esri Connector 320
 - Download the required driver 320
 - Connect to Esri Services 320
 - No authentication 320
 - OAuth (Tableau Desktop and Tableau Cloud) 321
 - OAuth (Tableau Server) 321
 - Configure ArcGIS Online 321

Configure Tableau Server	322
Troubleshoot Esri connections	322
Known limitations	322
See also	323
Exasol	323
Before you begin	323
Driver required	323
Make the connection and set up the data source	324
Sign in on a Mac	324
See also	325
Firebird 3	325
Before you begin	325
Driver required	325
Make the connection and set up the data source	325
Sign in on a Mac	326
Upgrade a Firebird extract	326
See also	327
Google Analytics	327
Before you begin	327
Recommendation	327
Setup a custom OAuth Client to use your company's IT policies	327
Make the connection and set up the data source	328
All data vs. sampled data returned from a query	330
Troubleshoot issues with returning all data	330
Return sampled data	330
See also	331
Google Analytics 4	331

- Before you begin 331
- Recommendation 331
 - Set up a custom OAuth Client to use your company's IT policies 331
- Make the connection and set up the data source 331
- Troubleshoot Google Analytics 4 332
 - Report Types 332
- Quotas 333
- See also 333
- Google BigQuery 333
 - Before you begin 333
 - Recommendation 333
 - Set up a custom OAuth Client to use your company's IT policies 333
 - Make the connection and set up the data source 334
 - Use customization attributes to improve query performance 336
 - Use Google BigQuery customization attributes 336
- How Tableau returns rows from Google BigQuery 336
 - How to specify the attributes 337
- Specify attributes in a .tdc file 337
 - Example of a .tdc file with recommended settings for large extracts 337
- Manually embed attributes in the XML of the workbook or data source file 338
 - Example of manually embedded attributes 338
 - Check if your workbook uses standard SQL or legacy SQL 338
 - Use BigQuery BI Engine to Analyze Data 339
- Troubleshoot Google BigQuery issues 339
 - Connections to multiple accounts 339
 - Web authoring with Internet Explorer 11 and Edge 340
- See also 340

Google BigQuery JDBC	340
Before you begin	340
Driver required	340
Make the connection in Tableau Desktop	340
Complete the following steps to sign in using a service account.	341
Complete the following steps to sign in using OAuth.	341
Make the connection in Tableau Cloud	341
Migrating existing workbooks	342
Google Cloud SQL	342
Before you begin	342
Driver required	342
Make the connection and set up the data source	342
Sign in on a Mac	343
See also	343
Google Drive	343
Before you begin	343
Make the connection and set up the data source	344
About .ttde and .hhyper files	345
Troubleshoot Google Drive issues	346
Data limit in Google Drive	346
Connections to multiple accounts	346
Web authoring with Internet Explorer 11 and Edge	346
See also	346
Google Sheets	346
Hortonworks Hadoop Hive	347
Before you begin	347
Driver required	348

Make the connection and set up the data source	348
Sign in on a Mac	349
Work with Hadoop Hive data	349
Work with date/time data	349
NULL value returned	349
High latency limitation	349
Truncated columns in Tableau	350
See also	350
IBM DB2	350
Before you begin	350
Port settings	351
SSL requirements	351
Driver required	351
Make the connection and set up the data source	351
See also	352
IBM Informix	352
Before you begin	352
Port settings	353
SSL requirements	353
Driver required	353
Make the connection and set up the data source	353
See also	354
IBM Netezza Performance Server	354
Before you begin	354
Driver required	355
Make the connection and set up the data source	355
See also	355

Impala	356
Before you begin	356
Driver required	356
Make the connection and set up the data source	357
Sign in on a Mac	358
See also	358
Intuit QuickBooks Online	358
Before you begin	358
Make the connection and set up a data source	359
Use the Sales and Expenses Line Items table to create accounting reports	360
Sales and Expenses Line Items table structure	360
Join tables with the Sales and Expenses Line Items table	362
Create the QuickBooks Online data source	363
Troubleshoot QuickBooks Online errors	363
Workbooks saved in previous versions of Tableau	363
Sorry, only administrators can buy apps... ..	363
Error Code: app_already_purchased	364
Changing a Connection Opens the My Apps Page	364
See also	365
Kognitio	365
Before you begin	365
Driver required	365
Make the connection and set up the data source	365
Sign in on a Mac	366
See also	366
Kyvos	367
Before you begin	367

- Driver required 367
- Make the connection and set up the data source 367
- Sign in on a Mac 368
- See also 368
- LinkedIn Sales Navigator 368
 - Before you begin 369
 - Make the connection and set up the data source 369
 - Use Accelerators 370
 - Date range selections can impact performance 370
 - Refresh LinkedIn Sales Navigator data 370
- MariaDB 370
 - Before you begin 370
 - Driver required 370
 - Make the connection and set up the data source 371
 - Sign in on a Mac 371
 - See also 371
- Marketo 372
 - Before you begin 372
 - Make the connection and set up the data source 372
 - Bulk API retrieves data for some tables 373
 - Use Accelerators 373
 - Date range selections can impact performance 373
 - See also 374
- Marketing Cloud Intelligence 374
 - Before you begin 374
 - Driver required 374
 - Make the connection and set up the data source 374

Sign in on a Mac	375
See also	375
MarkLogic	375
Before you begin	375
Driver required	376
Make the connection and set up the data source	376
See also	377
Microsoft Analysis Services	377
Before you begin	377
Driver required	377
Make the connection and set up the data source	378
Incompatible Measures and Dimensions	378
See also	379
Microsoft SQL Server	379
Before you begin	379
Driver required	380
Make the connection and set up the data source	380
Sign in on a Mac	382
Resolve "Worksheet Unavailable" error message	382
See also	382
MonetDB	382
Before you begin	382
Driver required	383
Make the connection and set up the data source	383
See also	384
MongoDB BI Connector	384
Before you begin	384

- Driver required 384
- Make the connection and set up the data source 384
- Sign in options 385
- See also 386
- MySQL 386
 - Before you begin 386
 - Driver required 386
 - Make the connection and set up the data source 386
 - Sign in on a Mac 387
 - See also 387
- OData 388
 - Before you begin 388
 - Make the connection and set up the data source 388
 - OData connector support 389
 - See also 389
- OneDrive and SharePoint Online 389
 - Before you begin 389
 - Recommendation 390
 - Make the connection and set up the data source 390
 - Use Data Interpreter to clean your data 391
 - Troubleshoot OneDrive and SharePoint Online 391
 - Connections to multiple accounts 391
 - Web authoring with Internet Explorer 11 and Edge 391
 - See also 391
- Oracle 392
 - Before you begin 392
 - Driver required 392

JDBC driver versus OCI driver	392
Make the connection and set up the data source	393
Sign in on a Mac	394
Use net services definitions in Tableau	394
Migrate workbook from Oracle OCI connector to Oracle JDBC connector	394
To migrate a workbook	394
See also	395
Oracle Eloqua	395
Before you begin	396
Make the connection and set up the data source	396
Use Accelerators	397
Date range selections can impact performance	398
Eloqua limits	398
Field limits	398
Daily table request limits	398
Incremental Refresh	398
See also	399
Oracle Essbase	399
Before you begin	399
Driver required	399
Make the connection and set up the data source	399
Set an accounts dimension	400
Build views with Oracle Essbase	400
Generations and Levels	401
Shared Members	401
Setting the Default Member	403
See also	404

Oracle NetSuite	404
Before you begin	404
Driver required	404
Make the connection and set up the data source	404
See also	405
Pivotal Greenplum Database	405
Before you begin	405
Driver required	405
Make the connection and set up the data source	405
Support for spatial columns	406
Sign in on a Mac	406
See also	406
PostgreSQL	407
Before you begin	407
Driver required	407
Make the connection and set up the data source	407
Sign in on a Mac	408
See also	409
Presto	409
Before you begin	409
Driver required	409
Make the connection and set up the data source	410
Sign in on a Mac	411
See also	411
Progress OpenEdge	411
Before you begin	411
Driver required	411

Make the connection and set up the data source	412
See also	412
Qubole Presto	412
Before you begin	413
Driver required	413
Make the connection and set up the data source	413
Sign in on a Mac	414
See also	414
Salesforce CRM	414
Before you connect	415
Recommendation	415
Setup a custom OAuth Client to use your company's IT policies	415
Make the connection and set up the data source	415
Work with a subset of columns	416
Refresh Salesforce data	416
Use Accelerators	416
Use joins in Salesforce	417
Cross-database join limitations with Salesforce	417
Troubleshoot Salesforce connections	417
Company account and user profile configuration	417
Errors during extract	418
See also	418
Salesforce Data Cloud	418
Tableau Desktop (version 2023.2 and later)	419
Tableau Desktop (version 2023.1 and earlier)	419
Step 1: Install the Salesforce Data Cloud.taco file	419
Step 2: Install the Salesforce Data Cloud JDBC driver	420

- Step 3: Enable a High Assurance Session 420
- Step 4: Connect to the Salesforce Data Cloud in Tableau Desktop 422
- Tableau Cloud and Tableau Server 422
- Next Steps 422
 - Use Accelerators for Quick Data Insights 422
- Salesforce Data Cloud Identity Resolution Accelerator 422
- Salesforce Data Cloud Email Marketing Campaign Accelerator 423
- Salesforce Data Cloud Customer Engagement Accelerator 423
- See also: 423
- Salesforce Data Cloud 423
 - Tableau Desktop (version 2023.2 and later) 424
 - Tableau Desktop (version 2023.1 and earlier) 424
 - Step 1: Install the Salesforce Data Cloud.taco file 424
 - Step 2: Install the Salesforce Data Cloud JDBC driver 425
 - Step 3: Enable a High Assurance Session 425
 - Step 4: Connect to the Salesforce Data Cloud in Tableau Desktop 427
 - Tableau Cloud and Tableau Server 427
 - Next Steps 427
 - Use Accelerators for Quick Data Insights 427
 - Salesforce Data Cloud Identity Resolution Accelerator 427
 - Salesforce Data Cloud Email Marketing Campaign Accelerator 428
 - Salesforce Data Cloud Customer Engagement Accelerator 428
 - See also: 428
- Salesforce Marketing Cloud 428
 - Driver required 429
 - MFA Work Around 429
 - Install the Connector 429

Configure the Marketing Cloud Instance	429
Configure your Subdomain	430
Refresh your data	430
See also	430
Splunk	430
Before you begin	430
Driver required	431
Make the connection and set up the data source	431
Join limitations with Splunk	432
See also	432
Splunk JDBC	432
Before you begin	433
Driver required	433
Make the connection and set up the data source	433
See also	434
Splunk JDBC	434
Before you begin	434
Driver required	434
Make the connection and set up the data source	434
See also	435
SAP HANA	435
Before you begin	435
Driver required	436
Make the connection and set up the data source	436
Sign in on a Mac	437
Convert an SAP HANA level hierarchy to a user hierarchy	438
Customize JDBC connections	439

- Install trusted SSL certificates on a Mac 439
- Select variables and input parameters 439
- Support for SAP HANA single sign-on (SSO) 440
 - Sign in to the server 441
 - Publish to the Server 441
- How to refresh HANA extracts when you use SSO 441
- Performance tips 441
 - Use bind variables 442
 - Use column metadata collection 442
 - TDC example for SAP HANA 442
- See also 443
- External OAuth for SAP HANA 443
 - Configure IDP on HANA 444
 - Configure the IDP 444
 - Connect to HANA 444
 - Okta 445
- SAP NetWeaver Business Warehouse 445
 - Install SAP software 445
 - Before you connect 446
 - Driver required 446
 - Make the connection and set up the data source 446
 - Support for SAPUILandscapexml 447
 - Connections in drop-down list might not work 447
 - Select variables and input parameters 448
 - Select the alias for a dimension 448
 - Support for SAP BW extracts 449
 - SAP BW extract features 449

SAP BW extract limitations	450
Data displays differently for extract and live connections	451
Frequently asked questions	452
Requirements	452
What versions do I need?	452
Do I need any special licenses like OpenHub to use Tableau with SAP BW?	452
Does the SAP BW connector require HANA?	452
Can I connect to SAP BW using Logon Groups?	453
Connection	453
Is the connection between Tableau and SAP BW a live connection or is it a Tableau extract?	453
Does Tableau support connecting directly to the underlying database tables that support the BW instance?	453
Performance	453
How does performance compare to existing tools we use?	453
Security	453
How does Tableau handle user security?	453
How does user security work with Tableau Server when I publish a dashboard? ...	453
See also	454
SAP SuccessFactors	454
Before you begin	454
Driver required	454
Make the connection and set up the data source	454
See also	455
SAP Sybase ASE	455
Before you begin	455
Driver required	455

- Make the connection and set up the data source 455
- See also 457
- SAP Sybase IQ 457
 - Before you begin 457
 - Driver required 457
 - Make the connection and set up the data source 458
 - See also 458
- ServiceNow ITSM 459
 - Before you begin 459
 - Connection requirements 459
 - Make the connection and set up the data source 460
 - Use Accelerators 461
 - Key considerations 461
 - ServiceNow enforces an account's access permissions 461
 - Custom tables not supported 461
 - ServiceNow provides table names 461
 - Display value fields aren't included in the data source 461
 - Use a local ServiceNow account 461
 - Date range selections can impact performance 462
 - Troubleshoot data access 462
 - For ServiceNow ITSM users 462
 - For ServiceNow administrators 462
 - See also 463
- ServiceNow 463
 - Before you begin 463
 - Make the connection and set up the data source 463
 - Connection installation 463

Refresh your data	464
See also	464
SharePoint Lists	465
Before you connect	465
Driver required	465
Make the connection and set up the data source	465
Connection tips	466
Sign in on a Mac	466
Refresh your data	467
See also	467
SharePoint Lists (JDBC)	467
Preparing to connect	467
Required API Permissions	467
Using a custom OAuth Client	468
Driver required	468
Configuring SharePoint Lists (JDBC) on Tableau Server	468
Make the connection and set up the data source	469
Sign in on a Mac	469
Refresh your data	469
See also	470
SingleStore	470
Before you begin	470
Driver required	470
Make the connection and set up the data source	470
Sign in on a Mac	471
See also	471
Snowflake	471

- Usage notes: Key-pair authentication with Snowflake 472
- Before you begin 472
 - Driver required 472
- Make the connection and set up the data source 473
 - Connect Tableau to your data 473
 - Access Token Timeout: Always Validate Access Token TDC 474
 - Customize the connection using driver parameters 475
 - Set up the data source 475
- Sign in on a Mac 476
- Default virtual warehouses in Snowflake 476
- Use a proxy for Snowflake 476
- Troubleshooting 477
 - Performance and Fetch Size 477
- Determining the current Fetch size 477
- Variable Field Length Limits 478
- Enable CAP_ODBC_FETCH_BUFFERS_RESIZABLE 478
- Frequently asked questions 479
- See also 479
- Configure OAuth for Snowflake Connections 479
 - Configure OAuth between Snowflake and Tableau 481
 - About using SSO with OAuth 481
 - Configure OAuth between Okta and Snowflake 482
 - About using MFA with OAuth 482
 - Other connection options 482
- Frequently asked questions 483
- See also 484
 - External OAuth for Snowflake 484

Configure IDP on Snowflake	484
Configure the IDP on Tableau	484
Connect to Snowflake	485
Okta	485
Configure Snowflake for Key-pair Authentication	486
Add Key-pair Authentication Details	486
See also	487
Spark SQL	487
Before you begin	487
Driver required	488
Make the connection and set up the data source	488
Sign in on a Mac	489
See also	489
Teradata	489
Before you begin	490
Driver required	490
Make the connection and set up the data source	490
Sign in on a Mac	491
Use query bands to increase performance	491
Use initial SQL commands	495
See also	496
Teradata OLAP Connector	496
Before you begin	496
Driver required	496
Make the connection and set up the data source	496
Work with Teradata OLAP data	497
See also	497

- TIBCO Data Virtualization 497
 - Before you begin 497
 - Driver required 498
 - Make the connection and set up the data source 498
 - See also 499
- Vertica 499
 - Before you begin 499
 - Driver required 499
 - Make the connection and set up the data source 500
 - Sign in on a Mac 500
 - See also 501
- Web Data Connector 2.0 501
 - Use a web data connector 501
 - Test and vet the web data connector 501
 - How to use a web data connector on Tableau Server and Tableau Cloud 502
 - Connect to the data source 502
 - Web data connector data source example 503
 - Optional settings 504
 - Tableau support for Web Data Connector 505
 - See also 505
- Other Databases (JDBC) 505
 - Before you begin 506
 - Specify the right JDBC driver 506
 - Dialect support 507
 - Gather connection information 507
 - Make the connection 507
 - Configure for publishing and cross-platform portability 508

Review your data	508
Change your database	509
Tableau support for Other Databases (JDBC) connections	509
See also	509
Tableau and JDBC	510
Tune JDBC connector performance	510
Tableau support for JDBC connections	510
Frequently asked questions	510
See also	513
Other Databases (ODBC)	513
Make the connection	514
Configure for publishing and cross-platform portability	515
Create a DSN	516
Tableau support for Other Databases (ODBC) connections	516
Tableau and ODBC	517
ODBC basics	517
How Tableau determines the capabilities of the ODBC driver	518
ODBC discovery	518
Tune ODBC connector performance	519
Tableau support for ODBC connections	519
ODBC FAQ	520
What's a typical use case for the ODBC connector?	520
Where do I get ODBC drivers for my database?	520
What ODBC version driver do I need?	520
Has Tableau tested database [x]?	521
What do I do if it doesn't work?	521
Should I use the named database connector or the ODBC connector?	521

- See also 521
- Use Partner-Built Connector from the Tableau Exchange 522
 - Choose and install a partner-built connection 522
 - Make the connection 522
 - Work with your data 523
 - See also 523
- Connectors Built with the Tableau Connector SDK 523
 - About Tableau Connector SDK and connector files 523
 - Support for Partner-built connectors 524
 - Build your own connector 524
 - Submit a connector to the Tableau Exchange 524
 - Use a connector built with Tableau Connector SDK 524
 - Connect Tableau to the data 526
 - About load order for connectors 526
 - See also 527
- Connectors Built with the Web Data Connector 3.0 SDK 527
 - About Web Data Connector 3.0 527
 - Build your own connector 528
 - Use a connector built with the Web Data Connector 3.0 SDK 528
 - Connect Tableau to the data 529
 - Load order for connectors 530
 - Known issues (Tableau Server only) 530
 - See also 530
- Connector Authentication 530
 - Configure SSL for JDBC Connections 531
 - One-Way SSL for JDBC Connections 531
 - Embed a certificate 531

Install a certificate in the system trust store	532
For Windows:	532
For Mac:	533
For Linux:	533
Use custom driver properties	534
Two-Way SSL for JDBC Connections	534
Use a .properties file to configure the client certificate and private key	535
Troubleshooting	535
See also	536
Oracle JDBC Connections with SSL	536
Require SSL	536
Configure one-way SSL for Oracle	537
Configure two-way SSL	538
Option 1: Embed client certificates and private key in the data source	538
Option 2: Use a properties file to configure the client certificate and private key	539
Publish a workbook	540
Convert key formats	540
See also	541
Customize and Tune a Connection	541
Use a TDC file to customize a connection	542
Structure of a TDC file	542
Use a properties file to customize a JDBC connection	544
Installing tdc and properties files	544
Tableau desktop application paths	545
Tableau Server paths	545
Customize Connection String for Native Connectors	546
Modify the connection string	546

- Use an allowlist to reduce security risk 547
- Use a TDC file 547
- Create a TDC file 548
- Native connector class list 549
- See also 550
- Example: Customize an ODBC Connection 550
- Make an ODBC connection 551
- Prerequisites 551
- Create a connection 551
- Review the XML structure of a TDS file 552
- Vendor and driver name 552
- Types of customizations 553
- Format of customization values 553
- Make customizations global with a TDC file 553
- Create a TDC file 554
- Structure of a TDC file 554
- Use the TDC file with Tableau Desktop 556
- Use the TDC file with Tableau Prep Builder 556
- Use the TDC file with Tableau Server 557
- Sample SQLite TDC file 559
- Customize your ODBC connection 559
- Common customizations for improving functionality 560
- Handle severely limited data sources 560
- Configure ODBC driver settings 560
- Advanced SQLite customizations 561
- ODBC documentation reference 561
- See also 561

Tableau JDBC Capability Customizations Reference	562
See also	568
Tableau Capability Customizations Reference	568
See also	585
ODBC/SQL Customizations Reference	586
Documentation resources for SQLGetInfo	586
SQLGetInfo long-integer values	586
SQLGetInfo short-integer values	589
SQLGetInfo string values	589
See also	591
Run Initial SQL	591
To use initial SQL	592
Parameters in an initial SQL statement	593
Defer execution to the server	595
Security and impersonation	595
Troubleshoot 'create table' for MySQL and Oracle connections	595
For MySQL connections, tables aren't listed after using initial SQL to create a table	595
For Oracle connections, using initial SQL to create a table causes Tableau to stall	595
Set Up Data Sources	596
Plan the Data Source	596
Tableau data sources	596
Combine Data	597
Methods of combining data	598
Relationships	599
Join	600

Data blending	600
Union	601
Considerations for a Tableau data source	601
Location and access	602
Shape and cleanliness	602
The data model and combining data	602
Metadata and customization	603
Scalability, security, and discoverability	603
Performance and freshness	604
Build quality data sources	604
Structure Data for Analysis	604
How structure impacts analysis	604
Data Structure	605
What is a row?	605
What is a field or column?	606
Categorizing fields	607
Binning & Histograms	608
Distributions and outliers	610
Data Types	612
Pivot and Unpivot Data	613
Wide data	613
Tall data	616
Normalization	619
Join Types	621
"Tidy" Data	622
Relate Your Data	622
What are relationships?	623

Requirements for relationships	623
Data that can't be related	624
Create and define relationships	625
Create a relationship	625
Move a table to create a different relationship	627
Change the root or base table of a data model	627
Remove a table from a relationship	627
View a relationship	628
Edit a relationship	629
Tips on creating relationships	629
Validate relationships in your data source	630
Dimension-only visualizations	631
Relationships (logical tables) versus joins (physical tables)	631
Relationships versus blends	634
Features of different options for combining data: Relationships, joins, and blends ..	635
Use Relationships for Multi-table Data Analysis	637
What's Changed with Data Sources and Analysis	641
Changes to data sources, the data model, and query semantics	642
Support for multi-table data sources	642
What didn't change?	642
New logical layer in the data source	642
Query semantics based on relationships	643
Migrated data sources	644
Web Authoring	645
Extracts	645
Changes to different parts of the interface	645
Data Source page changes	645

Data Grid	646
Data pane in worksheets	647
View Data	649
View Data column order changes in Tableau version 2020.2 and later	649
Changes to analysis with multi-table data sources	649
What didn't change?	650
Dimension-only visualizations	650
Unmatched values behavior for dimensions that might surprise you	651
Using a table's Count field instead of Number of Records	652
Cross-table calculations	652
Grand totals using SUM	652
Nulls and automatic joins that result from relationships	652
Unmatched null behavior	652
Dealing with unmatched nulls in the Edit Filter dialog box	653
Validating relationships	653
Questions about Relationships, the Data Model, and Data Sources	654
Relationships	654
Is a relationship just a different name for a join?	654
Can I use joins between logical tables?	655
Where did joins go? Can I still combine table data using joins?	656
Are relationships like blends? When should I use a blend?	656
Data sources, data model, and connections	656
How have data sources changed?	656
What are logical tables and physical tables?	657
Can relationships exist between tables from different connections?	657
Can I use inequality operators or calculated fields to define relationships?	657
Do all connection types support logical tables and relationships?	657

What types of data models are supported?	658
Is there a classic view of the Data Source page that I can use?	658
How do I create a single-table data source?	658
Has row-level security changed?	659
How do I use custom SQL in the new data model?	659
What happens to my older data sources when I open them in Tableau version 2020.2 and later?	659
Do I need to change my migrated data source to use relationships instead of joins?	660
How do I view or edit the data model on the web?	660
Can I use a data source on Tableau Server or Tableau Cloud (version 2020.2 and later) in a previous version of Tableau Desktop (version 2020.1 and earlier)?	660
Can published data sources be related to each other?	661
How do extracts work with related logical tables?	661
If I need to downgrade to Tableau version 2020.1 and earlier, what happens to relationships between logical tables?	661
How does the new data model work with cubes?	661
Interaction with other Tableau features and products	661
Does Explain Data work with multi-table data sources that use relationships?	661
Does Ask Data work with multi-table data sources?	662
How do new data modeling capabilities affect using Tableau Bridge?	662
When should I use Tableau Prep vs. authoring in Tableau Desktop, Tableau Cloud, or Tableau Server to create a data source?	662
Analysis with multi-table data sources	662
Does analysis work differently with multi-table data sources that use relationships?	662
Do LODs work the same with the new data model? When should I use an LOD?	663

- How can I tell if I combined my data correctly with relationships? 663
- Can I see the queries that Tableau is generating for relationships? 664
- Changes to different parts of the interface 664
 - How has the Data Source page changed? The data grid? View Data? The Data pane? 664
 - View Data column order changes in Tableau 2020.2 and later 665
 - How does Count of Table work versus Number of Records? 665
 - Where are sets, groups, and calculated fields shown? 665
- The Tableau Data Model 666
 - Layers of the data model 668
 - Understanding the data model 668
 - Build a new model 670
 - Multi-table model 670
 - Single-table model 671
 - Single-table model that contains other tables 672
 - Supported data model schemas 673
 - Single-table 673
 - Star and snowflake 673
 - Star and snowflake with measures in more than one table 674
 - Multi-fact analysis 675
 - Requirements for relationships in a data model 677
 - Factors that limit the benefits of using related tables 677
- How Relationships Differ from Joins 677
 - Characteristics of relationships and joins 679
 - Relationships 679
 - Joins 679
 - Requirements for using relationships 680

Factors that limit the benefits of using related tables	680
Where did joins go?	680
Optimize Relationship Queries Using Performance Options	681
What the Cardinality and Referential Integrity settings mean	682
Cardinality options	682
Referential Integrity options	683
Where did joins go?	683
Tips on using Performance Options	684
Terms defined	685
Cardinality and Referential Integrity	685
Cardinality	686
Referential Integrity	689
Test yourself	689
Why does it matter?	691
An example in Tableau	691
The right settings	692
The wrong settings: one-to-one	693
The wrong setting: joining	694
The wrong setting: incorrectly assuming referential integrity	694
Performance impacts	695
Under the hood	695
Keep the defaults	697
How Analysis Works for Multi-table Data Sources that Use Relationships	697
Considerations for analysis	698
Validating relationships	698
Dimension-only visualizations	699
When to use LOD calculations and expressions	700

Examples of multi-table analysis	700
Example 1: Analysis of a single question in joined data versus related data	700
Normalized data in multiple tables	704
Example 2: Dimension from a single table	706
Example 3: Dimensions from multiple tables	708
Example 4: Measures that can't be split by a dimension	709
Example 5: Dimension that isn't hierarchically related to a measure	711
Troubleshooting multi-table analysis	712
Don't Be Scared of Relationships	717
Use Relationships	718
Video: Migrated Data	718
Video: Relate tables	719
Add joins	719
Add unions	719
Video: Performance Options	719
Cardinality	720
Referential integrity	720
Example: Bookshop Data	720
Video: Work with multiple tables	721
The Data Source page	721
The Data pane	722
Number of Records and Count	722
Video: Basic calculations	722
Video: Sets and groups	722
Analyze related data	723
Question 1: How many editions are there for each book?	723
Video: Data validation and fixing the data model	724

Question 2: For authors with books in a series, who is has the most book tour events?	725
Video: Work with different levels of details	725
Tips when working with related data	727
Related resources	727
Don't Be Scared of Calculations in Relationships	727
Calculation types	728
Table level of detail	728
Assigning the level of detail	728
Example: Author book tours	729
Related resources	730
Don't Be Scared of Deeper Relationships	730
Why aren't all date fields equal?	731
What does missing data mean?	733
When nulls carry meaning	734
Hands-on exercises	735
If you get stuck	736
Related resources	739
About Multi-fact Relationship Data Models	740
Levels of relatedness	740
Example	743
Field-level relatedness indicators	743
Relatedness indicators on a worksheet	743
Relatedness warning dialog	744
Table-level relatedness in the data model	746
Unrelated tables	746
Related tables	746

Shared tables	747
Field-level relatedness in the analysis	747
Related fields	747
Unrelated fields	748
Stitching dimension	748
Not yet related fields	749
Ambiguously related fields	750
Measure from a shared table	751
Resolve unclear relationships between fields	751
Stitching vs resolving uncertainty	752
How joins are used for each level of relatedness	753
Related dimensions use inner joins	756
Unrelated dimensions use cross joins	756
Stitched dimensions use outer joins	757
Intermediate results are outer joined	758
Additional joins to retain measures	760
Related measures	760
Unrelated measures	762
Troubleshooting	762
Considerations when working with multi-fact relationship data models	762
Resolved issues	763
Known issues in 2024.2	764
When to Use a Multi-fact Relationship Model	764
Why did we build the capability to model unrelated tables?	765
Where did the name come from?	766
When to use multi-fact relationship data models	766
Multi-fact analysis	767

Other scenarios	768
Identify the base tables	769
Characteristics of base tables and shared tables	770
Try an additional base table instead	770
Build a Multi-fact Relationship Data Model	771
Build the model	771
Explore the model	773
Terminology	773
Identify a relationship tree	775
View relationship details	775
Select a relationship	775
Swap with base table	776
Example	776
Collapse a base table	777
Troubleshooting	778
Create a single data source	778
Example	778
Resolve a cycle	778
Data model restrictions	779
Cycles	779
Nested shared tables	780
Understand Tooltips for Multi-fact Relationship Data Models	780
Field-level relatedness	781
Know your data model	781
Unrelated dimension-dimension pair	782
Stitching dimensions	783
Comparing unrelated dimensions with stitched dimensions	783

An aside on how measure values are computed	784
Example	785
The value of a measure trails the dimension members	786
Unrelated dimension-measure pair	787
Measure from a shared table	788
Related measure	789
Filters	790
Join Your Data	791
Relationships vs Joins	791
Common issues	792
Create a join	792
Anatomy of a join	795
Join types	795
Join Clauses	796
About null values in join keys	796
Cross-database joins	796
Review Join Results in the Data Grid	799
Results in the data grid	799
Use calculations to resolve mismatches between fields in a join	799
Troubleshoot Joins	805
Over-counting values or duplicated data	805
Broken table joins and cross-database joins	806
Assuming Referential Integrity for Joins	807
Improve Performance for Cross-Database Joins	809
Feature conditions	809
Changing the preferred option for cross-database joins	810
About working with multi-connection data sources	812

Union data from within a connection	812
Collation	813
Maintain case sensitivity for Excel data	813
Calculations and multi-connection data sources	814
Stored procedures	814
Pivot data from within a connection	814
Make extract files the first connection (Tableau Desktop only)	814
Extracts of multi-connection data sources that contain connections to file-based data (Tableau Desktop only)	815
About queries and cross-database joins	815
Blend Your Data	816
Options to combine data	816
Steps for blending data	817
Understand primary and secondary data sources	818
Work across blended data sources	820
Define blend relationships for blending	821
Establish a link	822
Multiple links	824
Takeaway	826
Differences between joins and data blending	827
Left join	827
Data blending	828
Data blending at a glance	829
Data blending limitations	830
Alias Field Values Using Data Blending	830
To alias field values	831
Bring a Field into the Primary Data Source	833

To blend two data sources and create a primary group	834
Troubleshoot Data Blending	836
Common warnings and errors when blending data sources	836
No relationship to the primary data source	836
Primary and secondary connections are from tables in the same data source	836
Cannot blend the secondary data source because one or more fields use an unsupported aggregation	837
Data sources that contain logical tables cannot be used as secondary data sources for data blending	838
Asterisks show in the sheet	838
Resolve asterisks in the sheet	840
Null values appear after blending data sources	840
Blending issues after publishing data sources	841
Blending with a cube (multidimensional) data source	842
Other data blending issues	842
Blend on Summary Data	842
Step 1: Create a relationship between the primary and secondary data sources	843
Step 2: Bring summary data from the secondary data source into the primary data source	844
Step 3: Compare primary data source data to summary data of secondary data source	846
Union Your Data	847
Supported connectors	847
Union tables manually	849
To union tables manually	849
Union tables using wildcard search (Tableau Desktop)	850
To union tables using wildcard search	851
Expand search to find more Excel, text, JSON, .pdf data	852

Rename, modify, or remove unions	856
Matching field names or field ordering	857
Metadata about unions	858
Merge mismatched fields in the union	859
At a glance: Working with unions	861
Tableau Desktop and web authoring (Tableau Cloud and Tableau Server)	861
Tableau Desktop only	861
Create a Data Source or Add a New Connection with Clipboard Data	862
Connect to a Custom SQL Query	863
Connect to a custom SQL query	864
Examples of custom SQL queries	866
Errors when duplicate columns are referenced	871
Edit a custom SQL query	872
Use parameters in a custom SQL query	873
Tableau Catalog support for custom SQL	876
Supported queries	876
Supported features and functions	877
Supported lineage	877
See Also	878
Use a Stored Procedure	878
Notes on Stored Procedures	880
Stored Procedure Constraints for Teradata Databases	881
Stored Procedure Constraints for SQL Server Databases	881
Stored Procedure Constraints for SAP Sybase ASE Databases	882
Use Certified Data Sources	882
Certified data sources published to Tableau Server or Tableau Cloud	882
Convert a Field to a Date Field	884

- Verifying Date Fields 884
- Change the data type of the field 885
- Create a calculation using the DATEPARSE function 886
 - Creating the DATEPARSE calculation 887
 - Date Field Symbols 888
 - Hyper extracts 889
 - Locale considerations 889
- Create a calculation using the DATE function 890
- See Also 891
- Pivot Data from Columns to Rows 892
 - Pivot the data 892
 - Add to the pivot 893
 - Troubleshooting pivots 894
 - Pivot using custom SQL (Tableau Desktop) 894
 - To pivot data using custom SQL 895
- Clean Data from Excel, CSV, PDF, and Google Sheets with Data Interpreter 897
 - What does Data Interpreter do? 897
 - Turn on Data Interpreter and review results 898
 - Data Interpreter Example 900
 - When Data Interpreter is not available 904
- Split a Field into Multiple Fields 905
 - Find the Split option 905
 - Split on the web 906
 - Split fields 907
 - Split a field automatically 907
 - Split a field with custom split 907
 - Alternatives to splitting from the menu 908

Working with splits and custom splits	909
Troubleshooting splits and custom splits	909
Filter Data from Data Sources	910
Create a data source filter	911
To create a data source filter	911
Global filters and data source filters	911
Understand Field Type Detection and Naming Improvements	913
New fields added to underlying data	913
Fields that are treated as a dimension	913
Keywords Code, Key, and ID	913
Keywords Number, Num, and Nbr	914
Keywords related to dates	915
Field name clean-up	916
Field names with underscore, space, or tab characters	916
Field names and capitalization	916
Field names that are two or three letters long	917
Undo changes made by Tableau	918
Extract Your Data	919
Benefits of Extracts	919
Create an extract	920
Extract field descriptions	921
Data Storage	921
Logical tables	921
Physical tables	921
Tips for using the physical tables option	922
Filters	923
Aggregation	923

Number of rows	924
Incremental Refresh	925
Incremental Refresh and Advanced Settings tips	925
Extract tips	925
Remove the extract from the workbook	926
See extract history (Tableau Desktop)	927
Troubleshoot extracts	928
Extract feature updates	929
Date Range (Subrange)	929
Incremental Refresh	929
Extracts in the web	929
Logical and physical table extracts	929
Deprecation of .tde format	929
Changes to values and marks in the view	930
Date scenario 1	932
Date scenario 2	933
Date scenario 3	934
About the Compute Calculations Now option for extracts	936
New Extract API	936
	936
Extract Upgrade to .hyper Format	936
Discontinuation of support for .tde files	937
Manually upgrade your .tde extract using Tableau Desktop	937
Manually upgrade your .tde with a live connection	937
Refresh Extracts	937
Before you refresh extracts	938
Configure a full extract refresh	938

Publish to Tableau Server	938
Publish to Tableau Cloud	939
Configure an incremental extract refresh	939
Non-Unique column	940
Date range (subrange) refresh	940
Considerations when doing an Incremental refresh	942
See extract history (Tableau Desktop)	942
Add Data to Extracts	943
Add data from a file	943
Add data from a data source	944
Materialize Calculations in Your Extracts	944
When to materialize calculations	945
Materialize calculations	945
Materialize calculations in extracts already published to Tableau Cloud or Tableau Server	945
Calculations that cannot be materialized	945
Update Server Data Sources That Are Using Extracts	945
Update Tableau Server or Tableau Cloud extracts from Tableau Desktop	946
Tableau Data Extract Command-Line Utility	947
Run the utility	947
Syntax and parameters for the tableau refreshextract command	948
Using parameters	948
tableau refreshextract command options	948
Sample tableau refreshextract command	951
Syntax for tableau addfiletoextract	952
tableau addfiletoextract command options	953
Sample tableau addfiletoextract command	954

Using a config file	955
Create the config file	955
Reference the Config File from the Command Line	956
Syntax Differences for Config Files	956
Use Windows Task Scheduler to Refresh Extracts	956
Tableau Hyper API	956
Manage Data Sources	957
Edit Data Sources	957
How to edit the data source	957
Navigate the Data Grid	958
Sort columns	958
Sort rows	959
Change column names and reset field names	960
Rename a column	960
Reset names	960
Revert Tableau's automatic name changes	961
Create calculations	961
View extract data	962
Copy values	962
Examine your metadata	963
Default metadata view	963
Review metadata	963
Manage metadata	963
Change the location of your data source in a workbook	963
Change the location of a data source	964
Replace field references	964
Replace field references	965

Rename the data source	966
Rename a data source	966
Duplicate the data source (Tableau Desktop)	967
Refresh Data Sources	968
Live Connection	968
Extract	969
Published Data Source	969
Changes to underlying data	969
Replace Data Sources	970
Replace a Data Source	970
Replace the Data Source for a Single Sheet	971
Published Data Sources	971
Save Data Sources	972
Options for saving a local data source	972
Save a data source	973
Connect to your data source	973
Updating a data source after the underlying data location changes	973
Upgrade Data Sources	973
File formats and attributes	974
Excel	974
Text	975
Characters and formatting	976
Excel	976
Text	977
Data type detection	978
Excel	978
Text	979

- Data source connection properties 980
- Close Data Sources 980
- Cube Data Sources 982
 - What are cube data sources? 982
 - Create calculated members using MDX formulas 982
 - Tableau features that are affected when you use a cube data source 983
 - Create Slicing Filters 988
 - How to Create a Calculated Member 991
 - Defining Calculated Members 991
- Multidimensional Hierarchies 993
 - Drilling Down and Up in a Cube Data Source Hierarchy 994
 - Hierarchies in cube data sources 994
 - Drill up and down for all dimension members in a hierarchy 994
 - Drill up and down for individual dimension members in a hierarchy 995
 - Perfect Pivoting 998
 - Defining Unique Values 998
 - Utility Dimensions 1000
- Build Charts and Analyze Data 1005
 - Automatically Build Views with Ask Data 1005
 - Navigating to Ask Data lenses 1006
 - Ask Data from a lens page or dashboard object 1007
 - Navigate to a lens and learn more about its data 1007
 - Build queries by entering text 1008
 - Build queries by adding suggested phrases 1009
 - Build queries by adding fields and filters 1010
 - See how elements of your query are applied 1011
 - Rephrase your question 1012

Change the viz type	1012
Change fields, filters, and displayed data	1013
Adjust date filters	1015
Compare differences over time	1016
Apply simple calculations	1017
Add sheets with other vizzes	1018
Share Ask Data vizzes via email, Slack, or a link	1019
Send feedback to the lens owner	1019
Tips for successful queries	1020
Embed and Save Vizzes from Ask Data	1020
Embed an Ask Data lens in a web page	1020
Save vizzes in a new workbook	1021
Supported Analytical Functions for Ask Data	1021
Aggregations	1022
Grouping	1022
Sorting	1022
Numerical filters	1023
Numerical limits (top and bottom values)	1023
Categorical filters for text values	1023
Time filtering	1023
Create Lenses that Focus Ask Data for Specific Audiences	1024
Create or configure a lens page on your Tableau site	1025
Change the list of recommended visualizations	1027
Add or replace a recommended visualization	1027
Edit section titles and recommendation names, or delete recommendations	1027
Add an Ask Data lens to a dashboard	1028
Apply a different lens to an Ask Data dashboard object	1029

- Change a lens name, description, or project location 1029
- See how people use Ask Data with a lens 1030
- Let users email you questions about a lens 1030
- Permissions for publishing and viewing lenses 1031
- Optimize Data for Ask Data 1032
 - Optimize data in Ask Data 1032
 - Changing settings at the data source or lens level 1032
 - Add synonyms for field names and values 1034
 - Exclude values of specific fields from search results 1034
- Optimize data sources 1035
 - Optimize indexing for Ask Data 1035
 - Use data extracts for faster performance 1036
 - Ensure that users can access the data source 1036
 - Be aware of unsupported data source features 1036
 - Anticipate user questions 1037
 - Simplify the data 1037
 - Set appropriate field defaults 1037
 - Create hierarchies for geographic and categorical fields 1038
- Add Synonyms for Ask Data 1038
 - Add field and value synonyms for a specific data source or lens 1039
 - Add synonyms for multiple data sources 1040
 - Publish synonyms to a new data role 1041
 - Apply synonyms from an existing data role 1041
 - Change or remove an applied data role 1042
 - Edit field name or value synonyms for a data role 1042
- Disable or Enable Ask Data for a Site 1044
- Add Web Images Dynamically to Worksheets 1044

Prepare your data source	1045
Example data set:	1045
Assign an image role to your URLs	1046
From the Data Source page:	1046
From a worksheet:	1046
Add images to your visualizations	1047
Share your visualizations	1047
Troubleshoot image connections	1048
None of the images are displaying in my viz	1048
Some of the images aren't displaying in my viz	1049
The images aren't displaying outside of my worksheet	1050
Organize and Customize Fields in the Data Pane	1051
Organize the Data Pane	1051
Group by folder	1052
Create folders	1054
Add fields to folders	1054
Sort fields in the Data pane	1055
Find fields	1056
Search for a field	1057
Rename Fields	1058
Rename a field	1058
Revert to the Default Field Name	1059
Combine Fields	1059
Hide or Unhide Fields	1061
Add Calculated Fields to the Data Pane	1062
Edit Default Settings for Fields	1063
Set the default aggregation for a measure	1063

Add default comments for specific fields	1064
To add a default comment for a field	1064
Set the default number format	1065
Set the default color	1066
Set the default shape	1066
Set the default sort order for the values within a categorical field	1067
Create Aliases to Rename Members in the View	1067
Create an alias	1068
When the Alias option isn't available	1069
Measures can't be re-aliased	1069
Published data sources	1070
Convert Fields between Discrete and Continuous	1070
Convert measures	1070
Convert date fields	1070
Convert a Measure to a Dimension	1071
Convert a measure in the view into a discrete dimension	1071
Converting a measure in the Data pane into a dimension	1074
Create Hierarchies	1076
Create a hierarchy	1076
Drill up or down in a hierarchy	1077
Remove a hierarchy	1079
Group Your Data	1079
Create a group	1079
Create a group by selecting data in the view	1079
Create a group from a field in the Data pane	1080
Include an Other Group	1082
Edit a Group	1084

See also	1086
Color a View Using Groups	1086
Correct Data Errors or Combine Dimension Members by Grouping Your Data	1090
Create Sets	1092
Create a dynamic set	1092
Create a fixed set	1096
Add or remove data points from sets	1098
Use sets in the visualization	1098
Show In/Out members in a set	1098
Show members in a set	1101
Let users change set values	1101
Add a set action	1101
Show a set control in the view	1101
Combine sets	1102
Examples of sets	1104
Create the set	1104
Create the visualization	1105
Create a combined set	1106
Create the visualization	1109
Sets for Top N and Others	1113
Sets and supported data sources	1113
Step 1: Create the parameter	1114
Step 2: Create the top N customers set	1114
Step 3: Set up the view	1115
Step 4: Combine the Top N set with a dynamic parameter	1117
Additional tips for improving the view's functionality	1119
Create Parameters	1122

- Create a parameter 1122
- Edit a parameter 1126
 - Delete a parameter 1126
- Use a parameter 1126
 - Use a parameter in a calculation 1127
 - Use a parameter in a filter 1127
 - Use a parameter in a reference line 1128
- Show a parameter control in the viz 1128
- Make a dynamic parameter 1129
 - Parameter actions 1129
 - Dynamic current value 1129
- Troubleshoot parameters 1130
- Use Parameters to Make Views More Interactive 1131
 - Create the parameters 1131
 - Create the calculated fields 1133
 - Give viewers a way to interact with views 1134
 - Additional information 1135
- Example: Add a Parameter to a Map View 1136
 - Build a map view 1136
 - Create a calculated field to set a threshold 1140
 - Create a parameter 1141
 - Create and display the parameter control 1142
- Example: Swap Measures Using Parameters 1143
 - General steps 1143
 - Create the parameters 1143
 - Create calculated fields to change the measures in the view 1144
 - Set up the view 1145

Create calculated fields to change measures and specify aggregations	1146
Dates and Times	1149
Dates in Cube (Multidimensional) Data Sources	1149
Dates in Relational Data Sources	1149
Date Properties for a Data Source	1151
Date Property Options	1151
Default calendar	1151
Week start	1151
Fiscal year start	1152
Specific date fields	1152
Date format	1152
Day of the week sorting	1152
Supported date formats	1152
Change Date Levels	1153
Date level settings	1154
Use multiple date levels in the same viz	1157
Custom Dates	1160
Example - format column headers as Month, Day, Year	1161
Fiscal Dates	1162
Date Levels	1163
Perfect Pivoting with Dates	1164
Custom Date Formats	1165
How to find the custom date format field	1165
Format a date field in a view (Tableau Desktop)	1165
Format a date field in a view (Tableau Cloud and Tableau Server)	1167
Format a date field in the Data pane (Tableau Desktop only)	1167
Supported date format symbols	1168

Custom date format examples	1171
Support for Japanese era-based date formats	1172
Using literal text in a date format	1173
Format syntax in DATEPARSE function for extract data sources	1174
ISO-8601 Week-Based Calendar	1176
Set ISO-8601 as the default calendar	1177
Differences between ISO-8601 and Standard Gregorian calendars	1177
Date Functions that support ISO-8601	1178
DATEADD and DATEDIFF	1178
DATENAME	1178
DATEPART	1178
DATETRUNC	1179
Create a 4-4-5 calendar	1179
Step 1: Set up the visualization	1179
Step 2: Find the number of weeks in each quarter	1180
Step 3: Create the 4-4-5 calendar calculation	1181
Modify the pattern	1182
See Also	1182
Format Dates Using ISO-8601 Weeks and Years	1182
Sample format strings for the date December 31, 2013	1185
Continuous Dates	1186
Change the default	1186
See also	1187
Build Data Views from Scratch	1187
Start Building a Visualization by Dragging Fields to the View	1187
Different ways to start building a view	1187
Dragging basics	1188

Add headers	1190
Add axes	1192
Replace the Existing Axis	1192
Blend the Measures on Single Axis	1193
Add a Dual Axis	1194
Rearrange rows and columns	1194
Automatically add fields to the view with double-click	1195
Other resources	1199
Add Axes for Multiple Measures in Views	1201
Add individual axes for measures	1201
Blend axes for multiple measures into a single axis	1202
Compare two measures using dual axes	1204
Synchronize axes to use the same scale	1204
Synchronize axes with measures of different data types	1205
Customize the marks for a measure	1206
Tips	1208
Create a combo chart (assign different mark types to measures)	1208
Measure Values and Measure Names	1212
How you can use Measure Names and Measure Values	1212
The Measure Values card	1212
About Measure Names	1213
Create a visualization using Measures Names and Measure Values	1215
When Measure Names and Measure Values automatically get added to the view	1216
Blending Axes	1216
Using Show Me When Multiple Measures Are in the View	1217
How Measure Names and Measure Values work with Legends Per Measure ...	1219

Handling Null and Other Special Values	1219
Special values indicator	1219
Null numbers and dates, and negative values on log axes	1220
Hiding null values	1221
Unknown geographic locations	1221
Zero and negative values in treemaps	1221
Show or Hide Missing Values or Empty Rows and Columns	1223
Show missing values from a known range	1223
Toggle missing values	1223
Null vs Missing	1226
Show and Hide Empty Rows and Columns	1228
Use Show Me to Start a View	1229
Start a view based on fields that you select	1229
Create a Line Chart with Show Me	1232
Create a Scatter Plot with Show Me	1236
Add Detail	1238
Change the Type of Mark in the View	1238
Change the mark type	1238
Automatic mark	1240
Text	1240
Shape	1240
Bar	1241
Line	1242
Bar mark	1243
Line mark	1244
Area mark	1246
Square mark	1247

Circle mark	1248
Shape mark	1249
Text mark	1251
Map mark	1254
Pie mark	1256
Gantt Bar mark	1257
Polygon mark	1258
Density mark (Heatmap)	1259
Control the Appearance of Marks in the View	1261
Assign colors to marks	1262
Edit colors	1263
Change the size of marks	1263
Edit marks sizes	1265
Continuous axis mark sizing	1267
Add labels or text for marks	1269
Separate marks in the view by dimension members	1270
Add tooltips to marks	1271
Add a tooltip	1271
Tooltip options	1272
Change the shape of marks	1274
Edit shapes	1275
Use Custom shapes	1276
Tips for creating custom shapes	1280
Draw paths between marks	1281
Change the line type (linear, step, jump)	1281
Change the line pattern (solid, dashed, dotted)	1282
Create a path-encoded view	1283

Show, Hide, and Format Mark Labels	1284
Turn labels on or off	1284
Use a specific field as a label	1285
Change what labels appear	1285
Configure Marks to Label	1285
Show and hide individual mark labels	1287
Format mark labels	1287
Edit the label text	1288
Edit the label font	1288
Edit the label alignment	1288
Move mark labels manually	1289
Move Marks	1289
Example - Move marks forward	1289
Stack Marks	1291
Example: Stacking Bars	1291
Example: Stacking Lines	1292
Color Palettes and Effects	1293
Categorical Palettes	1293
Change the color for a value	1294
Select a different palette	1294
Quantitative Palettes	1295
Options for quantitative palettes	1297
Stepped Color	1297
Reversed	1297
Use Full Color Range	1298
Include totals	1298
Limit the color range	1298

Reset the color range	1299
Configure Color Effects	1299
Opacity	1299
Mark borders	1300
Mark halos	1302
Markers	1302
Example – Multiple Fields on Color	1303
Filter and Sort Data in the View	1308
Filter Data from Your Views	1308
Filtering Order of Operations	1309
Select to keep or exclude data points in your view	1309
Select headers to filter data	1310
Drag dimensions, measures, and date fields to the Filters shelf	1311
Filter categorical data (dimensions)	1312
Filter quantitative data (measures)	1314
Filter dates	1315
Filter table calculations	1318
Apply table calculation filter to totals	1318
Display interactive filters in the view	1319
Set options for filter card interaction and appearance	1321
Here are some of the general filter card options:	1321
Filter card modes	1322
For dimensions, you can choose from the following filter modes:	1323
For measures, you can choose from the following filter modes:	1324
Customize filter cards	1325
See Also	1327
Filter Data Across Multiple Data Sources	1328

- Before you start, you might want to know the following: 1329
- Step 1 Define relationships between your data sources 1329
- Step 2 Add a filter to the view 1330
- Step 3 Apply the filter to your worksheets 1330
 - Source fields and target fields 1332
 - Create Relative Date Filters 1333
- Step 1: Drag a date field to the filter shelf 1334
- Step 2: Select a time unit 1334
- Step 3: Define the date period 1335
- Step 4: Watch the view update 1336
 - Use Context Filters 1337
 - Create Context Filters 1337
 - Speed up Context Filters 1338
 - Example: Create Context Filters 1339
- Apply Filters to Multiple Worksheets 1342
 - Apply filters to all worksheets that use a related primary data source 1342
 - Apply filters to all worksheets that use the current primary data source 1343
 - Apply filters to select worksheets 1343
 - Apply filters to the current worksheet only 1344
 - Filter all worksheets on a dashboard 1345
- Sort Data in a Visualization 1345
 - Quickly sort from an axis, header, or field label 1345
 - Sort from an axis 1346
 - Sort from a header 1347
 - Sort from a field label 1347
 - Missing sort icons 1348
 - Sort options while authoring 1348

Sort from the toolbar	1348
Sort by drag and drop	1349
Sort specific fields in the viz	1350
Nested sorts	1350
Understanding “incorrect” sorts	1352
Clear sorts	1353
Remove the ability to sort	1353
Showcase Insights	1354
Show Totals in a Visualization	1354
Show grand totals	1354
In order to turn on grand totals:	1355
Options for calculating grand totals	1356
Grand totals and aggregations	1357
Show subtotals	1360
Move totals	1361
To move row totals to the left of the view:	1361
To move column totals to the top of the view:	1361
Configure total aggregation	1361
To configure all totals:	1361
To configure totals for a specific field:	1361
See Also	1362
Add Annotations	1362
Add an annotation	1362
Edit an annotation	1363
Rearrange an annotation	1364
To reposition the body	1365
To resize the body	1365

To resize the line	1365
To reposition the body:	1366
To resize the body:	1367
To move the line end point:	1367
To reposition the box	1368
To resize the box	1369
To reposition the text	1369
To resize the text width	1370
Format annotations	1370
Remove an annotation	1371
See Also	1371
Create Views in Tooltips (Viz in Tooltip)	1371
General steps to create a Viz in Tooltip	1372
Configure a Viz in Tooltip	1373
Create the source and target visualizations in a worksheet	1373
Insert a reference to the target worksheet in the source worksheet tooltip	1374
Change the size of the Viz in Tooltip	1377
Change the filter for the Viz in Tooltip	1378
Hide or show a Viz in Tooltip worksheet	1379
Hide a Viz in Tooltip worksheet	1379
Show a Viz in Tooltip worksheet	1380
Examples of Viz in Tooltip	1381
Tips and notes on using and configuring Viz in Tooltip	1385
Actions	1387
Types of actions	1387
Order of operations	1387
Filter Actions	1388

Create or edit a filter action	1388
Understanding available target fields	1392
Highlight Actions	1393
Legend Highlighting	1394
Turn on legend highlighting	1395
Turn off legend highlighting	1396
Legend highlighting in Tableau Desktop	1396
Highlight Data Points in Context	1397
Turn on highlighting	1398
Highlight Toolbar Button	1400
Create Advanced Highlight Actions	1402
See Also	1404
URL Actions	1404
Open a web page with a URL action	1405
Create an email with a URL action	1409
Using field and filter values in URLs	1410
Including aggregated fields	1411
Inserting parameter values	1412
Parameter Actions	1412
General steps for creating parameter actions	1413
Create a parameter action	1414
Examples of parameter actions	1417
Make reference lines dynamic	1418
Display a selective hierarchy	1423
Display summary data for selected marks	1429
Set Actions	1436
General steps for set actions	1437

Create a set action	1438
Examples of set actions	1441
Proportional brushing	1441
Asymmetric drill down	1448
Color scaling	1453
Relative dates	1457
Running Actions	1461
Actions and Dashboards	1462
Use a single view to filter other views in a dashboard	1462
Use multiple views to filter other views in a dashboard	1463
Navigate from one view to another view, dashboard, or story	1467
Interactively display a web page in a dashboard (Create in Tableau Desktop)	1469
Using Field and Filter Values in Action Names	1471
Build Common Chart Types in Data Views	1473
Create an Area Chart	1473
Build a Bar Chart	1475
Check your work: Watch steps 1-7 below	1481
One Step Further: Add Totals To Stacked Bars	1481
Other resources	1485
Build a Box Plot	1485
Check your work! Watch steps 1-10 below:	1492
Build a Bullet Graph	1492
Check your work! Watch steps 3 - 7 below:	1493
Swap reference line fields	1493
Edit the distribution	1494
Build with Density Marks (Heatmap)	1495
Build a Gantt Chart	1504

Check your work! Watch steps 1-14 below:	1511
Build a Highlight Table or Heat Map	1511
Modify the size to create a heat map	1515
Check your work! Watch steps 1-9 below:	1517
Build a Histogram	1518
Check your work! Watch steps 1–8 in action:	1526
Building Line Charts	1526
Check your work! Watch steps 1-7 below:	1534
Build a Packed Bubble Chart	1534
Check your work! Watch steps 1-7 below:	1540
Build a Pie Chart	1540
Check your work! Watch steps 1-4:	1544
Build a Scatter Plot	1544
Check your work! See steps 1-7 below:	1549
See Also	1549
Build a Text Table	1549
Check your work! Watch steps 1-8 below:	1557
Build a Treemap	1557
Check your work! Watch steps 1-7 below:	1561
Build a Combination Chart	1561
Build Advanced Chart Types	1567
Add a Calculated Column to a View	1567
Examples of when a calculation might be useful	1567
Combine first and last name	1567
Find a sequence inside a string	1569
Assign categories for value ranges	1570
Calculate percent change	1571

Follow along: create a YOY calculation	1572
Objective	1572
Create the necessary calculated fields	1573
Format the calculated fields	1574
Build the view	1574
Calculate Z-scores	1575
Visualize Key Progress Indicators	1577
Create a view that includes the field you want to assess	1578
Create a calculated field that establishes the threshold that demarcates success from failure	1578
Update the view to use KPI-specific shape marks	1579
Create a Pareto Chart	1581
Preparing for the analysis	1582
Create a bar chart that shows Sales by Sub-Category in descending order	1582
Add a line chart that also shows Sales by Sub-Category	1583
Add a table calculation to the line chart to show sales by Sub-Category as a run- ning total, and as a percent of total	1584
Create a Population Pyramid	1587
Create a Co-Occurrence Visualization Using a Parameter and a Set	1591
Create a Parameter	1591
Create Calculated Fields	1592
Create a Set	1592
Build the View	1593
Visualize Benford's Law	1594
Create calculated fields to use in your view	1594
Set up the view	1595
Create Bins from a Continuous Measure	1597

Create a Histogram from a Binned Dimension	1600
Build Data Views for Accessibility	1601
View controls that support accessibility	1601
Additional support for accessible views	1602
Additional resources	1603
Best Practices for Designing Accessible Views	1603
Keep it simple	1604
Titles and captions	1606
Additional text	1607
Color and contrast	1608
Publishing your view	1610
Author Views for Accessibility	1610
General steps	1610
Building the views	1610
Keep it simple	1611
Limit the number of marks in the view	1611
Orient your views for legibility	1614
Limit the number of colors and shapes in a view	1616
Use filters to reduce the number of marks in a view	1617
Show more text and make it helpful	1622
Font Size	1629
Edit alt text to make it more descriptive (Tableau Cloud and Tableau Desktop)	1630
Use color thoughtfully and provide contrast	1632
Dimension on Color	1632
Measure on Color	1633
Provide visual cues beyond color: position, size, and shape	1636

Putting it all together	1638
Walkthrough: The journey from less accessible to more accessible	1638
Step 1: Reduce the level of detail in the view.	1639
Step 2: Create a more aggregated view of the data.	1640
Step 3: Check the color palette settings.	1641
Step 4: Update and show text in the view.	1642
Step 5: Open the View Data window to the Summary tab.	1642
Publish and share the view	1643
Publishing to Tableau Public	1643
Turn off Web Edit permissions	1644
Share or embed the view	1645
Sample embed code	1645
About permissions	1646
Test the view	1646
Maps and Geographic Data Analysis in Tableau	1647
Start with these topics	1647
Get Started Mapping with Tableau	1647
Step 1: Connect to your geographic data	1647
Step 2: Join your data	1649
Step 3: Format your geographic data in Tableau	1651
Change the data type of a column	1651
Assign geographic roles to your geographic data	1652
Change from dimensions to measures	1653
Step 4: Create a geographic hierarchy	1656
Step 5: Build a basic map	1657
Step 6: Change from points to polygons	1658
Step 7: Add visual detail	1659

Add color	1660
Add labels	1660
Step 8: Customize your background map	1661
Step 9: Create custom territories	1663
Step 10: Create a dual axis map	1667
Step 11: Customize how others can interact with your map	1672
What's Next?	1672
Mapping Concepts in Tableau	1673
Why put your data on a map?	1673
When should you use a map to represent your data?	1673
What types of maps can you build in Tableau?	1675
Proportional symbol maps	1675
Choropleth maps (filled maps)	1676
Point distribution maps	1676
Density maps (heatmaps)	1677
Flow maps (path maps)	1678
Spider maps (origin-destination maps)	1679
Resources to help you get started	1680
Get your geographic data into Tableau	1680
Format your geographic fields	1681
See also	1681
The Mapping Workspace in Tableau	1681
The Data Pane	1682
The Marks Card	1684
The View Toolbar	1685
The Map Menu	1685
The Columns and Rows Shelves	1686

- The Map Visualization 1687
- See Also 1687
- Location Data that Tableau Supports for Building Map Views 1687
 - What to do if Tableau doesn't recognize your location data 1687
 - See Also 1688
 - Spatial File 1688
 - Before you connect 1688
 - Make the connection and set up the data source 1689
 - Spatial file data source example 1689
 - Work with the Geometry column 1690
 - About .tde and .hyper files in Tableau Desktop 1690
 - See also 1691
- Connect to Spatial Data in a Database 1691
 - Supported spatial data and SRIDs 1691
 - Connect to spatial columns 1692
 - Use Custom SQL and RAWSQL to perform advanced spatial analysis 1692
 - Connect to a Custom SQL query 1692
 - Custom SQL query examples 1693
- If your data has two sets of points, such as schools and parks, and you want to show where they intersect: 1693
- If you only want data around a certain point 1694
- If you get an error about mixed data types 1694
- If your data renders too slowly in Tableau 1695
 - Use RAWSQL 1695
- Troubleshooting spatial connections 1696
 - Performance issues 1696
 - Microsoft SQL Server error messages and solutions 1696

PostgreSQL + PostGIS, Oracle, and Pivotal Greenplum + PostGIS error messages and solutions	1698
Example - Build a map from Microsoft SQL Server spatial data	1699
Step 1: Connect	1699
Step 2: Build the map	1700
See Also	1703
Join Spatial Files in Tableau	1704
Join spatial files	1705
Troubleshoot spatial joins	1706
SQL Server error: Geometry is incompatible with geography	1706
Vertex ordering	1707
See Also:	1707
Spatial Parameters and Operators	1707
Spatial parameters	1707
Create a spatial parameter	1708
Visualize your spatial parameter	1708
Show a spatial parameter control on the viz	1709
Spatial operators	1709
Create a calculated field using a spatial operator	1709
Spatial operators available in Tableau	1710
DIFFERENCE	1710
INTERSECTION	1710
SYMDIFFERENCE	1710
UNION	1711
Geocode Locations Tableau Does Not Recognize and Plot Them on a Map	1711
Step 1: Create a CSV file with your location data	1712
Extend an Existing Role	1712

- Add New Roles 1714
 - Step 2 (Optional): Create a schema.ini file 1715
 - Step 3: Import custom geocoding files into Tableau Desktop 1715
- Where does Tableau store my custom geocoding data? 1716
- What happens to my custom geocoding data when I save my workbook? 1717
 - Step 4: Assign geographic roles to your fields 1717
 - See also 1718
- Create a schema.ini File 1718
 - To create a schema.ini file 1719
 - See also 1719
- Blend Geographic Data 1720
 - Step 1: Create a file that defines your geographic data 1720
 - Step 2: Connect to the data sources 1721
 - Step 3: Edit Relationships 1722
 - Step 4: Plot the data on a map view 1722
 - See also 1725
- Data Blending vs. Custom Geocoding 1725
 - Data Blending 1726
 - To blend geographic data 1726
 - Custom Geocoding 1727
 - See also 1727
- Assign Geographic Roles 1727
 - Assign a geographic role to a field 1728
 - Types of geographic roles in Tableau 1729
 - See also: 1730
- Edit Unknown or Ambiguous Locations 1731
 - Add more fields to view 1731

Edit locations in the Special Values menu	1731
Edit ambiguous locations	1732
Edit unknown locations	1733
Restrict Locations in the List	1735
See also:	1735
Build Maps in Tableau	1735
What type of map do you want to create?	1736
Simple Map	1736
Map from Spatial Files	1736
Proportional Symbol Map	1737
Point Distribution Map	1737
Heatmap (Density Map)	1738
Filled (Choropleth) Map	1738
Flow (Path) Map	1739
Origin-Destination Map	1739
Dual Axis (Layered) Map	1740
Filled Map with Pie Charts	1740
Build a Simple Map	1740
Build a simple point map	1741
Build a simple filled (polygon) map	1742
Build a heatmap (density map)	1743
See also:	1745
Create Tableau Maps from Spatial Files	1745
Where to find spatial files	1746
Connect to spatial files	1746
How Tableau interprets your spatial data	1747
The Geometry field	1747

- Join spatial data 1747
- Build a map view from spatial data 1747
 - Filter geometries to improve view performance 1748
 - Add levels of detail to the view 1749
- Customize the appearance of geometries 1750
 - Add color 1751
 - Hide polygon lines 1751
 - Specify which polygons or data points appear on top 1753
 - Adjust the size of data points 1754
- Build a dual-axis map from spatial data 1755
- See also 1759
- Create Geographic Layers for Maps 1759
 - Build a view using marks layers 1759
 - Add a marks layer 1759
 - Example: Working with mark layers 1760
 - Control mark selection in layers 1763
 - Disable mark selection 1763
 - Hide a layer 1763
 - Change layer settings 1764
 - Change layer order 1764
 - Rename layers 1765
 - Remove layers 1766
 - Add to Zoom Extent 1767
- Let users customize views with the Layer Control 1768
 - Enable the Layer Control 1769
 - Using the Layer Control 1770
 - Custom views with the Layer Control 1773

Create Maps that Show Quantitative Values in Tableau	1773
Your data source	1773
Basic map building blocks:	1774
Build the map view	1775
Point location and attribute meaning	1778
See Also:	1779
Create Maps that Highlight Visual Clusters of Data in Tableau	1779
Your data source	1780
Basic map building blocks	1780
Build the map view	1780
See also:	1783
Create Maps that Show Ratio or Aggregated Data in Tableau	1784
Your data source	1784
Basic map building blocks:	1785
Build the map view	1785
Add additional spatial context	1789
Note about color distribution	1790
Note about level of detail	1792
See also:	1792
Create Maps that Show a Path Over Time in Tableau	1792
Your data source	1793
Basic map building blocks:	1794
Build the map view	1794
See also:	1800
Create Heatmaps that Show Trends or Density in Tableau	1800
Your data source	1800
Basic map building blocks:	1801

Build the map view	1801
Adjust the appearance	1804
Create Maps that Show Paths Between Origins and Destinations in Tableau	1806
Example 1: Metro station traffic in Paris, France	1807
Set up your data source	1807
Basic map building blocks:	1809
Build the map view	1809
Filter the amount of information in the view	1813
Example 2: Bike share data in Seattle, Washington	1814
Set up your data source	1814
Basic map building blocks:	1816
Build the map view	1816
Filter the amount of information in the view	1819
See also:	1821
Create Dual-Axis (Layered) Maps in Tableau	1821
Create a dual-axis map from Tableau Latitude (generated) and Longitude (generated) fields	1822
Create a dual-axis map from custom latitude and longitude fields	1828
Create a dual-axis map from a combination of generated and custom latitude and longitude fields	1834
Best practices for creating dual-axis maps with two sets of latitude and longitude fields:	1834
Scenario 1: Use generated and custom latitude and longitude fields from a single data source	1835
Check your work! Watch steps 2 - 14 below:	1841
Scenario 2: Join spatial data with an independent data source and plot the data from both on the same map	1842
Check your work! Watch steps 1- 18 below:	1848

See Also	1848
Create Filled Maps with Pie Charts in Tableau	1848
Build the map view using layers	1850
Build the map view using a dual axis	1852
See also:	1854
Customize Maps	1854
Customize How Your Map Looks	1854
Select a Tableau background map style	1854
Import your own background map	1856
Add a static background image	1856
Show or hide map layers	1857
Add layers for U.S. demographic data	1861
Change the mark type	1862
Add levels of detail	1864
Add color	1865
Add labels	1866
Adjust the size of your data points	1867
Create custom tooltips	1869
See also:	1870
Create Territories on a Map	1870
Option 1: Select and group locations on a map	1871
Step 1: Select locations on the map to group into a territory	1872
Step 2: Create the first group (your first territory)	1872
Step 3: Continue grouping data to add territories	1873
Step 4: Add the group field to the view	1873
Option 2: Create a territory from a geographic field	1874
Change locations in your territory groups	1874

- Option 3: Geocode a territory field using another geographic field 1874
 - Step 1: Assign a geographic role to the territory field 1875
 - Step 2: Add the territory field to the view 1877
 - Blend custom territory data 1877
- Customize How People Interact with your Map 1878
 - Show a map scale 1878
 - Hide map search 1879
 - Hide the view toolbar 1879
 - Turn off pan and zoom 1879
 - See also: 1880
- Select Background Maps 1880
 - Change your background map: 1881
 - Change your default background map in Tableau Desktop (feature deprecated) 1881
 - Use the Offline background map 1881
- Use Mapbox Maps 1882
 - Add a Mapbox map to your workbook 1882
 - Create a map view using a Mapbox map 1883
 - Add or subtract map layers from the view 1884
 - See also: 1885
- Use Web Map Service (WMS) Servers 1885
 - Connect to a WMS server 1885
 - Save a WMS server as a Tableau map source 1885
 - Use a WMS background map 1886
 - Performance considerations 1887
 - Supported Spatial Reference Systems 1888
 - See also: 1890
- Save a Map Source 1890

See also:	1891
Import a Map Source	1891
See also:	1892
Explore Data in Maps	1892
Select marks, pan, and zoom	1893
Search for locations	1893
Find your current location	1893
Return to the initial view	1894
Search for Locations in Your Map	1895
Hide Map Search	1896
Measure Distances Between Data Points and Locations in a Map	1896
Step 1: Zoom in to an area or location	1897
Step 2: Select the Radial tool	1898
Measurement accuracy	1900
Change the units of measurement	1900
See also:	1901
Map Storing	1901
Use Background Images in Your Views	1901
Add background images to your workbook	1902
Build a view with a background image	1905
Edit a background image	1906
Enable or disable background images	1907
Add show and hide conditions to background images	1907
Remove a background image	1910
See Also	1911
Add Images of Google Maps and OpenStreetMap as Background Images in Tableau	1911

- Step 1: Find your map coordinates 1911
 - Option 1: Map data points onto Google Maps1911
 - Option 2: Map data points onto a map in OpenStreetMap 1912
- Step 2: Add your map image as a background image1912
- See also:1913
- Find Background Image Coordinates1913
 - Step 1: Create the coordinate table1914
 - Step 2: Connect to the coordinate table1915
 - Step 3: Import the background image 1915
 - Step 4: Find the coordinates1917
 - Other Ideas 1923
 - See also1924
- Add Viz Extensions to Your Worksheet1924
 - Add a Viz Extension to a worksheet 1924
 - Add a Viz Extension as a local file1924
 - Add a Viz Extension while authoring your viz1925
- Use the Marks card to encode your marks1927
- Ensure that extensions are allowed on Tableau Cloud1927
 - Data security, Network-enabled, and Sandboxed extensions1928
 - Allow or deny data access to a Network-enabled extension1928
 - Reset data access for your extension1928
- Ensure that JavaScript is enabled in Tableau Desktop1928
- Get support for Viz Extensions1928
- Analyze Data1929
 - Discover Insights Faster with Explain Data1929
 - Access to Explain Data1929
 - How Explain Data helps to augment your analysis1930

Get Started with Explain Data	1930
Run Explain Data on a dashboard, sheet, or mark	1931
Explain Data permissions required for seeing explanations	1933
Tips for using Explain Data	1933
Drill into explanations	1934
View analyzed fields	1934
Terms and concepts in explanations	1936
Explanation Types in Explain Data	1938
Explore underlying values	1938
Underlying Characteristics	1939
Extreme Values	1939
Visualize the Difference	1943
Null Values	1945
Number of Records	1946
Average Value of Mark	1948
Contributing Single Value	1950
Top Contributors	1953
Contributing Dimensions	1953
Contributing Measures	1955
Other things to explore	1957
Other Dimensions of Interest	1957
Requirements and Considerations for Using Explain Data	1959
What makes a viz a good candidate for Explain Data	1959
What data works best for Explain Data	1960
Situations where Explain Data is not available	1960
Control Access to Explain Data	1961
Who can access Explain Data	1962

Control who can use Explain Data and what they can see	1962
Editing mode	1962
Viewing mode	1963
Open the Explain Data Settings dialog box	1963
Include or exclude explanation types displayed by Explain Data	1964
Include or exclude fields used for statistical analysis	1965
Configure Tableau to allow users to share explanations via email and Slack	1966
How Explain Data Works	1967
What Explain Data is (and isn't)	1967
How explanations are analyzed and evaluated	1968
What is an expected range?	1968
Models used for analysis	1969
Analyzed Fields in Explain Data	1971
View fields analyzed by Explain Data	1972
To view fields used by Explain Data for statistical analysis	1973
Change fields used for statistical analysis	1974
To edit the fields used by Explain Data for statistical analysis	1975
Fields excluded by default	1977
Disable or Enable Explain Data for a Site	1978
Explore and Inspect Data in a View	1981
Select marks to highlight data points in the view	1981
Analyze selected marks using tooltips	1982
Highlight data by category in tooltips	1983
Explore data in maps	1984
Add analytics objects to the view (trend lines, forecasts, reference lines and bands)	1984
Compare marks data with recalculated lines	1985

Recalculated lines and highlight actions	1987
Use Data Details to see visualization information	1988
High visibility data quality warnings	1990
Fields can show upstream descriptions	1991
Zoom and Pan Views, and Select Marks	1992
Show or hide the view toolbar	1993
Zoom and pan	1994
Zoom in and out	1994
Zoom to a specific area	1994
Reset the view	1994
Pan a view	1994
Select marks	1995
Select individual or multiple marks	1995
Make rectangular selections	1996
Make radial selections	1996
Make lasso selections	1997
Undo and Redo	1998
Keyboard shortcuts	1998
Undo and Redo buttons	1998
I don't see the toolbar for these buttons	2000
Summary Card	2000
View Underlying Data	2001
Where you can open the View Data window	2002
Open View Data in a worksheet	2006
Open View Data in a viz for one or more marks	2007
Open View Data for the entire view	2007
Tableau Cloud and Tableau Server	2007

- Tableau Desktop 2008
 - Open View Data for the Data pane 2008
 - Open View Data in the Data Source page 2008
 - Customize the View Data window 2009
 - Download data from the View Data window 2013
 - Copy data from the View Data window 2014
 - Why can't I see the View Data icon? 2014
- Get Details About Fields and Sheets in a Workbook 2015
 - Display sheet details 2015
 - Display field details 2016
- Create Custom Fields with Calculations 2017
 - Get Started with Calculations in Tableau 2017
 - Why Use Calculated Fields 2017
 - Types of calculations 2018
 - Create a calculated field 2018
 - Use a calculated field in the view 2019
 - Step 1: Build the view 2019
 - Step 2: Add the calculated field to the view 2019
 - Edit a Calculated Field 2020
 - See Also 2021
 - Create a Simple Calculated Field 2021
 - Step 1: Create the calculated field 2022
 - Step 2: Enter a formula 2022
 - Check your work! Watch how to create a simple calculated field in action: 2022
 - See Also 2022
- Understanding Calculations in Tableau 2023
 - Why use calculations 2023

When to use calculations	2023
Types of Calculations in Tableau	2025
Basic expressions	2025
Row-level calculations	2027
Aggregate calculations	2028
Level of Detail (LOD) expressions	2030
Table calculations	2032
Continue to Choosing the Right Calculation Type on page 1	2036
See Also	2036
Choosing the Right Calculation Type	2036
Which calculation is right for your analysis?	2036
Basic expression or table calculation?	2037
Example:	2037
Basic expression or Level of Detail (LOD) expression?	2039
Example	2040
Table calculation or Level of Detail (LOD) expression?	2042
Table calculations only	2043
Example	2043
Continue to Tips for Learning How to Create Calculations on page 1	2045
Also in this series:	2045
Tips for Learning How to Create Calculations	2045
Also in this series:	2046
More calculations content:	2046
Functions in Tableau	2047
Number Functions	2047
Why use number functions	2047
Number functions available in Tableau	2047

ABS	2047
ACOS	2048
ASIN	2048
ATAN	2048
ATAN2	2049
CEILING	2049
COS	2049
COT	2050
DEGREES	2050
DIV	2051
EXP	2051
FLOOR	2051
HEXBINX	2052
HEXBINY	2052
LN	2053
LOG	2053
MAX	2053
MIN	2054
PI	2055
POWER	2056
RADIANS	2056
ROUND	2056
SIGN	2057
SIN	2057
SQRT	2058
SQUARE	2058
TAN	2058

ZN	2059
Create a number calculation	2059
See Also	2061
String Functions	2061
Why use string functions	2061
String functions available in Tableau	2062
ASCII	2062
CHAR	2062
CONTAINS	2062
ENDSWITH	2063
FIND	2063
FINDNTH	2064
LEFT	2064
LEN	2064
LOWER	2065
LTRIM	2065
MAX	2065
MID	2066
MIN	2067
PROPER	2068
REPLACE	2068
RIGHT	2069
RTRIM	2069
SPACE	2069
SPLIT	2069
STARTSWITH	2070
TRIM	2071

UPPER	2071
Create a string calculation	2071
SPLIT limitations by data source	2073
See Also	2074
Date Functions	2075
Gain familiarity with other date concepts	2075
Date functions available in Tableau	2075
DATE	2075
DATEADD	2076
DATEDIFF	2077
DATENAME	2077
DATEPARSE	2078
DATEPART	2079
DATETRUNC	2079
DAY	2080
ISDATE	2081
ISOQUARTER	2081
ISOWEEK	2081
ISOWEEKDAY	2082
ISOYEAR	2082
MAKEDATE	2082
MAKEDATETIME	2083
MAKETIME	2083
MAX	2084
MIN	2085
MONTH	2086
NOW	2086

QUARTER	2087
TODAY	2087
WEEK	2087
YEAR	2088
date_part	2088
The [start_of_week] parameter	2089
The date literal (#)	2089
Create a date calculation	2090
Type Conversion	2092
Why use type conversion functions	2092
Type conversion functions available in Tableau	2093
DATE	2093
DATETIME	2093
FLOAT	2094
INT	2094
MAKEDATE	2094
MAKEDATETIME	2095
MAKELINE	2095
MAKEPOINT	2096
MAKETIME	2096
STR	2097
Cast Boolean expressions	2097
Create a type conversion calculation	2097
See Also	2098
Logical Functions	2098
Why use logical calculations	2098
Logical functions and operators available in Tableau	2098

AND	2098
CASE	2099
ELSE	2100
ELSEIF	2101
END	2102
IF	2102
IFNULL	2103
IIF	2103
IN	2105
ISDATE	2105
ISNULL	2106
MAX	2106
MIN	2107
NOT	2108
OR	2109
THEN	2109
WHEN	2110
ZN	2111
Examples	2113
Create a logical calculation	2114
See Also	2115
Aggregate Functions in Tableau	2115
Why use aggregate functions	2115
Aggregate functions available in Tableau	2116
ATTR	2116
AVG	2116
COLLECT	2117

CORR	2117
COUNT	2118
COUNTD	2118
COVAR	2118
COVARP	2119
MAX	2120
MEDIAN	2121
MIN	2121
PERCENTILE	2122
STDEV	2122
STDEVP	2123
SUM	2123
VAR	2123
VARP	2123
Create an aggregate calculation	2123
Rules for aggregate calculations	2125
See also	2126
Pass-Through Functions (RAWSQL)	2126
RAWSQL Functions	2126
RAWSQL_BOOL("sql_expr", [arg1], ...[argN])	2127
Example	2127
RAWSQL_DATE("sql_expr", [arg1], ...[argN])	2127
Example	2127
RAWSQL_DATETIME("sql_expr", [arg1], ...[argN])	2127
Example	2127
RAWSQL_INT("sql_expr", [arg1], ...[argN])	2127
Example	2128

RAWSQL_REAL("sql_expr", [arg1], ...[argN])	2128
Example	2128
RAWSQL_SPATIAL	2128
Example	2128
RAWSQL_STR("sql_expr", [arg1], ...[argN])	2128
Example	2128
RAWSQLAGG_BOOL("sql_expr", [arg1], ...[argN])	2128
Example	2129
RAWSQLAGG_DATE("sql_expr", [arg1], ...[argN])	2129
Example	2129
RAWSQLAGG_DATETIME("sql_expr", [arg1], ...[argN])	2129
Example	2129
RAWSQLAGG_INT("sql_expr", [arg1,] ...[argN])	2129
Example	2129
RAWSQLAGG_REAL("sql_expr", [arg1,] ...[argN])	2129
Example	2130
RAWSQLAGG_STR("sql_expr", [arg1,] ...[argN])	2130
Example	2130
User Functions	2130
Why use user functions	2130
For embedding workflows in Tableau Cloud only	2131
User functions available in Tableau	2131
FULLNAME()	2131
ISFULLNAME	2132
ISMEMBEROF	2133
ISUSERNAME	2133
USERDOMAIN()	2134

USERNAME()	2134
USERATTRIBUTE	2135
USERATTRIBUTEINCLUDES	2136
Create a user calculation	2136
Before you begin	2138
Step 1: Create the users and groups	2138
Step 2: Create the visualization	2139
Step 3: Create the User Calculation	2144
Step 4: Add the user calculation to the Filters shelf	2145
Step 5: Test the calculation	2145
See Also	2146
Table Calculation Functions	2146
Why use table calculation functions	2146
Table calculation functions available in Tableau	2146
FIRST()	2146
Example	2146
INDEX()	2147
Example	2147
LAST()	2147
Example	2147
LOOKUP(expression, [offset])	2148
Example	2148
MODEL_EXTENSION functions	2149
MODEL_PERCENTILE(target_expression, predictor_expression(s))	2149
Example	2149
MODEL_QUANTILE(quantile, target_expression, predictor_expression(s))	2149
Example	2150

PREVIOUS_VALUE(expression)	2150
Example	2150
RANK(expression, ['asc' 'desc'])	2150
Example	2150
RANK_DENSE(expression, ['asc' 'desc'])	2151
RANK_MODIFIED(expression, ['asc' 'desc'])	2151
RANK_PERCENTILE(expression, ['asc' 'desc'])	2152
RANK_UNIQUE(expression, ['asc' 'desc'])	2152
RUNNING_AVG(expression)	2152
Example	2153
RUNNING_COUNT(expression)	2153
Example	2153
RUNNING_MAX(expression)	2153
Example	2154
RUNNING_MIN(expression)	2154
Example	2155
RUNNING_SUM(expression)	2155
Example	2155
SIZE()	2155
Example	2156
SCRIPT_functions	2156
TOTAL(expression)	2156
Example	2156
TOTAL(expression)	2159
Example	2159
WINDOW_CORR(expression1, expression2, [start, end])	2162
Example	2163

WINDOW_COUNT(expression, [start, end])	2163
Example	2163
WINDOW_COVAR(expression1, expression2, [start, end])	2163
Example	2164
WINDOW_COVARP(expression1, expression2, [start, end])	2164
Example	2164
WINDOW_MEDIAN(expression, [start, end])	2164
Example	2165
WINDOW_MAX(expression, [start, end])	2165
Example	2166
WINDOW_MIN(expression, [start, end])	2166
Example	2167
WINDOW_PERCENTILE(expression, number, [start, end])	2167
Example	2167
WINDOW_STDEV(expression, [start, end])	2167
Example	2168
WINDOW_STDEVP(expression, [start, end])	2168
Example	2168
WINDOW_SUM(expression, [start, end])	2168
Example	2169
WINDOW_VAR(expression, [start, end])	2169
Example	2169
WINDOW_VARP(expression, [start, end])	2169
Example	2169
Analytics Extension table calculation functions available in Tableau	2169
Model extension functions	2169
MODEL_EXTENSION_BOOL (model_name, arguments, expression)	2170

Example	2170
MODEL_EXTENSION_INT (model_name, arguments, expression)	2170
Example	2171
MODEL_EXTENSION_REAL (model_name, arguments, expression)	2171
Example	2171
MODEL_EXTENSION_STRING (model_name, arguments, expression)	2171
Example	2172
Script functions	2172
SCRIPT_BOOL	2172
Examples	2172
SCRIPT_INT	2172
Examples	2173
SCRIPT_REAL	2173
Examples	2173
SCRIPT_STR	2173
Examples	2174
Create a table calculation using the calculation editor	2174
Step 1: Create the visualization	2174
Step 2: Create the table calculation	2175
Step 3: Use the table calculation in the visualization	2176
Step 4: Edit the table calculation	2176
See Also	2177
Spatial Functions	2178
Spatial functions available in Tableau	2178
AREA	2178
BUFFER	2178
DIFFERENCE	2179

DISTANCE	2180
INTERSECTION	2180
INTERSECTS	2180
MAKELINE	2181
MAKEPOINT	2181
LENGTH	2182
OUTLINE	2182
SHAPETYPE	2182
SYMDIFFERENCE	2183
VALIDATE	2183
Use a spatial calculation	2183
Create a spatial data source using MAKEPOINT	2183
Create a visualization using MAKELINE	2185
Visualize an area with BUFFER	2186
Predictive Modeling Functions	2188
Why use predictive modeling functions	2188
Predictive modeling functions available in Tableau	2189
MODEL_PERCENTILE	2189
MODEL_QUANTILE	2189
Create a prediction calculation	2190
Step 1: Create a Visualization	2190
Step 2: Create the Calculated Field	2191
Step 3: Add the Prediction Calculation to the View	2191
Rules for Prediction Calculations	2192
Additional Functions	2193
REGEXP_REPLACE(string, pattern, replacement)	2193
REGEXP_MATCH(string, pattern)	2193

REGEXP_EXTRACT(string, pattern)	2194
REGEXP_EXTRACT_NTH(string, pattern, index)	2194
Hadoop Hive Specific Functions	2195
GET_JSON_OBJECT(JSON string, JSON path)	2195
PARSE_URL(string, url_part)	2195
PARSE_URL_QUERY(string, key)	2195
XPATH_BOOLEAN(XML string, XPath expression string)	2195
XPATH_DOUBLE(XML string, XPath expression string)	2195
XPATH_FLOAT(XML string, XPath expression string)	2196
XPATH_INT(XML string, XPath expression string)	2196
XPATH_LONG(XML string, XPath expression string)	2196
XPATH_SHORT(XML string, XPath expression string)	2196
XPATH_STRING(XML string, XPath expression string)	2197
Google BigQuery Specific Functions	2197
DOMAIN(string_url)	2197
GROUP_CONCAT(expression)	2197
HOST(string_url)	2197
LOG2(number)	2197
LTRIM_THIS(string, string)	2198
RTRIM_THIS(string, string)	2198
TIMESTAMP_TO_USEC(expression)	2198
USEC_TO_TIMESTAMP(expression)	2198
TLD(string_url)	2198
FORMAT() Function Workarounds in Tableau	2198
Tableau Functions (by Category)	2199
ABS	2199
ACOS	2199

ASIN	2200
ATAN	2200
ATAN2	2201
CEILING	2201
COS	2201
COT	2202
DEGREES	2202
DIV	2203
EXP	2203
FLOOR	2203
HEXBINX	2204
HEXBINY	2204
LN	2204
LOG	2205
MAX	2205
MIN	2206
PI	2207
POWER	2207
RADIANS	2208
ROUND	2208
SIGN	2209
SIN	2209
SQRT	2210
SQUARE	2210
TAN	2210
ZN	2211
ASCII	2211

CHAR	2211
CONTAINS	2212
ENDSWITH	2212
FIND	2212
FINDNTH	2213
LEFT	2213
LEN	2214
LOWER	2214
LTRIM	2214
MAX	2214
MID	2215
MIN	2216
PROPER	2217
REPLACE	2217
RIGHT	2218
RTRIM	2218
SPACE	2218
SPLIT	2219
STARTSWITH	2219
TRIM	2220
UPPER	2220
DATE	2221
DATEADD	2221
DATEDIFF	2222
DATENAME	2222
DATEPARSE	2223
DATEPART	2224

DATETRUNC	2224
DAY	2225
ISDATE	2226
ISOQUARTER	2226
ISOWEEK	2227
ISOWEEKDAY	2227
ISOYEAR	2227
MAKEDATE	2228
MAKEDATETIME	2228
MAKETIME	2229
MAX	2229
MIN	2230
MONTH	2231
NOW	2231
QUARTER	2232
TODAY	2232
WEEK	2233
YEAR	2233
date_part	2233
AND	2234
CASE	2235
ELSE	2236
ELSEIF	2237
END	2238
IF	2238
IFNULL	2239
IIF	2239

IN	2240
ISDATE	2241
ISNULL	2242
MAX	2242
MIN	2243
NOT	2244
OR	2244
THEN	2245
WHEN	2246
ZN	2247
ATTR	2248
AVG	2248
COLLECT	2248
CORR	2248
COUNT	2249
COUNTD	2249
COVAR	2250
COVARP	2250
MAX	2251
MEDIAN	2252
MIN	2253
PERCENTILE	2254
STDEV	2254
STDEVP	2254
SUM	2255
VAR	2255
VARP	2255

FULLNAME()	2255
ISFULLNAME	2256
ISMEMBEROF	2256
ISUSERNAME	2257
USERDOMAIN()	2258
USERNAME()	2258
USERATTRIBUTE	2259
USERATTRIBUTEINCLUDES	2259
FIRST()	2260
Example	2261
INDEX()	2261
Example	2261
LAST()	2261
Example	2262
LOOKUP(expression, [offset])	2262
Example	2263
MODEL_EXTENSION functions	2263
MODEL_PERCENTILE(target_expression, predictor_expression(s))	2264
Example	2264
MODEL_QUANTILE(quantile, target_expression, predictor_expression(s))	2264
Example	2264
PREVIOUS_VALUE(expression)	2264
Example	2265
RANK(expression, ['asc' 'desc'])	2265
Example	2265
RANK_DENSE(expression, ['asc' 'desc'])	2266
RANK_MODIFIED(expression, ['asc' 'desc'])	2266

RANK_PERCENTILE(expression, ['asc' 'desc'])	2266
RANK_UNIQUE(expression, ['asc' 'desc'])	2266
RUNNING_AVG(expression)	2267
Example	2267
RUNNING_COUNT(expression)	2267
Example	2268
RUNNING_MAX(expression)	2268
Example	2268
RUNNING_MIN(expression)	2268
Example	2269
RUNNING_SUM(expression)	2269
Example	2270
SIZE()	2270
Example	2270
SCRIPT_functions	2270
TOTAL(expression)	2270
Example	2271
TOTAL(expression)	2273
Example	2273
WINDOW_CORR(expression1, expression2, [start, end])	2276
Example	2277
WINDOW_COUNT(expression, [start, end])	2277
Example	2277
WINDOW_COVAR(expression1, expression2, [start, end])	2277
Example	2278
WINDOW_COVARP(expression1, expression2, [start, end])	2278
Example	2278

WINDOW_MEDIAN(expression, [start, end])	2278
Example	2279
WINDOW_MAX(expression, [start, end])	2279
Example	2280
WINDOW_MIN(expression, [start, end])	2280
Example	2281
WINDOW_PERCENTILE(expression, number, [start, end])	2281
Example	2281
WINDOW_STDEV(expression, [start, end])	2281
Example	2282
WINDOW_STDEVP(expression, [start, end])	2282
Example	2282
WINDOW_SUM(expression, [start, end])	2282
Example	2283
WINDOW_VAR(expression, [start, end])	2283
Example	2283
WINDOW_VARP(expression, [start, end])	2283
Example	2283
RAWSQL Functions	2284
RAWSQL_BOOL("sql_expr", [arg1], ...[argN])	2284
Example	2284
RAWSQL_DATE("sql_expr", [arg1], ...[argN])	2284
Example	2284
RAWSQL_DATETIME("sql_expr", [arg1], ...[argN])	2285
Example	2285
RAWSQL_INT("sql_expr", [arg1], ...[argN])	2285
Example	2285

RAWSQL_REAL("sql_expr", [arg1], ...[argN])	2285
Example	2285
RAWSQL_SPATIAL	2285
Example	2286
RAWSQL_STR("sql_expr", [arg1], ...[argN])	2286
Example	2286
RAWSQLAGG_BOOL("sql_expr", [arg1], ...[argN])	2286
Example	2286
RAWSQLAGG_DATE("sql_expr", [arg1], ...[argN])	2286
Example	2286
RAWSQLAGG_DATETIME("sql_expr", [arg1], ...[argN])	2287
Example	2287
RAWSQLAGG_INT("sql_expr", [arg1,] ...[argN])	2287
Example	2287
RAWSQLAGG_REAL("sql_expr", [arg1,] ...[argN])	2287
Example	2287
RAWSQLAGG_STR("sql_expr", [arg1,] ...[argN])	2287
Example	2288
AREA	2288
BUFFER	2288
DIFFERENCE	2289
DISTANCE	2289
INTERSECTION	2290
INTERSECTS	2290
MAKELINE	2291
MAKEPOINT	2291
LENGTH	2292

OUTLINE	2292
SHAPETYPE	2292
SYMDIFFERENCE	2293
VALIDATE	2293
Regular Expressions	2293
REGEXP_REPLACE(string, pattern, replacement)	2293
Example	2294
REGEXP_MATCH(string, pattern)	2294
Example	2294
REGEXP_EXTRACT(string, pattern)	2294
Example	2295
REGEXP_EXTRACT_NTH(string, pattern, index)	2295
Example	2295
Hadoop Hive Specific Functions	2295
GET_JSON_OBJECT(JSON string, JSON path)	2295
PARSE_URL(string, url_part)	2296
Example	2296
PARSE_URL_QUERY(string, key)	2296
Example	2296
XPath_BOOLEAN(XML string, XPath expression string)	2296
Example	2296
XPath_DOUBLE(XML string, XPath expression string)	2296
Example	2296
XPath_FLOAT(XML string, XPath expression string)	2296
Example	2297
XPath_INT(XML string, XPath expression string)	2297
Example	2297

XPATH_LONG(XML string, XPath expression string)	2297
Example	2297
XPATH_SHORT(XML string, XPath expression string)	2297
Example	2297
XPATH_STRING(XML string, XPath expression string)	2297
Example	2297
Google BigQuery Specific Functions	2298
DOMAIN(string_url)	2298
Example	2298
GROUP_CONCAT(expression)	2298
Example	2298
HOST(string_url)	2298
Example	2298
LOG2(number)	2298
Example	2298
LTRIM_THIS(string, string)	2298
Example	2298
RTRIM_THIS(string, string)	2299
Example	2299
TIMESTAMP_TO_USEC(expression)	2299
Example	2299
USEC_TO_TIMESTAMP(expression)	2299
Example	2299
TLD(string_url)	2299
Example	2299
Want to learn more about functions?	2299
See also	2299

Tableau Functions (Alphabetical)	2300
A	2300
ABS	2300
ACOS	2300
AND	2301
AREA	2301
ASCII	2302
ASIN	2302
ATAN	2303
ATAN2	2303
ATTR	2303
AVG	2303
B	2304
BUFFER	2304
C	2304
CASE	2304
CEILING	2305
CHAR	2306
COLLECT	2306
CONTAINS	2306
CORR	2307
COS	2308
COT	2308
COUNT	2308
COUNTD	2309
COVAR	2309
COVARP	2310

D	2310
DATE	2310
DATEADD	2311
DATEDIFF	2312
DATENAME	2312
DATEPARSE	2313
DATEPART	2314
DATETIME	2314
DATETRUNC	2314
DAY	2315
DEGREES	2316
DISTANCE	2316
DIV	2317
DOMAIN	2317
E	2317
ELSE	2317
ELSEIF	2318
END	2319
ENDSWITH	2320
ENDSWITH	2320
EXCLUDE	2320
EXP	2320
F	2321
FIND	2321
FINDNTH	2321
FIRST	2322
FIXED	2322

FLOAT	2322
FLOOR	2322
FULLNAME	2323
G	2323
GET_JSON_OBJECT	2323
GROUP_CONCAT	2323
H	2324
HEXBINX	2324
HEXBINY	2324
HOST	2325
I	2325
IF	2325
IFNULL	2325
IIF	2326
IN	2327
INCLUDE	2327
INDEX	2328
INT	2328
INTERSECTS	2328
ISDATE	2328
ISFULLNAME	2329
ISMEMBEROF	2329
ISNULL	2330
ISOQUARTER	2330
ISOWEEK	2331
ISOWEEKDAY	2331
ISOYEAR	2331

ISUSERNAME	2332
J	2332
K	2332
L	2332
LAST	2332
LEFT	2333
LEN	2333
LENGTH	2333
LN	2334
LOG	2334
LOG2	2334
LOOKUP	2334
LOWER	2335
LTRIM	2335
LTRIM_THIS	2335
M	2335
MAKEDATE	2335
MAKEDATETIME	2336
MAKELINE	2337
MAKEPOINT	2337
MAKETIME	2338
MAX	2338
MEDIAN	2339
MID	2339
MIN	2340
Model Extensions	2341
MODEL_PERCENTILE	2341

MODEL_QUANTILE	2341
MONTH	2342
N	2342
NOT	2342
NOW	2343
O	2343
OR	2343
OUTLINE	2344
P	2345
PARSE_URL	2345
PARSE_URL_QUERY	2345
PERCENTILE	2345
PI	2346
POWER	2346
PREVIOUS_VALUE	2346
PROPER	2346
Q	2347
Quarter	2347
R	2347
RADIANS	2347
RANK Table Calculation functions	2348
RAWSQL functions	2348
REGEXP functions	2348
REPLACE	2349
RIGHT	2349
ROUND	2349
RTRIM	2350

RTRIM_THIS	2350
RUNNING Table Calculation functions	2350
S	2351
SCRIPT Analytics Extensions	2351
SHAPETYPE	2351
SIGN	2351
SIN	2352
SIZE	2352
SPACE	2352
SPLIT	2353
SQRT	2353
SQUARE	2354
STARTSWITH	2354
STDEV	2354
STDEVP	2355
STR	2355
SUM	2355
T	2355
TAN	2355
THEN	2356
TIMESTAMP_TO_USEC	2357
TLD	2357
TODAY	2357
TOTAL	2357
TRIM	2358
U	2358
UPPER	2358

USEC_TO_TIMESTAMP	2358
USERDOMAIN	2358
USERNAME	2359
USER ATTRIBUTE JSON web token functions	2360
V	2360
VAR	2360
VARP	2360
W	2360
WEEK	2360
WHEN	2361
Window Table Calcs	2362
X	2362
XPATH functions.	2362
Y	2363
YEAR	2363
Z	2363
ZN	2363
See also	2364
Transform Values with Table Calculations	2364
What is a table calculation?	2364
The basics: addressing and partitioning	2365
Table (across)	2366
Table (down)	2366
Table (across then down)	2367
Table (down then across)	2368
Pane (down)	2369
Pane (across then down)	2370

Pane (down then across)	2370
Cell	2371
Specific Dimensions	2371
At the level	2372
Create a table calculation	2373
Step 1: Build the visualization	2373
Step 2: Add the table calculation	2374
Check your work!	2375
Edit a table calculation	2375
Remove a table calculation	2375
See Also	2375
Table Calculation Types	2376
Difference From calculation	2376
Example	2376
Moving calculation	2378
Example	2378
Add Secondary Calculation	2380
Percent Difference From calculation	2380
Example	2381
Percent From calculation	2382
Example	2383
Percent of Total calculation	2384
Example	2384
Percentile calculation	2386
Example	2386
Descending vs. Ascending	2388
Rank calculation	2388

Example	2388
Descending vs. Ascending	2389
Rank Type	2389
Running Total calculation	2390
Create the Basic View	2391
Add a Running Total table calculation to the basic view	2392
The Running Total doesn't have to be a sum	2393
Restarting every option	2393
Restarting every can be useful in the following situations:	2393
Add Secondary Calculation	2395
See Also	2397
Quick Table Calculations	2397
How does a quick table calculation differ from a table calculation?	2398
Apply a quick table calculation to the visualization	2398
Step 1 Set up the visualization	2398
Step 2 Apply the quick table calculation	2400
Step 3 (Optional) Customize the quick table calculation	2401
See Also	2403
Customize Table Calculations	2403
Customizing a Table Calculation Using Its Context Menu	2403
Customizing a Table Calculation Using the Calculation Editor	2403
Nested Table Calculations	2404
Create Level of Detail Expressions in Tableau	2405
How to create LOD expressions	2406
Step 1: Set up the Visualization	2406
Step 2: Create the LOD expression	2407
Step 3: Use the LOD expression in the visualization	2408

Use a Quick LOD expression	2409
LOD expression syntax	2410
{ }	2410
[FIXED INCLUDE EXCLUDE]	2410
FIXED	2410
INCLUDE	2411
EXCLUDE	2411
Table-scoped	2411
<dimension declaration>	2412
: (a colon)	2412
<aggregate expression>	2413
Types of LOD expressions	2413
FIXED	2413
Example	2413
INCLUDE	2415
Example 1	2415
Example 2	2416
EXCLUDE	2418
Example 1	2418
Example 2	2419
Table-Scoped	2420
See Also	2421
How Level of Detail Expressions Work in Tableau	2421
Row Level Expressions and View Level Expressions	2421
Limitations for Level of Detail Expressions	2423
Level of Detail Expressions Can Be Dimensions or Measures	2423
Filters and Level of Detail Expressions	2423

Aggregation and Level of Detail Expressions	2425
Level of Detail Expression is Coarser Than View Level of Detail	2425
Level of Detail Expression is Finer Than View Level of Detail	2426
Adding a Level of Detail Expression to the View	2426
Data Source Constraints for Level of Detail Expressions	2427
See Also	2429
Table-Scoped Level of Detail Expressions	2429
FIXED Level of Detail Expressions	2430
Example 1	2430
Step-by-Step	2430
Example 2	2433
INCLUDE Level of Detail Expressions	2435
Example 1	2435
Example 2	2437
EXCLUDE Level of Detail Expressions	2439
EXCLUDE	2440
Example 1	2440
Example 2	2442
Example 3	2443
Level of Detail Expressions and Aggregation	2444
Level of Detail Expression is Coarser Than View Level of Detail	2444
Level of Detail Expression is Finer Than View Level of Detail	2445
Adding a Level of Detail Expression to the View	2446
Filters and Level of Detail Expressions	2447
Data Source Constraints for Level of Detail Expressions	2448
Formatting Calculations in Tableau	2449
Calculation building blocks	2450

Example calculation explained	2450
At a glance: calculation syntax	2451
Calculation syntax in detail	2452
Function syntax	2452
Use the calculation editor reference pane	2452
Using multiple functions in a calculation	2453
Field syntax	2453
Operator syntax	2454
+ (addition)	2454
- (subtraction)	2455
* (multiplication)	2455
/ (division)	2455
% (modulo)	2455
==, =, >, <, >=, <=, !=, <> (comparisons)	2455
^ (power)	2456
AND	2456
OR	2456
NOT	2456
Other Operators	2456
Operator precedence	2456
Parentheses	2457
Literal expression syntax	2457
Numeric Literals	2458
String Literals	2458
Date Literals	2458
Boolean Literals	2458
Null Literals	2458

Add parameters to a calculation	2458
Add comments to a calculation	2459
Understanding data types in calculations	2459
String	2460
Date/Datetime	2460
Number	2460
Boolean	2460
See Also	2461
Best Practices for Creating Calculations in Tableau	2461
General Rule: Avoid using a calculated field multiple times in another calculation	2461
Example	2461
Tip 1: Convert multiple equality comparisons to a CASE expression or a group	2462
Solution 1	2462
Solution 2	2463
Tip 2: Convert multiple string calculations into a single REGEXP expression	2463
Example 1: CONTAINS	2463
Solution	2464
Example 2: STARTSWITH	2464
Solution	2464
Example 3: ENDSWITH	2465
Solution	2465
Tip 3: Manipulate strings with REGEXP instead of LEFT, MID, RIGHT, FIND, LEN	2465
Example 1	2465
Solution	2466
Example 2	2466

Solution	2466
Tip 4: Do not use sets in calculations	2466
Example	2466
Solution 1	2467
Solution 2	2467
Tip 5: Do not use sets to group your data	2467
Solution	2468
See Also	2468
Tips for Working with Calculated Fields in Tableau	2468
Drag and drop fields into the calculation editor	2468
Drag and drop formulas from the calculation editor to the Data pane	2469
Use the functions reference in the calculation editor	2469
Take advantage of auto-complete for formulas	2470
Drag table calculations into the calculation editor to edit them	2471
Resize text in the calculation editor	2471
See which sheets are using a calculated field	2472
Format numbers and dates	2472
Ad-Hoc Calculations	2472
Create an Ad-Hoc Calculation	2473
Multi-Line Ad-Hoc Calculations	2474
Ad-Hoc Calculations and Aggregation	2474
Ad-Hoc Calculations for Insight and Experimentation	2474
Managing Ad-Hoc Calculations	2475
Example - Spotighting Using Calculations	2475
Spot Trends	2477
Reference Lines, Bands, Distributions, and Boxes	2477
Types of Reference Lines, Bands, Distributions, and Boxes	2477

Add a Reference Line	2481
Add Reference Bands	2488
Add Reference Distributions	2493
Add a Bullet Graph	2495
Add a Box Plot	2498
Box Plot Alternatives: Show Me Vs. Add Reference Line, Band, or Box	2501
Edit Existing Reference Lines, Bands, and Distributions	2502
Remove Reference Lines, Bands, or Distributions	2502
Add Trend Lines to a Visualization	2503
Add trend lines to a view	2503
About adding trend lines (and when you can't add them)	2503
Edit a trend line	2504
Choose which fields to use as factors in the trend line model	2505
Remove Trend Lines	2508
See a description of a trend line or trend line model	2508
Trend Line Model Types	2510
Linear	2510
Logarithmic	2510
Exponential	2511
Power	2511
Polynomial	2511
Trend Line Model Terms	2512
Model formula	2512
Number of modeled observations	2512
Number of filtered observations	2512
Model degrees of freedom	2512
Residual degrees of freedom (DF)	2512

SSE (sum squared error)	2512
MSE (mean squared error)	2513
R-Squared	2513
Standard error	2513
p-value (significance)	2514
Analysis of Variance	2514
Individual trend lines	2514
Terms	2514
Value	2514
StdErr	2514
t-value	2514
p-value	2514
Assess Trend Line Significance	2515
Entire Model Significance	2515
Significance of Categorical Factors	2516
Trend Line Assumptions	2517
Assumptions Required to Compute Trend Lines	2517
Commonly Asked Questions About Trend Lines	2518
How do I change the confidence level used in the model?	2518
What does it mean if the p-value for the model is significant but the p-value for the specific field in the Analysis of Variance table is not significant?	2518
What does it mean if the p-value for the specific field in the Analysis of Variance table is significant but the p-value for the model is not significant?	2518
Drop Lines	2518
Find Clusters in Data	2520
Create clusters	2520
Clustering constraints	2523

Edit clusters	2523
Create a group from cluster results	2526
Constraints on saving clusters as groups	2527
Refit saved clusters	2527
How clustering works	2529
The clustering algorithm	2529
Criteria used to determine the optimal number of clusters	2532
What values get assigned to the "Not Clustered" category?	2532
Scaling	2533
Information on statistics models used for clusters	2533
Describe Clusters – Summary Tab	2533
Inputs for Clustering	2533
Summary Diagnostics	2534
Cluster Statistics	2534
Describe Clusters – Models Tab	2535
F-statistic	2535
p-value	2535
Model Sum of Squares and Degrees of Freedom	2535
Error Sum of Squares and Degrees of Freedom	2535
Example: Create clusters using World Economic Indicators data	2536
The objective	2536
Finding the right countries/regions	2536
Forecasting	2545
Forecasting Constraints	2545
How Forecasting Works in Tableau	2546
Overview	2546
Exponential Smoothing and Trend	2546

Seasonality	2547
Model Types	2549
Forecasting with Time	2550
Granularity and Trimming	2550
Getting More Data	2551
Create a Forecast	2552
Prediction Intervals	2553
Enhancing Forecasts	2554
Forecasting When No Date is in the View	2556
Forecast Field Results	2556
Forecasting a New Measure	2558
Changing the Forecast Result Type	2558
Configure Forecast Options	2558
Forecast Length	2559
Source Data	2559
Forecast Model	2560
Constraints on Multiplicative Models	2561
Prediction Interval	2561
Forecast Summary	2562
Forecast Descriptions	2562
Describe Forecast – Summary Tab	2563
Options Used To Create Forecasts	2563
Forecast Summary Tables	2563
Describe Forecast – Models Tab	2564
Model	2564
Quality Metrics	2564
Smoothing Coefficients	2566

Troubleshooting Forecasting	2567
Null Forecasts	2567
Resolving Forecasting Errors	2568
Predictive Modeling	2571
How Predictive Modeling Functions Work in Tableau	2571
Predictive modeling functions available in Tableau	2572
MODEL_PERCENTILE	2572
MODEL_QUANTILE	2572
The power of predictive modeling functions	2573
Syntax of predictive modeling functions in detail	2575
What is MODEL_QUANTILE?	2575
What is MODEL_PERCENTILE?	2575
What's being computed?	2576
What models are supported?	2577
Choosing your predictors	2577
Recommendations	2577
Limitations	2578
When will prediction calculations break?	2578
FAQ	2578
What about marks in multiple predictor-groups?	2578
What if ATTR Aggregation returns a * value?	2579
What about the "Compute Using" table calculation menu options?	2579
Why am I getting an error?	2579
Choosing a Predictive Model	2579
Supported models	2579
Linear regression	2579
Example:	2580

Regularized linear regression	2580
Example:	2580
Gaussian process regression	2580
Example:	2581
Choosing Predictors	2581
Measures as predictors	2582
Coefficient of determination, or R-squared value	2583
Dimensions as predictors	2586
Comparing R-squared values across predictors	2587
Building your predictive modeling function	2588
Compute Using and Data Partitioning in Predictive Modeling	2592
Recommendations for predictive modeling functions	2594
Choosing dimensions	2594
A note on partitioning	2595
What's going on?	2597
Example - Explore Female Life Expectancy with Predictive Modeling Functions	2601
Using MODEL_PERCENTILE	2602
Step 1: Create the prediction calculation	2602
Step 2: Add the prediction calculation to the view	2603
Step 3: Group the results by color	2604
Step 4: Compare life expectancy with birth rate	2606
Using MODEL_QUANTILE	2609
Step 1: Create the prediction calculations	2609
Step 2: Add the prediction calculation to the view	2610
Step 3: Add a prediction with a second predictor	2611
Step 4: Compare actual values to predicted values	2611
Predictive Modeling Functions in Time Series Visualizations	2613

Step 1: Create a visualization	2613
Step 2: Create a prediction calculation	2614
Step 3: Add the prediction calculation to the view	2615
Step 4: Extend the date range and densify the data	2616
Predictive Modeling with Generated Marks	2617
Calculate predictions on missing values	2618
Example of predictions on generated marks	2621
Illustration 1	2621
Illustration 2	2622
Illustration 3	2623
Regularization and Augmentation in Predictive Modeling	2623
Which models work with regularization and augmentation?	2623
What is regularization?	2624
What is augmentation?	2624
Configuring lambda and augmentation in your calculation	2625
Considerations for regularization and augmentation	2625
Example 1	2626
Example 2	2627
Resolve Errors in Predictive Modeling Functions	2628
General errors	2629
Gaussian process regression errors	2629
Invalid Compute Using dimension	2629
Dimension predictors conflict with level of detail visualized	2630
Multiple predictors conflict with each other	2631
There's not enough data to build a model	2631
A successful model couldn't be constructed from the data provided	2631
Gaussian process regression requires exactly one ordered dimension predictor	2632

- Gaussian process regression only supports dimensions as predictors 2633
- There's no training data for one or more prediction targets 2634
- There are more than 5,000 marks 2634
- Integrate Einstein Discovery Predictions in Tableau 2634
 - What is Einstein Discovery? 2634
 - Requirements for access 2635
 - Salesforce Requirements 2635
 - Tableau Requirements 2636
 - Analytics extension support for Einstein Discovery predictions 2637
 - Access Einstein Discovery predictions in Tableau calculated fields 2637
 - Einstein Discovery dashboard extension in Tableau 2638
 - Explore Predictions in Tableau with the Einstein Discovery Dashboard Extension . 2639
 - Use the Einstein Discovery dashboard extension 2640
 - How to read Einstein Discovery predictions 2641
 - Add and configure the Einstein Discovery dashboard extension 2642
 - Prepare the model and the workbook 2643
 - Configure the extension 2647
 - Troubleshoot field mapping 2652
- Pass Expressions with Analytics Extensions 2653
 - Configure an analytics extension 2653
 - Using Analytics Extensions in Web Authoring 2654
- Einstein Discovery 2655
 - Integrate Einstein Discovery models into Tableau 2655
 - Embed a prediction in a calculation 2656
 - Embed a prediction in a Tableau Table Extension 2658
 - Add optional parameters to the script generated by Model Manager 2658
- RServe 2661

Implementing RServe connections	2661
Intermediate certificate chain for RServe analytics extension	2661
MATLAB	2661
TabPy	2661
SCRIPT functions for expressions	2662
Directly query external analytics models	2663
Parts of the MODEL_EXTENSION function	2664
Custom Functions Explorer for deployed models	2664
Use the Custom Functions Explorer in Tableau Desktop	2665
Share a workbook that requires an analytics extension connection	2666
Publish a workbook that requires an analytics extension connection	2666
Troubleshooting Analytics Extensions Connections	2667
Errors that can occur when communicating with any analytics extension	2667
Errors that can occur only with an Rserve Server	2671
Other issues	2674
SCRIPT functions run even in logical statements that evaluate as false	2674
Integrate External Actions	2674
About Salesforce Flow	2674
How External Actions work	2675
Ways to use External Actions workflows	2675
Best practices for External Actions workflow authors	2676
Create a workflow	2677
Use a workflow	2679
Troubleshoot a workflow	2679
Access issues	2679
Authentication issues	2680
Error messages	2680

Flow issues	2681
Licensing issues	2682
Turn External Actions On or Off	2682
Table Extensions	2682
Benefits	2682
Prerequisites	2682
Create a Table Extension	2683
Compare extension types	2685
Dashboard Extensions	2685
Table Extensions	2685
Analytics Extensions	2686
Calculate Percentages in Tableau	2686
About percentages	2686
1. The data to which you compare all percentage calculations	2686
2. The aggregation	2687
Example	2687
How to calculate percentages	2689
Percentage options	2689
Percent of Table	2690
Percent of Column	2690
Percent of Row	2691
Percent of Pane	2692
Percent of Row in Pane	2692
Percent of Column in Pane	2693
Percent of Cell	2694
See Also	2695
Dashboards	2697

Best Practices for Effective Dashboards	2697
What's your goal?	2697
Know your purpose and audience	2697
Leverage the most-viewed spot	2697
Design for the real world	2698
Author at your final display size	2698
Limit the number of views	2699
Add interactivity to encourage exploration	2700
Show filters	2700
Enable highlighting	2701
Create a Dashboard	2703
Create a dashboard, and add or replace sheets	2703
Add interactivity	2704
Add dashboard objects and set their options	2705
Add an object	2706
Copy objects	2706
Set options for objects	2708
Detailed options for Image objects	2709
Detailed options for Navigation and Download objects	2710
Show and hide objects by clicking a button	2711
How hidden objects affect layouts	2712
Add and configure a Show/Hide button	2712
Security for Web Page objects	2713
Use HTTPS protocol when possible	2713
Security options for Web Page objects (Tableau Desktop only)	2714
Explore Dashboards with Data Guide	2714
Customize Data Guide as an author	2715

- Explore Data Guide as a dashboard user 2715
- Explore Data Guide at different levels 2716
 - Understand dashboard-level details 2716
 - Understand viz-level details 2717
 - Understand mark-level details 2719
- Control Data Guide visibility 2721
- Use Accelerators to Quickly Visualize Data 2721
 - Where to find Accelerators 2721
 - On the Tableau Exchange website 2722
 - In Tableau Desktop 2722
 - In Tableau Cloud 2722
 - Use an accelerator from the Tableau Exchange 2723
 - Add your data to the Accelerator in Tableau Desktop 2723
 - Use the data mapper 2723
 - Manually add your data 2726
 - Method 1: Replace the data source 2727
 - Fix broken references 2729
 - Method 2: Edit the data source 2730
 - Use an Accelerator directly in Tableau Cloud 2732
 - Change permissions to share Accelerators with colleagues 2732
 - Replace sample data with your data 2733
 - Fix grayed-out views by replacing field names 2733
 - Fix empty dashboards by changing default date ranges 2734
- Build an Accelerator for the Tableau Exchange 2735
 - Who can build an Accelerator 2735
- Use Dynamic Axis Ranges 2736
 - Supported field types 2736

Configure a dynamic axis range	2737
Understand limitations and edge cases	2737
Use Dynamic Axis Titles	2737
Supported field types	2738
Configure a dynamic axis title	2738
Understand limitations and edge cases	2738
Use Dynamic Zone Visibility	2739
Supported field types	2739
Configure a dynamic dashboard zone	2739
Size and Lay Out Your Dashboard	2742
Control overall dashboard size	2742
Dashboard size options	2742
Set overall dashboard size	2743
Group items using layout containers	2744
Layout container types	2744
Add a layout container	2745
Evenly distribute a layout container's items	2747
Automatically resize sheets in layout containers	2748
Remove a layout container to independently edit items it contains	2750
Tile or float dashboard items	2750
Tiled vs. floating layouts	2750
Float or tile a new item	2751
Switch an existing item from tiled to floating	2752
Size, position, reorder, and rename individual dashboard items	2752
Set an item's size and position	2752
Align items with a grid	2753
Reorder objects	2754

- Reorder any object in Tableau Cloud or Tableau Server 2754
- Reorder floating objects in Tableau Desktop 2754
- Rename items 2755
- Add padding, borders, and background colors around items 2756
- Visually integrate elements with transparency 2758
 - Make worksheet backgrounds transparent 2759
 - More steps for transparent maps 2759
 - Make a sheet partially transparent 2760
 - Float transparent legends, filters, highlighters, and parameters 2760
- Refine Your Dashboard 2761
 - Is everything in the right spot? 2762
 - Confirm placement 2762
 - Check label orientation and readability 2762
 - Review sizing and layout 2763
 - Test your work and adjust sizing 2763
 - Customize image display (Tableau Desktop only) 2764
 - Use a layout container 2765
 - Buy space with a floating layout 2769
 - Highlight the essentials 2771
 - Show just what your users need 2771
 - Eliminate clutter 2773
- Create a Sheet Selection Menu for a Dashboard 2774
- Rebrand a Dashboard 2781
 - Change the fonts and font color of your titles 2781
 - Change the marks colors 2782
 - Customize your tooltips 2784
 - Add an image or logo 2786

Create Dashboard Layouts for Different Device Types	2788
How the Default dashboard relates to device layouts	2789
Phone layouts and the Default dashboard	2789
Desktop and Tablet layouts and the Default dashboard	2790
Automatically add phone layouts	2790
Preview and manually add device layouts	2791
Customize a device layout	2793
Optimize for phones	2797
Optimize manual phone layouts	2797
Add links that trigger instant messages and phone calls	2797
Create phone-specific versions of views	2797
Shorten titles	2799
Optimize white space	2799
Publish the dashboard	2799
Test the dashboard	2800
Confirm which layout a device will display	2800
Build Accessible Dashboards	2802
Dashboard keyboard navigation and focus order	2803
Create accessible dashboards	2803
Walkthrough: make existing dashboards more accessible	2804
Format for accessibility at the dashboard and workbook level	2806
Aggregate and reduce marks	2808
Eliminate redundant information	2810
Use color and shape to differentiate marks	2810
Use filters to reduce the number of marks in a view	2815
Add captions and legends	2819
Publish and embed the dashboard	2821

- Manage Sheets in Dashboards and Stories 2822
 - Hide and show sheets 2822
 - What sheets can I hide? 2822
 - Hide or unhide all sheets 2822
 - Hide an individual sheet 2823
 - Unhide an individual sheet 2824
 - Navigate between sheets, dashboards, and stories 2825
 - Go from a dashboard or story to a sheet it contains 2825
 - Go from a sheet to related dashboards and stories 2826
- Use Dashboard Extensions 2827
 - Add an extension to a dashboard 2827
 - Configure a dashboard extension 2828
 - Reload a dashboard extension 2828
 - Data security, Network-enabled, and Sandboxed extensions 2829
 - Allow or deny data access to a Network-enabled extension 2829
 - Ensure that JavaScript is enabled in Tableau Desktop 2830
 - Ensure that extensions run on Tableau Cloud or Tableau Server 2830
 - Supported web browsers for Sandboxed extensions 2830
 - Supported versions of Tableau Server for Sandboxed extensions 2830
 - Get support for dashboard extensions 2830
- Stories 2833
 - The Story Workspace 2833
 - Best Practices for Telling Great Stories 2835
 - What's your story's purpose? 2835
 - The seven types of data stories 2835
 - Keep it simple 2837
 - Use 'Fit to' in your dashboards 2838

Plan for fast load times	2839
Create a Story	2840
Create a story point	2840
Explore layout options	2843
Format a story	2844
Resize captions (Tableau Desktop only)	2844
Fit a dashboard to a story	2844
Format a story's shading, title, and text objects (Tableau Desktop only)	2845
Clear all formatting (Tableau Desktop only)	2846
Delete a story point	2847
Present your story	2847
Example - A Story That Examines a Trend	2848
Frame the story	2848
Build the story	2848
Create a story worksheet	2848
State the question	2849
Start big	2850
Drill down	2853
Highlight outliers	2855
Show a trend	2857
Offer your analysis	2859
Answer the question	2860
Create a Tableau Data Story (English Only)	2862
Understand how Data Stories handles data	2862
Learn about how Data Stories are written	2863
Manage Data Stories for your site	2863
Add a Tableau Data Story to a Dashboard	2863

Choose the Right Story Type for Your Tableau Data Story	2868
Continuous	2868
Discrete	2869
Percent of whole	2870
Scatter plot	2870
Configure Settings for a Tableau Data Story	2871
Configure Tableau Data Story Settings: Analytics	2872
Configure analytics for your story	2872
Understand different types of analytics	2872
Correlation	2872
Clustering	2873
Distribution	2873
Segments	2873
Trend line	2873
Volatility	2874
Break down how analytics are used to generate stories	2874
Understand analytics for discrete stories	2874
Understand analytics for discrete stories	2876
Understand analytics for scatter plot stories	2877
Understand analytics for percent of whole stories	2878
Configure Tableau Data Story Settings: Characteristics	2879
Use dimension and measure characteristics	2879
Learn more about measure characteristics	2880
Formatting	2880
Content	2880
Sorting	2881
Configure Tableau Data Story Settings: Display	2881

Configure the display for your story	2882
Understand when to use story display settings	2882
Configure Tableau Data Story Settings: Drivers	2882
Set dimension drivers	2883
Understand dimension driver types	2883
Use secondary contributors	2883
Set metric drivers	2884
Configure Tableau Data Story Settings: Narrative	2885
Set verbosity	2885
Set drilldowns	2886
Add dimension terms	2886
Manage measure labels	2886
Configure Tableau Data Story Settings: Relationships	2887
Create Actual vs. Benchmark relationship for continuous or discrete stories	2887
Create Current/Most Recent vs. Previous Period relationship	2888
Customize Your Tableau Data Story	2888
Add your own insights	2889
Add headers and footers	2889
Add functions	2890
Add conditions	2890
Duplicate custom content	2891
Add custom content in drilldown sections	2892
Customize Your Tableau Data Story: Context Variables	2893
Set a context variable	2894
When to use a context variable: reference two or more measures	2895
When to use a context variable: period-over-period analysis	2897
Customize Your Tableau Data Story: Functions	2900

Average	2900
Count	2900
Difference	2901
DifferenceFromMean	2901
Direction	2901
Ending Label	2901
EndingValue	2901
Label	2901
LargestNegativeChangeDifference	2902
LargestNegativeChangeEndingLabel	2902
LargestNegativeChangeEndingValue	2902
LargestNegativeChangePercentDifference	2902
LargestNegativeChangeStartingLabel	2902
LargestNegativeChangeStartingValue	2902
LargestNegativePercentChangeDifference	2903
LargestNegativePercentChangeEndingLabel	2903
LargestNegativePercentChangeEndingValue	2903
LargestNegativePercentChangePercentDifference	2903
LargestNegativePercentChangeStartingLabel	2903
LargestNegativePercentChangeStartingValue	2903
LargestPositiveChangeDifference	2904
LargestPositiveChangeEndingLabel	2904
LargestPositiveChangeEndingValue	2904
LargestPositiveChangePercentDifference	2904
LargestPositiveChangeStartingLabel	2904
LargestPositiveChangeStartingValue	2904
LargestPositivePercentChangeDifference	2905

LargestPositivePercentChangeEndingLabel	2905
LargestPositivePercentChangeEndingValue	2905
LargestPositivePercentChangePercentDifference	2905
LargestPositivePercentChangeStartingLabel	2905
LargestPositivePercentChangeStartingValue	2905
LongestStreakDifference	2906
LongestStreakDirection	2906
LongestStreakEndingLabel	2906
LongestStreakEndingValue	2906
LongestStreakLength	2906
LongestStreakPercentDifference	2906
LongestStreakStartingLabel	2907
LongestStreakStartingValue	2907
MaxLabel	2907
MaxValue	2907
Median	2907
MinLabel	2907
MinValue	2907
PercentDifference	2908
PercentOfWhole	2908
PeriodLabel	2908
PeriodLabelNewest	2908
PeriodValue	2908
PeriodValueNewest	2908
Range	2909
SortAscendingLabel	2909
SortAscendingValue	2909

SortDescendingLabel	2909
SortDescendingValue	2909
StartingLabel	2909
StartingValue	2910
StartToFinishDifference	2910
StartToFinishPercentDifference	2910
StdDev	2910
Sum	2910
Total	2910
Value	2910
Z-Score	2911
Customize Your Tableau Data Story: Hide and Reorder Content	2911
Hide content and sections	2911
Reorder content within a section	2912
Add More Data to Your Tableau Data Story	2912
Use a hidden sheet	2913
Concatenate dimensions	2915
Stack multiple data stories	2916
Add a Pop-Up Tableau Data Story to Your Dashboard	2916
Create Custom Measure Relationships in Your Tableau Data Story	2918
Refresh Parameters in a Tableau Data Story	2920
Use a Table Calculation in a Tableau Data Story	2922
Format Your Work	2925
Visual Best Practices	2925
Format from largest to smallest	2925
Change color with purpose	2926
Discrete fields and categorical palettes	2926

Change colors for individual fields	2927
Continuous fields and quantitative palettes	2927
Limit colors	2928
Use fonts that optimize online readability	2929
Reinforce your story with tooltips	2930
Consider your axes	2932
Format at the Workbook Level	2932
Change lines in your workbook	2933
Change fonts in your workbook	2934
Upgrade or change your workbook theme (Tableau Desktop only)	2935
Reset a workbook to its default settings	2936
Format Animations	2937
Understanding simultaneous and sequential animations	2938
Simultaneous animations	2938
Sequential animations	2938
Animate visualizations in a workbook	2939
Reset animation settings for a workbook	2941
Completely disable all animations	2941
Format decimals for axes animations	2941
Why animations won't play	2942
Server rendering	2942
Unsupported browsers and features	2942
Format at the Worksheet Level	2942
Access worksheet formatting settings from Tableau Desktop	2942
Format fonts	2943
Format text alignment	2944
Format shading	2946

Format borders	2947
Format lines	2947
Format highlighters	2948
Format a filter card	2948
Format a parameter control card	2949
Copy and paste worksheet formatting (Tableau Desktop only)	2949
Access worksheet formatting settings from Tableau Cloud	2950
Format fonts	2950
Rotate labels	2950
Format shading	2952
Format lines	2953
Format interactive controls	2954
Format legends	2955
Format filters	2955
Format highlighters	2956
Format parameters	2956
Format borders and dividers	2957
Row and column divider level settings	2958
Edit Axes	2958
Edit an axis range	2959
Why can't I edit my axis?	2960
Hide and reshow axes and headers	2962
Change an axis range	2964
Change the axis scale to reversed or logarithmic	2966
About the symmetric log axis transform	2968
Change the appearance of an axis	2968
Format tick marks	2970

Examples: Use Different Axis Ranges (Uniform, Independent, Fixed)	2971
Build a view with a uniform axis range	2972
Build a view using independent axis ranges	2974
Build a view using a fixed axis range	2977
Format Text and Numbers	2981
Format Text	2981
Format fonts	2981
Format text alignment	2987
Format tooltips	2988
Edit worksheet titles, captions, and legend titles	2989
Use Custom Fonts	2990
Publish custom fonts	2991
Publishing a custom font work flow	2991
If	2992
Then	2992
Troubleshoot custom fonts in published workbooks	2992
Issue	2992
Possible Solution	2992
Format Individual Parts of the View	2993
Text elements	2993
Show titles and captions	2993
Edit titles and captions	2994
Format titles and captions	2994
Edit dashboard titles	2995
Format tooltips	2995
Dynamic text values	2996
Command buttons	2996

Selection by category	2996
Controls	2997
Show Controls	2997
Legends	2997
Filters	2997
Highlighters	2997
Parameters	2997
Format Controls on Tableau Desktop	2997
Format Controls on Tableau Cloud and Tableau Server	2998
Format Fields and Field Labels	2999
Format a field	2999
Format a field label	3000
Format Numbers and Null Values	3001
For Tableau Desktop	3002
Specify a number format	3002
Define a custom number format	3004
Custom number format examples	3004
Include special characters in a custom number format	3006
Set the default number format for a field	3006
Format a measure as currency	3007
Use locale to specify number formats	3009
Format null values	3010
For Tableau Server or Tableau Cloud	3012
Specify a number format	3012
Resize Tables and Cells	3015
Use commands to resize rows and columns	3015
Manually resize rows and columns	3016

Resize an entire table	3016
Resize cells	3017
Define Table Structure	3018
Set the aspect ratio	3019
Set the default number format	3019
Set row attributes	3019
Set column attributes	3021
Create Custom Color Palettes	3021
About the preferences file	3021
Edit the preferences file	3022
Create a categorical palette	3023
Create a sequential palette	3027
Create a diverging color palette	3029
Use discontinued (classic) color palettes	3031
Optimize Workbook Performance	3041
General tips	3041
Workbook Optimizer	3042
Run the Workbook Optimizer	3043
In Tableau Desktop	3043
In web authoring	3043
Optimizer categories	3043
Ignore a guideline	3044
Autofix a guideline	3044
The guidelines	3045
Calculation length	3045
From the Workbook Optimizer	3045
Additional information	3045

- Calculation uses multiple data sources 3046
 - From the Workbook Optimizer 3046
 - Additional information 3046
- Dashboard size not fixed 3046
 - From the Workbook Optimizer 3046
 - Additional information 3046
- Filter uses conditional logic 3047
 - From the Workbook Optimizer 3047
 - Additional information 3047
- Filter uses "Only Relevant Values" 3047
 - From the Workbook Optimizer 3047
 - Additional information 3047
- Live data connections 3048
 - From the Workbook Optimizer 3048
 - Additional information 3048
- Multiple connections in a data source 3048
 - From the Workbook Optimizer 3048
 - Additional information 3048
- Nested calculations 3048
 - From the Workbook Optimizer 3048
 - Additional information 3049
- Non-materialized calculations 3049
 - From the Workbook Optimizer 3049
 - Additional information 3049
- Number of data sources 3050
 - From the Workbook Optimizer 3050
 - Additional information 3050

Number of filters	3050
From the Workbook Optimizer	3050
Additional information	3051
Number of layout containers	3051
From the Workbook Optimizer	3051
Additional information	3051
Number of LOD calculations	3051
From the Workbook Optimizer	3051
Additional information	3052
Number of views in a dashboard	3052
From the Workbook Optimizer	3052
Additional information	3052
Number of workbook sheets	3053
From the Workbook Optimizer	3053
Additional information	3053
Unused data sources	3053
From the Workbook Optimizer	3053
Additional information	3054
Unused fields	3054
From the Workbook Optimizer	3054
Additional information	3054
Uses data blending	3054
From the Workbook Optimizer	3054
Additional information	3055
Uses date calculations	3055
From the Workbook Optimizer	3055
Additional information	3055

- Uses grouping 3055
 - From the Workbook Optimizer 3055
 - Additional information 3056
- Streamline your workbook 3056
 - Remove what you can 3056
 - Workbook 3056
 - Worksheets 3057
 - Dashboards 3057
 - Data sources 3057
 - Break up the workbook 3057
- General suggestions 3058
- Know Your Data at the Database Level 3058
 - Enable support for referential integrity 3058
 - Make sure database permissions support creating temp tables 3059
 - Create indexes for tables 3059
 - Break up your data 3059
 - Use a database server 3059
- Test Your Data and Use Extracts 3059
 - Test as close to the data as possible 3060
 - Connect with native database drivers 3060
 - Work with extracts instead of live data 3060
 - Reduce the amount of data 3061
 - Hide unused fields 3061
 - Optimize extracts 3061
 - Use extracts for file-based data 3061
 - Avoid using custom SQL 3061
- Design for Performance While You Build a View 3062

Use the Describe field to get to know your data	3062
Keep workbooks a reasonable size	3062
Turn off Automatic Updates	3062
Look for warnings	3062
Create Efficient Calculations	3063
Use parameters for conditional calculations	3064
Convert date fields	3064
Use CASE logic statements	3065
Aggregate measures	3065
Calculation tips	3065
Make Visualizations Faster	3066
Reduce the scope	3066
Limit the number of filters you show in the view	3066
Reduce the number of marks on the view	3067
Zoom without filtering	3068
Record and Analyze Workbook Performance	3068
Create a performance recording in Tableau Desktop	3069
Interpret a performance recording workbook	3069
Performance Summary	3069
Timeline	3069
Events	3070
Query	3071
Detailed Timeline	3072
Detailed Views	3072
Depth	3072
CPU and Elapsed Time	3073
Reduce Upload Times to Tableau Server	3073

Avoid publishing packaged workbooks	3073
Make extracts smaller	3074
See also	3074
Turn off Automatic Updates to Boost Performance	3074
Automatic updates for worksheets	3074
Identifying invalid states when automatic updates are off	3074
Automatic updates for filters	3075
How Automatic Updates Affect Dashboards and Stories	3076
Save Your Work	3077
For Tableau Desktop	3077
Automatically save a workbook	3077
Save a workbook	3078
Save a packaged workbook	3079
Save a bookmark	3079
For web authoring	3080
Save a workbook	3080
Save a copy of an existing workbook	3080
Save changes as a custom view	3081
See Also	3081
Packaged Workbooks	3082
Create a .twbx with file-based data sources	3082
Create a .twbx with non-file-based data sources	3084
Create a .twbx with Tableau Server data sources	3087
Unpackage a .twbx	3090
Save Workbooks with Tableau Public	3090
Save a workbook to Tableau Public	3090
Save a workbook locally with Tableau Desktop Public Edition	3092

Revert a Workbook to the Last Saved Version	3092
Autosave Workbooks	3093
How does Autosave work?	3093
Workbook file size	3093
What if multiple users edit the same workbook?	3093
Permissions requirement	3094
Export Views from Tableau Desktop to Another Application	3094
Copy a view as an image	3094
Export a view as an image file	3094
Export as a PowerPoint presentation	3095
Export to PDF	3095
Export Data from Tableau Desktop	3095
Export data in the data source	3096
Export your data to .csv file	3096
Extract your data	3097
Export the data source	3097
Export data used in the view	3097
Export data in the view to Microsoft Access or .csv	3098
Export crosstab of data in the view to Excel	3098
Copy data in the view to clipboard	3099
Copy crosstab of data in the view to clipboard	3100
Copying Information Between Workbooks	3101
What gets copied or saved with selected sheets	3102
How Tableau handles duplicate items	3102
Copy and paste sheets between workbooks	3102
Export and import sheets between workbooks	3103
Import an entire Tableau workbook	3104

- Print Views from Tableau Desktop 3105
 - Set up the page 3105
 - General settings (available for individual sheets, not dashboards) 3106
 - Layout settings 3106
 - Print Scaling settings 3106
 - Print a view 3107
 - Show Selections 3107
 - Change the Print Range 3107
 - Print to PDF 3108
 - Print to PDF using a Windows computer 3108
 - Print to PDF using a Mac computer 3109
- Publish Data Sources and Workbooks 3111
 - In other resources 3111
 - Why publish 3111
 - What you can publish 3112
 - Who can publish 3112
- Prepare for Publishing a Workbook 3113
 - What makes up a typical published workbook 3113
 - Decide how to access the data and keep it up-to-date 3114
 - The simple path to data authorization 3114
 - Scenarios where data authorization requires some extra effort 3115
 - Assess the workbook performance and ease of use 3116
- Simple Steps to Publish a Workbook 3116
 - Publish your workbook 3117
 - Let others know the workbook is available on the server 3118
- Comprehensive Steps to Publish a Workbook 3118
 - Variable publishing options 3119

Show or hide sheets	3119
Show sheets as tabs	3119
Show selections	3120
Include external files	3120
Preview device layouts	3121
Choose how to generate thumbnails for workbooks with user filters	3122
Publish Views to Salesforce	3123
Prerequisites	3123
Publish a view to Salesforce	3123
Who can see the published view in Salesforce?	3124
Visual Segment Creation to Data Cloud	3124
About segmentation	3125
Overview and examples	3125
Workflow	3125
Learn more	3126
Requirements for segmentation	3126
License requirements	3126
Data requirements	3126
Data sources and connections	3126
Data model configuration	3127
Authentication	3128
User permissions requirements	3128
Field requirements	3128
Filter requirements	3129
Create a segment using engagement data	3129
Create a segment in Tableau	3130
Make Workbooks Compatible with Older Versions	3132

Export to an earlier version from Tableau Desktop	3133
Downgrade a workbook when publishing to Tableau Server	3133
Download an older version from Tableau Cloud or Tableau Server	3135
Additional compatibility resources	3135
Best Practices for Published Data Sources	3135
What makes up a published data source	3136
Preparing a data source for publishing	3136
When to use an extract	3137
Publishing data to Tableau Cloud that it cannot reach directly	3137
Improving performance	3138
Enabling functionality the data source does not inherently support	3138
Publishing data separately or embedded in workbooks	3138
Keeping extracts up-to-date	3140
Additional resources	3140
Publish a Data Source	3141
General publishing steps	3141
Publish on-premises data (Tableau Cloud only)	3144
Publish with a Web Data Connector	3145
Hidden fields in workbooks	3145
See also	3146
Edit a Published Data Source	3146
Edit and test changes	3146
Roll back changes	3147
Understand supported connections	3147
Learn about permissions	3148
Edit data sources published by a flow	3148
Set Permissions as You Publish a Data Source or Workbook	3148

About setting permissions during publishing	3148
Tips for deciding whether to set permissions on content	3149
How to set permissions during publishing	3150
Assign permission templates	3151
Set Credentials for Accessing Your Published Data	3151
Set the authentication type	3151
Dropbox, OneDrive connections	3153
Workbook connections to Tableau data sources	3153
Virtual connections	3153
See also	3154
Authorize Access to Cloud Data Published to Tableau Cloud	3154
New IP addresses (after Hyperforce migration)	3155
IP address process change	3155
Pods migrated to Hyperforce	3155
Pods not migrated to Hyperforce	3157
Old IP addresses (before Hyperforce migration)	3158
Find authorization steps for your data provider	3161
Tableau Bridge connections to Tableau Cloud	3161
See also	3162
Use Bridge to Keep Data Fresh	3162
What is Bridge	3162
How does it work	3162
Who can use it	3163
Schedule Extract Refreshes as You Publish a Workbook	3164
Set up a schedule as you publish content	3164
Refreshing web data connector extracts	3165
Restrict Access at the Data Row Level	3165

How user-based filtering works	3166
Adding user filters to data sources	3167
Extracts vs. live connections with user filters	3167
See also	3169
Create a User Filter and Secure it for Publishing	3169
Prerequisites	3169
Create a user filter and map users to values manually	3169
To test or fine-tune the filter:	3171
Create a dynamic filter using a security field in the data	3171
Connect to the data and set up the user filter	3172
Filter a data source	3173
Global filters and data source filters	3174
Secure user filters on published content	3174
Copy selected field values from one user to another	3175
Use Tableau on the Web	3177
Get started	3177
Explore and manage content	3177
Author web views	3177
Share and collaborate	3177
What Can I Do with a Tableau Site?	3178
What is a site?	3178
How does my site work with Tableau Desktop?	3178
What can I do on the web?	3178
Tour Your Tableau Site	3180
Browse and find content	3180
Projects	3182
Workbooks	3184

Views	3185
Metrics	3186
Data sources	3187
Ask Data lenses	3188
Data roles	3188
Flows	3189
Virtual connections	3190
Access important content quickly	3191
View content as list or grid	3191
Sort content	3193
Identify and navigate sites	3194
Tableau Pulse	3195
Creators: Get Started with Web Authoring	3197
Step 1: Sign in and explore projects	3198
Step 2: Create a new workbook and connect to data	3199
Tableau Catalog users create workbooks from external assets	3201
Step 3: Prepare your data	3201
Parts of the data source page	3202
Step 4: Author a view	3203
Workspace area	3203
Different ways to start building a view	3204
Filtering data	3207
Using the Marks card	3208
Undo your work	3209
Build and edit views on the web	3209
Step 5: Present your work	3210
Format your work	3210

- Dashboards 3210
- Stories 3211
- Step 6: Save your work 3212
- Step 7: Collaborate and share your findings 3213
 - Collaborate 3213
 - Share Views and Insights 3213
- Creators: Connect to Data on the Web 3213
 - Open the Connect to Data page 3214
 - Tableau Server 3215
 - Connect to data On this site 3215
 - Connect to files 3215
 - Use connectors 3216
 - Tableau Server connectors 3216
 - Tableau Catalog Supported Connectors 3217
 - Tableau Cloud 3217
 - Connect to data On this site 3217
 - Connect to files 3218
 - Use connectors 3218
 - Tableau Cloud Connectors 3218
 - Tableau Catalog Supported Connectors 3219
 - Use Dashboard Starters 3219
 - Tableau Public 3220
 - Connect to files 3220
 - Use connectors 3220
 - Tableau Public Connectors 3220
 - After you connect 3220
 - Keep data fresh in web authoring 3221

Prepare Data on the Web	3221
Tour the Data Source page	3222
A: Left pane	3222
B: Canvas	3222
C: Data grid	3222
D: Metadata grid	3223
Set up data sources	3223
Edit and sort fields in the data grid	3223
Manage data sources	3223
Publish a Data Source on the Web	3224
Create and Edit Private Content in Personal Space	3224
Privacy in Personal Space	3225
Tableau Catalog and Personal Space	3225
Collaboration tools	3225
Extract refreshes in Personal Space	3225
Find content in Personal Space	3226
Publish a workbook to Personal Space	3227
Publish a workbook to Personal Space on Tableau Server or Tableau Cloud	3227
Publish a workbook to Personal Space from Tableau Desktop	3227
Move workbooks to Personal Space	3228
Move workbooks from Personal Space	3228
Upload Workbooks to a Tableau Site	3229
Upload a new workbook to a Tableau site	3229
Permissions and data source connections	3231
Edit Tableau Views on the Web	3231
Edit a published view	3232
Create a new workbook on the web from a published data source	3233

Create and Troubleshoot Metrics (Retired)	3234
Retirement of legacy metrics	3234
Find metrics on your site	3235
Components of a metric	3237
Timeline	3237
Comparison	3238
Status	3240
Create a metric from a view	3240
Select the mark to define your metric	3240
Describe and configure your metric	3242
Finalize your metric	3243
Overwrite a metric	3244
When you can't create a metric	3244
Edit a metric's configuration	3245
How metrics refresh	3246
Fix failing refreshes	3246
If the connected view is still listed	3247
If there is no connected view listed	3248
Resume suspended refreshes	3248
Metrics appear in Tableau Catalog	3249
View Acceleration	3250
Accelerate your view	3251
Refresh accelerated views	3253
Event based refresh of accelerated views	3253
Schedule based refresh of accelerated views	3253
Manage View Acceleration on your site	3254
Accelerate recommended views	3254

Manage Views recommended for acceleration	3255
Automatically suspend acceleration to save resources	3255
View and manage accelerated workbooks	3255
Manage View Acceleration notifications	3256
Understand user context for precomputation	3256
Keyboard Accessibility for Tableau Views	3257
Interact with views	3257
All components	3257
Navigation panel and toolbar	3257
Custom views toolbar window	3258
Comments pane	3258
Sheet tabs	3258
Legends	3259
Filters	3259
Filter controls and search	3260
Parameter controls	3260
Single value (list)	3260
Single value (dropdown)	3260
Slider	3261
View Data window	3261
Visualization headers	3264
Example: Navigate a View in Tableau Cloud or Tableau Server	3264
Manage Content	3268
Organize Your Favorites or Collections	3268
Navigate Visualizations with Assistive Technology	3269
Navigate marks in a visualization	3269
Navigate marks in the View Data pane	3270

- Explore and Manage Web Content 3271
 - What Can I Do with a Tableau Web View? 3271
 - Will I hurt the data? 3271
 - Filter and sort data 3271
 - Filter data 3271
 - Sort data 3272
 - See details about specific data points 3272
 - View underlying data 3274
 - Collaborate on data 3274
 - Add comments 3274
 - Share links 3275
 - Get views emailed to you on a schedule 3276
 - Download a view 3276
 - Find a recently accessed view 3277
 - Add a view to favorites 3277
 - Congratulations, data rockstar! 3278
 - See also 3278
- Use Tags 3278
 - See tags for an item 3278
 - Find tagged content 3281
 - When to use and when not to use tags 3283
 - Add tags 3284
 - Delete tags 3285
 - Other places tag information is surfaced 3287
 - Tag item count mismatch 3287
- Search Your Tableau Site 3287
 - Quick search 3287

Full search	3288
Mark Favorites	3290
Mark content as a favorite	3290
Remove an item from favorites	3291
Find favorites	3291
Organize your favorites	3292
Access favorites from a view	3293
Organize Items in a Collection	3293
Find collections	3294
Create a collection	3294
Add items to a collection	3295
Remove items from a collection	3297
Organize your collection	3299
Manage collection permissions	3300
Configure permissions	3300
Grant access by sharing	3300
Manage Web Content	3301
Access options	3301
Add or edit descriptions	3302
Describe projects, workbooks, and data sources	3302
Describe metrics, data roles, Ask Data lenses, and collections	3303
Describe flows	3304
Describe databases and tables (available if Tableau Catalog is enabled)	3305
Describe table columns (available if Tableau Catalog is enabled)	3306
Describe fields in a published data source (available if Tableau Catalog is enabled)	3307
How field descriptions are inherited (if Tableau Catalog is enabled)	3308

Access your content	3309
Perform actions	3311
Delete content	3314
Consequences of deleting content	3315
Work with Content Revisions	3315
Required permissions for revision history	3316
Publish your content	3316
View revision history	3317
Manage revisions	3318
Preview a workbook revision	3318
Download a workbook or data source revision	3319
Restore a workbook revision	3319
Restoring workbooks that require database credentials	3320
Restore a data source revision	3320
Delete a workbook or data source revision from history	3321
Potential revision history issues	3321
Overwriting content with the same name	3321
Data changes and deletions	3321
Turning revision history on and off	3322
Refresh Data or Pause Automatic Updates	3322
Refresh Data	3322
Pause Automatic Updates	3322
Stop long-running actions	3323
Use Custom Views	3323
Notes on custom views	3323
Create a custom view	3324
Find a custom view	3324

From a view	3324
From the workbook	3325
Set a default custom view	3325
Share a custom view	3325
Delete a custom view	3326
Take care when deleting	3326
Manage custom views	3326
Safely change content with custom views	3327
Maintain Content with Custom Views	3327
Changes known to impact custom views	3328
Workbook changes	3328
Data source changes	3329
Update content safely	3329
Modify a workbook	3329
Modify a workbook with web editing	3329
Modify a workbook with Tableau Desktop	3329
Modify a data source	3330
Investigate broken custom views	3330
Discover Recommended Views on Your Tableau Site	3331
Why are these views recommended?	3332
Whose names are shown?	3332
Which views appear as recommendations?	3332
Manage Your Account Settings	3333
Go to your Account Settings page	3333
Manage your credentials and passwords	3333
Manage multi-factor authentication verification methods	3334
Create and manage personal access tokens	3334

- Create a personal access token 3334
- Check when a personal access token expires 3335
- Revoke a personal access token 3335
- Remove connected clients 3336
- Change notification settings 3336
- Change subscription settings 3337
- Enable or disable data alerts 3337
- Enable or disable the Data Management features message 3337
- Change your start page 3338
- Change language and locale 3339
- Change your display name, password, or email address for Tableau Server 3339
 - Change your display name 3339
 - Change your password 3339
 - Change your email address 3340
- Change your display name or password for Tableau Cloud 3340
 - If you forgot your password 3340
 - If you're signed in to Tableau Cloud 3340
- Manage Saved Credentials for Data Connections 3341
 - Test connections using saved credentials 3342
 - Update saved credentials 3342
 - Clear all saved credentials 3342
 - Remove saved credentials 3343
- Share and Collaborate on the Web 3345
 - Share Web Content 3345
 - Share directly with other users 3345
 - Grant access to shared content 3347
 - Copy a link to share 3347

Share and embed views and metrics	3348
Embed views and metrics	3349
Share modified or custom views	3349
Find content shared with you	3350
Create a Subscription to a View or Workbook	3351
Set up a subscription for yourself or others	3351
Update or unsubscribe from a subscription	3354
Resume or delete suspended subscriptions	3355
See also	3355
Send Data-Driven Alerts from Tableau Cloud or Tableau Server	3356
Create a data-driven alert	3356
Add yourself to an existing data-driven alert	3356
Manage your data-driven alerts	3357
Manage your alert notifications	3357
Fix failing data-driven alerts	3358
Resume or delete suspended data-driven alerts	3358
Comment on Views	3358
Add comments	3359
Delete comments	3361
Embed Views and Metrics	3362
Embed Views into Webpages	3362
Copy the embed code	3363
Use the Embedding API	3363
Embed Metrics into Webpages (Retired)	3364
Copy the embed code	3364
Write your own embed code	3365
HTML example	3365

- JavaScript example 3365
- Parameters for embed code 3366
- Authentication for embedded metrics 3366
- How metric URLs are structured 3367
 - Metric URL structure 3367
 - JavaScript URL structure 3367
- Writing Embed Code for Views 3368
 - Use Tableau JavaScript 3368
 - Specify the View URL 3369
- Embed Code Parameters for Views 3370
 - Object parameters for JavaScript tags 3370
 - URL parameters for iframe tags 3385
- Add Filters to Embed Code for Views 3393
 - Filter on one field 3394
 - Filter on multiple fields 3395
 - Filter dates and times 3396
 - Filter measures 3397
- How View URLs Are Structured 3398
 - The structure of the base URL 3398
 - Adding parameters to the base URL 3398
 - Appending a query string 3398
 - Reflecting the capitalization of field names 3399
 - How query strings affect dashboards 3399
- Select an example view to work with 3399
- Filter the view 3400
 - Furniture only 3400
 - Consumer only 3400

Home Office and Consumer	3401
Furniture in the Central	3402
Exclusive filtering	3403
Special considerations for date filtering	3403
Example date parameters	3403
Parameters as DATEPART filters	3404
Control Load Order for Multiple Embedded Views	3404
Embed Dashboards	3405
Iframe dimensions and device layouts	3408
Embed Code for Custom Views	3408
Embed Views into Wikis	3410
Embed Images of Tableau Server Views	3411
Embed Tableau Server Views into SharePoint (Active Directory Authentication) ..	3411
Requirements	3412
Embedding a View into SharePoint	3412
Embed Tableau Server Views into SharePoint (Local Authentication)	3415
Requirements	3415
Edit Security Permissions for TableauEmbeddedView.dll	3415
Install and Deploy TableauEmbeddedView.wsp	3417
Verify the Web Part's Deployment	3418
Embed a View Using the Tableau Web Part	3418
Embed Tableau Views into Salesforce	3421
Requirements and Permissions	3421
Configure single sign-on (SSO)	3422
Add the Tableau view to the Lightning page	3422
Filter the view based upon the page context	3423
Apply filters based upon on Tableau and Salesforce fields	3424

- Link to a PNG, PDF, or CSV of a View 3425
- Download Views and Workbooks 3426
- Receive Notifications, Search, and Share Using the Tableau App for Slack 3428
 - Search, share, and access recents and favorites from Slack 3429
 - Receive Tableau notifications in Slack 3430
 - Comments 3430
 - Share 3431
 - Data-driven Alerts 3432
 - Manage Tableau notifications for Slack 3433
- Web Authoring and Tableau Desktop Feature Comparison 3434
 - Features listed by version 3434
 - General differences in web authoring 3434
 - Web authoring capabilities 3435
 - Data management 3435
 - Analytics 3437
 - Filtering and sorting 3438
 - Formatting 3439
 - Related topics 3440
- Install or Upgrade Tableau Desktop 3441
 - Accessing the repository from a previous version 3441
 - Accessing the repository from a beta version 3441
 - Turn Product Updates Off or On 3441
 - Turn off product updates 3442
 - Use the Help menu 3442
 - Run the installer (Windows only) 3442
 - Administrators control product updates 3443
- Maintain Licenses for Tableau Desktop and Tableau Prep 3443

View data about your license	3443
Automatically refresh product keys using zero downtime licensing	3445
Track Tableau Desktop license usage and expiration data	3446
Additional resources	3447
OAuth Overview	3447
OAuth workflow	3447
Practical OAuth analogy	3448
Configure a forward proxy for OAuth authentication	3449
Use Windows to connect to Tableau Desktop through a forward proxy	3449
Windows configuration option 1: Use system environment variables	3450
Windows configuration option 2: Configure Java net.properties proxy settings ..	3450
Use Mac to connect to Tableau Desktop through a forward proxy	3451
Use Windows to connect through a proxy that requires OAuth authorization	3452
Use Mac to connect through a proxy that requires OAuth authorization	3452
Use Windows to connect to Tableau Server through a forward proxy	3453
Configure the proxy	3453
Add exceptions	3453
Windows configuration option 1: Use system environment variables	3454
Windows configuration option 2: Configure Java net.properties proxy settings ..	3454
Use Linux to connect to Tableau Server through a forward proxy	3455
Use Windows to connect to Tableau Server through a proxy that requires OAuth authorization.	3456
Use Linux to connect to Tableau Server through a proxy that requires OAuth authorization.	3457
SSL handshake errors	3457
Keyboard Shortcuts	3459
Shortcuts for managing workbooks, sheets, and files (Tableau Desktop)	3459

Shortcuts for managing workbooks, sheets, and files (Tableau Server, Tableau Cloud)	3460
Shortcuts for data (Tableau Desktop)	3460
Shortcuts for data (Tableau Server, Tableau Cloud)	3461
Shortcuts for authoring views (Tableau Desktop)	3461
Shortcuts for authoring views (Tableau Server, Tableau Cloud)	3463
Shortcuts for resizing rows and columns (Tableau Desktop)	3465
Shortcuts for pages (Tableau Desktop)	3465
Shortcuts for selecting and navigating marks	3465
Shortcuts for flows (Tableau Prep Builder)	3466
Copyright	3469

Tableau Desktop and Web Authoring Release Notes

This topic describes what's new in the latest release. Use the viz below to explore new features in Tableau Desktop and web authoring. Click a feature name to display a tooltip with a link to documentation for that feature. Apply filters to refine your search.

- Click **Search by Feature** to see a list of new features for a product or version, or to explore when a feature was released. The dashboard currently defaults to Desktop (which includes web authoring features) and the latest released version of Tableau Desktop.
- Click **Upgrade Desktop** to see a list of all features specific to Tableau Desktop and web authoring.

Tip: Click the **Download** button in the viz toolbar (while no feature names are selected), and then select **Data** to export the list to a CSV file that you can customize.

Product	Release	Status	Feature Name
Tableau Cloud	November 2024	New	HANA Connector OAuth Enhance..
			Monitor generative AI usage
			Tableau Pulse personalized insig..
		Deprecated	Activity Log permission events
			Data Stories
	October 2024	New	Einstein Copilot for Tableau - assi..
			New IBM Informix Connector
		Updated	Snowflake External OAuth feature
			Snowflake Key-pair authentication
			Spatial Parameters and Operators

Click the Tableau logo in the bottom left corner of the viz toolbar to view this workbook on Tableau Public

Related resources

[New features in the latest release](#)

Get Started

This section gives you the basics on getting started with building views in Tableau, the Tableau workspace, and Tableau concepts.

For related topics and sites, also see:

- Short walkthrough of Tableau Desktop: [Build a Basic View to Explore Your Data](#) below
- In-depth Tableau Desktop tutorial: [Get Started with Tableau Desktop](#)
- On-demand webinars: [Secrets of Visual Analytics](#)
- Build basic chart types: [Build Common Chart Types in Data Views](#) on page 1473 and [Choose the Right Chart Type for Your Data](#) on page 201
- Build maps: [Maps and Geographic Data Analysis in Tableau](#) on page 1647
- Get started with using Tableau Cloud and Tableau Server: [Use Tableau on the Web](#) on page 3177.

Build a Basic View to Explore Your Data

This topic uses the Sample - Superstore data source to walk through how to create basic views and explore your data. It shows how your view of data in Tableau evolves through your process of exploration.

If you're using Tableau Cloud and Tableau Server to explore data and edit views, see [Use Tableau on the Web](#) on page 3177.

Connect to your data

The first step is to connect to the data you want to explore. This example shows how to connect to Sample - Superstore data in Tableau Desktop.

1. Open Tableau. On the start page, under **Connect**, click Microsoft Excel. In the Open dialog box, navigate to the `Sample - Superstore Excel` file on your computer. Go to `/Documents/My Tableau Repository/Datasources/version number/language`. Select `Sample - Superstore`, and then click **Open**.

2. After you connect to the Excel data, the Data Source page shows the sheets or tables in your data. Drag the "Orders" table to the *canvas* to start exploring that data.

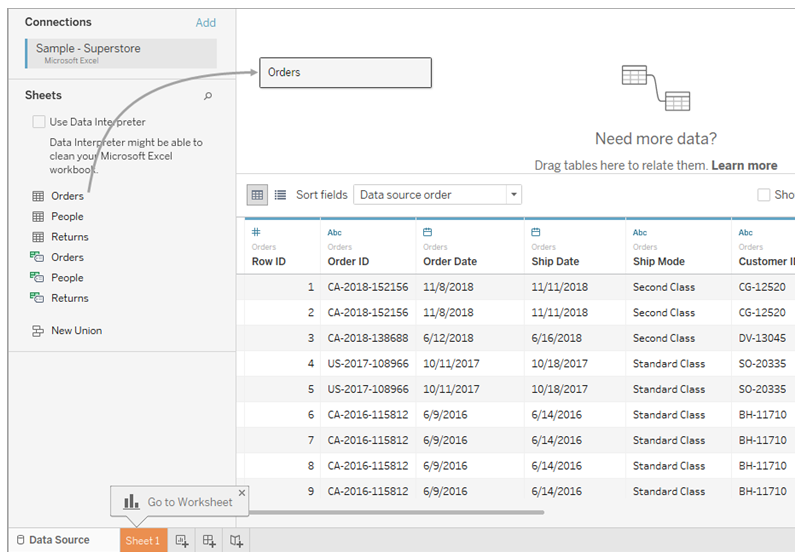

Depending on how your data is structured, you might need to do more data preparation and integration before you start exploring it in Tableau. For more details on connecting to your data, see [Connect to and Prepare Data on page 219](#) and [Tips for Working with Your Data on page 224](#).

3. Click the sheet tab to go to the new worksheet and begin your analysis.

About the Data pane

In the worksheet, the columns from your data source are shown as fields on the left side in the **Data** pane. The **Data** pane contains a variety of fields organized by table. For each table or folder in a data source, dimension fields appear above the gray line and measure fields appear below the gray line. Dimension fields typically hold categorical data such as product types and dates, while measure fields hold numeric data such as sales and profit. Sometimes a table or folder will contain only dimensions, or only measures to start with. For more information, see [Dimensions and Measures, Blue and Green on page 147](#).

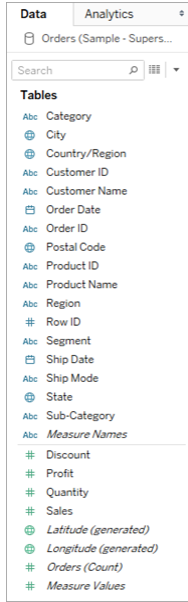

For more information about parts of the workspace, see [The Tableau Workspace on page 27](#).

If you have more than one data source in a workbook, click the data source connection name in the Data pane to select it for use. For more details, see [Navigate Data Sources in the Data Pane on page 45](#).

For details on the many ways you can customize the fields in the data pane, see [Organize and Customize Fields in the Data Pane on page 1051](#), [Edit Default Settings for Fields on page 1063](#), and [Work with Data Fields in the Data Pane on page 37](#).

If you have related dimension fields, sometimes you might want to group them in a folder, or as a hierarchy. For example, in this data source, Country, State, City, and Postal Code are grouped into a hierarchy named Location. You can drill down into a hierarchy by clicking the + sign in a field, or drill back up by clicking the - sign in a field.

Build the view

A **view** is a visualization or viz that you create in Tableau. A viz could be a chart, a graph, a map, a plot, or even a text table.

Before you start building a view, consider the question or questions you're hoping to answer with data. Every view that you build in Tableau should start with a question. What do you want to know?

Every time you drag a field into the view or onto a shelf, you're asking a question about the data. The question varies depending on the field you choose, where you place it, and the order in which you add it to the view.

For every question you ask, the view changes to represent the answer visually with marks represented by shapes, text, hierarchies, table structures, axes, color.

Different ways to start building a view

When you build a view, you add fields from the **Data** pane. You can do this in different ways.

For example:

- Drag fields from the **Data** pane and drop them onto the cards and shelves that are part of every Tableau worksheet.
- Double-click one or more fields in the **Data** pane.
- Select one or more fields in the **Data** pane and then choose a chart type from **Show Me**, which identifies the chart types that are appropriate for the fields you selected. For details, see [Use Show Me to Start a View](#) on page 1229.
- To start creating a tabular view, drop a field on the **Drop field here** grid.



For more details on building visualizations with fields, see [Start Building a Visualization by Dragging Fields to the View](#) on page 1187.

As you start exploring data in Tableau, you'll find there are many ways to build a view. Tableau is extremely flexible, and also very forgiving. As you build a view, if you ever take a path that isn't answering your question, you can always undo to a previous point in your exploration.

- To undo or redo, click undo ← or redo → on the toolbar.

You can undo all the way back to the last time you opened the workbook. You can undo or redo an unlimited number of times.

Build a view from scratch

These steps show how to build a basic view that shows year-by-year profit.

1. From the **Dimensions** area in the **Data** pane, drag the **Order Date** field to the **Columns** shelf. You might need to expand the Order hierarchy to see Order Date.

When you drag a field over a shelf, a plus sign indicates that the shelf can accept the field.

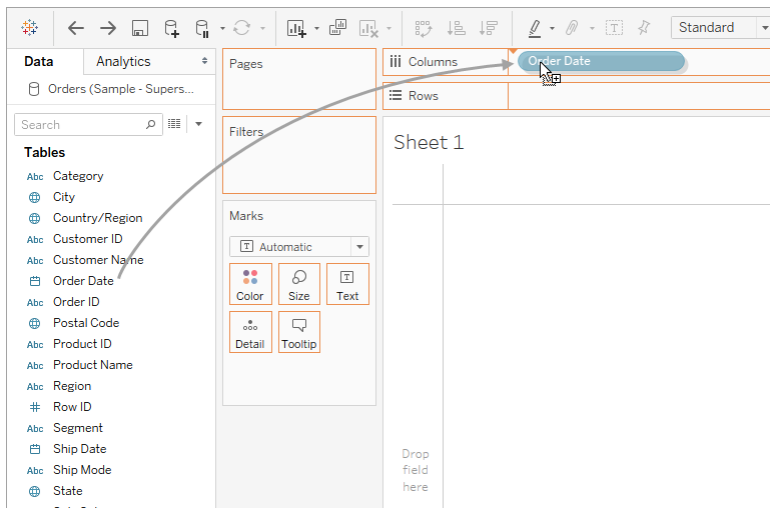

The resulting table has four columns and one row. Each column header represents a member of the Order Date field (the default date level is YEAR). Each cell contains a placeholder “Abc” label, which indicates that the current mark type for this view is text.

Order Date			
2021	2022	2023	2024
Abc	Abc	Abc	Abc

Notice that the field is colored blue, which indicates that it's *discrete*. For more information, see [Dimensions and Measures, Blue and Green](#) on page 147.

The default date level is determined by the highest level that contains more than one distinct value (for example, multiple years and multiple months). That means that if **[Order Date]** contained data for only one year but had multiple months, the default level would be month. You can change the date level using the field menu.

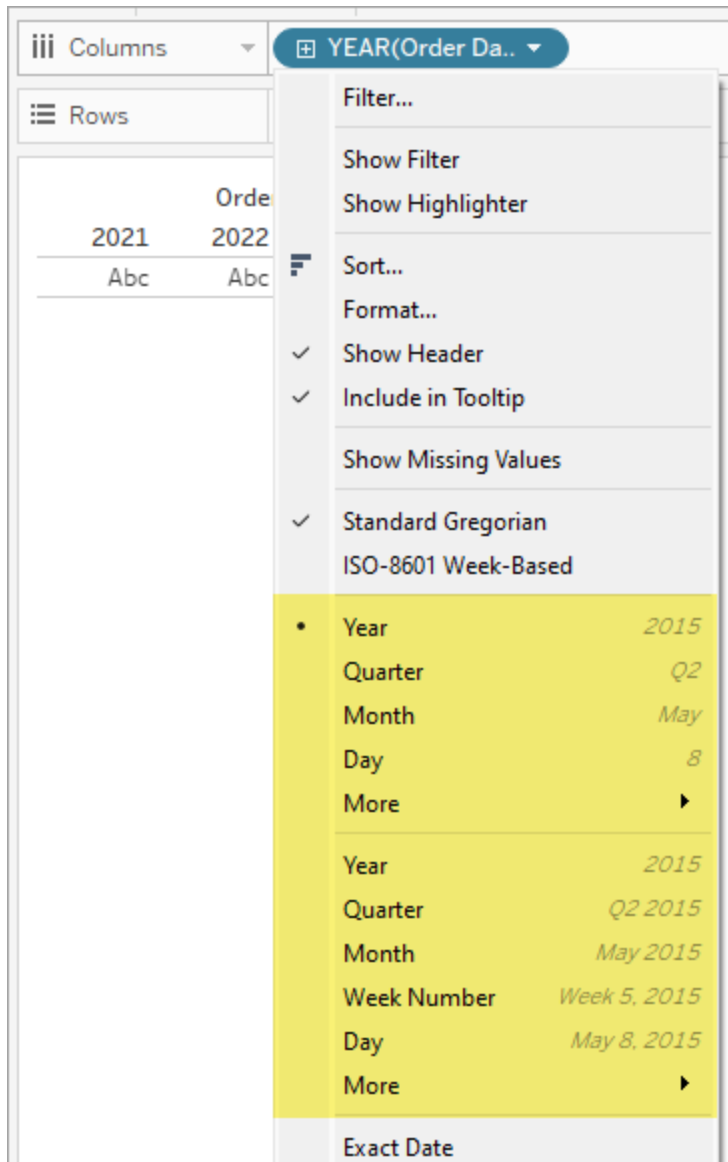

If you're wondering why there are two sets of date levels (from Year down to Day), the first set of options uses date parts (discrete labels, so "May" is the same value whether its of 2024 or 2034) and the second set of options uses date truncations (continuous values, so

May of 2024 is a different value than May of 2034). For more information, see [Change Date Levels on page 1153](#).

Tip: To hide the title on the sheet, select the drop-down to the right of the title (Sheet 1), and select **Hide Title**.

2. From the **Data** pane, drag the **Profit** field to the **Rows** shelf.

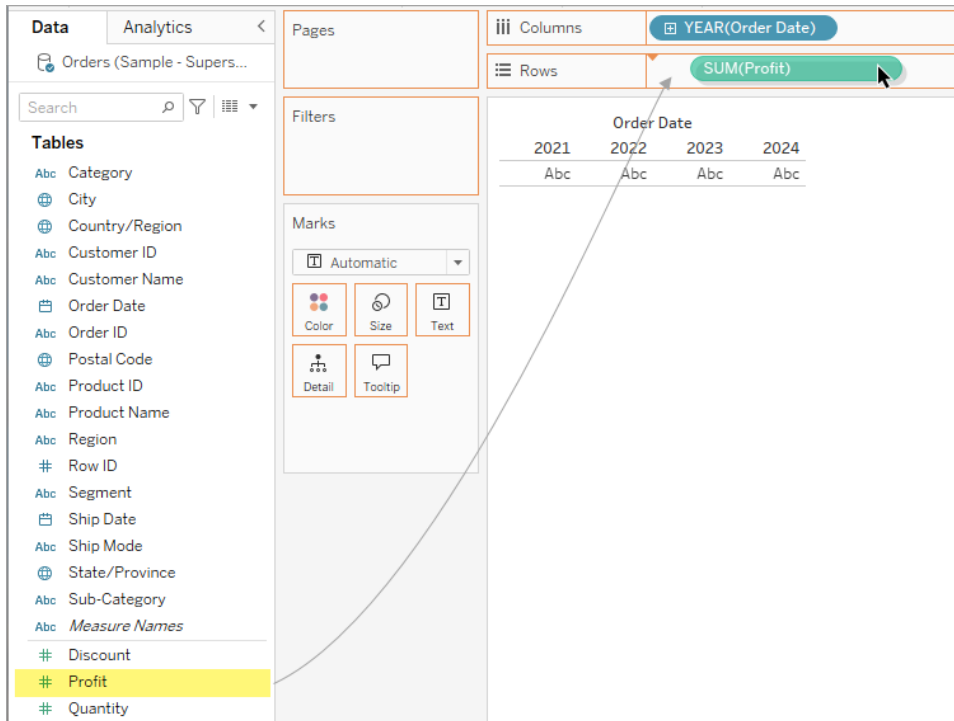

The **Profit** field is colored green on the **Rows** shelf, indicating that it's continuous. Also, the field name changes to **SUM(Profit)**. That's because measures are automatically aggregated when you add them to the view, and the default aggregation for this measure is SUM. For more information on what happens when you add a measure to a view—and why—see [Dimensions and Measures, Blue and Green on page 147](#).

Tableau transforms the table into a line chart and creates a vertical axis (along the left side) for the measure.

A line chart is a great way to compare data over time and identify trends effectively.

This line chart shows profit over time. Each point along the line shows the sum of profit for the corresponding year.

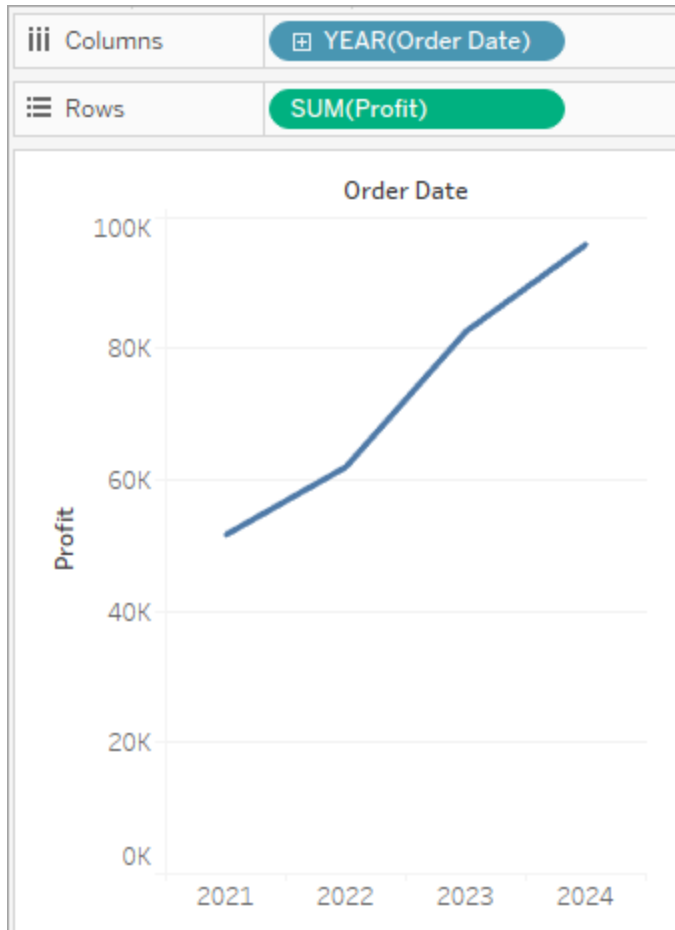

The next step is to drill a little deeper into the time dimension.

Drill into the data

This step shows how you can modify the view to show quarters in addition to years. As you drill down into the hierarchy, the view changes to become a nested table.

You can show **[Order Date]** by quarters using either of the following methods:

- Click the plus button  on the left side of the field **YEAR(Order Date)** field on Columns.

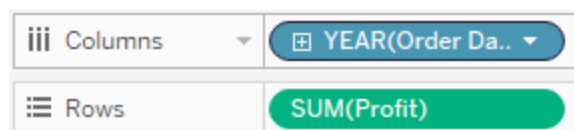

- Drag the **Order Date** field (again) from the Data pane and drop it on the **Columns** shelf to the right of **Year(Order Date)**.

The new dimension divides the view into separate panes for each year. Each pane, in turn, has columns for quarters. This view is called a nested table because it displays multiple headers, with quarters nested within years. The word "headers" is a little misleading in this example because the year headers are displayed at the top of the chart, while the quarter headers are displayed at the bottom.

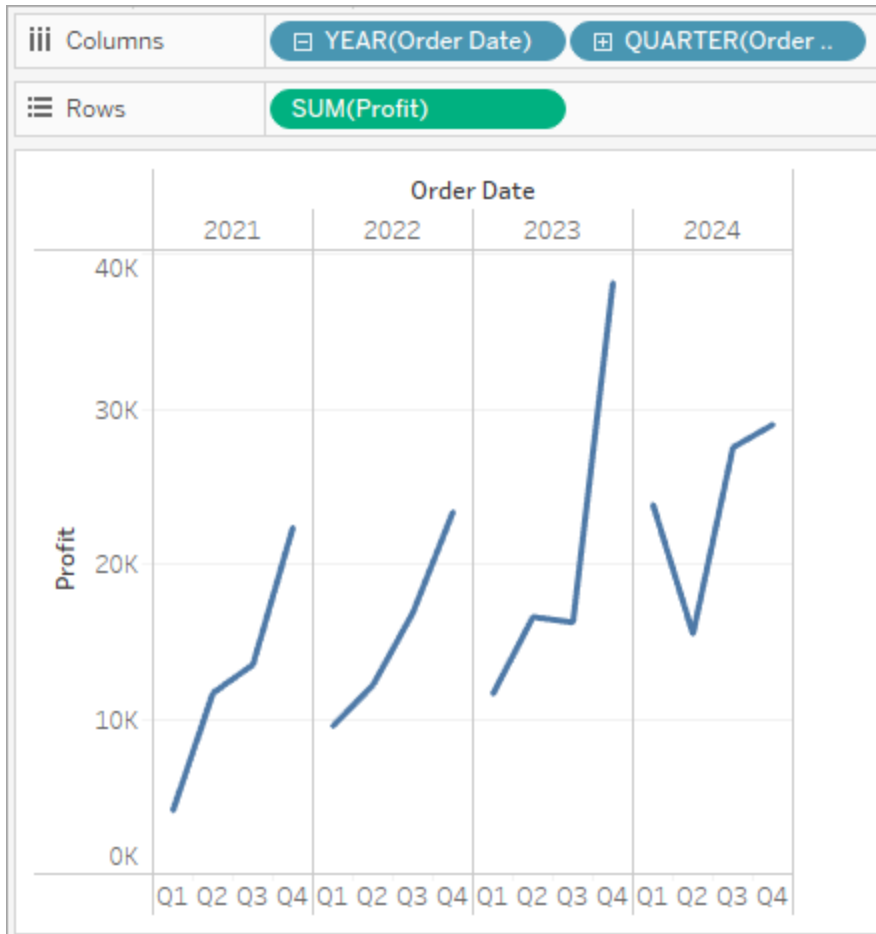

Increase the level of detail with small multiples

This step shows how you can modify the nested table view to add customer segment. It creates what we call a *small multiples* view.

Drag the **Segment** dimension from the **Data** pane, and then drop it just to the left of **SUM (Profit)** on Rows.

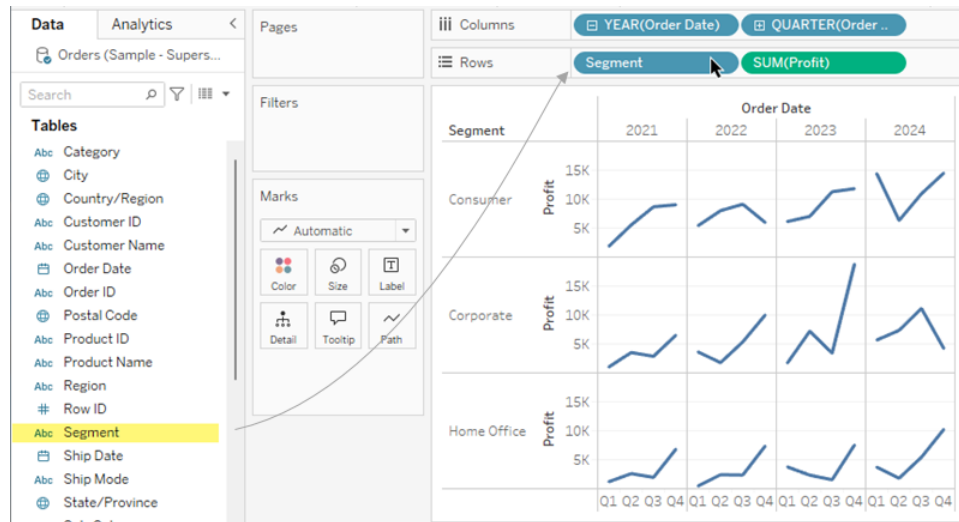

The field is added to the Rows shelf and row headers are created. Each header represents a member of the Segment field.

Optionally, you can achieve the same result by dropping **Segment** just to the left of the Profit axis in the view (shown in the image below). Tableau often supports multiple ways to add fields to the view.

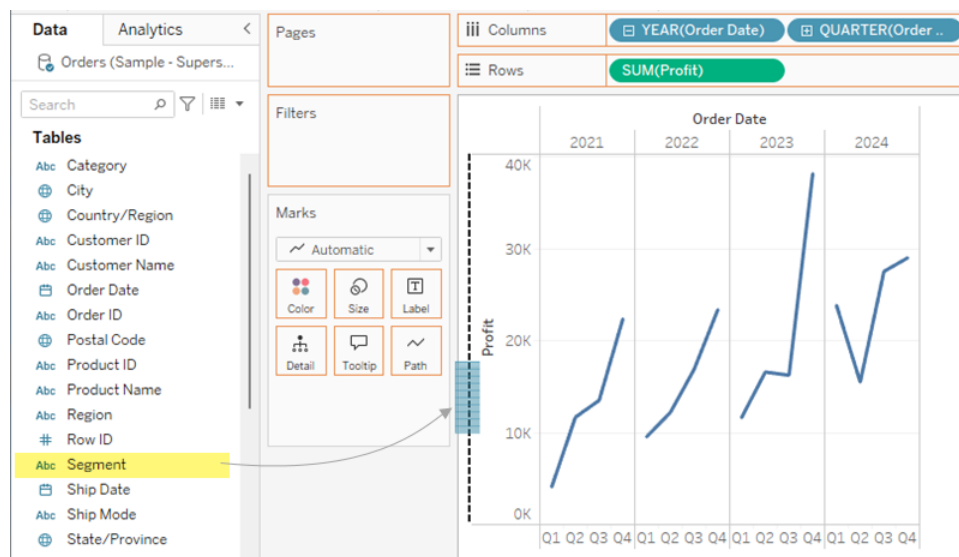

Note: Tableau doesn't allow you to place a dimension to the right of a measure on either the Rows or Columns shelves because that visual structure doesn't make sense in the view.

The new dimension divides the view into 12 panes, one for each combination of year and segment. This view is a more complex example of a nested table. Any view that contains this sort of grid of individual charts is referred to as a small multiples view.

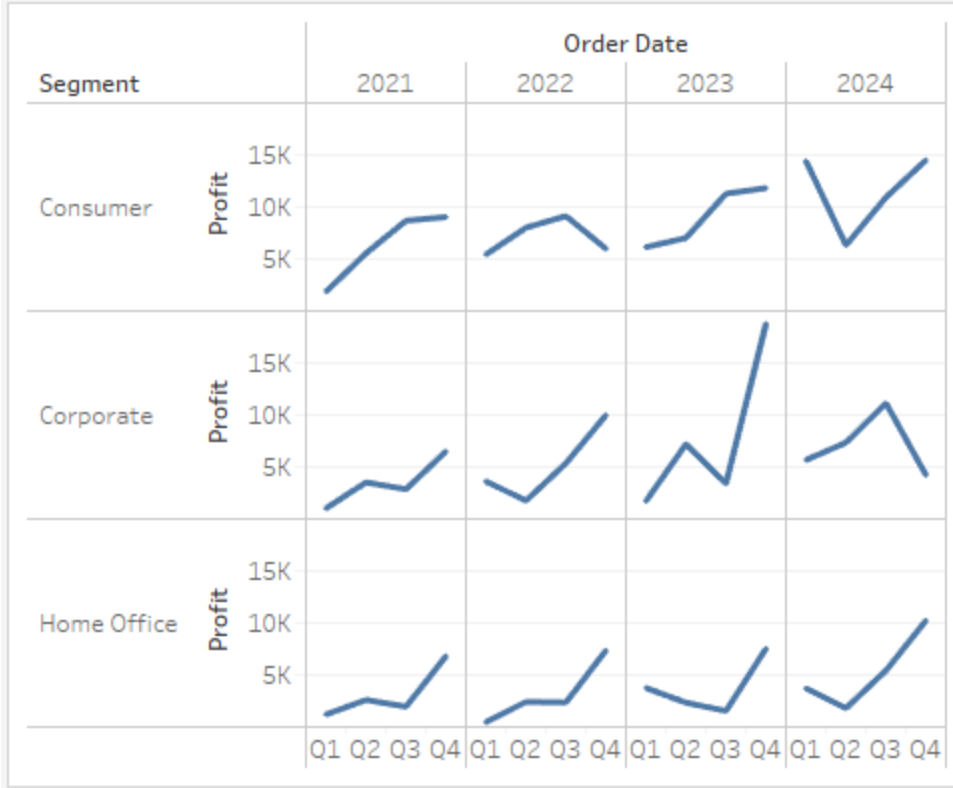

This could be the right amount of granularity for the view. Another option at this point would be to filter some of the data out of the view to simplify it.

Filter the view to focus your exploration

This section shows how you can focus your exploration by only showing a subset of the data, such as modifying the view to show only data for orders in 2018 and 2019.

1. Drag the **Order Date** measure from the **Data** pane and drop it on the **Filters** shelf.

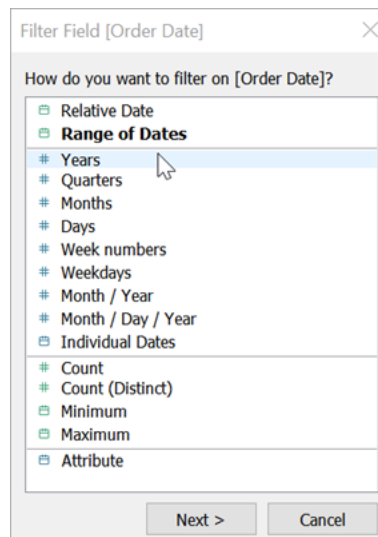

2. In the Filter Field dialog box, choose the date level you want to filter on—**Years**. Then click **Next**.
3. In the next pane, clear any two years that you don't want to include in the view, here 2021 and 2022.
4. When you are finished, click **OK**.

The view updates to only show data rows where Order Date is 2023 or 2024. Tableau can now allocate more space to the data that interests you.

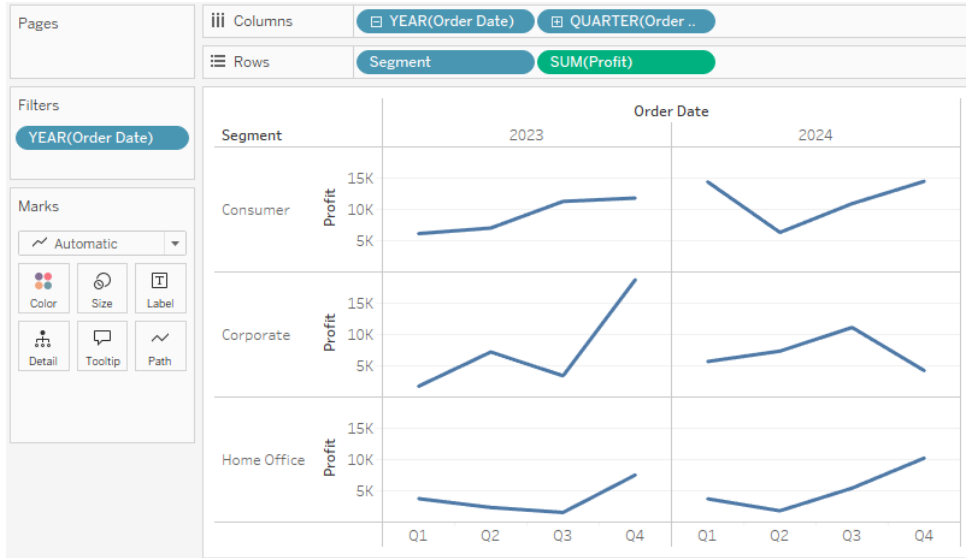

Next, you'll increase the detail in your data exploration by dragging a field to the Color property on the Marks card.

Use the Marks card to add depth to your analysis

This step shows how you can modify the view to color the marks based on the region.

1. Drag the **Region** dimension from the **Data** pane and drop it on **Color**.

Placing a dimension on **Color** separates the marks according to the members in the dimension, and assigns a unique color to each member. The color legend displays each member name and its associated color.

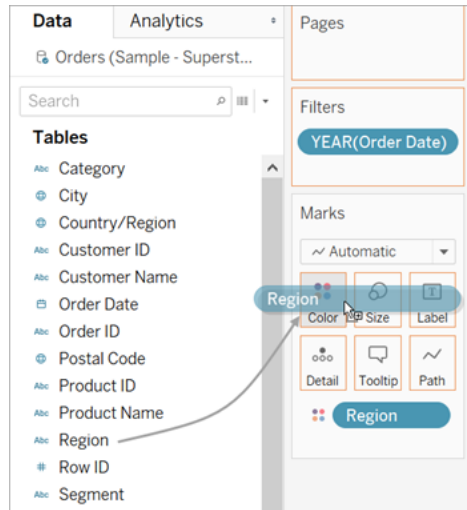

Each pane now has four lines, one for each region. The viz is now showing profit data summarized the Region level of detail.

The view now shows profit for each customer segment and region for 2018 and 2019.

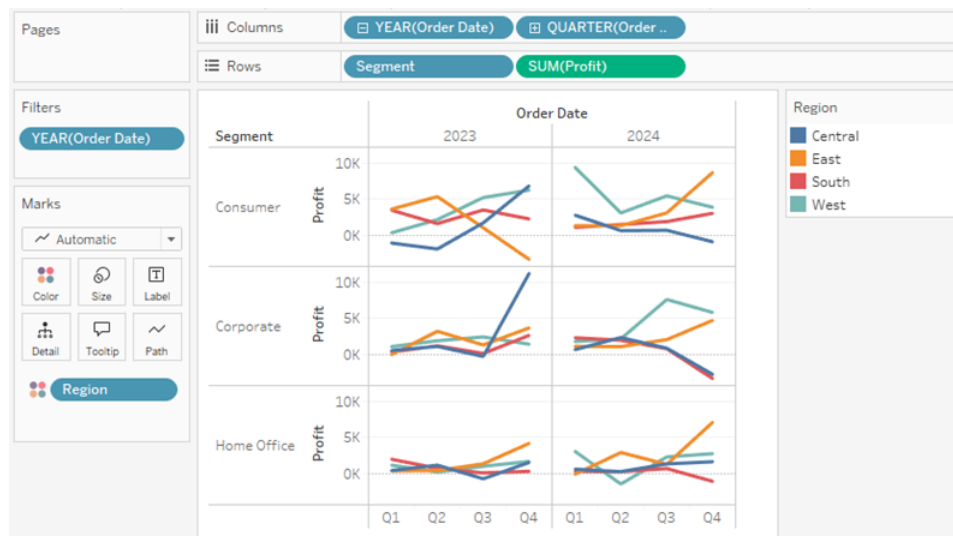

For more information on the Marks card and level of detail, see [Shelves and Cards Reference](#) on page 57, [Marks](#) on page 83, and [How dimensions affect the level of detail in the view](#) on page 151. Also see [Understanding the grain in your data](#) from Tableau Tim.

More resources

For related topics and sites, also see:

- In-depth Tableau Desktop tutorial: [Get Started with Tableau Desktop](#)
- On-demand webinars: [Secrets of Visual Analytics](#)
- Build basic chart types: [Build Common Chart Types in Data Views](#) on page 1473 and [Choose the Right Chart Type for Your Data](#) on page 201
- Build maps: [Maps and Geographic Data Analysis in Tableau](#) on page 1647
- Use Tableau Cloud and Tableau Server to explore data and edit views: [Use Tableau on the Web](#) on page 3177

Watch a video: You can see many Tableau concepts and product features discussed and demonstrated on the [Tableau Tim website](#) and [YouTube channel](#).

Tableau Desktop and Tableau Desktop Public Edition Feature Comparison

This guide provides an overview of the differences between Tableau Desktop and the free Tableau Desktop Public Edition.

Tip: Visit the Tableau Desktop [pricing page](#) to learn more about pricing options for Tableau Desktop

Both Tableau Desktop and Tableau Desktop Public Edition allow you to publish and showcase your visualizations on your Tableau Public profile. You can download from Tableau Public and reverse-engineer visualizations in the Desktop application.

Who should use Tableau Desktop Public Edition?

Important: Tableau Desktop Public Edition is not for commercial use.

- Individuals seeking to learn how to use Tableau
- Individuals looking to tell data stories using public datasets by publishing to Tableau Public
- Organizations looking to broadcast public information or embed public visualization on their own sites







Who should use Tableau Desktop?

Individuals or businesses that need to:

- Connect to Tableau Server or Tableau Cloud
- Connect to data sources that aren't supported by Tableau Public
- Analyze data with more than 15M rows
- Work with live data other than Google Sheets

Comparison guide

Features and Capabilities	Tableau Desktop Public Edition (free)	Tableau Desktop
Privacy and security		
Save visualizations locally		
Autorecovery		
Unlimited storage		
Publish or embed visualizations on other public sites		
Download or copy published workbooks		
Publish visualizations to Tableau Public		

Infrastructure deployment	 (Infrastructure available at no cost)	Self-hosted on premise (Role-based licenses)
Share visualizations to Tableau Cloud or Tableau Server		
Live data refresh	Limited data refresh (Google Sheets only. Data is refreshed automatically once every 24 hours)	
Data sources	Limited data source options (Google Sheets, JSON files, Microsoft Excel 2007 or later, OData, PDF, Spatial files, Statistical files, Text files, and more with Web Data Connector)	 (Can connect to all data sources)
Data source row limit	15M rows	Unlimited
Monitoring and metrics	Limited monitoring and metrics	

Tour the Tableau Environment

This section provides information on Tableau pages and its workspace, including panes, shelves, icons, and other elements in Tableau Desktop.

- [The Tableau Workspace](#) on page 27
- [Start Page](#) on the next page
- [Data Source Page](#) on page 24

If you are using Tableau on the web, see [Creators: Get Started with Web Authoring](#) on page 3197 and [Tour Your Tableau Site](#) on page 3180.

Start Page

The start page in Tableau Desktop is a central location from which you can do the following:

- Connect to your data
- Open your most recently used workbooks
- Discover and explore content produced by the Tableau community

The start page consists of three panes: **Connect**, **Open**, and **Discover**.

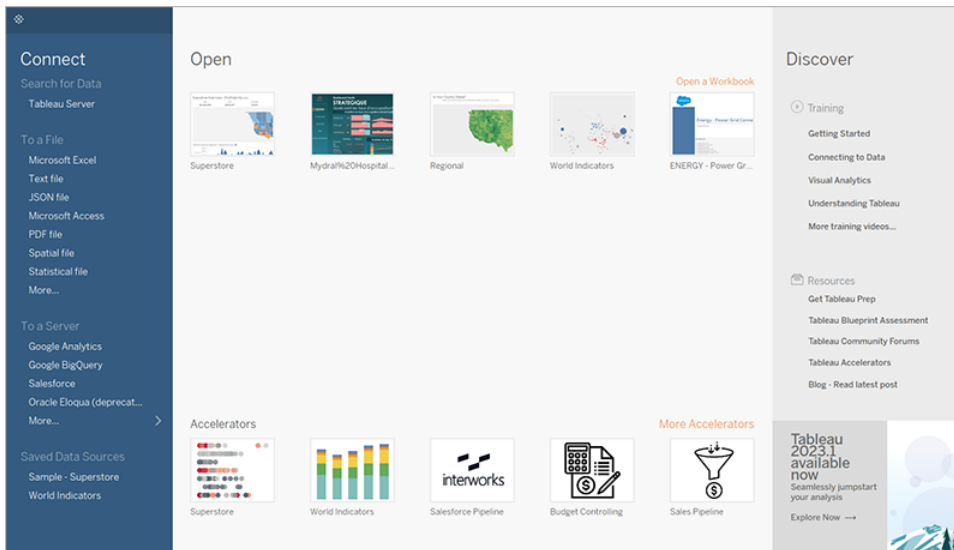

Connect

Connect to data and open saved data sources.

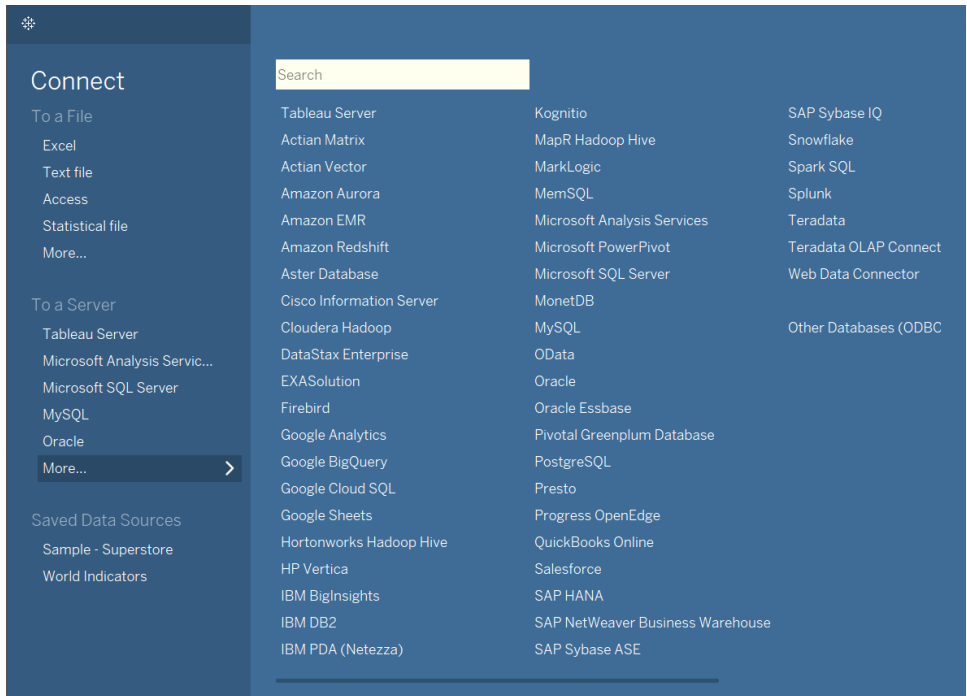

On the **Connect** pane, you can do the following:

- **Connect to data:** Under **To a File**, connect to data stored in Microsoft Excel files, text files, Access files, Tableau extract files, and statistical files, such as SAS, SPSS, and R. Under **To a Server**, connect to data stored in databases like Microsoft SQL Server or Oracle. The server names listed in this section change based on which servers you connect to and how often.
- **Open saved data sources:** Quickly open data sources that you have previously saved to your My Tableau Repository directory. Also, Tableau provides sample saved data sources that you can use to explore Tableau Desktop functionality. To follow along with examples in the Tableau Desktop documentation, you'll usually use the **Sample – Superstore** data source.

Open

Open recent workbooks, pin workbooks to the start page, and explore Accelerator and sample workbooks.

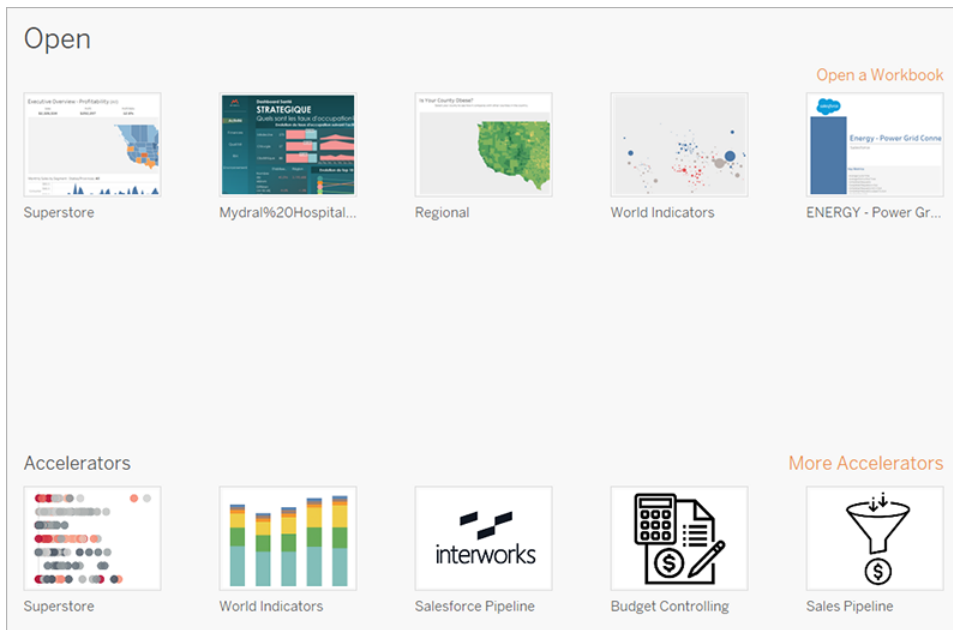

On the **Open** pane, you can do the following:

- **Open recently opened workbooks:** When you open Tableau Desktop for the first time, this pane is empty. As you create and save new workbooks, the most recently opened workbooks appear here. Click the workbook thumbnail to open a workbook, or if you don't see a workbook thumbnail, click the **Open a Workbook** link to find other workbooks that are saved to your computer.
- **Pin workbooks:** You can pin workbooks to the start page by clicking the pin icon that appears in the top-left corner of the workbook thumbnail. Pinned workbooks always appear on the start page, even if they weren't opened recently. To remove a recently opened or pinned workbook, hover over the workbook thumbnail, and then click the "x" that appears. The workbook thumbnail is removed immediately but will show again with your most recently used workbooks the next time you open Tableau Desktop.
- **Explore Accelerators:** Open and explore Accelerators and sample workbooks. The Superstore and World Indicators workbooks are samples that demonstrate what you can do with Tableau. The other three workbooks are Accelerators from the Tableau Exchange. Accelerators are pre-built dashboards targeted at different industries and applications that you can add your data to for quick analysis. **More Accelerators** shows all Accelerators from the Tableau Exchange. Prior to 2023.2, this section showed only sample workbooks.

Discover

See popular views in Tableau Public, read blog posts and news about Tableau, and find training videos and tutorials to help you get started.

The screenshot displays the 'Discover' section of the Tableau help page. It features a 'Training' section with four video thumbnails: 'Getting Started', 'Connecting to Data', 'Visual Analytics', and 'Understanding Tableau'. Below these is a link for 'More training videos...'. The 'VIZ OF THE WEEK' section highlights a visualization titled 'Brexit on Social Media' with a right-pointing arrow. The visualization itself is a line chart with two data series, one in blue and one in yellow, showing fluctuating trends over time. Below the chart, there are links for a blog post 'If I Were New to Tableau Again: 3 Things No One Told Me', the 'Tableau Conference 2016', and 'Forums'.

Data Source Page

During your analysis in Tableau, you have the flexibility to modify the data source. This can be done on the data source page, which Tableau directs you to after you establish the initial connection to your data. Additionally, you can access the data source page by selecting the **Data Source** tab from any location within the workbook.

The data source page generally consists of four main areas: left pane, canvas, data grid, and metadata grid.

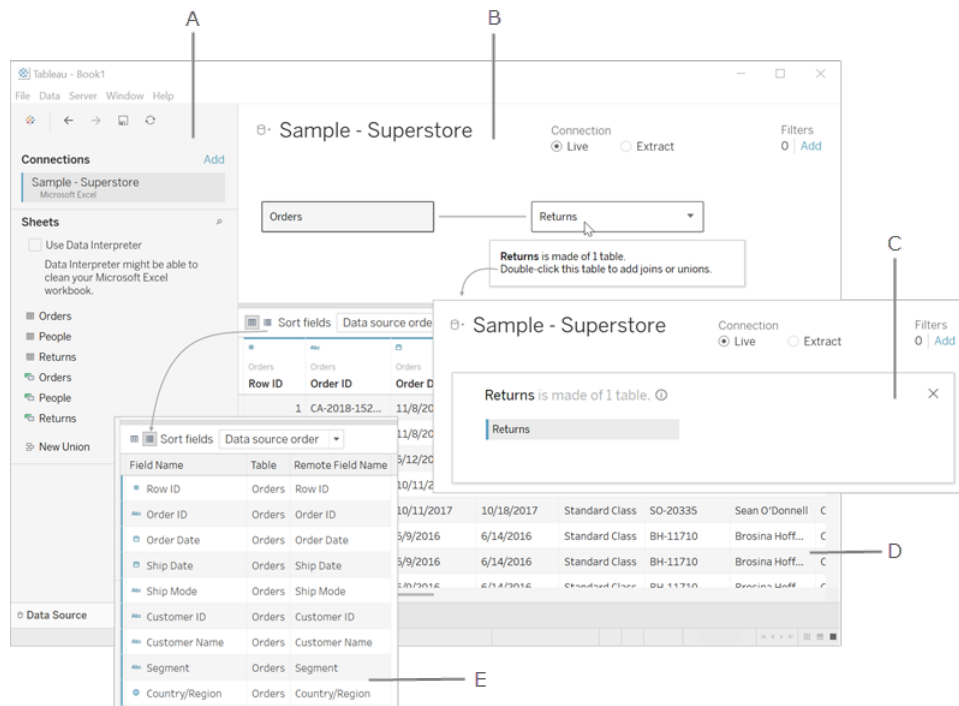

A. Left pane on the facing page: Displays the connected data source and other details about your data.

B. Canvas on the facing page: logical layer - The canvas opens with the logical layer, where you can create relationships between logical tables.

C. Canvas on the facing page: physical layer - Double-click a table in the logical layer to go to the physical layer of the canvas, where you can add joins and unions between tables.

D. Data grid on page 26: Displays the first 1,000 rows of the data contained in the Tableau data source.

E. Metadata grid on page 27: Displays the fields in your data source as rows.

Left pane

The left pane of the data source page displays details about your data. The data that Tableau Desktop is connected to. You can also use the left pane to add more connections to the data source to create cross-database joins.

- For file-based data, the left pane displays the file name and the worksheets in the file.
- For relational-based data, the left pane displays the server, the database, or schema, and the tables in the database.

Note: The left pane doesn't display for cube (multidimensional) data.

Canvas

When connecting to relational and file-based data sources in Tableau, you can drag tables onto the canvas area to begin setting up your data source. The canvas is divided into two layers: a logical layer and a physical layer. By default, the logical layer is displayed, showcasing the relationships between logical tables. To switch to the physical layer, double-click on a logical table in the logical view and start creating joins and unions between tables in the physical layer.

When working with cube data sources, the top section of the data source page will show the available catalogs, queries, and cubes that you can select from to configure your Tableau data source. This allows you to easily connect to and analyze data from cube sources within Tableau.

Note: Based on the type of data you are linked to, you have the ability to update your data whenever changes occur by utilizing various options. For instance, if you are connected to a data extract, you can refresh a specific extract by selecting the **Refresh** button located next to the Connection area on the left side of the pane. For more information about refresh options see [Refresh Data Sources on page 968](#). For more information about refreshing data extracts, see [Refresh Extracts on page 937](#).

Refreshing your data source

Depending on the type of data you're connected to you can refresh your data when that data has changed using a number of options.

Data grid

To analyze the fields and the first rows of data within the Tableau data source, utilize the data grid. The data grid allows for various modifications to be made to the Tableau data source, such as sorting or hiding fields, renaming fields, creating calculations, adjusting column or row sorting, and adding aliases. When working in the logical layer, you can view the data specific to the selected table.

The physical layer displays merged data resulting from joins and unions. For Web Data Connector, file- and relational-based data sources in Extract mode, the grid provides access to extract data, including extract only calculations.

- When you're in the logical layer, you see the data for the selected table.
- In the physical layer, you see the merged data based on the joins and unions.

Select fields

To select multiple fields in the grid, select a column, and then drag the mouse to select more columns.

To select all fields, click the area in the upper-left corner of the grid like in the following example.

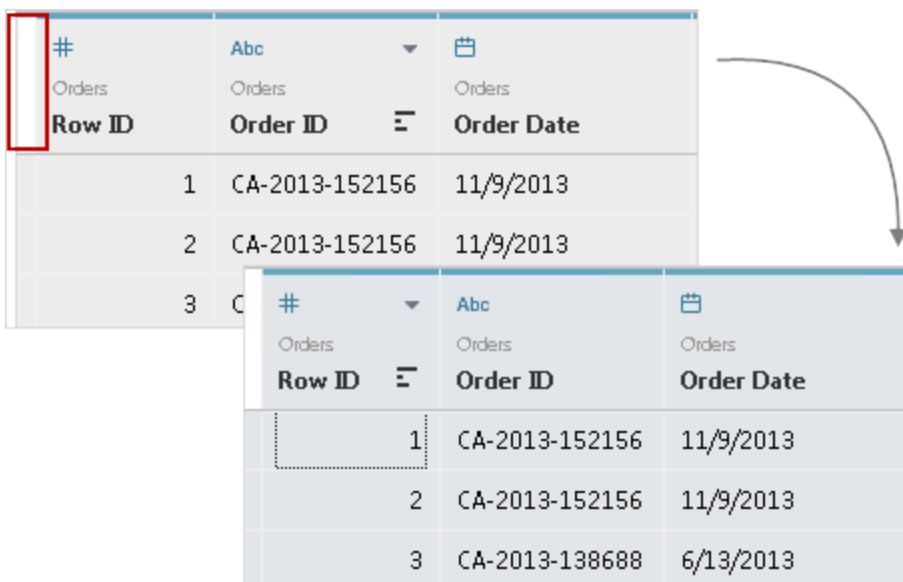

The diagram illustrates the process of selecting all fields in a data grid. It shows two instances of a data grid. In the first grid, the upper-left corner (the area containing the column headers and the first few rows) is highlighted with a red box. A curved arrow points from this area to a second grid, where the entire grid is selected, indicated by a dashed border around the first row and column headers.

#	Abc	
Orders	Orders	Orders
Row ID	Order ID	Order Date
1	CA-2013-152156	11/9/2013
2	CA-2013-152156	11/9/2013
3	CA-2013-138688	6/13/2013

Note: The grid isn't displayed for cube (multidimensional) data.

Metadata grid

The metadata grid will show the fields in your data source as rows, allowing you to analyze the structure of your Tableau data source and carry out regular management tasks like renaming fields or hiding multiple fields. When connected to cube or some extract only data, the metadata grid displays by default.

The Tableau Workspace

The Tableau workspace consists of menus, a toolbar, the Data pane, cards and shelves, and one or more sheets. Sheets can be worksheets, dashboards, or stories. For details on dashboard or story workspaces, see [Create a Dashboard](#) on page 2703 or [The Story Workspace](#) on page 2833.

If you are using Tableau on the web, see [Creators: Get Started with Web Authoring](#) on page 3197 and [Tour Your Tableau Site](#) on page 3180.

Workspace area



- A.** Workbook name. A workbook contains sheets. A sheet can be a worksheet, a dashboard, or a story. For more information, see [Workbooks and Sheets on page 95](#).
- B.** **Cards and shelves** - Drag fields to the cards and shelves in the workspace to add data to your view.
- C.** **Toolbar** - Use the toolbar to access commands and analysis and navigation tools.
- D.** **View** - This is the canvas in the workspace where you create a visualization (also referred to as a "viz").
- E.** Click this icon to go to the Start page, where you can connect to data. For more information, see [Start Page on page 20](#).
- F.** **Side Bar** - In a worksheet, the side bar area contains the **Data pane** and the **Analytics pane**.
- G.** Click this tab to go to the Data Source page and view your data. For more information, see [Data Source Page on page 24](#).
- H.** **Status bar** - Displays information about the current view.
- I.** Sheet tabs - Tabs represent each sheet in your workbook. This can include worksheets, dashboards, and stories. For more information, see [Workbooks and Sheets on page 95](#).

[Back to top](#)







Tableau Toolbar Button Reference







When you are creating or editing a view, you can use the toolbar at the top of the view to perform common actions.





In Tableau Desktop, you can hide or display the Tableau toolbar by selecting **Window > Show Toolbar**.





The table below explains the functions of each toolbar button. Some buttons are not available in all Tableau products. Also see [Visual Cues and Icons in Tableau Desktop on page 111](#).

Toolbar Button	Description
	<p>Tableau icon: Navigates to the start page. For more information, see Start Page on page 20.</p> <p>Note: Tableau Desktop only.</p>

Toolbar Button	Description
	<p>Undo: Reverses the most recent action in the workbook. You can undo an unlimited number of times, back to the last time you opened the workbook, even after you have saved. For more information, see Undo and Redo on page 1998.</p>
	<p>Redo: Repeats the last action you reversed with the Undo button. You can redo an unlimited number of times.</p>
	<p>Save: In Tableau Desktop, saves the changes made to the workbook. For more information, see Save Your Work on page 3077.</p> <p>In Tableau Server or Tableau Cloud, click File > Save or File > Save As to save your changes.</p>
	<p>New Data Source: In Tableau Desktop, opens the Connect pane where you can create a new connection or open a saved connection. For more information, see Connect to Your Data on page 219.</p> <p>In Tableau Server or Tableau Cloud, opens the Connect to a Data Source page, where you can connect to a published data source. For more information, see Connect to published data sources while web authoring on page 274.</p>
	<p>Pause Auto Updates: Controls whether Tableau updates the view when changes are made. Use the drop-down menu to automatically update the entire sheet or just use filters. For more information, see Refresh Data or Pause Automatic Updates on page 3322.</p>
	<p>Run Update: Runs a manual query of the data to update the view with changes when automatic updates are turned off. Use the drop-down menu to update the entire worksheet or just use filters.</p> <div style="background-color: #f0f0f0; padding: 10px; margin-top: 10px;"> <p>Note: Tableau Desktop only.</p> </div>
	<p>New Worksheet: Creates a new blank worksheet, use the drop-down menu to create a new worksheet, dashboard, or story.</p> <p>For more information, see Create new worksheets, dashboards, or</p>

Toolbar Button	Description
	stories on page 96.
	Duplicate: Creates a new worksheet containing the same view as the current sheet. For more information, see Duplicate a sheet on page 98 .
	Clear: Clears the current worksheet. Use the drop-down menu to clear specific parts of the view such as filters, formatting, sizing, and axis ranges.
	Swap: Moves the fields on the Rows shelf to the Columns shelf and vice versa. The Hide Empty Rows and Hide Empty Columns settings are always swapped with this button.
	Sort Ascending: Applies a sort in ascending order of a selected field based on the measures in the view. For more information, see Sort Data in a Visualization on page 1345 .
	Sort Descending: Applies a sort in descending order of a selected field based on the measures in the view. For more information, see Sort Data in a Visualization on page 1345 .
	<p>Totals: You can compute grand totals and subtotals for the data in a view. Select from the following options:</p> <ul style="list-style-type: none"> • Show Column Grand Totals: Adds a row showing totals for all columns in the view. • Show Row Grand Totals: Adds a column showing totals for all rows in the view. • Row Totals to Left: Moves rows showing totals to the left of a crosstab or view. • Column Totals to Top: Moves columns showing totals to the top of a crosstab or view. • Add All Subtotals: Inserts subtotal rows and columns in the view, if you have multiple dimensions in a column or row. • Remove All Subtotals: Removes subtotal rows or columns.

Toolbar Button	Description
	<p>Note: Tableau Server and Tableau Cloud only. In Tableau Desktop, click Analysis > Totals. For more information, see Show Totals in a Visualization on page 1354.</p>
	<p>Highlight: Turn on highlighting for the selected sheet. Use the options on the drop-down menu to define how values are highlighted. For more information, see Highlight Toolbar Button on page 1400.</p>
	<p>Group Members: Creates a group by combining selected values. When multiple dimensions are selected, use the drop-down menu to specify whether to group on a specific dimension or across all dimensions. For more information, see Correct Data Errors or Combine Dimension Members by Grouping Your Data on page 1090.</p> <p>Note: Tableau Desktop only. In Tableau Server and Tableau Cloud, create groups using the Group Members button on the tooltip.</p>
	<p>Show Mark Labels: Switches between showing and hiding mark labels for the current sheet. For more information, see Show, Hide, and Format Mark Labels on page 1284.</p>
	<p>Fix Axes: switches between a locked axis that only shows a specific range and a dynamic axis that adjusts the range based on the minimum and maximum values in the view. For more information, see Edit Axes on page 2958.</p> <p>Note: Tableau Desktop only.</p>
	<p>Format Workbook: Open the Format Workbook pane to change how fonts and titles look in every view in a workbook by specifying format settings at the workbook level instead of at the worksheet level.</p>

Toolbar Button	Description
	<p>Note: Tableau Server and Tableau Cloud only. In Tableau Desktop, click Format > Workbook. For more information, see Format at the Workbook Level on page 2932.</p>
	<p>Fit: Specifies how the view should be sized within the window. Select Standard, Fit Width, Fit Height, or Entire View. Note: This menu is not available in geographic map views.</p> <p>The Cell Size commands have different effects depending on the type of visualization. To access the Cell Size menu in Tableau Desktop click Format > Cell Size.</p>
	<p>Show/Hide Cards: Shows and hides specific cards in a worksheet. Select each card that you want to hide or show on the drop-down menu.</p> <p>In Tableau Server and Tableau Cloud, you can show and hide cards for the Title, Caption, Filter and Highlighter only.</p>
	<p>Presentation Mode: Switches between showing and hiding everything except the view (i.e., shelves, toolbar, Data pane). For more information, see Reorganizing the Workspace on page 105.</p> <p>Note: Tableau Desktop only.</p>
	<p>Download: Use the options under Download to capture parts of your view for use in other applications.</p> <ul style="list-style-type: none"> • Image: Displays the view, dashboard, or story as an image in a new browser tab. • Data: Displays the data from the view in a new browser window with two tabs: Summary, showing aggregated data for the fields shown in the view, and Underlying, showing underlying data for the selected marks in the visualization. If the new window does not open, you may need to disable your browser's popup blocker. • Crosstab: Saves the underlying data for the selected marks in the visualization to a CSV (comma-separated values) file which can

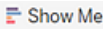
Toolbar Button	Description
	<p>then be opened in Microsoft Excel.</p> <ul style="list-style-type: none"> • PDF: Opens the current view as a PDF in a new browser window. From there you can save it to a file. If the new window does not open, you may need to disable your browser's pop-up blocker. <p>Note: Tableau Server and Tableau Cloud only.</p>
	<p>Share Workbook With Others: Publish your workbook to Tableau Server or Tableau Cloud. For more information, see Simple Steps to Publish a Workbook on page 3116.</p> <p>Note: Tableau Desktop only.</p>
	<p>Show Me: Helps you choose a view type by highlighting view types that work best with the field types in your data. An orange outline shows around the recommended chart type that is the best match for your data. For more information, see Use Show Me to Start a View on page 1229.</p>

[Back to top](#)

Show and Hide the Side Bar (Data pane)

The Side Bar contains the **Data** pane and the **Analytics** pane when you are editing a worksheet. Different panes are visible depending on what you are doing in the view (Data, Analytics, Story, Dashboard, Layout, Format). The most important thing to know about the Side Bar is that you can expand and collapse this area in the workspace.

To hide the side bar in Tableau Desktop, click the collapse arrow in the side bar.

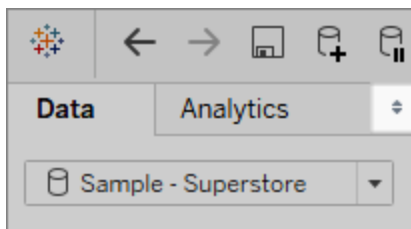

To hide the side bar on the web, click the collapse arrow in the side bar.

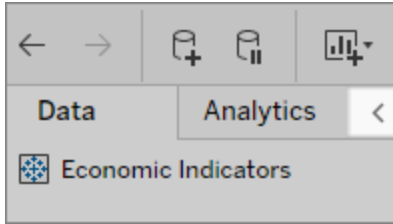

To show the side bar on Tableau Desktop, click the expand arrow in the bottom-left of the workspace (in the status bar).

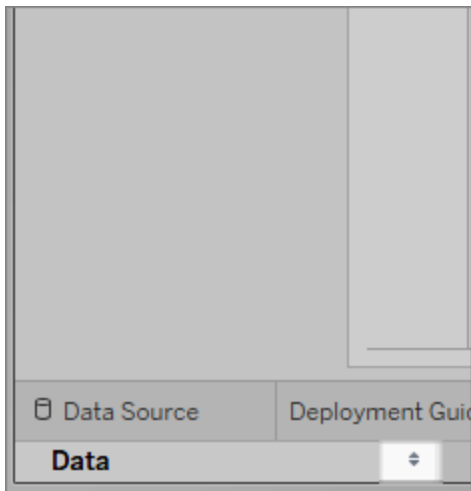

To show the side bar on the web, click the expand arrow in the side bar.

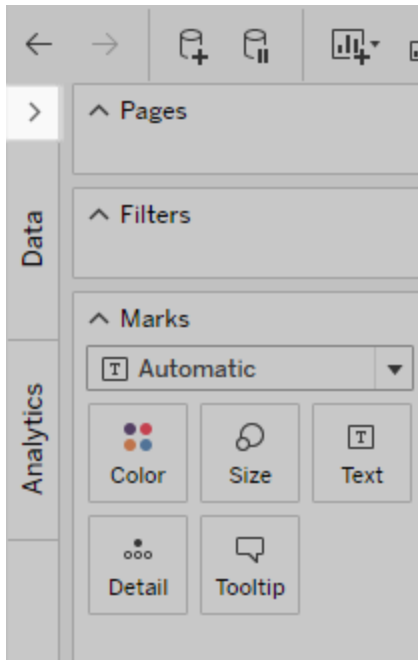

[Back to top](#)



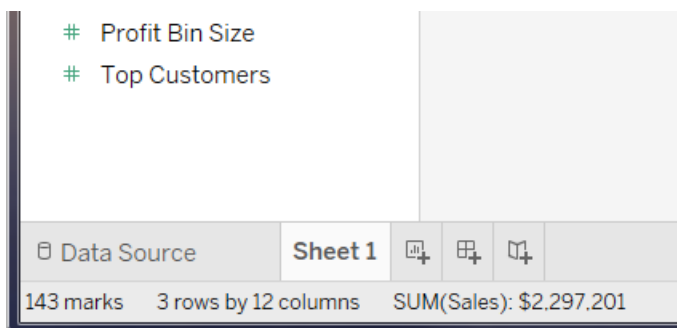

Status Bar Information

The status bar is located at the bottom of the Tableau workspace. It displays descriptions of menu items as well as information about the current view. For example, the status bar below shows that the view has 143 marks shown in 3 rows and 12 columns. It also shows that the SUM (Sales) for all the marks in the view is \$2,297,201.



You can hide the status bar by selecting **Window > Show Status Bar**.

Occasionally, Tableau will display warning icons in the bottom right corner of the status bar to indicate errors or warnings. Below are the possible warning icons and what they mean.

Warning Icon	Description
	<p>Cancel query indicator: When you cancel multiple queries, an indicator appears to show you how many queries are still running on the database and using resources.</p> <p>When you cancel a query in Tableau, the database is told to stop processing the query. However, some databases do not support cancel (MS Excel, MS Access, Essbase, Microsoft Analysis Services 2000). If you cancel a query using one of these types of data sources, the query is abandoned by Tableau but is still running in the background and using resources. When you have abandoned queries, an indicator appears in the bottom right corner of the workbook showing the number of queries still running . As queries in the background complete, the number will go down. It is important to monitor the number of queries running and not let the number get too high, otherwise you will see performance degradation of both Tableau and the underlying database.</p> <p>Note: Text, Microsoft Excel, and Microsoft Access data sources may be temporarily unavailable after canceling a query because of a lock performed internally. You may have to wait until the abandoned query has completed before re-connecting.</p>
	<p>Precision warning: Some fields are more precise in the database than Tableau can model. When you add a field to a view that contains values with more precision than Tableau can model, a warning icon  is displayed in the bottom right corner of the status bar.</p> <p>For example, a value in the database may have 22 decimal places but Tableau only supports up to 15. When you add that field to the view, you get a precision warning. If you click on the warning, you can read more details including the number of decimal places that have been truncated in the view.</p> <p>Remember that the precision of the data displayed in Tableau will always first be dependent on the data in your database. If the values in your database exceed 15 decimal places, when you add them to the view, the</p>

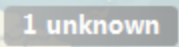
Warning Icon	Description
	<p>value is truncated and a precision warning appears.</p> <p>Note: Extracts of relational databases always use the Hyper double precision type, and never use the Hyper numeric type. So if you create an extract of a relational database, you only get 15 digits of precision. You can write to the Hyper API and use the numeric type to get up to 18 digits. For related information, see Numeric Types in Hyper API documentation.</p>
	<p>Special values indicator: If your data contains null values, unknown geographic locations, or negative or zero values on a logarithmic axis; the values are shown with an indicator in the lower right corner of the view. Click the indicator for options for handling these values. See Handling Null and Other Special Values on page 1219 to learn more about this indicator and how to handle these values.</p>

[Back to top](#)

Work with Data Fields in the Data Pane

Tableau displays data source connections and data fields for the workbook in the **Data** pane on the left side of the workspace.

Note: For details on how to start creating visualizations, see [Get Started on page 3](#). For details on the many ways you can customize the fields in the Data pane, see [Organize and Customize Fields in the Data Pane on page 1051](#) and [Edit Default Settings for Fields on page 1063](#).

Areas of the Data pane

After you connect to your data and set up the data source with Tableau, the data source connections and fields appear on the left side of the workbook in the Data pane. For details on connecting to data, see [Connect to and Prepare Data on page 219](#).

Current data source connections appear at the top of the **Data** pane. When you have more than one connection available, click a connection to select it and start working with that data.

You build visualizations by adding fields from the Data pane to the view. For details, see [Start Building a Visualization by Dragging Fields to the View](#) on page 1187.

Fields can be organized by table (**Group by Data Source Table**) or folder (**Group by Folder**). Dimensions are displayed above the gray line, and measures below the gray line for each table or folder. In some cases, a table or folder might contain only dimensions, or only measures to start with.

- Calculated fields are listed with their originating field, if all of their input fields come from the same table.
- Sets are listed with the table with their originating field.
- Parameters are global to the workbook and are displayed in the Parameters area.
- Fields that don't belong to a specific table are displayed in the general area below the tables. These include: aggregated calculations, calculations that use fields from multiple tables, Measure Names, and Measure Values.
- In version 2024.2 and later: Field names are displayed in light gray text in the Data pane when they're not related to any fields in use in the view. You can still use these fields for analysis in the viz, but unrelated fields are evaluated differently in analysis than fields that are related. You might see this behavior if you are [using a data source with multi-fact relationships](#).

Below the data source connections in the **Data** pane are the fields that are available in the currently selected data source. You can toggle between the **Data** and **Analytics** panes in a worksheet. For details on the Analytics pane, see [Apply Advanced Analysis to a View \(Analytics Pane\)](#) on page 48.

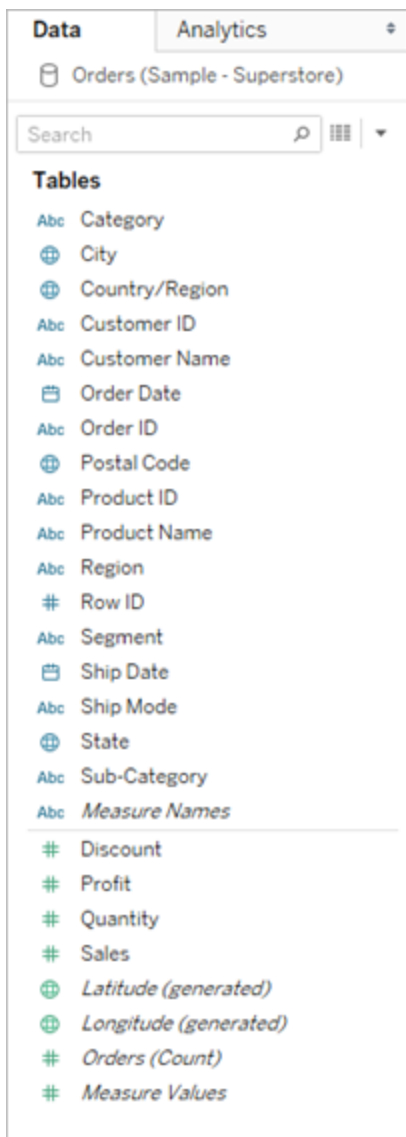

Fields from a single-table data source in the Data pane

The Data pane includes:

- **Dimension fields** – Fields that contain qualitative values (such as names, dates, or geographical data). You can use dimensions to categorize, segment, and reveal the details in your data. Dimensions affect the level of detail in the view. Examples of dimensions include dates, customer names, and customer segments.
- **Measure fields** – Fields that contain numeric, quantitative values can be measured. You can apply calculations to them and aggregate them. When you drag a measure into the view, Tableau applies an aggregation to that measure (by default). Examples of measures: sales, profit, number of employees, temperature, frequency.

- **Calculated fields** – If your underlying data doesn't include all of the fields you need to answer your questions, you can create new fields in Tableau using calculations and then save them as part of your data source. These fields are called calculated fields.
- **Sets** – Subsets of data that you define. Sets are custom fields based on existing dimensions and criteria that you specify. For more information, see [Create Sets on page 1092](#).

Named sets from an MS Analysis Services server or from a Teradata OLAP connector also appear in Tableau in this area of the Data pane. You can interact with these named sets in the same way you interact with other custom sets in Tableau.

- **Parameters** – Values that can be used as placeholders in formulas, or replace constant values in calculated fields and filters. For more information, see [Create Parameters on page 1122](#).

Note: For cube data sources, fields are explicitly defined as dimensions or measures when the database is created. For relational data sources, Tableau automatically organizes the fields. By default, fields containing text, date or boolean values are dimensions, while fields containing numerical values are measures.

By default the field names defined in the data source are displayed in the Data pane. You can rename fields and member names, create hierarchies, and organize the fields into groups and folders. For details, see [Edit Default Settings for Fields on page 1063](#), [Organize and Customize Fields in the Data Pane on page 1051](#), and [Create Hierarchies on page 1076](#)

Columns become measure and dimension fields in the view

Data sources contain fields. For relational data sources that you connect to, the fields are determined by the columns of a table or view. Each field contains a unique attribute of the data such as customer name, sales total, product type, and so on.

For cube (multidimensional) data sources, the fields are determined by the dimensions and measures of a cube. In Tableau, cube data sources are supported only in Windows.

Here's an example of fields from an Excel worksheet.

	A	B	C	D	E	F	G	H
1	Row ID	Order ID	Order Date	Ship Date	Ship Mode	Customer ID	Customer Na	Segment
2	1	CA-2013-152156	11/9/2014	11/12/2014	Second Class	CG-12520	Claire Gute	Consumer
3	2	CA-2013-152156	11/9/2014	11/12/2014	Second Class	CG-12520	Claire Gute	Consumer
4	3	CA-2013-138688	6/13/2014	6/17/2014	Second Class	DV-13045	Darrin Van H	Corporate
5	4	US-2012-108966	10/11/2013	10/18/2013	Standard Cla	SO-20335	Sean O'Donn	Consumer
6	5	US-2012-108966	10/11/2013	10/18/2013	Standard Cla	SO-20335	Sean O'Donn	Consumer
7	6	CA-2011-115812	6/9/2012	6/14/2012	Standard Cla	BH-11710	Brosina Hoffr	Consumer
8	7	CA-2011-115812	6/9/2012	6/14/2012	Standard Cla	BH-11710	Brosina Hoffr	Consumer
9	8	CA-2011-115812	6/9/2012	6/14/2012	Standard Cla	BH-11710	Brosina Hoffr	Consumer
10	9	CA-2011-115812	6/9/2012	6/14/2012	Standard Cla	BH-11710	Brosina Hoffr	Consumer
11	10	CA-2011-115812	6/9/2012	6/14/2012	Standard Cla	BH-11710	Brosina Hoffr	Consumer
12	11	CA-2011-115812	6/9/2012	6/14/2012	Standard Cla	BH-11710	Brosina Hoffr	Consumer
13	12	CA-2011-115812	6/9/2012	6/14/2012	Standard Cla	BH-11710	Brosina Hoffr	Consumer
14	13	CA-2014-114412	4/16/2015	4/21/2015	Standard Cla	AA-10480	Andrew Allen	Consumer
15	14	CA-2013-161389	12/6/2014	12/11/2014	Standard Cla	IM-15070	Irene Maddo	Consumer
16	15	US-2012-118983	11/22/2013	11/26/2013	Standard Cla	HP-14815	Harold Pawla	Home Office
17	16	US-2012-118983	11/22/2013	11/26/2013	Standard Cla	HP-14815	Harold Pawla	Home Office
18	17	CA-2011-105893	11/11/2012	11/18/2012	Standard Cla	PK-19075	Pete Kriz	Consumer
19	18	CA-2011-167164	5/13/2012	5/15/2012	Second Class	AG-10270	Alejandro Grc	Consumer
20	19	CA-2011-143336	8/27/2012	9/1/2012	Second Class	ZD-21925	Zuschuss Doi	Consumer
21	20	CA-2011-143336	8/27/2012	9/1/2012	Second Class	ZD-21925	Zuschuss Doi	Consumer
22	21	CA-2011-143336	8/27/2012	9/1/2012	Second Class	ZD-21925	Zuschuss Doi	Consumer

When you start building a visualization in a worksheet, these columns are available as fields in the Data pane. For details, see [Areas of the Data pane on page 37](#).

Each field has a data type (that you can change if needed), and a role: discrete dimension, continuous dimension, discrete measure, or continuous measure. For details, see [Data Types on page 157](#) and [Dimensions and Measures, Blue and Green on page 147](#).

Each field also includes some default settings, such as a default aggregation of SUM or AVG, depending on the structure of the current view. For details, see [Edit Default Settings for Fields on page 1063](#) and [Data Aggregation in Tableau on page 171](#).

Fields that Tableau automatically creates

The Data pane can also contain a number of fields that do not come from your original data: Measure Names and Measure Values, Number of Records, Latitude and Longitude.

Measure Names and Measure Values

- The **Measure Values** field contains all the measures in your data, collected into a single field with continuous values. Drag individual measure fields out of the Measure Values card to remove them from the view.
- The **Measure Names** field contains the names of all measures in your data, collected into a single field with discrete values.

For more details about how to use Measure Values and Measure Names in visualizations, see [Measure Values and Measure Names](#) on page 1212.

Count of Table

Starting with Tableau 2020.2, every table in a data source has a **Count** field, in the form of *NameofTable*(Count). The table count field is an automatically generated, calculated field.

COUNT of table = SUM of the number of records per table

To see the count for a table, drag its Count field into the view. To see the count for all tables, select the Count field for each table in the Data pane, and then click the Text Table in Show Me.

You can't build calculations on top of a table's Count field, and it is aggregate-only.

Number of Records (before version 2020.2)

You might see a Number of Records field if it is being used in a visualization from a previous version of Tableau.

In versions of Tableau before 2020.2, the **Number of Records** field is an automatically generated, calculated field that is set to the number 1. That number gets associated with each row in the data source. If you add the Number of Records field to the view, you will see the summed count of all the rows in a data source (the number of records). You can use the Number of Records field to get quick counts of various dimensions' values. Viewing the Number of Records can help you to see if your data joins are working the way you expect them to.

Latitude and Longitude (generated)

When Tableau interprets fields to be geographic fields that can be used with maps, it automatically geocodes the data and includes **Latitude (generated)** and **Longitude (generated)** fields. You can use these fields to overlay your data on live maps. For more information on how to use these fields, and best practices for building maps in Tableau, see [Maps and Geographic Data Analysis in Tableau](#) on page 1647 [Assign Geographic Roles](#) on page 1727, [Location Data that Tableau Supports for Building Map Views](#) on page 1687,

Perform common tasks in the Data pane

To select a data source connection for analysis, click the data source connection name in the Data pane. For more details, see [Navigate Data Sources in the Data Pane](#) on page 45.

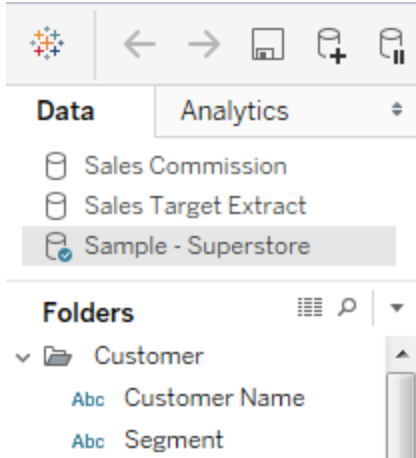

To view a context menu for the data source, click **Data** in the top menu and then click on the data source in the menu list. For more information, see [Edit Data Sources on page 957](#).

To search for fields in the Data pane, click the magnifying glass icon and then type in the text box.

To see the underlying data, click the **View Data** icon at the top of the **Data** pane.

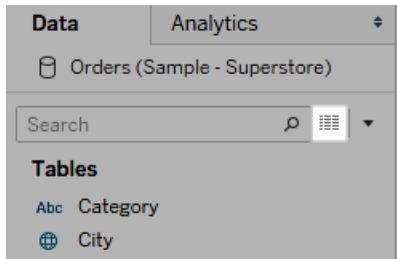

For more information, see [View Underlying Data on page 2001](#)

View Data: Sample - Superstore				
9,994 rows → <input checked="" type="checkbox"/> Show aliases				
Category	City	Country	Customer Name	
Office Supplies	Houston	United States	Darren Powers	
Office Supplies	Naperville	United States	Phillina Ober	
Office Supplies	Naperville	United States	Phillina Ober	
Office Supplies	Naperville	United States	Phillina Ober	
Office Supplies	Philadelphia	United States	Mick Brown	
Office Supplies	Athens	United States	Jack O'Briant	
Office Supplies	Los Angeles	United States	Lycoris Saunders	
Furniture	Henderson	United States	Maria Etezadi	
Office Sunnlies	Henderson	United States	Maria Ftezadi	

In cases where Tableau has misclassified a field as a dimension or a measure, possibly because of the data type, you can convert it and change its role.

To convert a measure to a dimension, drag the measure and drop it into the **Dimensions** area in the **Data** pane. For more details, see [Convert a Measure to a Dimension on page 1071](#).

Change data fields to fit your needs

When you drag a field into the view, it will have certain default settings and characteristics. You can customize a field that is already in the view, just for that instance of the field. Or you can change its settings in the Data pane to make the field use those settings going forward.

You can control the definition of a field in the view, depending on how you want to work with that field data.

Note: To change the default settings for a field before you drag it into the view, right-click it (Control-click on a Mac). You can then edit its settings and default properties from its context menu.

For details on the many ways you can customize the fields in the Data pane, see [Organize and Customize Fields in the Data Pane on page 1051](#) and [Edit Default Settings for Fields on page 1063](#).

Relational versus cube data

The Data pane for a relational and cube data source are shown below. Note that the panes look essentially the same for both data sources in that the fields are organized into dimensions and measures. However, the cube data source contains hierarchies for dimensions. For example, notice that the Employee dimension in the cube Data pane contains hierarchical members such as Manager Name and Employee Dept.

Relational data sources don't have built-in hierarchies. However, relational data sources often have related dimensions that have an inherent hierarchy. For example, a data source may have fields for Country, State, and City. These fields could be grouped into a hierarchy called Location. You can assemble relational hierarchies by dragging and dropping in the Data pane. For details, see [Create Hierarchies on page 1076](#).

Note: In Tableau, cube (multidimensional) data sources are supported only in Windows.

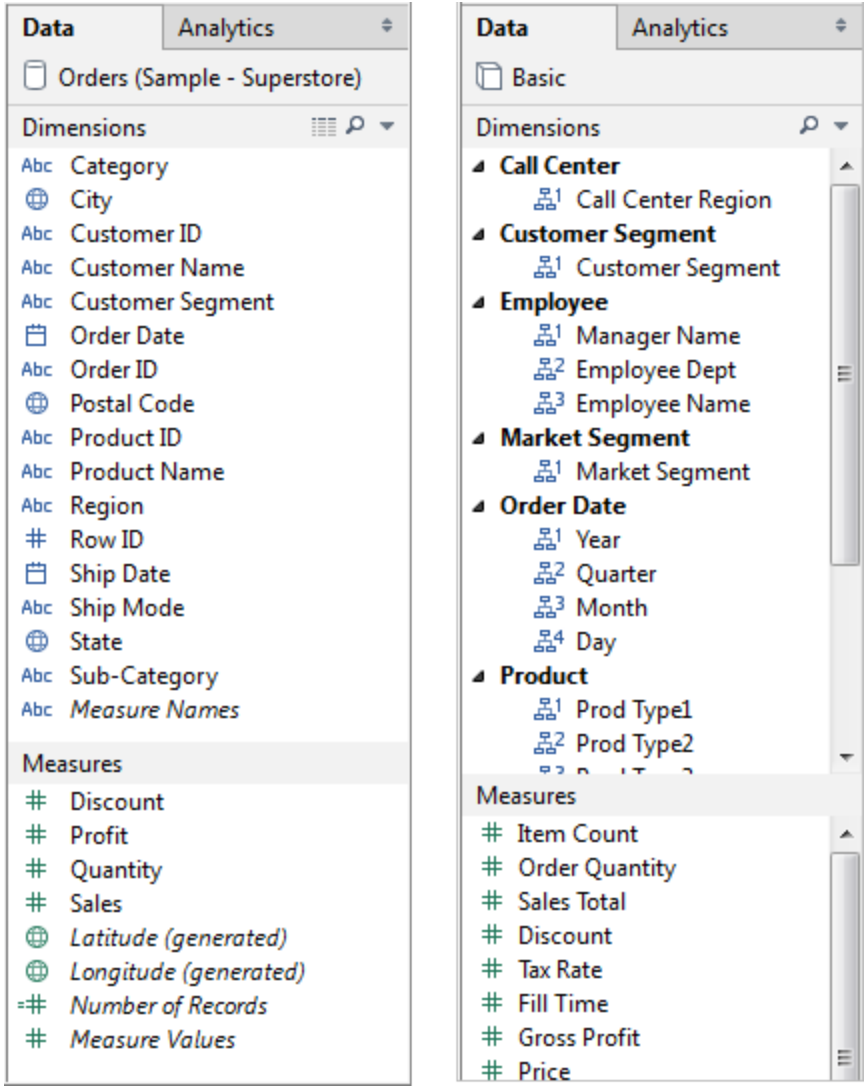

Data pane with relational data (left image) versus cube data (right image)

You can expand or collapse hierarchies in both relational and cube Data panes by clicking the arrow. You can hide the Data pane all together by clicking the minimize button  in the upper-right corner of the Data pane.

For information on cube data sources, see [Cube Data Sources](#) on page 982.

Navigate Data Sources in the Data Pane

The top of the Data pane lists all of the data sources in a given workbook. Click the data source you want to use to select it. The Data pane updates to show the corresponding fields in that data source.

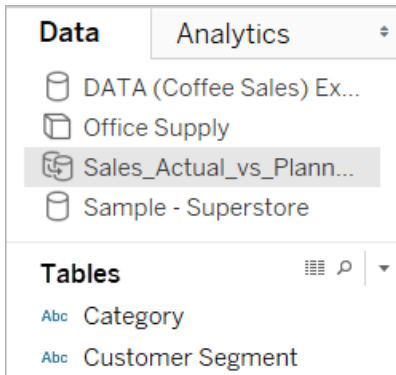

You can resize the data source list area in the Data pane to save space. When you resize to a limited vertical height, you can scroll down to a data source.

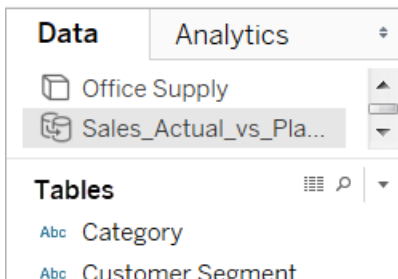

Each data source has an icon to indicate its type. For example, the icon can indicate whether the data source is relational, cube (multidimensional), or an extract. In Tableau, cube data sources are supported only in Windows.

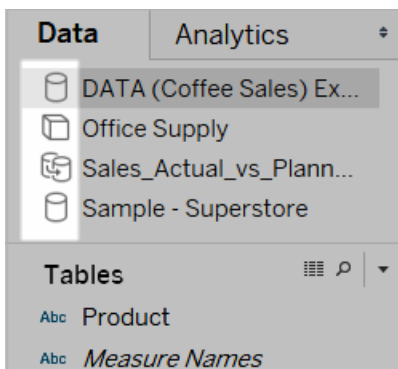

You can right-click (control-click on a Mac) the data source to access the commands that are on the Data menu. For example, you can right-click (control-click on a Mac) a data source and rename, export, or close it.

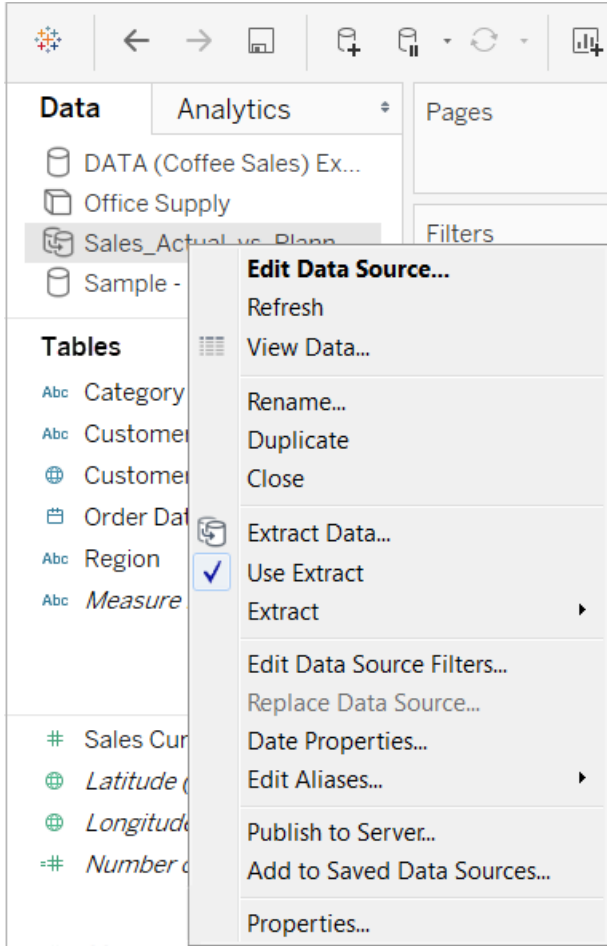

For details on the many ways you can customize and work with the fields in the Data pane, see [Organize and Customize Fields in the Data Pane](#) on page 1051, [Edit Default Settings for Fields](#) on page 1063, and [Work with Data Fields in the Data Pane](#) on page 37.

Navigate Between the Start Page and Workspace

When Tableau Desktop is already open, you can navigate to the start page by clicking the Tableau icon in the upper-left corner of the Tableau Desktop workspace.

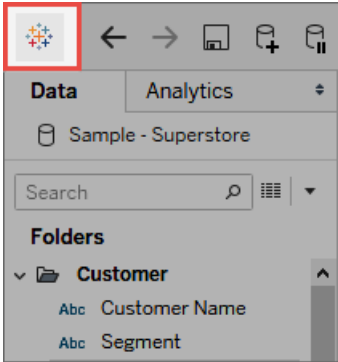

To go back to the Tableau workspace, click the Tableau icon in the start page.

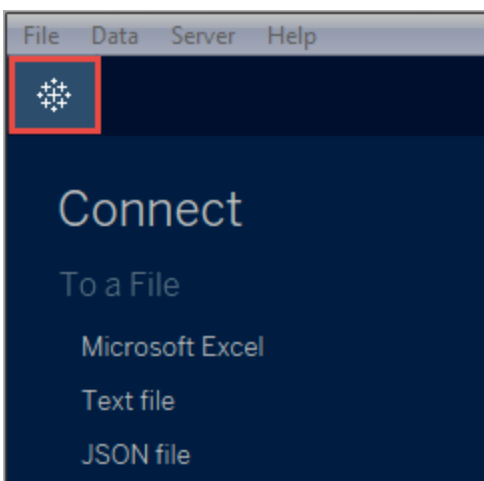

Apply Advanced Analysis to a View (Analytics Pane)

Drag reference lines, box plots, trend lines, forecasts, and other items into your view from the **Analytics** pane, which appears on the left side of the workspace. Toggle between the **Data** pane and the **Analytics** pane by clicking the tabs at the top of the side bar.



Tableau Desktop Analytics pane

In Tableau Desktop, options for adding Analytics objects to the view are available the **Analytics** pane or menu, or in context in the view. For example, reference lines and bands are available when you edit an axis, and trend lines and forecasts are available from the Analysis menu.

The **Analytics** pane provides drag-and-drop access for the various options.

On the web, most Analytics objects are available from the Analytics pane.

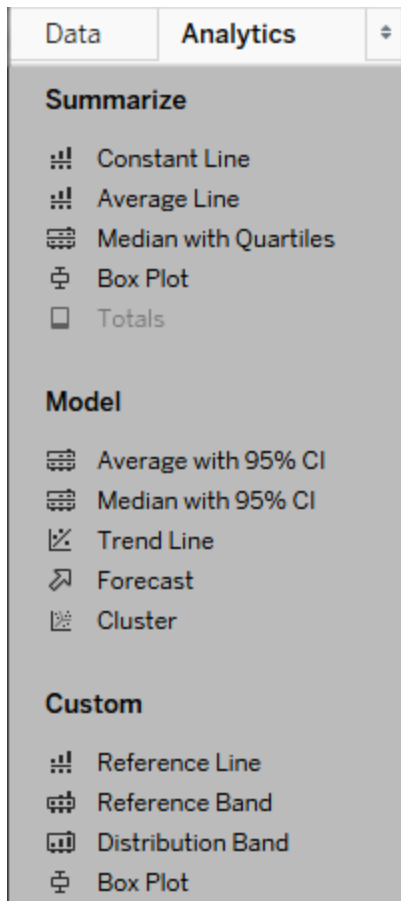
Add an analytics object to the view

To add an item from the **Analytics** pane, drag it into the view. When you drag an item from the **Analytics** pane, Tableau shows the possible destinations for that item. The range of choices varies depending on the type of item and the current view.

In a simple case, the drop target area would offer these three options:

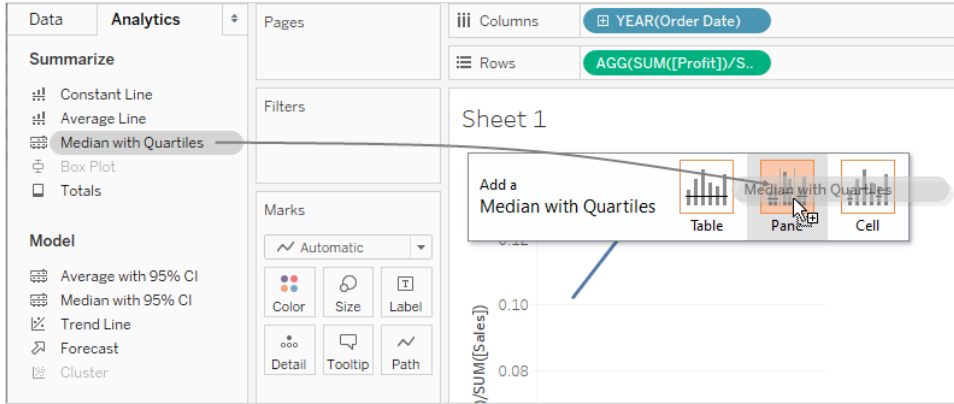

The terms **Table**, **Pane** and **Cell** define the scope for the item:

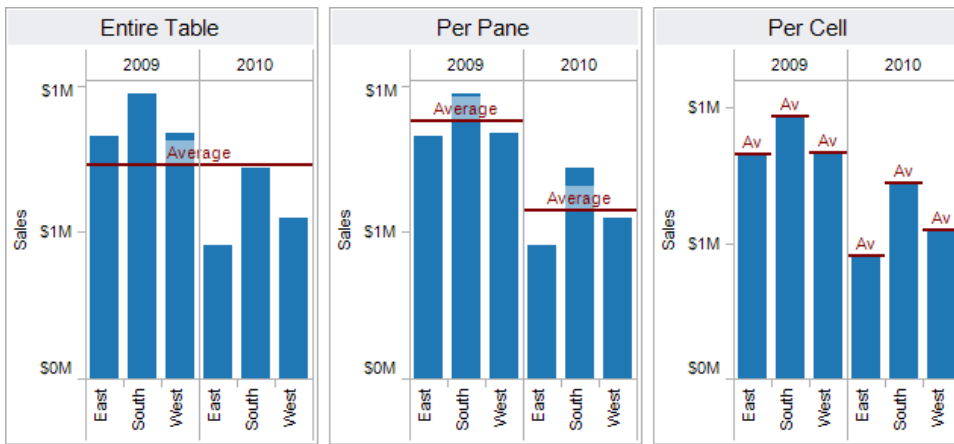

Adds a reference line to the entire table across all panes.

Adds a reference line on a per pane basis. Computed reference lines are recalculated for each pane in the view.

Adds a reference line within each cell. Computed reference lines are recalculated for each cell in the view.

For a more complicated view—for example, if the view contained a line chart with multiple or dual axes—Tableau would show you a drop target area that looked like this:

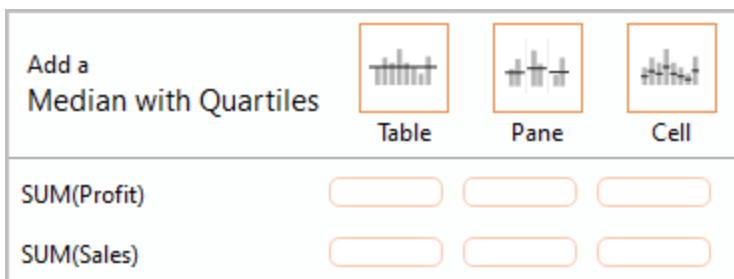

If you dropped the item in one of the three larger boxes in the header at the top of the drop target area—for example, the Table box—a separate median with quartiles would be added for each axis:

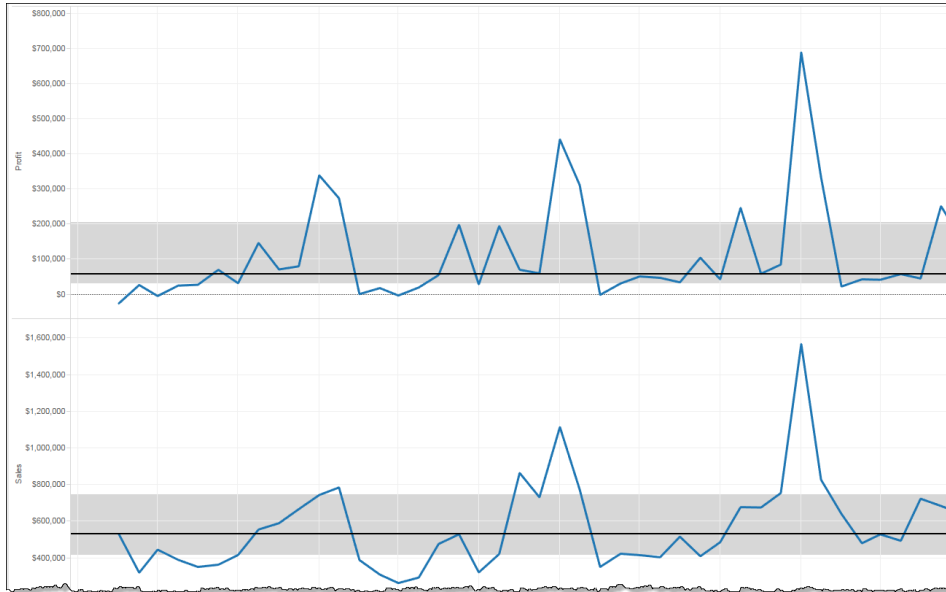

But if you drop the item in any of the six lower boxes aligned with a specific measure, the median with quartiles would only be added on the corresponding axis, with the specified scope.

Delete an analytics object from the view

You can delete an analytics object from the view by clicking Undo, or drag the object off the view to delete it.

You can also click on an item and choose **Remove** from the tooltip.

Note: Some **Analytics** pane items (**Median with Quartiles** and **Average with 95% CI**) add both a reference line and a reference distribution. Unless you are using Undo, you would need to delete these items separately.

Edit an analytics object in the view

To edit an item you have added from the Analytics pane, click on the item and select **Edit** from the tooltip. For additional editing options, see the section for a particular item type under Analytics object definitions, below.

Analytics object definitions

The following items can be dragged from the **Analytics** pane and dropped in the view. If an analytics object cannot be applied to the current configuration of fields in the view, it isn't available.

Constant Line

Adds one or more constant lines to the view. You can add a constant line for a specific measure, for all measures, or for date dimensions. When you add a constant line, Tableau displays a Value prompt where you specify the value for the constant:



Value:

In Tableau Desktop, the Value prompt for a date value is a calendar control:

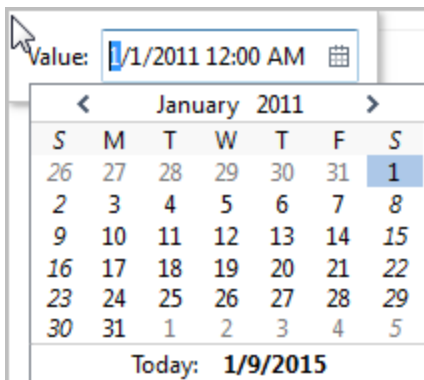

Value:

January 2011						
S	M	T	W	T	F	S
26	27	28	29	30	31	1
2	3	4	5	6	7	8
9	10	11	12	13	14	15
16	17	18	19	20	21	22
23	24	25	26	27	28	29
30	31	1	2	3	4	5

Today: 1/9/2015

You can click on a resulting constant line and choose **Edit** or **Remove**. In Tableau Desktop there is a third option: **Format**. Choosing **Edit** opens the Edit Reference Line dialog box. For details, see [Edit Existing Reference Lines, Bands, and Distributions](#) on page 2502 in the **Reference Lines, Bands, Distributions, and Boxes** article. Another way to edit a line in Tableau Desktop is to right-click (control-click on Mac) the relevant axis and choose **Edit Reference Line**.

Average Line

Adds one or more average lines to the view. You can add an average line for a specific measure or for all measures.

You can click on a resulting average line and choose a different aggregation, such as Total or Sum. You can also choose **Edit** or **Remove**. In Tableau Desktop there is a third option: **Format**.

Choosing **Edit** opens the Edit Reference Line dialog box. For details, see [Edit Existing Reference Lines, Bands, and Distributions](#) on page 2502 in the **Reference Lines, Bands, Distributions, and Boxes** article. Another way to edit a line in Tableau Desktop is to right-click (control-click on Mac) the relevant axis and choose **Edit Reference Line**.

Median with Quartiles

Adds one or more sets of median lines and distribution bands to the view. You can add a median with quartiles for a specific measure or for all measures.

The distribution bands are computed as quartiles; the middle two quartiles are shaded.

You can click on a resulting median line or distribution and choose **Edit** or **Remove**. In Tableau Desktop there is a third option: **Format**. Median lines and distributions must be edited, formatted, or removed separately. Choosing **Edit** opens the Edit Reference Line dialog box. You must click on the outer edge of a distribution band to see the options—clicking in the middle of the band has no effect. For details, see [Edit Existing Reference Lines, Bands, and Distributions](#) on page 2502 in the **Reference Lines, Bands, Distributions, and Boxes** article. Another way to edit a line or distribution in Tableau Desktop is to right-click (control-click on Mac) the relevant axis and choose **Edit Reference Line**. A submenu will offer you two choices: **Quartiles** and **Median**.

For information on distribution types, including quartiles, see [Add Reference Distributions](#) on page 2493 in the **Reference Lines, Bands, Distributions, and Boxes** article.

Box Plot

Adds one or more box plots to the view. You can add box plots for a specific measure or for all measures. The scope for a box plot is always **Cell** (and never **Table** or **Pane**).

Click or hover over any of the horizontal lines in the box plot to see statistical information about the whiskers, quartiles, and median.

You can also choose **Edit** or **Remove** when you click on a line. In Tableau Desktop there is a third option: **Format**. Choosing **Edit** opens the Edit Reference Line dialog box. Another way to edit a box plot in Tableau Desktop is to right-click (control-click on Mac) the relevant axis and choose **Edit Reference Line**.

Note: In Tableau Desktop, there are two items named **Box Plot** in the Analytics pane. For the Box Plot option in the Summarize section, Tableau will automatically add a box plot for the specified target. For the Box Plot option in the Custom section, Tableau will open the Edit Reference Line, Band, or Box dialog box after you specify a target.

Totals

Adds totals to the view. When you add totals, the drop options are **Subtotals**, **Column Grand Totals**, and **Row Grand Totals**.

For details, see [Show Totals in a Visualization on page 1354](#).

To remove totals, click the relevant column or row header and choose **Remove**.

In Tableau Desktop, you can also click on a totals column or row header after adding totals and set the aggregation for that row or column from the tooltip:

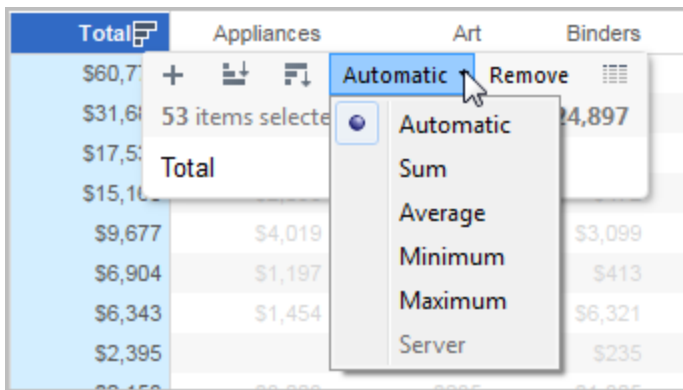

Average with 95% CI

Adds one or more sets of average lines with distribution bands; the distribution bands are configured at a 95% confidence interval. You can add these items for a specific measure or for all measures.

The confidence interval distribution bands shade the region in which the population average will fall 95% of the time.

You can click on a resulting average line or distribution and choose **Edit** or **Remove**. In Tableau Desktop there is a third option: **Format**. Choosing **Edit** opens the Edit Reference Line dialog box. The average lines and distributions must be edited, formatted, or removed separately. You must click on the outer edge of a distribution band to see the options—clicking in the middle of the band has no effect. Another way to edit a line or distribution in Tableau Desktop is to right-click (control-click on Mac) the relevant axis and choose **Edit Reference Line**. A submenu will offer you two choices: **Average** and **95% Confidence Interval**.

You can also remove lines and bands by dragging them off the view.

Median with 95% CI

Adds one or more sets of median lines with distribution bands; the distribution bands are configured at a 95% confidence interval. You can add these items for a specific measure or for all measures.

The confidence interval distribution bands shade the region in which the population median will fall 95% of the time.

You can click on a resulting median line or distribution and choose **Edit**, **Format**, or **Remove**. In Tableau Desktop there is a third option: **Format**. Choosing **Edit** opens the Edit Reference Line dialog box. The median lines and distributions must be edited, formatted, or removed separately. You must click on the outer edge of a distribution band to see the options—clicking in the middle of the band has no effect. Another way to edit a line or distribution in Tableau Desktop is to right-click (control-click on Mac) the relevant axis and choose **Edit Reference Line**. A submenu will offer you two choices: **Median** and **95% Confidence Interval**.

You can also remove lines and bands by dragging them off the view.

Trend Line

Adds one or more trend lines to the view. When you add trend lines, the drop options identify the trend line model types available in Tableau: **Linear**, **Logarithmic**, **Exponential**, and **Polynomial**. For some views, only a subset of these options is available.

For details, see [Trend Line Model Types](#) on page 2510

Click on a trend line to remove or edit it, or to see a statistical definition. You can also remove a trend line by dragging it off the view.

Forecast

Adds a forecast to the view. This option is only available in Tableau Desktop—not when you edit a view on the web. Forecasting is only possible when there is at least one measure in the view.

Forecasting is not supported for views based on multidimensional data sources. In addition, the view cannot contain any of the following:

- Table calculations
- Disaggregated measures
- Percent calculations
- Grand Totals or Subtotals
- Date values with aggregation set to Exact Date

A time series containing null values also imposes constraints.

For details, see [Forecasting on page 2545](#).

To remove, edit, or read a description of the current forecast, go to the Analysis menu and choose **Forecast**.

Custom Reference Line

You can add reference lines for a specific measure or for all measures in the view.

After you drag a reference line from the **Analytics** pane and drop it on a target, Tableau automatically opens an edit dialog box. See [Add a Reference Line on page 2481](#) in the **Reference Lines, Bands, Distributions, and Boxes** article for information on the available options. To return to this dialog box later, click on the line and choose **Edit**.

Custom Reference Band

You can add reference bands for a specific measure or for all measures in the view.

After you drag a reference band from the **Analytics** pane and drop it on a target, Tableau automatically opens the Edit Reference Line, Band, or Box dialog box. See [Add Reference Bands on page 2488](#) in the **Reference Lines, Bands, Distributions, and Boxes** article for information on the available options. To return to this dialog box later, click on the band and choose **Edit**. You must click on the outer edge of a reference band to see the options—clicking in the middle of the band has no effect.

Custom Distribution Band

You can add reference distributions for a specific measure or for all measures in the view.

After you drag a reference distribution from the **Analytics** pane and drop it on a target, Tableau automatically opens Edit Reference Line, Band, or Box dialog box. See [Add Reference Distributions on page 2493](#) in the **Reference Lines, Bands, Distributions, and Boxes** article for information on the available options. To return to this dialog box later, click on the band and choose **Edit**. You must click on the outer edge of a distribution band to see the options—clicking in the middle of the band has no effect.

Custom Box Plot

In Tableau Desktop—but not when you edit a view on the web—you can drag a box plot from the Custom section of the **Analytics** pane and drop it on a target. (But keep in mind that on the web, you can add a box plot from the Summarize section on the Analytics pane.) When you drag Box Plot from the Custom section, Tableau automatically opens Edit Reference Line, Band, or Box dialog box. See [Add a Box Plot on page 2498](#) in the **Reference Lines, Bands, Distributions,**

and Boxes article for information on the available options. The scope for a box plot is always **Cell** (and never **Table** or **Pane**).

Click any of the horizontal lines in the box plot to see statistical information about the whiskers, quartiles, and median.

To return to this dialog box later, click on the band and choose **Edit**.

Shelves and Cards Reference

Every worksheet in Tableau contains shelves and cards, such as Columns, Rows, Marks, Filters, Pages, Legends, and more.

By placing fields on shelves or cards, you:

- Build the structure of your visualization.
- Increase the level of detail and control the number of marks in the view by including or excluding data.
- Add context to the visualization by encoding marks with color, size, shape, text, and detail.

Experiment with placing fields on different shelves and cards to find the optimal way to look at your data.

Options for starting a view

If you aren't sure where to place a field, you can get let Tableau help you determine the best way to display the data.

- You can drag fields from the **Data** pane and drop them onto the cards and shelves that are part of every Tableau worksheet.
- You can double-click one or more fields in the **Data** pane.
- You can select one or more fields in the **Data** pane and then choose a chart type from **Show Me**, which identifies the chart types that are appropriate for the fields you selected. For details, see [Use Show Me to Start a View](#) on page 1229.
- You can drop a field on the **Drop field here** grid, to start creating a view from a tabular

perspective.



Columns and Rows shelves

Drag fields from the Data pane to create the structure for your visualizations.

The **Columns** shelf creates the columns of a table, while the **Rows** shelf creates the rows of a table. You can place any number of fields on these shelves.

When you place a dimension on the **Rows** or **Columns** shelves, headers for the members of that dimension are created. When you place a measure on the **Rows** or **Columns** shelf, quantitative axes for that measure are created. As you add more fields to the view, additional headers and axes are included in the table and you get an increasingly detailed picture of your data.

In the view shown below, the members of the **Segment** dimension are displayed as column headers, while the **Profit** measure is displayed as a vertical axis.



Tableau displays data using marks, where every mark corresponds to a row (or a group of rows) in your data source. The inner fields on the **Rows** and **Columns** shelves determine the default mark type. For example, if the inner fields are a measure and a dimension, the default mark type is a bar. You can manually select a different mark type using the Marks card drop-down menu. For more information, see [Change the Type of Mark in the View on page 1238](#).

Adding more fields to the **Rows** and **Columns** shelves adds more rows, columns, and panes to the table.

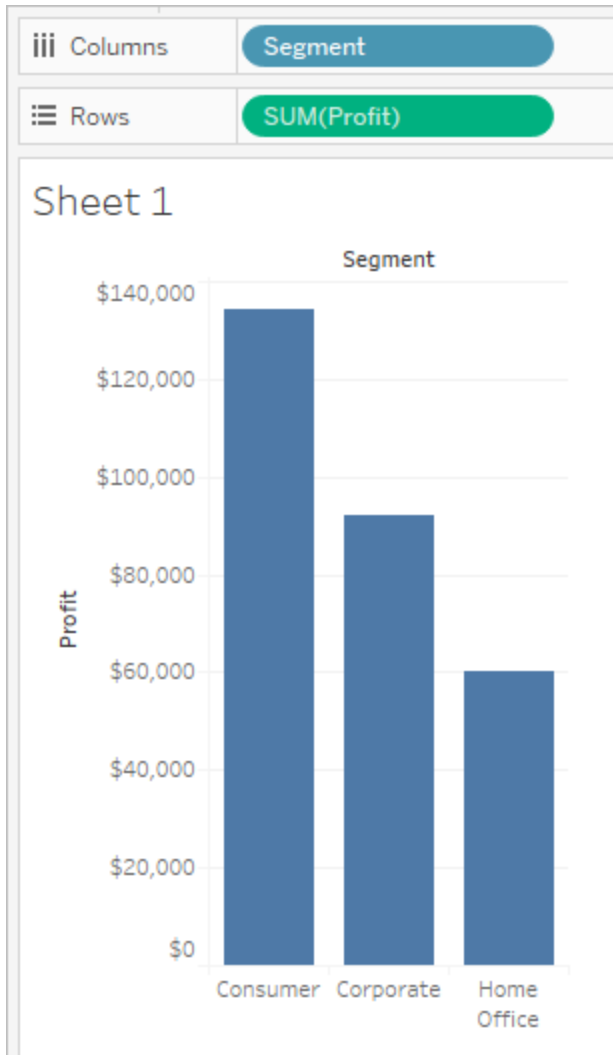
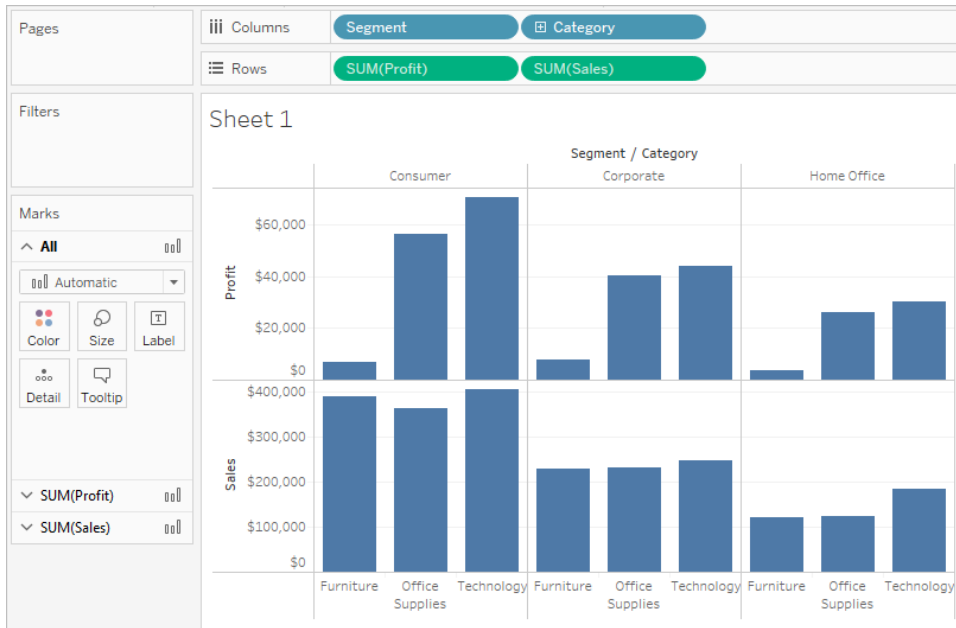

Hide rows and columns

Generally you will add dimensions and measures to create the rows and columns of the table and you'll either include all data or add filters to only show a subset. However, when you filter data it is also excluded from calculations and other computations performed on the summarized data in the table. Instead of filtering the data, you can hide the row or column so it doesn't display in the view but it is still included in calculations.

Tip: Hiding columns is especially useful when using table calculations that compare to a previous or next date value. In these cases, there will be a row or column that doesn't show data because there is no data to be compared to. Hide the empty column to keep the table calculation intact. For more details on table calculations, see [Table Calculation Types on page 2376](#).

For example, when calculating year-over-year growth, the first year wouldn't have a previous year to compare to, so the column is left blank. Filtering the first year would remove it from the view but it would also remove it from the calculation (the second year then doesn't have a previous year to compare to and is left blank). Instead of filtering, hiding the blank column keeps the calculation intact.

To hide a row or column:

Right-click (control-click on Mac) the row or column you want to hide, and then select **Hide**.

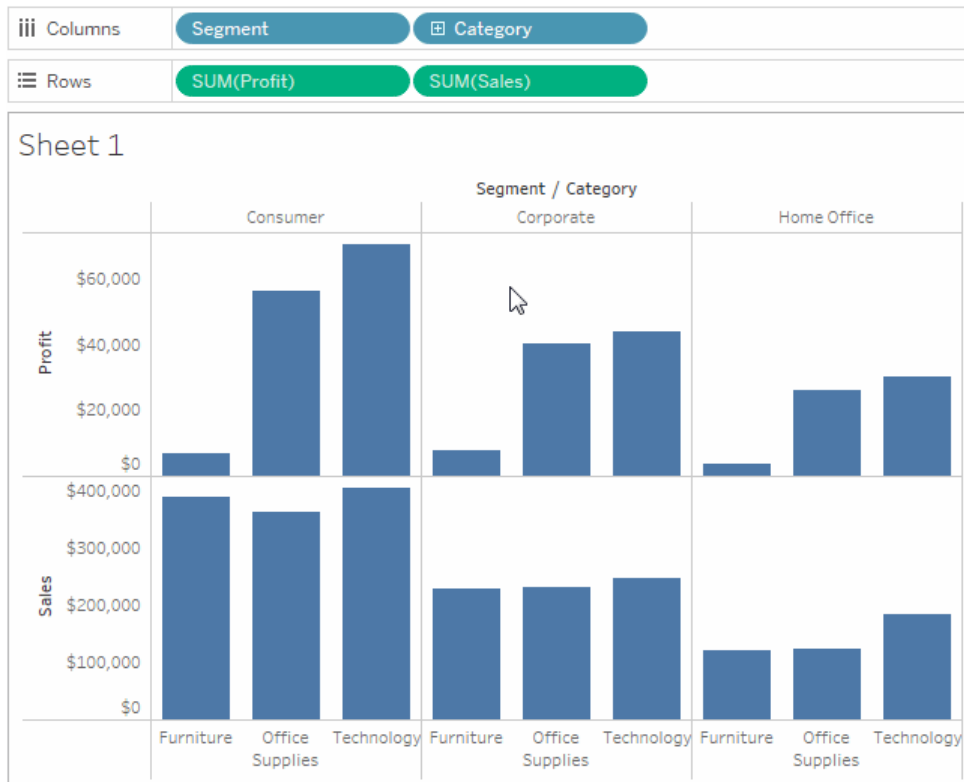

To show hidden data:

Open the field menu for a field that has hidden columns or rows and select **Show Hidden Data**.

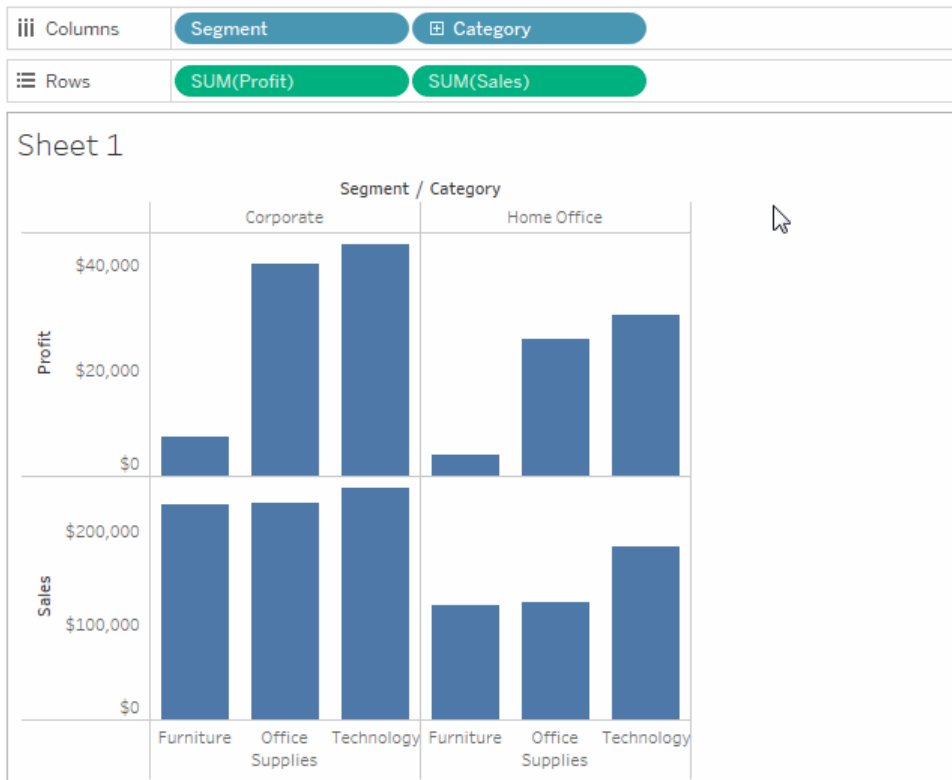

Marks card

The Marks card is a key element for visual analysis in Tableau. As you drag fields to different properties in the Marks card, you add context and detail to the marks in the view.

You use the Marks card to set the mark type (see [Change the Type of Mark in the View on page 1238](#)), and to encode your data with color, size, shape, text, and detail. To change the mark settings, see [Control the Appearance of Marks in the View on page 1261](#).

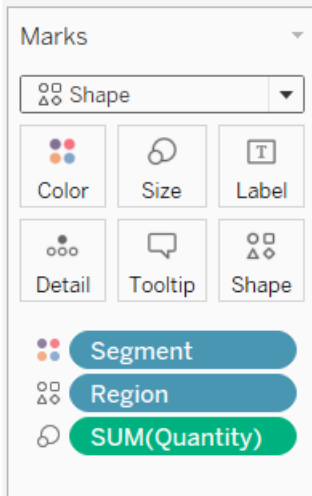

In this example, three different fields have been dragged to different properties in the Marks card. Segment is on Color, Region is on Shape, and Quantity is on Size.

After you add a field to the Marks card, you can click the icon next to the field to change the property it is using. You can also click the property buttons in the Marks card to change those settings.

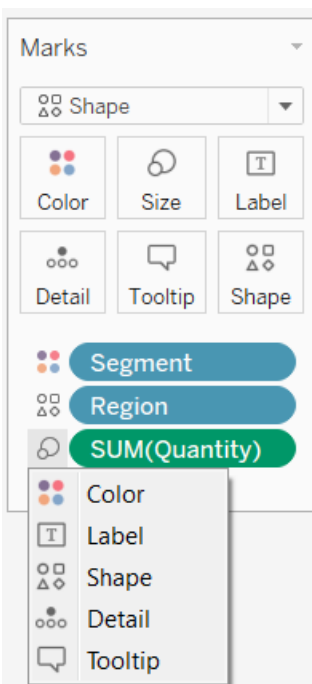

Many properties can have multiple fields. For example, you can add multiple fields to Label, Detail, Tooltip, and Color. Size and Shape can only have one field at a time. For more details, see [Control the Appearance of Marks in the View](#) on page 1261.

Note: By default, dragging a new field to **Color** replaces the existing fields. To add a new field to color without replacing the existing field, hold the SHIFT key on your keyboard while dragging a new field to **Color** on the Marks card.

Filters shelf

The Filters shelf allows you to specify which data to include and exclude. For example, you might want to analyze the profit for each customer segment, but only for certain shipping containers and delivery times. By placing fields on the Filters shelf, you can create such a view.

Note: This section presents a brief overview of filtering. For more information on filtering, see [Filter Data from Your Views](#) on page 1308.

You can filter data using measures, dimensions, or both at the same time. Additionally, you can filter data based on the fields that make up the columns and rows of the table. This is called an internal filter. You can also filter data using fields that don't contribute headers or axes to the table. This is called an external filter. All filtered fields display on the Filters shelf.

To illustrate the basic concepts of filtering, consider the following view.

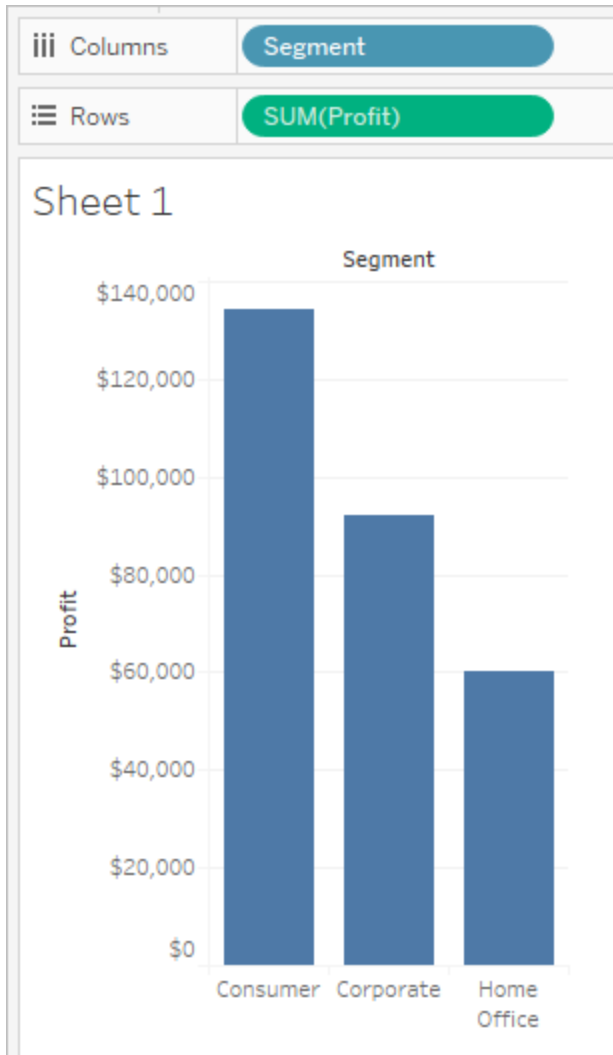

Suppose you are not interested in the Home Office data. You can remove this column from the view by filtering the **Segment** dimension. To do so, select **Filter** on the field menu or drag the **Segment** dimension to the **Filters** shelf. The Filter dialog box opens. By default all members are selected. Clear the check box for **Home Office** to exclude it from the view. All selected members will be included.

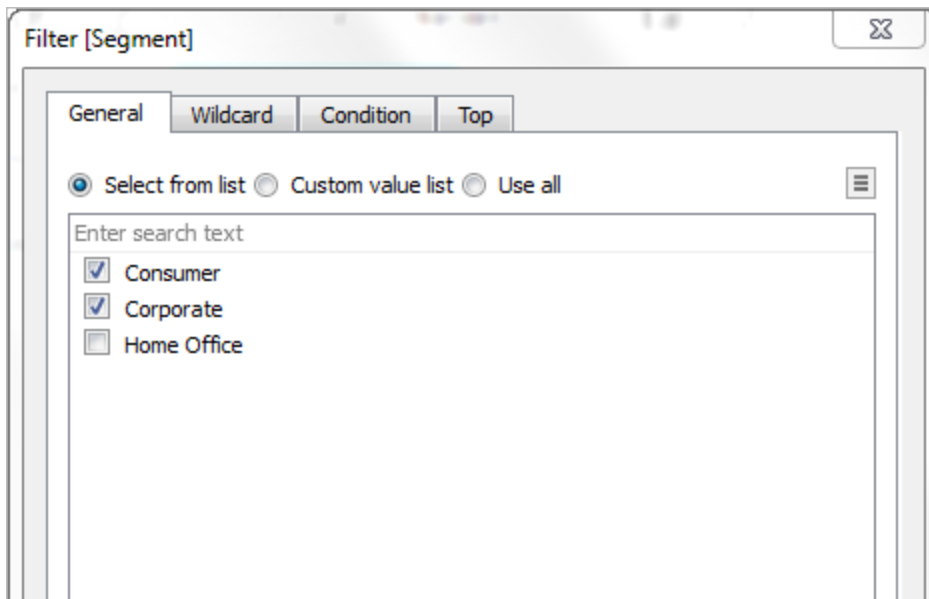

As shown below, the view updates and the Home Office column is removed. The filter is indicated by the **Segment** field on the **Filters** shelf.

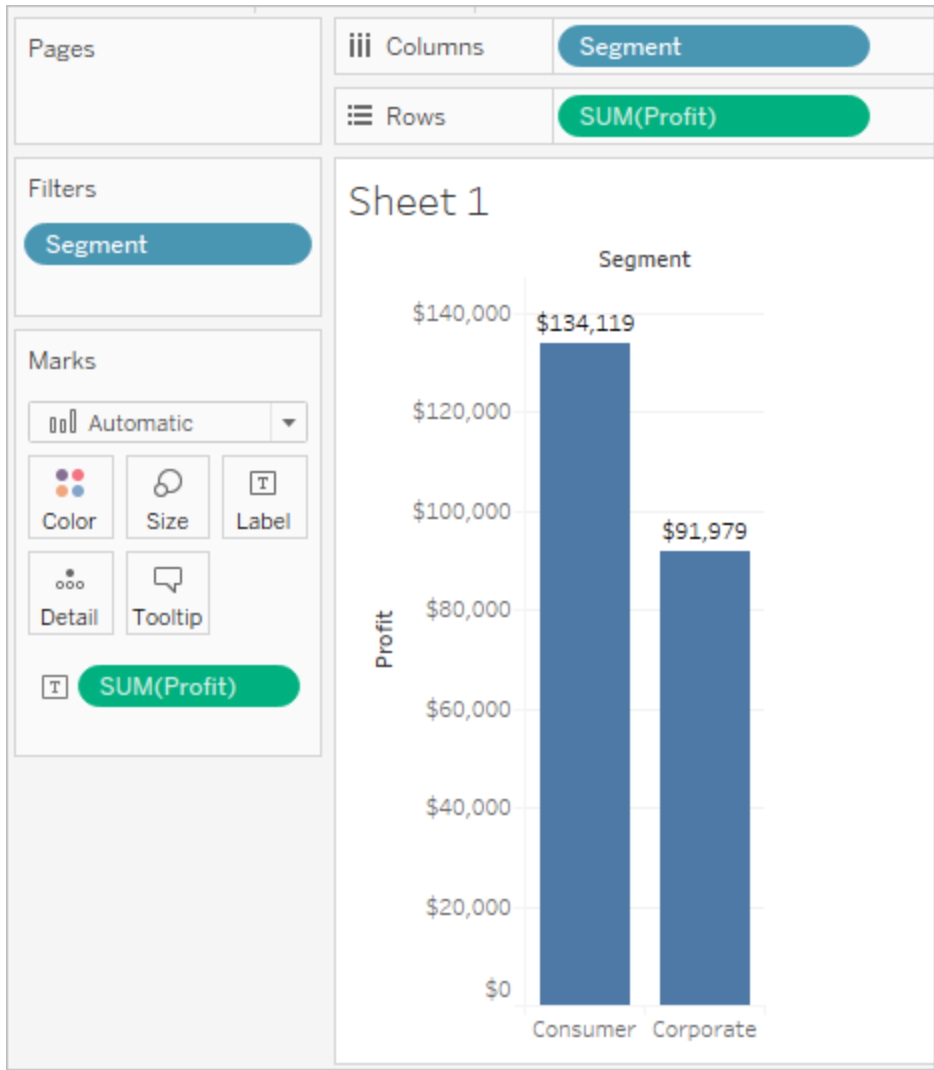

Suppose you want to only view profit for a category of the products. Even though the **Category** field is not used on the **Rows** and **Columns** shelves or on the Marks card, you can still add a filter. Drag the **Category** dimension to the **Filters** shelf. This is an example of an external filter because Category is not part of the view.

The Filter dialog box automatically opens. By default, none of the members are selected. Select the members you want to keep as part of the view. All cleared members are excluded. In this example, Office Supplies is selected.

The modified data view is shown below. The mark label shows that the sum of the profit for the Consumer segment has decreased to \$56,330. This number is derived by summing all the rows in the data source that are associated with the Corporate market and are part of the Office Supplies category.

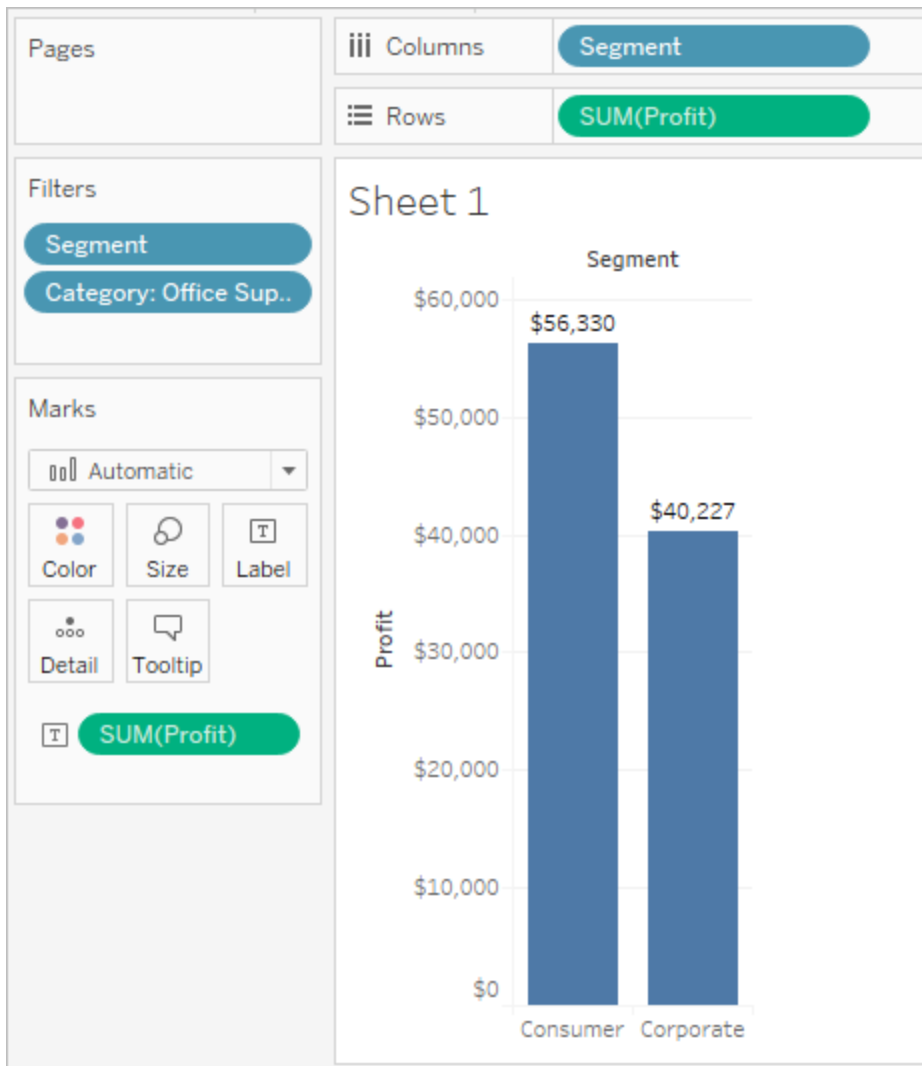

The order of fields placed on the Filters shelf does not affect the data view because the filters are independent. In other words, the result of filtering by customer segment, and then by container is the same as filtering by container and then by customer segment. For more information about the filtering order of operations, see [Filter Data from Your Views](#) on page 1308.

Pages shelf

The **Pages** shelf lets you break a view into a series of pages so you can better analyze how a specific field affects the rest of the data in a view. When you place a dimension on the **Pages** shelf you are adding a new row for each member in the dimension. When you place a measure on the **Pages** shelf, Tableau automatically converts the measure into a discrete measure.

The **Pages** shelf creates a set of pages, with a different view on each page. Each view is based on a member of the field you placed on the **Pages** shelf. You can easily flip through the views

and compare them on a common axis, using the controls that get added to the view when you move a field to the **Pages** shelf. For example, the view below shows the **Profit vs. Sales** by **Region** for each day throughout the month. The image below shows days 1, 2, 3, and 4. You would have to scroll down to see other days in the month.

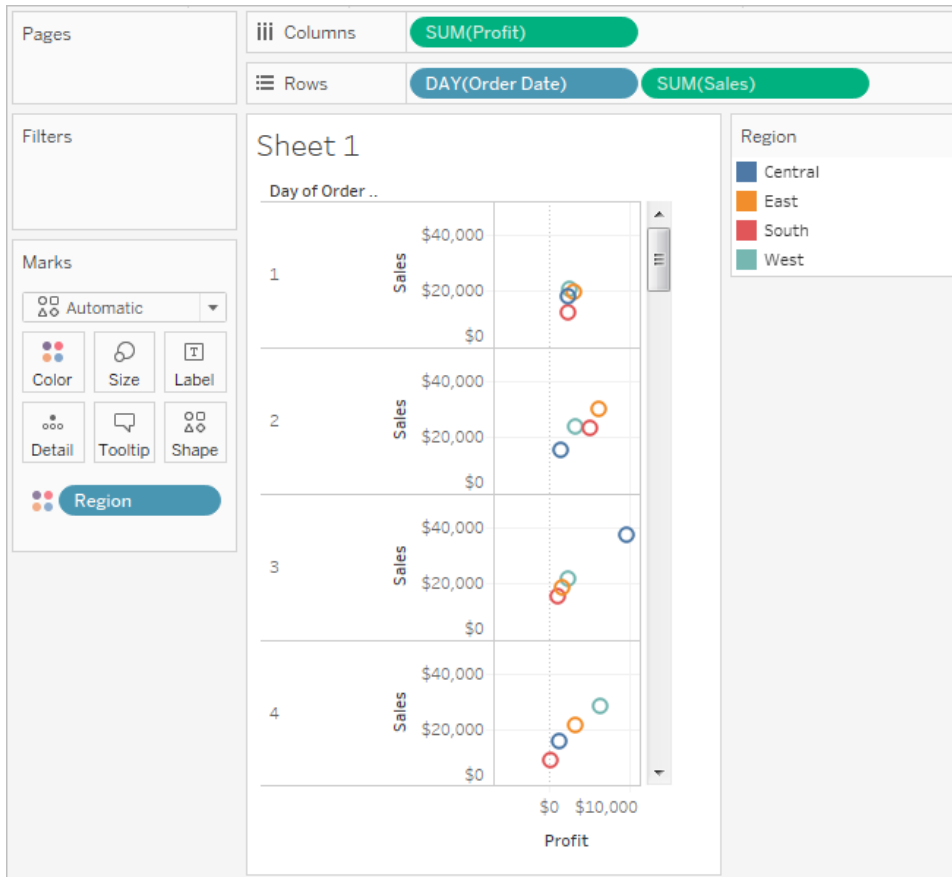

To make this view more user-friendly, move **DAY(Order Date)** to the **Pages** shelf and use the associated control to flip through the pages (one for each day). You can quickly discover hidden insights. In this example, it is interesting that the 19th is an especially big day in terms of sales and profit in the Western region.

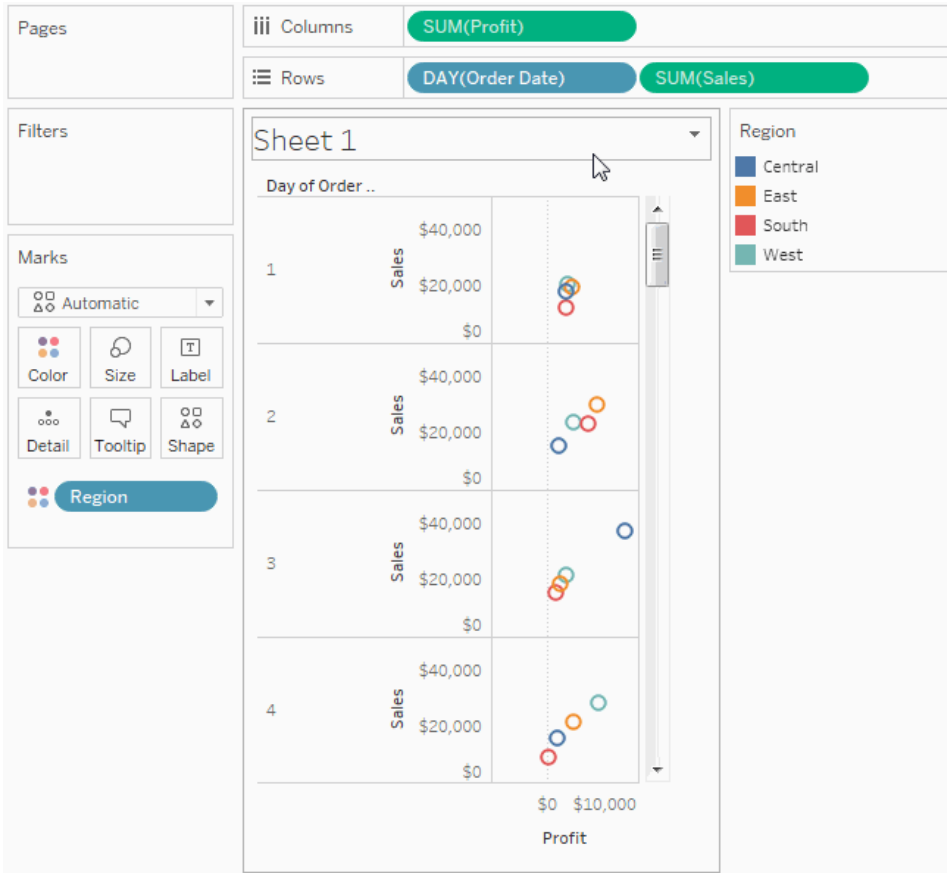

When you add a field to the **Pages** shelf, a page control is automatically added to the right of your view.

Use this control to navigate through the pages. There are three ways to navigate through the pages in a view:

- Jump to a specific page
- Manually advance through the pages
- Automatically advance through pages

Jump to a specific page

Select the member or value you want to view from the drop-down list to display a specific page.

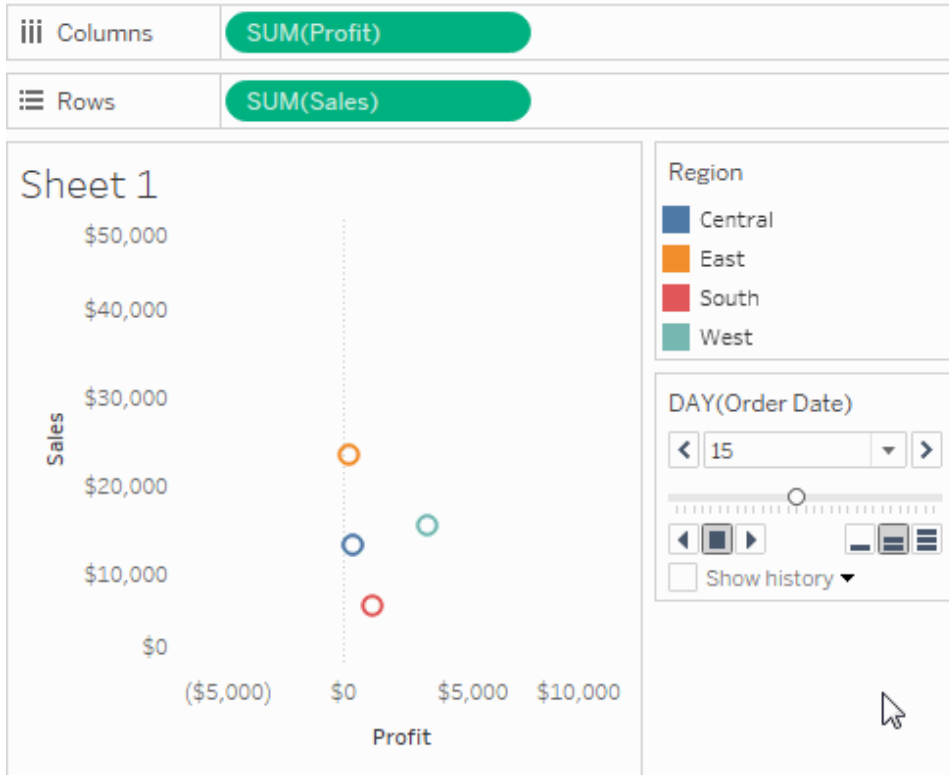

Manually advance through the pages

You can manually advance through the sequence of pages by doing any of the following:

- Use the forward and back buttons on either side of the drop-down list to navigate through the pages one at a time.
- Use the Page Slider to quickly scroll forward and backward in the sequence of pages.
- Use any of the following keyboard shortcuts to scroll forward and backward in the sequence of pages.

F4	Starts and stops forward playback
SHIFT + F4	Starts and stops backward playback
CTRL + .	Skip forward one page
CTRL + ,	Skip backward one page

On a Mac, these are the equivalent keyboard shortcuts.

F4	Starts and stops forward playback
Shift-F4	Starts and stops backward playback
Command-period	Skip forward one page
Command-comma	Skip backward one page

Automatically advance through pages

Use the playback controls to watch a slide show of the pages in the view. You can play forward or backward, and stop the playback at any time. You can control the speed of playback with the speed controls in the bottom right corner of the control. The smallest bar indicates the slowest playback speed.

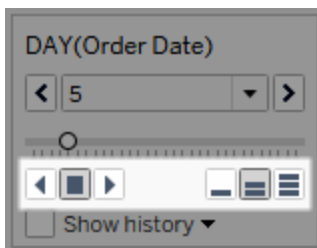

Show the Page history

Show page history using the Show History check box. With page history, marks from previous pages are shown on the current page.

In Tableau Desktop only: Open the drop-down control for history to specify what marks to show and when to show them.

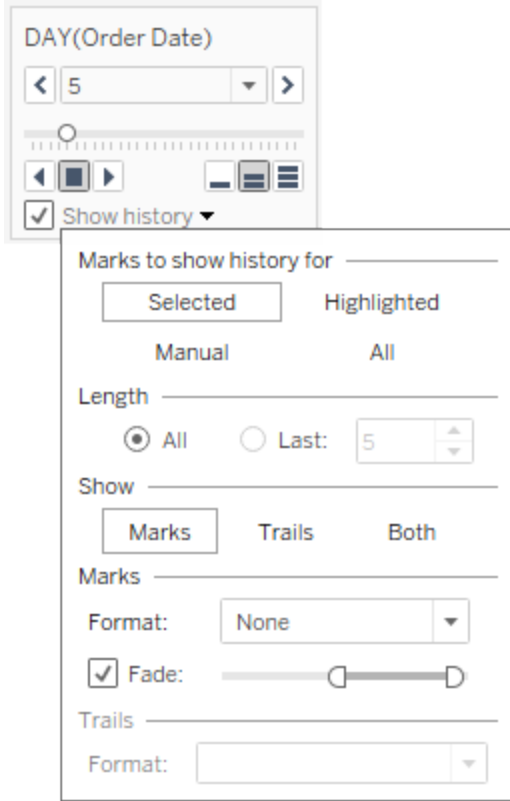

The history drop-down control has the following options:

- **Marks to show history for** – select whether you want to show history for just selected marks, highlighted marks, marks that you’ve manually selected to show history for, or all marks. To manually show history for marks, right-click (control-click on Mac) the mark in the view and select an option on the Page History menu.
- **Length** – select the number of pages to show in the history.
- **Show** – specify whether to show the historical marks, a line tracing through the previous values (trails), or both.
- **Marks** – format the historical marks including the color and how much to fade them if the color is set to automatic, the marks will either use the default mark color or the color encoding on the Color shelf.
- **Trails** – format the lines that are drawn through the historical marks. This option is only available if Trails is selected in the Show options.

Page trails may not display if there are multiple marks per color on a page. Make sure that the level of detail for the view is less than or equal to the level of detail on the **Pages** shelf and on the

Color target. Also, trails are only supported for discrete mark types such as squares, circles, or shapes. They are not supported when the mark type is Automatic.

Pages on dashboards (Tableau Desktop only)

When a dashboard contains multiple views that use the same field on the **Pages** shelf, you can control all of the views with a single page control by selecting the **Synchronized** option. This option is only available on the page control shown on a dashboard.

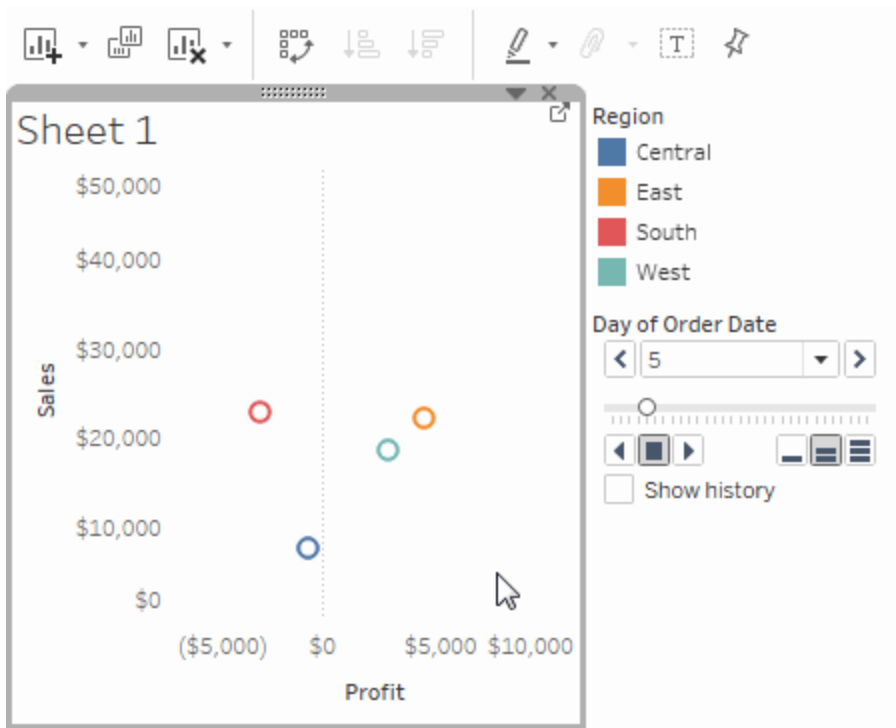

Additional Shelves, Legends, Cards, and Controls

Some shelves, legends, cards, or controls are only displayed as a result of things that you do as you work with views. For example, the Color legend is only displayed when there is a field on Color.



Tableau provides controls for moving or otherwise customizing these elements of the view.

The following list describes each such shelf, legend, card, or control.

- **Measure Values Shelf**– Measure Values is a special field that always appears in the Data pane and contains all the measures of your data collected into one field. Tableau automatically adds Measure Values to the view when multiple measures are sharing the same axis. When Measure Values is in the view, Tableau displays a Measure Values shelf that shows which measures are being included. You can add measures to or remove measures from this card. For more information, see [Measure Values and Measure Names on page 1212](#).
- **Color Legend** – Shows how colors are allocated when there is a field on Color.
- **Shape Legend** – Shows how shapes are allocated when there is a field on Shape.
- **Size Legend** – Shows how sizes are allocated when there is a field on Size.
- **Map Legend** – Shows the legend for the symbols and patterns on a map. The map legend is not available for all map providers.
- **Parameter Controls** – A separate parameter control is available for every parameter in the workbook. For more information, see [Create Parameters on page 1122](#).
- **Title** – A title is displayed by default for every view. The default title is the sheet name. Double-click a title (Control-click on a Mac) to edit it.
- **Caption** – Choose **Show caption** from the Worksheet menu to display a caption for the view.
- **Summary Card** – Choose **Show summary** from the Worksheet menu to display a summary card for the view. For more information, see [Summary Card on page 2000](#).
- **Page Control** – Provides options for navigating through pages when there is a field on the Pages shelf.

Parts of the View

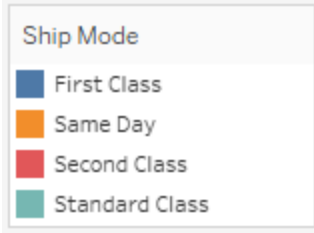
This section describes the basic elements of views that you can create in Tableau. You can show or hide parts of the view as needed (described below). Every view has a table in some form, which may include rows, columns, headers, axes, panes, cells, and marks. Views can optionally include tooltips, titles, captions, field labels, and legends.

The View area

Data views are displayed in a table on every worksheet. A table is a collection of rows and columns, and consists of the following components: Headers, Axes, Panes, Cells, and Marks. In addition to these, you can choose to show or hide Titles, Captions, Field Labels, and Legends.

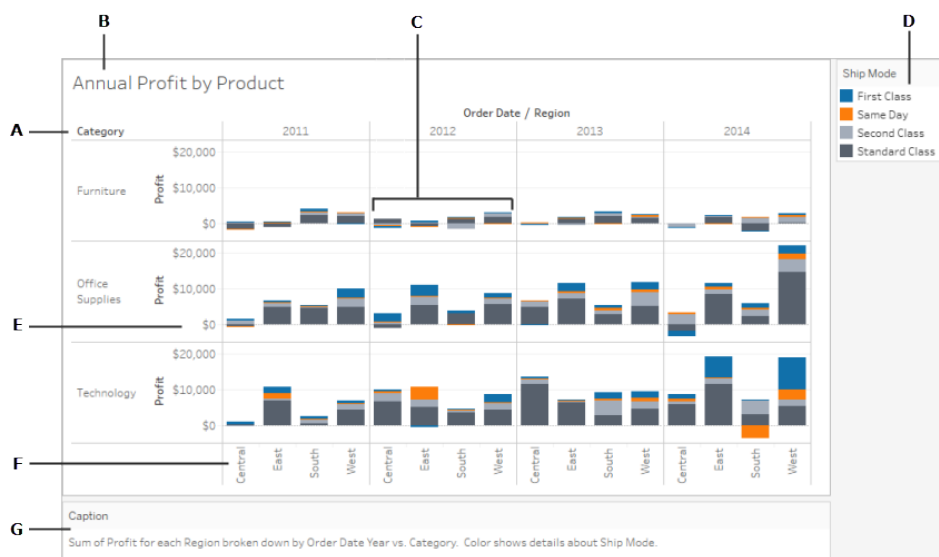

A. Field Labels on page 89 - The label of a discrete field added to the row or column shelf that describes the members of that field. For example, Category is a discrete field that contains three members; Furniture, Office Supplies and Technology.

B. Titles on page 86 - The name that you give your worksheet, dashboard, or story. Titles display automatically for worksheets and stories and you can turn them on to display them in your dashboards.

C. Marks on page 83 - The data that represents the intersection of the fields (dimensions and measures) included in your view. Marks can be represented using lines, bars, shapes, maps and so on.

D. Legends on page 91 - A key that describes how the data is encoded in your view. For example if you use shapes or colors in your view, the legend describes what each shape or color represents.

E. Axes on page 80 - Created when you add a measure (fields that contain quantitative, numerical information) to the view. By default, Tableau generates a continuous axis for this data.

F. Headers below - The member name of a field.

G. Captions on page 88 - Text that describes the data in the view. Captions can be automatically generated and can be toggled on and off.

Also see information on **Cells on page 82** and **Panes on page 82**.

Headers

Headers are created when you place a dimension or discrete field on the **Rows** shelf or the **Columns** shelves. The headers show the member names of each field on the shelves. For example, in the view below the column headers show the members of the **Order Date** field and the row headers show the members of the **Sub-Category** field.

Sheet 1

Sub-Category	Order Date			
	2012	2013	2014	2015
Accessories	\$25,014	\$40,524	\$41,896	\$59,946
Appliances	\$15,314	\$23,241	\$26,050	\$42,927
Art	\$6,058	\$6,237	\$5,910	\$8,914
Binders	\$43,488	\$37,453	\$49,485	\$72,986
Bookcases	\$20,037	\$38,544	\$26,275	\$30,024
Chairs	\$77,242	\$71,735	\$83,919	\$95,554
Copiers	\$10,850	\$26,179	\$49,599	\$62,899
Envelopes	\$3,856	\$4,512	\$4,730	\$3,379
Fasteners	\$661	\$545	\$960	\$858
Furnishings	\$13,826	\$21,090	\$27,874	\$28,915
Labels	\$2,841	\$2,956	\$2,827	\$3,861
Machines	\$62,023	\$27,764	\$55,907	\$43,545
Paper	\$14,835	\$15,288	\$20,638	\$27,718
Phones	\$77,391	\$68,314	\$78,660	\$105,643
Storage	\$50,329	\$45,048	\$58,632	\$69,834
Supplies	\$14,394	\$1,952	\$14,278	\$16,049
Tables	\$46,088	\$39,150	\$60,833	\$60,894

You can show and hide row and column headers at anytime.

To hide headers:

- Right-click (control-click on Mac) the headers in the view and select **Show Header**.

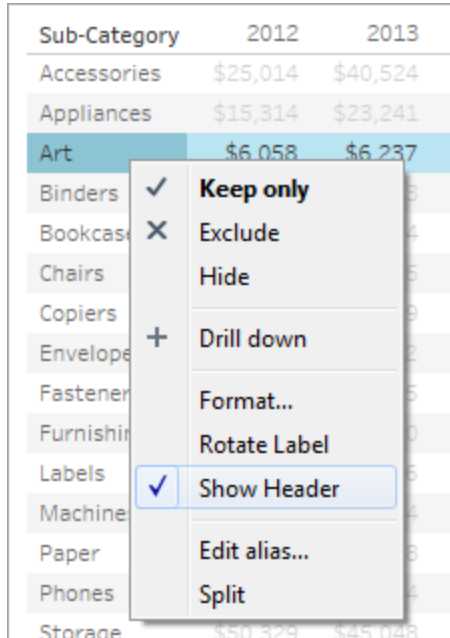

The screenshot shows a Tableau table with the following data:

Sub-Category	2012	2013
Accessories	\$25,014	\$40,524
Appliances	\$15,314	\$23,241
Art	\$6,058	\$6,237
Binders		
Bookcases		
Chairs		
Copiers		
Envelopes		
Fasteners		
Furniture		
Labels		
Machines		
Paper		
Phones		
Storage	\$50,329	\$45,048

A context menu is open over the 'Art' row, showing the following options: Keep only (checked), Exclude (X), Hide, Drill down (+), Format..., Rotate Label, Show Header (checked), Edit alias..., and Split.

To show headers:

- Select the field in the view whose headers you want to show and select **Show Header** on the field menu.

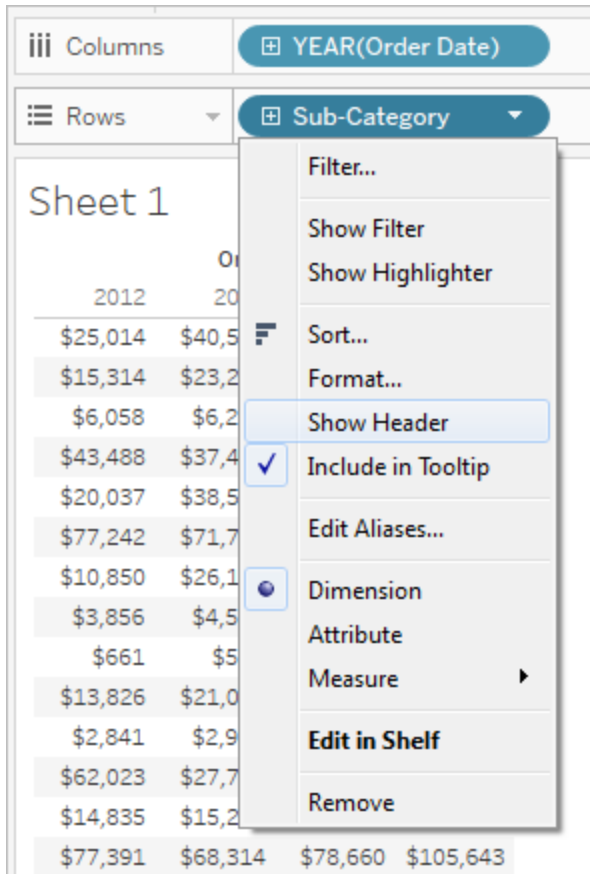

Hiding headers can be useful when you are working with multiple measures. For example, the view below shows both the sales and profit for each region along a single axis. You can see the view looks cluttered with the Measure Names headers showing. Because Measure Names is also indicated by the mark color, you can hide the excess headers to clean up the view.

Sheet 1

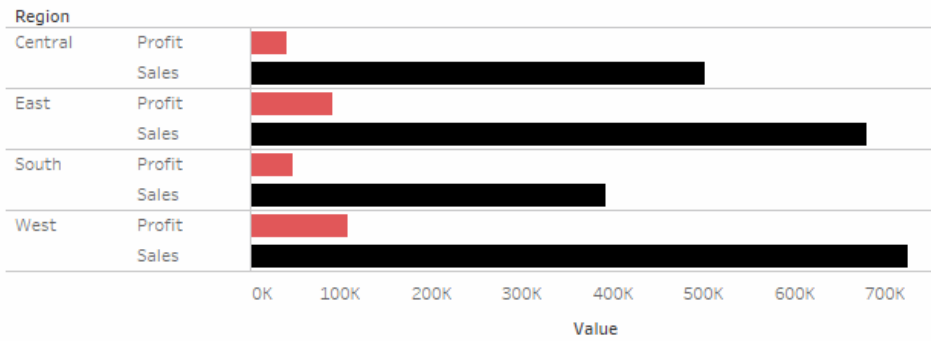

Axes

Axes are created when you place a measure or continuous field on the **Rows** or **Columns** shelves. By default, the values of the measure field are displayed along a continuous axis.

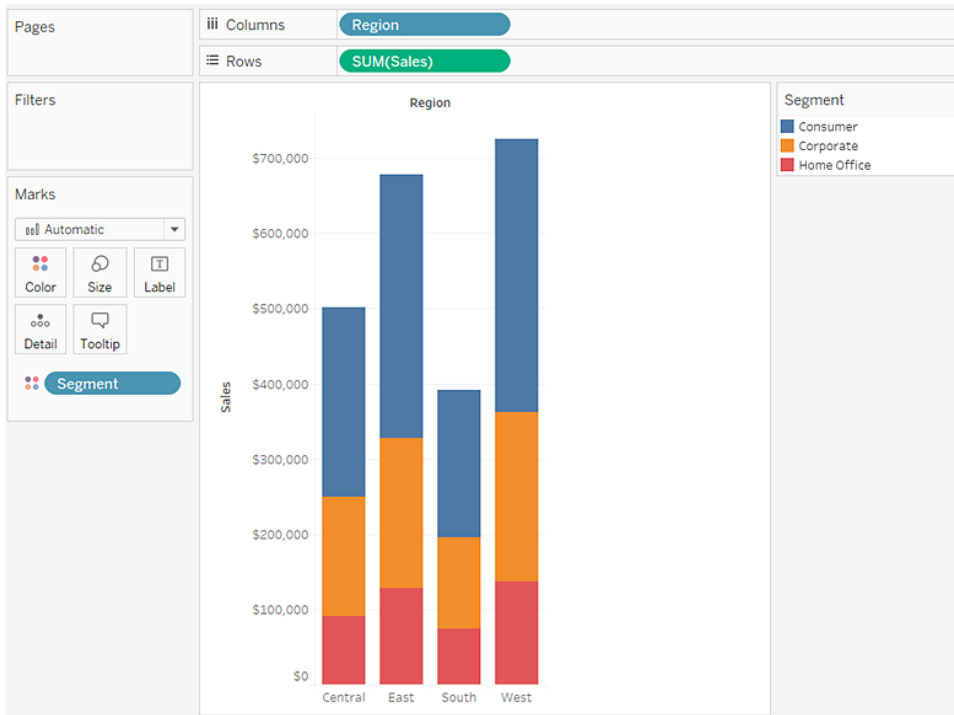

You can show and hide axes at any time.

To hide axes:

- Right-click (control-click on Mac) the axis in the view and select **Show Header** to clear the check mark next to this option.

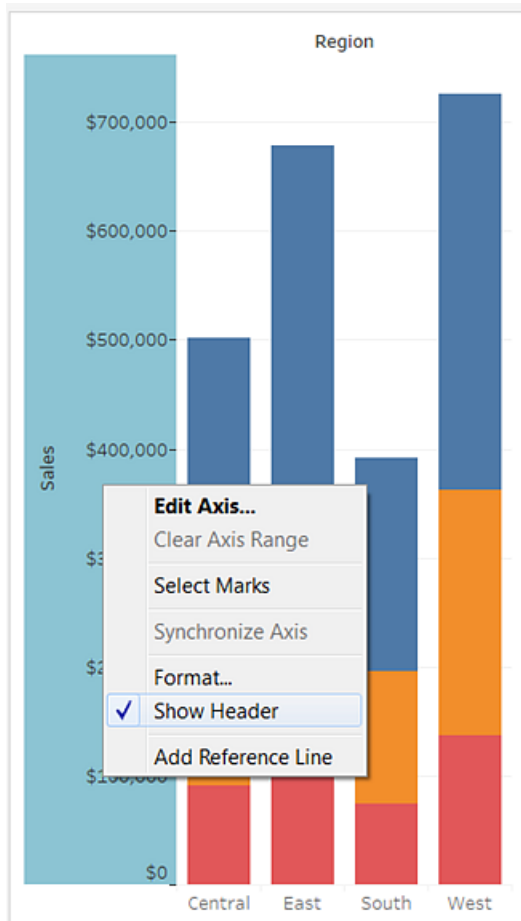

To show axes:

- Right-click (control-click on Mac) the measure in the view whose axis you want to show and select **Show Header** on the field menu.

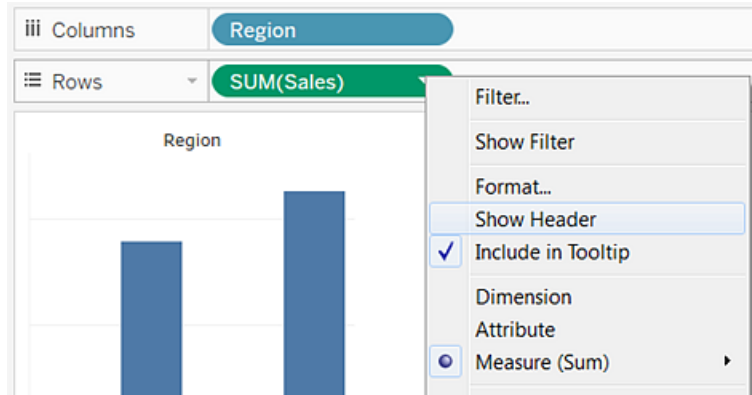

Panes

A pane is defined by the intersection of fields on the rows and columns shelves.

In a table calculation, this is seen as one or more cells that belong to the same field, which are computed down or across according to the calculation, as in the example below:

		Order Date			
Quarter of Order..	Month of Order ..	2011	2012	2013	2014
Q1	January				
	February	-\$9,136	-\$5,963	\$4,325	-\$24,420
	March	\$50,880	\$26,256	\$28,319	\$33,625
Q2	April				
	May	-\$4,647	-\$4,064	\$17,442	\$5,539
	June	\$10,947	-\$5,334	-\$17,261	\$2,609
Q3	July				
	August	-\$6,037	\$8,133	-\$5,175	\$13,088
	September	\$53,868	\$27,698	\$39,643	\$28,973
Q4	October				
	November	\$47,175	\$44,568	\$25,729	\$34,533
	December	-\$9,083	-\$1,053	\$15,045	-\$21,852

For more information, see [Transform Values with Table Calculations](#) on page 2364.

Cells

Cells are the basic components of any table you can create in Tableau, defined by the intersection of a row and a column. For example, in a text table, a cell is where the text is displayed, as shown in the view below:

The screenshot shows the Tableau interface with the following components:

- Columns:** QUARTER(Order Date)
- Rows:** Sub-Category
- Filters:** (Empty)
- Marks:** Text (Type), Color, Size, Text (Field), Detail, Tooltip, SUM(Sales) (Measure)

Sub-Categ..	Order Date			
	Q1	Q2	Q3	Q4
Accessories	\$19,582	\$26,455	\$54,293	\$67,050
Appliances	\$14,809	\$21,081	\$27,074	\$44,568
Art	\$3,385	\$6,820	\$7,452	\$9,462
Binders	\$30,426	\$35,847	\$66,393	\$70,746
Bookcases	\$14,149	\$18,660	\$38,762	\$43,309
Chairs	\$39,884	\$65,703	\$93,502	\$129,360
Copiers	\$26,550	\$26,180	\$25,829	\$70,969
Envelopes	\$3,075	\$2,555	\$4,078	\$6,769
Fasteners	\$397	\$483	\$830	\$1,314
Furnishings	\$11,364	\$20,390	\$23,504	\$36,448
Labels	\$1,447	\$2,500	\$4,044	\$4,495
Machines	\$51,256	\$41,640	\$36,712	\$59,630
Paper	\$11,310	\$16,770	\$21,253	\$29,146
Phones	\$49,484	\$68,998	\$90,318	\$121,207
Storage	\$30,292	\$47,747	\$61,055	\$84,749
Supplies	\$15,300	\$8,666	\$16,118	\$6,590
Tables	\$32,083	\$34,562	\$47,722	\$92,599

Marks

When you drag fields to the view, the data are displayed using marks. Each mark represents the intersection of all of the dimensions in the view.

For example, in a view with **Region** and **Year** dimensions, there is a mark for every combination of those two dimensions (East 2011, East 2012, West 2011, West 2012, etc.). In this case, the mark type is set to Text, so the **Abc** represents the location where the value for the text mark will appear—once a measure such as **Sales** is added to the view.

The screenshot shows the Tableau interface with the following components:

- Columns:** YEAR(Order Date)
- Rows:** Region

Region	Order Date			
	2011	2012	2013	2014
Central	Abc	Abc	Abc	Abc
East	Abc	Abc	Abc	Abc
South	Abc	Abc	Abc	Abc
West	Abc	Abc	Abc	Abc

For details on creating and customizing marks, see [Marks card on page 62](#), [Control the Appearance of Marks in the View on page 1261](#), [Change the Type of Mark in the View on page 1238](#), [Stack Marks on page 1291](#)

Marks can be displayed in many different ways including lines, shapes, bars, maps, and so on. You can show additional information about the data using mark properties such as color, size, shape, labels, etc. The type of mark you use and the mark properties are controlled by the Marks card. Drag fields to the Marks card to show more data. For example, the same view above is shown again below but this time with **Profit** on Color. With this additional information, it is clear that the West region had the highest profit in 2014.

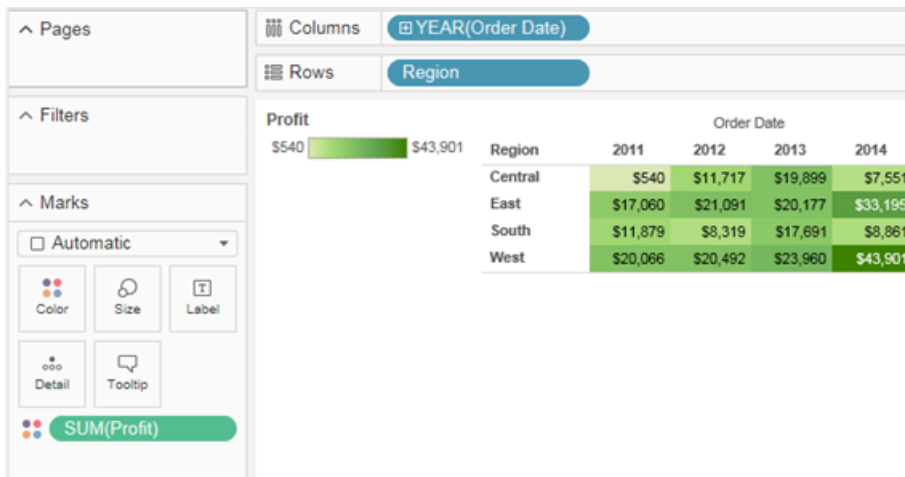

Control the marks in the view using the Marks card. Use the drop-down menu to specify the type of mark to show. Drag fields to the Marks card and use the drop-down controls to add more information to the view and control the color, shape, size, labels, and number of marks in the view.

Tooltips

Tooltips are additional data details that display when you hover over one or more marks in the view. When you select one or more marks and hover, tooltips also include options to filter marks (exclude or keep only), display marks that have the same values, create groups, create sets, or display the underlying data. If you don't want users to be able to access tooltip commands, you can disable them.

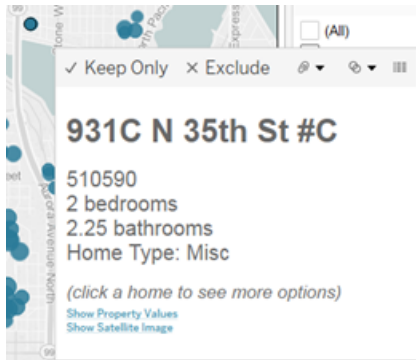

For details on formatting tooltips and other tooltip settings, also see [Format Individual Parts of the View](#) on page 2993, [Add tooltips to marks](#) on page 1271, and [Create Views in Tooltips \(Viz in Tooltip\)](#) on page 1371. For details on analysis options in tooltips, see [Explore and Inspect Data in a View](#) on page 1981

Tooltip command buttons for exploring data in a viz

The top of the tooltip lists commands for filtering data, creating a group, sorting the selection, and view the underlying data. For example, you can use the tooltip to quickly remove an outlier in a scatter plot. Each of the commands are described below.

To see tooltip commands, hover over a mark and then keep the cursor still. The

- **Keep Only** - creates a filter that removes all other data. See [Select to keep or exclude data points in your view](#) on page 1309 to learn more.
- **Exclude** - creates a filter that removes the selected data. See [Select to keep or exclude data points in your view](#) on page 1309 to learn more.
- **Group Members** - creates a group based on the selection. If the selection contains multiple dimensions, you can group on one dimension or all dimensions. See [Correct Data Errors or Combine Dimension Members by Grouping Your Data](#) on page 1090 to learn more.
- **Create Set** (Tableau Desktop only) - creates a new set containing the selected members. You can create a new set or add members to an existing set. See [Create Sets](#) on page 1092 to learn more.
- **View Data** - opens a window displaying the data. You can view the summarized data or the underlying data. See [View Underlying Data](#) on page 2001 to learn more.

These commands are visible by default. You can disable the commands in the **Edit Tooltip** dialog box by deselecting **Include command buttons**. Doing so will also hide the aggregation summary if multiple marks are selected.

Disable tooltip commands

If you don't want users to be able to access tooltip commands, you can disable them.

1. Click **Tooltip** on the Marks card or select **Worksheet > Tooltip**.
2. In the Edit Tooltip dialog box, clear the **Include command buttons** check box.

Tooltip settings apply to the active worksheet and can be different for each sheet in the workbook.

Body text and markup in tooltips

The body of a tooltip contains details about a specific mark or a selection of multiple marks. For example, in a bar chart showing sales by region, the tooltip body may include the actual sales amount and the region name. The default tooltip is based on the fields used in the view. You can customize what is shown in the tooltip by dragging fields to **Tooltip** on the Marks card.

To customize a tooltip and its formatting, click **Tooltip** on the Marks card.

Alternatively, you can select **Worksheet > Tooltip**.

Action links

If the sheet has any actions, the action links are listed below the body of the tooltip. An action adds context and interactivity to your data through filters, highlighting, and links to external resources. See [Actions on page 1387](#) to learn more about adding actions to your workbook.

Titles

You can show titles on any worksheet, dashboard, or story. For worksheets and stories, a title is displayed by default, but you can remove it. For dashboards, you can add a title. By default, the title is the name of the sheet, but you can edit the title to change the text and include dynamic values such as page number and sheet name. For more information about how to format titles, see [Format Individual Parts of the View on page 2993](#).

Show and hide titles in worksheets

Titles are shown by default for worksheets and are included as part of the worksheet, shown at the top of the view. You can move the title to the sides or the bottom of the view. However, when you move the title from the top of the view, it becomes a **Title** card and displays like any other card in the view.

Note: If you move a title from the top position and then hide it; when you show the title again, it appears back at the top of the worksheet in its default position.

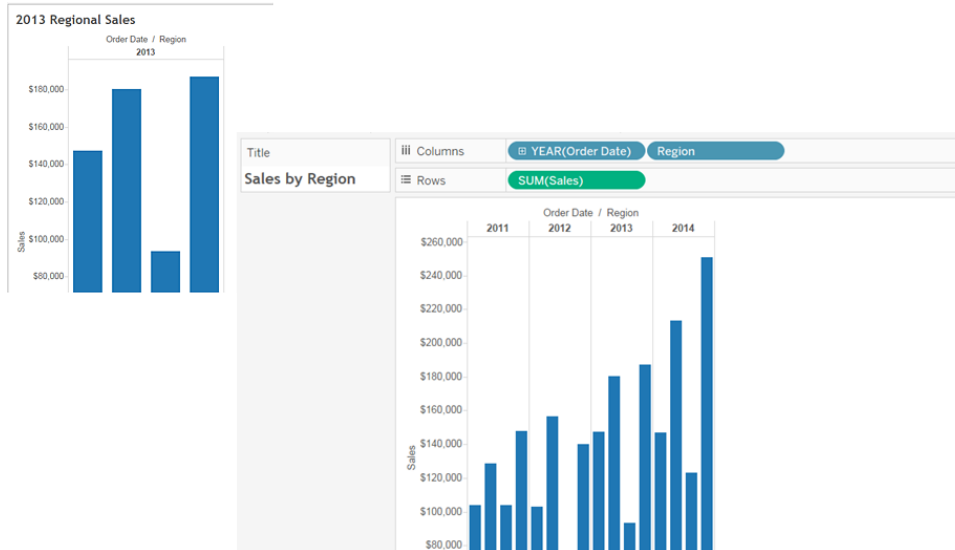

To show or hide titles in a worksheet

- From the toolbar menu, click **Worksheet > Show Title**.
- On the toolbar, click the drop-down arrow on the **Show/Hide Cards** button and select **Title** from the context menu.

Toggle the check mark on or off to show or hide the title.

Show and hide titles in dashboards

You can turn on titles for dashboards. The title appears as part of the dashboard.

To show or hide titles on a dashboard, from the toolbar menu, select **Dashboard > Show Title**.

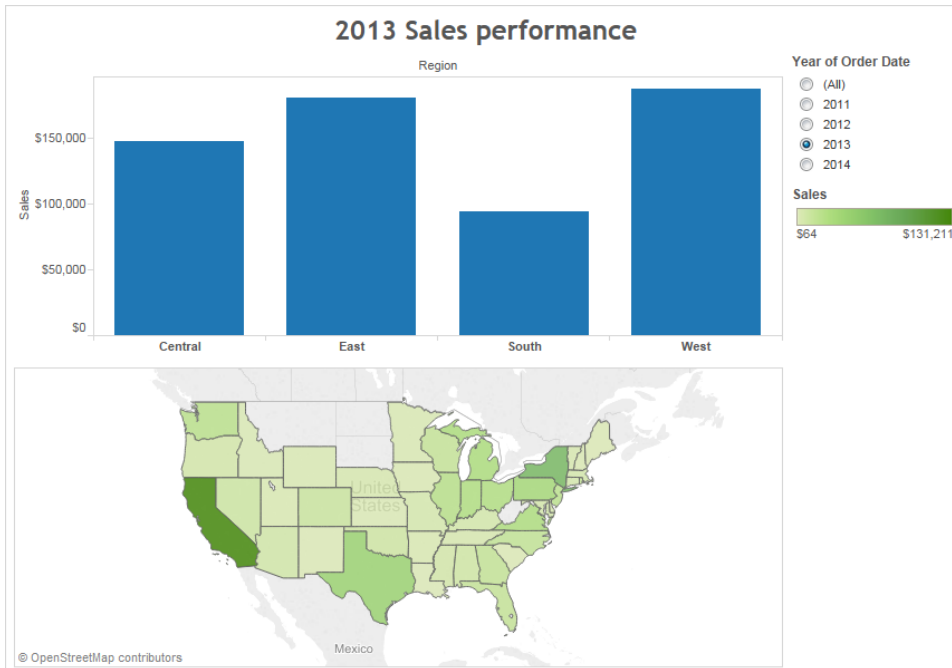

When you add worksheets to the dashboard, the title of the worksheet automatically shows, even if you turned off the title on the worksheet itself. To turn off the title for the worksheet on the dashboard, do the following steps:

1. In the dashboard, select the worksheet to highlight it.
2. In the top right corner of the highlighted worksheet, click the drop-down arrow and select **Title** in the context menu to clear the check mark.

Show and hide titles in stories

Story titles are displayed by default. To toggle story titles on or off, in the top menu, select **Story** > **Show Title** to add or remove the check mark.

Captions

All views can have a caption that is either automatically generated or manually created. The caption is displayed on the Caption card.

To show a caption in a worksheet, select it on the **Show/Hide Cards** toolbar menu  or select **Worksheet** > **Show Caption**.

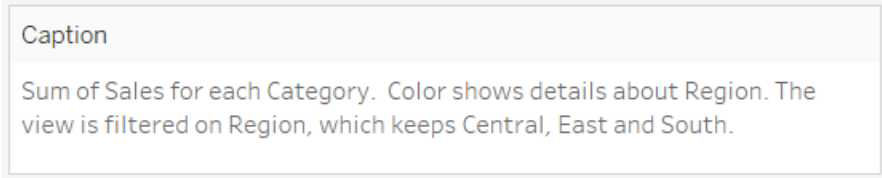

The caption is automatically generated by default.

To edit the caption, double-click the Caption area in the view. In the **Edit Caption** dialog box, you can use change the font, size, color, and alignment and style.

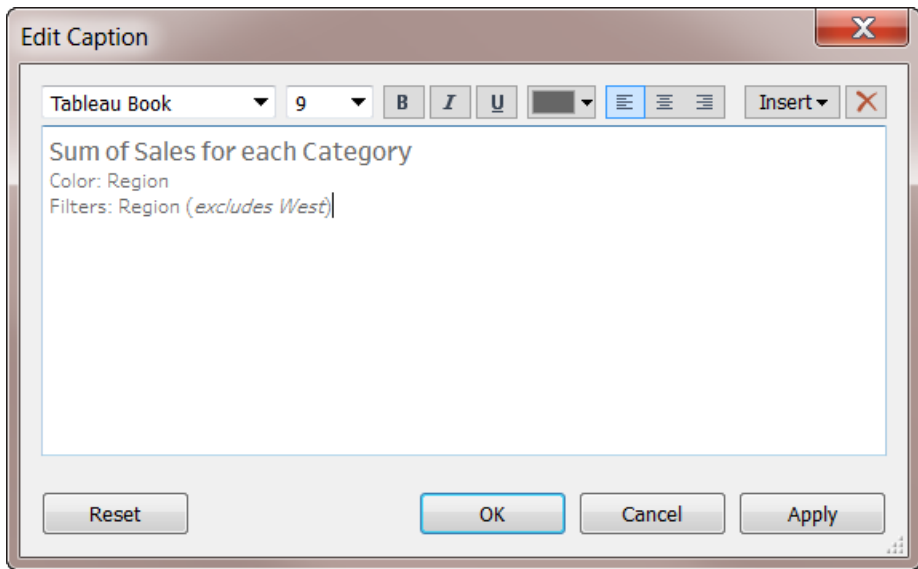

Click the **Insert** menu to add automatic text such as page number, sheet name, and field and parameter values.

The caption can optionally be included when printing, printing to PDF, and publishing to Tableau Server. When you export the view as an image to another application like Microsoft PowerPoint, you can optionally include the caption.

Field Labels

Placing discrete fields on the rows and column shelves creates headers in the view that display the members of the field. For example, if you place a field containing products on the rows shelf, each product name is shown as row headers.

In addition to showing these headers, you can show field labels, which are labels for the headers. In this example, the rows are labeled **Category**, to indicate that the discrete category names are members of the **Category** field.

		Region / Order Date			
		East			
Category		2012	2013	2014	2015
Furniture		47,233	53,817	46,387	60,854
Office Supplies		35,969	42,655	61,645	65,247
Technology		45,479	59,859	72,497	87,138

Field labels apply only to discrete fields. When you add continuous fields to the view, Tableau creates an axis. The axis is labeled with a header.

By default, field labels are shown.

To hide or show field labels, select **Analysis > Table Layout > Show Field Labels for Rows** or **Show Field Labels for Columns**.

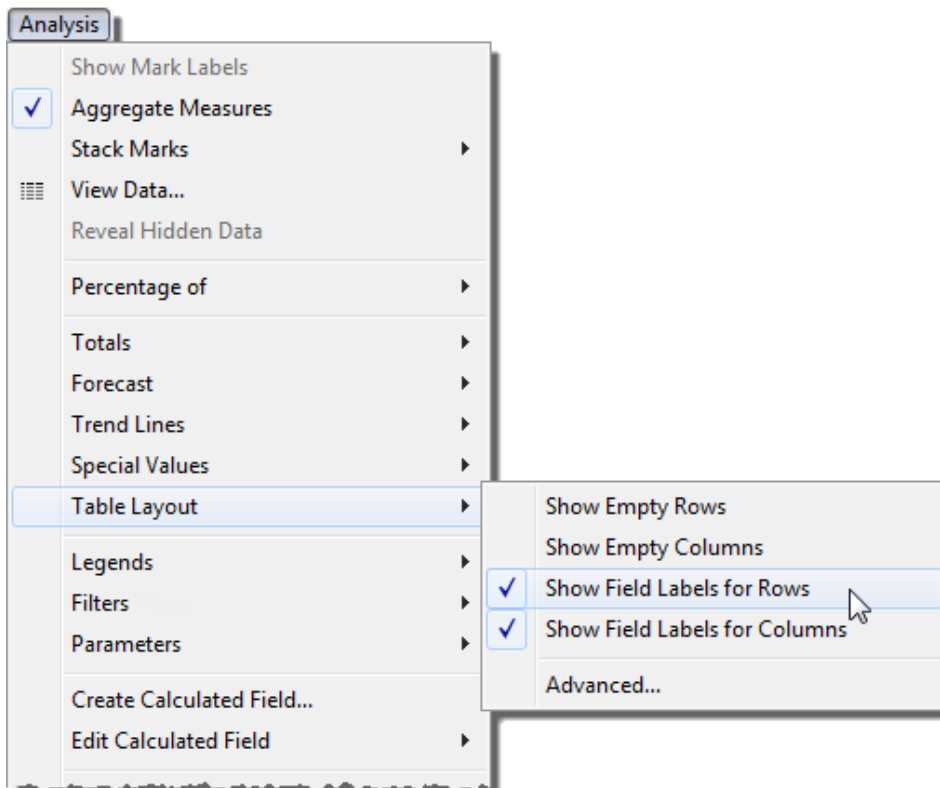

You can format the fonts, alignment, shading, and separators for field labels.

Legends

When you add fields to Color, Size, and Shape on the Marks card, a legend displays to indicate how the view is encoded with relation to your data.

Color Legend

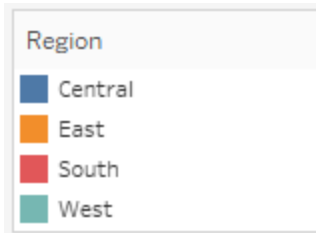

Size Legend

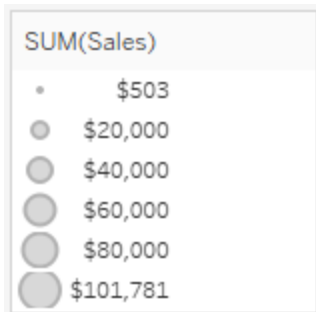

Shape Legend

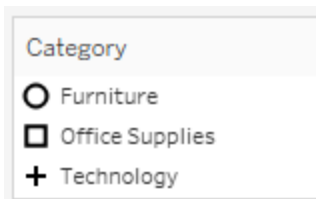

Not only do legends help you understand encodings, you can also use legends to sort, filter, and highlight specific sets of data. For more information, see [Legend Highlighting](#) on page 1394.

Measure values and color legends

If you include the **Measure Values** and **Measure names** fields in your views, you can create either a single combined color legend or separate color legends for your measures. If you drag the **Measure Values** field to Color on the Marks card, by default Tableau creates a single color legend that applies one color palette to all marks in the view. If you want to differentiate certain

measures in the view you can create separate color legends for the measures and assign a unique color palette to each legend.

For more information about Measure Values and Measure Names, see [Measure Values and Measure Names](#) on page 1212.

The following example shows how to create separate color legends. This example uses the Sample Superstore data set.

1. Connect to the Sample-Superstore data set.
2. From the Data pane:
 - Drag **Order Date** to the Columns shelf and **Category** and **Sub-Category** to the Rows shelf.
 - Drag **Measure Names** to the columns shelf and drop it to the right of **Order Date**.
 - Drag **Measure Values** to Color on the Marks card.
3. In the Measure Values card, drag measures off the card so that you keep **SUM(Sales)**, and **SUM(Profit)** only.
4. Click **Label** on the Marks card and select **Show mark labels** to show the measure values in the view.

When you drag **Measure Values** to Color on the Marks card, Tableau creates a single color legend and adds it to the view. Your view should look something like this.

The screenshot shows a Tableau view with a pivot table. The Columns shelf contains 'YEAR(Order Date)' and 'Measure Names'. The Rows shelf contains 'Category' and 'Sub-Category'. The view displays a table with columns for years (2012, 2013, 2014, 2015) and sub-columns for Profit and Sales. The data is color-coded based on the Measure Values legend. The legend ranges from -8,141 (dark blue) to 105,643 (dark red).

Category	Sub-Cate..	2012		2013		2014		2015	
		Profit	Sales	Profit	Sales	Profit	Sales	Profit	Sales
Furniture	Bookcases	-\$346	\$20,037	-\$2,755	\$38,544	\$212	\$26,275	-\$584	\$30,024
Furniture	Chairs	\$6,955	\$77,242	\$6,228	\$71,735	\$5,763	\$83,919	\$7,644	\$95,554
Furniture	Furnish..	\$1,973	\$13,826	\$3,052	\$21,090	\$3,935	\$27,874	\$4,099	\$28,915
Furniture	Tables	-\$1,124	\$46,088	-\$3,310	\$39,150	-\$2,951	\$50,333	-\$8,141	\$50,034
Office	Applianc..	\$2,459	\$15,314	\$2,512	\$23,241	\$5,301	\$26,050	\$7,865	\$42,927
Supplies	Art	\$1,407	\$6,058	\$1,485	\$6,237	\$1,409	\$5,910	\$2,227	\$8,914
Supplies	Binders	\$4,740	\$43,488	\$7,597	\$37,453	\$10,148	\$49,485	\$7,737	\$72,986
Supplies	Envelopes	\$1,495	\$3,856	\$1,960	\$4,512	\$2,067	\$4,730	\$1,442	\$3,379
Supplies	Fasteners	\$179	\$661	\$172	\$545	\$294	\$960	\$305	\$858
Supplies	Labels	\$1,286	\$2,841	\$1,323	\$2,956	\$1,193	\$2,827	\$1,745	\$3,861
Supplies	Paper	\$6,371	\$14,835	\$6,570	\$15,288	\$9,063	\$20,638	\$12,049	\$27,718
Supplies	Storage	\$4,166	\$50,322	\$3,505	\$45,048	\$6,240	\$53,534	\$7,368	\$59,034
Supplies	Supplies	\$490	\$14,394	-\$25	\$1,952	-\$699	\$14,278	-\$955	\$16,049
Technolo..	Accessor..	\$6,403	\$25,014	\$10,197	\$40,524	\$9,664	\$41,896	\$15,672	\$59,946
Technolo..	Copiers	\$2,913	\$10,850	\$9,930	\$26,179	\$17,743	\$49,599	\$25,032	\$62,899
Technolo..	Machines	\$369	\$62,023	\$2,977	\$27,764	\$2,907	\$55,907	-\$2,869	\$43,545
Technolo..	Phones	\$11,808	\$77,391	\$10,399	\$68,314	\$9,437	\$78,660	\$12,872	\$105,643

5. To create separate legends for each measure on the view, click the drop-down arrow on the **Measure Values** field in the Marks card and select **Use Separate Legends** from the context menu.

Tableau Desktop version

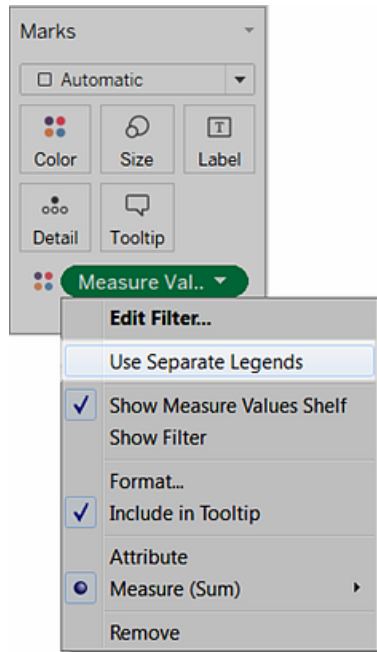

Web version



Tableau creates an individual color legend for each measure in the view using the default color palette.

The screenshot shows a Tableau dashboard with a pivot table. The columns are 'YEAR(Order Date)' and 'Measure Names'. The rows are 'Category' and 'Sub-Category'. The pivot table displays data for 2012, 2013, 2014, and 2015, with sub-columns for Profit and Sales. A color legend for 'SUM(Profit)' is visible on the right, showing a gradient from blue (-\$8,141) to red (\$25,032). The legend also includes 'SUM(Sales)' with values \$545 and \$105,643.

Category	Sub-Category	Order Date							
		2012		2013		2014		2015	
		Profit	Sales	Profit	Sales	Profit	Sales	Profit	Sales
Furniture	Bookcases	-\$346	\$20,037	-\$2,755	\$38,544	\$212	\$26,275	-\$584	\$30,024
	Chairs	\$6,955	\$77,242	\$6,228	\$71,735	\$5,763	\$83,919	\$7,644	\$95,554
	Furnishings	\$1,973	\$13,826	\$3,052	\$21,090	\$3,935	\$27,874	\$4,099	\$28,915
	Tables	-\$3,124	\$46,088	-\$3,510	\$39,150	-\$2,951	\$60,833	-\$8,141	\$60,894
Office Supplies	Appliances	\$2,459	\$15,314	\$2,512	\$23,241	\$5,301	\$26,050	\$7,865	\$42,927
	Art	\$1,407	\$6,058	\$1,485	\$6,237	\$1,409	\$5,910	\$2,227	\$8,914
	Binders	\$4,740	\$43,488	\$7,597	\$37,453	\$10,148	\$49,485	\$7,737	\$72,988
	Envelopes	\$1,495	\$3,856	\$1,960	\$4,512	\$2,067	\$4,730	\$1,442	\$3,379
	Fasteners	\$179	\$661	\$172	\$545	\$294	\$960	\$305	\$858
	Labels	\$1,286	\$2,841	\$1,323	\$2,956	\$1,193	\$2,827	\$1,745	\$3,861
	Paper	\$6,371	\$14,835	\$6,570	\$15,288	\$9,063	\$20,638	\$12,049	\$27,718
	Storage	\$4,166	\$50,329	\$3,505	\$45,048	\$6,240	\$58,632	\$7,368	\$69,834
	Supplies	\$490	\$14,394	-\$25	\$1,952	-\$699	\$14,278	-\$955	\$16,049
Technology	Accessories	\$6,403	\$25,014	\$10,197	\$40,524	\$9,664	\$41,896	\$15,672	\$59,946
	Copiers	\$2,913	\$10,850	\$9,930	\$26,179	\$17,743	\$49,599	\$25,032	\$62,899
	Machines	\$369	\$62,023	\$2,977	\$27,764	\$2,907	\$55,907	-\$2,869	\$43,545
	Phones	\$11,808	\$77,391	\$10,399	\$68,314	\$9,437	\$78,660	\$12,872	\$105,643

To assign a different color palette to the color legend, do one of the following:

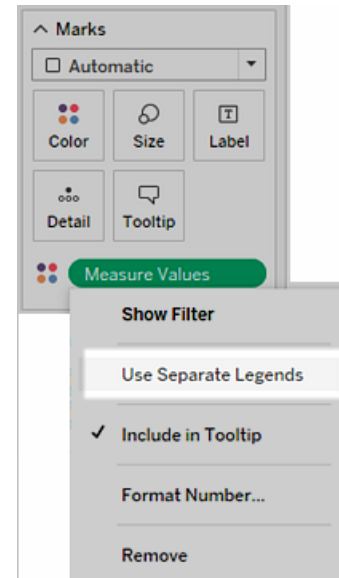
- In Tableau Desktop, click the drop-down arrow in the top right corner for each color legend and select **Edit Colors**. Then select a color from the Palette drop-down list.

- In Tableau Server or Tableau Cloud, click the drop-down arrow in the top right corner for each color legend. Then select a color from the Palette drop-down list.

Your view might look something like the following example:

Category	Sub-Category	Order Date							
		2012		2013		2014		2015	
Furniture	Bookcases	-\$346	\$20,037	-\$2,755	\$38,544	\$212	\$26,275	-\$584	\$30,024
	Chairs	\$6,955	\$77,242	\$6,228	\$71,735	\$5,763	\$83,919	\$7,644	\$95,554
	Furnishings	\$1,973	\$13,826	\$3,052	\$21,090	\$3,935	\$27,874	\$4,099	\$28,915
	Tables	-\$3,124	\$46,088	-\$3,510	\$39,150	-\$2,951	\$60,833	-\$8,141	\$60,894
Office	Appliances	\$2,459	\$15,314	\$2,512	\$23,241	\$5,301	\$26,050	\$7,865	\$42,927
	Art	\$1,407	\$6,058	\$1,485	\$6,237	\$1,409	\$5,910	\$2,227	\$8,914
	Binders	\$4,740	\$43,488	\$1,537	\$37,453	\$10,146	\$49,488	\$7,737	\$72,303
	Envelopes	\$1,495	\$3,856	\$1,960	\$4,512	\$2,067	\$4,730	\$1,442	\$3,379
	Fasteners	\$179	\$661	\$172	\$545	\$294	\$960	\$305	\$858
	Labels	\$1,286	\$2,841	\$1,323	\$2,956	\$1,193	\$2,827	\$1,745	\$3,861
	Paper	\$6,371	\$14,835	\$6,570	\$15,288	\$9,063	\$20,638	\$12,049	\$27,718
	Storage	\$4,166	\$50,329	\$3,505	\$45,048	\$6,240	\$58,632	\$7,368	\$69,834
	Supplies	\$490	\$14,394	-\$25	\$1,952	-\$699	\$14,278	-\$955	\$16,049
Technolo.	Accessories	\$6,403	\$25,014	\$10,197	\$40,524	\$9,654	\$41,896	\$15,673	\$59,948
	Copiers	\$2,913	\$10,850	\$9,930	\$26,179	\$17,743	\$49,599	\$25,032	\$62,899
	Machines	\$369	\$62,023	\$2,977	\$27,764	\$2,907	\$55,907	-\$2,869	\$43,545
	Phones	\$11,808	\$77,391	\$10,399	\$68,314	\$9,437	\$78,660	\$12,872	\$105,643

6. To combine the separate legends back to a single legend, click the drop-down arrow on the **Measure Values** field on the Marks card and select **Combine Legends** from the context menu.

Tableau Desktop version

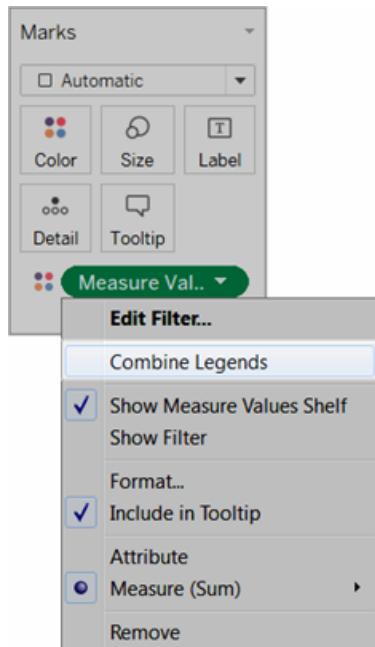

Web version

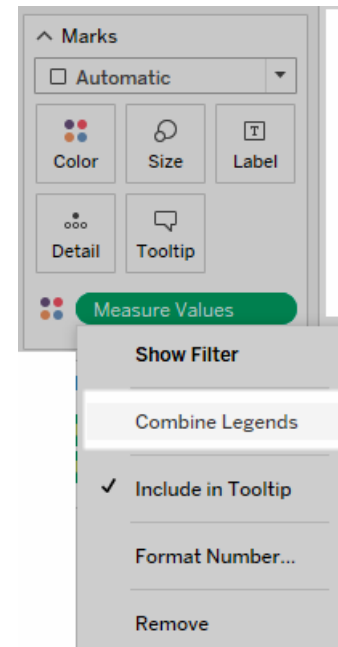

Workbooks and Sheets

Tableau uses a workbook and sheet file structure, much like Microsoft Excel. A workbook contains sheets. A sheet can be a worksheet, a dashboard, or a story.

- A **worksheet** contains a single view along with shelves, cards, legends, and the Data and Analytics panes in its side bar. For details on the worksheet workspace, see [The Tableau Workspace on page 27](#).
- A **dashboard** is a collection of views from multiple worksheets. The Dashboard and Layout panes are available in its side bar. For more details about creating dashboards, see [Dashboards on page 2697](#).
- A **story** contains a sequence of worksheets or dashboards that work together to convey information. The Story and Layout panes are available in its side bar. For more details about creating stories, see [Stories on page 2833](#).

For details on hiding or showing sheets in a workbook or Viz in Tooltip, see [Manage Sheets in Dashboards and Stories on page 2822](#) and [Hide or show a Viz in Tooltip worksheet on page 1379](#). For details on organizing sheets, see [Navigate and Organize Sheets on page 102](#). For details on creating and opening workbooks, see [Create or Open Workbooks on page 99](#).

About sheets

Each workbook can contain different types of sheets: views (also known as worksheets), dashboards, and stories.

- A worksheet is where you build views of your data by dragging and dropping fields onto shelves.
- A dashboard is a combination of several views that you can arrange for presentation or to monitor.
- A story is a sequence of views or dashboards that work together to convey information.

The sheets display along the bottom of the workbook as tabs. In this section you'll learn how to create, open, duplicate, hide, and delete sheets. You'll also learn how to organize sheets in a workbook.

Within a workbook, you can create new sheets, clear an entire worksheet, duplicate sheets, hide or show a worksheet, and delete a sheet. Tableau has several ways to view and organize the sheets in your workbook.

Create new worksheets, dashboards, or stories

There are several ways to create new sheets in a workbook, dashboard, or a story. You can create as many sheets in a workbook as you want.

To create a new worksheet, dashboard, or story, click the **New Worksheet**, **New Dashboard**, or **New Story** button at the bottom of the workbook.

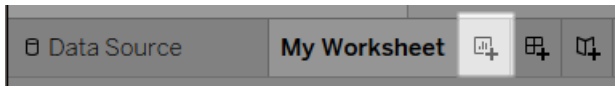

The **New Worksheet** button.

To rename a new worksheet, dashboard, or story, right-click (Ctrl-click on a Mac) the tab and then select the **Rename** command.

More ways to create new worksheets

Create a new worksheet by doing one of the following:

- Select **Worksheet > New Worksheet**.
- Right-click any open tab in the workbook, and select **New Worksheet** from the menu.
- On the toolbar, click the drop-down arrow on the **New Worksheet**  button and then select **New Worksheet**.
- Press Ctrl + M on your keyboard (Command-M on a Mac).

More ways to create new dashboards

Create a new dashboard by doing one of the following:

- Select **Dashboard > New Dashboard**.
- Click the **New Dashboard** button at the bottom of the workbook.

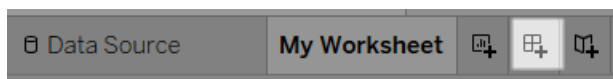

- Right-click on any open tab in the workbook, and select **New Dashboard** from the menu.

- On the toolbar, click the drop-down arrow on the New Worksheet  button and then select **New Dashboard**.

More ways to create new stories

Create a new story by doing one of the following:

- Select **Story > New Story**.
- Click the **New Story** button at the bottom of the workbook.

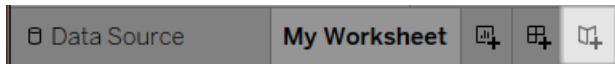

- Right-click on any open tab in the workbook, and select **New Story** from the menu.
- On the toolbar, click the drop-down arrow on the **New Worksheet**  button and then select **New Story**.

Undo, redo, or clear sheets

Every Tableau workbook contains a history of steps you have performed on the worksheets, dashboards, and stories in that workbook for the current work session.

To move backward through the history, click **Undo**  on the toolbar or press Ctrl + Z on your keyboard (Command-Z on a Mac).

To move forward through the history, click **Redo**  on the toolbar or press Ctrl + Y (Command-Y on a Mac) on your keyboard.

To remove all fields, formatting, sizing, axis ranges, filters, sorts, and context filters in

the sheet, click **Clear Sheet**  on the toolbar.

To clear specific aspects of the view, use the Clear Sheet drop-down menu.

Note: Using the clear commands on the toolbar does not clear the history. If you decide that you didn't want to clear the sheet, click the **Undo** button.

Duplicate a sheet

When you want to use an existing sheet as a jumping off point for more exploration, you can duplicate that sheet. The duplicated sheet contains all of the same fields and settings as a starting point for new analysis.

Duplicate creates a new version of a worksheet, dashboard, or story you can modify without effecting the original sheet.

To duplicate the active sheet, right-click the sheet tab (control-click on Mac) and select **Duplicate**.

Note: When you duplicate a dashboard, a new version of the dashboard is created, but it still references the original worksheets that were used to create the dashboard.

Duplicate as Crosstab

A crosstab (sometimes referred to as a Pivot Table) is a table that summarizes data in rows and columns of text. It is a convenient way to display the numbers associated with the data view.

To create a new cross-tab sheet based on the data in the current sheet, right-click the sheet tab (control-click on Mac) and select **Duplicate as Crosstab**. Or select **Worksheet > Duplicate as Crosstab**.

This command inserts a new worksheet or worksheets into your workbook and populates the sheet with a cross-tab view of the data from the original worksheet. Dashboards and stories cannot be duplicated as crosstabs.

Rename sheets

To rename the active sheet, right-click (control-click on Mac) the sheet in the sheet tab along the bottom of the workbook, and then click **Rename Sheet**.

Or, double-click the name of the sheet in a sheet tab, type a new name, and then click **Enter**.

See the underlying data in a sheet

To see the numbers behind the marks in your view

Hover over or click a mark to display the associated data in a tooltip. With the tooltip open, click the **View Data** command at the top of the tooltip to view underlying data.

Right-click the view (with no marks selected), and then click View Data.

You can copy and paste the data into Excel or another application. To export the underlying data, click **Export All**.

Delete sheets

Deleting a sheet removes it from the workbook. There must always be at least one worksheet in a workbook.

To delete the active sheet, right-click (control-click on Mac) the sheet in the sheet tab along the bottom of the workbook, and then click **Delete**.

Worksheets used in a dashboard or story cannot be deleted, but they can be hidden.

A worksheet used as Viz in Tooltip can be hidden or deleted.

Create or Open Workbooks

A workbook contains one or more sheets, each of which can be a worksheet, dashboard, or story. You can use workbooks to organize, save, share, and publish your results.

- [Create or open a workbook below](#)
- [Open a workbook that has an unsupported data connection on the Mac below](#)
- [Open a published workbook from the server on the next page](#)

Create or open a workbook

When you open Tableau, a new, blank workbook opens automatically.

To create a new workbook, select **File > New**

To open an existing workbook, click the thumbnail image of the workbook on the start page.

You can open multiple workbooks simultaneously. Each workbook appears in its own window.

Note: When you open multiple workbooks in Tableau Desktop on the Mac, multiple instances of the application are created, each with its own icon in the Dock. This differs from typical Mac application behavior, where one instance of the application handles all open documents.

Open a workbook that has an unsupported data connection on the Mac

When working in Tableau Desktop on the Mac, you might need to open a Windows workbook that contains data sources that are not supported in Tableau Desktop on the Mac. To do so, follow the steps below:

1. In Tableau Desktop on Windows, save the workbook as an extract. To create and save an extract, on the **Data** menu, select a data source, and then select **Extract Data**.

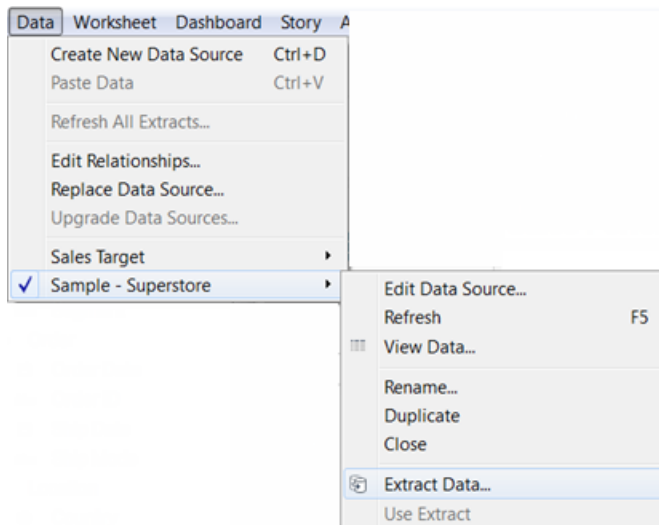

2. Open the extract file (.hyper) you saved in Tableau Desktop on your Mac.

Open a published workbook from the server

If you have been granted the **Download/Web Save As** permission for a published workbook, you can use Tableau Desktop to open the workbook from the server. When you open a workbook from the server and make changes, you can save it to your computer or, if you have been allowed the **Write/Web Save** permission, you can save the changes directly on the server.

To open a workbook from the server

1. Select **Server > Open Workbook**.

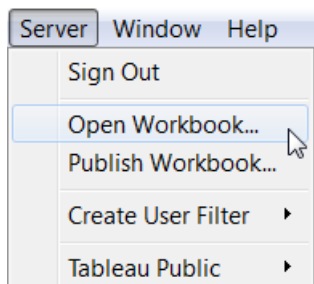

2. If you are not already signed in to Tableau Server or Tableau Cloud, do so at the prompt.

If you're not sure how to sign in to the server you use, see [Sign in to Tableau Server or Tableau Cloud](#) on page 193.

3. In the Open Workbook from Tableau Server dialog box, select the workbook you want to open, and then click **Open**.

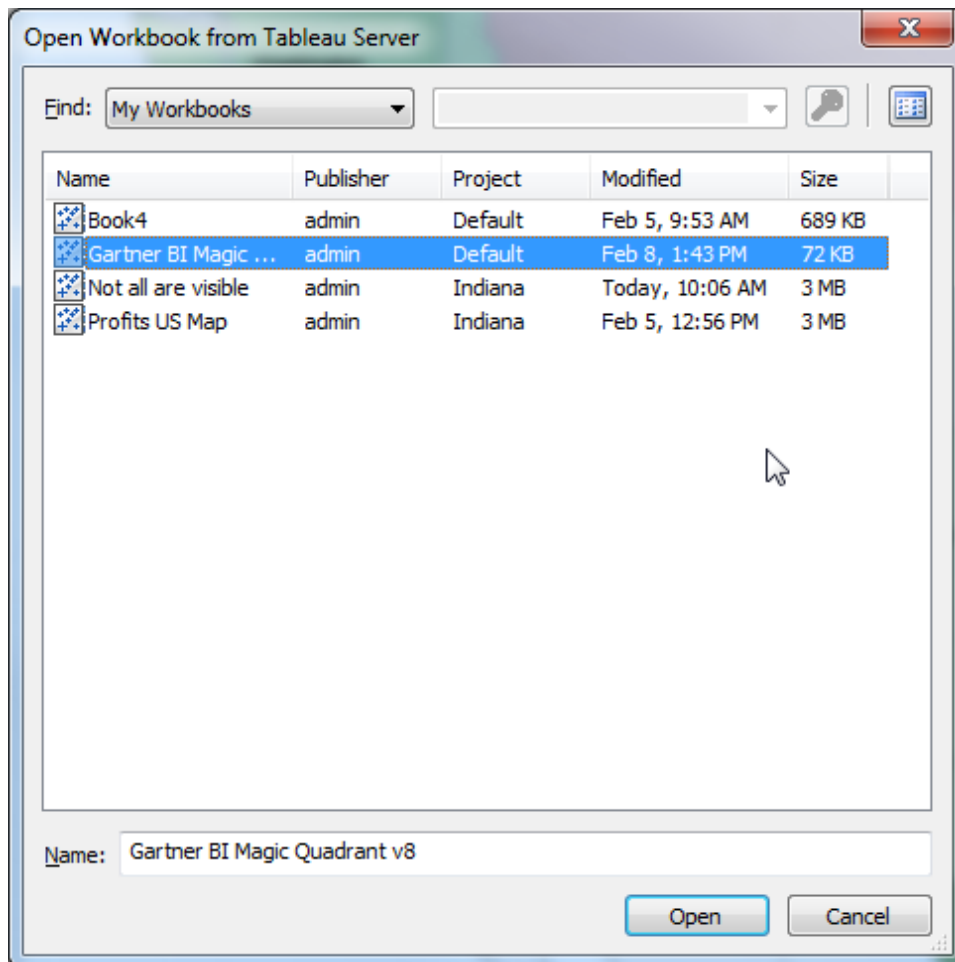

Tip: You can use the **Find** drop-down list or the Search box to browse or search for the workbook you want.

You can search all workbooks on the server or find by tags, publisher, project, or workbooks that you published.

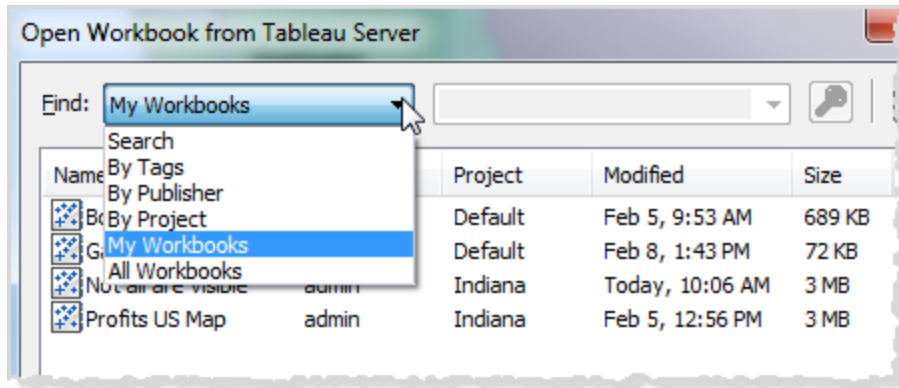

Navigate and Organize Sheets

You can navigate and organize sheets in a workbook using the sheet tabs, the filmstrips, or the sheet sorter.

Options for navigating, viewing, and organizing sheets

There are three ways to navigate and view the sheets in a workbook:

- Tabs at the bottom of the workbook
- In the filmstrip view
- In the sheet sorter view

The tabs are useful when you want to quickly navigate between a small number of sheets. If your workbook has a large number of sheets, you can use the sheet sorter to easily navigate them all.

You can also drag and drop to do the following:

- Reorder the sheets
- Create new sheets
- Duplicate or delete existing sheets from any of the views

Navigate with sheet tabs

Each sheet is represented as a tab along the bottom of the workbook. Select any tab to open the corresponding worksheet.

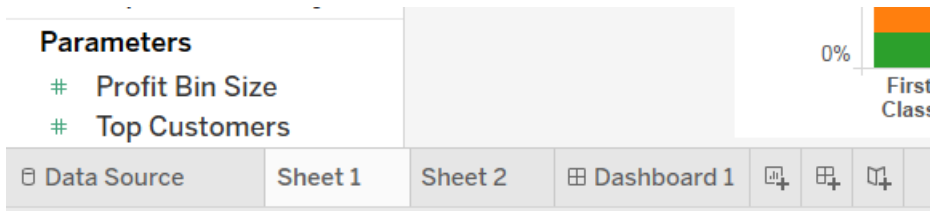

In the bottom right corner of the application window, there are several controls that you can use to advance through each sheet or quickly jump to the first or last sheet in the workbook. These controls are only available when there are too many sheet tabs to show across the bottom of the application window.

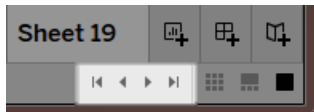

You can also navigate between sheets using the window menu or move through the multiple worksheets by pressing the left or right arrow keys on your keyboard.

To navigate through multiple worksheets, select a worksheet tab at the bottom of the workbook first.

Note: Navigating within a story is a different matter—there, you use the Navigator to move between story points. See [Create a Story on page 2840](#).

Show thumbnails with the filmstrip

Similar to the sheet tabs, the filmstrip displays along the bottom of the workbook. However, instead of just sheet names, the filmstrip also shows a thumbnail image of each sheet. The filmstrip is useful when you are using Tableau to present your analysis and works well when you are working in Presentation mode.

Open the filmstrip by clicking the **Filmstrip**  button on the status bar (bottom right corner) of the workbook. Just like with the tabs, select the thumbnail image for the sheet you want to open. You can right-click the images to specify commands that apply to each sheet.

Note: When viewed from a Retina display, workbooks that are created on a standard resolution device will show only the first thumbnail in the filmstrip in high resolution. To display all thumbnails in the filmstrip in high resolution, resave the workbook on a computer with Retina display.

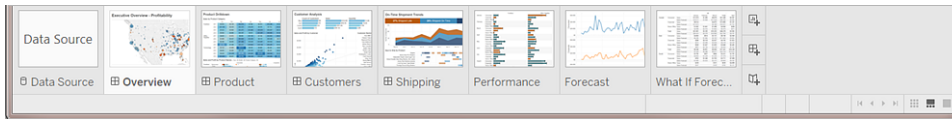

Manage many sheets with sheet sorter

The sheet sorter shows all sheets in a workbook as thumbnail images on a single page. The sheet sorter is useful when you have a large number of sheets in a workbook. Open the sheet

sorter by clicking the sheet sorter  button on the status bar (bottom right corner of the workbook).



Right-click a sheet (Control-click on the Mac) to see these commands. You can also right-click (Control-click on the Mac) to refresh the thumbnail image of a particular sheet or **Refresh All Thumbnails** at once. If you have a large number of sheets, refreshing your view can take some time.

Sheet commands

Use sheet commands to manage and organize your worksheets. For example you can create new sheets, duplicate sheets, copy formatting, apply color, or delete the sheet entirely.

You can access sheet commands on the right-click menu (Control-click on a Mac) in the worksheet, sheet sorter, or the filmstrip view. To apply commands to multiple sheets at once, press the Ctrl key (Shift key on a Mac), and then select the sheets.

To make it easier to identify and group sheets, you can assign a color to sheets. You can select from seven different colors. Selecting **None** clears the color.

Tableau Desktop and Web Authoring Help

To assign a color to sheets, select one or more sheets, right-click the sheets (Control-click on the Mac), select **Color**, and then pick a color.

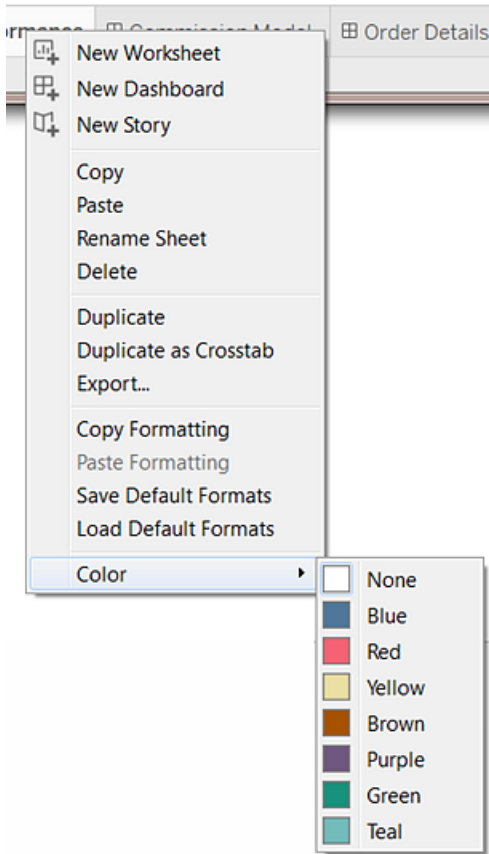

The color strip appears on the bottom of the tab or sheet.

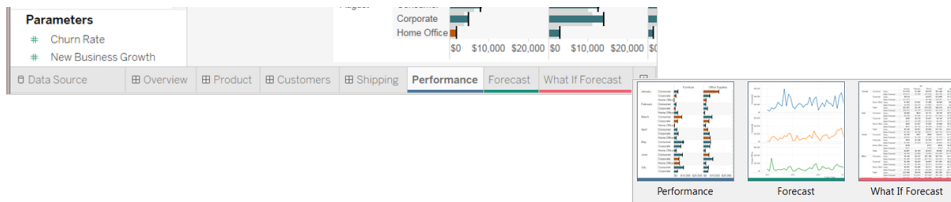

Reorganizing the Workspace

Every worksheet contains a variety of cards, shelves, legends, and so on. You can reorganize the workspace by rearranging cards, hiding and showing specific parts of the workspace, and hiding everything but the view using Presentation Mode.

Rearranging Cards

A worksheet contains several cards that contain shelves, legends, and other controls. Each card can be rearranged to create a custom workspace. To move a card, point the cursor at the title

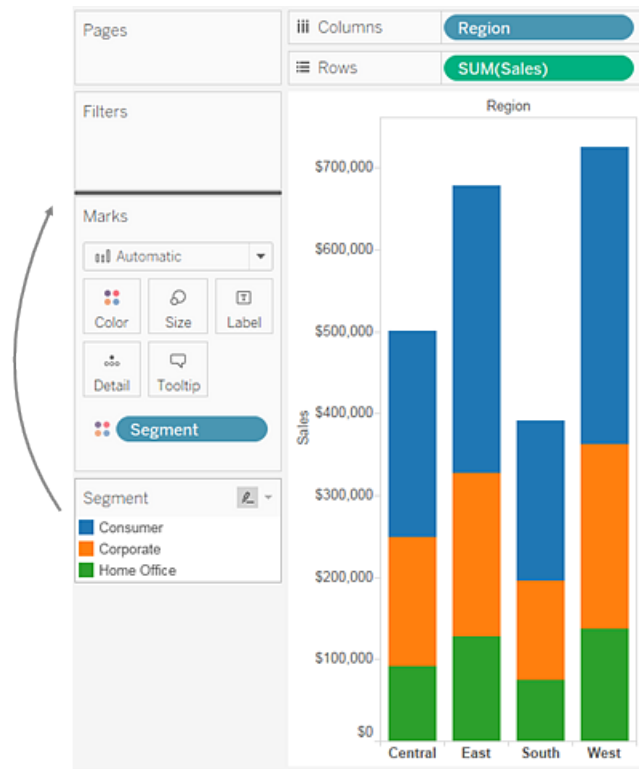

area of the card you want to move. When the cursor becomes the move symbol , click and drag the card to a new position. As you drag the card around the worksheet, the possible positions for it are highlighted with a black bar.



You can restore the worksheet windows to their default state by selecting **Reset Cards** on the Show/Hide Cards toolbar control.

Showing and Hiding Parts of the Workspace

Just about everything in the workspace can be turned on and off so you can avoid cluttering the worksheet with unnecessary cards, shelves, etc.

- To show and hide the toolbar or status bar, select **Window** and then select what you want to hide.
- To show and hide the window on the left side, which is either the Data pane (for worksheets), the Dashboard pane (for dashboards), or the Dashboards and Sheets pane (for stories); click the Minimize button  in the upper right corner of the pane. The pane is minimized to the bottom left corner of the workbook. Click the same button again to restore the pane.
- To show or hide a card click **Show/Hide Cards**  on the toolbar and then select the card you want to show or hide.





You can restore the worksheet windows to their default state by selecting **Reset Cards** on the **Show/Hide Cards** toolbar control.

Presentation Mode

Sometimes you may want to use Tableau to present your findings. Rather than hiding each card or shelf one at a time, you can switch to presentation mode. Presentation mode hides everything on the sheet except for the view and its associated legends, filter cards, parameter controls, and worksheet tabs.

- To switch in and out of presentation mode, click the Presentation Mode  button on the toolbar or select **Window > Presentation Mode**.

Use the presentation mode controls in the bottom right corner to move between sheets and more. Each presentation mode control is described below.

	Show Filmstrip - shows the sheets as thumbnails at the bottom of the workspace.
	Show Tabs - shows the sheet tabs at the bottom of the workspace.
	Previous/Next Sheet - advances forward or backward through the sheets in a workbook.
	Enter/Exit Full Screen - switches between expanding the workbook to fill the entire screen and showing it in a window.



Exit Presentation Mode - returns the workbook to showing the entire workspace including the menus, toolbar, and the Data pane.

Tableau File Types and Folders

You can save your work using several different Tableau specific file types: workbooks, bookmarks, packaged data files, data extracts, and data connection files. Each of these file types are described below. For related details, see [Save Your Work on page 3077](#).

- **Workbooks (.twb)** – Tableau workbook files have the .twb file extension. Workbooks hold one or more worksheets, plus zero or more dashboards and stories.
- **Bookmarks (.tbn)** – Tableau bookmark files have the .tbn file extension. Bookmarks contain a single worksheet and are an easy way to quickly share your work. For more information, see [Save a bookmark on page 3079](#).
- **Packaged Workbooks (.twbx)** – Tableau packaged workbooks have the .twbx file extension. A packaged workbook is a single zip file that contains a workbook along with any supporting local file data and background images. This format is the best way to package your work for sharing with others who don't have access to the original data. For more information, see [Packaged Workbooks on page 3082](#).
- **Extract (.hyper)** – Tableau extract files have the .hyper extension. Extract files are a local copy of a subset or entire data set that you can use to share data with others, when you need to work offline, and improve performance. For more information, see [Extract Your Data on page 919](#).
- **Data Source (.tds)** – Tableau data source files have the .tds file extension. Data source files are shortcuts for quickly connecting to the original data that you use often. Data source files do not contain the actual data but rather the information necessary to connect to the actual data as well as any modifications you've made on top of the actual data such as changing default properties, creating calculated fields, adding groups, and so on. For more information, see [Save Data Sources on page 972](#).
- **Packaged Data Source (.tdsx)** – Tableau packaged data source files have the .tdsx file extension. A packaged data source is a zip file that contains the data source file (.tds) described above as well as any local file data such as extract files (.hyper), text files, Excel files, Access files, and local cube files. Use this format to create a single file that you can then share with others who may not have access to the original data stored locally on your computer. For more information, see [Save Data Sources on page 972](#).

These files can be saved in the associated folders in the My Tableau Repository directory, which is automatically created in your My Documents folder when you install Tableau. Your work files can also be saved in other locations, such as your desktop or a network directory.

Changing the Repository Location

You can specify a new location for the Tableau repository if you are not using the default location in your Documents folder. For instance, if you are required to have your data on a network server instead of on your local machine, you can point Tableau at the remote repository.

1. Select **File > Repository Location**.
2. Select a new folder that will act as the new repository location in the Select a Repository dialog box.
3. Restart Tableau so that it uses the new repository.

Changing the repository location does not move the files contained in the original repository. Instead, Tableau creates a new repository where you can store your files.

Language and Locale

Tableau Desktop is localized into several languages.

When you first run Tableau, it recognizes your computer locale and uses the appropriate language if it's supported. If you're using an unsupported language, the application defaults to English.

Set a language

You can configure Tableau to display the user interface (menus, messages, etc.) by choosing **Help > Choose Language**. After you change this setting, you must restart the application for the changes to take effect. You don't need to change this setting for every workbook.

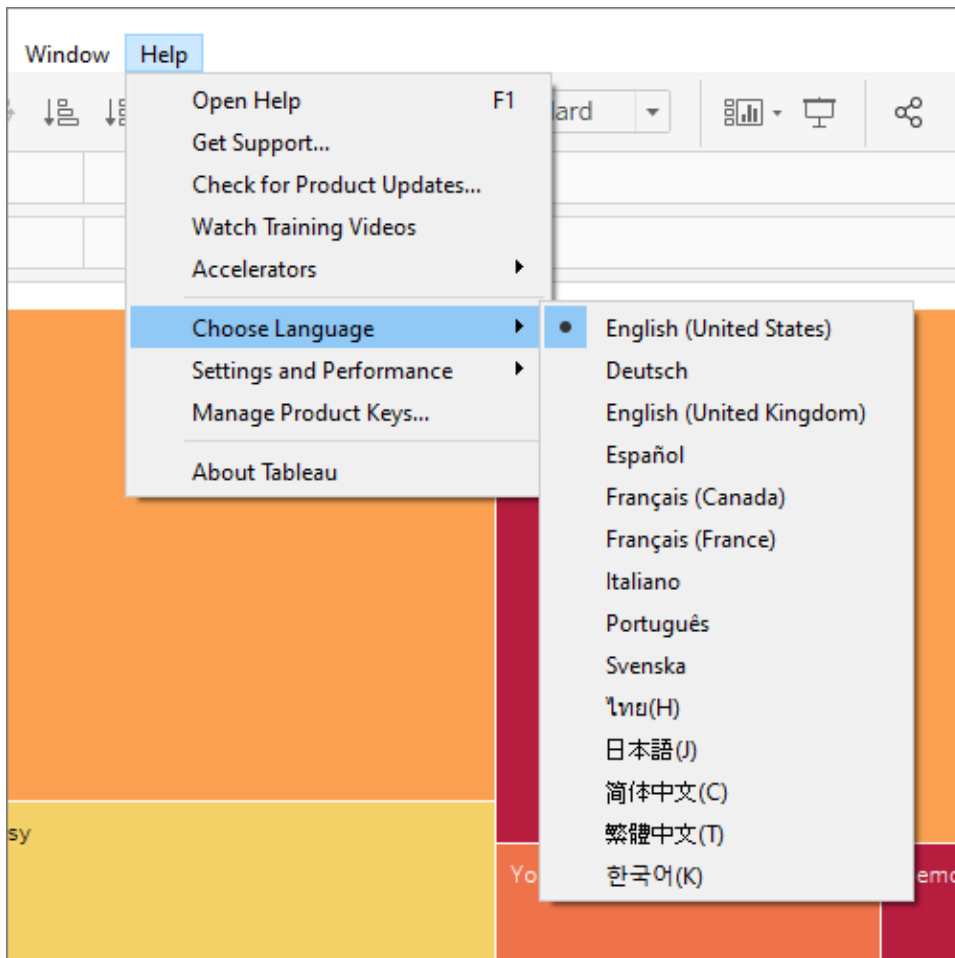

Set a locale

To configure date and number formatting, choose **File > Workbook Locale**. By default, the locale is set to **Automatic**, which means the locale matches the locale when the workbook is opened. This can be useful if you're authoring a workbook that will be viewed in many different languages and you want the dates and numbers to update accordingly. When you select a specific locale, the workbook doesn't change regardless of who opens it.

Tableau checks the following, in order, to determine the workbook locale:

1. Workbook Locale (explicit setting)
2. Windows Locale or Mac language
3. Tableau Language

If none of the above are set, then the workbook locale defaults to English.

Day of the Week Sorting



You should set your workbook locale so Tableau can sort the days of the week in the correct chronological order. Otherwise, Tableau sorts the names of the days alphabetically. If locales are appropriate, you can sort the days of the week manually. See [Sort Data in a Visualization on page 1345](#).





Visual Cues and Icons in Tableau Desktop

Tableau provides many visual cues to help you evaluate the type of data that's displayed in the Data pane and the state of a data view.

Data sources in the Data pane

The following table explains each of the icons used to describe the type of data sources in the Data pane. Each icon in the table can be modified by one of two indicators.

- A blue check mark indicates that the data source is the primary data source in the workbook. 
- An orange check mark indicates that the data source is the secondary data source in the workbook. 







Visual Cue	Description
	The workbook is directly connected to a relational data source or file.
	The workbook is connected to an extract that still references the underlying data.
	The workbook is connected to a cube (multidimensional) data source. In Tableau, cube data sources are supported only in Windows.
	The workbook is connected to an Excel table, sub-table, or named range.
	The workbook is connected to a data source that has been published to Tableau Server.

Fields in the Data Pane

The following table explains each of the icons displayed in the Data pane.

- Blue icons indicate that the field is discrete. [Abc](#)
- Green icons indicate that the field is continuous. <#>
- Icons preceded by the equal sign (=) indicate that the field is a user-defined calculation or a copy of another field. [=Abc](#)

For more information on field types, see [Dimensions and Measures, Blue and Green](#) on page 147.

Visual Cue	Field description
 Abc =Abc	Text or string values.
 # =#	Numeric values.
 =📅	Date values.
	Date and time values.
T F =T F	Boolean values (true or false).
	Geographical data. This icon also indicates the field has been assigned a geographic role. Use these fields when building map views. See Maps and Geographic Data Analysis in Tableau on page 1647.
	Geographical data from a custom geocoding file. See Geocode Locations Tableau Does Not Recognize and Plot Them on a Map on page 1711.
	A URL set to Image Role. See Add Web Images Dynamically to Worksheets on page 1044.



A calculation defined on the server.



A calculation defined in the database.



A user-defined set. See [Create Sets](#) on page 1092.



A server named set.



A set that was automatically created as a result of an action. See [Actions](#) on page 1387.



A user filter for published content. See [Restrict Access at the Data Row Level](#) on page 3165.



A numeric bin. See [Create Bins from a Continuous Measure](#) on page 1597.



A group. See [Correct Data Errors or Combine Dimension Members by Grouping Your Data](#) on page 1090.



A cluster group. See [Find Clusters in Data](#) on page 2520.



A relational hierarchy. See [Create Hierarchies](#) on page 1076.



A level in a multidimensional hierarchy. Levels greater than five are shown without numbers.





A folder that contains one or more fields. Folders are used to organize fields in the Data pane. See [Organize the Data Pane](#) on page 1051.



An attribute of a cube (multidimensional) data source. In Tableau, cube data sources are supported only in Windows.







A varying attribute of a cube (multidimensional) data source.

	The field is an active link for data blending. See Blend Your Data on page 816 .
	The field is a potential link for data blending. See Blend Your Data on page 816 .
	The field is unrelated. See About Multi-fact Relationship Data Models on page 740 .
	The field is a stitching field. See About Multi-fact Relationship Data Models on page 740 .
	The field is hidden. Click to unhide the field. See Hide or Unhide Fields on page 1061 .

Fields on Shelves

Fields placed on shelves use a combination of icons, colors, and text styles as visual cues.

Visual Cue	Description
	A blue field on a shelf indicates a discrete field. In most cases, adding a dimension to a shelf results in a blue field. Blue fields are discrete—they contain a finite number of values. Adding a blue field to a shelf creates headers. For details, see Headers on page 77 .
	A green field on a shelf indicates a continuous field. In most cases, adding a measure to a shelf results in a green field. Green fields are continuous—they contain an infinite number of values. Adding a green field to a shelf creates an axis. For details, see Axes on page 80 .
	The Sort icon indicates a field that has either a computed or manual sort order applied. See Sort Data in a Visualization on page 1345 .
	The sigma icon indicates a slicing filter in a multidimensional (cube) data source. See Create Slicing Filters on page 988 .



The Venn diagram icon indicates a set. See [Create Sets](#) on page 1092.



The unrelated icon indicates the field is unrelated to at least one other field in the viz. See [Field-level relatedness indicators](#) on page 743.



The related icon indicates the dimension is stitching otherwise unrelated fields. See [Field-level relatedness indicators](#) on page 743.



A field name shown in italics indicates the filter was generated and controlled by an action.

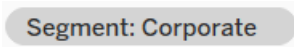

A gray field on the Filters shelf indicates a context filter. See [Use Context Filters](#) on page 1337.

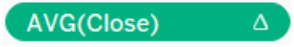

The delta icon indicates that the field is a table calculation. See [Transform Values with Table Calculations](#) on page 2364.



The plus and minus controls appear when the field is part of a hierarchy you can drill down or roll up.



The arrow icon indicates that a forecast is being displayed for the field. This icon is also used on the Forecast Indicator field, which is an automatic field used to distinguish between actual and forecast values. See [Forecasting](#) on page 2545.



A data source cylinder with an orange check mark indicates the field is from a secondary data source. See [Blend Your Data](#) on page 816.

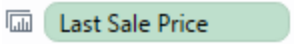

The filter is assigned to a specific worksheet.

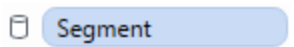





The filter is assigned to all worksheets with the same data source.

Internet Sales Amount 

The field is incompatible with one or more other fields in the view.

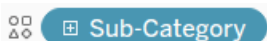
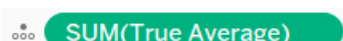
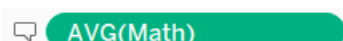

Fields on the Marks card

Fields placed on the Marks card use specific icons to describe how they appear in the view. For more details, see [Control the Appearance of Marks in the View on page 1261](#).

Visual Cue	Description
 Segment	The field is applied to Color on the Marks card.
 SUM(Profit) ▼	The field is applied to Size on the Marks card.
 AVG(Discou..) ▼	The field is applied to Label on the Marks card.
 Sub-Category	The field is applied to Shape on the Marks card.
 SUM(True Average)	The field is applied to Detail on the Marks card.
 AVG(Math)	The field is applied to Tooltip on the Marks card.
 YEAR(Date)	The field is applied to Path on the Marks card. Path is only available when the Line or Polygon mark type is selected from the Marks drop-down menu.

Sheets in the Dashboards and Worksheets pane

The following table explains each of the icons used to describe the type of sheet that can be placed in a story. A blue check mark indicates that a sheet is being used in one or more story points. 

Visual Cue	Description
	The sheet is a worksheet.
	The sheet is a dashboard.

Fields in the Calculation editor

Text in the calculation editor is color coded.

Visual Cue	Description
[Field Name]	Orange text. The field is a dimension or measure, or a set.
[Parameters].[Parameter Name]	Purple text. The field is a parameter. Tableau adds the prefix [Parameters] to avoid ambiguity when a parameter has the same name as another field
[Data source].[Field Name]	Orange text. The field is from a secondary data source. The data source name is added as a prefix.
Blue()	Blue text. A calculation function .

Tableau Concepts

What are dimensions and measures? Why are some fields dimensions and others measures?

Why is the background color blue for some fields, and green for others?

How does adding a filter affect my viz?

How does Tableau aggregate data in a view?

The topics in this section cover concepts that answer these questions to help you understand why Tableau does what it does.

If you're new to Tableau Desktop, also see other topics in [Get Started](#) on page 3.

If you're new to Tableau Public, also see Tableau Public [Resources](#).

Structure Data for Analysis

There are certain concepts that are fundamental to understanding data prep and how to structure data for analysis. Data can be generated, captured, and stored in a dizzying variety of formats, but when it comes to analysis, not all data formats are created equal.

Data preparation is the process of getting well formatted data into a single table or multiple related tables so it can be analyzed in Tableau. This includes both the structure, i.e. rows and columns, as well as aspects of data cleanliness, such correct data types and correct data values.

Tip: It may help to go through the following topic with a data set of your own. If you do not already have a data set you can use, see our tips for [finding good data sets](#).

How structure impacts analysis

The structure of your data may not be something you can control. The rest of this topic assumes you have access to the raw data and the tools needed to shape it, such as Tableau Prep Builder. However, there may be situations when you can't pivot or aggregate your data as desired. It is often still possible to perform the analysis but you may need to change your calculations or how you approach the data. For an example of how to perform the same analysis with different data structures, see Tableau Prep Day in the Life Scenarios: [Analysis with the Second Date in Tableau Desktop](#). But if you can optimize the data structure it will likely make your analysis much easier.

Data Structure

Tableau Desktop works best with data that is in tables formatted like a spreadsheet. That is, data stored in rows and columns, with column headers in the first row. So what should be a row or column?

What is a row?

A row, or record, can be anything from information around a transaction at a retail store, to weather measurements at a specific location, or stats about a social media post.

It's important to know what a record (row) in the data represents. This is the *granularity* of the data.

Here, each record is a day

Here, each record is a month

Date	Max TemperatureF	Mean TemperatureF	Min TemperatureF
1/1/2015	42		
1/2/2015	42		
1/3/2015	41		
1/4/2015	51		
1/5/2015	54		
1/6/2015	54		
1/7/2015	46		
1/8/2015	46		
1/9/2015	50		
1/10/2015	46		

Date	Max TemperatureF	Mean TemperatureF	Min TemperatureF
January	63	45	26
February	62	49	33
March	69	51	31
April	77	52	37
May	82	59	43
June	92	68	49
July	95	71	54
August	92	69	54
September	81	61	45
October	74	58	45
November	60	44	25

Tip: A best practice is to have a unique identifier (UID), a value that identifies each row as a unique piece of data. Think of it like the social security number or URL of each record. In Superstore, that would be Row ID. Note that not all data sets have a UID but it can't hurt to have one.

Try to make sure you can answer the question "What does a row in the data set represent?". This is the same as answering "What does the TableName(Count) field represent?". If you can't articulate that, the data might be structured poorly for analysis.

Aggregation and Granularity

A concept related to what makes up a row is the idea of aggregation and granularity, which are opposite ends of a spectrum.

Aggregation

- refers to how multiple data values are brought together into a single value, such as counting all the Google searches for Pumpkin Spice or taking the average of all the temperature readings around Seattle on a given day.
- By default, measures in Tableau are always aggregated. The default aggregation is SUM. You can change the aggregation to options like Average, Median, Count Distinct, Minimum, etc.

Granularity

- refers to how detailed the data is. What does a row or record in the data set represent? A person with malaria? A provinces' total cases of malaria for the month? That's the granularity.
- Knowing the granularity of the data is crucial to working with level of detail (LOD) expressions.

Understanding aggregation and granularity is a critical concept for many reasons; it impacts things like finding useful data sets, building the visualization you want, relating or joining data correctly, and using LOD expressions.

Tip: For more information, see [Data Aggregation in Tableau](#).

What is a field or column?

A *column* of data in a table comes into Tableau Desktop as a *field* in the data pane, but they are essentially interchangeable terms. (We save the term *column* in Tableau Desktop for use in the columns and rows shelf and to describe certain visualizations.) A field of data should contain items that can be grouped into a larger relationship. The items themselves are called *values* or *members* (only discrete dimensions contain members).

What values are allowed in a given field are determined by the *domain* of the field (see the note below). For example, a column for "grocery store departments" might contain the members "deli" "bakery", "produce", etc., but it wouldn't include "bread" or "salami" because those are items, not departments. Phrased another way, the domain of the department field is limited to just the possible grocery store departments.

Additionally, a well-structured data set would have a column for "Sales" and a column for "Profit", not a single column for "Money", because profit is a separate concept from sales.

- The domain of the Sales field would be values ≥ 0 , since sales cannot be negative.
- The domain of the Profit field, however, would be all values, since profit can be negative.

Note: *Domain* can also mean the values present in the data. If the column "grocery store department" erroneously contained "salami", by this definition, that value would be in the domain of the column. The definitions are slightly contradictory. One is the values that could or should be there, the other is values that actually are there

Categorizing fields

Each column in the data table comes into Tableau Desktop as a field, which appears in the **Data** pane. Fields in Tableau Desktop must be either a dimension or measure (separated by a line within tables in the **Data** pane) and either discrete or continuous (color coded: blue fields are discrete and green fields are continuous).

- *Dimensions* are qualitative, meaning they can't be measured but are instead described. Dimensions are often things like city or country, eye color, category, team name, etc. Dimensions are usually discrete.
- *Measures* are quantitative, meaning they can be measured and recorded with numbers. Measures can be things like sales, height, clicks, etc. In Tableau Desktop, measures are automatically aggregated; the default aggregation is SUM. Measures are usually continuous.
- *Discrete* means individually separate or distinct. Toyota is distinct from Mazda. In Tableau Desktop, discrete values come into the view as a label and they create panes.
- *Continuous* means forming an unbroken, continuous whole. 7 is followed by 8 and then it's the same distance to 9, and 7.5 would fall midway between 7 and 8. In Tableau Desktop, continuous values come into the view as an axis.
- Dimensions are usually discrete, and measures are usually continuous. However, this is not always the case. Dates can be either discrete or continuous.
 - Dates are dimensions and automatically come into the view as discrete (aka date parts, such as "August", which considers the month of August without considering other information like the year). A trend line applied to a timeline with discrete dates will be broken into multiple trend lines, one per pane.
 - We can choose to use continuous dates if preferred (aka date truncations, such as "August 2024", which is different than "August 2025"). A trend line applied to a timeline with continuous dates will have a single trend line for the entire date axis.

Tip: For more information, see [Dimensions and Measures, Blue and Green](#).

In Tableau Prep, no distinction is made for dimensions or measures. Understanding the concepts behind discrete or continuous are important, however, for things like understanding the detail versus summary presentation of data in the profile pane.

- **Detail:** the detail view shows every domain element as a discrete label and has a visual scrollbar to provide a visual overview of all the data.

- Summary: the summary view shows the values as binned on a continuous axis as a histogram.

Binning & Histograms

A field like age or salary is considered continuous. There is a relationship between the age 34 and 35, and 34 is as far from 35 as 35 is from 36. However, once we're past age 10 or so, we usually stop saying things like we're "9 and a half" or "7 and $\frac{3}{4}$ ". We're already binning our age to neat year-sized increments. Someone who is 12,850 days old is older than someone who is 12,790 days old, but we draw a line and say they're both 35. Similarly, age groupings are often used in place of actual ages. Child prices for movie tickets might be for kids 12 and under, or a survey may ask you to select your age group, such as 20-24, 25-30, etc.

Histograms are used to visualize the distribution of numerical data using binning. A histogram is similar to a bar chart, but rather than being discrete categories per bar, the rectangles making up the histogram span a *bin* of a continuous axis, such as range of the number of blossoms (0-4, 5-9, 10-14, etc.). The height of the rectangles is determined by frequency or count of those values. Here, the y-axis is the count of plants that fall into each bin. Seven plants have 0-4 blossoms, two plants have 5-9 blossoms, and 43 plants have 20-24 blossoms.

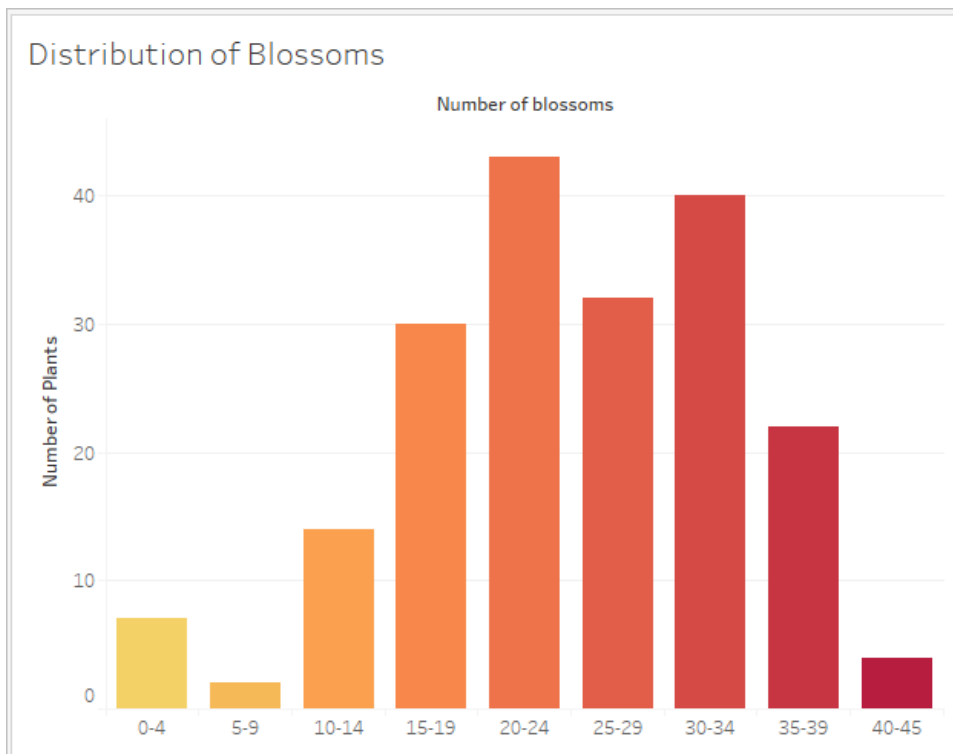

In Tableau Prep, the summary view is a histogram of binned values. The detail view shows the frequency for every value and has a visual scrollbar off to the side that shows the overall distribution of the data.

Summary view

Detail view

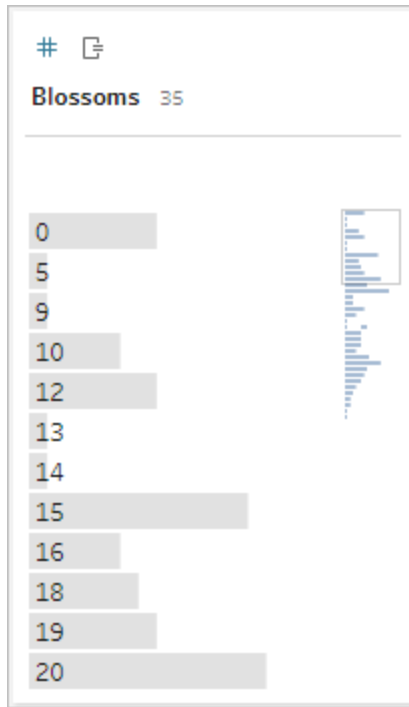
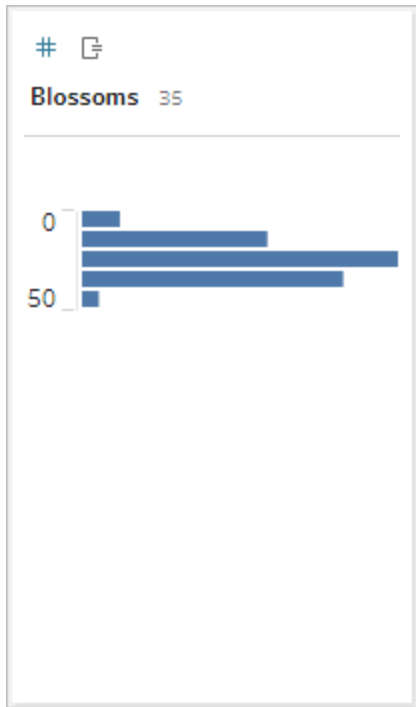

Distributions and outliers

Seeing the distribution of a data set can help with outlier detection.

- *Distribution*: the shape of the data in a histogram, though this depends on the size of the bins. Being able to see all your data in a histogram view can help identify if the data seems correct and complete. The shape of the distribution will only be of use if you know the data and can interpret whether or not the distribution makes sense.
 - For example, if we were to look at a data set of the number of homes with broadband internet from 1940-2017, we'd expect to see a very skewed distribution. However, if we were to look at the number of homes with broadband internet from January 2017 to December 2017 we'd expect a fairly uniform distribution.
 - If we were to look at a data set of Google searches for "Pumpkin Spice Latte", we'd

expect to see a fairly sharp peak in the fall, whereas searches for ""convert Celsius to Fahrenheit" would likely be fairly stable.

- *Outlier*: a value that is extreme compared to other values. Outliers may be correct values or they may be indicative of an error.
 - Some outliers are correct and indicate actual anomalies; these should not be removed or modified.
 - Some outliers indicate issues with data cleanliness, such as a salary of \$50 instead of \$50,000 because a period was typed instead of the comma.

Visual outlier detection with distributions

If you were to see a list like this:

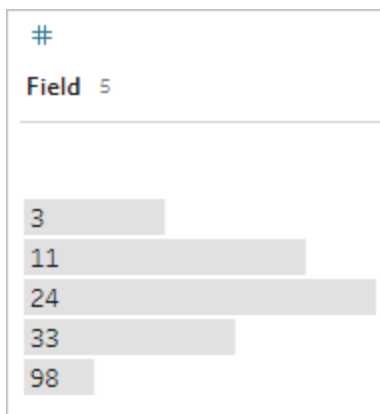

at first glance it doesn't look odd. But if, instead of a list of labels, this was plotted on a continuous binned axis, it would look like this:

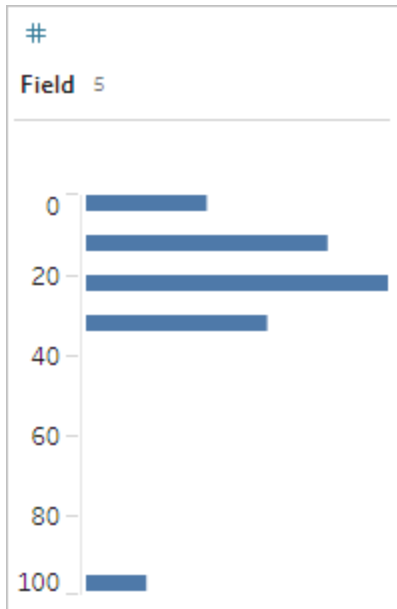

And it's much more obvious that the last observation is farther away from the first and may be an outlier due to error.

Data Types

Databases, unlike spreadsheets, usually enforce strict rules on data types. Data types classify the data in a given field and provide information about how the data should be formatted, interpreted, and what operations can be done to that data. For example, numerical fields can have mathematical operations applied to them and geographic fields can be mapped.

Tableau Desktop assigns whether a field is a dimension or measure, but fields have other characteristics that depend on their data type. These are indicated by the icon each field has (though some types share an icon). Tableau Prep uses the same data types. If data type is enforced on a column and an existing value doesn't match its assigned data type, it may be displayed as null (because "purple" doesn't mean anything as a number).

Some functions require specific data types. For example, you cannot use CONTAINS with a numerical field. Type functions are used to change the data type of a field. For example, DATEPARSE can take a text date in a specific format and make it a date, thus enabling things like automatic drill down in the view.

Icon	Data type
	Text (string) values
	Date values
	Date & Time values
	Numerical values
	Boolean values (relational only)
	Geographic values (used with maps)

Tip: For more information, refer to the Help article on [Data Types](#).

Pivot and Unpivot Data

People-friendly data is often captured and recorded in a wide format, with many columns. Machine-readable data, like Tableau prefers, is better in a tall format, with fewer columns and more rows.

Note: Traditionally, pivoting data means going from tall to wide (rows to columns), and unpivoting means going from wide to tall (columns to rows). However, Tableau uses the word *pivot* to mean going from wide (people-friendly) to tall (machine-readable) by turning columns into rows. In this document, *pivot* will refer to the Tableau sense of the word. For clarity, it can help to specify "pivot columns to rows" or "pivot rows to columns".

For more information, refer to the Help articles [Pivot Your Data](#) and [Tips for Working with your Data](#).

Wide data

In the WHO malaria data set, there is a column for country, then a column per year. Each cell represents the number of cases of malaria for that country and year. In this format we have 108

Tableau Desktop and Web Authoring Help

rows and 16 columns.

	A	B	C	D	E	F	G	H	I	J	K	L	M	N	O	P
1	Country	2014	2013	2012	2011	2010	2009	2008	2007	2006	2005	2004	2003	2002	2001	2000
2	Afghanistan	61362	39263	54840	77549	69397	64880	81574	92202	86129	116444	242022	360940	415356		94475
3	Algeria	0	0	55	1	1	0	3	27	1	2	3	6	8	8	35
4	Angola	2298979	1999868	1496834	1632282	1682870	1573422	1377992	1533485	1082398	889572					
5	Argentina	0	0	0	0	14	86	130	387	212	252	115	122	125	215	440
6	Armenia					0	0	0	0	0	7	47	29	52	79	141
7	Azerbaijan	0	0	3	4	50	78	72	108	143	242	386	482	506	1058	1526
8	Bahamas				6	1		14	6	49	1	2	3	1	4	2
9	Bangladesh	10216	3864	9901	51773	55873	63873	84690	59866	32857	48121	58894	54654	62269	54216	55599
10	Belize	19	20	33	72	150	256	540	845	844	1549	1066	1084	1134	1162	1486
11	Benin	1044235	1078834	705839	422968		889597									
12	Bhutan	19	15	0	194	436	972	329	793	1868	1825	2670	3806	6511	5982	5935
13	Bolivia (Plurinatio	7401	7342	7415	7143	13769	9743	9748	14610	19725	21442	14910	20343	14276	15765	31469
14	Botswana	1346	456	193	432	1046	1024	927	390		670	198	591	1640	3720	10510
15	Brazil	143415	177767	242758	267146	334667	309316	315746	458652	549469	606067	465004	408886	348259	388303	613241
16	Burkina Faso	5428655	3769051	3858046	428113	804539	182527	36514	44246	44265	21335	18256				
17	Burundi	4505372	4181287	3151076	1621874	3762447	1105673	876741	1101644	701721	272464	262206	262468	272120	212016	208066

It's easy for a person to read and understand this format. However, if we were to bring this data into Tableau Desktop, we get a field per column. We have a field for 2000, a field for 2001, a field for 2002, etc.



To think of it another way, there are 15 fields that all represent the same basic thing—number of reported cases of malaria—and no single field for time. This makes it very hard to do analysis across time as the data is stored in separate fields.

Example: working with wide data

Q: How would we create a map that shows the total number of malaria cases per country from 2000 to 2014?

A: Create a calculated field to sum all the years.

Tableau Desktop and Web Authoring Help

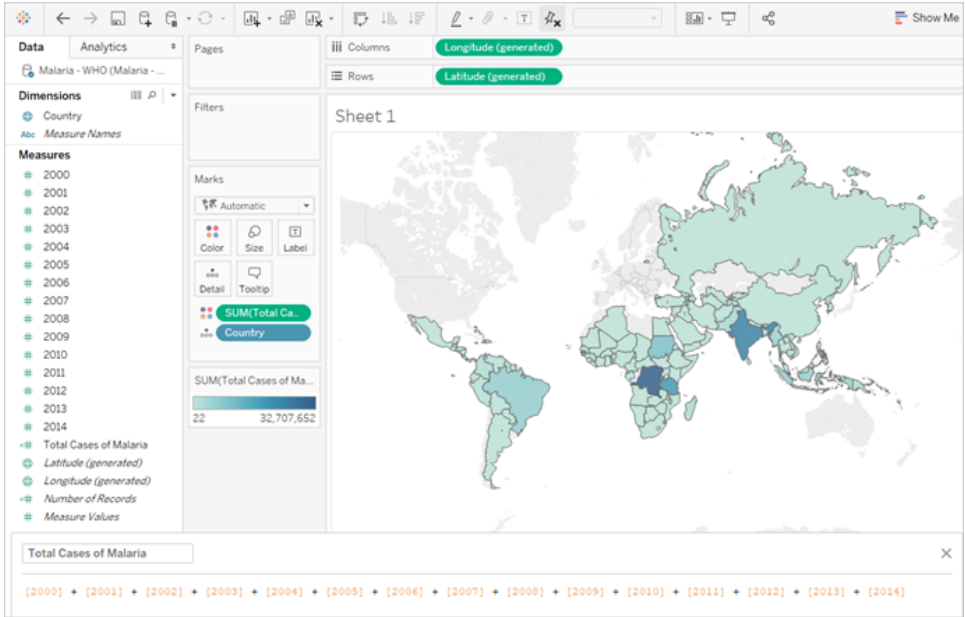

Note: this image has not been updated to reflect the most current UI. The Data pane no longer shows Dimensions and Measures as labels.

Another indication that this format isn't ideal for analysis can be seen in the fact that nowhere do we have information about what the actual values mean. For Algeria in 2012, we have the value 55. Fifty five what? It's not clear from the structure of the data.

	A	B	C	D	E
1	Country	2014	2013	2012	2011
2	Afghanistan	61362	39263	54840	77549
3	Algeria	0	0	55	1
4	Angola	2298979	1999868	1496834	1632282

If the name of the column isn't describing what the values are but rather conveys additional information, this is a sign the data needs to be pivoted.

Tall data

If we pivot the data, we reshape the data from wide to tall. Now, rather than having a column for each year, we have a single column, Year, and a new column, Reported Cases. In this format we have 1,606 rows and 3 columns. This data format is taller rather than wider.

	A	B	C
1	Country	Year	Reported Cases
2	Afghanistan	2000	94,475
3	Afghanistan	2001	
4	Afghanistan	2002	415,356
5	Afghanistan	2003	360,940
6	Afghanistan	2004	242,022
7	Afghanistan	2005	116,444
8	Afghanistan	2006	86,129
9	Afghanistan	2007	92,202
10	Afghanistan	2008	81,574
11	Afghanistan	2009	64,880
12	Afghanistan	2010	69,397
13	Afghanistan	2011	77,549
14	Afghanistan	2012	54,840
15	Afghanistan	2013	39,263
16	Afghanistan	2014	51,263

Now in Tableau Desktop, we have a field for Year and a field for Reported Cases as well as the original Country field. It's much easier to do analysis because each field represents a unique quality about the data set—location, time, and value.

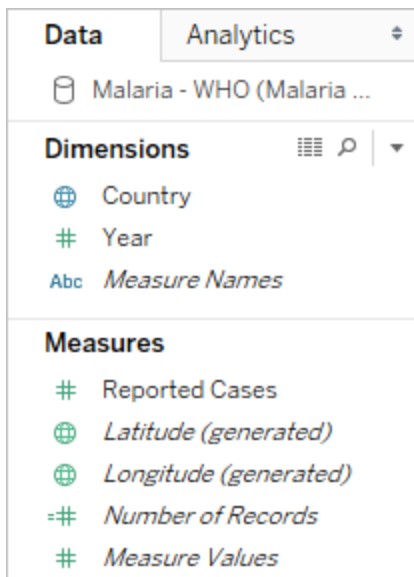

Note: this image has not been updated to reflect the most current UI. The Data pane no longer shows Dimensions and Measures as labels.

Example: working with tall data

Q: How would we create a map that shows the total number of malaria cases per country from 2000 to 2014?

A: Use the Reported Cases field.

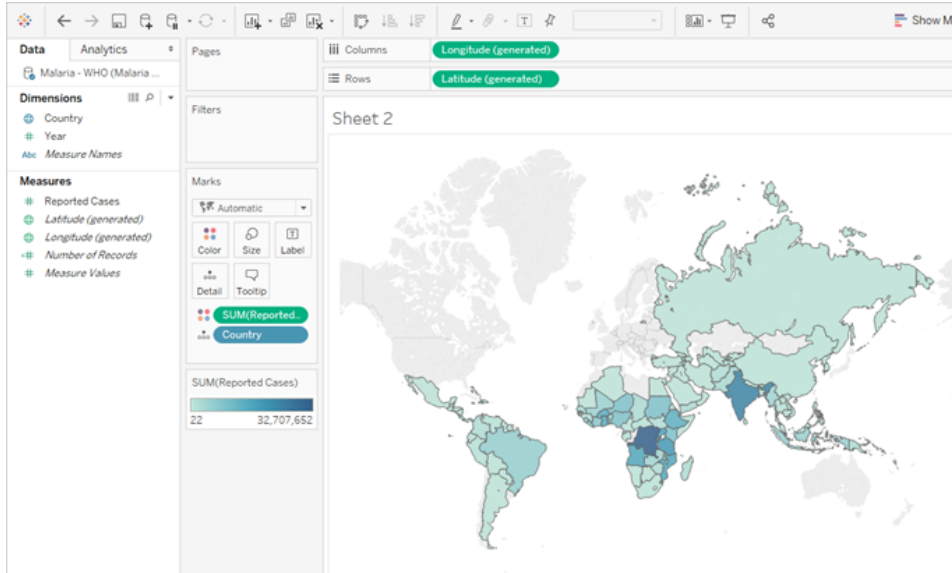

Note: this image has not been updated to reflect the most current UI. The Data pane no longer shows Dimensions and Measures as labels.

Now it's easy to see that for Algeria in 2012, the 55 refers to the number of reported cases (because we could label this new column).

	A	B	C
1	Country	Year	Reported Cases
28	Algeria	2011	1
29	Algeria	2012	55
30	Algeria	2013	0

Note: In this example, the wide data consisted of a single record per country. With the tall data format, there are now 15 rows for each country (one for each of the 15 years in the data). It's important to keep in mind that there are now multiple rows per country.

If there was a column for Land Area, that value would be repeated for each of the 15 rows for each country in a tall data structure. If you created a bar chart by bringing out **Country** to **Rows** and **Land Area** to **Columns**, by default the view would sum the land area for all 15 rows per country.

For some fields it may be necessary to compensate for double counting values by aggregating with an average or minimum rather than sum or filtering.

Normalization

Relational databases are made up of multiple tables that can be related or linked together in some way. Each table contains a unique identifier, or key, per record. By relating or joining on the keys, records can be linked to provide more information than is contained in a single table. What information goes into each table is dependent on the data model used, but the general principle is around reducing duplication.

For example, consider event planning for an event like a wedding. We need to keep track of information at the level of groups (such as families or couples) as well as the level of individuals.

A table could be created that combines all the information together:

ID	Name	Group	Dietary	Seating	Attending	Address	Invitation	Gift	Bride
10	Cedar	Tree	Omnivore	1	yes	87 Forest Ave	sent	pebble	yes
11	Redwood	Tree	Omnivore	1	yes	87 Forest Ave	sent	pebble	yes
12	Fir	Tree	Vegan	1	yes	87 Forest Ave	sent	pebble	yes
13	Madrona	Tree	Omnivore		no	87 Forest Ave	sent	pebble	yes
14	Chanterelle	Mushroom	Omnivore	2	yes	3 Troll St	sent	leaf	no
15	Cremini	Mushroom	Kosher	2	yes	3 Troll St	sent	leaf	no
16	Portobello	Mushroom	Omnivore	2	yes	3 Troll St	sent	leaf	no
17	Hydrangea	Flower				652 Meadow Ln	undeliverable		yes
18	Dahlia	Flower				652 Meadow Ln	undeliverable		yes

However, if an address is incorrect and needs to be fixed, it must be fixed across multiple rows, potentially leading to errors or conflicts. A better structure is to create two tables, one for information that pertains to the group (such as address and if the invitation was sent) and one for information pertaining to the individuals (for things like seating assignments and dietary restrictions).

Group table

Individual table

ID	Group	Address	Invitation	Gift	Bride
34	Tree	87 Forest Ave	sent		
35	Mushroom	3 Troll St	sent		
36	Flower	652 Meadow Ln	undeliverable		

ID	Name	Group	Dietary	Seating	Attending
10	Cedar	Tree	Omnivore	1	yes
11	Redwood	Tree	Omnivore	1	yes
12	Fir	Tree	Vegan	1	yes
13	Madrona	Tree	Omnivore		no
14	Chanterelle	Mushroom	Omnivore	2	yes
15	Cremini	Mushroom	Kosher	2	yes
16	Portobello	Mushroom	Omnivore	2	yes
17	Hydrangea	Flower			
18	Dahlia	Flower			

It's much easier to track and analyze group-level information in the group table and individual-level information in the individual table. For example, the number of chairs needed can be obtained from the number of Attending = Yes records in the individual table, and the number of stamps needed for thank-yous can be obtained from the number of records in the group table where Gift isn't null.

The process of breaking up all the data into multiple tables—and figuring out which table contains which columns—is called *normalization*. Normalization helps reduce redundant data and simplifies the organization of the database.

However, there may be times when information is needed that spans multiple tables. For example, what if we wanted to balance seating arrangements (individuals) such that groups from the bride's side are intermingled with groups from the groom's side? (The bride or groom affiliation is tracked at the group level.) To achieve this, we need to relate the tables back together so the individuals are associated with information about their group. Proper normalization isn't just breaking up tables, it also requires the presence of a shared, related field or unique identifier that can be used to combine the data back together again. Here, that related field is Group. That field is present in both tables, so we can join on this field and return to our original, single table format. This is a *denormalized* structure.

So why didn't we just keep the original denormalized table? It is harder to maintain and was storing redundant information. At scale, the level of data duplication can become massive. Storing the same information over and over isn't efficient.

Normalized tables have a few key properties:

- Each row needs a unique identifier
- Each table needs a column or columns that can be used to connect it back to other tables (key).

These shared (key) columns are used for relating or joining tables back together. For our data, the relationship or join clause would be on the Group field in each table.

Join Types

Although the default method for combining data in Tableau Desktop is relating, there are cases when you may want to join tables in Tableau Desktop or Tableau Prep Builder. For a basic overview of joins and join types, see [Join Your Data](#).

Name	# of Siblings
Taylor	2
Alex	3
Shannon	0
Tracy	1

Name	Eye Color
Taylor	Blue
Alex	Brown
Morgan	Brown

Inner Join

Name	# of Siblings	Eye Color
Taylor	2	Blue
Alex	3	Brown

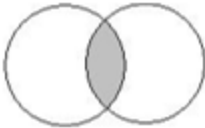

Left Join

Name	# of Siblings	Eye Color
Taylor	2	Blue
Alex	3	Brown
Shannon	0	<i>null</i>
Tracy	1	<i>null</i>

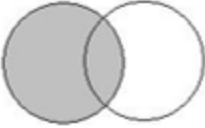

Right Join

Name	Eye Color	# of Siblings
Taylor	Blue	2
Alex	Brown	3
Morgan	Brown	<i>null</i>

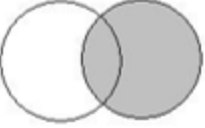

Outer Join

Name	# of Siblings	Eye Color
Taylor	2	Blue
Alex	3	Brown
Shannon	0	<i>null</i>
Tracy	1	<i>null</i>
Morgan	<i>null</i>	Brown

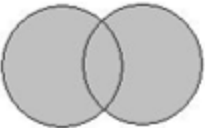

"Tidy" Data

Hadley Wickham published an article in 2014 in the Journal of Statistical Software called "Tidy Data" (August 2014, Volume 59, Issue 10). This article does an excellent job of laying out a framework for data that is well-structured for analysis. The article can be found [here \(Hadley Wickham's Academic Portfolio\)](#) or [here \(hosted by r-project.org\)](#).

Note: The article is hosted on external websites. Tableau cannot take responsibility for the accuracy or freshness of pages maintained by external providers. Contact the owners if you have questions regarding their content.

Find Good Data Sets

A good way to learn how to use Tableau Desktop (or build sample or proof-of-concept content) is to find a data set you find interesting. When you have real questions you want to answer with data, the steps of the analysis become easier and more meaningful.

The reality of data sets

There are two unavoidable facts about trying to find a data set that's not official, business-sanctioned data.

You won't find what you're looking for.

- Try to avoid strict expectations of what you need.
- Stay flexible and open minded about what you can use for a given project.
- Sometimes the data you want is behind a paywall—decide if it's worth it or not.

You'll have to clean up the data.

- Be prepared for basic [cleaning and shaping](#) to make sure the data is [well structured for analysis](#).
- You may need to [bring in other data sets](#).
- Having a data dictionary or metadata can be vital.
- [Calculations](#) may be necessary.

What makes a good data set

A good data set is one that suits your purpose. As long as that need is met, it's a good data set. However, there are some considerations that can help you weed out data sets that are unlikely to suit your purpose. On the whole, look for data sets that meet the following conditions:

1. Contain the elements you need
2. Are disaggregated data
3. Have at least a couple dimensions and a couple measures
4. Have good metadata or a data dictionary
5. Are useable (not in a proprietary format, too messy, or too cumbersome)

What makes Superstore super?

Superstore is one of the sample data sources that come with Tableau Desktop. Why is it such a good data set?

- **Necessary elements:** Superstore has dates, geographic data, fields with a hierarchy relationship (Category, Sub-Category, Product), measures that are positive and negative (Profit), etc. There are very few chart types you can't make with Superstore alone, and few features it can't be used to demonstrate.
- **Disaggregated:** The row-level data is each item in a transaction. Those items can be rolled up to the order level (via Order ID) or by any of the dimensions (such as date, customer, region, etc.)
- **Dimensions and measures:** Superstore has several dimensions allowing us to "slice and dice" by things like category or city. There are also multiple measures and dates, which open the possibilities for chart types and calculations.
- **Metadata:** Superstore has well-named fields and values. You don't need to look up what any values mean.
- **Small and clean:** Superstore is only a few megabytes so it takes up little room in the Tableau installer. It's also clean data, with only the correct values in each field and a good data structure.

1. A good data set has the elements you need for your purposes

If you're looking for a data set to build a specific visualization or to showcase specific functionalities, make sure the data set has the types of fields you need. For example, maps are a great visual but require geographic data. Basic demos often involve drilling down into dates, so the data would need at least one date field (and it would need to be more granular than just year to show drill down). Not all data sets need all these elements—know what you need for your purpose and don't waste time with data sets that are missing key elements.

Common elements for analysis:

- Dates
- Geographic data
- Hierarchical data
- "Interesting" measures—either substantial variation in magnitude or positive and negative values

Some features or viz types may require specific characteristics of the data such as:

- Clusters
- Forecasting
- Trend lines
- User filters
- **Spatial calculations**
- Certain calculations
- Bullet charts
- Control charts

2. A good data set is disaggregated (raw) data

If the data is too aggregated, there isn't much you can do for analysis. For example, if you want to look at trends in people Googling "Pumpkin Spice" but have yearly data, you can only look at a very high level overview. Ideally you want to get your hands on daily data, so you could see the huge spike when Starbucks starts offering #PSL.

What counts as disaggregated can vary by analysis. Note that due to privacy or practicality, some data sets will never be fully granular. For example, you would be unlikely to find a data set with case-by-case reporting of malaria by address, so monthly totals by region might be granular enough.

Aggregation and granularity

Understanding aggregation and granularity is a critical concept for many reasons; it impacts things like finding useful data sets, building the visualization you want, combining data correctly, and using LOD expressions. Aggregation and granularity are opposite ends of a spectrum.

Aggregation refers to how the data is combined together, such as summing all the searches for Pumpkin Spice or taking the average of all the temperature readings around Seattle on a given day.

- By default, measures in Tableau are aggregated. The default aggregation is SUM. You can change the aggregation to things like average, median, count distinct, minimum, etc.

Granularity refers to how detailed the data is. What does a row (aka record) in the data set represent? A person with malaria? A provinces' total cases of malaria for the month? That's the granularity. Knowing the granularity of the data is crucial.

For more information, see [Data Aggregation in Tableau](#) on page 171.

3. A good data set has dimensions and measures

Many visualization types require **dimensions** and **measures**

- If you only have dimensions, you're mostly limited to counting, calculating percentages, or using the **Count of Table** field.
- If you only have measures, you can't break out the values by anything. You can dis-aggregate the data entirely or work with the overall SUM or AVG, etc.

Which isn't to say a data set with only dimensions can't be useful. Demographic data is an example of dimension-heavy data, and much analysis around demographics is counting or percentage-based. But for a more analytically rich data set, you want at least a few dimensions and measures.

Dimensions and Measures, Discrete and Continuous

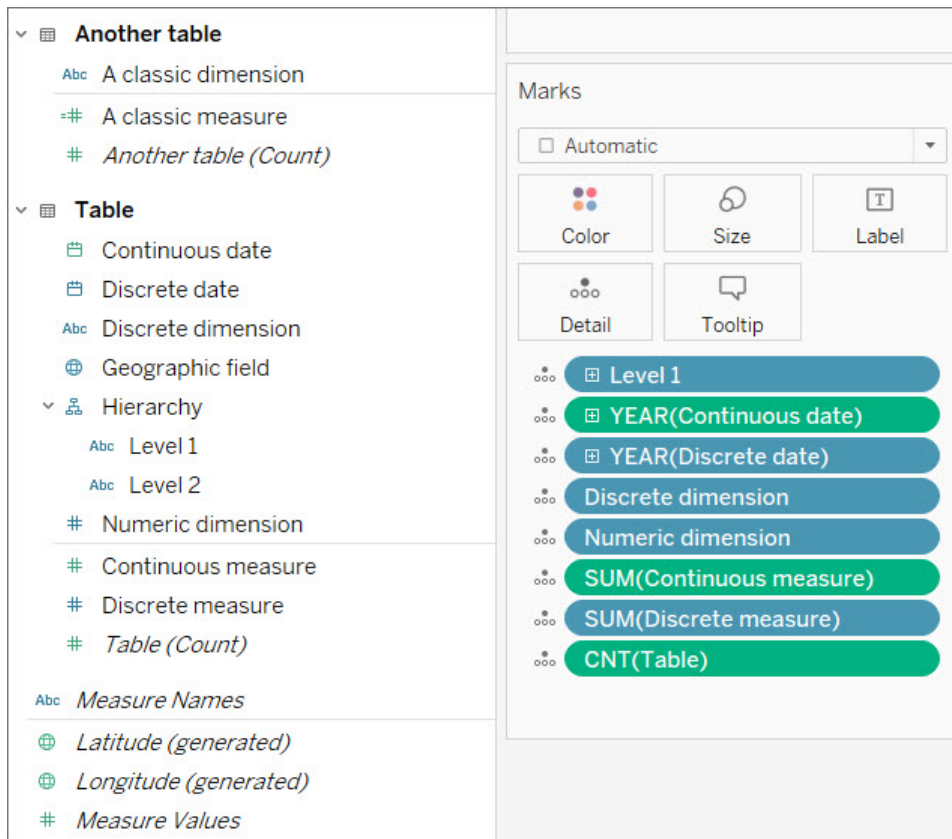

In the image above, note that the **Numeric dimension** doesn't have an aggregation on the Marks card, unlike both the **Continuous measure** and **Discrete measure**.

Dimensions and Measures

Fields are broken out into dimensions and measures with a horizontal line in the data pane. In Tableau, dimensions come out into the view as themselves, whereas measures are automatically aggregated; the default aggregation for a measure is SUM.

- **Dimensions** are qualitative, meaning they are described, not measured.
 - Dimensions are often things like city or country, eye color, category, team name, etc.
 - Dimensions are usually discrete.
- **Measures** are quantitative, meaning they can be measured and recorded (numeric).
 - Measures are often things like sales, height, number of clicks, etc.
 - Measures are usually continuous.

If you could do math with a field, it should be a measure. If you're ever not sure if a field should be a measure or a dimension, think about if you can do meaningful math with the values. Is there any meaning to $AVG(\text{RowID})$, the sum of two Social Security numbers, or dividing a postal code by

10? No. Those are dimensions that happen to be written as numbers. Think about how many countries have alphanumeric postal codes—they're just labels, even though in the US they're only numeric. Tableau can recognize many field names that indicate a numeric field is actually an ID or a postal code and tries to make those dimensions, but it's not perfect. Use the "could I do math with this?" test to decide if a numeric field should be a measure or dimension and rearrange the data pane as necessary.

Note: Although you can do math with dates (such as the DATEDIFF calculation), the standard convention is to categorize dates as dimensions.

Discrete and Continuous

Discrete or Continuous fields are somewhat aligned with the concepts of dimension and measure, but they're not identical.

- **Discrete** fields contain distinct values. They make headers or labels in the view and the pills are blue
- **Continuous** fields "form an unbroken whole". They make an axis in the view and the pills are green

A good way of understanding discrete and continuous is to look at a date field. Dates can be either discrete OR continuous.

- Looking at average temperatures in August across a decade or century means "August" is being used as a discrete, qualitative date part.
- Looking at the overall trend in reported malaria cases since 1960 would take a single, unbroken axis, meaning the date is being used as a continuous, quantitative value.

For more information, see [Dimensions and Measures, Blue and Green](#) on page 147.

Fields Created by Tableau

Tableau creates at least three fields, no matter what the data set is:

- *Measure Names* (a dimension)
- *Measure Values* (a measure)
- *TableName(Count)* (a measure)

And if there are geographic fields in the data set, Tableau also creates *Latitude (generated)* and *Longitude (generated)* fields.

Measure Names and **Measure Values** are two useful fields. For more information, see [Measure Values and Measure Names](#) on page 1212.

Count of Table provides the number of records for the table by counting the rows. This enables you to have at least one measure in your data set and can help with some analysis. You must understand the granularity of your data (what a row represents) to be able to define what the number of rows means.

Here, each row is a day, so the Count of Table would be the number of days:

Date	Max TemperatureF	Mean TemperatureF	Min TemperatureF
1/1/2015	42	34	26
1/2/2015	42	37	32
1/3/2015	41	38	35
1/4/2015	51	45	38
1/5/2015	54	52	49
1/6/2015	54	49	43
1/7/2015	46	44	42
1/8/2015	46	41	35
1/9/2015	50	44	38
1/10/2015	46	45	43

Here, each row is a month, so the Count of Table would be the number of months:

Date	Max TemperatureF	Mean TemperatureF	Min TemperatureF
January	63	45	26
February	62	49	33
March	69	51	31
April	77	52	37
May	82	59	43
June	92	68	49
July	95	71	54
August	92	69	54
September	81	61	45
October	74	58	45
November	60	44	25

4. A good data set has metadata or a data dictionary

A data set can only be useful if you know what the data *is*. There are few things more frustrating in the hunt for good data than opening a file that looks like this:

Diet	Source	Donor	Collection	Sex	OTU0	OTU1	OTU2	OTU3	OTU4
0	4	0	0	0	7.38E-14	9.05E-11	8.22E-11	3.86E-11	8.25E-11
1	12	1	0	0	1.54E-13	5.67E-11	3.12E-11	8.52E-11	1.73E-11
1	4	3	0	0	5.52E-13	3.46E-11	0.00077	4.76E-11	9.80E-11
0	4	0	0	1	5.69E-13	2.75E-11	8.08E-11	9.94E-11	5.90E-12
1	4	3	0	0	8.97E-13	8.33E-11	0.000274	8.49E-11	5.38E-11
0	4	0	0	0	9.43E-13	6.21E-11	1.41E-11	6.32E-11	9.17E-11
1	11	0	0	0	1.13E-12	1.85E-11	9.04E-11	4.09E-11	5.31E-11
1	4	0	0	0	1.49E-12	7.86E-12	8.87E-11	3.48E-11	8.16E-11
1	6	0	1	0	1.63E-12	4.42E-11	9.12E-11	8.53E-11	9.40E-12

What does a Source of 4 or 12 mean? And what information is in the fields OTU0-OTU4?

A good data set is one that has either well-labeled fields and members or a data dictionary so you can relabel the data yourself. Think of Superstore—it's immediately obvious what the fields and their values are, such as Category and its members Technology, Furniture, and Office Supplies. Or, for the microbiome data set in the image above, there is a **data dictionary** which explains each Source (4 is feces and 12 is stomach) and the taxonomy of each OTU (OTU3 is a bacterium of the genus *Parabacteroides*).

Data dictionaries can also be called metadata, indicators, variable definitions, glossaries, or any number of other things. At the end of the day, a data dictionary provides information about column names and members in a column. That information can be brought into the data source or viz in several ways, including:

- Rename the columns so they are easier to understand (this can be done in the data set itself or in Tableau).
- Re-alias the members of the field (this can be done in the data set itself or in Tableau).
- Create calculations to add the data dictionary information.
- Comment on the field in Tableau (comments do not appear on published vizs, only in the authoring environment).
- Use the data dictionary as another data source and combine the two data sources.

Losing a data dictionary can render a data set useless. If you're bookmarking a data set, bookmark the data dictionary, too. If you're downloading, download both and keep them in the same place.

5. A good data set is one you can use

As long as you can understand the data set and it has the information you need, even a small data set can pack a punch for analysis. Smaller data sets are also easy to store, share, and publish, and are likely to perform well.

Similarly, even if you find the "perfect" data set for your needs, if it requires an unrealistic amount of effort to clean up, it's not perfect after all. Knowing when to walk away from a data set that is too messy is important.

For example, this data set is from a Wikipedia article on relative letter frequencies. It started as 84 rows and 16 columns (pivoted to be 1,245 rows and 3 columns). The Excel file is 16KB. But with some groups, sets, calculations, and other manipulations, it enables robust analysis and interesting visuals.



[Click the image to download the workbook.](#)

Relabel your data

Once you find a good data set, you'll often need to relabel it. Relabeling data can be useful to either create fake data for samples or proof-of-concepts, or to make the data more readable.

Renaming a field changes how that field appears in Tableau, such as renaming "Sales" to "Pipeline Sales" or "State" to "Province".

Re-aliasing changes how the members of a field are displayed, such as re-aliasing values in a Country field so that CHN becomes China and RUS becomes Russia.

- The values in a discrete dimension field are called **members**. Only members can be re-aliased. Consider a measure field for temperature. A value of 54°F can't be changed without changing data itself. But re-aliasing the member "CHN" as "China" in a Country field is the same information, just labeled in another way.

Renaming and re-aliasing mean almost the same thing. It's the convention in Tableau that fields are named and members are aliased. For more information, see [Organize and Customize](#)

[Fields in the Data Pane](#) on page 1051 and [Create Aliases to Rename Members in the View](#) on page 1067.

Note: Renaming or re-aliasing only changes the appearance in Tableau Desktop; no changes are written back to the underlying data.

Relabel to make fake data

Relabeling existing data sets is a great way to make samples or proof-of-concept content more compelling.

1. Use an easy data set (like Superstore) to build what you want (a specific chart type, showing off certain functionality, etc.)
2. Rename the relevant fields, change tooltips, and otherwise change the textual aspects to mask what the data actually represents.

Important: Only do this when it's clear the information is fake. Be careful that people don't think it's real data and try to use it for analysis. For example, use silly names or meaningless field names like colors or animals.

Re-alias to make the data easier to use

It's more efficient to store the data as numeric values rather than string values, though numeric encoding can make the data harder to understand. For small data sets it probably won't make a performance impact, so prioritize being able to understand the data easily.

A downside to re-aliasing is that you no longer have access to those numeric values (making it harder to do things like sort, assign color gradients, etc.). Consider duplicating the field and re-aliasing the copy. Alternatively, a calculation in Tableau can be a good way to preserve the original information while also making it more easily understandable.

Re-alias with the CASE function

Calculations can be very powerful for re-aliasing. For example, CASE functions allow you to say, essentially, "when this field has a value of A, give me X. When the value is B, give me Y".

Here, the CASE function looks at the F-scale in a tornado data set and provides the written description associated with each numeric value:

```
CASE [F-scale]
WHEN "0" THEN "Some damage to chimneys; branches broken off trees;
```

```
shallow-rooted trees pushed over; sign boards damaged."  
WHEN "1" THEN "The lower limit is the beginning of hurricane wind  
speed; peels surface off roofs; mobile homes pushed off foundations or  
overturned; moving autos pushed off the roads..."  
WHEN "2" THEN "Roofs torn off frame houses; mobile homes demolished;  
boxcars overturned; large trees snapped or uprooted; highrise windows  
broken and blown in; light-object missiles generated."  
WHEN "3" THEN "Roofs and some walls torn off well-constructed houses;  
trains overturned; most trees in forest uprooted; heavy cars lifted  
off the ground and thrown."  
WHEN "4" THEN "Well-constructed houses leveled; structures with weak  
foundations blown away some distance; cars thrown and large missiles  
generated."  
WHEN "5" THEN "Strong frame houses lifted off foundations and carried  
considerable distances to disintegrate; ... trees debarked; steel  
reinforced concrete structures badly damaged."  
END
```

Now we can chose to use either the original "F-scale" field (0-5) or the "F-scale damage description" field in the viz.

Tips when looking for data sets

Note: Try to make sure you can answer the question "What does a row (aka record) in the data set represent?" If you can't articulate that, you might not understand the data well enough to be able to use it or it might be structured poorly for analysis.

- Keep track of where the data came from.
- Keep the data dictionary information with the data itself.
- Avoid stale data if you need the content to stay evergreen. Look for:
 - updatable data (stocks, weather, regularly published reports, etc.)
 - timeless data (the average mass of various animals isn't going to change from year to year)
 - data you can future-proof by artificially changing to historical or future dates
- Try simply Googling what you're looking for, you might be surprised.
- Don't be afraid to give up on a data set if it's too much work to prep.

Places to look for data

Where can you look for data? There are a potentially overwhelming number of places to find data sets. Here are some options to get you started. Note that the reality of data sets does apply to these sites—you probably won't find what you're thinking of right now, and you will most likely need to do some cleaning to get the data ready for analysis.

Disclaimer: Although we make every effort to ensure these links to external websites are accurate, up to date, and relevant, Tableau cannot take responsibility for the accuracy or freshness of pages maintained by external providers. Listing a site here is not an endorsement of any content or organization. Contact the external site for answers to questions regarding its content.

Tableau Public: Tableau Public is an amazing resource for Tableau-friendly data sets. Search for workbooks that are on a topic you're interested in, browse for inspiration, then download the workbook to access the data. Or check out the curated [Sample Data](#).

Wikipedia tables: Get data out of Wikipedia tables by: copying and pasting into a spreadsheet, [copying and pasting directly into Tableau](#), or using [Google sheets and the IMPORTHTML function](#) to create a Google spreadsheet of the data.

Google Dataset Search: "A search engine to unite the fragmented world of online datasets."

Data is Plural : Subscribe for a weekly newsletter with data sets, or browse the [archive](#).

Makeover Monday: "Join us every Monday to work with a given data set and create better, more effective visualizations and help us make information more accessible." You can see what other people have done with the same data set, kickstarting your analysis or giving inspiration. Use [#makeovermonday](#) on Twitter to participate.

Other sites

- [Tableau Web Data Connectors](#)
- [Data.world](#) and its [WDC for Tableau](#)
- [Github Open Data](#)
- [Kaggle](#)
- [datahub.io](#)
- [r/datasets](#)
- [WHO](#)
- [Data.UN.org](#)
- [WorldBank](#)

- [data.gov](#), [data.gov.au](#), [data.gov.uk](#), etc.
- [Airbnb](#)
- [Yelp](#)
- [Zillow](#)

Dimensions and Measures, Blue and Green

Tableau identifies each field as a dimension or measure in the **Data** pane, depending on the type of data the field contains. You use these fields to build your analysis.

About data field roles and types

Data fields are made from the columns in your data source. Each field is automatically assigned a data type such as integer, string, or date, and a role: a discrete dimension or continuous measure (or less commonly, a continuous dimension or discrete measure).

- *Dimensions* contain qualitative values (such as names, dates, or geographical data). You can use dimensions to categorize, segment, and reveal the details in your data. Dimensions affect the level of detail in the view.
- *Measures* contain numeric, quantitative values that you can measure. Measures are aggregated by default. When you drag a measure into the view, Tableau applies an aggregation on the pill.

Blue versus green fields

Tableau represents data differently in the view depending on whether the field is discrete or continuous). *Continuous* and *discrete* are mathematical terms.

- *Continuous* means "forming an unbroken whole, without interruption". These fields are colored green. When a continuous field is put on the Rows or Columns shelf, an axis is created in the view.
- *Discrete* means "individually separate and distinct." These fields are colored blue. When a discrete field is put on the Rows or Columns shelf, a header is created in the view.



Possible combinations of fields in Tableau

This table shows examples of what the different fields look like in the view. An instance of a field in the view (on the Rows shelf, for example) is sometimes referred to as a "pill".

Discrete Dimensions



Product Name

Continuous Dimensions (dimensions with a data type of String or Boolean can't be continuous)	
Discrete Measures	
Continuous Measures	

Note: With a cube (multidimensional) data source, the options for changing data roles are limited. In Tableau Desktop, cubes are supported only on Windows.) You can change some measures from continuous to discrete, but in general, you can't change data roles for fields in cube data sources. For related details, see [Cube Data Sources on page 982](#).

A visual cue when a field is a measure is that the pill is aggregated with a function, indicated

before the field name, such as: . To learn more about aggregation, see

[List of Predefined Aggregations in Tableau on page 175](#) and [Aggregate Functions in Tableau on page 2115](#).

But there are exceptions:

- If the entire view is disaggregated, then by definition no field in the view is aggregated. For details, see [How to Disaggregate Data on page 180](#).
- If you're using a multidimensional data source, fields are aggregated in the data source and measures fields in the view don't show that aggregation.
- And dimensions can sometimes be aggregated with specific aggregations such as MAX or ATTR.

Note: You can set the default aggregation and other properties and settings for fields. For details on customizing the fields in the Data pane, see: [Organize and Customize Fields in the Data Pane on page 1051](#), [Edit Default Settings for Fields on page 1063](#) and [Work with Data Fields in the Data Pane on page 37](#).

Examples of continuous and discrete fields used in a view

In the example on the left, because the **Quantity** field is **Continuous**, it creates a horizontal axis along the bottom of the view. The green pill and the axis help you to see that it's a continuous

field.

In the example on the right, the **Quantity** field is **Discrete**. It creates a horizontal headers instead of an axis. The blue pill and the horizontal headers help you to see that it's discrete.

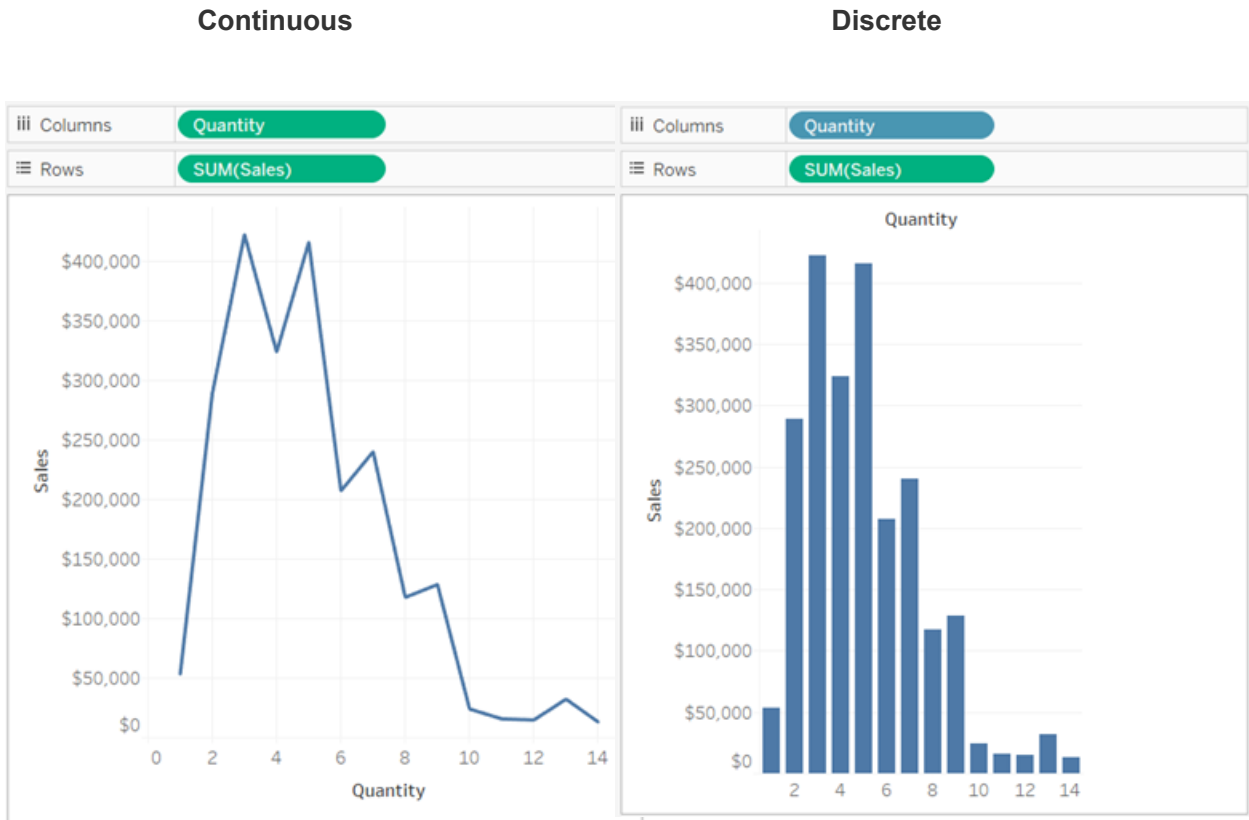

In both examples, the **Sales** field is set to **Continuous**. It creates a vertical axis because it's continuous and on the Rows shelf. If it was on the Columns shelf the axis would be horizontal. The SUM aggregation indicates that it's a measure.

The absence of an aggregation function in the **Quantity** field name indicates that it's a dimension.

Dimension fields in the view

When you drag a discrete dimension field to **Rows** or **Columns**, Tableau creates column or row headers.

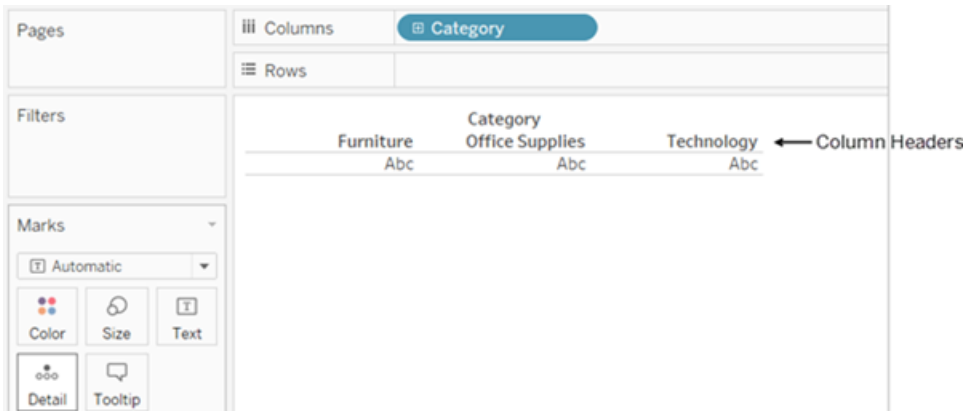

Often, fields from the **Dimension** area are discrete when you add them to a view, with a blue background. Date dimensions and numeric dimensions can be discrete or continuous, and all measures can be discrete or continuous.

After you drag a dimension to **Rows** or **Columns**, you can change the field to a measure by clicking the field and choosing **Measure**. Now the view contains a continuous axis instead of column or row headers, and the pill is green:

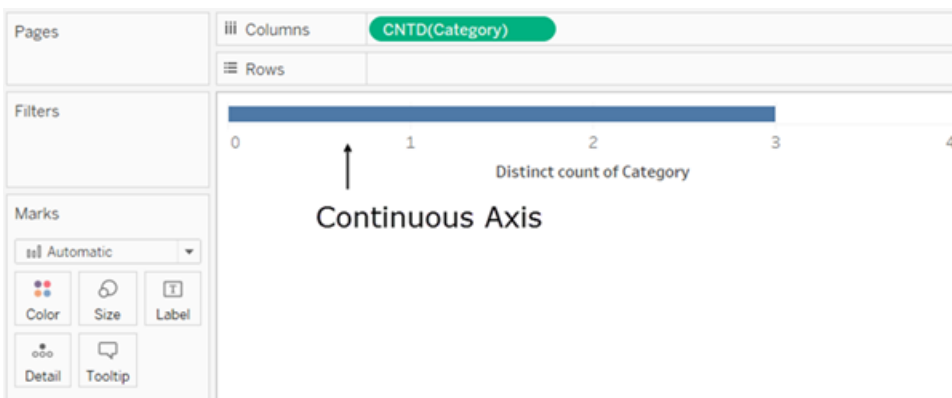

Date dimensions can be discrete or continuous. Dimensions containing strings or Boolean values can't be continuous.

Tableau doesn't aggregate dimensions. For a discussion of the different types of aggregation Tableau can perform, see [List of Predefined Aggregations in Tableau](#) on page 175.

In Tableau queries, dimensions in the view are expressed in SQL as "Group By" clauses.

For details on converting fields between continuous and discrete, see [Convert Fields between Discrete and Continuous](#) on page 1070.

How dimensions affect the level of detail in the view

The level of detail in a view refers to how granular the data is given the dimension and measure data in the view.

As you add dimensions to **Rows** or **Columns**, the number of marks in the view increases.

To understand why adding dimensions increases the number of marks in the view, do the following:

1. Drag **Segment** to **Columns**.

The status bar at the bottom of the Tableau window shows you that there are now three marks in the view:

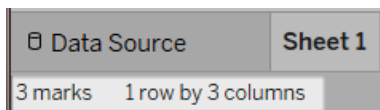

Those marks contain placeholder text, *Abc*, because you're only building the view's structure at this point.

2. Drag **Region** to **Columns**.

Now there are 12 marks. Three values in **Segment** multiplied by four values in **Region** is 12.

3. Drag [**Ship Date**] to **Rows**.

The total is now 57 marks (three segments by four regions by five years is 60, but three possible combinations have no data).

We could continue adding dimensions to **Rows** and **Columns** to see the number of total marks continues to increase. Encoding a dimension by a property on the Marks card (such as Color or Size) increases the number of marks without adding headers. This use of dimensions to determine the breakdown of marks is known as setting the *level of detail*.

Adding a dimension to any of the following locations in Tableau affects the level of detail:

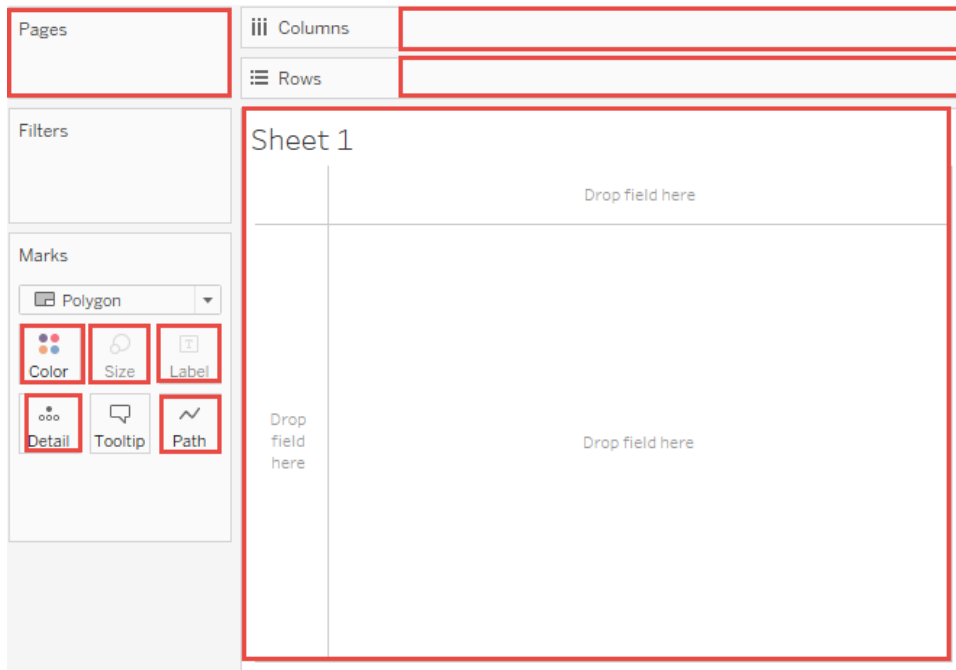

- The view now contains 57 separate instances of `abc`—the view is all structure and no content. Drag **Sales** to Text to see the values. The view can now be considered complete:

Year of S...	Segment / Region							
	Consumer				Corporate			
	Central	East	South	West	Central	East	South	West
2012	\$67,133	\$75,825	\$32,272	\$88,207	\$19,156	\$32,654	\$34,163	\$34,291
2013	\$49,640	\$85,683	\$49,245	\$80,654	\$29,454	\$49,703	\$18,033	\$38,771
2014	\$65,971	\$90,947	\$52,958	\$86,452	\$60,234	\$53,018	\$27,250	\$64,290
2015	\$68,976	\$97,846	\$59,291	\$105,655	\$48,801	\$65,034	\$42,440	\$87,293
2016	\$311	\$607	\$1,815	\$1,913	\$352			\$1,211

Notes

- Sometimes, adding a measure to the view can increase the number of marks in the view. For example, with **Sales** on **Rows**, the number of marks is 57. But if **Profit** is also put on **Rows**, the number of marks increases to 114. But this isn't the same as changing the view's level of detail.

- The number of marks in the view isn't always the same as multiplying the number of members of each dimension. There are multiple reasons why the number of marks could be lower. To force a mark to show for every possible combination you can **Show Missing Values**. For more information about how to show missing values, see [Show or Hide Missing Values or Empty Rows and Columns](#) on page 1223.

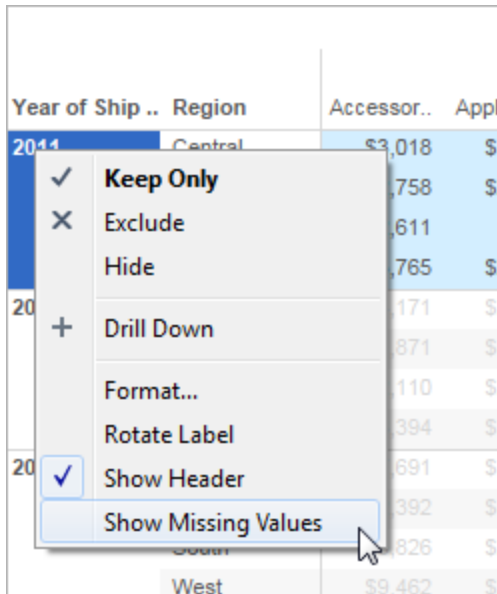

Measure fields in the view

When you drag a measure to the view, it's aggregated by default. The type of aggregation varies depending on the type of view. Always check the aggregation and change it if necessary. For details, see "Change the default aggregation" in [Edit Default Settings for Fields](#) on page 1063. For more details about aggregation, see [Data Aggregation in Tableau](#) on page 171.

When you drag a continuous field from the **Data** pane to **Rows** or **Columns**, Tableau creates a continuous axis for that field.

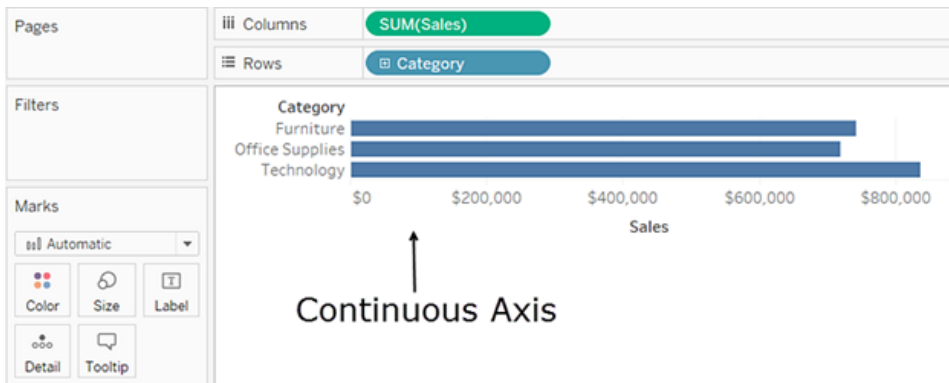

If you click the field and change it to **Discrete**, the values become column headers.

The screenshot shows the Tableau interface with a pivot table. The Columns shelf contains the field **SUM(Sales)** and the Rows shelf contains **Category**. The table displays sales data for Furniture, Office Supplies, and Technology. The column headers are **Sales**, **\$719,047**, **\$742,000**, and **\$836,154**. An arrow points to the column headers with the text "Column headers".

	Sales		
Category	\$719,047	\$742,000	\$836,154
Furniture		\$742,000	
Office Supplies	\$719,047		
Technology			\$836,154

Tableau continues to aggregate values for the field, because even though the field is now discrete, it's still a measure, and Tableau aggregates measures by default.

In cases where Tableau has misclassified a field as a dimension or a measure, possibly because of the data type, you can convert it and change its role. If a measure doesn't need to be aggregated (such as numeric IDs), convert the field to a dimension.

For related details, see [Convert a Measure to a Dimension](#) on page 1071.

For details on converting fields between continuous and discrete, see [Convert Fields between Discrete and Continuous](#) on page 1070.

How continuous and discrete fields change the view

Continuous and *discrete* are mathematical terms. Continuous means "forming an unbroken whole, without interruption"; discrete means "individually separate and distinct."

In Tableau, fields can be either continuous or discrete. When you drag a field from the **Data** pane to **Columns** or **Rows**, the values are continuous by default and Tableau creates an axis. When you drag a field from the **Data** pane to **Columns** or **Rows**, the values are discrete by default and Tableau creates column or row headers.

Continuous fields produce axes

If a field has values that are numbers that can be added, averaged, or otherwise aggregated, it's added as a measure field in the **Data** pane when you first connect to a data source. Tableau is assuming that the values are continuous.

Tableau displays an axis when you drag a continuous field to **Rows** or **Columns**. An axis is a measuring line that shows values between a minimum and a maximum. Rulers and analog thermometers are examples of physical objects that display axes.

While there are value labels on a continuous axis (0, 0.5, ... 3.0 in the following image), actual marks don't have to align with these tick marks. For example, in the following image, the blue bar actually extends to a value of 6.940 on the horizontal axis, not 7.0 exactly.

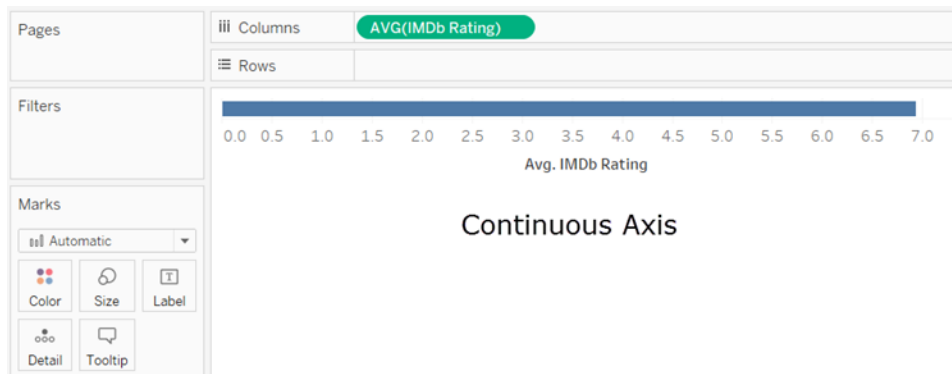

The number of potential values for continuous fields is impossible to anticipate. For example, if you have a field named **Ratings** and the initial values are 1, 3, 3.5, 3.6, and 4, that's five distinct values. But if you bring **Ratings** to **Rows**, the aggregated value is a sixth value (3.02) that didn't exist until you added the field to the view. And if you then applied a filter that eliminated two of the initial values, the average changes to a different value. And then if you changed the aggregation, ... You get the idea. The number of potential values is, if not infinite, then immense.

The fact that a field contains numbers doesn't automatically indicate that those values are continuous. Postal codes are the classic example: though they're often composed entirely of numbers, they're actually string values that shouldn't be added or averaged. If Tableau assigns such a field as a measure to the **Data** pane, drag it to a dimensions area to change it to a dimension.

Discrete fields create headers

If a field contains values that aren't numbers, it's identified as a dimension in the **Data** pane. Tableau treats the values as discrete.

Tableau creates headers when you drag a discrete field to **Columns** or **Rows**. The individual values for a discrete field become the row or column headings.

Discrete versus continuous fields on filters

- When you drop a discrete dimension field on the **Filters** shelf, Tableau prompts you to choose which members of the discrete field to include in the view.

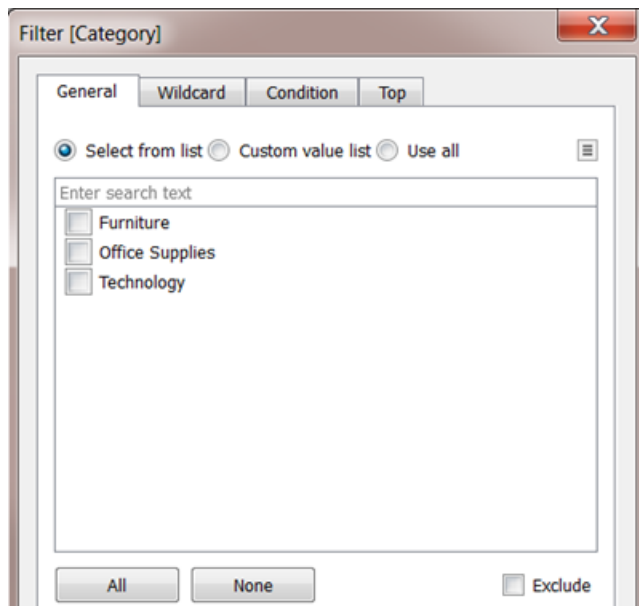

- When you drop a Date field on Filters, the result can be a discrete filter or a continuous filter. For more information, see [Filter dates](#) on page 1315.
- When you drop a continuous measure on Filters, Tableau first prompts you to choose an aggregation for the filter.
- When you drop a continuous dimension on Filters (other than a Date), Tableau prompts you to specify how to filter the continuous range of values.

For more on filtering various types of fields, see [Drag dimensions, measures, and date fields to the Filters shelf](#) on page 1311.

Discrete versus continuous fields on color

When you drop a discrete field on Color in the Marks card, Tableau displays a categorical palette and assigns a color to each value of the field.







When you drop a continuous field on Color, Tableau displays a quantitative legend with a continuous range of colors.

For more information about color palettes, see [Color Palettes and Effects](#) on page 1293.

Data Types

All fields in a data source have a data type. The data type reflects the kind of information stored in that field, for example integers (410), dates (1/23/2025) and strings ("Belgium"). The data type of a field is identified in the **Data** pane by one of the icons shown below.

Data type icons in Tableau

Icon	Data type
	Text (string) values
	Date values
	Date & Time values
	Numerical values
	Boolean values (relational only)
	Geographic values (used with maps)
	Image role (used with image link URLs)

Icon	Data type
	Cluster Group (used with Find Clusters in Data on page 2520)

You can change the data type for a field either on the **Data Source** page or in the **Data** pane.

Change the data type for a field in the Data Source page

Sometimes Tableau incorrectly interprets the data type of a field. For example, Tableau might interpret a field that contains dates as an integer data type, rather than a date data type.

You can change the data type for a field that was part of the original data source (as opposed to a calculated field created in Tableau) on the **Data Source** page.

1. Click the data type icon for the field (as shown in the table above).
2. Choose a new data type from the drop-down list:

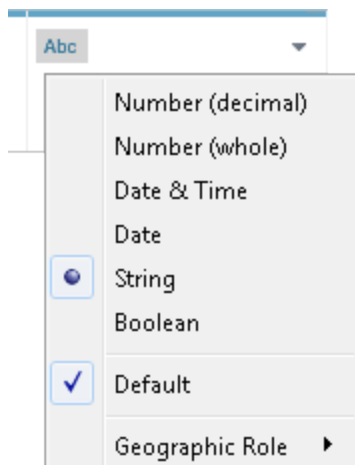

Tip: Be sure to change data types before you create an extract. Otherwise, your data may not be accurate. For example, if a floating-point field in the original data source is interpreted as an integer by Tableau, and you create your extract before you change the field's data type, the resulting floating-point field in Tableau will have some of its precision truncated.

For information on changing data types on the **Data Source** page, see [Data Source Page](#) on page 24.

Change the data type for a field in the Data pane

To change the data type of a field in the **Data** pane, click the icon to the left of the field name, and then choose a new data type from the drop-down list.

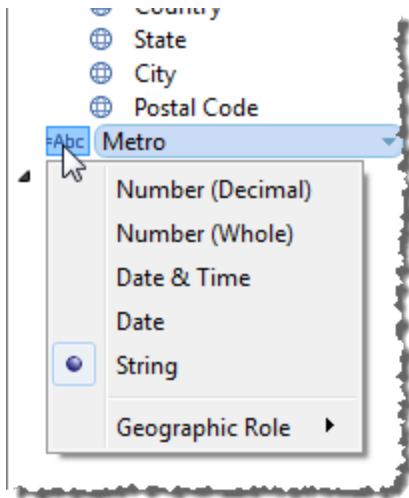

Change the data type for a field in the view

To change a field's data type in a view, right-click (control-click on a Mac) the field in the **Data** pane, choose **Change Data Type**, and then select the appropriate data type from the drop-down list.

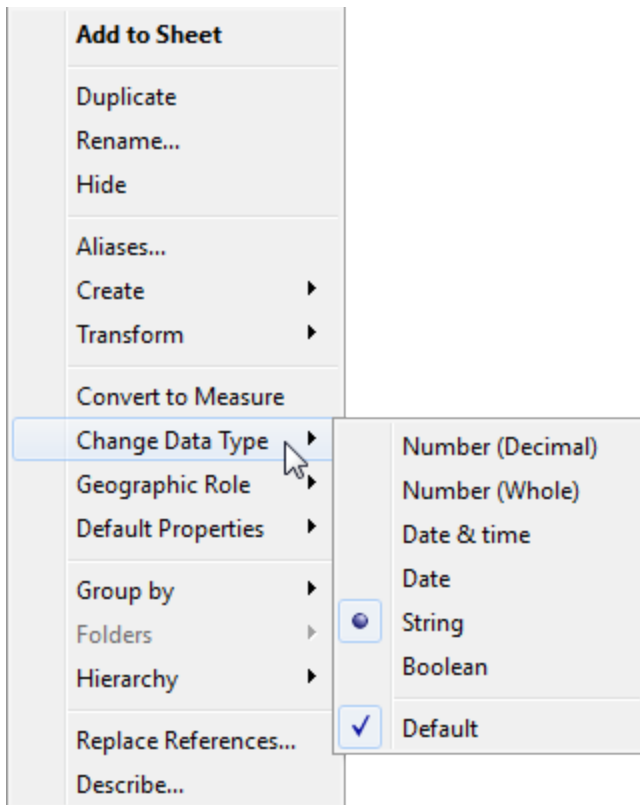

Note: Sometimes the data in your database is more precise than Tableau can model. When you add these values to the view, a precision warning appears in the right corner of the status bar. See [Status Bar Information](#) on page 35.

Mixed data types in data from files

Most columns in a Microsoft Excel, Microsoft Access, or CSV (comma-separated value) file contain values that are all of the same data type (Booleans, dates, numbers, or text). When you connect to the file, Tableau creates a field in the appropriate area of the **Data** pane for each column. Dates and text values are dimensions, and numbers are measures.

However, files that you connect to might include columns that have a mixture of data types, such as numbers and text, or numbers and dates. When you connect to the file, the mixed-value column is mapped to a field with a single data type in Tableau. Therefore, a column that contains numbers and dates might be mapped as a number data type (making it a measure) or it might be mapped as a date data type (in which case Tableau treats it as a dimension.)

Tableau determines how to map mixed-value columns to data types by the data types of the first 10,000 rows in an Excel data source, and the first 1,024 rows in a CSV data source. For

example, if most of the first 10,000 rows are text values, the entire column is mapped to use the text data type.

Note: Empty cells also create mixed-value columns because their formatting is different from text, dates, or numbers.

When Tableau determines a data type for each field, if the values in a field don't match that data type, Tableau handles the field in one of several different ways, depending on the data type. For example, sometimes Tableau populates those fields with Null values, as shown in the following table:

Mapped data type	Treatment of other data types in the field.
Text	Dates and numbers are treated as text. Nulls are not created.
Dates	Text is treated as Null. A number is treated as the day in numeric order from 1/1/1900.
Numbers	Text is treated as Null. A date is treated as the number of days since 1/1/1900.
Boolean	Text, dates, and numbers are treated as Null.

If using fields that are based on mixed-value columns introduces difficulties when analyzing your data, you can do one of the following:

- Format empty cells in your underlying data source so that they match the data type of the column.
- Create a new column that does not contain the mixed values.

Tableau's Order of Operations

The order of operations in Tableau, sometimes called the query pipeline, is the order in which Tableau performs various actions. Actions are also known as operations. Many operations apply filters, which means that as you build a view and add filters, those filters always execute in the order established by the order of operations.

Watch a Video: To see related concepts demonstrated in Tableau, watch [Understanding Tableau's Order of Operations](#), a 1-hour, free video presentation.

This article includes two scenarios for updating a view to correct problems resulting from the order of operations: converting a dimension filter to a context filter, and converting a table calculation to a FIXED level of detail expression.

About the order of operations (aka query pipeline)

Sometimes, you might expect Tableau to execute filters in one order, but the order of operations dictates that they be executed in a different order, which gives you unexpected results. When this happens, you can sometimes change the order in which operations are executed in the pipeline.

The Tableau order of operations includes the following, from top to bottom.

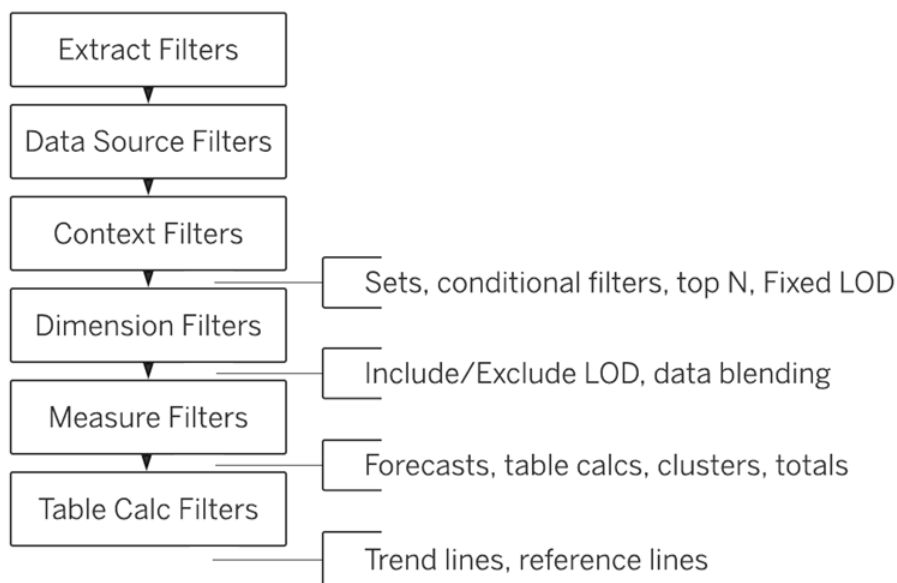

Note: In the order of operations, the [latest date filter](#) is global to the workbook, while context filters apply per worksheet. The latest date is determined just after the workbook opens for first use, after data source filters, but before context filters. At that point the date is set, and the latest date preset is used as a dimension filter.

Example 1: Convert a Dimension Filter to a Context Filter

This and the following example use the **Sample – Superstore** data source provided with Tableau Desktop.

In this example, the view addresses the following question: Who are the top 10 customers, by total sales, in New York City?

The view contains two dimension filters, one that you create on the **General** tab in the Filters dialog box, and the other on the **Top N** tab. The problem is that these filters are executing simultaneously, whereas you would like to general filter to be applied before the top n filter, so that the top n filter can act on the results as previously filtered by the general filter. The solution is to redefine one of the filters as a context filter so that a clear order of precedence is established.

Here are the steps for building this view.

1. Drag **Sales** to **Columns**.
2. Drag **City** and **[Customer Name]** to **Rows**.
3. Drag **City** from the **Data** pane again, this time to **Filters**. On the **General** tab in the Filter dialog box, set the filter to show just a single value: New York City. Do this by clicking **None** and then choosing **New York City**.

This creates a general dimension filter.

4. Click the **Sort Descending** button () on the toolbar. Your view now looks like this:

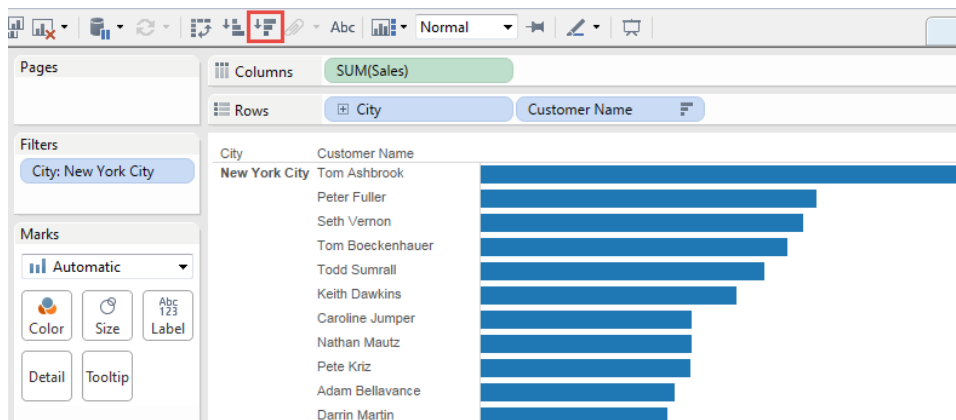

Note the first few names in the list: Ashbrook, Fuller, Vernon, etc.

- Now drag **[Customer Name]** from the **Data** pane to **Filters**, and create a Top 10 Filter, to show only the top 10 customers by total sales:

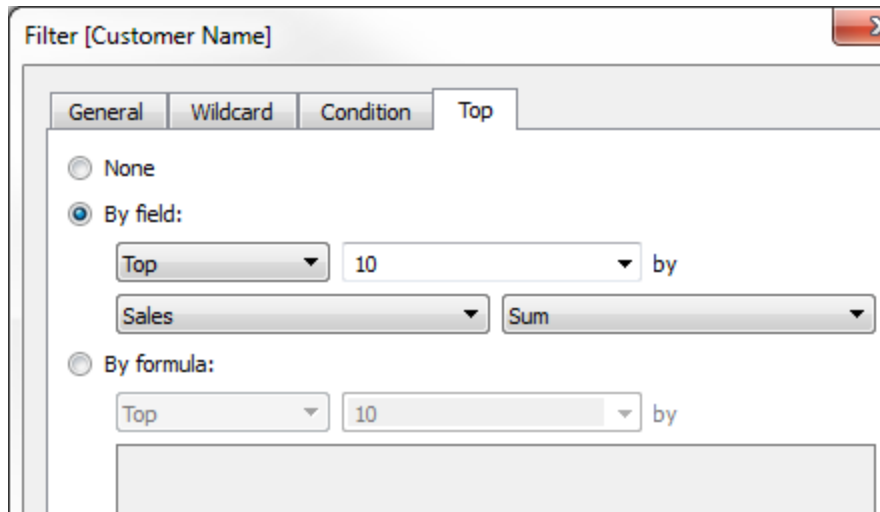

After you apply this second filter, the view looks right, but notice that the names shown are no longer the same as before:

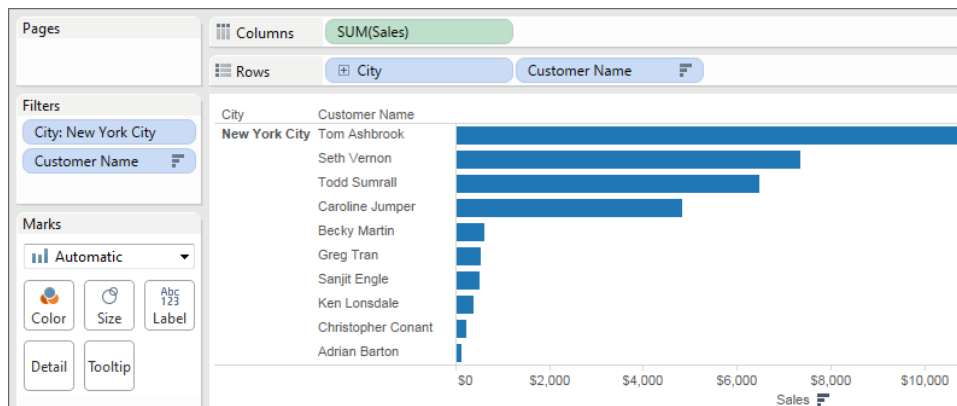

What happened to Peter Fuller, formerly in second place? The goal was to show the top 10 customers in New York City, but now the view is actually showing the top 10 customers overall.

The problem is that top and general dimension filters are applied simultaneously—they are both dimension filters, and they appear in the same place in the Tableau order of operations:

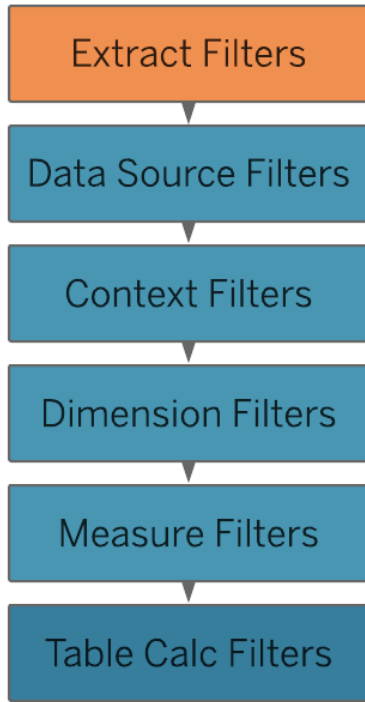

The solution is to add the general dimension filter (on **City**) to context—that is, by turning it into a context filter, which is executed before any other filter that you create in a worksheet.

For details, see [Use Context Filters](#) on page 1337.

6. Right-click **City** on the **Filters** shelf (Control-click on a Mac) and choose **Add to Context**. As a context filter, this filter now takes precedence over the dimension filter, and so the view now shows what it's supposed to:

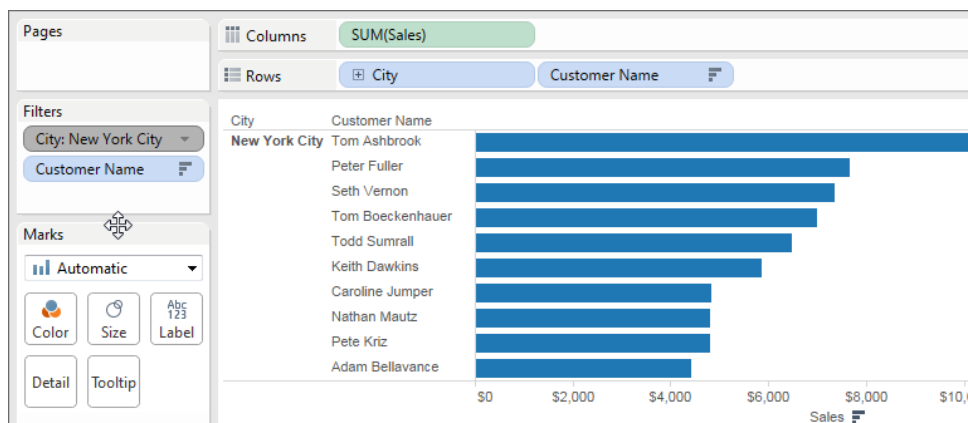



Example 2: Convert a Table Calculation to a FIXED Level of Detail Expression

In this example, the view addresses the following question: What is the percent of total sales by product sub-category?

The view contains a dimension filter and a table calculation. Tableau applies the dimension filter before executing the table calculation. To invert the order of these operations, use a FIXED level of detail expression instead of a table calculation.

Here are the steps for building this view.

1. In a new worksheet, drag **Sales** to **Columns**.
2. Drag **Sub-Category** to **Rows**.
3. Right-click **SUM(Sales)** on **Columns** and select a quick table calculation – **Percent of Total**.
4. Click the **Sort Descending** button () on the toolbar to sort the categories from most to least.
5. Click the **Show Mark Labels** button () on the toolbar to display measure values in the view.

Your view now looks like this:

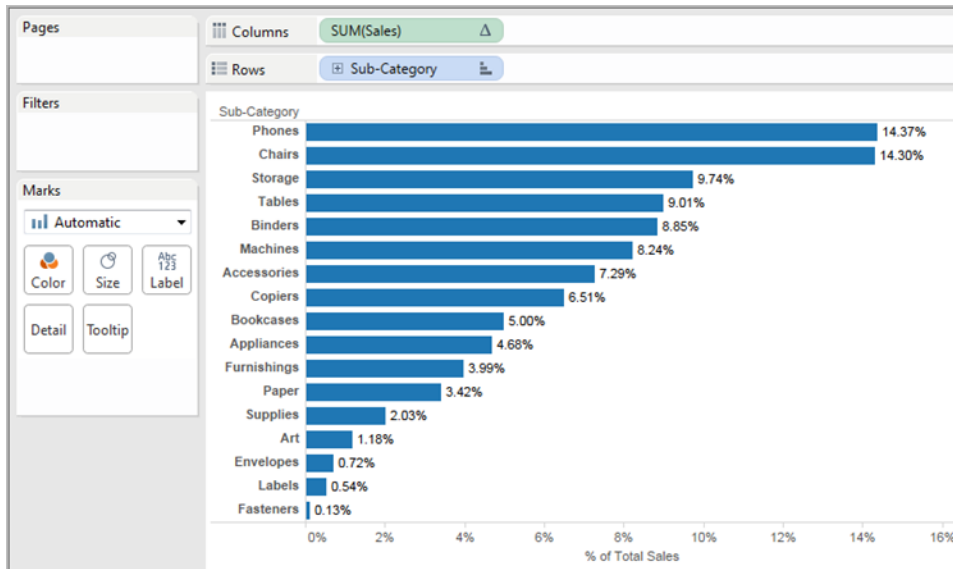

Note the percentages for the first few items: 14.37%, 14.30%, etc.

6. Right-click **Sub-Category** on **Rows** and choose **Show Filter**.
7. Clear the check mark for **Chairs** in the filter.

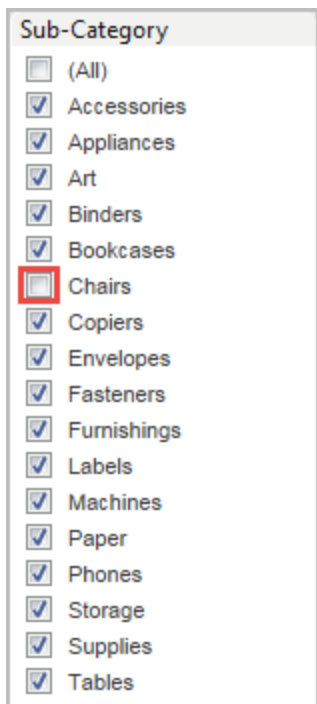

In the view, the percentages are now different—the highest percentage is now over 16%. In some cases, this may be just the result that you want (that is, for percentages to be recalculated as you work with the quick filter). But in other cases you may want the percentages to hold steady even as you filter items in or out. That’s what we want in this case.

In the order of operations, a dimension filter is applied before a table calculation:

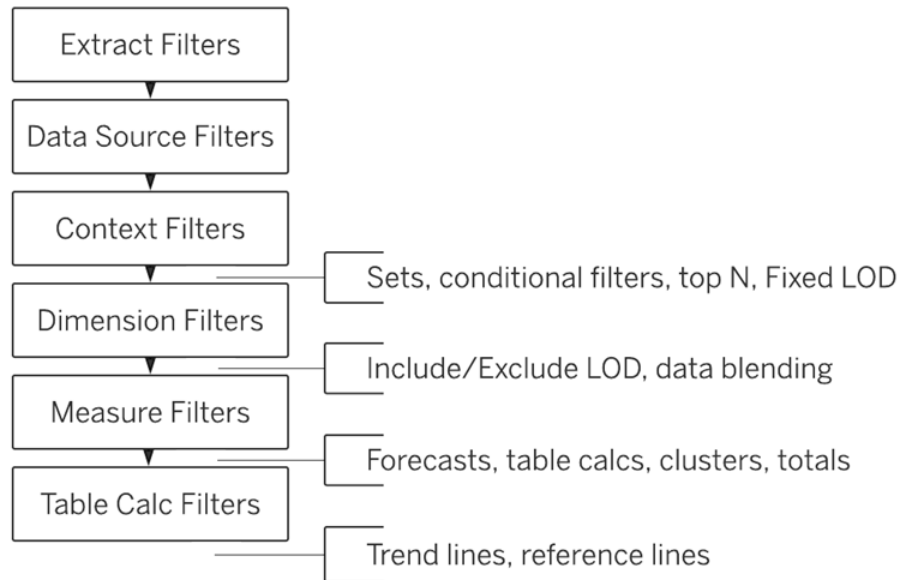

To have Tableau calculate the percentages before it acts on the quick filter, you create a **FIXED** level of detail expression, and then use that instead of the table calculation.

FIXED level of detail expressions compute a value using the specified dimensions, without reference to the dimensions in the view. In this case you’ll use it to establish percentages for the various sub-categories—percentages that won’t be affected by your general dimension filter. Why? Because **FIXED** level of detail expressions are computed before dimension filters are applied.

For details, see [Create Level of Detail Expressions in Tableau](#) on page 2405.

8. The **FIXED** level of detail expression must divide the sum of **Sales** (for a particular measure value) by the total sum of **Sales** for the view. Because the numerator is aggregated, the denominator must be as well, so the expression you write is:

```
SUM([Sales])/SUM({FIXED : SUM([Sales])})
```

- Save that expression as **FixedSumOfSales** and then drag it from the **Data pane** to **Columns**, dropping it to the right of the existing **SUM(Sales)** field that uses the table calculation. (Keep them both in the view for comparison.) Here is what your view now looks like:

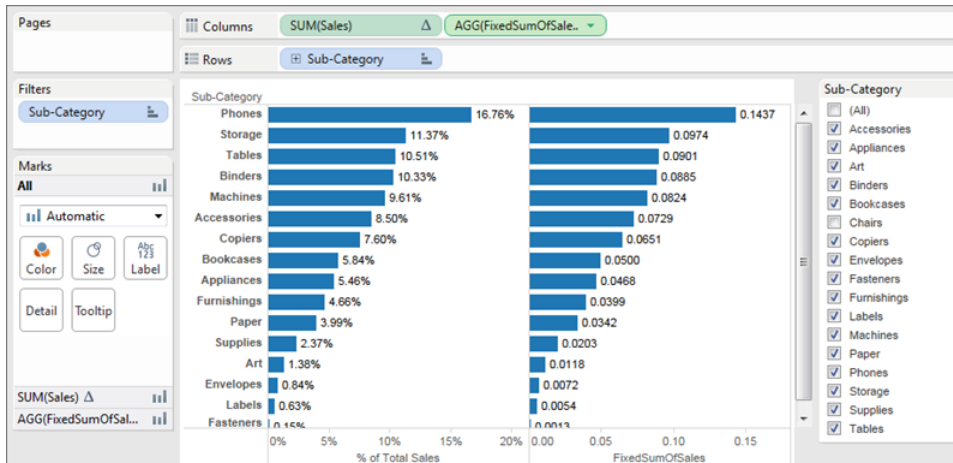

The percentage numbers in the chart on the right are now consistent, regardless of which fields you select or don't select with the quick filter. All that remains is to format the values for **FixedSumOfSales** so that they show as percentages.

- Right-click **FixedSumOfSales** on **Columns** and choose **Format**. In the **Format** pane, choose **Numbers** and then **Percentage**:

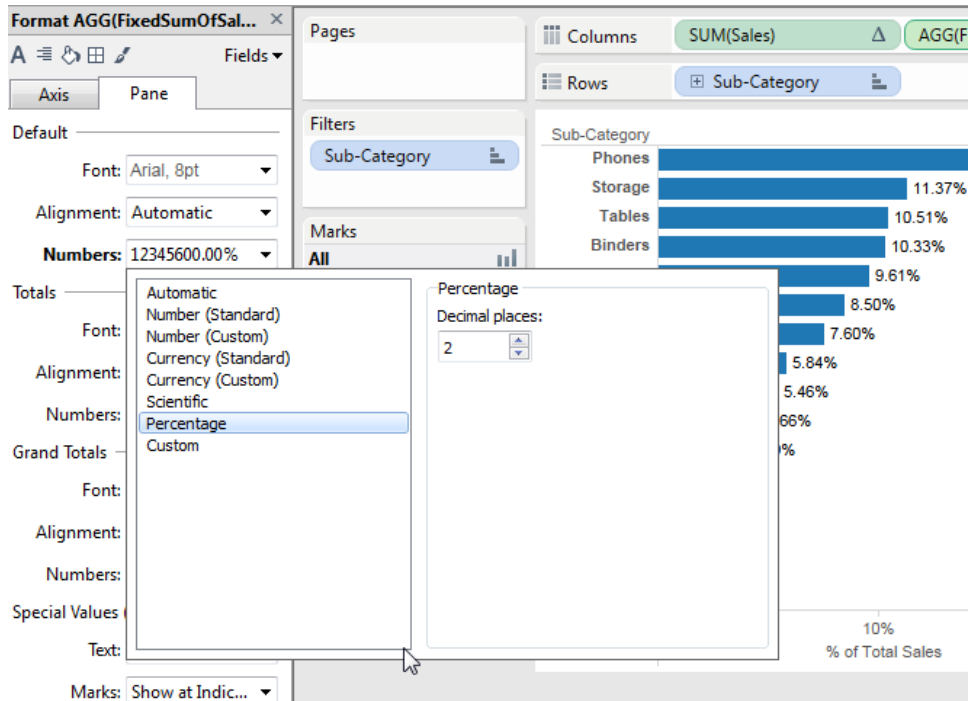

This gives you the final view:

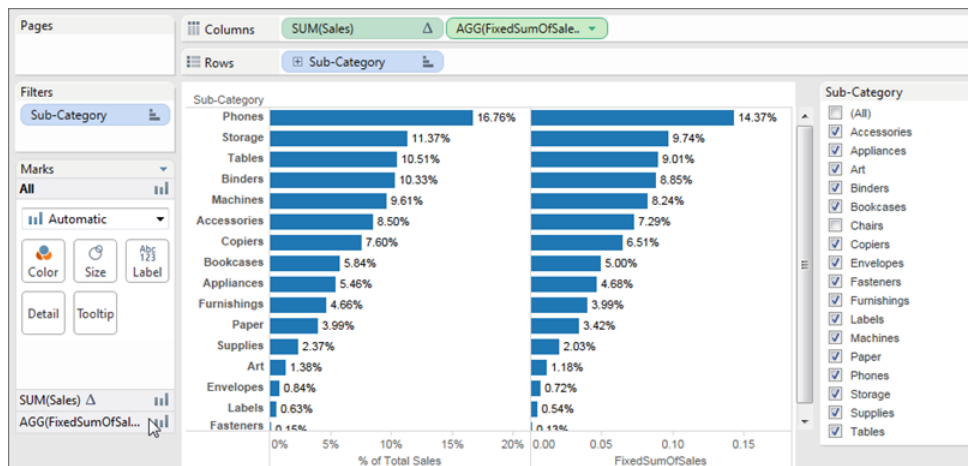

As you select or clear items in the **Sub-Category** quick filter, the percentages in the bar chart on the left change, but the percentages in the bar chart on the right do not.

Data Aggregation in Tableau

In Tableau, you can aggregate measures or dimensions, though it's more common to aggregate measures. Whenever you add a measure to your view, an aggregation is applied to that measure by default. The type of aggregation applied varies depending on the context of the view.

Change the Aggregation of a Measure in the View

When you add a measure to the view, Tableau automatically aggregates its values. Sum, average, and median are common aggregations; for a complete list, see [List of Predefined Aggregations in Tableau](#) on page 175.

The current aggregation appears as part of the measure's name in the view. For example, **Sales** becomes **SUM(Sales)**. Every measure has a default aggregation that is set by Tableau when you connect to a data source. You can view or change the default aggregation for a measure—see [Set the Default Aggregation for a Measure](#) on page 178.

You can aggregate measures using Tableau only for relational data sources. Multidimensional data sources contain data that is already aggregated. In Tableau, multidimensional data sources are supported only in Windows.

You can change the aggregation for a measure in the view from its context menu:

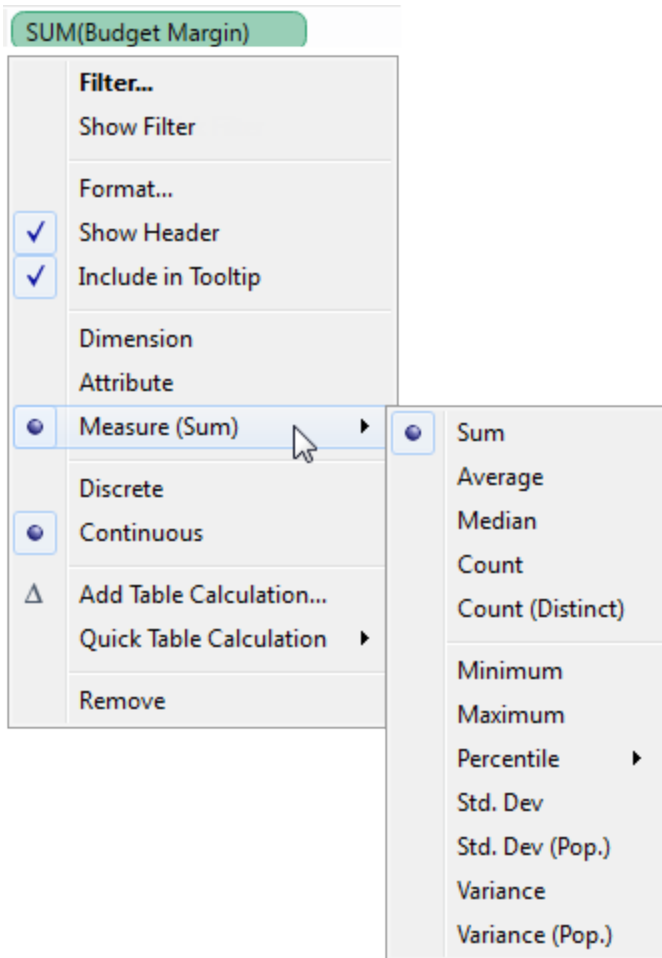

Aggregating Dimensions

You can aggregate a dimension in the view as **Minimum**, **Maximum**, **Count**, or **Count (Distinct)**. When you aggregate a dimension, you create a new temporary measure column, so the dimension actually takes on the characteristics of a measure.

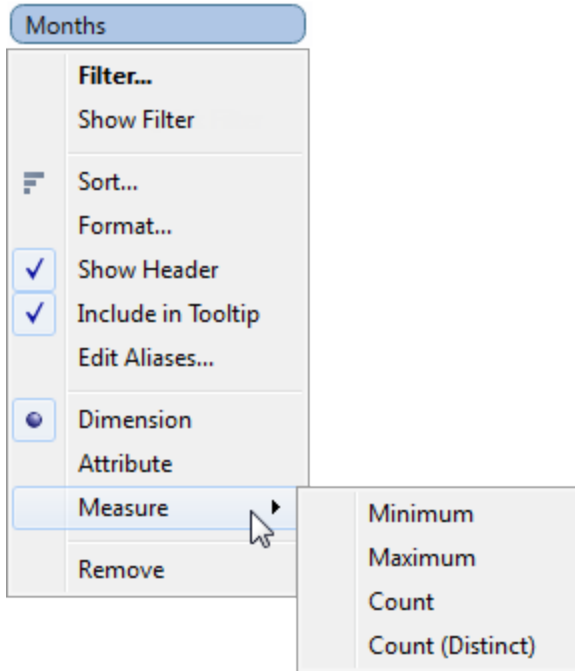

Another way to view a dimension is to treat it as an Attribute by choosing **Attribute** from the context menu for the dimension. The **Attribute** aggregation has several uses:

- It can ensure a consistent level of detail when blending multiple data sources.
- It can provide a way to aggregate dimensions when computing table calculations, which require an aggregate expression.
- It can improve query performance because it's computed

Tableau computes Attribute using the following formula:

```
IF MIN([dimension]) = MAX([dimension]) THEN MIN([dimension]) ELSE "*"
END
```

The formula is computed in Tableau after the data is retrieved from the initial query. The asterisk (*) is actually a visual indicator of a special type of Null value that occurs when there are multiple values. See [Troubleshoot Data Blending on page 836](#) to learn more about the asterisk.

Here is an example of using Attribute in a table calculation. The table shows sales by market, market size, and state. Suppose you wanted to compute the percent of total sales each state contributed to the market. When you add a Percent of Total quick table calc (see [Quick Table Calculations on page 2397](#)) that computes along State, the calculation computes within the red area. This is because the Market Size dimension is partitioning the data.

Columns		Measure Names		
Rows		Market	Market Size	State
Market	Market Size	State	Sales	% of Total Sales along State
Central	Major Market	Colorado	\$48,179	31.58%
		Illinois	\$69,883	45.80%
		Ohio	\$34,517	22.62%
	Small Market	Iowa	\$54,750	48.68%
		Missouri	\$24,647	21.92%
		Wisconsin	\$33,069	29.40%
East	Major Market	Florida	\$37,443	27.08%
		Massachusetts	\$29,965	21.67%
		New York	\$70,852	51.25%
	Small Market	Connecticut	\$25,429	63.07%
		New Hampshire	\$14,887	36.93%
South	Major Market	Texas	\$37,410	100.00%
	Small Market	Louisiana	\$23,161	34.82%
		New Mexico	\$15,892	23.89%

When you aggregate Market Size as an Attribute, the calculation is computed within the Market (East, in the following image), and Market Size is purely as a label.

Columns		Measure Names		
Rows		Market	ATTR(Market Size)	State
Market	Market Size	State	Sales	% of Total Sales along State
Central	Major Market	Colorado	\$48,179	18.18%
		Illinois	\$69,883	26.37%
		Ohio	\$34,517	13.02%
	Small Market	Iowa	\$54,750	20.66%
		Missouri	\$24,647	9.30%
		Wisconsin	\$33,069	12.48%
East	Major Market	Florida	\$37,443	20.97%
		Massachusetts	\$29,965	16.78%
		New York	\$70,852	39.68%
	Small Market	Connecticut	\$25,429	14.24%
		New Hampshire	\$14,887	8.34%
South	Major Market	Texas	\$37,410	36.00%
	Small Market	Louisiana	\$23,161	22.29%
		New Mexico	\$15,892	15.29%

List of Predefined Aggregations in Tableau

Sometimes it's useful to look at numerical data in an aggregated form such as a sum or an average. The mathematical functions that produce aggregated data are called aggregation functions. Aggregation functions perform a calculation on a set of values and return a single value. For example, a measure that contains the values 1, 2, 3, 3, 4 aggregated as a sum returns a single value: 13. Or if you have 3,000 sales transactions from 50 products, you might want to view the sum of sales per product to determine which products have the highest revenue.

Note: Using floating-point values with aggregations can sometimes lead to unexpected results. For details, see [Understanding data types in calculations](#) on page 2459.

Tableau provides a set of predefined aggregations that are shown in the table. You can set the default aggregation for any measure that isn't a calculated field that itself contains an aggregation, such as `AVG([Discount])`. See [Set the Default Aggregation for a Measure](#) on page 178. You can also set the aggregation for a field already in the view. For details, see [Change the Aggregation of a Measure in the View](#) on page 171.

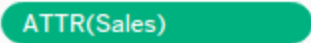
Aggregation	Description	Result for measure that contains 1, 2, 2, 3
Attribute	Returns the value of the given expression if it only has a single value for all rows in the group, otherwise it displays an asterisk (*) character. Null values are ignored. This aggregation is useful when aggregating a dimension. To set a measure in the view to this aggregation, right-click (control-click on Mac) the measure and choose Attribute . The field then changes to show the text ATTR: 	*
Dimension	Returns all unique values in a measure or dimension.	3 values (1, 2, 3)
Sum	Returns the sum of the numbers in a measure. Null values are ignored.	1 value (8)
Average	Returns the arithmetic mean of the numbers in a	1 value (2)

Aggregation	Description	Result for measure that contains 1, 2, 2, 3
	measure. Null values are ignored.	
Count (Distinct)	<p>Returns the number of unique values in a measure or dimension. When applied to a dimension, Tableau creates a new temporary column that is a measure because the result of a count is a number. You can count numbers, dates, booleans, and strings. Null values are ignored in all cases.</p> <p>This aggregation isn't available for the following types of workbooks:</p> <ul style="list-style-type: none"> • Workbooks created before Tableau Desktop 8.2 and that use Microsoft Excel or Text File data sources. • Workbooks that use legacy connections. • Workbooks that use Microsoft Access data sources. <p>If you're connected to a workbook that uses one of these types, Count (Distinct) is unavailable and Tableau shows the message "Requires extract." To use this aggregation, extract your data. See Extract Your Data on page 919.</p>	1 value (3)
Minimum	Returns the smallest number in a measure or continuous dimension. Null values are ignored.	1 value (1)
Maximum	Returns the largest number in a measure or in the given expression based on a sample population. Null values are ignored. Returns a Null if there are fewer than 2 members in the sample that aren't Null. Use this function if your data represents a sample of the population.	1 value (3)
Std. Dev (Pop.)	Returns the standard deviation of all values in the given expression based on a biased population. Assumes that	1 value (0.7071)

Aggregation	Description	Result for measure that contains 1, 2, 2, 3
	its arguments consist of the entire population. Use this function for large sample sizes.	
Variance	Returns the variance of all values in the given expression based on a sample. Null values are ignored. Returns a Null if there are fewer than 2 members in the sample that are not Null. Use this function if your data represents a sample of the population.	1 value (0.6667)
Variance (Pop.)	Returns the variance of all values in the given expression based on a biased population. Assumes that its arguments consist of the entire population. Use this function for large sample sizes.	1 value (0.5000)
Disaggregate	<p>Returns all records in the underlying data source. To disaggregate all measures in the view, select Aggregate Measures from the Analysis menu (to clear the check mark).</p> <p>Tableau allows you to view data in disaggregated form (relational databases only). When data are disaggregated, you can view the individual rows of your data source. For example, after discovering that the sum of sales for rubber bands is \$14,600, you might want to see the distribution of individual sales transactions. To answer this question, you must create a view that shows individual rows of data. That is, you must disaggregate the data (see How to Disaggregate Data on page 180). Another way to look at disaggregated data is to view the underlying data for all or part of a view. For more details, see View Underlying Data on page 2001.</p>	4 values (1, 2, 2, 3)

You can also define custom aggregations as described in [Aggregate Functions in Tableau on page 2115](#). Depending on the type of data view you create, Tableau applies these aggregations at the appropriate level of detail. For example, Tableau applies the aggregation to individual

dimension members (the average delivery time in the East region), all members in a given dimension (the average delivery time in the East, West, and Central regions), or groups of dimensions (the sum of sales for all regions and for all markets).

Set the Default Aggregation for a Measure

You can set the default aggregation for any measure that isn't a calculated field that itself contains an aggregation, such as `AVG([Discount])`. A default aggregation is a preferred calculation for summarizing a continuous or discrete field. The default aggregation is automatically used when you drag a measure to a view.

To change the default aggregation:

Right-click (control-click on Mac) a measure in the Data pane and select **Default Properties > Aggregation**, and then select one of the aggregation options.

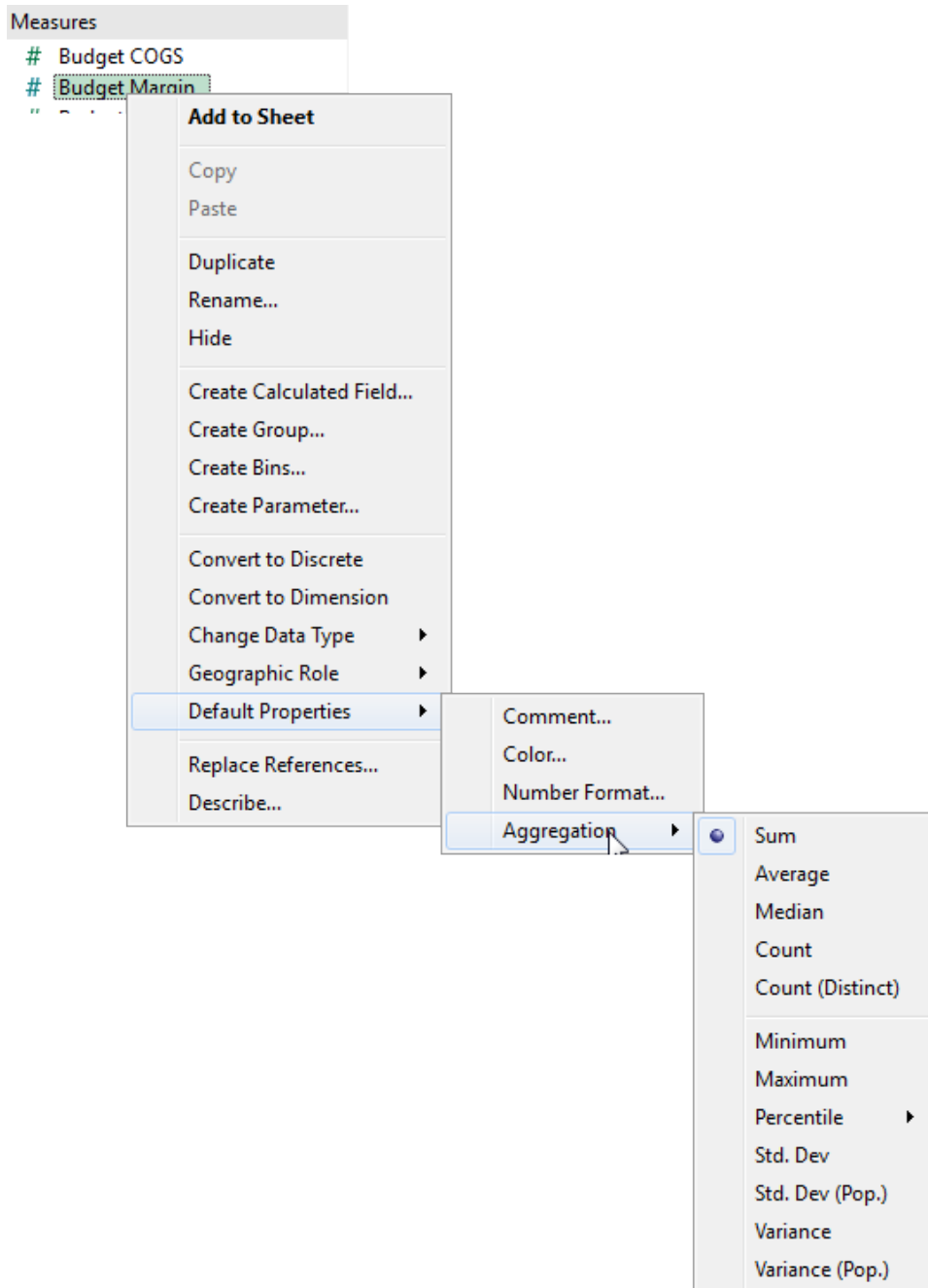

Note: You can use Tableau to aggregate measures only with relational data sources. Multidimensional data sources contain aggregated data only.

You can't set default aggregations for published data sources. The default aggregation is

set when the data source is initially published. [Create a Local Copy](#) of the published data source to adjust the default aggregation.

How to Disaggregate Data

Whenever you add a measure to your view, an aggregation is applied to that measure by default. This default is controlled by the **Aggregate Measures** setting in the **Analysis** menu.

If you decide you want to see all the marks in the view at the most detailed level of granularity, you can disaggregate the view. Disaggregating your data means that Tableau displays a separate mark for every data value in every row of your data source.

To disaggregate all measures in the view:

- Clear the **Analysis >Aggregate Measures** option. If it's already selected, click **Aggregate Measures** one time to deselect it.

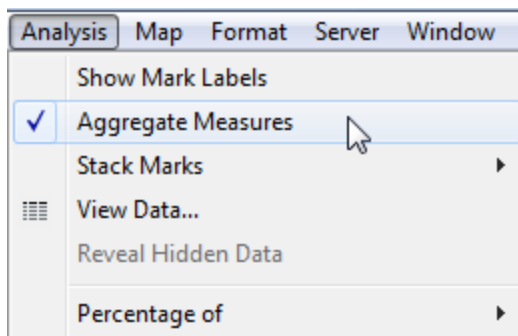

When **Aggregate Measures** is selected, Tableau attempts to aggregate measures in the view by default. Individual row values from your data source are aggregated into a single value (a single mark) at the level of detail in your view.

The different aggregations available for a measure determine how the individual values are collected: they can be added (SUM), averaged (AVG), or set to the maximum (MAX) or minimum (MIN) value from the individual row values.

For a complete list of the available aggregations, [List of Predefined Aggregations in Tableau on page 175](#).

The level of detail is determined by the dimensions in your view—for information about the concept of level of detail, see [How dimensions affect the level of detail in the view on page 151](#).

Disaggregating your data can be useful for analyzing measures that you may want to use both independently and dependently in the view. For example, you may be analyzing the results from a product satisfaction survey with the Age of participants along one axis. You can aggregate the **Age** field to determine the average age of participants or disaggregate the data to determine at what age participants were most satisfied with the product.

Disaggregating data can be useful when you're viewing data as a scatter plot. See [Example: Scatter Plots, Aggregation, and Granularity](#) below.

Note: If your data source is very large, disaggregating the data can result in a significant performance degradation.

Example: Scatter Plots, Aggregation, and Granularity

If you place one measure on the **Rows** shelf and another measure on the **Columns** shelf, you're asking Tableau to compare two numerical values. Typically, Tableau chooses a scatter plot as the default visualization in such cases. The initial view will most likely be a single mark, showing the sum for all values for the two measures. This is because you must increase the level of detail in the view.

[Start building the scatter plot](#) below
[Use dimensions to add detail](#) on the next page
[Try adding more fields to the rows and columns shelves](#)
on page 184
[Try disaggregating the data](#) on page 186

Start building the scatter plot

There are various ways to add detail to a basic scatter plot: **you can use dimensions to add detail**, you can add more fields to the Rows and Columns shelves, or you can **disaggregate the data**. You can also use any combination of these options. This topic looks at these alternatives using the **Sample-Superstore** data source.

To create the initial view, follow these steps:

1. Place the **Sales** measure on the **Columns** shelf.
2. Place the **Profit** measure on the **Rows** shelf.

The measures are automatically aggregated as sums. The default aggregation (SUM) is indicated in the field names. The values shown in the tooltip show the sum of sales and profit values across every row in the data source.

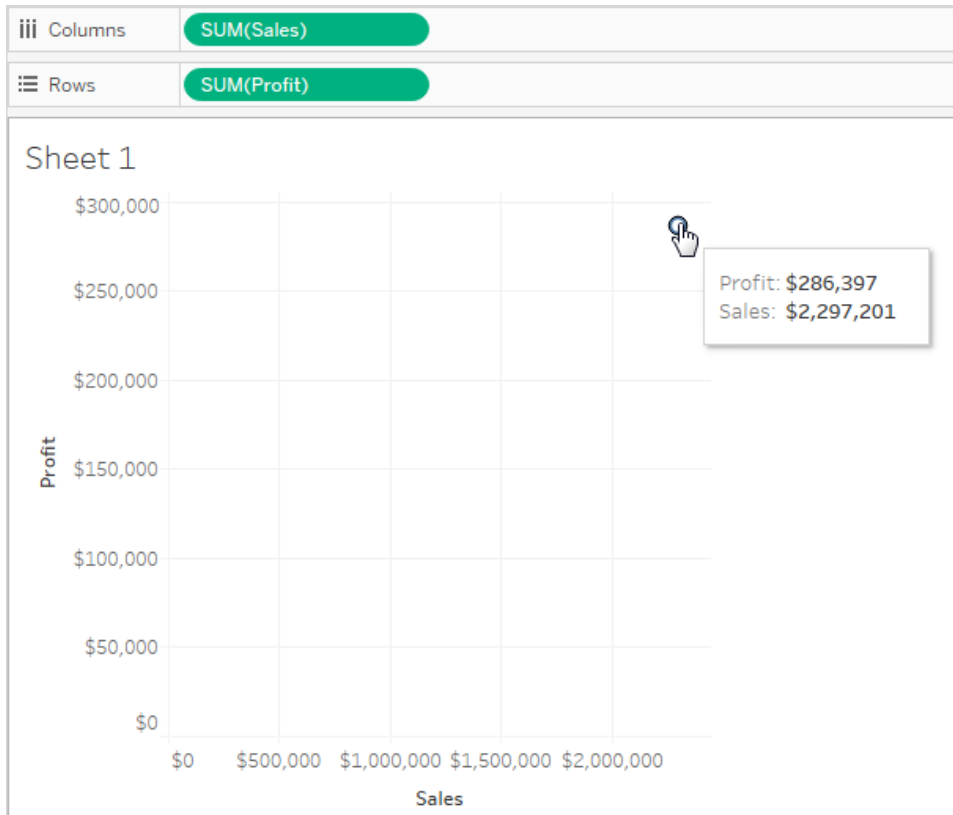

Follow these steps to use dimensions to add detail to the view and to disaggregate data.

Use dimensions to add detail

Follow these steps to develop the scatter plot view you created by adding dimensions to show more levels of detail.

1. Drag the **Category** dimension to **Color** on the Marks card.

This separates the data into three marks—one for each dimension member—and encodes the marks using color.

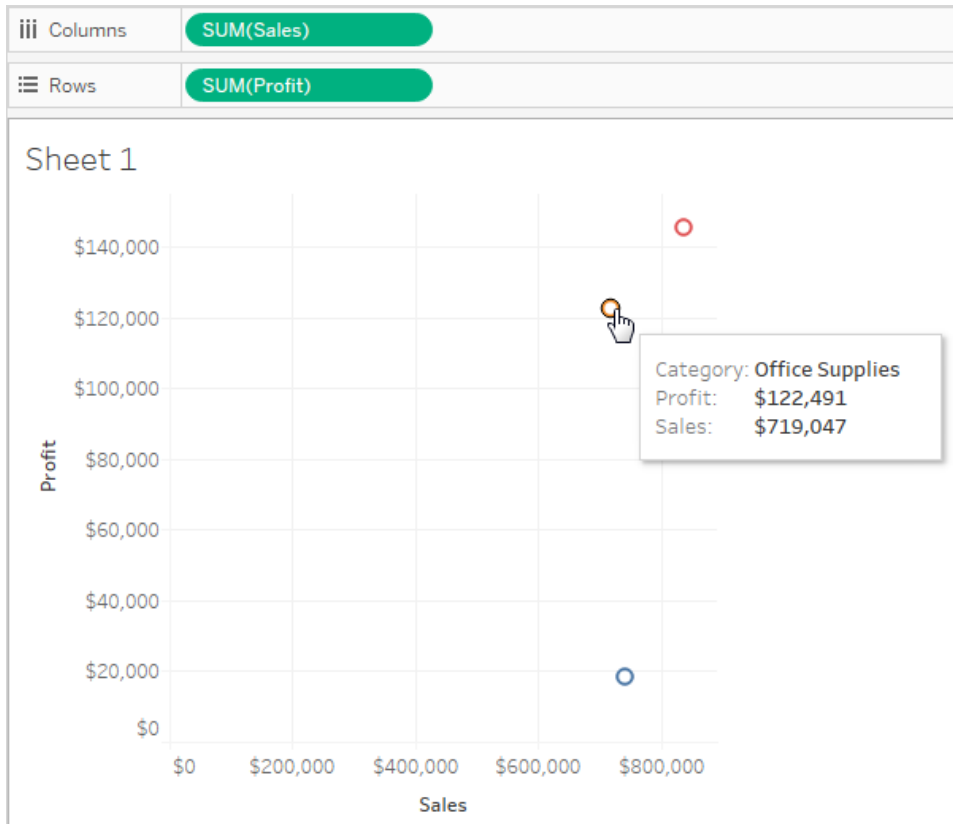

2. Drag the **State** dimension to **Detail** on the Marks card.

Now there are many more marks in the view. The number of marks is equal to the number of distinct states in the data source multiplied by the number of categories.

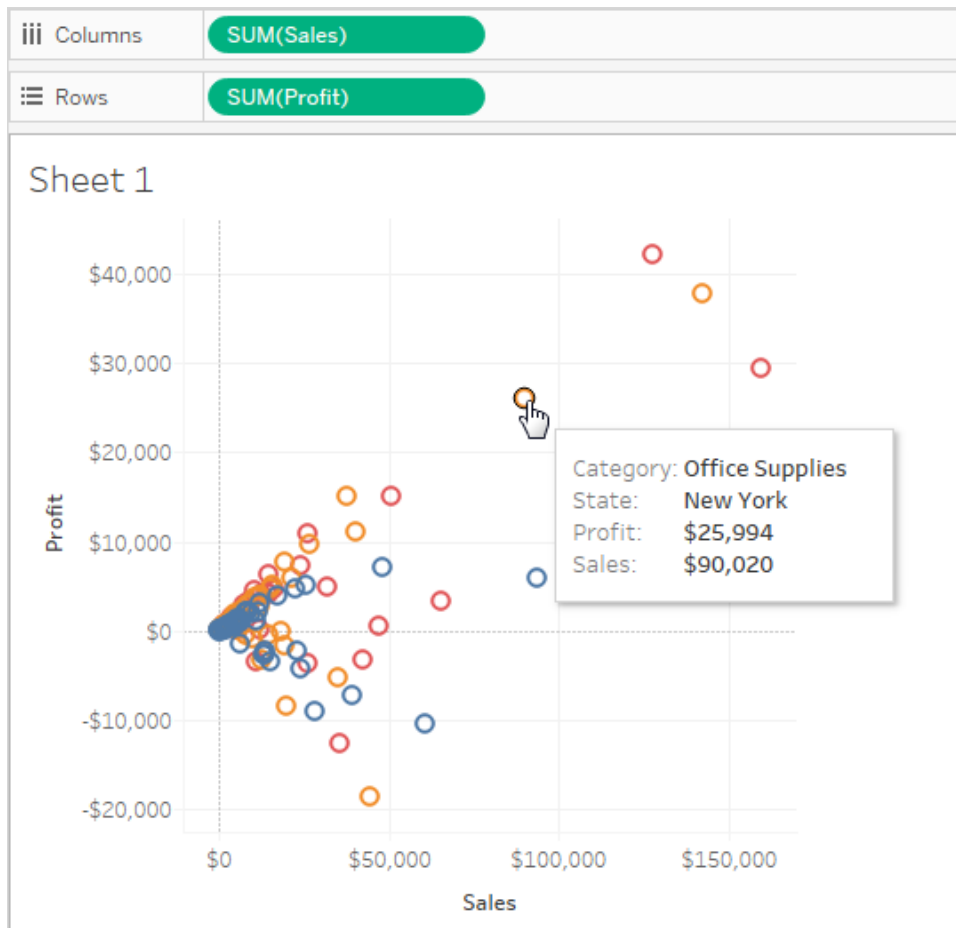

Although more marks are now displayed, the measures are still aggregated. So regardless of whether there's one row in the data source where State = North Dakota and Category= Furniture, or 100 such rows, the result is always a single mark.

Maybe this process is developing the view in a direction you find useful, or maybe you prefer to go in a different direction. You decide what questions to ask.

Try adding more fields to the rows and columns shelves

Revert to the original one-mark view and follow these steps to develop the scatter plot view by adding fields to the **Rows** and **Columns** shelves.

1. Drag the **State** dimension to the **Columns** shelf.

Even if you drop **Continent** to the right of **SUM(Sales)**, Tableau moves it to the left of **SUM(Sales)**. This is because you can't insert a dimension within a continuous axis. Instead, your view shows a separate axis for each member of the dimension.

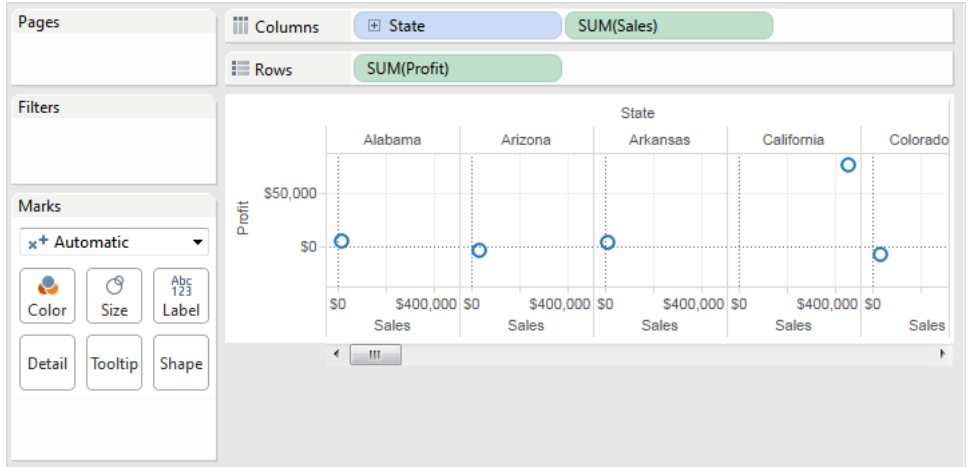

2. Drag the **Segment** dimension to the **Rows** shelf.

You now have a view that provides an overview of Sales and Profit across states and customer segments. It can be interesting to hover over the marks in the view to see tooltip data for various segments:

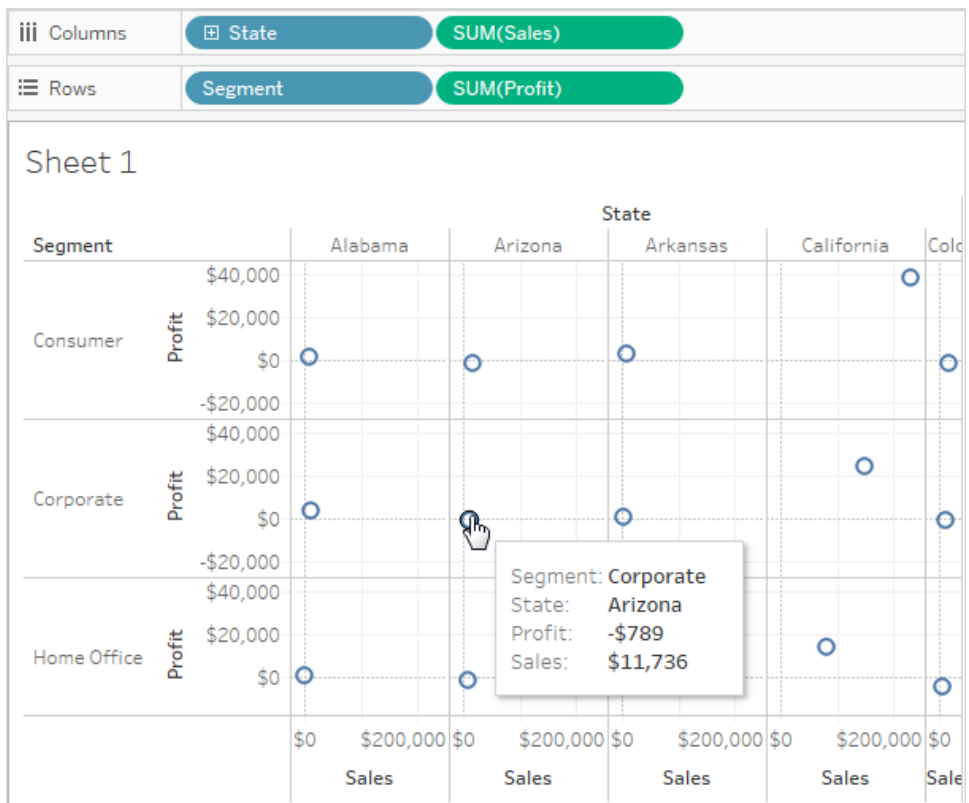

Try disaggregating the data

Another way to modify your original one-mark scatter plot to display more marks is by disaggregating the data.

Clear the **Analysis >Aggregate Measures** option. If it's already selected, click **Aggregate Measures** one time to deselect it.

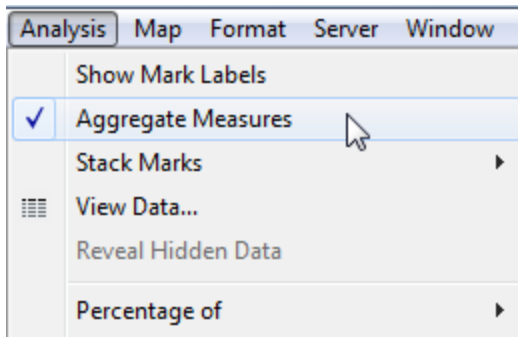

What you have done is to dis-aggregate the data, because this command is a switch that was originally selected (check mark present). Tableau aggregates data in your view by default.

Now you see many marks—one for each row in your original data source:

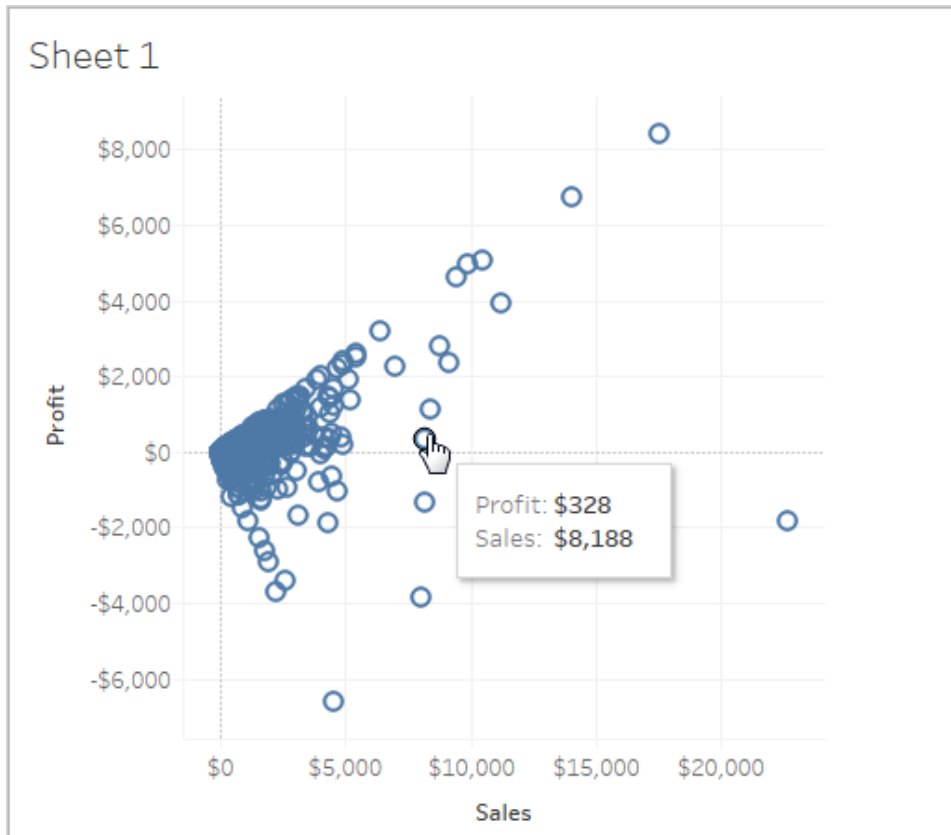

When you disaggregate measures, you no longer are looking at the average or sum for the values in the rows in the data source. Instead, the view shows a mark for every row in the data source. Disaggregating data is a way to look at the entire surface area of the data. It's a quick way to understand the shape of your data and to identify outliers. In this case, the view shows there's a consistent relationship between sales and profit, indicated by the line of marks aligned at a forty-five degree angle.

The Bookshop data set

The Bookshop data set was created for Tableau Desktop 2020.2 to showcase relationships—the new data modeling capabilities for combining data.

Download the files

You can choose to download the raw data and start from scratch building your own data model, or download one of the pre-built data sources to jump right into analysis with relationships.

- Raw data (xlsx)
 - [Bookshop.xlsx](#) - the raw data as an .xlsx file
 - [BookshopLibraries.xlsx](#) - additional library tables that introduce many-to-many relationships (contains only the additional library tables)
- Packaged data source (tdsx) files
 - [Bookshop.tdsx](#) - a packaged .tdsx file with the related data source already built and some metadata customizations added
 - [MinimalBookshop.tdsx](#) - the same tables as Bookshop.tdsx but without any metadata or cleanup
 - [Bookshop_libraries.tdsx](#) - a packaged .tdsx file that adds the library tables to Bookshop.tdsx (includes all tables).

To connect to a downloaded .tdsx

1. Open Tableau Desktop.
2. In the Connect pane on the left, choose the **More...** option under the **To a File** heading.
3. Navigate to where you downloaded the .tdsx and double click it (or select it then click Open).

About the data set

Bookshop consists of 13 tables, combined in the following manner:

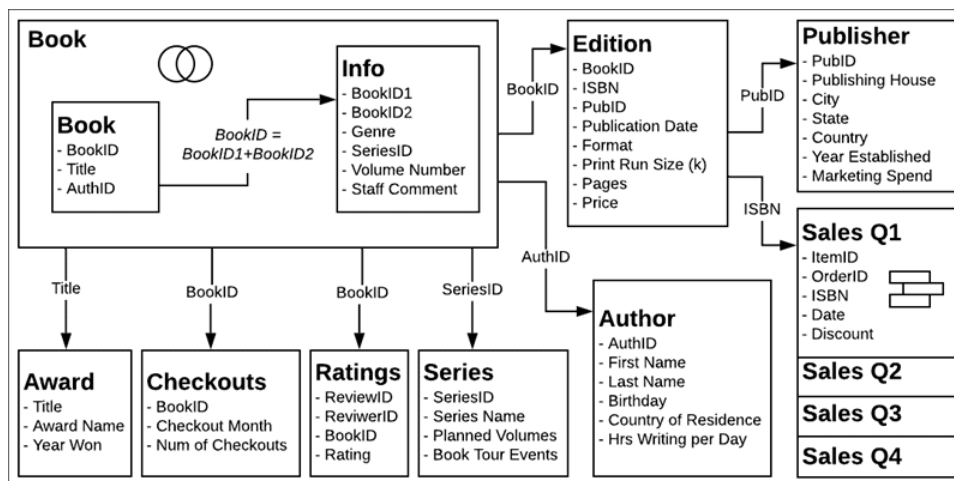

Note: A central concept for this data set is the idea of a *book* versus an *edition*. A book is a concept with attributes such as author, title, and genre. An edition is a physical version of the book, with attributes such as format (hardcover, paperback), publication date, and page count.

Data Dictionary

Some fields may need a little explanation.

- The **Rating** field in the Ratings table is on a scale of 1-5 with 5 being high.
- The **Format** field is a detailed breakdown of the format. Everything other than “Hardcover” could be considered “Paperback”.
- **ISBN** stands for International Standard Book Number and is a unique 13 digit identifier given to each edition of a book. The ISBN is represented in the barcode and is tied to the price.
- The **ItemID** and **OrderID** fields are hierarchical. An order may contain multiple items.
- The **Staff Comment** field contains summaries and reviews for some of the books.

If you build your own data source

1. The **Publisher** and **Sales** tables must be related to the **Edition** table.
2. The **Book** and **Info** tables can be related or joined, but it must be on the calculation
`BookID = [BookID1]+[BookID2]`.
 - An inner join is suggested.
 - The **Series** table can only be used once the Info table is part of the data source.

optional:

3. We recommend renaming the logical table of Book joined with Info “Book” or something similar.
4. The four Sales tables can be analyzed independently, but if they are unioned, we recommend renaming the union “Sales” or something similar.
5. Most of the fields used to form relationships aren’t needed for analysis and can be hidden once the data model has been built
 - Any field ending with ID can be hidden (the only “ID” fields that do are ReviewID and ReviewerID from Ratings and ItemID and OrderID from Sales).
 - ISBN should be kept, ideally from the Edition table, as the identifier of each edition. The ISBN field in the unioned Sales table can be hidden.
 - The Title field in the Award table can be hidden.

- The sheet and table fields from the Union also don't contain unique information and can be hidden.
6. To simplify the data model, the core tables are **Book**, **Author**, and **Edition**. The easiest tables to leave out with minimal impact would be **Checkouts** and **Ratings**, followed by **Award**, **Publisher**, **Sales**, or **Info** and **Series**.

Bookshop Libraries

The BookshopLibraries.xlsx file introduces new tables around libraries for the purpose of supporting many-to-many relationships. The Catalog table relates to the Editions table on ISBN. The Library Profiles table relates to the Catalog table as a many-to-many (n:n) relationship on LibraryID.

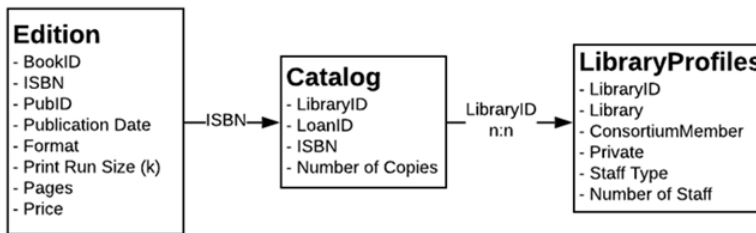

Data Dictionary

Library Profile

- The **Library** field is the name of the library.
- The **Library ID** field is an ID also used in the Catalog table.
- The **Consortium Member** field is a yes/no field that indicates if the library is part of the larger network of libraries that offer inter-library loans and share other services.
- The **Private** field is a yes/no field that indicates if this is a members-only library or a public institution.
- **Staff Type** and **Number of Staff** together describe how many Librarians, Library Assistants, and Library Technicians work for each library.

Catalog

- **LoanID** is a unique identifier for the combination of ISBN and library that is used to track the **Number of Copies** a library has. For example, if the Idle Hour Library has two paperback copies and one hardcover copy of a title, there will be two Loan IDs.
- The **Library ID** field is an ID also used in the Library Profile table.

Structure of the Library Profile table

The Library Profile table was originally formatted as an unpivoted table with a column for each staff type, below.

Library	LibraryID	Consortium Member	Private	Librarians	Library Technicians	Library Assistants
Idle Hour Library	L-IHL	Yes	No	53	61	16
The Bibliophile's Shelves	L-BS	Yes	Yes	4	3	0
Armchair Athanaeum	L-AA	No	Yes	6	0	0
Old Friend Library	L-OFL	Yes	No	3	5	17
Bide Awhile	L-BA	Yes	No	9	20	6
IndieUnBound	L-IUB	Yes	No	7	2	47
Page Station Book Exchange	L-PS	No	Yes	3	1	4

The table was pivoted across the Librarians, Library Technicians, and Library Assistants columns. The final format has a column for Staff Type and a column for Number of Staff. However, this means that there is more than one row for each library. The Library ID values are therefore not unique, and the pivoted version of the table must be related many-to-many to the Catalog table.

While this has the benefit of allowing a many-to-one relationship between Catalog and Profile, it isn't an ideal [structure for data analysis](#).

Explore

This data set, while fictional, supports various analytical scenarios and plenty of exploration. Some suggestions include:

- What books are the most popular? The least popular? Is that based on sales, reviews, checkouts, or another metric?
- Who was the youngest debut author? Who was the oldest?
- Do some publishing houses seem to specialize in any way?
- What was the longest time between editions of the same book?
- Are there any seasonal trends for sales? What about checkouts? Do any titles or genres have seasonal fluctuations?
- Are there any correlations between checkouts, print run size, book review ratings, and sales volume?
- Do the authors who spend the most time writing have the most successful books? Do they have the highest page count?
- When are most books published? Are there any anomalies?
- Are there any trends for genre, format, and price?
- What sort of distributions do the ratings have? Do those distributions vary by book? By genre? Do they seem to align with awards?
- How would you calculate the sales price, given that there is sometimes—but not always—a discount given at the time of sale?
- Do sales approximate the Pareto principle?
- Are there any patterns in the discounts?
- Do any tables in particular appear to have dirty data?

Bookshop Data Set Easter Eggs

- *Etaoin Shrdlu* is a reference to linotype hot type machines. *Palimpsest* is a manuscript-making reference.
- Author names were derived from a list of famous American authors with their first and last names shuffled.
- Publication dates today are usually on Tuesdays. This was reflected in the data, which assumes this industry standard holds into the year 2178.
- One book has no reviews, checkouts, or sales.
- The Checkouts data is based actual library data, with BookIDs mapped to titles, so the checkout trends are real-world.

- The Ratings data is based on actual book rating data, with BookIDs mapped to titles, so the distribution of ratings for a given book is real.
- The proportion of sales that are for a single book versus multiple books is based on real-world data from an independent bookstore.
- The Sales data is completely generated, but is based on actual seasonal and weekday trends for a resort town with a tourism-based economy (proportionally by month and day of the week, and for spring break and the winter holidays).
 - Sales spike over long weekends and spring break.
 - Sales are much higher on weekends and at their lowest on Tuesdays and Thursdays.
 - Peak season is the summer between the 4th of July and Labor Day.
 - Sales spike immediately after Thanksgiving and in the weeks leading up to Christmas.
- The ISBNs in the data set are fictitious but constructed following ISBN-13 principles:
 - EAN—989 (not actually in use)
 - Group number—28
 - Publisher registrant element—varying length (2-4 digits)
 - Title element, varying length (3-5 digits, depending on the registrant element length)
 - Check digit, created with the ISBN-13 check digit modular arithmetic calculation
- One of the developers working on this feature suggested a book with no editions, and the title *The Deep Grey*, so its BookID ends with the last three digits of his work phone number.
- There is an (intentional) error in the Edition table where two editions of BookID PA169 were labeled as Palimpsest Printing, but the ISBN indicates they were actually printed by Etaoin Shrdlu Press.

The person who created this data set had way too much fun making it, and clearly has a deep obsession with books. She hopes you enjoy the data set and it helps you appreciate the power, elegance, and beauty of relationships in Tableau.

Sign in to Tableau Server or Tableau Cloud

To access content on Tableau Server or Tableau Cloud, sign in via Tableau Desktop or a web browser.

Note: If you sign in via a web browser, it must be configured to allow first-party cookies.

Sign in from Tableau Desktop

Tableau Server

1. In Tableau Desktop, select **Server > Sign In**. Enter the name or address of your Tableau server, and then click **Connect**.

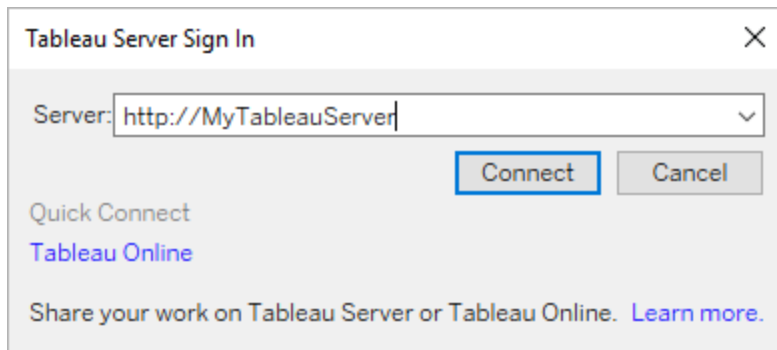

2. Do one of the following, which depends on if your Tableau Server is configured for **identity pools**:
 - Enter your user name and password, and then click **Sign In**. If you have access to multiple sites, select the one you want to use. You can also enter the name of the site and search for it.



- On the Tableau Server landing page, select the sign-in option that applies to you,

enter your user name and password, and then click **Sign In**.



Tableau Cloud

1. In Tableau Desktop, select **Server > Sign In**. Click **Tableau Cloud** in the bottom left corner.

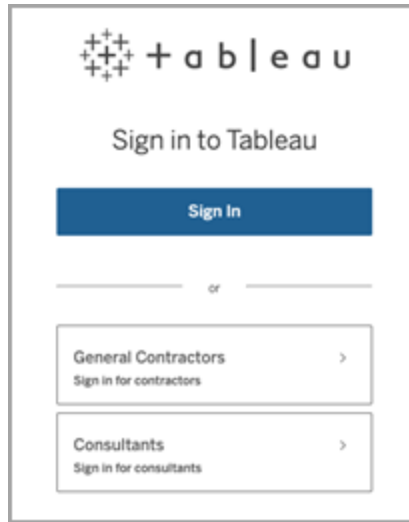
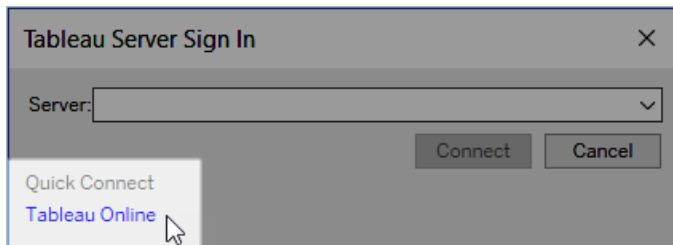

2. If your site is set up to use Tableau authentication, enter your user name (email address) and password you use for Tableau Cloud, and then click **Sign In**.

If multi-factor authentication (MFA) is enabled with Tableau authentication, you are prompted to verify your identity using the verification you selected during the MFA registration process. After verifying your identity, you are redirected to your site.

Notes:

- If you are signing in to Tableau Cloud or registering for MFA for the first time, see [Register for multi-factor authentication](#).
- You must be running Tableau Desktop 2021.1 and later to use MFA with Tableau authentication.

3. If you have access to multiple sites, select the one you want to use.



Automatically keep Tableau Desktop connected to Tableau Server or Online

When you connect to Tableau Server or Tableau Cloud, Tableau Desktop keeps you signed in from session to session, if you don't sign out. Next time you launch Tableau Desktop, you are automatically signed in to your most recent server connection. You can easily switch to other available server and site connections.

You can see the server and site you are signed into, as well as who you are signed in as, in two places:

- The **Server** menu shows the server and site that you are signed in to. **Sign out** shows you are signed in as.

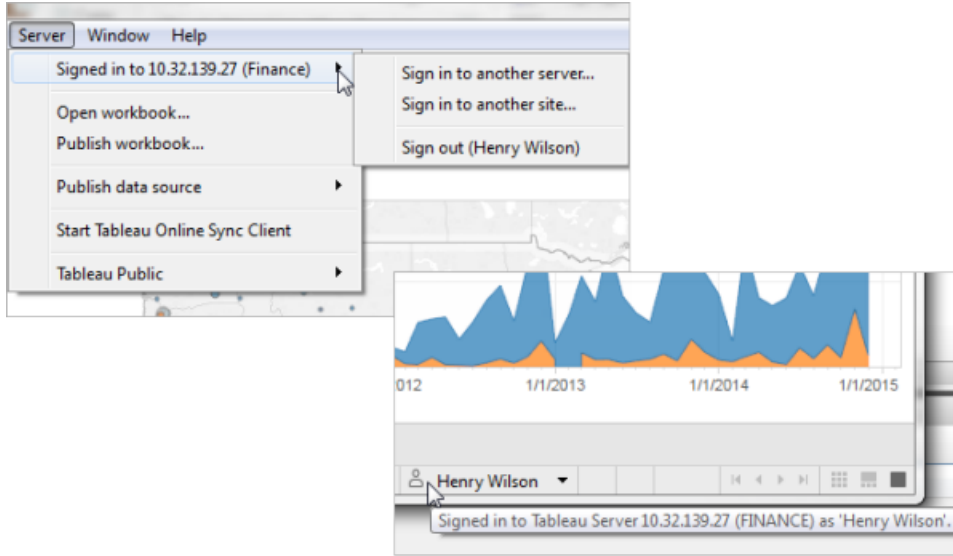

- The status bar also provides this information. Hover over the username to see the current server and site.

Switch servers, switch sites

To switch servers, on the **Server** menu, click **Sign in to another server**, and then enter the server name and your sign-in credentials.

If you have access to multiple sites, on the **Server** menu, click **Sign in to another site**. This option is only available for Tableau Server sites.

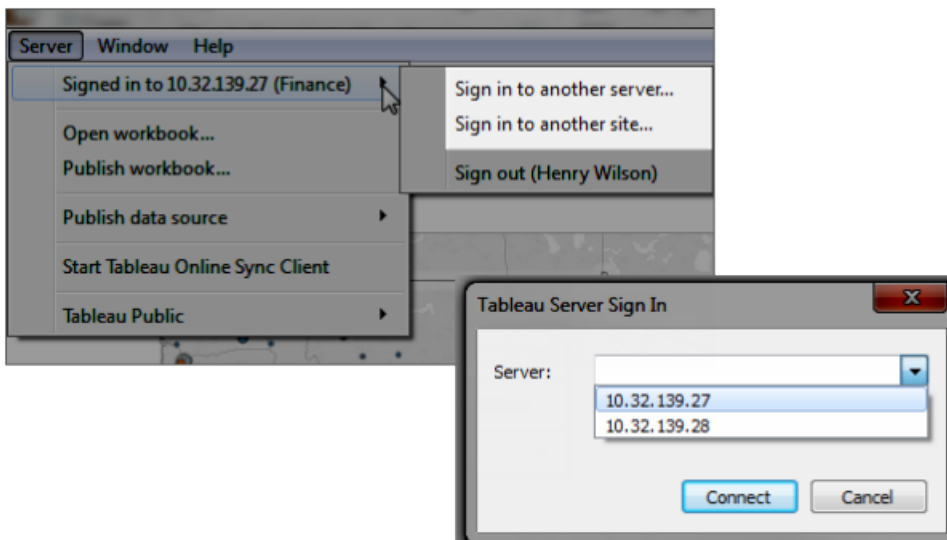

Sign out or clear all saved connections

When you sign in to a server and site, Tableau Desktop stores your credentials in a secure token that remembers your connection. After this token is in place, you can access the server directly, without having to sign in.

Click **Server > Sign out** to clear your sign-in credentials for the current connection. To remove all of your existing server connections, click **Help > Settings and performance > Clear saved server sign-ins**.

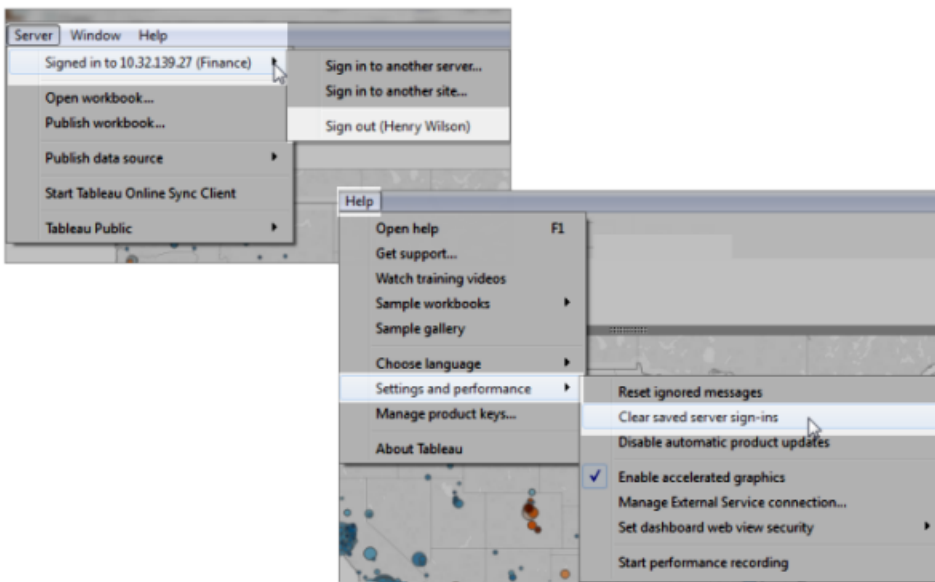

If you never want server sign-ins to be saved, a Tableau Server administrator can change the server settings to disallow connected clients. Be aware that this setting also affects other Tableau clients like Tableau Mobile. For more information, see [Authentication for Connected Devices](#) in the Tableau Server Help.

Switch user accounts from Tableau Desktop (Kerberos authentication only)

If your organization uses Tableau Desktop with Kerberos authentication and it doesn't succeed, you're prompted to provide a user name and password. To sign in as a different user for testing purposes, complete these steps:

1. On the Server menu, select **Switch User**.

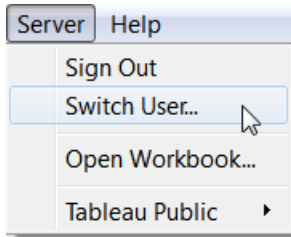

2. In the Tableau Server Sign In dialog box, provide the new user name and password.

To later sign in using your normal credentials, select **Server > Switch to Self**.

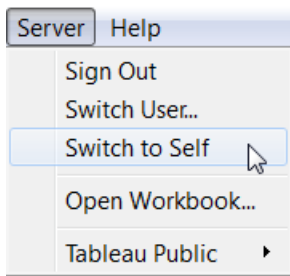

Sign in with another user account in a browser

If you are signed in to the wrong account, you can switch to another one.

1. Click **Sign Out** on the user menu in the upper-right corner of the page.

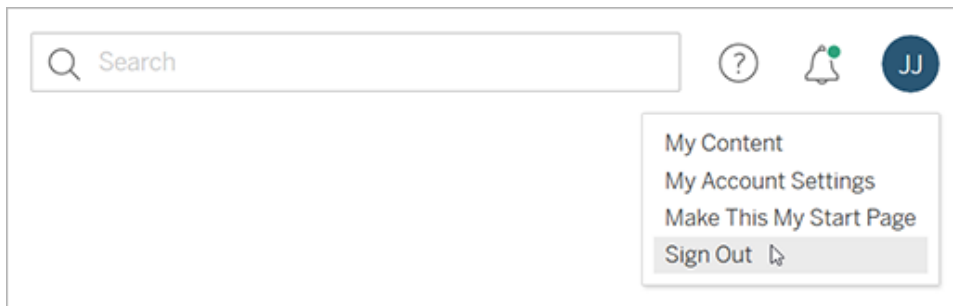

Note: If you do not see a **Sign Out** command on the Tableau Server user menu, you must use the sign-out interface provided by your organization's external identity provider (IdP). For more information, contact your administrator.

2. Type your user name and password, and then click **Sign In**



The image shows the Tableau sign-in interface. At the top left is the Tableau logo, which consists of a cluster of plus signs followed by the word "tableau" in a lowercase, sans-serif font. Below the logo are two input fields: the first contains the text "jjohnson" and the second contains seven asterisks. Below these fields is a prominent orange button with the text "Sign In" in white.

Sign in to a specific site in a browser (Tableau Server only)

If you are a member of multiple sites, you're prompted to select one when you sign in to the server. Either click a visible site name or search for a name to select from a list of matching sites.



The image shows the Tableau site selection interface. At the top left is the Tableau logo. Below it is the text "Select a Site". Underneath is a search input field with the placeholder text "Search for a site" and a magnifying glass icon. Below the search field is a list of site names: "Default" and "Finance". The "Default" site is highlighted with a light gray background.

The name of the current site is displayed on the site picker.

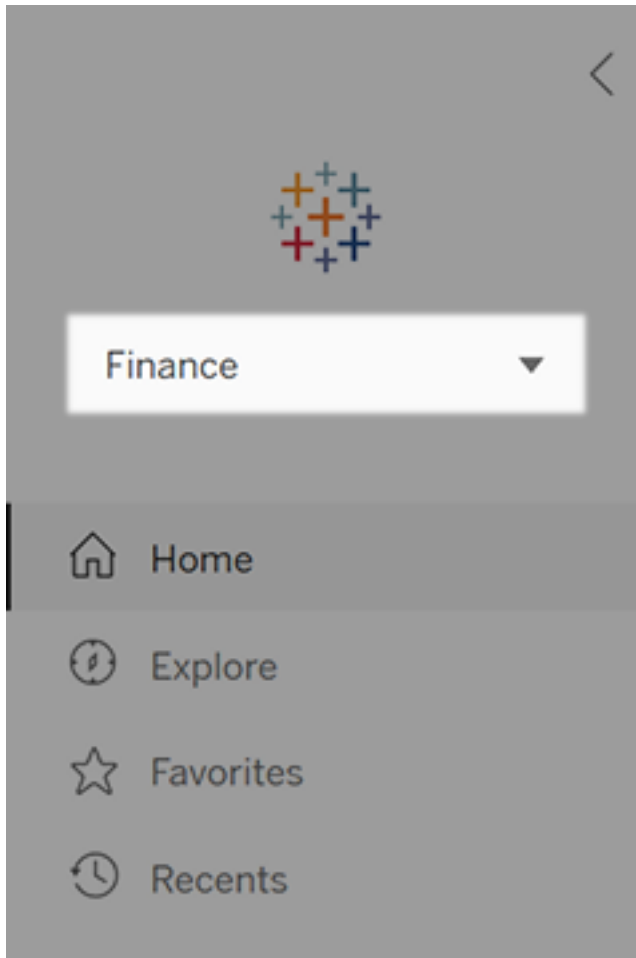

Choose the Right Chart Type for Your Data

What chart or graph works best for your data? In Tableau, form follows function. The visualization (or viz) you create depends on:

- The questions you are trying to ask
- The properties of your data
- How you want to present and communicate your insights to others

For example, showing the growth in sales each year requires a different visualization than showing the connection between discounted items and their profitability. Knowing what you need to show will help determine how you want to show it.

This topic presents nine different types of information that you can display with a visualization. This isn't a comprehensive list, and there are bound to be exceptions to these categories. With experience you will be able to more quickly assess what chart type you want to create. Because

Tableau is flexible, we encourage you to think outside the box. However, before you think outside the box, it's helpful to start with some common chart types.

Change over time

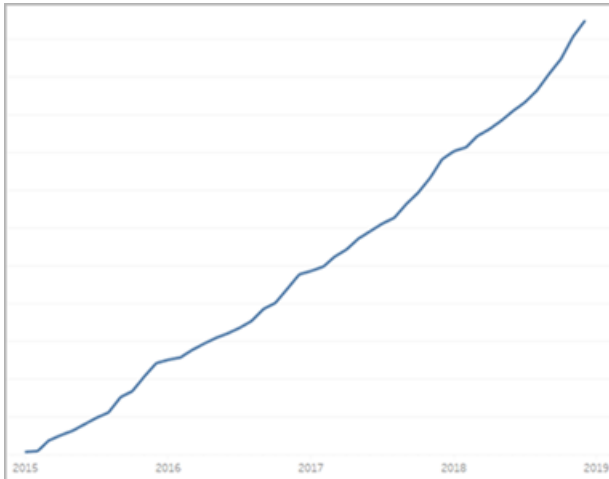

Related topics

- [Building Line Charts](#) on page 1526
- [Dates and Times](#) on page 1149
- [Continuous Dates](#) on page 1186

Showing a change over time for a measure is one of the fundamental categories of visualizations. There are many options for exploring change over time, including line charts, slope charts, and highlight tables.

To show change over time, you need to know the value you expect to change, and how to work with Date fields in Tableau.

What kind of question does this chart answer?

- How has this measure

changed in
the past
year?

- When did this measure change?
- How quickly has this measure changed?

More inspiration

- [Understand change over time with time-series analysis](#)
- [New Ways to Visualize Time](#)
- [Visualizing Time: Beyond the Line Chart](#)
- [Examples of Change Over Time](#)

Correlation

Sometimes you have two variables and are looking for the relationship

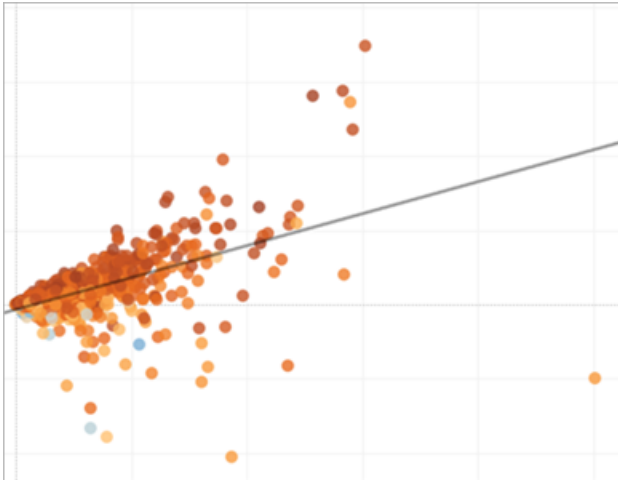

Related topics

- [Build a Scatter Plot](#) on page 1544
- [Create Heatmaps that Show Trends or Density in Tableau](#) on page 1800
- [Add Trend Lines to a Visualization](#) on page 2503

between them. For example, you may be looking for the relationship between classroom size and school graduation rate, or how much lung capacity relates to endurance. (But remember, correlation does not always equal causation.)

Correlation can be shown with scatter plots or highlight tables, and you can use Tableau's [analytics objects](#) to show the strength of the correlation.

What types of question can this chart answer?

- Are these two measures related? How strongly?

- Are some measures more related than others?
- How strongly related are these measures?

Magnitude

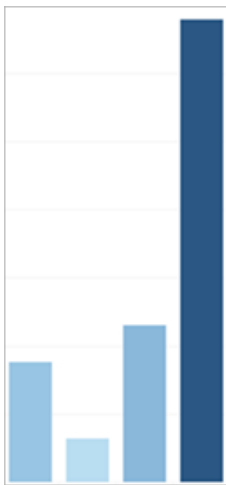

Related topics

- [Build a Bar Chart](#) on page 1475
- [Build a Packed Bubble Chart](#) on page 1534
- [Building Line Charts](#) on page 1526

Magnitude shows the relative size or value of two or more discrete items. If you are comparing sales for different regions, you are looking at magnitude.

Magnitude charts include bar charts, packed bubble charts, and line charts.

What types of question can this chart answer?

- Which of these dimen-

- Are there any exceptional dimensions?
- How large of a gap is there between the lowest and highest measure between these dimensions?

Deviation

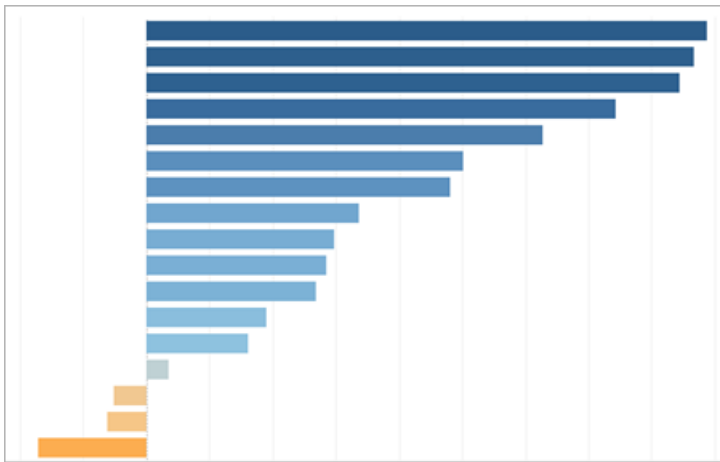

Deviation charts show how far a value varies from some baseline, such as the average or median. If you wanted to know which items had unusually high or low profit margins, you would use a deviation chart.

You can use bullet

Related topics

- [Build a Bar Chart](#) on page 1475
- [Build a Bullet Graph](#) on page 1492

- [Calculate Z-scores](#) on page 1575

charts, bar charts, and combination charts to show deviation. You can also find the statistical significance of the deviation using a Z-score.

What types of question can this chart answer?

- How far from the norm does this measure stray?
- How important are the deviations in this measure?
- Is there a pattern to the deviations?

Distribution

When you are trying to find the frequency of events within a

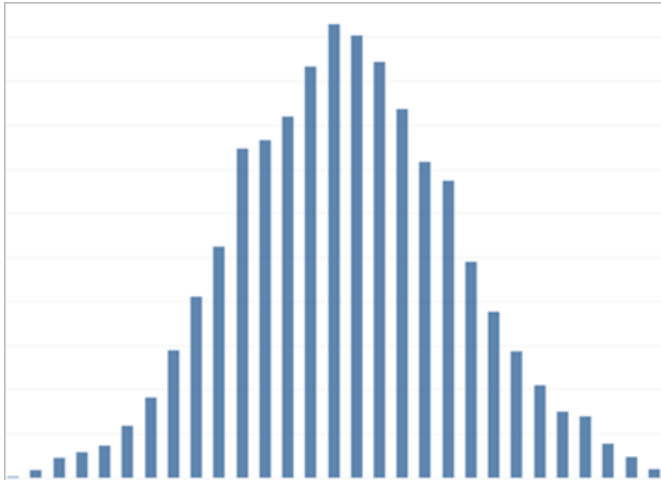

Related topics

- [Build a Histogram](#) on page 1518
- [Build a Box Plot](#) on page 1485
- [Create a Pareto Chart](#) on page 1581
- [Create a Population Pyramid](#) on page 1587

population, you are looking at the distribution. If you are showing the number of respondents to a survey by age, or the frequency of incoming calls by day, a distribution chart might be the best choice.

Distribution charts include histograms, population pyramids, Pareto charts, and box plots.

What types of question can this chart answer?

- Are events clustered around a certain probability?
- Which population group buys the most items?
- When are

the busiest
times in our
work day?

Ranking

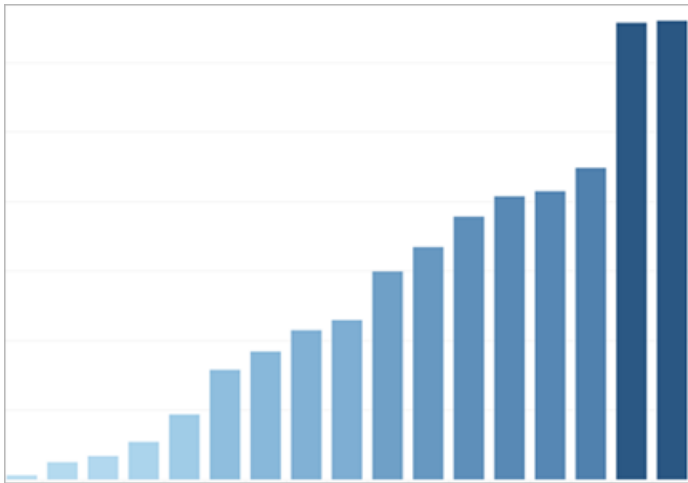

Related topics

- [Build a Bar Chart](#) on page 1475
- [Table Calculation Types](#) on page 2376
- [Sets for Top N and Others](#) on page 1113
- [Visualize Key Progress Indicators](#) on page 1577

Sometimes you not only want to depict the magnitude of some value, but also the relative ranking of all the members of your dimension. Showing the top ten sales people or demonstrating the under-performing states use a ranking chart.

Ranking charts are usually bar charts that integrate rank calculations, top n sets, or key progress indicators.

What types of question can this chart answer?

- How many people are

under-performing in the company?

- How much revenue is generated by our top ten customers?
- What is the value of our ten lowest revenue properties?

Part-to-Whole

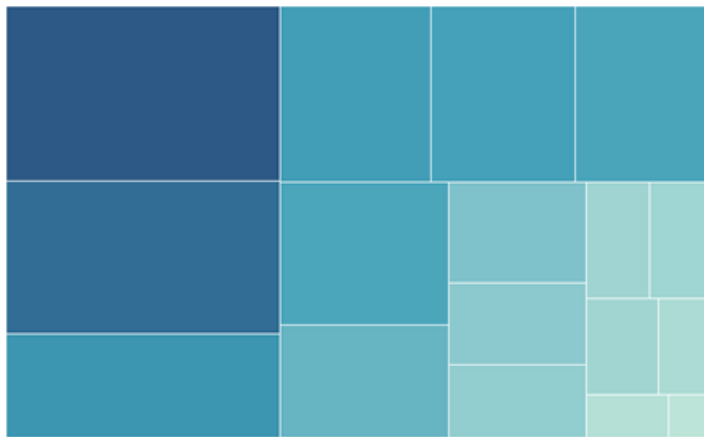

Part-to-Whole charts show how much of a whole an individual part takes up. For example, if you are showing how much each region contributes to overall sales, or how expensive each different shipping mode is for an individual product, you would use a part to whole chart.

Related topics

- [Build a Pie Chart](#) on page 1540
- [Build a Treemap](#) on page 1557
- [Create an Area Chart](#) on page 1473
- [Stack Marks](#) on page 1291

Part-to-Whole charts can be pie charts, area charts, stacked bar charts, or treemaps.

What types of question can this chart answer?

- How much does this value contribute to the total?
- How does the distribution of costs change each year?
- Do different items contribute different amounts to sales by region?

Spatial

Spatial charts can precise locations and geographical

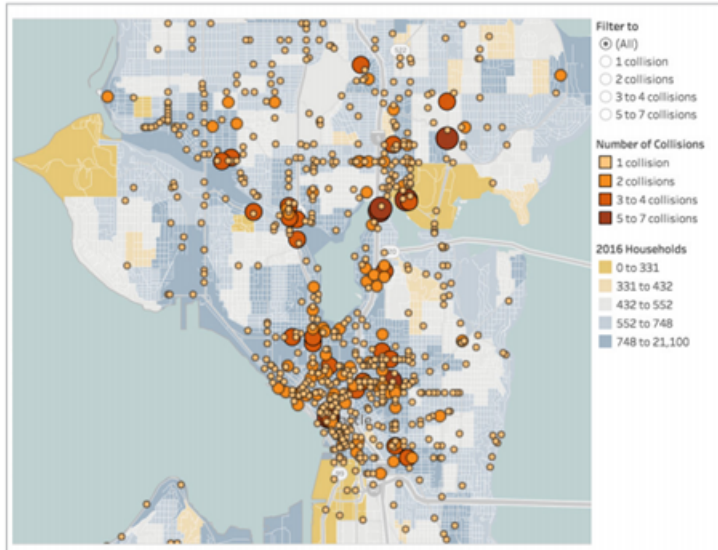

Related topics

- [Build a Simple Map](#) on page 1740
- [Create Maps that Show Quantitative Values in Tableau](#) on page 1773
- [Create Maps that Highlight Visual Clusters of Data in Tableau](#) on page 1779

patterns in your data. Showing the airport terminals with the most foot traffic or a map of all sales across the country are examples of spatial maps.

Spatial maps include filled maps, point distribution maps, symbol maps, and density maps.

What types of question can this chart answer?

- Which city has the highest sales?
- How far from distribution centers are our customers?
- How many people arrive at which gate?

Flow

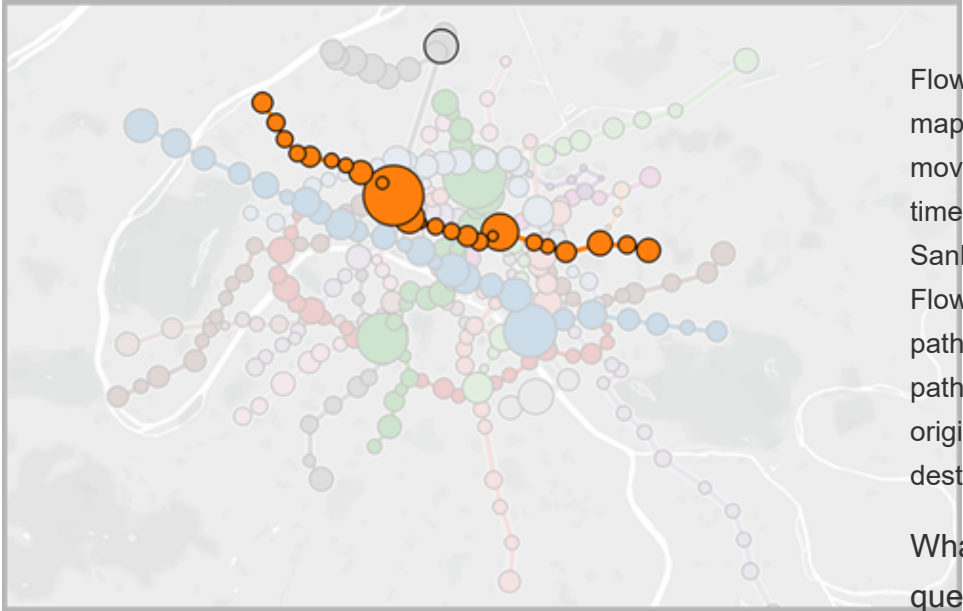

Flow charts can be maps that convey movement over time, such as Sankey diagrams. Flow maps include path over time and path between origin and destination charts.

What types of question can this chart answer?

Related topics

- [Create Maps that Show Paths Between Origins and Destinations in Tableau](#) on page 1806
- [Create Maps that Show a Path Over Time in Tableau](#) on page 1792

- What is the longest shipping route?
- How long are people lingering around gates?
- What are the bottlenecks to traffic in the city?

Related resources

For related content and examples of different types of visualizations you can create with Tableau, see:

- [Build Common Chart Types in Data Views](#) on page 1473 and [Build Advanced Chart Types](#) on page 1567 in Tableau help.
- [Which Chart or Graph is Right for You?](#) whitepaper on the Tableau website. Use your tableau.com account to sign in.
- [Visual Vocabulary](#) on Tableau Public by Tableau Visionary [Andy Kriebel](#) (also see [Andy's blog](#)).

Also see these free videos and presentations:

- Andy Cotgreave's [Best of the Tableau Web](#) and other blog posts on tableau.com.
- [Secrets of Visual Analytics](#) This four-part, on-demand webinar series introduces how to use Tableau for visual analytics. Use your tableau.com account to sign in.
- [Travel Tips for Your Visual Analysis Journey](#) (50 minutes) video presentation from Tableau Conference.

Tableau Workbook Performance Checklist

Before you start building your visualizations and dashboards, you will want to be aware of what choices might impact performance in your workbooks on Tableau Desktop, Tableau Cloud, and Tableau Server.

This checklist is intended to make you aware of things you will want to consider related to workbook performance. Remember that all environments are different and there is no simple cure for workbook performance. The items below are areas to explore. Any given item may not apply to your situation or be the cause of poor performance. Always test what helps in your specific case.

Learn more: For more in-depth and related information beyond this topic, see:

[Optimize Workbook Performance](#) on page 3041 topics in Tableau help

[Designing Efficient Workbooks](#) whitepaper on tableau.com

[Designing Efficient Workbooks](#) (1 hour) and [Best Practices for Dashboard Performance](#) (50 minutes) free, video presentations

[The Tableau Performance Optimization Flowchart](#) and [The Tableau Performance Checklist](#) in the [InterWorks blog](#).

General tips

This general list of considerations is a start in learning how to approach optimizing workbooks. It comes from the TL;DR page in the [Designing Efficient Workbooks](#) whitepaper.

- The cleaner your data is and the better it matches the structure of your questions, the faster your workbooks will run and the happier your life will be. Only connect to the data that you need for analysis.
- Extracts are a quick and easy way to make most workbooks run faster. If you don't need real-time data and aren't working over billions of rows of data, you should try them.
- The majority of slow dashboards are caused by poor design—in particular, too many charts on a single dashboard, or trying to show too much data at once. Keep it simple. Allow your users to incrementally drill down to details, rather than trying to show everything then filter (guided analysis).
- Don't work with data you don't need—both in terms of the fields you reference as well as the granularity of the records you return. Use filters, hide unused fields and aggregate.
- While reducing the data, make sure you use filters efficiently.
- Strings and dates are slow, numbers and Booleans are fast.
- There is no silver bullet for inefficient workbooks. Start by looking at the performance recorder to understand where the time is going. Long-running queries? Lots of queries? Slow calculations? Complex rendering? Use insights to focus your efforts in the right direction.
- Upgrading to the newest version may boost performance without needing anything else.
- If it is slow in the data source, it will be slow in Tableau Desktop. If it is slow in Tableau Desktop, it will (almost always) be slow in Tableau Server.
- Performance tuning is highly individualized to the context of your environment, data, analysis, and workbook. What works in one situation may not work in another--test and iterate to see what works in your specific case.

Data source and structure

- Prepare your data to match the structure of your analysis before you connect to it in Tableau Desktop. [Tableau Prep](#) is a helpful tool for getting your data ready.
- Enable support for [referential integrity](#).
- Index the tables in your relational database.
- Make sure database permissions support creating temp tables.
- Connect with native database drivers.

- Whenever possible, connect to an extract rather than a live data source.
- Limit the amount of data that you bring into Tableau to what is necessary for your analysis.
- Consider using aggregated extracts and extract filters.
- Optimize extracts and hide unused fields before creating an extract.
- Avoid using custom SQL.
- Identify when you should be joining, blending, or using a cross-database join.
- Keep joins as limited as possible. Consider using multiple data sources so each type of analysis is built off a well-designed join.
- Consider aggregating before blending.

Related topics and resources

- [Know Your Data at the Database Level](#) on page 3058
- [Test Your Data and Use Extracts](#) on page 3059
- [Designing Efficient Workbooks](#)

Building views and dashboards

- Keep it simple. Break massive workbooks up into separate files, and consider using fewer sheets on a dashboard.
- Reduce the number of marks in the view—only add the fields you need, and use filters judiciously.
- Turn off automatic updates when building a view. Set up multiple steps before asking Tableau to perform the actions.
- When possible, try to use the same level of detail on multiple sheets on a dashboard to enable query batching.
- Limit the number of filters used—use guided analytics and filter actions when possible.
- Use fixed-size dashboards. They don't have to be re-rendered for different window sizes.
- Custom geocoding can massively inflate the size of a workbook.

Related topics and resources

- [Design for Performance While You Build a View](#) on page 3062
- [Make Visualizations Faster](#) on page 3066
- [Turn off Automatic Updates to Boost Performance](#) on page 3074
- [Designing Efficient Workbooks](#)

Filtering

- Filtering is one of the most common causes of poorly performing workbooks and dashboards.
- Use Extract and Data Source filters to limit the amount of data being brought into Tableau.
- Filters are more efficient when the data source is indexed.
- Context filters are evaluated before other filters in the view and should be used to help force an order of operations, but they no longer help improve query performance.
- Be aware that using **Keep only** and **Exclude** to filter out discrete items can be performance heavy.
- Filtering on a categorical dimension value that summarizes many points—such as filtering a state instead of all the cities in that state—is more efficient.
- Filtering on a range of values is often faster than filtering on large itemized lists of discrete values.
- Cross-database filters can require multiple queries when values are updated. Enable the **Show Apply Button** option on filters to let users apply the filter after making their selections.
- The **Only Relevant Values** filter option creates a query each time the other filters are changed. For dashboards that use guided analytics, try using [Filter Actions](#) on page 1388 instead.
- Applying filters to multiple worksheets creates multiple queries.
- Enable the **Show Apply Button** option on filters. This lets you and your users click **Apply** to run a single query for multi-select filters.

Calculations

- Booleans and integers are faster than strings and dates.
- MIN and MAX functions perform better than AVG and ATTR.
- When possible, use native Tableau features—groups, sets, bins, custom date fields, combined fields, and aliases—instead of calculations.
- Use optimized functions like CONTAINS and DATEPARSE or MAKEDATE when possible, rather than more complicated manual calculations, especially with dates.
- COUNTD is one of the slowest functions types, avoid when possible.
- If a table calculation is performing badly, see if it can be expressed via a LOD expression, and vice versa.

Related topics and resources

- [Create Efficient Calculations](#) on page 3063
- [Designing Efficient Workbooks](#)

Other Suggestions

- Publishing to Tableau Server will not improve performance. Tune your workbook in Tableau Desktop first.
- Use the performance recorder to identify where to focus tuning efforts.
- Upgrade to the latest version of your Tableau product.

Related topics and resources

- [Record and Analyze Workbook Performance](#) on page 3068
- [Designing Efficient Workbooks](#)

Connect to and Prepare Data

Before you begin your analysis, you must connect to your data and then set up the data source. There are many optional configurations that you can make on the Data Source page that Tableau uses to interpret and interact with your data.

The topics in this section describe how to connect to your data and use these configurations in order to optimize your data source for analysis.

Connect to Your Data

Before you can build a view and analyze your data, you must first connect Tableau to your data. Tableau supports connecting to a wide variety of data, stored in a variety of places. For example, your data might be stored on your computer in a spreadsheet or a text file, or in a big data, relational, or cube (multidimensional) database on a server in your enterprise. Or, you might connect to public domain data available on the web such as U.S. Census Bureau information, or to a cloud database source, such as Google Analytics, Amazon Redshift, or Salesforce.

Starting in 2019.3, Tableau Catalog is available as part of the Data Management offering for Tableau Server and Tableau Cloud. When Tableau Catalog is enabled in your environment, in addition to connecting to published data sources, you can connect to databases and tables from **Tableau Server** on the **Connect** pane in Tableau Desktop. For more information about Tableau Catalog, see "About Tableau Catalog" in the [Tableau Server](#) or [Tableau Cloud](#) Help. Starting in 2021.4, Data Management includes virtual connections, a central access point to data. For more information, see "About Virtual Connections and Data Policies" in the [Tableau Server](#) or [Tableau Cloud](#) help.

Tableau Desktop

When you launch Tableau Desktop, the data connectors that are available to you are listed on the **Connect** pane, which is the left pane on the **Start** page. Under **Search for Data**, select **Tableau Server** to find data using Tableau Server or Tableau Cloud. File types are listed next, then common server types, or servers that you've recently connected to. Click **More** to see the complete list of data connectors you can use.

For supported files and databases, Tableau provides native connectors that are built for and optimized for those types of data. If your file or database type is listed under **Connect**, use this native connector to connect to your data. If your file or database type isn't listed, you might have

the option of creating your own connection using **Other Databases (JDBC)**, **Other Databases (ODBC)**, a **Web Data Connector**, or a **Connector Plugin** built using the Tableau Connector SDK. Tableau provides limited support for connections that you create using these options.

The data connectors supported by your copy of Tableau Desktop are determined by the version you purchased. For more information, see the list of [data connectors](#) on the Tableau website. After you've connected to data, you can save the connections to have them show up under the **Saved data sources** section on the **Connect** pane.

You supply different information for each data connection that you want to make. For example, for most data connections, you'll need to supply a server name and your sign-in information. With some data connections, you can [Run Initial SQL on page 591](#) statements, and SSL-enabled servers require that you select the **Require SSL** check box when you connect. The following sections discuss the specific information you must provide for each type of data you want to connect to.

Tip: You can quickly create a data source in Tableau by copying and pasting data using the clipboard. For more information, see [Create a Data Source or Add a New Connection with Clipboard Data on page 862](#).

Tableau Server and Tableau Cloud web authoring

Sign in to your Tableau site and select **New > Create Workbook** on the Home page to open the **Connect to Data** page. The tabs that you see on the pages depend on the product you have.

Tableau Server

On Tableau Server, select from the following tabs to connect to data:

- **On this site.** Browse to or search for published data sources. If you have Data Management, you can also connect to data using a virtual connection. If you have Data Management with Tableau Catalog enabled, you can additionally connect to external assets like databases, files, and tables.
- **Files.** Upload Excel or text-based data sources (.xlsx, .csv, .tsv) directly in your browser.
- **Connectors.** Connect to data housed in a cloud database or on a server in your enterprise.

For more information about connecting to data, see [Creators: Connect to Data on the Web on page 3213](#).

Tableau Cloud

On Tableau Cloud, select from the following tabs to connect to data:

- **On this site.** Browse to or search for published data sources. If you have Data Management, you can also connect to data using a virtual connection. If you have Data Management with Tableau Catalog enabled, you can additionally connect to external assets like databases, files, and tables.
- **Files.** Upload Excel or text-based data sources (.xlsx, .csv, .tsv) directly in your browser.
- **Connectors.** Connect to data housed in a cloud database or on a server in your enterprise.
- **Dashboard Starters.** Use to author and analyze data from Oracle Eloqua, Salesforce, ServiceNow ITSM, and QuickBooks Online.

For more information about connecting to data, see [Creators: Connect to Data on the Web](#) on page 3213.

The data connectors supported by your Tableau site are determined by your site's server and your license level. For more information, see [What Can I Do with a Tableau Site?](#) on page 3178

After you've connected to data, you can save the connections to have them show up in the **Data Sources** section of your site.

Request a new connector

If Tableau doesn't have a native (built-in) connector for your data, consider requesting one on Tableau Community. Use [Ideas](#) on Community to search for your connector to see if it's been requested, and if it has been, vote for it. If it's not listed, add it. Tableau regularly reviews Ideas on Community to help determine what features should be added to the product.

Supported Connectors

Follow the link below for information on how to connect to your specific data. Connectors are listed in the order that they appear on the **Connect** pane.

Excel

This article describes how to connect Tableau to Microsoft Excel file data and set up the data source. The Excel connector is for .xls and .xlsx files.

To connect to a .csv file, use the Text file connector.

Make the connection and set up the data source

1. After you open Tableau, under **Connect**, click **Microsoft Excel**.
2. Select the Excel workbook you want to connect to, and then click **Open**.
3. On the Data Source page, do the following:
 1. (Optional) Select the default data source name at the top of the page, and then enter a unique data source name for use in Tableau. For example, use a data source naming convention that helps other users of the data source figure out which data source to connect to.
 2. If your Excel file has one table, click the sheet tab to start your analysis.

Use custom SQL to connect to a specific query rather than the entire data source. For more information, see [Connect to a Custom SQL Query on page 863](#).

You can also connect to a named range or an Excel table (also known as an Excel list) in the same way you connect to a worksheet. Both the named range and Excel table function as a table in Tableau. When you connect to a named range or Excel table in Tableau, an icon appears next to the sheet in the Data Source page.

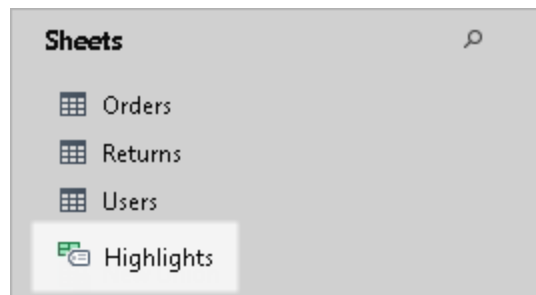

You can connect to multiple Excel workbooks at the same time as long as each connection in the data source has a unique name.

Note: Tableau does not support pivot tables in Excel.

Microsoft Excel data source example

The following is an example of a Microsoft Excel data source.

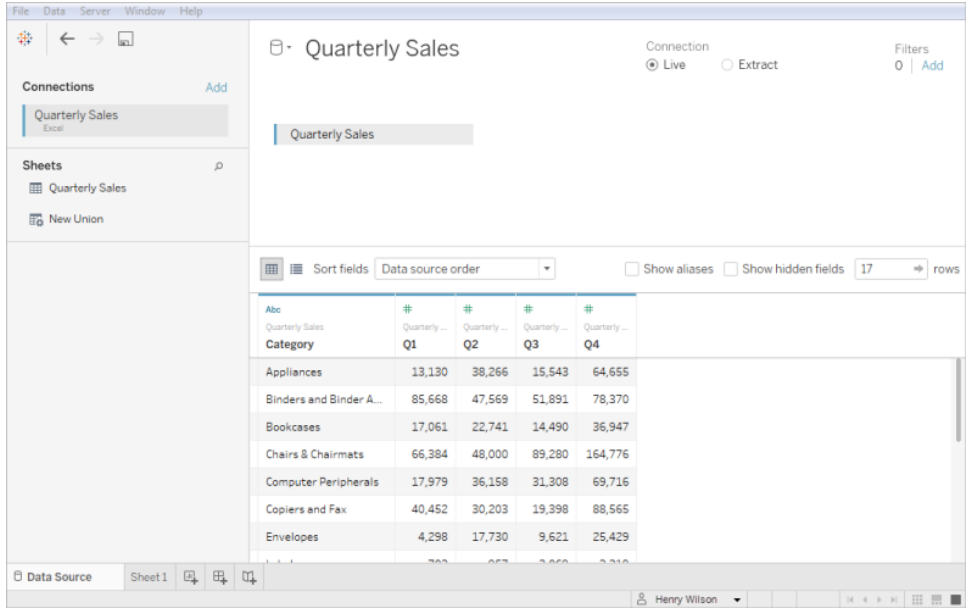

Get more data

Get more data into your data source by adding more tables or connecting to data in a different database.

- **Add more data from the current file:** From the left pane, drag additional tables to the canvas.
- **Add more data from different databases:** In the left pane, click **Add** next to Connections. This lets you set up a connection to another database or file.

The default method for combining multiple tables in Tableau is to use relationships. For more information, see [Use Relationships for Multi-table Data Analysis on page 637](#). You can also join or union tables. For more information, see [Plan the Data Source on page 596](#).

Set Excel table options

Excel table options are scoped to the connection. To change the table options, on the canvas, click the table drop-down arrow and then specify whether the data includes field names in the first row. If so, these names will become the field names in Tableau. If field names are not included, Tableau generates them automatically. You can rename the fields later.

Use Data Interpreter to clean your data

If Tableau detects that it can help optimize your data source for analysis, it prompts you to use Data Interpreter. Data Interpreter can detect sub-tables that you can use and remove unique

formatting that might cause problems later on in your analysis. For more information, see [Clean Data from Excel, CSV, PDF, and Google Sheets with Data Interpreter](#) on page 897.

About .tde and .hyper files

You might notice .tde or .hyper files when navigating your computer's directory. When you create a Tableau data source that connects to your data, Tableau creates a .tde or .hyper file. This file, also known as a shadow extract, is used to help improve the speed your data source loads in Tableau Desktop. Although a shadow extract contains underlying data and other information similar to the standard Tableau extract, a shadow extract is saved in a different format and can't be used to recover your data.

Note: .tde files are no longer supported for Tableau versions beyond 2024.2. All extracts are now in .hyper format.

Changes to the way values are computed

You might see differences between the data and the marks in your view, such as with case sensitivity. For sorting and comparing purposes, values are case insensitive. However, values are case sensitive for storing purposes. This becomes evident when values are displayed on the data source page.

For example, suppose you have a column in your data that contains the values "House", "HOUSE", and "houSe".

If you need to maintain case sensitivity for your data when performing a join, you can enable the **Maintain Character Case (Excel)** option from the Data menu on the Data Source tab.

See also

- [Set Up Data Sources](#) on page 596 – Add more data to this data source or prepare your data before you analyze it.
- [Build Charts and Analyze Data](#) on page 1005 – Begin your data analysis.

Tips for Working with Your Data

Data can be organized in various ways. To take advantage of Tableau Desktop, Tableau recommends that you connect to data that is formatted for analysis. Specifically, data that is:

- as granular as possible rather than aggregated (such as daily weather data rather than monthly averages)

- organized like a database table (rather than a column-oriented table such as a crosstab)
- stripped of extraneous information (anything that's not the data and its headers)

When data is structured for analysis, it's much easier to ask and answer questions. Tableau can aggregate raw data to the desired level, rather than being restricted by the aggregations already present in the data. Groups and hierarchies can be created as needed, and calculations can be performed in the flow of analysis.

Tableau Desktop has basic cleaning options and the Data Interpreter. Tableau Prep may be necessary for more complex formatting issues.

The following Tableau Desktop-specific sections highlight and provide suggestions for resolving some common formatting or issues that can make analyzing your data difficult.

Pivot data in crosstab format

When data is formatted as in crosstab format, the table is column oriented. In a column oriented table, the variables are stored as column headers. However, Tableau Desktop is optimized for row oriented data. In a row-oriented table, the variables are stored in the row values.

For example, suppose you have column-oriented table, which shows math, science, and history scores for grade school students.

ID	Gender	School	Math	Science	History
1	M	West	90	80	80
2	F	South	50	50	50
3	M	Central	50	80	80

Tableau Desktop is optimized to connect to row-oriented tables, where math, science, and history values are organized under a column called "Subject" and the scores for each student are organized under a column called "Score." You can pivot the columns in the rows, by manually editing your Excel data. Alternatively, connect to your Excel data from Desktop and then use the pivot option. For more information about the pivot option, see [Pivot Data from Columns to Rows on page 892](#).

ID	Gender		School	Subject	Score
1	M		West	Math	90
1	M		West	Science	80
1	M		West	History	80
2	F		South	Math	50
2	F		South	Science	50
2	F		South	History	50
3	M		Central	Math	50
3	M		Central	Science	80
3	M		Central	History	80

Remove pre-aggregated data

Data can often come pre-aggregated. That is, data can contain sums, averages, medians, etc. A common example of pre-aggregated data comes in the form of subtotals and grand totals.

Subtotals and grand totals data are computed from the raw data, but is not part of raw data itself.

For example, suppose you have a table that contains a row of subtotals information.

ID	Gender	School	Math	Science	History
1	M	West	90	80	80
2	F	South	50	50	50
3	M	Central	50	80	80
4	M	Central	100	90	80
5	F	West	90	100	80
		Subtotals	380	400	370

In this case, pre-aggregated data needs to be removed. To use subtotals and grand totals in your analysis, manually remove this type of information from your table. Then, connect to your Excel data from Desktop and calculate subtotals and totals using the totals option. For more information, see [Show Totals in a Visualization on page 1354](#). Alternatively, connect to your Excel data from Desktop, turn on Data Interpreter, and then use the totals option. For more information, see [Clean Data from Excel, CSV, PDF, and Google Sheets with Data Interpreter on page 897](#).

ID	Gender	School	Math	Science	History
1	M	West	90	80	80
2	F	South	50	50	50
3	M	Central	50	80	80
4	M	Central	100	90	80
5	F	West	90	100	80
Subtotals			380	400	370

Remove or exclude introductory text

Excel data that is delivered as a report can contain titles or blocks of introductory text. Because Desktop expects either column headers or row values in the first row of a table, this information can cause problems during your analysis.

For example, suppose you have a table that contains a report title and date.

Excel Report						
January, 2017						
	ID	Gender	School	Math	Science	History
	1	M	West	90	80	80
	2	F	South	50	50	50
	3	M	Central	50	80	80
	4	M	Central	100	90	80
	5	F	West	90	100	80

In this case, the title and date information needs to be removed. To use a title and date for a report, do one of the following:

- Manually remove this information from your Excel data. Then connect to your Excel data from Desktop and add a report title using the title option. For more information, see [Format Individual Parts of the View on page 2993](#).
- Connect to your Excel data from Desktop, turn on Data Interpreter, and then use the title option. For more information, see [Clean Data from Excel, CSV, PDF, and Google Sheets with Data Interpreter on page 897](#).
- If you cannot remove this information from your Excel data, create a named range and connect to the named range from Desktop. For more information, see [Excel on page 221](#).

Excel Report January, 2017						
	ID	Gender	School	Math	Science	History
	1	M	West	90	80	80
	2	F	South	50	50	50
	3	M	Central	50	80	80
	4	M	Central	100	90	80
	5	F	West	90	100	80

Flatten hierarchical headers to a single row

In general, Tableau Desktop expects only the first row in your Excel data to contain column headers. Data that contains multiple layers of column headers can cause problems during your analysis.

For example, suppose you have a table that contains one major header and multiple sub-headers.

California					
ID	Gender	School	Math	Science	History
1	M	West	90	80	80
2	F	South	50	50	50
3	M	Central	50	80	80
4	M	Central	100	90	80
5	F	West	90	100	80

In this case, the hierarchy of headers must be flattened or removed. To do this, you can manually create a new column for each header in the hierarchy directly in your Excel data. Alternatively, connect to your Excel data from Tableau Desktop and then turn on Data Interpreter. Verify that your headers are flattened correctly. For more information about Data Interpreter, see [Clean Data from Excel, CSV, PDF, and Google Sheets with Data Interpreter](#) on page 897.

ID	State	Gender	School	Math	Science	History
1	California	M	West	90	80	80
2	California	F	South	50	50	50
3	California	M	Central	50	80	80
4	California	M	Central	100	90	80
5	California	F	West	90	100	80

Make sure there are no blank cells

If you create new columns for your hierarchical headers, make sure that each cell in the new columns contains values.

ID	State	Gender	School	Math	Science	History
1	California	M	West	90	80	80
2		F	South	50	50	50
3		M	Central	50	80	80
4		M	Central	100	90	80
5		F	West	90	100	80
6	Oregon	M	North	70	80	100
7		F	East	80	80	100
8		F	West	50	80	80
9		F	West	100	80	100
10		M	West	80	80	90

While you might repeat the same value for each row, it's important that each row contains the data that associates it with the data that was stored in the hierarchical header. You must manually remove blank cells from your Excel data.

ID	State	Gender	School	Math	Science	History
1	California	M	West	90	80	80
2	California	F	South	50	50	50
3	California	M	Central	50	80	80
4	California	M	Central	100	90	80
5	California	F	West	90	100	80
6	Oregon	M	North	70	80	100
7	Oregon	F	East	80	80	100
8	Oregon	F	West	50	80	80
9	Oregon	F	West	100	80	100
10	Oregon	M	West	80	80	90

Remove blank rows

Make sure that there are no blank rows in your data. To fix blank rows, you must remove the blank rows from your Excel data.

ID	Gender	School	Math	Science	History
1	M	West	90	80	80
2	F	South	50	50	50
3	M	Central	50	80	80
4	M	Central	100	90	80
5	F	West	90	100	80
22	M	North	70	80	100
23	F	East	80	80	100
24	F	West	50	80	80
25	F	West	100	80	100
26	M	West	80	80	90

Add missing headers

Make sure that there are no missing column headers. To fix missing headers, you must manually add the missing headers directly to your Excel data.

		Gender	School	Math	Science	History
6	Oregon	M	North	70	80	100
7	Oregon	F	East	80	80	100
8	Oregon	F	West	50	80	80
9	Oregon	F	West	100	80	100
10	Oregon	M	West	80	80	90

Text File

This article describes how to connect Tableau to text file data and set up the data source. Tableau connects to delimited text files (*.txt, *.csv, *.tab, *.tsv).

Make the connection and set up the data source

1. After you open Tableau, under **Connect**, click **Text File**.
2. Select the file you want to connect to, and then click **Open**.

NOTE: Beginning with Tableau 2020.2, legacy Excel and Text connections are no longer supported. See the [Legacy Connection Alternatives](#) document in Tableau Community for alternatives to using the legacy connection.

3. On the data source page, do the following:
 - a. (Optional) Select the default data source name at the top of the page, and then enter a unique data source name for use in Tableau. For example, use a data source naming convention that helps other users of the data source figure out which data source to connect to. The default name is automatically generated based on the file name.
 - b. Click the sheet tab to start your analysis.

Use custom SQL to connect to a specific query rather than the entire data source. For more information, see [Connect to a Custom SQL Query on page 863](#).

Note: For text files, custom SQL is available only when using the legacy connection or in workbooks that were created before Tableau Desktop 8.2.

Text file data source example

Here is an example of a text file data source:

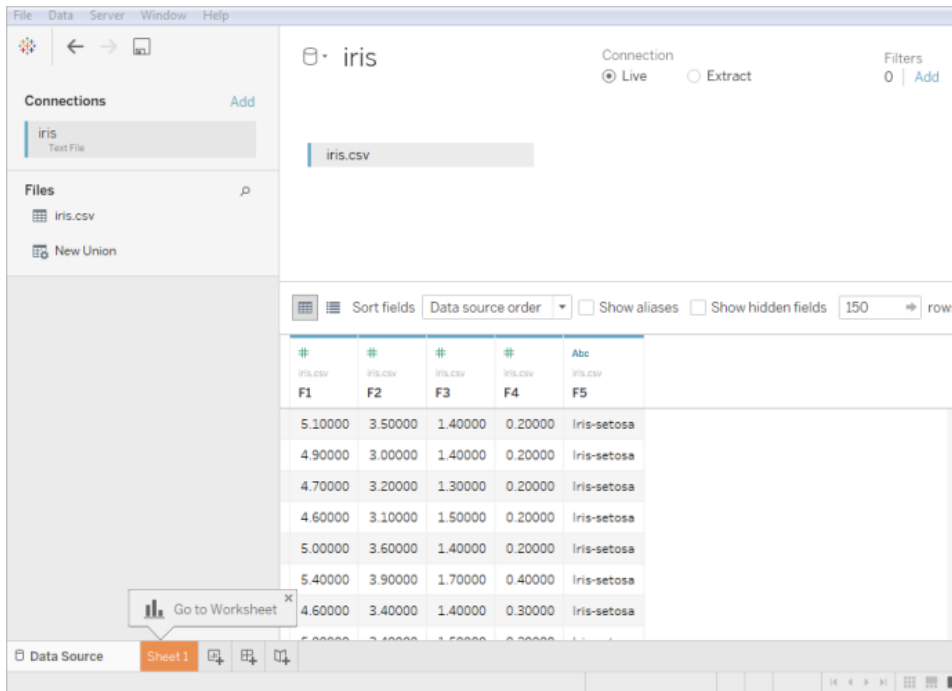

Optional settings

You can set the following options before building the view.

Get more data

Get more data into your data source by adding more tables or connecting to data in a different database.

- **Add more data from the current file:** From the left pane, drag additional tables to the canvas to combine data using a join or union. For more information, see [Join Your Data on page 791](#) or [Union Your Data on page 847](#).
- **Add more data from different databases:** In the left pane, click **Add** next to Connections. For more information, see [Join Your Data on page 791](#).

If a connector you want is not listed in the left pane, select **Data > New Data Source** to add a new data source. For more information, see [Blend Your Data on page 816](#).

Clean your data with Data Interpreter

If Tableau detects that it can help optimize your data source for analysis, it prompts you to use Data Interpreter. Data Interpreter can detect sub-tables that you can use and remove unique formatting that might cause problems later on in your analysis. For more information, see [Clean Data from Excel, CSV, PDF, and Google Sheets with Data Interpreter on page 897](#).

Set text file options

On the canvas, click the table drop-down arrow and then select whether the first row contains column names. This option is selected by default. Alternatively, you can have Tableau generate names when you connect. These names can be changed later. You can also select **Text file properties** to specify the following:

- Select the character that is used to separate the columns. Select from the list of characters or select **Other** to type in a custom character.
- Select the text qualifier that encloses values in the text file.
- Select a character set that describes the text file encoding. The available encodings are based on the operating system you are using. For example, on Windows, ANSI is listed as windows-1252 and OEM is listed as 437.

Note: In workbooks created prior to Tableau Desktop 8.2 or that use the legacy connection, you can select ANSI, OEM, UTF-8, UTF-16, or Other. When you select Other, you must specify the character set in the provided text field. This value is verified when the connection is attempted.

- Select the locale by which the file should be parsed. This option tells Tableau which decimal and thousands separator to use.

Review the data, pivot, split, and create calculations

The first 1,000 rows of the data in the data source are automatically displayed below the canvas in the data grid. If you add tables, remove tables, or make changes to the join conditions, the data grid updates with your changes. You can also do the following in the data grid:

- Change the data type or geographical role of a column by clicking the data type icon.
- Hide a field by clicking the column drop-down arrow and selecting **Hide**.
- Rename a field by double-clicking the field name.
- Reset a field name by clicking the column drop-down arrow and selecting **Reset Name**.
- Sort fields in both the data grid and metadata grid by selecting a sort option from the **Sort fields** drop-down list.
- Sort rows in the data grid by clicking the sort button next to the column name.
- Pivot fields to transform data in a crosstab format into a columnar format. This is only available for non-legacy connection types. For more information, see [Pivot Data from Columns to Rows on page 892](#).
- Split a string field into multiple fields. This is only available for non-legacy connection types. For more information, see [Split a Field into Multiple Fields on page 905](#).
- Create new calculations based on existing field in the Tableau data source. Click the column drop-down arrow and select **Create Calculated Field**.
- Copy values in the grid by selecting the values and then pressing Ctrl+C (Command-C on a Mac). Alternatively, to copy values in the metadata grid, select the values, right-click (Control-click on a Mac), and then select **Copy**.

Examine the data source structure and perform management tasks

Use the metadata area to quickly examine the general structure of the Tableau data source and its fields. If you are working with a particularly large data source, use the metadata area to perform routine data management tasks such as hide multiple fields at once or quickly rename or reset fields.

Connect live or use an extract

At the top of the Data Source page, select **Live** or **Extract** mode. If you choose to create an extract, the **Edit** link displays. Click **Edit** to set up filters that define a subset of the data that you

want to include in the extract. For more information, see [Extract Your Data on page 919](#).

Add data source filters

At the top of the data source page, click **Add** to add data source filters to control what data is used in included in the data source and therefore restrict the visibility and use of the fields in the data source.

Best practices

Collect files in a single directory

Collect all relevant text files for a multi-table connection in a single directory, with nothing else in that directory, so that users cannot inadvertently select a file that is not appropriate for the connection.

Text file column width and size considerations

If the text file contains columns that are more than 254 characters wide, Tableau cannot use these fields for workbooks that were created before Tableau Desktop 8.2 or that use the legacy connection. Either remove the columns, modify them to fit within 254 characters prior to connecting in Tableau, or upgrade the text file data source.

Large text files often perform poorly as a data source, because the queries can take a long time.

About .tde and .hyper files

You might notice .tde or .hyper files when navigating your computer's directory. When you create a Tableau data source that connects to your data, Tableau creates a .tde or .hyper file. This file, also known as a shadow extract, is used to help improve the speed your data source loads in Tableau Desktop. Although a shadow extract contains underlying data and other information similar to the standard Tableau extract, a shadow extract is saved in a different format and can't be used to recover your data.

Note: .tde files are no longer supported for Tableau versions beyond 2024.2. All extracts are now in .hyper format.

See also

- [Set Up Data Sources on page 596](#) – Add more data to this data source or prepare your data before you analyze it.

- [Build Charts and Analyze Data on page 1005](#) – Begin your data analysis.

Microsoft Access

This article describes how to connect Tableau to a Microsoft Access file (*.mdb, *.accdb) and set up the data source. Tableau supports all Access data types except OLE Object and Hyperlink.

Before you begin

Before you begin, gather this connection information:

- Access file name.
- If the file is password protected, you need the database password.
- If the file has workgroup security, you need workgroup security credentials:
 - Workgroup file name
 - User
 - Password

Use this connector with Tableau Desktop on a Windows computer.

Driver required

This connector requires a driver to talk to the database. If the driver is not installed on your computer, Tableau displays a message in the connection dialog box with a link to the [Driver Download](#) page where you can find driver links and installation instructions.

Make the connection and set up the data source

1. Start Tableau and under **Connect**, select **Microsoft Access**, select the Access file that you want to connect to, and then select **Sign In**.
 - Password protected - If the Access file is password protected, select **Database Password**, and then enter the password.
 - Workgroup security - If the Access file is protected by workgroup security, select **Workgroup Security**, and then enter the **Workgroup File** name, **User**, and **Password** into the corresponding text fields.
2. On the data source page, do the following:
 - a. (Optional) Select the default data source name at the top of the page, and then enter a unique data source name for use in Tableau. For example, use a data source

naming convention that helps other users of the data source figure out which data source to connect to. The default name is automatically generated based on the file name.

- b. Drag a table to the canvas. You can drag a table or query.
- c. Select the sheet tab to start your analysis.

Use custom SQL to connect to a specific query rather than the entire data source. For more information, see [Connect to a Custom SQL Query on page 863](#).

Note: If the Access file contains columns that are more than 254 characters wide, Tableau can't use these fields. Either remove the columns from the table or modify them to fit within 254 characters prior to connecting with Tableau.

See also

- [Set Up Data Sources on page 596](#) – Add more data to this data source or prepare your data before you analyze it.
- [Build Charts and Analyze Data on page 1005](#) – Begin your data analysis.

JSON File

This article describes how to connect Tableau to a local JSON file and set up the data source.

Make the connection and set up the data source

1. Start Tableau and under **Connect**, select **JSON File**. Then do the following:
 - a. Select the file you want to connect to, and then select **Open**.
 - b. In the Select Schema Levels dialog box, select the schema levels you want to view and analyze in Tableau, and then select **OK**. For more information, see [Select schema levels on the facing page](#).
2. On the data source page, do the following:
 - a. (Optional) Select the default data source name at the top of the page, and then enter a unique data source name for use in Tableau. For example, use a data source naming convention that helps other users of the data source figure out

which data source to connect to.

- b. Select the sheet tab to start your analysis.

JSON file data source example

Here is an example of a JSON file as a data source using Tableau Desktop on a Windows computer:

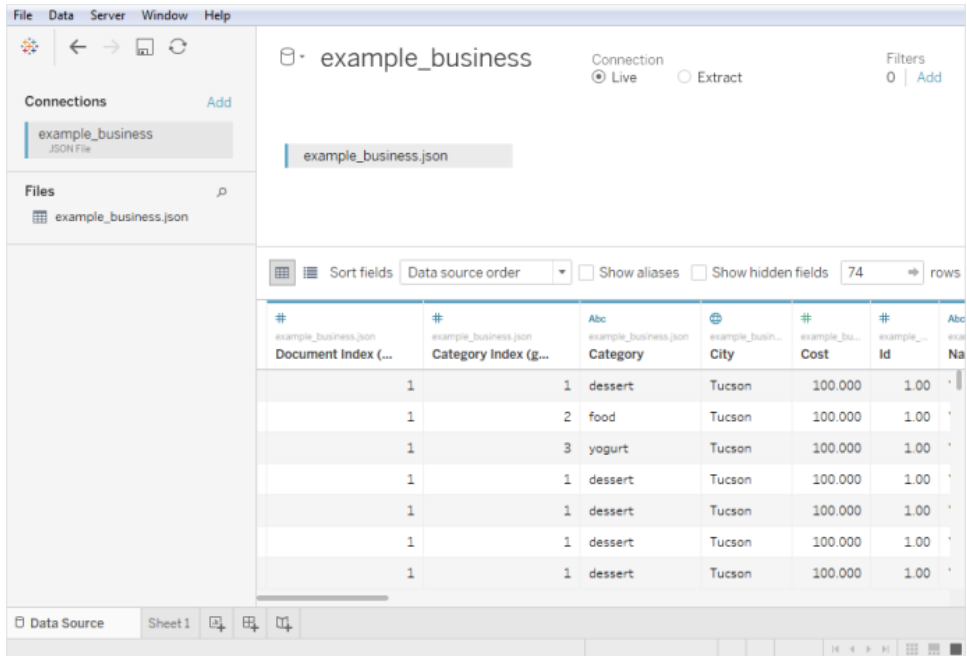

Select schema levels

When you connect Tableau to a JSON file, Tableau scans the data in the first 10,000 rows of the JSON file and infers the schema from that process. Tableau flattens the data using this inferred schema. The JSON file schema levels are listed in the Select Schema Levels dialog box. In Tableau Desktop, if your JSON file has more than 10,000 rows, you can use the "Scan Entire Document" option to create a schema.

Note: The "Scan Entire Document" option displays only for JSON files with more than 10,000 rows. It is not available on the web.

The schema levels that you select in the dialog box determine which dimensions and measures are available for you to view and analyze in Tableau. They also determine which data is published.

Note: When you publish a workbook to the web, any schema updates will not be available to the web version of the viz and may cause errors if the viz is subsequently refreshed

If you select a child schema level, the parent level is also selected.

For example, here's a snippet of a JSON file: The JSON file generates these schema levels:

```
{
  "quiz": {
    "sport": {
      "q1": {
        "question": "Which one is correct?",
        "options": [
          "New York Bulls",
          "Los Angeles Kings",
          "Golden State Warriros",
          "Huston Rocket"
        ],
        "answer": "Huston Rocket"
      },
    },
  },
  "maths": {
    "q1": {
      "question": "5 + 7 = ?",
      "options": [
        "10",
        "11",
        "12",
        "13"
      ],
      "answer": "12"
    },
    "q2": {
      "question": "12 - 8 = ?",
      "options": [
        "1",
        "2",
        "3",
        "4"
      ],
      "answer": "4"
    }
  }
}
```

Select Schema Levels

The schema levels you select determine which dimensions and measures are available for analysis in the worksheet.

<input checked="" type="checkbox"/>	Schema	Example Value
<input checked="" type="checkbox"/>	example_2.json	
<input checked="" type="checkbox"/>	quiz	
<input checked="" type="checkbox"/>	maths	
<input checked="" type="checkbox"/>	q1	
	answer	12
	question	5 + 7 = ?
<input checked="" type="checkbox"/>	options	["10", ...]
<input checked="" type="checkbox"/>	q2	
	answer	4
	question	12 - 8 = ?
<input checked="" type="checkbox"/>	options	["1", ...]
<input checked="" type="checkbox"/>	sport	
<input checked="" type="checkbox"/>	q1	
	answer	Huston Rocket

10 schema levels

Detect new fields

Sometimes, more fields exist in rows that were not scanned to create the inferred schema. If you notice that a field you need is missing under **Schema**, you can choose to do one of the following:

- Scan the entire JSON document. It may take a long time for the scan to complete.
- Select schema levels from the schema listed and then select **OK**. Tableau reads your entire document and if more fields are found, they are listed in the Select Schema Levels dialog box.

Whenever Tableau detects that new fields are available, for example, during an extract refresh or when Tableau creates an extract after you've selected the schema levels, either an information icon near the file name or a notification on the Select Schema Levels dialog box will indicate that additional fields have been found.

Change schema levels

You can change the schema levels you selected by going to the data source page and selecting **Data > [JSON file name] > Select Schema Level**. Or, hover over the file name on the canvas and select the drop-down menu > **Select Schema Level**.

Union JSON files

You can union JSON data. To union a JSON file, it must have a .json, .txt, or .log extension. For more information about union, see [Union Your Data on page 847](#).

When you union JSON files, the schema is inferred from the first 10,000 rows of every file in the union.

You can change the schema levels after you union files. For more information, see [Change schema levels above](#).

How dimension folders are organized for hierarchical JSON files

After you select the sheet tab, the selected schema levels of your JSON file show under **Dimensions** on the **Data** pane. Each folder corresponds with the schema level you selected, and the attributes associated with that schema level are listed as children of the folder.

For example, in the following image, **Address** is a dimension under the schema level **Businesses** folder. **Categories** is also a schema level, but because it is a list of values and not a hierarchy of data, it doesn't require its own folder, but is instead grouped under a parent folder.

Note that schema levels in the Select Schema Levels dialog box do not map directly to the folder

structure in the **Data** pane. Folders in the **Data** pane are grouped by object so that you can easily navigate to fields and still have context for where the fields come from.

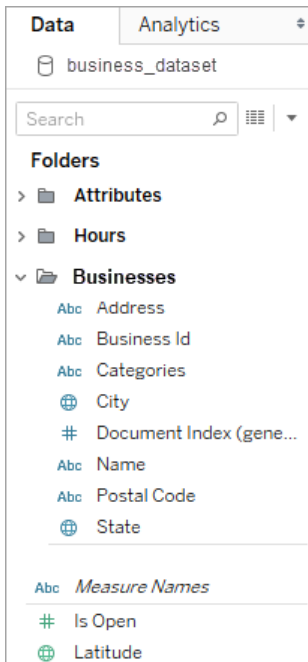

For each document, a unique index is generated and stored in the flattened representation of data. An index is also generated for each level in the schema.

For example, in the image above, in addition to the **Document Index (generated)** entry, the **Attribute** and **Hours** schema levels all have generated indexes.

Why measures are calculated in hierarchical JSON files

When a hierarchical JSON file is flattened, data might be duplicated. To keep measures consistent with their schema levels, Tableau creates level of detail (LOD) calculations to accurately represent the data at the schema level. The original measures are located in the **Source Measures** folder and you can use them, but we recommend that you use the calculated measures.

On the **Data** pane, calculated measures are labeled as **Number of <measure name> per <parent name>**.

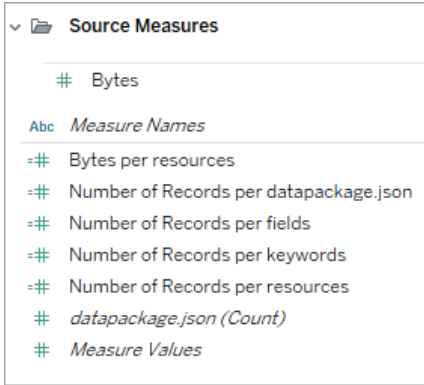

To view the LOD calculation for a measure, follow these steps:

1. Select the measure.
2. Select the drop-down arrow, and then select **Edit**.

The following example shows the LOD calculation for **Revenue per Document**. The formula selects the maximum revenue for each document index value.



The use of LOD calculations means that you can select multiple schema levels and be confident that the measures are not over-counted.

Tips for working with JSON data

These tips can help you work with your JSON data in Tableau.

- Do not exceed the 10x10 limit for nested arrays.
A high number of nested arrays creates a lot of rows. For example, 10x10 nested arrays result in 10 billion rows. When the number of rows Tableau can load into memory is exceeded, an error displays. In this case, use the Select Schema Levels dialog box to reduce the number of selected schema levels.
- A data source that contains more than 100 levels of JSON objects can take a long time to load.

A high number of levels creates a lot of columns, which can take a long time to process. As an example, 100 levels can take more than two minutes to load the data. As a best practice, reduce the number of schema levels to just the levels that you need for your analysis.

- A single JSON object cannot exceed 128 MB.

When a single object top-level array exceeds 128 MB, you must convert it to a file where the JSON objects are defined one per line.

- The pivot option is not supported.

About .tde and .hyper files

You might notice .tde or .hyper files when navigating your computer's directory. When you create a Tableau data source that connects to your data, Tableau creates a .tde or .hyper file. This file, also known as a shadow extract, is used to help improve the speed your data source loads in Tableau Desktop. Although a shadow extract contains underlying data and other information similar to the standard Tableau extract, a shadow extract is saved in a different format and can't be used to recover your data.

Note: .tde files are no longer supported for Tableau versions beyond 2024.2. All extracts are now in .hyper format.

See also

- [Set Up Data Sources on page 596](#) – Add more data to this data source or prepare your data before you analyze it.
- [Build Charts and Analyze Data on page 1005](#) – Begin your data analysis.

PDF File

This article describes how to connect Tableau to .pdf file data and set up the data source.

Note: Tableau doesn't support right-to-left (RTL) languages. If your PDF includes RTL text, characters might display in reverse order in Tableau.

Make the connection and scan your document for tables

1. After you open Tableau, under **Connect**, click **PDF File**.
2. Select the file you want to connect to, and then click **Open**.

3. In the Scan PDF File dialog box, specify the pages in the file that you want Tableau to scan for tables. You can choose to scan for tables in all pages, just a single page, or a range of pages.

Note: The scan counts the first page of the file as page 1, similar to most PDF readers. When you scan for tables, specify the page number that the PDF reader displays and not the page number that might be used in the document itself, which may or may not start from page 1.

For example, suppose you want to use "Table 1" from the image below. The PDF reader displays a number, and the .pdf file displays a different number. To correctly scan for this table, specify the page number that the PDF reader displays. In this example, you specify page 15.

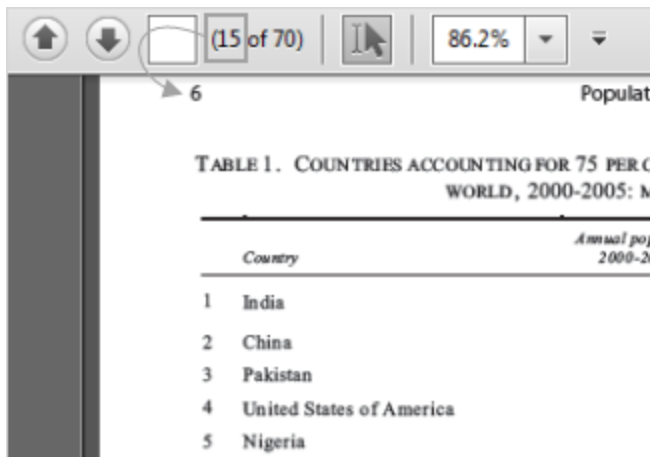

4. On the data source page, do the following:
 - a. (Optional) Select the default data source name at the top of the page, and then enter a unique data source name for use in Tableau. For example, use a data source naming convention that helps other users of the data source figure out which data source to connect to. The default name is automatically generated based on the file name.
 - b. If your file contains one table, click the sheet tab to start your analysis. Otherwise, from the left pane drag a table onto the canvas and then click the sheet tab to start your analysis.

About the tables in the left pane

Tables that are identified in the .pdf file are given unique names and are displayed in the left pane after a scan. For example, you might see a table name like "Page 1, Table 1." The first part of the table name indicates the page in the .pdf file the table came from. The second part of the table name indicates the order the table was identified. If Tableau has identified more than one table on a page, the second part of the table name can indicate one of two things:

- Tableau has identified another unique table or sub-table on the page.
- Tableau has interpreted the table on the page in another way. Tableau might provide multiple interpretations of a table depending on how the table is presented in your .pdf file.

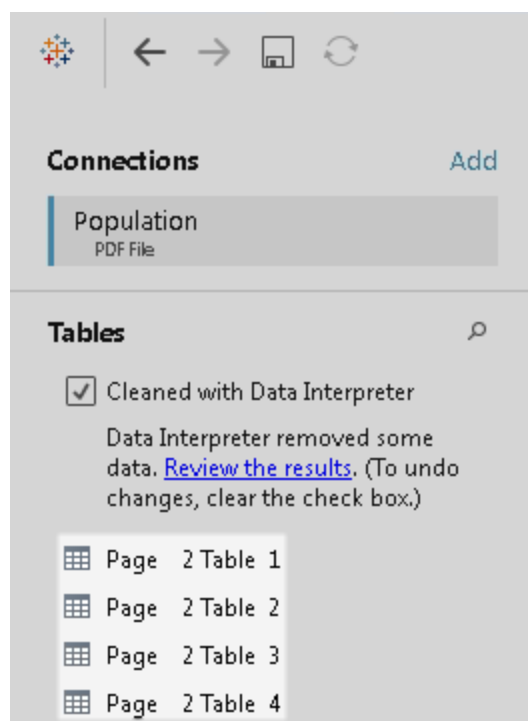

PDF file data source example

Here is an example of a PDF file data source:

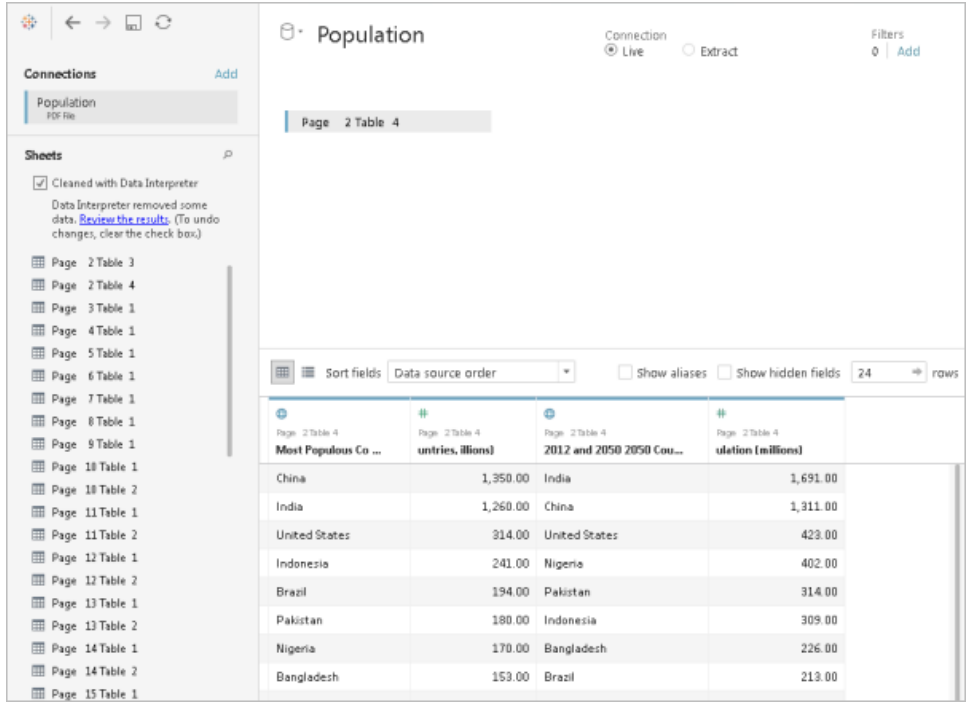

Get more data

Get more data into your data source by adding more tables or connecting to data in a different database.

- **Add more data from the current file:**
 - From the left pane, drag additional tables to the canvas to combine data using a join or union. For more information, see [Join Your Data on page 791](#) or [Union Your Data on page 847](#).
 - If the pages that were scanned in step 3 of the procedure listed above do not produce the tables that you need in the left pane, click the drop-down arrow next to the PDF File connection, and click **Rescan PDF file**. This option allows you to create a new scan so that you can specify different pages in the .pdf file to scan for

tables.

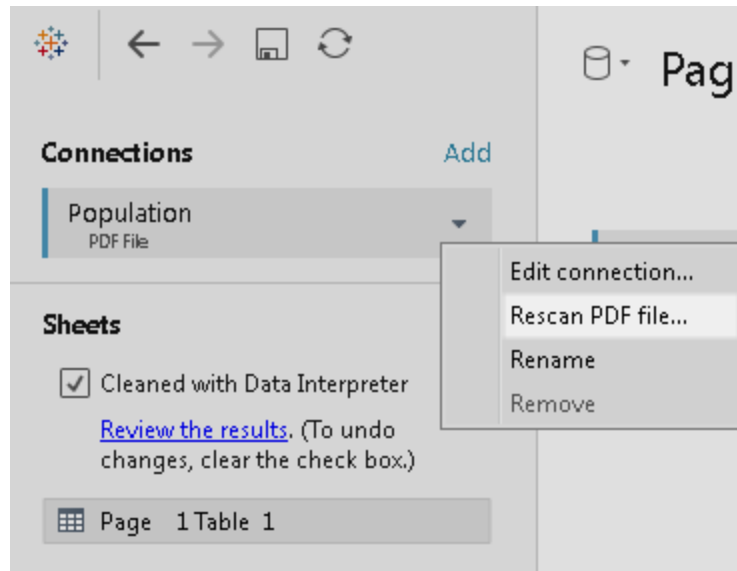

- **Add more data from a different database:** In the left pane, click **Add** next to Connections. For more information, see [Join Your Data on page 791](#).

If a connector you want is not listed in the left pane, select **Data > New Data Source** to add a new data source. For more information, see [Blend Your Data on page 816](#).

Set table options

You can set table options. On the canvas, click the table drop-down arrow and then specify whether the data includes field names in the first row. If so, these names will become the field names in Tableau. If field names are not included, Tableau generates them automatically. You can rename the fields later.

Use Data Interpreter to clean your data

If Tableau detects that it can help optimize your data source for analysis, it prompts you to use Data Interpreter. Data Interpreter can detect sub-tables that you can use and remove unique formatting that might cause problems later on in your analysis. For more information, see [Clean Data from Excel, CSV, PDF, and Google Sheets with Data Interpreter on page 897](#).

Union tables in your .pdf files

You can union tables in your file. For more information about union, see [Union Your Data on page 847](#).

When you use wildcard search to union tables, the result is scoped to the pages that were scanned in the initial file you connected to. For example, suppose you have three files: A.pdf, B.pdf, and C.pdf. The first file you connect to is A and you limit the scan for tables to page 1. When you use wildcard search to union tables from files B and C, the additional tables included in the union can only come from page 1 of B and page 1 of C.

Tips for working with .pdf files

The following tips can help you work with your .pdf files in Tableau.

- **Use PDF File connector to identify just the tables in your .pdf file.**

The primary goal of the PDF File connector is to find and identify *tables* in your .pdf file. Therefore, it ignores any other information in the file that does not appear to be part of a table, including titles, captions, and footnotes. If related data is stored in one of these areas, such as in the table title, you can use Tableau to first export the .pdf file data into a .csv file, manually add the data that was stored in the table title, and then connect to the .csv file instead. For more information, see [Export your data to .csv file](#) on page 3096.

- **Use standard tables.**

In general, Tableau works best with standard tables that use a tabular format.

Ideally, the tables in your .pdf file have column headers on a single line and have rows values on a single line as demonstrated in the example below.

CITY	RANK	TOTAL COMMUTE BY BIKE	TOTAL POPULATION
DAVIS, CA	1	23.2%	66,733
BERKELEY, CA	2	9.7%	118,851
BOULDER, CO	3	8.9%	105,101
SOMERVILLE, MA	4	7.4%	78,903
CAMBRIDGE, MA	4	7.4%	109,699
PALO ALTO, CA	5	7.3%	66,968
PORTLAND, OR	6	7.2%	619,445
EUGENE, OR	7	6.8%	160,552

Colors and shading used in or around the tables can affect how the tables are identified.

Tables that have unique formatting might require some cleanup or manual editing outside of Tableau. Unique formatting can include hierarchical headers, header names that span multiple lines, row values that span multiple lines, angle headers, and stacked tables as demonstrated in the examples shown below.

NYC Administrative Code or TLC Rule Violation	LICENSE TYPE	Manhattan	Brooklyn	Queens	Staten
80-13(A)(2), 54-13(A)(2), 55-13(A)(2) Moving Violations	UNIV	8,176			
80-14(G)(1), 55-14(G)(1), 54-14(E)(1) Use of Electronic Devices While Driving	UNIV	6,429			
19-506(b)(1) Operating For Hire Without TLC License	FHV	541			

CAKE DOUGHNUTS	
Plain Cake Doughnut	91 218 18
Glazed Cake Doughnut	105 299 19
Cinnamon Sugar Cake Doughnut	106 289 19
Peanut Butter Cake Doughnut	109 470 19
Chocolate Frosted Caked Doughnut	119 410 20
Pink Vanilla Cake Doughnut	119 460 20
Raspberry Glazed Cake Doughnut	105 299 19
Maple Frosted Cake Doughnut	119 430 19

Drivers	
TLC Driver License	153,4
Paratransit Driver License	1,86
Commuter Van Driver License	269
Total Driver Licenses	155,6
Bases	
Black Car Bases	278
Community Car Services	468
Luxury Limousine Bases	170
Commuter Van Authorizations	53
Paratransit Bases	122
Total Base Licenses	1,09

Note: Tableau does not support connections to .pdf files generated by scanning (optical character recognition) software.

- **Validate the data.**

Make sure that you validate the data in the tables that Tableau identifies in your .pdf file. You can validate the data by using either the data grid or if you used the Data Interpreter, the results workbook.

- **Avoid tables that span across pages.**

If your .pdf file contains a table that spans across pages, Tableau interprets that table as multiple tables. To resolve this issue, use a union to combine the tables. For more information, see [Union Your Data on page 847](#).

- **Rename .pdf files whose file names contain unicode characters.**

After connecting to a .pdf file that contains unicode characters in its file name, you might see the following error.

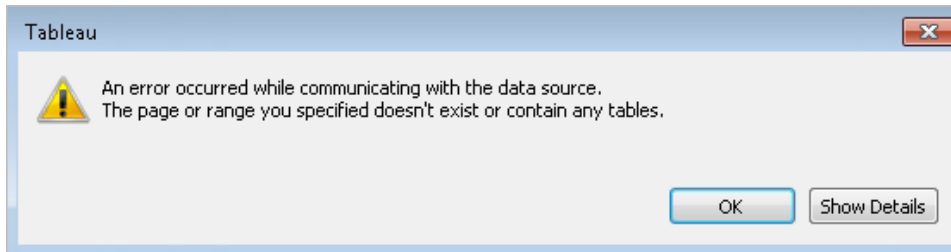

To resolve this issue, rename the file using non-unicode characters, and connect to your .pdf file again.

- **Do not use password protected .pdf files.**

After connecting to and scanning a .pdf file for tables, you might see the following error.



Tableau shows this error when your .pdf file is password protected and unable to access its contents. Tableau is unable to support connections to password protected .pdf files.

- **Alias values that are interpreted differently or incorrectly.**

In the data grid you might notice that some values are interpreted differently from the .pdf file. You can correct this interpretation by using aliases to rename specific values within a field.

For example, suppose you see the following table after connecting to your .pdf file. Some state abbreviations are being interpreted in lowercase form, which are highlighted in blue.

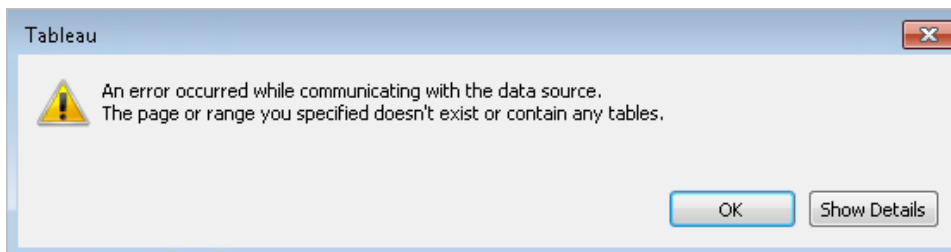
City	Rank
College Station, tx	20
Tempe, az	20
Oakland, ca	20
Detroit, MI	1
Pittsburgh, PA	2
Cincinnati, OH	3
Portland, or	4

You can resolve this issue by using aliases to change the lowercase abbreviations to uppercase abbreviations. To do this, click the drop-down arrow next to the column name and select **Aliases**.

- **Resolve column headers that are interpreted as table values.**

In the data grid you might also notice that some column headers in your .pdf file are interpreted as table values instead. This can occur if your .pdf file contains tables with unique formatting or hierarchical headers. In this scenario, try the Data Interpreter first. If Data Interpreter doesn't resolve the issue, consider manually renaming the columns to their appropriate names and filtering header names that are being treated as values by using data source filters.

For example, suppose you see the following table after connecting to your .pdf file. The table headers from the .pdf file are being interpreted as table values, which are highlighted in blue.

ABC	ABC	ABC	ABC
F1	F2	F3	F4
Table Pt 2.	Energy Production	Estimates	in Trillion BTu
<i>null</i>	<i>null</i>	<i>null</i>	<i>null</i>
Year	<i>null</i>	<i>null</i>	<i>null</i>
<i>null</i>	Coal	Gas	Oil
1960	318.8	.1	42.5
1961	316.5	.1	40.2
1962	315.6	.2	43.3

One way you can resolve a header issue like this is to follow steps similar to the following:

1. Double-click the column name, and then rename F1 to Year. Repeat this step for F2 through F4 for Coal, Gas, and Oil.
2. Click the data type icon for the Year column and change it to a number data type. This causes the non-numerical values in this column to convert to null values.
3. In the upper-right corner of the data source page, click **Add**, click the **Add** button, and then select the Year field.
4. In the Filter dialog box, select both the **Null** and **Exclude** check boxes.

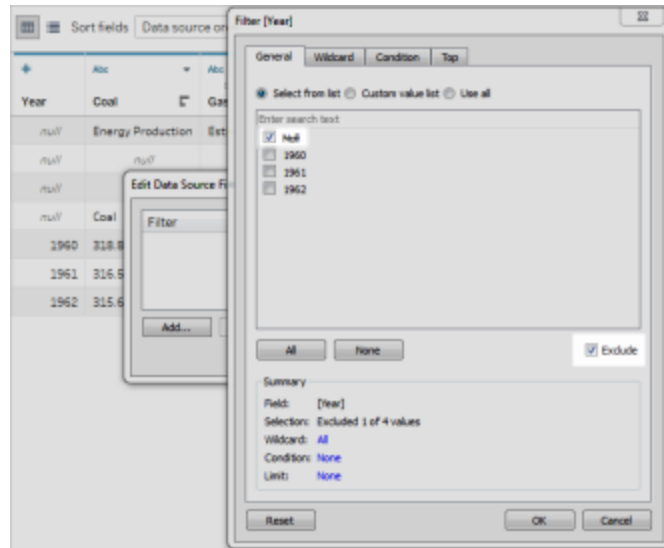

The rows in the Year column that contain null values are removed from the data grid, which affect the rows from the other columns in the table.

#	Abc	Abc	Abc
Year	Coal	Gas	Oil
1960	318.8	.1	42.5
1961	316.5	.1	40.2
1962	315.6	.2	43.3

About .tde and .hyper files

You might notice .tde or .hyper files when navigating your computer's directory. When you create a Tableau data source that connects to your data, Tableau creates a .tde or .hyper file. This file, also known as a shadow extract, is used to help improve the speed your data source loads in Tableau Desktop. Although a shadow extract contains underlying data and other information similar to the standard Tableau extract, a shadow extract is saved in a different format and can't be used to recover your data.

Note: .tde files are no longer supported for Tableau versions beyond 2024.2. All extracts are now in .hyper format.

See also

- [Set Up Data Sources on page 596](#) – Add more data to this data source or prepare your data before you analyze it.
- [Build Charts and Analyze Data on page 1005](#) – Begin your data analysis.

Spatial File

This topic describes how to connect Tableau to Shapefiles, MapInfo tables, KML (Keyhole Markup Language) files, TopoJSON files, GeoJSON files, and Esri File Geodatabases.

Note: Connecting to spatial data is supported in Tableau Desktop version 10.2 and later.

Before you connect

Before you can connect to spatial files, make sure to include all of the following files in the same directory:

- **For Esri shapefiles:** The folder must contain `.shp`, `.shx`, `.dbf`, and `.prj` files as well as `.zip` files of the Esri shapefile.
For Esri File Geodatabases: The folder must contain the File Geodatabase's `.gdb` or the `.zip` of the File Geodatabases's `.gdb`.
- **For MapInfo tables (Tableau Desktop only):** The folder must contain `.TAB`, `.DAT`, `.MAP`, and `.ID` or `.MID` and `.MIF` files.
- **For KML files:** The folder must contain the `.kml` file. (No other files are required.)
- **For GeoJSON files:** The folder must contain the `.geojson` file. (No other files are required.)
- **For TopoJSON files:** The folder must contain the `.json` or `.topojson` file. (No other files are required.)

Note: Flat files will pull in the contents of the entire folder. For performance reasons, remove unneeded files and reduce the amount of data in the files.

You can connect only to point geometries, linear geometries, and polygons in current versions of Tableau. You cannot connect to mixed geometry types.

If your data does not display diacritics (accent marks on characters) properly, check to make sure the file is **UTF-8** encoded.

Make the connection and set up the data source

In Tableau Desktop: click the New Data Source icon and select **Spatial file**.

In Tableau Cloud or Tableau Server (Creator role): Select **Create > Workbook**. Select the **Files** tab.

Then do the following:

1. Navigate to the folder that contains your spatial data and select the spatial file you want to connect to.
2. Select **Open**.

Spatial file data source example

Here is an example of a spatial file data source using Tableau Desktop on a Mac computer:

The screenshot shows the Tableau Desktop interface for a spatial file data source. The main window displays a table with the following columns and data:

STRA...	Abc	#	#	#	Abc	Abc	Abc	Abc
TERRESTRIAL_MAMMALS...	TERRESTRIAL_MA...	TERRESTRIAL...	TERRESTRI...	TERRESTRI...	TERRESTRIAL_MA...	TERRESTRIAL_MAMMAL...	TERRESTRIAL_MAMMAL...	TERRESTRIAL_MAMMA...
x	Binomial	Presence	Origin	Year	Island	Family Nam	Friendly N	Geometry
90.00	Phyllomys unicolor	1	1	2008	null	ECHIMYIDAE	Phyllomys unicolor	POLYGON
10.00	Coendou rufescens	1	1	2016	null	ERETHIZONTIDAE	Coendou rufescens	MULTIPOLYGON
14.00	Echiothrix leucura	1	1	2008	Sulawesi	MURIDAE	Echiothrix leucura	MULTIPOLYGON
14.00	Echiothrix leucura	2	1	2008	Sulawesi	MURIDAE	Echiothrix leucura	POLYGON
15.00	Echymipera clara	1	1	2008	New Guinea	PERAMELIDAE	Echymipera clara	POLYGON
15.00	Echymipera clara	1	1	2008	Japen Island	PERAMELIDAE	Echymipera clara	POLYGON
16.00	Echymipera echinis...	1	1	2008	New Guinea	PERAMELIDAE	Echymipera echinis...	MULTIPOLYGON
17.00	Echymipera davidi	1	1	2008	Kiriwina Isla...	PERAMELIDAE	Echymipera davidi	POLYGON
18.00	Echymipera kalubu	1	1	2016	Waigeo	PERAMELIDAE	Echymipera kalubu	POLYGON
18.00	Echymipera kalubu	1	1	2016	Vokeo	PERAMELIDAE	Echymipera kalubu	POLYGON
18.00	Echymipera kalubu	1	1	2016	Umboi	PERAMELIDAE	Echymipera kalubu	POLYGON
18.00	Echymipera kalubu	1	1	2016	Toikiwa	PERAMELIDAE	Echymipera kalubu	POLYGON
18.00	Echymipera kalubu	1	1	2016	Su Mios	PERAMELIDAE	Echymipera kalubu	POLYGON

Work with the Geometry column

There are many tasks that you can optionally perform on your data before you start your analysis, such as hiding or renaming fields. Note, however, the following restrictions apply when working with the Geometry column:

- You can't hide the Geometry column.
- You can't split the Geometry column.
- On the data source page, you can't create a calculated field using the Geometry column.

About .tde and .hyper files in Tableau Desktop

You might notice .tde or .hyper files when navigating your computer's directory. When you create a Tableau data source that connects to your data, Tableau creates a .tde or .hyper file. This file, also known as a shadow extract, is used to help improve the speed your data source loads in Tableau Desktop. Although a shadow extract contains underlying data and other information similar to the standard Tableau extract, a shadow extract is saved in a different format and can't be used to recover your data.

Note: .tde files are no longer supported for Tableau versions beyond 2024.2. All extracts are now in .hyper format.

See also

[Create Tableau Maps from Spatial Files](#) on page 1745

Statistical File

This article describes how to connect Tableau to a statistical file and set up the data source.

Tableau connects to SAS (*.sas7bdat), SPSS (*.sav), and R (*.rdata, *.rda) data files.

Note: As of version 2020.1, Tableau no longer supports statistical files compressed with SASYZCR2. Use a different compression scheme to make the file readable for Tableau.

Make the connection and set up the data source

1. Start Tableau and under **Connect**, select **Statistical File**, select the file that you want to connect to, and then select **Open**.
2. On the data source page, do the following:

- a. (Optional) Select the default data source name at the top of the page, and then enter a unique data source name for use in Tableau. For example, use a data source naming convention that helps other users of the data source figure out which data source to connect to.
- b. Select the sheet tab to start your analysis.

For information about connecting to more than one table, see [Join Your Data on page 791](#).

Statistical file data source example

Here is an example of a statistical file data source using Tableau Desktop on a Windows computer:

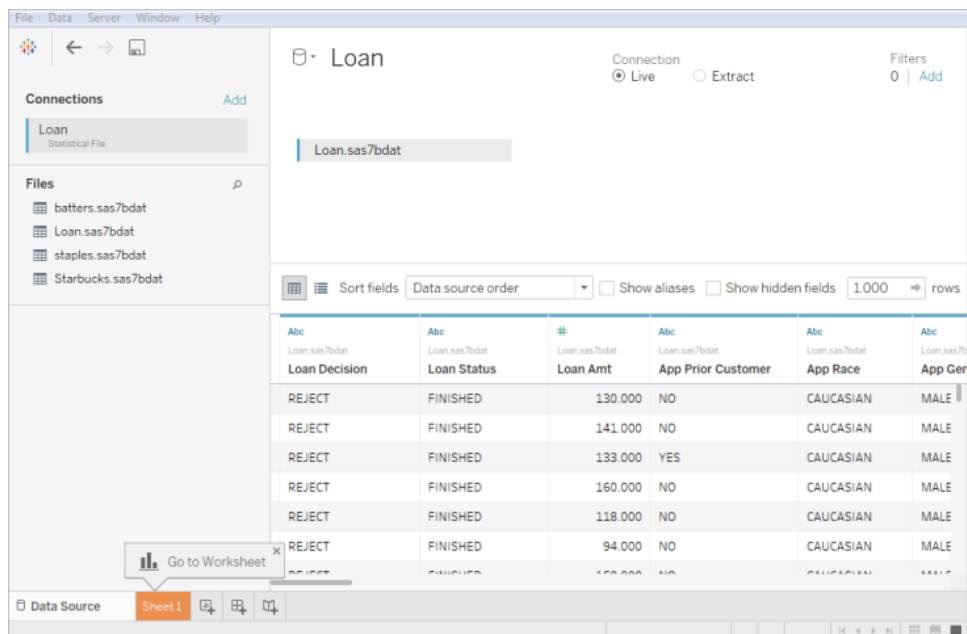

Note the following:

- The Statistical File connector does not support value labels.
- The Statistical File connector supports only one table per statistical file.

If an error message appears, "An error occurred while communicating with the data source," make sure that your statistical file contains only one object, and that the object is a data frame or a matrix. R files may contain hidden objects in what appears to be a clean workspace. To check for hidden objects, run `ls(environment(), all.names=TRUE)` from RStudio.

- You can change the character encoding for a statistical file. For more information, see [Change the character encoding for statistical files](#).

R data file object and format support

R data files should contain only one of the following types of objects:

- Two-dimensional matrices
- Vectors
- Factors
- Data frames

Note that if the R data file contains more than one object, Tableau will connect to the first one.

Tableau supports R data files that use binary format.

ASCII format files are not supported in Tableau Desktop. If you try to use an .rdata or .rda file with ASCII format, you'll see an error saying, "Unable to read from file the table "[TableauTemp].[filename.rdata]" does not exist". In this case, you can use RStudio to save the file to a binary format, as follows:

1. Download RStudio if you don't already have it.
2. Open your R data file in RStudio. You should see your data object in the global environment window on the upper right.
3. Save the object to a new file with the "save()" function as follows:

```
save(<objectName>, file="<filename>", ascii=FALSE)
```

where: <objectName> is your data object, <filename> is the name of your new file, and "FALSE" is case-sensitive

Tip: To quickly see documentation for this function, type "?save" at the command prompt.

Compressed files are not supported in Tableau Desktop. You must decompress files first with another program, such as Gzip or WinZip, before you connect with Tableau.

Change the character encoding for a statistical file

Tableau reads the data in a statistical file (for example, an SAS or R file) based on the file's character encoding or on information in an input file. R files typically use the character encoding of the operating system, compared to SAS and SPSS files, which include the character encoding information in the file. Sometimes, you might need to specify a different encoding. For example, if a colleague sends you a statistical file with Greek character encoding, then you must specify a

Greek character set to use the file with Tableau. If you need to use a different character set when reading from a statistical file, you can create a Tableau data source customization (TDC) file and specify the encoding to use.

Create the TDC file

A .tdc file is an XML file that applies to a single data source and contains vendor and driver name information of the data source provider. For the statistical file connector, the vendor and driver name is `stat-direct`.

To create a TDC file:

1. Open a plain text editor, such as Notepad.
2. Copy the information from the sample provided below, paste it into your text file, and then specify the `source-charset` value. (For a list of encodings, see [User-defined Encodings Supported by the Statistical File Connector](#) on the facing page.)
3. Save the file with a .tdc extension—for example, `r-statsfile.tdc`—to the My Tableau Repository\Datasources folder.

Sample TDC file sets the source-charset value

The following TDC file example sets the `source-charset` value to `shift-jis` for a statistical file data source.

```
<connection-customization class='stat-direct' enabled='true' version='10.0'>
<vendor name='stat-direct' />
<driver name='stat-direct' />
  <customizations>
    <customization name='source-charset' value='shift-jis' />
  </customizations>
</connection-customization>
```

Important: TDC files can be utilized to customize the functionality of a connection or to diagnose and resolve issues related to connecting to your data. Tableau is unable to thoroughly test every potential modification you might make with these files. Creating and using TDC files requires manual editing and it is crucial to test them thoroughly before deploying them in a production environment.

About .tde and .hhyper files

You might notice .tde or .hhyper files when navigating your computer's directory. When you create a Tableau data source that connects to your data, Tableau creates a .tde or .hhyper file. This file, also known as a shadow extract, is used to help improve the speed your data source loads in Tableau Desktop. Although a shadow extract contains underlying data and other information similar to the standard Tableau extract, a shadow extract is saved in a different format and can't be used to recover your data.

Note: .tde files are no longer supported for Tableau versions beyond 2024.2. All extracts are now in .hyper format.

See also

- [Set Up Data Sources on page 596](#) – Add more data to this data source or prepare your data before you analyze it.
- [Build Charts and Analyze Data on page 1005](#) – Begin your data analysis.

User-defined Encodings Supported by the Statistical File Connector

This topic lists character encodings supported by Tableau Statistical File connector. The list includes single-byte, multi-byte, and Unicode user-defined encodings, as well as single-byte and multi-byte encodings that cannot currently be mapped to the corresponding SAS encodings.

Single-byte user-defined encodings

ASCII

CSASCII

US-ASCII

US

ISO_646.IRV:1991

ISO646-US

646

ISO-IR-6

IBM367

CP367

ANSI_X3.4-1986

ANSI_X3.4-1968

ISO-8859-1

CSISOLATIN1

LATIN1

L1

ISO_8859-1:1987

ISO8859-1

ISO-IR-100

ISO-8859-1

IBM819

CP819

ISO-8859-15

LATIN-9

ISO_8859-15:1998

ISO_8859-15

ISO8859-15

ISO-IR-203

IBM850

CSPC850MULTILINGUAL

CP850

850

WINDOWS-1252

MS-ANSI

CP1252

ISO-8859-7

Tableau Desktop and Web Authoring Help

CSISOLATINGREEKISO_8859-7:1987

ISO_8859-7

ISO-IR-126

ISO-8859-7

GREEK8

GREEK

ELOT_928

ECMA-118

WINDOWS-1253

MS-GREEK

CP1253

ISO-8859-10

CSISOLATIN6

LATIN6

L6

ISO_8859-10:1992

ISO_8859-10

ISO8859-10

ISO-IR-157

WINDOWS-1257

WINBALTRIM

CP1257

ISO-8859-2

CSISOLATIN2

LATIN2

L2

ISO_8859-2:1987

ISO_8859-2

ISO8859-2

ISO-IR-101

IBM852

CSPCP852

CP852

852

WINDOWS-1250

MS-EE

CP1250

ISO-8859-5

CSISOLATINCYRILLIC

ISO_8859-5:1988

ISO_8859-5

ISO8859-5

ISO-IR-144

CYRILLIC

WINDOWS-1251

MS-CYRL

CP1251

CP866

CSIBM866

IBM866

866

TIS-620

TIS620.2533-1

TIS620.2533-0

Tableau Desktop and Web Authoring Help

TIS620.2529-1

TIS620-0

TIS620

ISO-IR-166

ISO-8859-11

CP874

CSISOLATIN5

LATIN5

L5

ISO_8859-9:1989

ISO_8859-9

ISO8859-9

ISO-8859-9

ISO-IR-148

CSIBM857

IBM857

CP857

857

WINDOWS-1254

MS-TURK

CP1254

CP1129

VPS

WINDOWS-1258

CP1258

ISO-8959-6

CSISOLATINARABIC

ISO_8859-6:1987

ISO_8859-6

ISO8859-6

ISO-IR-127

ECMA-114

ASMO-708

ARABIC

WINDOWS-1256

MS-ARAB

CP1256

ISO-8859-8

CSISOLATINHEBREW

ISO_8859-8:1988

ISO_8859-8

ISO8859-8

ISO-IR-138

HEBREW

IBM864

CSIBM864

CP864

WINDOWS-1255

MS-HEBR

CP1255

IBM862

CSPC862LATINHEBREW0x2E

CP862

862

Multi-byte user-defined encodings

CP936

WINDOWS-936

MS936

GBK

GB2312

CSISO58GB231280

ISO-IR-58

GB_2312-80

CHINESE

ISO-2022-CN

CP950

windows-950

ms-950

ms950

CSBIG5

CN-BIG5

BIGFIVE BIG5

BIG-FIVE

BIG-5

BIG5HKSCS

BIG5-HKSCS

EUC-TW

CSEUCTW

EUCTW

EUC-JP

CSEUCPKDFMTJAPANESE

EXTENDED_UNIX_CODE_PACKED_FORMAT_FOR_JAPANESE

EUCJP

EUC-JP

ISO-2022-JP

CSISO2022JP

ISO-2022-JP

CSSHIFTJIS

SJIS

SHIFT_JIS

SHIFT-JIS

MS_KANJI

CP932

EUC-KR

CSEUCKR

EUCKR

EUC-KR

UHC

CP949

EUC-CN

CSGB2312

GB2312

EUCCN

CN-GB

Unicode user-defined encodings

TF-8

UCS-2

UCS-2BE

UCS-2LE

UCS-4

UCS-4BE

UTF-16

UTF-16BE

UTF-16LE

UTF-32

UTF-32LE

UTF-32BE

UTF-7

Single-byte encodings that can't be mapped to SAS encodings

MACROMAN

CSMACINTOSH

MACINTOSH

MAC

ISO-8859-14

LATIN8

L8

ISO_8859-14:1998

ISO_8859-14

ISO8859-14

ISO-IR-199

ISO-CELTIC

MACGREEK

MACICELAND

ISO-8859-3

CSISOLATIN3

LATIN3

L3

ISO_8859-3:1988

ISO_8859-3

ISO8859-3

ISO-IR-109

ISO-8959-4

CSISOLATIN4

LATIN4

L4

ISO_8859-4:1988

ISO_8859-4

ISO8859-4

ISO-IR-110

ISO-8959-13

LATIN7

L7

ISO_8859-13

ISO8859-13

ISO-IR-179

ISO-8859-13

MACCENTRALEUROPE

MACCROATIAN

IBM855

CSIBM855

CP855

855

Tableau Desktop and Web Authoring Help

KOI8-R

CSKOI8R

MACCYRILLIC

KOI8-U

CSKOI8R

MACUKRAINIAN

ISO-8859-16

LATIN10

L10

ISO_8859-16:2001

ISO_8859-16

ISO8859-16

ISO-IR-226

MACROMANIAN

ARMSII-8

GEORGIAN-ACADEMY

MACTURKISH

TCVN

VISCII

CSVISCII

VISCII1.1-1

MACARABIC

MACHEBREW

WINDOWS-874

Multi-byte encodings that can't be mapped to SAS encodings

GB18030

HZ

HZ-GB-2312

CSISO2022JP

ISO-2022-JP

JOHAB

JOHAB

CP1361

ISO-2022-KR

CSISO2022KR

ISO-2022-KR

ISO-2022-JP

CSISO2022JP

ISO-2022-JP-1

ISO-2022-JP-2

CSISO2022JP2

ISO-2022-CN

CSISO2022CN

ISO-2022-CN-EXT

Other Files

This topic describes how to connect Tableau to supported file types, including Tableau Data Extract files and Tableau Workbooks.

1. Start Tableau and under **Connect**, select **Other Files**.
2. In the Open dialog box, navigate to and select a file.
3. Select **Open**.
4. (Optional) Select the default data source name at the top of the page, and then enter a unique data source name for use in Tableau. For example, use a data source naming convention that helps other users of the data source figure out which data source to connect to.
5. Select the sheet tab to start your analysis.

Tableau Data Extract data source example

Here is an example of a Tableau Data Extract file data source using Tableau Desktop on a Windows computer:

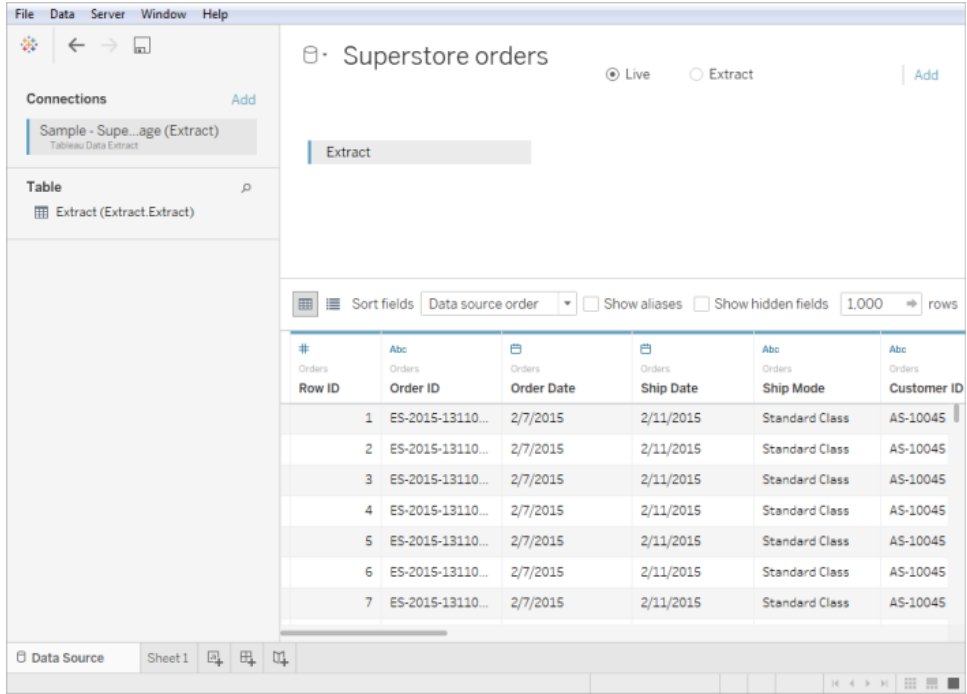

See also

- [Set Up Data Sources on page 596](#) – Add more data to this data source or prepare your data before you analyze it.
- [Build Charts and Analyze Data on page 1005](#) – Begin your data analysis.

Connect to Data by Using Tableau Server or Tableau Cloud

You can connect to data from either Tableau Desktop or a web browser by using Tableau Server or Tableau Cloud. The process differs slightly for each.

Starting in 2019.3, Tableau Catalog is available with Data Management in Tableau Server and Tableau Cloud. When Tableau Catalog is enabled in your environment, in addition to connecting to published data sources from Tableau Server or Tableau Cloud, you can connect to databases and tables from the **Search for Data** dialog on Tableau Desktop and the Connect to Data dialog in Tableau Web Authoring. For more information about Tableau Catalog, see "About Tableau

Catalog" in the [Tableau Server](#) or [Tableau Cloud](#) Help. Starting in 2021.4, Data Management includes virtual connections, a central access point to data. For more information, see "About Virtual Connections and Data Policies" in the [Tableau Server](#) or [Tableau Cloud](#) help.

Tableau Prep Builder can connect to published data sources and you can use them as an input data source for your flow starting in version 2019.3.1. If you have Data Management with Tableau Catalog enabled, starting in version 2020.2.2, you can also connect to databases and tables from the **Search for Data** results, just like Tableau Desktop. For more information, see [Connecting to published data sources](#) in the Tableau Prep Builder help.

Connect from Tableau Desktop

Note: Starting 2019.3, on the **Connect** pane, **Tableau Server** has moved to the top of the pane under **Search for Data**. Select this option to connect to Tableau Server or Tableau Cloud from Tableau Desktop.

1. Start Tableau Desktop and on the **Connect** pane, under **Search for Data**, select **Tableau Server**.
2. To connect to Tableau Server, enter the name of the server and then select **Connect**.

To connect to Tableau Cloud, select **Tableau Cloud** under **Quick Connect**.

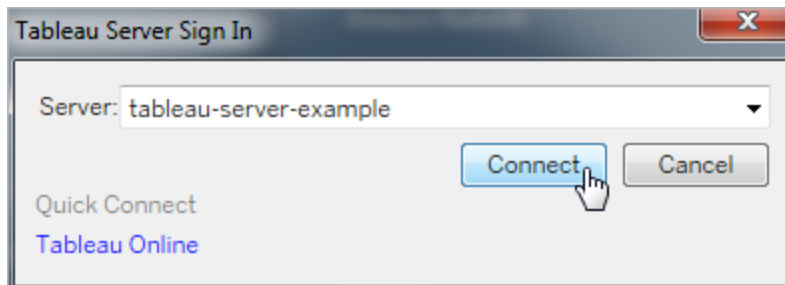

Tip: If you don't sign out, Tableau Desktop saves your server connection, so you can skip step 3. You can also skip it if Kerberos is enabled on Tableau Server and your computer has valid credentials. For more information, see [Automatically keep Tableau Desktop connected to Tableau Server or Online](#) on page 196.

3. To sign in:
 - For Tableau Server, enter your user name and password.
 - For Tableau Cloud, enter your email address and password.

4. Select data to connect to. The **Search for Data** dialog displays a scrollable list of mixed content that's popular. If you have a Data Management license, you can connect to data with a virtual connection, and if you have Data Management with Tableau Catalog enabled, you can also connect to external assets, like databases, files, and tables.

The responsive search field shows a list of suggestions that updates as you enter text. Filter search results by type of data, certification status, or other filters that depend on the type of data selected. For example, some types of data may allow you to filter based on tags, connection type, data quality warnings, or other criteria. Older versions of the dialog look and function slightly differently, but the overall function is similar.

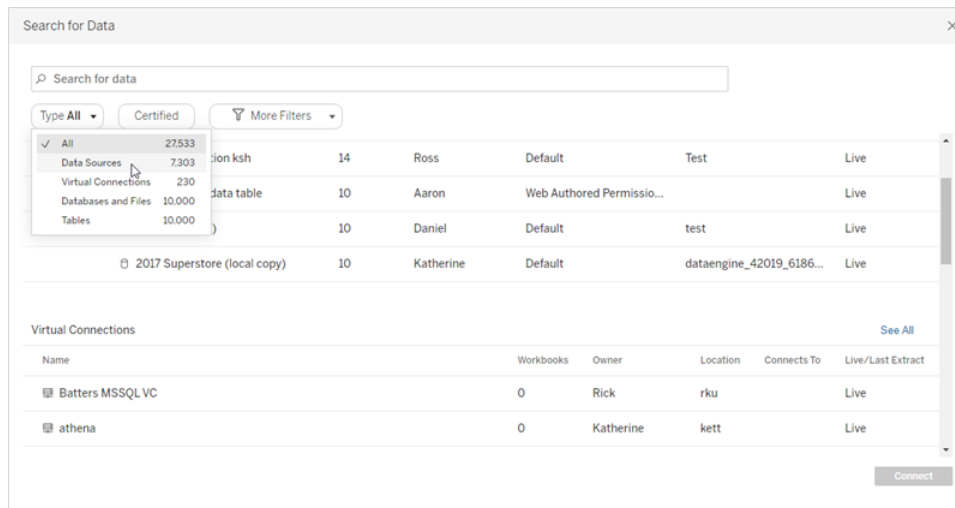

Note:

- Data that you don't have Connect permissions for is unavailable (gray).
 - External assets (databases, files, and tables) are unavailable (gray) until Catalog finishes ingesting them.
 - If you select a cube (multidimensional) data source, the Create Local Copy dialog box appears, and you must create a local copy of the data before you can start your analysis.
 - In Web Authoring, you can make a connection with a subset of the data connectors that Tableau Desktop supports. If a data source, database, file, or table is grayed out, you can't connect from Tableau Server or Tableau Cloud. You can, however, connect from the Tableau Desktop Connect pane, if you have the correct permissions.
5. After you select the data you want to connect to, click **Connect**.
 6. Select the sheet tab to start your analysis.

Data sources published to Tableau Server or Tableau Cloud are shown in the **Data** pane with a Tableau icon.

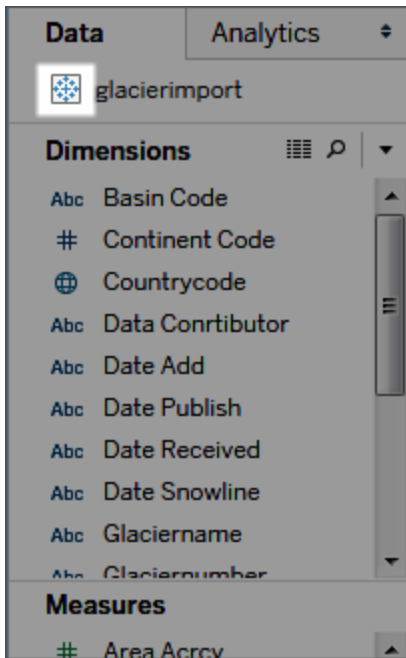

You might want to download a local copy of the data source so that you can, for example, work offline or make changes to a data source without modifying the original. To download a local copy, on the **Data** menu, select the data source, and then select **Create Local Copy**. A duplicate of the data source is added to the **Data** pane.

Sign in on a Mac

If you use Tableau Desktop on a Mac, when you enter the server name to connect, use a fully qualified domain name, such as mydb.test.ourdomain.lan, instead of a relative domain name, such as mydb or mydb.test.

Alternatively, you can add the domain to the list of Search Domains for the Mac computer so that when you connect, you need to provide only the server name. To update the list of Search Domains, go to **System Preferences > Network > Advanced**, and then open the **DNS** tab.

Connect to published data sources while web authoring

Tableau Desktop users who create and customize data connections for Tableau use can publish their data sources to Tableau Server or Tableau Cloud. Publishing enables sharing data among colleagues, including those who don't use Tableau Desktop, but have permission to edit workbooks in the web editing environment.

If you have permission to edit workbooks in a browser, follow these steps to connect to published data sources when you're signed in to Tableau Server or Tableau Cloud. For more information see [Edit Tableau Views on the Web](#) and [Using Tableau on the Web](#).

Note: To connect to data, you need permission to create and edit views.

Add more data to an existing view

1. On a Tableau Server or Tableau Cloud site, select a view to edit.
2. In editing mode, click the **New Data Source** icon .
3. In the **Connect to Data** page, the options you can see and select from depend on your permissions:

- **On this site.** Select a published data source from the list, and then select **Add data source**.

When Tableau Catalog is enabled in your environment, you can select **Data Sources, Databases and Files**, or **Tables and Objects** from the **Content Type** drop-down list. Then select the data you want to connect to and click **Connect**.

- **Files.** Drag and drop a file or upload one from your computer.
- **Connectors.** Connect to your data using one of the connectors listed.

Create a workbook with a published data source

You can also connect to a published data source when creating a new workbook:

1. On a Tableau Server or Tableau Cloud site, navigate to the **Explore** page, and select **All Data Sources** from the drop-down list.
2. In the list, select the check box next to the data you want to use.
3. At the top of the page, from the **Actions** drop-down menu, select **New Workbook**.

For information about connecting to data when you're authoring on the web, see [Creators: Connect to Data on the Web](#).

Action Vector

This article describes how to connect Tableau to an Actian Vector database and set up the data source.

Before you begin

Before you begin, gather this connection information:

- Virtual node name for the database you want to connect to
- Database name
- Authentication method: Authentication defined in the virtual node, or user name and password
- (Optional) Initial SQL statement to run every time Tableau connects

Use this connector with Tableau Desktop on a Windows computer.

Driver required

This connector requires a driver to talk to the database. If the driver is not installed on your computer, Tableau displays a message in the connection dialog box with a link to the [Driver Download](#) page where you can find driver links and installation instructions.

Make the connection and set up the data source

1. Start Tableau and under **Connect**, select **Action Vector**. For a complete list of data connections, select **More** under **To a Server**. Then do the following:
 - a. Enter the name of the virtual node for the database and the name of the database you want to connect to.
 - b. Specify whether to use authentication defined in the virtual node, or a specific user name and password.
 - c. (Optional) Select **Initial SQL** to specify a SQL command to run at the beginning of every connection, such as when you open the workbook, refresh an extract, sign in to Tableau Server, or publish to Tableau Server. For more information, see [Run Initial SQL on page 591](#).
 - d. Select **Sign In**.

If Tableau can't make the connection, verify that your credentials are correct. If you still can't connect, your computer is having trouble locating the server. Contact your network administrator or database administrator.

2. On the data source page, do the following:
 - a. (Optional) Select the default data source name at the top of the page, and then enter a unique data source name for use in Tableau. For example, use a data source naming convention that helps other users of the data source figure out which data source to connect to.

- b. From the **Schema** drop-down list, select a schema or use the text box to search for a schema by name.
- c. Under **Table**, select a table or use the text box to search for a table by name.
- d. Drag the table to the canvas, and then select the sheet tab to start your analysis.

Use custom SQL to connect to a specific query rather than the entire data source.
For more information, see [Connect to a Custom SQL Query on page 863](#).

See also

- [Set Up Data Sources on page 596](#) – Add more data to this data source or prepare your data before you analyze it.
- [Build Charts and Analyze Data on page 1005](#) – Begin your data analysis.

Alibaba AnalyticDB for MySQL

This topic describes how to connect Tableau to an Alibaba AnalyticDB for MySQL database and set up the data source.

Before you begin

Before you begin, gather this connection information:

- Name or IP address of the server that hosts the database you want to connect to
- Database name
- User name and password
- (Optional) Initial SQL statement to run every time Tableau connects

Driver required

This connector requires a driver to talk to the database. If the driver is not installed on your computer, Tableau displays a message in the connection dialog box with a link to the [Driver Download](#) page where you can find driver links and installation instructions.

Make the connection and set up the data source

1. Start Tableau and under **Connect**, select **Alibaba AnalyticDB for MySQL**. For a complete list of data connections, select **More** under **To a Server**. Then do the following:
 - a. Enter the **Server** name or IP address.
 - b. Enter the **Database** name.
 - c. Enter the **Username** and **Password**.

- d. (Optional) Select **Initial SQL** to specify a SQL command to run at the beginning of every connection, such as when you open the workbook, refresh an extract, sign in to Tableau Server, or publish to Tableau Server. For more information, see [Run Initial SQL on page 591](#).
- e. Select **Sign In**.

If Tableau can't make the connection, verify that your credentials are correct. If you still can't connect, your computer is having trouble locating the server. Contact your network administrator or database administrator.

2. On the data source page, do the following:
 - a. (Optional) Select the default data source name at the top of the page, and then enter a unique data source name for use in Tableau. For example, use a data source naming convention that helps other users of the data source figure out which data source to connect to.
 - b. Under **Table**, select a table or use the text box to search for a table by name.
 - c. Drag the table to the canvas, and then select the sheet tab to start your analysis.

Use custom SQL to connect to a specific query rather than the entire data source. For more information, see [Connect to a Custom SQL Query on page 863](#).

Sign in on a Mac

If you use Tableau Desktop on a Mac, when you enter the server name to connect, use a fully qualified domain name, such as mydb.test.ourdomain.lan, instead of a relative domain name, such as mydb or mydb.test.

Alternatively, you can add the domain to the list of Search Domains for the Mac computer so that when you connect, you need to provide only the server name. To update the list of Search Domains, go to **System Preferences > Network > Advanced**, and then open the **DNS** tab.

See also

- [Set Up Data Sources on page 596](#) – Add more data to this data source or prepare your data before you analyze it.
- [Build Charts and Analyze Data on page 1005](#) – Begin your data analysis.

Alibaba Data Lake Analytics

This topic describes how to connect Tableau to Alibaba Data Lake Analytics and set up the data source.

Before you begin

Before you begin, gather this connection information:

- Name or IP address for the server that hosts the database you want to connect to
- Port number
- Database name
- Username and password
- (Optional) Initial SQL statement to run every time Tableau connects

Driver required

This connector requires a driver to talk to the database. If the driver is not installed on your computer, Tableau displays a message in the connection dialog box with a link to the [Driver Download](#) page where you can find driver links and installation instructions.

Make the connection and set up the data source

1. Start Tableau and under **Connect**, select **Alibaba Data Lake Analytics**. For a complete list of data connections, select **More** under **To a Server**. Then do the following:
 - a. Enter the name or IP address for the **Server**.
 - b. Enter the **Port** number.
 - c. Enter the **Database** name.
 - d. Enter the **Username** and **Password**.
 - e. (Optional) Select **Initial SQL** to specify a SQL command to run at the beginning of every connection, such as when you open the workbook, refresh an extract, sign in to Tableau Server, or publish to Tableau Server. For more information, see [Run Initial SQL on page 591](#).
 - f. Select **Sign In**.

If Tableau can't make the connection, verify that your credentials are correct. If you still can't connect, your computer is having trouble locating the server. Contact your network administrator or database administrator.

2. On the data source page, do the following:
 - a. (Optional) Select the default data source name at the top of the page, and then enter a unique data source name for use in Tableau. For example, use a data source naming convention that helps other users of the data source figure out which data source to connect to.
 - b. Under **Table**, select a table or search for a table by name.

- c. Drag the table to the canvas, and then select the sheet tab to start your analysis.

Use custom SQL to connect to a specific query rather than the entire data source.

For more information, see [Connect to a Custom SQL Query on page 863](#).

Sign in on a Mac

If you use Tableau Desktop on a Mac, when you enter the server name to connect, use a fully qualified domain name, such as mydb.test.ourdomain.lan, instead of a relative domain name, such as mydb or mydb.test.

Alternatively, you can add the domain to the list of Search Domains for the Mac computer so that when you connect, you need to provide only the server name. To update the list of Search Domains, go to **System Preferences > Network > Advanced**, and then open the **DNS** tab.

See also

- [Set Up Data Sources on page 596](#) – Add more data to this data source or prepare your data before you analyze it.
- [Build Charts and Analyze Data on page 1005](#) – Begin your data analysis.

Alibaba MaxCompute

This topic describes how to connect Tableau to Alibaba MaxCompute and set up the data source.

Before you begin

Before you begin, gather this connection information:

- URL of the MaxCompute service
- User name and password
- (Optional) Initial SQL statement to run every time Tableau connects

Driver required

This connector requires a driver to talk to the database. If the driver is not installed on your computer, Tableau displays a message in the connection dialog box with a link to the [Driver Download](#) page where you can find driver links and installation instructions.

Make the connection and set up the data source

1. Start Tableau and under **Connect**, select **Alibaba MaxCompute**. For a complete list of data connections, select **More** under **To a Server**. Then do the following:

- a. Enter the URL for the **Server**.
- b. Enter the **Username** and **Password**.
- c. (Optional) Select **Initial SQL** to specify a SQL command to run at the beginning of every connection, such as when you open the workbook, refresh an extract, sign in to Tableau Server, or publish to Tableau Server. For more information, see [Run Initial SQL on page 591](#).
- d. Select **Sign In**.

If Tableau can't make the connection, verify that your credentials are correct. If you still can't connect, your computer is having trouble locating the server. Contact your network administrator or database administrator.

2. On the data source page, do the following:
 - a. (Optional) Select the default data source name at the top of the page, and then enter a unique data source name for use in Tableau. For example, use a data source naming convention that helps other users of the data source figure out which data source to connect to.
 - b. Under **Database**, select a database from the drop-down list or enter a database name.
 - c. Under **Table**, select a table or search for a table by name.
 - d. Drag the table to the canvas, and then select the sheet tab to start your analysis.

Use custom SQL to connect to a specific query rather than the entire data source. For more information, see [Connect to a Custom SQL Query on page 863](#).

Sign in on a Mac

If you use Tableau Desktop on a Mac, when you enter the server name to connect, use a fully qualified domain name, such as mydb.test.ourdomain.lan, instead of a relative domain name, such as mydb or mydb.test.

Alternatively, you can add the domain to the list of Search Domains for the Mac computer so that when you connect, you need to provide only the server name. To update the list of Search Domains, go to **System Preferences > Network > Advanced**, and then open the **DNS** tab.

See also

- [Set Up Data Sources on page 596](#) – Add more data to this data source or prepare your data before you analyze it.
- [Build Charts and Analyze Data on page 1005](#) – Begin your data analysis.

Amazon Athena

This article describes how to connect Tableau to Amazon Athena data and set up the data source.

Note: To connect to Amazon Athena you need ports 443 (ssl) and 444 to be open.

Before you begin

Before you begin, gather this connection information:

- Name of the server that hosts the database you want to connect to. The format should be as follows: `athena.[region].amazonaws.com`. For example: `athena.us-east-1.amazonaws.com`
- Name of the S3 staging directory. For example, `s3://aws-athena-query-results-123456785678-us-eastexample-2/`
- Amazon Web Services (AWS) access keys (access key ID and secret access key). For more information, see [Access keys](#) on the AWS website.
- (Optional) Initial SQL statement to run every time Tableau connects

Tip: To support multiple users and work groups, you can add a work group in the server field.

For example: `athena.us-east-1.amazonaws.com:443;Workgroup=Name`

Driver required

This connector requires a driver to talk to the database. If the driver is not installed on your computer, Tableau displays a message in the connection dialog box with a link to the [Driver Download](#) page where you can find driver links and installation instructions.

Make the connection and set up the data source

1. Start Tableau and under **Connect**, select **Amazon Athena**. For a complete list of data connections, select **More** under **To a Server**. Then do the following:
 - a. Enter the name of the server.
 - b. Enter the name of the S3 staging directory.
 - c. Enter your AWS access key ID in the **Username** field.
 - d. Enter your AWS secret access key in the **Password** field.

- e. (Optional) Select **Initial SQL** to specify a SQL command to run at the beginning of every connection, such as when you open the workbook, refresh an extract, sign in to Tableau Server, or publish to Tableau Server. For more information, see [Run Initial SQL on page 591](#).

- f. Select **Sign In**.

If Tableau can't make the connection, verify that your credentials are correct. If you still can't connect, your computer is having trouble locating the server. Contact your network administrator or database administrator.

2. On the data source page, do the following:

- a. (Optional) Under **Connections**, select the default data source.
- b. Select the catalog and database you want to work with.
- c. Drag one or more tables to your workspace.
- d. Select the sheet tab to start your analysis.

Use custom SQL to connect to a specific query rather than the entire data source. For more information, see [Connect to a Custom SQL Query on page 863](#).

Customize JDBC connections

Amazon Athena uses a JDBC connection, which you can customize using a properties file. For more information, see [Customize JDBC Connections Using a Properties File](#) in Tableau Community.

See also

- [Set Up Data Sources on page 596](#) – Add more data to this data source or prepare your data before you analyze it.
- [Build Charts and Analyze Data on page 1005](#) – Begin your data analysis.
- [Connect to your S3 data with the Amazon Athena connector in Tableau 10.3 \(and later\)](#) - Tableau blog post with links to Amazon Athena resources.
- [Tableau Desktop Fails To Connect to Amazon Athena through Proxy With Error Code 37CE01A3](#) - Tableau Knowledge Base article with steps for resolving the issue.

Amazon Aurora for MySQL

This article describes how to connect Tableau to Amazon Aurora MySQL and set up the data source.

Before you begin

Before you begin, gather this connection information:

- Name of the server that hosts the database you want to connect to
- User name and password
- Are you connecting to an SSL server?
- (Optional) Initial SQL statement to run every time Tableau connects

Note: For information about requirements and considerations when connecting to data using Prep Builder, see [Connect to Data](#) in the Tableau Prep Help.

Driver required

This connector requires a driver to talk to the database. If the driver is not installed on your computer, Tableau displays a message in the connection dialog box with a link to the [Driver Download](#) page where you can find driver links and installation instructions.

You can connect to your data using any of the following:

Make the connection and set up the data source

1. Start Tableau and under **Connect**, select **Amazon Aurora for MySQL**. For a complete list of data connections, select **More** under **To a Server**. Then do the following:
 - a. Enter the name of the server that hosts the database.
 - b. Enter the user name and password.
 - c. (Optional) Select **Initial SQL** to specify a SQL command to run at the beginning of every connection, such as when you open the workbook, refresh an extract, sign in to Tableau Server, or publish to Tableau Server. For more information, see [Run Initial SQL on page 591](#).
 - d. Select **Sign In**.

Select the **Require SSL** check box when connecting to an SSL server.

If Tableau can't make the connection, verify that your credentials are correct. If you still can't connect, your computer is having trouble locating the server. Contact your network administrator or database administrator.

2. On the data source page, do the following:

- a. (Optional) Select the default data source name at the top of the page, and then enter a unique data source name for use in Tableau. For example, use a data source naming convention that helps other users of the data source figure out which data source to connect to.
- b. From the **Database** drop-down list, select a database or use the text box to search for a database by name.
- c. Under **Table**, select a table or use the text box to search for a table by name.
- d. Drag the table to the canvas, and then select the sheet tab to start your analysis.

Use custom SQL to connect to a specific query rather than the entire data source. For more information, see [Connect to a Custom SQL Query on page 863](#).

Sign in on a Mac

If you use Tableau Desktop on a Mac, when you enter the server name to connect, use a fully qualified domain name, such as mydb.test.ourdomain.lan, instead of a relative domain name, such as mydb or mydb.test.

Alternatively, you can add the domain to the list of Search Domains for the Mac computer so that when you connect, you need to provide only the server name. To update the list of Search Domains, go to **System Preferences > Network > Advanced**, and then open the **DNS** tab.

See also

- [Set Up Data Sources on page 596](#) – Add more data to this data source or prepare your data before you analyze it.
- [Build Charts and Analyze Data on page 1005](#) – Begin your data analysis.

Amazon EMR Hadoop Hive

This article describes how to connect Tableau to an Amazon EMR (Elastic MapReduce) Hadoop Hive database and set up the data source.

Note: Starting in version 2018.2, Tableau supports Amazon EMR Hadoop Hive only, not Impala. Amazon no longer provides Impala drivers.

Before you begin

Before you begin, gather this connection information:

- Name of the server that hosts the database you want to connect to and port number
- Authentication method:
 - No Authentication
 - Kerberos
 - Username
 - Username and password
 - Microsoft Azure HDInsight Service (starting in version 10.2.1)
- Transport options depend on the authentication method you choose and can include the following:
 - Binary
 - SASL
 - HTTP
- Sign-in credentials depend on the authentication method you choose and can include the following:
 - User name
 - Password
 - Realm
 - Host FQDN
 - Service Name
 - HTTP Path
- Are you connecting to an SSL server?
- (Optional) Initial SQL statement to run every time Tableau connects

Driver required

This connector requires a driver to talk to the database. If the driver is not installed on your computer, Tableau displays a message in the connection dialog box with a link to the [Driver Download](#) page where you can find driver links and installation instructions.

Note: Make sure you use the latest available drivers. To get the latest drivers, see [Amazon EMR Hadoop Hive](#) on the Tableau Driver Download page.

Make the connection and set up the data source

1. Start Tableau and under **Connect**, select **Amazon EMR Hadoop Hive**. For a complete list of data connections, select **More** under **To a Server**. Then do the following:
 - a. Enter the name of the server that hosts the database and the port number to use.
 - b. In the **Authentication** drop-down list, select the authentication method to use. The information you are prompted to provide depends on the authentication method you choose.
 - c. If the **Transport** drop-down list is available, select the type of transport to use.
 - d. (Optional) Select **Initial SQL** to specify a SQL command to run at the beginning of every connection, such as when you open the workbook, refresh an extract, sign in to Tableau Server, or publish to Tableau Server. For more information, see [Run Initial SQL on page 591](#).
 - e. Select **Sign In**.

Select the **Require SSL** option when connecting to an SSL server.

If Tableau can't make the connection, verify that your credentials are correct. If you still can't connect, your computer is having trouble locating the server. Contact your network administrator or database administrator.

2. On the data source page, do the following:
 - a. (Optional) Select the default data source name at the top of the page, and then enter a unique data source name for use in Tableau. For example, use a data source naming convention that helps other users of the data source figure out which data source to connect to.
 - b. From the **Schema** drop-down list, select the search icon or enter the schema name in the text box and select the search icon, and then select the schema.
 - c. In the **Table** text box, select the search icon or enter the table name and select the search icon, and then select the table.
 - d. Drag the table to the canvas, and then select the sheet tab to start your analysis.

Use custom SQL to connect to a specific query rather than the entire data source. For more information, see [Connect to a Custom SQL Query on page 863](#).

Sign in on a Mac

If you use Tableau Desktop on a Mac, when you enter the server name to connect, use a fully qualified domain name, such as mydb.test.ourdomain.lan, instead of a relative domain name, such as mydb or mydb.test.

Alternatively, you can add the domain to the list of Search Domains for the Mac computer so that when you connect, you need to provide only the server name. To update the list of Search Domains, go to **System Preferences > Network > Advanced**, and then open the **DNS** tab.

Work with Hadoop Hive data

Work with date/time data

Tableau supports TIMESTAMP and DATE types natively. However, if you store date/time data as a string in Hive, be sure to store it in ISO format (YYYY-MM-DD). You can create a calculated field that uses the DATEPARSE or DATE function to convert a string to a date/time format. Use DATEPARSE() when working with an extract, otherwise use DATE(). For more information, see [Date Functions on page 2075](#).

For more information about Hive data types, see [Dates](#) on the Apache Hive website.

NULL value returned

A NULL value is returned when you open a workbook in Tableau 9.0.1 and later and 8.3.5 and later 8.3.x releases that was created in an earlier version and has date/time data stored as a string in a format that Hive doesn't support. To resolve this issue, change the field type back to **String** and create a calculated field using DATEPARSE() or DATE() to convert the date. Use DATEPARSE() when working with an extract, otherwise use the DATE() function.

High latency limitation

Hive is a batch-oriented system and is not yet capable of answering simple queries with very quick turnaround. This limitation can make it difficult to explore a new data set or experiment with calculated fields. Some of the newer SQL-on-Hadoop technologies (for example, Cloudera's Impala and Hortonworks' Stringer project) are designed to address this limitation.

See also

- [Set Up Data Sources on page 596](#) – Add more data to this data source or prepare your data before you analyze it.
- [Build Charts and Analyze Data on page 1005](#) – Begin your data analysis.

Amazon Redshift

This article describes how to connect Tableau to an Amazon Redshift database and set up the data source. For instructions on setting up OAuth with Amazon Redshift, see [Set Up Amazon Redshift IAM OAuth](#) in the [Tableau Server documentation](#) or the [Tableau Cloud documentation](#).

Before you begin

Before you begin, gather this connection information:

- Name of the server that hosts the database you want to connect to
- Authentication:
 - Username and Password
 - OAuth using [IAM](#)
 - OAuth config should be installed
 - IAM Role
 - OAuth using [IAM IDC](#)
 - OAuth config should be installed
 - Namespace (optional)
- Database name
- Are you connecting to an SSL server?
- (Optional) Initial SQL statement to run every time Tableau connects

Driver required

This connector requires a driver to talk to the database. If the driver is not installed on your computer, Tableau displays a message in the connection dialog box with a link to the [Driver Download](#) page where you can find driver links and installation instructions.

Make the connection and set up the data source

1. Start Tableau and under **Connect**, select **Amazon Redshift**. For a complete list of data connections, select **More** under **To a Server**. Then do the following:
 - a. Enter the name of the server that hosts the database and the name of the database you want to connect to.
 - b. Enter the username and password.
 - c. (Optional) **Enter custom driver parameters** to modify the connection.

- d. Select the **Require SSL** check box when connecting to an SSL server.
- e. (Optional) Select **Initial SQL** to specify a SQL command to run at the beginning of every connection, such as when you open the workbook, refresh an extract, sign in to Tableau Server, or publish to Tableau Server. For more information, see [Run Initial SQL on page 591](#).

- f. Select **Sign In**.

If Tableau can't make the connection, verify that your credentials are correct. If you still can't connect, your computer is having trouble locating the server. Contact your network administrator or database administrator.

2. On the data source page, do the following:

- a. (Optional) Select the default data source name at the top of the page, and then enter a unique data source name for use in Tableau. For example, use a data source naming convention that helps other users of the data source figure out which data source to connect to.
- b. From the **Schema** dropdown list, select a schema or use the text box to search for a schema by name.
- c. Under **Table**, select a table or use the text box to search for a table by name.
- d. Drag the table to the canvas, and then select the sheet tab to start your analysis.

Use custom SQL to connect to a specific query rather than the entire data source. For more information, see [Connect to a Custom SQL Query on page 863](#).

Customize the connection using driver parameters

There are times when you might want to modify the connection made with the Amazon Redshift connector. Starting in Tableau 2019.2.1, you can do this by appending driver parameters to the connection string in the **Custom driver parameters** text box:

Note: You can't change the driver parameters that Tableau generates; you can only append parameters.

In this example, `agarcia` enters parameters that enable federated authentication using IDP:

```
DbUser=agarcia;AutoCreate=1;AuthType=Plugin;plugin_name=e=Ping;IAM=1;idp_host=idp.business-example.com;idp_port=443;preferred_role=arn:aws:iam::12345:role/dev;partner_spid=urn:amazon:webservices;
```

In this example, you limit the number of rows fetched to 1000:

```
Fetch=1000;
```

For details about driver parameters, see [ODBC Driver Configuration Options](#) on the Amazon AWS website.

Sign in on a Mac

If you use Tableau Desktop on a Mac, when you enter the server name to connect, use a fully qualified domain name, such as mydb.test.ourdomain.lan, instead of a relative domain name, such as mydb or mydb.test.

Alternatively, you can add the domain to the list of Search Domains for the Mac computer so that when you connect, you need to provide only the server name. To update the list of Search Domains, go to **System Preferences > Network > Advanced**, and then open the **DNS** tab.

See also

- [Set Up Data Sources on page 596](#) – Add more data to this data source or prepare your data before you analyze it.
- [Build Charts and Analyze Data on page 1005](#) – Begin your data analysis.
- [Optimizing Your Amazon Redshift and Tableau Software Deployment for Better Performance](#) - Tableau whitepaper (registration or sign-in required)
- [Explore Big Data Analytics with Amazon Redshift](#) - Tableau on-demand webinar (registration or sign-in required)

Amazon S3

This article describes how to connect Tableau to the driverless Amazon S3 connector and set up the data source.

Before you begin

Before you begin, gather the following connection information:

- The AWS region of your S3 bucket.
- The S3 bucket name.
- Your AWS IAM access key for your S3 bucket (key ID and secret access key).

Permissions

Ensure that your AWS IAM user has read permissions for your S3 bucket.

Recommendations

The following recommendations can help increase performance.

- Optimal performance is achieved if the client is running in an AWS environment (for example, Tableau Desktop or Server installed in an EC2 instance or using Tableau Cloud).
- Cross region bucket support works but performance will be worse than same region access. There may be additional cost due to data egress fees.

Make the connection and set up the data source

1. Start Tableau and under **Connect**, select **Amazon S3** from the list of **Additional Connectors**.
2. Select **Install and Restart Tableau** to install the connector.
3. After Tableau restarts go to **Connect**, and then select **Amazon S3** from the list of installed connectors.
4. Enter your Bucket Region, Bucket Name, Access Key ID, and Secret Access Key.
5. Select **Sign In**.
6. In the contents of your bucket, select a file you want to connect to.
7. Select **Connect**.

Set up the data source

Complete the following steps to set up the data source.

1. (Optional) Select the default data source name at the top of the page.
2. Enter a unique data source name for use in Tableau.
3. Drag one or more files you want to connect to from the left pane into the canvas.
4. To start your analysis, select the Sheet 1 tab.

Union your data

You can union files from your S3 bucket. For more information about union, see [Union Your Data](#). To perform a wildcard union that includes files in subfolders, the root folder or bucket must have at least one file, matching the structure of the files contained in subfolders, to include in the union. This file is the first file that you connect to when creating the union.

Known issues and limitations

The following sections have known issues and limitations that can affect how successful you are when using the Amazon S3 connector.

Note: This connector isn't currently supported in Tableau Prep Web Authoring or virtual connections.

Authentication known issues and limitations

- Only Amazon IAM User secret key/access key authentication without session token is supported.

Publishing known issues and limitations

- Workbooks and data sources must be published using the 'Embedded password' authentication option. 'Prompt user' isn't currently supported.

Union known issues and limitations

- Only Tableau Desktop supports a Wildcard union.
- Web Authoring only supports user-defined manual union (dragging files).

File type known issues and limitations

- Parquet, .csv, compressed .gz, and Excel files are supported at this time.
- All data is, by design, imported in string format.
- You can't union or join across multiple file types in a single connection (for example, Parquet & .csv together).
- Only comma-delimited .csv files are currently supported.
- The file size limit is 15gb.
- The cumulative result set of a join or union cannot exceed 15gb.
- Excel files currently can't exceed ~100 mb due to performance issues with the Excel file parser in the connector.

Additional Parquet file known issues and imitations

- Parquet files must be in the format described in our [Hyper API documentation](#).
- Nested columns and therefore the nested types MAP and LIST aren't supported.
- The types BSON, UUID, and ENUM aren't supported.
- The physical type FIXED_LEN_BYTE_ARRAY without any logical or converted type isn't supported.
- The type DECIMAL is only supported up to 8 bytes (18 decimal digits). Consider using double if you need more than 18 decimal digits.
- The types TIME_MILLIS and TIME_NANOS aren't supported. Consider using TIME_MICROS instead.

- The deprecated BIT_PACKED encoding isn't supported. No recent Parquet files should use this encoding, as it's deprecated for over half a decade.
- The DELTA_LENGTH_BYTE_ARRAY encoding and the recent BYTE_STREAM_SPLIT encoding aren't supported, as they aren't written by any library. If you encounter any Parquet files using these encodings, let us know.
- Supported compressions are SNAPPY, GZIP, ZSTD, and LZ4_RAW.

See also

- [Set Up Data Sources on page 596](#) – Add more data to this data source or prepare your data before you analyze it.
- [Build Charts and Analyze Data on page 1005](#) – Begin your data analysis.
- [Optimizing Your Amazon Redshift and Tableau Software Deployment for Better Performance](#) - Tableau whitepaper (registration or sign-in required)
- [Explore Big Data Analytics with Amazon Redshift](#) - Tableau on-demand webinar (registration or sign in required)

Anaplan

This article describes how to connect Tableau to Anaplan data and set up the data source.

Warning: The Anaplan connector is deprecated as of the 2023.1 release. You can use the connector until it's been retired. Once the connector is retired, it's removed from the Tableau user interface and any data sources using the connector will no longer work as expected. The deprecated connector will be retired 1-2 releases after the replacement connector is made available.

Note: Tableau is working on a replacement connector. After it's complete it will be added to this page.

Note: You will need to allow access to `api.anaplan.com` and `auth.anaplan.com` in your network proxy or firewall configurations in order to use the Anaplan connector.

Before you begin

Before you begin, gather this information for connecting:

- An email address and password for your Anaplan account.
- The Anaplan workspace, model, and any exports (in CSV format) that you want to use. An Anaplan export action must be created in Anaplan before you can use the export in

Tableau. For more information about creating a module and export action in Anaplan, see [Tableau Connector for Anaplan](#) on the Anaplan Anapedia website.

Make the connection and set up the data source

1. Start Tableau and under **Connect**, select **Anaplan**. For a complete list of data connections, select **More** under **To a Server**. Then do the following:

- a. Do one of the following:

- Select **Credentials**, then enter your email address and password.

For single sign-on (SSO) support, ask your Anaplan Administrator to set up single sign-on. For more information, see [Single Sign-on \(SSO\)](#) on the Anaplan Anapedia website. Note that if SSO is enabled, you must be an exception user.

- Select **Certificate**, then upload files for the **Certificate** and **Private Key**.

Note: The uploaded certificate must be in the DER encoded binary X.509 format. The private key can be in PEM format.

An SSL certificate file typically contains text similar to this:

```
-----BEGIN CERTIFICATE-----  
A long base64 string  
-----END CERTIFICATE-----
```

A private key file typically contains text similar to this:

```
-----BEGIN PRIVATE KEY-----  
A long base64 string  
-----END PRIVATE KEY-----
```

- b. Select a workspace, model, and one or more exports.

Note: The export data must be in CSV format.

- c. Select **Connect**.

If Tableau can't make the connection, verify that your credentials or certificate and private key files are correct. If you still can't connect, your computer is having trouble

locating the server. Contact your network or Anaplan administrator for more assistance.

2. On the data source page, do the following:
 - a. (Optional) Select the default data source name at the top of the page, and then enter a unique data source name for use in Tableau. For example, use a data source naming convention that helps other users of the data source figure out which data source to connect to.
 - b. Under **Table**, select a table and drag it to the top of the canvas. If you have only one table, it appears on the canvas.
 - c. Select the sheet tab to go to the worksheet.

After you select the sheet tab, Tableau imports the data by creating an extract.

Creating extracts may take some time depending on the amount of data that is included.

Date range selections can impact performance

It's tempting to gather as much data as possible when you do an analysis, however, retrieving records from Anaplan can be time-consuming. Tableau doesn't know how much data there is in a particular date range until it retrieves the data. For this reason, you should restrict your date range at first, and then expand after you evaluate performance.

To give you a rough idea of how much time it might take to retrieve data from Anaplan, tests were conducted using a high-speed connection. This table shows how long it took in the test environment to retrieve a given number of records.

Number of records	Time to retrieve
100,000	1.7 minutes
250,000	4 minutes
500,000	8.5 minutes

Groom your data

All data from Anaplan is returned as type **String**. To groom your data, convert the fields to the proper data type, for example, **Number** or **Date**. You can also change **Geographic Role**, and you can convert a dimension to a measure. For information about changing the data type, see [Data Types on page 157](#).

To convert a dimension to a measure, in the **Data** pane on the worksheet, select the drop-down arrow next to the field name and select **Convert to Measure**.

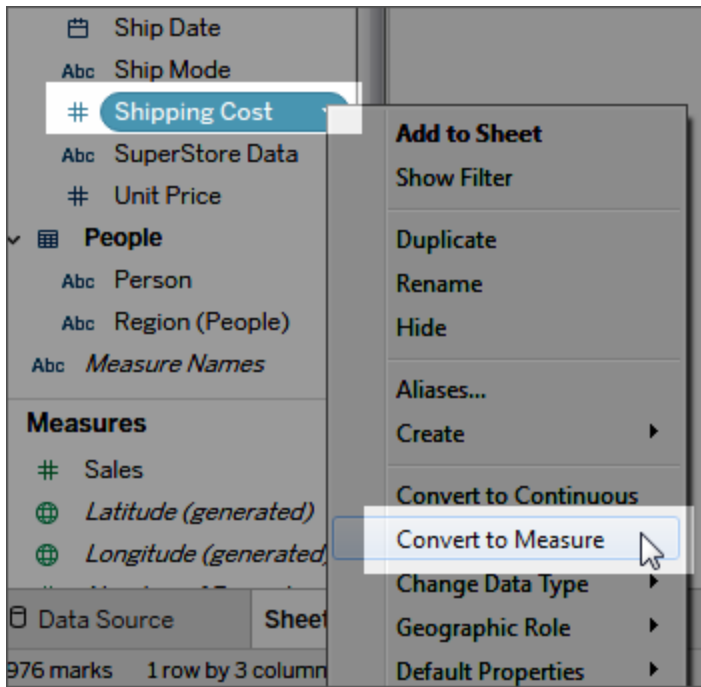

For information about dimensions and measures, see [Dimensions and Measures, Blue and Green](#) on page 147.

Refresh your data

Tableau supports only extract connections for Anaplan, not live connections. You can update the data by refreshing the extract; incremental refreshes are not supported. For more information, see [Refresh Extracts](#) on page 937. For information about refresh schedules, see [Schedule Extract Refreshes as You Publish a Workbook](#) on page 3164.

Note: When there is a scheduled refresh of the Tableau extract on Tableau Server or Tableau Cloud, an export action is called in Anaplan. The export action creates a blocking operation that locks the model in Anaplan.

See also

- [Set Up Data Sources on page 596](#) – Add more data to this data source or prepare your data before you analyze it.
- [Build Charts and Analyze Data on page 1005](#) – Begin your data analysis.

Apache Drill

This article describes how to connect Tableau to Apache Drill data and set up the data source.

Before you begin

Before you begin, gather this connection information:

- Type of connection:
 - Direct: server name
 - Zookeeper: quorum and cluster ID
- Authentication:
 - No authentication
 - User name and password

Driver required

This connector requires a driver to talk to the database. If the driver is not installed on your computer, Tableau displays a message in the connection dialog box with a link to the [Driver Download](#) page where you can find driver links and installation instructions.

Make the connection and set up the data source

1. Start Tableau and under **Connect**, select **Apache Drill**. For a complete list of data connections, select **More** under **To a Server**. Then do the following:
 - a. Select the **Connection** method:
 - **Direct** - Enter the **Server** name.
 - **Zookeeper** - Enter the **Quorum** and **Cluster ID**.
 - b. Select the **Authentication** method:
 - **No Authentication**

- **Username and password** - Enter the user name and password.
- c. Select **Sign In**.
2. On the data source page, do the following:
 - a. (Optional) Select the default data source name at the top of the page, and then enter a unique data source name for use in Tableau. For example, use a data source naming convention that helps other users of the data source figure out which data source to connect to.
 - b. Under **Schema**, select a schema from the drop-down list.
 - c. Under **Table**, select a table and drag it to the canvas.

For information about connecting to more than one table, see [Join Your Data on page 791](#).
 - d. Select the sheet tab to start your analysis.

Use custom SQL to connect to a specific query rather than the entire data source. For more information, see [Connect to a Custom SQL Query on page 863](#).

Sign in on a Mac

If you use Tableau Desktop on a Mac, when you enter the server name to connect, use a fully qualified domain name, such as mydb.test.ourdomain.lan, instead of a relative domain name, such as mydb or mydb.test.

Alternatively, you can add the domain to the list of Search Domains for the Mac computer so that when you connect, you need to provide only the server name. To update the list of Search Domains, go to **System Preferences > Network > Advanced**, and then open the **DNS** tab.

See also

- [Set Up Data Sources on page 596](#) – Add more data to this data source or prepare your data before you analyze it.
- [Build Charts and Analyze Data on page 1005](#) – Begin your data analysis.

Azure Data Lake Storage Gen2

This article describes how to connect Azure Data Lake Storage Gen2 and set up the data source.

Before you begin

Before you begin, review the items in the following list.

- Get your account credentials for Azure Active Directory via OAuth
- Get the URL for your Azure storage endpoint
- Tableau only supports OAuth for authentication. To allow authentication, you must safelist "connectors.tableau.com".

Note: This connector uses only the default tenant for your Azure account. To use Azure Data Lake Storage Gen2 resources with Tableau, they must be associated with the default tenant.

Recommendation

Setup a custom OAuth Client to use your company's IT policies

You can fully control your OAuth configuration according to your own IT policies with a custom OAuth client. The option to use your own OAuth client frees you from being tied to Tableau release cycles and Tableau's OAuth client rotation schedule. For information on how to configure your own OAuth client see, [Configure Custom OAuth for a site](#).

Make the connection and set up the data source

1. Start Tableau and under **Connect**, select **Azure Data Lake Storage Gen2**. For a complete list of data connections, select **More** under **To a Server**.
2. In the tab Tableau opens in your default browser, do the following:
 - a. Sign in to Azure Data Lake Storage Gen2 using your Azure account. Choose one from the list, or choose **Use another account** to enter your email address or phone number.
 - b. Select **Accept** so that Tableau can access your Azure Data Lake Storage Gen2 data.
 - c. Close the browser window when notified to do so.
3. On the data source page, do the following:

- a. On the **Browse** tab, enter the Azure storage endpoint for your Azure account.

Note: The storage account must have "Data Lake Storage Gen2" enabled.

- b. Navigate to the file you want to use and select it.

Or

- On the **File URL** tab, enter URL for the file.

About Azure storage accounts

When you use Tableau with Azure Data Lake Storage Gen2, the storage account you use must be set up with at least one of the following:

- Read permission explicitly granted for the files you want to access (Read / Execute for folders)
- Storage Blob Data Reader or Storage Blob Data Owner role assigned to the account

For more information about setting up a storage account, see [Create a storage account to use with Azure Data Lake Storage Gen2](#) on the Microsoft site.

An Azure storage account can have multiple endpoints associated with various services. In Tableau, you'll connect to the storage endpoint that is enabled for "Data Lake Storage Gen2".

When the storage account is configured, it must enable these CORS options for the Blob service to allow proper access from Tableau:

Allowed origins set to "*" Allowed methods set to "GET, OPTIONS"

Allowed headers set to "*"

An Azure storage account can have multiple endpoints associated with various services. In Tableau, you'll connect to the storage endpoint that is enabled for "Data Lake Storage Gen2".

See also

- [Set Up Data Sources on page 596](#) – Add more data to this data source or prepare your data before you analyze it.
- [Build Charts and Analyze Data on page 1005](#) – Begin your data analysis.

Azure SQL Database

This article describes how to connect Tableau to Azure SQL Database and set up the data source.

Note: If you're using Azure Active Directory via OAuth authentication, make sure you have already setup the server before you continue. For more information on server configuration, see [Configure Azure AD for OAuth and Modern Authentication](#).

Before you begin

Before you begin, gather this connection information:

- Fully qualified server name that hosts the database you want to connect to; for example, myserver-20171113.database.windows.net
- (Optional) Name of the database
- Authentication method:
 - Username and password
 - Active Directory password
 - Azure Active Directory via OAuth (integrated)

Note: To use this option, your system administrator must enable “user consent” in your organization's Azure Active Directory tenant. For more information, see Microsoft documentation on [configuring user consent](#).

- Sign in credentials depend on the authentication method you choose and can include the following:
 - Username and password
 - Active Directory username and password
 - Azure Active Directory instance URL
- Are you connecting to an SSL server?
- Do you want to set the database isolation level to read uncommitted data?
- (Optional) Initial SQL statement to run every time Tableau connects

Make the connection and set up the data source

1. Start Tableau and under **Connect**, select **Azure SQL Database**. For a complete list of data connections, select **More** under **To a Server**. Then do the following:
 - a. Enter the URL for the server that you want to connect to.
 - b. (Optional) Enter a database name if you want to connect to a contained database.
 - c. Specify how you want to sign in to the server — with a username and password, with an Active Directory username and password, or using an integrated Azure Active Directory sign in via OAuth.
 - d. Type your user name and password.
Or, if you use Azure Active Directory via OAuth, type an Azure Active Directory instance URL. See documentation from Microsoft on [endpoints](#) for more details.

Note: If your organization uses more than one Azure Active Directory tenant, the Azure Active Directory instance URL must match the tenant where the database is configured. You can find the tenant ID in your Azure portal, or from your Azure administrator.

- e. Select the **Require SSL** check box when connecting to an SSL server.
- f. Specify whether to **Read uncommitted data**. This option lets Tableau run at the read-uncommitted isolation level. Long queries from Tableau, including extract refreshes, can lock the database and delay transactions. Select this option to allow queries to read rows that have been modified by other transactions even when they haven't been committed yet. When this option is cleared, Tableau uses the default isolation level specified by the database.
- g. (Optional) Select **Initial SQL** to specify a SQL command to run at the beginning of every connection, such as when you open the workbook, refresh an extract, sign in to Tableau Server, or publish to Tableau Server. For more information, see [Run Initial SQL on page 591](#).
- h. Select **Sign In**.

If Tableau can't make the connection, verify that your credentials are correct. If you still can't connect, your computer is having trouble locating the server. Contact your network administrator or database administrator.

2. On the data source page, do the following:
 - a. (Optional) Select the default data source name at the top of the page, and then enter a unique data source name for use in Tableau. For example, use a data source naming convention that helps other users of the data source figure out which data

source to connect to.

- b. From the **Database** drop-down list, select a database.
- c. Under **Table**, select a table or use the search field to search for a table by name.

You can also specify a stored procedure in the database. For more information about stored procedures, including a list of constraints specific to SQL Server databases, see [Use a Stored Procedure on page 878](#).

- d. Drag a table to the canvas, and then select the sheet tab to start your analysis.

Use custom SQL to connect to a specific query rather than the entire data source. For more information, see [Connect to a Custom SQL Query on page 863](#).

Note: Tableau Desktop doesn't support the Microsoft SQL Server TIME data type. Fields of this data type aren't imported and don't appear in Tableau Desktop. If included in stored procedures, TIME data type fields won't appear in Tableau Desktop. For more information, see [Use a Stored Procedure on page 878](#).

Sign in on a Mac

If you use Tableau Desktop on a Mac, when you enter the server name to connect, use a fully qualified domain name, such as mydb.test.ourdomain.lan, instead of a relative domain name, such as mydb or mydb.test.

Alternatively, you can add the domain to the list of Search Domains for the Mac computer so that when you connect, you need to provide only the server name. To update the list of Search Domains, go to **System Preferences > Network > Advanced**, and then open the **DNS** tab.

Note: Azure Active Directory via OAuth (integrated) isn't supported on a Mac

See also

- [Set Up Data Sources on page 596](#) – Add more data to this data source or prepare your data before you analyze it.
- [Build Charts and Analyze Data on page 1005](#) – Begin your data analysis.

Azure SQL Synapse Analytics

This article describes how to connect Tableau to Azure Synapse Analytics (formerly Azure SQL Data Warehouse) and set up the data source.

Note: Make sure you have already setup the server before you continue. For more information on server configuration, see [Configure Azure AD for OAuth and Modern Authentication](#).

Before you begin

Before you begin, gather this connection information:

- Fully qualified server name that hosts the database you want to connect to; for example, myserver-20171113.database.windows.net
- (Optional) Name of the database
- Authentication method:
 - Username and password
 - Active Directory password
 - Azure Active Directory via OAuth (integrated)

Note: To use this option, your system administrator must enable “user consent” in your organization's Azure Active Directory tenant. For more information, see Microsoft documentation on [configuring user consent](#).

- Sign in credentials depend on the authentication method you choose and can include the following:
 - Username and password
 - Active Directory username and password
 - Azure Active Directory instance URL
- Are you connecting to an SSL server?
- Do you want to set the database isolation level to read uncommitted data?
- (Optional) Initial SQL statement to run every time Tableau connects

Driver required

This connector requires a driver to talk to the database. If the driver is not installed on your

computer, Tableau displays a message in the connection dialog box with a link to the [Driver Download](#) page where you can find driver links and installation instructions.

Make the connection and set up the data source

1. Start Tableau and under **Connect**, select **Azure Synapse Analytics**. For a complete list of data connections, select **More** under **To a Server**. Then do the following:
 - a. Enter the URL for the server that you want to connect to.
 - b. (Optional) Enter a database name if you want to connect to a contained database.
 - c. Specify how you want to sign in to the server — with a username and password, with an Active Directory username and password, or using an integrated Azure Active Directory sign-in via OAuth.
 - d. Type your user name and password.
Or, if you use Azure Active Directory via OAuth, type an Azure Active Directory instance URL. See documentation from Microsoft on [endpoints](#) for more details.

Note: If your organization uses more than one Azure Active Directory tenant, the Azure Active Directory instance URL must match the tenant where the database is configured. You can find the tenant ID in your Azure portal, or from your Azure administrator.

- e. Select the **Require SSL** check box when connecting to an SSL server.
- f. Specify whether to **Read uncommitted data**. This option lets Tableau run at the read-uncommitted isolation level. Long queries from Tableau, including extract refreshes, can lock the database and delay transactions. Select this option to allow queries to read rows that have been modified by other transactions even when they have not been committed yet. When this option is cleared, Tableau uses the default isolation level specified by the database.
- g. (Optional) Select **Initial SQL** to specify a SQL command to run at the beginning of every connection, such as when you open the workbook, refresh an extract, sign in to Tableau Server, or publish to Tableau Server. For more information, see [Run Initial SQL on page 591](#).
- h. Select **Sign In**.

If Tableau can't make the connection, verify that your credentials are correct. If you still can't connect, your computer is having trouble locating the server. Contact your network administrator or database administrator.

2. On the data source page, do the following:

- a. (Optional) Select the default data source name at the top of the page, and then enter a unique data source name for use in Tableau. For example, use a data source naming convention that helps other users of the data source figure out which data source to connect to.
- b. From the **Database** drop-down list, select a database.
- c. Under **Table**, select a table or use the search field to search for a table by name.

You can also specify a stored procedure in the database. For more information about stored procedures, including a list of constraints specific to SQL Server databases, see [Use a Stored Procedure on page 878](#).
- d. Drag a table to the canvas, and then select the sheet tab to start your analysis.

Use custom SQL to connect to a specific query rather than the entire data source. For more information, see [Connect to a Custom SQL Query on page 863](#).

Note: Tableau Desktop does not support the Microsoft SQL Server TIME data type. Fields of this data type are not imported and do not appear in Tableau Desktop. If included in stored procedures, TIME data type fields will not appear in Tableau Desktop. For more information, see [Use a Stored Procedure on page 878](#).

Sign in on a Mac

If you use Tableau Desktop on a Mac, when you enter the server name to connect, use a fully qualified domain name, such as mydb.test.ourdomain.lan, instead of a relative domain name, such as mydb or mydb.test.

Alternatively, you can add the domain to the list of Search Domains for the Mac computer so that when you connect, you need to provide only the server name. To update the list of Search Domains, go to **System Preferences > Network > Advanced**, and then open the **DNS** tab.

Note: Even though the **Azure Active Directory via OAuth** option shows up on the Azure SQL Synapse Analytics connector window, it isn't supported for MAC.

See also

- [Set Up Data Sources on page 596](#) – Add more data to this data source or prepare your data before you analyze it.
- [Build Charts and Analyze Data on page 1005](#) – Begin your data analysis.

Box

This article describes how to connect Tableau to Box data and set up the data source.

Before you begin

Before you begin, get the email address and password for your Box account.

Make the connection and set up the data source

1. On the start page, under **Connect**, click **Box**. For a complete list of connections, select **More** under **To a Server**. In the tab Tableau opens in your default browser, do the following:
 - a. Enter your email and password and then click **Authorize**.
 - b. Click **Grant access to Box**.
 - c. Close the browser window when notified to do so.
 - d. Search for or select the file to connect to, and then click **Connect**.

Note: This connector might not support all file types. Unsupported file types are grayed out.

2. On the data source page, do the following:
 - a. (Optional) Select the default data source name at the top of the page, and then enter a unique data source name for use in Tableau. For example, use a data source naming convention that helps other users of the data source figure out which data source to connect to.
 - b. Click the sheet tab to start your analysis.

Use Data Interpreter to clean your data

If Tableau detects that it can help optimize your data source for analysis, it prompts you to use Data Interpreter. Data Interpreter can detect sub-tables that you can use and remove unique formatting that might cause problems later on in your analysis. For more information, see [Clean Data from Excel, CSV, PDF, and Google Sheets with Data Interpreter](#) on page 897.

Adding Tableau to your Box account

You can officially enable Tableau as an approved app for your Box account. For information on enabling this feature, please see [Introducing Box App Center](#) on the Box website.

Limitations and known issues

The Box connector limits connecting to a single Excel, JSON, or text-based file.

Known issues

- If you click **Grant Access to Box** repeatedly during the authentication phase an error results.
- Long file names cause the column to be pushed out of alignment.
- The file window does not resize.
- When using web authoring or publishing to the web, you cannot use multiple Box accounts in the same workbook. You can have multiple Box account connections in Desktop.
- In Internet Explorer 11 and Edge, you cannot access a server using an unsecured connection (http). Use a secure connection (https) or switch to another browser.

See also

- [Set Up Data Sources on page 596](#) – Add more data to this data source or prepare your data before you analyze it.
- [Build Charts and Analyze Data on page 1005](#) – Begin your data analysis.

Cloudera Hadoop

This article describes how to connect Tableau to a Cloudera Hadoop database and set up the data source.

Note: For new connections to Impala databases, use the [Impala connector](#) rather than this one. (You can continue using this connector for existing connections.)

Before you begin

Before you begin, gather this connection information:

- Name of the server that hosts the database you want to connect to and port number
- Type of database: Hive Server 2 or Impala
- Authentication method:
 - No Authentication
 - Kerberos

Note: Due to Kerberos Domain Controller (KDC) restrictions, connection with MIT Kerberos is not supported.

- User Name
- User Name and Password
- Microsoft Azure HDInsight Service (starting in version 10.2.1)
- Transport options depend on the authentication method you choose and can include the following:
 - Binary
 - SASL
 - HTTP
- Sign-in credentials depend on the authentication method you choose and can include the following:
 - User name
 - Password
 - Realm
 - Host FQDN
 - Service name
 - HTTP path
- Are you connecting to an SSL server?
- (Optional) Initial SQL statement to run every time Tableau connects

Driver required

This connector requires a driver to talk to the database. If the driver is not installed on your computer, Tableau displays a message in the connection dialog box with a link to the [Driver Download](#) page where you can find driver links and installation instructions.

Note: Make sure you use the latest available drivers. To get the latest drivers, see [Cloudera Hadoop](#) on the Tableau Driver Download page.

Make the connection and set up the data source

1. Start Tableau and under **Connect**, select **Cloudera Hadoop**. For a complete list of data connections, select **More** under **To a Server**. Then do the following:
 - a. Enter the name of the server that hosts the database and the port number to use. If you are connecting using Cloudera Impala, you must use port 21050; this is the default port if you are using the 2.5.x driver (recommended).
 - b. In the **Type** drop-down list, select the type of database to connect to. Depending on the version of Hadoop and the drivers you have installed, you can connect to one of the following:
 - **Hive Server 2**
 - **Impala**
 - c. In the **Authentication** drop-down list, select the authentication method to use.
 - d. Enter the information that you are prompted to provide. The information you are prompted for depends on the authentication method you choose.
 - e. (Optional) Select **Initial SQL** to specify a SQL command to run at the beginning of every connection, such as when you open the workbook, refresh an extract, sign in to Tableau Server, or publish to Tableau Server. For more information, see [Run Initial SQL on page 591](#).
 - f. Select **Sign In**.

Select the **Require SSL** option when connecting to an SSL server.

If Tableau can't make the connection, verify that your credentials are correct. If you still can't connect, your computer is having trouble locating the server. Contact your network administrator or database administrator.
2. On the data source page, do the following:
 - a. (Optional) Select the default data source name at the top of the page, and then enter a unique data source name for use in Tableau. For example, use a data source naming convention that helps other users of the data source figure out which data source to connect to.
 - b. From the **Schema** drop-down list, select the search icon or enter the schema name in the text box and select the search icon, and then select the schema.

- c. In the **Table** text box, select the search icon or enter the table name and select the search icon, and then select the table.
- d. Drag the table to the canvas, and then select the sheet tab to start your analysis.

Use custom SQL to connect to a specific query rather than the entire data source. For more information, see [Connect to a Custom SQL Query on page 863](#).

Note: This database type supports only equal (=) join operations.

Sign in on a Mac

If you use Tableau Desktop on a Mac, when you enter the server name to connect, use a fully qualified domain name, such as mydb.test.ourdomain.lan, instead of a relative domain name, such as mydb or mydb.test.

Alternatively, you can add the domain to the list of Search Domains for the Mac computer so that when you connect, you need to provide only the server name. To update the list of Search Domains, go to **System Preferences > Network > Advanced**, and then open the **DNS** tab.

Work with Hadoop Hive data

Work with date/time data

Tableau supports **TIMESTAMP** and **DATE** types natively. However, if you store date/time data as a string in Hive, be sure to store it in ISO format (YYYY-MM-DD). You can create a calculated field that uses the **DATEPARSE** or **DATE** function to convert a string to a date/time format. Use **DATEPARSE()** when working with an extract, otherwise use **DATE()**. For more information, see [Date Functions on page 2075](#).

For more information about Hive data types, see [Dates](#) on the Apache Hive website.

NULL value returned

A **NULL** value is returned when you open a workbook in Tableau 9.0.1 and later and 8.3.5 and later 8.3.x releases that was created in an earlier version and has date/time data stored as a string in a format that Hive doesn't support. To resolve this issue, change the field type back to **String** and create a calculated field using **DATEPARSE()** or **DATE()** to convert the date. Use **DATEPARSE()** when working with an extract, otherwise use the **DATE()** function.

High latency limitation

Hive is a batch-oriented system and is not yet capable of answering simple queries with very quick turnaround. This limitation can make it difficult to explore a new data set or experiment

with calculated fields. Some of the newer SQL-on-Hadoop technologies (for example, Cloudera's Impala and Hortonworks' Stringer project) are designed to address this limitation.

See also

- [Set Up Data Sources on page 596](#) – Add more data to this data source or prepare your data before you analyze it.
- [Build Charts and Analyze Data on page 1005](#) – Begin your data analysis.

Databricks

This article describes how to connect Tableau to a Databricks database and set up the data source.

Before you begin

Before you begin, gather this connection information:

- Name of the server that hosts the database you want to connect to
- HTTP path to the data source
- Authentication method:
 - Databricks login (recommended)
 - Personal Access Token
- Sign in credentials to be used with your chosen authentication method:
 - Databricks login details (OAuth)
 - Personal Access Token password
- Get connection details for a Databricks compute resource.
- (Optional) Initial SQL statement to run every time Tableau connects

Driver required

This connector requires a driver to talk to the database. If the driver is not installed on your computer, Tableau displays a message in the connection dialog box with a link to the [Driver Download](#) page where you can find driver links and installation instructions.

Make the connection and set up the data source

1. Start Tableau and under **Connect**, select **Databricks**. For a complete list of data connections, select **More** under **To a Server**. Then do the following:
 - a. Enter the **Server Hostname**.
 - b. Enter the **HTTP Path** to the data source.

- c. Select the **Authentication** method: **Databricks login**(recommended) or **Personal Access Token**.

Note: Basic authentication using a Databricks user name and password reached end of life as of July 2024. For more information, see [End of life for Databricks-managed passwords](#).

- d. Enter the sign-in credentials for the authentication method you chose:
- For a Databricks login, sign in with your configured OAuth application. For more information, see [Configure Databricks sign-on from Tableau Server](#).
 - For personal access token, type the corresponding **Password**. (See [Personal Access Tokens](#) on the Databricks website for information on access tokens.)
- e. (Optional) Select **Initial SQL** to specify a SQL command to run at the beginning of every connection, such as when you open the workbook, refresh an extract, sign in to Tableau Server, or publish to Tableau Server. For more information, see [Run Initial SQL on page 591](#).
- f. Select **Sign In**.

If Tableau can't make the connection, verify that your credentials are correct. If you still can't connect, your computer is having trouble locating the server. Contact your network administrator or database administrator.

2. On the data source page, do the following:
- a. (Optional) Select the default data source name at the top of the page, and then enter a unique data source name for use in Tableau. For example, use a data source naming convention that helps other users of the data source figure out which data source to connect to.
 - b. Under **Schema**, select a schema or use the text box to search for a schema by name.
 - c. Under **Table**, select a table or use the text box to search for a table by name.
 - d. Drag the table to the canvas, and then select the sheet tab to start your analysis.

Use custom SQL to connect to a specific query rather than the entire data source. For more information, see [Connect to a Custom SQL Query on page 863](#).

Sign in on a Mac

If you use Tableau Desktop on a Mac, when you enter the server name to connect, use a fully qualified domain name, such as mydb.test.ourdomain.lan, instead of a relative domain name,

such as mydb or mydb.test.

Alternatively, you can add the domain to the list of Search Domains for the Mac computer so that when you connect, you need to provide only the server name. To update the list of Search Domains, go to **System Preferences > Network > Advanced**, and then open the **DNS** tab.

Databricks best practices and troubleshooting

To learn more about optimizing your workbooks, connections, and general Tableau performance, there is a wealth of advice available in [Optimize Workbook Performance on page 3041](#).

For information about best practices and troubleshooting when using Tableau with Databricks clusters, see the [Tableau](#) topic on the Databricks website.

See also

- [Set Up Data Sources on page 596](#) – Add more data to this data source or prepare your data before you analyze it.
- [Build Charts and Analyze Data on page 1005](#) – Begin your data analysis.

Denodo

This article describes how to connect Tableau to Denodo and set up the data source.

Before you begin

Before you begin, gather this connection information:

- Name of the server that hosts the database you want to connect to
- Name of the database
- Authentication method: Integrated Authentication, or Username and Password
- Are you connecting to an SSL server?
- (Optional) Initial SQL statement to run every time Tableau connects

Driver required

This connector requires a driver to talk to the database. If the driver is not installed on your computer, Tableau displays a message in the connection dialog box with a link to the [Driver Download](#) page where you can find driver links and installation instructions.

Update 20170515 of Denodo 6.0 required

If you can't connect Tableau to your Denodo data, you might need to ask your database administrator to apply update 20170515 to the Denodo 6.0 database. For more information about update 20170515 for Denodo 6.0, see the [Denodo](#) website. (Sign in required.)

Make the connection and set up the data source

1. Start Tableau and under **Connect**, select **Denodo**. For a complete list of data connections, select **More** under **To a Server**. Then do the following:
 - a. Enter the name of the server that hosts the database.
 - b. Enter the name of the database.
 - c. Select how you want to sign in to the server. Specify whether to use **Integrated Authentication** or **Username and Password**. If the server is password protected, and you are not in a Kerberos environment, you must enter the user name and password.

Note: If you're using a Mac, and it is not attached to the domain correctly, the Mac won't know that Kerberos is being used in the domain, and the **Authentication** drop-down list won't be available.

Select the **Require SSL** check box when connecting to an SSL server.

- d. (Optional) Select **Initial SQL** to specify a SQL command to run at the beginning of every connection, such as when you open the workbook, refresh an extract, sign in to Tableau Server, or publish to Tableau Server. For more information, see [Run Initial SQL on page 591](#).
 - e. Select **Sign In**.

If Tableau can't make the connection, verify that your credentials are correct. If you still can't connect, your computer is having trouble locating the server. Contact your network administrator or database administrator.
2. On the data source page, do the following:
 - a. (Optional) Select the default data source name at the top of the page, and then enter a unique data source name for use in Tableau. For example, use a data source naming convention that helps other users of the data source figure out which data source to connect to.

- b. Under **Table**, select a table or use the text box to search for a table by name.
- c. Click the sheet tab to start your analysis.

See also

- [Set Up Data Sources on page 596](#) – Add more data to this data source or prepare your data before you analyze it.
- [Build Charts and Analyze Data on page 1005](#) – Begin your data analysis.

Dremio Connector by Dremio

Note: This is a partner-built connector, created and supported by Dremio. See the [Dremio web site](#) for more information.

This article describes how to connect Tableau to a Dremio data lake and set up the data source.

Before you begin

Before you begin, gather this connection information:

- Name or IP address for the server that hosts the database you want to connect to
- Port number
- Username and password
- (Optional) Initial SQL statement to run every time Tableau connects

Driver required

This connector requires a driver to talk to the database. If the driver is not installed on your computer, Tableau displays a message in the connection dialog box with a link to the [Driver Download](#) page where you can find driver links and installation instructions.

Make the connection and set up the data source

1. Start Tableau and under **Connect**, select **Dremio** . For a complete list of data connections, select **More** under **To a Server**. Then do the following:
 - a. Enter the name or IP address for the **Server**.
 - b. Enter the **Port** number.
 - c. Enter the **Username** and **Password**.
 - d. (Optional) Select **Initial SQL** to specify a SQL command to run at the beginning of every connection, such as when you open the workbook, refresh an extract, sign in

to Tableau Server, or publish to Tableau Server. For more information, see [Run Initial SQL on page 591](#).

- e. Select **Sign In**.

If Tableau can't make the connection, verify that your credentials are correct. If you still can't connect, your computer is having trouble locating the server. Contact your network administrator or database administrator.

2. On the data source page, do the following:

- a. (Optional) Select the default data source name at the top of the page, and then enter a unique data source name for use in Tableau. For example, use a data source naming convention that helps other users of the data source figure out which data source to connect to.
- b. Under **Table**, select a table or search for a table by name.
- c. Drag the table to the canvas, and then select the sheet tab to start your analysis.

Use custom SQL to connect to a specific query rather than the entire data source. For more information, see [Connect to a Custom SQL Query on page 863](#).

Sign in on a Mac

If you use Tableau Desktop on a Mac, when you enter the server name to connect, use a fully qualified domain name, such as mydb.test.ourdomain.lan, instead of a relative domain name, such as mydb or mydb.test.

Alternatively, you can add the domain to the list of Search Domains for the Mac computer so that when you connect, you need to provide only the server name. To update the list of Search Domains, go to **System Preferences > Network > Advanced**, and then open the **DNS** tab.

See also

- [Set Up Data Sources on page 596](#) – Add more data to this data source or prepare your data before you analyze it.
- [Build Charts and Analyze Data on page 1005](#) – Begin your data analysis.

Dropbox

This article describes how to connect Tableau to Dropbox data and set up the data source.

Note: "Team" folders are currently unavailable through the Dropbox connector.

Before you begin

Before you begin, get the email address and password for your Dropbox account.

Make the connection and set up the data source

1. Start Tableau and under **Connect**, select **Dropbox**. For a complete list of data connections, select **More** under **To a Server**. In the tab Tableau opens in your default browser, do the following:
 - a. Enter your email and password and then select **Sign in**.
 - b. Select **Allow** to let Tableau Desktop access your Dropbox files and folders.
 - c. Close the browser window when notified to do so.
 - d. Search for or select the file to connect to, and then select **Connect**.

Note: This connector might not support all file types. Unsupported file types are grayed out.

2. On the data source page, do the following:
 - a. (Optional) Select the default data source name at the top of the page, and then enter a unique data source name for use in Tableau. For example, use a data source naming convention that helps other users of the data source figure out which data source to connect to.
 - b. Select the sheet tab to start your analysis.

Note: Tableau doesn't support pivot tables in Dropbox.

Use Data Interpreter to clean your data

If Tableau detects that it can help optimize your data source for analysis, it prompts you to use Data Interpreter. Data Interpreter can detect sub-tables that you can use and remove unique formatting that might cause problems later on in your analysis. For more information, see [Clean Data from Excel, CSV, PDF, and Google Sheets with Data Interpreter](#) on page 897.

Troubleshoot Dropbox issues

Connections to multiple accounts

When using web authoring or publishing to the web, you cannot use multiple Dropbox accounts in the same workbook. You can have multiple Dropbox account connections in Desktop.

Web authoring with Internet Explorer 11 and Edge

In Internet Explorer 11 and Edge, you cannot access a server using an unsecured connection (http). Use a secure connection (https) or switch to another browser.

See also

- [Set Up Data Sources on page 596](#) – Add more data to this data source or prepare your data before you analyze it.
- [Build Charts and Analyze Data on page 1005](#) – Begin your data analysis.

Esri Connector

In Tableau, you can connect to an **Esri (ArGIS) Server** and **ArcGIS Online**. The connector calls the Esri Services Directory REST API to find all MapServer and FeatureServer services. You can choose individual layers from those discovered services that are downloaded and stored in an extract.

Note: In Tableau 2022.1, the Esri connector replaced the Esri ArcGIS Server connector. The workbooks you created with the Esri ArcGIS Server (including published ones) will continue to function normally. All of those workbooks are built on extracts that are valid indefinitely. You can create new workbooks with the Esri connector.

Download the required driver

The Esri connector requires a driver to be installed. If the driver isn't installed on the host computer, the connection dialog box displays a link to the [Driver Download](#). All Tableau Cloud sites already have the driver installed.

Connect to Esri Services

There are two ways to connect to Esri services with the Esri connector: No authentication or OAuth.

No authentication

Use the no authentication method if your Esri server is publicly accessible. There are thousands of such endpoints, many of which are [listed here](#). You can set up layers on your Esri server to be publicly accessible.

Follow along with this example:

1. From Tableau Desktop or Tableau Server, install the driver.
2. Start Tableau and under **Connect**, select **Esri**.

If authoring in Tableau Cloud or Tableau Server, Select **New Workbook > Connectors > Esri**.

3. Change the value under `Connect` to `to A public-facing ArcGIS server`.
4. For the ArcGIS Server URL in this example, you can use `https://services.arcgis.com/P3ePLMys2RVChkJx/ArcGIS/rest/services/AGOL_Base_2018_Final/FeatureServer`
5. Select **Sign In** (Don't worry, you aren't actually signing in.)
6. You'll see layers representing geographic levels of detail. Double-click **County**.
7. Navigate to Sheet 1. (Tableau creates an extract from the layer.)
8. Drag (or double-click) the **Shape** field onto the canvas. A map of counties in the US appears.
9. Drag the **Median Age Cy** field onto color on the **Marks** card. A choropleth of Median Age from the 2018 census renders.

OAuth (Tableau Desktop and Tableau Cloud)

Use the OAuth method if you have an account and data saved on ArcGIS Online. You can retrieve layers from your account by entering your credentials in the Esri connector dialog.

1. From Tableau Desktop, install the driver (see above).
2. Start Tableau and under **Connect**, select **Esri**.

If authoring in Tableau Cloud or Tableau Server, select **New Workbook > Connectors > Esri**.

3. Select **Sign In**.
4. Provide your Esri credentials in the browser and select **Sign In** again.
5. A list of services available in your account appears.

OAuth (Tableau Server)

To use the OAuth mode to connect from Tableau Server to ArcGIS Online, you must first configure both the ArcGIS Online account and Tableau Server.

Configure ArcGIS Online

1. Obtain an ArcGIS Developer account.
2. Register a new OAuth application following the instructions found on the [arcGIS website](#).
3. Specify the Redirect URL as `https://<your Tableau Server Host>/auth/add_oauth_token`

4. Make note of the Redirect URL, Client ID, and Client Secret, as you need them to configure Tableau Server.

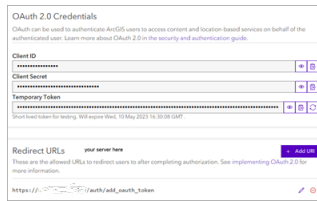

Configure Tableau Server

1. From Settings, scroll to **OAuth Clients Registry**.
2. Select **Add OAuth Client**.
3. In Connection Type, select **Esri**.
4. Fill in the Redirect URL, Client ID, and Client Secret from the ArcGIS Online configuration step mentioned previously.
5. Save your Settings changes.

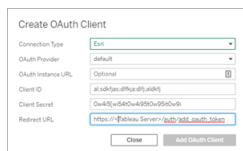

Troubleshoot Esri connections

Note: It's important to have the current driver (version 0.73.0 or later).

ArcGIS Server layers with large geometries may not successfully download, or the download may take a long time.

Known limitations

- When you use an OAuth connection, only items in the Owner's user account display.
- The Esri connector doesn't support definition queries. Thus, the selected layer downloads in its entirety.
- The Esri connector doesn't support live connections, and always creates an extract. A packaged workbook with an ArcGIS connection can be opened in versions of Tableau older than 2022.1, but you can't refresh the extract.

- The connector searches only for MapServer and FeatureServer service types.
- The connector ignores the esriFieldTypeBlob and esriFieldTypeRaster types.
- Esri geometry types are limited to the following:
 - esriGeometryPoint
 - esriGeometryMultipoint
 - esriGeometryLine
 - esriGeometryPath
 - esriGeometryPolyline
 - esriGeometryPolygon
 - esriGeometryEnvelope
- If the ArcGIS Server contains multiple layers or tables with identical names within a service, only one displays.

See also

- [Set Up Data Sources on page 596](#) – Add more data to this data source or prepare your data before you analyze it.
- [Build Charts and Analyze Data on page 1005](#) – Begin your data analysis.

Exasol

This article describes how to connect Tableau to data stored in the Exasol platform and set up the data source. Tableau can connect to Exasol version 4.2 and later.

Before you begin

Before you begin, gather this connection information:

- Name of the server you want to connect to
- User name and password
- (Optional) Initial SQL statement to run every time Tableau connects

Driver required

This connector requires a driver to talk to the database. If the driver is not installed on your computer, Tableau displays a message in the connection dialog box with a link to the [Driver Download](#) page where you can find driver links and installation instructions.

Make the connection and set up the data source

1. Start Tableau and under **Connect**, select **Exasol**. For a complete list of data connections, select **More** under **To a Server**. Then do the following:
 - a. Enter the name of the server that you want to connect to.
 - b. Enter the user name and password.
 - c. (Optional) Select **Initial SQL** to specify a SQL command to run at the beginning of every connection, such as when you open the workbook, refresh an extract, sign in to Tableau Server, or publish to Tableau Server. For more information, see [Run Initial SQL on page 591](#).
 - d. Select **Sign In**.
2. On the data source page, do the following:
 - a. (Optional) Select the default data source name at the top of the page, and then enter a unique data source name for use in Tableau. For example, use a data source naming convention that helps other users of the data source figure out which data source to connect to.
 - b. From the **Schema** drop-down list, select a schema or use the text box to search for a schema by name.
 - c. Under **Table**, select a table or use the text box to search for a table by name.
 - d. Drag the table to the canvas, and then select the sheet tab to start your analysis.

Use custom SQL to connect to a specific query rather than the entire data source. For more information, see [Connect to a Custom SQL Query on page 863](#).

Sign in on a Mac

If you use Tableau Desktop on a Mac, when you enter the server name to connect, use a fully qualified domain name, such as mydb.test.ourdomain.lan, instead of a relative domain name, such as mydb or mydb.test.

Alternatively, you can add the domain to the list of Search Domains for the Mac computer so that when you connect, you need to provide only the server name. To update the list of Search Domains, go to **System Preferences > Network > Advanced**, and then open the **DNS** tab.

See also

- [Set Up Data Sources on page 596](#) – Add more data to this data source or prepare your data before you analyze it.
- [Build Charts and Analyze Data on page 1005](#) – Begin your data analysis.

Firebird 3

This article describes how to connect Tableau to a Firebird database and set up the data source.

Note: In version 2020.1, the Firebird 3 connector replaced the Firebird connector. If you're using an earlier version of Tableau, go to the [Tableau Help](#) page and select the version you need from the drop-down list on the left. Then search for "Firebird" to find information on that connector.

Before you begin

Before you begin, gather this connection information:

- Name of the server that hosts the database you want to connect to
- Location of the database
- User name and password

Driver required

This connector requires a driver to talk to the database. If the driver is not installed on your computer, Tableau displays a message in the connection dialog box with a link to the [Driver Download](#) page where you can find driver links and installation instructions.

Make the connection and set up the data source

1. Start Tableau and under **Connect**, select **Firebird 3**. For a complete list of data connections, select **More** under **To a Server**. Then do the following:
 - a. Enter the name of the server that hosts the database.
 - b. Enter the database, or browse to the location of the database.
 - c. Enter the user name and password, and then select **Sign In**.

If Tableau can't make the connection, verify that your credentials are correct. If you still can't connect, your computer is having trouble locating the server. Contact your network administrator or database administrator.

2. On the data source page, do the following:
 - a. (Optional) Select the default data source name at the top of the page, and then enter a unique data source name for use in Tableau. For example, use a data source naming convention that helps other users of the data source figure out which data source to connect to.
 - b. Select a table, drag it to the canvas, and then select the sheet tab to start your analysis.

Starting in 2019.2, the Firebird connector no longer supports custom SQL connections.

Sign in on a Mac

If you use Tableau Desktop on a Mac, when you enter the server name to connect, use a fully qualified domain name, such as `mydb.test.ourdomain.lan`, instead of a relative domain name, such as `mydb` or `mydb.test`.

Alternatively, you can add the domain to the list of Search Domains for the Mac computer so that when you connect, you need to provide only the server name. To update the list of Search Domains, go to **System Preferences > Network > Advanced**, and then open the **DNS** tab.

Upgrade a Firebird extract

Beginning with version 10.5, Tableau has changed the format of extracts to the `.hyper` format. This format change requires Firebird extracts be opened and saved using an earlier version of Tableau before it can either be used with the current version of Tableau or be upgraded to the `.hyper` format. When you open and save the Firebird extract in an earlier version of Tableau, the Firebird extract is upgraded to a `.tde` format. To upgrade a Firebird extract, follow the steps listed below.

1. Get an earlier version of Tableau Desktop. To get an earlier version of Tableau Desktop, see the Tableau [Alternate Downloads Site](#) page.
2. Install the earlier version of Tableau Desktop, and then use it to open the Firebird extract.
3. Save the extract.
4. Open the upgraded Firebird extract using the current version of Tableau Desktop. The extract should work as expected.

Note: Starting with version 10.5, Tableau uses the .hyper format. You can upgrade your extract from a .tde to a .hyper format by selecting **Data > Extract > Upgrade**. For more information, see [Extract Upgrade to .hyper Format on page 936](#). For Tableau versions 2024.3 and beyond, you can no longer use or upgrade .tde files.

See also

- [Set Up Data Sources on page 596](#) – Add more data to this data source or prepare your data before you analyze it.
- [Build Charts and Analyze Data on page 1005](#) – Begin your data analysis.

Google Analytics

Note: Tableau adheres to [Google's API Services User Data Policy](#) and Limited Use Requirements when using or transferring information from Google APIs to other apps.

This article describes how to connect Tableau to Google Analytics (GA) and set up the data source.

Note: Google Analytics 4 property isn't supported.

Before you begin

Before you begin, gather this connection information:

- GA email address and password

Recommendation

Setup a custom OAuth Client to use your company's IT policies

You can fully control your OAuth configuration according to your own IT policies with a custom OAuth client. The option to use your own OAuth client frees you from being tied to Tableau release cycles and Tableau's OAuth client rotation schedule. For information on how to configure your own OAuth client see, [Configure custom OAuth for a site](#).

Make the connection and set up the data source

1. Start Tableau and under **Connect**, select **Google Analytics**. For a complete list of data connections, select **More** under **To a Server**. In the tab Tableau opens in your default browser, do the following:
 - a. Sign in to GA using your email or phone, and then select **Next** to enter your password.

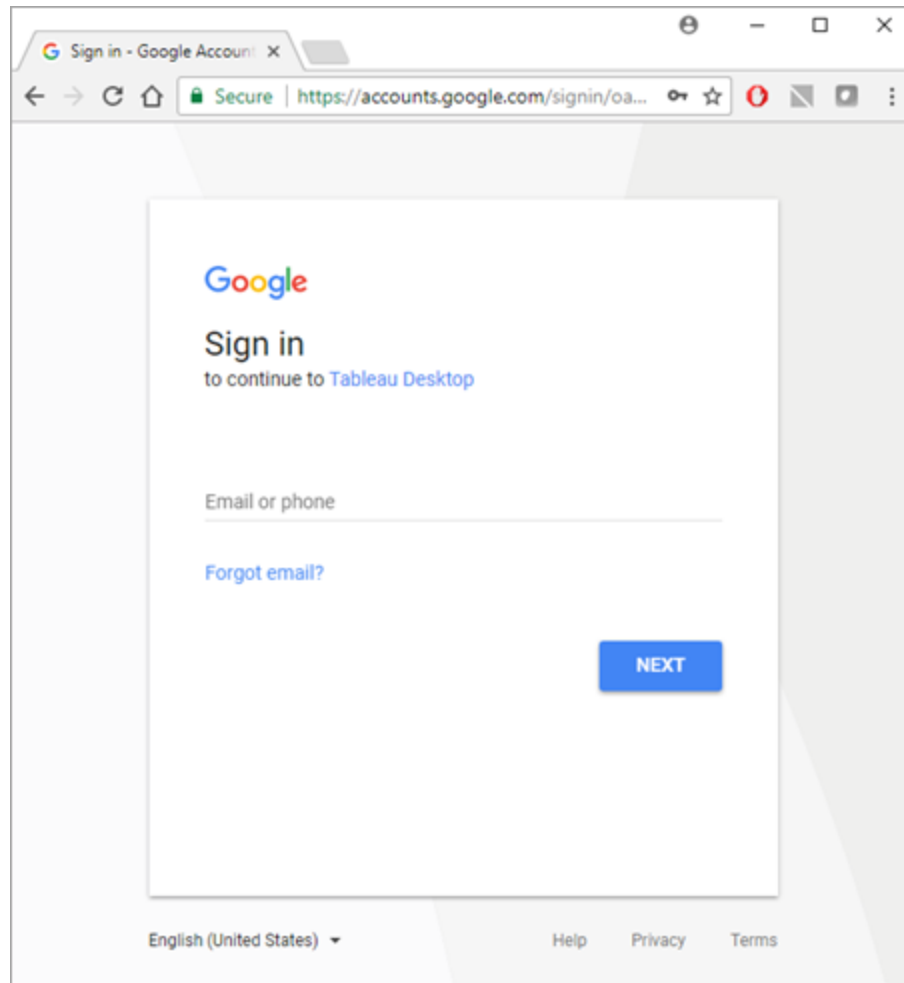

- b. Select **Allow** so that Tableau Desktop can access your GA data.
 - c. Close the browser window when notified to do so.
2. On the data source page, do the following:
 - a. (Optional) Select the default data source name at the top of the page, and then enter a unique data source name for use in Tableau. For example, use a data

source naming convention that helps other users of the data source figure out which data source to connect to.

- b. Follow the steps at the top of the data source page to complete the connection.

Step 1 – Select an Account, Property, and Profile using the dropdown menus.

Step 2 – Select filters for a date range and a segment.

- For **Date Range**, you can select one of the predefined date ranges or select specific dates. When selecting a date range, GA can provide complete data only up to the previous full day. For example, if you choose Last 30 days, data will be retrieved for the last 30-day period ending yesterday.
- For **Segment**, select a segment to filter your data. Segments are preset filters that you can set for a GA connection. Default Segments are defined by Google, and Custom Segments are defined by the user on the GA website. Segments also help prevent sampling to occur by filtering the data as defined by the segment. For example, with a segment, you can get results for a specific platform, such as tablets, or for a particular search engine, such as Google.

Note: GA restricts the amount of data that it returns in a query. When you try to retrieve more data than GA allows in a single query, GA returns sampled data instead. If Tableau detects that your GA query might return sampled data, Tableau attempts to bypass the query restriction to return all data instead. For more information, see [All data vs. sampled data returned from a query on the next page](#) below.

Step 3 – Add dimensions and measures by using the **Add Dimension** and **Add Measure** dropdown menus, or select a predefined set of measures from the **Choose a Measure Group** dropdown menu. Some dimensions and measures can't be used together. For more information, see [Dimensions & Metrics Reference Guide](#) on the Google developer website.

- c. Select the sheet tab to start your analysis. After you select the sheet tab, Tableau imports the data by creating an extract. Tableau Desktop supports only extracts for Google Analytics. You can update the data by refreshing the extract. For more

information, see [Extract Your Data on page 919](#).

All data vs. sampled data returned from a query

GA restricts the amount of data that it returns from a query and provides sampled data instead. Sampled data is a random subset of your data. When performing analysis on sampled data, you can miss interesting outliers, and aggregations can be inaccurate. If Tableau detects that your query might return sampled data, by default, Tableau creates multiple queries from your query, and then combines the results from the queries to return all data.

You see the following message when Tableau returns all data.

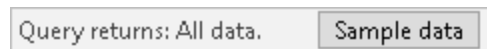

If the query stays within the boundaries of the query restrictions, GA doesn't return sampled data and you don't see the above message.

Troubleshoot issues with returning all data

If your query continues to return sampled data, consider the following:

- **Missing required context variable** - Google Analytics 4 property isn't supported.
- **Missing date dimension** – You must use the date dimension in your query to return all data.
- **Too much data** – Your query might contain too much data. Reduce the date range. The minimum date range is one day.
- **Non-aggregatable dimensions and measures** – Some dimensions and measures can't be separated into multiple queries. If you suspect a problematic dimension or measure in your query, hover over the **All data** button to see the tooltip that shows which dimensions or measures to remove from your query.
- **Legacy workbooks** – Workbooks created in Tableau Desktop 9.1 and earlier can't return all data. Open the legacy workbook in Tableau Desktop 9.2 and later and save the workbook.

Return sampled data

In cases when workbook performance is critical or there are specific dimensions and measures you want to use in your query that aren't supported by Tableau's default query process, use sampled data instead. To return sampled data, select the **Sample data** button.



See also

- [Set Up Data Sources on page 596](#) – Add more data to this data source or prepare your data before you analyze it.
- [Build Charts and Analyze Data on page 1005](#) – Begin your data analysis.

[5 Tips to Get More from Google Analytics](#) - Read the Tableau whitepaper (registration or sign in required).

Google Analytics 4

Note: Tableau adheres to [Google's API Services User Data Policy](#) and Limited Use Requirements when using or transferring information from Google APIs to other apps.

This article describes how to connect Tableau to Google Analytics 4 and set up the data source.

Before you begin

Before you begin, gather this connection information:

- Google Analytics email address and password

Recommendation

Set up a custom OAuth Client to use your company's IT policies

You can fully control your OAuth configuration according to your own IT policies with a custom OAuth client. The option to use your own OAuth client frees you from being tied to Tableau release cycles and Tableau's OAuth client rotation schedule. For information on how to configure your own OAuth client see, [Configure custom OAuth for a site](#).

Make the connection and set up the data source

1. Start Tableau and under **Connect**, select **Google Analytics 4** from the list of **Additional Connectors**.

2. Select **Install and Restart Tableau** to install the connector.
3. After Tableau restarts, under **Connect**, select **Google Analytics 4** from the list of Installed Connectors.
4. Sign in with your Google email address and password.
5. Check the permission box to allow Tableau to See and download your Google Analytics data.
6. Follow the steps in the Google Analytics 4 dialog window to complete the connection.
 - a. Select an **Account** and **Property**.
 - b. In **Date Range**, select a default date range or specific dates.

The date range can be Fixed Start and End Dates, relative to a Fixed Start Date, or Relative to Refresh Date (that is, the current date on which the connection is created or refreshed).

- c. Add dimensions and metrics (measures).

Note: Some dimensions and measures can't be used together. For more information, see [Dimensions & Metrics Reference Guide](#) on the Google developer website.

- d. Review your connection attributes and select **Connect**.
6. (Optional) On the **Data Source** page, select the default data source name at the top of the page, and then enter a unique data source name for use in Tableau.

For example, use a data source naming convention that helps other users of the data source figure out which data source to connect to.
7. Select the Sheet tab to start your analysis. After you select the sheet tab, Tableau imports the data by creating an extract.

Note: Tableau only supports extracts for Google Analytics 4. You can update the data by refreshing the extract. For more information, see [Extract Your Data](#).

Troubleshoot Google Analytics 4

Report Types

The Google Analytics 4 connector relies on the basic Core Reporting capabilities of the Google Analytics Data API. Cohort, Pivot, Realtime, and Funnel reports aren't currently supported.

Quotas

Usage of the Google Analytics 4 connector is subject to Google Analytics Data API quotas in the Core quota category. Additional details can be found in the [Google Analytics Data API guide](#).

See also

- [Set Up Data Sources on page 596](#) – Add more data to this data source or prepare your data before you analyze it.
- [Build Charts and Analyze Data on page 1005](#) – Begin your data analysis.

[5 Tips to Get More from Google Analytics](#) - Read the Tableau whitepaper (registration or sign in required).

Google BigQuery

This article describes how to connect Tableau to Google BigQuery and set up the data source.

Note: Some of the features and customizations listed in this article aren't supported in Tableau Prep Builder. For more information about connecting your data in Prep Builder, see [Connect to Data](#).

Before you begin

Before you begin, gather this connection information:

- Google BigQuery email or phone, and password

Recommendation

Set up a custom OAuth Client to use your company's IT policies

You can fully control your OAuth configuration according to your own IT policies with a custom OAuth client. The option to use your own OAuth client frees you from being tied to Tableau release cycles and Tableau's OAuth client rotation schedule. For information on how to configure your own OAuth client, see [Configure Custom OAuth for a site](#).

Make the connection and set up the data source

Note:Note: To use service account credentials for a new Google BigQuery data source, the connection must be created in Tableau Desktop.

1. Start Tableau and under **Connect**, select **Google BigQuery**.

Complete one of the following 2 options to continue.

Option 1:

1. In Authentication, select **Sign In using OAuth**.
2. Click **Sign In**.
3. Enter your password to continue.
4. Select **Accept** to allow Tableau to access your Google BigQuery data. You'll be prompted to close the browser.

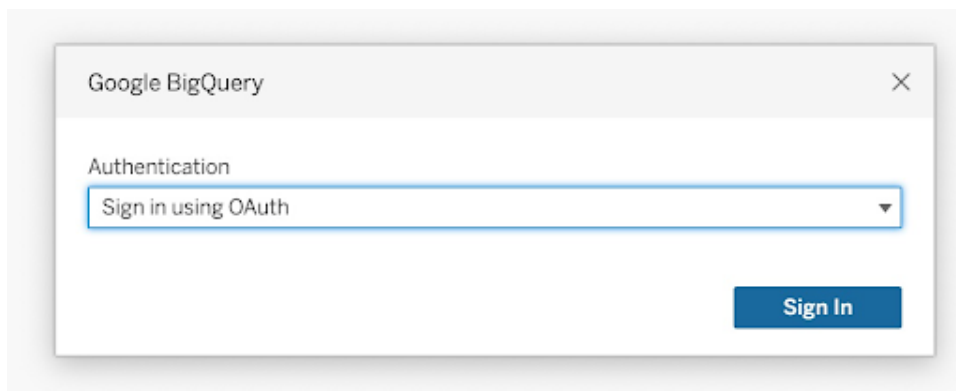

Option 2:

Tip: If you're using Tableau Server or Tableau Cloud for publishing, you have to start with logging into the product you're using, and then add your saved Google BigQuery credentials under account settings. This prevents an "Invalid credentials error".

1. In Authentication, select **Sign In using the Service Account (JSON) file**.
2. Enter the file path or use the **Browse** button to search for it.
3. Click **Sign In**.
4. Enter your password to continue.

5. Select **Accept** to allow Tableau to access your Google BigQuery data. You'll be prompted to close the browser.

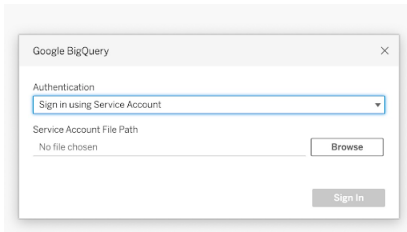

2. On the data source page, do the following:
 - a. (Optional) Select the default data source name at the top of the page, and then enter a unique data source name for use in Tableau. For example, use a data source naming convention that helps other users of the data source figure out which data source to connect to.
 - b. (Optional) From the **Billing Project** dropdown list, select a billing project. If you don't select a billing project, `EmptyProject` appears in the field after you've selected the remaining fields.
 - c. From the **Project** dropdown list, select a project. Alternatively, select **publicdata** to connect to sample data in BigQuery.
 - d. From the **Dataset** dropdown list, select a data set.
 - e. Under **Table**, select a table.

Use custom SQL to connect to a specific query rather than the entire data source. For more information, see [Connect to a Custom SQL Query](#) on page 863.

Notes:

- Google BigQuery has changed support from BigQuery legacy SQL (BQL) to standard SQL. Your workbooks upgrade to support standard SQL when you open them in Tableau.
- Because of the large volume of data in BigQuery, Tableau recommends that you connect live.
- The `Radians()` function isn't supported in Google BigQuery.

Use customization attributes to improve query performance

Note: Customization attributes aren't currently supported in Tableau Prep Builder.

You can use customization attributes to improve the performance of large result sets returned from BigQuery to Tableau Cloud, Tableau Server, and on Tableau Desktop.

You can have the customization attributes included in your published workbook or data source, as long as you specify the attributes before you publish the workbook or data source to Tableau Cloud or Tableau Server.

Use Google BigQuery customization attributes

Customization attributes accept integer values and affect both live queries and extract refreshes for the specified connection.

The following attributes help the most to increase the performance of large result sets:

bq-fetch-tasks	Number of parallel background tasks to use when fetching data using HTTP. The default is 10.
bq-large-fetch-rows	Number of rows to fetch in each batch for spool queries. The default is 50000.

The following attributes are also available and are used for small queries:

bq-fetch-rows	Number of rows to fetch in each batch for non-spool queries. The default is 10000.
bq-response-rows	Number of rows returned in non-spool non-batched queries. The default is 10000.

This capability setting accepts yes or no values and can be useful when testing:

CAP_BIGQUERY_FORCE_SPOOL_JOB	Force all queries to use the temp table approach. The default value is "no." Change the value to "yes" to turn on this attribute.
------------------------------	---

How Tableau returns rows from Google BigQuery

Tableau uses two approaches to return rows from BigQuery: the default non-spool approach, or the temp table (spool) approach:

- On the first attempt, queries are executed using the default, non-spool query, which uses the `bq-fetch-rows` setting.
- If the result set is too large, the BigQuery API returns an error and the Tableau BigQuery connector retries the query by saving the results into a BigQuery temp table. The BigQuery connector then reads from that temp table, which is a spool job that uses the `bq-large-fetch-rows` setting.

How to specify the attributes

You can specify attributes in one of two ways: in a Tableau Datasource Customization `.tdc` file, or in the workbook or data source XML.

Specify attributes in a `.tdc` file

To specify customization attributes during a publish workbook or publish data source operation from Tableau Desktop, follow these steps:

1. Create an XML file that contains the customization attributes.
2. Save the file with a `.tdc` extension, for example, `BigQueryCustomization.tdc`.
3. Save the file to the `My Tableau Repository\Datasources` folder.

The customization attributes in the `.tdc` files are read and included by Tableau Desktop when the data source or workbook is published to Tableau Cloud or Tableau Server.

Important: TDC files can be utilized to customize the functionality of a connection or to diagnose and resolve issues related to connecting to your data. Tableau is unable to thoroughly test every potential modification you might make with these files. Creating and using TDC files requires manual editing and it is crucial to test them thoroughly before deploying them in a production environment.

Example of a `.tdc` file with recommended settings for large extracts

```
<connection-customization class='bigquery' enabled='true' version='8.0' >
  <vendor name='bigquery' />
  <driver name='bigquery' />
  <customizations>
```

```

<customization name='bq-fetch-tasks' value='10' />

<customization name='bq-large-fetch-rows' value='10000' />

</customizations>

</connection-customization>

```

Manually embed attributes in the XML of the workbook or data source file

You can manually embed customization attributes inside the 'connection' tag in the workbook.twb file or the data source .tds file. The BigQuery customization attributes are bold in the following example to make them easier for you to see.

Example of manually embedded attributes

```

<connection CATALOG='publicdata' EXECCATALOG='some-project-123'
REDIRECT_URI='some-url:2.0:oob'
SCOPE='https://www.googleapis.com/auth/bigquery
https://www.googleapis.com/auth/userinfo.profile
https://www.googleapis.com/auth/userinfo.email' authentication='yes'
bq-fetch-tasks='10' bq-large-fetch-rows='10000'bq_schema='samples'
class='bigquery' connection-dialect='google-bql' connection-
protocol='native-api' login_title='Sign in to Google BigQuery' odbc-
connect-string-extras='' project='publicdata' schema='samples'
server='googleapis.com/bigquery' server-oauth='' table='wikipedia'
username=''>

```

Check if your workbook uses standard SQL or legacy SQL

In 2016, Google updated the BigQuery APIs to support standard SQL, in addition to still supporting BigQuery SQL (now called legacy SQL). Starting in Tableau 10.1, the Google BigQuery connector has been upgraded to support standard SQL, and also still supports legacy SQL. Standard SQL enables users of the BigQuery connector to use level of detail expressions, get faster metadata validation, and select a billing project with the connection.

Now, when you create a workbook, Tableau supports standard SQL by default. Tableau also supports legacy SQL using the **Use Legacy SQL** option on the **Data** pane. For example, when you open a workbook that was created using a previous version of Tableau Desktop, and if your workbook uses legacy SQL, the **Use Legacy SQL** option is selected.

You might want to configure the **Use Legacy SQL** option for the following reasons:

- You have an existing workbook that you want to update to use standard SQL to write level of detail expressions or to take advantage of other improvements. In this case, make sure that the **Use Legacy SQL** option isn't selected.
- You're creating a workbook that must connect to a legacy SQL view. You can't mix legacy SQL with standard SQL, so you must select the **Use Legacy SQL** option for the workbook to function.

In Google BigQuery, views are written in standard SQL or legacy SQL. You can join views written in standard SQL to views written in standard SQL, or views written in legacy SQL to views written in legacy SQL, and you can join views written in either version of SQL to a table. But you can't join views written in standard SQL and views written in legacy SQL in one workbook. When you join views, you must set the **Use Legacy SQL** check box to correspond to the SQL type used in the view you're connecting to.

Note: Tableau Desktop provides limited support for nested data when you use legacy SQL or standard SQL. For example, if a table contains nested data and you're using legacy SQL or standard SQL, on the data source page, **Update Now** won't work.

For more information about migrating from legacy SQL to standard SQL, see [Migrating from legacy SQL](#) on the Google Cloud Platform website.

Use BigQuery BI Engine to Analyze Data

You can use BigQuery BI Engine to perform fast, low-latency analysis services and interactive analytics with reports and dashboards backed by BigQuery. For more information, including instructions on how to integrate BigQuery BI Engine with Tableau, see [Analyze BigQuery data by using BI Engine and Tableau](#) in Google's documentation.

Troubleshoot Google BigQuery issues

Connections to multiple accounts

When using web authoring or publishing to the web, you can't use multiple Google BigQuery accounts in the same workbook. You can have multiple Google BigQuery account connections in Desktop.

When publishing flows, the credentials that you use to connect to Google BigQuery in your Input step must match the credentials that are set up in the **Settings** tab in the **My Account Settings** page for Google BigQuery in Tableau Server or Tableau Cloud. If you select different credentials or no credentials in your authentication setting when publishing the flow, the flow fails with an

authentication error until you edit the connection for the flow in Tableau Server or Tableau Cloud to match those credentials.

Web authoring with Internet Explorer 11 and Edge

In Internet Explorer 11 and Edge, you can't access a server using an unsecured connection (http). Use a secure connection (https) or switch to another browser.

See also

- [Set Up Data Sources on page 596](#) – Add more data to this data source or prepare your data before you analyze it.
- [Build Charts and Analyze Data on page 1005](#) – Begin your data analysis.
- [Set up Oauth for Google](#) -Configure Oauth connections for Tableau Server.
- [Oauth Connections](#) - Configure Oauth connections for Tableau Cloud.
- [Google BigQuery & Tableau: Best Practices](#) - Read the Tableau white paper (registration or sign in required)

Google BigQuery JDBC

This article describes how to connect Tableau Desktop and Tableau Cloud to Google BigQuery (JDBC).

Before you begin

Before you begin, gather this connection information.

- Google BigQuery billing project ID (Case Sensitive).

Tip: If you're using storage API to improve performance, the user account must have `bigquery.readsessions.getData` in their permissions.

Driver required

This connector requires a driver to talk to the database. If the driver isn't installed on your computer, Tableau displays a message in the connection dialog box with a link to the [Driver Download](#) (Link opens in a new window) page where you can find driver links and installation instructions.

Make the connection in Tableau Desktop

In Tableau Desktop, you can use 2 authentication methods with the Google BigQuery connector. You can sign in using a Service Account or using OAuth.

Complete the following steps to sign in using a service account.

1. Start Tableau and under **Connect**, select **Google BigQuery JDBC**.
2. Enter the **Billing Project ID**. Ensure that you're using the Google Cloud billing project id, not the billing project name.
3. In **Authentication**, select **Sign In using Service Account (JSON) file**.
4. Enter the file path or use the **Browse** button to search for it.
5. (Optional) Go to the **Advanced** tab.
6. On the **Advanced** tab, select **Use Storage API**, to get faster extracts.
7. Unselect the **Enumerate All Projects** option to help increase processing times.
8. After you make changes, choose **Sign In**.
9. Enter your password to continue.
10. Select **Accept** to allow Tableau to access your Google BigQuery data. You're then prompted to close the browser. After authentication, Tableau creates a workbook using the Billing Project ID you provided.

Complete the following steps to sign in using OAuth.

1. Start **Tableau** and under **Connect**, select **Google BigQuery JDBC**.
2. Enter the Billing Project ID. Ensure that you're using the Google Cloud billing project id, not the billing project name.
3. In **Authentication**, select **Sign In using OAuth**.
4. (Optional) Go to the **Advanced** tab.
5. On the **Advanced** tab, select **Use Storage API**, to get faster extracts.
6. Unselect the **Enumerate All Projects** option to help increase processing times.
7. Choose **Sign In**.
8. Select the account with your data in it.
9. Select **Continue** to allow Tableau to access your Google BigQuery data. After authentication, Tableau creates a workbook using the Billing Project ID you provided.

Make the connection in Tableau Cloud

In Tableau Cloud, you can use OAuth authentication methods with the Google BigQuery connector.

1. Start Tableau and under **Connect**, select **Google BigQuery JDBC**.
2. Enter the Billing Project ID. Ensure that you're using the Google Cloud billing project id, not the billing project name.
3. In **Authentication**, select Sign In using OAuth.
4. (Optional) Go to the **Advanced** tab.

5. On the **Advanced** tab, select **Use Storage API**, to get faster extracts.
6. Unselect the **Enumerate All Projects** option to help increase processing times.
7. Choose **Sign In**.
8. Select the account with your data in it.
9. Select **Continue** to allow Tableau to access your Google BigQuery data. After authentication, Tableau creates a workbook using the Billing Project ID you provided.

Migrating existing workbooks

To migrate workbooks from the Google BigQuery API connector to the JDBC connector you must manually change the data source to Google BigQuery (JDBC) and republish it.

Google Cloud SQL

This article describes how to connect Tableau to a Google Cloud SQL database instance and set up the data source.

Before you begin

Before you begin, gather this connection information:

- Name of the server that hosts the database you want to connect to
- User name and password

Driver required

This connector requires a driver to talk to the database. If the driver is not installed on your computer, Tableau displays a message in the connection dialog box with a link to the [Driver Download](#) page where you can find driver links and installation instructions.

Make the connection and set up the data source

1. Start Tableau and under **Connect**, select **Google Cloud SQL**. For a complete list of data connections, select **More** under **To a Server**. Then do the following:
 - a. Enter the name of the server that hosts the database.
 - b. Enter the user name and password, and then select **Sign In**.

If Tableau can't make the connection, verify that your credentials are correct. If you still can't connect, your computer is having trouble locating the server. Contact your network administrator or database administrator.

2. On the data source page, do the following:

- a. (Optional) Select the default data source name at the top of the page, and then enter a unique data source name for use in Tableau. For example, use a data source naming convention that helps other users of the data source figure out which data source to connect to.
- b. From the **Database** drop-down list, select a database or use the text box to search for a database by name.
- c. Under **Table**, select a table or use the text box to search for a table by name.
- d. Drag the table to the canvas, and then select the sheet tab to start your analysis.

Use custom SQL to connect to a specific query rather than the entire data source. For more information, see [Connect to a Custom SQL Query on page 863](#).

Sign in on a Mac

If you use Tableau Desktop on a Mac, when you enter the server name to connect, use a fully qualified domain name, such as mydb.test.ourdomain.lan, instead of a relative domain name, such as mydb or mydb.test.

Alternatively, you can add the domain to the list of Search Domains for the Mac computer so that when you connect, you need to provide only the server name. To update the list of Search Domains, go to **System Preferences > Network > Advanced**, and then open the **DNS** tab.

See also

- [Set Up Data Sources on page 596](#) – Add more data to this data source or prepare your data before you analyze it.
- [Build Charts and Analyze Data on page 1005](#) – Begin your data analysis.

Google Drive

This article describes how to connect Tableau to Google Drive and set up the data source.

Note: Google drive supports shared files as of 2023.1.

Before you begin

Before you begin, gather this connection information:

- Google email address and password

Make the connection and set up the data source

1. Start Tableau and under **Connect**, select **Google Drive**. For a complete list of data connections, select **More** under **To a Server**. In the tab Tableau opens in your default browser, do the following:
 - a. Sign in to Google Drive using your email or phone, and then select **Next** to enter your password. If multiple accounts are listed, select the account that has the Google Drive data you want to access and enter the password, if you're not already signed in.

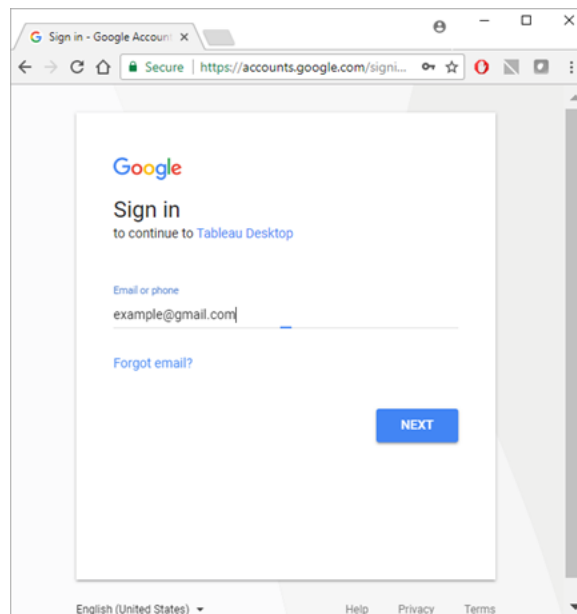

- b. Select **Allow** so that Tableau Desktop can access your Google Drive data.
 - c. Close the browser window when notified to do so.
 - d. Select a file from the list or use the text box to search for a file by name or URL, and then select **Connect**. You can also select a file under the Shared with me or Shared drives tab."

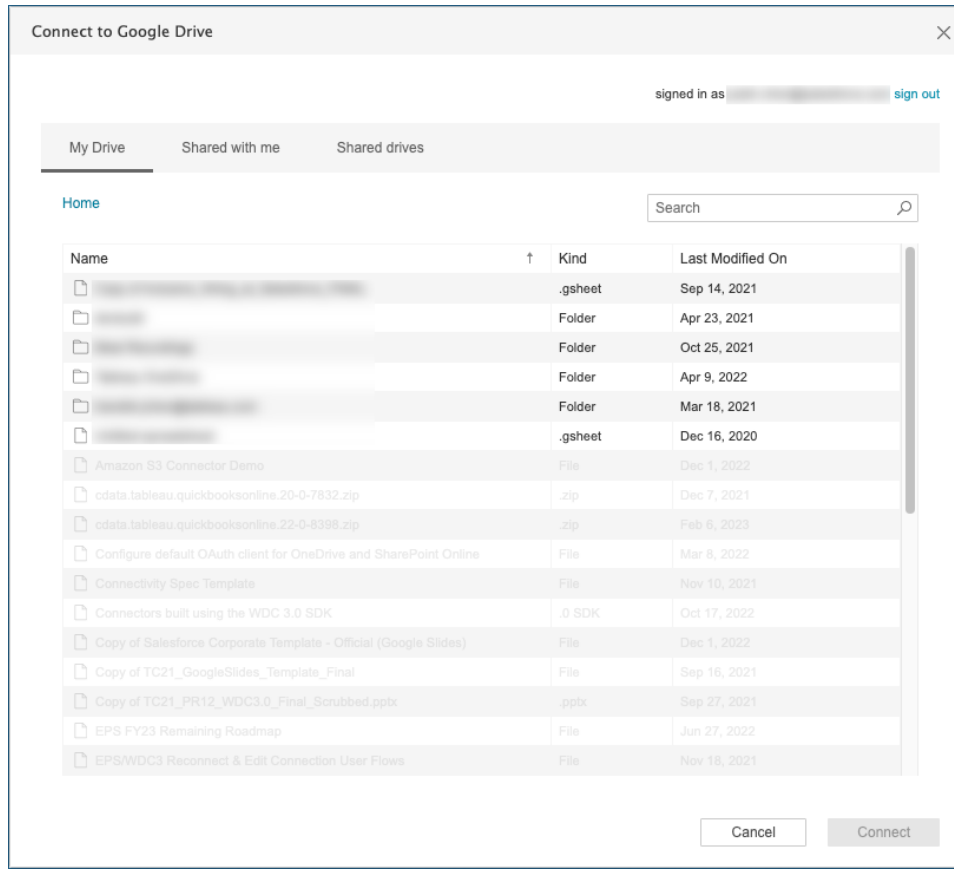

Note: This connector might not support all file types. Unsupported file types are grayed out.

2. On the data source page, do the following:
 - a. (Optional) Select the default data source name at the top of the page, and then enter a unique data source name for use in Tableau. For example, use a data source naming convention that helps other users of the data figure out which data source to connect to.
 - b. If your Google Drive file has one table, select the sheet tab to start your analysis.

About .ttde and .hhyper files

You might notice .ttde or .hhyper files when navigating your computer's directory. When you create a Tableau data source that connects to your data, Tableau creates a .ttde or .hhyper file. This file, also known as a shadow extract, is used to help improve the speed your data source loads in Tableau Desktop. Although a shadow extract contains underlying data and other information similar to the standard Tableau extract, a shadow extract is saved in a different format and can't be used to recover your data.

Note: .tde files are no longer supported for Tableau versions beyond 2024.2. All extracts are now in .hyper format.

Troubleshoot Google Drive issues

Note: The embedded password feature is disabled for Google Drive. You can use embedded <username> instead.

Data limit in Google Drive

Google Drive supports a limited number of cells (in the millions) for spreadsheets that are created in or converted to Google Sheets. For more information, see [Files you can store in Google Drive](#) in the Google Drive Help.

Connections to multiple accounts

When using web authoring or publishing to the web, you cannot use multiple Google Drive accounts, even when using different connections. You can have multiple Google Drive account connections in Desktop.

Web authoring with Internet Explorer 11 and Edge

In Internet Explorer 11 and Edge, you cannot access a server using an unsecured connection (http). Use a secure connection (https) or switch to another browser.

See also

- [Set Up Data Sources on page 596](#) – Add more data to this data source or prepare your data before you analyze it.
- [Build Charts and Analyze Data on page 1005](#) – Begin your data analysis.

Google Sheets

Important: the Google Sheets connector was fully deprecated in mid 2023.

To continue using your workbooks, you must access your data through Google Drive. For information about connecting to data in Google drive, including Google Sheets, see [Google Drive on page 343](#).

For information about swapping data sources, see [Replace Data Sources on page 970](#).

Hortonworks Hadoop Hive

This article describes how to connect Tableau to a Hortonworks Hadoop Hive database and set up the data source.

Before you begin

Before you begin, gather this connection information:

- Name of the server that hosts the database you want to connect to
- Authentication method:
 - No Authentication
 - Kerberos
 - User Name
 - User Name and Password
 - Microsoft Azure HDInsight Service (starting in version 10.2.1)
- Transport options depend on the authentication method you choose and can include the following:
 - Binary
 - SASL
 - HTTP
- Sign-in credentials depend on the authentication method you choose and can include the following:
 - User name
 - Password
 - Realm
 - Host FQDN
 - Service name
 - HTTP path
- Are you connecting to an SSL server?
- (Optional) Initial SQL statement to run every time Tableau connects

Driver required

This connector requires a driver to talk to the database. If the driver is not installed on your computer, Tableau displays a message in the connection dialog box with a link to the [Driver Download](#) page where you can find driver links and installation instructions.

Note: Make sure you use the latest available drivers. To get the latest drivers, see [Hortonworks Hadoop Hive](#) on the Tableau Driver Download page.

Make the connection and set up the data source

1. Start Tableau and under **Connect**, select **Hortonworks Hadoop Hive**. For a complete list of data connections, select **More** under **To a Server**. Then do the following:
 - a. Enter the name of server that hosts the database.
 - b. In the **Authentication** drop-down list, select the authentication method to use.
 - c. Enter the information that you are prompted to provide. The information you are prompted for depends on the authentication method you choose.
 - d. (Optional) Select **Initial SQL** to specify a SQL command to run at the beginning of every connection, such as when you open the workbook, refresh an extract, sign in to Tableau Server, or publish to Tableau Server. For more information, see [Run Initial SQL on page 591](#).
 - e. Select **Sign In**.

Select the **Require SSL** option when connecting to an SSL server.

If Tableau can't make the connection, verify that your credentials are correct. If you still can't connect, your computer is having trouble locating the server. Contact your network administrator or database administrator.
2. On the data source page, do the following:
 - a. (Optional) Select the default data source name at the top of the page, and then enter a unique data source name for use in Tableau. For example, use a data source naming convention that helps other users of the data source figure out which data source to connect to.
 - b. From the **Schema** drop-down list, select the search icon or enter the schema name in the text box and select the search icon, and then select the schema.

- c. In the **Table** text box, select the search icon or enter the table name and select the search icon, and then select the table.
- d. Drag the table to the canvas, and then select the sheet tab to start your analysis.

Use custom SQL to connect to a specific query rather than the entire data source. For more information, see [Connect to a Custom SQL Query on page 863](#).

Note: This database type only support equal (=) join operations.

Sign in on a Mac

If you use Tableau Desktop on a Mac, when you enter the server name to connect, use a fully qualified domain name, such as mydb.test.ourdomain.lan, instead of a relative domain name, such as mydb or mydb.test.

Alternatively, you can add the domain to the list of Search Domains for the Mac computer so that when you connect, you need to provide only the server name. To update the list of Search Domains, go to **System Preferences > Network > Advanced**, and then open the **DNS** tab.

Work with Hadoop Hive data

Work with date/time data

Tableau supports **TIMESTAMP** and **DATE** types natively. However, if you store date/time data as a string in Hive, be sure to store it in ISO format (YYYY-MM-DD). You can create a calculated field that uses the **DATEPARSE** or **DATE** function to convert a string to a date/time format. Use **DATEPARSE()** when working with an extract, otherwise use **DATE()**. For more information, see [Date Functions on page 2075](#).

For more information about Hive data types, see [Dates](#) on the Apache Hive website.

NULL value returned

A **NULL** value is returned when you open a workbook in Tableau 9.0.1 and later and 8.3.5 and later 8.3.x releases that was created in an earlier version and has date/time data stored as a string in a format that Hive doesn't support. To resolve this issue, change the field type back to **String** and create a calculated field using **DATEPARSE()** or **DATE()** to convert the date. Use **DATEPARSE()** when working with an extract, otherwise use the **DATE()** function.

High latency limitation

Hive is a batch-oriented system and is not yet capable of answering simple queries with very quick turnaround. This limitation can make it difficult to explore a new data set or experiment with

calculated fields. Some of the newer SQL-on-Hadoop technologies (for example, Cloudera's Impala and Hortonworks' Stringer project) are designed to address this limitation.

Truncated columns in Tableau

The default string column length for Hortonworks Hadoop Hive is 255 characters. For more information about Hortonworks Hive ODBC driver configuration options, and specifically about DefaultStringLength, see the [Hive ODBC Driver User Guide](#) from Hortonworks.

See also

- [Set Up Data Sources on page 596](#) – Add more data to this data source or prepare your data before you analyze it.
- [Build Charts and Analyze Data on page 1005](#) – Begin your data analysis.

IBM DB2

This article describes how to connect Tableau to an IBM DB2 database and set up the data source. You can also use this connector to connect to an IBM DB2 for z/OS database. See the [Technical Specifications](#) to confirm which DB2 databases are supported.

Note: Tableau supports all versions of IBM operating system platforms except for the "i" series.

Before you begin

Before you begin, gather this connection information:

- Name of the server that hosts the database you want to connect to (Host name) and port number
- Database name
- User name (User ID) and password
- Are you connecting to an SSL server?
- (Optional) Initial SQL statement to run every time Tableau connects

Use this connector with Tableau Desktop on a Windows computer.

Port settings

The port number is dependent on the type of server you are connecting to and whether you are connecting to an encrypted port. Generally, use 50000 for a non-encrypted port and 60000 for an encrypted port. It is possible that your server is configured to use a non-standard port. Contact your administrator if you don't know which port to connect to.

SSL requirements

This connector enables you to connect to your server using SSL authentication. If you work in an SSL environment, your computer is probably already configured to support SSL. If you have trouble making an SSL connection with Tableau, make sure that the following IBM software is installed on your computer:

- IBM Data Server Runtime Client v10.5fp3 or above
- GSK8 SSL Library

Note: The IBM Data Server Runtime Client and GSK8 Library must have the same bitness. For example, both must be either 32-bit or 64-bit. For more information, see [Installation of the GSK8 SSL Library](#) on the IBM website.

Driver required

This connector requires a driver to talk to the database. If the driver is not installed on your computer, Tableau displays a message in the connection dialog box with a link to the [Driver Download](#) page where you can find driver links and installation instructions.

Make the connection and set up the data source

1. Start Tableau and under **Connect**, select **IBM DB2**. For a complete list of data connections, select **More** under **To a Server**. Then do the following:
 - a. Enter the name of the server that hosts the database (the Host name), the port number, and the name of the database that you want to connect to.
 - b. Enter your user name (User ID) and password.

If Tableau can't make the connection, verify that your credentials are correct. If you still can't connect, your computer is having trouble locating the server. Contact your network administrator or database administrator.

- c. (Optional) Select **Initial SQL** to specify a SQL command to run at the beginning of every connection, such as when you open the workbook, refresh an extract, sign in to Tableau Server, or publish to Tableau Server. For more information, see [Run Initial SQL on page 591](#).
 - d. Select **Sign In**.
2. On the data source page, do the following:
 - a. (Optional) Select the default data source name at the top of the page, and then enter a unique data source name for use in Tableau. For example, use a data source naming convention that helps other users of the data source figure out which data source to connect to.
 - b. From the **Schema** drop-down list, select a schema or use the text box to search for a schema by name.
 - c. Under **Table**, select a table or use the text box to search for a table by name.
 - d. Drag a table to the canvas, and then select the sheet tab to start your analysis.

Use custom SQL to connect to a specific query rather than the entire data source. For more information, see [Connect to a Custom SQL Query on page 863](#).

Note: Tableau doesn't support the DECFLOAT data type.

See also

- [Set Up Data Sources on page 596](#) – Add more data to this data source or prepare your data before you analyze it.
- [Build Charts and Analyze Data on page 1005](#) – Begin your data analysis.

[Connecting Tableau to a Db2 database](#) - Review connection instructions on the IBM website.

IBM Informix

This article describes how to connect Tableau to an IBM Informix database and set up the data source.

Before you begin

Before you begin, gather this connection information:

- Name of the server that hosts the database you want to connect to (Host name) and port number
- Database name
- User name (User ID) and password
- Are you connecting to an SSL server?

Port settings

The port number is dependent on the type of server you are connecting to and whether you are connecting to an encrypted port. Generally, use 50000 for a non-encrypted port and 60000 for an encrypted port. It is possible that your server is configured to use a non-standard port. Contact your administrator if you don't know which port to connect to.

SSL requirements

This connector enables you to connect to your server using SSL authentication. If you work in an SSL environment, your computer is probably already configured to support SSL. If you have trouble making an SSL connection with Tableau, make sure that the following IBM software is installed on your computer:

- IBM Data Server Runtime Client v10.5fp3 or above
- GSK8 SSL Library

Note: The IBM Data Server Runtime Client and GSK8 Library must have the same bitness. For example, both must be either 32-bit or 64-bit. For more information, see [Installation of the GSK8 SSL Library](#) on the IBM website.

Driver required

This connector requires a driver to talk to the database. If the driver is not installed on your computer, go to the [Driver Download](#) page for instructions.

Make the connection and set up the data source

1. Start Tableau and under **Connect**, select **Informix**. For a complete list of data connections, select **More** under **To a Server**. Then do the following:
 - a. Enter the name of the server that hosts the database (the Host name), the port number, and the name of the database that you want to connect to.
 - b. Enter your user name (User ID) and password.

If Tableau can't make the connection, verify that your credentials are correct. If you still can't connect, your computer is having trouble locating the server. Contact your network administrator or database administrator.

- c. Select **Sign In**.
2. On the data source page, do the following:
 - a. (Optional) Select the default data source name at the top of the page, and then enter a unique data source name for use in Tableau. For example, use a data source naming convention that helps other users of the data source figure out which data source to connect to.
 - b. From the **Schema** drop-down list, select a schema or use the text box to search for a schema by name.
 - c. Under **Table**, select a table or use the text box to search for a table by name.
 - d. Drag a table to the canvas, and then select the sheet tab to start your analysis.

Use custom SQL to connect to a specific query rather than the entire data source. For more information, see [Connect to a Custom SQL Query on page 863](#).

See also

- [Set Up Data Sources on page 596](#) – Add more data to this data source or prepare your data before you analyze it.
- [Build Charts and Analyze Data on page 1005](#) – Begin your data analysis.

IBM Netezza Performance Server

This article describes how to connect Tableau to an IBM Netezza Performance Server database and set up the data source.

Before you begin

Before you begin, gather this connection information:

- Name of the server that hosts the database you want to connect to
- Database name
- User name and password
- Are you connecting to an SSL server?
- (Optional) Initial SQL statement to run every time Tableau connects

Use this connector with Tableau Desktop on a Windows computer.

Driver required

This connector requires a driver to talk to the database. If the driver is not installed on your computer, Tableau displays a message in the connection dialog box with a link to the [Driver Download](#) page where you can find driver links and installation instructions.

Make the connection and set up the data source

1. Start Tableau and under **Connect**, select **IBM Netezza Performance Server**. For a complete list of data connections, select **More** under **To a Server**. Then do the following:
 - a. Enter the name of the server that hosts the database.
 - b. Enter the name of the database that you want to connect to.
 - c. Enter the user name and password.

Select the **Require SSL** option when connecting to an SSL server.

- d. (Optional) Select **Initial SQL** to specify a SQL command to run at the beginning of every connection, such as when you open the workbook, refresh an extract, sign in to Tableau Server, or publish to Tableau Server. For more information, see [Run Initial SQL on page 591](#).
 - e. Select **Sign In**.
2. On the data source page, do the following:
 - a. (Optional) Select the default data source name at the top of the page, and then enter a unique data source name for use in Tableau. For example, use a data source naming convention that helps other users of the data source figure out which data source to connect to.
 - b. Under **Table**, select a table or use the text box to search for a table by name.
 - c. Drag a table to the canvas, and then select the sheet tab to start your analysis.

Use custom SQL to connect to a specific query rather than the entire data source. For more information, see [Connect to a Custom SQL Query on page 863](#).

See also

- [Set Up Data Sources on page 596](#) – Add more data to this data source or prepare your data before you analyze it.
- [Build Charts and Analyze Data on page 1005](#) – Begin your data analysis.

Impala

This article describes how to connect Tableau to an Impala database and set up the data source.

Before you begin

Before you begin, gather this connection information:

- Name and port of the server that hosts the database you want to connect to
- Authentication method:
 - No Authentication
 - Kerberos
 - User Name
 - User Name and Password
- Transport type (Username and Password authentication only):
 - Binary
 - SASL
- Sign-in credentials depend on the authentication method you choose and can include the following:
 - User name
 - Password
 - Realm
 - Host FQDN
 - Service name
- Are you connecting to an SSL server?
- (Optional) Initial SQL statement to run every time Tableau connects

Driver required

This connector requires a driver to talk to the database. If the driver is not installed on your computer, Tableau displays a message in the connection dialog box with a link to the [Driver Download](#) page where you can find driver links and installation instructions.

Note: Make sure you use the latest available drivers. To get the latest drivers, see [Impala](#) on the Tableau Driver Download page.

Make the connection and set up the data source

1. Start Tableau and under **Connect**, select **Impala**. For a complete list of data connections, select **More** under **To a Server**. Then do the following:
 - a. Enter the name of the server that hosts the database and the port number to use. Port 21050 is the default .
 - b. In the **Authentication** drop-down list, select the authentication method to use.
 - c. Enter the information that you are prompted to provide. The information you are prompted for depends on the authentication method you choose.
 - d. (Optional) Select **Initial SQL** to specify a SQL command to run at the beginning of every connection, such as when you open the workbook, refresh an extract, sign in to Tableau Server, or publish to Tableau Server. For more information, see [Run Initial SQL on page 591](#).
 - e. Select **Sign In**.

Select the **Require SSL** option when connecting to an SSL server.

If Tableau can't make the connection, verify that your credentials are correct. If you still can't connect, your computer is having trouble locating the server. Contact your network administrator or database administrator.
2. On the data source page, do the following:
 - a. (Optional) Select the default data source name at the top of the page, and then enter a unique data source name for use in Tableau. For example, use a data source naming convention that helps other users of the data source figure out which data source to connect to.
 - b. From the **Schema** drop-down list, select the search icon or enter the schema name in the text box and select the search icon, and then select the schema.
 - c. In the **Table** text box, select the search icon or enter the table name and select the search icon, and then select the table.
 - d. Drag the table to the canvas, and then select the sheet tab to start your analysis.

Use custom SQL to connect to a specific query rather than the entire data source. For more information, see [Connect to a Custom SQL Query on page 863](#).

Note: This database type supports only equal (=) join operations.

Sign in on a Mac

If you use Tableau Desktop on a Mac, when you enter the server name to connect, use a fully qualified domain name, such as mydb.test.ourdomain.lan, instead of a relative domain name, such as mydb or mydb.test.

Alternatively, you can add the domain to the list of Search Domains for the Mac computer so that when you connect, you need to provide only the server name. To update the list of Search Domains, go to **System Preferences > Network > Advanced**, and then open the **DNS** tab.

See also

- [Set Up Data Sources on page 596](#) – Add more data to this data source or prepare your data before you analyze it.
- [Build Charts and Analyze Data on page 1005](#) – Begin your data analysis.

Intuit QuickBooks Online

This article describes how to connect Tableau to Intuit QuickBooks Online data and set up the data source.

Note: Tableau is working on a replacement connector. After it's complete, it will be added to this page.

Warning: The Intuit QuickBooks connector is deprecated as of the 2023.1 release. You can use the connector until it's been retired. Once the connector is retired, it's removed from the Tableau user interface and any data sources using the connector will no longer work as expected. The deprecated connector will be retired 1-2 releases after the replacement connector is made available.

Note: For the most up-do-date information on this connector, see the [Intuit QuickBooks Online](#) help topic for the current version of Tableau.

Before you begin

Before you begin, gather this connection information:

- Your email address or user ID and password for your Quickbooks Online account.

Note: To connect Tableau to QuickBooks Online data, you must be a Company Administrator on the QuickBooks Online company. Only one administrator at your company can connect Tableau to QuickBooks Online.

QuickBooks Online doesn't support retrieving the Inventory Adjustment transactions. For information about when Inventory Adjustment transactions will be available in the QuickBooks Online API, see the responses to this [question](#) on the Intuit Developer website.

Make the connection and set up a data source

1. Start Tableau and under **Connect**, select **Intuit QuickBooks Online**. For a complete list of data connections, select **More** under **To a Server**. In the tab Tableau opens in your default browser, do the following:

- a. Enter your email address or user ID and password for your QuickBooks Online account.
- b. Select **Sign In**.

QuickBooks Online periodically prompts for two-step verification. If this happens, follow the prompts to get a code to confirm your Intuit account.

- c. If more than one company is associated with your account, select the company you want to connect to.
- d. Select **Authorize** to authorize Intuit to securely share your data with Tableau Desktop.

If Tableau can't make the connection, verify that your credentials are correct. If you still can't connect, your computer is having trouble locating the server. Contact your network administrator or database administrator.

2. On the data source page, do the following:
 - a. (Optional) Select the default data source name at the top of the page, and then enter a unique data source name for use in Tableau. For example, use a data source naming convention that helps other users of the data source figure out which data source to connect to.
 - b. Under **Table**, select a table and drag it to the top of the canvas.
 - c. Select the Sheet 1 tab to start your analysis.

After you select the sheet tab, Tableau imports the data by creating an extract. Note that Tableau Desktop supports only extracts for QuickBooks Online. You can

update the data by refreshing the extract. For more information, see [Extract Your Data on page 919](#).

Creating extracts may take some time depending on the amount of data that is included.

Use the Sales and Expenses Line Items table to create accounting reports

QuickBooks Online aggregates the information needed to create a variety of reports, such as profit and loss (P&L) statements and balance sheets. Because the data is aggregated by QuickBooks Online, you can't create these kinds of reports in Tableau. To remedy this, we've added a table in Tableau, Sales and Expenses Line Items, that includes line item details with all the fields you need to create these reports.

Sales and Expenses Line Items table structure

The Sales and Expenses Line Items table contains information for the following QuickBooks Online transactions (or documents):

Bill	Estimate	Purchase Order
Bill Payment	Invoice	Refund Receipt
Credit Memo	Journal Entry	Sales Receipt
Deposit	Payment	Vendor Credit
	Purchase	

Most of the transactions have children (or sub-items), for example, an invoice has detail items. Like this example:

Tableau Desktop and Web Authoring Help

#	SERVICE DATE	PRODUCT/SERVICE	DESCRIPTION	QTY	RATE	AMOUNT (USD)	TAX	CLASS
1	10/29/2007	Gardening	Weekly gardening services	1	110	110.00		Landscaping
2	11/05/2007	Gardening	Weekly gardening services plus pest control spraying	1	135	135.00		Landscaping
3	11/12/2007	Gardening	Weekly gardening services	1	110	110.00		Landscaping
4	11/12/2007	Plants/Trees:Misc Plants & Flow	Replaced dead flowers on side of school yard with assorted color	1	90	90.00		Landscaping
5	11/19/2007	Gardening	Weekly gardening services	1	110	110.00		Landscaping
6	11/26/2007	Gardening	Weekly gardening services	1	110	110.00		Landscaping
7								
Subtotal								665.00

Some transactions have group items, which consist of a group of other line items. Like this example:

#	SERVICE DATE	PRODUCT/SERVICE	DESCRIPTION	QTY	RATE	AMOUNT (USD)	TAX	CLASS
Line Item 1		Installation	Installation of landscape design	32	35	1,120.00		Landscaping
Group Line Item 2		Rock Fountain	Custom rock fountain Your customer will see all items in this bundle	1	675	675.00		
Children		Fountain	Rock Fountain	1	375		✓	Landscaping
		Pump	Fountain pump	1	75		✓	Landscaping
		Concrete	Concrete for fountain installation	1	15		✓	Landscaping
		Installation	Installation of landscape design	6	35			Landscaping
3								
Subtotal								1,795.00

The **Sales and Expenses Line Items** table denormalizes the "transaction to items" relationship by including one row per item and duplicating the transaction fields on each row. In the case of a group line item with children, the table includes the group child items instead of the group.

The following image shows how these two invoices appear in Tableau with the denormalized data:

Sheet 1

Doc Number	Line ID	Line Detail Type	Line Description	Line Amount	Txn Tax Detail T.	Total Amt
118	1	SalesItemLineDetail	Weekly gardening services	110.00	0.00	665.00
	2	SalesItemLineDetail	Weekly gardening service..	135.00	0.00	665.00
	3	SalesItemLineDetail	Weekly gardening services	110.00	0.00	665.00
	4	SalesItemLineDetail	Replaced dead flowers on ..	90.00	0.00	665.00
	5	SalesItemLineDetail	Weekly gardening services	110.00	0.00	665.00
	6	SalesItemLineDetail	Weekly gardening services	110.00	0.00	665.00
	SubTotalLineDetail	SubTotalLineDetail	Null	665.00	0.00	665.00
130	1	SalesItemLineDetail	Installation of landscape ..	1,120.00	38.37	1,833.37
	3	SalesItemLineDetail	Rock Fountain	375.00	38.37	1,833.37
	4	SalesItemLineDetail	Fountain pump	75.00	38.37	1,833.37
	5	SalesItemLineDetail	Concrete for fountain inst..	15.00	38.37	1,833.37
	6	SalesItemLineDetail	Installation of landscape ..	210.00	38.37	1,833.37
	SubTotalLineDetail	SubTotalLineDetail	Null	1,795.00	38.37	1,833.37

In addition to the transactions tables, the **Sales and Expenses Line Items** table contains information for the **Account** table.

Join tables with the Sales and Expenses Line Items table

Using the **Sales and Expenses Line Items** table, you can join the **Account** and transactions tables with it to get the detailed information you need for the report you want to create.

To join the **Account** table with each line in a transaction, join [Line Detail Account Ref Value] in the **Sales and Expenses Line Items** table to [ID Account] in the **Account** table.

For the QuickBooks Online transactions tables (for example, **Bill**, **Estimate**, **Purchase Order** and so on), join [Transaction Type] + [ID] + [Line ID] in the **Sales and Expenses Line Items** table to the equivalent fields in the transactions table. For example, if you create a join with the **Bill** transactions table, the [ID] field to join on for Bill is [(ID) Bill]; the [Line ID] field to join on for Bill is [Line ID (Bill)], and so on.

The following image shows multiple joins with the **Sales and Expenses Line Items** table on the left, as well as examples of the join clauses for the **Account** table and the **Bill** table on the right.

Tableau Desktop and Web Authoring Help

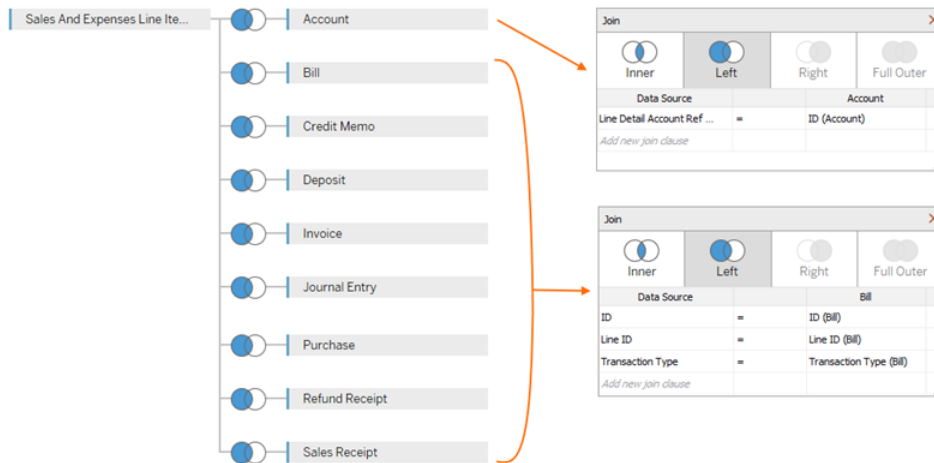

Create the QuickBooks Online data source

These are the general steps to get you started with making a data source that you can use to create various reports, such as P&L reports:

1. Connect to QuickBooks Online.
2. On the **Data Source** page, under **Table**, select the **Sales And Expenses Line Items** table.
3. Join one or more of the tables listed in [Sales and Expenses Line Items table structure on page 360](#) to the **Sales And Expenses Line Items** table to include the data you need for the report you want to create.
4. After you create your data source, you can build your statements and analyze your data.

Troubleshoot QuickBooks Online errors

You might see one of the following errors when you try to connect Tableau to your QuickBooks Online data.

Workbooks saved in previous versions of Tableau

Workbooks and data sources created prior to version 2018.2 of Tableau will not be able to access tables or fields added in later versions of the connector. To resolve this, open a new workbook and create a new connection to your QuickBooks Online data source. Copy and paste the worksheets you want to keep from the previous connection, or recreate them in Tableau.

Sorry, only administrators can buy apps...

QuickBooks Online requires that each user who connects an app to QuickBooks Online be a Company Administrator. The following Intuit error appears if you are not an administrator on the

company account:

Sorry, only administrators of <email address>'s Company can buy apps in the company.
Please contact administrator in the company or else choose another company.

To resolve this issue, ask your company account owner to make you a Company Administrator on the account.

Error Code: app_already_purchased

Only one Company Administrator is allowed to connect per application, for example to Tableau Desktop. If someone in your company has already connected Tableau to your QuickBooks Online account, the following Intuit error appears:

Oops! An error has occurred. Please close this window and try again.

Error Code: app_already_purchased

Message: The application has already been subscribed to by another user for this company. Please contact <email address> to make changes to this subscription.

To resolve this issue, you need to ask that Company Administrator to give up the application privileges for Tableau Desktop and provide them to you. If that's not possible, for example, because the administrator actively uses Tableau, another option is for the administrator to publish the data source to Tableau Server or Tableau Cloud, so that anyone with permission can access the data.

Changing a Connection Opens the My Apps Page

If you need to access another QuickBooks Online company, after you sign in (and possibly go through the two-step authentication process), Intuit might show the My Apps page, rather than the "select the company to connect to" page. To resolve this issue, follow these steps:

1. Close the My Apps page.
2. On the Tableau **Connect** pane, select Intuit QuickBooks Online.
3. If more than one company is associated with your account, select the company you would like to connect to.
4. Select **Authorize** to open the Tableau data source page.

See also

- [Set Up Data Sources on page 596](#) – Add more data to this data source or prepare your data before you analyze it.
- [Build Charts and Analyze Data on page 1005](#) – Begin your data analysis.

Kognitio

This article describes how to connect Tableau to a Kognitio database and set up the data source.

Warning: The Kognitio connector is deprecated as of the 2023.1 release. You can use the connector until it's been retired. Once the connector is retired, it's removed from the Tableau user interface and any data sources using the connector will no longer work as expected. Typically, a deprecated connector will be retired 1–2 releases after it is deprecated.

Before you begin

Before you begin, gather this connection information:

- Name of the server that hosts the database you want to connect to
- User name and password
- Are you connecting to an SSL server?
- (Optional) Initial SQL statement to run every time Tableau connects

Driver required

This connector requires a driver to talk to the database. If the driver is not installed on your computer, Tableau displays a message in the connection dialog box with a link to the [Driver Download](#) page where you can find driver links and installation instructions.

Make the connection and set up the data source

1. Start Tableau and under **Connect**, select **Kognitio**. For a complete list of data connections, select **More** under **To a Server**. Then do the following:
 - a. Enter the name of the server that hosts the database you want to connect to.
 - b. Enter the user name and password.
 - c. (Optional) Select **Initial SQL** to specify a SQL command to run at the beginning of every connection, such as when you open the workbook, refresh an extract, sign in

to Tableau Server, or publish to Tableau Server. For more information, see [Run Initial SQL on page 591](#).

- d. Select **Sign In**.

Select the **Require SSL** check box when connecting to an SSL server.

If Tableau can't make the connection, verify that your credentials are correct. If you still can't connect, your computer is having trouble locating the server. Contact your network administrator or database administrator.

2. On the data source page, do the following:

- a. (Optional) Select the default data source name at the top of the page, and then enter a unique data source name for use in Tableau. For example, use a data source naming convention that helps other users of the data source figure out which data source to connect to.
- b. From the **Schema** drop-down list, select a schema or use the text box to search for a schema by name.
- c. Under **Table**, select a table or use the text box to search for a table by name.
- d. Drag the table to the canvas, and then select the sheet tab to start your analysis.

Use custom SQL to connect to a specific query rather than the entire data source.

For more information, see [Connect to a Custom SQL Query on page 863](#).

Sign in on a Mac

If you use Tableau Desktop on a Mac, when you enter the server name to connect, use a fully qualified domain name, such as mydb.test.ourdomain.lan, instead of a relative domain name, such as mydb or mydb.test.

Alternatively, you can add the domain to the list of Search Domains for the Mac computer so that when you connect, you need to provide only the server name. To update the list of Search Domains, go to **System Preferences > Network > Advanced**, and then open the **DNS** tab.

See also

- [Set Up Data Sources on page 596](#) – Add more data to this data source or prepare your data before you analyze it.
- [Build Charts and Analyze Data on page 1005](#) – Begin your data analysis.

Kyvos

This topic describes how to connect Tableau to a Kyvos database and set up the data source.

Before you begin

Before you begin, gather this connection information:

- Name of the server that hosts the database you want to connect to
- Port number
- HTTP path to the server
- User name and password
- Are you connecting to an SSL server?
- (Optional) Initial SQL statement to run every time Tableau connects

Driver required

This connector requires a driver to talk to the database. If the driver is not installed on your computer, Tableau displays a message in the connection dialog box with a link to the [Driver Download](#) page where you can find driver links and installation instructions.

Make the connection and set up the data source

1. Start Tableau and under **Connect**, select **Kyvos**. For a complete list of data connections, select **More** under **To a Server**. Then do the following:
 - a. Enter the **Server** name.
 - b. Enter the **Port** number.
 - c. Enter the **HTTP Path** to the data.
 - d. Enter the **Username** and **Password**
 - e. Select the **Require SSL** check box when connecting to an SSL server.
 - f. (Optional) Select **Initial SQL** to specify a SQL command to run at the beginning of every connection, such as when you open the workbook, refresh an extract, sign in to Tableau Server, or publish to Tableau Server. For more information, see [Run Initial SQL on page 591](#).
 - g. Select **Sign In**.

If Tableau can't make the connection, verify that your credentials are correct. If you still can't connect, your computer is having trouble locating the server. Contact your network administrator or database administrator.

2. On the data source page, do the following:

- a. (Optional) Select the default data source name at the top of the page, and then enter a unique data source name for use in Tableau. For example, use a data source naming convention that helps other users of the data source figure out which data source to connect to.
- b. Under **Schema**, select a schema or use the text box to search for a schema by name.
- c. Under **Table**, select a table or use the text box to search for a table by name.
- d. Drag the table to the canvas, and then select the sheet tab to start your analysis.

Use custom SQL to connect to a specific query rather than the entire data source.

For more information, see [Connect to a Custom SQL Query on page 863](#).

Sign in on a Mac

If you use Tableau Desktop on a Mac, when you enter the server name to connect, use a fully qualified domain name, such as mydb.test.ourdomain.lan, instead of a relative domain name, such as mydb or mydb.test.

Alternatively, you can add the domain to the list of Search Domains for the Mac computer so that when you connect, you need to provide only the server name. To update the list of Search Domains, go to **System Preferences > Network > Advanced**, and then open the **DNS** tab.

See also

- [Set Up Data Sources on page 596](#) – Add more data to this data source or prepare your data before you analyze it.
- [Build Charts and Analyze Data on page 1005](#) – Begin your data analysis.

LinkedIn Sales Navigator

This topic describes how to connect Tableau to a LinkedIn Sales Navigator database and set up the data source.

Note: Tableau is working on a replacement connector. After it's complete, it will be added to this page.

Warning: The LinkedIn Sales Navigator connector is deprecated as of the 2023.1 release. You can use the connector until it's been retired. Once the Connector is retired, it's removed from the Tableau user interface and any data sources using the connector will no longer work as expected. The deprecated connector will be retired 1-2 releases after the replacement connector is made available.

Note: For the most up-to-date information on this connector, see the [LinkedIn Sales Navigator](#) help topic for the current version of Tableau.

Before you begin

Before you begin, get the email address or phone number, and password for the LinkedIn Sales Navigator account.

You need a Sales Navigator Enterprise plan and Sales Navigator administrator or reporting permissions. Note that a reporting user doesn't take up a Sales Navigator seat on the contract.

Make the connection and set up the data source

1. Start Tableau and under **Connect**, select **LinkedIn Sales Navigator**. For a complete list of data connections, select **More** under **To a Server**. Then do the following:
 - a. Select **Sign In** to authenticate to LinkedIn in your default browser.
 - b. Enter your email or phone number and your password for the LinkedIn Sales Navigator account.
 - c. Select **Sign in**.
 - d. Close the browser window when notified to do so.
 - e. In the LinkedIn Sales Navigator Connection dialog box, select the following:
 - **Contracts** : Custom or all
 - **Date Range**: Relative or fixed
 - f. Select **Connect**.

If Tableau can't make the connection, verify that your credentials are correct. If you still can't connect, your computer is having trouble accessing LinkedIn. Contact your network or database administrator.

2. On the data source page, do the following:
 - a. (Optional) Select the default data source name at the top of the page, and then enter a unique data source name for use in Tableau. For example, use a data source naming convention that helps other users of the data source figure out which data source to connect to.
 - b. Select a standard connection or create your own custom connection.

Under **Standard Connection**, you can select from a list of predefined selections of tables and joins that represent common scenarios and use cases. Or under **Table**, you can select a table or search for a table by name.

- c. Drag the standard connection or table to the canvas, and then select the sheet tab to start your analysis.

Use Accelerators

You can use an Accelerator to quickly build informative dashboard designs made specifically for key business metrics on Tableau Desktop and Tableau Cloud. For more information, see [Use Accelerators to Quickly Visualize Data](#) on page 2721.

Date range selections can impact performance

It's tempting to gather as much data as possible when you run an analysis. Tableau doesn't know how much data there is in a particular date range until it retrieves the data. For this reason, you should restrict your date range at first, and then expand after you evaluate performance.

Refresh LinkedIn Sales Navigator data

After you click the sheet tab, Tableau imports the data by creating an extract. Tableau Desktop supports only extracts for LinkedIn Sales Navigator. Note that the initial extract may take some time.

To refresh, select Data > [data source name] > Extract > Refresh.

MariaDB

This article describes how to connect Tableau to a MariaDB database and set up the data source.

Before you begin

Before you begin, gather this connection information:

- Name of the server that hosts the database you want to connect to
- User name and password
- (Optional) Initial SQL statement to run every time Tableau connects

Driver required

This connector requires a driver to talk to the database. If the driver is not installed on your computer, Tableau displays a message in the connection dialog box with a link to the [Driver Download](#) page where you can find driver links and installation instructions.

Make the connection and set up the data source

1. Start Tableau and under **Connect**, select **MariaDB**. For a complete list of data connections, select **More** under **To a Server**. Then do the following:
 - a. Enter the name of the server that hosts the database that you want to connect to.
 - b. Enter the user name and password, and then select **Sign In**.

If Tableau can't make the connection, verify that your credentials are correct. If you still can't connect, your computer is having trouble locating the server. Contact your network administrator or database administrator.
2. On the data source page, do the following:
 - a. (Optional) Select the default data source name at the top of the page, and then enter a unique data source name for use in Tableau. For example, use a data source naming convention that helps other users of the data source figure out which data source to connect to.
 - b. From the **Database** drop-down list, select a database.
 - c. Under **Table**, select a table or use the search field to search for a table by name.
 - d. Drag a table to the canvas, and then select the sheet tab to start your analysis.

Use custom SQL to connect to a specific query rather than the entire data source. For more information, see [Connect to a Custom SQL Query on page 863](#).

Sign in on a Mac

If you use Tableau Desktop on a Mac, when you enter the server name to connect, use a fully qualified domain name, such as mydb.test.ourdomain.lan, instead of a relative domain name, such as mydb or mydb.test.

Alternatively, you can add the domain to the list of Search Domains for the Mac computer so that when you connect, you need to provide only the server name. To update the list of Search Domains, go to **System Preferences > Network > Advanced**, and then open the **DNS** tab.

See also

- [Set Up Data Sources on page 596](#) – Add more data to this data source or prepare your data before you analyze it.
- [Build Charts and Analyze Data on page 1005](#) – Begin your data analysis.

Marketo

This article describes how to connect Tableau to Marketo data and set up the data source.

Note: Tableau is working on a replacement connector. After it's complete, it will be added to this page.

Warning: The Marketo connector is deprecated as of the 2023.1 release. You can use the connector until it's been retired. Once the Connector is retired, it's removed from the Tableau user interface and any data sources using the connector will no longer work as expected. The deprecated connector will be retired 1-2 releases after the replacement connector is made available.

Before you begin

Before you begin, gather this connection information:

- Custom Service Endpoint
- Client ID
- Client Secret

For details about how to create the custom service information you need from Marketo to connect, see the [Custom Service](#) topic on the Marketo website.

Make the connection and set up the data source

1. Start Tableau and under **Connect**, select **Marketo**. For a complete list of data connections, select **More** under **To a Server**. Then do the following:
 - a. Enter your Custom Service Endpoint, Client ID, and Client Secret.
 - b. Select **Sign In**.
 - c. Select **Filter Type: Relative date range** or **Fixed date range**, and then select or specify the range.
 - d. Select **Connect** to authorize Marketo to securely share your data with Tableau Desktop.

If Tableau can't make the connection, verify that your credentials are correct. If you still can't connect, your computer is having trouble locating the server. Contact your network or Marketo administrator.

2. On the data source page, do the following:
 - a. (Optional) Select the default data source name at the top of the page, and then enter a unique data source name for use in Tableau. For example, use a data

source naming convention that helps other users of the data source figure out which data source to connect to.

- b. Under **Table**, select a table and drag it to the top of the canvas.
- c. Select the sheet tab to start your analysis.

After you select the sheet tab, Tableau imports the data by creating an extract. Note that Tableau Desktop supports only extracts for Marketo. You can update the data by refreshing the extract. For more information, see [Extract Your Data on page 919](#).

Creating extracts may take some time depending on the amount of data that is included.

Bulk API retrieves data for some tables

Tableau uses the bulk API to retrieve data for the **All Activities**, **Leads**, and **Leads by List - <list name>** tables, thereby reducing the number of API calls. For more information, see the [Bulk Extract](#) documentation on the Marketo website.

You can use the Daily API Usage and Weekly API Usage tables to monitor your API usage.

Use Accelerators

You can use an Accelerator to quickly build informative dashboard designs made specifically for key business metrics on Tableau Desktop and Tableau Cloud. For more information, see [Use Accelerators to Quickly Visualize Data on page 2721](#).

Date range selections can impact performance

It's tempting to gather as much data as possible when you do an analysis, however, retrieving records from Marketo can be time-consuming. Tableau doesn't know how much data there is in a particular date range until it retrieves the data. For this reason, you should restrict your date range at first, and then expand after you evaluate performance.

To give you a rough idea of how much time it might take to retrieve data from Marketo, tests were conducted using a high-speed connection. This table shows how long it took in the test environment to retrieve a given number of records.

Number of records	Time to retrieve
1,000	4.5 seconds
10,000	45 seconds

100,000	8 minutes
1,000,000	75 minutes

See also

- [Set Up Data Sources on page 596](#) – Add more data to this data source or prepare your data before you analyze it.
- [Build Charts and Analyze Data on page 1005](#) – Begin your data analysis.

Marketing Cloud Intelligence

Note: The Marketing Cloud Intelligence connector replaced the Datorama connector.

This article describes how to connect Tableau to Marketing Cloud Intelligence.

Before you begin

Before you begin, gather this connection information:

- Name of the environment and workplace ID that you want to connect to
- User name and password
- (Optional) Initial SQL statement to run every time Tableau connects

Driver required

This connector requires a driver to talk to the database. If the driver is not installed on your computer, Tableau displays a message in the connection dialog box with a link to the [Driver Download](#) page where you can find driver links and installation instructions.

Make the connection and set up the data source

1. Start Tableau and under **Connect**, select **Marketing Cloud Intelligence**. For a complete list of data connections, select **More** under **To a Server**. Then do the following:
 - a. Choose the environment you want to work in.
 - b. Enter the workplace ID.
 - c. Enter the access token from [Marketing Cloud Intelligence](#).
 - d. Select **Sign In**.

If Tableau can't make the connection, verify that your credentials are correct. If you still can't connect, your computer is having trouble locating the server. Contact your network administrator or database administrator.

2. On the data source page, do the following:
 - a. (Optional) Select the default data source name at the top of the page, and then enter a unique data source name for use in Tableau. For example, use a data source naming convention that helps other users of the data source figure out which data source to connect to.
 - b. From the **Database** drop-down list, select a database.
 - c. Under **Table**, select a table or use the search field to search for a table by name.
 - d. Drag a table to the canvas, and then select the sheet tab to start your analysis.

Use custom SQL to connect to a specific query rather than the entire data source. For more information, see [Connect to a Custom SQL Query on page 863](#).

Sign in on a Mac

If you use Tableau Desktop on a Mac, when you enter the server name to connect, use a fully qualified domain name, such as mydb.test.ourdomain.lan, instead of a relative domain name, such as mydb or mydb.test.

Alternatively, you can add the domain to the list of Search Domains for the Mac computer so that when you connect, you need to provide only the server name. To update the list of Search Domains, go to **System Preferences > Network > Advanced**, and then open the **DNS** tab.

See also

- [Set Up Data Sources on page 596](#) – Add more data to this data source or prepare your data before you analyze it.
- [Build Charts and Analyze Data on page 1005](#) – Begin your data analysis.

MarkLogic

This article describes how to connect Tableau to a MarkLogic database and set up the data source.

Before you begin

Before you begin, gather this connection information:

- Name of the server that hosts the database you want to connect to
- Port number for the ODBC server process
- User name and password
- (Optional) Initial SQL statement to run every time Tableau connects

Use this connector with Tableau Desktop on a Windows computer.

Driver required

This connector requires a driver to talk to the database. If the driver is not installed on your computer, Tableau displays a message in the connection dialog box with a link to the [Driver Download](#) page where you can find driver links and installation instructions.

Make the connection and set up the data source

1. Start Tableau and under **Connect**, select **MarkLogic**. For a complete list of data connections, select **More** under **To a Server**. Then do the following:
 - a. Enter the name of the server that hosts the database you want to connect to.
 - b. Enter the port number for the ODBC server process of the database you want to connect to.
 - c. Enter your user name and password.
 - d. (Optional) Select **Initial SQL** to specify a SQL command to run at the beginning of every connection, such as when you open the workbook, refresh an extract, sign in to Tableau Server, or publish to Tableau Server. For more information, see [Run Initial SQL on page 591](#).
 - e. Select **Sign In**.

If the connection is unsuccessful, verify that your user name and password are correct and that the port number correctly identifies the MarkLogic database configured by your database administrator. If the connection continues to fail, your computer is having trouble locating the server. Contact your network administrator or database administrator.

2. On the data source page, do the following:
 - a. (Optional) Select the default data source name at the top of the page, and then enter a unique data source name for use in Tableau. For example, use a data source naming convention that helps other users of the data source figure out

which data source to connect to.

- b. From the **Schema** drop-down list, select a schema or use the text box to search for a schema by name.
- c. Under **Table**, select a table or use the text box to search for a table by name.
- d. Drag the table to the canvas, and then select the sheet tab to start your analysis.

Use custom SQL to connect to a specific query rather than the entire data source.

For more information, see [Connect to a Custom SQL Query](#) on page 863.

See also

- [Set Up Data Sources](#) on page 596 – Add more data to this data source or prepare your data before you analyze it.
- [Build Charts and Analyze Data](#) on page 1005 – Begin your data analysis.

[Tableau and MarkLogic Visualize Unstructured Data](#) - Read the Tableau blog post.

Microsoft Analysis Services

This topic describes how to connect Tableau to a Microsoft Analysis Services database and set up a data source.

Before you begin

Before you begin, gather this connection information:

- For a remote cube file: Server name, or URL if connecting to the server using HTTP
- For a local cube file: File name
- Authentication method: Windows Authentication or user name and password

Use this connector with Tableau Desktop on a Windows computer.

Driver required

This connector requires a driver to talk to the database. If the driver is not installed on your computer, Tableau displays a message in the connection dialog box with a link to the [Driver Download](#) page where you can find driver links and installation instructions.

Make the connection and set up the data source

1. Start Tableau and under **Connect**, select **Microsoft Analysis Services**. For a complete list of data connections, select **More** under **To a Server**. Then do the following:
 - a. Select whether to connect to a remote cube file on a server or to a local cube file.

To connect to a remote cube file, select **Server** and enter the name of the server in the text box. If you are connecting to the server using HTTP, you can enter the URL as the server name.

To connect to a local cube file, select **Local cube file** and select **Browse** to navigate to the cube file on your computer.
 - b. Select how you want to sign in to the server. Specify whether to use Windows Authentication or a specific user name and password. If the cube is password protected, and you are not in a Kerberos environment, you must enter your user name and password.

Specify whether to use Windows Authentication or a specific user name and password.
 - c. Select **Sign In**.

If Tableau can't make the connection, verify that your credentials are correct. If you still can't connect, your computer is having trouble locating the server. Contact your network administrator or database administrator.
2. On the data source page, do the following:
 - a. (Optional) Select the default data source name at the top of the page, and then enter a unique data source name for use in Tableau. For example, use a data source naming convention that helps other users of the data source figure out which data source to connect to.
 - b. Select a database.
 - c. Select a cube from the database.
 - d. Select the sheet tab to start your analysis.

Incompatible Measures and Dimensions

When you build views in Tableau using a Microsoft Analysis Services Cube you might see some fields highlighted in gray, or you might see a caution symbol on a field in the view with the message, "This measure is incompatible with one or more dimensions in this view." This occurs

because it is possible to have measures and dimensions that don't make a lot of sense when placed in the view together. For example, you may have a measure for Sales Quota. It won't make sense to place that measure against a dimension containing products if products don't have sales quotas.



Tableau helps you figure out the dimensions and measure that can be used together in meaningful ways by highlighting unrelated dimensions and measures in gray. So in the last example, when we place Sales Quota onto a shelf, the products dimensions are highlighted in gray. Highlighted dimensions are not disabled and can still be added to the view. When you add an incompatible measure to the view, the measure is marked with a caution symbol. For more information on working with cubes, see [Cube Data Sources](#) on page 982.

See also

- [Set Up Data Sources](#) on page 596 – Add more data to this data source or prepare your data before you analyze it.
- [Build Charts and Analyze Data](#) on page 1005 – Begin your data analysis.

Microsoft SQL Server

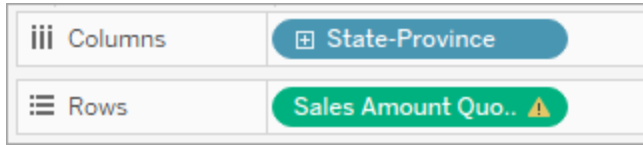
This article describes how to connect Tableau to a Microsoft SQL Server database and set up the data source.

Note: Use the Microsoft SQL Server connector to connect to Microsoft SQL Server Parallel Data Warehouse (PDW), Microsoft Azure Synapse Analytics (formerly Azure SQL Data Warehouse), or Microsoft Azure SQL Database.

Before you begin

Before you begin, gather this connection information:

- Name of the server you want to connect to
- (Optional) Port number if you want to connect to a non-default port

- (Optional) Database name if you want to connect to a contained database
- Authentication method: Windows Authentication or user name and password
- Are you connecting to an SSL server?
- Do you want to set the database isolation level to read uncommitted data?
- (Optional) Initial SQL statement to run every time Tableau connects

Driver required

This connector requires a driver to talk to the database. If the driver is not installed on your computer, Tableau displays a message in the connection dialog box with a link to the [Driver Download](#) page where you can find driver links and installation instructions.

Make the connection and set up the data source

1. Start Tableau and under **Connect**, select **Microsoft SQL Server**. For a complete list of data connections, select **More** under **To a Server**. Then do the following:
 - a. Enter the name of the server you want to connect to.

To connect to a non-default port, use the `<server name>, <port number>` format when entering the server name. For example, `ExampleServer, 8055`.
 - b. (Optional) Enter a database name if you want to connect to a contained database.
 - c. Select how you want to sign in to the server. Specify whether to use Windows Authentication or a specific user name and password. If the server is password protected, and you are not in a Kerberos environment, you must enter the user name and password.

Select the **Require SSL** check box when connecting to an SSL server.
 - d. Specify whether to **Read uncommitted data**. This option lets Tableau running at the read-uncommitted isolation level. Long queries from other transactions, including extract refreshes, can lock the database and delay Tableau's transactions. Select this option to allow queries to read rows that have been modified by other transactions even when they have not been committed yet. When this option is cleared, Tableau uses the default isolation level specified by the database.
 - e. (Optional) Select **Initial SQL** to specify a SQL command to run at the beginning of every connection, such as when you open the workbook, refresh an extract, sign in to Tableau Server, or publish to Tableau Server. For more information, see [Run](#)

[Initial SQL](#) on page 591.

- f. Select **Sign In**.

If Tableau can't make the connection, verify that your credentials are correct. If you still can't connect, your computer is having trouble locating the server. Contact your network administrator or database administrator.

2. On the data source page, do the following:

- a. (Optional) Select the default data source name at the top of the page, and then enter a unique data source name for use in Tableau. For example, use a data source naming convention that helps other users of the data source figure out which data source to connect to.

- b. From the **Database** drop-down list, select a database or use the text box to search for a database by name.

- c. Under **Table**, select a table or use the text box to search for a table by name.

You can also specify a stored procedure in the database. For more information about stored procedures, including a list of constraints specific to SQL Server databases, see [Use a Stored Procedure](#) on page 878.

Starting with Tableau version 2018.1, you can connect to spatial columns. For more information, see [Connect to Spatial Data in a Database](#) on page 1691.

- d. Drag the table or stored procedure to the canvas, and then select the sheet tab to start your analysis.

Use custom SQL to connect to a specific query rather than the entire data source. For more information, see [Connect to a Custom SQL Query](#) on page 863.

Starting with Tableau version 2018.1, you can use Custom SQL to perform advanced spatial analysis on spatial columns in Microsoft SQL Server. For more information, see [Use Custom SQL and RAWSQL to perform advanced spatial analysis](#) on page 1692.

Note: Tableau Desktop does not support the Microsoft SQL Server TIME data type. Fields of this data type are not imported and do not appear in Tableau Desktop. If included in stored procedures, TIME data type fields will not appear in Tableau Desktop. For more information, see [Use a Stored Procedure](#) on page 878.

Sign in on a Mac

If you use Tableau Desktop on a Mac, when you enter the server name to connect, use a fully qualified domain name, such as mydb.test.ourdomain.lan, instead of a relative domain name, such as mydb or mydb.test.

Alternatively, you can add the domain to the list of Search Domains for the Mac computer so that when you connect, you need to provide only the server name. To update the list of Search Domains, go to **System Preferences > Network > Advanced**, and then open the **DNS** tab.

Resolve "Worksheet Unavailable" error message

When you open a workbook, you may see a "Worksheet Unavailable" error message and then, when you select **Edit Connection**, you are prompted to provide your sign-in credentials. This error typically displays under one of two circumstances:

- You don't have access to a data connection used in the workbook.
- Your credentials are invalid, for example, your password has expired.

To resolve, verify that your sign-in credentials are correct. If they are, contact the Tableau administrator to ask about access to the data connection.

See also

- [Set Up Data Sources on page 596](#) – Add more data to this data source or prepare your data before you analyze it.
- [Build Charts and Analyze Data on page 1005](#) – Begin your data analysis.

[Connect to Spatial Data in a Database on page 1691](#)

MonetDB

This article describes how to connect Tableau to a MonetDB database and set up the data source.

Before you begin

Before you begin, gather this connection information:

- Name of the server that hosts the database you want to connect to
- Database name

- User name and password
- (Optional) Initial SQL statement to run every time Tableau connects

Use this connector with Tableau Desktop on a Windows computer.

Driver required

This connector requires a driver to talk to the database. If the driver is not installed on your computer, Tableau displays a message in the connection dialog box with a link to the [Driver Download](#) page where you can find driver links and installation instructions.

Make the connection and set up the data source

1. Start Tableau and under **Connect**, select **MonetDB**. For a complete list of data connections, select **More** under **To a Server**. Then do the following:
 - a. Enter the name of the server that hosts the database and the name of the database that you want to connect to.
 - b. Enter the user name and password.
 - c. (Optional) Select **Initial SQL** to specify a SQL command to run at the beginning of every connection, such as when you open the workbook, refresh an extract, sign in to Tableau Server, or publish to Tableau Server. For more information, see [Run Initial SQL on page 591](#).
 - d. Select **Sign In**.

If Tableau can't make the connection, verify that your credentials are correct. If you still can't connect, your computer is having trouble locating the server. Contact your network administrator or database administrator.

2. On the data source page, do the following:
 - a. (Optional) Select the default data source name at the top of the page, and then enter a unique data source name for use in Tableau. For example, use a data source naming convention that helps other users of the data source figure out which data source to connect to.
 - b. From the **Schema** drop-down list, select a schema.
 - c. Under **Table**, select a table or use the text box to search for a table by name.
 - d. Drag a table to the canvas, and then select the sheet tab to start your analysis.

Use custom SQL to connect to a specific query rather than the entire data source.
For more information, see [Connect to a Custom SQL Query](#) on page 863.

See also

- [Set Up Data Sources](#) on page 596 – Add more data to this data source or prepare your data before you analyze it.
- [Build Charts and Analyze Data](#) on page 1005 – Begin your data analysis.

MongoDB BI Connector

This article describes how to connect Tableau to MongoDB Business Intelligence (BI) data and set up the data source.

Before you begin

Before you begin, gather this connection information:

- Name of the server that hosts the database you want to connect to
- User name and password, if MongoDB authentication is enabled
- Database name associated with the user's credentials, if MongoDB authentication is enabled
- Are you connecting to an SSL server?
- (Optional) Initial SQL statement to run every time Tableau connects

You must install and run the MongoDB Connector for BI, version 2.1 or later, before you can connect Tableau to your MongoDB BI data.

To get the MongoDB Connector for BI, sign in to the MongoDB website and [download the connector](#). Follow the [Installation](#) instructions on the MongoDB website.

Driver required

This connector requires a driver to talk to the database. If the driver is not installed on your computer, Tableau displays a message in the connection dialog box with a link to the [Driver Download](#) page where you can find driver links and installation instructions.

Make the connection and set up the data source

1. Start Tableau and under **Connect**, select **MongoDB BI Connector**. For a complete list of data connections, select **More** under **To a Server**. Then do the following:

- a. Enter the name of the server.
- b. If MongoDB authentication is enabled, enter your user name with associated database name, and password. For information about the correct format to use, see [Sign in options below](#). If MongoDB authentication isn't enabled, proceed to step c.

Select the **Require SSL** check box when connecting to an SSL server. For more information about connecting with SSL to MongoDB, see [Connecting Tableau to MongoDB](#) on the MongoDB website.
- c. (Optional) Select **Initial SQL** to specify a SQL command to run at the beginning of every connection, such as when you open the workbook, refresh an extract, sign in to Tableau Server, or publish to Tableau Server. For more information, see [Run Initial SQL on page 591](#).
- d. Select **Sign In**.

If Tableau can't make the connection, verify that your credentials are correct. If you still can't connect, your computer is having trouble locating the server. Contact your network administrator or database administrator.

2. On the data source page, do the following:

- a. (Optional) Select the default data source name at the top of the page, and then enter a unique data source name for use in Tableau. For example, use a data source naming convention that helps other users of the data source figure out which data source to connect to.
- b. Select the sheet tab to start your analysis.

Sign in options

User accounts in MongoDB are associated with specific logical databases in MongoDB. So when users log into MongoDB, they need to specify the database name associated with the user's credentials. This is done by passing special options in the username string. For example, if user `henrywilson` is associated with the `example` database, he enters the following in the **Username** field.

```
henrywilson?source=example
```

You can use the `mechanism` option to define the authentication mechanism if you want to use a mechanism other than the default, SCRAM-SHA-1. For example, if user `henrywilson` wants to connect to the `example` database using challenge/response as the authentication mechanism, he enters the following in the **Username** field:

henrywilson?source=example,mechanism=MONGODB-CR

For more information about authentication options, see the [MongoDB](#) website.

See also

- [Set Up Data Sources on page 596](#) – Add more data to this data source or prepare your data before you analyze it.
- [Build Charts and Analyze Data on page 1005](#) – Begin your data analysis.

MySQL

This article describes how to connect Tableau to a MySQL database and set up the data source.

Before you begin

Before you begin, gather this connection information:

- Name of the server that hosts the database you want to connect to
- User name and password
- Are you connecting to an SSL server?
- (Optional) Initial SQL statement to run every time Tableau connects

Note: For information about requirements and considerations when connecting to data using Prep Builder, see [Connect to Data](#) in the Tableau Prep Help.

Driver required

This connector requires a driver to talk to the database. If the driver is not installed on your computer, Tableau displays a message in the connection dialog box with a link to the [Driver Download](#) page where you can find driver links and installation instructions.

Make the connection and set up the data source

1. Start Tableau and under **Connect**, select **MySQL**. For a complete list of data connections, select **More** under **To a Server**. Then do the following:
 - a. Enter the name of the server that hosts the database.
 - b. Enter the user name and password.

Select the **Require SSL** option when connecting to an SSL server.

- c. (Optional) Select **Initial SQL** to specify a SQL command to run at the beginning of every connection, such as when you open the workbook, refresh an extract, sign in to Tableau Server, or publish to Tableau Server. For more information, see [Run Initial SQL on page 591](#).
- d. Select **Sign In**.

If Tableau can't make the connection, verify that your credentials are correct. If you still can't connect, your computer is having trouble locating the server. Contact your network administrator or database administrator.

2. On the data source page, do the following:

- a. (Optional) Select the default data source name at the top of the page, and then enter a unique data source name for use in Tableau. For example, use a data source naming convention that helps other users of the data source figure out which data source to connect to.
- b. From the **Database** drop-down list, select a database or use the text box to search for a database by name.
- c. Under **Table**, select a table or use the text box to search for a table by name.
- d. Drag the table to the canvas, and then select the sheet tab to start your analysis.

Use custom SQL to connect to a specific query rather than the entire data source. For more information, see [Connect to a Custom SQL Query on page 863](#).

Sign in on a Mac

If you use Tableau Desktop on a Mac, when you enter the server name to connect, use a fully qualified domain name, such as mydb.test.ourdomain.lan, instead of a relative domain name, such as mydb or mydb.test.

Alternatively, you can add the domain to the list of Search Domains for the Mac computer so that when you connect, you need to provide only the server name. To update the list of Search Domains, go to **System Preferences > Network > Advanced**, and then open the **DNS** tab.

See also

- [Set Up Data Sources on page 596](#) – Add more data to this data source or prepare your data before you analyze it.

- [Build Charts and Analyze Data on page 1005](#) – Begin your data analysis.

OData

This article describes how to connect Tableau to an OData data source. Tableau connects to OData V1, V2, and V4.

Before you begin

Before you begin, gather this connection information:

- Server URL for the data you want to connect to
- Sign-in credentials (user name and password), if necessary

Make the connection and set up the data source

1. Start Tableau and under **Connect**, select **OData**. For a complete list of data connections, select **More** under **To a Server**. Then do the following:
 - a. In **Server**, type one of the following:
 - A service URL to access all feeds inside the service.
 - A feed URL to access a specific data feed.
 - b. From the **Authentication** dropdown, select the authentication mode for this connection.
 - If you select **Username and Password**, also type a username and password.
 - Otherwise, select **No Authentication**.
 - c. Select **Sign In**.

If Tableau can't make the connection, verify that your credentials are correct. If you still can't connect, your computer is having trouble locating the server. Contact your network administrator or database administrator.

2. On the data source page, do the following:
 - a. (Optional) Select the default data source name at the top of the page, and then enter a unique data source name for use in Tableau. For example, use a data source naming convention that helps other users of the data source figure out which data source to connect to.

Note: If you publish the data source to Tableau Server or Tableau Cloud, the data source name is limited to 255 characters. Longer names cause a `RepositoryException` error.

- b. Select the sheet tab to start your analysis.

After you select the sheet tab, Tableau imports the data by creating an extract. For more information about extracts, see [Extract Your Data on page 919](#).

Note: Tableau Desktop only supports extracts for OData.

OData connector support

- The OData connector supports only extracts, which means that some OData V4 functionality isn't supported. For example, interactive query arguments such as `$expand` or `$select`.
- Tableau supports these OData versions and formats:
 - OData V1 and V2 – We support OData XML/Atom format for feed responses.
 - OData V4 and V4.01 – We support OData-JSON format for feed responses.
- Tableau assumes metadata documents for all supported OData services are in XML format.
- Collection-valued properties aren't supported, Tableau interprets them as nulls.

Note: Tableau can't guarantee that using a third-party OData service, such as Intellex, or using a feed will result in successfully connecting and extracting data. Tableau customer support gives a basic level of troubleshooting for third-party OData connections. Tableau customer support doesn't have access to Apache Olingo library. Contact your system administrator for in-depth OData troubleshooting.

See also

- [Set Up Data Sources on page 596](#) – Add more data to this data source or prepare your data before you analyze it.
- [Build Charts and Analyze Data on page 1005](#) – Begin your data analysis.

OneDrive and SharePoint Online

This article describes how to connect Tableau to OneDrive, SharePoint Online document library data, and set up the data source.

Before you begin

Before you begin, complete the following tasks:

1. Get the email address and password for your Microsoft account.
2. Add Delegated Permission for Microsoft Graph API to Azure AD.
3. Grant Tableau consent to use the following Application Programming Interface (API) permissions to access files in OneDrive and your Sharepoint Online document libraries:
 - Files.Read.All
 - Sites.Read.All
 - User.Read
 - Offline_access

Note: The OneDrive and Sharepoint Online connector doesn't support tenant-specific connections. The application connection will need to be configured for multi-tenant on the Microsoft side.

Recommendation

Set up a custom OAuth Client to use your company's IT policies

You can fully control your OAuth configuration according to your own IT policies with a custom OAuth client. The option to use your own OAuth client frees you from being tied to Tableau release cycles and Tableau's OAuth client rotation schedule. For information on how to configure your own OAuth client see, [Configure Custom OAuth for a site](#).

Make the connection and set up the data source

Note: Supported file types for use in Tableau are Excel, .csv/text, and JSON.

1. Start Tableau and under **Connect**, select **OneDrive** and **SharePoint Online**. In the tab Tableau opens in your default browser, do the following:
 - a. Enter your email address and then select **Next**.
 - b. Enter your password and then select **Sign In**.
 - c. Select **Yes** to grant Tableau access to your OneDrive files and SharePoint Online document library files.
 - d. Close the browser pane when notified to do so.
 - e. Search for or select the file to connect to, and then select **Connect**. The file can be from one of three categories:

- OneDrive (personal files): files owned by you
- OneDrive (shared with you): files shared with you by another owner
- SharePoint Sites: files in SharePoint Online document libraries that you have access to

2. On the data source page, do the following:
 - a. (Optional) Select the default data source name at the top of the page, and then enter a unique data source name for use in Tableau. For example, use a data source naming convention that helps other users of the data source figure out which data source to connect to.
 - b. To start your analysis, select the sheet tab.

Note: Tableau doesn't support pivot tables in OneDrive or SharePoint Online document libraries.

Use Data Interpreter to clean your data

If Tableau detects that it can help optimize your data source for analysis, it prompts you to use Data Interpreter. Data Interpreter can detect subtables you can use and remove unique formatting that can cause problems later on in your analysis. For information on data cleaning, see [Clean Data from Excel, CSV, PDF, and Google Sheets with Data Interpreter](#).

Troubleshoot OneDrive and SharePoint Online

Connections to multiple accounts

When using web authoring or publishing to the web, you can't use multiple OneDrive accounts in the same workbook. You can have multiple account connections in Desktop.

Web authoring with Internet Explorer 11 and Edge

In Internet Explorer 11 and Edge, you can't access a server using an unsecured connection (http). Use a secure connection (https) or switch to another browser.

See also

- [Set Up Data Sources on page 596](#) – Add more data to this data source or prepare your data before you analyze it.
- [Build Charts and Analyze Data on page 1005](#) – Begin your data analysis.

Oracle

This article describes how to connect Tableau to an Oracle database and set up the data source.

Note: Beginning with Tableau 2020.2, if you want to publish a data source or workbook using `net_service_names` to Tableau Server, be sure to review the changes described in the Knowledge Base article, [Setting an Oracle Connection to Use TNSNames.ora or LDAP.ora](#).

Before you begin

Before you begin, gather this connection information:

- Name of the server that hosts the database you want to connect to and the Oracle service name and port, or the TNS name
- Authentication method: Integrated Authentication or user name and password
- Are you connecting to an SSL server? You must configure the Oracle client before you can use SSL with Tableau.

If you are using version 2020.2 or later, see [Require SSL for Oracle JDBC Connections](#).

- (Optional) Initial SQL statement to run every time Tableau connects

Driver required

This connector requires a driver to talk to the database. If the driver is not installed on your computer, Tableau displays a message in the connection dialog box with a link to the [Driver Download](#) page where you can find driver links and installation instructions.

JDBC driver versus OCI driver

Beginning with version 2020.2, Tableau recommends that you use the JDBC driver (available from the [Driver Download](#) page) with this connector. The newer JDBC driver resolves some limitations found with the OCI driver, such as no spatial support or Kerberos delegation on Linux.

Note: If you experience issues using the JDBC driver for this connector, an OCI driver is still available and can be used instead. See the [Driver Download](#) page for instructions.

Make the connection and set up the data source

1. Start Tableau and under **Connect**, select **Oracle**. For a complete list of data connections, select **More** under **To a Server**. Then do the following:

- a. Enter the server name or the TNS name.

- If you enter the server name, you must enter the Oracle service name and port number.

Note: To find the correct service name, open the tnsnames.ora file (in the ORACLE_HOME/network/admin directory by default) and search for the **net_service_name** section. Use the value listed for **service_name**.

- If you enter the TNS name, do **not** enter the Oracle service name and port number.

- b. Select how you want to sign in to the server. Specify whether to use Integrated Authentication or a specific user name and password.

Select the **Require SSL** check box when connecting to an SSL server.

- c. (Optional) Select **Initial SQL** to specify a SQL command to run at the beginning of every connection, such as when you open the workbook, refresh an extract, sign in to Tableau Server, or publish to Tableau Server. For more information, see [Run Initial SQL on page 591](#).

- d. Select **Sign In**.

If Tableau can't make the connection, verify that your credentials are correct. If you still can't connect, your computer is having trouble locating the server. Contact your network administrator or database administrator.

2. On the data source page, do the following:

- a. (Optional) Select the default data source name at the top of the page, and then enter a unique data source name for use in Tableau. For example, use a data source naming convention that helps other users of the data source figure out which data source to connect to.

- b. From the **Schema** drop-down list, select the search icon or enter the schema name in the text box and select the search icon, and then select the schema. **Note:** Search is case-sensitive.

- c. Under **Table**, select the search icon or enter the table name and select the search icon, and then select the table.

Note: Search is case-sensitive.

Tableau Desktop also supports connecting to Oracle table functions, which appear under **Stored Procedures** in the left pane of the Data Source page.

Starting with Tableau version 2020.2, you can connect to spatial columns. For more information, see [Connect to Spatial Data in a Database on page 1691](#).

- d. Drag a table to the canvas, and then select the sheet tab to start your analysis.

Use custom SQL to connect to a specific query rather than the entire data source.

For more information, see [Connect to a Custom SQL Query on page 863](#).

Sign in on a Mac

If you use Tableau Desktop on a Mac, when you enter the server name to connect, use a fully qualified domain name, such as mydb.test.ourdomain.lan, instead of a relative domain name, such as mydb or mydb.test.

Alternatively, you can add the domain to the list of Search Domains for the Mac computer so that when you connect, you need to provide only the server name. To update the list of Search Domains, go to **System Preferences > Network > Advanced**, and then open the **DNS** tab.

Use net services definitions in Tableau

To use your net services definitions in Tableau, you must set either `TNS_ADMIN` or `ORACLE_HOME` as an environment variable. To set `TNS_ADMIN` as the environment variable use the full path of the directory that contains the `tnsnames.ora` file. To set `ORACLE_HOME` as an environment variable use the path to the main Oracle directory.

Migrate workbook from Oracle OCI connector to Oracle JDBC connector

If you create a workbook using the Oracle OCI connector with SSL and later try to open it using the JDBC-based Oracle connector, Tableau won't be able to find the corresponding SSL certificate.

To migrate a workbook

1. Convert the certificate from PKCS12 format (used by Oracle Wallet) to JKS format. Use this command:

```
keytool -importkeystore -srckeystore PFX_P12_FILE_NAME -srcstoretype pkcs12 -  
srcstorepass PFX_P12_FILE -srcalias SOURCE_ALIAS -destkeystore KEYSTORE_FILE  
-deststoretype jks -deststorepass PASSWORD -destalias ALIAS_NAME
```

2. Modify oracle.properties to customize this connection as follows:

```
javax.net.ssl.trustStore = <new jks file path>  
javax.net.ssl.trustStoreType = JKS  
javax.net.ssl.trustStorePassword = <new jks file password>
```

See also

- [Set Up Data Sources on page 596](#) – Add more data to this data source or prepare your data before you analyze it.
- [Build Charts and Analyze Data on page 1005](#) – Begin your data analysis.
- [Tableau and JDBC](#) - Find tips for using and troubleshooting JDBC drivers with Tableau.
- [Require SSL for Oracle JDBC Connections](#) - Add trusted SSL certificates to your Oracle JDBC connection.
- [Troubleshooting Oracle Connection Errors](#) - Review the Tableau Knowledge Base article about how to troubleshoot errors.

Oracle Eloqua

This topic describes how to connect Tableau to Oracle Eloqua data and set up the data source. It also describes how date range selections can impact performance.

Note: Tableau is working on a replacement connector. After it's complete, it will be added to this page.

Warning: The Oracle Eloqua connector is deprecated as of the 2023.1 release. You can use the connector until it's been retired. Once the Connector is retired, it's removed from the Tableau user interface and any data sources using the connector will no longer work as expected. The deprecated connector will be retired 1-2 releases after the replacement connector is made available.

Note: For the most up-to-date information on this connector, see the [Oracle Eloqua](#) help topic for the current version of Tableau.

Before you begin

Before you begin, gather and confirm this information for connecting:

- You must be a member of the following Eloqua security groups:
 - Advanced Users - Marketing
 - API Users
- Company Name
- Username
- Password

Make the connection and set up the data source

1. Start Tableau and under **Connect**, select **Oracle Eloqua**. For a complete list of data connections, select **More** under **To a Server**. Then do the following:
 - a. Enter **Company Name**, **Username**, and **Password**, and then select **Sign In**.
 - b. Select **Filter Type: Relative date range** or **Fixed date range**, and then select or specify the range.
 - c. Select **Connect**.

If Tableau can't make the connection, verify that your credentials are correct. If you still can't connect, your computer is having trouble locating the server. Contact your network or Eloqua administrator.

After your credentials are verified, the Eloqua connector will only prompt you to authenticate when necessary. The **Sign Out** option will start the

authentication process again.

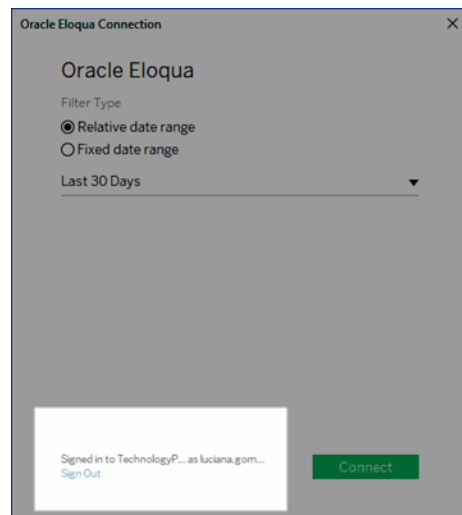

2. On the data source page, do the following:
 - a. (Optional) Select the default data source name at the top of the page, and then enter a unique data source name for use in Tableau. For example, use a data source naming convention that helps other users of the data source figure out which data source to connect to.
 - b. Under **Table**, select a table and drag it to the top of the canvas.
 - c. Select the sheet tab to start your analysis.

After you select the sheet tab, Tableau imports the data by creating an extract. Note that Tableau Desktop supports only extracts for Eloqua. You can update the data by refreshing the extract. For more information, see [Extract Your Data on page 919](#).

Creating extracts may take some time depending on the amount of data that is included.

Use Accelerators

You can use an Accelerator to quickly build informative dashboard designs made specifically for key business metrics on Tableau Desktop and Tableau Cloud. For more information, see [Use Accelerators to Quickly Visualize Data on page 2721](#).

Date range selections can impact performance

It's tempting to gather as much data as possible when you do an analysis, however, retrieving records from Eloqua can be time-consuming. Tableau doesn't know how much data there is in a particular date range until it retrieves the data. For this reason, you should restrict your date range at first, and then expand after you evaluate performance. You can modify the date range on the Data Source page. Under **Connections**, select the drop-down arrow for the connection and select **Edit connection**.

To give you a rough idea of how much time it might take to retrieve data from Eloqua, tests were conducted using a high-speed connection. This table shows how long it took in the test environment to retrieve a given number of records. The connector retrieves 1000 records per request.

Number of records	Time to retrieve
50,662 records	3 minutes 17 seconds
95,214 rows	6 minutes 14 seconds
194,679 rows	12 minutes 55 seconds

Eloqua limits

Field limits

Some Eloqua tables can be customized to have more than 250 fields. Tableau currently retrieves the first 250 fields and ignores the rest. When you select an Events, Custom Objects, Contracts, or Accounts table, Tableau will display a warning if there are more fields than Tableau can retrieve.

Daily table request limits

Each table requested by Tableau counts against a daily Eloqua request limit of 2000. When the limit is exceeded, Eloqua operations might choose to disable Tableau, in which case, they will contact the account owners. You can monitor your daily usage in Eloqua using the Eloqua Marketing Operations Center.

Incremental Refresh

For all the activity labels (with the exception of "Activities- all"), you can now implement incremental refreshes. For more information, please see [Refresh Extracts on page 937](#).

See also

- [Set Up Data Sources on page 596](#) – Add more data to this data source or prepare your data before you analyze it.
- [Build Charts and Analyze Data on page 1005](#) – Begin your data analysis.

Oracle Essbase

This article describes how to connect Tableau to an Oracle Essbase database.

Before you begin

Before you begin, gather this connection information:

- Name of the server that hosts the database you want to connect to
- User name and password

Use this connector with Tableau Desktop on a Windows computer.

Driver required

This connector requires a driver to talk to the database. If the driver is not installed on your computer, Tableau displays a message in the connection dialog box with a link to the [Driver Download](#) page where you can find driver links and installation instructions.

Make the connection and set up the data source

1. Start Tableau and under **Connect**, select **Oracle Essbase**. For a complete list of data connections, select **More** under **To a Server**. Then do the following:
 - a. Enter the name of the server that hosts the database.
 - b. Enter your user name and password to sign in to the server, and then select **Sign In**.

If Tableau can't make the connection, verify that your credentials are correct. If you still can't connect, your computer is having trouble locating the server. Contact your network administrator or database administrator.

2. On the data source page, do the following:
 - a. (Optional) Select the default data source name at the top of the page, and then enter a unique data source name for use in Tableau. For example, use a data source naming convention that helps other users of the data source figure out which data source to connect to.

- b. Search for or select an application.
- c. Search for or select a database from your application.
- d. Select the sheet tab to start your analysis.

Set an accounts dimension

In some case, the accounts dimension for your data source can appear in the Dimensions area of the Data pane. This might occur if there is an error in the cube and another field is identified as the accounts dimension or there is no accounts dimension set at all. The accounts dimension defines the fields that are included as measures. To correct this error, right-click the field and then select **Set as Accounts Dimension** from the context menu.

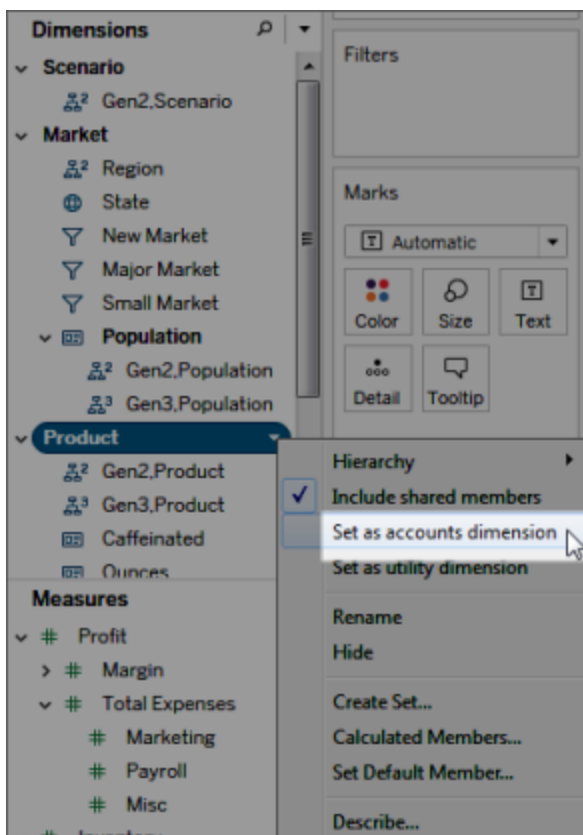

Build views with Oracle Essbase

When Tableau is connected to an Oracle Essbase data source, there are three important features that you should know about:

Generations and Levels

In Tableau, you can work with either the generations or the levels of a dimension. The generations of a dimension are all members that are an equal distance from the root of the dimension. The levels are all members that are an equal distance from the leaves of the dimension. For balanced dimensions, you'll typically want to work with generations. However, if your dimension is ragged, then it may make more sense to navigate using levels.

By default, the generations of each dimension are listed in the Data pane. When you drag a dimension to a shelf, all generations that are ancestors of the selected generation (all generations that are above it in the hierarchy) are automatically included in the placement.

If you would rather navigate using the levels of a dimension, right-click the name of the dimension and then select **Hierarchy > Levels**.

If you are using the same dimension in multiple worksheets, you can use levels in one worksheet and generations in another worksheet simultaneously. Furthermore, you can mix generations and levels from different dimensions in the same worksheet.

Shared Members

Shared members are dimension members that appear in more than one place in a hierarchy. For example, Diet Coke might be part of the product generation. But it might be shared by both the diet colas branch and the colas branch of the product hierarchy above it. In the database, however, the data about Diet Coke is stored just once.

By default, Tableau includes shared members in all generations (or levels) of a dimension. This means that a shared member might appear multiple times in a table. If you choose to exclude shared members, they will appear only once in a table. By default, shared members are included for all dimensions. To exclude shared members for a given dimension hierarchy, right-click the dimension name in the Data pane and select **Include Shared Members** from the menu.

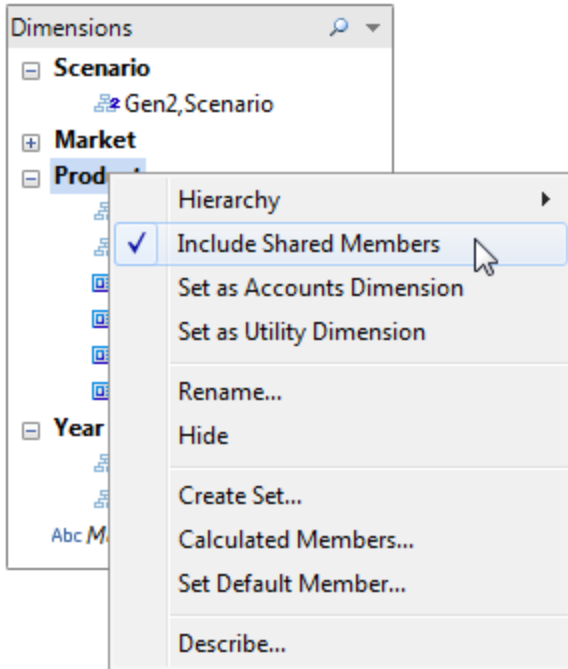

The figure below shows part of a data view where shared members are included (left) and excluded (right). Notice that diet drinks are shared members.

Includes Shared Members

The diet drinks are listed in both the Diet Drinks hierarchy and their respective drink hierarchies.

Does Not Include Shared Members

The diet drinks are only listed once, in their respective drink hierarchies.

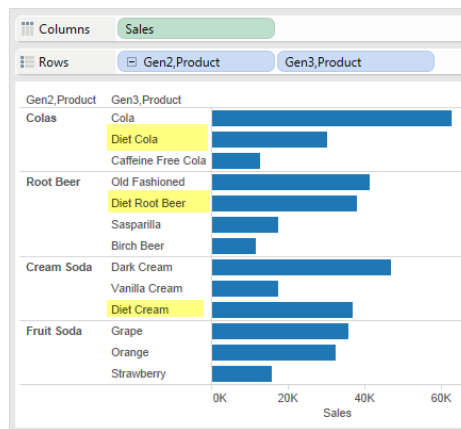

Setting the Default Member

All multidimensional data sources have default members that are set when the data source is first built. If you find that you are creating filters all the time to look at the same specific data, you may find it useful to change the default member. For example, if you are the regional manager for the Western region in a company and you only want to look at your region's numbers, you can set the default member to the Western region.

To change the default member in Tableau, right-click a dimension hierarchy and select **Set Default Member**.

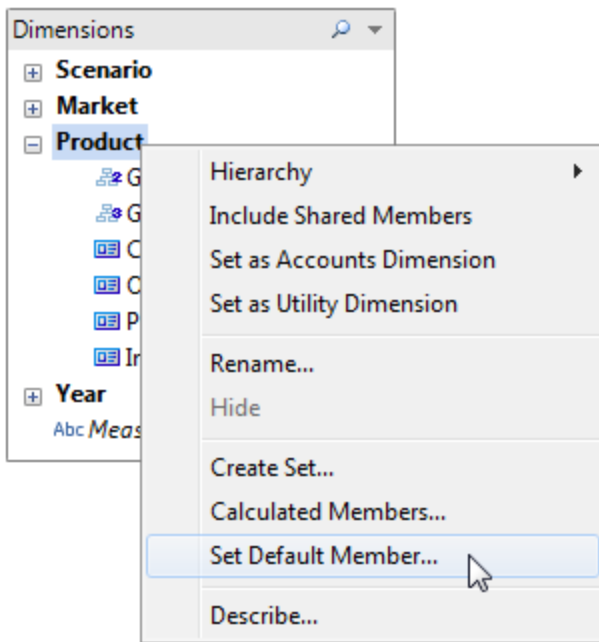

In the subsequent dialog box, select from the following options:

- Default member defined on cube – uses the default member that was defined when the cube was built. This is the default setting in Tableau.
- (All) member for the hierarchy – uses the ALL member for the selected hierarchy as the default member.
- Selected member – uses the member that you select in the bottom half of the dialog box as the default member.

The default member determines how you view the cube and so is much more powerful than applying filters. All fields will be calculated based on the default member you select. In addition, these default member settings are saved with the connection.

See also

- [Set Up Data Sources on page 596](#) – Add more data to this data source or prepare your data before you analyze it.
- [Build Charts and Analyze Data on page 1005](#) – Begin your data analysis.

Oracle NetSuite

This article describes how to connect Tableau to Oracle NetSuite and set up the data source.

Before you begin

Before you begin, gather this connection information:

- Environment Account ID.
- Authentication information

Driver required

This connector requires a driver to talk to the database. If the driver is not installed on your computer, Tableau displays a message in the connection dialog box with a link to the [Driver Download](#) page where you can find driver links and installation instructions.

Make the connection and set up the data source

1. Start Tableau and under **Connect**, select **Oracle NetSuite**. For a complete list of data connections, select **More** under **To a Server**. Then do the following:
 - a. Enter the Application ID.
 - b. Enter the Authentication information.
 - c. Select **Sign In**.
Note: If Tableau can't make the connection, verify that your credentials are correct. If you still can't connect, contact your database or network administrator.
2. On the data source page, complete the following steps:
 - a. (Optional) Select the data source name at the top of the page, and then enter a unique data source name.
 - b. From the Database drop-down list, select a database.

- c. Under Table, select a table or use the search field to search for a table by name.
- d. Drag a table to the canvas, and then select the sheet tab to start your analysis.

See also

- [Set Up Data Sources on page 596](#) – Add more data to this data source or prepare your data before you analyze it.
- [Build Charts and Analyze Data on page 1005](#) – Begin your data analysis.

Pivotal Greenplum Database

This article describes how to connect Tableau to a Pivotal Greenplum Database and set up the data source.

Before you begin

Before you begin, gather this connection information:

- Name of the server that hosts the database you want to connect to
- Database name
- User name and password
- (Optional) Initial SQL statement to run every time Tableau connects

Driver required

This connector requires a driver to talk to the database. If the driver is not installed on your computer, Tableau displays a message in the connection dialog box with a link to the [Driver Download](#) page where you can find driver links and installation instructions.

Make the connection and set up the data source

1. Start Tableau and under **Connect**, select **Pivotal Greenplum Database**. For a complete list of data connections, select **More** under **To a Server**. Then do the following:
 - a. Enter the name of the server that hosts the database and the name of the database you want to connect to.
 - b. Enter the user name and password.
 - c. (Optional) Select **Initial SQL** to specify a SQL command to run at the beginning of every connection, such as when you open the workbook, refresh an extract, sign in to Tableau Server, or publish to Tableau Server. For more information, see [Run Initial SQL on page 591](#).
 - d. Select **Sign In**.

If Tableau can't make the connection, verify that your credentials are correct. If you still can't connect, your computer is having trouble locating the server. Contact your network administrator or database administrator.

2. On the data source page, do the following:
 - a. (Optional) Select the default data source name at the top of the page, and then enter a unique data source name for use in Tableau. For example, use a data source naming convention that helps other users of the data source figure out which data source to connect to.
 - b. Select and drag a table to the canvas, and then select the sheet tab to start your analysis.

Use custom SQL to connect to a specific query rather than the entire data source. For more information, see [Connect to a Custom SQL Query on page 863](#).

Support for spatial columns

Starting with Tableau version 2019.2, you can connect to spatial columns. For more information, see [Connect to Spatial Data in a Database on page 1691](#).

For Pivotal Greenplum Databases with spatial columns, we recommend that you use the PostgreSQL driver that is installed on Windows by default with Tableau Desktop. (Tableau already uses the PostgreSQL driver on macOS.) To use the PostgreSQL driver, you must uninstall the Pivotal Greenplum Database driver on your Windows computer, if it's installed.

Sign in on a Mac

If you use Tableau Desktop on a Mac, when you enter the server name to connect, use a fully qualified domain name, such as mydb.test.ourdomain.lan, instead of a relative domain name, such as mydb or mydb.test.

Alternatively, you can add the domain to the list of Search Domains for the Mac computer so that when you connect, you need to provide only the server name. To update the list of Search Domains, go to **System Preferences > Network > Advanced**, and then open the **DNS** tab.

See also

- [Set Up Data Sources on page 596](#) – Add more data to this data source or prepare your data before you analyze it.
- [Build Charts and Analyze Data on page 1005](#) – Begin your data analysis.

PostgreSQL

This article describes how to connect Tableau to a PostgreSQL database and set up the data source.

Before you begin

Before you begin, gather this connection information:

- The name of the server that hosts the database you want to connect to
- Database name
- Authentication method: Integrated Authentication or username and password
- Are you connecting to an SSL server?
- (Optional) Initial SQL statement to run every time Tableau connects

Driver required

This connector requires a driver to talk to the database. If the driver is not installed on your computer, Tableau displays a message in the connection dialog box with a link to the [Driver Download](#) page where you can find driver links and installation instructions.

Make the connection and set up the data source

1. Start Tableau and under **Connect**, select **PostgreSQL**. For a complete list of data connections, select **More** under **To a Server**. Then do the following:
 - a. Enter the name of the server that hosts the database that you want to connect to.
 - b. Enter the name of the database.
 - c. Select how you want to sign in to the server. Specify whether to use **Integrated Authentication** or **User Name and Password**. If the server is password protected, and you aren't in a Kerberos environment, you must enter the username and password.

Note: If you're using a Mac that isn't attached to the domain correctly, the Mac won't know that Kerberos is being used in the domain, and the **Authentication** dropdown list isn't available.

Select the **Required SSL** check box when connecting to an SSL server.

- d. (Optional) Select **Initial SQL** to specify a SQL command to run at the beginning of every connection, such as when you open the workbook, refresh an extract, sign in to Tableau Server, or publish to Tableau Server. For more information, see [Run Initial SQL on page 591](#).
 - e. Select **Sign In**.

If Tableau can't make the connection, verify that your credentials are correct. If you still can't connect, your computer is having trouble locating the server. Contact your network administrator or database administrator.
2. On the data source page, do the following:
 - a. (Optional) Select the default data source name at the top of the page, and then enter a unique data source name for use in Tableau. For example, use a data source naming convention that helps other users of the data source figure out which data source to connect to.
 - b. Under **Table**, select a table or use the text box to search for a table by name.

Starting with Tableau version 2019.2, you can connect to spatial columns. For more information, see [Connect to Spatial Data in a Database on page 1691](#).
 - c. Drag the table to the canvas, and then select the sheet tab to start your analysis.

Use custom SQL to connect to a specific query rather than the entire data source. For more information, see [Connect to a Custom SQL Query on page 863](#).

Sign in on a Mac

If you use Tableau Desktop on a Mac, when you enter the server name to connect, use a fully qualified domain name, such as mydb.test.ourdomain.lan, instead of a relative domain name, such as mydb or mydb.test.

Alternatively, you can add the domain to the list of Search Domains for the Mac computer so that when you connect, you need to provide only the server name. To update the list of Search Domains, go to **System Preferences > Network > Advanced**, and then open the **DNS** tab.

Note: We don't recommend using [pgBouncer](#) since Tableau relies on stateful connections. If you must use pgBouncer with Tableau, then you must configure it in the following way.

```
server_reset_query=DISCARD ALL (the default)
```

See also

- [Set Up Data Sources on page 596](#) – Add more data to this data source or prepare your data before you analyze it.
- [Build Charts and Analyze Data on page 1005](#) – Begin your data analysis.

Presto

This article describes how to connect Tableau to a Presto database and set up the data source.

Tableau connects to Presto 141t from Teradata and to Presto on-premises and Amazon EMR Presto instances for Presto version 0.148.

Before you begin

Before you begin, gather this connection information:

- Name of the server that hosts the database you want to connect to
- Catalog
- Authentication method:
 - Username
 - LDAP

Note: LDAP authentication is available from Tableau Desktop version 10.3.2 forward.

- Sign-in credentials. Your choices depend on the authentication method you choose, and can include the following:
 - User name
 - Password
- Are you connecting to an SSL server?
- (Optional) Initial SQL statement to run every time Tableau connects

Driver required

This connector requires a driver to talk to the database. If the driver is not installed on your computer, Tableau displays a message in the connection dialog box with a link to the [Driver Download](#) page where you can find driver links and installation instructions.

Note: If you are connecting to PrestoDB, download the appropriate driver from the PrestoDB page. If you are connecting to Trino, (previously PrestoSQL), download the appropriate driver from the Trino page. The Trino driver only works in Tableau versions 2021.3, 2021.2.2, 2021.1.5, 2020.4.8, 2020.3.12, and above.

Make the connection and set up the data source

1. Start Tableau and under **Connect**, select **Presto**. For a complete list of data connections, select **More** under **To a Server**. Then do the following:

- a. Enter the name of the server you want to connect to.
- b. Enter the catalog name.
- c. Select the **Authentication** method: **Username** or **LDAP**, and enter the credentials you're prompted for.

Select the **Require SSL** check box when connecting to an SSL server.

- d. (Optional) Select **Initial SQL** to specify a SQL command to run at the beginning of every connection, such as when you open the workbook, refresh an extract, sign in to Tableau Server, or publish to Tableau Server. For more information, see [Run Initial SQL on page 591](#).
- e. Select **Sign In**.

If Tableau can't make the connection, verify that your credentials are correct. If you still can't connect, your computer is having trouble locating the server. Contact your network administrator or database administrator.

2. On the data source page, do the following:
 - a. (Optional) Select the default data source name at the top of the page, and then enter a unique data source name for use in Tableau. For example, use a data source naming convention that helps other users of the data source figure out which data source to connect to.
 - b. From the **Schema** drop-down list, select the search icon or enter the schema name in the text box and select the search icon, and then select the schema.
 - c. In the **Table** text box, select the search icon or enter the table name and select the search icon, and then select the table.
 - d. Drag the table to the canvas, and then select the sheet tab to start your analysis.

Use custom SQL to connect to a specific query rather than the entire data source.
For more information, see [Connect to a Custom SQL Query](#) on page 863.

Sign in on a Mac

If you use Tableau Desktop on a Mac, when you enter the server name to connect, use a fully qualified domain name, such as mydb.test.ourdomain.lan, instead of a relative domain name, such as mydb or mydb.test.

Alternatively, you can add the domain to the list of Search Domains for the Mac computer so that when you connect, you need to provide only the server name. To update the list of Search Domains, go to **System Preferences > Network > Advanced**, and then open the **DNS** tab.

See also

- [Set Up Data Sources](#) on page 596 – Add more data to this data source or prepare your data before you analyze it.
- [Build Charts and Analyze Data](#) on page 1005 – Begin your data analysis.
- [One-Way SSL for JDBC Connections](#) - Configure trust for a self-signed or CA certificate when you use one-way SSL with a JDBC connector.

Progress OpenEdge

This article describes how to connect Tableau to a Progress OpenEdge database and set up the data source.

Before you begin

Before you begin, gather this connection information:

- Name of the server that hosts the database you want to connect to
- Database name
- User name and password
- (Optional) Initial SQL statement to run every time Tableau connects

Use this connector with Tableau Desktop on a Windows computer.

Driver required

This connector requires a driver to talk to the database. If the driver is not installed on your computer, Tableau displays a message in the connection dialog box with a link to the [Driver](#)

[Download](#) page where you can find driver links and installation instructions.

Make the connection and set up the data source

1. Start Tableau and under **Connect**, select **Progress OpenEdge**. For a complete list of data connections, select **More** under **To a Server**. Then do the following:
 - a. Enter the name of the server that hosts the database you want to connect to.
 - b. Enter the name of the database.
 - c. Enter the user name and password.
 - d. (Optional) Select **Initial SQL** to specify a SQL command to run at the beginning of every connection, such as when you open the workbook, refresh an extract, sign in to Tableau Server, or publish to Tableau Server. For more information, see [Run Initial SQL on page 591](#).
 - e. Select **Sign In**.

If Tableau can't make the connection, verify that your credentials are correct. If you still can't connect, your computer is having trouble locating the server. Contact your network administrator or database administrator.
2. On the data source page, do the following:
 - a. (Optional) Select the default data source name at the top of the page, and then enter a unique data source name for use in Tableau. For example, use a data source naming convention that helps other users of the data source figure out which data source to connect to.
 - b. Under **Table**, select a table or use the text box to search for a table by name.
 - c. Drag the table to the canvas, and then select the sheet tab to start your analysis.

Use custom SQL to connect to a specific query rather than the entire data source. For more information, see [Connect to a Custom SQL Query on page 863](#).

See also

- [Set Up Data Sources on page 596](#) – Add more data to this data source or prepare your data before you analyze it.
- [Build Charts and Analyze Data on page 1005](#) – Begin your data analysis.

Qubole Presto

This article describes how to connect Tableau to Qubole Presto and set up the data source.

Note: As of 2020.3, the Qubole Presto connector is JDBC-based.

Before you begin

Before you begin, gather this connection information:

- End Point- end point URL based on the region where you have the Qubole account
- Catalog name ('hive' is the default)
- Cluster label
- Password (API token)
- (Optional) Initial SQL statement to run every time Tableau connects

Driver required

This connector requires a driver to talk to the database. If the driver is not installed on your computer, Tableau displays a message in the connection dialog box with a link to the [Driver Download](#) page where you can find driver links and installation instructions.

Make the connection and set up the data source

1. Start Tableau and under **Connect**, select **Qubole Presto**. For a complete list of data connections, select **More** under **To a Server**. Then do the following:
 - a. Enter the **End Point**.

Note: Advanced user can use additional properties in the **Endpoint** field; for example: `https://api.qubole.com;`

`LogLevel=6;LogPath=C:\\Users\\User\\Desktop`

For more information, see the "Additional Properties (Optional)" section of the [Setting the JDBC Connection String](#) topic on the Qubole website.

- b. Enter the **Catalog** name.
- c. Enter the **Cluster Label**.
- d. Enter the **Password**, which is an API token.
- e. (Optional) Select **Initial SQL** to specify a SQL command to run at the beginning of every connection, such as when you open the workbook, refresh an extract, sign in to Tableau Server, or publish to Tableau Server. For more information, see [Run Initial SQL on page 591](#).

f. Select **Sign In**.

If Tableau can't make the connection, verify that your credentials are correct. If you still can't connect, your computer is having trouble locating the server. Contact your network administrator or database administrator.

2. On the data source page, do the following:

- a. (Optional) Select the default data source name at the top of the page, and then enter a unique data source name for use in Tableau. For example, use a data source naming convention that helps other users of the data source figure out which data source to connect to.
- b. Under **Schema**, select a schema or use the text box to search for a schema by name.
- c. Under **Table**, select a table or use the text box to search for a table by name.
- d. Drag the table to the canvas, and then select the sheet tab to start your analysis.

Use custom SQL to connect to a specific query rather than the entire data source. For more information, see [Connect to a Custom SQL Query on page 863](#).

Sign in on a Mac

If you use Tableau Desktop on a Mac, when you enter the server name to connect, use a fully qualified domain name, such as mydb.test.ourdomain.lan, instead of a relative domain name, such as mydb or mydb.test.

Alternatively, you can add the domain to the list of Search Domains for the Mac computer so that when you connect, you need to provide only the server name. To update the list of Search Domains, go to **System Preferences > Network > Advanced**, and then open the **DNS** tab.

See also

- [Set Up Data Sources on page 596](#) – Add more data to this data source or prepare your data before you analyze it.
- [Build Charts and Analyze Data on page 1005](#) – Begin your data analysis.

Salesforce CRM

This article describes how to connect Tableau to Salesforce.com data and set up a data source.

Notes:

- Beginning with Tableau Desktop version 2020.4, OAuth is used for all sign-ins. Signing in with username and password is not an available option.

- Tableau Prep Builder version 2020.2.1 supports connecting to Salesforce.com data. However, not all connector options described in this article are supported. For information about what is supported by Tableau Prep Builder, see [Connect to Salesforce data](#) in the Tableau Prep Builder help.

Before you connect

Before you begin, gather this connection information:

- Credentials for signing in to Salesforce.com using OAuth

Recommendation

Setup a custom OAuth Client to use your company's IT policies

You can fully control your OAuth configuration according to your own IT policies with a custom OAuth client. The option to use your own OAuth client frees you from being tied to Tableau release cycles and Tableau's OAuth client rotation schedule. For information on how to configure your own OAuth client see, [Configure Custom OAuth for a site](#).

Make the connection and set up the data source

1. Start Tableau and under Connect, select **Salesforce**. For a complete list of data connections, select **More** under **To a Server**. Then do the following:
 - a. Enter your sign-in credentials for Salesforce.com.
 - b. Select **Log In**.
 - c. In the Allow Access dialog box, select **Allow**.

If the connection is unsuccessful, verify that the authentication information is correct. If the connection continues to fail, your computer is having trouble locating the server or you may not have permission to access the data. Contact your network administrator or Salesforce administrator.

2. On the data source page, do the following:
 - a. (Optional) Select the default data source name at the top of the page, and then enter a unique data source name for use in Tableau. For example, use a data source naming convention that helps other users of the data source figure out which data source to connect to.
 - b. Select a standard connection or create your own custom connection.

Under **Standard Connection**, you can select from a list of predefined queries, which represent commonly used objects, and drag it to the canvas. Or, under **Table**, you can select a single table, which includes any custom objects your company has created, and drag it to the canvas.

- c. Select the sheet tab to start your analysis.

Work with a subset of columns

Beginning with Tableau Desktop versions 2020.1, you can work with a subset of columns.

If you want to select a subset of columns to work with, double-click **New Custom SQL** and use this syntax:

```
SELECT <column1, column2, [...]columnN> FROM <table>
```

For example, to work with three columns from the Org table — Account Rep, Department, and Cost Code — you could type:

```
SELECT AccountRep, Department, CostCode from Org
```

For more information, see [Connect to a Custom SQL Query](#) on page 863.

Refresh Salesforce data

After you click the sheet tab, Tableau imports the data by creating an extract. Tableau Desktop supports only extracts for Salesforce.

Note: The initial extract may take some time depending on the amount of data that is included.

After the initial extract, you can do a full or incremental refresh of the extract. Incremental refreshes for Salesforce data include any Salesforce object that has been added or changed since the last incremental refresh. Results returned are limited to the previous 30 days.

To refresh, select **Data** > [data source name] > **Extract** > **Refresh (Incremental)** | **Refresh (Full)**.

Note: The incremental refresh option doesn't support Custom SQL.

Use Accelerators

You can use an Accelerator to quickly build informative dashboard designs made specifically for key business metrics on Tableau Desktop and Tableau Cloud. For more information, see [Use Accelerators to Quickly Visualize Data](#) on page 2721.

Use joins in Salesforce

When you set up the data source on the data source page, when you drag a table to the canvas, the list of tables you can select from to join is filtered. You can create joins on any string fields and on fields that are constrained references between tables. (Only left and inner joins are supported.) You can also add joins later. For more information, see [Join Your Data on page 791](#).

Note that Salesforce connections do not support non-equi joins and must use the equality operator (=).

Cross-database join limitations with Salesforce

Salesforce also supports combining tables from different databases using a cross-database join. For more information, see the "Combine tables from different databases" section in [Join Your Data on page 791](#).

When a Salesforce connection is included in a multi-connection data source, the data source won't support the following features:

- Live connections
- Extract filters
- Incremental updates to the extract
- Viewing your data in the data grid

Troubleshoot Salesforce connections

Tableau leverages the various force.com APIs to connect to Salesforce.com, Force.com, and Database.com data. These services have some restrictions on the type of data and the amount of data that you can access at a given time. If you are having trouble connecting, the following list of common restrictions may help you find a solution.

Company account and user profile configuration

In order for Tableau to connect to Salesforce data, all of the following must be enabled on both your company's account and your user profile:

- SOAP API for signing in
- REST API for getting meta data
- BULK API for downloading objects
- REST API for downloading objects that the BULK API does not support
- Replication SOAP APIs for retrieving changes in the data

To optimize for performance and ensure the APIs are available for all of their customers, Salesforce.com balances the load by limiting the number of concurrent API requests as well as limiting the total number of API requests overall. An error occurs if these limits are reached while connected using Tableau. See the Salesforce.com developer documentation to learn more about these limits.

Note: Some editions of Salesforce may not allow API access at all. Contact your Salesforce administrator to verify that your account has access to the above list of APIs.

Errors during extract

When you connect to Salesforce using Tableau, the data is automatically extracted into a Tableau Data Extract file. In some cases, certain fields cannot be extracted because of character limits. Specifically, text fields that are greater than 4096 characters and calculated fields will not be included in the extract. If you have calculated fields in your data, you will need to recreate them in Tableau after creating the extract.

In addition, the Force.com API restricts queries to 10,000 total characters.

See also

- [Set Up Data Sources on page 596](#) – Add more data to this data source or prepare your data before you analyze it.
- [Build Charts and Analyze Data on page 1005](#) – Begin your data analysis.
- [5 Ways to Maximize Your Salesforce Data](#) - Read the Tableau whitepaper (registration or sign in required).

Salesforce Data Cloud

The Salesforce Data Cloud connector was released with Tableau Desktop 2023.2. This connector seamlessly connects Tableau to Data Cloud, and is available for Tableau Desktop, Tableau Cloud, Tableau Server, and Tableau Prep. Compared to the older CDP connector, the Salesforce Data Cloud connector is easier to connect with, shows object labels instead of API names, and is powered by accelerated queries.

Note: Data Cloud was previously called Customer Data Platform (CDP). The Customer Data Platform connector was deprecated in October 2023, was made unavailable for new connections in Tableau Desktop 2024.2, and is removed entirely from Tableau Desktop

2024.3 and later. Existing assets that use the CDP connector must be recreated using the Salesforce Data Cloud connector.

If you're using Tableau Desktop 2023.1 or earlier, see [Tableau Desktop \(version 2023.1 and earlier\)](#) below.

Tableau Desktop (version 2023.2 and later)

Complete the following steps to connect to the Salesforce Data Cloud.

1. Select the **Data** menu, then **New Data Source**. (If you just launched Tableau Desktop, ignore this step.)
2. In the **Connect** pane, under the **To a Server** section, select **Salesforce Data Cloud**.
3. Log in and allow access when prompted.
4. Select the **Data space**. Data spaces represent a logical segregation of the data in Data Cloud. Data spaces didn't exist before the Salesforce June '23 release.
5. If using Tableau Desktop 2024.1 or later, use **Object** to filter by the type of Data Cloud object, or select **All Objects**.

Tableau Desktop (version 2023.1 and earlier)

Warning: The Customer Data Platform (CDP) was deprecated in October 2023, was made unavailable for new connections in Tableau Desktop 2024.2, and is removed entirely from Tableau Desktop 2024.3 and later. If you are using assets that use the CDP connector, Tableau strongly recommends you upgrade and use the Salesforce Data Cloud connector instead.

Step 1: Install the Salesforce Data Cloud.taco file

Note: This step applies to versions 2021.1–2021.3. Starting in version 2021.4, the Salesforce_CDP.taco file is automatically installed.

1. Remove or rename any Salesforce_CDP.taco files that have been previously installed to avoid conflicts. The Tableau Desktop.taco files are installed in the following locations:
 - MacOS: /Applications/Tableau Desktop <VERSION>.app/Contents/Resources/connectors/Salesforce_CDP.taco
 - Windows: C:\Program Files\Tableau\Tableau 2022.3\bin\connectors
2. Download the latest Salesforce Data Cloud connector (Salesforce_CDP.taco file) from the Tableau Exchange Connectors site: [Customer Data Platform Connector](#).
3. Move the.taco file to the Tableau connector directory:

- **Windows:** `C:\Users[Windows User]\Documents\My Tableau Repository\Connectors`
- **macOS:** `/Users/[user]/Documents/My Tableau Repository/Connectors`

Step 2: Install the Salesforce Data Cloud JDBC driver

Note: Tableau version 2023.1 for Desktop is only compatible with JDBC driver version 18 and above.

1. Download the latest JDBC driver (Salesforce-CDP-jdbc-[*version*].jar file) from the Salesforce CDP GitHub site: [Salesforce-CDP-jdbc](#).
2. Move the downloaded Salesforce-CDP-jdbc-[*version*].jar file to the following location:
 - **Windows:** `C:\Program Files\Tableau\Drivers`
 - **macOS:** `/Users/[user]/Library/Tableau/Drivers`

Note: Unhide the folders to view them.

Step 3: Enable a High Assurance Session

You can enable a High Assurance session in to ensure that your connected app is secure. This session policy requires users to verify their identity with multi-factor authentication when they log into the connected app.

1. Log in to Salesforce as a CDP Admin.
2. In the Salesforce Data Cloud, search for App Manager.
3. In the Setup's Quick Find, search for **Salesforce CDP Tableau Connection** in the list.
4. Select **Manage**.

IMPORTANT: Make sure you're clicking the dropdown for **Salesforce CDP Tableau Connection** only!

Tableau Desktop and Web Authoring Help

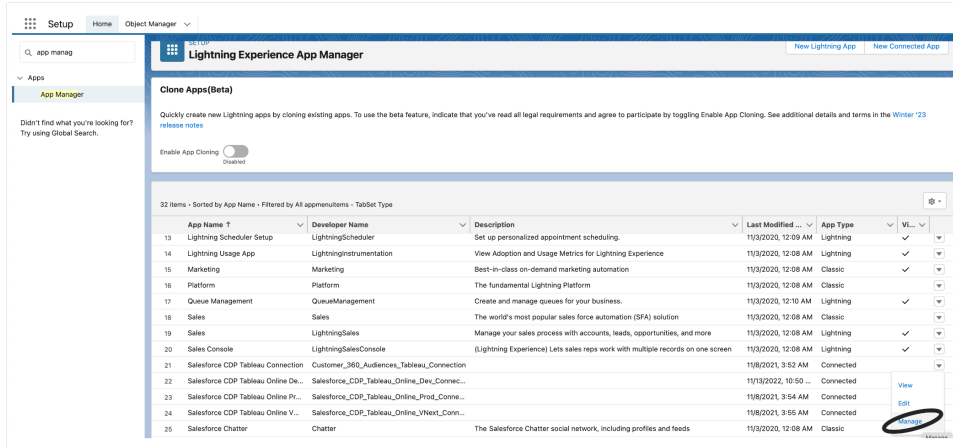

5. Select Edit Policies.

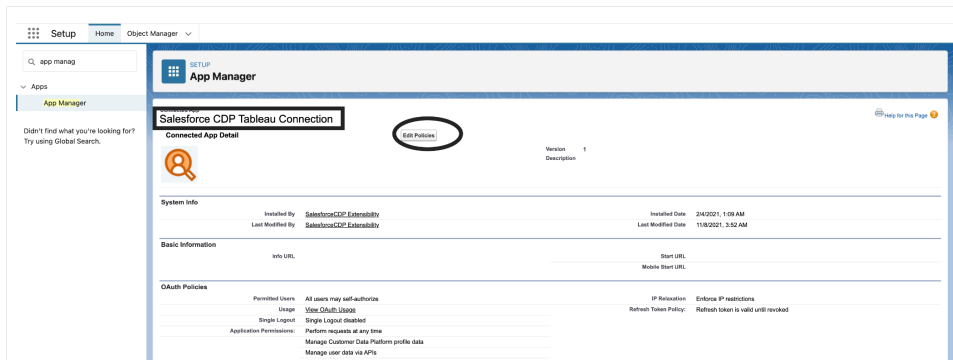

6. Under Session Policies, select the High assurance session-required check box.

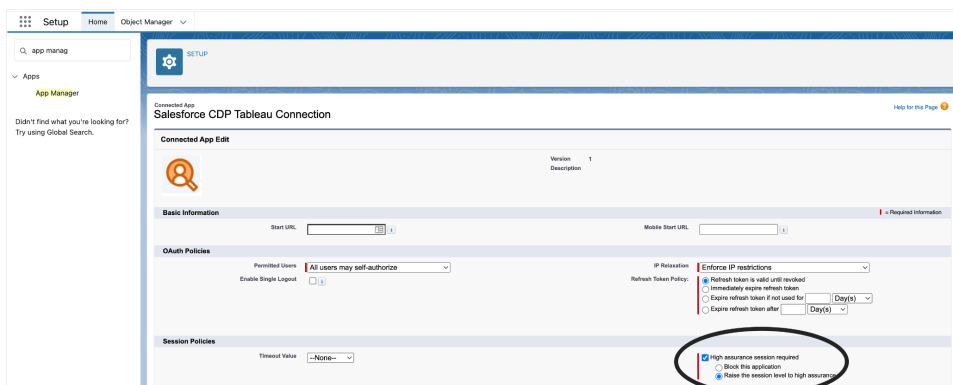

7. Select Save. High assurance config is now enabled.

Step 4: Connect to the Salesforce Data Cloud in Tableau Desktop

1. Launch Tableau Desktop (2021.1 and later).
2. Go to **Connect, To a Server**, and select **Salesforce CDP**.
3. In the Salesforce CDP dialog, confirm that *OAuth* is selected in the **Authentication** section and *https://login.salesforce.com* is selected in the **OAuth instance URL** section.
4. Select **Sign In** to open a pane in a web browser.
5. Sign in to Salesforce with your username and password.
6. Select **Allow**.
7. Close the browser pane.

Tableau Desktop is now connected to the Salesforce Data Cloud and you can perform Tableau operations.

Tableau Cloud and Tableau Server

Connecting using Tableau Cloud Web Authoring is similar to Tableau Desktop.

- **Tableau Cloud:** [Connect Tableau Cloud Web Authoring to Data Cloud](#)

Tableau Server requires additional configuration. Use the following links to find out more.

- **Tableau Server (Windows):** [Connect Tableau Server to Data Cloud](#)
- **Tableau Server (Linux):** [Connect Tableau Server to Data Cloud](#)

Next Steps

Use Accelerators for Quick Data Insights

You can quickly visualize your data using accelerators. Tableau Accelerators are pre-built dashboards designed to help you get a jump start on data analysis. Tailored to specific industries and enterprise applications. Accelerators are built with sample data that you can swap out for your own data, allowing you to discover insights with minimal setup. Accelerators are available on the [Tableau Exchange](#). For more information about accelerators, see [Use Accelerators to Quickly Visualize Data](#). You may want to try some of the following Salesforce Data Cloud accelerators.

Salesforce Data Cloud Identity Resolution Accelerator

You can use the Identity Resolution Accelerator to explore how identity resolution in Salesforce Data Cloud is working for your business. You can view your ingested sources, how they

contribute to unified individuals, and their composition. For more information, see [Salesforce Data Cloud Identity Resolution](#).

Salesforce Data Cloud Email Marketing Campaign Accelerator

With the CDP Email Marketing Campaign Accelerator you can monitor the efficiency of your email campaigns end to end. You can explore campaigns that have the highest conversion, email trends over time, and more. For more information, see [Salesforce Data Cloud Email Marketing Campaigns](#).

Salesforce Data Cloud Customer Engagement Accelerator

This accelerator is an exploratory dashboard that gives marketing and sales teams a comprehensive view of the engagement levels of customers across the following channels.

- Sales
- Email
- Messages (SMS)
- Website
- Push Notifications

The accelerator helps these teams to select the best channels to interact with the customer, develop relevant messaging, and create positive customer experiences to increase loyalty and retention. For more information, see [Salesforce Data Cloud Customer Engagement](#).

See also:

- Salesforce Help: [Set Up Tableau in Customer Data Platform](#)
- Salesforce Help: [Using Customer Data Platform Data in Tableau](#)

Salesforce Data Cloud

The Salesforce Data Cloud connector was released with Tableau Desktop 2023.2. This connector seamlessly connects Tableau to Data Cloud, and is available for Tableau Desktop, Tableau Cloud, Tableau Server, and Tableau Prep. Compared to the older CDP connector, the Salesforce Data Cloud connector is easier to connect with, shows object labels instead of API names, and is powered by accelerated queries.

Note: Data Cloud was previously called Customer Data Platform (CDP). The Customer Data Platform connector was deprecated in October 2023, was made unavailable for new connections in Tableau Desktop 2024.2, and is removed entirely from Tableau Desktop 2024.3 and later. Existing assets that use the CDP connector must be recreated using the Salesforce Data Cloud connector.

If you're using Tableau Desktop 2023.1 or earlier, see [Tableau Desktop \(version 2023.1 and earlier\)](#) below.

Tableau Desktop (version 2023.2 and later)

Complete the following steps to connect to the Salesforce Data Cloud.

1. Select the **Data** menu, then **New Data Source**. (If you just launched Tableau Desktop, ignore this step.)
2. In the **Connect** pane, under the **To a Server** section, select **Salesforce Data Cloud**.
3. Log in and allow access when prompted.
4. Select the **Data space**. Data spaces represent a logical segregation of the data in Data Cloud. Data spaces didn't exist before the Salesforce June' 23 release.
5. If using Tableau Desktop 2024.1 or later, use **Object** to filter by the type of Data Cloud object, or select **All Objects**.

Tableau Desktop (version 2023.1 and earlier)

Warning: The Customer Data Platform (CDP) was deprecated in October 2023, was made unavailable for new connections in Tableau Desktop 2024.2, and is removed entirely from Tableau Desktop 2024.3 and later. If you are using assets that use the CDP connector, Tableau strongly recommends you upgrade and use the Salesforce Data Cloud connector instead.

Step 1: Install the Salesforce Data Cloud.taco file

Note: This step applies to versions 2021.1–2021.3. Starting in version 2021.4, the Salesforce_CDP.taco file is automatically installed.

1. Remove or rename any Salesforce_CDP.taco files that have been previously installed to avoid conflicts. The Tableau Desktop.taco files are installed in the following locations:
 - MacOS: /Applications/Tableau Desktop <VERSION>.app/Contents/Resources/connectors/Salesforce_CDP.taco
 - Windows: C:\Program Files\Tableau\Tableau 2022.3\bin\connectors

2. Download the latest Salesforce Data Cloud connector (Salesforce_CDP.taco file) from the Tableau Exchange Connectors site: [Customer Data Platform Connector](#).
3. Move the.taco file to the Tableau connector directory:
 - Windows: C:\Users[Windows User]\Documents\My Tableau Repository\Connectors
 - macOS: /Users/[user]/Documents/My Tableau Repository/Connectors

Step 2: Install the Salesforce Data Cloud JDBC driver

Note: Tableau version 2023.1 for Desktop is only compatible with JDBC driver version 18 and above.

1. Download the latest JDBC driver (Salesforce-CDP-jdbc-[version].jar file) from the Salesforce CDP GitHub site: [Salesforce-CDP-jdbc](#).
2. Move the downloaded Salesforce-CDP-jdbc-[version].jar file to the following location:
 - Windows: C:\Program Files\Tableau\Drivers
 - macOS: /Users/[user]/Library/Tableau/Drivers

Note: Unhide the folders to view them.

Step 3: Enable a High Assurance Session

You can enable a High Assurance session in to ensure that your connected app is secure. This session policy requires users to verify their identity with multi-factor authentication when they log into the connected app.

1. Log in to Salesforce as a CDP Admin.
2. In the Salesforce Data Cloud, search for App Manager.
3. In the Setup's Quick Find, search for **Salesforce CDP Tableau Connection** in the list.
4. Select **Manage**.

IMPORTANT: Make sure you're clicking the dropdown for **Salesforce CDP Tableau Connection** only!

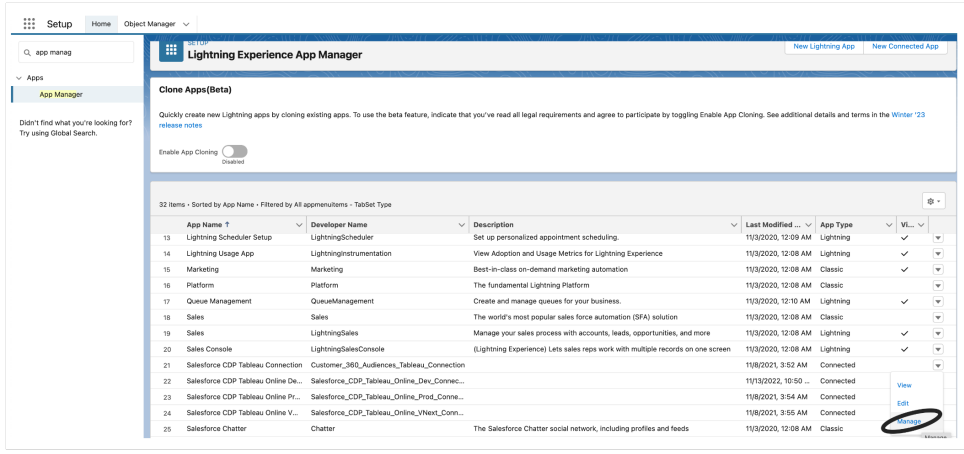

5. Select **Edit Policies**.

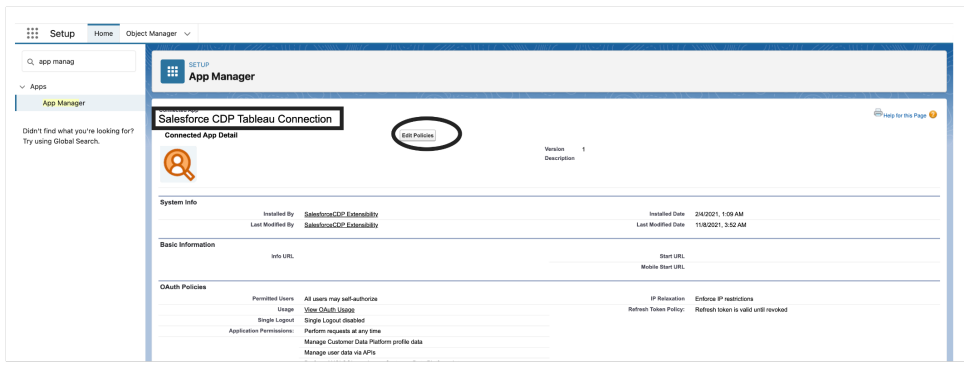

6. Under **Session Policies**, select the **High assurance session-required** check box.

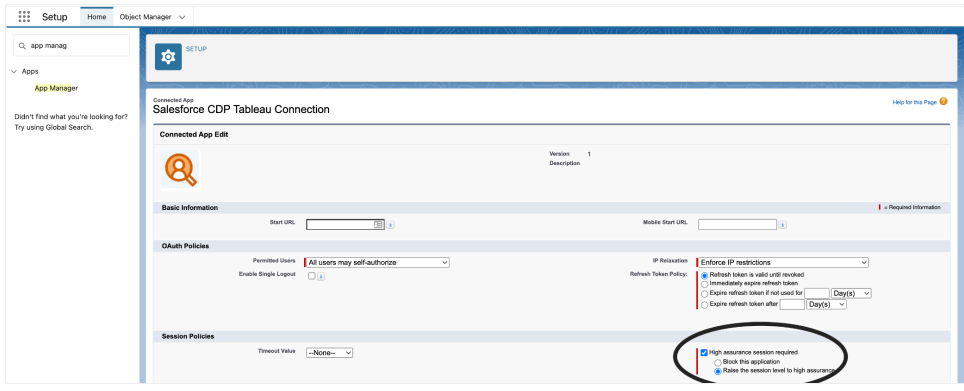

7. Select **Save**. High assurance config is now enabled.

Step 4: Connect to the Salesforce Data Cloud in Tableau Desktop

1. Launch Tableau Desktop (2021.1 and later).
2. Go to **Connect, To a Server**, and select **Salesforce CDP**.
3. In the Salesforce CDP dialog, confirm that *OAuth* is selected in the **Authentication** section and *https://login.salesforce.com* is selected in the **OAuth instance URL** section.
4. Select **Sign In** to open a pane in a web browser.
5. Sign in to Salesforce with your username and password.
6. Select **Allow**.
7. Close the browser pane.

Tableau Desktop is now connected to the Salesforce Data Cloud and you can perform Tableau operations.

Tableau Cloud and Tableau Server

Connecting using Tableau Cloud Web Authoring is similar to Tableau Desktop.

- **Tableau Cloud:** [Connect Tableau Cloud Web Authoring to Data Cloud](#)

Tableau Server requires additional configuration. Use the following links to find out more.

- **Tableau Server (Windows):** [Connect Tableau Server to Data Cloud](#)
- **Tableau Server (Linux):** [Connect Tableau Server to Data Cloud](#)

Next Steps

Use Accelerators for Quick Data Insights

You can quickly visualize your data using accelerators. Tableau Accelerators are pre-built dashboards designed to help you get a jump start on data analysis. Tailored to specific industries and enterprise applications. Accelerators are built with sample data that you can swap out for your own data, allowing you to discover insights with minimal setup. Accelerators are available on the [Tableau Exchange](#). For more information about accelerators, see [Use Accelerators to Quickly Visualize Data](#). You may want to try some of the following Salesforce Data Cloud accelerators.

Salesforce Data Cloud Identity Resolution Accelerator

You can use the Identity Resolution Accelerator to explore how identity resolution in Salesforce Data Cloud is working for your business. You can view your ingested sources, how they

contribute to unified individuals, and their composition. For more information, see [Salesforce Data Cloud Identity Resolution](#).

Salesforce Data Cloud Email Marketing Campaign Accelerator

With the CDP Email Marketing Campaign Accelerator you can monitor the efficiency of your email campaigns end to end. You can explore campaigns that have the highest conversion, email trends over time, and more. For more information, see [Salesforce Data Cloud Email Marketing Campaigns](#).

Salesforce Data Cloud Customer Engagement Accelerator

This accelerator is an exploratory dashboard that gives marketing and sales teams a comprehensive view of the engagement levels of customers across the following channels.

- Sales
- Email
- Messages (SMS)
- Website
- Push Notifications

The accelerator helps these teams to select the best channels to interact with the customer, develop relevant messaging, and create positive customer experiences to increase loyalty and retention. For more information, see [Salesforce Data Cloud Customer Engagement](#).

See also:

- Salesforce Help: [Set Up Tableau in Customer Data Platform](#)
- Salesforce Help: [Using Customer Data Platform Data in Tableau](#)

Salesforce Marketing Cloud

This article describes how to connect Tableau to the Salesforce Marketing Cloud connector. To begin, you must install the connector and configure the instance to accept Application Programming Interface (API) connections. The Marketing Cloud connector needs a plugin (.taco file) and a driver.

Note: Multi-factor authentication (MFA) isn't supported.

Driver required

Check that the driver is installed on your computer. If the driver isn't installed on your computer, Tableau displays a message in the connection dialog box with a link to the [Driver Download page](#), where you can find driver links and installation instructions.

MFA Work Around

If you are having problems using MFA with Salesforce Marketing Cloud. You first need to enable MFA on the web UI login, then follow the steps on the Tableau Exchange. To get the instructions, see:

[Salesforce Marketing Cloud](#)

Install the Connector

Complete the following steps to install the connector in Tableau.

1. In Tableau, in the **Connect** panel, locate the **To a Server** section.
2. Select **More**, and in the connections list, select **Salesforce Marketing Cloud**. If necessary, let Tableau install the connector and restart.
3. In the dialog that appears, enter the following information:
 - a. In **User**, enter the name of the Marketing Cloud API user.
 - b. In **Password**, enter the password associated with the API user account in Marketing Cloud.
 - c. In **Subdomain**, enter the subdomain listed as part of the SOAP Base URI in Marketing Cloud's configuration summary (for example, `https://<<SubDomain>>.soap.marketingcloudapis.com/`).
4. Click **Sign In** to finish making the connection.

Configure the Marketing Cloud Instance

The Marketing Cloud Connector needs an API integration to be configured and given appropriate privileges. After it's configured, your instance has a Subdomain value that can be entered into Tableau's connector dialog.

Note: Only Marketing Cloud Administrators can configure a subdomain.

Configure your Subdomain

1. Sign into the Marketing Cloud connector with your Marketing Cloud administrator ID.
2. Go to **Setup, Installed Packages**.
3. Select Create a new package.
4. In the **Name** field, enter a package name.
5. Choose **Create with enhanced functionality**.
6. Select **Save**.
7. In **Add Component**, under **Choose Your Component Type**, select the **API Integration** Component Type.
8. Select **Next**.
9. In **Add Component**, under **Choose Your Integration Type**, select **Server-to-Server**.
10. Select **Next**.
11. Choose your scopes. The SOAP Base URI populates.

Refresh your data

Tableau only supports data extract connections for the Marketing Cloud connector. You can update the data by refreshing the data extract. For more information, see [Refresh Extracts](#). For information about refresh schedules, see [Schedule Extract Refreshes as You Publish a Workbook](#).

See also

- [Set Up Data Sources](#) – Add more data to this data source or prepare your data before you analyze it.
- [Build Charts and Analyze Data](#) – Begin your data analysis.
- Salesforce Help: [Set Up Tableau in Customer Data Platform](#)
- Salesforce Help: [Enable Customer Data Platform in Tableau](#)
- Salesforce Help: [Using Customer Data Platform Data in Tableau](#)

Splunk

This article describes how to connect Tableau to Splunk data and set up a data source.

Note: The Splunk ODBC connector is compatible with Splunk Enterprise 6.

Before you begin

Before you begin, gather this connection information:

- Server URL, including the name of the database, if there are multiple databases
- User name and password
- (Optional) Initial SQL statement to run every time Tableau connects

Use this connector with Tableau Desktop on a Windows computer.

Driver required

This connector requires a driver to talk to the database. If the driver is not installed on your computer, Tableau displays a message in the connection dialog box with a link to the [Driver Download](#) page where you can find driver links and installation instructions.

Make the connection and set up the data source

1. Start Tableau and under **Connect**, select **Splunk**. For a complete list of data connections, select **More** under **To a Server**. Then do the following:

- a. Enter the server URL. You should use HTTPS to connect to Splunk data.

If your server contains multiple databases, enter the name of a specific database on the server.

Note: Database names are case sensitive.

- b. Enter your user name and password.
- c. (Optional) Select **Initial SQL** to specify a SQL command to run at the beginning of every connection, such as when you open the workbook, refresh an extract, sign in to Tableau Server, or publish to Tableau Server. For more information, see [Run Initial SQL on page 591](#).
- d. Select **Sign In**.

If Tableau can't make the connection, verify that your credentials are correct. If you still can't connect, your computer is having trouble locating the server. Contact your network administrator or database administrator.

2. On the data source page, do the following:
 - a. (Optional) Select the default data source name at the top of the page, and then enter a unique data source name for use in Tableau. For example, use a data source naming convention that helps other users of the data source figure out which data source to connect to.

- b. Under **Saved Search**, enter a saved search name in the text box or select a saved search from the list, and drag it to the box at the top of the data source page.
- c. Select the sheet tab to start your analysis.

Join limitations with Splunk

While you cannot create a join between Splunk tables, you can combine Splunk data from multiple tables by doing one of the following:

- **Set up and connect to a saved search:** Set up a saved search in Splunk that returns all the tables you need in a single search result. Then connect to this saved search from Tableau Desktop.
- **Use data blending:** Set up a data source for each Splunk table you need, then use data blending to combine the data. For more information, see [Blend Your Data on page 816](#).
- **Create an extract:** Create an extract of each Splunk table and then join the extracts together using a cross-database join. For more information, see [Extract Your Data on page 919](#) and [Join Your Data on page 791](#).

However, you can create a cross-database join between Splunk data and data from different databases (or files) with one exception. After adding a new connection to the Tableau data source, you must double-click the table in the left pane to add it to the canvas. You cannot drag the table from the left pane to the canvas as you normally would when creating a cross-database join. For more information about cross-database joins, see [Join Your Data on page 791](#).

Note: Creating a cross-database join between Splunk tables is not supported. A cross-database join between Splunk tables causes all the connections in the Tableau data source to disappear except for the last Splunk connection.

See also

- [Set Up Data Sources on page 596](#) – Add more data to this data source or prepare your data before you analyze it.
- [Build Charts and Analyze Data on page 1005](#) – Begin your data analysis.

Splunk JDBC

This article describes how to connect Tableau to Splunk data and set up a data source using the Splunk JDBC connector.

Before you begin

Before you begin, gather this connection information:

- Server URL, including the name of the database, if there are multiple databases
- User name and password
- Access Token
- HTTPEventCollectorToken

Driver required

This connector requires a driver to talk to the database. If the driver is not installed on your computer, Tableau displays a message in the connection dialog box with a link to the [Driver Download](#) page where you can find driver links and installation instructions.

Make the connection and set up the data source

1. Start Tableau and under **Connect**, select **Splunk JDBC**. For a complete list of data connections, select **More** under **To a Server**. Then do the following:
 - a. Enter the server URL. You should use HTTPS to connect to Splunk data.
 - b. Enter your user name and password.
 - c. Select **Sign In**

If Tableau can't make the connection, verify that your credentials are correct. If you still can't connect, your computer is having trouble locating the server. Contact your network administrator or database administrator.
2. On the data source page, do the following:
 - a. (Optional) Select the default data source name at the top of the page, and then enter a unique data source name for use in Tableau. For example, use a data source naming convention that helps other users of the data source figure out which data source to connect to.
 - b. Under **Saved Search**, enter a saved search name in the text box or select a saved search from the list, and drag it to the box at the top of the data source page.
 - c. Select the sheet tab to start your analysis.

See also

- [Set Up Data Sources on page 596](#) – Add more data to this data source or prepare your data before you analyze it.
- [Build Charts and Analyze Data on page 1005](#) – Begin your data analysis.

Splunk JDBC

This article describes how to connect Tableau to Splunk data and set up a data source using the Splunk JDBC connector.

Before you begin

Before you begin, gather this connection information:

- Server URL, including the name of the database, if there are multiple databases
- User name and password
- Access Token
- HTTPEventCollectorToken

Driver required

This connector requires a driver to talk to the database. If the driver is not installed on your computer, Tableau displays a message in the connection dialog box with a link to the [Driver Download](#) page where you can find driver links and installation instructions.

Make the connection and set up the data source

1. Start Tableau and under **Connect**, select **Splunk JDBC**. For a complete list of data connections, select **More** under **To a Server**. Then do the following:
 - a. Enter the server URL. You should use HTTPS to connect to Splunk data.
 - b. Enter your user name and password.
 - c. Select **Sign In**

If Tableau can't make the connection, verify that your credentials are correct. If you still can't connect, your computer is having trouble locating the server. Contact your network administrator or database administrator.

2. On the data source page, do the following:

- a. (Optional) Select the default data source name at the top of the page, and then enter a unique data source name for use in Tableau. For example, use a data source naming convention that helps other users of the data source figure out which data source to connect to.
- b. Under **Saved Search**, enter a saved search name in the text box or select a saved search from the list, and drag it to the box at the top of the data source page.
- c. Select the sheet tab to start your analysis.

See also

- [Set Up Data Sources on page 596](#) – Add more data to this data source or prepare your data before you analyze it.
- [Build Charts and Analyze Data on page 1005](#) – Begin your data analysis.

SAP HANA

This article describes how to connect Tableau to an SAP HANA database and set up the data source.

Note: This connector uses JDBC drivers for Mac, Linux, and Windows. The JDBC driver for Windows is new in Tableau version 2021.1. JDBC driver version 2.3.4 is the recommended version.

Before you begin

Before you begin, gather this connection information:

- Are you making a single-node or multi-node connection?
 - SingleNode: Database server name and port number.
 - MultiNode: Database server name, host name, and port numbers.
- Authentication:
 - Windows Authentication (Windows only)
 - Kerberos (Mac only)
 - Username and password
 - OAuth 2.0/OIDC. For more information on how to configure this, see [External OAuth for SAP HANA on page 443](#).
- Are you connecting to an SSL server?
- (Optional) Initial SQL statement to run every time Tableau connects

Driver required

This connector requires a driver to talk to the database. If the driver is not installed on your computer, Tableau displays a message in the connection dialog box with a link to the [Driver Download](#) page where you can find driver links and installation instructions.

Make the connection and set up the data source

1. Start Tableau and under **Connect**, select **SAP HANA**.
 - a. Select the type of connection:
 - **SingleNode**: Enter the name of the server that hosts the database you want to connect to, and if you're using a non-default port, the port number.
 - **MultiNode**: Enter the host name and port number of each server, separated by a comma. For example:

```
host1:30015,host2:30015,host3:30015
```

- b. Select how to sign into the server:

Windows:

- Select **Use Windows Authentication**, if your environment supports single sign-on (SSO).
- Select **Use a specific username and password** if the server is password protected and you aren't in a Kerberos environment, you must enter the user name and password.
- Select **Sign in using OAuth** to use OAuth 2.0/OIDC to federate identity from an external IdP to HANA, and select the **OAuth Provider** that you configured. For more information on how to configure this, see [External OAuth for SAP HANA on page 443](#).

Mac:

- Select **Kerberos**
- Select **Use a specific username and password**.
- Select **Sign in using OAuth** to use OAuth 2.0/OIDC to federate identity from an external IdP to HANA, and select the **OAuth Provider** that you configured. For more information on how to configure this, see [External OAuth for SAP HANA on page 443](#).

- c. Select the **require SSL** option when connecting to an SSL server.
 - d. (Optional) Select **Initial SQL** to specify a SQL command to run at the beginning of every connection, such as when you open the workbook, refresh an extract, sign in

to Tableau Server, or publish to Tableau Server. For more information, see [Run Initial SQL on page 591](#).

- e. Select **Sign In**.

If Tableau can't make the connection, verify that your credentials are correct. If you still can't connect, your computer is having trouble locating the server. Contact your network administrator or database administrator.

- 2. On the data source page, do the following:

- a. (Optional) Select the default data source name at the top of the page, and then enter a unique data source name for use in Tableau. For example, use a data source naming convention that helps other users of the data source figure out which data source to connect to.

- b. From the **Schema** drop-down list, select the search icon or enter the schema name in the text box and select the search icon, and then select the schema.

- c. In the **Table** text box, select the search icon or enter the table name and select the search icon, and then select the table.

Tableau Desktop also supports connecting to SAP HANA table functions, which appear under **Stored Procedures** in the left pane of the Data Source page.

- d. Drag the table to the canvas, and then select the sheet tab to start your analysis.

The default display is column labels.

Use custom SQL to connect to a specific query rather than the entire data source. For more information, see [Connect to a Custom SQL Query on page 863](#).

Note: When you create a self-join with an analytic view, and one of the tables has variables, make sure that the table with variables is on the left. Otherwise, the join may not return the expected results.

Sign in on a Mac

If you use Tableau Desktop on a Mac, when you enter the server name to connect, use a fully qualified domain name, such as mydb.test.ourdomain.lan, instead of a relative domain name, such as mydb or mydb.test.

Alternatively, you can add the domain to the list of Search Domains for the Mac computer so that when you connect, you need to provide only the server name. To update the list of Search Domains, go to **System Preferences > Network > Advanced**, and then open the **DNS** tab.

Convert an SAP HANA level hierarchy to a user hierarchy

When you create an SAP HANA data source or workbook, you can create your own hierarchy for use in Tableau. Tableau supports level hierarchies created in SAP HANA starting in version 2019.4. When you connect Tableau to an SAP HANA calculation view with a level hierarchy, the structure of the SAP HANA level hierarchy appears in the Data pane. If you want to modify the SAP HANA level hierarchy in Tableau, you must convert the SAP HANA level hierarchy to a user hierarchy.

Warning: After you convert an SAP HANA level hierarchy to a user hierarchy, you can't reverse it. If you decide you want to use the SAP HANA level hierarchy instead of the user hierarchy, you must start over.

To convert to a user hierarchy, complete the following steps:

1. In the **Data** pane, select the hierarchy.
2. In the drop-down menu, select **Convert to User Hierarchy**.

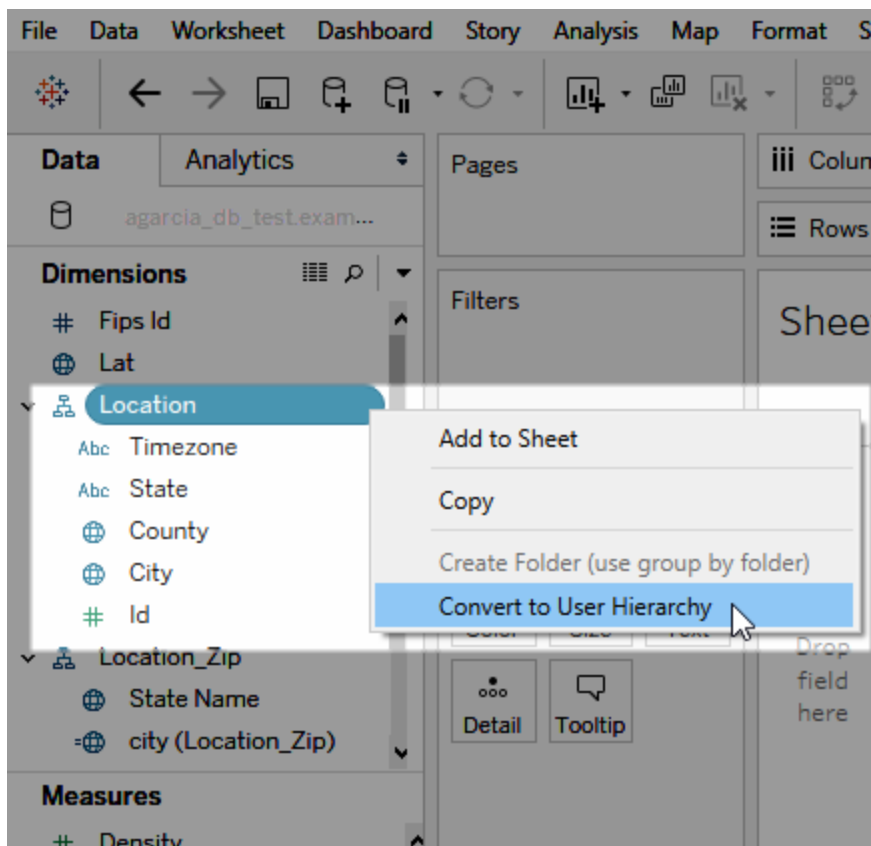

Customize JDBC connections

On Mac and Linux, SAP HANA uses a JDBC connection. You can customize the JDBC connection using a `.properties` file. For more information, see [Customize JDBC Connections Using a `.properties` File](#) in Tableau Community.

Install trusted SSL certificates on a Mac

If you want to use SSL/TLS to encrypt communications between Tableau Desktop and your database, you must add certificates to the Java certificate trust store. This is required if your database uses self-signed certificates. To connect Tableau Desktop to your database using SSL/TLS, complete the following steps:

1. Start the Terminal application, and navigate to your Java Home directory. This is located at `/Library/Internet Plug-Ins/JavaAppletPlugin.plugin/Contents/Home`, unless you've installed the JDK or set the `JAVA_HOME` environment variable.
2. Run the following command:

```
bin/keytool -importcert -keystore cacerts -alias <certificate name> -file <path to certificate file>
```

Note: Beginning with Tableau version 2020.2, you can import a custom certificate into the "System" keychain. For details, see [One-Way SSL for JDBC Connections](#).

Select variables and input parameters

If the table you use includes required or optional variables or parameters, the Variables and Input Parameters dialog box opens.

Enter values for Variables and Parameters or add a new Variable

Name	Current Value
Prod_Type	Equals "Coffee"
VAR_MarketSize	
VAR_Market	
VAR_ProductType	Equals "Coffee"
VAR_ProductType	Equals "Espresso"
VAR_ProductType	Equals "Herbal Tea"
VAR_ProductType	Equals "Tea"
<i>Add New</i>	

Edit Variable

Select an item from the list to change its values

OK Cancel

- Required variables and parameters display their current value or ***Required**.
- Optional variables and parameters display their current value or are blank.
- Prompt for the variable when the workbook is opened by selecting the check box under **Prompt**.

Select a variable or parameter and type or select a value for it. Repeat for all required values and any optional values that you want to include, and then select **OK**.

Note: You can use SQL query-based SAP HANA prompts.

Support for SAP HANA single sign-on (SSO)

You can access data, publish data sources, and publish workbooks to Tableau Server, without having to reenter your username and password by configuring SAP HANA to support single sign-on (SSO). To use SSO, you must publish data sources and workbooks to Tableau Server with **Viewer credentials** authentication. To enable **Viewer credentials** authentication, you must connect to SAP HANA using Windows Authentication on a Windows computer or Kerberos on a Mac. For more information, see [Publish to the Server on the facing page](#).

- Tableau Desktop requires SAP HANA driver version 1.00.85 or later.
- You must setup Tableau Server to support SSO for SAP HANA. For information, see [Configure SAP HANA for Single Sign-On](#) in the Tableau Server Help.

Sign in to the server

You can sign in to the SAP HANA server by entering the server name. Or you can select **Use Windows Authentication** on a Windows computer or **Kerberos** on a Mac. To finish, select **Sign In**.

Publish to the Server

You don't have to enter credentials to access a data source or a workbook if you publish it to Tableau Server with SSO enabled. To enable SSO when you publish a data source or workbook to Tableau Server, complete the following steps:

1. Select **Server, Publish Data Source** or **Server, Publish Workbook**.
2. Under **Data Sources**, choose **Edit**.
3. In the Manage Data Sources dialog box, do the following:
 - Select the **Publish Type: Embedded in workbook** or **Published separately**.
 - Select **Viewer credentials for Authentication**.
4. Choose **Publish**.

How to refresh HANA extracts when you use SSO

You can use the Tableau Data Extract Utility to automate the extract refresh task. For example, the following command refreshes a published SAP HANA extract named "mydatasource." This command specifies the following:

- The name of your Tableau Server
- The name of the data source to refresh

```
C:\Program Files\Tableau\Tableau 10.2\bin>tableau refreshextract --  
server https://mytableauserver --datasource mydatasource
```

For more information about the utility, see [Tableau Data Extract Command-Line Utility on page 947](#).

Performance tips

You can improve performance by enabling query parameter binding.

Use bind variables

To improve performance, Tableau can use bind variables for your SAP HANA queries.

- Queries: HANA can compile a query one time and execute it many times.
- Multi-node HANA deployments: Parametrized queries are optimally routed to the proper node.

To enable this feature, your Tableau Server Administrator can add the `CAP_ODBC_QUERY_USE_PREPARE_PARAMETER_MARKER` capability in a TDC file.

Note: This feature requires Tableau 2018.3 or later.

You can use `CAP_ODBC_QUERY_USE_PREPARE_PARAMETER_MARKER` with JDBC and ODBC.

Use column metadata collection

Tableau supports column metadata collection, which may improve the load time for some views.

When Tableau reads the column metadata for a table or view, it uses a prepared query on the table by default.

Note: Column metadata collection is usually the most accurate option, but it can take longer to process.

You can disable prepared query metadata using a TDC file. When you use column metadata collection, Tableau uses the ODBC API, `SQLColumns`. While this method is faster, it may not be as accurate. Use this option cautiously and only when it seems like a good approach for your data. Use the following capabilities to enable column metadata via `SQLColumns`:

- `CAP_ODBC_METADATA_SUPPRESS_EXECUTED_QUERY`
- `CAP_ODBC_METADATA_SUPPRESS_PREPARED_QUERY`

Note: To apply these capabilities to temporary tables, you must install Tableau Server 2019.3.6 or later.

TDC example for SAP HANA

Your TDC file should look like the following example.

```
<?xml version='1.0' encoding='utf-8' ?>
<connection-customization class='saphana' enabled='true' version='9.3'>
<vendor name='saphana' />
<driver name='saphana' />
<customizations>
<customization name='CAP_ODBC_QUERY_USE_PREPARE_PARAMETER_MARKER'
value='yes' />
</customizations>
</connection-customization>
```

For more information about using TDC files, see "Create a TDC file" in the [Customize and Tune ODBC Connections](#) topic. Also see the Knowledge Base article called [Using a TDC File with Tableau Server](#).

Important: Be sure you include `enabled='true'` in your connection-customization line.

See also

- [Set Up Data Sources on page 596](#) – Add more data to this data source or prepare your data before you analyze it.
- [Build Charts and Analyze Data on page 1005](#) – Begin your data analysis.
- [External OAuth for SAP HANA below](#) - Configure your connection to use an external IdP.
- [Configure SSL for JDBC Connections](#) - General information about installing trusted SSL certificates for JDBC connections.
- [Customize SAP HANA Connections to Enable SAML Encryption](#) - Article on enabling encryption by creating a TDC file.
- [Tableau and JDBC](#) - Tips for using and troubleshooting JDBC drivers with Tableau.
- [Customize and Tune a Connection](#) - Describes how to use TDC and .properties files to customize connections.
- [Using a TDC File with Tableau Server](#) - Tableau Knowledge Base article on using a TDC file with Tableau Server.

External OAuth for SAP HANA

Starting in Tableau 2024.3 for Tableau Cloud, you can use OAuth 2.0/OIDC to federate identity from an external identity provider to HANA.

Depending on the identity provider, there are different steps needed to configure the integration. This is a high-level overview.

Note: Single use refresh tokens are not supported for OAuth connections to Tableau at this time. In most cases, you can set up your identity provider (such as Okta) to use rolling refresh tokens instead. For more information, see your provider's OAuth documentation.

Configure IDP on HANA

For information on configuring your IdP on HANA, see [Single Sign-On Using JSON Web Tokens](#) in the SAP help system.

Here are some examples of different ways to set up IdP:

- Okta IdP using HANA Cockpit: [Empower your users to access SAP HANA data with Okta identities](#)
- Azure IdP using HANA Studio: [Setting Up an SAP HANA Instance with OAuth or SSO](#)

Configure the IDP

1. Create OAuth clients on the IDP for Tableau Desktop, and Tableau Server or Tableau Cloud. The Desktop client should enable **PKCE** and use `http://localhost` redirects.
2. Create the Tableau OAuth config files. For details on how to do this, see [OAuth Configuration and Usage](#) on [GitHub](#), and examples [here](#). We welcome examples for other IDPs.
 - a. Be sure to prefix the Tableau OAuth config IDs with “`custom_`”.
 - b. If your IDP supports dynamic localhost port then disable `OAuthCapFixedPortInCallbackUrl`. If your IDP does not support this, make sure to add several localhost callback URLs to the allowlist in the config file and on the IDP.
3. Install the new Tableau OAuth configuration files in the `OAuthConfigs` folder associated with each application on desktop hosts (Tableau Desktop, Tableau Prep Builder, Tableau Bridge), and on each Tableau Server and Tableau Cloud site that will be using OAuth, via the site settings page. For more details, see [Custom OAuth Configs on Desktop](#) and [Site Level OAuth Clients](#).

Connect to HANA

The user must select **Sign in using OAuth**, and select the **OAuth Provider** installed earlier.

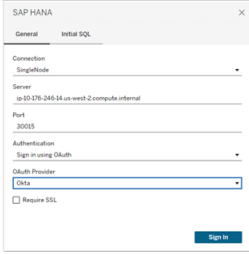

Okta

If using Okta it's better to use a “custom authorization server” rather than the “org authorization server.” The custom authorization servers are more flexible. There is a custom authorization server created by default, which is called “default”. The authorization URL should look like this:

`https://{yourOktaDomain}/oauth2/{authServerName}/v1/authorize`

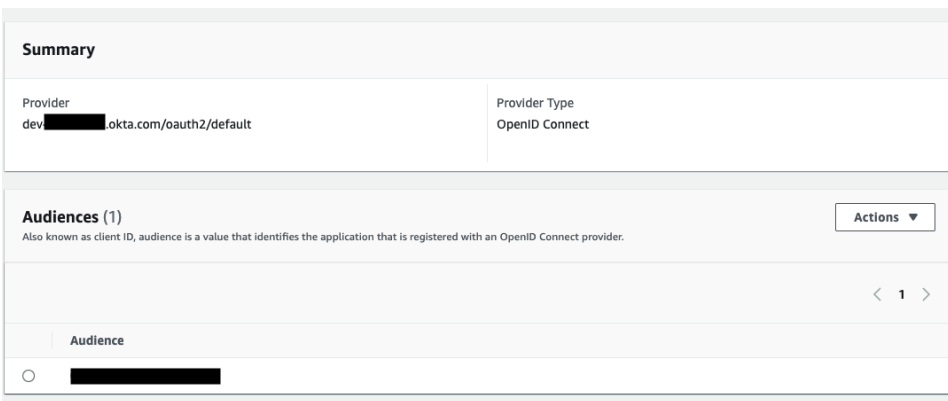

SAP NetWeaver Business Warehouse

This article describes how to connect Tableau to SAP NetWeaver Business Warehouse (BW) data and set up the data source.

Use this connector with Tableau Desktop on a Windows computer.

Install SAP software

Before you can connect Tableau to SAP BW data, you must install SAP software on your computer. For instructions on how to install SAP software, see [Connecting to SAP BW](#) on Tableau Community.

Before you connect

Before you connect, gather this connection information:

- Connection name
- Authentication: User name and password, or integrated authentication
- (Optional) Client for BW system
- (Optional) Language

If you want to use single sign-on, be sure that your SAP personal security environment (PSE) is configured for single sign-on.

Driver required

This connector requires a driver to talk to the database. If the driver is not installed on your computer, Tableau displays a message in the connection dialog box with a link to the [Driver Download](#) page where you can find driver links and installation instructions.

Make the connection and set up the data source

1. Start Tableau and under **Connect**, select **SAP NetWeaver Business Warehouse**. For a complete list of data connections, select **More** under **To a Server**. Then do the following:
 - a. Select a connection from the drop-down list.

A connection appears in the drop-down list if a system entry exists for it. You can create a new system entry using the SAP Logon utility, or contact your database administrator.
 - b. Select **Authentication** method:

Username and Password - Enter the user name and password to sign in to the server.

Integrated Authentication - Select this option if your environment is configured for single sign-on (SSO). This option is configured by the Tableau Server administrator. For more information, see [Enable Single Sign-On for SAP BW](#) in the Tableau Server Help.
 - c. Optionally, enter the **Client ID** for the BW system and the **Language**.
 - d. Select **Sign In**.

If Tableau can't make the connection, verify that your credentials are correct. If you still can't connect, your computer is having trouble locating the server. Contact your network administrator or database administrator.

2. On the data source page, do the following:
 - a. (Optional) Select the default data source name at the top of the page, and then enter a unique data source name for use in Tableau. For example, use a data source naming convention that helps other users of the data source figure out which data source to connect to.
 - b. Search for or select a catalog or InfoProvider.
 - c. Search for or select a cube or query.
 - d. Select the sheet tab to start your analysis.

Note: Tableau doesn't support link nodes.

Support for SAPUILandscape.xml

Prior to version 7.40 of the SAP GUI tools, SAP BW connections are defined on client computers in the saplogon.ini file. When you add a connection definition using SAP Logon, that definition is added to the saplogon.ini file. Tableau reads from that file to get the list of SAP BW systems to show in the **Select connection** drop-down list in the Tableau connection dialog box.

Starting in version 7.40 of the SAP GUI tools, the format of the connection definition file has changed to XML, and this connection information is now stored in SAPUILandscape.xml and SAPUILandscapeGlobal.xml. Note that Tableau doesn't support using the SAPLOGON_LSXML_FILE environment variable to specify the location of these files.

Tableau supports using landscape XML files located on a remote HTTP server.

Connections in drop-down list might not work

If you update to version 7.40 of the SAP GUI tools and then have issues with the **Select connection** drop-down list where connections don't work in Tableau, it might be because Tableau doesn't support `MessageServer` elements in the SAPUILandscape.xml and SAPUILandscapeGlobal.xml file. If a connection definition references a message server, the connection will display in the **Select connection** drop-down list, but it won't connect.

Select variables and input parameters

If the table you use includes required or optional variables or parameters, the Variables and Input Parameters dialog box opens.

Enter values for Variables and Parameters or add a new Variable

Name	Current Value
Prod_Type	Equals "Coffee"
VAR_MarketSize	
VAR_Market	
VAR_ProductType	Equals "Coffee"
VAR_ProductType	Equals "Espresso"
VAR_ProductType	Equals "Herbal Tea"
VAR_ProductType	Equals "Tea"
<i>Add New</i>	

Edit Variable

Select an item from the list to change its values

OK Cancel

- Required variables and parameters display their current value or ***Required**.
- Optional variables and parameters display their current value or are blank.
- Prompt for the variable when the workbook is opened by selecting the check box under **Prompt**.

Select a variable or parameter and type or select a value for it. Repeat for all required values and any optional values that you want to include, and then select **OK**.

Select the alias for a dimension

When you connect to SAP NetWeaver Business Warehouse (SAP BW) databases, you have the option to select which alias to use for dimensions. SAP BW offers a number of different options including long name, short name, medium name, and key. Sometimes the alias used by default is not very useful. You can right-click the dimension and change it to another option such as **Short name**, which changes the labels to something more meaningful.

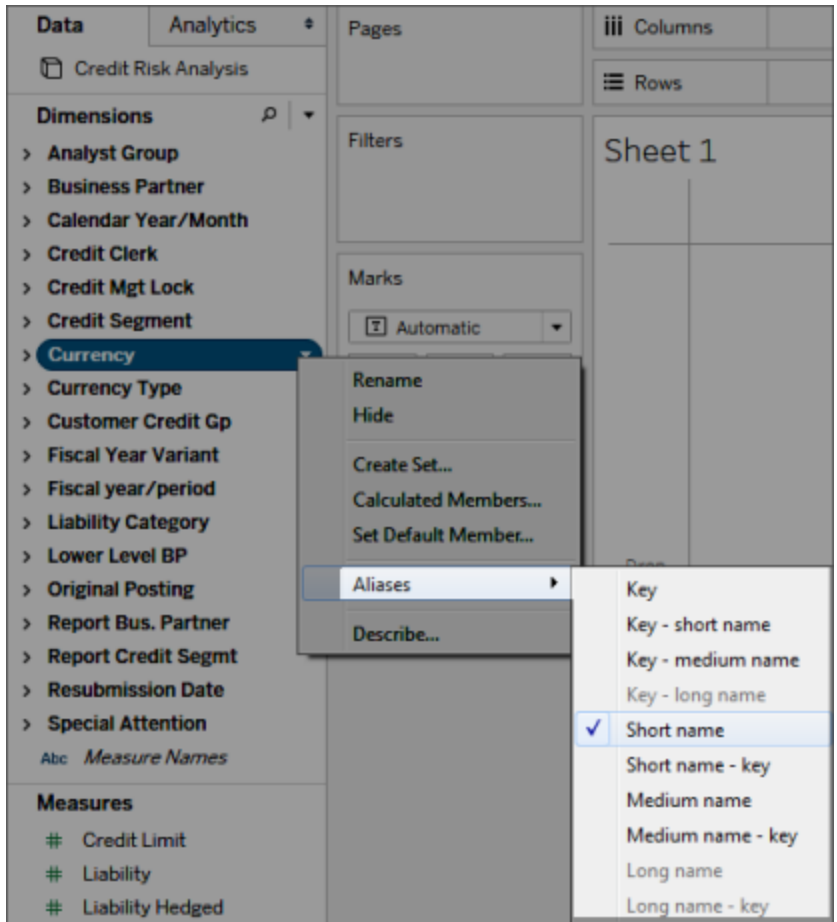

Support for SAP BW extracts

Starting in 10.4, you can create an extract of SAP BW data without the need for a special product key from Tableau. Prior to 10.4, SAP BW extracts were an unsupported beta feature. If you're using this beta feature, product keys will be extended through 2017, however, once the keys expire or to get support for this feature, you must upgrade to version 10.4.

When you create an extract from an SAP BW data source, Tableau converts data from the cube into a relational extract. This conversion can sometimes take a while based on the size of the cube. In addition, much of the cube metadata cannot be represented in the relational data model, so there are some limitations when working with extracts created from an SAP BW data source in Tableau Desktop. (Note that beta extract functionality was not supported in Tableau Desktop 9.0.)

SAP BW extract features

The following features are included in SAP BW extract functionality:

- The behavior of empty user filters has changed to be consistent with the behavior on other data sources. Using an empty user filter no longer hides the dimension.
- You can use **Hide** to hide dimensions before you extract data or refresh an extract. This reduces the size of the extract and the amount of time to perform an extract.
- Hiding a dimension takes priority over creating a user filter on the dimension.
- You can rename dimensions and measures in the data grid before extracting data.
- Tableau modifies the extract query slightly to fix some of the `[cube contains no data to transform]` errors.

SAP BW extract limitations

- Tableau supports only infocubes, or InfoProviders that contain only infocubes. A composite source that contains other BW object types is not supported.
- For large extracts, Tableau automatically partitions the query if the query fails or times out.
- BEx queries that contain more than 49 dimensions are not supported by SAP BW.
- You can't switch between a live connection and the extract. When you connect to an SAP BW data source, you'll have the option to Connect Live or Import the data. If you choose to Connect Live, the Extract options that are typically available for a connection are not an option. Further, if you choose to Import that data and create an extract, you cannot switch back to the live connection using the **Use Extract** command.
- You can't replace an extract with a live connection to SAP BW.
- Incremental extracts are not supported.
- When creating the extract, you can add filters to limit the data included in the extract, but these filters can be based only on hierarchies.
- Tableau doesn't support extracting the following SAP BW Objects:
 - Calculated sets.
 - Custom formatting and cell properties, except aliases.
 - User hierarchies. Hierarchies will collapse.
 - Pre-aggregated data.
 - Exception aggregation.
 - Compounding attribute.

Data displays differently for extract and live connections

In addition to the above limitations, you may notice some differences between an extract connection and live connection to SAP BW data. Specifically, when you connect to SAP BW directly, the dimensions, hierarchies, and levels are represented in the Data pane. After you create an extract, all of the fields are shown in a flat list.

Live connection

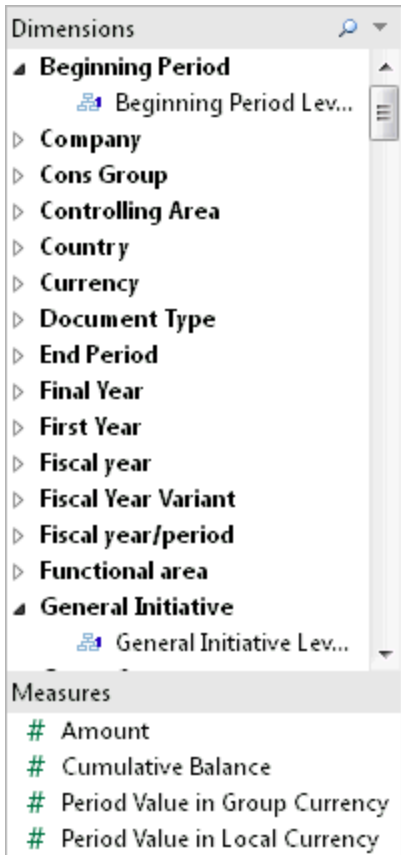

Extract connection

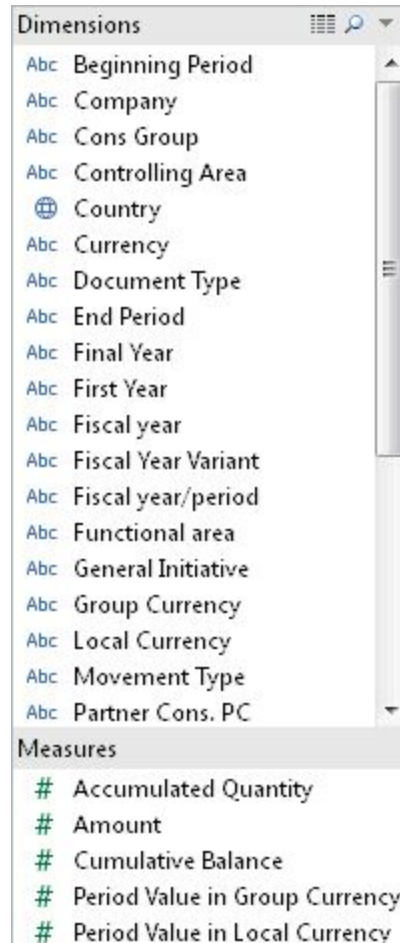

When you connect to an SAP BW data source and create an extract or connect to a Tableau Data Source file (.tds) that connects to an SAP BW extract, the fields display in the Data pane as expected. However, if you connect directly to the extract file, you will see extra fields that represent the alias options. All aliases are included in the extract and are typically hidden. You can hide the alias variants that you are not using by right-clicking the field and selecting **Hide**.

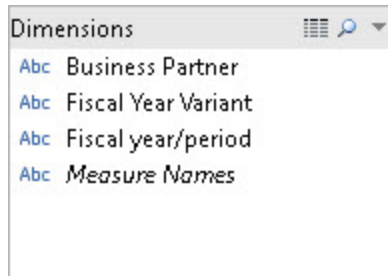
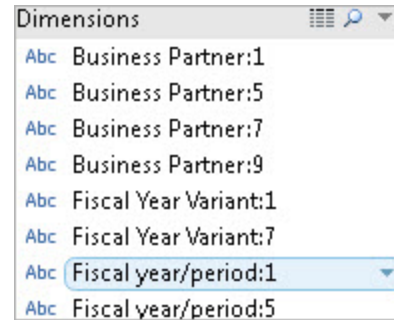
Aliases hidden**Aliases showing**

Frequently asked questions

Requirements

What versions do I need?

- For the client machine where Tableau Desktop or Tableau Server is installed: SAP GUI 7.30 or later for Windows.
- For the server machine: SAP BW 7.40 or later.
- Tableau Desktop or Tableau Server, any supported version. For information about which versions are supported, see [Supported Versions](#) on the Tableau website.

Do I need any special licenses like OpenHub to use Tableau with SAP BW?

Tableau uses the SAP OLE DB for OLAP provider (part of the Open Analysis Interfaces) to interact with SAP BW. This provider is a mechanism to do 'reporting' and retrieving 'reasonable' amounts of data. Unlike OpenHub, the interface is not designed for moving large amounts of data. You should verify with SAP that you have licensed SAP BW correctly for your environment and that your licensing terms permit the use of the OLE DB for OLAP provider for tools like Tableau.

Does the SAP BW connector require HANA?

No. The Tableau SAP BW connector does not require HANA. The connector will work with any of the supported SAP BW backend databases such as Oracle and SQL Server. However, you may use HANA if you prefer.

Can I connect to SAP BW using Logon Groups?

No. Tableau doesn't support connecting to SAP BW using Logon Groups.

Connection

Is the connection between Tableau and SAP BW a live connection or is it a Tableau extract?

Tableau supports live and extract connections to SAP BW data.

With a live connection you will always see the latest data in your workbooks and dashboards.

Does Tableau support connecting directly to the underlying database tables that support the BW instance?

No. Tableau does not support this method for connecting to the SAP BW system.

Performance

How does performance compare to existing tools we use?

System performance should be comparable to existing tools. If performance is an issue in your environment, you might want to consider adopting SAP HANA in your environment. For more information, see [SAP HANA](#) on the SAP website.

Security

How does Tableau handle user security?

Tableau leverages all the security policies already implemented in the SAP BW server. There is no need for you to duplicate this in Tableau. All user authentication and authorization is performed by SAP BW. Tableau passes your credentials to the SAP BW system to be authenticated. Once authenticated, you will see only the objects and data that your profile or role on the SAP BW system has been enabled to access.

How does user security work with Tableau Server when I publish a dashboard?

By default, worksheets and dashboards connected to SAP BW data require you to log into SAP BW with your SAP user name and password. However, Tableau Server can be configured to embed credentials so that you are taken directly to the published views and dashboards. In

In addition, Tableau Server offers an additional layer of security if desired. Tableau Server administrators can configure user authentication and authorization, independent and in addition to the SAP BW authentication and authorization. For more information about Tableau Server security, refer to the [Security](#) section of the Tableau Server Online Help.

See also

- [Set Up Data Sources on page 596](#) – Add more data to this data source or prepare your data before you analyze it.
- [Build Charts and Analyze Data on page 1005](#) – Begin your data analysis.

SAP SuccessFactors

This article describes how to connect Tableau to the SAP SuccessFactors application and set up the data source.

Before you begin

Before you begin, gather the following connection information:

- Environment Account ID
- Authentication information

Driver required

This connector requires a driver to talk to the database. If the driver is not installed on your computer, Tableau displays a message in the connection dialog box with a link to the [Driver Download](#) page where you can find driver links and installation instructions.

Make the connection and set up the data source

1. Start Tableau and under **Connect**, select **SuccessFactors**. For a complete list of data connections, select **More**, under **To a Server**. Then do the following:
 - a. Enter the application ID.
 - b. Enter the authentication information.
 - c. Select **Sign In**.

Note: If Tableau can't make the connection, verify that your credentials are correct. If you still can't connect, contact your network administrator or database administrator.

2. On the data source page, do the following:
 - a. (Optional) Select the default data source name at the top of the page, and then enter a unique data source name for use in Tableau. For example, use a data source naming convention that helps other users figure out which data source to connect to.
 - b. From the **Database** drop-down list, select a database.
 - c. Under **Table**, select a table or use the search field to search for a table by name.

See also

- [Set Up Data Sources on page 596](#) – Add more data to this data source or prepare your data before you analyze it.
- [Build Charts and Analyze Data on page 1005](#) – Begin your data analysis.

SAP Sybase ASE

This article describes how to connect Tableau to an SAP Sybase ASE database and set up the data source.

Tableau connects to Sybase ASE version 15.2 and later.

Before you begin

Before you begin, gather this connection information:

- Name of the server you want to connect to, port number, and if you use single sign-on, service name
- Authentication method: integrated authentication (single sign-on), or user name and password
- (Optional) Initial SQL statement to run every time Tableau connects

Use this connector with Tableau Desktop on a Windows computer.

Driver required

This connector requires a driver to talk to the database. If the driver is not installed on your computer, Tableau displays a message in the connection dialog box with a link to the [Driver Download](#) page where you can find driver links and installation instructions.

Make the connection and set up the data source

1. Start Tableau and under **Connect**, select **SAP Sybase ASE**. For a complete list of data connections, select **More** under **To a Server**. Then do the following:

- a. Enter the name of the server you want to connect to, and specify the port to use. Optionally, enter the service name. If you use single sign-on, you must enter the service name.
- b. Select the **Authentication** method:
 - Integrated Authentication** - Select this option if your environment is configured for single sign-on (SSO).
 - Username and Password** - Enter the user name and password to sign in to the server.
- c. (Optional) Select **Initial SQL** to specify a SQL command to run at the beginning of every connection, such as when you open the workbook, refresh an extract, sign in to Tableau Server, or publish to Tableau Server. For more information, see [Run Initial SQL on page 591](#).
- d. Select **Sign In**.

If Tableau can't make the connection, verify that your credentials are correct. If you still can't connect, your computer is having trouble locating the server. Contact your network administrator or database administrator.

2. On the data source page, do the following:

- a. (Optional) Select the default data source name at the top of the page, and then enter a unique data source name for use in Tableau. For example, use a data source naming convention that helps other users of the data source figure out which data source to connect to.
- b. From the **Database** drop-down list, select a database or use the text box to search for a database by name.
- c. From the **Schema** drop-down list, select a schema or use the text box to search for a schema by name.
- d. Under **Table**, select a table or use the text box to search for a table by name.

You can also specify a stored procedure in the database. To access stored procedures, the database must be appropriately configured with a linked server, which could be a remote server or a pointer to the database itself (known as *loopback*). For more information, see [Use a Stored Procedure on page 878](#).
- e. Drag a table or stored procedure to the canvas, and then select the sheet tab to start your analysis.

Use custom SQL to connect to a specific query rather than the entire data source.
For more information, see [Connect to a Custom SQL Query](#) on page 863.

Note: Kerberos authentication for SAP Sybase ASE doesn't support delegation. This means that if you selected **Integrated Authentication**, you can't use **Viewer credentials** as the **Authentication** method when you publish a workbook or data source to Tableau Server; you can only use **Server Run As account**, and the Tableau Server Run As User account must have an account in the SAP Sybase ASE database.

See also

- [Set Up Data Sources](#) on page 596 – Add more data to this data source or prepare your data before you analyze it.
- [Build Charts and Analyze Data](#) on page 1005 – Begin your data analysis.

SAP Sybase IQ

This article describes how to connect Tableau to an SAP Sybase IQ database and set up the data source.

Before you begin

Before you begin, gather this connection information:

- Name of the host that hosts the database you want to connect to
- (Optional) Server name. Tableau supports Sybase IQ multiplexes, so a server name is not required.
- Authentication method: Windows Authentication or user name and password
- (Optional) Initial SQL statement to run every time Tableau connects

Use this connector with Tableau Desktop on a Windows computer.

Driver required

This connector requires a driver to talk to the database. If the driver is not installed on your computer, Tableau displays a message in the connection dialog box with a link to the [Driver Download](#) page where you can find driver links and installation instructions.

Make the connection and set up the data source

1. Start Tableau and under **Connect**, select **SAP Sybase IQ**. For a complete list of data connections, select **More** under **To a Server**. Then do the following:
 - a. Enter the host name that hosts the database that you want to connect to.
 - b. (Optional) Enter the server name.
 - c. Select how you want to sign in to the server. Specify whether to use Windows Authentication or a specific user name and password. If the server is password protected, you must enter the user name and password.
 - d. (Optional) Select **Initial SQL** to specify a SQL command to run at the beginning of every connection, such as when you open the workbook, refresh an extract, sign in to Tableau Server, or publish to Tableau Server. For more information, see [Run Initial SQL on page 591](#).
 - e. Select **Sign In**.

If Tableau can't make the connection, verify that your credentials are correct. If you still can't connect, your computer is having trouble locating the server. Contact your network administrator or database administrator.

2. On the data source page, do the following:
 - a. (Optional) Select the default data source name at the top of the page, and then enter a unique data source name for use in Tableau. For example, use a data source naming convention that helps other users of the data source figure out which data source to connect to.
 - b. From the **Database** drop-down list, select a database or use the text box to search for a database by name.
 - c. Under **Table**, select a table or use the text box to search for a table by name.
 - d. Drag a table to the top area of the data source page, and then select the sheet tab to start your analysis.

Use custom SQL to connect to a specific query rather than the entire data source. For more information, see [Connect to a Custom SQL Query on page 863](#).

See also

- [Set Up Data Sources on page 596](#) – Add more data to this data source or prepare your data before you analyze it.

- [Build Charts and Analyze Data on page 1005](#) – Begin your data analysis.

ServiceNow ITSM

This article describes how to connect Tableau to ServiceNow IT Service Management (ITSM) data and set up the data source.

Warning: The ServiceNow ITSM connector is deprecated as of the 2023.1 release. You can use the connector until it's been retired. Once the connector is retired, it's removed from the Tableau user interface and any data sources using the connector will no longer work as expected. Typically, a deprecated connector will be retired 1–2 releases after it is deprecated. You can use the ServiceNow connector from the [Tableau Exchange](#) instead.

Note: For the most up-to-date information on this connector, see the [ServiceNow ITSM](#) help topic for the current version of Tableau.

Before you begin

Before you begin, gather this connection information:

- ServiceNow instance you want to connect to: cloud-based or on premises
- User name and password for a local ServiceNow account

Connection requirements

To connect Tableau to ServiceNow, make sure that the following requirements are met:

- **Use a local ServiceNow account.** The ServiceNow API doesn't support single sign-on (SSO), so the Tableau connector can only authenticate using a local ServiceNow account. For more information, see [Use a local ServiceNow account on page 461](#).
- **Have the correct permissions.** Access control lists (ACLs) must provide the user the permission required to access the data. For more information see [Troubleshoot data access on page 462](#).
- **For on-premises, CORS is configured.** Before you connect to an on-premises instance of ServiceNow, you must configure CORS for Tableau in ServiceNow. For more information, see [Configure CORS for Tableau on ServiceNow](#) in Tableau Community.
- **For cloud instances, proxy connection is required.** The native ServiceNow connector routes through "servicenow-auth-proxy.connectors.tableau.com" instead of directly from the local user's IP. The proxy is necessary due to the way OAuth 2.0 is designed. It stores the unique client ID and secret required by OAuth to permit Tableau Desktop access to ServiceNow.

Note: Don't apply IP address access controls in ServiceNow when using a proxy connection. If you do need to apply IP address access controls, use [Find denied IP addresses](#) to find the denied IPs, and then add Allow rules for them. Be aware of that an IP associated with "servicenow-auth-proxy.connectors.tableau.com" may change. This is a cloud service and does not have static IP. Tableau does not provide or update information about the IP.

Make the connection and set up the data source

1. Start Tableau and under **Connect**, select **ServiceNow ITSM**. For a complete list of data connections, select **More** under **To a Server**. Then do the following:
 - a. Select **Instance Location: Cloud-based** or **On Premise**.
 - b. Enter your ServiceNow instance, user name, and password for a local ServiceNow account.

Note: When you select **On Premise**, you must enter a full URL for the ServiceNow instance.
 - c. Select **Sign In**.
 - d. Select **Filter Type: Relative date range** or **Fixed date range**, and then select or specify the range.
 - e. Select **Connect**.

If Tableau can't make the connection, verify that your credentials are correct. If you still can't connect, your computer is having trouble locating the server. Contact your network or ServiceNow administrator.
2. On the data source page, do the following:
 - a. (Optional) Select the default data source name at the top of the page, and then enter a unique data source name for use in Tableau. For example, use a data source naming convention that helps other users of the data source figure out which data source to connect to.
 - b. Under **Table**, select a table and drag it to the top of the canvas.
 - c. Select the sheet tab to start your analysis.

After you select the sheet tab, Tableau imports the data by creating an extract. Note that Tableau Desktop supports only extracts for ServiceNow. You can update the data by refreshing the extract. For more information, see [Extract Your Data on page 919](#).

Creating extracts might take some time depending on the amount of data that is included.

Use Accelerators

You can use an Accelerator to quickly build informative dashboard designs made specifically for key business metrics on Tableau Desktop and Tableau Cloud. For more information, see [Use Accelerators to Quickly Visualize Data on page 2721](#).

Key considerations

ServiceNow enforces an account's access permissions

ServiceNow accounts that have the Admin role can retrieve encrypted password values from the User table. This file will be null for accounts with less permissions. Because ServiceNow enforces the access permissions assigned to the account, be aware that there might be other sensitive fields in your data that an Admin can access.

Custom tables not supported

The Tableau connector for ServiceNow ITSM supports the ITSM service, which doesn't include custom tables.

ServiceNow provides table names

When you view tables in the Tableau connector, the tables are labeled according to their ServiceNow label, not the table name. For example, the table "sys_user_role" is shown by its label, "User Role". This label is determined by the ServiceNow connector.

Display value fields aren't included in the data source

When you connect to a table that contains fields with display values (fields with a dv_ prefix), those fields aren't included when you create a data source. You can add the display values by joining to the appropriate related tables that contain those values.

Use a local ServiceNow account

You must use a local account to connect Tableau to your data. If you don't have a local ServiceNow account, we recommend that you ask your administrator to implement one of the following solutions:

- Create a local account and share it.
- Create a local account and temporarily share it long enough to extract the data and publish it to Tableau Cloud or Tableau Server. Then the administrator can save the new password and schedule refreshes.

- Create a local account on a non-production ("staging") instance and use it to create a data source. Give the data source to the administrator to edit the connection to point to the production instance, publish the data source to Tableau Cloud or Tableau Server, and schedule for data refreshes.
- Ask the administrator to publish the data sources you need.

Date range selections can impact performance

When you apply a date filter, it's tempting to gather as much data as possible when you do an analysis, however, retrieving records from ServiceNow ITSM can be time-consuming. Tableau doesn't know how much data there is in a particular date range until it retrieves the data. For this reason, you should restrict your date range at first, and then expand after you evaluate performance. Date filters are applied to these tables: `metric_instance`, `change_request`, `incident`, `task`, `problem`.

To give you a rough idea of how much time it might take to retrieve data from ServiceNow ITSM, tests were conducted using a high-speed connection. This table shows how long it took in the test environment to retrieve a given number of records.

Number of records	Time to retrieve
1,000	11 seconds
10,000	2 minutes
100,000	18 minutes

Troubleshoot data access

For ServiceNow ITSM users

If you see an error when you try to access data, for example, "You are not authorized to access this resource....," contact your ServiceNow administrator.

For ServiceNow administrators

ServiceNow uses access control lists (ACLs) to specify who has access to which data. Often the default permissions that are set for ServiceNow fulfillers are adequate for Tableau users to access the content they need to analyze ServiceNow ITSM data.

Tableau users need to access metadata about tables in ServiceNow, which is available in the following tables:

- `sys_dictionary` table (metadata about columns)
- `sys_db_object` table (metadata about tables)
- `sys_glide_object` table (metadata about field types)

If a Tableau user can't access ServiceNow ITSM data, make sure that the ACLs provide the user table level and field level read access to the tables above, and that there are no scripts that are locking down access.

To grant access to the metadata tables, as a best practice, you might consider creating a role with the ACLs needed to access the metadata tables, and then assign the role to a Tableau User group. Then, you can assign Tableau users to the group so that users can access the data needed for analysis in Tableau.

For information on the creation of an ACL, please see the [ServiceNow Access control list rules](#) on the ServiceNow website.

See also

- [Set Up Data Sources on page 596](#) – Add more data to this data source or prepare your data before you analyze it.
- [Build Charts and Analyze Data on page 1005](#) – Begin your data analysis.

ServiceNow

Applies to Desktop and server

This article describes how to connect Tableau to ServiceNow connector and set up the data source.

Note: Multi-factor authentication (MFA) isn't supported by this connector.

Before you begin

Before you begin, gather this connection information:

- ServiceNow instance you want to connect to: cloud-based or on premises
- User name and password with appropriate data access.

Make the connection and set up the data source

Connection installation

You can install the connector from the [Extension Gallery](#) or by clicking install from within Tableau Desktop.

This connector requires a plugin (taco file) and a driver to talk to the instance. You might already have the required driver installed on your computer. If the driver is not installed on your computer, Tableau displays a message in the connection dialog box with a link to the [Driver Download](#) page where you can find driver links and installation instructions.

1. Start Tableau and under **Connect**, select **ServiceNow**. For a complete list of data connections, select **More** under **To a Server**. Then do the following:
 - a. Enter your ServiceNow instance, user name, and password.
 - b. Select **Sign In**.
 - c. Select **Connect**.

If Tableau can't make the connection, verify that your credentials are correct. If you still can't connect, your computer is having trouble locating the server. Contact your network or ServiceNow administrator.
2. On the data source page, do the following:

(Optional) Select the default data source name at the top of the page, and then enter a unique data source name for use in Tableau. For example, use a data source naming convention that helps other users of the data source figure out which data source to connect to.

 - a. Under **Table**, select a table and drag it to the top of the canvas.
 - b. Select the sheet tab to start your analysis.

After you select the sheet tab, Tableau imports the data by creating an extract.

Refresh your data

Tableau only supports extract connections for ServiceNow, not live connections. You can update the data by refreshing the extract; incremental refreshes are not supported. For more information, see [Refresh Extracts](#). For information about refresh schedules see [Schedule Extract Refreshes as You Publish a Workbook](#).

See also

- [Set Up Data Sources on page 596](#) – Add more data to this data source or prepare your data before you analyze it.
- [Build Charts and Analyze Data on page 1005](#) – Begin your data analysis.

SharePoint Lists

The bundled connector was replaced by the SharePoint lists connector on the [Tableau Exchange](#).

Warning: The SharePoint Lists connector is deprecated as of the 2023.1 release. You can use the connector until it's been retired. Once the connector is retired, it's removed from the Tableau user interface and any data sources using the connector will no longer work as expected. Typically, a deprecated connector will be retired 1–2 releases after it is deprecated.

This article describes how to connect Tableau to SharePoint lists and set up the data source.

Note: Multi-factor authentication (MFA) isn't supported by the drivers currently available for Sharepoint Lists.

Before you connect

Before you begin, gather this connection information:

- The URL to the SharePoint site that contains the lists you want to connect to
- The edition of your SharePoint server: on premises or SharePoint Online
- The method of authentication: third-party SSO or integrated authentication
- The user name or email address, password, and (optionally) SSO domain, if needed

Driver required

This connector requires a driver to talk to the database. If the driver is not installed on your computer, Tableau displays a message in the connection dialog box with a link to the [Driver Download](#) page where you can find driver links and installation instructions.

Make the connection and set up the data source

1. Start Tableau and under **Connect**, select **SharePoint Lists**. For a complete list of data connections, select **More** under **To a Server**. Then do the following:
 - a. In the **SharePoint Site** text box, enter the SharePoint URL. Don't include the list name in the URL.
 - b. Select the **Edition: On Premise** or **SharePoint Online**.
 - c. Select the **Authentication** method: **Username and Password**, **Third-party SSO**, or **Integrated Authentication**.

- d. If the fields are available, enter the **Username** and **Password**, and optionally, enter **SSO Domain**.
 - e. Select **Sign In**.
2. On the data source page, do the following:
 - a. (Optional) Select the default data source name at the top of the page, and then enter a unique data source name for use in Tableau. For example, use a data source naming convention that helps other users of the data source figure out which data source to connect to.
 - b. Under **Table**, select a table and drag it to the top of the canvas.
 - c. Select the sheet tab to start your analysis.

Connection tips

- If you use SharePoint Online, select **Third-party SSO** as your **Authentication** type.
- If you use Kerberos, select **Integrated Authentication** as your **Authentication** type.
- If you use NTLM, select **Username and Password** as your **Authentication** type.
- If you select **Third-party SSO** as your **Authentication** type, enter your credentials, which might be your user name or email address, and your password. Optionally, enter the **SSO Domain**.

Note: Tableau currently supports only **Okta** and **OneLogin** for Third-party SSO connections.

- Any list you connect to will be the existing default SharePoint view only. This means that if any rows of data are filtered on the default view in SharePoint, you will not be able to retrieve the filtered data. If your goal is to access everything in the SharePoint list then you will need to adjust the default view to show all rows.

Sign in on a Mac

If you use Tableau Desktop on a Mac, when you enter the server name to connect, use a fully qualified domain name, such as mydb.test.ourdomain.lan, instead of a relative domain name, such as mydb or mydb.test.

Alternatively, you can add the domain to the list of Search Domains for the Mac computer so that when you connect, you need to provide only the server name. To update the list of Search Domains, go to **System Preferences > Network > Advanced**, and then open the **DNS** tab.

Both **Authentication** methods on a Mac require you to enter your user name and password to connect.

Refresh your data

Tableau supports only extract connections for SharePoint lists, not live connections. You can update the data by refreshing the extract; incremental refreshes are not supported. For more information, see [Refresh Extracts on page 937](#). For information about refresh schedules, see [Schedule Extract Refreshes as You Publish a Workbook on page 3164](#).

See also

- [Set Up Data Sources on page 596](#) – Add more data to this data source or prepare your data before you analyze it.
- [Build Charts and Analyze Data on page 1005](#) – Begin your data analysis.

SharePoint Lists (JDBC)

This document describes how to connect Tableau to the SharePoint Lists (JDBC) driver and set up the data source.

Note: The SharePoint Lists JDBC connector requires Tableau 2022.3 or later and the SharePoint Lists JDBC driver.

Preparing to connect

Before you begin, gather this connection information:

- The URL to the SharePoint site that contains the lists you want to connect to
- The edition of your SharePoint server: on premises or SharePoint Online
- The method of authentication: Azure AD, third-party SSO or integrated authentication
- The user name or email address, password, and (optionally) SSO domain, if needed

Required API Permissions

In SharePoint, grant Tableau the following application programming interface (API) permissions:

- profile
- openid

- email
- AllSites.Manage
- offline_access
- User.Read

Using a custom OAuth Client

Tableau recommends you set up a custom OAuth client, so you can fully control your OAuth configuration according to your own IT policies. The option to use your own OAuth client also frees you from being tied to Tableau release cycles and Tableau's OAuth client rotation schedule. For information on how to configure your own OAuth client see, [Configure Custom OAuth for a site](#).

Driver required

This connector requires a driver to talk to the database. If the driver is not installed on your computer, Tableau displays a message in the connection dialog box with a link to the [Driver Download](#) page where you can find driver links and installation instructions.

Configuring SharePoint Lists (JDBC) on Tableau Server

If you are using Tableau Server, both the connector and driver must first be installed on each server node.

1. Download the packaged Sharepoint Lists (JDBC) Tableau connector (TACO) file or "cdata.sharepoint.taco", from [Tableau Exchange](#).
2. Move the .taco file to the following directory on each node of your Tableau Server instances:
 - **Windows:** C:\ProgramData\Tableau\Tableau Server\data\tabsvc\vizqlserver\Connectors
 - **Linux:** [Your Tableau Server Install Directory]/data/tabsvc/vizqlserver/Connectors
3. Download and install the SharePoint Lists (JDBC) driver from the [Tableau Driver center](#). The JDBC driver (data.tableau.sharepoint.jar) needs to be placed in the following directory on each node of a Tableau Server instance:
 - **Windows:** C:\Program Files\Tableau\Drivers
 - **Linux:** /opt/tableau/tableau_driver/jdbc
4. Restart Tableau Server.
5. If you plan on using OAuth with SharePoint Lists (JDBC), some additional configuration of Tableau Server is also required. For more information, see [Configure Azure AD for OAuth and Modern Authentication](#).

Make the connection and set up the data source

1. Start Tableau and under **Connect**, select **SharePoint Lists (JDBC)**.
2. In the Server text box, enter the **SharePoint URL**.
3. Select the **Edition: On Premise** or **SharePoint Online**.
4. Select the **Authentication** method: **Azure AD**, **Username and Password**, **NTLM**, **ADFS** or **Basic**.
5. If Azure AD is chosen, select **Sign In**.
6. For other authentication methods, enter the required information, and then select **Sign In**.

Next, on the **Data** source page, do the following:

1. (Optional) Select the default data source name at the top of the page, and then enter a unique data source name for use in Tableau.

For example, use a data source naming convention that helps other users of the data source figure out which data source to connect to.

2. To start your analysis, select the sheet tab.

Sign in on a Mac

If you use Tableau Desktop on a Mac, when you enter the server name to connect, use a fully qualified domain name, such as mydb.test.ourdomain.lan, instead of a relative domain name, such as mydb or mydb.test.

Alternatively, you can add the domain to the list of Search Domains for the Mac computer so that when you connect, you need to provide only the server name. To update the list of Search Domains, go to **System Preferences > Network > Advanced**, and then open the **DNS** tab.

Both **Authentication** methods on a Mac require you to enter your user name and password to connect.

Refresh your data

Tableau supports only extract connections for SharePoint lists, not live connections. You can update the data by refreshing the extract; incremental refreshes are not supported. For more information, see [Refresh Extracts on page 937](#). For information about refresh schedules, see [Schedule Extract Refreshes as You Publish a Workbook on page 3164](#).

See also

- [Set Up Data Sources on page 596](#) – Add more data to this data source or prepare your data before you analyze it.
- [Build Charts and Analyze Data on page 1005](#) – Begin your data analysis.

SingleStore

This article describes how to connect Tableau to a SingleStore database and set up the data source.

Note: SingleStore was **formerly named MemSQL**.

Before you begin

Before you begin, gather this connection information:

- Name of the server that hosts the database you want to connect to
- User name and password
- Are you connecting to an SSL server?
- (Optional) Initial SQL statement to run every time Tableau connects

Driver required

This connector requires a driver to talk to the database. If the driver is not installed on your computer, Tableau displays a message in the connection dialog box with a link to the [Driver Download](#) page where you can find driver links and installation instructions.

Make the connection and set up the data source

1. Start Tableau and under **Connect**, select **SingleStore**. For a complete list of data connections, select **More** under **To a Server**. Then do the following:
 - a. Enter the name of the server that hosts the database.
 - b. Enter the user name and password.
 - c. (Optional) Select **Initial SQL** to specify a SQL command to run at the beginning of every connection, such as when you open the workbook, refresh an extract, sign in to Tableau Server, or publish to Tableau Server. For more information, see [Run Initial SQL on page 591](#).
 - d. Select **Sign In**.

Select the **Require SSL** check box when connecting to an SSL server.

If Tableau can't make the connection, verify that your credentials are correct. If you still can't connect, your computer is having trouble locating the server. Contact your network administrator or database administrator.

2. On the data source page, do the following:
 - a. (Optional) Select the default data source name at the top of the page, and then enter a unique data source name for use in Tableau. For example, use a data source naming convention that helps other users of the data source figure out which data source to connect to.
 - b. From the **Database** drop-down list, select a database or use the text box to search for a database by name.
 - c. Under **Table**, select a table or use the text box to search for a table by name.
 - d. Drag a table to the canvas, and then select the sheet tab to start your analysis.

Use custom SQL to connect to a specific query rather than the entire data source. For more information, see [Connect to a Custom SQL Query on page 863](#).

Sign in on a Mac

If you use Tableau Desktop on a Mac, when you enter the server name to connect, use a fully qualified domain name, such as mydb.test.ourdomain.lan, instead of a relative domain name, such as mydb or mydb.test.

Alternatively, you can add the domain to the list of Search Domains for the Mac computer so that when you connect, you need to provide only the server name. To update the list of Search Domains, go to **System Preferences > Network > Advanced**, and then open the **DNS** tab.

See also

- [Set Up Data Sources on page 596](#) – Add more data to this data source or prepare your data before you analyze it.
- [Build Charts and Analyze Data on page 1005](#) – Begin your data analysis.

Snowflake

This article describes how to connect Tableau to a Snowflake data warehouse and set up the data source.

Usage notes: Key-pair authentication with Snowflake

- To support using Key-pair authentication with Snowflake, you must install an ODBC driver from Snowflake that is version 3.4.0 or newer.
- Key-pair authentication is available for Tableau Desktop and Tableau Cloud starting with version 2024.3. It will be available in Tableau Server in a future release.
- Publishing workbooks with Snowflake key-pair authentication is not supported in web authoring. You must use Tableau Desktop to create the workbooks, which can then be published to Tableau Cloud.

Before you begin

Before you begin, gather this connection information:

- Name of the server name that you want to connect to
- Authentication method:
 - **OAuth**: Use this method if you want to enable federation from an IDP.
 - **Username and Password**: Use this method if you want to store user credentials in Snowflake.
 - **Okta Username and Password**: Use this method if you plan on using Okta to manage your authentication.
 - **Key-pair authentication**: use public and private key-pair credentials for a stronger security connection.
- Sign-in credentials needed for the authentication method you choose.
Note: If you are using Key-pair authentication, you need to use OpenSSL version 3.x or newer to create the keys.
- (Optional) Initial SQL statement to run every time Tableau connects.
- (Optional) Any custom driver parameters or a new Default VARCHAR size to use with this connection.

Note: To use Tableau Cloud with Key-pair authentication, you must also save credentials in Tableau Cloud before you can publish workbooks for sharing. For more information, see [Configure Snowflake for Key-pair Authentication on page 486](#).

Driver required

This connector requires a driver to talk to the database. If the driver is not installed on your computer, Tableau displays a message in the connection dialog box with a link to the [Driver Download](#) page where you can find driver links and installation instructions.

Note: To support using Key-pair authentication with Snowflake, you must install an ODBC driver from Snowflake that is version 3.4.0 or newer.

Make the connection and set up the data source

After you select Snowflake as your connection, a dialog displays with three tabs. Use the **General** tab to select the Server, Warehouse, and Authentication type. You can use the **Initial SQL** tab to optionally run a SQL command at the beginning of every connection. For more information, see [Run Initial SQL on page 591](#). Lastly, you can use the **Advanced** tab to optionally add custom driver parameters and a default VARCHAR size.

For information about how to configure OAuth for connections between Tableau and Snowflake, see [Configure OAuth for Snowflake Connections](#) and [External OAuth for Snowflake on page 484](#).

Connect Tableau to your data

1. On the **Connect** screen, under **To a Server**, select **More**, and then select **Snowflake**.
2. On the **General** tab, enter the name of the server that you want to connect to.
3. (Optional) Enter the **Role** and **Warehouse**.
4. Select the Authentication method you'll use: **Username and Password**, **Okta Username and Password**, **Sign in using OAuth**, or **Sign in using Key-pair**.
5. (Optional) Select **Initial SQL** if you want to run a SQL command at the beginning of every connection. For more information, see [Run Initial SQL on page 591](#).
6. (Optional) For Tableau Desktop and Server, enter any custom parameters on the **Advanced** tab you wish to use for this connection. (Not available on Tableau Cloud)
7. Complete the login steps for the selected authentication method:
 - Sign in using OAuth:
 1. Click **Sign In**.
 2. In the Web page that opens, log in to Snowflake by entering your Username and Password and selecting Log In. Alternately, select Single Sign On if Snowflake is configured to support SSO.
 3. Click **OK** to confirm authorization to access your Snowflake data.
 - Username and Password:
 1. Enter the username and optional password.
 2. Click **Sign In**.
 - Okta Username and Password:

1. Enter the username and optional password.
2. Enter the optional SAML IdP (The URL for your Okta server).
3. Click **Sign In**.
- Sign in using Key-pair
 1. In **Server**, enter the Snowflake server address.
 2. Enter the **Warehouse** and optionally the **Role**.
 3. In **Authentication**, select **Sign in using Key-pair**.
 4. Enter the **Username** associated with these keys.
 5. In **Private key file**, browse to the .p8 file containing your private key.
 6. (Optional) Enter the **Private key file password** if it is protected by one.
8. Next, follow the instructions under Set up the Data Source.

If Tableau can't make the connection, verify that your credentials are correct. If you still can't connect, your computer is having trouble locating the server. Contact your network administrator or database administrator.

Access Token Timeout: Always Validate Access Token TDC

The Snowflake access token expires after 10 minutes. In certain extract refresh processes, new connections are established later in the job when the access token has expired. To address this issue we have added a new capability, which is enabled by default starting in Tableau 2024.2. To enable this capability in older releases you can use the following TDC.

```
<connection-customization
class='snowflake' enabled='true' version='10.0'>
  <vendor name='snowflake' />
  <driver name='snowflake' />
  <customizations>
    <customization name='CAP_OAUTH_VALIDATE_ALWAYS' value='yes' />
  </customizations>
</connection-customization>
```

This TDC can be used with Tableau Desktop or Tableau Server by including it in the Tableau repository datasources folder. For Tableau Cloud, you can use Bridge and configure a custom TDC by connecting through there. For more information, see [Customize and Tune a Connection on page 541](#).

Note: Embedded TDCs are not supported with flows.

Customize the connection using driver parameters

You can modify the connection made with the Snowflake connector by appending driver parameters to the connection string in the **Advanced** tab.

Note: You can't change the driver parameters that Tableau generates; you can only append parameters.

For example, this syntax specifies a proxy server to use when the `no_proxy` values aren't met and host names are allowed to bypass the proxy server:

```
Proxy=http://proxyserver.company:80;no_proxy=.trustedserver.com;
```

For another custom driver parameters example, see [Use a proxy for Snowflake on the next page](#).

You can also enter an alternate size for VARCHAR in the **Default VARCHAR size (bytes)** field. For more details about using this field and the impacts on performance, see the Snowflake ODBC documentation.

Note: If you want customization without embedding it in the data source you can configure parameters in the registry on Windows (only parameters that are marked as "Configuration Parameters" are available). For details about driver parameters, see [ODBC Configuration and Connection Parameters](#) on the Snowflake website.

Set up the data source

On the data source page, do the following:

1. (Optional) Select the default data source name at the top of the page, and then enter a unique data source name for use in Tableau. For example, use a data source naming convention that helps other users of the data source figure out which data source to connect to.
2. From the **Warehouse** dropdown the warehouse or use the text box to search for a warehouse by name.

Note: If you leave this blank and don't select a warehouse, Tableau uses your default Snowflake virtual warehouse.

For more information, see [Default virtual warehouses in Snowflake](#) on the next page.

3. From the **Database** drop-down a database or use the text box to search for a database by name.
4. From the **Schema** drop-down a schema or use the text box to search for a schema by name.
5. Under **Table**, select a table or use the text box to search for a table by name.
6. Drag a table to the canvas, and then select the sheet tab to start your analysis.

Note: If you are publishing your workbooks when using Key Pair Authentication, make sure you select the proper authentication type in the **Manage Data Sources** section of the **Publish Workbook** window.

Sign in on a Mac

If you use Tableau Desktop on a Mac, when you enter the server name to connect, use a fully qualified domain name, such as mydb.test.ourdomain.lan, instead of a relative domain name, such as mydb or mydb.test.

Alternatively, you can add the domain to the list of Search Domains for the Mac computer so that when you connect, you need to provide only the server name. To update the list of Search Domains, go to **System Preferences > Network > Advanced**, and then open the **DNS** tab.

Default virtual warehouses in Snowflake

When you create a Snowflake data source, you're creating a Snowflake warehouse (for computational resources) and Snowflake databases (for data resource). Both warehouses and databases require permissions to access them. You can use different warehouses to access the same database, depending on the computation power you need, assuming you have permissions for each warehouse and database.

When you create a data source, you have the option to choose a warehouse from a drop-down list. If you leave this blank and don't select a warehouse, Tableau uses your default Snowflake virtual warehouse. If you subsequently publish that data source or workbook, when a user connects, Tableau will use that person's default Snowflake virtual warehouse.

Each user should be assigned a default warehouse so that Tableau can use that one as a default to open a workbook from a Snowflake data source.

Use a proxy for Snowflake

You can connect from Tableau through a proxy to Snowflake. If you're using Tableau version 2019.4 or later, you can configure it with the connector dialog by typing the required parameters

in the **Advanced** tab.

For example:

```
proxy=http://proxyserver.company:80
```

For information about the parameters you should use, see the [Snowflake documentation](#).

Note: Tableau doesn't use a DSN to connect to Snowflake, so you can ignore the instructions in the Snowflake documentation about using a DSN.

If you're using version of Tableau before 2019.4, you can configure it by entering the parameters in a TDC file using `odbc-extras`.

For example:

```
<connection-customization
class='snowflake' enabled='true' version='19.1'>
  <vendor name='snowflake' />
  <driver name='snowflake' />
  <customizations>
    <customization name='odbc-connect-string-
extras' value='proxy=http://proxyserver.company:80' />
  </customizations></connection-customization>
```

For more information, see the [Customize the Connection String for a Native Connector](#) article.

Troubleshooting

Performance and Fetch Size

To get the best performance, especially for extracts, Tableau needs to determine an optimal fetch size. There are two ways to improve this: setting limits on variable length fields, and enabling resizable fetch buffers. To get the best results you should use both.

Determining the current Fetch size

The fetch size used is logged in the `tabprotosrv` logs. `Tabprotosrv` is the driver sandbox process. Here is an example:

ODBCRowsetSource::ODBCRowsetSource: Attempting to set the row fetch size to 4128 rows, with 254 bytes per row

Note: Some of the suggestions below require TDCs, but those won't work on Tableau Cloud unless you are using Tableau Bridge. With Tableau Bridge, you can install the TDC on the bridge host to have it apply to all connections going through that host.

Variable Field Length Limits

When using unbounded VARCHAR or VARBINARY fields, the driver will return the field size as 16 MB. This causes Tableau to use a small fetch size to stay within memory limits, which results in slow query speeds. There are several ways to address this:

- Add a limit to the column definition on the database, such as VARCHAR(256), or wrap the table in a view which does the same.
- Use the "Default VARCHAR size (bytes) field on the **Advanced** tab when connecting to Snowflake in Tableau Desktop. This was renamed from "Max VARCHAR size" in Tableau 2024.3, but it does the same thing. It sets the default_varchar_size parameter for the ODBC driver, which will limit the field size returned to Tableau. For more information, see <https://docs.snowflake.com/en/developer-guide/odbc/odbc-parameters>.
- Use a TDC customization like below:

```
<connection-customization class='snowflake' enabled='true' version='10.0'>
<vendor name='snowflake' />
<driver name='snowflake' />
<customizations>
<customization name='CAP_ODBC_FETCH_BUFFERS_RESIZABLE' value='yes'/>
<customization name='odbc-connect-string-extras' value='default_varchar_
size=512;default_binary_size=512'/>
</customizations>
</connection-customization>
```

Enable CAP_ODBC_FETCH_BUFFERS_RESIZABLE

This is enabled by default starting in Tableau 2024.3. Before that, you may use a TDC. You would use a TDC like the one below if you wanted to configure the default_varchar_size in

the UI or on the database, rather than using the TDC.

```
<connection-customization class='snowflake' enabled='true' version='10.0'>
<vendor name='snowflake' />
<driver name='snowflake' />
<customizations>
<customization name='CAP_ODBC_FETCH_BUFFERS_RESIZABLE' value='yes' />
</customizations>
</connection-customization>
```

Frequently asked questions

Here's some common problems and steps to resolution.

I have an error "This Field XXX Does Not Exist" what do I do?

This error appears when you're using a calculation field, adding it to the worksheet, and replacing the data source with the Snowflake data (CustomSQL).

Use the **Replace Field References** function to resolve the error. For additional information on replacing field references, see [Replace Field References](#).

- [Best Practices for Using Tableau with Snowflake](#) on the Snowflake website (registration required).

See also

- [Set Up Data Sources on page 596](#) – Add more data to this data source or prepare your data before you analyze it.
- [Build Charts and Analyze Data on page 1005](#) – Begin your data analysis.

Configure OAuth for Snowflake Connections

When you connect to your Snowflake data, you have three authentication options to choose from.

OAuth: You can use [OAuth](#) to enable federation from an IDP.

Okta Username and Password: You can embed the IDP credentials in the connection (only for Okta).

Username and Password: User credentials are stored in Snowflake.

Usually, we recommend using OAuth. This option offers the best combination of functionality and security.

With OAuth, you can:

- Use an identity provider (IdP) to facilitate access.
- Configure it to provide a single sign-on (SSO) experience.
- Enforce multi-factor authentication (MFA).

OAuth 2.0 is an industry-standard protocol for authorization.

Note: Be careful not to confuse this with Tableau's **SAML IdP** authentication option in the connection dialog. You should connect using the **Sign-in using OAuth** option.

When you use OAuth, a key consideration is keeping access for content published to Tableau Server or Tableau Cloud. When Tableau content connects live to Snowflake via OAuth, owners must reauthenticate the workbook connection each time the access token expires (every 90 days by default).

See the Snowflake help topic, [Configure Snowflake OAuth for Partner Applications](#), for details on setting the access token expiration limit. If you have a business need to extend this period to prevent errors on your Tableau content, contact [Snowflake Support](#) for assistance. If you don't manually refresh your content before this time period, it can cause an error when the Tableau workbook tries to load.

Configure OAuth between Snowflake and Tableau

When creating a connection between Tableau and Snowflake, both must have OAuth configured.

- **Tableau:** Tableau includes credentials for Snowflake to allow access. This happens automatically when you use the Snowflake connector in Tableau Cloud and Tableau Desktop, as well as Tableau Server versions 2023.3 and older, so no additional OAuth configuration is required. For more information on configuring Tableau Server in version 2024.2 and beyond, see [Configure Oauth for Snowflake Connections](#) in Tableau Help.
- **Snowflake:**
 - For Tableau Desktop and Tableau Cloud, as well as Tableau Server versions 2023.3 and older, you'll [configure partner integrations for Snowflake](#).
 - For Tableau Server versions 2024.2 and beyond, you'll need to [configure a custom client integration for Snowflake OAuth](#).
- For Tableau versions 2024.3 and beyond, you can configure a 3rd party IdP (external OAuth) for Snowflake. For more information, see [External OAuth for Snowflake on page 484](#).

Note: Beginning with Tableau Server version 2020.4, your OAuth connection can use AWS PrivateLink or Azure Private Link. For more information, see [Configure OAuth for Snowflake Connections](#).

About using SSO with OAuth

Single Sign-On (SSO) adds another layer of security on top of OAuth authentication. A separate IdP configured for SSO manages authentication for all access activity across applications for your organization. All sign-in requests are routed to the SSO server, which displays a common sign-in dialog and checks the user's credentials against a centralized database.

Tip: You can use saved credentials to avoid getting reprompted for your password. For more information, see [Manage Saved Credentials for Data Connections](#).

Configure OAuth between Okta and Snowflake

Snowflake uses Okta as the default identity provider (IdP) that provides access tokens and authenticates identities. You'll need to configure settings in Snowflake and Okta for OAuth and single sign-on (SSO) capabilities.

In Okta, you'll define Okta as an OAuth authentication server and identify Snowflake as an OAuth resource. Follow the steps in this Snowflake help topic: [Configuring an Identity Provider for Snowflake](#).

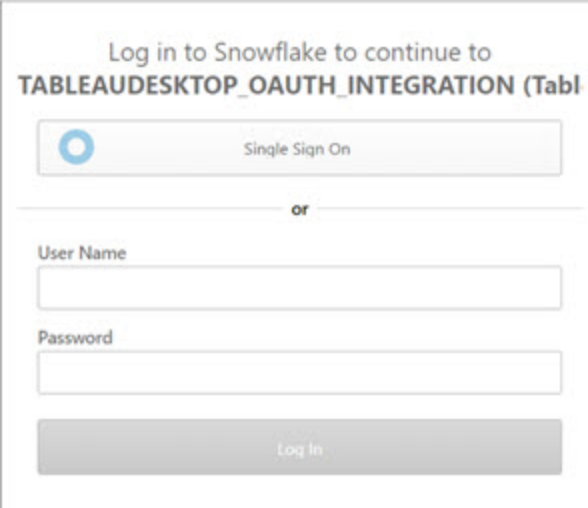

The screenshot shows a login interface for Tableau Desktop OAuth integration with Snowflake. At the top, it says "Log in to Snowflake to continue to TABLEAUDESKTOP_OAUTH_INTEGRATION (Tabl". Below this is a "Single Sign On" button with a blue circular icon. A horizontal line with the word "or" in the center separates this from the standard login fields. There are two input fields: "User Name" and "Password". At the bottom is a "Log In" button.

About using MFA with OAuth

Multi-factor authentication (MFA) introduces yet another layer of security. It needs two or more different methods of identification before the user can access a resource. Methods might include:

- A password
- A token from a second device
- Biometrics (fingerprint or eye scan, for example)
- Answer to a security question

You can optionally set up multi-factor authentication (MFA) with Okta or an other IdP for your connections between Tableau and Snowflake. For more on configuring MFA with Okta, see [Okta Help](#).

Other connection options

When you connect to Snowflake from Tableau Desktop, you have two other options:

- SAML IdP
- Username and Password

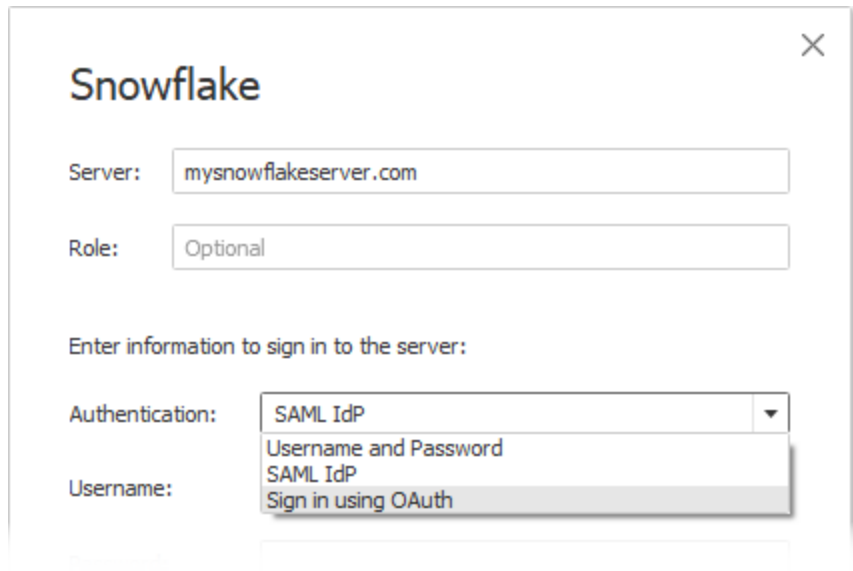

The **SAML IdP** option works only if Okta is your identity provider and if MFA is disabled for users in Okta. The **SAML IdP** option supports SSO but doesn't support MFA. In this case, publishing with embedded credentials will use a specific user, but you can't employ per-user "viewer credentials" when you use Okta SAML.

Note: In the past, some customers have used the "external browser" option with SAML IdP as a workaround to achieve SSO between Tableau Desktop and Snowflake. It won't work for Tableau Server. We recommend that you use the OAuth connection instead.

The **Username and Password** option uses the password stored by Snowflake. This option requires users to reauthenticate with their credentials whenever they connect to Snowflake or to embed these credentials.

Frequently asked questions

Why do my published Snowflake data extracts fail after a period of time?

It may be that your OAuth access token has expired. You'll need to manually reauthenticate to the data source to refresh the token. If you need to extend the lifetime of these tokens in the future, you can contact [Snowflake Support](#).

How do I choose between "Prompt User" and "Embed Credentials" options when publishing a Snowflake data source?

If you would like any user accessing the data source to use their own credentials when connecting to the data source and associated content, use the **Prompt User** option. You can choose to embed credentials so everyone who accesses that data source uses those specific credentials. This method is functionally similar to using a "service account".

How do I use the row-level security that I've set up on Snowflake?

When users are prompted to enter their own credentials to access Snowflake from Tableau, those credentials map to the privileges they have in the Snowflake account.

See also

- [OAuth Connections](#) — Learn more about OAuth support with Tableau.
- [OAuth \(Snowflake Help\)](#) — Learn about Snowflake with OAuth.
- [Summary of Security Features \(Snowflake Help\)](#) — Find information about how Snowflake supports OAuth, SSO, and other security features.
- [Manage Your Account Settings](#) — Read about how to create and revoke personal access tokens.

External OAuth for Snowflake

Starting in Tableau 2024.3, you can use OAuth 2.0/OIDC to federate identity from an external identity provider to Snowflake.

Depending on the identity provider, there are different steps needed to configure the integration. This is a high-level overview intended to guide your configuration without providing the necessary details you'll find in your identity provider documentation. It is assumed you are familiar with configuring OAuth and understand the technical details required in setting up authentication with an external identity provider.

Configure IDP on Snowflake

For information on configuring your IDP, see [External OAuth overview](#) in Snowflake's help system.

Configure the IDP on Tableau

1. Create OAuth clients on the IDP for Tableau Desktop, and on Tableau Cloud or Tableau Server. The Desktop client enables **PKCE** and uses `http://localhost` redirects.
2. Create the Tableau OAuth config file. For details on how to do this, see [OAuth Configuration and Usage](#) on [github](#), and examples [here](#). We welcome additional examples for

other IDPs.

- A. Be sure to prefix the Tableau OAuth config IDs with “custom_”.
 - B. If your IDP supports dynamic localhost port, disable `OAuth_CAP_FIXED_PORT_IN_CALLBACK_URL`. If your IDP does not support this, make sure to add several localhost callback URLs to the allowlist in the config file and on the IDP.
3. Install the new Tableau OAuth configuration files in the OAuthConfigs folder associated with each application on desktop hosts (Tableau Desktop, Tableau Prep Builder, Tableau Bridge), and on each Tableau Server and Tableau Cloud site that will be using OAuth via site settings page. For more details, see [Custom OAuth Configs on Desktop](#) and [Site Level OAuth Clients](#).

Connect to Snowflake

When connecting, you must select OAuth and choose the OAuth configuration installed earlier.

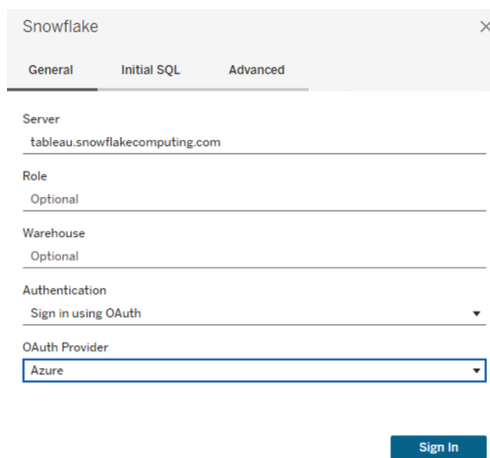

Okta

If using Okta it's better to use a “custom authorization server” rather than the “org authorization server.” The custom authorization servers are more flexible. There's a custom authorization server created by default, which is called “default”. The authorization URL should look like this:

```
https://{yourOktaDomain}/oauth2/{authServerName}/v1/authorize
```

Summary	
Provider dev-████████.okta.com/oauth2/default	Provider Type OpenID Connect
Audiences (1) Actions ▾ <small>Also known as client ID, audience is a value that identifies the application that is registered with an OpenID Connect provider.</small>	
< 1 >	
Audience	
○ ██████████	

Configure Snowflake for Key-pair Authentication

Note: Key-pair authentication is not available in Tableau Server until version 2025.1.

To publish workbooks using Snowflake data sources protected with Key-pair authentication from Tableau Desktop to a Tableau Cloud site, you must also configure Tableau Cloud to support those credentials. This involves adding your new or updated authentication details for Snowflake Key-pair authentication to the Saved Credentials section of your Account Settings.

Note: You need to use OpenSSL version 3.x or newer to create the keys for this authentication.

Note: Each instance of Tableau Desktop that uses Snowflake data protected by Key-pair authentication will require the user to provide the key file as part of connecting to data. For more information, see [Snowflake](#).

Note: Publishing workbooks with Snowflake key-pair authentication is not supported in web authoring. You must use Tableau Desktop to create the workbooks, which can then be published to Tableau Cloud.

Add Key-pair Authentication Details

1. Sign in to Tableau Cloud and navigate to your **My Account Settings** page.
2. Locate **Saved Credentials for Data Sources** in the **Security** section.
3. Next to **Snowflake**, click **Add**.

4. In the **Add a New Saved Credential** window, select **Key-pair Authentication**, and then click **Add**.
5. In the **Add Key-pair Authentication Credential** window, enter your Snowflake server, the optional Role, and the Username associated with these credentials.
6. For **Private Key File**, click Choose a file and select the .p8 file that contains your private key.
7. (Optional) If the key has a password or passphrase associated with it, enter it in the **Password** field, and then click **Add**.

You are now ready to share workbooks protected by Key-pair authentication from Tableau Desktop to Tableau Cloud.

See also

- [Snowflake](#) - Learn how to set up a connection to Snowflake to retrieve and analyze data.

Spark SQL

This article describes how to connect Tableau to a Spark SQL database and set up the data source. Tableau can connect to Spark version 1.2.1 and later.

You can use the Spark SQL connector to connect to a Spark cluster on Azure HDInsight, Azure Data Lake, Databricks, or Apache Spark.

Before you begin

Before you begin, gather this connection information:

- Name of the server that hosts the database you want to connect to and port number
- Authentication method:
 - No Authentication
 - Kerberos
 - User Name
 - User Name and Password
 - Microsoft Azure HDInsight Service
- Transport. Your choices depend on the authentication method you choose, and include the following:
 - Binary
 - SASL
 - HTTP
- Sign-in credentials. Your choices depend on the authentication method you choose, and can include the following:

- User name
- Password
- Realm
- Host FQDN
- Service Name
- HTTP Path
- Are you connecting to an SSL server?
- (Optional) Initial SQL statement to run every time Tableau connects

Driver required

This connector requires a driver to talk to the database. If the driver is not installed on your computer, Tableau displays a message in the connection dialog box with a link to the [Driver Download](#) page where you can find driver links and installation instructions.

Make the connection and set up the data source

1. Start Tableau and under **Connect**, select **Spark SQL**. For a complete list of data connections, select **More** under **To a Server**. Then do the following:
 - a. Enter the name of the server that hosts the database and the port number to use.
 - b. Connect to the database using SparkThriftServer. Note that the legacy SharkServer and SharkServer2 connections are provided for your use, but are not supported by Tableau.
 - c. Select the **Authentication** method. Then, based on your selection, enter the information you are prompted for.
 - d. Select **Sign In**.
 - If the server is password protected, and you are not in a Kerberos environment, you must enter the user name and password.
 - Select the **Require SSL** check box when connecting to an SSL server.
 - (Optional) Select **Initial SQL** to specify a SQL command to run at the beginning of every connection, such as when you open the workbook, refresh an extract, sign in to Tableau Server, or publish to Tableau Server. For more information, see [Run Initial SQL](#).

If Tableau can't make the connection, verify that your credentials are correct. If you still can't connect, your computer is having trouble locating the server. Contact your network administrator or database administrator.

2. On the data source page, do the following:

- a. (Optional) Select the default data source name at the top of the page, and then enter a unique data source name for use in Tableau. For example, use a data source naming convention that helps other users of the data source figure out which data source to connect to.
- b. From the **Schema** drop-down list, select the search icon or enter the schema name in the text box and select the search icon, and then select the schema.
- c. In the **Table** text box, select the search icon or enter the table name and select the search icon, drag the table to the canvas, and then select the sheet tab to start your analysis.

Use custom SQL to connect to a specific query rather than the entire data source. For more information, see [Connect to a Custom SQL Query on page 863](#).

Note: Starting in 2018.3, Kerberos authentication for Spark SQL supports delegation. In 2018.2 and earlier, delegation isn't supported, which means that in earlier versions you can't use **Viewer credentials** as the **Authentication** method when you publish a workbook or data source to Tableau Server; you can only use **Server Run As account**.

Sign in on a Mac

If you use Tableau Desktop on a Mac, when you enter the server name to connect, use a fully qualified domain name, such as mydb.test.ourdomain.lan, instead of a relative domain name, such as mydb or mydb.test.

Alternatively, you can add the domain to the list of Search Domains for the Mac computer so that when you connect, you need to provide only the server name. To update the list of Search Domains, go to **System Preferences > Network > Advanced**, and then open the **DNS** tab.

See also

- [Set Up Data Sources on page 596](#) – Add more data to this data source or prepare your data before you analyze it.
- [Build Charts and Analyze Data on page 1005](#) – Begin your data analysis.
- [Databricks and Tableau](#) - Read the Tableau user guide on the Databricks website.

Teradata

This topic describes how to connect Tableau to a Teradata database or a Teradata Unity server and set up the data source.

Before you begin

Before you begin, gather this connection information:

- For Teradata database: Name of the server you want to connect to
- For Teradata Unity server: URL of the server you want to connect to
- Authentication method: Teradata Database, LDAP, or Integrated Authentication
- Depending on the environment, the user name and password
- Do you need an encrypted connection?
- (Optional) Query banding and initial SQL statement to run every time Tableau connects

Driver required

This connector requires a driver to talk to the database. If the driver is not installed on your computer, Tableau displays a message in the connection dialog box with a link to the [Driver Download](#) page where you can find driver links and installation instructions.

Make the connection and set up the data source

1. Start Tableau and under **Connect**, select **Teradata**. For a complete list of data connections, select **More** under **To a Server**. Then do the following:
 - a. Enter the name of the server that hosts the database you want to connect to.
Note: You can connect to a Teradata Unity server by entering the appropriate URL in the **Server** text box.
 - b. Select how you want to sign in to the server. Specify whether to use the built-in **Teradata Database** authentication, **LDAP**, or **Integrated Authentication**.
If the server is password protected, and you are not in a Kerberos environment, you must select **Teradata Database** or **LDAP** and enter the user name and password.
 - c. Select the **Require Encryption** check box if you need an encrypted connection.
 - d. (Optional) Select **Query Banding and Initial SQL**.
 - e. Select **Sign In**.

If Tableau can't make the connection, verify that your credentials are correct. If you still can't connect, your computer is having trouble locating the server. Contact your network administrator or database administrator.

2. On the data source page, do the following:
 - a. (Optional) Select the default data source name at the top of the page, and then enter a unique data source name for use in Tableau. For example, use a data source naming convention that helps other users of the data source figure out which data source to connect to.
 - b. From the **Database** drop-down list, select the search icon or enter the schema name in the text box and select the search icon, and then select the database.
 - c. In the **Table** text box, select the search icon or enter the table name and select the search icon, and then select the table.

You can also specify a stored procedure in the database. For more information and for a list of constraints specific to Teradata databases, see [Use a Stored Procedure on page 878](#).

- d. Drag the table or stored procedure to the canvas, and then select the sheet tab to start your analysis.

Use custom SQL to connect to a specific query rather than the entire data source. For more information, see [Connect to a Custom SQL Query on page 863](#).

Sign in on a Mac

If you use Tableau Desktop on a Mac, when you enter the server name to connect, use a fully qualified domain name, such as mydb.test.ourdomain.lan, instead of a relative domain name, such as mydb or mydb.test.

Alternatively, you can add the domain to the list of Search Domains for the Mac computer so that when you connect, you need to provide only the server name. To update the list of Search Domains, go to **System Preferences > Network > Advanced**, and then open the **DNS** tab.

Use query bands to increase performance

When you connect to a Teradata database, you can optionally define query band statements that run during connection. These statements can increase performance, and they take advantage of the built-in security rules of the database.

Using query bands, you can pass parameters into the Teradata environment. Use these to set up a workbook to filter the data based on security rules that exist in the database. For example, you can pass in the Tableau Server user name for the current user so that when the view is loaded it only shows the data specific to that user. Query bands can also be used to improve performance.

When connecting to Teradata, you can define a map between the name of the attributes passed into the query band and the corresponding values from Tableau.

Note: This functionality is not currently supported for web authoring.

To set up query banding:

1. On the data source page, select **Data > Query Banding and Initial SQL**.
2. In the subsequent dialog box, specify name/value pairs in the top text box labeled Query Banding. You can use the **Insert** drop-down menu to add Tableau values. The Tableau values are described in the table below.

Value	Description	Example
<TableauMode>	The mode Tableau is operating in when generating queries. This value will either be "Connect" when retrieving metadata or "Analytical" when retrieving actual data.	Connect or Analytical
<LoginUser>	The user name of the person signed in to the database.	jsmith
<ServerUser>	The signed-in Server user. Does not include domain name. Note: ProxyUser returns the same value as ServerUser. However, ProxyUser sets up impersonation and stores the Tableau Server user in the query band parameter. If you are using query banding for security purposes, you should use ProxyUser instead. This will ensure that query results are not shared between different users. ServerUser	jsmith

Value	Description	Example
	<p>should only be used for auditing purposes.</p>	
<ServerUserFull>	<p>The signed-in server user including the domain name (if the server is using Active Directory).</p> <p>Note: <code>ProxyUserFull</code> returns the same value as <code>ServerUserFull</code>. However, <code>ProxyUserFull</code> sets up impersonation and stores the Tableau Server user in the query band parameter. If you are using query banding for security purposes, you should use <code>ProxyUserFull</code> instead. This will ensure that query results are not shared between different users. <code>ServerUserFull</code> should only be used for auditing purposes.</p>	domain.lan\jsmith
<ProxyUser>	Used when setting up impersonation on the server. Provides the username of the current server user.	jsmith
<ProxyUserFull>	Used when setting up impersonation on the server. Provides the username and domain name of the current server user.	domain.lan\jsmith
<TableauApp>	The name of the Tableau application.	Tableau Desktop Pro-

Value	Description	Example
		Professional or Tableau Server
<TableauVersion>	The version of the Tableau application	6100.11.0428.0300
<WorkbookName>	The name of the workbook. Note that this only works for data sources embedded in the workbook.	Financial-Analysis

An example query band statement is shown below. This example passes the user name for the current server user.

```

Applic-
ationName-
=<Tablea-
uAp-
p>Ver-
sion=<TableauVersion>ProxyUser=<ProxyUser>TableauMode=<TableauMode>

```

Tableau checks the statement for errors as you type. When it is valid a green check mark displays at the bottom of the text box.

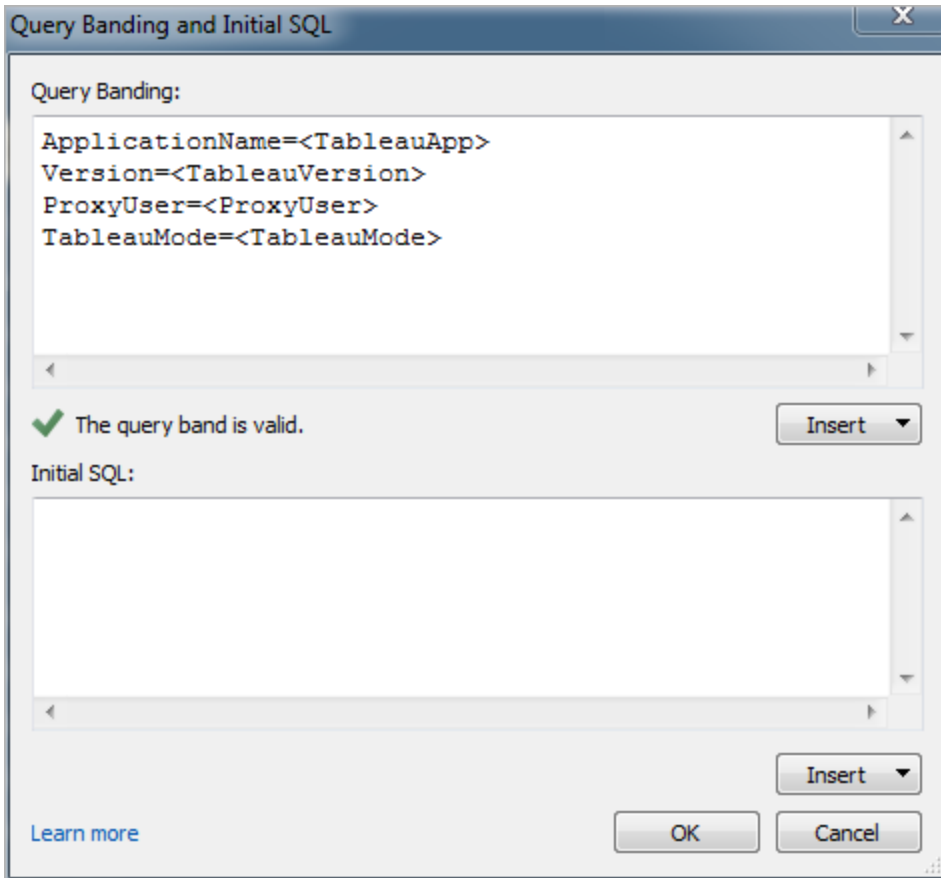

Use initial SQL commands

When you connect to a Teradata database, you can optionally specify a SQL command that will be run once upon connection. See [Run Initial SQL on page 591](#) to learn more about adding these commands to your connection.

Note: If Tableau detects that the Initial SQL payload cannot be delivered in one query, it attempts to split the query into separate statements, where each statement must end with a semicolon followed by a newline character, with no additional characters (such as an extra space) in between. This requirement is important because if a semicolon exists within the interior of a statement, for example within a string literal, it may not be safe to split the statement at that point. If the Initial SQL code that you specify in Tableau returns an error, and the same Initial SQL is deemed valid by the Teradata databases, it may be that Tableau has split the query incorrectly. If this happens, try reformatting the SQL code in Tableau manually.

See also

- [Set Up Data Sources on page 596](#) – Add more data to this data source or prepare your data before you analyze it.
- [Build Charts and Analyze Data on page 1005](#) – Begin your data analysis.

Teradata OLAP Connector

This article describes how to establish a Teradata OLAP connection.

Before you begin

Before you begin, gather this connection information:

- Connection name
- User name and password

Use this connector with Tableau Desktop on a Windows computer.

When you connect to Teradata OLAP data, you select from a list of connections, each representing a system data source name (DSN). A connection appears in the drop-down list if a system DSN exists for that connection. You can use the Windows ODBC Data Source Administrator utility to create a system DSN, or contact your database administrator.

Driver required

This connector requires a driver to talk to the database. If the driver is not installed on your computer, Tableau displays a message in the connection dialog box with a link to the [Driver Download](#) page where you can find driver links and installation instructions.

Make the connection and set up the data source

1. Start Tableau and under **Connect**, select **Teradata OLAP Connector**. For a complete list of data connections, select **More** under **To a Server**. Then do the following:

- a. Select a connection from the drop-down list.
- b. Enter your user name and password to log on to the server.

If Tableau can't make the connection, verify that your credentials are correct. If you still can't connect, your computer is having trouble locating the server. Contact your network administrator or database administrator.

- c. Select **Sign In**.

2. On the data source page, do the following:
 - a. (Optional) Select the default data source name at the top of the page, and then enter a unique data source name for use in Tableau. For example, use a data source naming convention that helps other users of the data source figure out which data source to connect to.
 - b. Search for or select a catalog.
 - c. Search for or select a cube from the catalog.
 - d. Select the sheet tab to start your analysis.

Work with Teradata OLAP data

Named sets from a Teradata OLAP data source are displayed in the **Sets** area of the **Data** pane in Tableau. You can interact with these named sets in the same way you interact with other custom sets in Tableau. For more information, see [Create Sets on page 1092](#). You can view underlying data for Teradata OLAP data sources, provided the database administrator has enabled this functionality. For more information, see [View Underlying Data on page 2001](#).

See also

- [Set Up Data Sources on page 596](#) – Add more data to this data source or prepare your data before you analyze it.
- [Build Charts and Analyze Data on page 1005](#) – Begin your data analysis.

TIBCO Data Virtualization

This article describes how to connect Tableau to a TIBCO Data Virtualization (formerly called Cisco Information Server) virtual database and set up the data source.

Before you begin

Before you begin, gather this connection information:

- Name of the server that hosts the data you want to connect to
- (Optional) Domain name
- Datasource name
- Authentication method: Windows Authentication, Kerberos, or user name and password

- Are you connecting to an SSL server?
- (Optional) Initial SQL statement to run every time Tableau connects

Use this connector with Tableau Desktop on a Windows computer.

Driver required

This connector requires a driver to talk to the database. If the driver is not installed on your computer, Tableau displays a message in the connection dialog box with a link to the [Driver Download](#) page where you can find driver links and installation instructions.

Make the connection and set up the data source

1. Start Tableau and under **Connect**, select **TIBCO Data Virtualization**. For a complete list of data connections, select **More** under **To a Server**. Then do the following:
 - a. Enter the name of the server that hosts the data you want to connect to.
 - b. (Optional) Enter the name of the domain.
 - c. Enter the name of the **Datasource** you want to connect to.
 - d. Select how you want to sign in to the server. Specify whether to use Windows Authentication, Kerberos, or a user name and password.

Select the **Require SSL** check box when connecting to an SSL server.
 - e. (Optional) Select **Initial SQL** to specify a SQL command to run at the beginning of every connection, such as when you open the workbook, refresh an extract, sign in to Tableau Server, or publish to Tableau Server. For more information, see [Run Initial SQL on page 591](#).
 - f. Select **Sign In**.

If Tableau can't make the connection, verify that your credentials are correct. If you still can't connect, your computer is having trouble locating the server. Contact your network administrator or database administrator.

2. On the data source page, do the following:
 - a. (Optional) Select the default data source name at the top of the page, and then enter a unique data source name for use in Tableau. For example, use a data source naming convention that helps other users of the data source figure out which data source to connect to.

- b. From the **Catalog** drop-down list, enter the catalog name in the text box, or select the catalog from the list.
- c. From the **Schema** drop-down list, enter the schema name in the text box, or select the schema from the list.
- d. Under **Table**, enter the table name in the text box, or select the table from the list.
- e. Drag the table to the canvas, and then select the sheet tab to start your analysis.

Use custom SQL to connect to a specific query rather than the entire data source. For more information, see [Connect to a Custom SQL Query on page 863](#).

See also

- [Set Up Data Sources on page 596](#) – Add more data to this data source or prepare your data before you analyze it.
- [Build Charts and Analyze Data on page 1005](#) – Begin your data analysis.

Vertica

This article describes how to connect Tableau to a Vertica database and set up the data source.

Before you begin

Before you begin, gather this connection information:

- Name of the server that hosts the database you want to connect to
- Database name
- User name and password
- (Optional) Initial SQL statement to run every time Tableau connects

Driver required

This connector requires a driver to talk to the database. If the driver is not installed on your computer, Tableau displays a message in the connection dialog box with a link to the [Driver Download](#) page where you can find driver links and installation instructions.

Make the connection and set up the data source

1. Start Tableau and under **Connect**, select **Vertica**. For a complete list of data connections, select **More** under **To a Server**. Then do the following:
 - a. Enter the name of the server that hosts the database and the name of the database that you want to connect to.
 - b. Enter the user name and password.
 - c. (Optional) Select **Initial SQL** to specify a SQL command to run at the beginning of every connection, such as when you open the workbook, refresh an extract, sign in to Tableau Server, or publish to Tableau Server. For more information, see [Run Initial SQL on page 591](#).
 - d. Select **Sign In**.

If Tableau can't make the connection, verify that your credentials are correct. If you still can't connect, your computer is having trouble locating the server. Contact your network administrator or database administrator.

2. On the data source page, do the following:
 - a. (Optional) Select the default data source name at the top of the page, and then enter a unique data source name for use in Tableau. For example, use a data source naming convention that helps other users of the data source figure out which data source to connect to.
 - b. From the **Schema** drop-down list, select a schema or use the text box to search for a schema by name.
 - c. Under **Table**, select a table or use the text box to search for a table by name.
 - d. Drag the table to the canvas, and then select the sheet tab to start your analysis.

Use custom SQL to connect to a specific query rather than the entire data source. For more information, see [Connect to a Custom SQL Query on page 863](#).

Sign in on a Mac

If you use Tableau Desktop on a Mac, when you enter the server name to connect, use a fully qualified domain name, such as mydb.test.ourdomain.lan, instead of a relative domain name, such as mydb or mydb.test.

Alternatively, you can add the domain to the list of Search Domains for the Mac computer so that when you connect, you need to provide only the server name. To update the list of Search Domains, go to **System Preferences > Network > Advanced**, and then open the **DNS** tab.

See also

- [Set Up Data Sources on page 596](#) – Add more data to this data source or prepare your data before you analyze it.
- [Build Charts and Analyze Data on page 1005](#) – Begin your data analysis.

[Vertica & Tableau Solution Overview](#) - Read the Tableau whitepaper (registration or sign in required).

[Vertica Integration with Tableau: Connection Guide](#) - Read the Vertica knowledge base article on the Vertica website.

Web Data Connector 2.0

This article describes web data connectors, what to do before you use a connector, and how to connect Tableau to a web data connector.

Note: As of 2022.3 the Web Data Connector 2.0 has been replaced by Web Data Connector 3.0. For more information, please see: [Web Data Connector SDK](#)

Warning: The Web Data 2.0 connector is deprecated as of the 2023.1 release. You can use the connector until it's been retired. Once the connector is retired, it's removed from the Tableau user interface and any data sources using the connector will no longer work as expected. Typically, a deprecated connector will be retired 1–2 releases after it is deprecated.

Use a web data connector

You can use a web data connector to connect to data that is accessible over HTTP and that doesn't already have a connector. A web data connector is an HTML file that includes JavaScript code. You can create your own web data connector or use one that has been created by someone else. The web data connector must be hosted on a web server running locally on your computer, on a web server in your domain, or on a third-party web server.

Test and vet the web data connector

You should use a web data connector that you trust. If you are unfamiliar with the web data connector, you or your Tableau Server administrator should test and vet the web data connector

before you use it. For more information, see [Testing and Vetting Web Data Connectors](#) in the Tableau Server Help.

How to use a web data connector on Tableau Server and Tableau Cloud

When you use a web data connector, Tableau creates an extract of the data that the connector accesses. You can refresh the extract in Tableau Desktop.

When you publish the data source or workbook to Tableau Server, you cannot refresh the extract on Tableau Server unless the web data connector is added to the safe list on Tableau Server. If the connector requires credentials to sign in to the web-based data source, you need to ensure that the credentials are embedded with the data source. For more information, see [Web Data Connectors in Tableau Server](#) in the Tableau Server Help.

After the web data connector has been tested and vetted, the server administrator can add the URL for the connector to the safe list on the server. The server administrator should give this URL to you and to anyone else who wants to use the connector in a workbook.

If you open a workbook on Tableau Server that was created using a web data connector, but the connector has not been added to the safe list on Tableau Server, and you want to be able to refresh the extract on Tableau Server, follow the process for testing, vetting, and adding the connector to the safe list. If the connector requires credentials to sign in, you need to ensure that the credentials are embedded with the data source. You can then refresh your data on Tableau Server.

When you publish to Tableau Cloud, as a security measure, Tableau Cloud can't connect to or refresh an extract created by a web data connector. To refresh some web data connector extracts, you can use Tableau Bridge. For more information, see [When to use Tableau Bridge to keep data fresh](#) in the Tableau Cloud Help.

When you publish to Tableau Public, because you can't add a web data connector to Tableau Public, you can't refresh web data connector extracts directly on Tableau Public.

Connect to the data source

1. Start Tableau and under **Connect**, select **Web Data Connector**. For a complete list of data connections, select **More** under **To a Server**.
2. Enter the URL of the web data connector that you want to connect to, and then press Enter.

Note: If you enter a URL to a website, rather than to a web data connector, an error message will appear.

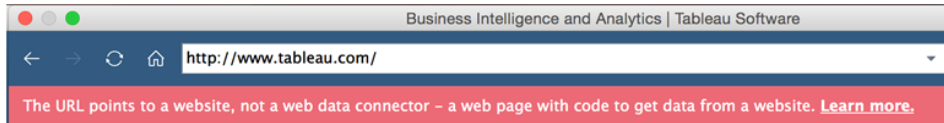

3. If the connector displays a web page, enter any information that you're prompted for, and then submit the page.
4. Wait while the connector retrieves your data and imports it into Tableau as an extract.
5. Select the sheet tab to start your analysis.

Web data connector data source example

An example of a web data connector data source is shown below. The first time you connect to a web data connector, the connection page outlines how to connect to the web data connector.

After you connect to a web data connector, on the connection page, you can do the following:

- View a history of all the web data connectors that you've connected to, or clear the history, in the drop-down list in the address bar.
- View your five most recently used connectors under Recent Connectors.
- Select links at the bottom on the window to learn more about web data connectors:
 - **What's this?** links to an overview of this feature.
 - **Use a connector** links to this topic.
 - **Build a connector** links to the [Web Data Connector SDK](#), which provides tools and documentation for building a web data connector.

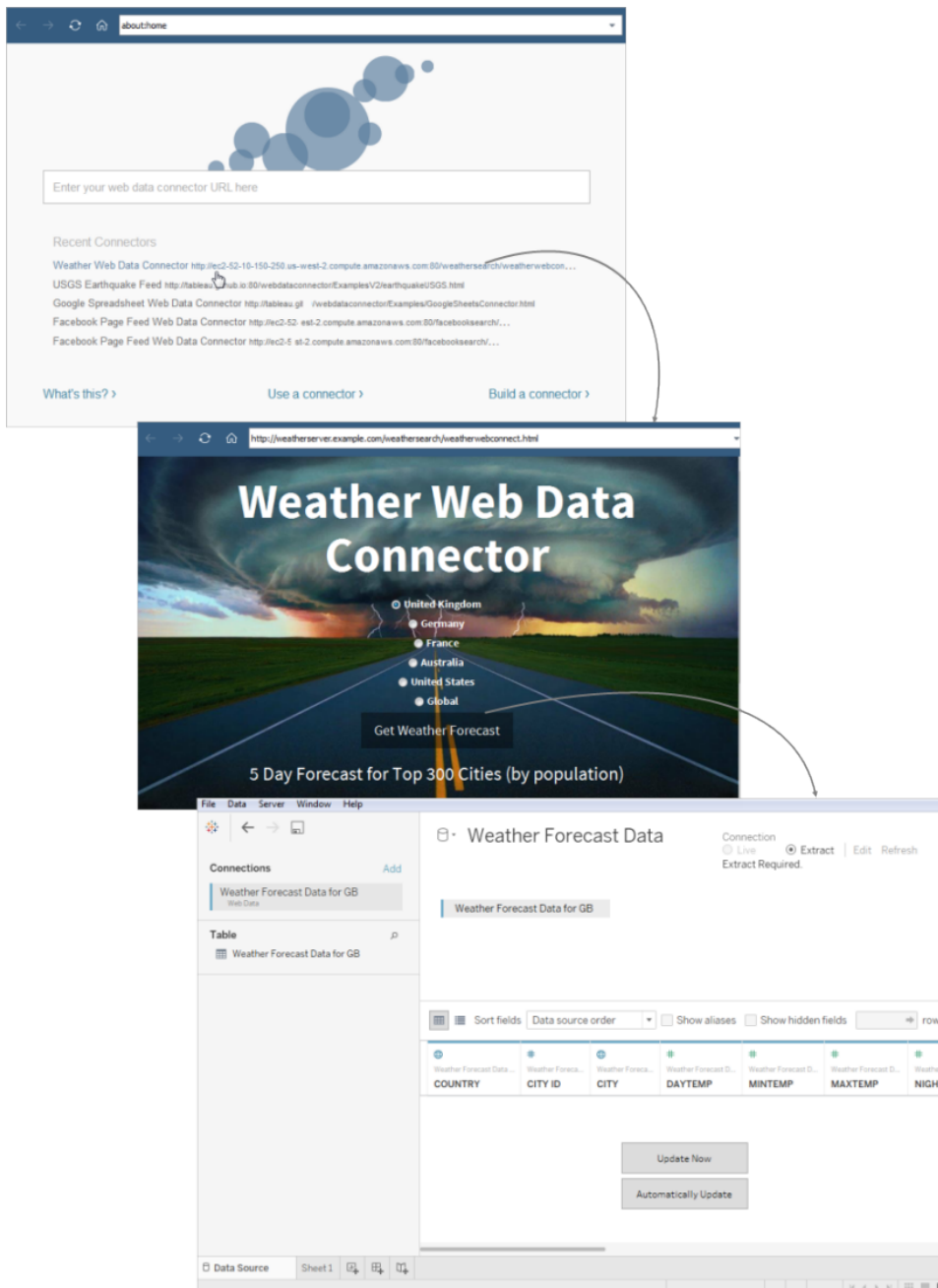

Optional settings

After you connect, you can make the following configuration changes to the data source before you start your analysis.

- **Sort fields and rows** – From the **Sort fields** drop-down list, select how you want to sort the columns in the grid or metadata grid. Sort the row values by selecting the sort button

next to the column name.

- **Rename or hide columns** – Select the column header drop-down arrow and select the option you want.
- **Split columns** – Depending on how the data is structured, you can split the columns in your data into new fields. For more information, see [Split a Field into Multiple Fields on page 905](#).
- **Create calculations** – Create a new calculation based on an existing field in the data source.
- **Copy values** – Copy values in the grid by selecting the values and then pressing Ctrl+C. Alternatively, to copy values in the metadata grid, select the values, right-click, and then select **Copy**.
- **Add new or edit other data sources** – Select the drop-down arrow next to the data source.

Tableau support for Web Data Connector

Tableau provides limited customer support for connections using the **Web Data Connector**. Tableau does not provide support for connectors or for other programs written to interface with the WDC API. However, you can submit questions and ask for help on the [Tableau developer community forums](#).

Tableau *does* provide support for the WDC library and SDK though. If you find an issue with the WDC library, the simulator, or any of the developer samples, [submit an issue on Github](#).

See also

- [Set Up Data Sources on page 596](#) – Add more data to this data source or prepare your data before you analyze it.
- [Build Charts and Analyze Data on page 1005](#) – Begin your data analysis.

Other Databases (JDBC)

When you start Tableau, under **Connect**, you can see the file and database types that are supported by Tableau Desktop. Select **More** to see the complete list. For supported files and databases, Tableau provides built-in connectors that are built for and optimized for those data sources.

Important: If your file or database type is listed under **Connect**, use that named connector to connect to your data.

If your file or database type is not listed on under **Connect**, you might be able to connect to it using the **Other Databases (JDBC)** connector. JDBC (Java Database Connectivity) is a standard way to connect to a database. If the database driver you want to connect with implements the JDBC standard, you can connect Tableau to your data using the JDBC driver for your database and the Tableau **Other Databases (JDBC)** connector.

When you use the **Other Databases (JDBC)** connector, you might notice significant performance differences between this "generic" connector and a named Tableau connector because the generic JDBC connection doesn't take advantage of the many connection-specific features used in a named connector to optimize performance.

Before you begin

Specify the right JDBC driver

JDBC drivers are self-contained .jar files. Place the .jar files in the folder for your operating system. (You need to create the folder if it doesn't already exist.)

- Windows: C:\Program Files\Tableau\Drivers
- Mac: ~/Library/Tableau/Drivers
- Linux: /opt/tableau/tableau_driver/jdbc

Note: If the driver includes only a single .jar file, simply copy it to C:\Program Files\Tableau\Drivers. If the driver includes multiple files, create a subfolder "A" under C:\Program Files\Tableau\Drivers, then copy all files to folder "A".

Also note these requirements:

- You must have read permissions on the .jar file.
- Tableau requires a JDBC 4.0 or later driver.
- Tableau requires a Type 4 JDBC driver.

Note: To prevent secrets from logging you need to enter the secrets for JDBC connectors in either the password field on the dialog or in the driver properties.

Dialect support

The **Other Databases (JDBC)** connector supports the following dialects, which are used to establish how Tableau translates the SQL queries that are sent to the database:

- MySQL
- PostgreSQL
- Generic SQL-92

Gather connection information

Gather the following connection information:

- JDBC connection string to enter in the URL field when you connect. Refer to the driver's documentation to make sure you use the correct format for your JDBC driver. Here is one example:

```
jdbc:postgresql://www.exampledatabase.com:5432/databasename
```

- `jdbc` - always use the `jdbc` prefix, or else you'll disable the sign in button.
- `postgresql` - defines the class of the JDBC driver you're using. Tableau checks for a matching driver in the Tableau driver folder. The JDBC driver has a sub-protocol associated with it, such as `postgresql` for PostgreSQL or `mysql` for MySQL.
- `www.exampledatabase.com` - the network address to your database server. You can use a host name or an IP address.
- `5432` - the port that the database is responding to at the network address specified.
- `databasename` - the name of the database or schema on your database server.
- The dialect you're using: MySQL, PostgreSQL, or SQL-92.
- Credentials for signing in to the server: user name and password.
- (Optional) JDBC properties file to customize the driver behavior. For more information, see [Customize JDBC Connections Using a Properties File](#) in Tableau Community.

Make the connection

To connect to your data using the JDBC driver, do the following:

1. Start Tableau and under **Connect**, select **Other Databases (JDBC)**. For a complete list of data connections, select **More** under **To a Server**.
2. Enter the JDBC connection string in **URL** field.
3. Select the **Dialect** from the drop-down list.
4. Enter the user name and password for signing in to the server.

5. (Optional) Browse to the JDBC properties file. When you use a properties file, it overrides class-level properties.
6. Select **Sign in**.

Important: When you use **Other Databases (JDBC)** to connect to a database, the outcome may vary and compatibility with Tableau Desktop features is not guaranteed.

If your connection works as you need it to, you can begin your analysis. If, however, you need to customize your JDBC connection to improve functionality and performance, refer to the articles under [See also on the facing page](#).

Configure for publishing and cross-platform portability

When you work with a generic JDBC connection, additional configuration is required to make sure that the workbooks and data sources you create can be used on different computers and platforms.

For publishing and for cross-platform portability, the driver must be installed to match the workbook or data source connection.

As an example, Ashley Garcia creates an **Other Databases (JDBC)** data source that connects using the associated JDBC driver installed on her Windows computer.

Ashley can do a couple of things with this data source to make it available for others to use.

- She can publish it to Tableau Server. When she does this, Ashley needs to ask the Tableau Server administrator to install the associated JDBC driver on the Tableau Server computer so that the data source can be accessed by Ashley and by others.
- She can email the data source to coworkers. Ashley needs to tell the coworkers to install the associated JDBC driver on their computers so that they can open the data source in Tableau Desktop.

When you try to open a workbook or data source created using the **Other Databases (JDBC)** connector and you don't have the JDBC driver installed, you'll see an error that includes the message `No suitable driver`. To resolve this error, contact the workbook or data source publisher or the Tableau Server administrator to get the JDBC driver that matches the workbook or data source. Then install the driver on your computer.

Review your data

Tableau probably hasn't tested the database your connecting to using the **Other Databases (JDBC)** connector, so it's important that you take some time to review your data to ensure that it

reflects what you expect.

To check the metadata, review the data tab and the data grid on the data source page to ensure that you see the right tables and columns, and that the data types are correct.

Change your database

When you connect to data using **Other Databases (JDBC)**, you specify the database that you are connecting to in the JDBC connection string in the **URL** field. After you connect, if you want to change to another database, you need to edit the connection string or add a new connection with the new string. Otherwise you will receive an error and see results like the following examples:

Tableau Desktop

Tableau Prep Builder



Tableau support for Other Databases (JDBC) connections

Tableau provides limited customer support for connections using **Other Databases (JDBC)**. For example, Support will help you if your connection works in Tableau Desktop, but doesn't work in Tableau Server. However, Tableau does not support creating or debugging JDBC properties files. For help, you can review the documentation listed under [See also below](#), and you can submit questions and ask for help on the [Tableau Developer Community forums](#).

See also

[Tableau and JDBC](#) – Provides tips for improving performance and solving common problems.

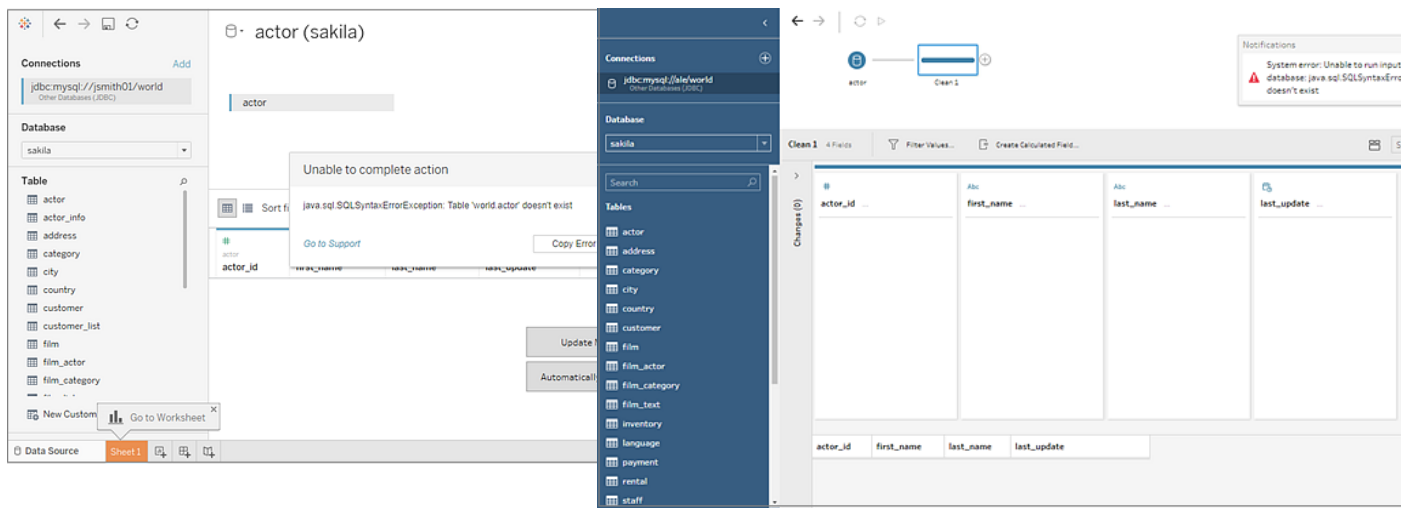
[Customize JDBC Connections Using a Properties File](#) in Tableau Community

Customizing JDBC Connections in Tableau Knowledge Base

Tableau and JDBC

Tableau supports JDBC (Java Database Connectivity) drivers for several connectors. This includes both official named connectors, such as Athena, and generic connector for use with other JDBC-based drivers, called **Other Databases (JDBC)**.

JDBC requires Java, which makes it platform-independent. Starting with version 2020.2, all Tableau applications are bundled with the Java Runtime, so you don't have to install it separately.

Note: If you're using a version of Tableau Desktop before 2020.2, see the [Driver Downloads](#) page for instructions on installing Java.

Tune JDBC connector performance

Tableau supports the ability to customize your JDBC data connection, which can improve the connection experience. For more information, see [Customize and Tune Connections](#).

Tableau support for JDBC connections

Tableau provides no guarantee or warranty that using the **Other Databases (JDBC)** connector with any particular JDBC driver or database will be able to successfully connect and query data. Some JDBC drivers will support the full Tableau interactive experience, while others may work only for creating extracts. Some JDBC drivers might not work with Tableau.

Note: Tableau will provide reasonable levels of customer support to assist in troubleshooting connections with JDBC drivers, but can't create or customize a connector to work with a specific JDBC driver.

Frequently asked questions

Here's a list of some common problems and steps to resolution.

I'm seeing a "Missing Java" message. What now?

This sometimes happens if you're using a version of Tableau before 2020.2 or using Kerberos on Windows. See the [Driver Downloads](#) page for instructions on installing the correct version of Java for your connector.

Starting with version 2020.2, all Tableau applications are bundled with the Java Runtime, so you won't have this error.

I'm seeing a "Missing Driver" message. What should I do?

Install the driver, and any libraries it depends on, in one of the following paths:

- Windows: C:\Program Files\Tableau\Drivers
- Mac: /Library/JDBC or ~/Library/JDBC
- Linux: /opt/tableau/tableau_driver/jdbc

Ensure that the driver is readable by the user running Tableau, or the Tableau service user.

I have multiple JDBC drivers installed for Tableau, but I'm having trouble connecting. What should I do?

If you have multiple JDBC drivers installed for Tableau, they may use different version of the same third-party library. This may cause problems in unpredictable ways. If you have strange errors while connecting, and you have multiple JDBC drivers installed in the JDBC drivers folder, then you can use the following steps to isolate them.

Suppose you have these libraries installed in the JDBC folder:

- athena-driver.jar
- athena-dependency.jar
- athena-dependency.so
- postgres-driver.jar

To isolate the Athena driver from the Postgres driver, install them in separate subdirectories:

- Athena/athena-driver.jar
- Athena/athena-dependency.jar
- Athena/athena-dependency.dll
- Postgres/postgres-driver.jar

After you've moved the drivers, restart Tableau.

I'm seeing a "ClassNotFoundException" (or similar) message. What should I do?

If you're running a JDBC driver that isn't Java 11 compatible, you may experience problems running Tableau.

If you think your issues might be caused by Java 11:

1. Download Java 64-bit JRE (Java Runtime Environment) or JDK (Java Development Kit) from AdoptOpenJDK:

- a. Go to <https://adoptopenjdk.net/releases.html>.
 - b. Select **OpenJDK 11**, and select **Hotspot**.
 - c. Select **Other Platforms** to view a full list of options.
 - d. Download the JRE or JDK for your operating system.
2. On the computer running Tableau, set an environment variable like one of the following:

```
TABLEAU_JAVA_HOME=C:\Program Files\AdoptOpenJDK\jre-8.0.232.09-hotspot
```

or

```
TABLEAU_JAVA_HOME=C:\Program Files\AdoptOpenJDK\jdk-8.0.252.09-hotspot
```

How do I resolve proxy problems?

Starting with version 2019.4, when Tableau runs on Windows, it reads proxy settings by enabling the `useSystemProxies` option for [Java](#).

In some cases, this can cause problems. For example, if you select “Use the same proxy server for all protocols,” the Java Virtual Machine tries to use a SOCKS proxy.

To find instructions for resolving this issue, see the Tableau Knowledge Base article called [Tableau Fails To Connect to Amazon Athena through Proxy With Error Code 37CE01A3](#). This article refers to Athena specifically, but this can apply to any JDBC connector.

I'm having trouble connecting to a server with SSL. What can I try?

If you see an error message like “Couldn't find SSL verification path,” you may need to configure a certificate or private keys.

See [One-Way SSL for JDBC Connections](#) for instructions on using a certificate. If you're using an Oracle JDBC driver, see [Oracle JDBC Connections with SSL](#) for information on using the appropriate certificates and/or key to connect.

Using Other Database (JDBC) connector with a Postgres JDBC driver, attempts to create extracts sometimes fail. What can I try?

You may run into errors if the Postgres driver fetch size isn't set and if auto-commit is enabled. The driver will attempt to handle too much data at a time, and won't be able to.

Try the following:

1. Set the fetch size for your data using `defaultRowFetchSize`.
See the [JDBC Driver](#) page on the PostgreSQL site for details.
2. Disable auto-commit by creating (or editing an existing) TDC file. Include the following in the TDC file:

```
<?xml version='1.0' encoding='utf-8' ?>
<connection-customization class="genericjdbc" enabled="true"
version="10">
<vendor name="genericjdbc"/>
<driver name="postgresql"/>
<customizations>
<customization name="CAP_JDBC_QUERY_DISABLE_AUTO_COMMIT"
value="yes"/>
</customizations>
</connection-customization>
```

Note: While this step is required when you use the Other Database (JDBC) connector, for named Tableau connector it isn't because auto-commit is already set by default.

For more information on using a TDC file for JDBC connections, see [Customize and Tune Connections](#).

See also

[Other Databases \(JDBC\)](#) – Describes how to connect to your data using the generic JDBC connector.

[Customize and Tune Connections](#) - Describes how to use TDC and .properties files to customize connections.

[One-Way SSL for JDBC Connections](#) – Provides instructions on using a certificate with a JDBC driver to access a server with SSL.

[Tableau JDBC Capability Customizations Reference](#) – Lists customizations you can use to define which Tableau capabilities are supported by the data source.

Other Databases (ODBC)

When you start Tableau, under **Connect**, you can see the file and database types that are supported by Tableau Desktop. Select **More** to see the complete list. For supported files and databases, Tableau provides built-in connectors that are built for and optimized for those data sources.

Important: If your file or database type is listed under **Connect**, use that named connector to connect to your data.

If your file or database type is not listed on under **Connect**, you might be able to connect to it using the **Other Databases (ODBC)** connector. ODBC (Open Database Connectivity) is a standard way to connect to a database. If the database driver you want to connect with implements the ODBC standard, you can connect Tableau to your data using the ODBC driver for your database and the Tableau **Other Databases (ODBC)** connector.

Note: For Tableau Desktop versions 2023.3 and later, 32-bit ODBC drivers are no longer supported. Only 64-bit drivers will appear in the DSN (Data Source Name) and Drivers drop-down menus.

Note: Tableau Prep Builder version 2019.2.2 supports connecting to data using the Other Databases ODBC connector. However, it doesn't support the same functionality as Tableau Desktop. For Tableau Prep Builder, follow the instructions in [Connecting using ODBC](#) in the Tableau Prep Builder online help.

Make the connection

To connect to your data using the ODBC driver, do the following:

1. Start Tableau and under **Connect**, select **Other Databases (ODBC)**. For a complete list of data connections, select **More** under **To a Server**.
2. Enter the information required to make the connection.

If table or schema names are not listed, click the search icon or enter the name in the text box and click the search icon, and then select the name.

Note: When you use **Other Databases (ODBC)** to connect to a database, the outcome may vary and compatibility with Tableau Desktop features is not guaranteed.

If your connection works as you need it to, you can begin your analysis. If, however, you need to customize your ODBC connection to improve functionality and performance, refer to the articles under **Other Databases (ODBC)** on the previous page.

Configure for publishing and cross-platform portability

When you work with a generic ODBC connection, additional configuration is required to make sure that the workbooks and data sources you create can be used on different computers and platforms.

For publishing and for cross-platform portability:

- We recommend that you use data source names (DSNs) to accommodate different drivers and configurations between systems.
- The driver and DSN must be installed and configured to match the workbook or data source connection.

Important: When you set up a DSN, be aware that sensitive data (for example, user name and password) is plaintext in the logs and readable by anyone with access to the logs.

As an example, Ashley Garcia creates an **Other Databases (ODBC)** data source that connects using a DSN for which she has the associated ODBC driver installed on her Windows computer. Here is an example of the data source configuration, including the data source name, that Ashley created:

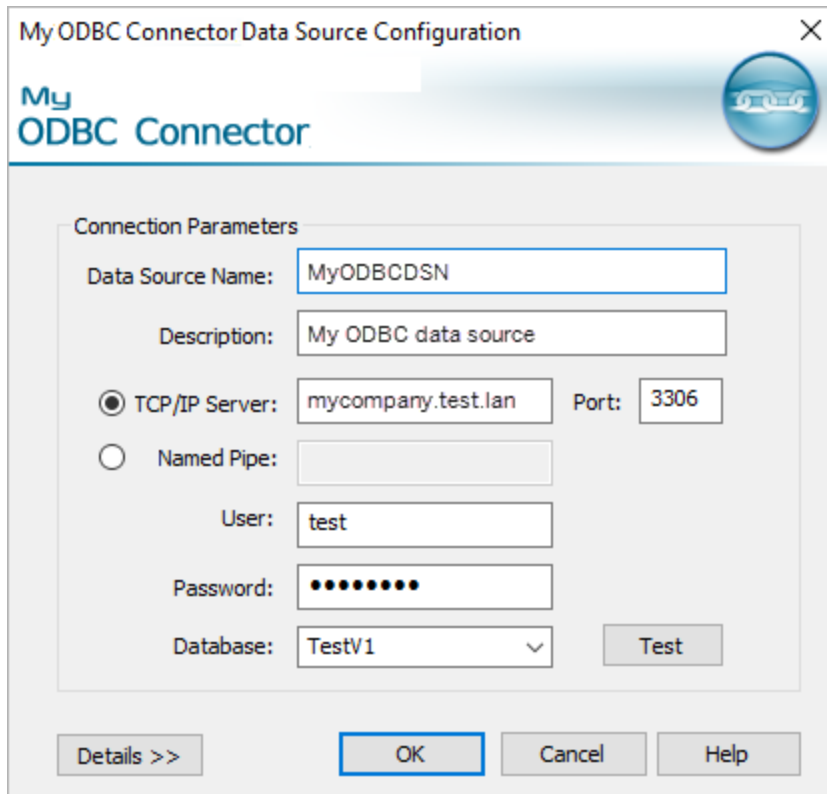

Ashley can do a couple of things with this data source to make it available for others to use.

- She can publish it to Tableau Server. When she does this, Ashley needs to ask the Tableau Server administrator to create the same DSN and install the associated ODBC driver on the Tableau Server computer so that the data source can be accessed by Ashley and by others.
- She can email the data source to coworkers. Ashley needs to tell the coworkers to install the associated ODBC driver and create the same DSN on their computers so that they can open the data source in Tableau Desktop.

When you try to open a workbook or data source created using the **Other Databases (ODBC)** connector and your workstation isn't configured correctly (you don't have the workbook or data source's DSN configured, or you don't have the ODBC driver installed), you'll see an error message that begins `Generic ODBC requires additional configuration`. To resolve this error, contact the workbook or data source publisher or the Tableau Server administrator to get the DSN and ODBC driver information that matches the workbook or data source. Then install the driver and configure the DSN on your computer.

Create a DSN

The method you use to create a DSN depends on your operating system.

- **Windows.** Create a DSN using the ODBC Driver Manager.
- **OS X.** Create a DSN using an ODBC Manager utility. If you don't have the utility installed your Mac, you can download one from, for example, <http://www.odbcmanager.net/>. Or you can manually edit the `odbc.ini` file.
- **Linux.** Manually create a DSN by editing the `odbc.ini` file.

Note: Review the documentation for your operating system for specific instructions on how to create a DSN.

Review the documentation for your operating system for specific instructions on how to create a DSN.

Tableau support for Other Databases (ODBC) connections

Tableau provides limited customer support for connections using **Other Databases (ODBC)**. For example, Support will help you with the sample code provided in Tableau documentation, or

if your connection works in Tableau Desktop, but doesn't work in Tableau Server. However, Tableau does not support creating or debugging custom TDC files. For help, you can review the other topics in this section, and you can submit questions and ask for help on the [Tableau Developer Community forums](#).

Tableau and ODBC

Tableau includes built-in connectors for many databases. These connectors take advantage of capabilities and optimizations specific to these data sources, and they're developed and tested to ensure they are robust and provide good performance.

But you might be working with a database that Tableau doesn't have a connection for. In that case, you still might be able to connect Tableau to the database. Tableau has a connector that uses the ODBC standard. By using ODBC, you can access any data source that supports the SQL standard and implements the ODBC API.

ODBC basics

ODBC (Open Database Connectivity) is an industry standard that enables a wide variety of software to access data. The basis of ODBC is a standard syntax for SQL queries that is used by software applications to connect to and request data from databases. The ODBC driver, usually provided by the database vendor, accepts requests in this standard syntax and converts the request to the native format that the target database prefers. In effect, the ODBC driver is a translation layer to convert from a general-purpose request to the database-specific request.

For example, the ODBC specification details that dates should be specified in SQL statements by using the syntax: `{d 'yyyy-mm-dd'}`. This format is then translated by the driver to the proper date syntax of the actual database. If you use the ODBC connector to connect to an Oracle database, the ODBC connector sends a request to the Oracle ODBC driver in this format:

```
select name from emp where birthdate > {d '1987-12-29'}
```

The driver converts your request to the actual format the Oracle database requires, which is this:

```
select name from emp where birthdate > '29-DEC-87'
```

The ODBC specification includes syntax for making function requests, join syntax, data types, and data type conversions. The SQL language itself supports complex concepts such as nested queries, correlated subqueries, temporary tables, and a variety of functions that can be used in select, where, group by, join clauses, and more. The ODBC driver is responsible for the proper conversion of all these requests to the syntax of the target database.

How Tableau determines the capabilities of the ODBC driver

There are differences in how each database vendor implements capabilities of the ODBC standard. Tableau uses a feature-discovery API in ODBC to question a database driver about the functionality it supports. One example of how Tableau changes behavior based on what the driver reports is the list of functions available when creating a calculated field. Fewer driver limitations means that more functions are available.

In some cases Tableau will require you to create a data extract from the data returned by the ODBC connector. And there are some ODBC drivers and databases that Tableau can't connect to.

ODBC discovery

During the initial connection, Tableau performs requests to the driver and SQL discovery queries in order to determine the capabilities of the driver.

Some examples of the capabilities discovery that Tableau performs include:

- Available scalar and aggregate functions.
- Available date and time manipulation functions.
- Can you create temporary tables?
- Can you use IF and SELECT into statements?
- Are subqueries supported?
- Are top and limit queries supported?
- What join styles are supported (outer, inner, full)?
- Supported data types.

Based on the outcome of the capabilities discovery, Tableau will classify the current connection as being in one of four categories:

- **Fully Functional.** This is a driver that supports all the functions and capabilities that Tableau uses.
- **Minor limitations.** This is a driver that has a small number of non-critical limitations. An example would be a driver that doesn't support the full set of numeric, string, or date functions that Tableau normally makes available. Tableau will modify its behavior to account for these limitations and proceed.

- **Major limitations.** This is a driver that has a large number of limitations or critical capabilities that Tableau relies upon but that are not supported. However, even with these major restrictions, Tableau might be able to connect well enough to create a Tableau extract to retrieve the data into Tableau for further work offline from the database. In this case, Tableau will recommend that you create an extract. When you create the extract, you might not be able to create a filter on the data source to reduce the amount of data in the extract. (For more information, see [Filter Data from Data Sources](#) on page 910.) After the data has been extracted, full Tableau functionality is available when working with the extract.
- **Fatal limitations.** This is a driver that does not support even the most minimal set of capabilities that Tableau needs in order to connect and run the basic queries to create extract files. Therefore, Tableau is unable to proceed any further with this driver.

After the connection is established, if Tableau has determined that the capabilities available classify this connection as anything less than fully functional, a message is displayed to inform you of the limitations that have been detected. For example, a connection to an ODBC driver with minor limitations displays this message:

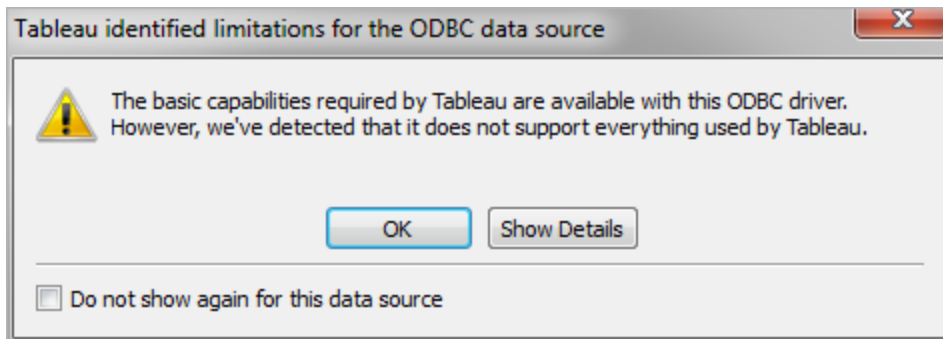

For more critical limitations, the warning dialog box will advise you to create a Tableau extract in order to proceed.

Tune ODBC connector performance

Tableau supports the ability to customize your ODBC data connection, which can improve the connection experience. For more information, see [Customize and Tune a Connection](#) on page 541.

Tableau support for ODBC connections

Tableau provides no guarantee or warranty that using Tableau with any particular ODBC driver or database will be able to successfully connect and query data. Some ODBC drivers will support

the full Tableau interactive experience, while others may work only for creating extracts. Some ODBC drivers might not work with Tableau.

Note: Tableau will provide reasonable levels of customer support to assist in troubleshooting connections with ODBC drivers, but can't create or customize a connector to work with a specific ODBC driver.

Note: For Tableau Desktop versions 2023.3 and later, 32-bit ODBC drivers are no longer supported. Only 64-bit drivers will appear in the DSN (Data Source Name) and Drivers drop-down menus.

ODBC FAQ

What's a typical use case for the ODBC connector?

The most common use case for an ODBC connection is to access data specifically to retrieve it into a Tableau extract. Bringing this data into a Tableau extract then allows the full Tableau capabilities to work with the data. Many ODBC drivers support the needed functionality to connect and perform the simpler queries required to perform an extract. Whether you extract all of the data or just select a few columns and set some filters to retrieve a relevant subset, this use of ODBC is a good scenario to keep in mind.

Where do I get ODBC drivers for my database?

Most database vendors distribute ODBC drivers for use with their databases. Contact your database vendor to obtain the drivers. Additionally there are a number of third party manufacturers of ODBC drivers that can provide drivers for a variety of common databases.

What ODBC version driver do I need?

Be sure your ODBC driver is a version 3 or higher driver, meaning it implements the ODBC specification version 3. Each driver provider will have their own version numbering system for their driver versions, which will likely be different from the ODBC version number it implements. The ODBC version 3 specification was introduced in 1995, so it is likely your database provider has a driver that implements this level of compliance. We have seen a number of Tableau customers with drivers that are not version 3 compliant (which fail to connect), who then upgraded to a newer driver and were able to proceed.

Has Tableau tested database [x]?

Tableau has tested ODBC connections with many data sources, but due to the volume of ODBC drivers available on the market we haven't tested against every possible driver, nor can Tableau perform this breadth of testing. The best recommendation for any particular driver is to give it a try, and let us know how it works.

What do I do if it doesn't work?

First check the driver version. If you look at the Tableau logs we will echo back the ODBC version level the driver reports. Search the logs for an entry like the following:

```
ODBCProtocol: driver ODBC version: 03.52
```

The number at the end indicates the ODBC version level. If it is less than 03.00, the driver needs to be upgraded.

If you get warnings when you connect about capabilities not supported, check with your database vendor to see if they have an updated driver that supports more capabilities. Not all drivers will work with Tableau.

Should I use the named database connector or the ODBC connector?

If you are connecting to a database for which Tableau has a named connection option, then use the named connector. The named connectors are optimized for the particular database.

See also

[Other Databases \(ODBC\) on page 513](#) – Describes how to connect to your data using the ODBC connector.

[Customize and Tune a Connection on page 541](#) – Describes how to customize connection information for improved functionality and performance.

[Tableau Capability Customizations Reference on page 568](#) – Lists customizations you can use to define which Tableau capabilities are supported by the data source.

[ODBC/SQL Customizations Reference on page 586](#) – Lists customizations that represent the parts of the ODBC and SQL standards that the ODBC driver reports supporting.

Use Partner-Built Connector from the Tableau Exchange

Tableau Desktop has dozens of supported connectors you can choose from. You can also find more connectors built by partners in the Tableau Exchange.

Note: Connectors from the Tableau Exchange are not currently supported for use with Tableau Bridge.

For information about creating your own connector and submitting it to the Tableau Exchange, see [Connectors Built with the Tableau Connector SDK](#).

Choose and install a partner-built connection

Partner-built or other custom connectors are available from the Connect pane. These connectors are listed under Additional Connections and are also available from the [Tableau Exchange connectors](#) page.

1. Click **Connections** in the left pane.
2. From the **Additional Connectors** section in the Connect pane, click on the connector you want to use.
3. Click **Install and Restart Tableau**.

After the connector is installed, it appears in the **To a Server** section of the Connect pane.

Note: If you receive a warning that the connectors can't load, install the .taco file you need from the [Tableau Exchange connectors](#) page. If you are prompted to install the drivers, go to [Tableau Exchange](#) for driver download instructions and locations.

Make the connection

To connect to your data using the connector you installed from the Tableau Exchange, do the following:

1. Start Tableau and under **Connect**, select the name of the connector you installed. For a complete list of data connections, select **More** under **To a Server**.
2. Enter the information required to make the connection.

If table or schema names are not listed, click the search icon or enter the name in the text box and click the search icon, and then select the name.

Work with your data

When you connect to data with a partner-built connector, it offers the same features as Tableau-supported connectors. Once you are connected, you can:

- [Define a data source](#)
- [Visualize your data](#)
- [Publish to a server](#) (when the server has the connector installed)

Note: Publishing to Tableau Cloud is not currently supported with partner-built connectors.

See also

- [Set Up Data Sources on page 596](#) – Add more data to this data source or prepare your data before you analyze it.
- [Build Charts and Analyze Data on page 1005](#) – Begin your data analysis.
- [Connectors Built with the Tableau Connector SDK](#) - Create your own connector and submit it to the Tableau Exchange.

Connectors Built with the Tableau Connector SDK

Tableau has great connectivity that allows you to visualize data from virtually anywhere. In addition to its dozens of built-in connectors and additional partner-built connectors (available on [Tableau Exchange](#)), Tableau gives you the tools to build a customized connector with the Tableau Connector SDK.

Note: Connectors built using the Tableau Connector SDK are sometimes called plugins because they “plug into” Tableau so you can connect to your data.

About Tableau Connector SDK and connector files

You can use the Tableau Connector SDK to build and custom a connector. Partner-built connectors (whether built by you or someone else) typically support most of the same features as built-in Tableau connectors. These include [defining a data source](#), [visualizing your data](#), [publishing to a server](#) (if the server has the connector), and so on.

Each connector is made up of a set of XML and JavaScript files, zipped into a single packaged .jar file, and give a ".taco" file extension. This TACO file is signed by the developer using a trusted public certificate authority. The XML and JavaScript files are configuration files that describe:

- UI elements needed to collect user input for creating a connection to a data source
- Any dialect or customizations needed for the connection
- How to connect using the ODBC or JDBC driver

A connector that is developed using the Tableau Connector SDK is appropriate for connecting to an ODBC or JDBC driver which interfaces using SQL. The underlying technology works well with relation databases.

Support for Partner-built connectors

Partner-built connectors are not supported directly by Tableau. However, if you need help, there are a few places you can look for more information.

- Some partner pages on Tableau Exchange provide a direct **Support** link to assist you.
- Look for a support link or README file on the **Driver Download** page associated with your connector.
- Contact the connector's creators through the **Developer Website** link in Tableau Exchange.

Build your own connector

To build your own customized connector, use the tools and instructions in the [Tableau Connector SDK](#) repository on GitHub.

Note: If you find an issue with the SDK or any of the developer samples, [submit an issue on GitHub](#).

Submit a connector to the Tableau Exchange

If you would like to submit your connector to the Tableau Exchange, follow [steps outlined in the Tableau Connector SDK](#).

Use a connector built with Tableau Connector SDK

After you build a connector with the Tableau Connector SDK, follow these steps to use it with Tableau:

Tableau Desktop and Web Authoring Help

1. Download the connector file, [connector name].taco.
2. Place the .taco file in the following directory (default location):
 - For 2021.2 and newer:

For Tableau Desktop	For Tableau Prep Builder	For Tableau Server, Tableau Prep Conductor, Tableau Prep Flow Authoring
<ul style="list-style-type: none"> • Windows - C:\Users\[Windows User-]\Documents\My Tableau Repository\Connectors • macOS - /Users/[user-]/Documents/My Tableau Repository/Connectors 	<ul style="list-style-type: none"> • Windows: C:\Users\[Windows User-]\Documents\My Tableau Prep Repository\Connectors • MacOS: /Users//Documents/My Tableau Prep Repository/Connectors 	<ul style="list-style-type: none"> • Windows: C:\Program Files\Tableau\Connectors • Linux: /opt/tableau/connectors

- For 2021.1 and older:

For Tableau Desktop	For Tableau Prep Builder	For Tableau Server, Tableau Prep Conductor, Tableau Prep Flow Authoring
<ul style="list-style-type: none"> • Windows - C:\Users\[Windows User-]\Documents\My Tableau Repository\Connectors 	<ul style="list-style-type: none"> • Windows: C:\Users\[Windows User-]\Documents\My Tableau Prep Repository\Connectors • MacOS: 	<ul style="list-style-type: none"> • Tableau Server: [Tableau_Server_Installation_Directory]/data/tabs-vc/vizqlserver/Connectors <p>To enable your connector for Prep, you also need to add your taco to the following locations:</p>

<ul style="list-style-type: none"> • macOS - /Users/ [user-]/Docu- ments/My Tableau Repos- itory/Con- nectors 	<ul style="list-style-type: none"> /User- s//Docu- ments/My Tableau Prep Repos- itory/Con- nectorsFor Tableau 	<ul style="list-style-type: none"> • Tableau Prep Conductor: [Tableau_Server_Install- ation_Dir- ect- ory]/data/t- abs- vc/flowprocessor/Connectors • Tableau Prep Flow Author- ing: [Tableau_Server_Install- ation_ Dir- ect- ory]/data/t- abs- vc/- flowqueryservice/Connectors
---	--	---

3. Before you connect, install the ODBC or JDBC driver. Follow the driver installation instructions provided by the source of your data.

Once you've installed the connector, it will appear in the list of connectors in Tableau.

Connect Tableau to the data

1. Start Tableau, and under **Connect**, select the name of the connector you just installed.
For a complete list of data connectors, select **More** under **To a Server**.
2. Enter the information that you're prompted for, and then select **Sign In**.
3. Wait while the connector retrieves your data into Tableau.
4. Select the sheet tab to start your analysis.

About load order for connectors

If a connector has the same class as a connector that has already been registered, the new connector will be rejected. This means that connectors loaded first have precedence when two connectors share the same class name.

Tableau loads connectors by directory in the following order:

1. Built-in Tableau connectors
2. Connectors located in `C:\Program Files\Tableau\Connectors` (Windows) or `opt/tableau/connectors` (Linux)

3. Connectors located in `My Tableau Repository/Connectors`
4. (Optional) Connectors in the dev path specified by `-DConnectPluginsPath`

See also

- [Set Up Data Sources on page 596](#) – Add more data to this data source or prepare your data before you analyze it.
- [Build Charts and Analyze Data on page 1005](#) – Begin your data analysis.
- [Tableau Connector SDK](#) - Find information and tools to build and test your own customized connector.
- [Use Partner-Built Connector from the Tableau Exchange on page 522](#) - Find and install a connector from the Tableau Exchange.

Connectors Built with the Web Data Connector 3.0 SDK

The Web Data Connector 3.0 is the latest version of the web data connector, Tableau's solution for connecting to data in web applications and services that are exposed through APIs rather than ODBC/JDBC drivers.

The Web Data Connector 3.0 SDK provides the tools that you need to build your own custom connector to web data. Additionally, partner-built connectors can be used from the Tableau Exchange.

Note: The Web Data Connector 3.0 was part of the 2022.3 Tableau release.

About Web Data Connector 3.0

In a departure from previous iterations of web data connector, and analogous to the Tableau Connector SDK, Web Data Connector 3.0 allows you to build a custom connector to web data and package the connector as a .taco file. WDC 3.0 connectors can be used like any driver-based connector built using the Tableau Connector SDK and don't require you to host the connector on your own web server.

Like other .taco connectors, WDC 3.0 connectors are packaged and signed .jar files containing a set of XML and Javascript/TypeScript files. These files define the look and behavior of the connector including:

- A web-based connector UI
- API calls to retrieve data from your application or service endpoint
- Instructions to map the retrieved data into Tableau extracts

Note: Web Data Connector 3.0 remains extract-only, but otherwise allows you to visualize your data and publish your analysis just like any other data source.

Important: There is a known issue with WDC 3.0-based connectors on Tableau Server. See [Known issues \(Tableau Server only\)](#) on page 530 below.

Build your own connector

To get started building your own custom connector, refer to the official [Web Data Connector 3.0 documentation](#).

Use a connector built with the Web Data Connector 3.0 SDK

After you build a connector with the Web Data Connector 3.0 SDK, follow these steps to use it with Tableau:

1. Download the connector file, [connector name].taco.
2. Place the .taco file in the following directory (default location):
 - For 2021.2 and newer:

For Tableau Desktop	For Tableau Prep Builder	For Tableau Server
<ul style="list-style-type: none"> • Windows - C:\Users\[Windows User-]\Documents\My Tableau Repository\Connectors • macOS - /Users/[user-]/Documents/My Tableau Repository/Connectors 	<ul style="list-style-type: none"> • Windows: C:\Users\[Windows User-]\Documents\My Tableau Prep Repository\Connectors • MacOS: /Users//Documents/My Tableau Prep Repository/Connectors 	<ul style="list-style-type: none"> • Windows: C:\Program Files\Tableau\Connectors • Linux: /opt/tableau/connectors

- For 2021.1 and older:

For Tableau	For Tableau Prep	For Tableau Server, Tableau Prep
-------------	------------------	----------------------------------

Desktop	Builder	Conductor, Tableau Prep Flow Authoring
<ul style="list-style-type: none"> • Windows - C:\Users\[Windows User-]\Documents\My Tableau Repository\Connectors • macOS - /Users/[user-]/Documents/My Tableau Repository/Connectors 	<ul style="list-style-type: none"> • Windows: C:\Users\[Windows User-]\Documents\My Tableau Prep Repository\Connectors • MacOS: /Users//[User-s//Documents/My Tableau Prep Repository/Connectors 	<ul style="list-style-type: none"> • Tableau Server: [Tableau_Server_Installation_Directory]/data/tabsvc/vizqlserver/Connectors <p>To enable your connector for Prep, you also need to add your taco to the following locations:</p> <ul style="list-style-type: none"> • Tableau Prep Conductor: [Tableau_Server_Installation_Directory]/data/tabsvc/flowprocessor/Connectors • Tableau Prep Flow Authoring: [Tableau_Server_Installation_Directory]/data/tabsvc/flowqueryservice/Connectors

Note: After you've installed the connector, it will appear in the list of connectors in Tableau.

If you find an issue with the WDC library, the simulator, or any of the developer samples, [submit an issue on Github](#).

Connect Tableau to the data

1. Start Tableau, and under **Connect**, select the name of the connector you just installed. For a complete list of data connectors, select **More** under **To a Server**.
2. Enter the information that you're prompted for, and then select **Sign In**.

3. Wait while the connector retrieves your data into Tableau.
4. Select the sheet tab to start your analysis.

Load order for connectors

If a connector has the same class as a connector that has already been registered, the new connector will be rejected. Connectors loaded first have precedence when two connectors share class names.

Tableau loads connectors by directory in the following order:

1. Built-in Tableau connectors
2. Connectors located in `C:\Program Files\Tableau\Connectors (Windows)` or `opt/tableau/connectors (Linux)`
3. Connectors located in `My Tableau Repository/Connectors`
4. (Optional) Connectors in the dev path specified by `-DConnectPluginsPath`

Known issues (Tableau Server only)

When trying to connect to a WDC 3.0-based connector on Tableau Server, users might see a "Tableau Server (Version <version number>) encountered an error while working with this worksheet" error message.

This error occurs because the Web Data Connector 3.0-based connector that the workbook was created with is not compatible with a multi-node Tableau Server. There is no workaround or resolution at this time. For more information, see the [When web authoring using WDC 3.0-based Connectors, receiving HTTP 503 along with error "encountered an error"](#) knowledge article.

See also

- [Set Up Data Sources on page 596](#) – Add more data to this data source or prepare your data before you analyze it.
- [Build Charts and Analyze Data on page 1005](#) – Begin your data analysis.
- [Tableau Connector SDK](#) - Find information and tools to build and test your own customized connector.
- [Use Partner-Built Connector from the Tableau Exchange on page 522](#) - Find and install a connector from the Tableau Exchange.

Connector Authentication

Many connectors available in Tableau, both natively supported and generic versions, support different types of authentication.

Configure SSL for JDBC Connections

Many JDBC connectors support one-way (standard) SSL, and some support two-way SSL. For those that don't have explicit support using Tableau, you may be able to enable it with customization. There are different ways that SSL can be configured for both types, and you can use the method that makes the most sense for your environment.

Note: For Tableau Cloud, if your server certificate is not signed by a common public root CA, and you don't have the option to embed the certificate, you can use Tableau Bridge. This will allow you to configure certificates and private keys as needed.

One-Way SSL for JDBC Connections

If you are using regular (one-way) SSL with a JDBC based connector, and you have self-signed certificates, or certificates that are signed by a non-public certificate authority (CA), then you will need to configure trust for your certificate.

With Tableau, you can configure one-way SSL trust for JDBC connections using one of these methods:

- [Embed a certificate](#) below
- [Install a certificate in the system trust store](#) on the next page
- [Use custom driver properties](#) on page 534

Embed a certificate

Some connectors support embedding the certificate in the workbook or data source. If that is available, then you can use Tableau Desktop to embed the CA certificate.

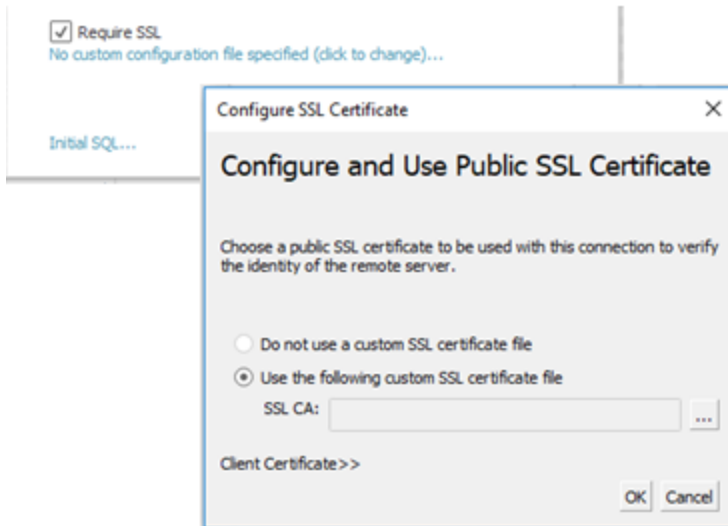

Install a certificate in the system trust store

If embedding is not available, you will need another way to configure trust. Also, it may be easier to do this than to embed the certificate in every workbook. Instructions are included for Windows, Mac, and Linux platforms below.

The default trust store location for Tableau Server is:

```
/opt/tableau/tableau_
server/packages/repository.20233.24.0514.1218/jre/lib/security/cacert
s
```

For Windows:

You can install your CA or self-signed certificate in the Windows root CA trust store. The Java Runtime looks for trusted CAs in the system root trust store. It does not look in the intermediate certificate storage.

Note: If you have installed your root CA, but are still having trouble making connections, it may be caused by missing intermediate certificates. While the TLS standard requires that servers send all certificates in their chain except the root certificate, not all servers are compliant. If your server doesn't send the intermediate certificates, you can either fix the server to properly forward intermediate certificates or install the intermediate certificates in the root trust store. Alternatively, you could choose to embed certificates in the data source or configure a trust store with driver properties.

1. In Windows, search for "certificates".
2. Select **Manage computer certificates**.
3. From the **Action** menu, select **All Tasks**, and then, depending on Windows version, do one of the following:
 - Select **Import** and then select **Local Machine**.
 - Select **Find Certificates**.
4. Browse to find your certificate file.
5. Import into "Trusted Root Certificate Authorities".

For Mac:

To install a custom certificate on a Mac, follow these steps to import the certificate into the "System" keychain.

Note: Loading certificates from keychain on Mac works for most, but not all, drivers. For other drivers, you may need to use a .properties file to configure the trust store. For more information, see [Customize and Tune Connections](#).

1. Go to <https://support.apple.com/guide/keychain-access/add-certificates-to-a-keychain-kyca2431/mac>.
2. Import the certificate into the "System" keychain (not "System Roots").
3. Enable trust as follows:
 - a. In the Keychain App, right-click the new certificate.
 - b. Select **Get Info**.
 - c. In the dialog, open the **Trust** section, and then select **When using this certificate always trust**.

For Linux:

Many Linux distributions will generate a trust store in Java format from the system certificates. You may need to install Java from the package manager for this file to be created.

This allows the JRE to use the same certificates as the operating system.

Note: Tableau Server looks for this file in the standard locations:

```
/etc/ssl/certs/java/cacerts  
/etc/pki/java/cacerts
```

To configure a different location, run:

```
tsm configuration set -k native_api.ConnectivityTrustStore -v <path-to-cacerts> --force-keys
```

This file should:

- Contain all trusted CAs and self-signed certificates.
- Contain only public keys.
- Be in JKS format.
- Be readable by the Tableau unprivileged user ("run as user").
- Use default JKS password "changeit"

To install a custom CA or self-signed certificate, see the documentation for your distribution. Run the appropriate commands to generate the key store. For example:

```
update-ca-certificates
```

Use custom driver properties

You can customize JDBC connection options, including the location of the trust store, with a `.properties` file. This is a plain-text file containing key-value pairs for each connection parameter.

For example, lines in this properties file are being used to configure trust settings:

```
javax.net.ssl.trustStore=C:\\My_Folder\\truststore.jks
javax.net.ssl.trustStoreType=JKS
javax.net.ssl.trustStorePassword=password
```

Note: For details on specific property settings, see the documentation for your driver.

When you create the file and save it to the correct location, the properties in the file are applied to all JDBC connections to the same data source type.

If you use the generic "[Other Database \(JDBC\)](#)" connector, you can specify a `.properties` file directly in the connection dialog.

For more information, see [Customize and Tune Connections](#).

Two-Way SSL for JDBC Connections

Some JDBC connections, such as Postgres, can also be configured to use two-way SSL authentication. This can be configured by using a `.properties` file to specify the locations and details of the trust store and keys.

Use a .properties file to configure the client certificate and private key

Note: For Tableau Cloud, if you require two-way SSL and your connector doesn't have an option to embed the keys, you will need to use Tableau Bridge and set up the SSL configuration there.

1. Modify the .properties file to reflect the key store and trust store settings. Use the following as an example. Be sure to replace “My_Folder” for the location of your files and “<password>” with your own password. Paths on OSX and Linux need only a single “/” to separate.

```
javax.net.ssl.trustStore=C:\\My_Folder\\truststore.jks
javax.net.ssl.trustStoreType=JKS
javax.net.ssl.trustStorePassword=<password>
javax.net.ssl.keyStore=C:\\My_Folder\\keystore.jks
javax.net.ssl.keyStoreType=JKS
javax.net.ssl.keyStorePassword=password
```

2. Save the .properties file to the appropriate datasources folder, depending on the Tableau product. If you are unsure, see the complete list of possible directories in [Customize and Tune a Connection](#) on page 541.
3. If you publish to Tableau Server, ensure that you install the .properties file, truststore.jks, and keystore.jks in the right locations for each Tableau Server node.

If you use this method, you don't need to upload certificates and key via the SSL dialog. Instead, simply click **Require SSL**. This causes the JDBC connector to read the locations of the key store and trust store from the .properties file.

Troubleshooting

Issues with using SSL often are related to incorrect certificate configuration.

One way to begin narrowing down the source of the issue is to verify what certificates are in use and where they are installed. With OpenSSL CLI tools installed, you can use the `s_client` command:

```
openssl s_client -connect hostname:port -showcerts
```

Replace `hostname` and `port` with the proper values for the system you are testing. When executed, this command will attempt to create an SSL connection, and then display the certificates sent from the server.

Some databases have a custom TLS handshake, and openssl supports a couple of those directly. As of the latest version those are postgres and mysql. If you are connecting to a postgres or mysql compatible database, and you have problems with the command above, you can try using the `-starttls` option to enable the protocol used by your database. For example:

```
openssl s_client -connect hostname:port -showcerts -starttls postgres
```

For more information about troubleshooting with OpenSSL, see [Using OpenSSL s_client commands to test SSL connectivity](#). You can find the full documentation for OpenSSL s_client in [OpenSSL Documentation](#).

See also

- [Require SSL for Oracle JDBC Connections](#) - Installation instructions for adding trusted SSL certificates to Oracle JDBC connections.
- [Oracle JDBC Connections with SSL](#) below

Oracle JDBC Connections with SSL

If you are connecting to an SSL (security socket layer) server, check the **Require SSL** check box.

Beginning in 2020.2, Oracle uses a JDBC connector. If your Oracle data source is configured to use SSL one-way or two-way authentication, you can include the appropriate certificates and/or key to connect.

Require SSL

If your connection requires SSL, do the following:

1. From the connector dialog, click **Require SSL**.

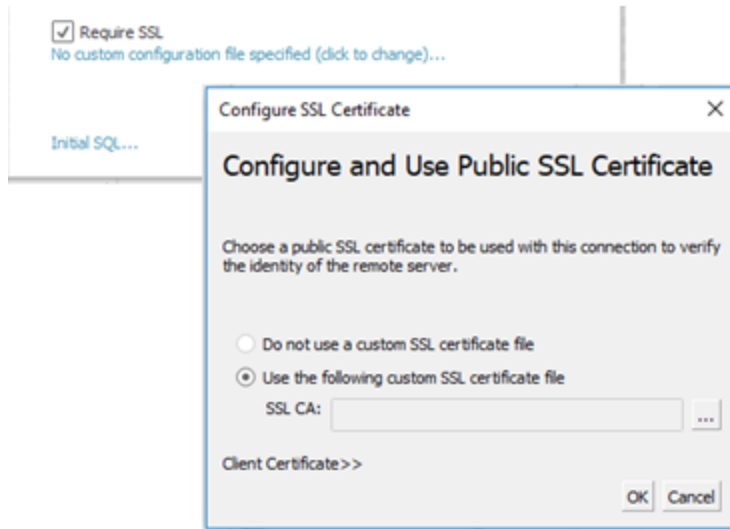

2. Configure SSL as appropriate for your connection:
 - If you are using self-signed certificates or a certificate from signed by a private CA, you may need to configure trust for one-way SSL connections. See [Configure one-way SSL for Oracle](#).
 - If you are using two way SSL, you will need to configure your client keys. See [Configure two-way SSL](#).

Configure one-way SSL for Oracle

To configure trust for your server certificate, see general instructions for JDBC connectors here: [Configure One-Way SSL for JDBC Connections](#).

If you decide to use properties files to configure trust, then use the following properties for the Oracle JDBC driver.

```
javax.net.ssl.trustStore=C:\My_Folder\truststore.jks  
javax.net.ssl.trustStoreType=JKS  
javax.net.ssl.trustStorePassword=password
```

Note: To publish a workbook to Tableau Server, both the Tableau Desktop and Tableau Server computers must have copies of the same Oracle properties file and truststore.jks file.

Configure two-way SSL

There are two options for configuring two-way SSL support with an Oracle connection:

- [Embed client certificates and private key in the data source](#)
- [Use a properties file to configure the client certificate and private key](#)

Option 1: Embed client certificates and private key in the data source

To embed an SSL certificate, client certificate, and client key:

1. Follow the steps in [Configure one-way SSL for Oracle](#) on the previous page to configure server trust, if necessary.
2. Click **Client Certificate >>**.

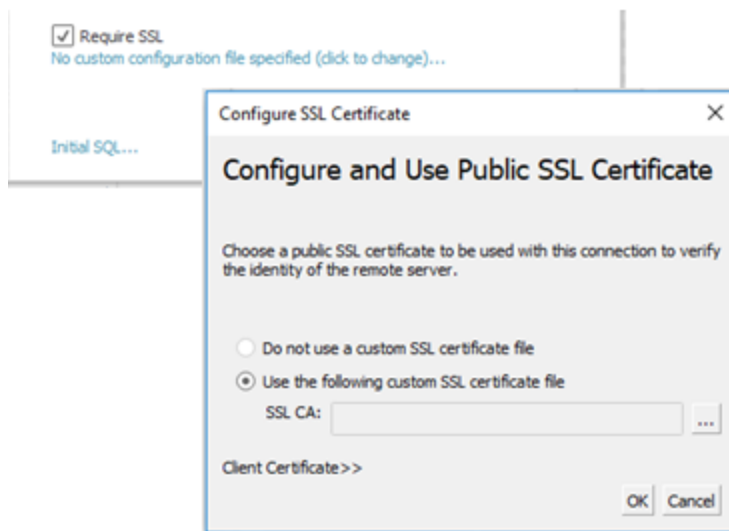

3. Specify the locations for the client certificate and client key.
The certificate and private key should be in unencrypted PEM format. See instructions

later in this document for suggestions on converting to the correct format.

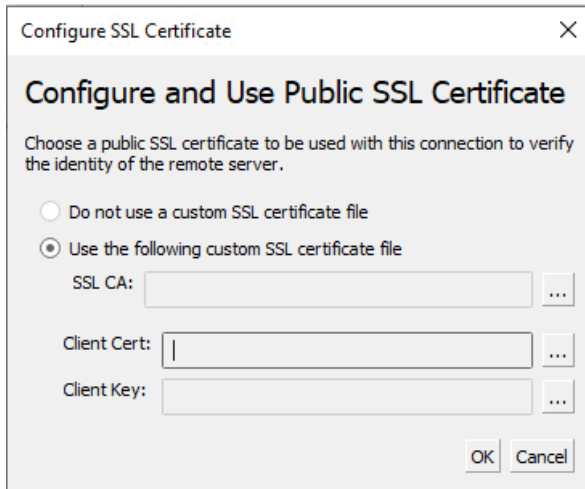

Option 2: Use a properties file to configure the client certificate and private key

To use a properties file for certificate and key configuration:

1. Modify the oracle.properties file to reflect the key store and trust store settings. Use the following as an example. Be sure to replace "My_Folder" for the location of your files and "<password>" with your own password. Paths on OSX and Linux need only a single "/" to separate.

```
javax.net.ssl.trustStore=C:\\My_Folder\\truststore.jks
javax.net.ssl.trustStoreType=JKS
javax.net.ssl.trustStorePassword=<password>
javax.net.ssl.keyStore=C:\\My_Folder\\keystore.jks
javax.net.ssl.keyStoreType=JKS
javax.net.ssl.keyStorePassword=password
```

2. Save oracle.properties to the <Document>\MyTableau Respository\Datasources folder.
3. Copy oracle.properties, truststore.jks, and keystore.jks to the Tableau Server computer.
This allows the workbook to be published to the Tableau Server.

If you use this method, you don't need to upload certificates and key via the SSL dialog. Instead, simply click **Require SSL**. This causes the Oracle JDBC connector to read the locations of the key store and trust store from oracle.properties file.

Publish a workbook

To publish a workbook to Tableau Server, be sure the following are true:

- If you use a properties file, both the Tableau Desktop and Tableau Server computers have copies of the same Oracle properties file, `truststore.jks`, and `keystore.jks`.
- The server uses the same Oracle JDBC connector as the Tableau Desktop computer.
- If you used the **embedding** option, select “embed password” option when you publish.

Convert key formats

There are several formats for storing SSL keys, including:

- Oracle Wallet
- JKS - Use this format if you want to configure SSL trust using properties files.
- PEM - Use this format if you want to embed the keys in the data source using Tableau interface.

The following are some suggested commands you can type at the command-line prompt to convert keys to the correct format. See the Oracle documentation for the more details.

To export server certificate from an Oracle wallet to PEM file:

```
orapki wallet export -wallet wallet_location -dn certificate_dn -cert output_certificate_filename.pem
```

To export server certificate and client keys from Oracle wallet to JKS:

```
orapki wallet pkcs12_to_jks -wallet ./ -pwd mypasswd -jksKeyStoreLoc ./ewalletK.jks -jksKeyStorepwd password -jksTrustStoreLoc ./ewalletT.jks -jksTrustStorepwd password
```

To export server certificate from JKS trust store to PEM file using keytool and OpenSSL:

1. Export JKS format to PKCS12 format:

```
keytool -importkeystore -srckeystore truststore.jks -destkeystore truststore.p12 -srcstoretype JKS -deststoretype PKCS12 -srcstorepass "password" -deststorepass "password"
```

2. Get the PEM file from PKCS12:

```
openssl pkcs12 -in truststore.p12 -out serverca.pem
```

To export server certificate and client keys from JKS trust store to PEM file using keytool and OpenSSL:

1. Export the certificate from the trust store as follows.

- a. Export JKS format to PKCS12 format:

```
keytool -importkeystore -srckeystore truststore.jks -destkeystore truststore.p12 -  
srcstoretype JKS -deststoretype PKCS12 -srcstorepass "password" -deststorepass  
"password"
```

- b. Get the PEM file from PKCS12:

```
openssl pkcs12 -in truststore.p12 -out serverca.pem
```

2. Export the client key and client certificate from the key store as follows.

- a. Use keytool to transform JKS format to PCKS12 format:

```
keytool.exe -importkeystore -srckeystore keystore.jks -destkeystore keystore.p12 -  
srcstoretype JKS -deststoretype PKCS12 -srcstorepass "password" -deststorepass  
"password"
```

- b. Use OpenSSL to export the client certificate:

```
openssl pkcs12 -in keystore.p12 -nokeys -out clientcert.pem
```

- c. Use OpenSSL to export the client key:

```
openssl pkcs12 -in keystore.p12 -nocerts -out clientkeyEncrypted.pem
```

- d. Use OpenSSL to transform the encrypted version to PKCS8 format:

```
openssl pkcs8 -topk8 -nocrypt -in clientkeyEncrypted.pem -out clientkey.pem
```

See also

- [Configure SSL for JDBC Connections](#) - More general information about installing trusted SSL certificates for JDBC connections.

Customize and Tune a Connection

You can make customizations to a connection string's parameters and to the connection's capabilities using a TDC file. This applies to both ODBC and JDBC connections.

If you're customizing a JDBC-based connection, you can also modify the connection string parameters in a properties file. For details, see [Use a properties file to customize a JDBC connection](#).

Important: TDC files can be utilized to customize the functionality of a connection or to diagnose and resolve issues related to connecting to your data. Tableau is unable to thoroughly test every potential modification you might make with these files. Creating and

using TDC files requires manual editing and it is crucial to test them thoroughly before deploying them in a production environment.

Use a TDC file to customize a connection

Note: You can only have one TDC file per connector. If there are multiple TDC files referring to the same connector, only one will be applied.

TDC (Tableau Datasource Customization) files are XML files with a “.tdc” filename extension. These files are used to customize Tableau-specific settings. For ODBC-based connection, you can also use a TDC file to define parts of the ODBC and SQL standards that the ODBC driver supports.

A TDC file contains a vendor name, driver name, and `<connection-customization>` (also includes the class) section. For a built-in connector, the vendor name and driver name must match the connector’s class name. Usually, the vendor name matches the driver name. Two generic class names are used for the Other Databases connectors:

- For the Other Databases (JDBC) connector, the class name is "genericjdbc".
- For Other Databases (ODBC) connector, the class name is "genericodbc".

If an existing workbook or data source file has an enabled customization section already, Tableau uses only the customizations it defines and not any defined in the TDC file.

Structure of a TDC file

Each TDC file follows this basic structure:

```
<connection-customization class=DSCLASS enabled='true' version='10.0'>
  <vendor name=VENDOR />
  <driver name=DRIVER />
  <customizations>
    <customization name='CAP_FAST_METADATA' value='yes' />
    <customization name='CAP_SOMETHING_ELSE' value='yes' />
    ...
  </customizations>
</connection-customization>
```

A TDC file has three main sections:

- Connection customization variables
- Vendor and driver names
- The customizations themselves

The `connection-customization` section includes the following:

- **class**: The data source you want to connect to and customize.
- **enabled**: Specifies whether the TDC file connection customizations are applied. In the TDC file, always set to “true”.
- **version**: Tableau ignores the version number.

The next section is crucial because it identifies the vendor name and driver name of the database provider for this TDC file's data source. Each TDC file can bind to only one data source type. For our native data sources, these names must both match the data source class name; for example, “teradata” for our Teradata connections. For ODBC data sources, the vendor name and driver name of the TDC file must match what is reported to Tableau by the database and driver; for example, “SQLite” and “SQLite3 ODBC Driver”, respectively.

The final section lists the actual connection customizations.

Here are two example TDC files: First, a generic ODBC connection, and second, a modification to a native Salesforce connection. Note these are for example purposes only and the customizations listed are not selected to accomplish a specific goal.

```
<?xml version='1.0' encoding='utf-8' ?>
<connection-customization class='genericodbc' enabled='true' version='8.10'>
  <vendor name='Gen_ODBC_Vendor' />
  <driver name='Gen_Driver' />
  <customizations>
    <customization name='CAP_FAST_METADATA' value='yes' />
    <customization name='CAP_ODBC_BIND_FORCE_MAX_STRING_BUFFERS' value='yes' />
    <customization name='CAP_ODBC_BIND_PRESERVE_BOM' value='yes' />
  </customizations>
</connection-customization>
```

```
<?xml version='1.0' encoding='utf-8' ?>
<connection-customization class='salesforce' enabled='true' version='8.10'>
  <vendor name='salesforce' />
```

```

<driver name='salesforce' />
<customizations>
  <customization name='CAP_ODBC_EXPORT_CONTINUE_ON_ERROR' value-
='yes' />
  <customization name='CAP_ODBC_EXPORT_FORCE_SINGLE_ROW_BINDING'
value='yes' />
  <customization name='CAP_ODBC_EXPORT_SUPPRESS_STRING_WIDTH_
VALIDATION' value='no' />
</customizations>
</connection-customization>

```

For more information about the customizations available, see:

- [Tableau JDBC Capability Customizations](#)
- [Tableau Capability Customizations Reference on page 568](#)
- [ODBC/SQL Customizations Reference on page 586](#)

Use a properties file to customize a JDBC connection

Properties files are used by JDBC and passed directly through to the JDBC driver. These are plain-text files with a “.properties” filename extension. They contain key-value pairs for each connection parameter.

Using a properties file with a JDBC connection is similar to using the `odbc-connect-string-extras` parameter in a TDC file for ODBC connections.

Note: A properties file should be in Latin-1 format (see <https://en.wikipedia.org/wiki/.properties>). However, as long as it includes only ASCII characters, you can safely save the file in UTF-8 format without a BOM (byte order mark).

In the file, place each key-value pair on its own line with no delimiter. Give the file the same name as its corresponding connector, but with a “.properties” filename extension. For example, the properties file for the SAP HANA connector would be “saphana.properties”.

Installing tdc and properties files

Once a customization file (either TDC or properties) is created, it must be placed in specific “Datasources” directories for it to be discovered and used by Tableau products. For example, if

users will be publishing content from Tableau Desktop to Tableau Server, the customizations should be copied to both product directories.

After the file is copied to the appropriate directories, Tableau (including all nodes if using Tableau Server) must be restarted for the changes to be recognized. See below for the directory path in a default installation.

Tableau desktop application paths

- **Desktop/Windows:** `C:\Users\myuser\My Tableau Repository\Datasources`
- **Desktop/Mac:** `~/Documents/My Tableau Repository/Datasources`
- **Prep Builder/Windows:** `C:\Users\myuser\Documents\My Tableau Prep Repository\Datasource`
- **Prep Builder/Mac:** `~/Documents/My Tableau Prep Repository/Datasources`
- **Bridge/Windows:** `C:\Users\myuser\Documents\My Tableau Bridge Repository\Datasources`
- **Bridge/Linux:** `/root/Documents/My_Tableau_Bridge_Repository/Datasources/`

Tableau Server paths

Note: Customization files must be copied to the appropriate directory for every server node in use.

- **Windows:**
- **Server:** `C:\Program Files\Tableau\Tableau Server-
\data\tabsvc\vizqlserver\Datasources`
`C:\Program Files\Tableau\Tableau Server\packages\bin.<build number>`
- **Virtual Connections:** `C:\Program Files\Tableau\Tableau Server-
\data\tabsvc\minerva\Datasources`
- **Prep Flows:** `C:\Program Files\Tableau\Tableau Server-
\data\tabsvc\flowprocessor\Datasources`
- **Prep Web Authoring:** `C:\Program Files\Tableau\Tableau Server-
\data\tabsvc\flowminerva\Datasources`
- **Linux:**
- **Server:** `/var/opt/tableau/tableau_server-
/data/tabsvc/vizqlserver/Datasources/`

- **Virtual Connections:** `/var/opt/tableau/tableau_server-
/data/tabsvc/minerva/Datasources/`
- **Prep Flows:** `/var/opt/tableau/tableau_server-
/data/tabsvc/flowprocessor/Datasources/`
- **Prep Web Authoring:** `/var/opt/tableau/tableau_server-
/data/tabsvc/flowminerva/Datasources/`

After you save the custom TDC or properties files to the correct location, and restart the applications, they will be applied to all connections for that same data source type.

Customize Connection String for Native Connectors

There are times when you might want to modify the connection made with a native connector. You can do this by creating a TDC (Tableau Datasource Customization) file that passes configuration changes to the connection using the `odbc-connect-string-extras` customization.

This article applies to connectors that use an ODBC driver.

Important: TDC files can be utilized to customize the functionality of a connection or to diagnose and resolve issues related to connecting to your data. Tableau is unable to thoroughly test every potential modification you might make with these files. Creating and using TDC files requires manual editing and it is crucial to test them thoroughly before deploying them in a production environment.

Modify the connection string

When Tableau connects using an ODBC driver, it creates and passes a connection string to the driver manager. The connection string identifies the driver and contains all the parameters for the driver.

Here's an example connection string:

```
DRIVER=BagelDB Driver;SERVER=bagel.db.lan;UID=creamcheese;PWD=bagel;
```

Let's say you want to override the DRIVER value of BagelDB Driver with BagelDB Driver 2.0 and add a port number. The connection string passed to the driver manager would be modified to:

```
DRIVER=BagelDB Driver 2.0;SERVER-  
R=bagel.db.lan;UID=creamcheese;PWD=bagel;PORT=54321
```

You can modify the connection string parameters by using a TDC and the **odbc-connect-string-extras** tag. In general, the only parameter that can be overridden is DRIVER. Other

parameters are appended to the end of the connection string. See how to "Use a TDC file" below.

Note: Because of security restrictions, there is limited support for the **odbc-connect-string-extras** customization on Tableau Online. Some parameters might not be supported.

Use an allowlist to reduce security risk

Important: The following procedure needs to be done by a Tableau Server administrator on Tableau Server and should be evaluated by your IT department for compliance with your organization's security guidelines.

The **odbc-connect-string-extras** customization can present a security risk. Your Tableau Server administrator can manage this risk by specifying a list of approved parameters in an allowlist (also known as a security list):

- Any parameters specified by `odbc-connect-string-extras` that are not on the list are filtered out.
- If there are no parameters specified in the list, then all parameters are allowed.

The allowlist is a comma-separated list with no spaces in between.

For example, to add the parameters **UseDeclareFetch** and **App** to the `safelist`, run the following commands:

```
tsm configuration set -k native_api.ODBCConnectionStringSecurityList -v UseDeclareFetch,App --force-keys
```

```
tsm pending-changes apply
```

For information about running `tsm` commands, see [tsm Command Line Reference](#) in the Tableau Server Help.

Use a TDC file

A TDC file is an XML file that contains a vendor name, a driver name, and a `<connection-customization>` section that can contain multiple types of customizations (both to the connection string and to the connection capabilities). For a native connector, the vendor name and driver name must match the connector's class name. See the "Native connector class list" below for values. Any existing workbook or data source file that already has an enabled customization section will use only the embedded customizations, not the TDC file.

Once you have created a TDC file, you must save it to the `Datasources` folder so that it can be used by your connection. If you create a workbook that you want to publish to Tableau Server, or if you use Tableau Prep or Tableau Bridge, then you need to save the TDC file to the `Datasources` directories for those products as well. For more information, see [Installing tdc and properties files](#).

Note: If you create a data source or workbook with customized `odbc-extras`, the information is embedded in the connection attributes. Because of this, you can publish a workbook or data source to Tableau Server without having to install the TDC file on Tableau Server.

In the TDC file, you can use the **`odbc-connect-string-extras`** customization to append attributes or override the `DRIVER` attribute to the connection string.

Create a TDC file

1. Open a plain text editor, such as Notepad or Notepad++.
2. Copy the information from the sample provided below, paste it into your text file, and then specify the class, vendor name, and driver name value. For native Tableau connectors, use the same value for class, vendor name, and driver name.
3. Save the file with a `.tdc` extension—for example, `mybagel.tdc`—to the `Datasources` folder for each Tableau product. For more information, see [Installing tdc and properties files](#).
4. Enter the customizations you want to make to the connection.

```
<connection-customization class='bagelDB' enabled='true' version='19.1'>
<vendor name='bagelDB' />
<driver name='bagelDB' />
<customizations>
  <customization name='odbc-connect-string-extras' value-
='DRIVER=BagelDB Driver 2.0;PORT=54321' />
</customizations>
</connection-customization>
```

Native connector class list

Locate your connector in the list below (listed in the format <connector>:<class>) to get the class value you need for customizing the TDC file.

- Actian Matrix: paraccel
- Actian Vector: vectorwise
- Amazon Aurora: aurora
- Amazon EMR (Hive): awshadoophive
- Amazon Redshift: redshift
- Spark SQL: spark
- Aster Database: astercluster
- Azure SQL Data Warehouse: azure_sql_dw
- Cloudera Hadoop: hadoophive
- Denodo: denodo
- Exasol : exasolution
- Firebird : firebird
- Google Cloud SQL: googlecloudsql
- Hortonworks Hadoop Hive: hortonworkshadoophive
- IBM: BigInsights bigsql
- IBM DB2: db2
- IBM PDA (Netezza): netezza
- Kognitio: kognitio
- MapR Hadoop Hive: maprhadoophive
- MariaDB: mariadb
- MarkLogic: marklogic
- MemSQL: memsql
- Microsoft SQL Server: sqlserver
- MonetDB: monetdb
- MongoDB BI Connector: mongodb
- MySQL: mysql
- Oracle Essbase: essbase
- Other Databases (ODBC): genericodbc
- Pivotal Greenplum Database: greenplum
- PostgreSQL: postgres
- Presto: presto
- Progress OpenEdge: progressopenedge
- SAP HANA: saphana
- SAP Sybase ASE: sybasease

- SAP Sybase IQ: sybaseiq
- Snowflake: snowflake
- Splunk: splunk
- Teradata: teradata
- Tibco Data Virtualization: composite
- Vertica: vertica

See also

Other Databases (ODBC) on page 513 – Describes how to connect to your data using the ODBC connector.

Example: Customize an ODBC Connection below - Step-by-step process showing how customization can be accomplished for capabilities and ODBC connection strings.

Tableau and ODBC on page 517 – Provides background information about ODBC, describes how Tableau determines the functionality of an ODBC driver, and lists frequently asked questions.

Tableau Capability Customizations Reference on page 568 – Lists customizations you can use to define which Tableau capabilities are supported by the data source.

ODBC/SQL Customizations Reference on page 586 – Lists customizations that represent the parts of the ODBC and SQL standards that the ODBC driver reports supporting.

Example: Customize an ODBC Connection

When you use a connector for a database that supports SQL, Tableau generates SQL statements that are tuned for that database. Because Tableau has no representation of the SQL dialect used by an ODBC data source, it must infer the supported syntax through a variety of tests. If a driver reports incorrect or incomplete information about the SQL dialect it supports, you can use Tableau customizations to fine tune this connection information in order to improve functionality and performance.

In this article, you will make an ODBC connection, examine the resulting Tableau Data Source (TDS) file and use part of it to create a Tableau Data source Customization (TDC) file that you can then use to customize your ODBC connection. Before you begin, you should be familiar with the content in **Tableau and ODBC** on page 517.

Note: Tableau will provide reasonable levels of customer support to assist in troubleshooting connections with ODBC drivers, but can't create or customize a connector to work with a specific ODBC driver.

Make an ODBC connection

This section shows you how to create an ODBC connection using an example. In the example, you connect to a SQLite database using the SQLite ODBC driver.

Prerequisites

The ODBC connection in this article is based on SQLite (<http://www.sqlite.org/>), an open-source database.

You need to download the following two items:

Disclaimer: This information refers to a third-party product. This example is not an endorsement of this product over any other competing products.

- The SQLite 32-bit ODBC driver (required for 32-bit or 64-bit Windows). Download and install the following (select the SQLite 2 drivers):

<http://www.ch-werner.de/sqliteodbc/sqliteodbc.exe>

- A sample SQLite database created from the Microsoft example Northwind database. Download and expand the following:

<http://download.vive.net/Northwind.zip>

Create a connection

To create an ODBC connection, you connect to the Northwind database using the SQLite3 ODBC driver, and then save the connection as a Tableau Data Source (TDS) file.

1. Open Tableau Desktop.
2. On the start page under **Connect**, click **Other Databases (ODBC)**.
Note: For a database that already has a **Tableau-supported connector**, you can click the name of that connector to create a connection.
3. Under **Connect Using**, select **Driver**, and then from the drop-down list, select **SQLite3 ODBC Driver**.
4. Click **Connect**.
5. Next to the **Database Name** text box, click **Browse**, navigate to the location of your **Northwind.sl3** file, and then click **Open**.
6. Click **OK** to close the dialog box, and then click **Sign In**.

7. On the data source page, in the **Table** text box, enter `Orders`.
8. Drag the **Orders** table to the canvas, and then click the sheet tab.
A "Tableau identified limitations for the ODBC data source" dialog box opens. You can review the details or dismiss the dialog box and continue. For more information, see [How Tableau determines the capabilities of the ODBC driver](#).
9. Select **Data > Orders [path to Northwind.sl3] > Add to Saved Data Sources**.
10. Click **Save**.
11. Close the workbook. When asked to save changes, click **No**.

Now you can open the TDS file to examine the SQLite connection.

Review the XML structure of a TDS file

Open the saved Tableau Data Source (TDS) file in a text editor to view its XML structure. By default, the file you created above is named `Northwind.sl3.tds` and is in the following path:

```
Users\[your name]\Documents\My Tableau Repository\Datasources
```

or

```
Users\[your name]\Documents\My Tableau Repository (Beta)\Datasources
```

This is an XML document describing the SQLite connection to the Northwind Orders table. Within the `<connection>` section, find the `<connection-customization>` element, which contains `<customization>` elements that you can edit.

Vendor and driver name

The connection customization section begins with the names Tableau detected for the ODBC driver and the database vendor. Tableau uses this information to associate a specific connection customization with a single type of ODBC data source. The section looks like this:

```
<connection-customization class='genericodbc' enabled='false' version='10.1'>
<vendor name='SQLite' />
<driver name='SQLite3 ODBC Driver' />
<customizations>
```

Types of customizations

Tableau permits two types of customizations: Tableau-specific capabilities, and ODBC API calls to `SQLGetInfo`. These customizations are made of name/value pairs, with the names following a convention of `CAP_` for Tableau capabilities and `SQL_` for the `SQLGetInfo` API calls.

The saved data source file contains examples of both types of customizations. These customizations represent the values that Tableau was able to detect by querying the driver when you connected. The list of customizations might be incomplete or incorrect. You can use customization to modify and shape Tableau's behavior when connecting to an ODBC data source.

The following articles contain a complete reference for the customizations. You should have an idea of how you need to adjust your ODBC connection to perform as you expect in your environment. Review the lists to get an idea of the customizations you can use to tune your ODBC connection.

- [Tableau Capability Customizations Reference on page 568](#)
- [ODBC/SQL Customizations Reference on page 586](#)

Format of customization values

- The customization values are all represented as strings for each name/value pair.
- Tableau capabilities are all Boolean values represented by yes or no.
- The `SQLGetInfo` values can be long-integer, short-integer, or string data, depending on the expected return value of `SQLGetInfo` for the given identifier.
- Many of the integer fields are bitmasks that represent a collection of capabilities.

Make customizations global with a TDC file

To make your customization changes apply to all connections for a given ODBC data source, you need to create a Tableau Data source Customization (TDC) file. This file contains only the `<connection-customization>` section and is applied to any new Tableau connection that matches the database vendor name and driver name described in the TDC file (as noted in [Vendor and driver name on the previous page](#)). Any existing workbook or data source file that already has an enabled customization section will use only the customizations that it supplies, not the TDC file.

Important: TDC files can be utilized to customize the functionality of a connection or to diagnose and resolve issues related to connecting to your data. Tableau is unable to thoroughly test every potential modification you might make with these files. Creating and using TDC files requires manual editing and it is crucial to test them thoroughly before deploying them in a production environment.

Create a TDC file

When you create a TDC file, you need to save it to the right location so that it can be used by your connection. If you create a workbook that you want to publish to Tableau Server, then you need to save the TDC file to the server as well. For more information, see [Using a TDC File with Tableau Server](#) in Tableau Knowledge Base.

Structure of a TDC file

Each TDC file follows this basic structure:

```
<connection-customization class=DSCLASS enabled='true' version='10.0'>
  <vendor name=VENDOR />
  <driver name=DRIVER />
  <customizations>
    <customization name='CAP_FAST_METADATA' value='yes' />
    <customization name='CAP_SOMETHING_ELSE' value='yes' />
    ...
  </customizations>
</connection-customization>
```

A TDC file has three main sections:

- Connection customization variables
- Vendor and driver names
- The customizations themselves

The `connection-customization` section includes the following:

- **class:** The data source you want to connect to and customize.
- **enabled:** Specifies whether the TDC file connection customizations are applied. In the TDC file, always set to “true”.
- **version:** Tableau ignores the version number.

The next section is crucial because it identifies the vendor name and driver name of the database provider for this TDC file's data source. Each TDC file can bind to only one data source type. For our native data sources, these names must both match the data source class name; for example, "teradata" for our Teradata connections. For ODBC data sources, the vendor name and driver name of the TDC file must match what is reported to Tableau by the database and driver; for example, "SQLite" and "SQLite3 ODBC Driver", respectively.

The final section lists the actual connection customizations.

Here are two example TDC files: First, a generic ODBC connection, and second, a modification to a native Salesforce connection. Note these are for example purposes only and the customizations listed are not selected to accomplish a specific goal.

```
<?xml version='1.0' encoding='utf-8' ?>
<connection-customization class='genericodbc' enabled='true' version='8.10'>
  <vendor name='Gen_ODBC_Vendor' />
  <driver name='Gen_Driver' />
  <customizations>
    <customization name='CAP_FAST_METADATA' value='yes' />
    <customization name='CAP_ODBC_BIND_FORCE_MAX_STRING_BUFFERS' value='yes' />
    <customization name='CAP_ODBC_BIND_PRESERVE_BOM' value='yes' />
  </customizations>
</connection-customization>
```

```
<?xml version='1.0' encoding='utf-8' ?>
<connection-customization class='salesforce' enabled='true' version='8.10'>
  <vendor name='salesforce' />
  <driver name='salesforce' />
  <customizations>
    <customization name='CAP_ODBC_EXPORT_CONTINUE_ON_ERROR' value='yes' />
    <customization name='CAP_ODBC_EXPORT_FORCE_SINGLE_ROW_BINDING' value='yes' />
    <customization name='CAP_ODBC_EXPORT_SUPPRESS_STRING_WIDTH_VALIDATION' value='no' />
  </customizations>
</connection-customization>
```

```
</customizations>
</connection-customization>
```

Use the TDC file with Tableau Desktop

1. Using a text editor, copy and paste the entire `<connection-customization>` section of your saved data source file. For reference, see the [Sample SQLite TDC file](#).
2. Name the file `odbc-sqlite.tdc` and save it to `Documents\My Tableau Repository\Datasources`.

Note: The file must be saved with a `.tdc` extension, but the name does not matter.

3. Restart Tableau Desktop to apply the change.
4. Create a new connection to SQLite as described in [Create a connection](#).
5. Go to and open the Tableau Desktop log file, and look for a record similar to the example below to verify that this customization file was applied to your new connection.

Log File Location	Example of Record
By default, <code>C:\User-s\<user>\documents\my code="" repository\logs<="" tableau=""></user>\documents\my></code>	Found matching TDC 'C:\\User-s\\<name>\\Documents\\My Tableau Repository\\Datasources\\odbc-sqlite.tdc' for class='genericodbc', vendor='SQLite', and driver='SQLite3 ODBC Driver'

Use the TDC file with Tableau Prep Builder

1. Using a text editor, copy and paste the entire `<connection-customization>` section of your saved data source file. For reference, see the [Sample SQLite TDC file](#).
2. Name the file `odbc-sqlite.tdc` and save it to the following location:
 - For Windows:

```
Documents\My Tableau Prep Repository\Datasource
```
 - For Mac:

```
Documents/My Tableau Prep Repository/Datasources
```

Note: The file must be saved with a `.tdc` extension, but the name does not matter.

3. Restart Prep to apply the change.
4. Go to and open the log file, and look for a record similar to the example below to verify that this customization file was applied to your new connection.

Log File Location	Example of Record
By default, C:\Users\ <user>\Documents\My Tableau Prep Repository\Logs</user>	Found matching TDC 'C:\\User-s\\<name>\\Documents\\My Tableau Prep Repos-itory\\Datasources\\odbc-sql-ite.tdc' for class='genericodbc', vendor='SQLite', and driver='SQLite3 ODBC Driver'

Use the TDC file with Tableau Server

1. Using a text editor, copy and paste the entire `<connection-customization>` section of your saved data source file. For reference, see the [Sample SQLite TDC file](#).
2. Name the file `odbc-sqlite.tdc` and save it to the following location:

- For Windows:

In Tableau Server versions prior to 2018.2:

```
Program Files\Tableau\Tableau Server<version>\bin
```

Starting in Tableau Server version 2018.2:

```
Program Files\Tableau\Tableau Server\packages\bin.<build number>
```

Or for all Tableau Server versions:

```
ProgramData\Tableau\Tableau Server\data\tabsvc\vizqlserver\Datasources
```

To save the file, you must be a Windows Administrator on the server computer.

- For Linux:

```
/var/opt/tableau/tableau_server/data/tabsvc/vizqlserver/Datasources/
```

Note: The file must be saved with a `.tdc` extension, but the name does not matter. The TDC file must be saved on all server nodes for consistent behavior.

- For Tableau Prep Conductor (running flows) or Prep Web Authoring (editing flows on the web), the TDC file must be placed in additional directories.

Prep Conductor

- For Windows:

```
<data directory>\tabsvc\flowprocessor\Datasources
```

- For Linux:

```
<data directory>/tabsvc/flowprocessor/Datasources
```

Prep Web Authoring

- For Windows:

```
<data directory>\tabsvc\flowminerva\Datasources
```

- For Linux:

```
<data directory>/tabsvc/flowmineva/Datasources
```

- Restart Tableau Server to apply the change.
- Go to and open the Tableau Server log file, and look for a record similar to the example below to verify that this customization file was applied to your new connection.

Log File Location	Example of Record
<install path>\Tableau Server\data\tabsvc\log\vizqlserver	Found matching TDC 'C:\\ProgramData\\Tableau\\Tableau Server-\\data\\tabsvc\\vizqlserver\\Datasources\\odbc-sqlite.tdc for class='genericodbc', vendor='SQLite', and driver='SQLite3 ODBC Driver'
<install path>\Tableau Server\data\tabsvc\log\background	
<install path>\Tableau Server\data\tabsvc\log\dataserver	
<install path>\Tableau Server\data\tabsvc\log\vizportal	

Sample SQLite TDC file

```
<?xml version='1.0' encoding='utf-8' ?>
<connection-customization class='genericodbc' enabled='true' version='7.8'>
<vendor name='SQLite' />
<driver name='SQLite3 ODBC Driver' />
  <customizations>
    <customization name='CAP_CREATE_TEMP_TABLES' value='yes' />
    <customization name='CAP_QUERY_BOOLEXPRESS_TO_INTEXPRESS' value='yes' />
    <customization name='CAP_QUERY_GROUP_BY_ALIAS' value='no' />
    <customization name='CAP_QUERY_GROUP_BY_DEGREE' value='yes' />
    <customization name='CAP_QUERY_JOIN_ACROSS_SCHEMAS' value='no' />
    <customization name='CAP_QUERY_JOIN_REQUIRES_SCOPE' value='no' />
    <customization name='CAP_QUERY_SUBQUERIES' value='yes' />
    <customization name='CAP_QUERY_SUBQUERIES_WITH_TOP' value='yes' />
    <customization name='CAP_SELECT_INTO' value='no' />
    <customization name='CAP_SELECT_TOP_INTO' value='yes' />
    <customization name='SQL_AGGREGATE_FUNCTIONS' value='127' />
    <customization name='SQL_SQL_CONFORMANCE' value='4' />
  </customizations>
</connection-customization>
```

Customize your ODBC connection

Let's assume that you've made an ODBC connection to your data source and verified that you can get the metadata and data you need. Now you need to determine if creating an extract or if using the live connection as is gives you the functionality you need. If it does, the TDC file you created is sufficient, and there is no need to customize your connection.

If the TDC file is not performing the way you want it to, you can customize the connection. You should have an idea of how you need to adjust your ODBC connection to perform as you expect in your environment. Review the lists to see the customizations you can use to tune your ODBC connection.

- [Tableau Capability Customizations Reference](#) on page 568
- [ODBC/SQL Customizations Reference](#) on page 586

Common customizations for improving functionality

The following customizations can help improve functionality for data sources with default capabilities that are not optimal.

- `CAP_SUPPRESS_DISCOVERY_QUERIES` – Setting this value to `true` prevents Tableau from performing any SQL queries at the beginning of the connection to determine the driver's capabilities. You will need to consider which other capabilities should be explicitly enabled, since Tableau will not be able to determine those automatically.
- `SQL_SQL_CONFORMANCE` – This setting indicates which level of the SQL standard is fully supported by the data source. Tableau works best with at least entry-level conformance, so this value should be at least `1` if the data source supports it.
- `SQLAggregateFunctions` – This setting indicates which aggregate functions are supported, such as `MIN`, `MAX`, `SUM`. A value of `'127'` indicates support for all standard SQL aggregate functions.

Handle severely limited data sources

Some data sources are so severely limited that Tableau is unable to complete the steps of creating a connection. Occasionally this is due to crashes within the driver, which cause Tableau to cease working. You can use a global TDC file to prevent Tableau from issuing queries or checking for capabilities that might be associated with the instability.

To create this file, you need to know the database vendor name and ODBC driver name.

1. Create a new connection in Tableau, open your log file, and then look for a line like the following:

```
GenericODBCProtocol::Connect: Detected vendor: 'SQLite' and
driver: 'SQLite3 ODBC Driver'
```

2. Create a TDC file with the listed `vendor` name and `driver` name. See [Vendor and driver name on page 552](#) for an example.
3. Use customizations, such as `CAP_SUPPRESS_DISCOVERY_QUERIES`, to constrain Tableau's interaction with a limited data source.

Configure ODBC driver settings

ODBC drivers provide dialog boxes for supplying connection details such as the server, user name, and password. Many offer advanced options for controlling the connection behavior. You should consider these options when exploring ways to improve the functionality or performance

of your ODBC connection. In particular, look for settings that control the items listed below, as these have been the cause of past issues with ODBC connections in Tableau:

- Transaction Isolation - Prefer `READ, COMMITTED`, or `SERIALIZABLE` to ensure that queries do not include data from pending transactions in their results.
- Cursors - Prefer Holdable or Scrollable over Streaming cursors. Since Tableau closes a transaction after every read-only analytical query, streaming cursors may become truncated and lead to incomplete results displayed in Tableau.
- Row/Resultset Buffers - Prefer larger buffer sizes to improve the performance of fetching numerous rows, which can greatly improve the speed of creating extracts. This is sometimes called the cache size or response size.
- Character Set - In decreasing order of preference: UTF-16, UTF-8, ASCII.

Advanced SQLite customizations

Tableau has special customizations for SQLite that are built in to the product. These customizations take precedence over any connection customizations for SQLite in the workbook file, data source file, or global TDS file. To make advanced changes to SQLite connection customizations, you need to trick Tableau into ignoring its own SQLite dialect. You can do so by changing the reported name of the database vendor (`<customization name='SQL_DBMS_NAME' value='SQLite' />`) to a different value such as `SQLite-Tableau`.

ODBC documentation reference

Microsoft's MSDN has documentation for the ODBC standard. The [ODBC Appendixes](#) are the most applicable as resources for the article information, specifically:

- Appendix C: [SQL Grammar](#) - especially the [SQL Minimum Grammar](#) and [ODBC Escape Sequences](#)
- Appendix D: [Data Types](#)
- Appendix E: [Scalar Functions](#)

See also

[Other Databases \(ODBC\) on page 513](#) – Describes how to connect to your data using the ODBC connector.

[Tableau and ODBC on page 517](#) – Provides background information about ODBC, describes how Tableau determines the functionality of an ODBC driver, and lists frequently asked questions.

Tableau Capability Customizations Reference on page 568 – Lists customizations you can use to define which Tableau capabilities are supported by the data source.

ODBC/SQL Customizations Reference on page 586 – Lists customizations that represent the parts of the ODBC and SQL standards that the ODBC driver reports supporting.

Customize the Connection String for a Native Connector – This article in Tableau Community describes how to modify the connection made with a native connector using the `odbc-connect-string-extras` customization.

Tableau JDBC Capability Customizations Reference

You can set the following capability customizations in the Tableau Datasource Customization (TDC) file to define which Tableau capabilities are supported by the JDBC connection.

Many of these customizations influence the type of SQL queries that Tableau issues. For settings that are not defined, Tableau attempts to determine the proper values for each capability by issuing various forms of SQL queries to experimentally verify which forms are supported.

CAP_CREATE_TEMP_TABLES	Set to 'yes' if Tableau can create temporary tables needed for certain complex or optimized queries. See also: CAP_SELECT_INTO.
CAP_CONNECT_STORED_PROCEDURE	Set to 'yes' to allow support for connecting to a stored procedure.
CAP_FAST_METADATA	Set to 'yes' if you have small to moderate size schemas. This capability controls whether Tableau should enumerate all of the objects immediately when you connect. Set the value to "yes" to enable this capability for better performance when creating new connections. Disable this capability to allow search for specific schemas or tables instead of retrieving all objects. You can search for all objects by using an empty string. This capability is available in 9.0 and later.
CAP_ISOLATION_LEVEL_READ_COMMITTED	Set to 'yes' to force the transaction isolation level to Read Committed if the data source supports it.

	Only one of the four transaction isolation levels should be set to 'yes'. See also: CAP_SET_ISOLATION_LEVEL_VIA_SQL.
CAP_ISOLATION_LEVEL_READ_UNCOMMITTED	Set to 'yes' to force the transaction isolation level to Read Uncommitted if the data source supports it. Only one of the four transaction isolation levels should be set to 'yes'. This capability can improve speed by reducing lock contention, but may result in partial or inconsistent data in query results. See also: CAP_SET_ISOLATION_LEVEL_VIA_SQL.
CAP_ISOLATION_LEVEL_REPEATABLE_READS	Set to 'yes' to force the transaction isolation level to Repeatable Reads if the data source supports it. Only one of the four transaction isolation levels should be set to 'yes'. See also: CAP_SET_ISOLATION_LEVEL_VIA_SQL.
CAP_ISOLATION_LEVEL_SERIALIZABLE	Set to 'yes' to force the transaction isolation level to Serializable if the data source supports it. Only one of the four transaction isolation levels should be set to 'yes'. This is a very conservative setting that may improve stability at the expense of performance. See also: CAP_SET_ISOLATION_LEVEL_VIA_SQL.
CAP_JDBC_BIND_DETECT_ALIAS_CASE_FOLDING	Set to 'yes' to allow Tableau to detect and recover from a JDBC data source that reports the field names in a result set using only uppercase or lowercase characters, instead of the expected field names.
CAP_JDBC_EXPORT_DATA_BATCH	Set to 'no' to disable the use of JDBC batch operations for data insert.
CAP_JDBC_METADATA_GET_INDEX_INFO	Set to 'no' to disable reading index information.

CAP_JDBC_METADATA_READ_FOREIGNKEYS	Set to 'no' to disable reading foreign key metadata.
CAP_JDBC_METADATA_READ_PRIMARYKEYS	Set to 'no' to disable reading primary key metadata.
CAP_JDBC_METADATA_USE_RESULTSET_FOR_TABLE	Set to 'yes' to get column metadata from the result set of a select * query. Available in Tableau 2020.4 and newer.
CAP_JDBC_QUERY_ASYNC	Set to 'yes' to run queries on another thread.
CAP_JDBC_QUERY_CANCEL	Set to 'yes' if driver can cancel queries.
CAP_JDBC_QUERY_DISABLE_AUTO_COMMIT	Set to 'yes' to disable the default auto-commit mode when running query. Available in Tableau 2020.4 and newer.
CAP_JDBC_QUERY_FORCE_PREPARE	Set to 'yes' to always prepare the query before execution. Available in Tableau 2020.4 and newer.
CAP_JDBC_SUPPRESS_EMPTY_CATALOG_NAME	Set to 'yes' to ignore missing catalog.
CAP_JDBC_SUPPRESS_ENUMERATE_DATABASES	Set to 'yes' to disable database enumeration.
CAP_JDBC_SUPPRESS_ENUMERATE_SCHEMAS	Set to 'yes' to disable schema enumeration.
CAP_JDBC_METADATA_SUPPRESS_PREPARED_QUERY	If CAP_JDBC_METADATA_USE_RESULTSET_FOR_TABLE is enabled, set this capability to 'yes' to disable preparing the query used for reading the table metadata. We will execute the query wrapped with a where-false clause.
CAP_JDBC_USE_ADAPTIVE_FETCH_SIZE	Set to 'yes' to use ResultSet metadata to determine optimal fetch size. May require CAP_JDBC_QUERY_FORCE_PREPARE to be

	enabled to work properly. Available in Tableau 2020.4 and newer.
CAP_MULTIPLE_CONNECTIONS_FROM_SAME_IP	Set to 'no' to prevent Tableau from creating more than one active connection to the database. This is a conservative setting that may increase stability at the expense of performance.
CAP_QUERY_BOOLEXPRESS_TO_INTEXPRESS	Set to 'yes' if Tableau must coerce any Boolean expressions to an integer value in order include in a result set.
CAP_QUERY_FROM_REQUIRES_ALIAS	Set to 'yes' if the FROM clause must provide an alias for the given table.
CAP_QUERY_GROUP_ALLOW_DUPLICATES	Set to 'no' if SQL queries cannot contain duplicate expressions in the GROUP BY clause (this is uncommon).
CAP_QUERY_GROUP_BY_ALIAS	Set to 'yes' if SQL queries with aggregations can reference the grouping columns by their corresponding alias in the SELECT list, e.g. GROUP BY "none_ShipCountry_nk".
CAP_QUERY_GROUP_BY_DEGREE	Set to 'yes' if SQL queries with aggregations can reference the grouping columns by the ordinal position of each column, e.g. GROUP BY 2, 5. See also: CAP_QUERY_SORT_BY_DEGREE
CAP_QUERY_HAVING_REQUIRES_GROUP_BY	Set to 'yes' if Tableau must use an artificial grouping field for any query which has a HAVING clause but no grouping columns.
CAP_QUERY_HAVING_UNSUPPORTED	Set to 'yes' if the SQL syntax for HAVING is unsupported. Tableau may be able to work around this using subqueries. See also: CAP_QUERY_SUBQUERIES.
CAP_QUERY_INCLUDE_GROUP_BY	Set to 'yes' to require all GROUP BY expressions

BY_COLUMNS_IN_SELECT	to also appear in the SELECT expression list.
CAP_QUERY_JOIN_ACROSS_SCHEMAS	Set to 'yes' if SQL queries can express joins between tables located in different schemas.
CAP_QUERY_JOIN_ASSUME_CONSTRAINED	Set to 'yes' to cull inner joins even if the database tables does do not have FK-PK relationships.
CAP_QUERY_JOIN_PUSH_DOWN_CONDITION_EXPRESSIONS	Set to 'yes' to rewrite joins to simplify the ON clause conditions to simple identifier comparisons.
CAP_QUERY_JOIN_REQUIRES_SCOPE	Set to 'yes' if SQL queries must scope each join clause within parentheses to ensure a proper order of evaluation.
CAP_QUERY_JOIN_REQUIRES_SUBQUERY	Set to 'yes' to force join expressions involving more than two tables to be composed with subqueries.
CAP_QUERY_NULL_REQUIRES_CAST	Set to 'yes' if the data source requires that all NULL literals are cast to an explicit data type.
CAP_QUERY_SELECT_ALIASES_SORTED	Set to 'yes' if Tableau must impose a deterministic order on the SELECT expressions (sorted by alias) to ensure that query results can be properly matched with each field in the Tableau visualization. This is only required for data sources which do not preserve the aliases of the SELECT expressions when returning metadata with the query results.
CAP_QUERY_SORT_BY_DEGREE	Set to 'yes' if SQL queries can reference the sorting columns by the ordinal position of each column, e.g. ORDER BY 2, 5. See also: CAP_QUERY_GROUP_BY_DEGREE.
CAP_QUERY_SUBQUERIES	Set to 'yes' if the data source supports subqueries.
CAP_QUERY_SUBQUERIES_WITH_	Set to 'yes' if the data source supports a TOP or

TOP	LIMIT row-limiting clause within a subquery.
CAP_QUERY_SUBQUERY_DATASOURCE_CONTEXT	Set to 'yes' to use subquery filtered query context to implement data source filters. This capability is available in Tableau 8.0 through Tableau 9.3 only.
CAP_QUERY_SUBQUERY_QUERY_CONTEXT	Set to 'yes' to force Tableau to use a subquery for context filters instead of a temporary table or locally cached results.
CAP_QUERY_TOP_N	Set to 'yes' if the data source supports any form of row-limiting clause. The exact forms supported are described below.
CAP_QUERY_TOPSTYLE_LIMIT	Set to 'yes' if the data source uses LIMIT as the row-limiting clause.
CAP_QUERY_TOPSTYLE_ROWNUM	Set to 'yes' if the data source supports an Oracle-style filter on ROWNUM as the row-limiting clause.
CAP_QUERY_TOPSTYLE_TOP	Set to 'yes' if the data source uses TOP as the row-limiting clause.
CAP_QUERY_USE_QUERY_FUSION	Set to 'no' to prevent Tableau from combining multiple individual queries into a single combined query. Turn off this capability for performance tuning or if the database is unable to process large queries. This capability is enabled by default and is available in Tableau 9.0 and later for all data sources except Tableau data extracts. Support for this capability in Tableau data extracts is available in Tableau 9.0.6.
CAP_SELECT_INTO	Set to 'yes' if Tableau can create a table on the fly from the resultset of another query. See also: CAP_CREATE_TEMP_TABLES.
CAP_SELECT_TOP_INTO	Set to 'yes' if Tableau can use a TOP or LIMIT

	row-limiting clause when creating a table from a query result set.
CAP_SET_ISOLATION_LEVEL_VIA_SQL	Set to 'yes' to force Tableau to set the transaction isolation level for the data source using a SQL query. CAP_SET_ISOLATION_LEVEL_VIA_SQL must be set to 'yes' when any one of the four CAP_ISOLATION_LEVEL capabilities has been set to 'yes'.
CAP_STORED_PROCEDURE_PREFER_TEMP_TABLE	Set to 'yes' to use a temporary table to support remote queries over the stored procedure result set.
CAP_STORED_PROCEDURE_REPAIR_TEMP_TABLE_STRINGS	Set to 'yes' to attempt to compute actual string widths if metadata indicates no width or non-positive width.
CAP_STORED_PROCEDURE_TEMP_TABLE_FROM_BUFFER	Set to 'yes' to populate the temporary table from a result set buffered in entirety.
CAP_STORED_PROCEDURE_TEMP_TABLE_FROM_NEW_PROTOCOL	Set to 'yes' to populate the temporary table from a separate protocol created for just this operation.
CAP_SUPPRESS_DISCOVERY_QUERIES	Set to 'yes' to prevent Tableau from detecting the supported SQL syntax for a variety of clauses.
CAP_SUPPRESS_DISPLAY_LIMITATIONS	Set to 'yes' to suppress displaying any warnings about limitations for this data source.

See also

[Other Databases \(JDBC\) on page 505](#) – Describes how to connect to your data using the Other Databases (JDBC) connector.

Tableau Capability Customizations Reference

You can set the following capability customizations in the Tableau Datasource Customization (TDC) file to define which Tableau capabilities are supported by the ODBC connection. For

more information, see [Customize and Tune a Connection on page 541](#).

Many of these customizations influence the type of SQL queries that Tableau issues. For settings that are not defined, Tableau attempts to determine the proper values for each capability by issuing various forms of SQL queries to experimentally verify which forms are supported, as described in [How Tableau determines the capabilities of the ODBC driver](#).

CAP_CREATE_TEMP_TABLES	Set to 'yes' if Tableau can create temporary tables needed for certain complex or optimized queries. See also: CAP_SELECT_INTO.
CAP_CONNECT_STORED_PROCEDURE	Set to 'yes' to allow support for connecting to a stored procedure.
CAP_FAST_METADATA	Set to 'yes' if you have small to moderate size schemas. This capability controls whether Tableau should enumerate all of the objects immediately when you connect. Set the value to "yes" to enable this capability for better performance when creating new connections. Disable this capability to allow search for specific schemas or tables instead of retrieving all objects. You can search for all objects by using an empty string. This capability is available in 9.0 and later.
CAP_ISOLATION_LEVEL_READ_COMMITTED	Set to 'yes' to force the transaction isolation level to Read Committed if the data source supports it. Only one of the four transaction isolation levels should be set to 'yes'. See also: CAP_SET_ISOLATION_LEVEL_VIA_SQL, CAP_SET_ISOLATION_LEVEL_VIA_ODBC_API.
CAP_ISOLATION_LEVEL_READ_UNCOMMITTED	Set to 'yes' to force the transaction isolation level to Read Uncommitted if the data source supports it. Only one of the four transaction isolation levels should be set to 'yes'. This capability can improve speed by reducing lock contention, but may result in partial or inconsistent data in query results. See also: CAP_SET_ISOLATION_LEVEL_VIA_SQL,

	CAP_SET_ISOLATION_LEVEL_VIA_ODBC_API.
CAP_ISOLATION_LEVEL_REPEATABLE_READS	Set to 'yes' to force the transaction isolation level to Repeatable Reads if the data source supports it. Only one of the four transaction isolation levels should be set to 'yes'. See also: CAP_SET_ISOLATION_LEVEL_VIA_SQL, CAP_SET_ISOLATION_LEVEL_VIA_ODBC_API.
CAP_ISOLATION_LEVEL_SERIALIZABLE	Set to 'yes' to force the transaction isolation level to Serializable if the data source supports it. Only one of the four transaction isolation levels should be set to 'yes'. This is a very conservative setting that may improve stability at the expense of performance. See also: CAP_SET_ISOLATION_LEVEL_VIA_SQL, CAP_SET_ISOLATION_LEVEL_VIA_ODBC_API.
CAP_SET_ISOLATION_LEVEL_VIA_ODBC_API	Set to 'yes' to force Tableau to set the transaction isolation level for the data source using the ODBC API. CAP_SET_ISOLATION_LEVEL_VIA_ODBC_API must be set to 'yes' when any one of the four CAP_ISOLATION_LEVEL capabilities has been set to 'yes'.
CAP_SET_ISOLATION_LEVEL_VIA_SQL	Set to 'yes' to force Tableau to set the transaction isolation level for the data source using a SQL query. CAP_SET_ISOLATION_LEVEL_VIA_SQL must be set to 'yes' when any one of the four CAP_ISOLATION_LEVEL capabilities has been set to 'yes'.
CAP_MULTIPLE_CONNECTIONS_FROM_SAME_IP	Set to 'no' to prevent Tableau from creating more than one active connection to the database. This is a conservative setting that may increase stability at the expense of performance.
CAP_ODBC_BIND_DETECT_ALIAS	Set to 'yes' to allow Tableau to detect and recover

CASE_FOLDING	from an ODBC data source that reports the field names in a result set using only upper-case or lower-case characters, instead of the expected field names.
CAP_ODBC_BIND_BOOL_AS_WCHAR_01LITERAL	Set to 'yes' to bind a Boolean data type as a WCHAR containing values '0' or '1'.
CAP_ODBC_BIND_BOOL_AS_WCHAR_TFLITERAL	Set to 'yes' to bind a Boolean data type as WCHAR containing values 't' or 'f'.
CAP_ODBC_BIND_FORCE_DATE_AS_CHAR	Set to 'yes' to force the Tableau native ODBC protocol to bind date values as CHAR.
CAP_ODBC_BIND_FORCE_DATETIME_AS_CHAR	Set to 'yes' to force the Tableau native ODBC protocol to bind datetime values as CHAR.
CAP_ODBC_BIND_FORCE_MAX_STRING_BUFFERS	Set to 'yes' to force the Tableau native ODBC protocol to use maximum-sized buffers (1MB) for strings instead of the size described by metadata.
CAP_ODBC_BIND_FORCE_MEDIUM_STRING_BUFFERS	Set to 'yes' to force the Tableau native ODBC protocol to use medium-sized buffers (1K) for strings instead of the size described by metadata.
CAP_ODBC_BIND_FORCE_SMALL_STRING_BUFFERS	Set to 'yes' to force the Tableau native ODBC protocol to use small buffers for strings instead of the size described by metadata.
CAP_ODBC_BIND_FORCE_SIGNED	Set to 'yes' to force binding integers as signed.
CAP_ODBC_BIND_PRESERVE_BOM	Set to 'yes' to preserve BOM when present in strings. Hive will return BOM and treat strings containing it as distinct entities.
CAP_ODBC_BIND_SKIP_LOCAL_DATATYPE_UNKNOWN	Set to 'yes' to prevent the native ODBC Protocol from binding to columns having local data type DataType::Unknown in the expected metadata.
CAP_ODBC_BIND_SPATIAL_AS_WKT	Set to 'yes' to force binding Spatial data as WKT

WKT	(Well Known Text)
CAP_ODBC_BIND_SUPPRESS_COERCE_TO_STRING	Set to 'yes' to prevent the Tableau native ODBC protocol from binding non-string data as strings (i.e. requesting driver conversion).
CAP_ODBC_BIND_SUPPRESS_INT64	Set to 'yes' to prevent the Tableau native ODBC protocol from using 64-bit integers for large numeric data.
CAP_ODBC_BIND_SUPPRESS_PREFERRED_CHAR	Set to 'yes' to prevent the Tableau native ODBC protocol from preferring a character type that differs from the driver default.
CAP_ODBC_BIND_SUPPRESS_PREFERRED_TYPES	Set to 'yes' to prevent the Tableau native ODBC protocol from binding any data according to its preferred wire types. With this capability set, Tableau will only bind according to the data types described by the ODBC driver via metadata.
CAP_ODBC_BIND_SUPPRESS_WIDE_CHAR	Set to 'yes' to prevent the Tableau native ODBC protocol from binding strings a WCHAR. Instead they will be bound as single-byte CHAR arrays, and processed locally for any UTF-8 characters contained within.
CAP_ODBC_CONNECTION_STATE_VERIFY_FAST	Set to 'yes' to check if a connection is broken with a fast ODBC API call.
CAP_ODBC_CONNECTION_STATE_VERIFY_PROBE	Set to 'yes' to check if a connection is broken with a forced probe.
CAP_ODBC_CONNECTION_STATE_VERIFY_PROBE_IF_STALE	Set to 'yes' to check if a connection is broken with a forced probe only if it is "stale" (i.e., unused for about 30 minutes).
CAP_ODBC_CONNECTION_STATE_VERIFY_PROBE_PREPARED_QUERY	Set to 'yes' to check if a connection is broken using a prepared query.

CAP_ODBC_CURSOR_DYNAMIC	Set to 'yes' to force the Tableau native ODBC protocol to set the cursor type for all statements to Dynamic (scrollable, detects added/removed/modified rows).
CAP_ODBC_CURSOR_FORWARD_ONLY	Set to 'yes' to force the Tableau native ODBC protocol to set the cursor type for all statements to Forward-only (non-scrollable).
CAP_ODBC_CURSOR_KEYSET_DRIVEN	Set to 'yes' to force the Tableau native ODBC protocol to set the cursor type for all statements to Keyset-driven (scrollable, detects changes to values within a row).
CAP_ODBC_CURSOR_STATIC	Set to 'yes' to force Tableau to set the cursor type for all statements to Static (scrollable, does not detect changes).
CAP_ODBC_ERROR_IGNORE_FALSE_ALARM	Set to 'yes' to allow the Tableau native ODBC protocol to ignore SQL_ERROR conditions where SQLSTATE is '00000' (meaning "no error").
CAP_ODBC_ERROR_IGNORE_SQLNODATA_FOR_COMMAND_QUERIES	Set to 'yes' to ignore when SQLExecDirect returns SQL_NO_DATA even when data is not expected back.
CAP_ODBC_EXPORT_ALLOW_CHAR_UTF8	Set to 'yes' to allow the use of single-byte char data type for binding Unicode strings as UTF-8.
CAP_ODBC_EXPORT_BIND_FORCE_TARGET_METADATA	Set to 'yes' to force binding for export based on all of the metadata from the target table instead of the ODBC metadata for the parameterized insert statement.
CAP_ODBC_EXPORT_BIND_PREFER_TARGET_METADATA	Set to 'yes' to prefer binding for export based on specific types of metadata from the target table instead of the ODBC metadata for the parameterized insert statement.

CAP_ODBC_EXPORT_BUFFERS_RESIZABLE	Set to 'yes' to allow export buffers to be reallocated after the first batch to improve performance.
CAP_ODBC_EXPORT_BUFFERS_SIZE_FIXED	Set to 'yes' to ignore the width of a single row when computing the total rows to insert at a time.
CAP_ODBC_EXPORT_BUFFERS_SIZE_LIMIT_512KB	Set to 'yes' to limit export buffers to 512 KB. This is an uncommon setting.
CAP_ODBC_EXPORT_BUFFERS_SIZE_MASSIVE	Set to 'yes' to force the use of large buffers for insert. If CAP_ODBC_EXPORT_BUFFERS_RESIZABLE is not set or disabled, a fixed row count is used.
CAP_ODBC_EXPORT_BUFFERS_SIZE_MEDIUM	Set to 'yes' to force the use of medium-sized buffers for insert. If CAP_ODBC_EXPORT_BUFFERS_RESIZABLE is not set or disabled, a fixed row count is used.
CAP_ODBC_EXPORT_BUFFERS_SIZE_SMALL	Set to 'yes' to force the use of small buffers for insert. If CAP_ODBC_EXPORT_BUFFERS_RESIZABLE is not set or disabled, a fixed row count is used.
CAP_ODBC_EXPORT_CONTINUE_ON_ERROR	Set to 'yes' to continue data insert despite errors. Some data sources report warnings as errors.
CAP_ODBC_EXPORT_DATA_BULK	Set to 'yes' to allow the use of ODBC bulk operations for data insert.
CAP_ODBC_EXPORT_DATA_BULK_VIA_INSERT	Set to 'yes' to allow the use of ODBC bulk operations based on 'INSERT INTO' parameterized queries.
CAP_ODBC_EXPORT_DATA_BULK_VIA_ROWSET	Set to 'yes' to allow the use of ODBC bulk operations based on a rowset cursor.
CAP_ODBC_EXPORT_FORCE_INDICATE_NTS	Set to 'yes' to force the use of indicator buffers for identifying null-terminated strings (NTS).

CAP_ODBC_EXPORT_FORCE_SINGLE_ROW_BINDING	Set to 'yes' to force the use of a single row for binding export buffers to insert data.
CAP_ODBC_EXPORT_FORCE_SINGLE_ROW_BINDING_WITH_TIMESTAMPS	Set to 'yes' to force the use of a single row for binding export buffers when dealing with timestamp data. This is required for some versions of Teradata.
CAP_ODBC_EXPORT_FORCE_STRING_WIDTH_FROM_SOURCE	Set to 'yes' to force the use of the source string width (from Tableau metadata), overriding the destination string width (from insert parameter metadata).
CAP_ODBC_EXPORT_FORCE_STRING_WIDTH_USING_OCTET_LENGTH	Set to 'yes' to force the use of the source string width from the octet length.
CAP_ODBC_EXPORT_SUPPRESS_STRING_WIDTH_VALIDATION	Set to 'yes' to suppress validating that the target string width can accommodate the widest source strings.
CAP_ODBC_EXPORT_TRANSACTIONS_COMMIT_BATCH_MASSIVE	Set to 'yes' to commit in massive batches of INSERT statements (~100,000). This may be useful with single-row export binding.
CAP_ODBC_EXPORT_TRANSACTIONS_COMMIT_BATCH_MEDIUM	Set to 'yes' to commit in medium-sized batches of INSERT statements (~50). A single statement may be bound to multiple records.
CAP_ODBC_EXPORT_TRANSACTIONS_COMMIT_BATCH_SMALL	Set to 'yes' to commit in small batches of INSERT statements (~5). A single statement may be bound to multiple records.
CAP_ODBC_EXPORT_TRANSACTIONS_COMMIT_BYTES_MASSIVE	Set to 'yes' to commit in massive batches of data (~100 MB).
CAP_ODBC_EXPORT_TRANSACTIONS_COMMIT_BYTES_MEDIUM	Set to 'yes' to commit in medium batches of data (~10 MB).

MEDIUM	
CAP_ODBC_EXPORT_TRANSACTIONS_COMMIT_BYTES_SMALL	Set to 'yes' to commit in small batches of data (~1 MB).
CAP_ODBC_EXPORT_TRANSACTIONS_COMMIT_EACH_STATEMENT	Set to 'yes' to commit after executing each INSERT statement. A single statement may be bound to multiple records.
CAP_ODBC_EXPORT_TRANSACTIONS_COMMIT_INTERVAL_LONG	Set to 'yes' to commit in long intervals of elapsed time (~100 seconds).
CAP_ODBC_EXPORT_TRANSACTIONS_COMMIT_INTERVAL_MEDIUM	Set to 'yes' to commit in medium intervals of elapsed time (~10 seconds).
CAP_ODBC_EXPORT_TRANSACTIONS_COMMIT_INTERVAL_SHORT	Set to 'yes' to commit in short intervals of elapsed time (~1 seconds).
CAP_ODBC_EXPORT_TRANSACTIONS_COMMIT_ONCE_WHEN_COMPLETE	Set to 'yes' to commit only once at the end after the export is complete.
CAP_ODBC_EXPORT_TRANSLATE_DATA_PARALLEL	Set to 'yes' to use parallel loops to translate Tableau DataValues to wire buffers on export.
CAP_ODBC_FETCH_ABORT_FORCE_CANCEL_STATEMENT	Set to 'yes' to cancel the statement handle upon interrupting SQLFetch with a cancel exception.
CAP_ODBC_FETCH_BUFFERS_RESIZABLE	Set to 'yes' to allow buffers to be reallocated after fetch to improve performance or handle data truncation.
CAP_ODBC_FETCH_BUFFERS_SIZE_FIXED	Set to 'yes' to ignore the width of a single row when computing the total rows to fetch.
CAP_ODBC_FETCH_BUFFERS_	Set to 'yes' to force the use of large buffers. If

SIZE_MASSIVE	CAP_ODBC_FETCH_BUFFERS_SIZE_FIXED is enabled, a fixed row count is used.
CAP_ODBC_FETCH_BUFFERS_SIZE_MEDIUM	Set to 'yes' to force the use of medium-sized buffers. If CAP_ODBC_FETCH_BUFFERS_SIZE_FIXED is enabled, a fixed row count is used.
CAP_ODBC_FETCH_BUFFERS_SIZE_SMALL	Set to 'yes' to force the use of small buffers. If CAP_ODBC_FETCH_BUFFERS_SIZE_FIXED is enabled, a fixed row count is used.
CAP_ODBC_FETCH_CONTINUE_ON_ERROR	Set to 'yes' to allow the Tableau native ODBC protocol to continue resultset fetch despite errors (some data sources report warnings as errors).
CAP_ODBC_FETCH_IGNORE_FRACTIONAL_SECONDS	Set to 'yes' to allow the Tableau native ODBC protocol to ignore the fractional seconds component of a time value when fetching query result set data. This is useful when working with data sources that do not follow the ODBC specification for fractional seconds, which must be represented as billionths of a second.
CAP_ODBC_FETCH_RESIZE_BUFFERS	Set to 'yes' to allow the Tableau native ODBC protocol to automatically resize buffers and fetch again if data truncation occurred.
CAP_ODBC_FORCE_SINGLE_ROW_BINDING	Set to 'yes' to force the Tableau native ODBC protocol to use a single row for result set transfers instead of the more efficient bulk-fetch.
CAP_ODBC_IMPORT_ERASE_BUFFERS	Set to 'yes' to reset the contents of data buffers before fetching each block.
CAP_ODBC_IMPORT_TRANSLATE_DATA_PARALLEL	Set to 'no' to disable decoding data locally in parallel.
CAP_ODBC_METADATA_FORCE_LENGTH_AS_PRECISION	Set to 'yes' to force the Tableau native ODBC protocol to use the column "length" as the numeric

	precision. This is an uncommon setting.
CAP_ODBC_METADATA_FORCE_NUM_PREC_RADIX_10	Set to 'yes' to force the Tableau native ODBC protocol to assume the numeric precision is reported in base-10 digits. This is an uncommon setting.
CAP_ODBC_METADATA_FORCE_UNKNOWN_AS_STRING	Set to 'yes' to force the Native ODBC Protocol to treat unknown data types as string instead of ignoring the associated column.
CAP_ODBC_METADATA_FORCE_UTF8_IDENTIFIERS	Set to 'yes' to force the protocol to treat identifiers as UTF-8 when communicating with the driver.
CAP_ODBC_METADATA_SKIP_DESC_TYPE_NAME	Set to 'yes' to remove the check for the SQL_DESC_TYPE_NAME attribute with the SQLColAttribute API.
CAP_ODBC_METADATA_STRING_LENGTH_UNKNOWN	Set to 'yes' to prevent Tableau from allocating memory based on the driver-reported string length, which may not be known or reported properly. Instead, Tableau will use a fixed-sized string length, and will reallocate as needed to handle string data that is too large for the fixed-size buffer.
CAP_ODBC_METADATA_STRING_TRUST_OCTET_LENGTH	Set to 'yes' to use the octet length reported by the driver for strings instead of computing it from the number of characters.
CAP_ODBC_METADATA_SUPPRESS_EXECUTED_QUERY	Set to 'yes' to prevent Tableau from executing a query as a means of reading metadata. While Tableau typically includes a row-limiting clause in such metadata queries (e.g., 'LIMIT', or 'WHERE 1=0'), this may not help when used with a Custom SQL connection for database systems with poor query optimizers. Note that this capability may prevent Tableau from determining the connection metadata properly.

<p>CAP_ODBC_METADATA_SUPPRESS_PREPARED_QUERY</p>	<p>Set to 'yes' to prevent Tableau from using a prepared query as a means of reading metadata. A prepared query is often the fastest way to accurately read metadata. However, not all database systems are capable of reporting metadata for a prepared query without actually executing the query. Note that certain metadata -- for example from connections using Custom SQL-- cannot be retrieved if this capability and CAP_ODBC_METADATA_SUPPRESS_EXECUTED_QUERY are both set.</p>
<p>CAP_ODBC_METADATA_SUPPRESS_READ_IDENTITY_COLUMNS</p>	<p>Set to 'no' to prevent reading identity column metadata.</p>
<p>CAP_ODBC_METADATA_SUPPRESS_SELECT_STAR</p>	<p>Set to 'yes' to prevent reading metadata using a 'select *' query.</p>
<p>CAP_ODBC_METADATA_SUPPRESS_SQLCOLUMNS_API</p>	<p>Set to 'yes' to prevent Tableau from using older, less accurate API for reading metadata from ODBC data sources. Setting this capability allows Tableau to read metadata by issuing a full 'select *' query, which is expensive but may enable connectivity for extremely limited or unstable data sources.</p>
<p>CAP_ODBC_METADATA_SUPPRESS_SQLFOREIGNKEYS_API</p>	<p>Set to 'yes' to prevent Tableau from attempting to read metadata describing foreign key constraints. Despite the simple nature of this ODBC API, some drivers may have unstable behavior or produce inaccurate results. Setting this capability may force Tableau to generate less efficient queries involving multi-table joins.</p>
<p>CAP_ODBC_METADATA_SUPPRESS_SQLPRIMARYKEYS_API</p>	<p>Set to 'yes' to prevent Tableau from reading primary key metadata using the SQLPrimaryKeys API or an equivalent query. This capability is</p>

	available in Tableau 9.1 and later.
CAP_ODBC_METADATA_SUPPRESS_SQLSTATISTICS_API	Set to 'yes' to prevent reading unique constraints and table cardinality estimates using the SQLStatistics API or an equivalent query. This capability is available in Tableau 9.0 and later.
CAP_ODBC_QUERY_USE_PREPARE_PARAMETER_MARKER	Enable to use prepared statements with parameter markers instead of literal values. Applies only for floating point, integer, and string values.
CAP_ODBC_REBIND_SKIP_UNBIND	Set to 'yes' to force the Tableau native ODBC protocol to rebind a column directly and skip unbinding, which reduces ODBC API calls when resizing buffers to refetch truncated data.
CAP_ODBC_SUPPORTS_LONG_DATA_BULK	Set to 'yes' if driver can fetch multiple long-data rows at a time.
CAP_ODBC_SUPPORTS_LONG_DATA_ORDERED	Set to 'yes' if driver requires long-data columns to come after non-long-data ones.
CAP_ODBC_SUPPRESS_INFO_SCHEMA_STORED_PROCS	Set to 'yes' to prevent the INFORMATION.SCHEMA schema from being queried when enumerating stored procedures.
CAP_ODBC_SUPPRESS_INFO_SCHEMA_TABLES	Set to 'yes' to prevent tables from "information_schema" schema from being returned by EnumerateTables.
CAP_ODBC_SUPPRESS_PG_TEMP_SCHEMA_TABLES	Set to 'yes' to prevent tables from "pg_temp" schema from being returned by EnumerateTables.
CAP_ODBC_SUPPRESS_PREPARED_QUERY_FOR_ALL_COMMAND_QUERIES	Set to 'yes' to execute all commands directly (i.e., no prepared statement).
CAP_ODBC_SUPPRESS_PREPARED_QUERY_FOR_DDL_COMMAND_QUERIES	Set to 'yes' to execute DDL commands (e.g. CREATE TABLE) directly (i.e., no prepared statement).

CAP_ODBC_SUPPRESS_PREPARED_QUERY_FOR_DML_COMMAND_QUERIES	Set to 'yes' to execute DML commands (e.g. INSERT INTO) directly (i.e, no prepared statement).
CAP_ODBC_SUPPRESS_PREPARED_QUERY_FOR_NON_COMMAND_QUERIES	Set to 'yes' to execute all non-command queries directly (no prepared statement).
CAP_ODBC_SUPPRESS_SYS_SCHEMA_STORED_PROCS	Set to 'yes' to explicitly add the "SYS" schema to the schema exclusions when enumerating stored procedures.
CAP_ODBC_TRANSACTIONS_COMMIT_INVALIDATES_PREPARED_QUERY	Set to 'yes' to indicate that a transaction will invalidate all prepared statements and close any open cursors.
CAP_ODBC_TRANSACTIONS_SUPPRESS_AUTO_COMMIT	Set to 'yes' to prevent the Native ODBC Protocol from using default auto-committing transaction behavior in ODBC. This capability cannot be used with CAP_ODBC_TRANSACTIONS_SUPPRESS_EXPLICIT_COMMIT.
CAP_ODBC_TRANSACTIONS_SUPPRESS_EXPLICIT_COMMIT	Set to 'yes' to prevent the Native ODBC Protocol from explicitly managing transactions. This capability cannot be used with CAP_ODBC_TRANSACTIONS_SUPPRESS_AUTO_COMMIT.
CAP_ODBC_TRIM_CHAR_LEAVE_PADDING	Set to 'yes' to leave whitespace padding at the end of a character or text data type. Most data sources will trim this whitespace automatically, but the behavior depends on the driver.
CAP_ODBC_TRIM_VARCHAR_PADDING	Set to 'yes' to force the Tableau native ODBC protocol to trim trailing whitespace from VARCHAR columns which the driver has erroneously padded.
CAP_ODBC_UNBIND_AUTO	Set to 'yes' to force the Tableau native ODBC protocol to unbind and deallocate columns automatically, which can reduce ODBC API calls.

CAP_ODBC_UNBIND_BATCH	Set to 'yes' to force the Tableau native ODBC protocol to unbind and deallocate columns in a single batch operation, which can reduce ODBC API calls.
CAP_ODBC_UNBIND_EACH	Set to 'yes' to force the Tableau native ODBC protocol to unbind and deallocate columns individually, which may improve stability.
CAP_ODBC_UNBIND_PARAMETERS_BATCH	Set to 'yes' to unbind all parameters in a single batch operation.
CAP_ORACLE_SHOW_ALL_SYNONYM_OWNERS	Set to 'yes' to list all the owners in the all_synonyms view for Oracle. This capability is available in 9.0 and later.
CAP_QUERY_BOOLEXPRESS_TO_INTEXPRESS	Set to 'yes' if Tableau must coerce any Boolean expressions to an integer value in order include in a result set.
CAP_QUERY_FROM_REQUIRES_ALIAS	Set to 'yes' if the FROM clause must provide an alias for the given table.
CAP_QUERY_GROUP_ALLOW_DUPLICATES	Set to 'no' if SQL queries cannot contain duplicate expressions in the GROUP BY clause (this is uncommon).
CAP_QUERY_GROUP_BY_ALIAS	Set to 'yes' if SQL queries with aggregations can reference the grouping columns by their corresponding alias in the SELECT list, e.g. GROUP BY "none_ShipCountry_nk".
CAP_QUERY_GROUP_BY_DEGREE	Set to 'yes' if SQL queries with aggregations can reference the grouping columns by the ordinal position of each column, e.g. GROUP BY 2, 5. See also: CAP_QUERY_SORT_BY_DEGREE
CAP_QUERY_HAVING_REQUIRES_GROUP_BY	Set to 'yes' if Tableau must use an artificial grouping field for any query which has a HAVING

	clause but no grouping columns.
CAP_QUERY_HAVING_UNSUPPORTED	Set to 'yes' if the SQL syntax for HAVING is unsupported. Tableau may be able to work around this using subqueries. See also: CAP_QUERY_SUBQUERIES.
CAP_QUERY_INCLUDE_GROUP_BY_COLUMNS_IN_SELECT	Set to 'yes' to require all GROUP BY expressions to also appear in the SELECT expression list.
CAP_QUERY_JOIN_ACROSS_SCHEMAS	Set to 'yes' if SQL queries can express joins between tables located in different schemas.
CAP_QUERY_JOIN_ASSUME_CONSTRAINED	Set to 'yes' to cull inner joins even if the database tables does do not have FK-PK relationships.
CAP_QUERY_JOIN_PUSH_DOWN_CONDITION_EXPRESSIONS	Set to 'yes' to rewrite joins to simplify the ON clause conditions to simple identifier comparisons.
CAP_QUERY_JOIN_REQUIRES_SCOPE	Set to 'yes' if SQL queries must scope each join clause within parentheses to ensure a proper order of evaluation.
CAP_QUERY_JOIN_REQUIRES_SUBQUERY	Set to 'yes' to force join expressions involving more than two tables to be composed with subqueries.
CAP_QUERY_NULL_REQUIRES_CAST	Set to 'yes' if the data source requires that all NULL literals are cast to an explicit data type.
CAP_QUERY_SELECT_ALIASES_SORTED	Set to 'yes' if Tableau must impose a deterministic order on the SELECT expressions (sorted by alias) to ensure that query results can be properly matched with each field in the Tableau visualization. This is only required for data sources which do not preserve the aliases of the SELECT expressions when returning metadata with the query results.
CAP_QUERY_SORT_BY_DEGREE	Set to 'yes' if SQL queries can reference the sorting

	columns by the ordinal position of each column, e.g. ORDER BY 2, 5. See also: CAP_QUERY_GROUP_BY_DEGREE.
CAP_QUERY_SUBQUERIES	Set to 'yes' if the data source supports subqueries.
CAP_QUERY_SUBQUERIES_WITH_TOP	Set to 'yes' if the data source supports a TOP or LIMIT row-limiting clause within a subquery.
CAP_QUERY_SUBQUERY_DATASOURCE_CONTEXT	Set to 'yes' to use subquery filtered query context to implement data source filters. This capability is available in Tableau 8.0 through Tableau 9.3 only.
CAP_QUERY_SUBQUERY_QUERY_CONTEXT	Set to 'yes' to force Tableau to use a subquery for context filters instead of a temporary table or locally cached results.
CAP_QUERY_TOP_0_METADATA	Set to 'yes' if the data source can handle a "TOP 0" request for retrieving metadata.
CAP_QUERY_TOP_N	Set to 'yes' if the data source supports any form of row-limiting clause. The exact forms supported are described below.
CAP_QUERY_TOPSTYLE_LIMIT	Set to 'yes' if the data source uses LIMIT as the row-limiting clause.
CAP_QUERY_TOPSTYLE_ROWNUM	Set to 'yes' if the data source supports an Oracle-style filter on ROWNUM as the row-limiting clause.
CAP_QUERY_TOPSTYLE_TOP	Set to 'yes' if the data source uses TOP as the row-limiting clause.
CAP_QUERY_USE_QUERY_FUSION	Set to 'no' to prevent Tableau from combining multiple individual queries into a single combined query. Turn off this capability for performance tuning or if the database is unable to process large queries. This capability is enabled by default and is available in Tableau 9.0 and later for all data

	sources except Tableau data extracts. Support for this capability in Tableau data extracts is available in Tableau 9.0.6.
CAP_QUERY_WHERE_FALSE_METADATA	Set to 'yes' if the data source can handle a "WHERE <false>" predicate for retrieving metadata.
CAP_SELECT_INTO	Set to 'yes' if Tableau can create a table on the fly from the resultset of another query. See also: CAP_CREATE_TEMP_TABLES.
CAP_SELECT_TOP_INTO	Set to 'yes' if Tableau can use a TOP or LIMIT row-limiting clause when creating a table from a query resultset.
CAP_STORED_PROCEDURE_PREFER_TEMP_TABLE	Set to 'yes' to use a temporary table to support remote queries over the stored procedure result set.
CAP_STORED_PROCEDURE_REPAIR_TEMP_TABLE_STRINGS	Set to 'yes' to attempt to compute actual string widths if metadata indicates no width or non-positive width.
CAP_STORED_PROCEDURE_TEMP_TABLE_FROM_BUFFER	Set to 'yes' to populate the temporary table from a result set buffered in entirety.
CAP_STORED_PROCEDURE_TEMP_TABLE_FROM_NEW_PROTOCOL	Set to 'yes' to populate the temporary table from a separate protocol created for just this operation.
CAP_SUPPRESS_DISCOVERY_QUERIES	Set to 'yes' to prevent Tableau from detecting the supported SQL syntax for a variety of clauses.
CAP_SUPPRESS_DISPLAY_LIMITATIONS	Set to 'yes' to suppress displaying any warnings about limitations for this data source.

See also

Other Databases (ODBC) on page 513 – Describes how to connect to your data using the ODBC connector.

Tableau and ODBC on page 517 – Provides background information about ODBC, describes how Tableau determines the functionality of an ODBC driver, and lists frequently asked questions.

Customize and Tune a Connection on page 541 – Describes how to customize connection information for improved functionality and performance.

ODBC/SQL Customizations Reference below – Lists customizations that represent the parts of the ODBC and SQL standards that the ODBC driver reports supporting.

ODBC/SQL Customizations Reference

You can set the following customizations in the Tableau Datasource Customization (TDC) file to define parts of the ODBC and SQL standards that the ODBC driver supports.

Documentation resources for SQLGetInfo

The names of these customizations come from the identifiers used as parameters to SQLGetInfo.

For more information, see the MSDN documentation and the source code header file `sqltext.h` for the numeric and bit-mask values associated with each customization.

- The Microsoft documentation for the ODBC API function SQLGetInfo:
<http://msdn.microsoft.com/en-us/library/ms711681%28VS.85%29.aspx>
- A sample header file, `sqltext.h`, for the ODBC API identifier values used with SQLGetInfo:

<http://cpansearch.perl.org/src/MIMER/DBD-Mimer-1.00/sqltext.h>

SQLGetInfo long-integer values

SQL_ODBC_INTERFACE_CONFORMANCE	Currently unused.
SQL_SQL_CONFORMANCE	Integer bitmask. Defines the level which the data source conforms to the SQL standard: '1' for entry-level SQL-92 conformance, '2' for FIPS 127-2 transitional, '4' for Intermediate and '8' for Full conformance.
SQL_CATALOG_USAGE	Integer bitmask. Defines the SQL statements in which a catalog identifier can be used.

SQL_SCHEMA_USAGE	Integer bitmask. Defines the SQL statements in which a schema identifier can be used.
SQL_AGGREGATE_FUNCTIONS	Integer bitmask. Defines which standard SQL aggregation forms are supported.
SQL_NUMERIC_FUNCTIONS	Integer bitmask. Defines which SQL scalar numeric functions are supported.
SQL_STRING_FUNCTIONS	Integer bitmask. Defines which SQL scalar string functions are supported.
SQL_TIMEDATE_FUNCTIONS	Integer bitmask. Defines which SQL scalar date / time functions are supported.
SQL_TIMEDATE_ADD_INTERVALS	Integer bitmask. Defines which date / time intervals are supported with the <code>TIMESTAMPADD</code> scalar function.
SQL_TIMEDATE_DIFF_INTERVALS	Integer bitmask. Defines which date / time intervals are supported with the <code>TIMESTAMPDIFF</code> scalar function.
SQL_DATETIME_LITERALS	Integer bitmask. Defines which SQL-92 literals are supported for representing DATE / TIME constants and INTERVALs.
SQL_SYSTEM_FUNCTIONS	Integer bitmask. Defines support for special SQL system scalar functions: <code>IFNULL</code> , <code>DBNAME</code> and <code>USERNAME</code> .
SQL_SQL92_VALUE_EXPRESSIONS	Integer bitmask. Defines which logical functions are supported for testing and manipulating values: <code>CASE</code> , <code>CAST</code> and <code>NULLIF</code> .
SQL_SQL92_NUMERIC_VALUE_FUNCTIONS	Integer bitmask. Defines which functions can produce a numeric value from non-numeric data, including: <code>EXTRACT</code> (for date / time part extraction), <code>CHAR_LENGTH</code> , <code>CHARACTER_LENGTH</code> and <code>POSITION(.. IN ..)</code> .
SQL_SQL92_STRING_FUNCTIONS	Integer bitmask. Defines which string manipulation functions are supported.

SQL_SQL92_DATETIME_FUNCTIONS	Integer bitmask. Defines which date / time manipulation functions are supported for determining the current date, time or timestamp.
SQL_OJ_CAPABILITIES	Integer bitmask. Defines which type of outer joins are supported.
SQL_SQL92_RELATIONAL_JOIN_OPERATORS	Integer bitmask. Defines which types of JOIN operators are supported, e.g. INNER, OUTER.
SQL_SQL92_PREDICATES	Integer bitmask. Defines which predicates are supported for logical tests of values, e.g. IS NULL, LIKE, IN.
SQL_CONVERT_FUNCTIONS	Integer bitmask. Defines which ODBC scalar functions are supported for CASTing or CONVERTing one data type to another.
SQL_CONVERT_TINYINT	Integer bitmask. Determines which other data types that this named type can be converted to using the ODBC scalar function CONVERT.
SQL_CONVERT_SMALLINT	Integer bitmask. Same as above.
SQL_CONVERT_INTEGER	Integer bitmask. Same as above.
SQL_CONVERT_BIGINT	Integer bitmask. Same as above.
SQL_CONVERT_REAL	Integer bitmask. Same as above.
SQL_CONVERT_FLOAT	Integer bitmask. Same as above.
SQL_CONVERT_DOUBLE	Integer bitmask. Same as above.
SQL_CONVERT_CHAR	Integer bitmask. Same as above.
SQL_CONVERT_VARCHAR	Integer bitmask. Same as above.
SQL_CONVERT_LONGVARCHAR	Integer bitmask. Same as above.
SQL_CONVERT_DECIMAL	Integer bitmask. Same as above.

SQL_CONVERT_NUMERIC	Integer bitmask. Same as above.
SQL_CONVERT_BIT	Integer bitmask. Same as above.
SQL_CONVERT_GUID	Integer bitmask. Same as above.
SQL_CONVERT_BINARY	Integer bitmask. Same as above.
SQL_CONVERT_VARBINARY	Integer bitmask. Same as above.
SQL_CONVERT_LONGVARBINARY	Integer bitmask. Same as above.
SQL_CONVERT_DATE	Integer bitmask. Same as above.
SQL_CONVERT_TIME	Integer bitmask. Same as above.
SQL_CONVERT_TIMESTAMP	Integer bitmask. Same as above.
SQL_CONVERT_INTERVAL_DAY_TIME	Integer bitmask. Same as above.

SQLGetInfo short-integer values

SQL_CURSOR_COMMIT_BEHAVIOR	Short integer value. "0" if the prepared statements are closed upon commit for the data source.
SQL_MAX_IDENTIFIER_LEN	Integer value. Defines the maximum number of characters that can be used in an identifier. Tableau leaves room for one extra character as the string terminator.
SQL_TXN_CAPABLE	Short integer value. "0" if the data source does not support the transaction.
SQL_QUOTED_IDENTIFIER_CASE	Integer bitmask.

SQLGetInfo string values

SQL_COLUMN_ALIAS	Boolean value. "Y" if the data source supports using
------------------	--

	aliases for columns listed in the SELECT clause.
SQL_IDENTIFIER_QUOTE_CHAR	String value. Indicates the character which can be used for quoting identifiers. Because the connection customization is an XML document, any entities must properly be encoded. For example, double-quotes will be '"'. Additionally this character is assumed to work as the opening and closing character around identifiers, so some data sources which require '[' to enclose identifiers will not be supported.
SQL_CATALOG_NAME_SEPARATOR	Character value. Indicates the separator character to use between identifiers when qualifying them with a catalog, schema or table name. This is typically the period character.
SQL_SPECIAL_CHARACTERS	String value. Indicates the special characters which are allowed in identifier strings.
SQL_CATALOG_TERM	String value. This is the descriptive term for a database catalog, which appears in the Tableau connection dialog for this ODBC data source.
SQL_SCHEMA_TERM	String value. This is the descriptive term for a database schema, which appears in the Tableau connection dialog for this ODBC data source.
SQL_TABLE_TERM	String value. This is the descriptive term for a database table, which appears in the Tableau connection dialog for this ODBC data source.
SQL_DRIVER_NAME	String value. This is the name of the database ODBC driver.
SQL_DRIVER_VER	String value. This is the version number of the ODBC driver.
SQL_DRIVER_ODBC_VER	String value. This is the version of the ODBC API which the driver supports.

SQL_ODBC_VER	String value. This is the version of ODBC which the Windows ODBC Driver Manager supports. This should not need to be customized.
SQL_DBMS_NAME	String value. This is the name of the database vendor.
SQL_DBMS_VER	String value. This is the version of the database system.
SQL_SERVER_NAME	String value. This is the named network address of the database server.
SQL_USER_NAME	String value. This is the name of the currently authenticated user.

See also

Other Databases (ODBC) on page 513 – Describes how to connect to your data using the ODBC connector.

Tableau and ODBC on page 517 – Provides background information about ODBC, describes how Tableau determines the functionality of an ODBC driver, and lists frequently asked questions.

Customize and Tune a Connection on page 541 – Describes customize connection information for improved functionality and performance.

Tableau Capability Customizations Reference on page 568 – Lists customizations you can use to define which Tableau capabilities are supported by the data source.

Run Initial SQL

Note: Tableau Prep Builder version 2019.2.2 and later supports using Initial SQL, but doesn't yet support all of the same options supported by Tableau Desktop. For information about using Initial SQL with Tableau Prep Builder, see [Use Initial SQL to query your connections](#) in the Tableau Prep Builder Salesforce Help.

When connecting to some databases, you can specify an initial SQL command that will run or use a cached value when a connection is made to the database, for example, when you open the workbook, refresh an extract, sign in to Tableau Server, or publish to Tableau Server.

Note: Initial SQL is different than a custom SQL connection. A custom SQL connection defines a relation (or table) to issue queries against. For more information, see [Connect to a Custom SQL Query](#).

You can use this command to:

- Set up temporary tables to use during the session.
- Set up a custom data environment.

You have the option to add an initial SQL command in the Server Connection dialog box or on the Data Source page.

Note: If your data source supports running an initial SQL statement, an **Initial SQL** link appears in the lower-left corner of the Server Connection dialog box. For information about your data source, see [Supported Connectors](#).

To use initial SQL

1. In the Server Connection dialog box, click **Initial SQL**. Or, on the Data Source page, select **Data > Initial SQL** or **Data > Query Banding and Initial SQL** depending on the database you connect to.
2. Enter the SQL command into the Initial SQL dialog box. You can use the **Insert** dropdown menu to pass parameters to your data source.

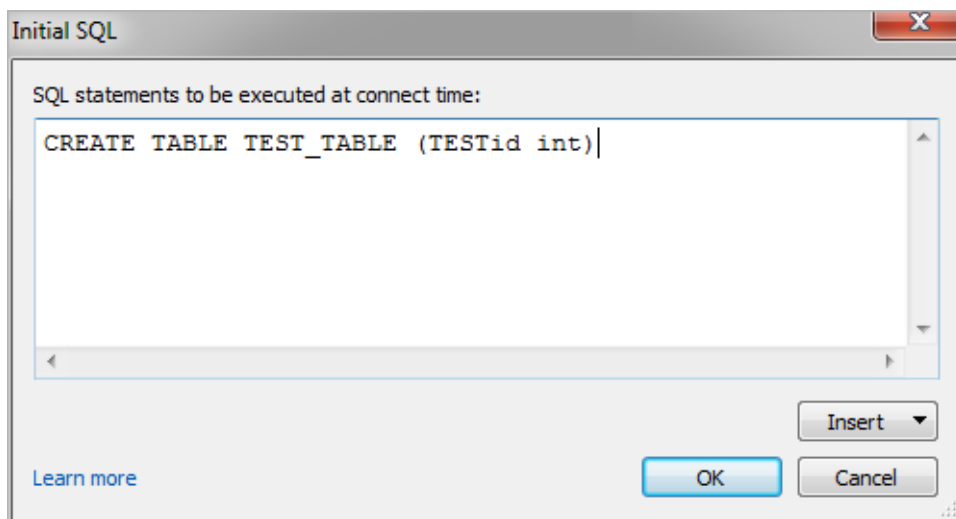

Note: Tableau doesn't examine the statement for errors. This SQL statement is sent to the database when you connect.

Your software license may restrict you from using initial SQL with your connection. If you publish to Tableau Server, the server must be configured to allow Initial SQL statements. By default, the server software is configured to allow these statements to run when the workbook is loaded in a web browser.

Administrators can configure the server to ignore initial SQL statements by using the `tsm configuration set` command:

```
tsm configuration set -k vizqlserver.initialsql.disabled -v true
```

If the server doesn't allow initial SQL statements, the workbook opens, but the initial SQL commands aren't sent.

For more information about the `tsm configuration set` command, see the [Tableau Server Help](#).

Parameters in an initial SQL statement

You can pass parameters to your data source in an initial SQL statement. The following list has several benefits of using parameters in a initial SQL statement.

- You can configure impersonation using the **TableauServerUser** or **TableauServerUserFull** parameters.
- If your data source supports it, you can set up row-level security (for example, for Oracle VPD or SAP Sybase ASE) to make sure that users see only the data that they're authorized to see.
- You can provide more details in logging, for example, the Tableau version or the workbook name.

The following parameters are supported in an initial SQL statement:

Parameter	Description	Example of returned value
TableauServerUser	The username of the current server user. Use when setting up impersonation on the server. Returns an empty string if the user	jsmith

	isn't signed in to Tableau Server.	
TableauServerUserFull	The username and domain of the current server user. Use when setting up impersonation on the server. Returns an empty string if the user isn't signed in to Tableau Server.	domain.lan\jsmith
TableauApp	The name of the Tableau application.	Tableau Desktop Tableau Professional Tableau Server
TableauVersion	The version of the Tableau application.	9.3
WorkbookName	The name of the Tableau workbook. Use only in workbooks with an embedded data source.	Financial-Analysis

Warning: Tableau Desktop doesn't include domain. You can include it if you aren't using delegation and you set tsm configuration set `-k DelegationUseFullDomainName=-v true--force-keys`

The following examples show different ways you can use parameters in an initial SQL statement.

- This example sets the security context on Microsoft SQL Server:

```
EXECUTE AS USER = [TableauServerUser] WITH NO REVERT;
```

- This example shows how, on a DataStax data source, you can use parameters to add detail to logging or to set up a session variable to track the data:

```
SET TABLEAUVERSION [TableauVersion];
```

- This example can be used to help set up row-level security for Oracle VPD:

```
begin
  DBMS_SESSION.SET_IDENTIFIER([TableauServerUser]);
end;
```

Note: Oracle PL/SQL blocks require a trailing semicolon to terminate the block. Consult Oracle documentation for the proper syntax.

Defer execution to the server

You can defer an initial SQL statement so that it's executed only on the server. One reason to defer execution to the server is if you don't have permission to execute the commands that set up impersonation. Use `<ServerOnly>`/`</ServerOnly>` tags to enclose the commands to be executed only on the server.

Example:

```
CREATE TEMP TABLE TempTable(x varchar(25));
INSERT INTO TempTable VALUES (1);
<ServerOnly>INSERT INTO TempTable Values(2);</ServerOnly>
```

Security and impersonation

When you use the **TableauServerUser** or **TableauServerUserFull** parameter in an initial SQL statement, you'll create a dedicated connection that can't be shared with other users. This can also restrict cache sharing, which can enhance security, but may also slow performance.

Troubleshoot 'create table' for MySQL and Oracle connections

For MySQL connections, tables aren't listed after using initial SQL to create a table

After you connect to MySQL and run an initial SQL statement, the tables might not show because of the way Tableau constructs the query.

```
CREATE TABLE TestV1.testtable77(testID int);
```

To resolve this issue, add `IF NOT EXISTS` to the SQL statement:

```
CREATE TABLE IF NOT EXISTS TestV1.TestTable(testID int);
```

For Oracle connections, using initial SQL to create a table causes Tableau to stall

After you connect to Oracle and run an initial SQL statement, Tableau is stalled with a spinning wheel because of the way Tableau constructs the query.

```
CREATE TABLE TEST_TABLE (TESTid int)
```

To resolve this issue, use the following SQL statement:

```
BEGIN
EXECUTE IMMEDIATE 'create table test_table(testID int)';
EXCEPTION
WHEN OTHERS THEN NULL;
END;
```

Set Up Data Sources

After you connect to your data, use the Data Source page to set up the data source and prepare your data for analysis. There are many optional configurations that you can make before you begin your analysis. The configurations that you make on the Data Source page creates the data source that Tableau uses to interpret and interact with your data.

The topics in this section describe how to use these configurations in order to optimize your data source for analysis.

Plan the Data Source

At the center of Tableau is your data. How successful you are with exploring data, answering questions, and building visualizations for yourself or others to consume all depend on the underlying data.

If your goal is to do some quick exploration or ad-hoc analysis, you might be able to hop in, connect to some data, drag and drop a bit to build some vizs, and hop out with the information you need. But if your goal is to create an analysis or data source that will be used more than once, it's best to think through and plan your data source.

Tableau data sources

A Tableau data source is the link between your source data and Tableau. It is essentially the sum of your data (either as a live connection or an extract), the connection information, the names of tables or sheets containing data, and the customizations that you make on top of data to work with it in Tableau. Those customizations include things like how the data is combined and metadata such as calculations, renamed fields, and default formatting.

A Tableau *data source* may contain multiple *data connections* to different databases or files. Connection information includes where the data is located, such as a file name and path or a

network location, and details on how to connect to your data, such as database server name and server sign-in information.

Note: The terms *data source* and *data connection* have been used indiscriminately in the past and may lack clear distinction in older materials.

It's also important to bear in mind the difference between the Tableau data source (Tableau's access to your data and all the customizations that may be involved) and the source data itself (such as a database or Excel spreadsheet). Planning a data source in the sense of designing a database is not the scope of this topic.

Tableau data sources can remain embedded in the workbook where they were originally created, or they can be published separately. Published Data Sources allow for centralization and scaling of curated data sources. See [Best Practices for Published Data Sources on page 3135](#) for more information.

Combine Data

If your data comes from one table, you can [connect to your data](#) to create the data source, drag the table onto the canvas, and then start building your view. But if your data is spread across multiple tables—or across multiple databases—you'll need to combine it. Combining data happens on the Data Source Page.

Single database

1. Connect to your data. This creates a data source.
2. Drag a table or sheet of data to the canvas and release it.
3. Drag a second table or sheet to the canvas and release it. Either a noodle will form, indicating an automatic relationship has formed, or the Edit Relationship dialog will open, prompting you to tell Tableau which field those tables relate the two tables.
4. Continue adding tables.

Multiple databases

1. Connect to your data. This creates a data source.
2. Drag a table or sheet of data to the canvas and release it.
3. After bringing out the first table of data, click the **Add** link to the right of the Connections heading in the Left pane.
4. Switch between data connections in the Left pane, then drag out the desired table to the canvas and release it. Either a noodle will form, indicating an automatic relationship has formed, or the Edit Relationship dialog will open,

- prompting you to tell Tableau which field those tables relate the two tables.
5. Continue adding tables, switching between data connections as relevant.

Note: In order to relate tables across different databases, they must be added as **data connections** within the same data source, not a new **data source**. Data connections are added from the Add link in the Left pane. New data sources can be created from the Data menu or the drop down menu from the icon next to the Data Source's name, as seen in the image below.

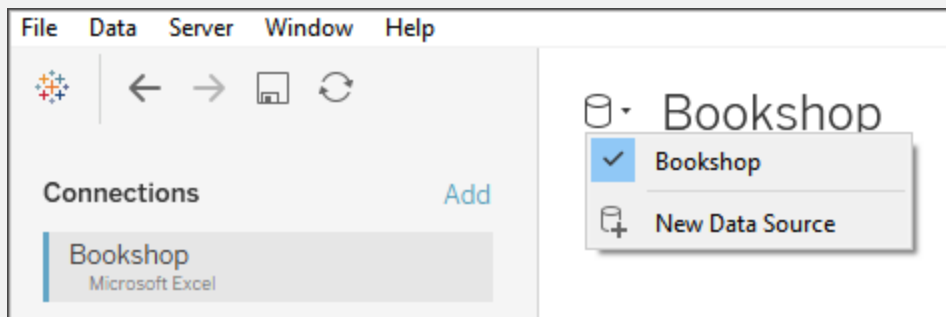

Methods of combining data

Relationships are the default way to combine data in Tableau. Relationships are a dynamic, flexible way to combine data from multiple tables for analysis. If necessary, tables can also be joined or unioned. Data sources can also be blended. Let's take a look the options for how data can be combined in Tableau and some of the situations when each method is useful.

Relationships	<p>Establish the potential for joins between two tables based on related fields. Does not merge data together to create a new, fixed table. During analysis, queries the relevant tables automatically using the contextually-appropriate joins to generate a custom table of data for that analysis.</p> <p>Maintains the appropriate level of detail, does not lose data, keeps appropriate aggregations, and handles nulls.</p>
Joins	Merge two tables of data based on a join clause and join type to form a

new, fixed table of data. Often used to add new columns of data across the same basic row structure.

May cause data loss with some join types if fields are not present in all tables. May cause data duplication if tables are at different levels of detail.

Unions Merge two or more tables of data to form a new, fixed table of data. Used to append (add new rows of) data across the same basic column structure.

Blends Work across two or more separate Tableau data sources. Data remains separate. Tableau queries the data sources independently and visualizes the results together in the view, based on the linking fields established for that sheet. Mimics the behavior of a left join and may filter data from secondary data sources.

Note: It's also possible to combine data with **Custom SQL**. Most of the time, it's best to combine data directly in the canvas or with data blending. This allows Tableau the greatest flexibility for optimization. However, in certain scenarios, there may be reasons to use Custom SQL. Keep in mind doing so can have performance implications because Tableau is forced to execute the Custom SQL statement as written.

Relationships

Relating is a method for working with data from multiple tables based on shared fields—columns—between those tables. Establishing a relationship informs Tableau how rows can be connected across tables. Tableau holds that information but does not immediately bring the rows together as happens with a hard coded join. Instead, when a visualization is created, the fields involved in the analysis are traced back through the relationship and the appropriate joins are created to return the correct data.

Because the data is never forced into a single table outside the context of a visualization, relationships are useful when the data is at different levels of detail, or granularity. For example, if you need to work with data about daily rainfall in one table but hourly temperatures in another.

For more information about how to combine tables using relationships, see [Relate Your Data on page 622](#)

For more information about how to combine tables using relationships, see [Relate Your Data on page 622](#) and these Tableau blog posts:

- [Relationships, part 1: Introducing new data modeling in Tableau](#)
- [Relationships, part 2: Tips and tricks](#)
- [Relationships, part 3: Asking questions across multiple related tables](#)

Note: In Tableau version 2024.2 and later, the Tableau data model supports multi-fact analysis and shared dimensions through multi-fact relationships. For more information, see [About Multi-fact Relationship Data Models](#), [When to Use a Multi-fact Relationship Model](#), and [Build a Multi-fact Relationship Data Model](#).

Join

Joining is a method for combining tables related by common fields. The result of combining data using a join is a table that extends horizontally by adding columns of data.

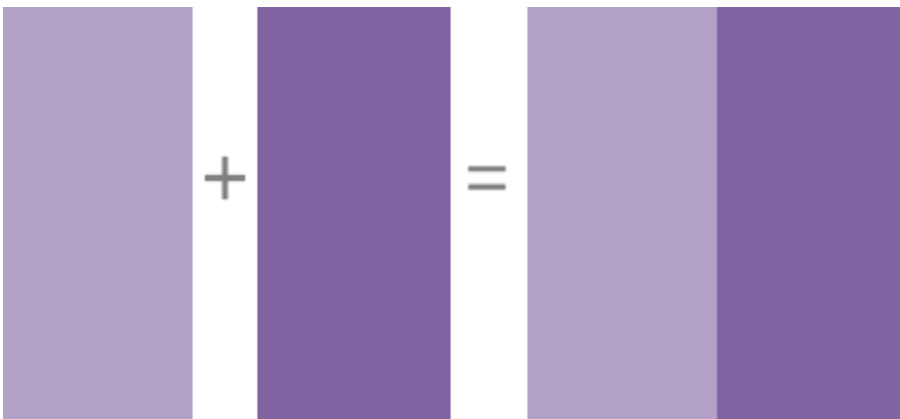

For more information about how to join data in Tableau, see [Join Your Data](#) on page 791.

Data blending

When you use data blending to combine your data, you combine data in what is called a primary data source with common fields from one or more secondary data sources.

Data blending is useful when you need to change how the data source is configured on a sheet-by-sheet basis, when you want to combine databases that don't allow relationships or joins such as cube data sources or Published Data Sources.

The result of combining data using data blending is a virtual table that extends horizontally by adding columns of data. The data from each data source will be aggregated to a common level before being displayed together in the visualization.

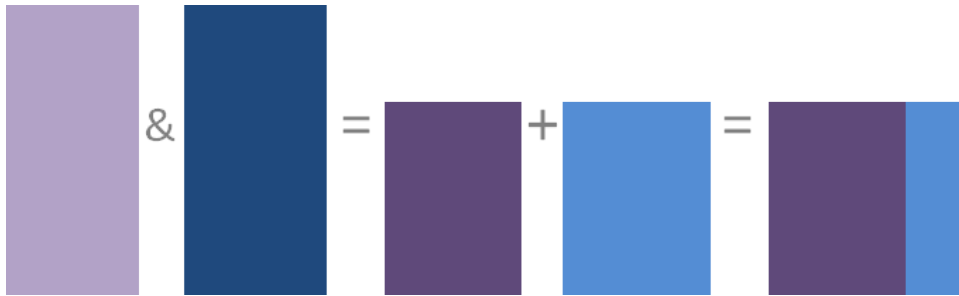

For more information about how data blending works and how to blend your data in Tableau, see [Blend Your Data on page 816](#).

Union

Unioning is a method for appending values (rows) to tables. You can union tables if they have the same columns. The result of combining data using a union is a virtual table that has the same columns but extends vertically by adding rows of data.



You can union tables in one of two ways: manually or using wildcard search. For more information about how to union data using one of these methods in Tableau, see [Union Your Data on page 847](#).

Considerations for a Tableau data source

Before anything else, make sure you're clear on the purpose of the data source. If you're creating a catch-all data source for a wide variety of users with broad questions, you'd go about it differently than if you were constructing a niche data source optimized for performance. It's important to know your goal from the outset.

With that goal in mind, there are several items to consider and plan before you build a data source in Tableau:

- Location and access
- Shape and cleanliness
- The data model and combining data
- Metadata and customization
- Scalability, security, and discoverability
- Performance and freshness

Location and access

The location of your data can be as simple as a single Excel file on your computer or a Google sheet you've created, or as complex as multiple databases using various technologies. Access can also involve specific drivers or connectors for a database or login information for a database server.

Questions to consider:

- Do the correct Tableau users have access and permissions to the data and to Tableau?
- What user account should be used to log into the database?
- Will user filtering or **row level security** be needed?
- Is the source data on premises or in the cloud?
 - This may have **implications if the data is published to Tableau Cloud**.
- Are there **Supported Connectors** on page 221?
- Are there any limitations for that database (does it support all the functionality you hope to use)?

Shape and cleanliness

Your organization may already have well-structured data that you can connect to or ETL processes you can leverage, or you may need to use Tableau Prep Builder to perform cleaning and shaping operations to get your data into a useful format.

Questions to consider:

- Is the data well-structured for use with Tableau?
- Should **Tableau Prep Builder** and Tableau Prep Conductor be used to clean and **auto-mate** data prep flows?
- What calculations or manipulations would be best done natively in Tableau?
- Is any of this data unnecessary? Is any data missing?

The data model and combining data

Tableau needs to know how to query the data, which is conveyed by **The Tableau Data Model** on page 666. If the data comes from multiple tables, the data needs to be combined. Methods

for combining data include relationships, joins, unions, and blends.

Questions to consider:

- Is the data spread across multiple systems?
- What is the best way to combine each table of data?

Metadata and customization

Data is often stored in a way that isn't easy for a person to use comfortably. For example, default field names can be unwieldy, custom formatting may be desired, definitions of abbreviations or codes may be missing, or common calculations may not be present in the underlying data. Creating a semantic layer with those pieces of information can make the data much easier to understand and use.

Questions to consider:

- What calculations should be added?
- Are the table and field names understandable?
- Are the default settings for the fields useful or should they be customized?
- Are there any adjustments that should be made to support [Tableau Catalog](#)?

Note that Explain Data does not support multi-table data sources at this time.

Scalability, security, and discoverability

A data source may remain in the workbook where it was created—an [embedded data source](#)—or it may be published to Tableau Server or Tableau Cloud independently of any analysis as a content asset all its own. This centralization of published data sources has the added benefit of security and scaling, allowing multiple users to access a consistent data source. Published data sources can also take advantage of [Tableau Catalog](#) and recommendations and provide a single source of truth for an organization.

Questions to consider:

- Should the data source stay embedded in the workbook?

(The following questions assume the data source is published)

- Where will the data source be published?
- Who will own the data source?
- What [authentication](#) and [permissions](#) should it have?
- Will it be [certified](#)?

Performance and freshness

In addition, Tableau data sources can be live connections to the source data or the data can be copied out as a refreshable extract. Extracts can boost the analysis performance or prevent resource drains against database systems.

Questions to consider:

- Should the data connection be live or an [extract](#)?
- If extracted, will there be a refresh schedule? ([Tableau Server](#) | [Tableau Cloud](#))
- If published to Tableau Cloud, will [Tableau Bridge](#) need to be used?

Build quality data sources

There's a lot that goes into a well-designed and performant data source. You don't have to publish your first attempt, though. Like creating a good visualization, building a data source can be an ongoing process. Try your hand at combining the data you think you need and then see if you can build the viz you want. You can always go back and write a new calculation or bring in another table of data. Do some user testing and ask a colleague if they can figure out your field names.

Of course, it's best to only publish data sources you're confident in and only certify ones that have passed quality assurance. By the time your data source is in front of users, they should be able to trust it.

Structure Data for Analysis

There are certain concepts that are fundamental to understanding data prep and how to structure data for analysis. Data can be generated, captured, and stored in a dizzying variety of formats, but when it comes to analysis, not all data formats are created equal.

Data preparation is the process of getting well formatted data into a single table or multiple related tables so it can be analyzed in Tableau. This includes both the structure, i.e. rows and columns, as well as aspects of data cleanliness, such correct data types and correct data values.

Tip: It may help to go through the following topic with a data set of your own. If you do not already have a data set you can use, see our tips for [finding good data sets](#).

How structure impacts analysis

The structure of your data may not be something you can control. The rest of this topic assumes you have access to the raw data and the tools needed to shape it, such as Tableau Prep Builder. However, there may be situations when you can't pivot or aggregate your data as desired. It is

often still possible to perform the analysis but you may need to change your calculations or how you approach the data. For an example of how to perform the same analysis with different data structures, see Tableau Prep Day in the Life Scenarios: [Analysis with the Second Date in Tableau Desktop](#). But if you can optimize the data structure it will likely make your analysis much easier.

Data Structure

Tableau Desktop works best with data that is in tables formatted like a spreadsheet. That is, data stored in rows and columns, with column headers in the first row. So what should be a row or column?

What is a row?

A row, or record, can be anything from information around a transaction at a retail store, to weather measurements at a specific location, or stats about a social media post.

It's important to know what a record (row) in the data represents. This is the *granularity* of the data.

Here, each record is a day

Here, each record is a month

Date	Max TemperatureF	Mean TemperatureF	Date	Max TemperatureF	Mean TemperatureF	Min TemperatureF
1/1/2015	42		January	63	45	26
1/2/2015	42		February	62	49	33
1/3/2015	41		March	69	51	31
1/4/2015	51		April	77	52	37
1/5/2015	54		May	82	59	43
1/6/2015	54		June	92	68	49
1/7/2015	46		July	95	71	54
1/8/2015	46		August	92	69	54
1/9/2015	50		September	81	61	45
1/10/2015	46		October	74	58	45
			November	60	44	25

Tip: A best practice is to have a unique identifier (UID), a value that identifies each row as a unique piece of data. Think of it like the social security number or URL of each record. In Superstore, that would be Row ID. Note that not all data sets have a UID but it can't hurt to have one.

Try to make sure you can answer the question "What does a row in the data set represent?". This is the same as answering "What does the TableName(Count) field represent?". If you can't articulate that, the data might be structured poorly for analysis.

Aggregation and Granularity

A concept related to what makes up a row is the idea of aggregation and granularity, which are opposite ends of a spectrum.

Aggregation

- refers to how multiple data values are brought together into a single value, such as counting all the Google searches for Pumpkin Spice or taking the average of all the temperature readings around Seattle on a given day.
- By default, measures in Tableau are always aggregated. The default aggregation is SUM. You can change the aggregation to options like Average, Median, Count Distinct, Minimum, etc.

Granularity

- refers to how detailed the data is. What does a row or record in the data set represent? A person with malaria? A provinces' total cases of malaria for the month? That's the granularity.
- Knowing the granularity of the data is crucial to working with level of detail (LOD) expressions.

Understanding aggregation and granularity is a critical concept for many reasons; it impacts things like finding useful data sets, building the visualization you want, relating or joining data correctly, and using LOD expressions.

Tip: For more information, see [Data Aggregation in Tableau](#).

What is a field or column?

A *column* of data in a table comes into Tableau Desktop as a *field* in the data pane, but they are essentially interchangeable terms. (We save the term *column* in Tableau Desktop for use in the columns and rows shelf and to describe certain visualizations.) A field of data should contain items that can be grouped into a larger relationship. The items themselves are called *values* or *members* (only discrete dimensions contain members).

What values are allowed in a given field are determined by the *domain* of the field (see the note below). For example, a column for "grocery store departments" might contain the members "deli", "bakery", "produce", etc., but it wouldn't include "bread" or "salami" because those are items, not departments. Phrased another way, the domain of the department field is limited to just the possible grocery store departments.

Additionally, a well-structured data set would have a column for "Sales" and a column for "Profit", not a single column for "Money", because profit is a separate concept from sales.

- The domain of the Sales field would be values ≥ 0 , since sales cannot be negative.
- The domain of the Profit field, however, would be all values, since profit can be negative.

Note: *Domain* can also mean the values present in the data. If the column "grocery store department" erroneously contained "salami", by this definition, that value would be in the domain of the column. The definitions are slightly contradictory. One is the values that could or should be there, the other is values that actually are there

Categorizing fields

Each column in the data table comes into Tableau Desktop as a field, which appears in the **Data** pane. Fields in Tableau Desktop must be either a dimension or measure (separated by a line within tables in the **Data** pane) and either discrete or continuous (color coded: blue fields are discrete and green fields are continuous).

- *Dimensions* are qualitative, meaning they can't be measured but are instead described. Dimensions are often things like city or country, eye color, category, team name, etc. Dimensions are usually discrete.
- *Measures* are quantitative, meaning they can be measured and recorded with numbers. Measures can be things like sales, height, clicks, etc. In Tableau Desktop, measures are automatically aggregated; the default aggregation is SUM. Measures are usually continuous.
- *Discrete* means individually separate or distinct. Toyota is distinct from Mazda. In Tableau Desktop, discrete values come into the view as a label and they create panes.
- *Continuous* means forming an unbroken, continuous whole. 7 is followed by 8 and then it's the same distance to 9, and 7.5 would fall midway between 7 and 8. In Tableau Desktop, continuous values come into the view as an axis.

- Dimensions are usually discrete, and measures are usually continuous. However, this is not always the case. Dates can be either discrete or continuous.
 - Dates are dimensions and automatically come into the view as discrete (aka date parts, such as "August", which considers the month of August without considering other information like the year). A trend line applied to a timeline with discrete dates will be broken into multiple trend lines, one per pane.
 - We can choose to use continuous dates if preferred (aka date truncations, such as "August 2024", which is different than "August 2025"). A trend line applied to a timeline with continuous dates will have a single trend line for the entire date axis.

Tip: For more information, see [Dimensions and Measures, Blue and Green](#).

In Tableau Prep, no distinction is made for dimensions or measures. Understanding the concepts behind discrete or continuous are important, however, for things like understanding the detail versus summary presentation of data in the profile pane.

- Detail: the detail view shows every domain element as a discrete label and has a visual scrollbar to provide a visual overview of all the data.
- Summary: the summary view shows the values as binned on a continuous axis as a histogram.

Binning & Histograms

A field like age or salary is considered continuous. There is a relationship between the age 34 and 35, and 34 is as far from 35 as 35 is from 36. However, once we're past age 10 or so, we usually stop saying things like we're "9 and a half" or "7 and $\frac{3}{4}$ ". We're already binning our age to neat year-sized increments. Someone who is 12,850 days old is older than someone who is 12,790 days old, but we draw a line and say they're both 35. Similarly, age groupings are often used in place of actual ages. Child prices for movie tickets might be for kids 12 and under, or a survey may ask you to select your age group, such as 20-24, 25-30, etc.

Histograms are used to visualize the distribution of numerical data using binning. A histogram is similar to a bar chart, but rather than being discrete categories per bar, the rectangles making up the histogram span a *bin* of a continuous axis, such as range of the number of blossoms (0-4, 5-9, 10-14, etc.). The height of the rectangles is determined by frequency or count of those values. Here, the y-axis is the count of plants that fall into each bin. Seven plants have 0-4 blossoms, two plants have 5-9 blossoms, and 43 plants have 20-24 blossoms.

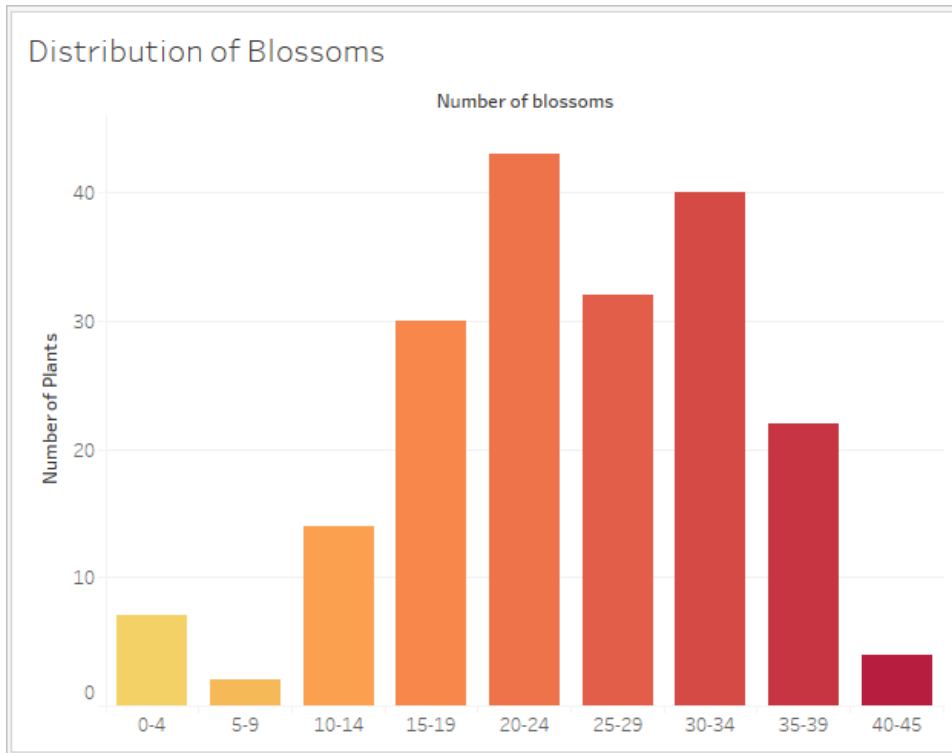

In Tableau Prep, the summary view is a histogram of binned values. The detail view shows the frequency for every value and has a visual scrollbar off to the side that shows the overall distribution of the data.

Summary view

Detail view

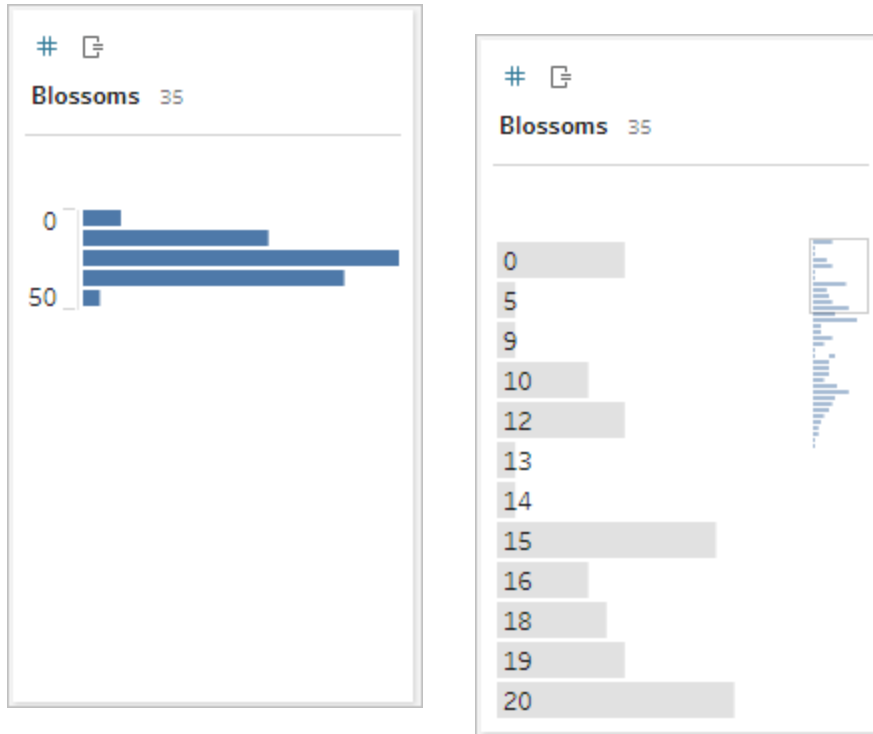

Distributions and outliers

Seeing the distribution of a data set can help with outlier detection.

- *Distribution*: the shape of the data in a histogram, though this depends on the size of the bins. Being able to see all your data in a histogram view can help identify if the data seems correct and complete. The shape of the distribution will only be of use if you know the data and can interpret whether or not the distribution makes sense.
 - For example, if we were to look at a data set of the number of homes with broadband internet from 1940-2017, we'd expect to see a very skewed distribution. However, if we were to look at the number of homes with broadband internet from January 2017 to December 2017 we'd expect a fairly uniform distribution.
 - If we were to look at a data set of Google searches for "Pumpkin Spice Latte", we'd expect to see a fairly sharp peak in the fall, whereas searches for ""convert Celsius to Fahrenheit" would likely be fairly stable.
- *Outlier*: a value that is extreme compared to other values. Outliers may be correct values or they may be indicative of an error.

- Some outliers are correct and indicate actual anomalies; these should not be removed or modified.
- Some outliers indicate issues with data cleanliness, such as a salary of \$50 instead of \$50,000 because a period was typed instead of the comma.

Visual outlier detection with distributions

If you were to see a list like this:

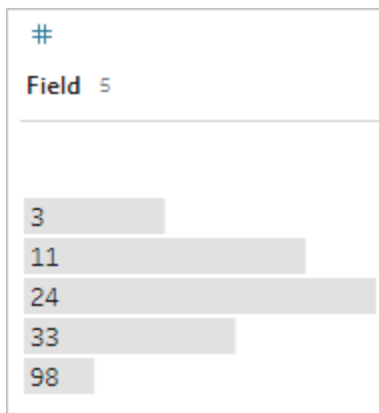

at first glance it doesn't look odd. But if, instead of a list of labels, this was plotted on a continuous binned axis, it would look like this:

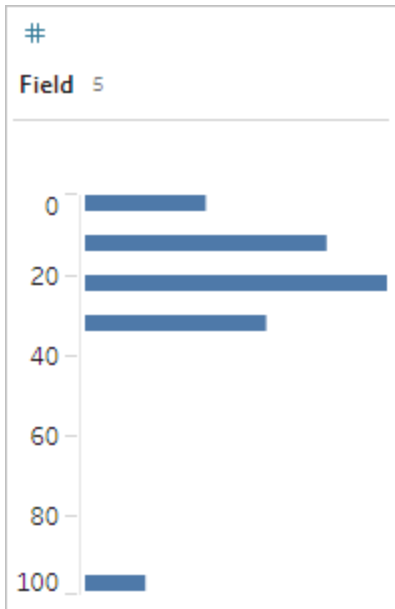

And it's much more obvious that the last observation is farther away from the first and may be an outlier due to error.





Data Types

Databases, unlike spreadsheets, usually enforce strict rules on data types. Data types classify the data in a given field and provide information about how the data should be formatted, interpreted, and what operations can be done to that data. For example, numerical fields can have mathematical operations applied to them and geographic fields can be mapped.

Tableau Desktop assigns whether a field is a dimension or measure, but fields have other characteristics that depend on their data type. These are indicated by the icon each field has (though some types share an icon). Tableau Prep uses the same data types. If data type is enforced on a column and an existing value doesn't match its assigned data type, it may be displayed as null (because "purple" doesn't mean anything as a number).

Some functions require specific data types. For example, you cannot use CONTAINS with a numerical field. Type functions are used to change the data type of a field. For example, DATEPARSE can take a text date in a specific format and make it a date, thus enabling things like automatic drill down in the view.

Icon	Data type
Abc	Text (string) values

Icon	Data type
	Date values
	Date & Time values
	Numerical values
	Boolean values (relational only)
	Geographic values (used with maps)

Tip: For more information, refer to the Help article on [Data Types](#).

Pivot and Unpivot Data

People-friendly data is often captured and recorded in a wide format, with many columns. Machine-readable data, like Tableau prefers, is better in a tall format, with fewer columns and more rows.

Note: Traditionally, pivoting data means going from tall to wide (rows to columns), and unpivoting means going from wide to tall (columns to rows). However, Tableau uses the word *pivot* to mean going from wide (people-friendly) to tall (machine-readable) by turning columns into rows. In this document, *pivot* will refer to the Tableau sense of the word. For clarity, it can help to specify "pivot columns to rows" or "pivot rows to columns".

For more information, refer to the Help articles [Pivot Your Data](#) and [Tips for Working with your Data](#).

Wide data

In the WHO malaria data set, there is a column for country, then a column per year. Each cell represents the number of cases of malaria for that country and year. In this format we have 108 rows and 16 columns.

	A	B	C	D	E	F	G	H	I	J	K	L	M	N	O	P
1	Country	2014	2013	2012	2011	2010	2009	2008	2007	2006	2005	2004	2003	2002	2001	2000
2	Afghanistan	61362	39263	54840	77549	69397	64880	81574	92202	86129	116444	242022	360940	415356		94475
3	Algeria	0	0	55	1	1	0	3	27	1	2	3	6	8	8	35
4	Angola	2298979	1999868	1496834	1632282	1682870	1573422	1377992	1533485	1082398	889572					
5	Argentina	0	0	0	0	14	86	130	387	212	252	115	122	125	215	440
6	Armenia					0	0	0	0	0	7	47	29	52	79	141
7	Azerbaijan	0	0	3	4	50	78	72	108	143	242	386	482	506	1058	1526
8	Bahamas				6	1		14	6	49	1	2	3	1	4	2
9	Bangladesh	10216	3864	9901	51773	55873	63873	84690	59866	32857	48121	58894	54654	62269	54216	55599
10	Belize	19	20	33	72	150	256	540	845	844	1549	1066	1084	1134	1162	1486
11	Benin	1044235	1078834	705839	422968		889597									
12	Bhutan	19	15	0	194	436	972	329	793	1868	1825	2670	3806	6511	5982	5935
13	Bolivia (Plurinatic	7401	7342	7415	7143	13769	9743	9748	14610	19725	21442	14910	20343	14276	15765	31469
14	Botswana	1346	456	193	432	1046	1024	927	390		670	198	591	1640	3720	10510
15	Brazil	143415	177767	242758	267146	334667	309316	315746	458652	549469	606067	465004	408886	348259	388303	613241
16	Burkina Faso	5428655	3769051	3858046	428113	804539	182527	36514	44246	44265	21335	18256				
17	Burundi	4563773	4141297	3151076	1671874	1762447	1185637	876741	1101644	701721	277464	242206	262450	277128	217016	208906

It's easy for a person to read and understand this format. However, if we were to bring this data into Tableau Desktop, we get a field per column. We have a field for 2000, a field for 2001, a field for 2002, etc.



To think of it another way, there are 15 fields that all represent the same basic thing—number of reported cases of malaria—and no single field for time. This makes it very hard to do analysis across time as the data is stored in separate fields.

Example: working with wide data

Q: How would we create a map that shows the total number of malaria cases per country from 2000 to 2014?

A: Create a calculated field to sum all the years.

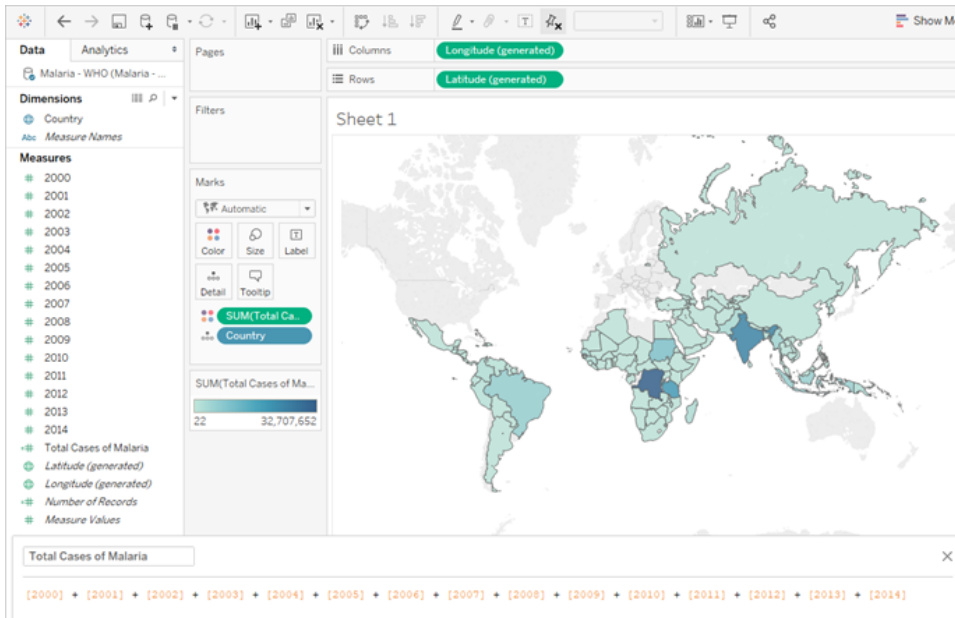

Note: this image has not been updated to reflect the most current UI. The Data pane no longer shows Dimensions and Measures as labels.

Another indication that this format isn't ideal for analysis can be seen in the fact that nowhere do we have information about what the actual values mean. For Algeria in 2012, we have the value 55. Fifty five what? It's not clear from the structure of the data.

	A	B	C	D	E
1	Country	2014	2013	2012	2011
2	Afghanistan	61362	39263	54840	77549
3	Algeria	0	0	55	1
4	Angola	2298979	1999868	1496834	1632282

If the name of the column isn't describing what the values are but rather conveys additional information, this is a sign the data needs to be pivoted.

Tall data

If we pivot the data, we reshape the data from wide to tall. Now, rather than having a column for each year, we have a single column, Year, and a new column, Reported Cases. In this format we have 1,606 rows and 3 columns. This data format is taller rather than wider.

	A	B	C
1	Country	Year	Reported Cases
2	Afghanistan	2000	94,475
3	Afghanistan	2001	
4	Afghanistan	2002	415,356
5	Afghanistan	2003	360,940
6	Afghanistan	2004	242,022
7	Afghanistan	2005	116,444
8	Afghanistan	2006	86,129
9	Afghanistan	2007	92,202
10	Afghanistan	2008	81,574
11	Afghanistan	2009	64,880
12	Afghanistan	2010	69,397
13	Afghanistan	2011	77,549
14	Afghanistan	2012	54,840
15	Afghanistan	2013	39,263
16	Afghanistan	2014	51,252

Now in Tableau Desktop, we have a field for Year and a field for Reported Cases as well as the original Country field. It's much easier to do analysis because each field represents a unique quality about the data set—location, time, and value.

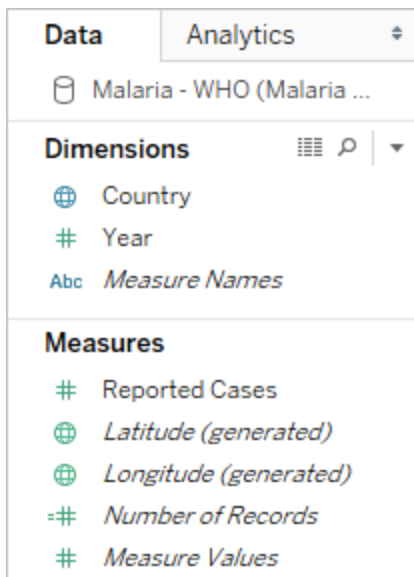

Note: this image has not been updated to reflect the most current UI. The Data pane no longer shows Dimensions and Measures as labels.

Example: working with tall data

Q: How would we create a map that shows the total number of malaria cases per country from 2000 to 2014?

A: Use the Reported Cases field.

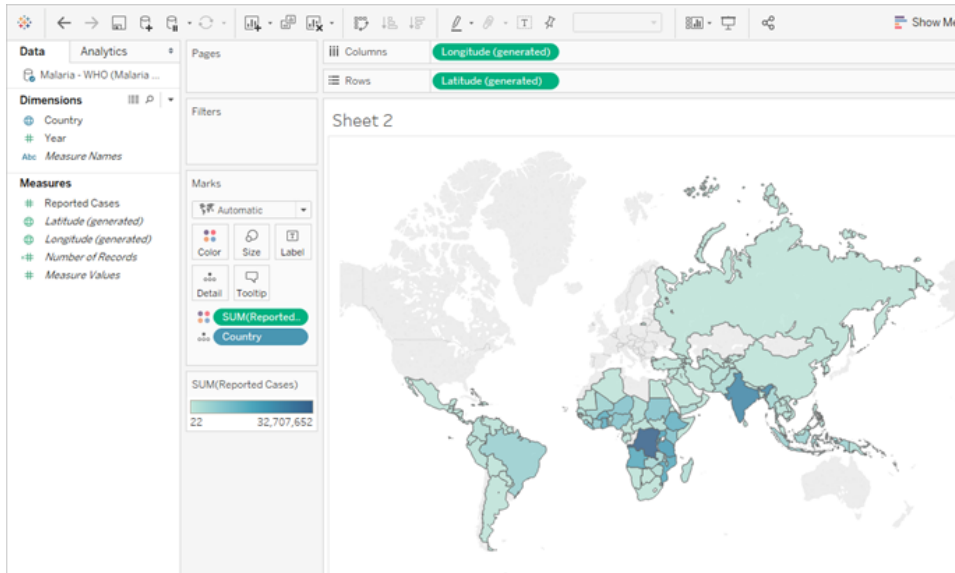

Note: this image has not been updated to reflect the most current UI. The Data pane no longer shows Dimensions and Measures as labels.

Now it's easy to see that for Algeria in 2012, the 55 refers to the number of reported cases (because we could label this new column).

	A	B	C
1	Country	Year	Reported Cases
28	Algeria	2011	1
29	Algeria	2012	55
30	Algeria	2013	0

Note: In this example, the wide data consisted of a single record per country. With the tall data format, there are now 15 rows for each country (one for each of the 15 years in the data). It's important to keep in mind that there are now multiple rows per country.

If there was a column for Land Area, that value would be repeated for each of the 15 rows for each country in a tall data structure. If you created a bar chart by bringing out **Country** to **Rows** and **Land Area** to **Columns**, by default the view would sum the land area for all 15 rows per country.

For some fields it may be necessary to compensate for double counting values by aggregating with an average or minimum rather than sum or filtering.

Normalization

Relational databases are made up of multiple tables that can be related or linked together in some way. Each table contains a unique identifier, or key, per record. By relating or joining on the keys, records can be linked to provide more information than is contained in a single table. What information goes into each table is dependent on the data model used, but the general principle is around reducing duplication.

For example, consider event planning for an event like a wedding. We need to keep track of information at the level of groups (such as families or couples) as well as the level of individuals.

A table could be created that combines all the information together:

ID	Name	Group	Dietary	Seating	Attending	Address	Invitation	Gift	Bride
10	Cedar	Tree	Omnivore	1	yes	87 Forest Ave	sent	pebble	yes
11	Redwood	Tree	Omnivore	1	yes	87 Forest Ave	sent	pebble	yes
12	Fir	Tree	Vegan	1	yes	87 Forest Ave	sent	pebble	yes
13	Madrona	Tree	Omnivore		no	87 Forest Ave	sent	pebble	yes
14	Chanterelle	Mushroom	Omnivore	2	yes	3 Troll St	sent	leaf	no
15	Cremini	Mushroom	Kosher	2	yes	3 Troll St	sent	leaf	no
16	Portobello	Mushroom	Omnivore	2	yes	3 Troll St	sent	leaf	no
17	Hydrangea	Flower				652 Meadow Ln	undeliverable		yes
18	Dahlia	Flower				652 Meadow Ln	undeliverable		yes

However, if an address is incorrect and needs to be fixed, it must be fixed across multiple rows, potentially leading to errors or conflicts. A better structure is to create two tables, one for information that pertains to the group (such as address and if the invitation was sent) and one for information pertaining to the individuals (for things like seating assignments and dietary restrictions).

Group table

Individual table

ID	Group	Address	Invitation	Gift	Bride
34	Tree	87 Forest Ave	sent		
35	Mushroom	3 Troll St	sent		
36	Flower	652 Meadow Ln	undeliverable		

ID	Name	Group	Dietary	Seating	Attending
10	Cedar	Tree	Omnivore	1	yes
11	Redwood	Tree	Omnivore	1	yes
12	Fir	Tree	Vegan	1	yes
13	Madrona	Tree	Omnivore		no
14	Chanterelle	Mushroom	Omnivore	2	yes
15	Cremini	Mushroom	Kosher	2	yes
16	Portobello	Mushroom	Omnivore	2	yes
17	Hydrangea	Flower			
18	Dahlia	Flower			

It's much easier to track and analyze group-level information in the group table and individual-level information in the individual table. For example, the number of chairs needed can be obtained from the number of Attending = Yes records in the individual table, and the number of stamps needed for thank-yous can be obtained from the number of records in the group table where Gift isn't null.

The process of breaking up all the data into multiple tables—and figuring out which table contains which columns—is called *normalization*. Normalization helps reduce redundant data and simplifies the organization of the database.

However, there may be times when information is needed that spans multiple tables. For example, what if we wanted to balance seating arrangements (individuals) such that groups from the bride's side are intermingled with groups from the groom's side? (The bride or groom affiliation is tracked at the group level.) To achieve this, we need to relate the tables back together so the individuals are associated with information about their group. Proper normalization isn't just breaking up tables, it also requires the presence of a shared, related field or unique identifier that can be used to combine the data back together again. Here, that related field is Group. That field is present in both tables, so we can join on this field and return to our original, single table format. This is a *denormalized* structure.

So why didn't we just keep the original denormalized table? It is harder to maintain and was storing redundant information. At scale, the level of data duplication can become massive. Storing the same information over and over isn't efficient.

Normalized tables have a few key properties:

- Each row needs a unique identifier
- Each table needs a column or columns that can be used to connect it back to other tables (key).

These shared (key) columns are used for relating or joining tables back together. For our data, the relationship or join clause would be on the Group field in each table.

Join Types

Although the default method for combing data in Tableau Desktop is relating, there are cases when you may want to join tables in Tableau Desktop or Tableau Prep Builder. For a basic overview of joins and join types, see [Join Your Data](#).

Name	# of Siblings
Taylor	2
Alex	3
Shannon	0
Tracy	1

Name	Eye Color
Taylor	Blue
Alex	Brown
Morgan	Brown

Inner Join

Name	# of Siblings	Eye Color
Taylor	2	Blue
Alex	3	Brown

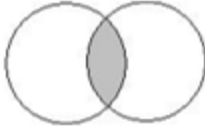

Left Join

Name	# of Siblings	Eye Color
Taylor	2	Blue
Alex	3	Brown
Shannon	0	<i>null</i>
Tracy	1	<i>null</i>

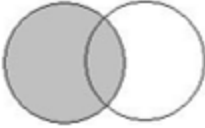

Right Join

Name	Eye Color	# of Siblings
Taylor	Blue	2
Alex	Brown	3
Morgan	Brown	<i>null</i>

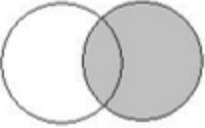

Outer Join

Name	# of Siblings	Eye Color
Taylor	2	Blue
Alex	3	Brown
Shannon	0	<i>null</i>
Tracy	1	<i>null</i>
Morgan	<i>null</i>	Brown

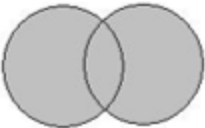

"Tidy" Data

Hadley Wickham published an article in 2014 in the Journal of Statistical Software called "Tidy Data" (August 2014, Volume 59, Issue 10). This article does an excellent job of laying out a framework for data that is well-structured for analysis. The article can be found [here](#) (Hadley Wickham's Academic Portfolio) or [here](#) (hosted by r-project.org).

Note: The article is hosted on external websites. Tableau cannot take responsibility for the accuracy or freshness of pages maintained by external providers. Contact the owners if you have questions regarding their content.

Relate Your Data

Relationships are a dynamic, flexible way to combine data from multiple tables for analysis. A relationship describes how two tables relate to each other, based on common fields, but doesn't merge the tables together. When a relationship is created between tables, the tables remain separate, maintaining their individual level of detail and domains.

Think of a relationship as a contract between two tables. When you're building a viz with fields from these tables, Tableau brings in data from these tables using that contract to build a query with the appropriate joins.

Learn more: The ability to combine data using relationships is an important feature of Tableau's new data modeling capabilities. For more information, see [What's Changed with Data Sources and Analysis](#). Learn more about how relationships work in these Tableau blog posts:

- [Relationships, part 1: Introducing new data modeling in Tableau](#)
- [Relationships, part 2: Tips and tricks](#)
- [Relationships, part 3: Asking questions across multiple related tables](#)

Watch a video: For an introduction to using relationships in Tableau, see this 5-minute video.

Note: The interface for editing relationships shown in this video differs slightly from the current release but has the same functionality.

Action Analytics also provides helpful video podcasts on using relationships in Tableau. For an introduction, see [Why did Tableau Invent Relationships?](#) Click "Video Podcast" in the Action Analytics website [Library](#) to see other podcasts.

What are relationships?

Relationships are the flexible, connecting lines created between the logical tables in your data source. Some people affectionately call relationships "noodles," but we usually refer to them as "relationships" in our help documentation.

We recommend using relationships as your first approach to combining your data because it makes data preparation and analysis easier and more intuitive. **Use joins only when you absolutely need to.**

Relationships provide several advantages over using joins for multi-table data:

- You don't need to configure **join types** between tables. You only need to select the fields to define the relationship.
- Related tables remain separate and distinct; they aren't merged into a single table.
- Relationships use joins, but they're automatic. Tableau automatically selects join types based on the fields being used in the visualization. During analysis, Tableau adjusts join types intelligently and preserves the native level of detail in your data.
- Tableau uses relationships to generate correct aggregations and appropriate joins during analysis, based on the current context of the fields in use in a worksheet.
- Multiple tables at different levels of detail are supported in a single data source. You can build data models that contain more tables, and reduce the number of data sources needed to build a viz.
- Unmatched measure values aren't dropped (no accidental loss of data).
- Using relationships prevents data duplication and filtering issues that can sometimes result from joins.
- Tableau generates queries only for the data that is relevant to the current view.

For related information, see:

- [Use Relationships for Multi-table Data Analysis](#)
- [How Relationships Differ from Joins](#)
- [How Analysis Works in Multi-table Data Sources that Use Relationships](#)
- [Don't Be Scared of Relationships](#)

Requirements for relationships

- When relating tables, the fields that define the relationships must have the same data type.
- You can't define relationships based on geographic fields.
- Circular relationships aren't supported in the data model.
- You can't define relationships between published data sources.

Factors that limit the benefits of using related tables are:

- Dirty data in tables (for example, tables that weren't created with a well-structured model in mind and contain a mix of measures and dimensions in multiple tables) can make multi-table analysis more complex.
- Using data source filters limits Tableau's ability to do join culling in the data. Join culling is a term for how Tableau simplifies queries by removing unnecessary joins.
- Tables with many unmatched values across relationships.
- In Tableau version 2024.2 and later, you can model shared dimensions and use multiple base tables using multi-fact relationships. For more information, see [About Multi-fact Relationship Data Models](#), [When to Use a Multi-fact Relationship Model](#), and [Build a Multi-fact Relationship Data Model](#).

Data that can't be related

Most relational connection types are completely supported. Cubes, SAP HANA (with OLAP attribute), JSON, and Google Analytics are limited to a single logical table in Tableau 2020.2. Stored procedures can only be used within a single logical table.

Published data sources can't be related to each other.

Unsupported

- Cube databases don't support the new logical layer. Connecting to a cube offers the same experience as pre-2020.2.
- Stored Procedures: Don't support federation, relationships, or joins. They're represented in a single logical table, and don't allow opening the Join/Union canvas (physical layer).
- Splunk: Doesn't support left joins (and therefore relating logical tables).
- JSON: Doesn't support federation, custom SQL, joins, or relationships (only unions).
- Data sources that don't support LOD calcs. For more information, see [Data Source Constraints for Level of Detail Expressions](#).

Limited support

- Salesforce and WDC Standard Connections: These are represented as joined tables within a logical table. Adding these connections is currently supported only for single, logical table data sources. Standard connections can't join to an existing table.
- SAP HANA: Doesn't currently support relating logical tables when the connection has the OLAP attribute set.

Create and define relationships

For a single base table model, after you drag the first table to the top-level canvas of the data source, each new table that you drag to the canvas must be related to an existing table. When you create relationships between tables in the logical layer, you're building the data model for your data source.

In version 2024.2 and later: For multiple base table models, each new table you add to the model must be related in at least one base table tree. For more information, see [Build a Multi-fact Relationship Data Model](#).

Create a relationship

You create relationships in the logical layer of the data source. This is the default view of the canvas that you see in the Data Source page.

The steps in this topic specifically address how to set up relationships for a single base table model.

in version 2024.2 and later, you can build a single base table model or a multiple base table model. For information on how to create multi-fact relationships with multiple base tables, see [Build a Multi-fact Relationship Data Model](#).

1. Drag a table to the canvas.
 - For a single base table model: The first table that you add to the canvas becomes the base table. All other tables that you add will be related to that table.
 - For a multiple base table model: You will need to decide which tables are base tables. To create another base table, drag a table from the left pane to the **New Base Table** drop area. For more information, see [Build a Multi-fact Relationship Data Model](#).
2. Drag another table to the canvas. When you see the "noodle" between the two tables that you want to relate, drop that table.

The relationship settings open below the canvas in the Table Details pane. Tableau automatically attempts to create the relationship based on existing key constraints and matching fields to define the relationship. If it can't determine the matching fields, you'll need to select them.

To change the fields: Select a field pair, and then select from the list of fields below to set a new pair of matching fields.

To add multiple field pairs: After you select the first pair, select **Close**, and then select **Add more fields**.

If no constraints are detected, a **Many-to-many** relationship is created and referential integrity is set to **Some records match**. These default settings are a safe choice and provide the most flexibility for your data source. The default settings support full outer joins and optimize queries by aggregating table data before forming joins during analysis. All column and row data from each table becomes available for analysis.

In many analytical scenarios, using the default settings for a relationship gives you all of the data you need for analysis. Using a many-to-many relationship will work even if your data is many-to-one or one-to-one. If you know the particular cardinality and referential integrity of your data, you can adjust the **Performance Options settings** to describe your data more accurately and optimize how Tableau queries the database.

3. Add more tables following the same steps, as needed.

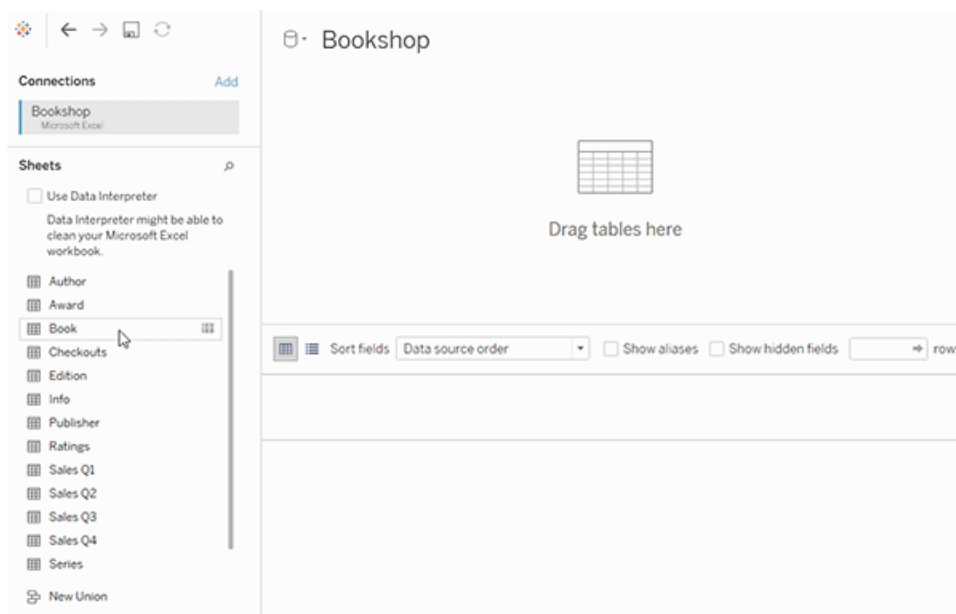

After you have built your multi-table, related data source, you can dive into exploring that data. For more information, see [How Analysis Works for Multi-table Data Sources that Use Relationships](#) on page 697 and [Troubleshooting multi-table analysis](#).

Note: The Salesforce connector doesn't support inequality operators. Google Big Query and MapR connectors support non-equal joins starting with version 2021.4. The MapR connector is deprecated as of version 2022.3.

Move a table to create a different relationship

To move a table, drag it next to a different table. Or, hover over a table, select the arrow, and then select **Move**.

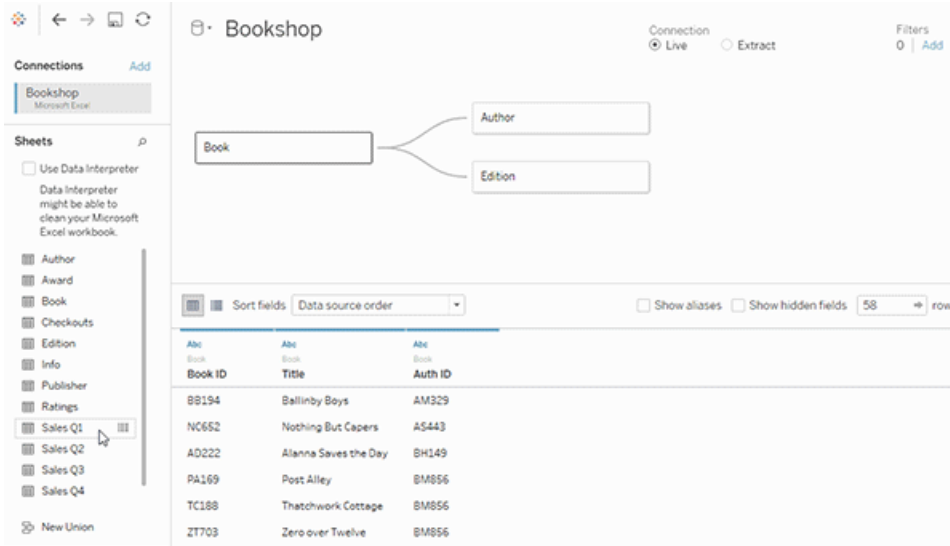

Tip: Drag a table over the top of another table to replace it.

Change the root or base table of a data model

You can swap the root table (version 2020.2 through 2024.1) or a base table (version 2024.2 and later) with another downstream table. Right-click another logical table in the data model, and then select **Swap with root** or **Swap with base table (table name)** to make the change.

Remove a table from a relationship

To move a table, hover over a table, select the arrow, and then select **Remove**.

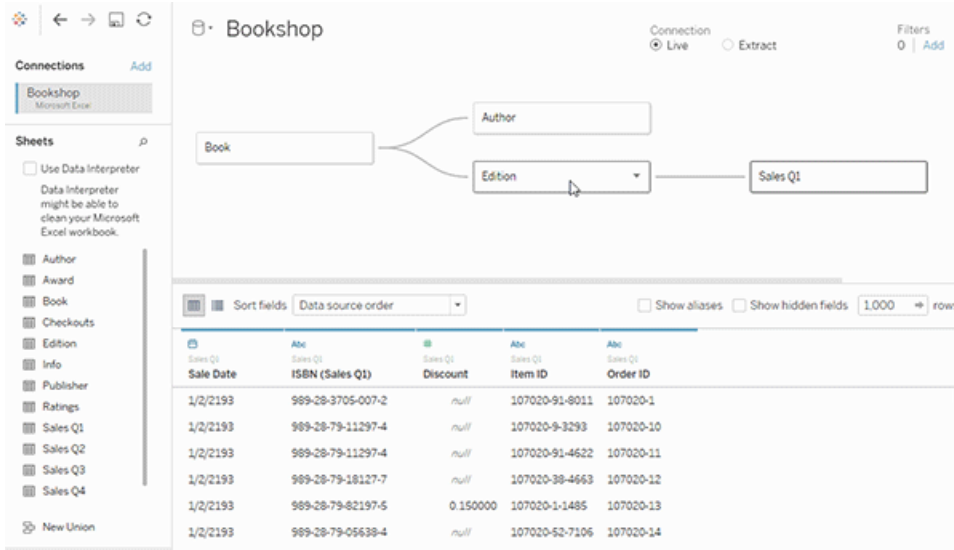

Deleting a table in the canvas automatically deletes its related descendants as well.

View a relationship

- Hover over the relationship line (noodle) to see the matching fields that define it. You can also hover over any logical table to see what it contains.

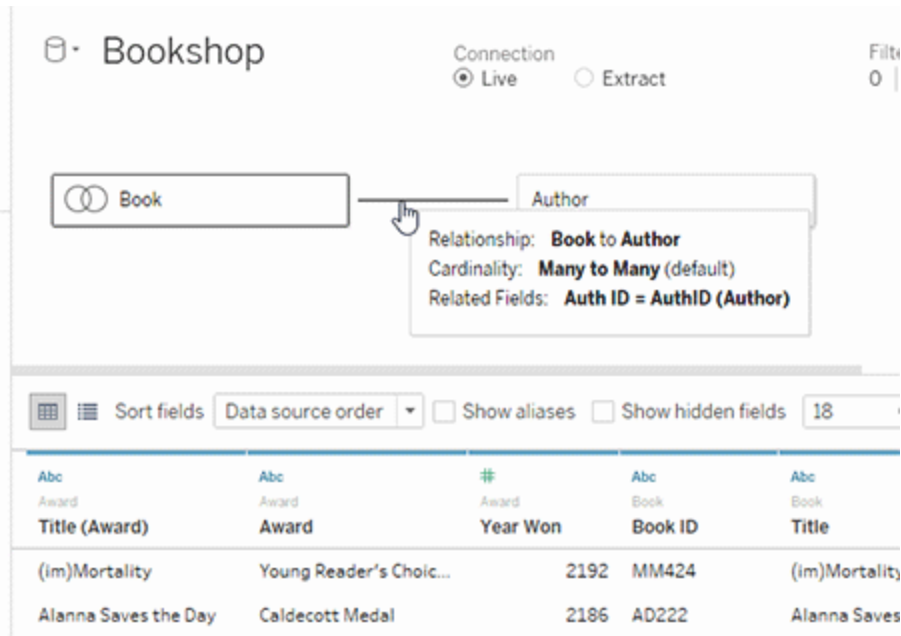

Edit a relationship

- Select a relationship line to open the relationship settings in the Table Details pane. You can add, change, or remove the fields used to define the relationship. Add more field pairs to create a compound relationship.
- To add multiple field pairs: After you select the first pair, select **Close**, and then select **Add more fields**.

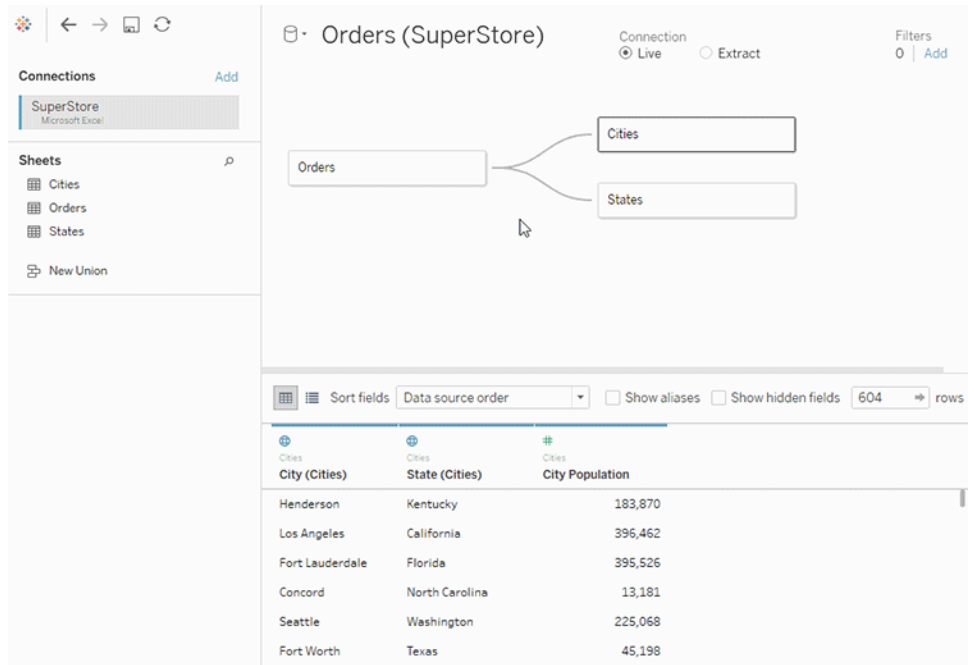

Tips on creating relationships

- The first table that you drag to the canvas becomes the root or base table for the data model in your data source. After you drag out the base table, you can drag out more tables in any order. You'll need to consider which tables should be related to each other, and the matching field pairs that you define for each relationship.
- Before you start creating relationships, viewing the data from the data source before or during analysis can be useful to give you a sense of the scope of each table. For more information, see [View Underlying Data on page 2001](#). You can also use View Data to see a table's underlying data when a relationship is invalid.
- If you're working with data in a star schema, it can be helpful to drag the fact table out first to make it the base table, and then relate dimension tables to that base table.

- Each relationship must be made of at least one matched pair of fields. Add multiple field pairs to create a compound relationship. Matched pairs must have the same data type in the underlying database. Changing the data type in the Data Source page doesn't change this requirement. Tableau uses the data type from the database for queries.
- Relationships can be based on calculated fields. You can also specify how fields should be compared by using operators when you define the relationship.
- Deleting a table in the canvas automatically deletes its related descendants as well.
- You can swap the root table (version 2020.2 through 2024.1) or a base table (version 2024.2 and later) with another downstream table. Right-click another logical table in the data model, and then select **Swap with root** or **Swap with base table (table name)** to make the change.

Validate relationships in your data source

You have several options for validating your data model for analysis. As you create the model for your data source, we recommend going to the sheet, selecting that data source, and then building a viz to explore record counts, unmatched values, nulls, or repeated measure values. Try working with fields across different tables to ensure everything looks how you expect it to.

What to look for:

- Are your relationships in the data model using the correct matching fields for their tables?
- What are the results of dragging different dimensions and measures into the view?
- Are you seeing the expected number of rows?
- Would compound relationships make the relationship more accurate?
- If you changed any of the [Performance Options settings](#) from the default settings, are the values in the viz what you expect? If not, check the settings, or reset to the default.

Options for validating relationships and the data model:

- Every table includes a count of its records, as a field named *TableName(Count)*, at the level of detail for that table. To see the count for a table, drag its Count field into the view. To see the count for all tables, select the Count field for each table in the Data pane, and then click the Text Table in Show Me.
- Click **View Data** in the Data pane to see the number of rows and data per table. Also, before you start creating relationships, viewing the data from the data source before or during analysis can be useful to give you a sense of the scope of each table. For more information, see [View Underlying Data](#).
- Drag dimensions onto rows to see the Number of Rows in the status bar. To see unmatched values, click the **Analysis** menu, and then select **Table Layout > Show**

Empty Rows or **Show Empty Columns**. You can also drag different measures to the view, such as `<YourTable>(Count)` from one of the tables represented in your viz. This ensures that you'll see all values of the dimensions from that table.

Tip: If you would like to see the queries that are being generated for relationships, you can use the Performance Recorder in Tableau Desktop.

1. Click the Help menu, and then select **Settings and Performance > Start Performance Recording**.
2. Drag fields into the view to build your viz.
3. Click the Help menu, and then select **Settings and Performance > Stop Performance Recording**.
4. In the Performance Summary dashboard, under Events Sorted By Time, click an "Executing Query" bar and view the query below.

Another more advanced option is to use the [Tableau Log Viewer](#) on GitHub. You can filter on a specific keyword using `end-protocol.query`. For more information, start with the [Tableau Log Viewer wiki page](#) in GitHub.

Dimension-only visualizations

When using a multi-table data source with related tables: If you build a dimension-only viz, Tableau uses inner joins and you won't see the full unmatched domain.

To see partial combinations of dimension values, you can:

- Use Show Empty Rows/Columns to see all of the possible rows. Click the **Analysis** menu, and then select **Table Layout > Show Empty Rows** or **Show Empty Columns**.
- Add a measure to the view, such as `<YourTable>(Count)` from one of the tables represented in your viz. This ensures that you'll see all values of the dimensions from that table.

For more information, see [Analysis in Multi-table vs. Single-table Data Sources](#) and [Troubleshooting multi-table analysis](#).

Relationships (logical tables) versus joins (physical tables)

While similar, joins and relationships behave differently in Tableau, and are [defined in different layers of the data model](#). You create relationships between logical tables at the top-level, logical layer of your data source. You create joins between physical tables in the physical layer of your data source.

Joins merge data from two tables into a single table before your analysis begins. Merging the tables together can cause data to be duplicated or filtered from one or both tables; it can also cause NULL rows to be added to your data if you use a left, right, or full outer join. When analyzing joined data, you need to make sure that you correctly handle the effects of the join on your data.

Note: When duplication or the filtering effects of a join might be desirable, use joins to merge tables together instead of relationships. Double-click a logical table to open the physical layer and add joined tables.

A relationship describes how two independent tables relate to each other but doesn't merge the tables together. This avoids the data duplication and filtering issues that might occur in a join and can make working with your data easier.

relationships	joins
Defined between logical tables in the Relationship Canvas (logical layer)	Defined between physical tables in the Join/Union canvas (physical layer)
Don't require you to define a join type	Require join planning and join type
Act like containers for tables that are joined or unioned	Are merged into their logical table
Only data relevant to the viz is queried. Cardinality and referential	Run as part of every query

relationships

joins

integrity settings can be adjusted to optimize queries.

Level of detail is at the aggregate for the viz

Level of detail is at the row level for the single table

Join types are automatically formed by Tableau based on the context of analysis. Tableau determines the necessary joins based on the measures and dimensions in the viz.

Join types are static and fixed in the data source, regardless of analytical context. Joins and unions are established prior to analysis and don't change.

Rows aren't duplicated

Merged table data can result in duplication

Unmatched records are included in aggregates, unless explicitly excluded

Unmatched records are omitted from the merged data

relationships	joins
Create independent domains at multiple levels of detail	Support scenarios that require a single table of data, such as extract filters and aggregation

Relationships versus blends

While both relationships and blends support analysis at different levels of detail, they have distinct differences. One reason you might use blends over relationships is to combine published data sources for your analysis.

relationships	blends
Defined in the data source	Defined in the worksheet between a primary and a secondary data source
Can be published	Can't be published
All tables are equal semantically	Depend on selection of primary and secondary data sources, and how those data sources are structured.

relationships	blends
Support full outer joins	Only support left joins
Computed locally	Computed as part of the SQL query
Related fields are fixed	Related fields vary by sheet (can be customized on a sheet-by-sheet basis)

Features of different options for combining data: Relationships, joins, and blends

There are many ways to combine data tables, each with their own preferred scenarios and nuances.

- Relate** Use when combining data from different levels of detail.
- Requires matching fields between two logical tables. Multiple matching field pairs can define the relationship.
 - Automatically uses correct aggregations and contextual joins based on how fields are related and used in the viz.
 - Supports many-to-many and outer joins.

- Relationships are consistent for the entire workbook and can be published.
- Can be published, but you can't combine published data sources by using relationships.
- Can't define relationships based on geographic fields.
- Using data source filters limits join culling benefits of relationships.

Join Use when you want to add more columns of data across the same row structure.

- Requires common fields between two physical tables.
- Requires establishing a join clause and a join type.
- Joined physical tables are merged into a single logical table with a fixed combination of data.
- May cause data loss if fields or values aren't present in all tables (dependent on join types used).
- May cause data duplication if fields are at different levels of detail.
- Can use data source fil-

ters.

- Union** Use when you want to add more rows of data with the same column structure.
- Based on matching columns between two tables.
 - Unioned physical tables are merged into a single logical table with a fixed combination of data.

- Blend** Use when combining data from different levels of detail.
- Can be used to combine published data sources, but can't be published.
 - Can be used between a relational data source and a cube data source.
 - Data sources can be blended on a per-sheet basis.
 - Are always effectively left joins (may lose data from secondary data sources).

Use Relationships for Multi-table Data Analysis

Tables that you drag into this canvas use relationships. Relationships are a flexible way to combine data for multi-table analysis in Tableau.

Think of a relationship as a contract between two tables. When you are building a viz with fields from these tables, Tableau brings in data from these tables using that contract to build a query with the appropriate joins.

We recommend using relationships as your first approach to combining your data because it makes data preparation and analysis easier and more intuitive. [Use joins only when you absolutely need to](#). Learn more about the basics of creating relationships in this 5-minute video.

Note: The interface for editing relationships shown in this video differs slightly from the current release but has the same functionality.

Learn more about how relationships work in these Tableau blog posts:

- [Relationships, part 1: Introducing new data modeling in Tableau](#)
- [Relationships, part 2: Tips and tricks](#)
- [Relationships, part 3: Asking questions across multiple related tables](#)

Also see video podcasts on relationships from [Action Analytics](#), such as [Why did Tableau Invent Relationships?](#) Click "Video Podcast" in the [Library](#) to see more.

In Tableau version 2024.2 and later, the Tableau data model supports multi-fact analysis and shared dimensions through multi-fact relationships. For more information, see [About Multi-fact Relationship Data Models](#), [When to Use a Multi-fact Relationship Model](#), and [Build a Multi-fact Relationship Data Model](#).

Are you building a new data source and workbook?

Drag a table to the Data Source page canvas to start building your data source.

A data source can be made of a single table that contains all of the dimension and measure fields you need for analysis...

Tableau Desktop and Web Authoring Help

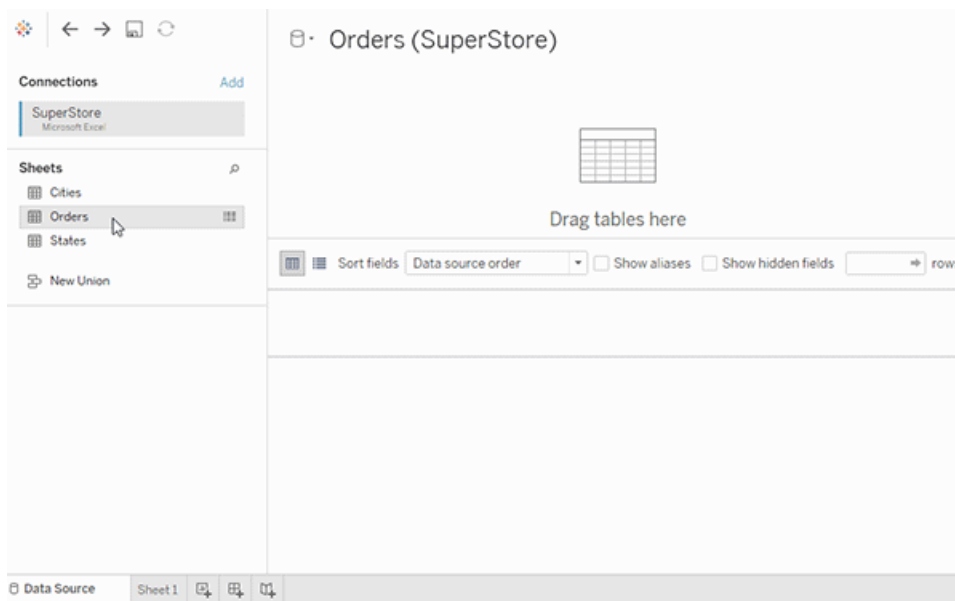

Or, you can create a multi-table data source by dragging out more tables and defining their relationships...

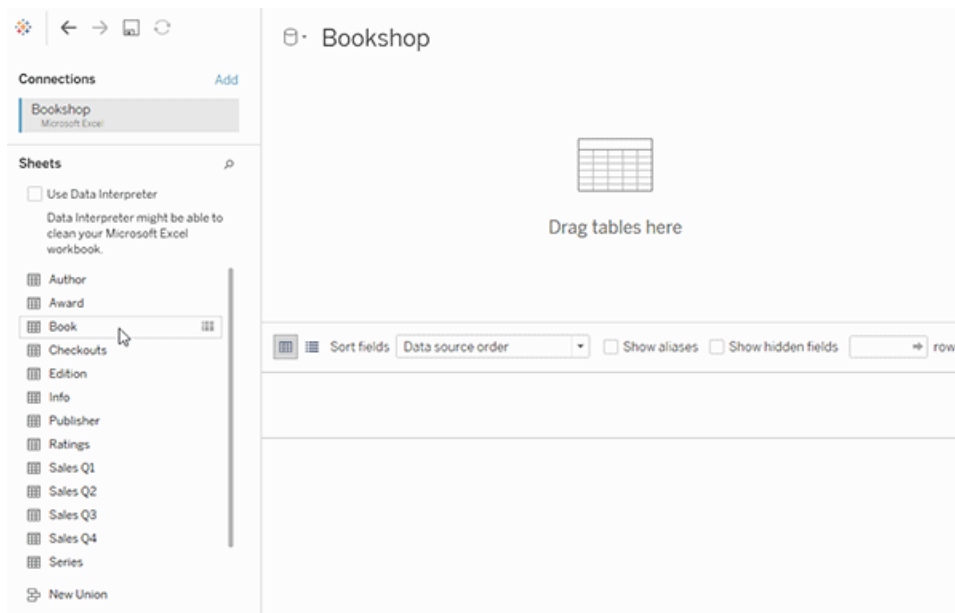

Watch this 1-minute video about getting started with using relationships.

Note: The interface for editing relationships shown in this video differs slightly from the current release but has the same functionality.

For more information about using relationships, see [Relate Your Data](#), [How Relationships Differ from Joins](#) on page 677, [The Tableau Data Model](#), and [Create and define relationships](#).

For more information on changes to data sources and analysis in Tableau 2020.2 and later, see [What's Changed with Data Sources and Analysis](#) and [Questions about Relationships, the Data Model, and Data Sources](#).

Are you opening an older workbook or data source?

When you open a pre-2020.2 workbook or data source in 2020.2, your data source will appear as a single logical table in the canvas, with the name "Migrated Data" or the original table name. Your data is preserved and you can continue to use the workbook as you did before.

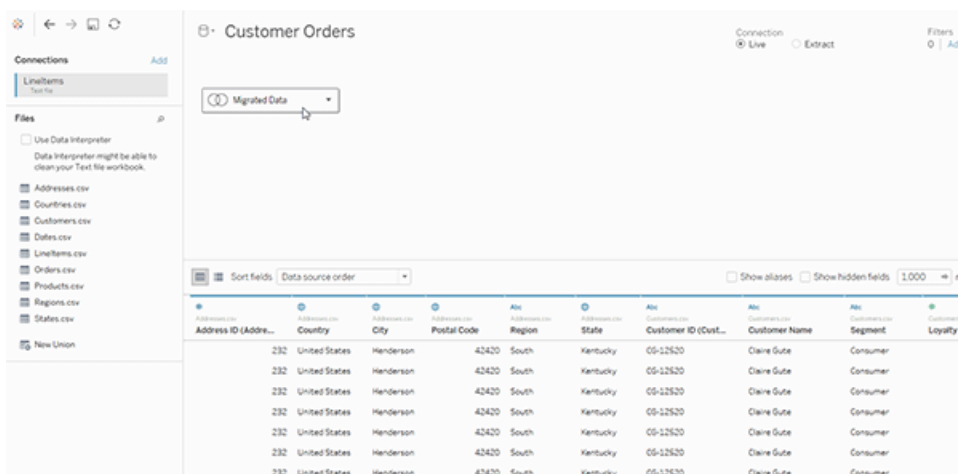

Address ID	Country	City	Postal Code	Region	State	Customer ID	Customer Name	Segment	Loyalty
232	United States	Henderson	42420	South	Kentucky	05-12520	Claire Gute	Consumer	
232	United States	Henderson	42420	South	Kentucky	05-12520	Claire Gute	Consumer	
232	United States	Henderson	42420	South	Kentucky	05-12520	Claire Gute	Consumer	
232	United States	Henderson	42420	South	Kentucky	05-12520	Claire Gute	Consumer	
232	United States	Henderson	42420	South	Kentucky	05-12520	Claire Gute	Consumer	
232	United States	Henderson	42420	South	Kentucky	05-12520	Claire Gute	Consumer	
232	United States	Henderson	42420	South	Kentucky	05-12520	Claire Gute	Consumer	

To see the physical tables that make up the single logical table, double-click that logical table to open it in the physical layer. You will see its underlying physical tables, including joins and unions.

For more information on changes to data sources and analysis in Tableau 2020.2 and later, see [What's Changed with Data Sources and Analysis](#) and [Questions about Relationships, the Data Model, and Data Sources](#).

What's Changed with Data Sources and Analysis

Starting in Tableau version 2020.2, several major enhancements make multi-table analysis easier and more intuitive.

Data modeling capabilities in Tableau help you more easily analyze data across multiple tables. With a logical layer and relationships in data sources, you can create multi-table data models in the form of star and snowflake schemas with multiple fact tables at different levels of detail (LOD).

- **Data sources are easier to build, maintain, and analyze.** Data sources have a new logical layer where you can create flexible relationships between tables. Create multi-table, multi-fact data models by relating tables at different levels of detail. Bring in data from multiple tables more easily and maintain fewer data sources to meet your analytical needs.
- **Relationships make the analysis experience more intuitive.** You no longer need to engage in extensive join planning and make assumptions about what join types will be required to make your data ready for analysis. Tableau automatically selects join types based on the fields being used in the visualization. During analysis, Tableau adjusts join types intelligently and preserves the native level of detail in your data. You can see aggregations at the level of detail of the fields in your viz rather than having to think about the underlying joins. Relationships can be many-to-many and support full outer joins. You don't need to use LOD expressions such as FIXED to deduplicate data in related tables.
- **The Data Source page, View Data window, and Data pane have been updated to support a multi-table analysis experience.** Your first view of the Data Source page canvas is the logical layer, where you can define relationships between tables. In support of multi-table analysis, several parts of the Tableau interface have changed. The Data Source page (canvas, data grid), View Data window, and the Data pane in the worksheet have all been updated to support a multi-table analysis experience. For more information, see [Changes to different parts of the interface](#). The API to access View Data has also been updated to support multi-table analysis.
- **Context-aware queries bring in relevant data when it's needed.** A data source that uses relationships makes it easier to bring more tables, more rows of data, and multiple fact tables into a single data source. Rather than querying the entire data source, Tableau brings in data from the tables that are needed for the worksheet, based on the fields at play in the visualization.

Watch a video: For an overview of data source enhancements and an introduction to using relationships in Tableau, see this 5-minute video.

Note: The interface for editing relationships shown in this video differs slightly from the current release but has the same functionality.

Learn more about how relationship queries work in these Tableau blog posts:

- [Relationships, part 1: Introducing new data modeling in Tableau](#)
- [Relationships, part 2: Tips and tricks](#)
- [Relationships, part 3: Asking questions across multiple related tables](#)

Also see video podcasts on relationships from [Action Analytics](#), such as [Why did Tableau Invent Relationships?](#) Click "Video Podcast" in the [Library](#) to see more.

Changes to data sources, the data model, and query semantics

Support for multi-table data sources

Data sources in Tableau recognize and preserve normalized data. With multi-table data sources, Tableau can handle multiple levels of detail in a single data source. This support makes it easier for you to prepare and explore your data without having to write specialized calculations to control aggregations like averages and totals. Combine tables in star and snowflake schemas to seamlessly relate multiple fact tables. The new logical layer uses contextual, dynamic joins and gives you better domain control (see [Supported data model schemas on page 673](#)).

Tableau recognizes and maintains the underlying relationships between tables, so fewer joins and calculations should be needed. Because these enhanced data sources can answer a wider variety of questions, you can consolidate the number of distinct data sources you need to create and maintain. Fewer data sources are needed to represent the same data.

What didn't change?

Relationships in the logical layer give you more options for combining data (nothing has been taken away). You can still create single-table data sources in Tableau. You can build a logical table using a combination of joins, unions, custom SQL, and so on. The behavior of single-table analysis in Tableau hasn't changed. Analysis over a single logical table that contains a mixture of dimensions and measures works the same as Tableau version 2020.1 and earlier.

Also see [Questions about Relationships, the Data Model, and Data Sources on page 654](#).

New logical layer in the data source

In previous versions of Tableau, the data model in your data source consisted of a single, physical layer where you could specify [joins](#) and unions. Tables added to the physical layer

(joined or unioned) create a single, flattened table (denormalized) for analysis.

Previous versions

2020.2 and later

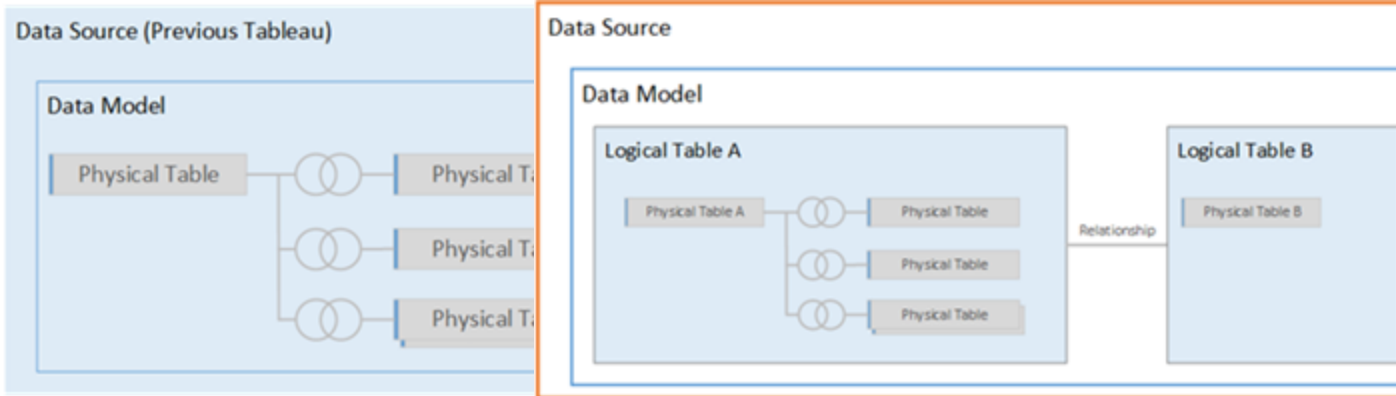

In Tableau version 2020.1 and earlier, the data model has only the physical layer

In Tableau version 2020.2 and later, the data model has two layers: the logical layer and the physical layer

Starting in Tableau version 2020.2, the data model in your data source includes a new semantic layer above the physical layer—called the logical layer—where you can add multiple tables and relate them to each other based on matched field pairs. Tables at the logical layer aren't merged in the data source, they remain distinct (normalized), and maintain their native level of detail.

Logical tables act like containers for physical tables. You can still use joins and unions between physical tables. Just double-click a logical table to open it and work with joins or unions.

The logical layer makes it easier for you to combine your data for a variety of analytics scenarios. You can use and create normalized data models in the form of star and snowflake schemas, and flexible models with fact tables at different grains.

For more information, see [The Tableau Data Model](#) on page 666 and [Supported data model schemas](#) on page 673.

Query semantics based on relationships

Relationships are a dynamic, flexible way to combine data from multiple tables for analysis. Relationships can be many-to-many and support full outer joins. You don't need to use LOD expressions such as FIXED to deduplicate data in related tables.

Think of a relationship as a contract between two tables. When you are building a viz with fields from these tables, Tableau brings in data from these tables using that contract to build a query with the appropriate joins.

We recommend using relationships as your first approach to combining your data because it makes data preparation and analysis easier and more intuitive. [Use joins only when you absolutely need to.](#)

- **No up-front join type.** You only need to select matching fields to define a relationship (no join types). Because you don't specify the join type, you won't see a Venn diagram when you're setting up relationships.
- **Automatic and context-aware.** Relationships defer joins to the time and context of analysis. Tableau automatically selects join types based on the fields being used in the visualization. During analysis, Tableau adjusts join types intelligently and preserves the native level of detail in your data. You can see aggregations at the level of detail of the fields in your viz rather than having to think about the underlying joins.
- **Flexible.** When you combine tables using relationships, it's like creating a custom, flexible data source for every viz, all in a single data source for the workbook. Because Tableau queries only tables that are needed based on fields and filters in a viz, you can build a data source that can be used for a variety of analytic flows.

For more information, see [Relate Your Data, Don't Be Scared of Relationships](#), and [Relationships, part 1: Introducing new data modeling in Tableau](#).

Note: To go to the original join canvas, double-click a logical table in the top level view (the logical layer of the data source). You can still add joins and unions between tables in the physical layer of the data source. For more information, see [The Tableau Data Model](#) on page 666.

Migrated data sources

When you open a pre-2020.2 workbook or data source in Tableau version 2020.2 and later, your data source will appear as a single logical table in the canvas. You can continue to use the workbook as you did before.

If your data source contained multiple joined or unioned tables, the single logical table is displayed with the name "Migrated Data". You can rename the Migrated Data table.

To see the physical tables that make up the single logical table, double-click that logical table to open it in the physical layer. You'll see its underlying physical tables, including joins and unions.

Tableau Desktop and Web Authoring Help

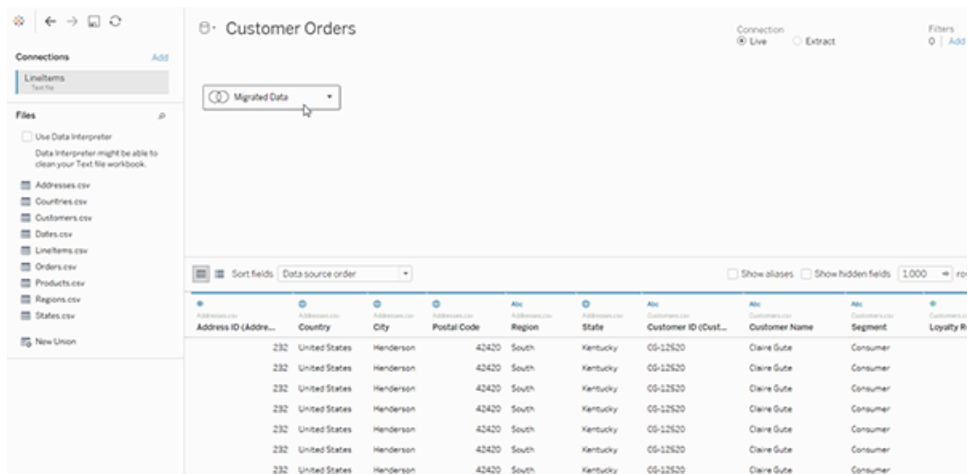

Web Authoring

Your workbook must use an embedded data source for you to be able to edit relationships and performance options in the Data Source page in web authoring in Tableau Server or Tableau Cloud.

Extracts

Extract data can be stored based on logical tables (replaces the Single Table option) or physical tables (replaces the Multiple Tables option). For more information, see [Extract Your Data on page 919](#).

Changes to different parts of the interface

Data Source page changes

The Data Source page canvas has two layers: a logical layer and a physical layer. The default view that you see in the Data Source page is new; it shows the logical layer, which uses relationships ("noodles") between tables.

You can still add joins and unions between tables in the physical layer, just double-click a logical table in the logical, top-level view to switch to the physical layer. For more information, see [The Tableau Data Model on page 666](#).

The screenshot displays the Tableau Desktop interface. On the left, the 'Connections' pane shows 'SuperStore' (Microsoft Excel) and the 'Sheets' pane lists 'Cities', 'Orders', 'States', and 'New Union'. The main workspace shows a data model with 'Orders' connected to 'Cities' and 'States'. Below the model, the 'Data Grid' is visible, showing columns for 'Category', 'City', 'Customer Name', 'Manufacturer', and 'Order Date'. The grid contains three rows of data.

Category	City	Customer Name	Manufacturer	Order Date
Furniture	Henderson	Claire Gute	Bush	11/8/2017
Furniture	Henderson	Claire Gute	Hon	11/8/2017
Office Supplies	Los Angeles	Darrin Van Huff	Universal	6/12/2017

Data Grid

When the data source is made of multiple, related tables, selecting a logical table displays that table's data in the data grid that is displayed below the data model. With relationships, the data hasn't been merged, so you will be seeing the values for the currently selected logical table. If you need to pivot columns, you must open a logical table and pivot the data in the physical table view of the data source.

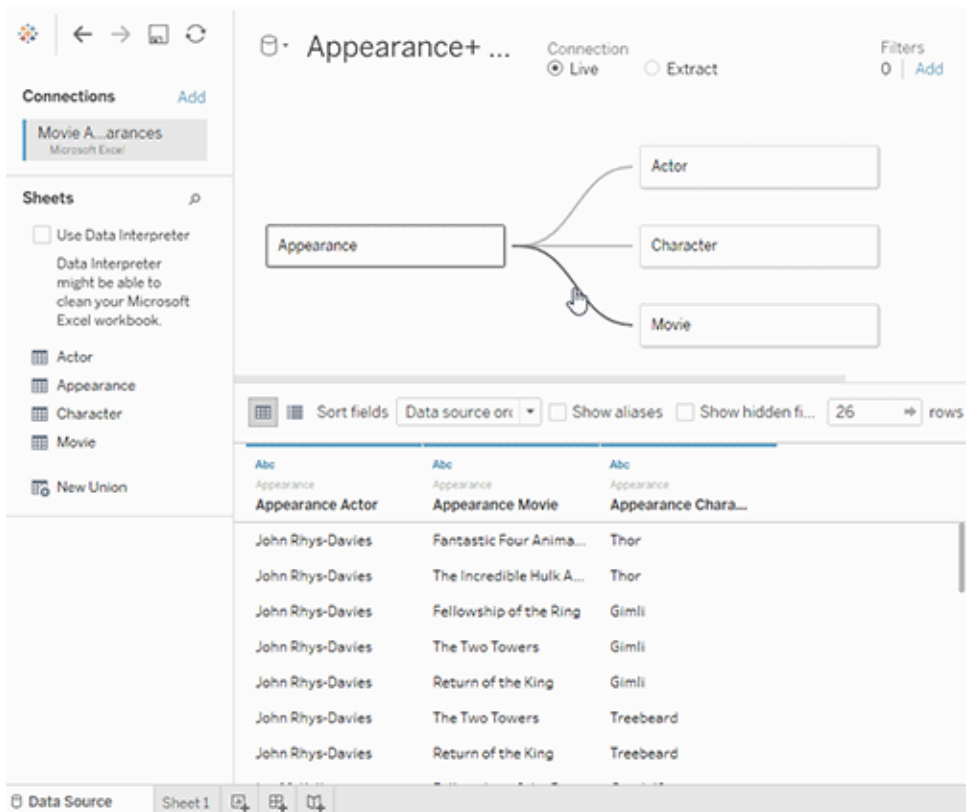

Data pane in worksheets

To support relationships and multi-table analysis, the Data pane has been updated.

You will no longer see the Dimensions and Measures labels in the Data pane. Dimension and measure fields can be organized by table (**Group by Data Source Table**) or folder (**Group by Folder**). Dimensions are displayed above the gray line, and measures below the gray line for each table or folder. In some cases, a table might show only dimensions, or only measures to start with.

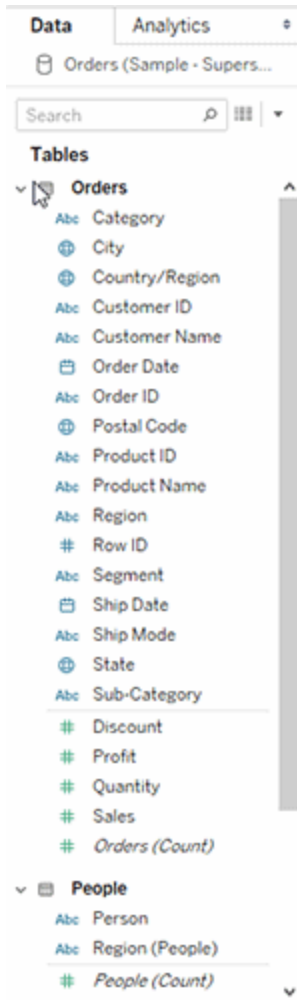

You will no longer see the Number of Records field in data sources that contain logical tables. Every table includes a count of its records, as a field named *TableName(Count)*, at the level of detail for that table. In the previous example you can see *Addresses(Count)*, *Customers(Count)*, and *LineItems(Count)*.

COUNT of table = SUM of Number of Records per table. You can't build calculations on top of a table's *Count* field. *Count* is aggregate-only.

Note: You might see the *Number of Records* field in the Data pane if you open a pre-2020.2 workbook that used *Number of Records* in a view.

Calculated fields are listed with their originating field, if all of their input fields come from the same table.

Sets and groups are displayed under the table with their originating field.

Fields that don't belong to a specific table or aren't grouped under a folder are displayed in the general area below the tables. These field types include: aggregated calculations, calculations that use fields from multiple tables, Number of Records when applicable, Measure Names, and Measure Values.

In version 2024.2 and later: Field names are displayed in light gray text in the Data pane when they're not related to any fields in use in the view. You can still use these fields for analysis in the viz, but unrelated fields are evaluated differently in analysis than fields that are related. You might see this behavior if you are [using a data source with multi-fact relationships](#).

View Data

In the View Data window, when the data source contains multiple logical tables, the number of rows and data are listed at the native level of detail for each table in separate tabs.

For more information, see [View Underlying Data on page 2001](#).

Calculated fields are listed with their originating field.

LOD calculations won't necessarily appear in View Data for a logical table because an LOD calculation might be at a different granularity than the table itself. If the dimensionality of an LOD calc includes fields from a single table, that LOD calculation will appear in its owning table in the Data pane.

View Data column order changes in Tableau version 2020.2 and later

When you open a data source from a Tableau version 2020.1 and earlier in Tableau version 2020.2 and later, the column order might be different. Columns might be displayed differently in the View Data window, and the column order might be different when you export it to CSV format.

This change in how column order is handled in the View Data window is required to support relationships and logical tables.

If you use scripts that depend on a customized column order, we recommend using the Tableau Extensions API for View Data to download underlying data to CSV format.

Changes to analysis with multi-table data sources

Using a data source that has multiple, related tables affects how analysis works in Tableau. Because multiple, related tables have independent domains and retain their native level of detail, when you drag fields into the view:

- Data is queried at its natural level of detail.
- Only data that is relevant to a viz is queried.

- The relationships between the tables affect the results of the query. The flow of building a viz can vary depending on how tables of fields are related to each other in the data model, or if they aren't related directly.

Benefits of using multi-table data sources with relationships:

- Relationships use joins, but they're automatic. Tableau automatically selects join types based on the fields being used in the visualization. During analysis, Tableau adjusts join types intelligently and preserves the native level of detail in your data.
- Tableau uses relationships to generate correct aggregations and appropriate joins during analysis, based on the current context of the fields in use in a worksheet.
- Multiple tables at different levels of detail are supported in a single data source, so fewer data sources are needed to represent the same data.
- Unmatched measure values aren't dropped (no accidental loss of data).
- Related tables reduce or eliminate data duplication and filtering issues that can sometimes result from joins.

For more information, see [Relate Your Data](#) on page 622, [How Analysis Works for Multi-table Data Sources that Use Relationships](#) on page 697 and [Troubleshooting multi-table analysis](#) on page 712.

For related information about how relationship queries work, see these Tableau blog posts:

- [Relationships, part 1: Introducing new data modeling in Tableau](#)
- [Relationships, part 2: Tips and tricks](#)

In Tableau version 2024.2 and later, the Tableau data model supports multi-fact analysis and shared dimensions through multi-fact relationships. For more information, see [About Multi-fact Relationship Data Models](#), [When to Use a Multi-fact Relationship Model](#), and [Build a Multi-fact Relationship Data Model](#).

What didn't change?

The behavior of single-table analysis in Tableau hasn't changed. Analysis over a single logical table that contains a mixture of dimensions and measures works as it did in Tableau pre-2020.2.

Dimension-only visualizations

When using a multi-table data source with related tables: If you build a dimension-only viz, Tableau uses inner joins and you won't see the full unmatched domain.

To see partial combinations of dimension values, you can:

- Use Show Empty Rows/Columns to see all of the possible rows. Click the **Analysis** menu, and then select **Table Layout > Show Empty Rows** or **Show Empty Columns**. Be aware that this setting will also trigger densification for Date and Numeric Bin fields, which might be unwanted.
- Add a measure to the view, such as *<YourTable>(Count)* from one of the tables represented in your viz. This step ensures that you'll see all values of the dimensions from that table.

Unmatched values behavior for dimensions that might surprise you

When you build a visualization that uses dimensions from multiple logical tables, the behavior can be initially surprising. By default, if the dimensions in a visualization or the inputs to a row-level calculations use fields from multiple logical tables, Tableau will only display results where all the dimensions have matching values.

For example, consider a data set that contains two logical tables, Customers and Purchases. Some Customers have made no Purchases and have no matching rows in the Purchases table. If you bring the dimension [Customers].[Customer Name] into play, you'll see a list of all customers whether they made a Purchase or didn't. If you then add the dimension [Purchases].[Product] to the visualization, Tableau will update to show the Customers who made purchases along with the Products they bought.

Here are several ways you can work with this default behavior:

- Use Show Empty Rows/Columns to see all of the possible rows and bring back the unmatched dimension values. Click the **Analysis** menu, and then select **Table Layout > Show Empty Rows** or **Show Empty Columns**. Be aware that this setting will also trigger densification for Date and Numeric Bin fields, which you might not want.
- Convert one of the dimensions to a measure. For example, switching to use COUNT ([Purchases].[Product]) will keep Customers with no purchases and display a "0" for them. This approach might not be viable if you want to see all of the Products.
- Bring a measure into the view from the table with unmatched values. For example, adding COUNT([Customers]) on the detail shelf would bring back the unmatched customers, while still showing all the Products.
- Instead of relating the two tables at the logical level, you can join them using an outer join at the physical level, as in previous versions of Tableau. This approach will show the unmatched values, with a few side effects. Queries will always be issued by querying both tables. NULL values will appear in visualizations and quick filters even when no fields from

the unmatched table are used. And, you'll have to write LOD calculations to remove any unwanted duplication introduced by the join.

Using a table's Count field instead of Number of Records

You will no longer see the Number of Records field in data sources that contain logical tables. Every table includes a count of its records, as a field named *TableName(Count)*, at the level of detail for that table. In the previous example you can see *Addresses(Count)*, *Customers(Count)*, and *LineItems(Count)*.

COUNT of table = SUM of Number of Records per table. You can't build calculations on top of a table's *Count* field. *Count* is aggregate-only.

Note: You might see the *Number of Records* field in the Data pane if you open a pre-2020.2 workbook that used *Number of Records* in a view.

Cross-table calculations

You can write calculations that span multiple tables. Be aware that cross-table calculations use inner join query semantics by default. The calculation lives on top of the join between the logical tables that it references. With relationships, it is possible to write row-level calculations across tables that result in outer joins.

Calculations are evaluated after Null dimensions are added, so you can change a Null to something else using a calculation like: `IFNULL([Dimension], "Missing")`.

Grand totals using SUM

Grand totals using SUM reflect the actual total at the native level of detail of a field's logical table, rather than the SUM of subtotals.

Nulls and automatic joins that result from relationships

In Tableau version 2020.2 and later, when performing joins that result from relationships, Tableau does not join nulls against nulls.

Unmatched null behavior

When you add a measure to the view, a Null dimension value is added when the measure has values that are not associated with a dimension.

This behavior occurs because Tableau treats unmatched values (or non-associated dimension values) the same as true NULL values in the underlying data source. Values for both will be aggregated together or filtered together.

For example, with `SUM(Sales), [State]` every matched State represents a state. Its `SUM(Sales)` is the sum for a single state. For unmatched nulls, `SUM(Sales)` may reflect many states.

If you don't want this behavior, you can clean your data to make sure that every row in the measure table matches a row in the dimension table. You can use Tableau Prep for this. Or, within a sheet, you can filter out the Null by clicking on the Null and selecting **Exclude**. After you do this, you can edit the relationship between the measure table and the dimensions table by selecting **All Records Match** in the Performance Options settings.

Dealing with unmatched nulls in the Edit Filter dialog box

When you apply a filter to a dimension, the rules for when the Null appears are:

- On the General tab, you can explicitly include or exclude the Null row using the check box.
- On the Wildcard tab, the setting won't impact whether or not Null appears (since it only filters out text values and Null is not treated as a text value).
- On the Condition or Top tabs, using a setting other than **None** will cause the "Null" state to be filtered out.

Validating relationships

You have several options for validating your data model for analysis. As you create the model for your data source, we recommend going to a sheet, selecting that data source, and then building a viz to explore record counts, expected data, unmatched values, nulls, or repeated measure values. Try working with fields across different tables to ensure everything looks how you expect it to.

What to look for:

- Are your relationships in the data model using the correct matching fields for their tables?
- Would adding multiple matching field pairs make the relationship more accurate?
- What are the results of dragging different dimensions and measures into the view from different tables?
- Are you seeing the expected number of rows?
- If you changed any of the **Performance Options settings** from the default settings, are the values that you are seeing in the viz what you would expect? If they aren't, you might want to check the settings, or reset to the default.

Options for validating relationships and the data model:

- Every table includes a count of its records, as a field named *TableName(Count)*, at the level of detail for that table. To see the count for a table, drag its Count field into the view.

To see the count for all tables, select the Count field for each table in the Data pane, and then click the Text Table in Show Me.

- Click **View Data** in the Data pane to see the number of rows and data per table. Also, before you start creating relationships, viewing the data from the data source before or during analysis can be useful to give you a sense of the scope of each table. For more information, see [View Underlying Data on page 2001](#).
- Drag dimensions onto rows to see the Number of Rows in the status bar. To see unmatched values, click the **Analysis** menu, and then select **Table Layout > Show Empty Rows** or **Show Empty Columns**. You can also drag different measures to the view, such as *<YourTable>(Count)* from one of the tables represented in your viz. This ensures that you will see all values of the dimensions from that table.

Tip: If you would like to see the queries that are being generated for relationships, you can use the Performance Recorder in Tableau Desktop.

1. Click the Help menu, and then select **Settings and Performance > Start Performance Recording**.
2. Drag fields into the view to build your viz.
3. Click the Help menu, and then select **Settings and Performance > Stop Performance Recording**. The Performance Recording workbook will automatically open.
4. In the Performance Summary dashboard, under Events Sorted By Time, click an "Executing Query" bar and view the query below.

Another more advanced option is to use the [Tableau Log Viewer](#) on GitHub. You can filter on a specific keyword using `end-protocol.query`. For more information, start with the [Tableau Log Viewer wiki page](#) in GitHub.

Questions about Relationships, the Data Model, and Data Sources

These are some of the questions we've heard related to data modeling and relationships in Tableau. If you have a question that isn't in this list, please share it with us by clicking the blue **Send feedback** icon in the bottom right corner of this Help page, (click Yes or No, add your question in the Comment field, and then click Send).

Relationships

Is a relationship just a different name for a join?

Relationships are a dynamic, flexible way to combine data from multiple tables for analysis. A relationship describes how two independent, logical tables relate to each other, but does not merge the tables together ([What is a logical table?](#)). When a relationship is created between

tables, the tables remain separate (normalized), maintaining their native level of detail and domains. You can use relationships to create multi-fact data models.

You can't set a join type for relationships. Relationships defer joins to the time and context of analysis. Tableau automatically selects what join types should be used based on the current fields in use in the viz. During analysis, Tableau adjusts join types intelligently and preserves the native level of detail in your data. You can see aggregations at the level of detail of the fields in your viz rather than having to think about the underlying joins.

Relationships can be many-to-many and support full outer joins. You don't need to use LOD expressions such as FIXED to deduplicate data in related tables.

Learn more: For related information on combining data using relationships, also see these topics and blog posts:

- [Relate Your Data](#)
- [The Tableau Data Model](#) on page 666
- [How Relationships Differ from Joins](#) on page 677
- [Use Relationships for Multi-table Data Analysis](#) on page 637
- [Don't Be Scared of Relationships](#) on page 717
- [Relationships, part 1: Introducing new data modeling in Tableau](#)
- [Relationships, part 2: Tips and tricks](#)
- [Relationships, part 3: Asking questions across multiple related tables](#)

Also see video podcasts on relationships from [Action Analytics](#), such as [Why did Tableau Invent Relationships?](#) Click "Video Podcast" in the [Library](#) to see more.

Can I use joins between logical tables?

You must use relationships between logical tables. You can only use joins between physical tables contained in a logical table. Double-click a logical table to open it.

We recommend using relationships as your first approach to combining your data because it makes your data preparation and analysis easier and more intuitive. Use joins only when you absolutely need to. Situations where you might still use joins include when you want to:

- Continue to use a data source from a pre-2020.2 version to Tableau that you have upgraded to 2020.2
- Explicitly use a specific join type
- Use a data model that supports shared dimensions

Where did joins go? Can I still combine table data using joins?

Joins are still an option for combining your data. You just need to open a logical table to work with joins (double-click a logical table to open it). Tables that you join get merged into a single logical table.

[Where did joins go? on page 680](#)

Are relationships like blends? When should I use a blend?

While both relationships and blends support analysis at different levels of detail, they have distinct differences. If you want to combine data from published data sources, blends are currently your only option.

You might also choose to use blends when the fields used to join two tables are dependent on the worksheet.

Blends only support left joins, while relationships support full outer joins. Blends can be customized on a per-sheet basis.

[Relationships versus blends on page 634](#)

Data sources, data model, and connections

How have data sources changed?

In Tableau version 2020.1 and earlier, tables that you combined in the Data Source page using joins and unions made up the data model in a data source. The data was merged into a single, flat table.

Starting in Tableau 2020.2, a new logical layer has been added to Tableau's data model. The logical layer and relationships expand your options for bringing the data you need into Tableau. You can now create normalized data sources with multiple tables at different levels of detail. Related tables aren't merged; they remain distinct. Using relationships makes creating and analyzing data across multiple tables more flexible and more intuitive.

You can still create single-table data sources in Tableau. You can build a logical table using a combination of joins, unions, custom SQL, and so on. The behavior of single-table analysis in Tableau has not changed. Analysis over a single logical table that contains a mixture of dimensions and measures works just as in Tableau pre-2020.2. When you upgrade a workbook or data source to Tableau version 2020.2 and later, will contain a single logical table that represents your pre-2020.2 data source, and it will work the same as it did before.

What are logical tables and physical tables?

Starting in Tableau version 2020.2, data sources use a data model that has two layers: a logical layer where you can relate tables, and a physical layer where tables can be joined or unioned. Tables that you drag to the logical layer use relationships and are called logical tables. Every logical table can contain one more physical tables in the physical layer.

For more information, see [The Tableau Data Model](#) on page 666.

Can relationships exist between tables from different connections?

Yes. You can create a data source with relationships between tables from different connections. For more information, see [Combine Data](#) on page 597 in [Plan the Data Source](#) on page 596.

Can I use inequality operators or calculated fields to define relationships?

In Tableau 2020.3 and later, you can create relationships based on calculated fields, and compare fields used for relationships using operators in the relationship definition.

Note that the following connectors do not support inequality operators:

- Google BigQuery
- MapR
- Salesforce

Do all connection types support logical tables and relationships?

Most relational connection types are completely supported. Cubes, SAP HANA (with OLAP attribute), JSON, and Google Analytics are limited to a single logical table in 20.2. Stored procedures can only be used within a single logical table.

Published data sources can't be related to each other.

Unsupported

- Cube databases do not support the new logical layer. Connecting to a cube offers the same experience as pre-2020.2.
- Stored Procedures: Don't support federation, relationships, or joins. They are represented in a single logical table, and don't allow opening the Join/Union canvas (physical layer).
- Splunk: Doesn't support left joins (and therefore relating logical tables).
- JSON: Doesn't support federation, custom SQL, joins, or relationships (only unions).
- Datasources that do not support LOD calcs. For more information, see [Data Source Constraints for Level of Detail Expressions](#) on page 2427.

Limited support

- **Salesforce and WDC Standard Connections:** These are represented as joined tables within a logical table. Adding them is currently only supported for single logical table data sources. Standard connections cannot join to an existing table.
- **SAP HANA:** Doesn't support relating logical tables when the connection has the OLAP attribute set.

What types of data models are supported?

See [The Tableau Data Model](#) on page 666 and [Supported data model schemas](#) on page 673

Is there a classic view of the Data Source page that I can use?

The physical layer of the Data Source page canvas is basically the "classic view" of the Data Source page in previous versions of Tableau.

The default view of Data Source canvas is the logical layer in Tableau version 2020.2 and later. You must double-click a logical table in the Data Source page canvas to go to the physical layer of the canvas.

How do I create a single-table data source?

Drag a single table into the canvas (logical layer) of the Data Source page. In the worksheet, use the fields from that table in the Data pane for analysis.

You can add more data inside the single, logical table by double-clicking the table. This opens the physical layer of the Data Source page canvas. If you need to use joins or unions, you can drag the tables you want to join or union into the physical layer canvas. The physical tables are merged into their single, logical table.

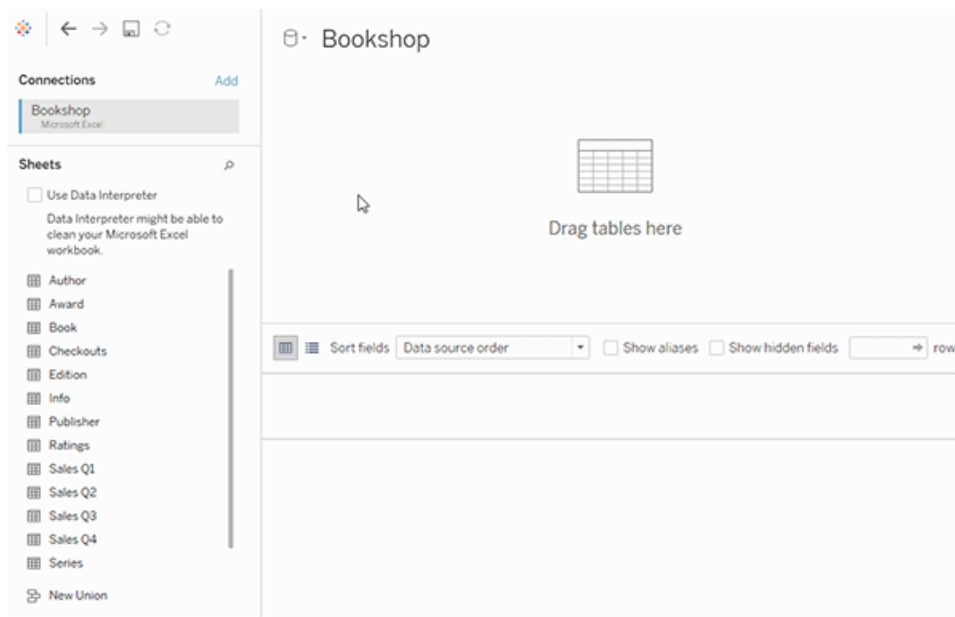

This example shows the Book table in the Relationships canvas (logical layer) of the data source. Double-clicking the Book logical table opens the Join/Union canvas (physical layer). The joins merge the Award and Info tables with the Book table.

Has row-level security changed?

Row-level security works the same. For information on row-level security, see [Best Practices for Row Level Security](#) in Tableau Server help.

How do I use custom SQL in the new data model?

Double-click the New Custom SQL option in the left pane of the Data Source page (as before). The custom SQL will be contained by a single logical table.

What happens to my older data sources when I open them in Tableau version 2020.2 and later?

The data is migrated without changes and you can continue to use the workbook as you did before.

When you open a pre-2020.2 workbook or data source in Tableau version 2020.2 and later, your data source will appear as a single logical table in the canvas with the name "Migrated Data". You can rename the Migrated Data table.

Your original, denormalized data may have been originally built from one or more tables using joins and unions. When you open the data source in Tableau version 2020.2 and later, Tableau

migrates the denormalized data model to a single logical table in the new data model to ensure that your data and workbooks are migrated without changes.

To see the physical tables that make up the single logical table, double-click that logical table to open it in the physical layer. You will see its underlying physical tables, including joins and unions.

Do I need to change my migrated data source to use relationships instead of joins?

If you have existing multi-table data sources defined using physical layer joins, they will still work as they did before. You don't have to change your data source. You can relate logical tables to your migrated table, but you can't downgrade logical tables.

You might consider changing your data source to use relationships instead of joins if you want to add more tables to your data model. This will require you to remove tables from the physical layer, and then add them to the logical layer.

How do I view or edit the data model on the web?

You can view and edit the data model of a published data source on the web. For more information, see [Edit a Published Data Source on page 3146](#).

Can I use a data source on Tableau Server or Tableau Cloud (version 2020.2 and later) in a previous version of Tableau Desktop (version 2020.1 and earlier)?

If you attempt to open a published data source or published workbook from Tableau Server or Tableau Cloud version 2020.2 and later in a previous version of Tableau Desktop (version 2020.1 and earlier), any logical tables that were related to the root table in the data source will be removed. Only the root table (the first table added to that data source model) will remain.

If you attempt to use a local data source in a previous version of Tableau:

- Tableau displays a warning that the data source is from a newer version of Tableau that isn't compatible with the previous version.
- On the Data Source page, only the root table will remain in the data source.
- In the Data pane in a Tableau Desktop worksheet, Tableau displays errors (red exclamation points) next to affected fields that are not part of the root table.

If you attempt to use a published data source in a previous version of Tableau:

- Tableau displays a warning that the data source is from a newer version of Tableau that isn't compatible with the previous version.

- In the Data pane in a Tableau Desktop worksheet, Tableau displays an error (red exclamation point) next to the selected data source and a message that the connection needs to be updated. Click **Show Details** for more information about the error.

Can published data sources be related to each other?

You can't relate published data sources to each other. But you can edit and view the data model for a published data source.

If you want to combine data from published data sources, blends are currently your only option.

[Relationships versus blends on page 634](#)

How do extracts work with related logical tables?

Extract data is now stored based on logical tables (replaces the Single Table option) or physical tables (replaces the Multiple Tables option). For more information, see [Extract Your Data on page 919](#).

If I need to downgrade to Tableau version 2020.1 and earlier, what happens to relationships between logical tables?

If you downgrade a workbook to Tableau version 2020.1 and earlier, any logical tables that were related to the root table in the model will be removed from the data source. Only the root table (the first table added to that model) will remain.

All sheets in the workbook used fields from logical tables (non-root) become invalid, because their tables and fields have been removed from the data model.

Downgrading works best for workbooks that contain single-table data sources.

How does the new data model work with cubes?

Cubes work the same as in previous versions of Tableau. A cube data source will appear as a single-table data source, just like it is today. You can't create relationships using cube data.

Interaction with other Tableau features and products

Does Explain Data work with multi-table data sources that use relationships?

In Tableau version 2020.3 or later, you can use Explain Data with data sources that contain multiple, related tables. Cardinality and Referential Integrity settings for relationships must be set up correctly for Explain Data to analyze multi-table, related data.

In Tableau version 2020.2 and earlier, you can use Explain Data with a single-table data sources only. Your data source can have a single, logical table that is defined by one or more physical tables.

Does Ask Data work with multi-table data sources?

Ask Data fully supports multi-table, normalized data sources.

How do new data modeling capabilities affect using Tableau Bridge?

Using the latest version of Tableau Bridge should provide full compatibility with Tableau version 2020.2 and later data modeling functionality.

When should I use Tableau Prep vs. authoring in Tableau Desktop, Tableau Cloud, or Tableau Server to create a data source?

Tableau Prep cleans data, and creates flows, extracts, and published data sources that contain physical tables.

In Tableau Desktop, and in Tableau Cloud and Tableau Server web authoring, you can create data sources that use normalized data models. These data models can be made of logical tables and physical tables, and your data sources can be saved as live data sources or as extracts.

Only logical tables can be related. Physical tables can be joined and unioned.

Analysis with multi-table data sources

Does analysis work differently with multi-table data sources that use relationships?

Using a data source that has multiple, related tables affects how analysis works in Tableau. Because multiple, related tables have independent domains and retain their native level of detail, when you drag fields into the view:

- Data is queried at its natural level of detail.
- Only data that is relevant to a viz is queried.
- The relationships between the tables affect the results of the query. The flow of building a viz can vary depending on how tables of fields are related to each other in the data model, or if they aren't related directly.

For more information, see [Don't Be Scared of Relationships](#), [How Analysis Works for Multi-table Data Sources that Use Relationships](#) on page 697, [Unmatched values behavior for dimensions that might surprise you](#) on page 651, and [Troubleshooting multi-table analysis](#) on page 712.

Note: In Tableau version 2024.2 and later, the Tableau data model supports multi-fact analysis and shared dimensions through multi-fact relationships. For more information, see [About Multi-fact Relationship Data Models](#), [When to Use a Multi-fact Relationship Model](#), and [Build a Multi-fact Relationship Data Model](#).

Do LODs work the same with the new data model? When should I use an LOD?

LOD expressions and calculations work the same. Since Tableau now understands the level of detail (LOD) of your input tables, you shouldn't need to use LOD calculations to remove unwanted duplication due to joins.

You may still want to use LOD calcs to:

- Handle unwanted duplication in your source tables.
- Compute multi-level aggregations (e.g. an average over a sum)
- To do cohort analysis (e.g. to compute the first order date for each customer)

If the dimensionality of an LOD calculation includes fields from a single table, that LOD calculation will appear in its owning table in the Data pane.

How can I tell if I combined my data correctly with relationships?

You have several options for validating your data model for analysis. As you create the model for your data source, we recommend going to a sheet, selecting that data source, and then building a viz to explore record counts, expected data, unmatched values, nulls, or repeated measure values. Try working with fields across different tables to ensure everything looks how you expect it to.

What to look for:

- Are your relationships in the data model using the correct matching fields for their tables?
- Would adding multiple matching field pairs make the relationship more accurate?
- What are the results of dragging different dimensions and measures into the view?
- Are you seeing the expected number of rows?
- If you changed any of the [Performance Options settings](#) from the default settings, are the values that you are seeing in the viz what you would expect? If they aren't, you might want to check the settings, or reset to the default.

Options for validating relationships and the data model:

- Every table includes a count of its records, as a field named *TableName(Count)*, at the level of detail for that table. To see the count for a table, drag its Count field into the view.

To see the count for all tables, select the Count field for each table in the Data pane, and then click the Text Table in Show Me.

- Click **View Data** in the Data pane to see the number of rows and data per table. Also, before you start creating relationships, viewing the data from the data source before or during analysis can be useful to give you a sense of the scope of each table. For more information, see [View Underlying Data on page 2001](#).
- Drag dimensions onto rows to see the Number of Rows in the status bar. To see unmatched values, click the **Analysis** menu, and then select **Table Layout > Show Empty Rows** or **Show Empty Columns**. You can also drag different measures to the view, such as *<YourTable>(Count)* from one of the tables represented in your viz. This ensures that you will see all values of the dimensions from that table.

Can I see the queries that Tableau is generating for relationships?

If you would like to see the queries that are being generated for relationships, you can use the Performance Recorder in Tableau Desktop.

1. Click the Help menu, and then select **Settings and Performance > Start Performance Recording**.
2. Drag fields into the view to build your viz.
3. Click the Help menu, and then select **Settings and Performance > Stop Performance Recording**. The Performance Recording workbook will automatically open.
4. In the Performance Summary dashboard, under Events Sorted By Time, click an "Executing Query" bar and view the query below.

Another more advanced option is to use the [Tableau Log Viewer](#) on GitHub. You can filter on a specific keyword using `end-protocol.query`. For more information, start with the [Tableau Log Viewer wiki page](#) in GitHub.

Changes to different parts of the interface

How has the Data Source page changed? The data grid? View Data? The Data pane?

The Data Source page (canvas, data grid), View Data, and Data pane have been updated to support a multi-table analysis experience.

Your first view of the data source canvas is now the logical layer, which is where you define relationships. The data grid shows row data for each table's level of detail.

In the Data pane, fields and calculated fields are automatically organized by their native level of detail.

The View Data window displays row level data at the correct level of detail, without replication, to make validation easier. Get row counts for each table in the Data pane using *Table(Count)* fields.

[Data Source page changes on page 645](#)

[Data Grid on page 646](#)

[View Data on page 649](#)

[Data pane in worksheets on page 647](#)

View Data column order changes in Tableau 2020.2 and later

When you open a data source from a previous version of Tableau in Tableau 2020.2 and later, the column order may be different. Columns may be displayed differently in the View Data window, and the column order may be different when you export it to CSV format.

This change in how column order is handled in the View Data window is required to support relationships and logical tables.

If you use scripts that depend on a customized column order, we recommend using the Tableau Extensions API for View Data to download underlying data to CSV format.

How does Count of Table work versus Number of Records?

You will no longer see the Number of Records field in data sources that contain logical tables. Every table includes a count of its records, as a field named *TableName(Count)*, at the level of detail for that table. In the previous example you can see *Addresses(Count)*, *Customers(Count)*, and *LineItems(Count)*.

COUNT of table = SUM of Number of Records per table. You can't build calculations on top of a table's *Count* field. *Count* is aggregate-only.

Note: You might see the *Number of Records* field in the Data pane if you open a pre-2020.2 workbook that used *Number of Records* in a view.

Where are sets, groups, and calculated fields shown?

If the field belongs to a table, it is listed under the table. If it doesn't, it is listed in the general area at the bottom of the Data pane.

Calculated fields are listed with their originating field, if all of their input fields come from the same table.

Sets and groups are displayed under the table with their originating field.

Fields that don't belong to a specific table are displayed in the general area below the tables. These include: aggregated calculations, calculations that use fields from multiple tables, Measure Names, and Measure Values.

The Tableau Data Model

Every data source that you create in Tableau has a data model. You can think of a data model as a diagram that tells Tableau how it should query data in the connected database tables.

The tables that you add to the canvas in the **Data Source** page create the structure of the data model. A data model can be simple, such as a single table. Or it can be more complex, with multiple tables that use different combinations of relationships, joins, and unions.

The data model has two layers:

- The default view that you first see in the Data Source page canvas is the *logical layer* of the data source. You combine data in the logical layer using relationships (or noodles). Think of this layer as the Relationships canvas in the Data Source page. For more information, see [Use Relationships for Multi-table Data Analysis](#).
- The next layer is the *physical layer*. You combine data between tables at the physical layer using **joins** and unions. Each logical table contains at least one physical table in this layer. Think of the physical layer as the Join/Union canvas in the Data Source page. Double-click a logical table to view or add joins and unions.

Logical Layer

Noodles = Relationships

Physical Layer

Venn diagram = Joins

Logical Layer

Physical Layer

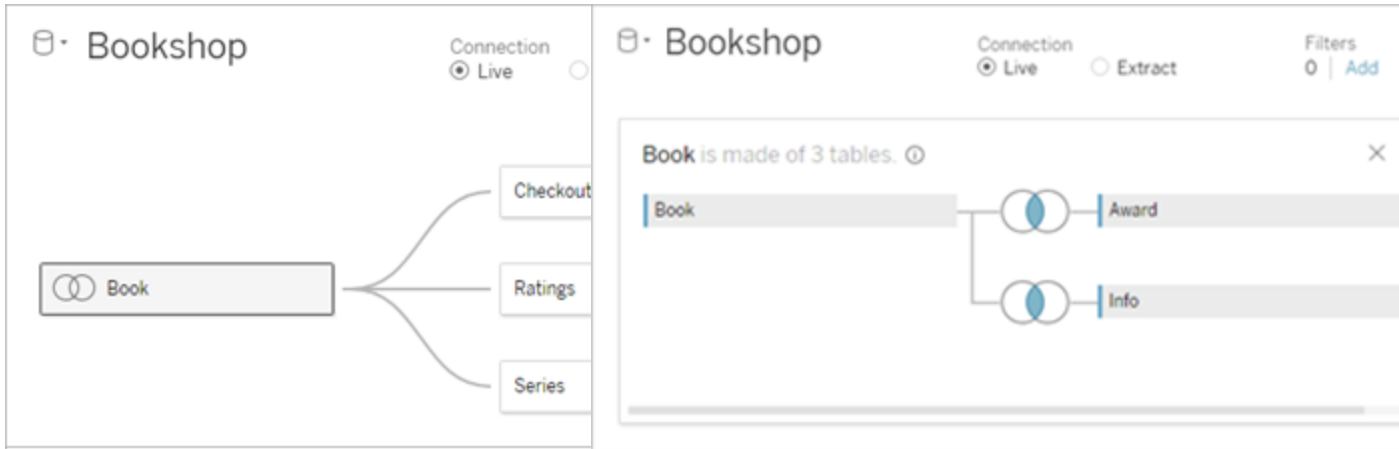

The top-level view of a data source with multiple, related tables. This is the logical layer. Logical tables can be combined using relationships (noodles). They don't use join types. They act like containers for physical tables.

Double-click a logical table to open it and see its physical tables. Physical tables can be combined using joins or unions. In this example, the Book logical table is made of three, joined physical tables (Book, Award, Info).

Logical Layer

Physical Layer

Relationships canvas in the Data Source page

Join/Union canvas in the Data Source page

Tables that you drag here are called logical tables

Tables that you drag here are called physical tables

Logical tables can be related to other logical tables

Physical tables can be joined or unioned to other physical tables

Logical tables are like containers for physical tables

Double-click a logical table to see its physical tables

Level of detail is at the row level of the logical table

Level of detail is at the row level of merged physical tables

Logical tables remain distinct (normalized), not merged in the data source

Physical tables are merged into a single, flat table that defines the logical table

Layers of the data model

The top-level view that you see of a data source is the **logical layer** of the data model. You can also think of it as the Relationships canvas, because you combine tables here using relationships instead of joins.

When you combine data from multiple tables, each table that you drag to the canvas in the logical layer must have a relationship to another table. You do not need to specify join types for relationships; during analysis Tableau automatically selects the appropriate join types based on the fields and context of analysis in the worksheet.

The **physical layer** of the data model is where you can combine data using joins and unions. You can only use pivots in this canvas. You can think of it as the Join/Union canvas. In previous versions of Tableau, the physical layer was the only layer in the data model. Each logical table can contain one or more physical tables.

Important: You can still create single-table data sources in Tableau that use joins and unions. The behavior of single-table analysis in Tableau has not changed. Your upgraded workbooks will work the same as they did before 2020.2.

Learn more: For related information on combining data using relationships, also see these topics and blog posts:

- [How Relationships Differ from Joins](#) on page 677
- [Use Relationships for Multi-table Data Analysis](#) on page 637
- [Relate Your Data](#)
- [Relationships, part 1: Introducing new data modeling in Tableau](#)
- [Relationships, part 2: Tips and tricks](#)
- [Relationships, part 3: Asking questions across multiple related tables](#)

Also see video podcasts on relationships from [Action Analytics](#), such as [Why did Tableau Invent Relationships?](#) Click "Video Podcast" in the [Library](#) to see more.

Understanding the data model

In previous versions of Tableau (pre-2020.2), the data model had a physical layer only. In Tableau 2020.2 and later, the data model has the logical (semantic) layer and a physical layer. This gives you more options for combining data using schemas to fit your analysis.

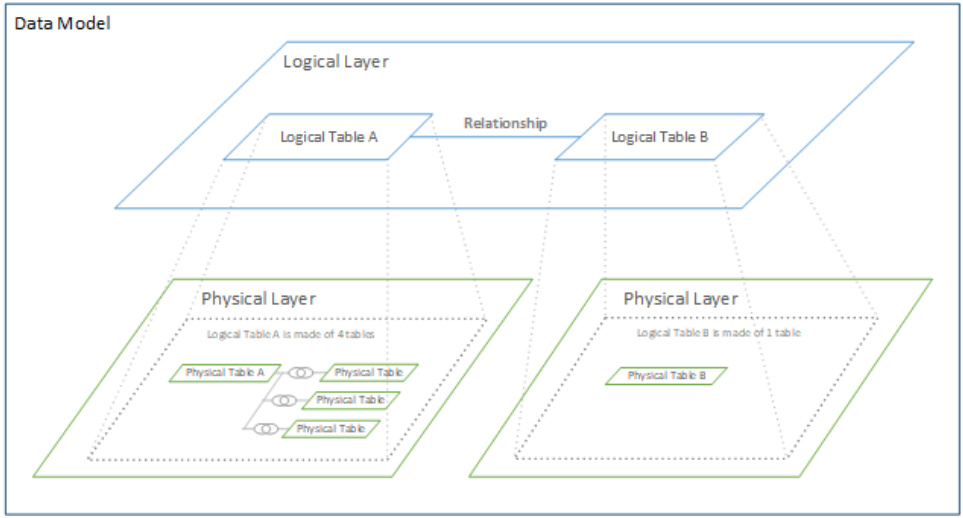

In Tableau 2020.2 and later, a logical layer has been added in the data source. Each logical table contains physical tables in a physical layer.

In earlier versions of Tableau (pre-2020.2), the data model in your data source consisted of a single, physical layer where you could specify joins and unions. Tables added to the physical layer (joined or unioned) create a single, flattened table (denormalized) for analysis.

Previous versions

2020.2 and later

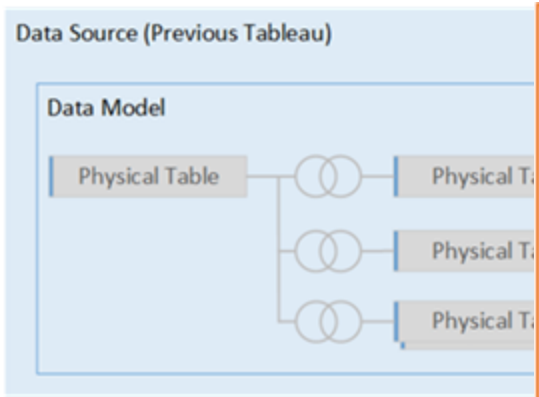

In versions of Tableau before 2020.2, the data model has only the physical layer

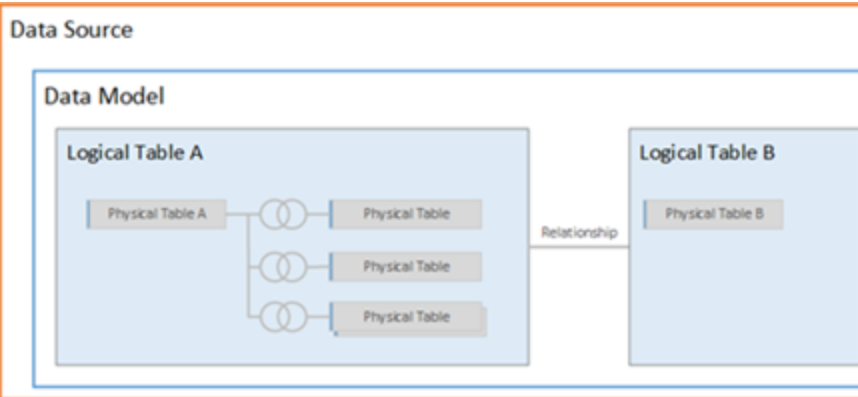

In 2020.2 and later, the data model has two layers: the logical layer and the physical layer

In Tableau 2020.2 and later, the data model in your data source includes a new semantic layer above the physical layer—called the logical layer—where you can add multiple tables and relate them to each other. Tables at the logical layer are not merged in the data source, they remain distinct (normalized), and maintain their native level of detail.

Logical tables act like containers for merged physical tables. A logical table can contain a single, physical table. Or it can contain multiple physical tables merged together through joins or unions.

Build a new model

When you add one or more tables to the logical layer, you are essentially building the data model for your data source. A data source can be made of a single, logical table, or you can drag multiple tables to the canvas to create a more complex model.

- The first table that you drag to the canvas becomes the root table for the data model in your data source.
- After you drag out the root table, you can drag out additional tables in any order. You will need to consider which tables should be related to each other, and the matching field pairs that you define for each relationship.
- If you are creating a star schema, it can be helpful to drag the fact table out first, and then relate dimension tables to that table.
- Deleting a table in the canvas automatically deletes its related descendants as well. If you delete the root table, all other tables in the model are also removed.
- Each relationship must be made of at least one matched pair of fields. Add multiple field pairs to create a compound relationship. Matched pairs must have the same data type. Changing the data type in the Data Source page does not change this requirement. Tableau will still use the data type in the underlying database for queries.
- Relationships can be based on calculated fields.
- You can specify how fields used in the relationships should be compared by using operators when you define the relationship.

For more information about relationships, see [Create and define relationships](#) in [Relate Your Data](#).

Multi-table model

- To create a multi-table model, drag tables to the logical layer of the Data Source page canvas.

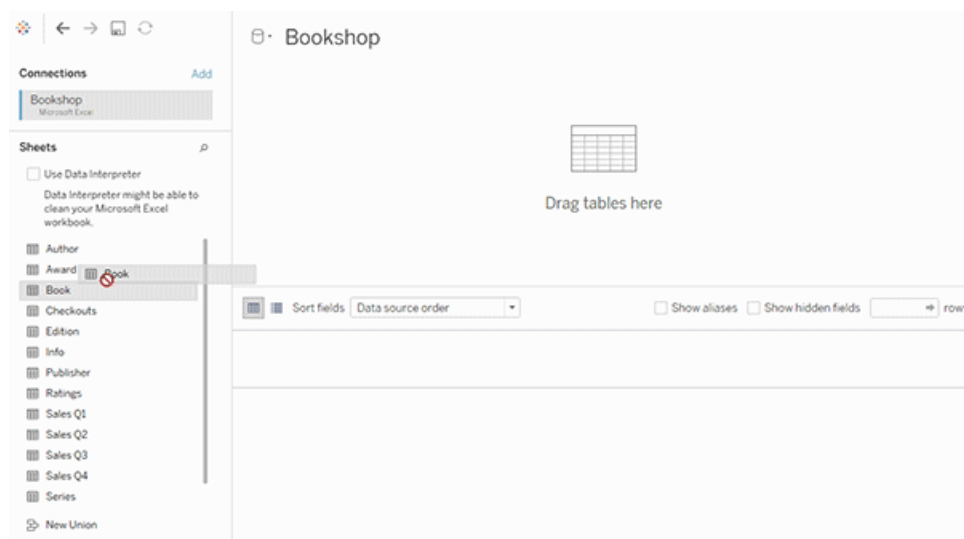

Tables that you drag to the logical layer of the Data Source page canvas must be related to each other. When you drag additional tables to the logical layer canvas, Tableau automatically attempts to create the relationship based on existing key constraints and matching fields to define the relationship. If it can't determine the matching fields, you will need to select them.

If no constraints are detected, a **Many-to-many** relationship is created and referential integrity is set to **Some records match**. These default settings are a safe choice and provide the most a lot of flexibility for your data source. The default settings support full outer joins and optimize queries by aggregating table data before forming joins during analysis. All column and row data from each table becomes available for analysis.

You can add more data inside any logical table by double-clicking the table. This opens the physical layer of the Data Source page canvas. If you need to use joins or unions, you can drag the tables you want to join or union into the physical layer canvas. The physical tables are merged in their logical table.

Follow the steps in [Create and define relationships](#) to combine multiple tables.

Single-table model

- To create a single-table model, drag a table into the logical layer canvas of the Data Source page. You can then use the fields from that table in the Data pane for analysis.

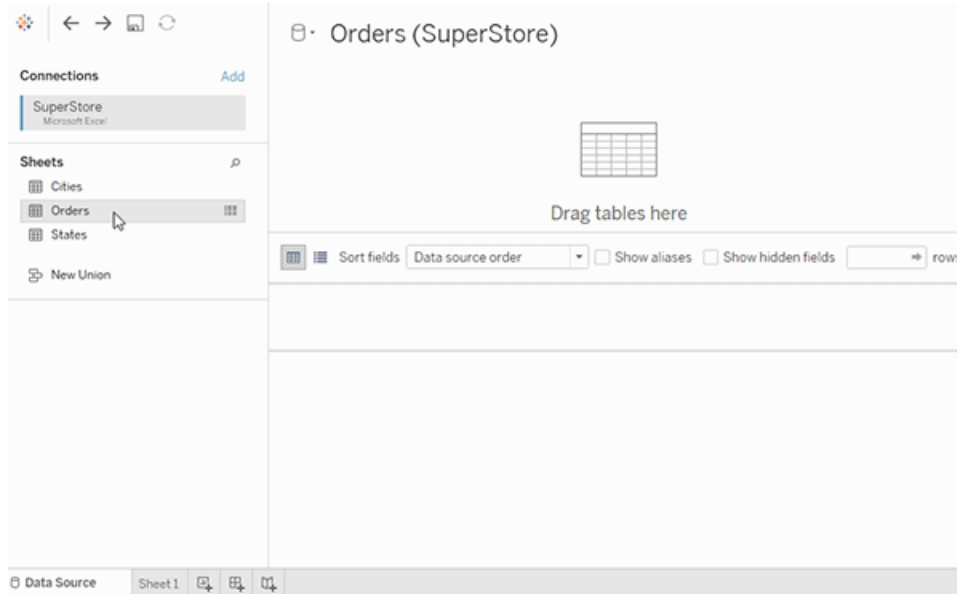

Single-table model that contains other tables

You can add more data inside the single, logical table by double-clicking the table. This opens the physical layer of the Data Source page canvas. If you need to use joins or unions, you can drag the tables you want to join or union into the physical layer canvas. The physical tables are merged in their logical table.

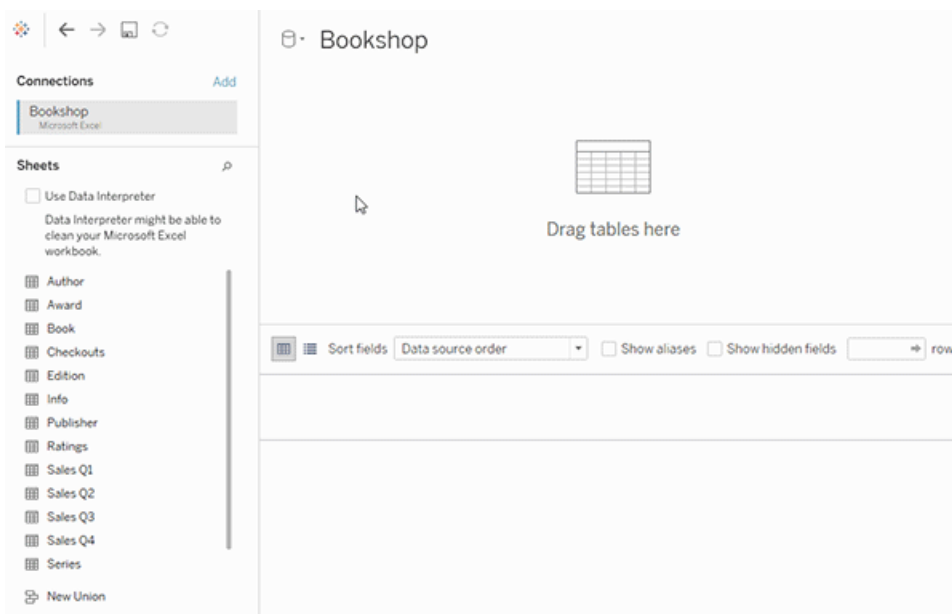

This example shows the Book table in the Relationships canvas (logical layer) of the data source. Double-clicking the Book logical table opens the Join/Union canvas (physical layer).

In this example, the joins merge the Award and Info tables with the Book table. In this case, the join between Book and Award will be one-to-many, at the level of detail of awards. This would duplicate measure values for Book and Info. To avoid duplication, you could relate Award and Info to Book instead of joining them inside of the Book logical table.

Supported data model schemas

The data modeling capabilities in Tableau (version 2020.2 and later) are designed to make analysis over common multi-table data scenarios—including star and snowflake data models—easy. The following types of models are supported in Tableau data sources.

Single-table

Analysis over a single logical table that contains a mixture of dimensions and measures works just as in Tableau pre-2020.2. You can build a logical table using a combination of joins, unions, custom SQL, and so on.



Star and snowflake

In enterprise data warehouses, it is common to have data structured in star or snowflake schemas where measures are contained in a central fact table and dimensions are stored separately in independent dimension tables. This organization of data supports many common analysis flows including rollup and drill down.

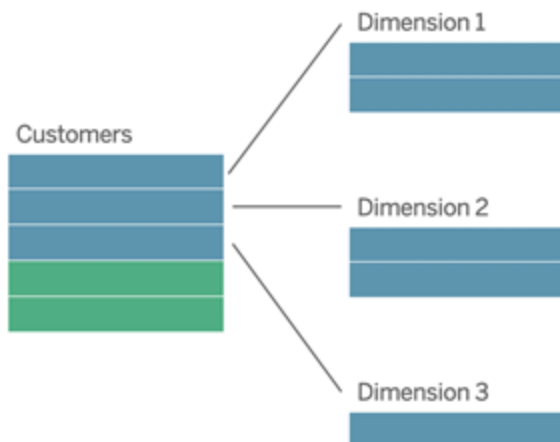

These models can be directly represented with relationships in the data modeling capabilities available in Tableau 2020.2 and later.

Drag the fact table into the model first and then relate the dimension tables to the fact table (in a star schema) or to other dimension tables (in a snowflake).

Typically, in a well-modeled star or snowflake schema, the relationships between the fact table and the dimension tables will be many-to-one. If this information is encoded in your data warehouse, Tableau will automatically use this to set the relationship's Performance Options. If not, you can set this information yourself. For more information, see [Optimize Relationship Queries Using Performance Options](#).

In a well-modeled star or snowflake schema, every row in the fact table will have a matching entry in each of the dimension tables. If this is true and captured in your data warehouse integrity constraints, Tableau will automatically use this information to set the referential integrity setting in Performance Options. If some fact table rows do not have a matching row in a dimension table (sometimes called "late-arriving dimensions" or "early-arriving facts"), Tableau will default to retaining all rows when computing measures, but may drop values when showing dimension headers. For more information, see [Optimize Relationship Queries Using Performance Options](#).

Star and snowflake with measures in more than one table

In some star or snowflake schemas, all the measures for your analysis are contained in the fact table. However, it is often true that additional measures of interest may be related to the dimension tables in your analysis. Even if the dimension tables do not contain measures, it is common in analysis to want to count or otherwise aggregate dimension values. In these cases, the distinction between fact tables and dimension tables is less clear. To create clarity when

viewing your data model, we recommended adding the finest grain table to the data source canvas first, and then relating all other tables to that first table.

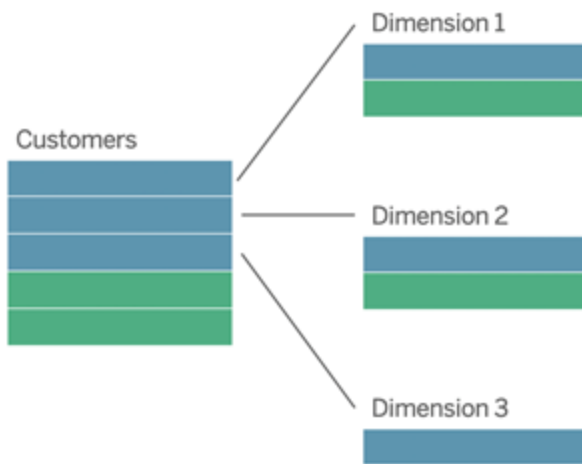

If you were to join these tables together into a single logical table, the measures in the dimension tables would be replicated, resulting in distorted aggregates unless you took precautions to deduplicate the values using LOD calculations or COUNT DISTINCT. However, if you instead create relationships between these tables, Tableau will aggregate measures before performing joins, avoiding the problem of unnecessary duplication. This relieves you of the need to carefully track the level of detail of your measures.

Multi-fact analysis

In version 2024.2 and later, Tableau's data modeling capabilities support multi-fact analysis through the use of multi-fact relationships. For in-depth information on how to create multi-fact relationships data models, see:

- [About Multi-fact Relationship Data Models](#)
- [When to Use a Multi-fact Relationship Model](#)
- [Build a Multi-fact Relationship Data Model](#)

A multi-fact relationship model—a data model with multiple base tables—permits unrelated tables in the model when shared tables also exist in the model. During analysis, fields from a shared table "stitch" together otherwise unrelated tables of data based on the shared dimensions they have in common (such as happening in the same place or at the same time). All the benefits of relationships are maintained, including the retention of each table's grain, or native level of detail.

Similar to a single base table data model, Tableau determines the best join type to use behind the scenes based on the structure of the viz. But in a multi-fact relationship model, the join options are expanded to include outer and cross joins to handle different levels of relatedness. For more information, see [About Multi-fact Relationship Data Models](#).

Note: In versions 2020.2 through 2024.1, you can add fact tables (containing measures) to star and snowflake models only if they are related to a single dimension table.

For example, you can bring two or more fact tables together to analyze a shared dimension, such as in Customer 360-like analyses. These fact tables can be at a different level of detail than the dimension table, or from each other. They can also have a many-to-many relationship with the dimension table. In these scenarios, Tableau will ensure that values are not replicated before aggregation.

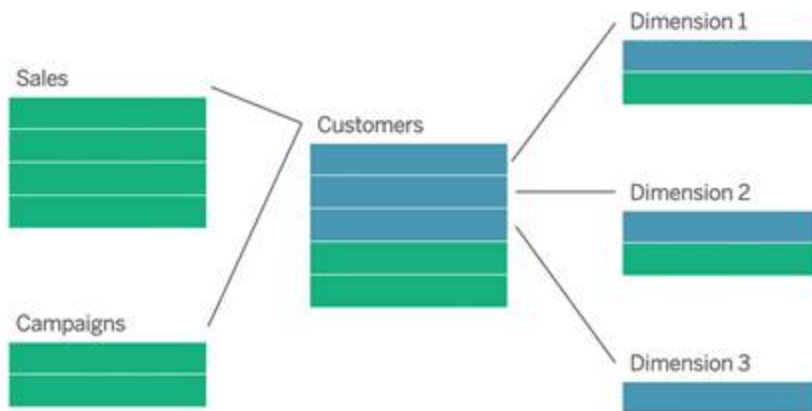

If you don't have a shared dimension table that relates your fact tables, you can sometimes dynamically build one using custom SQL or by using joins or unions of other dimension tables.

Two fact tables can be related directly to each other on a common dimension. This type of analysis works best when one of the fact tables contains a superset of the common dimension.

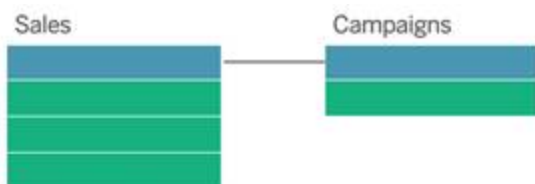

There are various scenarios that may indicate you should build a multi-fact relationship model with multiple base tables rather than a single base table data source:

- **Circular relationships.** Circular relationships are not supported. If you're trying to build a data source with a cycle, use multi-fact relationships and make the downstream table another base table instead.
- **Conformed dimensions and Contextual OR relationships.** If you have a series of tables that are related on the same sets of relationship clauses (such as date and location), those dimensions should be pulled out and made into shared tables instead.
 - This is especially useful because multiple relationship clauses must all be true (logically, an AND) for the tables to be related for those records.
 - If, instead, you want to analyze records where one may be true at a time (a contextual OR), this flexibility is provided by setting up a data model with shared dimension tables instead.
- **Equivalent blends.** If you're using a blend but want to have an equivalent blend without primary and secondary data sources, build a data model that combines the data sources from the blend with their linking fields in a shared table or tables.

Requirements for relationships in a data model

- When relating tables, the fields that define the relationships must have the same data type. Changing the data type in the Data Source page does not change this requirement. Tableau will still use the data type in the underlying database for queries.
- You can't define relationships based on geographic fields.
- Circular relationships aren't supported in the data model.
- You can't define relationships between published data sources.

Factors that limit the benefits of using related tables

- Dirty data in tables (i.e. tables that weren't created with a well-structured model in mind and contain a mix of measures and dimensions in multiple tables) can make multi-table analysis more complex.
- Using data source filters will limit Tableau's ability to do join culling in the data. Join culling is a term for how Tableau simplifies queries by removing unnecessary joins.
- Tables with a lot of unmatched values across relationships.
- In versions 2020.2 through 2024.1: Interrelating multiple fact tables with multiple dimension tables (attempting to model shared or conformed dimensions). In version 2024.2 and later, you can use multi-fact relationships to address these cases.

How Relationships Differ from Joins

Relationships are a dynamic, flexible way to combine data from multiple tables for analysis. You don't define join types for relationships, so you won't see a Venn diagram when you create them.

Think of a relationship as a contract between two tables. When you are building a viz with fields from these tables, Tableau brings in data from these tables using that contract to build a query with the appropriate joins.

- **No up-front join type.** You only need to select matching fields to define a relationship ([no join types](#)). Tableau first attempts to create the relationship based on existing key constraints and matching field names. You can then check to ensure they are the fields you want to use, or add more field pairs to better define how the tables should be related.
- **Automatic and context-aware.** Relationships defer joins to the time and context of analysis. Tableau automatically selects join types based on the fields being used in the visualization. During analysis, Tableau adjusts join types intelligently and preserves the native level of detail in your data. You can see aggregations at the level of detail of the fields in your viz rather than having to think about the underlying joins. You don't need to use LOD expressions such as FIXED to deduplicate data in related tables.
- **Flexible.** Relationships can be many-to-many and support full outer joins. When you combine tables using relationships, it's like creating a custom, flexible data source for every viz, all in a single data source for the workbook. Because Tableau queries only tables that are needed based on fields and filters in a viz, you can build a data source that can be used for a variety of analytic flows.

For more information, see [Relate Your Data](#) and [Don't Be Scared of Relationships](#).

Joins are still available as an option for combining your data. Double-click a logical table to go to the join canvas. For more information, see [Where did joins go? on page 680](#)

Watch a video: For an introduction to using relationships in Tableau, see this 5-minute video.

Note: The interface for editing relationships shown in this video might differ slightly from the current release but has the same functionality.

Also see video podcasts on relationships from [Action Analytics](#), such as [Why did Tableau Invent Relationships?](#) Click "Video Podcast" in the [Library](#) to see more.

For related information about how relationship queries work, see these Tableau blog posts:

- [Relationships, part 1: Introducing new data modeling in Tableau](#)
- [Relationships, part 2: Tips and tricks](#)
- [Relationships, part 3: Asking questions across multiple related tables](#)

Characteristics of relationships and joins

Relationships are a dynamic, flexible way to combine data from multiple tables for analysis. We recommend using relationships as your first approach to combining your data because it makes data preparation and analysis easier and more intuitive. **Use joins only when you absolutely need to.**

Here are some advantages to using relationships to combine tables:

- Make your data source easier to define, change, and reuse.
- Make it easier to analyze data across multiple tables at the correct level of detail (LOD).
- Do not require the use of LOD expressions or LOD calculations for analysis at different levels of detail.
- Only query data from tables with fields used in the current viz.

Relationships

- Are displayed as flexible noodles between logical tables
- Require you to select matching fields between two logical tables
- Do not require you to select join types
- Make all row and column data from related tables potentially available in the data source
- Maintain each table's level of detail in the data source and during analysis
- Create independent domains at multiple levels of detail. Tables aren't merged together in the data source.
- During analysis, create the appropriate joins automatically, based on the fields in use.
- Do not duplicate aggregate values (when Performance Options are set to Many-to-Many)
- Keep unmatched measure values (when Performance Options are set to Some Records Match)

Joins

Joins are a more static way to combine data. Joins must be defined between physical tables up front, before analysis, and can't be changed without impacting all sheets using that data source. Joined tables are always merged into a single table. As a result, sometimes joined data is missing unmatched values, or duplicates aggregated values.

- Are displayed with Venn diagram icons between physical tables
- Require you to select join types and join clauses
- Joined physical tables are merged into a single logical table with a fixed combination of data
- May drop unmatched measure values

- May duplicate aggregate values when fields are at different levels of detail
- Support scenarios that require a single table of data, such as extract filters and aggregation

Requirements for using relationships

- When relating tables, the fields that define the relationships must have the same data type. Changing the data type in the Data Source page does not change this requirement. Tableau will still use the data type in the underlying database for queries.
- You can't define relationships based on geographic fields.
- Circular relationships aren't supported in the data model.
- You can't define relationships between published data sources.

Factors that limit the benefits of using related tables

- Dirty data in tables (i.e. tables that weren't created with a well-structured model in mind and contain a mix of measures and dimensions in multiple tables) can make multi-table analysis more complex.
- Using data source filters will limit Tableau's ability to do join culling in the data. Join culling is a term for how Tableau simplifies queries by removing unnecessary joins.
- Tables with a lot of unmatched values across relationships.
- In versions 2020.2 through 2024.1: Interrelating multiple fact tables with multiple dimension tables (attempting to model shared or conformed dimensions). In version 2024.2 and later, you can use multi-fact relationships to address these cases. For more information, see [Multi-fact analysis with relationships](#) and [About Multi-fact Relationship Data Models](#).

Where did joins go?

You can still specify joins between tables in the physical layer of a data source. Double-click a logical table to go to the Join/Union canvas in the physical layer and add joins or unions.

Every top-level, logical table contains at least one physical table. Open a logical table to view, edit, or create joins between its physical tables. Right-click a logical table, and then click **Open**. Or, just double-click the table to open it.

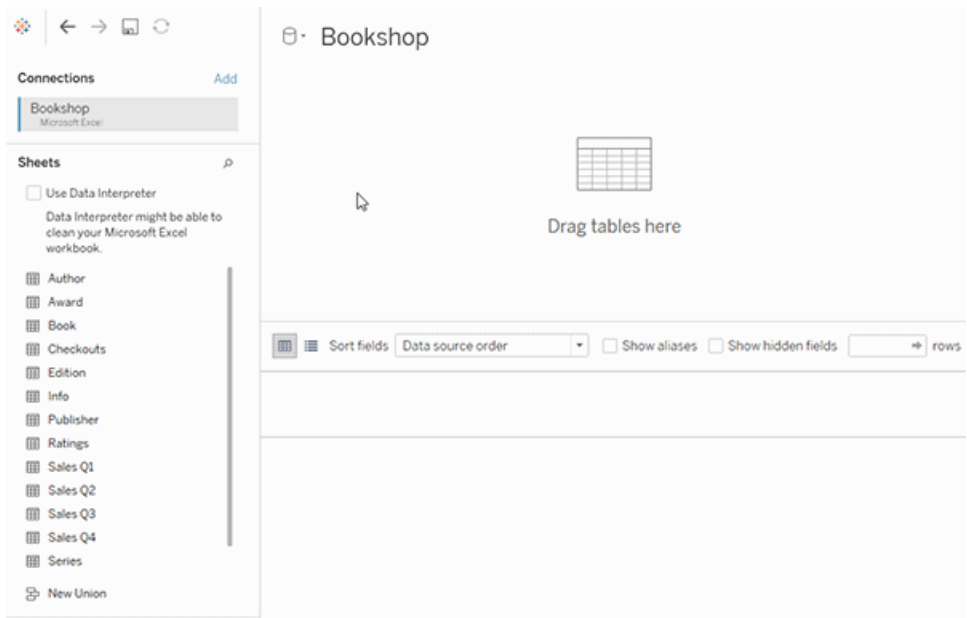

When you create a data source, it has two layers. The top-level layer is the logical layer of the data source. You combine data between tables in the logical layer using relationships.

The next layer is the physical layer of the data source. You combine data between tables at the physical layer using joins. For more information, see [Logical and physical tables in the data model](#).

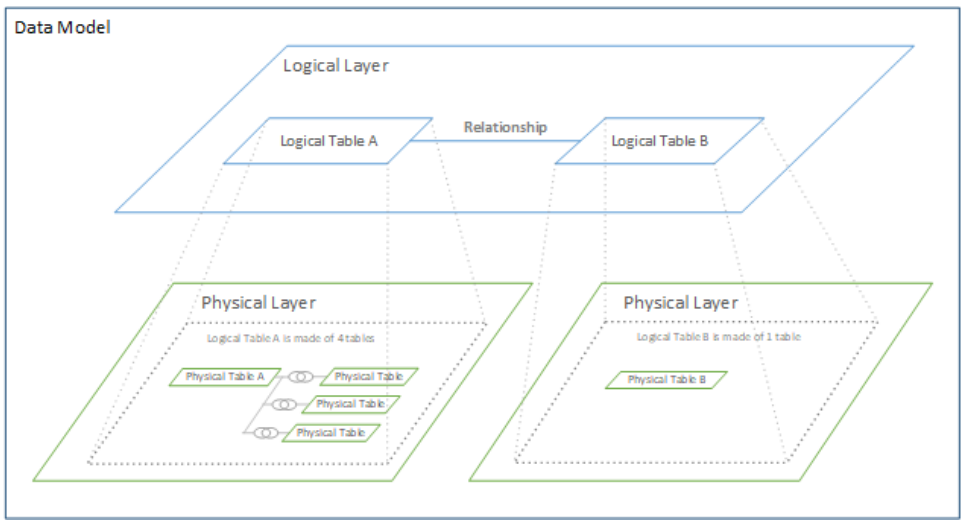

Optimize Relationship Queries Using Performance Options

Performance Options are optional settings that define the cardinality (uniqueness) and referential integrity (matching records) between the two tables in a relationship. These settings help Tableau

optimize queries during analysis.

- **If you aren't sure what to choose**, use the recommended default settings indicated by Tableau. Using the defaults is safe and will automatically generate correct aggregations and joins during analysis. If you don't know the cardinality or referential integrity, you don't need to change these settings.
- **If you know the shape of your data**, you can optionally change these settings to represent uniqueness and matching between the records in the two tables.

In many analytical scenarios, using the default settings for a relationship will give you all of the data you need for analysis. In some scenarios, you might want to adjust the Performance Options settings to describe your data more accurately. For more details about using relationships to combine and analyze data, see [Relate Your Data](#) and this Tableau blog post: [Relationships, part 1: Introducing new data modeling in Tableau](#).

What the Cardinality and Referential Integrity settings mean

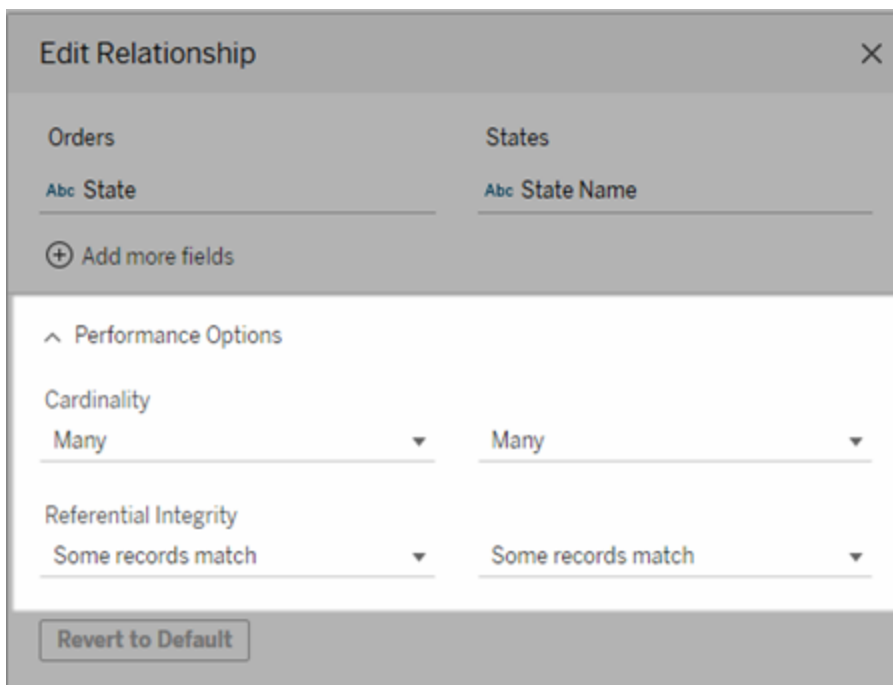

Cardinality options

Cardinality settings determine if Tableau aggregates table data before or after automatically joining the data during analysis.

- Select **Many** if the field values aren't unique, or you don't know. Tableau will aggregate the relevant data before forming joins during analysis.
- Select **One** if field values are unique. During analysis, the relevant data will be joined before aggregation. Setting this option correctly optimizes queries in the workbook when the field values in the relationship are unique. However, selecting **One** when field values aren't unique can result in duplicate aggregate values being shown in the view.

Note: Selecting **One** treats records as if each key value is unique and there is at most only one row with a null value.

Referential Integrity options

Referential Integrity settings determine the type of join used to get the dimension values for a measure during analysis.

- Select **Some Records Match** if some values in the field don't have a match in the other table, or you don't know. During analysis, Tableau uses outer joins to get dimensions values for a measure. All measure values will be shown in the view, even unmatched measures.
- Select **All Records Match** if values in the field are guaranteed to have a match in the other table. This setting generates fewer and simpler joins during analysis, and optimizes queries. You might see inconsistent results during analysis (unmatched values removed or missing in view) if there are unmatched values in this table.

Notes: Selecting **All Records Match** treats records as if no null values exist in the fields used for the relationship. During analysis, Tableau will use inner joins to get dimension values for a measure. By default, Tableau will never join null keys.

For more information about Cardinality and Referential integrity as concepts, see [Cardinality and Referential Integrity](#).

Where did joins go?

You can still specify joins between tables in the physical layer of a data source. Double-click a logical table to go to the join canvas.

Every top-level, logical table contains at least one physical table. Open a logical table to view, edit, or create joins between its physical tables. Right-click a logical table, and then click **Open**. Or, just double-click the table to open it.

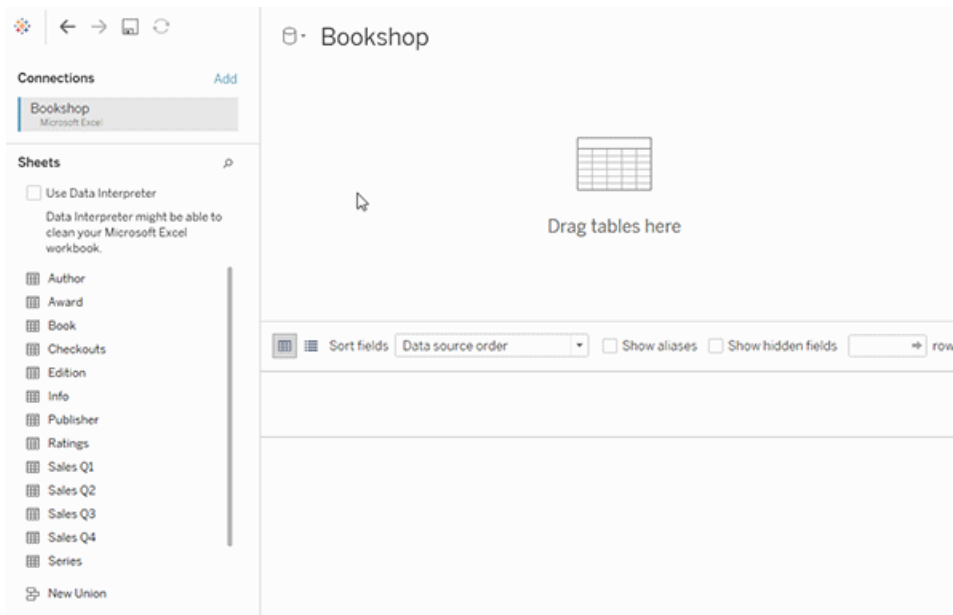

When you create a data source, it has two layers. The top-level layer is the logical layer of the data source. You combine data between tables in the logical layer using relationships.

The next layer is the physical layer of the data source. You combine data between tables at the physical layer using joins. For more information, see [Logical and physical tables in the data model](#).

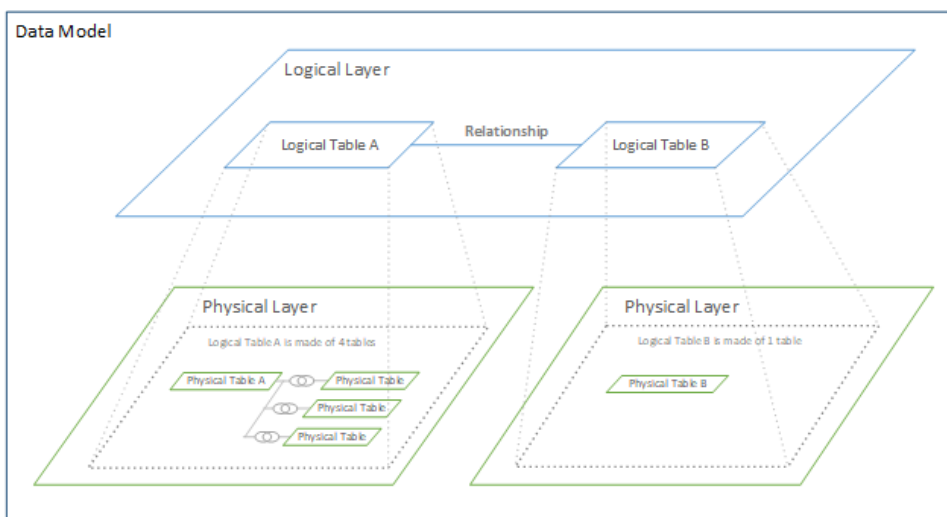

Tips on using Performance Options

If you know the shape of your data, you can use the optional settings in Performance Options to establish the cardinality of the tables to each other (one-to-one, one-to-many, many-to-many)

and indicate referential integrity (values from one table will always have match in the other table).

Instead of thinking of the settings in Performance Options as “yes” and “no”, think of them as “yes” and “I don’t know”. If you are sure that a table's values are unique, select **One**. If you are sure that each record in one table matches one or more records in the other table, select **All Records Match**. Otherwise, leave the default settings as they are.

If you aren't sure about the shape of your data, use the default settings. When Tableau can't detect these settings in your data, the default settings are:

- Cardinality: Many-to-Many
- Referential integrity: Some Records Match

If Tableau detects key relationships or referential integrity in your data, those settings will be used and indicated as "detected".

To reapply the default settings, click **Revert to Default**.

Terms defined

Cardinality refers to the uniqueness of data contained in a field (column) or combination of fields. When the tables you want to analyze contain many rows of data, queries can be slow (and performance of the overall data source is affected) so we recommend choosing a method for combining data based on the cardinality of the related columns between tables.

- **Low cardinality:** When related columns have a lot of repeated data. For example, a table called Products might contain a Category column that contains three values: Furniture, Office Supplies, and Technology.
- **High cardinality:** When related columns have highly unique data. For example, a table called Orders might contain an Order ID column that contains a unique value for every order of product.

Referential integrity means that one table will always have a matching row in the other table. For example, a Sales table will always have a matching row in the Product Catalog table.

Cardinality and Referential Integrity

Setting up a data source, no matter how you combine the data, requires understanding the data structure of each table and how they can be combined. There are several key elements that should be considered:

- **Level of detail:** how detailed the data is—its granularity. This can be thought of as answering the question “what defines a row?”. For more information on granularity, see [Structure Data for Analysis on page 604](#)

- **Shared field:** there must be at least one field that can be used to form the link between tables. For a join, these fields define the *join clause*. In related tables, they establish the *relationship*.
- **Cardinality:** how many or how few unique values there are for the shared field (uniqueness). For more information, see the next section.
- **Referential Integrity:** a value in one table is guaranteed to have a match in the other table. In other words, there can't be a record in one table that does not have a corresponding record in the other table. For more information, see below.

Cardinality

Cardinality in a single column or field refers to how unique its values are. Low cardinality means there are only a few unique values (such as in a field for eye color). High cardinality means there are a lot of unique values (such as in a field for phone numbers).

Cardinality between tables is similar, but refers to whether a row from one table *could be* linked with more than one row in another table. (It's important to remember that cardinality does not address whether there is missing data in either table. The presence or absence of missing data is referential integrity. Although these concepts work together, they are two different attributes of the relationship.)

The options are one-to-one, one-to-many, many-to-one, or many-to-many.

One-to-one

- *Definition:* Each value of the shared field in one table is related to **at most** one value in the shared field in the other table.
- *Abbreviation:* 1:1



Example: Every car has its own license plate and a license plate is specific to an individual car. Car-to-license is one-to-one.

Note that even if a car is unregistered or a license plate number hasn't yet been assigned to a car, that discrepancy is described by the referential integrity. A car can only have one license plate and a license plate can only be assigned to one car, so the cardinality remains one-to-one.

One-to-many or Many-to-one

- *Definition:* Each value of the shared field in one table can be related to multiple rows the other table (that value is repeated in the other table).
- *Abbreviation:* m:1 or 1:m
- The order of the tables determines whether it is many-to-one or one-to-many (similar to left and right joins).

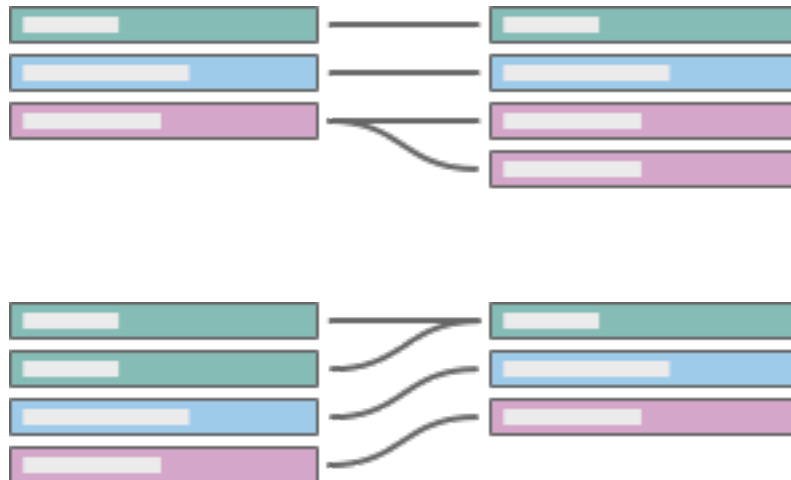

Examples: Many

employees have the same manager.
 Employees-to-manager is many-to-one.
 Manager-to-employee is one-to-many.

Many-to-many

- Multiple values of the shared field in one table can be related to multiple rows in the other table (values of the shared field can be repeated in multiple rows in either table).
- Abbreviated as m:m.
- This is the default setting if no other settings are detected in the data source.



Examples: An actor is in many movies and a movie has many actors. Actor-to-movie is many-to-many. Multiple books can be purchased in the same transaction and a book can be purchased multiple times. ISBN-to-OrderID is many-to-many.

Cardinality can be specified in the Performance Options settings. For more information, see [Optimize Relationship Queries Using Performance Options](#) on page 681.

Referential Integrity

There's a related concept called referential integrity, which means a row in one table will always have a matching row in the other table, as determined by the value of their shared fields. If the database contains no records for cars without license plates or license plates without cars, that relationship has referential integrity.

In Tableau, referential integrity is configured on each side of the relationship. In the Performance Options settings, **Some records match** means there isn't (or you don't know if there is) referential integrity. **All records match** means there is referential integrity. The default setting is to not assume referential integrity (Some records match).

For more information, see [Optimize Relationship Queries Using Performance Options](#) on page 681.

Test yourself

Can you define the cardinality and referential integrity of each diagram? What does this mean in words?

Example:

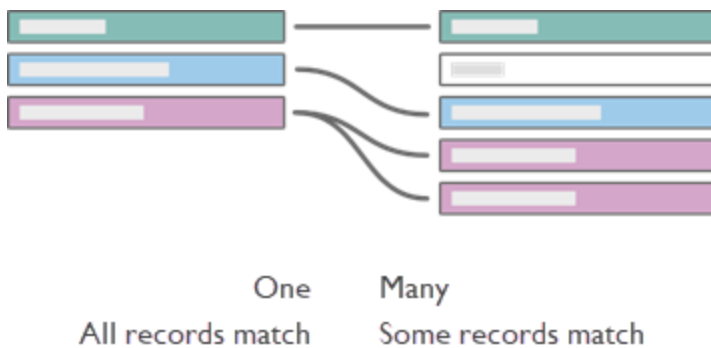

If we set the left table as books and the right table as authors linked on AuthorID, translate the diagram into words:

- **One book can have multiple authors** (the purple records show one row in the book table on the left corresponding to multiple records in the author table on the right).
- **No authors have more than one book** (each author record on the right leads only one book record on the left).

- **There are no books without authors** (no records on the left fail to correspond to a record on the right).
- **Some authors may not have books** (the gray author record on the right has no corresponding book record on the left.)

Click each section below to expand it.

Check your knowledge

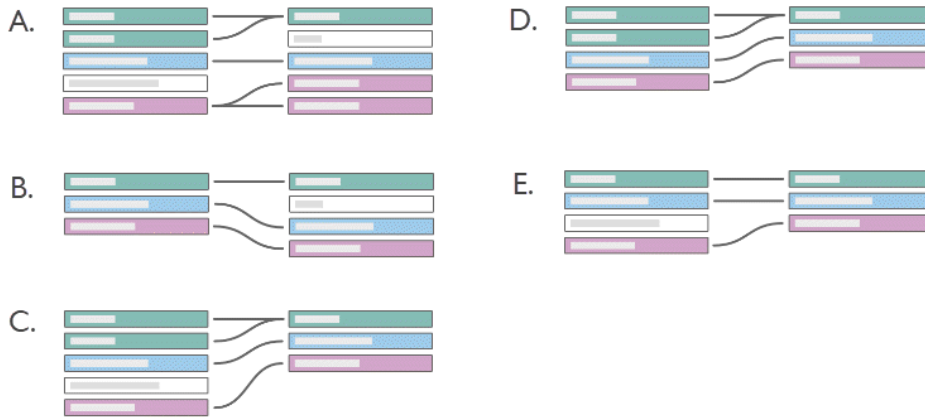

Solution

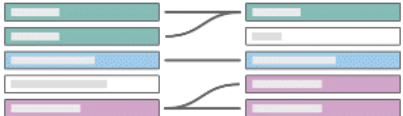
A. 

	Many	Many
Some records match		Some records match

An author can write multiple books; there may be authors without books. A book may have multiple authors; there may be books without authors.

B. 

	One	One
All records match		Some records match

Each book has exactly one author. Each author has written at most one book; there may be authors without books.

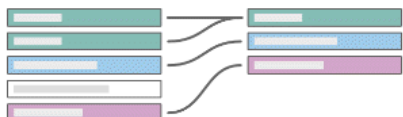
C. 

	Many	One
Some records match		All records match

Every author has at least one book; there may be authors with multiple books. Each book has at most one author; there may be books without authors.

D. 

	Many	One
All records match		All records match

Every author has at least one book; there may be authors with multiple books. Each book has exactly one author.

E. 

	One	One
Some records match		All records match

Every author has exactly one book. Every book has at most one author; there may be books without authors.

Why does it matter?

Correctly configuring the cardinality or referential integrity settings can boost performance through query optimization. Incorrect configurations, however, can lead to issues of aggregation due to loss or duplication of data. The default Performance Option settings are **Many** for cardinality and **Some records match** for referential integrity. These should only be adjusted if you are sure of the correct characteristics of your data.

For more information about how Tableau handles each setting, see [What the Cardinality and Referential Integrity settings mean](#) on page 682.

An example in Tableau

Let's explore what happens when cardinality is configured improperly.

Note: The following example uses a subset of tables from [The Bookshop data set on page 187](#). You can [download the workbook](#) to follow along, or download the raw data to create the data sources yourself. The tables used are **Books**, **Info** and **Edition** from *Bookshop.xlsx* (keeping only some fields) and **LibraryProfile** and **Catalog** from *BookshopLibraries.xlsx*.

The Book and Info tables have a one-to-one relationship—Info is essentially additional columns for the Book table. Because of this, while they could be related, it makes sense to join them to create a new logical table that has all the columns. Edition has a many-to-one relationship with this combined table as there can be multiple editions for a single book, usually with different formats. (Note that the diagram below shows the relationship from the Book+Info table to Edition, so it is one-to-many.)

Edition is related to Catalog as a one-to-many relationship on ISBN. The Catalog and LibraryProfile tables are related many-to-many on Library ID. The key point is that the LibraryProfiles table has multiple rows per library, one for each staff type (Librarian, Library Assistant, Library Technician). For more information about the structure of these tables, see [The Bookshop data set on page 187](#).

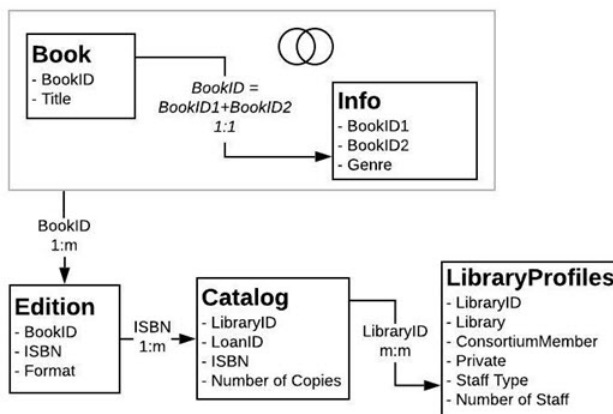

The right settings

When the Catalog-LibraryProfile relationship is set up correctly, we can make a simple viz that shows the number of staff for each library for several books. This is a silly viz to make, but it's useful to illustrate the point. Idle Hour Library has 130 staff regardless of which book we're talking about. There are three values for staff type, so each total is made up of three records—the number in parentheses.

Title	Bide Awhile	Idle Hour Library	IndieUnBound	Old Friend Libr..
Alanna Saves the Day	35 (3)	130 (3)	56 (3)	25 (3)
Banana Slug and the Glass Half Full	35 (3)	130 (3)	56 (3)	25 (3)
Banana Slug and the Lost Cow	35 (3)	130 (3)	56 (3)	25 (3)
Banana Slug and the Mossy Rock	35 (3)	130 (3)	56 (3)	25 (3)
Banana Slug and Xyr Friends	35 (3)	130 (3)	56 (3)	25 (3)
Heliotrope Pajamas	35 (3)	130 (3)	56 (3)	25 (3)

Staff count by library and title. (Numbers in parentheses indicate the number of records in each mark.)

The wrong settings: one-to-one

When the relationship is erroneously set as one-to-one, in the viz each title from Catalog is effectively paired with only one record from the LibraryProfile table (as indicated by the record count in parentheses).

Title	Bide Awhile	Idle Hour Library	IndieUnBound	Old Friend Libr..
Alanna Saves the Day	6 (1)	16 (1)	2 (1)	3 (1)
Banana Slug and the Glass Half Full	6 (1)	16 (1)	2 (1)	3 (1)
Banana Slug and the Lost Cow	6 (1)	16 (1)	2 (1)	3 (1)
Banana Slug and the Mossy Rock	6 (1)	16 (1)	2 (1)	3 (1)
Banana Slug and Xyr Friends	6 (1)	16 (1)	2 (1)	3 (1)
Heliotrope Pajamas	6 (1)	16 (1)	2 (1)	3 (1)

Staff count by library and title. (Numbers in parentheses indicate the number of records in each mark.)

Above, we can see that each library only displays their minimum number of staff. (Refer to the bolded numbers in the viz below. The lowest number of staff is the number reflected in the Staff Count viz.)

Staff Type	Bide Awhile	Idle Hour Library	IndieUn..	Old Friend L..
Librarians	9	53	7	3
Library Assistants	6	16	47	17
Library Technicians	20	61	2	5
Grand Total	35	130	56	25

Staff breakdown by type and library.

For more information about how relationships become contextual joins for a viz, see [Introducing the new data modeling in Tableau](#) on the Tableau blog.

The wrong setting: joining

While there are ways to work around this sort of issue—Level of Detail expressions being a common one—joining tables that have different granularity or “many” in their cardinality can cause duplication. Here, the staff counts are accurate for titles that only have one format, but for the books that have two formats in the Editions table, that doubling is passed along to the staff counts as well (note the record counts in parentheses that are 6 instead of the correct 3).

Title	Bide Awhile	Idle Hour Library	IndieUnBound	Old Friend Libr..
Alanna Saves the Day	35 (3)	130 (3)	56 (3)	25 (3)
Banana Slug and the Glass Half Full	35 (3)	260 (6)	56 (3)	25 (3)
Banana Slug and the Lost Cow	35 (3)	260 (6)	56 (3)	25 (3)
Banana Slug and the Mossy Rock	35 (3)	260 (6)	56 (3)	25 (3)
Banana Slug and Xyr Friends	35 (3)	260 (6)	56 (3)	25 (3)
Heliotrope Pajamas	35 (3)	260 (6)	112 (6)	25 (3)

Staff count by library and title. (Numbers in parentheses indicate the number of records in each mark.)

The wrong setting: incorrectly assuming referential integrity

Telling Tableau there is referential integrity (all records match) when this isn't the case can cause dropped values. Here, these two vizzes are similar but the one on the right is from a data source configured to assume referential integrity. That viz has lost the nulls. While this can be fine in some circumstances, it's important to understand what those nulls represent. Here, where the viz shows the number of editions in each library, the nulls indicate two editions that are present in the edition table but aren't held by any library. This could be an important oversight, and it's one that incorrectly assuming referential integrity would overlook.

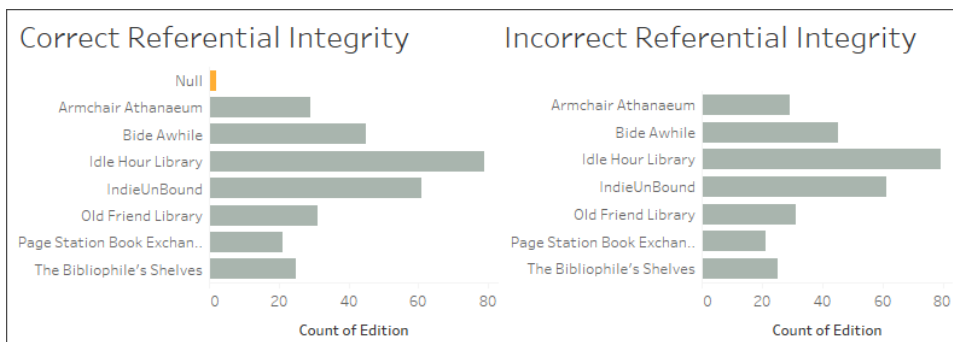

[Explore the workbook](#) and its data sources to see what other issues may arise from improperly combined tables.

Performance impacts

If mis-configuring these settings can cause missing or duplicated data, why does Tableau allow them to be changed at all? In many cases, you can and should leave the default settings: relate tables instead of joining, leave the cardinality as many-to-many, and don't assume referential integrity. Especially if you're not sure what the settings should be.

However, cardinality and referential integrity are Performance Options because there can be performance implications to the defaults. If you're sure about the structure of your data, configuring the correct settings can reduce the query execution to improve the speed.

Under the hood

Note: This section uses analogies to other data combination techniques to provide a conceptual framework only. It is not a technical description of how Tableau uses the performance settings for relationships.

Cardinality

The cardinality of the relationship impacts when aggregation happens. This can be thought of in terms of blending. Data blending queries two data sources independently. Each data source is aggregated as necessary to the desired level of detail for the view regardless of the other data source. For relationships, the cardinality setting impacts whether the aggregation happens before or after the join.

In the example above, the Many setting means the number of staff for each library is aggregated before combining that data with the book information, thus ensuring every book has the correct numbers. When the cardinality was incorrectly set to One, the number of staff was not aggregated before it was combined with the book data, leading to incorrect values.

Note that not only are the incorrect values shown, all the values are assigned to the staff type Librarians, despite the fact they are taken from all three staff types. Misconfiguration of this setting can cause unpredictable and incorrect values. This filtering of results only happens when a field from another table on the other side of the incorrectly set relationship is used in the view.

Staff Counts m:m				
Staff Type	Bide Awhile	Idle Hour		Old Friend Library
		Library	IndieUnBound	
Librarians	9	53	7	3
Library Assistants	6	16	47	17
Library Technicians	20	61	2	5

Staff Counts 1:1 (multi table)				
Staff Type	Bide Awhile	Idle Hour		Old Friend Library
		Library	IndieUnBound	
Librarians	6	16	2	3
Library Assistants				
Library Technicians				

Staff Counts 1:1 (single table)				
Staff Type	Bide Awhile	Idle Hour		Old Friend Library
		Library	IndieUnBound	
Librarians	9	53	7	3
Library Assistants	6	16	47	17
Library Technicians	20	61	2	5

If the values are unique, however, Tableau is free to remove the pre-join aggregation if it optimizes the query.

Referential Integrity

Although referential integrity refers to a setting for relationships, it can be thought of in terms of join types. A full outer join will retain all records, regardless of whether or not there is a match in the other table, but at a performance cost. If you're not sure if records would be lost, an outer join is safer. This is how tables are treated when there may not be referential integrity (Some records match).

An inner join will retain only those records where there is a match from both tables, dropping records that do not appear in each table. If you know an inner join won't eliminate necessary data, it is more efficient. If the Performance Options are set to All records match, referential integrity is assumed and joins are performed without considering unmatched values.

An incorrect referential integrity setting can have a filter-like effect on the combined data, removing unmatched values. For more information on the power of retaining unmatched

records, see [Asking questions across multiple related tables](#) on the Tableau blog. For more information on join types, see [Join Your Data](#) on page 791.

Keep the defaults

If your analysis has acceptable performance, we strongly encourage leaving the default Performance Option settings of many-to-many and not assuming referential integrity. The power of relationships comes from their ability to provide accurate, contextually appropriate results based on the tables that are used in the analysis. Changing these settings removes the [semantic flexibility of relationships](#).

How Analysis Works for Multi-table Data Sources that Use Relationships

Using a data source that has multiple, related tables affects how analysis works in Tableau. Because multiple, related tables have independent domains and retain their native level of detail, when you drag fields into the view:

- Data is queried at its natural level of detail.
- Only data that is relevant to a viz is queried.
- The relationships between the tables affect the results of the query. The flow of building a viz can vary depending on how tables of fields are related to each other in the data model, or if they aren't related directly.

For an overview of data source enhancements and an introduction to using relationships, see this 5-minute video.

Note: The interface for editing relationships shown in this video and in this topic differs slightly from the current release but has the same functionality.

Learn more about how relationships work in [Don't Be Scared of Relationships](#) on page 717 and these Tableau blog posts:

- [Relationships, part 1: Introducing new data modeling in Tableau](#)
- [Relationships, part 2: Tips and tricks](#)
- [Relationships, part 3: Asking questions across multiple related tables](#)

Also see video podcasts on relationships from [Action Analytics](#), such as [Why did Tableau Invent Relationships?](#) Click "Video Podcast" in the [Library](#) to see more.

In Tableau version 2024.2 and later, the Tableau data model supports multi-fact analysis and shared dimensions through multi-fact relationships. For more information, see [About Multi-fact Relationship Data Models](#), [When to Use a Multi-fact Relationship Model](#), and [Build a Multi-fact Relationship Data Model](#).

Note: You can still create single-table data sources in Tableau. You can build a logical table using a combination of joins, unions, custom SQL, and so on. The behavior of single-table analysis in Tableau has not changed. Analysis over a single logical table that contains a mixture of dimensions and measures works just as in Tableau pre-2020.2.

Considerations for analysis

Validating relationships

You have several options for validating your data model for analysis. As you create the model for your data source, we recommend going to a sheet, selecting that data source, and then building a viz to explore record counts, expected data, unmatched values, nulls, or repeated measure values. Try working with fields across different tables to ensure everything looks how you expect it to.

What to look for:

- Are your relationships in the data model using the correct matching fields for their tables?
- Would adding multiple matching field pairs make the relationship more accurate?
- What are the results of dragging different dimensions and measures into the view?
- Are you seeing the expected number of rows?
- If you changed any of the [Performance Options settings](#) from the default settings, are the values that you are seeing in the viz what you would expect? If they aren't, you might want to check the settings, or reset to the default.

Options for validating relationships and the data model:

- Every table includes a count of its records, as a field named *TableName(Count)*, at the level of detail for that table. To see the count for a table, drag its Count field into the view. To see the count for all tables, select the Count field for each table in the Data pane, and then click the Text Table in Show Me.
- Click **View Data** in the Data pane to see the number of rows and data per table. Also, before you start creating relationships, viewing the data from the data source before or during analysis can be useful to give you a sense of the scope of each table. For more information, see [View Underlying Data](#) on page 2001.

- Drag dimensions onto rows to see the Number of Rows in the status bar. To see unmatched values, click the **Analysis** menu, and then select **Table Layout > Show Empty Rows** or **Show Empty Columns**. You can also drag different measures to the view, such as *<YourTable>(Count)* from one of the tables represented in your viz. This ensures that you will see all values of the dimensions from that table.

Tip: If you would like to see the queries that are being generated for relationships, you can use the Performance Recorder in Tableau Desktop.

1. Click the Help menu, and then select **Settings and Performance > Start Performance Recording**.
2. Drag fields into the view to build your viz.
3. Click the Help menu, and then select **Settings and Performance > Stop Performance Recording**. The Performance Recording workbook will automatically open.
4. In the Performance Summary dashboard, under Events Sorted By Time, click an "Executing Query" bar and view the query below.

Another more advanced option is to use the [Tableau Log Viewer](#) on GitHub. You can filter on a specific keyword using `end-protocol.query`. For more information, start with the [Tableau Log Viewer wiki page](#) in GitHub.

Dimension-only visualizations

When using a multi-table data source with related tables: If you build a dimension-only viz, Tableau uses inner joins and you won't see the full unmatched domain.

To see partial combinations of dimension values, you can:

- Use Show Empty Rows/Columns to see all of the possible rows. Click the **Analysis** menu, and then select **Table Layout > Show Empty Rows** or **Show Empty Columns**. Be aware that this setting will also trigger densification for Date and Numeric Bin fields, which may be unwanted.
- Add a measure to the view, such as *<YourTable>(Count)* from one of the tables represented in your viz. This ensures that you will see all values of the dimensions from that table.

For more information, also see [Unmatched values behavior for dimensions that might surprise you](#) on page 651 and [Troubleshooting multi-table analysis](#) on page 712.

When to use LOD calculations and expressions

Because Tableau understands the level of detail (LOD) of your input tables, you shouldn't need to use LOD calcs to remove unwanted duplication due to joins.

You may still want to use LOD calcs to:

- Handle unwanted duplication in your source tables.
- Compute multi-level aggregations (e.g. an average over a sum)
- To do cohort analysis (e.g. to compute the first order date for each customer)

If the dimensionality of an LOD calc includes fields from a single table, that LOD calculation will appear in its owning table in the Data pane.

Examples of multi-table analysis

The following set of examples show how data might be queried across multiple, related tables. This multi-table data source contains a short list of actors' appearances in different movie roles.

A row in the Appearances table means that an Actor played a particular Character in a specific Movie. In this data set, an Actor can have zero or more Appearances.

Learn more about how relationships work in these Tableau blog posts:

- [Relationships, part 1: Introducing new data modeling in Tableau](#)
- [Relationships, part 2: Tips and tricks](#)

Example 1: Analysis of a single question in joined data versus related data

When you connected to data in Tableau before 2020.2, your data source could consist of a single table, or multiple tables that were joined or unioned together into a single, denormalized table. Starting with Tableau 2020.2, Tableau recognizes and preserves normalized data for multi-table data sources, where the table data remains separate, and each table maintains its native level of detail. The following examples show how analysis differs between single table and multi-table data sources.

This example shows three tables of movie data: Appearances, Actors, and Movies.

Tableau Desktop and Web Authoring Help

Abc Appearances Movie	Abc Appearances Character	Abc Appearances Actor
The Fellowship of the Ring	Gimli	John Rhys-Davies
The Return of the King	Gimli	John Rhys-Davies
The Return of the King	Treebeard	John Rhys-Davies
The Two Towers	Gimli	John Rhys-Davies
The Two Towers	Treebeard	John Rhys-Davies
Casino Royale	James Bond	Peter Sellers
Dr. Strangelove	Dr. Strangelove	Peter Sellers
Dr. Strangelove	Group Captain Mandr...	Peter Sellers
Dr. Strangelove	President Muffley	Peter Sellers
From Russia With Love	James Bond	Sean Connery
The Hunt for the Red October	Marko Ramius	Sean Connery

Abc Actors Actor	# Actors Height (cm)
John Rhys-Davies	185
Peter Sellers	173
Sean Connery	189
Jodie Foster	161

Abc Movies Movie	Abc Movies World Premiere	Abc Movies Gross (USD millions)
The Fellowship of the Ring	12/19/2001	869
The Return of the King	12/18/2002	1,119
The Two Towers	12/17/2003	923
Casino Royale	4/13/1967	22
Dr. Strangelove	1/29/1964	94
From Russia With Love	5/27/1964	24
The Hunt for the Red October	3/2/1990	200
Casablanca	11/26/1942	4

These tables can be joined together, joining the Appearances table with the Actors table on Actor = Actor and the Appearances table with the Movies table on Movie = Movie. If the joins are full outer joins so no rows are lost, the final output looks like this. Note that fields that are used in the join clauses appear twice.

Sort fields | Data source order

Abc Actors Actor (Actors)	# Actors Height (cm)	Abc Appearances Movie	Abc Appearances Character	Abc Appearances Actor	Abc Movies Movie (Movies)	Abc Movies World Premiere	# Movies Gross (USD millio...
John Rhys-Davies	185	The Fellowship of the Ring	Gimli	John Rhys-Davies	The Fellowship of the Ring	12/19/2001	869
John Rhys-Davies	185	The Return of the King	Gimli	John Rhys-Davies	The Return of the King	12/18/2002	1,119
John Rhys-Davies	185	The Return of the King	Treebeard	John Rhys-Davies	The Return of the King	12/18/2002	1,119
John Rhys-Davies	185	The Two Towers	Gimli	John Rhys-Davies	The Two Towers	12/17/2003	923
John Rhys-Davies	185	The Two Towers	Treebeard	John Rhys-Davies	The Two Towers	12/17/2003	923
Peter Sellers	173	Casino Royale	James Bond	Peter Sellers	Casino Royale	4/13/1967	22
Peter Sellers	173	Dr. Strangelove	Dr. Strangelove	Peter Sellers	Dr. Strangelove	1/29/1964	94
Peter Sellers	173	Dr. Strangelove	Group Captain Mandr...	Peter Sellers	Dr. Strangelove	1/29/1964	94
Peter Sellers	173	Dr. Strangelove	President Muffley	Peter Sellers	Dr. Strangelove	1/29/1964	94
Sean Connery	189	From Russia With Love	James Bond	Sean Connery	From Russia With Love	5/27/1964	24
Sean Connery	189	The Hunt for the Red October	Marko Ramius	Sean Connery	The Hunt for the Red October	3/2/1990	200
Jodie Foster	161	null	null	null	null	null	null
null	null	null	null	null	Casablanca	11/26/1942	4

Data that is brought together into a single table in this way is called denormalized or flattened.

This joined data is flattened data. Each row consists of an actor’s appearance as a character in a movie (so John Rhys-Davies has two rows for The Return of the King because he played two characters); therefore the granularity of the data is at the level of a character in a movie.

Information that is relevant in multiple rows is duplicated. The Return of the King’s premiere date is present twice because there are two characters from that movie in the data set. John Rhys-Davies’ height is listed five times because there are 5 unique combinations of character/movie for him as an actor.

This flattened data therefore has some characteristics to be aware of. For example, if you wanted to plot actor height by the average gross of their movies, you might assume we could bring out

Height to columns and Gross to Rows, then take the average of the Gross. But if you do that the default view doesn't seem right. Here John Rhys-Davies is supposed to be 925cm tall, which is over 30 feet!

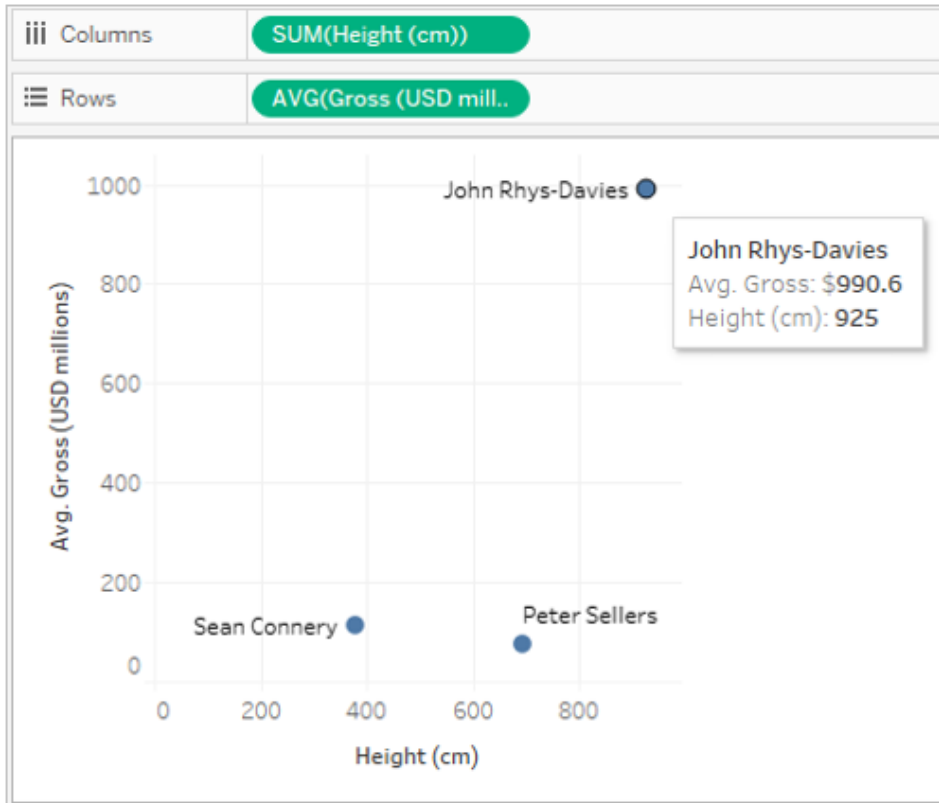

This is because the default aggregation is SUM. There are 5 rows in the data for him, so we get his true height of 185cm five times. You could fix this by changing the aggregation on Height, say to average or minimum. This effectively returns the value for only one row (since they are all the same).

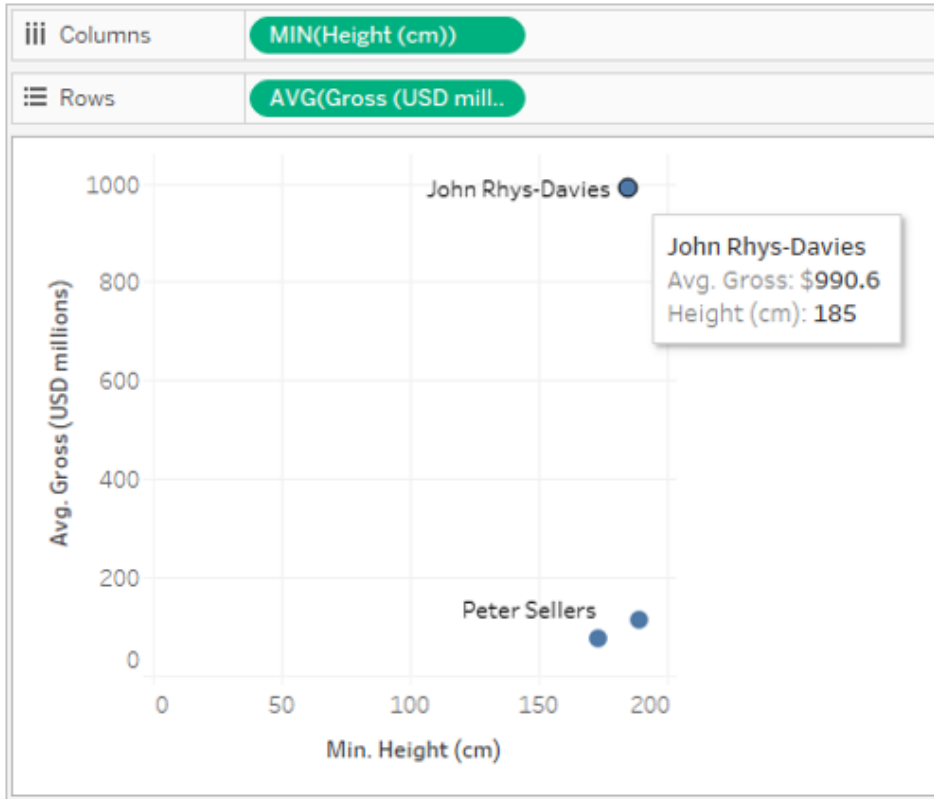

When you change the aggregation the heights are much more realistic. But now you need to pay attention to average gross. Remember that Tableau considers all five rows for John Rhys-Davies' height. When you think about the average gross for the movies he was in, it shouldn't be the average of five rows, but rather the average of three movies. You don't want to count the gross for Return of the King twice just because he played two characters in it. But is that what is happening?

Doing some quick math, the Lord of the Rings movies should have an average of $(869 + 923 + 1119)/3$, or \$970.3. However, the value in the scatterplot is \$990.6. The current average is from the five rows $(869 + 923 + 923 + 1119 + 1119)/5$.

This isn't as easy to fix as the height issue with changing the aggregation. You need to use a **Level of Detail (LOD) expression** to alter which level of detail Tableau looks at, going from the default—Appearance—up to the level of Movie. You could create a calculation for LOD Gross as `{FIXED [Movie] : MIN([Gross (USD millions)])}` and then take the average of that new LOD Gross field for our view.

The LOD expression can be read as “for each movie, return its minimum Gross”. This removes the duplication problem because the gross is always returned per movie, even though the view is constructed with movie and actor.

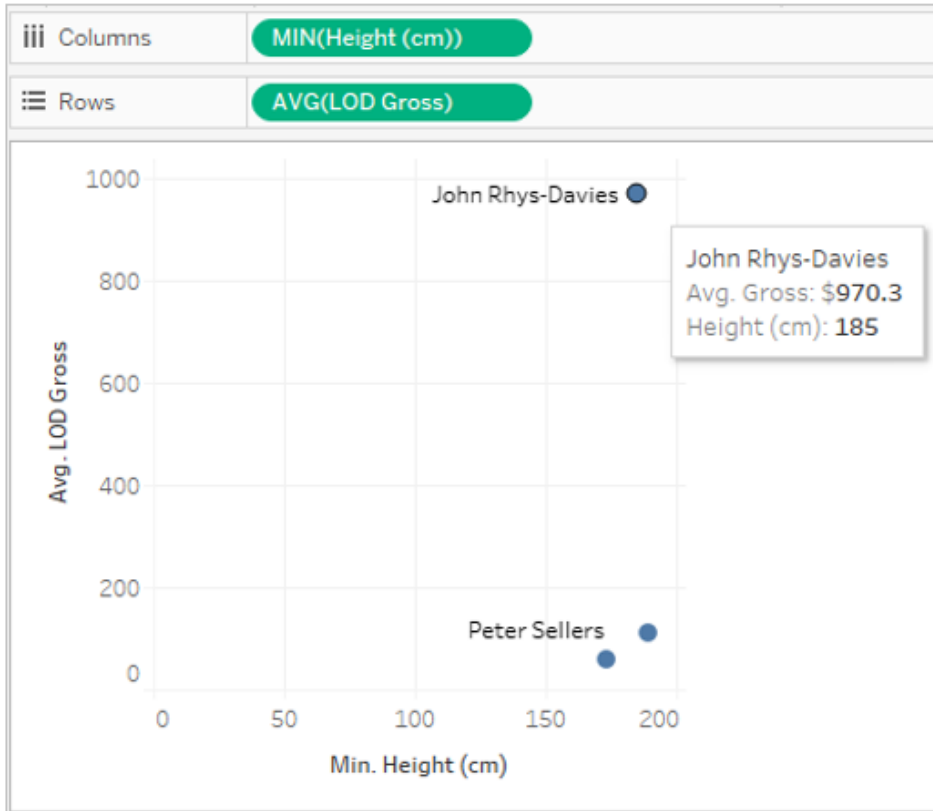

Now the numbers are correct. John Rhys-Davies is 185cm tall, and the average gross for his movies in this data set is 970.3. You would need to understand how data was being replicated and how Tableau aggregated the data to display it before you could ensure the correct values were returned.

Normalized data in multiple tables

Creating relationships between logical tables may seem similar to creating joins, but instead of flattening the data into a single table, with all the replications that can entail, Tableau stays aware of the relationships between the tables. Information is brought out of each table at the appropriate level of detail and related to other data.

On the **Data Source** page, you won't see the "full" grid view of the flattened table. It doesn't exist. Tableau keeps all three tables as they are and merely establishes the relationships, pulling together the required data as needed by the view.

Tableau Desktop and Web Authoring Help

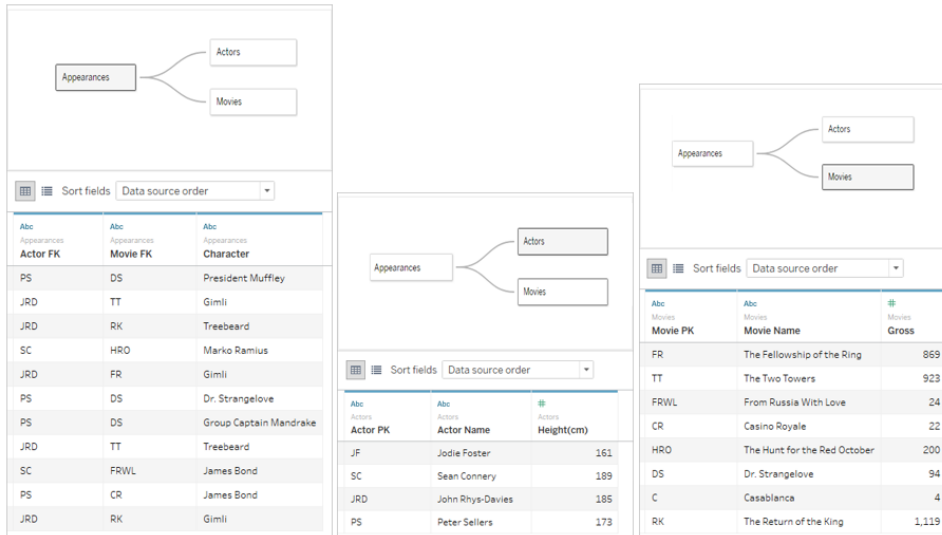

To create the same scatterplot, drag Height and Gross into the view, and set Gross to average. That's it! Tableau looks at the way each table's data is related to data from other related tables and infers how the height should be displayed (by actor) and how the average gross should be computed (by movie).

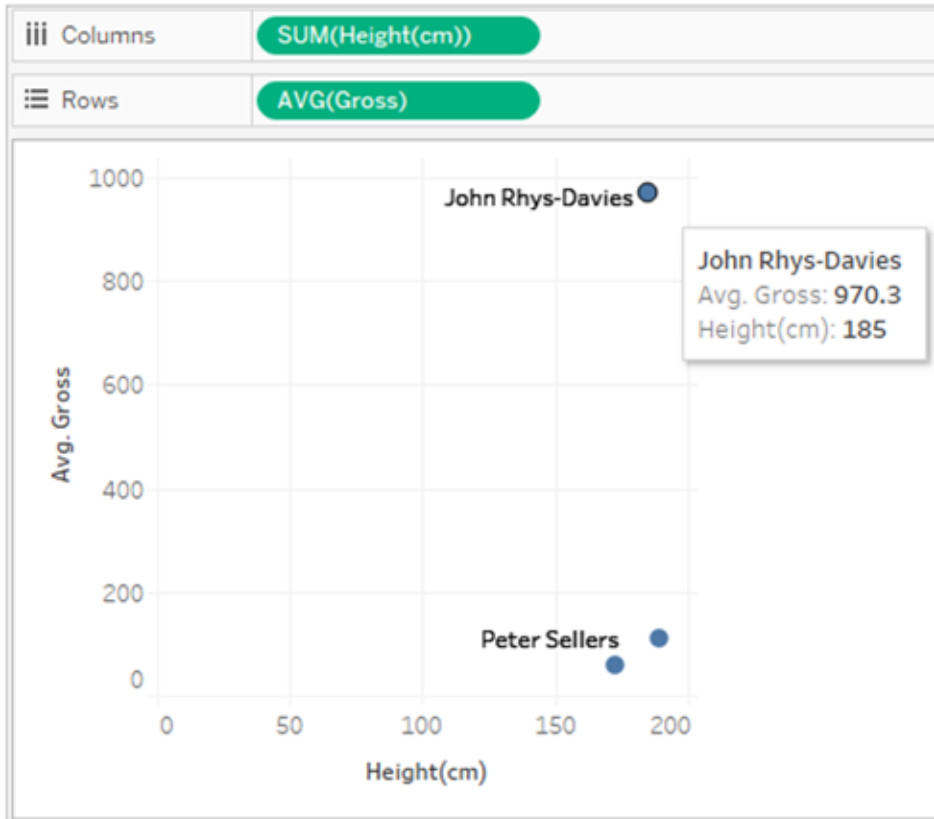

Example 2: Dimension from a single table

If the dimensions in your visualization come from a single table, Tableau queries just the one table and shows results for the entire domain. You can add measures and still see the entire domain.

For example, using the Movie Appearances data source introduced above, adding the Actor field to a visualization results in the following visualization:

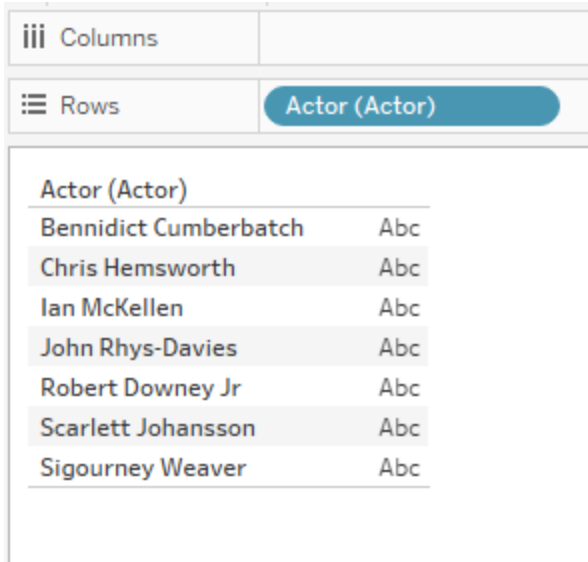

The screenshot shows the Tableau interface with the Columns shelf empty and the Rows shelf containing 'Actor (Actor)'. Below the shelves, a table is displayed with the following data:

Actor (Actor)	
Bennidict Cumberbatch	Abc
Chris Hemsworth	Abc
Ian McKellen	Abc
John Rhys-Davies	Abc
Robert Downey Jr	Abc
Scarlett Johansson	Abc
Sigourney Weaver	Abc

Because the only dimension in the viz came from the Actors table, Tableau will run a query against just the Actors table. All actors that appear in the Actors table are displayed in the viz, regardless of whether they have any Appearances.

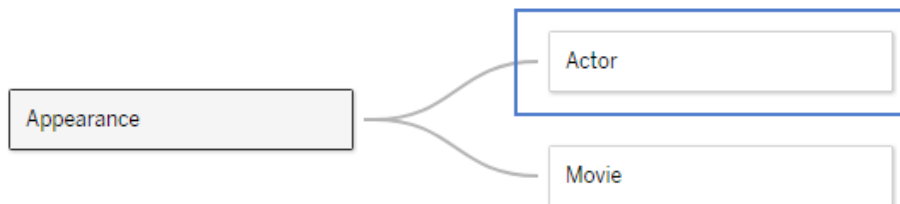

Bringing the Appearance Actor field into the view as a measure, and then applying a COUNT aggregation creates a view that shows the number of appearances by actors. Notice that Sigourney Weaver does not have any appearances, but her name is still in the view.

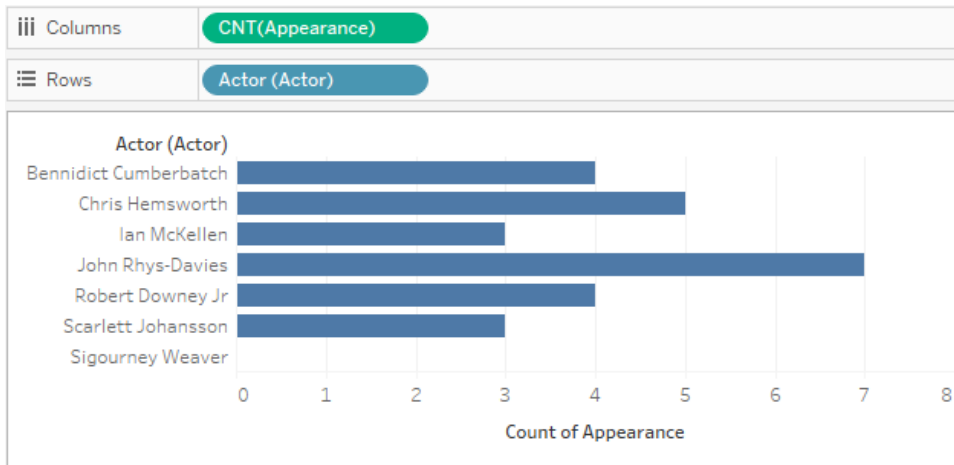

Example 3: Dimensions from multiple tables

If the dimensions in the view are from multiple tables, Tableau finds the table that relates all the dimensions and shows the domain from that table. As a result, some dimension values that you saw in Example 1 change.

For example, dragging a field from the Movies table into the viz changes the query. Because the Movies and Actors tables are related by the Appearances table, the query returns only the Actor/Movie pairs that exist in the Appearances table.

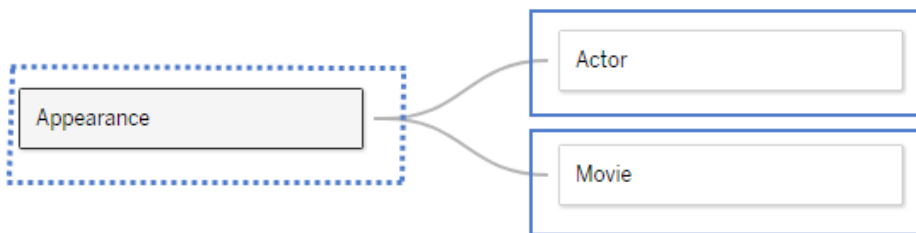

Because Sigourney Weaver does not have any Appearances in this data set (and, thus, is not related to any of the Movies in the data set), the viz of Actor/Movie pairs does not show her:

Columns		
Rows		
Actor (Actor)	Movie (Movie)	
Bennidict Cumberbatch	Avengers Infinity War	Abc
	Dr Strange	Abc
	Sherlock	Abc
	Thor Ragnarok	Abc
Chris Hemsworth	Avengers Age of Ultron	Abc
	Avengers Infinity War	Abc
	Dr Strange	Abc
	The Avengers	Abc
Ian McKellen	Thor Ragnarok	Abc
	Fellowship of the Ring	Abc
	Return of the King	Abc
John Rhys-Davies	The Two Towers	Abc
	Fantastic Four Animated ..	Abc
	Fellowship of the Ring	Abc
	Return of the King	Abc
Robert Downey Jr	The Incredible Hulk Anima..	Abc
	The Two Towers	Abc
	Avengers Age of Ultron	Abc
	Avengers Infinity War	Abc
Scarlett Johansson	Sherlock Holmes	Abc
	The Avengers	Abc
	Avengers Age of Ultron	Abc
Scarlett Johansson	Avengers Infinity War	Abc
	The Avengers	Abc
	Avengers Age of Ultron	Abc

Example 4: Measures that can't be split by a dimension

If a measure can't be split by a dimension, Tableau replicates the measure across that dimension.

The next visualization shows the total amount grossed by Movie. Since both fields come from the Movies table, Tableau will query only the Movies table.

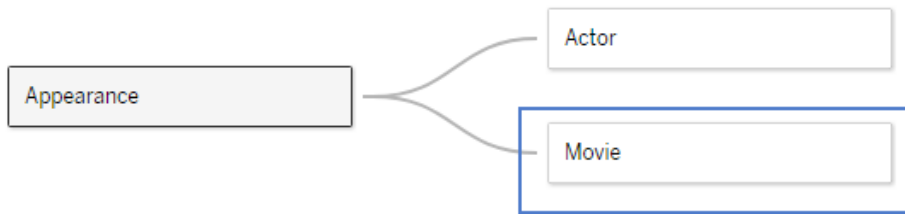

The Movies table includes the already aggregated Gross receipts for each movie, as shown in the following visualization (the gross for Infinity War was not available at the time this data set was created and is shown as zero).

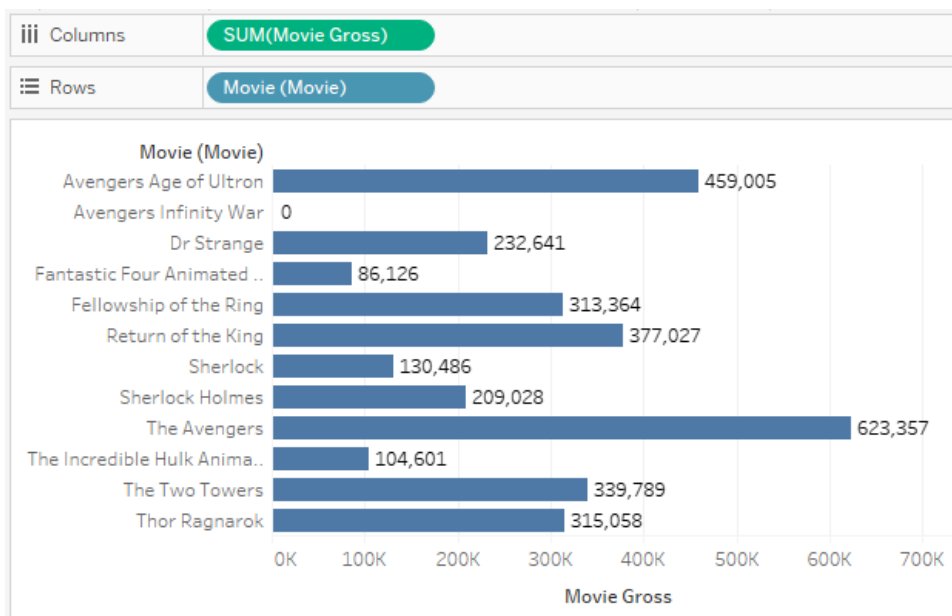

If you add Actor to this visualization, Tableau knows that it cannot break down the Movie Gross receipts by Actor, since this more granular information is not available in the data model. Instead, Tableau shows the Movie Gross receipts for each movie, replicated across actors.

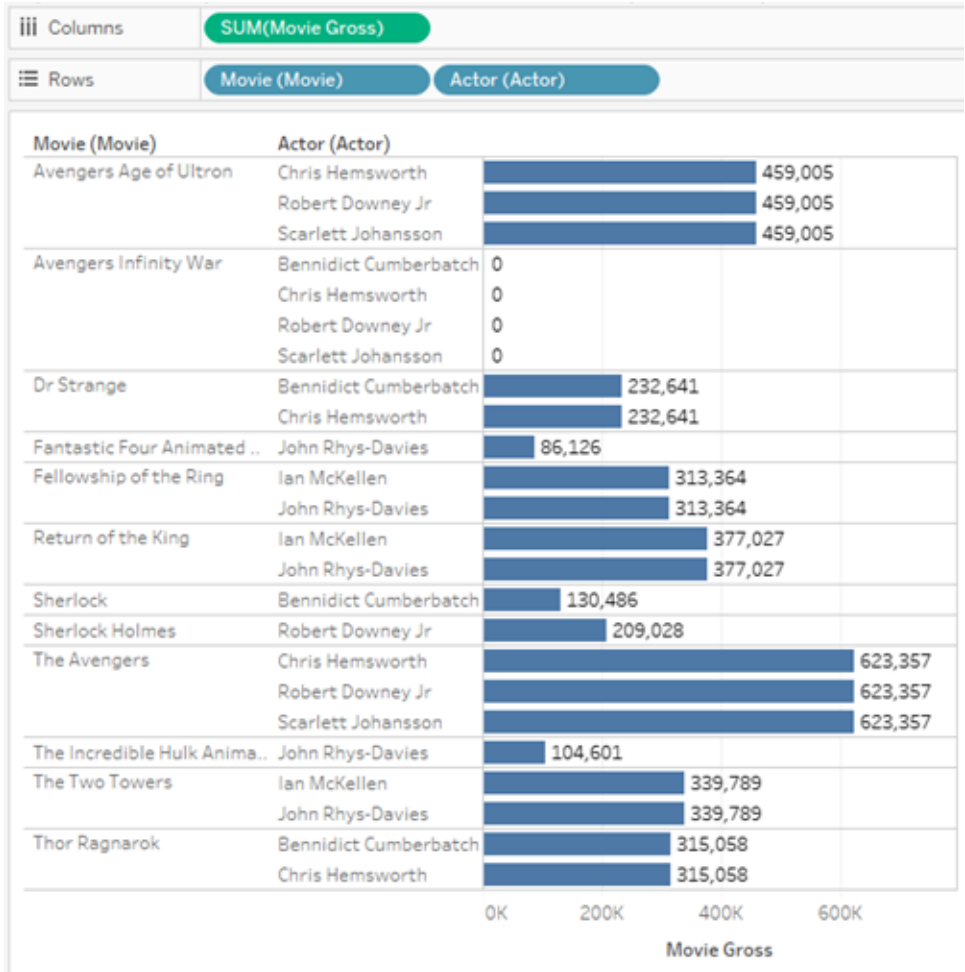

Example 5: Dimension that isn't hierarchically related to a measure

Removing the Movie dimension from the previous visualization queries the sum of the Movie Gross measure for each Actor. The result is the aggregated Movie Gross for every movie the actor appeared in.

In this case there isn't a hierarchical relationship between the dimension, Actor, and the measure, Movie Gross—multiple actors may have appeared in the same movie. For example, Benedict Cumberbatch and Chris Hemsworth both appeared in Dr. Strange. In this case, Tableau includes the Movie Gross for Dr. Strange in both actors' totals.

Because the same Movie Gross value is included in multiple actors' totals, Tableau won't directly sum over these values.

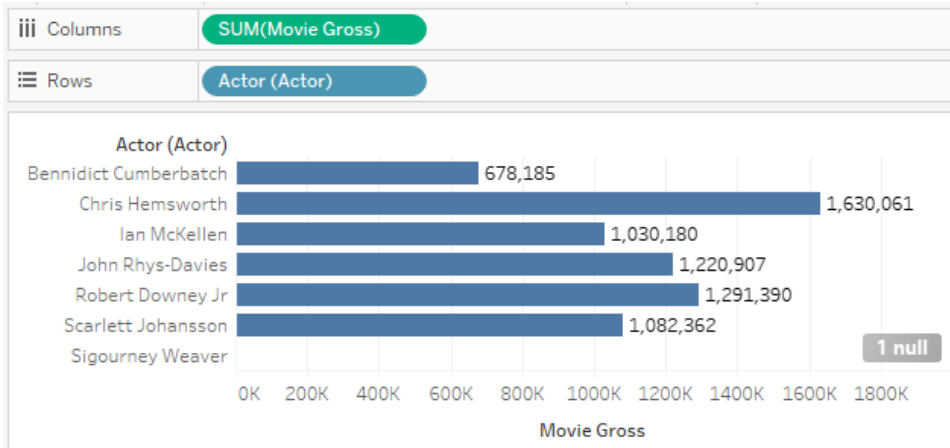

However, when totals are shown for this visualization, note that Tableau correctly computes the total Movie Gross without including duplicate movies.

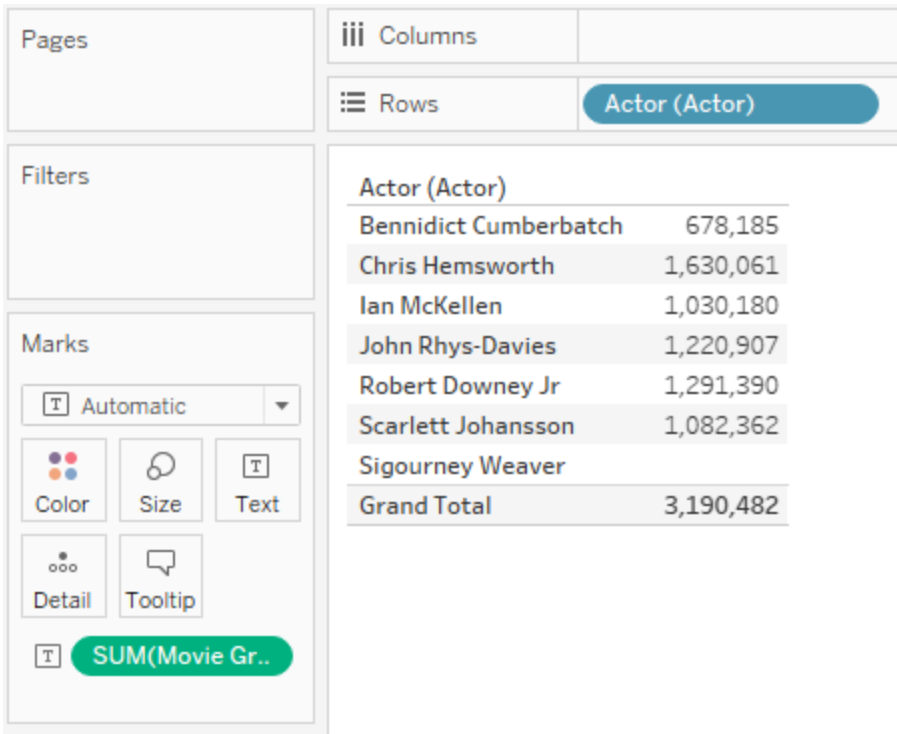

Troubleshooting multi-table analysis

The following situations are possible with multi-table, related tables. This table describes known scenarios and high-level descriptions for how to troubleshoot your analysis.

Analysis Situation	Description
Inner join for dimension-only vizs	<p>You may not immediately see all of the values you were expecting when you add multiple dimensions to the same view. Or, you might notice that adding a new dimension to the viz from a different table causes some values to disappear from the viz.</p> <p>Tableau will use queries that preserve the combination of values that actually exist in the data. This means that you will see rows that would be produced by an inner join of the tables providing dimensions to the viz.</p> <p>If you want to see partial combinations of the dimension values, you can either turn on Show Empty Rows/Columns to see all of the possible rows, or you can add a measure, such as <i><MyTable>(Count)</i>, from one of the tables represented in the view to ensure you see all values of the dimensions from that table.</p>
Constants in calculations	<p>In a multi-table datasource, constant values behave as though they come from their own table with a single row. If you aggregate a constant value, it will behave as though the aggregate was on a single row. Sum(10) will always equal 10. Avg(10) will also always equal 10. Count(10) will always equal 1.</p> <p>To ensure backwards compatibility, constant values on a single-logical table data source will behave as though the constant value is replicated for each value in the table.</p> <p>Constants in row level calculations do not change the row level of detail of the calculation. The calculation [Sales] + 10 will behave as though it came from the same table as the [Sales] field.</p>
Forcing outer join	<p>Tableau ensures that all measure values are represented in the viz (along with all combinations of dimen-</p>

Analysis Situation	Description
I'm not seeing the measure values I would expect from a cross-table calculation	<p>sion values that actually occur in the data) so if you want to ensure you are seeing all of the possible values in your data including "unmatched nulls" you can do so by bringing measures into the view from each table in the worksheet.</p> <p>The domain of a calculation is the inner join of its inputs. If there are not matching values from all of the inputs of the measure calculation they will not be included in the measure calculation.</p> <p>Consider using an LOD calculation to move the measure values to the same object before creating the row-level calculation.</p>
Calculation to switch between fields from different logical tables gives unexpected results	<p>If you have a calculation that switches between row level fields, either using a case statement, if statement, or a function like "IFNULL", you may see unexpected results, because this calculation is being computed for every row, where row is the inner join between the inputs of the calculation.</p> <p>A better approach is to switch between Aggregated values, rather than trying to switch within the row level calculation. This will also produce better performance in single table scenarios.</p> <p>Alternately, this is only an issue for calculations that span between tables, so using LOD calculations to bring all of the fields to the same table will work as well.</p> <p>Don't do this:</p> <pre data-bbox="691 1625 1365 1696">SUM(IF [Parameter] == "Foo" THEN [Field 1] ELSE [Field 2] END)</pre> <p>Do this:</p>

Analysis Situation	Description
Unexpected unmatched nulls	<pre>IF [Parameter] == "Foo" THEN SUM([Field 1]) ELSE SUM([Field 2]) END</pre> <p>You may see measure values associated with a null dimension value that you didn't expect. This can possibly be a sign that the relationships in the data source were incorrectly configured. It may also indicate that there are actually unmatched values from the table that contains the measure, that have no corresponding row in the dimension table.</p> <p>In the past, this data might have been lost if the wrong join type was selected. When you use relationships, these unmatched values are preserved. If you don't want to see the unmatched values, you can exclude them using a filter.</p>
Incorrect aggregate values	<p>Are you using relationships or joins? With relationships, aggregates are computed correctly by default. When using joins, you may need to write LOD calcs to deduplicate values.</p> <p>Have you incorrectly set Performance Options on relationships? Try resetting the Performance Options to the default and see if that produces the correct aggregations.</p>
Dimensions replicate measure values rather than partitioning them.	<p>Check that the fields used to define relationships are correct.</p>
Dimension filters don't subset measures.	
Tableau is generating too many queries or queries with many left joins	<p>Check the logs or performance recording to see how many queries are generated and how many left joins are used. With the new data modeling capabilities, Tableau</p>

Analysis Situation	Description
Queries have many sub-queries	<p>generates queries with left joins and/or additional queries to make sure that unmatched measure values are always included in the visualization. If you don't need to see the unmatched values, use filters to remove the unmatched (NULL) values from your visualization. This should result in fewer queries.</p> <p>If you know that your data doesn't have any unmatched values, you can set the Referential Integrity setting for each relationship to "All Values Match" in Performance Options. This will also result in fewer queries.</p> <p>You can also reduce the complexity of your visualization to reduce the number of queries generated. Removing measures and hiding Filter controls are key ways to simplify queries multi-table, related data.</p> <p>Check the logs or performance recording to see the complexity of the queries Tableau generates.</p>
I was using joins to filter data	<p>Tableau automatically generates subqueries to deduplicate data, when necessary, to generate correct aggregates. This is similar to queries generated by LOD calculations.</p> <p>If you know the relationships between the logical tables in your data have many-to-one or one-to-one cardinality, then you can set this cardinality information in the relationship Performance Options. This will allow Tableau to eliminate unnecessary subqueries since it will know that no duplication can happen.</p> <p>In 2020.2, Tableau will work hard to recover unmatched values. Sometimes that means it will use a left join where you might have specified an inner join to intentionally filter out data.</p>

Analysis Situation**Description**

If you filter out the unmatched values that are brought in by this join, Tableau will be able to optimize the query back to an inner join.

Depending on your specific scenario, it might make sense to model this inner join as a physical join within a logical table. This is especially powerful if a table containing measures is being used to filter a dimension table, as it will not introduce additional measure replication.

Don't Be Scared of Relationships

The new data modeling capabilities create flexible data sources built around relationships.

Relationships combine data from different tables by looking at what columns (fields) those tables have in common and using that information to bring information from each table together in the analysis.

Unlike joins or unions, relationships form a data source without flattening multiple tables into a single table. Because of this, related data sources know which table each field is from. That means each field keeps its context, or level of detail. Related data sources can therefore handle tables with different granularity without issues of duplication or data loss.

In a related data source, the joins aren't fixed up front. Instead of merging all the data (and having to work with all the data regardless of what each viz requires), only the relevant data is combined—per sheet and as necessary. As you drag and drop, Tableau evaluates the relationships of the relevant fields and tables. Those relationships are used to write queries with the correct join types, aggregations, and null handling.

You can think about how the data fits together and what questions you want to answer, rather than how to combine the data or compensate for artifacts from the data source.

Relationships don't replace the previous ways of combining data: joins, unions, and blends. Rather, relationships are the new, flexible way to bring data together from multiple sources. The existing methods aren't going away, and are still useful in specific scenarios.

Note: For related information on how relationship queries work, see these Tableau blog posts:

- [Relationships, part 1: Introducing new data modeling in Tableau](#)
- [Relationships, part 2: Tips and tricks](#)
- [Relationships, part 3: Asking questions across multiple related tables](#)

Also see video podcasts on relationships from [Action Analytics](#), such as [Why did Tableau Invent Relationships?](#) Click "Video Podcast" in the [Library](#) to see more.

Use Relationships

This topic walks through building a related data source and using one for analysis. If you would like to follow along, you can [download the Bookshop data set](#). Choose Bookshop.xlsx for the raw data to start from scratch, or MinimalBookshop.tdsx to start with the related data source basics configured for you.

Note: Relationships are available in Tableau 2020.2 and later.

Video: Migrated Data

If you open an existing workbook from a previous version of Tableau (version 2020.1 or earlier) in Tableau 2020.2 or later, your data source tab might show a **Migrated Data** table.

[There are multiple videos embedded in this topic. For your convenience, a transcript is provided in the expandable section underneath each video.](#)

Migrated Data video transcript

If you open a workbook created before relationships were available (before version 2020.2), your data source may look different. If there were joined or unioned tables, they appear as a single logical table named Migrated Data. Double click to see the underlying tables—they're still there, and your analysis will still behave as expected.

Note that when you're only using the Migrated Data table, the Data pane behaves more like previous versions of Tableau Desktop.

You can even relate new tables to the directly to the Migrated Data table to extend the data model.

Once you've added relationships to the data model, the Data pane updates to the new layout, with dimensions and measures maintained within each table, and the Migrated Data table is displayed as a single, merged table.

Video: Relate tables

Note: The interface for editing relationships shown in this video differs slightly from the current release but has the same functionality.

Relate tables video transcript

To build a data source of related tables, connect to your data and drag a table to the canvas. Drag out a second table. A relationship will automatically form if it can. If Tableau cannot detect the related fields, you will be prompted to select them yourself.

The canvas you're seeing is a new layer of the data model where you can relate tables together. Dragging out additional tables adds them to the data model. The noodle shows which tables are related.

Relationships can be based on calculated fields. You can also specify how fields should be compared by using operators when you define the relationship.

Add joins

You can create a join by double clicking on a table to open the join canvas (also referred to as the physical layer), and then dragging out a table to create a join. Creating joins is the same experience as previous versions of Tableau—you can set a join clause, including a calculation if necessary, and configure the join type.

Once you close the join canvas, the table on the relationship canvas (also referred to as the logical layer) has a join icon to indicate the underlying join. This is because a join merges its tables together to form a single, new table. Related tables remain distinct.

Add unions

Add unions by dragging out New Union. Unions, like joins, actually merge the data, and show an icon on the logical layer. We recommend always renaming unions—or any tables with unclear names—to something more useful.

Video: Performance Options

Note: The interface for editing relationships shown in this video differs slightly from the current release but has the same functionality.

Performance Options video transcript

For any relationship, there are performance options as well as related fields. Tableau automatically chooses safe defaults for these options. However, if you are sure of the characteristics of your data, changing these options can give Tableau more information about how to best configure automatic joins during analysis. Setting the cardinality and referential integrity options gives Tableau more information about how to optimize queries.

Cardinality

Cardinality indicates whether or not the linking field records are unique. If multiple books can have the same author, but each author is listed only once in the author table, the cardinality for AuthID would be Many for Books and One for Author between those two tables. This setting impacts how Tableau handles aggregation before or after the join.

Referential integrity

Referential integrity indicates whether or not a record in one table is guaranteed to have a relationship in another table. If every book has an author, Book has referential integrity to Author. If not every author has a book, Author does not have referential integrity to Book. This setting impacts how Tableau chooses a join type and handles unmatched records.

For more information, see [Cardinality and Referential Integrity](#) on page 685.

Example: Bookshop Data

We'll do some analysis with this data source in a moment, so let's talk about the data.

The data set is around (fictitious) books, and it's important to consider the distinction between a book and an edition. A book is the conceptual work itself, with attributes such as the title, author, and genre. There are also editions of a book, with attributes such as a price and format (hardcover or paperback), that are identified with an ISBN. An edition of a book has a publisher and a page count, whereas a book may have won an award or be in a series.

You can follow along by downloading [MinimalBookshop.tdsx](#), or be adventurous and build the model yourself from [Bookshop.xlsx](#). Note that you can hide many of the ID fields once the tables are combined.

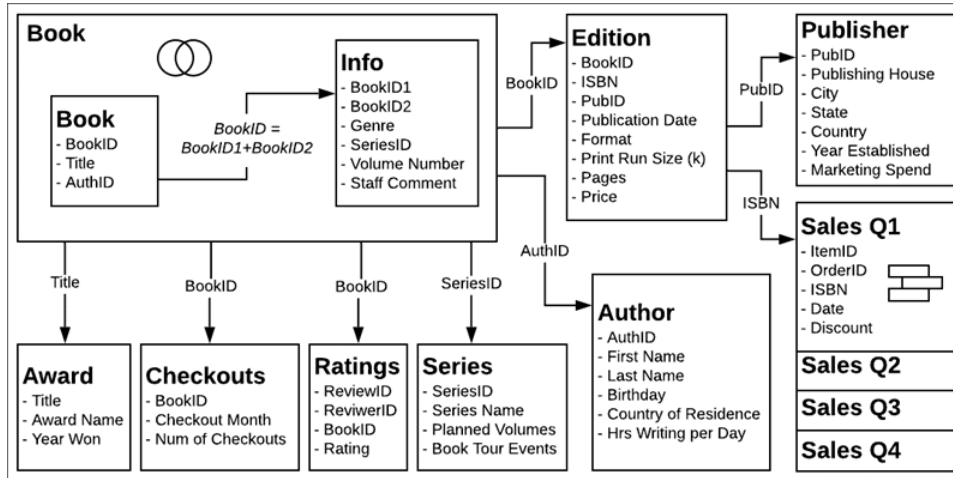

Video: Work with multiple tables

Note: The interface for editing relationships shown in this video differs slightly from the current release but has the same functionality.

Work with multiple tables video transcript

The Data Source page

Before we go to a sheet tab, notice that the data grid view, below, shows only the fields from one table at a time. If we click to another table, we'll see the data it contains. There is no overall view because related data is not brought together until it's used in an analysis. For now, the data remains in each table and is therefore displayed by table.

If we click on a table with an underlying join or union, we do see that merged data, with any nulls that may involve.

The Data pane

When we click onto a sheet, you may notice that the Data pane looks different than in previous versions of Tableau. Instead of the primary organization of dimensions and measures, it's now focused on tables. Each table has its own breakdown for dimensions and measures, indicated by this line. It's possible to still group by folders instead, if you choose.

Number of Records and Count

There is also no **Number of Records** field. This is because the concept of Number of Records has changed. There isn't a single Number of Records for the data source. Each table has a **Count** field, which can be thought of as a local Number of Records for that table.

To get a sense of the number of records for multiple tables at the same time, you can use Measure Names and Measure Values or multi-select the count fields and use Show Me to create a viz.

Video: Basic calculations

Basic calculations video transcript

There are a few calculations we can do to make this data set a bit friendlier. First, we can create a calculation for the full author name that brings together first name and last name. We'll create a calculation called **Author Name** that is simply first name, a space, and last name. Note that this calculation stays in the Author table because it uses fields only from that table.

```
[First Name] + " " + [Last Name]
```

When we make a sale, the sales amount is a combination of the price—fixed by the publisher and specific to the edition, or the ISBN—and any discount at the time of the sale. So the calculation **Sales Amount** will be price times one minus the discount. Note that we're using the ZN—or Zero Null—function to handle sales without discounts so we don't get nulls. This calculation goes to the shared area at the bottom of the Data pane as it uses fields from multiple tables. Aggregated calculations will also go to the bottom of the Data pane.

```
[Price] * (1-ZN([Discount]))
```

Video: Sets and groups

Sets and groups video transcript

We'll create a set for books to identify if they're in a series. In the Book table, right click on **Title** and select Create > Set. We'll name it **In a series**. On the **Condition** tab, choose **By field** with **Series Name, Count**, as ≥ 1 .

In the Edition table, the Format field is quite detailed, including specifying mass market and trade paperback. Sometimes that detail is useful, but sometimes we want to generalize between hardcover and paperback. Right click on **Format** field in the Data pane and select Create > Group. We'll name it **Cover**. Control-click to select everything except Hardcover and then click **Group**. The name of the group is automatically highlighted, and we can call it **Paperback**.

Like with the Author Name calculation, these items we just created are relevant within a single table and therefore stay within those tables in the Data pane.

Analyze related data

Let's do some comparisons of how analysis looks between relationships and joins. We recommend that you download the companion workbooks for [Question 1](#) and [Question 2](#) rather than continue with your own data source from above. If you identify issues with the data source configuration or steps for Question 1, note that they are intentional for the purposes of the scenario.

Question 1: How many editions are there for each book?

Important: The video for Question 1 was recorded on beta software. The released version of 2020.2 correctly handles our attempt to introduce an error in the related data source. If you follow along, your workbook will not match the video—the relationships values will be correct. Please bear with us while we attempt to outsmart our product and force an error for educational purposes.

We'll set this up by doing some basic analysis with both data sources. We'll build a bar chart with each one, looking at the number of editions by title.

Related

Using the related data source:

1. Bring Title to Rows
2. Bring Edition (Count) to Columns
3. Click the Label icon in the toolbar to turn on labels

Joined

Using the joined data source:

1. Bring Title to Rows
2. Bring ISBN to Columns
3. Right Click on the pill and select Measure > Count

4. Click the Sort Descending icon in the toolbar
4. Click the Label icon in the toolbar to turn on labels
5. Click the Sort Descending icon in the toolbar

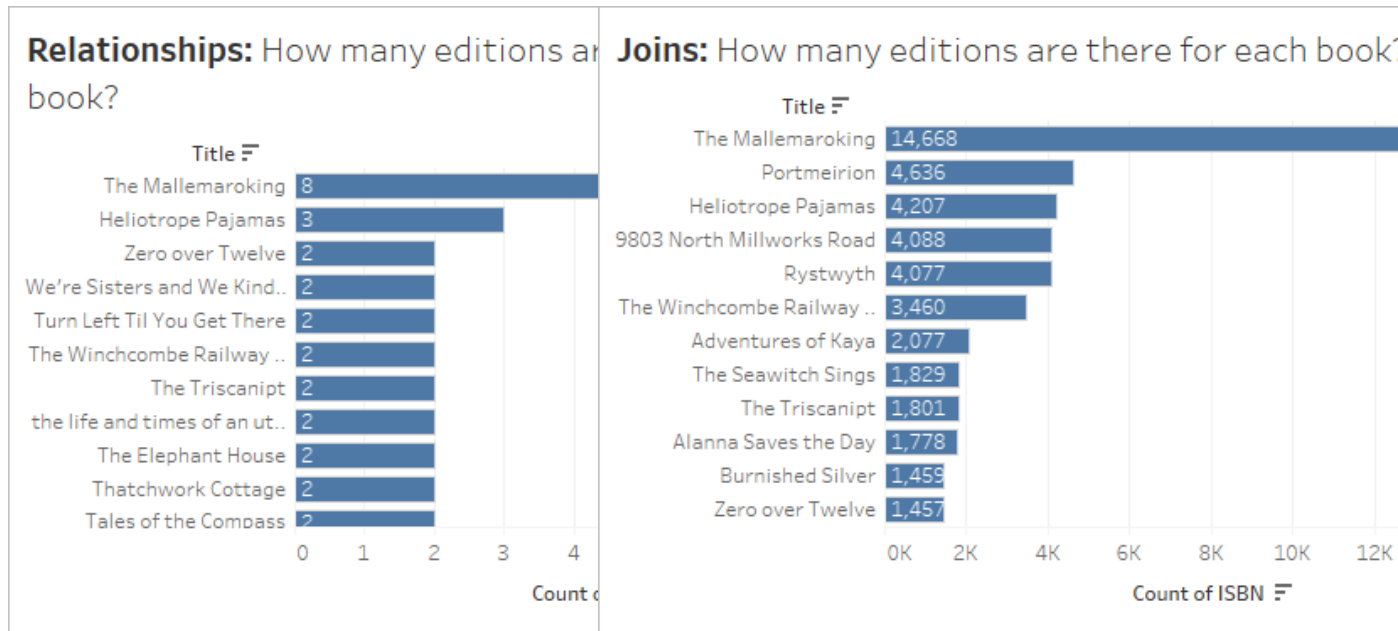

It's immediately clear that Count is not the right aggregation for the joined data. However, something isn't right with the related data, either. Let's view the data and see what's going on and how to fix it. Watch the video (or read its transcript) to see how.

Video: Data validation and fixing the data model

Question 1 video transcript

Joined

Here we're looking at our joined data. On the joined viz, we'll take a look at a mark's underlying data.

This view data dialog has two tabs, Summary and Full Data.

- There are tons of rows for the same book—this is likely duplicated because of all the joins.

To handle the duplication, we'll change the aggregation on the ISBN field in the view to Count Distinct. Remember that we'll need to think about this duplication in almost every analytic scenario and address it with the correct aggregation, filtering, or how we structure the viz.

Related

Let's take a look at the structure of our related data source, and we'll take a peek at what's going on with our join as well. On the related viz, we'll take a look at a mark's underlying data.

And we see that the view data dialog again has two tabs, but this time it's the Edition tab instead of Full Data. Every table used in the viz will have its own tab.

- There's a doubling of rows for this book—and we know that joins can cause duplication, and that the Book table in this data source is really the Book table joined with Info and Award.

We can create a viz with Title and Award Name and scroll down to investigate. And sure enough, The Mallemaroking has won two awards. It would be better to relate these tables than to join them.

We'll go back to the Data Source tab and remove the Awards table from the join and relate it instead. And now we don't have to worry about the duplication issue any more for this data source.

Question 2: For authors with books in a series, who is has the most book tour events?

Video: Work with different levels of details

Question 2 video transcript

Let's look at which authors we'll be working with. Using the related data source, we'll bring **Author Name** and **Series Name** to Rows.

Because related data sources pare down unmatched data in tables that only contain dimensions, we're focusing on the data that is relevant to us. We can see that there are seven authors, two of whom have written for two series. If you don't want to see only matched values, you can restore

those unmatched values (which is more like the legacy behavior) by going to the Analysis menu > Table Layout and checking Show Empty Rows.

Related

Using the related data source:

1. Bring the set **In a series** from the Book table to the filter shelf. The default is to filter only to members in the set.
2. Bring **Author Name** to Rows.
3. Bring **Book Tour Events** to Columns.

Joined

Using the joined data source:

1. Bring the set **In a series** to the filter shelf.
2. Bring **Author Name** to Rows.
3. Bring **Book Tour Events** to Columns.

Our numbers here look a bit off.

For the joined data, we know there's duplication because of the join, and we also know some authors span series. Because of this, we can't just change the aggregation to, say, MIN or MAX, because we lose information for authors with works in multiple series.

What we really want is the number of events per series, visualized by author. This is a classic case for Level of Detail (LOD) expressions. We'll create a calculation **Series Events**:

```
{FIXED [Series Name] : MIN ([Book Tour Events])}
```

Note that the MIN is to handle duplication of events for a single series.

Now if we bring this new field to Columns instead of the original events field, we'll get the correct values.

For the related data, we didn't need to do any of that. Relationships are smart enough to understand the native level of detail and the way the Author table relates through the Book and

Info tables through to the Series table, and to correctly join and aggregate the Events measure back to Author Name—all without having to write LOD calculations.

So don't be scared of relating your data. See for yourself! You can [download the Bookshop data](#) or use some of your own. Try filtering, using table calculations, building a variety of chart types, configuring performance options, and pushing relationships as far as you can.

Tips when working with related data

- [View Underlying Data on page 2001](#) often to verify what data a mark represents.
- If you aren't required to join—and there are [reasons](#) you may need to—using a relationship provides more flexibility.
- If you don't want to see only matched values, you can restore those unmatched values by going to the Analysis menu > Table Layout > Show Empty Rows.

Related resources

Ready to tackle calculations with Relationships? Check out [Don't Be Scared of Calculations in Relationships](#) below.

Ready to keep exploring how to do complex analysis with Relationships? Check out [Don't Be Scared of Deeper Relationships on page 730](#).

For more information on the technical underpinnings of relationships straight from the Product Management team, check out the series on relationships on the Tableau Blog.

- [Relationships, part 1: Introducing new data modeling in Tableau](#)
- [Relationships, part 2: Tips and tricks](#)
- [Relationships, part 3: Asking questions across multiple related tables](#)

Also see video podcasts on relationships from [Action Analytics](#), such as [Why did Tableau Invent Relationships?](#) Click "Video Podcast" in the [Library](#) to see more.

Don't Be Scared of Calculations in Relationships

Calculations can be intimidating. Calculations in a data source that uses relationships can seem more intimidating. But there's no reason to be scared of calculations in relationships.

Note: if you aren't yet comfortable with the principles behind data sources that use relationships, it might help to read [Don't Be Scared of Relationships on page 717](#) before diving into this topic.

Calculation types

A **row-level calculation** is something that is computed for each record in the data. For example, each sale transaction has a sales amount, the price, potentially adjusted by the discount percentage: `Price * (1 - ZN([Discount]))`. This is computed row-by-row for each transaction—the results can be thought of as adding a new column in the data source for Sales Amount.

There are also **aggregate calculations**. Aggregate calculations are computed at the level of detail of the visualization and their value depends on the structure of the view. Counts are an example of an aggregate calculation. The value of `Count([Title])` depends on whether we're looking at the count by format, author, or sales day.

See [our blog](#) for more information about types of calculations.

Table level of detail

Because each table in the Tableau data source can have its own level of detail, which table a calculation is associated with has a large impact. For example, historically in Tableau (pre 2020.2, before relationships), it was possible to count the number of records in the data source by creating a calculation with the constant value 1 and summing it. 1 was assigned to each row in the data source so the sum was equal to the number of rows.

Now, however, that calculation would have a value of 1. There is no global level of detail for the entire data source, and a constant calculation lives in the unassigned area at the bottom of the Data pane. It has its own level of detail. Summing 1 is simply 1.

As mentioned previously, calculations that have the same level of detail as a table—usually because they contain a field from the table—belong in that table in the Data pane. For example, the concatenation of First Name and Last Name to get the full name of each author (that is, `[First Name] + " " + [Last Name]`) is placed in the Author table.

However, if we were to use fields from multiple tables in one calculation, the calculation would go to the unassigned area at the bottom of the Data pane. This is called a cross-table row-level calculation; it requires a row-level join of the tables involved, which can impact performance. (Make sure the correct cardinality is set in the Performance Options of the relationship).

Assigning the level of detail

Because the level of detail of a table controls what a calculation's results represent, it's important to have calculations in the appropriate tables. A FIXED Level of Detail expression can be used to pull a calculation into a specific table. The field the expression is fixed to (the [dimension declaration](#)) determines the level of detail of the results.

Example: Author book tours

Q: How many book tour events is each author participating in?

A: This number should “belong” to each author, so it should go in the author table.

- **Author Book Tour Events** = {FIXED [Author Name] : SUM([Book Tour Events])}
- (This can be thought of in plain language as “for each author, total the number of book tour events associated with them”)

Q: How many authors are not doing any book tours?

A: It’s tempting to try a calculation like

- COUNTD(IF ISNULL([Book Tour Events]) THEN ([Author Name]) END).
- (This can be thought of in plain language as “if Book Tour Events is null, then return the author’s name. Count each unique author name”)

However, this is a cross-table row-level calculation because Book Tour Events is from the Series table and Author Name is from the Author table. And cross-table calculations like that use inner joins, which means when there’s no corresponding value from both tables, the row is dropped from the join results. Which in turn means we’re asking Tableau to count something that doesn’t exist. Note that if the two fields were in the same table, however, this would be a fine way to do it. There’s nothing wrong with the calculation as it stands other than the fact it doesn’t play well with the structure of the data source.

Instead, we need to indicate the presence or absence of book tour events for each author—and keep those results in the Author table. Once each author is flagged as “participating in a book tour” or not, we can count the number who aren’t doing book tours.

- **Book tour participant?** = IF {FIXED [Author Name] : COUNT([Book Tour Events])} = 0 THEN "No" ELSE "Yes" END
- (This can be thought of in plain language as “For each author, count the number of book tour events. If that count is zero, label the author ‘No’, otherwise label them ‘Yes’”. By naming the field “Book tour participant?” the no’s and yes’s will line up.)

Now we can count the number of Nos and answer the original question.

If our calculation is **Authors without book tours** = IF [Book tour participant?] = "No" THEN ([Author Name]) END, we’ll get a list of authors who aren’t doing book tours. (This can be thought of as “for every author where Book tour participant? is no, list the author’s name.”)

If our calculation is `COUNTD(IF [Book tour participant?]= "No" THEN ([Author Name]) END)`, we'll get a numeric answer that will live in the unassigned area at the bottom of the data pane. Why? Because this calculation is aggregated.

Bonus Question:

It's also possible to use the structure of the Book tour participant? calculation directly to return the list of author names. `IF {FIXED [Author Name]: COUNT([Book Tour Events])} = 0 THEN ([Author Name]) END`. Where would this calculation go in the Data Pane? Why? Try it in your own copy of Tableau Desktop, or [download this workbook](#) to see. (Requires Tableau Desktop 2020.2 or higher. Once in the workbooks, right click the calculation in the Data pane and select Edit to open the calculation editor and see an explanation in the calculation comments.)

Related resources

Feeling a bit overwhelmed and want to go back a step? Try [Don't Be Scared of Relationships on page 717](#).

Ready to keep exploring how to do complex analysis with Relationships? Check out [Don't Be Scared of Deeper Relationships](#) below.

For more information on the technical underpinnings of relationships straight from the Product Management team, check out the series on relationships on the Tableau Blog.

- [Relationships, part 1: Introducing new data modeling in Tableau](#)
- [Relationships, part 2: Tips and tricks](#)
- [Relationships, part 3: Asking questions across multiple related tables](#)

Also see video podcasts on relationships from [Action Analytics](#), such as [Why did Tableau Invent Relationships?](#) Click "Video Podcast" in the [Library](#) to see more.

Don't Be Scared of Deeper Relationships

Because of the nature of relationships, understanding where fields come from, their domain, and what nulls represent is more important than ever. Remember that anyone viewing the viz without access to the Data source page or the Data pane will be reliant on the title or other information presented by the author to interpret the viz correctly.

Note: if you aren't yet comfortable with the principles behind data sources that use relationships, it might help to read [Don't Be Scared of Relationships on page 717](#) before diving into this topic.

Why aren't all date fields equal?

It's important to remember that just because two field names contains the word "Date" doesn't mean the contents of those fields are identical. Let's look at an example that sticks with the level of Year. That is, we don't care about the values for months and days, we're only interested in what years the fields cover.

There are multiple fields in [The Bookshop data set on page 187](#) with a data type of Date.

- Birthday
- Publication Date
- Sales Date
- And Year Won and Year Established also contain date information, though they are numeric fields.
 - NB: If the icon in the data pane is green, this field is continuous. Right click on the field name in the Data pane and choose **Convert to Discrete**. The icon should turn blue. Do this for both "Year Won" and "Year Established" if necessary.

But the domain—the values in each field—vary. Bring each field in turn to the rows shelf and look at the number of marks in the bottom left corner, removing each field before bringing out the next.

- YEAR(Birthday) has 27 marks, meaning the domain contains 27 different years.
- YEAR([Publication Date]) has 15 marks, so its domain consists of 15 years.
- Year Won has 11 marks
- Year Established has four marks
- YEAR([Sales Date]) has one mark

This difference in domain is very important to keep in mind. If we related the Edition and Award table on YEAR([Publication Date]) to Year Won, we could wind up with analyses that use an inner join and are therefore trimmed down to just the years when an award was won—thus dropping all books from years without awards. (Note that this is not the same thing as filtering out books without awards. Non-award winning books that were published in the same year as an award-winning book will be preserved. All books from years with no awards will be dropped entirely. The filtering action from the join is at the level of year, not book.)

Example: Publication Date and Birthday

If we bring Publication Date to Columns and Birthday to Rows, we get a table of Abcs. You can [download the workbook](#) and explore this table on your own. (Requires Tableau Desktop 2020.2 or later.)

Year of Birthday	2178	2179	2180	2181	2182	2183	2184	2185	2186	2187	2188	2189	2190	2191	2192
2120										Abc	Abc		Abc		
2122								Abc							
2129		Abc			Abc	Abc				Abc	Abc			Abc	
2130						Abc		Abc							
2133				Abc	Abc		Abc	Abc							
2141				Abc					Abc	Abc	Abc				
2143														Abc	Abc
2145	Abc	Abc						Abc	Abc	Abc					
2146					Abc	Abc									
2147	Abc	Abc	Abc	Abc											
2148															Abc
2149	Abc	Abc	Abc				Abc	Abc						Abc	Abc
2150	Abc					Abc	Abc	Abc	Abc	Abc	Abc				Abc
2151		Abc			Abc									Abc	Abc
2153					Abc										
2154										Abc	Abc				
2155				Abc	Abc	Abc		Abc	Abc	Abc	Abc	Abc	Abc	Abc	
2156		Abc		Abc		Abc	Abc	Abc	Abc	Abc	Abc	Abc			Abc
2157														Abc	Abc
2160												Abc	Abc		
2161													Abc		
2163												Abc			
2169							Abc	Abc							

Abc is simply a placeholder because there is no data other than the years. Tableau has no values to make marks with, but the Abc shows where marks could go.

Notice that there is a lot of blank space in this table. There is no placeholder for the Publication year 2180 and the Birthday 2133. This means the author born in 2133 did not publish in the year 2180.

Sure. But why do we care?

Imagine you wanted to do some analysis over time. Are Hardcover sales increasing over time? You might imagine your graph as a timeline that filters Format to only Hardcover with Sales (Count) on Rows and date on Columns. But which date field? Publication Date? Birthday? Sales Date? These fields are well named and it's fairly obvious that if we have a question about sales we should use Sales Date. Not all data sets have clear names, though. If the fields were something like "Date1" and "Date3" it would be much harder to tell. Especially if the analytical question isn't clearly thought through.

What table a field comes from and what the domain of the field represents have a crucial impact on analysis.

By changing the date field, we can change the analysis entirely. Consider these two vizzes:

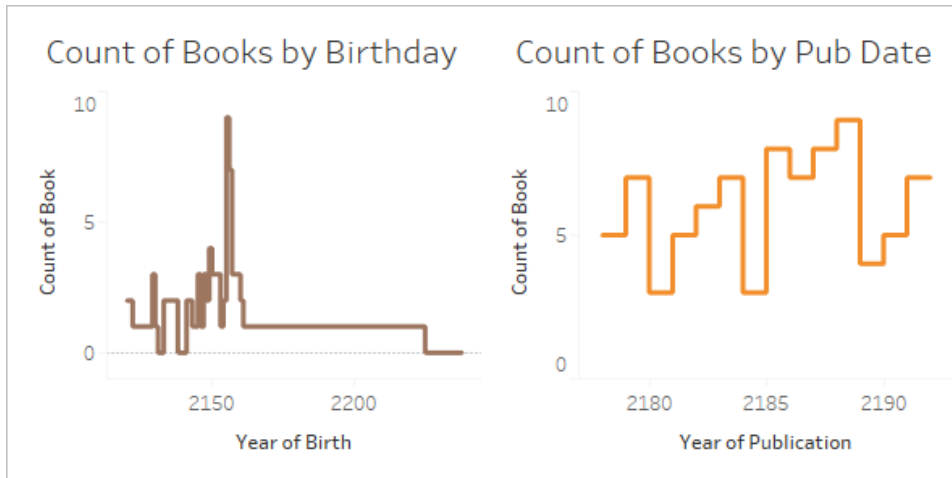

The first could be interpreted as “How many books were written by authors born in each year?”. It answers questions like “Have older authors written more books?” (No) or “Author(s) born in which year are the most prolific?” (2155).

The second could be interpreted as “How many books were published each year?”. It answers questions like “Which year had the most published books?” (2188) or “Is book publication steady over time?” (No).

It’s awkward to phrase the question for the viz that uses birthday because it’s an awkward combination of concepts. But Tableau doesn’t judge and will let you ask whatever question you like—whether you mean to or not. That’s a vital takeaway. If you bring out Date3 when you should have used Date1, Tableau will give you a viz. But not all date fields mean the same thing and it’s up to the author to know which field to use for the correct analysis.

For more information about the importance of what table a field comes from, check out [this blog post](#).

What does missing data mean?

There’s a difference between zero and null.

Zero means we measured and something isn’t there. We know the value and it is zero. If I have zero speeding tickets, I probably don’t speed much.

- NB: 0 and 1 are often used interchangeably with True/False, or other binomial values like Yes/No or Pass/Fail. In this case, zero is being used as a label, not a numeric value.

Null means we don’t know: we haven’t measured or we didn’t record the data. If my driving record is simply blank for speeding tickets, we have no idea if I speed or not.

Nulls can represent either missing data or nonexistent data.

- For my driving record, if the speeding tickets value is null, it’s conceivable that I could have a speeding ticket that wasn’t recorded. We should assume that data is missing.
- Nonexistent data could be recorded as N/A, but is often simply not recorded because we don’t need to track impossible things. How many speeding tickets did I get while riding a bus? That data likely won’t be present in the data set. In a matrix of “Modes of transportation” and “speeding tickets”, there are combinations that simply don’t make sense. We may assume that data is nonexistent.

When nulls carry meaning

It takes knowledge of the data to be able to recognize if a null is truly unknown (lack of information for number of speeding tickets) or if it represents nonexistent data (lack of information about speeding tickets as a bus passenger). Is the data trustworthy enough that a lack of information can be taken as nonexistent data rather than missing data? When subject matter expertise is applied, nulls can be meaningful.

Looking again at the table of Abcs, we can analyze the spaces without placeholders. We’ll assume this data is reliable and a null means the data is nonexistent rather than incomplete.

Year of Birthday	Publication Date														
	2178	2179	2180	2181	2182	2183	2184	2185	2186	2187	2188	2189	2190	2191	2192
2120										Abc	Abc		Abc		
2122								Abc							
2129		Abc			Abc	Abc				Abc	Abc				Abc
2130						Abc		Abc							
2133				Abc	Abc		Abc	Abc							
2141				Abc					Abc	Abc	Abc				
2143														Abc	Abc
2145	Abc	Abc						Abc	Abc	Abc					
2146					Abc	Abc									
2147	Abc	Abc	Abc	Abc											
2148		Abc													Abc
2149	Abc	Abc	Abc				Abc	Abc						Abc	Abc
2150	Abc					Abc		Abc	Abc	Abc	Abc				Abc
2151		Abc			Abc									Abc	Abc
2153					Abc										
2154									Abc	Abc					
2155				Abc	Abc	Abc		Abc	Abc	Abc	Abc	Abc	Abc		
2156		Abc		Abc		Abc	Abc		Abc	Abc	Abc	Abc			Abc
2157														Abc	Abc
2160												Abc	Abc		
2161													Abc		
2163											Abc				
2169								Abc	Abc						

The lack of a placeholder means an author was born that year (so the row exists), and a book was published that year (so the column exists), but the published book was not written by an author born in that year (so the cell is empty). We can meaningfully assign a label to that empty space: Nothing Published. We could even do analysis on those nulls—for example, for the dates present in the data, how many years went by for each author without publishing a book?

Note: There are also gaps in the domain of Birthdays. No authors were born in 2131 or 2132, so Year goes from 2130 to 2133 (the rows for 2131 and 2132 do not exist). These missing years can be interpreted as “no books in this data set had authors born in those years”. However, as pointed out above when talking about the domain of the date fields, the fact there are missing values in the domain is important information to consider when building relationships or choosing which field to use for a header or axis in a viz.

For more information about working with nulls in relationships, check out [this blog post](#).

Hands-on exercises

Write a title for each viz. Can you describe what is happening in plain language? [Download the workbook](#) to explore the live vizzes. (This workbook uses a slightly tweaked version of [The Bookshop data set on page 187](#) and uses only two tables. The date fields have been adjusted so they can be used as the related field.)

To read the matrix of vizzes:

- The bars show the number of editions (purple) and number of awards (green) per year.
- Each column has a different date field for the axis. The left-hand column is Publication Year from the Edition table, the center column is Year Won from the Award table, and the right-hand column is a calculated field that used publication date but if that field is null uses Year won (this calculation is used to ensure that both domains are fully represented).
- Each row is a different relationship for how the Award and Edition table are combined. The top row relates the tables on Book ID, the middle row relates them on Year, and the bottom row relates them on both Book ID and Year.
- The bars for the year 2183 are thicker to make comparison easier. In the solution below, that is the year whose values are looked at in detail.
- Note that the two vizzes that are shaded have identical values.

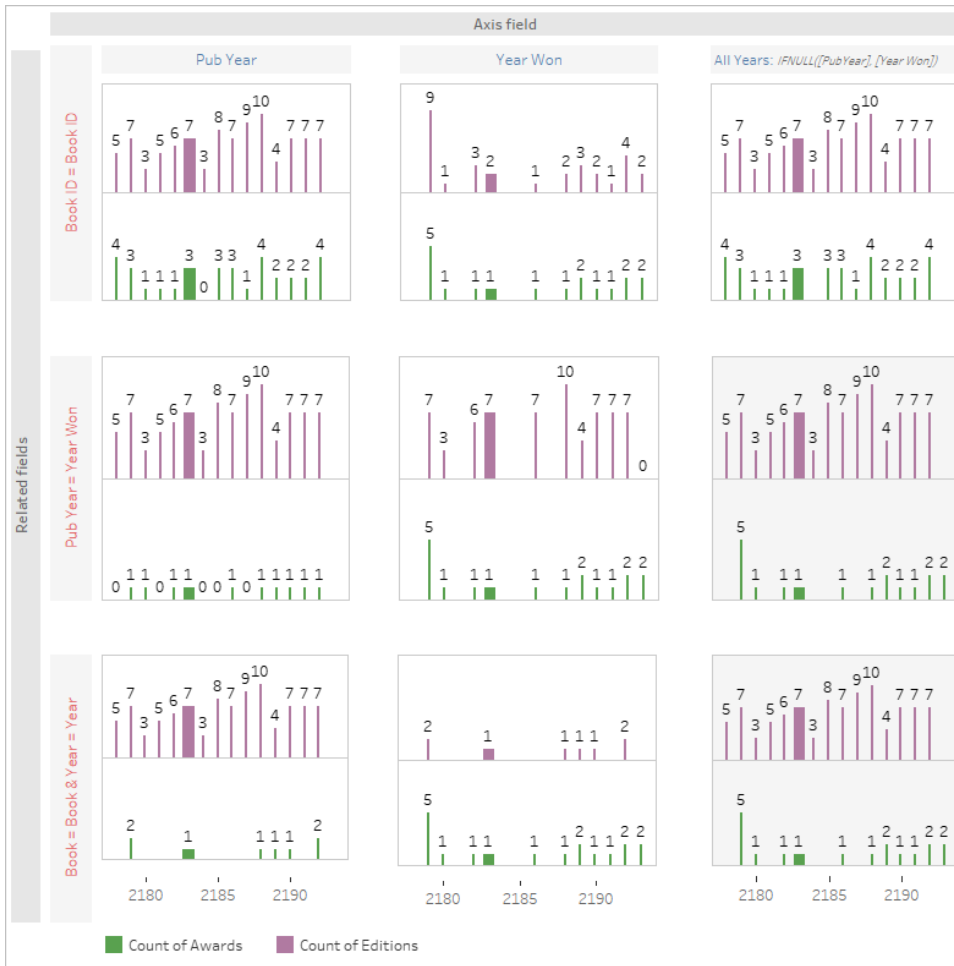

If you get stuck

Walk through each part of the viz step-by-step. Look at the data source structure, the axis and headers, and the fields used for the marks (and which tables they come from). Think about nulls and why they might be there. View the data for a specific mark or two to see which records it contains.

Tableau Desktop and Web Authoring Help

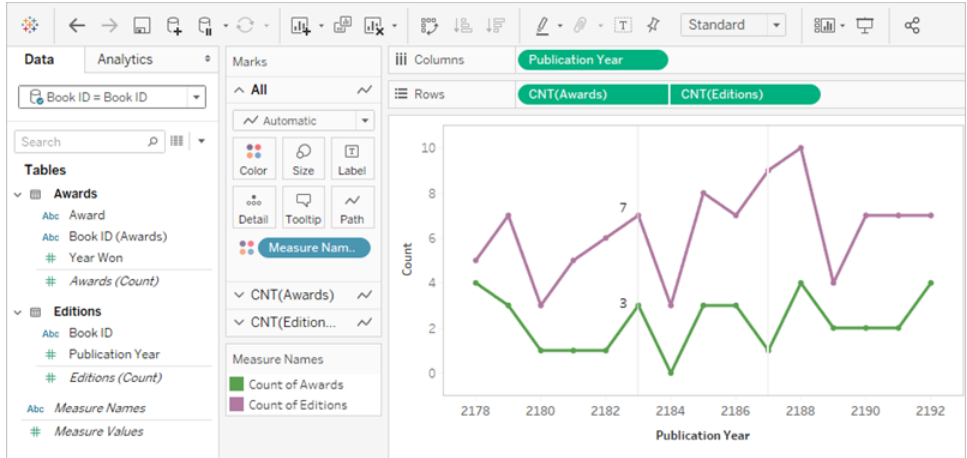

- The data source is Awards related to Editions on Book ID.
- The date axis is Publication Year
- The values are Count of Awards and Count of Editions.

Try to pick a single mark in the viz and define it. For the year 2183, the viz shows there are seven editions and three awards. Use [View Underlying Data on page 2001](#) to investigate which records are represented in each mark.

Editions

Publication Year	Book ID
2183	WG715
2183	DY800
2183	TM925
2183	QQ737
2183	IA439
2183	WO506
2183	DE571

Awards

Publication Year	Award	Book ID (Awards)	Year Won
2183	Nebula Award	TM925	2179
2183	Hugo Award	TM925	2179
2183	Pulitzer	WO506	2183

Together, this can be interpreted as “return the seven books published in 2183, then for those books, list any awards they won *regardless of when they won the award*”. TM925 was originally published in 2179 and the hardcover edition won two awards in that year. In 2183, a different edition of the book was published, perhaps in paperback. The value for Count of Award is tied to the book, not the year.

So the viz overall could be interpreted as “the number of editions published each year, and how many awards were won by books published in that year” or “the number of editions published each year and the number of awards won by those books”.

Solution to the hands-on exercise

The year 2183—the thicker bars—is the year focused on for interpretation. Information about editions is in purple and information about awards is in green. The year 2187 is also called out in the descriptions because it is a year when no awards were won but books were published. As such, it is a good illustration of the power of which date field is used for the axis. This nuance is addressed in blue in the description. The importance of the field(s) used to set up the relationship is called out in pink.

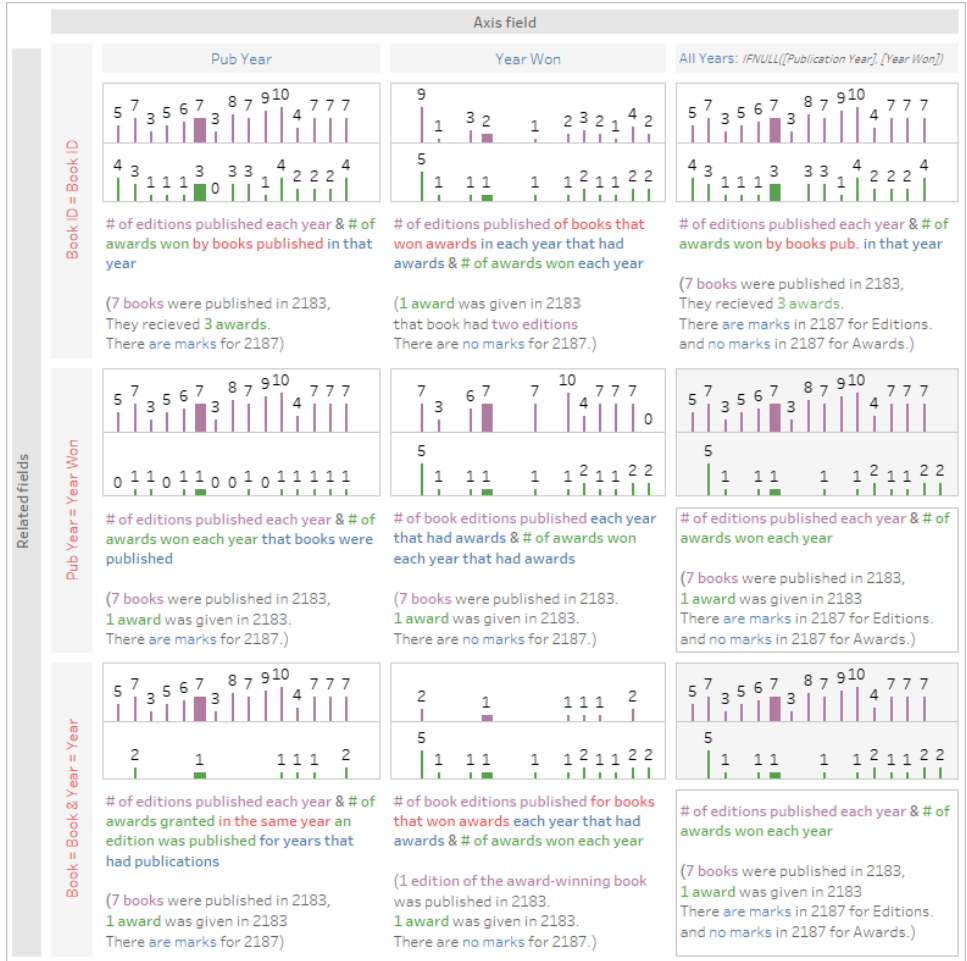

This visual is provided for your convenience, but a better experience may be to [download the workbook](#) and open it in Tableau Desktop 2020.2 or later so you can make use of interactivity such as tooltips and View Data. If you prefer to look at the sheets more closely, you can right click on either dashboard tab at the bottom and choose Unhide all Sheets. This will make all the individual vizs available, and from each sheet you can see the Data pane and the authoring environment, including which fields are on which shelves. Note that in order to achieve the three different relationships (the rows of the matrix above), there are three different data sources.

Related resources

- Feeling a bit overwhelmed and want to go back a step? Try [Don't Be Scared of Relationships on page 717](#).
- Ready to tackle calculations with Relationships? Check out [Don't Be Scared of Calculations in Relationships on page 727](#).

For more information on the technical underpinnings of relationships straight from the Product Management team, check out the series on relationships on the Tableau Blog.

- [Relationships, part 1: Introducing new data modeling in Tableau](#)
- [Relationships, part 2: Tips and tricks](#)
- [Relationships, part 3: Asking questions across multiple related tables](#)

Also see video podcasts on relationships from [Action Analytics](#), such as [Why did Tableau Invent Relationships?](#) Click "Video Podcast" in the [Library](#) to see more.

About Multi-fact Relationship Data Models

Multi-fact relationships let you build data sources with more than one *base table*. Using multiple base tables in your data model allows you to perform multi-fact analysis in Tableau.

By establishing *trees* of tables, rooted in a base table, you can model data structures with different conceptual domains and use their shared characteristics to connect them. This type of analysis is often referred to as multi-fact analysis, conformed dimensions, or shared dimensions. In Tableau, we call this a multi-fact relationship data model because you use relationships to build it. A multi-fact relationship data model always contains multiple base tables. Base tables are the left-most tables in the data model. For guidance on how to determine which tables to use as base tables, see [When to Use a Multi-fact Relationship Model on page 764](#).

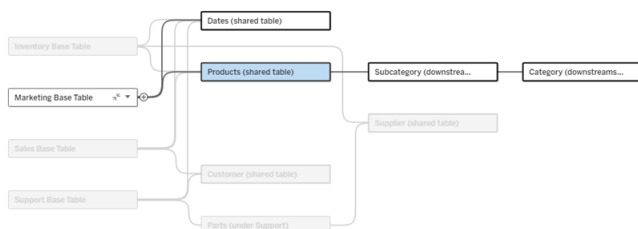

A multiple base table data model with one base table's tree highlighted.

Levels of relatedness

Data models with multiple base tables have a lot of flexibility to how pieces of data can relate—or not relate—to each other.

Note: Relatedness at any level is only relevant in data models with multiple base tables. Prior to multi-fact relationship data models, either everything was related (within a single data source) or nothing was (blending across multiple data sources).

Relatedness in the data model

Tables are related, unrelated, or shared based on the structure of the data model. In a data source, the relatedness of tables is a constant. As a brief overview:

- *Related tables* are in the same tree.
 - Prior to 2024.2, all data sources were single base table data sources consisting of a single tree, and in a single base table data source all tables are related.
- *Unrelated tables* are in different trees. Base tables are always unrelated to each other. Tables that are downstream of exactly one base table are also unrelated to tables in other trees.
- *Shared tables* have multiple incoming relationships and belong to more than one tree.
 - Tables downstream from a table with multiple incoming relationships are also considered shared.

Relatedness during analysis

Fields can be related, unrelated, not yet related, ambiguously related, or they can act as stitching fields. The relatedness among a group of fields is determined on a sheet-by-sheet basis based on the structure of the data model, what fields are actively in use (that is, on the shelves as pills), and if those fields are dimensions or measures.

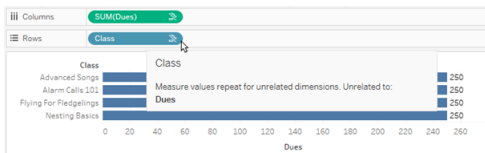

To make a visualization with fields from multiple tables, Tableau has to perform joins behind the scenes to compute the values. The type of join used depends on the **relatedness of the fields**. As a brief overview:

- When *related fields* are used in a viz, dimensions are inner joined and measure values are broken down by the dimensions.
 - It's a little more complicated than that—additional joins might be needed behind the scenes to ensure that **no measure values are dropped**. But in a dimension-only viz, related dimensions are inner joined and that's the main concept here.
 - This is the same behavior as single-base table models.
- When *unrelated fields* are used in a viz, dimensions are cross joined. Measure values are table scoped (that is, aggregated locally to a single value for their entire table) and repeated.

- It's also possible for fields to be *not yet related* or *ambiguously* related, which means that for the combination of active fields, there is more than one way for the relationships between their tables to be resolved. If Tableau encounters uncertainty, it treats the fields as unrelated.
- When fields are *stitched* based on a shared field, dimensions are outer joined. Measure values are aggregated at the level of whatever dimension they can be broken down by and might be repeated.
 - *Stitching dimensions* are similar to [linking fields in data blending](#). Results are calculated for each pair of related fields, then the unrelated values are stitched together across the shared values of the dimension shared between them.

All of these concepts and definitions are discussed in more detail later in this topic.

An aside on dimensions and measures

In Tableau, *measures* are *aggregations*—they're aggregated up to the *granularity* set by the *dimensions* in the view. The value of a measure therefore depends on the context of the dimensions. For example, "number of cereal boxes" depends on if we mean the total inventory or the number of boxes per brand.

Dimensions are usually categorical fields, such as country or brand. In Tableau, dimensions set the granularity, or the *level of detail*, of the view. We typically want to group our data into marks by some combination of categories. What dimensions we use to build the view determines how many marks we have.

When a measure is used without dimensions, it's said to be *table scoped*. This means its value is the fully aggregated value for the entire table. As soon as we use a dimension such as brand in the viz, the measure is broken down more granularly. The total number of cereal boxes is now per brand.

Aggregation refers to how the data is combined. Tableau's default aggregation is SUM. You can change the aggregation to other options, including: average, median, count distinct, minimum, and so on. *Granularity* refers to how detailed or broken down the measure is—which is controlled by the dimensions. Unless the granularity of the measure is row level (aka disaggregated), its value must be aggregated.

Example

Raw data			
	Mini	Normal	ValuePak
Bran Flakes		3	2
Cheerios	10	8	3
Froot Loops		5	
Grape Nuts		3	
Lucky Charms	4		16

What's the value of "number of boxes of cereal?"

Well, it depends on the aggregation type and the granularity as set by the dimensions.

- Aggregations:
 - Sum (or total)
 - Average
- Granularity:
 - Table scoped / fully aggregated (the blue bars in the example)
 - Broken down by the **Brand** dimension (the colored bars in the example)

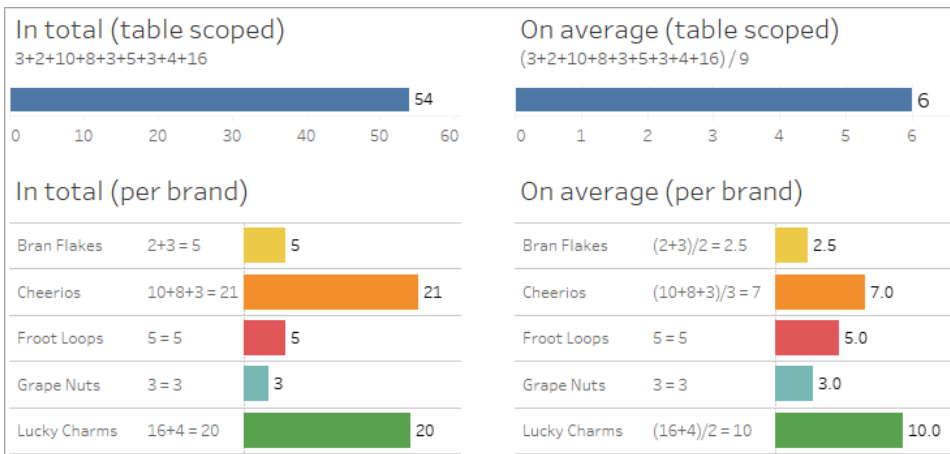

Field-level relatedness indicators

There are several visual clues that can help you understand the degree of relatedness for fields you're using in an analysis.

Relatedness indicators on a worksheet

- **Unrelated icon:** Tableau uses an unrelated icon ∞ to indicate not everything in the view is related. If you see an unrelated icon on a pill in the view or in the Data pane, you can hover

over the icon [to get more information](#).

- The related icon  indicates that field is stitching together unrelated fields.
- **Light gray field names:** Field names are displayed in light gray text in the Data pane when they're not related to *any* fields in use on shelves. You can still use these fields for analysis in that viz, but unrelated fields are **evaluated differently** in analysis than fields that are related. On hover, these fields also display an unrelated icon.

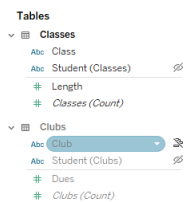

Note: In previous versions of Tableau, light gray field names indicated that the fields were hidden and **Show hidden fields** was selected. Hidden fields, when shown, are now indicated with a clickable eye icon .

Relatedness warning dialog

When unrelated fields are used together in a viz, Tableau shows a warning dialog to let you know that the fields aren't related. This warning appears each time you add an unrelated field to prevent accidental cross joins that might impact performance.

- If you want to use unrelated fields without stitching, click **Add** to continue adding the field to the viz.
- If you want to stitch unrelated fields, a best practice is to bring out the stitching field before an otherwise unrelated field. The dialog won't show if the stitching field is already in use. See [How joins are used for each level of relatedness on page 753](#) for more information about how stitching prevents cross joins.

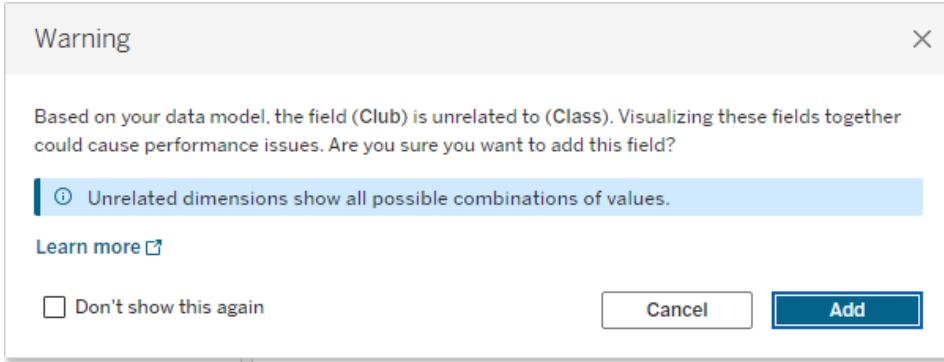

When multiple fields are being added or are already present in the view, the **Details** area appears in the dialog. Expand it to see more information about the relatedness of all the fields in use and identify where the unrelatedness issue is coming from.

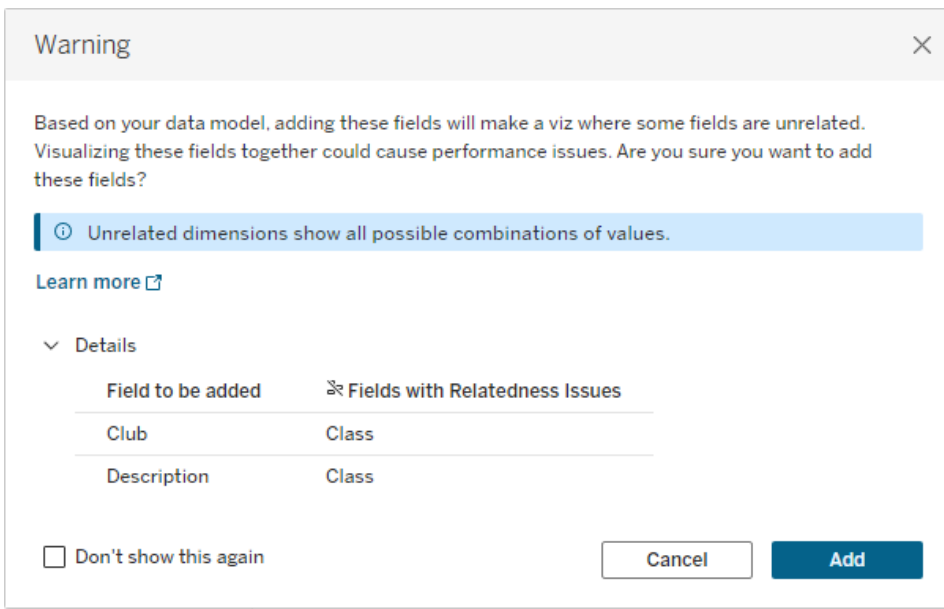

To stop the warning message from appearing at all, select the option **Don't show this again**. You can always re-enable these warning messages again by turning them back on:

- In Tableau Desktop, open the **Help** menu > **Settings and Performance** > **Reset Ignored Messages**.
- In a browser, clear your cached data. For example in Chrome, open the **3 dots menu** > **Delete Browsing Data...** > Choose **"Cached images and files"** > **Delete data**.

Table-level relatedness in the data model

In a data model with multiple base tables, each base table defines a set of tables that are related and form a conceptual *tree*. These trees must be connected by at least one shared table to ensure the overall data source is a single entity.

What might previously have been two data sources that could be blended using linking fields can now be a single data source with two trees, connected by the shared tables that contain those common fields.

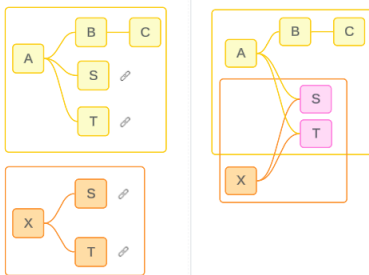

Tip:How tables are related in the data model impacts how their fields can be related in the analysis. It can be useful to refer back to the Data Source tab during analysis to see how a table fits into the overall data model.

Let's walk through what tables are related, unrelated, or shared using this example data source. There are two trees, one established by base Table A and one by base Table B.

Unrelated tables

Base tables are fundamentally unrelated. Similarly, any tables that exist solely in a single tree are unrelated to tables in other trees.

Table A and Table X are unrelated

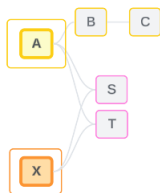
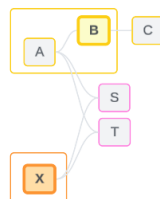

Table B and Table X are unrelated



Related tables

Tables in the same tree are considered related.

Table A and Table S are related

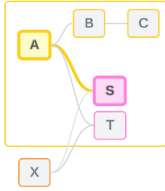
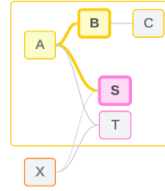

Table B and Table S are related (through Table A)



Shared tables

Shared tables have multiple incoming relationships. These tables belong to multiple trees and are shared across them.

Table S and Table T are shared.

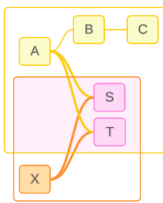

Field-level relatedness in the analysis

Relatedness between fields is determined on a sheet-by-sheet basis based on the structure of the data model, what fields are actively in use (that is, what fields are in the viz as pills on shelves), and if those fields are dimensions or measures. How field relatedness impact the results of a viz is covered in [the next section](#).

Let's walk through some scenarios using the same example data source. Each field's name indicates which table it is from, such as FieldB from Table B. Fields can be dimensions or measures unless otherwise noted.

Related fields

At a high level, fields are related when Tableau can clearly determine how to evaluate them together based on a relationship path within a single tree.

For example, FieldB (from Table B) and FieldS (from Table S) are related.

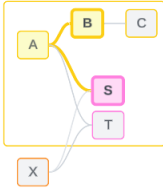

Unrelated fields

At a high level, fields are unrelated in any case when they're not related. This could be because the fields are from unrelated tables, such as using fields from two base tables. In this case, fields from different base tables are fundamentally unrelated.

For example, FieldA and FieldX are unrelated.

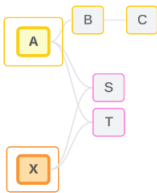

Or fields can be treated as unrelated for a point in time—such as in ambiguous or not yet related cases. For the most part, you can rely on **relatedness indicators** to alert you when fields are unrelated in the context of a viz.

Stitching dimension

Stitching is how Tableau evaluates fields from unrelated tables in a multi-fact data model during analysis. In a viz, using a dimension from a shared table stitches together otherwise unrelated fields and allows them to be evaluated simultaneously in the same viz. Think of this as juxtaposing results from two trees together based on a dimension they share.

For example, if a viz is built with FieldA and FieldX, these two fields are unrelated. Adding DimensionS introduces a stitching field.

- FieldA and DimensionS are evaluated together.
- FieldX and DimensionS are evaluated together.
- Those intermediate results are brought together based on the values of DimensionS.
- FieldA and FieldX are now stitched.

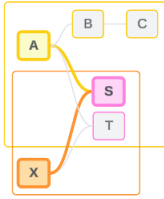

Tip: A best practice is to use a stitching field in the viz before bringing out an unrelated field. For example, drag out DimensionS first, or FieldA then DimensionS then FieldX, instead of FieldA then FieldX then DimensionS. Adding the stitching field first ensures that Tableau is always aware of how to evaluate the relationships and avoids potential performance issues from evaluating unrelated dimensions together with cross joins.

Stitching requires a dimension from a shared table to be active in the viz. Fields placed on the Filters shelf or on the Tooltip property of the Marks card aren't considered active for the purposes of stitching.

Not yet related fields

Fields can also have multiple ways they could be related but aren't yet. This happens when there's more than one possible relationship between two shared tables (or downstream shared tables).

Consider FieldS and FieldT. Their tables are related to each other both through the tree defined by base Table A and through the tree defined by base Table X.

In a viz with just FieldS and FieldT, there's no information about which tree should be used to relate them. Without additional information Tableau can't evaluate whether to relate these fields through Base Table A's tree or Base Table B's tree.

FieldS and FieldT are treated as unrelated although there are multiple potential relationships.

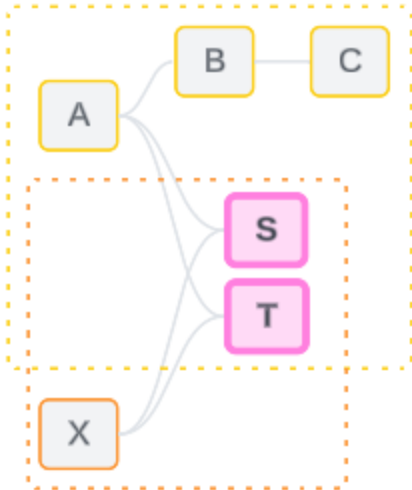

These could-be-but-aren't-yet-related fields are evaluated as unrelated because Tableau can't clearly determine their relationship path. Unlike truly unrelated fields which can only be stitched, not yet related fields can be resolved and the fields can be directly related.

Ambiguously related fields

Fields can also be ambiguously related. This happens when there is more than one active possible relationship between shared tables (or downstream shared tables). Unlike not yet related fields, which can be thought of as hypo-related or under related, ambiguously related fields are hyper-related or over related.

Consider FieldS and FieldT. Their tables are related to each other both through the tree defined by base Table A and through the tree defined by base Table X.

In a viz with FieldA, Field X, FieldS, and FieldT, there's too much information to decide which tree should be used to relate them. Without trimming the information, Tableau can't evaluate whether to relate these fields through Base Table A's tree or Base Table B's tree.

FieldS and FieldT are treated as unrelated although there are multiple active relationships.

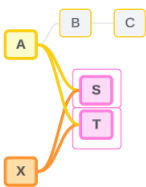

These ambiguously related fields are evaluated as unrelated because Tableau can't clearly determine their relationship path. Unlike truly unrelated fields which can only be stitched, ambiguously related fields can be resolved and the fields can be directly related.

Measure from a shared table

When a dimension is used from a shared table, it stitches together fields from its unrelated upstream tables. Measure can't stitch, however, and the value of a measure depends on its related dimensions.

In a viz with DimensionA and DimensionX, these two dimensions are unrelated. If MeasureS is brought out from Table S, it is unrelated to the combination DimensionA and DimensionX together. Although it could be related to either one independently, it can't be simultaneously related to both of them in the same viz.

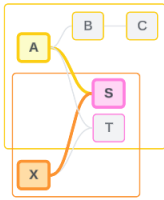

A shared measure can be considered a type of ambiguity or over relatedness and is resolved the same way.

Resolve unclear relationships between fields

Whenever there is uncertainty about how to relate fields, Tableau won't make an arbitrary decision and instead treats them as unrelated. It's often better to relate these fields by clarifying the uncertainty around which tree to use.

Resolving not yet related fields is done by adding a field to establish which tree to use. Resolving ambiguously related fields is done by removing fields to establish which tree to use.

Example:

Resolving not yet related: add a field

- In a viz of FieldS and FieldT, adding a field from Table A, B, or C to the viz makes Base Table A's tree active and resolves the desired path between FieldS and FieldT.
- Alternatively, using a field from Table X resolves the desired path between FieldS and FieldT to Base Table X's tree.

Resolving ambiguously related: remove a field or fields

- In a viz of FieldA, FieldX, FieldS, and FieldT, removing FieldX makes only Base Table A's tree active and resolves the desired path between FieldS and FieldT.

- Alternatively, removing FieldA resolves the desired path between FieldS and FieldT through Base Table X's tree.

Resolving a shared measure: remove a field or fields

- In a viz of DimensionA, DimensionX, and MeasureS, removing DimensionX makes only Base Table A's tree active and resolves the desired path between DimensionA and MeasureS.
- Alternatively, removing DimensionA resolves the desired path between DimensionX and MeasureS through Base Table X's tree.

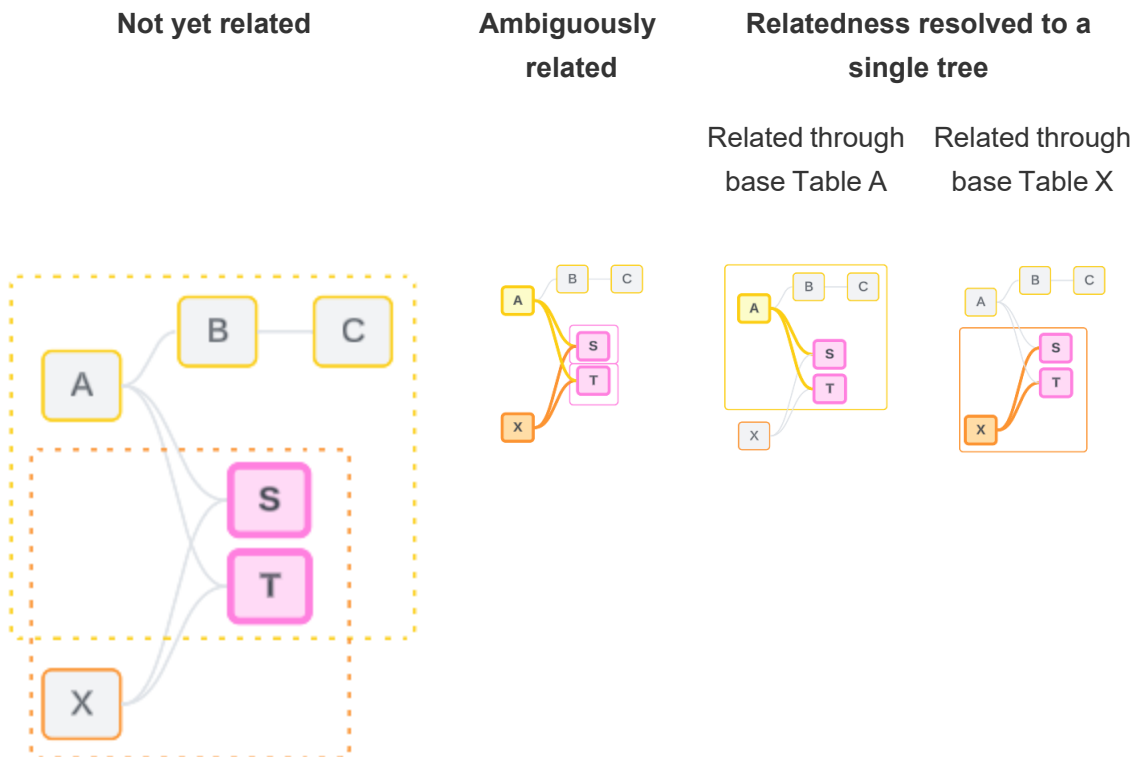

Resolving uncertainty is similar to using a FIXED Level of Detail (LOD) expression. In a FIXED LOD expression, you tell Tableau what level of detail to aggregate to by defining the dimension declaration. Uncertainty is resolved by changing the structure of the viz to make only one tree active, thus telling Tableau what relationship paths it can consider to perform the analysis.

Stitching vs resolving uncertainty

Both stitching and resolving uncertainty are ways of dealing with unrelatedness, but they have different outcomes:

Stitching

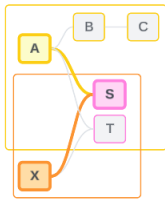

Unrelated FieldA and FieldX stitched by DimensionS

Juxtaposes unrelated fields based on shared attributes

Uses multiple base table logic to calculate results

Analysis involves unrelated tables

Resolving uncertainty

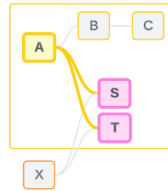

FieldS and FieldT evaluated through the tree defined by base Table A

Narrows down which relationship path to use when there are multiple options (ambiguity or a shared measure), or establishes a relationship path when there wasn't one (not yet related).

Uses single base table logic to calculate results

Analysis involves shared tables

How joins are used for each level of relatedness

After the field-level relatedness has been determined, Tableau has to evaluate the results to create the actual visualization. The queries used to calculate the values shown in a viz rely on joins. Whether fields are related, unrelated, or stitched has a different impact on what joins are performed. Remember, ambiguously related and not yet related fields are treated as unrelated in this context.

To explain relatedness and joins, this section covers tables and their fields, plus the values in those fields. Consider the following data model with two base tables, Classes and Clubs, and a shared table, Students.

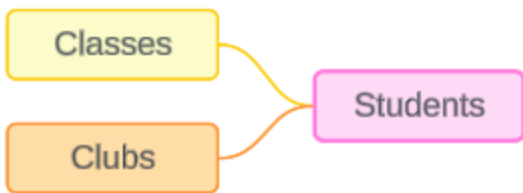

Classes

Clubs

Students

Classes 7 rows 3 fields		Clubs 7 rows 3 fields		Students 5 rows 3 fields		
Class	Student ...	Club	Student ...	Bus Rider	Student	# Students Age
Nesting Basics	Robin	Photography	Finch	yes	Finch	3
Advanced Songs	Sparrow	Travel	Cardinal	yes	Cardinal	4
Flying For Fledgelings	Robin	Juggling	Sparrow	no	Sparrow	6
Nesting Basics	Sparrow	Art	Finch	yes	Robin	3
Advanced Songs	Finch	Art	Cardinal	no	Jay	8
Nesting Basics	Finch	Art	Sparrow	10		
Alarm Calls 101	<i>Null</i>	First Aid	Robin	0		

Fields:

- **Class**, a dimension with values of Nesting Basics, Advanced Songs, Flying for Fledglings, and Alarm Calls 101
- **Length**, a measure
- **Student**, a dimension used to relate to the Student table

Fields:

- **Club**, a dimension with values of Photography, Travel, Juggling, Art, and First Aid
- **Dues**, a measure
- **Student**, a dimension used to relate to the Student table

Fields:

- **Bus Rider**, a dimension with values of yes or no
- **Student**, a dimension with values of Finch, Cardinal, Sparrow, Robin, and Jay. Used to relate to the other two tables
- **Age**, a measure

This very simple model illustrates how the high-level join logic is calculated for multi-fact relationship data models. For more information about the basics of joins used in single base table data models built on relationships, see [How Analysis Works for Multi-table Data Sources that Use Relationships](#).

Should this example be a data model with multiple base tables?

For this three table data model, it might be tempting to set it up as a single base table model, as Classes-Students-Clubs or Clubs-Students-Classes, or with Students as a base table. As a rule, multi-fact relationship data models are intended for specific kinds of data schemas or analysis scenarios. If your data model **has characteristics that are best suited to a multi-fact relationship data model**, set it up that way to keep your base tables conceptually unrelated. However, if your data doesn't require this type of structure, a single base table model can be simpler to use.

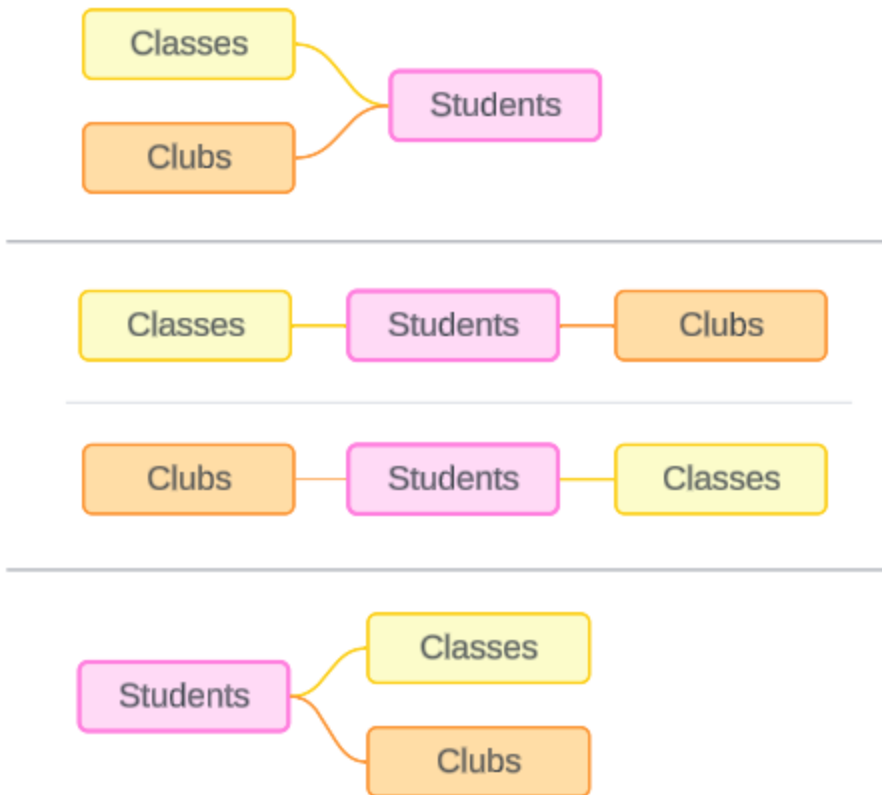

Models that could be built for these three tables: (1) Classes and Clubs as base tables with Students as a shared table, (2) linearly, starting with either Classes or Clubs, and (3) Students as a single base table with Classes and Clubs as downstream tables.

In this particular instance, there's nothing about these tables, the data, or the model that truly requires multiple base tables. We're using this model as an example to keep it simple so the focus can be on the join logic. Or you could imagine that there's another related table, Rooms, that we're simply ignoring to avoid over complicating the discussion.



As a best practice, however, only use a multi-fact relationship model when your data requires it.

Related dimensions use inner joins

Related dimensions are inner joined. Inner joins drop any dimension values that aren't shared across both tables.

- Tableau uses additional logic to ensure measure values aren't lost. This section uses only dimensions to demonstrate the basics of how Tableau applies inner joins to related dimensions.

The following example shows how related dimensions only return rows that are present in the data. No students are in the Alarm Calls 101 class, so it's not present in the results. Cardinal and Jay aren't in any classes, so they're not present in the results.

Inner Join: Classes-Students (related)

Student	Class	
Finch	Advanced Songs	■
	Nesting Basics	■
Robin	Flying For Fledgelings	■
	Nesting Basics	■
Sparrow	Advanced Songs	■
	Nesting Basics	■

Student

- Finch
- Robin
- Sparrow

Unrelated dimensions use cross joins

Unrelated dimensions—on their own, without a stitching dimension—are cross joined.

In a cross join, every value from one dimension is combined with every value from the other dimension, even if a resulting combination doesn't actually exist in the data. In this example, the cross join adds a row for each possible combination of Class and Club.

The screenshot shows the Tableau Desktop interface. On the left, there are shelves for Pages, Filters, and Marks. The Marks shelf is set to 'Automatic' and includes Color, Size, and Text. The main view displays a table titled 'Cross Join: Classes-Clubs (unrelated)'. The table has three columns: 'Class', 'Club', and an unlabeled column. The data is as follows:

Class	Club	
Advanced Songs	Art	Abc
	First Aid	Abc
	Juggling	Abc
	Photography	Abc
Alarm Calls 101	Art	Abc
	First Aid	Abc
	Juggling	Abc
	Photography	Abc
Flying For Fledgelings	Art	Abc
	First Aid	Abc
	Juggling	Abc
	Photography	Abc
Nesting Basics	Art	Abc
	First Aid	Abc
	Juggling	Abc
	Photography	Abc
	Travel	Abc

It's important to recognize when a cross join is occurring in your analysis. Although there's a row for Advanced Songs + First Aid in the results table for the cross join, no students are actually in this combination of activities (we'll see proof of this in the stitching example in the next section).

Why is it important to recognize that not all cross join results are based in the data? Imagine you were trying to build a schedule for classes and clubs so there were no conflicts for any students. There aren't any students in Advanced Songs and First Aid, so you could ignore this result and schedule that class and club simultaneously. The cross join doesn't represent combinations of values that actually exist in the data.

Additionally, cross joins when there is high cardinality (a large number of unique values) can impact performance. Imagine cross joining every phone number with every email address in your contacts. That would be a huge explosion of combinations and a potentially costly operation.

Stitched dimensions use outer joins

Unrelated dimensions—in the presence of a stitching dimension—are outer joined.

In this example, both the Classes table and Clubs table are related to the shared Students table but not to each other, so the fields Class and Club are unrelated. Adding the Student dimension

lets Tableau know which values from Class and which values from Club should be juxtaposed in the analysis. We call this outer join behavior *stitching*.

Student	Class	Club	
Cardinal	Null	Art	■
		Travel	■
Finch	Advanced Songs	Art	■
		Photography	■
	Nesting Basics	Art	■
Robin	Flying For Fledgelings	First Aid	■
	Nesting Basics	First Aid	■
Sparrow	Advanced Songs	Art	■
		Juggling	■
	Nesting Basics	Art	■
		Juggling	■

Stitching is similar to data blending in that there are intermediate results that are brought back together for the overall results. Unlike blending, however, stitching is an outer join, not a left join, and doesn't drop values from either side. There's no concept of primary or secondary data sources when it's all one data source, so both of the unrelated fields are given equal precedence.

Intermediate results are outer joined

What goes into the outer join for stitched fields? An immediate inner join is computed for each of the unrelated fields and the stitching field in turn, then those intermediate results are outer joined based on the values of the stitching dimension.

Example

An inner join for Student and Class...

Tableau Desktop and Web Authoring Help

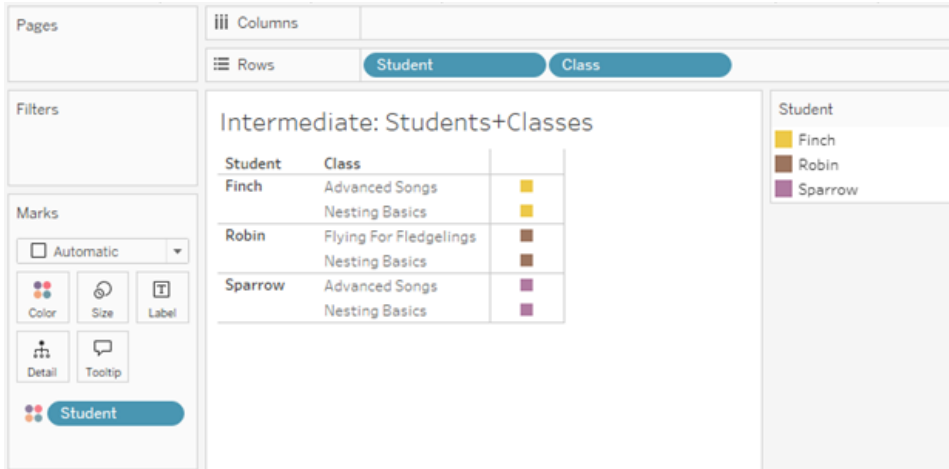

...and an inner join for Student and Club...

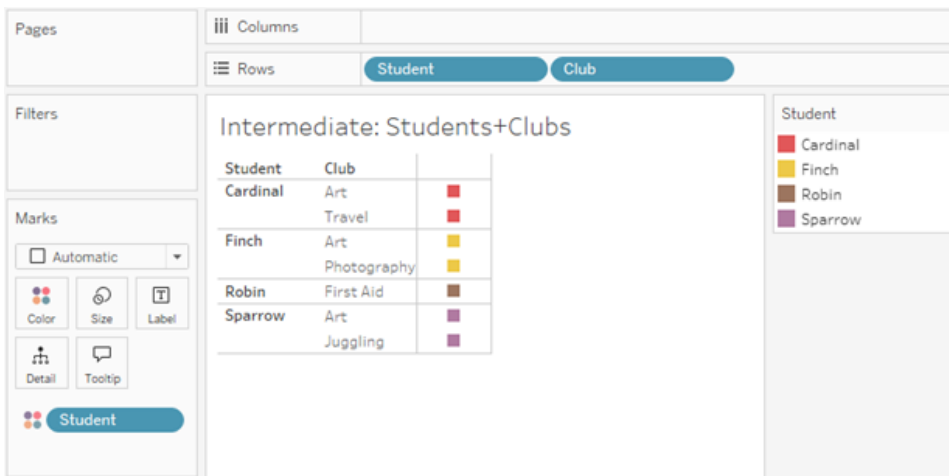

...are then outer joined on Student.

Outer Join: Students-Classes-Clubs (stitched)

Student	Class	Club	
Cardinal	Null	Art	■
		Travel	■
Finch	Advanced Songs	Art	■
		Photography	■
	Nesting Basics	Art	■
		Photography	■
Robin	Flying For Fledgelings	First Aid	■
	Nesting Basics	First Aid	■
Sparrow	Advanced Songs	Art	■
		Juggling	■
	Nesting Basics	Art	■
		Juggling	■

Additional joins to retain measures

In addition to the join logic for dimensions, measures can introduce additional joins. When relationships were first introduced in Tableau, one of the **core principles was that measure values aren't lost**. This is also maintained in multi-fact relationship data models.

The essential details are:

- Measure values are broken down only by related dimensions.
- Measure values repeat for unrelated dimensions.
- Dimension values that would be dropped in dimension-only vizs may be returned if there are relevant measure values associated with them.

Note: Remember that measures are aggregations—they're computed at the level of detail (the granularity) set by the combination of dimensions in the viz. This is referred to as a measure being *broken down* by a dimension. When a measure is used without any dimensions, it is said to be *table scoped*. This means the measure's value is the fully aggregated value. As soon as we use a dimension in the viz, the measure is broken down more granularly based on the dimension values. The value of a measure in an analysis therefore depends on the context of the dimensions.

Related measures

Consider the subset of dimension values that are returned for an inner join on the related dimensions **Student** and **Class**. There are three student values, Finch, Robin, and Sparrow; and three class values, Advanced Songs, Nesting Basics, and Flying for Fledgelings.

Student	Class	
Finch	Advanced Songs	■
	Nesting Basics	■
Robin	Flying For Fledgelings	■
	Nesting Basics	■
Sparrow	Advanced Songs	■
	Nesting Basics	■

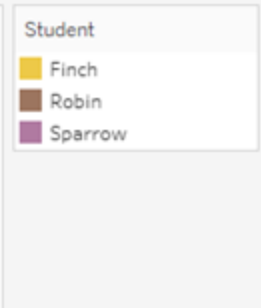

If we add the **Length** measure from the Class table, we see that all four classes are shown and there's a null for Student. Every class **Length** is displayed, at the level of **Class**.

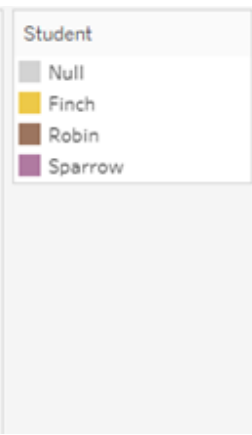
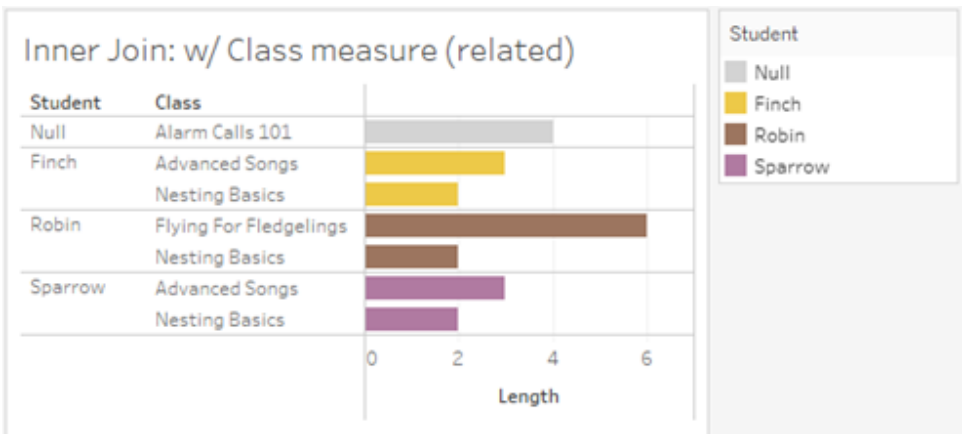

If we instead add the **Age** measure from the Student table, we see that all five students are shown and there are two nulls for Class. The results preserve every student, even if they're not in a class. Every student **Age** is displayed, at the level of **Student**.

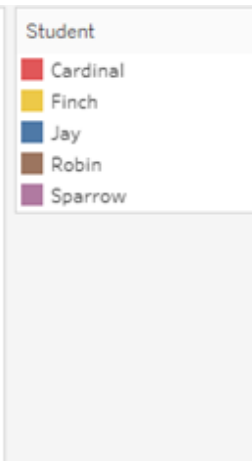
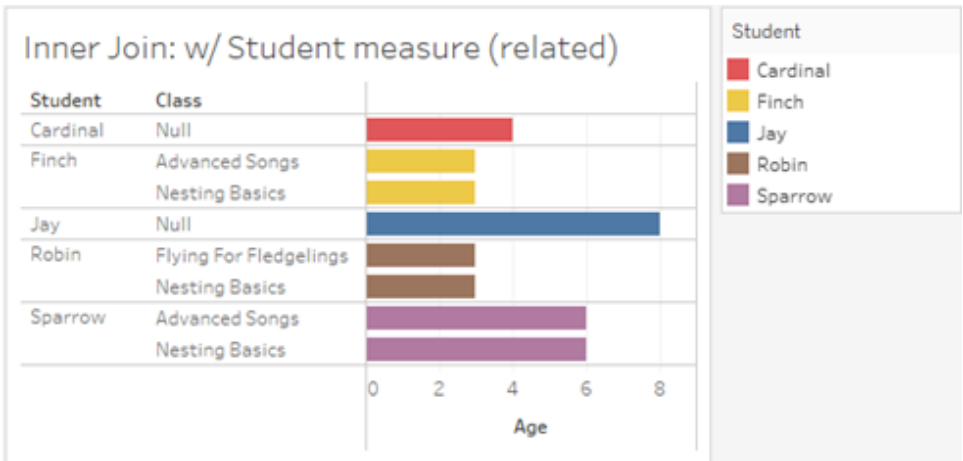

Unrelated measures

Measure values are repeated for unrelated dimension values.

If we look at the **Length** measure from the Classes table and the unrelated **Club** dimension, the measure is table scoped and repeated across all the dimension values of **Club**.

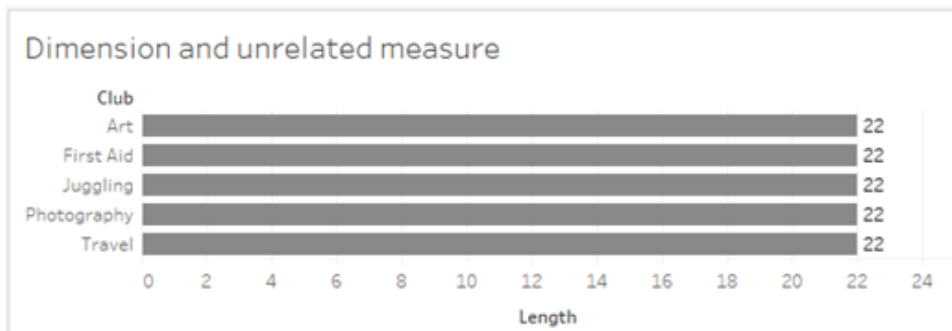

In the presence of a stitching dimension, measures can be both broken down and repeated.

Here, the measure **Age** is from the Students table and is broken down to the level of student. Each time a student is repeated based on the dimensions for **Class** and **Club**, the **Age** value is repeated.

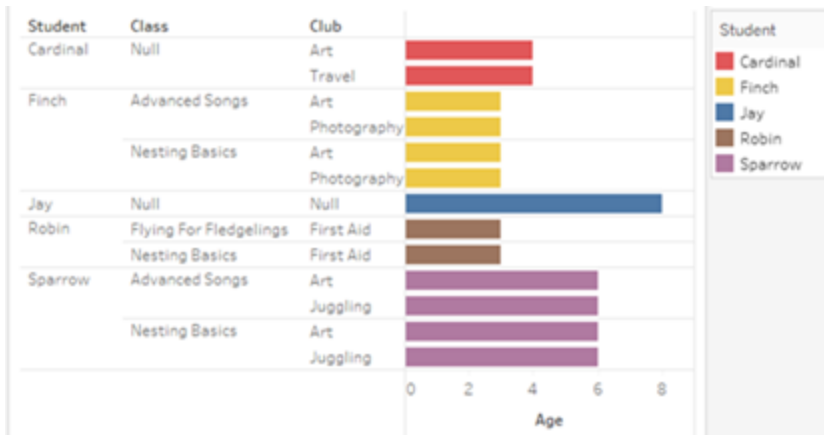

Troubleshooting

Considerations when working with multi-fact relationship data models

Per table extract filters

All extract filters for a multi-fact relationship data model extract are per-table (not pervasive). Because of this, filtering results may be different between live and extract connection.

Row level calculations

Row level calculations can only refer to fields which share the same upstream base table. That is, row level calculations can't be performed across trees.

Combined Fields

All fields in a combined field must share an upstream table. That is, you can't create a combined field using fields that are in different trees.

Sets

Sets can only be created with a definition that involves fields that share the same upstream base table. However, in a viz, the option to Add to Set may be available from a mark when that mark is defined by fields unrelated to the fields used to define the set. If you choose Add to Set, Tableau will add only the related fields to the set definition. This is different from the behavior for Add to Set in single base table data sources, when Add to Set adds everything that defines the mark.

Validate INCLUDE level of detail expressions

INCLUDE LOD expressions can't be evaluated across unrelated fields. Because relatedness between fields is evaluated on a sheet-by-sheet basis, it's possible to have a valid LOD expression in the Data pane or calculation editor that becomes invalid in the context of a specific viz (in the presence of an unrelated dimension). When this happens, the LOD pill will turn red. You can update the LOD expression to remove unrelated field conflicts, change the structure of the viz, or remove the LOD expression from the viz.

Updating Published Data Sources

As a best practice, create a copy of an existing published data source if you plan to modify it to become a multi-fact relationship data model when not all of its connected workbooks need the new data model. Don't update the existing version of the data source unless all its workbooks need the new tables. Publish the modified data source as a new data source and create new workbooks from it. This will prevent the existing workbooks from being converted to use VDS instead of data server when they don't need the functionality, preventing the potential for a performance hit.

Resolved issues

Resolved Issue

Extracts

Local data source (in a workbook): Attempting to

Fixed as of

- **Tableau Cloud:** Resolved as of mid July updates. This also applies to public.tableau.com.

extract a multi-fact relationship data source will give a "No such table" error.

Published data source: Extracting a published multi-fact relationship data source appears to succeed, but field values can be swapped.

EXCLUDE Level of Detail expressions

Only INCLUDE LODs should be validated in the presence of unrelated fields. However, EXCLUDE LODs may also be incorrectly marked as not valid in the same conditions.

Nested user calculations

Nested user calculations are not available in published data sources with a multi-fact relationship data model.

- **Tableau Desktop:** Resolved as of maintenance release 2024.2.1 released July 24th, 2024
- **Tableau Server:** Resolved as of maintenance release 2024.2.1 released July 24th, 2024

If you still see these issues in Tableau Desktop or Tableau Server, upgrade to a version from July 24th, 2024 or later.

Known issues in 2024.2

Relatedness indicators with multiple Marks cards

When a viz is built with multiple measures on the Rows shelf or on the Columns shelf, each measure gets its own Marks card. The logic used to determine relatedness indicators (the unrelated icon, the text in tooltips, and the relatedness warning dialog) may not give expected results depending on which Marks card is open. The viz itself, however, is correctly computed based on the relatedness of each pair of fields. There is a planned fix for this behavior.

BatchQueryProcessor

BatchQueryProcessor must be enabled to support multi-fact relationship data models. This is expected behavior with no currently planned fix.

Tableau Pulse

Pulse may not work with multi-fact relationship data models. You may be prevented from creating a metric definition, or any metrics that are created may be blank. This is not expected behavior but there is no currently planned fix yet.

When to Use a Multi-fact Relationship Model

A multi-fact relationship model is a data model that lets you add unrelated tables in a single data source and then uses related fields during visual analysis to essentially stitch the tables together

based on the context. Unlike blending, the data exists within a single data source—the concepts of primary and secondary data sources don't apply and no data is dropped from left joins. Unlike a single table data model, multiple base tables maintain their own context regarding tables shared between them. A multi-fact relationship data model gives you more options for performing multi-fact analysis in Tableau.

Imagine you want to analyze how weather and ice cream sales trend together. Weather and ice cream sales both happen at specific times and specific places, but there's no direct connection between ice cream sales and weather. These are unrelated pieces of data that both relate to the shared concepts of date and location.

This question lends itself to creating a multi-fact relationship model. Ice Cream Sales and Weather each can be added as a base table and related on Date and Location, which are shared tables.

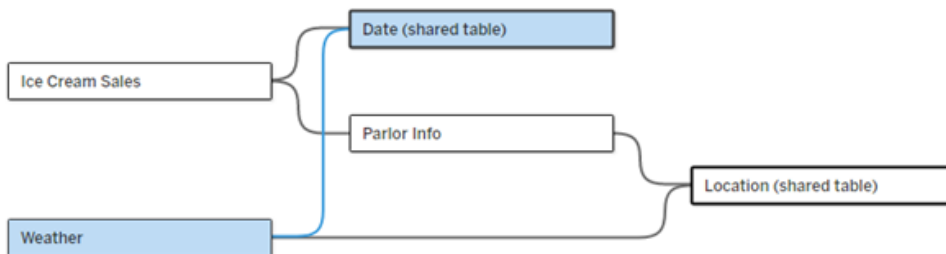

A multiple base table data model, with two unrelated tables (Ice Cream Sales and Weather) and two shared tables (Date and Location). There is an intermediate table, Parlor Info, between Ice Cream Sales and Location.

Why did we build the capability to model unrelated tables?

Analysis often involves bringing together tables of data that don't even have a direct relationship to each other but that both relate to the same, common information (such as date or location). A multi-fact relationship model supports loose semantic coupling by introducing the concept of degrees of relatedness and the ability to build a data model with multiple, unrelated base tables.

- Semantic coupling is a term used to describe how tightly combined data is. A *join* or a *union* is a tight semantic coupling; they bring multiple tables together into a new physical table that then acts as a single table. A *relationship* is a looser coupling between tables that ties tables together logically, maintaining their distinct status as separate tables. Even further along the semantic coupling spectrum is *data blending*, where results from separate data sources are visually combined based on elements shared between both

them. A *multi-fact relationship model* is closer to the blending end of the spectrum, but within a single data source instead of across data sources.

A multi-fact relationship model—a data model with multiple base tables—permits unrelated tables in the model as long as shared tables exist in the model, too. During analysis, fields from a shared table "stitch" together otherwise unrelated tables of data based on the shared dimensions they have in common (such as happening in the same place or at the same time). All the benefits of relationships are maintained, including the retention of each table's grain, or native level of detail.

Similar to a single base table data model, Tableau determines the best join type to use behind the scenes based on the structure of the viz. But in a multi-fact relationship model, the join options are expanded to include outer and cross joins to handle different levels of relatedness. For more information, see [About Multi-fact Relationship Data Models on page 740](#).

Where did the name come from?

Multi-fact relationships get their name from multi-fact analysis. In a data warehouse model, data is stored in a central fact table surrounded by dimension tables. In this context, *fact* refers to measurements or metrics, which are numeric fields of data that capture facts about the data—Tableau's measures. Dimension tables contain attributes about these facts.

Schemas based on fact tables are often structured as a star or snowflake, depending on how the dimension tables are organized. When analysis needs to be performed across fact tables, this is called multi-fact analysis. Analysis is done in the context of the common dimension tables, known as shared dimensions or conformed dimensions. In Tableau you build these data models using relationships, so we've named this suite of capabilities multi-fact relationships.

When to use multi-fact relationship data models

If your data consists of tables that are all related to each other, you can stick with single base table data sources built with relationships. A multi-fact relationship model is called for when your data spans different concepts, either in the form of multiple fact tables, or different unrelated contexts.

Whenever possible, build your data sources with a single base table. In a single base table data model every table is related and there is no need to consider degrees of relatedness. Only use multi-fact relationships when that data model structure is called for.

Multi-fact analysis

Multi-fact analysis is a core use case for multi-fact relationships in Tableau. In this example, Fact A and Fact B share a table Date.

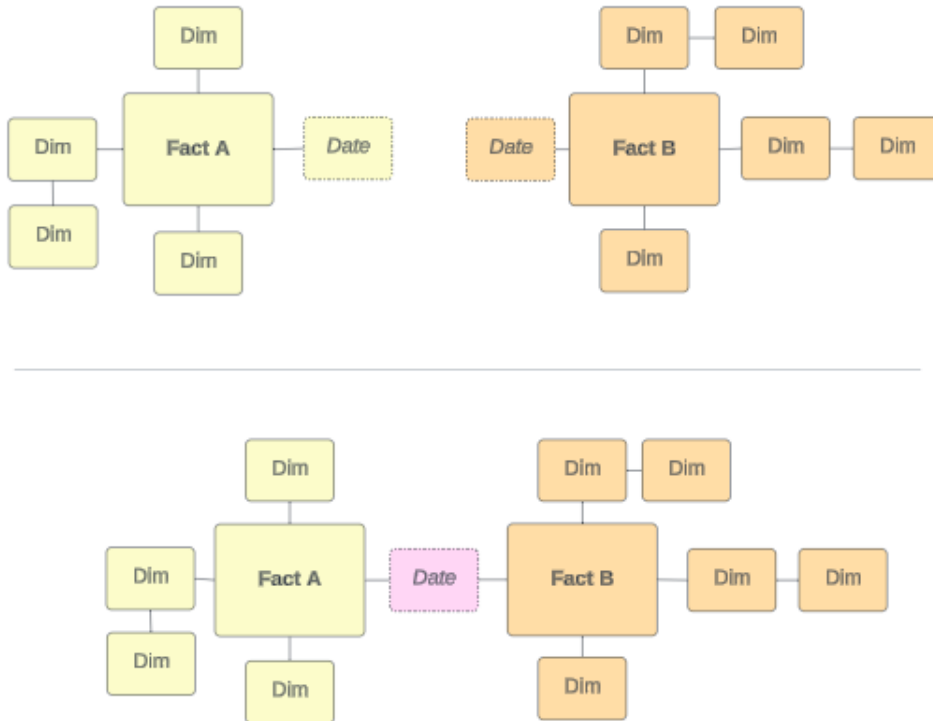

To model this in Tableau, the fact tables become base tables and multiple incoming relationships are established for their shared dimension table.

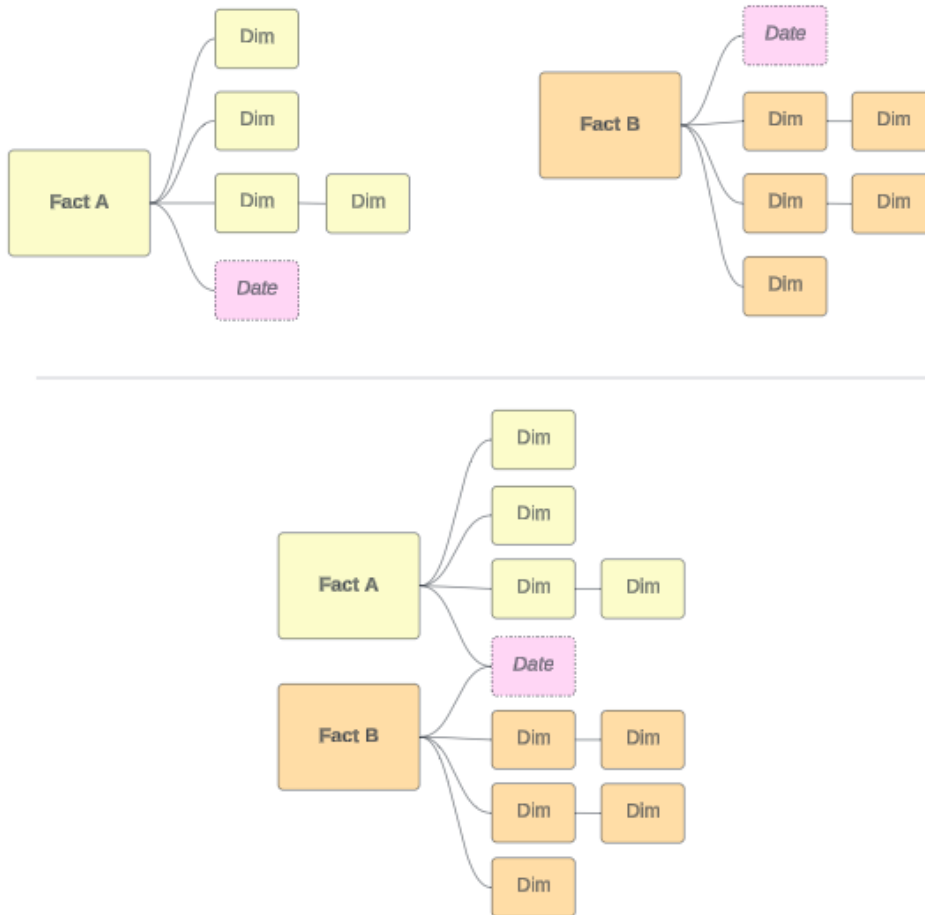

Other scenarios

Multi-fact relationship data models aren't just for multi-fact analysis, however. Tableau doesn't require a strict definition of fact or dimension tables. Any table can be a base table (although it should suit the [characteristics of base tables](#)). Some scenarios that indicate a multiple base table data source might be helpful include:

- **Moving through stages**, such as base tables for applications, transcripts, and alumni events for a shared student table.
- **Different contexts for the same events**, such as base tables for the events of medical appointments and billing invoices, with shared tables to set the context to doctors or patients.
- **Different domains that may correlate**, such as scenarios that would previously be best handled with data blending, like ice cream sales and weather correlated through the shared tables of date and location.

Learn more about when multi-fact relationships are useful in this Tableau blog post: [When and How to Use Multi-fact Relationships in Tableau](#).

Identify the base tables

In a multi-fact relationship model, directionality matters. That is to say, which tables are the base tables along the left side of the model and which tables are shared downstream impacts how the relationships are evaluated to return the analytical results.

Consider a conceptual bow tie of invoices, appointments, doctors, and patients:



The correct way to build the data model in Tableau is with Invoices and Appointments as the base tables, and with Doctors and Patients as the shared tables (not with Doctors and Patients as the base tables).

Correct: Invoices and Appointments as the base tables

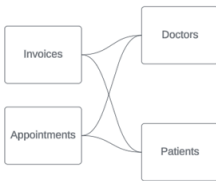

Incorrect: Doctors and Patients as the base tables

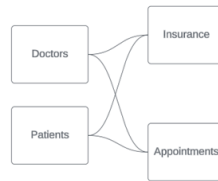

Conceptually, a patient (or doctor) is the entity that stitches together the event of an appointment and the event of an invoice.

If your data model is backwards (such as with Doctors and Patients as the base tables instead of Appointments and Invoices), the [outer join stitching behavior](#) won't be as useful. Your analysis might show a lot of table scoped measures and ambiguity. If you find yourself with ambiguously related fields that you weren't expecting, reevaluate the tables you are using as base tables and see if your data model needs to be reversed.

Characteristics of base tables and shared tables

If you're performing multi-fact analysis, the fact tables become the base tables and any shared dimension tables are shared tables. Tableau doesn't require a strict adherence to fact and dimension table characteristics. However, there are certain attributes that can help you identify which tables should be base tables and which should be shared tables.

Base table	Shared table
Fact tables in a data warehouse schema	Shared or conformed dimension tables in a data warehouse schema
Specific to the context or analysis (flight information, energy usage)	Consistent concept across various contexts (date, location)
Measure heavy	Primarily dimensions
More frequently updated/transactional (medical appointments, prescriptions, vitals)	More stable/durable (doctor, patient)
Has foreign key fields	Has primary key fields
Event based (class schedule, grade on an assignment)	Entity based (student, classroom)

Note that if there are intermediate tables between a base table and a shared table, you can **swap which one is the base table** without fundamentally altering the data model. (Such as Parlor Info and Ice Cream Sales in the first example.) What matters is which tables are upstream of the shared tables and which are shared.

Try an additional base table instead

There are various scenarios that may indicate you should build a multi-fact relationship model with multiple base tables rather than a single base table data source:

- If you're trying to build a data source with a cycle, the downstream table should be another base table instead.

- If you have a series of tables that are related on the same sets of relationship clauses (such as date and location), those dimensions should be pulled out and made into shared tables instead.
 - This is especially useful because multiple relationship clauses must all be true (logically, an AND) for the tables to be related for those records.
 - If, instead, you want to analyze records where one may be true at a time (a contextual OR), this flexibility is provided by setting up a data model with shared dimension tables instead.
- If you're using a blend but want to have an equivalent blend without primary and secondary data sources, build a data model which combines the data sources from the blend with their linking fields in a shared table or tables.

Build a Multi-fact Relationship Data Model

Analysis often involves bringing together tables of data that don't have a direct relationship to each other yet both relate to the same, common information such as date or location. This type of analysis is sometimes referred to as multi-fact analysis with shared dimensions.

To perform this kind of analysis in Tableau, you need to create a data source that uses multiple base tables connected by shared tables.

- *Base tables* are the left-most tables in the data model on the Data Source tab. For guidance on how to determine which tables to use as base tables, see [When to Use a Multi-fact Relationship Model on page 764](#).
- *Shared tables* are downstream tables with multiple incoming relationships. These tables contain fields that can be used to stitch together unrelated fields during analysis in a viz. Date and Location are examples of commonly shared tables.

Build the model

Building a multi-fact relationship data model is essentially the same as creating any other data source that uses relationships, but with two additional pieces: additional base tables and multiple incoming relationships to shared tables.

1. [Connect to your data](#). You can use [multiple data connections](#) if your tables aren't all in the same database.
2. Drag a table onto the canvas to create the first base table.

3. Drag another table from the left pane to the **New Base Table** drop area.



Tableau shows a warning that you're building a data model with multiple base tables. We recommend that you only set up a multiple base table model if your data needs it. Otherwise, use a single base table model to avoid the complexities that come with a multiple base table model.



4. Drag another field to the canvas and relate it to one of the base tables. **Configure each relationship if necessary.**

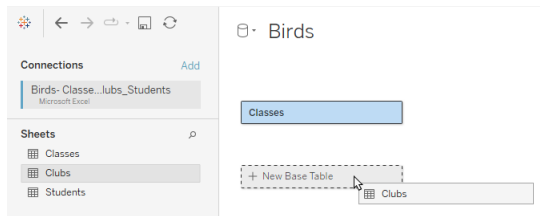
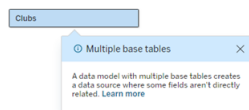
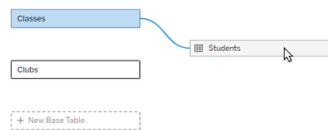

5. Hover over the not-yet-related base table to display a plus sign (affectionately known as a "meatball").

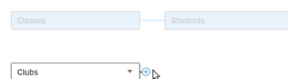

6. Drag the plus sign icon to the shared table to create a new incoming relationship (also known as a "noodle").



7. *Optional:* Continue adding downstream tables and base tables. Click and drag the plus sign icon to build shared tables as needed.

Note: Rather than starting with the base tables, you can also build a single base table model first and add additional base tables later.

Explore the model

A data model with multiple base tables is built with relationships, but not all tables are related to each other to the same degree. Each base table defines a *tree*, which contains every table related to that base table, either directly related or downstream from a related table. Shared tables exist in multiple trees. For more information about degrees of relatedness, see [About Multi-fact Relationship Data Models on page 740](#).

When you view a model with multiple base tables, there are various options for exploring and managing the data model. These options are especially useful when a data model is complex.

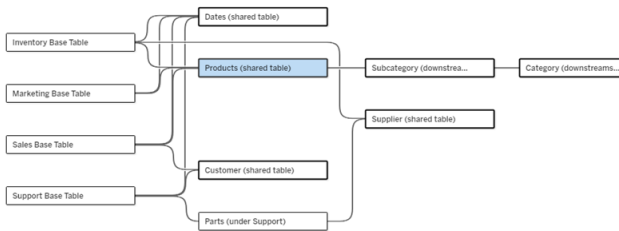

An example of a complex data model with four base tables, multiple shared tables, and downstream tables that are both shared and unshared between the base tables.

2024.2 introduced some new layout details for the data model. In a multi-fact relationship data model, relationships bundle together to help track how many incoming relationships a table has, and shared tables (and downstream shared tables) have a bolder outline than tables that aren't shared.

Terminology

Tables in a multiple base table data model have specific roles. Base tables and shared tables are the only tables that must exist in a multi-fact relationship data model. (Without more than one base table, it's not a multi-fact relationship data model. Without a shared table connecting the base tables, it's not a valid data model.)

Because of the often complex nature of these models, it's useful to have a shared terminology for discussing other types of tables by how they fit into the data model.

- **Base tables** are on the far left and have no incoming relationships.
 - In the example, Inventory, Marketing, Sales, and Support are base tables.

- *Sub-base tables* are between a base table and a shared table.
 - In the example, Parts is a sub-base table.
- *Shared tables* have more than one incoming relationship.
 - In the example, Products, Dates, Customer, and Supplier are shared tables.
- *Downstream shared tables* have exactly one incoming relationship and have a shared table somewhere upstream of them.
 - In the example, Subcategory and Category are downstream shared tables.
- *Downstream unshared tables* have exactly one incoming relationship and have no shared tables upstream of them.
 - In the example, there are no downstream unshared tables.

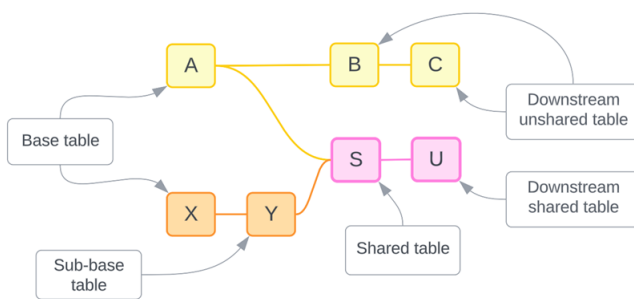

Test your understanding: identify the types of tables in the example data source

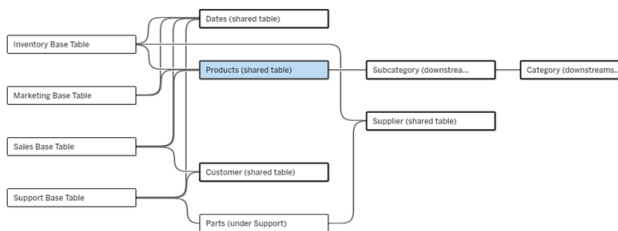

- **Base tables:** Inventory, Marketing, Sales, and Support
- **Sub-base table:** Parts
- **Shared tables:** Products, Dates, Customer, and Supplier
- **Downstream shared tables:** Subcategory and Category
- **Downstream unshared tables:** none

Identify a relationship tree

Hover over a table to highlight the tables it's related to. Tableau emphasizes the tree for that table and deemphasizes unrelated tables.

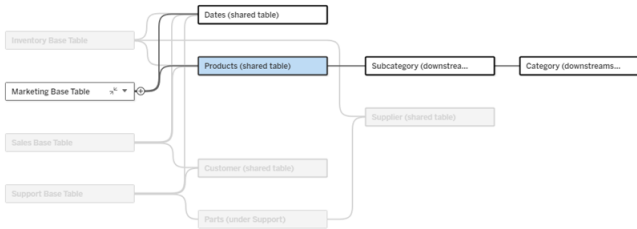

The Marketing base table tree consists of two shared tables, Dates and Products, and downstream shared tables Subcategory and Category.

View relationship details

Hover over a relationship or bundle of relationships to see the details in a tooltip.

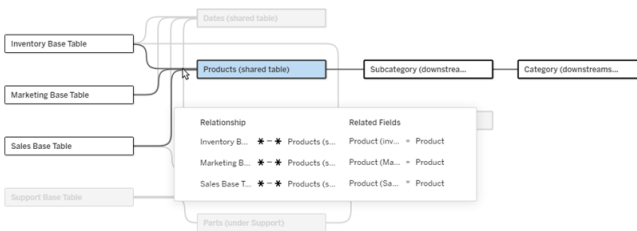

The incoming relationships to the Products table include three individual relationships to the Inventory, Marketing, and Sales base tables.

Select a relationship

When a relationship is selected, it is highlighted in blue in the data model canvas and its details appear in the Table Details pane below the data model canvas. The Table Details pane is where you can **inspect or modify the relationship clause**.

There are multiple ways to select a relationship:

- Click a relationship line (noodle) in the canvas. Every relationship has a clickable zone that selects just that noodle.
- Right-click or control-click a table in the canvas to open its menu. Select the **Select Relationship** option and choose which table's relationship you want.

- Click a bundle of relationships in the canvas to bring up a persistent tooltip (hovering over a bundle brings up the tooltip, you have to click to make it persist). Then select a row in the tooltip details to highlight that relationship in the model.
- Open the menu in the toolbar of the Table Details pane and select the desired relationship. You can also use this menu to select a specific table to see its preview in the pane.

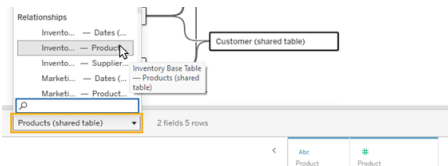

Swap with base table

Intermediate tables in a relationship between a base table and shared tables give you the option to swap the downstream table with the base table. This is purely a visual change to aid with conceptual understanding and doesn't change the structure of the data model.

Right-click or control-click a downstream table and select **Swap with base table (table name)**. The swap option is also only present on the downstream table and not the base table.

The swap option is not available for tables which would alter the data model if swapped, such as shared tables or downstream shared tables. Only downstream unshared tables or sub-base tables can be swapped with base tables.

Example

In this example, the **Parlor Info** and the **Ice Cream Sales** tables can be swapped without changing the data model's fundamental structure. No other tables can be swapped.

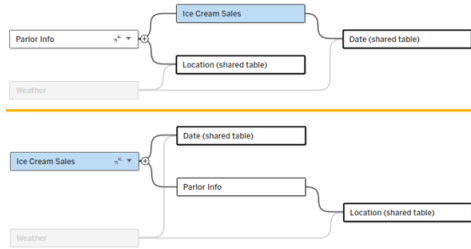

- Ice Cream Sales is related to both Parlor Info and the shared Date table.
- Parlor Info is related to both Ice Cream Sales and the shared Location table.
- Weather is related to both the shared tables of Date and Location.

These two models are conceptually equivalent:



Collapse a base table

You can also collapse a relationship path, or tree, to just its base table to temporarily simplify the view of the data model.

Click the Collapse  or Expand  buttons on a base table to collapse or expand its entire tree. Alternatively, right-click or ctrl-click on a downstream table and select **Collapse this path** or **Collapse other paths**. This option is not available on shared tables or tables downstream of shared tables.

Collapsing a tree to its base table is purely visual and won't trigger the Unrelated Tables alert. A collapsed path is indicated by a base table with a stacked table and an Expand button. Collapsing affects all tables and relationships that are relevant only to that tree, so tables that are shared with an uncollapsed path are not hidden.

Use the Expand  button to re-open the base table and everything in the tree.

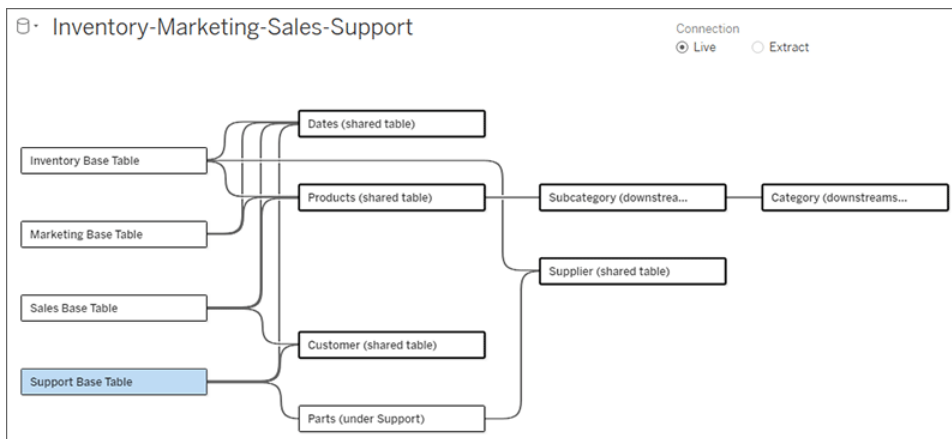

Troubleshooting

Create a single data source

All tables must be related to the entire data source in some way. If there are any tables that aren't related to the overall data model, an alert appears. The alert remains until no tables or trees are fully separate from the rest of the data model. When the alert is active, the data source can't be published and you can't use the data source in an analysis.

You can open the alert and set **Visually Separate Unrelated Tables** to identify which tables triggered the alert. This option is useful when you have a complex model and need to identify which table or tables aren't yet related to the rest of the data model.

Example

In the steps under **Build a model**, an alert displays in Step 4 before a relationship is added to connect the second base table.

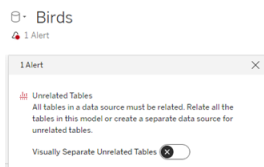

Setting **Visually Separate Unrelated Tables** to On moves the table **Clubs** underneath the **Unrelated Tables** line. Relating **Clubs** to **Students** resolves the alert.

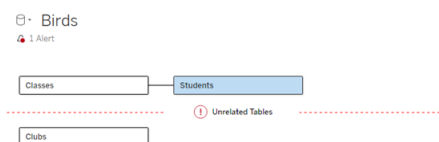

Resolve a cycle

Even if some tables aren't directly related to each other, the entire data model must be a cohesive whole. In this example, each base table defines a tree but there is no shared table connecting them. This isn't a valid model for analysis.

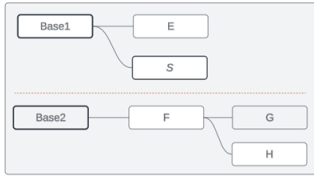

The two groups of related tables need to be combined via a shared table...

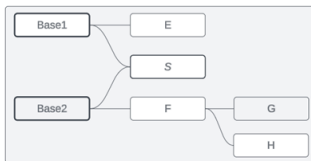

...or the data model needs to be created as two separate data sources.

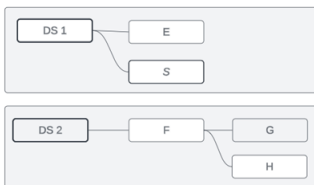

Data model restrictions

Some relationship paths between tables are not supported in a multi-base table model. If you're unable to drop the meatball when you attempt to create a second incoming relationship on a table, make sure the structure you're trying to create is supported in Tableau. Examples of unsupported models include:

Cycles

Cycles—where there's more than one relationship path from an upstream table to the same downstream table—are not supported. This unsupported structure is sometimes called a bowtie. To model this kind of relationship between tables in Tableau, use multiple base tables instead of a bowtie by converting the downstream table to another base table.

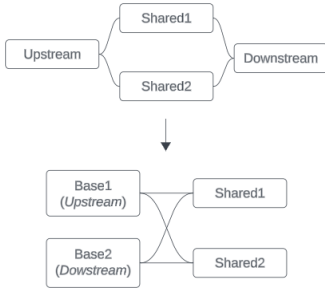

The data model must be a *directed acyclical graph*. This means every incoming relationship to a table must be traceable upstream to a different base table.

Not supported. Table X has two incoming relationships that are both from tables downstream from Base Table A

Supported. Tables S and T both have multiple incoming relationships, but each one is from a different base table.

Supported. Although it may visually look like there's a cycle, the incoming relationships for both Table S and Table T can be traced back to different base tables.

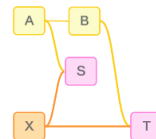
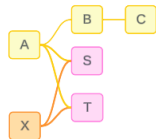
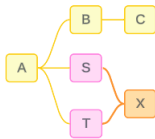

Nested shared tables

Nested shared tables are not supported. Any tables downstream from a shared table (a table with multiple incoming relationships) can only have one incoming relationship.

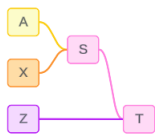



Not supported. Table T is downstream from a shared table and can't receive an additional incoming relationship.

Understand Tooltips for Multi-fact Relationship Data Models

Note: For single table data sources or single-base table data sources, all the tables are related. Everything on this page refers to multiple base table data sources.

Field-level relatedness

Data models with multiple base tables have a lot of flexibility in how the tables can relate—or not relate—to each other. The relatedness of the *tables* is a constant based on the data model. However, the relatedness of *fields* in a viz depends on what fields are active (that is, what fields are in use on the worksheet shelves as pills). At the level of a single viz, Tableau evaluates active fields in pairs to determine **how they relate to each other**.

An unrelated icon  on a field means it's unrelated to at least one other field in the viz. This icon can appear in a pill on a shelf or in the Data pane. (In some instances, there may be a related icon ) Hovering over the icon opens a tooltip with more information. There are different messages for different types of field relatedness:

- Unrelated dimension-dimension pair
- Unrelated dimension-measure pair
- Stitching dimension
- Measure from a shared table
- Unrelated filter pair

The messages also varies slightly depending on whether the field is in use on a shelf or in the Data pane.

- **On a shelf:** The tooltip for pills on shelves provides information about how the fields in the viz are related to each other and what impact that has on how Tableau computed the results.
- **In the Data pane:** The tooltip for fields in the data pane provides information about what *would* happen if that field were added to the viz. Fields in the Data pane can also be de-emphasized with light gray text if they don't related to any fields in the viz.

Tip: In Tableau, aggregated dimensions—such as ATTR(dimension) or MIN(dimension)—act like measures.

Know your data model

Whenever you're working with a data model that contains multi-fact relationships, it's useful to refer to the model regularly on the Data Source page. The examples in this topic are based on a data model with two base tables, Classes and Clubs, and two shared tables, Students and Rooms.

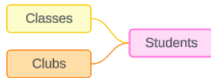

Classes

Classes 7 rows 3 fields		
Alt Classes Class	Alt Classes Student (Classes)	# Classes Length
Nesting Basics	Robin	2
Advanced Songs	Sparrow	3
Flying For Fledgelings	Robin	6
Nesting Basics	Sparrow	2
Advanced Songs	Finch	3
Nesting Basics	Finch	2
Alarm Calls 101	Null	4

Fields:

- **Class**, a dimension with values of Nesting Basics, Advanced Songs, Flying for Fledglings, and Alarm Calls 101
- **Length**, a measure
- **Student**, a dimension used to relate to the Students table

Clubs

Clubs 7 rows 3 fields		
Alt Clubs Club	Alt Clubs Student (Clubs)	# Clubs Dues
Photography	Finch	50
Travel	Cardinal	90
Juggling	Sparrow	80
Art	Finch	10
Art	Cardinal	10
Art	Sparrow	10
First Aid	Robin	0

Fields:

- **Club**, a dimension with values of Photography, Travel, Juggling, Art, and First Aid
- **Dues**, a measure
- **Student**, a dimension used to relate to the Students table

Students

Students 5 rows 3 fields		
Alt Students Bus Rider	Alt Students Student	# Students Age
yes	Finch	3
yes	Cardinal	4
no	Sparrow	6
yes	Robin	3
no	Jay	8

Fields:

- **Bus Rider**, a dimension with values of yes or no
- **Student**, a dimension with values of Finch, Cardinal, Sparrow, Robin, and Jay. Used to relate to the base tables
- **Age**, a measure

Unrelated dimension-dimension pair

Unrelated dimensions are cross joined, which can result in combinations of dimension members across the headers that do not reflect actual combinations of data in the underlying tables.

The message for an unrelated dimension-dimension pair is:

- **On a shelf:** Unrelated dimensions show all possible combinations of values. Unrelated to: <list of dimensions>
- **In the Data pane:** If used, this dimension will show all possible combinations of values with unrelated dimensions: <list of dimensions>

- **Grayed out in the Data pane:** This dimension isn't related to any dimensions in the viz. If used, it will show all possible combinations of values with other unrelated dimensions.

Cross joins can be expensive operations that negatively impact performance. Because of this, Tableau also displays a **Relatedness warning dialog on page 744** if you add an unrelated dimension to the viz.

Stitching dimensions

Although there are analytically relevant reasons to visualize unrelated dimensions alone, a common "happy path" for analysis with multiple base tables is to use a stitching dimension in addition. In the presence of a stitching dimension, the unrelated dimensions are no longer cross joined but are outer joined instead. Outer joins may still introduce nulls, but the dimension member headers are trimmed down from every possible combination to combinations that are relevant to at least one side of the outer join. They also don't have the same potential for performance impacts as cross joins. If there are no other relatedness issues that would call for an unrelated icon, a stitching dimension shows a related icon  instead.

The message for a stitching dimension is:

- **On a shelf:** This dimension stitches together the following fields:
<list of fields>
- **In the Data pane:** If used, this dimension will stitch together the following fields: <list of fields>
- **Grayed out in the Data pane:** doesn't apply, stitching only occurs in a viz

Comparing unrelated dimensions with stitched dimensions

Unrelated: Cross join Stitched: Outer join of intermediate inner joins

Class	Club
Advanced Songs	Art
Advanced Songs	First Aid
Advanced Songs	Photography
Advanced Songs	Travel
Alarm Calls 101	Art
Alarm Calls 101	First Aid
Alarm Calls 101	Photography
Alarm Calls 101	Travel
Flying For Fledglings	Art
Flying For Fledglings	First Aid
Flying For Fledglings	Photography
Flying For Fledglings	Travel
Nesting Basics	Art
Nesting Basics	First Aid
Nesting Basics	Photography
Nesting Basics	Travel

A viz showing a cross join of Class and Club with rows for every combination of Advanced Songs/Alarm Calls 101/Flying for Fledglings/Nesting Basics with Art/First Aid/Juggling/Photography.

Student	Class	Club
Cardinal	Null	Art
Cardinal	Null	Travel
Finch	Advanced Songs	Art
Finch	Nesting Basics	Art
Finch	Nesting Basics	Photography
Robin	Flying For Fledglings	First Aid
Robin	Nesting Basics	First Aid
Sparrow	Advanced Songs	Art
Sparrow	Nesting Basics	Art
Sparrow	Nesting Basics	Juggling
Sparrow	Nesting Basics	Juggling

A viz showing the results of an outer join of the Student-Class inner join and the Student-Club inner join. Not all combinations of classes and clubs are represented, and there are rows for students and clubs without a class.

An aside on how measure values are computed

When a measure isn't related to a dimension, it can't be broken down by that dimension's members (that is, you can't break down the average class length per club when clubs don't have a class length). Instead, the measure will be aggregated at a different level than the dimension member's headers in the view.

Terminology for dimensions and measures

In Tableau, *measures* are *aggregations*—they're aggregated up to the *granularity* set by the *dimensions* in the view. The value of a measure therefore depends on the context of the dimensions. For example, "number of cereal boxes" depends on if we mean the total inventory or the number of boxes per brand.

Dimensions are usually categorical fields, such as country or brand. In Tableau, dimensions set the granularity, or the *level of detail*, of the view. We typically want to group our data into marks by some combination of categories. What dimensions we use to build the view determines how many marks we have.

Aggregation refers to how the data is combined. Tableau's default aggregation is SUM. You can change the aggregation to other options, including: average, median, count distinct, minimum, and so on. *Granularity* refers to how detailed or broken down the measure is—which is controlled by the related dimensions. Unless the granularity of the measure is row level (aka disaggregated), its value must be aggregated.

Example

Raw data			
	Mini	Normal	ValuePak
Bran Flakes		3	2
Cheerios	10	8	3
Froot Loops		5	
Grape Nuts		3	
Lucky Charms	4		16

What's the value of "number of boxes of cereal"?

Well, it depends on the aggregation type and the granularity as set by the dimensions.

- Aggregations:
 - Sum (or total)
 - Average
- Granularity:
 - Table scoped / fully aggregated (the blue bars in the example)
 - Broken down by the **Brand** dimension (the colored bars in the example)

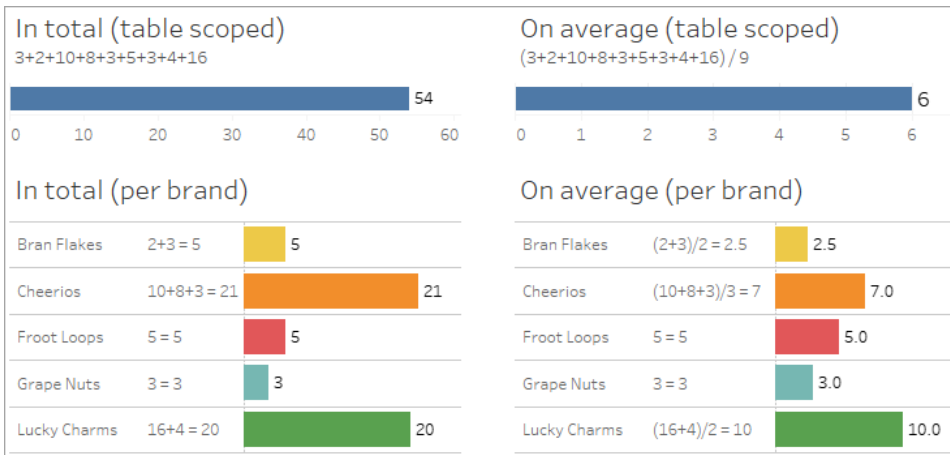

The value of a measure trails the dimension members

A measure's value is determined by the dimensions it is related to. A measure without a related dimension is table scoped. A measure with a related dimension is broken down by the related dimension's members (that is, the value of the measure is computed for each dimension member). If a related dimension's members are repeated due to the presence of an unrelated dimension, the measure's values are repeated based on its dimension members.

1. A measure without a dimension is table scoped to its overall value.

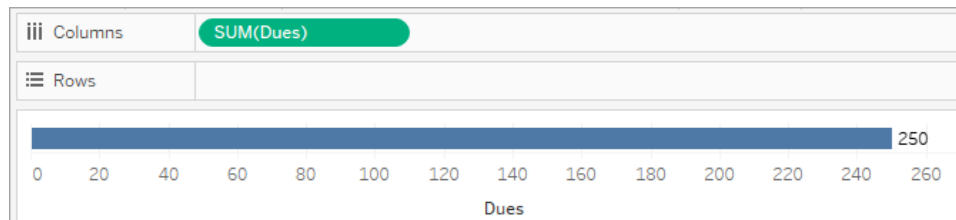

2. A measure, in the presence of an unrelated dimension alone, is table scoped and repeated for the unrelated dimension's members.

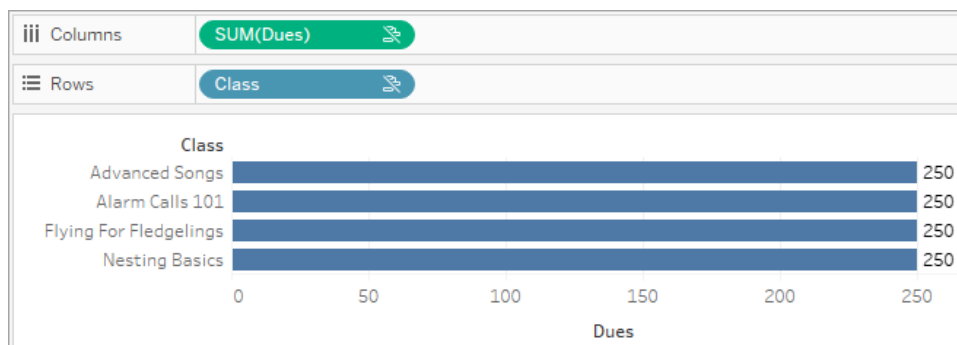

3. A measure in the presence of related dimension is broken down more granularly and its value is computed per member of the related dimension.

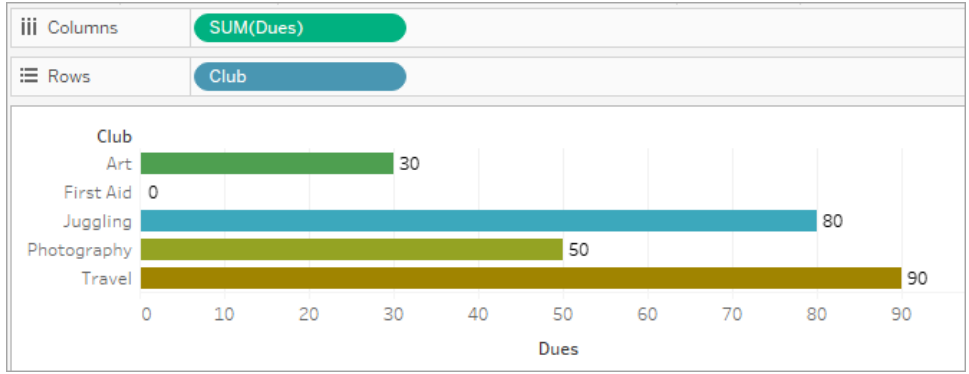

4. A measure, in the presence of an unrelated dimension and a related dimension, is broken down by the dimension it's related to. Wherever those related dimension members are repeated for unrelated dimensions, the measure value trails along with its related dimension member.

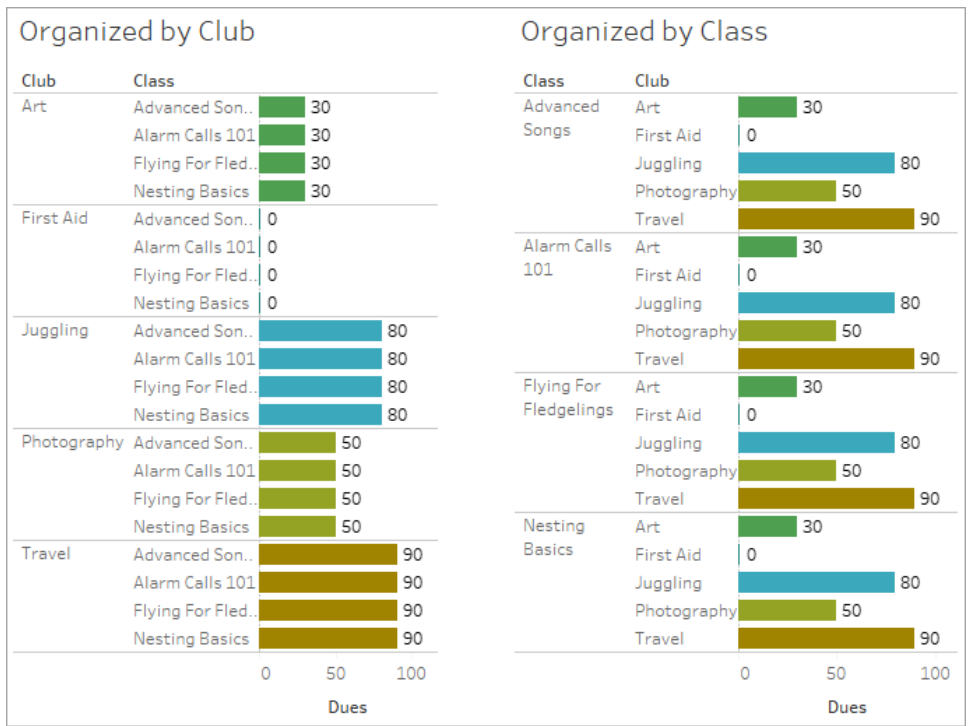

Because dues are per club, the value of dues for each club is repeated every time that club is repeated.

Unrelated dimension-measure pair

The message for the measure is:

- **On a shelf:** This measure can't be broken down by unrelated dimensions: <list of dimensions>.
- **In the Data pane:** If used, this measure won't be broken down by unrelated dimensions: <list of dimensions>
- **Grayed out in the Data pane:** This measure isn't related to any dimensions in the viz. If used, it won't be broken down.

The message for the dimension is:

- **On a shelf:** This dimension can't break down unrelated measures: <list of measures>
- **In the Data pane:** If used, this dimension won't break down unrelated measures: <list of measures>
- **Grayed out in the Data pane:** This dimension isn't related to any measures in the viz. If used, it won't break down measure values.

The result in a viz is a repeated value for the measure across the unrelated dimension's values. This behavior is similar to when an LOD expression is used to set the level of aggregation for a measure at a different level of detail from the native granularity of the viz. An unrelated dimension is essentially EXCLUDED from the computation of the measure's aggregated value.

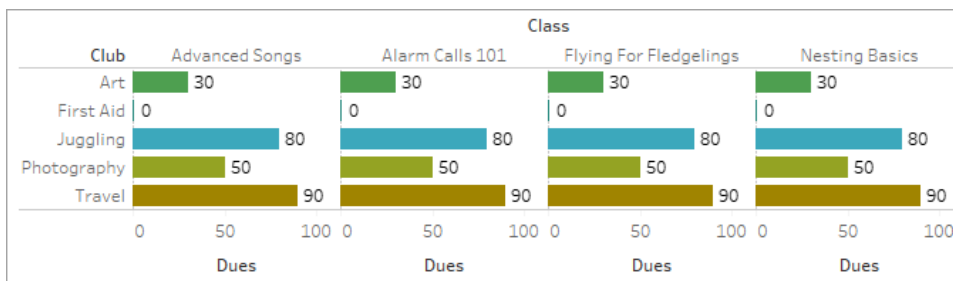

Measure from a shared table

When a dimension from a shared table (like Students) is used, it stitches together the dimensions from otherwise unrelated tables (such as Classes and Clubs). But what if instead of a dimension, you use a measure from the Students table instead?

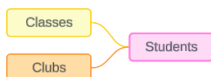

Measures can't stitch. Additionally, their value is determined by their related dimensions. In a case where there are unrelated dimensions visualized together, the measure can't be broken

down by those dimensions simultaneously. In this case, we treat the measure as unrelated to the combination of dimensions even though it would be related to either dimension individually.

The message for a measure shared across unrelated dimensions is:

- **On a shelf:** This measure can't be simultaneously broken down by the following combination of dimensions: <list of dimensions>
- **In the Data pane:** If used, this measure won't be broken down by the following combination of dimensions in the viz: <list of dimensions>

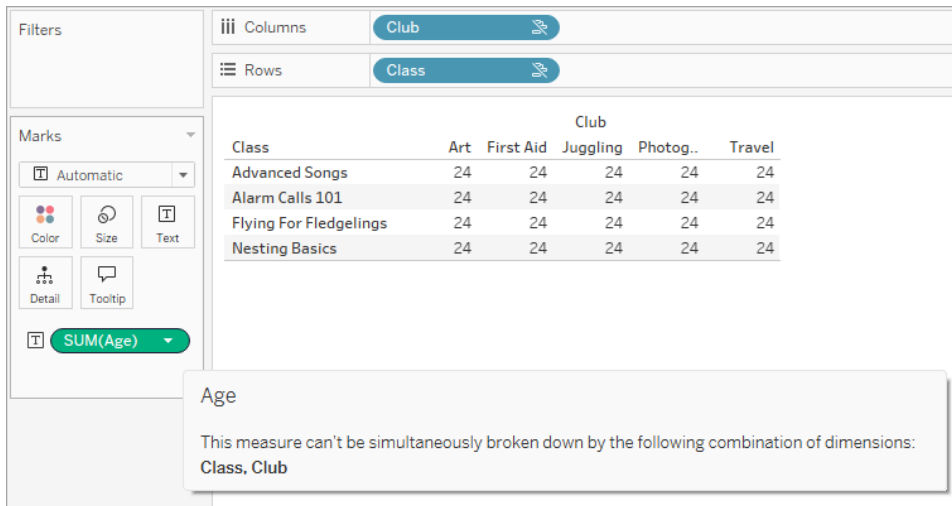

To resolve this and prevent the measure from being table scoped, the unrelated dimensions could be stitched or one or more dimensions could be removed until there is a clear relationship path for aggregating the measure.

Related measure

When a measure is related to some dimensions in the viz but not others, the measure may have an additional message in the tooltip that explains what dimensions it is related to. This can help explain how the measure is aggregated. This message only appears when the measure is also unrelated to a dimension in the viz. Otherwise, it's standard behavior that the measure is aggregated to the level of detail of its related measures.

- **On a shelf:** This measure is aggregated to the level of detail of related dimensions: <dimensions in the viz this measure is related to>

- **In the Data pane:** If used, this measure will be aggregated to the level of detail of related dimensions: <dimensions in the viz this measure is related to>

This message is intended to help identify which dimension or dimensions are considered when the measure value is computed. In the example of clubs and dues and classes, the tooltip for the measure clarifies the value is aggregated at the level of detail of Club and repeated for the dimension Classes.

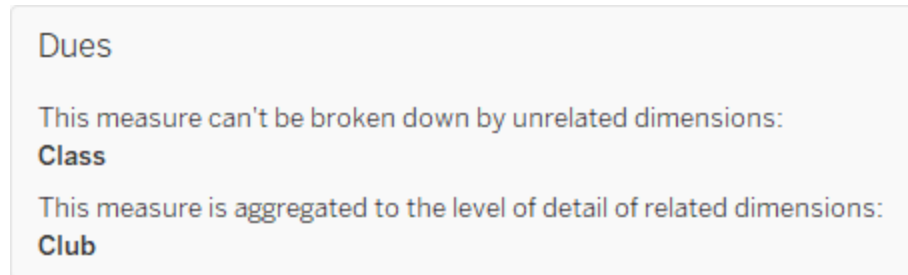

Filters

Relatedness is also evaluated for fields on the filter shelf compared to fields otherwise active in the viz.

An icon and tooltip appears when a filter is unrelated to at least one field in the viz. Both the filter field and field in the viz have a tooltip.

The message for an unrelated filter is:

- **On the filter shelf:** This filter doesn't apply to unrelated fields: <fields>
- **In the viz:** This field isn't filtered by unrelated filters: <fields>
- **In the Data pane:** If used, this field will be ignored by unrelated filters: <fields>

The behavior of filters also depends on their relatedness to other fields in the viz. A filter doesn't impact the values of fields it isn't related to. Unless the filter is set to no values (excluding everything or including nothing), the viz will remain unchanged for any fields that aren't related to the filter. However, deselecting every option in the filter will return a blank viz.

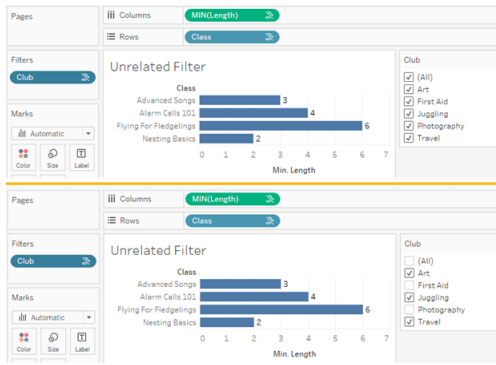

Two screenshots of viz with an unrelated filter, showing that deselecting options in the interactive filter control doesn't impact the viz

Related fields are filtered as expected. In a more complex viz with a combination of related and unrelated fields (such as in a stitching context), the filter will only impact values that are related to the filter field.

Join Your Data

It is often necessary to combine data from multiple places—different tables or even data sources—to perform a desired analysis. Depending on the structure of the data and the needs of the analysis, there are several ways to combine the tables.

Relationships vs Joins

The default method in Tableau Desktop is to use relationships. Relationships preserve the original tables' level of detail when combining information. Relationships also allow for context-based joins to be performed on a sheet-by-sheet basis, making each data source more flexible. Relationships are the recommended method of combining data in most instances. For more information, see [How Relationships Differ from Joins on page 677](#).

However, there may be times when you want to directly establish a join, either for control or for desired aspects of a join compared to a relationship, such as deliberate filtering or duplication.

Note: Relationships eventually leverage joins (just behind the scenes). For example, a relationship across data sources will produce a cross-database join when the viz uses fields from tables in different data sources. As such, [Improve Performance for Cross-Database Joins on page 809](#) may be relevant.

Common issues

- To view, edit, or create joins, you must open a logical table in the relationship canvas—the area you see when you first open or create a data source—and access the join canvas.
- **Published Tableau data sources cannot be used in joins.** To combine published data sources, you must edit the original data sources to natively contain the join or use a data blend.
- When joining tables, the fields that you join on must be the same data type. If you change the data type after you join the tables, the join will break.
- Fields used in the join clause cannot be removed without breaking the join. To join data and be able to clean up duplicate fields, use Tableau Prep Builder instead of Desktop

Tip: While Tableau Desktop has the capability to create joins and do some basic data shaping, Tableau Prep Builder is designed for data preparation. If you need to do multiple joins, clean up field names, change data types, perform multiple pivots, or other sorts of involved data prep, consider using [Tableau Prep Builder](#).

Create a join

1. To create a join, connect to the relevant data source or sources. See [Connect to Your Data](#) on page 219.

These can be in the same data source (such as tables in a database or sheets in an Excel spreadsheet) or different data sources (this is known as a cross-database join). If you combined tables using a cross-database join, Tableau colors the tables in the canvas and the columns in the data grid to show you which connection the data comes from.

Note: Not all data sources support cross-database joins, including published Tableau data sources. To combine published data sources, edit the original data sources to natively contain the join or use a data blend.

2. Drag the first table to the canvas.

Tableau Desktop and Web Authoring Help

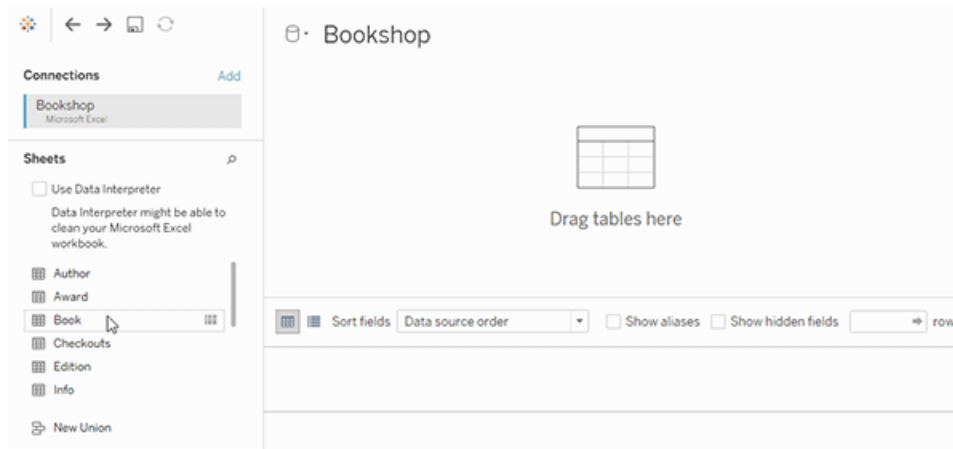

Note that if you drag out a second table at this point a relationship will form.

3. Select Open from the menu or double-click the first table to open the join canvas (physical layer).

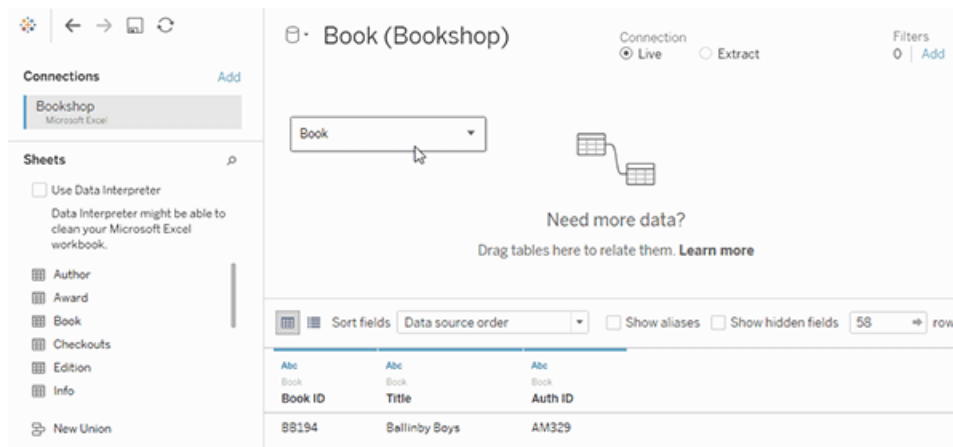

Double-clicking a table on the relationship canvas opens the join canvas

4. Double-click or drag another table to the join canvas.

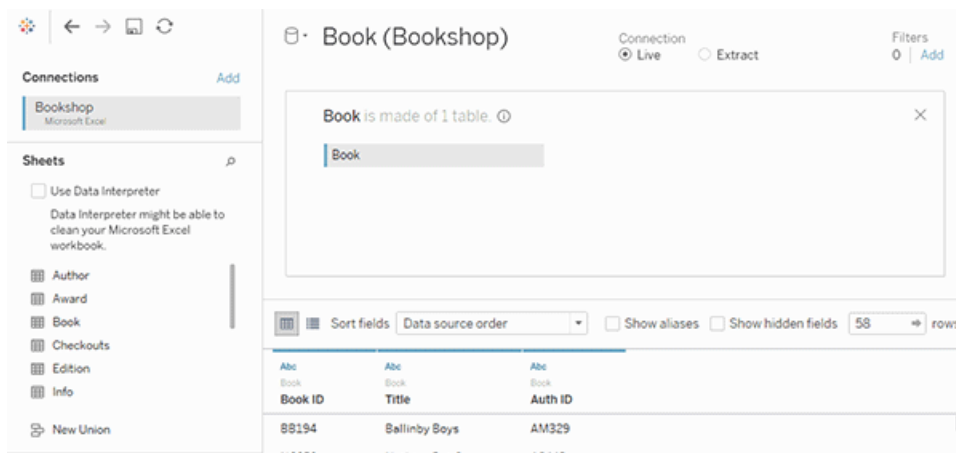

If your next table is from another data source entirely, in the left pane, under

Connections, click the **Add** button (⊕ in web authoring) to add a new connection to the Tableau data source. With that connection selected, drag the desired table to the join canvas.

5. Click the join icon to configure the join. Add one or more join clauses by selecting a field from one of the available tables used in the data source, choosing a join operator, and a field from the added table.

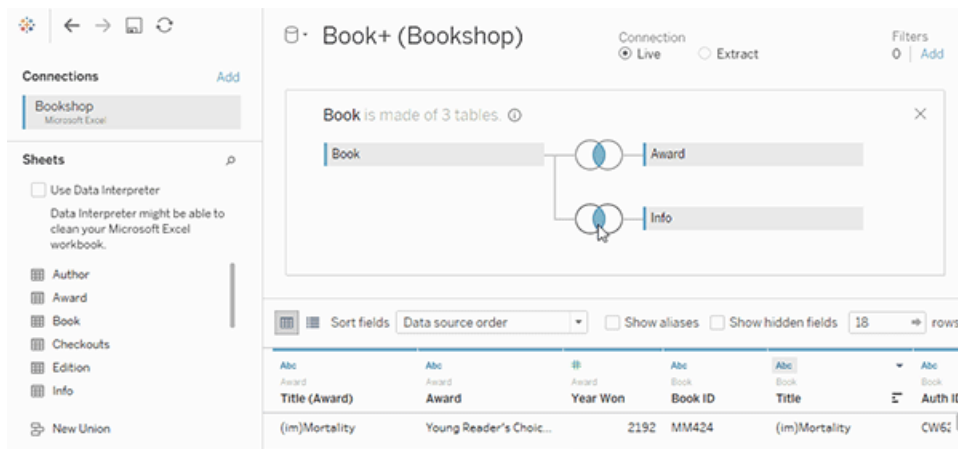

Note: You can delete an unwanted join clauses by clicking the "x" that displays when you hover over the right side of the join clause.

6. When finished, close the join dialog and join canvas.





After you've created a join, [Join Your Data on page 791](#). To troubleshoot your join, see [Join Your Data on page 791](#).

Anatomy of a join

Joins are defined by their type as well as the join clause.

Join types

In general, there are four types of joins that you can use in Tableau: inner, left, right, and full outer. If you aren't sure what join type you want to use to combine data from multiple tables, you should use relationships.

Join Type	Result
Inner 	When you use an inner join to combine tables, the result is a table that contains values that have matches in both tables. When a value doesn't match across both tables, it is dropped entirely.
Left 	When you use a left join to combine tables, the result is a table that contains all values from the left table and corresponding matches from the right table. When a value in the left table doesn't have a corresponding match in the right table, you see a null value in the data grid.
Right 	When you use a right join to combine tables, the result is a table that contains all values from the right table and corresponding matches from the left table. When a value in the right table doesn't have a corresponding match in the left table, you see a null value in the data grid.
Full outer 	When you use a full outer join to combine tables, the result is a table that contains all values from both tables. When a value from either table doesn't have a match with the other table, you see a null value in the data grid.
<i>Union</i>	Though union is not a type of join, union is another method for combining two or more tables by appending rows of data from one table to another. Ideally, the tables that you union have the same number of fields, and those fields have



matching names and data types. For more information about union, see [Union Your Data](#) on page 847.

Not all databases support all join types. If an option is unavailable in the join dialog, it is likely due to a constraint from your data source.

Join Clauses

A join is performed by setting up one or more join clauses. The join clause tells Tableau which fields are shared between the tables and how to match the corresponding rows. For example, rows with the same ID are aligned in the results table.

Join clauses most often use the equality operator (=) which matches rows with the same values. It is also possible to perform non-equi joins, such as less than (<) and not equal (<>).

A join can also have multiple join clauses. For example, if First name and Last name are stored in separate columns, it may be beneficial to join only if “First name = First name” and “Last name = Last name”. Both conditions will have to be true for rows to be joined. Alternatively, if the goal was to return results when the last name is shared but the first name is not, the join clauses could be “First name <> First name” and “Last name = Last name”.

Join clauses can also contain calculations. For example, the join clause could be the concatenation of the name fields “[First name] + [Last name] = [First name] + [Last name]”. Note that not all data source connections support calculations in join clauses.

About null values in join keys

In general, joins are performed at the database level. If the fields used to join tables contain null values, most databases return data without the rows that contain the null values. However, for certain single-connection data sources, Tableau provides an additional option to allow you to join fields that contain null values with other fields that contain null values.

After you've set up your data source, on the data source page, select **Data > Join null values to null values**.

If the option is greyed out, it is not available for your data source. Note that if you add a second connection to a data source that uses this option, the join reverts back to the default behavior of excluding rows with null values.

Cross-database joins

Tableau allows joins from tables in different data sources, albeit with some limitations from the database side on which platforms are compatible. Cross-database joins require a multi-

connection data source—that is, you create a new *connection* to each database before you join the tables.

1. Once you've connected to the first source of data, use the Add option in the data pane to add another connection.

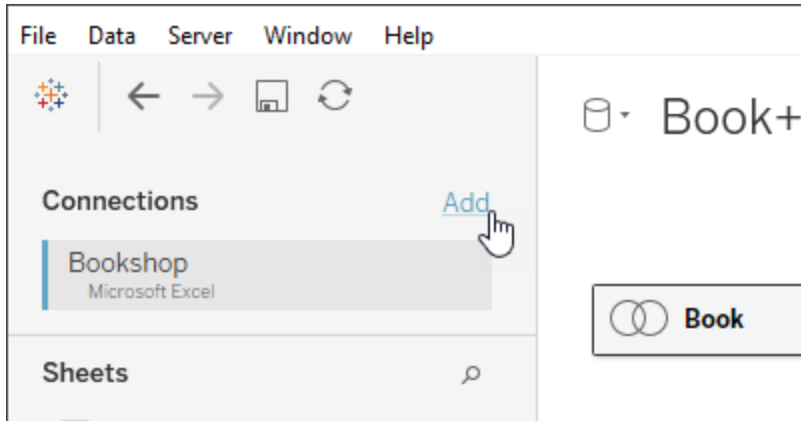

Note: If the connector you want is not available from the **Connect** list when you're trying to add another connection, cross-database joins are not supported for the combination of sources that you want to join. This includes connections to cube data (e.g., Microsoft Analysis Services), most extract-only data (e.g., Google Analytics and OData), and published Tableau Server data sources.

2. This creates a second connection rather than an entirely different data source. You can switch between the two (or more) connections while on the data source tab.

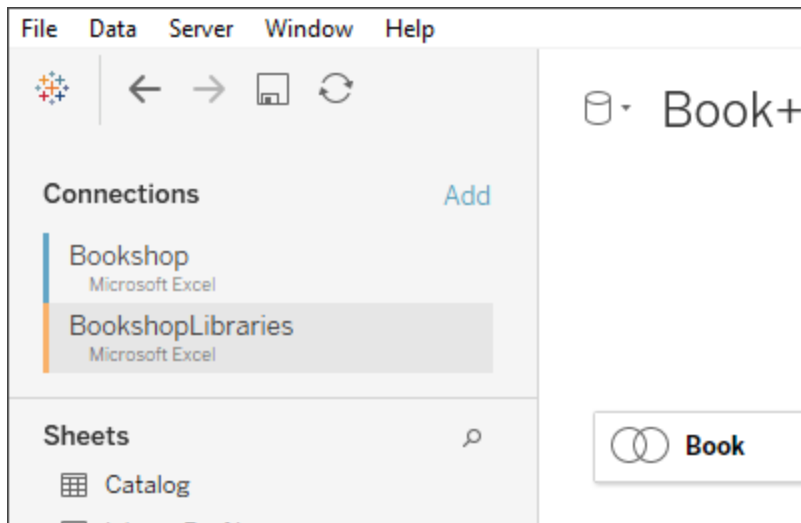

- Once you move to a worksheet and begin analysis, the data source functions as a single, combined data source. This is in contrast to two independent data sources that can be toggled between on a worksheet.

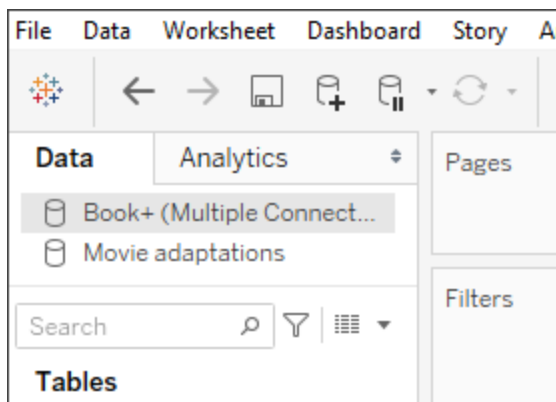

The **Book+** data source contains two connections with a cross-database join. It functions as a single data source. The **Movie adaptations** data source is an independent data source.

Note: Typically, joining tables from the same database yields better performance. This is because querying data that is stored on the same database takes less time and leverages the native capabilities of the database to perform the join. For more information on cross-database join performance, see [Improve Performance for Cross-Database Joins](#) on page 809.

Review Join Results in the Data Grid

After you have created a join on the canvas, review the data grid to make sure the join produces the results that you expect. If the data grid displays data that you don't expect, you might need to modify the join.

Results in the data grid

- **No data:** If no data displays in the data grid, you might need to change the join type or a join field used in the join condition. If you suspect a mismatch between fields in the join, use a calculation instead. For more information, see [Use calculations to resolve mismatches between fields in a join below](#).
- **Duplicate data:** If you see duplicate data, there are a few things you can do. Consider relating the tables instead of joining. For more information, see [Relate Your Data](#).
- **Missing data:** If some data is missing from the data grid, you might need to change the join type or a join field used in the join condition. Again, if you suspect a mismatch between fields in the join, use a calculation instead. For more information, see [Use calculations to resolve mismatches between fields in a join below](#).
- **Many null values:** If you see many null values that you do not expect, you might need to change the join type from the full outer type to the inner type.
- **All null values for one table:** If all values for one table is null, there are no matches between the tables that you are joining. If this is not expected, consider changing the join type.

Use calculations to resolve mismatches between fields in a join

When the fields in a join condition don't match—that is a mismatch between the values in the fields used in a join condition, the data grid can show little or no data at all. A mismatch between fields can occur for several reasons but often caused by the differences in format of the string values or date values in the fields. In many cases, you can resolve mismatches between the fields in your join by using a calculation.

Most functions are available for you to use in a calculation to create and replace a field in the join condition, with the exception of aggregate functions and table calculation functions.

Note: Join calculations are not supported for QuickBooks Online, Marketo, Oracle Eloqua, Anaplan, ServiceNow ITSM, and web data connectors.

String mismatch

A common mismatch scenario when working with string data occurs when one of the fields on one side of the join condition is equivalent to two or more fields on the other side of the join condition. In this case, you can use a calculation to combine the two fields so that its format matches the other field in the join condition.

For example, suppose you want to join two tables that contain the following data:

Patron

First name	Last name	Branch	Member since	Units borrowed	Fees	Suggested limit
Alan	Wang	North	200-0	1	0	15
John	Smith	North	200-0	36	3.50	15
Ashley	Garcia	South	200-0	243	11.30	15
Fred	Suzuki	North	200-0	52	.90	15

Contact

Name	Member number	Emergency contact	Relationship	Emergency number
Adam Davis	555-032-4	Ellen Davis	Partner	555-0884
Alan Wang	555-035-6	Jean Wilson	Mother	555-0327
Fred Suzuki	555-018-8	Jim Suzuki	Brother	555-3188
Henry Wilson	555-010-0	Laura Rodriguez	Partner	555-0103
Michelle Kim	555-019-9	Steven Kim	Partner	555-0125

The common fields between the two tables appear to be name. However, in the Patron table the first and last names are in separate columns and in the Contact table the first and last names are in the same column. To join the tables on names, you can use a calculation in the left side of the join condition to merge the first name and last name columns together.

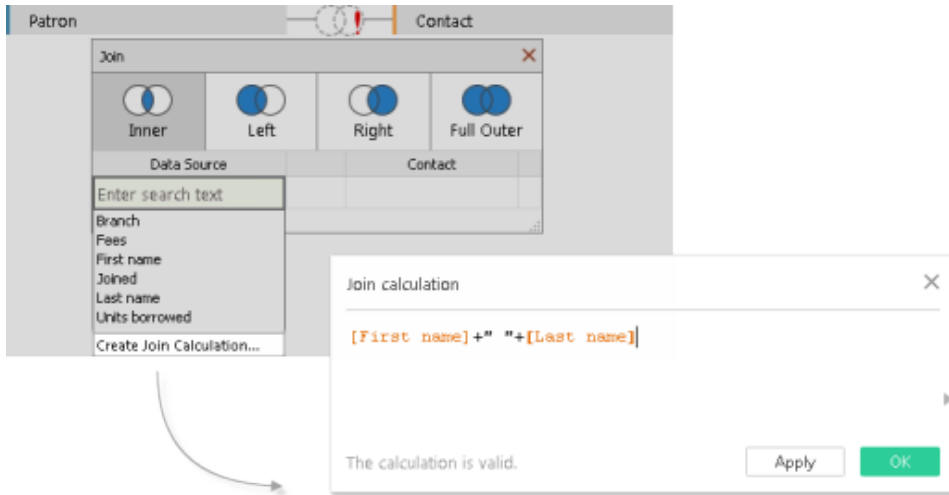

The result is a calculated field on the left side of the join condition that is accessible only from the join dialog. This calculation converts the field in the Patron table into a format that now matches the format of the field in the Contact table on the right side of the join condition.

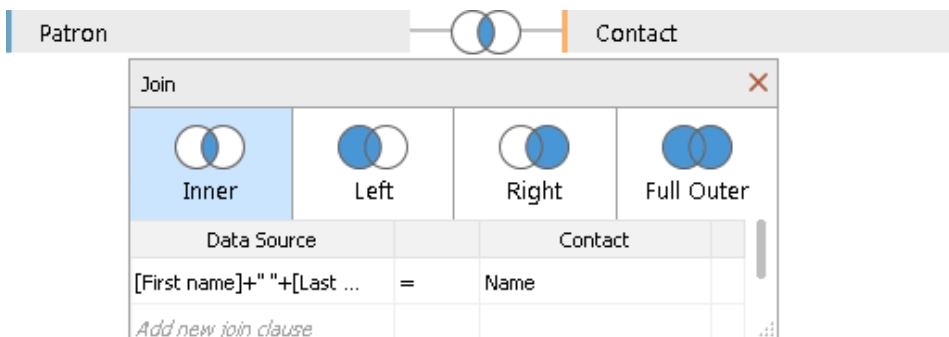

Using the calculation in the join produces the following combined table:

First name	Last name	Branch	Member since	Units borrowed	Fees	Suggested limit	Name	Phone number
Alan	Wang	North	2000	1	0	15	Alan Wang	555-0356

First name	Last name	Branch	Member since	Units borrowed	Fees	Suggested limit	Name	Phone number
Fred	Suzuki	North	2000	52	.90	15	Fred Suzuki	555-0188

Date mismatch

A common mismatch scenario when working with date data occurs when the date values in one field of the join condition are captured at a different level of detail than the other field in the join condition. In this case you can use a calculation in the join condition to change the format of the field on one side of the join condition so that its format matches the other field in the join condition.

For example, suppose you have the following two tables of data:

Projector rental

Date	Reservation type	Requester ID
1/1/2000	Individual	23344-5589
1/28/2002	K-12	36594-8999
1/29/2002	Non-profit	23344-8888
12/5/2002	K-12	36594-8999
5/5/2003	Non-profit	33401-5476
3/12/2004	Non-profit	33401-5476
3/15/2004	City	21189-

Patron

ID	First name	Last name	Branch	Member since	Units borrowed	Fees	Suggested limit
45461-3981	Adam	Davis	West	2012	25	0	10
23250-2870	Alan	Wang	North	2000	1	0	15
29800-0916	Amanda	Smith	North	2001	54	6.4	15
23344-5566	Ashley	Garcia	South	2000	243	11.30	15
90000-5122	Brian	Frank	East	2011	12	.10	10
92149-1769	Elizabeth	Johnson	West	2010	19	.5	10

Date	Reser- vation type	Requ- ester ID	ID	First nam- e	Last nam- e	Bra- nch	Me- mbe- r sinc- e	Units bor- rowe- d	Fe- es	Sugg- ested limit
006		6980								
7/8/20- 07	K-12	33401- 5476	23344- 5589	Fred	Suz- uki	Nort- h	2000	52	.90	15
1/4/20- 08	Indi- vidual	56049- 5523	34455- 6677	Henr- y	Wils- on	Sou- th	2005	3	.2	15
3/8/20- 09	Non- profit	23344- 5566	93950- 2870	Jane	John- son	We- st	2017	0	0	10
2/14/2- 014	Non- profit	23344- 5566	23344- 8978	John	Smith	Nort- h	2000	36	3.5- 0	15
12/21/- 2015	Non- profit	23344- 5566								
2/10/2- 016	Non- profit	23344- 5566								

To find out more information about new patron behavior, joining the Patron table to the Projector Rental table might provide some insight about which library services motivate new memberships. The common fields between the two tables appear to be "Date" and "Member since." However, the date values in each field are captured at different levels of detail. To join these tables on their respective date fields, use a combination of DATE functions in a calculation on each side of the join condition to make the level of detail in each field match.

```
DATE (DATETRUNC ('year', [Date])) DATE ('01/01/'+STR([Member since]))
```

Using the calculation in the join produces the following combined table:

Date	Reservation type	Requester ID	ID	First name	Last name	Branch	Member since	Units borrowed	Fees	Suggested limit
1/1/2000	Individual	23344-5589	23250-2870	Alan	Wang	North	2000	1	0.00	15
1/1/2000	Individual	23344-5589	23344-5589	Fred	Suzuki	North	2000	52	0.90	15
1/1/2000	Individual	23344-5589	23344-5566	Ashley	Garcia	South	2000	243	11.30	15
1/1/2000	Individual	23344-5589	23344-8978	John	Smith	North	2000	36	3.50	15

To determine if a patron rented the projector in the same year he or she started his or her membership, add one more clause to the join based on ID.

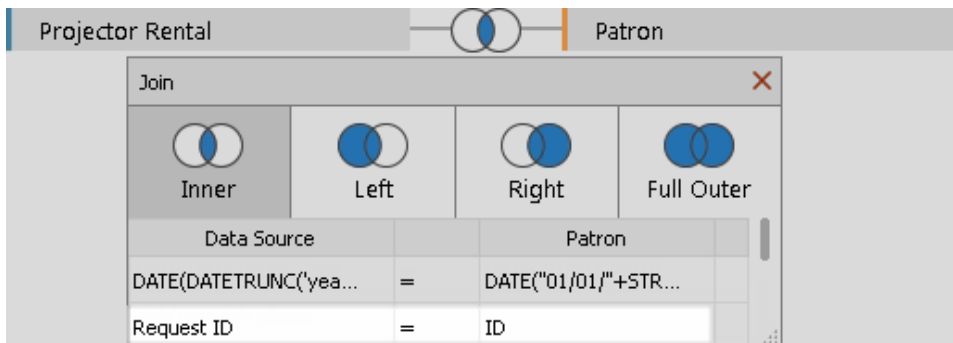

The result of the additional join condition shows that only one patron might have started his membership to rent a projector.

Date	Reservation type	Requester ID	ID	First name	Last name	Branch	Joined	Units borrowed	Fees	Suggested limit
1/1/2000	Individual	233445-589	233445-589	Fred	Suzuki	North	2000	52	0.90	15

Troubleshoot Joins

Note: If your join is mis-counting data, it could be a sign you should be using a relationships instead. For more information about relationships, see [Relate Your Data on page 622](#). For information about how Tableau handles combining data from different levels of detail (such as many-to-many relationships), see [Cardinality and Referential Integrity](#).

Over-counting values or duplicated data

When you connect to and join multiple tables together, you set up a *denormalized* version of the data. In some cases, Tableau treats the multiple tables as one table. When multiple tables are treated as one table, after the tables are joined, *all* tables are queried. This can cause values to be over-counted.

For example, suppose you have two tables. The first table contains employee information, such as employee ID and salary. The second table contains organizational information, such as department names.

Table 1

Employee ID	Name	Salary
20106	Kim, Michelle	63,000
20107	Wilson, Henry	61,000
20108	Smith, John	65,000

Table 2

Department	Hire Date	Employee ID	Organization
Development	6/16/2016	20289	Strategy
Support	7/28/2015	20107	Operations
Support	8/05/2016	20299	Operations
Sales	8/25/2016	20107	Operations

If you join these tables on **Employee ID**, an employee's salary is counted more than once because the employee is associated with multiple departments.

Employee ID	Name	Salary	Department	Hire Date	Organization
20107	Wilson, Henry	61,000	Support	7/28/2015	Operations
20107	Wilson, Henry	61,000	Sales	8/25/2016	Operations

This is an example of one-to-many cardinality (one employee ID in Table 1 has multiple results in Table 2). For more information on cardinality between tables, see [Optimize Relationship Queries Using Performance Options](#) on page 681.

To help resolve this issue, you can do one of the following:

- **Relate the data:** Instead of creating a join, which might duplicate your data, you can use relationships. For more information, see [Relate Your Data](#) on page 622.

Change the aggregation: Depending on your analysis, you can use the **MIN** or **AVG** aggregation to remove over-counting.

For example, if you change the aggregation of **Salary** from SUM to MIN or from SUM to AVG.

- **Create a calculated field that removes the duplicate values:** You can create a calculation that divides the sum of the field being duplicated by the number of instances of the field that is causing the duplication.

For example, the Salary values are being duplicated by the number of instances of Employee ID for Wilson, Henry. In this case, in the view replace Salary with a calculated field that uses the following formula: `SUM ([Salary]) / COUNT ([Employee ID])`.

You could also use a Level of Detail Expression to delete the duplicate data. For more information, see [Removing Duplicate Data with LOD Calculations](#) in the Tableau Knowledge Base.

- **Use custom SQL:** Tableau supports using custom SQL for connecting to multiple tables in a data source. You can pre-aggregate the tables before joining them with a GROUP BY clause. This option requires some knowledge about writing SQL queries and assistance from a database expert if possible. For more information about how to connect to a custom SQL query from Tableau, see [Connect to a Custom SQL Query](#) on page 863.

Broken table joins and cross-database joins

Before you join tables (from the same data source or using a cross-database join), make sure that the data types of the join keys match. If the data types of the join keys don't match, the join breaks, which is indicated by a red exclamation point and the error text "type mismatch between join fields". To fix a broken join, use one of the following suggestions:

- You can change the format of a field (including its data type) in the join dialog to make the join keys match by creating a join calculation. A join calculation supports a subset of

calculations that lets you modify the format of the join key in one or more tables that you want to combine. To create a join calculation, click the join icon between the tables that have a broken join, click the field whose format needs to be modified, and then select **Create Join Calculation**. For more information, see [Troubleshoot Joins on page 805](#).

- For text or Excel-based data, modify the data type of one of the text or Excel fields in the join key using the data type menu in the data grid.
- **Tableau Desktop only:** For most connections, you can use the **Convert to custom SQL** option to change the data type of one of the fields in the join key, using a function like CAST (). The **Convert to custom SQL** option is available only when the data source contains only one connection. In this case, remove the second connection and then select **Data > Convert to custom SQL**.

Assuming Referential Integrity for Joins

In some cases, you can improve query performance for joins by selecting the option to **Assume Referential Integrity** from the **Data** menu. When you use this option, Tableau will include the joined table in the query only if it is specifically referenced by fields in the view.

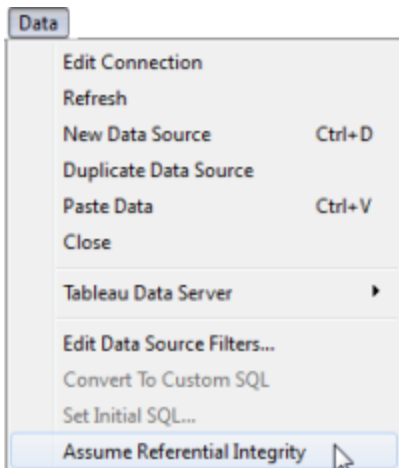

Using this setting is appropriate when you know that your data has referential integrity (see definition below) but your database is not enforcing or cannot enforce referential integrity. If you have the option of configuring referential integrity in your database that is a better option than using this setting because it can improve performance both in the database and in Tableau. The **Assume Referential Integrity** option in Tableau can only affect performance on Tableau's end. If your data does not have referential integrity and you turn on this setting, query results may not be reliable.

To understand what referential integrity is, imagine connecting to sales data that has two tables: Sales and Product Catalog. These two tables are shown below:

Sales			Product Catalog	
Product ID (Foreign Key)	Sale Amount	Transaction Date	Product ID (Primary Key)	Product Name
1	100	10/1/2012	1	10 Inch Tablet
1	2000	10/2/2012		
2	50	9/30/2012	2	Smart Phone
3	10	8/21/2012	3	Desk Lamp
			4	Memory Stick

Because all products that are sold must have a listing in the Product Catalog, every row in the Sales table has a matching row in the Product Catalog table. When these two tables are joined on Product ID, you end up with a table that looks like this:

Product ID	Product Name	Product ID	Sale Amount	Transaction Date
1	10 Inch Tablet	1	100	10/1/2012
1	10 Inch Tablet	1	2000	10/2/2012
2	Smart Phone	2	50	9/30/2012
3	Desk Lamp	3	10	8/21/2012

Now let's say you build a view to look at Sale Amount by Region. By default, dragging the Sale Amount field to the view may create a query like this:

```
SELECT SUM([Sales Amount]) FROM [Sales] S INNER JOIN [Product Catalog] P ON S.ProductID = P.ProductID
```

By selecting **Assume Referential Integrity**, you tell Tableau that the joined tables have referential integrity. In other words, you are confirming that the Sales table will always have a matching row in the Product Catalog table. Because that is true, Tableau doesn't need any information from the Product Catalog table in order to return these results. When you drag the Sales Amount field into the view, Tableau can simplify the query to:

```
SELECT SUM([Sales Amount]) FROM [Sales]
```

This simplified query can often return quicker results because it removes the join operation. This option impacts only inner joins and does not affect data sources with a single table.

Improve Performance for Cross-Database Joins

Important: This feature temporarily moves data outside of Tableau. Be sure that the database you're connected to is from a trusted source.

When joining data between a single database and a single file, Tableau can improve performance by choosing to perform the join using the database instead of Hyper. This default setting allows Tableau to choose the fastest approach (Hyper or the connected database). If Tableau uses the connected database, the data from the file connection is moved into temporary tables in the database and the join is performed there.

Feature conditions

The option to use the connected database for the join is only available if the following conditions are met:

- The data source consists of one or more file-based connections and a single SQL-based connection.
- The files to be joined must be one of the following file types: Microsoft Excel, PDF, or Text (.csv, .txt, .tsv or .tab).
- The connected database is one of the following:
 - Microsoft SQL Server
 - Oracle
 - PostgreSQL
 - Vertica
 - Teradata
- In **web authoring**: The **Allow users to use web authoring** option is enabled.

Changing the preferred option for cross-database joins

1. Connect to the first data source.
 - In **Tableau Desktop**: On the Start page, under **Connect**, connect to a supported file type or supported database type. This step creates the first connection in the Tableau data source.
 - In **web authoring**: From the **Home** or **Explore** page, click **Create > Workbook** to start a new workbook and then connect to your data. This step creates the first connection in the Tableau data source.
2. Select the file or database that you want to connect to, then double-click or drag a table to the canvas.

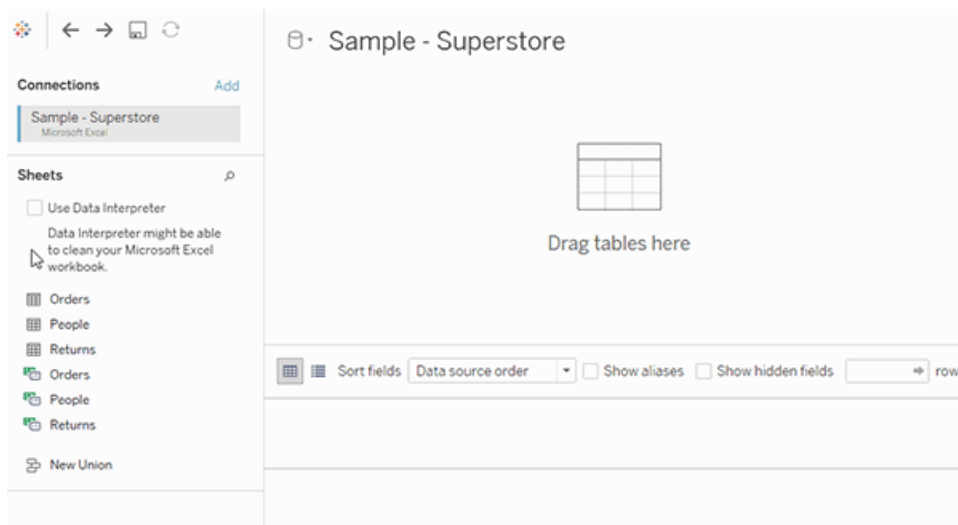

3. In the left pane, under **Connections**, click the **Add** button (⊕ in web authoring) to add your second connection to the Tableau data source.

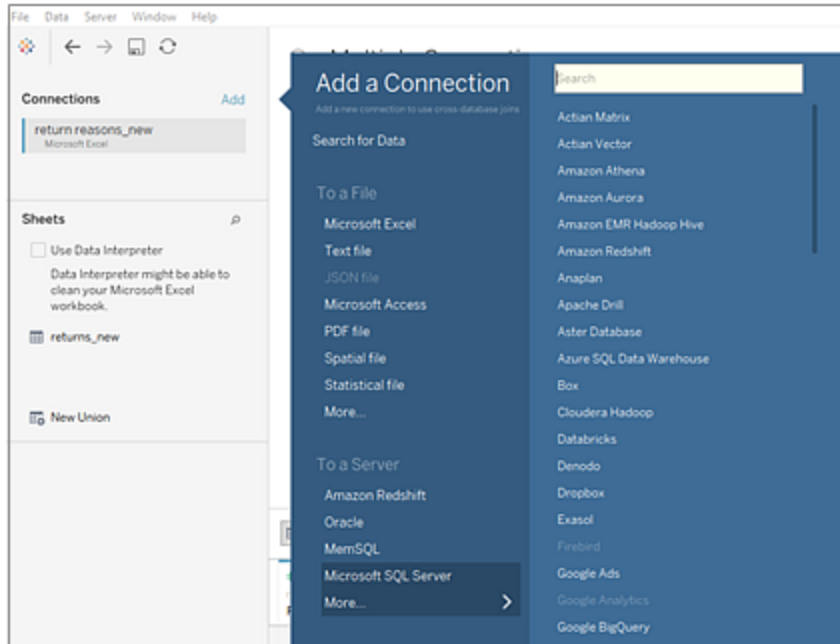

The **Cross-database join** option is displayed.

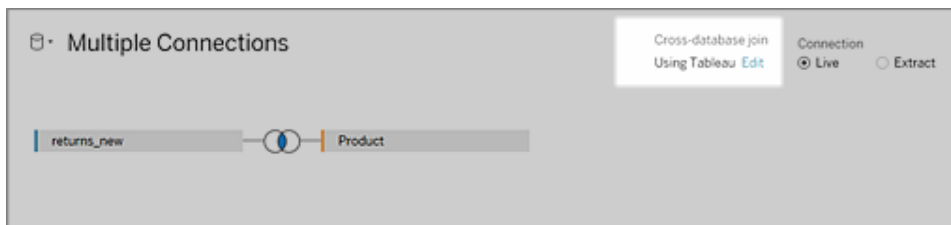

Note: If you don't see this option, check that you're using only supported data source types and that you have at least two data sources (one database and one or more files of supported types).

4. To change how Tableau performs the join, next to the **Cross-database join** option, click **Edit**.
5. In the **Cross-Database Join** dialog, select one of the following options, then click **OK**:
 - **Always perform joins in the database.** This option forces Tableau to use the live database to perform the join.
 - **Let Tableau decide where to join.** This option is the default and allows Tableau to choose the fastest option to perform the join - either Hyper or the database you're

connected to.

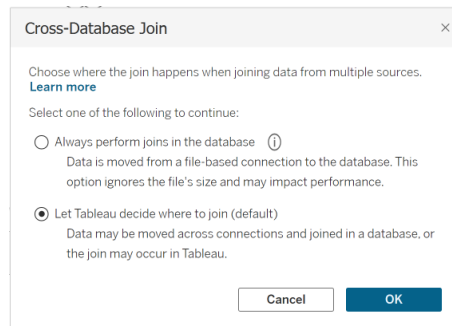

The **Cross-database join** option on the **Multiple Connections** panel will update to reflect your choice.



Important: If you select **Let Tableau decide where to join**, Tableau chooses the fastest option when performing the join. This behavior is predetermined by a set of criteria including join types. For instance, Tableau always chooses Hyper for non-inner joins.

If Tableau uses Hyper to perform the join, this process happens in the background and no indicator is shown to identify where the join was performed.

6. Add one or more join clauses by selecting a field from one data source, a join operator, and a field from the added table. Inspect the join clause to make sure it reflects how you want to connect the tables.

About working with multi-connection data sources

Working with multi-connection data sources is just like working with any other data source, with a few caveats, discussed in this section.

Union data from within a connection

To union data, you must use text tables or Excel tables from the same connection. That is, you can't union tables from different databases. In Tableau Desktop, you can union tables across different Excel workbooks and files in different directories. For more information, see the [Union tables using wildcard search \(Tableau Desktop\)](#) on page 850.

If you need to union data from different databases, use [Tableau Prep](#).

Collation

Collation refers to the rules of a database that determine how string values should be compared and sorted. Usually, the collation is handled by the database. However, when you work with cross-database joins, you might join columns that have different collations.

For example, suppose your cross-database join used a join key comprised of a case-sensitive column from SQL Server and a case-insensitive column from Oracle. In cases like this, Tableau maps certain collations to others to minimize interpreting values incorrectly.

The following rules are used in cross-database joins:

- If a column uses collation standards of the International Components for Unicode (ICU), Tableau uses the collation of the other column.
- If all columns use collation standards of the ICU, Tableau uses the collation of the column of the left table.
- If no columns use collation standards of the ICU, Tableau uses a binary collation. A binary collation means the locale of the database and data type of the columns determine how string values should be compared and sorted.

Maintain case sensitivity for Excel data

If you need to maintain case sensitivity for your Excel data when performing joins, enable the **Maintain Character Case (Excel)** option from the Data menu.

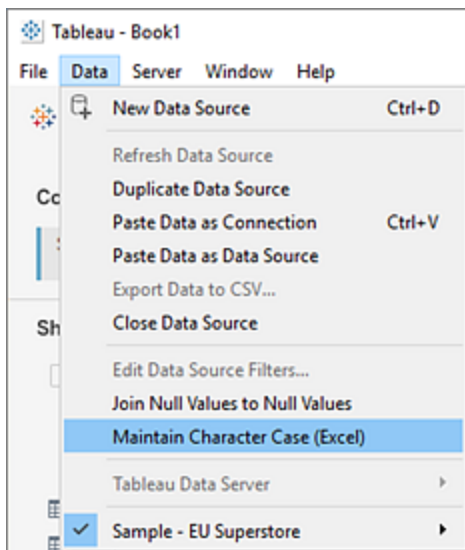

When this option is selected, Tableau maintains the casing and uniquely identifies values with different casing instead of combining them, resulting in a different number of rows.

For example, consider one worksheet with "House" and another with "house" and "HOUSE". By default, Tableau ignores the casing and considers all three variations of "house" as the same. With the **Maintain Character Case (Excel)** option enabled, when you join your tables, Tableau preserves the character casing differences. "House", "house", and "HOUSE" are treated as different values.

Note: This option is available for all Tableau supported languages and isn't dependent on the locale of your operating system. This option is only available for Microsoft Excel data sources.

Calculations and multi-connection data sources

Only a subset of calculations can be used in a multi-connection data source.

- **In Tableau Desktop:** You can use a specific calculation if it's both:
 - Supported by all the connections in the multi-connection data source
 - Supported by Tableau extracts.
- **In web authoring (Tableau Cloud and Tableau Server):** You can use a specific calculation if it's supported by all the connections in the multi-connection data source.

Stored procedures

Stored procedures aren't available for multi-connection data sources.

Pivot data from within a connection

To pivot data, you must use text columns or Excel columns from the same connection. That is, you can't include columns from different databases in a pivot.

Make extract files the first connection (Tableau Desktop only)

When connecting to extract files in a multi-connection data source, make sure that the connection to the extract (.hyper) file is the first connection. This preserves any customizations that might be a part of the extract, including changes to default properties, calculated fields, groups, aliases, and so on.

Note: If you must connect to multiple extract files in your multi-connection data source, only the customizations in the extract in the first connection are preserved.

Extracts of multi-connection data sources that contain connections to file-based data (Tableau Desktop only)

If you're publishing an extract of a multi-connection data source with file-based data such as Excel, selecting the **Include external files** option copies the file-based data as part of the data source. In this case, a copy of your file-based data can be downloaded and its contents accessed by other users. If there's sensitive information in the file-based data that you've intentionally excluded from your extract, *don't* select **Include external files** when you publish the data source.

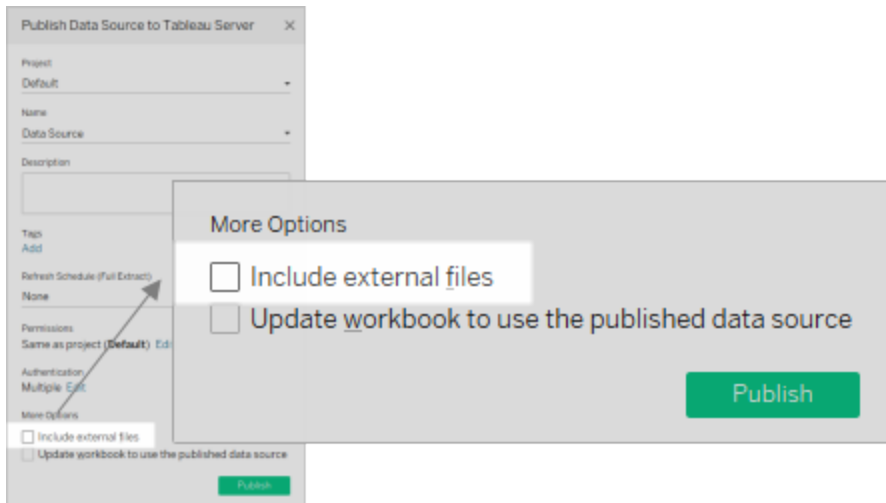

For more information about publishing data sources, see [Publish a Data Source](#) on page 3141.

About queries and cross-database joins

For each connection, Tableau sends independent queries to the databases in the join. The results are stored in a temporary table, in the format of an extract file.

Important: Cross-database joins may move data between databases. Be sure the databases you're joining are trusted sources.

For example, suppose you create connections to two tables, `dbo.listings` and `reviews`. These tables are stored in two different databases, SQL Server and Excel. Tableau queries the database in each connection independently. The database performs the query and applies customizations such as filters and calculations, and Tableau stores the results for each connection in a temporary table. In this example, `FQ_Temp_1` is the temporary table for the connection to SQL Server and `FQ_Temp_2` is the temporary table for the connection to Excel.

SQL Server table Excel table

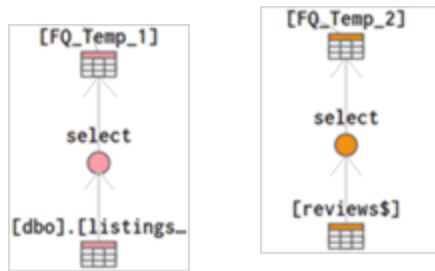

When you perform a cross-database join, the temporary tables are joined by Tableau Desktop. These temporary tables are necessary for Tableau to perform cross-database joins.

After the tables have been joined, a Top N filter is applied to limit the number of values shown in the data grid to the first 1,000 rows. This filter is applied to help maintain responsiveness of the data grid and the overall performance of the Data Source page.

Joined tables

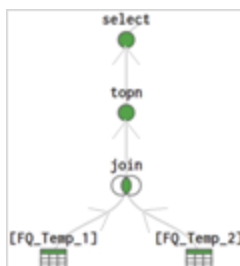

Blend Your Data

Data blending is a method for combining data from multiple sources. Data blending brings in additional information from a secondary data source and displays it with data from the primary data source directly in the view.

Data blending is particularly useful when the blend relationship—the linking fields—need to vary on a sheet-by-sheet basis, or when combining published data sources.

Options to combine data

There are several ways to combine data, each with their own strengths and weaknesses.

Relationships are the default method and can be used in most instances, including across tables with different levels of detail. Relationships are flexible and adapt to the structure of the

analysis on a sheet by sheet basis. However, you can't create relationships between tables from published data sources.

Joins combine tables by adding more columns of data across similar row structures. This can cause data loss or duplication if tables are at different levels of detail, and joins must be established before analysis can begin. You can't use a published data source in a join.

Blends, unlike relationships or joins, never combine the data directly. Instead, blends query each data source independently, aggregate the results to the appropriate level, then present the results together visually in the view. Because of this, blends can handle different levels of detail and also work with published data sources. Blends don't create a new, blended data source (and therefore can't be published as a "blended data source"). Instead, they are simply blended results visualized per sheet.



Steps for blending data

Data blending is performed on a sheet-by-sheet basis and is established when a field from a second data source is used in the view.

To create a blend in a workbook, you need to connect to at least two data sources. Then bring a field from one data source to the sheet—it becomes the primary data source. Switch to the other data source and use a field on the same sheet—it becomes a secondary data source. A linking icon will appear in the data pane, indicating which field(s) are being used to blend the data sources.

1. Ensure that the workbook has multiple data sources. The second data source should be added by going to **Data > New data source**.

Tip: Blending requires two or more distinct data sources, listed independently in the Data pane. Adding another *connection* to the first data source enables relationships and joins on the Data Source page.

2. Drag a field to the view. This data source will be the primary data source.
3. Switch to another data source and verify there is a blend relationship to the primary data source.
 - If there is a linking field icon (), the data sources are automatically linked. As long as there is at least one active link, the data can be blended.
 - If there are broken link icons (), click the icon next to the field that should link the two data sources. The slash will go away, representing an active link.

- If a link icon does not appear next to the desired field, see [Define blend relationships for blending on page 821](#).

4. Drag a field into the view from the secondary data source.

As soon as this second data source is used in the same view, a blend is established. In the example below, our primary data source is **Movie Adaptations** and the secondary data source is **Bookshop**.

- The primary data source is indicated with a blue check mark on the data source. Fields from the primary data source used in the view have no indication.
- The secondary data source is indicated with an orange check mark on the data source and an orange bar down the side of the Data pane. Fields from the secondary data source used in the view have an orange check mark.

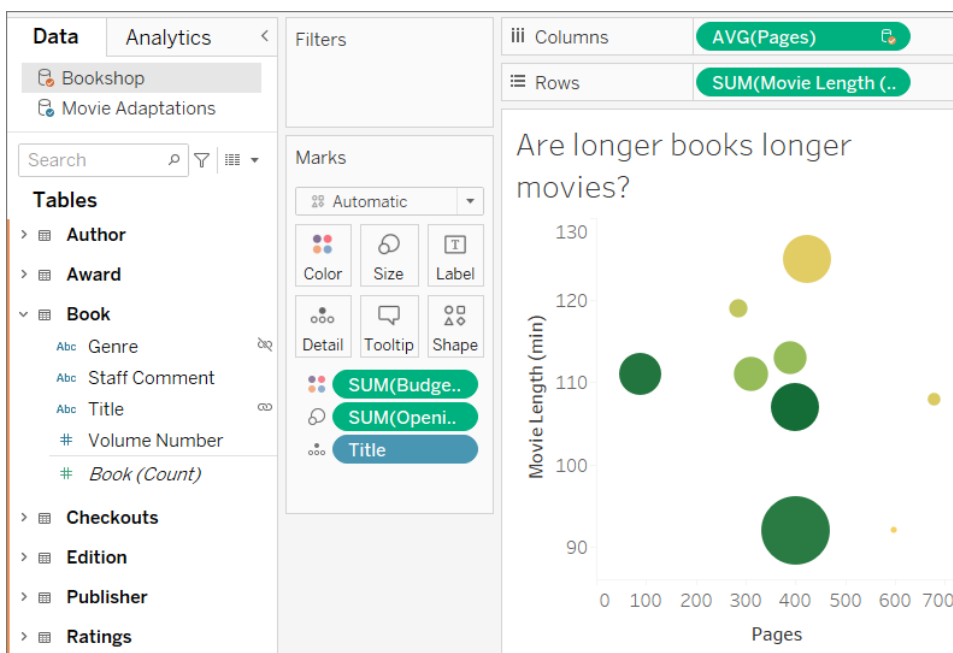

Understand primary and secondary data sources

Data blending requires a primary data source and at least one secondary data source. The first data source used in the view becomes the primary data source and defines the view. This can restrict values from the secondary data source—only values that have corresponding matches in the primary data source appear in the view. This is comparable to a left join.

For example, if the primary data source has a Month field that only contains April, May, and June, any view built around months will only display April, May, and June, even if the secondary

data source has values for twelve months. If the desired analysis involves all twelve months, try switching which data source is primary by rebuilding the sheet and using the other data source first.

Learn more: the effects of data source order

The following examples below use the same data sources linked on the same field, and the viz is built the same way both times. The difference between the results is due to which data source is designated as the primary.

1. Here, the Month field from the **Rainfall** data source is brought into the view first. Because **Rainfall** only contains three months, when the **Pollen** data set is added as a secondary, only three months are brought into the view.

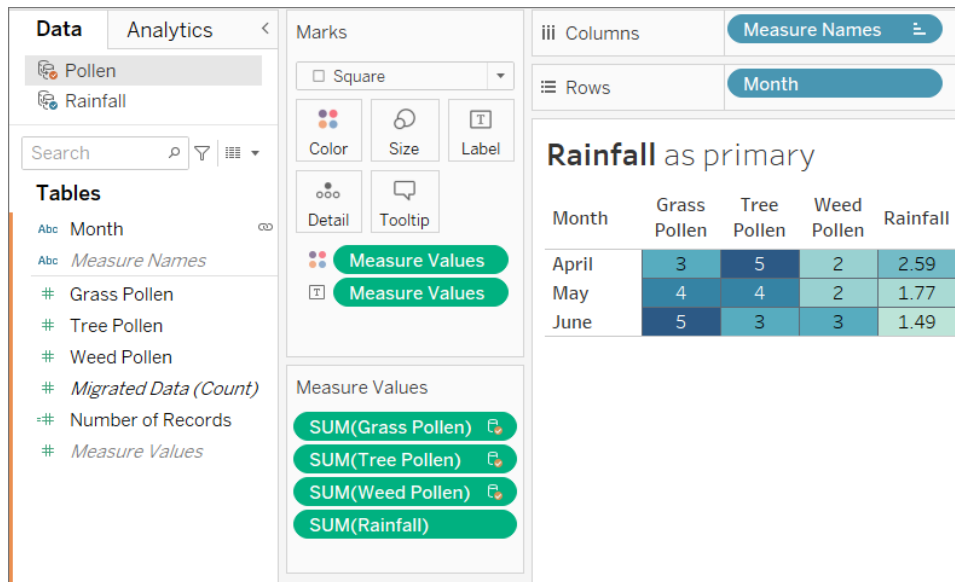

2. On another sheet, the Month field from the **Pollen** data set is brought into the view first. All twelve months are displayed. When the **Rainfall** data set is added as a secondary, **Rainfall** is only available for the three months in that data set.

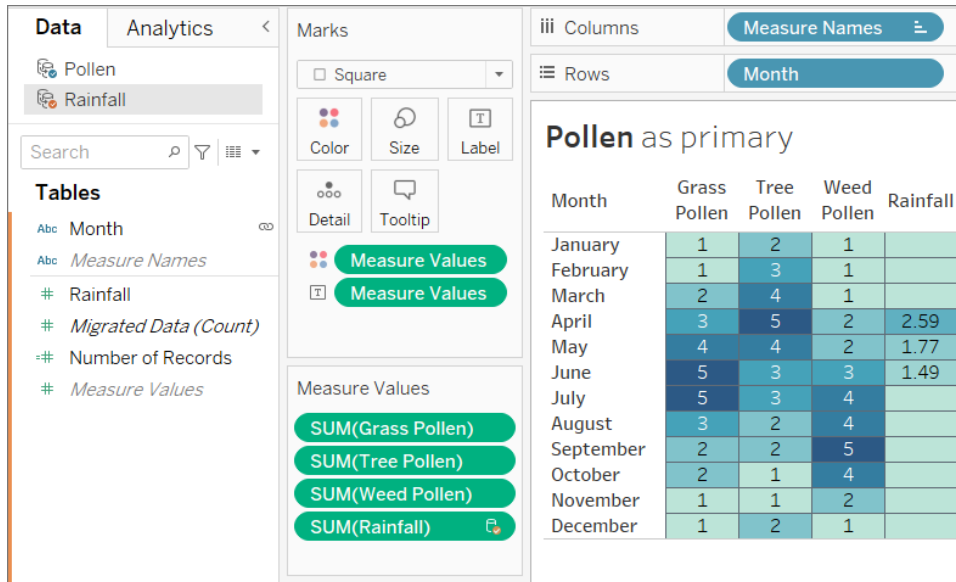

Work across blended data sources

Due to the nature of a data blend, there are some things to keep in mind when working across blended data sources.

Performing calculations with fields from more than one data source can be slightly different than an ordinary calculation. A calculation must be created in a single data source; the top of the calculation editor indicates which data source the calculation is in.

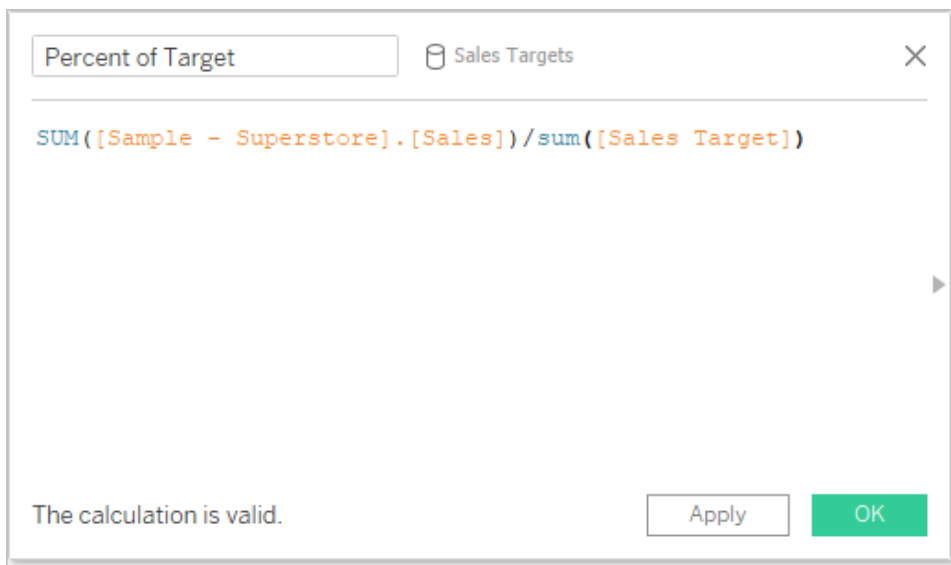
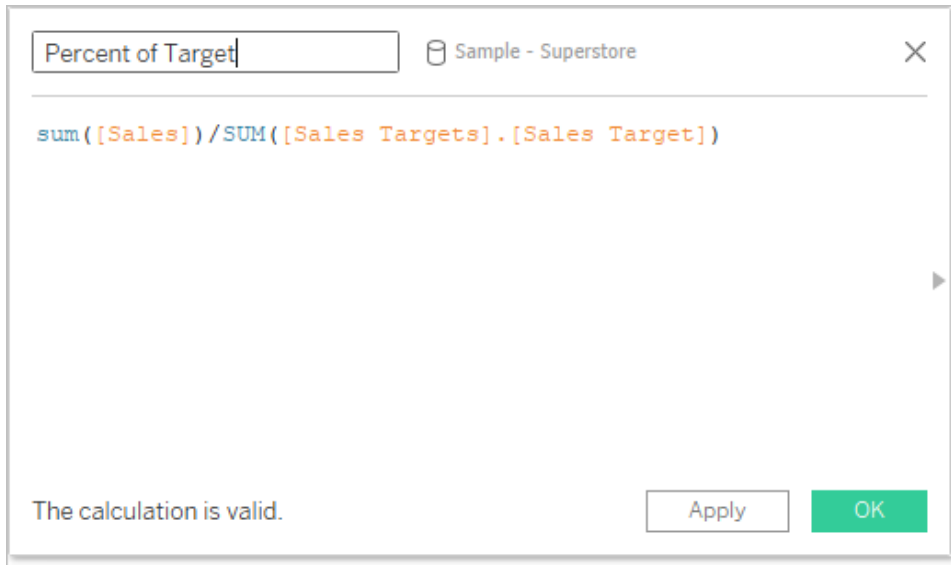

- **Aggregation.** Any fields used from another data source will come in with an aggregation—by default, SUM, but this can be changed. Because calculations cannot mix aggregate and non-aggregate arguments, fields from the calculation's host data source must also be aggregated. (In the images below, the **SUM** aggregation was added automatically and the **sum** aggregation was added manually.)
- **Dot notation.** Any field referenced in the calculation that belong to another data source refers to its data source using dot notation. (In the images below, for the calculation built in **Sample - Superstore**, the Sales Target field becomes **[Sales.Targets].[Sales Target]**. When the calculation is built in **Sales Targets**, the Sales field becomes **[Sample - Superstore].[Sales]**.)
- These are equivalent versions of the same calculation built in each data source. In both cases, this is SUM(Sales) / SUM(Sales Target).



In addition to handling calculations slightly differently, there are some limitations on secondary data sources. You may not be able to sort by a field from a secondary data source, and action filters may not work as expected with blended data. For more information, see [Other data blending issues](#) on page 842.

Define blend relationships for blending

In order for Tableau to know how to combine the data from multiple sources, there must be a common dimension or dimensions between the data sources. This common dimension is called the linking field. Active linking fields are identified in the Data pane for the secondary data source



with an active link icon () and potential linking fields are identified with a broken link icon (). Linking fields are not indicated on the primary data source.

For example, in a blend of transactional and quota data, a geographic field might be the desired the linking field so you can analyze both quota and performance towards that quota for the same region.

Note: In order for the blend to function, the linking fields must also share values or members. Tableau builds the view of blended data based on the shared values. For example, if **Color** is the linking field in both data sources, Tableau will match data on "Purple" from the primary and "Purple" from the secondary. But "Lt. Blue" will not map correctly to "Light Blue", so one of them would need to be realiaised. Like renaming fields to help Tableau identify linking fields, you can edit aliases for members in those fields. For more information, see [Create Aliases to Rename Members in the View](#) on page 1067.

Establish a link

If the linking field in the primary and secondary data sources have the same name, Tableau automatically creates the relationship. When a primary data source is established (that is, a field is in use in the view) and the secondary data source is selected in the Data pane, any fields with

the same name between the two data sources will display a link icon ( or ) in the *secondary* data source. If the related field from the primary data source is used in the view, the link becomes active automatically.

If there are no link icons on the secondary data source, you may need to help Tableau establish the link in one of two ways:

1. If common dimensions don't have the same name (such as "Title" and "Book Title"), renaming one will let Tableau identify them as common dimensions and establish the link.
2. Alternatively, you can manually define a relationship between the fields in the primary and secondary data sources. See below for more information on creating manual link relationship

There can be as many active or potential linking fields as necessary. Click the broken link icon () in the data pane to make the relationship active.

Manually define a link relationship

If your common dimensions do not share the same name, you can map the relationship between them manually.

1. Select **Data > Edit Blend Relationships....**
2. In the Blend Relationships dialog box, verify that the primary data source is selected from the **Primary data source** drop-down list.
3. Select the secondary data source in the **Secondary data source** pane. Any existing, automatic blend relationships are visible (and can be deleted by hovering over the row and clicking the x). Select **Custom** in the relationships list, and then click **Add**.

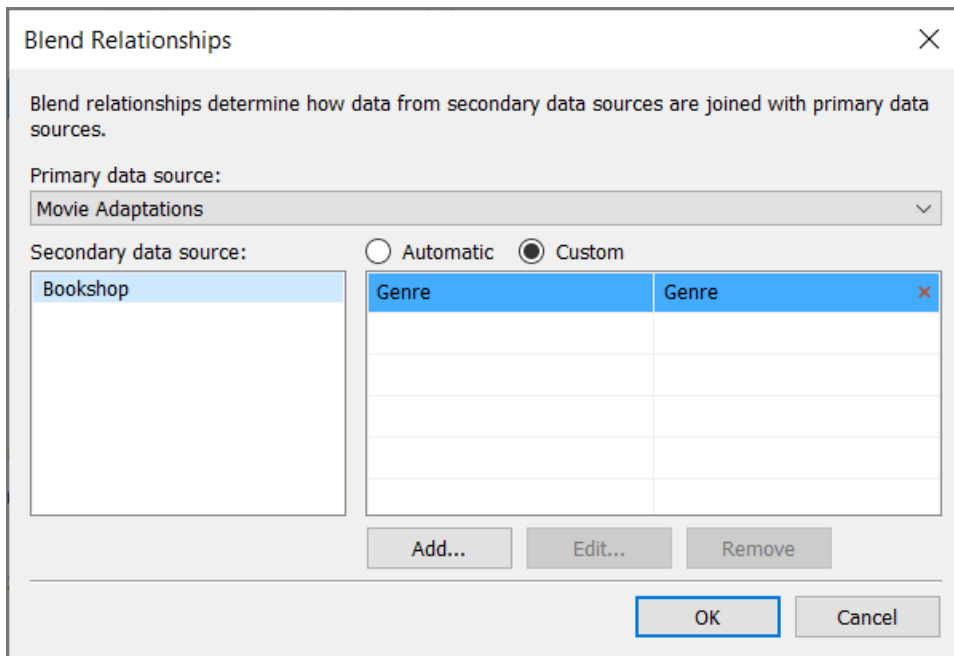

4. In the Add/Edit Field Mapping dialog box, do the following:
 - a. Select a field from the primary data source.
 - b. Select the comparable field from the secondary data source.
 - c. Click **OK**.

In this example, **Segment** is mapped to **Cust Segment**.

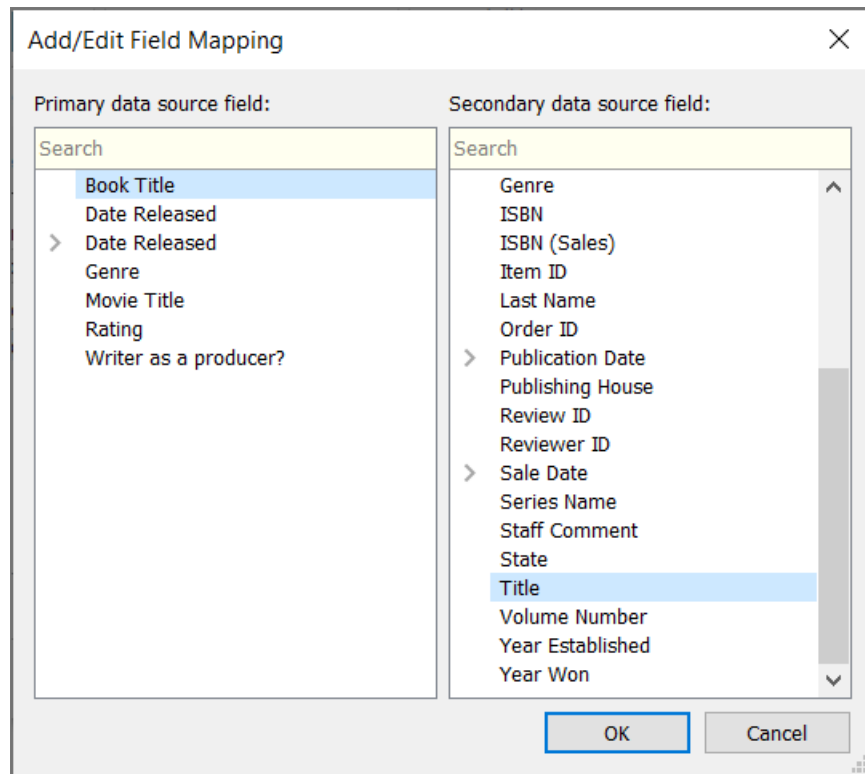

Tip: For dates, the relationship can be specified precisely. Expand the date field and select the desired aspect of the date, such as exact date, month, year, etc.

5. Create as many field mappings as desired, then click **OK**.

Multiple links

As with relationships or joins, there are times when the links between the data sources are defined by more than one field. For example, if regional sales quotas are monthly, a blend between transactional sales data and quota data needs to be established on both region and month for the correct data to be brought together in the view. Multiple links can be active at the same time.

Learn more: the impact of multiple linking fields

When data is blended based on multiple fields, values are included in the view only where the combination of data from those fields matches across both data sets. Let's look at an example to

understand this.

We have two tables, one for birds that were actually seen by birdwatchers, and one for birds that were reported as seen.

Birdwatcher	Species seen	Location	Number of birds
A	Grackle	Beach	1
	Oriole	Pier	2
B	Kiskadee	Beach	4
C	Kiskadee	Beach	5
	Oriole	Tree	3

and

Birdwatcher	Species seen	Evidence Type	Number of reports
A	Kiskadee	journal entry	1
	Oriole	photograph	1
B	Grackle	journal entry	1
C	Grackle	journal entry	1
	Kiskadee	photograph	1

If we set up a blended view with the fields **Birdwatchers** and **Number of birds** from the primary data source (**Birds seen**) and bring in the field **Number of reports** from the secondary data source (**Birds reported**), Tableau automatically blends on **Birdwatcher**.

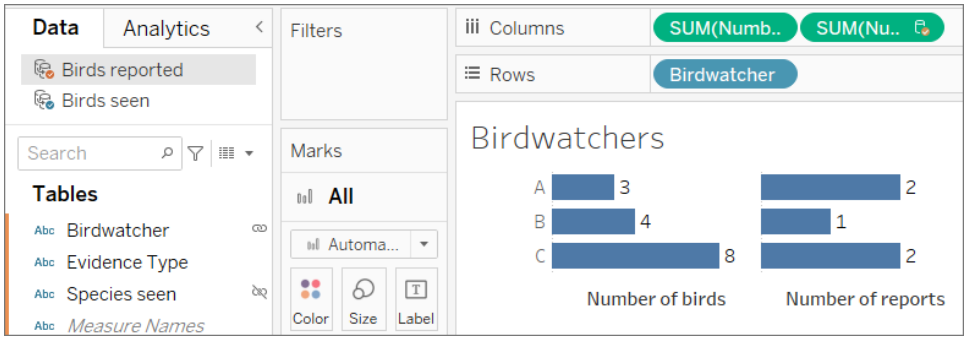

We see that birdwatcher A saw three birds and made two reports, B saw four birds and made one report, and C saw 8 birds and made two reports.

But there's another possible linking field, **Species seen**. Why not blend on this, too? Will it make a difference?

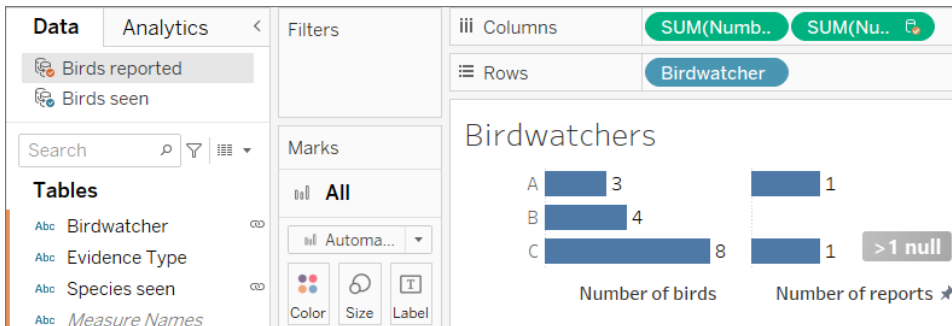

It makes quite a dramatic difference. Now we see that there is only one report each for birdwatchers A and C, and B has a null. What's going on?

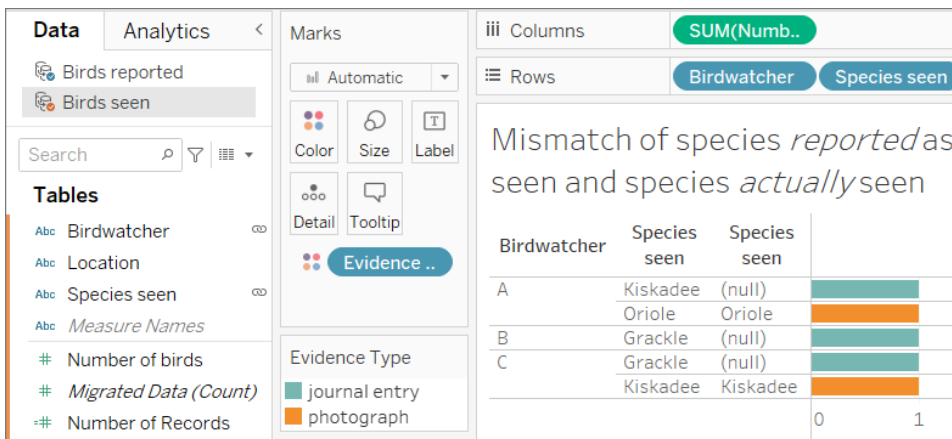

It turns out that these birdwatchers aren't very honest. When they only reported their sightings based on a journal entry (blue bars in the image above), the species they reported seeing didn't match what they actually saw (note the nulls in the second column, from the **Birds seen** secondary data source). When they backed up the report with a photograph (orange bars), they were honest (both columns of **Species seen** match).

Because three reports didn't match on species, those rows of data were dropped when **Species seen** was used as a linking field. The view only shows data where values for both linking fields match.

Takeaway

Be careful when linking on multiple fields. Although it can be very easy to click the icon and establish an active link, over-linking or linking on undesired fields can have a serious impact on

the analysis.

Differences between joins and data blending

Data blending simulates a traditional left join. The main difference between the two is when the aggregation is performed. A join combines the data and then aggregates. A blend aggregates and then combines the data.

Left join

When you use a left join to combine data, a query is sent to the database where the join is performed. A left join returns all rows from the left table and any corresponding rows from the right table. The results of the join are then sent back to Tableau and aggregated for display in the visualization.

A left join takes all rows from the left table. The common columns are **User ID** and **Patron ID**; where there is corresponding information from the right table, that data is returned. Otherwise, there is a null.

User ID	District	Level	Type
1	2	3	G
2	3	4	J
4	5	6	M
1	2	3	W



Branch	Patron ID	District	Level
A001	1	2	3
B001	2	3	4
C001	1	2	3

User ID	District	Level	Branch	Type
1	2	3	A001	G
1	2	3	A001	W
1	2	3	C001	G
1	2	3	C001	W
2	3	4	B001	J
4	5	6	<i>null</i>	M

Suppose you have the same tables, but flip the order. This new left join produces different results. Again, a left join takes all the data from the new left table, but essentially ignores a row from the right table. The row of data for User ID = 4 is not included because there is no row for Patron ID = 4 in the left table.

Branch	Patron ID	District	Level
A001	1	2	3
B001	2	3	4
C001	1	2	3



User ID	District	Level	Type
1	2	3	G
2	3	4	J
4	5	6	M
1	2	3	W



User ID	District	Level	Branch	Type
1	2	3	A001	G
1	2	3	A001	W
1	2	3	C001	G
1	2	3	C001	W
2	3	4	B001	J

Data blending

When you use data blending to combine data, a query is sent to the database for each data source that is used on the sheet. The results of the queries are sent back to Tableau as aggregated data and presented together in the visualization.

Note: Aggregating measures is straightforward—we can take the sum, average, maximum, or other aggregation of a number with ease. Measure values are aggregated based on how the field is aggregated in the view. However, all fields from a secondary data source must be aggregated. How does that work for dimensions? Dimension values are aggregated using the **ATTR** aggregate function, which returns a single value for all rows in the secondary data source. If there are multiple values contained in those rows, an asterisk (*) is shown. This can be interpreted as "there are multiple values in the secondary data source for this mark in the view".

The view uses all values from the primary data source (functioning as the left table) and the corresponding rows from the secondary data source (the right table) based on the linking field (s).

Suppose you have the following tables. If the linking fields are **User ID** and **Patron ID**, not all values can be a part of the resulting table because of the following:

- A row in the left table does not have a corresponding row match in the right table, as indicated by the null value in the results.
- There are multiple corresponding values in the rows in the right table, as indicated by the asterisk (*) in the results.

User ID	District	Level	Type
1	2	3	G
2	3	4	J
4	5	6	M
1	2	3	W

Branch	Patron ID	District	Level
A001	1	2	3
B001	2	3	4
C001	1	2	3

User ID	District	Level	Branch	Type
1	2	3	*	G
2	3	4	B001	J
4	5	6	<i>null</i>	M
1	2	3	*	W

When measures are involved, they are also aggregated, as seen below:

Branch	Patron ID	District	Level	Fines
A001	1	2	3	10.00
B001	2	3	4	20.00
C001	1	2	3	30.00

↓

User ID	District	Level	Type
1	2	3	G
2	3	4	J
4	5	6	M
1	2	3	W

Branch	Patron ID	District	Level	Fines
*	1	2	3	40.00
B001	2	3	4	20.00
*	1	2	3	40.00

User ID	District	Level	Type	Branch	Fines
1	2	3	G	*	40.00
2	3	4	J	B001	20.00
4	5	6	M	<i>null</i>	<i>null</i>
1	2	3	W	*	40.00

Important: an asterisk (*) in a view with blended data indicates multiple values. This can be resolved by ensuring there is only one matching value in the secondary data source for each mark in the primary data source, potentially by swapping the primary and secondary data sources. For more information, see [Troubleshoot Data Blending on page 836](#).

Data blending at a glance

- Data blending occurs on a sheet-by sheet basis.
- The order in which fields are used determines which data source is the primary versus the secondary data source.

- The primary data source is indicated with a blue check mark, any secondary data sources and fields from secondary data sources have an orange check mark.
- Linking fields can be automatically determined based on shared field names or the blend relationship can be manually created.
- Data blending behaves similarly to a left join, which may result in missing data from the secondary data source.
- Asterisks (*) may appear. This indicates multiple dimension values in a single mark, because data blending takes aggregated results and combines them in the view.
- A secondary data source can be used to re-alias the field values in a primary data source. For more information, see [Alias Field Values Using Data Blending](#) below.

Data blending limitations

- There are some data blending limitations around non-additive aggregates, such as COUNTD, MEDIAN, and RAWSQLAGG. For more information, see [Troubleshoot Data Blending on page 836](#)
- Blended data sources cannot be published as a unit. Instead, publish each data source separately (to the same server) and then blend the published data sources.
- Data from secondary data sources must always be aggregated in calculations.
- If you are blending a cube data source, it must be the primary data source.

Alias Field Values Using Data Blending

Data blending is a method for combining data. Data blending works by supplementing the data in the primary data source with the data in the secondary data source.

Aliasing is the alternative name that you can assign to a value in a dimension field. You can use aliases to rename specific values within a dimension. This can be useful when you want to show more relevant or descriptive dimension values in your view than what the original data provides.

You can use data blending as a method for re-aliasing values in a data source by using field values from another data source. To do this, there must be a field in the secondary data source that contains aliases for a field in the primary data source.

For example, suppose you have a primary data source that contains information on fruit, including fruit names and code values that the fruit are associated with. A secondary data source contains a field with more descriptive code values.

Primary data source		Secondary data source
Fruit	Fruit ID	Alternate ID
Apple	A	APP
Banana	B	BAN

When you re-alias a field in your primary data source, you can create a view that replaces the original code values with the more descriptive code values.

Note: After you have used the secondary data source to provide aliases for the primary data source, you no longer need the secondary data source and can close it.

To alias field values

1. Set up the primary and secondary data sources and establish a relationship between the data sources. For more information, see [Blend Your Data on page 816](#). The data sources used in this example are Fruit Stand and Alternate ID.

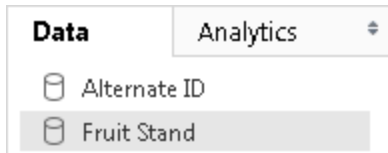

2. Select the primary data source in the **Data** pane, and then drag the field that you want to alias to the view.

For this example, Fruit Stand is the primary data source.

3. Select the secondary data source in the **Data** pane, and drag the field that contains the alias information to the view.

For this example, Alternate ID is the secondary data source. **Note:** The field you are using to alias the field values in the primary data source cannot be the linking field you are using to link the primary and secondary data sources.

In this example, Alternate ID field in the secondary data source contains the aliasing information needed by the Fruit Stand field in the primary data source.

Columns		
Rows		
Fruit ID	Alternate ID	
A	APP	Abc
B	BAN	Abc
C	CAN	Abc
D	DUR	Abc
E	EMB	Abc

- Right-click (control-click on a Mac) the field from the secondary data source and select **Edit Primary Aliases**.

Values in the primary data source must have corresponding alias values in the secondary data source. An asterisk under **Has Alias** confirms that the data sources have corresponding alias values .

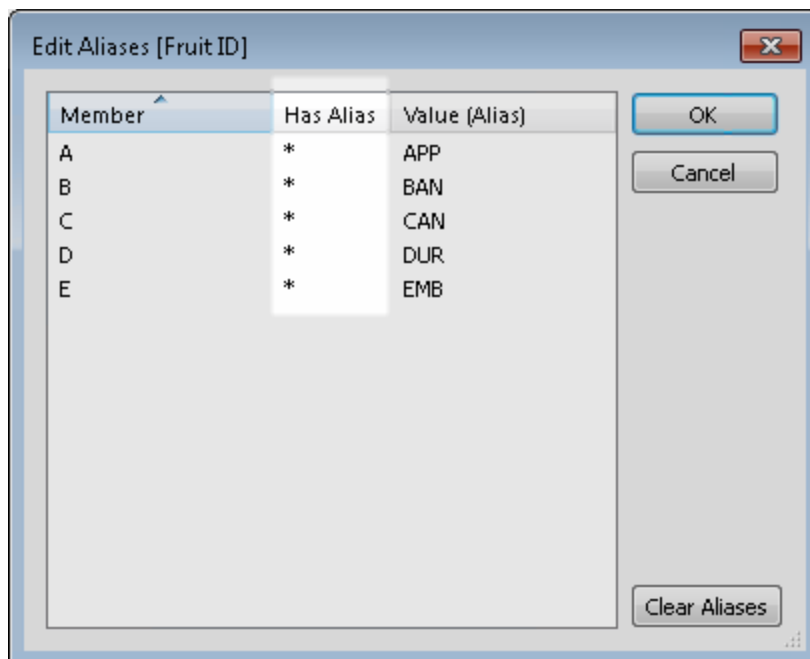

Note: If asterisks don't appear under **Has Alias**, then either the secondary data source doesn't have the corresponding aliases to match the field values in the primary data source, or there is more than one field value in the primary data source that has the same

alias in the secondary data source. In cases like this, aliasing field values in the primary data source with data from the secondary data source is not possible.

5. Click **OK**. The alias values in the secondary data source replace the field values in the primary data source. In this example, the more descriptive code values from Alternate ID field replaces the values in the Fruit ID field.

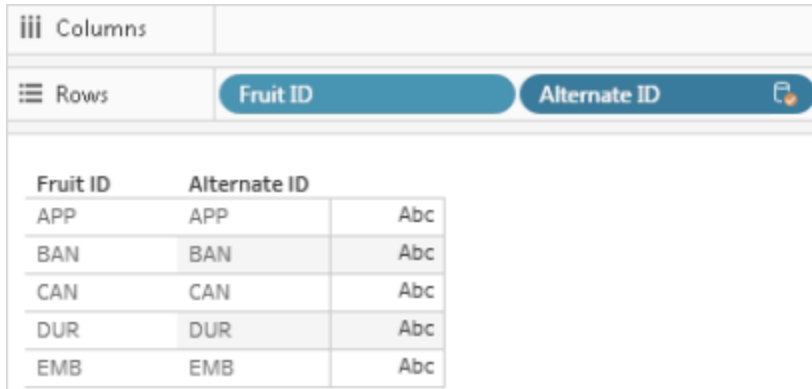

Fruit ID	Alternate ID	
APP	APP	Abc
BAN	BAN	Abc
CAN	CAN	Abc
DUR	DUR	Abc
EMB	EMB	Abc

6. (Optional) Select the secondary data source from the **Data** menu, and select **Close**.

Bring a Field into the Primary Data Source

Data blending is a method for combining data. Data blending works by supplementing the data in the primary data source with the data in the secondary data source.

In cases where you might only need just *some* of the data in the secondary data source, you can create a primary group to bring only the fields that you need into the primary data source. This eliminates the need for the secondary data source, which reduces the size of the workbook and can improve workbook performance.

For example, suppose you have two data sources: Superstore and Population. The Superstore data source contains lots of data, but most importantly, it contains data about states and the region each of the states is associated with. The Population data source contains state and population data, but doesn't contain any data about regions. In this case, you can blend the Population and Superstore data sources to create a primary group. Then so that you can pull in the Region field from the Superstore data source into the Population data source, thereby eliminating the need for the Superstore data source all together.

To blend two data sources and create a primary group

1. Download and open the following workbook from Tableau Public.
 - a. Go to <https://public.tableau.com/profile/tableau.docs.team#!/vizhome/BringaFieldintothePrimaryDataSource/Sheet1>.
 - b. Click **Download Workbook** in the upper-right corner and then open the workbook.

In the workbook, the **State** dimension is already on the **Rows** shelf, making it the first field in the view and establishing the Population data source as the primary data source for the sheet. The Superstore data source is also included in the workbook and functions as the secondary data source.

2. In the **Data** pane, select Superstore, and then drag the **Region** dimension to the **Rows** shelf and place it in front of **State**.

The view shows the regions from the Superstore data source (secondary) and the states in the Population data source (primary) that are associated with those regions. There are two states, Alaska and Hawaii, from Population data source (primary) that are not associated with a specific region. These two states are assigned to a "null" region.

Region	State	Value
Null	Alaska	Abc
	Hawaii	Abc
Central	Illinois	Abc
	Indiana	Abc
	Iowa	Abc
	Kansas	Abc
	Michigan	Abc
	Minnesota	Abc
	Missouri	Abc
	Nebraska	Abc
	North Dakota	Abc
	Oklahoma	Abc
	South Dakota	Abc
	Texas	Abc
	Wisconsin	Abc
East	Connecticut	Abc

3. Right-click the **Region** field in the **Rows** shelf from the Superstore data source (secondary), and select **Create Primary Group**.
4. In the Edit Group dialog box, drag Alaska and Hawaii (from the "null" region) to the **West** region. This task assigns the states in the Population data source (primary) in the "null" region into a region.

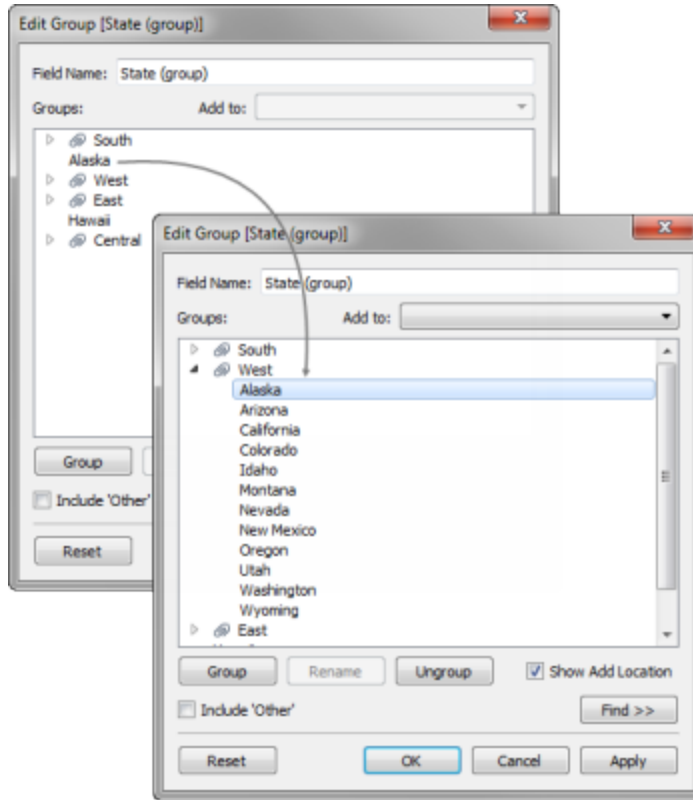

5. Click **OK** to close the Edit Group dialog box.
6. In the **Data** pane, select the State data source (secondary). Now you see a new group field listed in the Population data source (primary) called **State (group)**.
7. Drag the **State (group)** dimension over the Region dimension on the **Rows** shelf to replace it.
8. Drag the **2016 Population** measure to the **Columns** shelf to see Population based on the regions from the Superstore (secondary) data source.
9. (Optional) You can close the Superstore data source (secondary), and then continue with your analysis. You can also publish the data source or workbook without the secondary

data source. This is because the field you were using from the secondary data source, **Region**, is replaced by the primary group field that you created in the primary data source.

Troubleshoot Data Blending

When you use data blending to combine your data from different data sources, there are a few common issues that might arise. This topic lists them and describes how you can respond to each situation.

Common warnings and errors when blending data sources

No relationship to the primary data source

When you drag a field from a secondary data source to the view, you might see a warning that says:

Fields cannot be used from the [name of secondary data source] data source, because there is no blend relationship to the primary data source. In the Data pane, switch to the [name of secondary data source] data source, and click at least one link icon to blend these data sources.

This warning occurs when you have no active links in the secondary data source

For example, suppose you have two data sources that are related by the **State** and **Date** fields.

At least one of these fields must have the active link icon () next to it in the secondary data

source. You can make the link active by clicking a broken link icon () in the **Data** pane or by using the linking field from the primary data source in the view.

The secondary data source may not have any links to the primary data source. Look in the **Data** pane for the link icon. Tableau automatically links fields that have the same name. If your fields do not have the same name, you must define a link between them. For more information, see [Blend Your Data on page 816](#).

Primary and secondary connections are from tables in the same data source

When you drag a field from a secondary data source to the view, you might see a warning that says:

The primary and secondary connections are from tables in the same data source. Instead of linking the connections, use the Data menu to join the data. Joins can integrate data from many tables and may improve performance and filtering.

This warning occurs when the workbook contains separate data sources that connect to the same database. Though you can combine data in this way, Tableau recommends that you use a join or relationship to combine data from the same database instead, as they can leverage some of the database's native optimizations in ways blending can't.

Cannot blend the secondary data source because one or more fields use an unsupported aggregation

Data blending has some limitations regarding non-additive aggregates such as COUNTD, MEDIAN, and RAWSQLAGG. Non-additive aggregates are aggregate functions that produce results that cannot be aggregated along a dimension. Instead, the values have to be calculated individually. All Number functions, except for MAX and MIN, are non-additive aggregates. For more information, see [Tableau Functions \(by Category\) on page 2199](#).

These limitations cause certain fields in the view to become invalid under certain circumstances. If you hover your mouse cursor over one of these invalid fields, you see the following error:

Cannot blend the secondary data source because one or more fields use an unsupported aggregation.

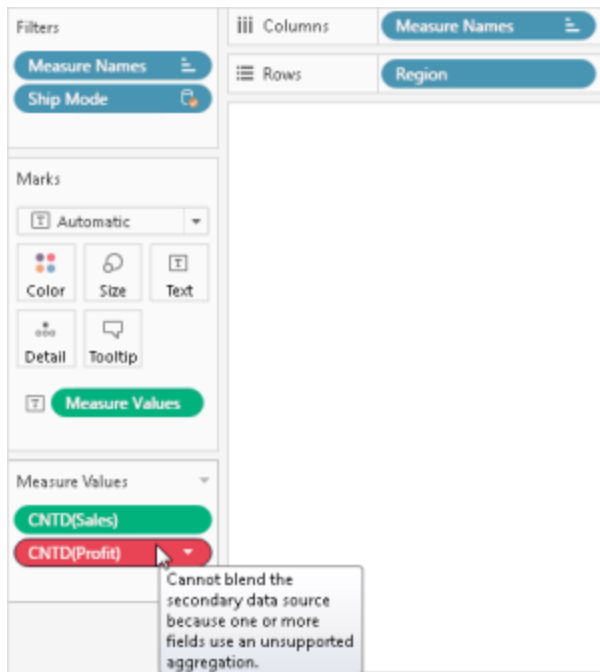

This error can occur for one of the following reasons:

- **Non-additive aggregates from the primary data source:** Non-additive aggregates are only supported in the primary data source if the data in the data source comes from a relational database that allows the use of temporary tables. To work around this issue, consider creating an extract of your data source. Extracts support temporary tables.
- **Non-additive aggregates from the secondary data source:** Non-additive aggregates are only supported in the secondary data source if the linking field from the primary data source is included in the view and no non-aggregated dimensions from the secondary data source is included in the view. Some number functions can still be used if they include an additive aggregation. For example, use `ROUND(SUM([Sales]),1)` instead of `ROUND([Sales],1)`.
- **Non-additive aggregates from a multi-connection data source that uses a live connection:** Multi-connection data sources that connect to data using a live connection do not support temporary tables. Therefore, using a multi-connection data source that connects to data using a live connection prohibits the use of blending functionality with non-additive aggregates. To work around this issue, consider creating an extract of your multi-connection data source. Extracts support temporary tables.
- **LOD expressions from the secondary data source:** This error can also appear when you use a level of detail expression in a view that uses data blending. To resolve the error, make sure the linking field in the primary data source is in the view before you use an LOD expression from the secondary data source and remove any dimensions, including dimension filters, from the secondary data source.

Data sources that contain logical tables cannot be used as secondary data sources for data blending

The secondary data source can use logical joins as long as the following conditions are satisfied:

- All active linking fields from the primary data source must be included in the view on a shelf other than the Filters shelf
- All fields from the secondary data source are aggregated, including dimensions

Asterisks show in the sheet

When you blend data, make sure that there is only *one* matching value in the secondary data source for each mark in the primary data source. If there are multiple matching values, you see an asterisk in the view that results after you blend data.

For example, suppose you have two data sources: Population and Superstore. The primary data source, Population, has a field called **State**. The secondary data source, Superstore, contains fields called **State** and **Segment**. In the secondary data source, each state has multiple segments. Alabama, for example, has three segments: Consumer, Corporate, and Home Office.

Primary data source

Secondary data source

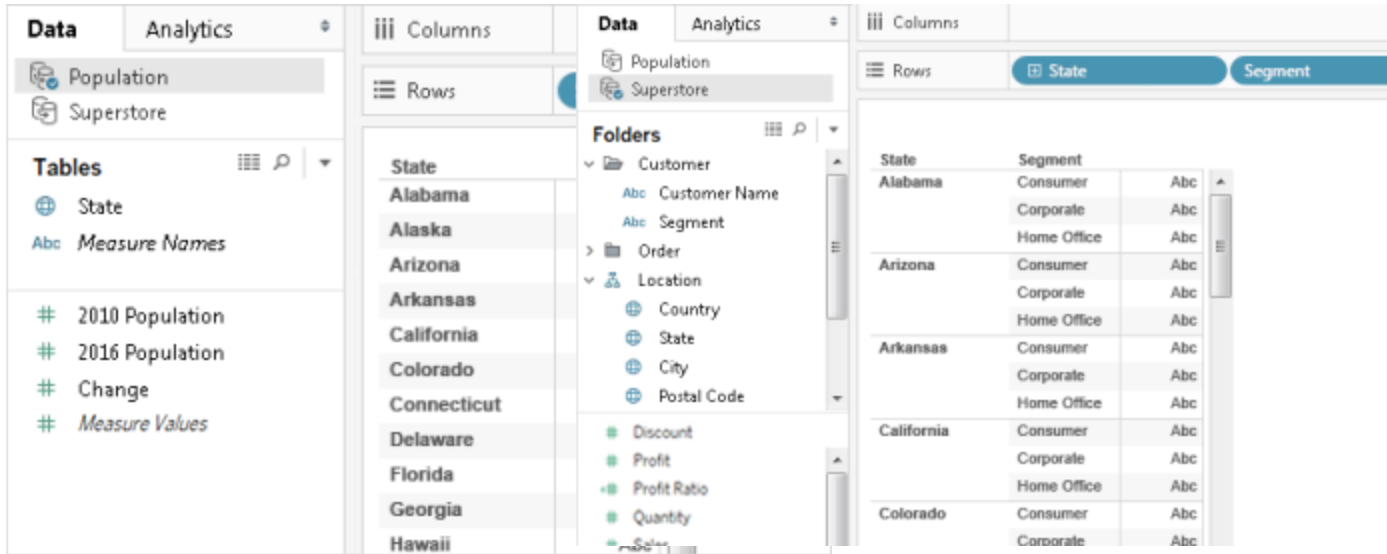

When you blend the two data sources on the **State** field, you create a link where individual state values (in the primary data source) can have multiple segment values (in the secondary data source). In this case, multiple values for segments in the secondary data source for each corresponding state value in the primary data source cause asterisks to appear in the view, as demonstrated by the images below.

Blended data

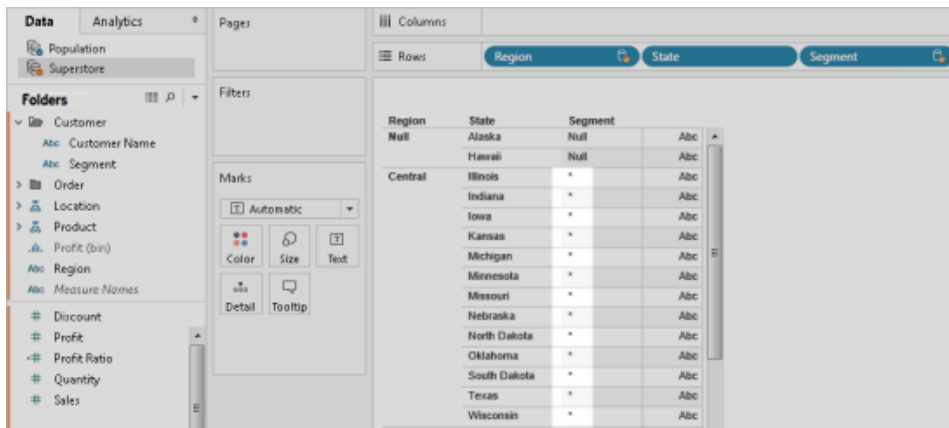

Resolve asterisks in the sheet

Avoid asterisks in the sheet by making sure that there is only *one* matching value in the secondary data source for each mark in the primary data source. Though the way you ensure this depends on the data and the view you're trying to create, consider one of the following suggestions to resolve asterisks in the sheet.

- Add field with a higher level of granularity from the primary data source to the sheet.

For example, suppose you have a view similar to the example used above. Consider adding a field such as City into the sheet because its values are at a higher level of granularity than a field like State.

- Rebuild the view to switch the primary and secondary data sources with each other. In general, you should make the data source whose values have a higher level of granularity the primary data source.

For example, suppose you have a view similar to the example used above. Consider making Superstore the primary data source and Population the secondary data source.

Null values appear after blending data sources

Null values can sometimes appear in place of the data you want in the view when you use data blending. Null values can appear for a few reasons:

- The secondary data source does not contain values for the corresponding values in the primary data source.
- The data types of the fields you are blending on are different.
- The values in the primary and secondary data sources use different casing.

Data blending works by supplementing the data in the primary data source with data from the secondary data source based on the linking field. This means Tableau takes all the data in the primary data source, and only the corresponding matches in the secondary data source. If Tableau cannot identify at least one matching value in the secondary data source for the corresponding value in the primary data source, null values appear.

You can resolve this issue by doing the following:

- **Insert data in the secondary data source:** Insert missing data in the secondary data source so that all records in the primary data source have a match. For example, suppose your primary data source contains values for all 50 U.S. states, but your secondary data

source only has values for 30 U.S. states. To resolve this issue, you can add values for the remaining 20 U.S. states to the underlying data set of the secondary data source.

Alternatively, you might be able to [Bring a Field into the Primary Data Source](#) on page 833 or [Alias Field Values Using Data Blending](#) on page 830 to work around null values if you cannot modify the underlying data.

- **Verify data types in the primary and secondary data sources match:** For example, both data sources should use string data for the fields you are blending on, or both fields should contain numbers. You can't blend fields where one field contains numbers and the other contains strings.
- **Verify the casing of the values in the primary and secondary data sources match:** If one data source uses a mix of upper- and lowercase names, and the other uses only uppercase, you'll see null values. For more information, see [Nulls Show When Data Blending](#).

Blending issues after publishing data sources

When you make a field-level customization that blends two data sources, the customization is based on one of the data sources, the primary data source. Then, when the primary and secondary data sources are published to Tableau Server or Tableau Cloud, the primary data source, which contains the customization (i.e., the reference to the secondary data source) no longer works. The customization no longer works because the blend relationship between the primary and secondary data sources is lost. This is because the blend relationship between the primary and secondary data sources is defined at the workbook level.

For example, suppose you have two data sources: Store - Main and Store - West. You create a field-level customization, like a calculation, that combines the sales totals from the primary data source, Store - Main, with the sales totals from the secondary data source, Store - West. As soon as you publish the data sources to Tableau Server or Tableau Cloud, the calculation in Store - Main no longer works. This is because the calculation refers to the secondary data source, Store - West, whose location is now undetermined.

To work around this scenario, do the following:

1. Before creating any field-level customizations, publish each data source first.
2. Connect to each data source.
3. Create a workbook that contains the field-level customizations that you need.
4. Publish the workbook to Tableau Server.

You can use this workbook as a "template" that can be shared and downloaded by you and others.

Blending with a cube (multidimensional) data source

Cube data sources can only be used as the primary data source for blending data in Tableau. They cannot be used as secondary data sources.

Other data blending issues

For other issues that emerge while blending data, see the following links.

Sort is not available

- For issues sorting on a calculated field, see [Sorting by Fields is Unavailable for Data Blended Measures](#).
- For issues with a computed sort, see [Sort Options Not Available from Toolbar When Data Blending](#).

Actions do not behave as expected

- Fields from the secondary data source cannot be added to a URL action. See [Fields from Blended Data Source Unavailable for URL Actions](#).
- Action filters are not behaving as expected. See [Action Filters with Blended Data Not Working as Expected](#).

Unexpected values and field changes

- Duplicate totals after every date value in the view. See [Issues with Blending on Date Fields](#).
- Underlying data shows different values than blended data. See [Underlying Data from Secondary Data Source Not Displayed or Consistent with Blended Data](#).

Blend on Summary Data

Data blending is a method for combining data. Data blending works by supplementing the data in the primary data source with the data in the secondary data source.

When one of the data sources that you're working with is large, you can reduce query time by using data blending to combine data in the primary data source with summary data from the secondary (large data source).

For example, suppose you have two data sources: Store - North and Store - South. Store - North is the primary data source and Store - South is the large secondary data source. To reduce query times when working with a large data source like Store - South, you can use data blending to blend only on the summary data of the large secondary data source (Store - South) with the data in the smaller and presumably faster primary data source (Store - North).

To blend on summary data, you can do the following:

1. Create a relationship between data sources.
2. Bring summary data from the secondary data source into the primary data source.
3. Compare primary data source data to summary data in the secondary data source.

Step 1: Create a relationship between the primary and secondary data sources

1. Download and open the following from Tableau Public.
 - a. Go to <https://public.tableau.com/profile/tableau.docs.team#!/vizhome/BlendonSummaryData/Sheet1>.
 - b. Click **Download Workbook** in the upper-right corner.

In the workbook, the Order Date dimension is already on the Columns shelf, making it the first field in the view and establishing *Store - North* as the primary data source for the sheet. The *Store - South* data source is also included in the workbook and functions as the large secondary data source.

2. Select **Data > Edit Relationships**.
3. In the Relationships dialog box, select **Custom**, and then click **Add**.
4. In the Add/Edit Field Mapping dialog box, in both lists, click the arrow next to Order Date, select **Year(Order Data)**, and then click **OK**.
5. In the Relationships dialog box, click **Add** again.
6. In the Add/Edit Field Mapping dialog box, in both lists, click **Prod Type 1**, and then click

OK.

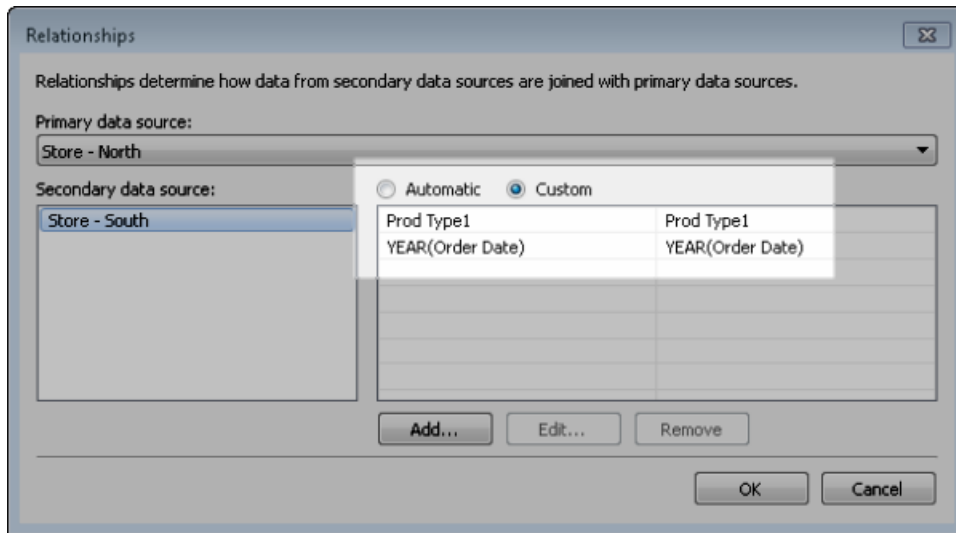

Step 2: Bring summary data from the secondary data source into the primary data source

1. In the Data pane, select the Store - North data source.
2. Select **Analysis > Create Calculated Field**.
3. In the calculation dialog box, do the following:
 - a. In the name text box, enter **Sales for Store - South**.
 - b. In the formula text box, type the ZN function, the SUM function, and the Sales Totals field from the Store - South data source.

Your formula should look like the following: `ZN(SUM([Store - South].[Sales Total]))`

This formula pulls in just the sales data from the large secondary data source.

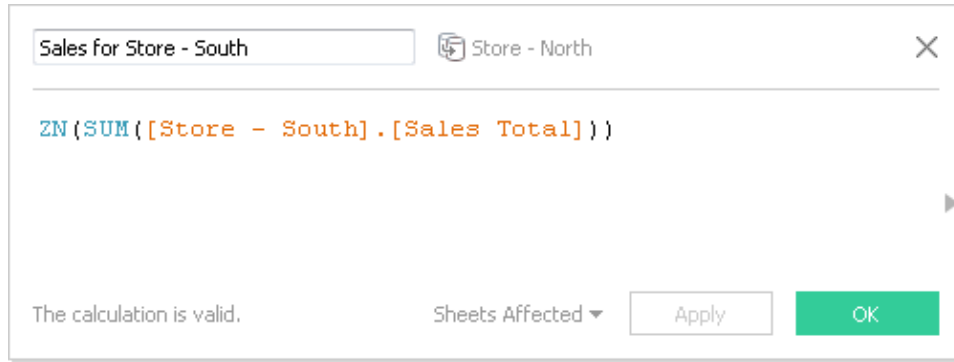

4. Select **Analysis > Create Calculated Field**.

5. In the calculation dialog box, do the following:

- a. In the name text box, enter **Total Sales (North and South)**.
- b. In the formula text box, type the following:

```
IF ISNULL([Sales for Store - South]) THEN 0 ELSE [Sales for Store - South]END
```

+

```
IF ISNULL (SUM([Sales Total])) THEN 0 ELSE SUM([Sales Total]) END
```

This formula adds the sales data from the large secondary data source to the sales data in the primary data source to get combined sales for Store - South and Store - North.

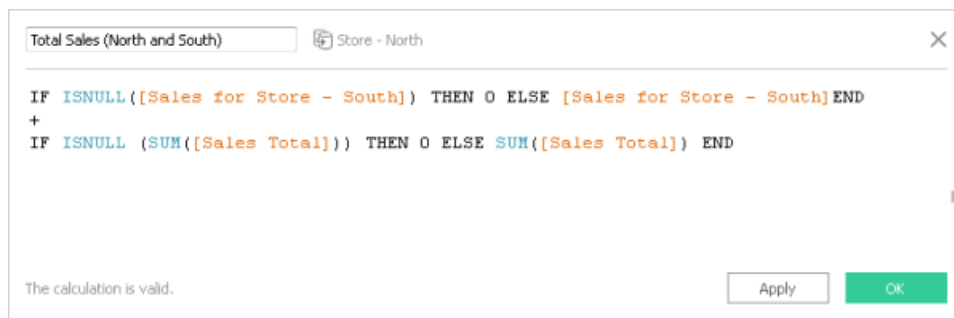

Step 3: Compare primary data source data to summary data of secondary data source

1. From the Data pane, drag **Order Date** to the Columns shelf and **Prod 1** to Rows shelf.
2. Drag **Measure Names** to the Rows shelf, and then to the Filters shelf.
3. In the Filter dialog box, click **None**, and then select **Sales Total**, **Sales for Store - South**, **Total Sales (North and South)** check boxes.

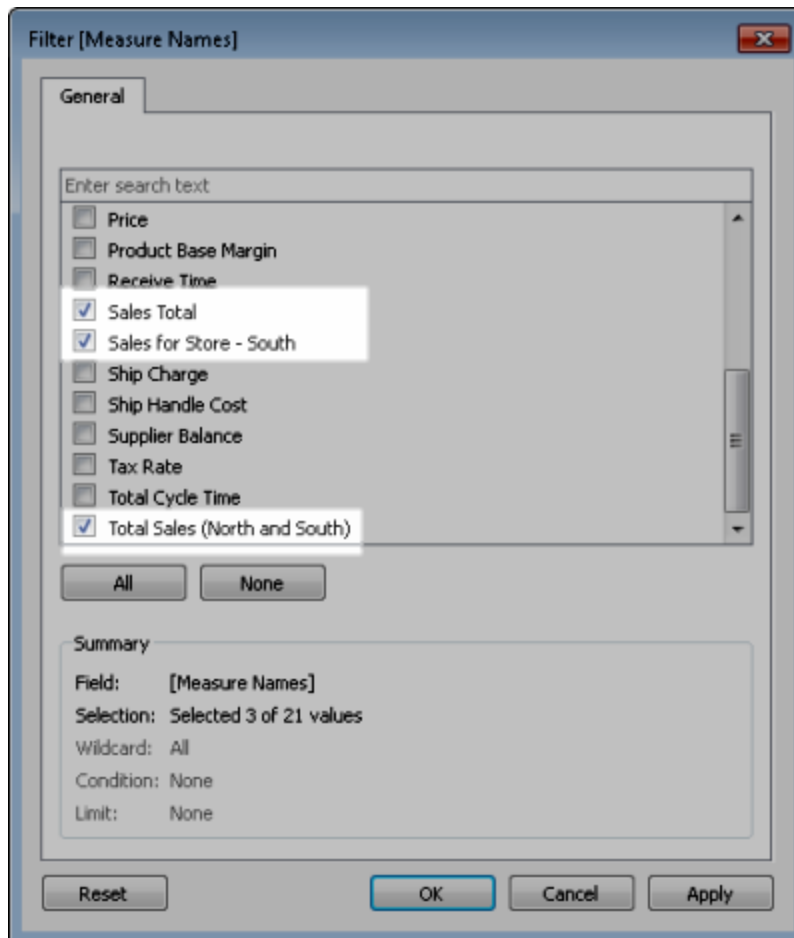

4. From the Data pane, drag **Measure Values** to Text.

The final result is a view that summarizes primary data source and secondary data source data on the Order Year and product category.

The screenshot shows the Tableau Desktop interface with a pivot table. The Columns shelf contains 'YEAR(Order Date)' and the Rows shelf contains 'Measure Names' and 'Prod Type1'. The view is titled 'Sheet 1' and displays a table with the following data:

		Order Date					
		1997	1998	1999	2000	2001	2002
Sales Total	FURNITURE	5,537,544	5,661,287	5,678,312	5,938,958	5,966,809	5,226,176
	OFFICE SUPPLIES	4,154,015	4,225,035	4,141,064	3,760,214	3,907,569	3,826,844
	TECHNOLOGY	6,722,790	7,629,904	6,863,829	6,477,433	6,420,297	6,549,857
Sales for Store - South	FURNITURE	5,537,544	5,661,287	5,678,312	5,938,958	5,966,809	5,226,176
	OFFICE SUPPLIES	4,154,015	4,225,035	4,141,064	3,760,214	3,907,569	3,826,844
	TECHNOLOGY	6,722,790	7,629,904	6,863,829	6,477,433	6,420,297	6,549,857
Total Sales (North and South)	FURNITURE	11,075,088	11,322,574	11,356,624	11,877,915	11,933,619	10,452,352
	OFFICE SUPPLIES	8,308,030	8,450,070	8,282,127	7,520,427	7,815,138	7,653,688
	TECHNOLOGY	13,445,581	15,259,809	13,727,659	12,954,865	12,840,595	13,099,715

Note: The example sales data in both Store - North and Store - South are identical and therefore yield same results for both **Sales Total** and **Sales for Store - South** fields.

Union Your Data

You can union your data to combine two or more tables by appending values (rows) from one table to another. To union your data in Tableau data source, the tables must come from the same connection.

Supported connectors

If your data source supports union, the **New Union** option displays in the left pane of the data source page after you connect to your data. Supported connectors may vary between Tableau Desktop and Tableau Server and Tableau Cloud.

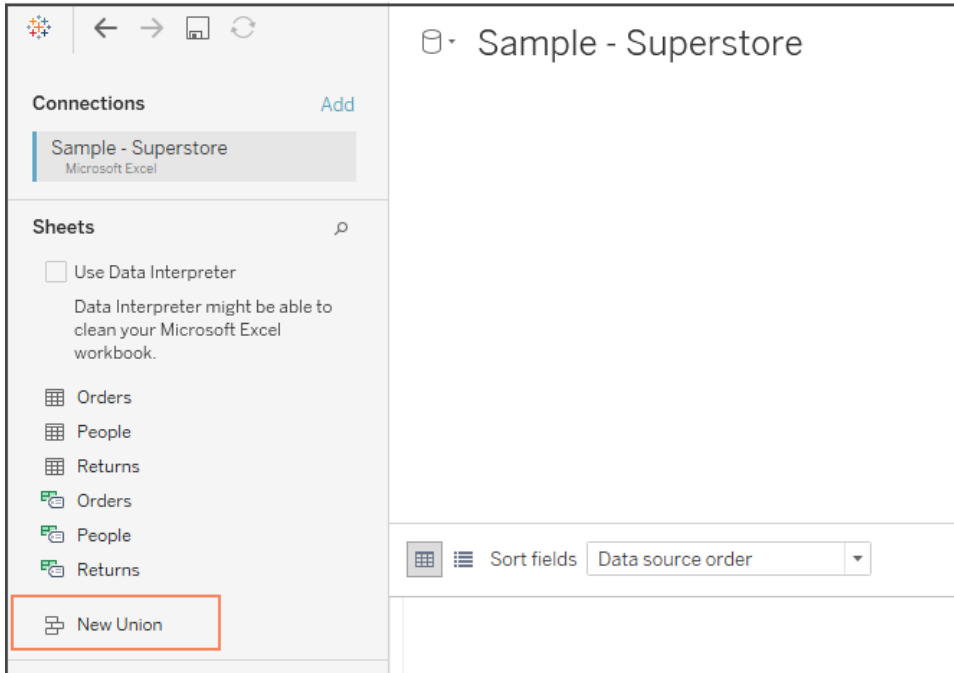

For best results, the tables that you combine using a union must have the same structure. That is, each table must have the same number of fields, and related fields must have matching field names and data types.

For example, suppose you have the following customer purchase information stored in three tables, separated by month. The table names are "May2016," "June2016," and "July2016."

May2016				June2016				July2016			
D-ay	Cus-tomer	Purch-ases	Ty-pe	D-ay	Cus-tomer	Purch-ases	Ty-pe	D-ay	Cus-tomer	Purch-ases	Ty-pe
4	Lane	5	Cre-dit	1	Lisa	3	Cre-dit	2	Mario	2	Cre-dit
10	Chris	6	Cre-dit	28	Isaac	4	Ca-sh	15	Wei	1	Ca-sh
28	Juan	1	Cre-dit	28	Sam	2	Cre-dit	21	Jim	7	Ca-sh

A union of these tables creates the following single table that contains all rows from all tables.

Union

Day	Customer	Purchases	Type
4	Lane	5	Credit
10	Chris	6	Credit
28	Juan	1	Credit
1	Lisa	3	Credit
28	Isaac	4	Cash
28	Sam	2	Credit
2	Mario	2	Credit
15	Wei	1	Cash
21	Jim	7	Cash

Union tables manually

Use this method to manually union distinct tables. This method allows you to drag individual tables from the left pane of the Data Source page and into the Union dialog box.

To union tables manually

1. On the data source page, double-click **New Union** to set up the union.

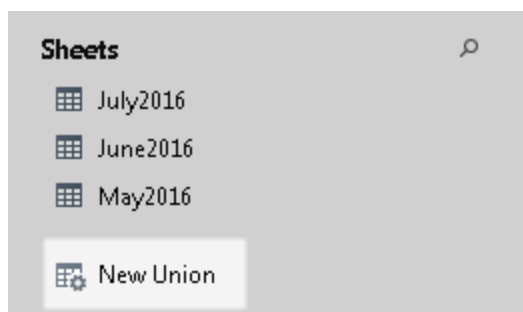

2. Drag a table from the left pane to the Union dialog box.

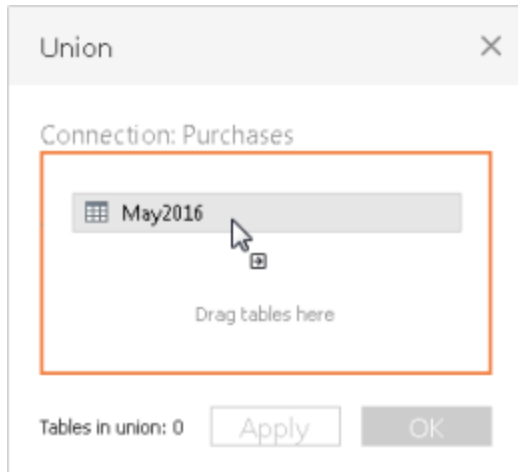

3. Select another table from the left pane and drag it directly below the first table.

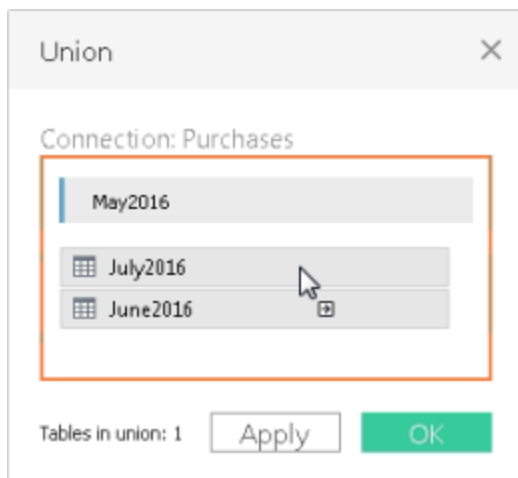

Tip: To add multiple tables to a union at the same time, press **Shift** or **Ctrl** (**Shift** or **Command** on a Mac), select the tables you want to union in the left pane, and then drag them directly below the first table.

4. Click **Apply** or **OK** to union.

Union tables using wildcard search (Tableau Desktop)

Use this method to set up search criteria to automatically include tables in your union. Use the wildcard character, which is an asterisk (*), to match a sequence or pattern of characters in the Excel workbook and worksheet names, Google Sheets workbook and worksheet names, text file names, JSON file names, .pdf file names, and database table names.

When working with Excel, text file data, JSON file, .pdf file data, you can also use this method to union files across folders, and worksheets across workbooks. Search is scoped to the selected connection. The connection and the tables available in a connection are shown on the left pane of the Data source page.

To union tables using wildcard search

1. On the data source page, double-click **New Union** to set up the union.



2. Click **Wildcard (automatic)** in the Union dialog box.

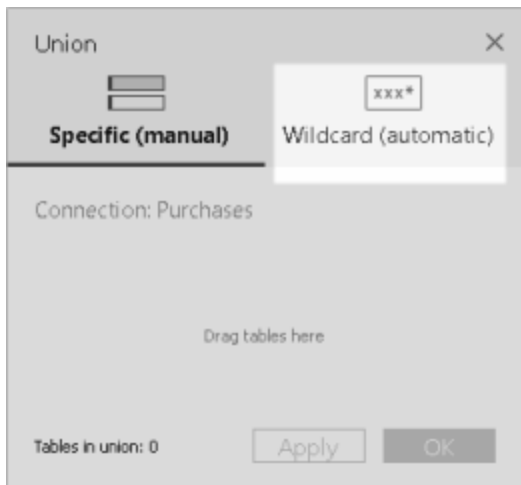

3. Enter the search criteria that you want Tableau to use to find tables to include in the union.

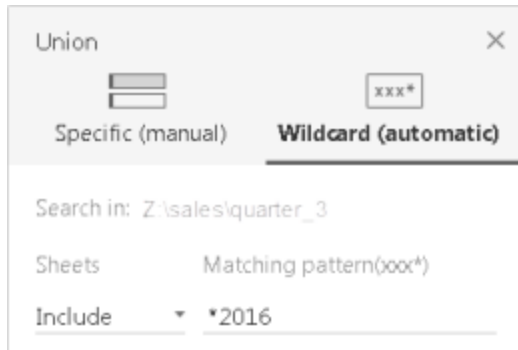

For example, you can enter ***2016** in the **Include** text box to union tables in Excel worksheets that end with "2016" in their names. Search criteria like this will result in the union of May2016, June2016, and July2016 tables (Excel worksheets), from the selected connection. In this case, the connection is called Sales, and the connection made to the Excel workbook containing the worksheets you wanted was in the quarter_3 folder in the sales directory (e.g., Z:\sales\quarter_3).

4. Click **Apply** or **OK** to union.

Expand search to find more Excel, text, JSON, .pdf data

The tables initially available to union are scoped to the connection you've selected. If you want to union more tables that are located outside of the current folder (for Excel, text, JSON, .pdf files) or in a different workbook (for Excel worksheets), select one or both check boxes in the Union dialog box to expand your search.

For example, suppose you want to union all Excel worksheets that end with "2016" in its name outside of the current folder. The initial connection is made to an Excel workbook located in the same directory in the above example, Z:\sales\quarter_3.

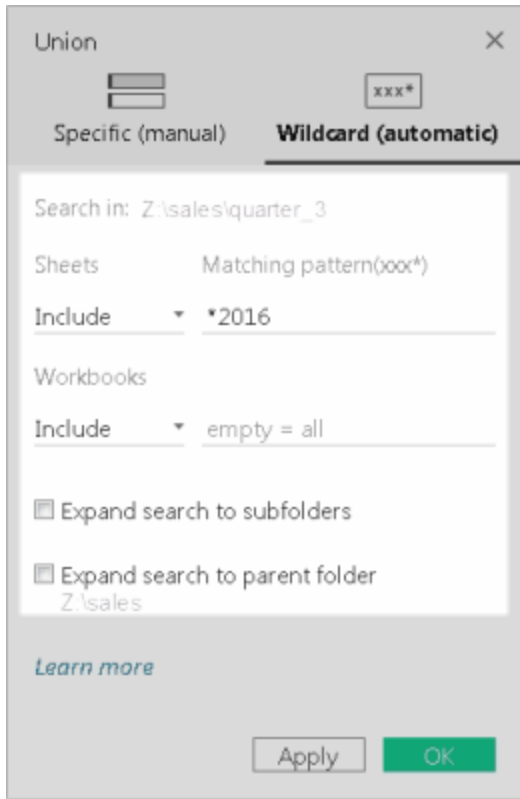

- **Include:** If you enter ***2016** in the **Include** text box and leave the remaining search criteria of the dialog as is, Tableau looks for all Excel worksheets that end with "2016" in its name inside the current folder.

In the diagram below, the yellow highlighted item represents the current location, that is, the Excel workbook that you created a connection to in the "quarter_3". The green box represents the tables belonging to workbooks and sheets that are unioned as result of this search criteria.

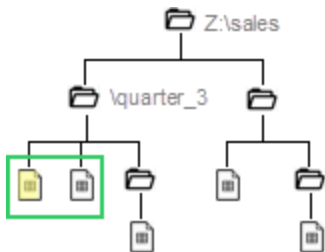

- **Include + Expand search to subfolders:** If you enter ***2016** in the **Include** text box and select the **Expand search to subfolders** check box, Tableau does the following:

- Looks for all Excel worksheets that end with "2016" in their names inside the current folder.
- Looks for additional Excel worksheets that end with "2016" in their names that are located in Excel workbooks in subfolders of the "quarter_3" folder.

In the diagram below, the yellow highlighted item represents the current location, that is, the Excel workbook that you created a connection to in the "quarter_3" folder. The green box represents the tables belonging to workbooks and worksheets that are unioned as a result of this search criteria.

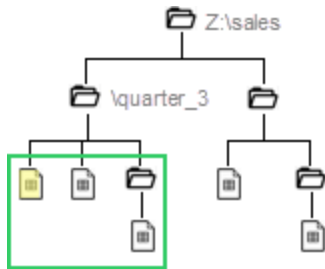

- **Include + Expand search to parent folder:** If you enter *2016 in the **Include** text box and select the **Expand search to parent folder** check box, Tableau does the following:
 - Looks for all Excel worksheets that end with "2016" in their names inside the current folder, "quarter_3."
 - Looks for additional Excel worksheets that end with "2016" in their names that are located in parallel folders of the "quarter_3" folder. In this example, "quarter_4" is the parallel folder.

In the diagram below, the yellow highlighted item represents current location, that is, the Excel workbook that you created a connection to in the "quarter_3" folder. The green boxes represent the tables belonging to the workbook and worksheets that are unioned as a result of this search criteria.

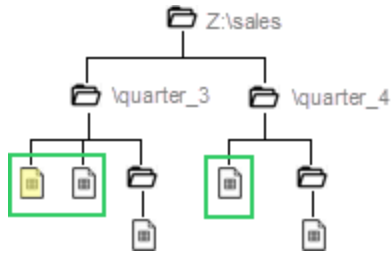

- **Include + Expand search to subfolders + Expand search to parent folder:** If you enter ***2016** in the **Include** text box and select both the **Expand search to subfolders** and **Expand search to parent folder** check boxes, Tableau does the following:
 - Looks for all Excel worksheets that end with "2016" in their names inside the current folder, "quarter_3."
 - Looks for additional Excel workbooks that are located in the subfolders of the current folder, "quarter_3."
 - Looks for additional Excel workbooks that are located in parallel folders and subfolders of the "quarter_3" folder. In this example, "quarter_4" is the parallel folder.

In the diagram below, the yellow highlighted item represents the current location, that is, the Excel workbook that you created a connection to. The green box represents the tables belonging to the workbook and worksheets that are unioned as a result of this search criteria.

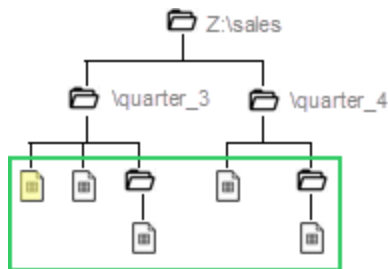

Note: When working with Excel data, wildcard search includes named ranges but excludes tables found by Data Interpreter.

Rename, modify, or remove unions

Perform basic union tasks directly in the canvas of the Data Source page.

To rename a union

1. Double-click the logical table that contains unioned physical tables.
2. Double-click the union table on the physical layer canvas.
3. Enter a new name for the union.



To add or remove tables in the union

1. Double-click the logical table that contains unioned physical tables.
2. Click the union drop-down arrow and then select **Edit Union**.
3. You can drag additional tables that you want to union from the left pane, or hover over a table until the remove icon displays and then click the icon to remove the table.

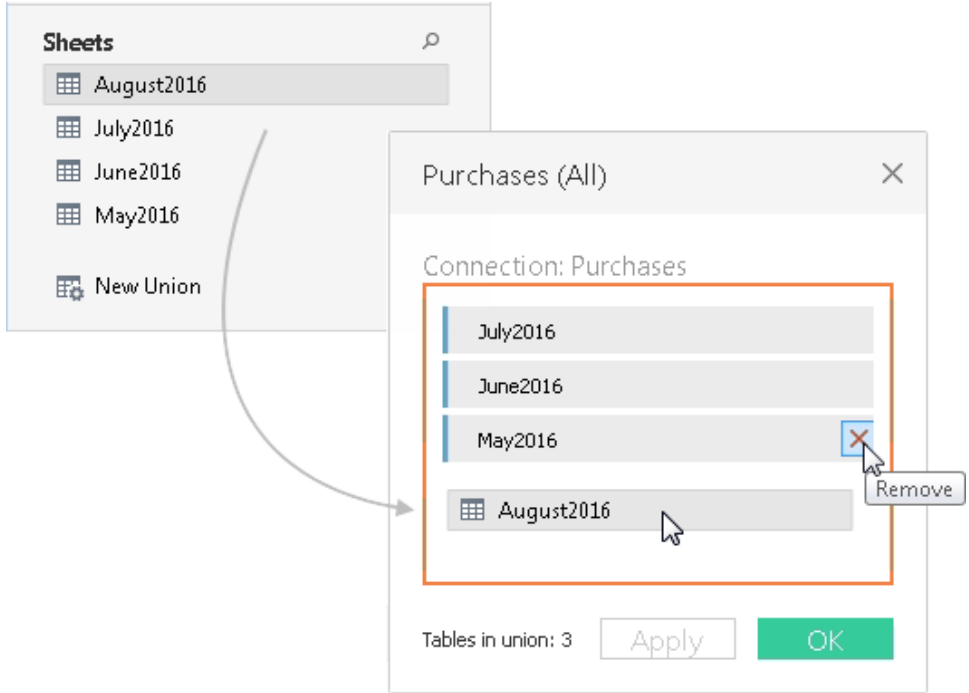

4. Click **Apply** or **OK** to complete the task.

To remove a union

- Double-click the logical table that contains unioned physical tables, and then click the union drop-down arrow and select **Remove**.

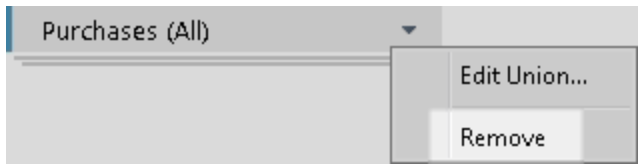

Matching field names or field ordering

Tables in a union are combined by matching field names. When working with Excel, Google Sheets, text file, JSON file or .pdf file data, if there are no matching field names (or your tables do not contain column headers), you can tell Tableau to combine tables based on the order of the fields in the underlying data by creating the union and then selecting **Generate field names automatically** option from the union drop-down menu.

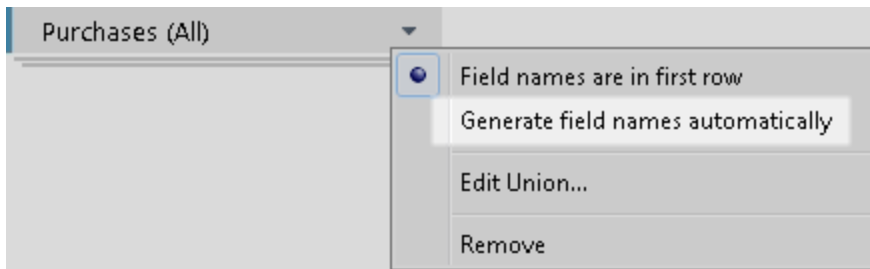

Metadata about unions

After you create a union, additional fields about the union are generated and added to the grid. The new fields provide information about where the original values in the union come from, including the sheet and table names. These fields are useful when unique information that is critical to your analysis is embedded in the sheet or table name.

For example, the tables used in the example above have unique month and year information stored in the table name instead of in the data itself. In this case, you can use the **Table Name** field that is generated by the union to access this information and use it in your analysis.

Project	#	Type	Sheet	Table Name
Lee	1	Credit	August2016	August2016
Philip	1	Credit	August2016	August2016
Wei	5	Cash	August2016	August2016
Maria	2	Cash	August2016	August2016
Max	2	Credit	July2016	July2016
Wendy	1	Cash	July2016	July2016
Jim	7	Cash	July2016	July2016
Lisa	3	Credit	June2016	June2016
Isaac	4	Cash	June2016	June2016
Sam	2	Credit	June2016	June2016
Arnold	5	Credit	June2016	June2016
Lane	5	Credit	May2016	May2016
Chris	6	Credit	May2016	May2016
Juan	1	Credit	May2016	May2016

Sheet	Table Name
August2016	August2016
August2016	August2016
August2016	August2016
August2016	August2016
August2016	August2016
July2016	July2016
July2016	July2016

If a named range is used in a union, null values display under the **Sheet** field.

Note: You can use the fields generated by a union, such as **Sheet or Table Name**, as join keys. You can use a unioned table in a join with another table or unioned table.

Merge mismatched fields in the union

When field names in the union do not match, fields in the union contain null values. You can merge the non-matching fields into a single field using the merge option to remove the null values. When you use the merge option, the original fields are replaced by a new field that displays the first non-null value for each row in the non-matching fields.

You can also create your own calculation or, if possible, modify the underlying data to combine the non-matching fields.

For example, suppose a fourth table, "August2016", is added to the underlying data. Instead of the standard "Customer" field name, it contains an abbreviated version called "Cust."

August2016

Day	Cust.	Purchases	Type
7	Maria	2	Credit
9	Kathy	1	Credit
18	Vijay	7	Cash

A union of these tables creates a single table that contains all rows from tables, with several null values. You can use the merge option to combine the related customer fields into a single field.

Union (with null values)

Da- y	Cus- tomer	Purcha- ses	Typ- e	Cus- t.
4	Lane	5	Cre- dit	null
10	Chris	6	Cre- dit	null

Union (with columns that have been merged)

Da- y	Purcha- ses	Typ- e	Cus- tomer, Cust.
4	5	Cre- dit	Lane

Da- y	Cus- tomer	Purcha- ses	Typ- e	Cus- t.
28	Juan	1	Cre- dit	null
1	Lisa	3	Cre- dit	null
28	Isaac	4	Cas- h	null
28	Sam	2	Cre- dit	null
2	Mario	2	Cre- dit	null
15	Wei	1	Cas- h	null
21	Jim	7	Cas- h	null
7	null	2	Cre- dit	Mari- a
9	null	1	Cre- dit	Kat- hy
18	null	7	Cas- h	Vija- y



Da- y	Purcha- ses	Typ- e	Cus- tomer, Cust.
10	6	Cre- dit	Chris
28	1	Cre- dit	Juan
1	3	Cre- dit	Lisa
28	4	Cas- h	Isaac
28	2	Cre- dit	Sam
2	2	Cre- dit	Mario
15	1	Cas- h	Wei
21	7	Cas- h	Jim
7	2	Cre- dit	Maria
9	1	Cre- dit	Kathy
18	7	Cas- h	Vijay

After you merge fields, you can use the field generated from the merge in a pivot or split, or use the field as a join key. You can also change the data type of the field generated from a merge.

To merge mismatched fields

1. Select two or more columns in the grid.
2. Click the column drop-down arrow, and then select **Merge mismatched fields**.

To remove a merge

- Click the column drop-down arrow of the merged field and select **Remove merge**.

At a glance: Working with unions

Tableau Desktop and web authoring (Tableau Cloud and Tableau Server)

- A unioned table can be used in a join.
- A unioned table can be used in a join with another unioned table.
- The fields generated by a union, **Sheet** and **Table name**, can be used as the join key.
- If a named range is used in union, null values display under the **Sheet** field.
- The field generated from a merge can be used in a pivot.
- The field generated from a merge can be used as a join key.
- The data type of the field generated from a merge can be changed.
- Union tables from within the same connection. That is, you cannot union tables from different databases.

Tableau Desktop only

- When working with Excel data, wildcard search includes named ranges but excludes tables found by Data Interpreter.
- The field generated from a merge can be used in a pivot or split.
- To union a JSON file, it must have a .json, .txt, or .log extension. For more information about working with JSON data, see [JSON File on page 236](#).
- When using wildcard search to union tables in a .pdf file, the result of the union is scoped to the pages that were scanned in the initial .pdf file you connected to. For more information about working with data in .pdf files, see [PDF File on page 242](#).
- Stored procedures cannot be unioned.
- When working with database data, you can convert your union into custom SQL.

Create a Data Source or Add a New Connection with Clipboard Data

Sometimes you want to pull in data from an outside source for some quick analysis. Rather than create a whole data source and then connect in Tableau, you can copy and paste the data directly into your workbook. Tableau automatically creates a data source that you can begin analyzing.

When you paste data on the data source page, Tableau creates a new connection in the existing data source.

When you paste data on the sheet, Tableau creates a new data source that you can begin analyzing. When you paste the data as a data source, the data source is saved as a text file to your Tableau Repository when you save the workbook.

You can copy and paste data from a variety of office applications including Microsoft Excel and Microsoft Word. You can also copy and paste HTML tables from web pages. Tables that are copied as comma separated values or tab delimited can be pasted into Tableau.

Note: Not all applications use these formats when copying.

1. Select the data you want and copy it to the clipboard.
2. Open Tableau Desktop and do one of the following:
 1. On the data source page, select **Data > Paste Data as Connection** or **Paste Data as Data Source**.

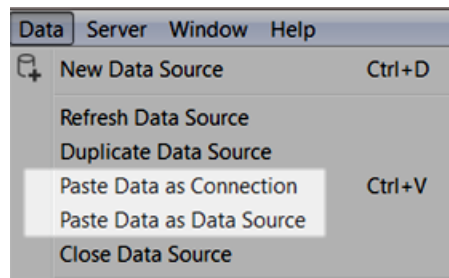

2. On the sheet, select **Data > Paste** to paste the data as a data source.

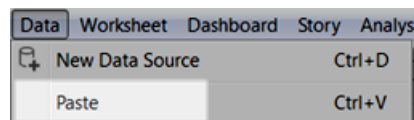

3. Select **File > Save** to save the data source.

When you save the workbook, the data source either becomes a part of the existing data source or is added to your repository, depending on which of the methods you choose. If you paste the data as a data source, the data source is saved with the workbook when you save the workbook as a packaged workbook (.twbx).

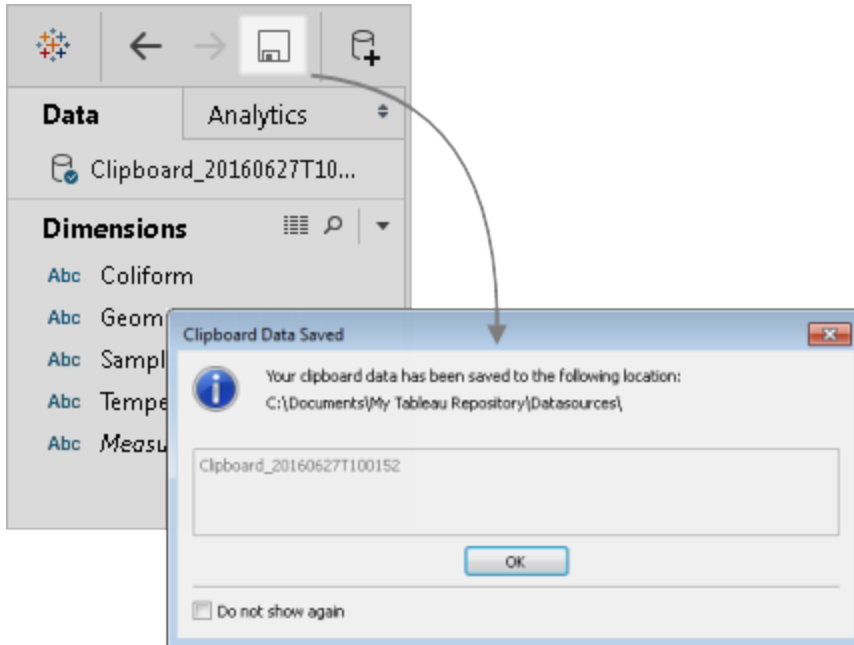

Connect to a Custom SQL Query

Note: Using custom SQL can affect performance of a workbook. Working with your DBA will ensure the best possible custom SQL query. In order to perform the operations necessary for building views in Tableau Desktop, Tableau must be able to control WHERE, GROUP BY and other SQL clauses. Because a custom SQL query may contain those elements, and Tableau cannot inject them into the existing SQL, Tableau must wrap the custom SQL statement within a select statement. When a custom SQL connection is performing slowly, or produces an error, it is often the result of the custom SQL wrapping that Tableau Desktop performs.

For most databases, you can connect to a specific query rather than the entire data set. Because databases have slightly different SQL syntax from each other, the custom SQL you use to connect to one database might be different from the custom SQL you might use to connect to

another. However, using custom SQL can be useful when you know exactly the information you need and understand how to write SQL queries.

Though there are several common reasons why you might use custom SQL, you can use custom SQL to union your data across tables, recast fields to perform cross-database joins, restructure or reduce the size of your data for analysis, etc.

For Excel and text file data sources, this option is available only in workbooks that were created before Tableau Desktop 8.2 or when using Tableau Desktop on Windows with the legacy connection. To connect to Excel or text files using the legacy connection, connect to the file, and in the Open dialog box, click the **Open** drop-down menu, and then select **Open with Legacy Connection**.

NOTE: Beginning with Tableau 2020.2, legacy Excel and Text connections are no longer supported. See the [Legacy Connection Alternatives](#) document in Tableau Community for alternatives to using the legacy connection.

Connect to a custom SQL query

1. After connecting to your data, double-click the **New Custom SQL** option on the Data Source page.

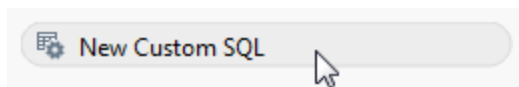

2. Type or paste the query into the text box. The query must be a single SELECT* statement.

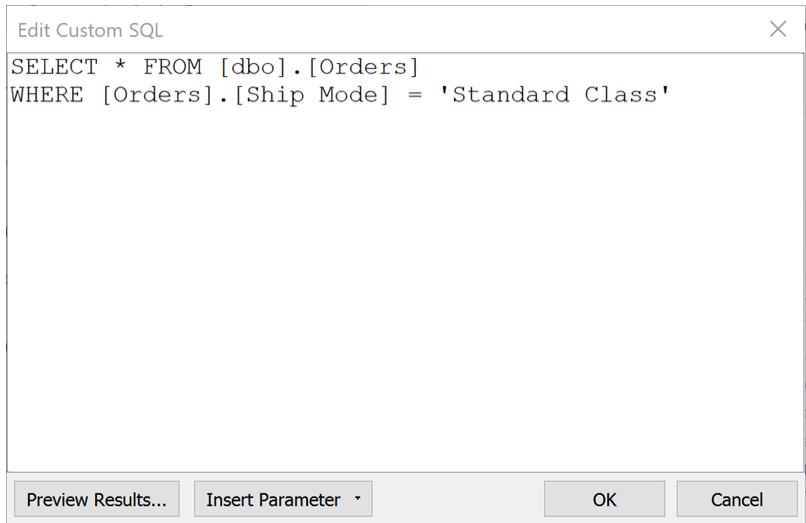

3. When finished, click **OK**.

When you click OK, the query runs and the custom SQL query table appears in the logical layer of the canvas. Only relevant fields from the custom SQL query display in the data grid on the Data Source page.

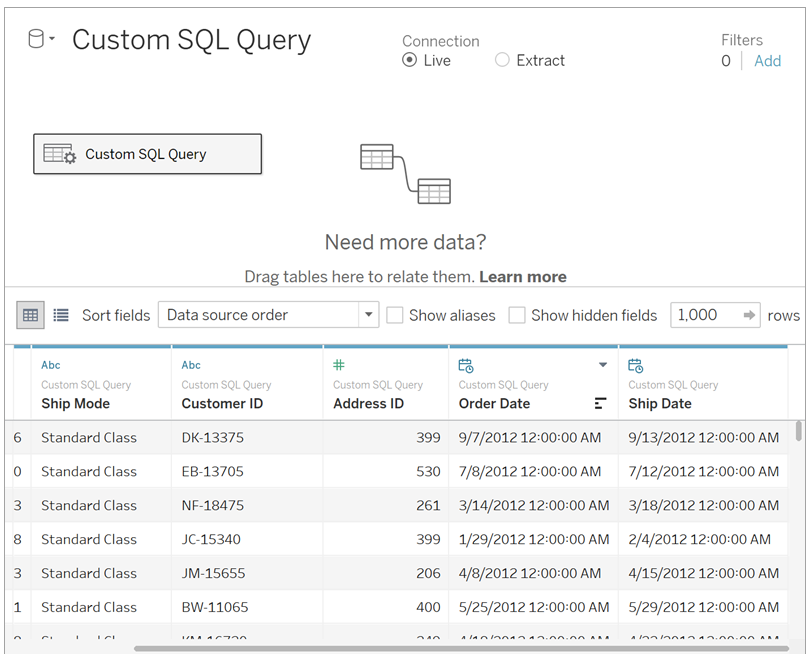

For more information about the logical and physical layers of the canvas, see [The Tableau Data Model](#) on page 666.

Examples of custom SQL queries

Combine your tables vertically (union)

If you need to append data to each other, you can use the union option in the physical layer of the canvas in Tableau. In some cases your database does not support this option, so you can use custom SQL instead.

For example, suppose you have the following two tables: November and December.

November		December	
Guest ID	Party Size	Guest ID	Party Size
3005	4	3009	2
3006	2	3010	2
3007	2	3011	4
3008	2	3012	5
		3013	3
		3014	4
		3015	2

You can use the following custom SQL query to append the second table, December, to the first table, November:

```
SELECT * FROM November UNION ALL SELECT * FROM December
```

The result of the query looks like this in the data grid:

Abc Custom SQL Query Guest ID	# Custom SQL Query Party Size
3005	4.00000
3006	2.00000
3007	2.00000
3008	2.00000
3009	2.00000
3010	2.00000
3011	4.00000
3012	5.00000
3013	3.00000
3014	4.00000
3015	2.00000

For more information about the union option, see [Union Your Data](#) on page 847.

Change the data type of a field to do a cross-database join

When you want to perform a join between two tables in the physical layer of the canvas, the data type of the fields you join on must be the same. In cases when the data type of the fields are not the same, you can use custom SQL to change the data type (cast) the field before performing the join.

For example, suppose you want to join two tables, Main and Sub, using the Root and ID fields, respectively. The Root field is a number type and the ID field is a string type. You can use the following custom SQL query to change the data type of Root from a number to a string so that you can join the Main and Sub tables using the Root and ID fields.

```
SELECT [Main].[Root] AS [Root_Number]
CAST([Main].[Root] AS INT) AS [Root_String]
FROM [Main]
```

The result of this query shows the original Root field and the Root field cast as a string.

#	Abc
Custom SQL Query	Custom SQL Query
Root_Number	Root_String
7,981.00	7981
740.00	740
741.00	741
742.00	742
1,760.00	1760

For more information about joins and cross-database joins, see [Join Your Data](#) on page 791.

Reduce the size of your data

When working with very large data sets, sometimes you can save time while working with your data if you reduce its size first.

For example, suppose you have a large table called FischerIris. You can use the following custom SQL query to retrieve the specified columns and records thereby reducing the size of the data set that you connect to from Tableau.

```
SELECT
  [FischerIris].[Species] AS [Species],
  [FischerIris].[Width] AS [Petal Width],
  COUNT([FischerIris].[ID]) AS [Num of Species]
FROM [FischerIris]
WHERE [FischerIris].[Organ] = 'Petal'
AND [FischerIris].[Width] > 15.0000
GROUP BY [FischerIris].[Species], [FischerIris].[Width]
```

Restructure your data (pivot)

In some cases, you might be working with a table that needs to be restructured before analysis. Though this type of task can be done in the physical layer of the canvas in Tableau by using options like pivot, your database might not support it. In this case, you can use custom SQL instead.

For example, suppose you have the following table:

Season ID	Items - Don't like	Items - Defective	Items - Too small	Items - Too big
R000151493		1	3	20
R000151493		2	44	1
R000151495		0	0	0
R000151495		0	17	1
R000151497		1	0	0
R000151497		0	15	0
R000151789		0	0	0
R000151789		0	12	4
R000151813	3	0	0	3
R000151813	3	0	53	1
R000151815	0	0	0	0
R000151815	0	0	0	0
R000151855	0	0	0	3
R000151855	59	0	22	0
R000151857	4	0	14	18
R000151857	0	0	0	33
R000153013	0	0	21	0
R000153013	9	1	19	0

To change its structure and optimize your data for analysis in Tableau, you can use the following custom SQL query:

```
SELECT Table1.Season ID AS [Season ID],
Table1.Items - Don't like AS [Quantity],
"Don't Like" AS [Reason]
FROM Table1
UNION ALL
SELECT Table1.Season ID AS [Season ID],
Table1.Items - Defective AS [Quantity],
"Defective" AS [Reason]
FROM Table1
UNION ALL
SELECT Table1.Season ID AS [Season ID],
Table1.Items - Too big AS [Quantity],
"Too Big" AS [Reason]
FROM Table1
UNION ALL
SELECT Table1.Season ID AS Season ID,
Table1.Items - Too small AS [Quantity]
"Too Small" AS [Reason]
FROM Table1
```

The result of the query looks like this in the data grid:

Abc Custom SQL Query Season ID	Abc Custom SQL Query Quantity	Abc Custom SQL Query Reason
R000151493	<i>null</i>	Don't Like
R000151493	<i>null</i>	Don't Like
R000151495	<i>null</i>	Don't Like
R000151495	<i>null</i>	Don't Like
R000151497	<i>null</i>	Don't Like
R000151497	<i>null</i>	Don't Like
R000151789	<i>null</i>	Don't Like
R000151789	<i>null</i>	Don't Like
R000151813	3	Don't Like
R000151813	3	Don't Like
R000151815	0	Don't Like
R000151815	0	Don't Like
R000151855	0	Don't Like
R000151855	59	Don't Like

For more information about the pivot option, see [Pivot Data from Columns to Rows on page 892](#).

Combine (join) and aggregate your data

If you need to combine tables and aggregate your data, you can use both a join and default aggregation type options in the physical layer of the canvas in Tableau. In some cases you might need to use custom SQL instead.

For example, suppose you have the following two tables: Orders and Vendors.

Orders

Order	CustomerID	VendorID
10248	32	1
10249	90	3
10250	81	2

Vendors

VendorID	Name
1	Tminus Shipping
2	Packing You
3	ShipWise Express

You can use the following custom SQL query to find a count on the number of orders and do a left join on the Orders and Vendors tables:

```
SELECT Vendors.Name, COUNT(Orders.Order) AS Number Of Orders
FROM Orders
LEFT JOIN Vendors
ON Orders.VendorID=Vendors.VendorID
GROUP BY Name;
```

The result of the query looks like this:

Abc Custom SQL Query Name	# Custom SQL Query Number Of Orders
Packing You	1
ShipWise Express	1
Tminus Shipping	1

For more information about joins, see [Join Your Data](#) on page 791.

Errors when duplicate columns are referenced

If your custom SQL query references duplicate columns, you may get errors when trying to use one of the columns in your analysis in Tableau. This will happen even if the query is valid. For example, consider the following query:

```
SELECT * FROM authors, titleauthor WHERE authors.au_id =
titleauthor.au_id
```

The query is valid, but the **au_id** field is ambiguous because in this case it exists in both the “authors” table and the “titleauthor” table. Tableau will connect to the query but you will get an error anytime you try to use the **au_id** field. This is because Tableau doesn’t know which table you are referring to.

Note: It is a best practice to define column aliases with an AS clause whenever possible in a Custom SQL Query. This is because each database has its own rules when it comes to automatically generating a column name whenever an alias is not used.

Edit a custom SQL query

To edit a custom SQL query

1. On the data source page, in the canvas, double-click the custom SQL query in the logical layer.
2. Hover over the custom SQL table in the physical layer until the arrow displays.



3. Click the arrow and then select **Edit Custom SQL Query**.
4. In the dialog box, edit the custom SQL query.

To change a custom SQL query name

When you drag a custom SQL query to the logical layer of the canvas, Tableau gives it a default name: Custom SQL Query, Custom SQL Query1, and so on. You can change the default name to something more meaningful.

1. On the data source page, in the logical layer of the canvas, select the drop-down arrow in the custom SQL query table and select **Rename**.

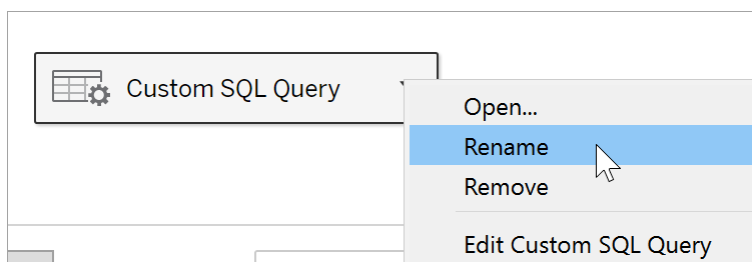

2. Enter the name you want to use for your custom SQL query.

Use parameters in a custom SQL query

You can use parameters in a custom SQL query statement to replace a constant value with a dynamic value. You can then update the parameter in the workbook to modify the connection. For example, you may connect to a custom SQL query that provides web traffic data for a particular page that is specified by a pageID. Instead of using a constant value for the pageID value in the SQL query, you can insert a parameter. Then after finishing the connection, you can show a parameter control in the workbook. Use the parameter control to switch out the pageID and pull in data for each page of interest without having to edit or duplicate the connection.

In **Tableau Desktop**, you can create a parameter directly from the Custom SQL dialog box or use any parameters that are part of the workbook. If you create a new parameter, it becomes available for use in the workbook just like any other parameter. See [Create Parameters on page 1122](#) to learn more.

For **web authoring (in Tableau Cloud or Tableau Server)**, you can use an existing parameter published from Tableau Desktop. You cannot create a new parameter in web authoring.

To add a parameter to a custom SQL query

1. On the data source page, in the canvas, hover over the table until the edit icon displays, and then click the edit button.
2. At the bottom of the dialog box, click **Insert Parameter**.
3. Select a constant value in the SQL statement and then, from the **Insert Parameter** drop-down menu select the parameter you want to use instead. If you have not created a parameter yet, select **Create a new parameter**. Follow the instructions in [Create Parameters on page 1122](#) to create a parameter.

Note: Parameters can only replace literal values. They cannot replace expressions or identifiers such as table names.

In the example below, the custom SQL query returns all orders that are marked as Urgent priority. In the custom SQL statement, the order priority is the constant value. If you want to change the connection to see the High priority orders, you would have to edit the data source.

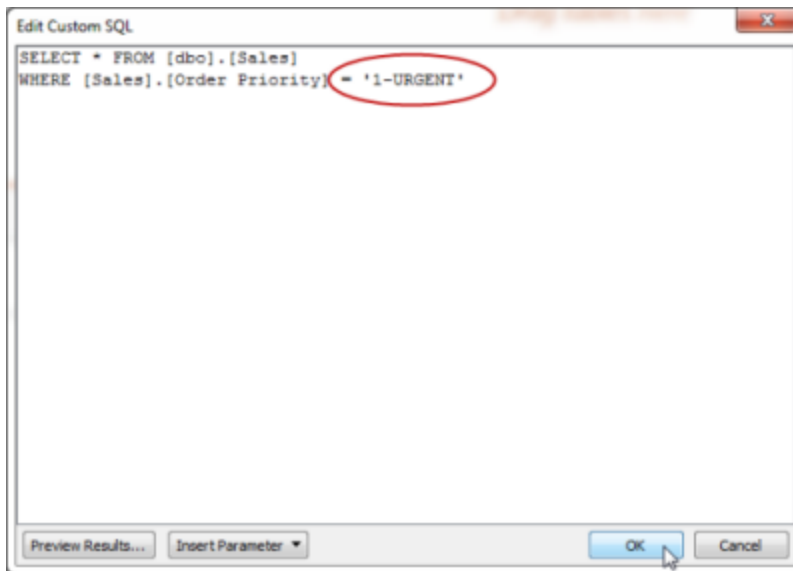

Instead of creating and maintaining many variations of the same query, you can replace the constant order priority value with a parameter. The parameter should contain all of the possible values for Order Priority.

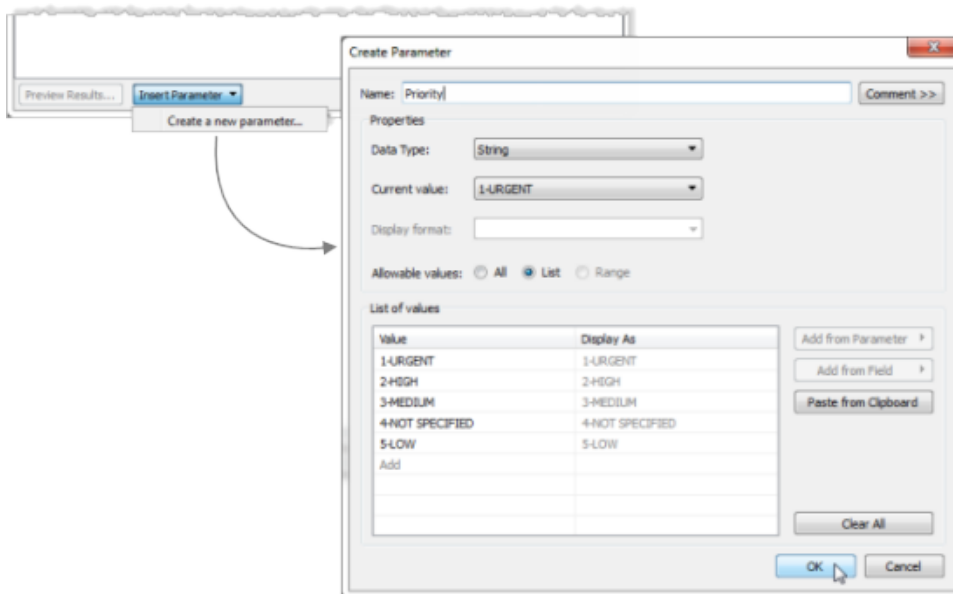

After you create a parameter, you can insert it into the SQL statement to replace the constant value.

Tableau Desktop and Web Authoring Help

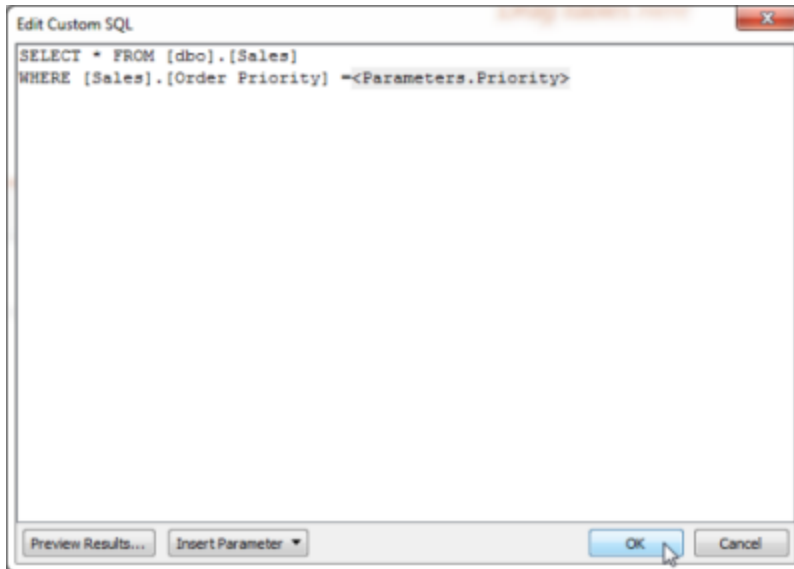

After you finish editing the connection, the new parameter is listed in the Parameters area at the bottom of the Data pane and the parameter control displays on the right side of the view. As you select different values, the connection updates.

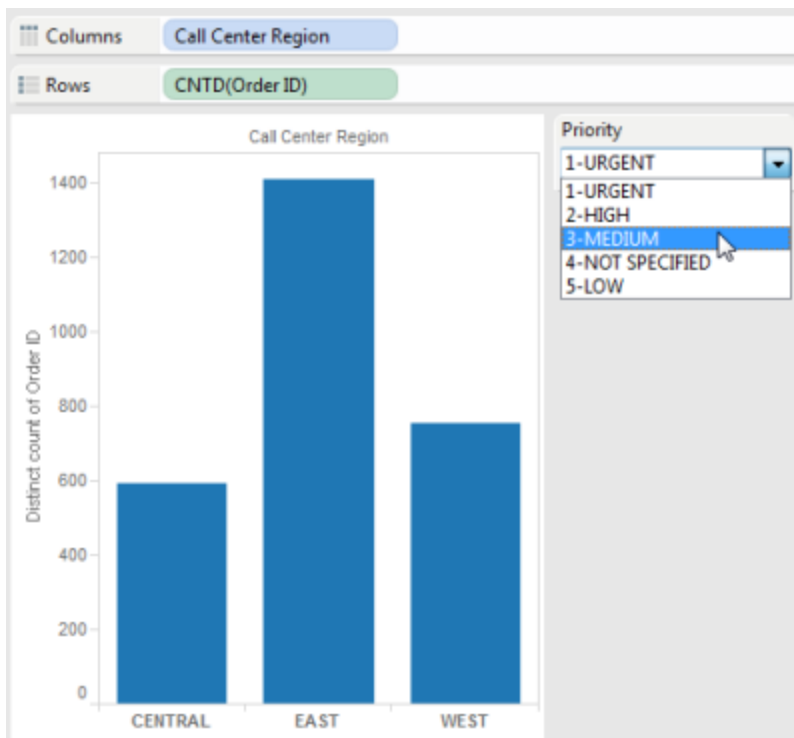

Note: If you are using an extract, you must refresh the extract in order to reflect changes to the parameter. Publishing a data source that uses Custom SQL parameters includes the parameters. The parameters are transferred to any workbooks that connect to the data source.

Tableau Catalog support for custom SQL

Support for custom SQL in Tableau Catalog depends on the custom SQL query.

Tableau Catalog is available as part of the Data Management offering for Tableau Server and Tableau Cloud. For more information about Tableau Catalog, see "About Tableau Catalog" in the [Tableau Server](#) or [Tableau Cloud](#) Help.

Supported queries

Catalog supports custom SQL queries that meet the ANSI SQL-2003 standard, with three known exceptions:

- Time zone expressions
- Multiset expressions
- Tableau parameters

Starting in 2021.4, Tableau Catalog also supports use of the Transact-SQL (T-SQL) dialect in Custom SQL, with the following exceptions:

- Hints
- FOR clauses
- OPENROWSET, OPENXML, and OPENJSON functions
- ODBC scalar functions
- FOR SYSTEM_TIME
- TABLESAMPLE
- MATCH expression
- CONTAINS expression
- FREETEXT expression

Starting in Tableau Cloud October 2023 and Tableau Server 2023.3, Tableau Catalog also offers support for custom SQL queries that use PostgreSQL, with the following exceptions:

- XML function
- JSON functions and operators

Supported features and functions

Catalog supports the following additional functionality for data sources, workbooks, and flows with connections that use the MySQL or PostgreSQL drivers, for example, Amazon Aurora for MySQL, Amazon RedShift, Pivotal Greenplum Database, MemSQL, Denodo, and others.

- MySQL GROUP_CONCAT function
- PostgreSQL arrays
- PostgreSQL EXTRACT() function

Other custom SQL scenarios and functionality might work, but Tableau doesn't specifically test for or support them.

Supported lineage

When an asset uses custom SQL, a message with a **Show Custom SQL Query** button appears on the **Lineage** tab of the asset page. Click the button to see the custom SQL used in the connection. Then, if you would like to copy the custom SQL to your clipboard, click **Copy**.

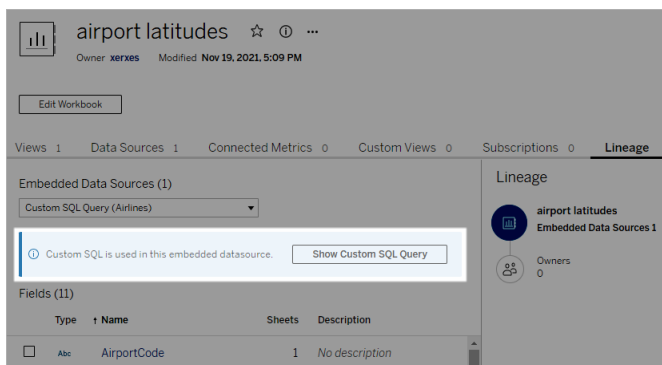

Some types of custom SQL can cause the upstream lineage to be incomplete. When this happens, a message appears with that information. Field details cards might not contain links to connected columns, or might not show any connected columns at all. Column details cards might not contain links to fields that use the column, or might not show any fields at all.

If you are examining a table's lineage, note that Catalog doesn't support showing column information in the lineage for table metadata gathered using custom SQL. However, if other assets use the same table and don't use custom SQL, Tableau Catalog might be able to display information about the columns that it has discovered through these other assets.

In the following screenshot, the factAccountOpportunityByQuarter table was indexed because it's used by a data source. However, because it's referenced by a custom SQL query, the column information isn't available.

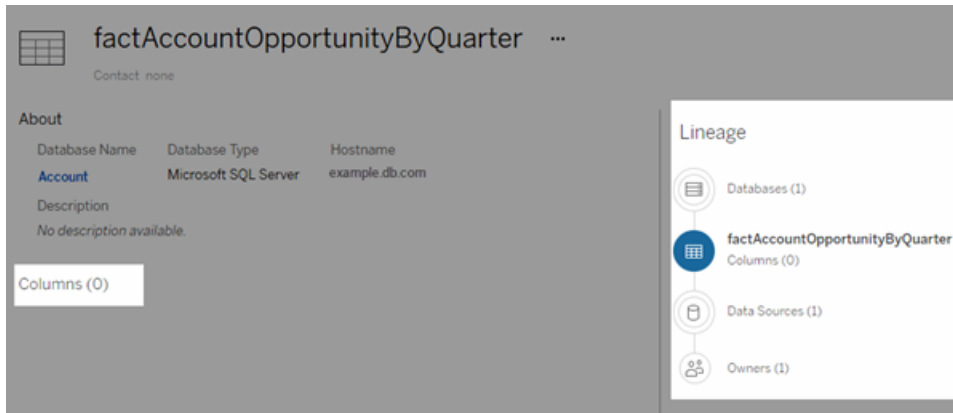

In a case where more than one data source, workbook, or flow uses a table, any of the assets downstream from that table that uses a custom SQL query are excluded when column-level filters are applied. As a result, fewer downstream assets show in the lineage than are actually used.

For more information about using the lineage, see "Use Lineage for Impact Analysis" in the [Tableau Server](#) or [Tableau Cloud](#) Help.

See Also

[Use Custom SQL and RAWSQL to perform advanced spatial analysis](#) on page 1692

Use a Stored Procedure

A stored procedure is a subroutine available to applications that access a relational database system. When you connect to a SAP Sybase ASE, Microsoft SQL Server, or Teradata database with Tableau, you can use a stored procedure to define the connection.

For Oracle, you can use a table function to define the connection. Oracle table functions act similarly to stored procedures and are listed under **Stored Procedures** on the Data Source page.

When you create a data source using one of these data types, available procedures are listed under **Stored Procedures**, as shown in the Microsoft SQL Server example:

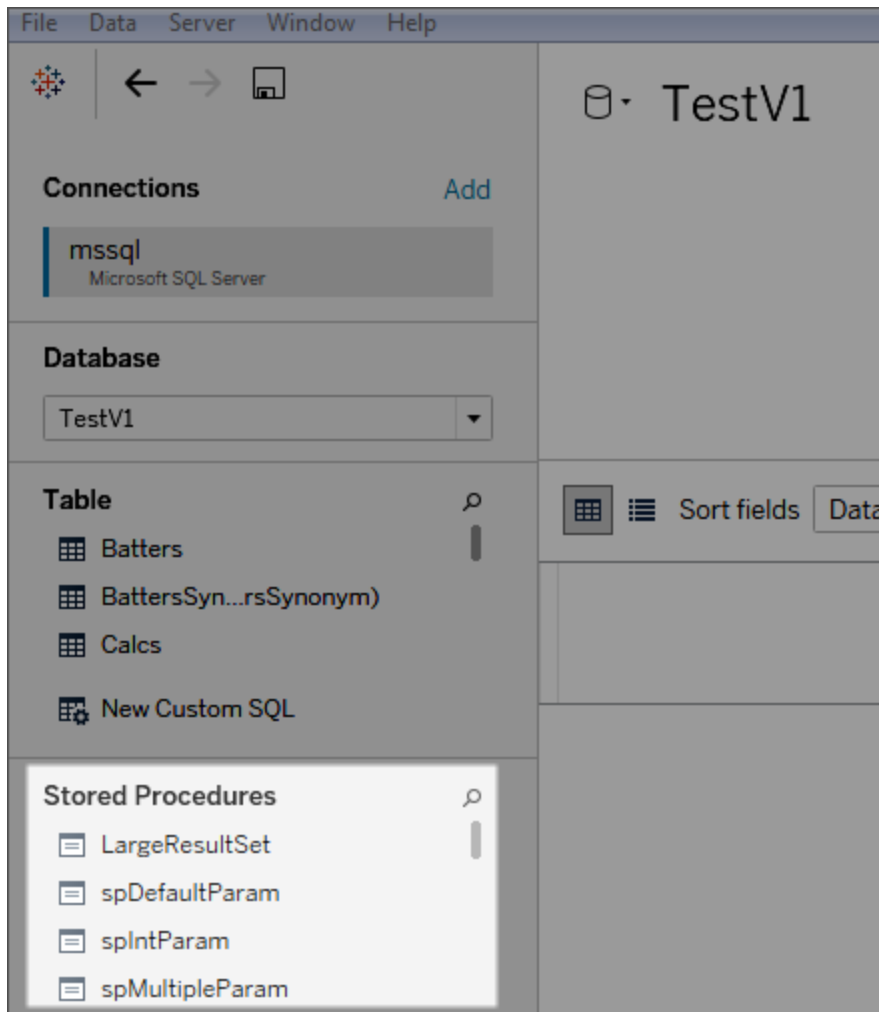

From the left pane, drag the procedure to the canvas or double-click one of the listed procedures. If parameters are available in the procedure, the Parameters dialog box automatically displays.

Instead of entering a value, you can use an existing Tableau parameter, or create a new Tableau parameter for the value:

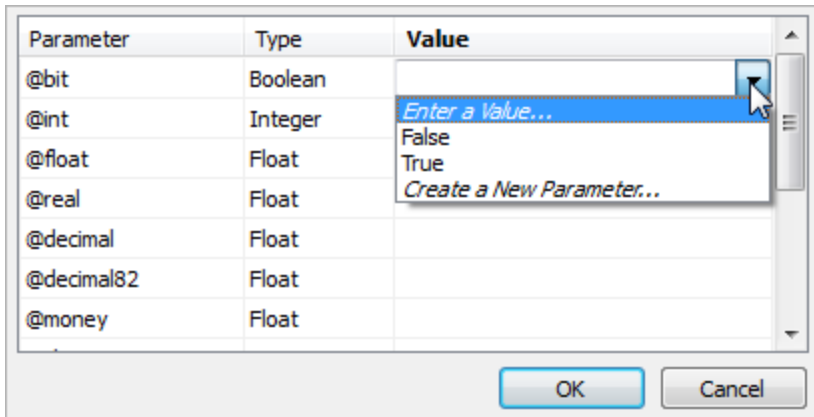

If you then expose the Tableau parameter in the view, users are able to change the value of the parameter in the procedure interactively.

Stored procedures don't support federation, relating, or joining. They are represented in a single logical table in the logical layer, and don't allow opening the Join/Union canvas (physical layer).

Notes on Stored Procedures

If you use stored procedures to define a data source for Tableau, keep the following in mind:

- If a stored procedure returns more than one result set, Tableau reads the first one and ignores the rest.
- If a stored procedure has output parameters, Tableau filters out the stored procedure.
- Stored procedures that have parameters of a non-scalar type are excluded.
- Result set columns that don't have matching types in Tableau (such as varbinary, geometry, and hierarchyid) are logged. If all result set columns map to unknown data types, Tableau displays a message:
"The result set... has no usable columns."
- Stored procedures that return no result sets are listed on the data source page but fail if selected.
- If no value is provided for a parameter that the stored procedure requires, an error occurs. Tableau cannot determine in advance whether parameters are required.
- Tableau does not perform any transaction management for stored procedures. That is, stored procedure writers must not depend on Tableau to start transactions before invoking stored procedures, or to commit them afterward.

- Column names must be unique for stored procedures to work. If two columns have the same name, or if no name is provided, the procedure can result in an error.
- If there are multiple queries in a stored procedure (for example, to read values from another table or to hold temporary combinations) each of the queries must return the same sets of columns in the same order (same names and data types). To ensure that column order and names match in the query results, you may need to explicitly `CAST` to ensure the data type is correct, for example `CAST(Username as VARCHAR(20))`, and explicitly name the columns. If a stored procedure does not follow these guidelines, an error message can result:

"InsertData: unbound column error"

- If there are multiple queries in a stored procedure (for example, to read values from another table or to hold temporary combinations) and the procedure is generating an error, try adding `SET NOCOUNT ON` to the top of the procedure. This prevents the message which shows the count of number of rows affected by a Transact-SQL statement from being returned as part of the result set for a query.

In addition, the following constraints apply for specific databases.

Stored Procedure Constraints for Teradata Databases

The following constraints apply for stored procedures on Teradata databases.

- Values must be provided for every parameter. If the user does not provide a value for one or more parameters, Tableau displays a Teradata database error stating there are too few values provided for the stored procedure.

Stored Procedure Constraints for SQL Server Databases

The following constraints apply for stored procedures on SQL Server databases.

- If the result set for a stored procedure contains columns of type `IMAGE` or `TEXT`, the stored procedure will fail with an "Incorrect syntax" error message.
- If the total width of the result set (number of bytes in each row) exceeds 8060, the stored procedure fails. This can occur with very wide tables (hundreds of columns) or with tables having large text columns, intended to hold thousands of characters of text.
- Tableau does not display stored procedures from schema "sys".
- If the user does not provide a value for one or more parameters that the procedure requires, Tableau displays a SQL Server database error in the form "The procedure

requires a value for parameter @x but one was not provided."

- Stored procedures that contain multiple queries should follow the guidelines listed in Notes on Stored Procedures (above).
- Tableau Desktop does not support the Microsoft SQL Server TIME data type. When fields of this type are included in a stored procedure on a Microsoft SQL Server database Tableau Desktop will not import them.

Stored Procedure Constraints for SAP Sybase ASE Databases

The following constraints apply for stored procedures on SAP Sybase ASE databases (Windows only).

- The database must have a properly configured remote server.
- If the user does not provide a value for one or more parameters that the procedure requires, Tableau displays a Sybase ASE database error in the form "The procedure requires a value for parameter @x but one was not provided."

Use Certified Data Sources

To speed up the process of validating and setting up data, use certified data sources. Certified data sources are carefully chosen by site administrators and project leaders.

By taking advantage of relevant content that's already available, you can avoid duplicating work and spend more time on your analysis.

Note: To access these features in Tableau Desktop, you need to sign in to Tableau Server or Tableau Cloud from the **Server** menu.



Certified data sources published to Tableau Server or Tableau Cloud

Certified data sources appear with a unique certification badge. Hover over the badge to learn who certified the data source, read any descriptive notes they've provided, and confirm the connection type.

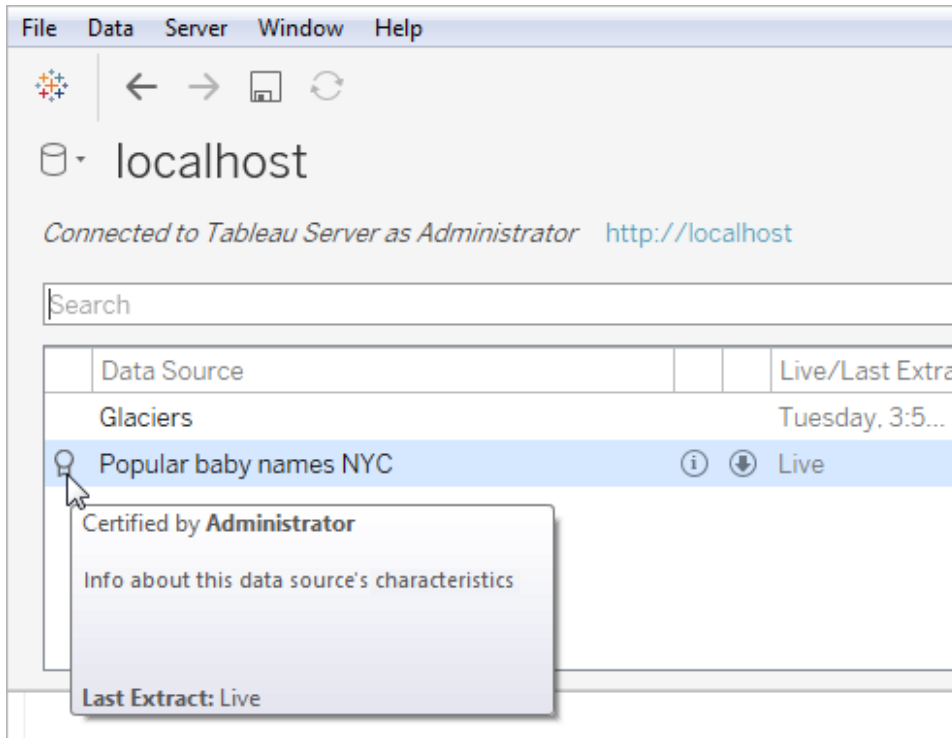
Here's how certified data sources look when you connect to data in Tableau Desktop.



And here's how you can identify certified data sources in Tableau Server or Tableau Cloud.

Type	Name	
<input type="checkbox"/> ☆ 	Audit Tables	...
<input type="checkbox"/> ☆ 	Background Tasks	...
<input type="checkbox"/> ☆ 	Resources and Extracts	...



EXTRACT

Last refresh Oct 17, 2018, 12:36 PM

Owner **Tatiana**

Certified by **Isaac**

Audit Tables ☆ ...

Convert a Field to a Date Field

Each database stores Date fields in slightly different ways. Tableau does its best in interpreting the date fields, but sometimes a field will be imported to Tableau as a text string or numerical field. If this happens, there are a few steps we can take to resolve the issue.

Verifying Date Fields

A date field might appear as a string
in the Data Source page

Or as a string in the Data pane

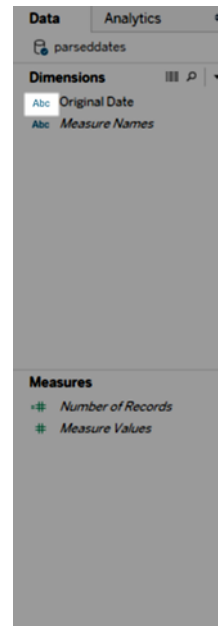
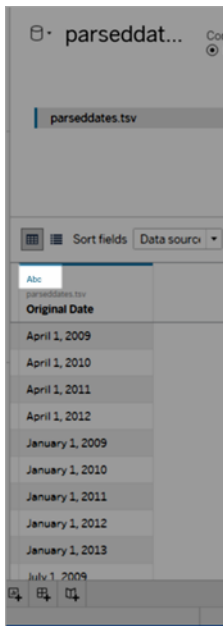

When dates are interpreted as strings, you will lose all of the features and conveniences of working with date fields, such as drilling down, using date calculations, and switching between Continuous and Discrete measures.

If your dates aren't interpreted correctly, take the following steps in order:

1. [Change the data type of the field below](#)
2. [Create a calculation using the DATEPARSE function on the next page](#)
3. [Create a calculation using the DATE function on page 890](#)

Change the data type of the field

The first step in resolving a date field interpretation issue is to make sure the data type is set to **Date** or **Date & Time**.

1. In the **Data Source** or **Data** pane, click the data type icon and change the data type to **Date** or **Date & Time**

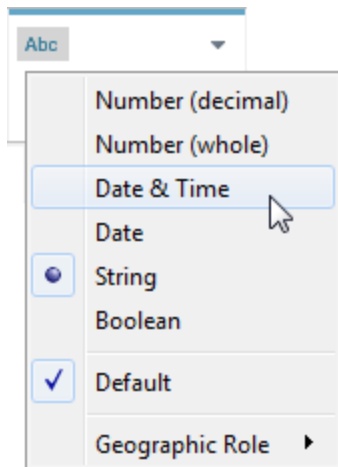

2. Inspect the data in the view or **Data Source** pane. If you see many Null values, return the data type to **String** and proceed to [Create a calculation using the DATEPARSE function below](#) to correct the issue.

Original Date
11/1/2013 12:09:00 A...
<i>null</i>
<i>null</i>
<i>null</i>
<i>null</i>
<i>null</i>
<i>null</i>
<i>null</i>

Create a calculation using the DATEPARSE function

Dates are stored in a nearly infinite array of formats. Some date fields have years before months, others separate the parts of the date with periods, and still others use a combination of formats. When Tableau cannot interpret a date field, it might be because the particular format cannot be translated.

The DATEPARSE function lets you clearly define which parts of your field are which parts of a date. In essence, you are creating a map that Tableau can use to translate the string into a date field. This map is referred to as the **format**.

Note: This function is available through the following connectors: non-legacy Excel and text file connections, Amazon EMR Hadoop Hive, Cloudera Hadoop, Google Sheets, Hortonworks Hadoop Hive, MapR Hadoop Hive, MySQL, Oracle, PostgreSQL, and Tableau extracts. Some formats may not be available for all connections.

Note: DATEPARSE is not supported on Hive variants. Only Denodo, Drill, and Snowflake are supported.

Creating the DATEPARSE calculation

1. Inspect the current format of your date field. Note where months, years, hours, and days are displayed in your field. You will need this information for the DATEPARSE function.

A	B	C	D	
				Abc
01-APR-14	01	00	10.000000000 PM	Abc
01-APR-14	01	01	51.000000000 PM	Abc
01-APR-14	01	02	55.000000000 PM	Abc
01-APR-14	01	18	14.000000000 PM	Abc

A. Day of month

B. Month

C. Year

D. Hour, minute, second, millisecond, period

2. Right click your date field in the Dimensions pane and select **Create > Calculated Field**.
3. In the dialog, write the DATEPARSE function. The DATEPARSE function has two parts: the **format** and the **string**. The **string** is field you wish to convert, which must be a string data type.

Dateparse
×

```
DATEPARSE('dd-MMM-YY HH.mm.ss.AAAAAAAAA aa', [Original Date])
```

A

B

A. Format

B. String

The **format** is the guide Tableau will use to interpret the string as a date. Each part of a date or time string has a matching symbol, as seen in the table below. The format must exactly duplicate the way that the date is displayed. For example, if a single year code ("Y") is used when the string has a 2-digit year code ("97"), the calculation might return null values.

Note: The exception to the format exactly duplicating the displayed string is that long form parts of dates ("September") can be formatted with four symbols ("September" = "MMMM").

The format must include all spaces, hyphens, and other non-alphanumeric symbols in order to interpret the string correctly.

Date Field Symbols

Date Part	Symbol	Example String	Example Format
Year	y	97, 2017	yy, y or yyyy
Year of "Week of year"	Y	1997	Y
Time Zone	Z, z	-0800, PST-08:00, PST	Z, ZZZZ, zzz
Month	M	9, 09, Sep, September	M, MM, MMM, MMMM
Week of year (1-52)	w	8, 27	w, ww
Quarter of year	Q	Q2, 2nd quarter	QQQ, QQQQ
Day of week	E	Mon, Monday	EEE, EEEE
Day of month	d	1, 15	d, dd
Day of year (1-365)	D	23, 143	D, DD, DDD
Period (am/pm)	a	AM, am, PM	aa, aaaa

marker)			
Hour (1-12), Hour (0-23)	h, H	1, 10, 16	h, hh, HH
Minute	m	8, 59	m, mm
Second in a minute	s	5, 05	s, ss
Fractional second	S	2, 23, 235, 2350	S, SS, SSS, SSSS
Milliseconds in day	A	34532	AAAAA

For a more complete list of date symbols, please see the [Formatting Date and Times Overview on the International Components](#) for Unicode page.

Note: Some date formats are not supported by all databases and file types.

4. Check your format against the string displayed in Tableau. If the symbols and formatting is correct, select OK to create the new calculated field. The calculated field will act as a date field in your view.

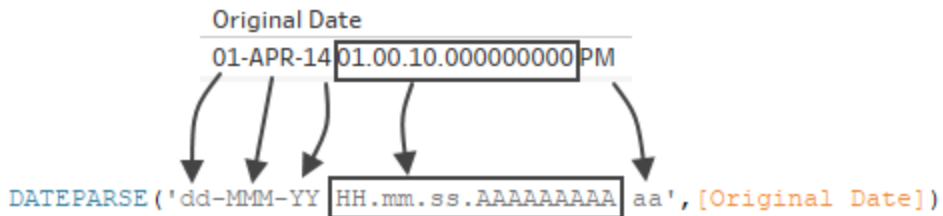

Hyper extracts

For .hyper extract data sources, the symbols are defined by the Unicode Consortium. For more information, go to [Format syntax in DATEPARSE function for extract data sources on page 1174](#) to see a the subset of field types and symbols that can be used with the DATEPARSE function in .hyper extracts.

Locale considerations

The DATEPARSE function relies on the locale specified by your computer settings to interpret and then display the strings that you want to convert. More specifically, the locale will affect

whether a certain format can be recognized. This means that if a format is not supported by the locale, then you might see a null value or no value returned. For example, suppose you have the following string in your data:

```
12Sep2016:9:8:8.6546
```

The values returned from the DATEPARSE function for this string are different based on locale. In the English locale you will get a certain value, but for the Japanese locale you will get no value. In this case, no value is returned because the Japanese locale does not recognize “Sep.”

Datetime value

English locale	Japanese locale
#9/12/2016 9:08:09 AM#	-

As with all dates, after you have used the DATEPARSE function to convert a string to a datetime type, by default Tableau will display the datetime value in the default format of your locale. If the locale changes, the result of the DATEPARSE function might display your new datetime value in a different format.

Note: Because of a Jet limitation, the DATEPARSE function cannot correctly identify locale information specified by your computer settings in extracts created from Access data sources. To resolve this issue, consider exporting your Access data to Excel.

Create a calculation using the DATE function

If the DATEPARSE function is not available for the data that you're working with, or the field you are trying to convert is a number data type, you can use the DATE function instead.

The DATE function converts a number, string or date expression to a date type. When you create a calculation that uses the DATE function, Tableau creates a new field in your Tableau data source that allows you to interact with your date data as a date. To successfully produce date values from a number, string, or date expression using the DATE function, Tableau needs to be able to interpret the components of the string into date parts. After the components of the date are identified, Tableau uses the computer locale to determine the default format of the date.

For example, suppose the table you're working with contains a column of date data that is called "Original Date." The "Original Date" column is a string type.

Original Date
03Jan2017
05Jan2017
07Mar2017
19Mar2017
30Apr2017

In this case, you can create a calculated field called "New Date" that uses an expression in a DATE function to convert the string values in the "Original Date" field into date values.

For this example, the date expression is comprised of the LEFT function to isolate the day component, the MID function to isolate the month component, and the RIGHT function to isolate the year component.

```
DATE (LEFT([Original Date], 2) + "/" + MID([Original Date],3,3) + "/"
+ RIGHT([Original Date],4))
```

The "New Date" calculation produces the following column:

New Date
1/3/2017
1/5/2017
3/7/2017
3/19/2017
4/30/2017

In this example, the new date values are based on an English locale and default formatting.

See Also

[Custom Date Formats](#) on page 1165

[Format Dates Using ISO-8601 Weeks and Years](#) on page 1182

[Date Functions](#) on page 2075

[All Functions \(by Category\): Date](#)

[STR\(\) Function Ignores the Default Date and Number Formatting](#) (Tableau Knowledge Base)

Pivot Data from Columns to Rows

Sometimes, analyzing data that is stored in a crosstab format can be difficult in Tableau. When working with Microsoft Excel, text file, Google Sheets, and .pdf data sources, you can pivot your data from crosstab format into columnar format. If you are working with other data sources, you can [Pivot using custom SQL \(Tableau Desktop\)](#) on page 894.

For example, suppose you have the number of devices sold by quarter for three vendors in three separate fields. You can pivot your data so that the vendor is in one field and the number of devices sold is in another field.

Quarter	Samsung	Nokia	Apple
Q1 '12	89.2800	83.1600	33.1200
Q2 '12	90.4300	83.4200	28.9400
Q3 '12	97.9600	82.3000	24.6200
Q4 '12	106.9600	85.0500	43.4600
Q1 '13	100.6600	63.2200	38.3300
Q2 '13	107.5300	60.9500	31.9000
Q3 '13	117.0500	63.0500	30.3300
Q4 '13	119.2100	63.5800	50.2200

Quarter	Pivot Field Names	Pivot Field Values
Q4 '12	Apple	43.460
Q1 '13	Apple	38.330
Q2 '13	Apple	31.900
Q3 '13	Apple	30.330
Q4 '13	Apple	50.220
Q1 '10	Nokia	110.110
Q2 '10	Nokia	111.470
Q3 '10	Nokia	117.460
Q4 '10	Nokia	122.280

Pivot the data

After you have set up the data source, in the grid, select two or more columns. Click the drop-down arrow next to the column name, and then select **Pivot**. New columns called "Pivot field names" and "Pivot field values" are created and added to the data source. The new columns replace the original columns that you selected to create the pivot.

Quarter	Samsung	Nokia	Apple
Q4 '11	93.8300	111.7000	35.46
Q1 '12	89.2800	83.1600	33.12
Q2 '12	90.4300	83.4200	28.94
Q3 '12	97.9600	82.3000	24.62
Q4 '12	106.9600	85.0500	43.4600
Q1 '13	100.6600	63.2200	38.3300
Q2 '13	107.5300	60.9500	31.9000
Q3 '13	117.0500	63.0500	30.3300
Q4 '13	119.2100	63.5800	50.2200

Add to the pivot

To add more data to the pivot, select another column, click the drop-down arrow next to the column name, and then select **Add Data to Pivot**. Make sure that the pivot columns and values look as expected before you begin your analysis.

Quarter	LG	Pivot Field Values
Q1 '10	27.19	8.270
Q2 '10	29.37	8.740
Q3 '10	27.48	13.480
Q4 '10	30.12	16.010
Q1 '11	24.00	16.880
Q2 '11	24.42	19.630
Q3 '11	21.0100	17.300
Q4 '11	16.9400	35.460

To remove a pivot, click the drop-down arrow next to the name of a pivot column, and then select **Remove Pivot**.

Troubleshooting pivots

- **Red fields in the view and fields with exclamation points in the Data pane:**
Because the original fields are replaced with new pivot fields, any references to the original fields in the view will no longer work. They cause fields to become red in the view or show a red exclamation point next to the field in the **Data** pane.
- **Null values in the grid:** If all of the original fields used in the pivot are removed, for example in an extract refresh, null values display in the pivot fields.
- **No pivot option:** Pivot appears when you select two or more columns in a single Microsoft Excel, text file, Google Sheets, and .pdf data source. If using a different data source in Tableau Desktop, you can use custom SQL to pivot.

Pivot using custom SQL (Tableau Desktop)

You can also use custom SQL to pivot your data, even if you aren't working Excel, text file, Google Sheets, and .pdf data sources. When you use the UNION ALL operator in a custom SQL query, you can take values from distinct columns and put them into a new column.

For example, suppose you have a table called **Contest**.

Contest

Runner	Start Time	End Time
Amanda	9/3/2016 3:04 PM	9/3/2016 3:25 PM
Oscar	9/3/2016 3:04 PM	9/3/2016 3:21 PM
William	9/3/2016 3:04 PM	9/3/2016 3:16 PM

To optimize your analysis of this data in Tableau, you can use the following custom SQL query to pivot the "Start Time" and "End Time" columns so that their values are in a single column.

```
Select [Runner]
, 'Start' as [Action]
, [Start Time] as [Time]
From [Contest]
Union ALL
```

```
Select [Runner]
, 'End' as [Action]
, [End Time] as [Time]
From [Contest]
```

The above custom SQL query does the following:

- Pivots the **Start Time** column header into a string value called **Start** and adds that value to a new column called **Action**.
- Pivots the **End Time** column header into a string value called **End** and adds that value to a new column called **Action**.
- Pivots the **Start Time** and **End Time** columns so that their values are in a new column called **Time**.

The following table shows the results of this custom SQL query.

Runner	Action	Time
Amanda	Start	9/3/2016 3:04 PM
Oscar	Start	9/3/2016 3:04 PM
William	Start	9/3/2016 3:04 PM
Amanda	End	9/3/2016 3:25 PM
Oscar	End	9/3/2016 3:21 PM
William	End	9/3/2016 3:16 PM

To pivot data using custom SQL

1. Connect to your data.
2. Double-click the **New Custom SQL** option in the left pane. For more information, see [Connect to a Custom SQL Query](#) on page 863.
3. In the **Edit Custom SQL** dialog box, copy and paste the following custom SQL query and replace the contents with information about your table:

```

Select [Static Column]
, 'New Value (from Column Header 1)' as [New Column Header]
, [Pivot Column Values 1] as [New Values]

From [Table]

Union ALL

Select [Static Column]
, 'New Value (from Column Header 2)' as [New Column Header]
, [Pivot Column Values 2] as [New Values]

From [Table]

Union ALL

Select [Static Column]
, 'New Value (from Column Header 3)' as [New Column Header]
, [Pivot Column Values 3] as [New Values]

From [Table]

```

Where the following is true:

- ***Static Column***: A comma-delimited list of the columns from *Table*, both dimensions and measures, which should not be included in the pivot.
- ***New Value (from Column Header 1-3)***: New names that you give to the original column headers, which are used as row values in the pivot.
- ***Pivot Column Values 1-3***: The columns whose values need to be pivoted into a single column.
- ***New Column Header***: The name you give the new column that contains the new row values from *New Value (from Column Header 1-3)*.
- ***New Values***: The name give the new column that contains the original values from *Pivot Column Values 1-3*.
- ***Table***: The table that you connected to.

4. Click **OK**.

Clean Data from Excel, CSV, PDF, and Google Sheets with Data Interpreter

When you track data in Excel spreadsheets, you create them with the human interface in mind. To make your spreadsheets easy to read, you might include things like titles, stacked headers, notes, maybe empty rows and columns to add white space, and you probably have multiple tabs of data too.

When you want to analyze this data in Tableau, these aesthetically pleasing attributes make it very difficult for Tableau to interpret your data. That's where Data Interpreter can help.

Tip: Though Tableau's Excel add-in is no longer supported, Data Interpreter can help you reshape your data for analysis in Tableau.

What does Data Interpreter do?

Data Interpreter can give you a head start when cleaning your data. It can detect things like titles, notes, footers, empty cells, and so on and bypass them to identify the actual fields and values in your data set.

It can even detect additional tables and sub-tables so that you can work with a subset of your data independently of the other data.

After Data Interpreter has done its magic, you can check its work to make sure it captured the data that you wanted and identified it correctly. Then, you can make any necessary adjustments.

After you select the data that you want to work with, you might also need to do some additional cleaning steps like pivoting your data, splitting fields, or adding filters to get the data in the shape you want before starting your analysis.

Note: If your data needs more cleaning than what Data Interpreter can help you with, try [Tableau Prep](#).

Turn on Data Interpreter and review results

1. From the **Connect** pane, connect to an Excel spreadsheet or other connector that supports Data Interpreter such as Text (.csv) files, PDF files or Google sheets.
2. Drag a table to the canvas (if needed), then on the **Data Source** page, in the left pane, select the **Use Data Interpreter** check box to see if Data Interpreter can help clean up your data.

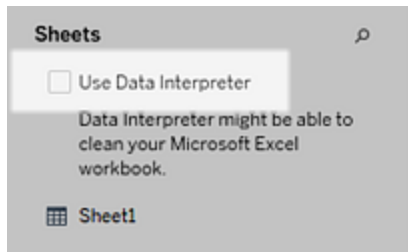

Note: When you clean your data with Data Interpreter, Data Interpreter cleans all the data associated with a connection in the data source. Data Interpreter does not change the underlying data.

3. In the Data pane, click the **Review the results** link to review the results of the Data Interpreter.

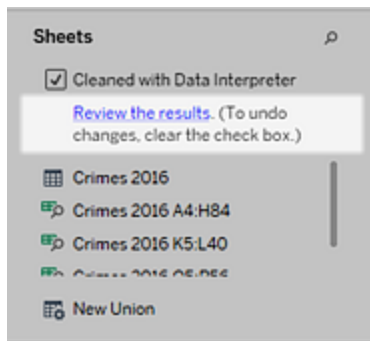

A copy of your data source opens in Excel on the **Key for the Data Interpreter** tab. Review the key to find out how to read the results.

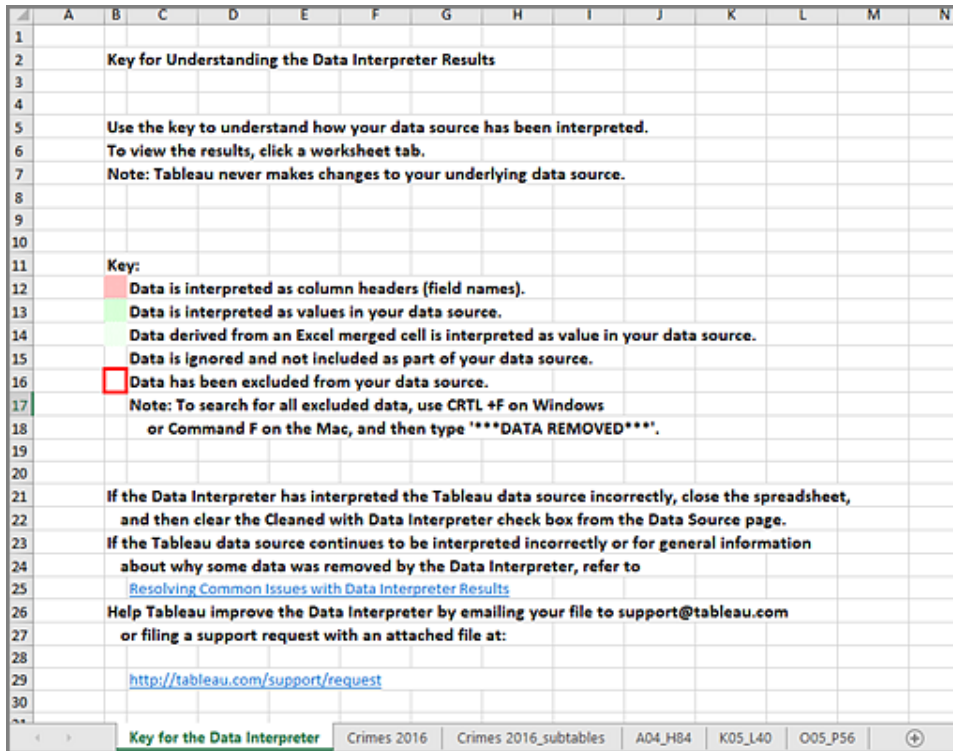

4. Click each tab to review how Data Interpreter interpreted the data source.

If Data Interpreter found additional tables, also called found tables or sub-tables, they are identified in the <sheet name>_subtables tab by outlining their cell ranges. A separate tab is also included for each sub-table, color coded to identify the header and data rows.

If Data Interpreter does not provide the expected results, clear the **Cleaned with Data Interpreter** check box to use the original data source.

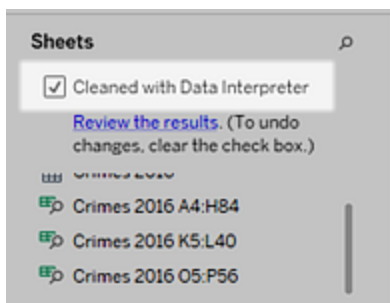

5. To replace the current table with any of the found tables, drag the current table off the canvas and then drag the found table that you want to use to the canvas.

If Data Interpreter has misidentified the range of the found table, after you drag the found table to the canvas, click the drop-down arrow on that table, and then select **Edit Found Table** to adjust the corners of the found table (the top-left cell and bottom-right cell of the table).

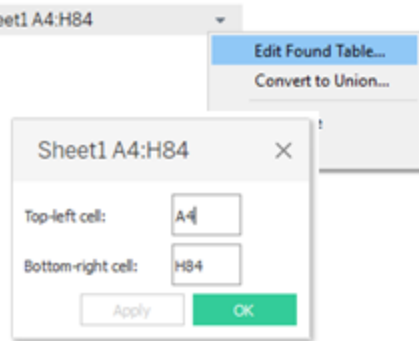

6. After you have the data that you want to work with, you can apply any additional cleaning operations to your data so that you can analyze it.

Data Interpreter Example

In this example we are connecting to an Excel spreadsheet with violent crime data by city and state for the year 2016. This spreadsheet includes multiple tables on one sheet and some extra formatting.

Violent Crimes in 2016 in the United States by City and State									
Location		Months							
city	state	Apr	Jun	Jul	Aug	Sep	Oct		
Albuquerque	New Mexico							46	
Anaheim	California								26
Anchorage	Alaska	1							17
Arlington	Texas								85
Atlanta	Georgia								16
Aurora	Colorado					28			
Austin	Texas								22
Bakersfield	California								230
Baltimore	Maryland								28
Boston	Massachusetts								38
Buffalo	New York								3
Chandler	Arizona								
Charlotte-M	North Carolina			25					
Chicago	Illinois								536
Chula Vista	California	2				1			
Cincinnati	Ohio							50	
Cleveland	Ohio							89	
Colorado Sp	Colorado						15		70
Columbus	Ohio								9
Corpus Chris	Texas								118
Dallas	Texas								33
Denver	Colorado								221
Detroit	Michigan	5							30
Durham	North Carolina								14
El Paso	Texas								34
Fort Wayne	Indiana								49
Fort Worth	Texas	7							19
Fresno	California								
Greensboro	North Carolina								20

state	Total Crimes 2016
Alabama	12
Alaska	26
Arizona	132
California	515
Colorado	64
D.C.	100
Florida	210
Georgia	85
Hawaii	5
Illinois	536
Indiana	155
Kansas	10
Kentucky	95
Louisiana	327
Maryland	230
Massachusetts	28
Michigan	221
Minnesota	26
Missouri	278
Nebraska	25
Nevada	128
New Jersey	86
New Mexico	46
New York	290
North Carolin	82
Ohio	217
Oklahoma	82
Oregon	14
Pennsylvania	258

State	Population 2016
Alabama	480545
Alaska	741522
Arizona	6908642
Arkansas	2988231
California	39296476
Colorado	5530105
Connecticut	3587685
Delaware	952698
District of Co	684336
Florida	20656589
Georgia	10313620
Hawaii	1428683
Idaho	1480026
Illinois	12835726
Indiana	6634007
Iowa	3130869
Kansas	2907731
Kentucky	4438113
Louisiana	4686157
Maine	1330232
Maryland	6024752
Massachusetts	6827721
Michigan	9933445
Minnesota	5525050
Mississippi	2985415
Missouri	6091176
Montana	1038606
Nebraska	1907603
Nevada	293254

- A. Title
- B. Merged header cells
- C. Extra white space
- D. Sub-tables

Tableau Desktop and Web Authoring Help

The extra formatting in this spreadsheet makes it difficult for Tableau to determine what the field headers and values are.

Instead, it reads the data vertically and assigns each column the default value F1, F2, F3 (Field 1, Field 2, Field 3) and so on. Blank cells are read as null values.

Row	F1	F2	F3	F4	F5	F6	F7	F8	F9	F10	F11	F12	F13	F14	F15	F16	F17	F18	F19	F20	F21	F22	F23	F24	F25	F26	F27	F28	F29	F30	F31	F32	F33	F34	F35	F36
Valent Crimes in 2011																																				
Location		Months																																		
city	state	Apr	Jun	Jul	Aug	Sep	Oct	state	Total Crimes 2016	State	Population 2016																									
Albuquerque	New Mexico						46		Alabama	12	Alabama	4802545																								
Anahem	California		4						Alaska	26	Alaska	741522																								
Anchorage	Alaska	1				26			Arizona	132	Arizona	6908642																								
Arlington	Texas					17			California	615	Arkansas	2988231																								
Atlanta	Georgia						85		Colorado	64	California	39296476																								

To see if Data Interpreter can help clean this data set, we select **Use Data Interpreter**.

Data Interpreter detected the proper headings for the fields, removed the extra formatting and found several sub-tables. The sub-tables are listed in the **Sheets** section in the Data pane and are named using the original sheet name and the cell ranges for each sub-table.

In this example there are three sub-tables: **Crimes 2016 A4:H84**, **Crimes 2016 K5:L40**, and **Crimes 2016 O5:P56**.

Row	Location	city	state	Months	Months	Months	Months	Months	Months	Months	Months	state	Total Crimes 2016	State	Population 2016
Albuquerque	New Mexico									46		Alabama	12	Alabama	4,802,545
Anahem	California			4								Alaska	26	Alaska	741,522
Anchorage	Alaska	1							26			Arizona	132	Arizona	6,908,642
Arlington	Texas							17				California	615	Arkansas	2,988,231
Atlanta	Georgia								85			Colorado	64	California	39,296,476
Aurora	Colorado								26			D.C.	105	Colorado	5,630,105
Austin	Texas								29			Florida	210	Connecticut	3,687,685
Bakersfield	California					22						Georgia	85	Delaware	952,699
Baltimore	Maryland											Hawaii	220	Idaho	1,606,300
												Iowa	31	District of Columbia	684,308

To examine the results of the Data Interpreter more closely, we click the **Review the results** link in the Data pane to view an annotated copy of the spreadsheet.

Here we see a copy of the original data, color coded to identify which data was identified as header data and which data was identified as field values.

	A	B	C	D	E	F	G	H	I	J	K	L	M	N	O	P	Q
1	Violent Crimes in 2016 in the United States by City and State																
2																	
3																	
4	Location	Location	Months	Months	Months	Months	Months	Months									Header
5	city	state	Apr	Jun	Jul	Aug	Sep	Oct		state	Total Crimes 2016		State	Populatio	Header		
6	Albuquerque	New Mexico						46		Alabama	12		Alabama	4860545	Data		
7	Anaheim	California			4					Alaska	26		Alaska	741522	Data		
8	Anchorage	Alaska	1					26		Arizona	132		Arizona	6908642	Data		
9	Arlington	Texas					17			California	515		Arkansas	2988231	Data		
10	Atlanta	Georgia						85		Colorado	64		California	39296476	Data		
11	Aurora	Colorado						16		D.C.	105		Colorado	5530105	Data		
12	Austin	Texas					28			Florida	210		Connectic	3587685	Data		
13	Bakersfiel	California		22						Georgia	85		Delaware	952698	Data		
14	Baltimore	Maryland							230	Hawaii	9		District of	684336	Data		
15	Boston	Massachusetts						28		Illinois	536		Florida	20656589	Data		
16	Buffalo	New York						38		Indiana	151		Georgia	10313620	Data		
17	Chandler	Arizona						3		Kansas	10		Hawaii	1428683	Data		

The next tab shows us the sub-tables that Data Interpreter found, outlined by the cell ranges.

	A	B	C	D	E	F	G	H	I	J	K	L	M	N	O	P	Q
1	Violent Crimes in 2016 in the United States by City and State																
2																	
3																	
4	Location	Location	Months	Months	Months	Months	Months	Months									
5	city	state	Apr	Jun	Jul	Aug	Sep	Oct		state	Total Crimes 2016		State	Population 2016			
6	Albuquerque	New Mexico						46		Alabama	12		Alabama	4860545			
7	Anaheim	California			4					Alaska	26		Alaska	741522			
8	Anchorage	Alaska	1					26		Arizona	132		Arizona	6908642			
9	Arlington	Texas					17			California	515		Arkansas	2988231			
10	Atlanta	Georgia						85		Colorado	64		California	39296476			
11	Aurora	Colorado						16		D.C.	105		Colorado	5530105			
12	Austin	Texas					28			Florida	210		Connectic	3587685			
13	Bakersfiel	California		22						Georgia	85		Delaware	952698			
14	Baltimore	Maryland							230	Hawaii	9		District of	684336			
15	Boston	Massachusetts						28		Illinois	536		Florida	20656589			
16	Buffalo	New York						38		Indiana	151		Georgia	10313620			
17	Chandler	Arizona						3		Kansas	10		Hawaii	1428683			
18	Charlotte	North Carolina		25						Kentucky	95		Idaho	1680026			
19	Chicago	Illinois							536	Louisiana	127		Illinois	12835726			
20	Chula Vist	California	2				1			Maryland	230		Indiana	6634007			
21	Cincinnati	Ohio						50		Massachu	28		Iowa	3130869			
22	Cleveland	Ohio						89		Michigan	221		Kansas	2907731			
23	Colorado	Colorado					15			Minnesota	26		Kentucky	4436113			
24	Columbus	Ohio						70		Missouri	223		Louisiana	4686157			
25	Corpus Ch	Texas		9						Nebraska	29		Maine	1330232			
26	Dallas	Texas						118		Nevada	128		Maryland	6024752			
27	Denver	Colorado					33			New Jerse	86		Massachu	6823721			
28	Detroit	Michigan	5						221	New Mexi	46		Michigan	9933445			
29	Durham	North Carolina							30	New York	290		Minnesota	5525050			
30	El Paso	Texas						14		North Car	82		Mississip	2985415			
31	Fort Wayr	Indiana						34		Ohio	217		Missouri	6091176			

In this example the first sub-table, **Crimes 2016 A4:H84**, has the main data that we want to work with. To use this table as our data table, we can simply drag the original table off the canvas and then drag the new table to the canvas.

Tableau Desktop and Web Authoring Help

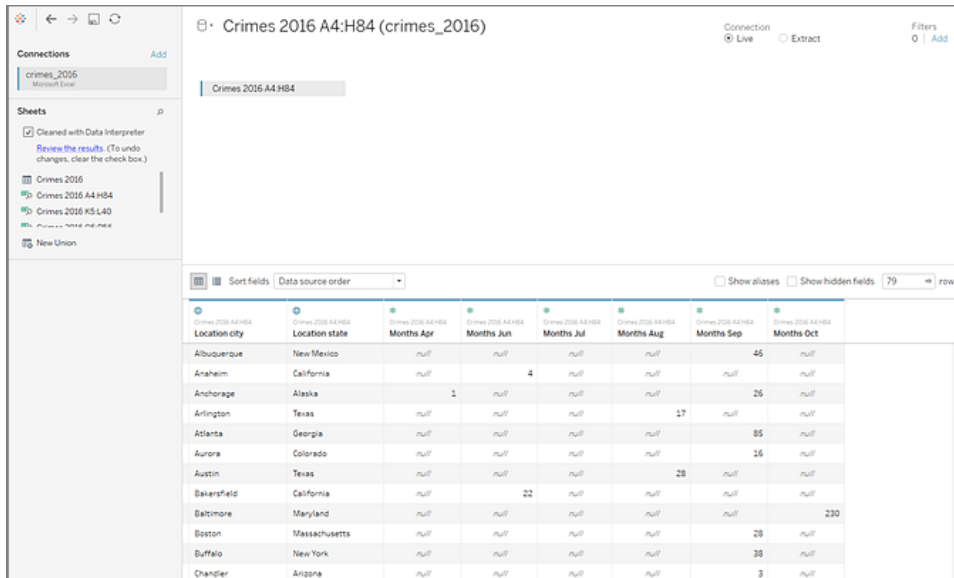

The screenshot shows the Tableau Desktop interface. The main view displays a data table with the following columns: Location city, Location state, Months Apr, Months Jun, Months Jul, Months Aug, Months Sep, and Months Oct. The data is as follows:

Location city	Location state	Months Apr	Months Jun	Months Jul	Months Aug	Months Sep	Months Oct
Albuquerque	New Mexico	null	null	null	null	45	null
Anaheim	California	null	4	null	null	null	null
Anchorage	Alaska	1	null	null	null	26	null
Arlington	Texas	null	null	null	17	null	null
Atlanta	Georgia	null	null	null	null	85	null
Aurora	Colorado	null	null	null	null	16	null
Austin	Texas	null	null	null	28	null	null
Bakersfield	California	null	22	null	null	null	null
Baltimore	Maryland	null	null	null	null	null	230
Boston	Massachusetts	null	null	null	null	28	null
Buffalo	New York	null	null	null	null	38	null
Chandler	Arizona	null	null	null	null	3	null

Once we have the data that we want to work with in the canvas, we can do some additional clean up on the data. For example we can:

- Change the field names so that they represent city, state, and month names.
- Pivot the months fields.
- Drag in the third sub-table **Crimes 2016 o5:P56** and join it to our first sub-table on the **State** field to include state populations for our analysis.
- Hide any duplicate fields that were added as a result of the join.

The results might look something like this:

Sort fields Data source order				
Crimes 2016 A4:HB4 City	Crimes 2016 A4:HB4 State	Crimes 2016 O5:P56 Population 2016	Abc Pivot Months	# Pivot Crimes
Phoenix	Arizona	6,908,642	August	111
Pittsburgh	Pennsylvania	12,787,085	August	<i>null</i>
Plano	Texas	27,904,862	August	5
Portland	Oregon	4,085,989	August	<i>null</i>
Raleigh	North Carolina	10,156,689	August	<i>null</i>
Riverside	California	39,296,476	August	7
Sacramento	California	39,296,476	August	<i>null</i>
San Antonio	Texas	27,904,862	August	<i>null</i>
San Diego	California	39,296,476	August	30
San Francisco	California	39,296,476	August	<i>null</i>
San Jose	California	39,296,476	August	35
Santa Ana	California	39,296,476	August	<i>null</i>
Seattle	Washington	7,280,934	August	14
St. Louis	Missouri	6,091,176	August	133
St. Petersburg	Florida	20,656,589	August	14

Now we are ready to start analyzing our data in Tableau.

When Data Interpreter is not available

The Data Interpreter option might not be available for the following reasons:

- **The data source is already in a format that Tableau can interpret:** If Tableau Desktop doesn't need extra help from Data Interpreter to handle unique formatting or extraneous information, the Data Interpreter option is not available.
- **Many rows or many columns:** The Data Interpreter option is not available when your data has the following attributes:
 - Data contains more than 2000 columns.
 - Data contains more than 3000 rows and more than 150 columns.
- **The data source is not supported:** Data Interpreter is only available for Microsoft Excel, Text (.csv) files, PDF files and Google Sheets. For Excel, your data must be in the .xls or .xlsx format.

Split a Field into Multiple Fields

If you have string fields in your data that contain multiple distinct pieces of information (for example, the first and last name of a customer) you may be able to split the values into separate fields.

Customer Name	Customer Name - ...	Customer Name - ...
Claire Gute	Claire	Gute
Claire Gute	Claire	Gute
Darrin Van Huff	Darrin	Van
Sean O'Donnell	Sean	O'Donnell
Sean O'Donnell	Sean	O'Donnell
Brosina Hoffman	Brosina	Hoffman
Brosina Hoffman	Brosina	Hoffman
Brosina Hoffman	Brosina	Hoffman

You can use split options in Tableau Desktop to separate the values based on a separator (delimiter) or a repeated pattern of values present in each row. In the example of Customer Name, the common separator is a space (" ") between first and last name.

Find the Split option

Tableau Desktop—but not web editing in the browser—has a menu option for automatic or custom splits. These are based on the SPLIT string function, which can also be used manually in a calculation for complete control over the split.

Not all data sources support SPLIT. You can tell if your data supports the **SPLIT function** by checking for the Split and Custom Split menu options:

- On the Data Source page, check the menu for **Split** and **Custom Split**.

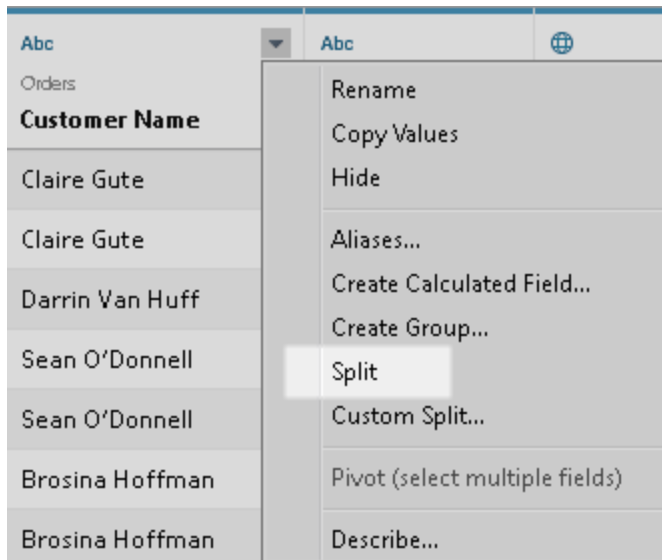

- From the Data pane on a sheet, check the menu for **Transform > Split** and **Custom Split**.

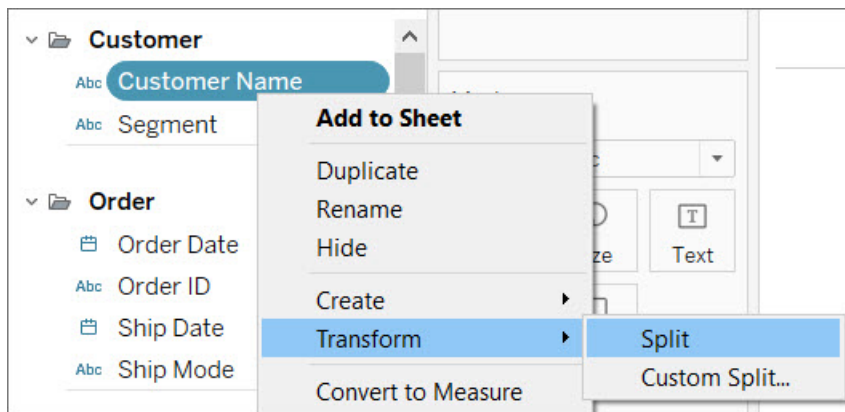

Split on the web

Web authoring doesn't support splitting from a menu. To split data while working in the browser, you can manually create a SPLIT calculation. See [Alternatives to splitting from the menu on page 908](#).

Split fields

A string field can be split automatically based on a common separator that Tableau detects in the field. You can also manually define the split

Depending on the connection type, a split can automatically separate a field's values in up to ten new fields.

Split a field automatically

On the Data Source page, in the grid, click the drop-down arrow next to the field name, then select **Split**.

In the Data pane, right-click the field you want to split, and then select **Transform > Split**.

The results of the split are standard calculated fields that can be edited or deleted like any other calculated field. The data type of the new fields generated by the split can vary depending on the pattern combination that Tableau detects.

Split a field with custom split

Use the custom split option for more control over the split. You can specify the separator and choose to split the values at the first N occurrences of the separator, the last N occurrences, or at all occurrences.

On the Data Source page, in the grid, click the drop-down arrow next to the field name. Select **Custom Split**.

From the Data pane, in the Data pane, right-click the field you want to split, and then select **Transform > Custom Split**.

The new fields generated by the custom split always result in a string data type.

Note: In some cases, if the automatic split takes too long to generate new fields or Tableau can't find a common separator, the custom split dialog box displays.

Custom split is useful when the number of separators varies from value to value. Automatic split can't be used in these cases.

For example, suppose a field Employee Info has the following values:

- jsmith| accounting | north
- dnguyen | humanresources

- lscott | recruiting | west
- karnold |recruiting |west

The custom split could be configured to split on the pipe character ("|") and split off all columns. For the value without a region, the third result field will be null for that row.

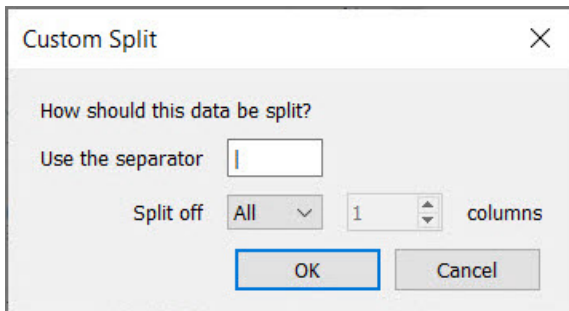

Alternatives to splitting from the menu

Split manually using the SPLIT function

The SPLIT function works similarly to a custom split, but only one result field is returned per calculation. You define the separator and specify which value to return by providing a token number.

For example, to split Customer Name into First Name and Last Name, create two calculated fields:

- First Name: `SPLIT([Customer Name], " ", 1)`
- Last Name: `SPLIT([Customer Name], " ", 2)`

The Employee Info example (such as "jsmith| accounting | north") would use three calculated fields:

- Username: `SPLIT([Employee Info], |, 1)`
- Department: `SPLIT([Employee Info], |, 2)`
- Region: `SPLIT([Employee Info], |, 3)`

For more information, see the [SPLIT function](#).

Split manually using LEFT and RIGHT functions

If your use case is more to extract a specific part of a string than to split it based on a separator, you can use the LEFT and RIGHT functions. These return only a portion of the string based on a specified number of characters.

For example, if the value of a row is IGW8892:

Calculation	Result
<code>RIGHT([Value], 4)</code>	8892
<code>LEFT([Value], 4)</code>	IGW8
<code>LEFT(RIGHT([Value], 2) , 1)</code>	9

For more information, see LEFT and RIGHT in [String Functions on page 2061](#).

Use regular expressions for fields contain mixed separators

Fields can't be split automatically if the separator types are different. For example, suppose a field includes the following values:

- smith.accounting
- dnguyen-humanresources
- lscott_recruiting
- karnold_recruiting

In cases like this, consider using regular expressions to extract the desired information. For more information, see [Additional Functions on page 2193](#).

Working with splits and custom splits

Things to keep in mind when working with splits and custom splits.

- New fields can't be used as keys to join tables, but can be used to blend data sources.
- New fields can't be used in a pivot.
- Split and custom split options aren't supported for sets, groups, parameters, and bins.
- Microsoft SQL Server only allows up to four split fields.
- To generate more than ten new fields, consider splitting multiple times. You can use split again on a field from the first split that still includes multiple pieces of information.

Troubleshooting splits and custom splits

Known issues you might experience when using splits and custom splits:

- **Split and custom split options missing for a supported data source type:** Split and custom split options are available only for fields that are a string data type.

- **Null values:** After creating a split or a custom split, new fields might contain null values or no values at all. Null values or empty cells happen when there are no values for the expected new fields.
- **Data has been removed:** Tableau might use portions of the field's values as a separator. If a portion of a field's value is used as a separator, those values no longer appear in the new fields.

For example:

Original value	Split field values
Zip-98102	98102
Zip-98109	98109
Zip-98119	98199
Zip-98195	98195

The split doesn't create a separate field for "Zip-" because that entire string is used as the separator.

Filter Data from Data Sources

You can create filters on a data source, thereby reducing the amount of data in the data source. This feature is available to Creators when authoring in Tableau Cloud and Tableau Server.

If you create an extract from a data source that already has data source filters in place, those filters are automatically recommended as extract filters, and will appear in the Extract dialog. Those recommended filters are not required to be part of the Extract filter list, and can safely be removed without affecting the existing set of data source filters.

Data source filters can be useful for restricting the data users can see when you publish a workbook or data source. When you publish a data source to Tableau Server, the data source and any associated files or extracts are transported in entirety to the Server. As you publish a data source you can define access permissions for downloading or modifying the data source, and you can also choose the users and groups who can remotely issue queries through Tableau Server against that data source. When users have query permission and no download permission, you can share a rich data model having calculated fields, aliases, groups, sets and more—but only for querying.

Furthermore, users who query published data source will never be able to see or modify any data source filters present on the originally published data source, but all of the users' queries will be subject to those data source filters. This is a great way to offer a restricted subset of your data, for example by filtering dimensions for specific users and groups, or by defining data source filters based on a fixed or relative date range. This is often useful for data security, and it also allows you to manage performance of the remote database which Tableau Server will ultimately query on a user's behalf. For systems that rely heavily on partitions or indexing, data source filters may yield tremendous control over the performance of queries issued by Tableau.

Create a data source filter

The primary way to create a data source filter is from the data source page.

To create a data source filter

1. On the data source page, click **Add** in the Filters section in the upper-right corner of the page.

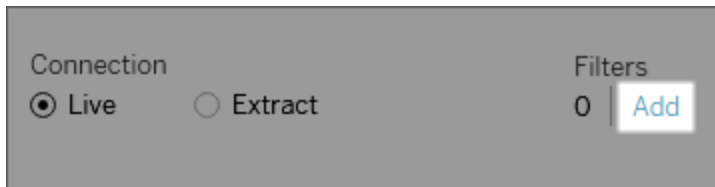

To create a data source filter on a worksheet, right-click (control-click on a Mac) the data source and choose **Edit Data Source Filters**.

Whether you start from the Data Source page or from a worksheet, you see an Edit Data Source Filter dialog box, listing any existing data source filters.

2. Click **Add** to open an Add Filter dialog box listing all fields in the data source.
3. Click to select a field to filter; then specify how the field should be filtered, just as you would for a field on the Filters shelf.

To add an additional data source filter, repeat this procedure.

Global filters and data source filters

When you create a data source filter, any global filters that use that data source are displayed automatically in the **Edit Data Source Filters** dialog box.

In Tableau Desktop, you can promote a global filter to be a data source filter. To promote the global filter to be a data source filter, click **OK**.

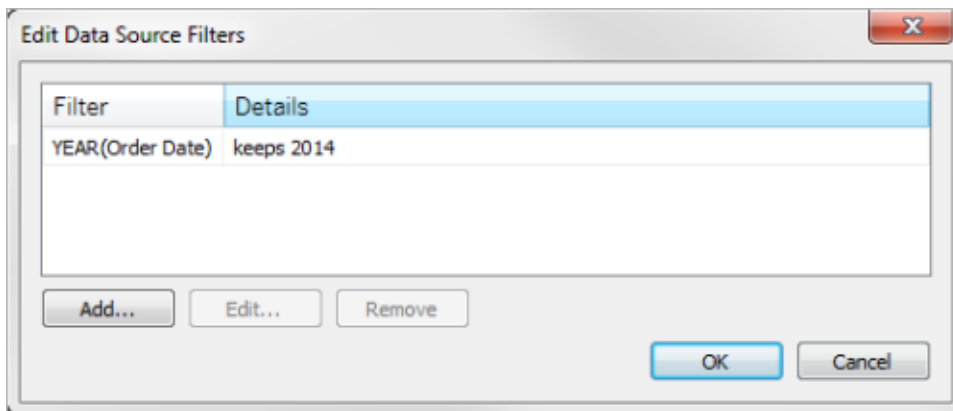

If you promote a global filter to be a data source filter in Tableau Desktop, that global filter will no longer be visible in worksheets of the workbook (because it becomes a data source filter).

Important: Be aware that you do not need to select a global filter in the **Edit Data Source Filters** dialog box to promote it. When you click **OK**, all global filters in the list will be promoted.

To prevent a global filter from being promoted to a data source filter, select the global filter in the **Edit Data Source Filters** dialog box, and then click **Remove**.

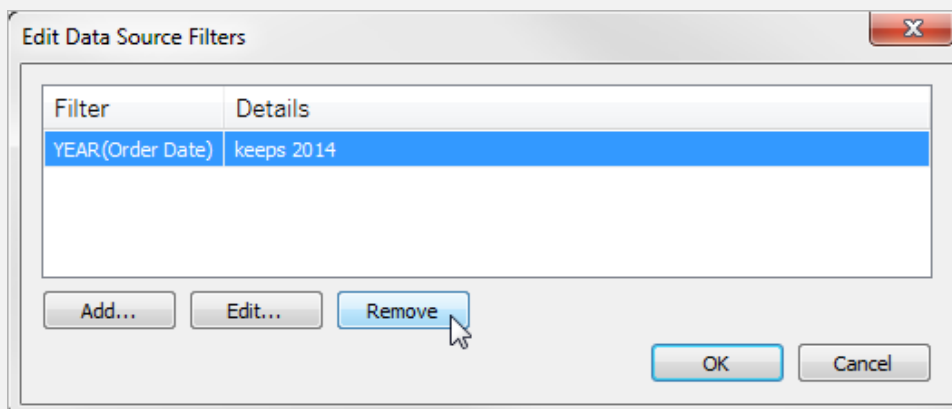

Understand Field Type Detection and Naming Improvements

Tableau uses a collection of commonly used patterns to detect and transform your data to make it easier for you to interact with. For example, when you work with fields in the Data pane, Tableau takes the data from your data source, detects its type, and divides it into dimensions and measures.

Note: Tableau never changes your underlying data.

Tableau can also detect fields that should be treated as dimensions and clean up field names by making them more readable. You see these improvements only when the field names, which come from column headers in your data source, meet the patterns or conditions described below.

New fields added to underlying data

If you add new fields to your underlying data, and then refresh the data source in Tableau, the newly added fields will retain their original database names. If you would like Tableau to automatically rename those fields, you will need to create a new connection to that same data source.

If you prefer to maintain the field types and field names from the underlying data, see the [Undo changes made by Tableau](#) section at the bottom of this article.

Fields that are treated as a dimension

Field names that contain certain keywords are treated as dimensions, even if the values for those fields are numeric.

Keywords Code, Key, and ID

Field names that contain the following keywords and meet the conditions listed are treated as dimensions instead of measures.

Conditions:

- Contains keywords Code, ID, or Key.
- Keywords are either separated from other text in the field name by non-letter characters, all capitalized, or the first letter is capitalized in a field name that otherwise has mixed casing.
- Keywords are at the beginning or end of the field name, with leading or trailing non-letter characters. In Chinese, Japanese, and Korean, the key word must be located at the end of the field name.

Language	Keywords
English (UK and US)	Code, Id, Key
Chinese (Simplified)	代码, ID, 键
Chinese (Traditional)	代碼, ID, 金鑰
French (Canada and France)	Code, ID, clé
German	Code, ID, Schlüssel
Italian	Codice, ID, chiave
Japanese	コード, ID, キー
Korean	코드, ID, 키
Portuguese	Código, ID, chave
Spanish	Código, ID, clave
Swedish	Kod, ID, nyckel
Thai	รหัส, ID, คีย์

Keywords Number, Num, and Nbr

Field names that end with Number, Num, or Nbr are treated as a dimension instead of a measure. For example, “Record Number” is treated as a dimension but “Number of Records” is not. In addition, the Korean field name must be four or fewer characters long.

Language	Keywords
English (UK and US)	Number, Num, Nbr
Chinese (Simplified)	数字
Chinese (Traditional)	數字
French (Canada and France)	Nombre
German	Nr, Nummer

Language	Keywords
Italian	Numero, N°
Japanese	数值
Korean	숫자
Portuguese	Número
Spanish	Número
Swedish	Nummer
Thai	ตัวเลข

Keywords related to dates

Field names containing keywords that are recognized as date parts are treated as dimensions. These field names can only contain only one additional word unrelated to dates to qualify. For example, “Fiscal Year” is treated as a dimension but “Fiscal Year Information” is not. In addition, Chinese field names must be four or fewer characters long and cannot contain digits. Japanese and Korean field names must be four or fewer characters long.

Language	Keywords
English (UK and US)	Year, Yr, Day, Day of Week, Week, Wk, Month, Quarter, Qtr, FY
Chinese (Simplified)	年, 天, 周中某天, 周, 月, 季度, 会计年度
Chinese (Traditional)	年, 天, 週中某天, 週, 月, 季, 會計年度
French (Canada and France)	Année, Jour, Jour de la Semaine, Semaine, Mois, Trimestre, AF
German	Jahr, Tag, Wochentag, Woche, Monat, Quartal, GJ
Italian	Anno, Giorno, Giorno della Settimana, Settimana, Sett, Mese, Trimestre, Trim, AF

Japanese	年, 日, 曜日, 週, 月, 四半期, 年度
Korean	년, 일, 요일, 주, 월, 분기, 회계 연도
Portuguese	Ano, Dia, Dia da Semana, Semana, Mês, Trimestre, AF
Spanish	Año, Día, Día de la Semana, Semana, Mes, Trimestre, AF
Swedish	År, Dag, Veckodag, Vecka, Månad, Kvartal, Räkenskapsåret
Thai	ปี, วัน, วันของสัปดาห์, สัปดาห์, เดือน, ไตรมาส, FY

Field name clean-up

Field names that contain specific characters or capitalized in a certain way are renamed. Field values that include square brackets are automatically converted to parentheses.

Field names with underscore, space, or tab characters

Non-leading and trailing underscore () characters in field names are converted into space () characters. Carriage return or line feed characters in a field name are removed. However, field names that contain leading underscore characters remain unchanged. In addition, leading and trailing spaces in field names are removed. This type of field name clean up applies only to English, French, German, Portuguese, and Spanish languages.

Example 1: The field name “Country_Name” is converted to “Country Name”.

Example 2: The field name “_Days_On_Market” is converted to “_Days On Market”.

Field names with multiple underscore characters in a row remain unchanged. For example, “Country__Name” remains as “Country__Name”.

If a field name contains multiple tab characters, the tabs are converted to underscores.

Field names and capitalization

Field names that use all capital letters with non-letter characters are converted to all lower-case letters except for the characters immediately after the non-letter character.

Additionally, field names that use all lower-case letters are converted so the first letter in the field name is capitalized.

This type of field name clean up applies only to English, French, German, Portuguese, and Spanish languages.

Example 1: The field name “PC1” is converted to “Pc1.” The field name “COUNTRY_NAME” is converted to “Country Name”. However, “Budget COGS” remains as “Budget COGS” .

Example 2: The field name “FDA” does not change. However, the field name “FDA_Sales” is converted to “Fda Sales”.

Example 3: The field name “age” is converted to “Age”.

Space characters are added to the case boundaries of field names that contain mixed casing with non-letter characters.

Example: The field name “ThisCase” is converted to “This Case”.

Field names that are two or three letters long

Field names that are two or three letters long that are part of a multiple word phrase are converted so that each letter in the word is capitalized, unless the two or three letter word contains a vowel (i.e., a, e, i, o, or u).

Example: The field name "Unit Qty" is converted to "Unit QTY". However, the field name "Sales Amt" remains as "Sales Amt".

Several three-letter acronyms are converted to all uppercase. Examples of three-letter acronyms include the following:

CIF	FDA	MPI
DMA	FOB	MSA
DOB	FTE	SKU
EIN	KPI	UPC
ESP	LOB	URL
		USD

The following field names are converted to all lowercase letters unless the name occurs at the beginning of the field name:

1st	as	down	of	th (suffix following a number)
2nd	at	for	on	than
3rd	but	in	off	the
a	by	inclu.	or	to
an	de	into	over	vs
and	da	la	per	with

Note: The casing of field names that are one letter long remain unchanged.

Undo changes made by Tableau

If you prefer to maintain the field types and field names specified by the underlying data, you can undo changes made by Tableau either manually, at the data source level, or automatically, at the application level.

To undo changes manually

1. Open your workbook and go to the Data Source page.
2. Click the drop-down arrow for the field with changes you want to undo and select **Reset name**.

If there are multiple fields you wish to change

1. Open your workbook and go to the Data Source page.
2. Optionally, click the metadata grid button.
3. **Ctrl+Click** (Windows) or **Command+Click** (Mac) to select the fields with changes you want to undo.
4. Click the drop-down arrow for any of the fields selected and select **Reset name**.

To automatically undo changes made by Tableau at the application level, follow the procedure in the [Overriding Automatic Field Renaming](#) article. This method affects all data sources that you access from Tableau Desktop.

Extract Your Data

A data extract is a subset of information that is saved separately from the original dataset. It serves two purposes: to enhance performance and to utilize Tableau features that may not be available or supported in the original data. By creating a data extract, you can effectively reduce the overall data volume by applying filters and setting other limitations.

After a data extract is created, it can be refreshed with the latest data from the original source. During the refresh process, you have the flexibility to choose between a full refresh, which replaces all existing content in the extract, or an incremental refresh, which only includes new rows since the previous refresh.

Note: Starting from version 2024.1, Tableau introduces a feature that enables users to perform incremental refreshes on extracts using a non-unique key column.

Benefits of Extracts

- **Handling large datasets:** Extracts can handle massive amounts of data, even reaching billions of rows. This allows users to work with extensive datasets efficiently.
- **Improved performance:** Interacting with views that utilize extract data sources results in better performance compared to views connected directly to the original data. Extracts optimize query performance, resulting in faster data analysis and visualization.
- **Enhanced functionality:** Extracts provide access to additional Tableau functionality that may not be available or supported by the original data source.

For instance, users can leverage extracts to compute Count Distinct, enabling more advanced calculations and analysis.

- **Offline data access (Tableau Desktop):** Extracts allow for offline access to data. This means that even when the original data source isn't available, users can still save, manipulate, and work with the data locally.

Create an extract

There are multiple options available within your Tableau workflow to create an extract, but the main approach is explained below.

1. After you connect to your data and set up the data source on the Data Source page, in the upper-right corner, select **Extract**, and then select the **Edit** link to open the Extract Data dialog box.

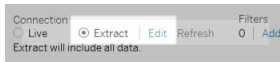

2. Under Data Storage, select either **Logical Tables** or **Physical Tables**. For assistance with this step see the [Data Storage](#) section.
3. Expand **Filters** to set up filters to limit how much data gets extracted based on fields and their values.

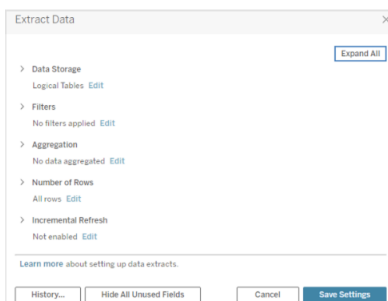

4. Select **Aggregate data for visible dimensions** to aggregate the measures using their default aggregation.
5. (Optional) Select **Roll up dates** to a specified date level such as Year, Month, etc.



6. Select the number of rows you want to extract. You can extract **All rows**, **Sample**, or the **Top N** rows.
7. Check the box for **Incremental refresh**, then indicate the table you want to refresh, choose a column in the database to identify new rows, and optionally set a minimum date range for the refresh.
8. When finished, choose **Save Settings**.

9. Select the sheet tab. This initiates the creation of the extract.
10. Next, select a location to save the extract.
11. Enter an extract file name.
12. Select **Save**. If the Save dialog box doesn't display, see the [Troubleshoot extracts section](#).

Extract field descriptions

You can configure numerous fields when creating an extract. This section walks you through each field.

Data Storage

Under Data Storage you can select either Logical or Physical tables. Logical tables store data in one extract table for each logical table in the data source. On the other hand, physical tables store data in one extract table for each physical table in the data source.

Logical tables

If you want to limit the amount of data in your extract and use additional extract properties like filters, aggregation, or Top N, you should select Logical Tables.

- This option also works well when your data includes pass-through functions (RAWSQL).
- Tableau uses Logical Tables as the default structure for storing extract data.
- If you choose this option and your extract includes joins, the joins are applied when the extract is created.

Physical tables

If your extract consists of tables combined with equality joins and meets the Conditions for using the Physical Tables option, you should select Physical Tables. This option performs joins at query time and can potentially improve performance and reduce the size of the extract file.

Considerations for using the Physical Tables option. To store your extract using the Physical Tables option, the data in your extract must meet all of the following conditions.

- All joins between physical tables are equality (=) joins.
- The data types of the columns used for relationships or joins are identical.
- No pass-through functions (RAWSQL) used.
- No incremental refresh configured.

- No extract filters are configured.
- No Top N or sampling configured.
- When the extract is stored as physical tables, you can't append data to it.
- For logical tables, you can't append data to extracts that have more than one logical table.

Tips for using the physical tables option

Tableau generally recommends that you use the default data storage option, Logical Tables, when setting up and working with extracts. In many cases, some of the features you need for your extract, like extract filters, are only available to you if you use the Logical Tables option.

Physical Tables option for extracts that are larger than expected

The Physical Tables option should be used sparingly to help with specific situations such as when your data source meets the Conditions for using the Physical Tables option and the size of your extract is larger than expected. To determine if the extract is larger than it should be, the sum of rows in the extract using the Logical Tables option must be higher than the sum of rows of all the combined tables before the extract has been created. If you encounter this scenario, try using the Physical Tables option instead.

Alternative filtering suggestions when using the physical tables option

When using the Physical Tables option, other options to help reduce the data in your extract, like extract filters, aggregation, Top N and Sampling are disabled. If you need to reduce the data in an extract that uses the Physical Tables option, consider filtering the data before it's brought into Tableau Desktop using one of the following suggestions:

Connect to your data and define filters using custom SQL

Instead of connecting to a database table, connect to your data using custom SQL instead. When creating your custom SQL query, make sure that it contains the appropriate level of filtering that you need to reduce the data in your extract. For more information about custom SQL in Tableau Desktop, see [Connect to a Custom SQL Query](#).

Define a view in the database

If you have write access to your database, consider defining a database view that contains just the data you need for your extract and then connect to the database view from Tableau Desktop.

Row-level security with extracts

If you want to secure extract data at the row level, using the Physical Tables option is the recommended way to achieve this scenario. For more information about row-level security in Tableau, see [Restrict Access at the Data Row Level](#).

General table considerations

Both the Logical Tables and Physical Tables options only affect how the data in your extract is stored. The options don't affect how the tables in your extract are displayed on the Data Source page.

For example, suppose your extract consists of one logical table that contains three physical tables.

If you directly open the extract (.hyper) file that has been configured to use the default option, Logical Tables, you see one table listed on the Data Source page.

However, if you open the extract using the packaged data source (.tdsx) file or the data source (.tdsx) file with its corresponding extract (.hyper) file, you see all three tables that comprise the extract on the Data Source page.

Filters

Use filters to set up filters to limit how much data gets extracted based on fields and their values.

Aggregation

Aggregation allows you to aggregate measures. You can also select **Roll up dates** to a specified date level such as Year, Month, etc. The examples below show how the data will be extracted for each aggregation option you can choose.

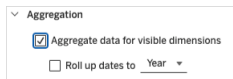

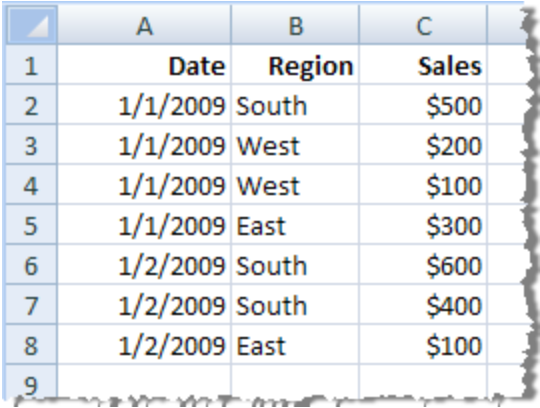
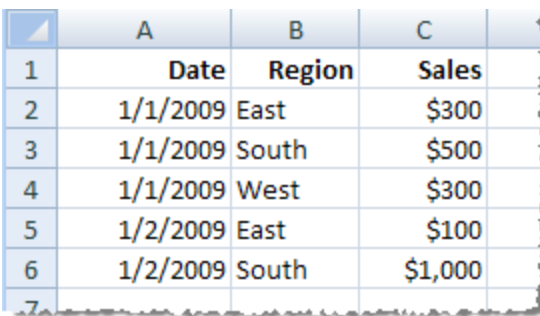
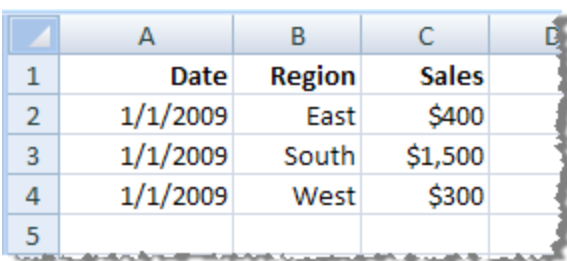
<p>Original data</p>	 <table border="1"> <thead> <tr> <th></th> <th>A</th> <th>B</th> <th>C</th> </tr> </thead> <tbody> <tr> <td>1</td> <td>Date</td> <td>Region</td> <td>Sales</td> </tr> <tr> <td>2</td> <td>1/1/2009</td> <td>South</td> <td>\$500</td> </tr> <tr> <td>3</td> <td>1/1/2009</td> <td>West</td> <td>\$200</td> </tr> <tr> <td>4</td> <td>1/1/2009</td> <td>West</td> <td>\$100</td> </tr> <tr> <td>5</td> <td>1/1/2009</td> <td>East</td> <td>\$300</td> </tr> <tr> <td>6</td> <td>1/2/2009</td> <td>South</td> <td>\$600</td> </tr> <tr> <td>7</td> <td>1/2/2009</td> <td>South</td> <td>\$400</td> </tr> <tr> <td>8</td> <td>1/2/2009</td> <td>East</td> <td>\$100</td> </tr> </tbody> </table>		A	B	C	1	Date	Region	Sales	2	1/1/2009	South	\$500	3	1/1/2009	West	\$200	4	1/1/2009	West	\$100	5	1/1/2009	East	\$300	6	1/2/2009	South	\$600	7	1/2/2009	South	\$400	8	1/2/2009	East	\$100	<p>Each record is shown as a separate row. There are seven rows in your data.</p>
	A	B	C																																			
1	Date	Region	Sales																																			
2	1/1/2009	South	\$500																																			
3	1/1/2009	West	\$200																																			
4	1/1/2009	West	\$100																																			
5	1/1/2009	East	\$300																																			
6	1/2/2009	South	\$600																																			
7	1/2/2009	South	\$400																																			
8	1/2/2009	East	\$100																																			
<p>Aggregate data for visible dimensions <i>(no roll up)</i></p>	 <table border="1"> <thead> <tr> <th></th> <th>A</th> <th>B</th> <th>C</th> </tr> </thead> <tbody> <tr> <td>1</td> <td>Date</td> <td>Region</td> <td>Sales</td> </tr> <tr> <td>2</td> <td>1/1/2009</td> <td>East</td> <td>\$300</td> </tr> <tr> <td>3</td> <td>1/1/2009</td> <td>South</td> <td>\$500</td> </tr> <tr> <td>4</td> <td>1/1/2009</td> <td>West</td> <td>\$300</td> </tr> <tr> <td>5</td> <td>1/2/2009</td> <td>East</td> <td>\$100</td> </tr> <tr> <td>6</td> <td>1/2/2009</td> <td>South</td> <td>\$1,000</td> </tr> </tbody> </table>		A	B	C	1	Date	Region	Sales	2	1/1/2009	East	\$300	3	1/1/2009	South	\$500	4	1/1/2009	West	\$300	5	1/2/2009	East	\$100	6	1/2/2009	South	\$1,000	<p>Records with the same date and region have been aggregated into a single row. There are five rows in the extract.</p>								
	A	B	C																																			
1	Date	Region	Sales																																			
2	1/1/2009	East	\$300																																			
3	1/1/2009	South	\$500																																			
4	1/1/2009	West	\$300																																			
5	1/2/2009	East	\$100																																			
6	1/2/2009	South	\$1,000																																			
<p>Aggregate data for visible dimensions <i>(roll up dates to Month)</i></p>	 <table border="1"> <thead> <tr> <th></th> <th>A</th> <th>B</th> <th>C</th> <th>D</th> </tr> </thead> <tbody> <tr> <td>1</td> <td>Date</td> <td>Region</td> <td>Sales</td> <td></td> </tr> <tr> <td>2</td> <td>1/1/2009</td> <td>East</td> <td>\$400</td> <td></td> </tr> <tr> <td>3</td> <td>1/1/2009</td> <td>South</td> <td>\$1,500</td> <td></td> </tr> <tr> <td>4</td> <td>1/1/2009</td> <td>West</td> <td>\$300</td> <td></td> </tr> </tbody> </table>		A	B	C	D	1	Date	Region	Sales		2	1/1/2009	East	\$400		3	1/1/2009	South	\$1,500		4	1/1/2009	West	\$300		<p>Dates have been rolled up to the Month level and records with the same region have been aggregated into a single row. There are three rows in the extract.</p>											
	A	B	C	D																																		
1	Date	Region	Sales																																			
2	1/1/2009	East	\$400																																			
3	1/1/2009	South	\$1,500																																			
4	1/1/2009	West	\$300																																			

Number of rows

You can extract All rows or the Top N rows. Tableau first applies any filters and aggregation and then extracts the number of rows from the filtered and aggregated results. The number of rows options depend on the type of data source you're extracting from. You might not see the Sampling option in the Extract Data dialog box because some data sources don't support sampling.

Note(s): Any fields that you hide first in the Data Source page or on the sheet tab will be excluded from the extract. Click the **Hide All Unused Fields** button to remove the hidden fields from the extract.

Incremental Refresh

Most data sources support an incremental refresh. Rather than refreshing the entire extract, you can configure a refresh to add only the rows that are new since the previous time you extracted the data.

For example, you may have a data source that is updated daily with new sales transactions. Rather than rebuild the entire extract each day, you can add the new transactions that occurred that day.

Incremental Refresh and Advanced Settings tips

This section helps you with tips to prevent errors you can encounter when setting up these features.

Incremental Refresh:

- In Number of Rows, you need to select **All Rows**.
- Incremental Refresh isn't available if you enable Aggregation.

Advanced Settings:

- Advanced Settings aren't compatible with Filters.

Extract tips

Save your workbook to preserve the connection to the extract

After you create an extract, the workbook begins to use the extract version of your data. However, the connection to the extract version of your data isn't saved until you save the workbook. This means if you close the workbook without saving the workbook first, the workbook will connect to the original data source the next time you open it.

Toggle between sampled data and entire extract

When you're working with a large extract, it can be helpful to create a smaller sample of the data. This allows you to set up your view without having to run lengthy queries every time you add a field to your analysis. You can easily switch between using the sample data and the complete data source by selecting the appropriate option in the Data menu.

Don't connect directly to the extract

When you save extracts to your computer, you can directly connect to them using a new Tableau Desktop. However, it isn't recommended for a few of the following reasons:

- **The names of the tables may be different.** Extracts use special naming to ensure that each table has a unique name, which might be hard to understand.
- **You can't update or refresh the extract.** When you connect directly to an extract, Tableau considers it as the original source of data, rather than a copy. This means you can't link it back to your original data source.
- **The structure and relationships between tables will be lost.** The arrangement and connections between tables are stored in the .tds file, not in the .hyper file. Therefore, when you connect directly to the .hyper file, you lose this information. If you use logical tables storage for the extract, you won't see any references to the original physical tables.

Don't use an extract if you connect to a virtual connection with user functions in the data policy

If a virtual connection has a data policy that contains [User Functions on page 2130](#) (for example, `USERNAME ()`) and you connect to it from a workbook or data source and create an extract there, the extract will contain only the rows that match the virtual connection data policy at the time the extract is created. To take advantage of a virtual connection with user functions in the data policy, use a live connection from the workbook or data source to the virtual connection instead of an extract.

Remove the extract from the workbook

You can remove an extract at any time by selecting the extract data source on the **Data** menu and then selecting **Extract > Remove**. When you remove an extract, you can choose to **Remove the extract from the workbook only** or **Remove and delete the extract file**. The latter option deletes the extract from your hard drive.

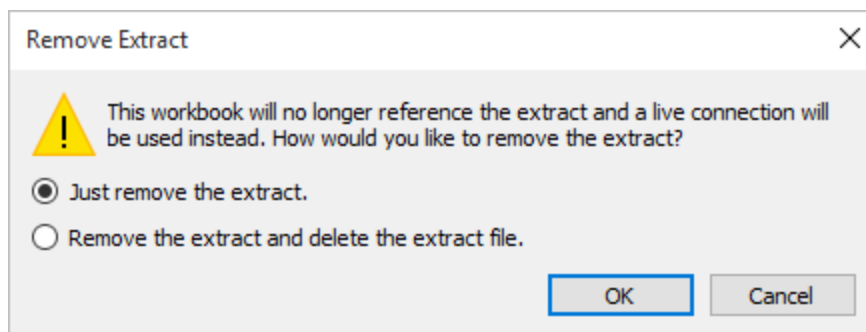

See extract history (Tableau Desktop)

You can see when the extract was last updated and other details by selecting a data source on the **Data** menu and then selecting **Extract > History**.

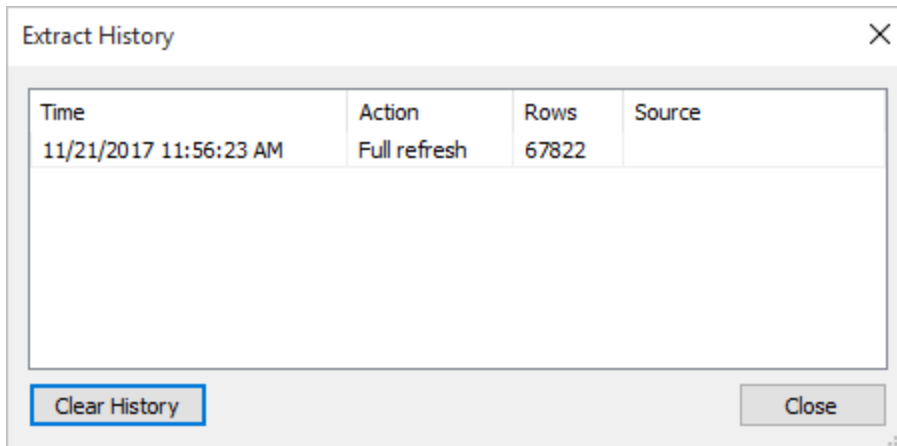

If you open a workbook that is saved with an extract and Tableau can't locate the extract, select one of the following options in the Extract Not Found dialog box when prompted:

- **Locate the extract:** Select this option if the extract exists but not in the location where Tableau originally saved it. Click **OK** to open an Open File dialog box where you can specify the new location for the extract file.
- **Remove the extract:** Select this option if you have no further need for the extract. This is equivalent to closing the data source. All open worksheets that reference the data source are deleted.
- **Deactivate the extract:** Use the original data source from which the extract was created, instead of the extract.
- **Regenerate the extract:** Recreates the extract. All filters and other customizations you specified when you originally created the extract are automatically applied.

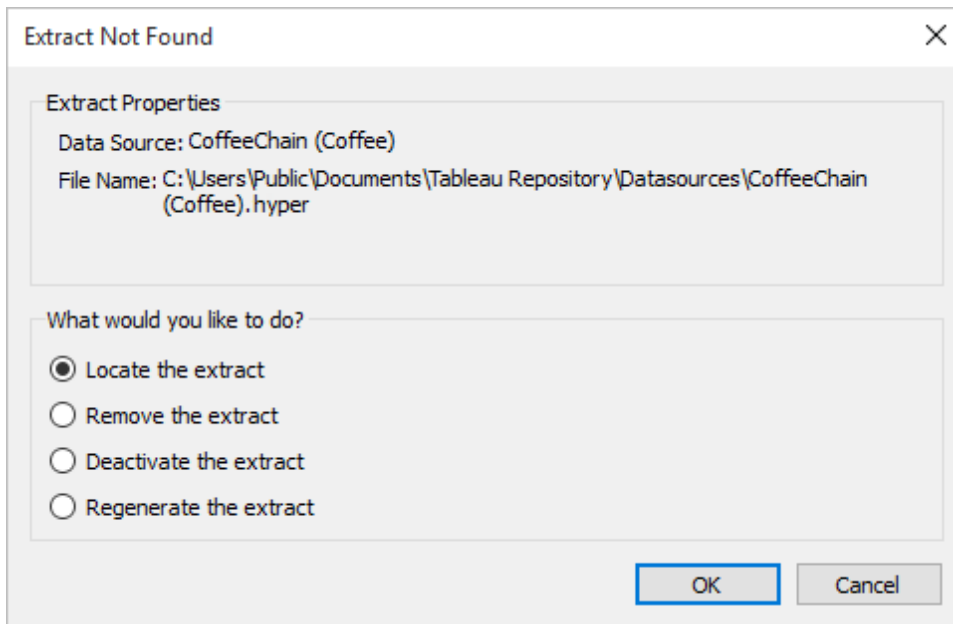

Troubleshoot extracts

- **Creating an extract takes a long time:** Depending on the size of your data set, creating an extract can take a long time. However, after you've extracted the data and saved it to your computer, performance can improve.
- **Extract isn't created:** If your data set contains a large number of columns (for example, in the thousands), in some cases Tableau might not be able to create the extract. If you encounter problems, consider extracting fewer columns or restructuring the underlying data.
- **Save dialog doesn't display or extract isn't created from a .twbx:** If you follow the procedure before this to extract data from a packaged workbook, the Save dialog doesn't display. When an extract is created from a packaged workbook (.twbx), the extract file is automatically stored in the package of files associated with the packaged workbook. To access the extract file that you created from the packaged workbook, you must unpackage the workbook. For more information, see [Packaged Workbooks on page 3082](#).

Extract feature updates

Date Range (Subrange)

Beginning with version 2024.2, Tableau has added a new feature called subrange refresh for incremental refresh. This feature allows users to specify a minimum date range for refreshing extracts. For example, users can choose to refresh data from the last 14 days from the refresh date. By utilizing this feature, users can speed up extract refreshes and save on costs related to unnecessary full extracts.

Incremental Refresh

Starting from version 2024.1, Tableau introduces a feature that enables users to perform incremental refreshes on extracts using a non-unique key column. There's a new UI that supports these advanced settings.

This update introduces an additional step in the process. During an incremental refresh, Tableau first removes rows from the extract that match the previously recorded highest value.

Subsequently, Tableau queries for all rows that have a value higher than or equal to the previous highest value. This approach ensures that any deleted rows are accounted for, along with any newly added ones.

Extracts in the web

Beginning with version 2020.4, extracts are available in web authoring and content server. Now, you no longer have to use Tableau Desktop to extract your data sources. For more information, see [Create Extracts on the Web](#).

Logical and physical table extracts

With the introduction of logical tables and physical tables in the Tableau data model in version 2020.2, extract storage options have changed from Single Table and Multiple Tables, to Logical Tables and Physical Tables. These options better describe how extracts will be stored. For more information, see [Extract Your Data on page 919](#).

Deprecation of .tde format

Note: Beginning in March 2023, extracts using the .tde format are deprecated in Tableau Cloud, Tableau Public, and Tableau Server (version 2023.1.0). Version 2024.2 is the last version that can open .tde format files. For more information, see [Extract Upgrade to .hyper Format on page 936](#).

Beginning with version 10.5, when you create an extract it uses the .hyper format. Extracts in the .hyper format take advantage of the improved data engine, which supports faster analytical and query performance for larger data sets.

Similarly, when an extract-related task is performed on a .tde extract using version 10.5 and later, the extract is upgraded to a .hyper extract. After a .tde extract is upgraded to a .hyper extract, it can't be reverted to .tde extract. For more information, see [Extract Upgrade to .hyper Format](#) on page 936.

Changes to values and marks in the view

To improve extract efficiency and scalability, values in extracts can be computed differently in versions 10.5 and later compared to versions 10.4 and earlier. Changes to how the values are computed can affect the way marks in your view are populated. In some rare cases, the changes can cause your view to change shape or become blank. These changes can also apply to multi-connection data sources, data sources that use live connections to file-based data, data sources that connect to Google Sheets data, cloud-based data sources, extract-only data sources, and WDC data sources.

To get an idea of some of the differences you might see in your view using version 2022.4, see the sections after this.

Format of date and date time values

In versions 10.5 and later, extracts are subject to more consistent and stricter rules around how date strings are interpreted through the DATE, DATETIME, and DATEPARSE functions. This affects how dates are parsed, or the date formats and patterns that are allowed for these functions. More specifically, the rules can be generalized as the following:

1. Dates are evaluated and then parsed by column, not by row.
2. Dates are evaluated and then parsed based on the locale of where the workbook was created, not on the locale of the computer where the workbook is opened.

These new rules allow extracts to be more efficient and to produce results that are consistent with commercial databases.

However, because of these rules, particularly in international scenarios where the workbook is created in a locale different from the locale that the workbook is opened in or the server that the workbook is published to, you might see that 1.) date and datetime values change to different date and datetime values or 2.) date and datetime values change to *Null*. When your date and datetime values change to different date and datetime values or become *Null*, it's often an indication that there are issues with the underlying data.

Here are some common reasons why you might see changes to your date and datetime values in your extract data source using version 10.5 and later.

Common causes of changes to date/datetime values	Common causes of null values
<ul style="list-style-type: none"> • When a function has to parse multiple date formats in a single column. Where the date is ambiguous and can be interpreted in several different ways, the date will be interpreted based on the format Tableau has determined for that column. For some examples, see Date scenario 1 on the next page and Date scenario 2 on page 933 below. • When a function has to parse a YYYY-MM-DD (ISO) format. For an example, see Date scenario 3 on page 934. • When a function doesn't have enough information to derive the time, it can interpret a value as "00:00:00.0", using "0" for hour, minute, second, and millisecond. • When a function doesn't have enough information to derive the day, it can interpret a value as "1" or "January" for month. • When a function parses years, it's interpreted as the following: <ul style="list-style-type: none"> • Year "07" is interpreted as "2007" • Year "17" is interpreted as "2017." 	<ul style="list-style-type: none"> • When a function has to parse multiple date formats in a single column. After Tableau determines the date format, all other dates in the column that deviate from the format become null values. For some examples, see Date scenario 1 on the next page and Date scenario 2 on page 933 below. • When a function has to parse a YYYY-MM-DD (ISO) format. Values that exceed what is allowed for "YYYY," or "MM," or "DD" cause null values. For an example, see Date scenario 3 on page 934. • When a function has to parse date values that contain trailing characters. For example, time zone and daylight savings suffixes and keywords, such as "midnight" cause null values. • When a function has to parse an invalid date or time. For example, 32/3/2012 causes a null

Common causes of changes to date/datetime values	Common causes of null values
<ul style="list-style-type: none"> • Year "30" is interpreted as "2030." • Year "69" interpreted as "2069." • Year "70" is interpreted as "1970." 	<p>value. In another example, 25:01:61 causes a null value.</p> <ul style="list-style-type: none"> • When a function has to parse contradicting inputs. For example, suppose the pattern is 'dd.MM (MMMM) y' and the input string is '1.09 (August) 2017', where both "9" and "August" are months. The result is a null value because the month values aren't the same. • When a function has to parse contradicting patterns. For example, a pattern that specifies a mix of Gregorian year (y) and ISO week (ww) causes null values.

Date scenario 1

Suppose you have a workbook created in an English locale that uses .tde extract data source. The table after this shows a column of string data contained in the extract data source.

10/31/2018
31/10/2018
12/10/2018

Based on the particular English locale, the format of the date column was determined to follow the MDY (month, day, and year) format. The following tables show what Tableau displays based on this locale when the DATE function is used to convert string values into date values.

October 31, 2018
October 31, 2018
December 10, 2018

If the extract is opened in a German locale, you see the following:

31 Oktober 2018
31 Oktober 2018
12 Oktober 2018

However, after the extract is opened in a German locale using version 10.5 and later, the DMY (day, month, and year) format of the German locale is strictly enforced and causes a *Null* value because one of the values doesn't follow the DMY format.

Null
October 31, 2018
October 12, 2018

Date scenario 2

Suppose you have another workbook created in an English locale that uses a .tde extract data source. The following table shows a column of numeric date data contained in the extract data source.

1112018
1212018
1312018
1412018

Based on the particular English locale, the format of the date column was determined to follow the MDY (month, day, and year) format. The following tables show what Tableau displays based on this locale when the DATE function is used to convert the numeric values into date values.

11/1/2018
12/1/2018
Null
Null

Date scenario 3

Suppose you have a workbook that uses a .tde extract data source. The following table shows a column of string data contained in the extract data source.

2018-10-31
2018-31-10
2018-12-10
2018-10-12

Because the date uses the ISO format, the date column always follows the YYYY-MM-DD format. The following tables show what Tableau displays when the DATE function is used to convert string values into date values.

October 10, 2018
Null
December 10, 2018
October 12, 2018

Note: In versions 10.4 (and earlier), ISO format and other date formats could have produced differing results depending on the locale of where the workbook was created. In an English locale for example, both 2018-12-10 and 2018/12/10 could produce December 12, 2018.

However, in a German locale 2018-12-10 could produce December 12, 2018 and 2018/12/10 could produce October 12, 2018.

Sort order and case sensitivity

Extracts have collation support and therefore can more appropriately sort string values that have accents or are cased differently.

For example, suppose you have a table of string values. In terms of sort order, this means that a string value like Égypte is now appropriately listed after Estonie and before Fidji.

About Excel data:

With regard to casing, this means that how Tableau stores values have changed between version 10.4 (and earlier) and version 10.5 (and later). However, the rules for sorting and comparing values haven't. In version 10.4 (and earlier), string values like "House," "HOUSE," and "houSe" are treated the same and stored with one representative value. In version 10.5 (and later), the same string values are considered unique and therefore stored as individual values. For more information, see [Changes to the way values are computed](#) on page 224.

Breaking ties in Top N queries

When a Top N query in your extract produces duplicate values for a specific position in a rank, the position that breaks the tie can be different when using version 10.5 and later. For example, suppose you create a top 3 filter. Positions 3, 4, and 5 have the same values. When using version 10.4 and earlier, the top filter can return 1, 2, and 3 positions. However, when using version 10.5 and later, the top filter can return 1, 2, and 5 positions.

Precision of floating-point values

Extracts are better at taking advantage of the available hardware resources on a computer and therefore able to perform mathematical operations in a highly parallel way. Because of this, real numbers can be aggregated by .hyper extracts in different order. When numbers are aggregated in different order, you might see different values in your view after the decimal point each time the aggregation is computed. This is because floating-point addition and multiplication are not necessarily associative. That is, $(a + b) + c$ isn't necessarily the same as $a + (b + c)$. Also, real numbers can be aggregated in different order because floating-point multiplication isn't necessarily distributive. That is, $(a \times b) \times c$ isn't necessarily the same as $a \times b \times c$. This type of floating-point rounding behavior in .hyper extracts resemble that of floating-point rounding behavior in commercial databases.

For example, suppose your workbook contains a slider filter on an aggregated field comprised of floating point values. Because the precision of floating-point values have changed, the filter might now exclude a mark that defines the upper or lower bound of the filter range. The absence of these numbers could cause a blank view. To resolve this issue, move the slider on the filter or remove and add the filter again.

Accuracy of aggregations

Extracts optimize for large data sets by taking better advantage of the available hardware resources on a computer and therefore able to compute aggregations in a highly parallel way. Because of this, aggregations performed by .hyper extracts can resemble the results from commercial databases more than the results from software that specializes in statistical computations. If you're working with a small data set or need a higher level of accuracy, consider performing aggregations through reference lines, summary card statistics, or table calculation functions like variance, standard deviation, correlation, or covariance.

About the Compute Calculations Now option for extracts

If the **Compute Calculations Now** option was used in a .tde extract using an earlier version of Tableau Desktop, certain calculated fields were materialized and therefore computed in advance and stored in the extract. If you upgrade the extract from a .tde extract to a .hyper extract, the previously materialized calculations in your extract aren't included. You must use the **Compute Calculations Now** option again to ensure that materialized calculations are a part of the extract after the extract upgrade. For more information, see [Materialize Calculations in Your Extracts on page 944](#).

New Extract API

You can use the Extract API 2.0 to create .hyper extracts. For tasks that you previously performed using the Tableau SDK, such as publishing extracts, you can use the Tableau Server REST API or the Tableau Server Client (Python) library. For refresh tasks, you can use the Tableau Server REST API as well. For more information, see [Tableau Hyper API on page 956](#).

Extract Upgrade to .hyper Format

In Tableau version 2018, we introduced the .hyper format for Tableau extracts to replace the old .tde format. The .hyper format has been the standard format used by Tableau to create extracts since 2018, and the large majority of extracts are now .hyper files. Beginning in early 2023, Tableau discontinued support for the .tde format on Tableau Cloud and Tableau Public. For more details about this deprecation, see this [Tableau Community post](#).

Discontinuation of support for .tde files

Beginning in 2023, the `.tde` format for Tableau extracts was deprecated. This format was replaced by the `.hyper` format in 2018 but continued to be valid for uploaded files until March 2023.

- This change took place for Tableau Cloud and Tableau Public as of March 2023.
- Beginning with version 2023.1.0 of Tableau Server, the uploading of `.tde` format files is disabled.
- 2024.2 is the last version of Tableau Desktop that supports any `.tde`-based workbooks, data sources, or bookmarks. Versions 2024.3 and beyond only support `.hyper` format.

Manually upgrade your .tde extract using Tableau Desktop

If you manage extracts locally, you can manually upgrade your `.tde` extract to a `.hyper` extract using Tableau Desktop.

Note: This functionality is only available in Tableau Desktop versions 2024.2 and older.

1. In Tableau Desktop, open a workbook that uses a `.tde` extract.
2. Select the extract data source from the **Data** menu and then select **Extract > Upgrade**.
3. Select **File > Save**, which saves the workbook and also completes the extract upgrade.

Manually upgrade your .tde with a live connection

If your `.tde` file uses a live connection (as opposed to an extract), you need to upgrade the file by following the instructions in this [Tableau Community post about updating to .hyper files](#). It is not possible to update `.tde` files with live connections using Tableau Desktop.

Refresh Extracts

When the original data changes, you can refresh the extract using Desktop by selecting a data source on the **Data** menu, and then selecting **Extract** and **Refresh**. Extracts can be set up in two ways: fully refreshed or incrementally refreshed.

With a full refresh, all the data in the extract is replaced with the latest information from the original data source. An incremental refresh only adds the new rows since the last refresh. If you want more details on how to extract your data, you can visit the [Extract Your Data Page](#).

Note: You can also automate extracting refreshes using the Tableau Data Extract Command-Line Utility. For more information, see [Tableau Data Extract Command-Line Utility on page 947](#).

Before you refresh extracts

If you want to refresh an extract, make note of the file format of the extract before you perform an extract refresh. If you perform a refresh on an `.tde` extract using version 2022.4, the extract is upgraded to `.hyper` extract automatically. While there are many benefits of upgrading to a `.hyper` extract, you'll be unable to open the extract with previous versions of Tableau Desktop. For more information, see [Extract Upgrade to .hyper Format on page 936](#).

Note: `.tde` files are no longer supported in any form after version 2024.2 of Tableau, and they must be upgraded to `.hyper` format to be used.

Configure a full extract refresh

By default, extracts are configured to fully refresh. This means that every time you refresh the extract, all of the rows are replaced with the data in the original data source. While this kind of refresh ensures that you have an exact copy of what is in the original data, depending on the size of the extract, a full refresh can sometimes take a long time and be expensive on the database. If an extract isn't configured for an incremental refresh, selecting to refresh the extract will perform a full refresh of the extract.

Publish to Tableau Server

If you plan to publish the extract as a data source to Tableau Server, you can specify a schedule for the extract refresh during publishing.

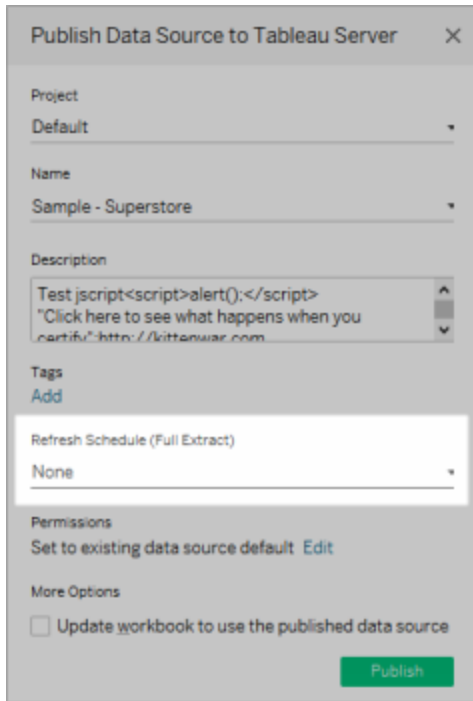

Similarly, if you're publishing the extract in a workbook to Tableau Server, you can also specify a schedule for the extract refresh during publishing. For more information, see [Schedule Extract Refreshes as You Publish a Workbook](#) on page 3164.

Publish to Tableau Cloud

If you plan to publish the extract as a data source to Tableau Cloud, your options for refreshing your data depend on the characteristics of your data sources. For more information on refreshing data from specific data sources, see [Extract refresh options by data source](#).

Configure an incremental extract refresh

Most data sources support an incremental refresh. Rather than refreshing the entire extract, you can configure a refresh to add only the rows that are new since the previous time you extracted the data.

For example, you may have a data source that is updated daily with new sales transactions. Rather than rebuild the entire extract each day, you can add the new transactions that occurred that day. Then once a week you might want to do a full refresh just to be sure you have the most up-to-date data.

Non-Unique column

Starting from version 2024.1, Tableau introduces a feature that enables users to perform incremental refreshes on extracts using a non-unique key column. This update introduces an additional step in the process.

Date range (subrange) refresh

Beginning with version 2024.2, Tableau has introduced a new feature that enables users to specify a specific time range for refreshing data from the source. Users can opt for incremental refresh when configuring an extract and set a minimum date range for the refresh. For instance, they can choose to refresh data from the last 14 days starting from the refresh date. This functionality is useful for data sources that allow for inserts and retroactive modifications within a defined time period, ensuring that any changes and new data are captured during the incremental extract refresh.

In a qualifying incremental refresh without a set 'Minimum date range to refresh' (that is, Subrange refresh), Tableau will initially eliminate rows from the extract that match the previously recorded highest value. Subsequently, Tableau queries for all rows that have a value higher than or equal to the previous highest value. This approach ensures that any deleted rows are accounted for, along with any newly added ones.

The Advanced Settings feature provides two options for managing data updates. You can choose to replace the last rows added by refreshing values that are equal to or greater than the last recorded value. Or you can opt to keep the last rows added by only refreshing the extract with values greater than the last recorded value.

Note: If the data structure of the source data changes (for example, a new column is added), you'll need to do a full extract refresh before you can start doing incremental refreshes again.

You can follow the following steps to set up an extract to be refreshed incrementally.

1. Select a data source on the **Data** menu, and then select **Extract Data**.
2. In the Extract Data dialog box, select **All rows** as the number of Rows to extract. Incremental refresh can only be defined when you're extracting all rows in the database.

Note: You can't increment a sample extract.

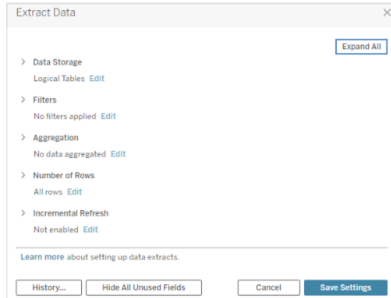

3. Select **Incremental refresh**.

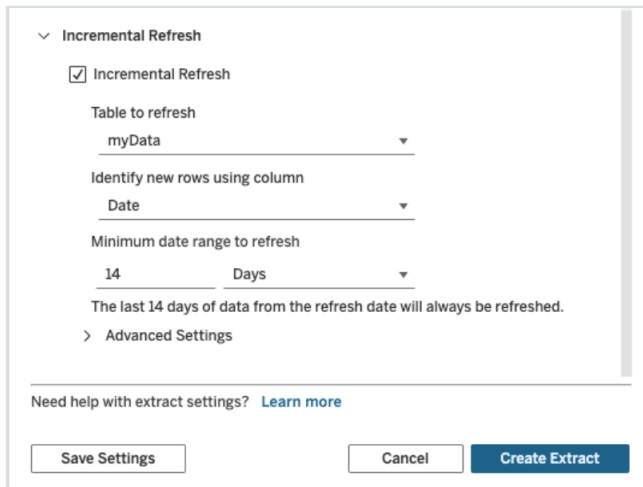

Note: Incremental Refresh isn't available if you enable Aggregation.

4. Specify a column in the database that will be used to identify new rows.
For example, you can select a Date field or an ID column that monotonically increases as rows are added to the database.
5. (Optional) If you select a Date or Datetime column in Tableau, you can perform a partial refresh of the extract data by specifying a specific date range. Determine the number of days and specify the date/time scale to establish the minimum date range for the refresh (for example, 14 days from the refresh date).
6. (Optional) If no minimum refresh range is established, expand Advanced Settings to establish how new rows are retrieved. You can choose to replace the last rows added by refreshing values that are equal to or greater than the last recorded value. Or you can opt to keep the last rows added by only refreshing the extract with values greater than the last

recorded value.

Note: When filters are added, the Advanced Settings for Incremental Refresh will appear grayed out and the default setting of "Don't replace the last rows added" will be enforced. The purpose of this is to avoid any conflicts that may arise between certain filter criteria and the advanced incremental refresh logic that will "Replace the last rows added".

7. To finish, select **Save Settings**.

The previous steps can be used to define a new extract or edit an existing extract for an incremental refresh.

Considerations when doing an Incremental refresh

Editing an extract

If you're editing an existing extract, the last refresh is shown so you can be sure you're updating the extract with the correct data.

Full Refresh

A Full Refresh replaces all of the rows with the data in the original data source every time you refresh the extract. A Full Refresh can take longer and be expensive on the database.

Data Engine

The data engine, which is the underlying mechanism that Tableau uses to create extracts, stores time values with a precision of up to 3 decimal places. If you specify a datetime or timestamp column for **Identify new rows using column**, and your database uses a higher precision than Tableau, you can end up with duplicate rows after an incremental refresh. For example, if the database has two rows, one with a datetime value of 2015-03-13 17:30:56.502352 and one with a datetime value of 2015-03-13 17:30:56.502852, Tableau will store both rows using a datetime value of 2015-03-13 17:30:56.502 thereby creating duplicate rows.

See extract history (Tableau Desktop)

You can see a history of when the extract was refreshed by selecting a data source on the **Data** menu and then select **Extract > History**.

The Extract History dialog box shows the date and time for each refresh, whether it was full or incremental, and the number of rows that were added. If the refresh was from a file, it also shows the source file name.

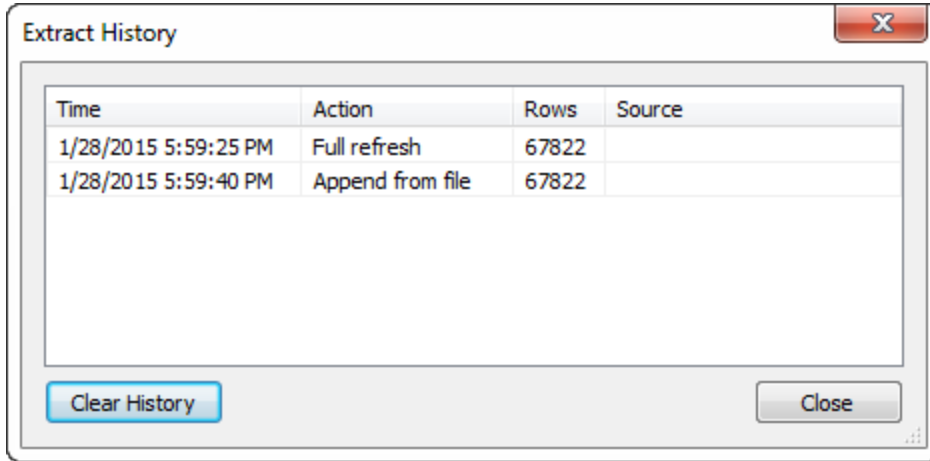

Add Data to Extracts

There are two ways you can add new data to an extract: from a file or from a data source. However, to add new data, you must first connect to data and create a new data source, and the columns in the file or data source must match the columns in the extract.

Add data from a file

You can add new data to an extract from a file-based data source. Use this option when the file type of the extract is the same as the file type of the data that you want to add. Alternatively, you can add data from an extract (.hyper) file. For example, you may have text files that are generated for a task that is performed every day. To add each day's worth of information to your extract whose original data source is also a text file, use the **Append Data from File** command.

1. On the **Data** menu, select a data source, and then select **Extract > Append Data from File**.
2. Browse to and select the file that has the new data.

Note: By default, the file format of the extract's original data source is used. To add data from a Tableau data extract, click the file format drop-down list, and then select **Hyper Extracts (*.hyper)**.

3. When finished, click **OK**.

Add data from a data source

You can also add new data to an extract from another data source that's already open in the workbook. Use this option when the data from the data source that you want to add matches the extract data source before it was extracted. For example, you created an extract from a SQL Server database that has the past ten years worth of data. However, the maintained version of that data is stored on a different SQL Server database. You can add new data to the extract by using the **Append Data from Data Source** command.

Note: Joins or custom SQL should be specified in the data source before adding data to the extract.

1. On the **Data** menu, select a data source, and then select **Extract > Append Data from Data Source**.
2. In the dialog box, select the data source that you want to append.
3. When finished, click **OK**.

Using either option will add new rows to the extract. To see a summary of the number of rows that were added, select a data source on the **Data** menu and then select **Extract > History**.

Note: When you refresh this extract, the data will be replaced with the data from the original data.

Materialize Calculations in Your Extracts

You can use the **Compute Calculations Now** option to materialize calculations in your extract. When calculations are materialized, certain calculations are computed in advance and its values stored in the extract. Depending on the complexity of the calculations used in your extract, this can potentially speed up future queries by allowing Tableau to compute certain calculations in advance. Tableau can then use the precomputed value rather than computing the value each time a query against a calculation is made.

If the formula for a calculation that Tableau has already materialized changes or the calculation is deleted from the data source, the materialized calculation is removed from the extract until you use the **Compute Calculations Now** option again.

When to materialize calculations

You should not use the **Compute Calculations Now** option for all your extracts. Instead, try this option only when the query performance of your extract is slow as a result of complex calculations, such as string manipulations and regular expressions.

Materialize calculations

To materialize calculations in your extract, do the following:

1. In Tableau Desktop, select the extract data source from the **Data** menu.
2. Select **Extract > Compute Calculations Now**.

Materialize calculations in extracts already published to Tableau Cloud or Tableau Server

If you need to retroactively materialize calculations in extracts that are already published to Tableau Cloud or Tableau Server, you have the following options:

- You can download the extract, open the extract in Tableau Desktop, use the **Compute Calculations Now** option (as described above), and then republish the extract.
- As a site administrator or data source owner, you can use `tabcmd` to refresh the published extract with the `--addcalculations` option to materialize the calculations. For more information about the `tabcmd` command option, see [refreshextracts](#) in the Tableau Cloud Help or [refreshextracts](#) in the Tableau Server Help.

Note: Materializing calculations can increase the size of the extract.

Calculations that cannot be materialized

The following calculations cannot be materialized:

- Calculations that use unstable functions such as `NOW()` and `TODAY()`
- Calculations that use external functions such as `RAWSQL` and `R`
- Table calculations
- Level of detail (LOD) calculations
- Calculations that use column groups, until the dependent column group is materialized with an extract refresh

Update Server Data Sources That Are Using Extracts

You have the following options for updating extract data sources that are published to Tableau Server or Tableau Cloud:

- **Option 1:** You can add the data source or a workbook that connects to it to a refresh schedule in Tableau Server or Tableau Cloud (cloud-based data sources only).
- **Option 2:** You can update the data source in Tableau Desktop and then republish it.
- **Option 3:** You can add to or refresh the data source on Tableau Server or Tableau Cloud, from Tableau Desktop, without first adding to or refreshing the extract in Tableau Desktop.

The remainder of this topic describes option 3.

Update Tableau Server or Tableau Cloud extracts from Tableau Desktop

Before you attempt to update an extract data source on Tableau Server or Tableau Cloud, verify first that Tableau Desktop is connected to a published data source. You can verify that Tableau Desktop is connected to a published data source by the Tableau Server icon next to the data source name in the Data pane:

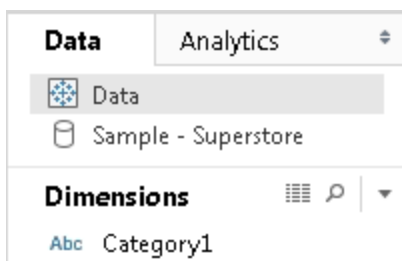

To update the published data source, do the following:

1. In Tableau Desktop, right-click (control-click on a Mac) the data source in the Data pane
2. Select **Tableau Data Server**, and choose one of the following options:

- **Edit Server and Site Path**

If you have changed the location of the data source in Tableau Server or Tableau Cloud, choose this option to point Tableau Desktop to the new, correct location.

- **Refresh from Source**

Refreshes the extract (full or incremental) using the original data.

This command is available only for extracts that include a connection to the original data. If you connected directly to an extract file (.hyper) and then published it, the connection to the original data is not included and this option is therefore unavailable.

- **Append from Data Source**

Updates the extract from another open (and compatible) data source. If you connected directly to an extract file (.hyper) and then published it, the connection to the original data is not included and this option is therefore unavailable.

Note: If you see the Tableau Data Server option, but the commands in the submenu are unavailable, the data source exists on the server, but is not an extract.

It is also possible to update an extract on Tableau Server using a command-line utility. For more information, see [Tableau Data Extract Command-Line Utility](#) below.

Tableau Data Extract Command-Line Utility

You can automate extract refresh tasks using the Tableau Data Extract Command-Line Utility. This is a command-line utility that comes with Tableau Desktop, through which you can refresh published extract data sources or append data to them from a file.

Requirements for using the Tableau Data Extract Command-Line Utility include the following:

- It is available with Tableau Desktop on Windows and can run only on a Windows system.
- It is not available with the trial version of Tableau Desktop.
- You can use it for extract data sources that don't use OAuth.
- You can use it to refresh single-connection data sources only. It does not work for multi-connection data sources.

Deprecated October 2022: This utility isn't available in later releases due to the [multi-factor authentication](#) requirement in Tableau Cloud. To refresh data sources or virtual connections data that Tableau Cloud can't reach directly, use Tableau Bridge instead. For more information, see [Set Up a Bridge Refresh Schedule](#).

To initiate refresh jobs using a script, use tabcmd [refreshextracts](#) or REST API [Run Extract Refresh Task](#).

Run the utility

1. Open the Command Prompt as an administrator and change to the Tableau Desktop bin directory. For example:

```
cd C:\Program Files\Tableau\Tableau 2022.4\bin
```

2. Use either of the following commands, adding parameters described in the tables below.

- `tableau refreshextract`
- `tableau addfiletoextract`

Note: When using the utility, always specify `tableau` on the command line or in scripts, never `tableau.exe`.

Note: To troubleshoot, check the logs in the `tableaucom.txt` file in the `\My Tableau Repository\Logs` folder.

Note: In a multiple-site environment, specify the site to which the command applies.

Syntax and parameters for the `tableau refreshextract` command

Use `tableau refreshextract` to refresh an extract on Tableau Server or Tableau Cloud. Refreshing an extract updates an existing extract with any modifications that have been made to the data source since the last refresh.

To see help for this command, at the Windows command prompt, type the following command:

```
tableau help refreshextract
```

Using parameters

- All options have a full form that you use with a double hyphen (for example, `--server`).
- Some options also have a short form that you use with a single hyphen (for example, `-s`).
- If the value for an option contains spaces, enclose it in quotation marks.
- The source being refreshed must be the original data source, not an extract (`.hyper`).

`tableau refreshextract` command options

Short Form	Full Form	Description
	<code>--source-user-name <user name></code>	A valid user name for the data source connection. Use this option with <code>--source-password</code> , or use

`--original-file` instead of the user name and password options.

Note: You must provide the user name and password when refreshing a published extract, even if the data source was originally published with embedded credentials.

<pre>--source-pass- word "<pass- word>"</pre>	<p>The password for the data source user.</p>
<pre>--original- file <path and file name></pre> <p>or</p> <pre>--original- file <path and folder name></pre>	<p>Path and file name for the data source to be refreshed on the server. For example: <code>--original-file c:\folder\file.csv</code></p> <p>To refresh a multi-file data source, pass the path to a folder that contains the data files. For example: <code>--original-file c:\folder.</code></p> <p>If the file is on a network share, use the UNC format for the path: <code>\\server\path\filename.csv</code></p>
<pre>--force-full- refresh</pre>	<p>If the data source is set up for incremental refreshes, use this option to force a full extract refresh. If this option is not included, an incremental refresh is performed. Not all data sources support incremental refresh.</p>
<pre>-s <server http address></pre>	<pre>--server <URL></pre> <p>The URL for the Tableau server on which the data is published.</p> <p>For Tableau Cloud, specify <code>https://online.tableau.com.</code></p>
<pre>-t <site id></pre>	<pre>--site <siteid></pre> <p>In a multiple-site environment, specifies the site to which the command applies. For Tableau Cloud, use this argument if your user name is associated with more than one site. For Tableau Server, if you do not</p>

specify a site, the default site is assumed.

The site id is independent of the site name, and it is indicated in the URL when you view the site in a browser. For example, if the URL for the page you see after signing in to Tableau Cloud is

```
https://online.tableau.com/t/vernazza/views
```

the site id is *vernazza*.

<code>--datasource</code> <code><datasource></code>	The name of the data source, as published to Tableau Server or Tableau Cloud.
<code>--project <projectname></code>	The project to which the data source belongs. If this option is not included, the default project is assumed. If the project you want to specify is a child project nested within a project hierarchy, you must use this parameter along with the <code>--parent-project-path</code> parameter.
<code>--parent-project-path</code> <code>path/to/project</code>	If a project to which the data source is published is not at the top level of a project hierarchy, use this parameter along with the <code>--project</code> parameter to specify the path to a nested project. Use the forward slash character (/) to delimit project levels in the hierarchy. Use the backward slash (\), to escape instances of forward or backward slash characters in project names. For example, for a project named Sandbox, in project Social, under top-level Marketing:
	<pre>--project Sandbox --parent-project-path Marketing/Social</pre>
<code>-u <username></code>	<code>--username</code> <code><username></code> Valid Tableau Server or Tableau Cloud user.

Tableau Desktop and Web Authoring Help

<code>-p "<password>"</code>	<code>--password "<password>"</code>	The password for the specified Tableau Server or Tableau Cloud user.
	<code>--proxy-user-name <user-name></code>	The user name for a proxy server.
	<code>--proxy-password "<password>"</code>	The password for a proxy server.
<code>-c "<path and file name>"</code>	<code>--config-file "<path and file name>"</code>	Path and file name information for a file containing configuration options for the command. Always enclose the path in double quotation marks. For more information, see Using a config file on page 955 below.

Sample tableau refreshextract command

The following command refreshes an extract named CurrentYrOverYrStats that has been published to Tableau Server on-premises. This command specifies the following:

- The name of your Tableau Server.
- Server user name and password.
- Project name.
- The name of the data source to refresh, along with the data source username and password.

```
C:\Program Files\Tableau\Tableau 2022.4\bin>tableau
refreshextract --server https://our_server_name --username
OurServerSignIn --password "OurServerPwd" --project "New
Animations" --datasource "CurrentYrOverYrStats" --source-username
OurDatabaseSignIn --source-password "OurDatabasePassword"
```

The following command refreshes an extract named CurrentYrOverYrStats that has been published to Tableau Cloud. This command specifies the following:

- Tableau Cloud user and password.
- Tableau Cloud site and project names.

- The data source, which in this case is hosted by a cloud-based data source provider (for example, Salesforce.com), and the username and password to sign in to the hosted data source.

```
C:\Program Files\Tableau\Tableau 2022.4\bin>tableau
refreshextract --server https://online.tableau.com --username
email@domain.com --password "OurServerPwd" --site vernazza --
project "New Animations" --datasource "CurrentYrOverYrStats" --
source-username database_user@hosted_datasource_provider.com --
source-password "db_password"
```

To refresh an extract of file-based data source, provide the path to the original file from which you created the extract. If the file is on a network share, use the UNC format instead of a mapped drive.

```
C:\Program Files\Tableau\Tableau 2022.4\bin>tableau
refreshextract --server https://online.tableau.com --username
email@domain.com --password "OurServerPwd" --site vernazza --
project "New Animations" --datasource "CurrentYrOverYrStats" --
original-file "\\server\path\filename.csv"
```

Syntax for `tableau addfiletoextract`

Use `tableau addfiletoextract` to append file content to an extract that has been published to Tableau Server or Tableau Cloud. This command combines the two files.

If you want simply to update an existing extract with the latest changes, use the `refreshextract` command instead. Using `addfiletoextract` to update an existing extract will duplicate data instead.

To see help for this command, at the Windows command prompt, type the following command:

```
tableau help addfiletoextract
```

All options have a full form that you use with a double hyphen (for example, `--server`). Some options also have a short form that you use with a single hyphen (for example, `-s`). If the value for an option contains spaces, enclose it in quotation marks.

tableau addfiletoextract command options

Short Form	Full Form	Description
	<code>--file <path and file name></code>	Path and file name information for the data file containing data to append. The file can be from Excel, Access, a Tableau data extract, or a delimited text file. It cannot be password protected. Use UNC format if the file is on a network share. For example, <code>\\server\path\filename.csv</code>
<code>-s <server http address></code>	<code>--server <URL></code>	The URL for the Tableau server on which the data is published. For Tableau Cloud, specify <code>https://online.tableau.com</code> .
<code>-t <site id></code>	<code>--site <site id></code>	In a multiple-site environment, specifies the site to which the command applies. For Tableau Cloud, you must include this argument if your user name is associated with more than one site. For Tableau Server, if you do not specify a site, the default site is assumed.
	<code>--datasource <datasource></code>	The name of the data source, as published to Tableau Server or Tableau Cloud.
	<code>--project <projectname></code>	The project to which the data source belongs. If this option is not included, the default project is assumed. If the project you want to specify is a child project nested within a project hierarchy, you must use this parameter along with the <code>--parent-project-path</code> parameter.
	<code>--parent-project-path path/to/project</code>	If a project to which the data source is published is not at the top level of a project hierarchy, use this parameter along with the <code>--project</code>

		<p>parameter to specify the path to a nested project.</p> <p>Use the forward slash character (/) to delimit project levels in the hierarchy. Use the backward slash (\), to escape instances of forward or backward slash characters in project names.</p> <p>For example, for a project named Sandbox, in project Social, under top-level Marketing:</p> <pre>--project Sandbox --parent-project-path Marketing/Social</pre>
-u <username>	--username <username>	Valid Tableau Server or Tableau Cloud user.
-p "<password>"	--password "<password>"	The password for the specified Tableau Server or Tableau Cloud user.
	--proxy-username <username>	The user name for a proxy server.
	--proxy-password "<password>"	The password for a proxy server.
-c "<path and filename>"	--config-file "<path and filename>"	Path and file name information for a file containing configuration options for the command. Always enclose the path in double quotation marks. For more information, see Using a config file on the facing page below.

Sample tableau addfiletoextract command

```
C:\Program Files\Tableau\Tableau 2022.4\bin>tableau
addfiletoextract --server https://our_server_name --username
OurServerSignIn --password "OurServerPwd" --project "New
Animations" --datasource "CurrentYrOverYrStats" --file
"C:\Users\user1\Documents\DataUploadFiles\AprMay.csv"
```

```
C:\Program Files\Tableau\Tableau 2022.4\bin>tableau
addfiletoextract --server https://online.tableau.com --username
email@domain.com --password "OurServerPwd" --site vernazza --
project "New Animations" --datasource "CurrentYrOverYrStats" --
file "C:\Users\user2\Documents\DataUploadFiles\AprMay.csv"
```

Using a config file

You can use a plain text editor, such as Notepad or Text Edit, to create a config (configuration) file that you can use with `tableau refreshextract` or `tableau addfiletoextract`. A config file can be useful if you expect to update the same data source regularly over time. Instead of having to type the same options each time you run a command, you specify the config file. A config file also has the advantage of not exposing user names and passwords on the command line.

Create the config file

For example, say you created a file called `config.txt` and saved it to your Documents folder. And in the file, you included the parameter information shown below.

For an extract published to Tableau Server:

```
server=https://our_server_name
username=OurServerSignIn
password=OurServerPwd
project=New Animations
datasource=CurrentYrOverYrStats
```

For an extract from a hosted data source, published to Tableau Cloud, where **server** is **https://online.tableau.com**:

```
server=https://online.tableau.com
site=vernazza
username=email@domain.com
password=OurPassword
project=New Animations
datasource=CurrentYrOverYrStats
source-username=database_user@hosted_datasource_provider.com
source-password=db_password
```

Reference the Config File from the Command Line

After you create the config file, you run the `tableau refreshextract` or `tableau addfiletoextract` command, pointing to the config file as the only option you use on the command line, and enclosing the config file's path in double quotation marks. The syntax is as follows:

```
tableau refreshextract --config-file "<path>"
```

For example, to refresh the extract specified in the sample in the [Create the config file on the previous page](#) section, you would run the following command (making sure that you are working in the bin directory for your version of Tableau Desktop):

```
C:\Program Files\Tableau\Tableau 2022.4\bin>tableau  
refreshextract --config-file  
"C:\Users\user1\Documents\config.txt"
```

Syntax Differences for Config Files

The syntax for specifying options inside a config file differs from the syntax you use on the command line in the following ways:

- Option names do not begin with dashes or hyphens.
- You use an equals sign (with no spaces) to separate option names from option values.
- Quotation marks are not necessary (or allowed) around values, even when they include spaces (as for the `project` option in the example shown earlier).

Use Windows Task Scheduler to Refresh Extracts

You can use Windows Task Scheduler, in combination with the Tableau Data Extract Command-Line Utility, to automate regular updates to Tableau Desktop data sources from within your corporate firewall. You can configure a task to occur once per day, week, or month, or after a specific system event. For example, run the task when the computer starts.

To learn more, see the [Task Scheduler How To...](#) page in the Microsoft TechNet library.

Tableau Hyper API

You can use the Tableau Hyper API to create `.hyper` extract files (supported in Tableau 10.5 and later). Using the Hyper API you can build applications that can insert, read, update and delete data from those files.

- For more information about the Tableau Hyper API, see the [Hyper API documentation](#).
- For more information about the `.hyper` format, see [Extract Upgrade to .hyper Format on page 936](#).

If you are using Tableau 10.5 and later, you can still use the [Upgrade from the Extract API 2.0 to the Hyper API](#) to create `.hyper` files. However, the Hyper API provides you more options for working with the extract files and offers improved performance.

The Hyper API runs on Windows, Linux, and macOS and supports multiple programming languages, including C++, Java, and Python, and .NET (C#).

Manage Data Sources

The topics in this section describe the tasks you can perform after you have set up data sources.

Edit Data Sources

To enhance the functionality of your workbook, you can modify the data source it relies on. By editing your data source, you can accomplish various tasks, such as adding tables through a join operation. For a detailed understanding of common editing tasks, you can refer to the following resources:

- Adding tables to your data with a Join: Learn how to combine multiple tables in your data source to gain comprehensive insights and make more informed analyses. To explore this topic further, click on the following link: [Join Your Data on page 791](#)
- Connecting to a Custom SQL Query (Tableau Desktop): Discover how to connect Tableau Desktop to a custom SQL query, enabling you to leverage the power of SQL to extract and manipulate data according to your specific requirements. For more information on this topic, please visit: [Connect to a Custom SQL Query on page 863](#)
- Using a Stored Procedure (Tableau Desktop): Gain insights into utilizing stored procedures in Tableau Desktop, empowering you to execute predefined sets of actions or calculations on your data. To delve deeper into this subject, access the following link: [Use a Stored Procedure on page 878](#) (Tableau Desktop)

How to edit the data source

1. On the **Data** menu, select a data source.
2. Select **Edit Data Source**.

- On the data source page, make the changes to the data source. The data table updates with the data from the new data source.

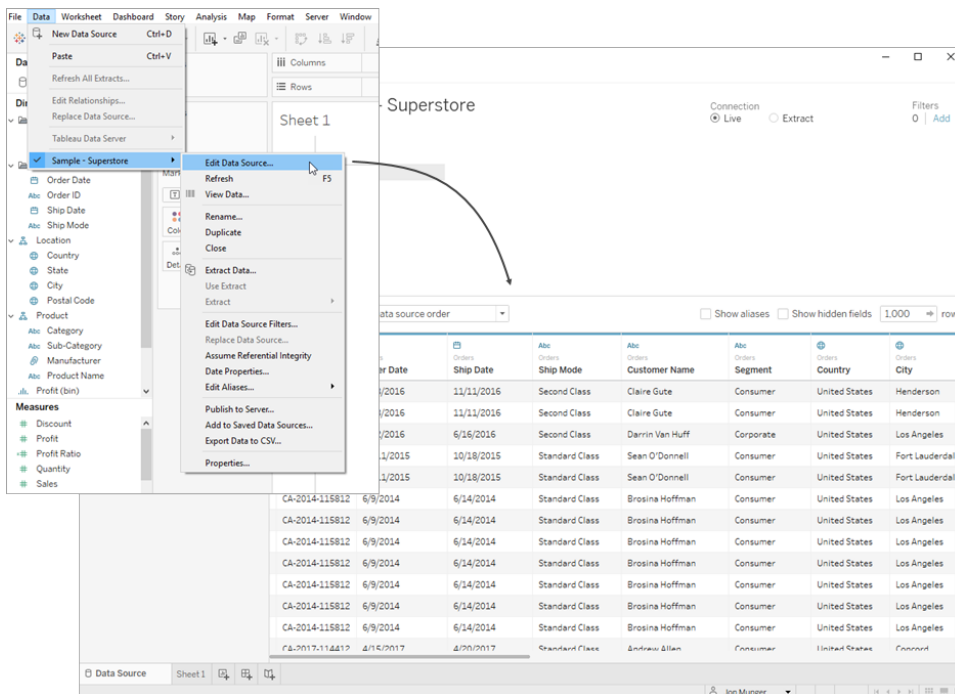

Navigate the Data Grid

Within the Data Source page, you are provided with options to analyze and visualize your data. One of these options is sorting, which enables you to arrange your data in a structured manner. By sorting columns and rows, you can easily organize and make sense of the information at hand.

Sort columns

Sorting columns is a simple and efficient way to bring order to your data. Whether you prefer to sort them based on table or data source, the process is straightforward. In the grid, you can sort columns by accessing the Sort fields dropdown list and selecting the desired sorting option.

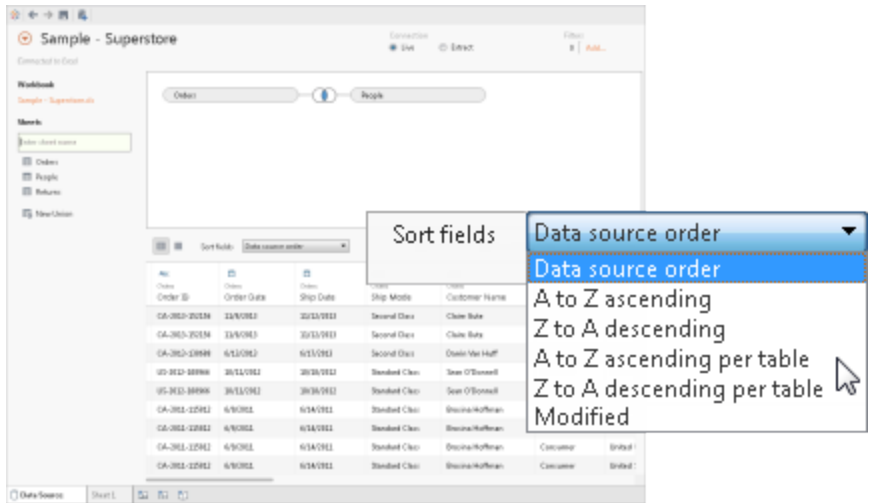

Note: A modified sort state can occur when some tasks cause new columns to be added to the grid.

Sort rows

To arrange rows in a specific order, simply utilize the sort button. Give it a single click to sort rows in ascending order. For descending order, click the sort button once more. To remove the selection, click the sort button again.

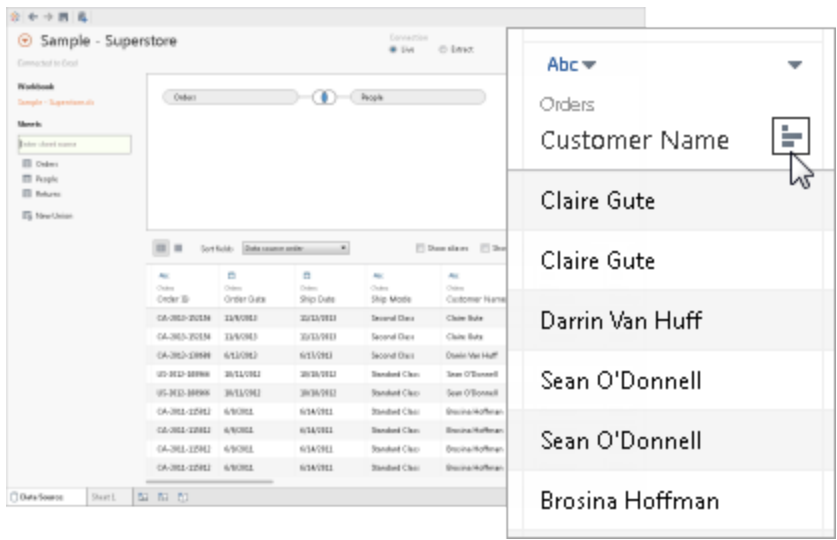

Change column names and reset field names

In Tableau, it is crucial to have clear and meaningful column names for effective data analysis and visualization.

Rename a column

To rename a column in Tableau, simply follow these steps:

1. Locate the column whose name you wish to change.
2. Double-click on the current name of the column.
3. Enter the desired new name for the field.
4. Press Enter or click outside the field to save the changes.

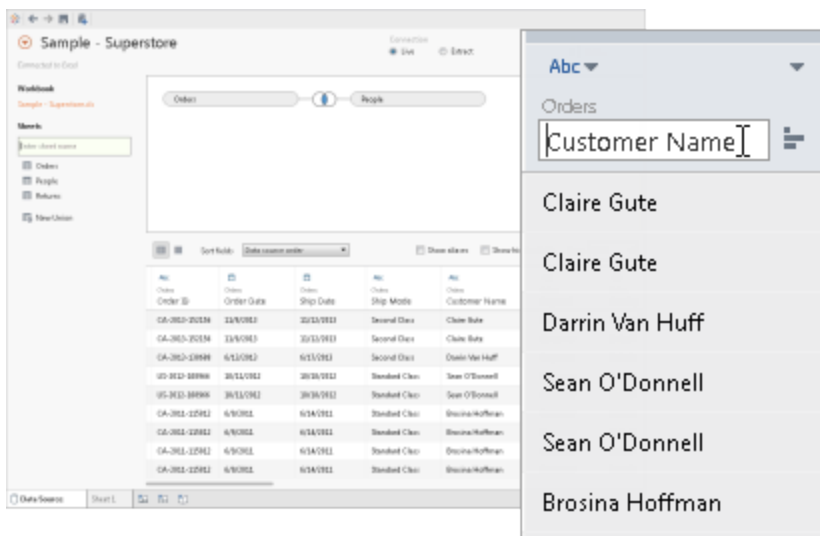

Reset names

If you have made changes to a field name and want to revert back to the original name, Tableau provides a reset option. Complete the following steps to reset the name.

1. Click on the column dropdown menu.
2. Select the **Reset Name**.

The name will be reset to its original name as specified in the underlying data.

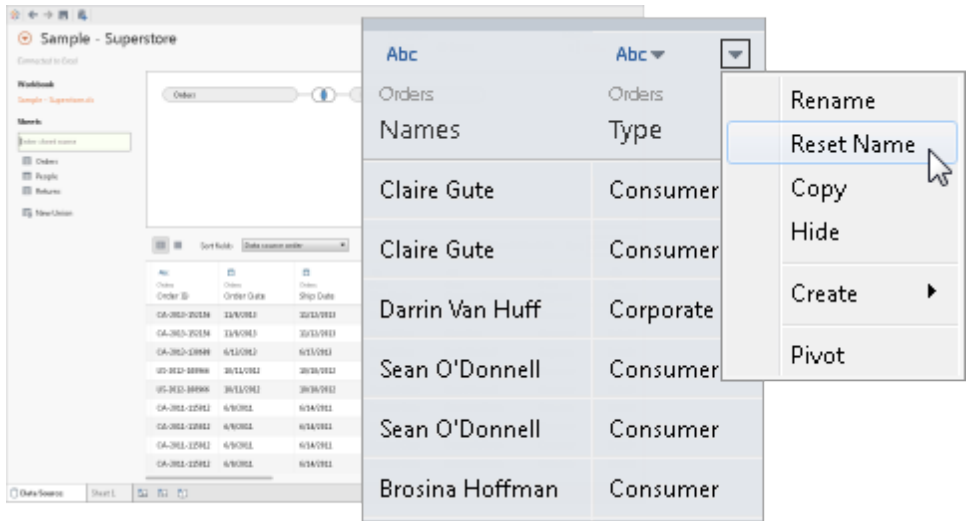

Revert Tableau's automatic name changes

The Revert command will reset any field names that have been automatically modified by Tableau's naming improvements. For more information, see [Understand Field Type Detection and Naming Improvements on page 913](#).

Create calculations

Calculations allow you to perform complex data manipulations and get new insights from your existing dataset. Tableau offers three primary types of calculations:

- Basic expressions
- Level of Detail (LOD) expressions
- Table calculations

For help on choosing which calculation to use, see [Choosing the Right Calculation Type](#).

You can create calculations, groups, or bins based on existing fields in the data source. To start, click the column dropdown arrow and select one of the options.

Note: If you create an aggregate calculation, the values displayed in the grid aren't meaningful until the calculation is used in the context of the view's level of detail.

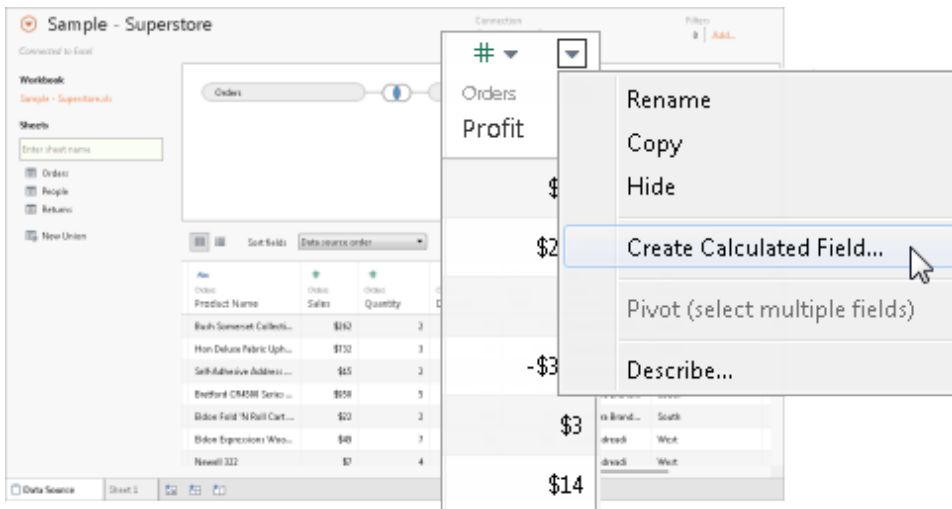

View extract data

When using the Web Data Connector, you can view the extracted data in the grid. This includes extract-only calculations such as MEDIAN. It is important to note that when in Extract mode, the order of rows in the data source may differ from the order of rows in Live mode.

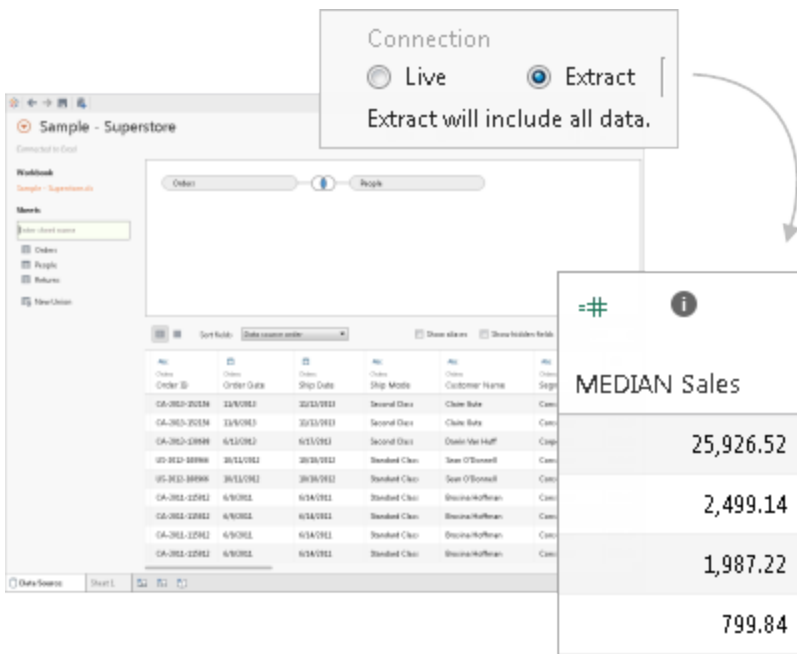

Copy values

To copy values in the grid, follow these steps.

1. Select the desired values.
2. Right-click on the selected values.
3. Choose **Copy** from the menu.

Examine your metadata

Utilize the metadata grid within Tableau to efficiently analyze and modify the organization of your data source. The metadata grid offers a way to assess the columns in your data and their respective data types. You can carry out routine management tasks such as column renaming, hiding, altering data types, and modifying the geographical role of a column.

Note: When dealing with multi-dimensional data sources, the specific metadata management tasks may differ.

Default metadata view

After you have successfully configured your data source, the information will be displayed in the grid. In the case of connecting to a cube (multidimensional) data source, the data will be automatically presented. The default view can be different for alternative data source types like Salesforce or Tableau data extracts.

Review metadata

The metadata grid displays the columns from your data source as rows, providing essential information about each column. For every row, you can find details such as the data type of the column, the field name in the Tableau data source, the name of the physical table in the underlying data source, and the remote field name.

Manage metadata

Depending on the type of data you're connected to, you can perform routine management tasks like hiding multiple columns at once or quickly renaming columns.

Change the location of your data source in a workbook

As you work with data in your workbook, there may come a time when you need to change the location of your data source. Whether the name or location of the data source has changed, or you want to apply your analysis to a similar data source, this section will walk you through the process of redirecting your workbook to the correct location without losing any of your work.

Change the location of a data source

1. Right-click (control-click on a Mac) the data source you wish to edit in the data pane.
2. From the menu, select **Edit Connection**.
3. In the Edit Connection dialog box, you have two options:
 - Navigate to the new location of the data source by browsing your computer's file system.
 - Select a new data source altogether by clicking on the **Browse** button and choosing a different file.
4. After you have selected the new location or data source, select **OK** to save the changes.

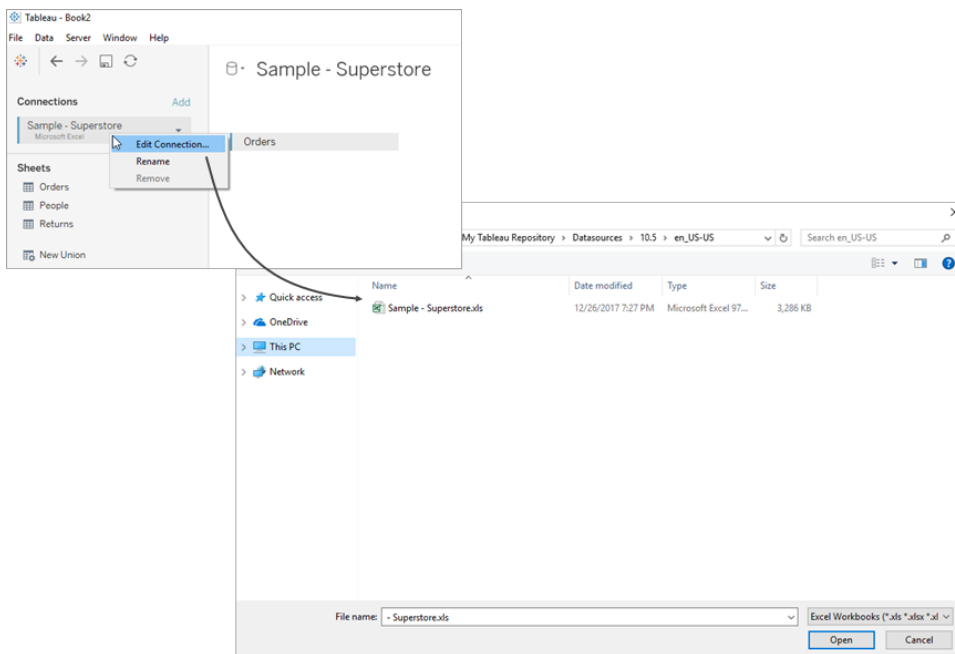

Replace field references

When you establish a successful connection with a new data source, all worksheets in the workbook that were previously using the original data source will now be linked to the new data source. However, if the new data source doesn't have the same field names as the original workbook, the fields will be considered invalid and marked with an exclamation point. To resolve this issue, you can easily replace the references of these fields.

For instance, let's say you have a workbook connected to a data source that includes a field called "Customer Name." Later, you modify the data source to connect to a new one that contains all the same data, but the field name has been changed to "Name." In this case, the "Customer Name" field will still appear in the Data pane, but it will be marked as invalid.

Tableau Desktop and Web Authoring Help

To make the field valid again, you can replace its references. This means you can map the invalid field to a valid field in the new data source. For example, you can map "Customer Name" to "Name."

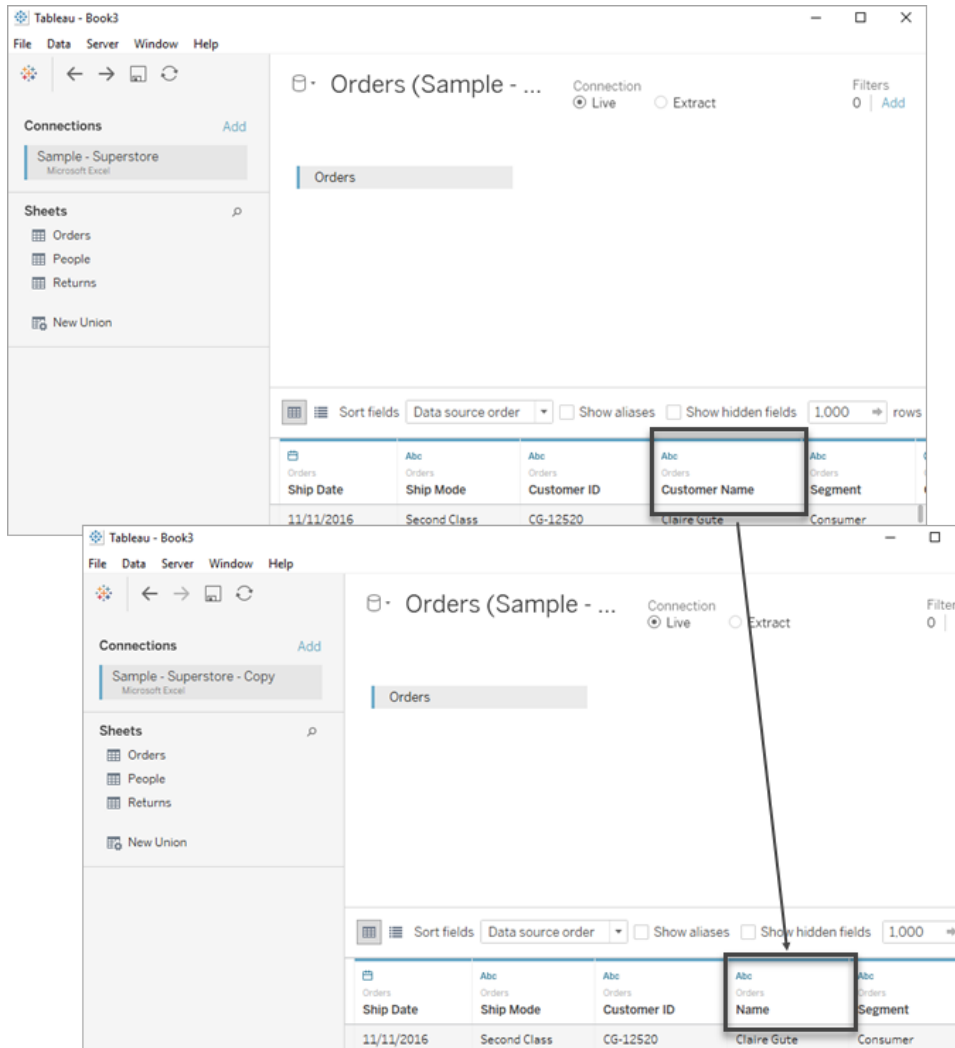

Replace field references

1. Right-click (or control-click on a Mac) the invalid field in the data pane.
2. Select **Replace References**.
3. In the Replace References dialog box, choose a field from the new data source that corresponds to the invalid field.

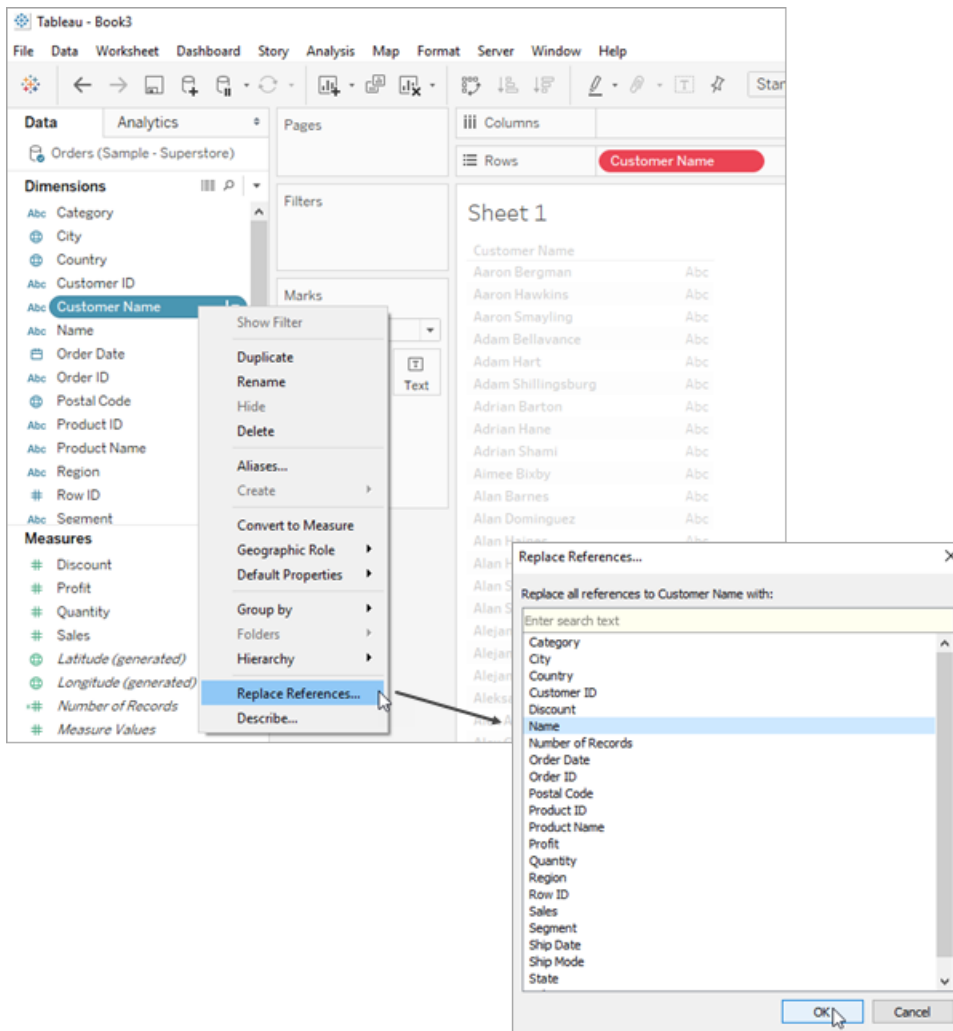

Rename the data source

When you establish a connection to a data source in Tableau Desktop, you will be prompted to give it a name. This name is used to identify the data source within Tableau and can be helpful when you have multiple data sources connected to a single workbook. It allows you to keep track of the specific details of each connection.

Rename a data source

1. Go to the Data menu.
2. Select **Rename**.

By naming your connections appropriately, you can easily distinguish between different data sources and manage them efficiently. You can also review the properties of a connection by selecting the data source on the Data menu and choosing **Properties**.

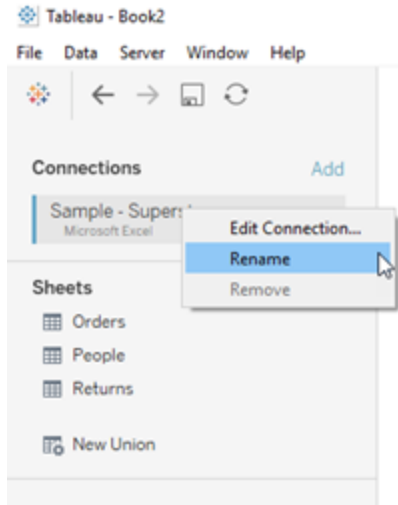

Duplicate the data source (Tableau Desktop)

Sometimes you'll want to make changes to a data source such as add more tables, hide and show fields, or set field defaults. When you make these changes it affects all sheets that use the data source. You can duplicate the data source so you can make the changes without affecting the existing sheets. To duplicate a data source in Tableau Desktop, follow these steps:

1. Open your workbook in Tableau Desktop.
2. Go to the Data menu at the top of the screen.
3. Select the data source that you want to duplicate.
4. From the dropdown menu, choose **Duplicate**.

Note: After you duplicate a data source, the name of the duplicate will have "copy" appended to it. This ensures that you can differentiate between the original and the duplicate source.

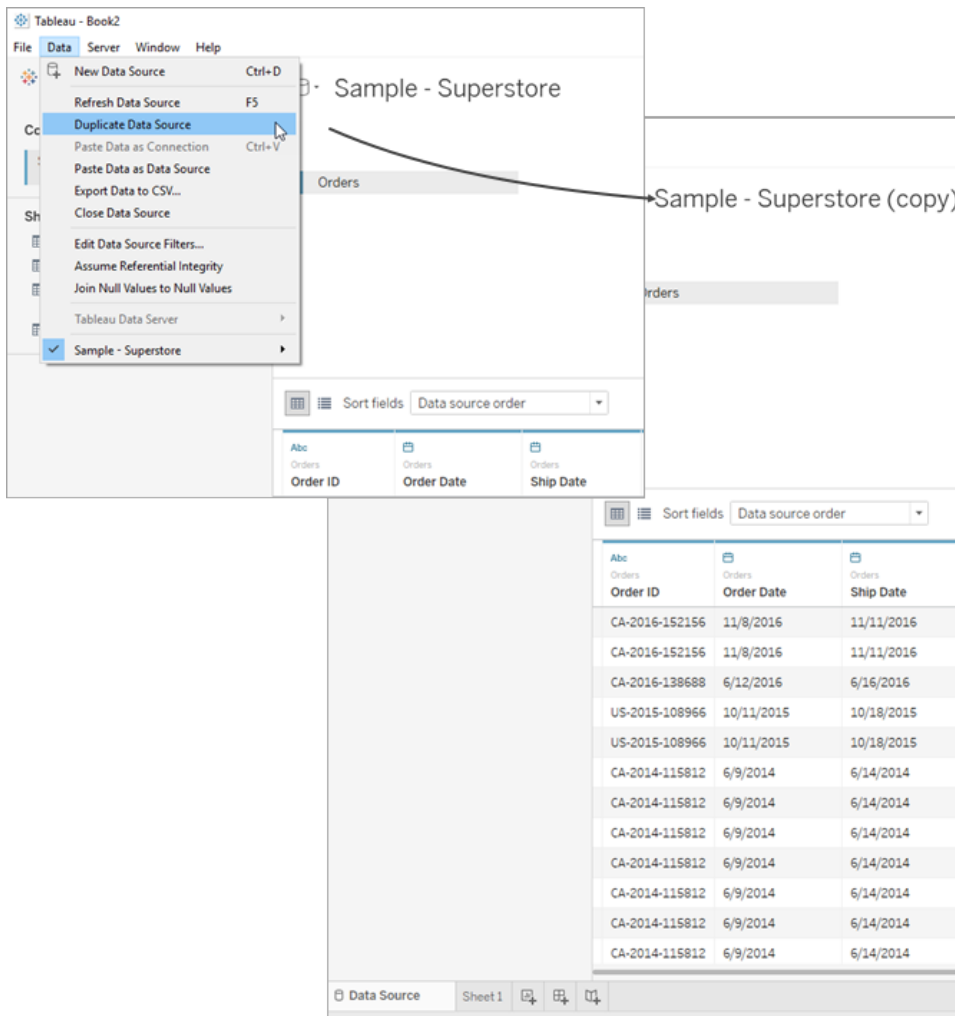

Refresh Data Sources

If you are connected to a data source that has been modified, you can immediately update Tableau Desktop with the changes by selecting a data source on the **Data** menu and then selecting **Refresh**.

Not every connection will behave in the same way. There are three primary connection types: Live Connection, Extract, and Published Data Source. The type of connection is displayed by the icon next to your data source in the Data Pane.

Live Connection



A live connection sends queries to the database and updates the view depending on the results. However, the specific fields queried are defined when the connection is initially created. Refreshing the data source will update any new or changed fields. For more information, see [Connect to Your Data on page 219](#).

Extract



Refreshing an extract will query the data source the extract was created from and rebuild the extract. This process might take some time, depending upon the size of the extract. For more information, see [Extract Your Data on page 919](#).

Published Data Source



When connected to a Published Data Source, the data source can be either a live connection or an extract. Selecting the **Data Source** tab will display whether the Published Data Source is a live connection or an extract. If the data source is an Extract, all refreshes of the extract are managed by Tableau Server and can only be refreshed by the server.

For more information, see [Best Practices for Published Data Sources on page 3135](#).

Changes to underlying data

If a field that is used in a Tableau worksheet is removed from the underlying data of the data source and then the data source is refreshed, a warning message displays indicating that the field will be removed from the view and the worksheet will not display correctly because of the missing field.

If the underlying data changes—for example, if new fields or rows are added, data values or field names are changed, or data is deleted, Tableau will reflect those changes the next time you connect to the data source. However, because Tableau Desktop queries the data and does not import the data, you can immediately update Tableau to reflect the data modifications without disconnecting, provided the changes have been saved in the underlying data first.

Note about web authoring (Tableau Cloud and Tableau Server): If you connect to a published **flat file** (Excel or text) directly in Tableau Cloud or Tableau Server, that data will not be refreshed even if it's modified. If your data is in an **on-premises server** and is

published to the web through Tableau Desktop, it will be rendered as an extract and won't be refreshed. If you need to keep data published through Tableau Desktop fresh on the web, you can use Tableau Bridge. To learn more about these requirements, see [Keep Data Fresh](#) and [Use Bridge to Keep Data Fresh](#) on page 3162

Replace Data Sources

Note: Replacing a data source isn't supported by Tableau Cloud or Tableau Server.

Users can update a workbook or sheet with a different data source. Replacing a data source doesn't merge or edit the data sources. It redirects fields used in the worksheet to map to corresponding fields in the new data source. Any fields that the user creates in the *original* data source are copied over to the new data source. Fields that aren't included in the original data source must be manually copied and pasted to the *new* data source before replacing the old one. When you replace a data source, the folder structures aren't copied over.

The two data sources don't have to be identical, any differences between the data sources will affect the sheets in the workbook and the fields in the view. Any fields, groups, sets, and calculated fields that don't exist in the new data source (or have a different name) are removed from the Data pane. For more information about how to replace field references to fix invalid fields, see [Edit Data Sources](#) on page 957.

Replace a Data Source

Complete the following steps to replace a data source.

1. Open a workbook that connects to the *original* data source.
2. Select **Data > New Data Source** and then connect to the *new* data source.
3. On the Data Source page, drag a table to the canvas to set up the data source (if this isn't automatically done for you).
4. Go to the sheet tab and select **Data > Replace Data Source**.

Note: You must have at least one field in the view to make the **Replace Data Source** option available.

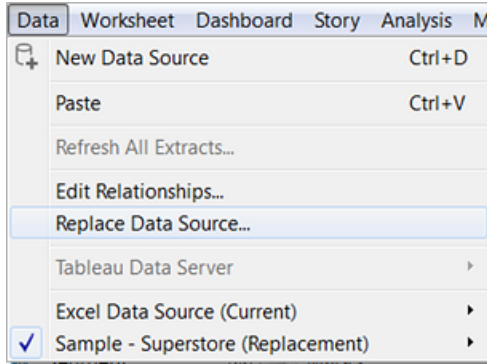

5. In the Replace Data Source dialog box, select the **Current** data source and the **Replacement** data source.
6. (optional) Under the **Current** field, select the checkbox to replace the current worksheet only.
7. When finished, select **OK**.

All worksheets, dashboards, and stories that used the *original* data source are updated to use the *new* data source. You can click **Undo** on the toolbar to revert the change and return to the original data source.

Note: You can only replace one data source with another data source when both data sources are relational data sources, or when both data sources are cube (multidimensional) data sources. In Tableau, cube data sources are supported for Windows only.

Replace the Data Source for a Single Sheet

If you wish to replace the data source for a single sheet, select the checkbox for **Replace current worksheet only**.

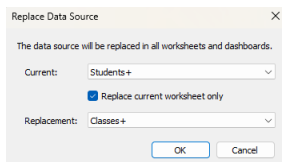

Published Data Sources

When users publish a data source from a workbook, the current workbook in Tableau Desktop will automatically connect to the published data source and close the local data source. For more information on publishing a data source see [Publish a Data Source on page 3141](#).

Save Data Sources

If you've created a data connection that you might want to use with other workbooks or share with colleagues, you can export (save) the data source to a file. You might want to do this also if you've added joined tables, default properties, or custom fields—such as groups, sets, calculated fields, and binned fields—to the Data pane.

Note: This topic describes how to save a data source that you reuse locally, if you do not publish to Tableau Server or Tableau Cloud. For information about sharing data sources on a server, see [Publish Data Sources and Workbooks](#).

Options for saving a local data source

You can save a data source to either of the following formats:



Data Source (.tds) - contains only the information you need to connect to the data source, including the following:

- Data source type
- Connection information specified on the data source page; for example, database server address, port, location of local files, tables
- Groups, sets, calculated fields, bins
- Default field properties; for example, number formats, aggregation, and sort order

Use this format if everyone who will use the data source has access to the underlying file or database defined in the connection information. For example, the underlying data is a CSV file on your computer, and you are the only person who will use it; or the data is hosted on a cloud platform, and your colleagues all have the same access you do.



Packaged Data Source (.tdsx) - contains all information in the data source (.tds) file, as well as a copy of any local file-based data or extracts.

A packaged data source is a single zipped file. Use this format if you want to share your data source with people who do not have access to the underlying data that is defined in the connection information.

Save a data source

1. In Tableau Desktop, open the workbook that has the connection to the data you want to save as a file.
2. At the top of the **Data** pane, right-click (Control-click on Mac) the name of the data source, and then select **Add to Saved Data Sources**.
3. Enter a file name, select the file type (.tds or .tdsx), and then click **Save**.

Connect to your data source

By default, Tableau saves .tds and .tdsx files to the **Datasources** folder under your Tableau repository. When you use the default location, you can connect to the data source on the **Connect** pane.

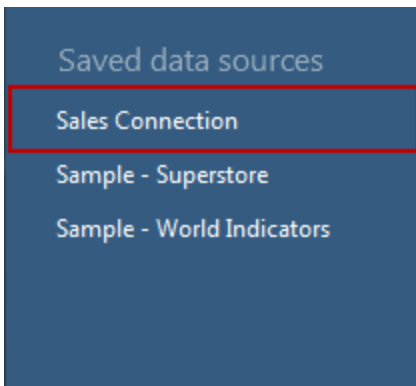

If you specified a different location, you can connect to the data source by selecting **File > Open** and navigating to it.

Updating a data source after the underlying data location changes

If you move a local data file that a .tds file contains a reference to, when you try to open the data source in Tableau, you will be prompted to locate or replace the original data source. If you replace the original data source, the replacement data must be of the same type (for example, Excel or MySQL). To avoid saving a specific file path, save the data source as a .tdsx file.

Upgrade Data Sources

If you have workbooks that were created before Tableau Desktop 8.2 that use Microsoft Excel or text file data sources, or you are using the Excel or text file legacy connection option, you have the option to upgrade the data sources in your workbook. By upgrading your Excel and text file

data sources you can take advantage of 1.) better data interpretation, and 2.) compatibility on the Mac. If you are considering upgrading an existing workbook to use the new connection, review the tables below to compare how your data is processed and displayed between the legacy and default connection types.

If there are certain capabilities of the Jet driver that your data relies on, you might need to use the legacy connection to get the expected results. Workbooks that were created before Tableau Desktop 8.2 that use Excel and text file data sources automatically use the legacy connection. To create a new workbook that uses the legacy connection, in Tableau Desktop, navigate to your Excel or text file data, click the drop-down arrow on **Open**, and then select **Open with Legacy Connection**.

NOTE: Beginning with Tableau 2020.2, legacy Excel and Text connections are no longer supported. See the [Legacy Connection Alternatives](#) document in Tableau Community for alternatives to using the legacy connection.

File formats and attributes

The following tables show some examples of the types of Excel and text files, and tables that you can connect to in Tableau when using the legacy and default connections types.

Excel

Your Data	Legacy Connection	Default Connection
.xlsb file format	Allows connections to Excel data in .xlsb file format.	Does not allow connections to Excel data in .xlsb format. Connections to Excel data in .xls or .xlsx file formats can be used instead.
Excel built-in named ranges	Allows connections to built-in named ranges.	Built-in named ranges are hidden.
Hidden sheet	Allows connections to a table in a hidden sheet.	Hides a table in a hidden sheet.
Very hidden sheet	Allows connections to a table in a very hidden sheet.	Hides a table in a very hidden sheet.

Your Data	Legacy Connection	Default Connection
Table that contain charts	Allows connections to tables that contain Excel charts. However, the table does not contain any values.	Hides tables that contain Excel charts.
Empty table	Allows connections to an empty table.	Hides an empty table.
Table headers	Treats the first row of a table as a header.	Automatically detects whether the first row of a table is a header.
Table width	Limits the table width to 255 columns.	No table width constraints.
Empty columns and rows	Empty columns and rows are visible.	Empty columns and rows are hidden because they do not contain any values.

Text

Your Data	Legacy Connection	Default Connection
File name length	Does not allow connections to a file whose file name is more than 64 characters long.	No length constraints for file names.
Multiple period in the file name	Does not allow connections to a file whose file name contains multiple periods.	No period constraints for file names.
Number of columns in the file	Uses the number of fields present in the first row to determine the number of columns in the file.	Scans the entire file and uses the most common number of fields in a row to determine the number of columns in the file.
Headers rows	Does not automatically detect whether the first row in the file is a	Automatically detects whether the first row in the file is a header.

Your Data	Legacy Connection	Default Connection
	header. Note: You can manually specify that the first row in the file is a header.	Note: You can manually override the detection.
Empty columns	Empty columns are visible.	Empty columns are hidden because they do not contain any values.

Characters and formatting

The following tables show some examples of how your Excel and text file data might be displayed in Tableau when using the legacy and default connection types.

Excel

Your Data	Legacy Connection	Default Connection
Number of characters in the field name	Field names are truncated to 64 characters.	No constraint on the number of characters in a field name.
Special characters in field names	Special characters are not allowed in field names. For example, special characters like quotation marks and periods are converted to number signs. Brackets are converted to parentheses.	Special characters are allowed in field names.
Leading and trailing spaces in field names	Leading and trailing spaces in field names are allowed.	Leading and trailing spaces in field names are automatically removed from column names.
Duplicate field names	For duplicate field names, an index number is appended onto the field name. For example, Test Scores1.	For duplicate field names, a space and an index number are appended to the field

Your Data	Legacy Connection	Default Connection
		name. For example, Test Scores 1.
Excel cell formatting	Supports cell formatting configured using the Format Cells option in Excel.	Does not support cell formatting configured using the Format Cells option in Excel.
Precision with currency values	Fields that contain currency values are represented with a maximum precision of four digits	Full precision of currency values is represented.

Text

Your Data	Legacy Connection	Default Connection
Special characters in file names	Special characters are not allowed in file names. For example, special characters like periods are converted to number signs.	Special characters are allowed.
Characters in header field names	Automatically removes leading spaces from header field names.	Automatically removes leading and trailing spaces from header field names.
Field separators	Recognizes only commas as field separators. Note: You can manually override the detection.	Automatically detects the field separator. Note: You can manually override the detection.
Text enclosed with quotation marks	Quotation marks used to enclose text values remain visible.	Quotation marks used to enclose text values are automatically hidden.
ANSI and OEM	ANSI and OEM code pages are	ANSI an OEM code pages are auto-

Your Data	Legacy Connection	Default Connection
code pages	supported.	atically converted to be cross-platform compatible.
BOM code pages	Inconsistently supports BOM code pages.	Supports BOM code pages.

Data type detection

The following tables show some examples of how data type is detected and how certain values are displayed in Tableau when using the legacy and default connection types.

Excel

Data Type Detection	Legacy Connection	Default Connection
Columns	Data type of a column is determined by the first 8 rows. Note: After the data type of a column in the table has been determined, it cannot be changed.	Data type of a column is determined by the 95% of the first 10000 rows. Note: You can manually override the detection.
Date values without time	Date values are assigned a datetime data type.	Date values without time are assigned a date data type. Date values with time are assigned a datetime data type.
Number values	All number values are represented as real numbers.	Number values without decimal points are represented as integers.
Null values	If a column contains a null cell, the data type for the column is automatically designated as a string data type.	Null cells do not affect data type detection.

Data Type Detection	Legacy Connection	Default Connection
Reference errors or empty cells	If a column contains cells with reference errors or empty cells, the entire column is interpreted as a string data type.	Reference errors or cells with no values do not affect the data type detection.
Overriding data type detection	After the data type of a column in the table has been determined, it cannot be changed.	Data type of a column can be changed after the automatic detection.
Time value precision	The smallest measurement of time values is whole seconds.	The smallest measurement of time values is fractional seconds.
DecimalSymbol and CurrencyDecimalSymbol schema.ini values	Both DecimalSymbol and CurrencyDecimalSymbol schema.ini values are recognized.	DecimalSymbol and CurrencyDecimalSymbol schema.ini values are recognized. However if both values are used, DecimalSymbol takes precedence.
Cells formatted as text	The data type of a column is detected as a string data type when cells are formatted as text using the Format Cells option in Excel.	Does not support cell formatting configured using the Format Cells option in Excel.

Text

Data Type Detection	Legacy Connection	Default Connection (8.2 and later)
Columns	Data type of a column is determined by the first 25 rows.	Data type of a column is determined by the first 1024 rows.

Data Type Detection	Legacy Connection	Default Connection (8.2 and later)
Boolean (True/False) values	Boolean values are assigned the string data type.	Boolean values are assigned the boolean data type.
Values that become null	Spaces in a cell, whether enclosed in quotation marks or not, are treated as null values. Columns with null values are detected as the string data type.	Two field separators in a row are treated as a null value. Null values are ignored during data type detection.

Data source connection properties

The following table shows examples of the differences in data source connection properties in Tableau when using the legacy and default connection types.

Property	Legacy Connection	Default Connection
Custom SQL	Custom SQL is allowed.	Does not allow the use of Custom SQL.
Join type	Allows left, right, and inner join types.	Allows left, right, inner, and full outer join types.
Join operators	Allows equal to (=), greater than (>), greater than or equal to (>=), less than (<), less than or equal to (<=), and not equal to (<>) join operators.	Allows equal to (=) join operators.

Close Data Sources

You can close a data source at any time. Doing so does not modify the data source. Instead, it disconnects Tableau from the data so that you can no longer query it. Additionally, the data source is cleared from the Data pane and all open worksheets associated with the data source are cleared. If you accidentally close a data source, use the Undo button to reopen it. Close a data source by doing one of the following:

- Right-click (control-click on a Mac) the data source at the top of the Data pane and select **Close**.

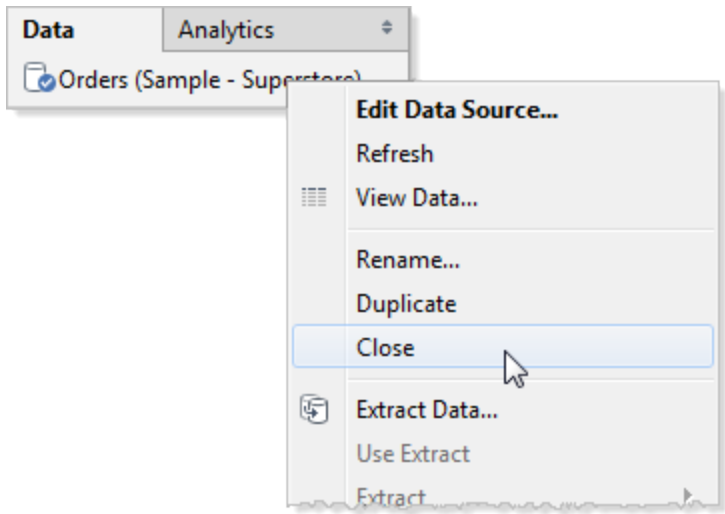

- Select a data source on the **Data** menu and then select **Close**.

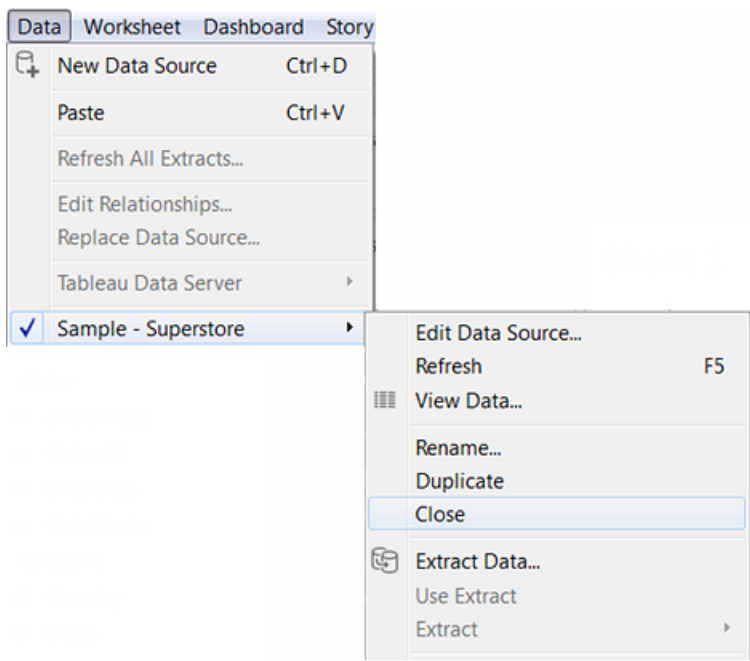

Note: When authoring on the web, the data source cannot be used by any worksheets for you to be able to close the data source.

Cube Data Sources

Cube data sources (also known as multidimensional or OLAP data sources) have certain characteristics that differentiate them from relational data sources when you work with them in Tableau. This topic describes these differences, and also identifies some Tableau features that are not available when you connect to a cube data source. In many cases there are alternative approaches that you can use to compensate for the unavailability of these features with cube data sources, but you may also have the option to connect directly to a relational database that was used as the source for a cube data source. Talk to your database administrator to find out if this is an option.

Note: Cube data sources are supported only for Tableau Desktop on Windows—not for the Mac.

What are cube data sources?

A cube data source is a data source in which hierarchies and aggregations have been created by the cube's designer in advance.

Cubes are very powerful and can return information very quickly, often much more quickly than a relational data source. However, the reason for a cube's speed is that all its aggregations and hierarchies are pre-built. These definitions remain static until the cube is rebuilt. Thus, cube data sources are not as flexible as relational data sources if the types of questions you need to ask were not anticipated by the original designer, or if they change after the cube was built.

The cube data sources supported in Tableau are

- Oracle Essbase
- Teradata OLAP
- Microsoft Analysis Services (MSAS)
- SAP NetWeaver Business Warehouse
- Microsoft PowerPivot

Create calculated members using MDX formulas

When working with a cube data source, you can create calculated members using MDX formulas instead of creating Tableau formulas. MDX, which stands for Multidimensional Expressions, is a query language for OLAP databases. With MDX calculated members, you can create more complex calculations and reference both measures and dimensions. A calculated

member can be either a calculated measure, which is a new field in the data source just like a calculated field, or a calculated dimension member, which is a new member within an existing hierarchy. For details, see [How to Create a Calculated Member on page 991](#).

Tableau features that are affected when you use a cube data source

When you use a cube data source, not all Tableau features work the same as with relational data sources, or are even available. The following table details the differences.

Feature	Status for Cube Data Sources
Actions	<p>With Microsoft Analysis Services connections, drill-down actions defined in the cube are not available in Tableau.</p> <p>Cube data sources do not accept actions from relational or other cube data sources.</p> <p>For example, suppose you have a workbook with a view that uses a MySQL data source, a second view that uses cube data source A, and a third view that uses cube data source B. Actions in the view using the MySQL data source won't affect the views using the cube data sources, and actions in the view for one cube data source won't affect the other. But actions in the views using the cube data sources will affect the view using the MySQL data source.</p>
Advanced analytics features	<p>Level of detail expressions, trend lines, forecasting, and clustering are not supported for cube data sources.</p>
Aggregate calculation functions	<p>Cube data sources are pre-aggregated and thus do not support aggregation functions, such as <code>SUM ()</code>, <code>AVG ()</code>, and <code>CNT ()</code>.</p> <p>It may be possible to use Table Calculations to perform aggregation operations on the cell-level results from the cube in Tableau.</p>
Aliases	<p>Aliases for cube databases are created by the cube's designer and can be activated in Tableau by selecting the data source from the Data menu and then choosing Alias File. Talk to your database administrator to find out whether your database has aliases available. Aliases are not supported by Microsoft Analysis Services databases.</p>

	By default, the alias for every member of every dimension is initially defined to be the original member name.
Bins	<p>For cube data sources, the Create Bin command is not available for measures.</p> <p>You can, however, write a calculation that takes cube cell results and bins them. For example:</p> <pre>str((INT([Internet Sales Amount]/1000)) * 1000)</pre>
Cube KPI data type	<p>When connected to Microsoft Analysis Services, any KPI calculations defined in the cube are not available.</p> <p>However, you can write your own KPI calculations in Tableau. You can also use Tableau parameters to create highly flexible what-if KPI analysis. For more information, see Visualize Key Progress Indicators on page 1577.</p>
Cube lag functions	<p>For cube data sources, you cannot use cube lag functions in the Tableau calculation editor. You can use Tableau Table Calculations to calculate certain percentages and totals instead. For more information, see Transform Values with Table Calculations on page 2364.</p> <p>Alternatively, you can use an MDX Lag function directly in Tableau using a calculated member. For example:</p> <pre>Avg ({ [Date].[Calendar].CurrentMember.Lag(4) : [Date].[Calendar].CurrentMember } , [Measures].[Internet Sales Amount])</pre>
Custom multidimensional expression (MDX) statements	When connected to a cube, you cannot make a connection to a custom MDX statement. All sub-cube definitions need to be created on the server by implementing necessary cube perspectives, partitions, dimensions, or cell security.
Data blending	Cube data sources can only be used as the primary data source for blending data in Tableau. They cannot be used as secondary data sources. For details, see Troubleshoot Data Blending on page 836 .
Date dimensions	For cube data sources, date dimensions are typically organized into hierarchies that contain levels such as year, quarter, and month. In addition,

	<p>some multidimensional data sources have time intelligence enabled, which makes it possible to look at data levels different ways, such as Months by Year, Months by Quarter, Weekends, etc. These levels are represented as attributes of the hierarchy. For details, see Dates and Times on page 1149.</p>
Data source filters	<p>Data source filters are not available for cube data sources. All field values must be defined in the cube prior to analysis in Tableau.</p>
Extracts	<p>You cannot create extracts from most cube data sources. Cube and relational data sources have incompatible data structures, which makes extracting data from a cube and storing it in a relational data source, such as the data engine, impossible in most cases.</p> <p>Starting in 10.4, you can create SAP BW extracts without the need for a special product key from Tableau. For information about support for and limitations of SAP BW extracts, see SAP NetWeaver Business Warehouse on page 445.</p>
Filters	<p>When you display a filter for a cube dimension, all levels of the hierarchy for that dimension are included in the filter. For example:</p>

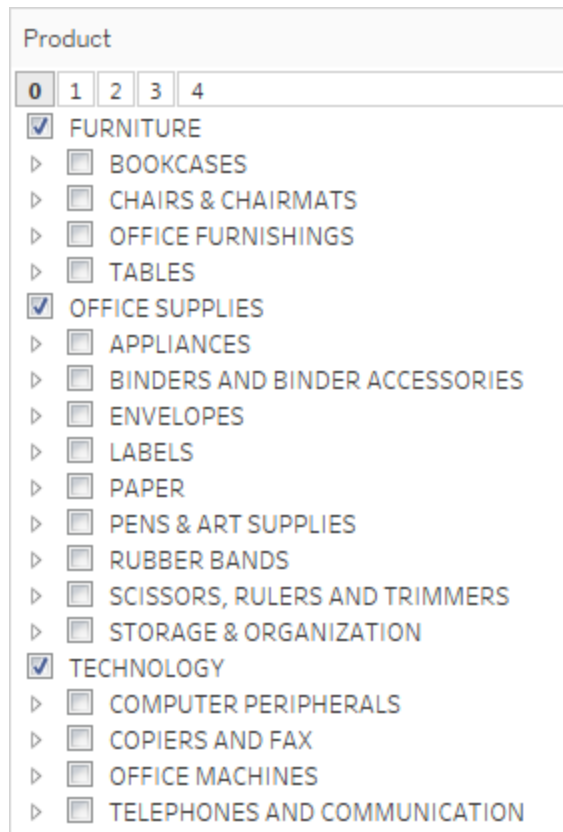

You can use cube attributes as filters, to show just a single level instead of a hierarchy. In the Data pane, attributes appear in the Dimensions

section and are indicated by this icon: 

Slicing filters behave differently with a cube data source than with a relational data source. See [Create Slicing Filters on page 988](#) for details.

Some dimension filter card options are not available. For example, single value (drop-down), multiple values (custom list), etc. Instead, dimensional filters shown in the view retain their hierarchical look and feel, and cannot be changed into specific list types. You can create a Tableau set containing certain values from the hierarchy and then use the set as a filter in the view with the expected filter options (right-click the set in the Data pane, and then click **Show Filter**).

Groups

You cannot create groups when working with a cube data source. Any

	<p>concept of groupings should be pre-defined in the cube as dimensional attributes or cube sets.</p> <p>However, you can write multidimensional expressions (MDX) directly in Tableau using a calculated member to create a group. For example:</p> <pre>[Customer].[Customer Geography].[France] + [Customer].[Customer Geography].[Germany]</pre>
Hierarchies	<p>For cube data sources, hierarchies must be defined in the cube prior to analysis.</p>
Parameters	<p>For cube data sources, you cannot use parameter values to filter dimensions in an MDX calculation.</p>
Publishing	<p>Workbooks using cube data source can be published to Tableau Server, but do not support pass-through connections. This means that you cannot make a connection from Tableau Server using such a data source. It also means you cannot create a workbook using the data source in Tableau Server. For details, see Cube Data Sources in the Tableau Server help.</p> <p>Publishing a cube data source to Tableau Server gives you the ability to store the data source on the server. However, to use the data source, you must download the data source to Tableau Desktop and use it locally.</p> <p>Workbooks that use cube data source cannot be published to Tableau Cloud.</p>
Sets	<p>Cube data sources support hierarchical sets, which filter data to the selected members and all of their descendants. For details, see Examples of sets on page 1104.</p>
Tableau string functions	<p>With cube data sources, dimensions are not available in the calculation editor.</p> <p>However, you can write MDX inside Tableau using a calculated member to manipulate dimensional values. For example:</p> <pre>LEFT([Product].[Product Categories].DataMember.MemberValue, LEN([Product].</pre>

	<code>[Product Categories].DataMember.MemberValue)-5)</code>
Type conversions	<p>For cube data sources, some type conversion functions are not available in the calculation editor. As a rule, data type conversions should be defined in the cube prior to analysis.</p> <p>In particular, changing the data type of a cube dimension to a date in Tableau sometimes gives incorrect information. This feature is supported for some cube dimensions, depending on how the dates are formatted in the cube.</p> <p>You can write Multidimensional Expressions (MDX) directly in Tableau using a calculated member to change the data type of a cube dimension to a date. For example:</p> <pre>CDATE ([Date] . [Date] . CurrentMember . MemberValue)</pre>

Create Slicing Filters

Slicing filters, also known as slicers or calculation filters, are dimension filters that behave differently for multidimensional data sources than they do for relational data sources.

In Tableau, multidimensional data sources are supported only in Windows.

A slicing filter exists when:

- The dimension that you place on the Filters shelf is not also on any other shelf in the view.
- The filter is defined to include multiple values. For example:

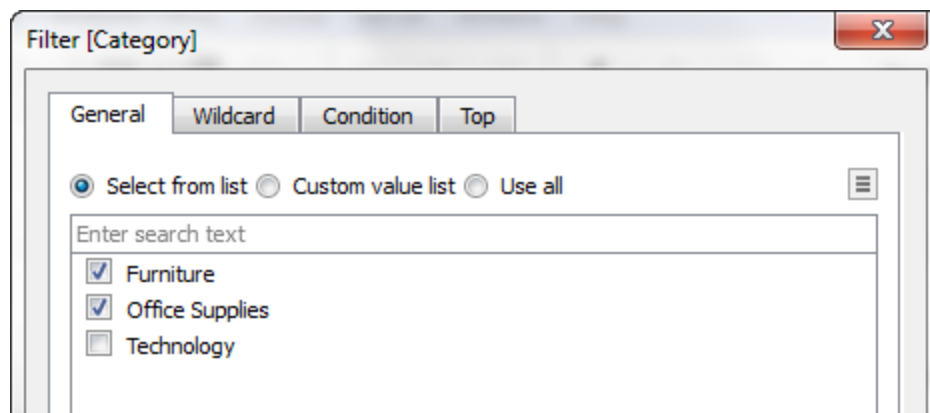

For relational data sources, there is nothing remarkable about a slicing filter. Tableau recalculates values for each measure in the view using the configured aggregations.

But because multidimensional data sources contain data that is aggregated in the data source, no aggregation can be defined for the “slice” that the dimension filter cuts through the values of individual measures. Tableau therefore automatically performs a summation. And because multiple values are defined, the result is the sum of a group of sums.

For example, consider the view shown below, which shows profit by region and state.

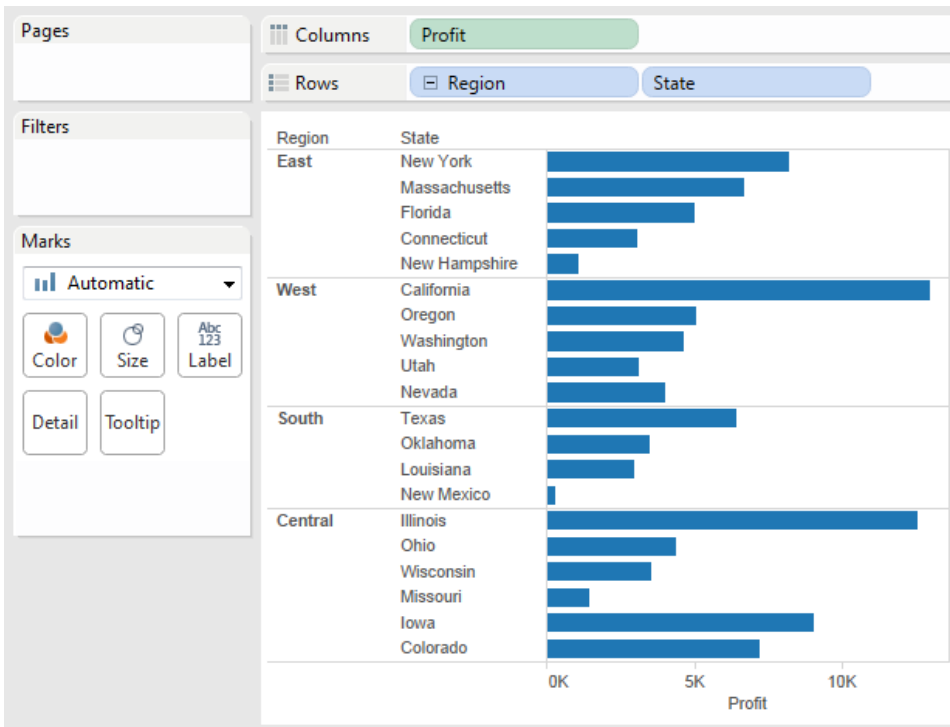

A slicing filter that includes the Q3 and Q4 members of the Quarter dimension is then applied to the data.

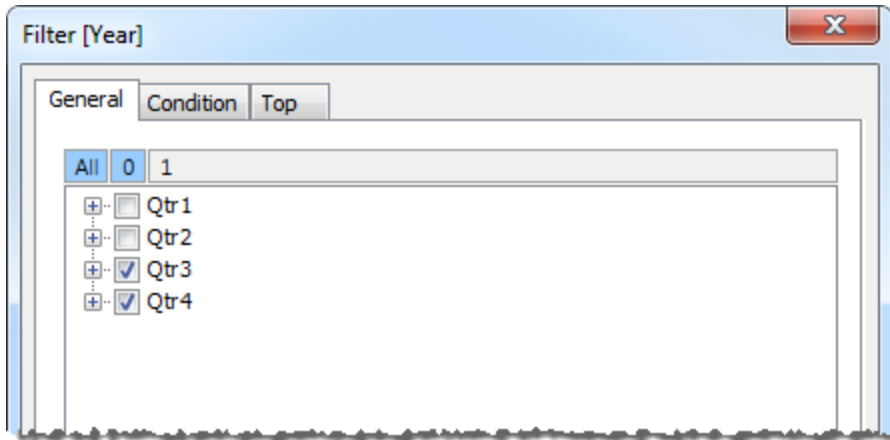

In the resulting view, the profit for Oregon in the West region is 2,567. This number was calculated by summing data values for Qtr3 and Qtr4.

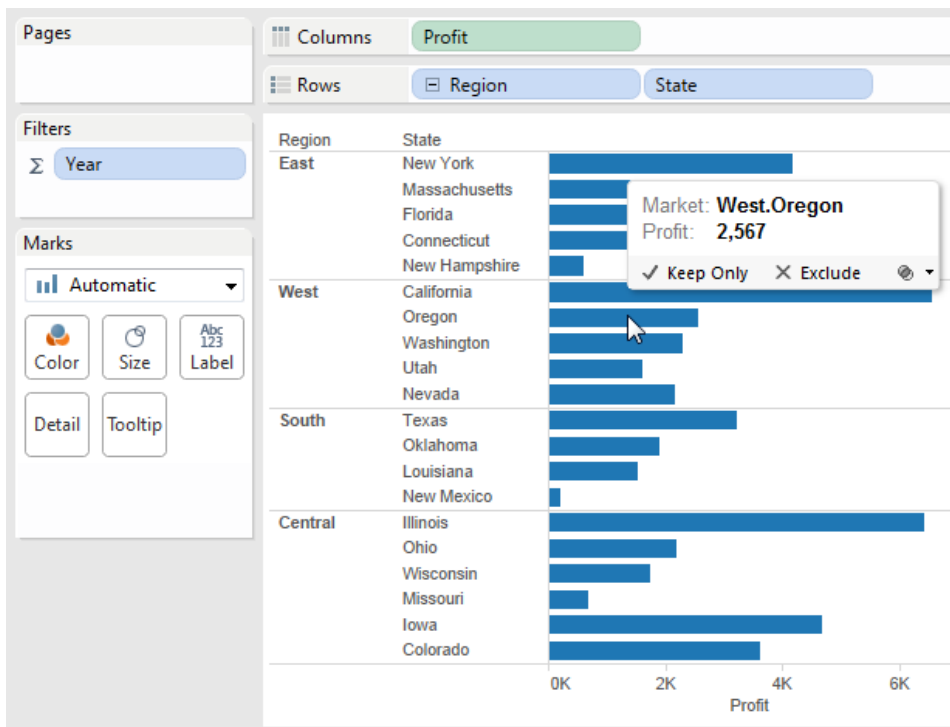

The summation symbol (Σ) you see on the Filters shelf in the view above indicates that this is a slicing filter. If the original aggregation for a field is non-additive (for example, Count Distinct) the values you see after applying a slicing filter may be unexpected.

How to Create a Calculated Member

If you are using a multidimensional data source, you can create calculated members using MDX formulas instead of Tableau formulas. A calculated member can be either a calculated measure, which is a new field in the data source just like a calculated field, or a calculated dimension member, which is a new member within an existing hierarchy. For example, if a dimension Product has three members (Soda, Coffee, and Crackers) you can define a new calculated member Beverages that sums the Soda and Coffee members. When you then place the Products dimension on the **Rows** shelf it displays four rows: Soda, Coffee, Crackers, and Beverages.

Note: In Tableau, multidimensional data sources are supported only in Windows.

Defining Calculated Members

You can define a calculated dimension member by selecting **Calculated Members** from the Data pane menu. In the Calculated Members dialog box that opens, you can create, delete, and edit calculated members.

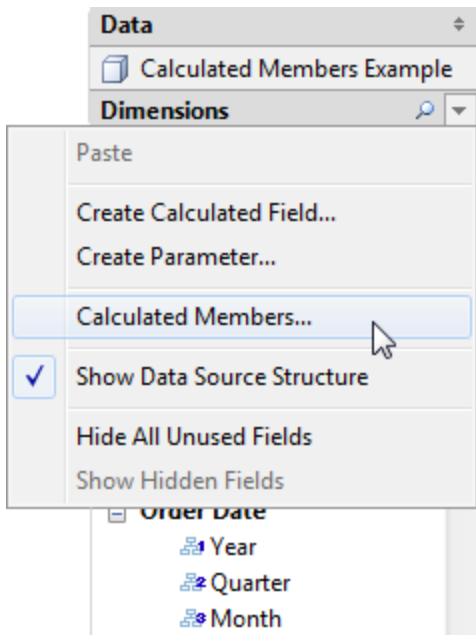

To create a new calculated member do the following:

1. Click New to add a new row to the list of calculated members at the top of the dialog box.

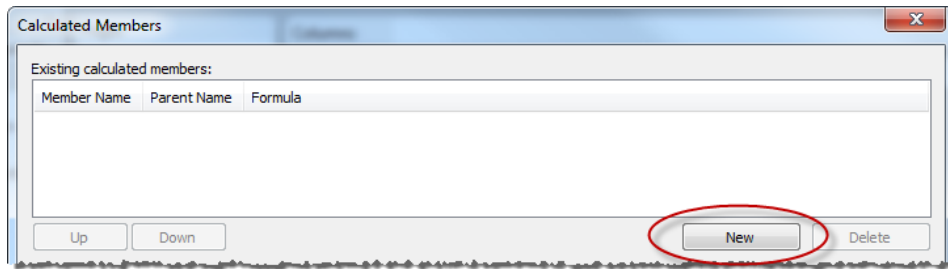

2. Type a Name for the new calculated member in the Member Definition area of the dialog box.

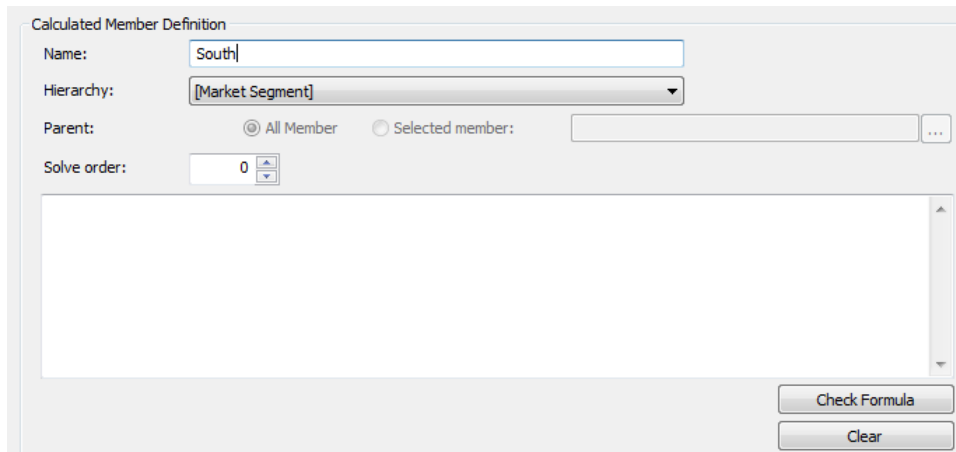

3. Specify the **Parent** member for the new calculated member. **All Member** is selected by default. However, you can choose **Selected Member** to browse the hierarchy and select a specific parent member.

Note: Specifying a parent member is not available if you are connected to Oracle Essbase.

4. Give the new member a solve order.

Sometimes a single cell in your data source can be defined by two different formulas. The solve order defines the precedence given to each formula. Formulas with a lower solve order are solved first. The default solve order is zero.

5. If you are connected to a Microsoft Analysis Services data source, the calculation editor contains a **Run before SSAS** check box. Choose this option to execute the Tableau calculation before any Microsoft Analysis Services calculations. For information on connecting to Microsoft Analysis Services data sources, see [Microsoft Analysis Services on page 377](#)
6. Type or paste an MDX expression into the large white text box.
7. Click **Check Formula** to verify that the formula is valid.
8. When finished, click **OK**.

The new member displays in the **Data** pane either in the Measures area, if you chose [Measures] as the parent member, or in the Dimensions area under the specified parent member. You can use the new member just like any other field in the view.

Multidimensional Hierarchies

Multidimensional data sources contain hierarchies. For example, your database might contain a Product dimension that includes members such as product family, product department, and so on organized into a hierarchy, or you might have a Time dimension that includes years, quarters, and months.

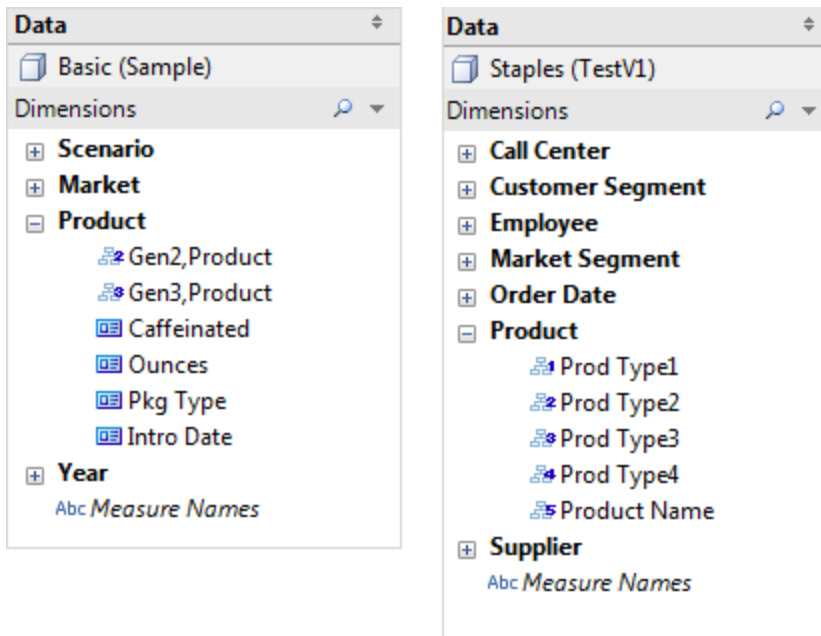

Note: In Tableau, multidimensional data sources are supported only in Windows.

Drilling Down and Up in a Cube Data Source Hierarchy

Note: The following applies only to certain multidimensional data sources.

Multidimensional (cube) data sources contain hierarchies. One of the most useful ways to navigate hierarchies is to drill down or drill up. For example, if you are examining the sales totals for various years, you can then drill down and view sales for all of the months within each year. Alternatively, if you are examining sales totals for all months, you can then drill up and view the sales for each year.

Hierarchies in cube data sources

When connected to cube data sources, you cannot create or customize hierarchies in Tableau. Hierarchies must be created in the cube **before** you connect to it in Tableau.

Hierarchies appear with the following icon in the Data pane: 

You can see an example of a hierarchy below:

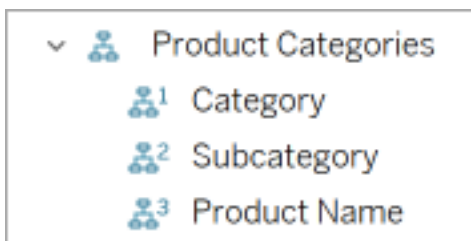

Note: You can only drill up or down in fields that are part of a hierarchy.

Drill up and down for **all** dimension members in a hierarchy

To drill up or down for all dimension members in a hierarchy:

- On the Columns or Rows shelf, or the Marks card, click the plus sign (+) on a field to drill down, or the minus sign (-) to drill up.

Tableau Desktop and Web Authoring Help

The screenshot shows the Tableau Desktop interface. The Columns shelf is empty, and the Rows shelf contains the 'Category' field. The Marks card is set to 'Automatic' and includes 'Sales Amount'. The Filters shelf contains 'Product Categories'. The main view displays a table with the following data:

Category	Sales Amount
Accessories	\$739,312.49
Bikes	\$62,137,014.43
Clothing	\$1,331,553.75
Components	\$8,210,376.13

Drill up and down for **individual** dimension members in a hierarchy

To drill down and drill up for individual dimension members in a hierarchy:

- Right-click a table header and select **Drill Down** or **Drill Up** .

This screenshot is identical to the one above, showing the Tableau Desktop interface with the 'Category' field on the Rows shelf and 'Sales Amount' on the Marks card. The table displays sales data for Accessories, Bikes, Clothing, and Components.

Category	Sales Amount
Accessories	\$739,312.49
Bikes	\$62,137,014.43
Clothing	\$1,331,553.75
Components	\$8,210,376.13

This is often referred to as non-uniform drill down because you expose only the members of interest instead of exposing all the members of a given level.

For example, you can see the difference between drilling down for all dimension members and drilling down for individual dimension members below.

Individual dimension member: Bikes

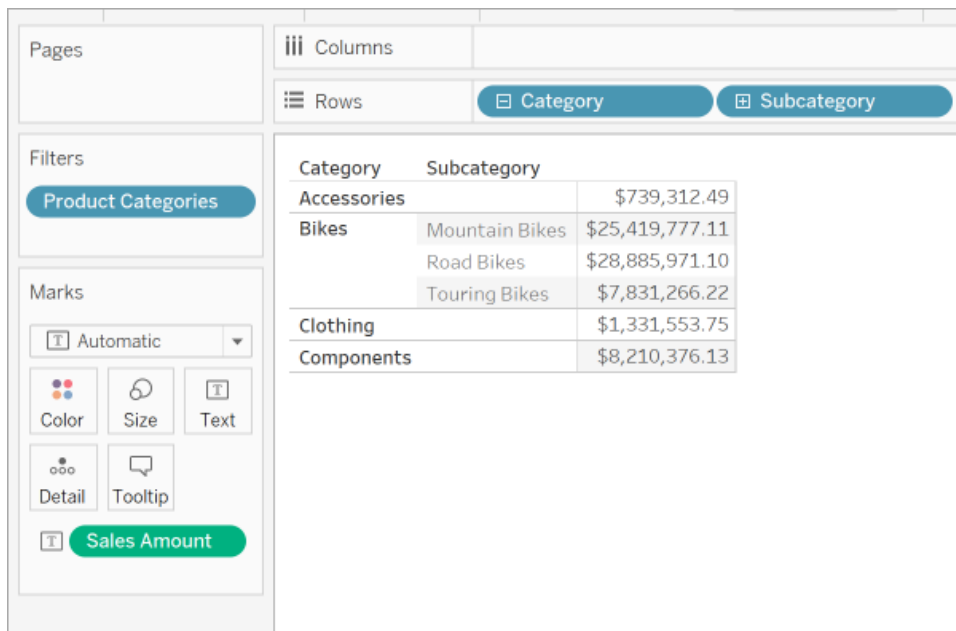

Category	Subcategory	
Accessories		\$739,312.49
Bikes	Mountain Bikes	\$25,419,777.11
	Road Bikes	\$28,885,971.10
	Touring Bikes	\$7,831,266.22
Clothing		\$1,331,553.75
Components		\$8,210,376.13

All dimension members

Category	Subcategory	
Accessories	Bike Racks	\$135,667.84
	Bike Stands	\$20,829.00
	Bottles and Cages	\$36,314.58
	Cleaners	\$10,353.42
	Fenders	\$28,617.96
	Helmets	\$291,103.34
	Hydration Packs	\$55,923.42
	Locks	\$11,024.98
	Pumps	\$9,307.96
	Tires and Tubes	\$140,170.00
Bikes	Mountain Bikes	\$25,419,777.11
	Road Bikes	\$28,885,971.10
	Touring Bikes	\$7,831,266.22
Clothing	Bib-Shorts	\$114,307.95
	Caps	\$30,724.64
	Gloves	\$158,190.73
	Jerseys	\$447,551.45
	Shorts	\$272,187.62
	Socks	\$22,400.04
	Tights	\$141,029.15
	Vests	\$145,162.17
Components	Bottom Brackets	\$32,582.84
	Brakes	\$41,645.93
	Chains	\$6,203.66
	Cranksets	\$129,766.15
	Derailleurs	\$42,945.57
	Forks	\$55,917.61
	Handlebars	\$120,580.62
	Headsets	\$43,038.31
	Mountain Frames	\$3,444,986.06
	Pedals	\$102,284.77
	Road Frames	\$2,757,749.72
	Saddles	\$34,773.23
	Touring Frames	\$892,354.49
Wheels	\$505,547.17	

One reason to use a non-uniform drill down is if your data source has a ragged hierarchy (asymmetric layout). You also might want to view the children for just the member of interest.

Note: Drilling down and drilling up results in filtering the data.

Perfect Pivoting

Note: The following applies only to certain multidimensional data sources.

In Tableau, perfect pivoting refers to working with hierarchies in these ways:

- Using varying levels of detail including skipping levels (for example, Country and City, but not State).
- Using varying levels of detail on different worksheet shelves simultaneously (for example, Product Family on the Columns shelf and Product Department on Color).
- Using varying levels of detail out of order (for example, Quarter before Year).

For example, in the following view the Market hierarchy is broken up to show the State level as Rows and the Region level as Color.

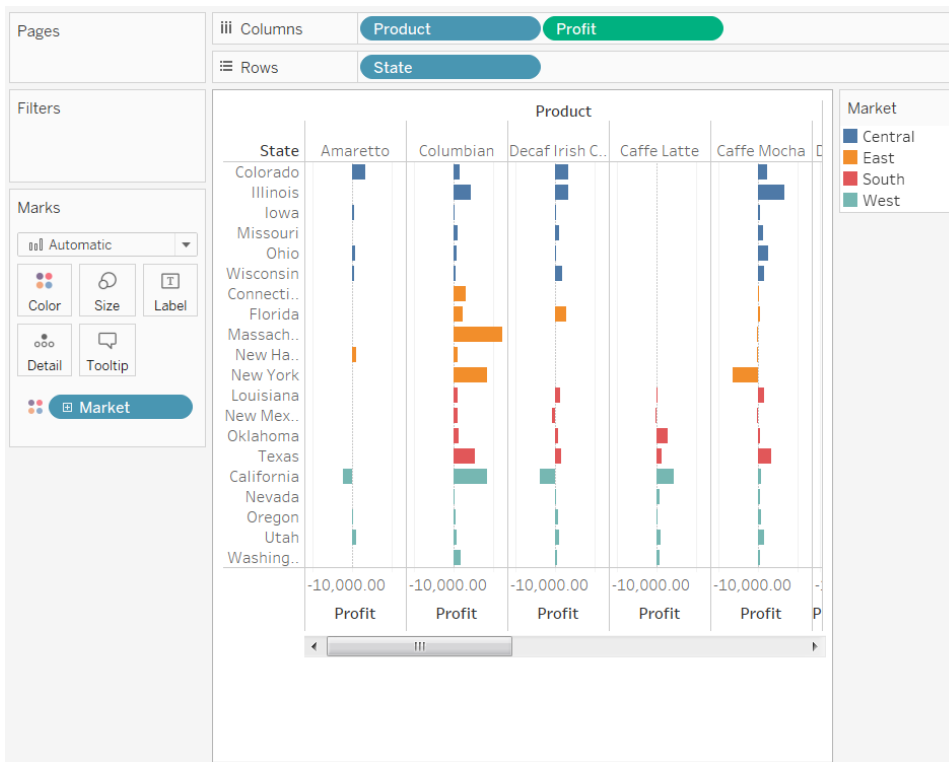

Defining Unique Values

Note: The following applies only to certain multidimensional (cube) data sources.

Sometimes, when you are building views in Tableau, a field will have multiple members with the same name. For example, you may have a view showing the average profit by month over several years. The month February appears multiple times (once for each year).

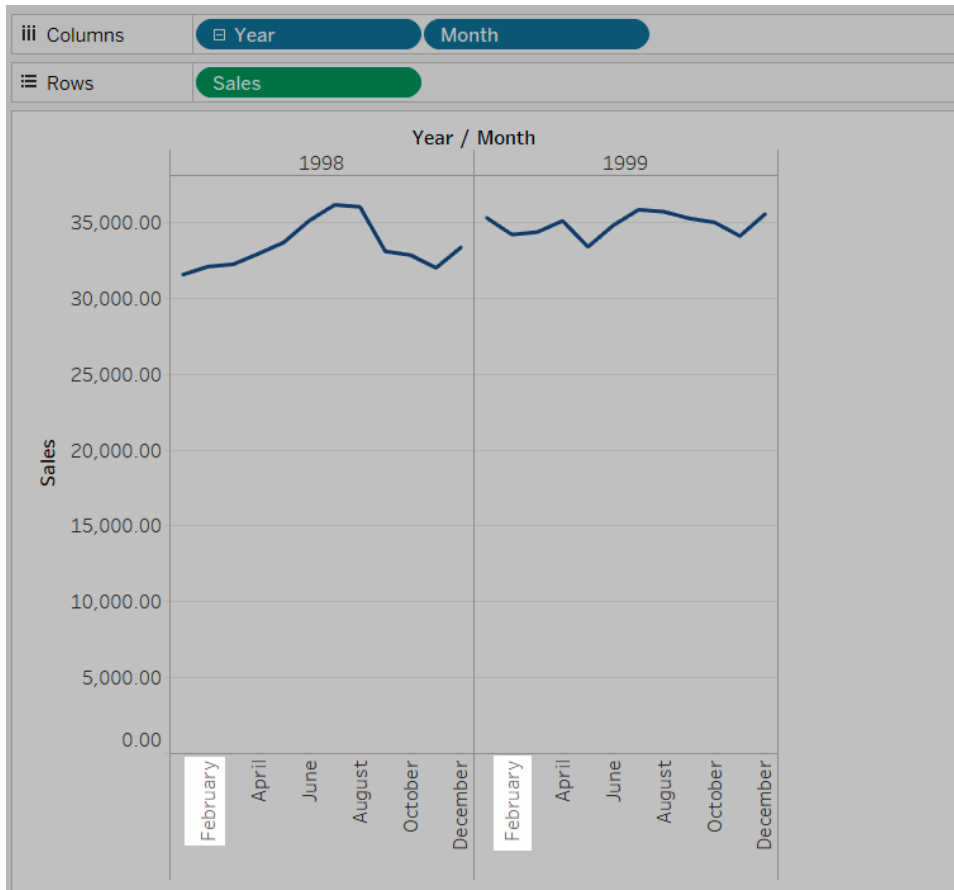

While the name, February, is repeated, each instance of February can either be considered similar or unique. If you consider them similar, they will appear in the same column if you decided to move the Year field to the Color. However, if you consider them unique, they will be treated as two different values.

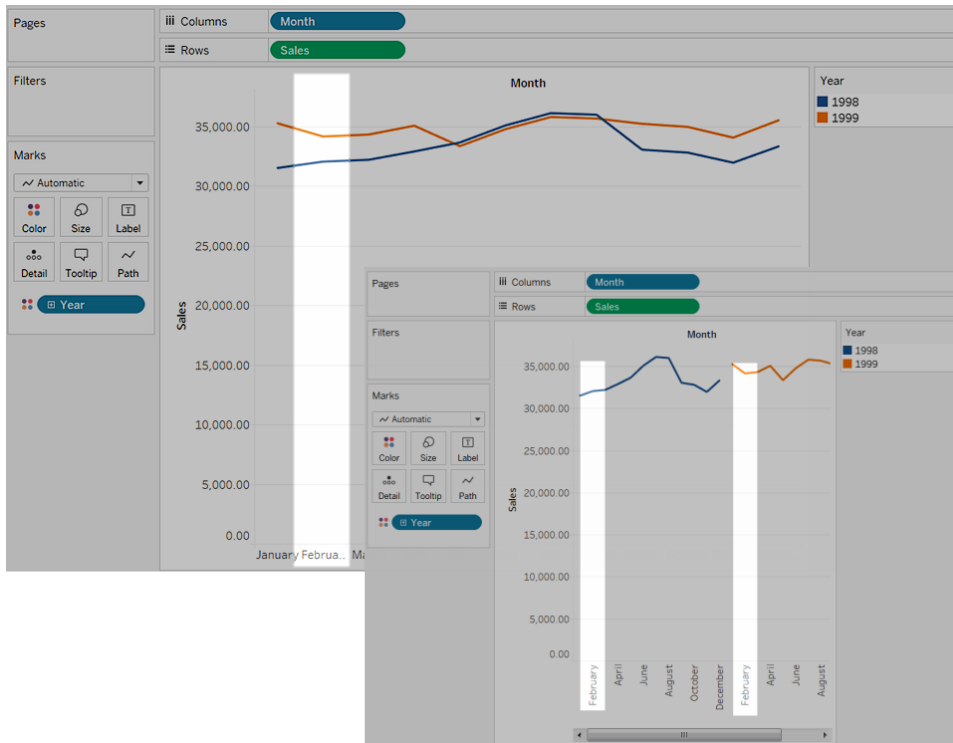

It is generally okay to consider repeated names within date and time fields (like in the previous example) similar but if there are repeated names in the Customer Name field, you won't want to consider the two customers as the same person.

To define how you want Tableau to determine whether repeated values are unique, right-click (control-click on Mac) on the dimension in the **Data** pane and select one of the following on the **Unique Values** context menu:

- **By Key:** each member is considered unique based on the key given to it by the system administrator when the database is set up. Members with the same name but different keys are treated as unique values.
- **By Name:** each member is considered unique based on the member name. Members with the same name (regardless of their keys) are treated as if they are the same.

By default, unique date and time values are determined by name and all other values are determined by key.

Utility Dimensions

Note: The following applies only to certain multidimensional data sources.

Oracle Essbase databases sometimes have special dimensions used to model comparative values such as Actual vs. Budgeted or Current Year vs. Previous Years. These dimensions are the utility dimensions and are often set up as Scenario or Years. For example, the members of a Scenario dimension are shown below.

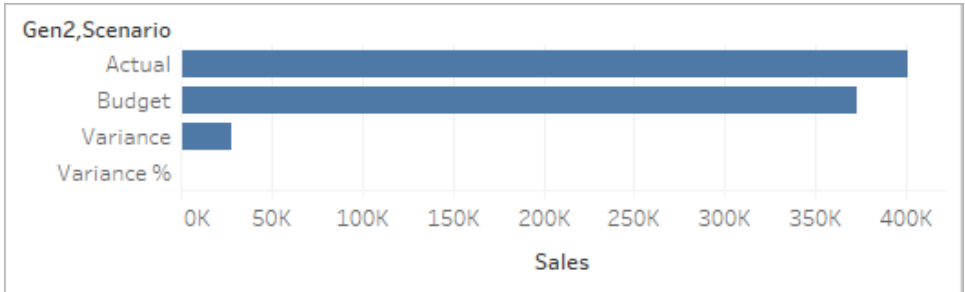

In the above view, you can see Actual Sales, Budgeted Sales, and so on. However, what if you wanted compare Actual Sales to Budgeted Sales in a bullet graph? In that case you need to set the Scenario dimension to be used as the utility dimension. When you set a dimension as the utility dimension you can then specify which member of the utility dimension to use for each measure in the view. For example, below is a bullet graph showing actual sales to budgeted sales by region.

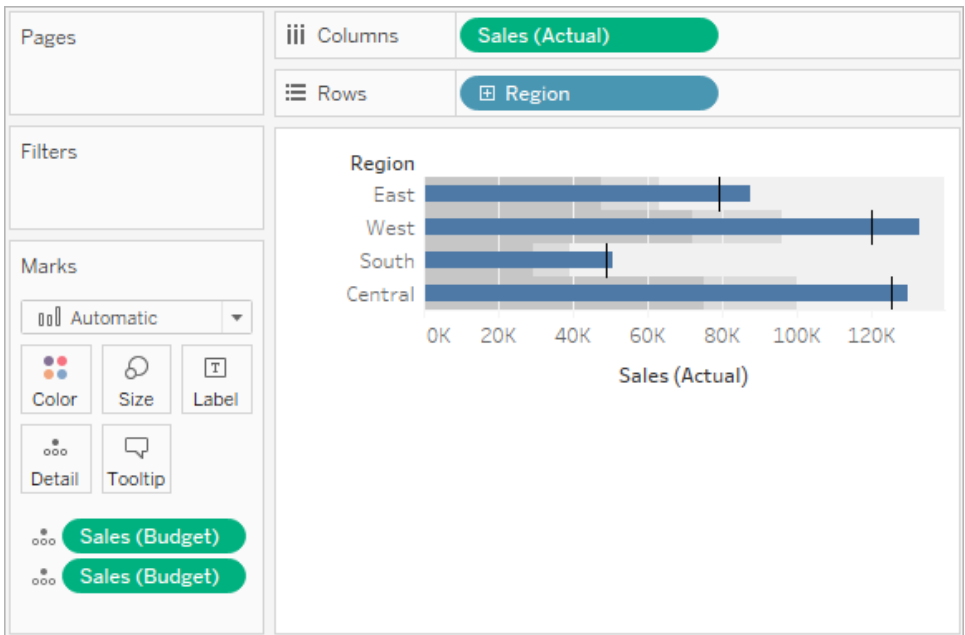

You can see that the Sales measure is used twice in the view: once to show actual and once to show budgeted.

To use a dimension as the utility dimension:

1. Right-click the dimension in the Data pane and select **Set as utility dimension**.

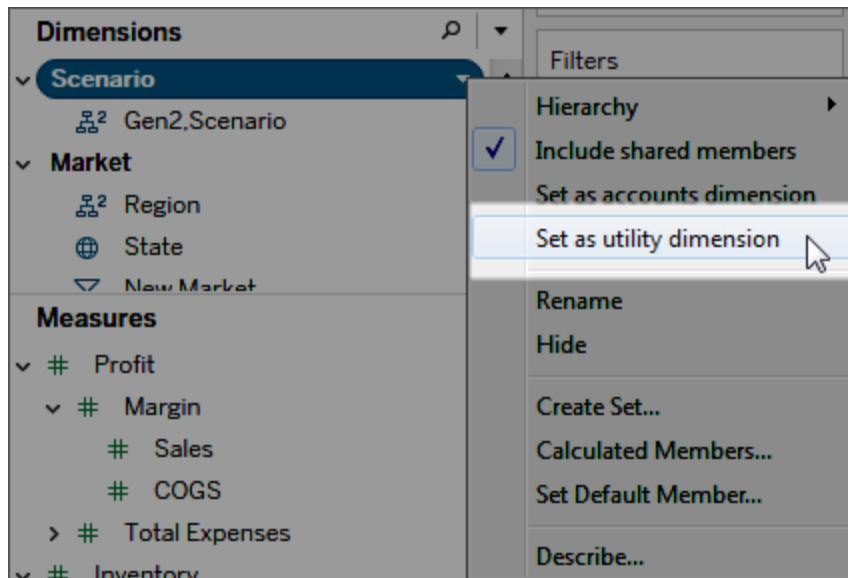

The dimension in the Data pane (in this example, Scenario) can no longer be used as a dimension field in the view. The Measures area of the Data pane indicates that there is a utility dimension (in this example, (by Scenario) indicates the utility dimension).

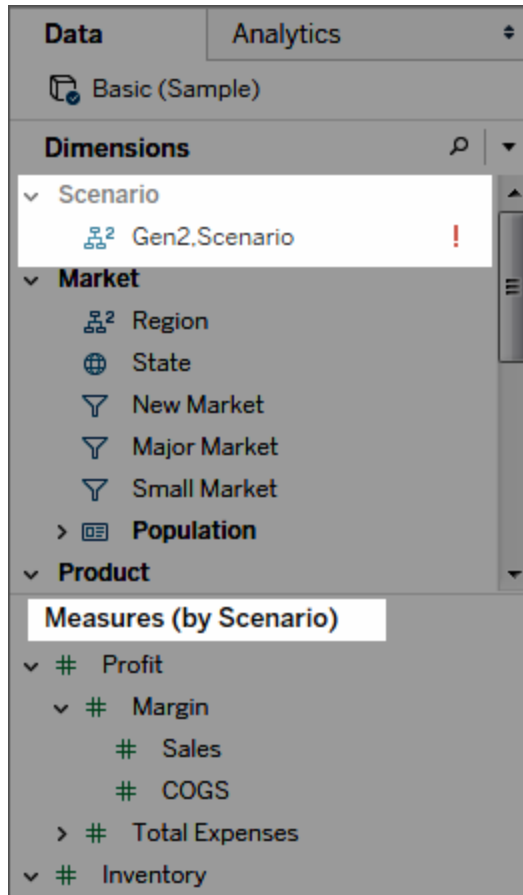

2. Drag a measure to the view.
3. Open the field menu for the measure in the view and select the member of the utility dimension you want to anchor the measure to.

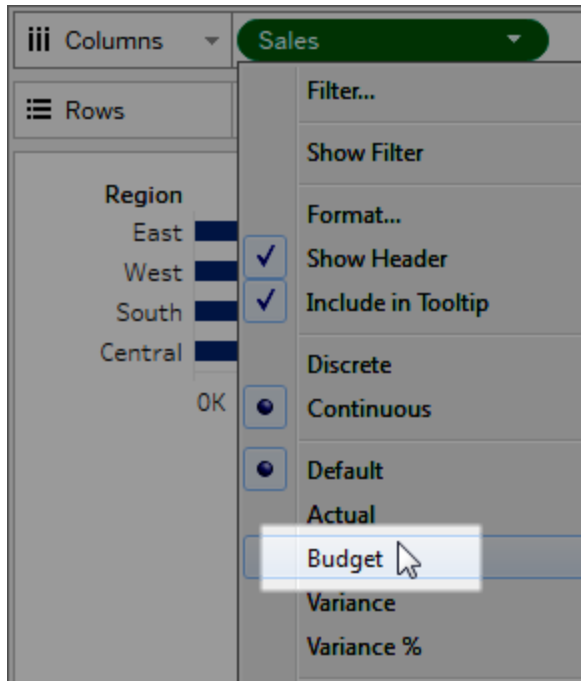

To remove a utility dimension:

Open the drop-down menu at the top of the Data pane and select **Clear utility dimension**.

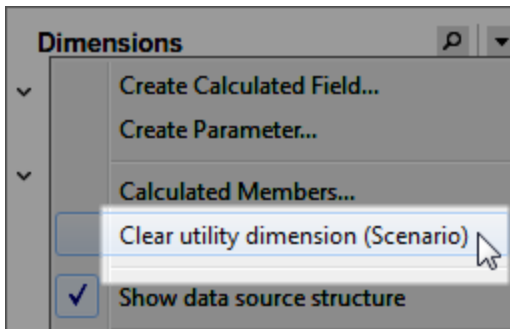

When you remove the utility dimension, measures that reference it in the view are no longer valid.

Build Charts and Analyze Data

Tableau Desktop is a kind of laboratory in which you can discover the meaning that lies hidden in your data.

In this section you can discover the various features at your disposal as you build views, and learn the basic skills you need to create elegant, insightful views, dashboards, and stories.

Automatically Build Views with Ask Data

Important changes for Ask Data and Metrics

Tableau's Ask Data and Metrics features were retired in Tableau Cloud in February 2024 and in Tableau Server version 2024.2. With advances in natural language technologies, we're developing an improved interface that will make it easier to ask questions of your data and stay on top of changes. For more information, see [How Tableau AI and Tableau Pulse are reimagining the data experience](#).

Ask Data lets you type a question in common language and instantly get a response right in Tableau. Answers come in the form of automatic data visualizations, with no need to manually drag-and-drop fields or understand the nuances of your data's structure.

Ask Data lets you ask sophisticated questions naturally, with support for key analytical concepts such as time series and spatial analysis, and an understanding of conversational phrases such as "last year" and "most popular."

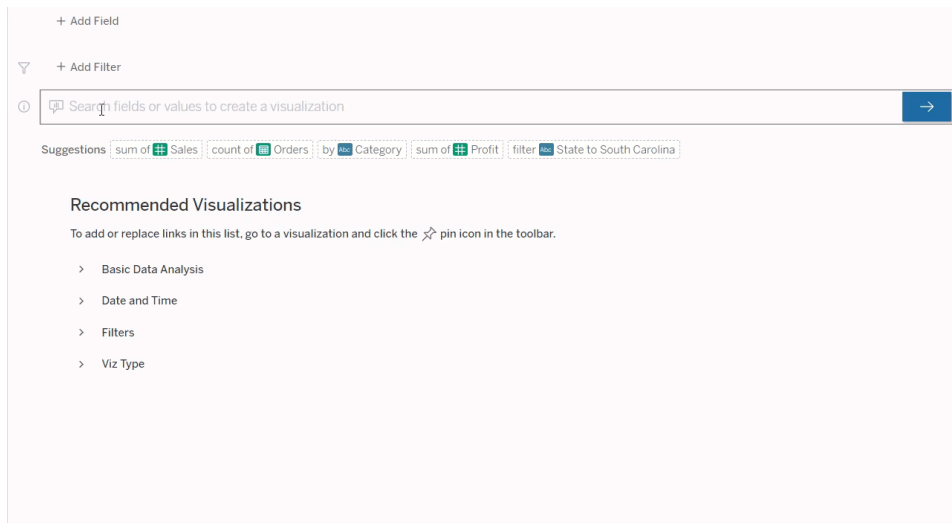

Navigating to Ask Data lenses

Before you can query a data source with Ask Data, a **Tableau author must first create a lens** that specifies the subset of data fields the lens uses.

In Tableau, here are all the places where you can access an Ask Data lens:

- On the All Lenses page at the top level of your Tableau Cloud or Tableau Server site.

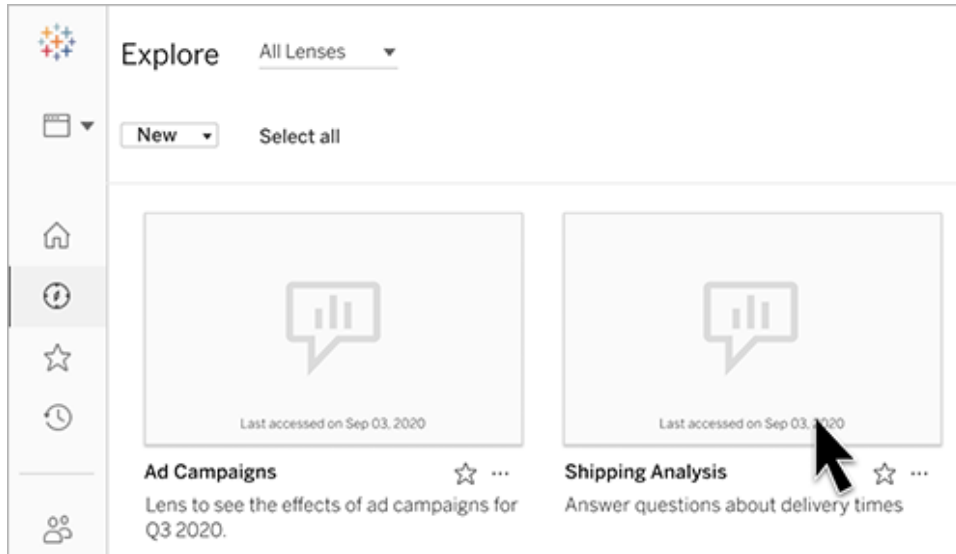

- On the Ask Data tab for a data source for which lenses have been created.

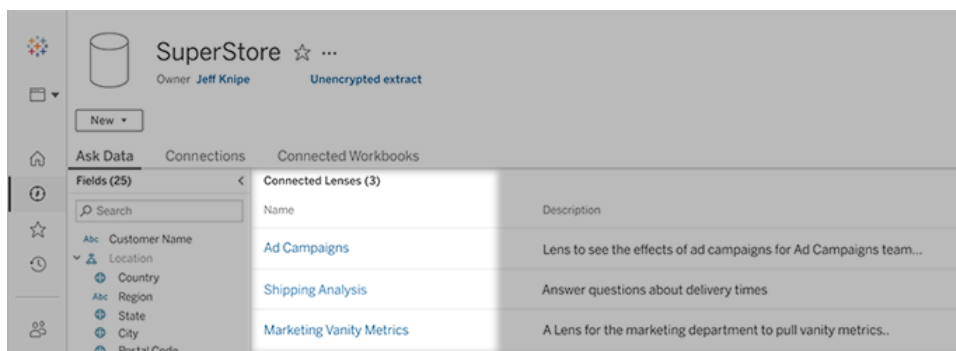

- In an Ask Data object on a dashboard.

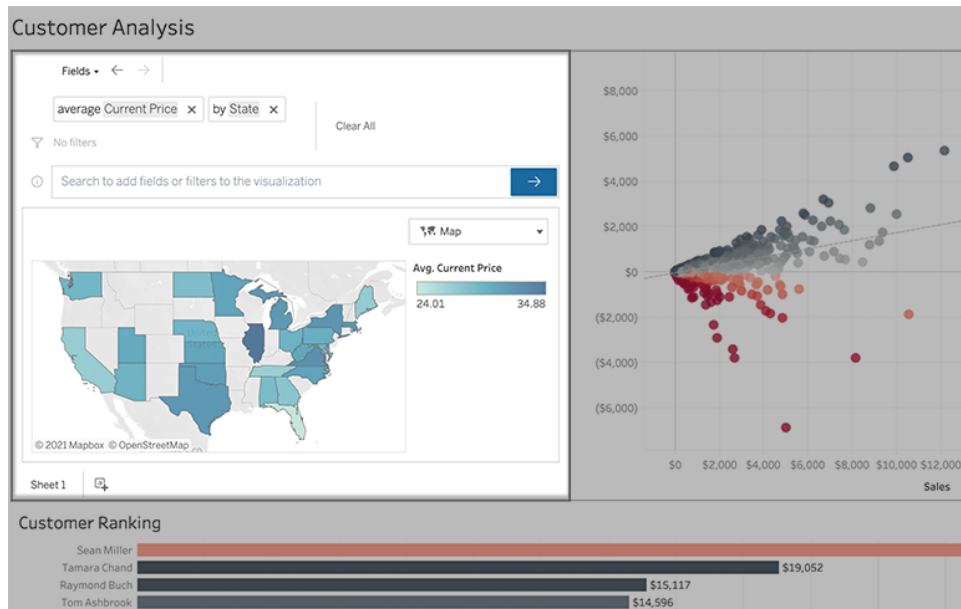

Ask Data from a lens page or dashboard object

Navigate to a lens and learn more about its data

1. Navigate to a lens via the All Lenses page for your Tableau site, the Ask Data tab for a data source, or an Ask Data object on a dashboard.
2. (Optional) Under **Recommended Visualizations**, click an entry to quickly see visualizations the lens author has created for your organization.

If the recommendations don't address your current data analysis needs, [build a query](#) to create your own question.

3. In the Data pane at left, briefly hover over each field to learn more about the data it contains.

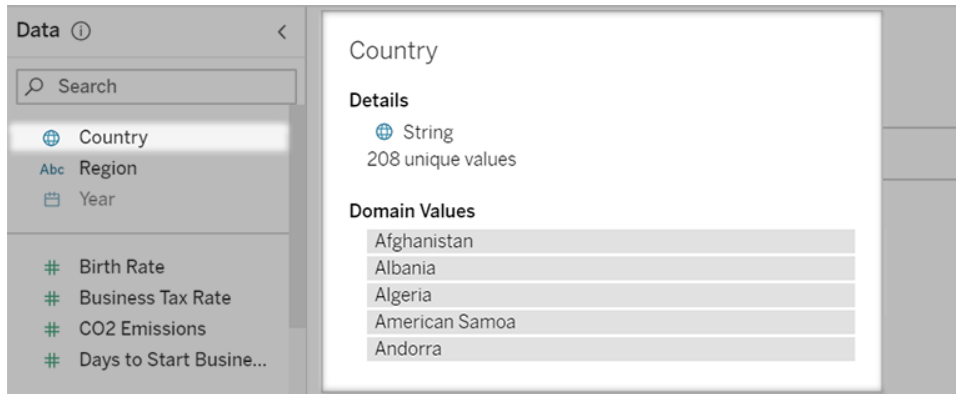

In a narrower dashboard object, the Data pane may be hidden, but you can see the same information by clicking the **Fields** drop-down menu.

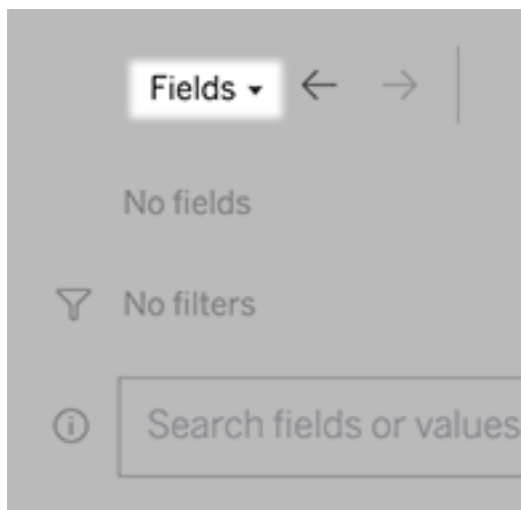

Build queries by entering text

1. Type in the box reading **Search fields or values to create a visualization**.

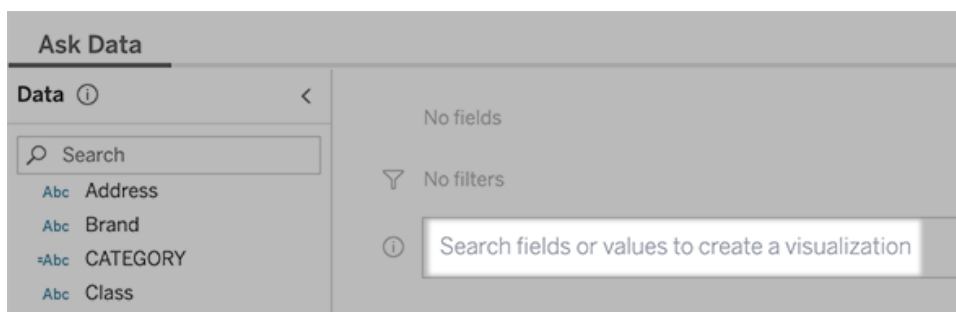

- As you type, Ask Data searches data fields, functions, and string values and displays results in a drop-down list. Click items in the list to add them to your current entry, shown above the search box. To automatically create a viz using the current entry, press **Enter** at any time.

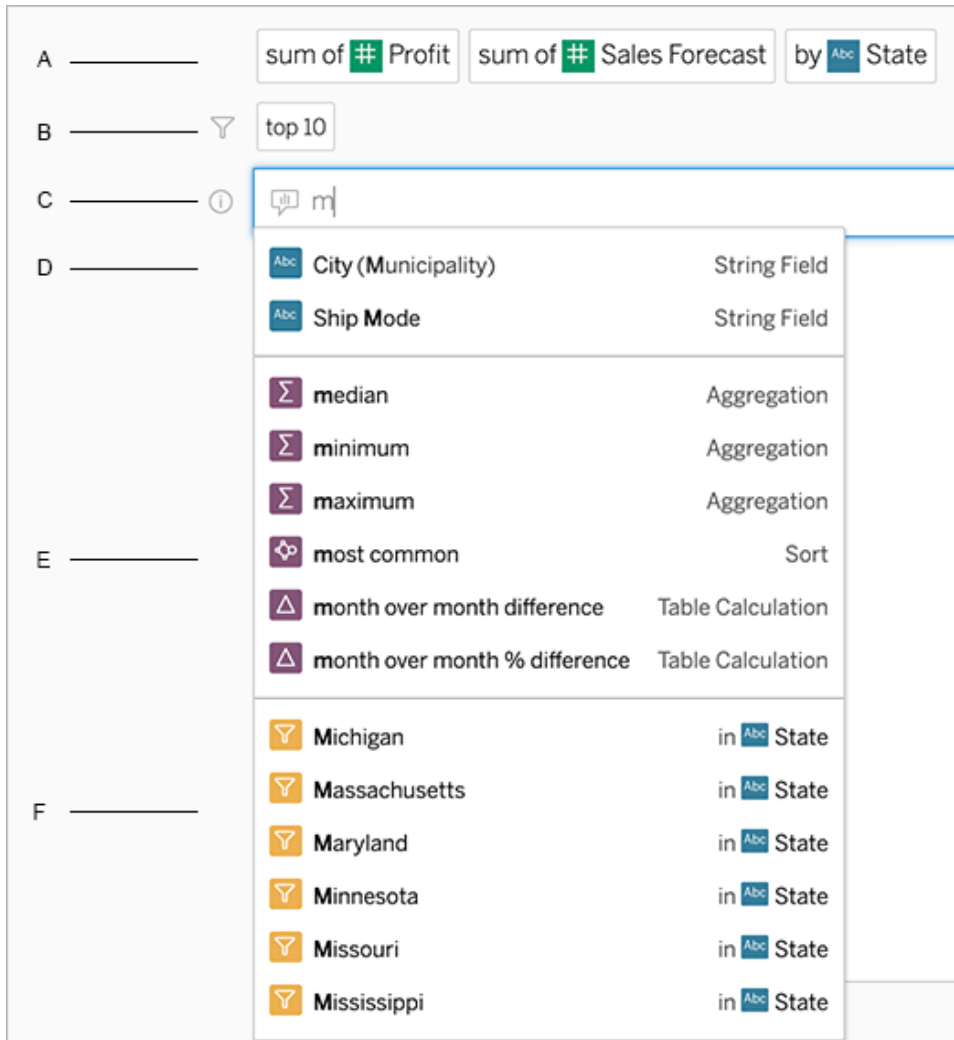

Modifying a query by searching for fields and analytical functions

A. Current entry B. Current filters C. Search box D. Returned fields E. Returned analytical functions F. Returned field values

Build queries by adding suggested phrases

Tableau will suggest phrases based on the most common queries asked in your lens and by others in your organization. When you open your lens, you'll notice suggestions that will help you get quick answers to common questions.

You can add these suggestions to your query by clicking them. As you add phrases to your query, the suggestions dynamically update with more relevant phrases. The view automatically builds with each selection.

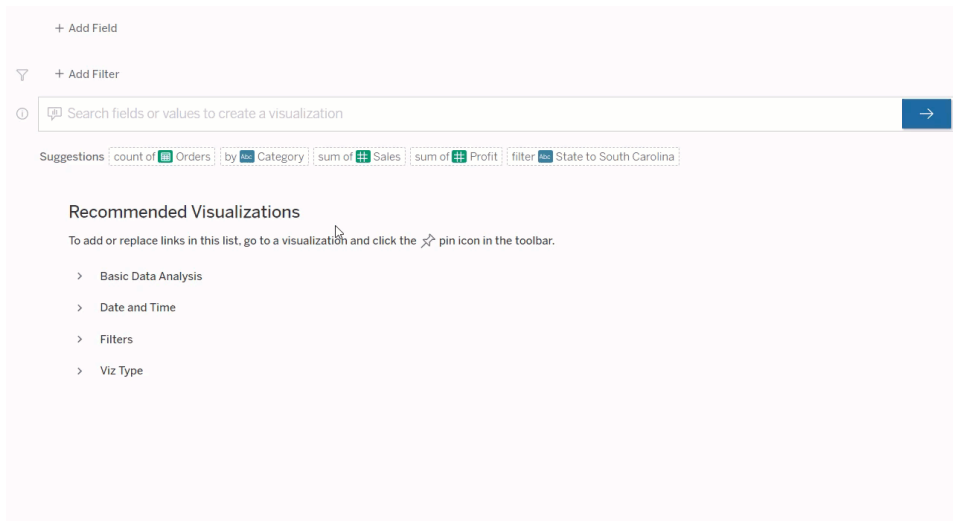

Build queries by adding fields and filters

1. Click **Add Field** or **Add Filter**.

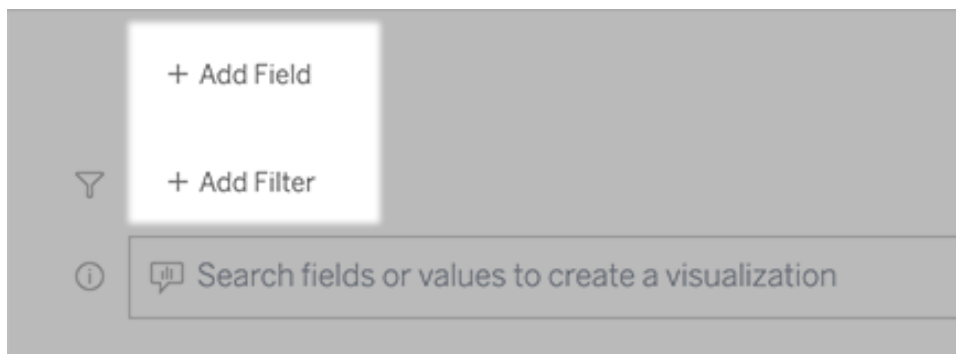

2. Click the desired field. (To narrow down a long list, first type in the **Search Fields** box.)

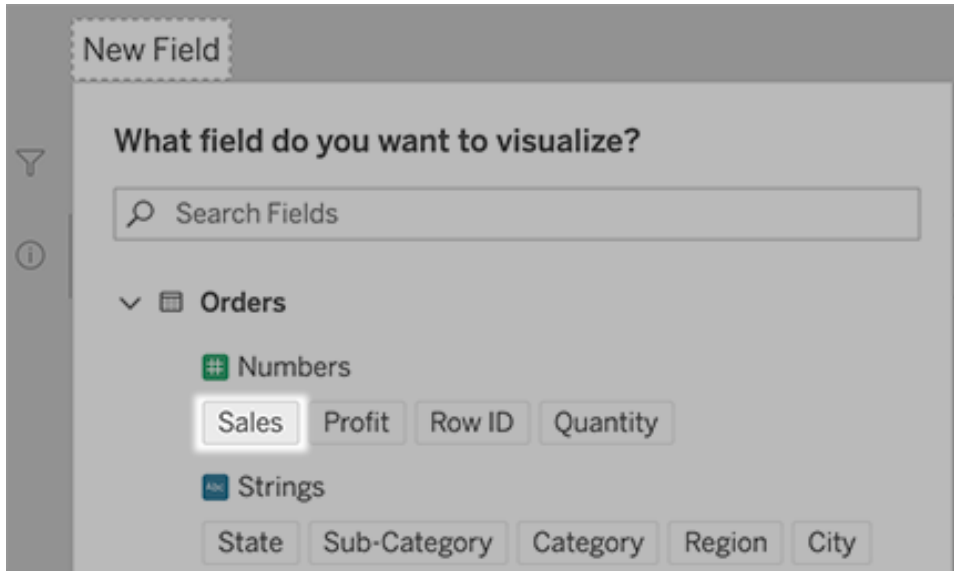

3. Set any sub-options, such as aggregation type for a numeric field, or grouping for string and date fields.
4. To add more fields or filters, click the plus sign.

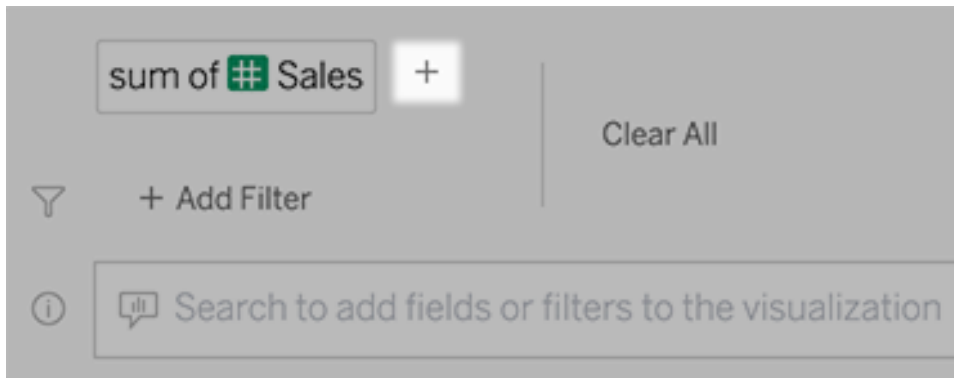

See how elements of your query are applied

To see how elements of your query are applied, hover over them in the text box or the interpretation above it. Words that aren't used are grayed out, helping you rephrase your query in a way that's clearer to Ask Data.

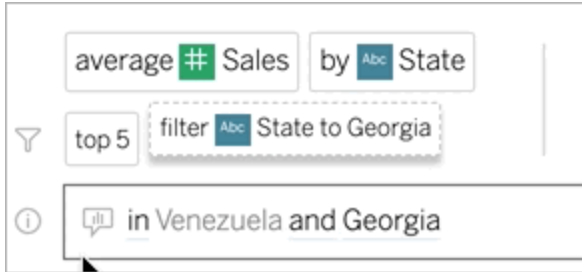

Rephrase your question

You can rephrase questions by clicking options, data fields, and filters in the user interface.

Change the viz type

If the default viz doesn't fully reveal your data, click the menu at upper right, and choose from these supported viz types:

- Bar Chart
- Gantt Bar
- Heat Map
- Histogram
- Line Chart
- Map
- Pie Chart
- Scatter
- Stacked Bar Chart
- Text Table
- Treemap

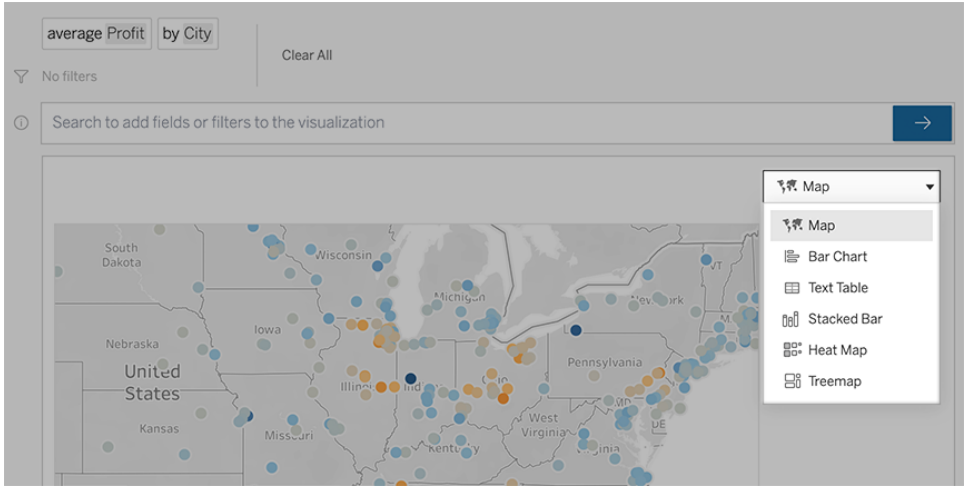

Note: To automatically create certain viz types, Ask Data sometimes adds fields such as "Number of Records" to your entries.

Change fields, filters, and displayed data

Ask Data gives you several ways to fine-tune how field values are displayed.

- To switch the fields used for the vertical and horizontal axes, click the Swap Axes button

 to the left of the viz selection menu:

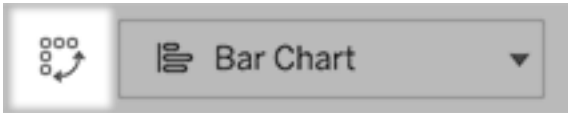

- To change a field, first click it in your query entry, and then click the field name below. (To change fields used in difference calculations, see [Compare differences over time on page 1016.](#))

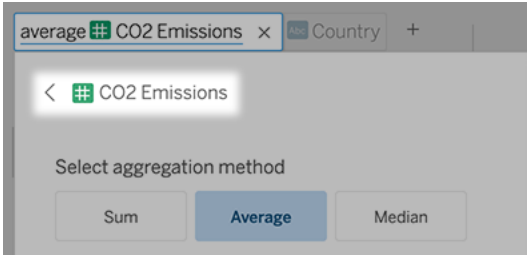

- To change a field's aggregation or grouping type (for example, from average to sum), click the field name in the text box, and then choose a different aggregation or grouping.

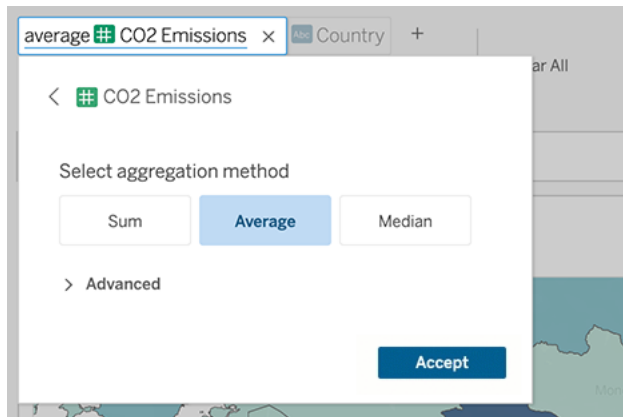

- For categorical filters, click values (for example, "exclude United States" in the example below) to change specific values or enter wildcard parameters.

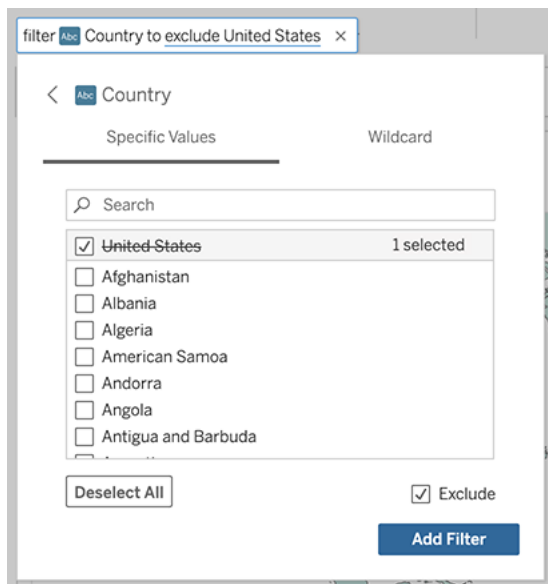

- To adjust a numeric range, click words such as "high" or "cheap."

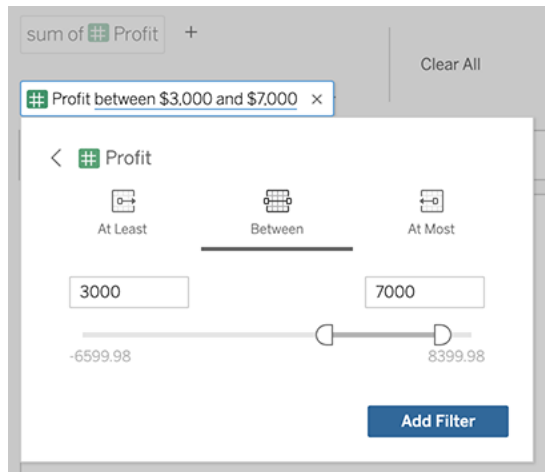

- To delete a field or filter, hover over it and click the **X**.

Adjust date filters

To adjust a date filter, click words such as "last" or "previous." Then click one of the following:

- **Specific Dates** to enter a specific time period or date value
- **Relative Dates** to show a date range relative to the present day
- **Range of Dates** to enter specific start and end points

Specific Dates offers some unique options in the **Date Detail** menu:

- **Time Period** options show a single continuous date range
- **Date Value** options show ranges that can repeat in multiple time periods. For example, to see combined sales performance for Q1 across multiple years, under Date Value, you would choose Quarters.

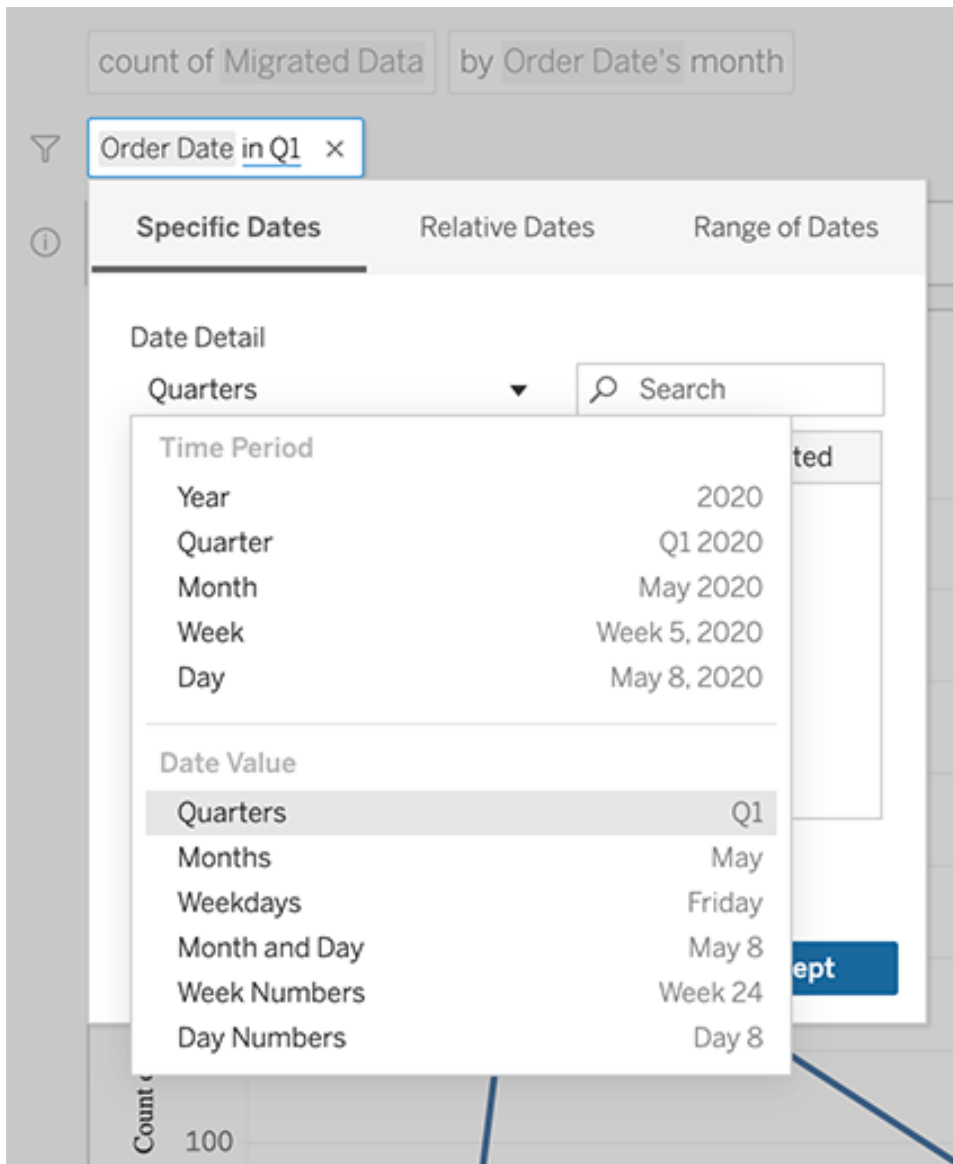

Compare differences over time

Ask Data lets you compare time periods with phrases such as "year over year" or "quarter over quarter." The results appear as difference or percent difference table calculations in workbooks you save from Ask Data.

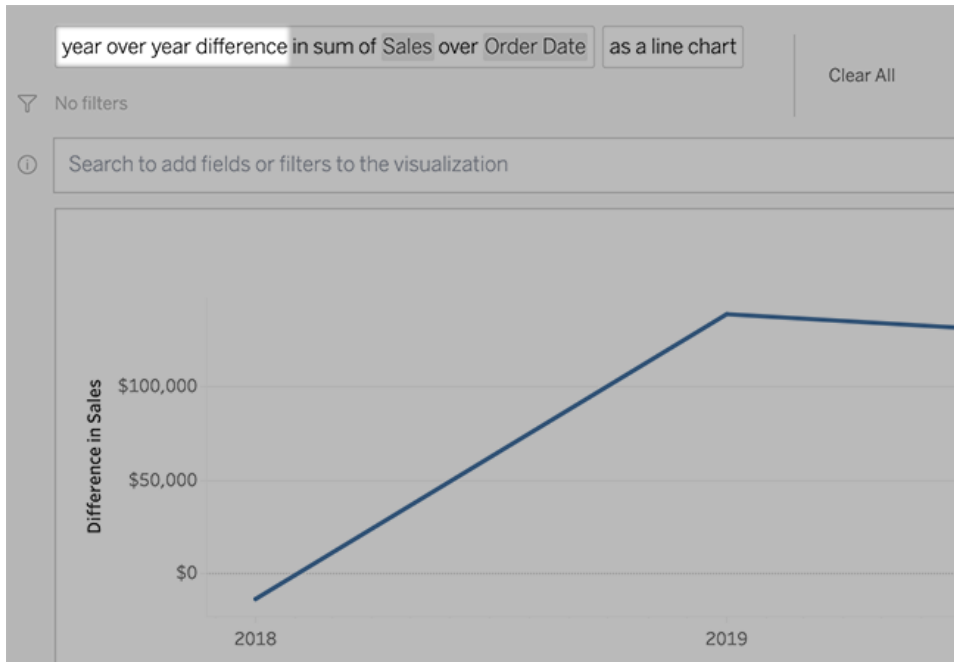

In the text box, click a difference calculation to choose other fields, aggregation methods, and time periods.

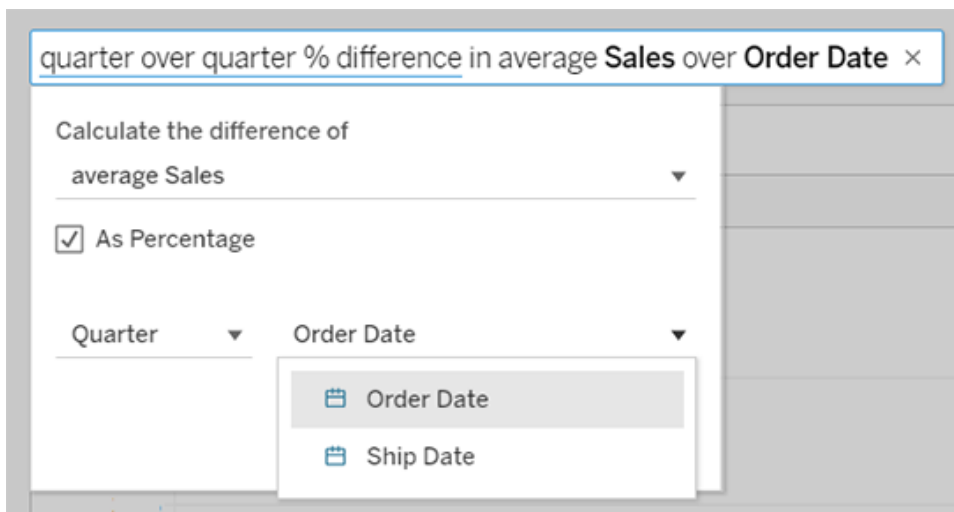

Apply simple calculations

Ask Data supports simple calculations between two measures, which you can apply using these symbols:

- + sums the measures

- produces the difference between them

* multiplies

/ divides

In workbooks you save from Ask Data, these calculations don't become calculated fields but instead ad hoc calculations on the Columns, Rows, or Marks shelves. For more information, see [Ad-Hoc Calculations](#) on page 2472.

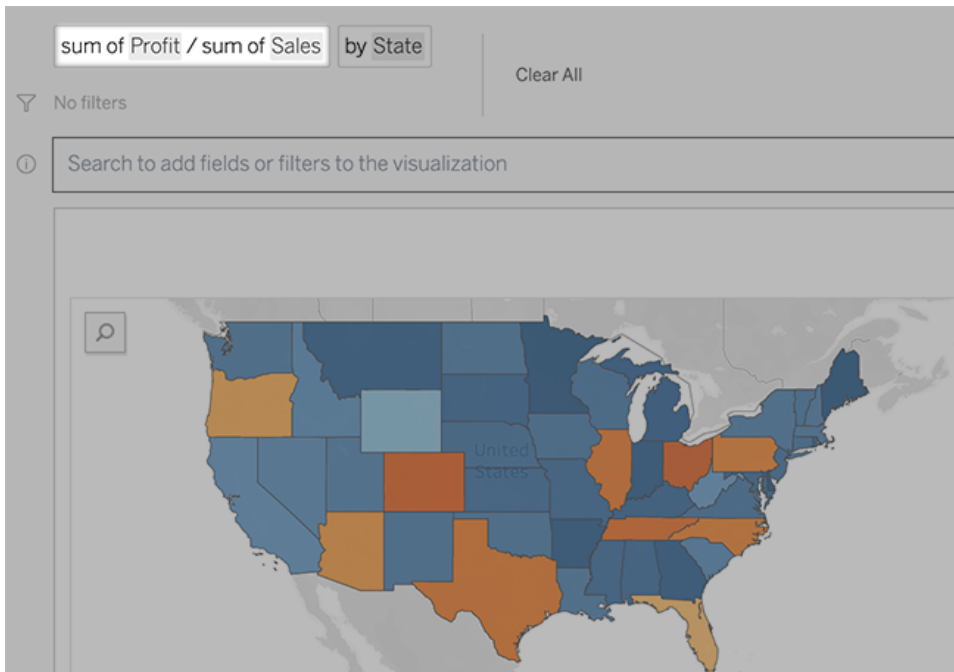

Add sheets with other vizzes

To quickly create multiple different vizzes from a lens, add sheets in Ask Data.

At the bottom of the web page, do any of the following:

- Click the **Add Sheet** icon to the right of named sheets.

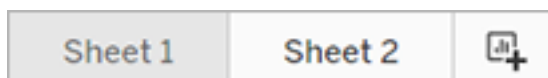

- Right-click a sheet name, and choose either **Duplicate** or **Delete**.

(To rename sheets from Ask Data, you need to save them in a new workbook.)

Share Ask Data vizzes via email, Slack, or a link

You can quickly share Ask Data vizzes with anyone who has access to a lens.

1. In the upper right corner of the browser, click the Share icon.



2. Do either of the following:
 - To share the viz via email or Slack, enter specific user names in the text box. (Email and Slack integration must previously be configured by your Tableau administrator.)
 - To copy a URL you can paste into custom emails and other messages, click **Copy Link**.

Tip: To find your Slack notifications, read [Receive Notifications, Search, and Share Using the Tableau App for Slack](#) on page 3428.

Send feedback to the lens owner

If you have questions about the structure of a lens or how best to use it with Ask Data, you can send feedback directly to the author. (This option is enabled by default, but lens authors may disable it.)

1. To the left of the query box for Ask Data, click the **Ask Data tips** icon.

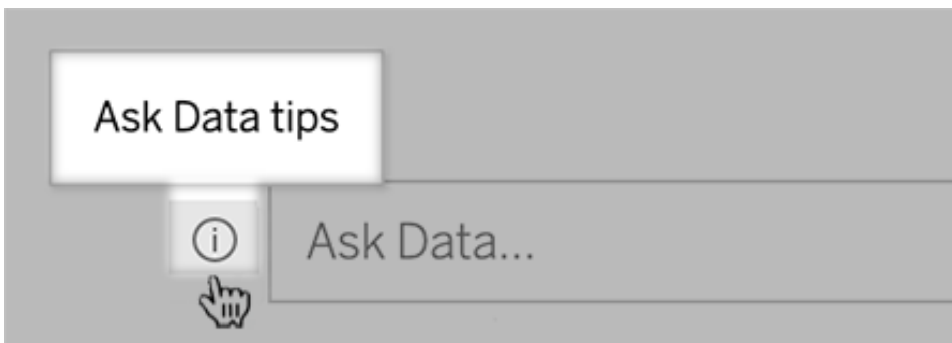

2. At the bottom of the tips dialog, click **Contact the Lens Author**.

Tips for successful queries

As you structure questions for Ask Data, apply these tips to get better results.

- **Use keywords** — For example, instead of "I want to see all the countries that these airports are in, try "by airport and country."
- **Use exact wording for field names and values** — For example, if your lens includes Airport Code, Airport Name, and Airport Region fields, specify those by name.
- **See a ranked list** — Ask Data maps terms such as "best" and "worst" to Top 1 and Bottom 1, respectively. If you want to see broader rankings, use "high" and "low" instead. For example, enter "houses with low sale prices."
- **Query table calculations** — In query expressions for table calculation fields, note that you can't filter, limit, or include "year over year difference."
- **Surround unusually long values with quotation marks** — To analyze long field values that contain line returns, tabs, or more than ten words, surround them with quotation marks. To improve performance, Ask Data doesn't index fields of that length, or anything beyond the first 200,000 unique field values.

Embed and Save Vizzes from Ask Data

Important changes for Ask Data and Metrics

Tableau's Ask Data and Metrics features were retired in Tableau Cloud in February 2024 and in Tableau Server version 2024.2. With advances in natural language technologies, we're developing an improved interface that will make it easier to ask questions of your data and stay on top of changes. For more information, see [How Tableau AI and Tableau Pulse are reimagining the data experience](#).

If you're a Tableau Creator, after you [create vizzes with Ask Data](#), you can embed and save them.

Embed an Ask Data lens in a web page

After you ask a question with an Ask Data lens, an **Embed Code** icon appears in the toolbar. Click it to copy code you can incorporate into any web page.

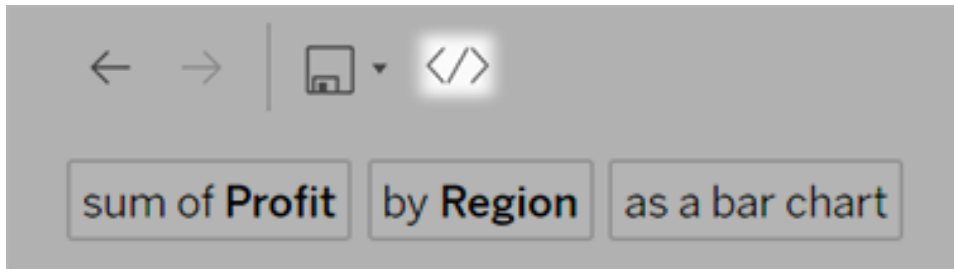

When web pages with a lens embedded in them load, the lens opens without a viz, waiting for users to ask a question.

To see a lens embedded in a web page, users must have a Tableau license and permission to connect to the lens. They can interact with Ask Data just as they would in the Tableau Cloud or Tableau Server interface, but they can't save resulting vizzes.

Save vizzes in a new workbook

Save vizzes from Ask Data to combine them with other Tableau views and dashboards in a workbook, where you can access Tableau's full range of data analysis and visualization tools.

Tip: To incorporate an interactive Ask Data experience into workbooks instead of a finished viz, see [Add an Ask Data lens to a dashboard on page 1028](#).

1. Above the viz, click the save icon , and choose **Save as** if you're saving the viz for the first time, or **Save** to overwrite a previously saved version.
2. If you chose **Save as**, select **Embed password for data source** if people who lack access will be viewing the viz.

To quickly navigate to the saved workbook, click the save icon again, and choose **Edit workbook**.

Supported Analytical Functions for Ask Data

Important changes for Ask Data and Metrics

Tableau's Ask Data and Metrics features were retired in Tableau Cloud in February 2024 and in Tableau Server version 2024.2. With advances in natural language technologies, we're developing an improved interface that will make it easier to ask questions of your data and stay

on top of changes. For more information, see [How Tableau AI and Tableau Pulse are reimagining the data experience](#).

Ask Data supports the core analytical functions of Tableau, including aggregations, grouping, sorting, and numeric and categorical filtering.

Note: Ask Data requires English analytical phrases but works great with non-English data. For example, you could ask “how many pedidos where fruta is manzanas” if you have Spanish data about orders of fruit for a grocery.

Aggregations

When using Ask Data, example aggregation phrases include “Sum of Sales”, “Average Profit”, or “Count of Customers”. You can also use common synonyms for these terms, such as “mean” for average or “cnt” for count.

- Sum
- Average
- Median
- Count
- Distinct count
- Minimum
- Maximum

Grouping

Grouping phrases include the word “by”, with examples like “by Region” and “by Sales”.

This expression is equivalent to placing a dimension or unaggregated measure on the Columns or Rows shelf while authoring a standard Tableau viz.

Sorting

Examples of sorting phrases include “sort Products in ascending order by sum of Profit” or “sort Customer Name in alphabetical order”. You can also use synonyms like “from smallest” for ascending order and “from largest” for descending.

- Ascending
- Descending

- Alphabetical

Numerical filters

Ask Data lets you filter data down to the numerical range you're interested in and then **fine-tune that range as needed**. Example phrasing includes “sum of Sales at least \$2,000” or “prices between \$10 and \$20”.

- At least
- At most
- Between

Numerical limits (top and bottom values)

You can quickly see the top and bottom values of a field with phrases like “top 10 cars sold last year” or “bottom Region by average Profit”.

- Top
- Bottom

Ask Data also supports common terms that people tend to use with their data, like “low”, “high”, “lowest”, and “highest”. With currency-based fields, you can use synonyms for these terms, like “cheap” for low and “expensive” for high (for example, “show me the cheapest houses in Ballard”).

Categorical filters for text values

Categorical filters let you narrow data down to the specific text values you're interested in.

Examples for each type of filter appear below:

- Is (for example, State is “Ohio”)
- Is not (State is not “Ohio”)
- Starts with (State starts with “O”)
- Ends with (State ends with “O”)
- Contains (State contains “O”)
- Does not contain (State does not contain “hi”)

Time filtering

Ask Data supports time filtering with phrases like “Sales in the last 10 years” or “Profit between 2012 and 2014”. You can also use synonyms of phrases below, like “starts in” instead of “starting

at”.

- In (followed by specific date)
- Previous
- Last
- Following
- Next
- Between
- Starting at
- Ending at

Tip: You can also [compare differences over time](#) with table calculations.

Create Lenses that Focus Ask Data for Specific Audiences

Important changes for Ask Data and Metrics

Tableau's Ask Data and Metrics features were retired in Tableau Cloud in February 2024 and in Tableau Server version 2024.2. With advances in natural language technologies, we're developing an improved interface that will make it easier to ask questions of your data and stay on top of changes. For more information, see [How Tableau AI and Tableau Pulse are reimagining the data experience](#).

Most people don't need information from an entire data source but instead want data visualizations relevant to their job function, like sales, marketing, or support. To optimize Ask Data for different audiences like these, Tableau authors create separate Ask Data *lenses*, which query a selected subset of fields. For the selected fields, authors can specify synonyms for field names and values, reflecting terms the lens audience uses in common language (for example, "SF" for "San Francisco"). Lens authors then customize the recommended visualizations that appear below the Ask Data query box, which provide answers to users with a single click.

Note: Ask Data lenses can be created only for data sources published separately to a Tableau site. Lenses can't be created for data sources embedded in workbooks or those with a virtual connection.

Create or configure a lens page on your Tableau site

On your Tableau site, each lens has a separate page where users can query Ask Data and authors can configure lens fields, synonyms, and suggested questions.

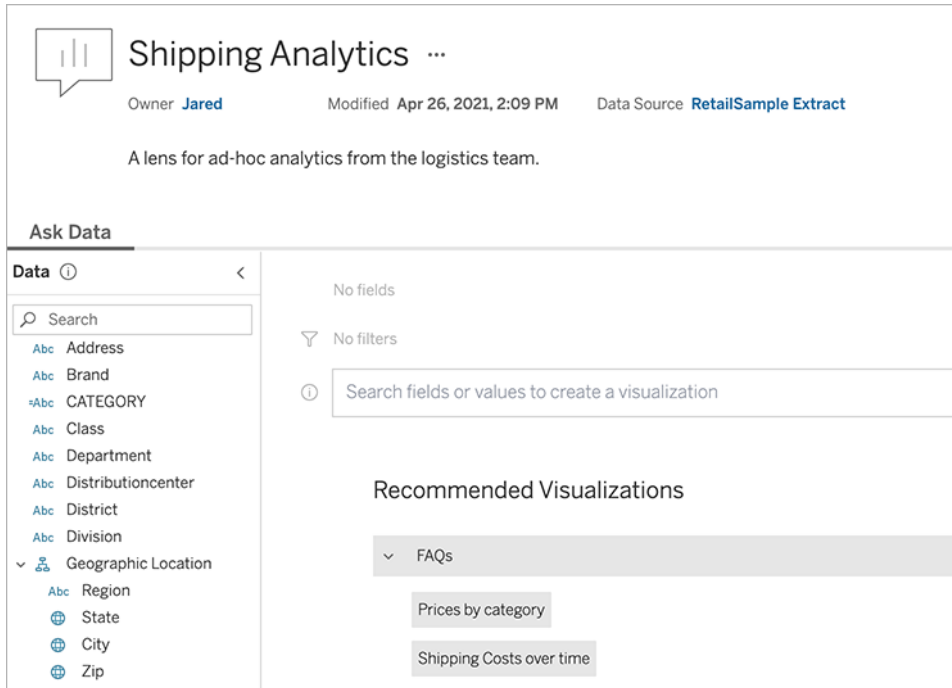

A lens page on a Tableau site

1. To create a lens page on your Tableau site, go to a data source page, and choose **New > Ask Data Lens**.

To configure an existing lens, go to the lens page on your site. (From an Ask Data object in a dashboard, you can click the pop-up menu in the upper corner and choose **Go to Lens Page**.)

2. If you're creating a new lens, enter a name, description, and project location, and then click **Publish Lens**.
3. At the top of the Fields pane at left, click the pencil icon. Then select the relevant fields for lens users, and click **Save**.

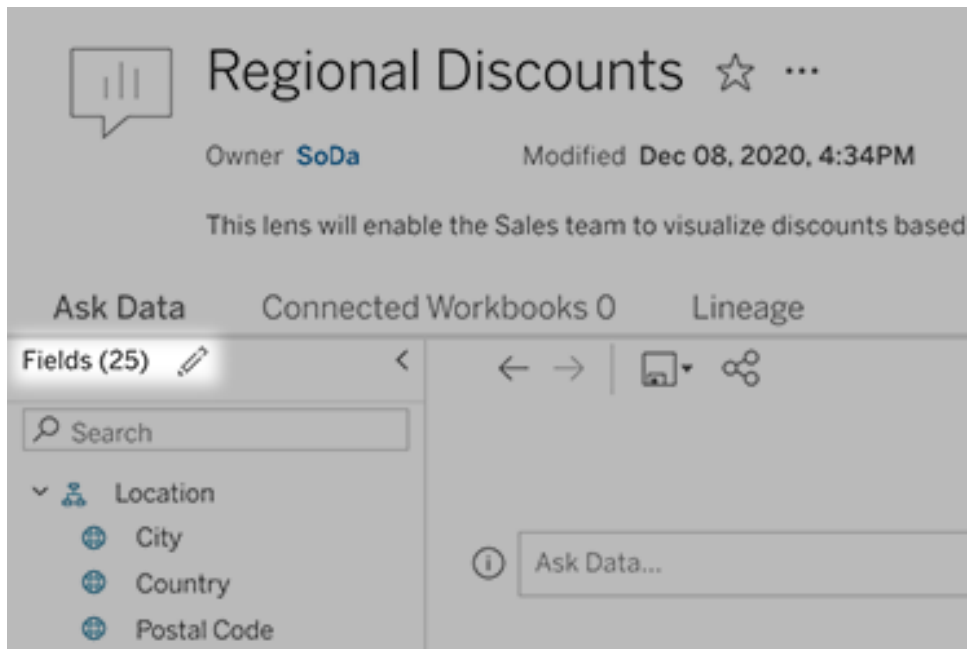

4. At left, hover over individual tables or fields, and click the pencil icon:



Then do any of the following:

- Provide a more representative name by clicking the pencil icon to the right.

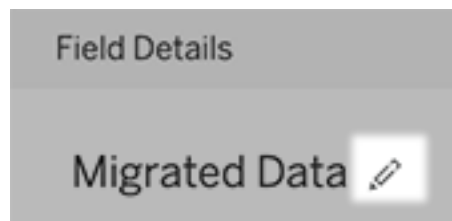

- Add common synonyms for field names and values that lens users may enter in their queries. For detailed instructions, see [Add Synonyms for Ask Data](#).
- Edit descriptions that appear when users hover over fields.

Change the list of recommended visualizations

To address common queries from lens users, you can customize the recommended visualizations that appear below the query box.

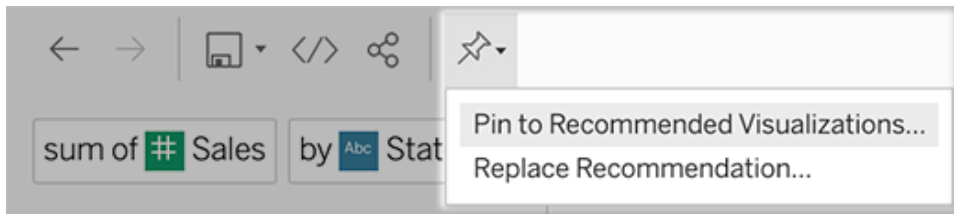

Add or replace a recommended visualization

1. Enter a query into the text box, and press Enter or Return.
2. After the visualization appears, from the pin icon in the toolbar, choose either **Pin to Recommended Visualizations** or **Replace Recommendation**.



3. For a new recommendation, enter a name, and choose the section in which you want it to appear. For a replacement recommendation, choose the existing one you want to overwrite.

Edit section titles and recommendation names, or delete recommendations

- To edit a section title, click the pencil icon  to the right of the title.
- To change the name of a recommendation, hover over it and click the pencil icon . To delete a recommendation, click the X.

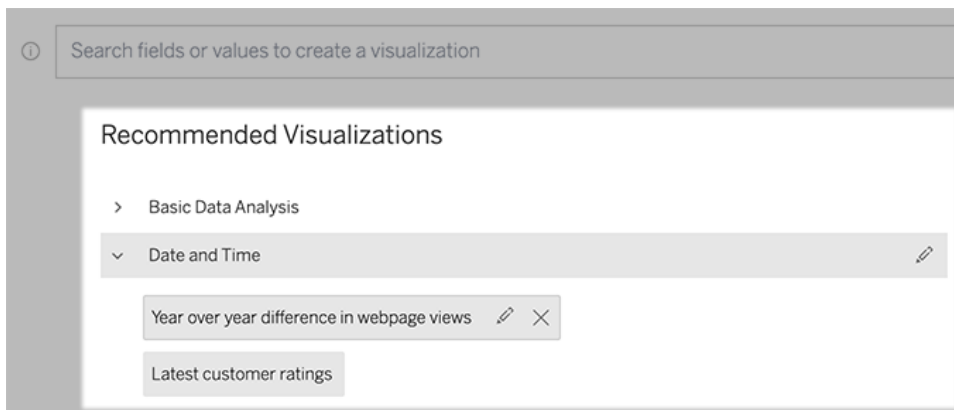

Add an Ask Data lens to a dashboard

On a dashboard, you can add an Ask Data object that lets users query a published data source via a lens on your Tableau site.

1. While editing a dashboard in Tableau Cloud or Tableau Server, drag the Ask Data object to the canvas.

Note: In Tableau Desktop, you can also drag an Ask Data object to the canvas for placement purposes. But to select a lens, you will need publish to Tableau Cloud or Tableau Server and edit the object there.

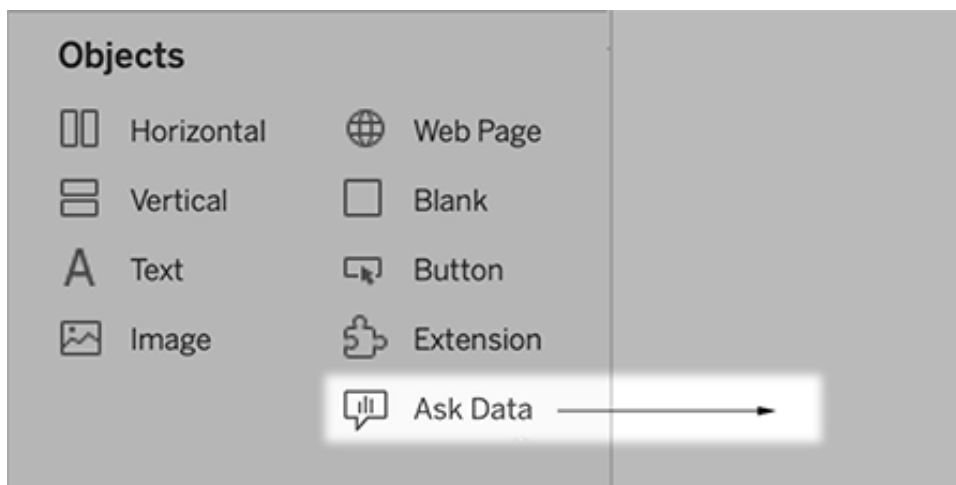

2. Select a published data source previously connected to the workbook.
 3. To use an existing lens, select it, and click **Use Lens**.
- Or, to create a new lens, do one of the following:
- If there are no lenses for the data source, click **Go to Data Source Page**.
 - If lenses already exist, click the data source name at the bottom of the dialog.
5. (New lenses only) Complete the steps in [Create or configure a lens page on your Tableau site on page 1025](#).
 6. Under **Toolbar Options for Lens Users**, select the buttons you want available to users.
 - **Add Visualization to Pins** lets users [add to the Recommended Visualizations list](#), which appears just below the query box.
 - **Publish as Workbook** lets users [save visualizations as workbook sheets](#) to their Tableau site.

- **Share Visualization** lets users [share via email, Slack, or a link](#).

In the lens, the publish (save icon), pin, and share options appear in the upper right corner:

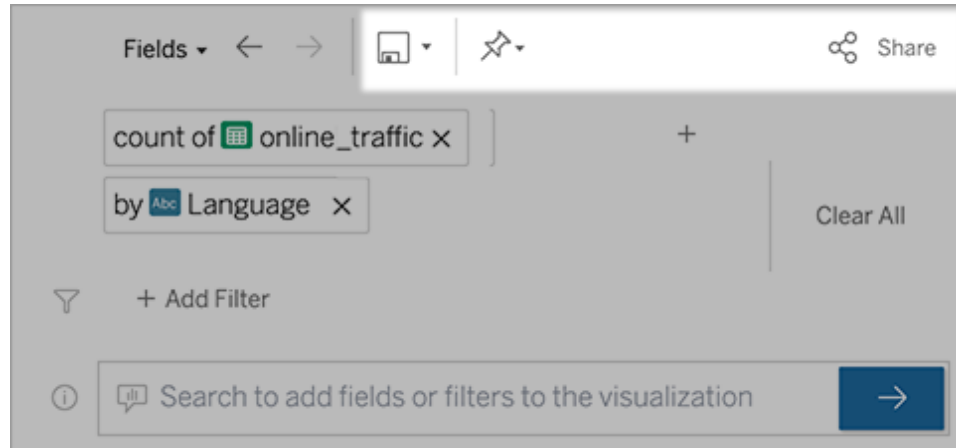

7. (New lenses only) After you finish creating the lens, return to the Lens object in your dashboard, and click **Refresh**. Then select the new lens, and click **Use Lens**.

Apply a different lens to an Ask Data dashboard object

1. From the pop-up menu at the top of the object, choose **Configure**.

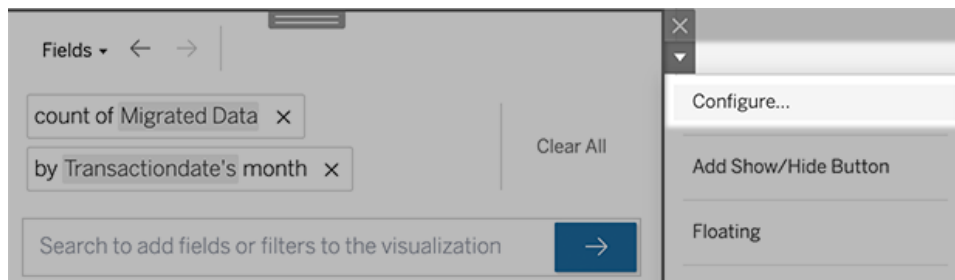

2. Go to [Add an Ask Data lens to a dashboard](#) on the previous page, and repeat steps 2 onward.

Change a lens name, description, or project location

1. Navigate to the lens page on Tableau Cloud or Tableau Server.
2. To the right of the lens name at the top of the page, click the three dots (...), and choose **Edit Workbook**.
3. Click **Edit Lens Details**.

See how people use Ask Data with a lens

For data source owners and lens authors, Ask Data provides a dashboard that reveals the most popular queries and fields, the number of visualization results that users clicked, and other helpful information. Filters let you narrow data down to specific users and time ranges. These stats help you further optimize a lens to increase the success of your users.

Note: If you use Tableau Server, you can access this data in the Tableau Server Repository to create custom dashboards.

1. In Tableau Server or Tableau Cloud, navigate to a lens page.
2. To the left of the Ask Data text box, click the "Ask Data tips" icon.

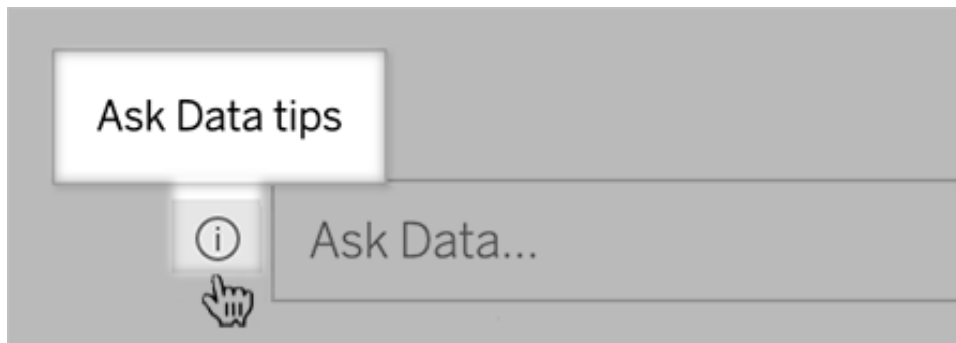

3. In the lower-left corner of the tips dialog, click **Usage Analytics**.

Let users email you questions about a lens

As a lens owner, you can allow users to email you with questions about data structure, expected results, and more. This option is on by default, but you can turn it off using the steps below.

1. In Tableau Server or Tableau Cloud, navigate to a lens page.
2. To the left of the Ask Data text box, click the "i" shown above in [See how people use Ask Data with a lens above](#).
3. At the bottom of the tips dialog, click the eye icon next to "Contact the Lens Author" to

enable or disable feedback.

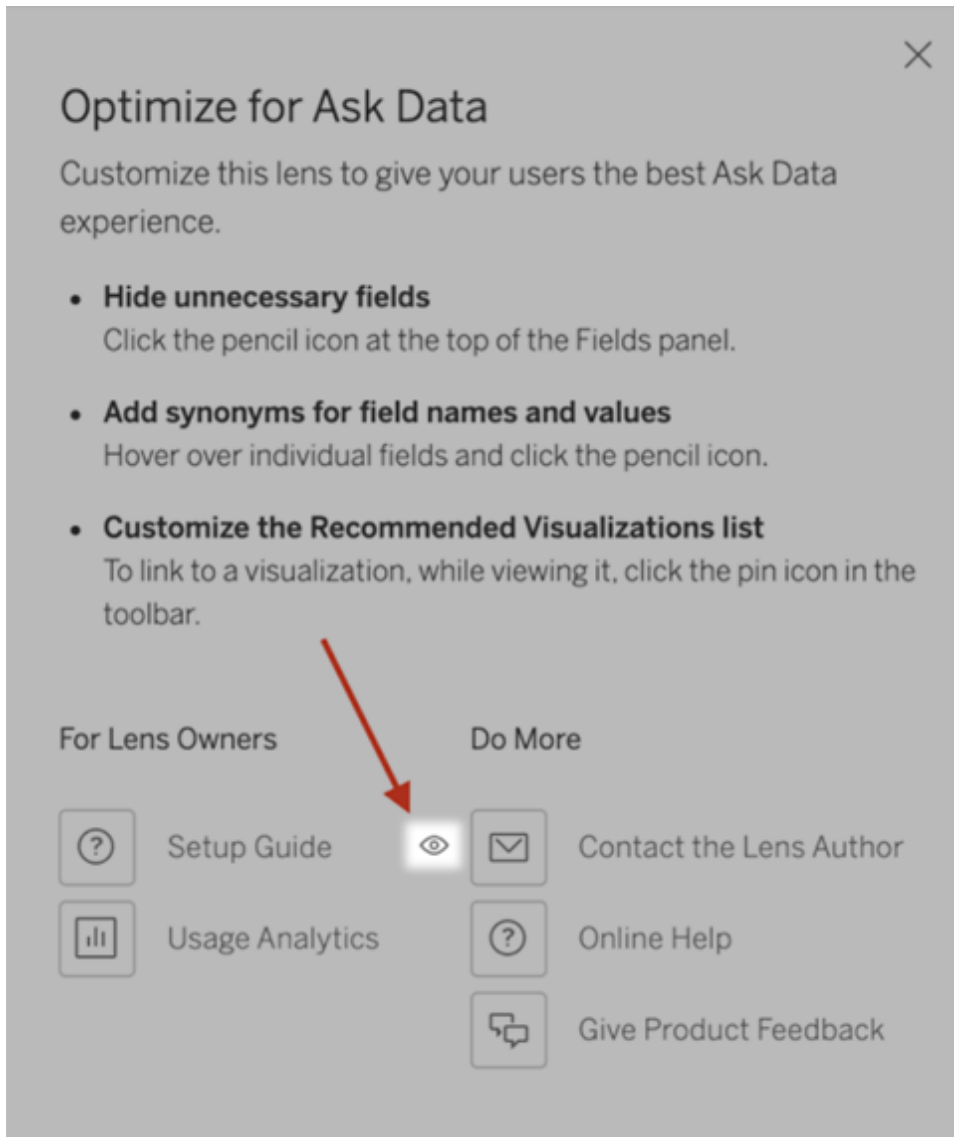

Permissions for publishing and viewing lenses

For Ask Data objects in dashboards, no change to permissions should be required: by default, existing workbook authors can create lenses, and existing dashboard audiences can view them. But for reference, here's a detailed outline of required lens permissions for both dashboards and direct access via a data source page.

To create and publish a lens, a user needs:

- The Creator or Explorer user role
- Lens Creation permission for the data source (inherited by default from the Connect permission)
- Write permission for the parent project to which the lens is published

To access and interact with a published lens, a user needs:

- The Viewer role or above
- Connect permission for the data source
- View permission for the lens

Note: By default, lens permissions like View reflect a project's permissions for workbooks. If Tableau administrators want to change default lens permissions, they can do so either individually for each project, or in bulk using the permissions API.

Optimize Data for Ask Data

Important changes for Ask Data and Metrics

Tableau's Ask Data and Metrics features were retired in Tableau Cloud in February 2024 and in Tableau Server version 2024.2. With advances in natural language technologies, we're developing an improved interface that will make it easier to ask questions of your data and stay on top of changes. For more information, see [How Tableau AI and Tableau Pulse are reimagining the data experience](#).

If you manage and publish data sources, here are some tips to help make users of Ask Data more successful. By spending a little extra time on this process, you'll open up data analysis to a wider range of people at your organization, helping them independently answer questions and gain deeper insights.

Optimize data in Ask Data

In the Data pane on the left of the Ask Data interface, data source owners can add synonyms for fields and exclude irrelevant values.

Changing settings at the data source or lens level

When changing settings in the Data pane for Ask Data, pay close attention to whether you're at the data source or lens level. (For more information, see [Create Lenses that Focus Ask Data for Specific Audiences](#).)

- At the data source level, you'll see the cylindrical data source icon in the upper left corner. Here, changes you make in the Data pane will apply by default to all subsequently created lenses.

Note: For extracts, two cylinders will appear.

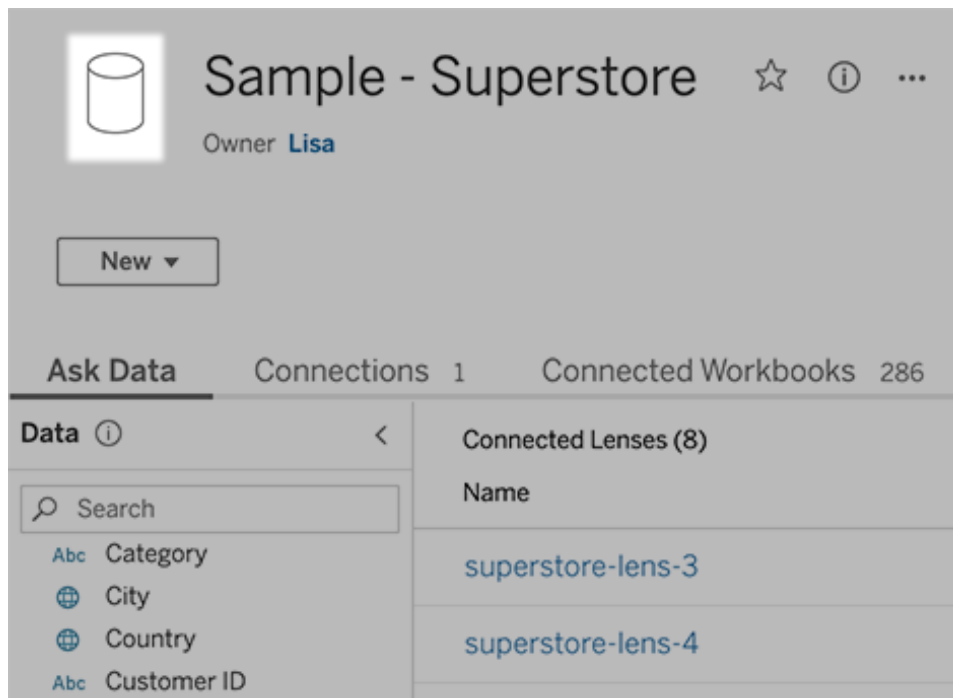

- For an individual lens, you'll see the quotation icon in the upper left corner. Here, changes you make in the Data pane will apply to this lens alone.

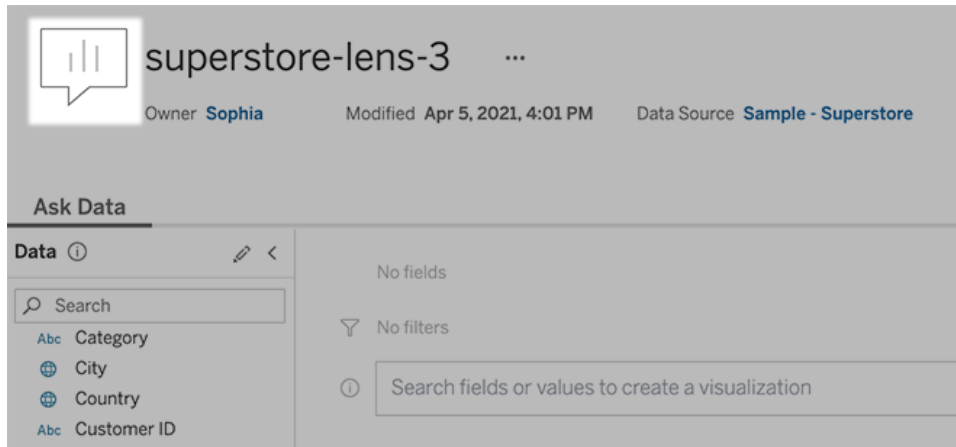

Add synonyms for field names and values

People may not use the same terminology found in your data source, so data source owners and Tableau administrators can [add synonyms for specific data field names and values](#). Synonyms you enter are available throughout your organization, making data analysis quicker and easier for everyone.

Exclude values of specific fields from search results

To improve the usability of search results in Ask Data, you can exclude the values of specific fields from indexing. Though Ask Data doesn't add non-indexed values to search results, the values still appear in visualization results when relevant. For example, if you don't index values from a "Product" field because they add unnecessary detail to search results, Ask Data can still display values such as "iPhone 12" in resulting data visualizations. And users can manually add non-indexed values to queries by surrounding them with quotation marks (for example, "Sales for Product containing "iPhone 12"").

Note: This field-level setting is ignored if [the value indexing setting for the data source](#) is set to Disabled. Field names and related synonyms are always indexed.

1. Go to the Ask Data tab for a data source or individual lens.
2. Hover over a data source field at left, and click the **Edit Field Details** icon (the pencil).



3. Deselect **Index field values**.

Either click the text box that appears to reindex the data source now, or let it reindex based on its regular indexing schedule.

Optimize data sources

To create the best experience for Ask Data users, optimize the original data source.

Note: Ask Data doesn't support multidimensional cube data sources, or non-relational data sources like Google Analytics, or data sources with a virtual connection.

Optimize indexing for Ask Data

Data source owners can change how often field values are indexed for Ask Data, optimizing system performance.

1. At the top of a data source page, click the Details icon:

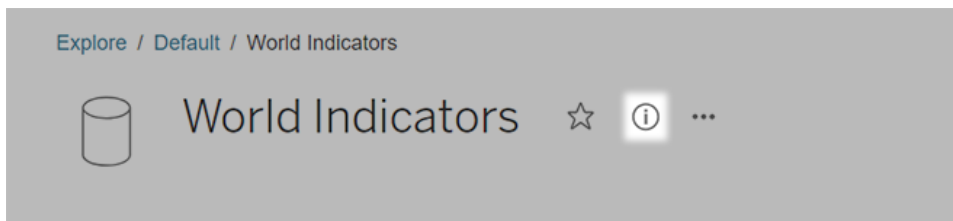

2. In the Ask Data section, click **Edit**.
3. Choose an indexing option for field values:
 - **Automatic** checks for changes every 24 hours and analyzes the data source if it is live, has had an extract refreshed, or has been republished. Choose this option for a

data source frequently used with Ask Data, so it will be ready before users query it.

- **Manual** analyzes the data source only when Tableau creators manually trigger indexing on the data source page. Choose this option if the data source changes frequently but users query it with Ask Data only occasionally.

To trigger manual indexing, go to the data source page, click the circled “i” in the Data pane at left, and then click **Reindex Data Source**.

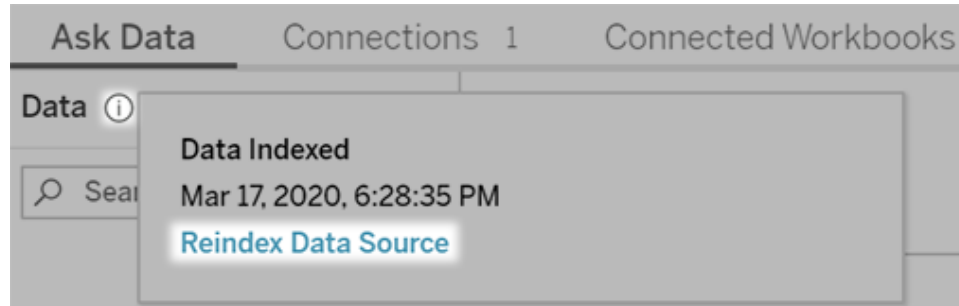

- **Disabled** analyzes only field names, not values.

4. Click **Save**

Use data extracts for faster performance

For improved performance and support for large data sets, use Ask Data with published extracts rather than live data sources. For more information, see [Create an extract](#).

Ensure that users can access the data source

To use Ask Data, users must have permission to connect to the individual data source. If a data source has row-level permissions, those permissions also apply to Ask Data, which won't recognize secure values or make related statistical recommendations.

Be aware of unsupported data source features

Ask Data supports all Tableau data source features except the following. If your data source contains these, Ask Data users won't be able to query related fields.

- Sets
- Combined fields
- Parameters

Anticipate user questions

Anticipate the kinds of questions your users will ask, and then optimize your data source for those questions using these techniques:

- Clean and shape data in [Tableau Prep](#) or a similar tool.
- [Join data](#) to include all fields users may have questions about in one table, improving performance.
- Add [calculated fields](#) that answer common user questions.
- Create [bins with appropriate sizes](#) for quantitative variables that users are likely to want to see as a histogram or another binned form.

Simplify the data

To make data easier to understand by both users and Ask Data, simplify the data source as much as possible during the data prep process.

1. Remove any unnecessary fields to improve performance.
2. Give each field a unique and meaningful name.
 - For example, if there are five field names that start with “Sales ...”, better distinguish them so Ask Data can properly interpret the term “sales”.
 - Rename “Number of records” to something more meaningful. For example, use “Number of earthquakes” in a data source where each record is an earthquake.
 - Avoid field names that are numbers, dates, or boolean (“true” or “false”) values.
 - Avoid names which resemble analytical expressions such as “Sales in 2015” or “Average Products Sold”.
3. Create meaningful [aliases for field values](#), reflecting terms people would use in conversation.

Set appropriate field defaults

To help Ask Data analyze data correctly, ensure that default field settings reflect the content of each field.

- [Set data types](#) for text, time, date, geographic, and other values.
- [Assign the proper data role](#): dimension or measure, continuous or discrete.
- For each measure, [assign appropriate default settings](#) in Tableau Desktop, such as color, sort order, number format (percentage, currency, etc.), and aggregation function. For example, SUM may be appropriate for “Sales”, but AVERAGE might be a better default for “Test Score”.

Tip: It's particularly helpful to set a default comment for each field, because these comments appear as informative descriptions when users hover over fields in Ask Data.

Create hierarchies for geographic and categorical fields

For time data, Tableau automatically creates hierarchies, which let users quickly drill up and down in vizzes (for example, from day to week to month). For geographic and categorical data, however, we recommend that you [create custom hierarchies](#) to help Ask Data produce visualizations that reflect the relationships between fields. Be aware that Ask Data won't show the hierarchies in the data pane.

Ask Data doesn't index hierarchy names, only names of fields within hierarchies. For example, if a geographic hierarchy named "Location" contains "Country" and "City" fields, users should enter "Country" and "City" in their questions for Ask Data.

Add Synonyms for Ask Data

Important changes for Ask Data and Metrics

Tableau's Ask Data and Metrics features were retired in Tableau Cloud in February 2024 and in Tableau Server version 2024.2. With advances in natural language technologies, we're developing an improved interface that will make it easier to ask questions of your data and stay on top of changes. For more information, see [How Tableau AI and Tableau Pulse are reimagining the data experience](#).

People may not use the same terminology found in your data source, so data source owners and Tableau administrators can add synonyms for specific data field names and values. Synonyms you enter are available throughout your organization, making data analysis quicker and easier for everyone.

Note: You can't use synonyms that reflect standard analytical terms like "by" or "max". Likewise, you can't create synonyms for these special types of data: sets, bins, clusters, hierarchies, combined fields, table calculations, or latitude and longitude.

Add field and value synonyms for a specific data source or lens

1. Go to [the Ask Data tab for a data source or individual lens](#).
2. Hover over a data source field at left, and click the **Edit Field Details** icon (the pencil).



3. To enter synonyms for the field name, use the **Synonyms** text box.
4. To enter synonyms for field values, click the arrow in the lower left corner.

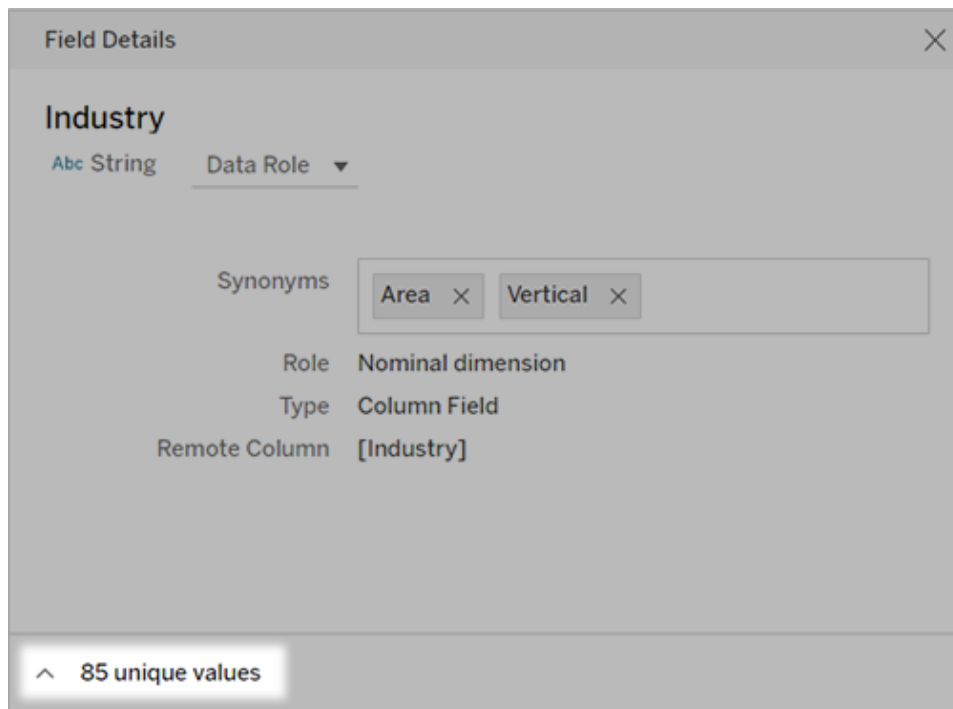

Then use the search box to find specific values, and enter synonyms for them at right.

✕

Field Details

Industry
Abc String Data Role ▼

▼ 85 unique values 🔍 Search

Value	Synonyms
Banking	Lenders ✕ Credit Unions ✕
Food & Beverages	
Investment Management	Financial Advisors ✕ Stock Analysts ✕
Insurance	
Pharmaceutical	RX ✕
Supermarkets	Grocers ✕

Tip: To help Ask Data better interpret users' questions, make synonyms for field values unique and short.

Add synonyms for multiple data sources

When a field or value has similar usage throughout your organization, use data roles to apply the same synonyms across multiple data sources. For example, data roles are a great choice if every subsidiary uses the same names for business departments, or if product lines have a consistent set of sub-products.

Using data roles for synonyms saves you a lot of time, because you can manage them centrally in Tableau Cloud or Tableau Server. From Ask Data, you can publish new data roles and apply existing ones created in Ask Data or [Tableau Prep](#).

Publish synonyms to a new data role

1. Follow the steps for [adding field name and value synonyms](#) for a specific data source.
2. From the **Data Role** menu, choose **Publish Data Role**.
3. Enter a name for the role, and then click **Publish**.

Apply synonyms from an existing data role

Note: When applying existing data roles, you can select only roles you have permission to access.

1. Go to [the Ask Data tab for a data source or individual lens](#).
2. Hover over a data field at left, and click the **Edit Field Details** icon (the pencil).



3. From the **Data Role** menu, choose **Apply Data Role**.
4. Enter search terms to narrow the list of roles. Then select a role from the list, and click **Apply**.

Synonyms from the role appear grayed out, but you can [edit them on the central page for the data role](#).

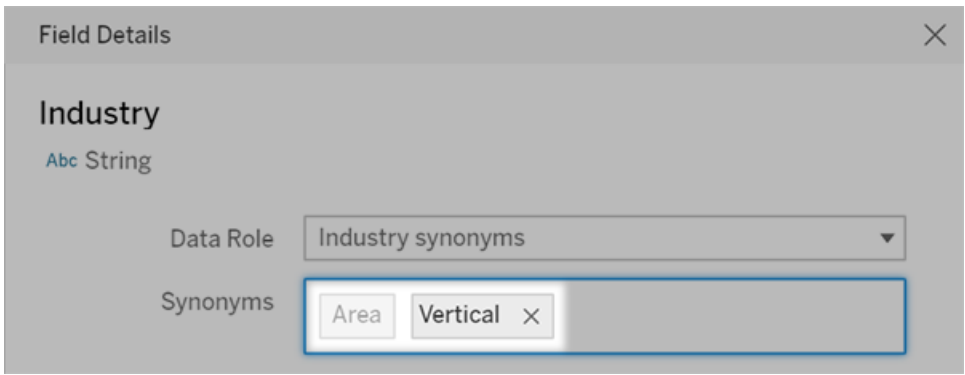

Grayed-out synonyms must be edited on the data role page. In this example, “Area” comes from a data role, while “Vertical” is specific to the current data source.

Change or remove an applied data role

Note: You cannot change built-in data roles for geographic fields like country, state, province, or city.

1. Go to [the Ask Data tab for a data source or individual lens](#).
2. Hover over a data source field at left, and click the **Edit Field Details** icon .
3. Click the name of the currently applied data role, and choose either **Apply a Different Data Role** or **Remove Data Role**.

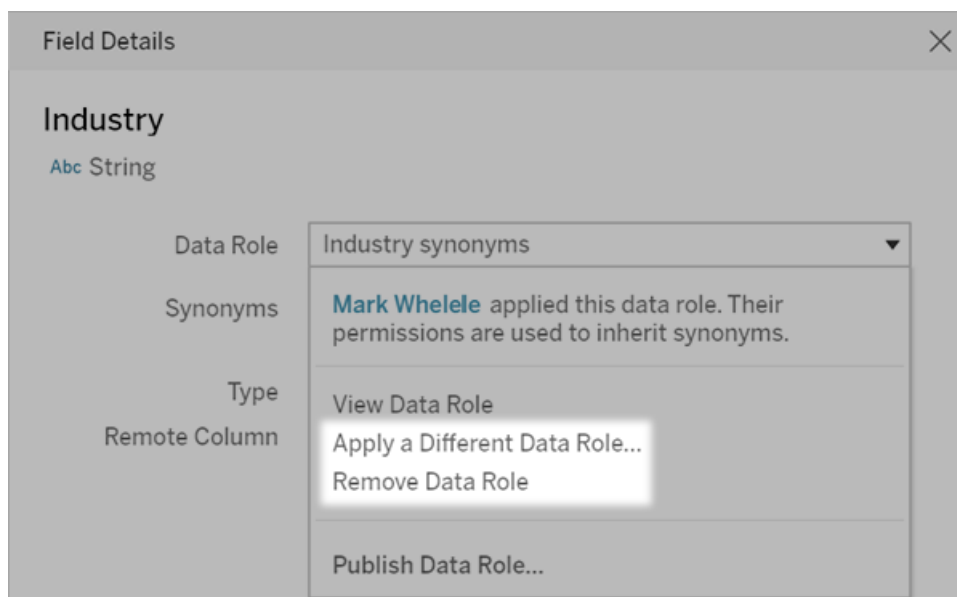

Edit field name or value synonyms for a data role

1. Go to [the Ask Data tab for a data source or individual lens](#).
2. Hover over a data source field at left, and click the **Edit Field Details** icon .
3. Click the name of the currently applied data role, and choose **View Data Role**.
4. On the central page for the data role, do the following:
 - To edit synonyms for the field name, click the **Synonyms** section at top. Then add or remove synonyms in the text box, and click **Save**.

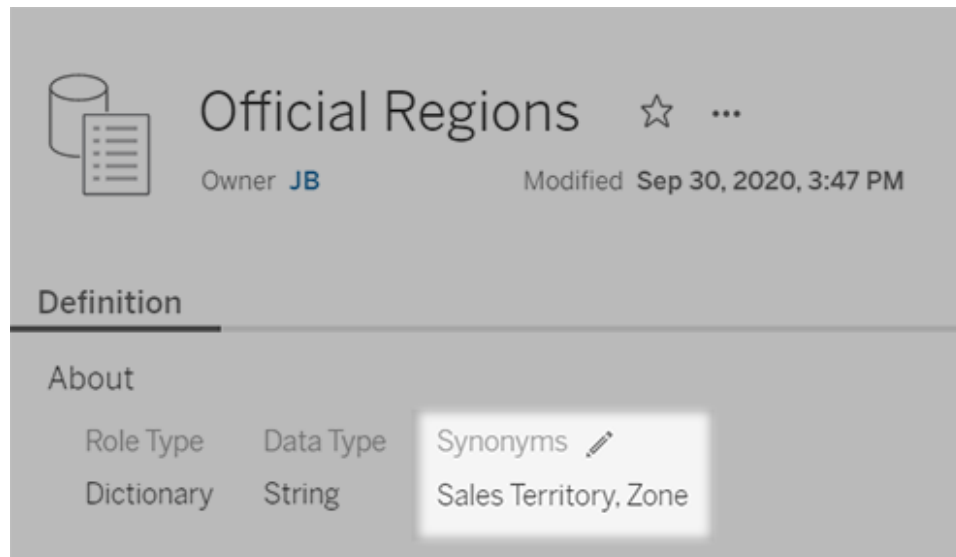

- To edit synonyms for field values, click the pencil icon next to **Values**.

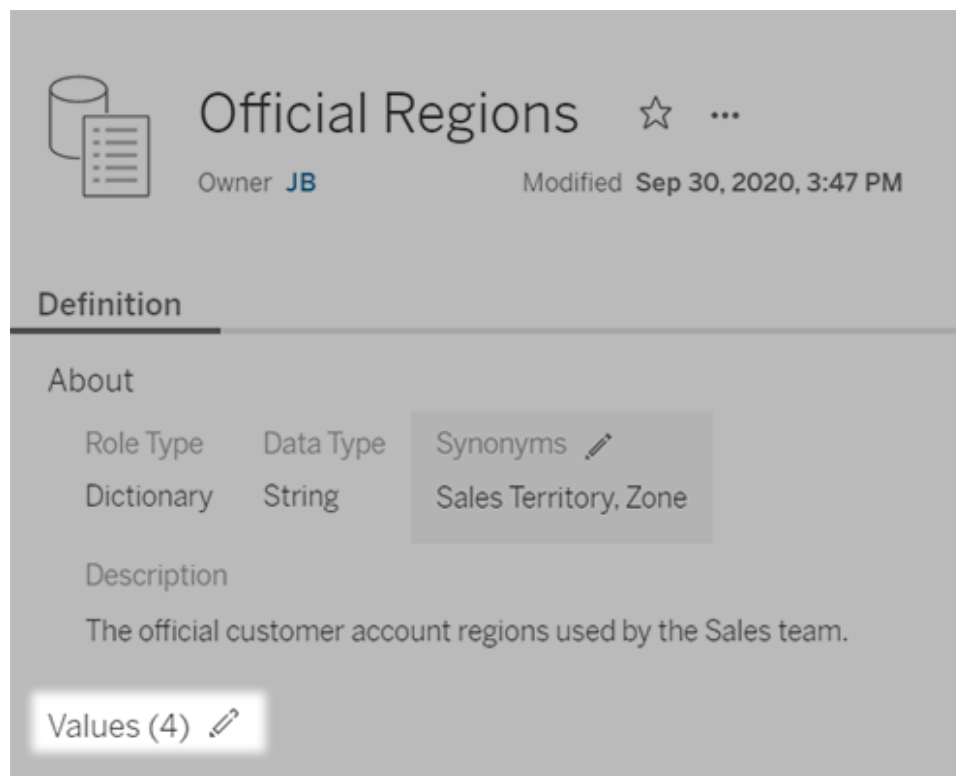

Then edit values in the **Synonyms** column, and click **Save**. For fields with long lists of values, use the search box at right to narrow things down.

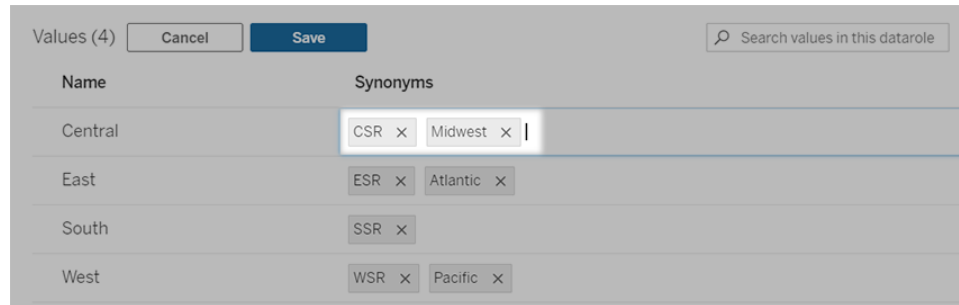

Disable or Enable Ask Data for a Site

Important changes for Ask Data and Metrics





Tableau's Ask Data and Metrics features were retired in Tableau Cloud in February 2024 and in Tableau Server version 2024.2. With advances in natural language technologies, we're developing an improved interface that will make it easier to ask questions of your data and stay on top of changes. For more information, see [How Tableau AI and Tableau Pulse are reimagining the data experience](#).

Ask Data is enabled for sites by default, but Tableau administrators may disable it.

1. Go to the **General** site settings.
2. (Tableau Server only) In the **Web Authoring** section, select **Let users edit workbooks in their browser**.
3. In the **Availability of Ask Data** section, choose from these options:
 - **Enabled** enables creation of Ask Data lenses for all published data sources.
 - **Disabled** hides Ask Data throughout the site, while preserving information about previously created lenses so they can be restored if Ask Data is re-enabled.

Add Web Images Dynamically to Worksheets

At Tableau, we know that images are a powerful tool when analyzing data. Imagine that you're looking at a viz of monthly shoe sales. The data is telling you that you sold more high heels than wedges, but you can't picture the difference in the two types of shoe. That's where Image Role comes in. You can dynamically add web images to your worksheets and use them in your headers to add visual detail.

Product Name	Product Image URL	
Flats		12,118
High Heels		15,865
Running Shoes		14,200
Wedges		8,665

Prepare your data source

Image Role can be assigned to discrete dimension fields that contain URLs that point to web images. To prepare your data, be sure that your image fields meet the requirements set by Tableau to be assigned an image role:

- Make sure your URLs navigate to .png, .jpeg, .jpg, .svg, .webp, .jfif, .ico, or .gif image files.
- Verify that each URL begins with http or https. If a transport protocol isn't included, Tableau assumes https.
- Optimize the number of images used in your data set. Usually, you can load up to 500 images per field.
- Ensure that each image file is smaller than 200 kb.

Note: If you're using Tableau 23.1 or earlier, your URLs must navigate to image files with .jpg, .jpeg, or .png file extensions.

In Tableau 23.2 and later, .gif files are supported, but .gif *animations* will only show on Tableau Cloud and Tableau Server with a client-side render. In Tableau Desktop and Tableau Server with a server-side render, the .gif file will show as a static image.

Depending on the complexity of your viz, Tableau may default to a server-side render, which limits the number of images to 100 per field. To learn more about complexity settings and server-side rendering, see [Configure Client-Side Rendering](#).

Example data set:

Product Name	Product Image URL	Product Sales
--------------	-------------------	---------------

Flats	https://img.example.com/flats.png	12,118
High Heels	https://img.example.com/highheels.png	15,865
Running Shoes	https://img.example.com/runningshoes.png	14,200
Wedges	https://img.example.com/wedges.png	8,665

Assign an image role to your URLs

After you've connected to your data source, you can assign an Image Role to your URLs from either the Data Source page or on the Data pane in a worksheet.

From the Data Source page:

1. Locate the column that has image URLs.
2. Right-click (control click on Mac) the icon on the top left of the column and select **Image Role > URL**.

The icon changes to an image icon, and your images are ready to use.

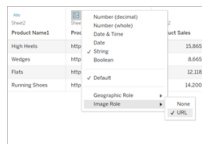

From a worksheet:

1. Open a new worksheet.
2. Locate a discrete dimension field that has image URLs.
3. Right-click (control click on Mac) the dimension field and select **Image Role > URL**.

The icon changes to an image icon, and your images are ready to use.

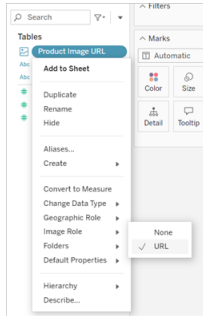

Add images to your visualizations

From your worksheet, drag the Image Role field onto the Rows or Columns shelf. You can now see image searches along with their associated data on your viz.

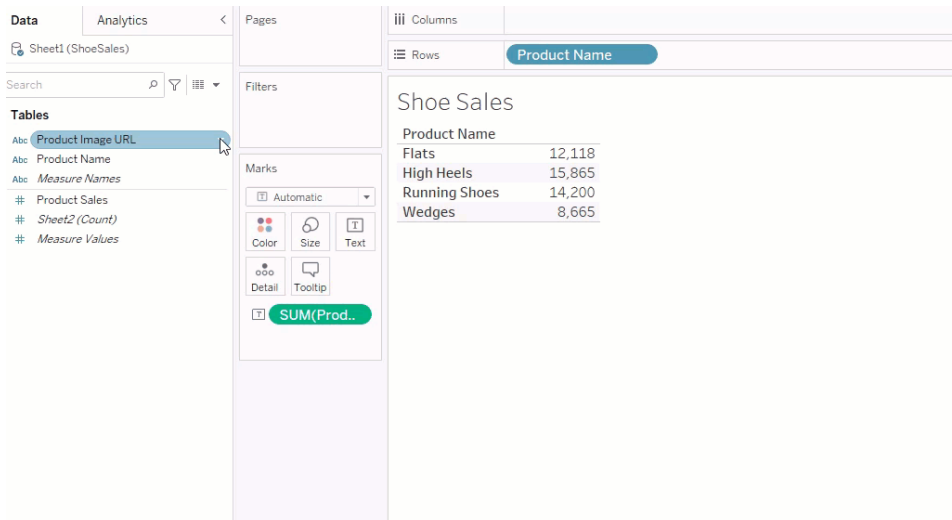

Shoe Sales	
Product Name	
Flats	12,118
High Heels	15,865
Running Shoes	14,200
Wedges	8,665

Share your visualizations

You can export your workbooks with images and share them. Be sure that the images used in your vizs are available to be viewed by everyone you share your vizs with. For example, if you're using images that are hosted on an internal server behind a firewall, be sure that everyone you share the viz with has sufficient permissions to access the images. In this example, users who view the viz while connected to the same server shouldn't have any issues seeing the

images. But users who export the viz to a pdf on a Tableau Cloud server may not be able to see the images.

If you export your workbook and your viewer attempts to open it in Tableau 2022.3 or earlier, your viewer won't be able to see the images.

Note: It's a best practice to always align an Image Role field with a text description to make the content accessible for screen readers and other accessibility software.

Troubleshoot image connections

Sometimes images won't display if you exceed the number of images allowed per field, have large image files on a complex viz, or are viewing the viz on a mobile device. This section helps you troubleshoot those errors.

None of the images are displaying in my viz

There are too many images in the viz

Depending on the complexity of your viz, you can typically load 500 images per field. If you have a complex viz, it may default to server-side rendering. With server-side rendering, you can load 100 images per field.

If you get an error message that there are too many images in the viz, filter out images and try again.

Tableau couldn't access the images

If you receive broken image icons instead of your images, first confirm that you have sufficient permissions to view the images (or if, for example, they're behind a firewall). Tableau must be able to access the images, and the images can't require a separate authentication to view them.

If you're sure that you have permission to view the images and they're within the size requirements, check that web images are enabled on your settings page.

In Tableau Desktop:

1. From your workbook, click **Help** in the toolbar.
2. Select **Settings and Performance > Set Dashboard Web View Security**.
3. Make sure that **Enable Web Page Objects and Web Images** is checked.

In Tableau Cloud:

1. From the home page, click **Settings**.
2. Under general, scroll down and locate **Web Page Objects and Web Images**.
3. Make sure that **Enable Web Page Objects and Web Images** is checked.

Some of the images aren't displaying in my viz

The image file is too large

Each image file must be smaller than 200 kb to render. Check your image file size and try again.

You're using an earlier version of Tableau

If you're using Tableau 23.1 or earlier, only .png, .jpeg, and .jpg image files are supported. Upgrade your version of Tableau or use a supported file type for the version of Tableau you're using.

The image URL must begin with http or https

Each image URL must begin with either http or https. Tableau doesn't currently support FTP/SMTP calls. Verify your URL format and try again.

The image file must be a URL

An Image Role can be assigned to only URLs that navigate to .png, .jpeg, or .jpg, .svg, .webp, .jiff, .ico, .bmp, or .gif image files. Verify your URL format and try again.

The image file type isn't supported

An Image Role can be assigned to only URLs that navigate to .png, .jpeg, or .jpg, .svg, .webp, .jif, .ico, .bmp, or .gif image files. Verify your URL format and try again.

If you're using Tableau 23.1 or earlier, only .png, .jpeg, and .jpg image files are supported. Upgrade your version of Tableau or use a supported file type for the version of Tableau you're using.

In Tableau 23.2 and later, .gif files are supported, but .gif *animations* will only show on Tableau Cloud and Tableau Server with a client-side render. In Tableau Desktop and Tableau Server with a server-side render, the .gif file will show as a static image.

The image file contains bad characters

An Image Role can't be assigned to URLs that have the following characters:

```
<> & \ ^ '
```

or the following character sequences:

```
.. \\. \r \n \t
```

Verify that your URL doesn't contain any of these characters or character sequences and try again.

The images aren't displaying outside of my worksheet

The images aren't displaying in Viz in Tooltip

Viz in Tooltip is processed with server-side rendering, which allows you to load up to 100 images per field. Verify that you have fewer than 100 images per field and try again.

For more about server and client-side rendering, see [Configure Client-Side Rendering](#).

For more about using Viz in Tooltip, see [Create Views in Tooltips \(Viz in Tooltip\)](#).

The images aren't displaying in View in Thumbnail

View Thumbnail is processed with server-side rendering, which allows you to load up to 100 images per field. Verify that you have fewer than 100 images per field and try again.

For more about server and client-side rendering, see [Configure Client-Side Rendering](#).

The images aren't displaying when I export my workbook

All exports and export-related features are processed with server-side rendering, which allows you to load up to 100 images per field. Verify that you have fewer than 100 images per field and try again.

The images aren't displaying on a mobile device

Mobile devices have a lower complexity threshold than computers, so the processing is completed through server-side rendering, which allows you to load up to 100 images per field. Verify that you have fewer than 100 images per field and try again.

You can change the complexity settings on your mobile device. For more info on complexity thresholds, see [Configure the complexity threshold for computers and mobile devices](#).

Organize and Customize Fields in the Data Pane

The Data pane has many features to help you organize and customize your fields.

Group and sort options are only available for relational data sources—not for cubes (multidimensional data sources).

Organize the Data Pane

Single table data sources default to grouping by folder. Multi-table data sources default to grouping fields by the table they came from.

Grouping by folder lets you manually decide how to organize fields.

Grouping by table puts dimensions and measures together under their table. This structure is useful when fields with similar names appear in multiple tables.

Regardless of the default, you can switch between grouping by data source table and grouping by folder.

Tip: You can change between grouping by folder or grouping by table at any time. All folder information is preserved.

Group by folder

Items in the Data pane like fields, parameters, and sets can be manually grouped into folders.

- Open the Data Pane menu (under the data sources) and select **Group by Folder**.

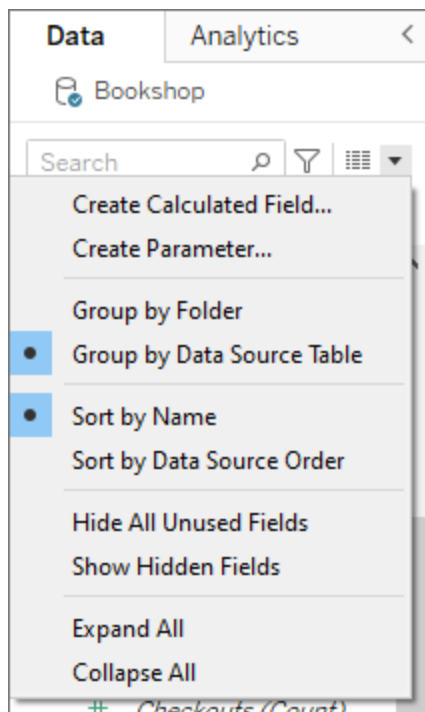

- Or right-click on a field in the Data pane and select **Group by > Folder**.

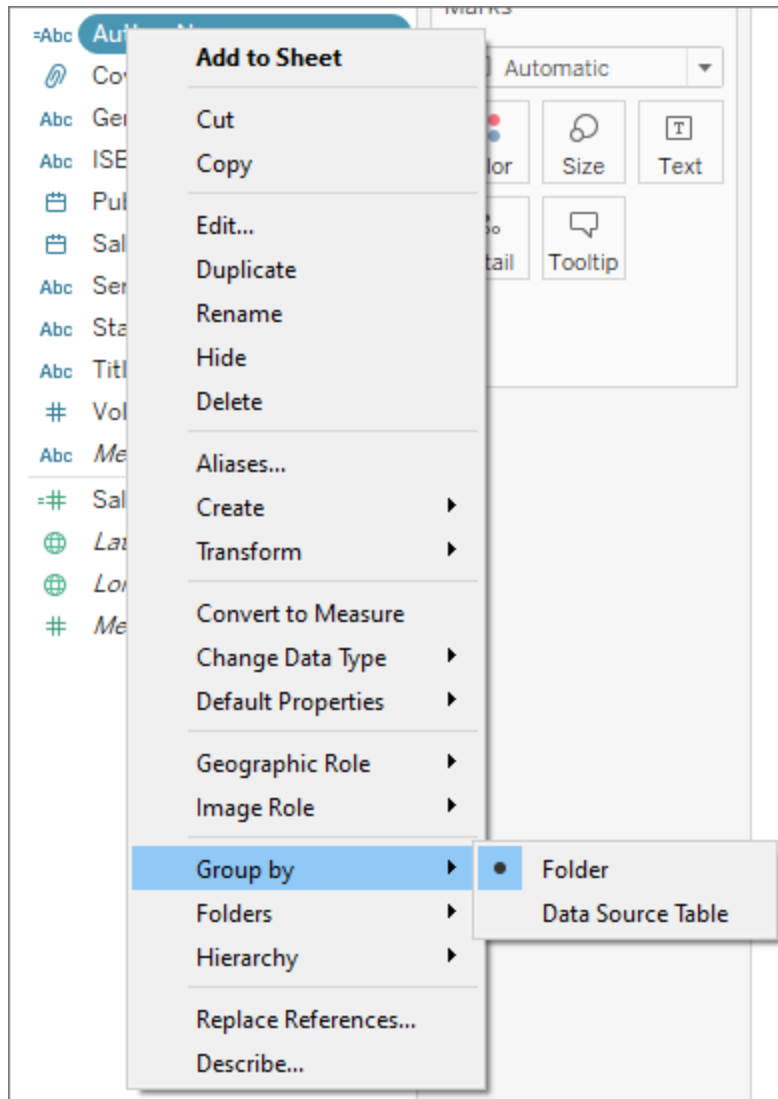

Note: Many of the context menus in the Data pane change depending on how you access them. If the menu doesn't have what you're looking for, try opening the menu from another place. It's accessible from right-clicking on a field, right-clicking on white space in the Data pane, or using the drop-down menu by the search bar.

Some options only appear or are grayed out based on other settings (such as Create folder).

Before folders are set up, all fields are listed together with dimensions at the top and measures at the bottom.

Create folders

After you set the Group by option to Folder, you must create your folders.

1. In the Data pane, select the fields you want to group together and right-click (or right-click an empty area in the Data pane).
2. Select **Folders > Create Folder**.
3. When prompted, name the new folder.

Folders are sorted alphabetically in the Data pane. You can start the folder name with a number to force them to appear in a specific order.

Add fields to folders

After you create the folder structure, it's time to put fields in the folders.

- Drag a field on top of the folder name. If the folder is expanded, you can drag the field into the general area of the folder.

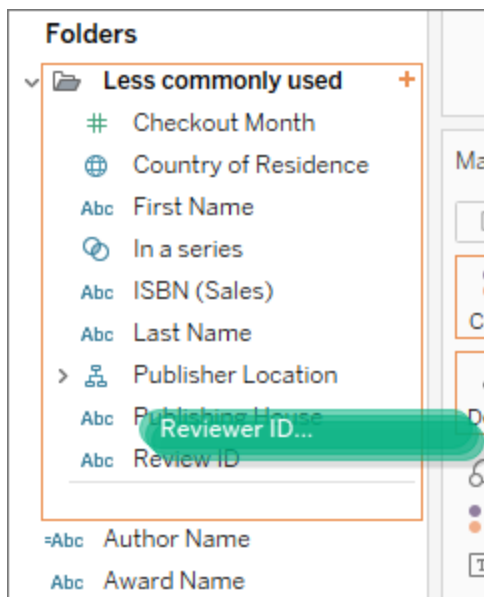

- Or you can right click on a field and select **Folder > Add to Folder >** then choose the

desired folder.

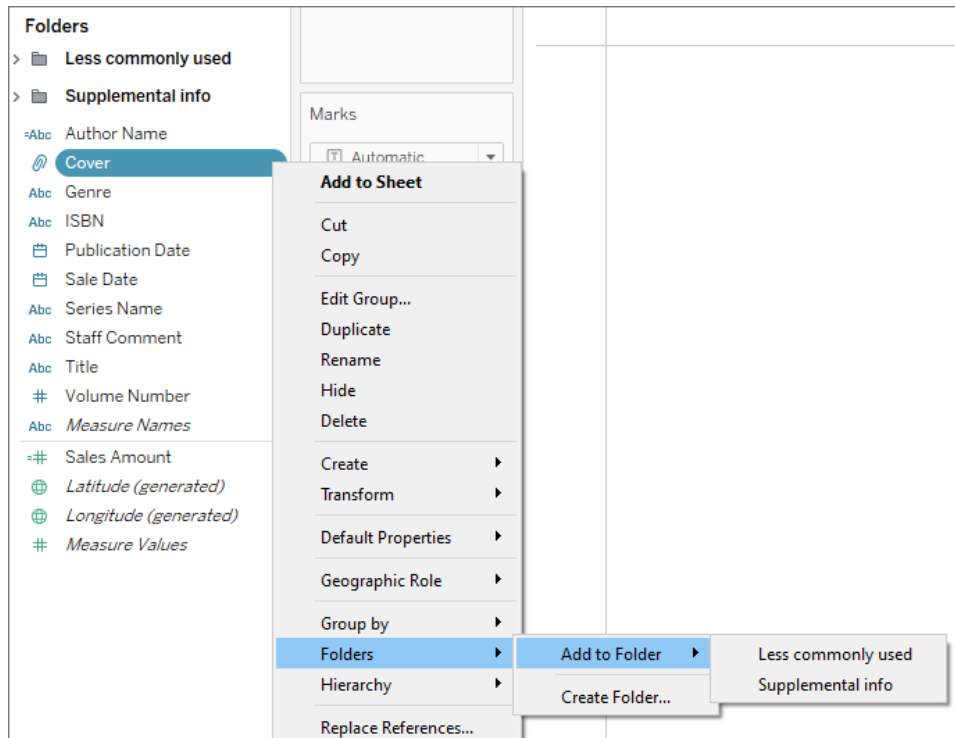

Fields can only appear in one folder, but you can duplicate (right-click > Duplicate) a field you want to have available in more than one folder.

Sort fields in the Data pane

Whether they're grouped by table or by folder, you can configure how fields are sorted. These **Sort by** options are also in the Data pane menu.

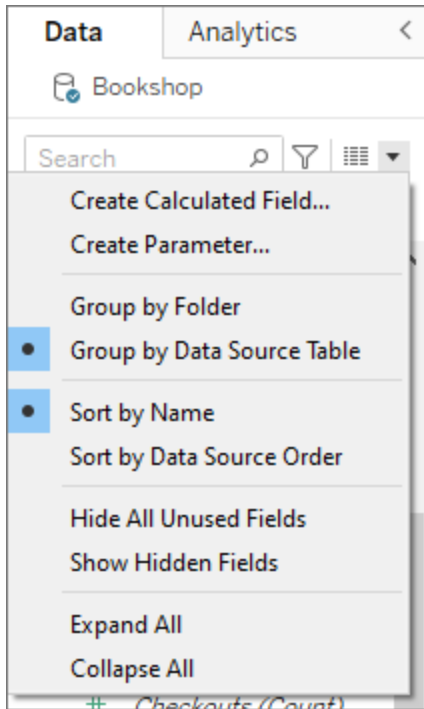

You can sort by one of the following options:

- **Sort by Name.** Lists the dimensions and measures in alphabetical order according to their field aliases.
- **Sort by Data Source Order.** Lists the dimensions and measures in the order they're listed in the underlying data source.

Find fields

You can filter the Data pane to only show certain types of fields. Select the **Filter by** icon next to the search box to show the clickable list of options: dimensions, measures, calculations, or fields with comments. Clear the filter using the X in the search box.

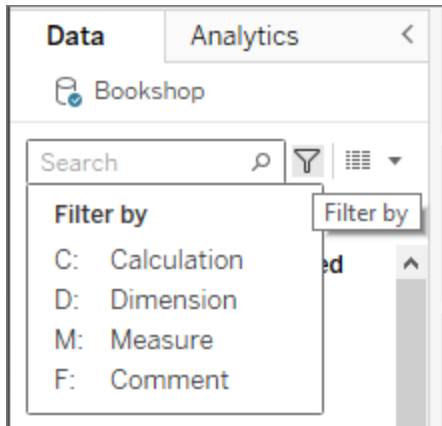

Search for a field

You can search the Data pane for items like fields, folders, or hierarchies.

1. Click into the search bar at the top of the Data pane under the data sources.
2. As you type in the search box, the contents of the Data pane are filtered to show items that contain the typed string.

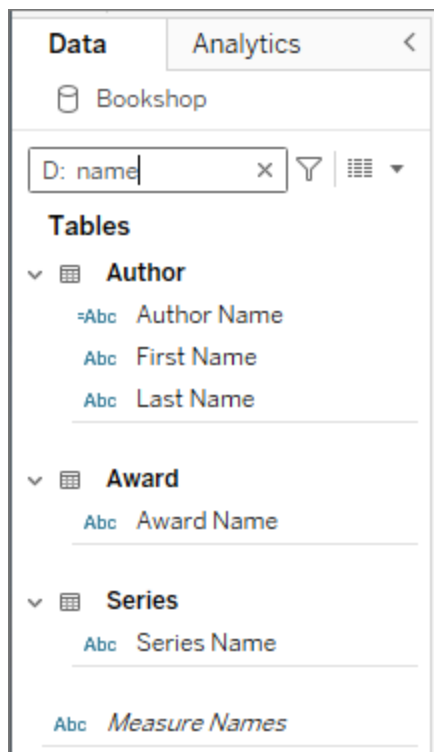

3. Use the **Filter by** prefixes to limit your search to specific types of fields, such as typing "D:" before searching "name" to return only dimensions that contain the string "name".
 - **C:** for calculations
 - **D:** for dimensions
 - **M:** for measures
 - **F:** for fields with comments

Rename Fields

You can rename fields in the Data pane. For example, you could rename a field named **Customer Segment** in the data source to be **Business Segment** in Tableau. You can also rename user-created fields. Renaming a field doesn't change the name of the field in the underlying data source, rather it's given a special name that appears only in Tableau workbooks. The changed field name is saved with the workbook and when you export the data source. You can rename any type of field: dimensions, measures, sets, or parameters.

Rename a field

1. Click field name in the Data pane and hold the mouse button down until the field name is shown in an edit box:

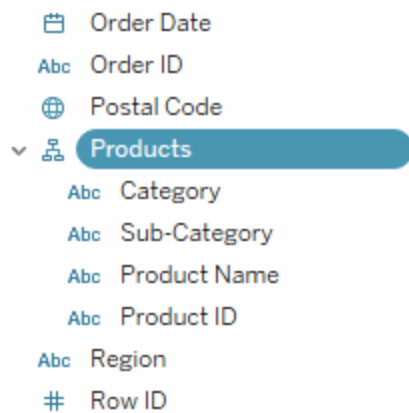

You can also press F2 or Ctrl + Enter to make the field name editable.

2. Type the new name for the field and press Enter.

The field displays with the new name in the Data pane.

Revert to the Default Field Name

To revert a field's name, click the field name in the Data pane and hold the mouse button down until the name is shown in the box. At the right of the edit field is a small circular arrow that you can click to restore the original data source field name:

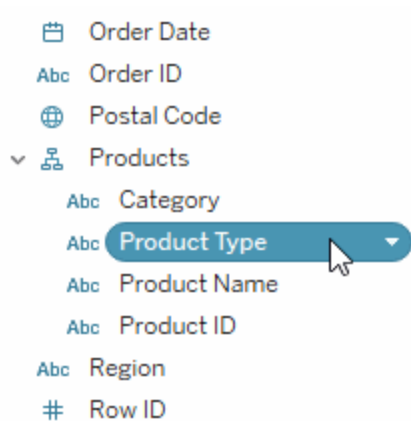

To revert the names of multiple fields that were in the original data source, select them all, right-click, and then choose **Reset Names**.

Combine Fields

Combine fields to create a cross product of members from different dimensions. You can combine dimensions if you want to encode a data view using multiple dimensions.

To combine the fields, select multiple dimensions in the Data pane and then right-click (control-click on a Mac) the fields and select **Create > Combined Field**.

Note: For cube (multidimensional) data sources, you must select levels from different hierarchies. In Tableau, cube data sources are supported only in Windows.

For example, the selections in the example produce a new field that consists of the Category and Sub-Category dimensions.

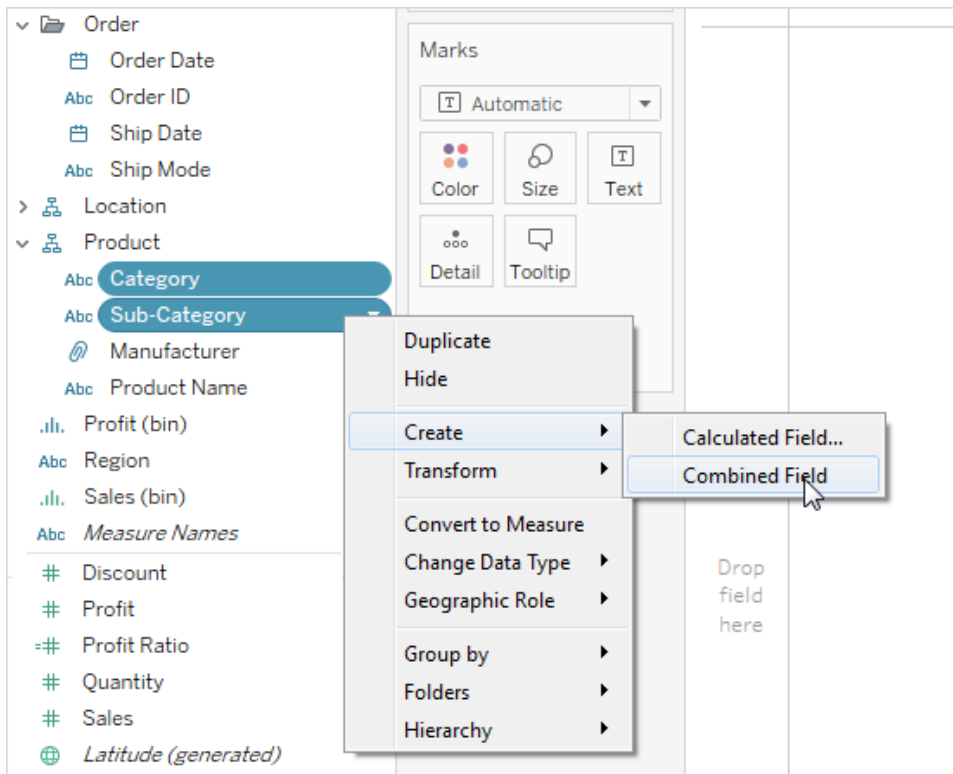

The two dimensions are combined into a new dimension. The name of the field is automatically created from the names of the original fields. Right-click (control-click on a Mac) the new field and select **Rename** to change the name.

When you use the new field in a view, a header is created for each combination of the two original dimensions. For example, the following view shows the members of the combined Category and Sub-Category fields.

Pages		Columns	Region	
Filters		Rows	Sub-Category & Categ..	
Marks		Sheet 2		
Automatic		Region		
Color		Sub-Category & Category ..	Central	East
Size		Accessories, Technology	\$33,956	\$45,033
Text		Appliances, Office Supplies	\$23,582	\$34,188
Detail		Art, Office Supplies	\$5,765	\$7,486
Tooltip		Binders, Office Supplies	\$56,923	\$53,498
SUM(Sales)		Bookcases, Furniture	\$24,157	\$43,819
		Chairs, Furniture	\$85,231	\$96,261
		Copiers, Technology	\$37,260	\$53,219
		Envelopes, Office Supplies	\$4,637	\$4,376
		Fasteners, Office Supplies	\$778	\$820
		Furnishings, Furniture	\$15,254	\$29,071
		Labels, Office Supplies	\$2,451	\$2,603

Note: For cube data sources, to choose to display the fully qualified name, right-click (control-click on a Mac) the combined field in the Data pane and select **Qualify Member Names**.

Hide or Unhide Fields

You can selectively hide or show fields in the Data pane.

- **To hide a field:** right-click (control-click on a Mac) the field and select **Hide**.
- **To show hidden fields:** select **Show Hidden Fields** on the Data pane menu. The hidden fields are then shown in the Data pane with a hidden icon .
- **To unhide a field:** show hidden fields, then click the icon to unhide the field.
- **To hide all unused fields:** select **Hide All Unused Fields** on the Data pane menu to quickly hide all the fields that aren't being used in the workbook.

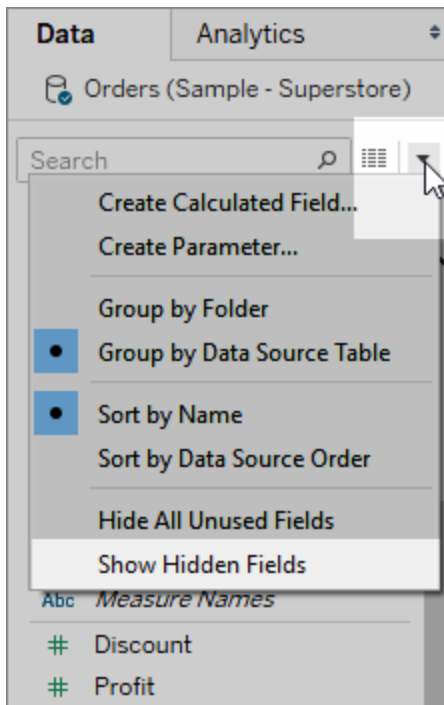

Note: Hiding fields can be a good way to decrease the size of a data extract file because hidden fields are automatically excluded from the extract.

Add Calculated Fields to the Data Pane

You can create calculated fields that appear in the Data pane. These new computed fields can be used like any other field. Select **Create Calculated Field** on the Data pane menu.

Alternatively, select **Analysis > Create Calculated Field**.

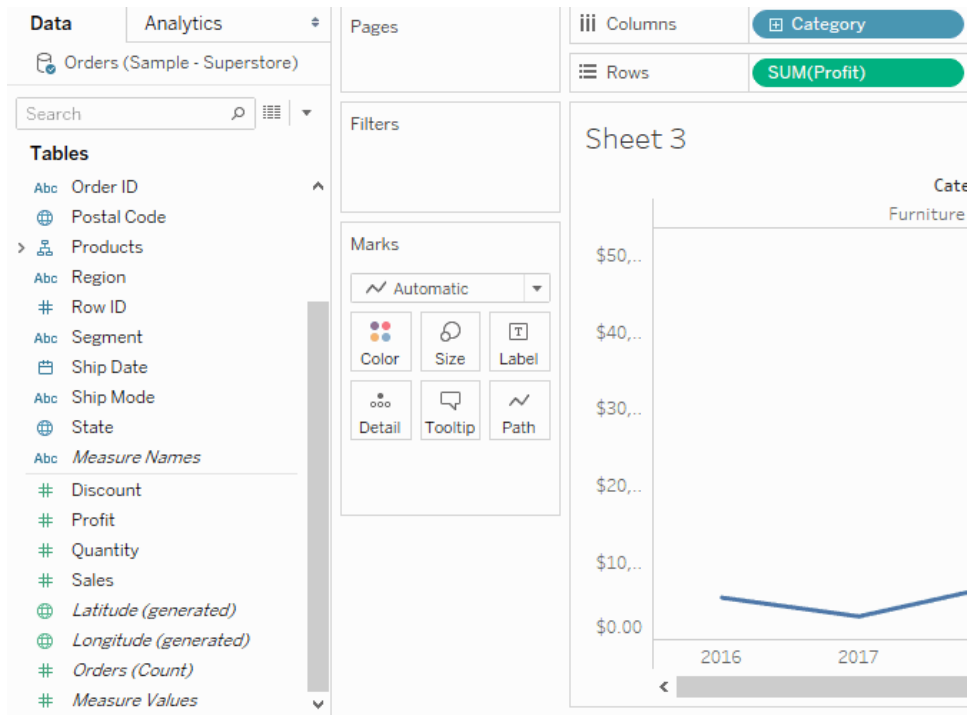

Edit Default Settings for Fields

When you drag fields to shelves, the data is represented as marks in the view. The fields and their marks are displayed initially based on their default settings. You can control these default settings by clicking the drop-down arrow on a field.

The **Default Properties** menu includes default settings for aggregation, comments, number formatting, color, shape, and totals (based on the type of field).

Set the default aggregation for a measure

You can specify a default aggregation for any measure. The default aggregation will be used automatically when the measure is first totaled in the view.

1. Right-click (control-click on a Mac) any measure in the Data pane and select **Default Properties > Aggregation**.
2. In the Aggregation list, select an aggregation.

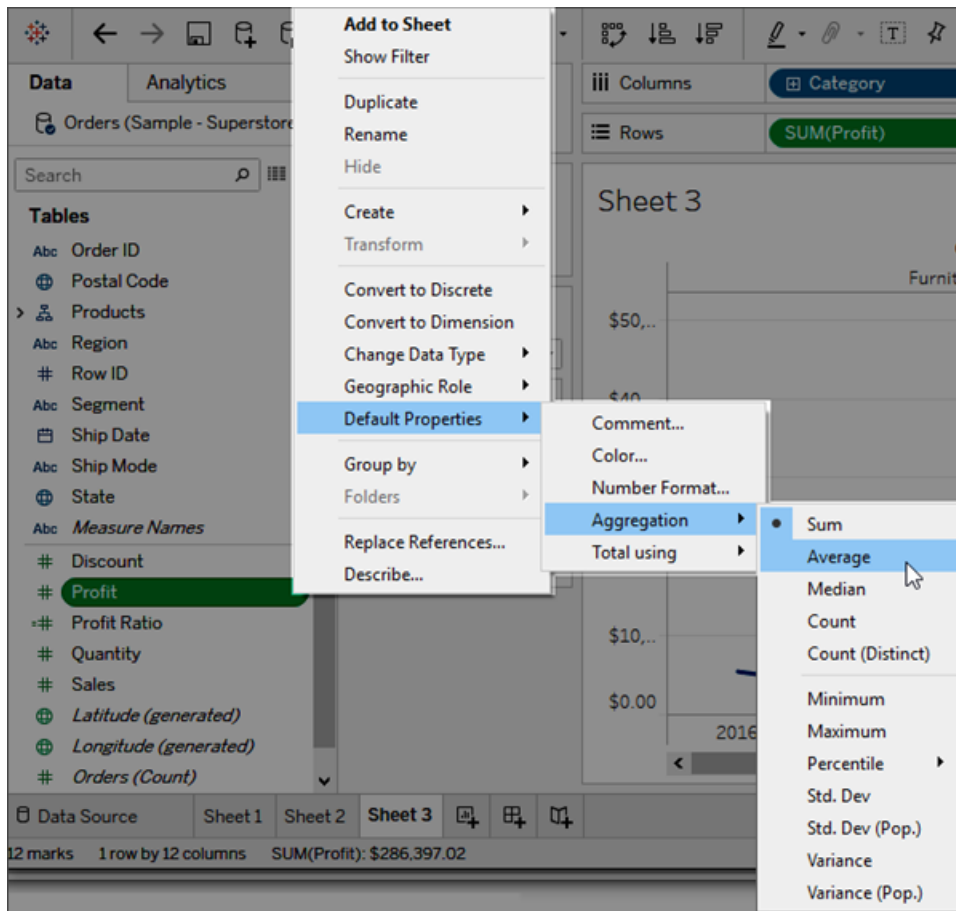

Whether you are specifying the aggregation for a field on a shelf or the default aggregation in the Data pane, you can select from several aggregations. See [Data Aggregation in Tableau on page 171](#) to learn about each type of aggregation.

Add default comments for specific fields

Fields can have comments that describe them. The comments display in a tooltip in the Data pane and in the Calculated fields dialog box. Field comments are a good way to give more context to the data in your data source. Comments are especially useful when you are building a workbook for others to use.

To add a default comment for a field

1. Right-click (control-click on a Mac) a field in the Data pane and select **Default Properties > Comment**.

2. Write a comment in the subsequent dialog box. Comments support rich text formatting that will be represented in the tooltip.

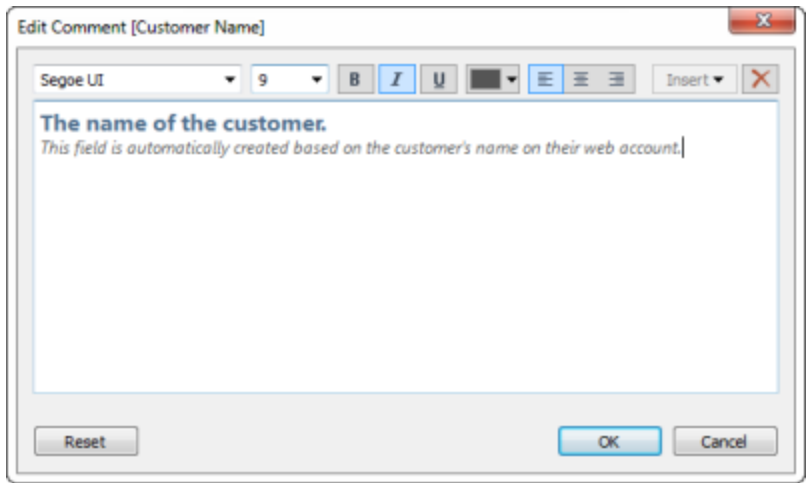

3. When finished, click **OK**.

Now when you hover the cursor over the field in the Data pane, you see the comment.

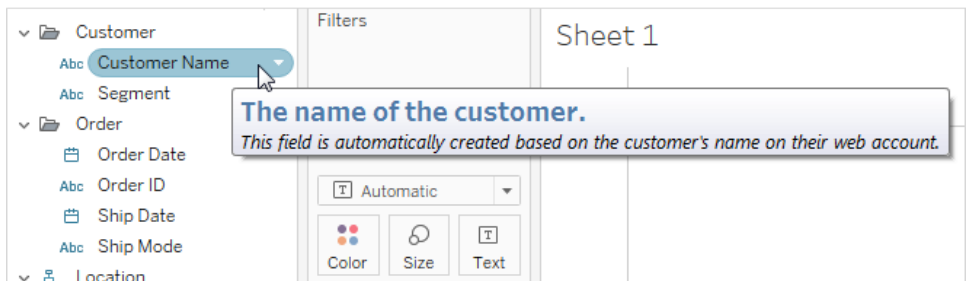

Set the default number format

You can set the default number format for date and number fields. For example, you may want to always show the Sales values as currency using the U.S. dollar sign and two decimal places. Or you may want to always show Discount as a percentage.

To set the default formats, right-click (control-click on Mac) a date or number field and select either **Date Format** or **Number Format** on the Default Properties menu. A dialog box opens where you can specify a default format.

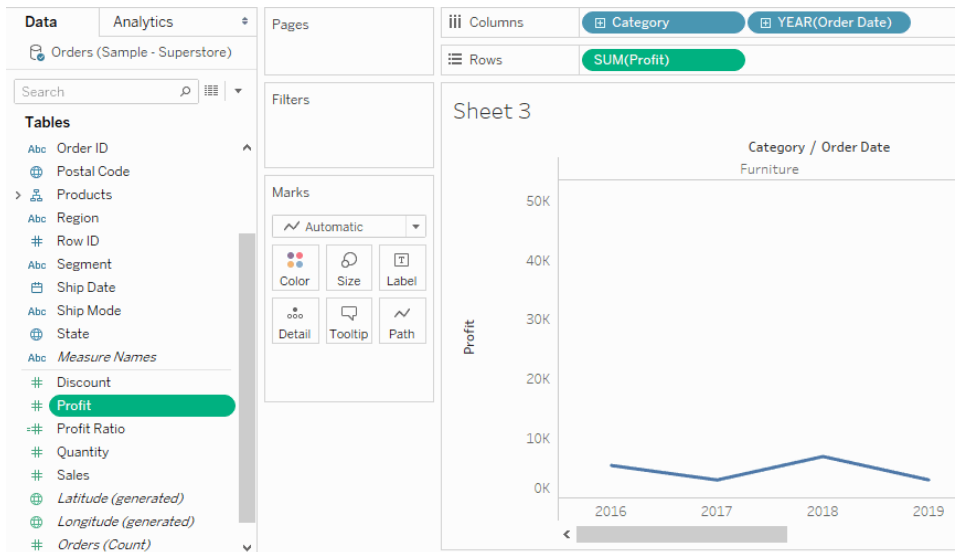

Set the default color

When you use a dimension to color encode the view, default colors are assigned to the field's values. Color encodings are shared across multiple worksheets that use the same data source to help you create consistent displays of your data. For example, if you define the Western region to be green, it will automatically be green in all other views in the workbook. To set the default color encodings for a field, right-click (control-click on Mac) the field in the Data pane and select **Default Properties > Color**.

For information about color properties, and how to configure and customize colors in Tableau, see [Color Palettes and Effects](#) on page 1293,

Set the default shape

When you use a dimension to shape encode the view, default shapes are assigned to the field's values. Shape encodings are shared across multiple worksheets that use the same data source to help you create consistent displays of your data. For example, if you define that Furniture products are represented with a square mark, it will automatically be changed to a square mark in all other views in the workbook.

To set the default shape encodings for a field, right-click (control-click on Mac) the field in the Data pane and select **Default Properties > Shape**.

Set the default sort order for the values within a categorical field

You can set a default sort order for the values within a categorical field so that every time you use the field in the view, the values will be sorted correctly. For example, let's say you have an Order Priority field that contains the values High, Medium, and Low. When you place these in the view, by default they will be listed as High, Low, Medium because they are shown in alphabetical order. You can set a default sort so that these values are always listed correctly.

To set the default sort order, right-click (control-click on a Mac) a dimension and select **Default Properties > Sort**. Then use the sort dialog box to specify a sort order.

Note: The default sort order also controls how the field values are listed in a filter in the view.

Create Aliases to Rename Members in the View

You can create aliases (alternate names) for members in a dimension so that their labels appear differently in the view.

Aliases can be created for the members of discrete dimensions only. They can't be created for continuous dimensions, dates, or measures.

Create an alias

1. In the Data pane, right-click a dimension and select **Aliases**.

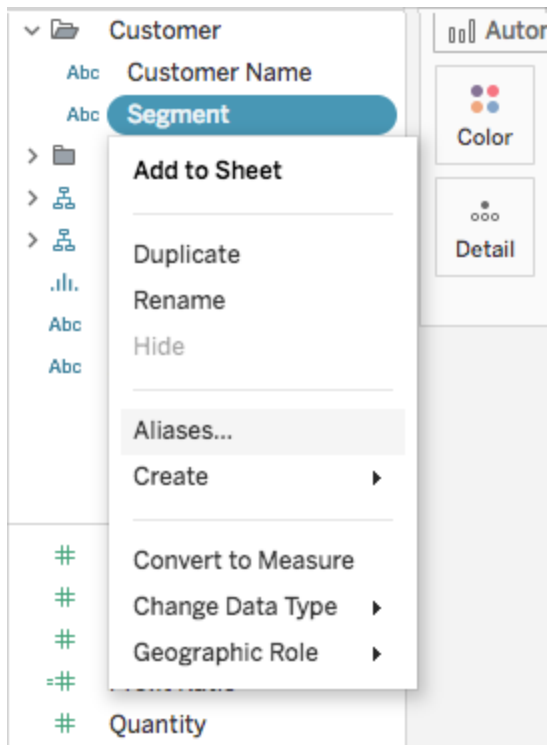

Tip: If the **Aliases** option doesn't appear in the dialog, verify that you aren't connected to a published data source and the field you're trying to alias is a discrete dimension.

2. In the Edit Aliases dialog box, under **Value (Alias)**, select a member and enter a new name.

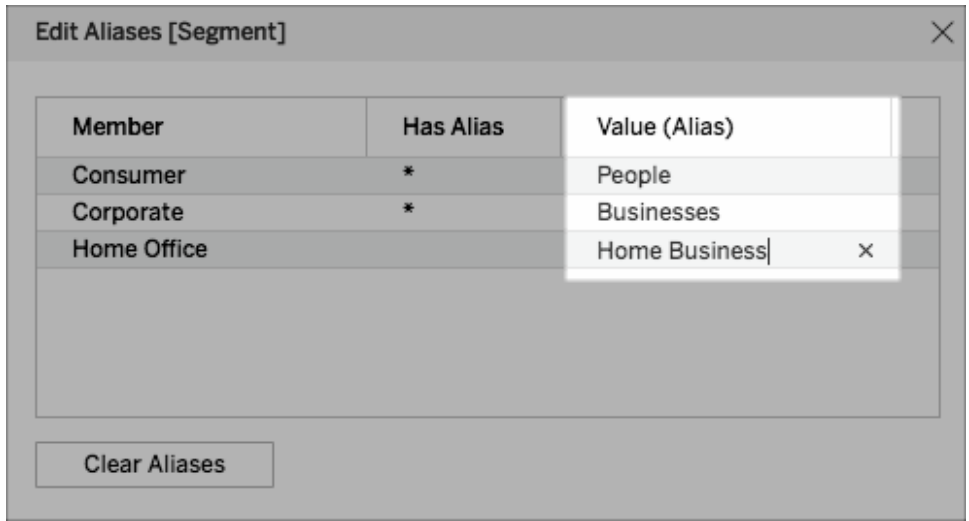

Tip: To reset the member names back to their original names, click **Clear Aliases**.

3. To save your changes:
 - In Tableau Desktop, click **OK**.
 - On Tableau Server or Tableau Cloud, click the **X** icon in the top-right corner of the dialog box.

When you add the field to the view, the alias names appear as labels in the view. For example,

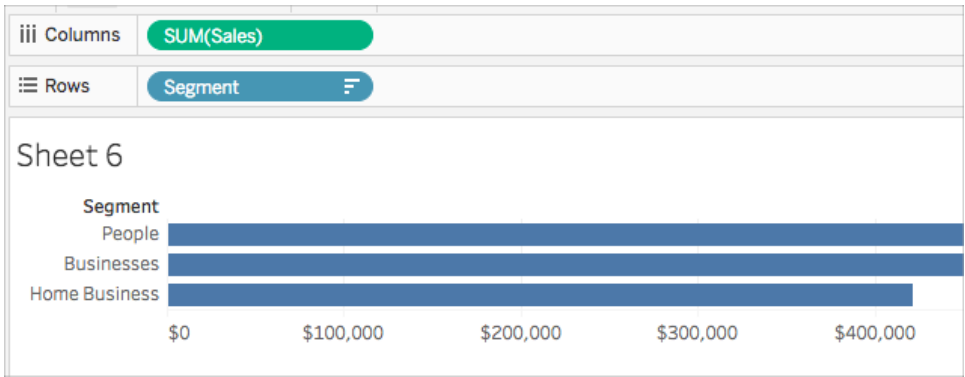

When the Alias option isn't available

Measures can't be re-aliased

Tableau doesn't permit re-aliasing measures because it involves modifying data values themselves. If you have a field in your data that contains values such as *0* and *1* but actually encodes information such as *no* and *yes*, Tableau interprets this as a continuous measure. You

can convert it to a discrete dimension and then re-alias the values. For more information about discrete vs continuous and dimensions vs measures, see:

- [Dimensions and Measures, Blue and Green](#) on page 147
- [Convert a Measure to a Dimension](#) on the facing page
- [Convert Fields between Discrete and Continuous](#) below

Published data sources

Alternatively, the Alias option can be missing for a discrete dimension because you're connected to a published data source. When using a published data source, you can't create or edit aliases. You can only change aliases on fields that you create in your workbook. You can edit aliases for the Measure Names field on the published datasource unless they have been set before publishing. If you didn't publish the data source, you can duplicate the field (right click > **Duplicate**) and edit aliases for the duplicate field without restriction.

Convert Fields between Discrete and Continuous

You can convert measures from discrete to continuous or from continuous to discrete. And you can convert date dimensions and other numeric dimensions to be either discrete or continuous. For more information on continuous and discrete fields, see [Dimensions and Measures, Blue and Green](#) on page 147.

You can also [Convert a Measure to a Dimension](#) on the facing page.

Convert measures

You can convert measures from discrete to continuous or from continuous to discrete. Click the field and choose **Discrete** or **Continuous**. The field is green when it is continuous, and blue when it is discrete.

For measures in the **Data** pane, right-click the field and choose **Convert to Discrete** or **Convert to Continuous**. The color of the field changes accordingly.

Convert date fields

You can convert Date fields between discrete and continuous. Discrete dates act as labels and continuous dates will have an axis similar to a measure.

Click any Date field in the view and choose one of the options on the context menu to change it from discrete to continuous or from continuous to discrete.

To convert a Date field in the **Data** pane (and thus to determine the default result when you drag it into a view), right-click the field and choose **Convert to Discrete** or **Convert to Continuous**.

Convert a Measure to a Dimension

You can convert a field from a measure to a dimension in the current view. Or, if you want the change to affect all future uses of the field in the workbook, you can convert a field in the **Data** pane from a measure to a dimension. For more information on dimensions and measures, see [Dimensions and Measures, Blue and Green](#) on page 147.

You can also [Convert Fields between Discrete and Continuous](#) on the previous page.

Convert a measure in the view into a discrete dimension

You can drag a measure field from the **Data** pane but then use it as a dimension in the view. For example, suppose you want to know the aggregated sales totals for each possible discount rate. The view you are aiming for looks like this:

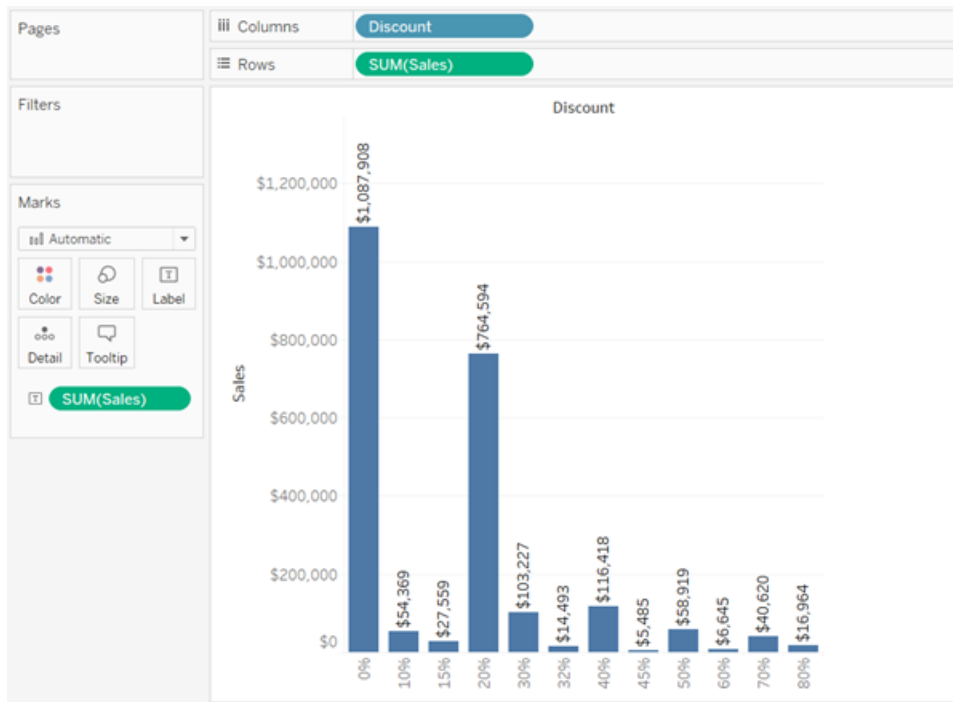

The **Discount** field contains numeric data, so when you connect to the data source, Tableau assigns it to the **Measures** area in the **Data** pane. In the **Sample - Superstore** data source, which is included with Tableau Desktop, the values for **Discount** range from 0% to 80%.

Here are the steps to create the view shown above:

1. Drag **Sales** to **Rows** and **Discount** to **Columns**. Tableau shows you a scatter plot—this is the default chart type when you put one measure on **Rows** and another on **Columns**.



Tableau aggregates **Discount** as AVG, and **Sales** as SUM. The fields are both continuous, so along the bottom and left side of the view Tableau displays axes (and not column or row headers).

2. To treat **Discount** as a dimension, click the drop-down arrow on the field (on the **Columns** shelf) and select **Dimension** from the context menu. Tableau no longer aggregates the values for **Discount**, so what you see now is a line. But the values for **Discount** are still continuous, so Tableau still shows continuous axes for both fields:

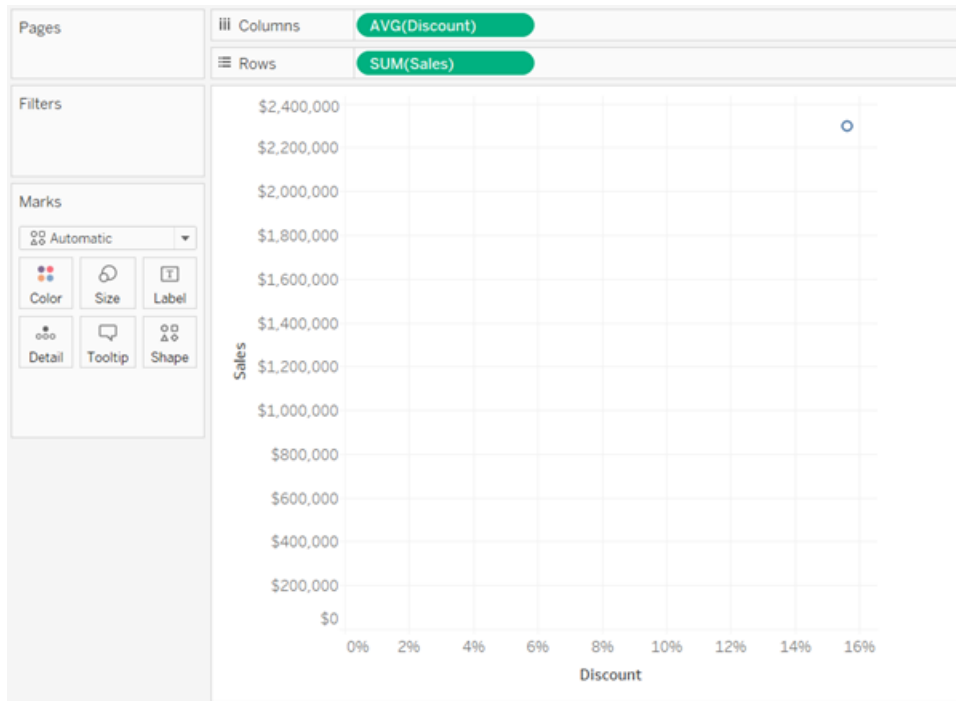
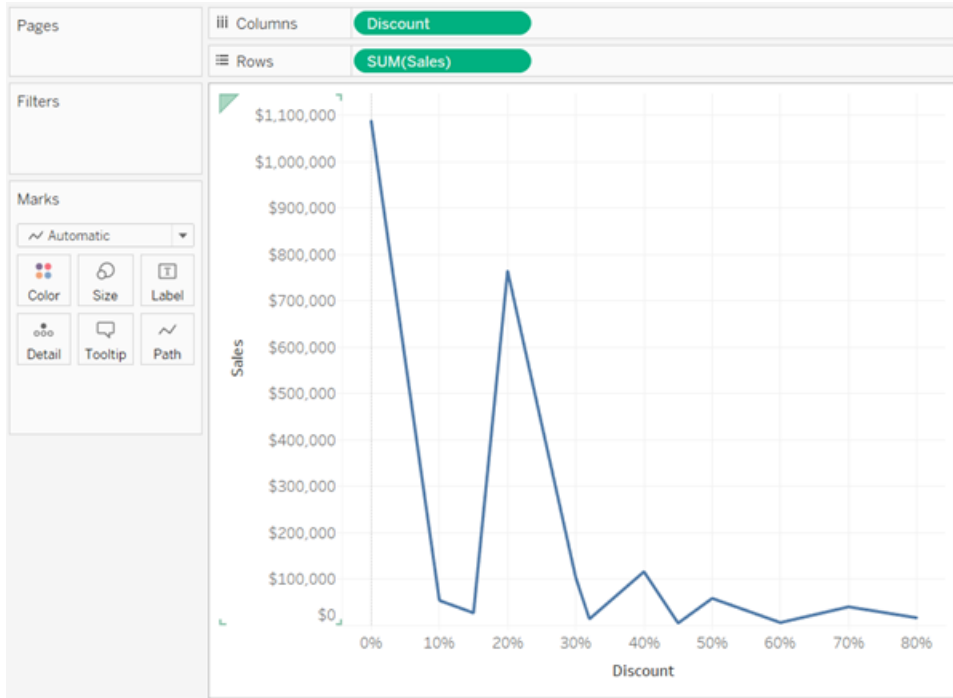

- To complete the process, click the drop-down arrow on the **Discount** again and select **Discrete** from the context menu. The transformation of **Discount** is now complete. You now see the bar chart as in the initial image at the beginning of this topic. Across the bottom, you now see column headers (0%, 10%, 20%, etc.) instead of an axis.

Let's review how we got to this point:

Action	Result
Convert Discount from a measure to a dimension...	Sales values are no longer aggregated according to discount rate, resulting in a line chart instead of a scatter plot.
Convert Discount from continuous to discrete...	Tableau shows headers at the bottom of the view, instead of a continuous axis.

The only thing left to do is to drag **Sales** to Label and then format the labels for readability.

The resulting chart is somewhat useful because there are only 12 unique values for **Discount** in the data source. Had there been a unique value for each row, which would not have been unusual for a numeric field, the number of individual bars in the resulting view would have been equal to the number of rows in the data source, which would probably not result in a useful visualization.

Converting a measure in the Data pane into a dimension

When you first connect to a data source, Tableau assigns most fields that contain quantitative, numerical information (that is, fields where the values are numbers) as measure fields in the **Data** pane. The exception is for fields where the name suggests the data type, such as Year or Month (which Tableau would identify as Date dimensions) or fields containing words like “ID” and “Key,” which Tableau would categorize as dimensions, even when they are numeric.

However, you might decide that some of these fields that Tableau has categorized as measures should actually be dimensions. Postal codes are a classic example—they often consist entirely of numbers, but the information is categorical and not continuous—you would never want to aggregate postal codes by adding or averaging them. Similarly, a field containing individuals' ages may be categorized as a measure by default in Tableau because it contains numeric data. In some cases you may want to add or average ages, but you might also want to look at each individual age as a bin or category, in which case you want Tableau to create headers for this field rather than an axis. If this is how you want to use age in your view, you can convert the field to a dimension.

To convert a measure to a dimension in the **Data** pane, do either of the following.

- Click and drag the field from a measures area in the **Data** pane and drop it into a dimensions area (above the line).

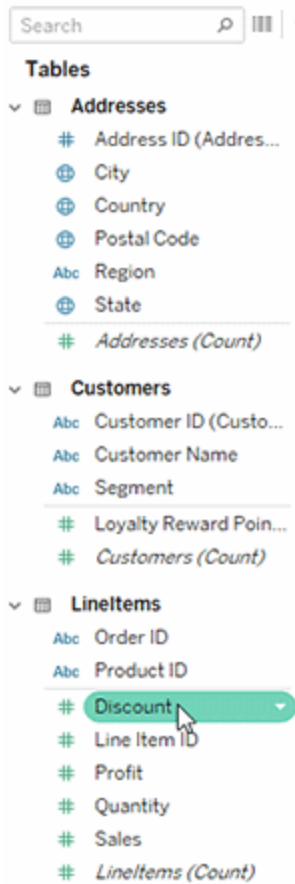

- Right-click (control-click on a Mac) the measure in the **Data** pane and select **Convert to Dimension**.

If you place a field that you converted from a measure to a dimension on a shelf, it now produces headers instead of an axis.

Columns		Category		
Rows		Quantity		
Quantity	Furniture	Office Supplies	Technology	
1	\$18,491	\$17,224	\$17,536	
2	\$87,642	\$94,617	\$106,832	
3	\$137,952	\$142,844	\$141,265	
4	\$85,081	\$88,262	\$150,328	
5	\$127,640	\$136,841	\$151,180	
6	\$73,934	\$65,456	\$67,732	
7	\$69,862	\$74,779	\$95,267	
8	\$43,690	\$36,475	\$37,595	
9	\$55,255	\$32,040	\$41,211	
10	\$13,438	\$3,864	\$6,755	
11	\$7,035	\$3,695	\$5,042	
12	\$8,783	\$2,342	\$3,743	
13	\$8,300	\$15,895	\$8,143	
14	\$4,896	\$4,712	\$3,524	

Create Hierarchies

When you connect to a data source, Tableau automatically separates date fields into hierarchies so you can easily break down the viz. You can also create your own custom hierarchies. For example, if you have a set of fields named Region, State, and County, you can create a hierarchy from these fields so that you can quickly drill down between levels in the viz.

Create a hierarchy

To create a hierarchy:

1. In the **Data** pane, drag a field and drop it directly on top of another field.

Note: When you want to create a hierarchy from a field inside a folder, right-click (control-click on a Mac) the field and then select **Create Hierarchy**.

2. When prompted, enter a name for the hierarchy and click **OK**.
3. Drag additional fields into the hierarchy as needed. You can also re-order fields in the hierarchy by dragging them to a new position.

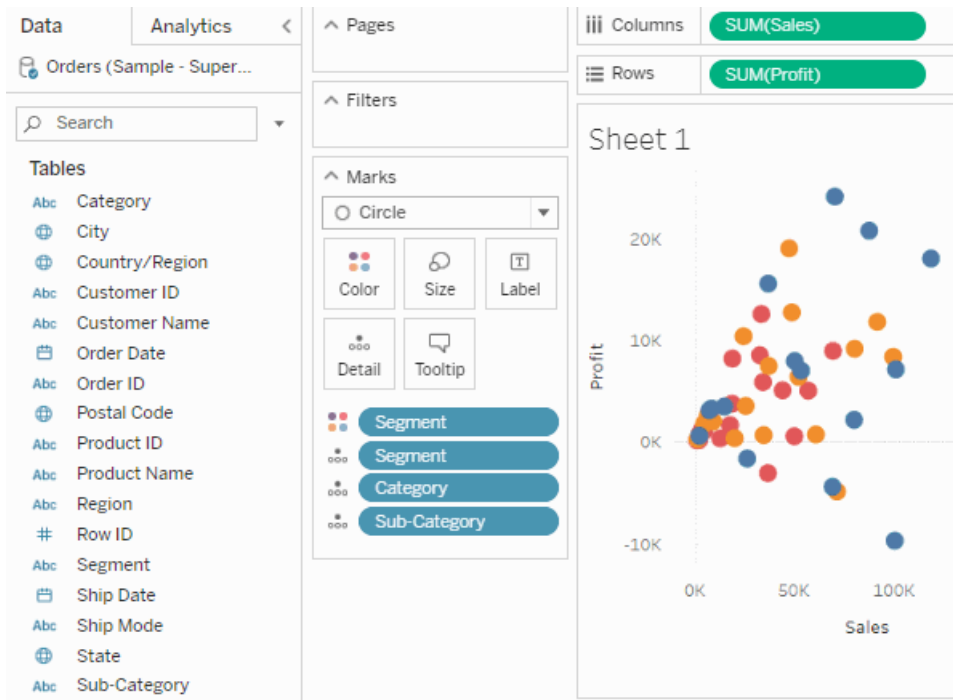

Drill up or down in a hierarchy

When you add a field from a hierarchy to the visualization, you can quickly drill up or down in the hierarchy to add or subtract more levels of detail.

To drill up or down in a hierarchy in Tableau Desktop or in web authoring:

- In the visualization, click the + or - icon on the hierarchy field.

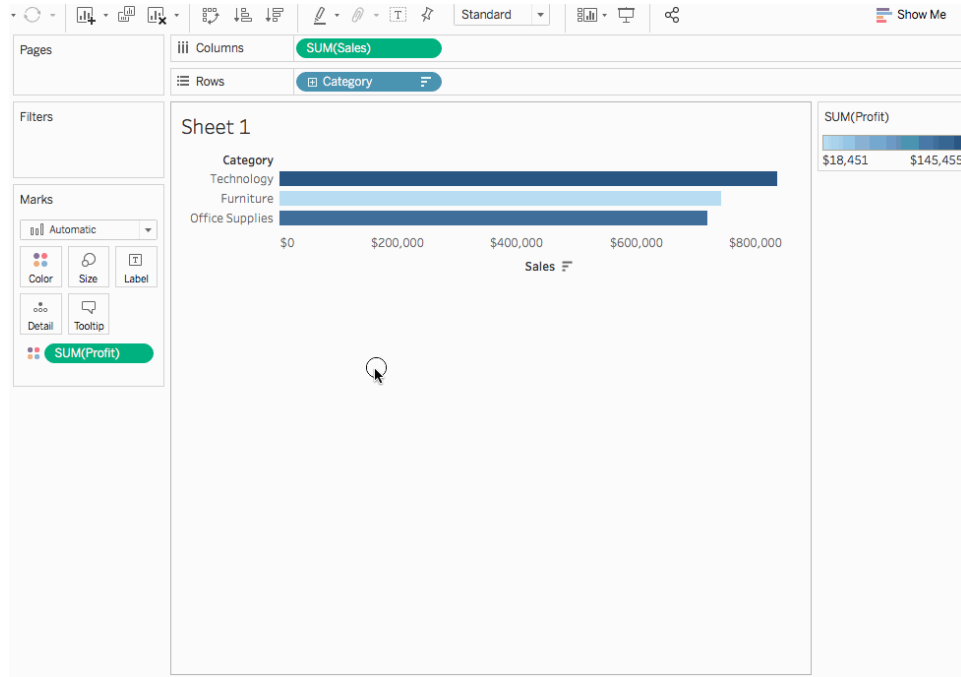

When you are editing or viewing the visualization on the web, you have the option of clicking the + or - icon next to a field label.

Sales by Product Category

		Jan	Feb	Mar	Apr
Furniture + ⤵	2011	\$5,952	\$2,130	\$14,574	\$7,945
	2012	\$11,740	\$3,319	\$12,315	\$10,476
	2013	\$7,623	\$3,926	\$12,473	\$13,406
	2014	\$5,984	\$6,866	\$10,597	\$9,053
Office Supplies	2011	\$4,851	\$1,072	\$8,606	\$11,155
	2012	\$1,809	\$5,427	\$15,824	\$12,559
	2013	\$5,300	\$6,683	\$17,458	\$10,640
	2014	\$21,704	\$7,390	\$14,317	\$14,922
Technology	2011	\$3,143	\$1,609	\$32,511	\$9,195

Remove a hierarchy

To remove a hierarchy:

- In the **Data** pane, right-click (control-click on a Mac) the hierarchy and select **Remove Hierarchy**.

The fields in the hierarchy are removed from the hierarchy and the hierarchy disappears from the Data pane.

Group Your Data

You can create a group to combine related members in a field. For example, if you are working with a view that shows average test scores by major, you might want to group certain majors together to create major categories. English and History might be combined into a group called Liberal Arts Majors, while Biology and Physics might be grouped as Science Majors.

Groups are useful for both correcting data errors (e.g., combining CA, Calif., and California into one data point) as well as answering "what if" type questions (e.g., "What if we combined the East and West regions?").

Create a group

There are multiple ways to create a group. You can create a group from a field in the **Data** pane, or by selecting data in the view and then clicking the group icon.

Create a group by selecting data in the view

1. In the view, select one or more data points and then, on the tooltip that appears, click the

group icon  .

Note: You can also select the group icon on the toolbar at the top of the workspace.

If there are multiple levels of detail in the view, you must select a level to group the members. You can select to group all dimensions, or just one.

Create a group from a field in the Data pane

1. In the **Data** pane, right-click a field and select **Create > Group**.

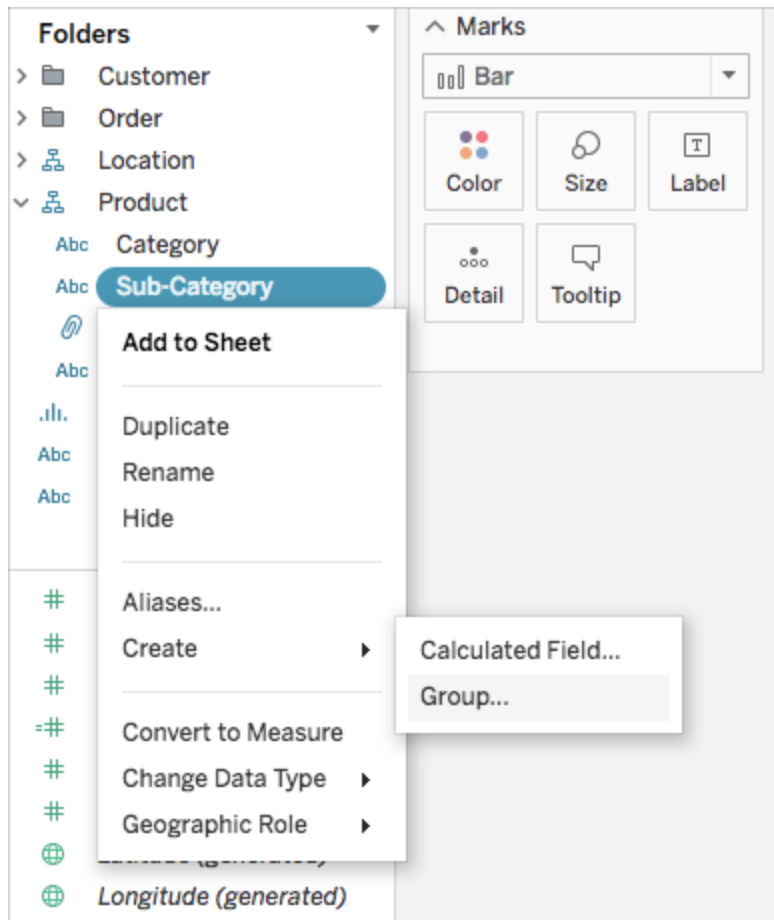

2. In the Create Group dialog box, select several members that you want to group, and then

click **Group**.

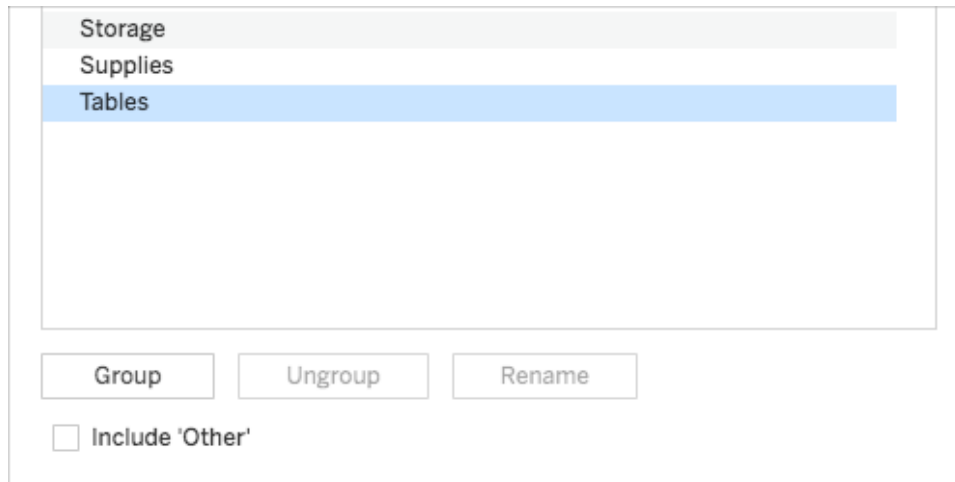

The selected members are combined into a single group. A default name is created using the combined member names.

To rename the group, select it in the list and click **Rename**.

Tip: You can search for members using the **Find** option near the bottom-right of the dialog box. (Tableau Desktop only)

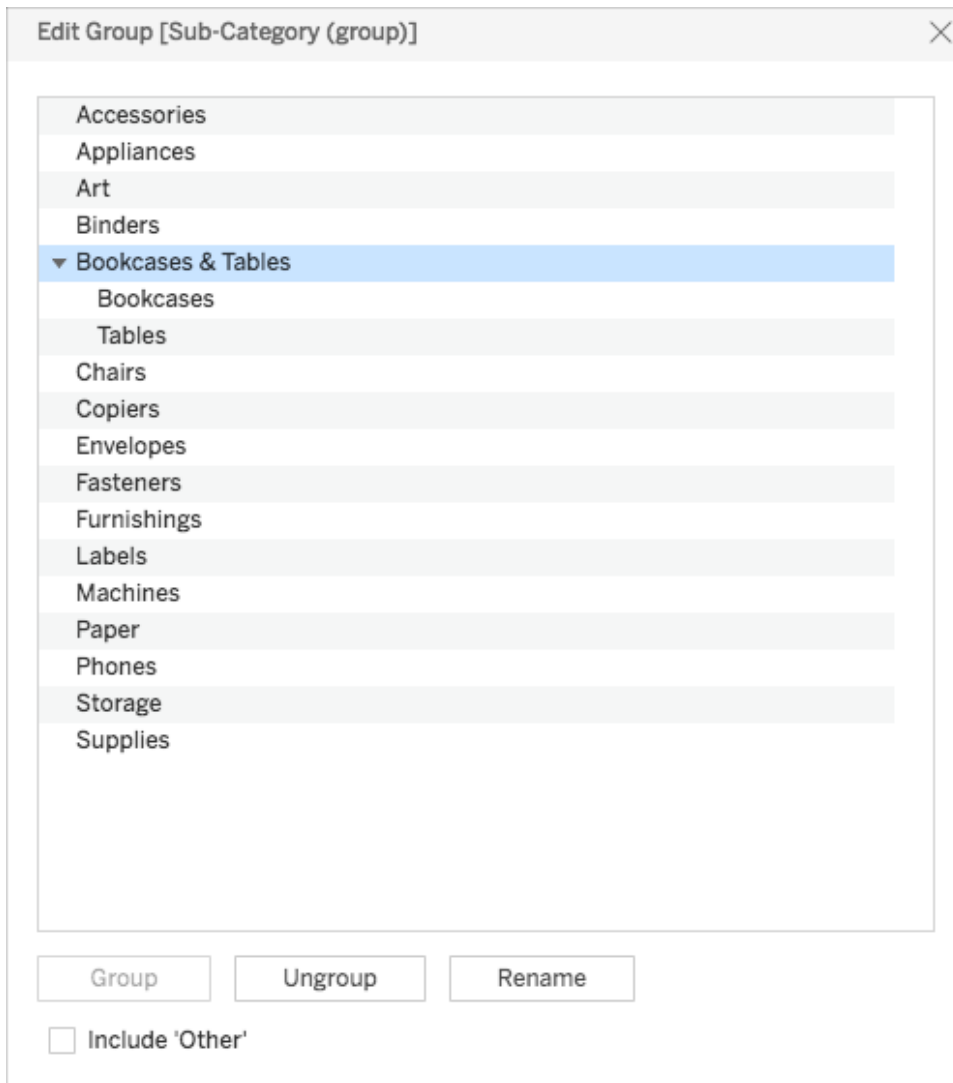

Include an Other Group

When you create groups in Tableau, you have the option to group all remaining, or non-grouped members in an Other group.

The Include Other option is useful for highlighting certain groups or comparing specific groups against everything else. For example, if you have a view that shows sales versus profit product category, you might want to highlight the high and low performing categories in the view, and group all the other categories into an "Other" group.

Includes Other

Does not include Other

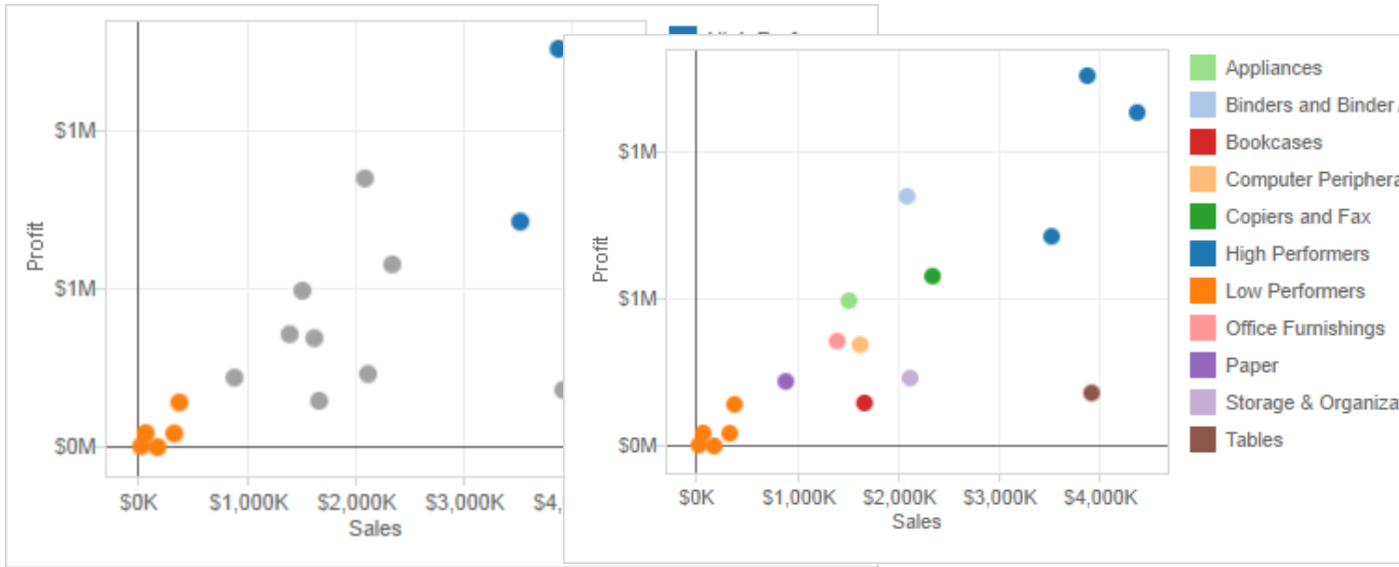

To include an Other group:

1. In the **Data** pane, right-click the group field and select **Edit Group**.
2. In the Edit Group dialog box, select **Include 'Other'**.

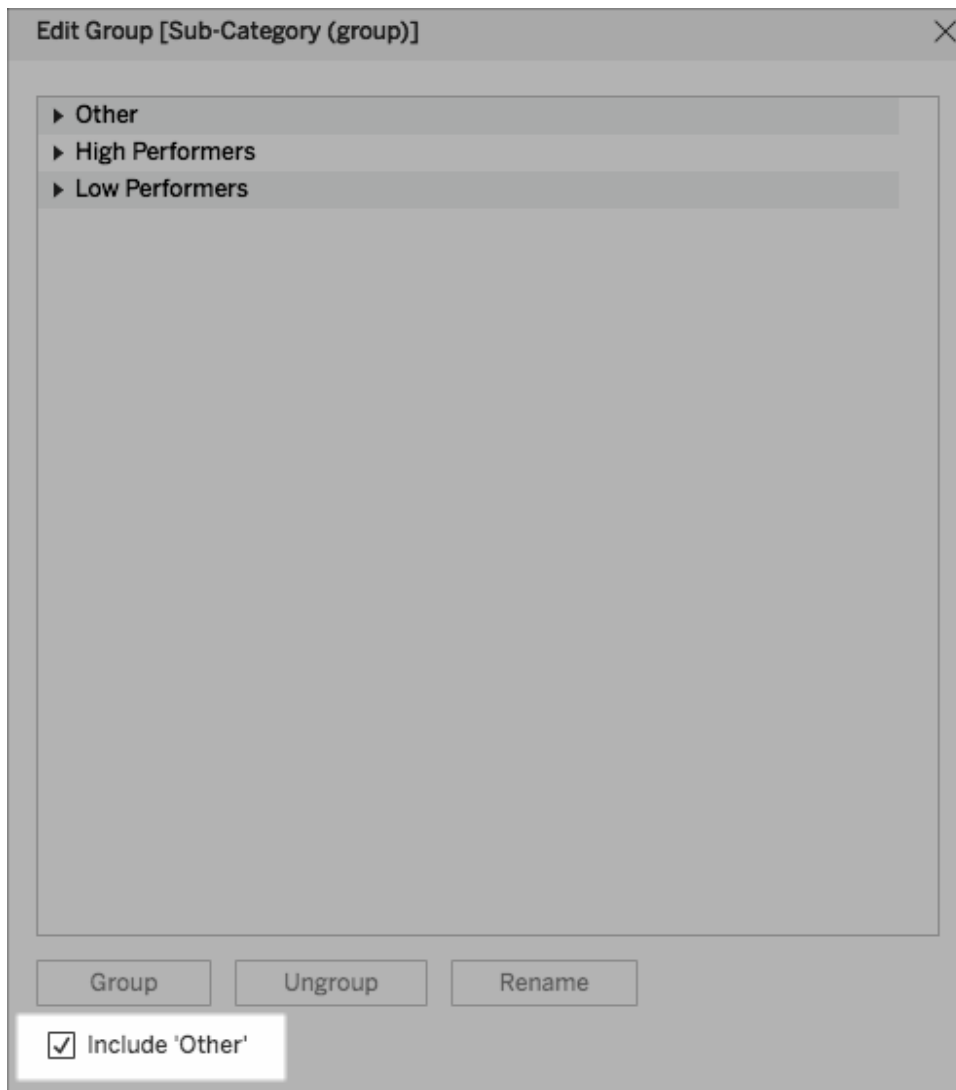

Edit a Group

After you have created a grouped field, you can add and remove members from the groups, create new groups, change the default group names, and change the name of the grouped field. You can make some changes directly in the view, and others through the Edit Group dialog box.

To add members to an existing group:

- In the **Data** pane, right-click the group field, and then click **Edit Group**.

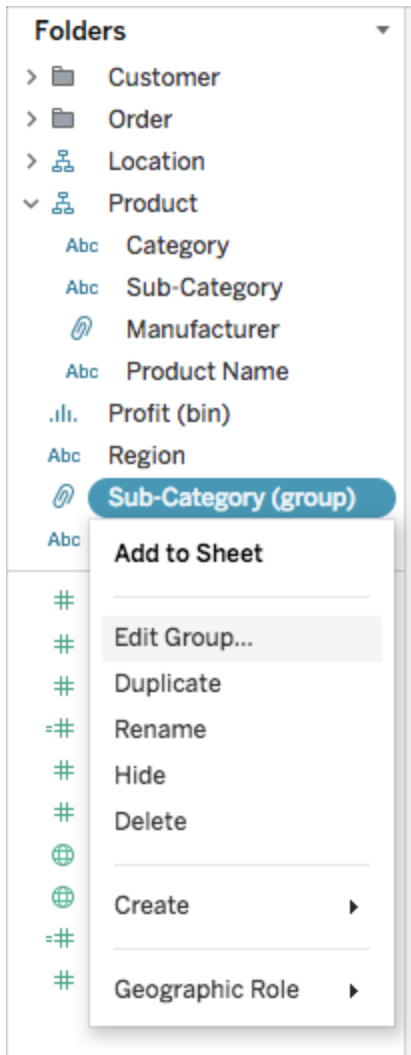

- In the Edit Group dialog box, select one or more members and drag them into the group you want.
- Click **OK**.

To remove members from an existing group:

- In the **Data** pane, right-click the group field, and then click **Edit Group**.
- In the Edit Group dialog box, select one or more members, and then click **Ungroup**.

The members are removed from the current group. If you have an Other group, the

members are added to it.

- Click **OK**.

To create a new group in a group field:

- In the **Data** pane, right-click the group field, and then click **Edit Group**.
- In the Edit Group dialog box, select one or more members, and then click **Group**.
- Click **OK**.

Note: To rename a group, select the group in the Edit Group dialog box, and then click **Rename**.

See also

[Color a View Using Groups](#) below

[Correct Data Errors or Combine Dimension Members by Grouping Your Data](#) on page 1090

Color a View Using Groups

In addition to correcting data errors and combining dimensions, you can visually identify groups of related marks by selecting marks directly. This technique is especially useful when working with a scatter plot or a view that doesn't have headers that you can select when defining the group.

1. Press and hold the **CTRL** or **Shift** key on the keyboard to select one or more marks in the view. On a Mac, use the **Shift** key.
2. To create a group do one of the following:
 - For Tableau Desktop, click the **Group** button  on the toolbar or right-click and select **Group**.

- For Tableau Server or Tableau Cloud, click the **Group** icon on the tooltip.

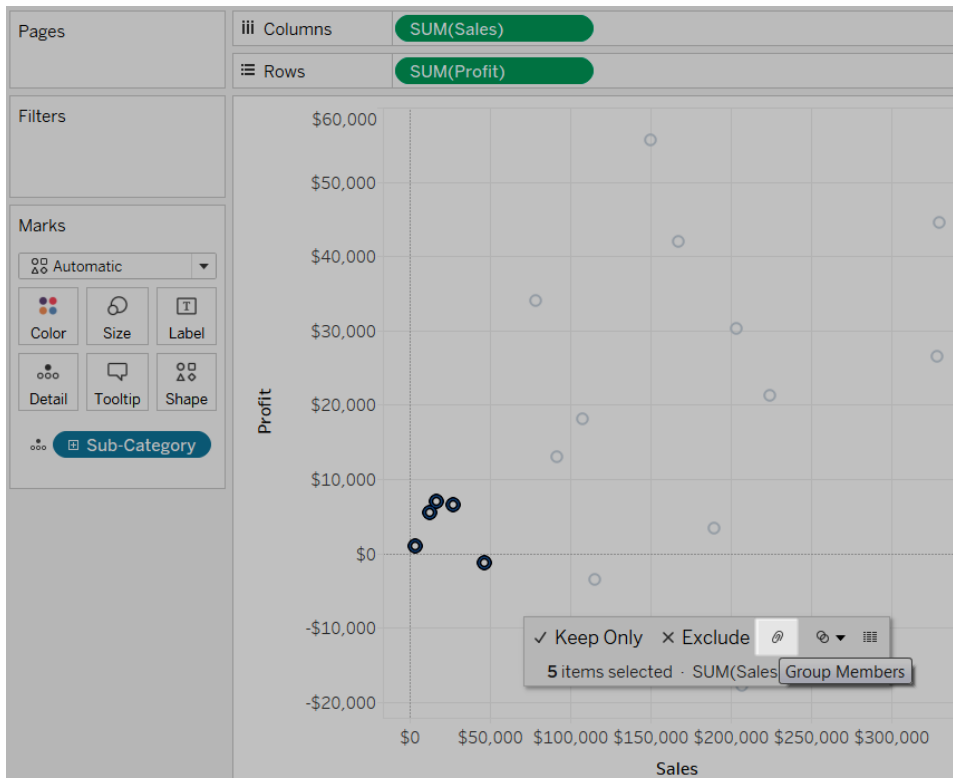

The selected marks are grouped and all other members are combined into an "Other" category. The new group field is automatically added to Color. For more information about grouping fields using Other, see [Include an Other Group](#) on page 1082.

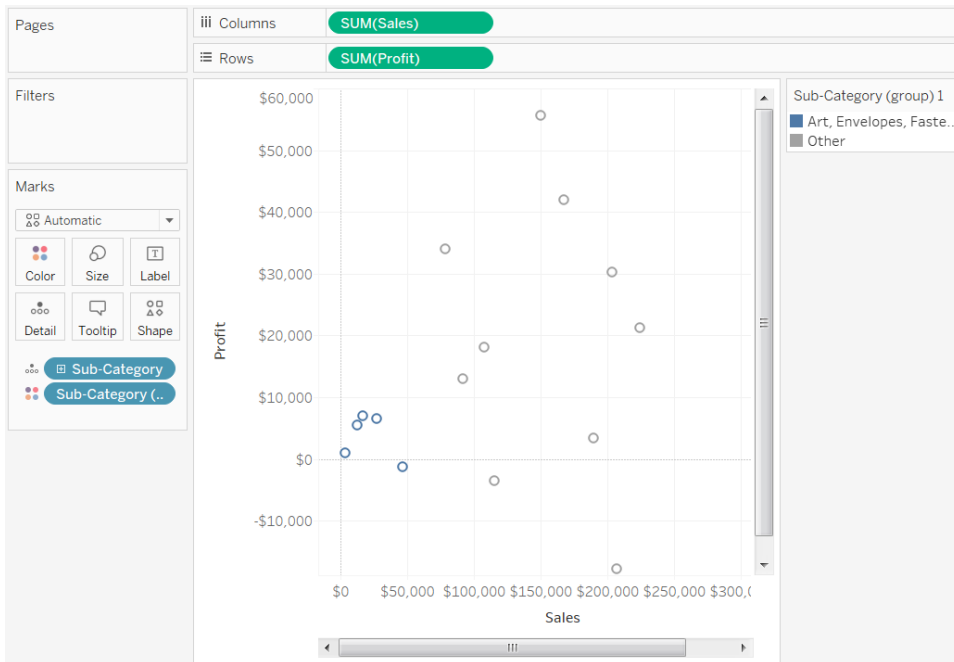

Note: If there were already fields on **Color**, they are moved to **Detail** and replaced with the group field.

When you create groups by selecting marks, it's possible that the marks will represent multiple dimensions. For example, you may have a scatter plot that shows the Sales vs. Profit by Region and Sub-Category. In this case, a selection of marks will represent members of both the Region and Sub-Category dimensions. When the selection represents multiple dimensions, the **Group** menu lets you choose to group on **All Dimensions** or on a particular dimension.

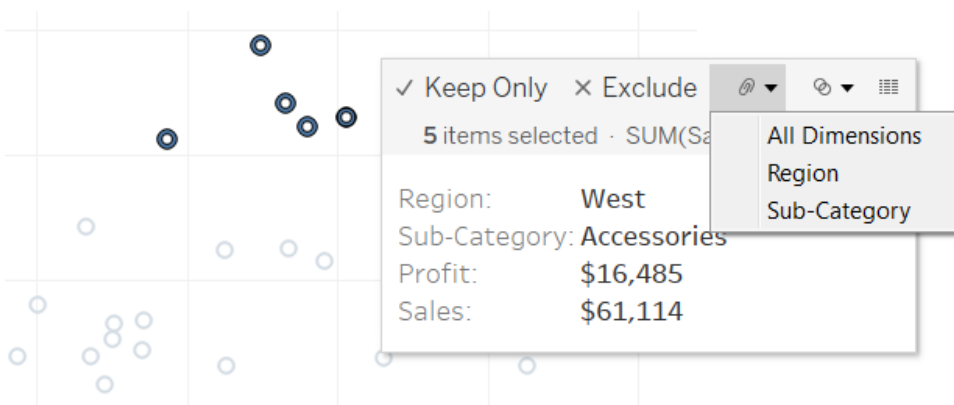

In the example above, the 5 selected marks represent a region and the following sub-category combinations .

- West, Copiers
- West, Binders
- West, Accessories
- East, Copiers
- Central, Copiers
- South, Art
- South, Envelopes
- South, Labels
- West, Envelopes
- West, Labels

The views below show the results of grouping these measures on All Dimensions, Sub-Category, and Region.

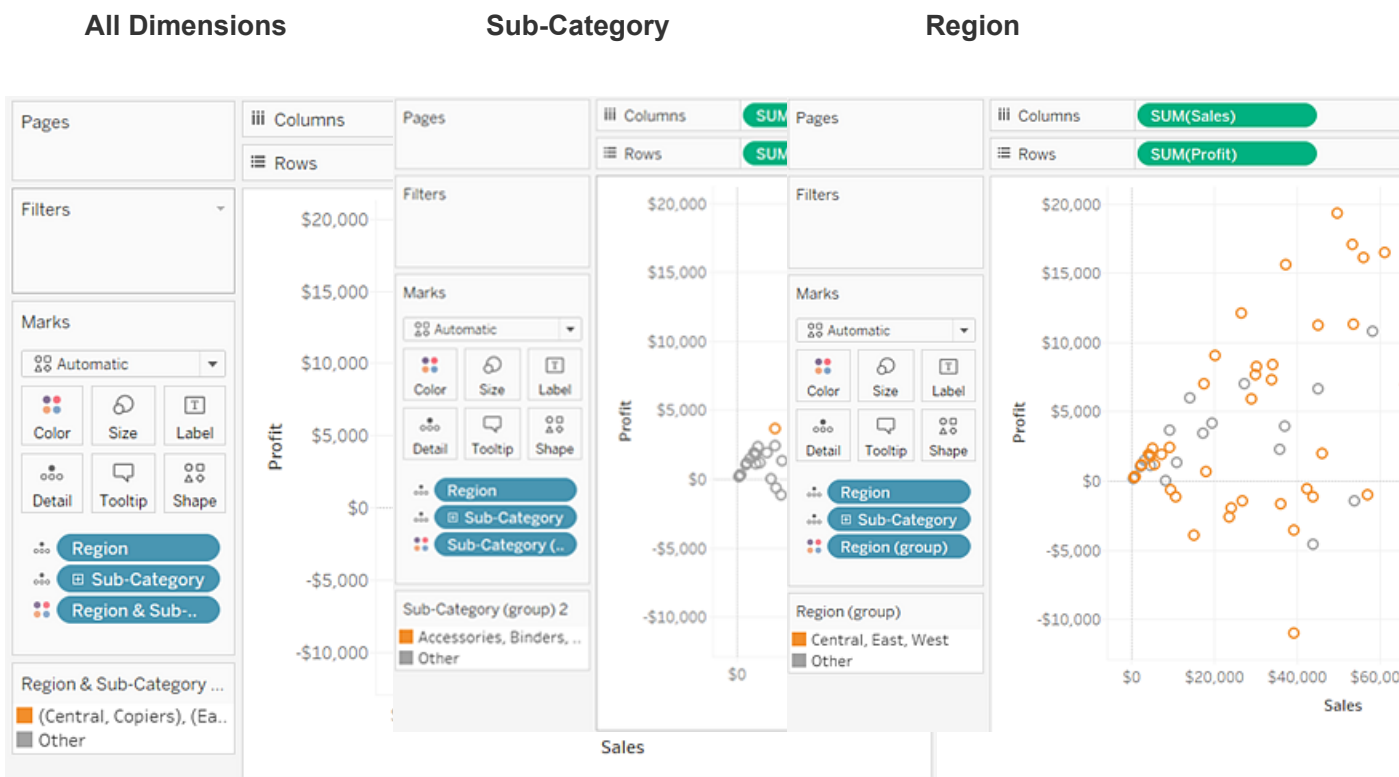

The 5 marks are combined and the rest of the marks are added to an "Other" category.

All marks associated with any of the three sub-categories are combined and everything

All marks associated with the four regions are combined and everything else is added

else is added to an "Other" category.

Correct Data Errors or Combine Dimension Members by Grouping Your Data

If you are using groups to correct data errors (for example, to combine "CA" and "California") or to combine dimensions members (for example, to combine "East" and "West" regions), the easiest option is to select headers in the view.

1. Press and hold the **CTRL** or **Shift** key on the keyboard to multi-select headers in the view. On a Mac, press and hold the Command key.
2. To create a group, do one of the following:
 - On Tableau Desktop, click the **Group** button  on the toolbar, right-click and select **Group** or click the **Group** icon on the tooltip.

- On Tableau Server or Tableau Cloud, click the **Group** icon on the tooltip.

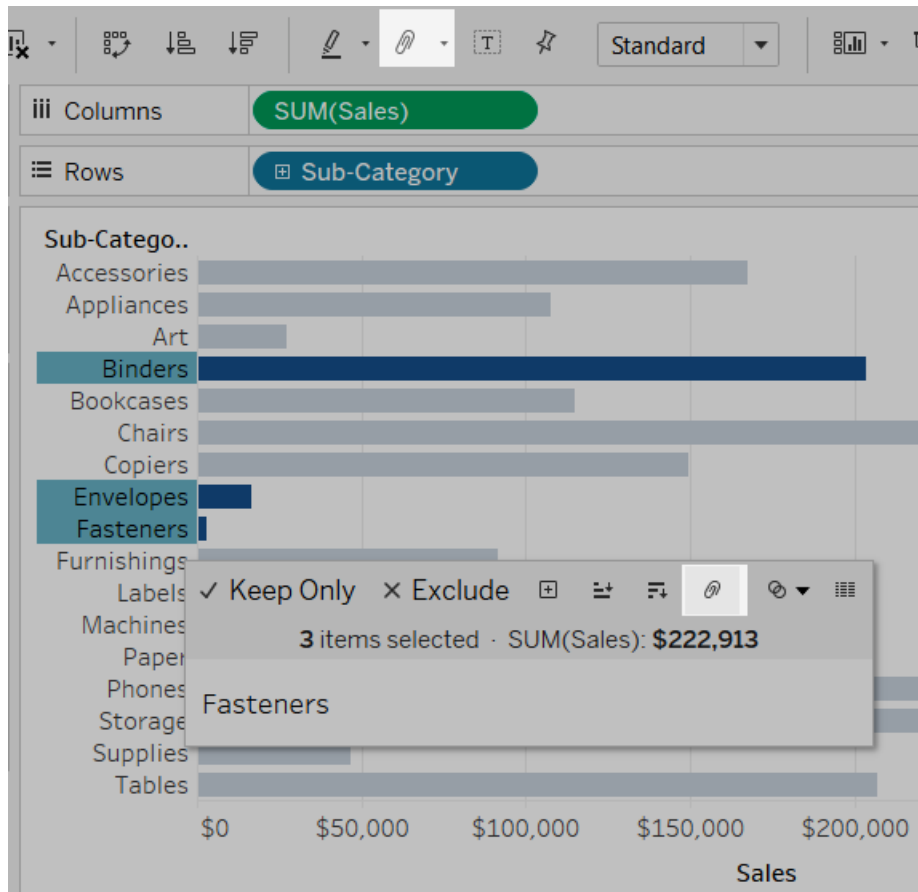

The selected members are combined into a single member. In this example, the view now shows the SUM(Sales) across all binders, envelopes and fasteners as a single mark. A default is automatically constructed using the combined member names. The dimension on the Rows or Columns shelf is replaced with the new grouped field.

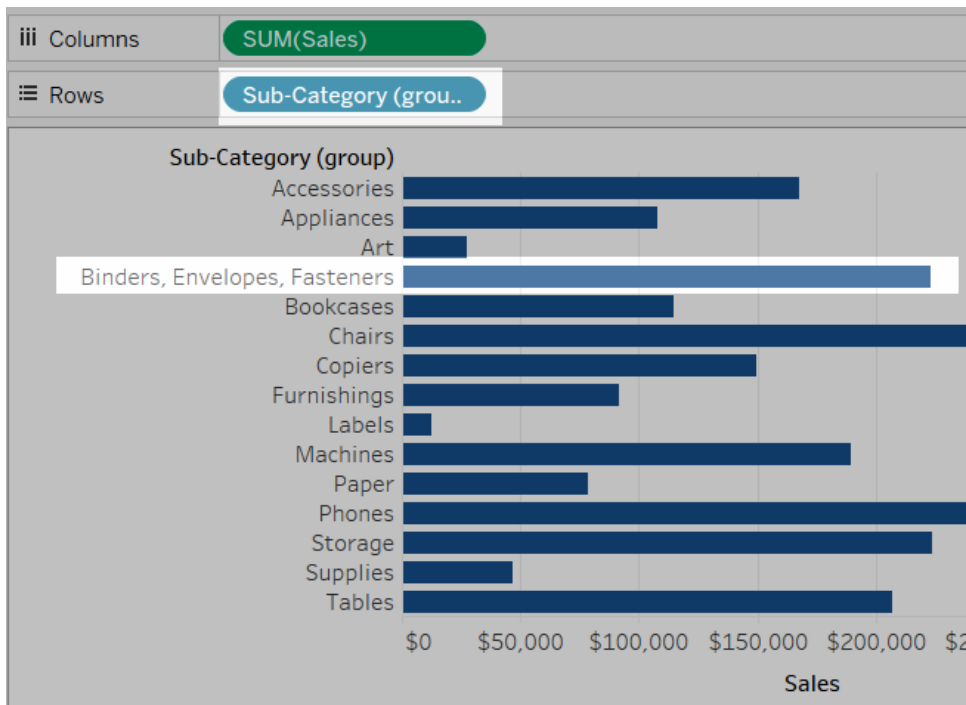

Create Sets

You can use sets to compare and ask questions about a subset of data. Sets are custom fields that define a subset of data based on some conditions.

You can make sets more dynamic and interactive by using them in [Set Actions on page 1436](#). Set actions let your audience interact directly with a viz or dashboard to control aspects of their analysis. When someone selects marks in the view, set actions can change the values in a set.

In addition to a Set Action, you can also allow users to change the membership of a set by using a filter-like interface known as a Set Control, which makes it easy for you to designate inputs into calculations that drive interactive analysis. For details, see [Show a set control in the view on page 1101](#).

Create a dynamic set

There are two types of sets: dynamic sets and fixed sets. The members of a dynamic set change when the underlying data changes. Dynamic sets can only be based on a single dimension.

To create a dynamic set:

1. In the Data pane, right-click a dimension and select **Create > Set**.
2. In the Create Set dialog box, configure your set. You can configure your set using the following tabs:

- **General:** Use the General tab to select one or more values that will be considered when computing the set.

You can alternatively select the **Use all** option to always consider all members even when new members are added or removed.

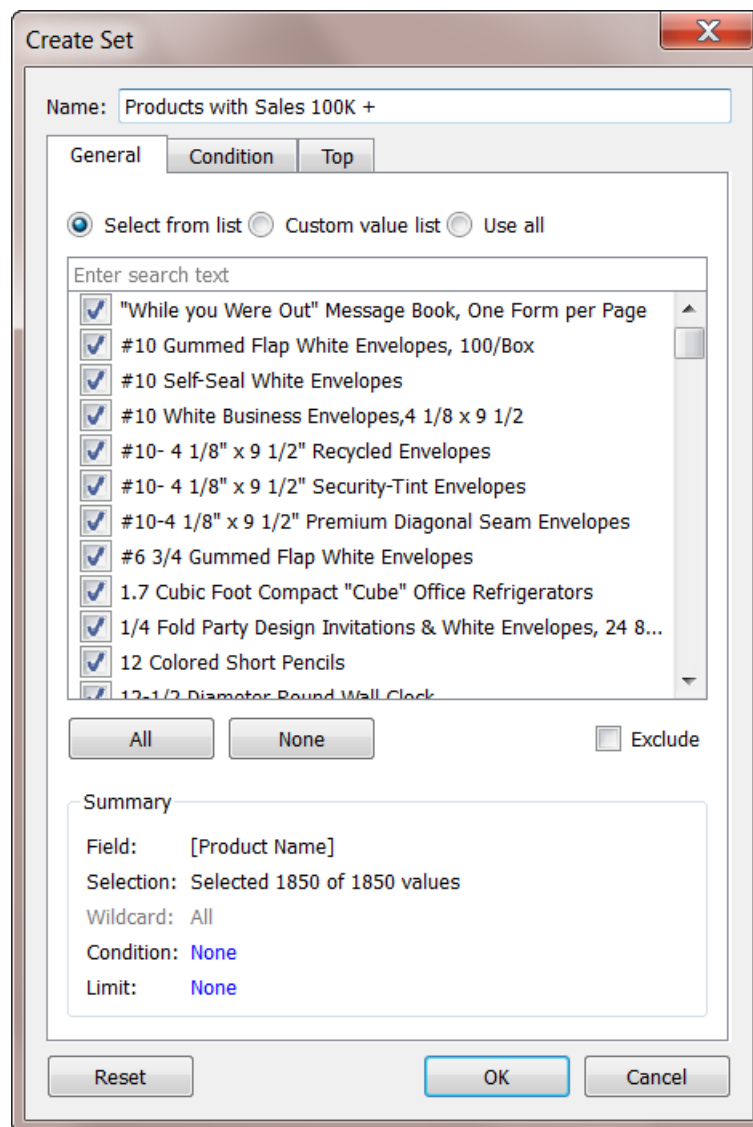

- **Condition:** Use the Condition tab to define rules that determine which members to include in the set.

For example, you might specify a condition that is based on total sales that only includes products with sales over \$100,000.

Create Set

Name: Products with Sales 100K +

General Condition Top

None

By field:

Sales Sum

>= 100,000

Range of Values

Min: Load

Max:

By formula:

Reset OK Cancel

Note: Set conditions work the same as filter conditions. See [Filter Data from Your Views](#) on page 1308 to learn more.

- **Top:** Use the Top tab to define limits on what members to include in the set.

For example, you might specify a limit that is based on total sales that only includes the top 5 products based on their sales.

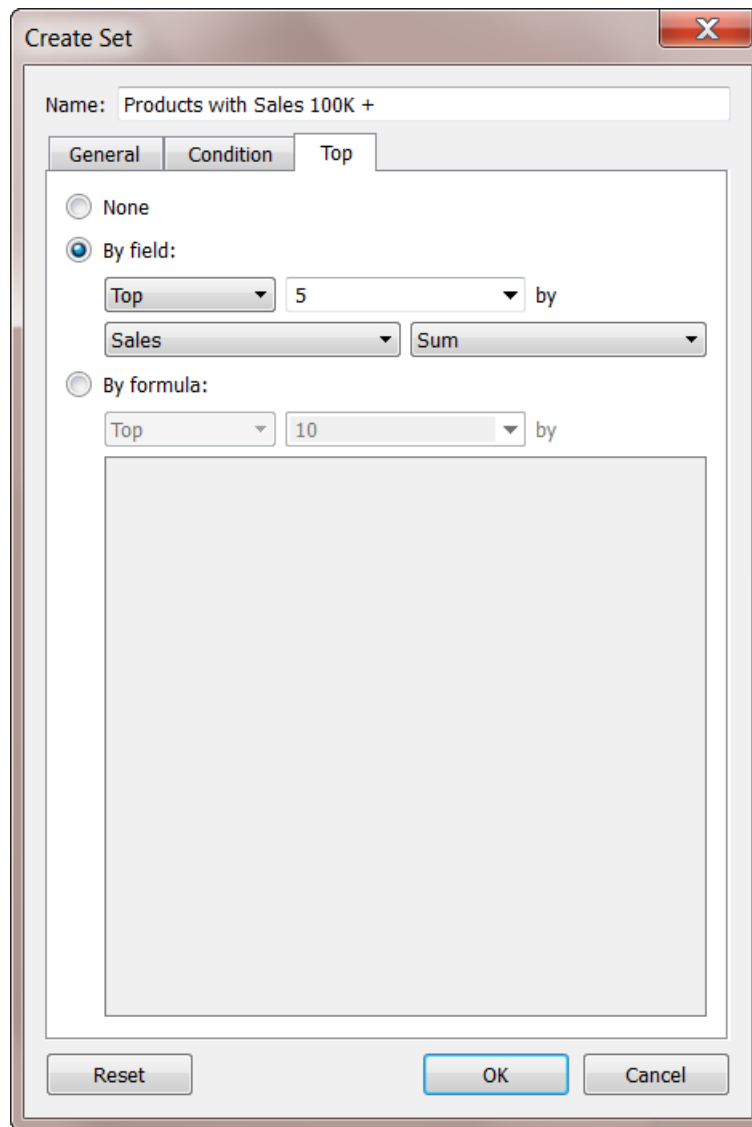

Note: Set limits work the same as Filter limits. See [Filter Data from Your Views on page 1308](#) to learn more.

3. When finished, click **OK**.

The new set is added to the bottom of the Data pane, under the Sets section. A set icon  indicates the field is a set.

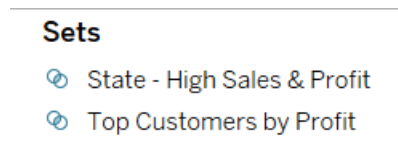

Create a fixed set

The members of a fixed set do not change, even if the underlying data changes. A fixed set can be based on a single dimension or multiple dimensions.

To create a fixed set:

1. In the visualization, select one or more marks (or headers) in the view.
2. Right-click the mark(s) and select **Create Set**.





3. In the Create Set dialog box, type a name for the set.
4. Optionally complete any of the following:
 - By default, the set includes the members listed in the dialog box. You can select the option to **Exclude** these members instead. When you exclude, the set will

include all of the members you didn't select.

- Remove any dimensions that you don't want to be considered by clicking the red "x"

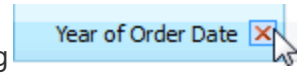
icon that appears when you hover over a column heading



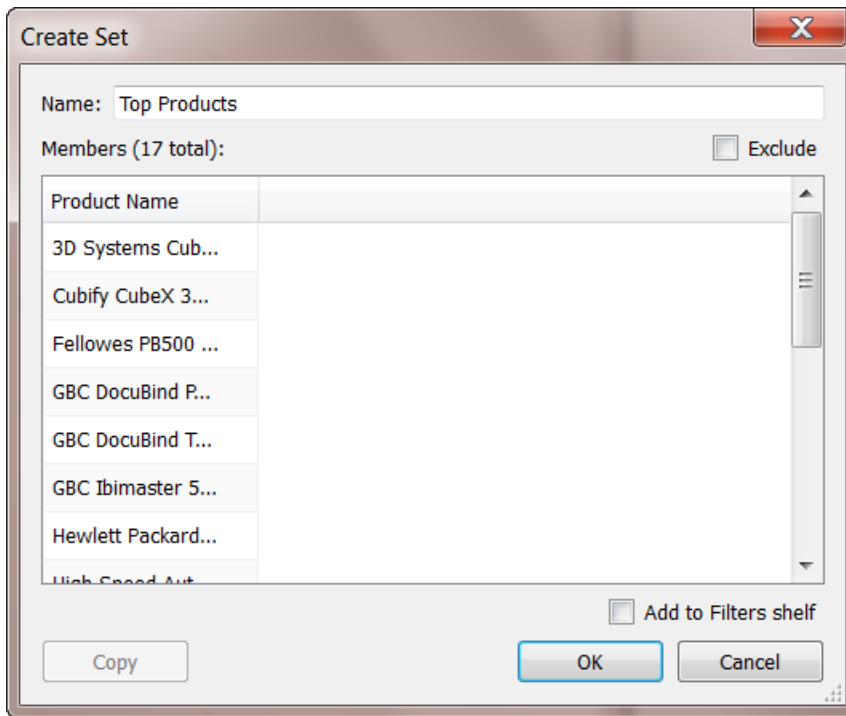

- Remove any specific rows that you don't want to include in the set by clicking the red "x" icon that appears when you hover over the row .
- If the marks you selected represent multiple dimensions, each member of the set will be a combination of those dimensions. You can specify the character that separates the dimension values. To do so, for **Separate members by**, enter a character of your choice.
- Select **Add to Filters shelf** to automatically move the set to the Filters shelf once it is created.



5. When finished, click **OK**.

The new set is added to the bottom of the Data pane, under the Sets section. A set icon  indicates the field is a set.

Sets

-  State - High Sales & Profit
 -  Top Customers by Profit
-

Add or remove data points from sets

If you created a set using specific data points, you can add more data to or subtract data from the set.

To add or remove data points from a set:

1. In the visualization, select the data points you want to add or remove.
2. In the tooltip that appears, click the Sets drop-down menu icon, and then select **Add to [set name]** or **Remove from [set name]** to add or remove data from a particular set.

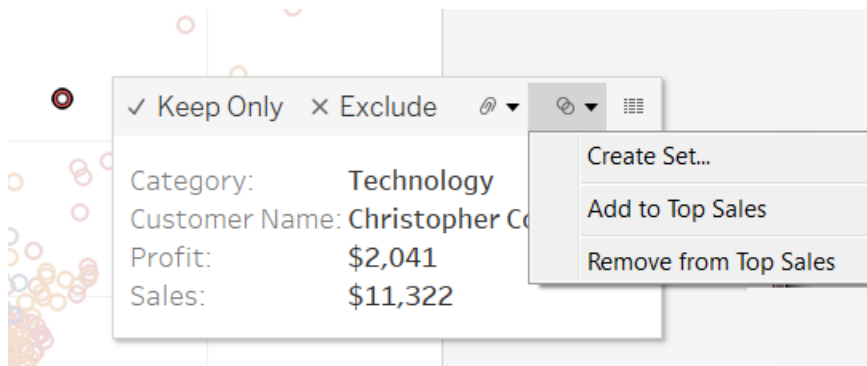

Use sets in the visualization

After you create a set, it displays at the bottom of the Data pane in the Sets section. You can drag it into the viz like any other field.

When you drag a set to the viz in Tableau Desktop, you can choose to show the members of the set or aggregate the members into In/Out categories.

In Tableau Server or Tableau Cloud you can only aggregate the members of the set into In/Out categories.

Show In/Out members in a set

In most cases, when you drag a set to the viz, Tableau displays the set using the In/Out mode. This mode separates the set into two categories:

- In - The members in the set.
- Out - The members that aren't part of the set.

For example, in a set defined for the top 25 customers, the top customers would be part of the In category and all other customers would be part of the Out category.

Using the In/Out mode makes it easy to compare the members in the set to everything else.

To show In/Out members in the visualization:

- In Tableau Desktop, right-click the set in the visualization workspace and select **Show In/Out of Set**.

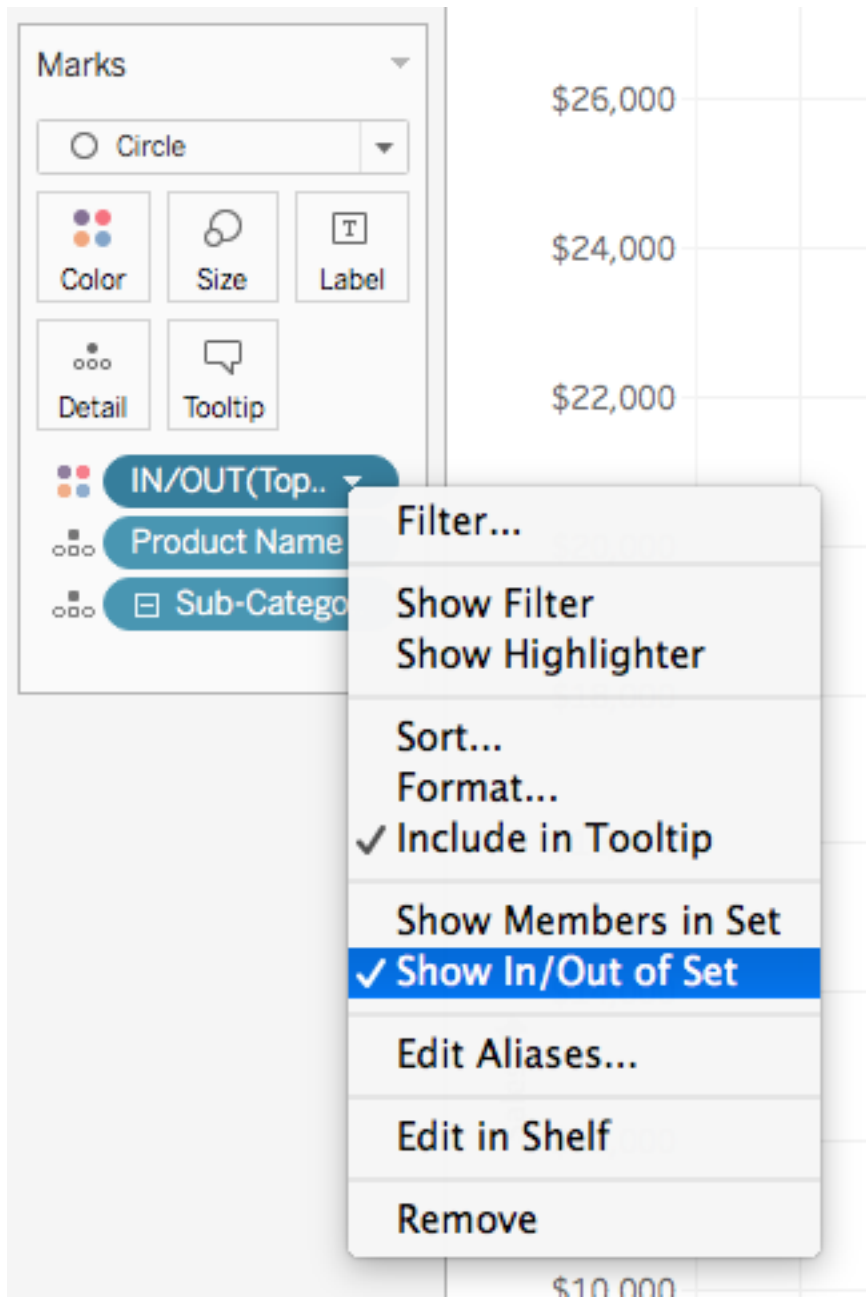

When a set is in In/Out mode, the field on the shelf is prefaced by the text, "IN/OUT", followed by the set name.

Note: In/Out mode is not available in workbooks created before version 8.2 that use Microsoft Excel or text file data sources, workbooks that use the legacy connection, or workbooks that use Microsoft Access data sources.

Show members in a set

As an alternative to showing the set using In/Out mode, you can list the members in the set. Showing the members in the set automatically adds a filter to the view that includes only the members of the set.

To switch a set to list the individual members:

- In the visualization workspace, right-click the set and select **Show Members in Set**.

Note: To display the fully qualified member names for cubes, right-click the set in the Data pane and select **Qualify Member Names**.

Let users change set values

Add a set action

You can use set actions to give your audience more control over their analysis of your visualization.

Set actions take an existing set and update the values contained in that set based on a user's action in the viz. As the author, you can use a set or sets that you have already created to define the scope of the set action.

For details on how to create and use set actions, see [Set Actions on page 1436](#).

Show a set control in the view

To give your audience the ability to quickly modify members of a set, you can also display a Set Control. A set control is a worksheet card that is very similar to a parameter control or filter card. You can add set controls to worksheets and dashboards and they are included when you publish to Tableau Server or Tableau Cloud, or save to the web on Tableau Public.

To display the set control, right-click (Control-click) the set in the Data pane and select **Show Set**.

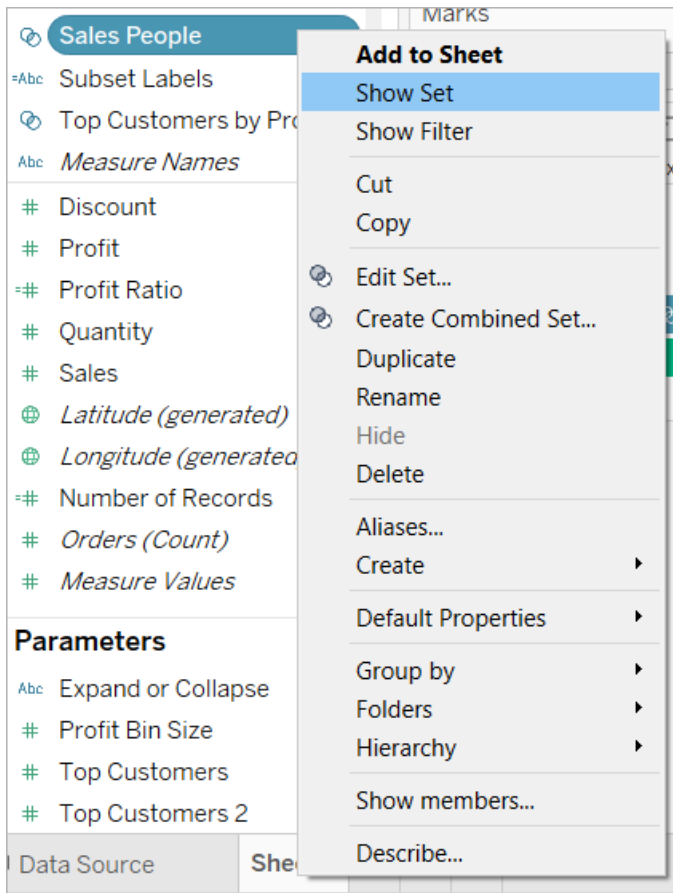

Like other cards, set controls have a menu that you can open using the drop-down arrow in the upper right corner of the card. Use this menu to customize the display of the control, which supports both single-value and multiple-value selection modes. For example, you can show radio buttons for individual selection, or a drop-down list that supports multiple selections.

Note: You can only display a set control for dynamic sets—not fixed sets. This is by design, as fixed sets aren't meant to change in membership. In addition, if the dynamic set is not in play in the view (that is, if it's not referenced in a calculation or instantiated on the sheet), the context menu item will be disabled, reminding you to add the set to the view.

Combine sets

You can combine two sets to compare the members. When you combine sets you create a new set containing either the combination of all members, just the members that exist in both, or members that exist in one set but not the other.

Combining sets allows you to answer complex questions and compare cohorts of your data. For example, to determine the percentage of customers who purchased both last year and this year, you can combine two sets containing the customers from each year and return only the customers that exist in both sets.

To combine two sets, they must be based on the same dimensions. That is, you can combine a set containing the top customers with another set containing the customers that purchased last year. However, you cannot combine the top customers set with a top products set.

To combine sets:

1. In the Data pane, under Sets, select the two sets you want to combine.
2. Right-click the sets and select **Create Combined Set**.
3. In the Create Set dialog box, do the following
 - Type a name for the new combined set.
 - Verify that the two sets you want to combine are selected in the two drop-down menus.
 - Select one of the following options for how to combine the sets:
 - **All Members in Both Sets** - the combined set will contain all of the members from both sets.
 - **Shared Members in Both Sets** - the combined set will only contain members that exist in both sets.
 - **Except Shared Members** - the combined set will contain all members from the specified set that don't exist in the second set. These options are equivalent to subtracting one set from another. For example, if the first set contains Apples, Oranges, and Pears and the second set contains Pears and Nuts; combining the first set except the shared members would contain just Apples and Oranges. Pears is removed because it exists in the second set.
 - Optionally specify a character that will separate the members if the sets represent multiple dimensions.
4. When finished, click **OK**.

Note: This functionality is not available in workbooks created before version 8.2 that use Microsoft Excel or text file data sources, workbooks that use the legacy connection, or workbooks that use Microsoft Access data sources.

Examples of sets

There are many ways you can use sets to answer complex questions and compare cohorts of data. Below are some examples of ways you can use sets to define and compare subsets of data.

How do members of a set contribute to the total?

You may have all kinds of questions surrounding how the members in a set contribute to the overall total. For example, what percent of total sales come from repeat customers? You can answer these types of questions using the IN/OUT mode for a set.

The example below uses sales data to create a set for customers who have purchased 5,000 USD or more in products.

Create the set

1. Right-click (control-click on Mac) the **Customer Name** dimension in the Data pane and select **Create > Set**.

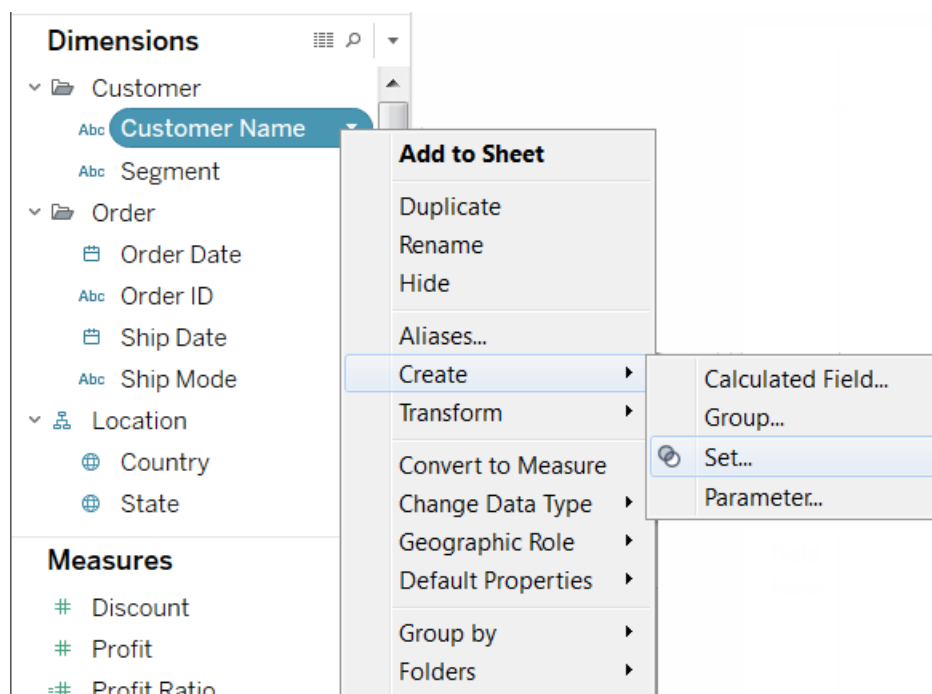

2. In the Create Set dialog box, type a name for the set. In this example, we'll call the set, "Customers"
3. Select the **Use all** option so the condition always applies to all values even when new customers are added.
4. On the Condition tab, click **By field**, and then define a condition that only includes customers when **Sum** of **Sales** is greater than or equal to **5,000**.

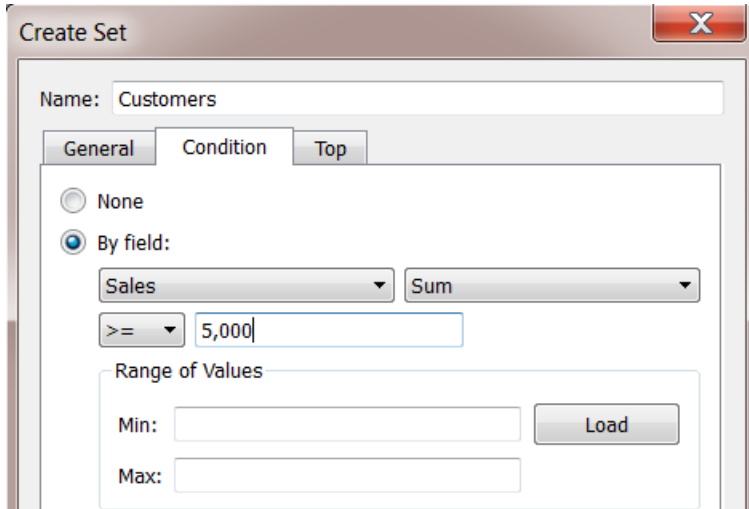

5. Click **OK**.

Create the visualization

1. Drag the new set from the **Sets** area at the bottom of the **Data** pane to the **Rows** shelf.
2. Drag **Sales** to the **Columns** shelf. The view now shows the total sales for customers who have purchased more than 5,000 USD of product and the total sales for all other customers.

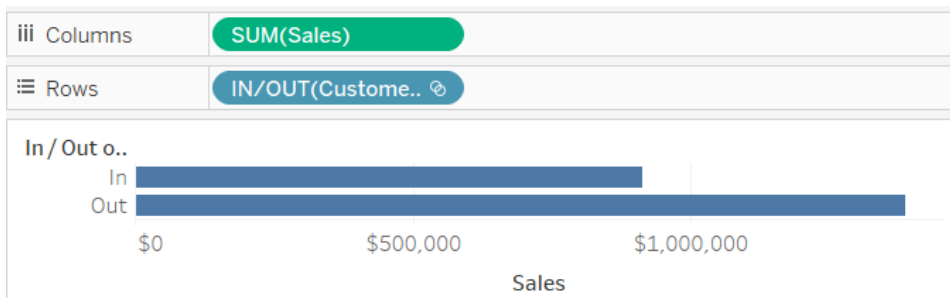

3. Finally, click on the drop-down arrow on the **Sum (Sales)** field on the Column shelf and select **Quick Table Calculation > Percent of Total** on the context menu.

The view now shows that customers with sales greater than or equal to 5,000 make up about 39% of the overall sales.

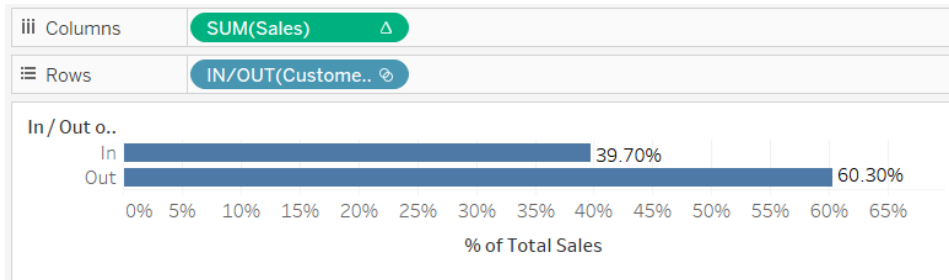

How many members of a set exist in another set?

Another common use of sets is to compare subsets of data or cohorts. For example, you may wonder how many customers that purchased last year also purchased this year. Or if a customer purchased a specific product, what other products did they buy? You can answer these types of questions by creating multiple sets and combining them. The example below uses sales data to determine how many customers who purchased in 2012 also purchased in 2013.

Create a combined set

1. Drag the **Customer Name** field to the Rows shelf.
2. Drag the **Order Date** field to the Filters shelf.
3. In the Filter Field dialog box, select **Years** and click **Next**.
4. In the Filter dialog box, select **2012** and click **OK**.

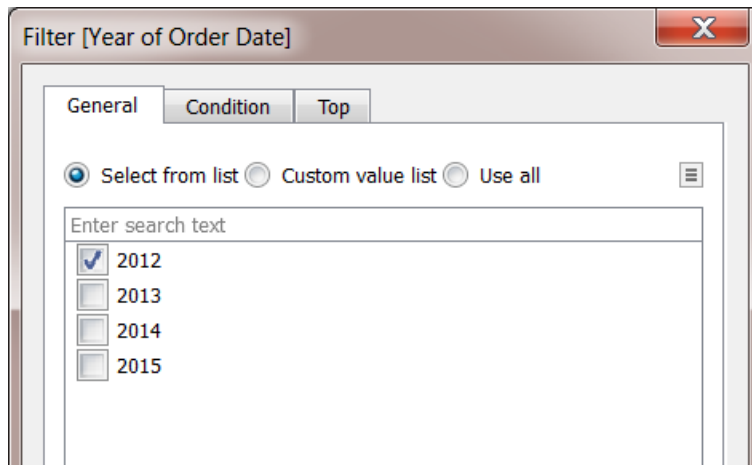

5. Back in the view, press CTRL + A (Command-A on a Mac) on your keyboard to select all of the customers.
6. Right-click (control-click on Mac) the selection and select **Create Set**.

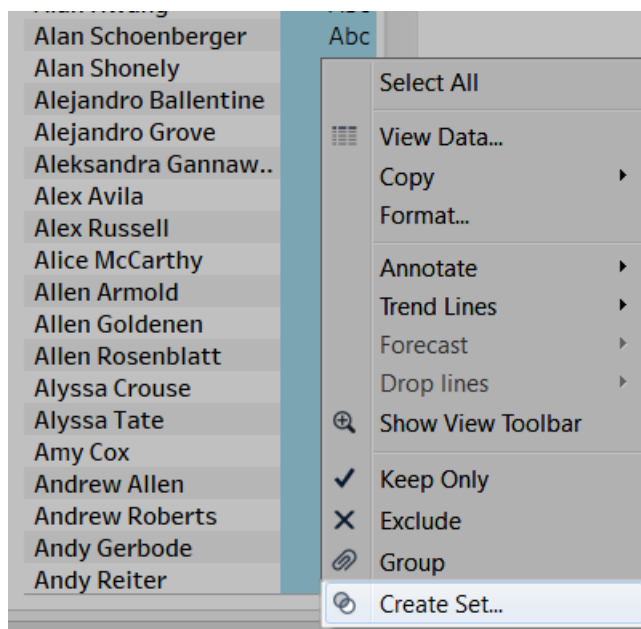

7. In the Create Set dialog box that opens, type a name for the set. In this example, we'll call the set "Customers (2012)".
8. Click **OK**.
9. On the **Filters** shelf, right-click (control-click on Mac) **Order Date** and select **Edit Filter**.

- In the Filter dialog box, change the filter to only include **2013** instead of **2012**, and then click **OK**.

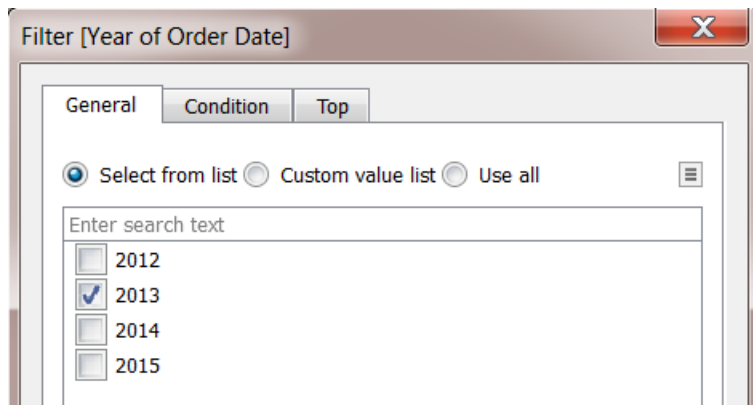

- Again, press CTRL + A (Command-A on a Mac) on your keyboard to select all of the customers.
- In the view, right-click (control-click on Mac) the selection and select **Create Set**.
- In the Create set dialog box that opens, type a name for the set. This set will be called "Customers (2013)".
- Click **OK**.
- In the **Data** pane, select both the **Customers 2012** and **Customers 2013** by holding the Ctrl key (Command key on a Mac) on your keyboard as you select.
- Right-click (control-click on Mac) the selection and select **Create Combined Set**.

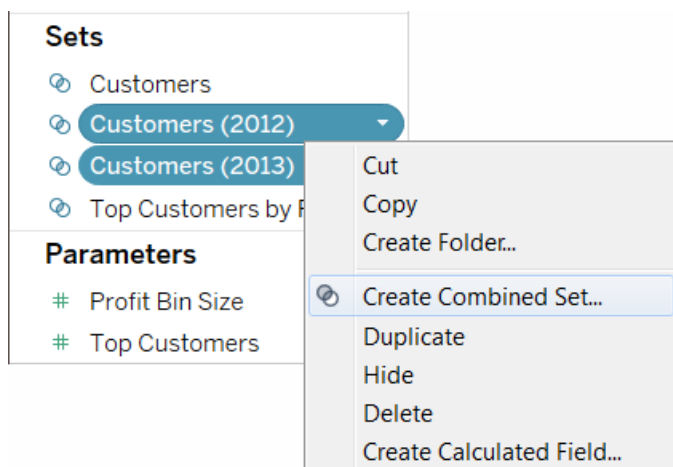

17. In the Create Set dialog box, type a name for the new set. In this example, we'll call the set "Customers (2012 & 2013)".
18. Make sure the correct two sets are selected in the drop-down menus.
19. Select the option to include **Shared Members in Both Sets**.

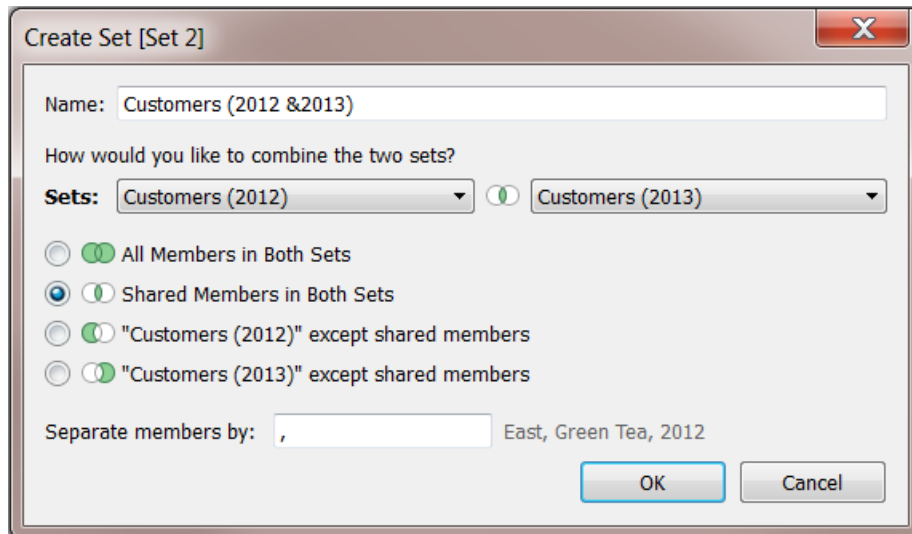

20. Click **OK**.

Create the visualization

1. At the bottom of the workbook, click the New Worksheet  icon.
2. In the new worksheet, drag the **Customer Name** dimension to the **Rows** shelf.
3. Click the drop-down arrow on the Customer Name field on the Rows shelf and select **Measure > Count (Distinct)** from the context menu.
4. Finally, from the **Sets** area of the **Data** pane, drag the **Customers (2012 & 2013)** field to the **Filters** shelf. You can see that 437 customers purchased products in both 2012 and

2013.

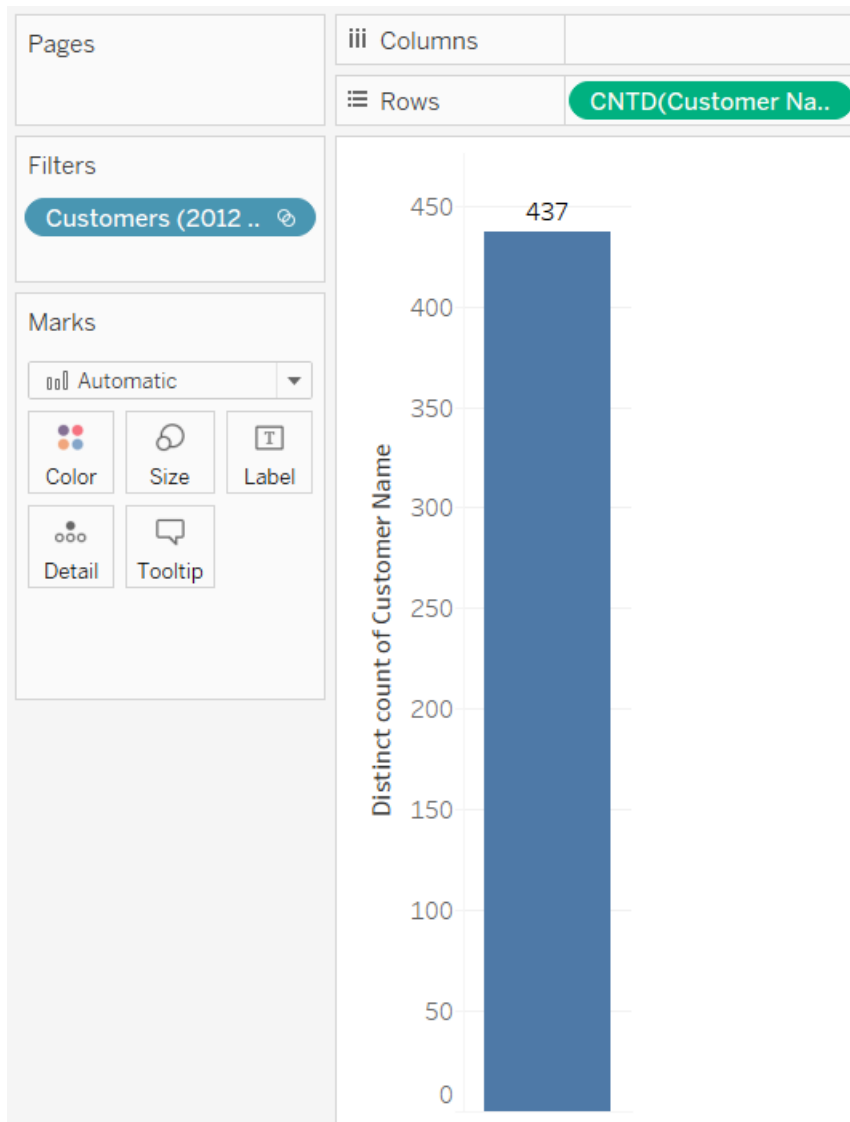

Hierarchical sets and descendants

A hierarchical set filters data to the selected members and all of their descendants. They are unique to multidimensional (cube) data sources and are defined within the data source prior to connecting to Tableau Desktop.

When you create sets in Tableau from a cube data source, descendants and any hierarchical structures are automatically included with the selected members.

For example, a set named **Dairy** is created from the **Product** hierarchy. As shown below, it includes only the Dairy product department.

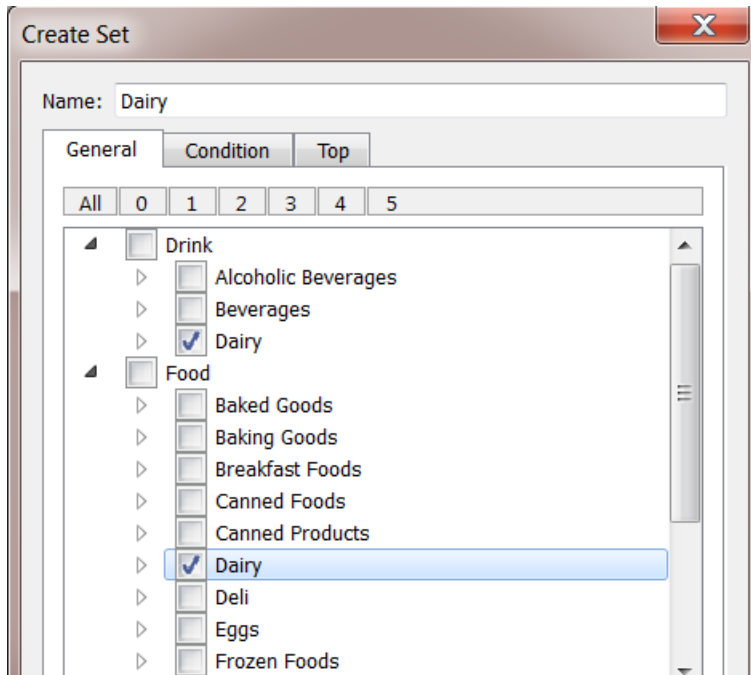

Consider the following view. The **Product Department** dimension is placed on the **Rows** shelf and the **Store Sales** measure is placed on the **Columns** shelf.

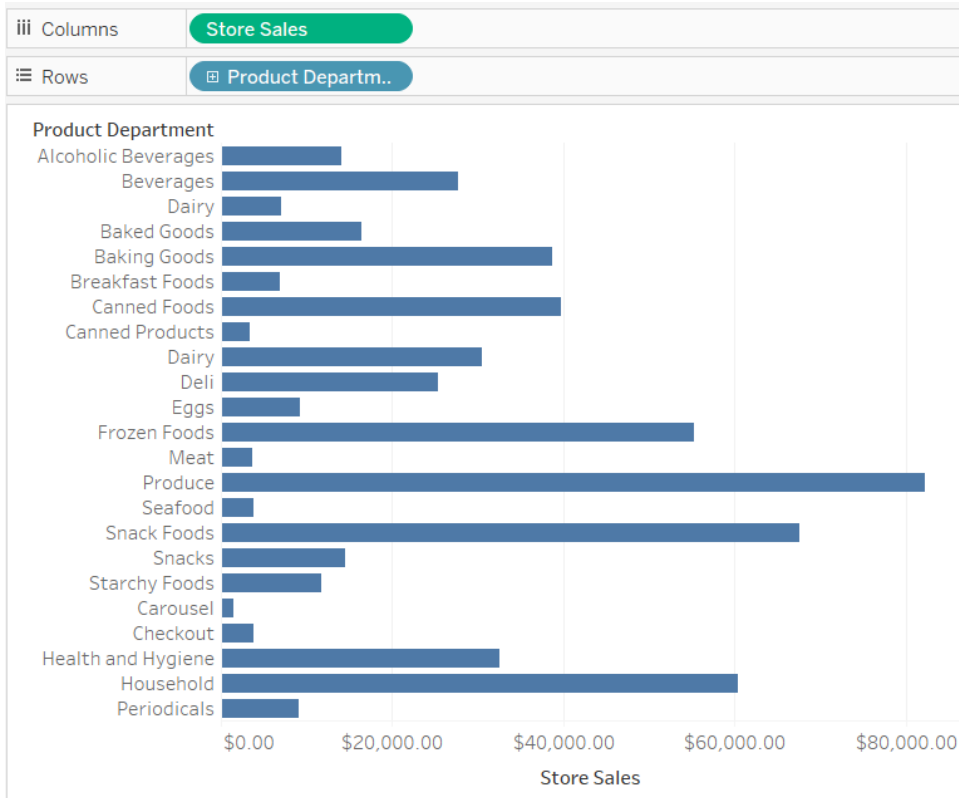

If you place the **Dairy** set on the **Filters** shelf, you can see that the view is filtered to include only the Dairy product categories.

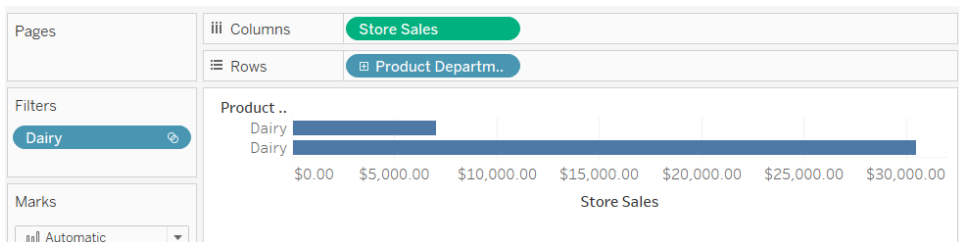

As shown below, you can drill down into **Product Department** to reveal the **Product Category**, **Product Subcategory**, and **Brand Name** levels. As these descendants are revealed, row headers are added to the view. This is because a set filter allows you to view the levels of detail contained within the filtered members.

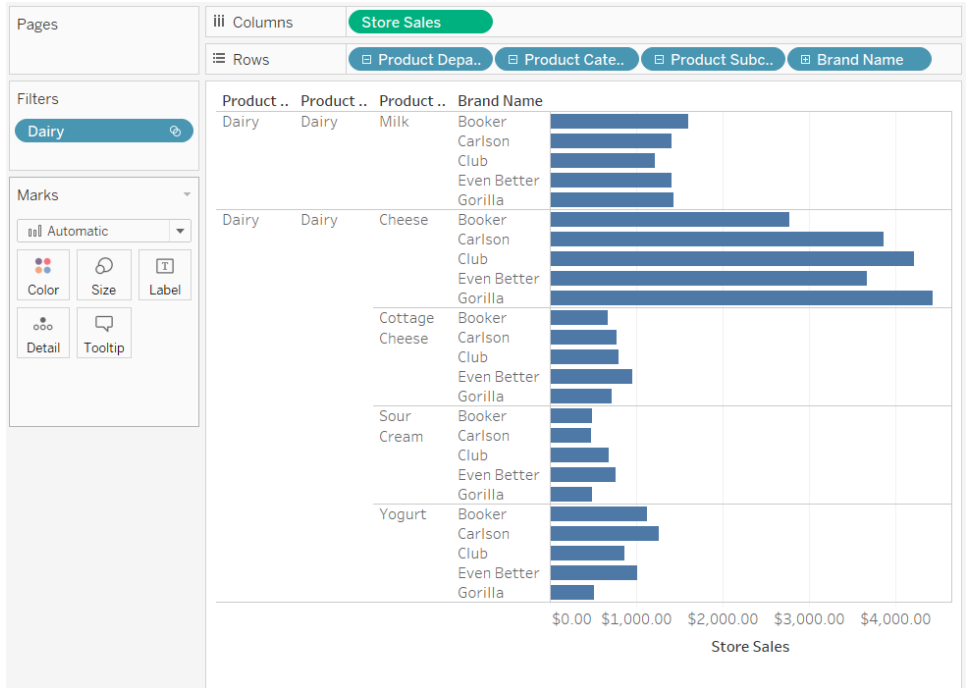

Sets for Top N and Others

If you collect large sets of data that you want to visualize, you might find that limiting the amount of information displayed to an important subset of records helps you work with and answer questions about the data more effectively.

This article describes how to create an interactive view that separates your customers into two dynamic groups:

- The top N customers
- All other customers

The view includes a control that your users can adjust to change the number of customers included in the top customers group. When they change the number, the view updates accordingly.

Sets and supported data sources

The method described in this article for creating a view of the top customers uses the In/Out functionality of sets.

Sets were introduced with Tableau Desktop version 8.0.

For live connections, the In/Out functionality requires a relational or multidimensional data source.

If you use a file-based data source, such as a Microsoft Excel workbook or text file, you can take an extract with which you can create sets.

Step 1: Create the parameter

1. In Tableau Desktop, open a new workbook and connect to the **Sample-Superstore** data source.
2. Open a new worksheet.
3. In the Data pane, click the drop-down arrow in the upper right corner and select **Create Parameter**.
4. In the Create Parameter dialog box, do the following:
 - In the **Name** text box, type **Top Customers 2**.
 - For **Data type**, select **Integer**.
 - For **Current value**, type **5**.
 - For **Allowable values**, click **Range**.
 - Under Range of values, do the following:
 - Click **Minimum** and type **5**.
 - Click **Maximum** and type **20**.
 - Click **Step size** and type **5**.

This parameter will be used, in combination with the top N set you will create in the next step, to quickly adjust the top N value in the view.

Step 2: Create the top N customers set

1. In the Data pane, right-click the **Customer Name** dimension and select **Create > Set**.
2. In the Create Set dialog box that opens, do the following:
 - In the **Name** text box, type **Top N Customers by Sales**.
 - Click the **Top** tab.
 - Select **By Field**.
 - From the field drop-down list (Category), select **Sales**.
 - From the aggregation drop-down list, select **Sum**.
 - When finished, click **OK**.

Step 3: Set up the view

1. From the Data pane, under **Sets**, drag **Top N Customers by Sales** to the **Rows** shelf.
2. Drag the **Customer Name** dimension to the **Rows** shelf, positioning it to the right of the set.
3. Drag the **Sales** measure to the **Columns** shelf.
4. On the toolbar, click the Sort Descending button  to make sure that the set is working.

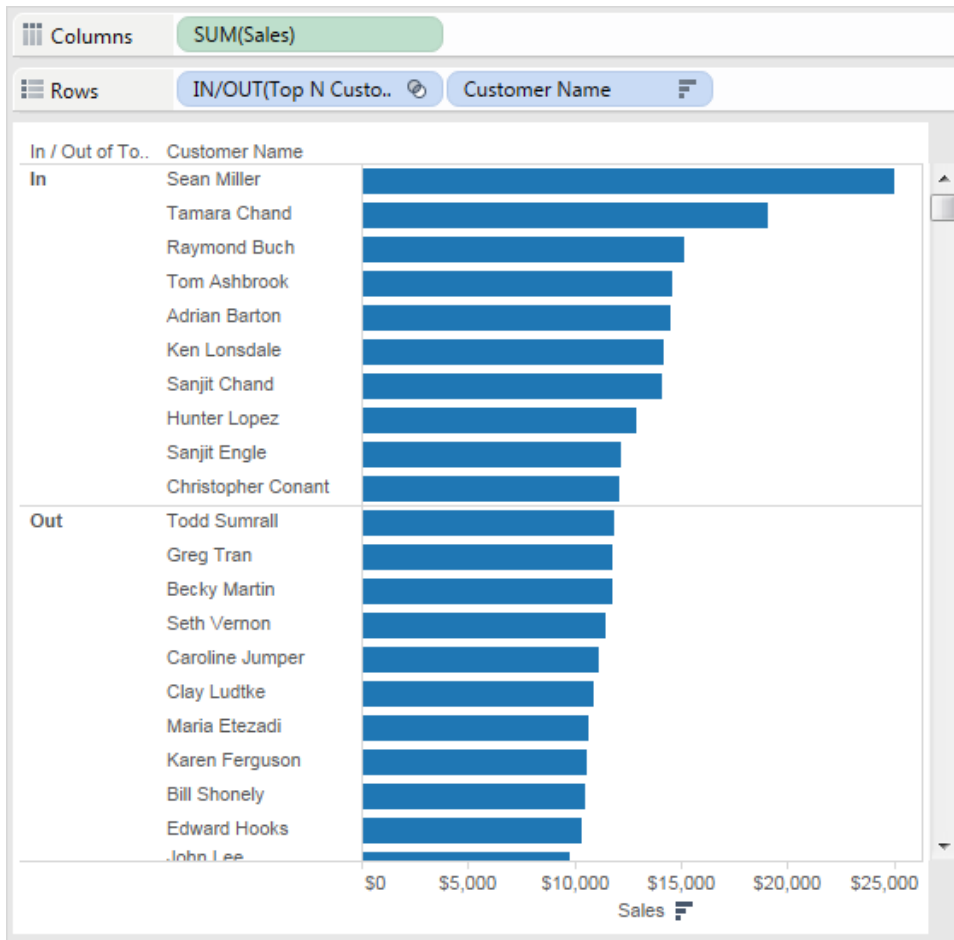

5. In the Data pane, right-click the **Top N Customers by Sales** set, and then click **Create Calculated Field**.
6. In the Calculated Field dialog box that opens, complete the following steps:

- In the **Name** text box, type **Subset Labels**.
- In the **Formula** text box, type the following formula to create dynamic labels for the customers in the set:

```
IF [Top N Customers by Sales]
  THEN "Top " + str([Top Customers 2]) + " Customers"
  ELSE "Others"
  END
```

- When finished, click **OK**.
7. From the Data pane, drag **Subset Labels** to the **Rows** shelf, placing it between the Top N set and the **Customer Name** dimension.
 8. On the **Rows** shelf, right-click the **IN/OUT(Top N Customers by Sales)** set, and then clear **Show Header**.

This hides the In/Out labels while retaining the sort order so that your top N subset always appears at the top of the view.

9. From the Data pane, drag the **Top N Customers by Sales** set to **Color** on the **Marks** card.

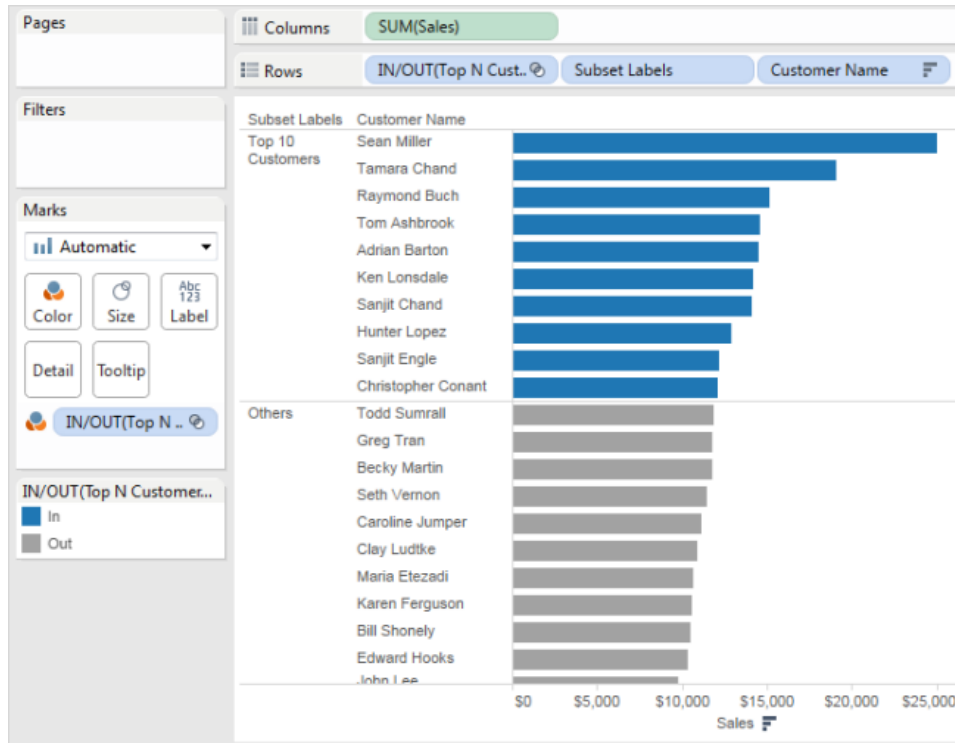

Step 4: Combine the Top N set with a dynamic parameter

1. In the Data pane, right-click **Top N Customers by Sales**, and then select **Edit Set**.
2. In the Edit Set dialog box, do the following:
 - Select the **Top** tab.
 - Click the value drop-down menu, and select the **Top Customers 2** parameter.
 - Click **OK**.

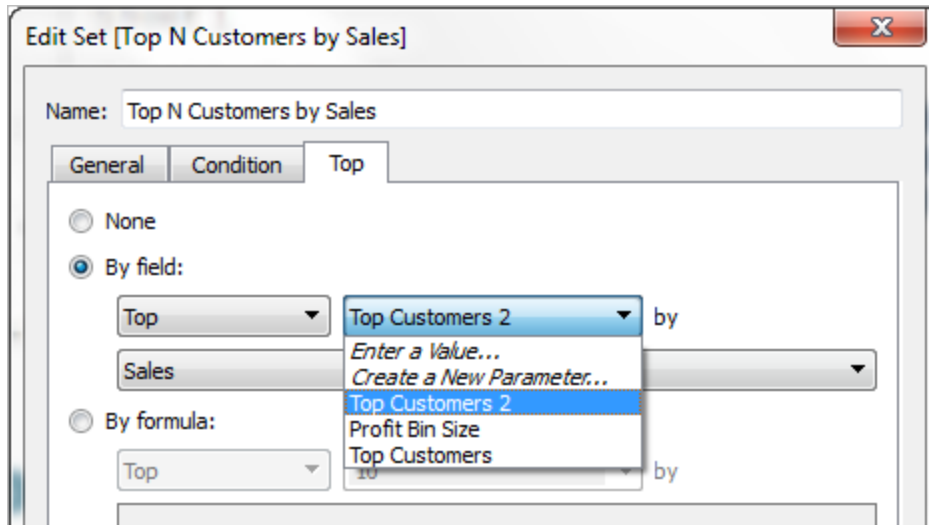

This links the **Top N Customers by Sales** set to the **Top Customers 2** dynamic parameter, instead of to a static list of 10.

This parameter will be used in combination with the Top N Customers by Sales set, to adjust the top N value in the view.

3. In the Data pane, under Parameters, right-click the **Top Customers 2** parameter, and select **Show Parameter**.

You can control the top N value by using the **Top Customers 2** parameter control that appears in the view.

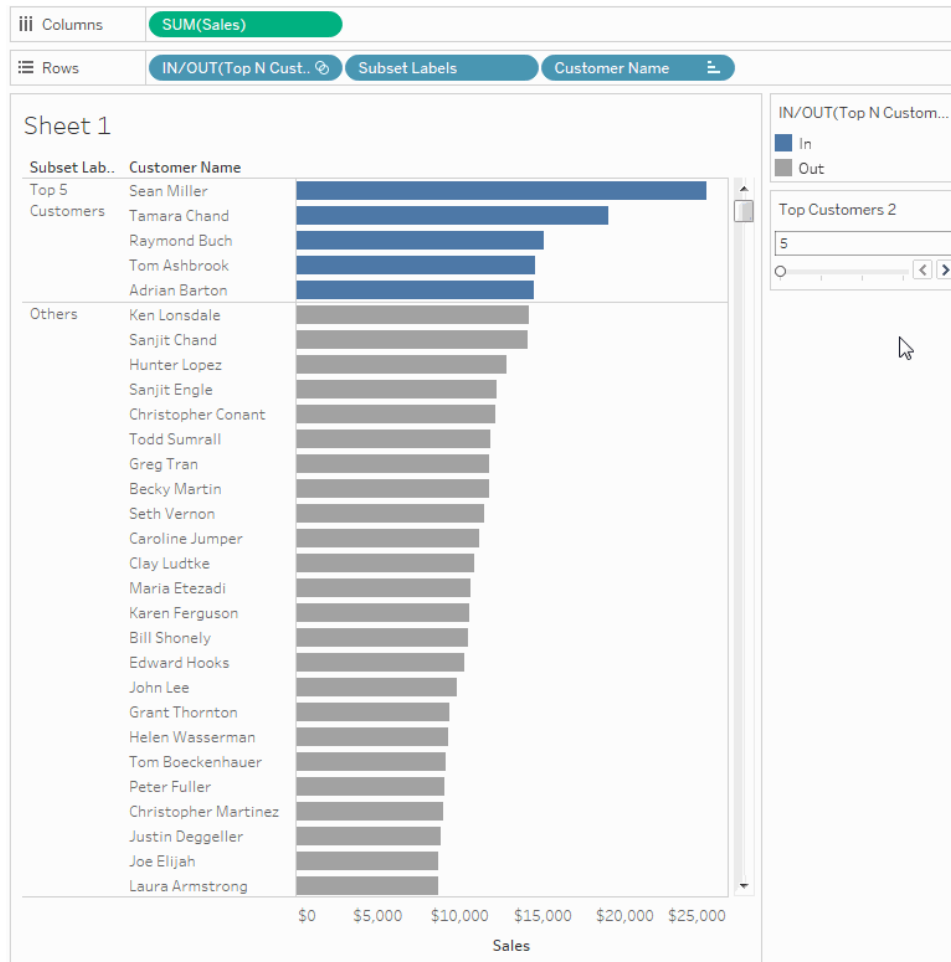

Additional tips for improving the view's functionality

Here are some additional steps you can take to give your viewers more flexibility in displaying the customer subsets.

1. From the Data pane drop-down menu, select **Create Parameter**.
2. In the Create Parameter dialog box that opens, do the following:
 - For **Name**, type **Expand or Collapse**.
 - For **Data type**, select **String**.
 - For **Allowable values**, select **List**.
 - In the **List of values**, type the values **Expand** and **Collapse**.

Create Parameter

Name:

Properties

Data type:

Current value:

Value when workbook opens:

Display format:

Allowable values: All List Range

List of values

Value	Display As
Expand	Expand
Collapse	Collapse
Add	

Fixed When workbook opens

- When finished, click **OK**.
3. Select **Analysis > Create Calculated Field**.
 4. In the Create Calculated Field dialog box that opens, do the following to create a calculation that uses the parameter you just created. This calculation enables viewers to specify how to view customers in the Others subset:
 - For **Name**, enter **Customer Names Calc**.
 - In the formula box, type the following formula, and then click **OK**:

```
IF [Expand or Collapse]="Collapse" THEN
  IF [Top N Customers by Sales]
  THEN [Customer Name]
  ELSE "Others" END
ELSE [Customer Name] END
```
 5. In the Data pane, under Parameters, right-click the **Expand or Collapse** parameter, and select **Show Parameter**.
 6. From the **Columns** shelf, drag the **SUM(Sales)** measure to **Label** on the **Marks** card.

- From the Data pane, drag **Customer Names Calc** directly on top of the **Customer Name** field on the **Rows** shelf, so that it replaces it.

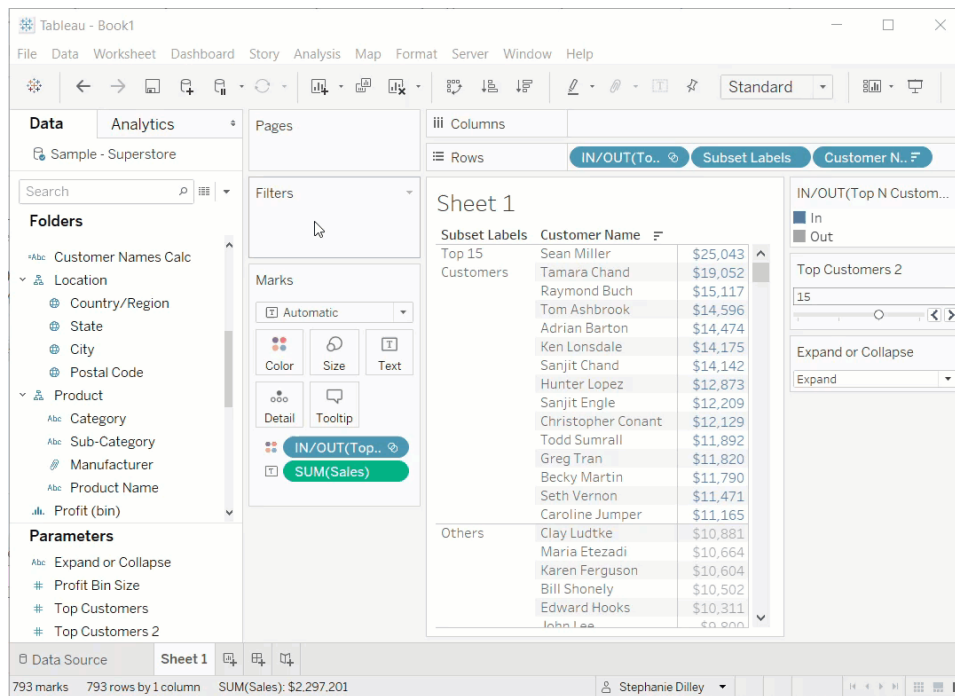

Now you can use the **Expand or Collapse** parameter control to see the list of names in the top N customers and the remaining customers rolled up into a single **Others** entry.

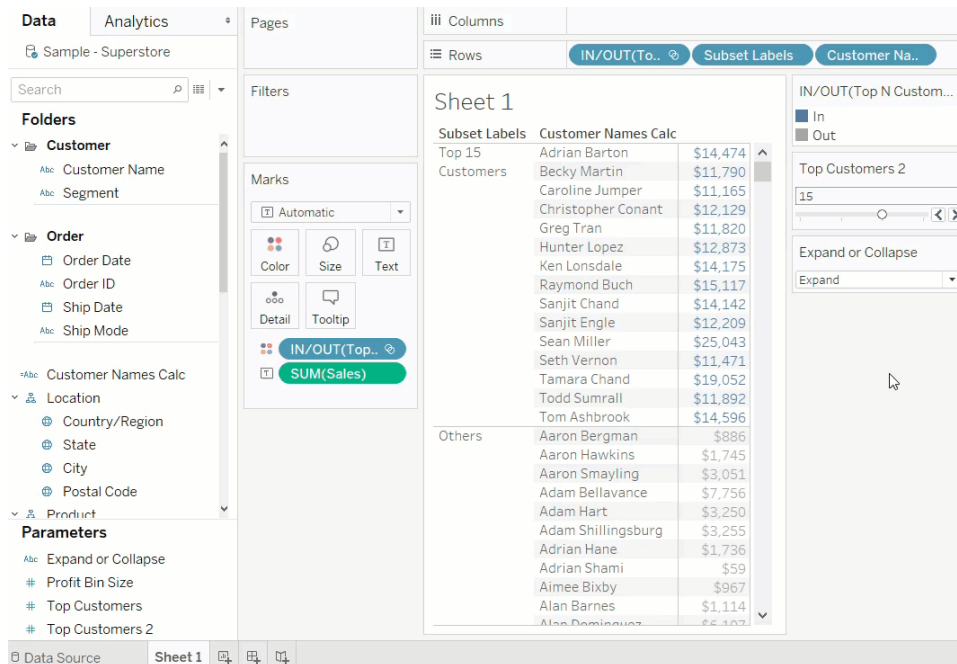

Create Parameters

A parameter is a workbook variable such as a number, date, or string that can replace a constant value in a calculation, filter, or reference line.

For example, you may create a calculated field that returns True if Sales is greater than \$500,000 and otherwise returns False. You can replace the constant value of “500000” in the formula with a parameter. Then, using the parameter control, you can dynamically change the threshold in your calculation.

To use a parameter, you must:

1. Set up the initial parameter.
2. Use the parameter in an element such as a calculation, filter, or reference line.
3. Adjust the parameter value by:
 - Showing the parameter control
 - Using a parameter action
 - Setting a dynamic parameter to update automatically

Create a parameter

To create a parameter from the Data pane:

1. In the Data pane, click the dropdown arrow in the upper right corner and select **Create Parameter**.

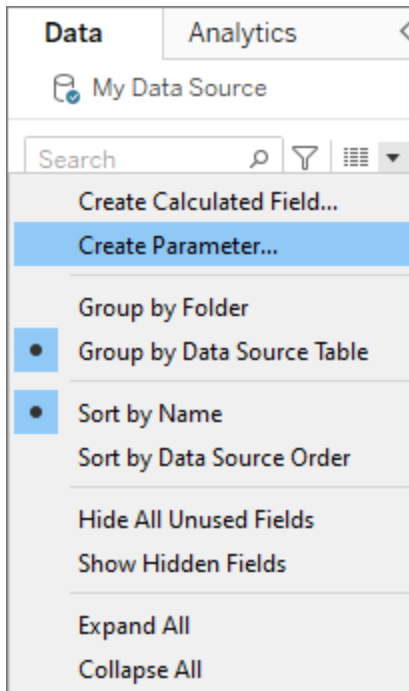

2. In the Create Parameter dialog box, give the field a **Name**.

Create Parameter

Name

My Parameter

Properties

Data type	Display format
Float	1
Current value	Value when workbook opens
1	Current value

Allowable values

All List Range

Cancel OK

3. Specify the data type for the values it accepts:

Properties

Data type

Integer

- Float
- ✓ Integer
- String
- Boolean
- Date
- DateTime

4. *Optional:* Specify a current value. This is the default value for the parameter.

5. *Optional*: Specify a value when the workbook opens.
6. Specify the display format to use in the parameter control (Tableau Desktop only).

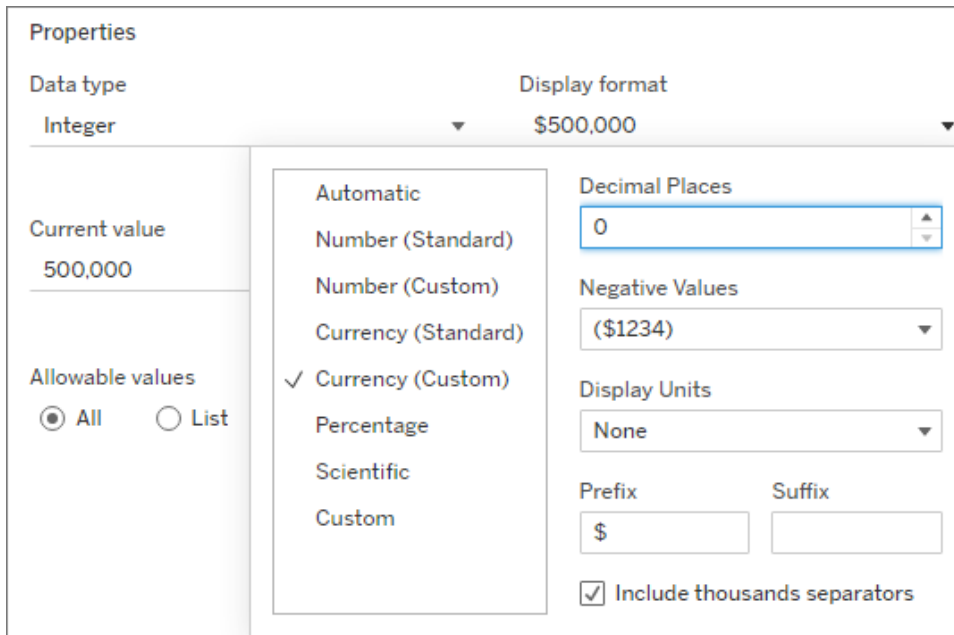

7. Specify how the parameter accepts values. You can select from the following options:
 - **All**: The parameter control is a simple text field.
 - **List**: The parameter control provides a list of possible values for you to select from.
 - If you select List, you must specify the list of values. Click in the left column to type your list of values, or you can add members of a field or paste from the clipboard by selecting **Add values from**.

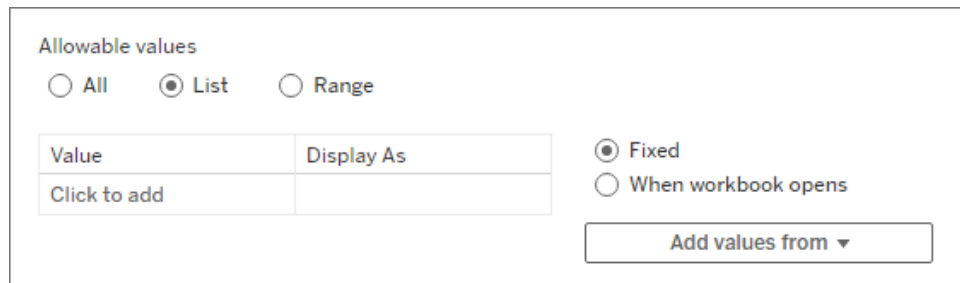

- **Range**: The parameter control lets you select values within a specified range.
 - If you select Range, you must specify a minimum, maximum, and step size. The step size controls the jumps between values, such as letting you choose each number (5, 6, 7...) or going from 5 to 10 to 15.

The availability of these options is determined by the data type. For example, a string parameter doesn't support Range.

To refresh the parameter's list of values (or domain) whenever the workbook opens, select **List** or **Range**, and then select **When the workbook opens**. Notice that some options are grayed out because the workbook is dynamically pulling values from the data source.

8. When finished, click **OK**.

The parameter is now listed in the Parameters section at the bottom of the Data pane.

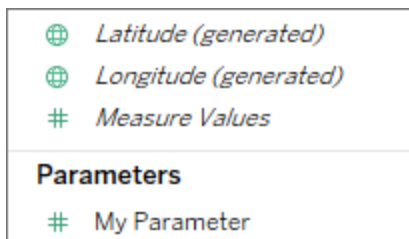

Edit a parameter

You can edit parameters from the Data pane or the parameter control. Editing is for things like changing the allowable range or the data type. To simply change the value or a parameter, use the parameter control. See [Show a parameter control in the viz on page 1128](#).

To edit a parameter:

1. Do one of the following:
 - Right-click the parameter in the Data pane and select **Edit**.
 - Select **Edit Parameter** on the parameter control menu.
2. In the Edit Parameter dialog box, make your changes.
3. Click **OK**. The parameter is updated along with any elements that use it.

Delete a parameter

To delete a parameter, right-click it in the Data pane and select **Delete**. Any calculated fields that use the deleted parameter become invalid.

Use a parameter

A parameter won't do anything until it's tied to an element in the viz. Parameters can be referenced in calculations, filters, and reference lines. Parameters are global across the workbook and can be used in any worksheet.

After the element references the parameter, be sure to **Show a parameter control in the viz on the next page** (or set up a parameter action, or a dynamic parameter). If there's no way to change the value of the parameter, it doesn't do any good to have it set up in the first place.

Use a parameter in a calculation

Parameters give you a way to dynamically modify values in a calculation. Rather than manually editing the calculation (and all dependent calculations), you can use a parameter. Then when you want to change the value, you open the parameter control, change the value, and all calculations that use that parameter are updated.

To use a parameter in a calculation, type the name of the parameter and it appears in the suggested options, just like typing a field name. You can also drag the parameter from the Data pane and drop it in the calculation editor.

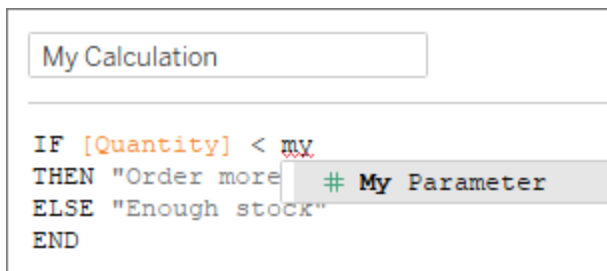

Use a parameter in a filter

Parameters give you a way to dynamically modify values in a Top N filter. Rather than manually setting the number of values you want to show in the filter, you can use a parameter. A list of parameters is available in the dropdown lists on the **Top** tab of the Filter dialog box. Select the parameter you want to use in the filter.

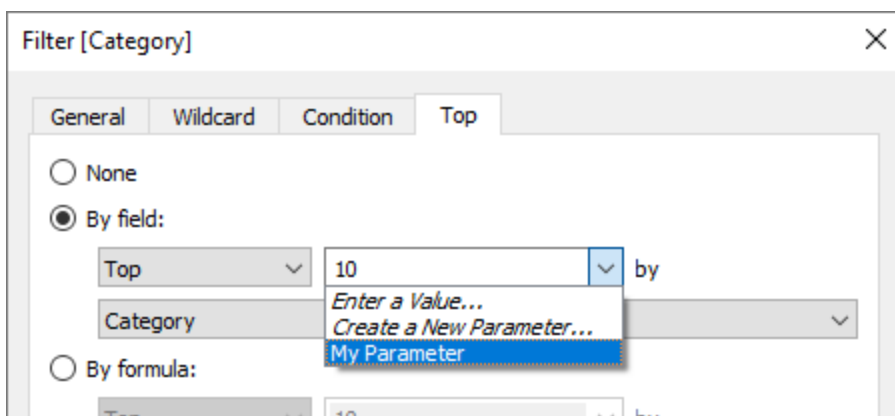

Use a parameter in a reference line

Parameters give you a way to dynamically modify a reference line, band, or box. For example, instead of showing a reference line at a fixed location on the axis, you can reference a parameter. Then you can use the parameter control to move the reference line.

A list of parameters is available in the **Value** dropdown list in the Add Reference Line, Band, or Box dialog box. Select the parameter you want to use. The reference line is drawn at the Current Value specified by the parameter.

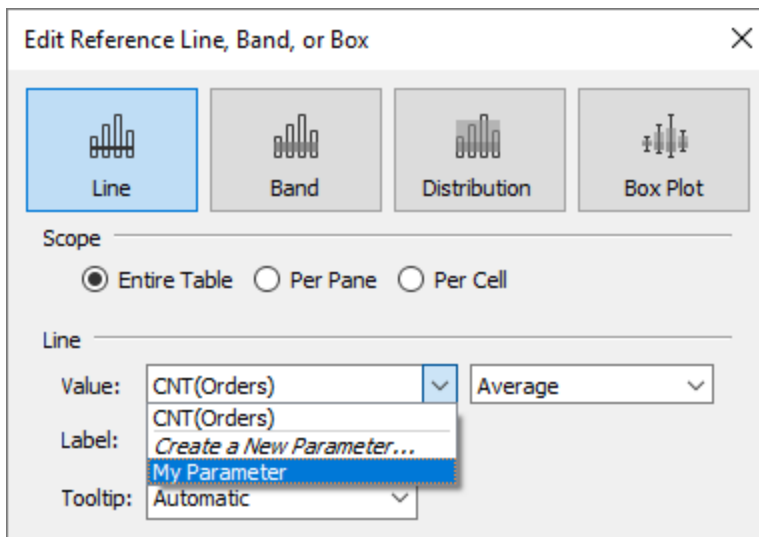

Show a parameter control in the viz

The parameter control is a worksheet card that lets you modify the parameter value. Parameter controls are similar to filter cards in that they contain controls that modify the view. You can open parameter controls on worksheets and dashboards and they're included when you save to the web or publish to Tableau Server.

To open the parameter control, right-click (Control-click) the parameter in the Data pane and select **Show Parameter**.

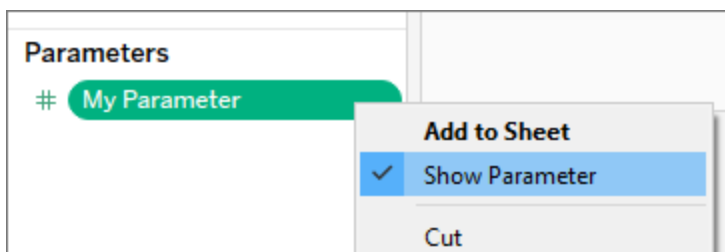

Like other cards, parameter controls have a menu that you can open using the dropdown arrow in the upper right corner of the card. Use this menu to customize the display of the control. For example, you can show a list of values as radio buttons, a compact list, a slider, or a type in field.

The options available on this menu depend on the data type of the parameter and whether it accepts all, a list, or a range of values.

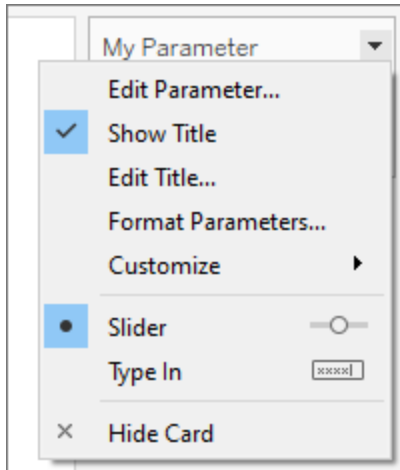

Make a dynamic parameter

Parameter actions

You can make your parameters more dynamic and interactive by using them in [Parameter Actions on page 1412](#). Parameter actions let your audience change a parameter value through direct interaction with a viz, such as clicking or selecting a mark.

Dynamic current value

You can create a parameter that can refresh its current value to the result of a calculation, a list of values (based on a field), or a range of values. This refresh happens each time the workbook is opened or whenever you select **Refresh** from the data source's context menu.

Use a calculation as the current value of a parameter

If the current value is the result of a calculation, it must be a single-value, view-independent calculation. If the calculation's result could be more than one value, the workbook can't choose a default value. The calculation must also be view-independent so that the value won't change as the viz changes.

To do this, you can use a FIXED level of detail (LOD) expression that isn't dependent on the structure of the viz. All parts of the calculation must be inside the FIXED LOD expression. If you

use a FIXED LOD expression as the default value and are using context filters, the dynamic parameter won't reflect any context filters.

For more information on LOD expressions, see [Create Level of Detail Expressions in Tableau](#) on page 2405.

Note: We don't recommend using a dynamic parameter in a data extract filter because it impacts performance. If you use a dynamic parameter for a data extract filter, Tableau needs to first process all the data to determine the value of the parameter, and thus which data to filter. For example, if you use a dynamic parameter filter to return the last 30 days of data, Tableau evaluates the entire data source to find the last 30 days of data and then filters it. This results in reduced performance and a longer time to load.

Troubleshoot parameters

Here are a few scenarios when a default parameter value or a refreshable list of parameter values (domain) won't update as expected:

- The default field returns a value whose data is incompatible with the parameter's data type.
- The default field for the parameter's current value doesn't return a single value.
- The default field returns null.
- The default field is in a data source that isn't connected.
- The default field was deleted.
- The user cancels the query to the data source while Tableau is attempting to connect.

In Tableau Desktop, these queries are initially evaluated when the workbook is opened and Tableau connects to the fields' data sources for the first time. You can also evaluate the queries by refreshing the data source. To do this, press F5, or open the data source's context menu and select **Refresh**. On Tableau Server and Tableau Cloud, you can refresh the data source by clicking the Data Source Refresh button in the toolbar. In this case, however, remember that the value returned depends on the server's cache policies.

If the default fields fail to return values, the parameter behaves as follows:

- The current value keeps the latest valid value.
- The list of values are empty because Tableau doesn't serialize the values returned from the query in the workbook.

The current value must be in the list of values for it to be assigned to the parameter. If the list of values is empty, the parameter will get assigned a fallback value according to the data type (1 for integer, 1.0 for float, "" for string, and the current date for date and datetime).

Use Parameters to Make Views More Interactive

Parameters are useful when you want to add interactivity and flexibility to a report, or to experiment with what-if scenarios. Suppose you are unsure which fields to include in your view or which layout would work best for your viewers. You can incorporate parameters into your view to let viewers choose how they want to look at the data.

When you use parameters, you need to tie them to the view in some way:

- You can use parameters in calculations and calculated fields that are used in the view.
- You can display the parameter control in the view for users to select parameters.
- You can reference parameters in [parameter actions](#).

Before you begin, decide which fields you want to make interactive. For example, you could allow users to view the categories within a dimension by color, or to view sales data over a period of time that they choose, and so on. The example described here sets up a table for which users can select the dimensions to display in the columns and rows.

Watch a video: For an in-depth presentation, watch [Parameters | Oh, the places you'll go!](#) (45 minutes).

Learn more: See [Use Parameters to Add Multiple Views to Your Viz](#) on the Tableau [blog](#) and multiple practical topics on how to use parameters on the [Data School](#) website.

Create the parameters

These steps use the Superstore sample to create new parameters.

1. In the Data pane, click the drop-down arrow in the upper right corner and select **Create Parameter**.
2. In the Create Parameter dialog box, complete the following steps:
 - a. Name the parameter so that viewers can tell what changing it will do. This example uses **Select Column 1 Heading**.
 - b. For **Data type**, select **String**.
 - c. For **Allowable Values**, select **List**, type **None** as the first value in the list, and then press **Enter**.

- d. Complete the list by typing the names of the additional dimension fields that you want to expose through the parameter.

Note: This example uses the customer name, customer segment, region, department, and category fields. These are all dimensions of the same data type (string). If you wanted to include a measure such as profit in this list, one option would be to convert the measure to a string value. You would do this when you build the calculated field, using the `STR()` function. This article covers only the single data type scenario.

The **Display As** aliases default to the field name, and for this exercise you can leave them as they are.

Create Parameter

Name:

Properties

Data type:

Current value:

Value when workbook opens:

Display format:

Allowable values: All List Range

List of values

Value	Display As
None	None
Customer Name	Customer Name
Customer Segment	Customer Segment
Region	Region
Department	Department
Category	Category
Add	

Fixed When workbook opens

Add values from

- e. Click **OK** to return to the Calculated Field dialog box.

3. Repeat the previous step to create the following additional parameters:

- Select Column 2 Heading
- Select Row 1 Heading
- Select Row 2 Heading

Tip: Instead of typing each value in the list, click **Add values from > Parameters** to add them from **Select Column 1 Heading**.

Create the calculated fields

These steps use the Superstore sample to build the calculated fields that will take advantage of your parameters.

1. In the Data pane, click the drop-down arrow in the upper right corner and select **Create Calculated Field**.
2. In the Calculated Field dialog box, for **Name**, type **Column 1 Category**.
3. In the Calculated Field dialog box, for **Formula**, build the following calculation:

```

CASE [Select Column 1 Heading]
WHEN 'Customer Name' THEN [Customer Name]
WHEN 'Customer Segment' THEN [Customer Segment]
WHEN 'Region' THEN [Region]
WHEN 'Department' THEN [Department]
WHEN 'Category' THEN [Category]
ELSE ''
END
    
```

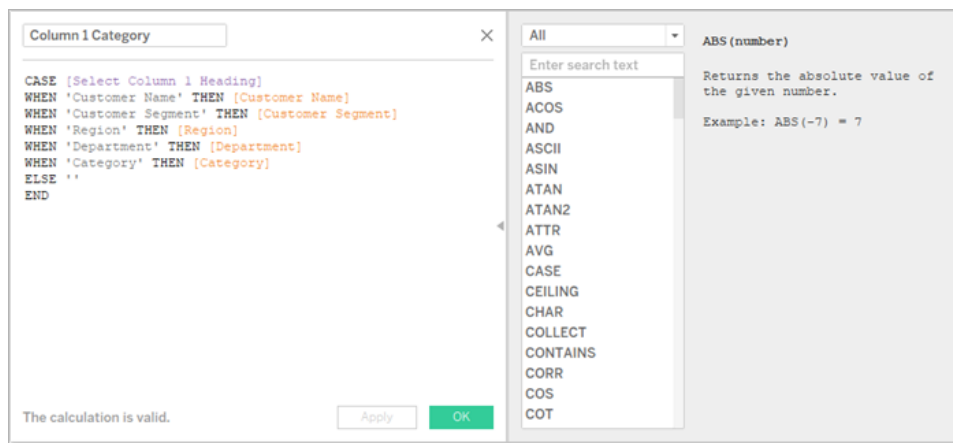

Confirm that the status message indicates that the formula is valid, and then click **OK**.

Note: ELSE accounts for the **None** value that you included in the parameter, and it returns an empty string.

4. Create three more calculated fields, one for each of the additional parameters you created:

Parameter name	Calculated field name
Select Column 2 Heading	Column 2 Category
Select Row 1 Heading	Row 1 Category
Select Row 2 Heading	Row 2 Category

The basic formula for each calculated field is the same as in the previous step, except that you reference a different parameter in each `CASE` statement.

Give viewers a way to interact with views

Next, expose the parameter control so users can select the categories they want to display.

1. For each parameter you created, do the following:

Under Parameters, right-click the parameter and select **Show Parameter Control**.

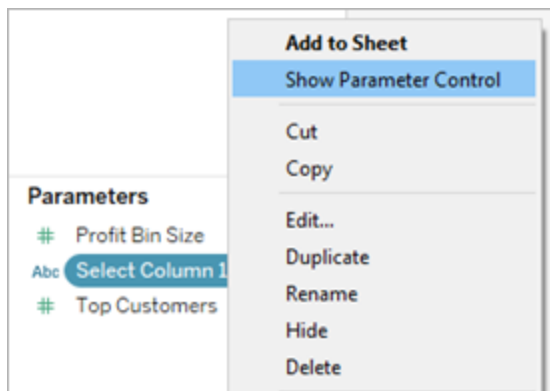

2. From the Data pane, drag the calculated fields you created to the Columns and Rows shelves.

- From the Data pane, drag a measure to the view. In this example, **Sales** is placed on **Label** on the Marks card.
- Test your parameters by selecting fields in the parameter controls.

Tips:

- Sort the dynamic dimension fields alphabetically.
- Hide field labels for rows and columns.

	Region	Furniture				Office Supplies		
		Bookcases	Chairs & Chairmats	Office Furnishings	Tables	Appliances	Binders and Binder Accessories	Envelopes
Consumer	Central	\$13,744	\$77,482	\$21,336	\$63,355	\$15,283	\$33,412	\$1,929
	East	\$26,188	\$76,484	\$20,717	\$63,102	\$9,221	\$36,127	\$1,908
	South	\$11,664	\$29,831	\$12,669	\$35,076	\$24,097	\$27,154	\$1,481
	West	\$41,028	\$121,585	\$14,808	\$67,400	\$15,207	\$6,937	\$32,326
Corporate	Central	\$38,255	\$139,235	\$41,303	\$123,086	\$58,497	\$56,719	\$16,556
	East	\$32,631	\$110,812	\$30,666	\$95,268	\$49,228	\$89,138	\$17,314
	South	\$48,177	\$57,515	\$16,653	\$55,407	\$24,714	\$31,254	\$3,318
	West	\$142,822	\$100,158	\$26,880	\$90,218	\$35,501	\$48,044	\$7,275
Home Office	Central	\$37,953	\$71,701	\$53,555	\$52,917	\$57,314	\$57,364	\$3,197
	East	\$7,688	\$58,804	\$26,850	\$100,094	\$30,957	\$41,971	\$11,344
	South	\$13,013	\$39,512	\$47,167	\$86,505	\$22,067	\$32,739	\$3,667
	West	\$20,750	\$42,817	\$70,414	\$47,993	\$14,417	\$16,396	\$4,373
Small Business	Central	\$27,631	\$39,492	\$18,362	\$38,810	\$38,752	\$41,496	\$7,324
	East	\$17,596	\$134,088	\$17,551	\$46,125	\$45,180	\$84,031	\$22,507
	South	\$10,448	\$34,641	\$10,890	\$37,095	\$3,900	\$16,810	\$6,551
	West	\$17,707	\$30,428	\$14,604	\$59,471	\$12,389	\$18,990	\$6,852

- Reset all parameters to **None** and publish the workbook to Tableau Server.

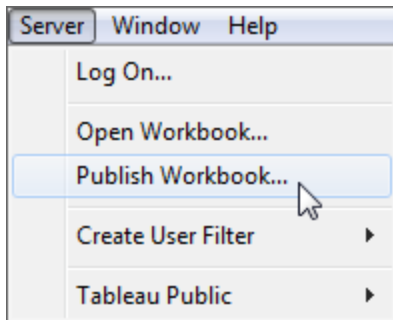

Viewers can set up their own reports, save their parameter settings, and share views with others.

Additional information

For information about building views dynamically, see [Swap Measures Using Parameters](#).

For information about the different areas in the Tableau interface in which you can create and incorporate parameters, see [Create Parameters on page 1122](#) and its related topics in the Tableau Help.

Disclaimer: This topic includes information about parameters from a third-party blog, [The Information Lab: Data School](#). Please note that while we make every effort to keep references to third-party content accurate, the information we provide here might change without notice as content on their website changes.

Example: Add a Parameter to a Map View

This example uses the World Indicators sample data source to demonstrate the following:

- How to build a map view that shows the birth rate for each country in the world.
- How to create a calculated field that distinguishes countries/regions with a low birth rate from those with a high birth rate.
- How to create and display a parameter so that users can set the threshold for low vs. high birth rate.

Build a map view

1. In the **Data** pane, double-click **Latitude** and then **Longitude**.
Tableau puts **Longitude** on **Columns**, **Latitude** on **Rows**, and displays a map of the world.
2. Drag the **Year** dimension to **Filters**.
3. In the Filter Field [Year] dialog box, choose **Years** and then click **Next**:

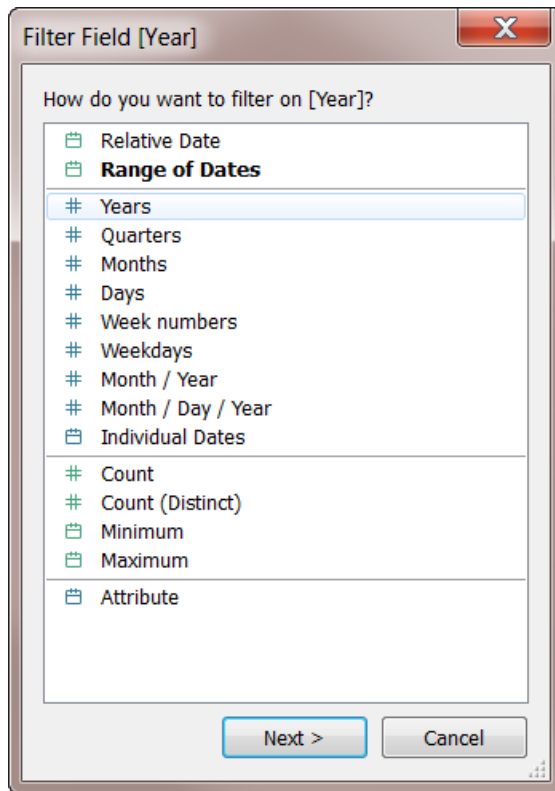

4. In the Filter [Year of Year] dialog box, select **2012** and then click **OK**:

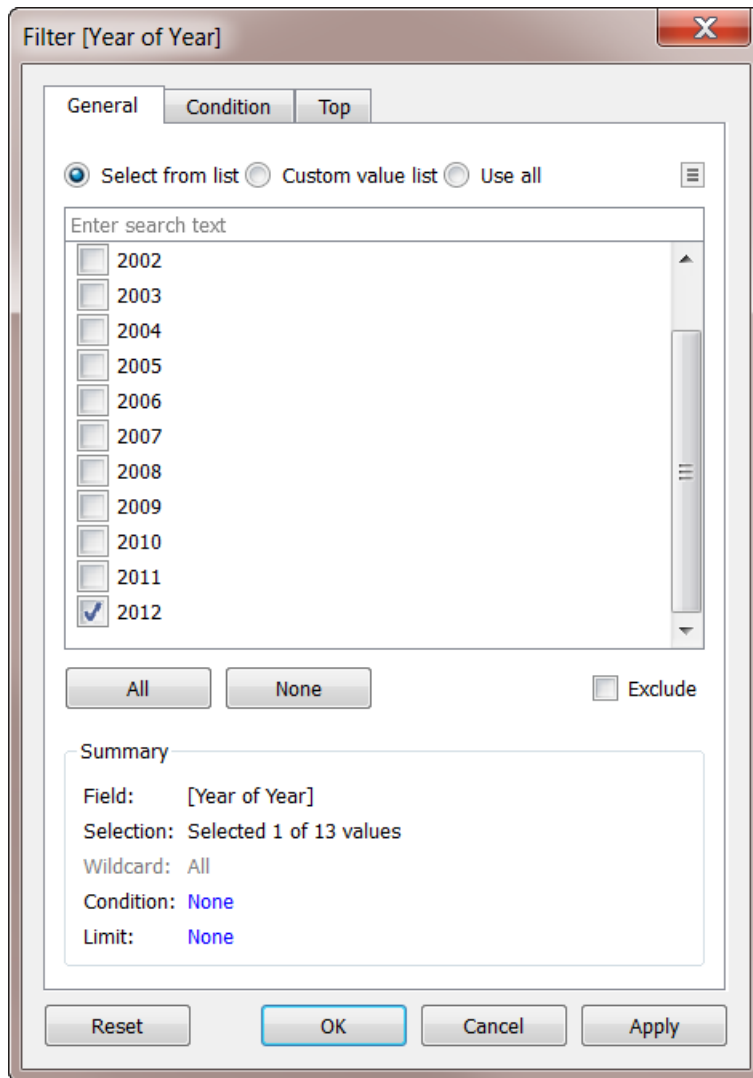

5. Drag the **Country** dimension to **Detail**.
6. Set the Marks type to Map:

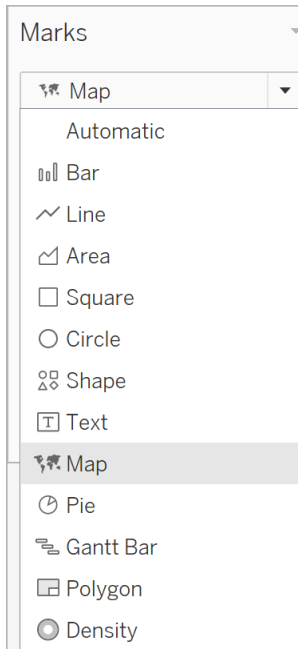

7. Drag the **Birth Rate** measure to **Label**.

You now have a map that shows birth rates for countries/regions around the world:

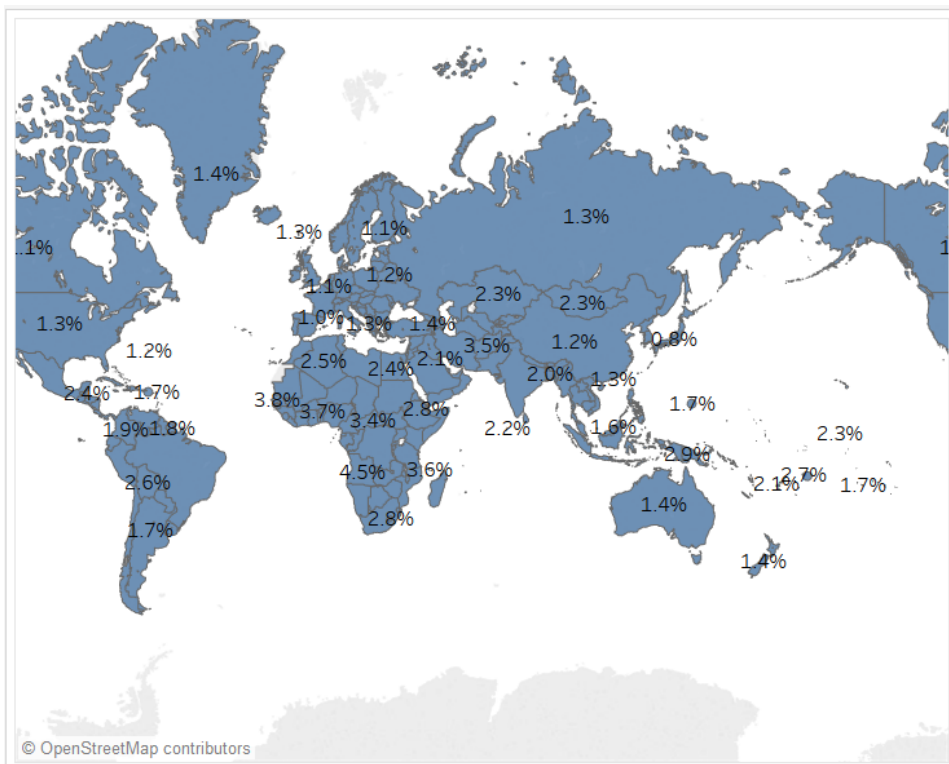

You can zoom the map or hover to see a tooltip for any country.

Create a calculated field to set a threshold

Next, you'll distinguish a low birth rate from a high birth rate.

1. From the top menu, select **Analysis > Create Calculated Field** .
2. Name the field `High Birth Rate` and type or paste this calculation in the formula field:

```
IF ([Birth Rate]) >= 0.014 THEN "High" ELSE "Low" END
```

The value 0.014 is equivalent to 1.4%. The range of actual values that we can see on the map range from below 1% up to nearly 5%.

When you click **OK** to apply and save this calculation, Tableau categorizes it as a dimension.

3. Drag **High Birth Rate** to **Color**.

The map now shows low birth rate countries/regions in one color and high birth rate countries/regions in another:

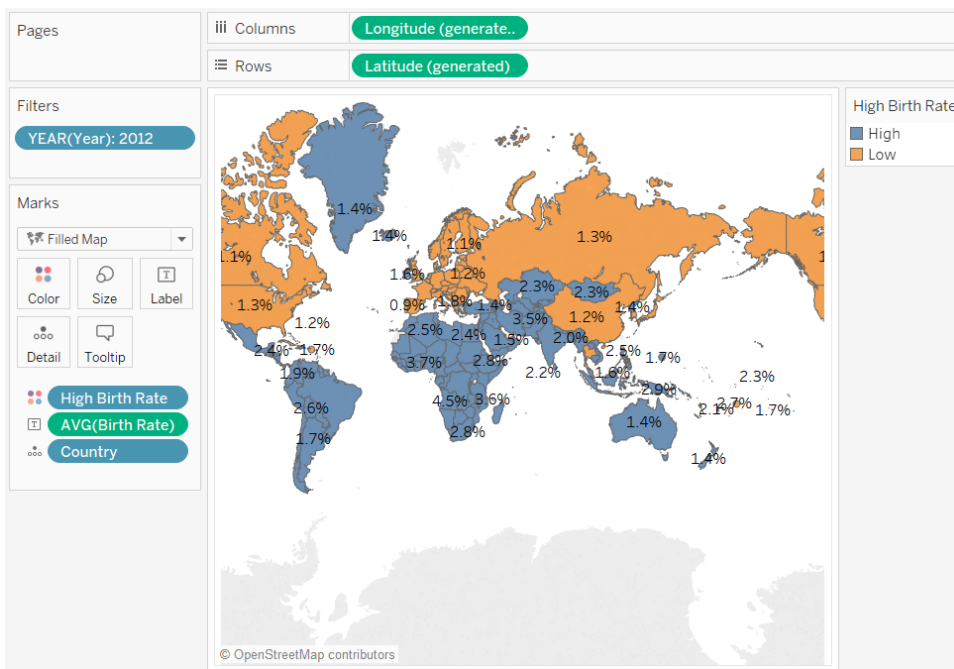

But the definition of high birth rate as anything equal to or greater than 1.4% is arbitrary—that value was chosen because it divided the world's countries/regions about evenly.

Instead, you can let users define that threshold, or give them a control that they can use to see how changing the threshold changes the map. To do this, you create a parameter.

Create a parameter

1. Right-click (control-click on a Mac) in the **Data** pane and select **Create > Parameter**.

Note: If you clicked on a field on the Data pane, some fields might be filled. You can just change the fields as needed.

2. In the Create Parameter dialog box, name the new parameter `Set Birth Rate` and configure it as shown:

The screenshot shows the 'Edit Parameter [Set Birth rate]' dialog box. The 'Name' field contains 'Set Birth Rate'. The 'Properties' section shows 'Data type' set to 'Float', 'Current value' set to '0.019', and 'Display format' set to '1.90%'. The 'Allowable values' section has three radio buttons: 'All', 'List', and 'Range', with 'Range' selected. The 'Range of values' section has three checked checkboxes: 'Minimum' (0.005), 'Maximum' (0.06), and 'Step size' (0.001). There are 'Set from Parameter' and 'Set from Field' buttons next to the minimum and maximum fields. The dialog has 'OK' and 'Cancel' buttons at the bottom.

For information on the fields in the Create Parameter dialog box, see [Create Parameters on page 1122](#).

Because the **Data Type** is **Float**, the parameter control, when you display it in the next procedure, will be in the form of a slider. This is because floating point values are continuous—there are an infinite number of possible values.

The **Current value** sets the default for the parameter: 0.019 is 1.9%. The **Range of values** section sets the minimum and the maximum values and the step size—that is, the least amount by which the value can change.

3. Click **OK**.

Create and display the parameter control

Now you must connect the parameter to the **High Birth Rate** field.

1. Right-click **High Birth Rate** in the **Data** pane and select **Edit**.
2. Replace the hard-coded 0.014 value in the field definition with the parameter name:

```
IF ([Birth Rate]) >= [Set Birth Rate] THEN "High" ELSE "Low" END
```

Then click OK.

3. Right-click the **Set Birth Rate** parameter in the **Data** pane and select **Show Parameter Control**.

By default, the parameter control is shown on the right. Now you and users of your view can raise or lower this value incrementally to see how changing the definition of "high birth rate" affects the map.

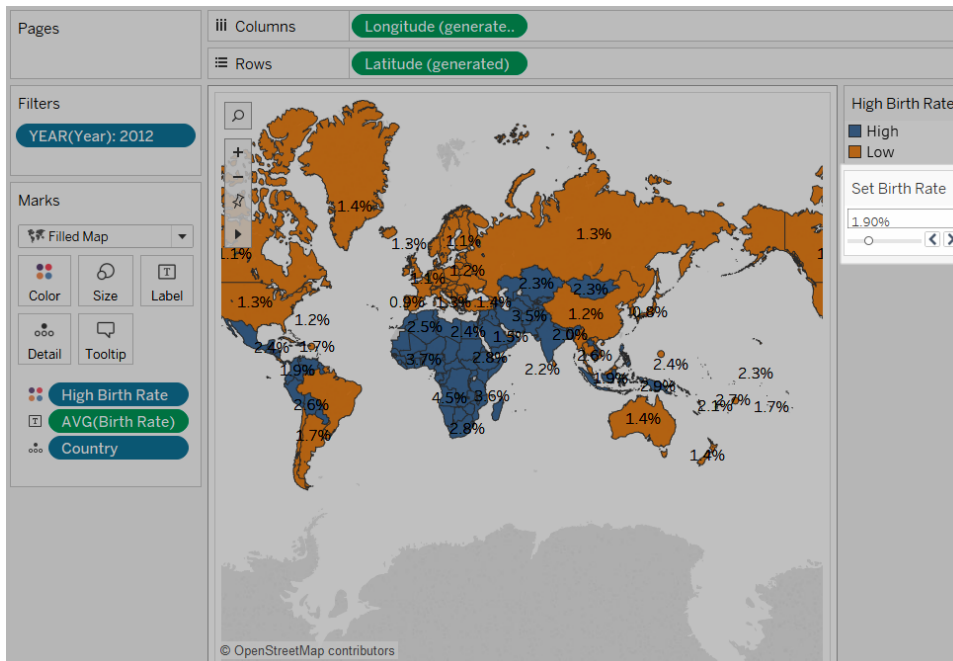

Example: Swap Measures Using Parameters

You may want to create a view that shows how the values of two measures compare against each other. But what if you also wanted to be able to choose which measures were being compared—or better yet, add a control to the view that would let any user select the measures to be compared. You can create such a view using parameters and calculated fields. The calculated fields replace the measures in the view and can be set interactively by the user with parameter controls or parameter actions. Using swap measures also allows you to use [Dynamic Axis Titles](#).

General steps

1. Create the parameters.
2. Create calculated fields to change the measures in the view.
3. Set up the view.

This article includes an additional section that you can use as an alternative to step 2:

- Create calculated fields to change measures and specify aggregations

The following sections break these procedures down into specific instructions.

The scenario uses the **Sample - Superstore** data source provided with Tableau Desktop.

Create the parameters

Follow these steps.

1. In the Data pane, click the drop-down arrow in the upper right corner and select **Create Parameter**.
2. In the Create Parameter dialog box, do the following:
 - a. Name the parameter **Placeholder 1 Selector**.
 - b. Set the **Data type** to **String**.
 - c. Skip down to the **Allowable values** field, and choose **List**.
 - d. Type individual measure names in the **List of values** area: **Discount**, **Profit**, **Quantity**, and **Sales**.

The Create Parameter dialog box should now look like this:

Create Parameter

Name
Placeholder 1 Selector

Properties

Data type: String
Display format: Discount

Current value: Discount
Value when workbook opens: Current value

Allowable values

All List Range

Value	Display As
Discount	Discount
Profit	Profit
Quantity	Quantity
Sales	Sales
Click to add	

Fixed
 When workbook opens

Add values from ▾

Remove Selected

Cancel OK

e. Click **OK** to close the Edit Parameter dialog box.

3. Create a second parameter, **Placeholder 2 Selector**, with the exact same configuration.

There are different ways you can do this. The easiest way is to click **Placeholder 1 Selector** in the **Data** pane, choose **Duplicate**, and then change the name of the duplicated parameter to **Placeholder 2 Selector**.

Create calculated fields to change the measures in the view

Follow these steps.

1. Choose **Analysis > Create Calculated Field** to open the calculation editor. Name the calculation **Placeholder 1** and type or paste the following in the formula area:

```
CASE [Placeholder 1 Selector]
WHEN "Discount" THEN [Discount]
WHEN "Profit" THEN [Profit]
WHEN "Quantity" THEN [Quantity]
WHEN "Sales" THEN [Sales]
END
```

Note: The calculated field must reference the **Value** entry for a given row, and not the **Display As** value.

2. Click **OK** to exit the calculation editor.
3. Create a second calculated field, **Placeholder 2**, with the same definition. Again, the easiest way to do this is to click **Placeholder 1** in the **Data** pane, choose **Duplicate**, and then change the name of the duplicated field to **Placeholder 2**. Then replace **Placeholder 1** selector with **Placeholder 2**.

Set up the view

Follow these steps.

1. Drag **Placeholder 2** to **Columns** and **Placeholder 1** to **Rows**.
Because you dragged measures to both shelves, the default view is a scatter plot. For more on why Tableau does this, see [Example: Scatter Plots, Aggregation, and Granularity on page 181](#).
2. Drag **Customer Name** to **Detail** and **Region** to **Color**.
3. In the Parameters area of the Data pane, click each **Placeholder 1 Selector** and choose **Show Parameter Control**. Then do the same for **Placeholder 2 Selector**.
4. Tableau displays the parameter controls beyond the right side of the view by default. Drag them over to the left side to make them easier for your users to see.

Your view is now complete. The parameter controls let users select the measures to be used on the X and Y axes. For example, the view below on the left shows **Quantity** vs. **Discount**, while in the view the right the parameter controls have been used to show **Profit** vs. **Sales**.

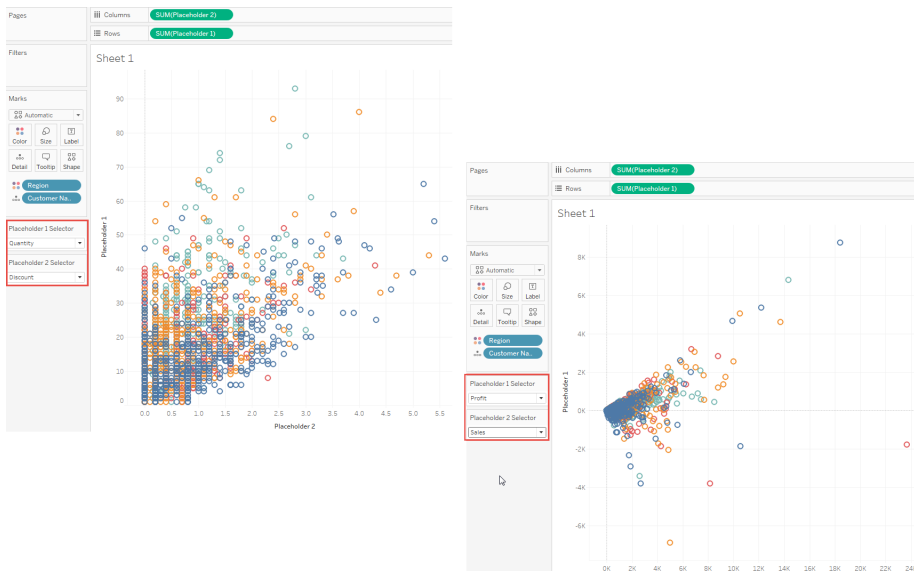

Create calculated fields to change measures and specify aggregations

As an alternative to the **Create calculated fields to change the measures in the view** section, above, consider creating calculated fields that specify aggregations for individual measures. As written above, the calculated fields do not specify aggregations. Notice in the image above that Tableau automatically assigns an aggregation (SUM) to the **Placeholder 1** and **Placeholder 2** fields. But you know your data, and you may want to dictate which aggregation Tableau uses for your measures. So instead of the calculated field definition above, consider a definition like the following:

```
CASE [Placeholder 1 Selector]
WHEN "Discount" THEN SUM([Discount])
WHEN "Profit" THEN AVG([Profit])
WHEN "Quantity" THEN SUM([Quantity])
WHEN "Sales" THEN AVG([Sales])
END
```

It's up to you to decide whether to explicitly aggregate measures in your field definitions. The only thing you cannot do is mix-and-match: that is, you cannot define aggregations for some measures, but not for others.

Here's how the **Profit vs. Sales** scatter plot changes when you specify AVG as the aggregation for these fields, as opposed to not specifying an aggregation and letting Tableau default to SUM:

Profit vs. Sales with default aggregation

Profit vs. Sales with explicit aggregation

Tableau Desktop and Web Authoring Help

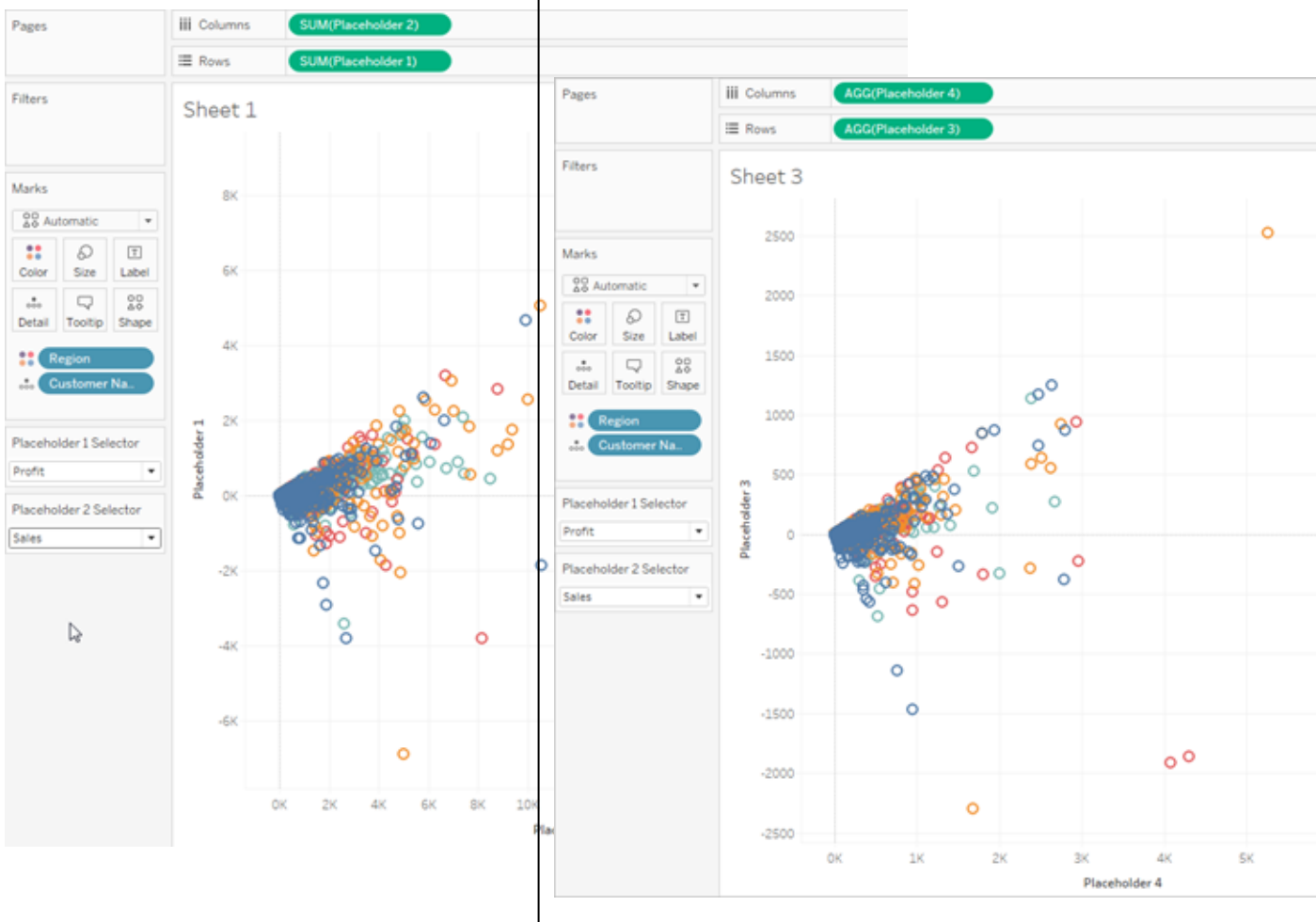

Similar, but different.

Dates and Times

How you work with dates in Tableau depends on whether you are using a relational or cube (multidimensional) data source. This section discusses the differences.

Dates in Cube (Multidimensional) Data Sources

In Tableau Desktop, cube (multidimensional) data sources are supported only in Windows.

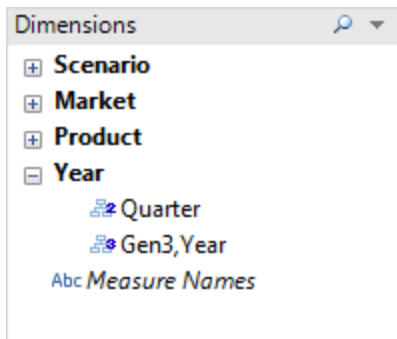

For cube data sources, dates dimensions are usually organized into hierarchies that contain levels such as year, quarter, and month. In addition, some multidimensional data sources have time intelligence enabled, which makes it possible to look at data levels different ways, such as Months by Year, Months by Quarter, Weekends, etc. These levels are represented as attributes of the hierarchy. Hierarchies and attributes are defined when the cube is created and you cannot modify them in Tableau. For example, the **Year** dimension from an Oracle Essbase data source is shown below.



When you place a multidimensional date on a shelf, the field is treated like any other dimension. For example, you can drill down, drill up, and so on.

Dates in Relational Data Sources

For relational data sources, dates and times are automatically placed in the Dimensions area of

the **Data** pane and are identified by the date  or date-time  icon. For example, the Order Date and Ship Date dimensions from an Excel data source are shown below.

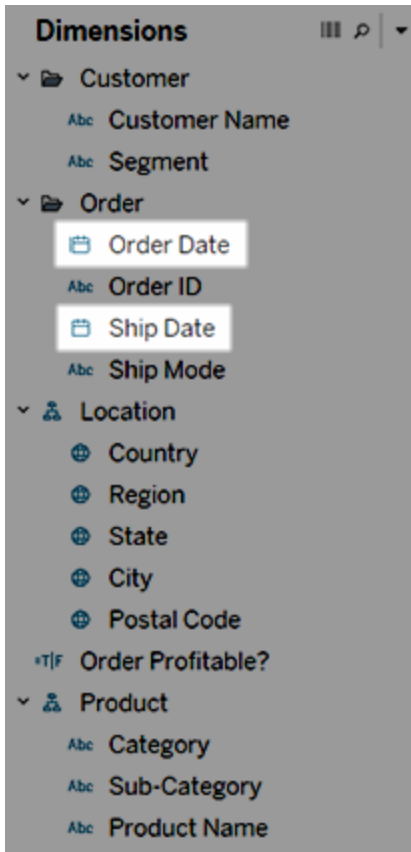

When you place a relational date on a shelf, the field name is automatically modified to reflect the default date level. Tableau defines the default date level to be the level at which there are multiple instances. For example, if the date field includes multiple years, the default level is year. However, if the date field contains data for just one year but includes multiple months, then the default level is month.

If you don't want Tableau to automatically select a date level and would rather have a date dimension be a continuous field, you can right-click (control-click on Mac) the field in the **Data** pane and select **Convert to Continuous**. The dimension then turns green in the **Data** pane; now when you use that dimension in a view, it will be continuous. You can easily revert back by selecting **Convert to Discrete** from the field's context menu in the **Data** pane. You can also convert a field in the view to continuous while it is on a shelf by selecting **Continuous** on its context menu (which you can see when you right-click (control-click on Mac) the field). The field on the shelf turns green but the field in the **Data** pane is still discrete.

Date Properties for a Data Source

You can set date properties for a data source. To do so, right-click (control-click on Mac) a data source in the **Data** pane and choose Date Properties. The

Date Property Options

Default calendar

Specifies which calendar system to use, **Standard Gregorian** or **ISO-8601 Week-Based**. Setting the default calendar determines how dates are used in the view by default. See [Date Functions on page 2075](#)

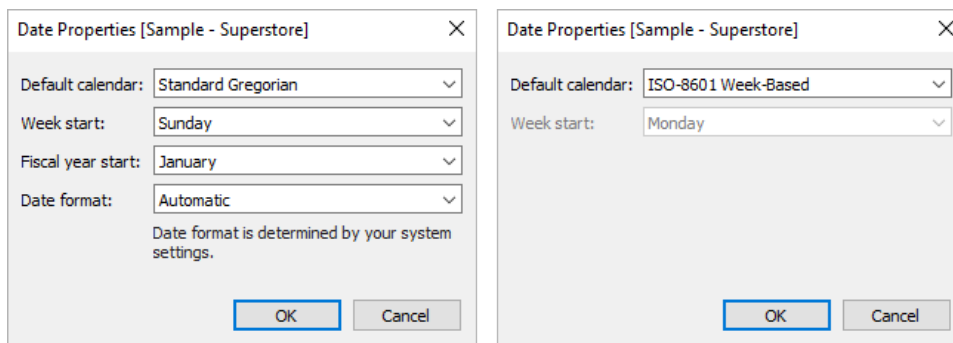

Week start

Specifies which day is considered the first day of the week. You can override the data source level **Week start** for certain date functions by including a `start_of_week` parameter. See [Date Functions on page 2075](#).

The initial value for this setting is sometimes determined by your data source. If the data source doesn't initialize the start-of-week day, then Tableau consults the system's locale settings. The day that is considered the first day of the week varies from region to region. For example, Sunday is the first day of the week in the US, while Monday is the first day in the EU.

This setting is unavailable for multidimensional data sources because this information is defined when the cube designer creates the datetime dimension.

After a data source is created, the **Week start** value doesn't automatically update to stay in sync with the host operating system (for example, if the published data source is used in a different country). Calendar controls reflect the workbook locale rather than the data source's **Week start** setting.

Note: An exception is a week truncation that shows the week number. This function uses the data source's **Week start** setting to provide a consistent week number value in the calendar.

Fiscal year start

Specifies which month is considered the first month of the fiscal year. This setting is applied to the data source overall.

Specific date fields

To specify whether a particular field uses the standard calendar (Jan. 1 - Dec. 31) or the fiscal calendar:

1. Right-click the field in the Data pane
2. Select **Default Properties > Fiscal Year Start**

For any date field in the view, you can then specify whether to use the standard calendar or the fiscal calendar. For details, see [Fiscal Dates on page 1162](#).

Date format

Specifies the default format for date fields in locations such as the tooltip or labels. To override the default date format, right-click the field in the Data pane and select **Default Properties > Date Format**, then set a format.

Day of the week sorting

If Tableau sorts the names of days of the week alphabetically, check your workbook locale. The local setting tells Tableau how to sort the days of the week in the correct chronological order. For information on setting the locale, see [Language and Locale on page 109](#).

If none of the supported locales is appropriate, you can sort the days of the week manually. See [Sort Data in a Visualization on page 1345](#).

Supported date formats

When working with dates, Tableau retrieves date formats automatically from the data source.

For a list of supported date formats, see the table of supported date format symbols in [Custom Date Formats on page 1165](#).

Change Date Levels

To change the date level of a field, drag it to Rows or Columns (or another shelf), click its context menu, and then select a level.

Each level has a preview to indicate the effect of the setting.

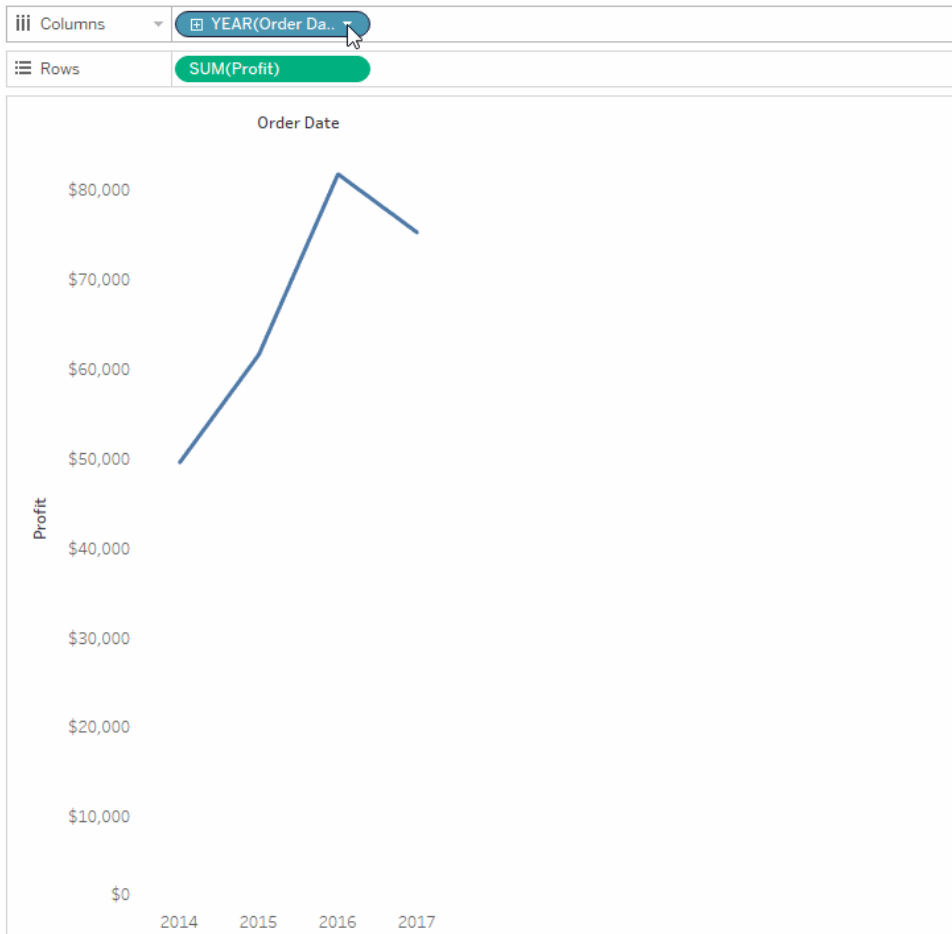

Learn more: For related concepts about dates, see [Dates in Tableau make me want to tear my hair out!](#) in the [VizPainter](#) blog by Tableau Visionary, Josh Milligan. For an in-depth demonstration of how date parts and date values work, see the free video presentation [Greatest of All Time Analytics: Conquering Date Calculations](#) (58 minutes).

In Tableau Desktop, cube (multidimensional) data sources are supported only in Windows. For cube (multidimensional) dates, the levels available in the context menu are given by the levels defined in the date hierarchy.

Date level settings

The date level settings are organized by sections for date parts and date values.

Date parts give you data aggregated to the level of a specific part of a date. For example, the month of May for any year or the eighth day of any month.

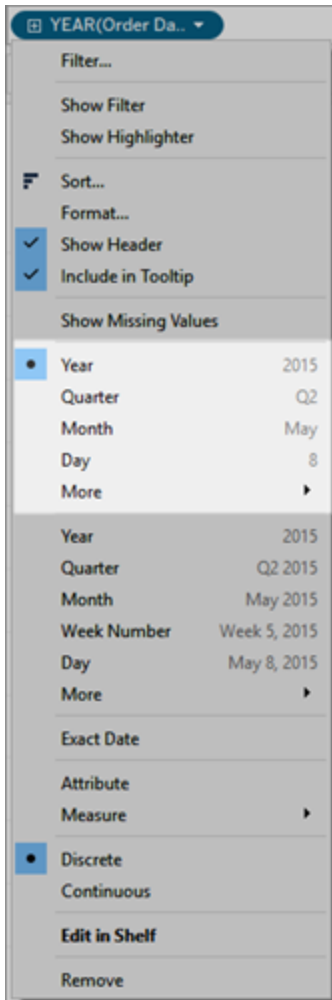

Date Parts

Date values give you the actual date, truncated to a specific level, such as May 2015 or May 8, 2015.

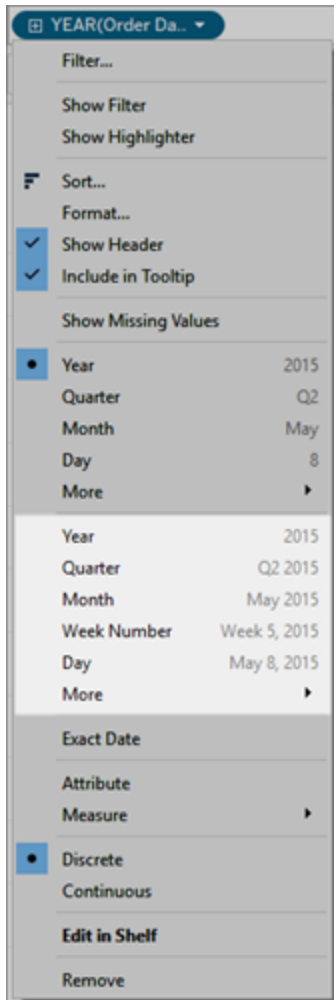

Date Values (also known as truncated dates or Date Truncs)

To get the most granular level of detail, which is also known as row-level or record-level data, you can select **Exact Date**.

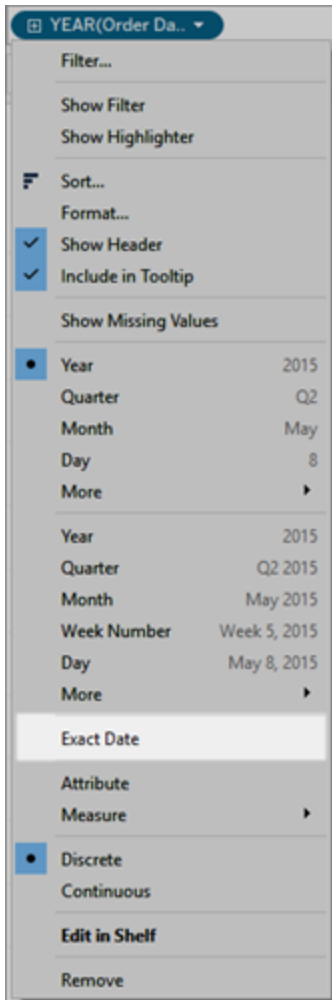

Exact Date

When you select a particular level, Tableau performs a computation on the date field. Suppose a particular row in your data source has a date entry of 01/23/16. The year is 2016, the quarter is 1 because January falls in the first quarter, and the week number is 4 because January 23rd falls in the fourth week.

How the date level is computed depends on how Date Properties are configured for the data source. For more information, see [Date Properties for a Data Source](#) on page 1151.

Note: Not all date levels are always relevant. For example, if the date format doesn't include time information such as hour, minute, or second, then these options don't add any data to your view.

Use multiple date levels in the same viz

You can work with dates at varying levels of detail simultaneously. To do so, click the  control on a date field in the view. This is known as drilling into a date. For example, if you drill into a discrete date **YEAR(Order Date)**, Tableau adds a second field to the right of the initial date, **QUARTER(Order Date)**. You can continue drilling down until you reach the finest available granularity for the date field.

You can also drag date fields to the **Rows** or **Columns** shelf multiple times to nest them and to drill down into them at varying levels of detail.

For example, this view drills down from the year level to display the quarter level as well.

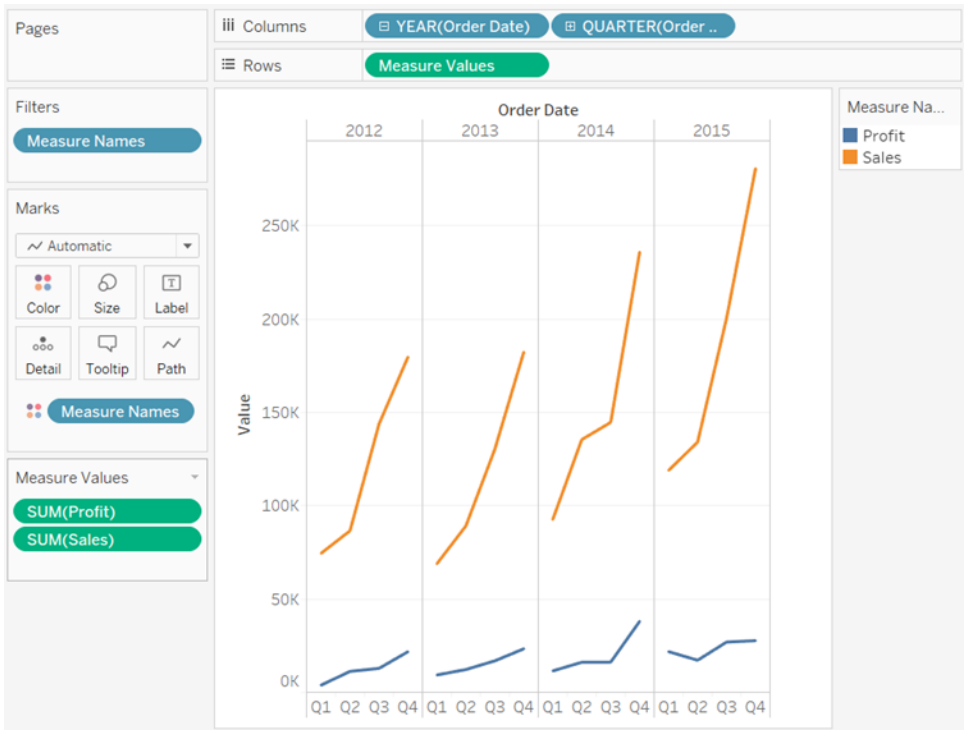

By removing one of the date fields, and then selecting **Month** from the remaining date field's context menu, you can look at each month across all years.

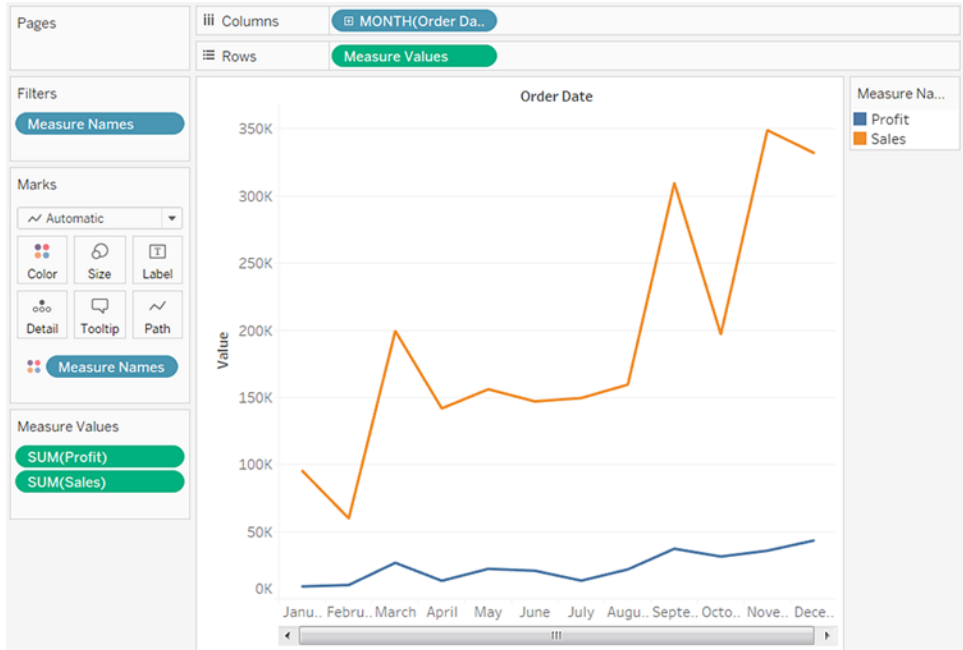

To display even finer granularity, select Month from the lower, continuous section of the field's context menu.



Tableau then displays the dates across the range of available years, at a month-by-month level of granularity.



Custom Dates

Custom dates are useful if you always use a date at a specific level, or if you want to create calc that rely on a binned or truncated date.

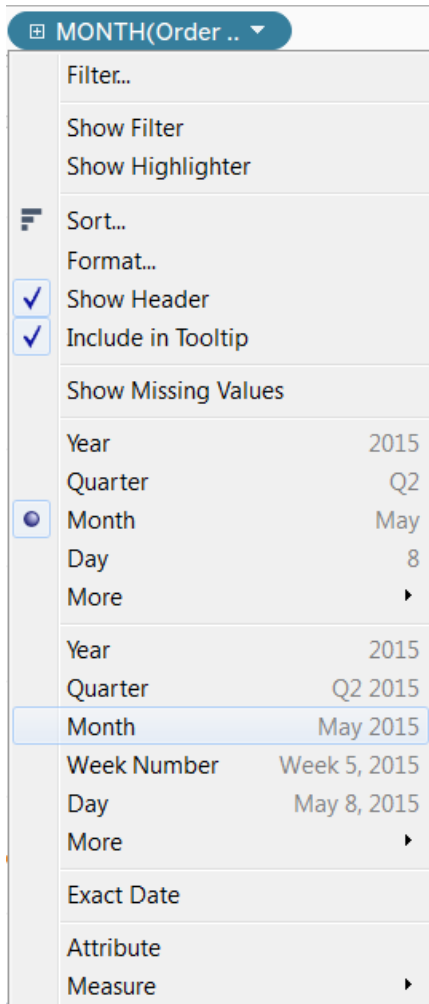
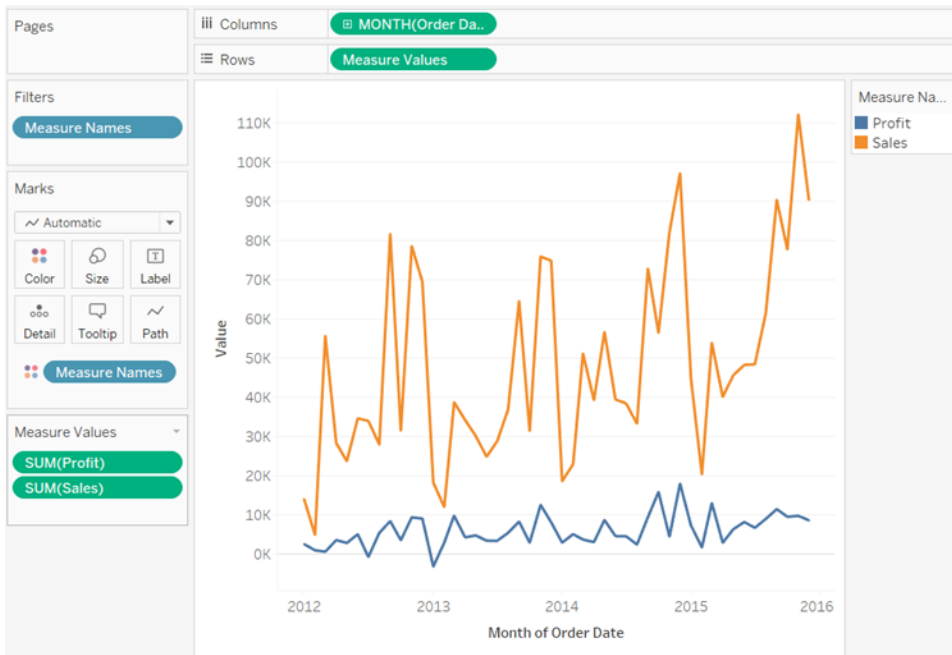
You can create a custom date in the **Data** pane or writing a calc with the `DATEPART` or `DATETRUNC` functions.

1. Right-click (control-click on Mac) a date field in the **Data** pane and select **Create > Create Custom Date**.
2. From the **Detail** list, select the level you want.
3. Specify whether you want the custom date to be discrete (**Date Parts**) or continuous (**Date Value**).

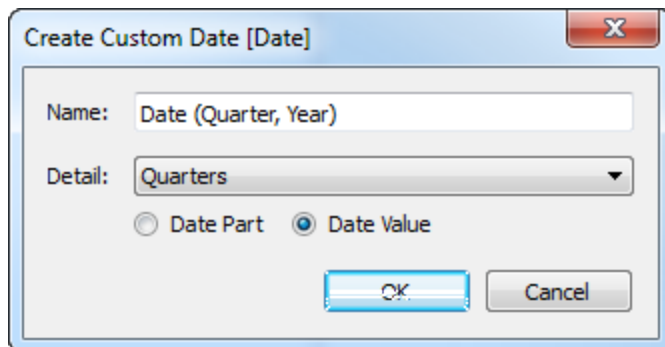

- 4. Optional: Enter your own name for the field.
- 5. When you're finished, click **OK**.

Custom dates created this way appear as new fields in the **Data** pane.

Example - format column headers as Month, Day, Year

This example uses the Sample - Superstore data source.

- 1. Drag [**Order Date**] to **Columns**.
- 2. Drag **Sales** to **Rows**.
- 3. Right-click [**Order Date**] on the **Columns** shelf and choose **More > Custom**.
- 4. In the Custom Date dialog box, choose **Month / Day /Year** from the **Detail** drop-down list.

The view now has the column headers in the correct format:

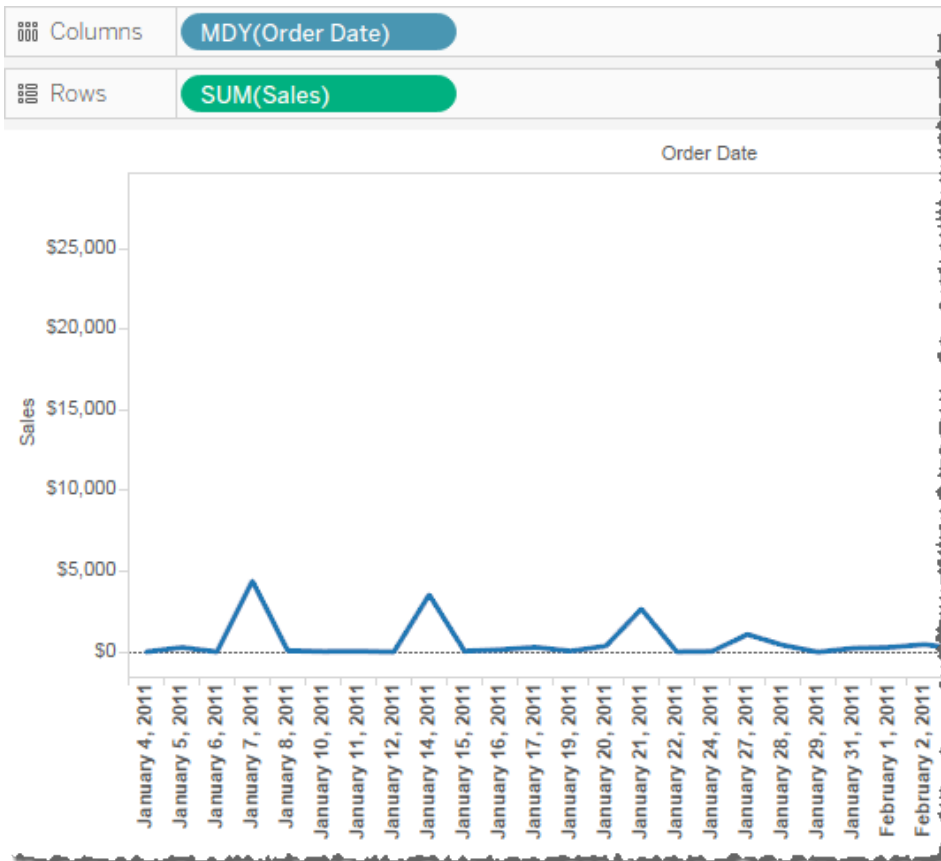

Fiscal Dates

In some situations, a date field needs to be expressed in terms of an organization's fiscal year. Calendar years run from January 1st until December 31st, but an organization's fiscal year might start in a different month. For example, a company's fiscal year might run from June 1st through May 31st. In such cases, it's appropriate to display some date values in a view using fiscal equivalents (Fiscal Year, Fiscal Quarter, and Fiscal Week Number) rather than their calendar equivalents.

To set the fiscal year start month for a data source, follow these steps:

1. Right-click (Control-click on Mac) the data source in the **Data** pane to open the Date Properties dialog box.
2. Set the **Fiscal year start** field to the appropriate month.

For each date dimension, you set the fiscal year start-month separately. In the **Data** pane, right-click a date dimension (Ctrl-click on Mac), and select **Default Properties > Fiscal Year Start**.

Whether a given level of a date dimension is affected by the use of the Fiscal Calendar depends on the specific case.

Date Level	When Converted to Fiscal
Year	Reflects the fiscal year. For example, if Fiscal year start is set to April, the year for the date June 1, 2004 would be shown as FY 2005.
Quarter	The Quarter reflects the fiscal quarter. For example, if Fiscal year start is set to April, the quarter for the date June 1, 2004 would be Q1.
Month	No change in behavior. The calendar month is the same as the fiscal month.
Day	No change in behavior. The calendar day is the same as the fiscal day.
Hour	No change in behavior. The calendar hour is the same as the fiscal hour.
Minute	No change in behavior. The calendar minute is the same as the fiscal minute.
Second	No change in behavior. The calendar second is the same as the fiscal second.
Week Number	The Week Number reflects the fiscal week number. For example, if Fiscal year start is set to April, the week number for the date April 1, 2004 would be 1.
Weekday	No change in behavior. The calendar weekday is the same as the fiscal week-

Date Level	When Converted to Fiscal
	day.
MM/YYYY	No change in behavior. This date format always displays calendar dates, even when a fiscal year has been assigned.
M/D/Y	This date format always displays Calendar dates, even when a fiscal year has been assigned.

The only date levels that explicitly indicate that the fiscal calendar is in use are the Year and Quarter level. Specifically, fiscal years and quarters are shown with the FY prefix. This is not true for fiscal months or week numbers, however, which are not shown with any special fiscal markings.

Fiscal year designations for any given date dimension are applied to all instances of the field in the Tableau workbook. Fiscal dates can only be applied to dimensions in a relational data source.

Fiscal year formatting is applied to all date formats that include a year, or a year and a quarter. In particular, if you apply a custom date format, and only use the “y” and “q” placeholders, then `FY` will be prepended to each year.

Date Levels

When a date dimension is using a fiscal calendar, only the following date parts and truncations present in the view will reflect the fiscal calendar:

Date part or truncation When using a fiscal calendar

Year date part	Fiscal year start is set to April, the year for the date June 1, 2004 would be shown as FY 2005.
Quarter date part	Fiscal year start is set to April, the quarter for the date June 1, 2004 would be Q1.
Week Number date part	Fiscal year start is set to April, the week number for the date April 1, 2004 would be 1.
Year date truncation	Fiscal year start is set to May, the date June 1, 2004 would become May 1, 2004.
Quarter date truncation	Fiscal year start is set to July, the date June 1, 2004 would become April

cation 1, 2004.

Perfect Pivoting with Dates

You can perfect pivot dates by placing different date levels on different worksheet shelves simultaneously. Place the date field on a variety of shelves and then select the desired date level from the fields' context menus.

For example, the following line chart displays years as column headers and then color-encodes the marks by quarter.

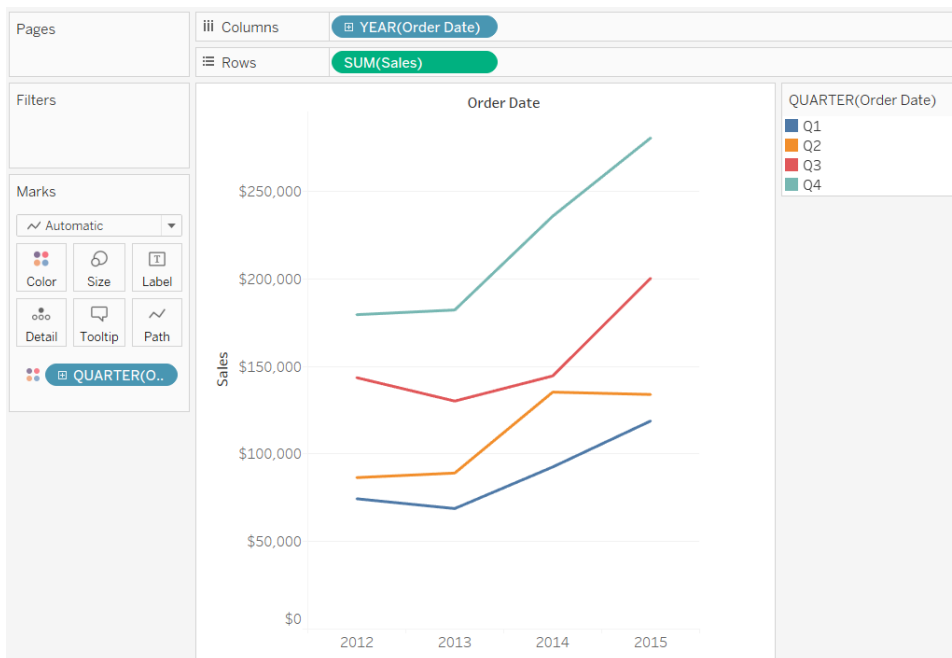

You can separate the marks by month and by quarter as shown below.

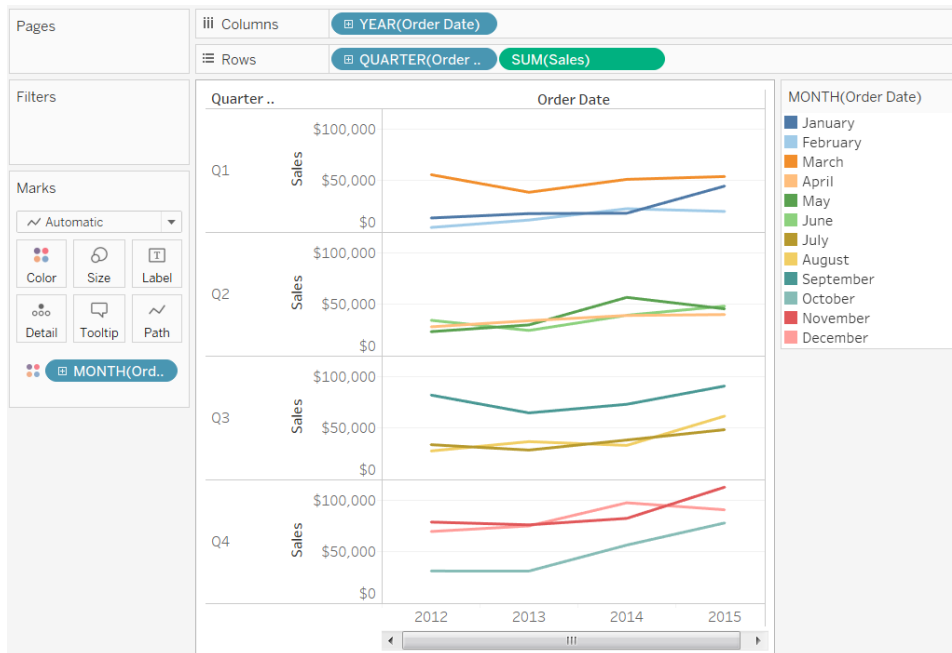

Custom Date Formats

This article discusses using the custom date format field to format dates in a view. For an overview of how Tableau works with dates, see [Dates and Times](#), or [Changing Date Levels](#). For setting date properties for a **data source**, see [Date Properties for a Data Source](#).

How to find the custom date format field

Format a date field in a view (Tableau Desktop)

To format a date field in the view in Tableau Desktop, right-click (Control-click on a Mac) the field and choose **Format**.

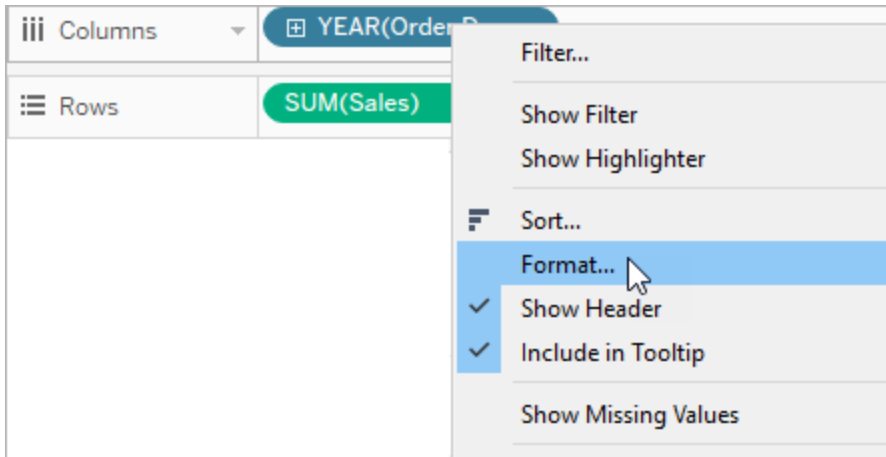

This opens the **Format** panel to the left of your view. Select the **Dates** field.

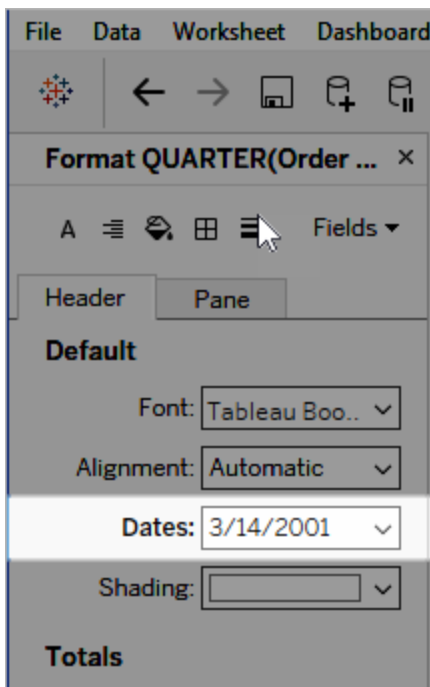

When you format dates, Tableau presents a list of available formats. Usually, the last item in the list is **Custom**. You can specify a custom date using format symbols listed in the Supported date format symbols table, either alone or in combination.

Format a date field in a view (Tableau Cloud and Tableau Server)

To format a date field in the view in Tableau Cloud and Tableau Server, right-click (Control-click on a Mac) the field and choose **Format Date**.

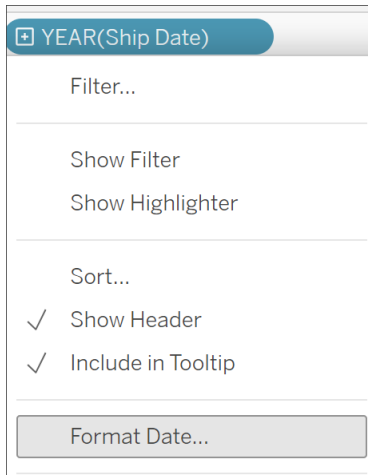

Format a date field in the Data pane (Tableau Desktop only)

To format a date field in the **Data** pane, right-click the field and choose **Default Properties > Date Format**.

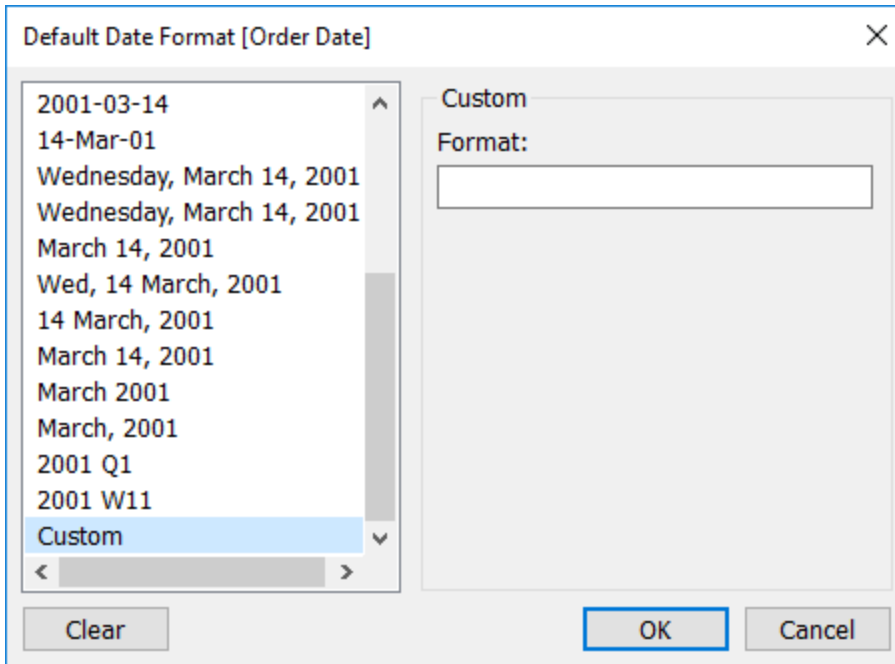

The date formats in the table are supported when your workbook is connected to a Tableau extract or has a live connection to a data source that also supports the date format. (Refer to your data source's documentation to verify that the date format you want is supported.)

Tableau retrieves date formats from the data source. Tableau Server can also retrieve date formats from the Run As user account on the server that's running Tableau Server.

Note: The following date formats might not be the same as those used with the [Type Conversion](#) function. See [Convert Strings to Date Fields](#) for more information.

Supported date format symbols

Use the following symbols to construct a custom date format.

Symbol	Description
(:)	Time separator. In some locales, a different character is used to represent the time separator. The time separator separates hours, minutes, and seconds when time values are formatted. The actual character used as the time separator in formatted output is determined by your system settings.
(/)	Date separator. In some locales, a different character is used to

	represent the date separator. The date separator separates the day, month, and year when date values are formatted. The actual character used as the date separator in formatted output is determined by your system settings.
c	Display the date as dddd and display the time as tttt, in that order. Display only date information if there's no fractional part to the date serial number; display only time information if there's no integer portion.
d	Display the day as a number without a leading zero (1-31).
dd	Display the day as a number with a leading zero (01-31).
ddd	Display the day as an abbreviation (Sun, Sat).
dddd	Display the day as a full name (Sunday, Saturday).
ddddd	Display the date as a complete date (including day, month, and year), formatted according to your system's short date format setting. The default short date format is m/d/yy.
dddddd	Display a date serial number as a complete date (including day, month, and year) formatted according to the long date setting recognized by your system. The default long date format is mmm dd, yyyy.
aaaa	The same as dddd, only it's the localized version of the string.
w	Display the day of the week as a number (1 for Sunday through 7 for Saturday).
ww	Display the week of the year as a number (1-54).
M	Display the month as a number without a leading zero (1-12). If m immediately follows h or hh, the minute rather than the month is displayed.
MM	Display the month as a number with a leading zero (01-12). If m immediately follows h or hh, the minute rather than the month is displayed.

MMM	Display the month as an abbreviation (Jan-Dec).
MMMM	Display the month as a full month name (January-December).
MMMMM	Display the month as a single letter abbreviation (J-D)
oooo	The same as MMMM, but localized.
q	Display the quarter of the year as a number (1- 4).
y	Display the day of the year as a number (1-366).
yy	Display the year as a 2-digit number (00-99).
yyyy	Display the year as a 4-digit number (100-9999).
h	Display the hour as a number without leading zeros (0-23).
Hh	Display the hour as a number with leading zeros (00-23).
N	Display the minute as a number without leading zeros (0 59).
Nn	Display the minute as a number with leading zeros (00 59).
S	Display the second as a number without leading zeros (0 59).
Ss	Display the second as a number with leading zeros (00 59).
000	Display milliseconds. Use a period character as a separator before specifying milliseconds.
t t t t	Display a time as a complete time (including hour, minute, and second), formatted using the time separator defined by the time format recognized by your system. A leading zero is displayed if the leading zero option is selected and the time is before 10:00 A.M. or P.M. The default time format is <code>h : mm : s s</code> .
AM/PM	Use the 12-hour clock and display an uppercase AM with any hour before noon; display an uppercase PM with any hour between noon and 11:59 P.M.
am/pm	Use the 12-hour clock and display a lowercase AM with any hour before noon; display a lowercase PM with any hour between noon and 11:59 P.M.

A/P	Use the 12-hour clock and display an uppercase A with any hour before noon; display an uppercase P with any hour between noon and 11:59 P.M.
a/p	Use the 12-hour clock and display a lowercase A with any hour before noon; display a lowercase P with any hour between noon and 11:59 P.M.
AMPM	Use the 12-hour clock and display the AM string literal as defined by your system with any hour before noon; display the PM string literal as defined by your system with any hour between noon and 11:59 P.M. AMPM can be either uppercase or lowercase, but the case of the string displayed matches the string as defined by your system settings. The default format is AM/PM.

Custom date format examples

Any of the date format symbols in the table above can be used alone or in combination.

Specifying a custom format yyyy-MM-dd HH:mm:ss.000 would produce dates in the format 2015-05-10 11:22:16.543. Such a format might be appropriate for scientific data.

Specifying a custom format DDDD DD would produce dates that show the Weekday and the Day, as shown below.

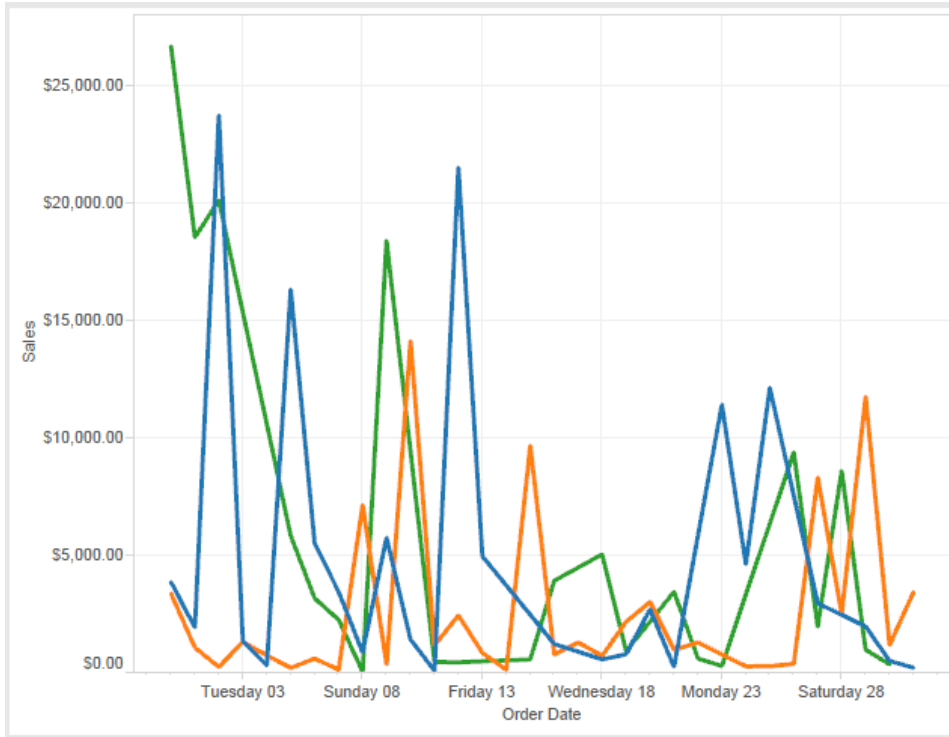

Specifying a custom format `yy-mm-dd (dddd)` would produce dates in the format **18-01-04 (Thursday)**.

Specifying a custom format `"Q"1 YYYY` would produce dates that show **Q1 2018**.

Support for Japanese era-based date formats

Tableau supports Japanese emperor-era-based date (Wareki) formats. Here's how to apply an era-based date format to a field in your view:

1. Set your workbook locale to Japanese.
2. Right-click the field in the view for which you want to set a date format.
3. Choose **Format**.
4. In the **Format** pane, from the **Dates** drop-down list, select a format.

If the format that you want isn't listed, you can construct your own date format. To do this, choose **Custom format** in the **Dates** box, then type your format using the Tableau date placeholders. The following era-based year placeholders are available:

Symbol	Description
g	Short era name (such as H for the Heisei era).

gg	Era name (such as 平成).
ggg	Long era name (for Japanese, this is the same as the regular era name).
e	Era-based year, such as 1 for the first year of an era.
ee	Era-based year, such as 01 for the first year of an era. If there's only one digit, then the era-based year will have a zero added to the front.

If your workbook locale isn't Japanese, you can create a custom date format, then insert the language code !ja_JP! in front of your format, so that it looks like this:

```
!ja_JP! gg ee"年"mm"月"dd"日"
```

The language code forces the date to be treated as if it's a Japanese date.

Era-based dates aren't fully supported by the Tableau Server browser view. In particular, if you publish a workbook that contains an interactive filter, the e and g placeholders won't be filled in:

Order Date gg ee年 01月 01日  gg ee年 12月 31日

To avoid this issue, don't show era-based dates in interactive filters if your workbook will be viewed in a browser.

Using literal text in a date format

You may want your date format to include some words or phrases, such as **Fiscal Quarter q of yyyy**. However, if you type that text directly into the Tableau format box, it may treat the letters like date parts:

Quarter of Order Date

Fi01/1/2010a1 1quarter 1 of 2010

Fi04/1/2010a1 2quarter 2 of 2010

Fi07/1/2010a1 3quarter 3 of 2010

Fi10/1/2010a1 4quarter 4 of 2010

To prevent Tableau from doing this, put double quotes around the letters and words that shouldn't be treated as date parts: "Fiscal Quarter" q "of" yyyy.

If you want a literal quote inside of a quoted section, insert this code: "\ ". For example, the format "Fiscal \" Quarter" would be formatted as **Fiscal " Quarter**.

Format syntax in DATEPARSE function for extract data sources

If you're using the DATEPARSE function in an extract, use the syntax defined by the Unicode Consortium.

The following table lists the field types that can be represented in the format parameter of the DATEPARSE function. Click the field type to get information about the symbols, field patterns, examples, and descriptions from the Unicode Consortium website.

Unit of time	Notes
Era	n/a
Year	<p>All symbols are supported in .hyper extracts except for "U".</p> <p>Notes:</p> <ul style="list-style-type: none"> • Negative values denote a year before Christ (BC). For example, <code>DATEPARSE('y', '-10')</code> returns the first January of 11BC and <code>DATEPARSE('y', '-0')</code> returns the first January of 1BC. • When working with the calendar year "y", the pattern "yy" requests the two low-order digits of the year. For numbers < 70, the DATEPARSE function returns the year 2000+x. For numbers >=70, the DATEPARSE function returns the year 1900+x. • When working with "Y" in "ISO week date" based calendars, the year transition occurs on a week boundary and may differ from the calendar year transition. The "Y" designation is used in conjunction with pattern character "w" in ISO year-week calendar. The ISO week date system is effectively a leap week calendar system that is part of the ISO 8601 date and time standard. Similar to "y", negative values for "Y" denote a year before Christ (BC).
Month	<p>All symbols are supported in .hyper extracts except for "l".</p> <p>Notes:</p>

Unit of time	Notes
	<ul style="list-style-type: none"> The month designations are used in conjunction with "d" for the day number. In contrast to ICU, .hyper extracts allow values 1–12. Other values cause an error.
Week	<p>All symbols are supported in .hyper extracts except for "W".</p> <p>Notes:</p> <ul style="list-style-type: none"> When working with "w", in contrast to ICU, .hyper extracts allow only valid weeks. A year has 52 or 53 weeks (ISO 8601). The DATEPARSE function validates the input. For example, an error occurs for the 53rd week of 2016 because the 53rd week doesn't exist for 2016. When working with "W", ICU doesn't support this designation, but it's useful for dates like 1st Monday of September.
Day	<p>Notes:</p> <ul style="list-style-type: none"> When working with "d", in contrast to ICU, .hyper extracts only allow valid day numbers. For example, an error occurs for the 31st of February. When working with "D", in contrast to ICU, .hyper extracts only allow valid day numbers. For example, an error occurs for the 366th day of 2017.
Hour	<p>Only "h" and "H" symbols are supported in .hyper extracts.</p> <p>Notes:</p> <ul style="list-style-type: none"> When working with "h", .hyper extract don't allow negative values for this field. Negative values cause an error. When working with "H", .hyper extracts don't allow

Unit of time	Notes
	negative values for this field. Negative values cause an error.
Minute	Note: In contrast to ICU, .hyper extracts don't allow negative values for this field. Negative values will cause an error.
Second	Notes: <ul style="list-style-type: none"> • In contrast to ICU, .hyper extracts don't allow negative values for this field. Negative values will cause an error. • When working with "S", <code>DATEPARSE('ss.SSSS', '12.3456')</code> returns 1990-01-01 00:00:12:3456 AD.
Quarter	Note: In contrast to ICU, .hyper extracts only allow values 1–4. All other values cause an error.
Weekday	Notes: <ul style="list-style-type: none"> • When working with "e" and "ee", in contrast to ICU, .hyper extracts only allow values 1–7. All other values cause an error. • When working with "c.cc", in contrast to ICU, .hyper extracts only allow values 1–7. All other values cause an error.
Period	n/a

ISO-8601 Week-Based Calendar

The ISO-8601 Week-Based Calendar is an international standard for date-related data. The purpose of the ISO-8601 calendar is to provide a consistent and clear method to represent and calculate dates. ISO-8601 calendars divide dates into years, quarters, weeks, and weekdays. Unlike the Gregorian calendar, ISO-8601 calendars have a consistent number of weeks in each quarter and a consistent number of days each week. This makes the ISO-8601 calendar popular when calculating retail and financial dates.

Set ISO-8601 as the default calendar

To set the ISO 8601 calendar for a data source, follow these steps:

1. Right-click (control-click on Mac) the data source in the **Data** pane to open the Date Properties dialog box.
2. Set the **Default calendar** field to ISO-8601 Week-based.

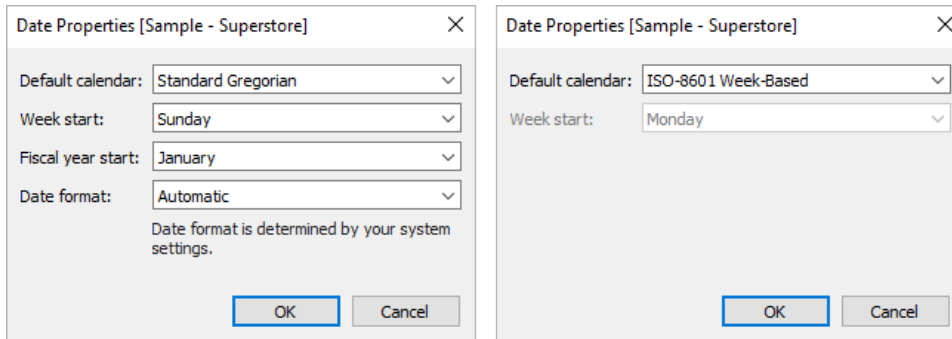

For each date field on the shelf, you can set the calendar type separately. In the shelf, right-click a date dimension (Ctrl-click on Mac), and select **ISO-8601 Week-Based**.

Differences between ISO-8601 and Standard Gregorian calendars

Not all date levels are relevant in a fiscal calendar.

Gregorian	ISO-8601	Differences between calendars
Year	ISOYEAR	ISO-8601 years always start on the first Monday closest to January 1. This means the year may start anywhere between December 29 and January 4. Gregorian calendars always start the year on January 1. This can cause some discrepancy in years between the two calendar systems around those dates. Each ISO-8601 year is either a <i>long</i> or a <i>short</i> year, with 52 or 53 weeks, depending on when the ISO-8601 year begins.
Quarter	ISOQUARTER	The first three quarters in the ISO-8601 always have 13 weeks. The last quarter has either 13 weeks (in a short year) or 14 weeks (in a long year).

Gregorian	ISO-8601	Differences between calendars
Month		The ISO-8601 week-based calendar doesn't use months. Many retail and financial systems divide ISO-8601 quarters into three segments of 4-4-5 weeks, though other "month" patterns also exist. These can be defined using calculations. See Create a 4-4-5 calendar on the facing page .
Week Number	ISOWEEK	All weeks in the ISO-8601 week-based calendar have exactly 7 days and start on a Monday. Each week belongs to single year, unlike the Gregorian calendar which permits weeks to extend across years. Long years have 53 weeks, short years have 52 weeks.
Day		The ISO-8601 week-based calendar doesn't use numerical days (such as the 14th or 23rd).
Weekday	ISOWEEKDAY	ISO-8601 weekdays always start on Monday and are represented as single digits. Monday is 1, Tuesday is 2, through to 7 for Sunday.

Date Functions that support ISO-8601

The following date functions are compatible with the ISO-8601 week-based calendar.

DATEADD and DATEDIFF

The result truncates an ISO-8601 date to the nearest ISO level if non-ISO-8601 date parts (`day` or `month`) are used. For example, adding one month to an ISO-8601 date results in the `iso-week` changing.

DATENAME

The result is a Gregorian date unless you use the `iso-year`, `iso-quarter`, `iso-week`, or `iso-weekday` date parts.

DATEPART

The result is a Gregorian date unless you use the `iso-year`, `iso-quarter`, `iso-week`, or `iso-weekday` date parts.

DATETRUNC

Truncates an ISO-8601 date to the nearest ISO level. For example, even though the ISO-8601 doesn't use months, truncating the ISO date at 'month' displays the first *iso-week* of the Gregorian month.

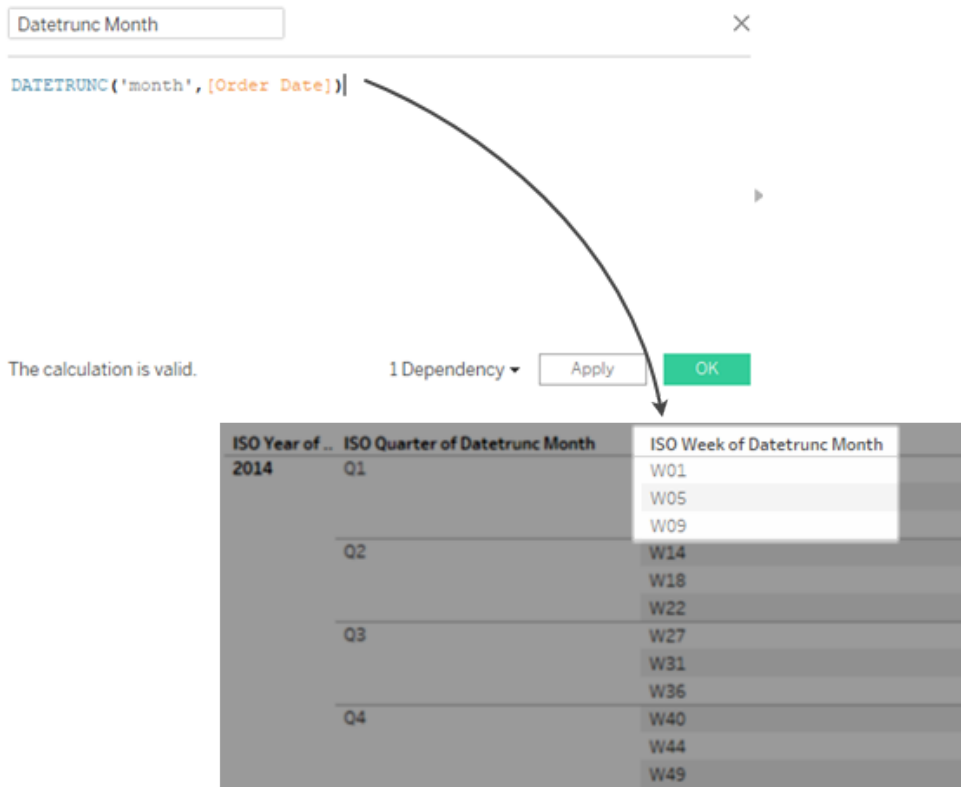

Create a 4-4-5 calendar

The ISO-8601 week-based calendar doesn't use months. Many retail and financial systems divide ISO-8601 quarters into three segments of 4-4-5 weeks, though other segment systems also exist.

Follow along with these steps to learn how to implement a 4-4-5 calendar in Tableau Desktop.

Step 1: Set up the visualization

1. Open Tableau Desktop and connect to the **Sample-Superstore** saved data source.
2. Right-click the data source in the Data pane to open the Date Properties dialog box. Change the default calendar to ISO-8601 Week-based.

3. From the **Data** pane, drag **Order Date** to the **Rows** shelf.
4. On the Rows shelf, click the '+' icon on ISOYEAR(Order Date) to expand out ISOQUARTER(Order Date).
5. From the **Data** pane, drag **Sales** to the **Columns** shelf.

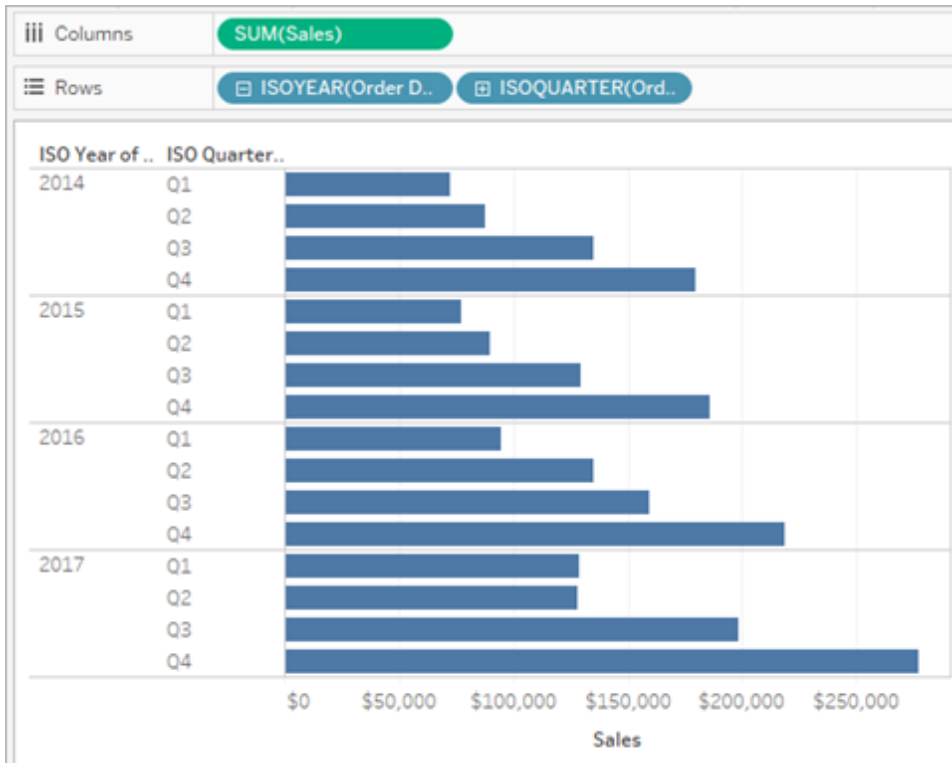

Step 2: Find the number of weeks in each quarter

In a 4-4-5 segment calendar, each quarter is divided into 3 segments (analogous to months) with 4 or 5 weeks in them. We must find how many weeks are in each quarter to divide them into segments.

1. Select Analysis > Create Calculated Field.
2. Name the calculated field **Week of Quarter**
3. Enter the following calculation in the calculation dialog

```
DATEPART('iso-week', [Order Date]) - (DATEPART('iso-quarter', [Order Date]) - 1) * 13
```

Step 3: Create the 4-4-5 calendar calculation

1. Select Analysis > Create Calculated Field.
2. Name the calculated field **4-4-5 Segment**.
3. Enter the following calculation in the calculation dialog

```
IF([Week of Quarter] <= 4) THEN "1" ELSEIF ([Week of Quarter] <= 8) THEN "2" ELSE "3" END
```

The values 1, 2, 3 are labels for the three segments and can be replaced with any value you choose.

4. From the data pane, drag the **4-4-5 Segment** calculated field to the Rows shelf.

The resulting viz now has each quarter broken down into three segments.

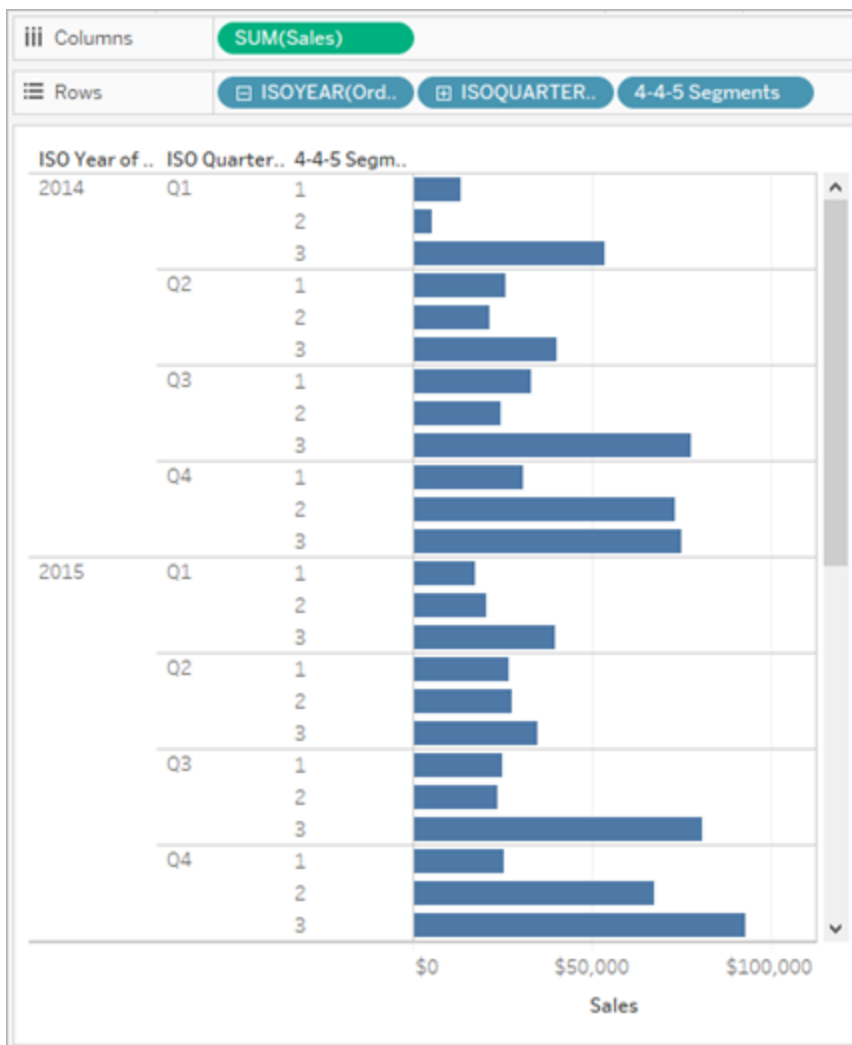

Modify the pattern

In the **4-4-5 Segment** calculation, the cutoffs ≤ 4 and ≤ 8 come from the 4-4-5 pattern.

The first segment's cutoff is ≤ 4 for the first four weeks (1-4). The second segment's cutoff is ≤ 8 (encompassing weeks 5–8), and the remaining weeks (9-13) are captured in the ELSE portion. (IF statements are calculated until a condition is true, so the second segment only needs to specify the upper limit.)

These cutoffs can be modified for other patterns. Specifically:

- 4-5-4 cutoffs: 4 (for the first four weeks, 1–4) and 9 (for the next five weeks, 5–9)
- 5-4-4 cutoffs: 5 and 9

See Also

[Dates and Times](#) on page 1149

[Date Functions](#) on page 2075

Format Dates Using ISO-8601 Weeks and Years

For many European locales (listed below), Tableau allows you to format dates using ISO-8601 weeks and years.

Expand to see European locales that support ISO-8601 in Tableau

da-DK, Danish (Denmark)

se-SE, Sami, Northern (Sweden)

rm-CH, Romansh (Switzerland)

sms-FI, Sami, Skolt (Finland)

is-IS, Icelandic (Iceland)

de-DE, German (Germany)

km-KH, Khmer (Cambodia)

nl-NL, Dutch (Netherlands)

Tableau Desktop and Web Authoring Help

smj-SE, Sami, Lule (Sweden)
fi-FI, Finnish (Finland)
nn-NO, Norwegian Nynorsk (Norway)
it-IT, Italian (Italy)
it-CH, Italian (Switzerland)
nb-NO, Norwegian Bokmål (Norway)
pl-PL, Polish (Poland)
sv-SE, Swedish (Sweden)
et-EE, Estonian (Estonia)
lv-LV, Latvian (Latvia)
hsb-DE, Upper Sorbian (Germany)
kl-GL, Greenlandic (Greenland)
mk-MK, Macedonian (North Macedonia)
fo-FO, Faroese (Faroe Islands)
se-NO, Sami, Northern (Norway)
as-IN, Assamese (India)
fy-NL, Frisian (Netherlands)
se-FI, Sami, Northern (Finland)
ps-AF, Pashto (Afghanistan)
prs-AF, Dari (Afghanistan)
de-CH, German (Switzerland)
sv-FI, Swedish (Finland)
dsb-DE, Lower Sorbian (Germany)
de-LU, German (Luxembourg)
fr-CH, French (Switzerland)
smj-NO, Sami, Lule (Norway)
de-LI, German (Liechtenstein)

sma-NO, Sami, Southern (Norway)

sma-SE, Sami, Southern (Sweden)

smn-FI, Sami, Inari (Finland)

The week and year numbering in an ISO-8601 calendar is different from a standard Gregorian calendar. Here's how January 2nd, 2011 would be represented:

Calendar System	Week Number	Year Number
Standard Gregorian	1	2011
ISO-8601	52	2010

When formatting dates, it's important to ensure that your month, week and year numbers all come from the same calendar system. Otherwise, the date might not make sense. There are two ways to do this:

- Let Tableau guess which calendar system you want to use for each placeholder. For example, if you type `mm_yyyy` (a month followed by a year), Tableau uses the standard Gregorian year. In this case, it makes sense to use that year with a month number.
- In your format string, place an annotation after each week (`ww`) or year (`yyyy`) placeholder, to indicate what kind of placeholder it should be:

Annotation	Calendar to Use	Example Format String
[Y]	ISO-8601	ww[Y] yyyy[Y]
[y]	Standard Gregorian	ww[y] yyyy[y]

Important: To get correct ISO-8601 week numbering, your computer's location must be set to one of the [above](#) locales, and you must set your data source start of week to Monday. (For information on how to do this, see [Date Properties for a Data Source on page 1151](#).)

Otherwise, Tableau will number weeks using your data source start of week setting, which may result in partial weeks at the beginning and end of years being created.

Note: ISO week numbering will not occur if you are using a fiscal year that doesn't start in January, regardless of the locale you choose.

Sample format strings for the date December 31, 2013

Here are sample format strings for the date December 31, 2013, where m stands for a month or day-of-month placeholder. Time placeholders, such as hours, minutes, and seconds, don't influence whether or not a year is week-based or year-based.

Format string	Formatted output
yyyy	2013
yyyy[Y]	2014
yyyy ww	2014 1
yyyy mm	2013 12
ww yyyy	1 2014
mm yyyy	12 2013
ww yyyy[y]	1 2013
mm yyyy[Y]	12 2014
yyyy mm ww	2013 12 1
mm yyyy ww	12 2013 1
ww mm yyyy	1 12 2013
ww mm yyyy[Y]	1 12 2014
ww yyyy mm	1 2014 12 (format is ambiguous)
ww yyyy[y] mm	1 2013 12
ww yyyy mm yyyy	1 2014 12 2013
ww yyyy yyyy mm	1 2014 2013 12
yyyy mm ww yyyy	2013 12 1 2014

Continuous Dates

By default, dates come into the view as a discrete field. Date parts (such as year or month) can be used like any other discrete field and create labels in the view.

However, you can change dates to continuous if you choose. Select one of the Continuous date options on the field's context menu to use date truncations (such as March 2020 or 25/03/2022) instead of date parts. Continuous dates create an axis in the view.

Discrete date part

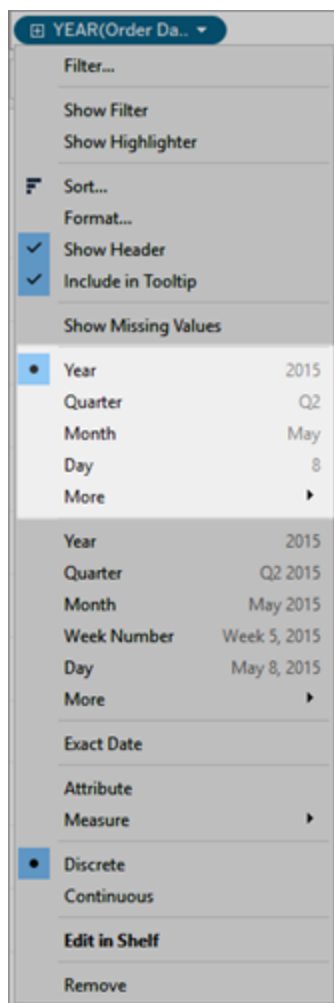

Continuous date truncation

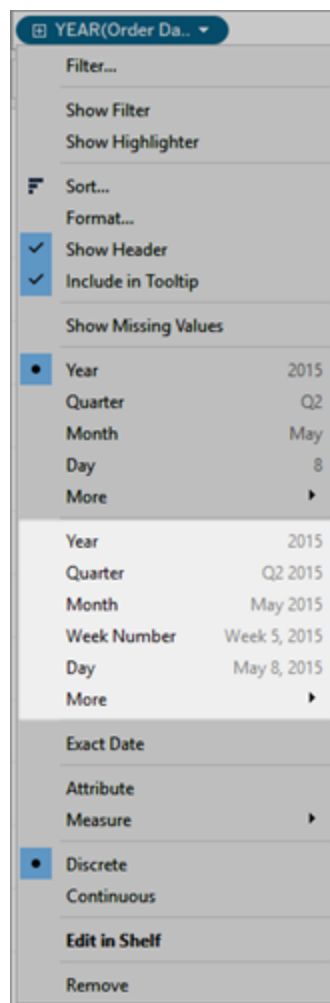

Change the default

To make a given date field continuous by default, right-click (control-click on Mac) the field in the **Data** pane and select **Convert to Continuous**. The field turns green and defaults to a

continuous date when used in the view. To revert to discrete again, right-click (control-click on Mac) the field in the **Data** pane and select **Convert to Discrete**.

See also

For more information on the impact of using a continuous or discrete field, refer to [Dimensions and Measures, Blue and Green on page 147](#).

Build Data Views from Scratch

This section describes the various features at your disposal and tasks related to building visualizations in Tableau.

Every view that you build in Tableau should start with a question. What do you want to know? Every time you drag a field into the view or onto a shelf, you are asking a question about the data. The question will vary depending on where you drag various fields, the types of fields, and the order in which you drag fields into the view.

For every question you ask about your data, the marks in your viz update to represent the answer visually—with shapes, text, size, color, headers, axes, hierarchies, or table structures.

For information on building and viewing visualizations on the web, see [Use Tableau on the Web on page 3177](#).

Looking for a data set to work with? Check out our tips to [find good data sets](#).

Start Building a Visualization by Dragging Fields to the View

The basic structure for every view is made of dimension and measure fields placed on the Rows and Columns shelves, and on different properties in the Marks card.

You build visualizations by adding fields from the Data pane to the view. As you build a visualization, you can add as many fields as necessary to different areas of the view, and then move those fields around as you explore your data.

Different ways to start building a view

When you build a view, you add fields from the **Data** pane. You can do this in different ways. For example:

- Drag fields from the **Data** pane and drop them onto the cards and shelves that are part of every Tableau worksheet.
- Double-click one or more fields in the **Data** pane.
- Select one or more fields in the **Data** pane and then choose a chart type from **Show Me**, which identifies the chart types that are appropriate for the fields you selected. For details, see [Use Show Me to Start a View](#) on page 1229.
- Drop a field on the **Drop field here** grid, to start creating a view from a tabular perspective.



As you start exploring data in Tableau, you will find there are many ways to build a view. Tableau is extremely flexible, and also very forgiving. As you build a view, if you ever take a path that isn't answering your question, you can always undo to a previous point in your exploration.

- To undo or redo, click undo ← or redo → on the toolbar.

You can undo all the way back to the last time you opened the workbook. You can undo or redo an unlimited number of times.

Dragging basics

When you begin creating a new data view on a blank worksheet, you can drag a field from the **Data** pane and drop it directly into the view, rather than to a shelf.

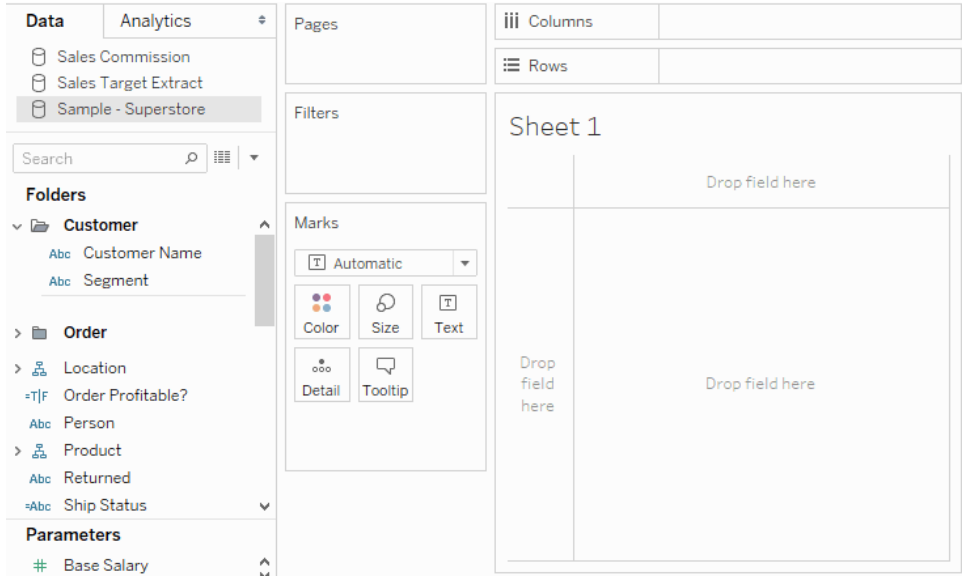

In Tableau Desktop, while dragging fields, you can hover over the different areas in the view to see how the field will be incorporated into the structure of the view. For example, dimensions typically add a row and column headers to the view, while measures add continuous axes. Below are some examples of how fields can be added to the view.

Dimensions add headers

Measures add axes

Show Me automatically adds the field according to best practices

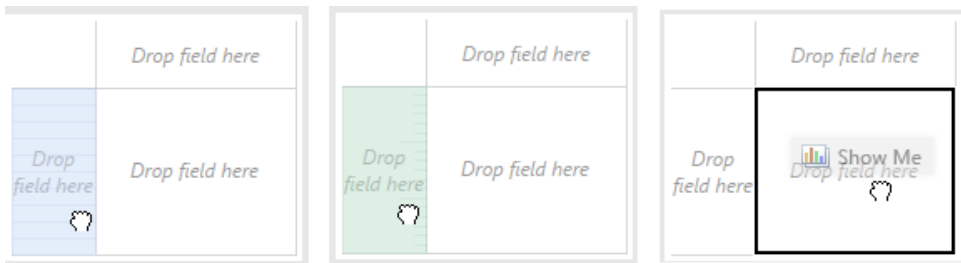

For a more advanced discussion of dimensions and measures, see [Dimensions and Measures, Blue and Green](#) on page 147.

When you drop a field on one of the active areas in the view, the field is added to the view and also to one of the shelves or cards. For example, in the view below the **Segment** dimension was added to the **Rows** shelf and the **Profit** measure was added to the **Columns** shelf—and automatically aggregated so that the values in the data are summed.

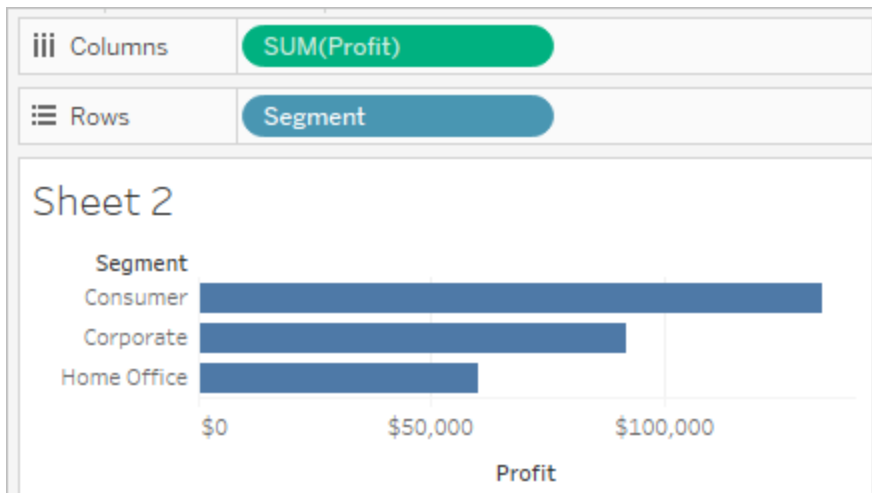

You can, of course, also drag fields directly to the shelves instead of to the active areas in the view. You can also drag fields from one shelf to another shelf. To remove a field from a shelf, drag it off the worksheet or select **Remove** from the field's menu (available when you right-click (control-click on Mac) a field in the view). In Tableau Desktop, you can also quickly remove multiple fields from a shelf by right-clicking (control-click on Mac) the shelf and selecting **Clear Shelf**.

Add headers

You can add headers to a view by dragging a discrete (blue) dimension and dropping it to either side of an existing header, or to the left of an axis. For example, in the view below you can add the **Region** dimension by dragging it and dropping it to the right of the Sub-Category names.

Tableau Desktop and Web Authoring Help

The screenshot shows the Tableau Desktop interface. On the left is the Data pane with a search bar and a list of folders: Location (Region, Country/Region, State, City, Postal Code), Product (Category, Sub-Category), and Parameters (Base Salary). The Columns shelf contains 'Segment' and the Rows shelf contains 'Sub-Category'. The Marks card is set to 'Automatic'. The main view is a table titled 'Sheet 1' with the following data:

Sub-Category	Segment		
	Consumer	Corporate	Home Office
Accessories	Abc	Abc	Abc
Appliances	Abc	Abc	Abc
Art	Abc	Abc	Abc
Binders	Abc	Abc	Abc
Bookcases	Abc	Abc	Abc
Chairs	Abc	Abc	Abc
Copiers	Abc	Abc	Abc
Envelopes	Abc	Abc	Abc
Fasteners	Abc	Abc	Abc
Furnishings	Abc	Abc	Abc
Labels	Abc	Abc	Abc
Machines	Abc	Abc	Abc
Paper	Abc	Abc	Abc
Phones	Abc	Abc	Abc

As you hover over the view, a dotted black line indicates active areas where you can add headers.

If you drop **Region** there, it adds a column for Region along the top of the table, and slices the data so that you see results for each region within each sub-category.

Sheet 2

Sub-Category	Region	Segment		
		Consumer	Corporate	Home Of..
Accessories	Central	Abc	Abc	Abc
	East	Abc	Abc	Abc
	South	Abc	Abc	Abc
	West	Abc	Abc	Abc
Appliances	Central	Abc	Abc	Abc
	East	Abc	Abc	Abc
	South	Abc	Abc	Abc
	West	Abc	Abc	Abc
Art	Central	Abc	Abc	Abc
	East	Abc	Abc	Abc
	South	Abc	Abc	Abc
	West	Abc	Abc	Abc
Binders	Central	Abc	Abc	Abc
	East	Abc	Abc	Abc

Add axes

You can add axes by dragging a continuous (green) measure and dropping it on an active area in the view. If an axis already exists in the view you can replace the existing axis, blend the new measure with the existing axis, or add a secondary axis.

Replace the Existing Axis

Drag the new measure to the top left portion of the axis in the view. A small square drop zone appears and a single axis icon displays to indicate that a single axis will be left when you drop the measure. In this case you are replacing one measure (**Sales**) with another (**Profit**).

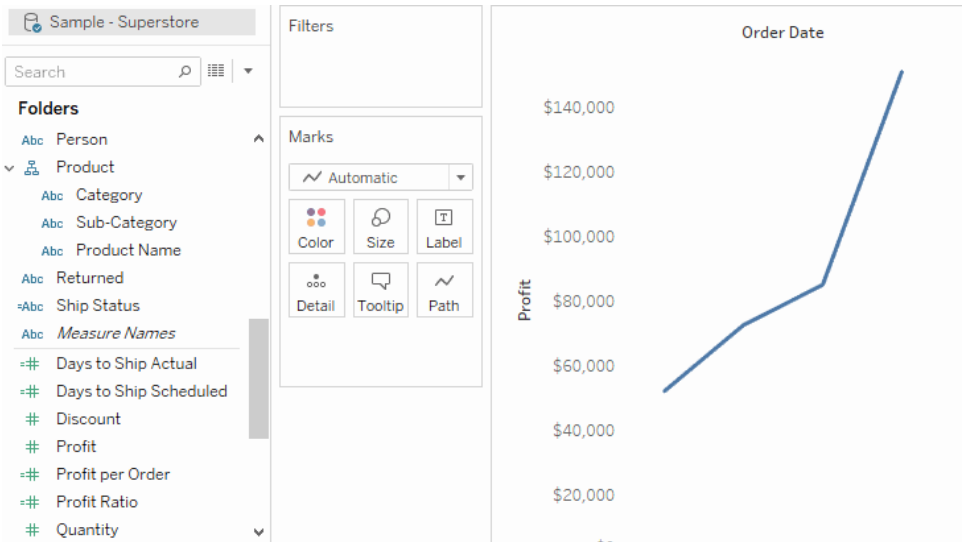

Blend the Measures on Single Axis

You can show multiple measures on a single axis by dragging the new measure directly on top of the existing axis. Blending measures uses the Measure Names and Measure Values fields. For more information, see [Measure Values and Measure Names](#) on page 1212.

In the image below you are adding a second measure (**Profit**) to the existing measure (**Sales**) on the axis.

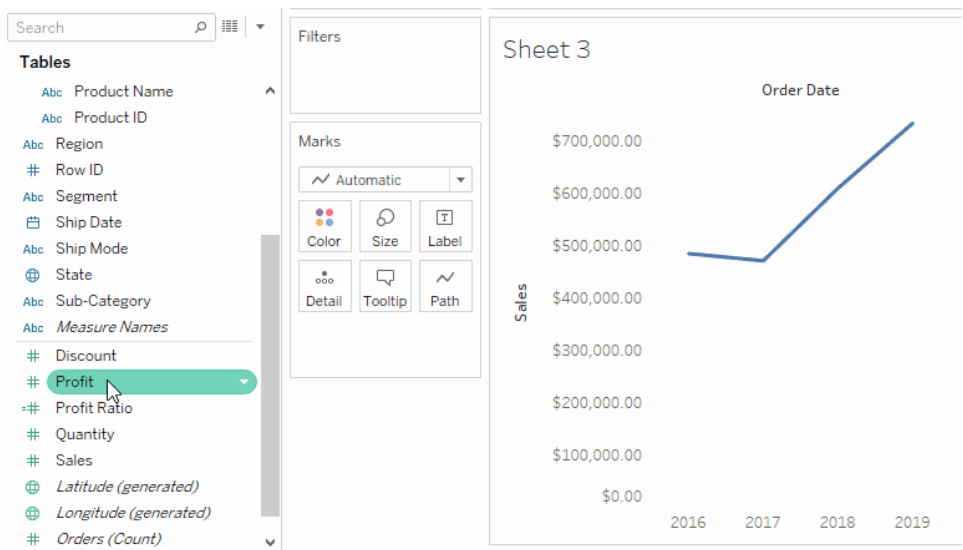

The result is a view with both measures plotted along a single axis. In this case, Sales is shown in orange and Profit is shown in blue.

Add a Dual Axis

Drag the field to the right side of the view to add the measure as a dual axis. Dual Axes are useful when you want to compare two fields that have different scales. In this case, blending the two axes would distort the view. Instead you can add a dual axis.

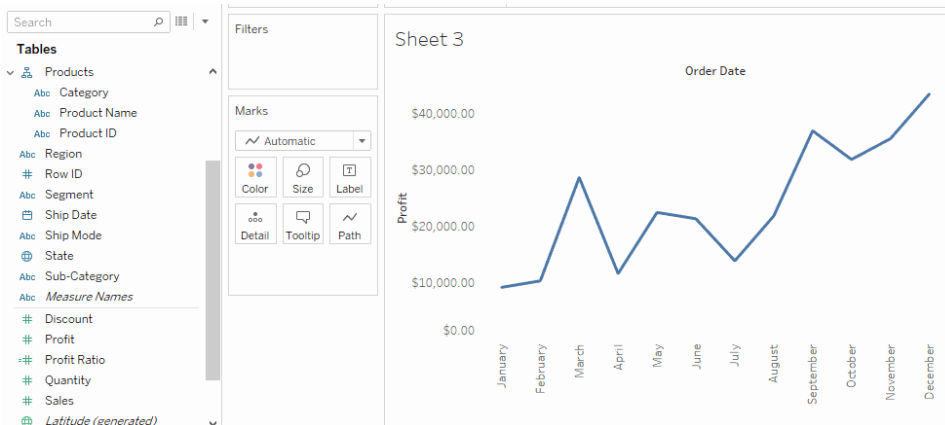

The result is a dual axis view where the Profit axis corresponds to the blue line and the Sales axis corresponds to the orange line.

You can add up to four axes to the view: two on the Columns shelf and two on the Rows shelf. To turn a measure into a dual axis, right-click (control-click on Mac) a field on the **Rows** or **Columns** shelf and select **Dual Axis**.

Rearrange rows and columns

You can rearrange the rows and columns in the view by changing the order of the fields in the Rows and Columns shelves, or by dragging the selection border for headers or an axis.

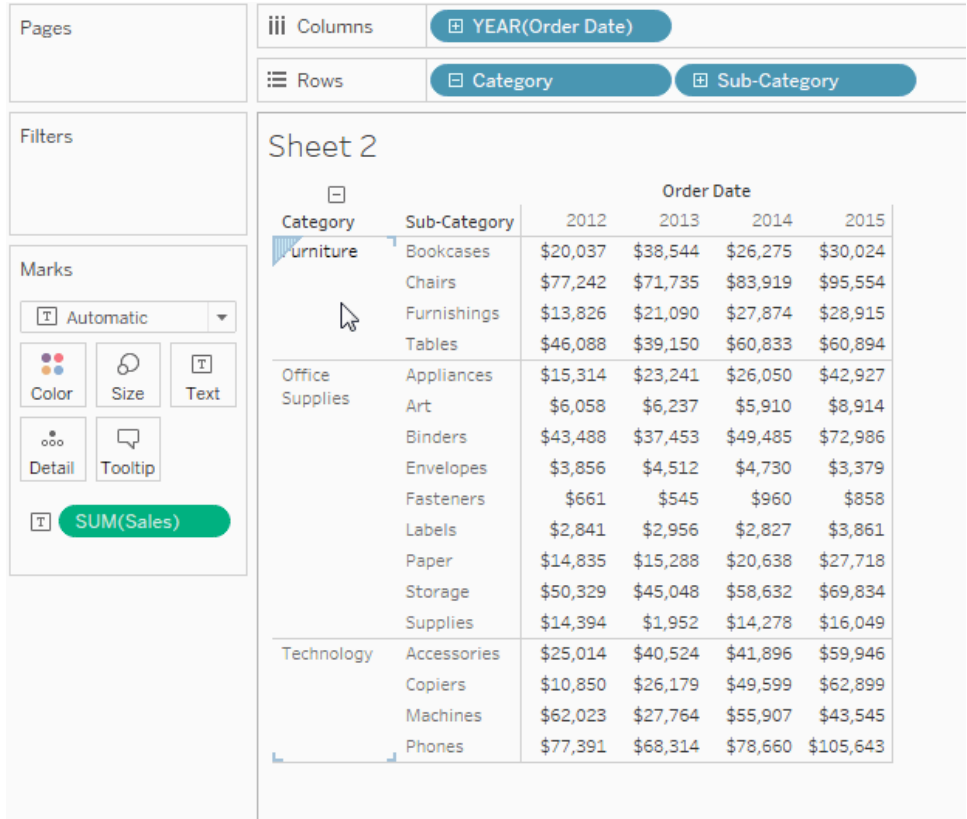

Automatically add fields to the view with double-click

Tableau supports an additional method for automatically generating views of data called Automatic Double-Click. To use this method, double-click fields in the Data pane you are interested in. Tableau automatically adds each field to the view. That is, each double-click results in an additional field added to a shelf in an intelligent way. Like **Show Me**, this function leverages Tableau’s ability to make an intelligent “best guess” of how the data should be displayed. Double-clicking sometimes creates a view that you can use without further modification. More often, it can provide a starting point, which you can then modify to get the ideal result.

1. Double-clicking the **Profit** measure in the **Data** pane automatically adds that field to the view in an intelligent way.

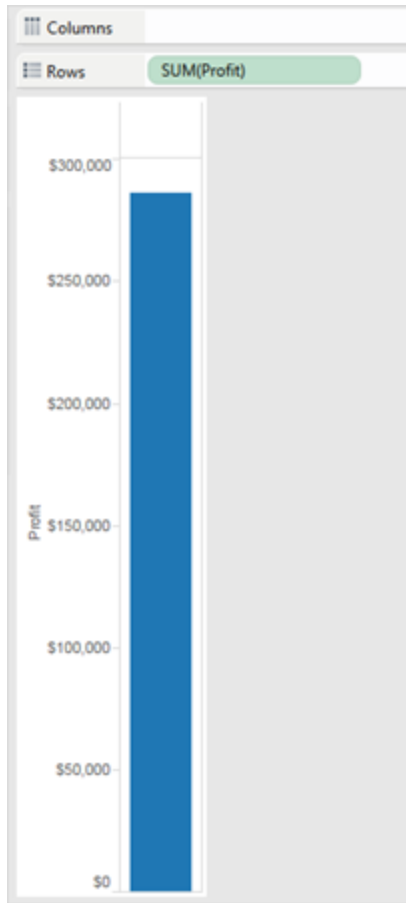

2. Double-clicking the **Category** dimension in the **Data** pane automatically adds that field to the view based on the fact that Profit is already on the Rows shelf.

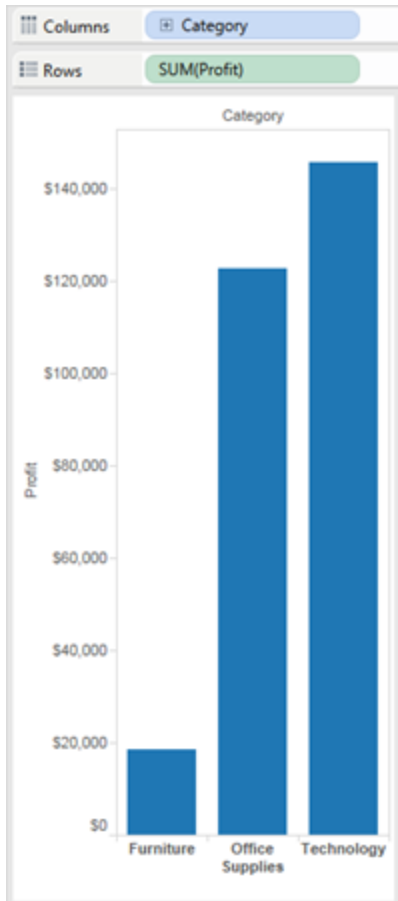

3. Double-clicking the **Order Date** dimension in the **Data** pane automatically adds that field to the **Columns** shelf based on the placement of other fields in the view. As you double-click fields they are successively added to the view. The order in which you click fields determines the type of view created.

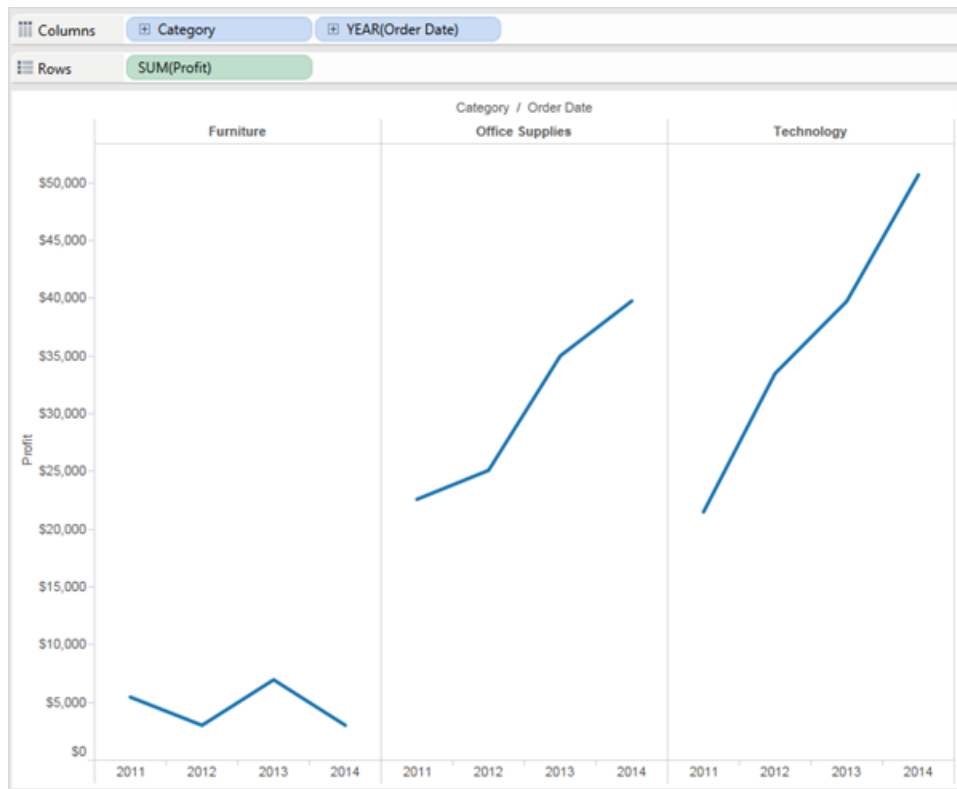

The following table describes some of the rules used in creating automatic views by double-clicking fields in the **Data** pane.

Text Table	Adding a dimension first produces a text table (or cross-tab). All subsequent clicks on fields result in refinement of the text table.
Bars	Adding a measure first and then a dimension produces a bar view. All subsequent clicks result in refinement of the bar view, unless a date dimension is added, at which time the view is changed to a line.
Line	Adding a measure and then a date dimension produces a line view. All subsequent clicks result in refinement of the line view.
Continuous Line	Adding a continuous dimension and then a measure produces a continuous line view. Subsequent dimensions result in refinement of the continuous line view. Subsequent measures add quantitative axes to the view.
Scatter	Adding a measure and then another measure produces a scatter view. Subsequent dimensions result in refinement to the scatter view. Subsequent measures will create a scatter matrix.

Maps

Adding a geographic field produces a map view with latitude and longitude as axes and the geographic field on the Level of Detail shelf. Subsequent dimensions add rows to the view while subsequent measures further refine the map by adding size and color encoding.

Other resources

[Build a Basic View to Explore Your Data](#) on page 3

[Build Common Chart Types in Data Views](#) on page 1473

Add Axes for Multiple Measures in Views

There are several different ways to compare multiple measures in a single view. You can:

- Create individual axes for each measure.
- Blend two measures to share an axis.
- Add dual axes where there are two independent axes layered in the same pane.

In any of these cases you can customize the marks for each axis to use multiple mark types and add different levels of detail. Views that have customized marks are called combination or combo charts.

Note: For details on how to edit axes, see [Edit Axes on page 2958](#).

Add individual axes for measures

To add individual axes for each measure, drag measures to the **Rows** and **Columns** shelves.

- Adding a continuous field on the Rows shelf adds an additional axis to the rows of the table.
- Adding a continuous field on the Columns shelf adds an additional axis to the columns of the table.

The example below shows quarterly sales and profit. The Sales and Profit axes are individual rows in the table and have independent scales.

The Order Date field on the Columns shelf is a discrete date dimension. Because it is discrete, it creates headers rather than an axis. For details on how to edit axes, see [Edit Axes on page 2958](#).

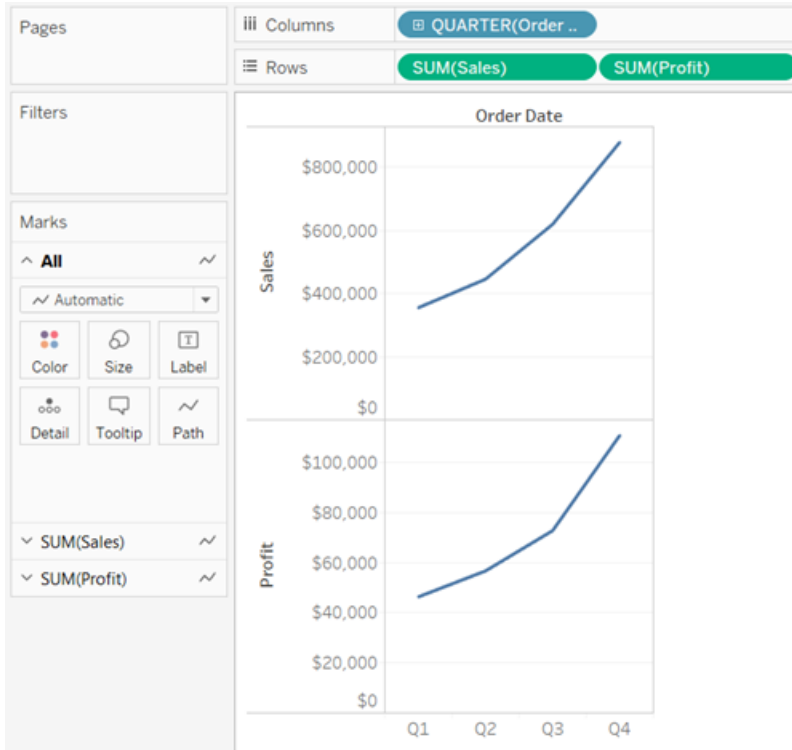

Blend axes for multiple measures into a single axis

Measures can share a single axis so that all the marks are shown in a single pane.

To blend multiple measures, drag one measure or axis and drop it onto an existing axis.

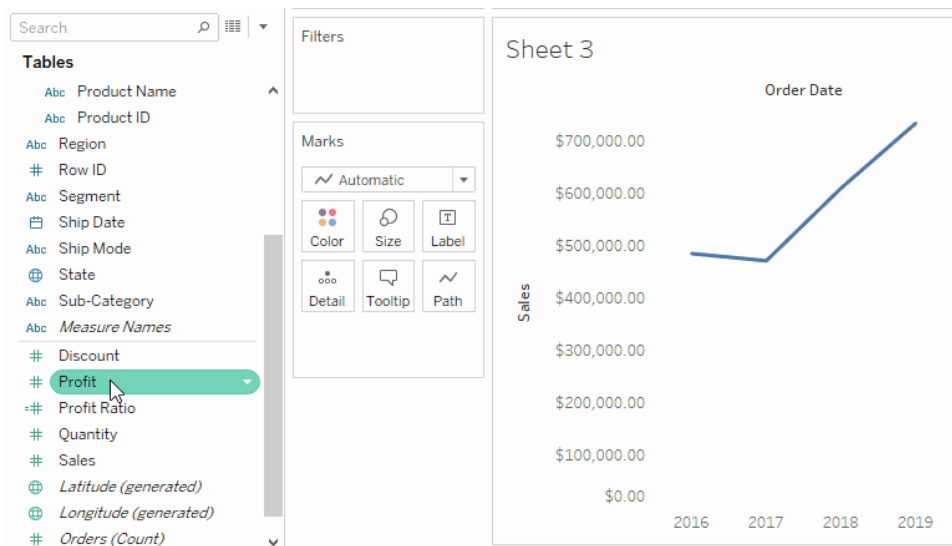

Instead of adding rows and columns to the view, when you blend measures there is a single row or column and all of the values for each measure is shown along one continuous axis. For example, the view below shows quarterly sales and profit on a shared axis.

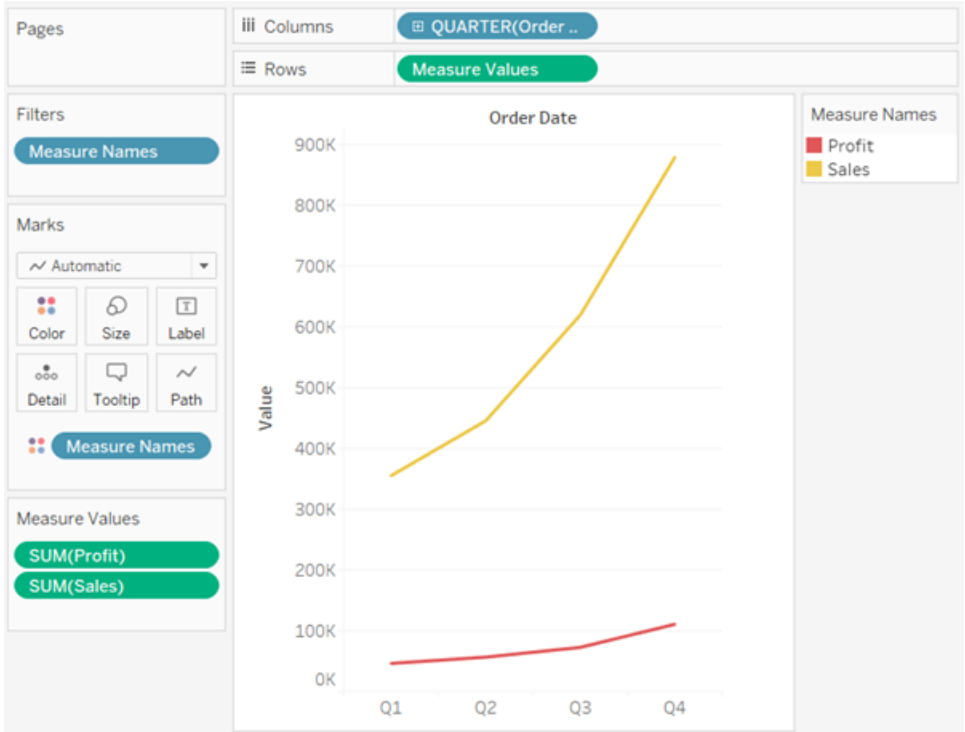

Note: If you drag a measure on to the canvas and only see a single ruler indicator instead of the double ruler indicator shown below, Tableau creates dual axes instead of a blended axis. For more information about how to create dual axes, see [Compare two measures using dual axes on the next page](#).

Blending measures uses the **Measure Names** and **Measure Values** fields, which are generated fields that contain all of the measure names in your data source and all of the measure values. The shared axis is created using the **Measure Values** field. The **Measure Names** field is added to **Color** on the Marks card so that a line is drawn for each measure. Finally, the **Measure Names** field is filtered to only include the measures you want to blend.

Note: Blending axes is most appropriate when comparing measures that have a similar scale and units. If the scales of the two measures are drastically different, the trends may be distorted.

Compare two measures using dual axes

You can compare multiple measures using dual axes, which are two independent axes that are layered on top of each other. Dual axes are useful for analyzing two measures with different scales.

To add a measure as a dual axis, drag the field to the right side of the view and drop it when you see a black dashed line appear.

You can also right-click (control-click on Mac) the measure on the Columns or Rows shelf and select **Dual Axis**.

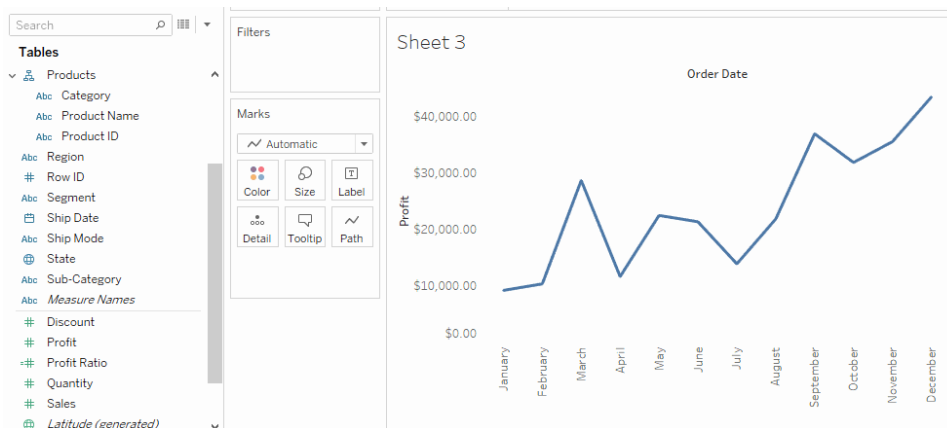

The result is a dual axis view where the Profit axis corresponds to the blue line and the Sales axis corresponds to the orange line.

You can add up to four layered axes: two on the Columns shelf and two on the Rows shelf.

Synchronize axes to use the same scale

To align the two axes in a dual axes chart to use the same scale, right-click (control-click on Mac) the secondary axis, and select **Synchronize Axis**. This aligns the scale of the secondary axis to the scale of the primary axis.

In this example, the Sales axis is the secondary axis and the Profit axis is the primary axis.

Note: To synchronize axes, the data types for both measures must be the same. If the data types for your measures are different, see the section below.

You can synchronize dual axes for numeric data types that don't match. For example, you

can synchronize an axis that uses an integer data type and an axis that uses decimal data type.

If you would like to change which axis is the primary, and which axis is the secondary, select the field on the Columns or Rows shelf that is the secondary, and drag it in front of the primary field on the shelf until you see an orange triangle appear.

In this example, you can select the **SUM(Sales)** field on the **Rows** shelf, and drag it in front of the **SUM(Profit)** field. The Sales axis is now the primary and the Profit axis is the secondary.

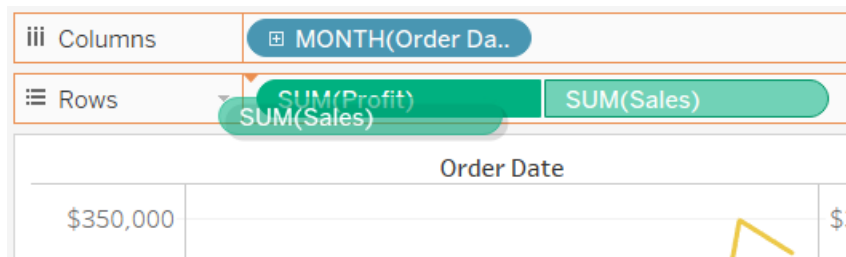

Synchronize axes with measures of different data types

The **Synchronize Axis** option ensures that you make a scaled and correct comparison in a dual axes chart. However, sometimes this option may not be available (grayed out). This is because the data type of one of the axes is different from the other.

Note: In a chart with dual axes, starting with version 2018.1, you can synchronize dual axes for numeric data types that don't match. For example, you can synchronize an axis that uses an integer data type and an axis that uses decimal data type.

To resolve this issue, you must change the data type of one of the axes. Follow the example below to change the data type for an axis.

1. Click the new Worksheet  icon to open a new worksheet.
2. Drag **Order Date** to Columns, then click the drop-down arrow on the field on the shelf and select **Month** from the context menu.
3. Drag **Sales** to Rows, then drag **Quantity** to the right side of the view and drop it when you see a black dashed line appear to create a dual axis.

If you right-click on the **Quantity** Axis, you can see that the **Synchronize Axis** option is grayed out

4. In the Data pane, click on the drop-down arrow on the **Quantity** field, and select **Change Data Type > Number (decimal)** in the context menu. This changes the data type for this field.

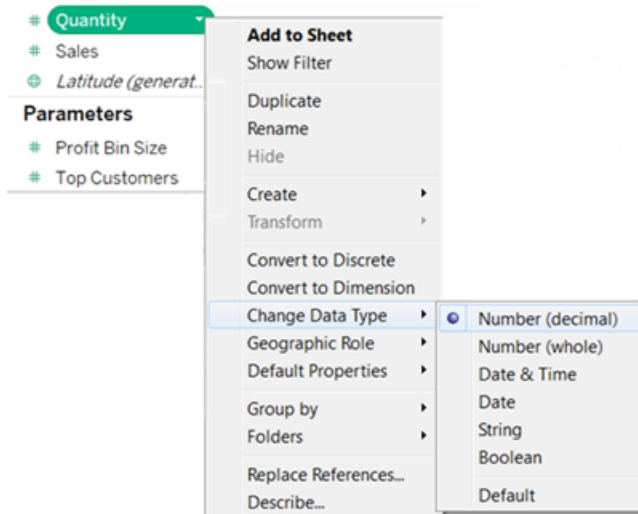

5. Replace the **Quantity** measure on the view.
6. Right-click the secondary axis, and then select **Synchronize Axis**.

Customize the marks for a measure

1. Select the Marks card for the measure that you want to customize. There is a Marks card for each measure on the Rows and Columns shelves.

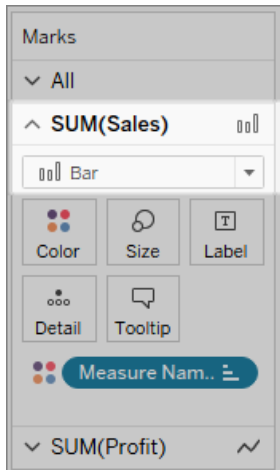

2. Select a new mark type for the measure.

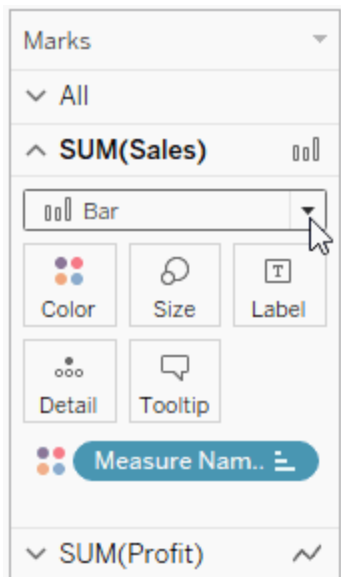

Any changes to the mark type, shape, size, color, detail and other mark properties will be applied to the selected measure.

For example, in the view below the **Sales** Marks card is active. The Mark Type has been changed to **Bar** and when **Product Type** is placed on **Color** on the **Sales** Marks card, the encoding and level of detail is only applied to the Sales marks. The Budget Sales mark is not broken down by Product Type.

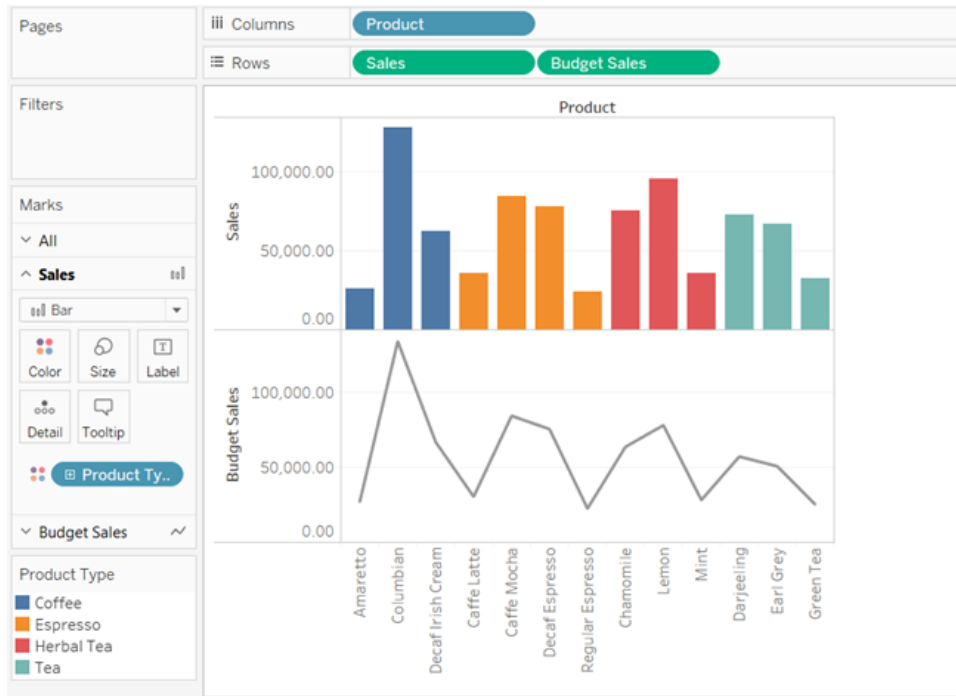

Tips

- Select a field in the Marks card to modify only its properties.
- Select the **All** Marks card to modify properties for all measures at once.
- To change the order of a field's marks in the view, right-click its axis, and then select **Move marks to front**.

Create a combo chart (assign different mark types to measures)

When working with multiple measures in a view, you can customize the mark type for each distinct measure. Because each measure can have customized marks, you can customize the level of detail, size, shape, and color encoding for each measure too.

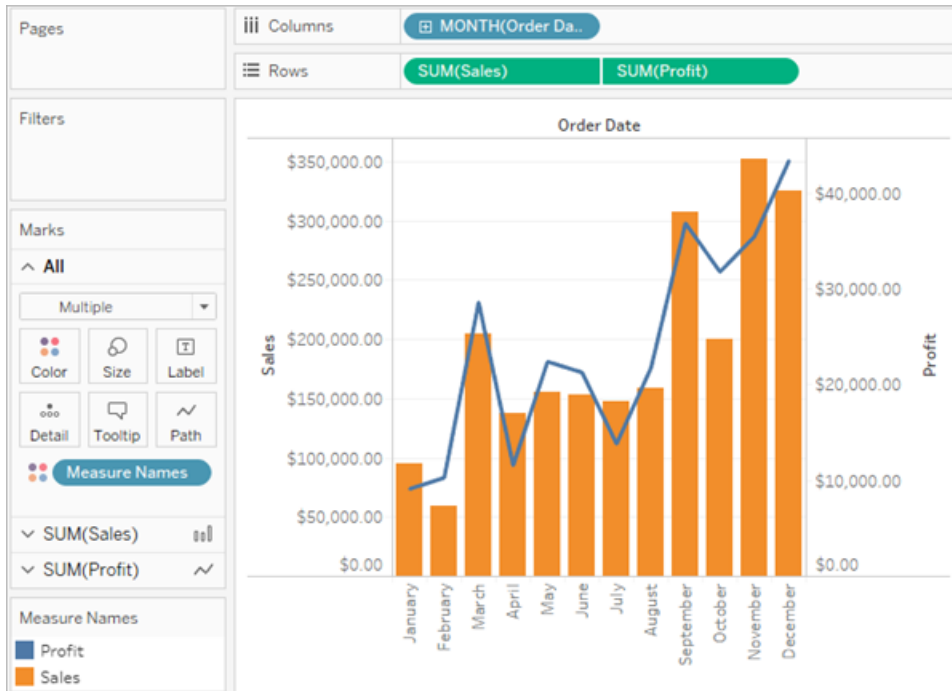

For example, you could create a view that uses two measures in dual axes. One measure shows Profit with a line mark, and the other measure shows Sales with bar marks. You could also choose to display the measures as individual axes or blended axes.

To create a combo chart like this example

1. Connect to the Sample - Superstore data source.
2. Drag the Order Date measure to the Columns shelf, and then click Order Date change Year to Month.

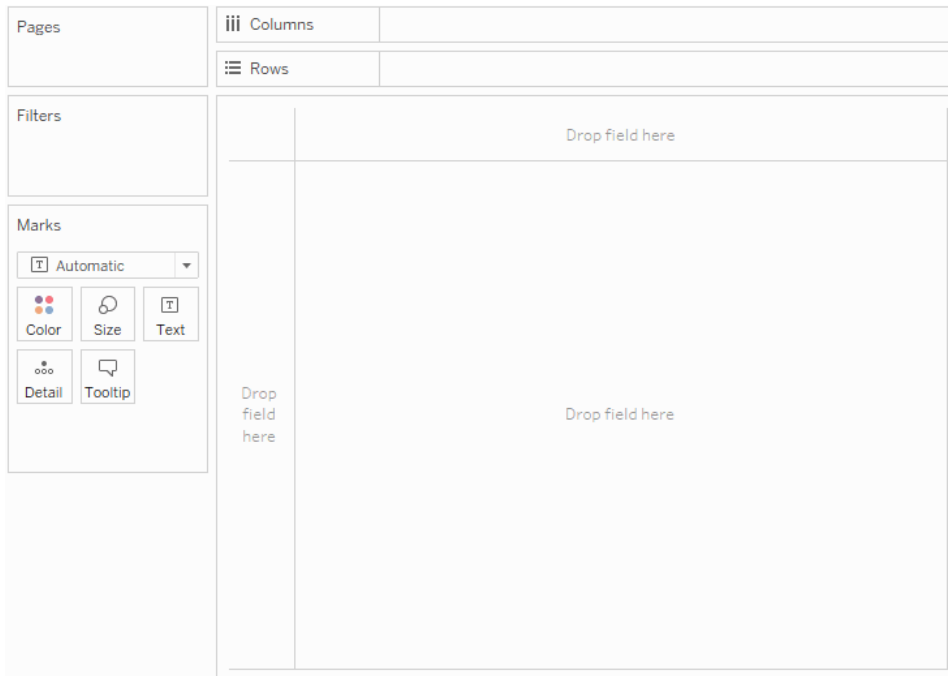

3. Drag the Sales measure to the Rows shelf.

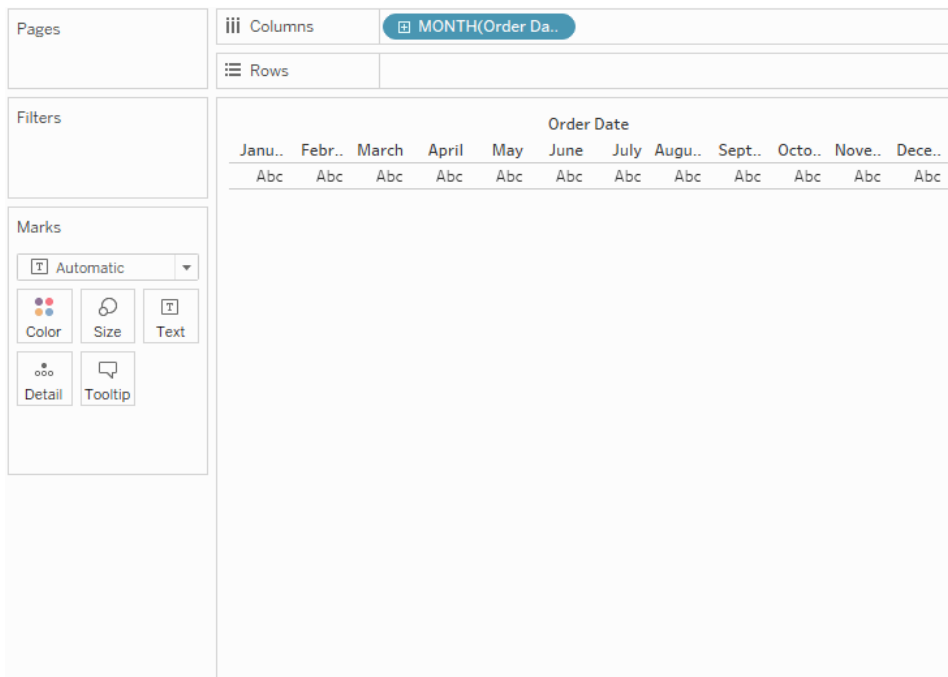

4. Drag the Profit measure to the right side of the view and drop it when you see a black dashed line appear.

Tableau Desktop and Web Authoring Help

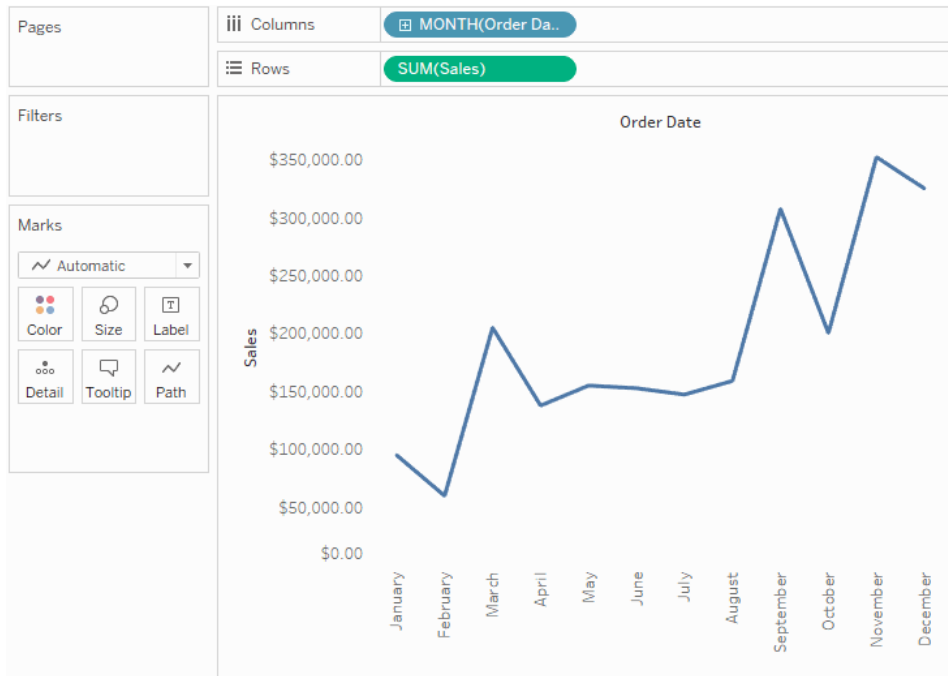

5. Click the Sales card. Change the Sales mark type to **Bar**.

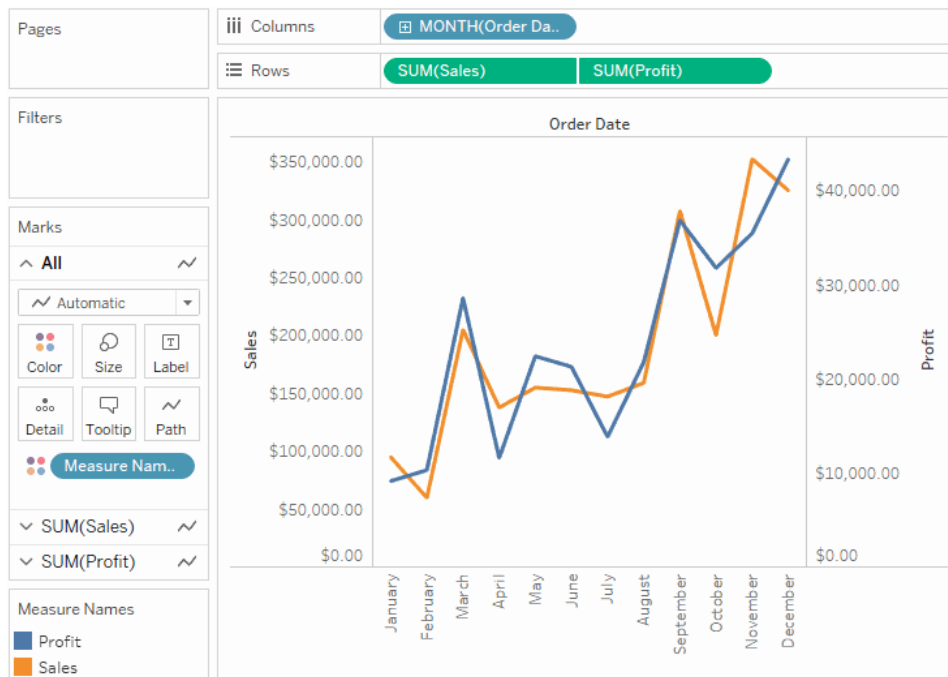

Optional: To adjust the colors used for the Sales and Profit marks:

1. Click the **All** card, click **Color**, and then click **Edit Colors**.
2. Click the Profit data item, and then click a different color in the palette. Click the Sales data item, and then click a different color in the palette.
3. Click **Apply**, and then click **OK**.

Measure Values and Measure Names

The Data pane always contains a number of fields that do not come from your original data, two of which are **Measure Values** and **Measure Names**. Tableau automatically creates these fields so that you can build certain types of views that involve multiple measures.

- The **Measure Values** field contains all the measures in your data, collected into a single field with continuous values. Drag individual measure fields out of the Measure Values card to remove them from the view.
- The **Measure Names** field contains the names of all measures in your data, collected into a single field with discrete values.

How you can use Measure Names and Measure Values

Tableau automatically creates these fields so that you can build certain types of views that involve multiple measures.

Measure Values and **Measure Names** are in most respects like other fields in Tableau:

- You can display a filter for **Measure Names**.
- You can format **Measure Values**—the formatting is then inherited as the default formatting for all measures.
- You can drop **Measure Values** and **Measure Names** on shelves.
- You can assign aliases to the values for **Measure Names**.
- You can change the manual sort order for the values for **Measure Names**.

The Measure Values card

When **Measure Values** is in the view, Tableau creates a **Measure Values** card, outlined in red, below, that lists the measures in the data source with their default aggregations.

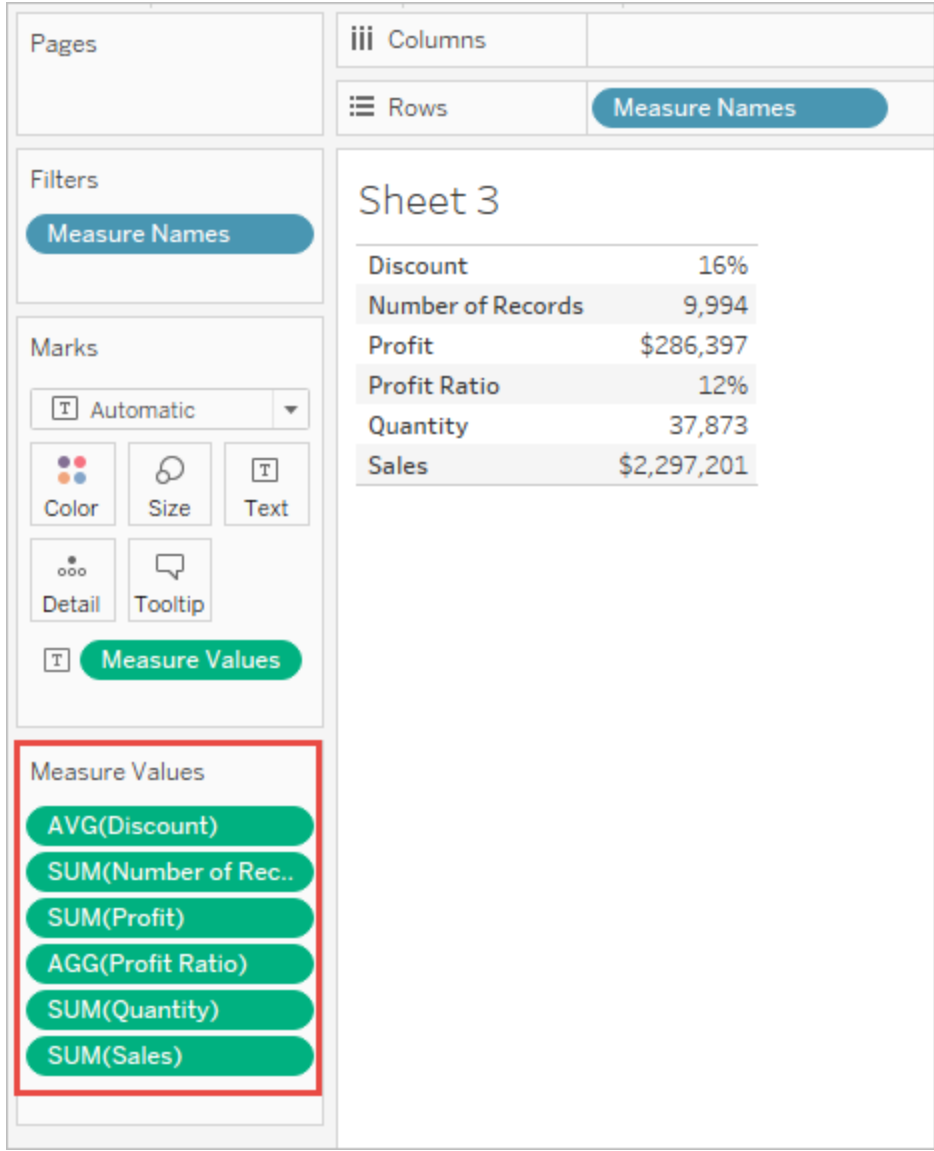

You can remove individual measures from the view by dragging them out of the **Measure Values** card.

About Measure Names

When you want to show multiple measures in a view, you can use the **Measure Values** and the **Measure Names** fields. When you add **Measure Names** to a view, all of the measure names appear as row or column headers in the view. The headers include each measure name. This feature becomes useful when you are working with a text table that shows multiple measures. For example, suppose you have a text table containing the aggregated profit of each product category by region.

Columns: Category

Rows: Region

Filters:

Marks: Automatic, SUM(Profit)

Sheet 2

Region	Category		
	Furniture	Office Supplies	Technology
Central	-\$2,871	\$8,880	\$33,697
East	\$3,046	\$41,015	\$47,462
South	\$6,771	\$19,986	\$19,992
West	\$11,505	\$52,610	\$44,304

Now suppose you want to show both the **Profit** and the **Sales** for each category and region. When you add **Sales** to the text table (by dragging it and dropping it in the view), the measures are combined and the **Measure Values** field is added to Text. The **Measure Names** field is automatically added to the **Rows** shelf.

Columns: Category

Rows: Region, Measure Names

Filters:

Marks: Automatic, Measure Values

Measure Values: SUM(Profit), SUM(Sales)

Sheet 2

Region		Category		
		Furniture	Office Supplies	Technology
Central	Profit	-\$2,871	\$8,880	\$33,697
	Sales	\$163,797	\$167,026	\$170,416
East	Profit	\$3,046	\$41,015	\$47,462
	Sales	\$208,291	\$205,516	\$264,974
South	Profit	\$6,771	\$19,986	\$19,992
	Sales	\$117,299	\$125,651	\$148,772
West	Profit	\$11,505	\$52,610	\$44,304
	Sales	\$252,613	\$220,853	\$251,992

Notice how the header names removed the aggregation label by default. You may want to include the aggregations or call it "Total Profit" and "Total Sales." To change the measure names, right-click (control-click on Mac) the Measure Names field on the Rows shelf and select **Edit Aliases**. Make the changes and click **OK**.

Region		Category		
		Furniture	Office Supplies	Technology
Central	Total Profit	-\$2,871	\$8,880	\$33,697
	Total Sales	\$163,797	\$167,026	\$170,416
East	Total Profit	\$3,046	\$41,015	\$47,462
	Total Sales	\$208,291	\$205,516	\$264,974
South	Total Profit	\$6,771	\$19,986	\$19,992
	Total Sales	\$117,299	\$125,651	\$148,772
West	Total Profit	\$11,505	\$52,610	\$44,304
	Total Sales	\$252,613	\$220,853	\$251,992

Create a visualization using Measures Names and Measure Values

You can use **Measure Values** and **Measure Names** to display the values for all measures in you data source, using their default aggregations, simultaneously. The view below was created with the Sample - Superstore data source. It shows the values of all measures in the Data pane, using their default aggregations.

To create this view

Create a new worksheet using the Superstore example workbook.

Drag **Measure Values** to Rows

Click Text Table in Show Me.

Text Table from Show Me.

Sheet 3	
Discount	16%
Number of Records	9,994
Profit	\$286,397
Profit Ratio	12%
Quantity	37,873
Sales	\$2,297,201

Of course, this view is not well suited for any more than a quick survey of your data because you can't generate a great deal of insight by comparing numbers that aren't measuring the same thing—**Profit** and **Sales** are both in dollars, but **Discount** and **Profit Ratio** are percentages.

When **Measure Names** and **Measure Values** automatically get added to the view Tableau will automatically add **Measure Names** and **Measure Values** fields to the view in response to certain actions on your part.

Blending Axes

You can show multiple measures on the same continuous axis by blending axes. For details, see [Blend axes for multiple measures into a single axis](#) on page 1202. When you use this

technique, Tableau automatically adds Measure Names and Measure Values to the view, allowing you add additional measures to the blended axis.

Using Show Me When Multiple Measures Are in the View

When there are multiple measures in the view, Tableau will automatically add **Measure Names** and **Measure Values**—or just **Measure Names**—when you choose certain visualization types from Show Me.

- When you choose side-by-side bars when there are multiple measures in the view, Tableau adds both **Measure Values** and **Measure Names**. For example, your original view might use lines to show **Sales** and **Profit** over time:

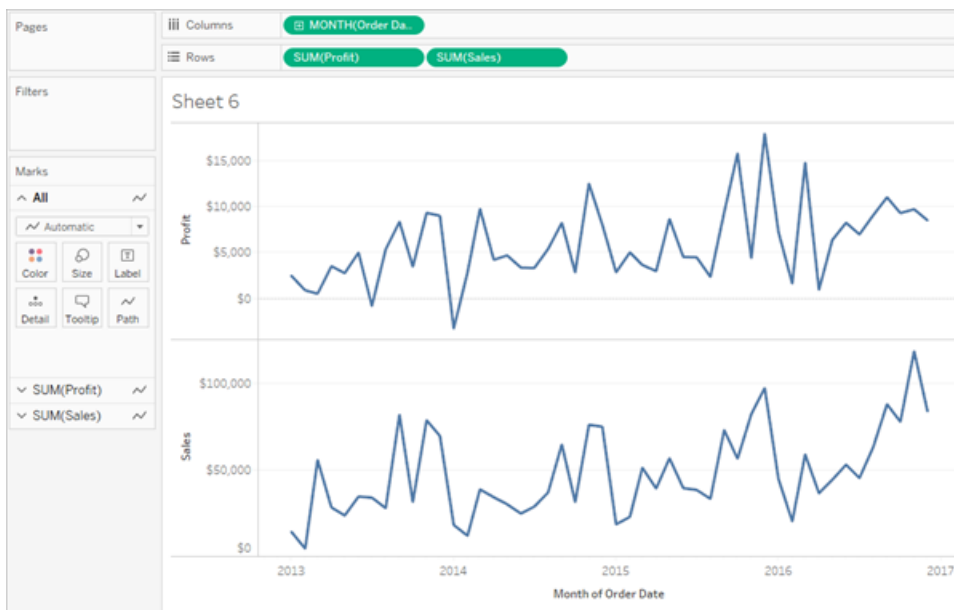

- If you choose side-by-side lines from Show Me, the view updates to include **Measure Names** and **Measure Values**:

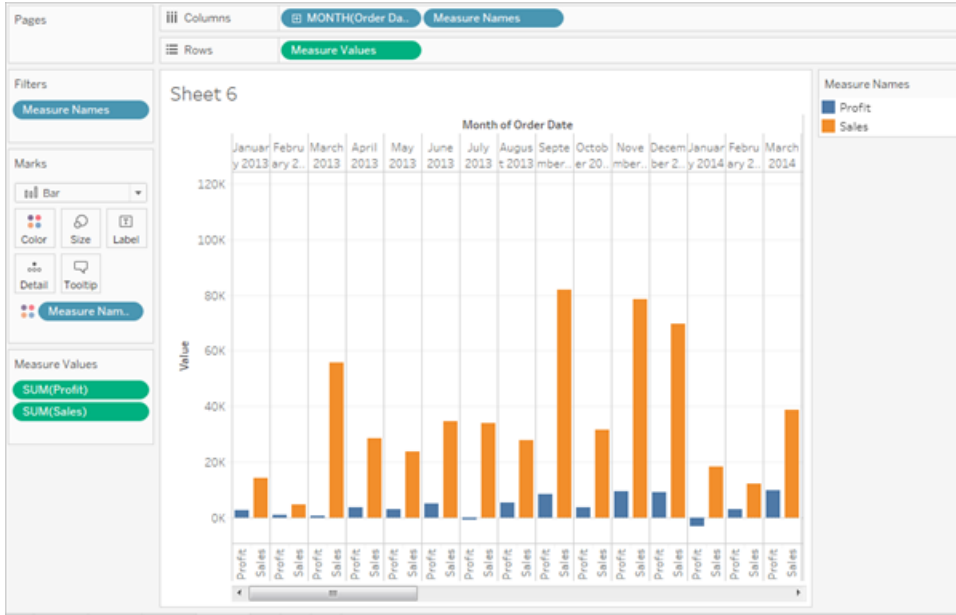

- When you choose side-by-side circles from Show Me when there are multiple measures in the view, Tableau adds **Measure Values** and **Measure Names**:

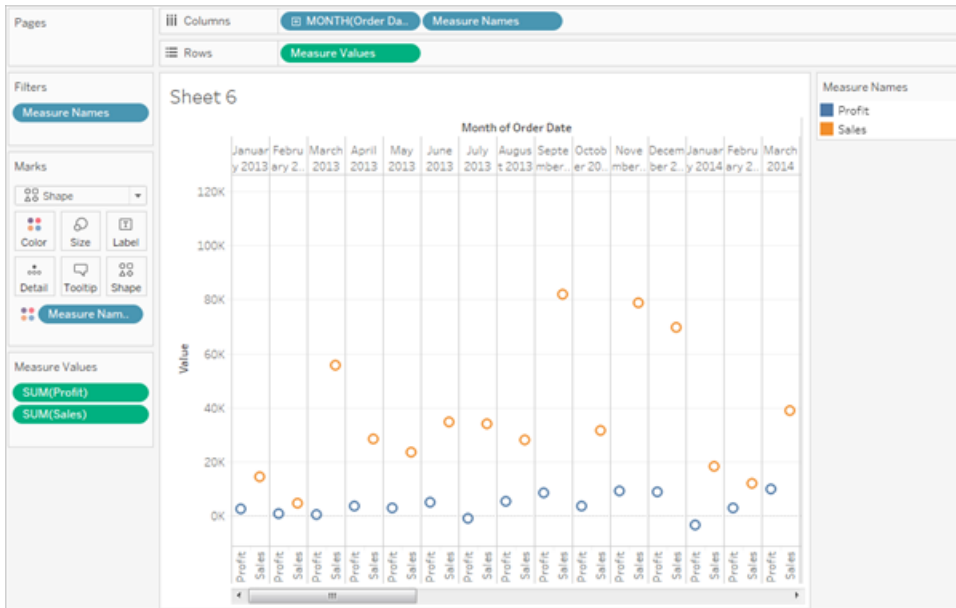

- When you choose dual lines from Show Me when there are multiple measures in the view, Tableau adds **Measure Names** but not **Measure Values**:

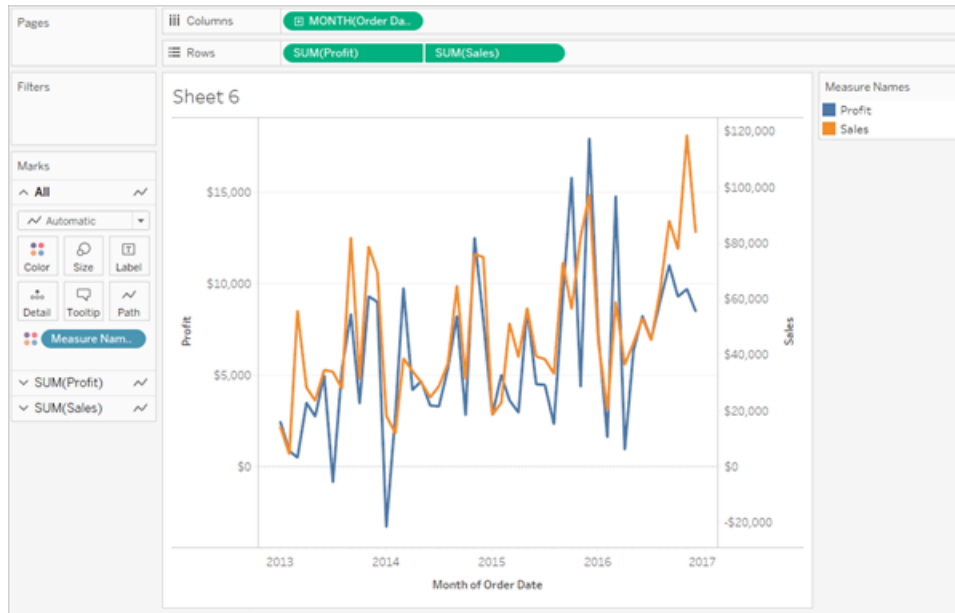

This is similar to blending axes, except that Tableau uses separate value ranges (one on the left of the view and one on the right) to make the lines align as closely as possible. With blended axes, Tableau uses a single value range and the lines may or may not align well.

How Measure Values and Measure Names work with Legends Per Measure

When **Measure Values** and **Measure Names** are in the view, you can color code data for each individual measure. For details, see [Measure values and color legends](#) on page 91.

Handling Null and Other Special Values

Some data requires special handling in Tableau. Specifically:

- null values
- unrecognized or ambiguous geographic locations
- negative or zero values when working with a logarithmic scale
- negative or zero values when working with treemaps

Special values indicator

When your data contains any of these special values, Tableau cannot plot them in the view. Instead, it displays an indicator in the lower right corner of the view. Click the indicator to see options for how to handle these values.

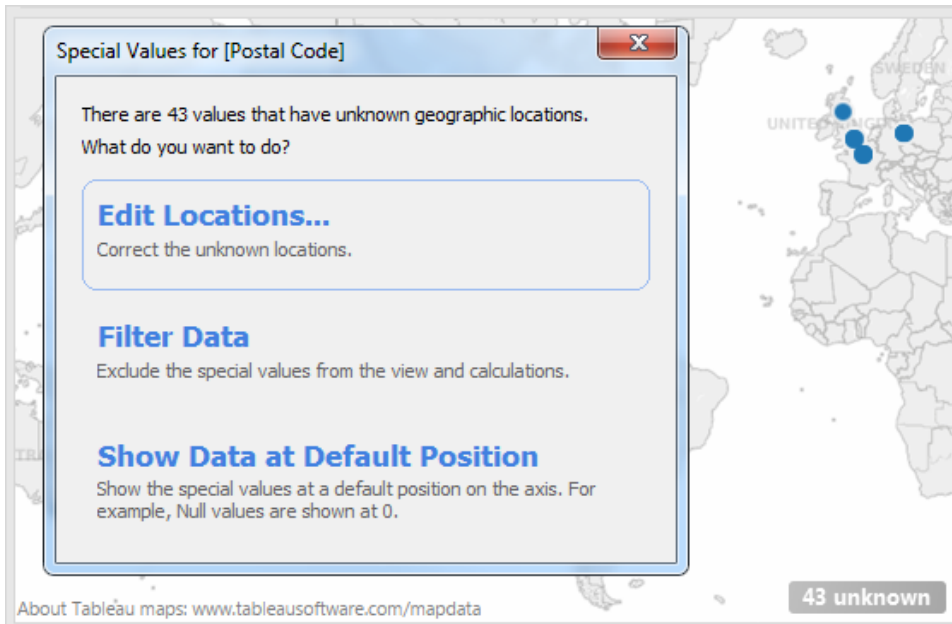

If you don't know how to handle the values, you can choose to leave the special values indicator. Generally, you should continue to show the indicator so that you know there is data that is not being shown in the view. However, to hide the indicator, right-click (control-click on a Mac) it and select **Hide Indicator**.

Null numbers and dates, and negative values on log axes

A null value is a field that is blank, and signifies missing or unknown values.

When you drag a measure or continuous date to the view, the values are shown along a continuous axis. If the field contains null values, or if there are zeroes or negative values on a logarithmic axis, Tableau cannot plot them. When these values exist, Tableau displays an indicator in the lower right corner of the view that says unknown values exist. Click the indicator and choose from the following options:

- **Filter Data** - exclude the null values from the view using a filter. When you filter data, the null values are also excluded from any calculations used in the view.
- **Show Data at Default Position** - show the data at a default location on the axis. The null values will still be included in calculations. The default position depends on the data type. The table below defines the defaults.

Type of Data	Default Position
Numbers	0

Type of Data	Default Position
Dates	12/31/1899
Negative Values on a Log Axis	1
Unknown Geographic Location	(0,0)

Hiding null values

- To filter null dimensions or discrete measures, drag the pill to the Filter shelf and deselect **Null**. The null value will appear in the list with discrete values, where you can then remove it.
- When a measure contains null values, they are usually plotted in a view as zero. To see other options, including how to suppress these null values altogether, see [Format null values on page 3010](#).

Note: See [Logical Functions on page 2098](#) for functions, such as ISNULL() and IFNULL(), which you can use to handle null values with a calculated field.

Unknown geographic locations

When working with maps and geographic fields, unknown or ambiguous locations are identified by the indicator in the lower right corner of the view. Click the indicator and choose from the following options:

- **Edit Locations** - correct the locations by mapping your data to known locations.
- **Filter Data** - exclude the unknown locations from the view using a filter. The locations will not be included in calculations.
- **Show Data at Default Position** - show the values at the default position of (0, 0) on the map.

Zero and negative values in treemaps

When working with treemaps, any null or zero values display in the indicator in the lower right corner of the view. Click the indicator and choose from the following options:

- **Filter Data** - exclude the unknown locations from the view using a filter. The locations will not be included in calculations.

- **Use Absolute Values** - use the absolute value to determine the size of the corresponding area in the view. For example, both values of 5 and -5 are shown as the same size.

Show or Hide Missing Values or Empty Rows and Columns

When you're working with dates or numeric bins, Tableau only shows the values that are represented in your data. If your data does not contain the complete range of values, the missing values will not be shown.

Consider the following data set. It contains a column for **Month** and a column for **Size**. There are rows for January through May and September through December, with no data recorded for June, July, or August. If you create a line chart in Tableau, the missing months will not be shown. You can optionally show the missing months to make it clear that there was no data recorded during that time.

Month	Size
January	7
February	6
March	3
April	9
May	7
September	5
October	5
November	8
December	7

Show missing values from a known range

Tableau can infer the missing months of June, July, and August from this example data set because there's a clearly defined possible domain, such as for dates or numeric bins. If your data contains Monday, Tuesday, Wednesday, Saturday, and Sunday, Tableau can fill in the missing values as Thursday and Friday. However, if your data set was a list of colors such as Teal, Green, Blue, and Yellow, Tableau can't infer the missing values because there's no definitive way to know what the rest of the values should be.

If you don't see the option for **Show Missing Values**, your data doesn't meet the requirement where Tableau can determine the missing values.

Toggle missing values

By default, missing header values in a date range or numeric bins are not shown. The x-axis in this example goes from May to September.

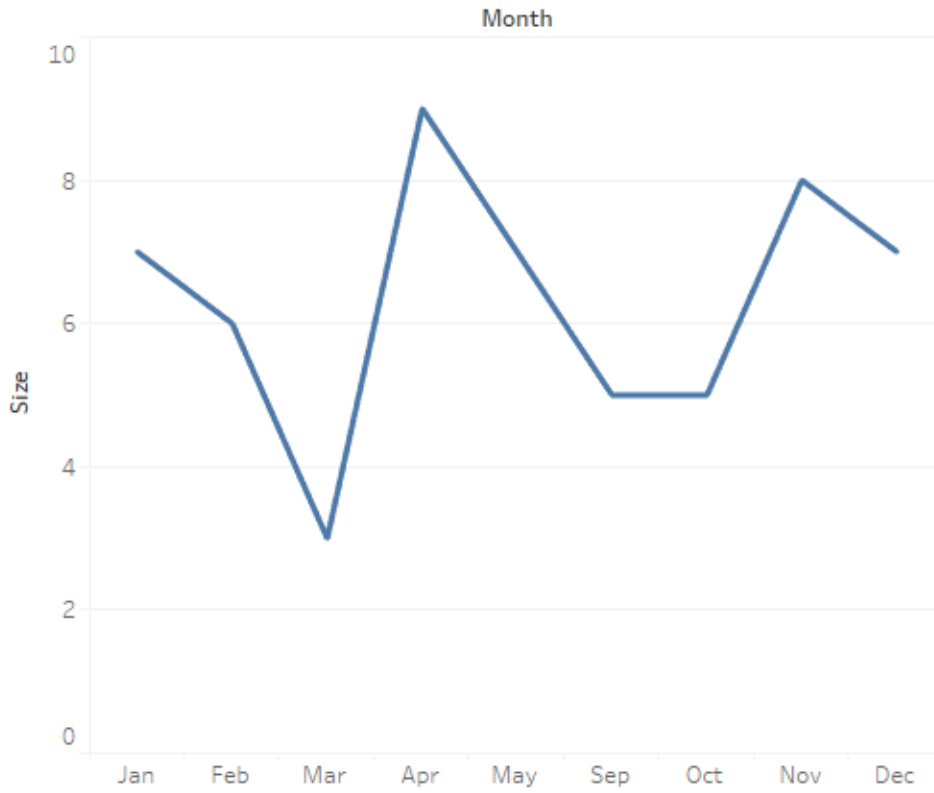

You can display the missing header values to indicate incomplete data.

- Right-click (control-click on Mac) the date or bin headers and select **Show Missing Values**.

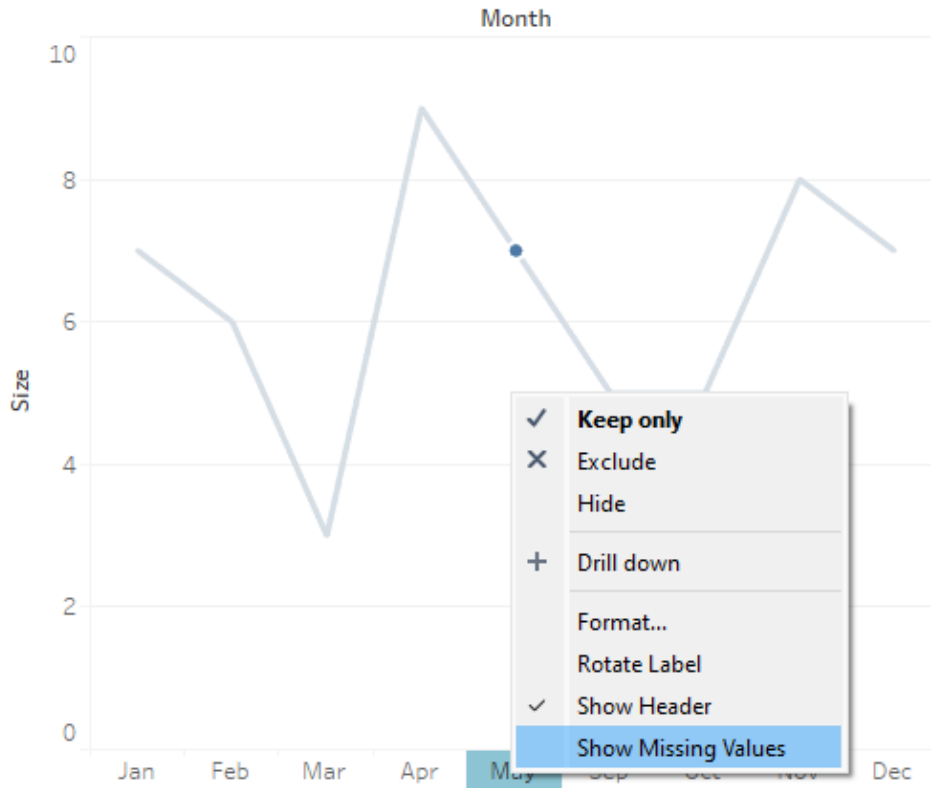

The x-axis in this example updates to include headers for June, July, and August.

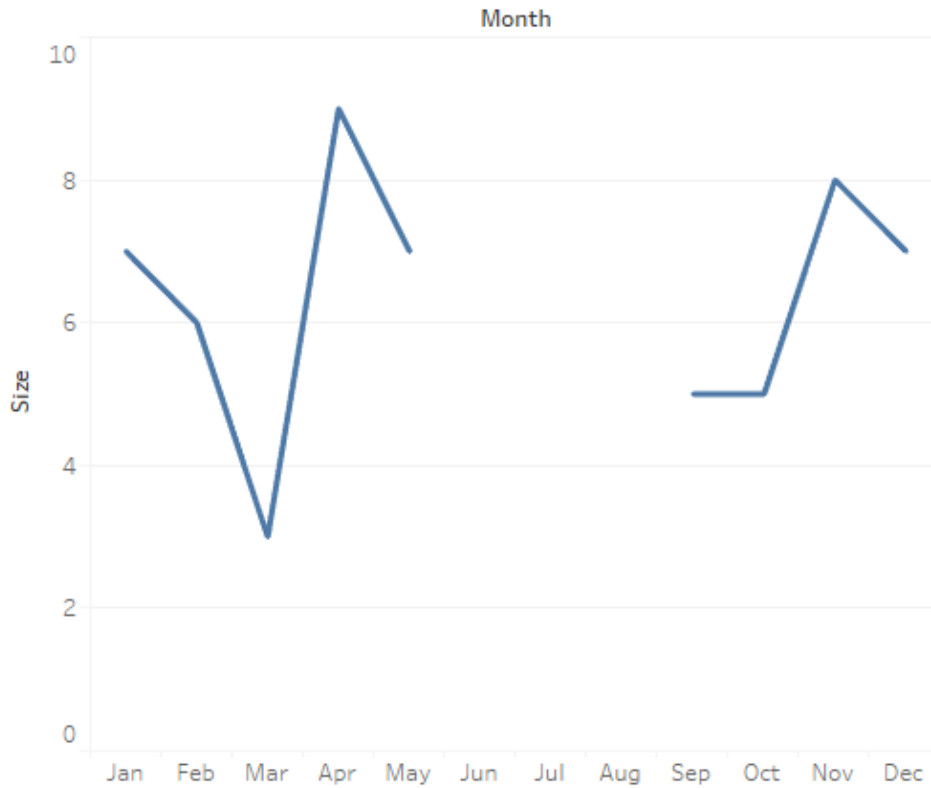

To go back to the default behavior, you can turn Show Missing Values back off.

- Right-click (control-click on Mac) the date or bin headers and uncheck **Show Missing Values**.

Null vs Missing

There's a difference between missing header values and null data. In the example of the missing months, June, July, and August are missing from the data set as entire rows. March is present as a row in the data, but the value for the Size column for March is empty. This is a null value.

Month	Size
January	7
February	6
March	
April	9
May	7
September	5
October	5
November	8
December	7

In a viz, there is a null indicator only for nulls, not for gaps due to missing header values.

Null indicator

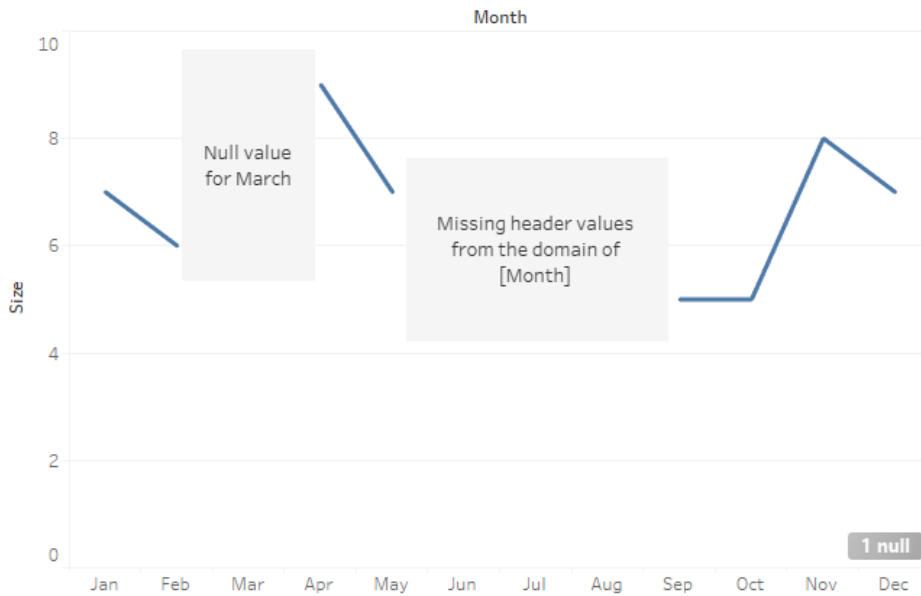

You can replace null values with a calculated field using the ZN() function. ZN replaces nulls (but not missing header values) with zeros. Size for March is null, so ZN(Size) would put a zero for March. However, there are no rows at all for June, July, or August. ZN would not create rows or add zeros for those months as they are missing rather than null.

Null and ZN versus missing data

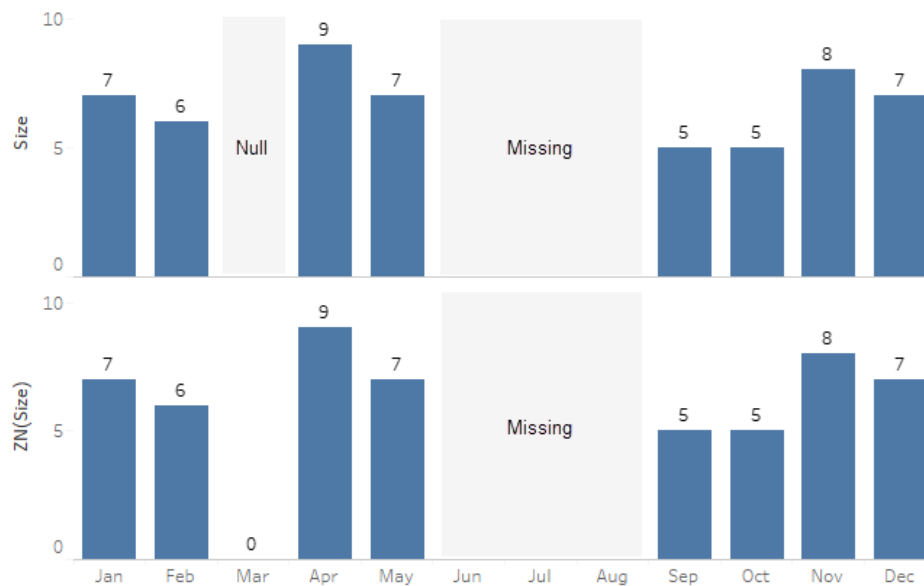

See [Number Functions](#) on page 2047 for details about the ZN function, or [Format null values](#) on page 3010 for more information about how to handle nulls.

Note: You can also perform calculations on missing values that are shown in the view. To do this, open the **Analysis** menu at the top, and then select **Infer Properties from Missing Values**. For an example of this, see [Predictive Modeling with Generated Marks](#) on page 2617.

Show and Hide Empty Rows and Columns

Available in Tableau Desktop only.

When you are working with fields that are not dates or numeric bins, Tableau hides empty rows and columns by default.

For example, imagine you're looking at student clubs and the students who are in those clubs. If there's a student who isn't in a club, that student's name won't appear in a dimension-only viz of student and club. You can show empty rows by selecting **Analysis > Table Layout > Show Empty Rows**.

Empty Rows Hidden (default)

Jay isn't in any clubs, so there's no row for the student Jay. Every row has a placeholder

Empty Rows Shown

Jay isn't in any clubs, but empty rows are shown so there is a row for Jay with no

mark (Abc).

placeholder mark (Abc).

Club	Student	
Art	Cardinal	Abc
	Finch	Abc
	Sparrow	Abc
First Aid	Robin	Abc
Juggling	Sparrow	Abc
Photography	Finch	Abc
Travel	Cardinal	Abc

Club	Student	
Null	Jay	
Art	Cardinal	Abc
	Finch	Abc
	Sparrow	Abc
First Aid	Robin	Abc
Juggling	Sparrow	Abc
Photography	Finch	Abc
Travel	Cardinal	Abc

Similarly, show any empty columns by selecting **Analysis > Table Layout > Show Empty Columns**.

Note: If you are working with multi-fact relationships in data sources with multiple base tables, there may be more complex logic that determines when nulls are seen in empty rows. For more information, see [About Multi-fact Relationship Data Models on page 740](#).

Use Show Me to Start a View

Show Me creates a view based on the fields already used in the view and any fields you've selected in the Data pane. Open Show Me by clicking **Show Me** on the toolbar  .

Start a view based on fields that you select

To use Show Me, select the fields you want to analyze in the Data pane, and then select the type of view you want to create in the Show Me pane. Tableau automatically evaluates the selected fields and gives you the option of several types of views that would be appropriate for those fields. Show Me also highlights the visualization type that best matches the data.

1. In the **Data** pane, select the fields that you want to analyze. Hold the Ctrl key (Command key on a Mac) to make multiple selections.

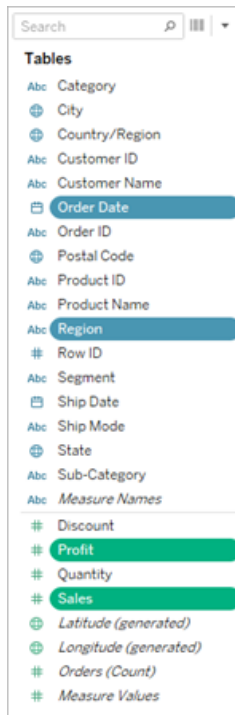

2. Click **Show Me** on the toolbar and then select the type of view you want to create.



Any view type that is not gray will generate a view of your data. As you hover over each view type, the description at the bottom shows the minimum requirements. In this example, stacked bars is selected.

- Tableau automatically creates a view of the data.



Create a Line Chart with Show Me

In this example, you use **Show Me** to create a line chart that displays profit as a function of time.

- In the **Data** pane, select **[Order Date]** and **Profit**. Hold down the Ctrl key (or the command key on a Mac) as you select the fields

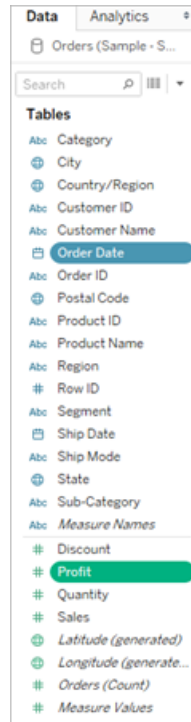

2. Click **Show Me** on the toolbar to display the **Show Me** card, if it isn't already displayed.

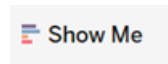

3. In the **Show Me** pane, see what type of view Tableau suggests.



Because a date dimension and a measure are selected, Tableau suggests you build a line view. A line is often the optimal way to look at how measure values change over time.

The view below shows the resulting chart. Each point on the line represents the sum of profit for the corresponding year.

Tableau Desktop and Web Authoring Help



You can more easily see the points by clicking the **Show Mark Labels** button on the toolbar.



Create a Scatter Plot with Show Me

In this example you use **Show Me** to build a scatter plot to show sales versus profit for each product and customer.

1. In the **Data** pane, select the **Customer Name** and **Product Name** dimension fields, and the **Profit** and **Sales** measure fields. To select multiple fields, hold down the Ctrl key (or the command key on a Mac) as you click fields.

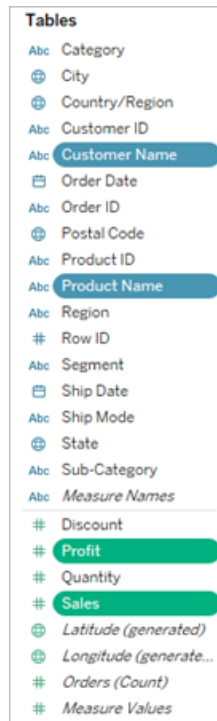

2. Click **Show Me** on the toolbar.

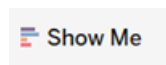

3. Select the scatter plot chart type from **Show Me**.



Tableau creates a scatter plot using the fields you selected. You can drag fields to further refine the view.

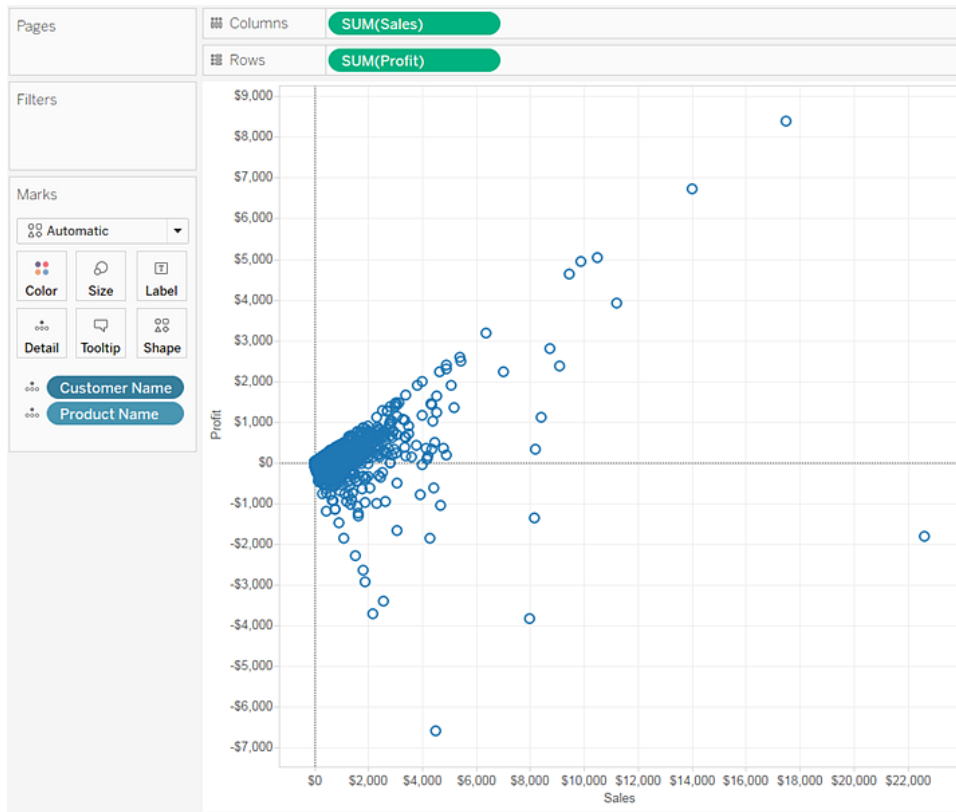

Add Detail

The Marks card is a key element for doing visual analysis in Tableau. When you drag measures and dimensions to the Marks card, you encode your data with color, size, shape, text, and other properties that add context, detail, and meaning to the marks in the view.

Change the Type of Mark in the View

You can change the type of marks displayed in the view to fit your analysis. For example, you can change the marks from bars to lines. This article describes how to change the type of marks used in the view, and explains the different types of marks available. For related information on marks, see [Control the Appearance of Marks in the View](#) on page 1261 and [Marks card](#) on page 62.

Change the mark type

To change the mark type:

- On the **Marks card** on page 62, click the Mark Type drop-down and select an option from the list.

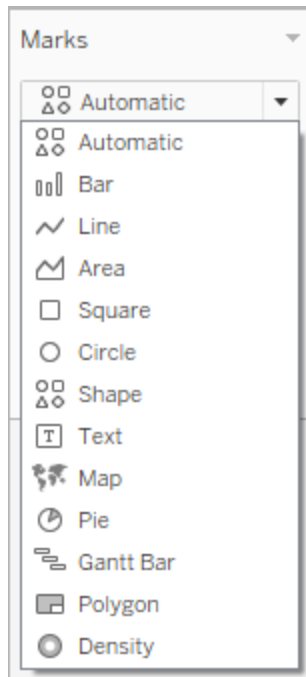

For descriptions of each mark type, see the following sections:

- [Automatic mark](#)
- [Bar mark](#)
- [Line mark](#)
- [Area mark](#)
- [Square mark](#)
- [Circle mark](#)
- [Shape mark](#)
- [Text mark](#)
- [Map mark](#)
- [Pie mark](#)
- [Gantt Bar mark](#)
- [Polygon mark](#)
- [Density mark](#)

Automatic mark

When the Marks card drop-down menu is set to **Automatic**, Tableau automatically selects the best mark type for your data view. The mark type that is automatically selected is determined by the inner fields on the **Rows** and **Columns** shelves. The icon in the Marks card drop-down menu indicates which type of mark was automatically selected. The mark types below are automatically selected for the following scenarios.

Text

The Text mark type is automatically selected when there are dimensions as inner fields on both the **Rows** and **Columns** shelves.

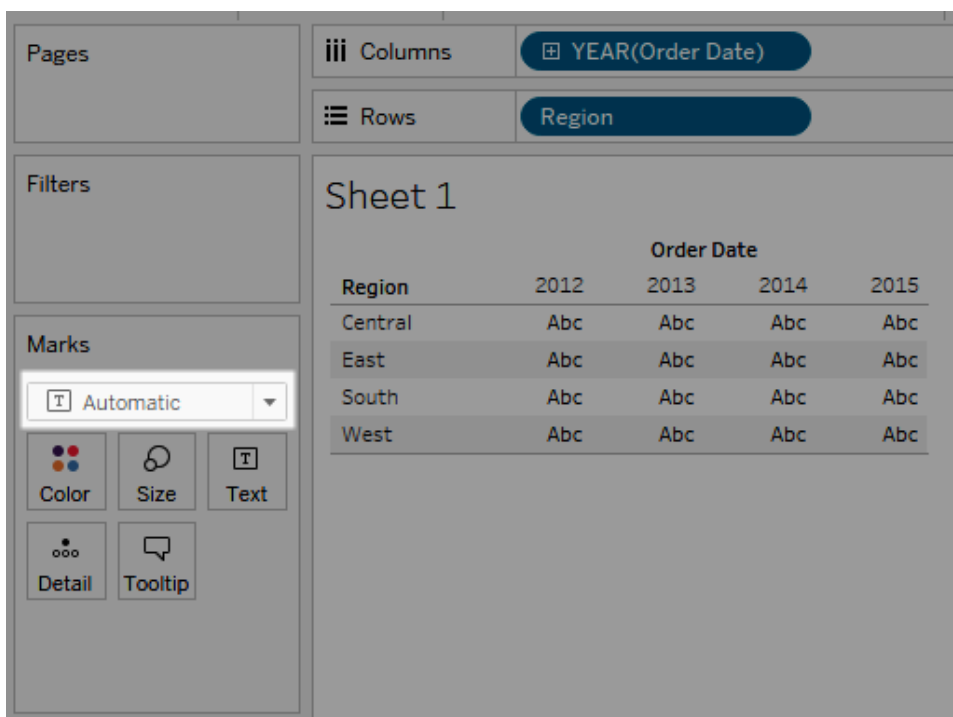

Shape

The Shape mark type is selected when there are measures as inner fields on both the **Rows** and **Columns** shelves.

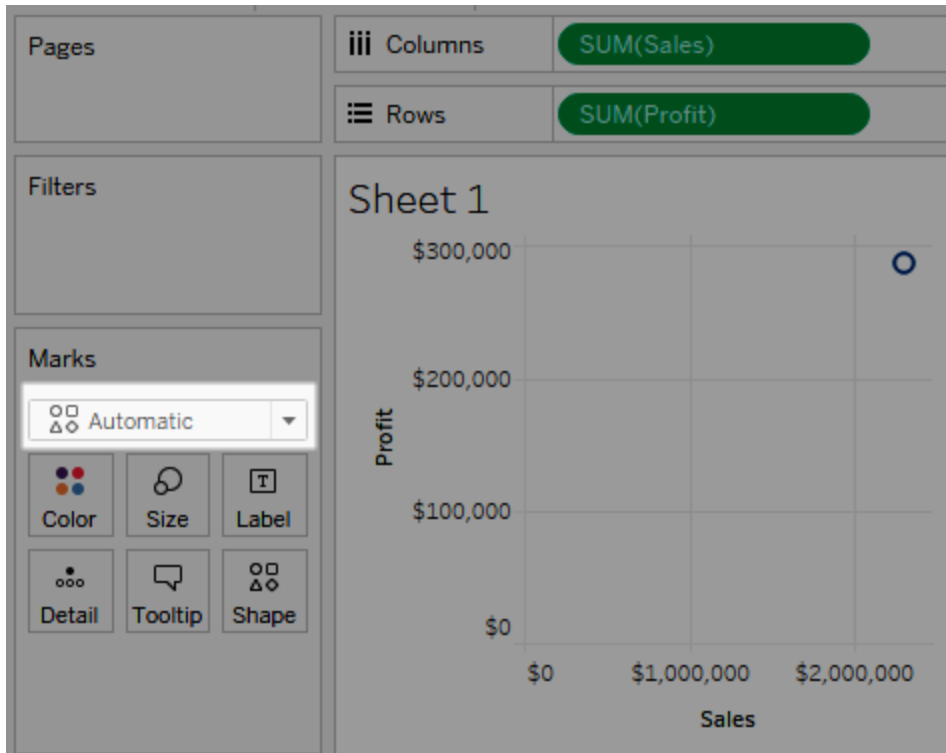

Bar

The Bar mark type is selected when there is a dimension and a measure as inner fields on **Rows** and **Columns** shelves.

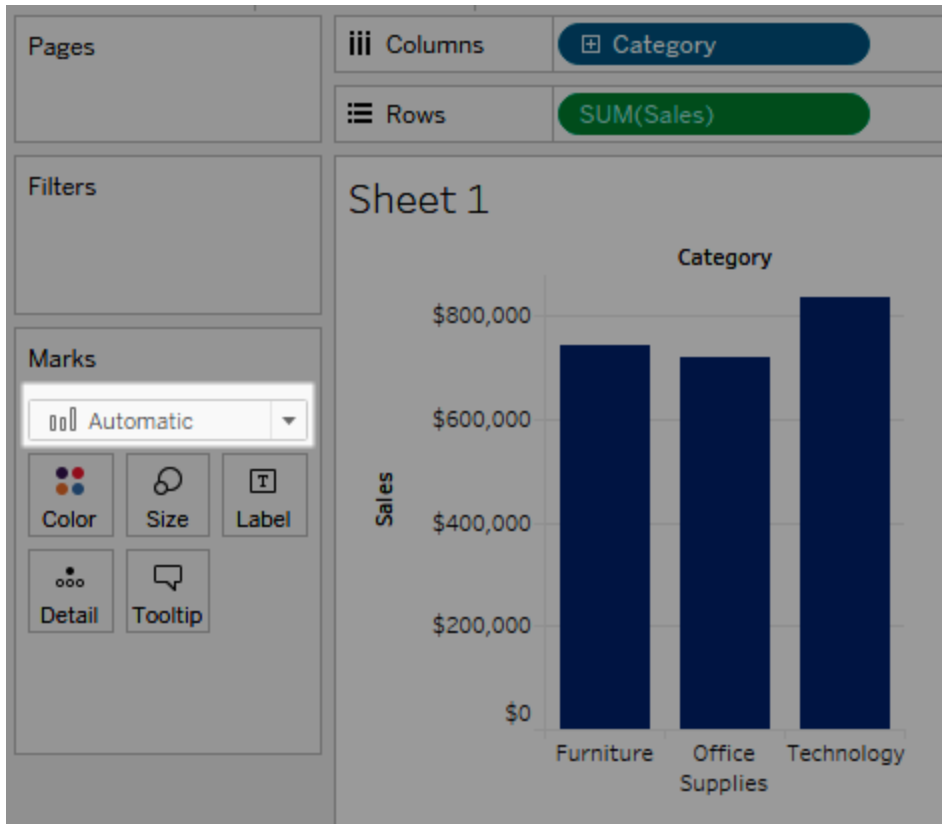

Line

The Line mark type is selected when there is a date field and a measure as the inner fields on the **Rows** and **Columns** shelves.

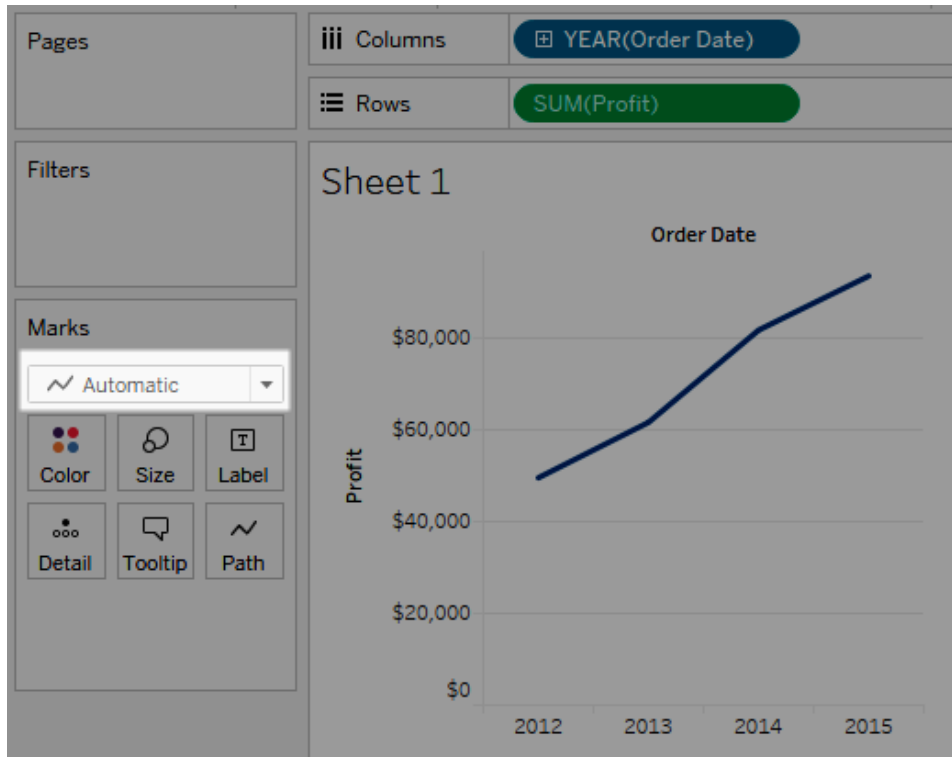

Note: You can override the default selection and use any mark type that provides insight into your data. However, you should exercise some caution when manually selecting a mark type because the resulting view might hide important information about your data.

Bar mark

The Bar mark type is useful when you want to compare measures across categories, or when you want to break data down into stacked bars. Tableau displays your data using bars when:

- The Marks card drop-down menu is set to **Automatic**, and you place a dimension and a measure as the inner fields on the **Rows** and **Columns** shelves. If the dimension is a date dimension, the Line mark is used instead.
- You select **Bar** from the Marks card drop-down menu.

Marks are automatically stacked.

Note: For views where the mark type is Bar and there are continuous (green) fields on both **Rows** and **Columns**, Tableau supports additional options and defaults for sizing the bar

marks on the axis where the bars are anchored. See the Continuous axis mark sizing section in [Change the size of marks](#) on page 1263 for details.

The data view shown below displays a dimension as the columns of the table, and a measure as the rows of the table. It is also color-encoded by a dimension (**Category**). Because the Marks card drop-down menu is set to **Automatic**, data is displayed using bars.

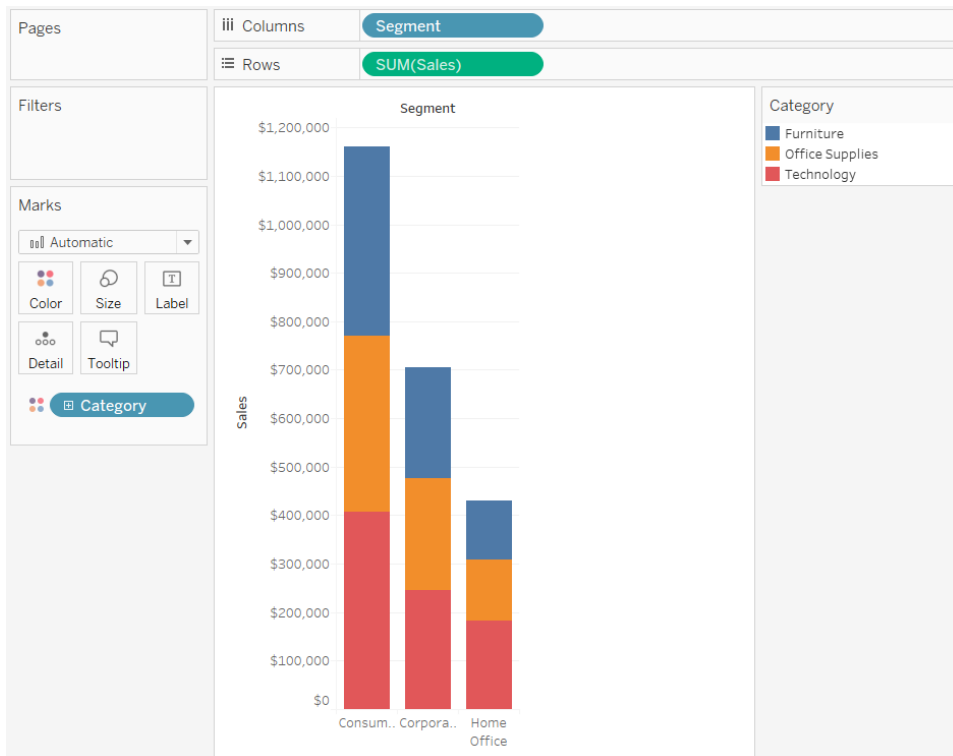

To try some hands-on exercises for building bar charts, see [Build a Bar Chart](#) on page 1475.

Line mark

The line mark type is useful when you want to see trends in data over time, your data are ordered, or interpolation makes sense. Tableau displays data using lines when:

- The Marks card drop-down menu is set to **Automatic**, and you place one or more measures on either the **Columns** shelf or the **Rows** shelf, and then plot the measures against a date dimension or a continuous dimension.
- You select **Line** from the Marks card drop-down menu.

Note: In views that use the line mark type, you can use the **Path** property in the Marks card to change the type of line mark (linear, step, or jump), or to encode data by connecting marks using a particular drawing order. For details, see [Path properties](#) in the [Control the Appearance of Marks in the View](#) on page 1261

The data view shown below displays a date dimension as the columns of the table and a measure as the rows of the table.

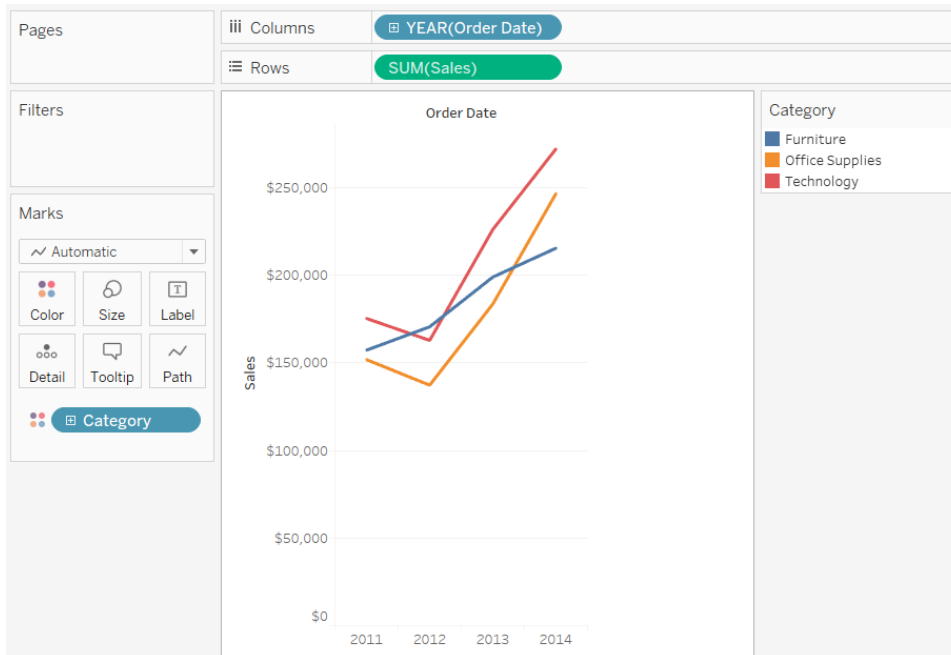

As the density of data increases, trends are often easier to see when using lines. This view shows 93 data points.

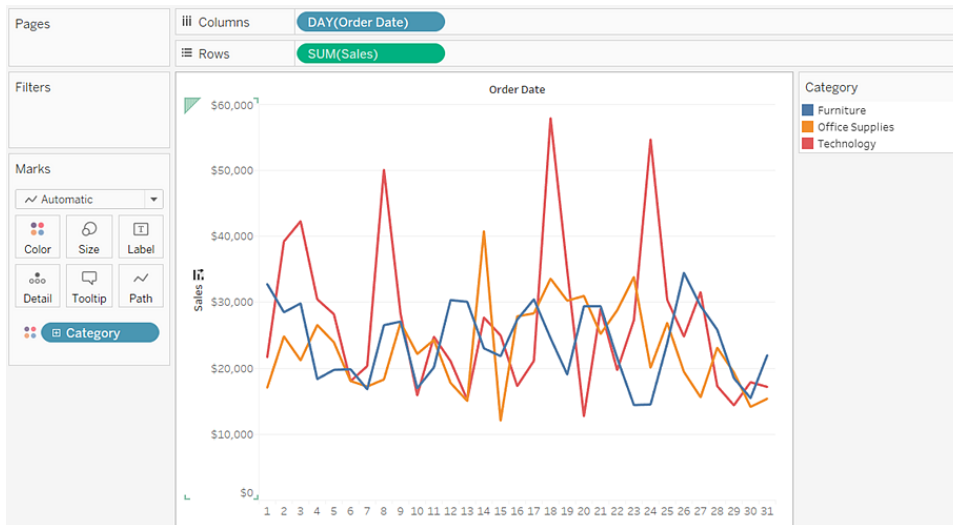

To try some hands-on exercises for building line charts, see [Building Line Charts on page 1526](#).

Area mark

The Area mark type is useful when you have a view where the marks are stacked and do not overlap. For more information about stacked marks, see [Stack Marks on page 1291](#). In an area chart, the space between each line and the next line is filled with a color. This type of chart is not the best way to show specific values along the line but it can clearly show the total values so you can get an idea of how a dimension is contributing to an overall trend. Tableau displays your data using areas when:

- The Marks card drop-down menu is set to **Automatic** and one or more measures is plotted against a date dimension or continuous dimension. The **Analysis > Stack Marks** option must also be selected.

The view below shows a date dimension on the **Columns** shelf and a measure on the **Rows** shelf. Each line represents the sales for a product category. The lines have been stacked so that they do not overlap.

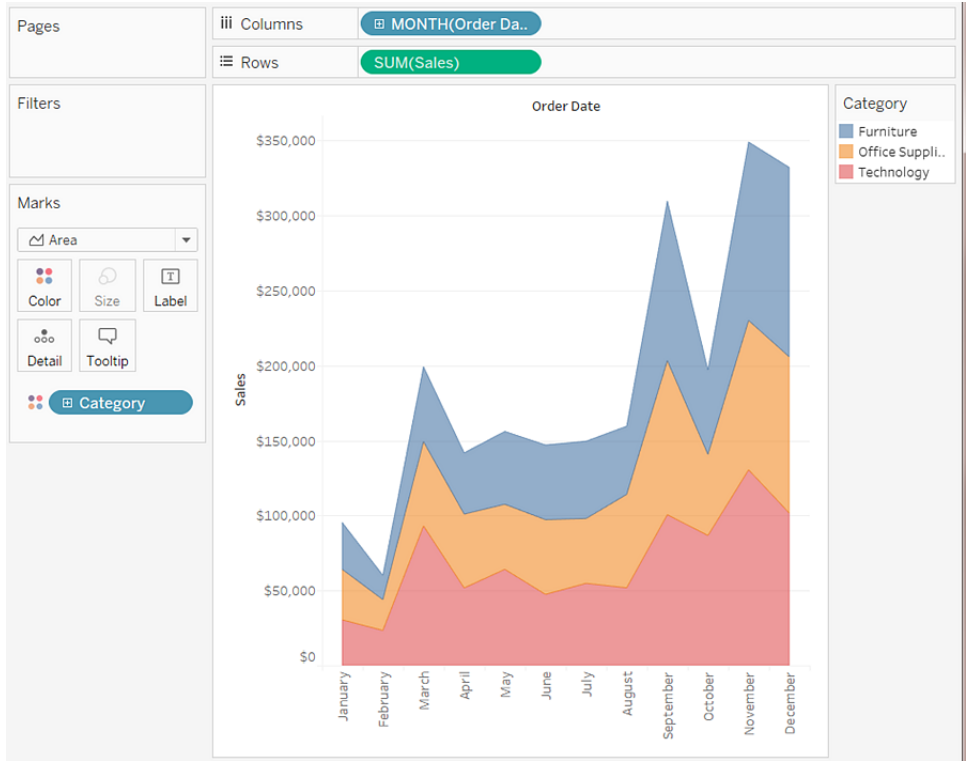

Note: You can add labels, edit the color legend, and highlight areas. In addition, you can turn on color effects, such as mark borders. For more information, see [Control the Appearance of Marks in the View](#) on page 1261.

Square mark

The square mark type is useful when you want to clearly see individual data points. When you select **Square** from the **Marks** card drop-down menu, Tableau displays your data using squares.

The view shown below displays several dimensions on both the rows and columns shelves. By default, the data is displayed using text. However, when you place a measure on **Color**, Tableau converts the marks to squares and creates a heat map. To try some hands-on exercises for building highlight tables, see [Build a Highlight Table or Heat Map](#) on page 1511.

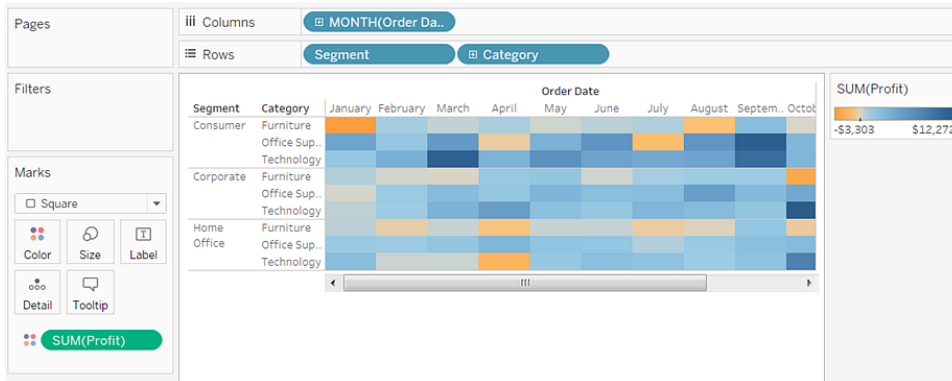

When you add additional levels of detail by placing a dimension on **Detail**, **Color**, **Shape**, **Size**, or **Label** on the **Marks** card, the squares are displayed side-by-side and wrap to fill the cell. If the window is too small to show all of the squares, an ellipsis indicates that there are more values than you can see.

You can also use the square mark to create treemaps. A treemap displays hierarchical data as a set of nested rectangles. To try a hands-on exercise for building a treemap, see [Build a Treemap on page 1557](#).

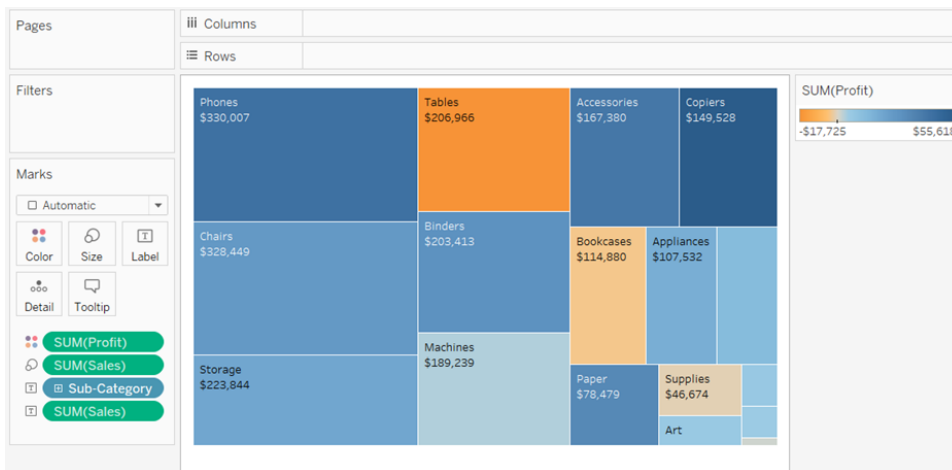

Circle mark

When you select **Circle** from the Marks card drop-down menu, Tableau displays your data using filled circles.

If the mark type was set to **Automatic**, Tableau would display the data using a shape (that is, an open circle).

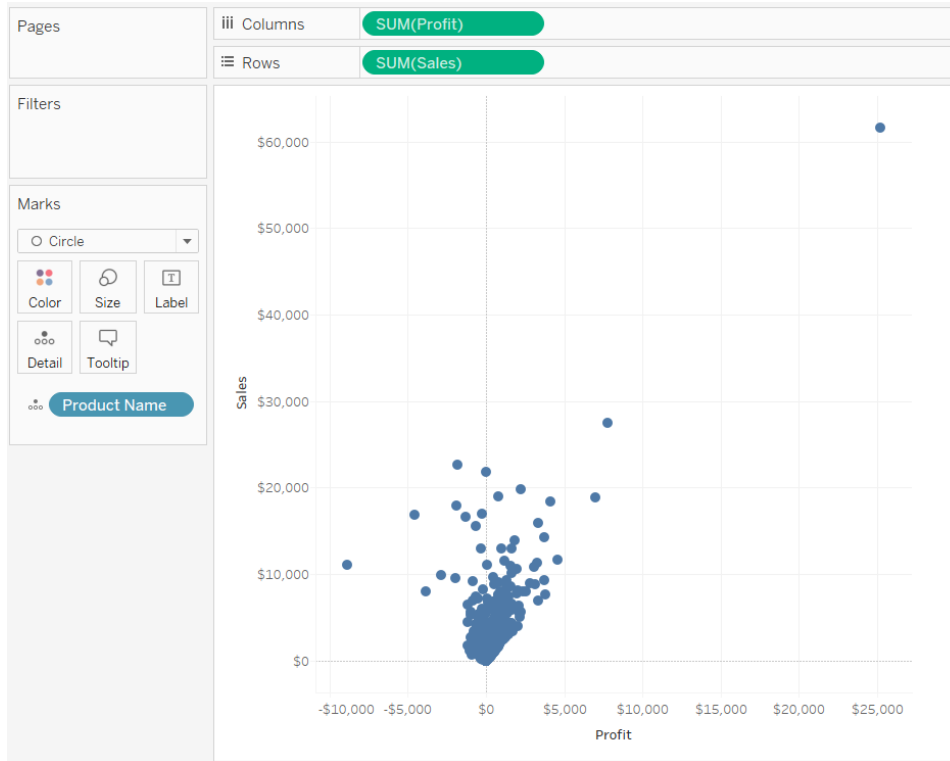

Shape mark

The shape mark type is useful when you want to clearly see individual data points while also viewing categories associated with those points. Tableau displays your data using a shape when:

- The Marks card drop-down menu is set to **Automatic**, and you place one or more measures on both the **Rows** and the **Columns** shelves.
- You select **Shape** from the Marks card drop-down menu.

The view shown below displays the data from two measures. Because the Marks card drop-down menu is set to **Automatic**, the data are displayed using a shape.

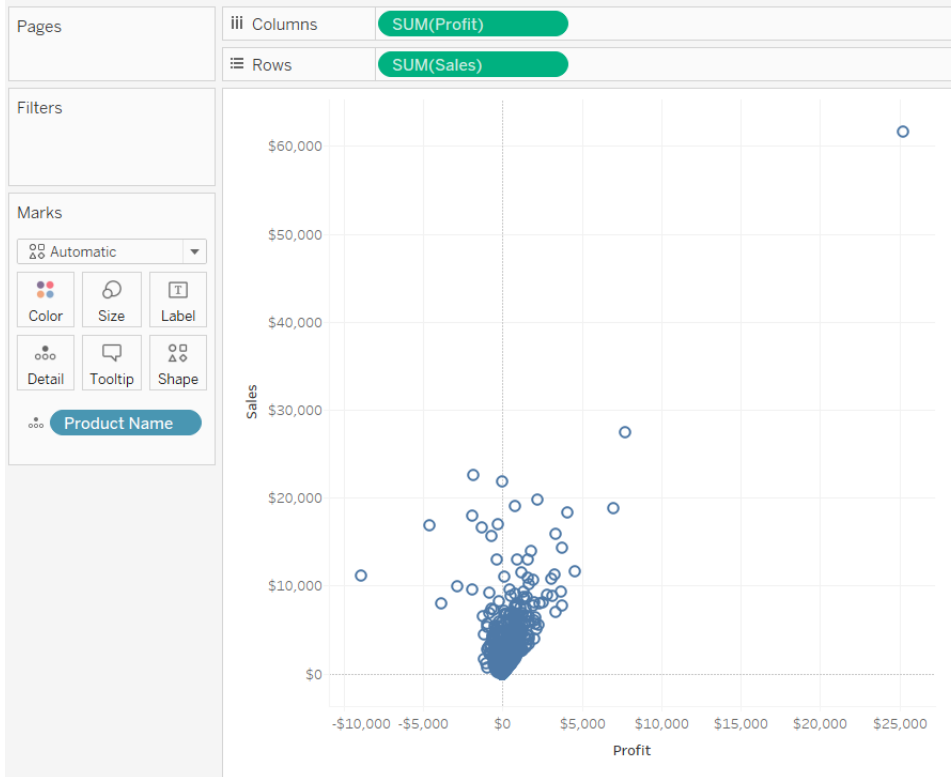

By default, the shape used is an open circle. To select a different shape, click **Shape** on the Marks card. Twenty unique shapes are available:

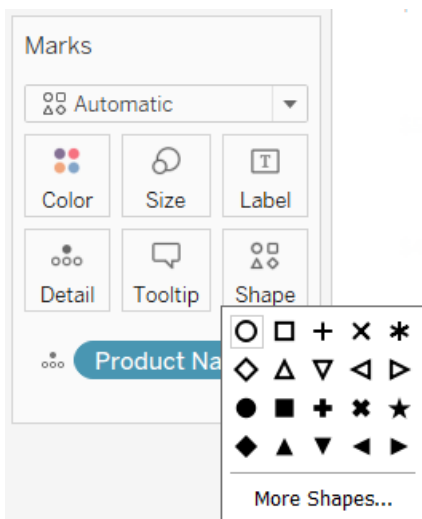

To add more data to the view, you can place a field on **Shape** on the Marks card. Tableau separates the marks according to the values in the field. If the field is a dimension, each member is assigned a unique shape. If the field is a measure, the measure is automatically binned into

distinct buckets and each bucket is assigned a unique shape. The shape legend displays how shapes are distributed.

As shown below, the **Ship Mode** dimension is placed on **Shape** on the Marks card to encode each mark with information about how the order was shipped.

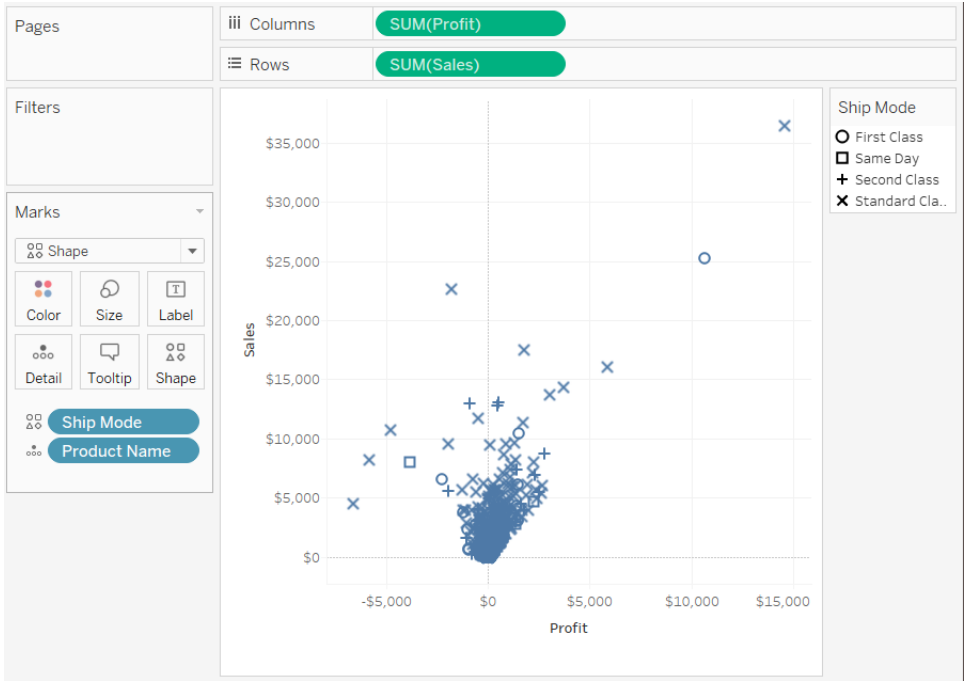

For details on how to build a scatterplot, see [Build a Scatter Plot on page 1544](#).

Text mark

The Text mark type is useful when you want to display the numbers associated with one or more dimension members. This type of view is often called a text table, a cross-tab, or a pivot table.

Tableau displays your data using text when:

- The Marks card drop-down menu is set to **Automatic**, and you place one or more dimensions as the inner fields on both the **Rows** and the **Columns** shelves.
- You select **Text** from the Marks card drop-down menu.

Initially, the data is displayed as **Abc**.

The screenshot shows the Tableau Desktop interface. On the left, the 'Columns' shelf contains 'YEAR(Order Date)' and the 'Rows' shelf contains 'Sub-Category'. The 'Marks' card is set to 'Automatic'. The main view, titled 'Sheet 1', displays a pivot table with the following data:

Sub-Catego..	Order Date			
	2012	2013	2014	2015
Accessories	Abc	Abc	Abc	Abc
Appliances	Abc	Abc	Abc	Abc
Art	Abc	Abc	Abc	Abc
Binders	Abc	Abc	Abc	Abc
Bookcases	Abc	Abc	Abc	Abc
Chairs	Abc	Abc	Abc	Abc
Copiers	Abc	Abc	Abc	Abc
Envelopes	Abc	Abc	Abc	Abc
Fasteners	Abc	Abc	Abc	Abc
Furnishings	Abc	Abc	Abc	Abc
Labels	Abc	Abc	Abc	Abc
Machines	Abc	Abc	Abc	Abc
Paper	Abc	Abc	Abc	Abc

To complete the view, you must place a field (typically a measure) on **Text** on the Marks card. In the view below, the **Sales** measure, which is aggregated as a sum, is used to complete the table.

Sub-Catego..	2011	2012	2013	2014
Accessories	\$25,014	\$40,524	\$41,896	\$59,946
Appliances	\$15,314	\$23,241	\$26,050	\$42,927
Art	\$6,058	\$6,237	\$5,910	\$8,914
Binders	\$43,488	\$37,453	\$49,485	\$72,986
Bookcases	\$20,037	\$38,544	\$26,275	\$30,024
Chairs	\$77,242	\$71,735	\$83,919	\$95,554
Copiers	\$10,850	\$26,179	\$49,599	\$62,899
Envelopes	\$3,856	\$4,512	\$4,730	\$3,379
Fasteners	\$661	\$545	\$960	\$858
Furnishings	\$13,826	\$21,090	\$27,874	\$28,915
Labels	\$2,841	\$2,956	\$2,827	\$3,861
Machines	\$62,023	\$27,764	\$55,907	\$43,545
Paper	\$14,835	\$15,288	\$20,638	\$27,718
Phones	\$77,391	\$68,314	\$78,660	\$105,643
Storage	\$50,329	\$45,048	\$58,632	\$69,834
Supplies	\$14,394	\$1,952	\$14,278	\$16,049
Tables	\$46,088	\$39,150	\$60,833	\$60,894

Note: To create a cross-tab of any data view, select **Worksheet > Duplicate as Crosstab**.

When you add additional levels of detail by placing a dimension on **Detail, Color, Shape, Size,** or **Text** on the Marks card, the values are shown side-by-side and wrap to fill the cell. Allowing the text to stack up makes it possible to create word cloud visualizations like the one shown below.

If the application window is too small for all of the text values, some of the displayed text values will be truncated.

Sub-Catego..	Order Date			
	2012	2013	2014	2015
Accessories	\$552 ...	\$438 ...	\$32 ...	\$522 ...
Appliances	\$715 ...	\$294 ...	\$114 ...	\$156 ...
Art	\$178 ...	\$98 ...	\$42 ...	\$153 ...
Binders	\$6 \$13 ...	\$17 \$6 ...	\$11 ...	\$9 \$64 ...
Bookcases	\$2,095 ...	\$7,406 ...	\$5,161 ...	\$3,954 ...
Chairs	\$461	\$1,084 ...	\$230 ...
Copiers	\$1,200 ...	\$2,700 ...	\$480 ...	\$480 ...
Envelopes	\$69 ...	\$51 ...	\$45 ...	\$9 \$64 ...
Fasteners	\$26 ...	\$22 ...	\$78 ...	\$68 ...

If the application window is too small for all of the text values, the cell displays an ellipses to indicate that there are more values than can be displayed. Number values that can't be displayed are indicated with pound signs (#).

For details on how to build a text table, see [Build a Text Table](#) on page 1549.

Map mark

The Map mark type uses geocoding to fill a polygon or line with a color based on data. The primary use of the map mark type is for creating polygon or line maps. The area to be filled is defined by the geographic fields used in the view. Tableau displays data using a filled map when:

- A geographic dimension is on **Detail** on the Marks card, along with **Latitude** and **Longitude** on the **Rows** and **Columns** shelves. A measure or continuous dimension is added to **Color** on the Marks card.
- You select **Map** from the Marks card drop-down menu.

The data view below shows a map with the **State** geographic dimension on **Detail** on the Marks card. The **Profit** measure is on **Color** on the Marks card.

The polygon for each state is filled with a color based on the profit for that state. The profit in Texas is low (in fact, negative) while the profit in California is high.

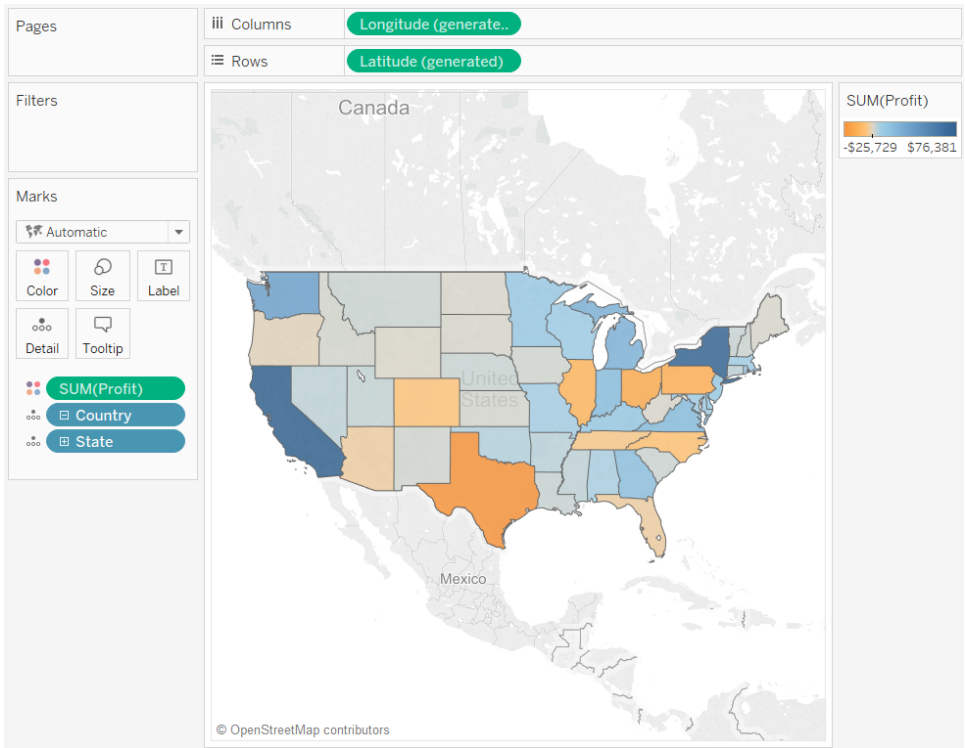

You can also use the Map mark type when you are plotting two measures against each other. By default, placing measures on both the **Rows** and **Columns** shelves creates a scatter plot. However, adding a geographic dimension allows you to change the mark type to Map. Each mark becomes the area defined by the geographic field. For example, the view below shows **Sales** versus **Profit** for a selection of states. Rather than showing a round mark with a label for each state, the view uses the Map mark type to draw the outline of each state. While this works well for recognizable areas, it is not the best choice for areas that are similar in shape or difficult to recognize.

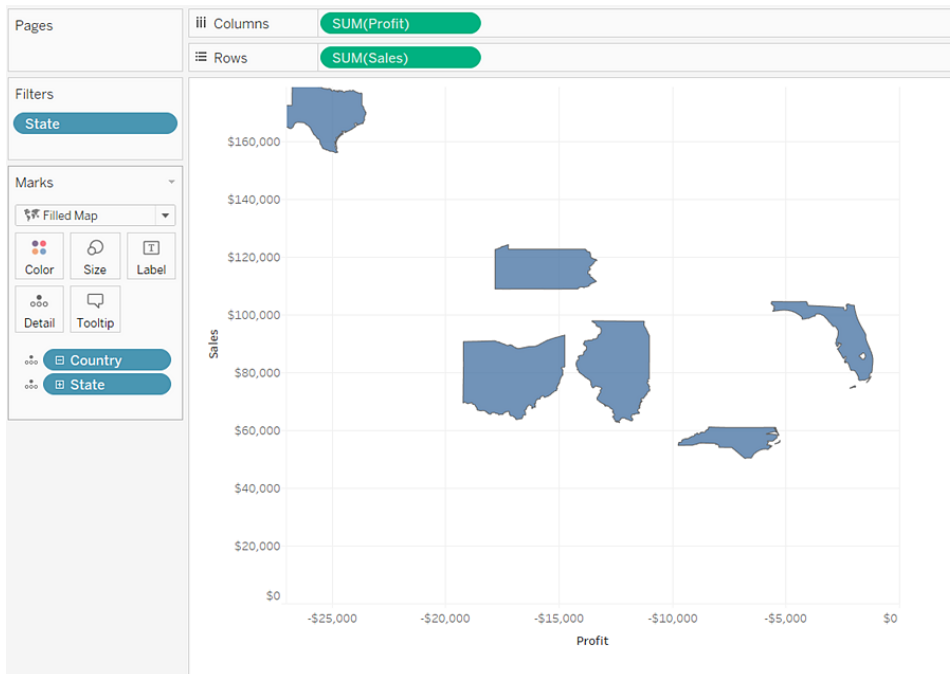

For more details on building maps, see [Get Started Mapping with Tableau](#) on page 1647 and [Maps and Geographic Data Analysis in Tableau](#) on page 1647.

Pie mark

You can use the Pie mark to show proportions. Although generally this type of information can be better shown using stacked bar charts, there are cases where pie marks can be very effective—for example, when trying to convey the percentage allocation of marketing expenses by state where the spending of geographically close states are very relevant.

Tableau will never use the Pie mark as an automatic mark type, but you can select **Pie** from the Marks card drop-down menu.

When you select the Pie mark type, an additional target named Angle is displayed on the Marks card. The Angle target determines the angular measure of the pie wedges. For example, if you place a measure such as **Sales** on **Angle** on the Marks card, the 360 degrees of the pie corresponds to the total sum of sales, and each wedge is divided by the values of the field on **Color** on the Marks card.

The view below shows the time it took to ship products by various ship modes. The data overlays a map and shows data by state. We can see that standard class shipping takes the longest in most areas.

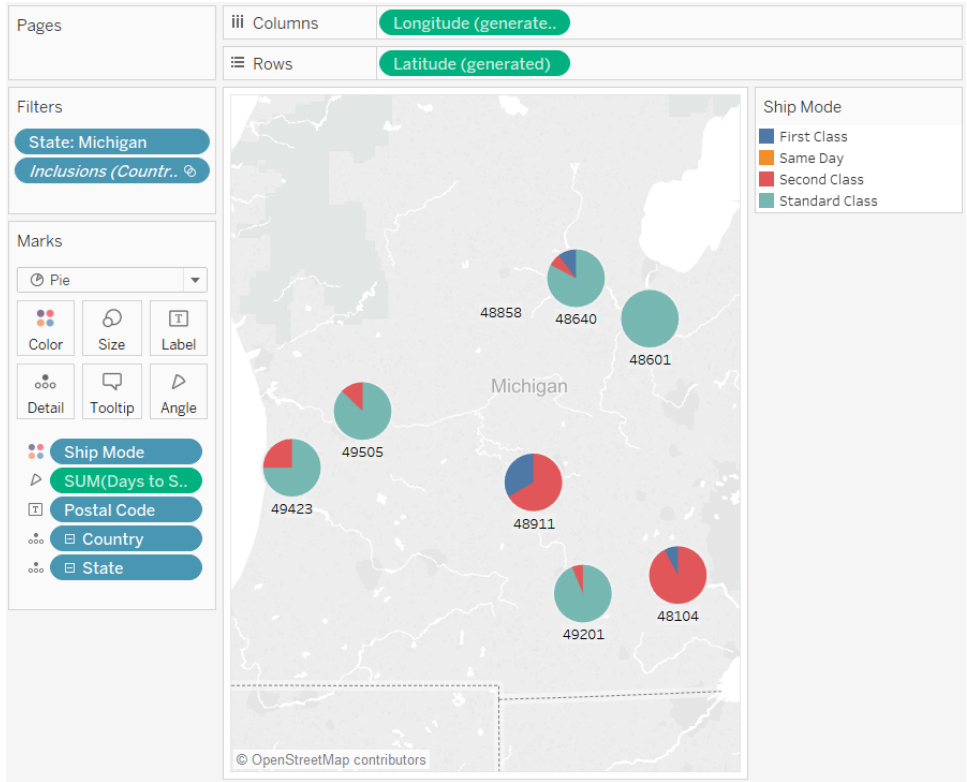

For details on how to build and use pie charts, see [Build a Pie Chart](#) on page 1540 and [Get Started Mapping with Tableau](#) on page 1647.

Gantt Bar mark

- The Marks card drop-down menu is set to **Automatic** and you place one or more dimensions on either the **Columns** shelf or the **Rows** shelf, and then plot the dimensions against a continuous quantity.
- You select **Gantt Bar** from the Marks card drop-down menu.

The distinguishing characteristic of Gantt Bars is that the length of every mark is proportional to the measure placed on **Size** on the Marks card.

The view below displays a dimension as a function of a continuous date. If the Marks card drop-down menu is set to **Automatic**, the data would be displayed using bars. Selecting **Gantt Bar** and adding additional fields will display a view like the following.

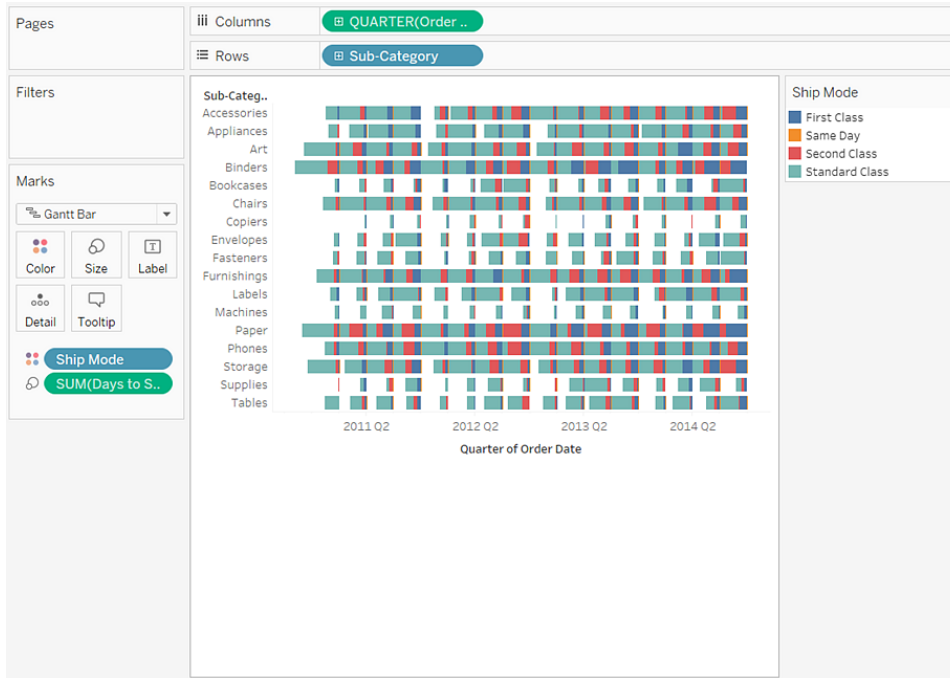

In particular, placing the **Days to Ship** measure on **Size** on the Marks card causes every bar in the view to be drawn with a length that indicates the delivery time of an order. Additionally, placing the **Ship Mode** dimension on **Color** on the Marks card causes each bar to be colored according to the ship mode.

For details on how to build Gantt Bar chart, see [Build a Gantt Chart on page 1504](#).

Polygon mark

Polygons are points connected by lines enclosing an area. The polygon mark type is useful when you want to connect points to create data areas. Tableau displays data using polygons when you select Polygon from the **Marks** menu.

The polygon mark is not commonly used and often requires a specially constructed data source.

The view shown below comes from a specially constructed data source that holds geographic and election data. It displays the 48 contiguous US states as a function of latitude and longitude and color-encodes each state by the 2000 presidential election results.

If **Marks** is set to Automatic, the data will be displayed using a shape. Manually selecting Polygon and adding additional fields to the view causes a different view to be created.

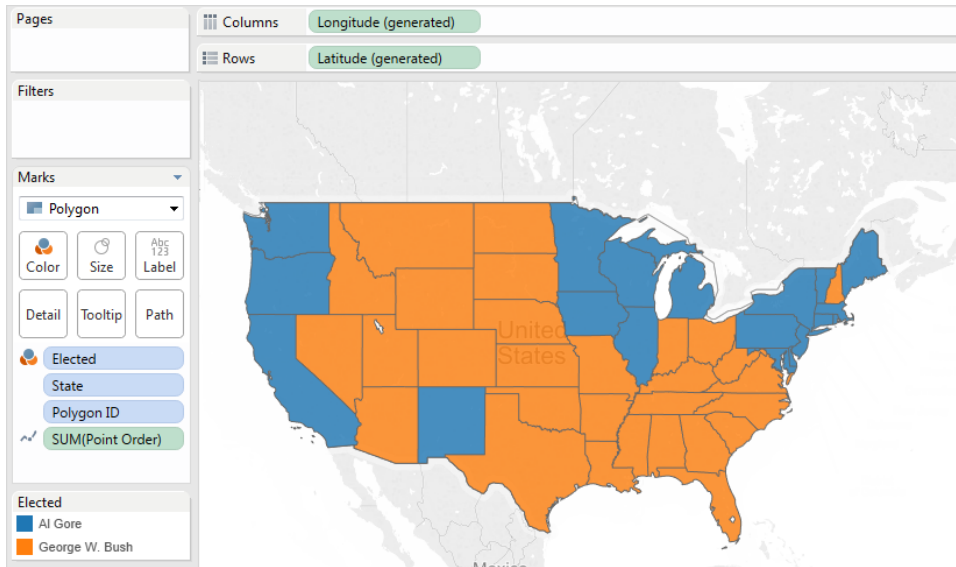

Every state is considered to be a polygon in the data source. The **PolygonID** field on the **Detail** target is distinct for each US state. You can remove states from the view by filtering this field.

Additionally, you can specify the drawing order of the lines that constitute each polygon by placing a field on the **Path** target. In this example, the **PointOrder** measure is used to draw each state.

Density mark (Heatmap)

You can use the density mark to visualize patterns or trends in dense data with many overlapping marks. Although generally this type of information can be shown using a circle mark, there are cases where density marks can be very effective—for example, when there are many data points in an area, and you need to understand where those marks are most concentrated. The density mark can be used effectively with maps or charts that use point-based marks (scatterplots, unit histograms, box plots over individual marks, or point maps).

Tableau does this by grouping overlaying marks, and color-coding them based on the number of marks in the group.

Density marks work by using color to show the relative intensity of data in a given area of the chart. You can adjust the colors of the density mark by selecting **Color** from the Marks card. Choose from ten density color palettes, or any of the existing color palettes.

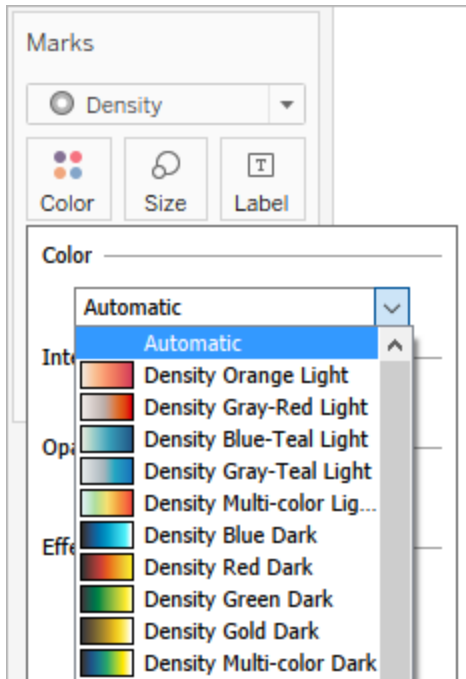

In the Color menu, use the Intensity slider to increase or decrease the vividness of the density marks. For example, increasing intensity, or vividness, lowers the "max heat" spots in your data, so that more appear.

Low Intensity (50%)

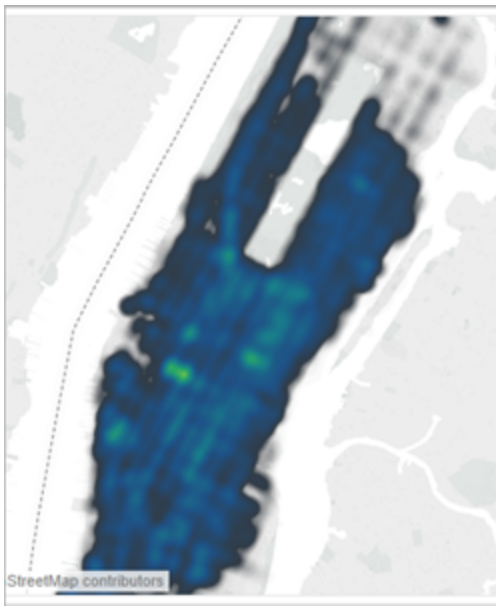

High Intensity (80%)

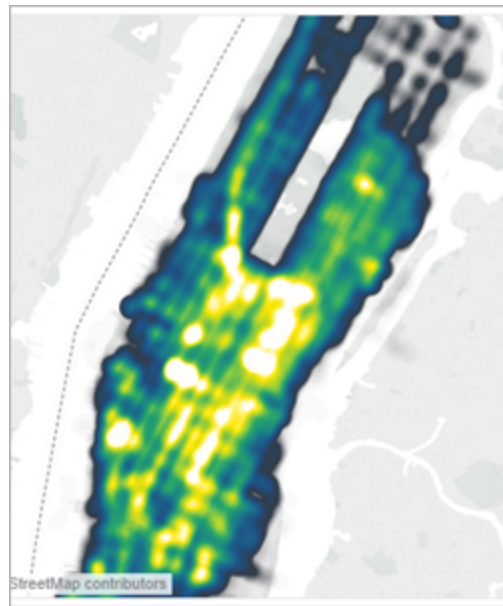

The view shown below comes from a data source that contains many geographic points for one month of taxi pickups in Manhattan. It displays the location and frequency of taxi pickups, with lighter colors being most frequent.

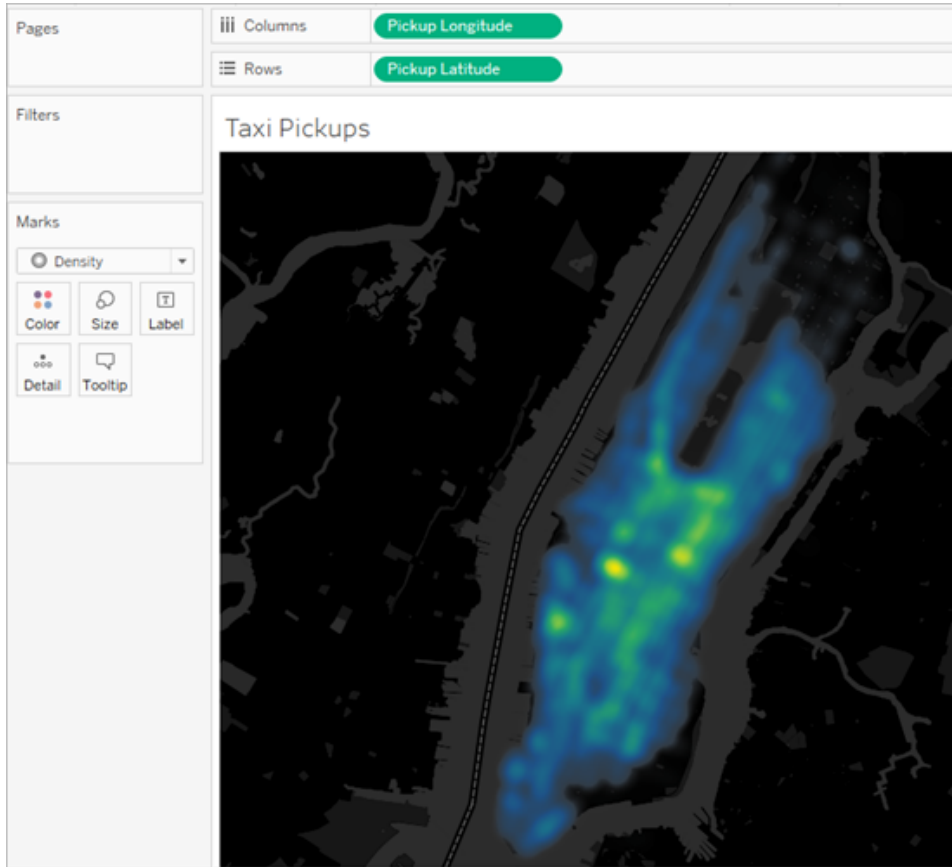

You can select **Density** from the Marks card drop-down menu.

For details on how to build a density map or a density chart, see [Create Heatmaps that Show Trends or Density in Tableau](#) on page 1800 and [Build with Density Marks \(Heatmap\)](#) on page 1495.

Control the Appearance of Marks in the View

Control color, size, shape, detail, text, and tooltips for marks in the view using the Marks card. Drag fields to buttons on the Marks card to encode the mark data. Click the buttons on the Marks card to open Mark properties. For related information on marks, see [Change the Type of Mark in the View](#) on page 1238 and [Marks card](#) on page 62.

Note: The order of dimension fields on the Marks card is hierarchical from top to bottom, and affects sorting in the view. Tableau first considers the topmost dimension field when ordering marks in the view, and then considers the dimensions beneath it on the Marks card.

Assign colors to marks

To assign a color to marks in the view, do one of the following:

- On the Marks card, click **Color**, and then select a color from the menu.

This updates all marks in the view to the color you choose. All marks have a default color, even when there are no fields on **Color** on the **Marks** card. For most marks, blue is the default color; for text, black is the default color.

- From the **Data** pane, drag a field to **Color** on the Marks card.

Tableau applies different colors to marks based on the field's values and members. For example, if you drop a discrete field (a blue field), such as Category, on Color, the marks in the view are broken out by category, and each category is assigned a color.

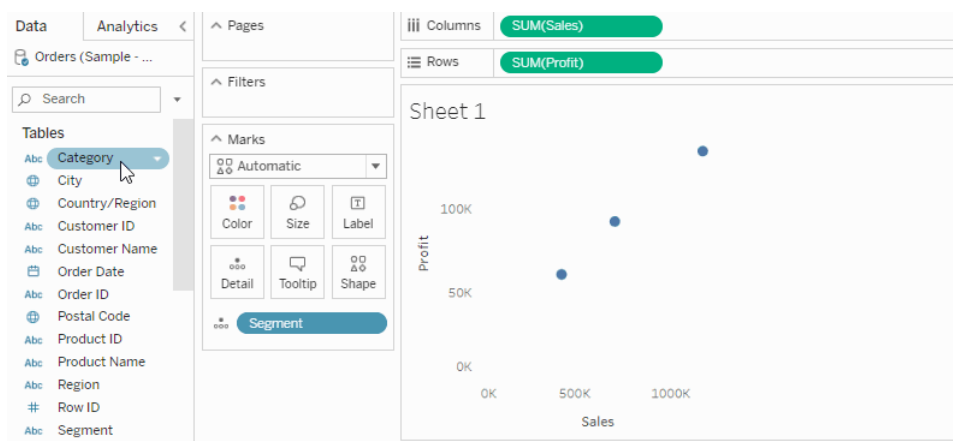

If you drop a continuous field, such as SUM(sales), on Color, each mark in the view is

colored based on its sales value.

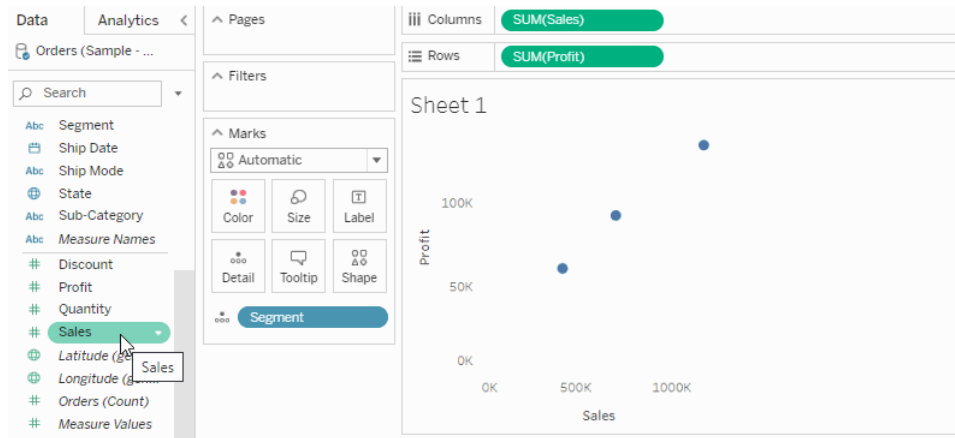

Edit colors

To change the color palette or customize how color is applied to your marks:

- On the Marks card, click **Color** > **Edit Colors**.

For more information, see [Color Palettes and Effects on page 1293](#).

Change the size of marks

To change the size of marks in the view, do one of the following:

- On the Marks card, click **Size**, and then move the slider to the left or right.

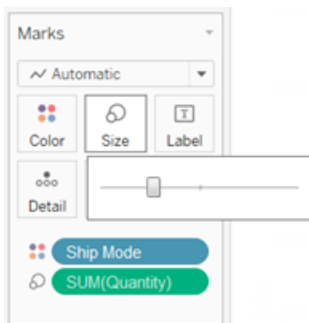

The Size slider affects different marks in different ways, as described in the following table.

Mark Type	Description
Circle, Square, Shape, Text	Makes the mark bigger or smaller.

Mark Type	Description
Bar, Gantt Bar	Makes bars wider or narrower.
Line	Makes lines thicker or thinner.
Polygon	You cannot change the size of a polygon.
Pie	Makes the overall size of the pie bigger and smaller.

The size of your data view is not modified when you change marks using the **Size** slider. However, if you change the view size, the mark size might change to accommodate the new formatting. For example, if you make the table bigger, the marks might become bigger as well.

- From the **Data** pane, drag a field to **Size** on the Marks card.

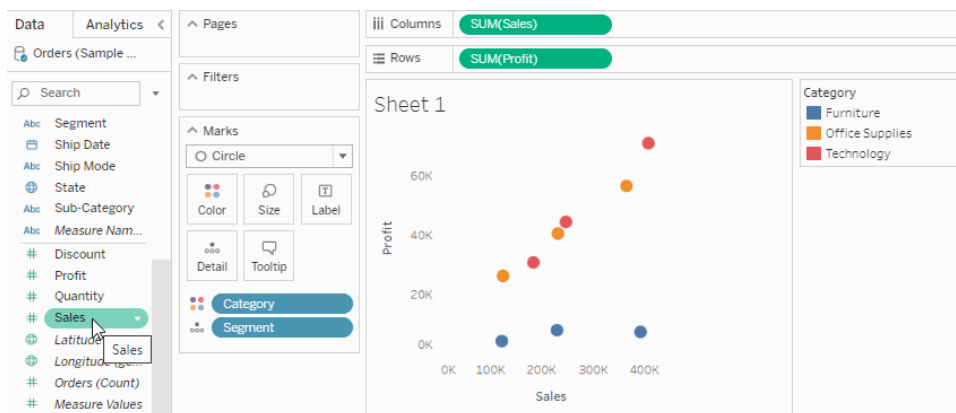

When you place a discrete field on **Size** on the **Marks** card, Tableau separates the marks according to the members in the dimension, and assigns a unique size to each member. Because size has an inherent order (small to big), categorical sizes work best for ordered data like years or quarters.

Size-encoding data with a discrete field separates the marks in the same way as the **Detail** property does, and then provides additional information (a size) for each mark. When you add categorical size encoding to a view, Tableau displays a legend showing the sizes assigned to each member in the field on the **Size** target. You can modify how these sizes are distributed using the Edit Sizes dialog box.

When you place a continuous field on **Size** on the **Marks** card, Tableau draws each mark with a different size using a continuous range. The smallest value is assigned the smallest sized mark and the largest value is represented by the largest mark.

When you add quantitative size encoding to the view, Tableau displays a legend showing the range of values over which sizes are assigned. You can modify how these sizes are distributed using the Edit Sizes dialog box.

Edit marks sizes

To edit the size of marks, or change how size is being applied to marks in the view:

1. On the Size legend card (which appears when you add a field to Size on the Marks card), click the drop-down arrow in the right-hand corner and select **Edit Sizes**.

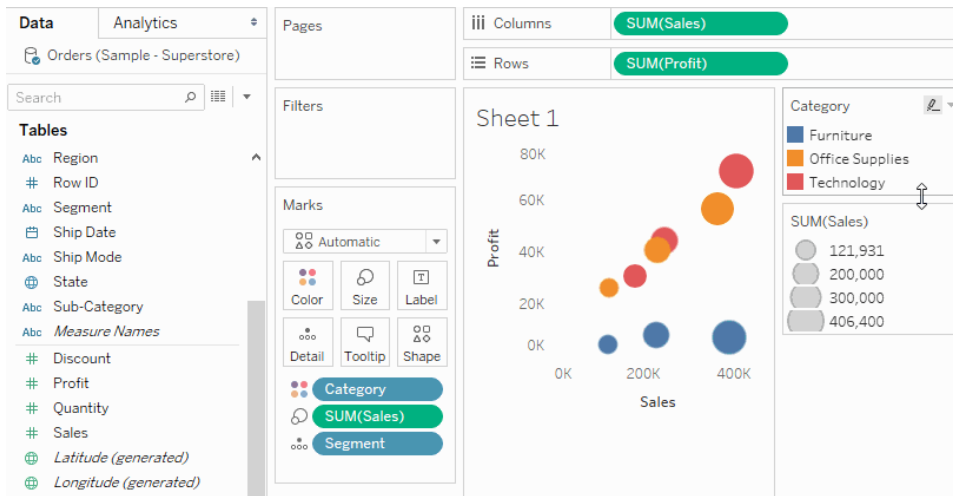

2. In the Edit Sizes dialog box that appears, make your changes and then click **OK**.

The options available depend on whether the field being applied to Size is a continuous or discrete field.

For continuous fields, you can do the following:

- For **Sizes vary**, click the drop-down box and select one of the following:
 - **Automatically** - Selects the mapping that best fits your data. If the data is numeric and does not cross zero (all positive or all negative), the From zero mapping is used. Otherwise, the By range mapping is used.
 - **By range** - Uses the minimum and maximum values in the data to determine the distribution of sizes. For example, if a field has values from 14 to 25, the sizes are distributed across this range.

- **From zero** - Sizes are interpolated from zero, assigning the maximum mark size to the absolute value of the data value that is farthest from zero.
- Use the range slider to adjust the distribution of sizes. When the From zero mapping is selected from the Sizes vary drop-down menu, the lower slider is disabled because it is always set to zero.
- Select **Reversed** to assign the largest mark to the smallest value and the smallest mark to the largest value. This option is not available if you are mapping sizes from zero because the smallest mark is always assigned to zero.
- To modify the distribution of sizes, select the **Start value in legend** and **End value for range** check boxes and type beginning and end values for the range.

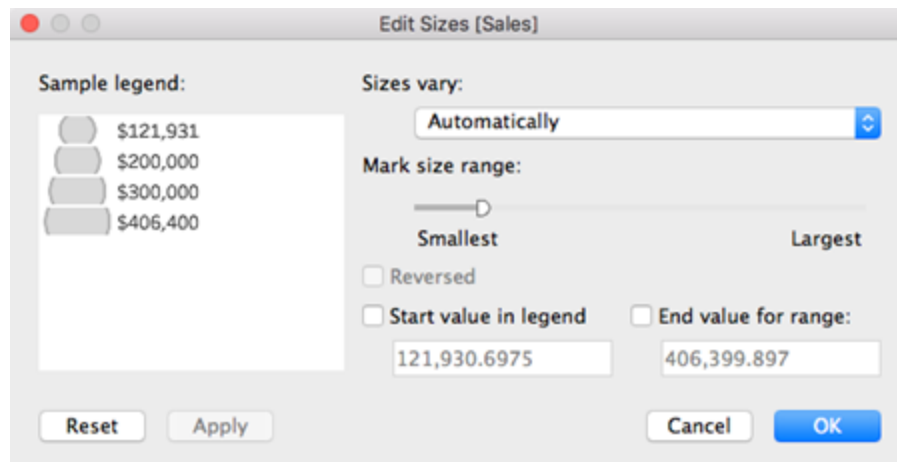

For discrete fields, you can do the following:

- Use the range slider to adjust the distribution of sizes.
- Select **Reversed** to assign the largest mark to the smallest value and the

smallest mark to the largest value.

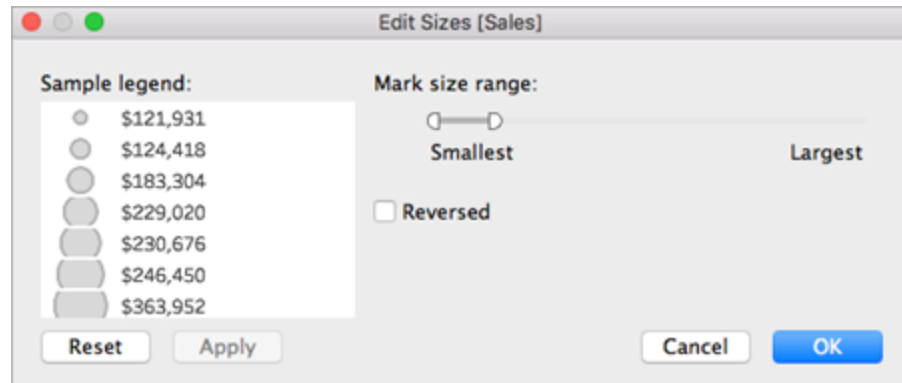

Continuous axis mark sizing

For views where the mark type is **Bar** and there are continuous (green) fields on both **Rows** and **Columns**, Tableau supports additional options and defaults for sizing the bar marks on the axis where the bars are anchored.

- The bar marks in histograms are continuous by default (with no spaces between the marks), and are sized to match the size of the bins. See [Build a Histogram on page 1518](#) for an example.
- When there is a field on **Size**, you can determine the width of the bar marks on the axis where the bars are anchored by using the field on **Size**. To do this, click the **Size** card and select **Fixed**.

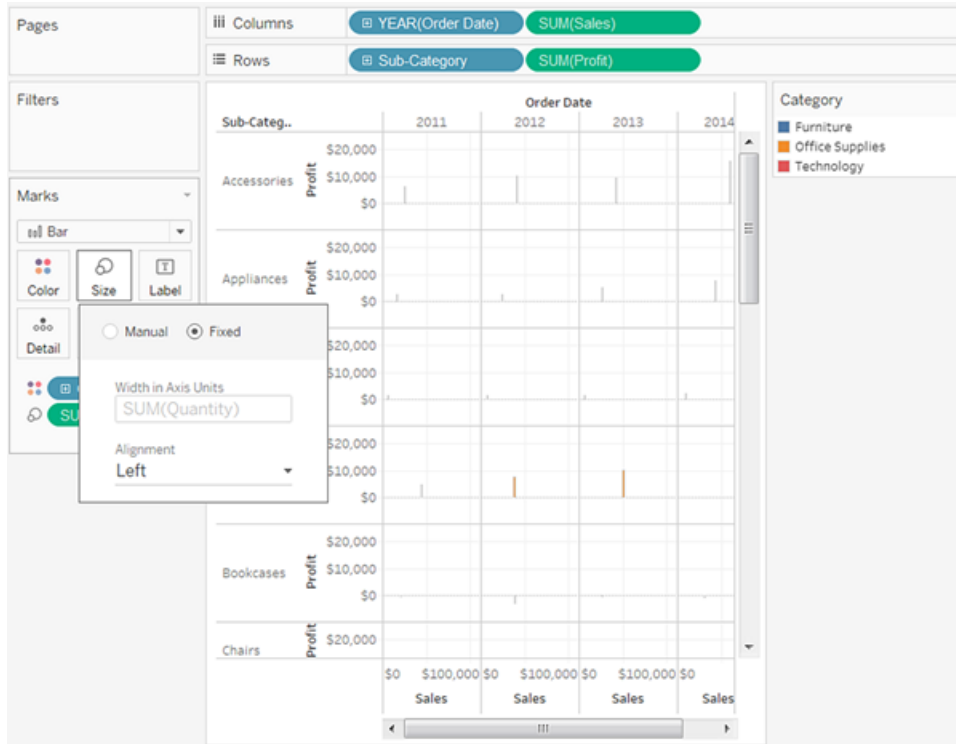

- When there is no field on **Size**, you can specify the width of the bar marks on the axis where the bars are anchored in axis units. To do this, click the **Size** card, choose **Fixed**, and then type a number in the **Width in axis units** field.

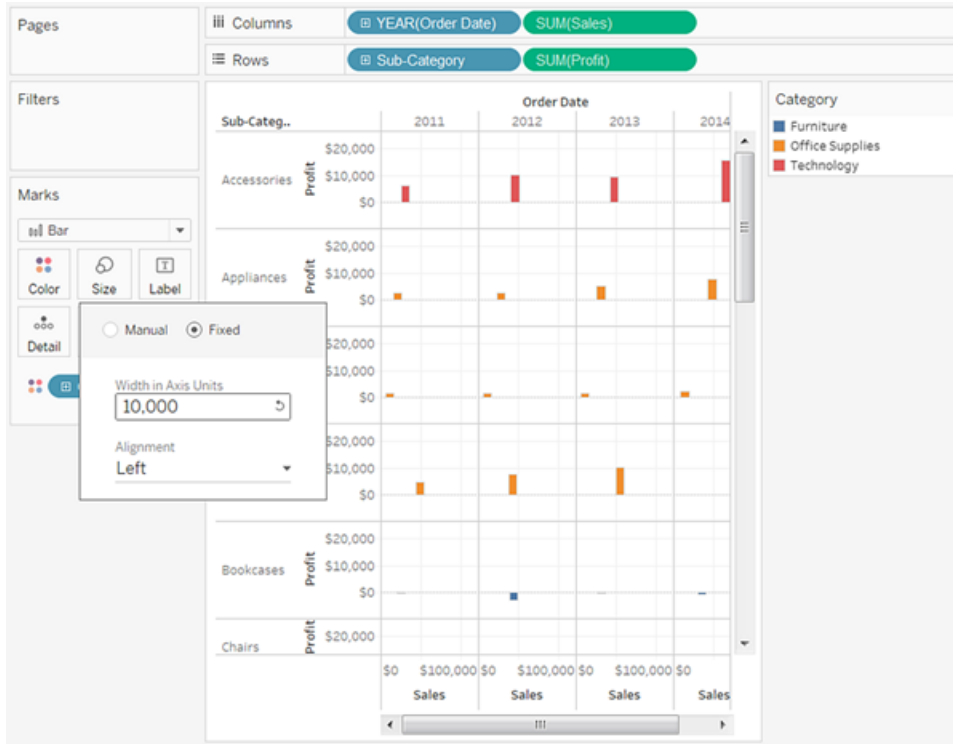

- When there is a continuous date field on the axis where the bars are anchored, the width of the marks is set to match the level of the date field. For example, if the level of the continuous date field is MONTH, the bars are exactly one month wide—that is, slightly wider for 31-day months than for 30-day months. You can configure the width of the bars by clicking the **Size** card, choosing **Fixed**, and then typing a number in the **Width in days** field, but the resulting bar widths don't take into account the varying lengths of time units such as months and years.

Add labels or text for marks

To add mark labels or text to the visualization:

- From the **Data** pane, drag a field to **Label** or **Text** on the Marks card.

When working with a text table, the Label shelf is replaced with Text, which allows you to view the numbers associated with a data view. The effect of text-encoding your data view depends on whether you use a dimension or a measure.

- **Dimension** – When you place a dimension on **Label** or **Text** on the Marks card, Tableau separates the marks according to the members in the dimension. The text labels are driven by the dimension member names.

- Measure – When you place a measure on **Label** or **Text** on the Marks card, the text labels are driven by the measure values. The measure can be either aggregated or disaggregated. However, dis-aggregating the measure is generally not useful because it often results in overlapping text.

Text is the default mark type for a text table, which is also referred to as a cross-tab or a PivotTable.

	Segment		
Sub-Categ..	Consumer	Corporate	Home Office
Accessories	\$87,105	\$48,191	\$32,085
Appliances	\$52,820	\$36,589	\$18,124
Art	\$14,252	\$8,590	\$4,276
Binders	\$118,161	\$51,560	\$33,691
Bookcases	\$68,633	\$34,006	\$12,241
Chairs	\$172,863	\$99,141	\$56,445
Copiers	\$69,819	\$46,829	\$32,880
Envelopes	\$7,771	\$5,943	\$2,763
Fasteners	\$1,681	\$783	\$560
Furnishings	\$49,620	\$25,001	\$17,084
Labels	\$6,709	\$4,102	\$1,675
Machines	\$79,543	\$60,277	\$49,419
Paper	\$36,324	\$23,883	\$18,272
Phones	\$169,933	\$91,153	\$68,921
Storage	\$100,492	\$79,791	\$43,560
Supplies	\$25,741	\$19,435	\$1,497
Tables	\$99,934	\$70,872	\$36,160

Separate marks in the view by dimension members

To separate marks in the view (or add more granularity):

- From the **Data** pane, drag a dimension to **Detail** on the Marks card.

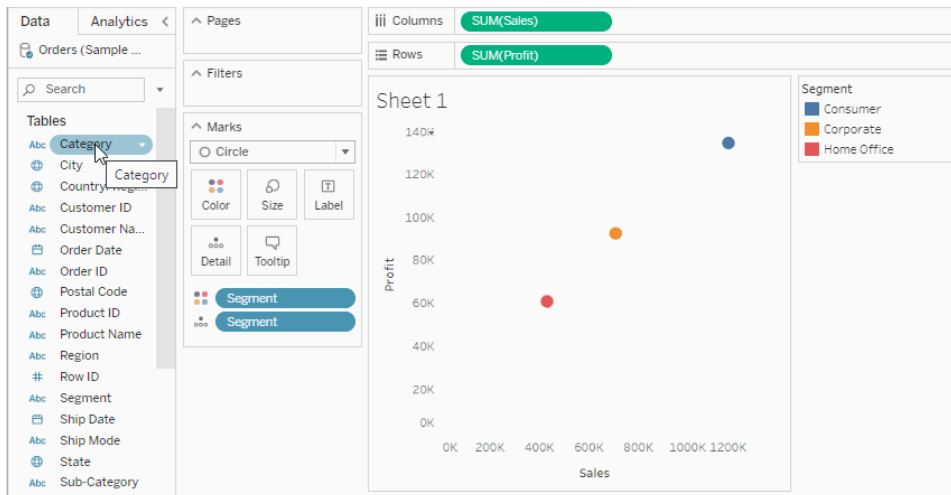

When you drop a dimension on **Detail** on the Marks card, the marks in a data view are separated according to the members of that dimension. Unlike dropping a dimension on the **Rows** or **Columns** shelf, dropping it on **Detail** on the Marks card is a way to show more data without changing the table structure.

Add tooltips to marks

Tooltips are details that appear when you hover over one or more marks in the view. Tooltips are also convenient for quickly filtering or removing a selection, or viewing underlying data. You can edit a tooltip to include both static and dynamic text. You can also modify which fields are included in a tooltip and whether you want to be able to use those fields to select marks in the view.

For details on showing a visualization from a worksheet in a tooltip (Viz in Tooltip), [Create Views in Tooltips \(Viz in Tooltip\)](#) on page 1371.

Add a tooltip

1. Drag a field to **Tooltip** on the **Marks** card.
2. Click **Tooltip** on the **Marks** card to open the Edit Tooltip dialog box, where you can add text, rearrange the tooltip contents, and insert more fields.

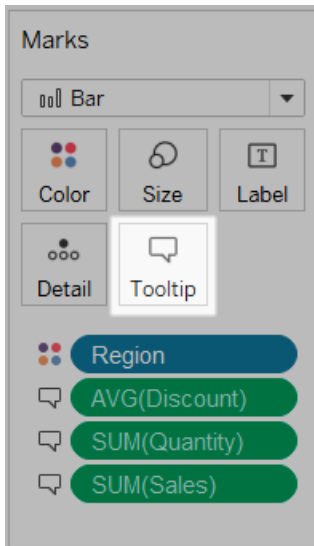

Note: Dimensions are added to the tooltip using the ATTR aggregation, which means the tooltip may sometimes display as an asterisk. The asterisk indicates that there are multiple dimension members that apply to the mark you are pointing at. For example, a mark may represent the aggregated sales for all regions. Adding the Region field to the tooltip results in an asterisk because the mark represents more than one region. To avoid showing an asterisk, add the dimension to Detail on the Marks card or use it elsewhere in the view to ensure the marks are at the same level of detail.

Tooltip options

After you open the Edit Tooltip dialog box, there are several options that you can choose from to format the tooltips in your view and configure their behavior. You can choose from the options below.

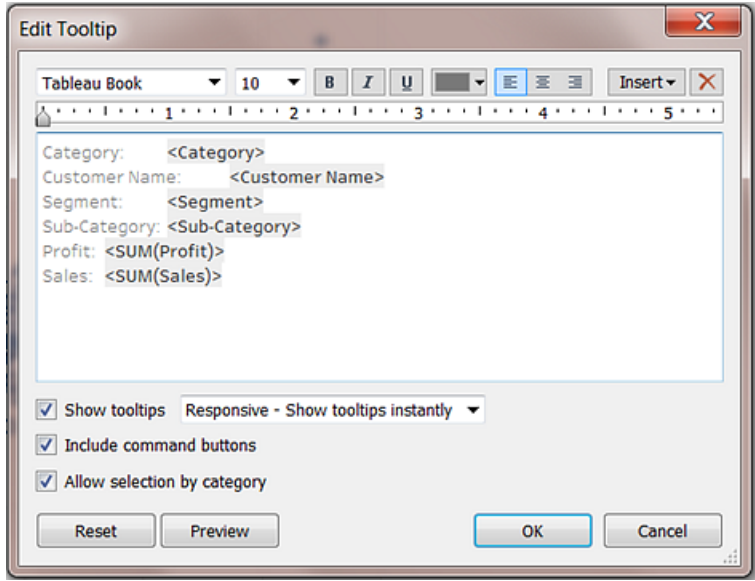

- **Format tooltips:** Tooltips are specified on a per-sheet basis and can be formatted using the tools on the top of the Edit Tooltip dialog box.
- **Adding dynamic text:** Use the **Insert** menu at the top of the dialog box to add dynamic text such as field values, sheet properties, and more. The **All Fields** command on the **Insert** menu adds all field names and values that are used in the view to the tooltip for any mark in the view.
- **Show tooltips:** Tooltips are shown by default. If you prefer to hide automatic tooltips, clear the **Show Tooltips** check box.
- **Configure tooltip behavior:** Configure how tooltips behave by selecting one of the following options in the drop-down list next to the **Show Tooltips** check box:
 - **Responsive - Show tooltips instantly:** Select this option to show tooltips instantly as you move the cursor over the marks in the view. This is the default for all views. With this option, tooltips appear without command buttons. You must first click a mark in the view to see the command buttons.
 - **On Hover - Show tooltips on hover:** Select this option to show tooltips only after you rest the cursor on a mark. However, with this option, command buttons appear on the tooltip without any further action from you (unless you specify otherwise in the Edit Tooltips dialog box).
- **Show commands:** Select the **Include command buttons** check box to add **Keep Only**, **Exclude**, **Group Members**, **Create Set** and **View Data** buttons at the top of the tooltip.

These buttons show both in Tableau Desktop and when the view is published to the web or viewed on a mobile device.

For more information about grouping members, see [Correct Data Errors or Combine Dimension Members by Grouping Your Data](#) on page 1090. For more information about creating sets, see [Create Sets](#) on page 1092.

- **Select marks in a view from the tooltip.** Select the **Allow selection by category** check box to be able to select marks in a view that have the same value by clicking on a discrete field in a tooltip. If this check box is selected, you can use this feature to select marks in a view in Tableau Desktop, when the view is published to the web or viewed on a mobile device.
- **Add or remove fields:** To add and remove fields when using the automatic tooltip, right-click (control-click on Mac) the field on one of the shelves in the view and select **Include in Tooltip**.

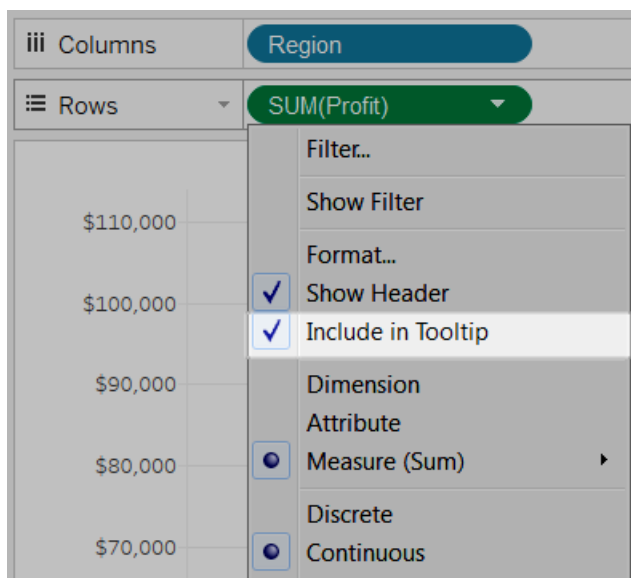

Note: The **Include in Tooltip** option is only available if you have not customized the tooltip. If you have customized the tooltip, you can return to the automatic tooltip by clicking **Tooltip** on the Marks card and then clicking **Reset** in the Edit Tooltip dialog box.

Change the shape of marks

To change the shapes of marks:

- From the **Data** pane, drag a field to **Shape** on the Marks card.

When you place a dimension on **Shape** on the **Marks** card, Tableau separates the marks according to the members in the dimension, and assigns a unique shape to each member. Tableau also displays a shape legend, which shows each member name and its associated shape. When you place a measure on **Shape** on the **Marks** card, the measure is converted to a discrete measure.

Shape-encoding data separates the marks in the same way as the Detail property does, and then provides additional information (a shape) for each mark. Shape is the default mark type when measures are the inner most fields for both the **Rows** shelf and the **Columns** shelf.

In the view below, the marks are separated into different shapes according to the members of the **Customer Segment** dimension. Each shape reflects the customer segment's contribution to profit and sales.

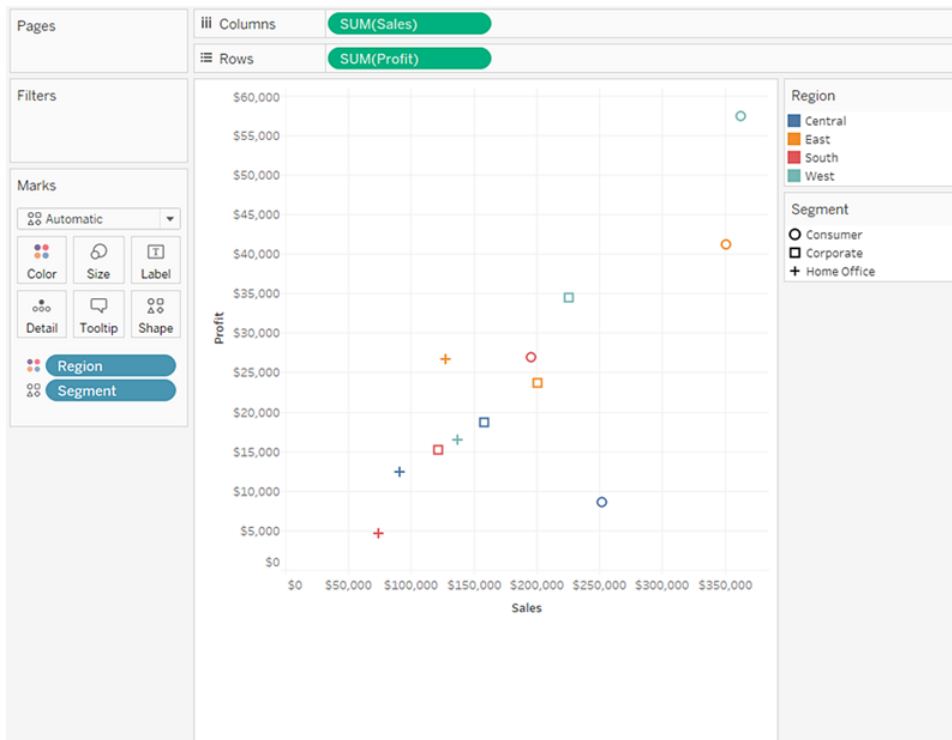

Edit shapes

By default, ten unique shapes are used to encode dimensions. If you have more than 10 members, the shapes repeat. In addition to the default palette, you can choose from a variety of shape palettes, including filled shapes, arrows, and even weather symbols.

1. Click **Shape** on the **Marks** card, or select **Edit Shape** on the legend's card menu.
2. In the Edit Shape dialog box, select a member on the left and then select the new shape in the palette on the right. You can also click **Assign Palette** to quickly assign the shapes to the members of the field.

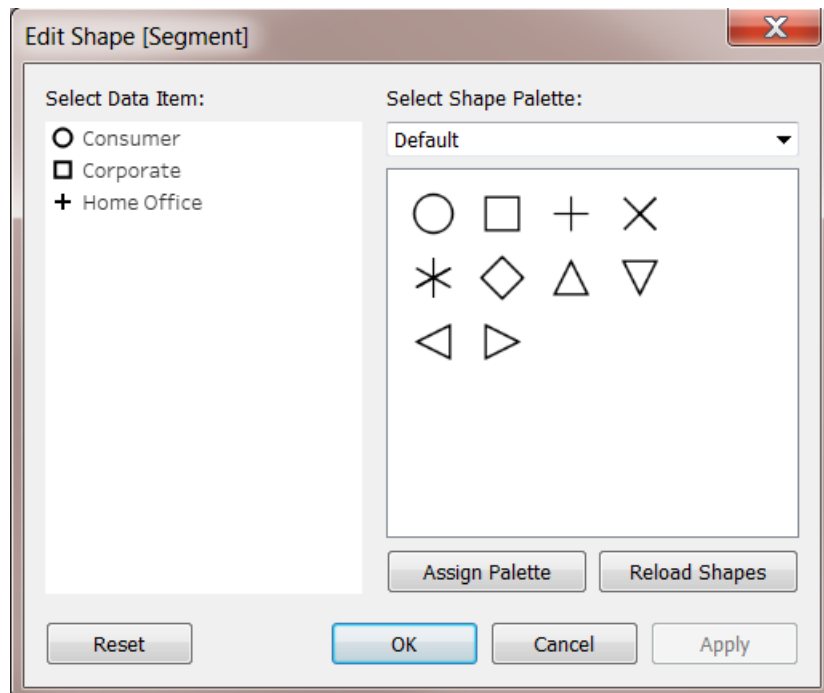

Select a different shape palette using the drop-down menu in the upper right.

Note: Shape encodings are shared across multiple worksheets that use the same data source. For example, if you define Furniture products to be represented by a square, they will automatically be squares in all other views in the workbook. To set the default shape encodings for a field, right-click (control-click on Mac) the field in the **Data** pane and select **Default Properties > Shape**.

Use Custom shapes

You can add custom shapes to a workbook by copying shape image files to the Shapes folder in your Tableau Repository, which is located in your Documents folder. When you use custom shapes, they are saved with the workbook. That way the workbook can be shared with others.

Tableau Desktop and Web Authoring Help

1. Create your shape image files. Each shape should be saved as its own file and can be in any of several image formats including bitmap (.bmp), portable network graphic (.png), .jpg, and graphics interchange format (.gif).
2. Copy the shape files to a new folder in the My Tableau Repository\Shapes folder in your Documents folder. The name of the folder will be used as the name of the palette in Tableau. In the example below, two new palettes are created: Maps and My Custom Shapes.

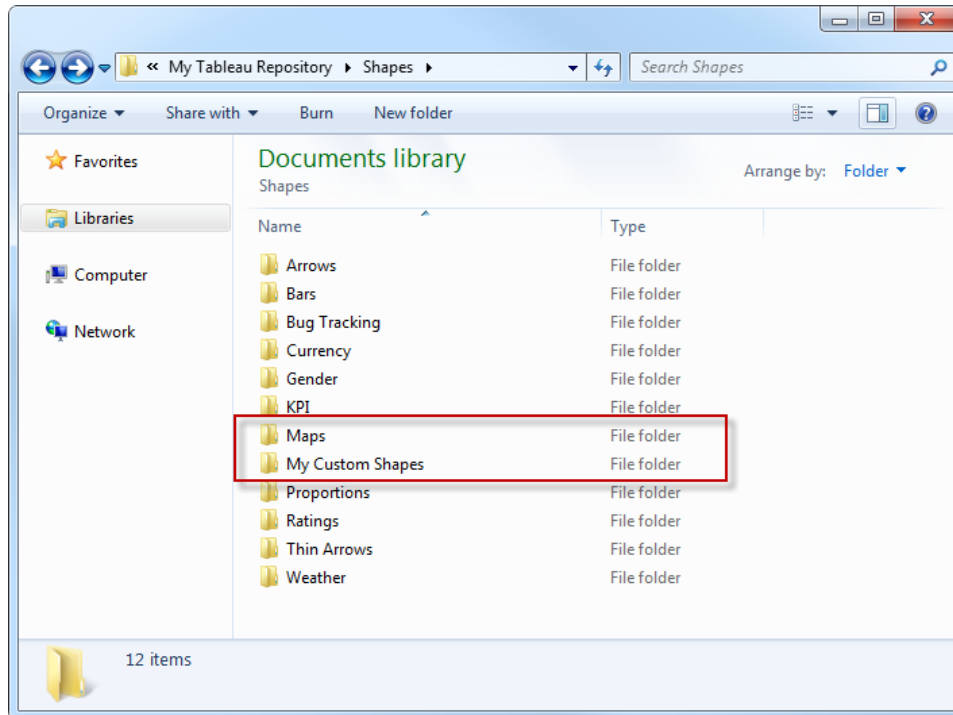

3. In Tableau, click the drop-down arrow on the shape legend, and select **Edit Shape**.

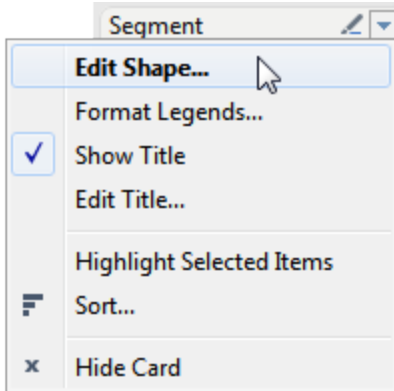

4. Select the new custom palette in the drop-down list. If you modified the shapes while Tableau was running, you may need to click **Reload Shapes**.

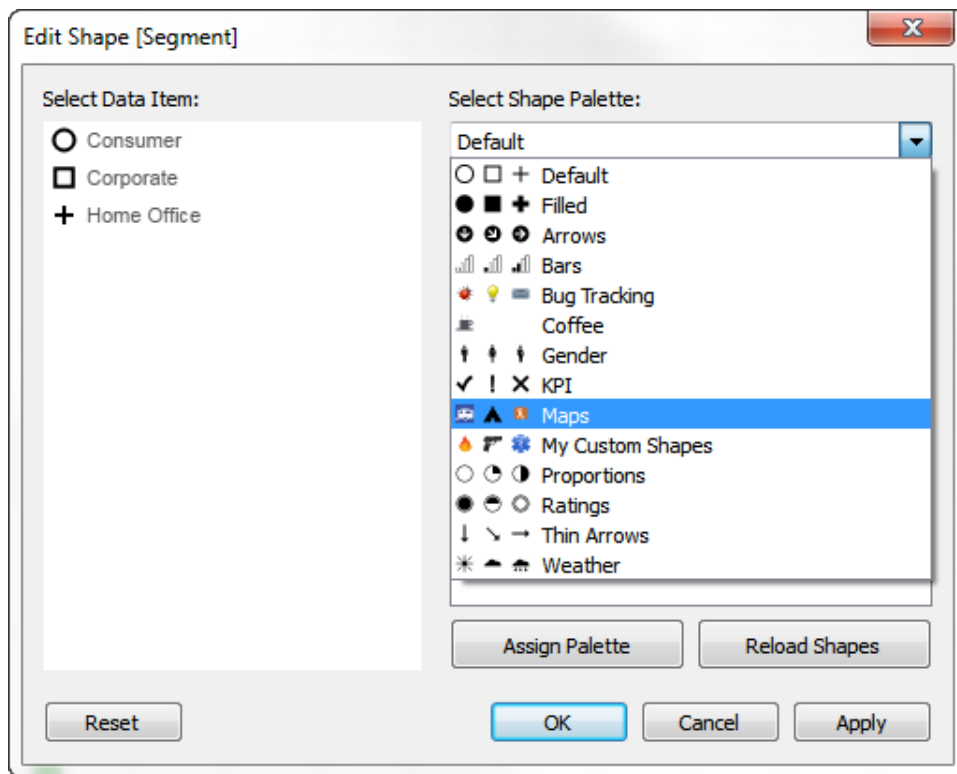

5. You can either assign members shapes one at a time, or click **Assign Palette** to automatically assign the shapes to the members.

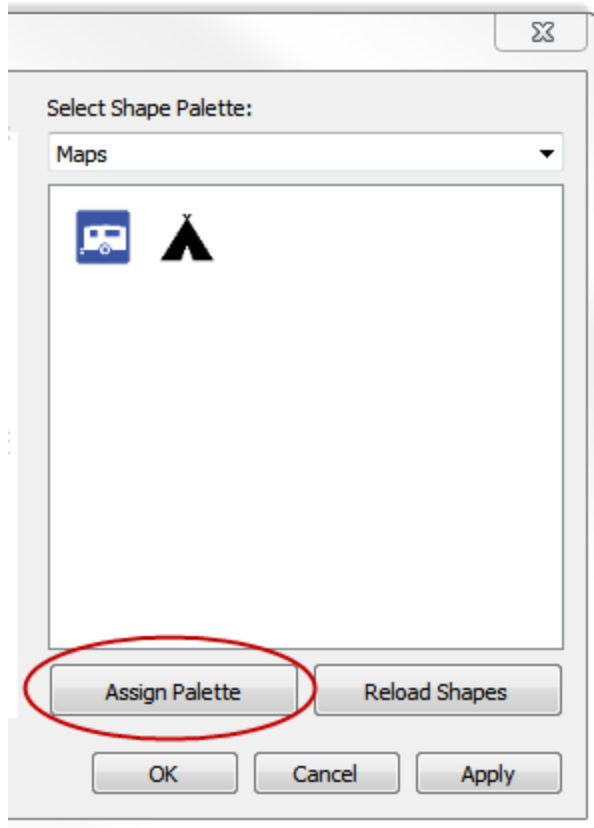

Note: You can return to the default palette by clicking the **Reset** button. If you open a workbook that uses custom shapes that you don't have, the workbook will show the custom shapes because the shapes are saved as part of the workbook. However, you can click **Reload Shapes** in the Edit Shapes dialog box to use the ones in your repository instead.

Below are some examples of views that use both the default and custom shape palettes.

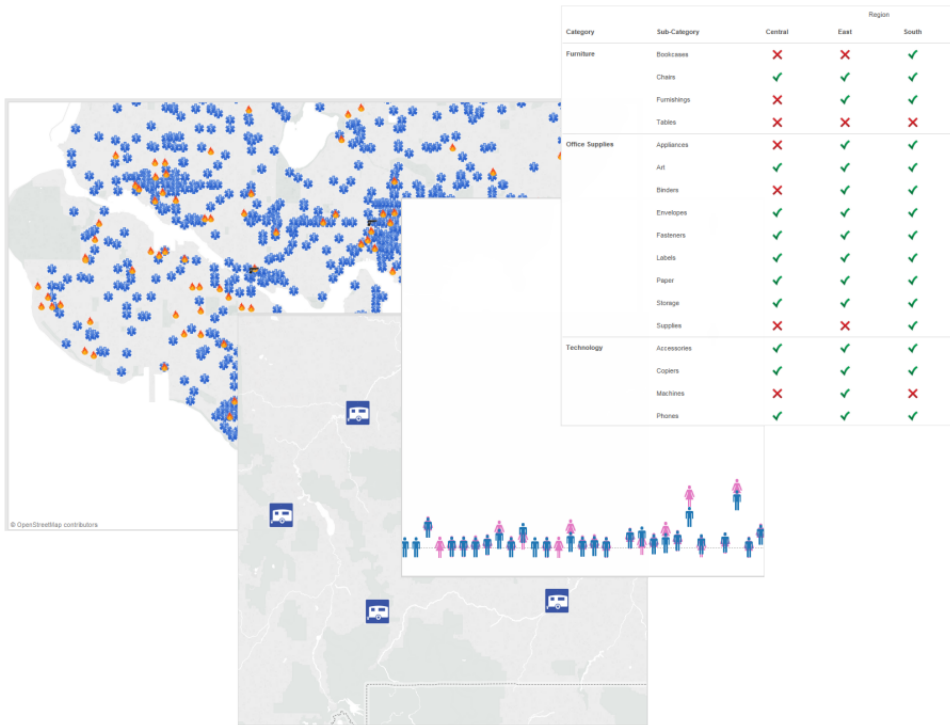

Tips for creating custom shapes

When you create custom shapes there are a few things that you can do to improve how your shapes look and function in the view. If you are creating your own shapes, we recommend following general guidelines for making icons or clip art.

- **Suggested size** - Unless you plan on using Size to make the shapes really large, you should try to make your original shape size close to 32 pixels by 32 pixels. However, the original size depends on the range of sizes you want available in Tableau. You can resize the shapes in Tableau by clicking Size on the **Marks** card, or by using the cell size options on the **Format** menu.
- **Adding color encoding** - If you plan to also use Color to encode shapes, you should use a transparent background. Otherwise, the entire square of the image will be colored rather than just the symbol. GIF and PNG file formats both support transparency. GIF files support transparency for a single color that is 100% transparent, while PNG files support alpha channels with a range of transparency levels available on every pixel in the image. When Tableau color encodes a symbol, the amount of transparency for each pixel won't be modified, so you can maintain smooth edges

Note: Avoid including too much transparency around an image. Make the size of the custom shape as close to the size of the image as possible. Extra transparent pixels around the edges of the image can negatively effect the hover or click behavior near the image, especially when custom shapes overlap each other. When the actual shape area is bigger than what is visible, it can make hovering and clicking the shape more difficult and less predictable for users.

- **File formats** - Tableau doesn't support symbols that are in the Enhanced Meta File format (.emf). The shape image files can be in one of the following formats: .png, .gif, .jpg, .bmp, and .tiff.

Draw paths between marks

The Path property is available when the **Line** or **Polygon** mark type is selected in the **Marks** card drop-down menu. For more information about how to change the type of mark displayed in your viz, see [Change the Type of Mark in the View on page 1238](#).

You can use the Path property in the Marks card to change the **type of line mark (linear, step, or jump)**, or to encode data by connecting marks **using a particular drawing order**. You can path-encode your data using either a dimension or a measure.

- **Dimension** – When you place a dimension on **Path** on the Marks card, Tableau connects the marks according to the members in the dimension. If the dimension is a date, the drawing order is driven by the date order. If the dimension includes words such as customer names or product types, the drawing order is driven by the order of the members in the data source. You can change the order that data points are connected by changing the sort order of the members. For more information, see [Sort Data in a Visualization on page 1345](#).
- **Measure** – When you place a measure on **Path** on the **Marks** card, Tableau connects the marks according to the values of the measure. The measure can be aggregated or disaggregated.

Change the line type (linear, step, jump)

When the mark type is set to be a line (Automatic or Line), you can click the **Path** property in the Marks card to change the line type.

Use these line types for numeric data that remains constant for periods of time, with noticeable changes or deltas – such as account balances, inventory levels, or interest rates. Step lines work

well for emphasizing the magnitude of change. Jump lines help to emphasize the duration of change between data points.

1. Click **Path** in the Marks card.
2. Select **Linear**, **Step**, or **Jump** to change the line type.

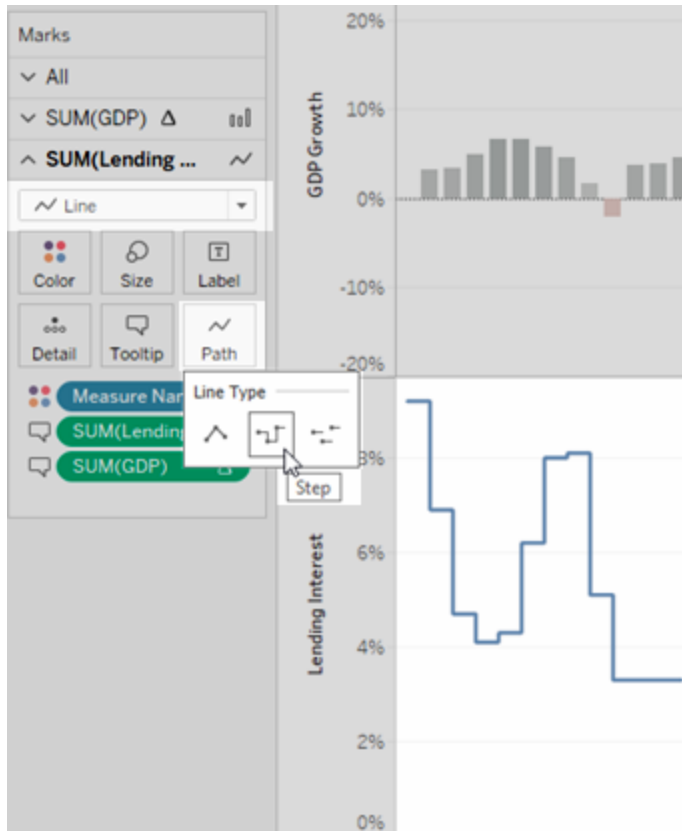

Change the line pattern (solid, dashed, dotted)

Starting in Tableau 23.2, when the mark type is set to be a line (Automatic or Line), you can click the **Path** property in the Marks card to change the line pattern.

Use different line patterns to help differentiate secondary measures. For example, when you want to highlight actual values vs baseline metrics. Line Patterns are helpful when indicating that specific lines are thresholds (such as goals and limits) and other measures are less certain (such as a forecast or modeled data). Line patterns soften the visual weight of a line and can help certain trends from being the primary focus when comparing multiple trends against one another.

1. Click **Path** in the Marks card.
2. Select **Solid line**, **Dashed line**, or **Dotted line** to change the line pattern.

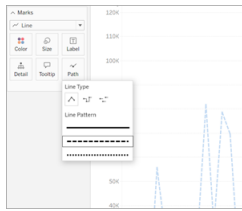

Note: Dashed and dotted line patterns aren't compatible with continuous size encoding. If you have a mark set to change size or thickness based on a quantitative value, you must use a solid line pattern.

Create a path-encoded view

To create a useful path-encoded view, your data table should contain at least one measure. You can't create a path that connects only categorical data (dimensions).

The view below was created using storm data from the Atlantic basin in 2010. The view uses line marks with the path determined by the date of the storm. This lets you see the path of the storm. By placing the continuous date on **Path** on the **Marks** card, this tells Tableau to draw the lines in chronological order. For more information, see [Create Maps that Show a Path Over Time in Tableau](#) on page 1792 and [Create Maps that Show Paths Between Origins and Destinations in Tableau](#) on page 1806.

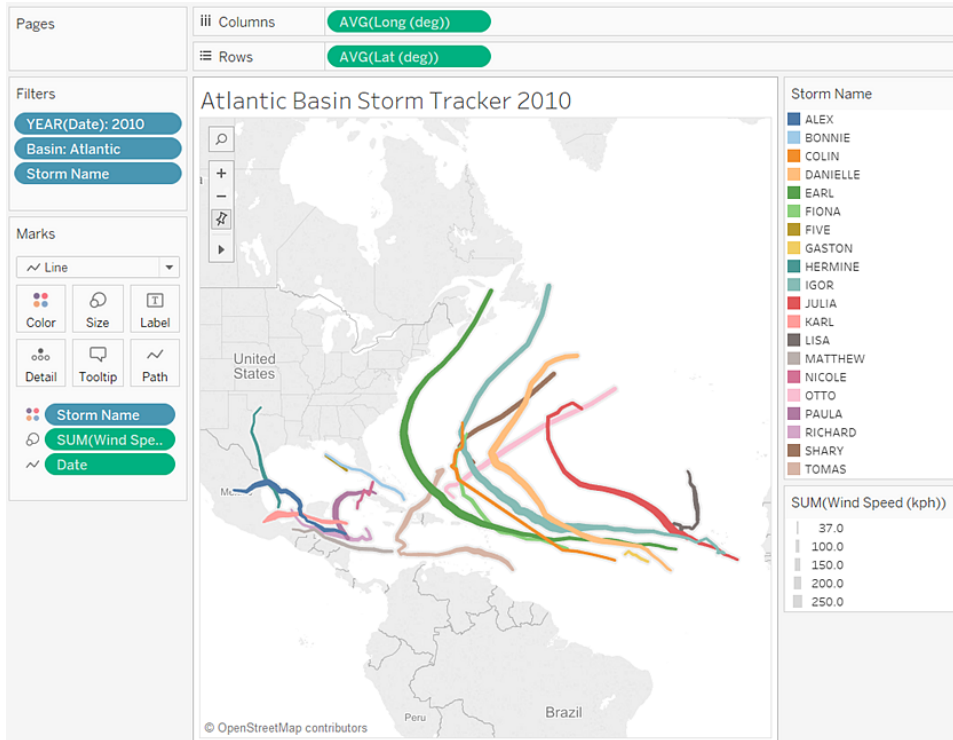

Show, Hide, and Format Mark Labels

You can add labels to the marks in your viz. Labels can display the data already represented in that mark, or additional fields can be added to the Label shelf on the Marks card.

Labels aren't quite the same thing as annotations (which are more like comments than labels). For more information on annotations, see [Add Annotations](#) on page 1362.

Turn labels on or off

To show mark labels in a viz, do one of the following:

- Select the Mark Label button in the tool bar 
- On the Marks card, select **Label**, and then select **Show mark labels**.
- Drag a field to the Label shelf on the Marks card.

Note: If the Mark type is Text (including Automatic text), the label shelf may say **Text** instead of **Label**.

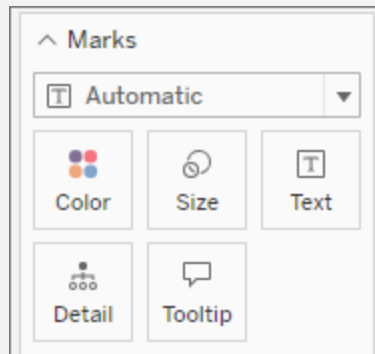

To turn off labels, select the Mark Label button again or clear the Show mark labels option.

Use a specific field as a label

If you didn't specify what field to use as the label, Tableau will use a default field. To set a specific field as the label, drag the desired field to the **Label** shelf on the Marks card.

Change what labels appear

By default, all marks are labeled unless the labels would overlap. Overlap can often be illegible if there are too many marks nearby, but you can turn it on if you choose.

On the Marks card, click **Label**. Check the option **Allow labels to overlap other marks**.

Configure Marks to Label

The **Marks to Label** section offers more nuanced settings for what labels appear.

Not all options are available at all times. Some, like Line Ends, only appear when the structure of the viz supports it. The appearance of the dialog differs depending on if you're using Tableau Desktop or web editing in the browser.

Label options in Tableau Desktop: All

Label option in Web Editing: Min/Max

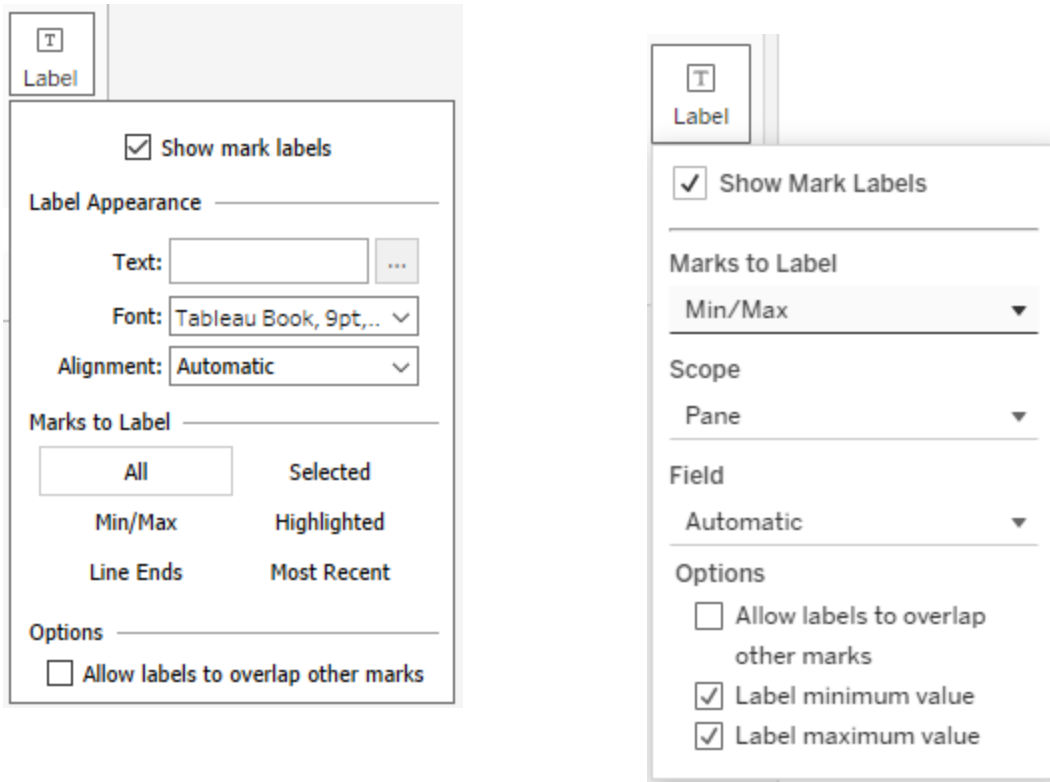

On the Marks card, click **Label**. Select an option:

- **All**. Label all marks in the viz. (This is the default)
- **Min/Max**. Label only the minimum and maximum values for a field in the viz. Additional options appear with this setting:
 - Scope: you can label the min/max for the entire table, per pane, per cell, or per line/pie.
 - Field: set which field's min/max is used.
 - Options: you can choose to label only the min or max or both.
- **Line Ends**. Label the ends of all lines. Use the Additional options if you want to label only the start or end.
- **Selected**. Labels appear when you select one or more marks in the viz.
- **Highlighted**. Label only the highlighted marks in the view. Highlighting can occur in several ways:
 - Selecting a member in a legend
 - Selecting a mark or marks in the viz (this is the same behavior as the Selected option)

- Using the Highlighter. For more information about how to use the Highlighter, see [Highlight Data Points in Context on page 1397](#).
- **Most Recent.** Label the most recent marks in the view. When there's a date field in the view, you can label all marks that correspond to the most recent date or time in the view. Like Min/Max, this setting has a scope option.

Show and hide individual mark labels

You might want to show labels for only individual marks, or hide specific overlapping mark labels.

In the viz, right click the mark you want to show or hide a mark label for, select **Mark Label**, and then select one of the following options:

- **Automatic:** select this option to turn the label on and off depending on the view and the settings in the Label drop-down menu.
- **Always Show:** select this option to show the mark label.
- **Never Show:** select this option to hide the mark label.

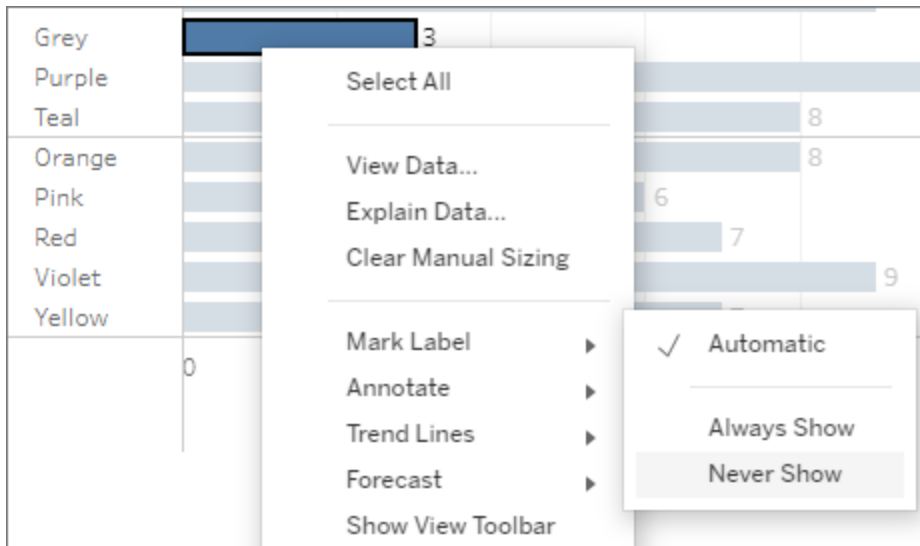

Format mark labels

There are several formatting options to help you adjust the appearance of the labels. You can customize the text, adjust the font properties, and set an alignment. These options only available in Tableau Desktop.

Edit the label text

Note: A field must be on the Label shelf before you can edit the label text.

1. On the Marks card, click **Label**.
2. In the dialog box that opens, under **Label Appearance**, click the more options button [...] next to **Text**.
3. Edit the text.
 - You can edit aspects of the font and alignment in this text editor, but for more complete options, use the Label dialog itself(see the next sections).
 - You can use the Insert button in the editor to add more fields to the label, but only fields that were added to the Label shelf are available in that drop down.
4. Select **OK**.

Edit the label font

1. On the Marks card, click **Label**.
2. In the dialog box that opens, under **Label Appearance**, click the **Font** drop-down. Here you can:
 - Select a font type, size, and emphasis.
 - Select a color for the labels:
 - To select a specific color, click a color from the options.
 - To match labels to the color of their marks, click **Match Mark Color**.
 - Adjust the opacity of the labels by moving the slider at the bottom of the menu.

Edit the label alignment

1. On the Marks card, click **Label**.
2. In the dialog box that opens, under **Label Appearance**, click the **Alignment** drop-down. Here you can:
 - Align the label horizontally (left, center, right).
 - Change the direction of the text.
 - Align the label vertically (bottom, middle, top).
 - Set the Wrap to automatic, on, or off.

Move mark labels manually

Once a label is present, you can drag it to a new position. For example, in a stacked bar chart, the mark labels are automatically placed in the center of each bar. However, you may want to stagger the labels so that the longer ones don't overlap.

Select the mark label and, without releasing the mouse button, drag the label to its desired location.

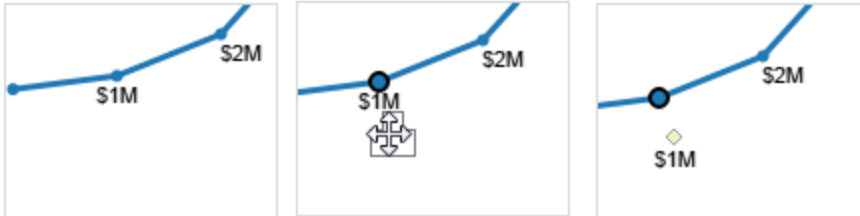

Move Marks

In a dual-axis view that contains many marks, some marks can become hidden behind others, making it difficult to see details in your view. Tableau provides a **Move Marks** option to move selected marks forward or backward, depending on the axis that you select.

To move marks forward or backward, right-click on one of your axes and select one of the following options:

- **Move Marks to Front**
- **Move marks to Back**

Example - Move marks forward

In this example, suppose you have a view that uses the **Circle** mark type on a dual axis and shows department **Sales** and **Profit** for each **Category**.

The shape of each mark represents **Sales** and **Profit**, while **Category** is encoded as **Color**. The right axis represents the **Sales** mark, while the left represents the **Profit** mark.

Because the profit marks are in front, it is difficult to see the **Sales** marks in the **Office Supplies** category.

To move the **Sales** marks in front of the **Profit** marks, do the following:

1. Right-click on the **Sales** axis.
2. Select **Move marks to front** from the context menu.

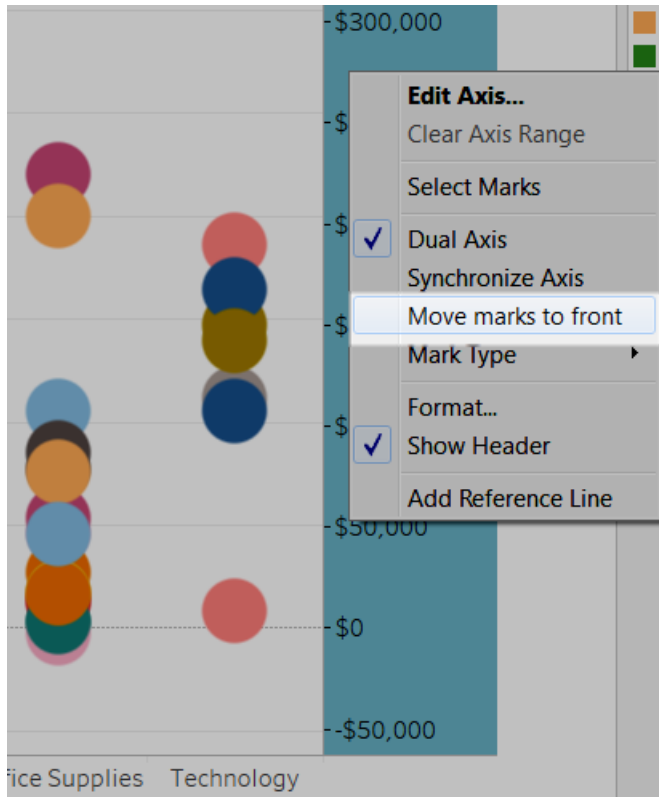

By moving the **Sales** mark to the front, you can now see that rubber bands are below \$100,000 in sales, whereas they were nearly invisible before.

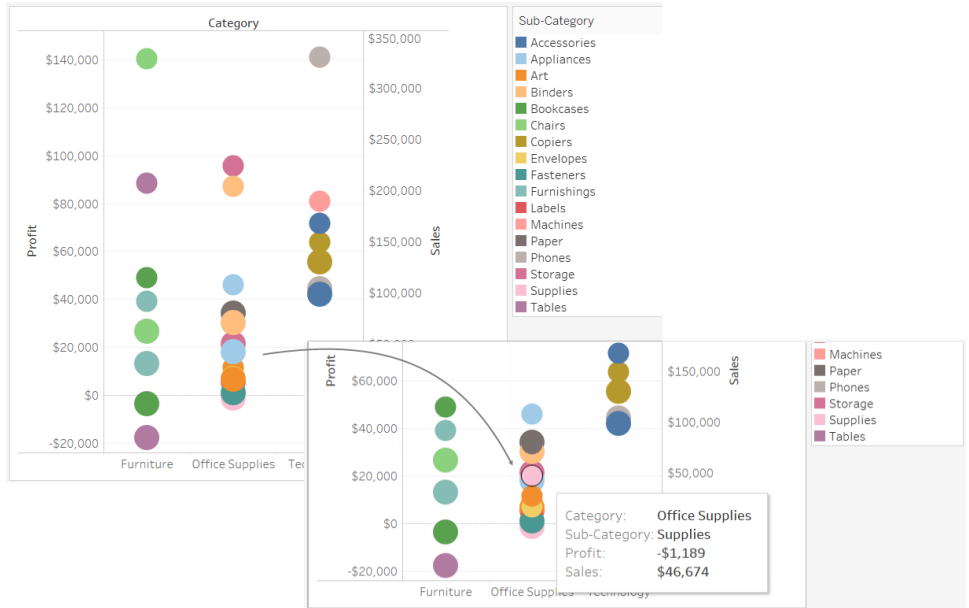

Stack Marks

Stacking marks is relevant when your data view includes numeric axes. That is, at least one measure has been placed on the **Rows** or **Columns** shelves. When marks are stacked, they are drawn cumulatively along an axis. When marks are not stacked, they are drawn independently along an axis. That is, they are overlapping.

Stacking marks is particularly useful for bar charts which is why Tableau automatically stacks bars. You might find that stacking marks is useful for other marks such as lines as well.

You can control whether marks are stacked or overlapping in any given view by selecting the **Analysis > Stack Marks** menu item.

You can either allow Tableau to automatically select whether the marks are stacked or you can specify **On** or **Off**. The default setting is **Automatic**. When you are in automatic mode, the Stack Marks menu shows whether stacked marks is on or off.

Selecting **On** or **Off** on the **Stack Marks** menu, switches into manual mode. Your selection remains throughout any changes you make to the view.

The following examples illustrate stacking marks.

Example: Stacking Bars

Consider the stacked bars view shown below. It was created by placing a dimension on the **Columns** shelf, placing a measure on the **Rows** shelf, and color-encoding the data by a dimension (that is, dropping a dimension on **Color** on the Marks card).

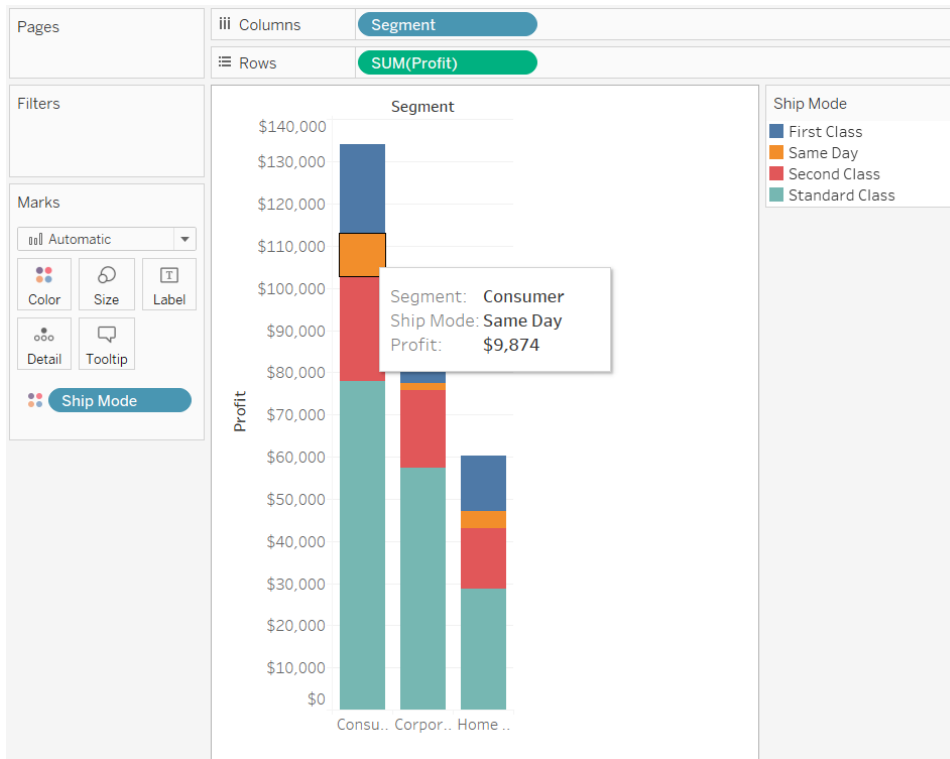

Example: Stacking Lines

Consider the data view shown below. It was created by placing a date dimension on the **Columns** shelf, placing a measure on the **Rows** shelf, and color-encoding the data by a dimension (that is, dropping a dimension on **Color** on the Marks card). Because the mark type is Line, the marks are not automatically stacked. Instead, they are drawn independently from the horizontal axis.

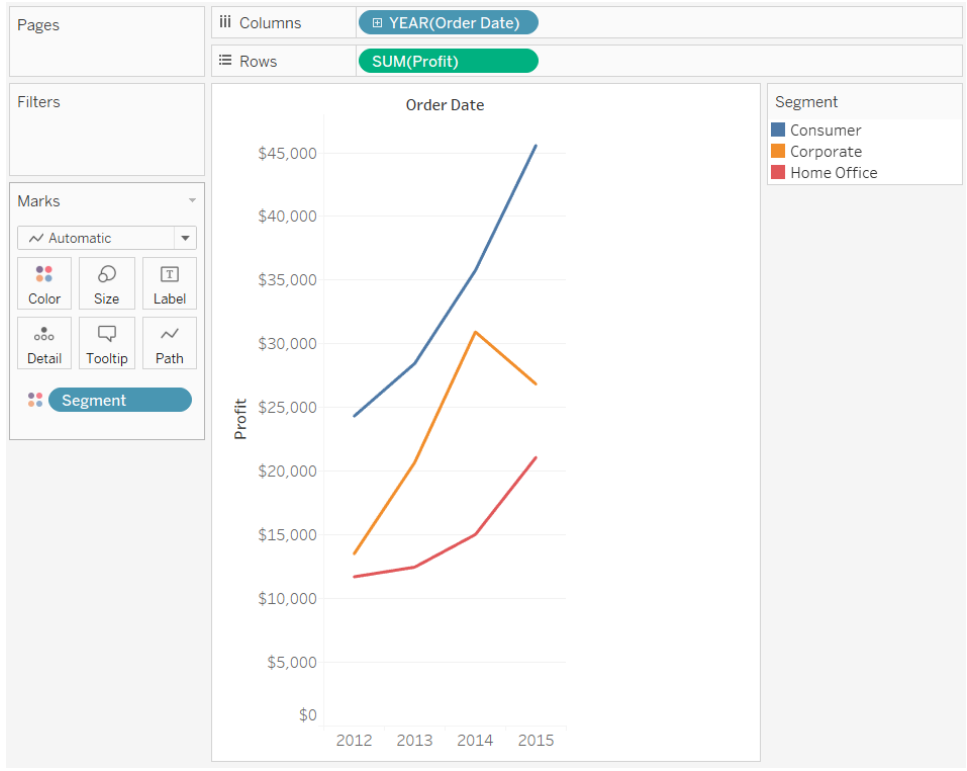

Color Palettes and Effects

All marks have a default color, even when there are no fields on **Color** on the **Marks** card. For most marks, blue is the default color; for text, black is the default color. Also see [Assign colors to marks](#) on page 1262 and [Example – Multiple Fields on Color](#) on page 1303.

Categorical Palettes

When you drop a field with discrete values (typically a dimension) on **Color** on the **Marks** card, Tableau uses a categorical palette and assigns a color to each value of the field. Categorical palettes contain distinct colors that are appropriate for fields with values that have no inherent order, such as departments or shipping methods.

To change colors for values of a field, click in the upper-right corner of the color legend. In Tableau Desktop, select **Edit Colors** from the context menu. In Tableau Server or Tableau Cloud, the Edit Colors dialog opens automatically.

Tableau Desktop version

Web version

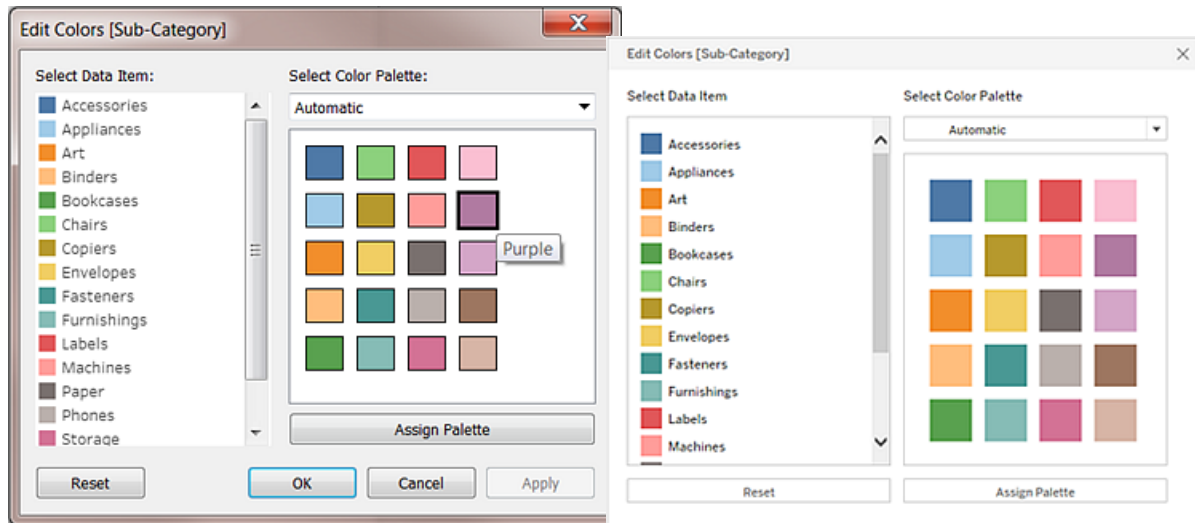

Change the color for a value

1. Click on an item on the left, under **Select Data Item**.
2. Click a new color in the palette on the right. In Tableau Desktop you can hover over a swatch to identify the color.
3. Repeat for as many values that you want to change.
4. In Tableau Desktop, click **OK** to exit the Edit Colors dialog box. In Tableau Server or Tableau Cloud, simply close the dialog box.

Select a different palette

The **Select Color Palette** drop-down list in the Edit Colors dialog box provides color palettes that you can use for discrete fields. The list contains both categorical and ordinal palettes.

At the top of the list are categorical palettes, such as *Tableau 10*. As noted above, categorical palettes are appropriate for discrete fields with no inherent order.

At the bottom of the list are ordinal palettes such as *Orange*. Ordinal palettes contain a range of related colors and are appropriate for fields that have an associated order, such as dates or numbers.

After you select a palette, click **Assign Palette** to automatically assign the new palette colors to the members in the field.

To return to the Automatic palette and the default color assignments, click **Reset** in the Edit Colors dialog box.

Quantitative Palettes

When you drop a field with continuous values on the **Marks** card (typically a measure), Tableau displays a quantitative legend with a continuous range of colors.

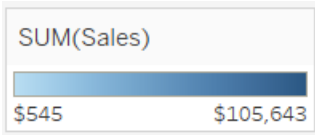

You can change the colors used in the range, the distribution of color, and other properties. To edit colors, click in the upper right of the color legend. In Tableau Desktop, select **Edit Colors** from the context menu. In Tableau Server or Tableau Cloud, the Edit Colors dialog opens automatically.

When there are both negative and positive values for the field, the default range of values will use two color ranges and the Edit Colors dialog box for the field has a square color box on either end of the range. This is known as a diverging palette.

Tableau Desktop version

Web version

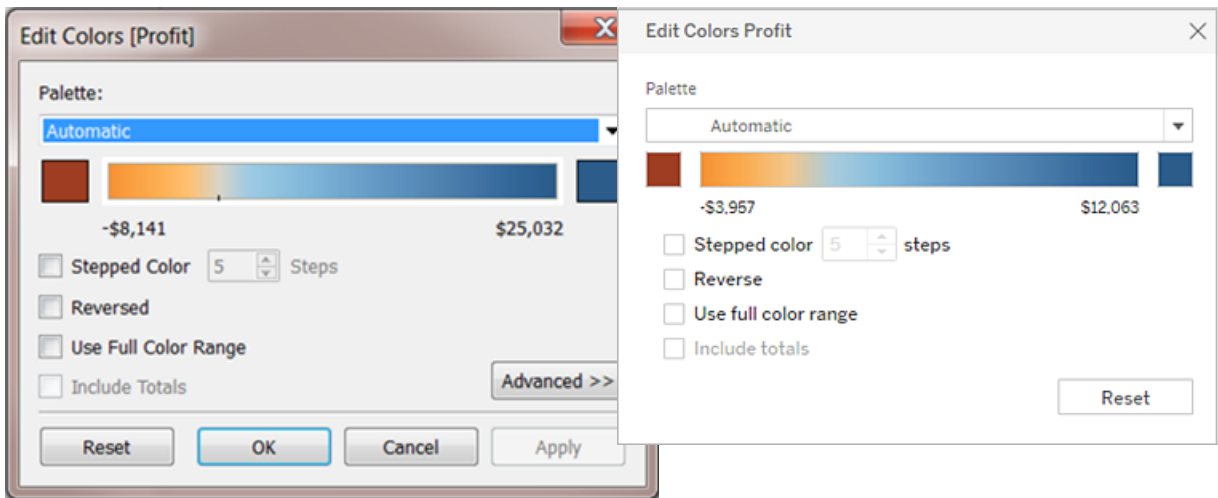

Edit Colors dialog box for a diverging palette

When all values are either positive or negative, the default range of values will use a single color range and the Edit Colors dialog box for the field has a square color box only at the right end of the range. This is known as a sequential palette.

Tableau Desktop version

Web version

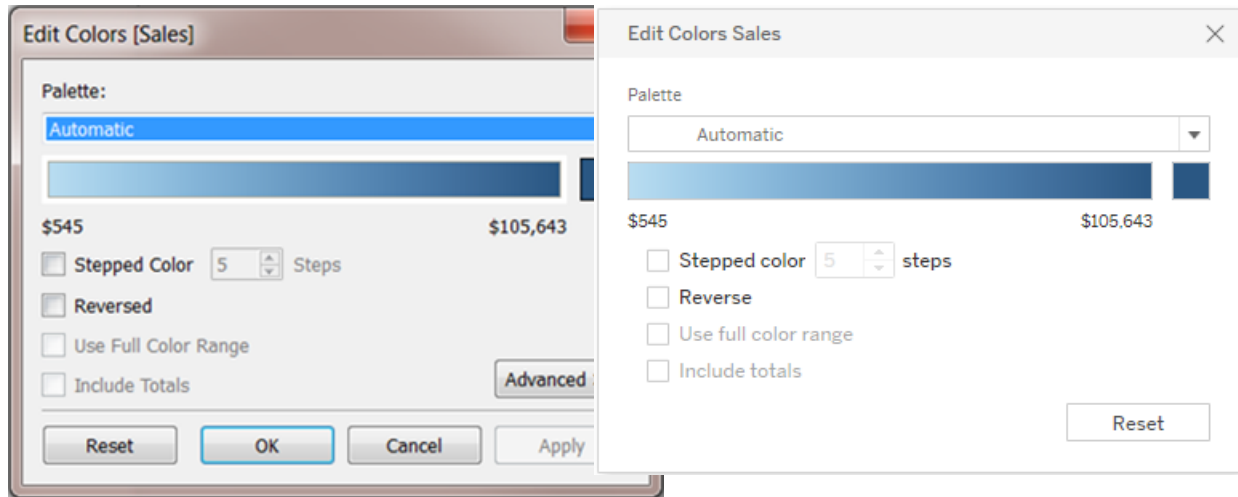
*Edit Colors dialog box for a sequential palette*

You can specify whether Tableau uses a diverging or a sequential palette for a continuous field on **Color**, and also configure the range of colors for the field's values.

The **Palette** drop-down list provides a range of color palettes from which you can choose. There are two types of quantitative palettes available for continuous fields:

- All palettes with *Diverging* in the name are diverging quantitative palettes—for example, *Orange-Blue Diverging*. You can choose a diverging palette for any continuous field—it isn't necessary for the range of values to contain both positive and negative numbers.

To change the colors for a diverging palette, click one of the square color boxes at either end of the palette spectrum. Depending on whether you are authoring in Tableau Desktop or on the web, do one of the following:

- In Tableau Desktop, in the color configuration dialog box (which is part of your computer's operating system), select a color from the color picker or enter custom values.
- In Tableau Server or Tableau Cloud, enter a custom Hex value in the **Custom Color** field. If the value isn't valid, no changes are made.
- All other palettes are sequential quantitative palettes. To change the colors for a sequential palette, click the square color box at the right end of the palette spectrum to either open the color configuration dialog box (Tableau Desktop), or enter a custom Hex value in the **Custom Color** field (Tableau Server or Tableau Cloud).

Options for quantitative palettes

The following options are available in the Edit Colors dialog box for a continuous field.

Note: Options differ where noted for Tableau Server and Tableau Cloud.

Stepped Color

Select **Stepped Color** to group values into uniform bins, where each bin is associated with a color. Use the spin control to specify how many steps (bins) to create. For example, for a range of values from 0 to 100 you could specify five steps to sort values into five bins (0-20, 20-40, etc.).

Tableau Desktop version

Web version

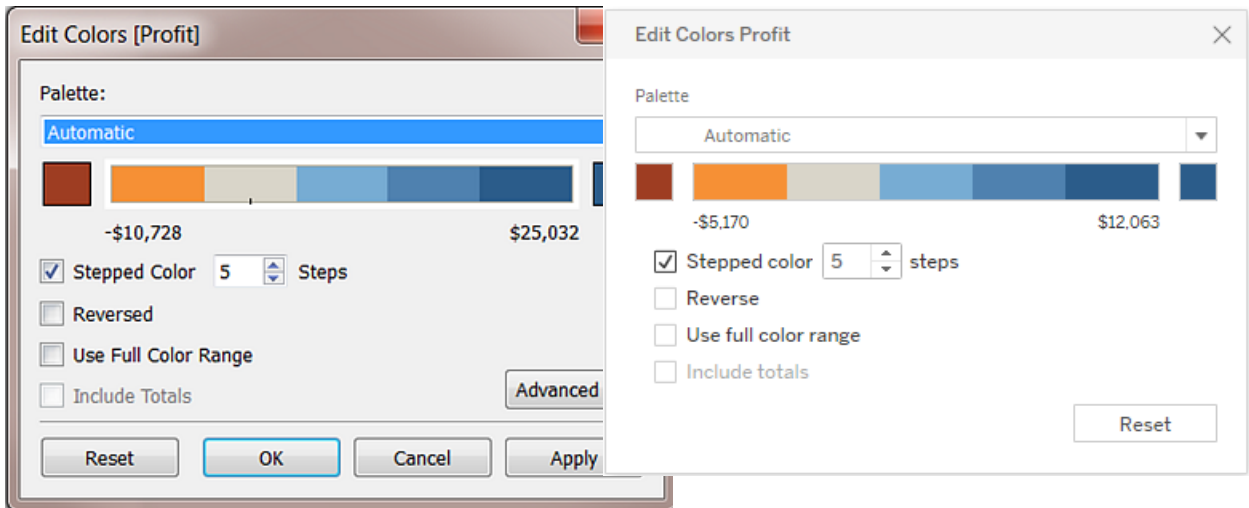

If a diverging color palette is selected, the point where the palette transitions between colors is shown on the color ramp with a small black tick mark. When the number of steps is odd, the mark is placed in the middle of the transitional step. When the number of steps is even, the mark is placed at the boundary between the steps where the color changes.

Reversed

Select **Reversed** to invert the order of colors in the range. For example, if you want lower values to have a darker intensity in a sequential palette, reverse the palette. For a diverging palette, reversing the color palette means swapping the two colors in the palette, in addition to inverting the shades within each color range.

Use Full Color Range

With a diverging (two-color) palette, you can select to **Use Full Color Range**. Tableau assigns both the starting number and the ending number a full intensity for both color ranges. So if the range is from -10 to 100, the color representing negative numbers will be adjusted to change in shade much more quickly than the color representing positive numbers. If you don't select **Use Full Color Range**, Tableau assigns the color intensity as if the range of values was from -100 to 100, so that the change in shade is the same on both sides of zero. This means there will be much less change on the negative side, where actual values only range from -10 to 0, than on the positive side, where values range from 0 to 100.

The image on the left below shows a red-green diverging color palette for values from -858 to 72,986. Without using the full color range, -858 (associated with the small box at the lower right of the chart) shows as gray, because -858 is only about 1% as far to the negative side as 72,986 is to the positive side. When the full color range is used, as in the image on the right, -858 shows as a dark red, equal in intensity to the maximum positive value.

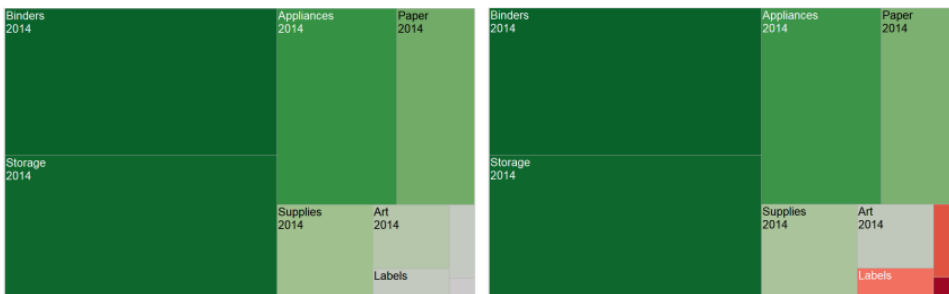

Include totals

Select **Include Totals** to include totals, sub-totals and grand totals in the color encoding. This option only applies when total values are included in the view.

Limit the color range

In Tableau Desktop, when you click **Advanced** in the Edit Colors dialog box, you can choose to specify the start, end, and center values for the range by selecting the check box and typing a new value into the field and the color ramp is adjusted accordingly.

The **Start** value is the lower limit in the range, the **End** value is the upper limit, and the **Center** value is where the neutral color is located on a diverging color palette.

Note: This option is not currently available in Tableau Server or Tableau Cloud.

Reset the color range

To return to the Automatic palette and the default color assignments, click **Reset** in the Edit Colors dialog box.

Note: If you are in web authoring mode and click **Reset**, the color palette will return to the default settings. Any options that were set in the **Advanced** option will also be reset. To undo this action, you can click **Undo** in the top menu. If your changes have already been saved, you must change the Advanced options in Tableau Desktop and republish the view.

Configure Color Effects

Click the **Color** drop down on the **Marks** card to configure additional **Color** settings not related to the actual colors shown.

Tableau Desktop version **Web version**

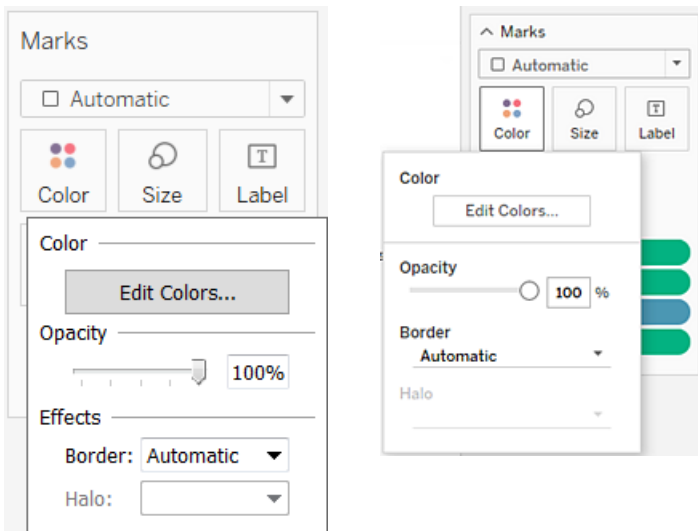

Opacity

Modify the opacity of marks by moving the slider.

Adjusting opacity is especially useful in dense scatter plots or when you are looking at data overlaying a map or background image. As you slide the slider toward the left, marks become more transparent.

Mark borders

By default, Tableau displays all marks without a border. You can turn on mark borders for all mark types except text, line, and shape. On the **Color** drop-down control, select a mark border color.

Tableau Desktop version

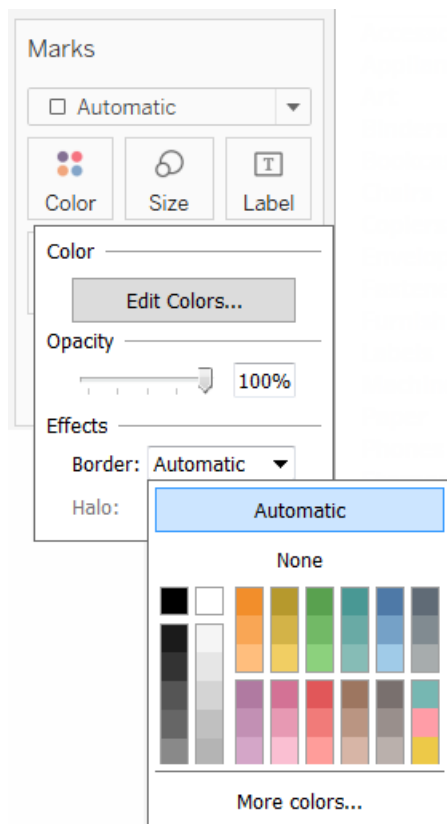

Web version

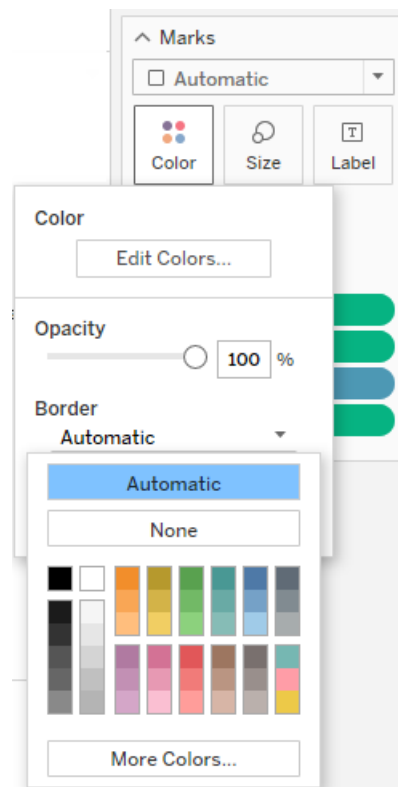

Borders can be useful for visually separating closely spaced marks. For example, the views below show a scatterplot with mark borders turned on (left) and turned off (right). When borders are turned on, marks are easier to distinguish in areas where they are tightly clustered.

Tableau Desktop and Web Authoring Help

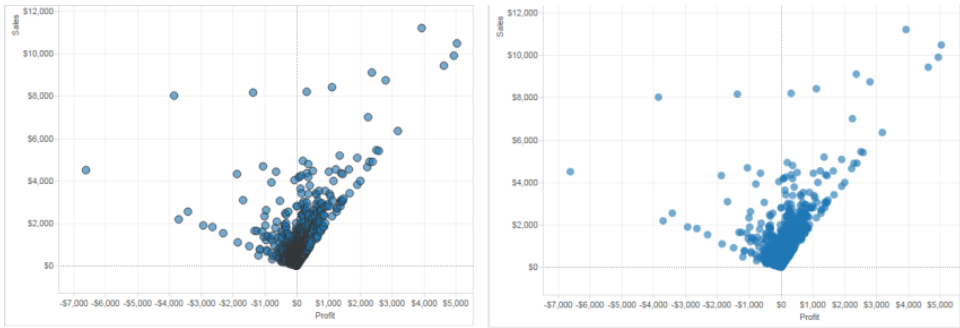

Note: You can also use the opacity setting to show the density of marks.

When you are viewing a large number of color-encoded small marks, it is usually better to leave mark borders off. Otherwise borders can dominate the view, making it difficult to see the color encoding.

For example, the views below show bars that are segmented by a large number of color-encoded dimension members. With mark borders turned on (right), some of the narrower marks are difficult to identify by color. With borders turned off (left), the marks are easy to distinguish.

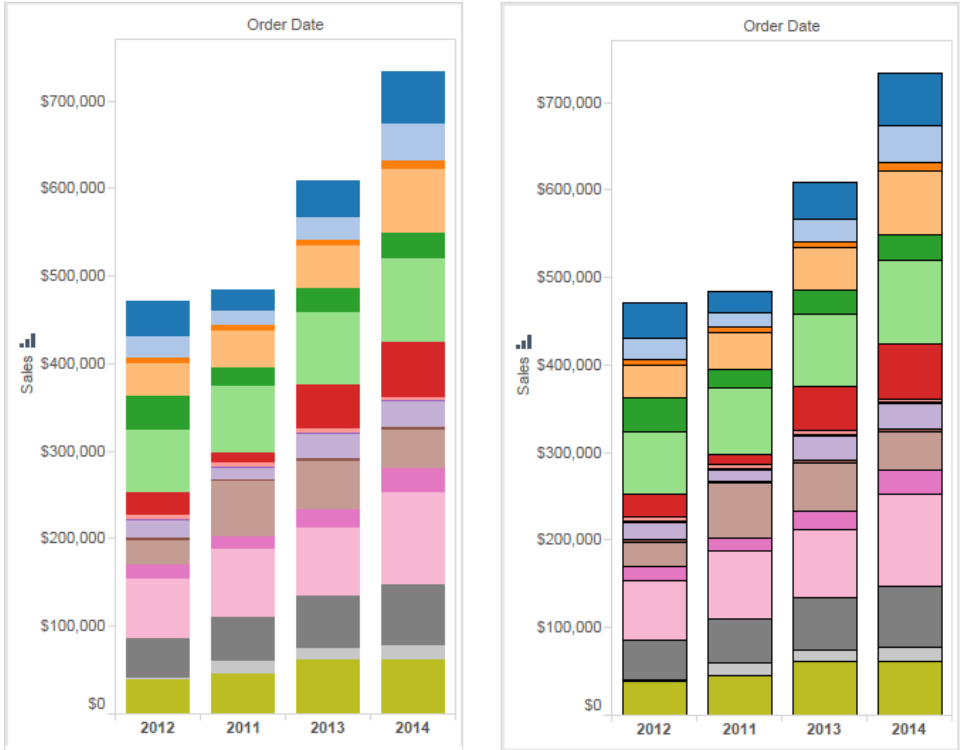

Mark halos

To make marks more visible against a background image or map, surround each mark with a solid contrasting color called a halo. Mark halos are available when you have a background image or a background map. On the **Color** drop-down control, select a mark halo color.

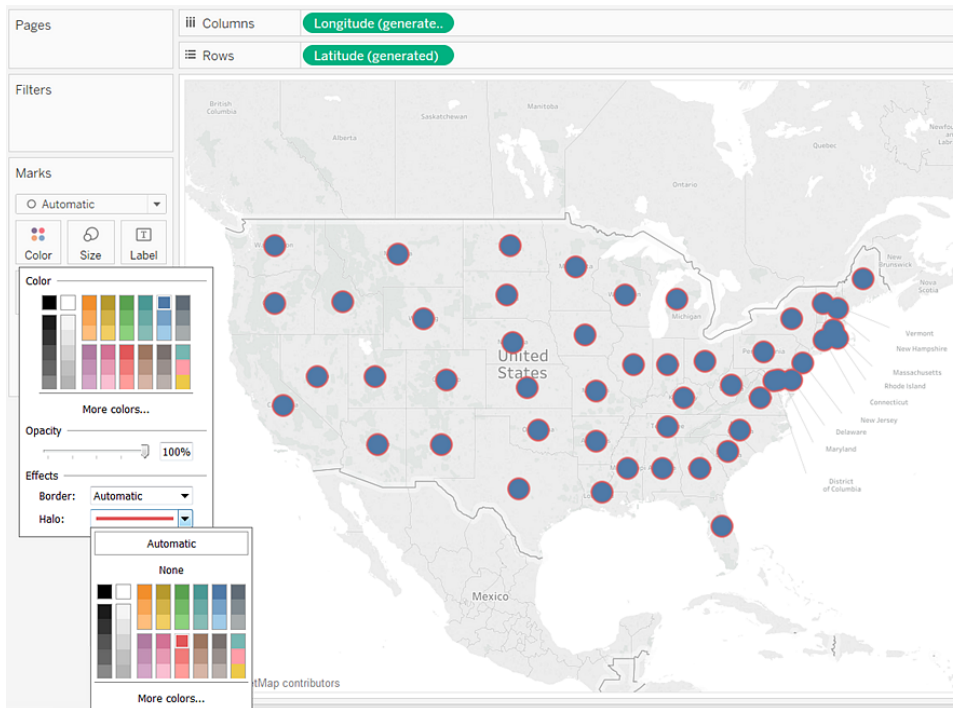

Markers

In Tableau Desktop, when you are using the Line mark type, you can add a marker effect to show or hide points along the line. You can show selected points, all points, or no points. On the **Color** drop-down control, select a marker in the **Effects** section.

Note: This option is not currently available in Tableau Server or Tableau Cloud.

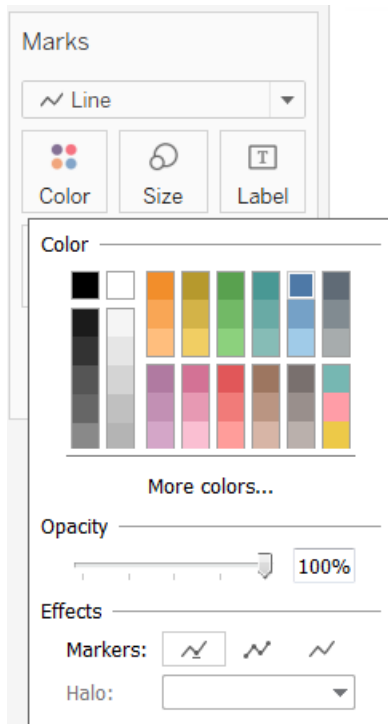

Example - Multiple Fields on Color

If you drop one field on Color and then drop a different field on Color, the second field replaces the first field. However, depending on the chart type, for example treemaps and bullet graphs, you can put multiple fields on color. You can use one field to set the hue, and the other to show gradations within that hue.

Follow these steps, using the Sample - Superstore data source, to build a treemap with two fields on Color.

1. Drag **Category** and **Sub-Category** to **Columns**.
2. Drag **Sales** to **Size** on the **Marks** card.
3. Click **Show Me** in the toolbar, then select the Treemap chart type.



Tableau moves all fields to the **Marks** card, putting **SUM(Sales)** on both **Size** and **Color**, and **Category** and **Sub-Category** on **Label**:

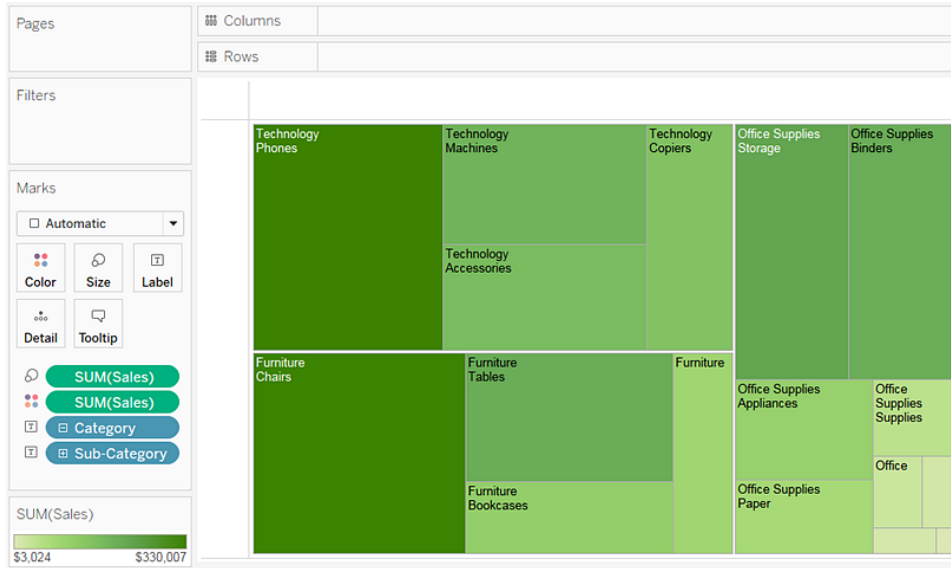

4. Click the label icon to the left of **Category** on the **Marks** card and select **Color**:

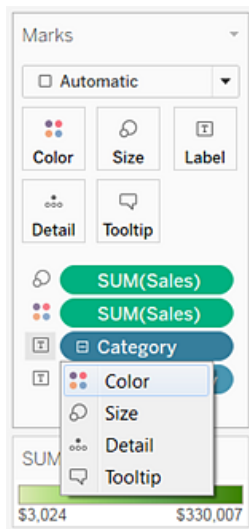

Category replaces **SUM(Sales)** on **Color**. The marks are still sized by the sum of **Sales**, but now they are colored by **Category**:

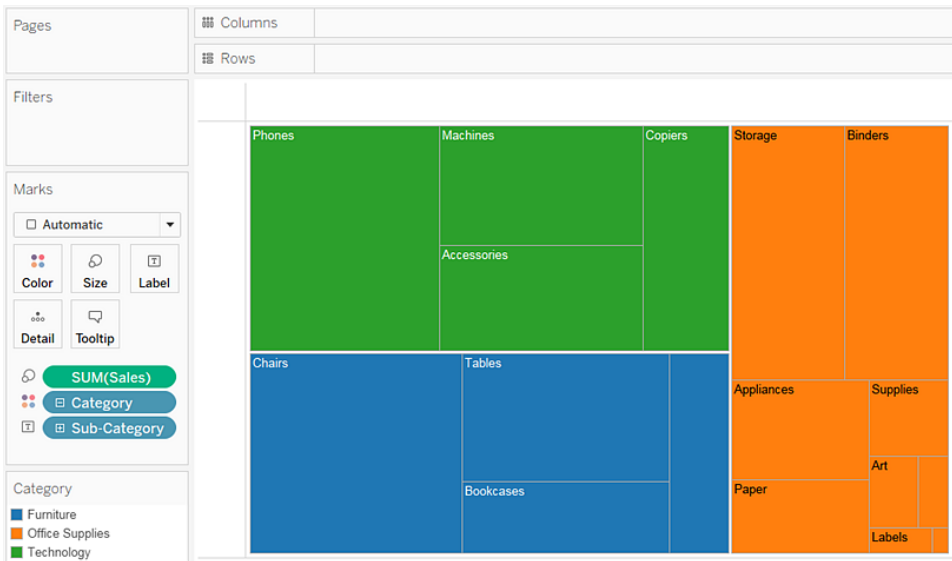

5. Click the label icon to the left of **Sub-Category** on the Marks card and select **Color**.
Tableau uses distinct, categorical colors for the first field, **Category**, and a range of sequential shades to distinguish values for the second field, **Sub-Category**:

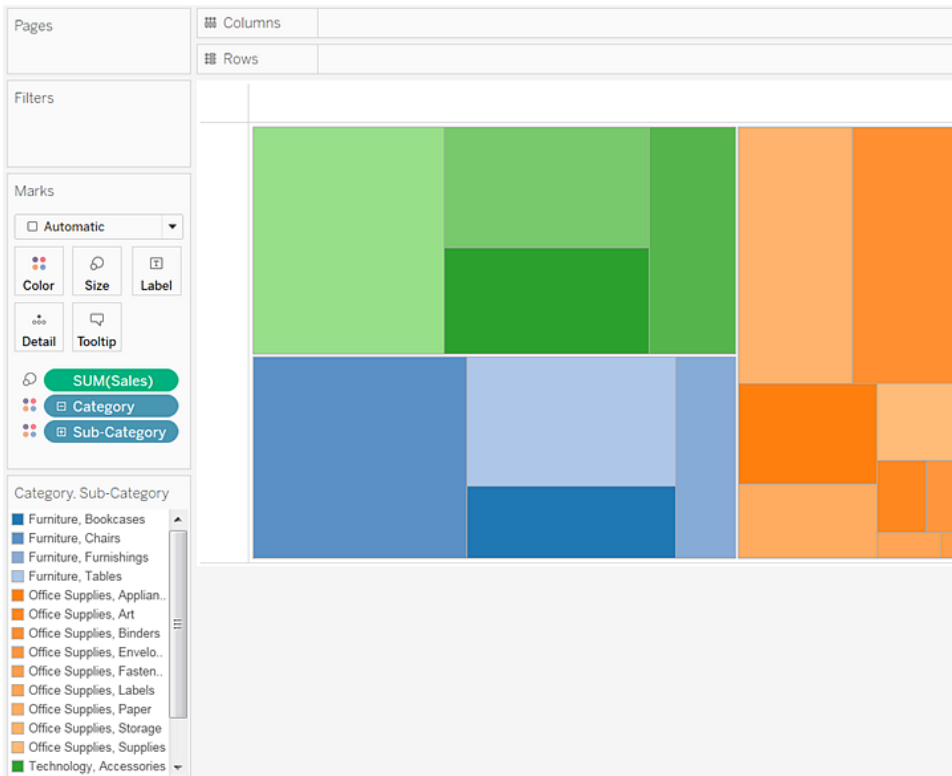

The size of the individual rectangles is still determined by **Sales**, per **Category** and **Sub-Category**.

The two fields on **Color** (**Category** and **Sub-Category**) are related within a hierarchy, so if you swap their positions on the **Marks** card, moving **Sub-Category** to be above **Category**, the effect is the same as if you had removed **Category** from the view altogether. The treemap changes to show a uniquely colored rectangle for each **Sub-Category**:

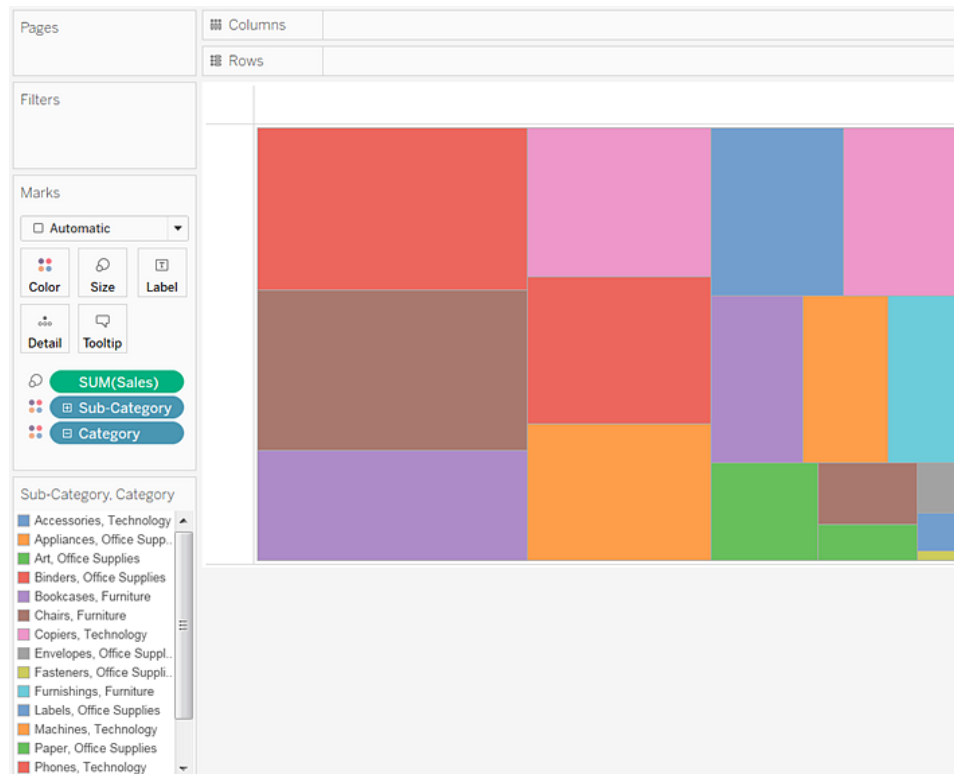

When the two fields on Color are not related within a hierarchy, you can switch the order of the fields on the Marks card so that the field that was used for categorical colors was used for sequential shades, and vice versa.

If you aren't satisfied with the colors that Tableau used, you can change them. To open the Edit Colors dialog, do one of the following:

- In Tableau Desktop, double-click the color legend.
- In Tableau Server or Tableau Cloud, click the drop-down arrow in the top right-hand corner of the legend.

6. Make the view more readable by adding **Category**, **Sub-Category**, and **Sales** to **Label**. Users can hover to see tooltips for any rectangle that is too small to show text by default.

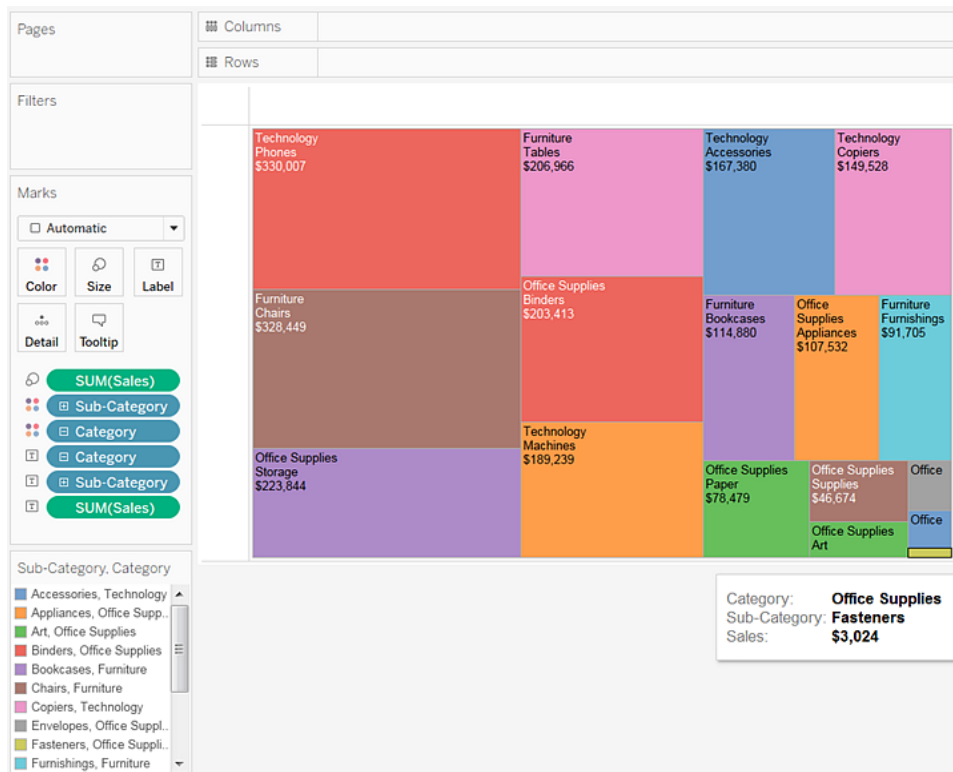

Filter and Sort Data in the View

This section describes the various ways you can filter and sort data in Tableau visualizations. Read the following articles for information on how to filter data from your visualizations and across multiple worksheets and data sources, sort data in the visualization, create nested sorts, and more.

Filter Data from Your Views

Filtering is an essential part of analyzing data. This article describes the many ways you can filter data from your view. It also describes how you can display interactive filters in the view, and format filters in the view.

Filtering Order of Operations

Before you begin filtering data in Tableau, it's important to understand the order in which Tableau executes filters in your workbook.

Tableau performs actions on your view in a very specific order; this is called the Order of Operations. Filters are executed in the following order:

1. Extract filters
2. Data source filters
3. Context filters
4. Filters on dimensions (whether on the Filters shelf or in filter cards in the view)
5. Filters on measures (whether on the Filters shelf or in filter cards in the view)

To learn more, see [Tableau's Order of Operations on page 161](#).

Note: When you drag a discrete dimension to the Filters shelf, the **Filter** dialog box offers four tabs for filtering: General, Wildcard, Condition, and Top. The settings on each of these tabs are additive starting with the General tab; what you set on each tab will affect the filter results on each tab to the right. For details on the Filter dialog box, see [Drag dimensions, measures, and date fields to the Filters shelf on page 1311](#) and [Filter categorical data \(dimensions\) on page 1312](#).

Select to keep or exclude data points in your view

You can filter individual data points (marks), or a selection of data points from your view. For example, if you have a scatter plot with outliers, you can exclude them from the view so you can better focus on the rest of the data.

To filter marks from the view, select a single mark (data point) or click and drag in the view to select several marks. On the tooltip that appears, you can:

- Select **Keep Only** to keep only the selected marks in the view.

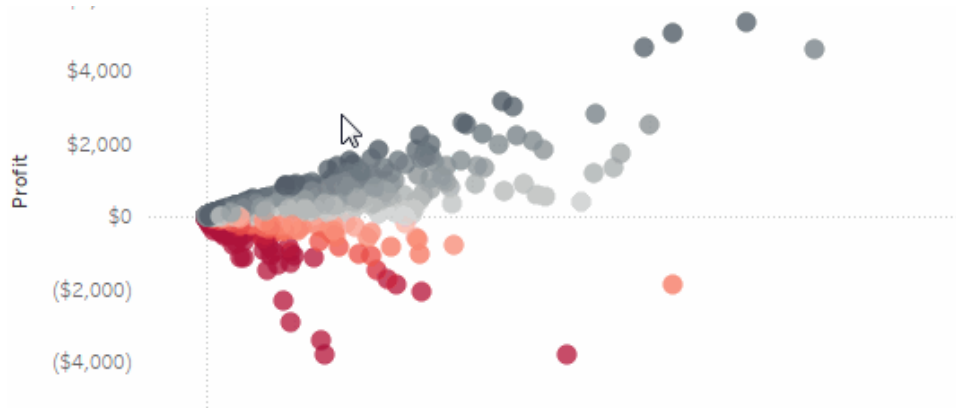

- Select **Exclude** to remove the selected marks from the view.

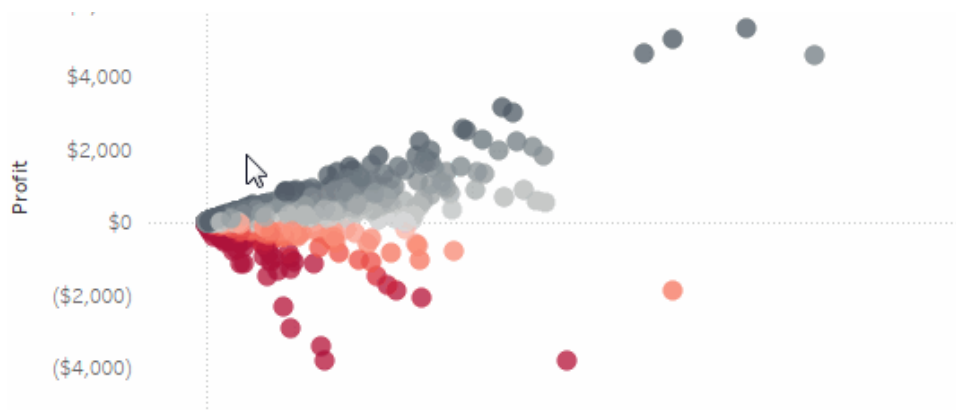

Note: These filtering options are not available if a Wildcard Match filter is already specified for the same field. See [Drag dimensions, measures, and date fields to the Filters shelf on the facing page](#) to learn more about Wildcard Match filters.

Select headers to filter data

You can also select headers to filter them from your view.

To filter entire rows or columns of data from your view, select the header in the view. On the tooltip that appears, select to **Exclude** or **Keep Only** the selected data.

When you select a table header that is part of a hierarchy, all of the next level headers are also selected. For example, the view shown below consists of two unrelated dimensions placed on the **Columns** shelf, and two levels of the same hierarchy placed on the **Rows** shelf.

The selected row headers include the Furniture member of the **Category** dimension, and the Binders and Labels members of the **Sub-category** dimension. When Furniture is selected, all members from the next (inner) level in the hierarchy are automatically selected. In this case, that means the Bookcases, Chairs, Furnishings, and Tables members.

iii Columns		Region		State							
Rows		Category		Sub-Category							
Sheet 21		Region / State									
		Central									
		North									
Category	Sub-Catego..	Illinois	Indiana	Iowa	Kansas	Michigan	Minnes..	Missouri	Nebras..	Dakota	Oklaho..
Furniture	Bookcases	\$4,283				\$810		\$213			\$342
	Chairs	\$14,563	\$6,463	\$1,408		\$13,878	\$6,079	\$61	\$564		\$3,963
	Furnishings	\$2,878	\$1,514	\$49	\$111	\$1,916	\$232	\$941	\$1,381		\$1,445
	Tables	\$6,551	\$3,519	\$1,185		\$5,717	\$1,300	\$1,722			\$2,534
Office	Appliances	\$975	\$4,160		\$82	\$4,324	\$2,844	\$3,670	\$501		\$1,491
Supplies	Art	\$930	\$389	\$147	\$163	\$1,005	\$103	\$240	\$19	\$182	\$59
	Binders	\$4,539	\$4,012	\$248	\$612	\$22,822	\$12,470	\$1,876	\$128	\$26	\$445
	Envelopes	\$384	\$890	\$13		\$310	\$31	\$71			\$407
	Fasteners	\$141	\$8	\$46	\$24	\$110	\$43		\$58	\$7	
	Labels	\$225	\$276		\$19	\$881	\$161	\$15	\$14		\$64
	Paper	\$3,456	\$1,880	\$316	\$303	\$2,011	\$320	\$302	\$333		\$197
	Storage	\$9,080	\$4,120	\$13	\$394	\$6,187	\$3,398	\$1,792	\$1,165	\$705	\$2,345
	Supplies	\$178			\$358	\$74	\$37	\$4,217	\$17		\$22
Technology	Accessories	\$5,536	\$2,279		\$92	\$4,933	\$1,520	\$1,022	\$240		\$1,817
	Copiers	\$5,920	\$18,500			\$1,150	\$550	\$5,500			
	Machines	\$3,756	\$84			\$3,411					
	Phones	\$16,772	\$5,460	\$1,154	\$757	\$6,731	\$775	\$565	\$3,046		\$4,551

Drag dimensions, measures, and date fields to the Filters shelf

Another way to create a filter is to drag a field directly from the Data pane to the Filters shelf.

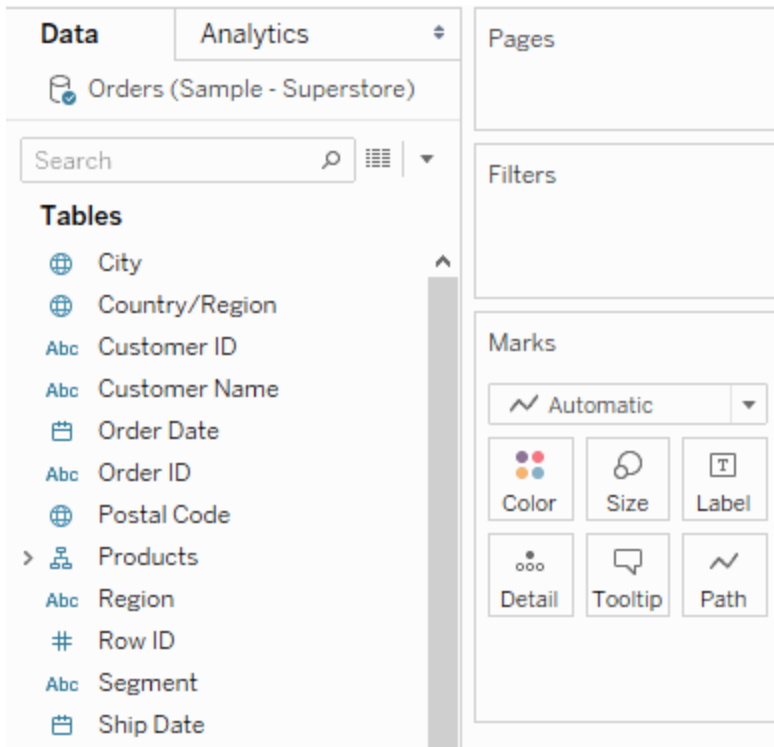

When you add a field to the Filters shelf, the Filter dialog box opens so you can define the filter. The Filter dialog box differs depending on whether you are filtering categorical data (dimensions), quantitative data (measures), or date fields.

Filter categorical data (dimensions)

Dimensions contain discrete categorical data, so filtering this type of field generally involves selecting the values to include or exclude.

When you drag a dimension from the Data pane to the Filters shelf in Tableau Desktop, the following Filter dialog box appears:

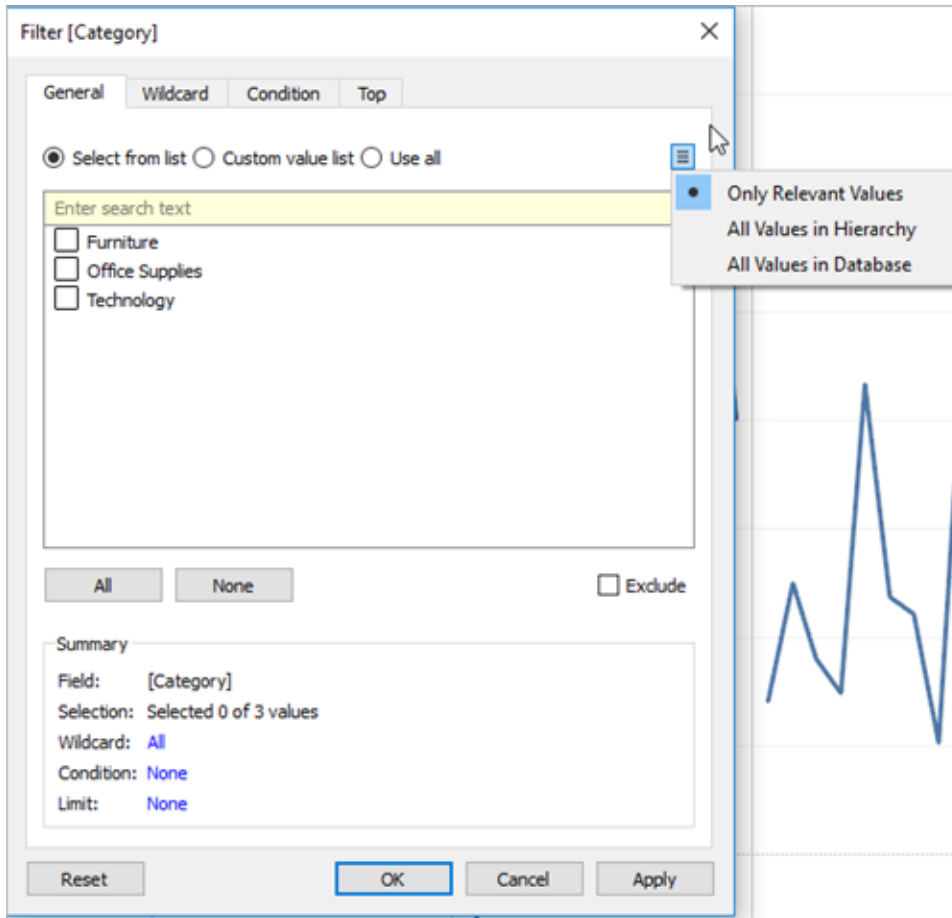

- **General:** Use the General tab to select the values you want to include or exclude.
- **Wildcard:** Use the Wildcard tab to define a pattern to filter on. For example, when filtering on email addresses you might want to only include emails from a specific domain. You can define a wildcard filter that ends with "@gmail.com" to only include Google email addresses.
- **Condition:** Use the Condition tab in the Filter dialog box to define rules to filter by. For example, in a view showing the average Unit Price for a collection of products, you may want to only show the Products that have an average unit price that is greater than or equal to \$25. You can use the built-in controls to write a condition or you can write a custom formula.
- **Top:** Use the Top tab in the Filter dialog box to define a formula that computes the data that will be included in the view. For example, in a view that shows the average Time to Ship for a collection of products, you can decide to only show the top 15 (or bottom) products by Sales. Rather than having to define a specific range for Sales (e.g., greater

than \$100,000), you can define a limit (top 15) that is relative to the other members in the field (products).

Important Note: Each tab adds additional definitions to your filter. For example, you can select to exclude values under the General tab, and also add limits under the Top tab. Selections and configurations from both tabs are applied to your filter.

At any time, you can see the definitions of your filter under Summary on the General tab.

Filter quantitative data (measures)

Measures contain quantitative data, so filtering this type of field generally involves selecting a range of values that you want to include.

When you drag a measure from the Data pane to the Filters shelf in Tableau Desktop, the following dialog box appears:

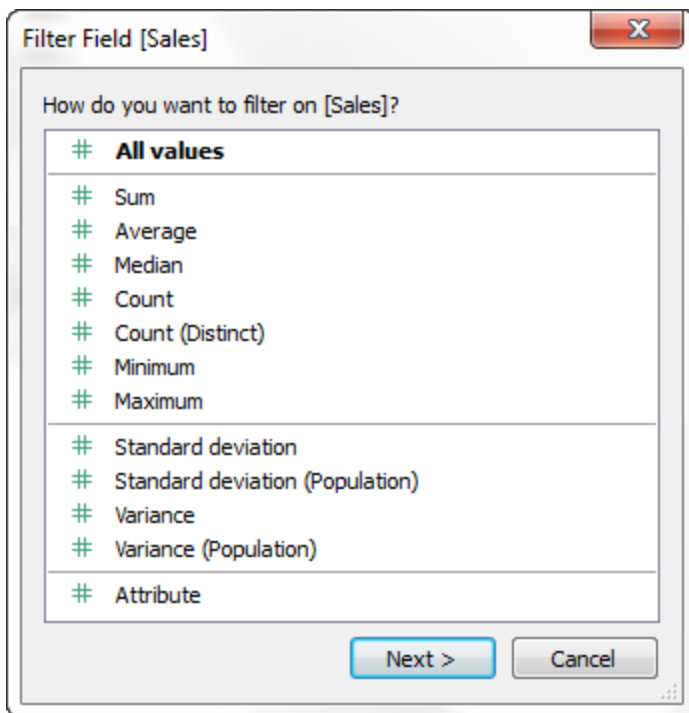

Select how you want to aggregate the field, and then click **Next**.

In the subsequent dialog box, you're given the option to create four types of quantitative filters:

Range of Values: Select the Range of Values option to specify the minimum and maximum values of the range to include in the view. The values you specify are included in the range.

At Least: Select the At Least option to include all values that are greater than or equal to a specified minimum value. This type of filter is useful when the data changes often so specifying an upper limit may not be possible.

At Most: Select the At Most option to include all values that are less than or equal to a specified maximum value. This type of filter is useful when the data changes often so specifying a lower limit may not be possible.

Special: Select the Special option to filter on Null values. Include only Null values, Non-null values, or All Values.

Note: If you have a large data source, filtering measures can lead to a significant degradation in performance. It is sometimes much more efficient to filter by creating a set containing the measure and then apply a filter to the set. For more information about creating sets, see [Create Sets on page 1092](#).

Filter dates

When you drag a date field from the Data pane to the Filters shelf in Tableau Desktop, the following Filter Field dialog box appears:

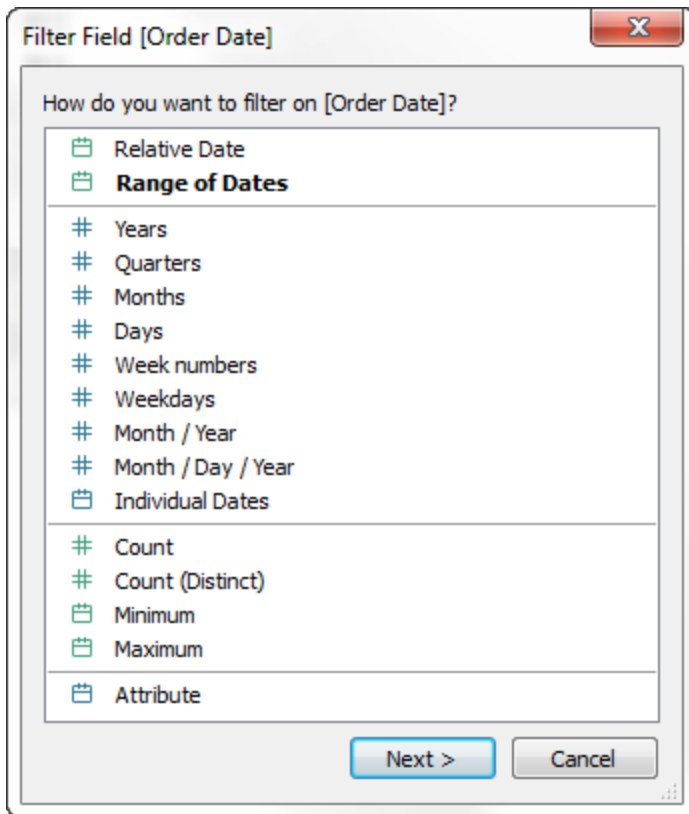

You can select whether you want to filter on a relative date; filter between a range of dates; or select discrete dates or individual dates to filter from the view.

- **Filter relative dates:** Click Relative dates to define a range of dates that updates based on the date and time you open the view. For example, you may want to see Year to Date sales, all records from the past 30 days, or bugs closed last week. Relative date filters can also be relative to a specific anchor date rather than today.
- **Filter a range of dates:** Select Range of dates to define a fixed range of dates to filter. For example, you may want to see all orders placed between March 1, 2009 and June 12, 2009.
- **Filter discrete dates:** Select a discrete date value in the dialog box if you want to include entire date levels. For example, if you select Quarters, you can choose to filter specific quarters (e.g. Q1, Q2, Q3, Q4) from your view, regardless of the year.

Latest date preset: If you want to ensure that only the most recent date in a data source is selected in the filter when the workbook is shared or opened, select a discrete date such as Month/Day/Year or Individual Dates and then, on the General tab, select **Filter to latest date value when workbook is opened**.

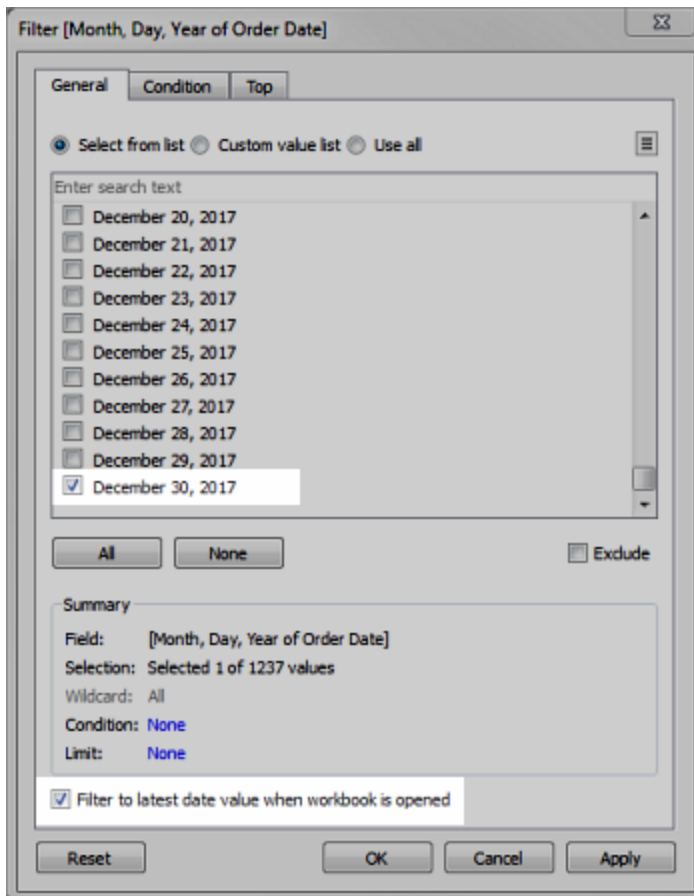
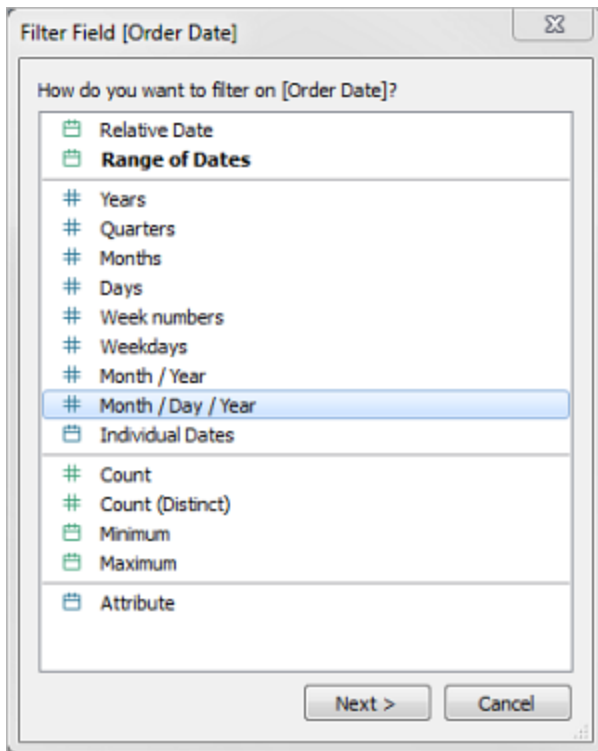

Notes: When you filter to the latest date value, this setting applies only to data source filters in a workbook.

In the order of operations, the latest date filter is global to the workbook, while context filters apply per worksheet. The latest date is determined just after the workbook opens for first use, after data source filters, but before context filters. At that point the date is set, and the latest date preset is used as a dimension filter.

If you are using additional filters in views (including relative date filters and context filters), the latest date value setting may result in an empty view with no data when those additional filters do not select data from the latest date in the database.

On Tableau Server and Tableau Cloud, presets are applied when the view first loads in the browser, but not when the browser or data is refreshed.

- **Filter individual dates:** Select Individual dates to filter specific dates from your view.
- **Additional date filter options:** When you select Relative dates or Range of dates, the Filter dialog box opens. In that dialog box, you can define a Starting date or Ending date. You can also select Special to include null dates, non-null dates, or all dates.

Filter table calculations

To create a table calculation filter, create a calculated field, and then place that field on the Filters shelf.

Filters based on table calculations do not filter out underlying data in the data set, because table calculation filters are applied last in the order of operations. This means Tableau evaluates any table calculations in the view first, and then applies table calculation filters on the results in the current view.

Apply table calculation filter to totals

When you show totals in a view and you want a table calculation filter to apply to the totals, you can select **Apply to totals** in the drop-down menu for that filter (on the Filters shelf). This option lets you decide when a table calculation filter should be applied to totals.

The screenshot shows the Tableau Desktop interface. The Columns shelf contains 'MONTH(Order Date)' and the Rows shelf contains 'Category'. The Filters shelf contains 'Order Date' and 'Latest Values Filter: True'. A context menu is open over the 'Latest Values Filter: True' filter, with the 'Apply to Totals' option selected. The main view displays a table with columns for 'Month of Order Date' (October 2012, November 2012, December 2012) and rows for 'Category' (Furniture, Office Supplies, Technology, Grand Total).

Month of Order Date			
Category	October 2012	November 2012	December 2012
Furniture			\$143,101
Office Supplies			\$83,246
Technology			\$128,363
Grand Total	\$351,247	\$256,020	\$354,709

This screenshot is similar to the first one, but the 'Apply to Totals' option in the context menu is now checked with a blue checkmark. The main view now shows a filtered table for 'December 2012'.

Month of ..	
Category	December 2012
Furniture	\$143,101
Office Supplies	\$83,246
Technology	\$128,363
Grand Total	\$354,709

This options is available when you show totals in the view, and you add a table calculation filter to the view. Select **Apply to totals** to apply the table calculation filter to all of the results in the table, including the totals.

Display interactive filters in the view

When an interactive filter is shown, you can quickly include or exclude data in the view.

Note: In web authoring, interactive filters are automatically added to the view when you drag a field to the Filters shelf.

To show a filter in the view:

1. In the view, click the field drop-down menu and select **Show Filter**.



The field is automatically added to the Filters shelf (if it is not already being filtered), and a filter card appears in the view. Interact with the card to filter your data.

Note: In Tableau Desktop, you can add an interactive filter to the view for a field that is not currently used in the view. To do so, In the Data pane, click the field drop-down menu, and then select **Show Filter**.

Set options for filter card interaction and appearance

After you show a filter, there are many different options that let you control how the filter works and appears. You can access these options by clicking the drop-down menu in the upper right corner of the filter card in the view.

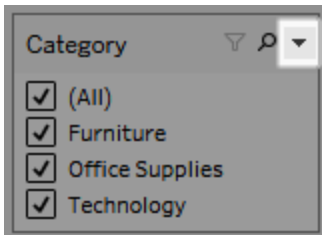

Some options are available for all types of filters, and others depend on whether you're filtering a categorical field (dimension) or a quantitative field (measure).

You can customize how filters appear in the view, in dashboards, or when published to Tableau Server or Tableau Cloud.

Here are some of the general filter card options:

- **Edit Filter** - This option opens the main Filter dialog box so you can further refine the filter by adding conditions and limits.
- **Remove Filter** - Removes the filter from the Filters shelf and removes the filter card from the view.
- **Apply to worksheets** - Allows you to specify whether the filter should apply to only the current worksheet or be shared across multiple worksheets. For more information, see [Apply Filters to Multiple Worksheets](#) on page 1342.
- **Format Filters** (Tableau Desktop only) - Customize the font and colors of all your filter cards in the view.
- **Only relevant values** - Specifies which values to show in the filter. When you select this option other filters are considered and only values that pass these filters are shown. For example, a filter on State will only show the Eastern states when a filter on Region is set.

You can use the toggle at the top of the filter card to switch between this option and the All Values in Database option.

- **All values in hierarchy** - Specifies which values to show in the filter. When you create a filter from a hierarchical field, this option is selected by default. Filter values are displayed based on relevance of the parent/child relationships in the hierarchy.
- **All values in database** - Specifies which values to show in the filter. When you select this option all values in the database are shown regardless of the other filters on the view.
- **All values in context** (Tableau Desktop only) - When one of the filters in the view is a context filter, select this option on a different filter to only display values that pass through the context filter. For more information, see [Use Context Filters on page 1337](#).
- **Include values** - When this option is selected, the selections in the filter card are included in the view.
- **Exclude values** - When this option is selected, the selections in the filter card are excluded from the view.
- **Hide Card** (Tableau Desktop only) - Hides the filter card but does not remove the filter from the Filters shelf.

Filter card modes

You can control the appearance and interaction of your filter card in the view by selecting a filter card mode.

To select a filter card mode, in the view, click the drop-down menu on the filter card and then select a mode from the list.

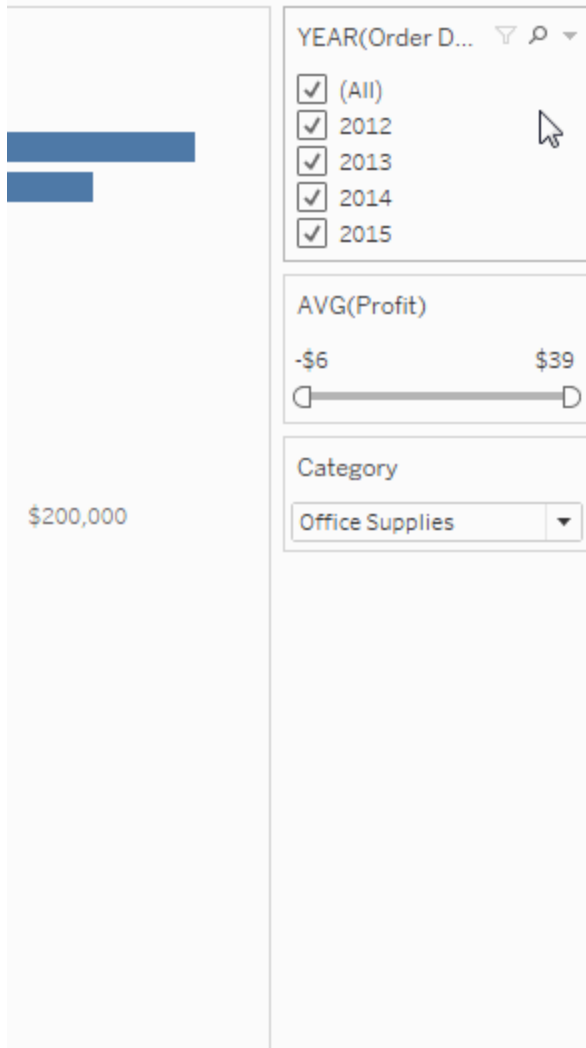

The types of filter card modes you see in the list of options depend on whether your filter is on a dimension or a measure. Below you can find brief descriptions of the types of filter card modes available for dimensions and measures.

For dimensions, you can choose from the following filter modes:

- **Single Value (List):** Displays the values of the filter as a list of radio buttons where only a single value can be selected at a time.
- **Single Value (Dropdown):** Displays the values of the filter in a drop-down list where only a single value can be selected at a time.
- **Single Value (Slider):** Displays the values of the filter along the range of a slider. Only a single value can be selected at a time. This option is useful for dimensions that have an

implicit order such as dates.

- **Multiple Values (List):** Displays the values in the filter as a list of check boxes where multiple values can be selected.
- **Multiple Values(Dropdown):** Displays the values of the filter in a drop-down list where multiple values can be selected.
- **Multiple Values (Custom List):** Displays a text box where you can type a few characters and search for the value. Alternatively, you can type or paste a list of values into the text box to create a custom list of values to include.
- **Wildcard Match:** Displays a text box where you can type a few characters. All values that match those characters are automatically selected. You can use the asterisk character as a wildcard character. For example, you can type “tab*” to select all values that begin with the letters “tab”. Pattern Match is not case sensitive. If you are using a multidimensional data source, this option is only available when filtering single level hierarchies and attributes.

For measures, you can choose from the following filter modes:

- **Range of Values/Dates:** shows the filtered values as a pair of sliders that you can adjust to include or exclude more values. Click on the upper and lower limit readouts to enter the values manually.

The darker area inside the slider range is called the data bar. It indicates the range in which data points actually lie in the view. Use this indicator to determine a filter that makes sense for the data in your data source. For example, you may filter the Sales field to only include values between \$200,000 and \$500,000 but your view only contains values between \$250,000 and \$320,000. The range of data you can see in the view is indicated by the data bar while the sliders show you the range of the filter.

- **Note:** Data bars only show in filters where the filtered field is also used in the view (e.g., on Columns, Rows, or on the Marks card, and so on) and are at the same aggregation level as the field on the Filters shelf. For example, a filter on SUM (Sales) will only display data bars if the SUM(Sales) field is used in the view. It won't show if AVG(Sales) is used in the view. Even though in both scenarios, the filtered field, Sales is used in the view; in the latter case the aggregation is different

than the aggregation of the filter.

- **At Least/Starting Date:** shows a single slider with a fixed minimum value. Use this option to create a filter using an open ended range.
- **At Most/Ending Date:** shows a slider with a fixed maximum value. Use this option to create a filter using an open ended range.
- **Relative to Now:** this option shows a control where you can define a dynamic date range that updates based on when you open the view. The option is only available for filters on continuous date fields.
- **Browse periods:** shows common date ranges such as past day, week, month, three months, one year, and five years. This option is only available for filters on continuous date fields.

Note: When you expose a filter for Measure Values or Measure Names as a single value list, selecting All will automatically convert the filter to a multiple values list. For information on Measure Values and Measure Names, see [Measure Values and Measure Names on page 1212](#).



Customize filter cards

In addition to the general filter options and the filter modes, you control how your filter appears in the worksheet, on dashboards, or when published to the web even further in Tableau Desktop.

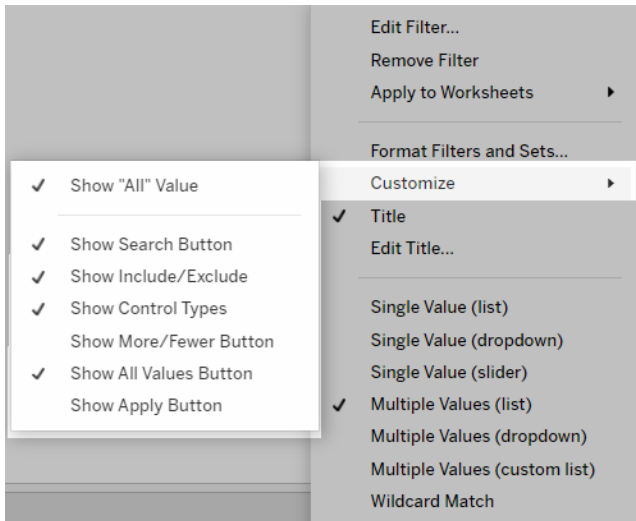
To customize filters, click the filter card drop-down menu and select **Customize**.



You can select from the following options:

- **Show “All” Value** - toggles whether to show the “All” option that displays by default in multiple values and single value lists.
- **Show Search Button** - toggles whether to show the search button at the top of the filter.
- **Show Include/Exclude** - toggles whether to show the Include Values and Exclude Values commands on the filter card menu. When shown, users can switch the filter between include and exclude modes.
- **Show Control Types** - toggles whether to let users change the type of quick filter shown. For example, when shown, a user can change a multiple values list to a compact list.
- **Show More/Fewer button** - toggles whether to show the More/Fewer button  at the top of the filter.
- **Show All Values button** - toggles whether to display the Show All Values button  on the filter card.

Whenever data is excluded in the filter, the small red "x" appears on the Show All Values button. When all values are showing, the red "x" disappears.

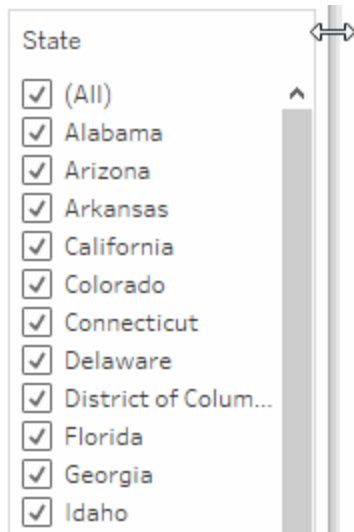

- **Show Apply Button** - toggles whether to show the Apply button at the bottom of the filter. When shown, changes to the filter are only applied after you click the button. Pending changes are indicated with a green color. This option is only available in multiple values lists and dropdowns. This options is available in web authoring.
- **Show Readouts** - controls whether the minimum and maximum values are displayed as text above a range of values. The readouts can be used to manually type a new value instead of using the sliders.
- **Show Slider** - controls whether the slider displays. When this option is cleared, the filter only displays the readouts.
- **Show Null Controls** - shows a drop-down list that lets you control how the filter handles null values. You can select from values in a range; values in a range and null values; null values only, non-null values, or all values.

Note: Not all of the above options are available for views published to Tableau Server or Tableau Cloud.

See Also

- [Filter Data from Data Sources](#) on page 910
- [Restrict Access at the Data Row Level](#) on page 3165

Filter Data Across Multiple Data Sources

While working with multiple data sources in a workbook, you might want to compare the data between them using a field they have in common. To do so, you can apply a filter across multiple primary data sources.

For example, the following dashboard shows the order quantity, average sales, and average profit for customers. It has three views. Each of the views uses a different data source as its primary data source, and those data sources all have a field in common: Customer Name. There is also a filter card in the view for Customer Name.



This is an interesting dashboard with a lot of great information, but you might want to update all of the views in the dashboard at the same time by the customer you're analyzing. For example, maybe you want to see the average sales, profit, and number of orders you've received from one of your customers, Aaron Riggs.

To do so, you can filter all three data sources on the Customer Name field.

Follow the steps below to learn how to filter data across multiple data sources.

Before you start, you might want to know the following:

Starting with version 10.0, you can filter data across multiple primary data sources. You cannot filter data across secondary data sources. Filtering data across a worksheet's secondary data source is not currently supported in Tableau Desktop.

If you want to filter data across secondary data sources, consider the following alternatives:

- Join tables that are in the same data source, instead of blending them. For more information, see [Join Your Data on page 791](#).
- Create a cross-database join if your tables are in different data sources. For more information, see [Join Your Data on page 791](#).
- Make the primary data source the secondary data source, and the secondary data source the primary. **Note:** This might not always be feasible given the level of detail you want in the final view.

Note: To ensure the data strings with mixed capitalization are treated as case-insensitive in the filter, create a calculated field using the UPPER() string function, and then create the filter relationship using that calculated field.

For more FAQs about cross data-source filters, see the [Cross data-source filtering FAQs](#) forum post in the Tableau Community.

Step 1 Define relationships between your data sources

Before you can create relationships between data sources, you must ensure that there is a common field between the data sources you're mapping. The fields do not need to be named the same in each data source, but they should have some data in common.

After you've identified the common fields, you must create relationships between them, or *map the fields* to one another.

If the fields happen to have the same name, Tableau might recognize them as related automatically. You can modify an existing relationship that was created automatically by Tableau, or create a new relationship between two fields in different data sources, by following the procedure below.

To define a relationship between your two data sources:

1. Select **Data > Edit Relationships**.
2. In the Edit Relationships dialog box, do the following:
 - Select a data source for **Primary data source**, and select a data source for **Secondary data source**.
 - Select **Custom**.
 - To define a relationship between fields that have different names, click **Add**.
To edit an existing relationship, select the fields on the right, and then click **Edit**.
3. In the Add/Edit Field Mapping dialog box, do the following, and then click **OK**:
 - Under **Primary data source field**, select a field.
 - Under **Secondary data source field**, select a field with similar data to the field you selected for the primary data source.

For more information about editing relationships, see [Blend Your Data on page 816](#).

Note: After you define your relationships, you do not need to enable blends (that is, you do not have to click the link icon in the **Data** pane) to filter across your data sources.

For more information about the difference between primary and secondary data sources, see [Blend Your Data on page 816](#).

Step 2 Add a filter to the view

After you have defined relationships between your data sources, go to one of your worksheets and drag a dimension to the **Filters** shelf. Then select to include or exclude data from the view. For more information about filtering your data, see [Filter Data from Your Views on page 1308](#).

Optional Step: Display a filter card in the view. Right-click the field on the **Filters** shelf and select **Show filter**. A filter card for that field appears in the view.

For more information about filter cards (previously known as quick filters), see [Display interactive filters in the view on page 1319](#).

Step 3 Apply the filter to your worksheets

After you set up your filter, you can apply that filter to all the worksheets in your workbook that use related data sources, or you can apply it to selected worksheets.

- To apply the filter to all worksheets that use related data sources, right-click the field on the **Filters** shelf and select **Apply to worksheets > All using related data sources**.

The Customer Name field is added to the **Filters** shelf on every worksheet that uses a related data source. An icon is added next to the field on the **Filters** shelf, indicating that the filter is being applied to multiple data sources.

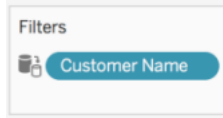

If you hover over the field on the Filters shelf in any worksheet, you can find details about the type of filter, the source field for the filter, and the other sheets the filter applies to.

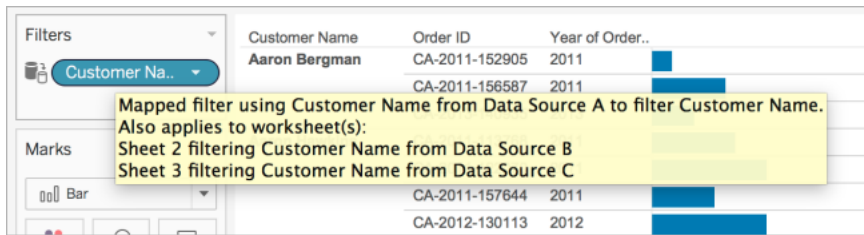

- To apply the filter to selected worksheets, right-click the field on the **Filters** shelf and select **Apply to worksheets > Selected worksheets**.

The Customer Name field is added to the **Filters** shelf on the worksheets you selected. An icon is added next to the field on the **Filters** shelf to indicate that the filter is being applied to select worksheets.

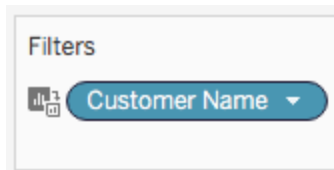

Now, on the dashboard, when you filter the view down to Aaron Riggs, all three views update and you can see that Aaron made orders in 2010, 2011, and 2013, and spent an average of 3,700 USD. The average profit for these orders was approximately 1,000 USD.

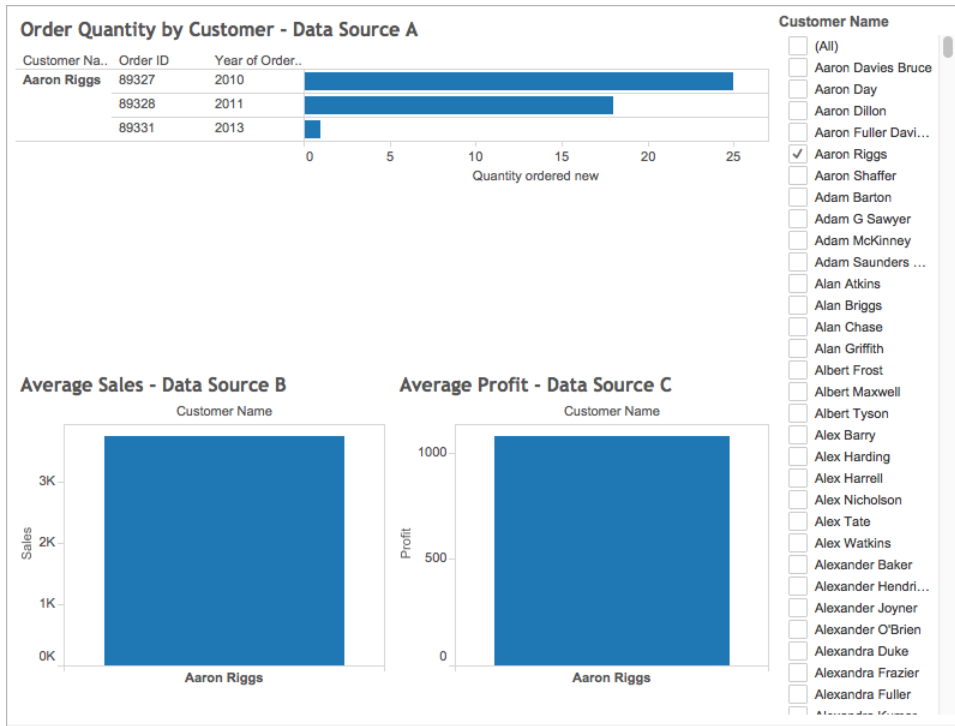

Source fields and target fields

When you apply a filter to multiple data sources, you create a source field and one or more target fields. Both source fields and target fields appear on the **Filter** shelf in their respective worksheets.

The source field is the field you're filtering with.

The target field on any given worksheet is a field from another data source that is related to the source field. This is the field that is actually being filtered on that worksheet.

The source field determines the data that is included or excluded from the target fields. For example, let's say you have three worksheets that use three separate data sources (A, B, and C) as their primary data source. Each of the data sources has a field in common (Fruit), and the data is as follows:



Fruit from data source A	Fruit from data source B	Fruit from data source C
Apples	Apples	Apples
Oranges	Grapefruit	Grapefruit



Bananas	Oranges	Oranges
	Pears	Tomatoes
		Bananas

If the Fruit field from data source A is the source field for the cross data source filter, then the data that appears for the target fields is as follows:

Fruit from data source A - Source field	Fruit from data source B - Target field	Fruit from data source C - Target field
Apples	Apples	Apples
Oranges	Oranges	Oranges
Bananas		Bananas

Any data that does not match the data in the source field is excluded from the target fields, and will not appear in your worksheets or in your filter cards.

On the Filters shelf, source fields are indicated with either a  icon when the source field applies to all worksheets with a related data source, or a  icon when it applies to select worksheets.

Target fields are indicated with a  icon on the field on the Filters shelf. They are also indicated with a  or  icon next to the field on the Filters shelf.

Create Relative Date Filters

Relative date filters dynamically update to show a time period relative to when you open the view, such as the current week, the year to date, or the past 10 days. Relative date filters make it easy to create views that always show the most recent data.

Step 1: Drag a date field to the filter shelf

Drag a date field from the **Data** pane to the Filters shelf. In the Filter Field dialog box, click **Relative Date**, and then click **Next**.

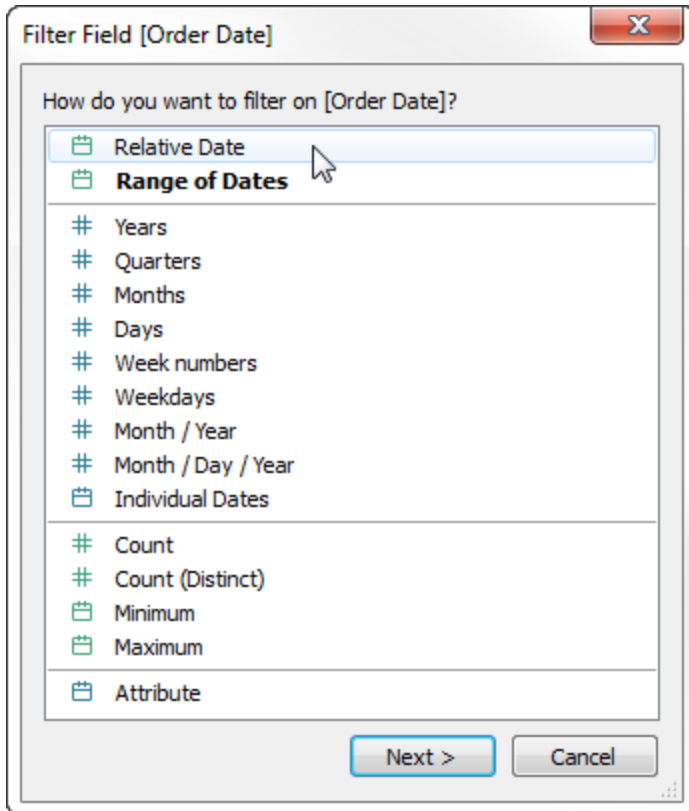

Step 2: Select a time unit

In the Filter dialog box, click **Relative dates**, and then select the unit of time for the filter. For example, to show only the last three weeks, select **Weeks**.

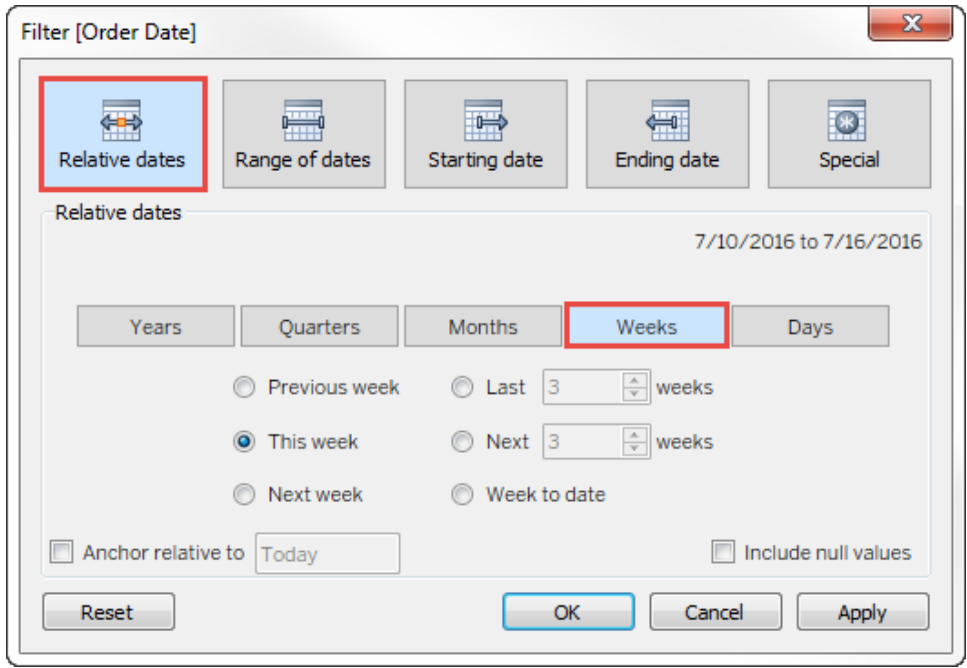

Step 3: Define the date period

Use the options in the lower part of the Filter dialog box to specify which date period to include in the view. For example, to show the last three weeks, click **Last**, and then enter the number **3**.

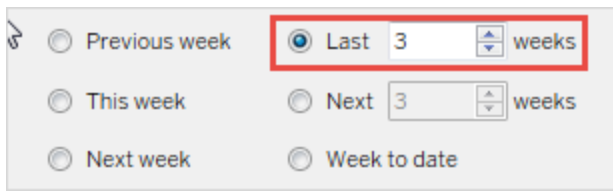

The specific range of time that you have selected is displayed in the upper right of the Filter dialog box.

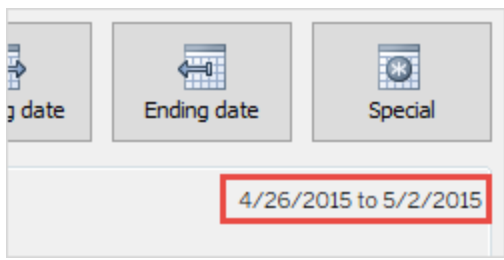

Note: “Last” date periods include the complete current unit of time, even if some dates haven't occurred yet. For example, if you select the last month and the current date is January 7th, Tableau will display dates for January 1st through January 31st.

Step 4: Watch the view update

The view will now update to always show the relative date range you've chosen.

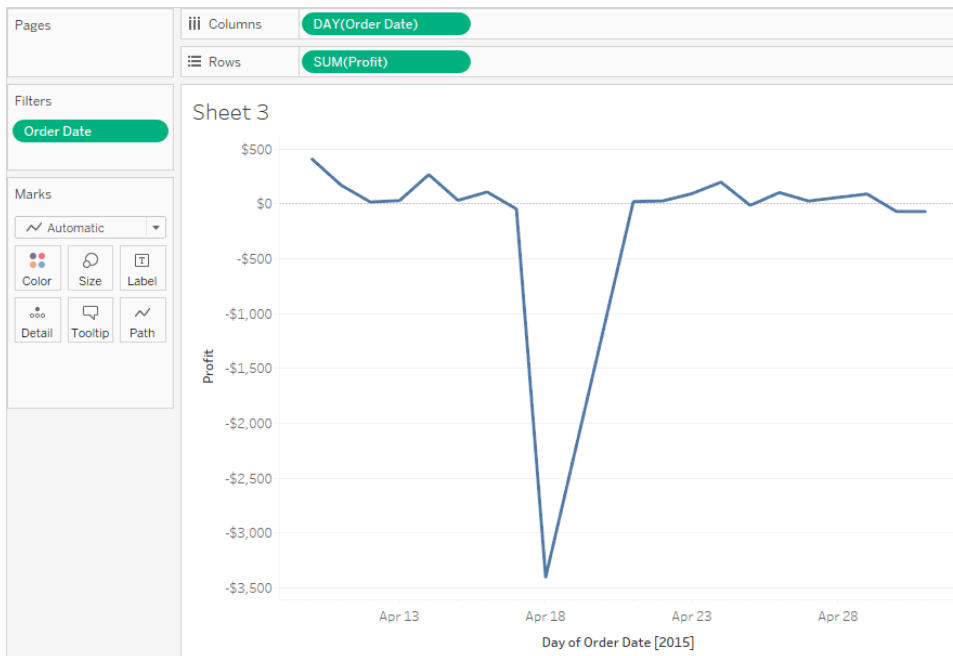

Once created, you can show relative date filters in the view as cards. See [Display interactive filters in the view](#) on page 1319. To confirm the specific date range, users can click the menu on the filter card:

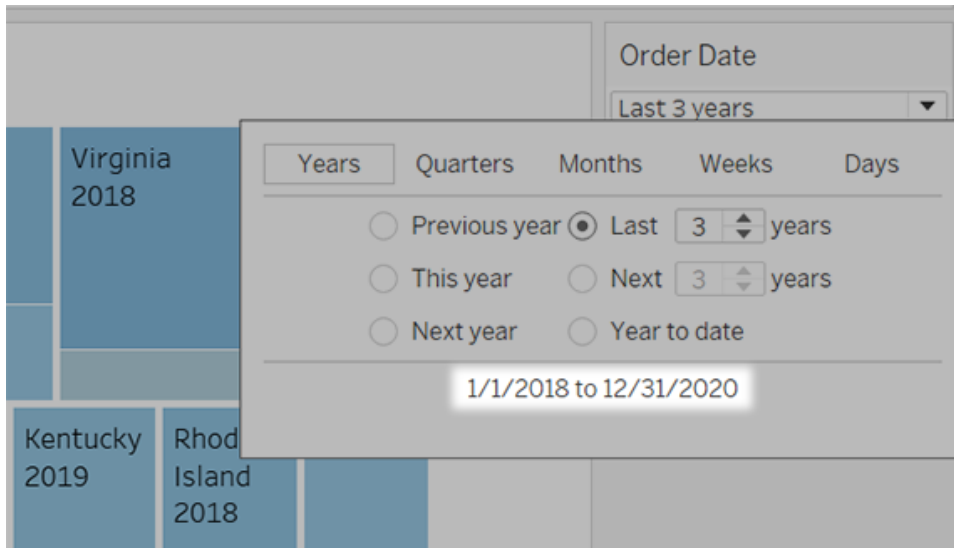

Use Context Filters

By default, all filters that you set in Tableau are computed independently. That is, each filter accesses all rows in your data source without regard to other filters. However, you can set one or more categorical filters as context filters for the view. You can think of a context filter as being an independent filter. Any other filters that you set are defined as dependent filters because they process only the data that passes through the context filter.

You may create a context filter to:

- Force a filter to be carried out first.
- Create a dependent numerical or top N filter. You can set a context filter to include only the data of interest, and then set a numerical or a top N filter.

For example, suppose you're in charge of breakfast products for a large grocery chain. Your task is to find the top 10 breakfast products by profitability for all stores. If the data source is very large, you can set a context filter to include only breakfast products. Then you can create a top 10 filter by profit as a dependent filter, which would process only the data that passes through the context filter.

Create Context Filters

To create a context filter, select **Add to Context** from the context menu of an existing categorical filter. The context is computed once to generate the view. All other filters are then computed relative to the context. Context filters:

- Appear at the top of the Filters shelf.
- Are identified by a gray color on the Filters shelf.
- Cannot be rearranged on the shelf.

As shown below, the **Ship Mode** dimension is set to be the context for a view. The **Region** filter is computed using only the data that passes through **Ship Mode**.

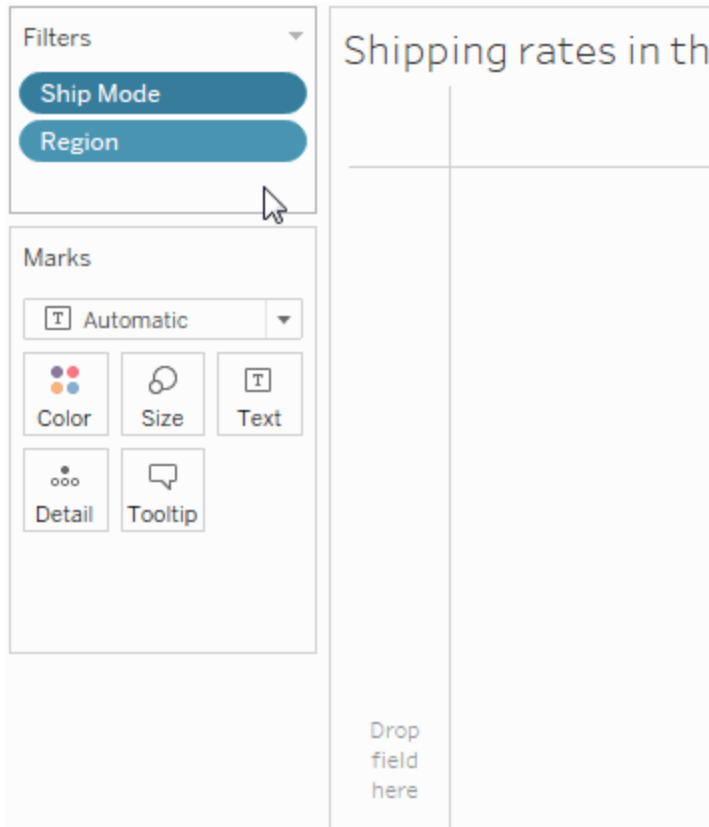

You can modify a context filter by:

- Removing the field from the Filters shelf – If other context filters remain on the shelf, a new context is computed.
- Editing the filter – A new context is computed each time you edit a context filter.
- Selecting **Remove from Context** – The filter remains on the shelf as a standard filter. If other context filters remain on the shelf, a new context is computed.

Speed up Context Filters

To improve performance of context filters, especially on large data sources, follow these general rules.

- Using a single context filter that significantly reduces the size of the data set is much better than applying many context filters.
- Complete all of your data modeling before creating a context. Changes in the data model, such as converting dimensions to measures, require recomputing the context.
- Set the necessary filters for the context and create the context before adding fields to other shelves. Doing this work first makes the queries that are run when you drop fields on other shelves much faster.
- If you want to set a context filter on a date you can use a continuous date. However, using date bins like YEAR(date) or context filters on discrete dates are very effective.

Note: Context filters can adversely affect any query performance improvements when you use the **Assume Referential Integrity** option in the Data menu of the data source. For more information, see [Assuming Referential Integrity for Joins](#) on page 807.

Example: Create Context Filters

This example walks you through how to create a context filter. First you'll filter a view to show the top 10 products by sales. Then you'll create a context filter on product category so you can see the top 10 furniture products.

1. Use the **Sample - Superstore** data source to create the initial view shown below. The view shows the sales for all sub-categories, sorted with the highest sale at the top.

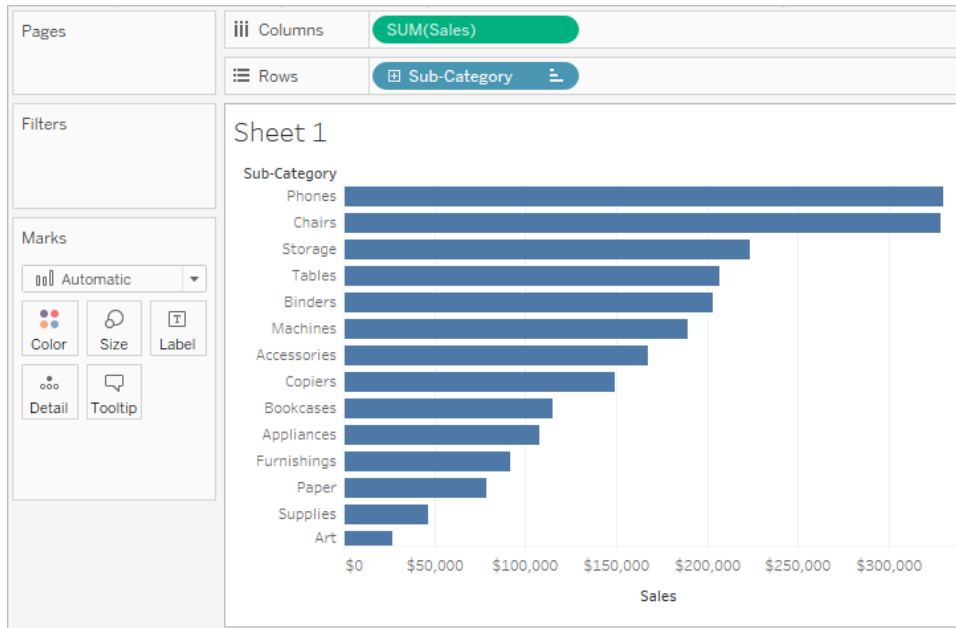

- Now create a Top 10 filter to just show the top selling products. You can create this filter by dragging the **Sub-Category** field to the Filters shelf. In the Filter dialog box, switch to the **Top** tab and define a filter that is Top 10 by Sum of Sales. See [Filter Data from Your Views on page 1308](#) to learn more about defining a Top N filter.

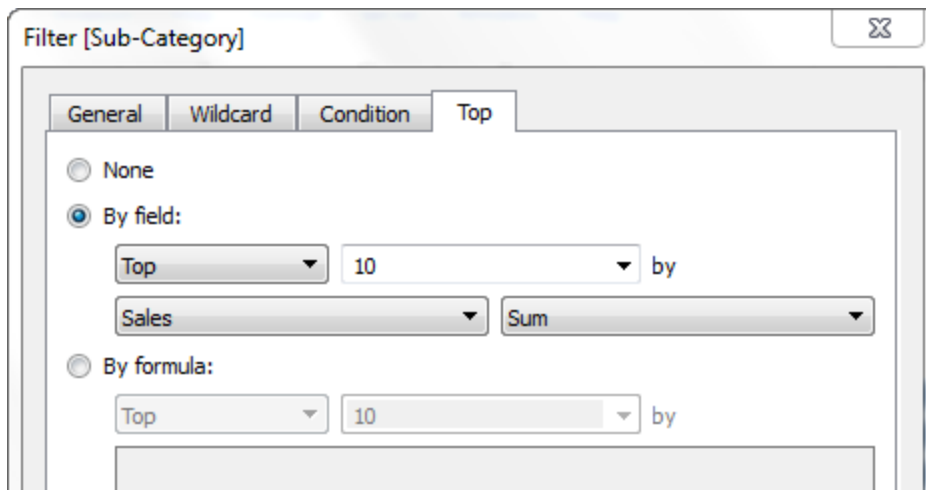

- When you click **OK**, you'll see that the view is filtered to show the top 10 product sub-categories in terms of sales.

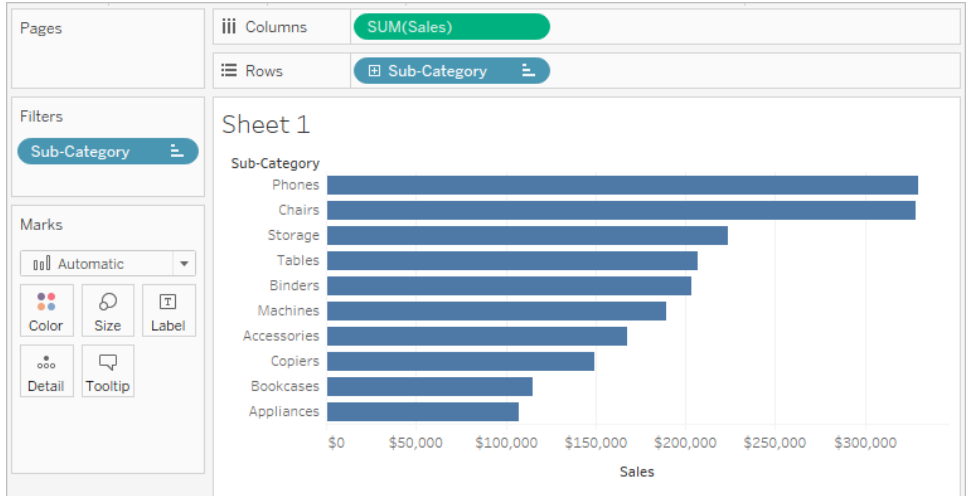

- Now, let's add another filter to show only furniture products. Drag the **Category** field to the Filters shelf and select only **Furniture**. When finished, click **OK**.

The view is filtered but instead of 10 products, it now shows 3. This is because by default all filters are evaluated separately and the view shows the intersection of the results. So this view shows that three of the top 10 overall products are furniture products.

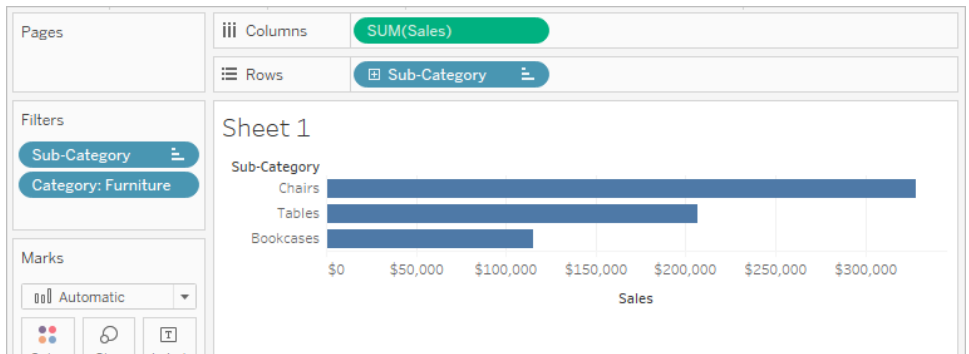

- To find out what the top 10 furniture products are we need to make the Category filter a context filter. Right-click the field on the Filters shelf and select **Add to Context**.
- The filter is marked as a context filter and the view updates to show the top four furniture products. Why not 10? Because only four of the sub-categories contain furniture. But we now know that the Top 10 filter is being evaluated on the results of that context.

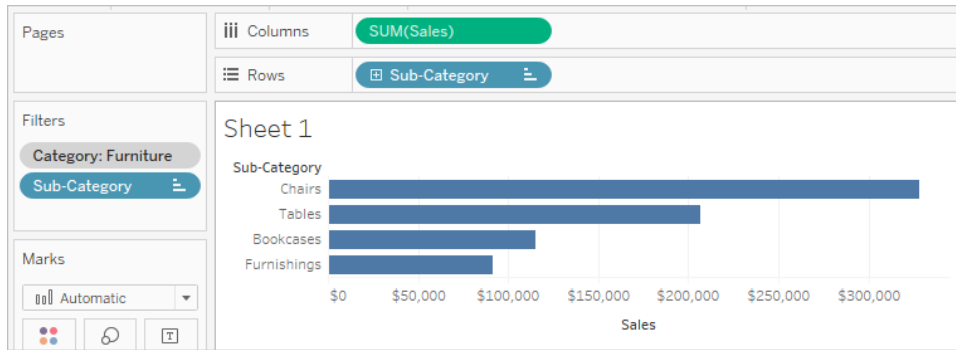

Apply Filters to Multiple Worksheets

When you add a filter to a worksheet, by default it applies to the current worksheet. Sometimes, however, you might want to apply the filter to other worksheets in the workbook.

You can select specific worksheets to apply the filter to or apply it globally to all worksheets that use the same data source or related data sources. For example, you might have a filter that only includes a specific region or product of interest. Rather than adding this filter every time you create a new worksheet, you can simply create the filter once and then apply it to multiple worksheets.

For examples of global filters, see [The Global Filters Tab](#) on [Ryan Sleeper's](#) website, and [Dashboard Design: Adding Interactivity](#) on the [Interworks blog](#).

Apply filters to all worksheets that use a related primary data source

This option applies the filter to all worksheets that use related data sources as their primary data source.

Note: To apply a filter to worksheets that use a related primary data source in web authoring, relationships between the data sources must be set up in Tableau Desktop, and then published to the web.

For more information, see [Filter Data Across Multiple Data Sources](#) on page 1328.

To apply a filter to all worksheets using a related primary data source:

- On the Filters shelf, right-click the field and select **Apply to Worksheets > All Using Related Data Sources**.

Filters that use this option are global across the workbook.

Filters that apply to all related data sources are marked with an icon. The filter is automatically created on any existing worksheets, and on any new worksheets you create that use a related data source.

Any changes you make to the filter affects all of those worksheets.

Apply filters to all worksheets that use the current primary data source

This option applies the filter to all worksheets that use the current worksheet's primary data source as their primary data source.

To apply a filter to all worksheets using the current primary data source:

- On the Filters shelf, right-click the field and select **Apply to Worksheets > All Using This Data Source**.

Filters that use this option are global across the workbook.

Filters that apply to all worksheets are marked with a data source icon . The filter is automatically created on any new worksheets you create after you drag a field to the view.

Any changes you make to the filter affects all of those worksheets.

Note: If you are blending multiple data sources in a view, **All Using This Data Source** adds the filter to all sheets that use the same primary data source in the current sheet. The sheets that the filter gets applied to is not based on the filter field's data source.

Apply filters to select worksheets

This option opens a dialog box where you can select from a list of worksheets that use the same data source or related data sources.

To apply a filter to select worksheets:

- On the Filters shelf, right-click the field and select **Apply to Worksheets > Selected Worksheets**.
- In the Apply Filter to Worksheets dialog box, select the worksheets that you want to apply the filter. If any of the sheets already contain a filter on the same field, the dialog box will provide details about the filter.

If you select the sheet, the current filter will override any existing filter selections.

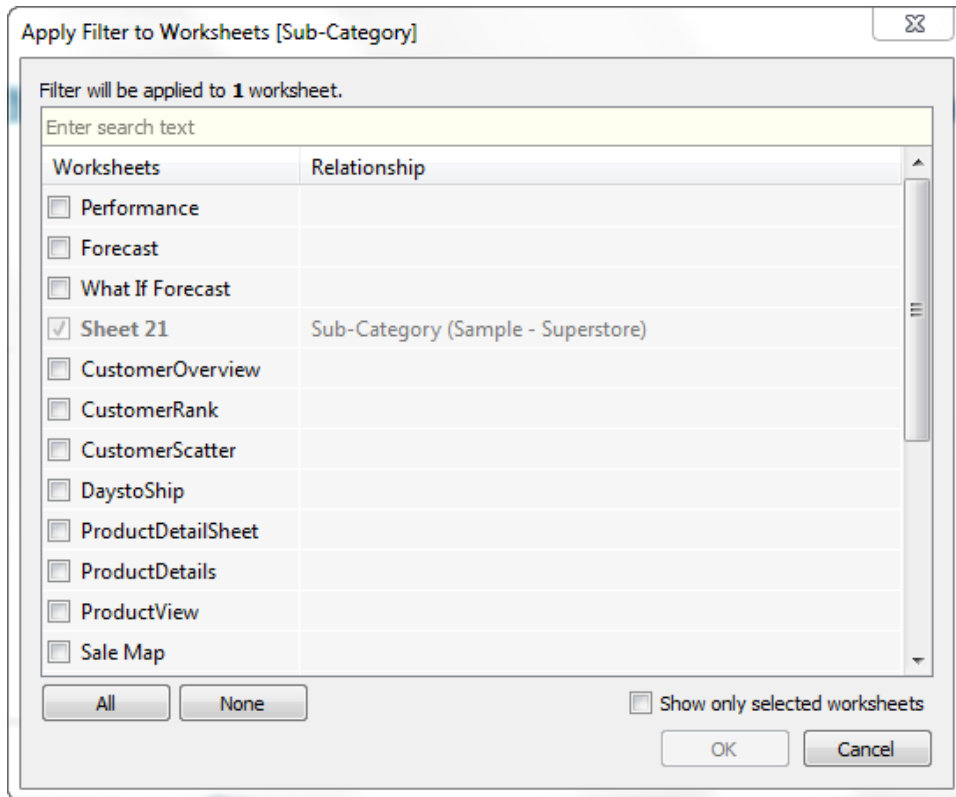

Filters that apply to a selection of worksheets are marked with the worksheet icon . Any changes you make to the filter affect all of the selected worksheets.

Apply filters to the current worksheet only

This option only applies to the current worksheet. This option is selected by default when you create new filters. Filters that are local to the current worksheet are shown without any additional icons.

To apply a filter to the current worksheet only:

- On the Filters shelf, right-click the field and select **Apply to Worksheets > Only This Worksheet**.

If you apply a filter to all worksheets or selected worksheets and then change the setting to apply the filter to just the current worksheet, the filters are not removed from all other worksheets.

Rather, the filters are disconnected and they are all made local to their respective worksheets. You can go to each worksheet and remove the filter or modify selections.

Filter all worksheets on a dashboard

This option applies the filter to all worksheets in the dashboard that use the same data source or related data sources as their primary data source.

To filter all worksheets on a dashboard:

- In a dashboard, click the drop-down menu on a filter card and select **Apply to Worksheets > Selected worksheets**.
- In the Apply Filter to Worksheets dialog box, click **All on dashboard**, and then click **OK**.

Note: In previous versions of Tableau Desktop, the **All Using This Data Source** option was called Make Global and the **Only This Worksheet** option was Make Local.

Sort Data in a Visualization

There are many ways to sort data in Tableau. When viewing a visualization, data can be sorted using single click options from an axis, header, or field label. In the authoring environment, additional sorting options include sorting manually in headers and legends, using the toolbar sort icons, or sorting from the sort menu.

Tip: Download the [workbook](#) used in these examples to explore on your own (requires Tableau Desktop).

Quickly sort from an axis, header, or field label

There are multiple ways to sort a visualization with single click sort buttons.

In all cases, **one** click sorts descending, **two** clicks sorts ascending, and **three** clicks clear the sort.

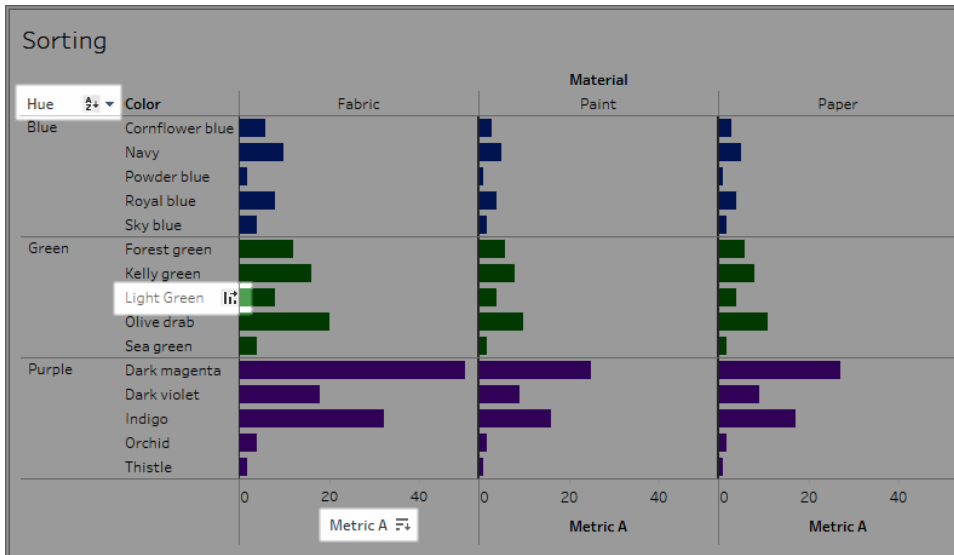

Sort icons displayed on an axis (Metric A), header (Light Green) or field label (Hue)

The sort updates if the underlying data changes.

Sort from an axis

1. Hover over a numerical axis to bring up the sort icon.
2. Click the icon to sort.

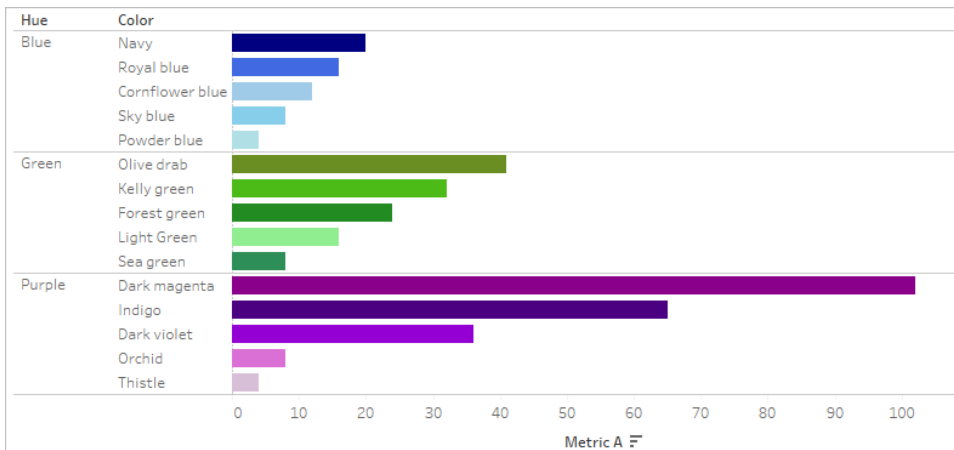

Sort: Color is sorted within each Hue in decreasing order of Metric A

In this example, the sort is applied to **Color** (sorting the rows) based on the values for **Metric A**. If there are hierarchical dimensions like above, the sort is applied to the innermost dimension. In this example, **Color** will sort inside **Hue**. Dark magenta can't sort to the top of the viz because it must stay inside the pane for the Purple hue.

Sort from a header

1. Hover over a header to bring up the sort icon.
2. Click the icon to sort.

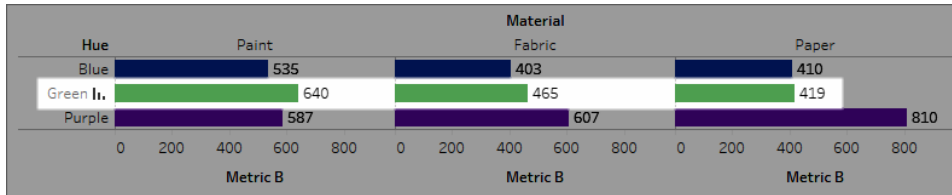

Sort: Materials are arranged in decreasing order of Metric B for Green.

In this example, the sort is applied to **Material** (sorting the order of the columns—Paint, Fabric, and Paper) based on the values for Green, since that header was used for the sort.

Note: The sort option is also available from the tooltip for a header. The header tooltip sort option is displayed even when the view contains a table calculation (but not in the header sort option). If the view contains a table calculation, this option creates a manual sort based on the data currently in the view.

Sort from a field label

1. Hover over a field label to bring up the sort icon.

The sort icon for a field label is slightly different from a header or axis. The default option is alphabetical sorting, but there's also a menu where you can choose to sort by a field in the view.

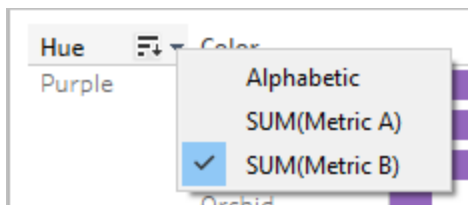

2. Click the A-Z icon to sort alphabetically. Or, click the menu to select a field to sort by. The icon switches to the bar icon and you can click to sort.

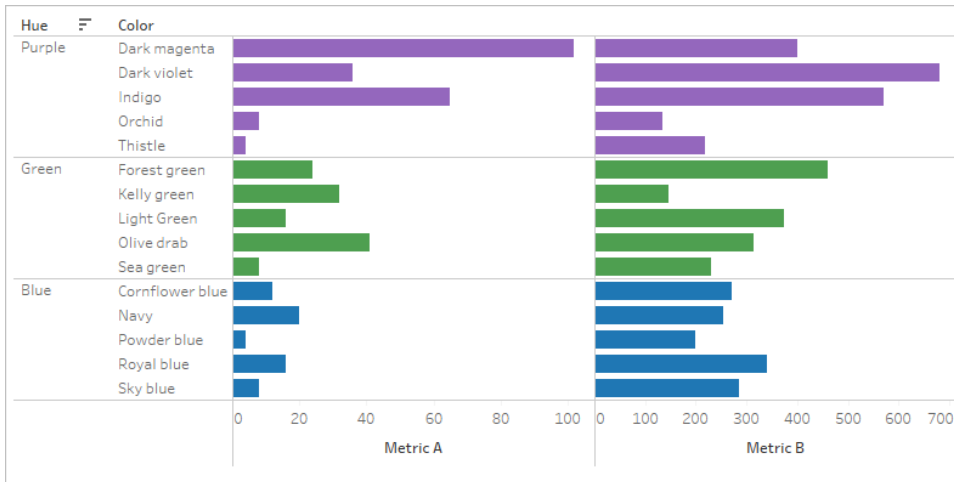

Sort: Hues are arranged in descending order by Metric B.

In this example, the sort is applied to the outermost dimension (Hue) based on total Metric B. (Metric B is aggregated for all the colors within each hue and Hue is sorted. Therefore, Purple is first, then Green, then Blue.)

Missing sort icons

If the sort icons don't appear, this functionality may have been turned off or it might not be possible to sort the view. Sort icons aren't available on the axes in scatterplots or for table calculations. For example, scatterplots can't be sorted from a numerical axis because the positions of the marks are fully determined by the data.

Sort options while authoring

In an authoring environment, additional options are available.

Sort from the toolbar

1. Select the dimension you wish to sort.

If you don't select a field before sorting, the default behavior is to sort the deepest dimension.

2. Choose the appropriate sort button (ascending or descending) in the toolbar.

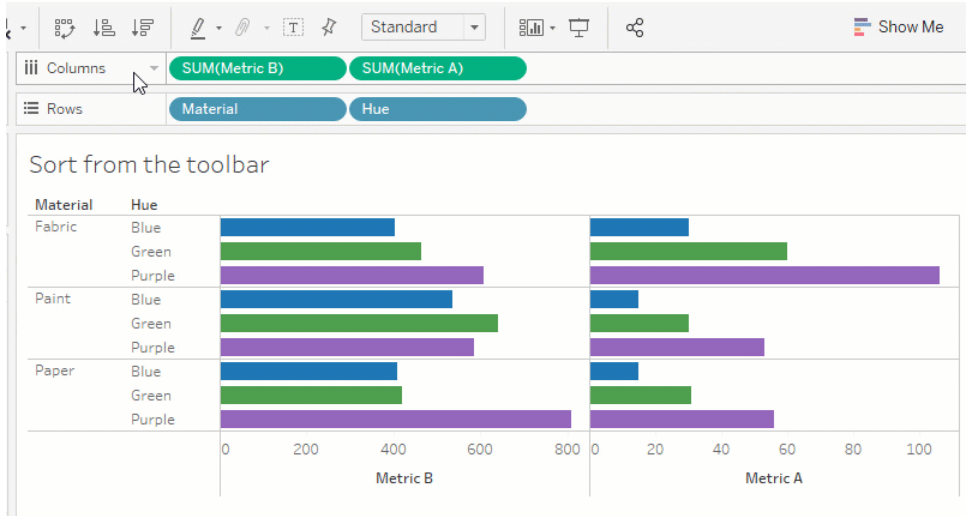

In this example, the sort is applied to **Hue** unless the **Material** field is selected before sorting. The toolbar sort also applies to the leftmost measure, in this case Metric B. To sort by Metric A, it would be necessary to reverse their order on the Columns shelf or use another method of sorting. This example demonstrates the effect of sorting by Material. Hue is removed from the view.

Sort by drag and drop

To manually sort, select a header in a viz or on a legend and drag it to the correct location—a heavy black line indicates where to drop the header.

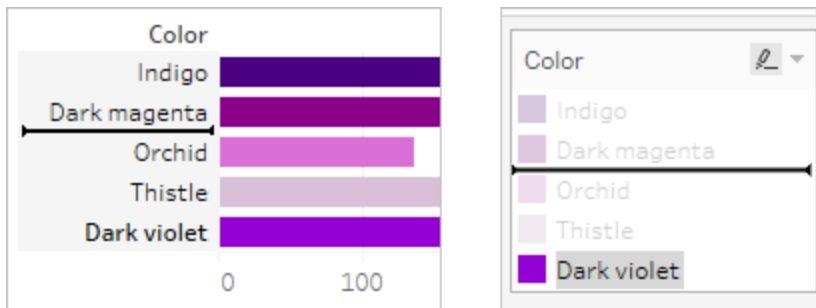

Note: Sorting on a legend also changes the order of the marks, not simply how the legend is displayed. Whatever is bottommost in the legend becomes the bottommost mark in the viz. This can either mean closest to the axis or header, or actually underneath in the case of scatterplots and other viz types that may have overlapping marks.

Sort specific fields in the viz

Tableau uses the current International Components for Unicode (ICU) library to determine sort order. You can customize sorting by using the Sort menu for specific fields. (The Sort menu is not available for continuous measures.)

1. Right-click (Windows) or control-click (Mac) the field you want to sort, and select **Sort**.
2. Select a **Sort By** option, and configure its behavior:
 - **Data Source Order** sorts based on how the data is sorted in the data source. Generally for relational data sources, this tends to be natural sort order. Natural sort order is an alphabetic sort where multi-digit numbers are treated as a single character. For example, natural sorting puts 2 before 19 because 2 is less than 19, whereas alphabetic sorting puts 19 before 2 because 1 is less than 2.

If you are using a multidimensional cube data source, data source order is the defined in hierarchical order of the members within a dimension.
 - **Alphabetic** sorts the data alphabetically. This sort is case sensitive, sorts [A-Z] before [a-z], and treats digits individually (that is, 19 comes before 2).

To create a non-case sensitive sort, create a calculated field using the UPPER() or LOWER() functions to remove variation in capitalization. For more information, see [String Functions on page 2061](#).
 - **Field** lets you specify the field value used to determine the sort order. The field doesn't need to be used in the visualization. You can also select an aggregation for the sorting field. The aggregation options available depend on the field type.
 - **Manual** lets you select a value and move it to the desired position, either by dragging it in the list or using the arrows to the right.
 - **Nested** lets you select the field value used to determine the sort order. The field doesn't need to be used in the visualization. You can also select an aggregation for the sorting field. The aggregation options available depend on the field type.

Nested sorts

When the values to be sorted occur in multiple panes, there are two ways to sort: nested and non-nested (or comparative). In the image below, all three values for **Hue** occur for all three **Materials**. Nested sorting considers values independently per pane rather than in aggregate across panes.

Nested

Non-nested

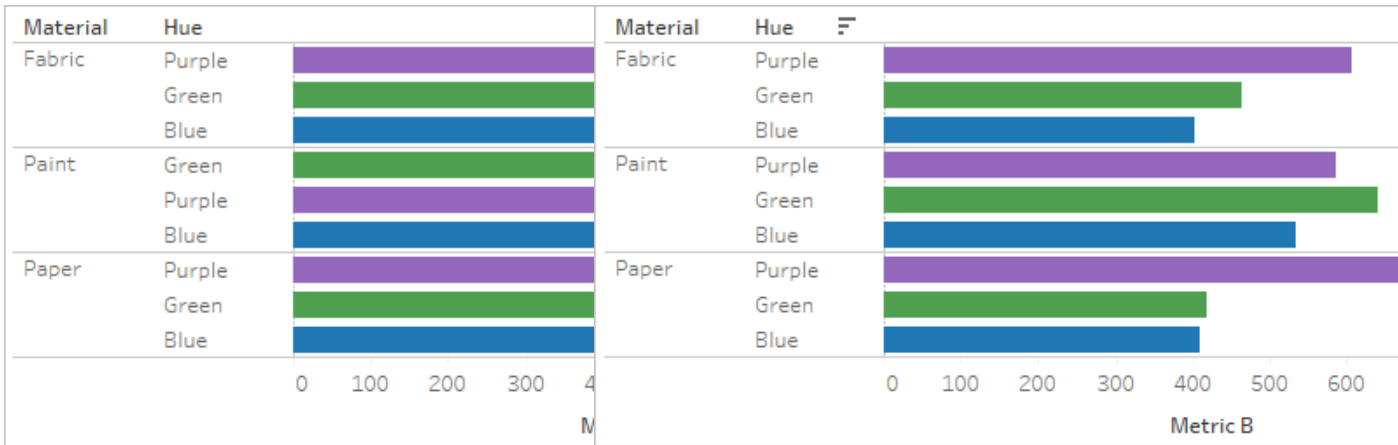

A nested sort considers each pane independently and sorts the rows per pane.

Purple is sorted above Green for Fabric and Paper, but below Green for Paint.

Nested sorts look correct within the context of the pane, but don't convey the aggregated information about how the values compare overall.

Sorting from an axis gives a nested sort by default.

A non-nested sort considers the value across panes and has the same order of values per pane.

Purple is above Green for all materials because in aggregate, Purple is higher than Green.

Non-nested sorts may look incorrect in a single pane, but consistently convey how the aggregated values compare overall.

Sorting from a field label gives a non-nested sort by default.

Note: When creating a nested sort, the sort is inherited when you drill down through the dimensions. For example, a nested sort on Hue will apply to Color.

If a dimension has been placed on the same shelf as a measure, that measure has an axis in the view for each value of the dimension. Using the axis sort icon generates a nested sort specifically for that value.

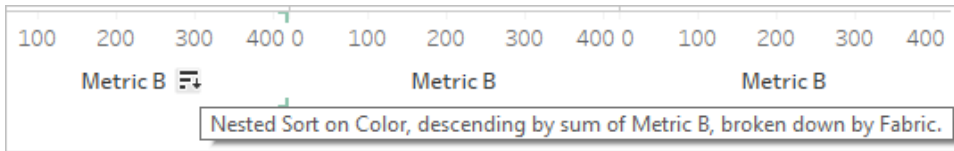

In this scenario, an additional field is added to the sort menu dialog for the sorted dimension. To stop breaking down the sort by this value, uncheck the box for Filter By.

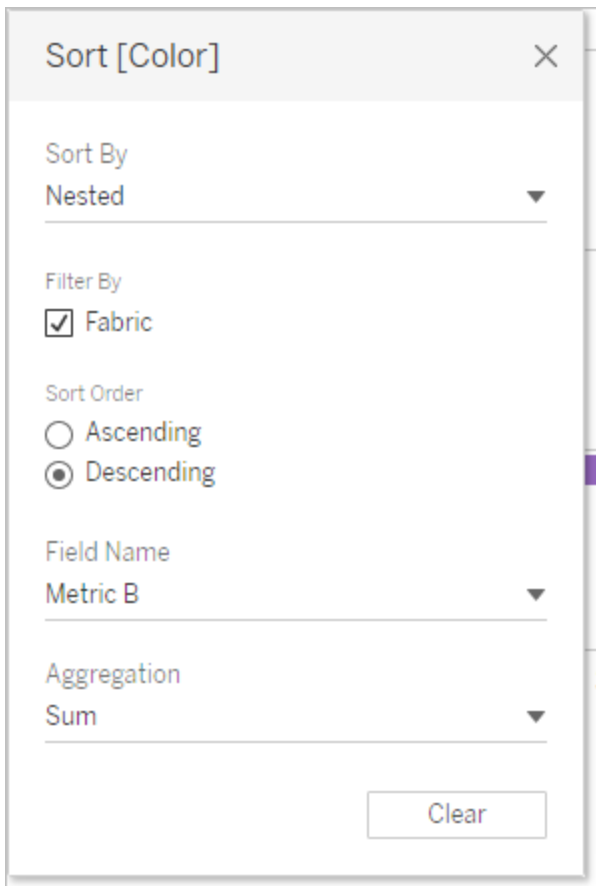

Understanding “incorrect” sorts

It’s easy to think a view is sorted incorrectly when in fact the sort logic is not clear. A view with a nested sort when a non-nested sort is expected (or vice versa) can be perceived as incorrect. Sorting when there are multiple panes can also give results that seem unsorted.

For example, this view might seem unsorted when in fact it’s sorted on Hue by Metric A.

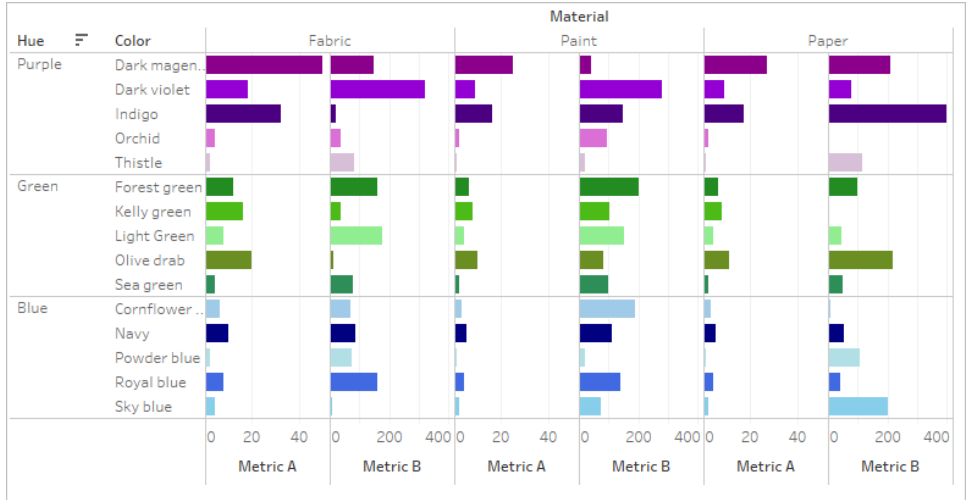

Simplifying the view makes the sort more obvious.

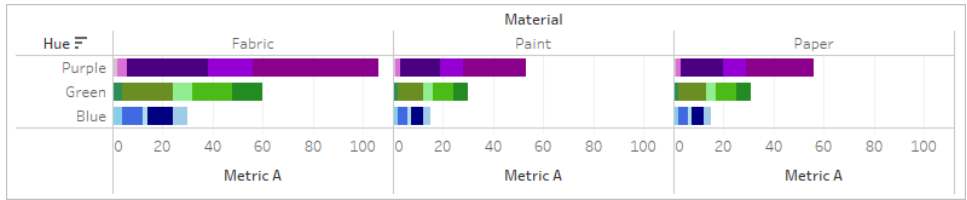

Hovering over the sort icons to see the description of the sort or temporarily simplifying the view can help clarify what is going on.

Clear sorts

You can sort data from many areas of a view. Sometimes it can be useful to clear all sorts at once.

To remove the sort on a specific field, right click to open the menu and select **Clear Sort**.

To remove all sorts in the view, open the menu next to the clear sheet icon in the toolbar and select Clear Sorts. Or, from the Worksheet menu, click **Clear > Sorts**.

Remove the ability to sort

As an author, you can disable the sort icons in published content. This can be useful to preserve the current sort as you built it. Navigate to the Worksheet menu and uncheck the option to **Show Sort Controls**. This will prevent the sort icons from appearing when a consumer of the view hovers over an axis, header, or field label.

Hiding field labels, headers, or the axis will also remove the sort icons.

Showcase Insights

This section describes the various ways you spotlight data insights. Read the following articles for information on how to show totals, add annotations, and embed visualizations in tooltips when you hover over a data point. For text elements such as titles and captions, see [Format Individual Parts of the View on page 2993](#).

Show Totals in a Visualization

This article demonstrates how to show grand totals and subtotals in a visualization, as well as how to customize how those totals are calculated and where they appear in the visualization.

Show grand totals

To show grand totals in a visualization:

1. Click the **Analytics** pane.
2. In the **Analytics** pane, under Summarize, drag **Totals** into the Add Totals dialog, and drop it over either the **Row Grand Totals** or **Column Grand Totals** option.

The screenshot shows the Tableau Desktop interface. The 'Data' pane on the left contains dimensions like Customer, Order, Location, and Product, and measures like Profit and Profit Ratio. The 'Analytics' pane is open, showing the 'SUM(Sales)' measure. The 'Columns' shelf contains 'Region' and the 'Rows' shelf contains 'Category' and 'Sub-Category'. The main view displays a pivot table with the following data:

Category	Sub-Catego..	Region			
		Central	East	South	West
Furniture	Bookcases	\$24,157	\$43,819	\$10,899	\$36,004
	Chairs	\$85,231	\$96,261	\$45,176	\$101,781
	Furnishings	\$15,254	\$29,071	\$17,307	\$30,073
	Tables	\$39,155	\$39,140	\$43,916	\$84,755
Office Supplies	Appliances	\$23,582	\$34,188	\$19,525	\$30,236
	Art	\$5,765	\$7,486	\$4,656	\$9,212
	Binders	\$56,923	\$53,498	\$37,030	\$55,961
	Envelopes	\$4,637	\$4,376	\$3,346	\$4,118
	Fasteners	\$778	\$820	\$503	\$923
	Labels	\$2,451	\$2,603	\$2,353	\$5,079
	Paper	\$17,492	\$20,173	\$14,151	\$26,664
	Storage	\$45,930	\$71,613	\$35,768	\$70,533
	Supplies	\$9,467	\$10,760	\$8,319	\$18,127
Technology	Accessories	\$33,956	\$45,033	\$27,277	\$61,114
	Copiers	\$37,260	\$53,219	\$9,300	\$49,749
	Machines	\$26,797	\$66,106	\$53,891	\$42,444
	Phones	\$72,403	\$100,615	\$58,304	\$98,684

Row grand totals appear automatically on the right-side of the visualization. Column grand totals appear automatically at the bottom of the visualization. For information how to move where totals appear, see [Move totals on page 1361](#).

In order to turn on grand totals:

- The view must have at least one header – Headers are displayed whenever you place a dimension on the **Columns** shelf or the **Rows** shelf. If column headers are displayed, you can calculate grand totals for columns. If row headers are displayed, you can calculate grand totals for rows.
- Measures must be aggregated – The aggregation determines the values displayed for the totals. See [Grand totals and aggregations on page 1357](#) for more information.
- Grand totals cannot be applied to continuous dimensions.

You can also display totals for graphical views of data. In the figure below, only column totals are calculated because the table contains only column headers.

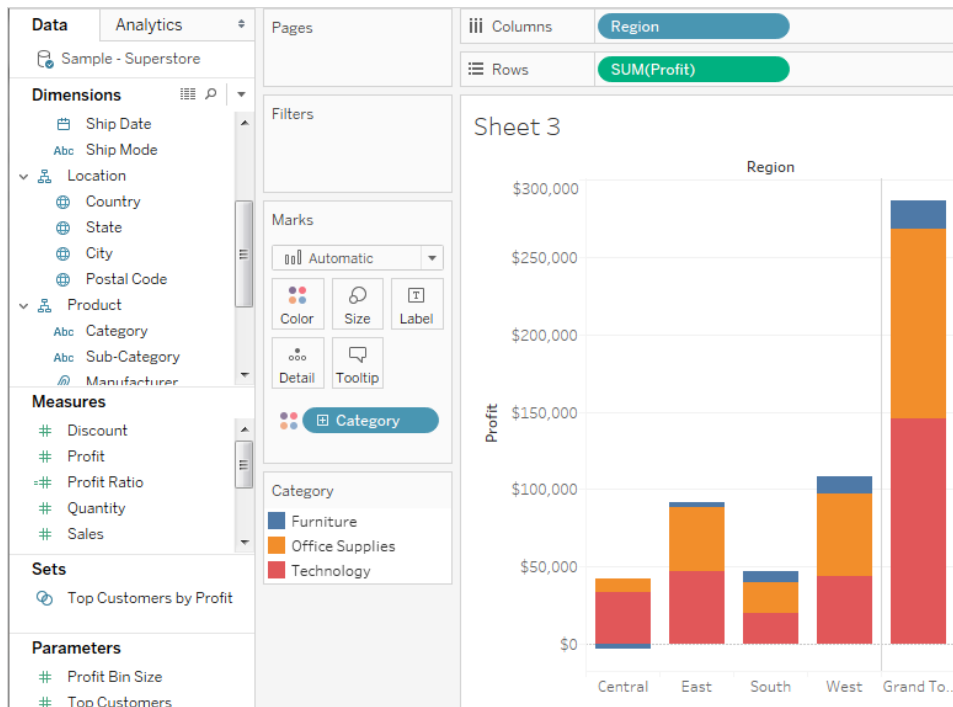

Note: By default, totals are computed on the server if you are connected to a Microsoft Analysis Services data source, and locally if you are connected to an Essbase data source, using the aggregation specified in the cube. Refer to [Configure total aggregation on page 1361](#) to learn more.

Options for calculating grand totals

When you first turn on grand totals, the totals are computed using disaggregated data in the underlying data source. Consider the following view:

The screenshot shows the Tableau interface with the following configuration:

- Columns:** Region
- Rows:** Ship Mode, Category
- Marks:** AVG(Sales)

The resulting view is a pivot table titled "Sheet 4" with the following data:

Ship Mode	Category	Region				Grand T..
		Central	East	South	West	
First Class	Furniture	\$329	\$306	\$390	\$348	\$339
	Office Supplies	\$111	\$120	\$120	\$98	\$111
	Technology	\$300	\$524	\$292	\$571	\$463
Same Day	Furniture	\$316	\$367	\$225	\$338	\$329
	Office Supplies	\$79	\$103	\$82	\$89	\$89
	Technology	\$320	\$689	\$767	\$620	\$614
Second Class	Furniture	\$332	\$347	\$402	\$390	\$366
	Office Supplies	\$127	\$140	\$151	\$142	\$139
	Technology	\$381	\$312	\$604	\$345	\$389
Standard Class	Furniture	\$348	\$356	\$336	\$351	\$349
	Office Supplies	\$119	\$115	\$123	\$116	\$118
	Technology	\$449	\$522	\$500	\$381	\$457

The average that you see at the right of the first row under Grand Total is \$339. But if you compute the average for the four values you see in the row (\$329, \$306, \$390, \$348), the result comes to \$343.25, not \$339. The discrepancy is due to the fact that Tableau is averaging the data in the underlying data source. In this case there are more than four numbers to average, perhaps many more. The result is derived by averaging all values that have the properties Ship Mode = First Class, Category = Furniture, without regard to region.

To see totals that correspond to the numbers you see in your view requires two averaging operations in Tableau: first, values for the individual marks (or cells) in the view must be derived—for example, by averaging all values that have the properties Ship Mode = First Class, Category = Furniture, and Region = Central. Then the results for each region must be derived, by averaging the results for the individual marks. Fortunately, you do not need to perform two operations. To display a result of this type, from the **Analysis** menu choose **Totals > Total All Using > Average**. Now the average is performed on the values you see, and not on the disaggregated data in the data source:

		Region					Grand T..
Ship Mode	Category	Central	East	South	West		
First Class	Furniture	\$329	\$306	\$390	\$348	\$343	\$112
	Office Supplies	\$111	\$120	\$120	\$98		\$422
	Technology	\$300	\$524	\$292	\$571		\$311
Same Day	Furniture	\$316	\$367	\$225	\$338	\$311	\$88
	Office Supplies	\$79	\$103	\$82	\$89		\$599
	Technology	\$320	\$689	\$767	\$620		\$367
Second Class	Furniture	\$332	\$347	\$402	\$390	\$367	\$140
	Office Supplies	\$127	\$140	\$151	\$142		\$410
	Technology	\$381	\$312	\$604	\$345		\$348
Standard Class	Furniture	\$348	\$356	\$336	\$351	\$348	\$118
	Office Supplies	\$119	\$115	\$123	\$116		\$463
	Technology	\$449	\$522	\$500	\$381		

This kind of total is sometimes referred to as a two-pass total, because the average you see in the grand total column is aggregated twice--once to derive the column or row value, and then again across column or rows to derive the grand total.

Grand totals and aggregations

When you turn on grand totals, the initial values are computing using the current aggregation for the fields in the view. In this case, totals are based on the underlying data rather than the data in the view.

For example, if you are totaling the **SUM(Profit)** for several products, the grand total will be the sum of the sums of profit. For aggregations such as SUM, you can easily verify the grand total because a summation of a group of sums is still a summation. However, be aware that your results may be unexpected when using other aggregations, especially custom aggregations. For details, See [Configure total aggregation on page 1361](#). You can verify any calculation such as an aggregation or a grand total by viewing the underlying disaggregated data.

The following table summarizes the standard aggregations and the grand totals that are calculated by default when, from the Analysis menu, **Totals >Total All Using** is set to the default value **Automatic**.

Note: Only Automatic totals are available for table calculations and fields from a secondary data source. Total aggregations cannot be applied to table calculations or fields from a secondary data source.

For more information, see [Showing Grand Totals with Blended Data](#) and [Grand Totals and](#)

Subtotals Do Not Show Expected Numbers With Table Calculations in the Tableau Knowledge Base.

Aggregation	Calculation Description
Sum	Shows the sum of the values shown in the row or column.
Average	Shows the average of the values shown in the row or column.
Median	Shows the median for the values shown in the row or column.
Count; Count Distinct	Shows how many values or distinct values are displayed in the rows and columns in the view.

Aggregation	Calculation Description
Minimum	Shows the minimum value shown in the row or column.
Maximum	Shows the maximum value shown in the row or column.
Percentile	Shows the average percentile for all values shown in the row or column.
Standard Deviation	The grand total using standard deviation is the standard deviation of the values shown in the row or column.
Variance	The grand total using variance is not the vari-

Aggregation	Calculation Description
	ance of the rows and columns in which they reside but rather of the underlying data behind the row or column.

Show subtotals

To show subtotals in a visualization:

1. Click the **Analytics** pane.
2. In the **Analytics** pane, under Summarize, drag **Totals** into the Add Totals dialog, and drop it over **Subtotals**.

The screenshot shows the Tableau Desktop interface. On the left, the 'Data' pane is open to the 'Analytics' view. The 'Dimensions' shelf contains 'Customer', 'Order', 'Location', and 'Product'. The 'Measures' shelf contains 'Discount', 'Profit', and 'Profit Ratio'. The 'Marks' card is set to 'Automatic', and 'SUM(Sales)' is selected. The 'Columns' shelf contains 'Region' and the 'Rows' shelf contains 'Category' and 'Sub-Category'. The main view displays a pivot table titled 'Sheet 1' with subtotals.

Category	Sub-Catego..	Region				Grand Total
		Central	East	South	West	
Furniture	Bookcases	\$24,157	\$43,819	\$10,899	\$36,004	\$114,880
	Chairs	\$85,231	\$96,261	\$45,176	\$101,781	\$328,449
	Furnishings	\$15,254	\$29,071	\$17,307	\$30,073	\$91,705
	Tables	\$39,155	\$39,140	\$43,916	\$84,755	\$206,966
Office Supplies	Appliances	\$23,582	\$34,188	\$19,525	\$30,236	\$107,532
	Art	\$5,765	\$7,486	\$4,656	\$9,212	\$27,119
	Binders	\$56,923	\$53,498	\$37,030	\$55,961	\$203,413
	Envelopes	\$4,637	\$4,376	\$3,346	\$4,118	\$16,476
	Fasteners	\$778	\$820	\$503	\$923	\$3,024
	Labels	\$2,451	\$2,603	\$2,353	\$5,079	\$12,486
	Paper	\$17,492	\$20,173	\$14,151	\$26,664	\$78,479
	Storage	\$45,930	\$71,613	\$35,768	\$70,533	\$223,844
Supplies	\$9,467	\$10,760	\$8,319	\$18,127	\$46,674	
Technology	Accessories	\$33,956	\$45,033	\$27,277	\$61,114	\$167,380
	Copiers	\$37,260	\$53,219	\$9,300	\$49,749	\$149,528
	Machines	\$26,797	\$66,106	\$53,891	\$42,444	\$189,239
	Phones	\$72,403	\$100,615	\$58,304	\$98,684	\$330,007
Grand Total		\$501,240	\$678,781	\$391,722	\$725,458	\$2,297,201

Move totals

By default, row grand totals and subtotals appear on the right of the view, and column grand totals and subtotals appear at the bottom of the view.

In Tableau Desktop, you can also select to display totals on the left or top of the view.

To move row totals to the left of the view:

- Select **Analysis > Totals**, and then select **Row Totals to Left**.

To move column totals to the top of the view:

- Select **Analysis > Totals**, and then select **Column Totals to Top**.

Configure total aggregation

When totals are turned on in the visualization (either grand totals, subtotals, or both), you can specify how totals should be computed. For example, you can choose to calculate totals using a sum, average, minimum, or maximum.

To configure all totals:

- Select **Analysis > Totals > Total All Using**, and then select an aggregation from the list.

To configure totals for a specific field:

- Right-click (Control-click on a Mac) a field in the view, select **Total using**, and then select an aggregation from the list.

When you choose **Automatic**, totals are based on the underlying data, which is disaggregated, and not on the data in the view. See [Options for calculating grand totals on page 1356](#). For details on how Tableau computes totals using the current aggregation, see [Grand totals and aggregations on page 1357](#).

When you choose any of the other values (**Sum**, **Average**, **Minimum**, or **Maximum**), all totals are computed using the selected aggregation. The computations are performed on the aggregated data you see in the view.

An additional value, **Server**, may be available. Server computation is not always available and sometimes the totals will be blank for specific members in the view. When using server computation keep in mind the following information:

- Server computation is only available for ASO cubes.
- Server computation is not available for dynamic hierarchies. This means that if the members in the view are part of a dimension or hierarchy that is tagged as dynamic, they cannot be included in the set of values you are using to compute the totals and will show up as blank in the view.
- If you are computing totals for a calculated field whose formula makes assumptions about other calculated members at different levels in the hierarchy, the totals will display as blank in the view.

See Also

[Apply Advanced Analysis to a View \(Analytics Pane\) on page 48](#)

Add Annotations

You can add annotations to a visualization to call out a specific mark, a specific point, such as a location on a map, or an area, such as a cluster of scatter marks.

Note: In web authoring, you can create and delete annotations by right-clicking the view (in a worksheet or dashboard), and then selecting point or mark annotation. Right-click the annotation again to edit or remove the annotation. Formatting and moving annotations are not currently supported on the web.

To add and format other text elements on a visualization, see [Format Individual Parts of the View on page 2993](#).

Add an annotation

To add an annotation to your viz:

1. In a worksheet, right-click (control-click on Mac) a data point or a spot on the viz where you want to add an annotation and select **Annotate**, and then select the type of annotation you want to add.

There are three types of annotations in Tableau:

- **Mark** - select this option to add an annotation that is associated with the selected mark. This option is only available if a data point (mark) is selected.
- **Point** - select this option to annotate a specific point in the view.
- **Area** - select this option to annotate an area in the viz, such as a cluster of outliers or a targeted region.

2. In the Edit Annotation dialog box that opens, type the text you want to show in the annotation.

Use the **Insert** menu to insert dynamic variables into the annotation text. For example, the annotation can display data values that update as the underlying data changes. The dynamic variables that are available are dependent on whether you are annotating a mark, point, or area.

3. When finished, click **OK**.

The viz updates with your annotation.

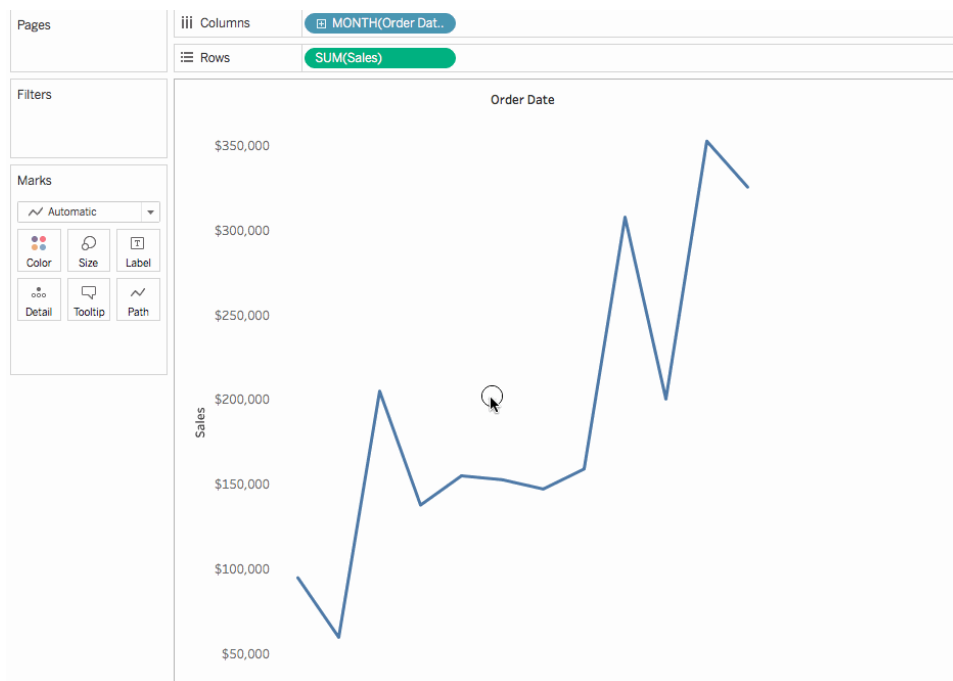

Edit an annotation

To edit an annotation:

1. Right-click (control-click on a Mac) the annotation in the viz and select **Edit**.
2. In the Edit Annotation dialog box that opens, edit the annotation text and then click **OK**.

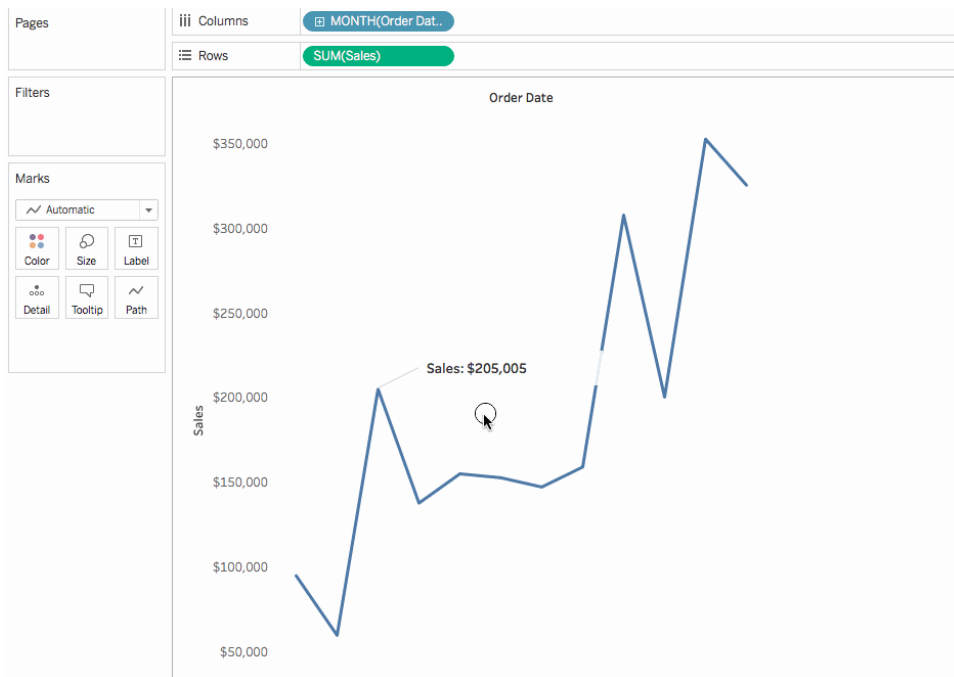

Rearrange an annotation

After you add an annotation, you can move it around, resize it, adjust the line, and move the text. Each type of annotation can be rearranged and modified in different ways. This section discusses how to rearrange, resize, and modify each type of annotation.

Mark annotations

When you select a mark annotation the body and line are selected and several resize handles display. Use these handles to resize the body and line.

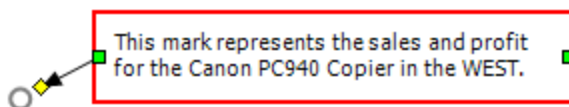

To reposition the body

- Click and drag the body of the selected annotation to a new position.

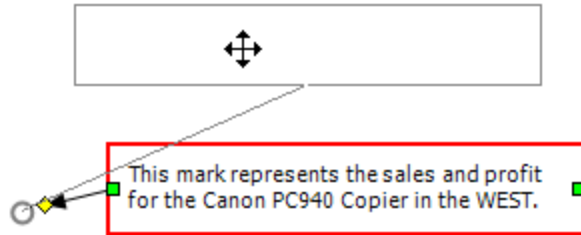

To resize the body

- Click and drag the body resize handle left and right. The text and height are automatically adjusted to fit the width of the body.

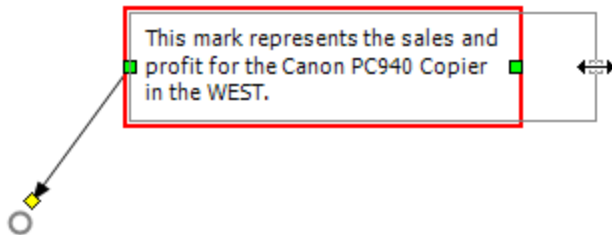

To resize the line

- Click and drag the line resize handle 

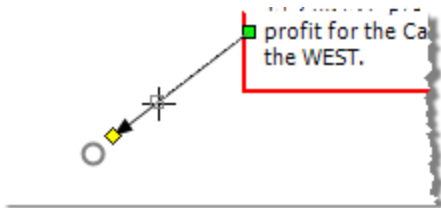

Point Annotations

A point annotation marks a specific point in the view, such as a reference line or a value on an axis. Point annotations display as text with a line. When you select a point annotation, several resize handles display. Use these handles to reposition and resize the body and line.

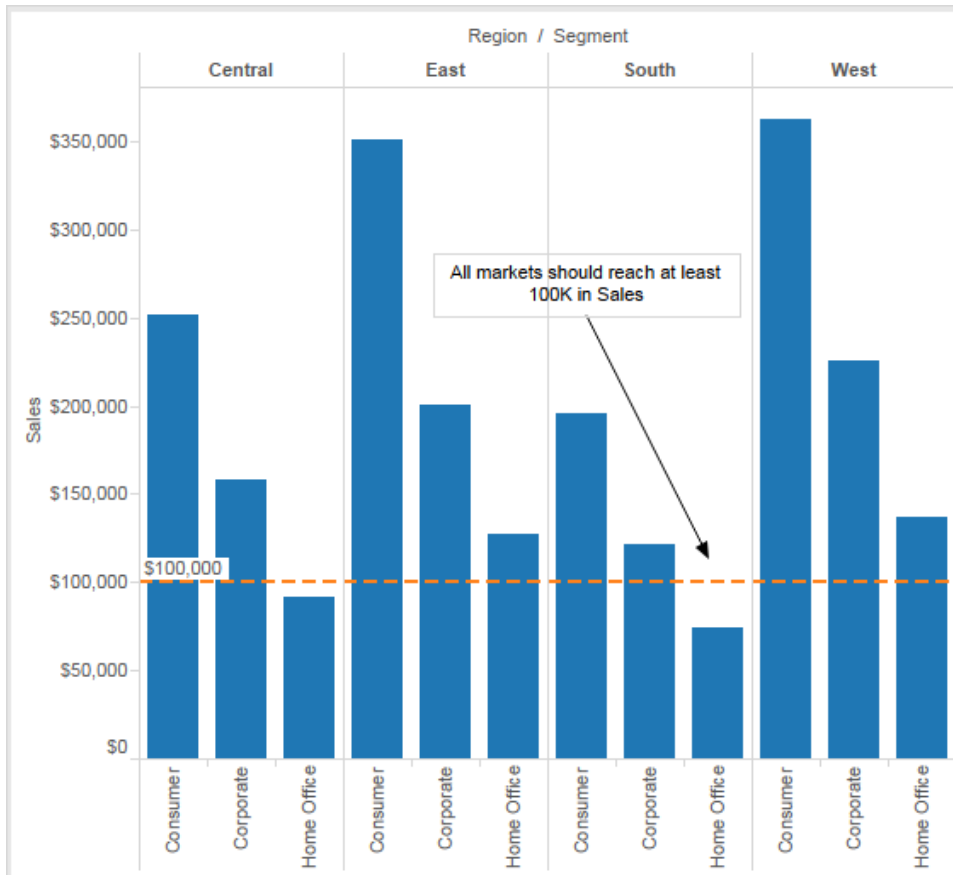

To reposition the body:

- Click and drag the body of the selected annotation to a new position. As you move the body, the line is automatically resized so that it continues to point at the specific point you

selected.

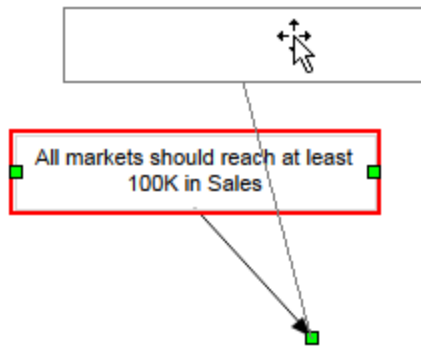

To resize the body:

- Click and drag the side resize handles ■ left and right. The text and height are automatically adjusted to fit the width of the body.

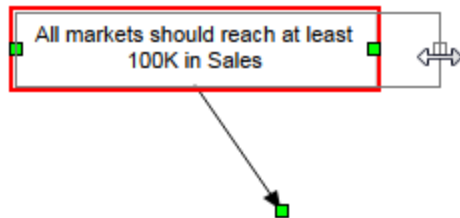

To move the line end point:

- Click and drag the end point of the line ■ so that it points at a new location.

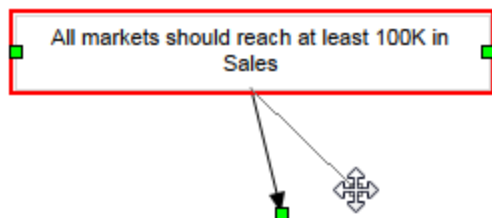

Area Annotations

An area annotation is a way to highlight or call out an area in the view. Area annotations are not associated with any particular mark, in fact, these annotations are commonly used to call out several marks. When you select an area annotation, several resize handles and two text handles display. Use these handles to reposition and resize the box and text.

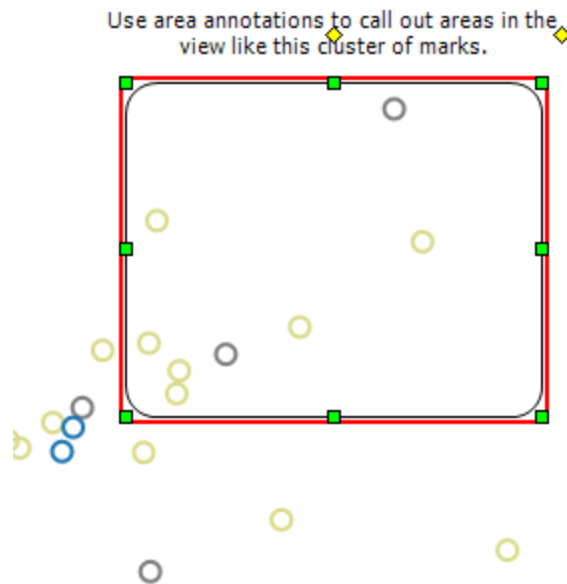

To reposition the box

- Click and drag the box of the selected annotation to a new position.

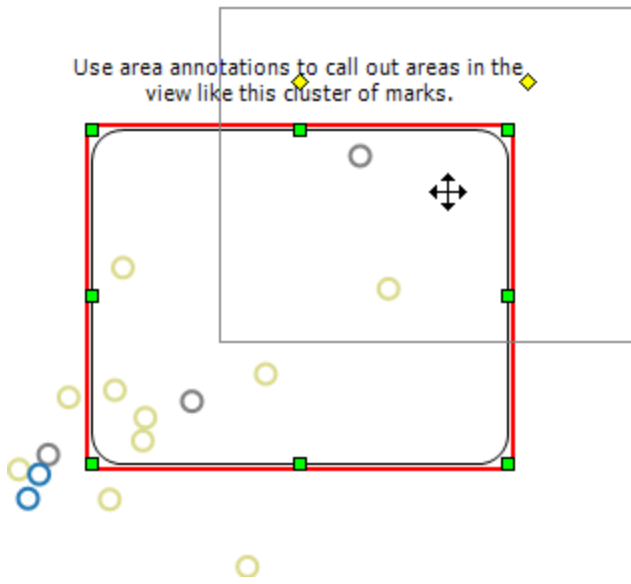

To resize the box

- Click and drag one of the box resize handles ■

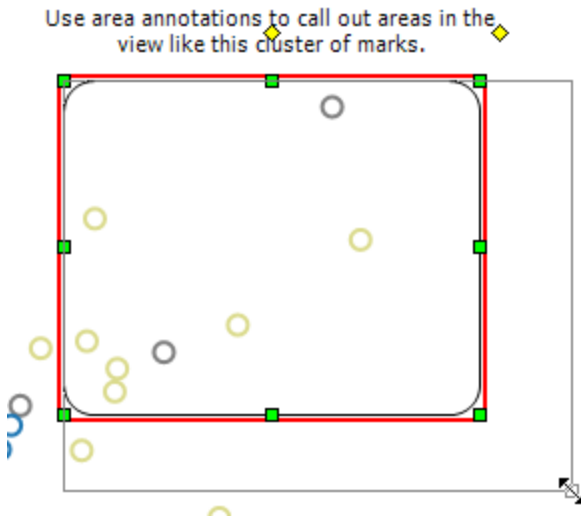

To reposition the text

- Click and drag the center text handle ◆ to a new position.

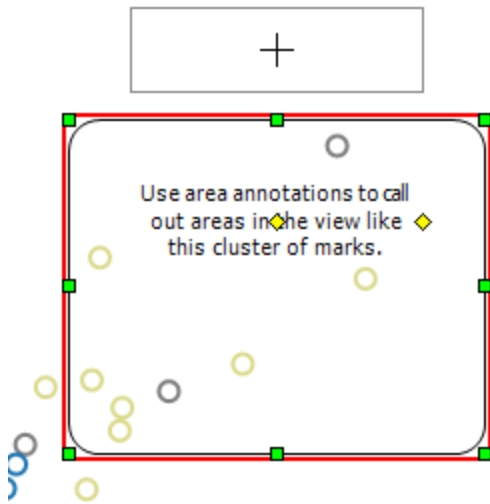

To resize the text width

- Click and drag the right text handle  left and right. The text height is automatically adjusted to fit the width.

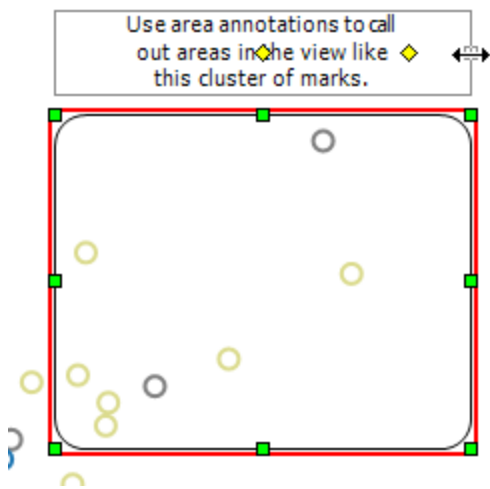

Format annotations

You can modify the text, body, and line of an annotation. For example, you can specify whether the body should be a box, a single edge, or not shown at all. Additionally, you can specify whether the lines on mark and point annotations end with an arrow, dot, or a simple line.

To format annotations:

1. Select one or more annotations, right-click (control-click on Mac) one of the selected annotations, and then select **Format**.

The **Format** pane opens on the left-side of the workspace, over the **Data** pane.

2. In the **Format** pane, use the drop-downs to specify font properties, text alignment, line style, and shading.

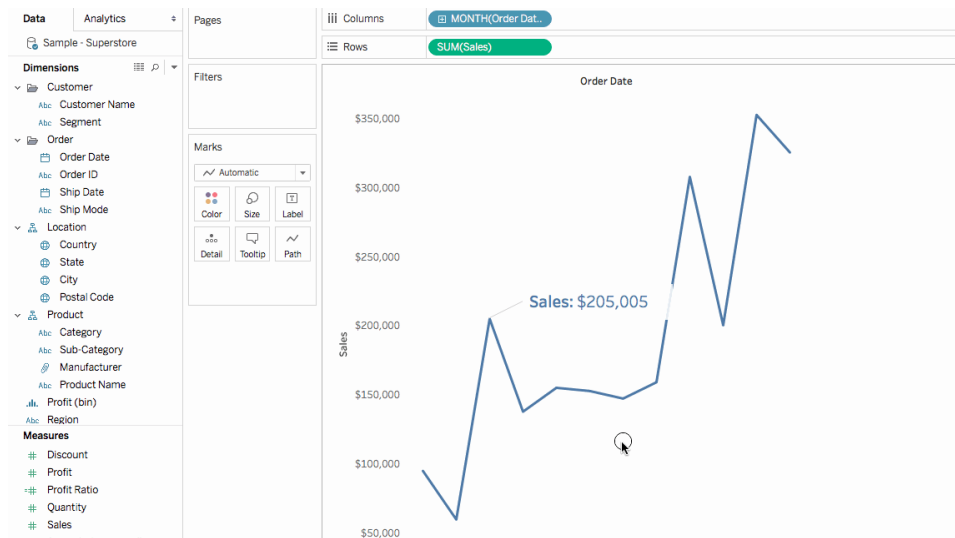

Remove an annotation

To remove annotations from the viz:

1. Select one or more annotations in the viz.
2. Right-click (control-click on Mac) one of the selected annotations and select **Remove**.

See Also

[Show, Hide, and Format Mark Labels](#) on page 1284

Create Views in Tooltips (Viz in Tooltip)

As you craft views and look for ways to reveal more details about data to your audience, you can embed visualizations within tooltips—also known as "Viz in Tooltip."

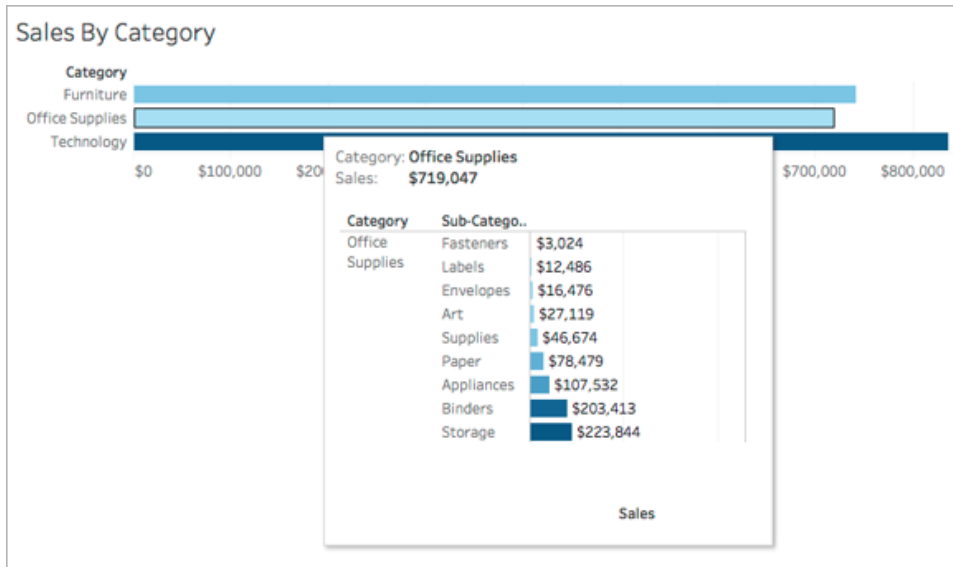

When a user hovers over a mark, the tooltip displays relevant data and details from another visualization filtered to that mark.

You can show related vizzes in tooltips to help your audience engage with the data at a different or deeper level, while keeping them in the current context and maximizing the space available for the current view.

Watch a video: For advanced tips, watch [Next Level Viz in Tooltip](#), a 55-minute free video presentation.

For information on how to edit regular tooltips, see [Format tooltips](#) on page 2995.

General steps to create a Viz in Tooltip

1. Create a visualization in the *source* worksheet in Tableau.
2. Create a visualization in a *target* worksheet view to serve as the Viz in Tooltip. Give the worksheet a name that helps you identify it as a Viz in Tooltip.
3. In the source worksheet, click Tooltip in the Marks card. In the Tooltip Editor, insert a reference to the Viz in Tooltip target worksheet. For details, see [Configure a Viz in Tooltip](#) on the facing page.
4. **Optional:** Hide the target sheet for the Viz in Tooltip. For details, see [Create Views in Tooltips \(Viz in Tooltip\)](#) on the previous page.
5. Test the resulting Viz in Tooltip by hovering over different marks in the source worksheet view. If the Viz in Tooltip is too large for the tooltip window, adjust the height and width of

the target worksheet visualization. You might also consider simplifying the structure and detail in the target visualization. For details, see [Change the size of the Viz in Tooltip on page 1377](#).

Notes:

By default, Viz in Tooltip is filtered on *All Fields*. Change the level of detail for Viz in Tooltip by defining a filter on *Selected Fields*. For details, see [Change the filter for the Viz in Tooltip on page 1378](#).

In Tableau version 2023.3 and later, Viz in Tooltip is not available for totals and grand totals.

Notes: By default, Viz in Tooltip is filtered on *All Fields*. Change the level of detail for Viz in Tooltip by defining a filter on *Selected Fields*. For details, see [Change the filter for the Viz in Tooltip on page 1378](#).

In Tableau version 2023.3 and later, Viz in Tooltip is not available for totals and grand totals.

Configure a Viz in Tooltip

You will need a *source* worksheet visualization and a *target* worksheet visualization to create a Viz in Tooltip.

These steps use the example of a source view that is a map showing sales profits by state, and a target sheet with a chart that shows profits by product sub-category.

Create the source and target visualizations in a worksheet

1. In Tableau, figure out the worksheet that you want to use as your source visualization. Or build a new visualization on a new worksheet. This will be your source view.
2. Create a new worksheet to serve as the target visualization.
Keep the number of filters used in the target view to a minimum.
3. Name the target view so that you will be able to identify it in a list of other sheets.

Insert a reference to the target worksheet in the source worksheet tooltip

1. In the source sheet, click the Tooltip button in the Marks card to open the Tooltip Editor.

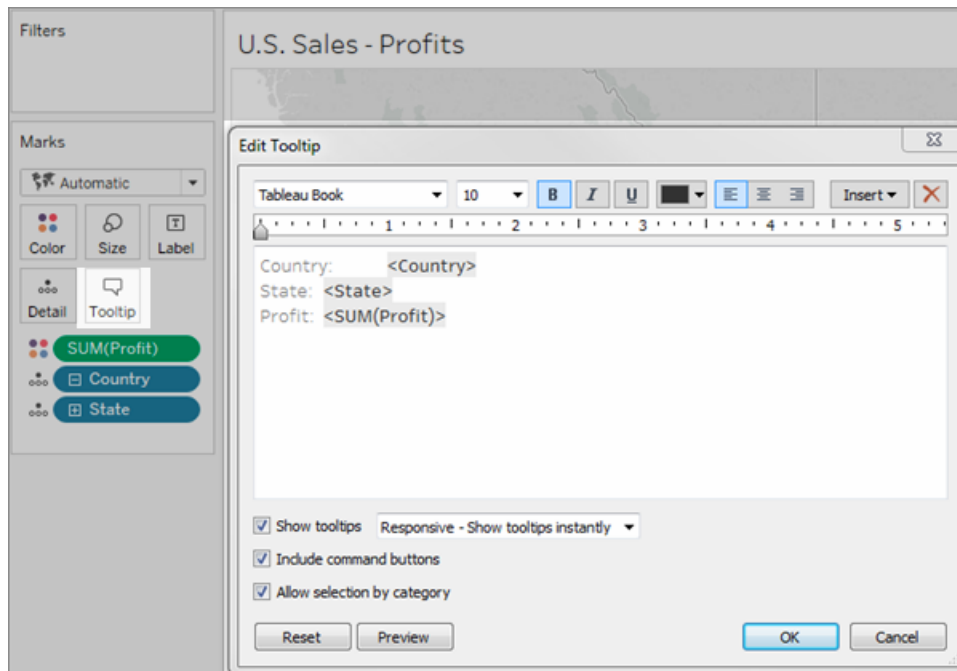

2. Click the **Insert** menu in the Tooltip Editor. In the **Insert** menu, select **Sheets**, and then select a target sheet.

For example:

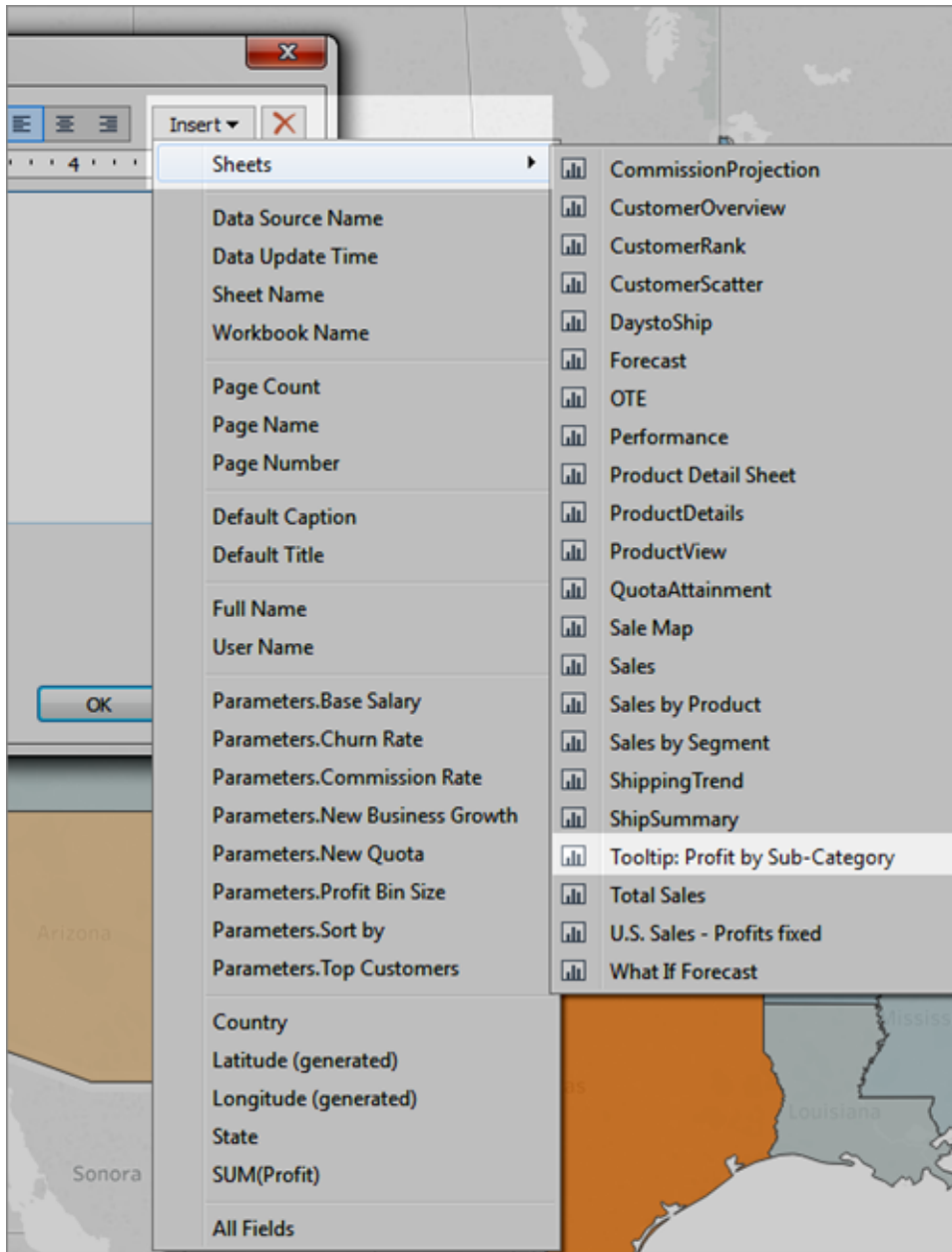

The markup for the Viz in Tooltip is automatically added. (In this example, the original markup fields have been removed.)

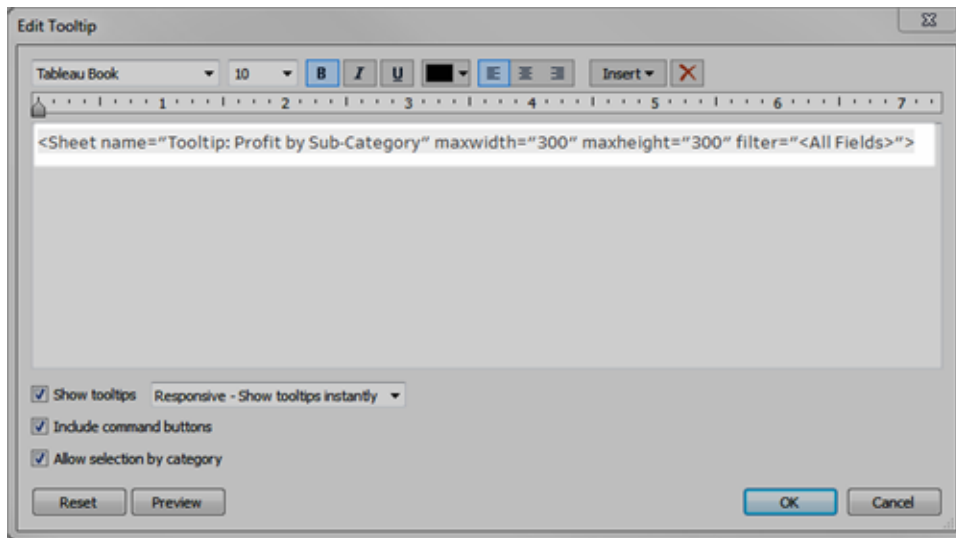

Example of markup automatically generated for Viz in Tooltip

This is the resulting markup for this example:

```
<Sheet name="Tooltip: Profit by Sub-Category" maxwidth="300"
maxheight="300" filter="<All Fields>">
```

By default, the Viz in Tooltip is filtered on All Fields (filtered on all fields possible, and on the most specific level of detail).

Click **OK**.

3. Go back to the source sheet and test the Viz in Tooltip. Hover over different marks to see the resulting Viz in Tooltip. Make adjustments to the target view as necessary to improve the Viz in Tooltip.

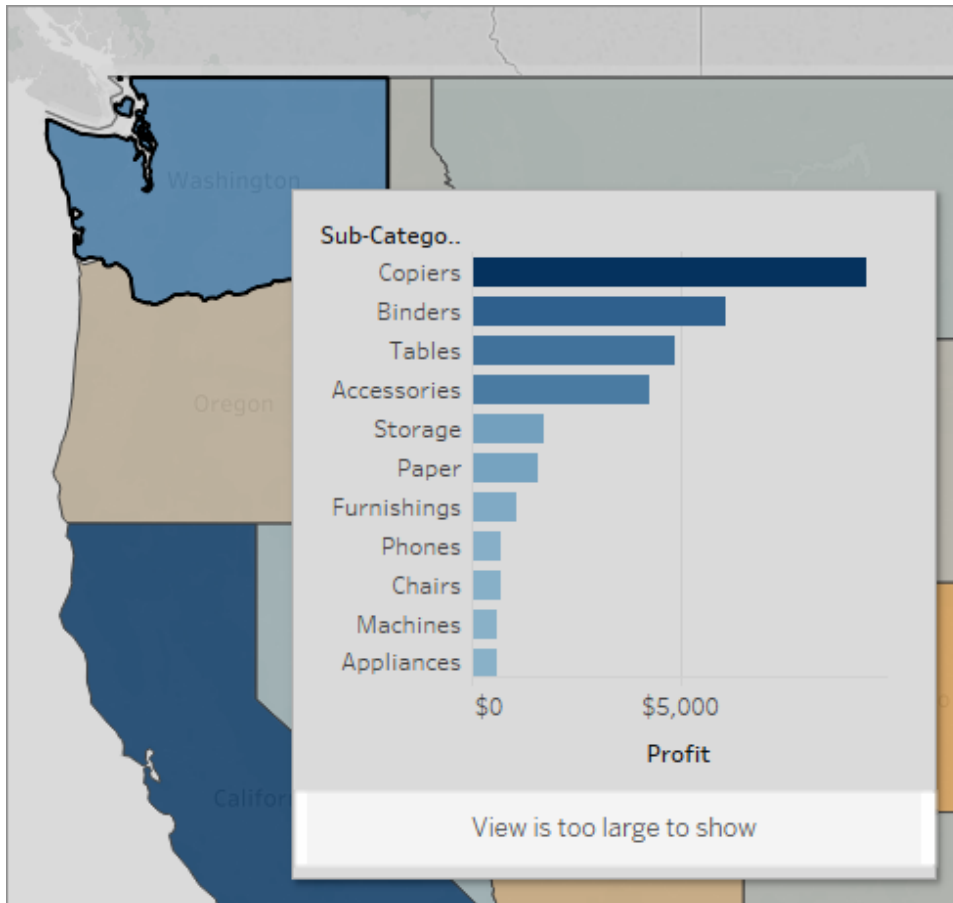

The Viz in Tooltip in this example shows a message that indicates that some of the data in the target view is not being shown. If you see this message, you can adjust the height and width settings in the parameters for the Viz in Tooltip to make the view size larger.

Change the size of the Viz in Tooltip

You can manually change the `maxwidth` and `maxheight` values to resize the Viz in Tooltip. The default size is 300 by 300 pixels. To change the size, manually replace "300" with another value. If you need to set the value greater than 600 pixels, you might want to reconsider whether the target view is a good candidate for Viz in Tooltip.

1. In the source sheet, click the Tooltip button in the Marks card to open the Tooltip Editor.
2. Select the number value for `maxwidth` and `maxheight` and type a different value to replace it. For example:

```
<Sheet name="Tooltip: Profit by Sub-Category" maxwidth="500"
maxheight="500" filter="<All Fields>">
```

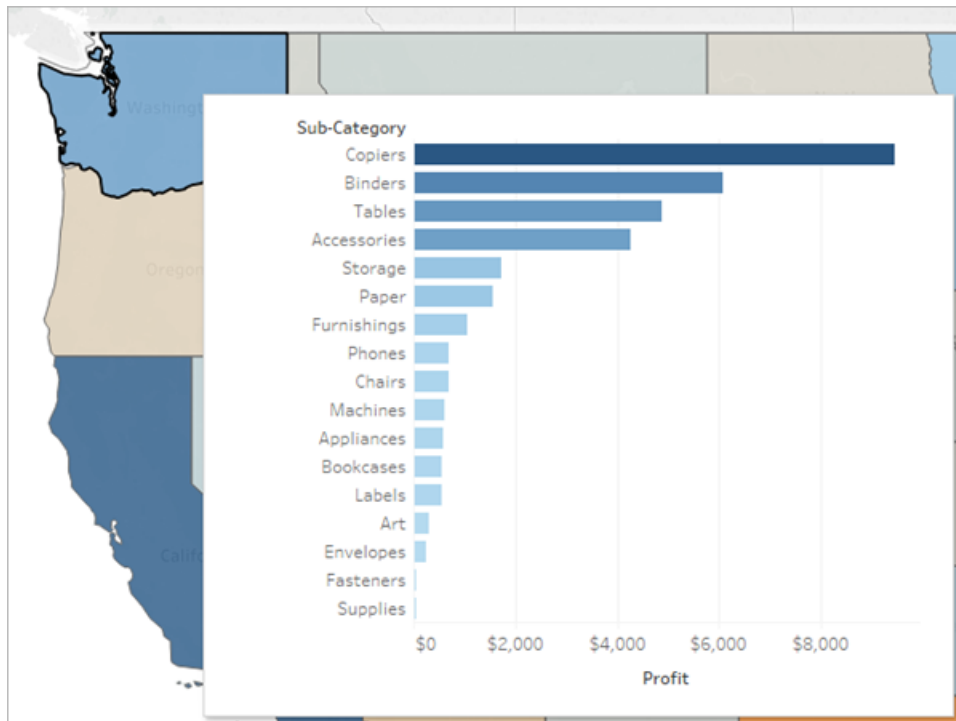
3. Click **OK**

Example of a Viz in Tooltip set to 500 pixels width and height. The author also created more space for the header text in the in the target sheet view.

Change the filter for the Viz in Tooltip

By default, Viz in Tooltip is filtered on *All Fields*. This means the view is filtered on all dimensions in the current view (not including fields on the Filters shelf), at the most specific level of detail.

You can change the level of detail for Viz in Tooltip by defining a filter on selected fields, similar to filtering on **Selected Fields** in Filter Actions.

1. In the source sheet, click the Tooltip button in the Marks card to open the Tooltip Editor.
2. Place your cursor within the filter value (`filter="<place cursor here>"`), and then click the **Insert** menu to select an available field. Or, manually replace the `<All Fields>` value with the name of a field in the view. For example:

```
<Sheet name="Tooltip: Profit by Sub-Category" maxwidth="300"
maxheight="500" filter="<State>">
```

You can also filter more than one selected field by separating the field names with a comma. For example:

```
<Sheet name="Tooltip: Profit by Sub-Category" maxwidth="300"
maxheight="500" filter="<Country>,<State>">
```

To filter on date level, you will need to include the string that specifies the date level with the field name. For example:

```
<Sheet name="Tooltip: Profit by Month" maxwidth="300"
maxheight="300" filter="<MONTH(Order Date)>">
```

Note: The date filter in the Viz in Tooltip script must match exactly the date level of the field in the view.

Hide or show a Viz in Tooltip worksheet

You can hide and show a worksheet used for Viz in Tooltip with options similar to those for dashboards and stories.

Hide a Viz in Tooltip worksheet

Note: If the source sheet is hidden for a dashboard, you will first need to first unhide that worksheet from its dashboard to access it. For details, see [Manage Sheets in Dashboards and Stories](#) on page 2822.

To hide a Viz in Tooltip worksheet, from the tab for the target worksheet that is the Viz in Tooltip, select **Hide**.

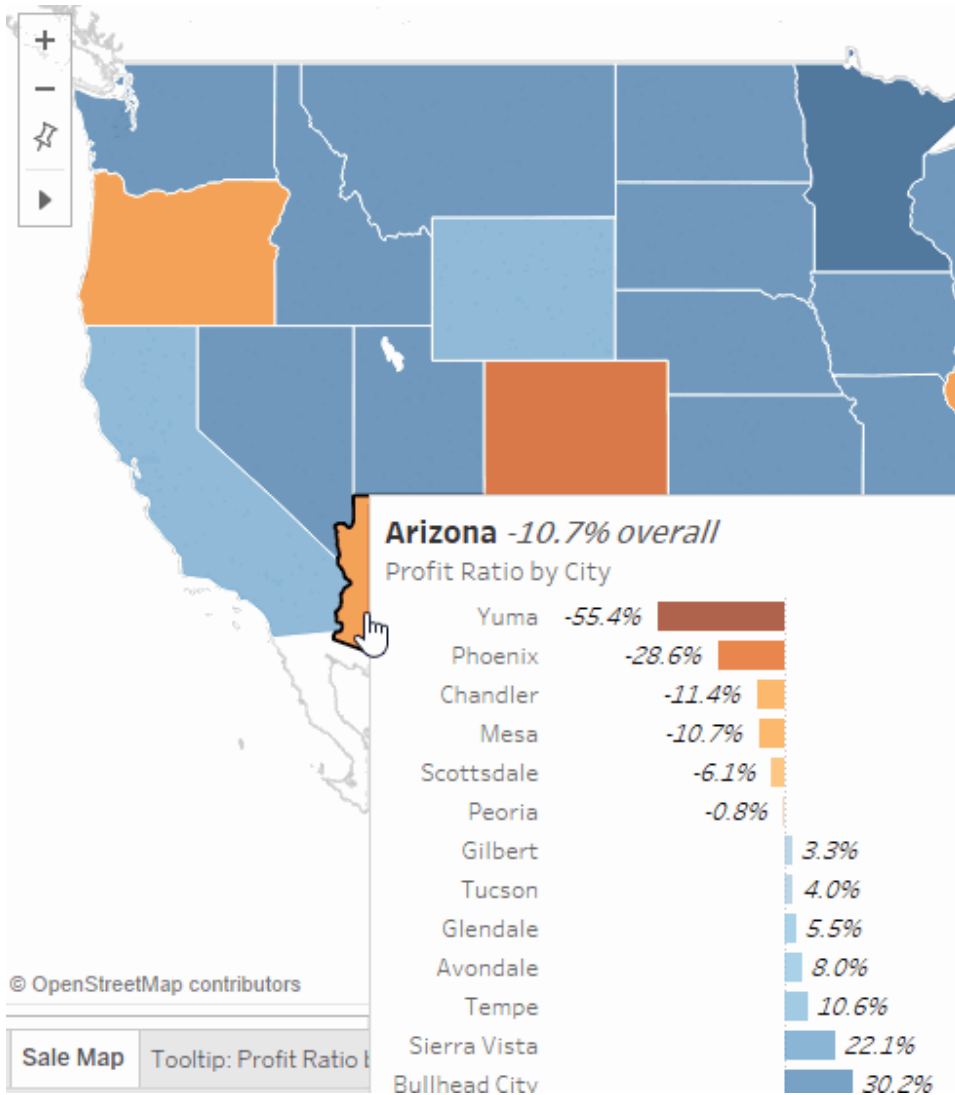

Show a Viz in Tooltip worksheet

To show a Viz in Tooltip worksheet, from the tab for the source worksheet, select **Unhide All Sheets**.

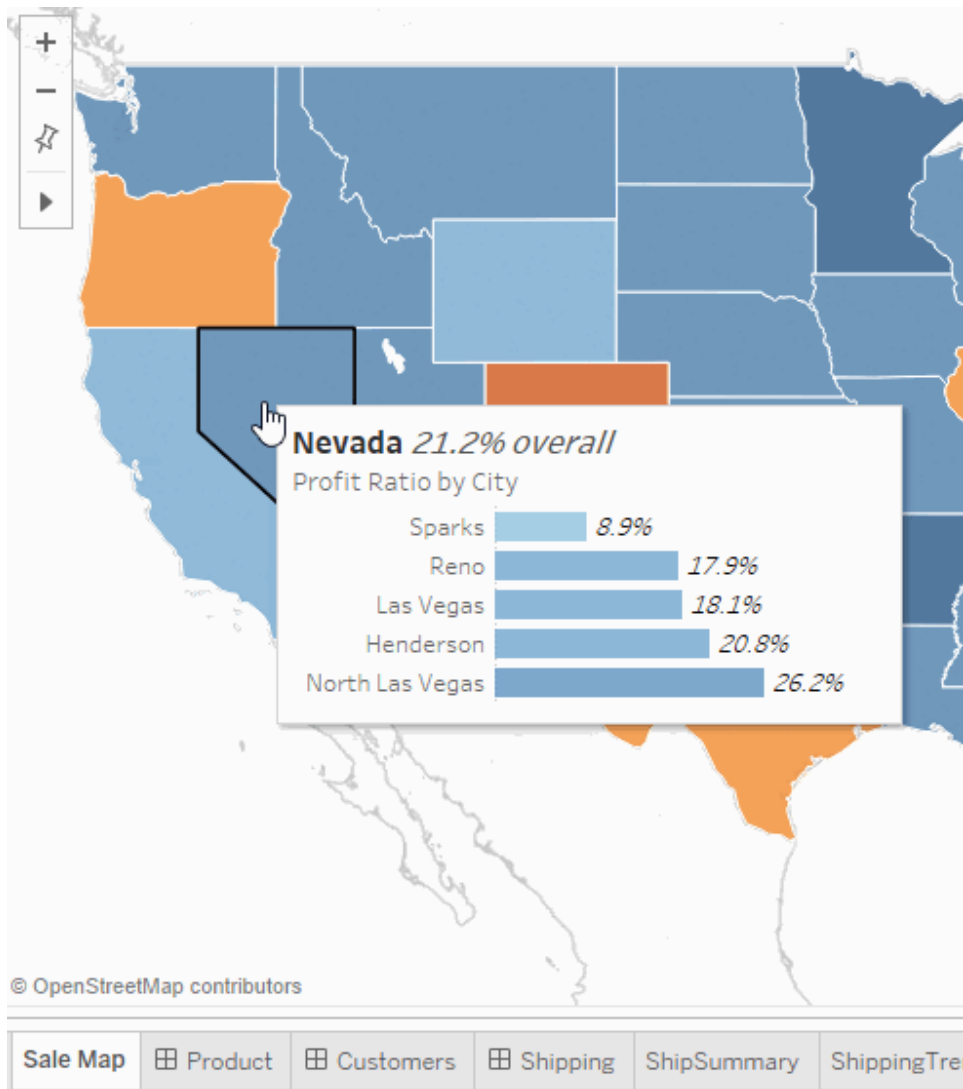

Examples of Viz in Tooltip

When you create a Viz in Tooltip, users can hover over a mark to examine details-on-demand, within the context of the original view. A Viz in Tooltip is a static image of data from another view that is relevant to a mark in the current view. Hovering over or selecting the mark reveals data from another sheet—filtered for that mark—in its tooltip.

Watch a video: To see more examples and related concepts, see [Next Level Viz in Tooltip](#), a 55-minute free video presentation.

Use Viz in Tooltip to show:

- Data at another level of detail

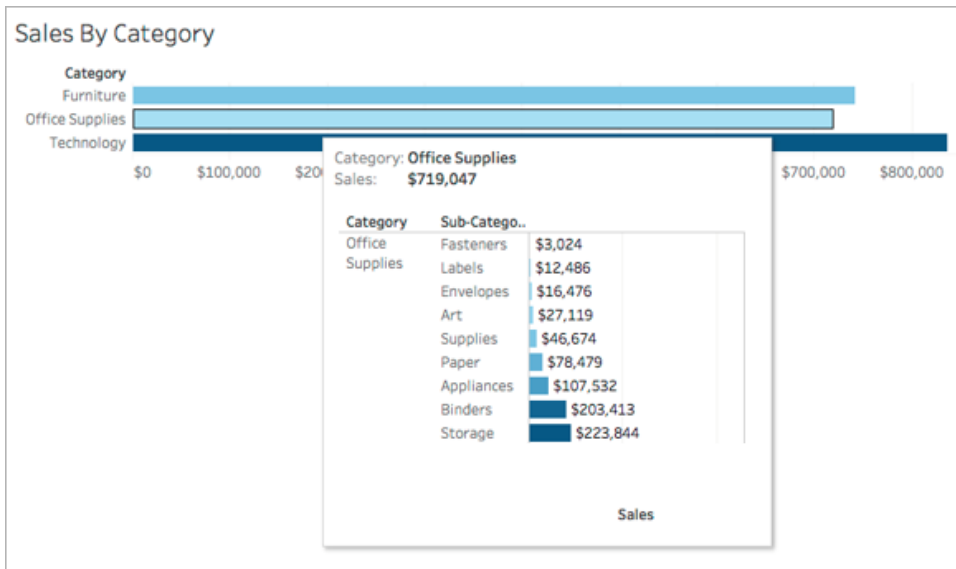

- Different, but relevant data

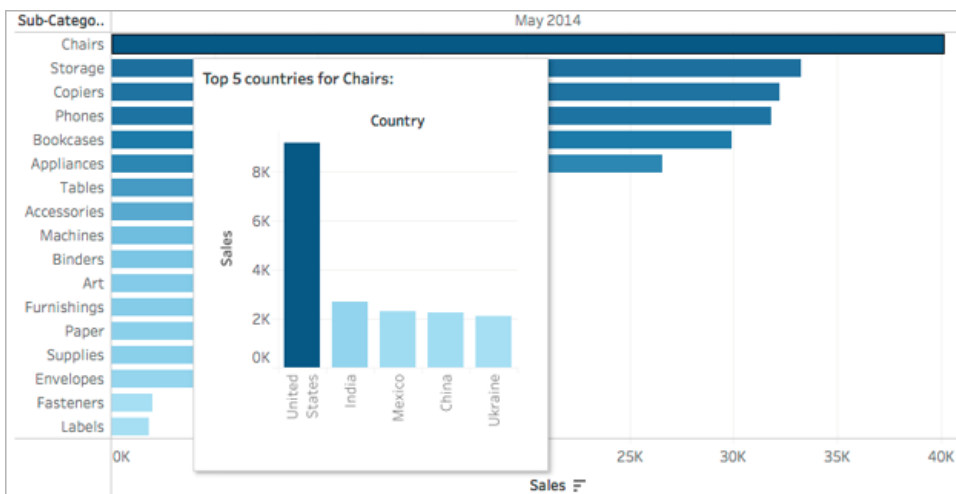

- How the value of a mark changes over time

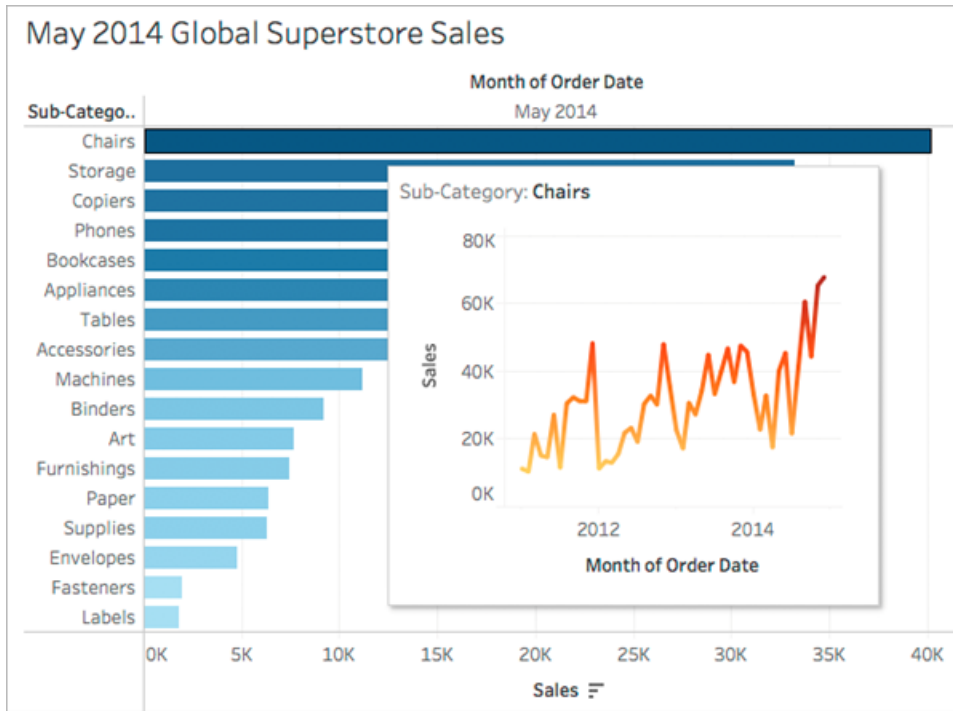

- Multiple visualizations in one tooltip

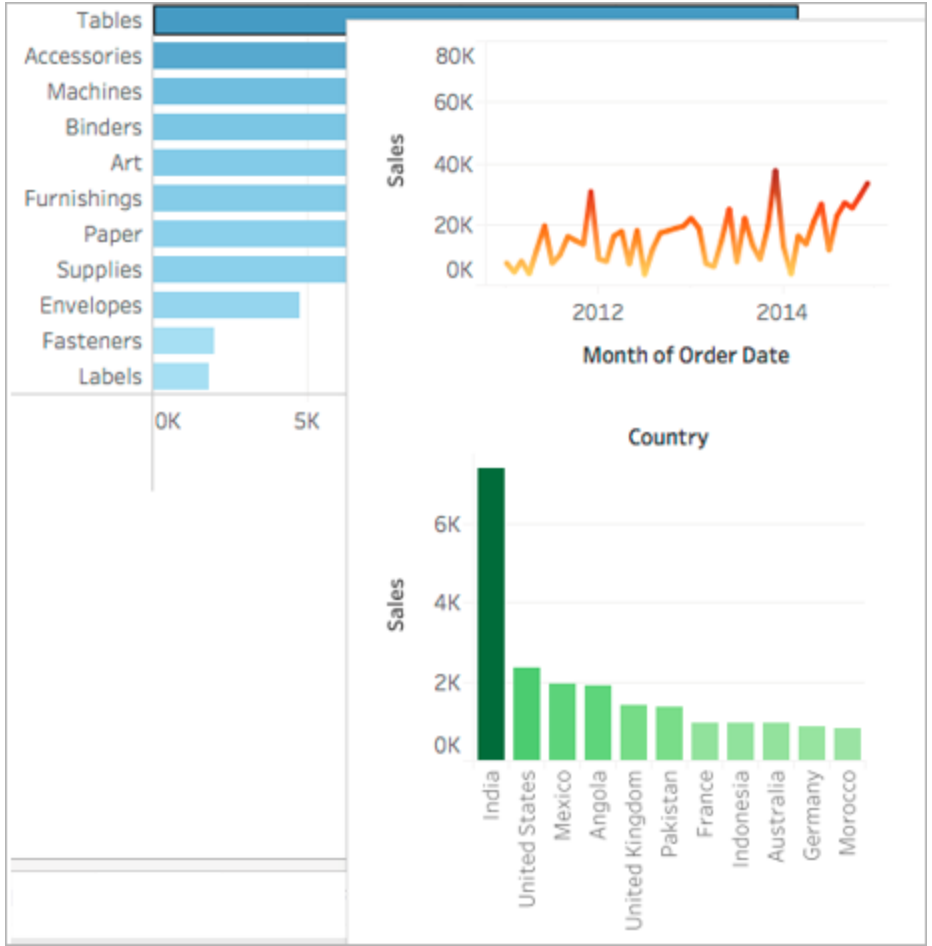

- A legend for the main view

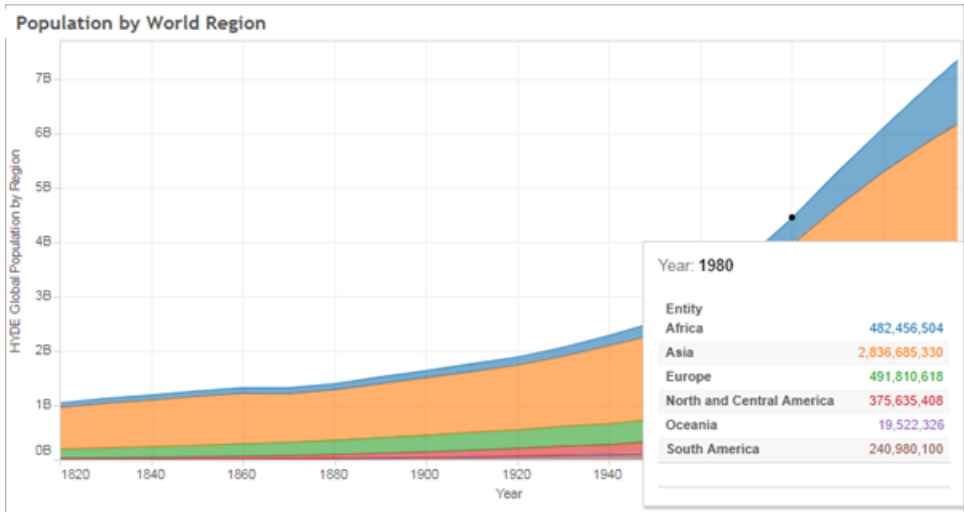

When you show related views in tooltips, you can help your audience engage with the data at a deeper level, while maximizing the space available for the current view.

Tips and notes on using and configuring Viz in Tooltip

- You can use worksheets to create a Viz in Tooltip, but you cannot use dashboards or stories to create a Viz in Tooltip.
- A Viz in Tooltip is a static image of a target view, not an interactive sheet. A Viz in Tooltip cannot have its own Viz in Tooltip.
- You will need a *source* worksheet visualization and a *target* worksheet visualization to create a Viz in Tooltip. You will need to create a target view to make it available in the Tooltip Editor.
- Use a standard naming scheme for the target sheets you plan to show in tooltips, such as Tooltip: *Name of View*. Using a standard naming scheme will help you keep track of views that you are using in tooltips.
- For the target view, consider the size of the view data and how the view will look in the tooltip. You will be able to specify the size for the Viz in Tooltip when you configure it, but you will need to check to see how it is displaying and possibly make adjustments to the view before you publish it.

Remember that the target view is displayed in the context of the source view. Keeping the target visualization simple can help with performance and reduce cognitive load.

- If you click Show Me in the source sheet and it changes the view structure, all tooltip edits including Viz in Tooltip references will be reset. You will need to reconfigure the Viz in Tooltip.
- One target sheet can be referenced by one Viz in Tooltip source sheet at a time, because filters are applied directly to the referenced sheet. When a sheet is already being used as a target sheet in a tooltip, it becomes unavailable for selection in the Tooltip Editor.
- By default, Viz in Tooltip is filtered on *All Fields*, which considers all fields in the view (at the most specific level of detail) when identifying matching records. You can change the level of detail for Viz in Tooltip by defining a filter on *Selected Fields*, similar to filtering on **Selected Fields** in Filter Actions. For related details, see [Create Advanced Highlight Actions on page 1402](#).

Filtering on *Selected Fields* does not work across different data sources. If the source and target views are using different data sources, filtering on *All Fields* will automatically detect

the fields in common (if they share the same alias), and filter on them. Filtering on *Selected Fields*, however, will not work.

Actions

Add context and interactivity to your data using actions. Users interact with your visualizations by selecting or hovering over marks, or selecting a link in a tooltip menu, and the actions you set up can respond with navigation and changes in the view.

For example, in a dashboard showing home sales by neighborhood, you could use actions to display relevant information for a selected neighborhood. Selecting a neighborhood in one view can trigger an action that highlights the related houses in a map view, filters a list of the houses sold, then opens an external web page showing census data for the neighborhood. For related information and examples, see [A Rough Guide to Dashboard Actions](#) on the Tableau Public blog.

Types of actions

There are several types of actions, each with a different purpose:

- **Filter.** Use the data from one view to filter data in another.
- **Highlight.** Call attention to marks of interest by dimming all others.
- **Go to URL.** Create hyperlinks to external resources, such as a web page or file.
- **Go to Sheet.** Simplify navigation to other worksheets, dashboards, or stories in the same workbook.
- **Change Parameter.** Let users change parameter values by directly interacting with marks on a viz.
- **Change Set Values.** Let users change the values in a set by directly interacting with marks on a viz.

Order of operations

Actions are executed by Tableau in a specific order:

1. Parameter
2. Set
3. Filter
4. Go to sheet
5. Highlight
6. Go to URL

Within each type, actions are performed in alphabetical order. That is, if there are two filter actions, filter action *"A Filter Action"* is performed before *"This is a Filter"*.

Filter Actions

Filter actions send information between worksheets. Typically, a filter action sends information from a selected mark to another sheet showing related information. Behind the scenes, filter actions send data values from the relevant source fields as filters to the target sheet.

For example, in a view showing the sales price of houses, when you select a particular house, a filter action can show all comparable houses in a different view. The source fields for the filter might contain sales price and square footage.

Watch a video to see real-world examples of actions. Filter actions are covered at the 2:20 mark.

Create or edit a filter action

1. Do either of the following:

- On a worksheet, select **Worksheet > Actions**.
- On a dashboard, select **Dashboard > Actions**.

From the drop-down menu of a dashboard sheet, you can also select **Use as Filter**. In the Actions dialog box, "generated" appears in the default names of

actions created this way.

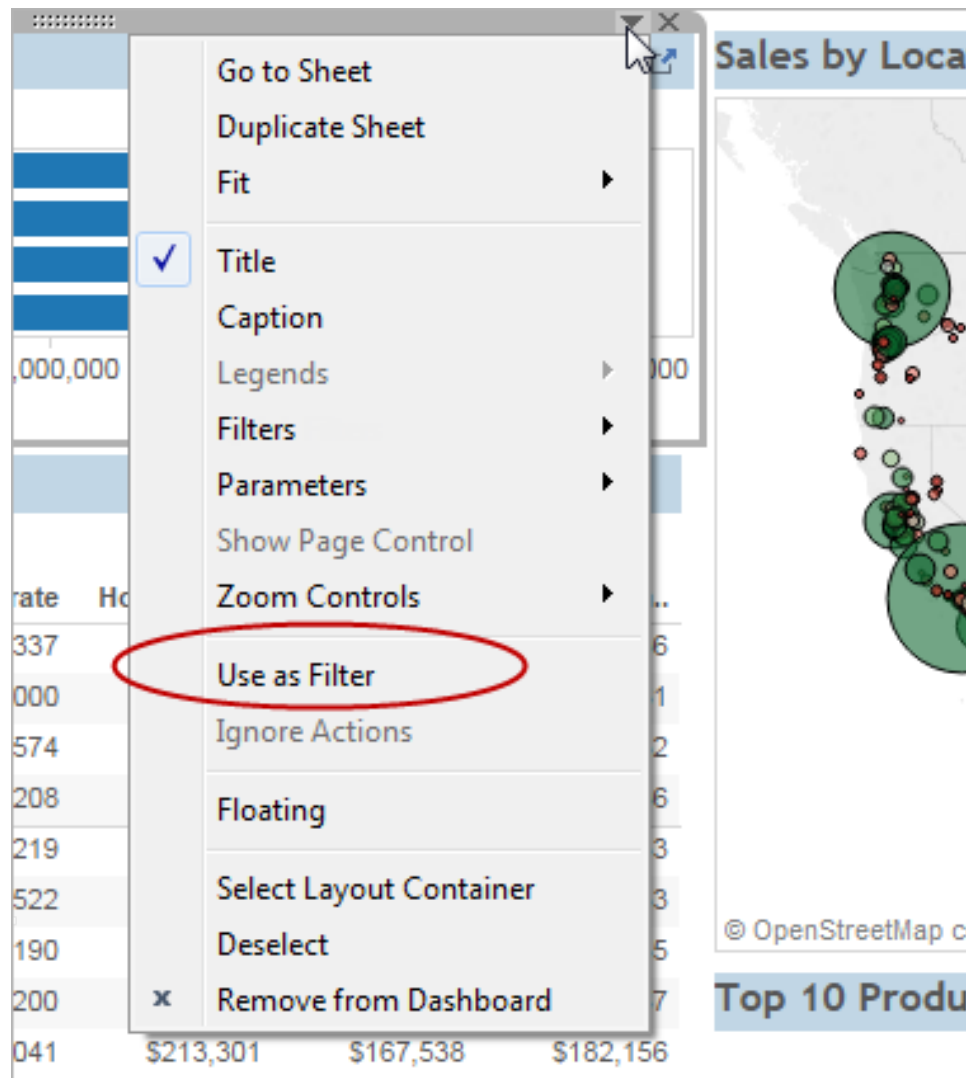

2. In the Actions dialog box, click **Add Action**, and then select **Filter**. Or select an existing action, and choose **Edit**.

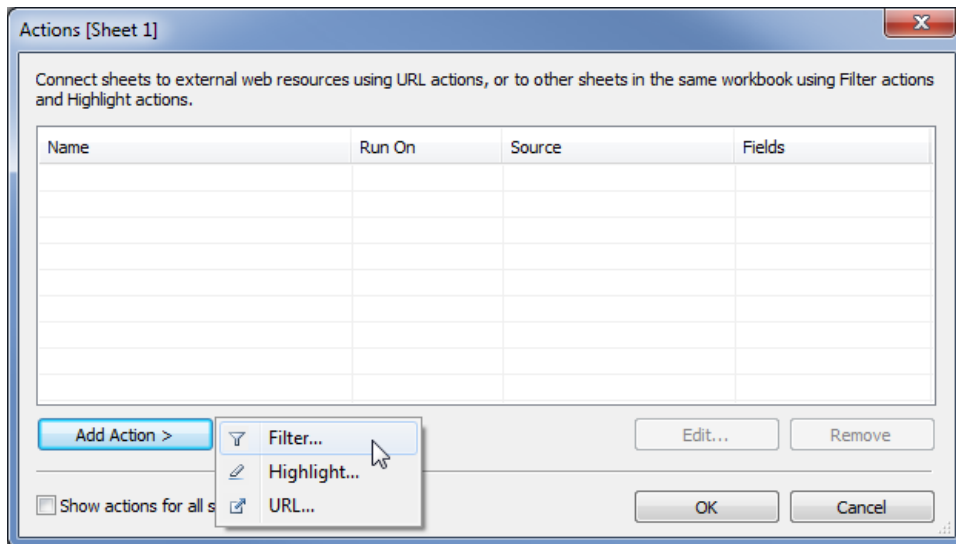

3. Specify a name for the action.

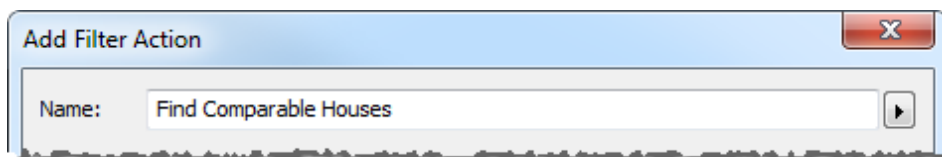

Tip: If you plan to launch an action from a tooltip menu, use a descriptive name so users will understand the action's purpose. From the menu to the right of the Name box, you can **insert variables that are drawn from the values of selected fields**.

4. Select a source sheet or data source. If you select a data source or dashboard, you can select related sheets you want to launch the action from.

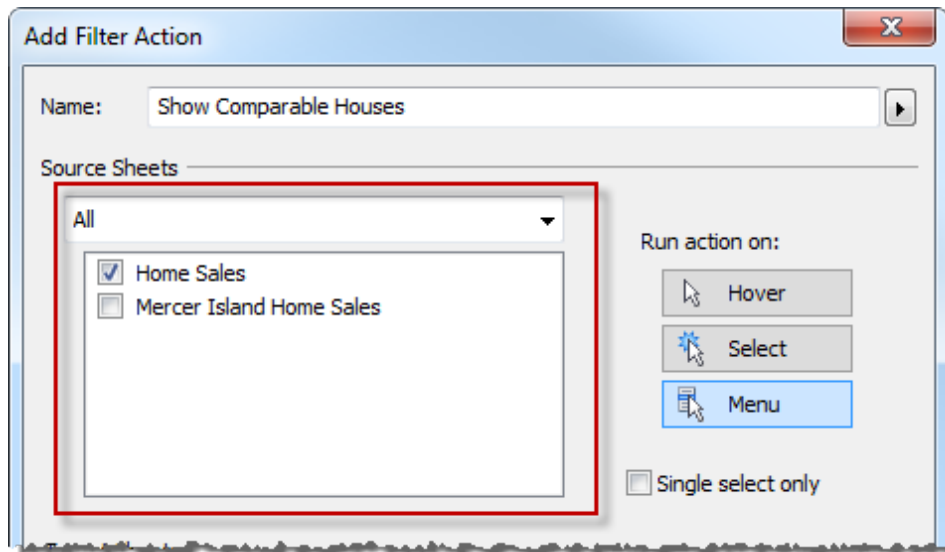

5. Specify how the action runs:

- **Hover** - Runs when you mouse over marks in the view.
- **Select** - Runs when you click marks in the view. If you want to avoid running the action when multiple marks are selected, also select **Single-select only**.
- **Menu** - Runs when you right-click (Windows) or Control-click (macOS) a mark in the view, and then click an option in the tooltip menu.

6. Select a target sheet. When you select a dashboard, you can select one or more sheets within it.

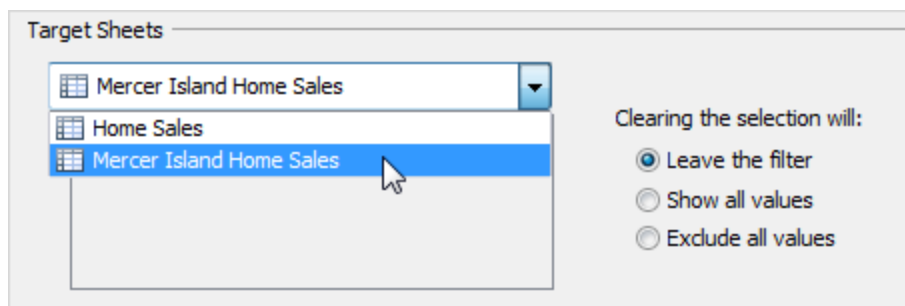

7. Specify what happens when the selection is cleared in the view:

- **Leave the filter** - Continues to show filtered results on the target sheets. (In web-authoring mode, this is labeled **Keep filtered values**.)
- **Show all values** - Changes the filter to include all values.

- **Exclude all values** - Changes the filter to exclude all values. This option is useful when you're building dashboards that only show some sheets if a value in another sheet is selected.
8. Specify the data that you want to show on the target sheets. You can filter on **All Fields** or **Selected Fields**.
 9. If you chose **Selected Fields**, click a drop-down menu in the **Source Field** column, and select a field. Then select a target data source and field.

Filter

All fields Selected fields

<input type="checkbox"/>	Source Field	Target Data Source	Target Field
<input type="checkbox"/>	Click to add ▼		

Note: Filter actions that depend on a **user function**, such as USERNAME(), will not work because **row-level security** restricts access to the data.

Understanding available target fields

In the Add Filter dialog box, the fields available in the Target Field drop-down list are limited to the data type of the Source Field. For example, if you select a text field for the source, only text fields are available as targets.

If you are connected to a relational data source, you can add sheet links across data sources even if the field names don't match. For example, if one data source has a Latitude field while another has a Lat field, you can associate the fields using the drop down lists in the Add Filter dialog box. When using a multidimensional data source, the destination sheet must use the same data source as the source sheet, and the source and target field names must match. (In Tableau, multidimensional data sources are supported only in Windows.)

Highlight Actions

Highlight actions allow you to call attention to marks of interest by coloring specific marks and dimming all others. You can highlight marks in the view using a variety of tools. For example, you can manually select the marks you want to highlight, use the legend to select related marks, use the highlighter to search for marks in context or create an advanced highlight action.



The following table describes the different methods you can use to highlight marks in a view, dashboard, or story.

Highlight method	Benefits	When you might use this
Select marks on page 1995	<ul style="list-style-type: none"> Manually select a group of marks to highlight in a view. Your selection is saved with the workbook. 	<ul style="list-style-type: none"> When you want to manually highlight a selection of marks and dim all others. Works well with small domains or views with a small amount of data.
Legends	<ul style="list-style-type: none"> Supports one-way and two-way highlighting. Highlight on color, size, or shape. You can disable or enable the highlighting action for the workbook or sheets from the toolbar. Your selection is saved with the workbook and can be included in dashboards and stories and when publishing. 	<ul style="list-style-type: none"> When you want to focus on select members in a view and dim all others. When you want to highlight using only the legend or the legend and the view. Works well with small domains or views with a small amount of data.
Highlighter	<ul style="list-style-type: none"> Search for data points in a view using keywords or select from a drop-down list. Highlight marks while maintaining the context of the other data points. 	<ul style="list-style-type: none"> When you want to highlight a mark or group of marks for a discrete field that is included in the view. When you want to do ad hoc comparisons with instant

	<ul style="list-style-type: none"> • Values automatically update when the underlying data is updated. • Highlighters added to worksheets also appear on dashboards and stories. 	<p>highlighting.</p> <ul style="list-style-type: none"> • Works well with large domains and large amounts of data.
Actions (Tableau Desktop only)	<ul style="list-style-type: none"> • Highlight data based on criteria that you define. • Specify the source and target sheets to apply the highlight action to. • Specify the fields to use for highlighting. • You can specify different types of actions to run on the same click (for example, filter and highlight). 	<ul style="list-style-type: none"> • When you want to build interactive exploration into a dashboard. • When you want to highlight data points in a dashboard using specific fields.

Legend Highlighting

You can use legend highlighting to focus your users' attention on specific marks in a view. When legend highlighting is on, marks associated with the legend item are highlighted and the other marks are dimmed.

You can enable either one-way  or two-way  highlighting to highlight marks in the view. The icon at the top of the legend indicates which mode you're using.

- One-way highlighting enables you to highlight marks using the values in the legend.
- Two-way highlighting enables you to highlight marks using either the legend or the view. This is the default. When you highlight marks in the view, the matching member in the legend is also highlighted.

You can also turn off highlighting for the workbook or the sheet from the toolbar. This action hides the highlight icon on the legend. For more information about using the toolbar highlighting option, see [Highlight Toolbar Button on page 1400](#).

In this example, the views below show the relationship between order quantity and profit for several products. The view on the left uses the standard functionality for the color legend, where

all marks are colored based on their shipping mode. The view on the right uses legend highlighting to call out the products that were delivered via Second Class shipping.

Normal Color Legend

Color Legend Highlighting Enabled

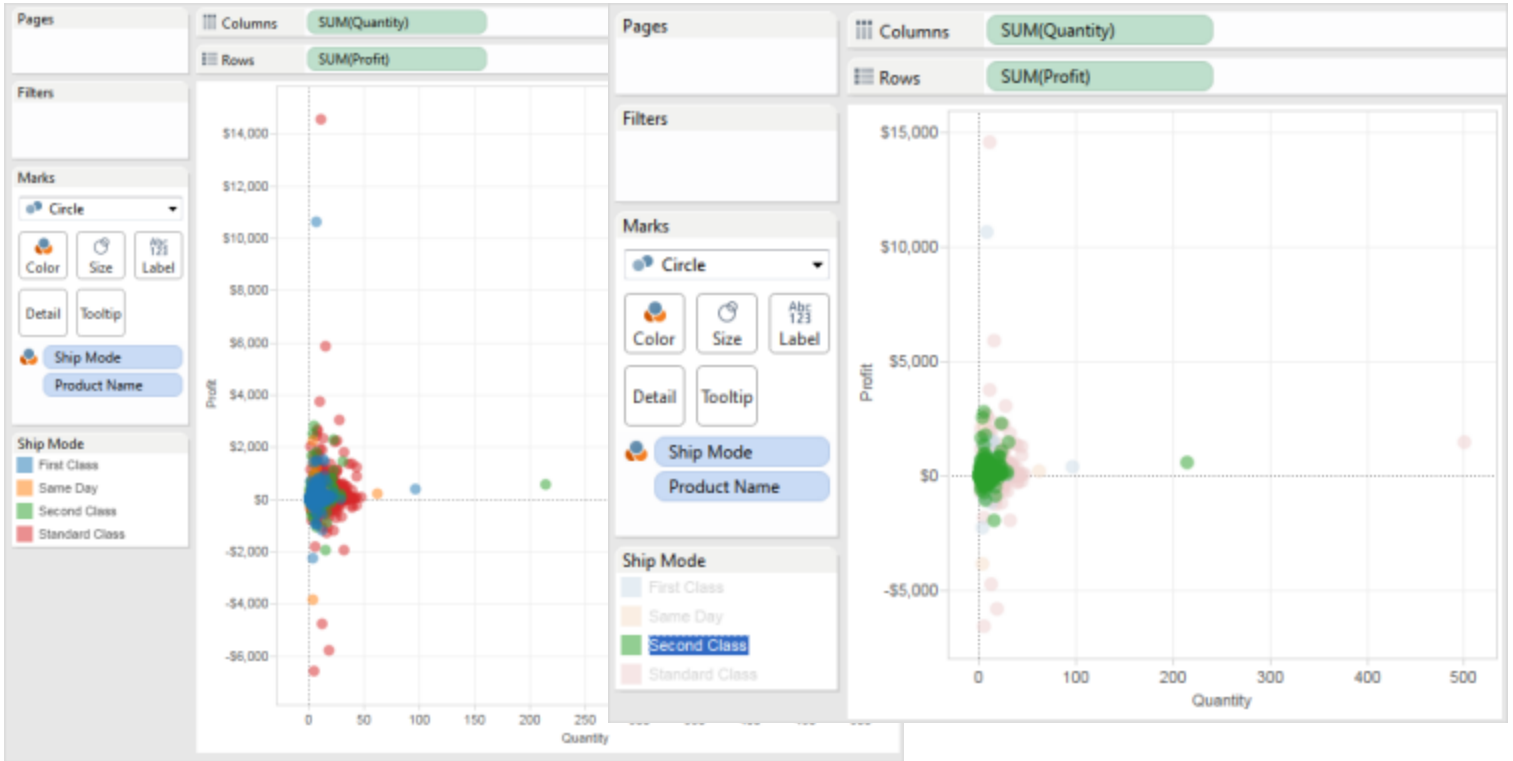

You can easily switch between legend highlighting and normal modes using the legend card menu. For color legends, if you like how a view is highlighted, you can assign the highlight colors to the color palette. The old colors are replaced with the highlight colors.

Turn on legend highlighting

1. Click the **Highlight** button  at the top of the legend.

If you're using Tableau Desktop you can also turn on legend highlighting by selecting **Highlight Selected Items** on the legend card menu.

This example shows highlighting using the color legend. Color legend highlighting is turned on by default.

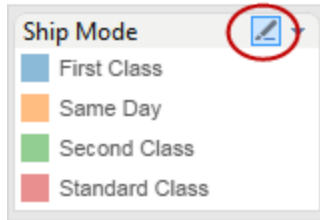

2. Select an item in the color legend.

After legend highlighting is turned on, you can quickly focus on specific data in the view by selecting different items in the color legend. When you turn on legend highlighting, a highlight action is created that you can modify in the Actions dialog box.

Turn off legend highlighting

Click the **Highlight** button  at the top of the legend. This changes highlighting to one-way and you can use the legend to highlight matching marks in the view.

Legend highlighting in Tableau Desktop

If you're using Tableau Desktop you can also turn off legend highlighting by selecting **Highlight Selected Items** on the legend card menu. When you turn legend highlighting off the action is removed from the Actions dialog box.

If you like how the view is highlighted and want to keep a specific member highlighted even when you turn off legend highlight mode, you can assign the highlight colors to the existing color palette. The original color legend is discarded and the highlight colors become the new color palette for the legend.

To assign the highlight colors to the color palette, select **Assign Highlight Colors to Palette** on the color legend card menu.

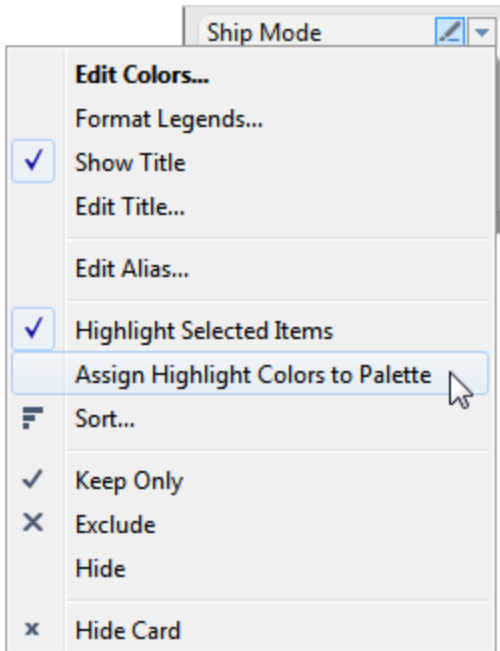

Highlight Data Points in Context

When you have a view with a large amount of data you might want to explore your data interactively and highlight a specific mark or group of marks while still maintaining the context of where those marks show in your view.

To do this you can turn on the Highlighter for one or more discrete fields that are included in your view and that affect the level of detail (see [How dimensions affect the level of detail in the view on page 151](#) for more information).

You can use keywords to search for matching data points. The highlighter immediately highlights the marks that match or partially match your keyword search. If you update the underlying data source for your view the data shown in the highlighter is automatically updated too.

In the example below, the Highlighter is turned on for the **College** field. Entering a partial keyword search for **Public** returns two possible matches. In the view, Tableau highlights the group of marks that match the partial search: **Public Affairs** and **Public Health**.

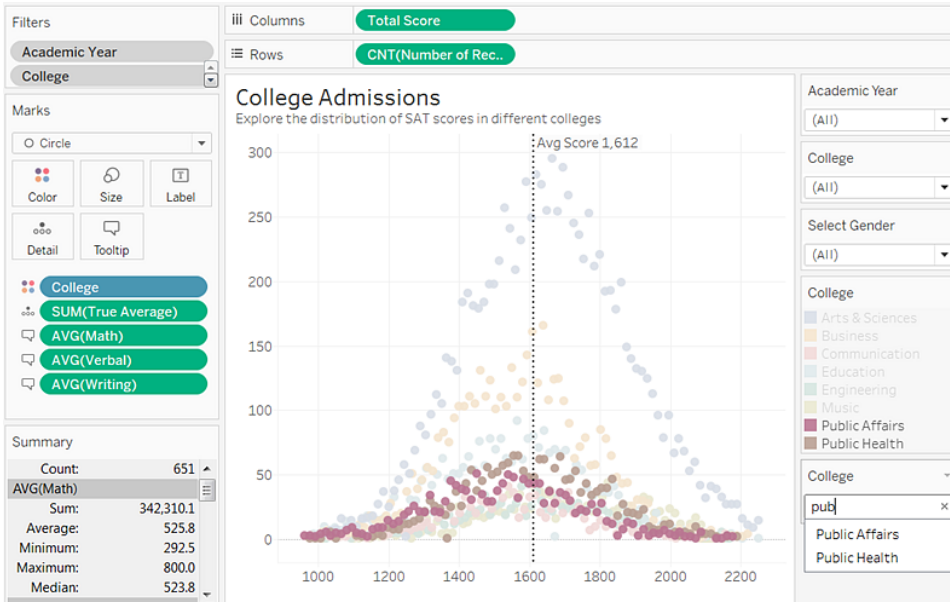

You can turn on highlighters for as many discrete fields in our view as you need. However, you can only highlight using one value set at a time. If you want to include the highlight option on dashboards and stories, turn them on in the worksheet before you add them to the dashboard, or select the worksheet on the dashboard, and then select **Analysis > Highlighters** from the top menu and select from the fields in the list.

Tableau Desktop only: If you want to change the format for the highlighter card after you turn it on, select **Format > Highlighter**.

Highlighters work across worksheets on a dashboard if the same field is included across those worksheets. If the same field is not found, then no match is found for the highlighted value, and the values in those worksheets are dimmed. If you have multiple highlighters showing on a dashboard, only one highlighter can be active at a time. In this situation, the highlight shows for the highlighter that was used last.

Turn on highlighting

1. Right-click on a discrete field that is included in the view and impacts the level of detail in the view. Then select **Show Highlighter** from the context menu.

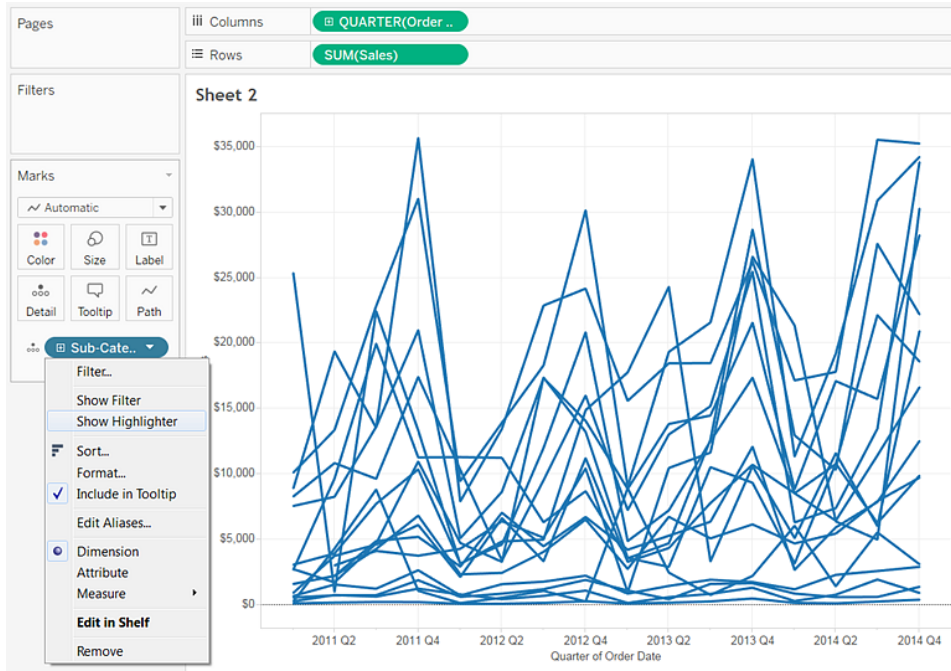

2. Click in the highlighter dialog box and do one of the following:
 - Enter a keyword to search for matching marks to highlight.
 - Enter a partial key word to search for all relevant matches that contain your search text.
 - Select an item in the drop-down list. You can select one item at a time.
 - Hover over items in the drop-down list to highlight marks in the view for an ad hoc analysis experience.

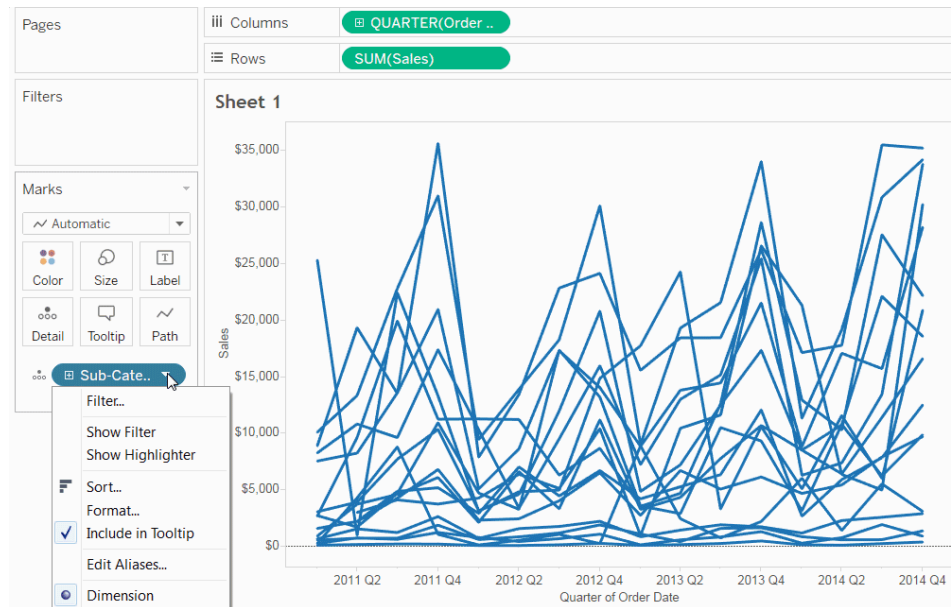

Click the image above to replay the animation.

- Repeat steps 1 and 2 to add additional highlighters.

You can also show mark labels on highlighted marks. To turn on mark labels, on the Marks card, click **Label**, select the **Show mark labels** check box and select **Highlighted** in the Marks to Label section.

Highlight Toolbar Button

Another way to add a highlight action is to use the highlight button in the toolbar. Similar to legend highlighting, the toolbar button lets you highlight a collection of related marks in the view and functions the same way that two-way highlighting does. To turn on highlighting, select the fields you want to use for highlighting on the toolbar menu. The drop-down list shows the active fields in the view. Then select a mark in the view to see the related data.

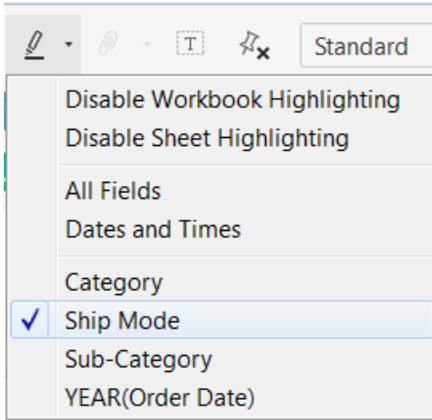

For example, the view below shows **Sales** vs. **Profit** by **Region**. If you turn on highlighting for **Ship Mode**, when a mark is selected, all other marks that were shipped via that mark's ship mode are highlighted. In this example you can quickly see all products from across the United States that were shipped via Second Class.



The toolbar menu also lets you highlight on **All Fields** or **Dates and Times**. **All Fields** considers all fields in the view when identifying matching records; **Dates and Times** considers all date and time fields in the view.

When you use the Highlight toolbar button in Tableau Desktop, an action is created in the Actions dialog box. You can modify the action to create more advanced highlighting behavior. For more information about editing actions, see [Create Advanced Highlight Actions](#) below.

Finally, you can use the toolbar button to disable highlighting across the entire workbook or for just the active sheet. These options disable highlighting for legends only. They do not turn off the ability to manually highlight marks or use the Highlighter control.

When you turn off highlighting from the toolbar button, the highlight icon is hidden on the legend, and the **Highlight Selected items** menu option is grayed out on the context menu for the legend.

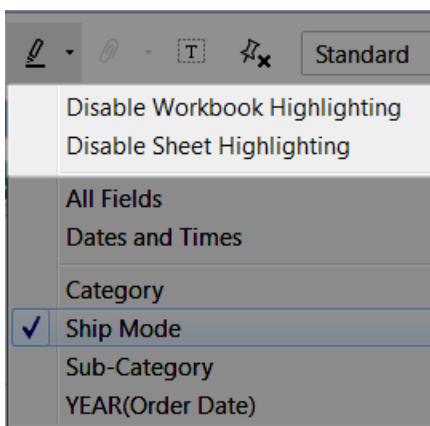

Create Advanced Highlight Actions

You can define more advanced highlight actions using the Actions dialog box. There you can specify source and target sheets and the fields you want to use for highlighting. Follow the steps below to create a highlight action.

1. On a worksheet select **Worksheet > Actions**. From a dashboard, select **Dashboard > Actions**.
2. In the Actions dialog box click the **Add Action** button and then select **Highlight**.

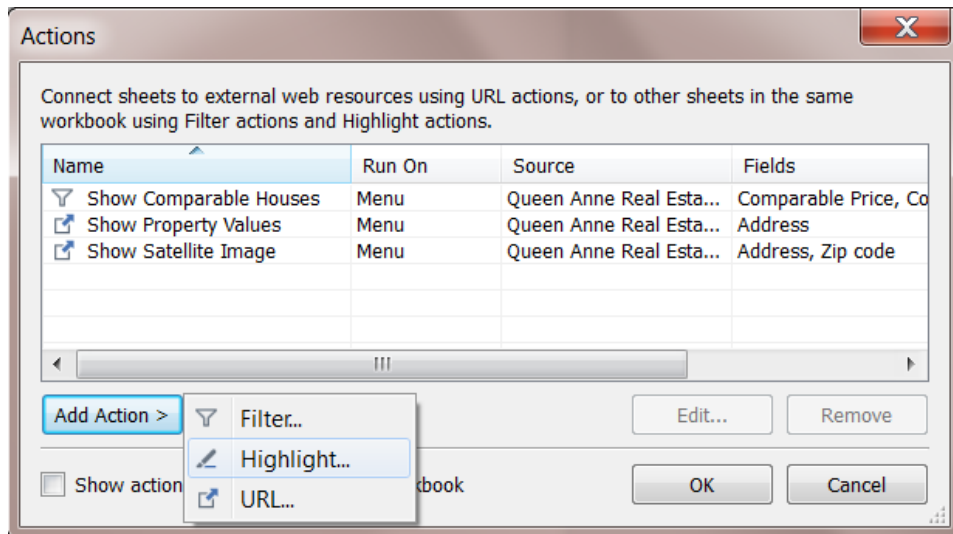

3. Name the action to identify it in the Actions dialog box. Try to make the name descriptive, such as, *Highlight Products Shipped by Delivery Truck*. You can select variables from a drop-down list and use them in the name. Then they are filled in based on the values of the selected field.
4. Use the drop-down list to select the source sheet or data source. If you select a data source or a dashboard sheet, you can further select individual sheets within them.

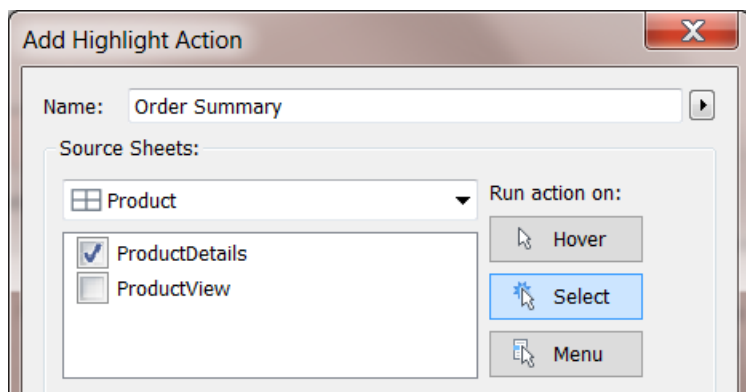

5. Select how you want to trigger the action. You can select from the following options:
 - **Hover** - Rest the pointer over a mark in the view to run the action. This option works well for highlight and filter actions within a dashboard.
 - **Select** - Click a mark in the view to run the action. This option works well for all types of actions.

- **Menu** - Right-click (control-click on Mac) a selected mark in the view and then select an option on the context menu. This option works well for filter and URL actions.
6. Select a target sheet. If you select a dashboard, you can further select individual sheets within the dashboard.

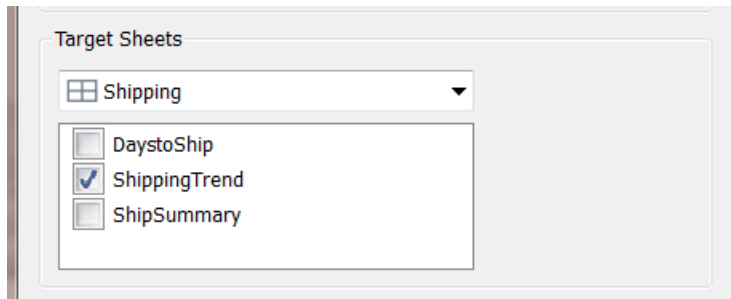

7. Select the fields you want to use for highlighting. Select from the following options:
- **All Fields** - Marks in the target sheet are highlighted when they match the marks selected in the source sheet. All fields are considered when determining a match.
 - **Dates and Times** - Marks in the target sheet are highlighted when their date and time match those of the marks selected in the source sheet. The source and target worksheets can only have one date field each, however the date fields can have different names.
 - **Selected Fields** - Marks in the target sheet are highlighted based on select fields. For example, highlighting using the Ship Mode field will result in an action that highlights all marks in the target sheet that have the same ship mode as the selected mark in the source sheet.
8. When finished, click **OK** twice to close the dialog boxes and return to the view.

See Also

[Highlight Actions](#) on page 1393

[Highlight Data Points in Context](#) on page 1397

URL Actions

A URL action is a hyperlink that points to a web page, file, or other web-based resource outside of Tableau. You can use URL actions to create an email or link to additional information about

your data. To customize links based on your data, you can automatically enter field values as parameters in URLs.

Tip: URL actions can also open in a web page object in a dashboard. See [Actions and Dashboards](#) to learn more.

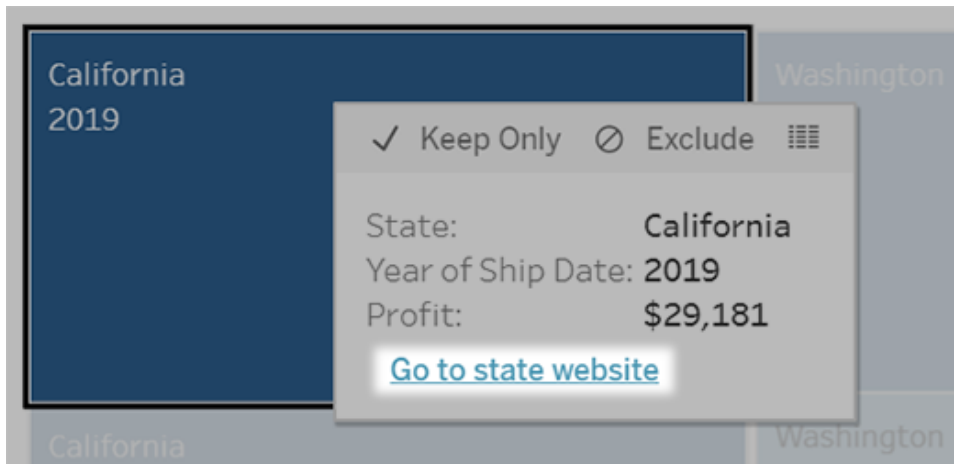

A URL action run from a tooltip menu. The link reflects the action name, not the target URL.

Open a web page with a URL action

1. On a worksheet, select **Worksheet > Actions**. From a dashboard, select **Dashboard > Actions**.
2. In the Actions dialog box, click **Add Action** and then select **Go to URL**.
3. In the next dialog box, enter a name for the action. To enter field variables in the name, click the **Insert** menu to the right of the **Name** box.

Note: Give the action a descriptive name, because the link text in the tooltip is the name of the action, not the URL. For example, when linking to more product details, a good name could be "Show More Details".

4. Use the drop-down list to select a source sheet or data source. If you select a data source or dashboard you can select individual sheets within it.

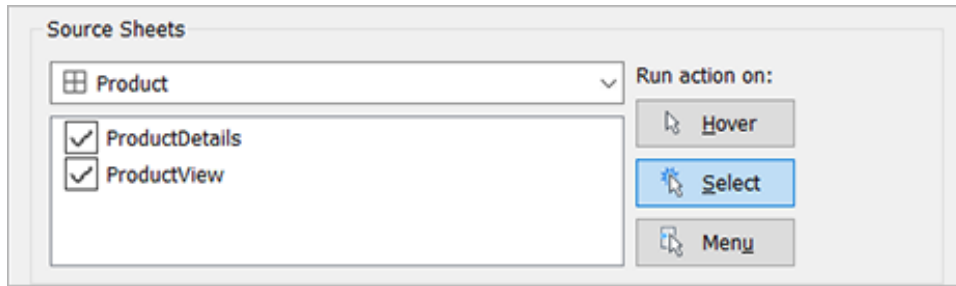

5. Select how users will run the action.

If you

choose this option... **The action is run when the user...**

- | | |
|---------------|---|
| Hover | Mouses over a mark in the view. This option works best for highlight actions within a dashboard. |
| Select | Clicks a mark in the view. This option works well for all types of actions. |
| Menu | Right-clicks (control-clicks on Mac) a selected mark in the view, then clicks an option in a tooltip (menu). This option works particularly well for URL actions. |

6. For URL Target, specify where the link will open:

- **New Tab if No Web Page Object Exists** — Ensures that the URL opens in a browser on sheets that lack web page objects. This is a good choice when Source Sheets is set to All or a data source.
- **New Browser Tab** — Opens in the default browser.
- **Web Page Object** — (Available only for dashboards with Web Page objects) Opens in the web page object you select.

URL Target

New Tab if No Web Page Object Exists
 New Browser Tab
 Web Page Object

7. Enter a URL

- The URL should start with one of the following prefixes: `http`, `https`, `ftp`, `mailto`, `news`, `gopher`, `tsc`, `tsl`, `sms`, or `tel`

Note: If no prefix is entered, `http://` is automatically appended to the beginning and the URL action will work in Tableau Desktop. However, if a URL action with no prefix is published to Tableau Server or Tableau Cloud, it will fail in the browser. Always provide a fully qualified URL for actions if the dashboard will be published.

Note: You can specify an ftp address only if the dashboard doesn't contain a web object. If a web object exists, the ftp address won't load.

- Tableau Desktop also supports local paths like `C:\Example folder-example.txt`, as well as file URL actions.
- To enter field and filter values as dynamic values in the URL, click the **Insert** menu to the right of the URL. Be aware that any referenced fields must be used in the view. For details, see [Using field and filter values in URLs on page 1410](#).

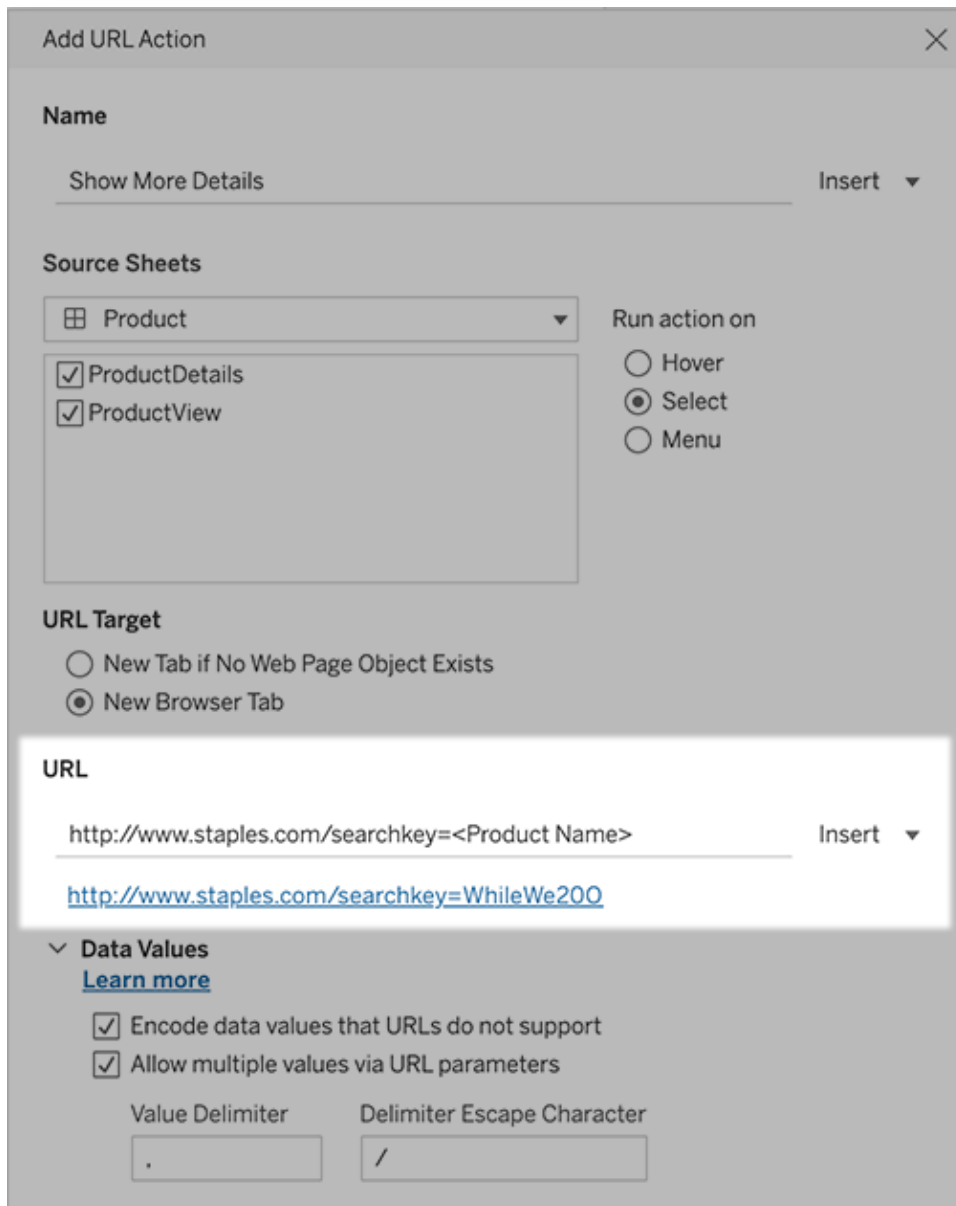

Add URL Action [X]

Name

Show More Details Insert ▼

Source Sheets

Product ▼

ProductDetails

ProductView

Run action on

Hover

Select

Menu

URL Target

New Tab if No Web Page Object Exists

New Browser Tab

URL

http://www.staples.com/searchkey=<Product Name> Insert ▼

<http://www.staples.com/searchkey=WhileWe200>

▼ **Data Values**

[Learn more](#)

Encode data values that URLs do not support

Allow multiple values via URL parameters

Value Delimiter: .

Delimiter Escape Character: /

Below the URL you enter is a hyperlinked example you can click for testing.

8. (Optional) In the Data Values section, select any of the following options:
- **Encode Data Values that URLs Do Not Support** — Select this option if your data contains values with characters that browsers don't allow in URLs. For example, if one of your data values contains an ampersand, such as “Sales & Finance,” the ampersand must be translated into characters that your browser understands.
 - **Allow Multiple Values via URL Parameters** — Select this option if you are linking to a web page that can receive lists of values via parameters in the URL. For

example, say you select several products in a view and you want to see each product's details hosted on a webpage. If the server can load multiple product details based on a list of identifiers (product ID or product name), you could use multi-select to send the list of identifiers as parameters.

When you allow multiple values, you must also define the delimiter escape character, which is the character that separates each item in the list (for example, a comma). You must also define the Delimiter Escape, which is used if the delimiter character is used in a data value.

Create an email with a URL action

1. On a worksheet, select **Worksheet > Actions**. From a dashboard, select **Dashboard > Actions**.
2. In the Actions dialog box, click **Add Action**, and select **Go to URL**.
3. In the Source Sheets drop-down list, select the sheet that contains the field with the email addresses you want to send to.
4. In the URL box, do the following:
 - Type **mailto:**, and click the **Insert** menu at right to select the data field that contains email addresses.
 - Type **?subject=**, and enter text for the Subject line.
 - Type **&body=**, and click the **Insert** menu at right to select the fields of information that you want to include in the body of the email.

In the example below, the "Email" field contains the email addresses, the subject is "City Information", and the body text of the email consists of the city and state data that is associated with the email address.

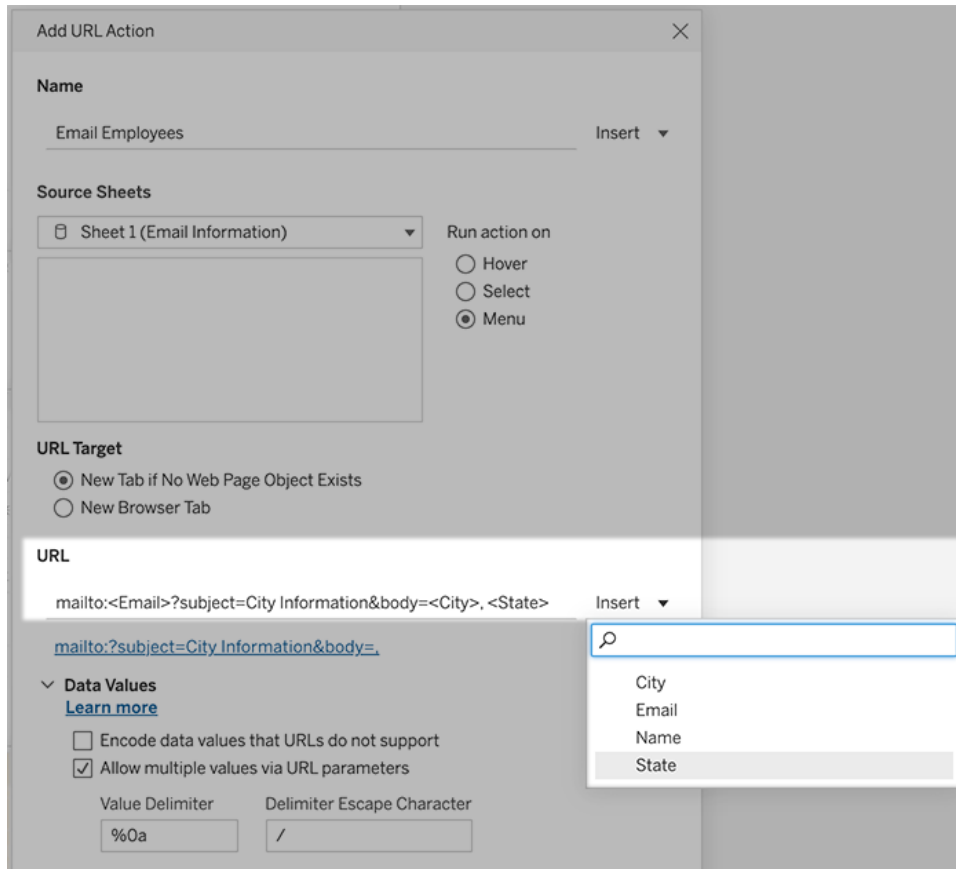

5. (Optional) Display data from your workbook in the body of your email as a vertical list instead of the default horizontal list. For example, suppose you have a horizontal list of cities, such as Chicago, Paris, Barcelona, which you would rather display vertically, like this:

Chicago

Paris

Barcelona

To make the list vertical, in the Data Values section, do the following:

- Deselect **Encode Data Values that URLs Do Not Support**
- Select **Allow Multiple Values via URL Parameters**.
- Type **%0a** in the **Value Delimiter** text box to add line breaks between each item in the list. (These are the URL-encoded characters for a line break.)

Using field and filter values in URLs

When users trigger URL actions from selected marks, Tableau can send field, filter, and parameter values as variables in the URL. For example, if a URL action links to a mapping

website, you could insert the address field to automatically open the currently selected address on the website.

1. In the Edit URL Action dialog box, begin typing the URL for the link.
2. Place the cursor where you want to insert a field, parameter, or filter value.
3. Click the **Insert** menu to the right of the text box and select the field, parameter, or filter you want to insert. The variable appears within angle brackets. You can continue adding as many variables as you need.

Note: Any referenced fields must be used in the view. Otherwise, the link won't display in the viz, even if it functions when you click Test Link.

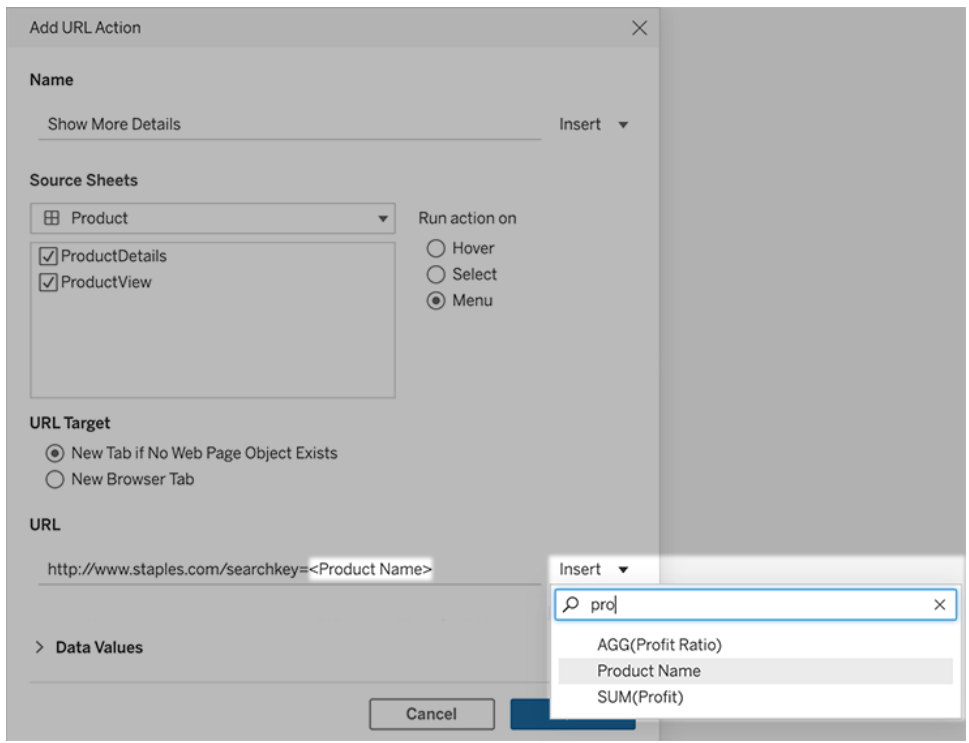

Including aggregated fields

The list of available fields includes only non-aggregated fields. To use aggregated field values as link parameters, first create a related calculated field, and add that field to the view. (If you don't need the calculated field in the visualization, drag it to Detail on the Marks card.)

Inserting parameter values

When inserting parameter values, URL actions send the Display As value by default. To instead send the actual value, add the characters `~na` after the parameter name.

For example, say you have a parameter that includes IP addresses, with Actual Value strings such as 10.1.1.195 and Display As strings with more friendly values such as `Computer A (10.1.1.195)`. To send the actual value, you'd revise the parameter in the URL to look like this: `http://<IPAddress~na>/page.htm`.

Parameter Actions

Use parameter actions to let your audience change a parameter value through direct interaction with a viz, such as clicking or selecting a mark. You can use parameter actions with reference lines, calculations, filters, and SQL queries, and to customize how you display data in your visualizations.

Parameter actions open up new possibilities for creating summary values and statistics without using calculations. You can configure parameter actions to let users select multiple marks that are automatically aggregated into a single parameter value. For example, a parameter action could show the `AVG(Sales)` or `COUNTD(Orders)` for currently selected marks.

For examples of how parameter actions can be used, see [Examples of parameter actions on page 1417](#).

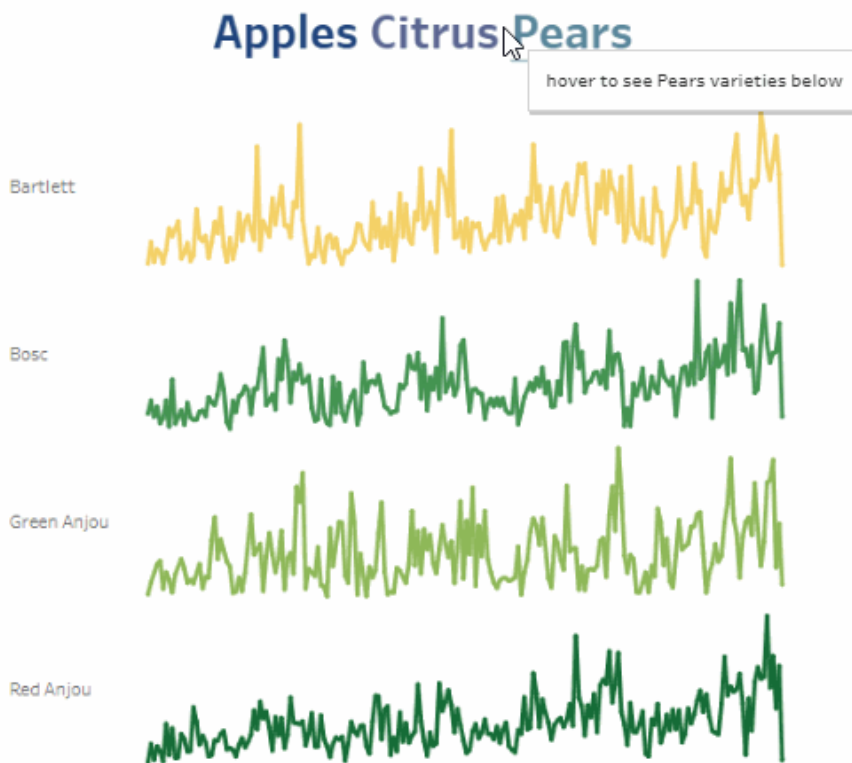

You can create parameter actions in Tableau Desktop, Tableau Cloud, and Tableau Server.

When you define a parameter action, it must include:

- the source sheet or sheets it applies to.
- the user behavior that runs the action (hover, select, or menu).
- the target parameter, the source field, and the respective aggregation (if applicable).

The parameter referenced in the action must also be referenced in some part of the visualization. You can do this in different ways, such as referencing the parameter in a calculated field or reference line that is used in the viz. You can also build a view that uses a source field that is referred to in the parameter action.

General steps for creating parameter actions

1. Create one or more parameters. For more information, see [Create Parameters on page 1122](#).

2. **Optional:** Depending on the behavior you want to make available to users for their analysis, you might want to create a calculated field that uses the parameter. For details on creating calculated fields, see [Create a calculated field on page 2018](#).
3. Build a visualization that will make use of parameter actions.

For example, if you created a calculated field that uses the parameter, build the view using that calculated field. Or, drag a field that you plan to tie to the parameter into the view.
4. Create a **parameter action** that uses a parameter. You can create multiple parameter actions for different purposes. The parameter action must refer to the sheet name of the visualization, the parameter name, and the source field that the parameter will be associated with.
5. Test the parameter action and adjust its settings or other related elements in your visualization as needed to get the behavior you want your audience to experience.

Note: It is helpful to understand how you can use parameters in Tableau before you start using them in parameter actions. For more information:

- Read the [Create Parameters on page 1122](#) help topic and related parameter topics.
- See [Use Parameters to Add Multiple Views to Your Viz](#) on the Tableau [blog](#) and multiple practical topics on how to use parameters on the [Data School](#) website, such as [Four Steps to Creating a Parameter](#).
- For an in-depth presentation, watch [Parameters | Oh, the places you'll go!](#) (45 minutes).

Create a parameter action

1. In a worksheet, select **Worksheet >Actions**. In a dashboard, select **Dashboard >Actions**.
2. In the Actions dialog box, click **Add Action** and then select **Change Parameter**.

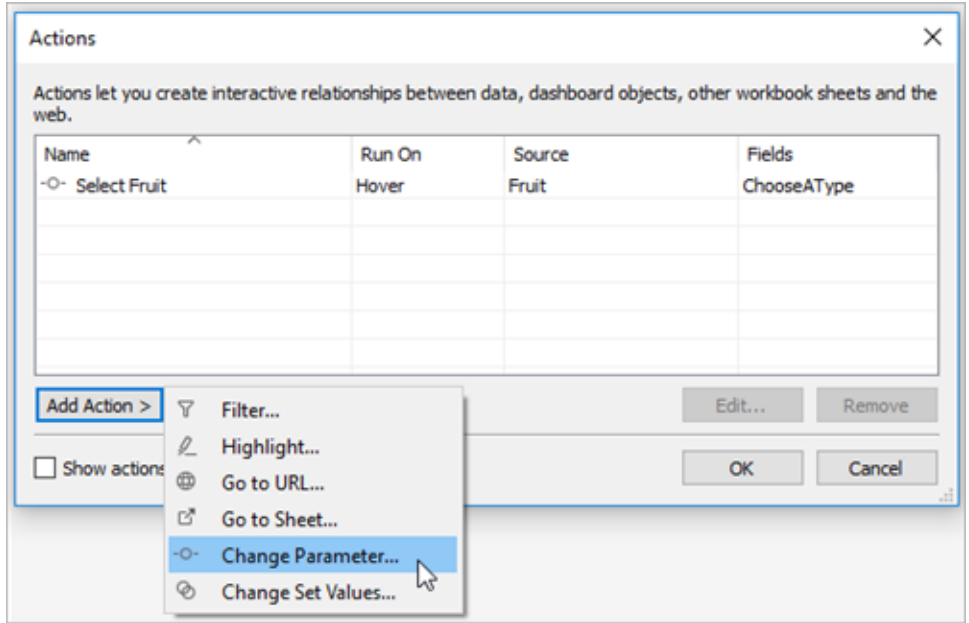

3. In the **Actions** dialog box, specify a meaningful name for the action.
4. Select a source sheet or data source. The current sheet is selected by default. If you select a data source or dashboard you can select individual sheets within it.

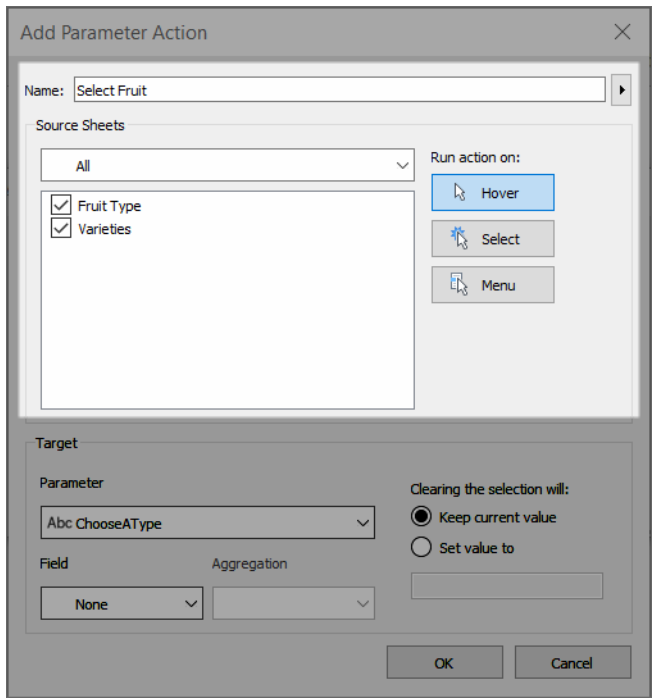

5. Select how users will run the action.

- **Hover** - Runs when a user hovers the mouse cursor over a mark in the view. Also exposes an option for the action in the mark's tooltip.
 - **Select** - Runs when a user clicks a mark or selects multiple marks in the view.
 - **Menu** - Runs when a user right-clicks (macOS: control-clicks) a selected mark in the view, then selects an option on the context menu. Also exposes an option for the action in the mark's tooltip.
6. Under **Target**, specify the target parameter and a source field. All parameters in the workbook are available in the **Parameter** list.

To let your users select multiple marks that get aggregated into a single parameter value, select an aggregation type.

Note: If you want your users to be able to select multiple marks, you will need to select an aggregation. If **Aggregation** is set to **None**, and multiple marks that contain different values for the source field are selected, the parameter action will not run.

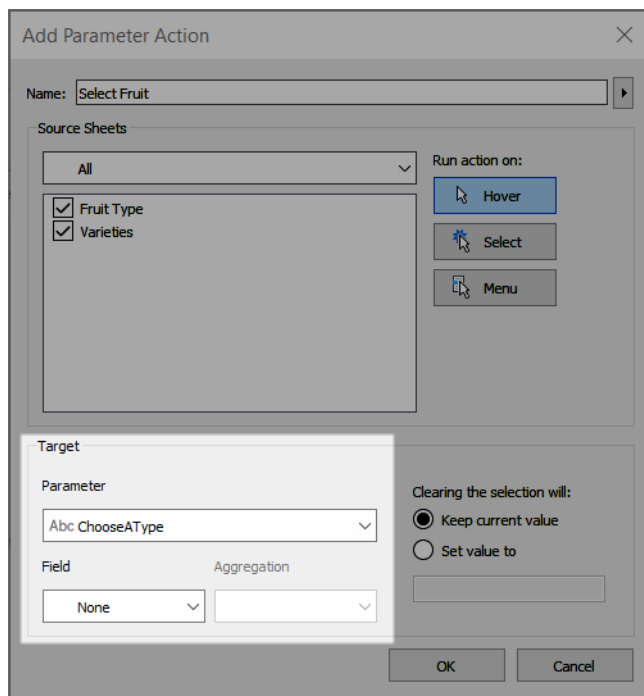

The aggregation that you choose for the parameter action can be different than the aggregation used for that field in the view. For example, you could create a view that uses

SUM(Sales), but set the Sales source field referenced in the parameter action to use Average for the aggregation. Note that if you then change the aggregation of the Sales field in the view to AVG(Sales), you will need to update the parameter action to reference the Sales field again.

7. Specify what will happen when the selection is cleared.
 - **Keep current value** - Current parameter value will remain in the view.
 - **Set value to** - Parameter value will revert to the indicated value.

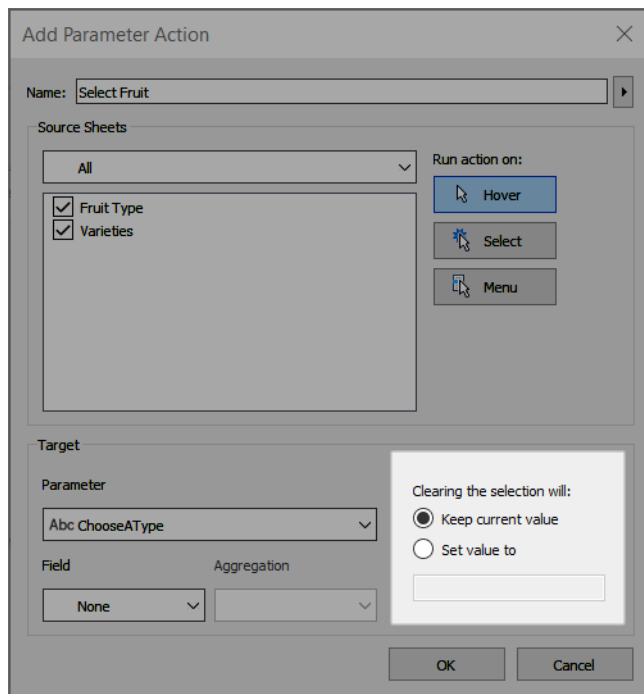

8. Click **OK** to save your changes and return to the view.
9. Test the parameter action by interacting with the visualization. Tweak some of the settings for the action to adjust the behavior as needed.

Examples of parameter actions

The following examples demonstrate how you can use parameter actions, but these are just the beginning of what is possible. To follow along, it helps to be familiar with creating and using parameters and calculated fields. For more information, see [Create Parameters on page 1122](#) and [Create a calculated field on page 2018](#).

For additional examples of how you can use parameter actions, see:

- [How and when to use parameter actions](#)
- [Parameter Actions: KPI Navigator](#)
- [Parameter Actions: Year over Year Comparison](#)
- [Parameter Actions: Layered Analysis](#)
- [Parameter Actions: Concatenation](#)
- [3 Creative Ways To Use Tableau Parameter Actions](#) from Tableau Visionary Ryan Sleeper on the [PlayfairData](#) website.
- [Tableau Parameter Actions Sneak Peek](#) from Tableau Visionary Joshua Milligan on the [VizPainter](#) website.

Make reference lines dynamic

This example demonstrates how you could use a parameter action to interactively update a reference line, without using a calculation.

Reference lines provide a convenient way to compare values in a visualization. You can then use parameter actions to make reference lines dynamic. You can associate the reference line with a parameter, and then use a parameter action to make the parameter interactive. As your users interact with the view, the reference lines automatically update to provide more context to the data.

Tableau Desktop and Web Authoring Help

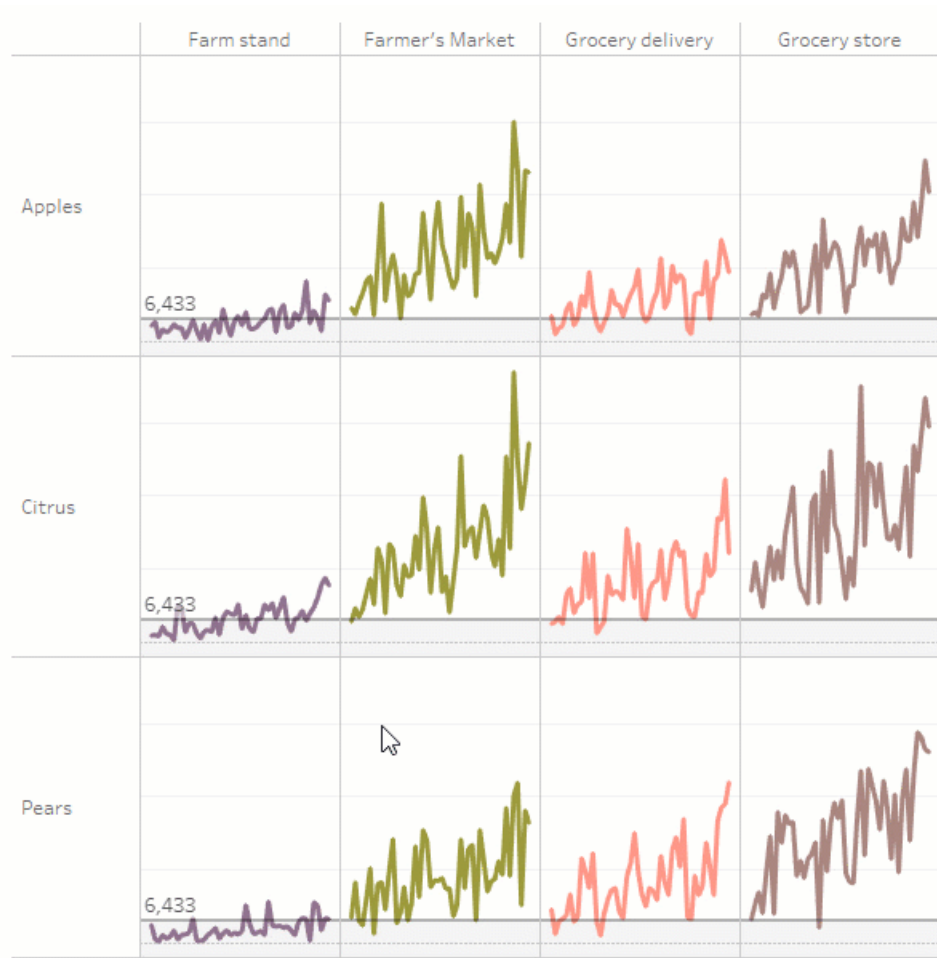

The following fields are used in this view.

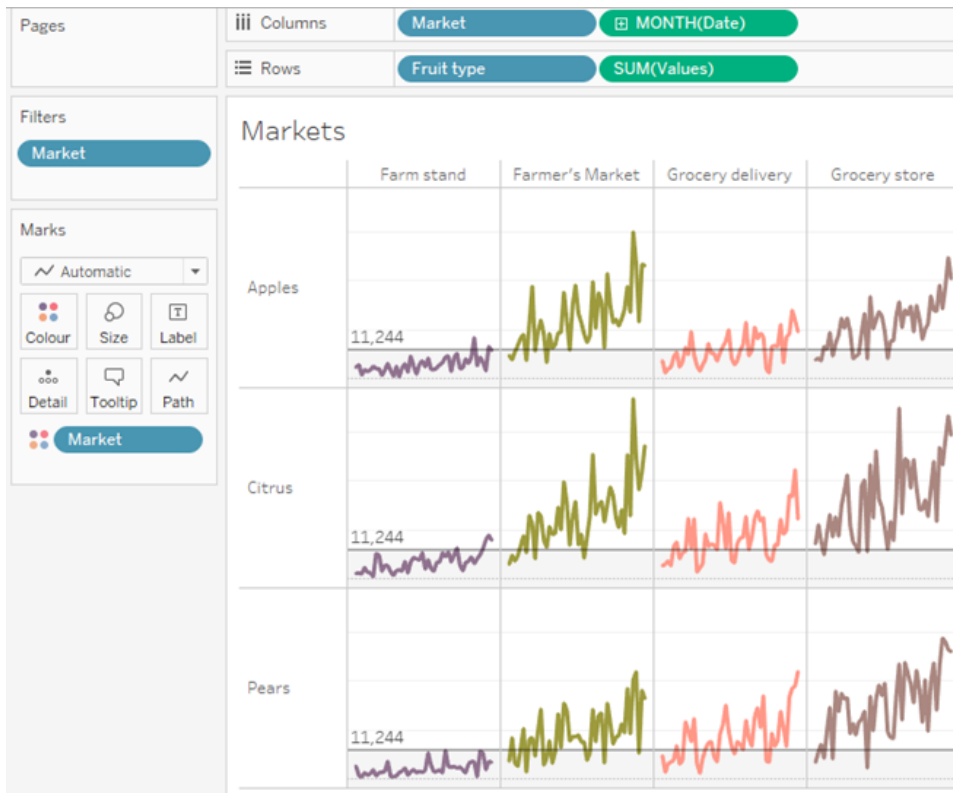

Dynamic reference lines example details

1. Create the parameter. The parameter is named *Threshold*. The data type is set to Float.

The screenshot shows the "Edit Parameter [Threshold]" dialog box. The Name field contains "Threshold". The Data type is set to "Float". The Current value is "1". The Display format is "Automatic". The Allowable values are set to "All".

2. Create a reference line that uses the Threshold parameter. The label is set to Value. The Fill Below option is set to a light gray color.

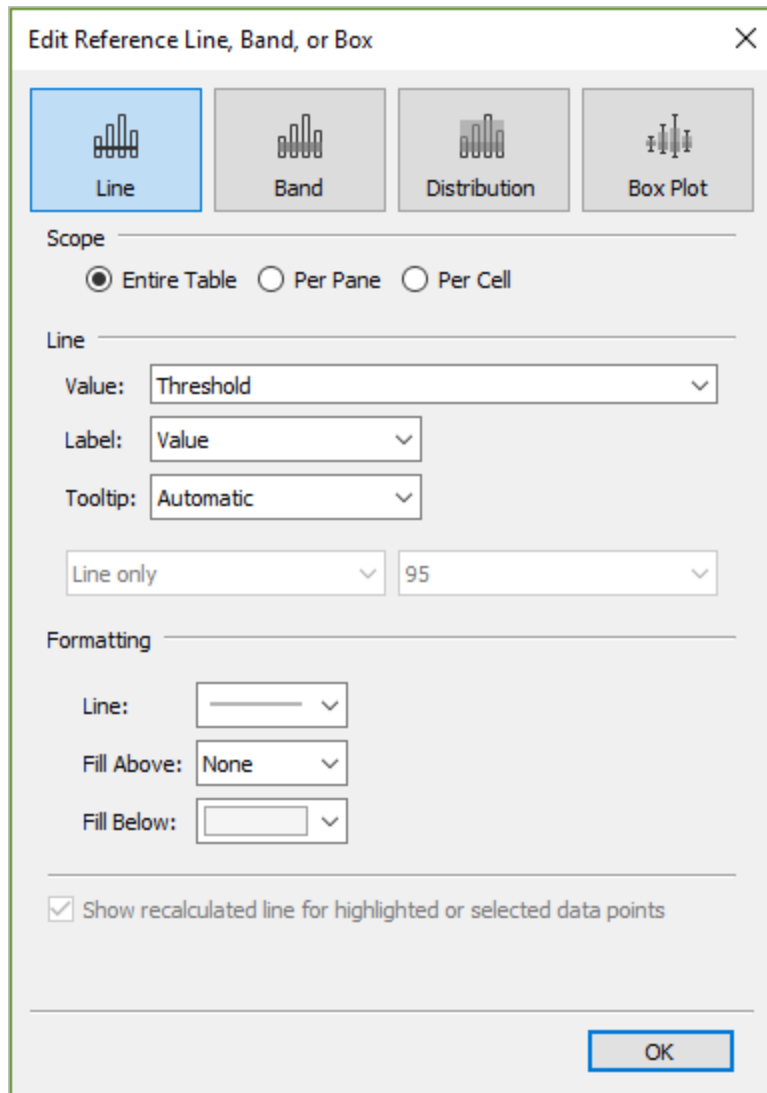

3. Create a parameter action. This action references the Threshold parameter and the Values field. The action runs on Hover.

Edit Parameter Action

Name:

Source Sheets

Run action on:

Target Parameter

Value

Field:

Aggregation:

4. Test the parameter action in the sheet. Hovering over a mark in the view updates the reference line to see how that value appears in context with the other categories of data.

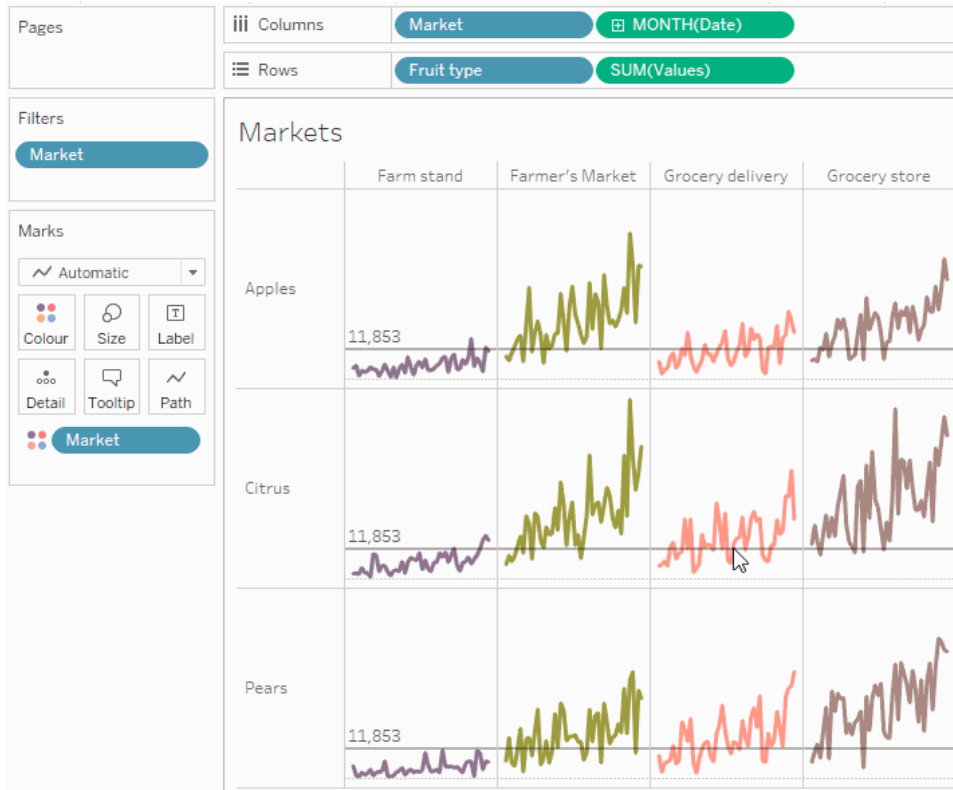

Display a selective hierarchy

This example demonstrates how you could use a parameter action that is referenced by a calculated field to let your audience control what information is being displayed in a view.

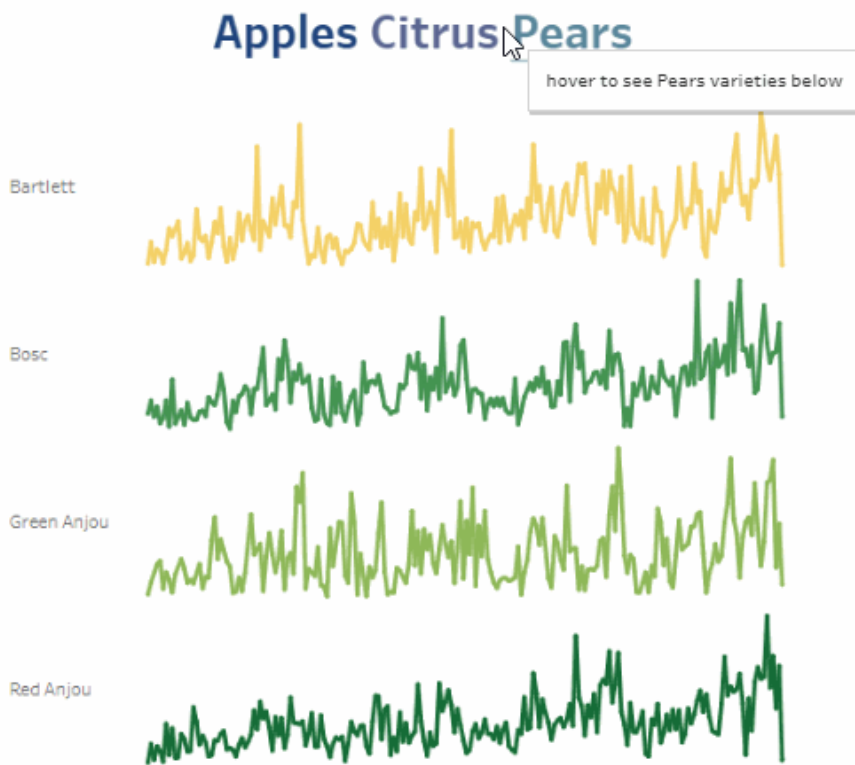

One common use for parameters is using a parameter to change the input value in a calculation. This example uses a parameter *ChooseAType* for the type of fruit and a calculated field *Varieties* that returns the varieties for the type of fruit. The calculated field has been added to the view instead of the original field *Fruit variety*. Users can select a fruit type using a parameter control to change the fruit type and varieties being displayed.

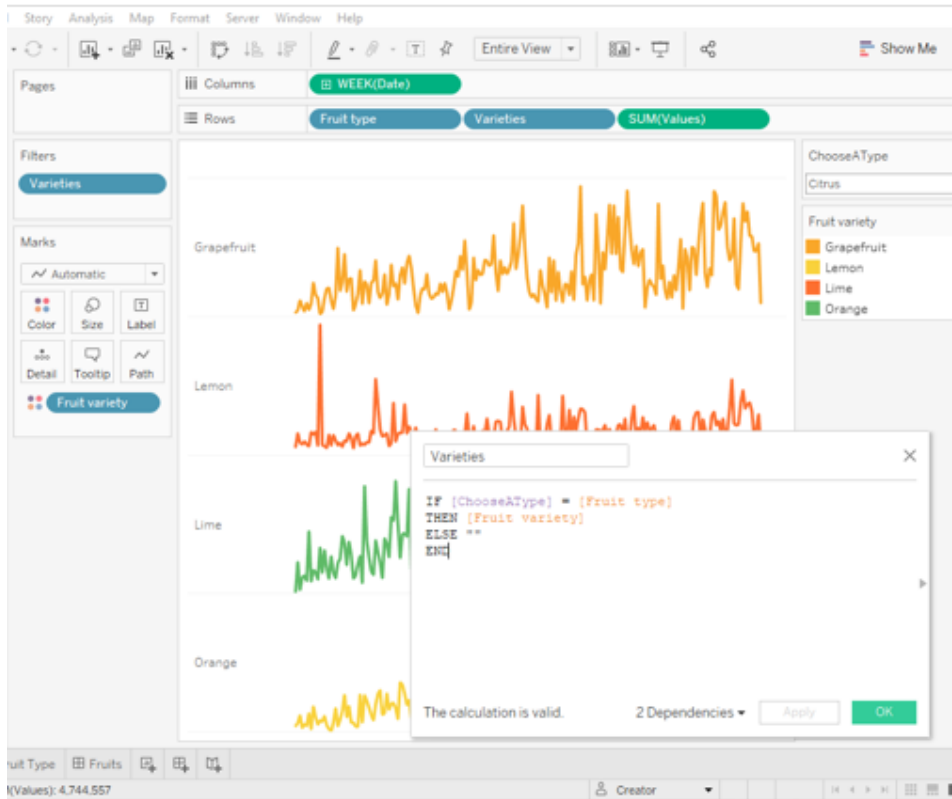

Using a parameter with a calculation and a parameter control to interactively change a parameter value

This is one way to let your users explore the data in the view. Parameter actions make this same scenario possible, but with added functionality and benefits. When you create a parameter action that updates the value of the parameter based on a user interacting with the marks in the view:

- User interaction with the viz is more natural. Your users can stay in the flow of exploring the data. Rather than needing to interact with a parameter control, your users can hover or click in the viz to update the parameter value.
- If the data source is updated at some time in the future, and more fruit type and fruit variety values are added, those values will automatically be displayed in the viz and are automatically available to the parameter.

To incorporate parameter actions, this example makes use of a second sheet (*Fruit Type*) that consists of the names of the fruit types. The two sheets (*Fruit Type* and *Varieties*) are combined into a dashboard (*Fruits*).

Selective hierarchy example details

1. The workbook shown in the image above uses the *ChooseAType* parameter and the *Varieties* calculated field.

The *ChooseAType* parameter is set to allow *All Values*.

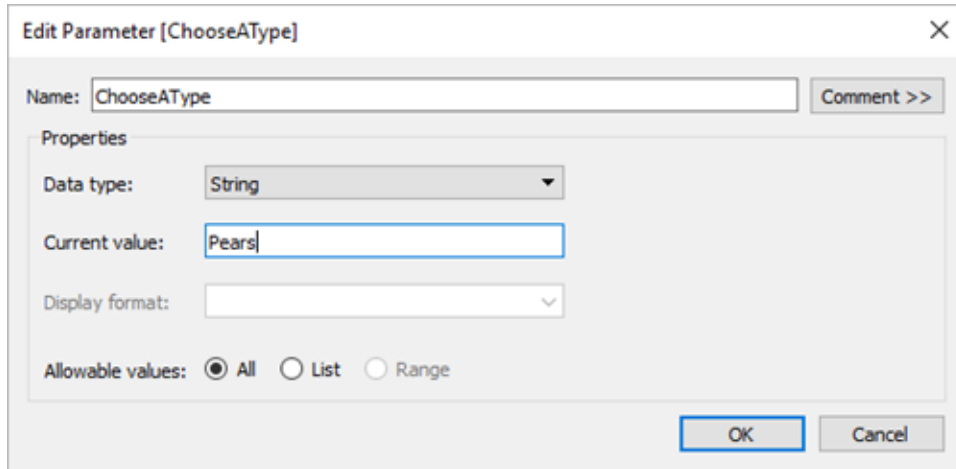

The *Varieties* calculated field references the *ChooseAType* parameter to show the values from the *Fruit variety* field based on the current value selected for *Fruit type*.



2. The workbook uses a parameter action named *Select Fruit*. To create the parameter action, the author clicked a sheet, and then selected **Worksheet > Actions > Add Action > Change Parameter**.

The action uses the Fruit data source. Because the parameter and calculation both need to be aware of the *Fruit type* field to function, both the *Fruit Type* and *Varieties* sheets need to be selected.

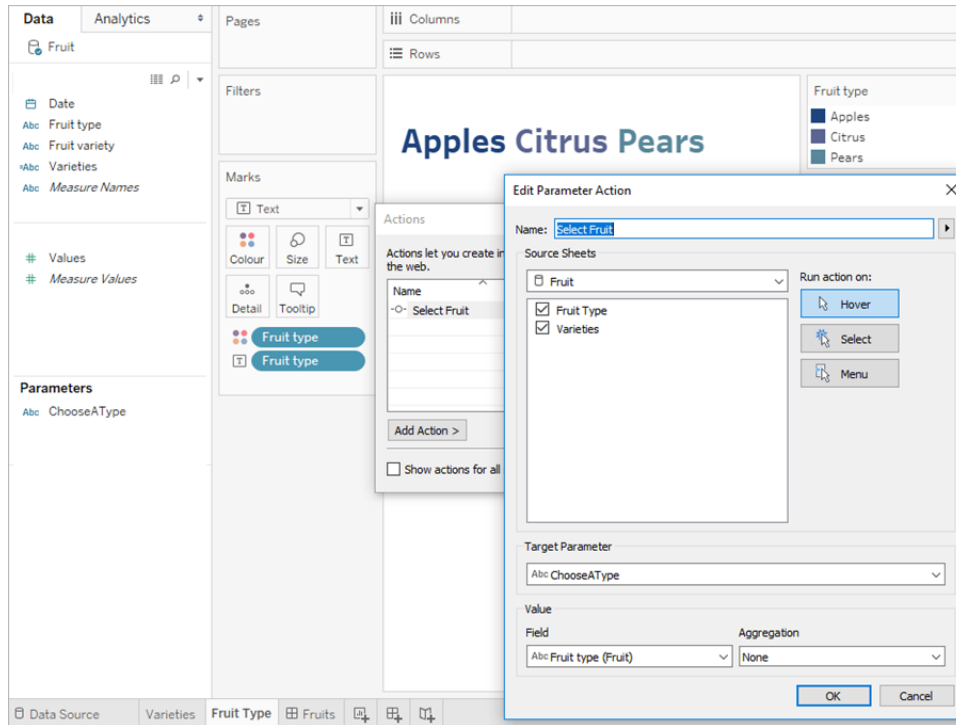

The parameter *ChooseAType* is associated with the *Fruit type* field. The parameter action will run whenever a user hovers over the fruit type text in the *Fruits* dashboard, or in the *Fruit Type* sheet.

In the *Varieties* sheet, the *Fruit type* field is on the Rows shelf, but the Show Header option is unchecked for that field to remove the fruit type label from this view.

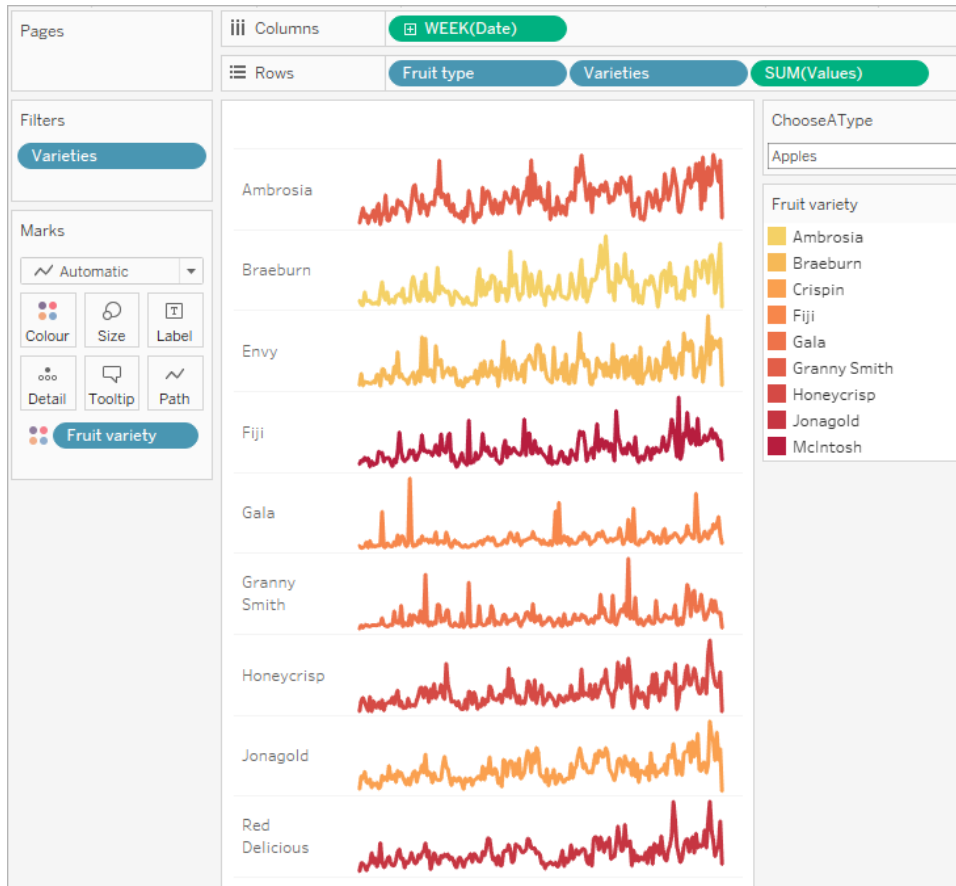

3. Test the parameter action in the Fruits dashboard. Hovering over the fruit type updates the view to show the varieties of that fruit.

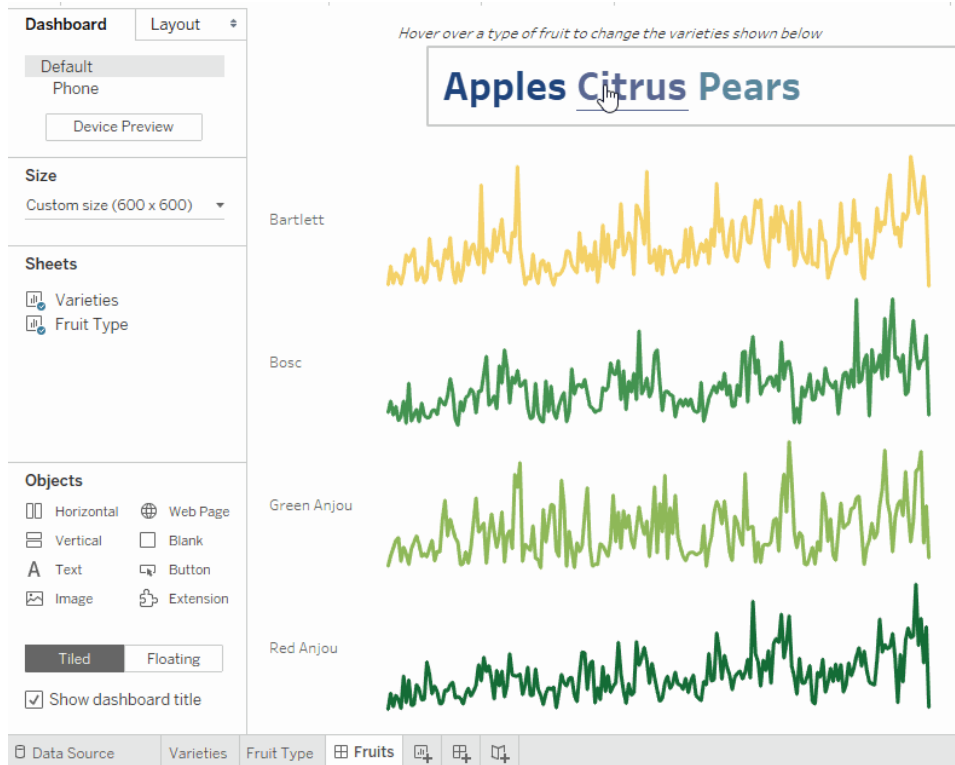

Display summary data for selected marks

Getting summary statistics for a subset of data is a valuable analytical tool. This example shows how you can use aggregated parameter actions for selected marks to automatically generate summary data.

This view of a sheet named Options shows fruit varieties and their intended markets.

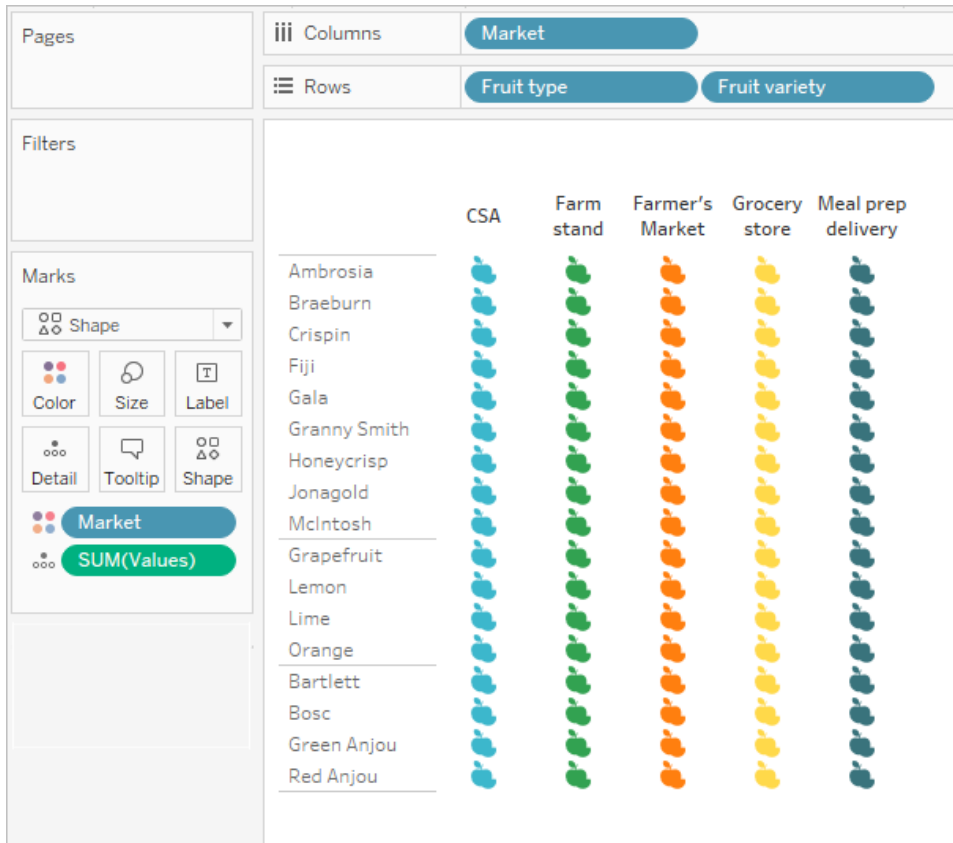

The SUM(Values) field needs to be present on both sheets for the parameter to work. SUM (Values) is placed on **Detail** in the Marks card in this view.

The previous Options view will function as a selector for this second view, a scatter plot that plots the same marks against their total value and quantity. SUM(Values) is placed on Rows in this view.

Tableau Desktop and Web Authoring Help

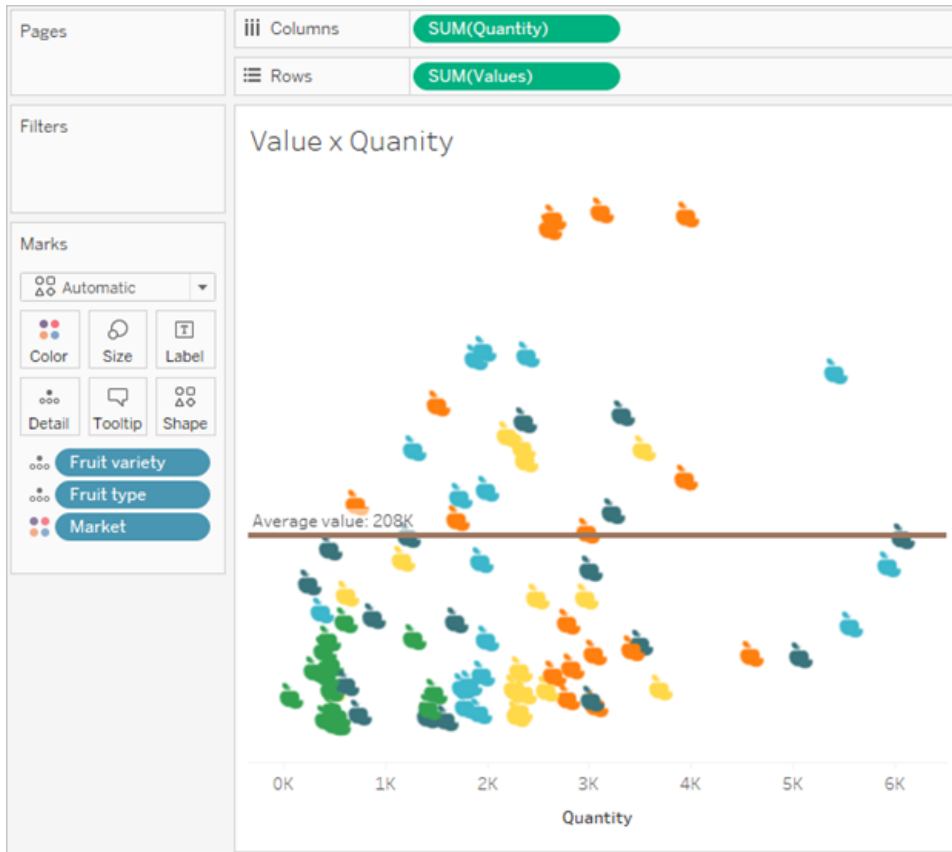

A parameter action will be used to make the two views work together in a dashboard.

Select a fruit and market from the left (by clicking headers or icons) to see the average value and quantity in the scatterplot update for that selection.



Summary data example details

1. Create the parameter. This parameter is named *Average Value*. The data type is set to Float.

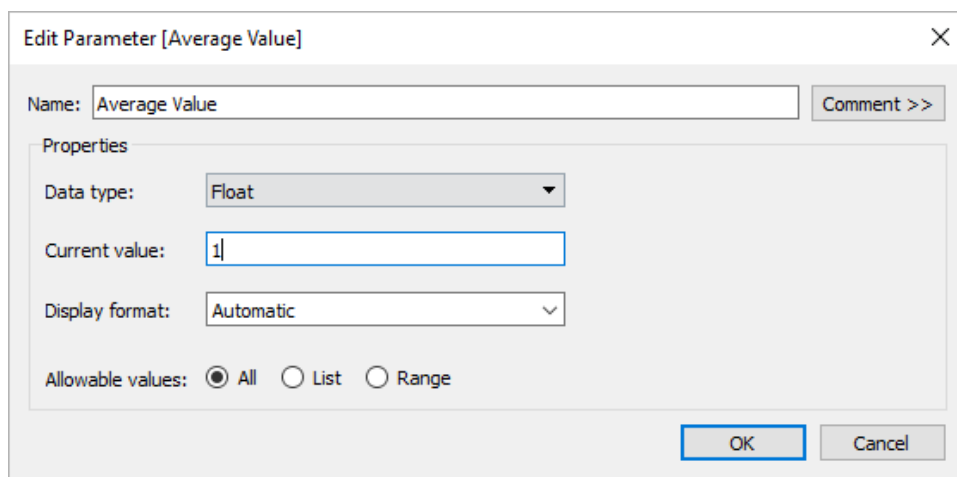

2. Create a reference line that uses the Average Value parameter. The label is set to Custom with the text "Average value: <Value>". The Line option is set to a brown color.

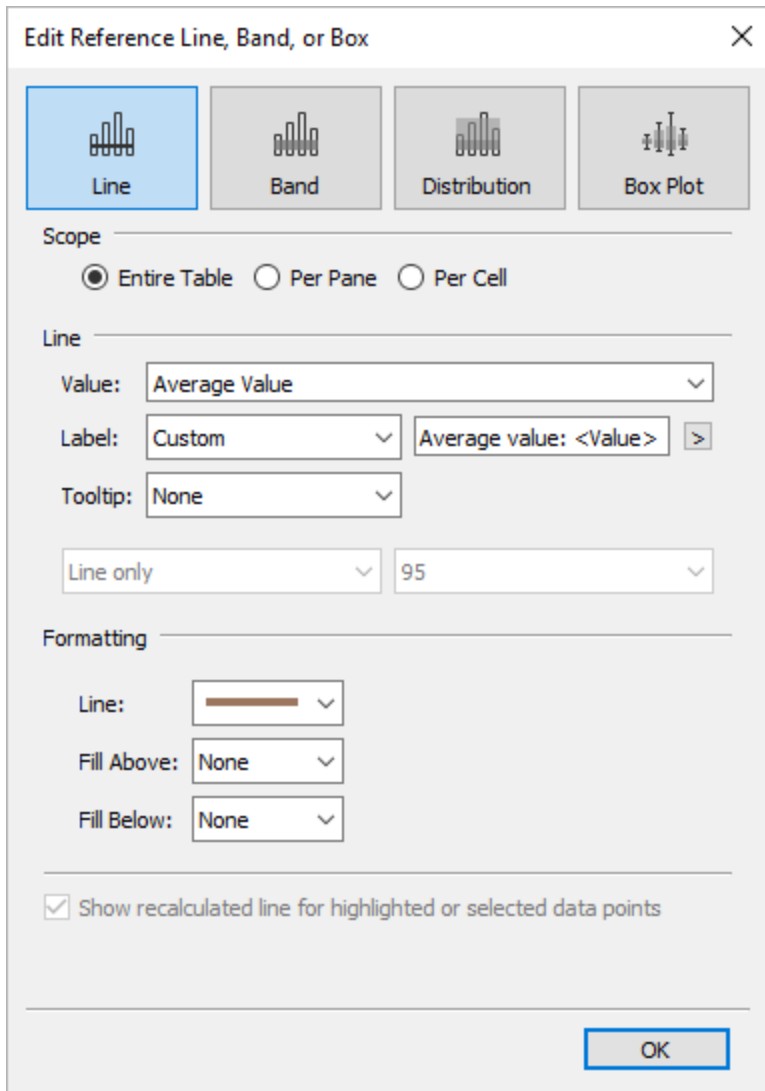

3. The two sheets are combined in a dashboard. To create the parameter action, click the dashboard tab, and then select **Dashboard > Actions > Add Action > Change Parameter**.

The action is named *Average Value*. The target parameter references the Average Value parameter. The source field is set to SUM(Values) (Fruit).

The setting for aggregation is where the summary statistic information comes into play. By choosing Average, Median, Count, etc., you set the parameter to update with the statistic of your choosing.

The aggregation is set to Average. Also note that the aggregation for the source field in the view can be different from the aggregation that you use for the parameter action.

Edit Parameter Action

Name:

Source Sheets

Dashboard 1

Options

Value x Quantity

Run action on:

Target Parameter

Average Value

Value

Field	Aggregation
# SUM(Values) (Fruit)	Average

Optionally, you could also create a highlight action for marks selected in the Options view.

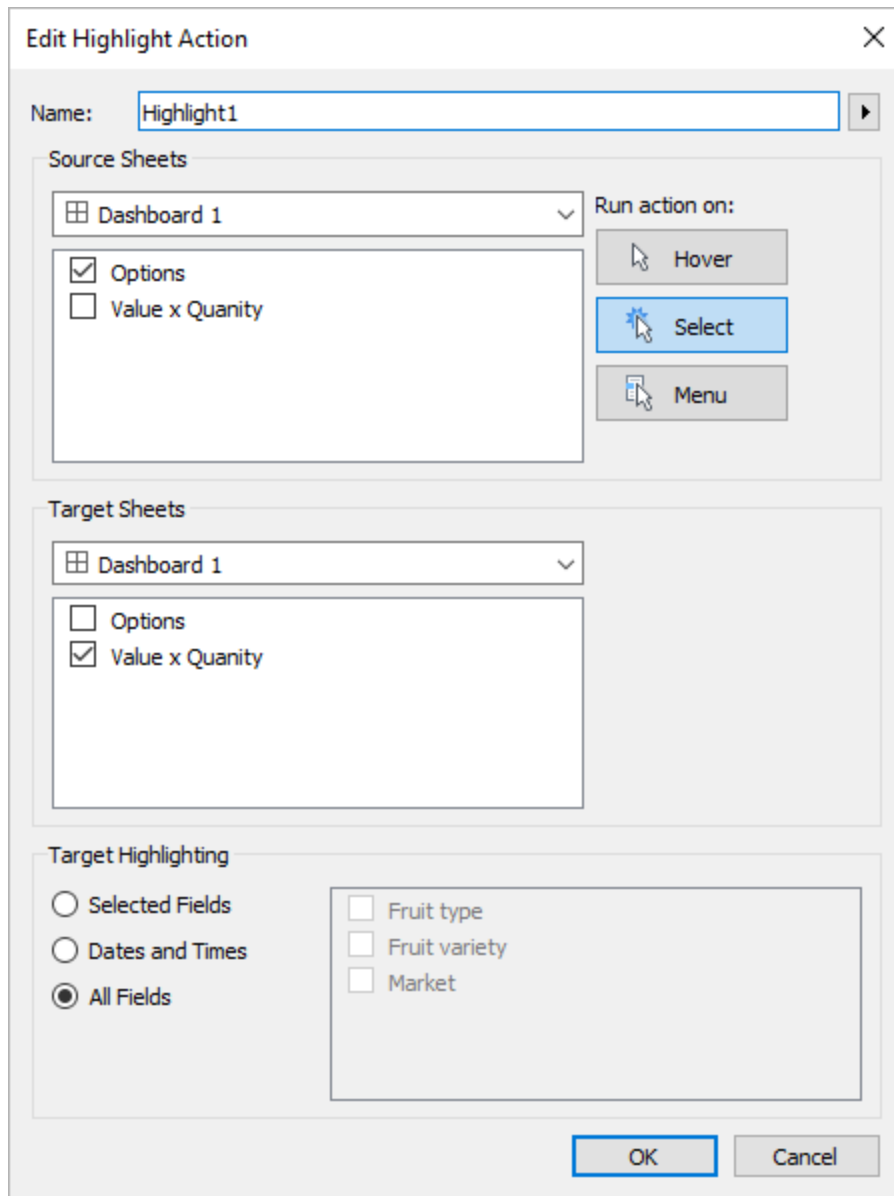

4. Test the parameter action in the dashboard. As you select headers and marks, the reference line updates dynamically and displays the average of the values.

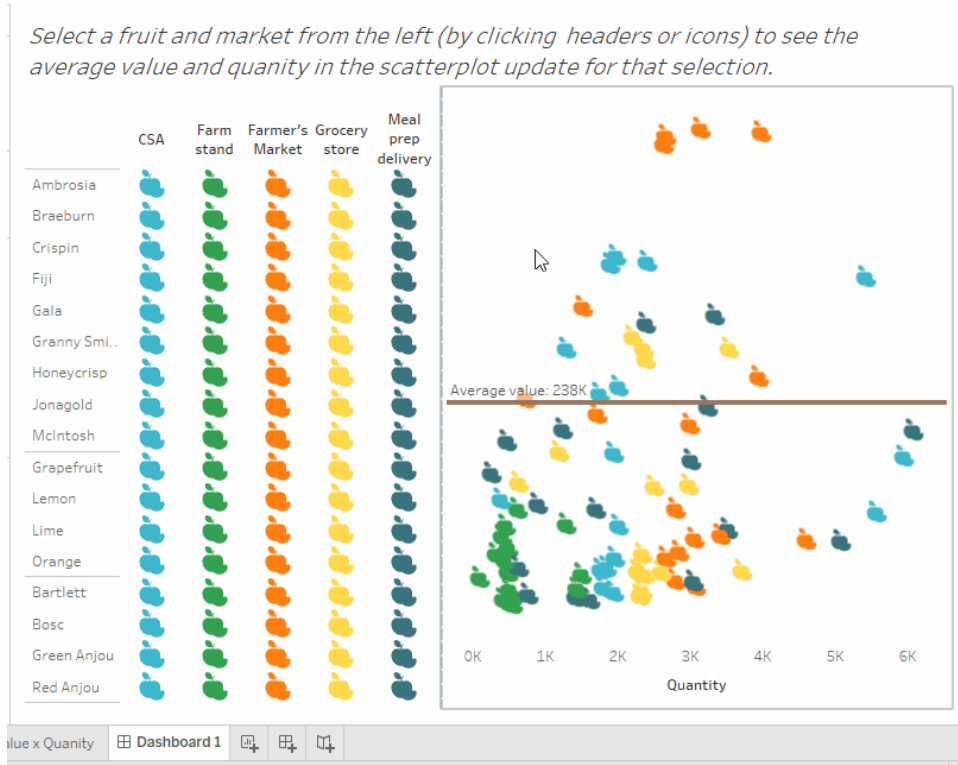

Set Actions

Use set actions to let your audience interact directly with a viz or dashboard to control aspects of their analysis. When someone selects marks in the view, set actions can change the values in a set. For examples on how set actions can be used, see [Examples of set actions on page 1441](#).

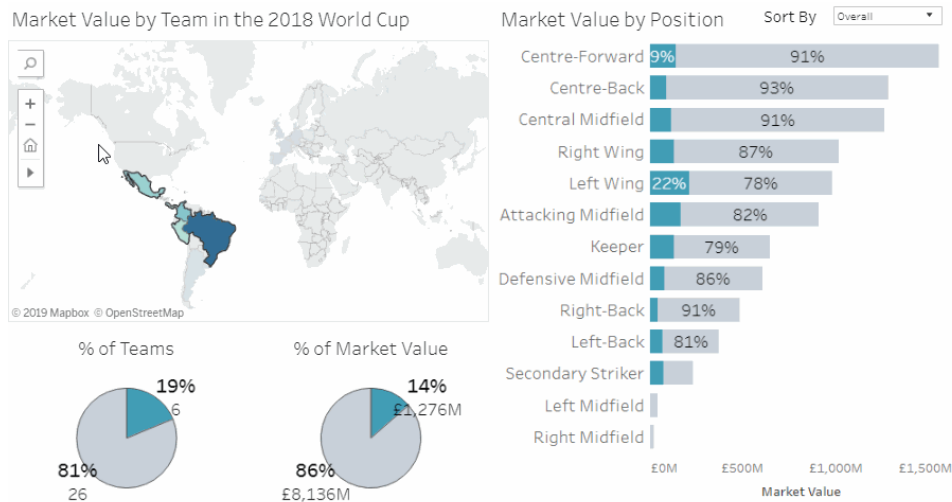

Set actions take an existing set and update the values contained in that set based on user actions in a viz. You can define the set action to include:

- the source sheet or sheets it applies to.
- the user behavior that runs the action (hover, select, or menu).
- the target set (the data source and set to be used).
- what happens when the selection is cleared.

To change or affect a visualization, the set referenced in the action must be used somehow in the visualization. You can do this in different ways, such as using the set in a calculated field that you then use to build the viz, or by placing the set in the view or on a Marks card property.

You can create set actions in Tableau Desktop, Tableau Cloud, and Tableau Server. However, set actions can't be used with [Stories on page 2833](#).

General steps for set actions

1. Create one or more sets. The sets you create will be associated with the data source that is currently selected. For details on creating sets, see [Create Sets on page 1092](#).
2. Create a **set action** that uses one of the sets you created. You can create multiple set actions for different purposes.
3. Depending on the behavior you want to make available to users for their analysis, you might want to create a calculated field that uses the set. For details on creating calculated fields, see [Create a calculated field on page 2018](#).
4. Build a visualization that uses a set referenced by a set action. For example, if you create a calculated field that uses the set, build the view using that calculated field. Or, drag the set to Color in the Marks card.
5. Test the set action and adjust its settings as needed to get the behavior you want your audience to experience.

Getting Started: For an overview of what you need to know to create set actions, see [On Your Marks, Get Set, Go: Everything You Need to Know to Get Started with Set Actions](#) on the [Data Viz Linds](#) blog.

Create a set action

1. In a worksheet, select **Worksheet >Actions**. In a dashboard, select **Dashboard >Actions**.
2. In the Actions dialog box, click **Add Action** and then select **Change Set Values**.

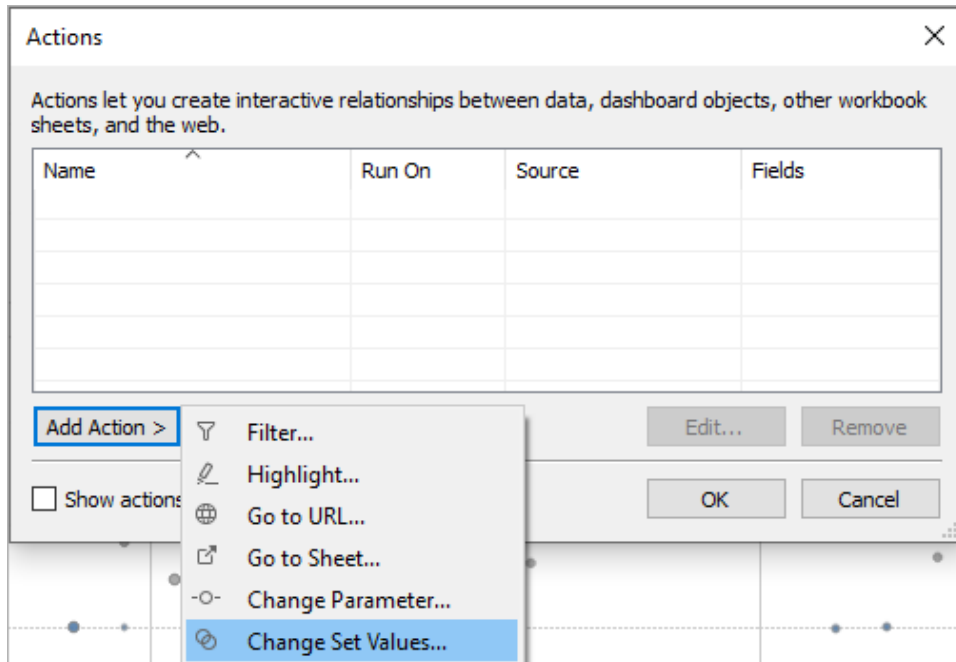

3. In the **Add/Edit Set Action** dialog box, specify a meaningful name for the action.
4. Select a source sheet or data source. The current sheet is selected by default. If you select a data source or dashboard you can select individual sheets within it.

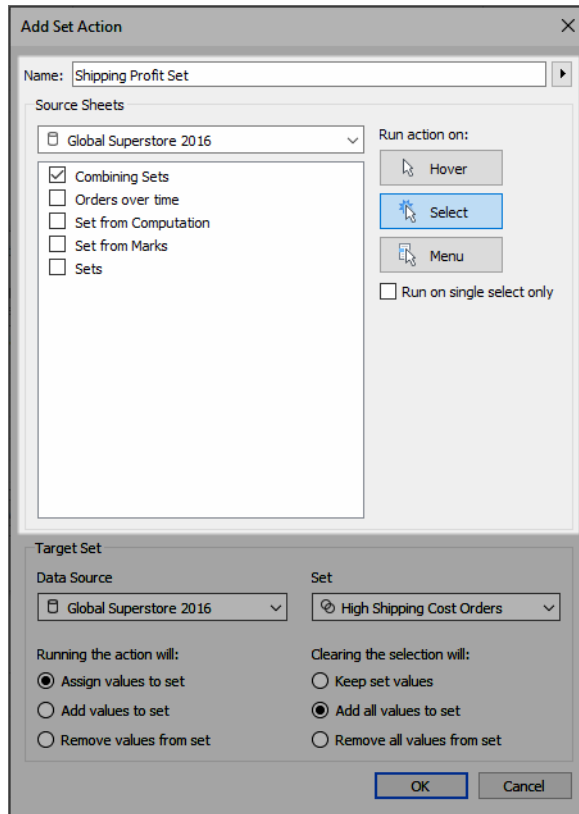

5. Select how users will run the action.

- **Hover** - Runs when a user hovers the mouse cursor over a mark in the view.
- **Select** - Runs when a user clicks a mark in the view. This option works well for set actions.
- **Menu** - Runs when a user right-clicks (control-clicks on Mac) a selected mark in the view, then selects an option on the context menu.

6. Specify the target set. First, select the data source, and then select the set.

The sets available in the Target Set lists are determined by the data source that you select and the sets that you have created in the workbook that are associated with that data source.

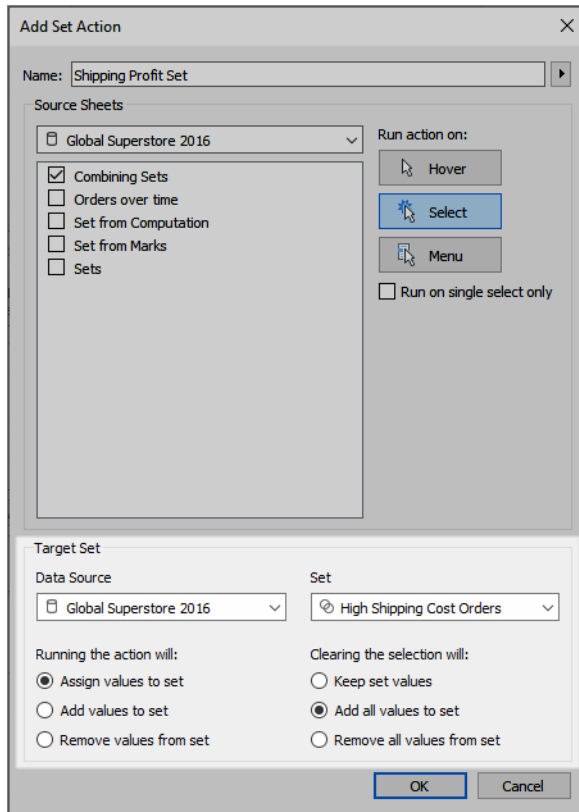

In this example, the target set is using *Global Superstore 2016* as the data source and *High Shipping Cost Orders* as the set.

7. Specify what happens when the action is run in the view:
 - **Assign values to set** - Replaces all values in the set with the values selected.
 - **Add values to set** - Adds individually selected values to the set.
 - **Remove values from set** - Removes individually selected values from the set.

Note: Selecting **Add values to set** or **Remove values from set** via the Set Action dialog modifies the values selected in the General tab of the set's definition—just like **Assign values to set** does. This differs from the **Add to** and **Remove from** functionality available only in authoring mode via the set's context menu in the tooltip. The latter unions or removes values to and from the set after the condition specified has been applied.

8. Specify what happens when the selection is cleared in the view:

- **Keep set values** - Current values in the set remain in the set.
 - **Add all values to set** - Adds all possible values to the set.
 - **Remove all values from set** - Removes previously selected values from the set.
9. Click **OK** to save your changes and return to the view.
 10. Test the set action by interacting with the visualization. Tweak some of the settings for the action to adjust the selection behavior as needed.

Examples of set actions

The following examples show just a few of the ways you can use set actions. To follow along, you will need to be familiar with creating and using sets and calculated fields. For details, see [Create Sets on page 1092](#) and [Create a calculated field on page 2018](#).

Learn more: For additional in-depth examples of how you can use set actions demonstrated in Tableau, see:

- [8 ways to bring powerful new comparisons to viz audiences with set actions](#) in the [Tableau blog](#)
- [8 analytic concepts to express with Tableau set actions](#) (Tableau blog)
- [Designing advanced analytics applications with Tableau set actions](#) (Tableau blog)
- Topics on set actions on the [Data Viz Linds](#) blog
- Set action examples in the [Art of the Vizable](#) website by TabLabs.

Watch a video:

- [Ready, set, action!](#) (1 hour)
- [Sets Appeal](#) (1 hour)
- [Beyond set actions | Interactive statistics](#) (1 hour)

Proportional brushing

A classic use case for set actions is proportional brushing, described in [How to do proportional highlighting with set actions](#) on the [Tableau blog](#) and [Tableau Set Actions](#) from [The Information Lab blog](#) (along with other examples).

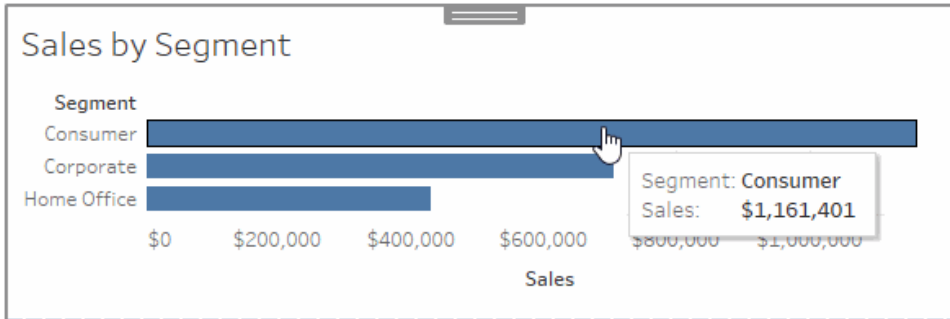

Sales by Subcategory

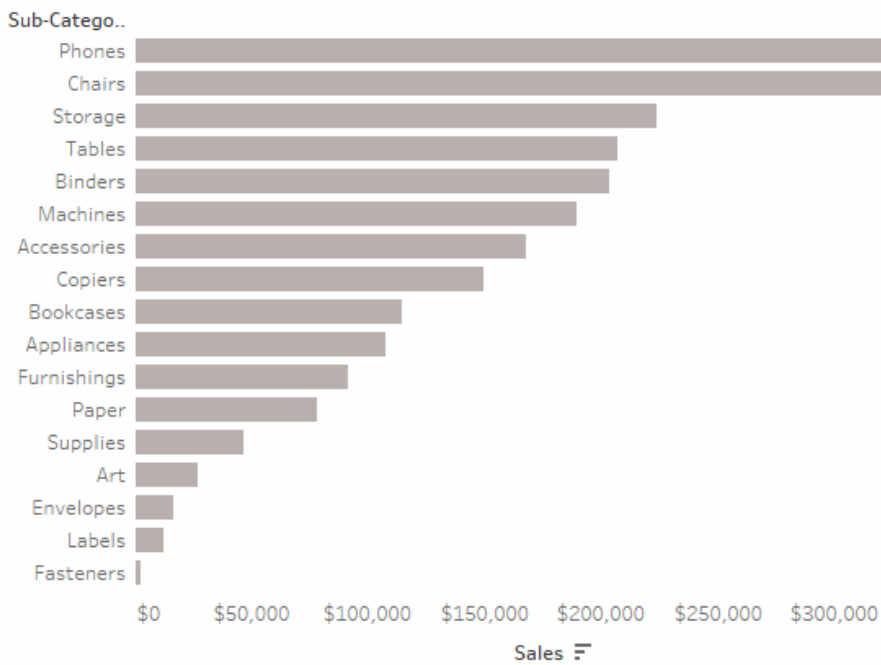

Proportional brushing example details

This example uses the **Sample - Superstore** data source. This set action changes the color of existing marks in the view based on the proportion of the mark that is in or out of the set.

1. Connect to **Sample - Superstore** data in Tableau Desktop.
2. In a new sheet, drag the **Sales** measure to Columns, and drag the **Segment** dimension to Rows.

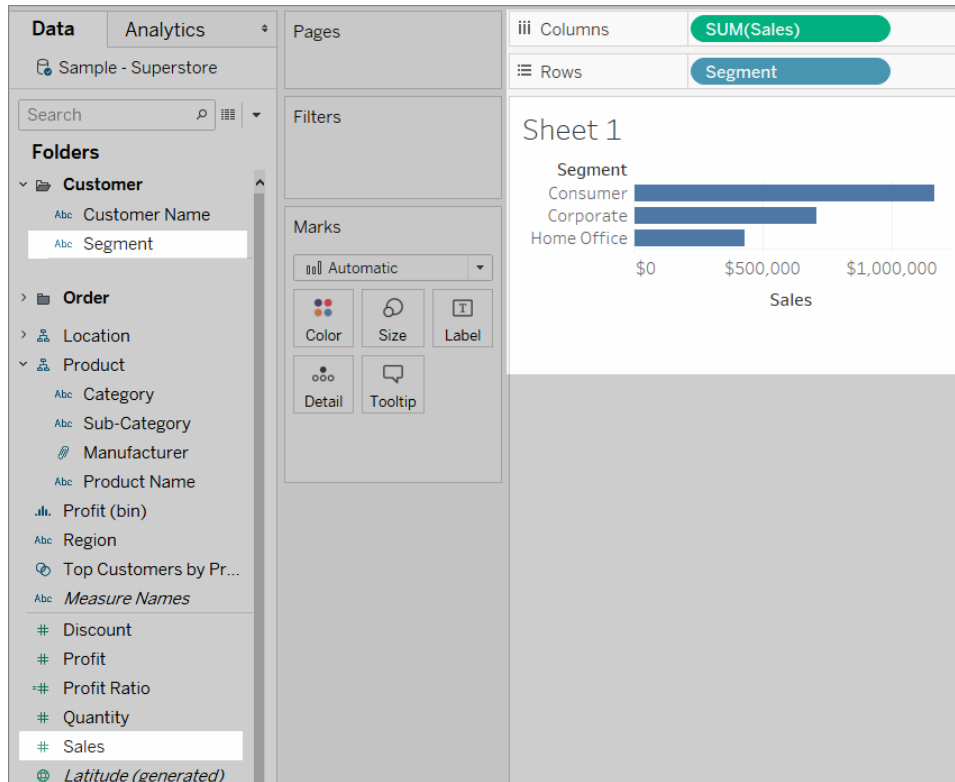

3. In another blank sheet, drag the **Sales** measure to Columns, and drag the **Sub-Category** dimension to Rows.

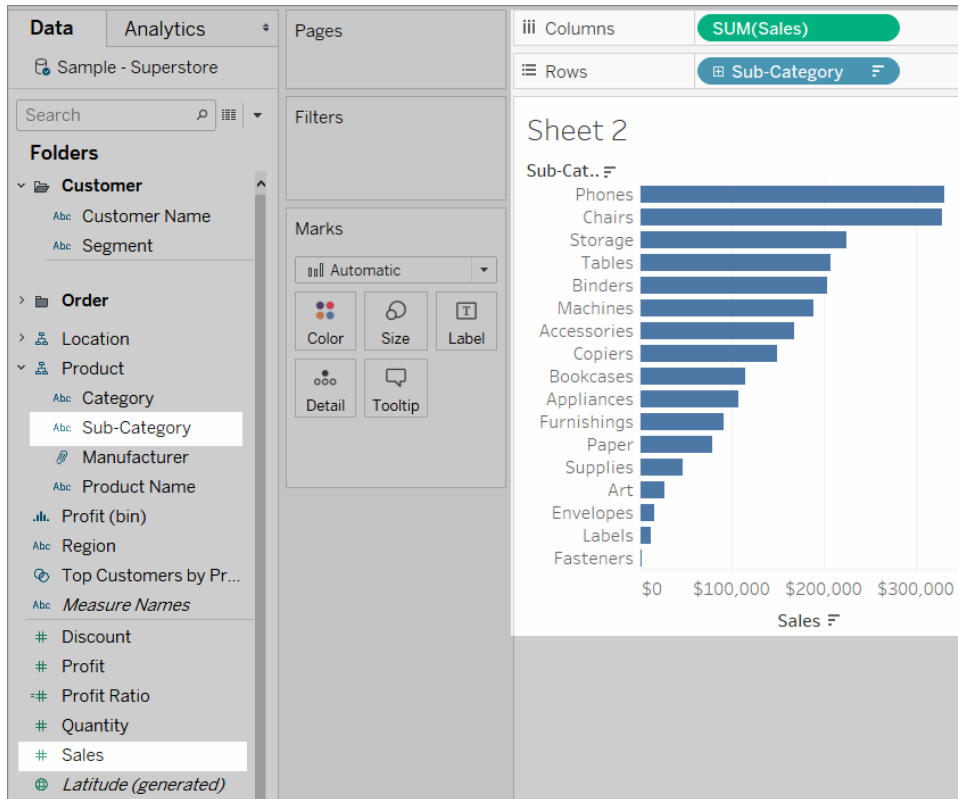

4. Create a set for the **Segment** dimension named *Segment Set*.

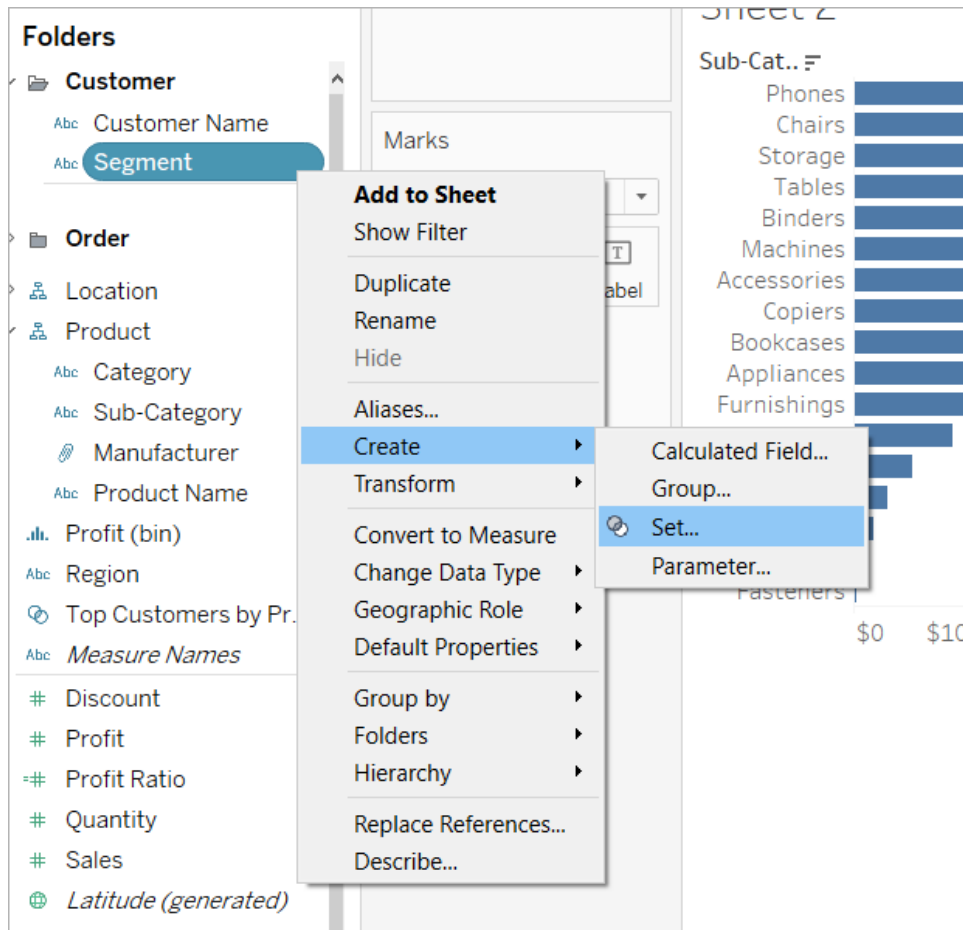

5. In the sheet that shows Sales by Sub-Category, drag **Segment Set** onto **Color** in the Marks card.

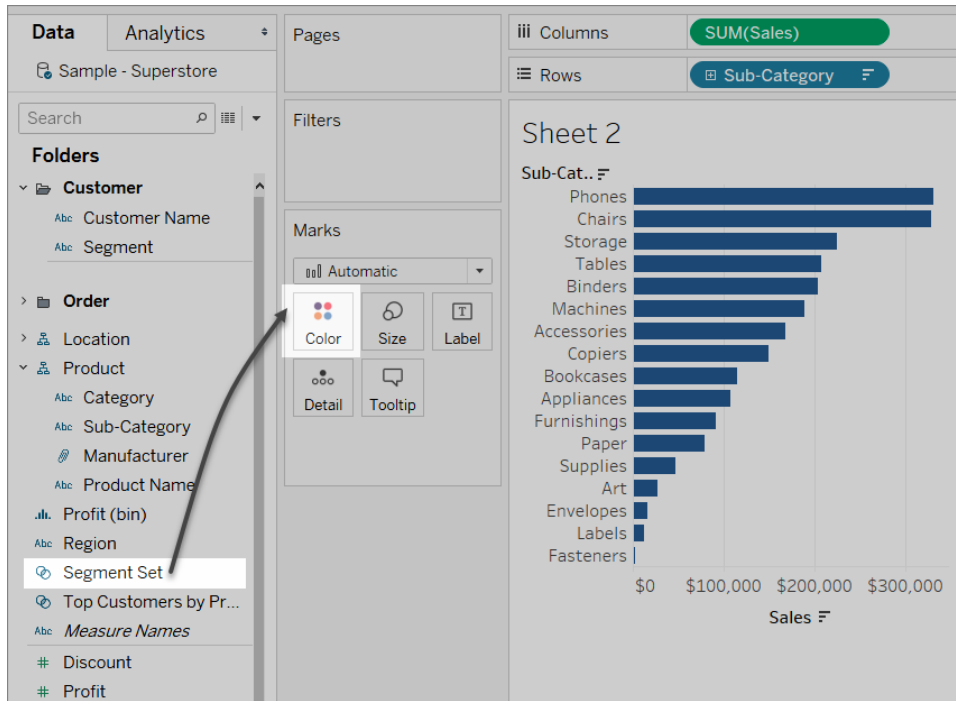

Swap the colors used to show marks IN or OUT of the set.

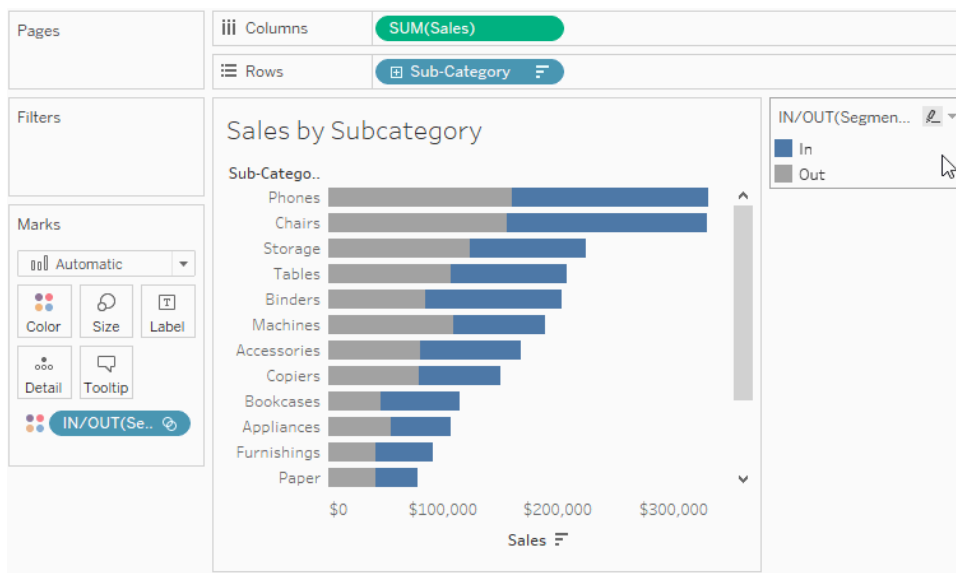

6. Create a new dashboard. Drag both sheets into the dashboard.

On the **Dashboard** menu, select **Actions**. Click **Add Action**, and then select **Change Set Values**.

Tableau Desktop and Web Authoring Help

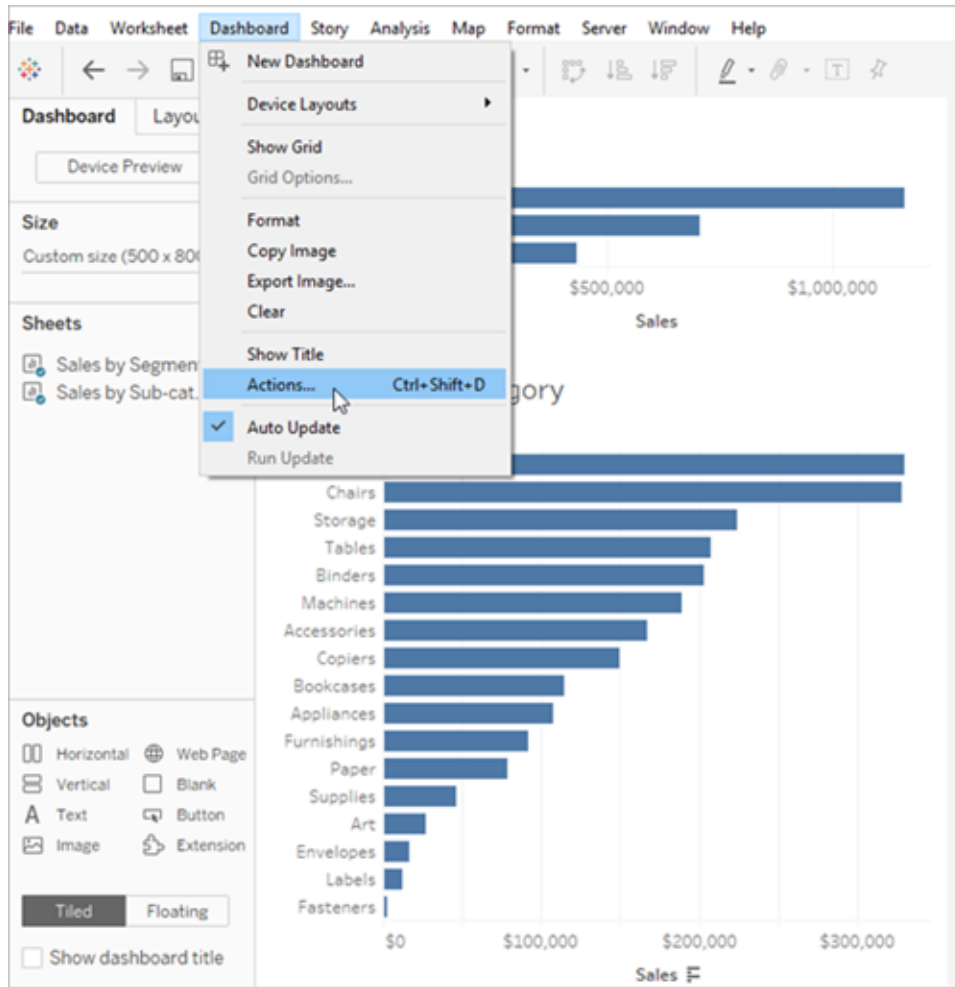

7. Configure the action using the same settings as shown in the image below.

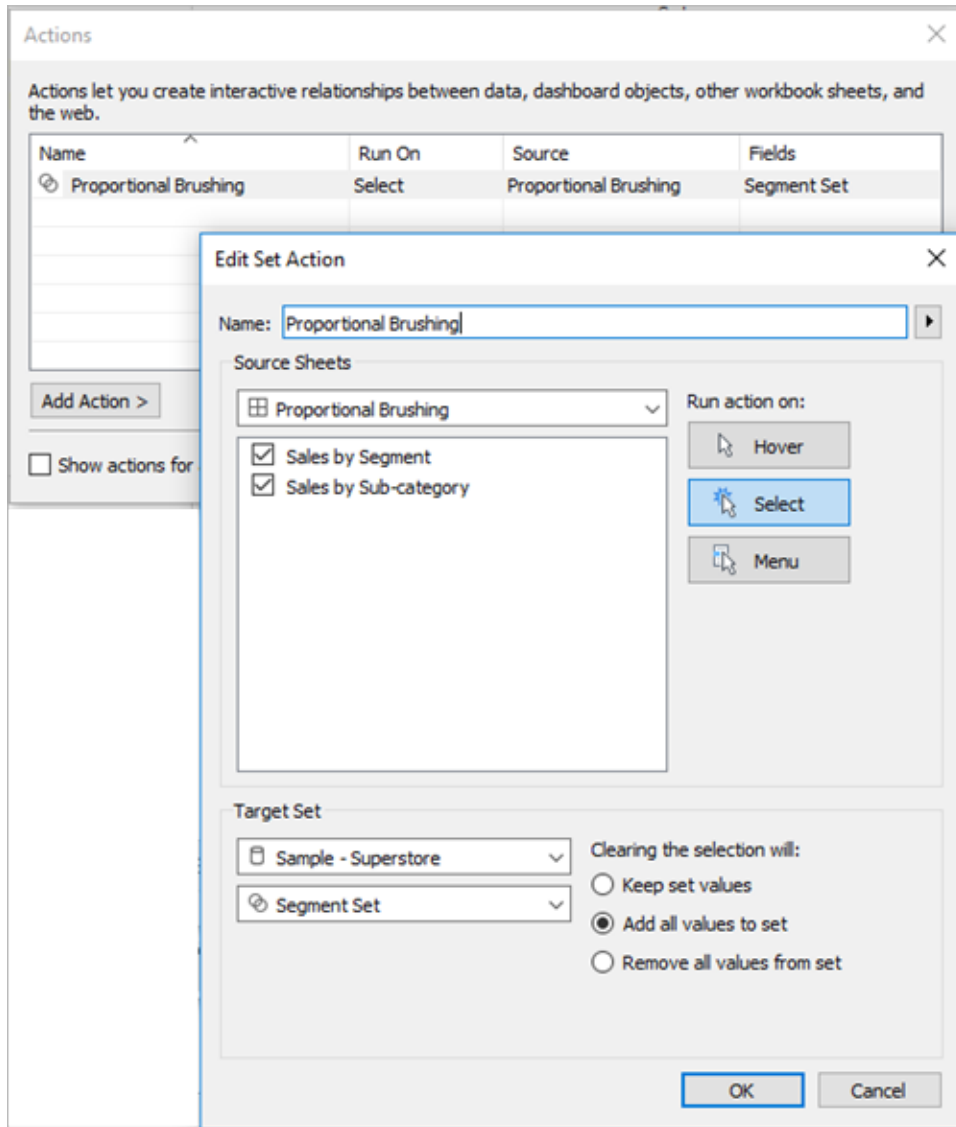

8. Click **OK** to save your changes and return to the view.
9. Test the set action by clicking the marks for each segment.

Asymmetric drill down

Set actions can also be used across multiple sets for more complex interactions. If a data set has hierarchical information, such as Category, Sub-Category, and Manufacturer, normally drilling down the hierarchy expands all values at a given level. However, you can use set actions for asymmetric drill down, opening only the next hierarchy level for the selected value.

Asymmetric Drill Down

Category	Asymmetric Sub-Category
Furniture	\$742,000
Office Supplies	\$719,047
Technology	\$836,154

Asymmetric drill down example details

This example uses the **Sample - Superstore** data source.

Set actions are used here in conjunction with two calculated fields to create an asymmetric drill down experience.

1. Create a set for the Category field named *Category set*.

Choose any category to be a member of that set. The membership is temporary and will be overwritten by the set action.

2. Create a calculated field named *Asymmetric Sub-Category*.

Right-click the **Sub-Category** field in the Data pane, and then select **Create Calculated Field**.

Type the following calculation:

```
IF [Category set] THEN [Sub-Category] ELSE [Category] END
```

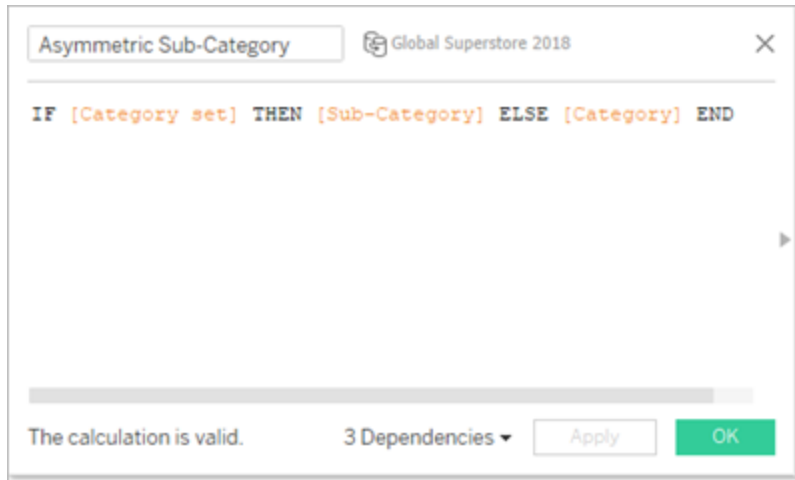

If the category of the mark or marks in the view is in the Category Set, the calculation will return the Sub-categories for that Category. Otherwise, it will return the Category again.

The set isn't in use in the view yet and has no action associated with it, so it is static for the moment.

3. Build the view by dragging the **Category** and **Asymmetric Sub-Category** fields to Rows (in that order). Then Drag **Sales** to Text in the Marks card.

Tableau Desktop and Web Authoring Help

The screenshot shows the Tableau Desktop interface with a data table in Sheet 3. The table has three columns: Category, Asymmetric S., and SUM(Sales). The 'Asymmetric S.' column is highlighted, indicating a set action. The 'SUM(Sales)' column is also highlighted. The interface includes a Data pane on the left, a Marks card in the center, and a Columns shelf on the right.

Category	Asymmetric S..	SUM(Sales)
Furniture	Bookcases	\$114,880
	Chairs	\$328,449
	Furnishings	\$91,705
	Tables	\$206,966
Office Supplies	Office Supplies	\$719,047
Technology	Technology	\$836,154

4. Create a set action.

On the Worksheet menu, select **Actions**. Click **Add Action**, and then select **Change Set Values**.

Name the action *Asymmetric Drill to Sub-Category*.

Add Set Action

Name:

Source Sheets

Asymmetric Drill Down
 Sales by Segment
 Sales by Subcategory

Run action on:

Target Set

Clearing the selection will:

Keep set values
 Add all values to set
 Remove all values from set

Select the following options:

- Source Sheets: Make sure the only the current sheet is selected.
- Run action on: Choose **Select**. This will make the action apply when the user selects a mark or marks in the view.
- Target Set: Select the current data source from the first drop-down list and the Category set from the second drop-down list.
- Clearing the selection: Select **Remove all values from set**.

Click **OK** to save your changes.

5. Test the set action.

When you click on a header or mark in the view, it will expand out to the next level. Clicking a category bar will expand its sub-categories.

Color scaling

Color values in a viz often can be distorted by outliers. When one country has a significantly higher value than other countries, the nuance of differences between those non-extreme values can be lost.

A set action can update the values in a Country set based on the selection in the viz. That set is then used in a calculated field that computes the value of the relevant measure for only countries in that set, and that calculated field is placed on color. Now, when countries are selected in the map, the color palette is based only on those countries, showing greater visual differences between those values.

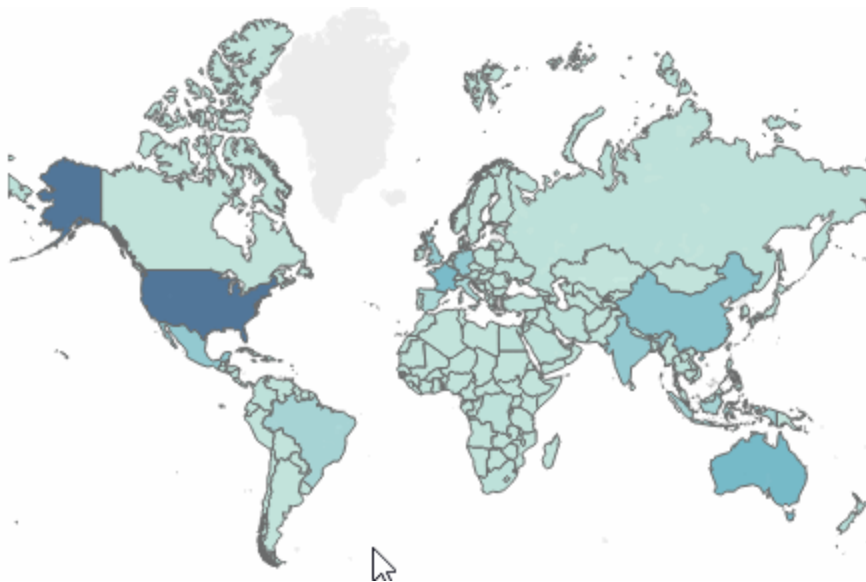

Color scaling example details

This example uses the [Global Superstore data source](#).

1. Create a set on the **Country** field named *Country set*. Chose any country to be a member of the set. The membership is temporary and will be overwritten by the set action.
2. Create a calculated field named *Country Shipping Cost*.

Right-click in the Data pane, and then select **Create Calculated Field**.

Type the following calculation:

```
IF [Country set] THEN ([Shipping Cost]) END
```

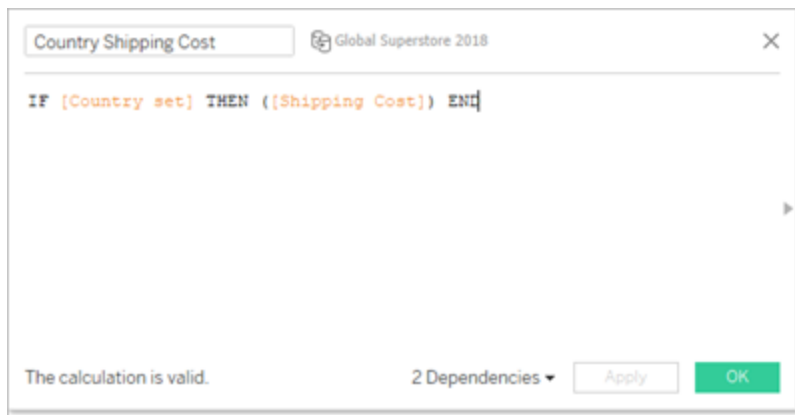

If the country of the mark(s) in the view is in the Country set, the calculation returns the Shipping Cost. Otherwise, it does nothing.

The calculated field ties the set into the view.

3. Double-click the **Country** dimension to automatically create a map.
4. Drag **Country Shipping Cost** to Color in the Marks card. The map should automatically update to a filled map.

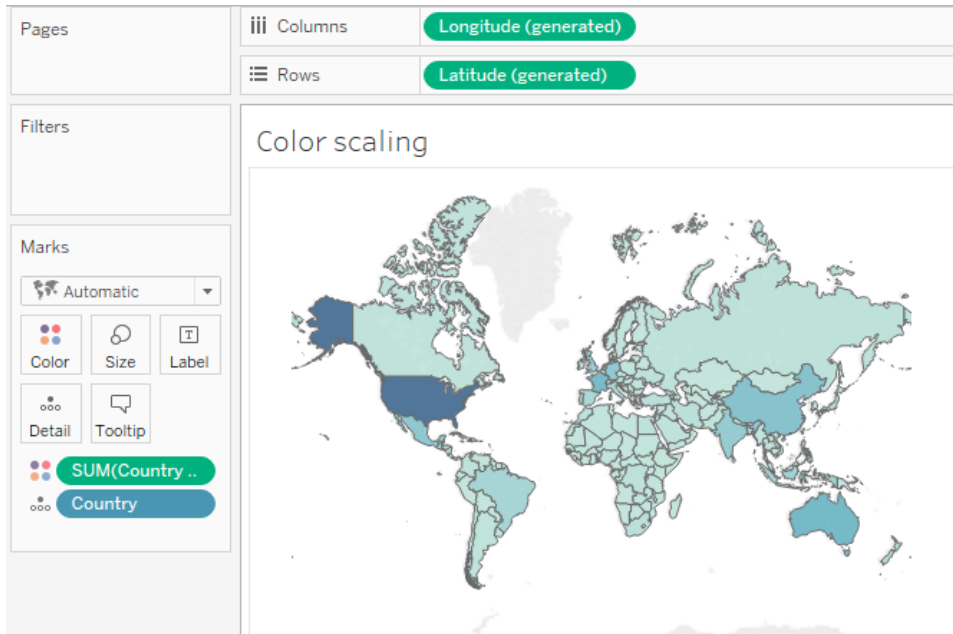

5. Create the set action: *Country color scaling*.

On the Worksheet menu, select **Actions**. Click **Add Action**, and then select **Change Set Values**.

Name the action *Country color scaling*.

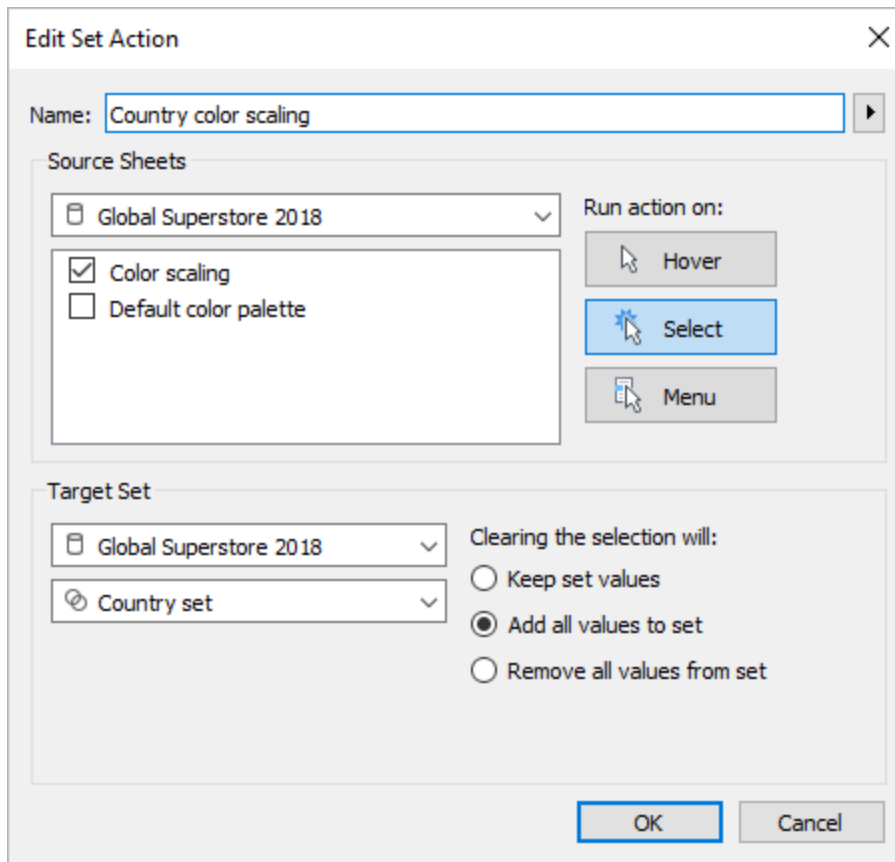

Select the following options:

- Source Sheets: Select only the current sheet.
- Run action on: Choose **Select**. This will make the action apply when the user selects a mark or marks in the view.
- Target Set: Select the current data source from the first drop-down list and the Category set from the second drop-down list.
- Clearing the selection: Select **Add all values to set**.

6. Click **OK** to save your changes.

7. Test the set action.

When you select a mark or group of marks in the view, the color palette responds by representing the values for those marks, not the entire data set.

Relative dates

This dashboard example contains multiple relative date calculations. Based on a target date, the dashboard displays the difference from the previous day, the percent change from the same month in the previous year, the Year to Date sales for the current year, and Year to Date sales for the previous year.

The set action in this dashboard updates the target date and relevant date calculations in response to a user clicking a mark on a timeline.

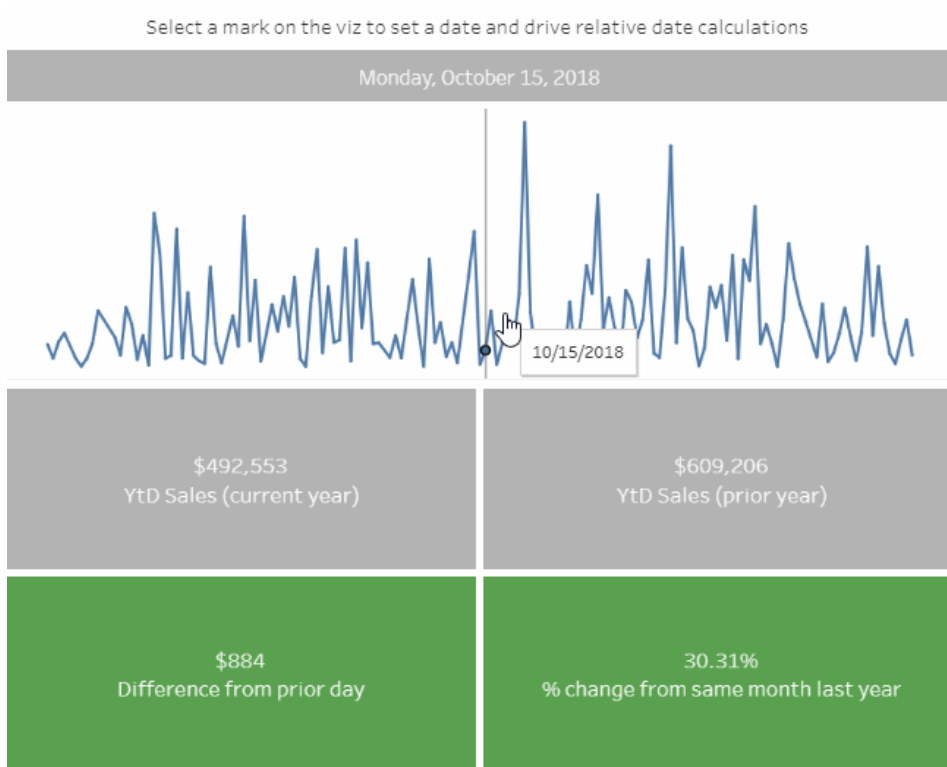

Relative date example details

This example uses the [Global Superstore data source](#).

The set action in this example is applied to the Timeline sheet in the dashboard, and uses that sheet to drive the behavior of the dashboard. When a user selects a mark in the Timeline view, the set action updates the Selected Date set with a single date value.

In this example:

- A Selected Date set is built on the Order Date field.
- An Update Target Date set action updates the Selected Date set so the date value for the mark selected in the view is the only value in the set.
- A Target Date calculated field captures the date value from the Selected Date set, and that calculated field is referenced by other relative date calculations in the viz.
- Each sheet in the dashboard uses calculated fields to update its displayed values.

Note: Because this example is more complex, the description below gives a summary of the major steps and settings involved rather than specific details.

Timeline sheet settings

Sales is on Rows. A calculated field named **Target Date** is placed on Detail to make it available to the reference line.

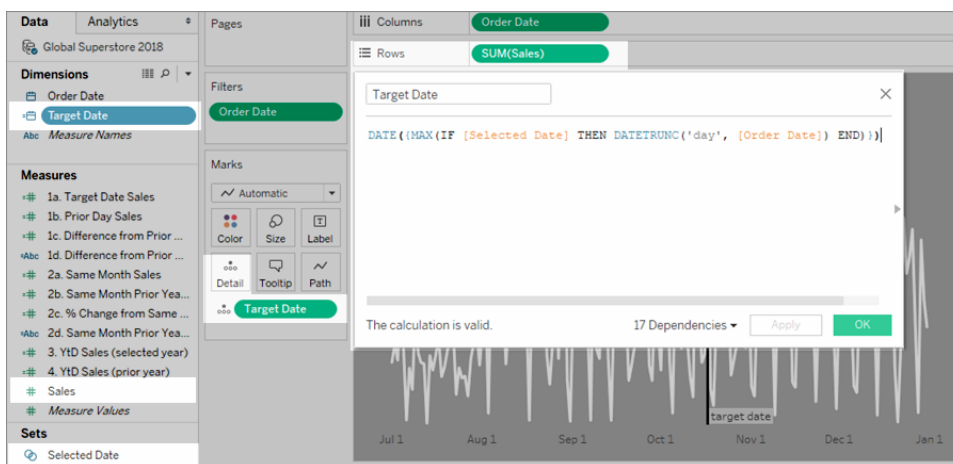

Starting in Tableau 2020.2: The above image doesn't reflect the latest user interface. For each table or folder in the Data pane, a gray line separates dimensions (above line) and measures (below line). The Dimensions and Measures labels are no longer used in the Data pane.

Order Date is on Columns as Exact Date.

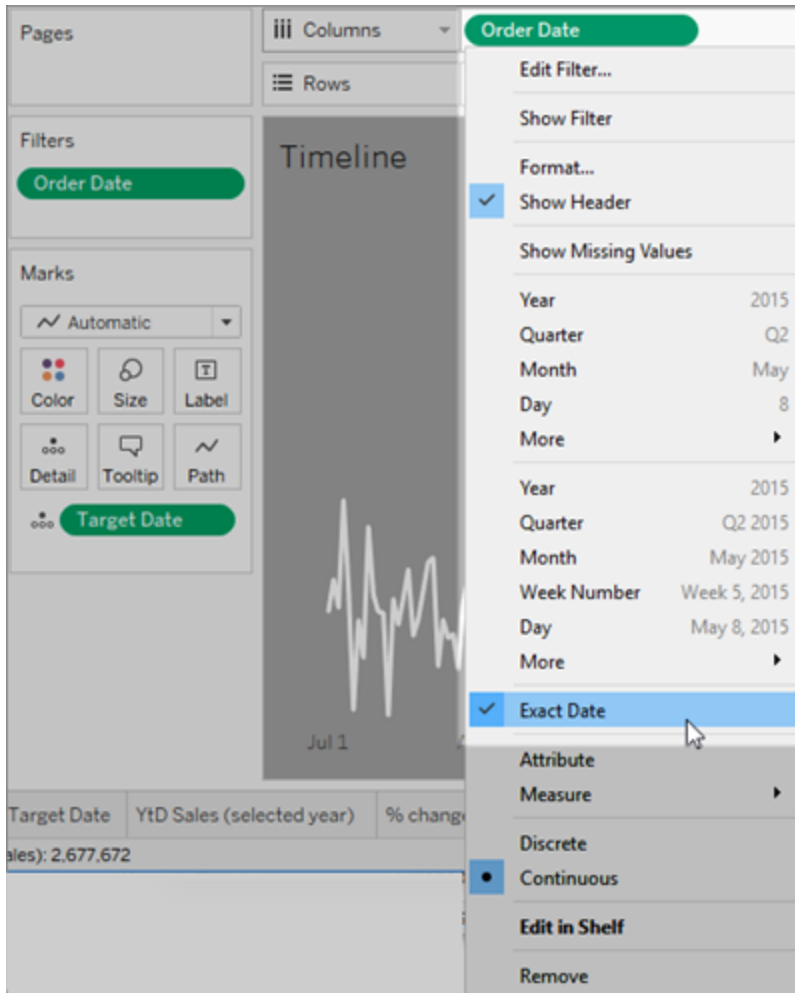

The reference line is applied to the Order Date field and is set to be the Minimum of Target Date.

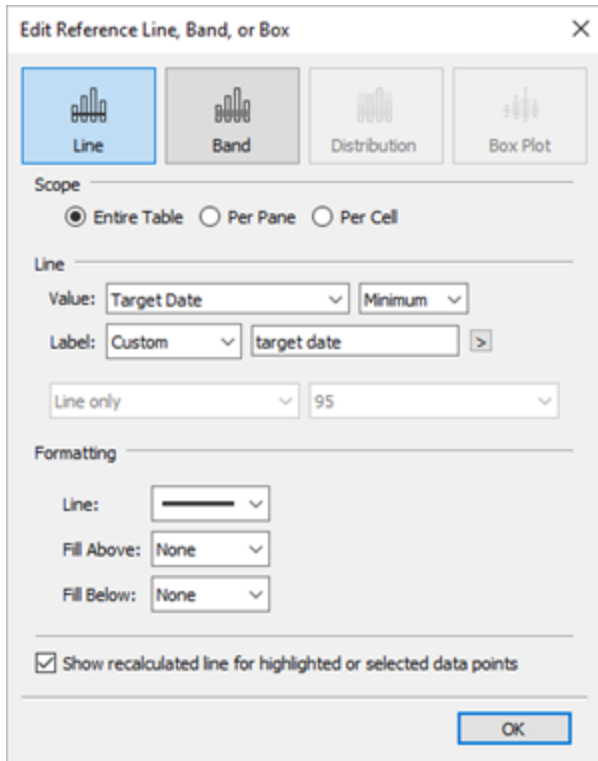

A set action is applied to this sheet that updates the Selected Date set based on what mark is selected in the view.

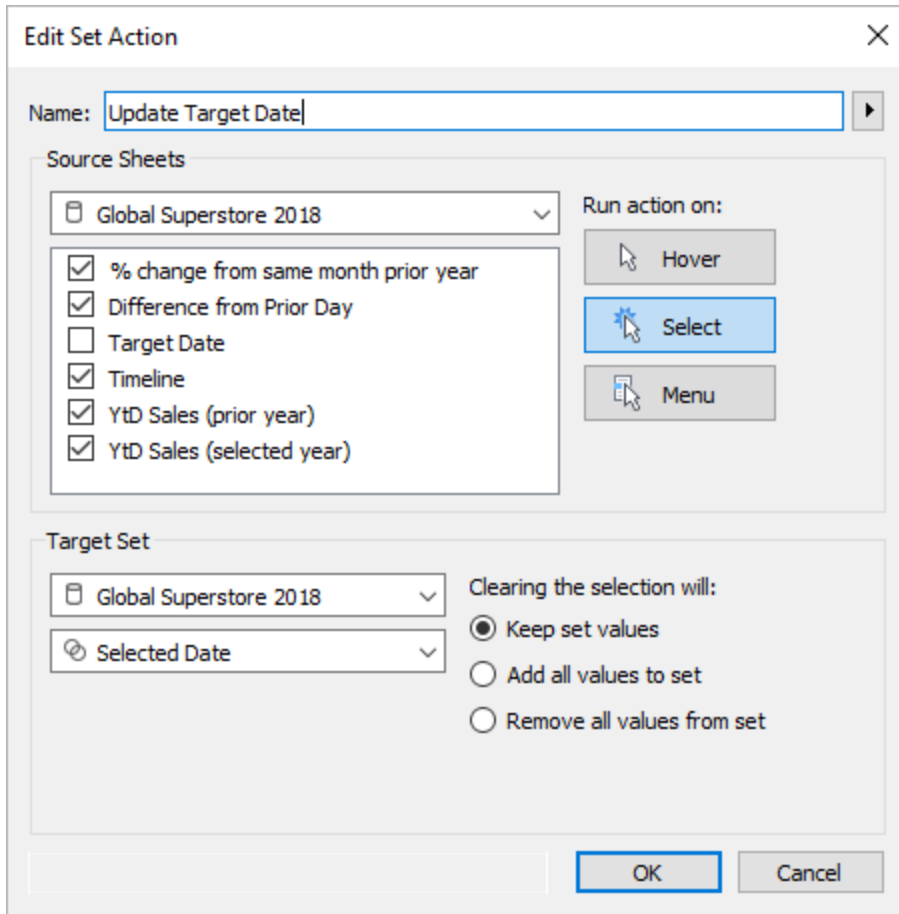

Running Actions

Depending on how the action is created, you can run an action using one of the following three methods:

- **Hover** - Rest the pointer over a mark in the view to run the action. This option works well for highlight and filter actions within a dashboard.
- **Select** - Click on a mark in the view to run the action. This option works well for all types of actions.
- **Menu** - On Tableau Desktop, right-click (control-click on Mac) a selected mark in the view and then select an option on the context menu. On Tableau Server or Tableau Cloud, left-click (click on Mac) a selected mark in the view to see the context menu. This option works well for filter and URL actions.

Hover

Select

Menu

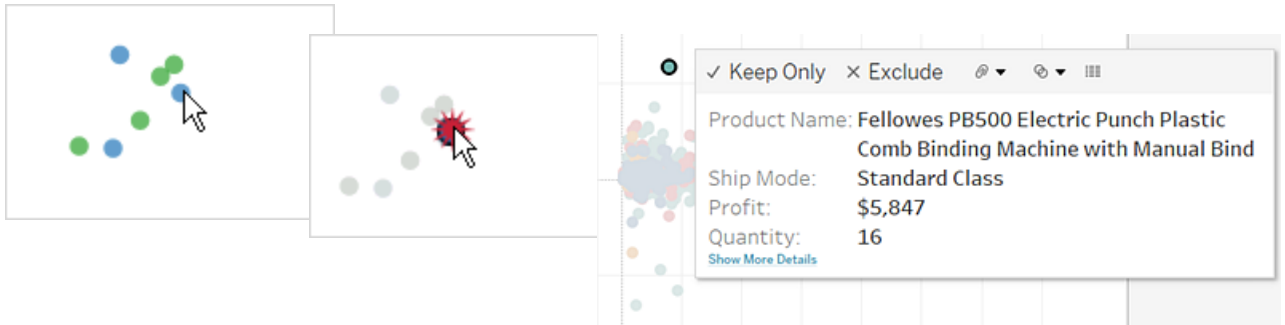

Links are not always visible for every worksheet and mark. Because links are mapped to specific fields in the data source, links will only be available for the worksheets that use the mapped fields. For example, if you add a hyperlink that uses both Latitude and Longitude as parameters in the link, the link will only be available to worksheets that use Latitude and Longitude in the view. Additionally, the link is only available on marks and headers that contain relevant values.

Actions and Dashboards

Because a dashboard can contain multiple views, a single filter or highlight action can have broad impact. Dashboards can also contain web page objects, which you can target with interactive URL actions.

Use a single view to filter other views in a dashboard

Imagine you have a dashboard that contains three views about profitability: a map, a bar chart, and a table of customer names. You can use a filter action to make one of the views in your dashboard, such as the map, the controlling view for the filter action. When your users select a region in the map, the data in the other views is filtered so that it relates to just that region.

1. On the dashboard, select the view you want to use as a filter.
2. On the view's shortcut menu, choose **Use as Filter**. You can perform the same action by

clicking the Use as Filter icon .

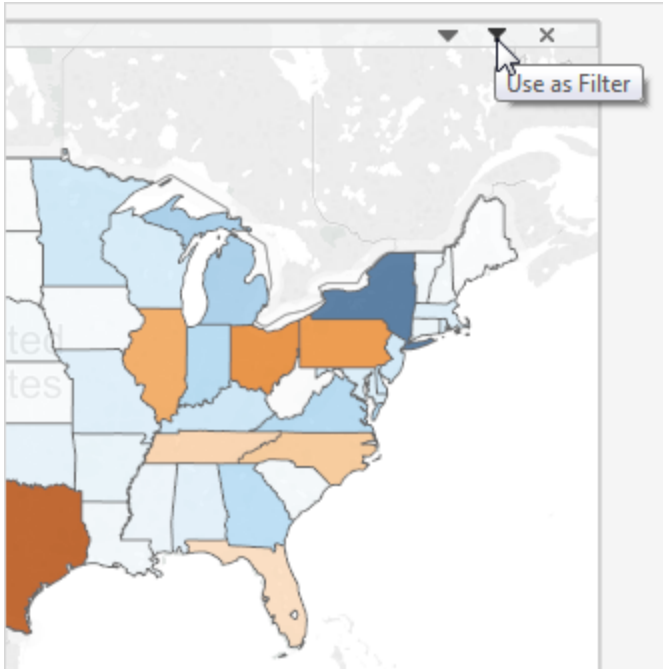

You can also use filter actions to filter the data on a dashboard when the data comes from multiple data sources. For more information, see [Filtering Across Multiple Data Sources Using a Parameter](#) in the Tableau Knowledge Base.

For more information about filter actions, see [Filter Actions](#) on page 1388.

Use multiple views to filter other views in a dashboard

Similar to how you can use a single view to filter other views in a dashboard, you can also use multiple views as a filter. The trick is to not only use these views as filters, but to also disable their ability to be filtered themselves.

1. Create or open a dashboard that has at least three views.

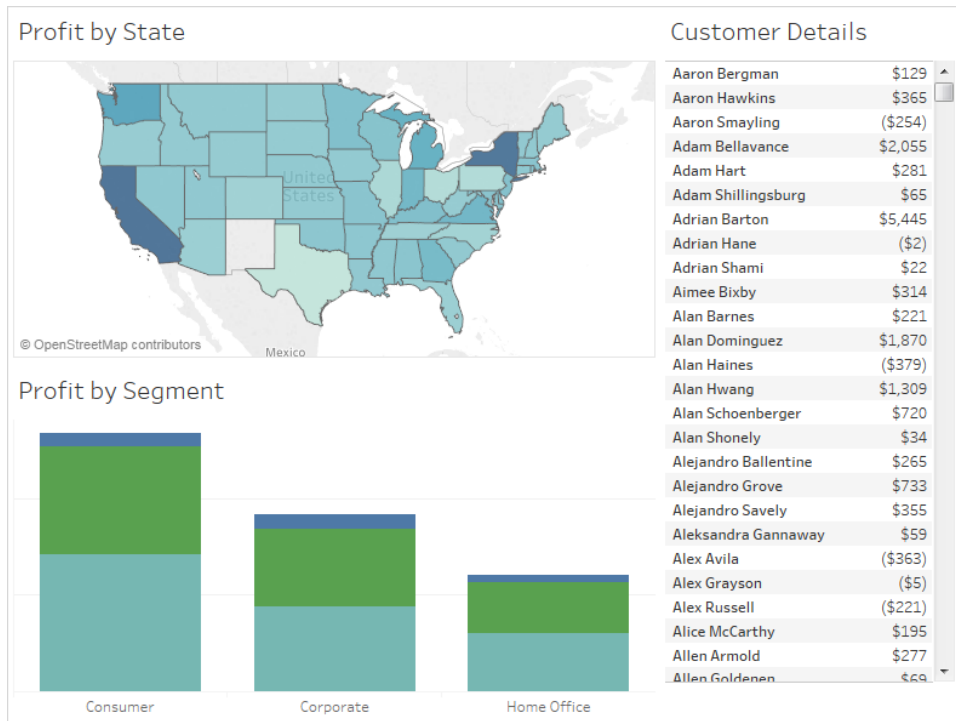

2. Select the first view that you want to use as a filter (such as a map), and from its shortcut menu, select **Use as Filter**.

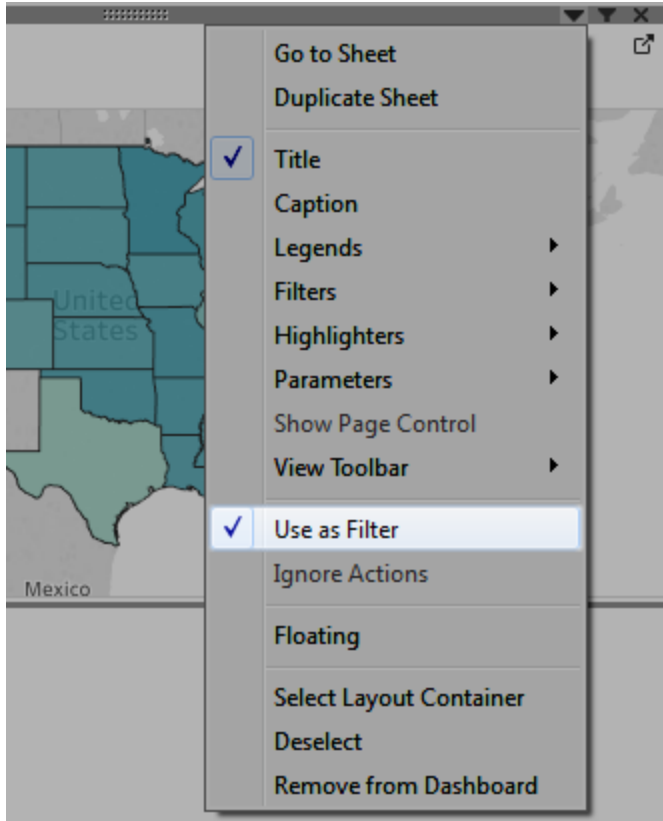

3. Open the same view's shortcut menu again and select **Ignore Actions**. This ensures that other filter actions, including the one you'll create next, will not affect this view.

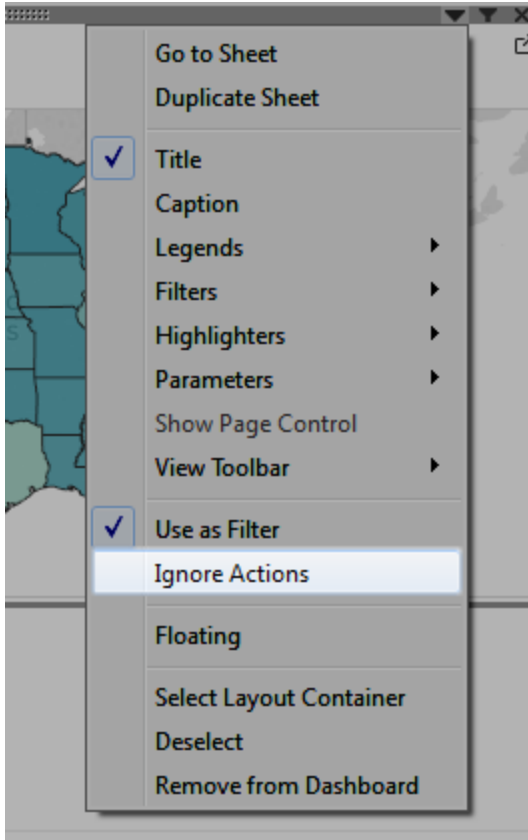

4. Repeat the steps 2 and 3 for any other views you want to use as a filter.

Now, selecting marks in these controlling views filters data in one or more detail views—all without affecting any other controlling views.

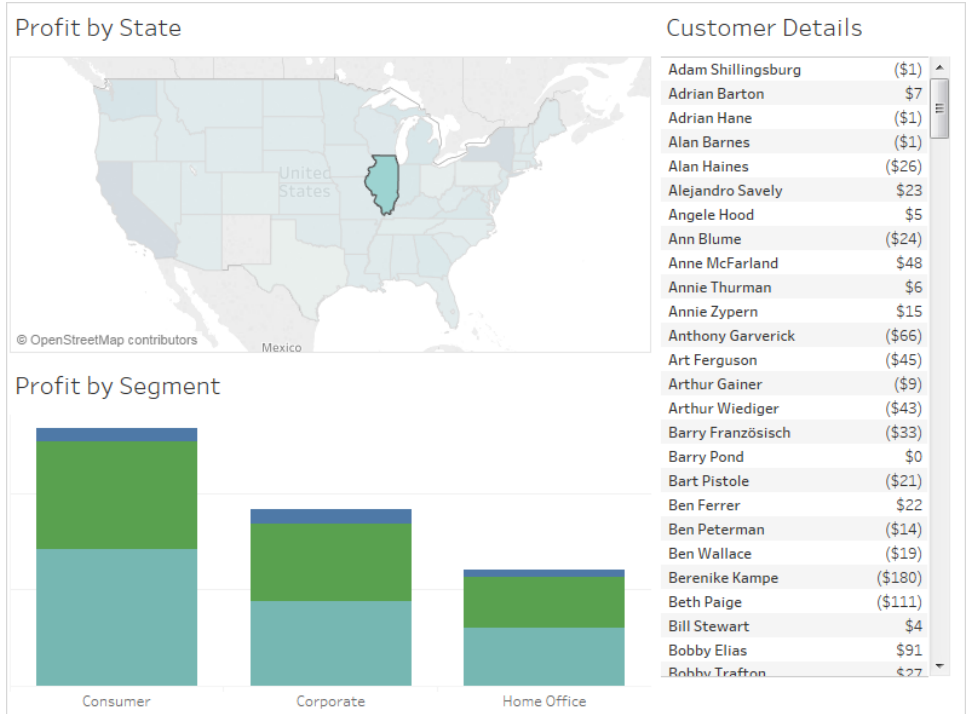

Navigate from one view to another view, dashboard, or story

Use the Go to Sheet action to let users quickly navigate to a related visualization—a dashboard, sheet, or story—when they click on a mark or a tooltip menu item in the original view.

Note: To simply navigate from one dashboard to another, without requiring users to interact with data, consider using [the Navigation object](#).

1. From your dashboard, select **Dashboard > Actions**.
2. In the Actions dialog box, click **Add Action** and then select **Go to Sheet**.

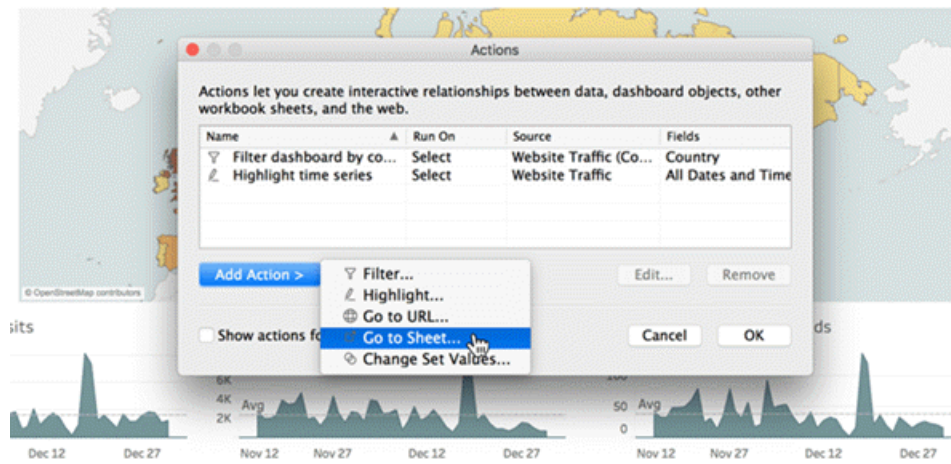

3. Specify a name for the action. (If you choose to run the action using a tooltip menu, the name you specify here is what the tooltip displays.)

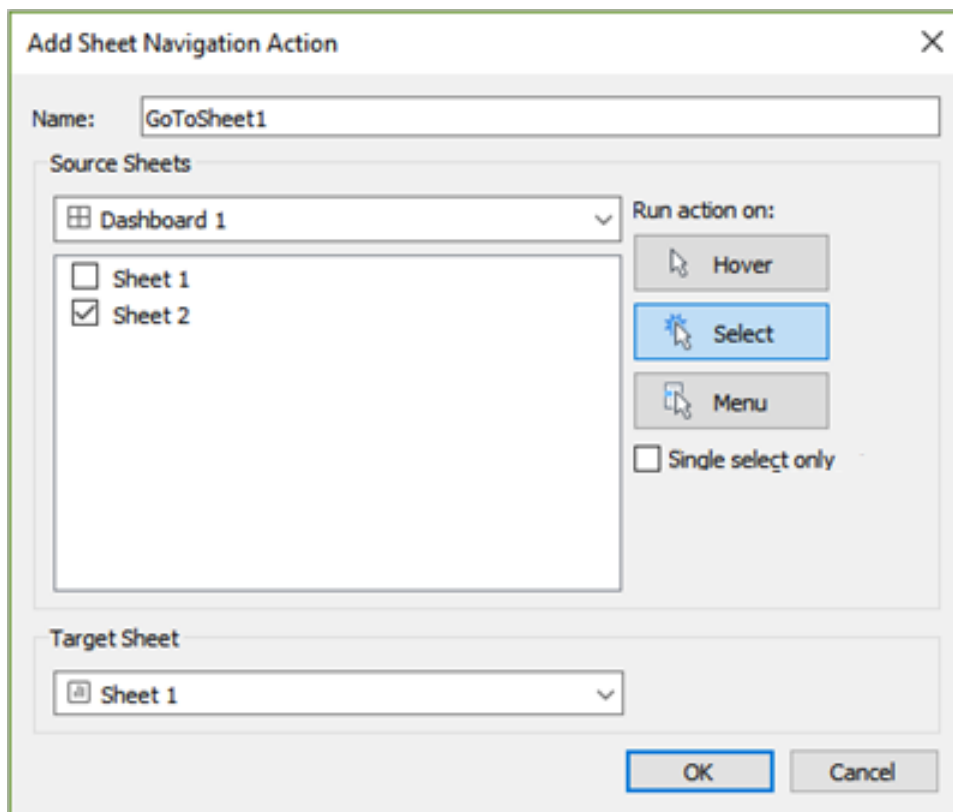

4. Select a source sheet that will initiate the action.
5. Specify how people viewing your dashboard will run the action. **Select** or **Menu** are the best choices for a navigation action.

If you choose **Select**, consider selecting **Single-select only** so users won't navigate away from the view when multiple marks are selected.

6. For the target sheet, select the navigation destination that appears when users click marks or tooltip menu items in the source sheet. Then click **OK**.

Interactively display a web page in a dashboard (Create in Tableau Desktop)

To interactively display information from the web inside a dashboard, you can use a URL action with a web page object. For example, you might have a dashboard that shows profits by country. In addition to showing the profit data in your dashboard, you also want to display supplemental information about the countries from a web site.

Tip: To easily organize and target multiple web page objects in a dashboard, **rename them**.

1. Drag a **Web Page** object onto your dashboard, and enter a URL.

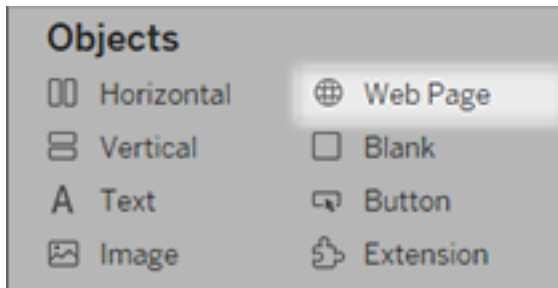

2. From your dashboard, select **Dashboard > Actions**.
3. In the Actions dialog box, click **Add Action** and then select **Go to URL**.
4. Specify a name for the link. If you choose to run the action using a menu, such as a menu option on a tooltip, the name you specify here is what's displayed.

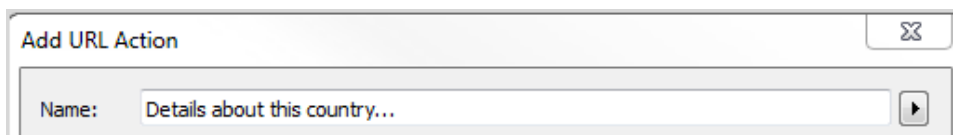

5. Under Source Sheets, select the view or data source that will initiate the action. For example, if you want the action to be initiated when a user clicks a link on a map's tooltip, select the map view.
6. Specify whether people viewing your dashboard will run the action on hover, select, or menu. For details, see [Running Actions on page 1461](#).
7. Enter the URL, starting with the http:// or https:// prefix, such as `http://www.example.com`.

You can use field values as parameters in your URL. For example, if Country is a field used by a view in your dashboard, you can use `<Country>` as a parameter in your URL. For details, see [URL Actions on page 1404](#).

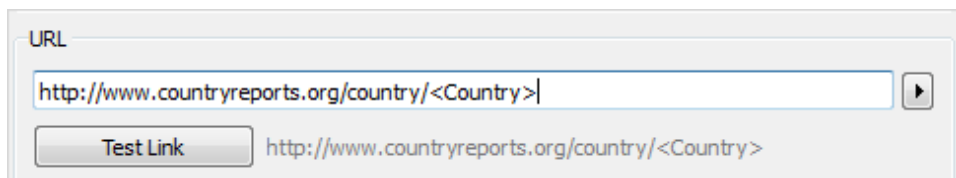

8. For URL Target, select **Web Page Object**, and select the object you created in step 1.

When you launch the action, a web page automatically loads within the dashboard rather than opening a separate browser window.

1. In the Add Action dialog box, begin typing the name for the action.
2. Place the cursor where you want to insert the field or filter value.
3. Click the arrow to the right of the text box and select the field or filter you want to add as a variable. The field or filter name is added between angle brackets.

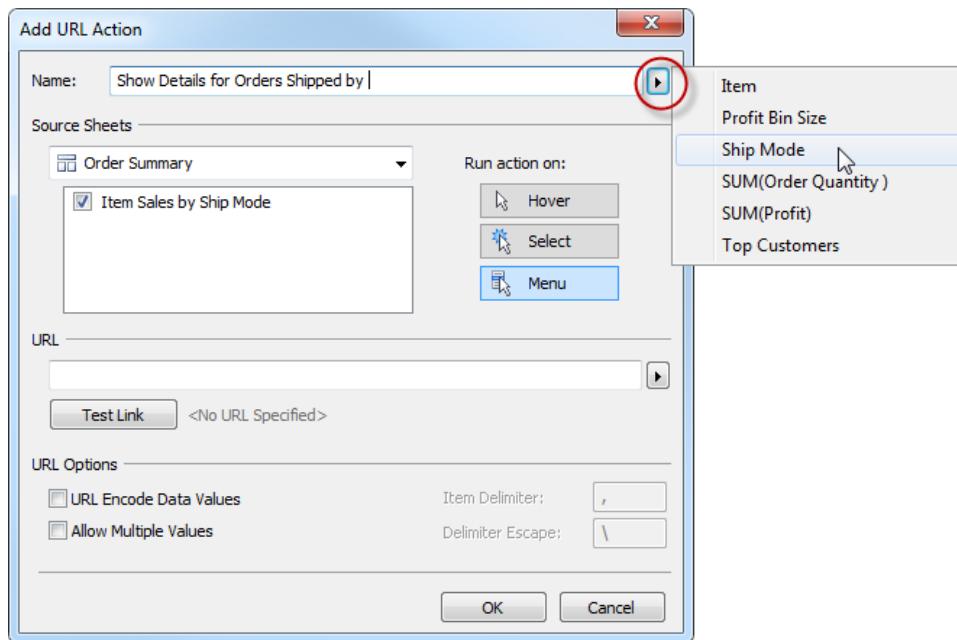

Here's a finished example for an action run from a tooltip menu:

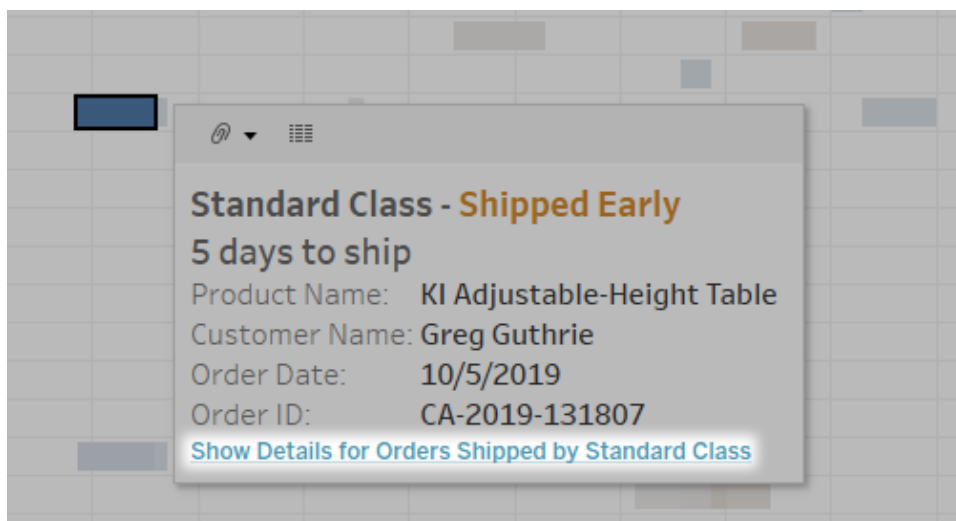

Build Common Chart Types in Data Views

This section includes detailed exercises that guide you through the steps involved in building some common chart types in data views. All exercises use the **Sample - Superstore** data source, which is included with Tableau Desktop. This collection of topics is just a sample of the many types of data views that you can create in Tableau. For details on options for building views from scratch, see [Build Data Views from Scratch on page 1187](#) and [Build a Basic View to Explore Your Data on page 3](#).

Create an Area Chart

An area chart is a line chart where the area between the line and the axis are shaded with a color. These charts are typically used to represent accumulated totals over time and are the conventional way to display stacked lines. Follow the steps below to create an area chart.

The basic building blocks for an area chart are as follows:

Mark type:	Area
Columns shelf:	Dimension
Rows shelf:	Measure
Color:	Dimension

To create an area chart, follow the steps below:

1. Open Tableau Desktop and connect to the **Sample - Superstore** data source.
2. Navigate to a new worksheet.
3. From the **Data** pane, drag **Order Date** to the **Columns** shelf.
4. On the Columns shelf, right-click **YEAR(Order Date)** and select **Month**.

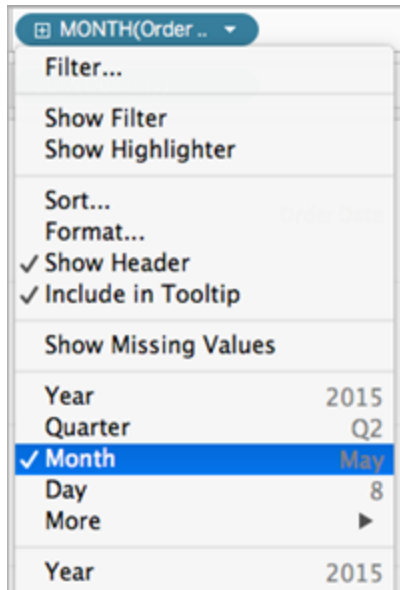

5. From the **Data** pane, drag **Quantity** to the **Rows** shelf.
6. From the **Date** pane, drag **Ship Mode** to **Color** on the Marks card.
7. On the Marks card, click the Mark Type drop-down and select **Area**.

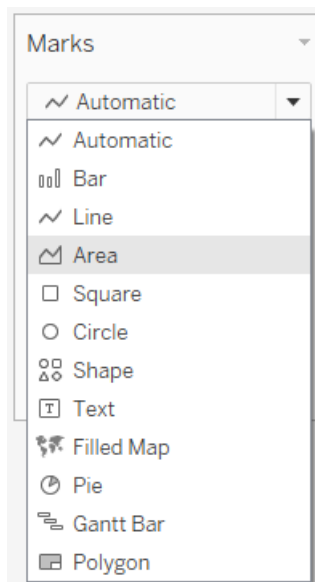

The visualization updates to the following:

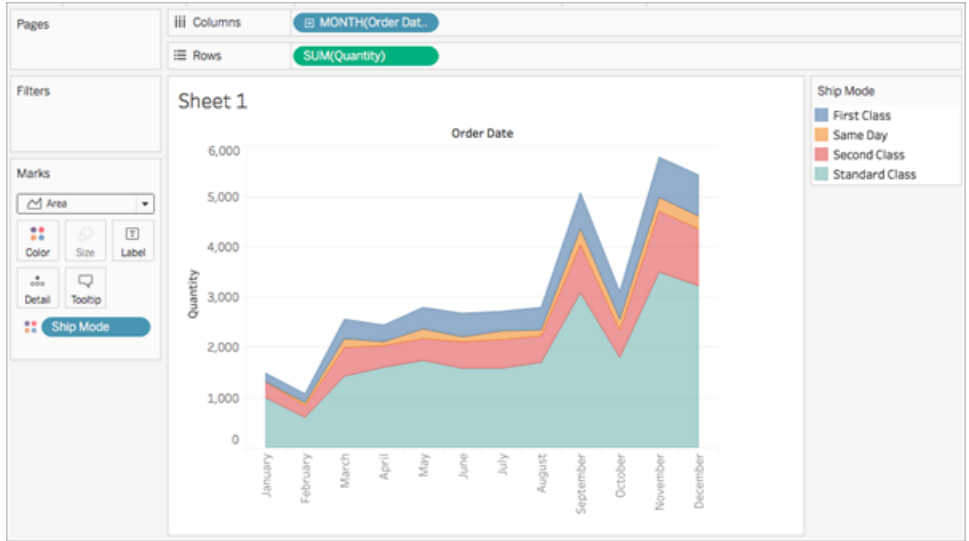

You can add formatting to an area chart. For example, you can edit the color legend and turn on mark labels and borders. For more information, see [Format at the Worksheet Level](#) on page 2942.

You can also use highlight actions with area charts. For example, selecting a color in the legend or turning on the highlighter will highlight the entire area instead of just the line. For more information, see [Highlight Actions](#) on page 1393.

Build a Bar Chart

Use bar charts to compare data across categories. You create a bar chart by placing a dimension on the **Rows** shelf and a measure on the **Columns** shelf, or vice versa.

A bar chart uses the **Bar** mark type. Tableau selects this mark type when the data view matches one of the two field arrangements shown below. You can add additional fields to these shelves.

For more information about the **Bar** mark type, see [Bar mark](#) on page 1243.

Note: At the end of the procedure is an extra step you can take to display totals at the tops of the bars.

Creates Vertical Bars

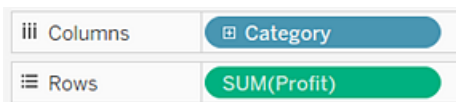

Creates Horizontal Bars

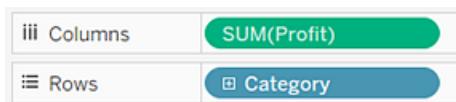

To create a bar chart that displays total sales over a four-year period, follow these steps:

1. Connect to the **Sample - Superstore** data source.

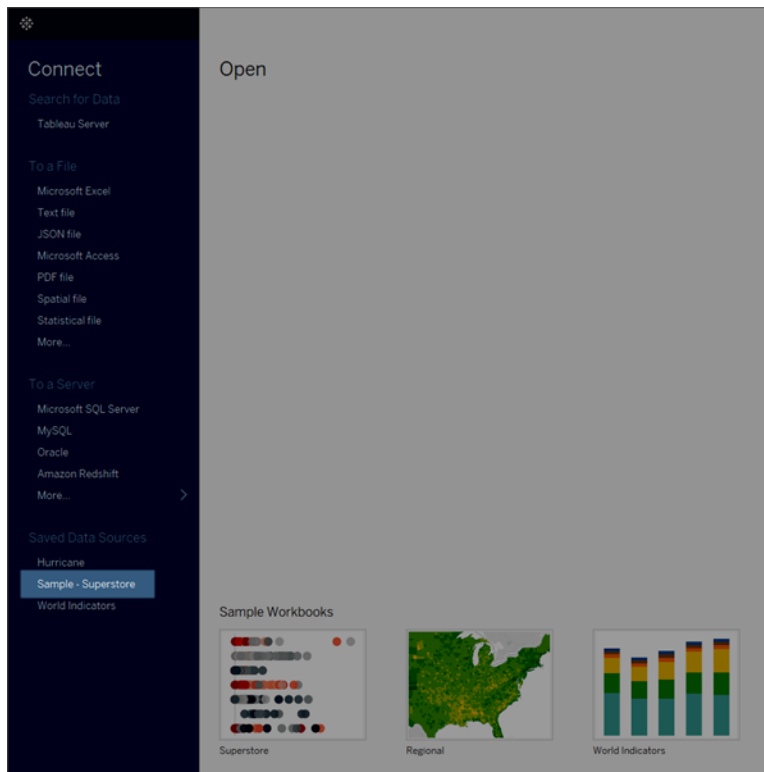

Note: In Tableau 2020.2 and later, the Data pane no longer shows Dimensions and Measures as labels. Fields are listed by table or folder.

2. Drag the **Order Date** dimension to **Columns** and drag the **Sales** measure to **Rows**.

Notice that the data is aggregated by year and column headers appear. The Sales measure is aggregated as a sum and an axis is created, while the column headers move to the bottom of the view. Tableau uses **Line** as the mark type because you added the date dimension.

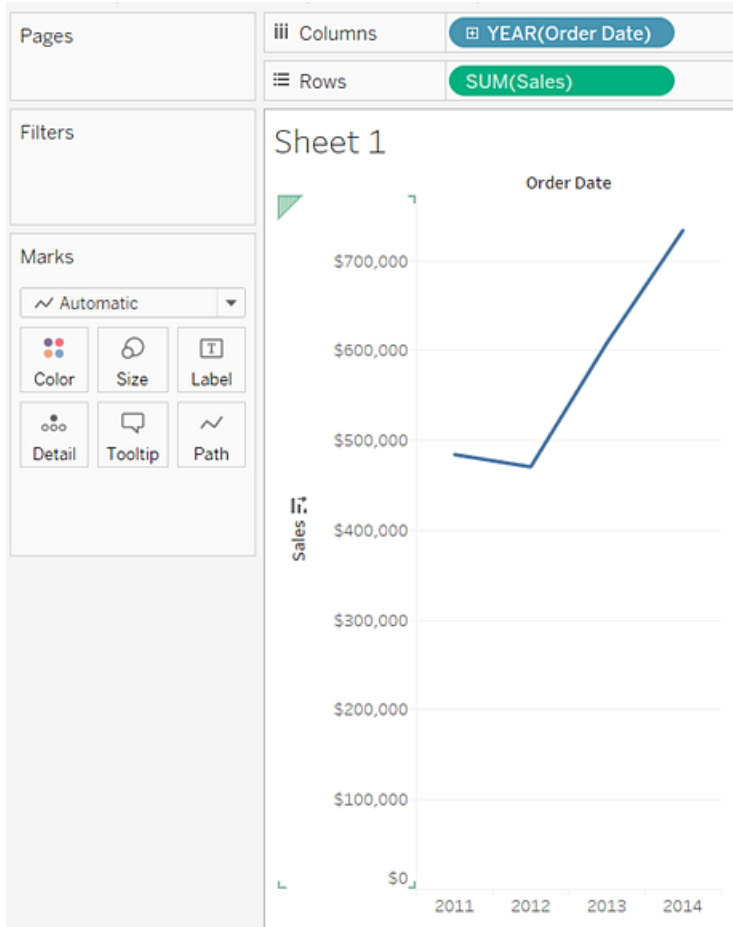

3. On the **Marks** card, select **Bar** from the drop-down list.

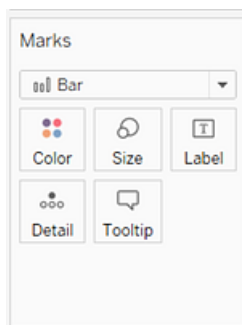

The view changes to a bar chart.

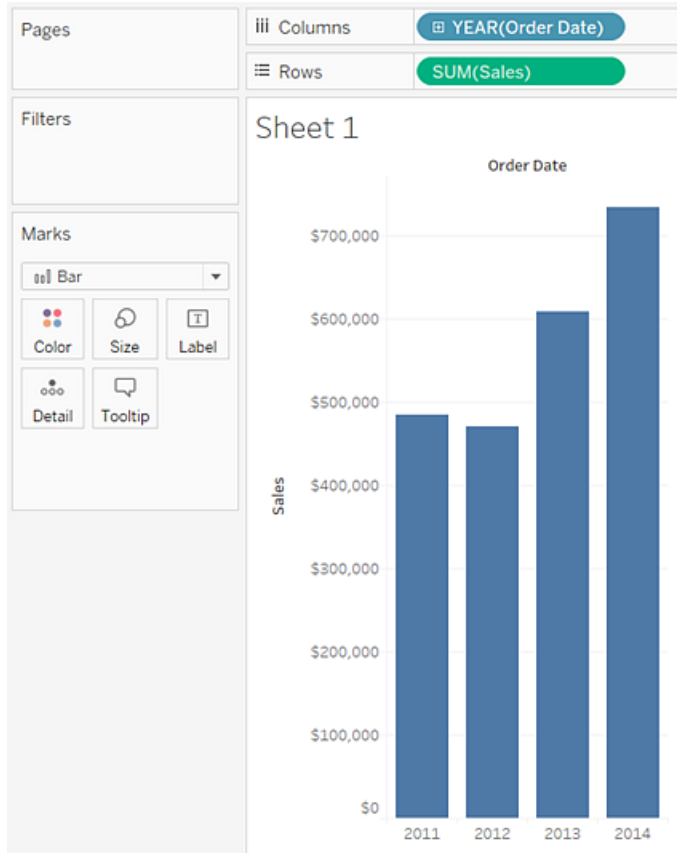

The marks (which are bars in this case) are vertical because the axis is vertical. The length of each mark represents the sum of the sales for that year. The actual numbers you see here might not match the numbers you see—the sample data changes from time to time.

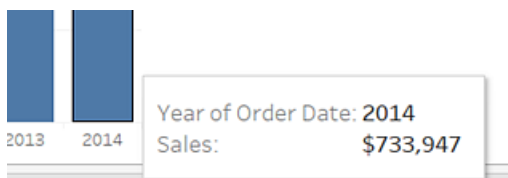

4. Drag the **Ship Mode** dimension to **Color** on the **Marks** card.

The view shows how different shipping modes have contributed to total sales over time. The ratios look consistent from year to year.

Tableau Desktop and Web Authoring Help

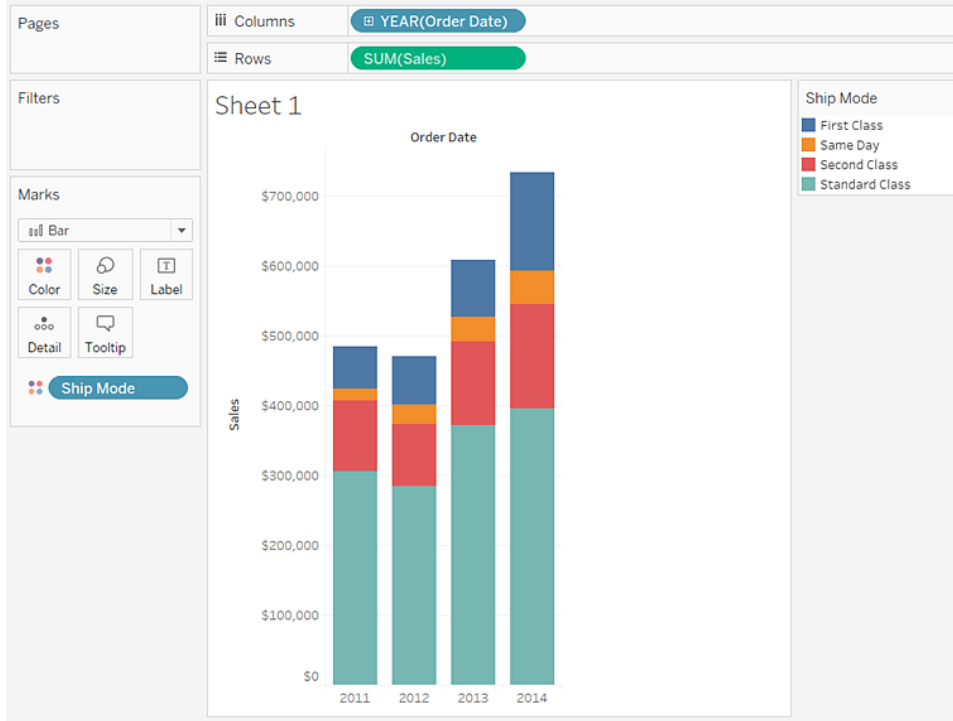

5. Drag the **Region** dimension to **Rows**, and drop it to the left of **Sales** to produce multiple axes for sales by region.

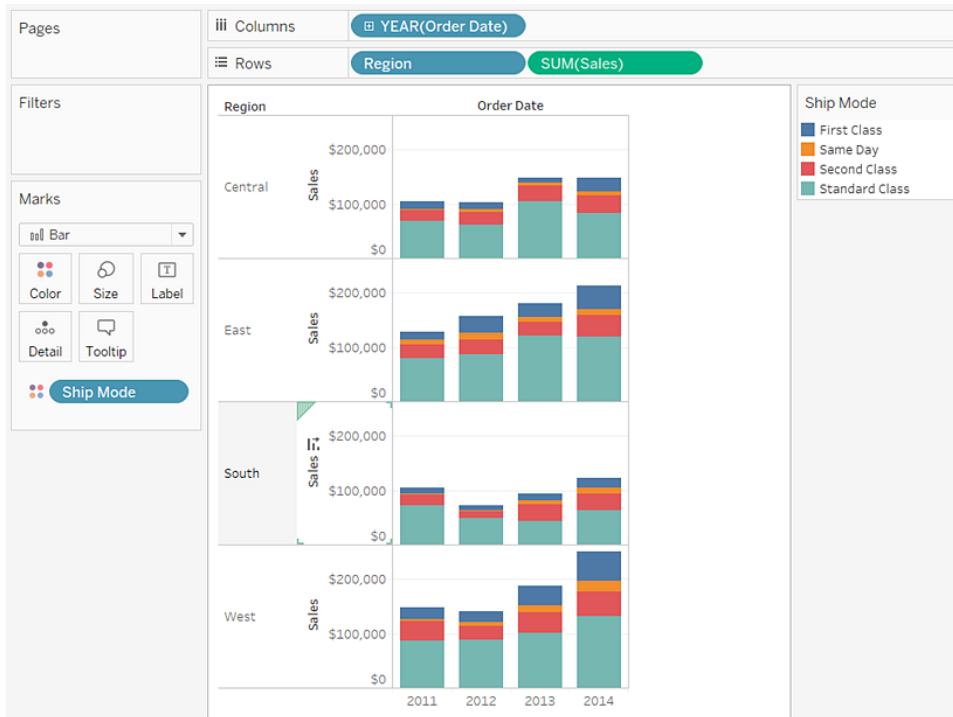

6. To view data in the West region only, you can filter out the other regions. To do this, drag the **Region** dimension again, this time from the **Data** pane to the **Filters** shelf.

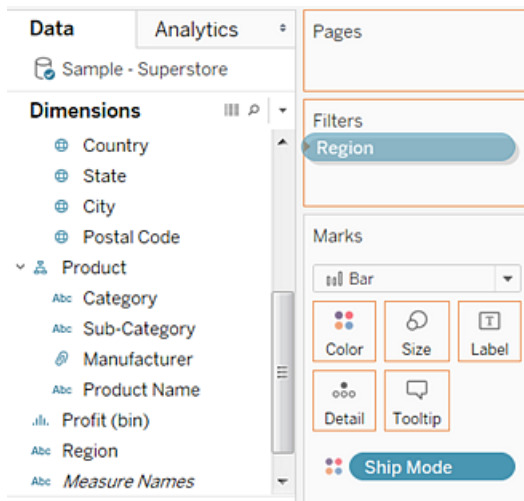

7. In the Filter [Region] dialog box, clear the **Central**, **East**, and **South** check boxes, and then click **OK**.

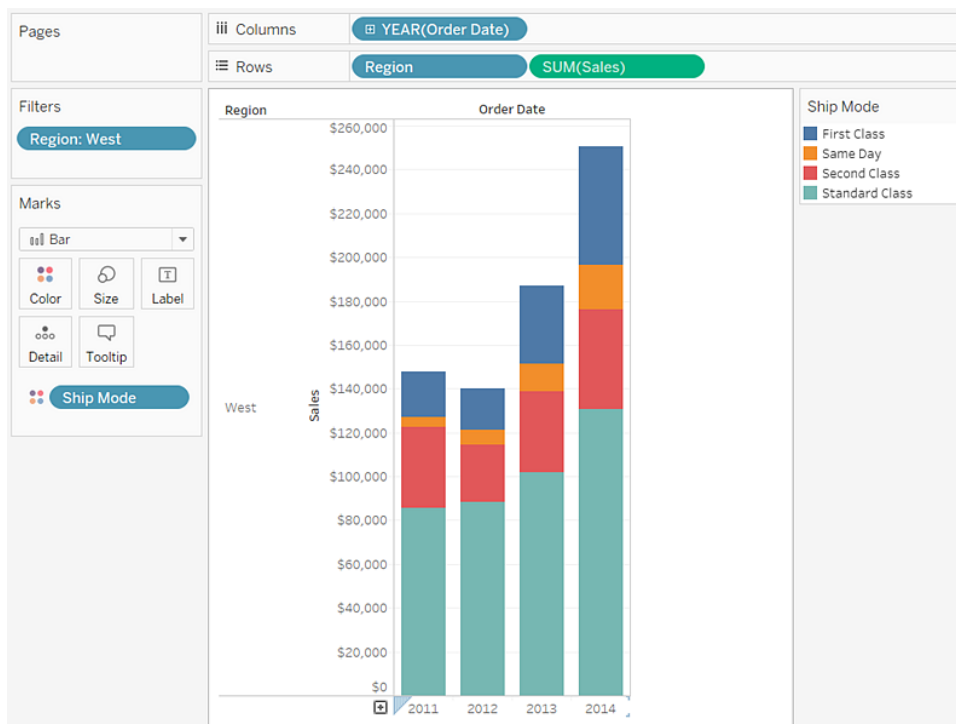

This view gives you insight into your data—for example, how the ship mode changed in the West over the four-year period.

Check your work: Watch steps 1-7 below

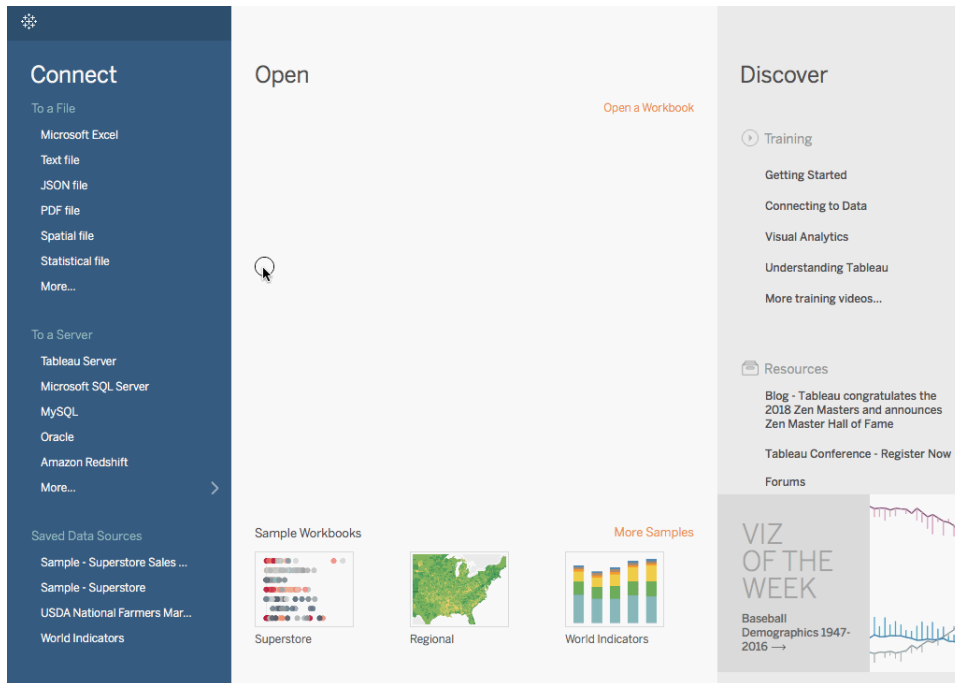

Note: In Tableau 2020.2 and later, the Data pane no longer shows Dimensions and Measures as labels. Fields are listed by table or folder.

One Step Further: Add Totals To Stacked Bars

Adding totals to the tops of bars in a chart is sometimes as simple as clicking the **Show Mark Labels** icon in the toolbar. But when the bars are broken down by color or size, each individual segment would be labeled, rather than the total for the bar. With a few steps, you can add a total label at the top of every bar even when the bars are subdivided as in the view you just created. In the following procedure you will technically be adding a reference line. But by configuring that "line" in a certain way, you end up with the labels you want.

1. From the **Analytics** pane, drag a **Reference Line** into the view and drop it on **Cell**.

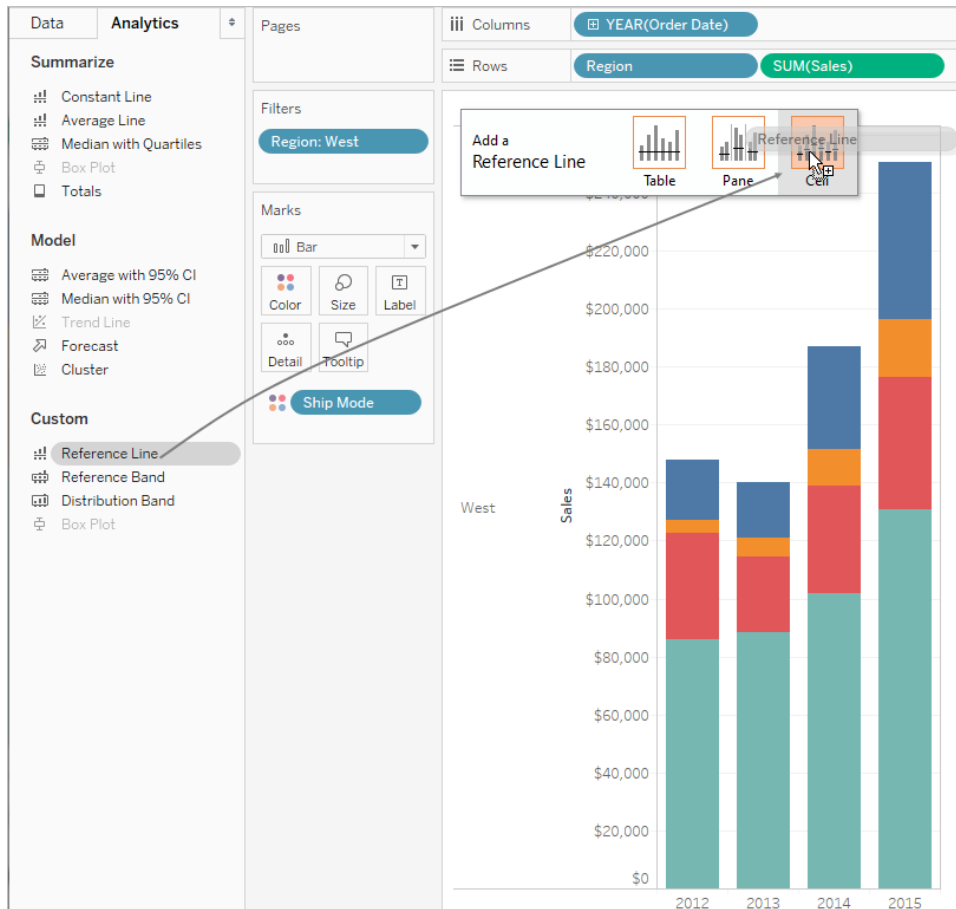

2. In the Edit Line, Band, or Box dialog box, set the aggregation for **SUM(Sales)** to **Sum**, set **Label** to **Value**, and set **Line** under Formatting to **None**:

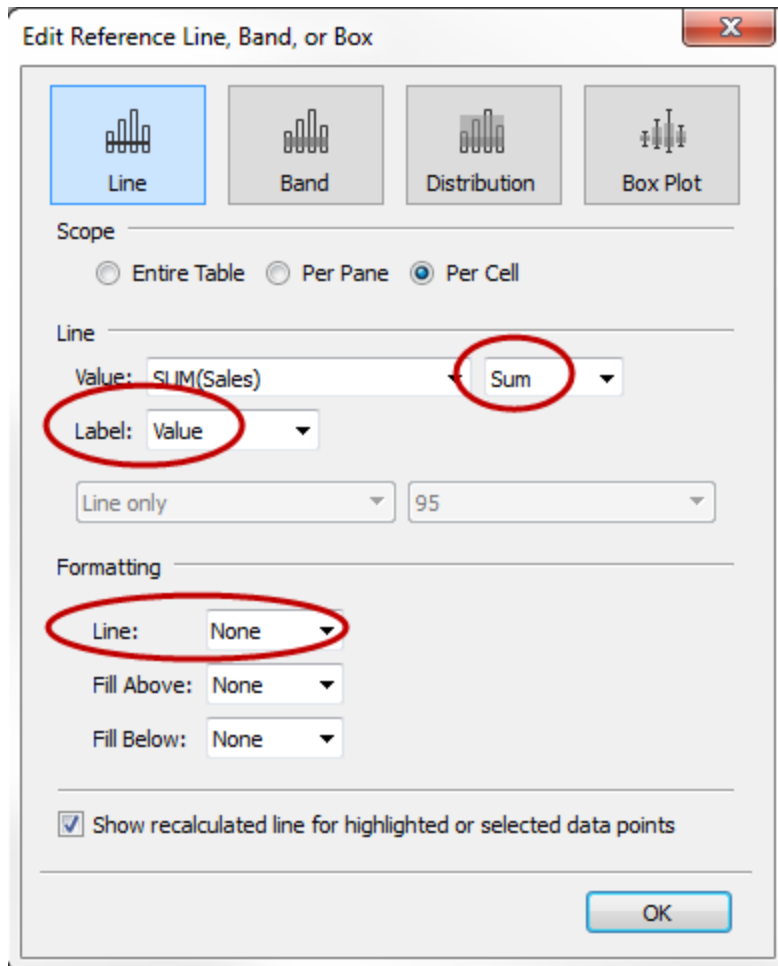

Then click **OK** to close the Edit Reference Line, Band, or Box dialog box.

Your view now has currency totals at the top of each bar:

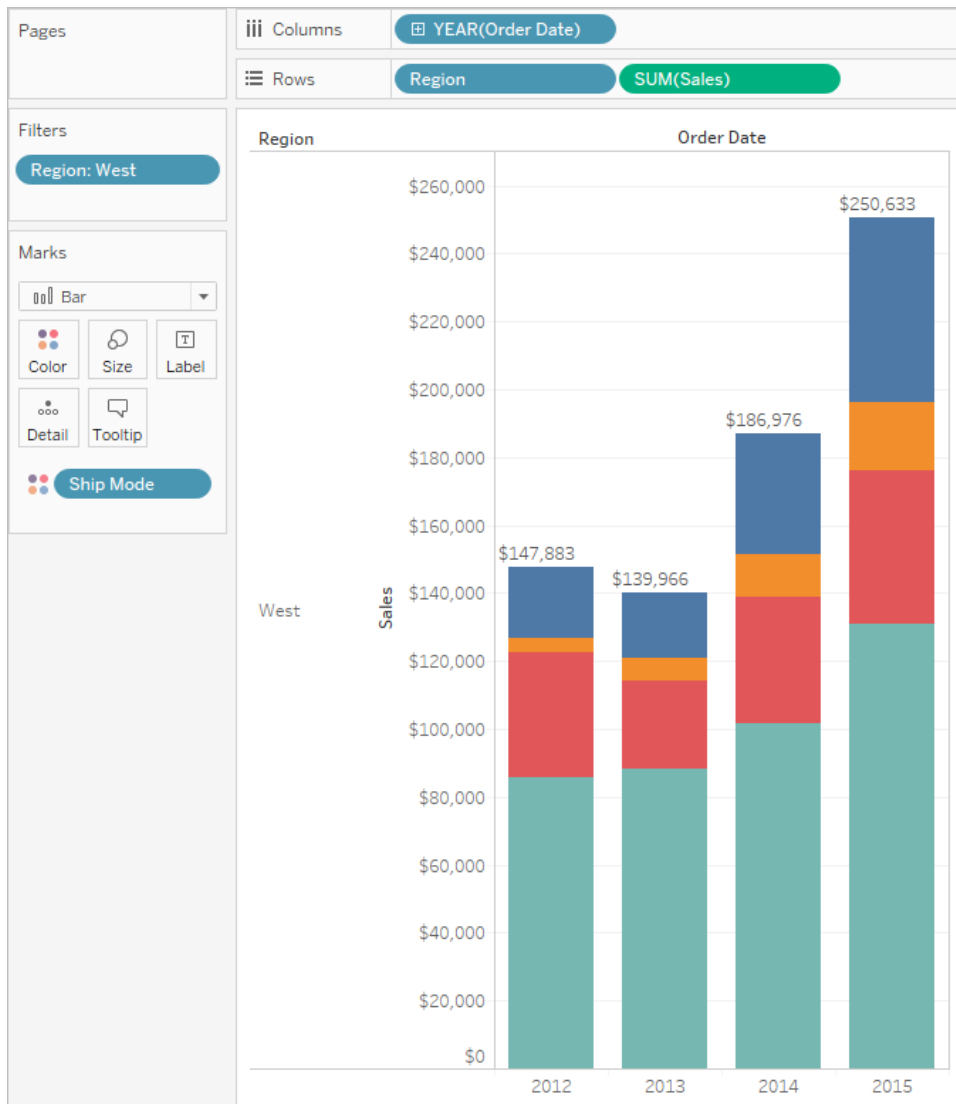

You may need to adjust the view to make it look just right. If the bars are too narrow, the numbers are truncated; to fix this, press **Ctrl + Right** on the keyboard to make the bars wider. Or if you want to center the totals over the bars—by default, they are left-aligned. Do the following:

3. Right-click any of the totals on the bar chart and select **Format**.
4. In the Format window, in the **Reference Line Label** area, open the **Alignment** control and select the Center option for Horizontal alignment:

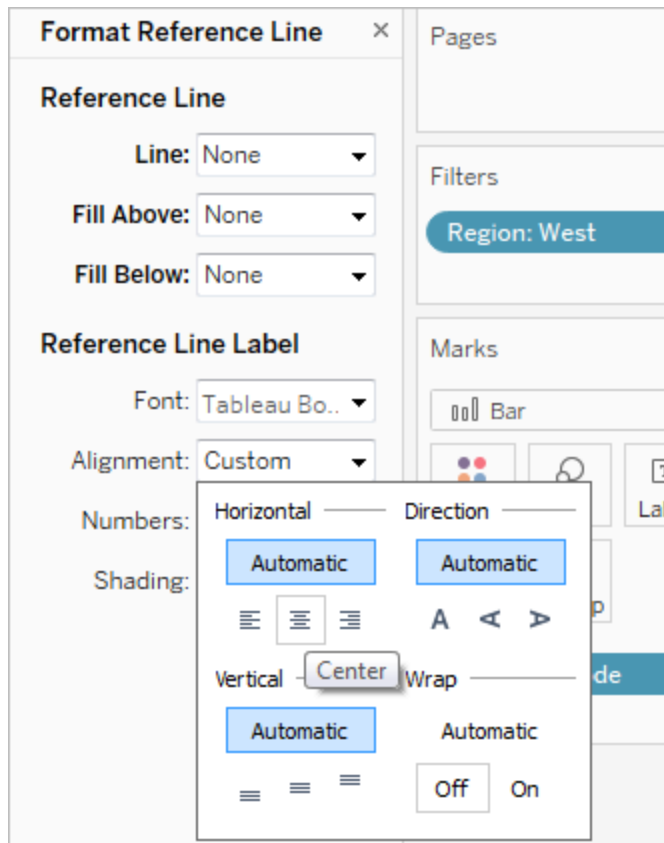

Other resources

[Creation of a Grouped Bar Chart](#) A knowledge base article with embedded videos that describes how to create grouped bar charts, also known as side-by-side bar charts.

Build a Box Plot

Use box plots, also known as box-and-whisker plots, to show the distribution of values along an axis.

Boxes indicate the middle 50 percent of the data (that is, the middle two quartiles of the data's distribution).

You can configure lines, called *whiskers*, to display all points within 1.5 times the interquartile range (in other words, all points within 1.5 times the width of the adjoining box), or all points at the maximum extent of the data, as shown in the following image:

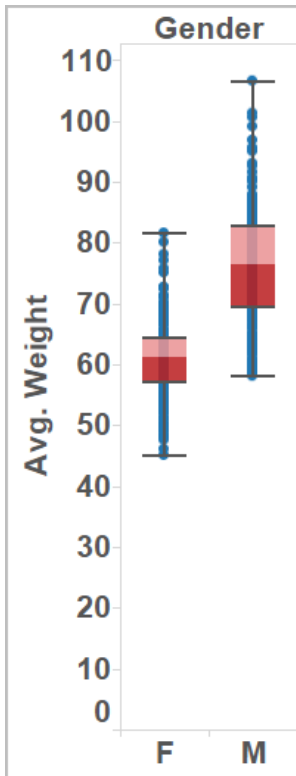

The basic building blocks for a box and whisker plot are as follows:

Mark type:	Circle
Columns shelf:	Dimension
Rows shelf:	Measure
Detail:	Dimension
Reference Line:	Box Plot For information on how to add a reference line, see Reference Lines, Bands, Distributions, and Boxes on page 2477.

To create a box plot that shows discounts by region and customer segment, follow these steps:

1. Connect to the **Sample - Superstore** data source.
2. Drag the **Segment** dimension to **Columns**.
3. Drag the **Discount** measure to **Rows**.

Tableau creates a vertical axis and displays a bar chart—the default chart type when there is a dimension on the **Columns** shelf and a measure on the **Rows** shelf.

4. Drag the **Region** dimension to **Columns**, and drop it to the right of **Segment**.

Now you have a two-level hierarchy of dimensions from left to right in the view, with regions (listed along the bottom) nested within segments (listed across the top).

5. Click **Show Me** in the toolbar, then select the box-and-whisker plot chart type.



Tableau displays the a box plot:

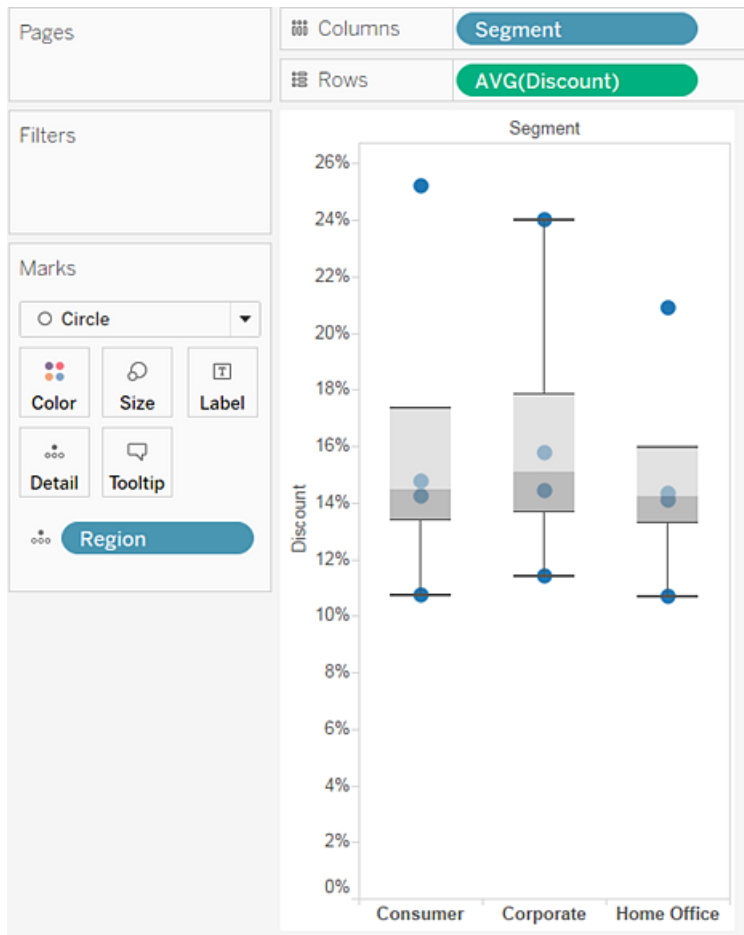

Notice that there are only a few marks in each box plot. Also, Tableau reassigned **Region** from the **Columns** shelf to the **Marks** card. When you changed the chart type to a box plot, Tableau determined what the individual marks in the plot should represent. It determined that the marks should represent regions. We'll change that.

6. Drag **Region** from the **Marks** card back to **Columns**, to the right of **Segment**.



The horizontal lines are flattened box plots, which is what happens when box plots are based on a single mark.

Box plots are intended to show a distribution of data, and that can be difficult when data is aggregated, as in the current view.

7. To disaggregate data, select **Analysis > Aggregate Measures**.

This command turns aggregation on or off, and because data is aggregated by default in Tableau, the first time you select this command, it disaggregates the data.

For more information, see [How to Disaggregate Data on page 180](#).

Now, instead of a single mark for each column in the view, you see a range of marks, one for each row in your data source.

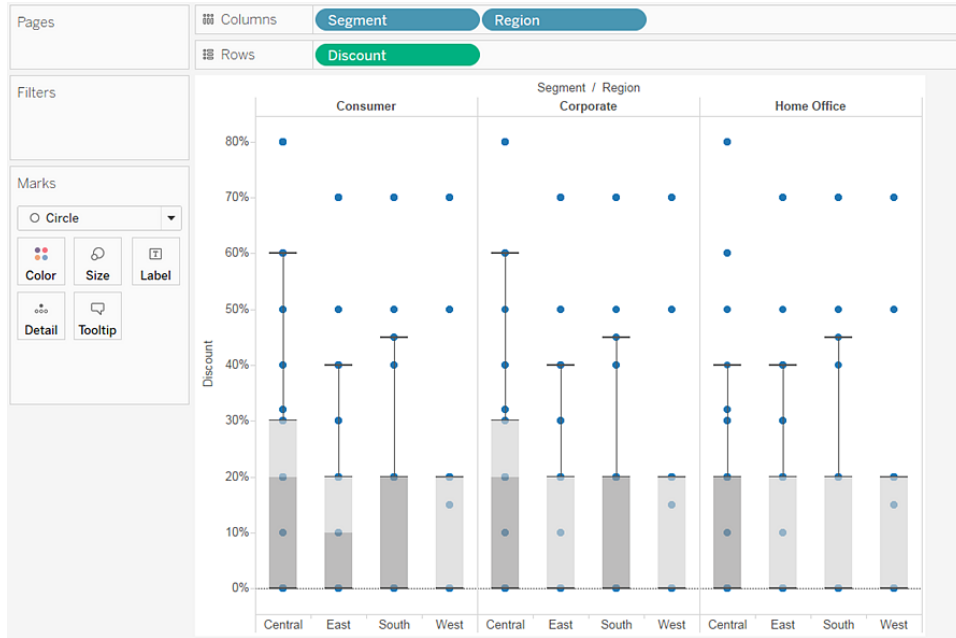

The view now shows the information we want to see. The remaining steps make the view more readable and appealing.

8. Click the **Swap**  button to swap the axes:

The box plots now flow from left-to-right:

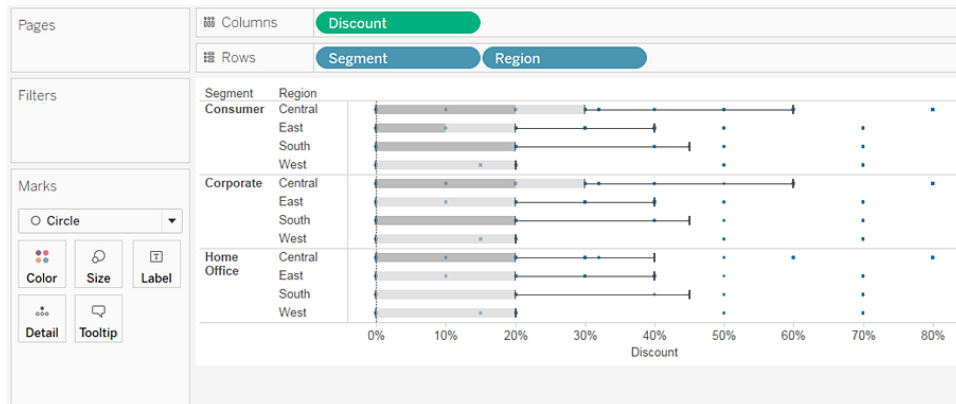

9. Right-click (control-click on Mac) the bottom axis and select **Edit Reference Line**.
10. In Edit Reference Line, Band, or Box dialog box, in the **Fill** drop-down list, select an interesting color scheme.

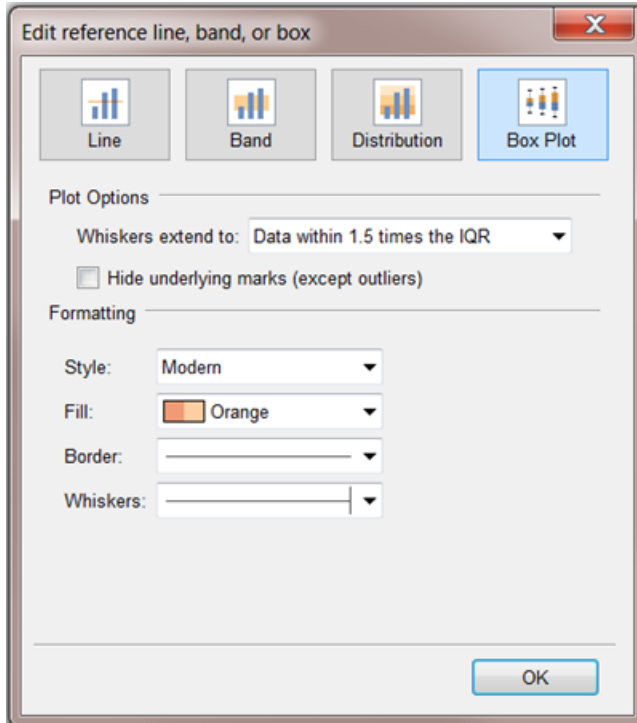

For more on these options, see [Add a Box Plot on page 2498](#) in the **Reference Lines, Bands, Distributions, and Boxes** article.

Now your view is complete:



You can see that the discount was the same for all segments in the West. You can also see that the interquartile range (from the 25th percentile to the 75th percentile) for discount was greatest in the Central region for the consumer and corporate segments.

For more information about box plots, see [Reference Lines, Bands, Distributions, and Boxes on page 2477](#).

Check your work! Watch steps 1-10 below:

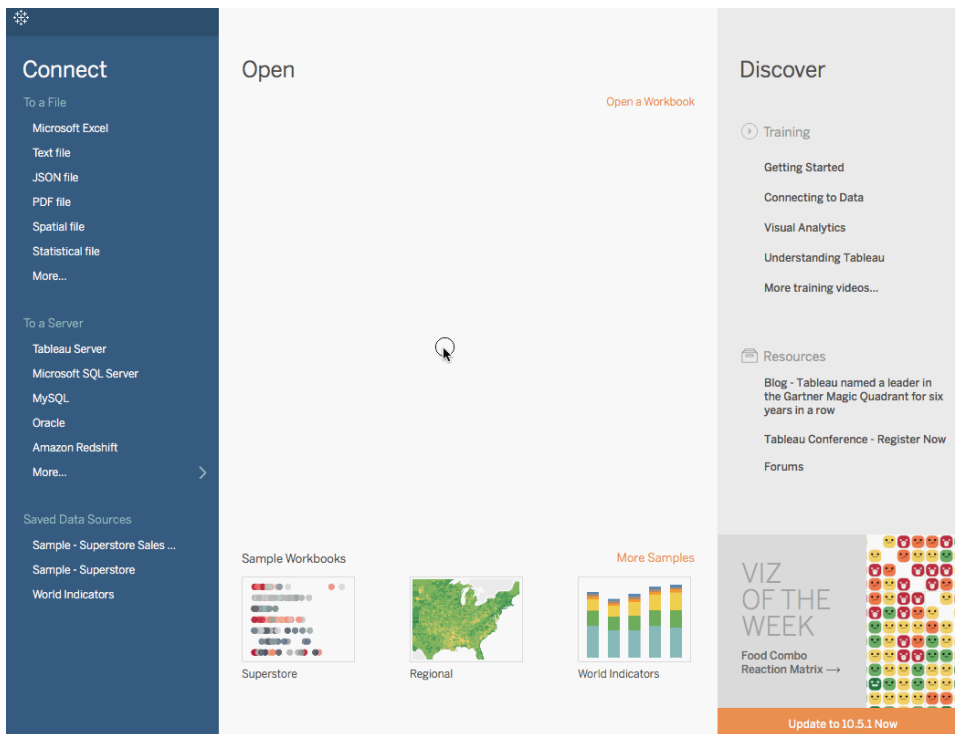

Note: In Tableau 2020.2 and later, the Data pane no longer shows Dimensions and Measures as labels. Fields are listed by table or folder.

Build a Bullet Graph

A bullet graph is a variation of a bar graph developed to replace dashboard gauges and meters. A bullet graph is useful for comparing the performance of a primary measure to one or more other measures. Below is a single bullet graph showing how actual sales compared to estimated sales.

Follow the steps below to learn how to create a bullet graph.

1. Open Tableau Desktop and connect to the **World Indicators** data source.
2. Navigate to a new worksheet.
3. Hold down Shift on your keyboard and then, on the **Data** pane, under **Development** select **Tourism Inbound** and **Tourism Outbound**.
4. In the upper-right corner of the application, click **Show Me**.
5. In Show Me, select the **Bullet Graph** image.

6. Click **Show Me** again to close it.
7. From the **Data** pane, drag **Region** to the **Rows** shelf.

The graph updates to look like the following:

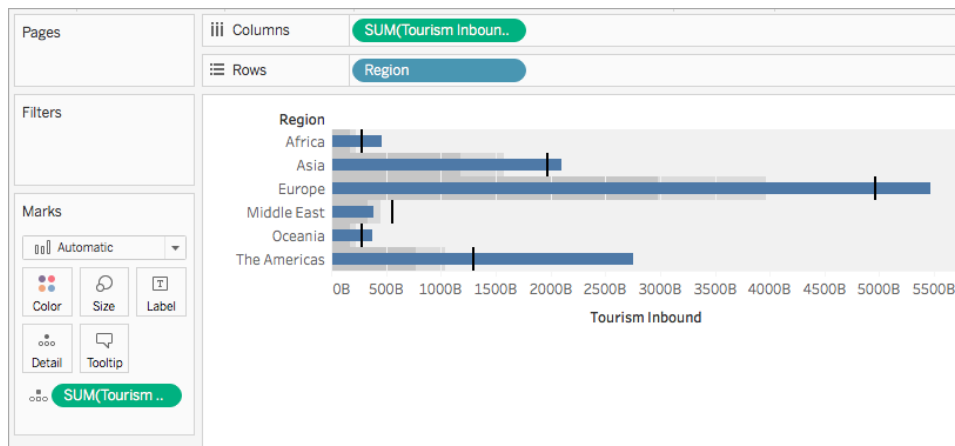

Check your work! Watch steps 3 - 7 below:

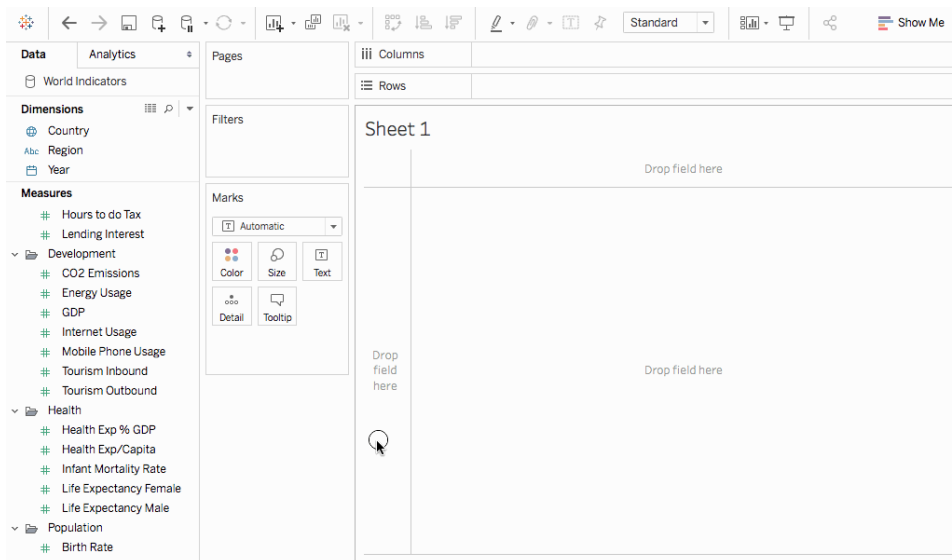

Note: In Tableau 2020.2 and later, the Data pane no longer shows Dimensions and Measures as labels. Fields are listed by table or folder.

Swap reference line fields

Sometimes you might want to swap the reference lines fields. For example, the actual sales is shown as a reference distribution instead of a bar.

To swap the two measures, right-click (control-click on the Mac) the axis and select **Swap Reference Line Fields**.

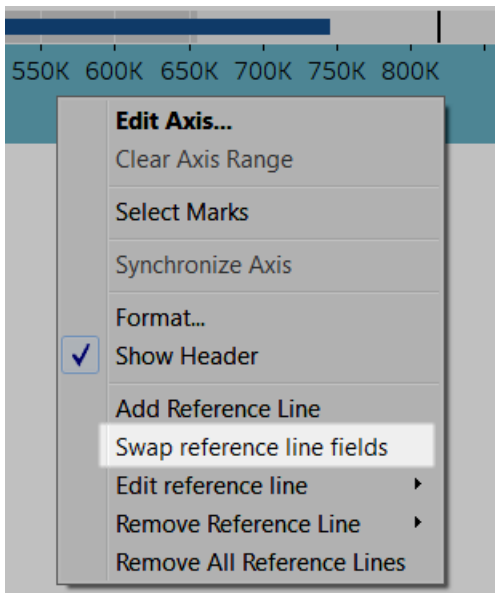

Edit the distribution

Right-click (control-click on the Mac) the axis in the view and select **Edit Reference Line**, and then select one of the reference lines to modify.

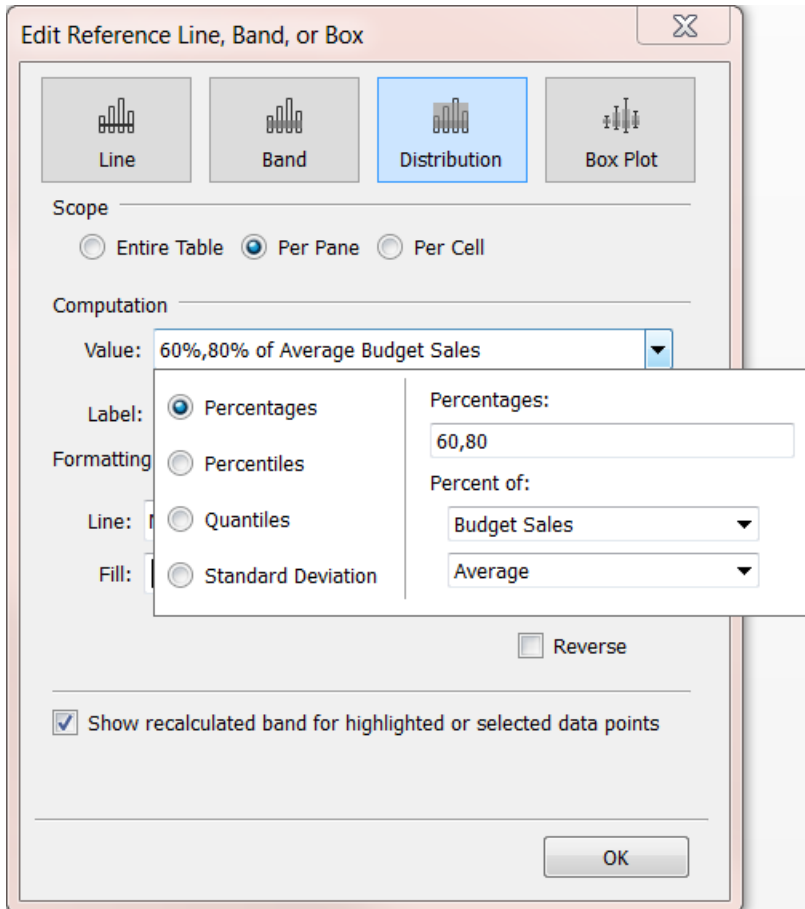

Build with Density Marks (Heatmap)

Use density chart to visualize patterns or trends in dense data with many overlapping marks. Tableau does this by grouping overlaying marks, and color-coding them based on the number of marks in the group.

Density maps help you identify locations with greater or fewer numbers of data points.

In Tableau, you can create a chart using the density mark by placing at least one continuous measure on the Columns shelf, and at least one dimension or measure on the Rows shelf (or vice versa), and then adding a field to the Marks card.

Note: Density charts work best when used with data sources containing many data points.

The basic building blocks for a density chart are as follows:

Mark type:	Density
-------------------	---------

Rows and Columns:	At least one continuous measure, and at least one measure or dimension
Marks card:	At least one continuous measure

Density charts use the **Density** mark type. By default, Tableau will use the automatic mark type.

To show how density charts can help make sense of overlapping marks in Tableau, we're going to start with a scatter plot with a large number of marks and re-create it as a density chart.

To use a density chart to see orders by date, follow these steps:

1. Open the **World Indicators** data source from the **Saved Data Sources** section of the Start screen.



2. From the Health folder, drag **Infant Mortality** to the Columns shelf. Tableau aggregates the measure as a sum and creates a horizontal axis.
3. Drag the **Life Expectancy Female** to the **Rows** shelf.

Now you have a one-mark scatter plot.

Tableau Desktop and Web Authoring Help

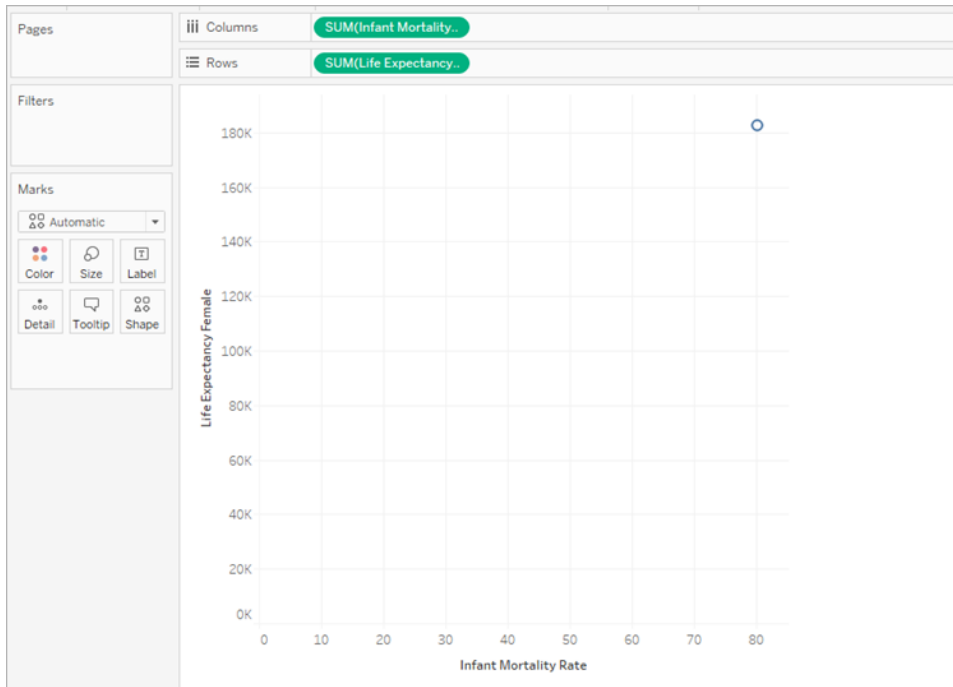

- Both Infant Mortality and Life Expectancy are listed as a **Sum**, rather than average. Right click on both of these measures and to change Measure(Sum) to **Average**.

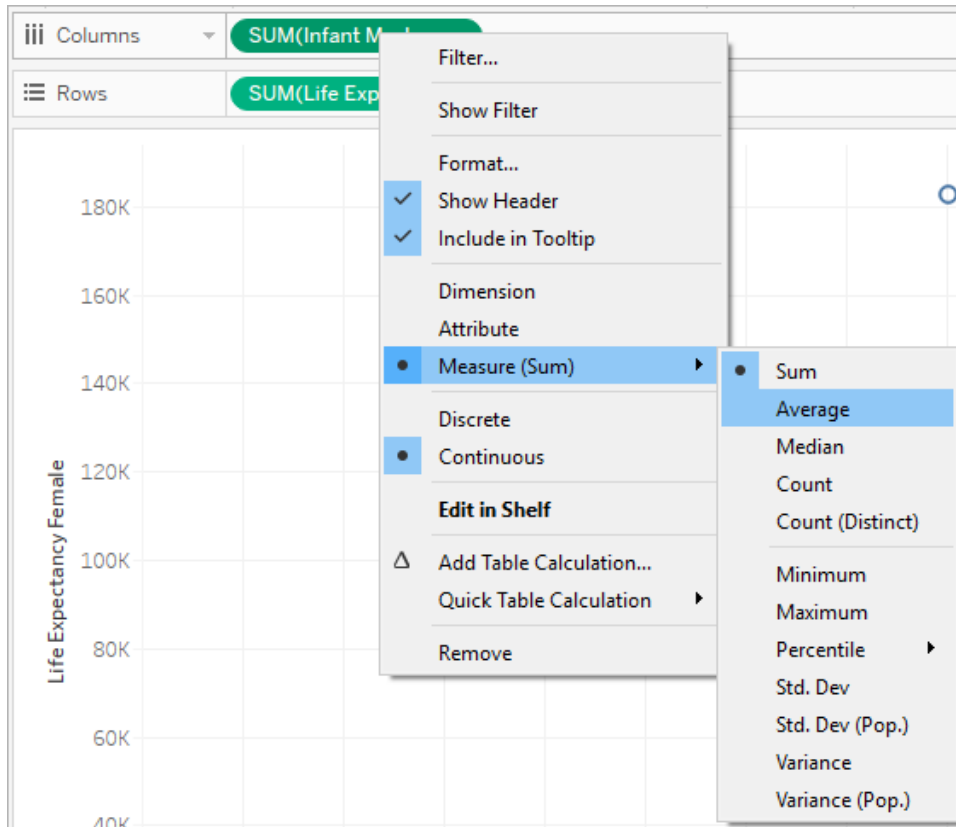

5. Drag the **Country** dimension to **Details** on the Marks card.

Now there are many more marks in your view. The number of marks in your view is now equal to the number of distinct countries in this data set. If you hover over a mark, you can see the country name, female life expectancy, and infant mortality rate.



We've created a basic scatter plot, but there are lots of overlapping marks in the view and it's hard to see where the marks are most dense.

6. On the **Marks** card, select **Density** from the menu to change this scatter plot into a density chart.



Tableau created a density chart by overlaying marks, called kernels, and color-coding where those kernels overlap. The more overlapping data points, the more intense the color is.



Tableau selected a blue color palette by default, but you can choose from ten density color palettes or any of the existing color palettes.

7. Select **Color** from the **Marks** card and select **Density Multi-color Light** from the menu.

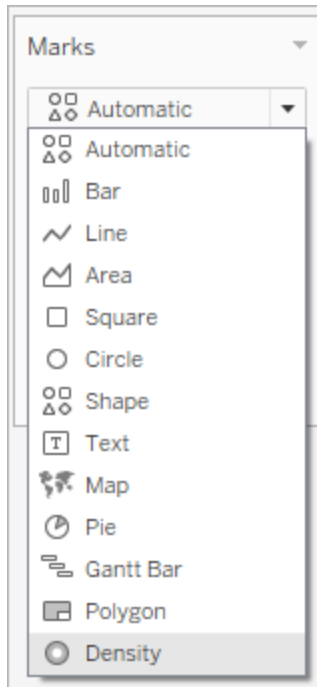
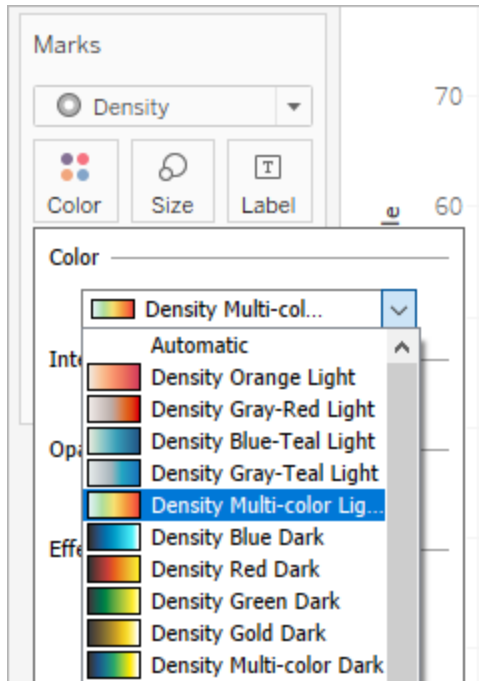

The names of the color palettes indicate whether they're designed for use on charts with dark or light backgrounds. Since our chart has a light background, we picked a "Light" palette.

This changes the color palette on your chart. More concentrated areas will appear red, while areas without overlapping marks will appear green.

Note: Color legends are not available for density marks.

8. In the Color menu, use the Intensity slider to increase or decrease the vividness of the density marks. For example, increasing intensity, or vividness, lowers the "max heat" spots in your data, so that more appear.

Tableau Desktop and Web Authoring Help

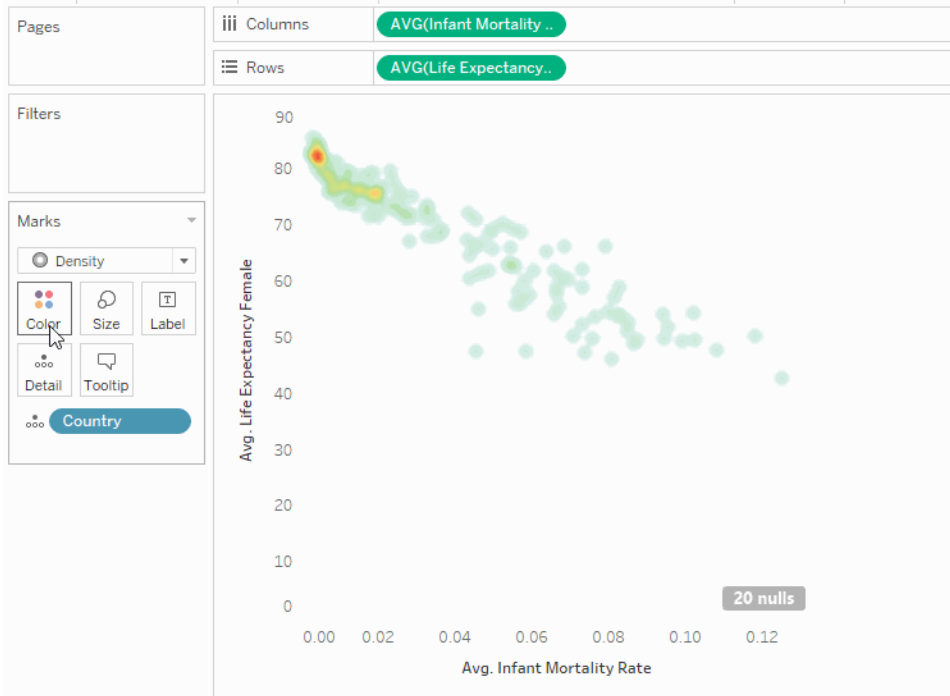

9. Select **Size** from the Marks card to adjust the size of the density's kernel.

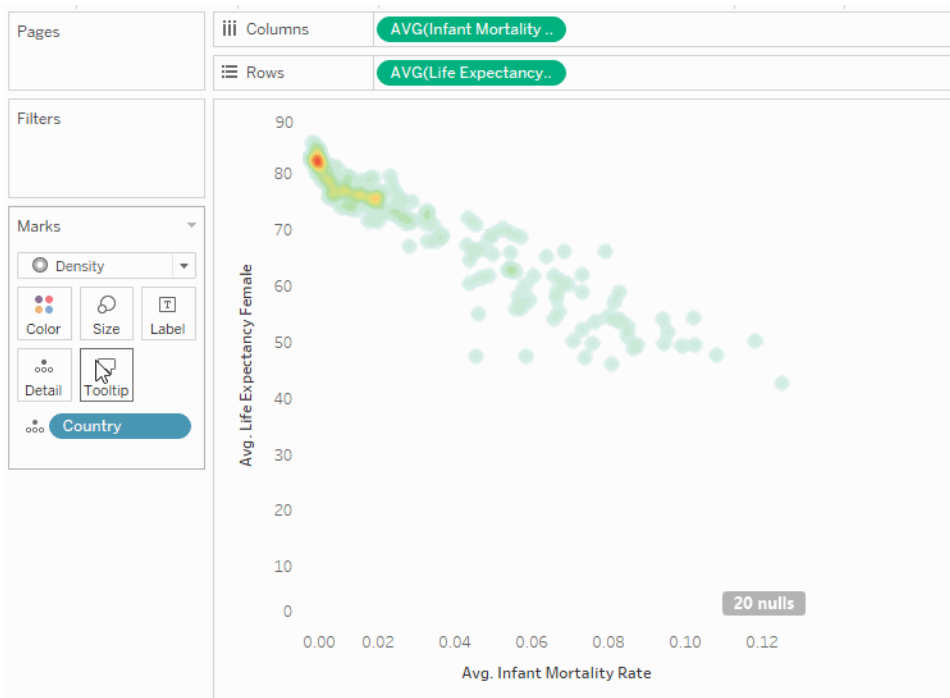

For more information, see [Change the Type of Mark in the View](#) on page 1238 and [Create Heatmaps that Show Trends or Density in Tableau](#) on page 1800.

Build a Gantt Chart

Use Gantt charts to show the duration of events or activities.

In a Gantt chart, each separate mark (usually a bar) shows a duration. For example, you might use a Gantt chart to display average delivery time for a range of products.

The basic building blocks for a gantt chart are as follows:

Mark type:	Automatic or Gantt Bar
Columns shelf:	Date or Time field (continuous measure)
Rows shelf:	Dimension(s)
Size:	Continuous measure

For more information about the Gantt bar mark type, see [Gantt Bar mark on page 1257](#).

To create a Gantt chart that shows how many days elapse on average between order date and ship date, follow these steps:

1. Connect to the **Sample - Superstore** data source.
2. Drag the **Order Date** dimension to **Columns**.

Tableau aggregates the dates by year and creates column headers with labels for the years.

3. On the **Columns** shelf, click the **Year (Order Date)** drop-down arrow, and then select **Week Number**.

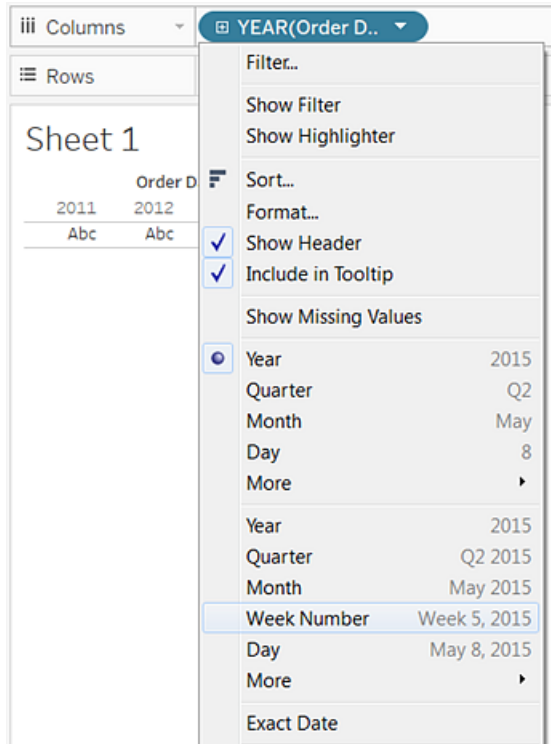

The column headers change. Individual weeks are indicated by tick marks because there are 208 weeks in a four-year span—too many to show as labels in the view.

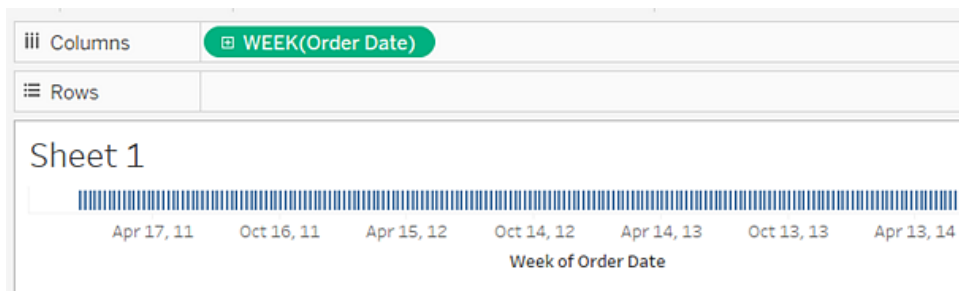

4. Drag the **Sub-Category** and **Ship Mode** dimensions to the **Rows** shelf. Drop **Ship Mode** to the right of **Sub-Category**.

This builds a two-level nested hierarchy of dimensions along the left axis.

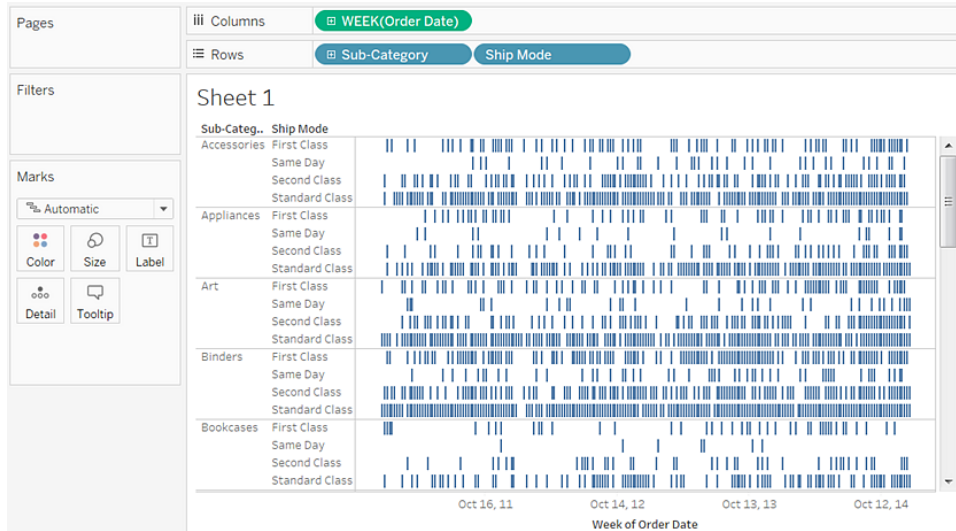

Next, we'll size the marks according to the length of the interval between the order date and the ship date. To do this, create a calculated field to capture that interval.

5. In the toolbar menu, click **Analysis > Create Calculated Field**. You can also right-click (Control-click on Mac) any field in the **Data** pane and select **Create > Calculated Field**.

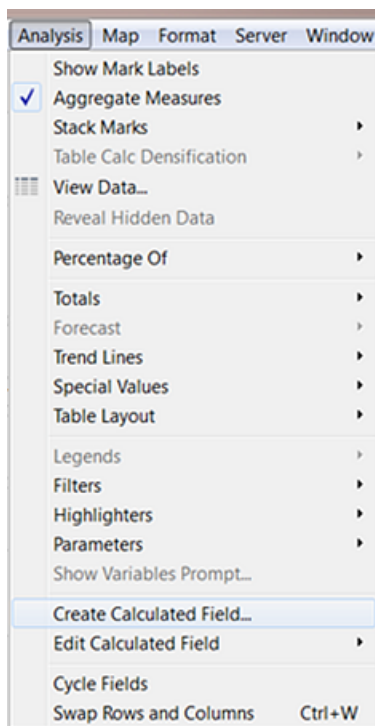

6. In the calculation dialog box, name your calculated field **OrderUntilShip**.

7. Clear any content that's in the **Formula** box by default.
8. In the **Formula** box, enter the following formula and then click **OK**:

```
DATEDIFF('day', [Order Date], [Ship Date])
```

The formula creates a custom measure that captures the difference between the **Order Date** and **Ship Date** values, in days.

9. Drag the **OrderUntilShip** measure to **Size** on the **Marks** card.

The default aggregation for **OrderUntilShip** is **Sum**, but in this case it makes more sense to average the values.

10. Right-click (Control-click on Mac) the **SUM(OrderUntilShip)** field on the **Marks** card, and then select **Measure (Sum) > Average**.

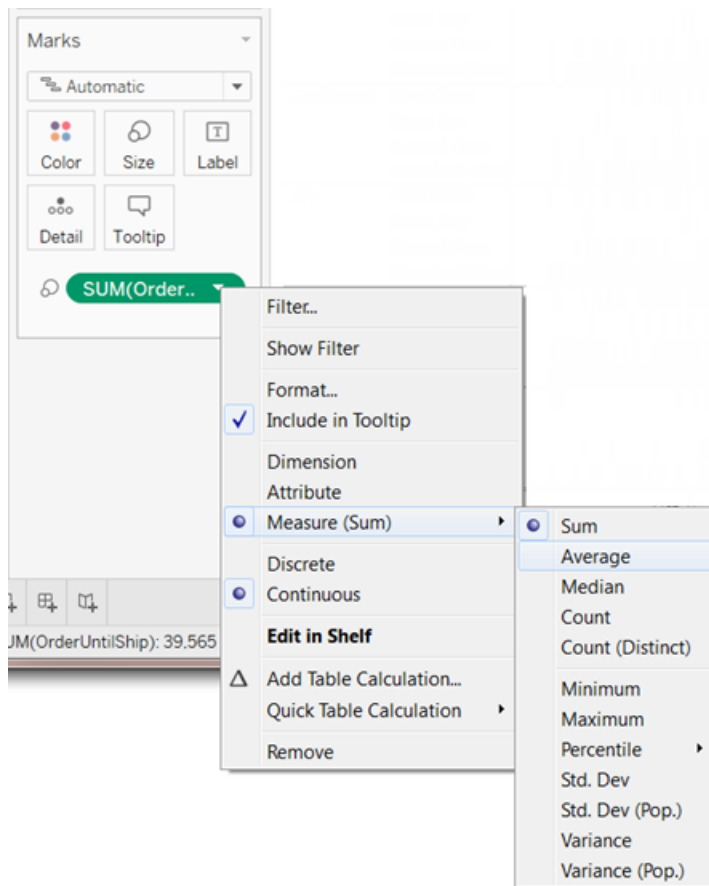

The view is coming along. But there are too many marks squeezed into the view.

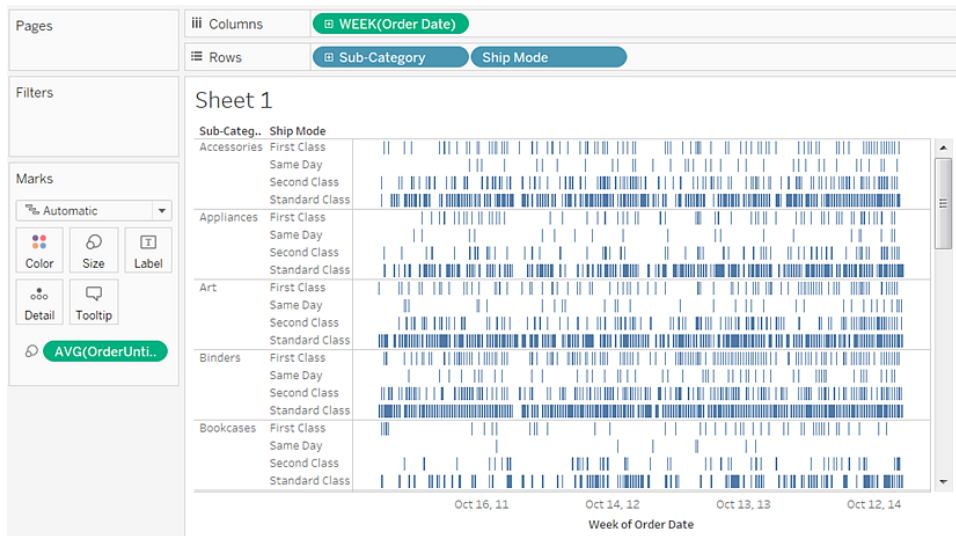

We can make our data more readable by filtering down to a smaller time window.

11. Hold down the Ctrl key (Option key on the Mac) and drag the **Week(Order Date)** field from the **Columns** shelf to the **Filter** shelf.

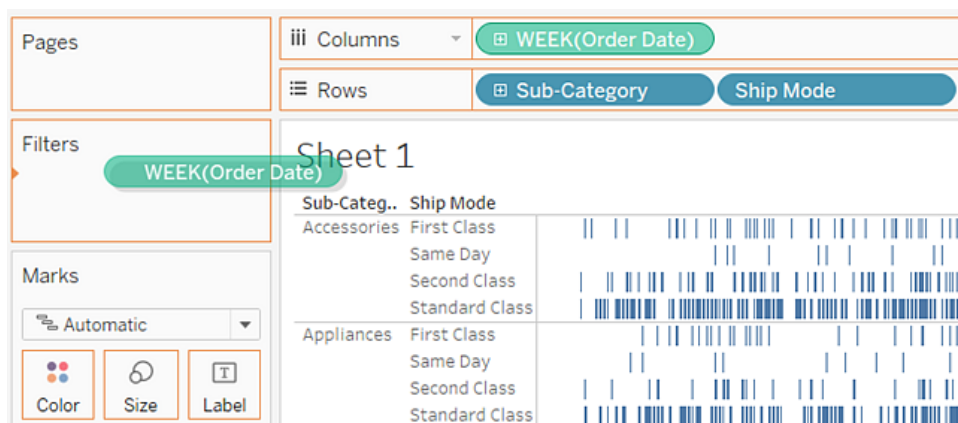

By holding down the Ctrl key (or the Option key), you tell Tableau that you want to copy the field to the new location, with whatever customizations you have added, without removing it from the old location.

12. In the Filter Field dialog box, select **Range of Dates** and then click **Next**.

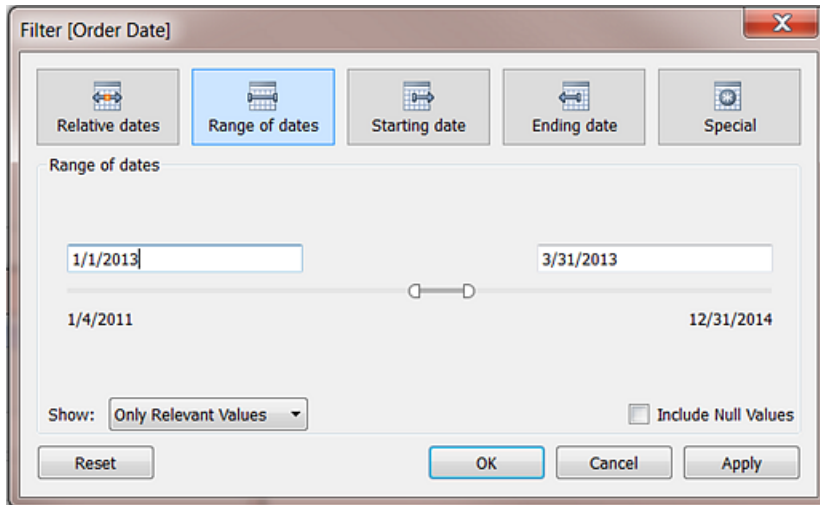

13. Set the range to a three-month time interval, such as 1/1/2013 to 3/31/2013, and then click **OK**.

It can be difficult to get the exact date using the sliders—it's easier just to enter the numbers you want directly into the date boxes or use the calendar to select the dates.

14. Drag the **Ship Mode** dimension to **Color** on the **Marks** card.

Now your view shows you all sorts of information about the lag between order times and ship times.

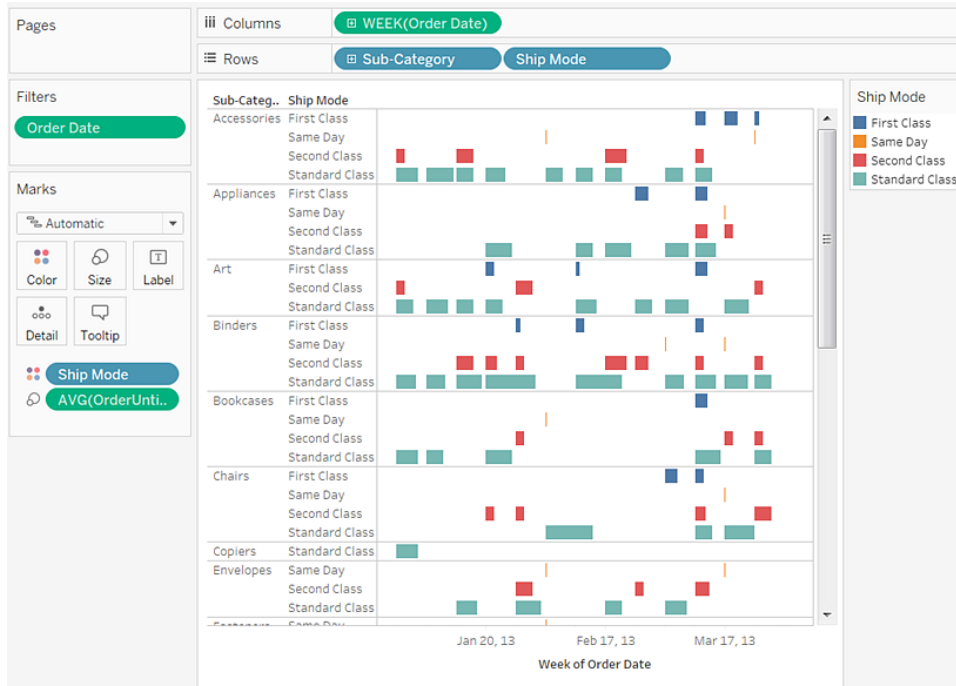

For example, you can see which ship modes are more prone to longer lag times, whether lag times vary by category, and whether lag times are consistent over time.

Note: If you publish this view to Tableau Server, you can include filters that let users interact with the view by varying the time window, or filtering out various sub-categories or ship modes. For more information, see [Publish Data Sources and Workbooks](#) on page 3111.

Check your work! Watch steps 1-14 below:

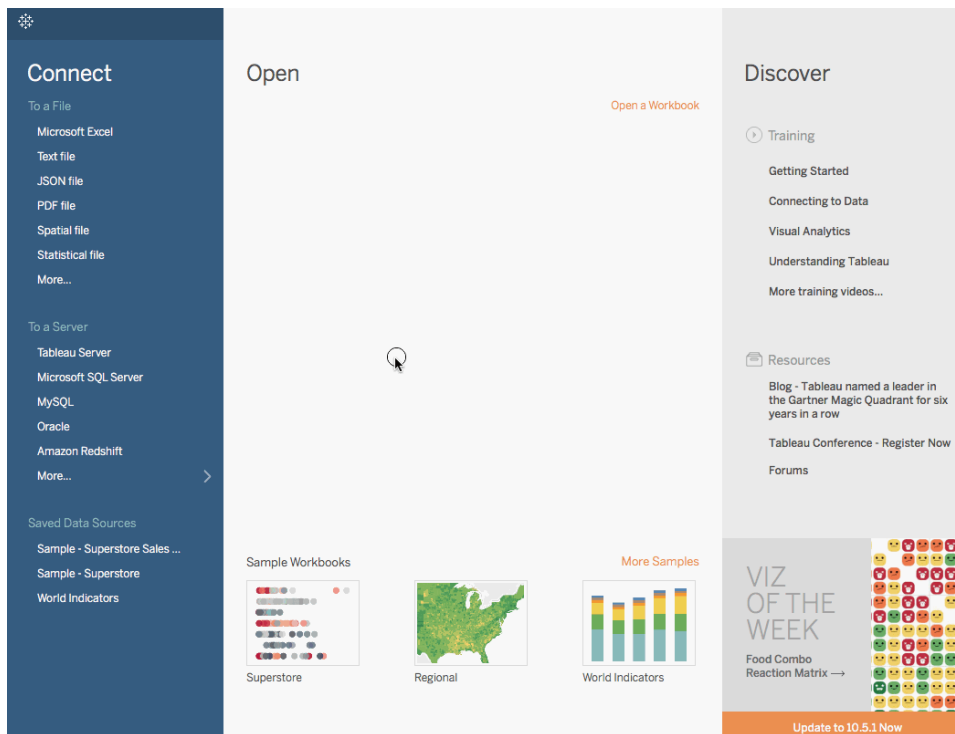

Note: In Tableau 2020.2 and later, the Data pane no longer shows Dimensions and Measures as labels. Fields are listed by table or folder.

Build a Highlight Table or Heat Map

Use highlight tables to compare categorical data using color.

In Tableau, you create a highlight table by placing one or more dimensions on the **Columns** shelf and one or more dimensions on the **Rows** shelf. You then select **Square** as the mark type and place a measure of interest on the **Color** shelf.

You can enhance this basic highlight table by setting the size and shape of the table cells to create a heat map.

To create a highlight table to explore how profit varies across regions, product sub-categories, and customer segments, follow these steps:

1. Connect to the **Sample - Superstore** data source.
2. Drag the **Segment** dimension to **Columns**.

Tableau creates headers with labels derived from the dimension member names.

3. Drag the **Region** and **Sub-Category** dimensions to **Rows**, dropping **Sub-Category** to the right of **Region**.

Now you have a nested table of categorical data (that is, the **Sub-Category** dimension is nested within the **Region** dimension).

4. Drag the **Profit** measure to **Color** on the **Marks** card.

Tableau aggregates the measure as a sum. The color legend reflects the continuous data range.

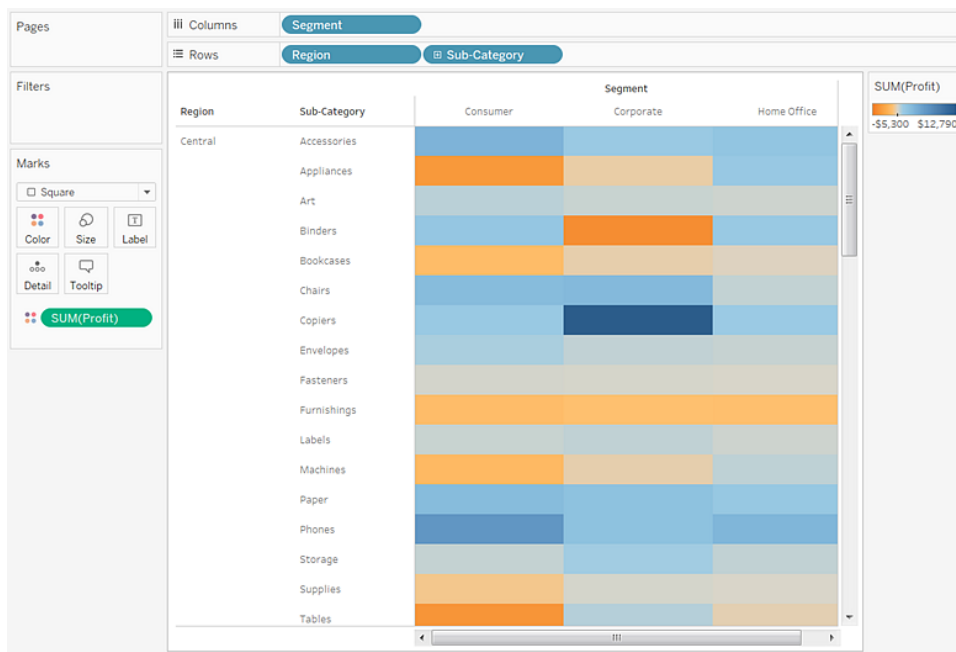

In this view, you can see data for only the Central region. Scroll down to see data for other regions.

In the Central region, copiers are shown to be the most profitable sub-category, and binders and appliances the least profitable.

5. Click **Color** on the **Marks** card to display configuration options. In the **Border** drop-down list, select a medium gray color for cell borders, as in the following image:

Tableau Desktop and Web Authoring Help

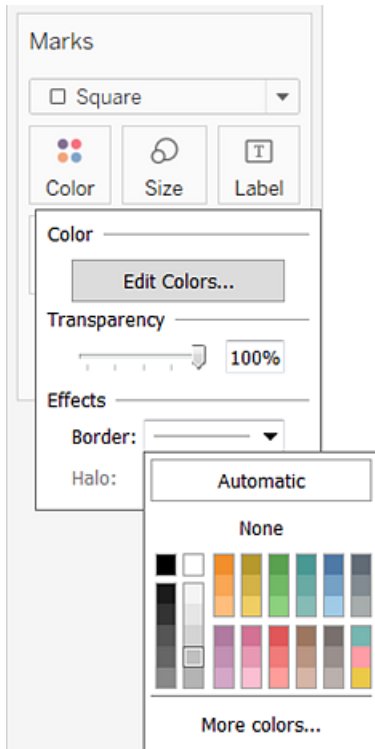

Now it's easier to see the individual cells in the view:

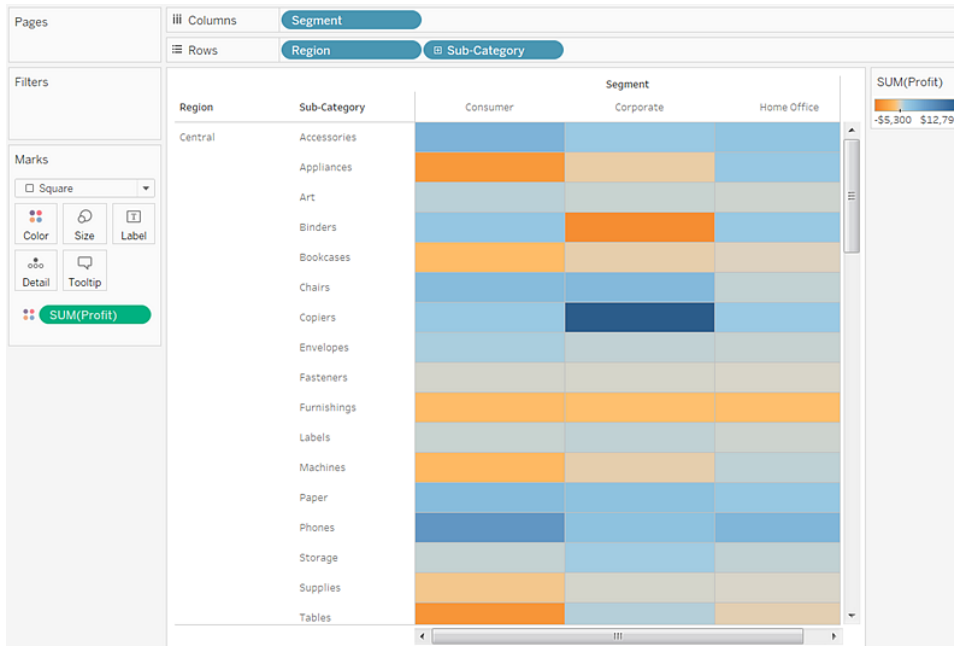

6. The default color palette is Orange-Blue Diverging. A Red-Green Diverging palette might be more appropriate for profit. To change the color palette and to make the colors more distinct, do the following:
 - Hover over the **SUM(Profit)** color legend, then click the drop-down arrow that appears and select **Edit Colors**.
 - In the **Edit Colors** dialog box, in the **Palette** field, select **Red-Green Diverging** from the drop-down list.
 - Select the **Use Full Color Range** check box and click **Apply** and then click **OK**.

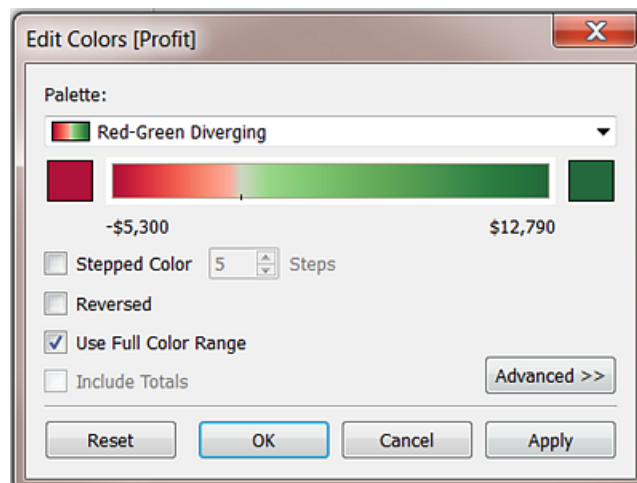

When you select this option, Tableau assigns the starting number a full intensity and the ending number a full intensity. If the range is from -10 to 100, the color representing negative numbers changes in shade much more quickly than the color representing positive numbers.

When you do not select **Use Full Color Range**, Tableau assigns the color intensity as if the range was from -100 to 100, so that the change in shade is the same on both sides of zero. The effect is to make the color contrasts in your view much more distinct.

For more information about color options, see [Color Palettes and Effects on](#)

page 1293.



Modify the size to create a heat map

7. Drag the **Sales** measure to **Size** on the **Marks** card to control the size of the boxes by the Sales measure. You can compare absolute sales numbers (by size of the boxes) and profit (by color).

Initially, the marks look like this:

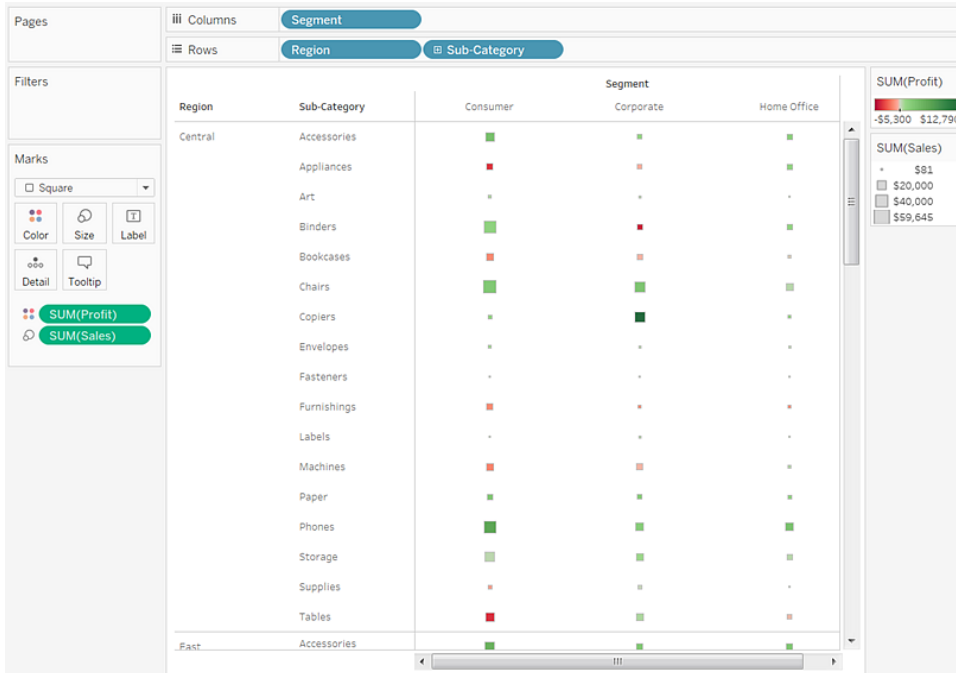

8. To enlarge the marks, click **Size** on the **Marks** card to display a size slider:

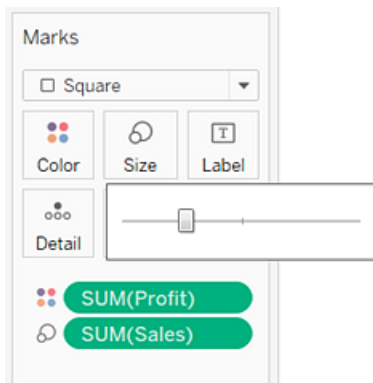

9. Drag the slider to the right until the boxes in the view are the optimal size. Now your view is complete:

Tableau Desktop and Web Authoring Help

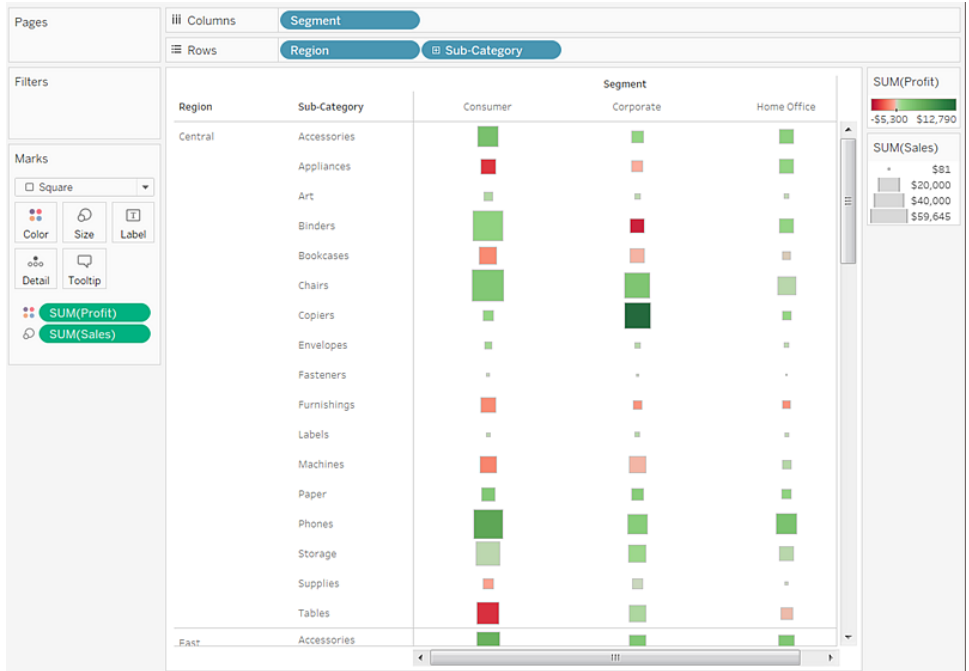

Check your work! Watch steps 1-9 below:

The screenshot shows the Tableau Desktop 'Open' pane. On the left is the 'Connect' pane with options like 'Microsoft Excel', 'Text file', 'JSON file', 'PDF file', 'Spatial file', 'Statistical file', and 'More...'. Below these are 'To a Server' options (Tableau Server, Microsoft SQL Server, MySQL, Oracle, Amazon Redshift) and 'Saved Data Sources' (Sample - Superstore Sales..., Sample - Superstore, World Indicators). The main 'Open' area shows 'Open a Workbook' and 'Sample Workbooks' (Superstore, Regional, World Indicators) with a 'More Samples' link. On the right is the 'Discover' pane with 'Training' (Getting Started, Connecting to Data, Visual Analytics, Understanding Tableau, More training videos...), 'Resources' (Blog - Tableau named a leader in the Gartner Magic Quadrant for six years in a row, Tableau Conference - Register Now, Forums), and a 'VIZ OF THE WEEK' section for 'Food Combo Reaction Matrix' with an 'Update to 10.5.1 Now' button at the bottom.

Note: In Tableau 2020.2 and later, the Data pane no longer shows Dimensions and Measures as labels. Fields are listed by table or folder.

Build a Histogram

A histogram is a chart that displays the shape of a distribution. A histogram looks like a bar chart but groups values for a continuous measure into ranges, or bins.

The basic building blocks for a histogram are as follows:

Mark type:	Automatic
Rows shelf:	Continuous measure (aggregated by Count or Count Distinct)
Columns shelf:	Bin (continuous or discrete). <i>Note: This bin should be created from the continuous measure on the Rows shelf. For more information on how to create a bin from a continuous measure, see Create Bins from a Continuous Measure on page 1597.</i>

In Tableau you can create a histogram using **Show Me**.

1. Connect to the **Sample - Superstore** data source.
2. Drag **Quantity** to **Columns**.
3. Click **Show Me** on the toolbar, then select the histogram chart type.



The histogram chart type is available in **Show Me** when the view contains a single measure and no dimensions.

Three things happen after you click the histogram icon in **Show Me**:

- The view changes to show vertical bars, with a continuous x-axis (1 – 14) and a continuous y-axis (0 – 5,000).
- The **Quantity** measure you placed on the **Columns** shelf, which had been aggregated as SUM, is replaced by a continuous **Quantity (bin)** dimension. (The green color of the field on the **Columns** shelf indicates that the field is continuous.)
To edit this bin: In the Data pane, right-click the bin and select **Edit in Shelf**.
- The **Quantity** measure moves to the **Rows** shelf and the aggregation changes from SUM to CNT (Count).

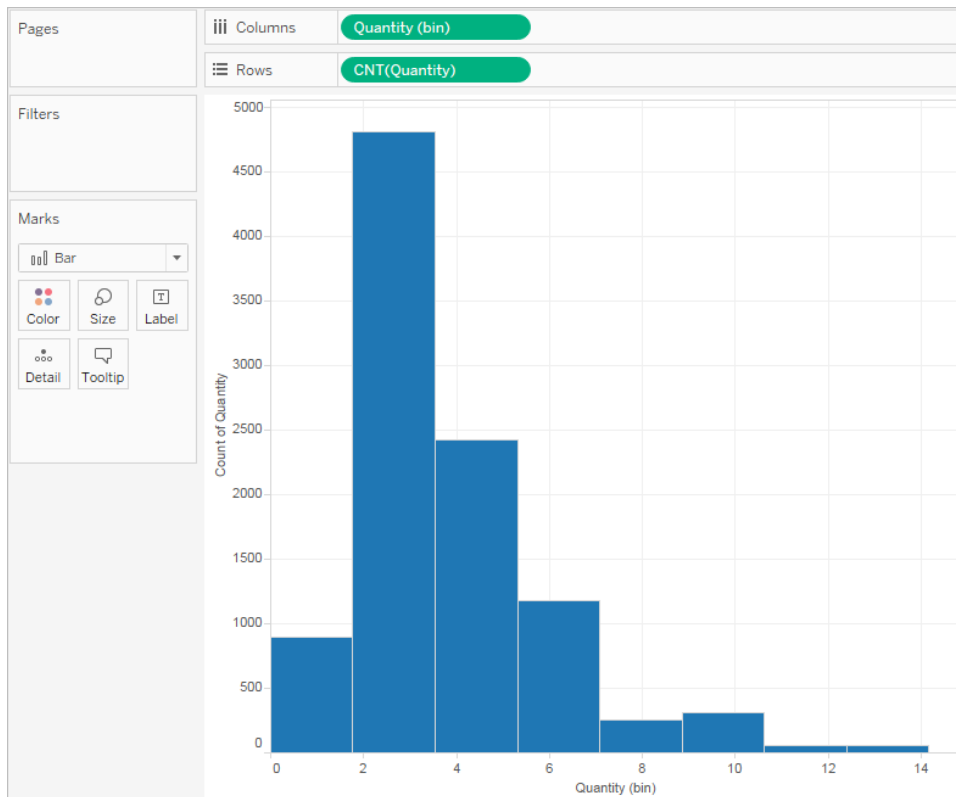

The **Quantity** measure captures the number of items in a particular order. The histogram shows that about 4,800 orders contained two items (the second bar), about 2,400 orders contained 4 items (the third bar), and so on.

Let's take this view one step further and add **Segment** to **Color** to see if we can detect a relationship between the customer segment (consumer, corporate, or home office) and the quantity of items per order.

4. Drag **Segment** to **Color**.

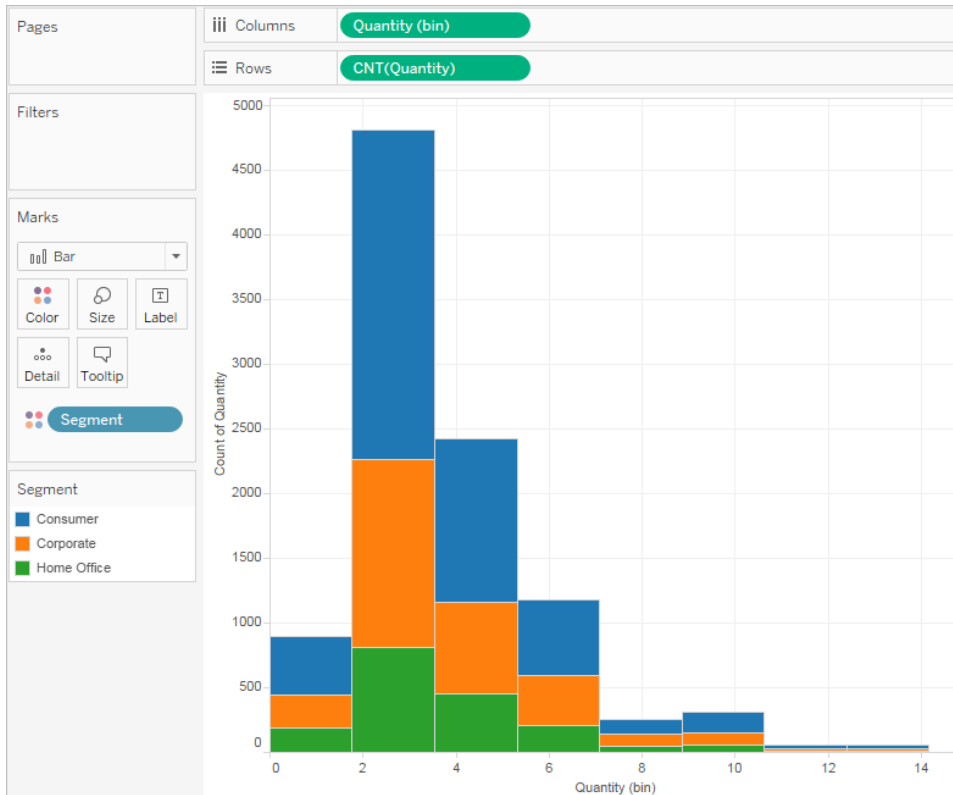

The colors don't show a clear trend. Let's show the percentage of each bar that belongs to each segment.

5. Hold down the Ctrl key and drag the **CNT(Quantity)** field from the **Rows** shelf to **Label**.

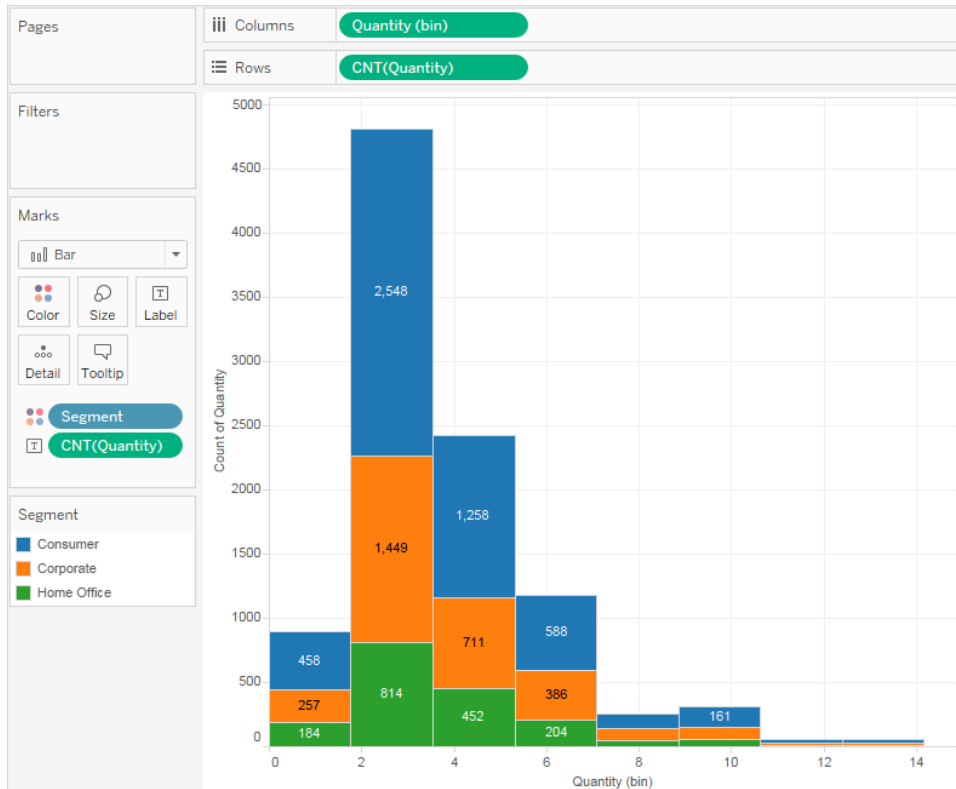

Holding down the Ctrl key copies the field to the new location without removing it from the original location.

- Right-click (Control-click on a Mac) the **CNT(Quantity)** field on the **Marks** card and select **Quick Table Calculation > Percent of Total**.

Now each colored section of each bar shows its respective percentage of the total quantity:

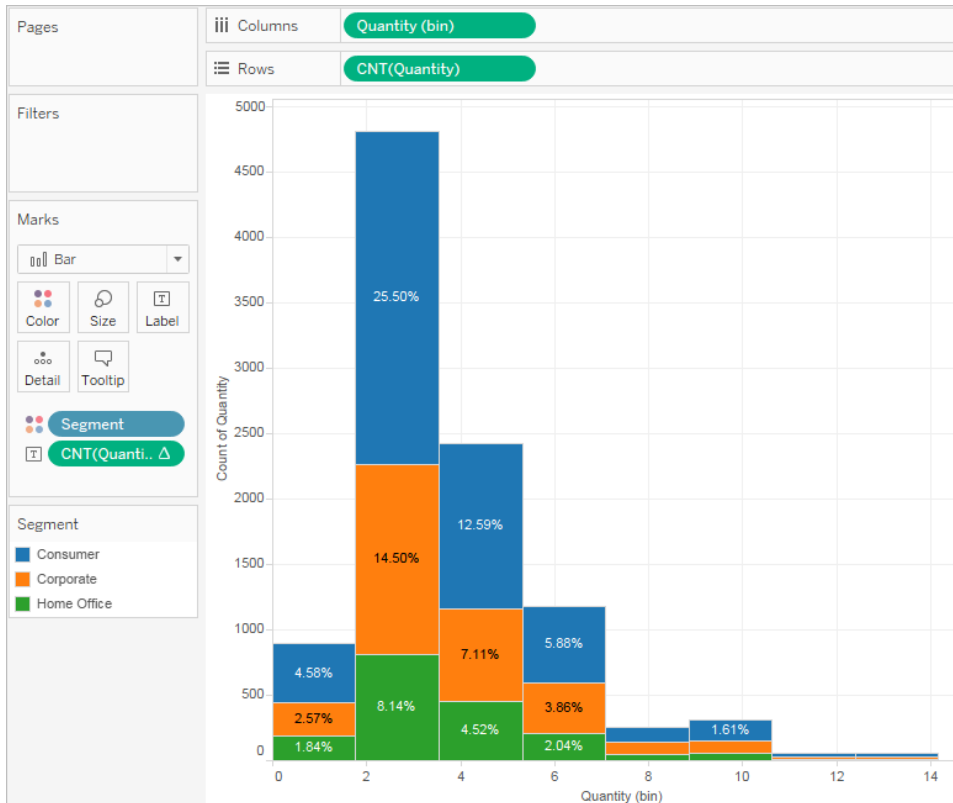

But we want the percentages to be on a per-bar basis.

7. Right-click the **CNT(Quantity)** field on the **Marks** card again and select **Edit Table Calculation**.
8. In the Table Calculation dialog box, change the value of the **Compute Using** field to **Cell**.

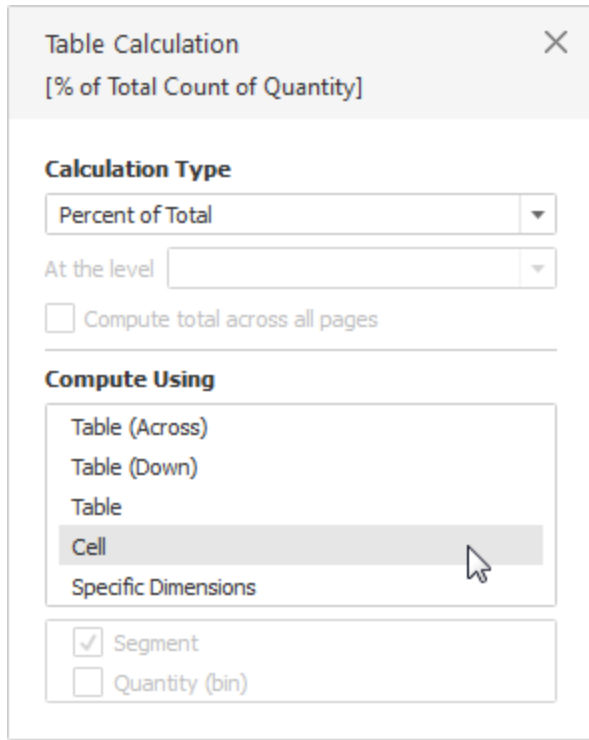

Now we have the view that we want:

Tableau Desktop and Web Authoring Help

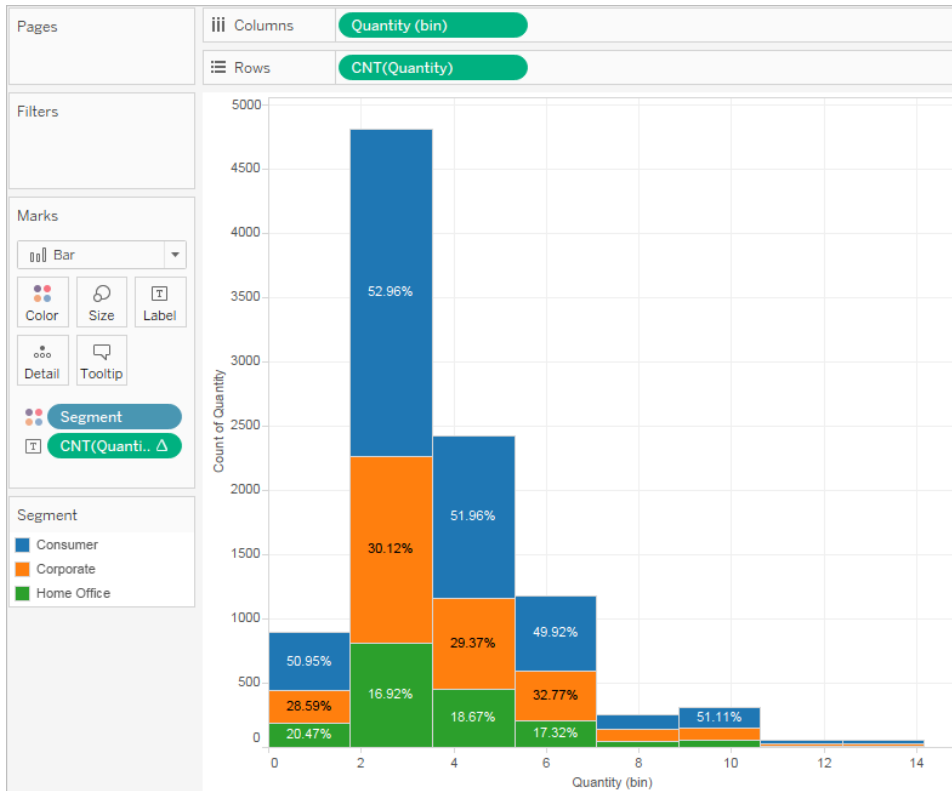

There's still no evidence that the percentages by customer segment show any trend as the number of items in an order increases.

Check your work! Watch steps 1-8 in action:

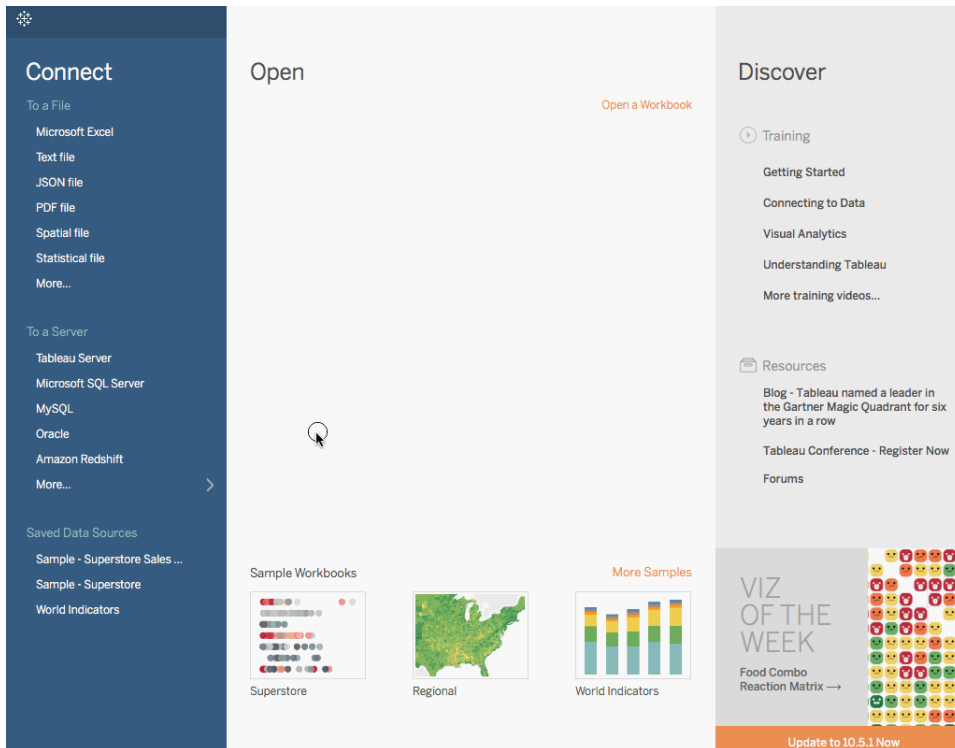

Note: In Tableau 2020.2 and later, the Data pane no longer shows Dimensions and Measures as labels. Fields are listed by table or folder.

Building Line Charts

Line charts connect individual data points in a view. They provide a simple way to visualize a sequence of values and are useful when you want to see trends over time, or to forecast future values. For more information about the line mark type, see [Line mark on page 1244](#).

Note: In views that use the line mark type, you can use the **Path** property in the Marks card to change the type of line mark (linear, step, or jump), or to encode data by connecting marks using a particular drawing order. For details, see [Path properties in the Control the Appearance of Marks in the View on page 1261](#)

To create a view that displays the sum of sales and the sum of profit for all years, and then uses forecasting to determine a trend, follow these steps:

1. Connect to the **Sample - Superstore** data source.
2. Drag the **Order Date** dimension to **Columns**.

Tableau aggregates the date by year, and creates column headers.

3. Drag the **Sales** measure to **Rows**.

Tableau aggregates **Sales** as SUM and displays a simple line chart.

4. Drag the **Profit** measure to **Rows** and drop it to the right of the **Sales** measure.

Tableau creates separate axes along the left margin for **Sales** and **Profit**.

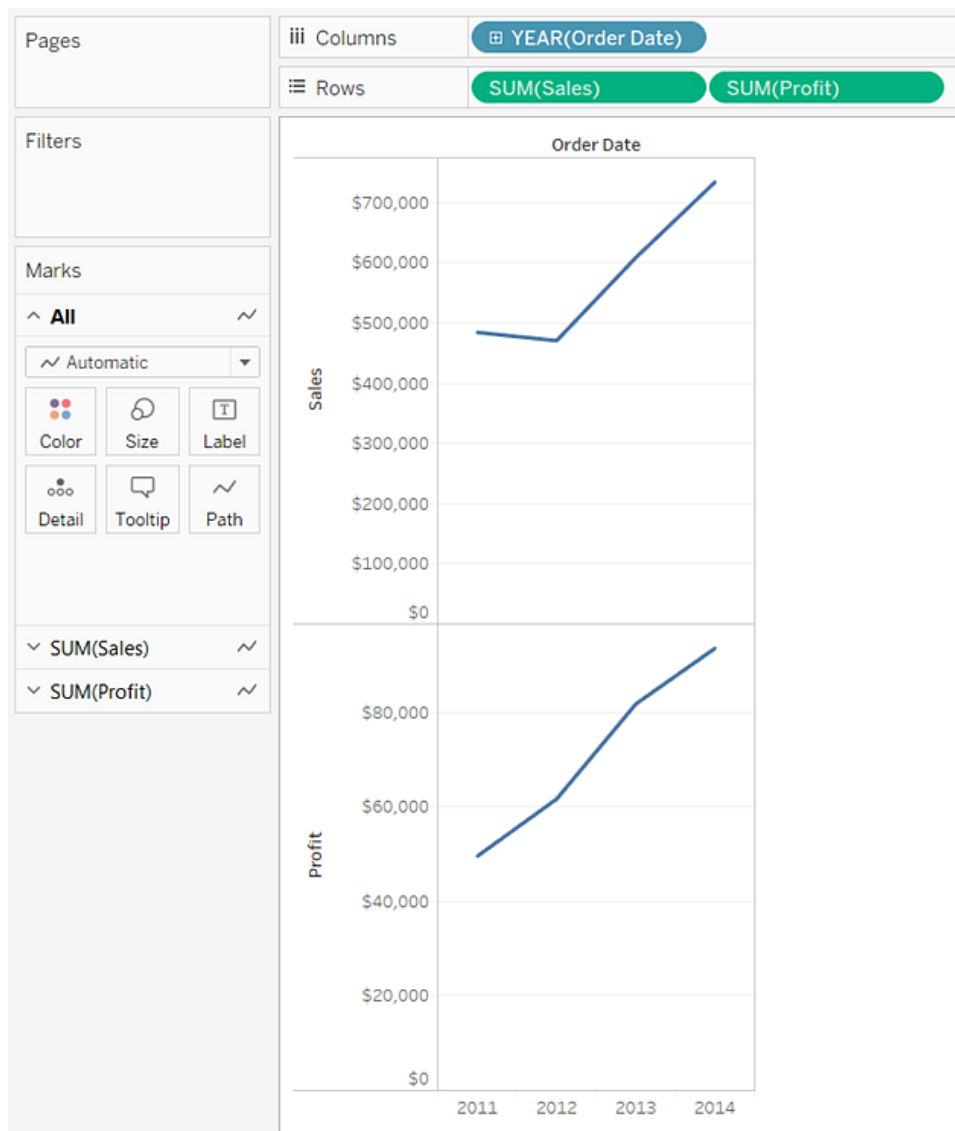

Notice that the scale of the two axes is different—the **Sales** axis scales from \$0 to \$700,000, whereas the **Profit** axis scales from \$0 to \$100,000. This can make it hard to see that sales values are much greater than profit values.

When you are displaying multiple measures in a line chart, you can align or merge axes to make it easier for users to compare values.

For more information about aligning the axes, see [Compare two measures using dual axes](#) on page 1204.

For more information about enforcing a single axis across multiple measures, see [Blend axes for multiple measures into a single axis](#) on page 1202.

With either of these options, you can create a combination chart to change the mark type for one of your measures.

For more information, see [Create a combo chart \(assign different mark types to measures\)](#) on page 1208.

5. Drag the **SUM(Profit)** field from **Rows** to the **Sales** axis to create a blended axis. The two pale green parallel bars indicate that **Profit** and **Sales** will use a blended axis when you release the mouse button.

Tableau Desktop and Web Authoring Help

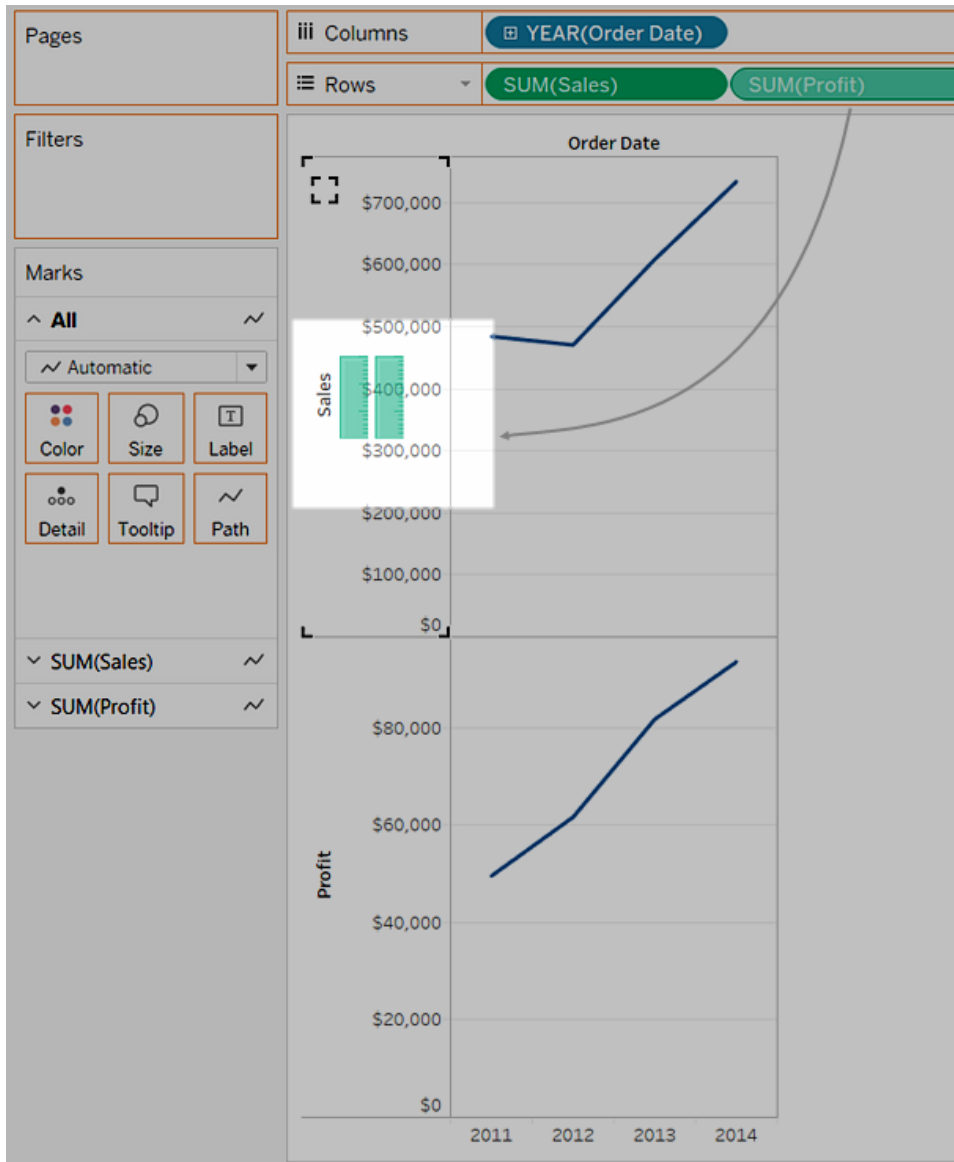

The view updates to look like this:

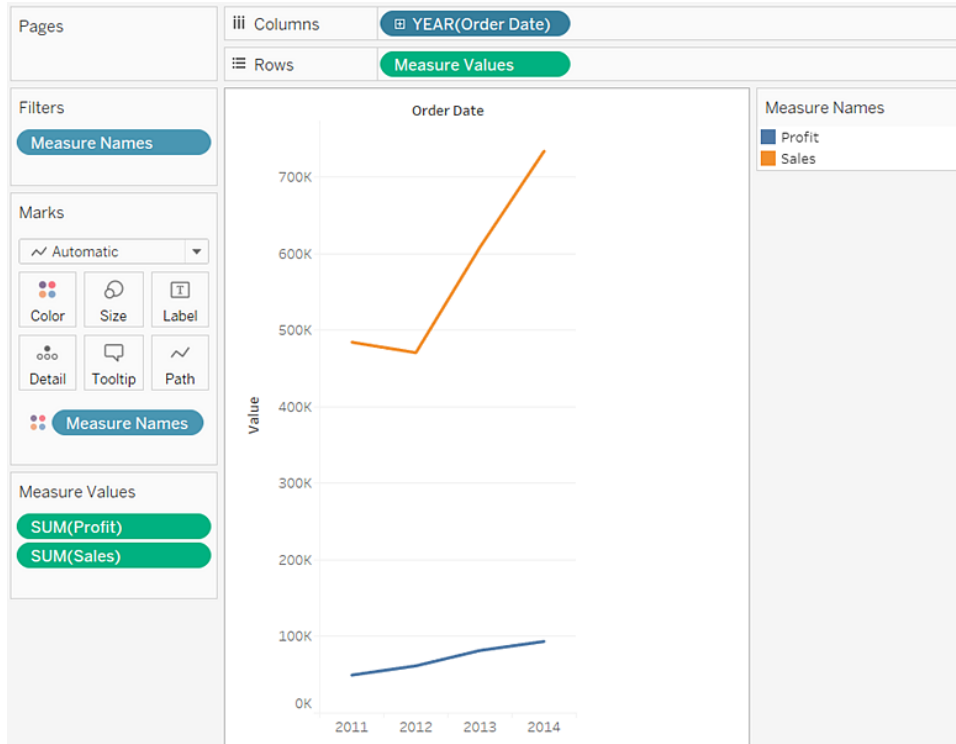

The view is rather sparse because we are looking at a summation of values on a per-year basis.

6. Click the drop-down arrow in the **Year(Order Date)** field on the **Columns** shelf and select **Month** in the lower part of the context menu to see a continuous range of values over the four-year period.

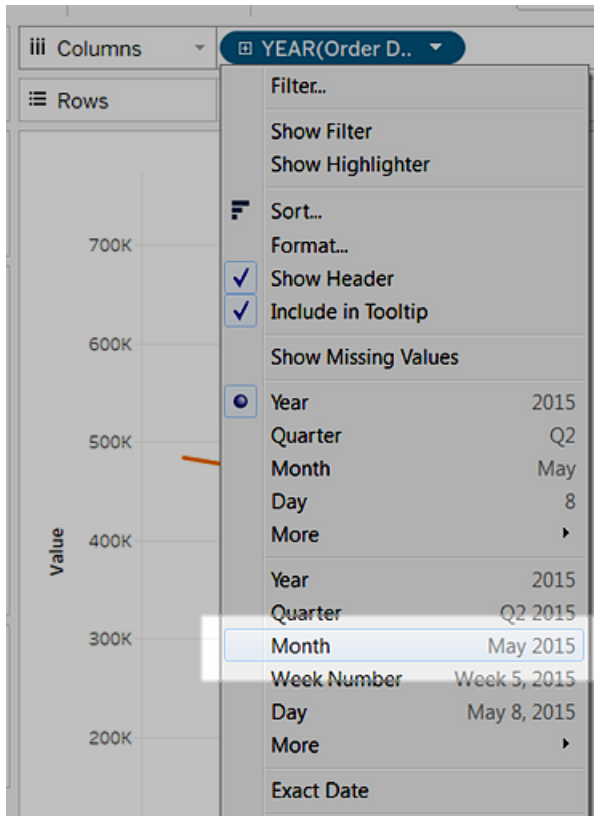

The resulting view is a lot more detailed than the original view:

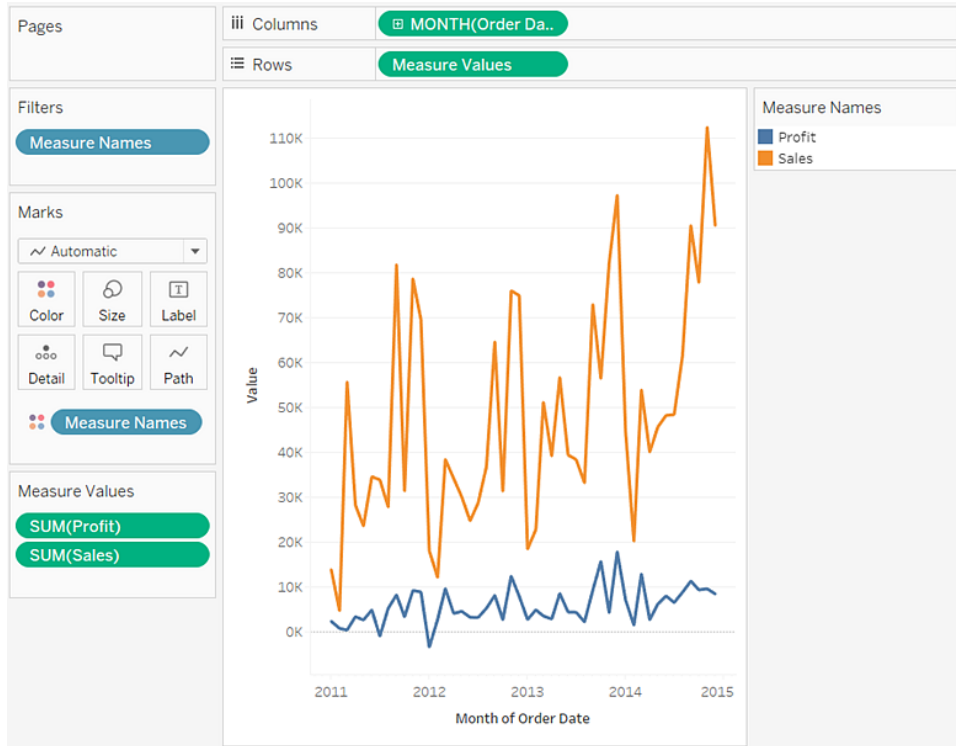

Notice that the values seem to go much higher just before the end of each year. A pattern like that is known as *seasonality*. If we turn on the forecasting feature in the view, we can see whether we should expect that the apparent seasonal trend will continue in the future.

- To add a forecast, in the **Analytics** pane, drag the **Forecast** model to the view, and then drop it on **Forecast**.

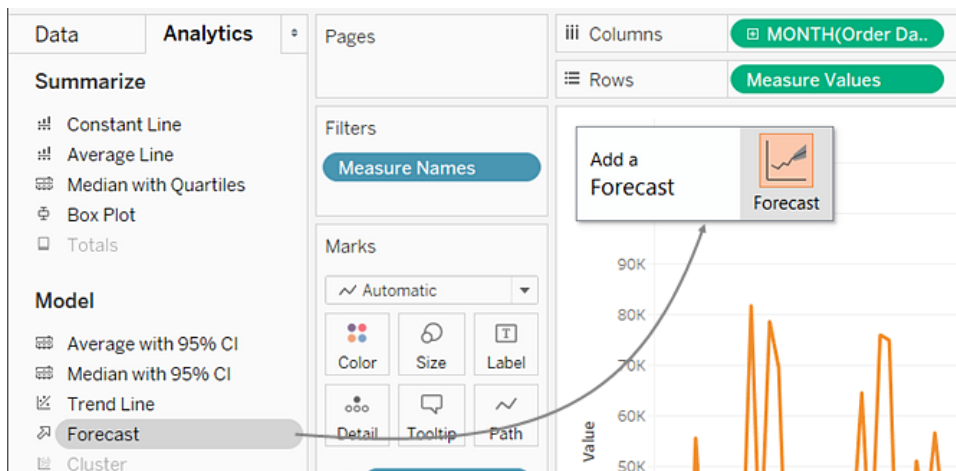

We then see that, according to Tableau forecasting, the seasonal trend does continue into the future:

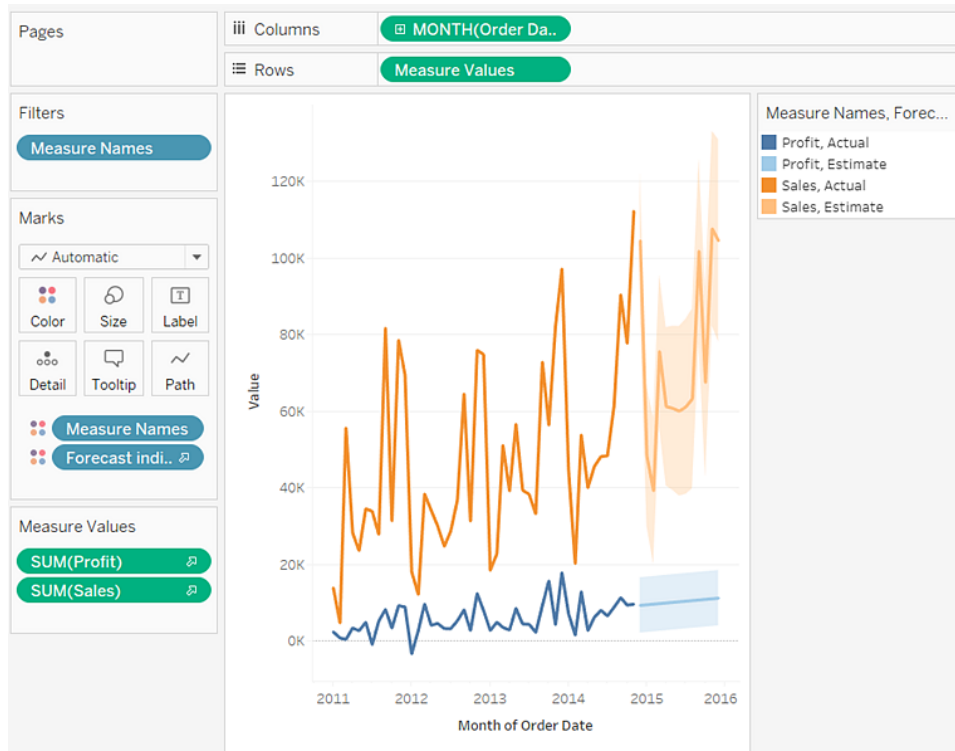

Check your work! Watch steps 1-7 below:

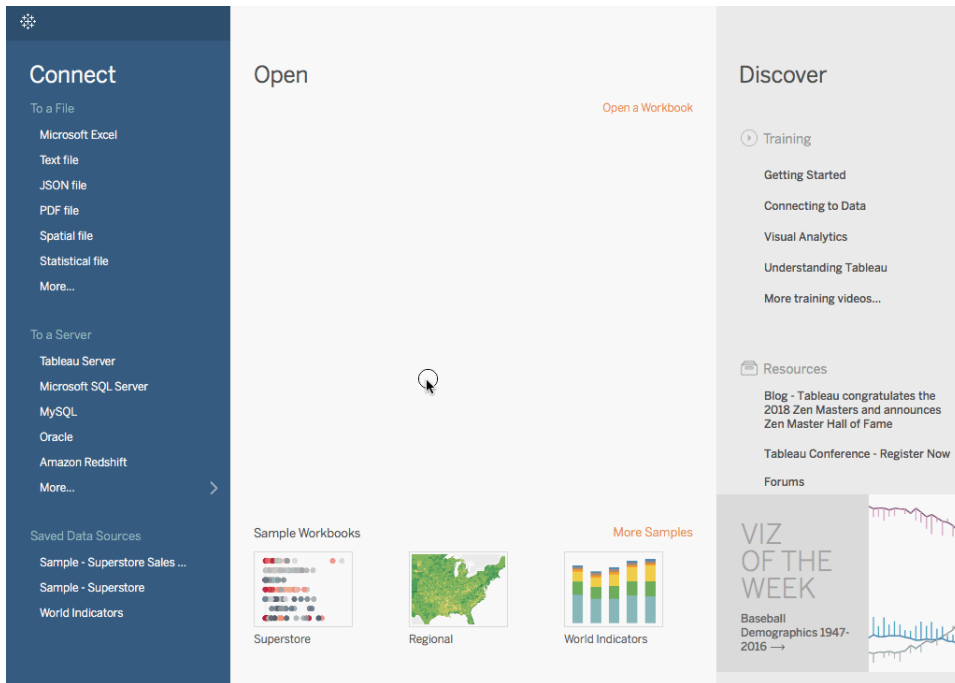

Note: In Tableau 2020.2 and later, the Data pane no longer shows Dimensions and Measures as labels. Fields are listed by table or folder.

Build a Packed Bubble Chart

Use packed bubble charts to display data in a cluster of circles. Dimensions define the individual bubbles, and measures define the size and color of the individual circles.

The basic building blocks for a packed bubble chart are as follows:

Mark type:	Circle
Detail:	Dimension
Size:	Measure
Color:	Dimension or Measure
Label (optional):	Dimension or Measure

To create a basic packed bubble chart that shows sales and profit information for different product categories, follow these steps:

1. Connect to the **Sample - Superstore** data source.

2. Drag the **Category** dimension to **Columns**.

A horizontal axis displays product categories.

3. Drag the **Sales** measure to **Rows**.

The measure is aggregated as a sum and a vertical axis appears.

Tableau displays a bar chart—the default chart type when there is a dimension on the **Columns** shelf and a measure on the **Rows** shelf.

4. Click **Show Me** on the toolbar, then select the packed bubbles chart type.



Tableau displays the following packed bubble chart:

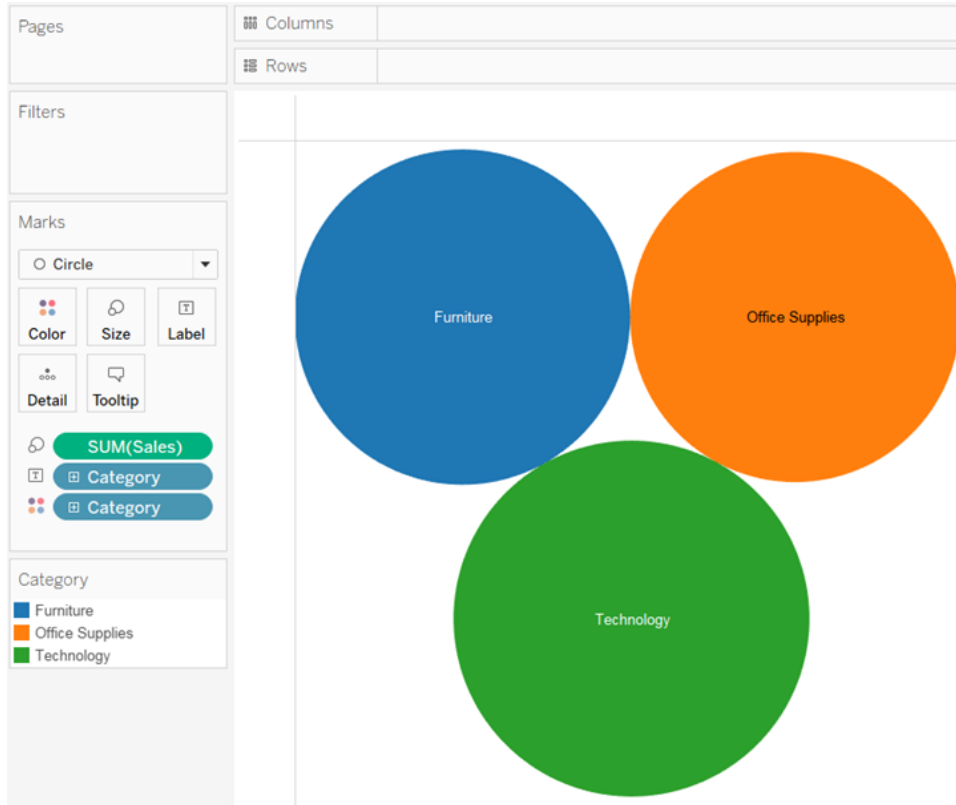

5. Drag **Region** to **Detail** on the **Marks** card to include more bubbles in the view.

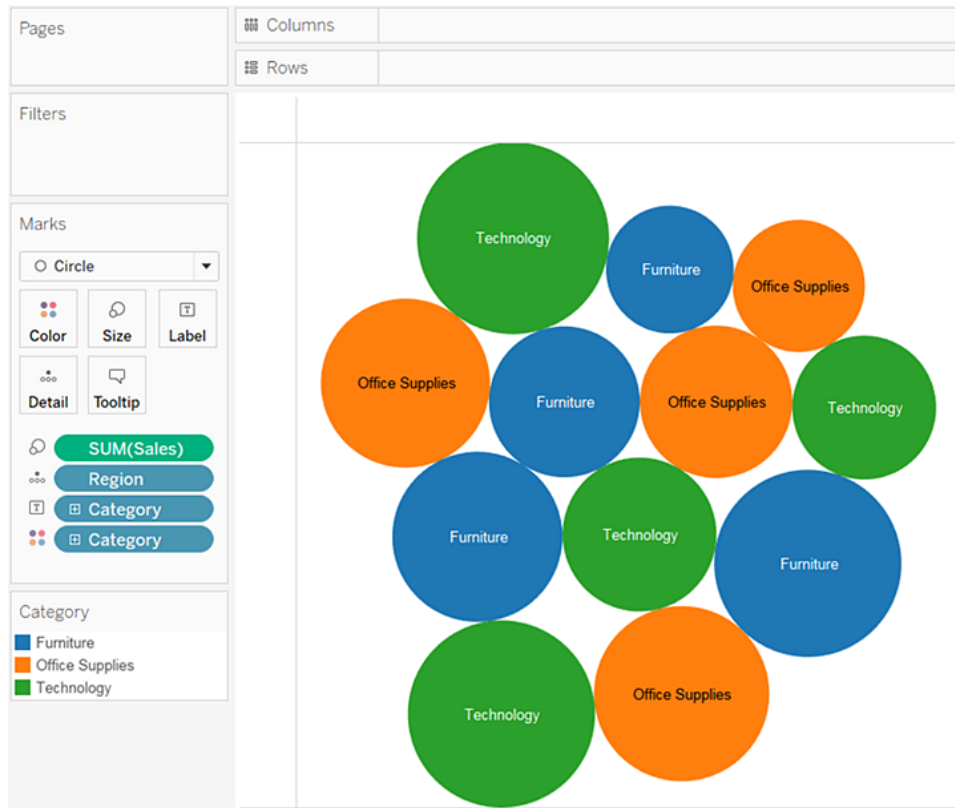

Next we'll add another layer of information to the view.

6. Drag **Profit** to **Color** on the **Marks** card:

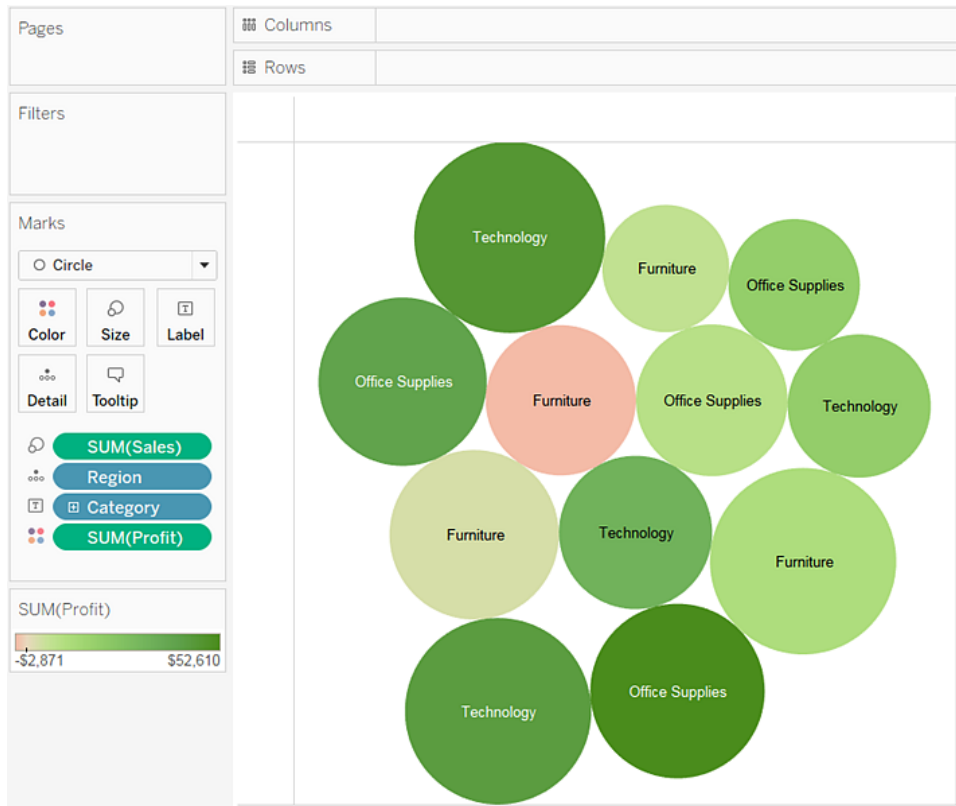

7. Drag **Region** to **Label** on the **Marks** card to clarify what each bubble represents.

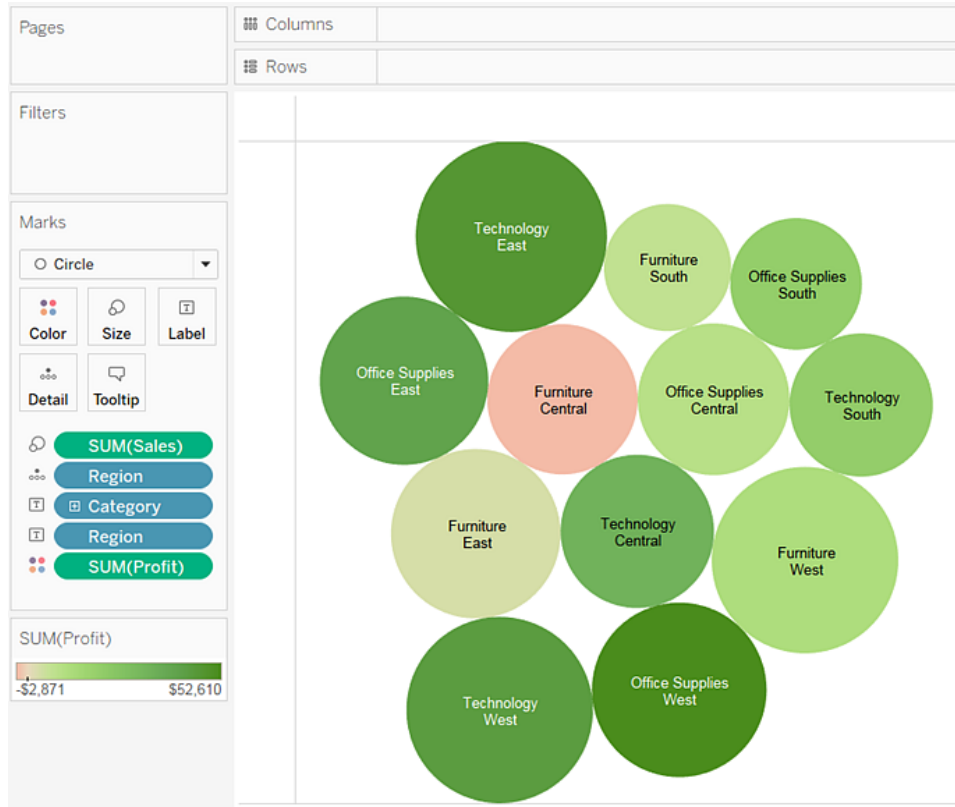

The size of the bubbles shows the sales for different combinations of region and category. The color of the bubbles shows the profit (the darker the green, the greater the profit).

For information about formatting mark labels, see [Show, Hide, and Format Mark Labels](#) on page 1284.

To further develop this view, you might edit the colors for **Profit** to show negative profit in a different color, or create a calculated field to show profit divided by sales (that is, profit margin) and then drop that on **Color** instead of absolute profit. For more information, see [Color Palettes and Effects](#) on page 1293.

Check your work! Watch steps 1-7 below:

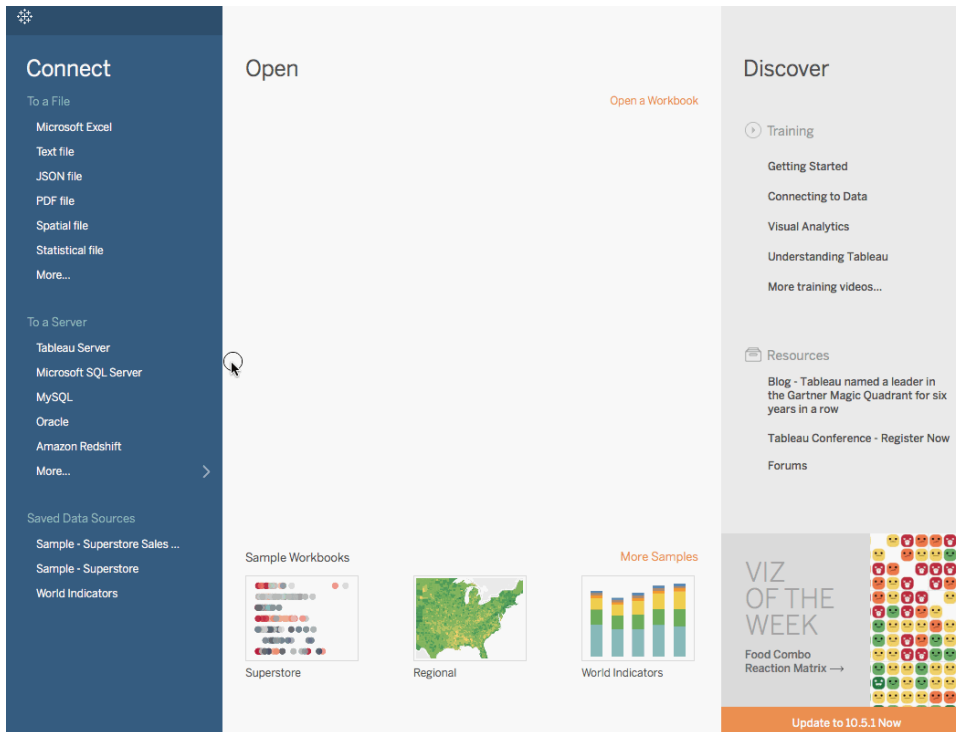

Note: In Tableau 2020.2 and later, the Data pane no longer shows Dimensions and Measures as labels. Fields are listed by table or folder.

Build a Pie Chart

Use pie charts to show proportions of a whole.

The basic building blocks for a pie chart are as follows:

Mark type:	Pie
Color:	Dimension
Angle:	Measure

To create a pie chart view that shows how different product categories contribute to total sales, follow these steps:

1. Connect to the **Sample - Superstore** data source.

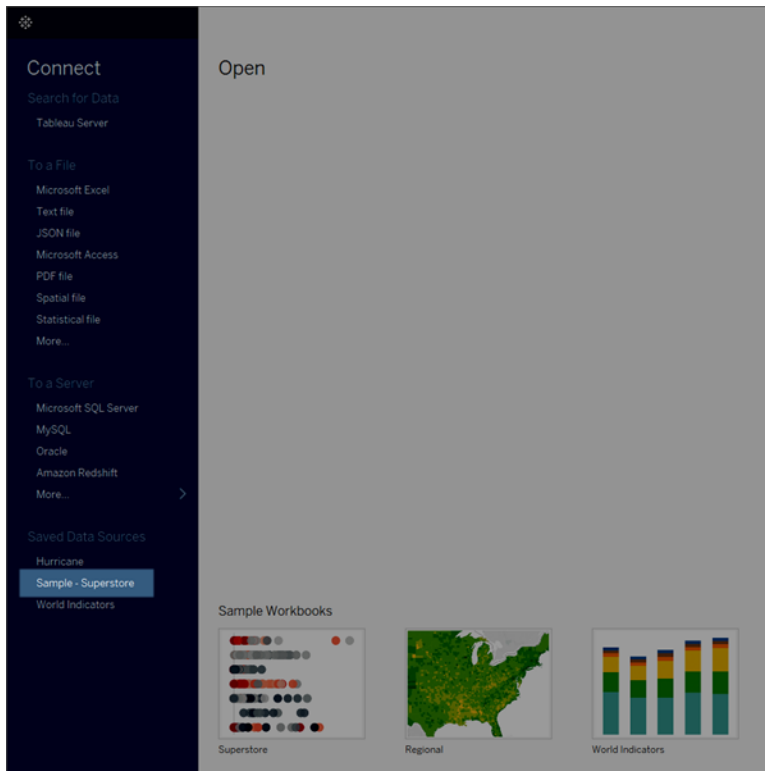

2. Drag the **Sales** measure to **Columns** and drag the **Sub-Category** dimension to **Rows**.

Tableau aggregates the **Sales** measure as a sum. By default, Tableau displays a bar chart.

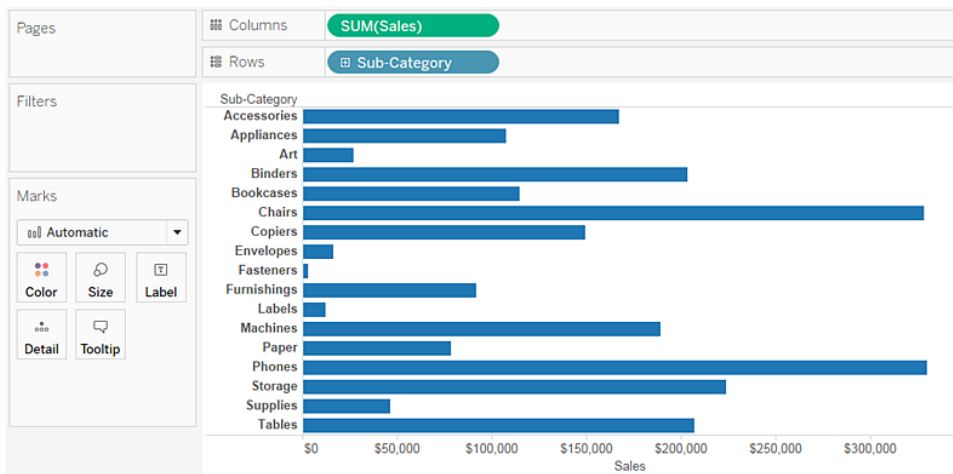

3. Click **Show Me** on the toolbar, then select the pie chart type. Pie charts require at least one or more dimensions and one or two measures. Aggregate fields, such as Profit Ratio, don't contribute to those requirements.



The result is a rather small pie. To make the chart bigger, navigate to the Fit menu in the toolbar and select **Entire View**.

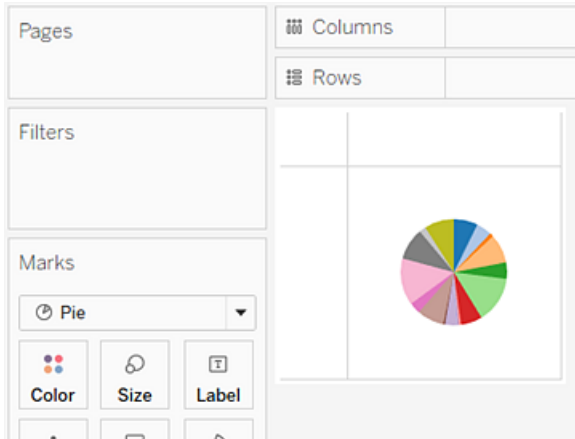

4. Add labels by dragging the **Sub-Category** dimension from the **Data** pane to **Label** on the **Marks** card.

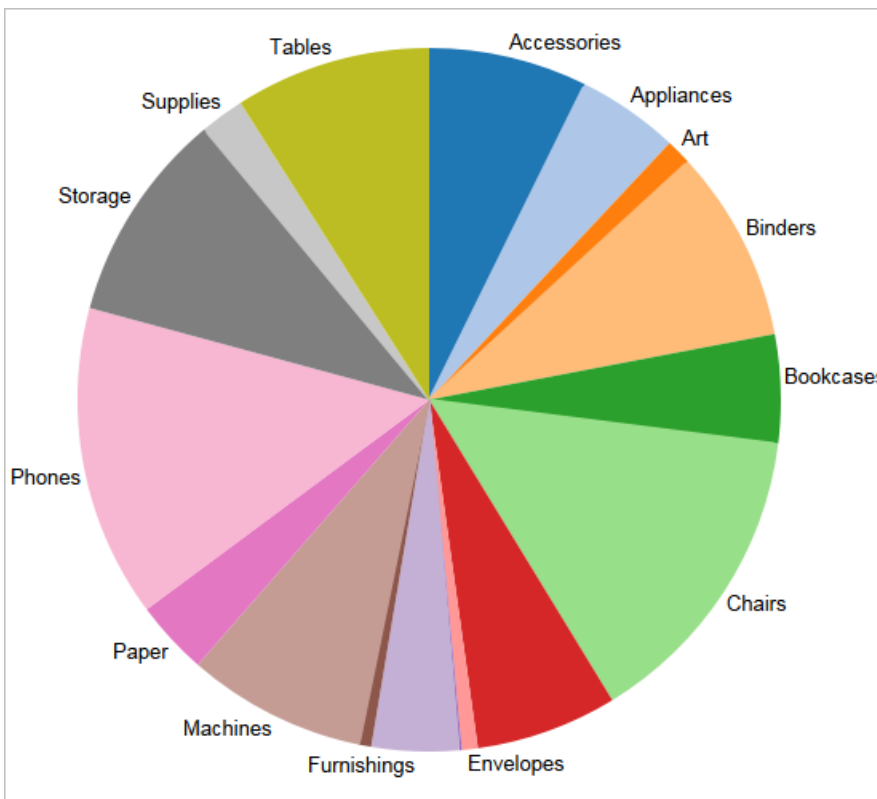

If you don't see labels, press **Ctrl + Shift + B** (press **⌘ + ⌘ + B** on a Mac) to make sure most of the individual labels are visible.

You can make a pie chart interactive in a dashboard. For more information, see [Actions and Dashboards](#) on page 1462.

Note: Pie charts can also be used as a mark type in a visualization. For more information, see [Pie mark on page 1256](#).

Check your work! Watch steps 1-4:

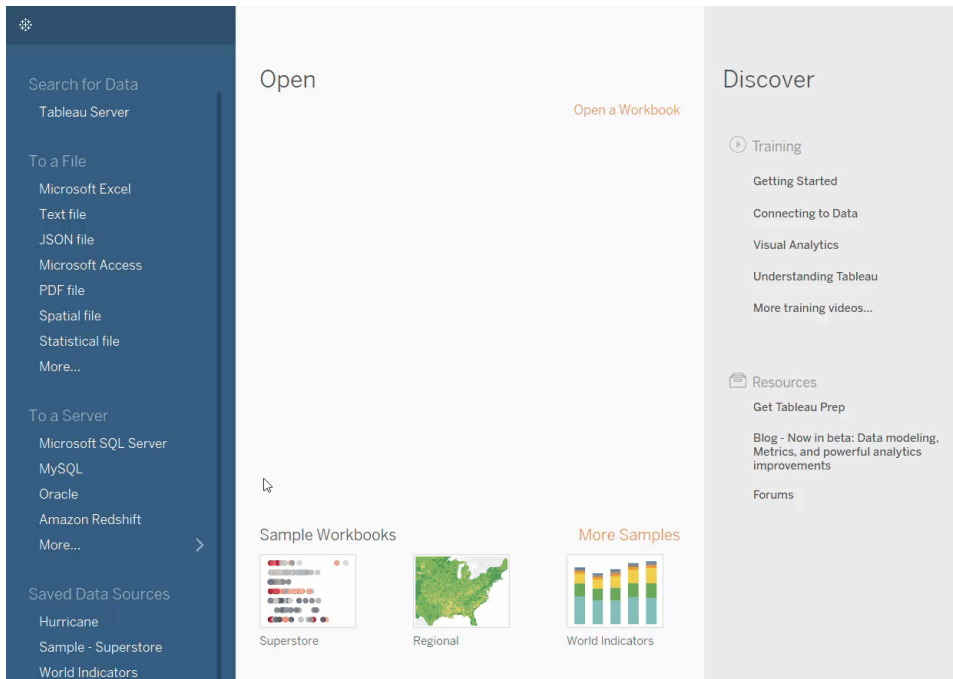

Build a Scatter Plot

Use scatter plots to visualize relationships between numerical variables.

In Tableau, you create a scatter plot by placing at least one measure on the **Columns** shelf and at least one measure on the **Rows** shelf. If these shelves contain both dimensions and measures, Tableau places the measures as the innermost fields, which means that measures are always to the right of any dimensions that you have also placed on these shelves. The word "innermost" in this case refers to the table structure.

Creates Simple Scatter Plot

Columns	SUM(Sales)
Rows	SUM(Profit)

Creates Matrix of Scatter Plots

Columns	Region	SUM(Sales)
Rows	Category	SUM(Profit)

A scatter plot can use several mark types. By default, Tableau uses the shape mark type. Depending on your data, you might want to use another mark type, such as a circle or a square. For more information, see [Change the Type of Mark in the View on page 1238](#).

To use scatter plots and trend lines to compare sales to profit, follow these steps:

1. Open the **Sample - Superstore** data source.
2. Drag the **Profit** measure to **Columns**.

Tableau aggregates the measure as a sum and creates a horizontal axis.

3. Drag the **Sales** measure to **Rows**.

Tableau aggregates the measure as a sum and creates a vertical axis.

Measures can consist of continuous numerical data. When you plot one number against another, you are comparing two numbers; the resulting chart is analogous to a Cartesian chart, with x and y coordinates.

Now you have a one-mark scatter plot:

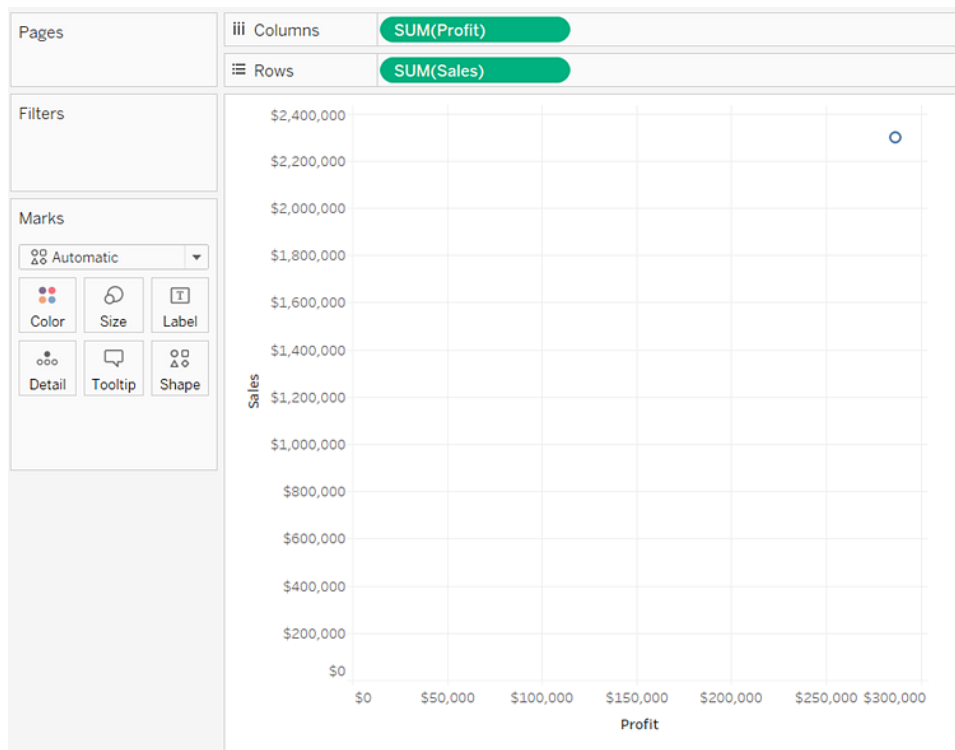

4. Drag the **Category** dimension to **Color** on the Marks card.

This separates the data into three marks—one for each dimension member—and encodes the marks using color.

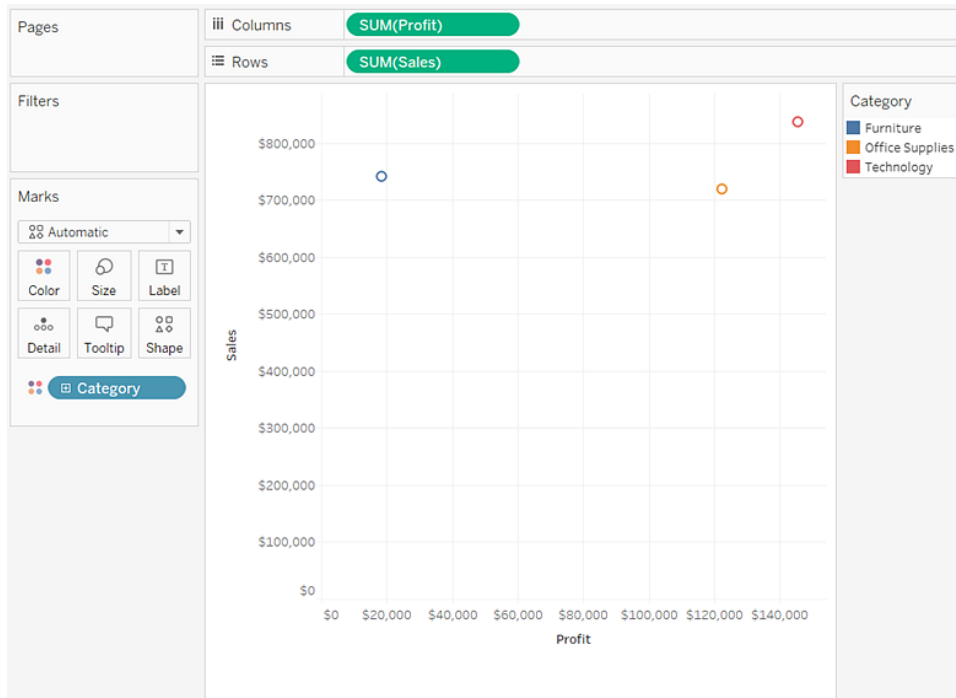

5. Drag the **Region** dimension to **Detail** on the **Marks** card.

Now there are many more marks in the view. The number of marks is equal to the number of distinct regions in the data source multiplied by the number of departments. (If you're curious, use the **Undo** button on the toolbar to see what would have happened if you'd dropped the **Region** dimension on **Shape** instead of **Detail**.)

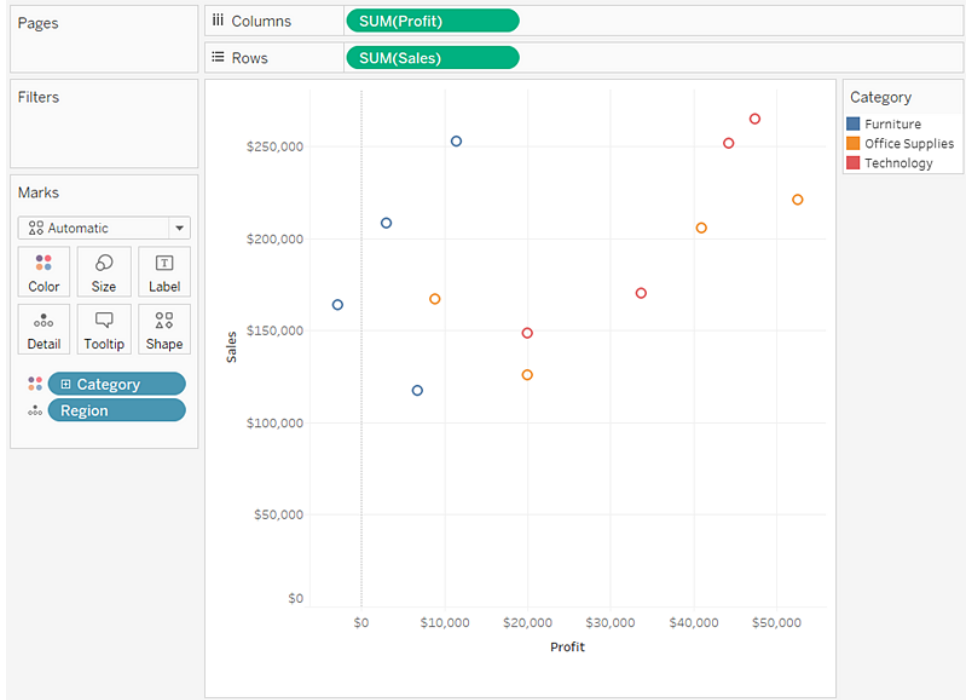

- To add trend lines, from the **Analytics** pane, drag the **Trend Line** model to the view, and then drop it on the model type.

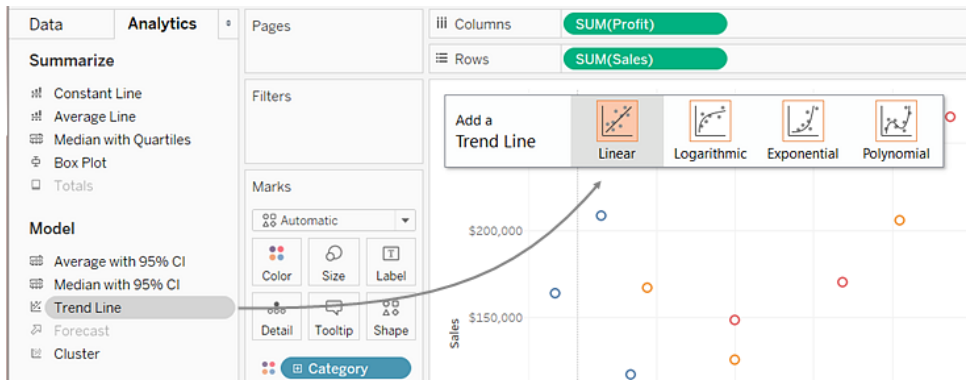

A trend line can provide a statistical definition of the relationship between two numerical values. To add trend lines to a view, both axes must contain a field that can be interpreted as a number—by definition, that is always the case with a scatter plot.

Tableau adds three linear trend lines—one for each color that you are using to distinguish the three categories.

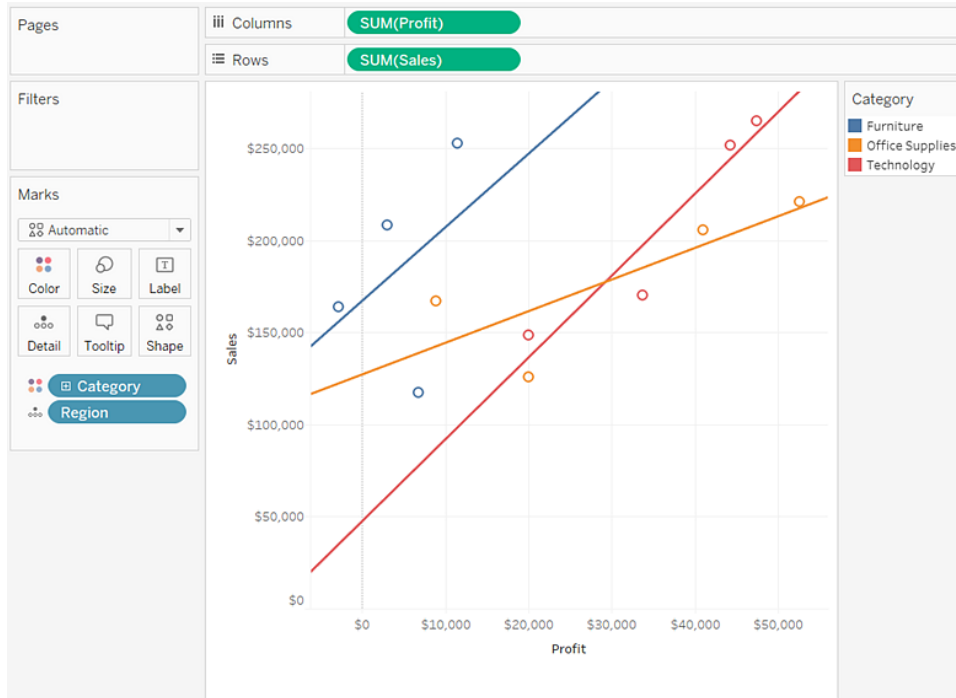

7. Hover the cursor over the trend lines to see statistical information about the model that was used to create the line:

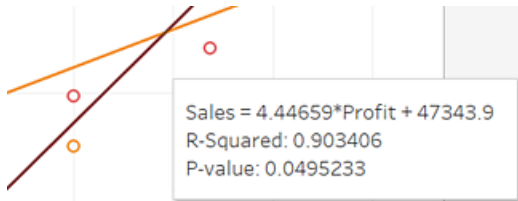

For more information, see [Assess Trend Line Significance](#) on page 2515. You can also customize the trend line to use a different model type or to include confidence bands. For more information, see [Add Trend Lines to a Visualization](#) on page 2503.

Check your work! See steps 1-7 below:

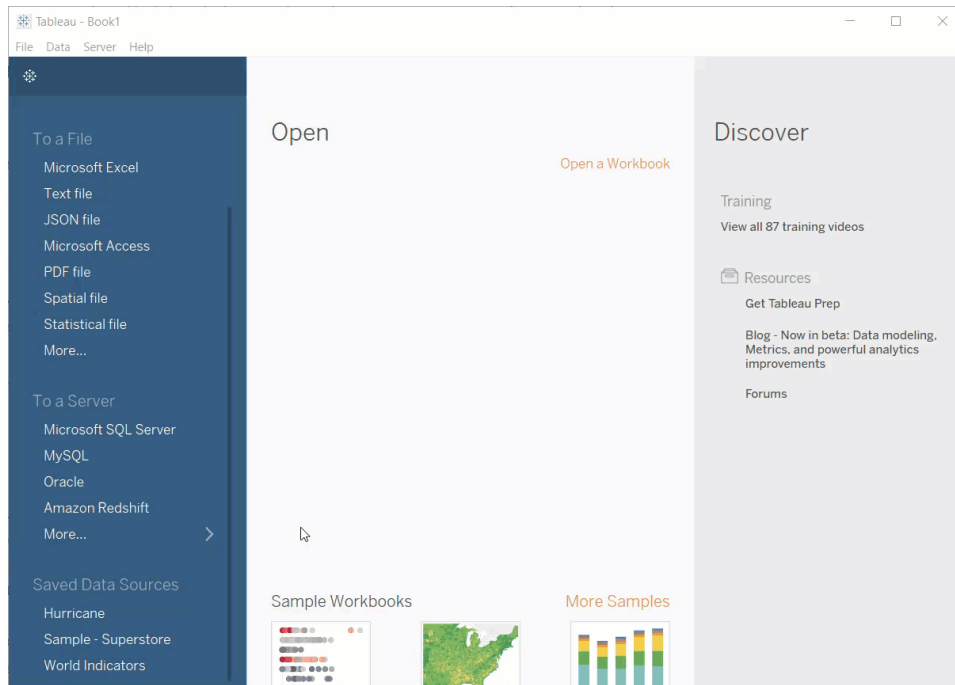

See Also

[Example: Scatter Plots, Aggregation, and Granularity on page 181](#)

Build a Text Table

In Tableau, you typically create text tables (also called cross-tabs or pivot tables) by placing one dimension on the **Rows** shelf and another dimension on the **Columns** shelf. You then complete the view by dragging one or more measures to **Text** on the **Marks** card.

A text table uses the text mark type. Tableau uses this mark type automatically if the view is constructed using only dimensions (assuming the mark type is set to **Automatic**). For more information about the text mark type, see [Text mark on page 1251](#).

To create a text table that shows sales totals by year and category, follow these steps:

1. Connect to the **Sample - Superstore** data source.
2. Drag the **Order Date** dimension to **Columns**.
Tableau aggregates the date by year and creates column headers.
3. Drag the **Sub-Category** dimension to **Rows**.

Tableau creates row headers. Columns with headers plus rows with headers means that a valid table structure now exists. For more information about changing the layout for row and column headers, see [Define Table Structure on page 3018](#).

Now you can add a measure to the view to see actual data.

4. Drag the **Sales** measure to **Text** on the **Marks** card.

Tableau aggregates the measure as a sum.

Sub-Categ..	Order Date			
	2011	2012	2013	2014
Accessories	\$25,014	\$40,524	\$41,896	\$59,946
Appliances	\$15,314	\$23,241	\$26,050	\$42,927
Art	\$6,058	\$6,237	\$5,910	\$8,914
Binders	\$43,488	\$37,453	\$49,485	\$72,986
Bookcases	\$20,037	\$38,544	\$26,275	\$30,024
Chairs	\$77,242	\$71,735	\$83,919	\$95,554
Copiers	\$10,850	\$26,179	\$49,599	\$62,899
Envelopes	\$3,856	\$4,512	\$4,730	\$3,379
Fasteners	\$661	\$545	\$960	\$858
Furnishings	\$13,826	\$21,090	\$27,874	\$28,915
Labels	\$2,841	\$2,956	\$2,827	\$3,861
Machines	\$62,023	\$27,764	\$55,907	\$43,545
Paper	\$14,835	\$15,288	\$20,638	\$27,718
Phones	\$77,391	\$68,314	\$78,660	\$105,643
Storage	\$50,329	\$45,048	\$58,632	\$69,834
Supplies	\$14,394	\$1,952	\$14,278	\$16,049
Tables	\$46,088	\$39,150	\$60,833	\$60,894

Tableau uses text as the mark type. Each cell in the table displays the sum of sales for a particular year and sub-category.

We can see that the chairs and phones sub-categories had the highest sales in every year.

5. Drag the **Region** dimension to **Rows** and drop it to the left of **Sub-Category**. A small triangle will appear to indicate that the new field will be inserted to the left of the existing field.

Sub-Categ..	2011	2012
Accessories	\$25,014	\$40,524
Appliances	\$15,314	\$23,241
Art	\$6,058	\$6,237
Binders	\$43,488	\$37,453
Bookcases	\$20,037	\$38,544
Chairs	\$77,242	\$71,735
Copiers	\$10,850	\$26,179
Envelopes	\$3,856	\$4,512
Fasteners	\$661	\$545
Furnishings	\$13,826	\$21,090
Labels	\$2,841	\$2,956

The view now breaks out sales by region, in addition to year and sub-category.

Region	Sub-Categ..	Order Date			
		2011	2012	2013	2014
Central	Accessories	\$4,439	\$7,795	\$10,802	\$10,920
	Appliances	\$3,659	\$4,975	\$6,015	\$8,933
	Art	\$822	\$1,132	\$1,520	\$2,291
	Binders	\$15,871	\$5,891	\$14,056	\$21,105
	Bookcases	\$1,834	\$8,298	\$8,385	\$5,640
	Chairs	\$20,754	\$17,909	\$23,350	\$23,218
	Copiers	\$3,270	\$12,810	\$17,500	\$3,680
	Envelopes	\$1,599	\$871	\$971	\$1,197
	Fasteners	\$122	\$89	\$247	\$320
	Furnishings	\$2,536	\$2,529	\$5,116	\$5,074
	Labels	\$1,048	\$305	\$511	\$587
	Machines	\$16,292	\$1,852	\$2,659	\$5,995
	Paper	\$2,347	\$3,544	\$5,366	\$6,235
	Phones	\$9,926	\$19,364	\$19,902	\$23,211
Storage	\$11,093	\$8,331	\$12,812	\$13,694	
Supplies	\$440	\$324	\$4,295	\$4,408	
Tables	\$7,785	\$6,857	\$13,923	\$10,589	
East	Accessories	\$6,054	\$17,911	\$6,231	\$14,837
	Appliances	\$5,779	\$6,691	\$9,427	\$12,291

Regions are listed alphabetically. You can drag **Region** to the right of **Sub-Category** to organize the view first by sub-category, and then by region.

Columns		YEAR(Order Date)			
Rows		Sub-Category	Region		
Sub-Categ..	Region	Order Date			
		2011	2012	2013	2014
Accessories	Central	\$4,439	\$7,795	\$10,802	\$10,920
	East	\$6,054	\$17,911	\$6,231	\$14,837
	South	\$5,595	\$4,142	\$9,380	\$8,160
	West	\$8,926	\$10,676	\$15,482	\$26,030
Appliances	Central	\$3,659	\$4,975	\$6,015	\$8,933
	East	\$5,779	\$6,691	\$9,427	\$12,291
	South	\$2,120	\$3,850	\$5,607	\$7,948
	West	\$3,755	\$7,725	\$5,001	\$13,754
Art	Central	\$822	\$1,132	\$1,520	\$2,291
	East	\$1,290	\$1,707	\$1,883	\$2,606
	South	\$566	\$1,362	\$1,391	\$1,337
	West	\$3,380	\$2,035	\$1,116	\$2,681
Binders	Central	\$15,871	\$5,891	\$14,056	\$21,105
	East	\$6,347	\$14,207	\$18,956	\$13,989
	South	\$8,307	\$13,467	\$4,112	\$11,143
	West	\$12,963	\$3,889	\$12,361	\$26,748
Bookcases	Central	\$1,834	\$8,298	\$8,385	\$5,640
	East	\$10,863	\$19,653	\$5,964	\$7,338
	South	\$794	\$1,239	\$3,709	\$5,157
	West	\$6,545	\$9,354	\$8,217	\$11,888

You can use a table calculation to show percentages of total instead of raw dollar values. First, you must determine how to frame the calculation.

In this case, there are three dimensions in the view: **Order Date**, **Sub-Category**, and **Region**.

You could show percentages of total for a single dimension, but that can be unwieldy. For example, if you show percentages just by region, the percentages would be calculated across the two remaining dimensions: **Sub-Category** (there are 17 sub-categories) and **Year(Order Date)** (there are 4 years). So you would be dividing the total $17 \times 4 = 68$ ways. That would make for some tiny percentages.

Instead, show percentages using two dimensions: **Year(Order Date)** and **Region**. Then the percentages are calculated on the remaining dimension, **Sub-Category**, that is, you calculate percent of total within each highlighted area shown below.

		Order Date			
Region	Sub-Categ..	2011	2012	2013	2014
Central	Accessories	\$4,439	\$7,795	\$10,802	\$10,920
	Appliances	\$3,659	\$4,975	\$6,015	\$8,933
	Art	\$822	\$1,132	\$1,520	\$2,291
	Binders	\$15,871	\$5,891	\$14,056	\$21,105
	Bookcases	\$1,834	\$8,298	\$8,385	\$5,640
	Chairs	\$20,754	\$17,909	\$23,350	\$23,218
	Copiers	\$3,270	\$12,810	\$17,500	\$3,680
	Envelopes	\$1,599	\$871	\$971	\$1,197
	Fasteners	\$122	\$89	\$247	\$320
	Furnishings	\$2,536	\$2,529	\$5,116	\$5,074
	Labels	\$1,048	\$305	\$511	\$587
	Machines	\$16,292	\$1,852	\$2,659	\$5,995
	Paper	\$2,347	\$3,544	\$5,366	\$6,235
	Phones	\$9,926	\$19,364	\$19,902	\$23,211
Storage	\$11,093	\$8,331	\$12,812	\$13,694	
Supplies	\$440	\$324	\$4,295	\$4,408	
Tables	\$7,785	\$6,857	\$13,923	\$10,589	
East	Accessories	\$6,054	\$17,911	\$6,231	\$14,837
	Appliances	\$5,779	\$6,691	\$9,427	\$12,291

The dimensions that you use to frame your calculation are called the *addressing fields*, and the fields in which you run your calculation are the *partition fields*.

For more information about these concepts, see [The basics: addressing and partitioning](#) on page 2365.

6. To create a table calculation to show percentages, right-click (control-click on Mac) the **SUM(Sales)** field on the **Marks** card, and then select **Add Table Calculation**.

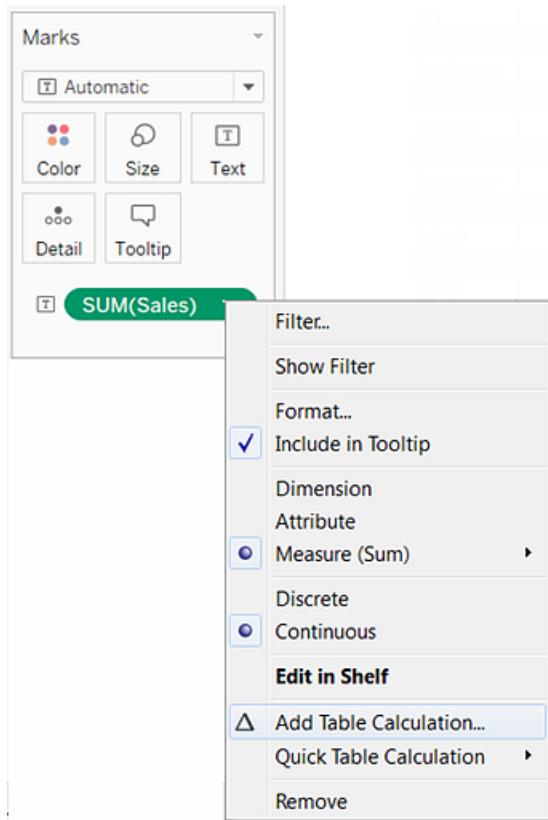

7. In the Table Calculation dialog box, set **Calculation Type** to **Percent of Total**.

The options in the dialog box change depending on the type of calculation you choose.

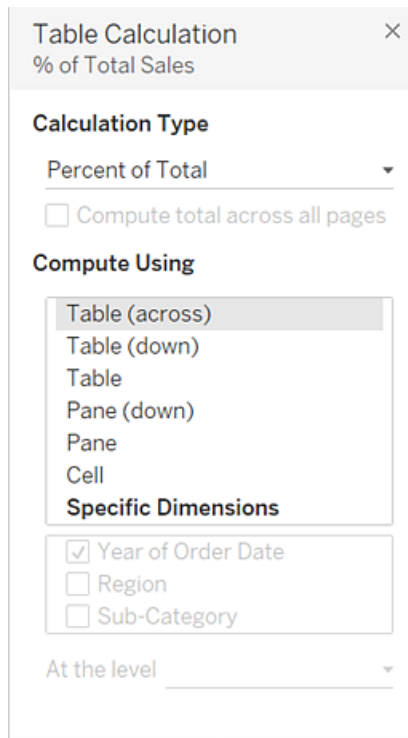

For more information about using table calculations, see [Transform Values with Table Calculations](#) on page 2364.

8. For the Calculation definition, select **Pane (Down)**, and then close the Table Calculation dialog box.

Now we see percentages calculated within each sub-category, duplicated for each year within each region. The numbers within each highlighted area add up to 100%.

Region	Sub-Categ..	Order Date			
		2011	2012	2013	2014
Central	Accessories	4.27%	7.58%	7.33%	7.42%
	Appliances	3.52%	4.84%	4.08%	6.07%
	Art	0.79%	1.10%	1.03%	1.56%
	Binders	15.28%	5.73%	9.53%	14.35%
	Bookcases	1.77%	8.07%	5.69%	3.83%
	Chairs	19.99%	17.41%	15.84%	15.78%
	Copiers	3.15%	12.45%	11.87%	2.50%
	Envelopes	1.54%	0.85%	0.66%	0.81%
	Fasteners	0.12%	0.09%	0.17%	0.22%
	Furnishings	2.44%	2.46%	3.47%	3.45%
	Labels	1.01%	0.30%	0.35%	0.40%
	Machines	15.69%	1.80%	1.80%	4.08%
	Paper	2.26%	3.45%	3.64%	4.24%
East	Phones	9.56%	18.82%	13.50%	15.78%
	Storage	10.68%	8.10%	8.69%	9.31%
	Supplies	0.42%	0.32%	2.91%	3.00%
	Tables	7.50%	6.67%	9.44%	7.20%
	Accessories	4.70%	11.46%	3.45%	6.96%
	Appliances	4.49%	4.28%	5.22%	5.76%

Pane (Down) is the appropriate choice because it specifies that the calculation should be performed from top to bottom within each pane of the table. The table has two vertical dimensions, so **Table (Down)** would have calculated the percent of total from top to bottom for the entire table, ignoring the **Region** dimension.

The pane is always the finest level of detail for the relevant direction (across or down). If you had three dimensions on the vertical axis, you might have had to use field names to define the calculation, because only the dimension furthest to the left on the **Rows** shelf (defined as Table) and the dimension furthest to the right (defined as Pane) could be captured with the structural options.

Check your work! Watch steps 1-8 below:

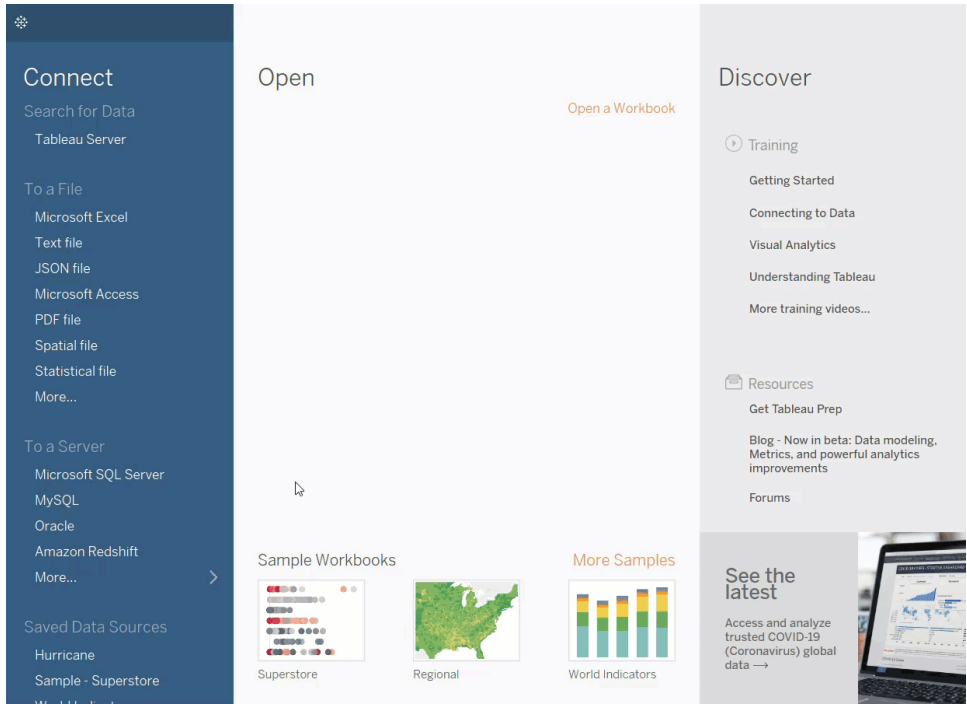

Build a Treemap

Use treemaps to display data in nested rectangles. You use dimensions to define the structure of the treemap, and measures to define the size or color of the individual rectangles. Treemaps are a relatively simple data visualization that can provide insight in a visually attractive format.

The basic building blocks for a treemap are as follows:

Mark type:	Automatic or Square
Color:	Dimension or Measure
Size	Measure
Label or Detail:	Dimension(s)

To create a treemap that shows aggregated sales totals across a range of product categories, follow the steps below.

1. Connect to the **Sample - Superstore** data source.
2. Drag the **Sub-Category** dimension to **Columns**.

A horizontal axis appears, which shows product categories.

3. Drag the **Sales** measure to **Rows**.

Tableau aggregates the measure as a sum and creates a vertical axis.

Tableau displays a bar chart—the default chart type when there is a dimension on the **Columns** shelf and a measure on the **Rows** shelf.

4. Click **Show Me** on the toolbar, then select the treemap chart type.



Tableau displays the following treemap:

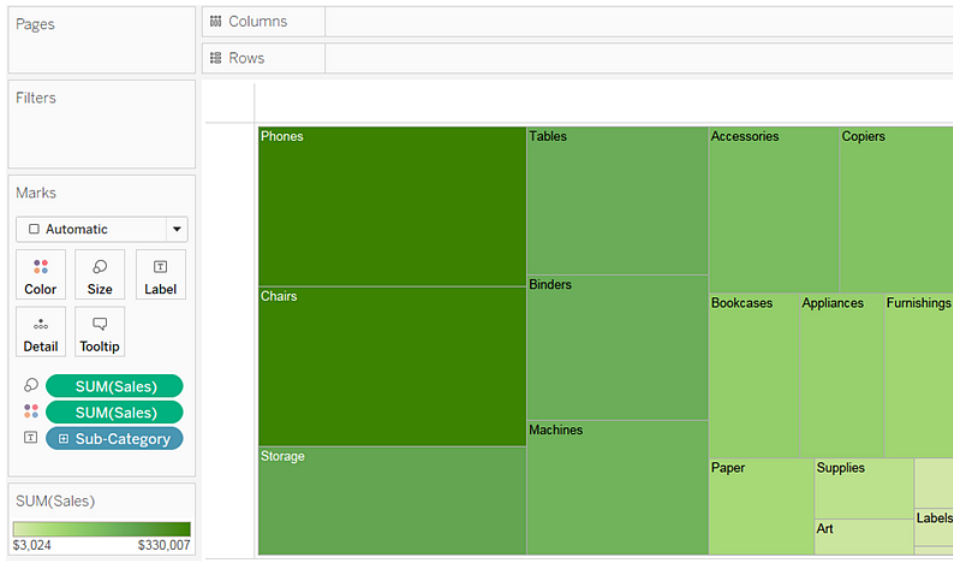

In this treemap, both the size of the rectangles and their color are determined by the value of **Sales**—the greater the sum of sales for each category, the darker and larger its box.

5. Drag the **Ship Mode** dimension to **Color** on the **Marks** card. In the resulting view, **Ship Mode** determines the color of the rectangles—and sorts them into four separate areas accordingly. **Sales** determines the size of the rectangles:

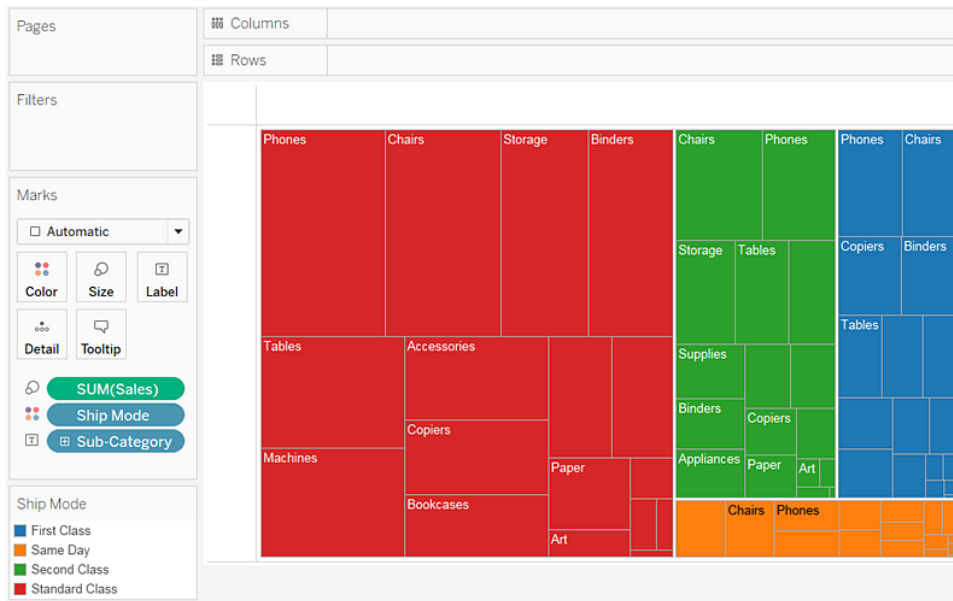

6. Try another option to modify the treemap: click the **Undo** button to remove **Ship Mode** from view.

7. Drag the **Profit** measure to **Color** on the **Marks** card. Now **Profit** determines the color of the rectangles, and **Sales** determines their size:

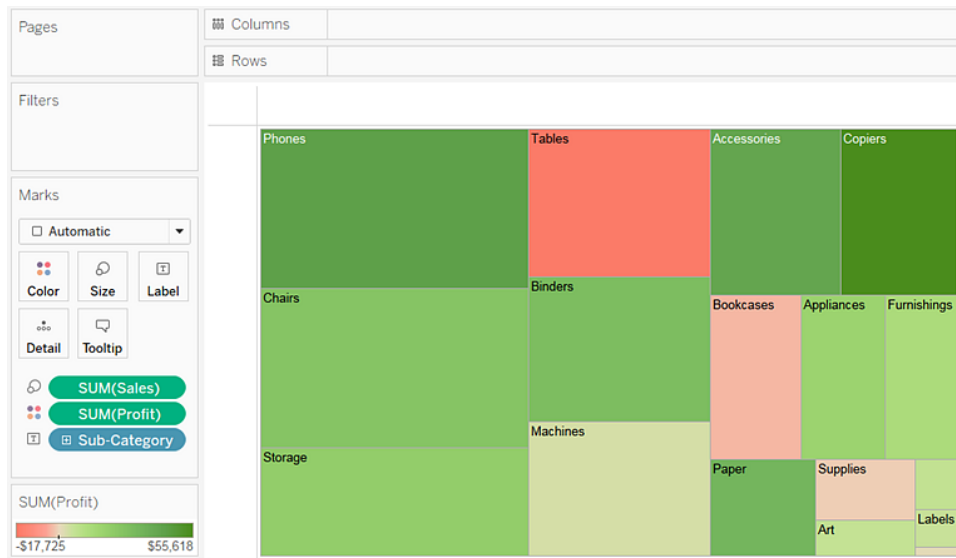

With treemaps, **Size** and **Color** are the crucial elements. You can place measures on **Size** and **Color**, but placing a measure anywhere else has no effect. Treemaps can accommodate any number of dimensions, including one or even two on **Color**. But beyond that, adding dimensions only breaks the map into an ever greater number of smaller rectangles. For information on how to place two dimensions on **Color** in a treemap, see [Example – Multiple Fields on Color](#) on page 1303.

Check your work! Watch steps 1-7 below:

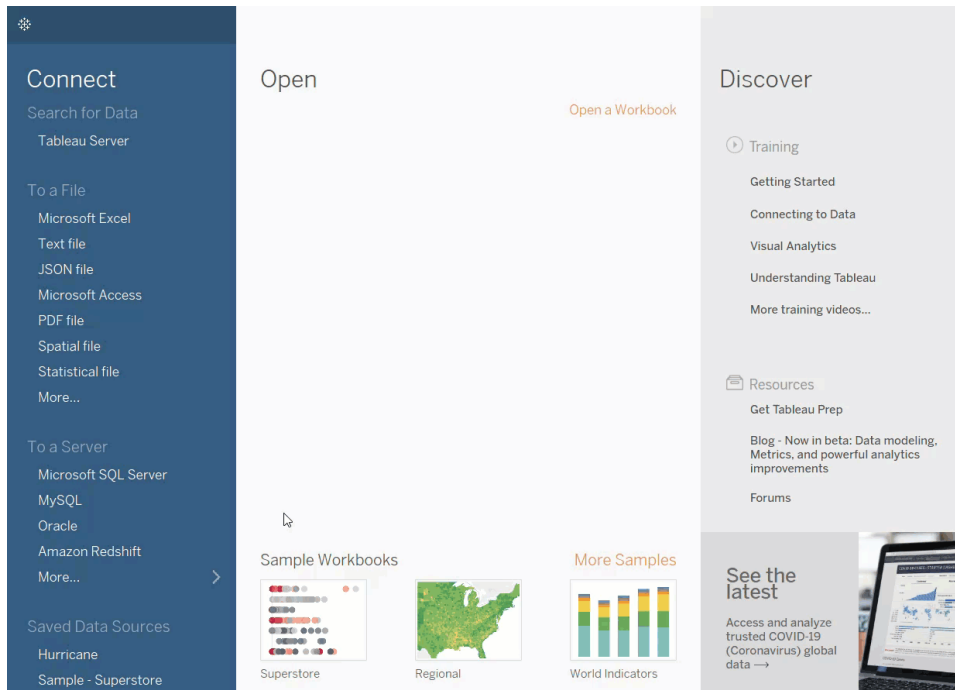

Build a Combination Chart

Combination charts are views that use multiple mark types in the same visualization. For example, you may show sum of profit as bars with a line across the bars showing sum of sales. You can also use combination charts to show multiple levels of detail in the same view. For example, you can have a line chart with individual lines showing average sales over time for each customer segment, then you can have another line that shows the combined average across all customer segments.

To create a combination chart, follow the steps below:

1. Open Tableau Desktop and connect to the **Sample - Superstore** data source.
2. Navigate to a new worksheet.
3. From the **Data** pane, drag **Order Date** to the **Columns** shelf.
4. On the Columns shelf, right-click **YEAR(Order Date)** and select **Month**.

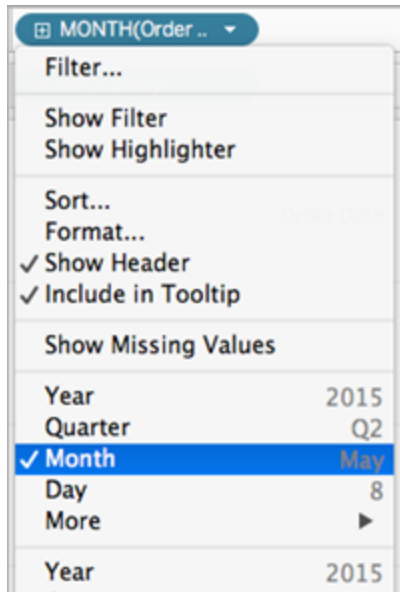

5. From the **Data** pane, drag **Sales** to the **Rows** shelf.
6. From the **Data** pane, drag **Profit** to the **Rows** shelf and place it to the right of SUM (Sales).
7. On the Rows shelf, right-click **SUM(Profit)** and select **Dual-Axis**.

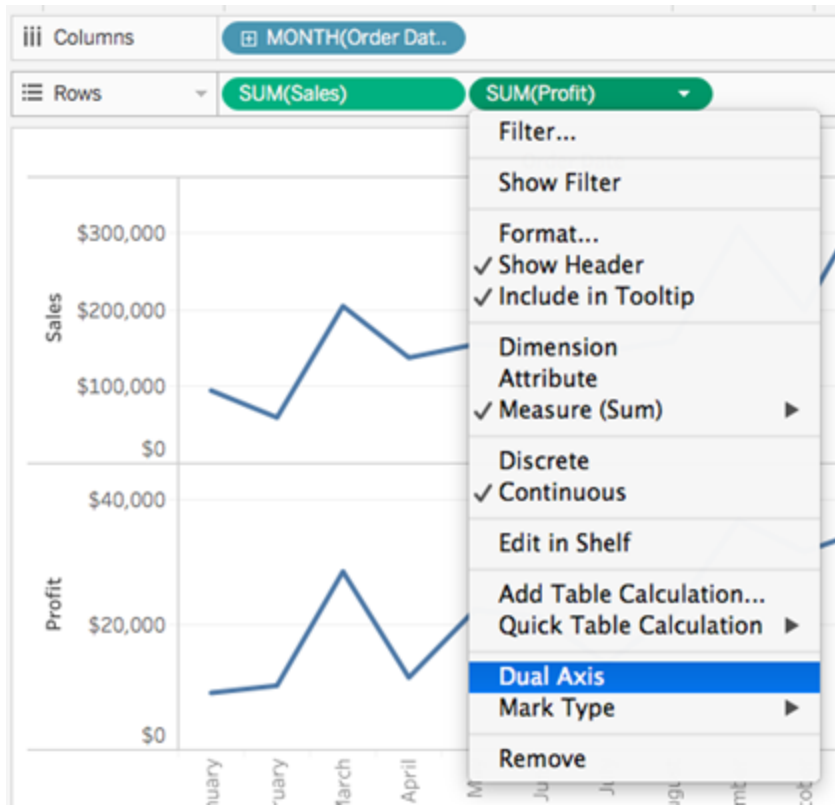

The view updates. Measure Names is added to Color on the Marks card to differentiate the lines.

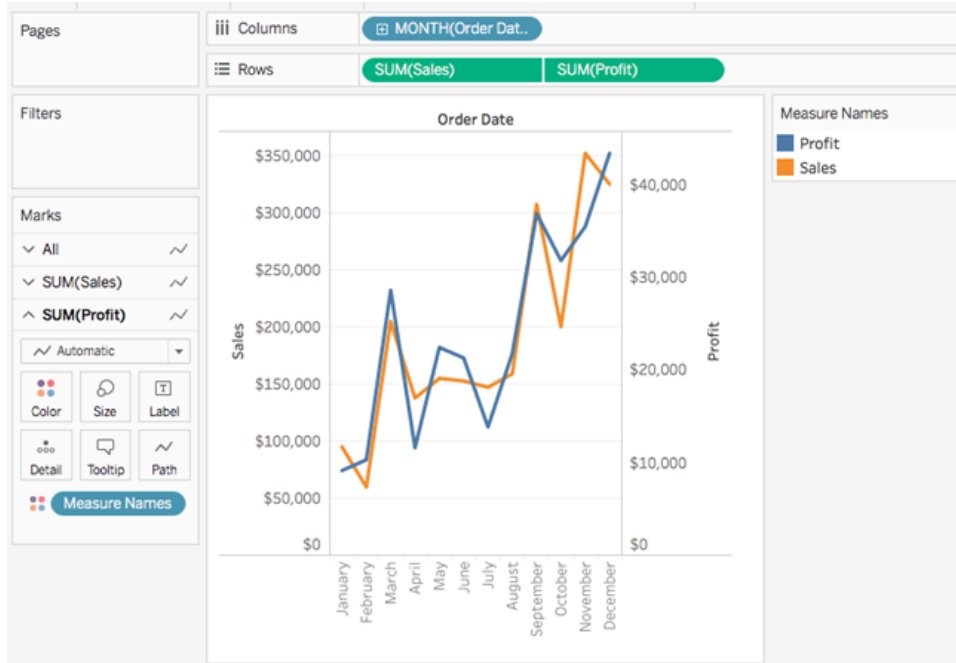

Note: Some marks can be hidden behind others. To move the marks forward or backward, right-click one of the axes in the visualization and select Move Marks to Back or Move Marks to Front.

- On the SUM(Profit) Marks card, click the Mark Type drop-down and select **Bar**.

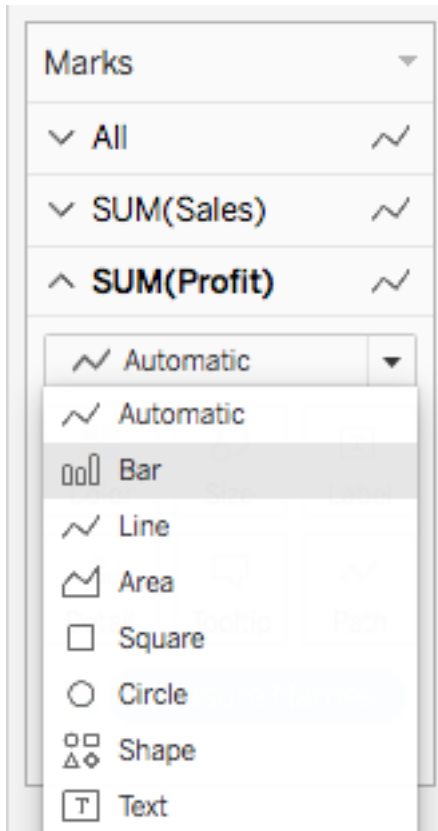

9. In the visualization, right-click the **Profit** axis and select **Synchronize Axis**.

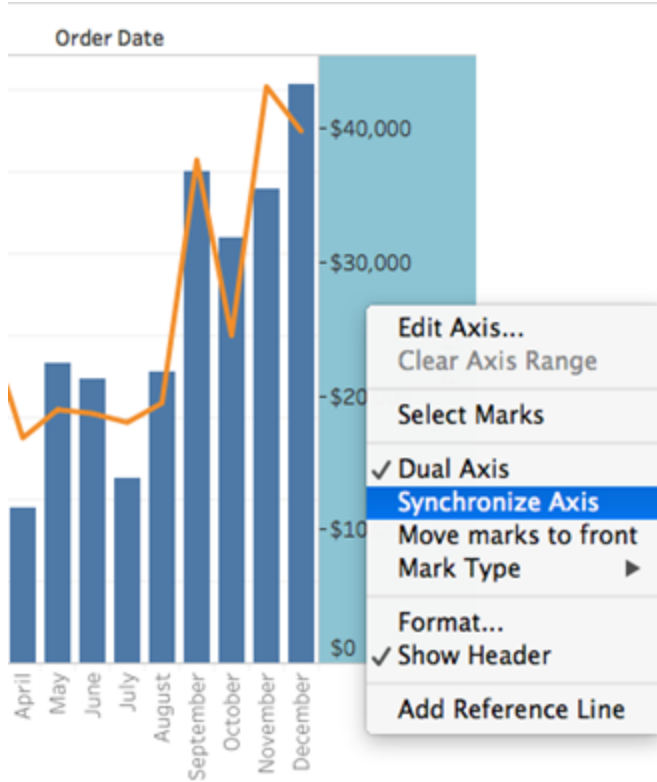

The view updates to look like this:

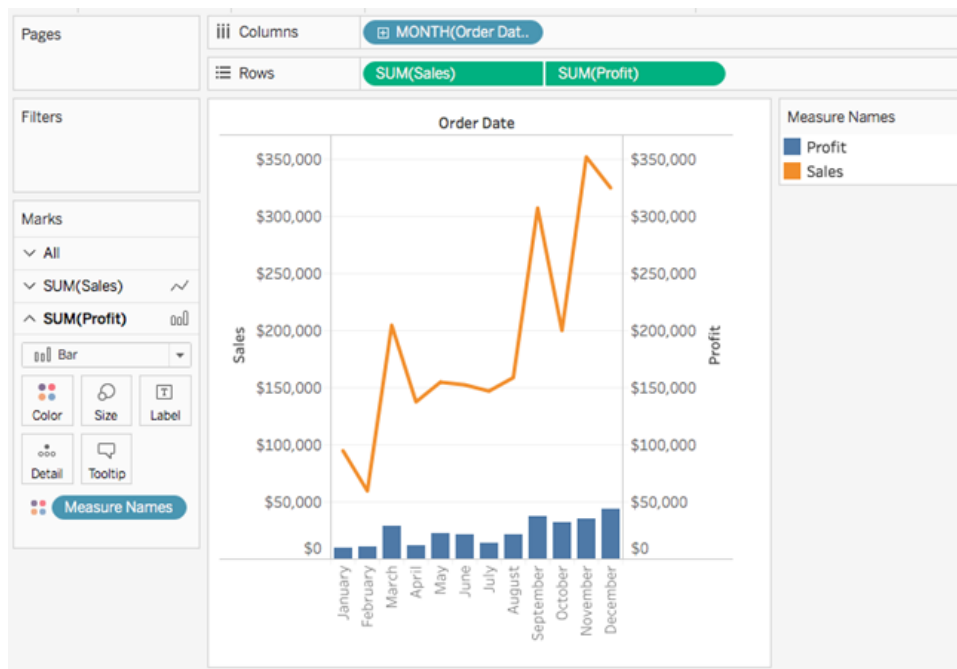

Build Advanced Chart Types

The topics in this section illustrate how to create views that include industry-standard analytical benchmarks and visualization types.

Note: Most of these examples can only be built in Tableau Desktop—not as you edit views on the web. Before attempting to follow the steps in one of these topics, check the Applies To line at the top of the topic to determine whether the procedure is valid for editing on the web. If Tableau Server and Tableau Cloud are not listed, then the procedure will not work on the web.

Add a Calculated Column to a View

Sometimes your data may not have all the pieces you need for your analysis. A common way to handle this is to create a calculated column (also referred to as a calculated field or just a calculation) that modifies the existing data. Calculations can be created by opening the **Analysis** menu and selecting **Create Calculated Field...**

It's important to note that there are often several different ways to achieve the same results for a calculated field. Additionally, the correct value of a calculation may depend on how the data is shaped and how the visualization is set up. Make sure you understand your data structure and how the viz will be built when determining how to write a calculation.

Examples of when a calculation might be useful

Combine first and last name

You may have First name and Last name in two different columns and want a single field for name.

Abc Names First name	Abc Names Last name	Abc Names Real person
James	Herriot	no
Helen	Alderson	no
Siegfried	Farnon	no
Tristan	Farnon	no
Donald	Sinclair	yes
Alfred	Wight	yes
Joan	Danbury	yes
Brian	Sinclair	yes

The calculation:

[First name] + " " + [Last name]

A finished viz might look like this

The screenshot shows the Tableau Desktop interface. The Columns shelf is empty, and the Rows shelf contains 'First name' and 'Last name'. The Marks card is set to 'Text'. A calculated field named 'Full name' is applied to the Marks card. The main view displays a table with three columns: 'First name', 'Last name', and 'Full name'. The 'Full name' column contains the concatenated values of the first and last names, separated by a space. A tooltip is visible over the 'Full name' column, showing the calculation: `[First name] + " " + [Last name]`.

First name	Last name	Full name
Alfred	Wight	Alfred Wight
Brian	Sinclair	Brian Sinclair
Donald	Sinclair	Donald Sinclair
Helen	Alderson	Helen Alderson
James	Herriot	James Herriot
Joan	Danbury	Joan Danbury
Siegfried	Farnon	Siegfried Farnon
Tristan	Farnon	Tristan Farnon

Find a sequence inside a string

You may want to flag every record that has a certain manufacturing code XYZ in the Product ID field.

Abc Manufacturing Product ID	Abc Manufacturing Unit Cost	# Manufacturing Number on hand
4_ABC_2	\$44	277
47_XYZ_5	\$20	193
9_GHI_7	\$30	41
56_MNO_12	\$34	103
88_ABC_16	\$11	67
86_XYZ_9	\$43	216
26_GHI_17	\$11	198
1_MNO_9	\$19	213
23_ABC_4	\$14	39
43_XYZ_3	\$16	185
5_GHI_7	\$4	252
32_MNO_3	\$1	273

The calculation will return "true" if the code is present and "false" if not.

```
CONTAINS([Product ID], "XYZ")
```

A finished viz might look like this, with the calculation on Color.

The screenshot shows the Tableau Desktop interface. On the left, the 'Columns' shelf contains 'Product ID'. The 'Marks' card is set to 'Automatic'. The 'Filters' shelf is empty. The 'Marks' card shows 'Color' selected, with a dropdown menu open showing 'XYZ Manufact...'. The 'Columns' shelf shows a list of product IDs with corresponding colored squares: 1_MNO_9 (blue), 4_ABC_2 (blue), 5_GHL_7 (blue), 9_GHL_7 (blue), 23_ABC_4 (blue), 26_GHI_17 (blue), 32_MNO_3 (blue), 43_XYZ_3 (orange), 47_XYZ_5 (orange), 56_MNO_12 (blue), 86_XYZ_9 (orange), and 88_ABC_16 (blue). The 'Columns' shelf also shows a calculated field 'CONTAINS ([Product ID], "XYZ")' with a status 'The calculation is valid.' and '1 Dependency'.

Assign categories for value ranges

You want to assign categories based on several thresholds.

Student	GPA
001	2.90000
002	3.40000
003	2.50000
004	4.00000
005	3.80000
006	3.10000
007	3.20000

The calculation will evaluate each student's GPA against the cutoff value and assign a label.

```
IF [GPA] <3 THEN "Needs Improvement" ELSEIF [GPA] <3.5 THEN
"Sufficient" ELSE "Excellent" END
```

A finished viz might look like this, with the calculation on Color.

Tableau Desktop and Web Authoring Help

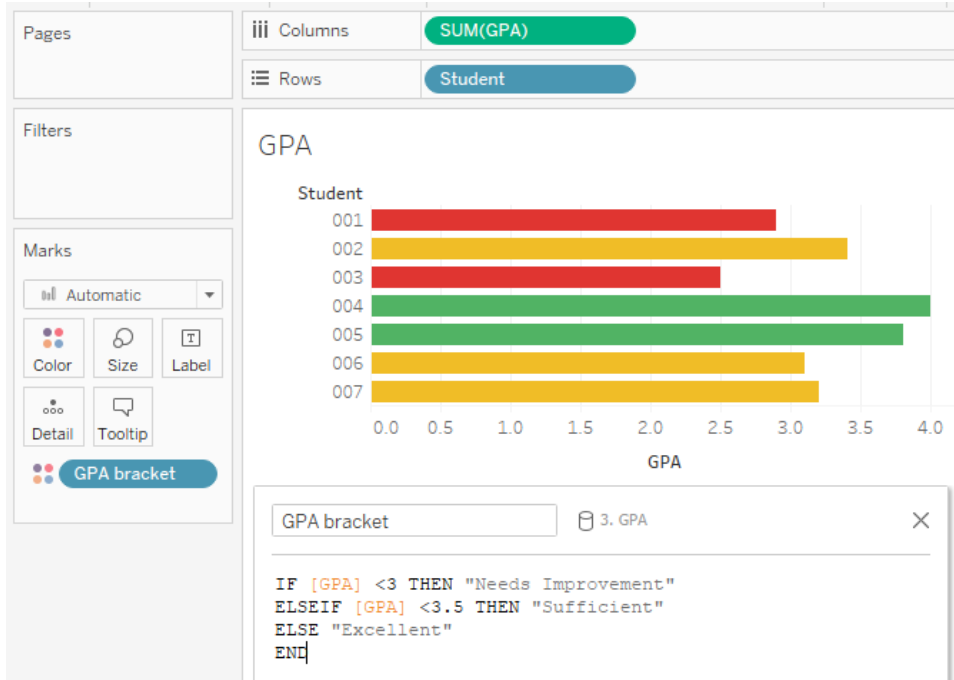

Calculate percent change

You want to display the year-over-year (YOY) percentage change in the weight of children from age 1 to age 2.

Abc Babies Baby	# Babies Age	# Babies Weight
A	1	19.3600
A	2	26.4000
B	1	22.6600
B	2	30.1400
C	1	17.3800
C	2	24.1000
D	1	21.3400
D	2	24.2000

This calculation is for the *difference/original* for each child.

```
(SUM((IF [Age] = 2 THEN [Weight] ELSE 0 END)) - SUM((IF [Age] = 1
THEN [Weight] ELSE 0 END)))/SUM(IF [Age] = 1 THEN [Weight] ELSE 0
END)
```

A finished viz might look like this.



This example is one where the calculation could change quite a lot based on the structure of the data. If there was a field for weight at age 1 and weight at age 2, for example, the calculation would only need to be $([\text{Weight at age 2}] - [\text{Weight at age 1}]) / [\text{Weight at age 1}]$. However, the data structure detailed above is more standard and more likely to be encountered.

Follow along: create a YOY calculation

Objective

To create a view like the following, that shows sales results for two years in the first two columns, and then the year-over-year change, as a percentage, in the third column. The scenario uses the **Sample - Superstore** data source provided with Tableau Desktop to show how to build the viz.

Sub-Catego..	2013	2014	YOY Change
Accessories	\$25,014	\$40,524	62.00%
Appliances	\$15,314	\$23,241	51.77%
Art	\$6,058	\$6,237	2.95%
Binders	\$43,488	\$37,453	-13.88%
Bookcases	\$20,037	\$38,544	92.37%
Chairs	\$77,242	\$71,735	-7.13%
Copiers	\$10,850	\$26,179	141.29%
Envelopes	\$3,856	\$4,512	17.02%
Fasteners	\$661	\$545	-17.56%
Furnishings	\$13,826	\$21,090	52.53%
Labels	\$2,841	\$2,956	4.05%
Machines	\$62,023	\$27,764	-55.24%
Paper	\$14,835	\$15,288	3.05%
Phones	\$77,391	\$68,314	-11.73%
Storage	\$50,329	\$45,048	-10.49%
Supplies	\$14,394	\$1,952	-86.44%
Tables	\$46,088	\$39,150	-15.05%

Create the necessary calculated fields

1. Connect to the **Sample - Superstore** data source.
2. Choose **Analysis > Create Calculated Field** to open the calculation editor. Name the calculation **2013** and type or paste the following in the formula area:

```
IF YEAR([Order Date]) = 2013 THEN [Sales] ELSE 0 END
```
3. Create a second calculated field and name it **2014**; the formula is the same except with 2014 instead of 2013:



```
IF YEAR([Order Date]) = 2014 THEN [Sales] ELSE 0 END
```
4. Create a third calculated field, **YOY Pct. Change**, to calculate the change from 2013 to

2014:

$$(SUM([2014]) - SUM([2013])) / SUM([2013])$$

Format the calculated fields

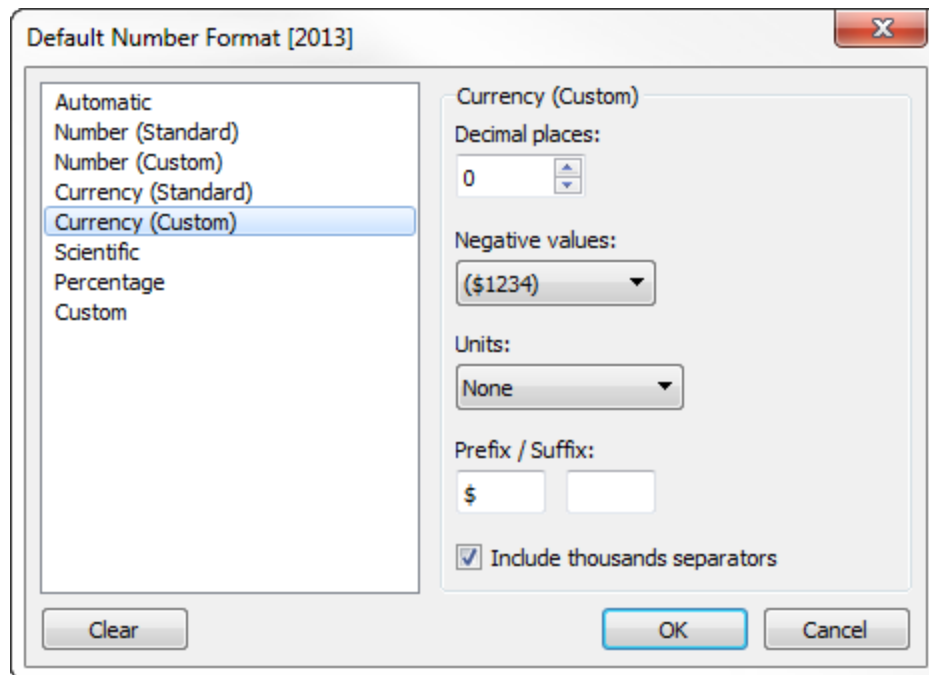
1. Click **2013** in the Measures area of the **Data** pane and choose **Default Properties > Number Format**.
2. In the Default Number Format dialog box, set the format to **Currency (Custom)** and the **Decimal places** to **0**.



3. Format the **2014** measure the exact same way.
4. Format the **YOY Pct. Change** field as **Percentage**, with **2** decimal places.

Build the view

1. Drag **2013** to Text on the Marks card.
2. Double-click **2014** and then **YOY Pct. Change**.
3. Drag **Measure Names** from **Rows** to **Columns**.
4. Drag **Sub-Category** to **Rows**.

Your view should now look like the one at the beginning of this section.

Calculate Z-scores

In statistics, the z-score (or standard score) of an observation is the number of standard deviations that it is above or below the population mean.

To calculate a z-score you must know the population mean and the population standard deviation. In cases where it is impossible to measure every observation of a population, you can estimate the standard deviation using a random sample.

Create a z-score visualization to answer questions like the following:

- What percentage of values fall below a specific value?
- What values can be considered exceptional? For example, in an IQ test, what scores represent the top five percent?
- What is the relative score of one distribution versus another? For example, Michael is taller than the average male and Emily is taller than the average female, but who is relatively taller within their gender?

As a general rule, z-scores lower than -1.96 or higher than 1.96 are considered unusual and interesting. That is, they are statistically significant outliers.

This article demonstrates how to calculate a z-score in Tableau.

1. Connect to the **Sample - Superstore** data source provided with Tableau Desktop.
2. Create a calculated field to calculate average sales.

Choose **Analysis > Create Calculated Field** to open the calculation editor. Name the calculation **Average Sales** and type or paste the following in the formula area:

```
WINDOW_AVG(SUM([Sales]))
```

3. Create another calculated field to calculate the standard deviation. Name the calculation **STDEVP Sales** and type or paste the following in the formula area:

```
WINDOW_STDEVP(SUM([Sales]))
```

4. Create one more calculated field, this one to calculate the z-score. Name the calculation **Z-score** and type or paste the following in the formula area:

```
(SUM([Sales]) - [Average Sales]) / [STDEVP Sales]
```

5. Drag **Z-Score** from the **Data** pane to **Columns** and **State** to **Rows**.

Notice that the **Z-score** field on Columns has a table calculation icon on the right side (that is, a small triangle):



The **STDEVP Sales** function is based on the **WINDOW_STDEVP** function, which is a table calculation function. The **Z-Score** function, in turn, is a table calculation function because it includes **STDEVP Sales** in its definition. When you use a calculated field that includes a table calculation function in a view, it's the same as adding a table calculation to a field manually. You can edit the field as a table calculation. In fact, that's what you do next.

6. Click the **Z-score** field on Columns and choose **Compute Using > State**.

This causes the z-scores to be computed on a per-state basis.

7. Click the **Sort Descending** icon on the toolbar:



8. Hold down the Ctrl key and drag the **Z-score** field from **Columns** to **Color**.

Ctrl + Drag copies a field as currently configured to an additional location.

9. Ctrl + Drag **Z-score** from Columns once again. This time drop it on **Label**.

You now have a distribution of z-scores broken out by state. California and New York both have z-scores greater than 1.96. You could conclude from this that California and New York have significantly higher average sales than other states.

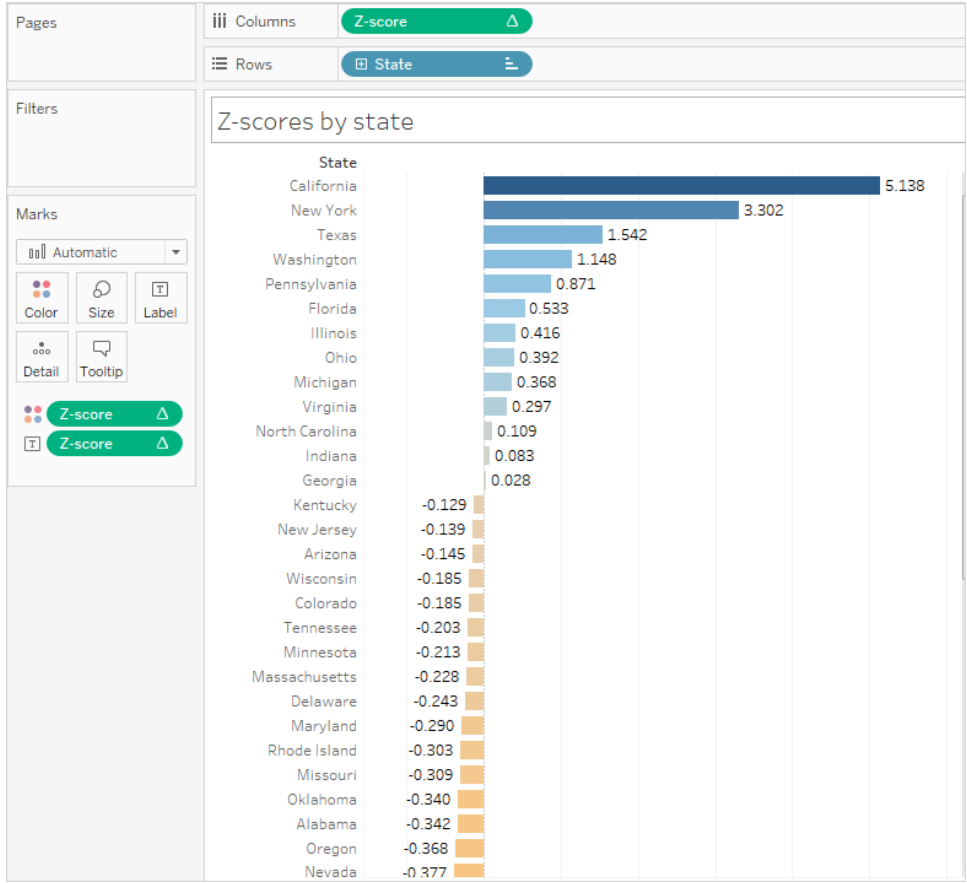

Visualize Key Progress Indicators

This article shows how to create a view that shows Key Progress Indicators (KPIs). A Key Performance Indicator is a measurable value that shows how effectively a company is achieving key business objectives. At a high level, the procedure requires you to do the following:

1. Create a view that includes the field or fields (measures) you want to assess.
2. Create a calculated field that establishes the threshold that demarcates success from failure.
3. Update the view to use KPI-specific shape marks to show which values are above the threshold and which are below.

Note: When connected to Microsoft Analysis Services, any KPI calculations defined in the cube are not available in Tableau. But as the procedure below demonstrates, you can write your own KPI calculations directly inside Tableau, and then use Tableau parameters

to create highly flexible what-if KPI analysis. For more on special considerations for cube data sources, see [Cube Data Sources](#) on page 982.

The scenario uses the **Sample - Superstore** data source provided with Tableau Desktop to show how to build a KPI view that displays a green check mark for any sales figure over \$25,000, and a red X for any sales figure under \$25,000.

Create a view that includes the field you want to assess

In this case, that field is **Sales**.

1. Connect to the **Sample - Superstore** data source.
2. From the Data pane, drag **Sub-Category** to **Rows** and **Region** to **Columns**.
3. From the Data pane, drag **Sales** to **Text** on the Marks card.

Create a calculated field that establishes the threshold that demarcates success from failure

1. In the **Analysis** menu, select **Create Calculated Field** to open the calculation editor. Name the calculation KPI and type or paste the following in the formula area

```
IF SUM ([Sales]) > 25000 THEN "Above Benchmark" ELSE "Below  
Benchmark" END
```

2. Click **OK**.

Update the view to use KPI-specific shape marks

1. On the Marks card, select Shape from the drop-down list of views:

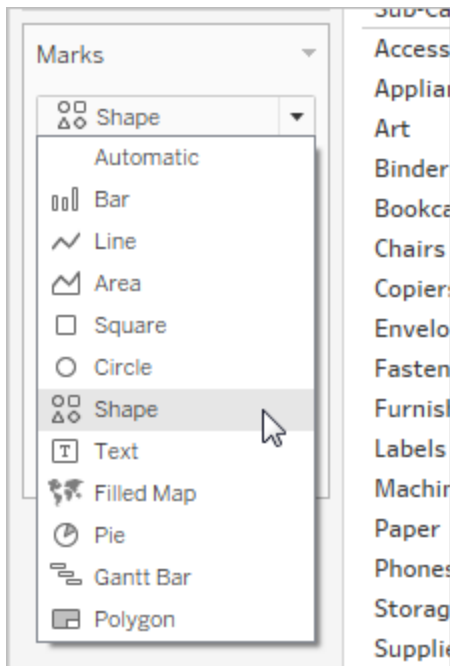

2. Drag the **KPI** field from the **Measures** area of the **Data** pane to **Shape** on the Marks card.
3. Click **Shape** on the Marks card to open the **Edit Shape** dialog box.
4. From the **Select Shape Palette** drop down list, choose **KPI**.

Now you are ready to associate specific values for the KPI field with specific shapes.

5. Click **Above Benchmark** under **Select Data Item** and then click the green check mark in the palette.
6. Click **Below Benchmark** under **Select Data Item** and then click the red X in the palette.

The Edit Shape dialog box should now look like this:

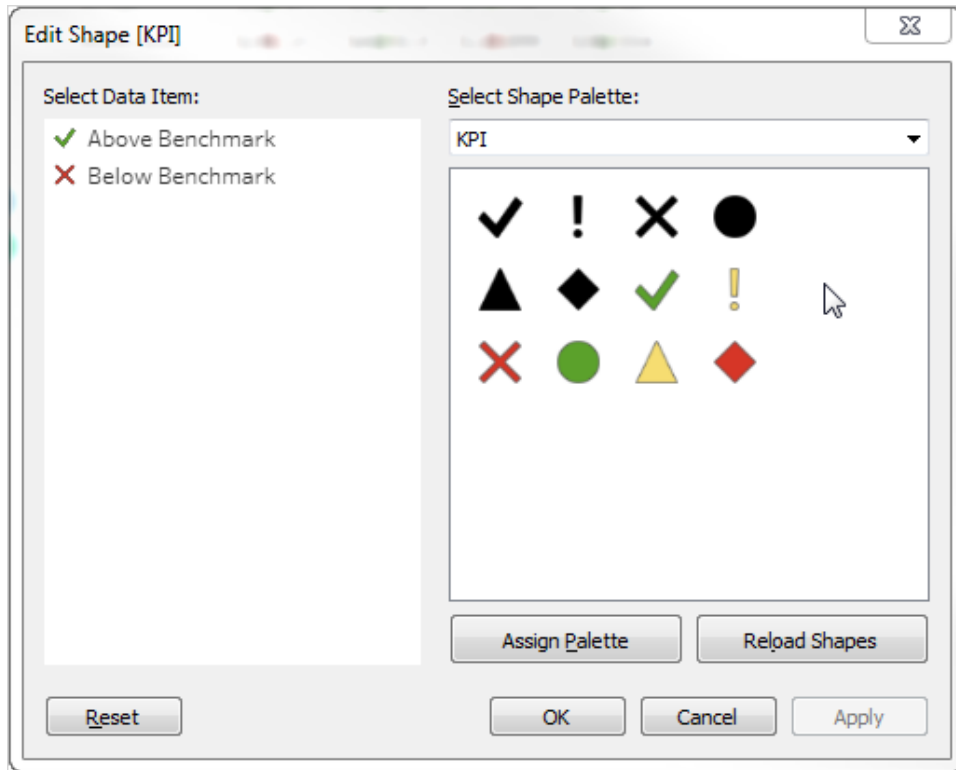

7. Click **OK** to close the Edit Shape dialog box.

The shapes in the view show the correct indicators. Now you just need to hide the sales numbers.

8. Drag **SUM(Sales)** on the Marks card to **Detail**.

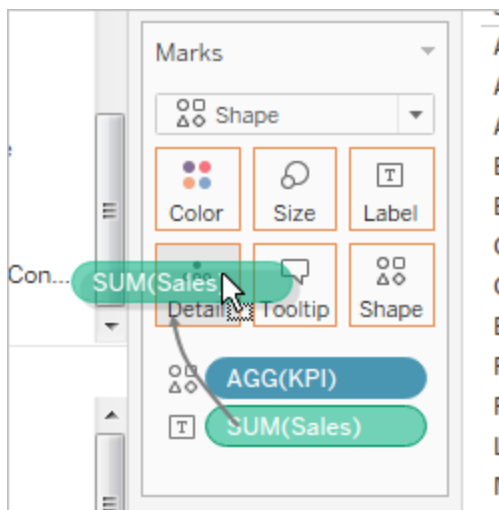

You now have a completed view that show how individual products (sub-categories) are performing across all four regions:

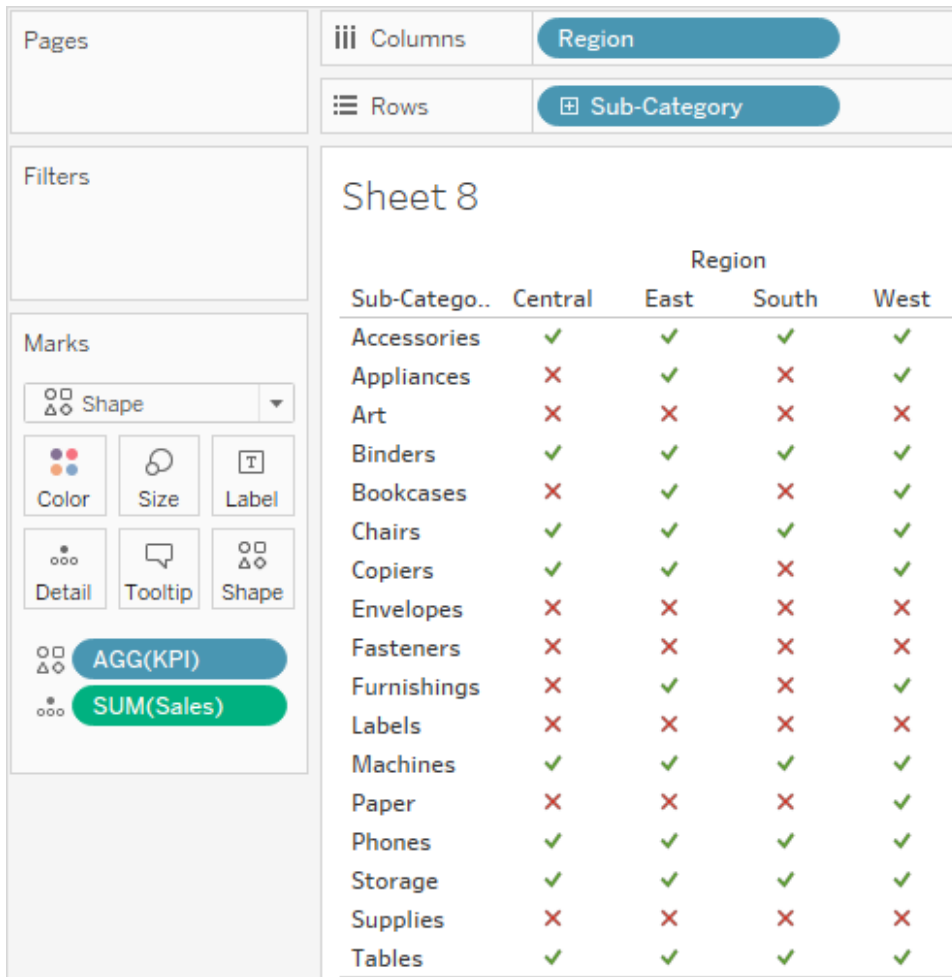

The view may not be terribly exciting on its own, but it would make a nice addition to a dashboard that showed other performance metrics.

Create a Pareto Chart

A Pareto chart is a type of chart that contains both bars and a line graph, where individual values are represented in descending order by bars, and the ascending cumulative total is represented by the line. It is named for Vilfredo Pareto, an Italian engineer, sociologist, economist, political scientist, and philosopher, who formulated what has become know as the Pareto principal.

Pareto made the observation that 80% of land was typically owned by 20% of the population. Pareto extended his principle by observing that 20% of the peapods in his garden contained 80% of the peas. Eventually, the principal was further extrapolated by others to propose that for many

events, roughly 80% of the effects come from 20% of the causes. In business, for example, 80% of profits not infrequently derive from 20% of the available products.

In Tableau, you can apply a table calculation to sales data to create a chart that shows the percentage of total sales that come from the top products, and thus identify the key segments of your customer base that are most important for your business's success.

The procedure uses the **Sample - Superstore** data source provided with Tableau Desktop.

Preparing for the analysis

Before starting your analysis, decide what questions you want answered. These questions determine the category (dimension) and number (measure) on which to base the analysis. In the example to follow, the question is which products (captured by the **Sub-Category** dimension) account for the most total sales.

At a high level, the process requires you to do the following:

1. Create a bar chart that shows **Sales** by **Sub-Category**, in descending order.
2. Add a line chart that also shows **Sales** by **Sub-Category**.
3. Add a table calculation to the line chart to show sales by Sub-Category as a **Running Total**, and as a **Percent of Total**.

The scenario uses the **Sample - Superstore** data source provided with Tableau Desktop

Create a bar chart that shows Sales by Sub-Category in descending order

1. Connect to the **Sample - Superstore** data source.
2. From the **Data** pane, drag **Sub-Category** to **Columns**, and then drag **Sales** to **Rows**.
3. Click **Sub-Category** on **Columns** and choose **Sort**.

In the Sort dialog box, do the following:

- a. Under **Sort order**, choose **Descending**.
- b. Under **Sort by**, choose **Field**.
- c. Leave all other values unchanged, including **Sales** as the selected field and **Sum** as the selected aggregation.
- d. Click **OK** to exit the Sort dialog box.

Products are now sorted from highest sales to lowest.

Add a line chart that also shows Sales by Sub-Category

1. From the Data pane, drag **Sales** to the far right of the view, until a dotted line appears.

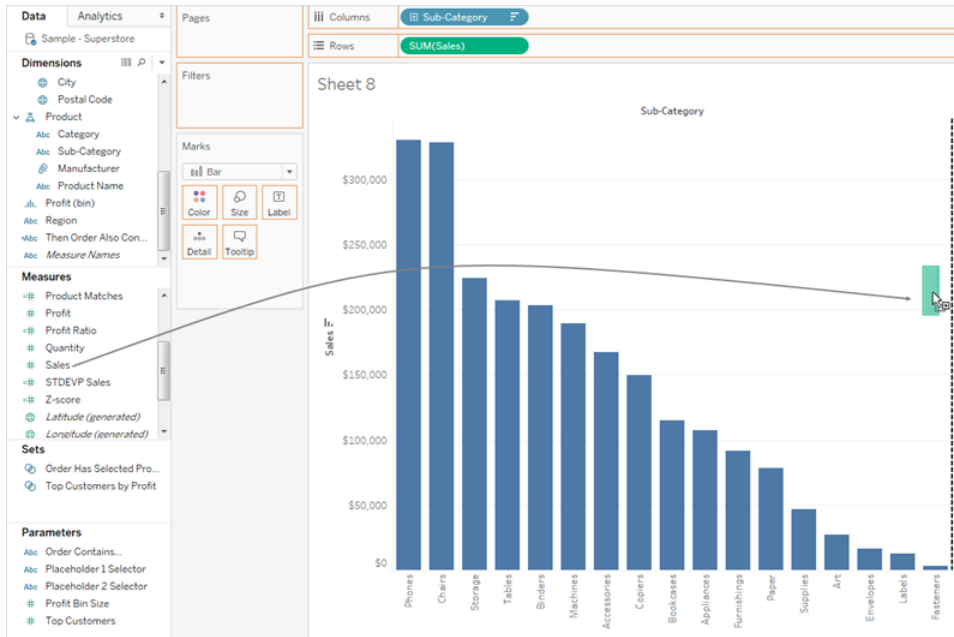

Note: In Tableau 2020.2 and later, the Data pane no longer shows Dimensions and Measures as labels. Fields are listed by table or folder.

2. Drop Sales, to create a dual-axis view. It's a bit hard to see that there are two instances of the Sales bars at this point, because they are configured identically.
3. Select **SUM(Sales) (2)** on the Marks card, and change the mark type to **Line**.

This is what the view should look like at this point:

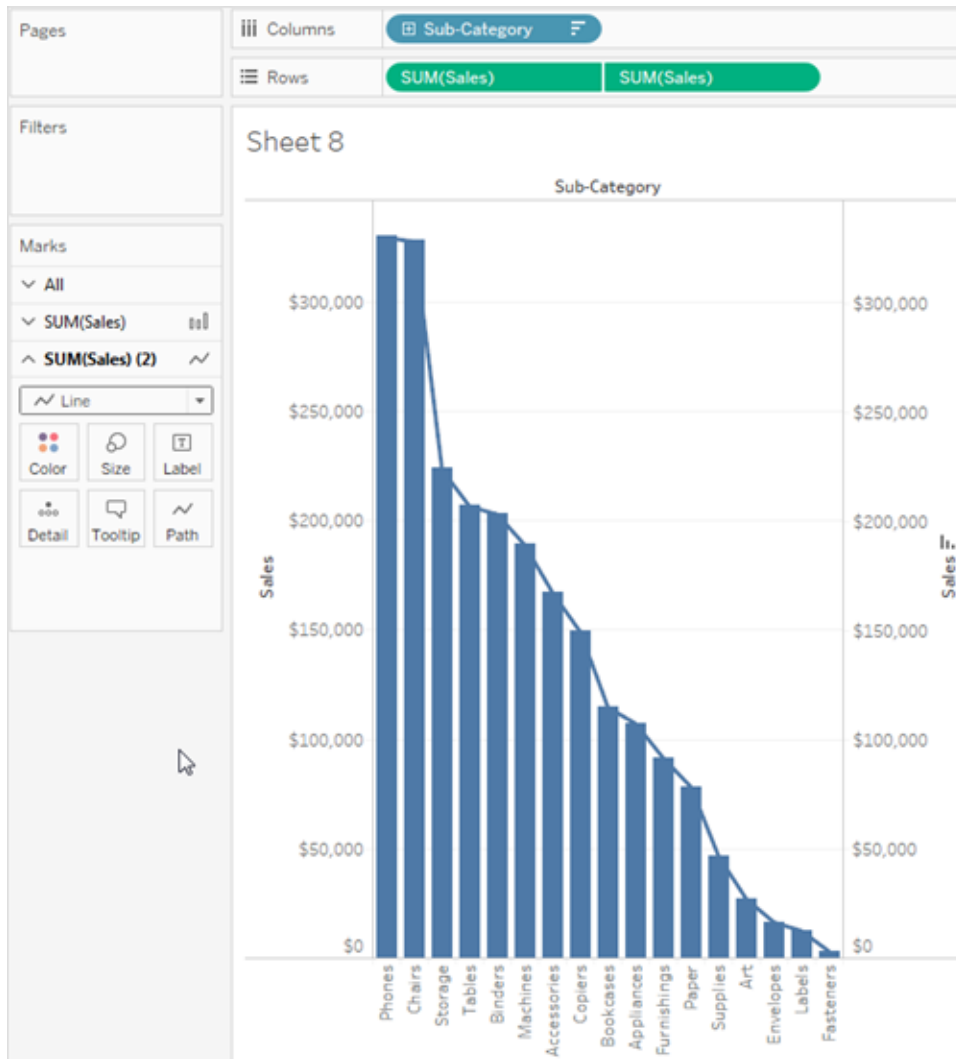

Add a table calculation to the line chart to show sales by Sub-Category as a running total, and as a percent of total

1. Click the second copy of **SUM(Sales)** on **Rows** and choose **Add Table Calculation**.
2. Add a primary table calculation to **SUM(Sales)** to present sales as a running total.

Choose **Running Total** as the **Calculation Type**.

Do not close the Table Calculation dialog box.

3. Add a secondary table calculation to present the data as a percent of total.

Click **Add Secondary Calculation** and choose **Percent of Total** as the **Secondary Calculation Type**.

This is what the Table Calculation dialog box should look like at this point:

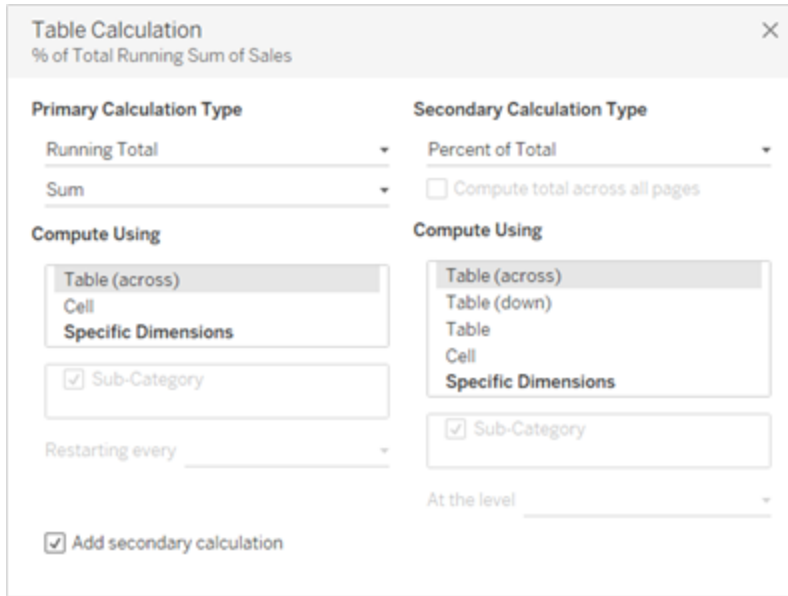

4. Click the X in the upper-right corner of the Table Calculations dialog box to close it.
5. Click Color in the Marks card to change the color of the line.

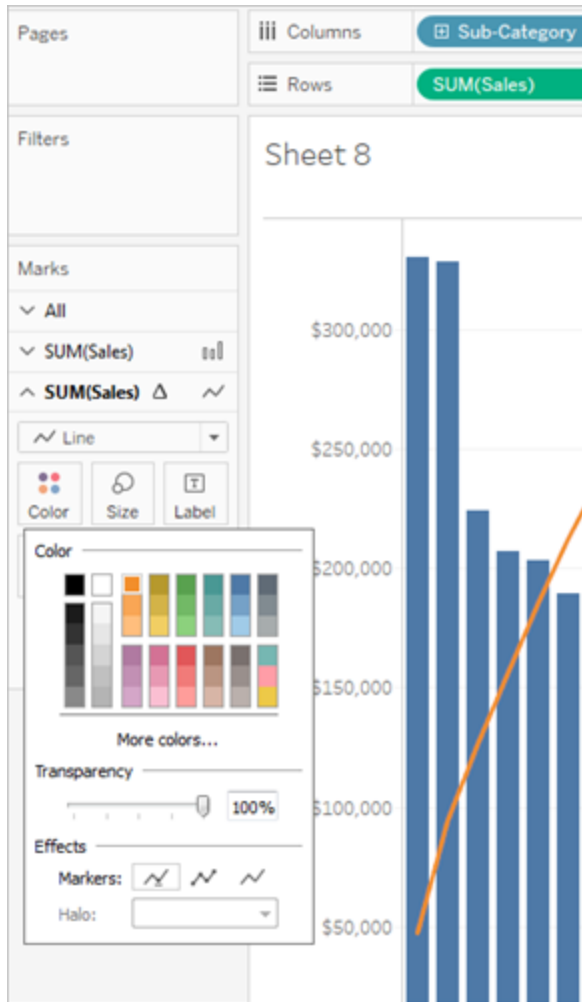

The result is now a Pareto chart:

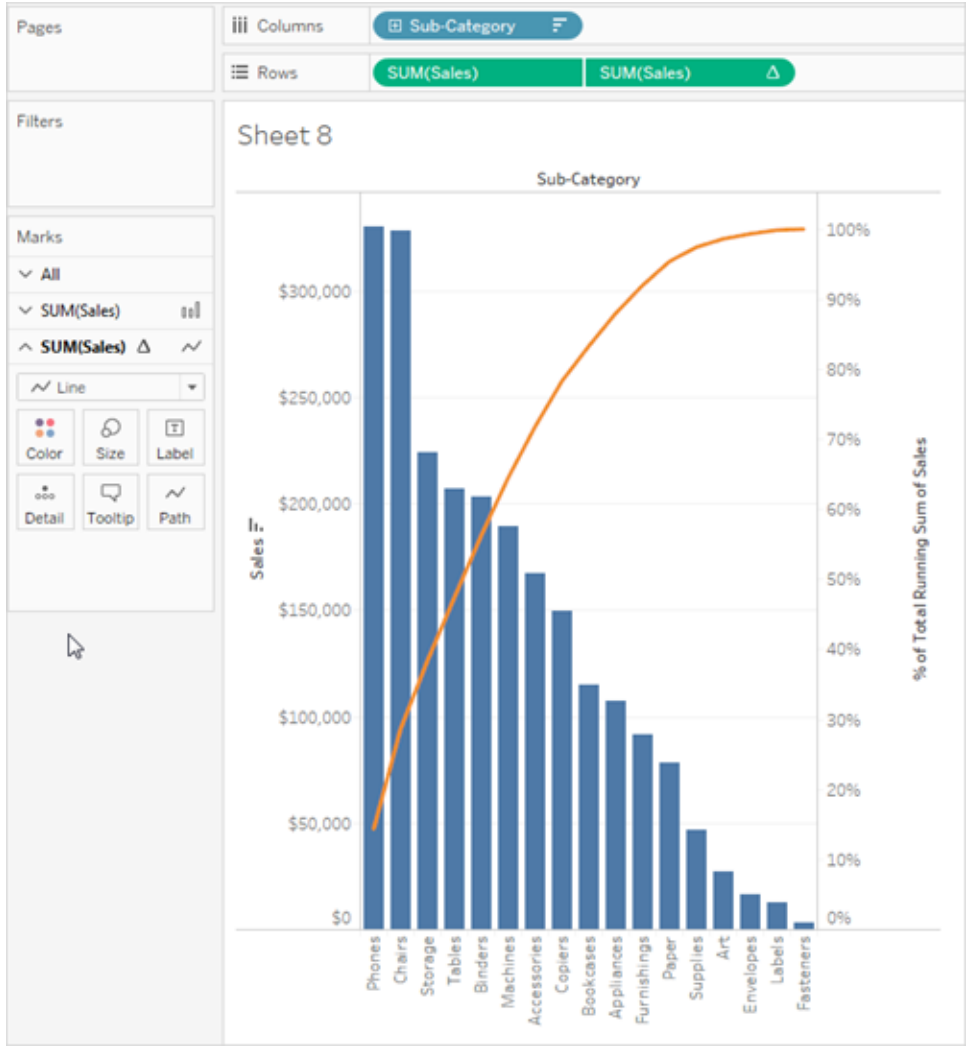

Create a Population Pyramid

A population pyramid, also known as an age structure diagram, shows the distribution of various age groups in a population.

A common distribution often used with this type of visualization is female and male populations by age. To create a population pyramid using Tableau, first separate the population (measure) into two groups, females and males, and then create "bins" for the age cohorts you want to represent in the population pyramid.

For example, suppose you are working with a table from the United States Census Bureau that contains population, gender, and age data.

To create a bin and divide a measure into two groups.

1. Download and open the following workbook from Tableau Public.
 1. Go to <https://public.tableau.com/profile/tableau.docs.team#!/vizhome/CreateaPopulationPyramid/Sheet1>.
 2. Click **Download Workbook** in the upper-right corner and then open the workbook.
2. Select **Worksheet > Clear > Sheet**.
3. In the Data pane, right-click the **Age** field and select **Create > Bins**.
4. In the Create Bins dialog box, enter a bin size based on the age groups you're interested in focusing on, and then click **OK**.

In this example, the bin size is 10. This means that the age cohorts are defined by increments of 10 years.

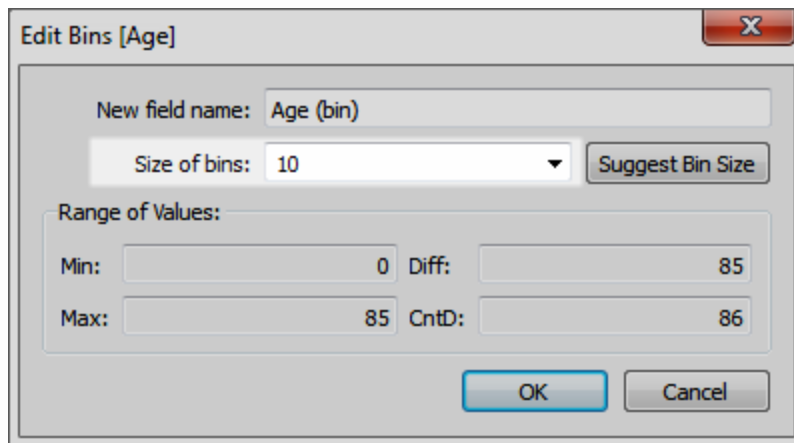

The screenshot shows the 'Edit Bins [Age]' dialog box. It has a title bar with a close button (X). The main area contains the following fields and controls:

- 'New field name:' text box containing 'Age (bin)'
- 'Size of bins:' dropdown menu set to '10', with a 'Suggest Bin Size' button to its right.
- 'Range of Values:' section with four input fields:
 - 'Min:' set to '0'
 - 'Diff:' set to '85'
 - 'Max:' set to '85'
 - 'CntD:' set to '86'
- 'OK' and 'Cancel' buttons at the bottom.

5. Drag the bin you just created to the Rows shelf.

Columns	
Rows	
	Age (bin)
0	Abc
10	Abc
20	Abc
30	Abc
40	Abc
50	Abc
60	Abc
70	Abc
80	Abc

6. Select **Analysis > Create a Calculated Field**, and then do the following:
 - Enter a name for the calculation. For this example, enter **Male Population**.
 - Enter a formula similar to the following to isolate the male constituent from population:

```
IF [Gender] = 1 THEN [ESTBASE2010] END
```

In this case, the census data has defined the Gender value for male as "1." The field "ESTBASE2010" contains estimated population values.
7. Similar to the step 5, select **Analysis > Create a Calculated Field**, and then do the following:
 - Enter a name for the calculation. For this example, enter **Female Population**.
 - Enter a formula similar to the following to isolate the female constituent from population:

```
IF [Gender] = 2 THEN [ESTBASE2010] END
```

In this case, the census data has defined the Gender value for female as "2." The field "ESTBASE2010" contains estimated population values.
8. Drag the calculated fields you created to the Columns shelf and the **Gender** field to the Color shelf.

Note: To change the color assignments, click the Color shelf and then click **Edit Colors**.

- Right-click the axis for Male Population, select **Edit Axis**, and then select the check box for **Reversed** to reverse the order the values display on the axis, and then click **OK**.

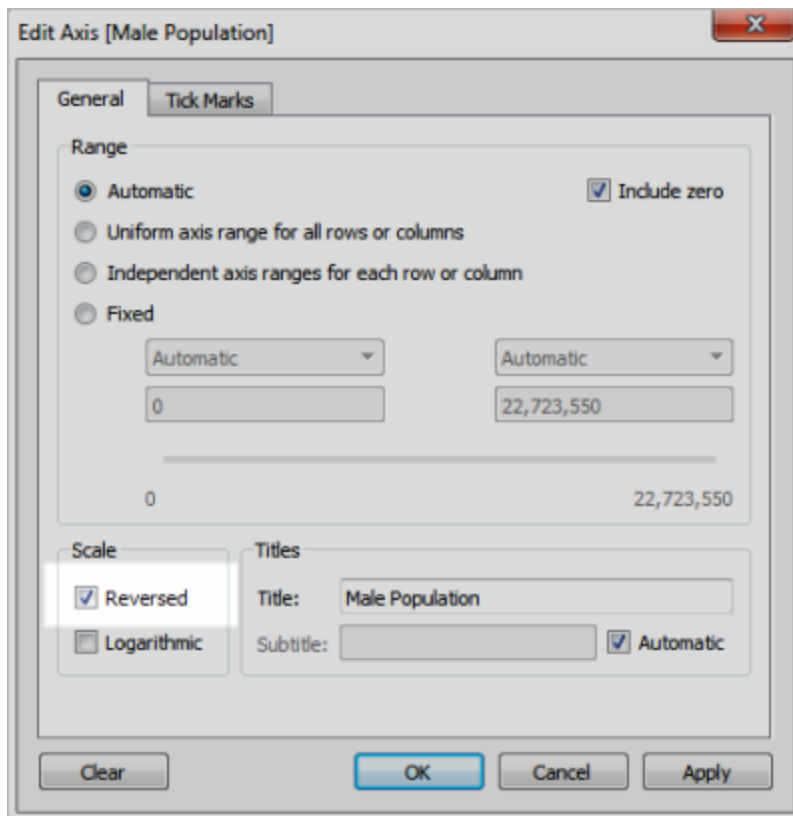

After changing the sort order of the bin, the population pyramid looks like the following:

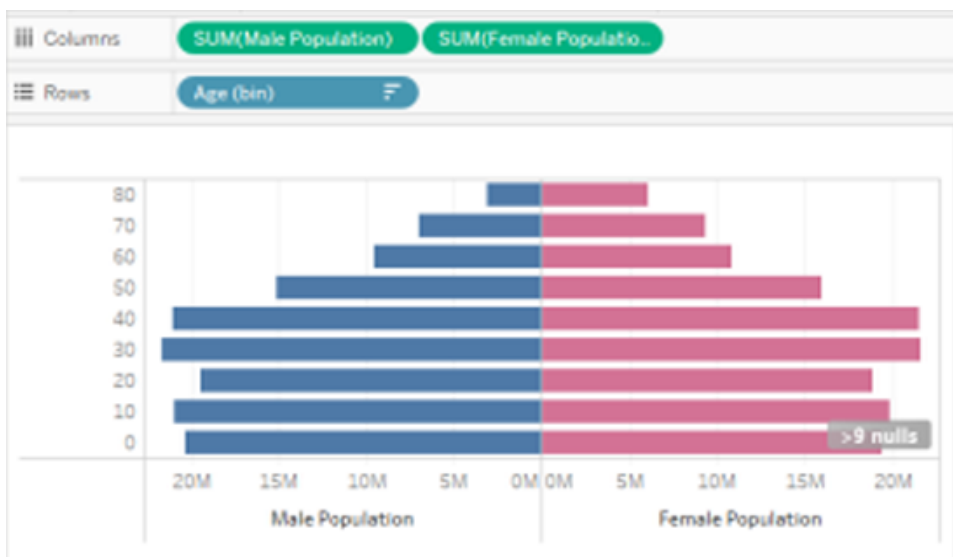

Create a Co-Occurrence Visualization Using a Parameter and a Set

You can create co-occurrence visualizations in Tableau. With a co-occurrence visualization, users can pick one field value and then see which other fields values it co-occurs with, and how often. One practical application of such analysis is a market basket analysis, which you can use to discover and understand customer purchasing behavior. You can use a market basket analysis to answer questions like the following:

- How many people bought both Product A and Product B?
- What other products do people who purchased Product A generally buy?
- Which other courses do students who enrolled in Course A frequently enroll in?

Follow the steps in this article to create a co-occurrence visualization (in this case, a market basket analysis view) using a parameter, calculated fields, and a set. At a high level, the steps involved are:

1. Create a parameter that you will use to dynamically modify the view based on the item you select.
2. Create calculated fields that you will use to return which items are also ordered when a particular item is ordered.
3. Create a set to determine whether an order has the item that was selected in the parameter control.
4. Build the view to display which items are also contained in an order with the selected item.

The scenario uses the **Sample - Superstore** data source provided with Tableau Desktop. The details are covered in the following sections.

Create a Parameter

Follow these steps to create a parameter and then display a parameter control that users can use to pick a **Sub-Category** value.

1. Connect to the **Sample - Superstore** data source.
2. Right-click (control-click on a Mac) in the **Data** pane and select **Create > Parameter**.
3. In the Create Parameter dialog box, do the following:

- a. Name the parameter **Order Contains**.
 - b. For the **Data Type**, choose **String**.
 - c. For **Allowable Values**, choose **List**.
 - d. In the **List of values** section click **Add from Field > Sub-Category**.
 - e. Click **OK**.
4. Right-click the **Order Contains** parameter in the Data pane and choose **Show Parameter Control**.

Create Calculated Fields

Follow these steps to create the calculated fields that you will use to show which items are also ordered when the item selected by the user (via the parameter control) is ordered.

1. Create a calculated field to identify products that the order also contains (in addition to the one that the user selects).

Choose **Analysis > Create Calculated Field** to open the calculation editor. Name the calculated field **Then Order Also Contains** and type or paste the following in the formula area:

```
IF [Sub-Category] <> [Order Contains] THEN [Sub-Category] END
```

You may have to replace `<>` with `<>` after you paste.

2. Create another calculated field to identify matching products.

Name the field **Product Matches** and type or paste the following in the formula area:

```
IF [Sub-Category] = [Order Contains] THEN 1 END
```

Create a Set

1. Now create a set to determine whether an order has the item that was selected in the parameter control.
2. Hover the cursor over the **Order ID** dimension in the Data pane, click the down arrow at the right end of the field, and choose **Create > Set**.

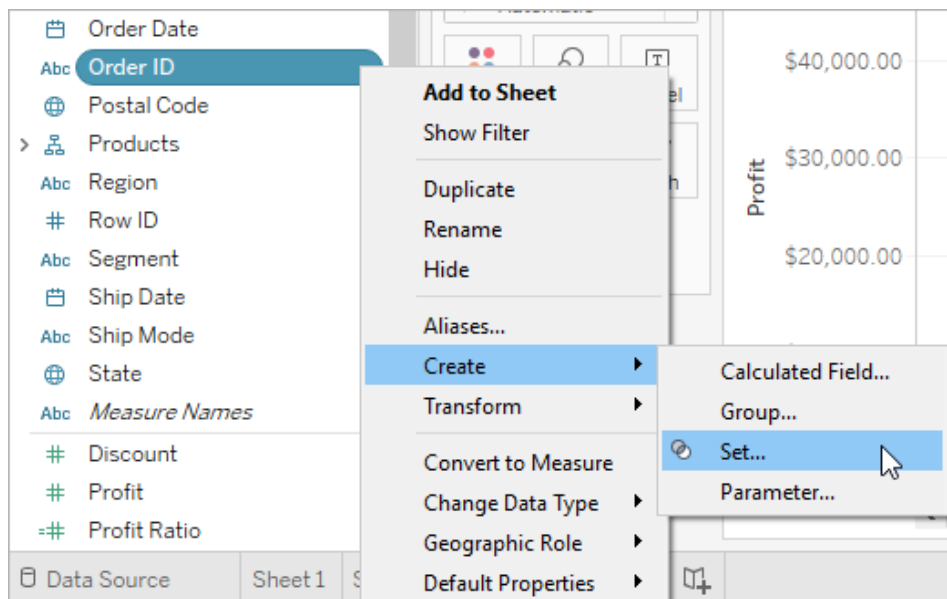

3. In the Create Set dialog box, type **Order Has Selected Product** in the **Name** text box.
4. Go to the Condition tab, select **By field**, and in the drop-down lists make the following selections and entries to build the condition:
 - a. In the first drop-down list, select **Product Matches**.
 - b. In the second drop-down list, select **Sum**.
 - c. In the next drop-down list, select **>=**.
 - d. In the last text box, type **1**.
 - e. Click **OK**.
5. Click **OK**.

Build the View

Finally, build the view to display which items are also contained in an order with the selected item.

1. Drag **Then Order Also Contains** to **Columns**.
2. Drag **Order ID** to **Rows**.
In the warning dialog box, click **Add all members**.
3. Click the **Order ID** field on Rows and choose **Measure > Count (Distinct)** to change the aggregation.
4. Right-click (control-click on a Mac) the Null bar on the x-axis and choose **Exclude**.
5. Drag the **Order Has Selected Product** set to the **Filters** shelf.
6. Press **Ctrl+W** to swap the fields on Rows and Columns.

You (or your users) can now use the **Order Contains** parameter control to select an item in an order, and then see a bar chart showing which other items are also included in orders with the selected item.

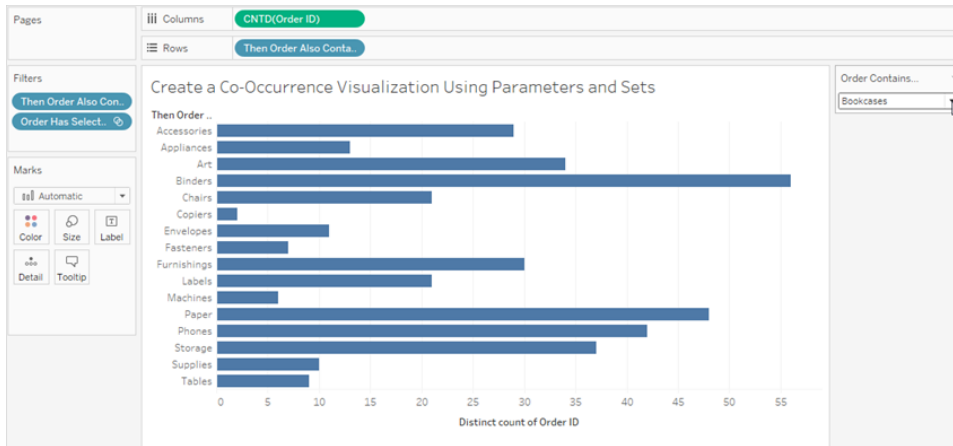

Visualize Benford's Law

Benford's Law is a mathematical law that states that the leading, or left-most, digit in many real-life data sources is distributed in a very specific manner. Specifically, the number 1 occurs as the leading digit about 30% of the time, and as numbers get larger they occur less frequently, with the number 9 occurring less than 5% of the time. When fraudsters are fabricating data, they may not know to create fake data that conforms to Benford's law, and in some cases this makes it possible to detect fake data or at least to create doubt about its veracity.

This article describes how to apply Benford's Law to Sales data, using the **Sample - Superstore** data source provided with Tableau Desktop.

The process requires you to do the following:

1. Create calculated fields to use in your view.
2. Set up the view.

The following sections break these procedures down into specific instructions.

Create calculated fields to use in your view

1. In the **Analysis** menu, select **Create Calculated Field** to open the calculation editor. Name the calculation **Leftmost Integer** and type or paste the following in the formula area:

```
LEFT (STR ([Sales]), 1)
```

2. Create a second calculated field and name it **Benfords Law**. Type or paste the following in the formula area:

```
LOG(INT([Leftmost Integer])+1)-LOG(INT([Leftmost Integer]))
```

Set up the view

1. From the **Data** pane, drag **Leftmost Integer** to **Columns**, and then drag **Orders(Count)** to **Rows**.
2. Click **CNT(Orders)** on Rows and choose **Quick Table Calculation > Percent of Total**.

Your view now shows the distribution of first digits, and the size of the bars (decreasing from left to right) suggests that the data in this case conforms to Benford's law. But we can do more to frame the data by adding reference distributions.

3. From the **Data** pane, drag **Benfords Law** to Detail on the Marks card. Click **Benfords Law** on the Marks card and select **Measure > Minimum**.
4. Switch from the **Data** pane to the **Analytics** pane and drag **Distribution Band** into the view. Drop it on **Cell**.

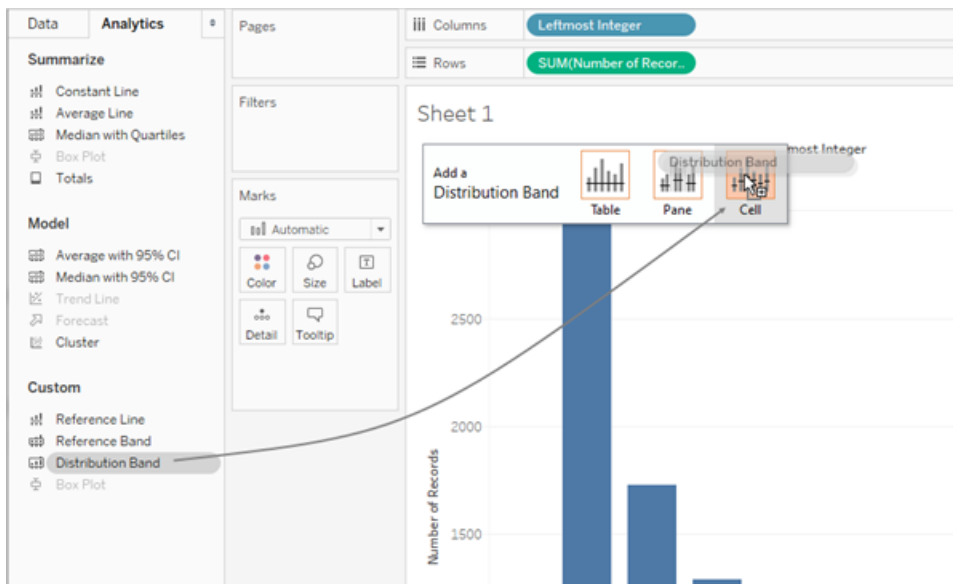

Note: Distribution Bands are supported on web platforms starting with Tableau 10.2.

5. In the Edit Reference Line, Band, or Box dialog box, do the following:
 - a. Click in the Value field to view an additional set of options:

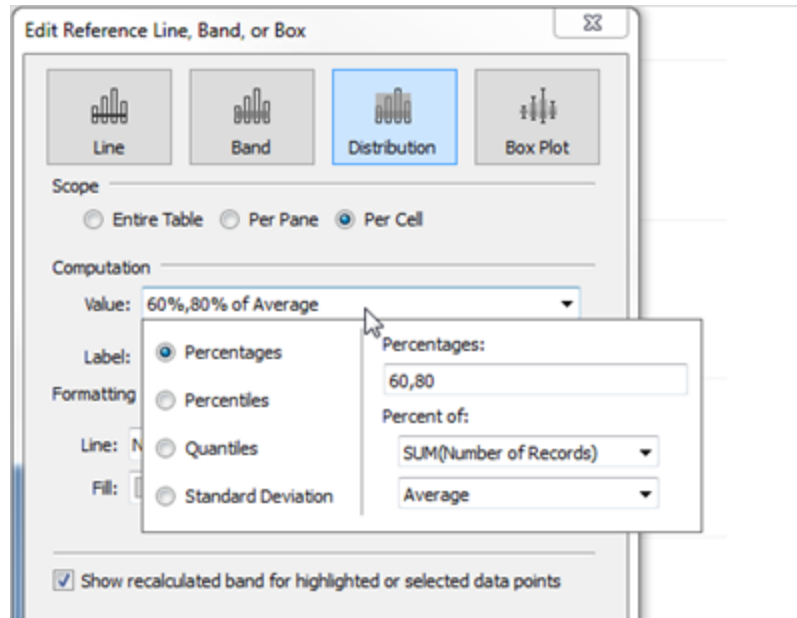

- b. In the Percentages area, type 80, 100, 120.

This specifies that you want bands spanning from 80 to 100 percent, and from 100 to 120 percent. Next you will specify what value the percentages are referencing.

- c. In the **Percent of** field, choose **MIN(Benfords Law)**.

The Value field should now read 80%, 100%, 120% of Average Min. Benfords Law.

The remaining steps configure the appearance of the reference bands:

- d. Set **Label** to **None**.
 - e. Set **Line** to the thinnest available line.
 - f. Choose **Fill Below**.
 - g. From **Fill**, select **Stoplight**.
 - h. Click **OK** to exit the Edit Reference Line, Band, or Box dialog box.

6. Click the toolbar button to display mark labels: 

The finished view should look like this:

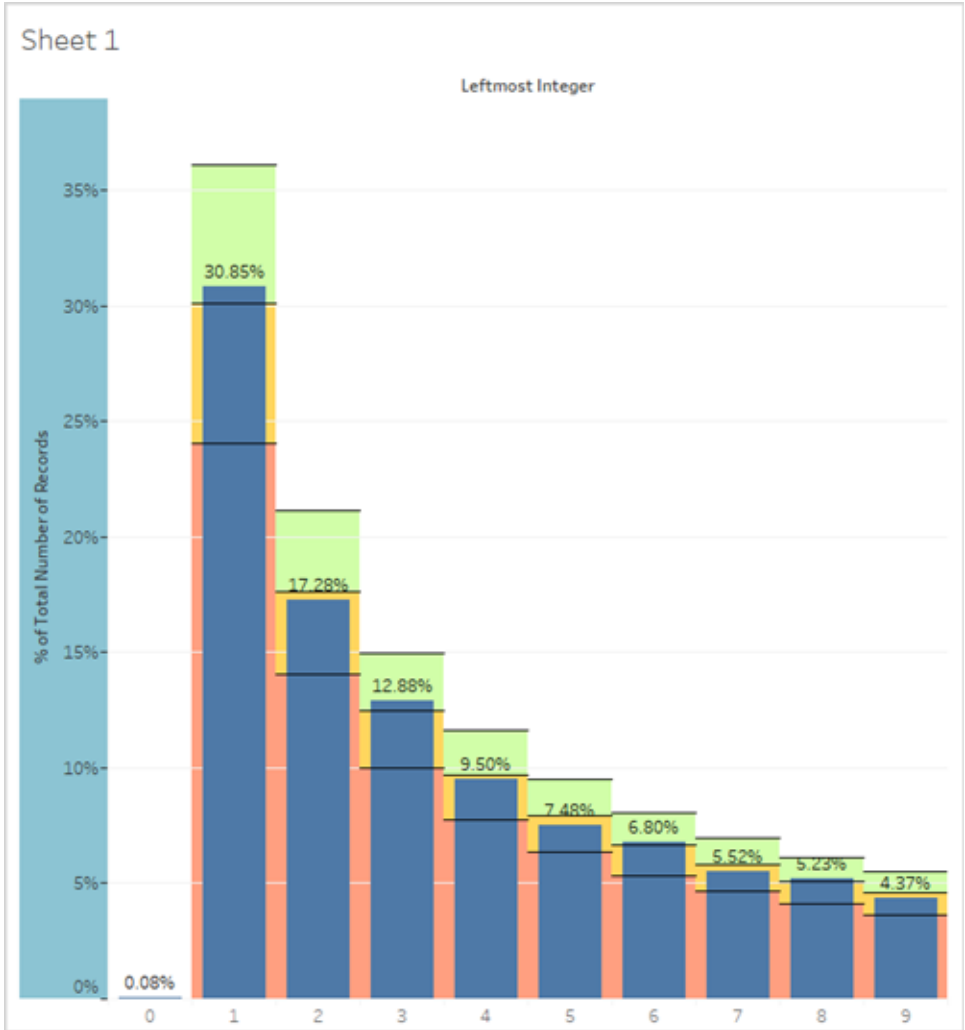

Even though Superstore is demo data, it's realistic as far as conforming to Benford's law. The blue bars that indicate actual percentages of initial digits align very well with the 100% value (that is, the line that separates the green zone from the yellow zone in the distribution bands) that shows expected Benford values in the view.

Create Bins from a Continuous Measure

Sometimes it's useful to convert a continuous measure (or a numeric dimension) into bins.

Any discrete field in Tableau can be considered as a set of bins. For example, suppose you create a view with **Profit** on **Rows** and **State** on **Columns**. You could consider the **State** field as a set of bins—each profit value is sorted into a bin corresponding to the state from which the value was recorded. But if you want to see values for **Profit** assigned to bins without reference to

a dimension, you can create a numeric bin, with each individual bin corresponding to a range of values.

Note: You can bin data only for relational data sources and binned fields cannot be used in calculations. However, it is possible to create a calculated field that will replicate a bin of a specific size. For example: $(\text{FLOOR}([\text{Sales}]/1000) * 1000)$ will create bins with a size of 1000 that can be used with cube data sources and calculated fields.

When you create bins from a measure you create a new dimension. That's because you are creating a field with a limited and discrete set of possible values out of a field with an unlimited, continuous range of values. However, once the dimension is created, you can convert it to a continuous dimension. This can be useful, for example, if you want to create a histogram. See [Create a Histogram from a Binned Dimension](#) on page 1600.

Create a Binned Dimension:

1. In the **Data** pane, right-click (control-click on Mac) a measure and select **Create > Bins**.

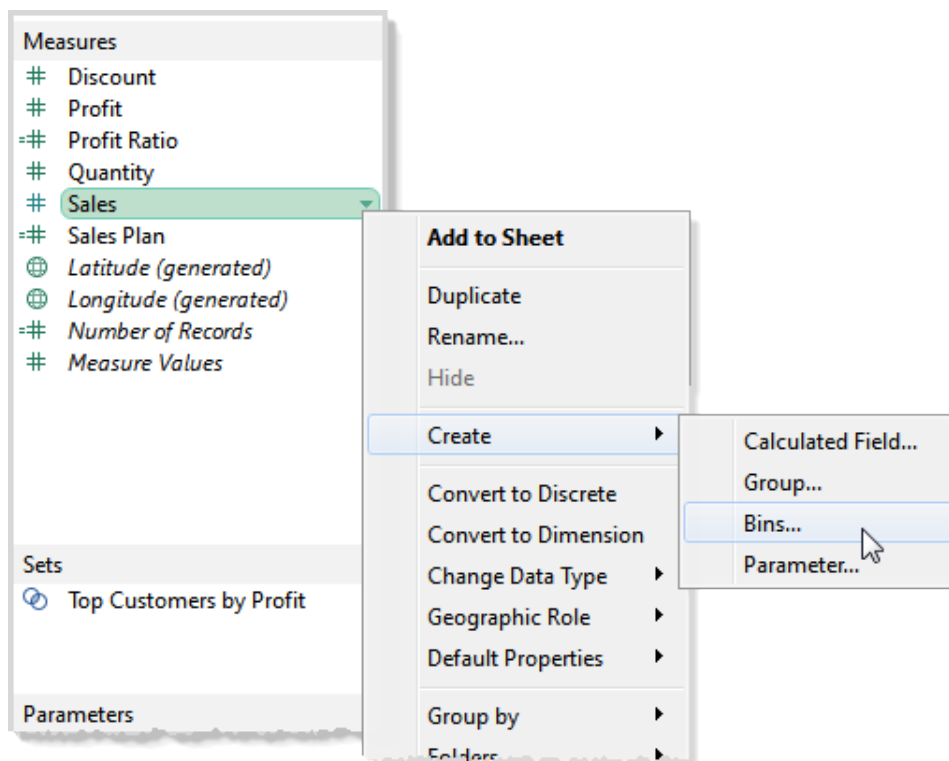

2. In the Create Bins dialog box, accept the proposed New field name or specify a different name for the new field.

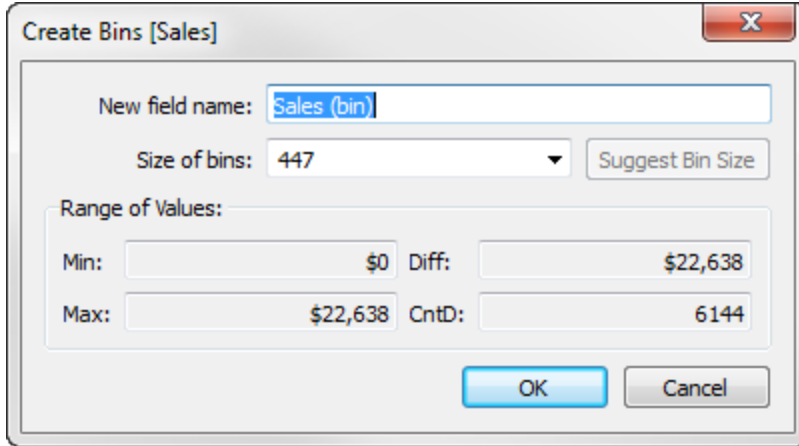

On the web, the dialog box is named Edit Bins and has a slightly different appearance, but the options are the same.

3. Either enter a value in the **Size of bins** field or have Tableau calculate a value for you.
 - If Tableau can perform the optimizing calculation quickly enough, the value you see initially in **Size of bins** is Tableau's estimate of the optimal bin size.
 - If Tableau cannot perform the optimizing calculation quickly, the **Size of bins** field defaults to 10. In this case you can click **Suggest Bin Size** to have Tableau perform the optimizing calculation. The formula that Tableau uses to calculate an optimal bin size is $\text{Number of Bins} = 3 + \log_2(n) * \log(n)$.

In the formula, n is the number of distinct rows in the table. The size of each bin is determined by dividing the difference between the smallest and the largest values by the number of bins.

The four read-only fields in the lower part of the Create Bins dialog box show you the data that Tableau uses to suggest a bin size. You can also consider these values if you want to set a bin size manually. The values are:

Min	The field's minimum value.
Max	The field's maximum value.
Diff	The difference between the field's minimum and maximum values.
CntD	The number of distinct values (rows) in the data.

After you click **OK** to dismiss the Create Bins dialog box, a new binned field appears in the **Data** pane.

When you add a binned dimension to the view, each bin acts as an equal-sized container that summarizes data for a specific range of values. Column or row headers are created, where each bin label designates the lower limit of the range of numbers that is assigned to the bin. Note that the lower limit is inclusive.

Create a Histogram from a Binned Dimension

If you create a binned dimension, you can use it as the starting point for creating a histogram. Using the **Sales (bin)** dimension created according to the instructions above, use the following steps to create a histogram.

Note: A quicker way to create a histogram is using Show Me. See [Build a Histogram on page 1518](#) in the Build-It-Yourself Exercises section for information on creating a histogram using Show Me.

1. Click the **Sales (bin)** dimension in the Data pane and choose **Convert to continuous**.
2. Drag the **Sales (bin)** dimension from the Data pane and drop it on the **Columns** shelf.
3. Drag the original **Sales** field from the Data pane and drop it on the **Rows** shelf.
4. Click **SUM(Sales)** on **Rows** and change the aggregation from Sum to Count.

The result is a histogram:

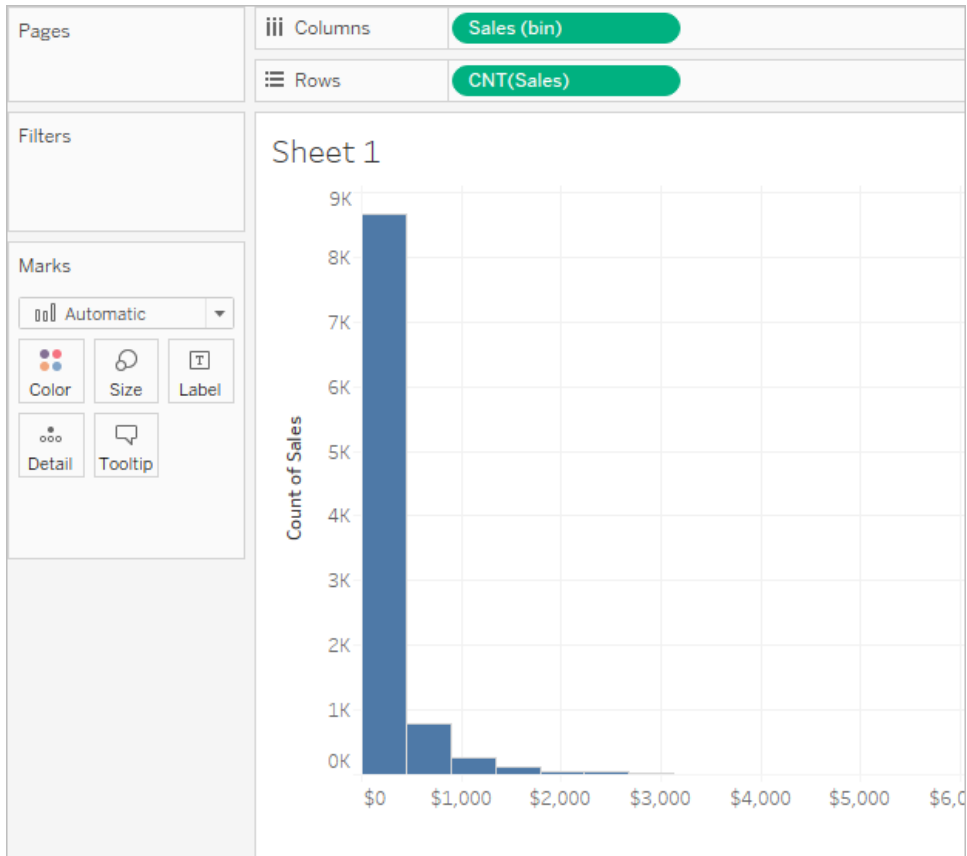

Build Data Views for Accessibility

If you want to make your views accessible to as many people as possible, or if you work in an environment that is subject to US Section 508 requirements, other accessibility-related laws and regulations, you can use Tableau to build data views that help you align to the Web Content Accessibility guidelines (WCAG 2.1 AA). This includes building views that are accessible to users who use screen readers, braille keyboards, keyboard-only navigation, and so on.

View controls that support accessibility

You can use Tableau Desktop to create an accessible view that includes elements that align with Web Content Accessibility guidelines (WCAG 2.1 AA), and then publish and embed that view in a web page that similarly aligns with WCAG 2.1 AA.

The example below shows a view with a scatter plot chart and includes various elements that improve accessibility. For more details, see [Best Practices for Designing Accessible Views](#) on page 1603 and [Author Views for Accessibility](#) on page 1610.



Title (1), single and multi-value filters (2), categorical legends (3), captions (4), tabs (5), alt text for vizzes (6), Color Blind palette (7), View Data window (8).

Note: The color blind palette can help you select colors that can be recognized by users with visual impairments. When you assign colors to different dimension values make sure that they provide enough contrast and aren't too close to each other on the light-dark spectrum.

Additional support for accessible views

In addition to the controls shown in the illustration, Tableau also supports the following features to help you create accessible views:

- Keyboard navigation
- Programmatic context for assistive technologies (using ARIA roles)
- A text equivalent for charts and visualizations
- Compliance with contrast standards

- Authentication when signing in to Tableau Server for embedded views
- Alt text for visualizations (Tableau Cloud version 23.2 and later)

Note: If you use a data source that requires authentication, you can embed the credentials for the data source when you publish to prevent the authentication page from showing and make it more accessible. For information about how to embed credentials for the data source, see [Set Credentials for Accessing Your Published Data on page 3151](#), "Set the authentication type," Embedded password section.

Additional resources

The following external resources can help you when designing your views for accessibility.

- [Web Content Accessibility Guidelines \(WCAG 2.1\)](#)
- [Color Contrast Tips and Tools](#)
- [Color Contrast Analyzer](#)

Disclaimer: Although we make every effort to ensure these links to external websites are accurate, up to date, and relevant, Tableau cannot take responsibility for the accuracy or freshness of pages maintained by external providers. Contact the external site for answers to questions regarding its content.

For information, guidelines and examples about how to create accessible views, refer to the following topics in this section.

Best Practices for Designing Accessible Views

You created a great view, and you want to make it more accessible to make sure that all of your users can see and understand the data that you've put together.

Tableau supports several controls to enable you to build accessible views and help you align with US Section 508 requirements and the Web Content Accessibility guidelines (WCAG 2.1 AA).

Ensure that content shared from Tableau Cloud or Tableau Server follows the steps in [Author Views for Accessibility on page 1610](#) and aligns with the following WCAG 2.1 AA principles:

- **Perceivable** - Information and user interface components must be presented to users in a way that they can perceive. Consider including text alternatives and alternate ways to present the content.

- **Operable** - The user interface components and navigation must be accessible to users from the different devices or methods that they use to interact with the view.
- **Understandable** -The information presented in the view must be understandable to your users. For example, using clearly distinguishable names and labels for different elements shown in your view.

Follow the best practices described in this article and incorporate the steps described in [Author Views for Accessibility on page 1610](#) to build views that are accessible to all of your users when published on Tableau Server or Tableau Cloud.

Keep it simple

WCAG 2.1 AA principle: Understandable

You might have a lot of information that you want to communicate with your view. However, dense views can be difficult to understand or navigate using a screen reader or keyboard. Use the following guidelines to help you communicate everything that you want to without overwhelming your users with an over-packed view.

- Aggregate your data whenever possible to help reduce the number of marks you're showing. Also, showing more than 1000 marks in the view can cause the view to be rendered by the server instead of the browser and server-rendered views aren't yet supported for WCAG alignment.

Users can also access the **View Data** page (enabled by default) to review the underlying data for the marks or can download the data from that page to an accessible application to view it that way.

Example: This example shows two different bar chart views to illustrate the difference between a detailed and aggregated view.

Not easily accessible - Too many marks More accessible - Aggregated view

Tableau Desktop and Web Authoring Help

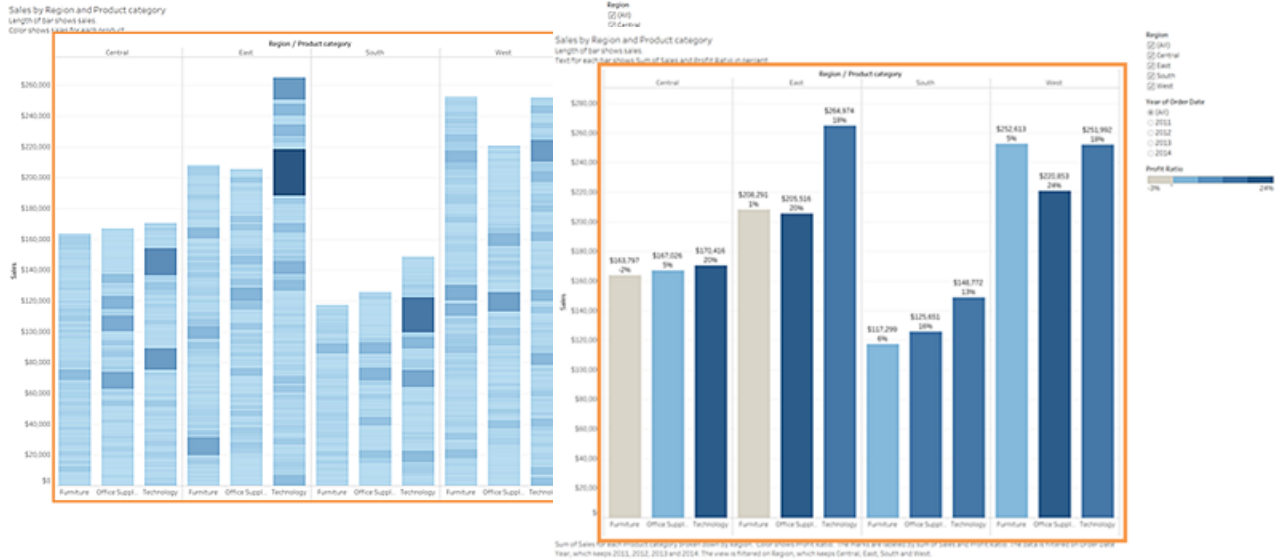

- This much detail makes the view harder to understand.
- The view is showing over 5000 marks and doesn't include enough text to indicate what the different marks represent.
- It's too difficult to use for users who need screen readers.

- This example shows the same view with the data aggregated at a higher level.
- Key data points are still included, but they're now easier for users to read and understand.
- The number of marks is reduced from over 5000 to about 20.
- Users can still read the underlying details for the marks by placing focus on the view and then pressing **Enter** to open the **View Data** page.

- Consider using simple graphic elements like bar charts or line charts that allow you to use text, color, and shapes to add more context to the view.
- Limit the number of marks to only those that emphasize the most important data points.

For information and examples about how to build this type of view, see [Keep it simple](#) on page 1611 in [Author Views for Accessibility](#) on page 1610.

Titles and captions

WCAG 2.1 AA principle: Perceivable, Understandable

Providing good descriptive text in titles and captions provides context to users who are using assistive technology, and can help them understand the data in your view. Use the following guidelines to adapt the visual nature of Tableau to meet the needs of all of your users.

- Think about your views as a supplement to the text you use to describe it.
- Use text in titles and captions to describe your visualizations and what you are showing.
- Use simple, easy-to-understand language. Avoid jargon, acronyms, or abbreviations.
- Don't include words like "image of" or "picture of" in your text descriptions, because screen readers sometimes already include this information.
- Avoid using all capital letters (for example in headings or titles), because they can be difficult to read.

Example: This example shows two different bar charts. One using very little text and the other using titles and captions to add context

Not easily accessible - Too little text

More accessible - Adding descriptive text to provide context

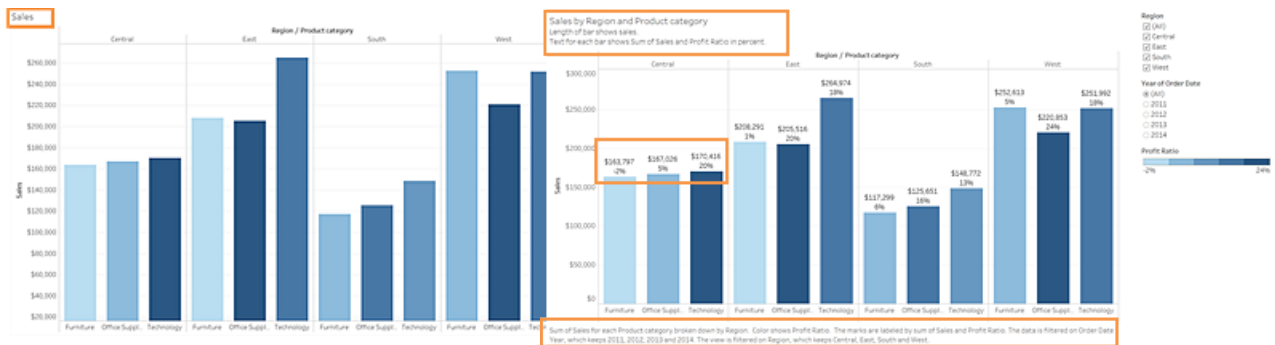

- A one-word title isn't descriptive enough.
- The marks are differentiated by color and size. But without additional text, the context for these marks can be difficult to

- This example shows the same view, but includes additional explanatory text in both the title and the caption.
- The same contrast color scale and size differentiators are used, but

understand.

- There's no caption or other explanatory text to help explain this view.

labels are added to the bar marks to give additional context.

For information and examples about how to build a view that includes text for context, see [Show more text and make it helpful](#) on page 1622 in [Author Views for Accessibility](#) on page 1610.

Additional text

WCAG 2.1 AA principle: Perceivable, Understandable

Using text beyond just titles and captions throughout your view can help users understand the context of the different elements that you're showing, as well as help describe the relationship between the different controls (such as legends and filters) and your data.

Use the following guidelines when adding additional text:

- Use text in headings on legends or filters to describe the control and what it does. You can also use text zones on a dashboard to add additional context for your visualizations to further describe what you are showing.
- Add alternative text (alt text) to visualizations. Tableau started automatically generating alt text for vizs in Tableau 23.1. In Tableau 23.2 and later, you can edit the auto-generated alt text to add additional context that you know is important to your audience.
- Refer to controls by label whenever possible. For example, changing the label for a legend from **Subcategory** to **Color key for product type** can help users understand the relationship between the controls and the data.
- If you include link text in your view, use text that describes where the link takes the user. For example, use link text like "Global Warming statistics for 1990-2000." Avoid wording like "Click here," "More," or "More information." These link text examples are too generic and can be confusing to users.
- **Example:** The following example shows two bubble charts. One view uses only the text that shows by default when creating a view and one view has additional text that adds context throughout the view to help convey meaning.

Not easily accessible - Too little text

More accessible - More descriptive text



- This view uses only default text for the sheet title and default labels for the filters and legend.
- The marks are differentiated by size and color only.
- There's no caption or other explanatory text included in the view to help provide context.
- This example shows the same view, but includes additional explanatory text.
- Additional text was added to the title and caption to explain the relationship of the marks and provide additional context about what the view is showing.
- Mark labels are added to show profit numbers so that users don't have to rely on the color only to understand this information.

For information and examples about how to build a view that includes additional text for context, see [Show more text and make it helpful](#) on page 1622 and [Author Views for Accessibility](#) on page 1610 in [Author Views for Accessibility](#) on page 1610.

Color and contrast

WCAG 2.1 AA principle: Perceivable, Understandable

You can use color to help distinguish marks in your view. However, for users with visual impairments, using color alone doesn't always provide enough of a distinction, especially when there are many marks in a view. Use the following guidelines when using color in your views:

- Tableau provides a color-blind palette that you can use to help you select appropriate colors for your view. For any color palette that you use, try to provide enough contrast and assign colors that differ from each other on the light-dark spectrum.
- For line marks, use additional options like shapes, size, and labels to help distinguish them.
- Use **contrast analyzer** tools to help select the best text colors and backgrounds with sufficient contrast ratios. Make sure that color contrast for text is strong and meets the contrast ratio standards of 4.5:1 (3:1 for large text).

Example: This example shows two line charts. One that uses color only to differentiate the lines and the other that uses more appropriate colors plus shapes to differentiate marks

Not easily accessible - Using only color to differentiate marks

More accessible - Using color and shape to differentiate marks

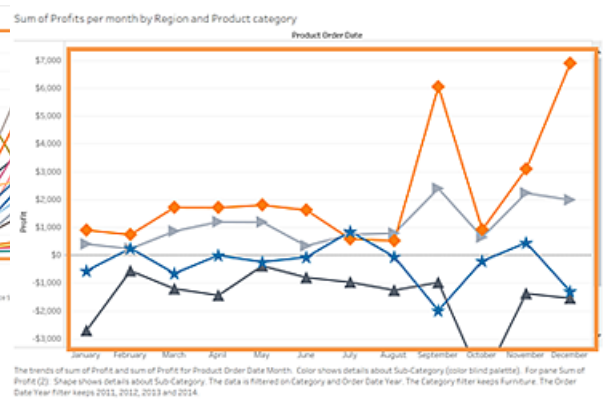
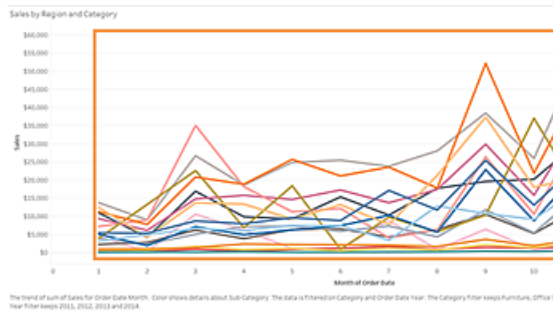

- This view uses only color to distinguish the lines from one another.
- The marks in the view aren't using a color-palette that is fully accessible to users with visual impairments.

- This example shows the same view, but uses both color and shape to identify the marks.
- A color legend and a shape legend with clear titles identify what the colors and shapes represent in the view.

For information and examples about how to build a view that uses color to help distinguish marks, see [Author Views for Accessibility](#) below in [Author Views for Accessibility](#) below.

Publishing your view

WCAG 2.1 AA principle: Perceivable, Operable, Understandable

To make your views available to your users, publish your view to Tableau Server or Tableau Cloud, in the toolbar menu, click **Share**/ Users can interact with the view and toolbar buttons using a screen reader or a keyboard. For more information, see [Keyboard Accessibility for Tableau Views](#) on page 3257.

For information about how to publish and embed workbooks, find the embed code to copy into your web pages, and turn off the toolbar, see [Publish and share the view](#) on page 1643 in [Author Views for Accessibility](#) below.

Author Views for Accessibility

This article provides more detail on the design guidelines discussed in [Best Practices for Designing Accessible Views](#) on page 1603, and steps on how to create these views in Tableau Desktop (version 10.2 and later).

General steps

As a content author, you can create views that help you align with Web Content Accessibility Guidelines (WCAG) following these general steps:

Step 1: Author views following accessibility best practices.

Step 2: Publish the views to Tableau Server or Tableau Cloud (version 10.2 and later).

Step 3: Share the link for users to access the content in Tableau Cloud or Tableau Server, or embed the views in a web page for users to access the content.

Creating views using best practices guidelines can make them more accessible; they're treated by screen readers as images with a title and a description. Users will be able to use keyboard navigation to open the View Data pane and access the underlying data for the view.

Building the views

Many of the principles that apply to creating effective views in Tableau also apply to creating accessible views. The main difference in creating accessible views is that you should always

provide other types of mark encoding when you use color in the view. You also want to use text more liberally in the view to provide context for the view and its marks.

Keep it simple

When creating accessible views, keep it simple. Simplicity helps people more easily see the relationships and intersections in your data.

How can you make a view more simple? Emphasize only the most relevant and important data. Reduce the marks in the view to only show what is needed. Limit the level of detail and granularity in the view to prevent cognitive overload.

When you design your views, keep in mind that your users will be accessing the underlying data in the view. The data you include in the view is what screen readers read when users access the underlying data in the Summary tab of the View Data pane.

Guidelines that support simplicity:

- [Limit the number of marks in the view](#)
- [Orient your views for legibility](#)
- [Limit the number of colors and shapes in a single view](#)
- [Use filters to reduce the number of marks in the view at a given time](#)

Limit the number of marks in the view

Keep the number of marks below 1,000 to ensure the view will be rendered in the browser and not on the server.

Note: Client-rendered views can be more accessible than server-rendered views. To ensure an embedded view is rendered in the browser, make sure the view has fewer than 1,000 marks, including items in legends and filters.

You can see the number of marks a view has when you're authoring the view in Tableau Desktop (bottom-left corner of the window).

Example of a view with too many marks

The following example shows a view with over 20,000 marks. The view shows a more granular level of detail in the data (versus aggregated). Multiple dimensions (Region, Category, Sub-Category) and measures (Sales, Profit, Profit per Order, and Profit Ratio) have been added to the view. Product Name is on Detail, which adds a mark for every product included in the data set.



Example of a view with fewer marks

The next example shows a more accessible view (fewer than 100 marks). The data is aggregated and shows a less granular level of detail in the data. Two dimensions (Region and Product Category) and one measure (Sales) are used in the view.

For more details about these concepts, see [Data Aggregation in Tableau](#) on page 171 and [How dimensions affect the level of detail in the view](#) on page 151.

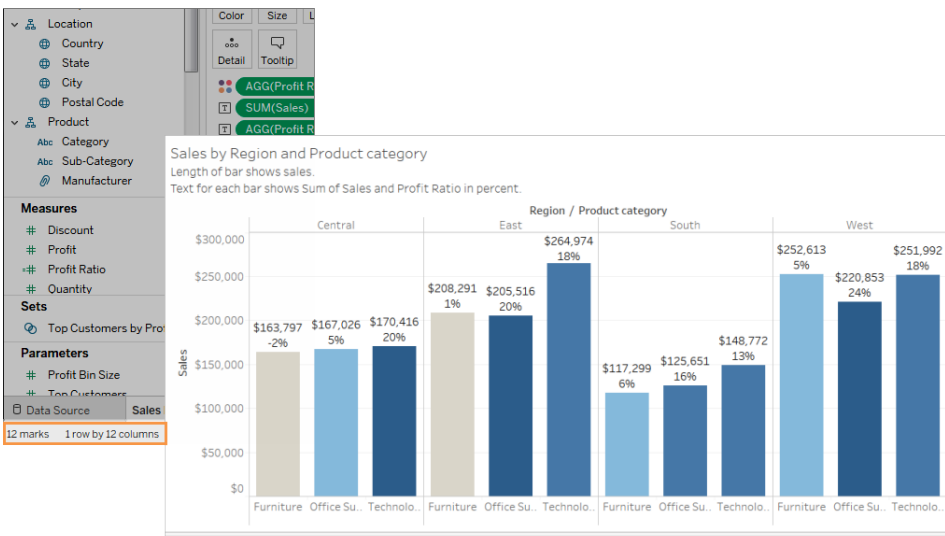

There are several ways you can limit the number of marks:

- Create views of aggregated data rather than showing more granular levels of detail in the view. Don't place dimensions that contain thousands of values on **Detail** in the Marks card.
- If you want to use a dimension that is in a hierarchy, but not make the hierarchy available in the view, use a copy of that particular dimension. Copy the field you want to use from the hierarchy and build the view with the copied version of the dimension.

Doing this prevents users from expanding the hierarchy in the embedded view, which might increase the number of marks in the view and result in the view being rendered on the server instead of the browser.

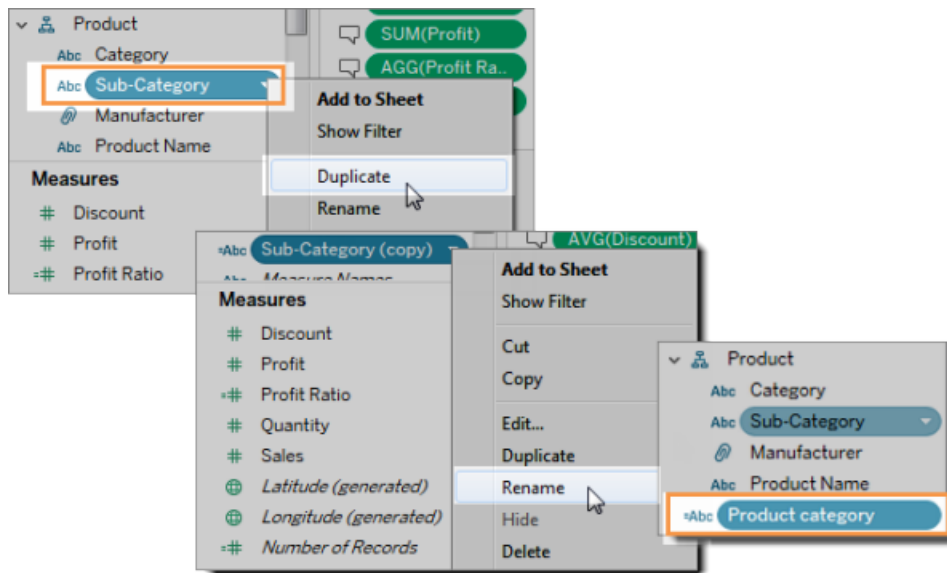

1. Right-click a dimension in the hierarchy, and then select **Duplicate**. A copy of the dimension appears.
 2. Right-click the copied dimension, and then select **Rename**. Give the copied dimension a unique, meaningful name. Now use that dimension to build the view.
- Limit the number of measures and dimensions used to create the view.

Less accessible: The next example shows a view with four measures on Rows and three dimensions on Columns. More fields create a more complex view.



More accessible: This view has two dimensions on Columns and one measure on Rows. Fewer fields in the view structure reduces cognitive overload.

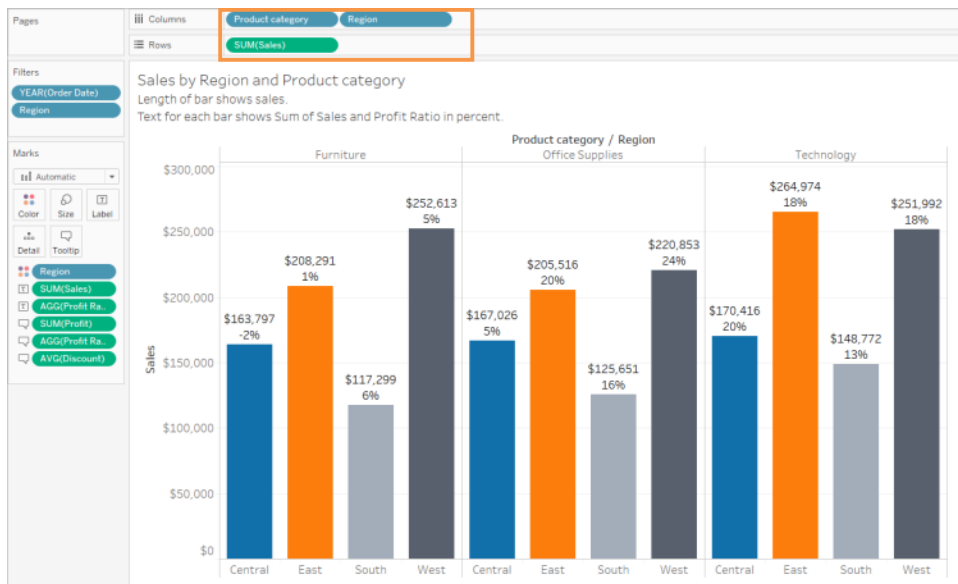

Orient your views for legibility

Horizontally oriented labels and headers are easier to read than vertically oriented labels.

Less accessible: In this example, the text is being displayed vertically.

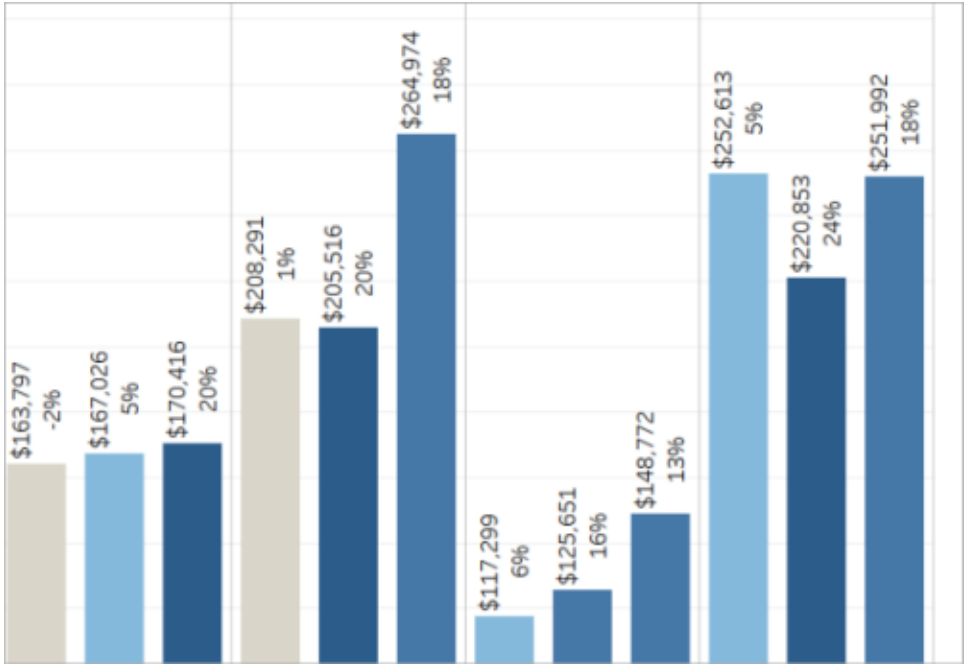

More accessible: In this example, space has been added to the view to allow the text to be displayed horizontally.

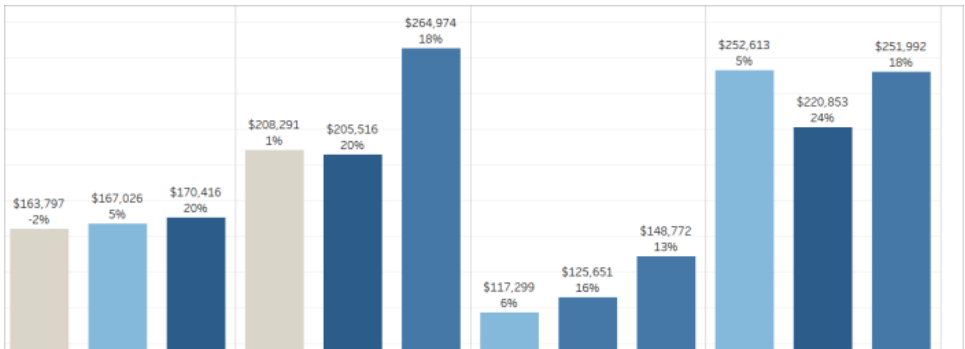

To change the orientation of the view and its headers and labels, you can click the **Swap** button on the toolbar, or you can resize the view to allow more room for horizontal labels. In this example, the table was resized. For details, see [Resize Tables and Cells](#) on page 3015.

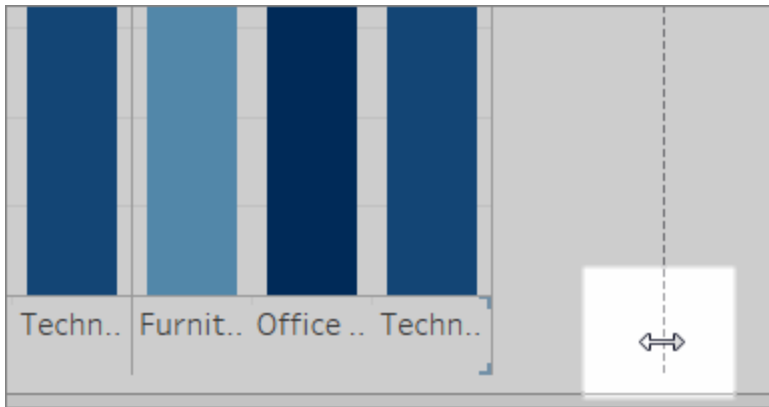

Limit the number of colors and shapes in a view

If you're showing a dimension on Color or Shape, don't use more than 10 colors and shapes in one view so that users can distinguish each color and shape and see important patterns.

Don't do this: In the following example, the line colors have started repeating after the 10th mark applied to Product type.

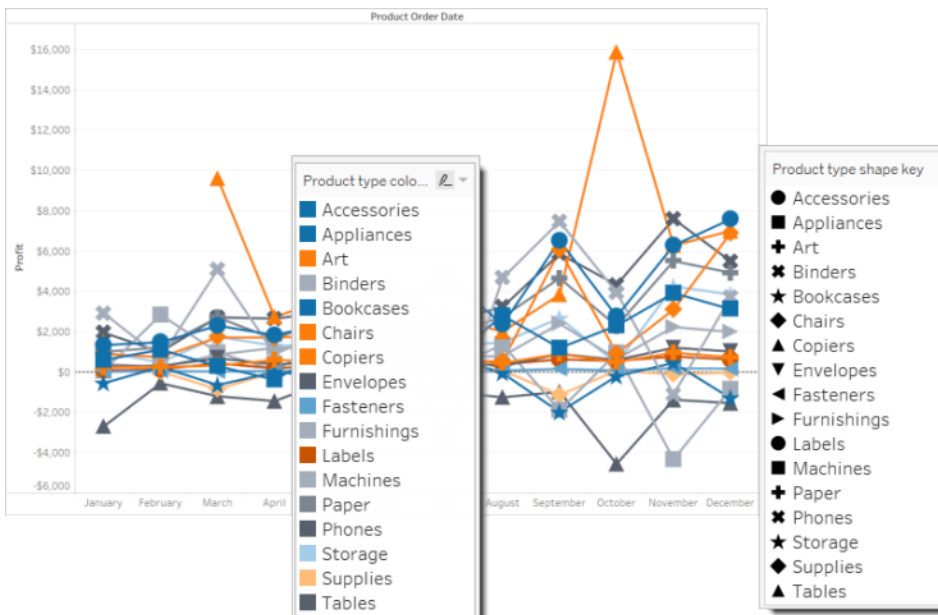

Do this: In the next example, filters have been used to limit the number of marks that can be shown at a time. As a result, the number of colors and shapes in the view is never more than ten.

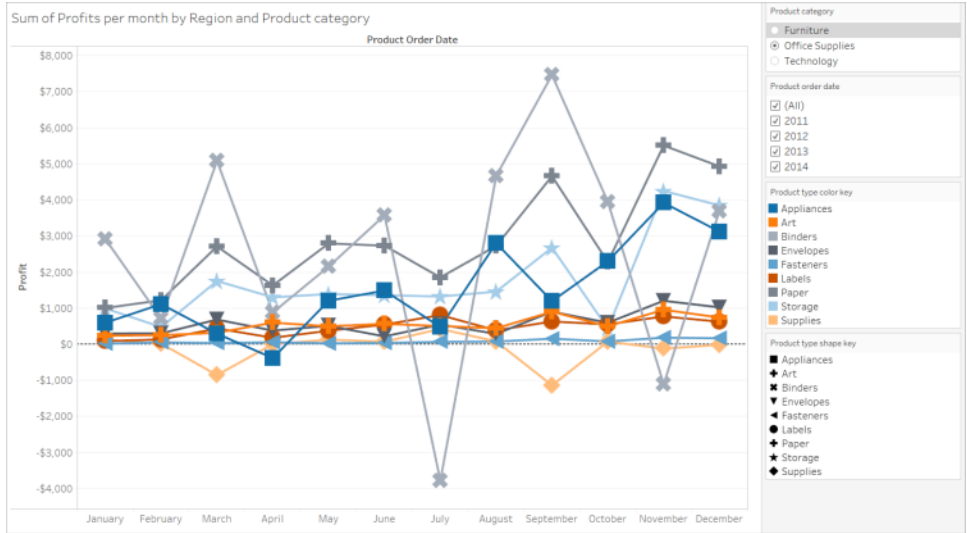

Use filters to reduce the number of marks in a view

Using filters helps to focus the number of marks in the view to only what you want users to see. For more details about creating filters, see [Filter Data from Your Views](#).

You can also show the following filter modes to allow users to control what data is in the view. The filter modes that support more accessible views in Tableau are:

- **Single Value (list):** a filter with radio buttons. Only one item can be selected at a time. Giving your users single-value filters is a great way to reduce the number of marks in the view.
- **Multiple Values (list):** a filter with a list of items (with check boxes) that can be selected at the same time. Multiple-value filters will allow more marks to be shown at the same time.

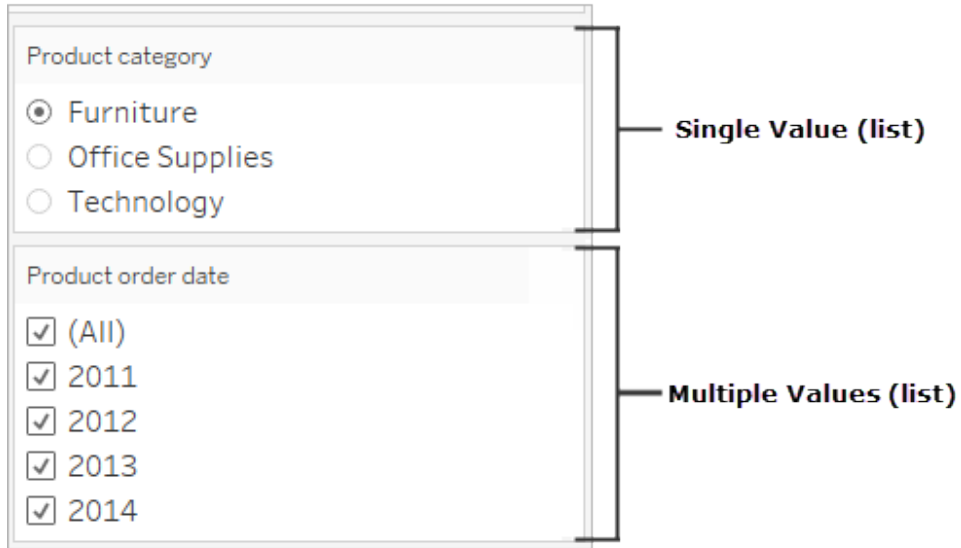

- **Single Value (dropdown):** a filter with a dropdown list of items. Only one item can be selected at a time. Giving your users single-value filters is a great way to reduce the number of marks in the view.
- **Multiple Values (dropdown):** a filter with a dropdown list of items that can be selected at the same time. Multiple-value filters allow more marks to be shown at the same time.

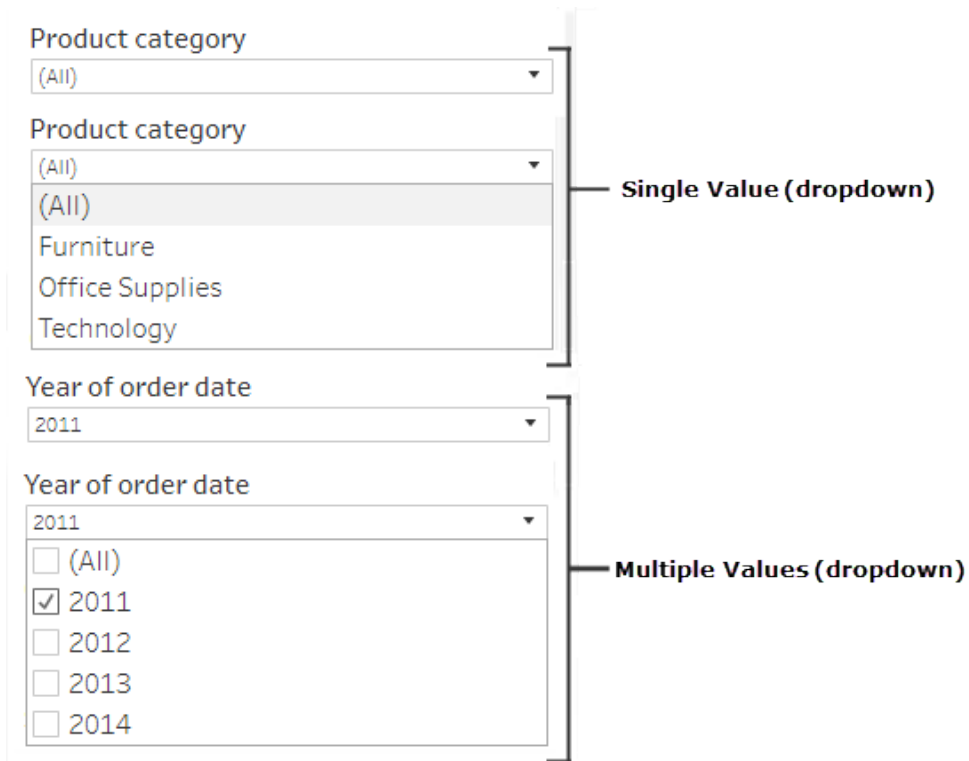

To show a filter, right-click the field you want to use as a filter, and then select **Show Filter**.

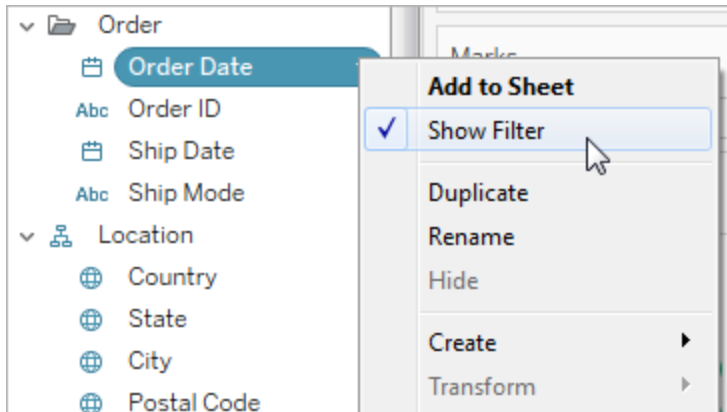

To select the filter mode, in the drop-down menu for a filter, select a **Single Value (list)**, **Single Value (dropdown)**, **Multiple Values (list)**, or **Multiple Values (dropdown)** filter.

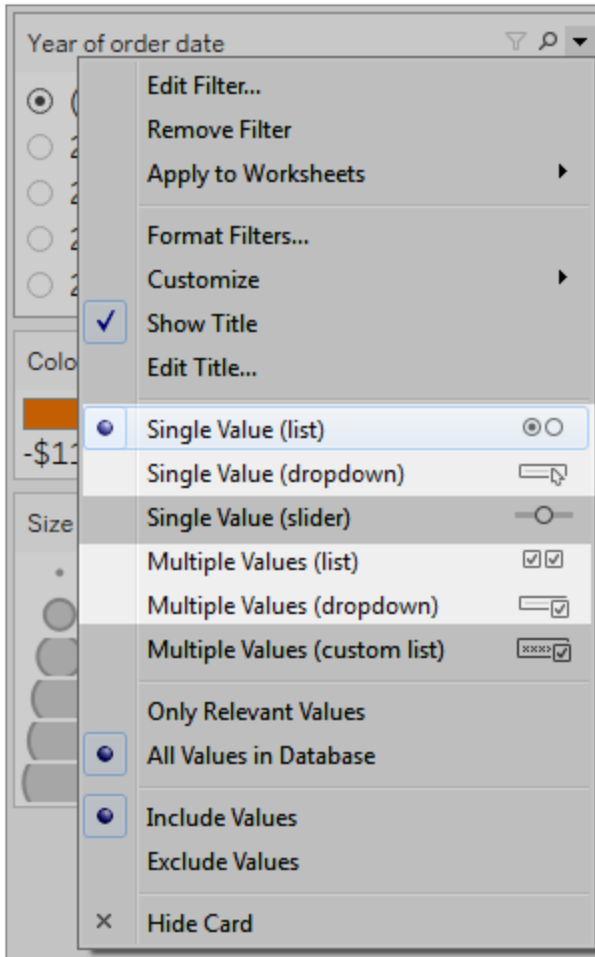

For a Single Value (list) or Single Value (dropdown filter), you can remove the **All** option from the filter. In the drop-down menu for the filter, select **Customize** and then clear the **Show "All" Value** option.

The following image shows the **Customize** option in a filter.

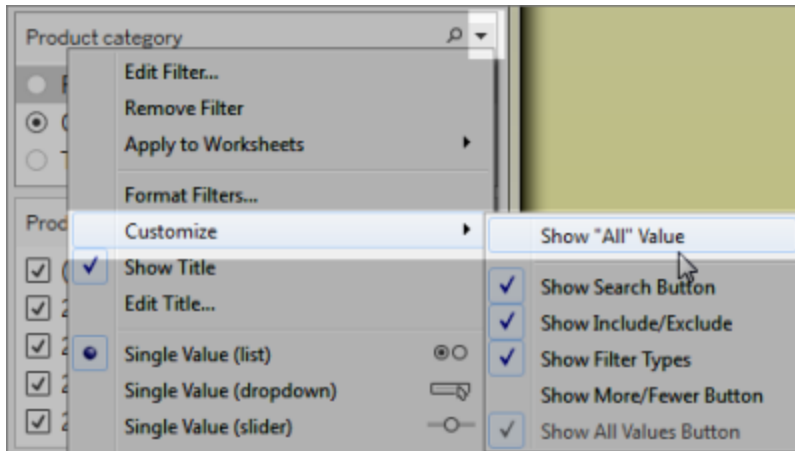

When you're using multiple filters in a worksheet, keep the following guidance in mind:

- When you're creating a view, test the browser zoom up to 200% to make sure all of the components in the view display as intended.
- Avoid positioning filters horizontally in a worksheet. In instances where the browser window isn't wide enough, components in the view (such as filters) will overlap with the visualization.
- Don't reposition the filters after you add them to the view. If you reposition the filters or change their order, the tab order may change.

This example shows a view with a **Single Value (list)** filter for the Product category and a **Multiple Values (list)** filter for Product order date. The **Single Value (list)** filter only allows one product type to be shown at a time (**All** is hidden).

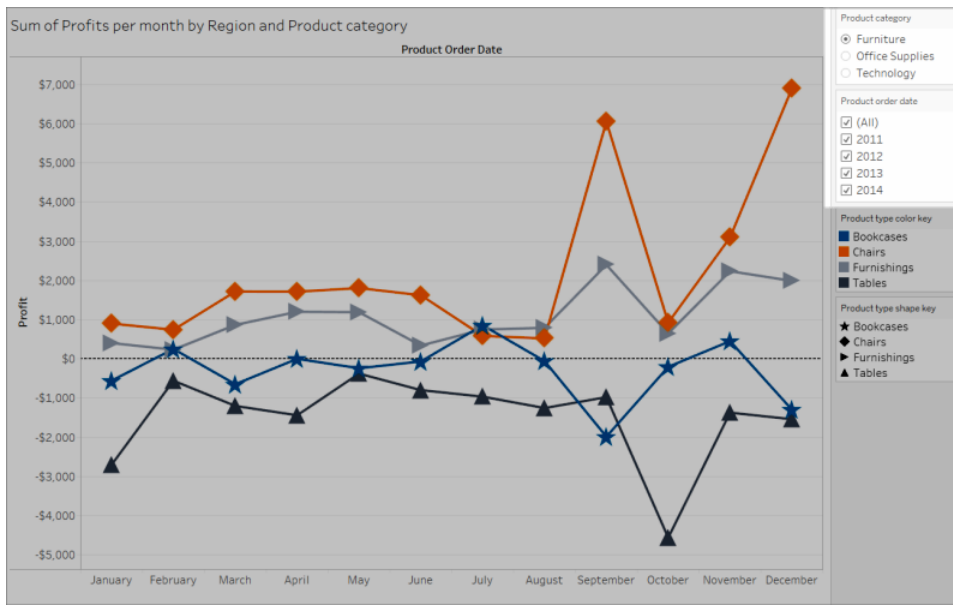

Show more text and make it helpful

In your views, make sure you show titles, captions, and mark labels. You can edit titles and captions to provide more context and details that help users understand the view.

- Be precise and consistent in how you name every object in the view.
- Provide text that explains how components of a visualization relate.
- Simplify text to remove redundancies.

You can also rename measures and dimensions in the Data pane to make sure field names in the view are meaningful.

Here are the different elements in a view that you can show and edit:

- **Titles (worksheet, filters, and legends).** Show titles for the worksheet, filters, and legends. The default title text is the sheet name or field name referenced by the filter or legend. You can edit any title to provide more context.
- **Captions (in worksheets).** Show the caption in the worksheet. The default caption text gives a summary of what is shown the view. You can add to this text to provide more context.
- **Labels (Marks card, Label button).** By default, labels aren't shown in a view, so you must select the option to show them.

Less accessible: This example shows a view with limited text. Many text elements aren't shown: the worksheet caption, mark labels, a descriptive title, and additional text about the view in the Title area. Also, the filter and legend titles haven't been edited to provide more context.



More accessible: This example shows the same view with multiple text elements shown to provide more detail and context. Titles and captions are shown in the worksheet. The worksheet title was edited to include text that describes how data is indicated in the view. The worksheet caption includes the default summary text that is automatically generated by Tableau. The legend titles have been edited to make more sense in this view. Mark labels show Profit values so that users don't have to rely only on seeing the color.



You also can build views that show only text, such as this example of a Text Table view that shows similar data.

Sales by Region, Product category, and Product type

Product category	Product type	Region			
		Central	East	South	West
Furniture	Bookcases	\$24,157	\$43,819	\$10,899	\$36,004
	Chairs	\$85,231	\$96,261	\$45,176	\$101,781
	Furnishings	\$15,254	\$29,071	\$17,307	\$30,073
	Tables	\$39,155	\$39,140	\$43,916	\$84,755
Office Supplies	Appliances	\$23,582	\$34,188	\$19,525	\$30,236
	Art	\$5,765	\$7,486	\$4,656	\$9,212
	Binders	\$56,923	\$53,498	\$37,030	\$55,961
	Envelopes	\$4,637	\$4,376	\$3,346	\$4,118
	Fasteners	\$778	\$820	\$503	\$923
	Labels	\$2,451	\$2,603	\$2,353	\$5,079
	Paper	\$17,492	\$20,173	\$14,151	\$26,664
	Storage	\$45,930	\$71,613	\$35,768	\$70,533
	Supplies	\$9,467	\$10,760	\$8,319	\$18,127
Technology	Accessories	\$33,956	\$45,033	\$27,277	\$61,114
	Copiers	\$37,260	\$53,219	\$9,300	\$49,749
	Machines	\$26,797	\$66,106	\$53,891	\$42,444
	Phones	\$72,403	\$100,615	\$58,304	\$98,684

Sum of Sales broken down by Region vs. Product category and Product type. The data is filtered on Order Date Year, which keeps 2011, 2012, 2013 and 2014. The view is filtered on Region, which keeps Central, East, South and West.

To show and edit titles and captions for the worksheet

1. Select **Worksheet > Show Title**, and then select **Worksheet > Show Caption**.

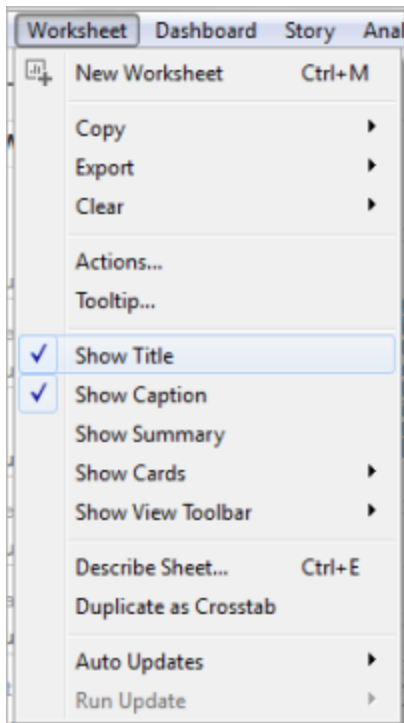

2. In the Title box at the top of the view, click the drop-down menu, and then click **Edit title**.

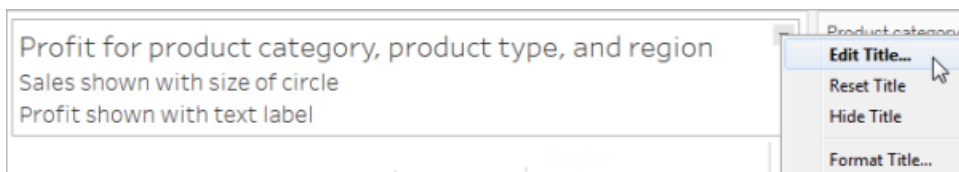

Type text in the text area and format it, and then click **OK**. You can add text in addition to markup text, or replace the markup text.

3. In the Caption box, click the drop-down menu, and then click **Edit caption**.

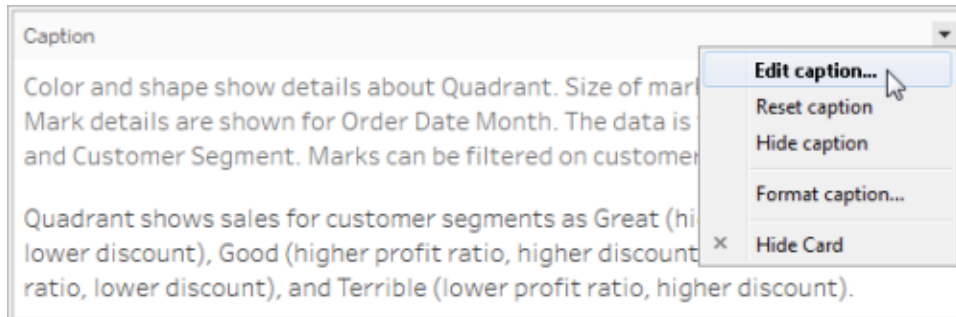

Type text in the text area and format the text, click the drop-down menu, and then click **OK**. You can add text in addition to the default text, or replace the default text.

To show mark labels in the view

- Click **Label** in the Marks card, and then click **Show mark labels**.

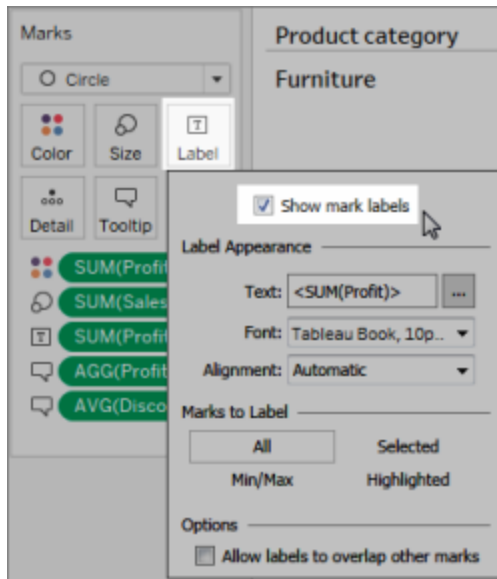

To edit field names in the Data pane

1. Right-click the dimension or measure, and then click **Rename**.

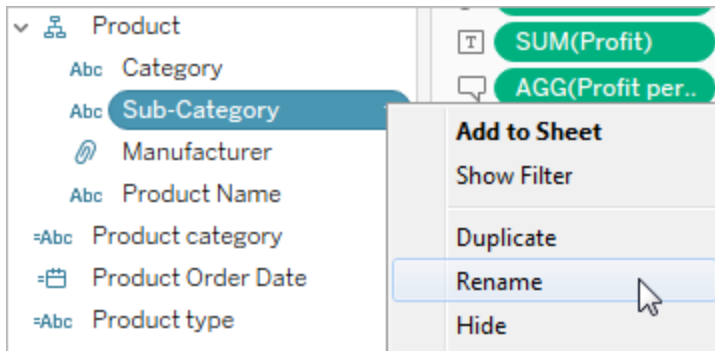

2. Edit the name, and then press **Enter**.

For more details, see [Rename fields](#).

To edit filter or legend titles

The text associated with legends and filters should clearly describe their purpose. Edit titles for filters and legends to indicate function. Refer to filters by name in any instructions that you provide in the worksheet title or caption.

1. Click the drop-down menu for the filter, and then click **Edit Title**.

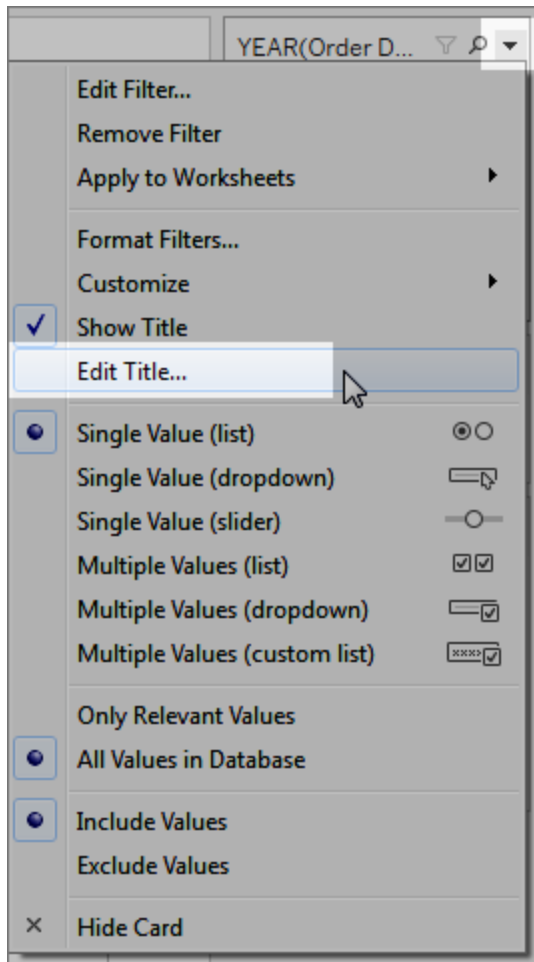

2. Edit the text, and then select **OK**.

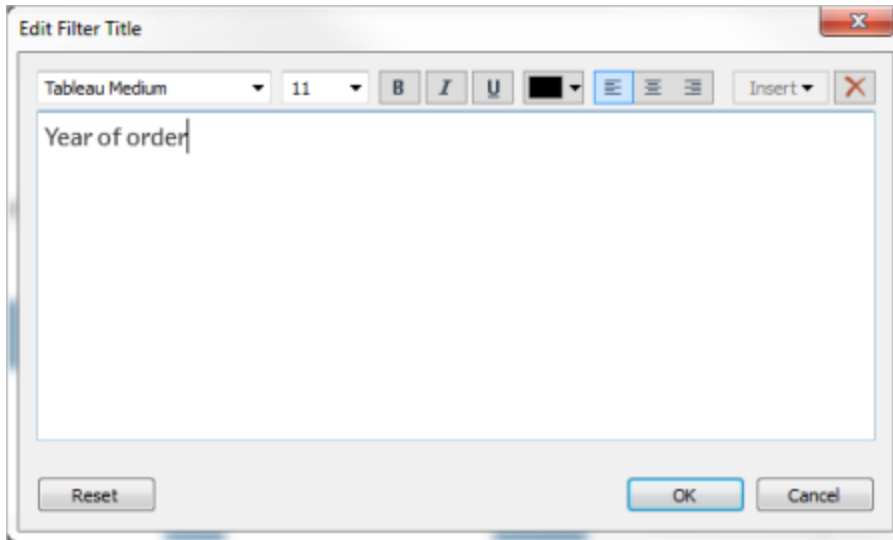

Font Size

Increasing the font size of your text can make it more accessible. Select **Format > Workbook** to change the default text sizes for the entire workbook. For more details, see [Format Your Work](#).

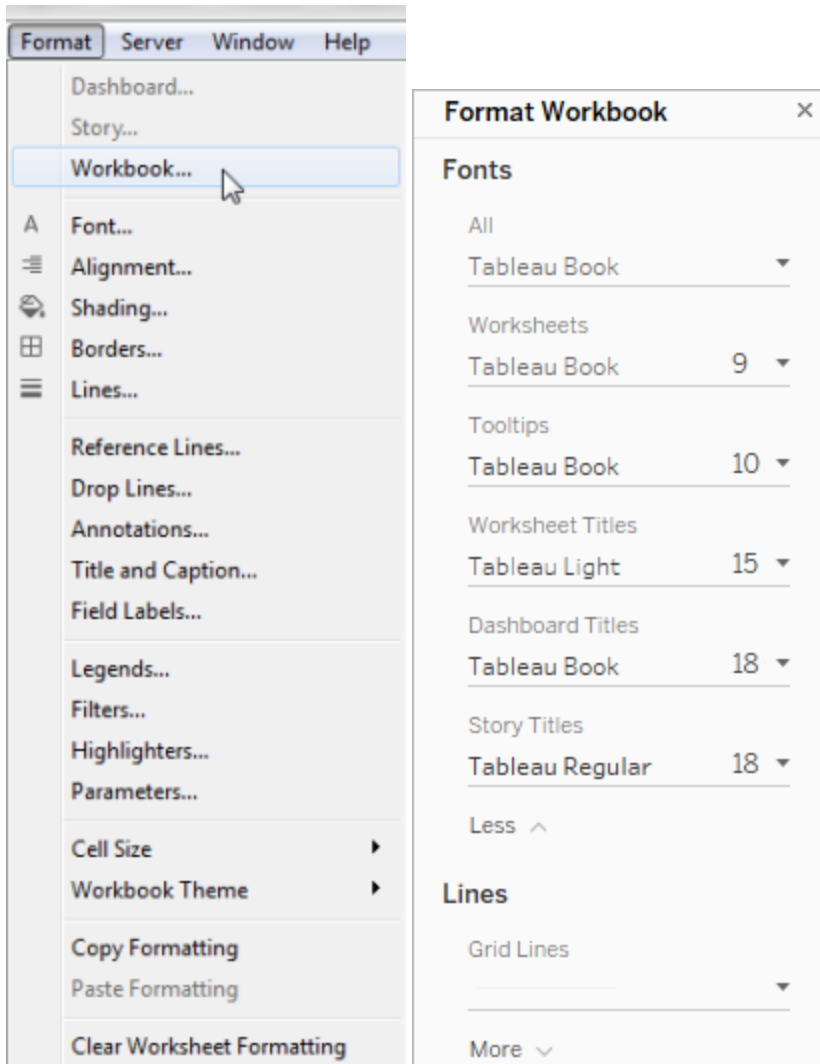

You can also change the font size at the worksheet level.

Edit alt text to make it more descriptive (Tableau Cloud and Tableau Desktop)

Starting in Tableau Cloud 23.2 and Tableau Desktop 23.3, you can customize the alt text auto-generated by Tableau, which can help make it more descriptive and meaningful to your audience.

In a dashboard, you can access the alt text editor through the context menu.

1. Tap the viz to select it, expand the More Options menu, and choose **Accessibility**.

2. Update the alt text in the alt text description box, and then select **OK**.

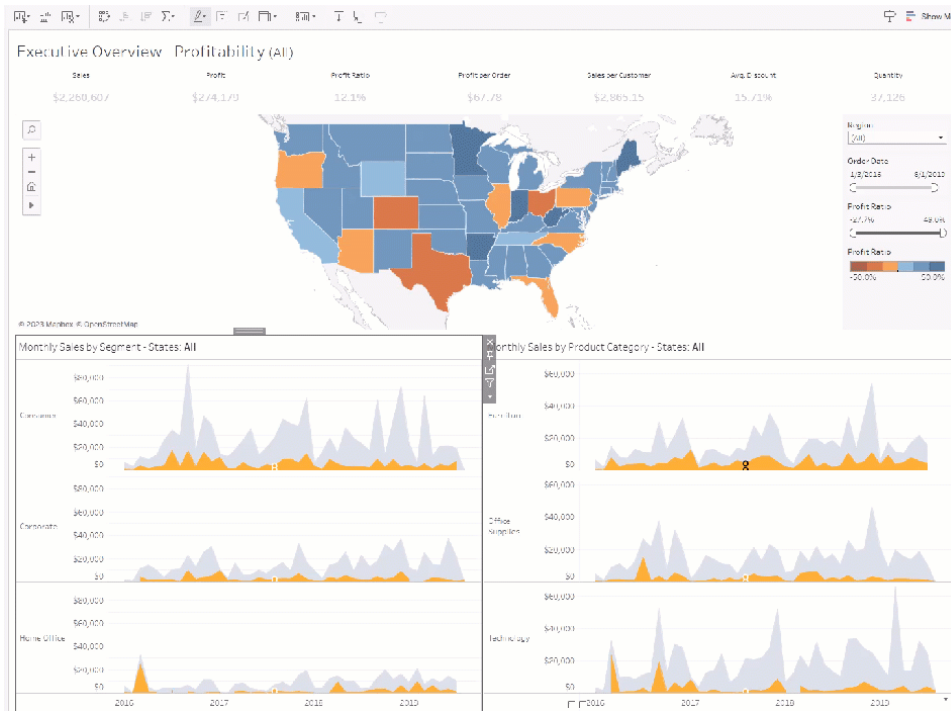

In a worksheet, you can access the alt text editor through the toolbar or the Data Guide pane.

From the toolbar:

1. Select **Worksheet** and choose **Accessibility**.
2. Update the alt text in the alt text description box, and then select **OK**.

From the Data Guide pane:

1. In authoring mode, open the Data Guide pane by clicking the Data Guide  icon.
2. Under **Accessibility**, select **Edit alt text**.

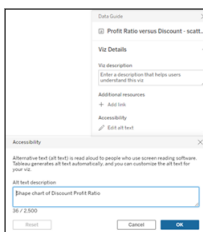

3. Update the alt text in the alt text description box, and then select **OK**.

Note: You must be in authoring mode to edit alt text. If you don't have access to the Data Guide, check with your administrator. They may have hidden the Data Guide for your organization.

Use color thoughtfully and provide contrast

Different color palettes are available depending on the type of field being placed on Color in the Marks card. For any color palette that you use, make sure that you're providing enough contrast and assign colors that differ from each other on the light-dark spectrum.

- For dimensions (discrete), a suggested practice is to use the **Color Blind** palette. You may need to adjust the colors assigned to different dimension values. Try to provide enough contrast and assign colors that differ from each other on the light-dark spectrum. For monochromacy, try using the **Seattle Grays** palette with **Stepped Color** set to 5.
- For measures (continuous), try using the **Blue** or **Orange-Blue Diverging** palette with the **Stepped Color** option set to 5. You may need to adjust the number of steps used. For monochromacy, consider using the **Gray** palette with **Stepped Color** set to 5.

For text color, general guidelines are that the visual presentation of text and images of text has a contrast ratio of at least 4.5:1 (large text 3:1). Tableau's default color formatting follows these prescribed contrast ratios. You can use a [contrast analyzer](#) tool to test the contrast ratios of text colors and backgrounds.

Important: When you use color in the view, you must also provide other types of encoding for marks, such as labels, size, shape, and position. Don't rely on color alone to communicate differences in marks.

Dimension on Color

Less accessible: This view shows an example of a discrete dimension being placed on Color, which is set to the Tableau 20 palette. The line path provides helpful position information, but the colors don't provide a clear distinction between the line marks.

Tableau Desktop and Web Authoring Help

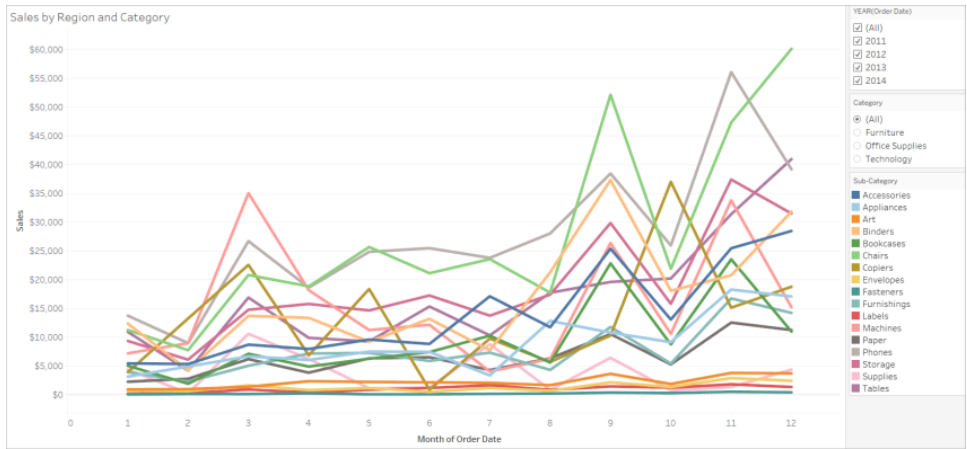

More accessible: In the next example, the Color Blind palette is being used. Shape is also being used to reinforce what is being shown in color.

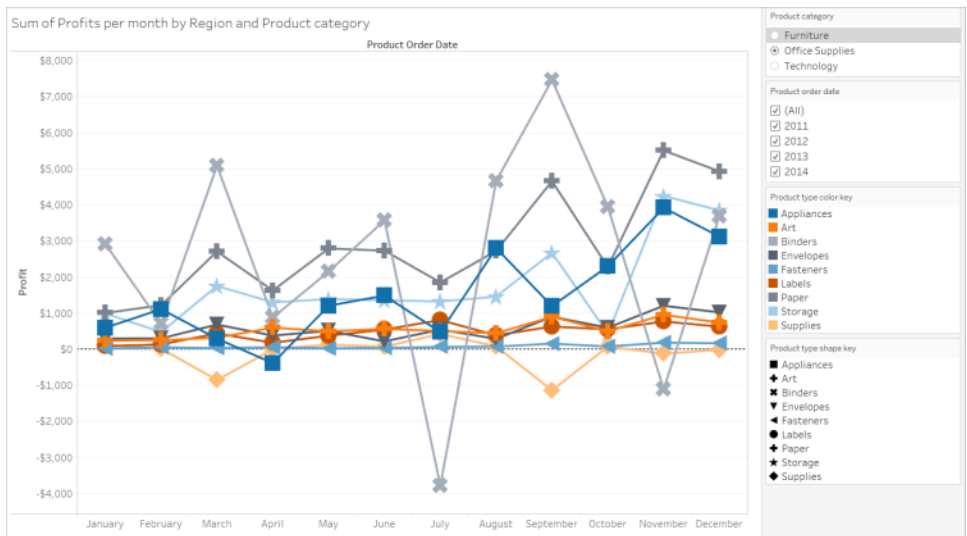

Measure on Color

Less accessible: This view shows an example of a continuous measure placed on Color, which is set to the Blue-Teal palette with gradient colors. The view doesn't provide enough contrast between colors and there's insufficient contrast on the light-dark spectrum. The use of size helps this view, but this color palette can make it hard for people with color vision deficiencies to see contrast differences between marks.

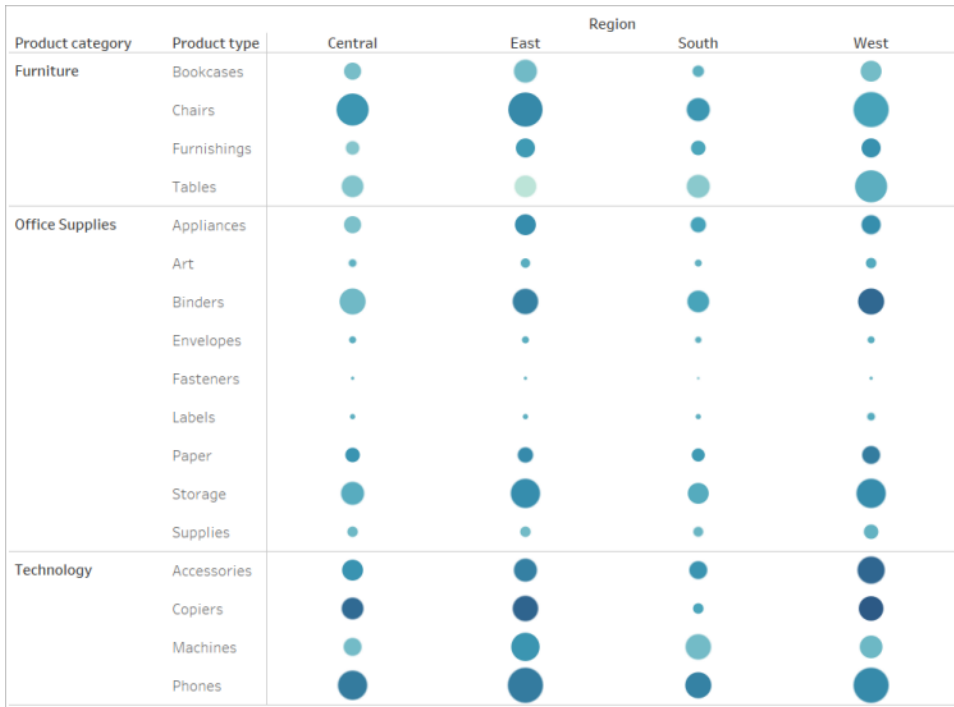

More accessible: This view uses the Orange-Blue Diverging palette with stepped colors. This palette provides improved contrast between marks.

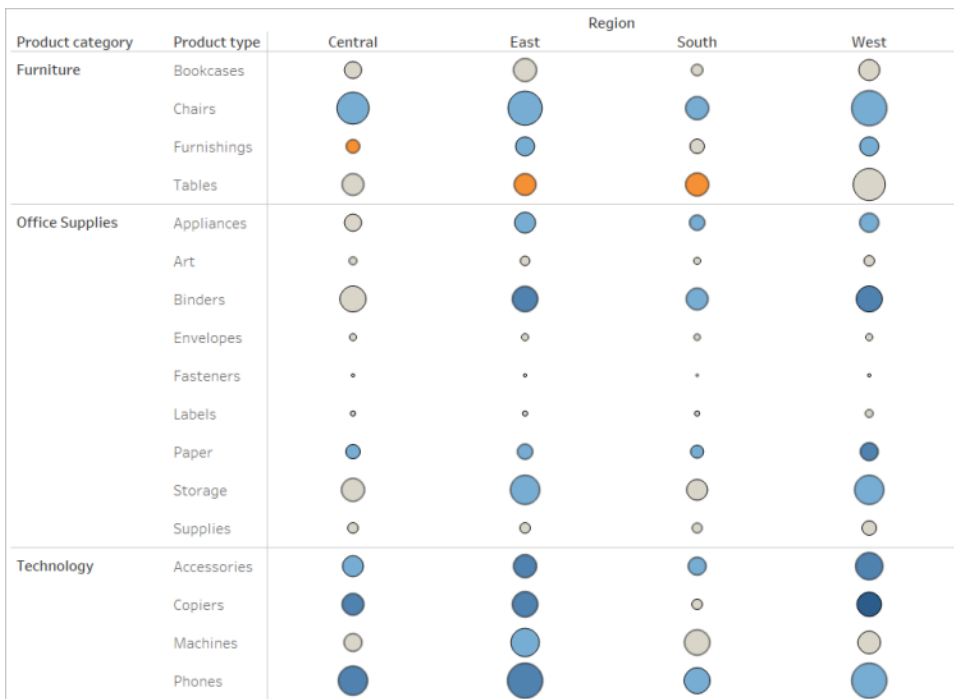

To select a palette

You must already have a measure or dimension on Color in the view for this option to be available.

1. Click **Color** in the Marks card, and then click **Edit Colors**.
2. For **Select Color Palette**, click the drop-down arrow and select the palette.

This example shows selecting the Color Blind palette.

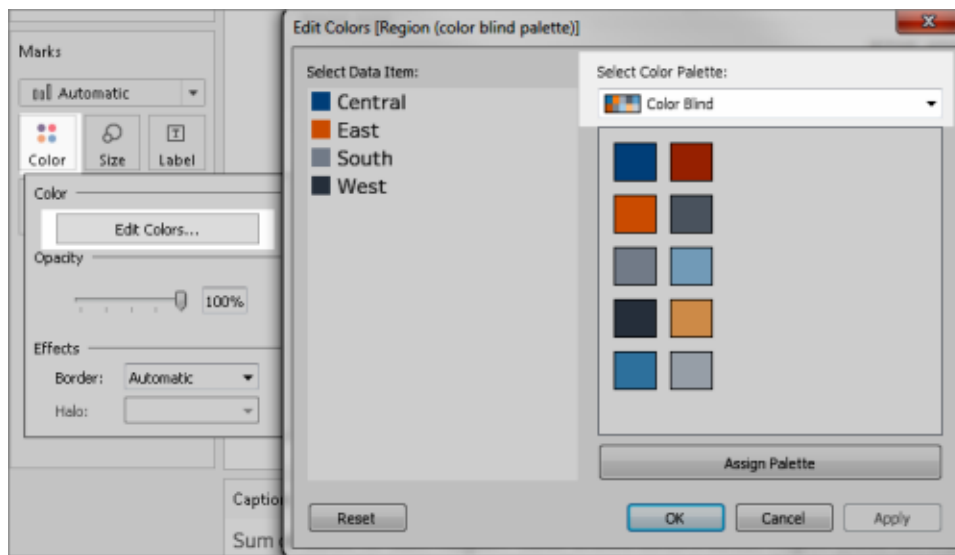

For the Color Blind palette, click **Assign Palette**, and then click **OK**. Otherwise, click **OK**.

To change the color of a value:

1. Click a value on the left, under **Select Data Item**.
2. Click a new color in the palette on the right. Hover over a swatch to identify the color. Repeat for many values that you want to change.
3. Click **OK** to exit the Edit Colors dialog box.

The following example shows the Orange-Blue Diverging palette with Stepped Color set to 5 steps.

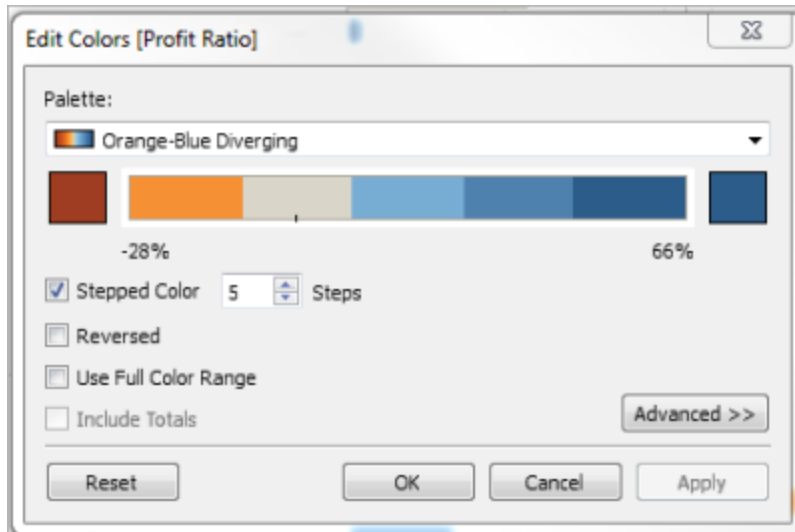

3. For the Color Blind palette, click **Assign Palette**, and then click **OK**. Otherwise, click **OK**.

For details about colors and palettes, see [Color Properties](#).

Provide visual cues beyond color: position, size, and shape

When you use color for field values, you must also provide other types of encoding for marks, [such as labels](#), and position, size, and shape. Use position, size, or shape for the same field values to reinforce the differences between marks. These mechanisms all communicate information about the data to your users.

If you're using color to show measure or dimension values, make sure that you provide enough light-dark spectrum contrast for the colors that you assign to different marks.

Less accessible: This example shows the same scatter plot with no use of color, shape, or size to create contrast. The position of the marks provides meaningful information, but the view could make use of more visual cues.

Tableau Desktop and Web Authoring Help



More accessible: This example shows a calculated field named Quadrant being used on color and shape. Position, color, and shape are used to distinguish each mark. The axes also clarify the mark position and meaning.

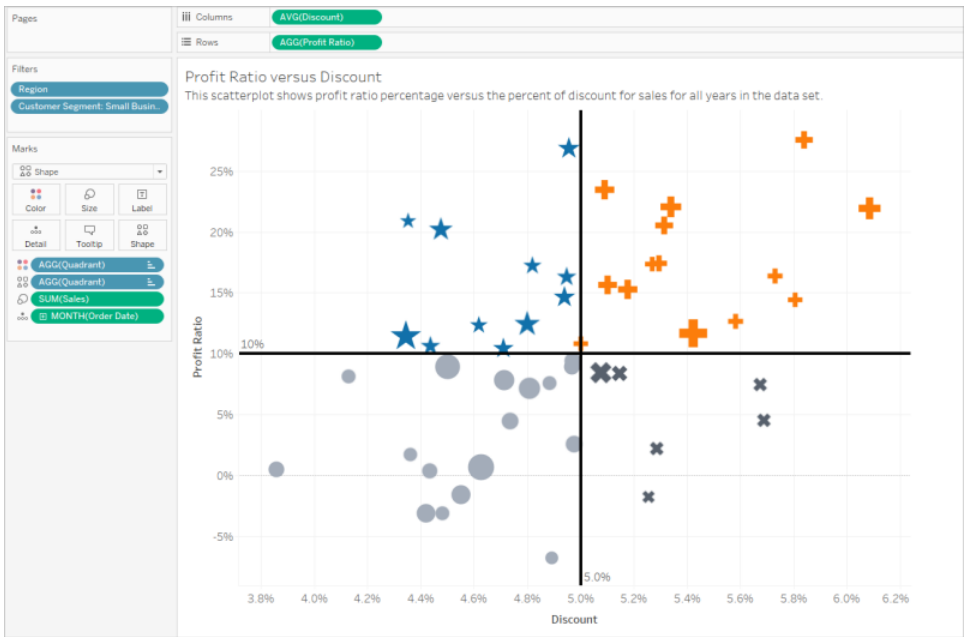

Putting it all together

This next example shows how text, shape, color, and size can all work together to create an accessible view. Sales are represented by the size of each circle (mark). Profit represented by color and text. The title and caption for the view are shown and have been edited to provide more context. The filter and legend titles have also been edited to provide more context.

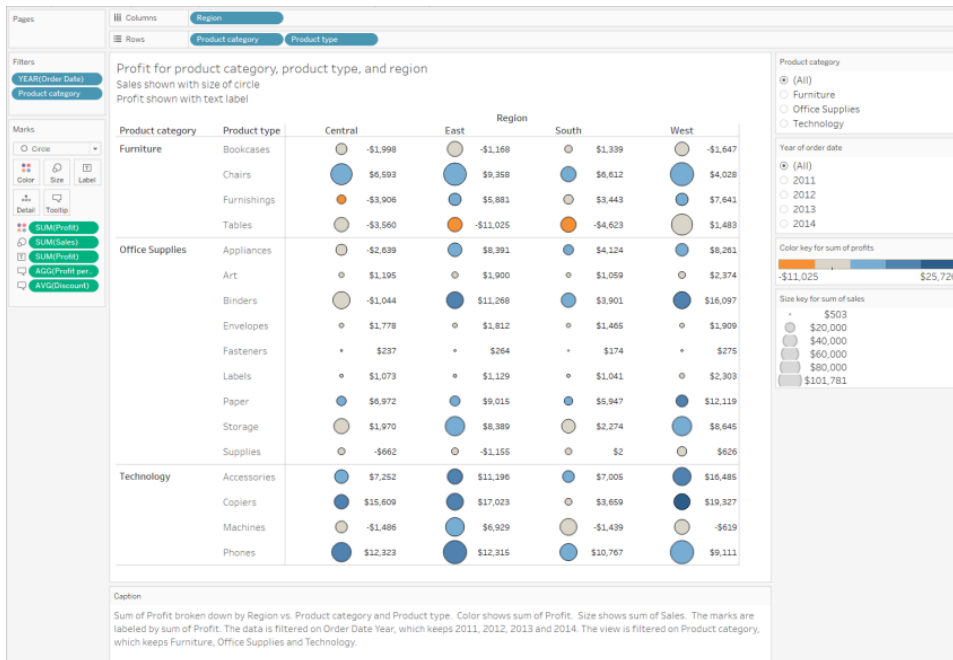

Walkthrough: The journey from less accessible to more accessible

Let's convert a viz that isn't very accessible into one that is. The data in this starting view has a more granular level of detail and a structure that could contribute to cognitive overload with a screen reader.

Tableau Desktop and Web Authoring Help



This view is designed to show total sales for each sales region, along with the profit ratio, to determine which types of products seem to be selling well but aren't actually profitable. Profit and Profit per Order are also shown.

We'll make changes to it based on the concepts and best practices mentioned previously in this article.

Step 1: Reduce the level of detail in the view.

Because the Product Name dimension is on Detail, every product in the data set is being represented with a mark in the view.

- Remove Product Name from Detail. This change reduces the number of marks in the view from over 20,000 to 272.

Reducing the number of marks in the view helps to ensure the embedded view will be rendered on the browser instead of the server.



Step 2: Create a more aggregated view of the data.

1. Reduce the number of measures on Columns and the number of dimensions on Rows.
2. Remove Region (we can use a filter for Region). The number of marks changes to 68.
3. Replace Category and Sub-Category (both dimensions that are part of the Product hierarchy) with copies (not part of a hierarchy) that have been renamed Product category and Product type. Remove the Sub-Category filter.

Doing this prevents users from expanding the hierarchy in the embedded view, which might increase the number of marks in the view and result in the view being rendered on the browser instead of the server.

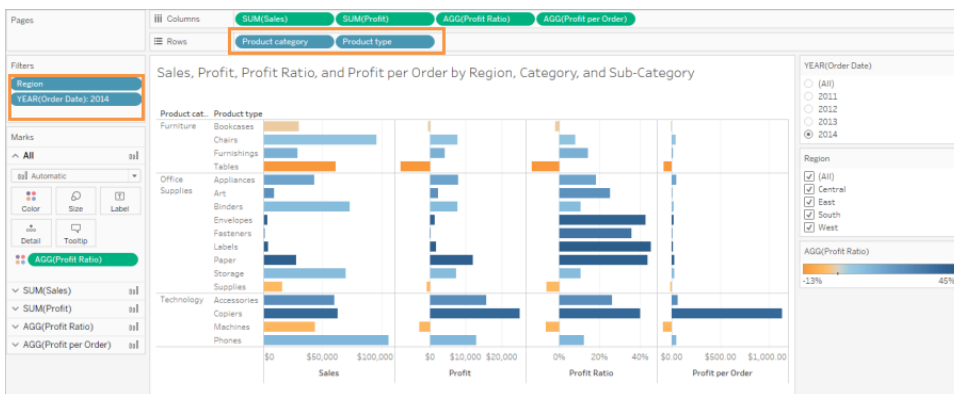

The view is already more aggregated and simplified, but we'll keep going.

Tableau Desktop and Web Authoring Help

- Move the Profit, Profit per Order, and Profit Ratio from the Columns shelf to **Tooltip**.

The number of marks is now 17. The underlying details in the data will still be available in the View Data window, but the reduced number of marks ensures the view will be more accessible because it will be rendered in the browser.

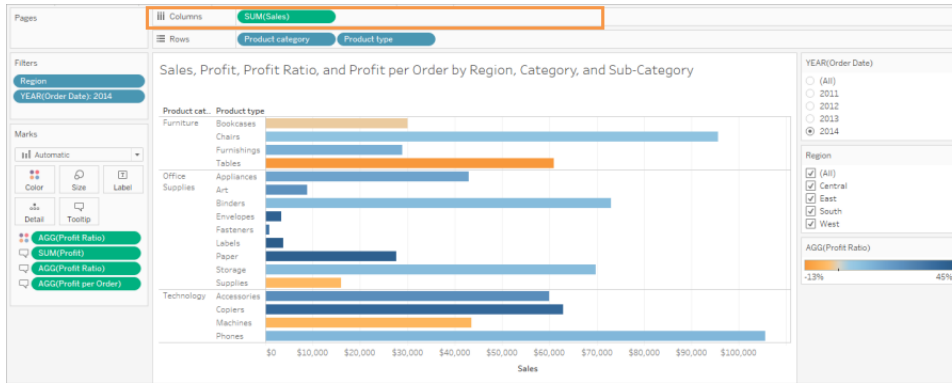

Step 3: Check the color palette settings.

The palette is set to Orange-Blue Diverging.

- Set **Stepped Color** to 5.

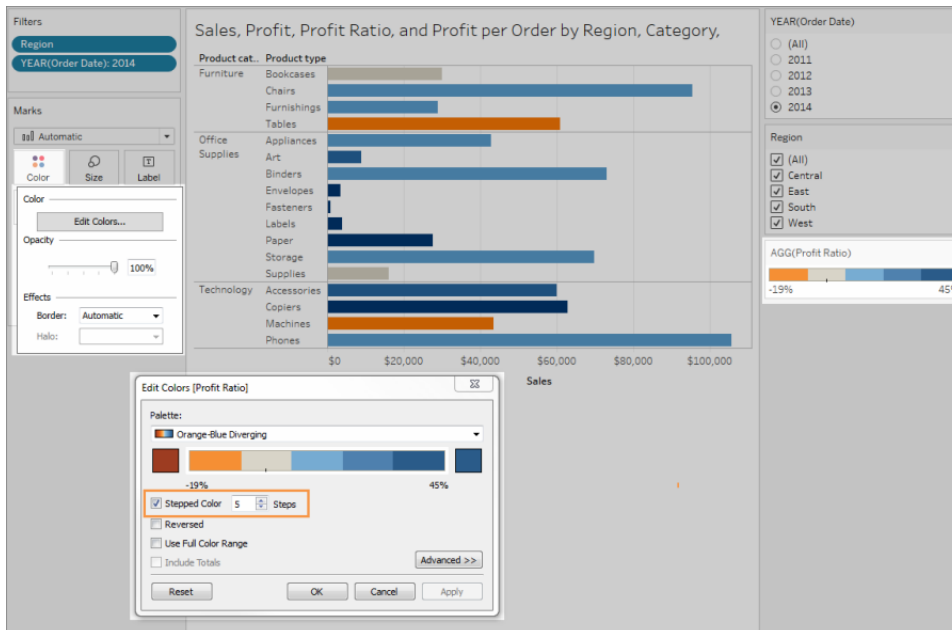

Step 4: Update and show text in the view.

1. Change the Title to make sense with the new view.
2. Show the worksheet Caption.
3. Show Mark labels.
4. Drag Profit Ratio to Label in the Marks card.
5. Edit the filter and legend titles.

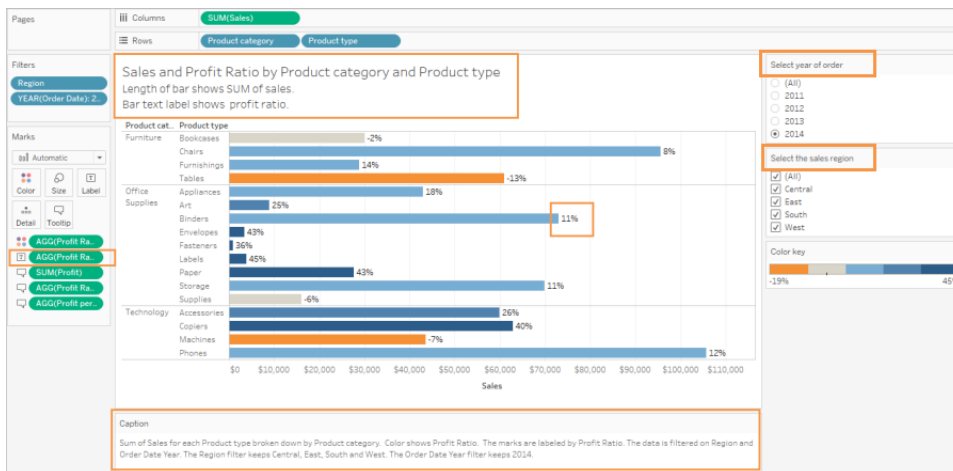

Step 5: Open the View Data window to the Summary tab.

This is the text that screen readers will read for this view. The four measures are included in the underlying data for each product type.

Summary 17 rows 6 fields						
Product category	Product type	Profit per Order	Profit Ratio	Profit	Sales	
Furniture	Tables	\$-81.41	-13%	-\$8,141	\$60,894	
Furniture	Furnishings	\$14.04	14%	\$4,099	\$28,915	
Furniture	Chairs	\$43.93	8%	\$7,644	\$95,554	
Furniture	Bookcases	\$-7.68	-2%	-\$584	\$30,024	
Office Supplies	Supplies	\$-16.19	-6%	-\$955	\$16,049	
Office Supplies	Storage	\$27.29	11%	\$7,368	\$69,834	
Office Supplies	Paper	\$29.82	43%	\$12,049	\$27,718	
Office Supplies	Labels	\$15.86	45%	\$1,745	\$3,861	
Office Supplies	Fasteners	\$4.76	36%	\$305	\$858	
Office Supplies	Envelopes	\$20.31	43%	\$1,442	\$3,379	
Office Supplies	Binders	\$17.83	11%	\$7,737	\$72,986	
Office Supplies	Art	\$8.70	25%	\$2,227	\$8,914	
Office Supplies	Appliances	\$49.47	18%	\$7,865	\$42,927	
Technology	Phones	\$45.97	12%	\$12,872	\$105,643	
Technology	Machines	\$-89.66	-7%	-\$2,869	\$43,545	
Technology	Copiers	\$1,137.81	40%	\$25,032	\$62,899	
Technology	Accessories	\$62.44	26%	\$15,672	\$59,946	

Publish and share the view

After you create your views, to make them more accessible, you can:

- Publish views to Tableau Server or Tableau Cloud and share the link, or embed the view in an accessible web page. For information about how to publish a view, see [Comprehensive Steps to Publish a Workbook on page 3118](#).
- Make sure users have permissions to access to the views and are able to view the underlying data in the View Data window.

Publishing to Tableau Public

After creating your workbook and saving to Tableau Public, the "Allow workbook and its data to be downloaded by others" option must be enabled in order for the end user to be able to open the View Data window.

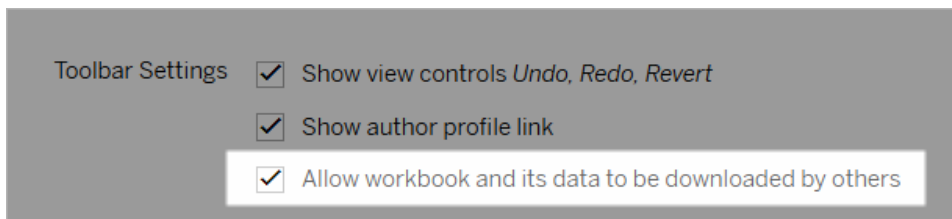

Turn off Web Edit permissions

To prevent your users from seeing the Edit option in the view toolbar, set the Web Edit permission to Deny when you publish your workbook. You should also let your Tableau Cloud administrator know when you publish workbooks that should not allow users to access web editing mode.

1. In Desktop, select Server > Publish Workbook.
2. Under Permissions, select Edit, select All Users, and then select Edit again.

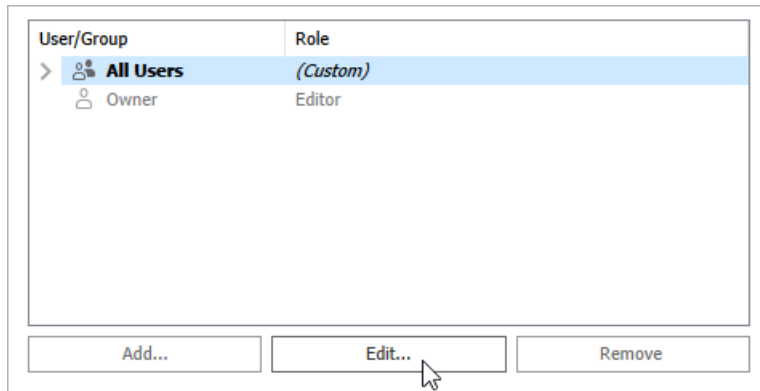

3. For the Web Edit permissions, select Deny. Click Apply, then click Ok.

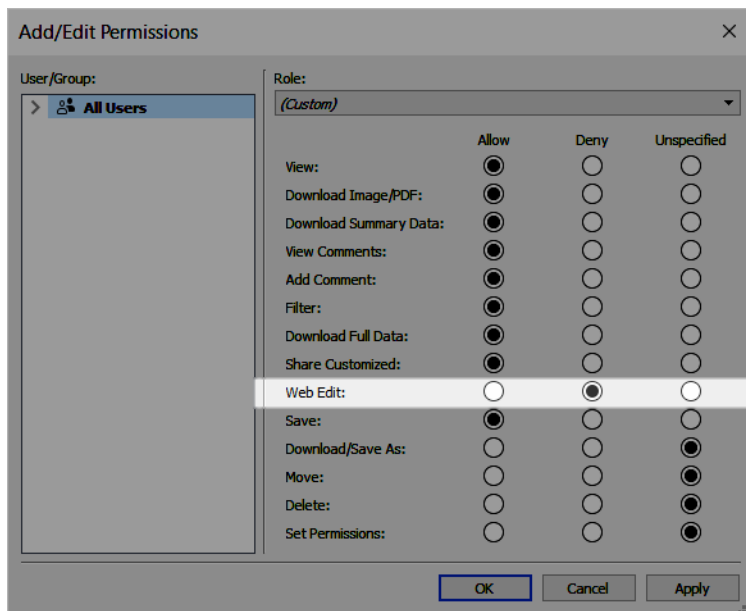

Share or embed the view

When you're ready to share, go to the view in Tableau Server or Tableau Cloud and click the **Share** button in the view toolbar to copy the link or share with a user on the site. The view toolbar and navigation panel are supported for conformance, and include a "Skip to Content" option for keyboard navigation as well as a focus indicator.

Alternately, views can be embedded in the HTML code of a WCAG-conformant web page. For more information about how to embed views, see [Embed Views into Webpages on page 3362](#).

Sample embed code

```
<script type='text/javascript' src='http://Your_
Server/javascripts/api/viz_v1.js'></script>
<div class='tableauPlaceholder' style='width: 1256px; height: 818px;'>
  <object class='tableauViz' width='1256' height='818'
style='display:none;'>
  <param name='host_url' value='http%3A%2F%2FYour_Server%2F' />
  <param name='site_root' value='' />
  <param name='name' value='name of the visualization' />
  <param name='tabs' value='yes' />
  <param name='showShareOptions' value='true' />
  </object>
</div>
```

In a view URL:

```
https://myserver/t/Sales/views/MyCoSales/SalesScoreCard?embed=y
```

Embedded views must be rendered on the browser (not the server)

Server-rendered views are less accessible than client-rendered views. To ensure an embedded view is rendered in the browser, make sure the view has fewer than 1,000 marks, or set *render* to *true* in the URL for the embedded view.

For example:

```
http://localhost/views/Supplies/MyView?:render=true
```

Client-side rendering is enabled (*true*) by default.

About permissions

Users who need access to the underlying data will need the proper site role and permissions to view and interact with your embedded views. This includes having access to the projects and workbooks that contain the views. At the minimum, your users need View and Download Summary Data permissions. The ability to view the underlying data is necessary for users who use screen readers.

Users viewing the embedded view should have:

- Site role of Explorer, Viewer, or Guest.
Note: The Viewer site role is more limited and won't be able to use filters or view the Full Data tab.
- **View** permission for the project that the workbook is in.
- **View** permissions for the workbook and its views.
- **Download Summary Data** permission to read the underlying data in the view on the **Summary** tab of the View Data window.
- **Download Full Data** permission if the user needs to be able to read all of the available data in the data source on the **Full Data** tab of the View Data window.

For information about how to set permissions for workbooks and views, see [Set Content Permissions](#) in the Tableau Cloud help.

Test the view

Test your embedded view using [keyboard shortcuts for embedded views](#). Provide your users with this information in your user documentation.

Maps and Geographic Data Analysis in Tableau

When it comes to plotting your data on a map, Tableau has got you covered. This section provides all the documentation you need to get started with creating maps in Tableau.

Start with these topics

Get Started Mapping with Tableau below	Map Data
Mapping Concepts	Build Maps
The Mapping Workspace in Tableau on page 1681	Customize Maps

Get Started Mapping with Tableau

This tutorial walks you through some of the most common tasks you might perform when creating maps in Tableau.

You'll learn how to connect to and join geographic data; format that data in Tableau; create location hierarchies; build and present a basic map view; and apply key mapping features along the way.

If you're new to building maps in Tableau, this a great place to start.

Step 1: Connect to your geographic data

Geographic data comes in many shapes and formats. When you open Tableau Desktop, the start page shows you the connectors available in the left **Connect** pane. These are how you will connect to your data.

You can work with geographic data by connecting to spatial files, or you can connect to location data stored in spreadsheets, text files, or on a server.

Spatial files, such as a shapefile or geoJSON file, contain actual geometries (points, lines, or polygons), whereas text files or spreadsheets contain point locations in latitude and longitude coordinates, or named locations that, when brought into Tableau, connect to the Tableau geocoding (stored geometries that your data references).

For a complete list of connections Tableau supports, see the list of [Data Connections](#) on the Tableau website.

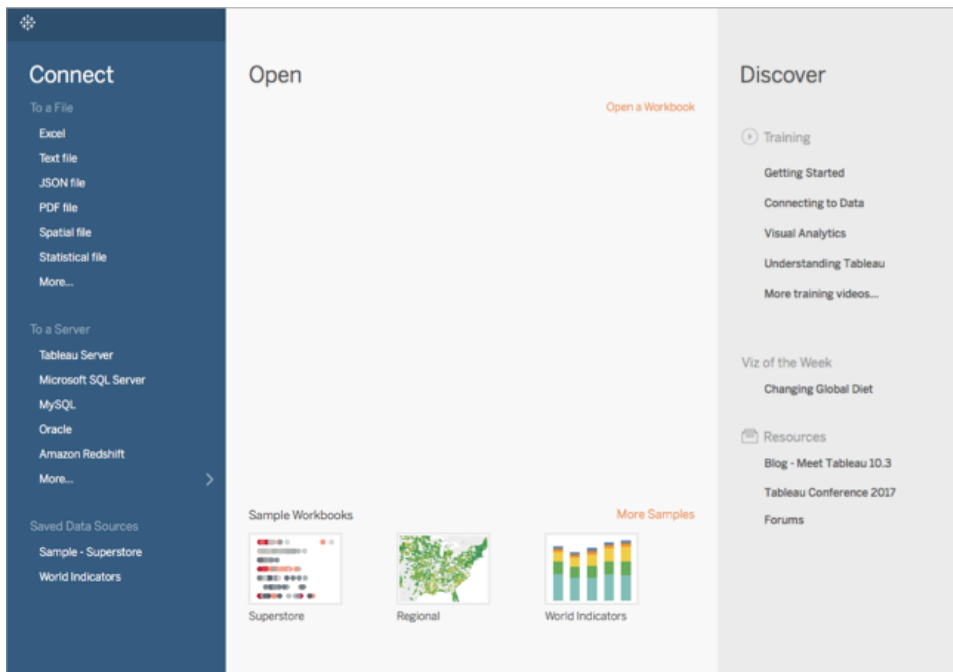

For this tutorial, you are going to connect to an Excel file that comes with Tableau Desktop. It contains location names that Tableau can geocode. When you build a map view, the location names reference the geometries stored in the Tableau Map Service based on the geographic role you assign to the field. You'll learn more about geographic roles later in this tutorial.

1. Open Tableau Desktop.
2. In the Connect pane, click **Excel**.
3. Navigate to **Documents > My Tableau Repository > Data Sources**, and then open the **Sample - Superstore.xls** file.

Once you connect to the data source, your screen will look like this:

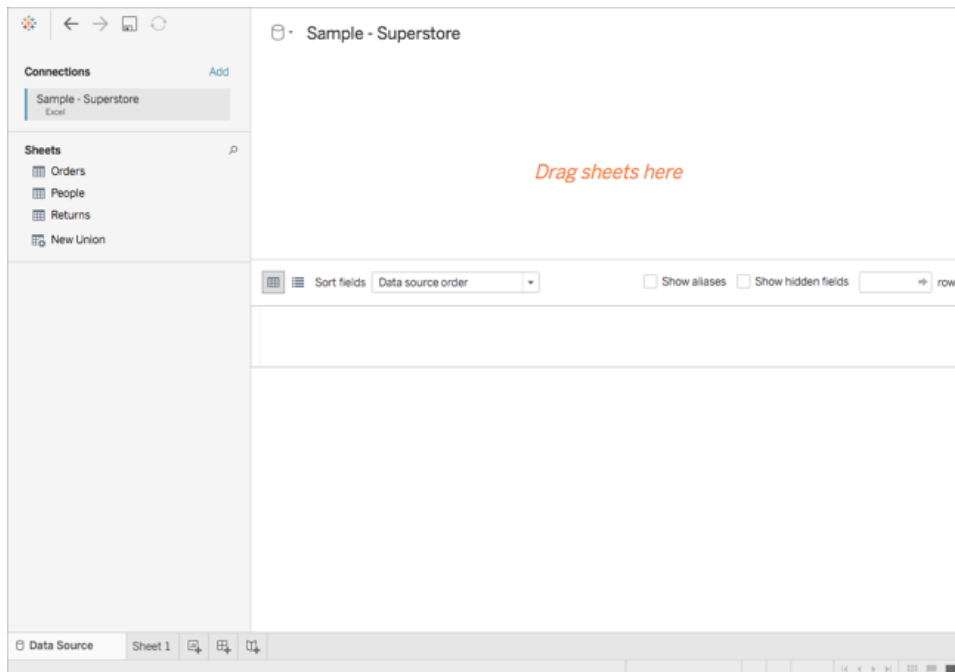

This is called the Data Source page, and it is where you can prepare your location data for use in Tableau.

Some of the tasks you can perform on the Data Source page include the following, but you don't have to do all these things to create a map view:

- Adding additional connections and joining your data
- Adding multiple sheets to your data source
- Assigning or changing geographic roles to your fields
- Changing the data type of your columns (from numbers to strings, for example)
- Renaming columns
- Splitting columns, such as splitting a full address into multiple columns for street, city, state, and postal code

For more information about the Data Source page and some of the tasks you can perform while on it, see the topics in the [Set Up Data Sources on page 596](#) section.

Step 2: Join your data

Your data is often held in multiple data sources or sheets. As long as those data sources or sheets have a column in common, you can join them in Tableau. Joining is a method for combining the related data on those common fields. The result of combining data using a join is a virtual table that is typically extended horizontally by adding columns of data.

Joining is often necessary with geographic data, particularly spatial data. For example, you can join a KML file that contains custom geographies for school districts in Oregon, U.S. with an Excel spreadsheet that contains demographic information about those school districts.

For this example, you will join two sheets in the Sample-Superstore data source.

1. On the left side of the Data Source page, under Sheets, double-click **Orders**.
2. Under Sheets, double-click **People**.

Tableau creates an inner-join between the two spreadsheets, using the Region column from both spreadsheets as the joining field. Now there is a sales person assigned to every location in your data source, as well as to regions.

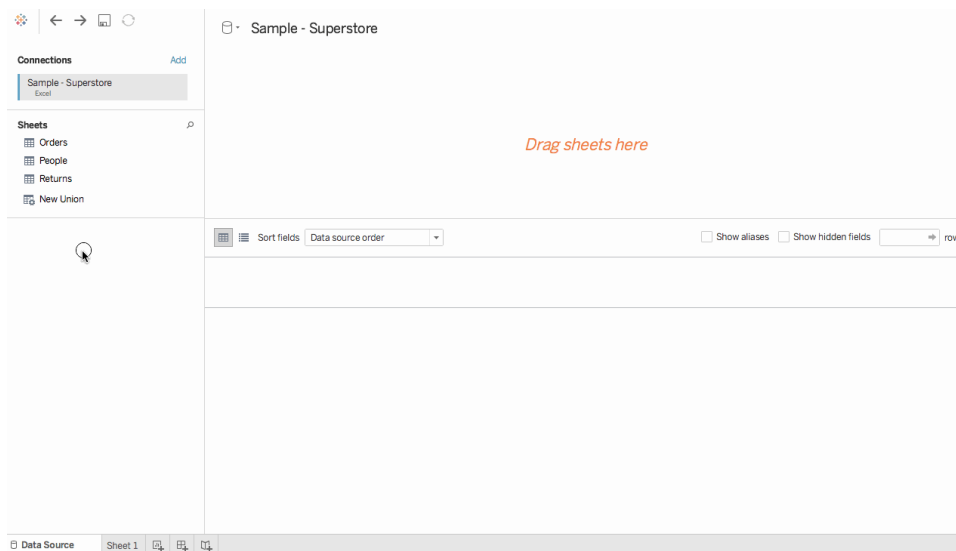

To edit this join, click the join icon (the two circles). You can edit the join in the Join dialog box that opens. For more information about joining data in Tableau, see [Join Your Data](#)

on page 791.

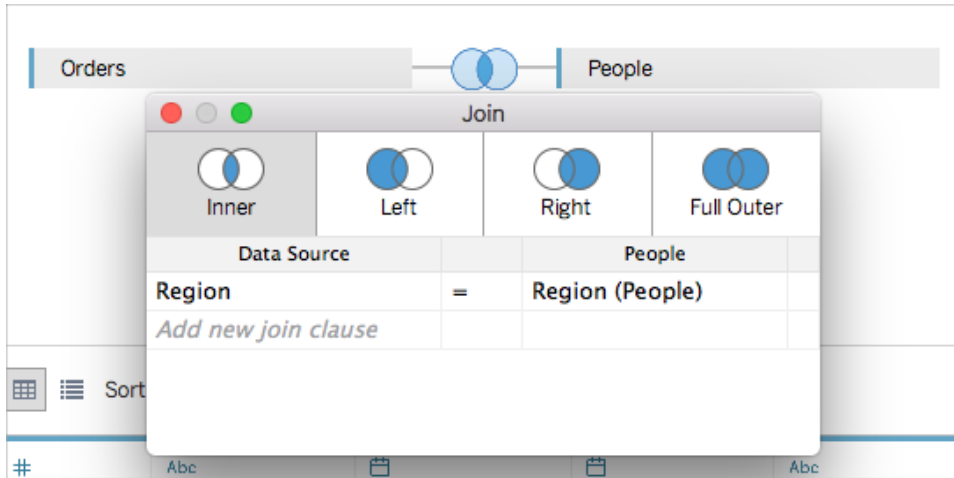

Step 3: Format your geographic data in Tableau

After you set up your data source, you might need to prepare your geographic data for use in Tableau. Not all of these procedures will always be necessary to create a map view, but it's important information to know when it comes to preparing geographic data for use in Tableau.

Depending on the type of map you want to create, you must assign certain data types, data roles, and geographic roles to your fields (or columns).

For example, in most cases, your latitude and longitude fields should have a *data type* of **number (decimal)**, a *data role* of **measure**, and be assigned the **Latitude** and **Longitude geographic roles**. All other geographic fields should have a *data type* of **string**, a *data role* of **dimension**, and be assigned the appropriate geographic roles.

Note: If you are connecting to a spatial file, a Geometry field is created. It should have a data role of measure.



This step demonstrates how to format your geographic data to meet this criteria.

Change the data type of a column

When you first connect to geographic data, Tableau assigns data types to all of your columns. These data types include Number (decimal), Number (whole), Date and Time, Date, String, and Boolean. Sometimes Tableau does not get these data types right, and you must edit them. For example, Tableau might assign a Postal Code column a data type of Number (whole). To create map views, your Postal Code data must have a data type of String.

To change the data type of a column:

1. On the Data Source page, click the data type icon (the globe) for Postal Code and select **String**.

 Orders State	 Orders Postal Code	Abc Orders Region	▼ Abc Orders Product ID
Kentucky	42420	South	FUR-BS-10001798
Kentucky	42420	South	FUR-CH-10000454
California	90036	West	OFF-LA-10000240
Florida	33311	South	FUR-TA-10000577
Florida	33311	South	OFF-ST-10000760
California	90032	West	FUR-FU-10001487
California	90032	West	OFF-AR-10002833
California	90032	West	TEC-PH-10002275
California	90032	West	OFF-BI-10003910
California	90032	West	OFF-AP-10002892

For more information about data types, see [Data Types](#) on page 157.

Assign geographic roles to your geographic data

In Tableau, a *geographic role* associates each value in a field with a latitude and longitude value. When you assign the correct geographic role to a field, Tableau assigns latitude and longitude values to each location in that field by finding a match that is already built in to the installed geocoding database. This is how Tableau knows where to plot your locations on the map.

When you assign a geographic role to a field, such as State, Tableau creates a Latitude (generated) field and a Longitude (generated) field.

Geographic roles are sometimes automatically assigned to your data, such as in this example. You can tell a geographic role has been assigned to your data because the column includes a globe icon.

If a geographic role is not automatically assigned, you can manually assign one to your field. You don't need to do so for this example, but it's important to know how so you can do it for your own data.

To assign or edit a geographic role:

1. On the Data Source page, click the globe icon.
2. Select **Geographic Role**, and then select a role that best matches your data.

For example, in this case, the Country column does not have a geographic role assigned to it, so the Country/Region geographic role is assigned.

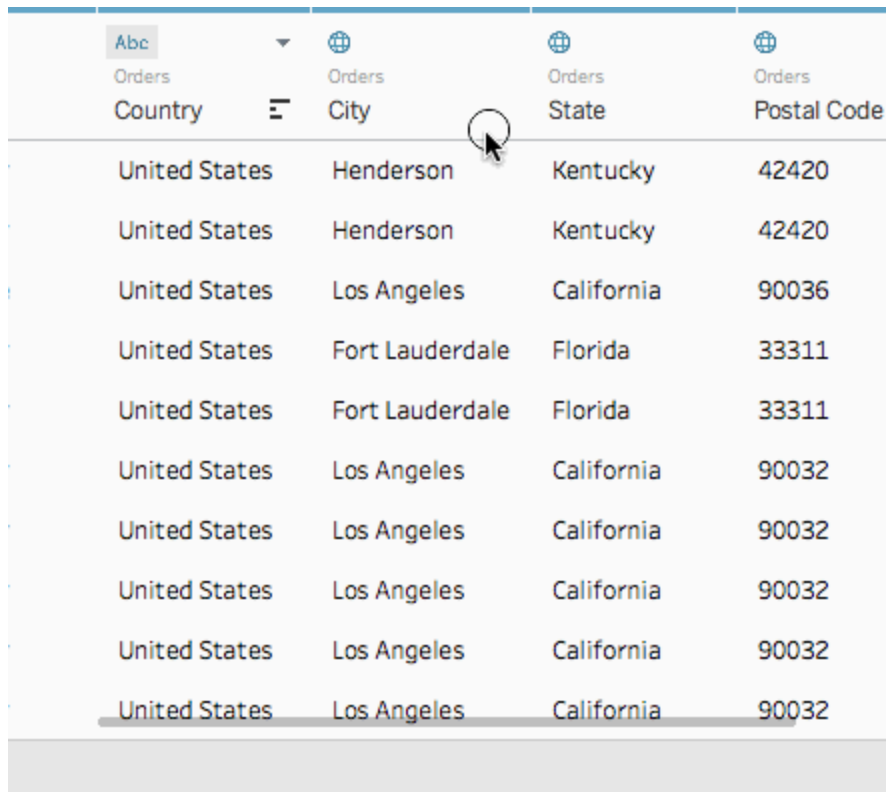

Orders Country	Orders City	Orders State	Orders Postal Code
United States	Henderson	Kentucky	42420
United States	Henderson	Kentucky	42420
United States	Los Angeles	California	90036
United States	Fort Lauderdale	Florida	33311
United States	Fort Lauderdale	Florida	33311
United States	Los Angeles	California	90032
United States	Los Angeles	California	90032
United States	Los Angeles	California	90032
United States	Los Angeles	California	90032
United States	Los Angeles	California	90032

Note: If you have difficulties assigning geographic roles to your data, or have data that is not built in to the Tableau map server, there are a few things you can do to get that data into Tableau. See [Assign Geographic Roles](#) on page 1727.

Change from dimensions to measures

When you connect to geographic data, Tableau also assigns data roles to all of your columns. A column can be a *dimension* or *measure*. In most cases, your latitude and longitude columns

should be measures. For special cases, such as if you want to plot every location in your data source on a map without the ability to drill up or down a level of detail (such as from City to State), they can be dimensions. A great example of this is a [point distribution](#) map.

The rest of your geographic data should be dimensions.

You don't need to change the data role of a column for this example, but it's important to know how so you can do it for your own data. Feel free to practice here. You can always undo any changes you make.

To change the data role of a column:

1. On the Data Source page, click **Sheet 1**.

Your workspace updates to look like this:

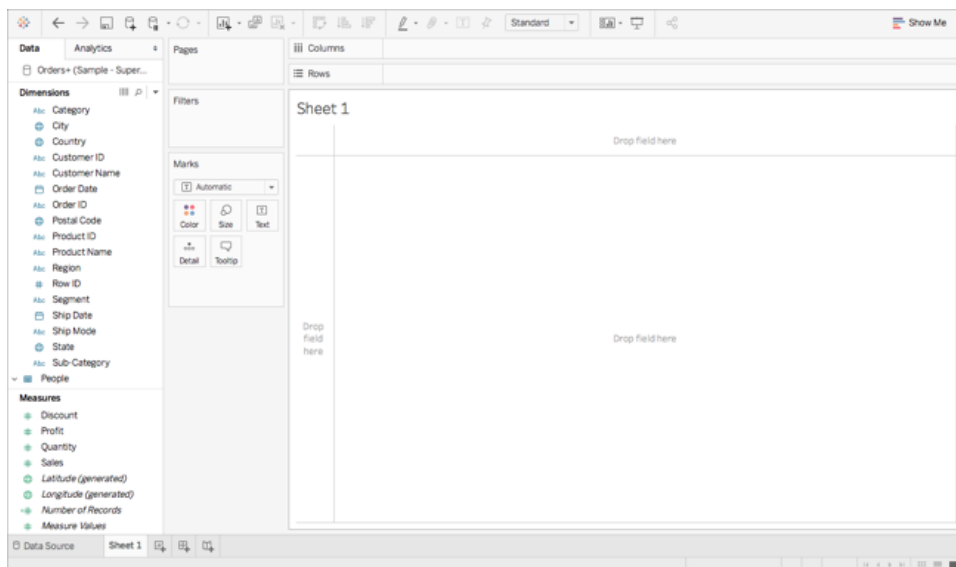

This is called a worksheet, and it is where you will build your map. On the left-side of the screen is the **Data** pane. All of the columns in your data source are listed as fields in this pane. For example, Country and State. These fields contain all the raw data in your columns. Note that Tableau has generated a Latitude and Longitude field (*Latitude (generated)* and *Longitude (generated)*). This is because you assigned geographic roles to your data.

The fields in the data pane are divided into measures and dimensions. The fields placed in the Dimensions section of the Data pane are often categorical data, such as Date and Customer ID, while the fields placed in the Measures section of the Data pane are often quantitative data, such as Sales and Quantity.

2. In the **Data** pane, under Dimensions, select a field, such as Row ID, and drag it down to the Measures section.

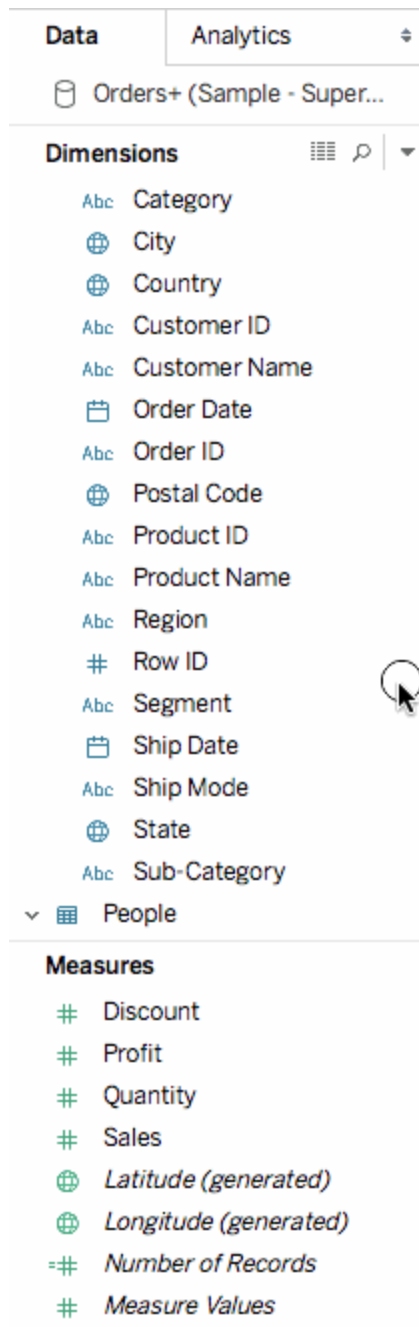

The field is added to the Measures section and changes from blue to green. You just converted a Dimension to a Measure. To convert a field from a measure to a dimension, drag the field from the Measures section up to the Dimensions section.

For more information, see [Dimensions and Measures, Blue and Green](#) on page 147.

Step 4: Create a geographic hierarchy

Now that you are in the worksheet space, you can create geographic hierarchies. This is not required to create a map view, but creating a geographic hierarchy will allow you to quickly drill into the levels of geographic detail your data contains, in the order you specify.

To create a geographic hierarchy:

1. In the Data pane, right-click the geographic field, **Country**, and then select **Hierarchy > Create Hierarchy**.
2. In the Create Hierarchy dialog box that opens, give the hierarchy a name, such as Mapping Items, and then click **OK**.

At the bottom of the Dimensions section, the Mapping Items hierarchy is created with the Country field.

3. In the Data pane, drag the State field to the hierarchy and place it below the Country field.
4. Repeat step 3 for the City and Postal Code fields.

Tableau Desktop and Web Authoring Help

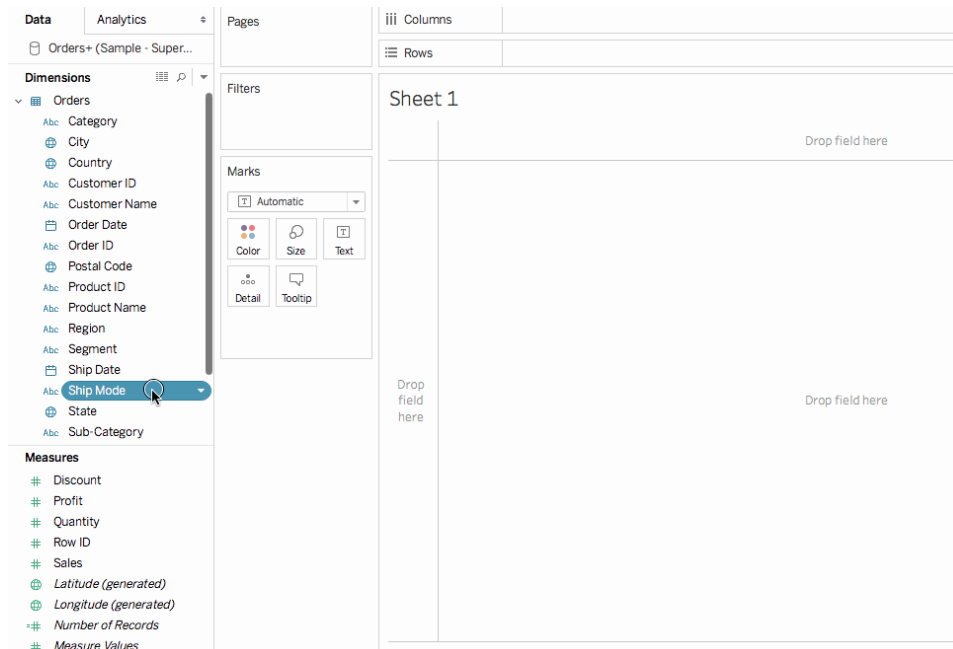

When you are finished, your hierarchy should be in the following order:

- Country
- State
- City
- Postal Code

Step 5: Build a basic map

Now that you have connected to and joined your data, formatted your data, and built a geographic hierarchy, you are now ready to start building your map. You will start by building a basic map view.

1. In the Data pane, double-click **Country**.

The Country field is added to Detail on the Marks card, and Latitude (generated) and Longitude (generated) are added to the Columns and Rows shelves. A map view with one data point is created. Since a geographic role is assigned to Country, Tableau creates a map view. If you double-click any other field, such as a dimension or measure, Tableau adds that field to the Rows or Columns shelf, or the Marks card, depending on what you already have in the view. Geographic fields are always placed on Detail on the Marks card, however.

Since this data source only contains one country, (United States), that is the only data point shown. You will need to add more levels of detail to see additional data points. Since you created a geographic hierarchy, this is easy.

2. On the Marks card, click the **+** icon on the **Country** field.

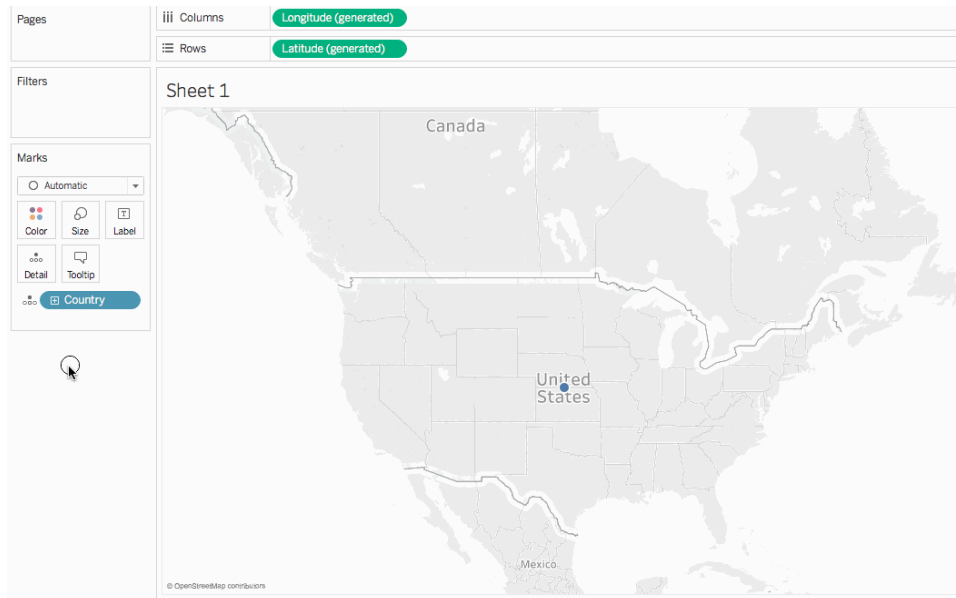

The State field is added to Detail on the Marks card and the map updates to include a data point for every state in the data source.

If you did not create a hierarchy, the **+** icon on the Country field will not be available. In this case, to add State as another level of detail, manually drag **State** from the **Data** pane to **Detail** on the Marks card.

Congratulations! You now have a basic map view that you can customize and build upon in the next steps.

Step 6: Change from points to polygons

The default map type in Tableau is often a point map. When you have geographic roles assigned to your geographic data, however, it's easy to change those data points to polygons.

Note: Filled maps are not available for cities or airports.

1. On the Marks card, click the Mark Type drop-down and select **Filled Map**.

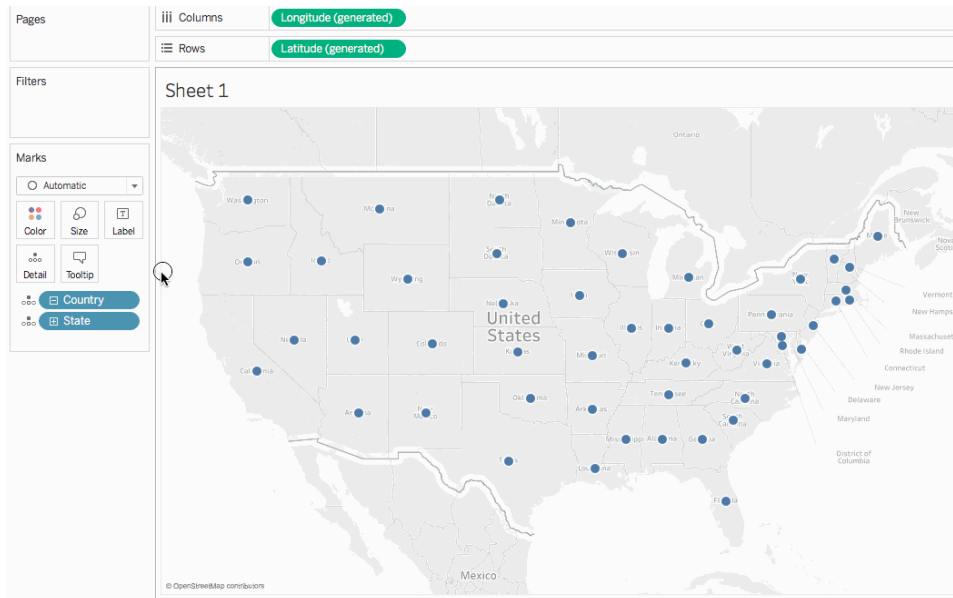

The map updates to a polygon map.

Step 7: Add visual detail

You can add measures and dimensions to the Marks card to add visual detail to your view. In this example, you will add color and labels to the view.

Add color

- From Measures, drag **Sales** to **Color** on the Marks card.

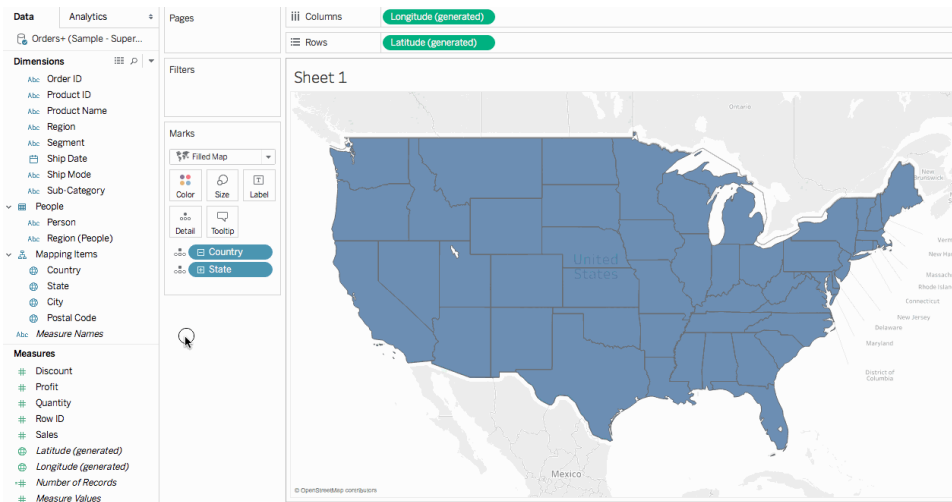

Each state is colored by sum of sales. Since Sales is a measure, a qualitative color palette is used. If you place a dimension on color, then a categorical color palette is used.

Add labels

1. From Measures, drag **Sales** to **Label** on the Marks card.

Each state is labeled with sum of sales. The numbers need a little bit of formatting, however.

2. In the Data pane, right-click **Sales** and select **Default Properties > Number Format**.
3. In the Default Number Format dialog box that opens, select **Number (Custom)**, and then do the following:
 - For **Decimal Places**, enter **0**.
 - For **Units**, select **Thousands (K)**.
 - Click **OK**.

The labels and the color legend update with the specified format.

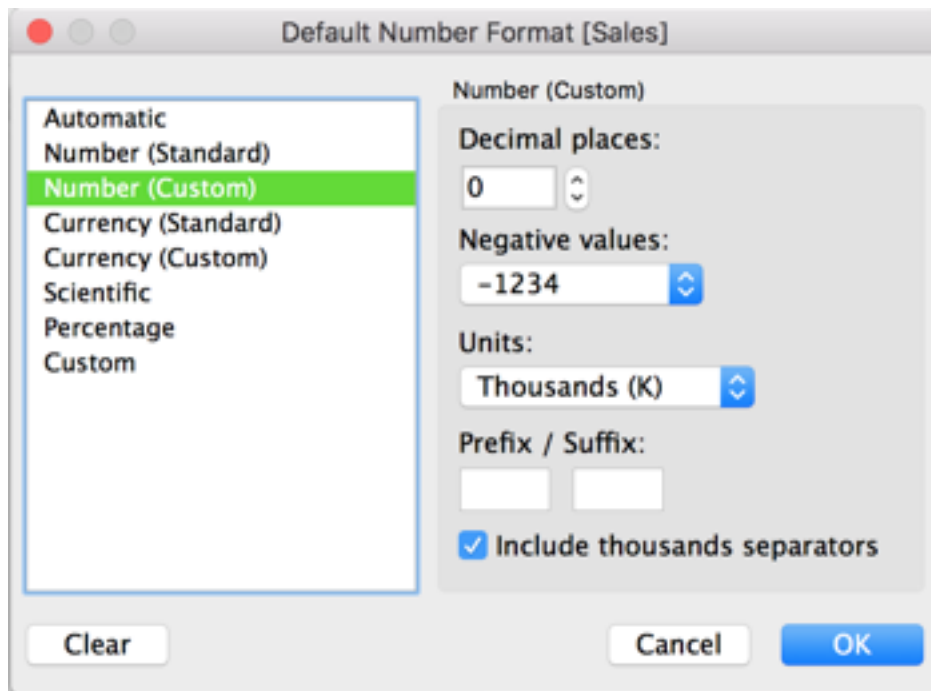

Step 8: Customize your background map

The background map is everything behind your marks (borders, oceans, location names, etc.) You can customize the style of this background map, as well as add map layers and data layers. In addition to customizing the background maps, you can also connect to your own WMS server or Mapbox map. For more information, see [Use Web Map Service \(WMS\) Servers on page 1885](#) and [Use Mapbox Maps on page 1882](#).

To customize your background map:

1. Select **Map > Map Layers**.

The Map Layers pane appears on the left side of the workspace. This is where all background map customization happens.

2. In the Map Layers pane, click the **Style** drop-down and select **Normal**.

The background map updates to look like this:

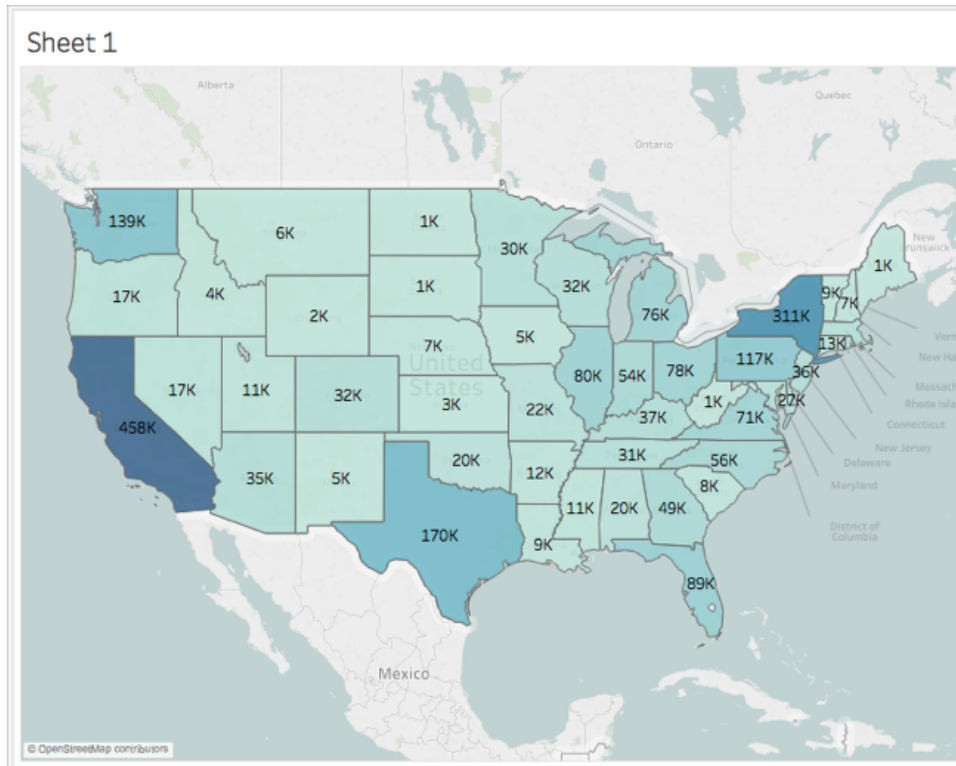

3. In the Map Layers pane, under Map Layers, select **Coastlines**, and then clear **Country/Region Borders**, **Country/Region Names**, **State/Province Borders**, and **State/Province Names**.

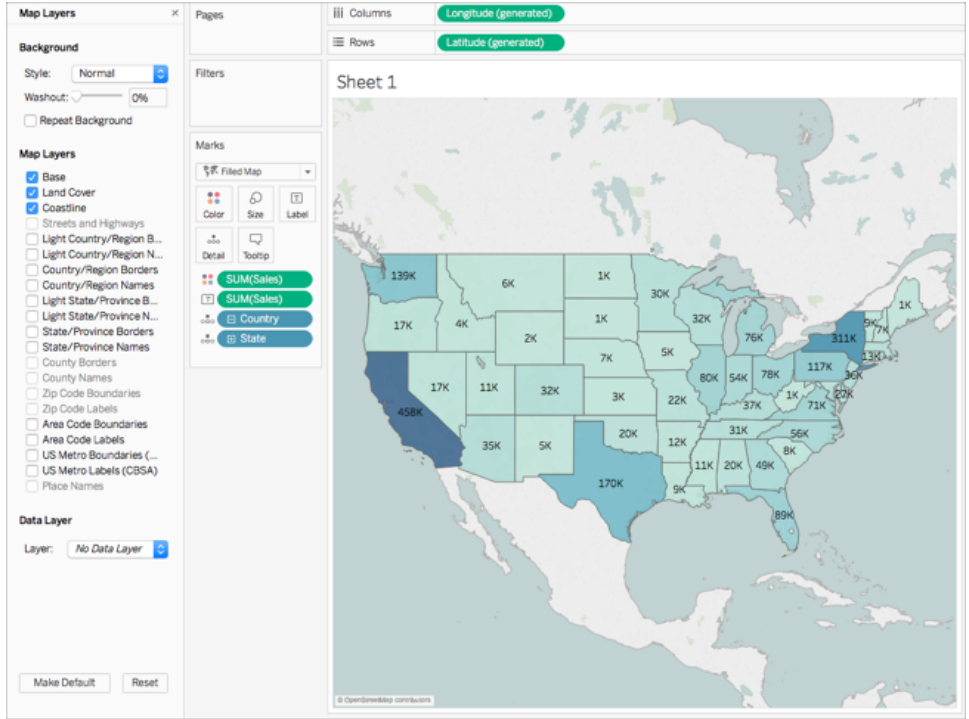

4. At the top of the Map Layers pane, click the **X** to return to the **Data** pane.

The background map is now simplified to draw attention to your data.

Step 9: Create custom territories

As you build your map view, you might want to group existing locations together to create your own territories or regions, such as sales territories for your organization.

1. In the Data pane, right-click **State** and select **Create > Group**.
2. In the Create Group dialog box that opens, select **California, Oregon, and Washington**, and then click **Group**. Each group you create represents a territory.

Note: To multi-select, hold down Ctrl (Command on Mac) as your select states.

3. Right-click the new group you just created and select **Rename**.
4. Rename the group, **West Coast**.
5. For the next territory, select **Alabama, Florida, Georgia, Louisiana, Mississippi, South Carolina, and Texas**, and then click **Group**.
6. Rename this group, **South**.

- For the third territory, select **Connecticut, Delaware, District of Columbia, Main, Maryland, Massachusetts, New Hampshire, New Jersey, New York, Pennsylvania, Rhode Island, Vermont**, and finally, **West Virginia**, and then click **Group**.
- Rename this group, **East Coast**.
- Select **Include Other** to group the remaining states.
- Rename the **Other** group, **Central**.

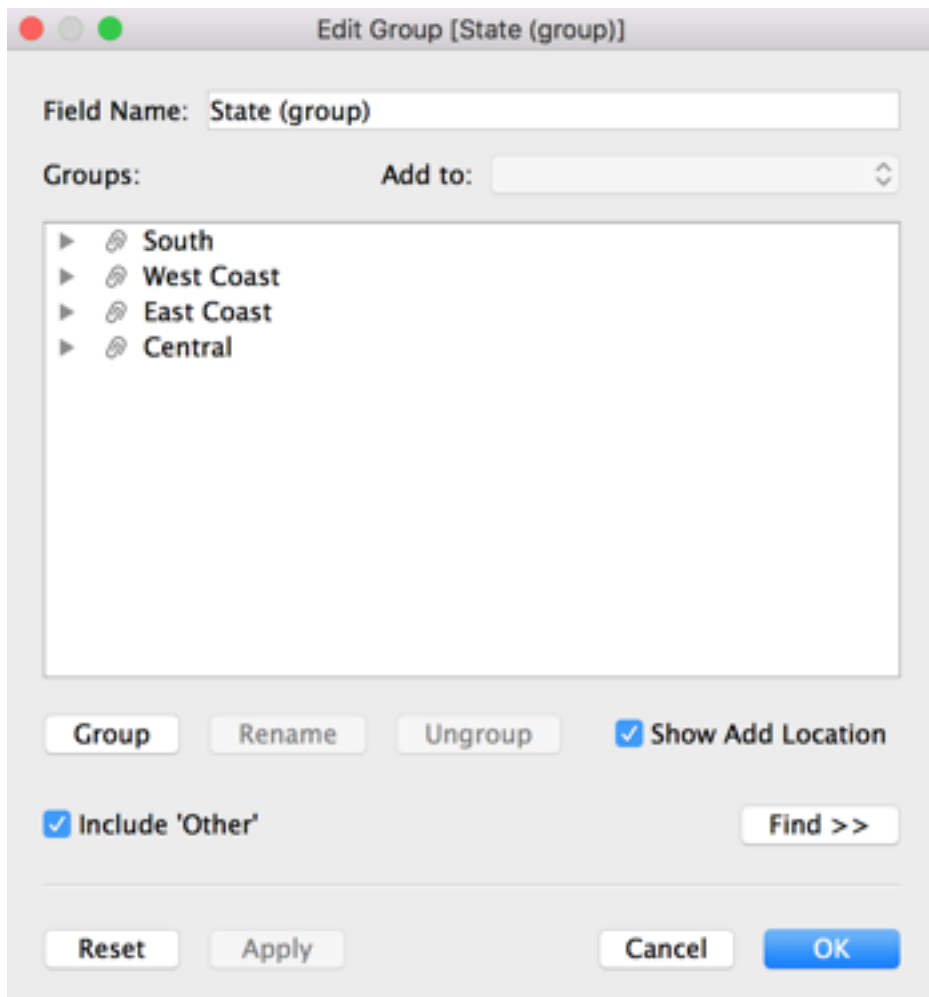

- Click **OK**.

A **State (group)** field appears in the **Data** pane beneath your other mapping items.

- From the Data pane, drag **State (group)** to **Color** on the Marks card.

The view updates to look like this:

Tableau Desktop and Web Authoring Help

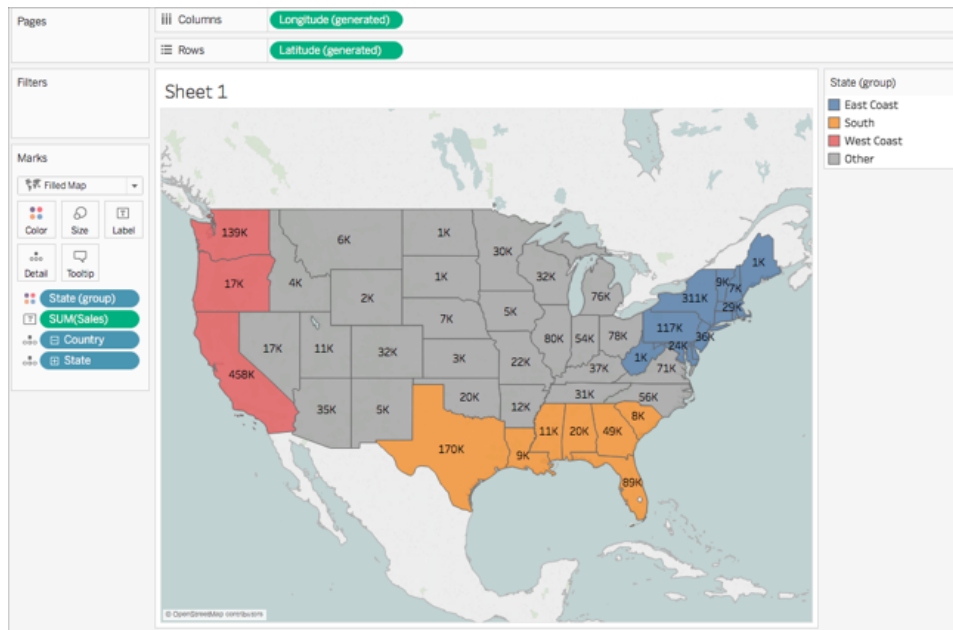

Notice that each group has a different color.

13. On the Marks card, click the **Color** icon and select **Edit Colors**.
14. In the Edit Colors dialog box that appears, select **Assign Palette**, and then click **OK**.

The marks update with new colors.

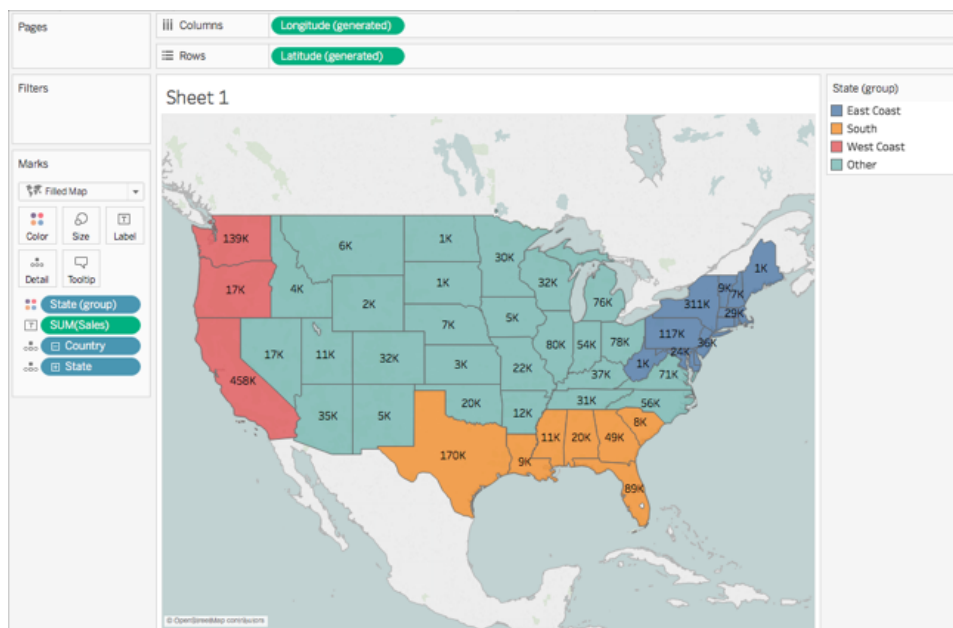

15. From Measures, drag **Sales** to **Tooltip** on the Marks card.

When you hover over a state, a tooltip appears with the sales for that state, among other information. You'll learn how to edit this tooltip later.

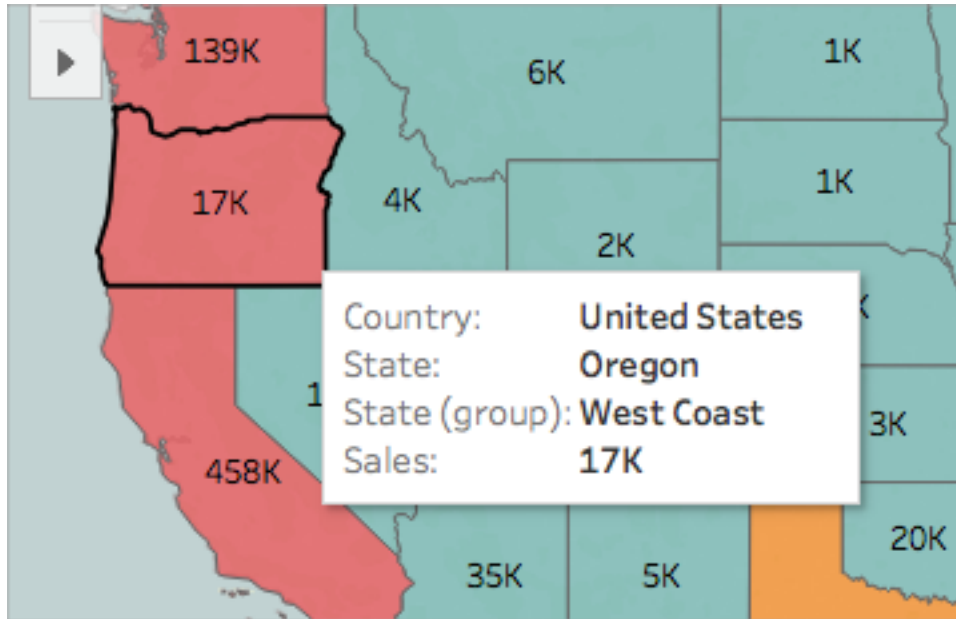

16. On the Marks card, click the minus (-) icon on the **Country** field to remove State from the level of detail.

If you did not create a hierarchy, you can drag **State** from the view to remove it. You can remove any field by dragging it from the view.

The states no longer appear on the map. Notice how the sum of sales has updated for the labels and in the tooltip? This is because custom territories aggregate at the level of the group, rather than separately for each location within the group. So the sum of sales you are seeing in the West Coast group, for example, are the total sales for California, Oregon, and Washington combined.

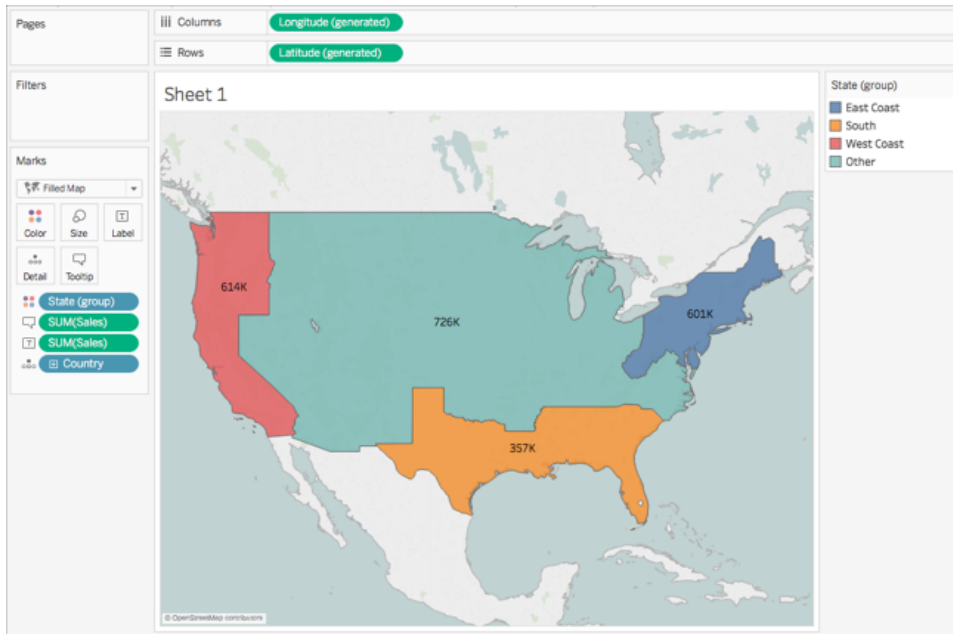

Step 10: Create a dual axis map

So far you have created two map views: one that shows the sales per state, and one that shows the sales per region. Could you layer these maps on top of one another? Yes! In Tableau, you can create a map with two layers of marks. This is called a dual axis map in Tableau, and is often used to layer points over polygons. In this example, you will layer two polygons maps.

To create a dual axis map:

1. From the Data pane, drag **Longitude (generated)** to the **Columns** shelf and place it to the right of the first Longitude field.

The view updates with two identical maps.

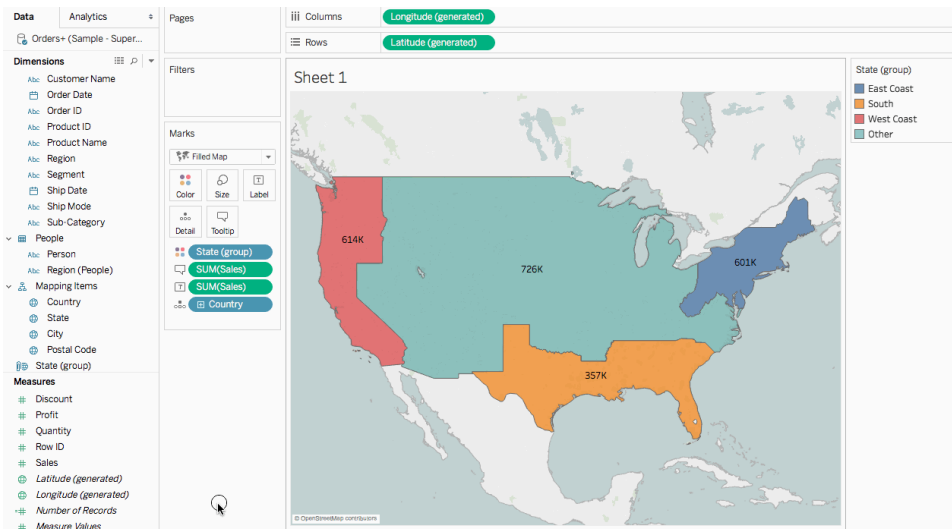

There are now three tabs on the Marks card: one for each map view, and one for both views (All). You can use these to control the visual detail of the map views. The top Longitude tab corresponds to the map on the left of the view, and the bottom Longitude tab corresponds to the map on the right of the view.

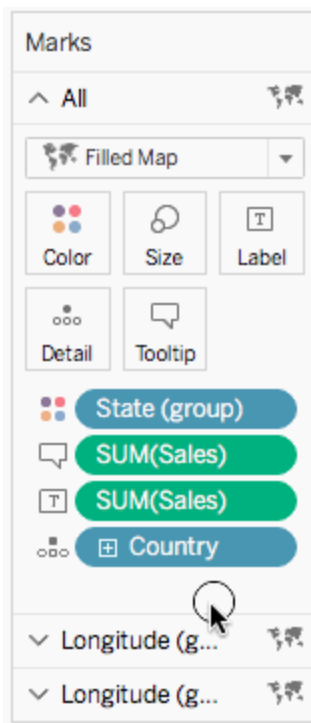

2. On the Marks card, select the top **Longitude (generated)** tab.

3. From Measures, drag **Sales** to **Color** on the top Longitude (generated) Marks card.
The map on the left updates.
4. On the top Longitude (generated) Marks card, click the **+** icon on the **Country** field to drill back down to the State level of detail.
5. On the Marks card, click **Color**, and then select **Edit Colors**.
6. In the Edit Colors dialog box that opens, click the Palette drop-down, select **Gray**, and then click **OK**.

At this point, your maps look like this:

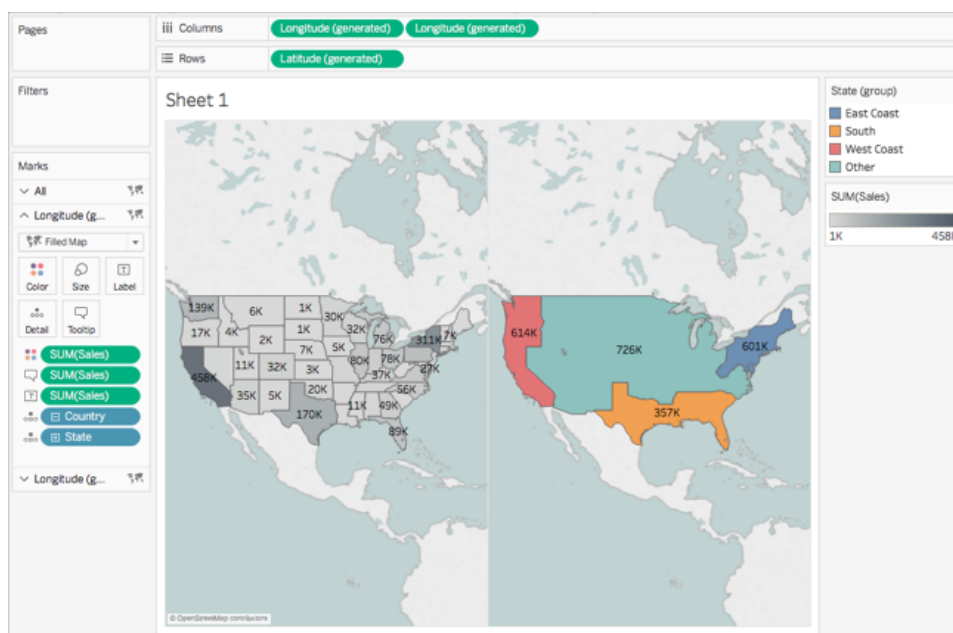

7. On the Columns shelf, right-click the **Longitude (generated)** field on the right and select **Dual Axis**.

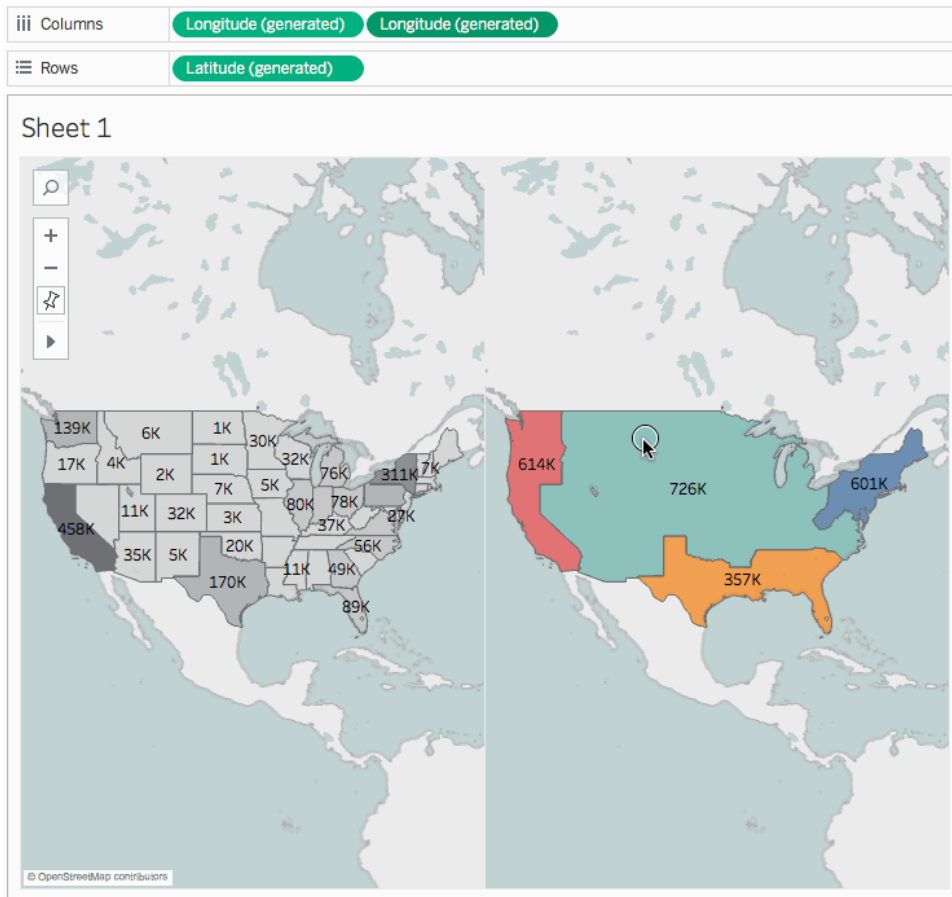

8. On the Marks card, select the bottom **Longitude (generated)** tab.
9. On the bottom **Longitude (generated)** Marks card, drag both **SUM(Sales)** fields from the view to remove them.

The labels for each map no longer overlap.

10. On the bottom **Longitude (generated)** Marks card, click **Color**, and then, for **Opacity**, enter **50%**.

This is a crucial step if you want to be able to see the map on the bottom layer.

The map view updates to look like this:

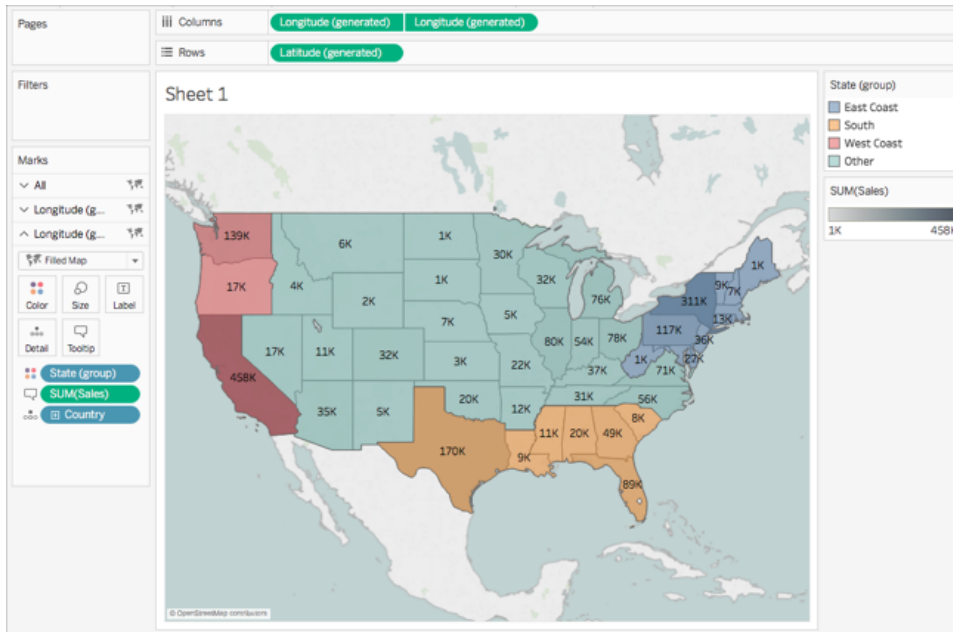

You can now see how each state performed within each group.

11. On the bottom **Longitude (generated)** Marks card, click **Tooltips**.

An Edit Tooltip dialog box opens.

12. Copy the following text and paste it into the Edit Tooltip dialog box, and then click **OK**:

Total <State (group)> region sales: **<SUM(Sales)>**

The tooltip looks similar to this:

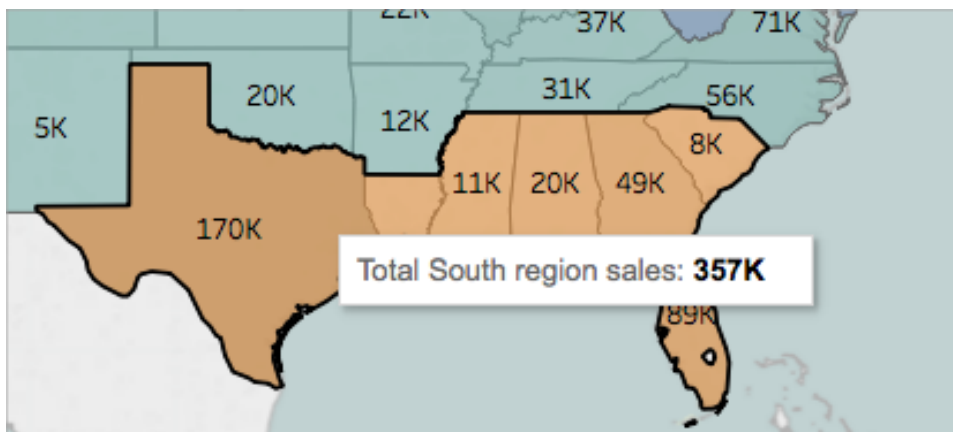

Congrats! You've created a dual axis map! There's only one thing left to do.

For more information about dual axis maps, see [Dual Axis Mapping - Many Ways](#) on the Tableau Community.

Step 11: Customize how others can interact with your map

Now that you have created your map view, you can customize how people will interact with it. For example, you might now want anyone to be able to zoom in or out of your map, or pan. Or perhaps you want to display a map scale? You can customize these two options and more in the Map Options dialog box.

To customize how others can interact with your map:

1. Select **Map > Map Options**.
2. In the Map Options dialog box that appears, do the following:
 - Select **Show Map Scale**.
 - Clear **Show Map Search**.
 - Clear **Show View Toolbar**.

A scale appears in the bottom-right corner of the map, and the map search icon and the toolbar in the top left corner of the map disappear. You can still pan and zoom using keyboard shortcuts. For more information, see [Zoom and Pan Views, and Select Marks on page 1992](#).

And that's a wrap! Your map view is now ready to be presented or combined with another view in a dashboard. For more information about dashboards, see [Create a Dashboard on page 2703](#).

Want to check your work? Download the [example workbook](#) from Tableau Public.

What's Next?

[Learn some mapping visualization basics.](#)

[Learn about the types of maps you can build in Tableau and how to create them.](#)

Looking for more advanced content? See the [mapping series on the Tableau Community](#).

Explore [other Help content](#) about mapping.

Got a specific question or problem? Check out the [Mapping Forum](#) on the Tableau Community or search the [Knowledge Base](#).

Mapping Concepts in Tableau

If you want to analyze your data geographically, you can plot your data on a map in Tableau. This topic explains why and when you should put your data on a map visualization. It also describes some of the types of maps you can create in Tableau, with links to topics that demonstrate how to create each one.

If you're new to maps in Tableau, this is a great place to start learning.

Why put your data on a map?

There are many reasons to put your data on a map. Perhaps you have some location data in your data source? Or maybe you think a map could really make your data pop? Both of those are good enough reasons to create a map visualization, but it's important to keep in mind that maps, like any other type of visualization, serve a particular purpose: they answer spatial questions.

You make a map in Tableau because you have a spatial question, and you need to use a map to understand the trends or patterns in your data.

But what is a spatial question? Some examples might be:

- Which state has the most farmers markets?
- Where are the regions in the U.S. with the high obesity rates?
- Which metro station is the busiest for each metro line in my city?
- Where did the storms move over time?
- Where are people checking out and returning bikes from their local bike share program?

All of these are spatial questions. However, is a map the best way to answer them?

When should you use a map to represent your data?

If you have a spatial question, a map view might be a great way to answer it. However, that might not always be the case.

Take for example, the first question from the previous list: Which state has the most farmers markets?

If you had a data source with a list of farmers markets per state, you might create a map view like the one below. Can you easily tell the difference between New York and California? Which one has more farmers markets?

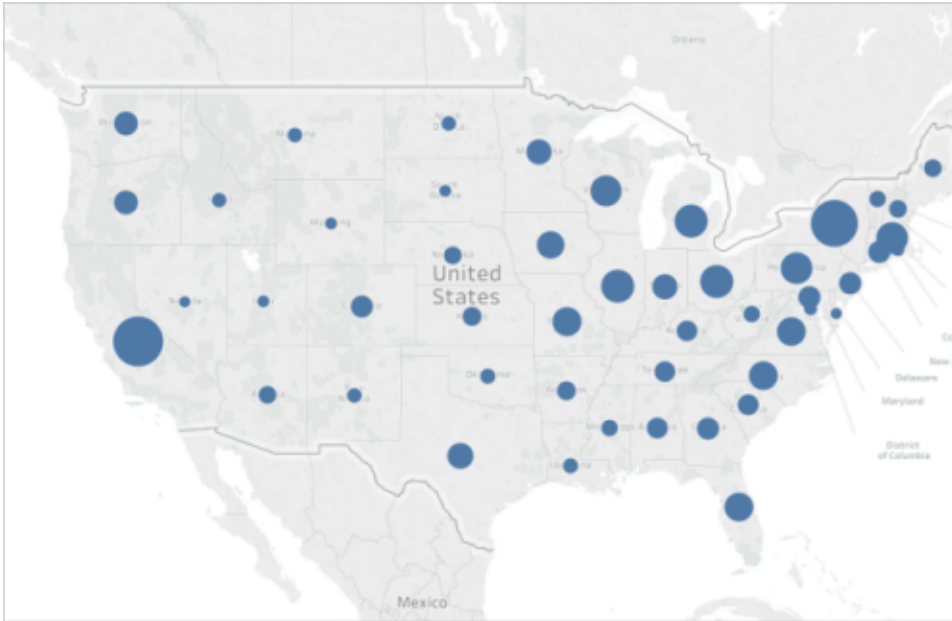

What if you create a bar chart instead? Now is it easy to spot the state with the most farmers markets?

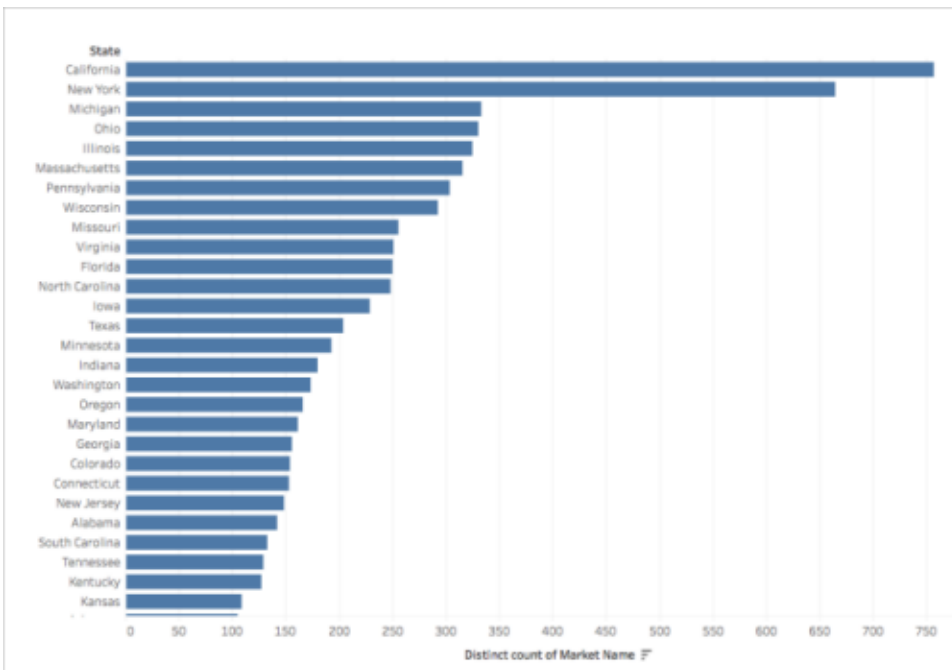

The above example is one of many where a different type of visualization would be better to answer a spatial question than a map.

So when do you know if you should use a map view?

One general rule is to ask yourself whether you could answer your question faster, or easier with another visualization. If the answer is yes, then perhaps a map view isn't the best visualization for the data you're using. If the answer is no, then take the following into account:

Maps that answer questions well have both appropriate data representation, and attractive data representation. In other words: the data isn't misleading, and the map is appealing.

If your map is beautiful, but the data is misleading, or not insightful, you run the risk of people misinterpreting your data. That's why it's important to create maps that represent your data accurately, as well as attractively.

What types of maps can you build in Tableau?

With Tableau, you can create the following common map types:

- **Proportional symbol maps** below
- **Choropleth maps (filled maps)** on the next page
- **Point distribution maps** on the next page
- **Density maps (heatmaps)** on page 1677
- **Flow maps (path maps)** on page 1678
- **Spider maps (origin-destination maps)** on page 1679

Proportional symbol maps

Proportional symbol maps are great for showing quantitative data for individual locations. For example, you can plot earthquakes around the world and size them by magnitude.

For more information about proportional symbol maps, and to learn how to create them in Tableau, see [Create Maps that Show Quantitative Values in Tableau](#) on page 1773.

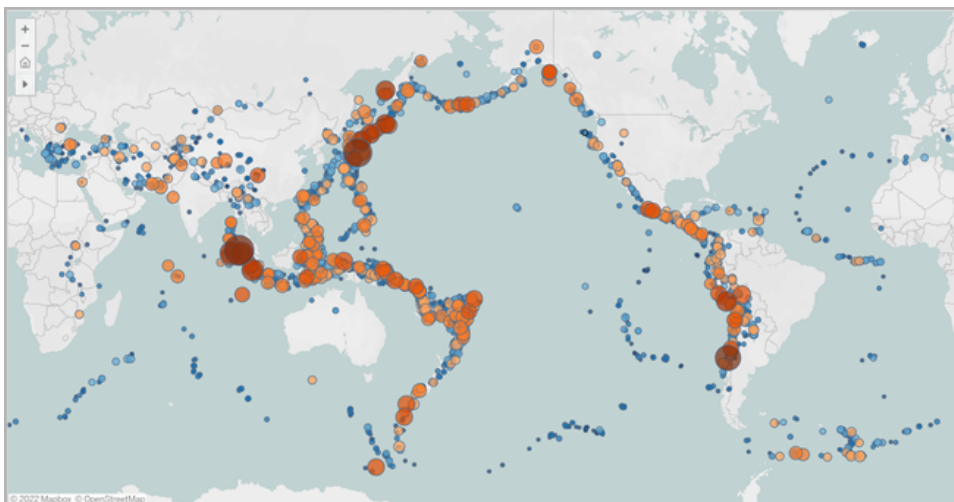

Choropleth maps (filled maps)

Also known as filled maps in Tableau, Choropleth maps are great for showing ratio data. For example, if you want to see obesity rates for every county across the United States, you might consider creating a choropleth map to see if you can spot any spatial trends.

For more information about Choropleth maps, and to learn how to create them in Tableau, see [Create Maps that Show Ratio or Aggregated Data in Tableau](#) on page 1784.

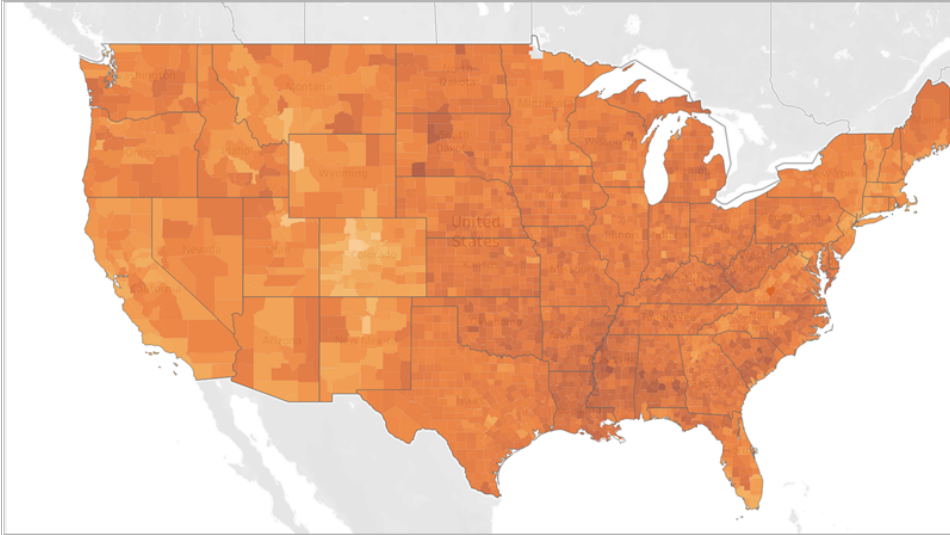

Point distribution maps

Point distribution maps can be used when you want to show approximate locations and are looking for visual clusters of data. For example, if you want to see where all the hailstorms were in the U.S. last year, you can create a point distribution map to see if you can spot any clusters.

For more information about point distribution maps, and to learn how to create them in Tableau, see [Create Maps that Highlight Visual Clusters of Data in Tableau](#) on page 1779.

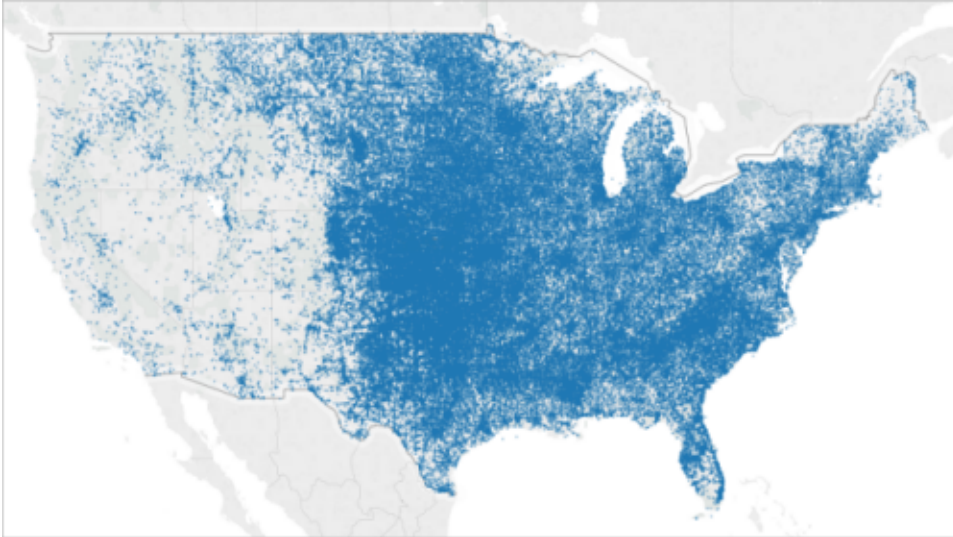

Density maps (heatmaps)

Density maps, also called heatmaps, can be used when you want to show a trend for visual clusters of data. For example, if you want to find out which areas of Manhattan have the most taxi pickups, you can create a density map to see which areas are most popular.

For more information about density maps, and to learn how to create them in Tableau, see [Create Heatmaps that Show Trends or Density in Tableau](#) on page 1800.

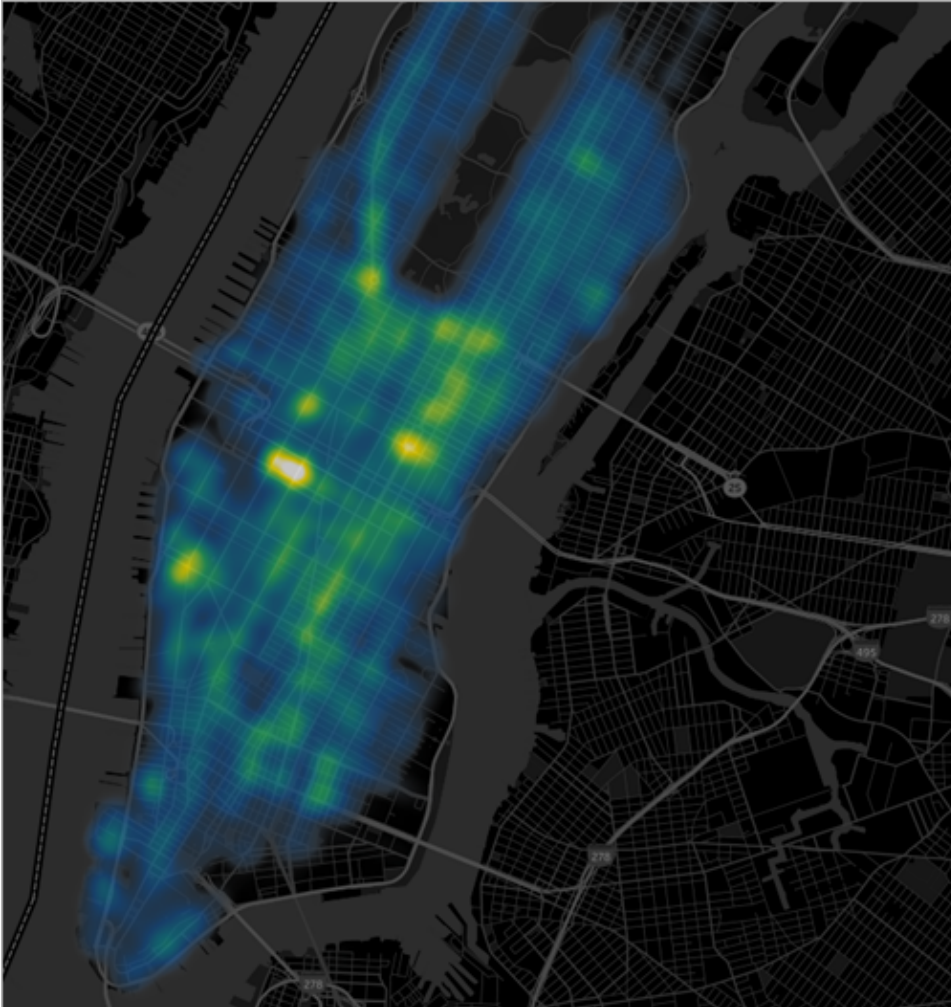

[Back to top](#)

Flow maps (path maps)

You can use flow maps to connect paths across a map and to see where something went over time. For example, you can track the paths of major storms across the world over a period of time.

For more information about flow maps, and to learn how to create them in Tableau, see [Create Maps that Show a Path Over Time in Tableau](#) on page 1792.

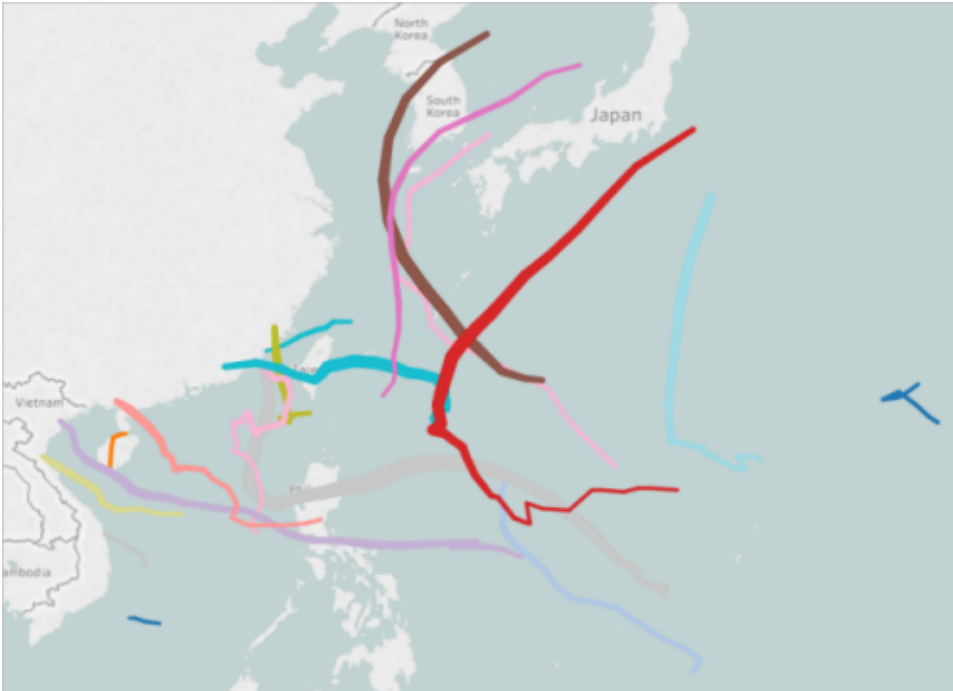

Spider maps (origin-destination maps)

You can use a spider map to show how an origin location and one or more destination locations interact. For example, you can connect paths between metro stations to plot them on a map, or you can track bike share rides from an origin to one or more destinations.

For more information about spider maps, and to learn how to create them in Tableau, see [Create Maps that Show Paths Between Origins and Destinations in Tableau](#) on page 1806.

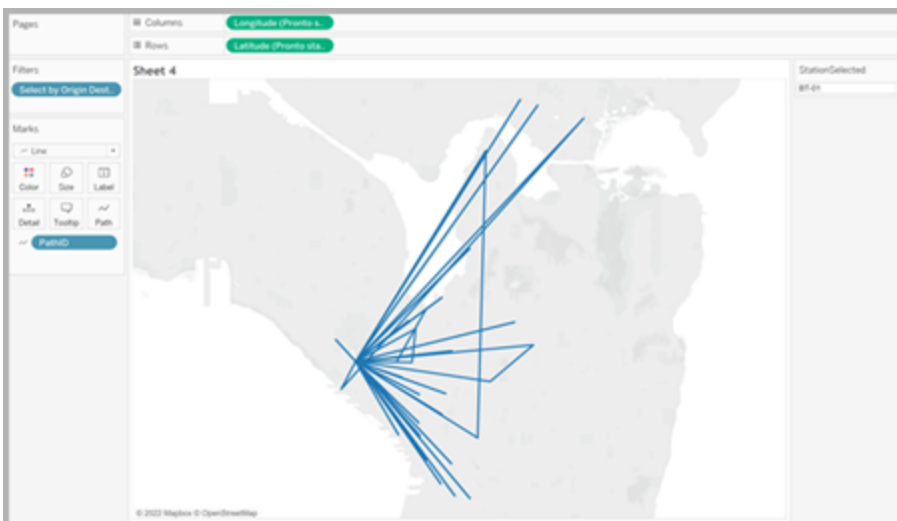
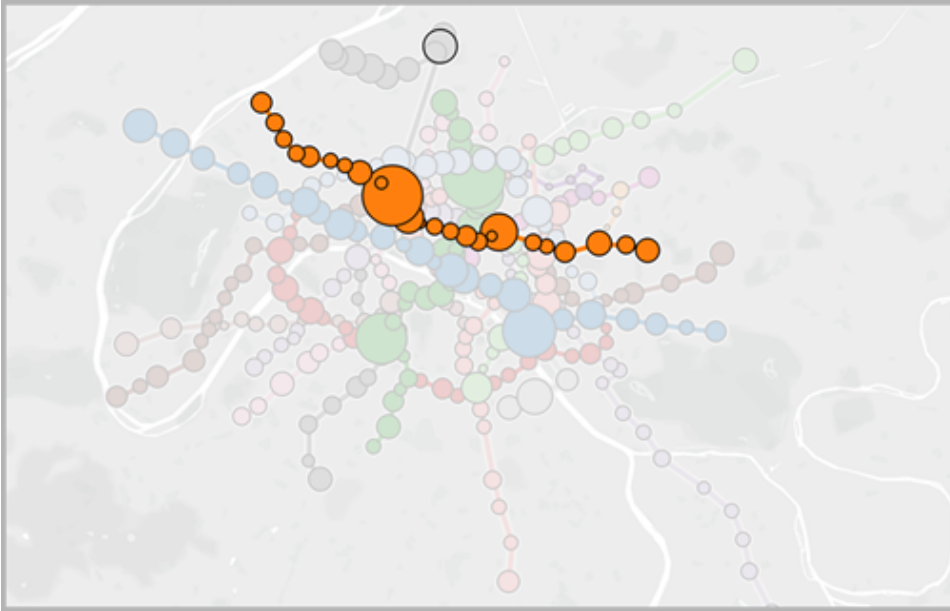

Resources to help you get started

Before you get started with building map views in Tableau, review some of the following resources.

Get your geographic data into Tableau

- [Create Tableau Maps from Spatial Files](#) on page 1745: If you have Esri Shapefiles, Mapinfo tables, or KML files, start here.

- [Geocode Locations Tableau Does Not Recognize and Plot Them on a Map](#) on page 1711: If you have data that Tableau doesn't recognize, start here.
- [Blend Geographic Data](#) on page 1720: If you have geographic data you want to blend with another data source, start here.

Format your geographic fields

- [Assign Geographic Roles](#) on page 1727: After you bring your geographic data into Tableau, you'll need to format that data for use in Tableau.

See also

[Build-It-Yourself: Build a map view](#)

[Customize How Your Map Looks](#) on page 1854

[Use Mapbox Maps](#) on page 1882

[Use Web Map Service \(WMS\) Servers](#) on page 1885

The Mapping Workspace in Tableau

The mapping workspace in Tableau consists of the following elements.

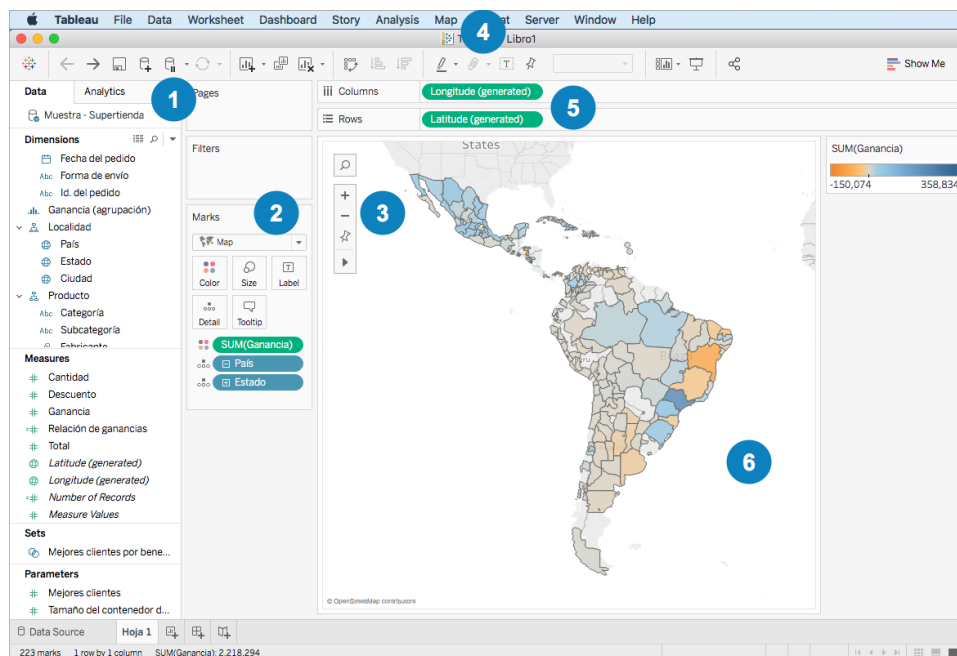



The Data Pane

The Data pane organizes your location data into dimensions and measures. Typically, your location fields (country, state, and city names, for example) should be dimensions, and your latitude and longitude fields should be measures. However, there are some scenarios where latitude and longitude fields can be dimensions.

In the Data pane, a globe icon next to a location field means that a geographic role is assigned to that field. For more information, see [Assign Geographic Roles](#) on page 1727.

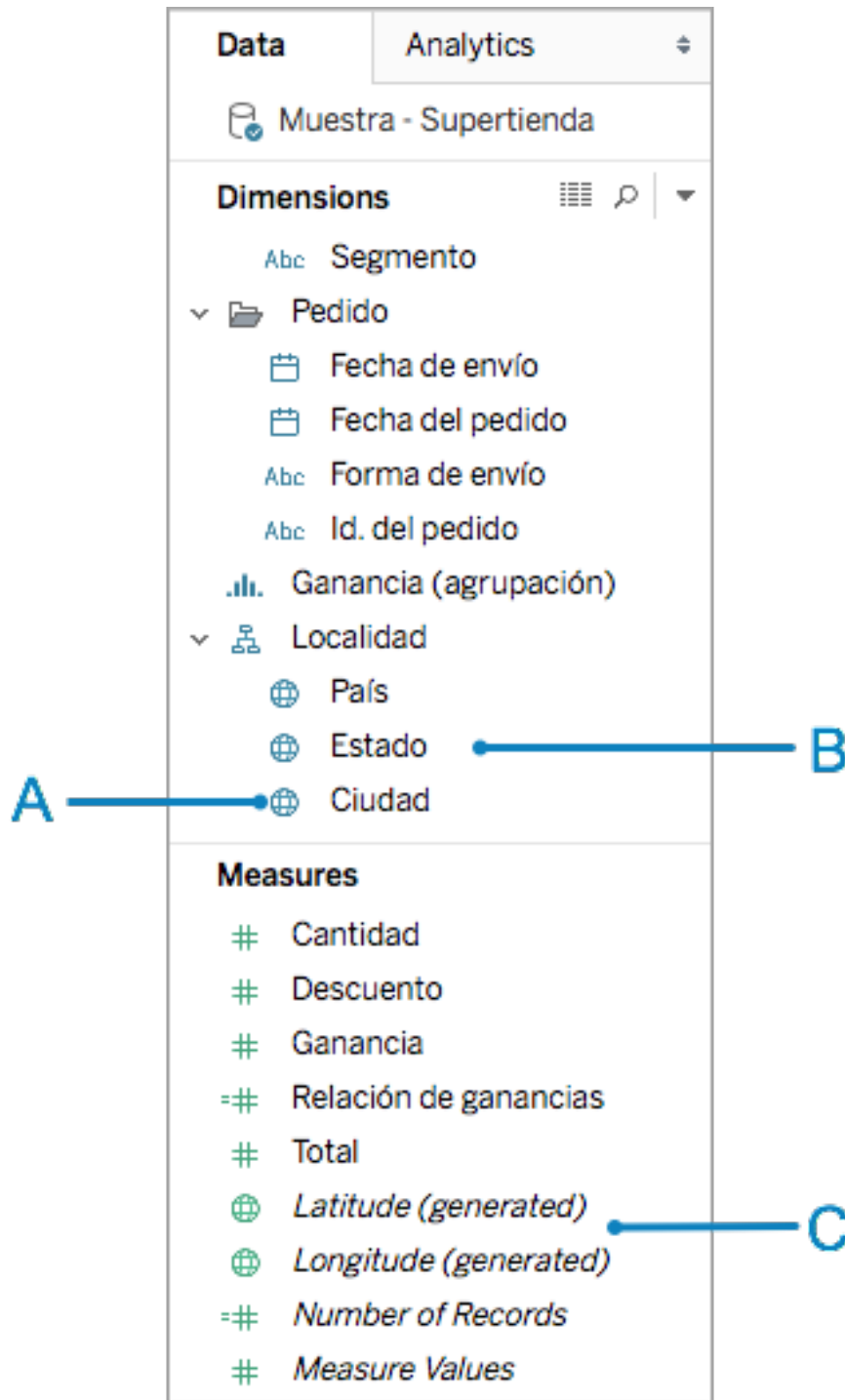

A: Globe icon - indicates that a field is a geographic field and can be automatically mapped by Tableau.

B: Location fields - These categorical fields, often location names, can be found under Dimensions. They are often recognized by Tableau.

C: Latitude and Longitude generated fields - When you have geographic fields in your data source, Tableau often generates Latitude and Longitude fields. You can use these to build your map, or you can include your own latitude and longitude fields.

2

The Marks Card

The Marks card is where you control the granularity and visual detail of your map view. In the Marks card, you can drag locations to Detail to add more granularity, drag fields to Color, Size, or Label to add visual detail, or change the map type from a point map to a polygon map.

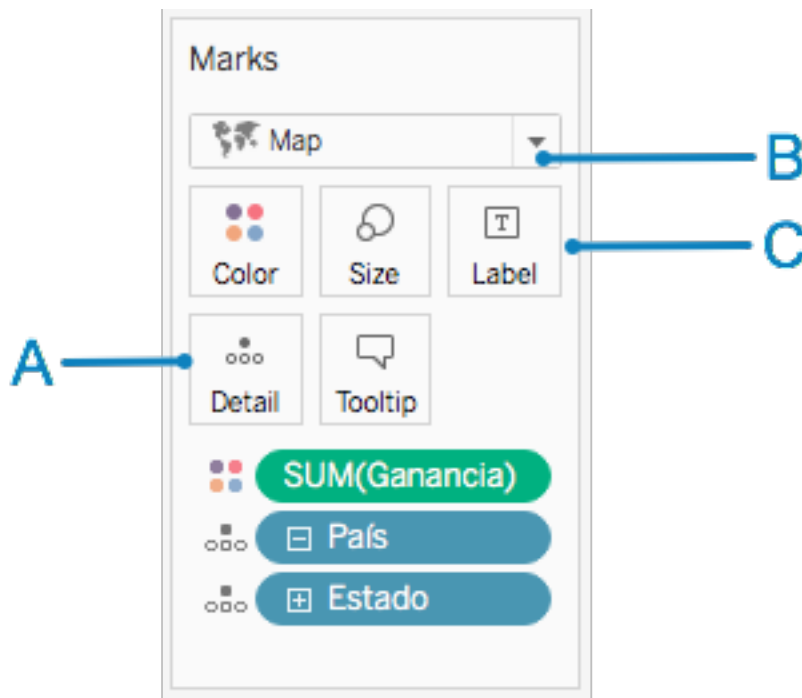

A: Add location fields to Detail to create a map and add granularity to the view.

B: Select the Automatic mark type for a point map and the Map mark type for a polygon (filled) map.

C: Add fields to Color, Size, and Label to change the visual detail of the marks (data points) in the view.

3

The View Toolbar

The view toolbar holds many of the tools you might need to explore your map data.

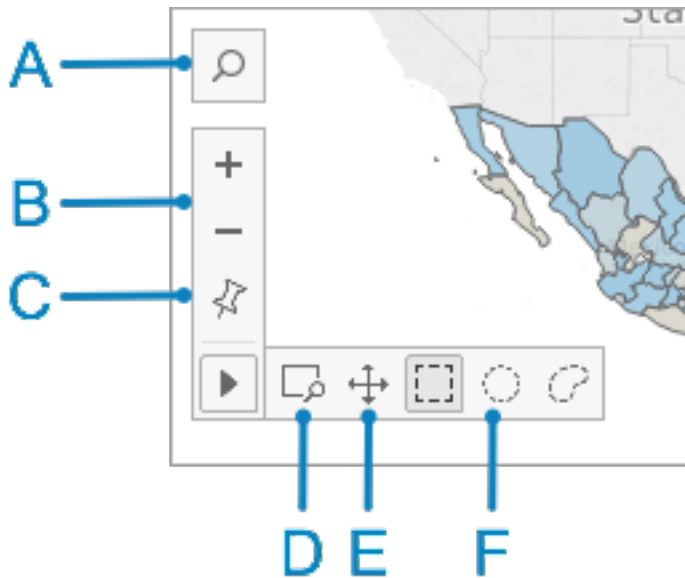

A: Use the map search icon to search for locations in your map.

B: Use the plus and minus icons to zoom in and out of the map.

D: Use the zoom area icon to zoom in to a specific area in the map.

E: Use the pan icon to pan around the map.

F: Use the selection tools to select data points within a rectangle, circle, or drawn area. You can also measure distances with the circle selection tool. For more information, see [Measure Distances Between Data Points and Locations in a Map](#) on page 1896.

4

The Map Menu

The Map menu holds several maps-specific options:

- Select **Map > Background Maps** to add a map service (such as Mapbox or a WMS server) or to switch between the background maps you have available in your workbook. For more information, see [Import your own background map on page 1856](#).
- Select **Map > Background Images** to add a static image instead of a background map to your view.
- Select **Map > Geocoding** to import locations that Tableau does not recognize into your workbook. For more information, see [Geocode Locations Tableau Does Not Recognize and Plot Them on a Map on page 1711](#).
- Select **Map > Edit Locations** to edit your location data to match the Tableau map data. For more information, see [Edit Unknown or Ambiguous Locations on page 1731](#).
- Select **Map > Map Layers** to customize your background map style, add or remove map layers, or add U.S. data layers. For more information see [Customize How Your Map Looks on page 1854](#).
- Select **Map > Map Options** to control if people can pan and zoom, search for locations, or use the view toolbar. For more information, see [Customize How People Interact with your Map on page 1878](#)

5

The Columns and Rows Shelves

The Columns and Rows shelves are where you put your latitude and longitude fields. Longitude is placed on the Columns shelf, and Latitude is placed on the Rows shelf, regardless of whether they are your latitude and longitude fields, or the generated fields Tableau creates.

Columns	Longitude (generated)
Rows	Latitude (generated)



The Map Visualization

This is your map. As you makes changes to your map, the viz updates. This visualization is dynamic and can be interacted with. Hover over the marks to learn more information about each location. You can edit the information that displays in the tooltip that appears using the Tooltip button on the Marks card. For more information, see [Add tooltips to marks on page 1271](#) and [Create Views in Tooltips \(Viz in Tooltip\) on page 1371](#).

In addition to the options available in the mapping workspace, Tableau provides many other options for analyzing your data. You can [create custom territories](#), [filter data from your view](#), [set up parameters](#), [create sets](#), and much more.

See Also

[Get Started Mapping with Tableau on page 1647](#)

Location Data that Tableau Supports for Building Map Views

Tableau supports worldwide airport codes, cities, countries, regions, territories, states, provinces, and some postcodes and second-level administrative districts (county-equivalents). U.S. area codes, Core Based Statistical Areas (CBSA), Metropolitan Statistical Areas (MSA), Congressional districts, and Zip codes are also supported by Tableau. Additionally, any latitude and longitude coordinates are supported, as long as they are in decimal degrees.

Note: See [About Tableau Maps](#) on the Tableau website for a complete list of location data by country that Tableau supports.

What to do if Tableau doesn't recognize your location data

- **If Tableau recognizes your location data and automatically assigns geographic roles to your fields** (you'll know this has happened because there will be a globe icon  next to them in the **Data** pane), then you're ready to build a map view. Just double-click one of those geographic fields and you've got a map.

- **If Tableau does not immediately recognize your location data**, and you can't build a map view, you'll need to assign geographic roles to your fields. See the [Assign a geographic role to a field on page 1728](#) section to learn how.

Note: This procedure only works if your location data is supported by Tableau. If your data isn't supported by Tableau, there are a couple of things you can try in the meantime to map that data in Tableau:

- [Edit location names in your data source to match Tableau location names](#)
- [Custom geocode your data](#)
- [Blend your geographic data](#)
- [Use spatial data to build a map view](#)

Note: Connecting to spatial data is only supported on Tableau Desktop version 10.2 and later.

See Also

[About Tableau Maps Data](#)

[About Tableau Maps Partners](#)

Spatial File

This topic describes how to connect Tableau to Shapefiles, MapInfo tables, KML (Keyhole Markup Language) files, TopoJSON files, GeoJSON files, and Esri File Geodatabases.

Note: Connecting to spatial data is supported in Tableau Desktop version 10.2 and later.

Before you connect

Before you can connect to spatial files, make sure to include all of the following files in the same directory:

- **For Esri shapefiles:** The folder must contain `.shp`, `.shx`, `.dbf`, and `.prj` files as well as `.zip` files of the Esri shapefile.

For Esri File Geodatabases: The folder must contain the File Geodatabase's `.gdb` or the `.zip` of the File Geodatabases's `.gdb`.

- **For MapInfo tables** (Tableau Desktop only): The folder must contain `.TAB`, `.DAT`, `.MAP`, and `.ID` or `.MID` and `.MIF` files.
- **For KML files**: The folder must contain the `.kml` file. (No other files are required.)
- **For GeoJSON files**: The folder must contain the `.geojson` file. (No other files are required.)
- **For TopoJSON files**: The folder must contain the `.json` or `.topojson` file. (No other files are required.)

Note: Flat files will pull in the contents of the entire folder. For performance reasons, remove unneeded files and reduce the amount of data in the files.

You can connect only to point geometries, linear geometries, and polygons in current versions of Tableau. You cannot connect to mixed geometry types.

If your data does not display diacritics (accent marks on characters) properly, check to make sure the file is **UTF-8** encoded.

Make the connection and set up the data source

In Tableau Desktop: click the New Data Source icon and select **Spatial file**.

In Tableau Cloud or Tableau Server (Creator role): Select **Create > Workbook**. Select the **Files** tab.

Then do the following:

1. Navigate to the folder that contains your spatial data and select the spatial file you want to connect to.
2. Select **Open**.

Spatial file data source example

Here is an example of a spatial file data source using Tableau Desktop on a Mac computer:

Binomial	Presence	Origin	Year	Island	Family Nam	Friendly N	Geometry
Phyllomys unicolor	1	1	2008	null	ECHIMYIDAE	Phyllomys unicolor	POLYGON
Coendou rufescens	1	1	2016	null	ERETHIZONTIDAE	Coendou rufescens	MULTIPOLYGON
Echiothrix leucura	1	1	2008	Sulawesi	MURIDAE	Echiothrix leucura	MULTIPOLYGON
Echiothrix leucura	2	1	2008	Sulawesi	MURIDAE	Echiothrix leucura	POLYGON
Echymipera clara	1	1	2008	New Guinea	PERAMELIDAE	Echymipera clara	POLYGON
Echymipera clara	1	1	2008	Japen Island	PERAMELIDAE	Echymipera clara	POLYGON
Echymipera echinis...	1	1	2008	New Guinea	PERAMELIDAE	Echymipera echinis...	MULTIPOLYGON
Echymipera davidi	1	1	2008	Kiriwina Isla...	PERAMELIDAE	Echymipera davidi	POLYGON
Echymipera kalubu	1	1	2016	Waigeo	PERAMELIDAE	Echymipera kalubu	POLYGON
Echymipera kalubu	1	1	2016	Vokeo	PERAMELIDAE	Echymipera kalubu	POLYGON
Echymipera kalubu	1	1	2016	Umboi	PERAMELIDAE	Echymipera kalubu	POLYGON
Echymipera kalubu	1	1	2016	Tolokiwa	PERAMELIDAE	Echymipera kalubu	POLYGON
Echymipera kalubu	1	1	2016	Su Mios	PERAMELIDAE	Echymipera kalubu	POLYGON

Work with the Geometry column

There are many tasks that you can optionally perform on your data before you start your analysis, such as hiding or renaming fields. Note, however, the following restrictions apply when working with the Geometry column:

- You can't hide the Geometry column.
- You can't split the Geometry column.
- On the data source page, you can't create a calculated field using the Geometry column.

About .tde and .hhyper files in Tableau Desktop

You might notice .tde or .hhyper files when navigating your computer's directory. When you create a Tableau data source that connects to your data, Tableau creates a .tde or .hhyper file. This file, also known as a shadow extract, is used to help improve the speed your data source loads in Tableau Desktop. Although a shadow extract contains underlying data and other information similar to the standard Tableau extract, a shadow extract is saved in a different format and can't be used to recover your data.

Note: .tde files are no longer supported for Tableau versions beyond 2024.2. All extracts are now in .hhyper format.

See also

[Create Tableau Maps from Spatial Files](#) on page 1745

Connect to Spatial Data in a Database

You can use spatial columns stored in your database to build map visualizations in Tableau. You can connect to supported spatial data sources and build visualizations with them to analyze spatial data, or you can connect to custom SQL or RAWSQL queries to perform advanced spatial analysis.

Tableau supports direct connections to spatial data using these connectors:

- Amazon Redshift
- Microsoft SQL Server
- PostgreSQL + PostGIS
- Pivotal Greenplum + PostGIS
- Oracle
- Snowflake

For information on using these connectors, see the [Microsoft SQL Server](#) on page 379, [PostgreSQL](#) on page 407, [Pivotal Greenplum Database](#) on page 405, [Oracle](#) on page 392, or [Snowflake](#) on page 471 connector examples.

Supported spatial data and SRIDs

For **Microsoft SQL Server**, only Geography-type spatial data is supported.

PostgreSQL + PostGIS, **Oracle**, and **Pivotal Greenplum + PostGIS** support Geography- and Geometry-type fields. Geometry fields must specify the geo-type (for example, POINT, LINESTRING) and SRID to be recognized as a spatial field. Geography fields must specify the geo-type to be recognized.

Note: In PostgreSQL + PostGIS, you can connect to tables with both mixed geometry types (points, lines, and polygons), but Tableau won't render these simultaneously.

The following **SRIDs** are supported by these connectors:

- NAD83 (EPSG:4269)
- ETRS89 (EPSG:4258)

- WGS84 (EPSG:4326)

In PostgreSQL + PostGIS, SRID always defaults to WGS84 (EPSG: 4326).

Tableau supports both live and extract connections using these connectors.

Connect to spatial columns

1. Open Tableau and connect to your data.
For more information on how to connect to data using supported connectors, see the [Microsoft SQL Server](#) on page 379, [PostgreSQL](#) on page 407, [Oracle](#) on page 392, [Pivotal Greenplum Database](#) on page 405 or [Snowflake](#) on page 471 connector examples.
2. On the Data Source page, in the left pane under Table, drag a table that contains spatial data onto the canvas.

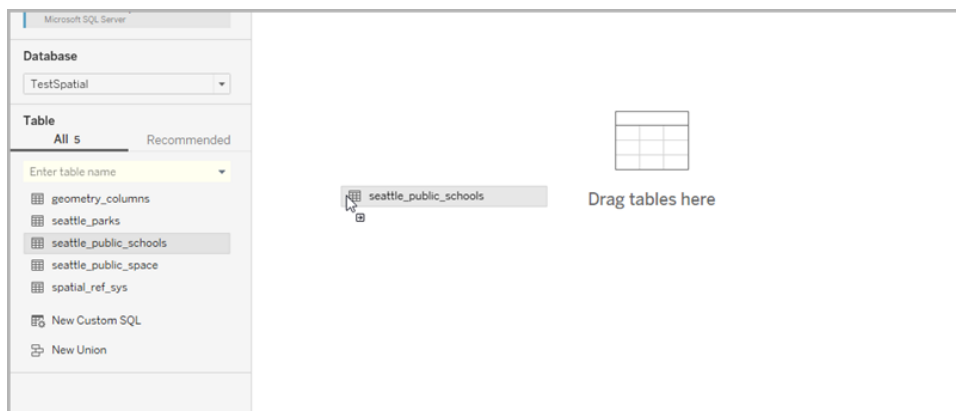

Spatial columns display the same name they have in your database.

You're now ready to build a map in Tableau using spatial data. For more information on how to create maps from spatial files, see [Build a map view from spatial data on page 1747](#).

Use Custom SQL and RAWSQL to perform advanced spatial analysis

Connect to a Custom SQL query

1. Open Tableau and connect to your database.
2. On the Data Source page, in the left pane, drag **New Custom SQL** onto the canvas.
3. Type or paste your query into the Edit Custom SQL dialog box that appears. For examples of Custom SQL you can use with spatial data, see [Custom SQL query](#)

[examples](#) on the facing page.

- When finished, click **OK**.

For more information, see [Connect to a Custom SQL Query](#) on page 863

Custom SQL query examples

The following queries are examples. Note that Custom SQL queries will vary from data source to data source.

If your data has two sets of points, such as schools and parks, and you want to show where they intersect:

```
SELECT S.[name] as SchoolName, P.[name] as PubSpaceName, S.geog_
schools.STBuffer(<Parameters.Radius>) as Geog_School, P.geog_pub_space as Geog_
Pub_Space FROM TestSpatial.dbo.seattle_public_schools S LEFT JOIN
TestSpatial.dbo.seattle_pub_space P ON S.geog_schools.STBuffer
(<Parameters.Radius>). STIntersects(P.geog_pub_space) = 1
```

This example query produces a row for each case where a public space polygon is within Radius distance (meters) from a school. The result of the query looks like this in the data grid:

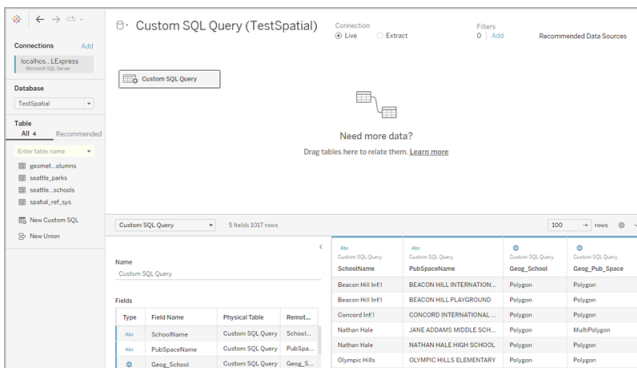

Note: This example references a parameter named "Radius." It measures distance (meters) and has the following settings:

- Data type: Float
- Current Value: 600
- Allowable values: Range
- Minimum: 100

- Maximum 2,000
- Step size: 50

Using the parameter, you can adjust the relationship between schools and public spaces dynamically.

For more information, see [Use parameters in a custom SQL query](#) on page 873.

If you only want data around a certain point

```
SELECT * FROM [Test_spatial_<username>].[dbo].[SDOT_Collisions]
C WHERE C.geom.STIntersects(geography::STGeomFromText('POINT(-
122.344706 47.650388)', 4326).STBuffer(1000))=1
```

This example query limits data to 1000 meters around the POINT. The radius can be a parameter, like [the parameter used in the first example](#).

Or, rather than a point and radius, a rectangle can be used. For example:

```
SELECT * FROM [Test_spatial_<username>].[dbo].[SDOT_Collisions]
C
WHERE C.geom.STIntersects(geography::STGeomFromText('POLYGON ((-
122.3625 47.6642,-122.3625 47.6493,-122.3427 47.6493,-122.3422
47.6642,-122.3625 47.6642))', 4326))=1
```

The winding order of the polygon points (clockwise vs. counter-clockwise) determines which set of points you get. You can reverse the winding order with the SQL Server function `ReorientObject()`.

If you get an error about mixed data types

```
SELECT *, F.geom.STGeometryType() as geomtype FROM [Test_
spatial_<username>].[dbo].[us_historic_fire_perimeters_dd83] F
WHERE F.geom.STGeometryType() = 'MultiPolygon' OR
F.geom.STGeometryType() = 'Polygon'
```

This example query filters out the geometry-type spatial data, since Tableau can't render geometry-type spatial data for Microsoft SQL Server connections. You can select other spatial types as well.

If your data renders too slowly in Tableau

```
SELECT [Id], [OBJECTID], [fire_num], [year_], [acres], [fire_
name], [unit_id], [Shape_Leng], [Shape_Area], [geom].Reduce(500)
as SimpleGeom
FROM [Test_spatial_<username>].[dbo].[us_historic_fire_
perimeters_dd83]
WHERE [geom].Reduce(500).STGeometryType() = 'MultiPolygon' OR
[geom].Reduce(500).STGeometryType() = 'Polygon'
```

This example query may greatly reduce data size. (Some objects are reduced to Points, and these are discarded.)

Use RAWSQL

To use RAWSQL with spatial data, you can create a calculated field using either the RAWSQL_SPATIAL or RAWSQLAGG_SPATIAL functions. For example:

```
RAWSQL_SPATIAL("Select %1.STIntersection(%2.STBuffer(200))",
[school_geom], [park_geom])
```

This formula returns unique spatial data based on the intersection of two values.

```
RAWSQLAGG_SPATIAL("ST_ConvexHull(ST_Collect(%1))", [Geog])
```

```
RAWSQLAGG_SPATIAL("ST_ConcaveHull(ST_Collect(%1), %2, false)",
[Geog], [ParameterValue])
```

Each of these return a bounding area around the supplied data points. ConcaveHull is a minimum bounding area based on the precision, which in this function is the parameter value.

For more information about using RAWSQL with spatial data, see [Pass-Through Functions \(RAWSQL\) on page 2126](#). For more information about how to create calculated fields, see [Create a calculated field on page 2018](#).

Note: RAWSQL spatial functions aren't available when connected to **Oracle**.

Note: It's possible to cause errors when using RAWSQL specific to PostGIS functions when using PostgreSQL + PostGIS.

Troubleshooting spatial connections

Performance issues

When working with joined spatial columns with a large number of records, duplicate marks can occur. This can result in slow performance.

To improve performance, extract the joined data source. For more information, see [Extract Your Data on page 919](#).

Microsoft SQL Server error messages and solutions

When the spatial table is using an unsupported spatial reference

Error message:

An error occurred while communicating with the Microsoft SQL Server data source '<data source name>'.

Bad Connection: Tableau couldn't connect to the data source.

[Microsoft][ODBC Driver 13 for SQL Server][SQL Server]Operand type clash: geometry is incompatible with geography

[Microsoft][ODBC Driver 13 for SQL Server][SQL Server]Statement(s) could not be prepared.

Solution:

- Export the spatial data from Microsoft SQL Server to a Shapefile and connect to it in Tableau. Spatial file connections go through a data transformation process that supports thousands of projections.
- Export the data from Microsoft SQL Server and transform the data using a GIS tool like QGIS or ArcGIS. Then reload the table back into Microsoft SQL Server.

When the spatial table includes multiple types of spatial objects

Error message:

Unable to complete action

The spatial operation resulted in a MixedGeometry or MixedGeography, which Tableau doesn't support yet.

The spatial operation resulted in a MixedGeometry or MixedGeography, which Tableau doesn't support yet.

Solution:

Use Custom SQL to filter the data. For more information, see [If you get an error about mixed data types on page 1694](#) Custom SQL example.

When measures are being aggregated in the visualization

Error message:

An error occurred while communicating with the Microsoft SQL Server data source '<data source name>'

Bad Connection: Tableau could not connect to the data source.

Cannot perform an aggregate function on an expression containing an aggregate or a subquery.

Solution:

Disaggregate measures in the visualization: Select **Analysis**, and then clear **Aggregate Measures**.

PostgreSQL + PostGIS, Oracle, and Pivotal Greenplum + PostGIS error messages and solutions

When using mixed SRIDs and one of the SRIDs is unsupported

Error message:

An error occurred while communicating with the PostgreSQL data source '<data source name>'.
Bad Connection: Tableau could not connect to the data source.
Error: Operation on mixed SRID geometries;
Error while executing the query
<query> from <datasource>
HAVING (COUNT(1) > 0)

Solution:

Disaggregate measures in the visualization: Select **Analysis**, and then clear **Aggregate Measures**. This eliminates the error message and the data where the SRID is unsupported.

When the spatial table is using an unsupported spatial reference

In PostgreSQL + PostGIS, you can connect to a table with unsupported SRIDs, but the Geometry column will display as "Unknown."

Solution:

- Export the spatial data from PostgreSQL + PostGIS to a Shapefile and connect to it in Tableau. Spatial file connections go through a data transformation process that supports thousands of projections.
- Export the data from PostgreSQL + PostGIS and transform the data using a GIS tool like QGIS or ArcGIS. Then reload the table back into PostgreSQL + PostGIS.

When a query result exceeds the limit of 1GB

Error message:

ERROR: array size exceeds the maximum allowed (1073741823); Error while executing the query"

```
SELECT ST_Collect(geom) FROM <data source>
```

Solution:

Rewrite the calculation to be more efficient. See [Best Practices for Creating Calculations in Tableau](#) on page 2461 or [Create Efficient Calculations](#) on page 3063.

Example - Build a map from Microsoft SQL Server spatial data

The following example demonstrates how to create the map below, which shows schools within 600 meters of parks in Seattle, Washington.

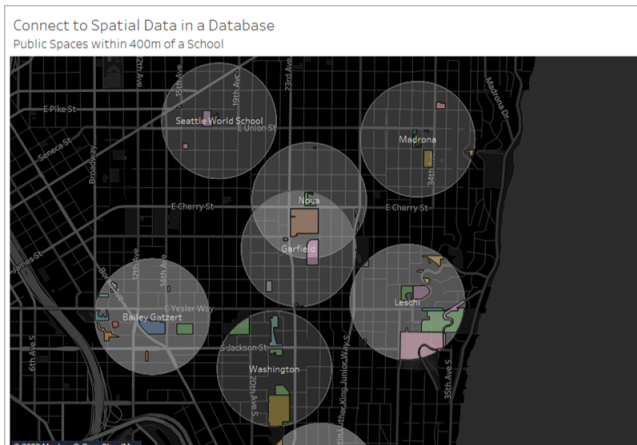

This example uses a Microsoft SQL Server connection to a database called, TestSpatial. The following tables from this database are used:

- seattle_schools
- seattle_public_space

Step 1: Connect

1. Open Tableau Desktop and connect to Microsoft SQL Server.
2. On the Data Source page, in the left pane, drag **New Custom SQL** onto the canvas.
3. Type or paste a query into the Edit Custom SQL dialog box that appears.

For this example, the following query is used:

```
SELECT S.[name] as SchoolName, P.[name] as PubSpaceName, S.geog_
schools.STBuffer(<Parameters.Radius>) as Geog_School, P.geog_pub_space as
Geog_Pub_Space FROM TestSpatial.dbo.seattle_public_schools S FULL JOIN
TestSpatial.dbo.seattle_public_space P ON S.geog_schools.STBuffer
(<Parameters.Radius>). STIntersects(P.geog_pub_space) = 1
```

Note: This example references a parameter named "Radius." For more information, see [Use parameters in a custom SQL query](#) on page 873.

The result of this query looks like the following:

Name	SchoolName	PubSpaceName	Geog_School	Geog_Pub_Space
Beacon Hill Int'l	BEACON HILL INTERNATIONAL		Polygon	Polygon
Beacon Hill Int'l	BEACON HILL PLAYGROUND		Polygon	Polygon
Concord Int'l	CONCORD INTERNATIONAL		Polygon	Polygon
Nathan Hale	JANE ADDAMS MIDDLE SCH.		Polygon	MultiPolygon
Nathan Hale	NATHAN HALE HIGH SCHOOL		Polygon	Polygon
Olympic Hills	OLYMPIC HILLS ELEMENTARY		Polygon	Polygon

Step 2: Build the map

1. Go to a new worksheet.
2. In the **Data** pane, double-click a spatial field.

In this example, **Geog_School** is used. When double-clicked, it's automatically added to Detail on the Marks card and a map view is created.

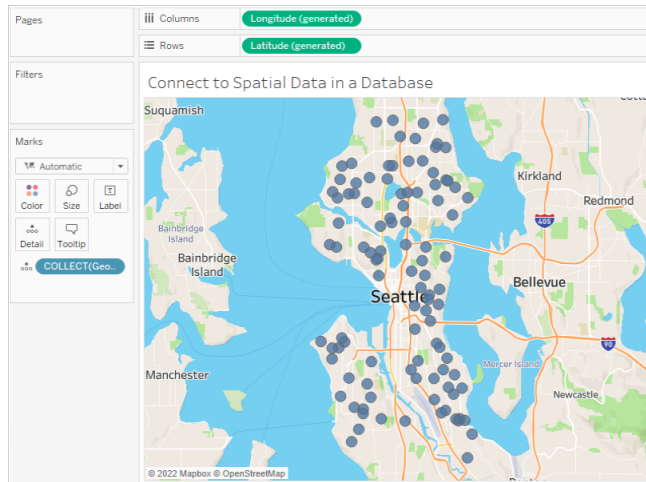

3. From the **Data** pane, drag a dimension field to **Label** on the Marks card. In this example, **School Name** is used.
4. Select **Analysis > Create Calculated field**.
5. In the Calculation editor that opens, do the following:
 - Name the calculated field. In this example, the calculated field is named **Intersection**.
 - Enter a RAWSQL formula. This example uses the following formula:

```
RAWSQL_SPATIAL ("Select %1.STIntersection(%2)", [Geog_School], [Geog_Pub_Space])
```

This formula returns unique spatial data based on the intersection of two geometries.
 - When finished, click **OK**.
6. Select **Analysis**, and then clear **Aggregate Measures**.
7. From the **Data** pane, drag the new calculated field (in this case, **Intersection**) to a new layer on the worksheet.

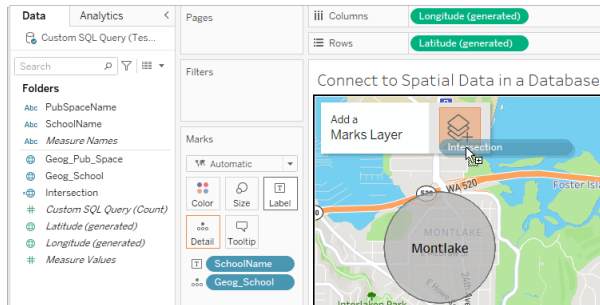

The map updates with a new layer of polygons from the Intersection field. The marks are unique spatial shapes because of the RAWSQL formula.

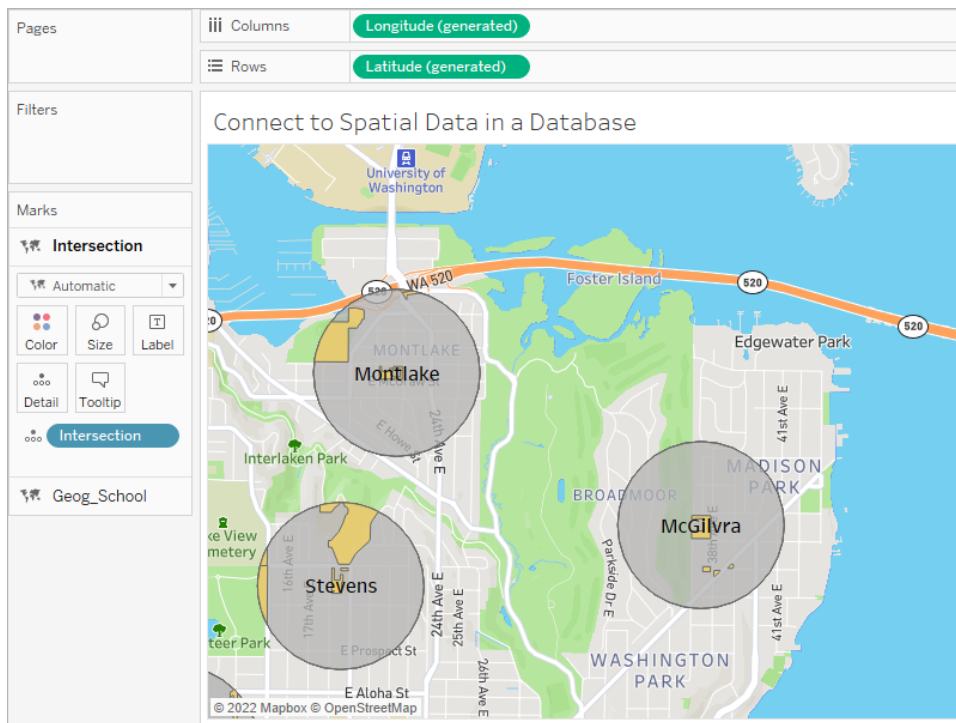

8. From the **Data** pane, drag a dimension field to **Detail** on the Marks card. This disaggregates the marks.
In this example, the dimension **PubSpaceName** is used.
9. From the **Data** pane, drag the same dimension field to **Color** on the Marks card.
In this example, each public space is now assigned a color.

Tableau Desktop and Web Authoring Help

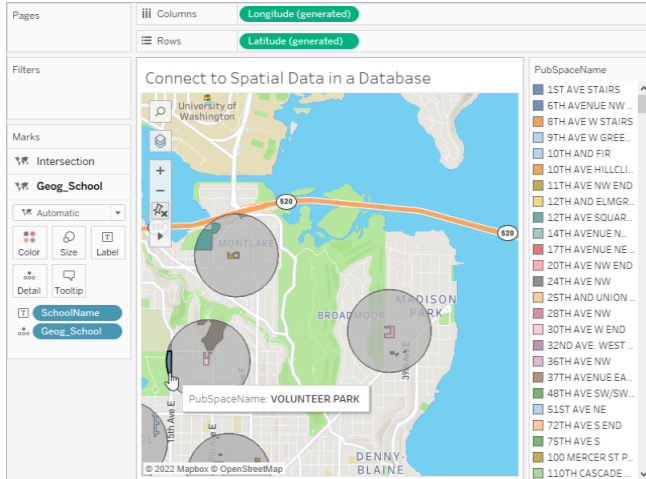

1. Format the map. For more information, see [Customize How Your Map Looks on page 1854](#)

In this example, the following formatting is applied:

- The School buffer marks (Geog_School) are colored gray.
- The School Name mark labels are colored white.
- The map background style is set to Dark.
- The Streets and Highways layer is shown on the background map.

The map is now finished.

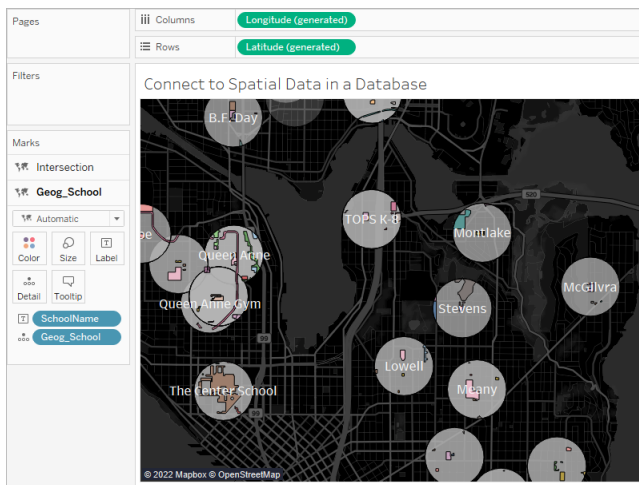

See Also

[Create Tableau Maps from Spatial Files on page 1745](#)

[Connect to a Custom SQL Query](#) on page 863

[Pass-Through Functions \(RAWSQL\)](#) on page 2126

[Get Started with Calculations in Tableau](#) on page 2017

[Spatial Join Slow and Returns Inverted Results Using KML or SQL Spatial Data Imported from Shapefile or GeoJSON](#)

Join Spatial Files in Tableau

You can use spatial data to create maps or other chart types in Tableau. If you have two spatial data sources, you can join them using their spatial features (geography or geometry). You can either join two spatial files together or use a spatial calculation to join a spatial file with non-spatial data that includes latitude and longitude fields.

Tableau supports connection to the following spatial data sources:

- Shapefiles
- MapInfo tables
- Keyhole Markup Language (KML) files
- GeoJSON files
- TopoJSON files
- Esri File Geodatabases

If you have WKT (well known text) in a CSV or Excel file, you can import the data and then translate it to spatial data on the Data Source page. You can also use MAKEPOINT to convert data that has latitude and longitude coordinates into spatial data. See [Create a spatial data source using MAKEPOINT](#) on page 2183.

For more information on the types of spatial files you can connect to in Tableau, and how to connect to them, see the [Spatial File on page 1688](#) connector example.

Important note: In Tableau 2021.3 or later, you can create spatial joins between point/polygon, polygon/line, polygon/polygon, and line/polygon features. In Tableau 2021.2 and earlier versions, you can only create spatial joins between points and polygons.

Join spatial files

Tip: To create, edit, or view spatial joins, you must first open a logical table in the relationship canvas—the area you see when you first open or create a data source—and access the join canvas.

1. Open Tableau and connect to the first spatial data source.
2. Open the join canvas for your data source by double-clicking the table on the canvas to open the join canvas (physical layer).
3. On the upper-left side of the Data Source page, under Connections, click **Add**.
4. In the Add a Connection menu that appears, connect to your second data source. Drag the second data source onto the join canvas.

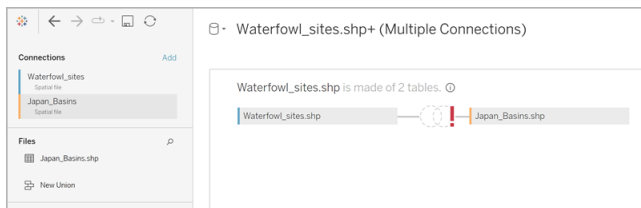

5. Click the **Join** icon.
6. In the Join dialog box that appears, do the following:

- Select a join type.

For more information about each of these types, see [Join Your Data on page 791](#).

- Under **Data Source**, select a spatial field to join by.

Note: Geometry is the default field name for spatial file sources except in SQL

Server, where users create field names. Spatial fields have a globe icon  next to them.

- For the second data source, select another spatial field. If your second data source isn't a spatial file and contains latitude and longitude fields, select **Create Join Calculation** as the join clause so that your data can be used in a spatial join. For more information, see [Spatial Functions on page 2178](#).
- Click the = sign and then select **Intersects** from the drop-down menu. You can only

intersect two spatial fields.

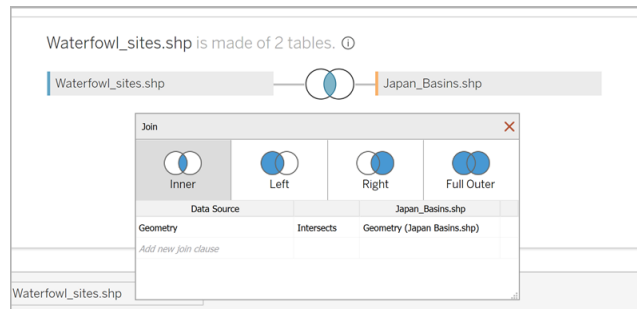

- When finished, close the Join dialog box.

The map updates to show the count of waterfowl sightings in each basin, and you're ready to start analyzing your spatial data.

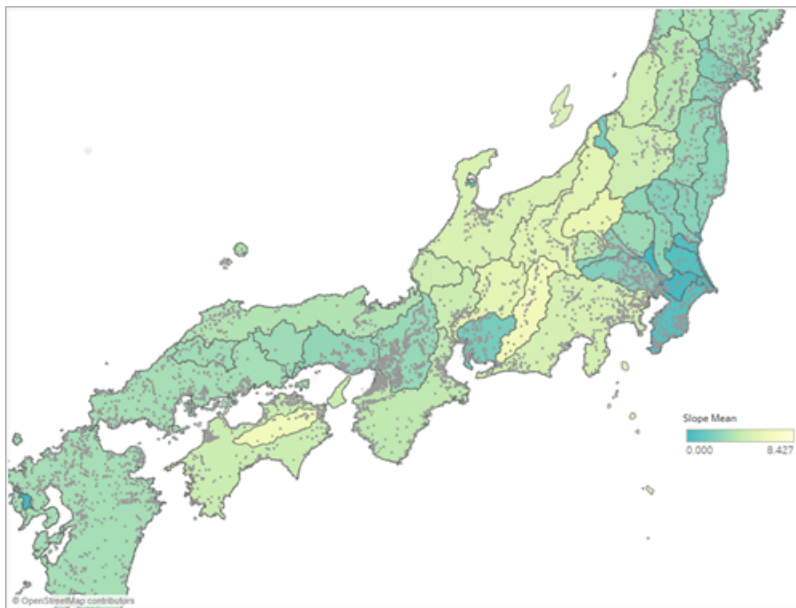

For more information on building different chart types, see [Build Charts and Analyze Data](#) on page 1005.

Troubleshoot spatial joins

SQL Server error: Geometry is incompatible with geography

Although SQL Server supports both a geography and a geometry data type, Tableau only supports geography data type from SQL Server from the following geographies: EPSG:WGS84

= 4326, EPSG:NAD83 = 4269, EPSG:ETRS89=4258. If you try to add a different geography, or a geometry field from SQL Server to your analysis, you'll receive an error.

Vertex ordering

Different spatial systems may order their vertices differently. If two spatial files contain two different vertex orders, it may cause problems with your analysis. Tableau interprets ordering specification according to the order of the spatial data source.

For more information, see [Spatial Join Slow and Returns Inverted Results Using KML or SQL Spatial Data Imported from Shapefile or GeoJSON](#) and [Supporting advanced spatial analytics with changes to lines and polygon edges in Tableau](#) in the Tableau Knowledge Base.

See Also:

[Spatial File](#) on page 1688

[Join Your Data](#) on page 791

[Create Tableau Maps from Spatial Files](#) on page 1745

[Create Dual-Axis \(Layered\) Maps in Tableau](#) on page 1821

Spatial Parameters and Operators

Spatial parameters

You can create a spatial parameter to use in calculations from spatial data. You can load spatial parameters from a data source, or you can use well-known text (WKT) to create spatial parameters in Tableau. A spatial parameter can be a point, polygon, multipolygon, line, or a homogenous collection of these types. You can use spatial parameters the same way you use other parameters in Tableau, such as parameter controls, parameter actions, and dynamic values.

Note: Spatial parameters can only be created with fields from spatial data, such as latitude and longitude coordinates. They can't be created with text string fields. For example, a country field is a text string that may have a geographic role applied, but it's still a text string.

Create a spatial parameter

To create a parameter from the Data pane:

1. Click the dropdown arrow in the upper right corner and select **Create Parameter**.

Alternatively, you can right click a field and select **Create Parameter**.

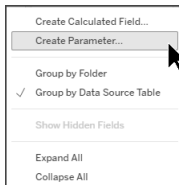

2. In the Create Parameter dialog box, name your spatial parameter.
3. Open the Data Type dropdown, and select **Spatial**.

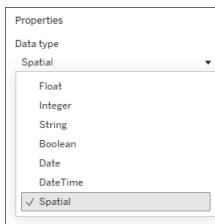

4. Under Allowable Values, select **All** or **List**.
Choosing List allows you to populate the values by using WKT or from a field. For List domain parameters, we recommend using an alias when naming your parameter. For example, instead of naming your spatial parameter POINT(-73.9856 40.7484079), name it Empire State Building. The use of an alias is only available for List domain parameters.
5. Open the dropdown menu next to **Add values from** and select a field. You can also type the WKT values directly into the grid
6. Select **OK**.

The spatial parameter appears at the bottom of the Data pane under the Parameters section.

Visualize your spatial parameter

To visualize the spatial parameter, the parameter needs to be used in a calculation.

1. Select **Analysis > Create Calculated Field**.
2. In the Calculation Editor that opens, name your calculated field.

3. In the Calculation Editor, drag your parameter and drop it in the formula.
4. Select **OK**.

The new calculated field is added to the Data pane. It has an = in front of the data type icon to show it's a calculated field. You can now visualize your parameter by dropping onto a map layer or double-clicking the pill.

You can change the parameter values by using a parameter control, a parameter action, or a dynamic parameter.

Show a spatial parameter control on the viz

A parameter control is a worksheet card that lets you modify the parameter value. They're similar to filter cards in that they contain controls that modify the view.

To show the spatial parameter control, right-click (Control-click on Mac) the parameter in the Data pane and select **Show Parameter**.

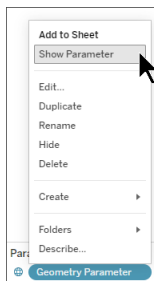

You can use the spatial parameter control in several different ways. As a type-in control, you can type in WKT to set your parameter value, or you can type in the parameter's alias. You can also use list or dropdown controls to view your spatial parameter.

To learn more about Parameters and how to use them, see [Create Parameters](#).

Spatial operators

Starting in Tableau version 24.3, you can use spatial operators in a calculation.

To learn more about calculated fields and how to use them, see [Create a Simple Calculated Field in Tableau](#).

Create a calculated field using a spatial operator

1. In a worksheet in Tableau, select **Analysis > Create Calculated Field**.
2. In the Calculation Editor that opens, name your calculated field.

- In the Calculation Editor, use a spatial operator in the formula.

For example: `UNION([Geometry])`

- Select **OK**.

The new calculated field is added to the Data pane with an  icon in front of the data type icon to indicate it's a calculated field used with a spatial operator.

Spatial operators available in Tableau

DIFFERENCE

Operator	DIFFERENCE
Definition	Computes the portions of regions remaining when all regions in the second argument are carved out of the first argument in areas that overlap. Discards regions from the second argument in areas that don't overlap.
Example	

INTERSECTION

Operator	INTERSECTION
Definition	Computes and returns the portions of regions in the second argument that overlap regions in the first argument.
Example	

SYMDIFFERENCE

Operator	SYMDIFFERENCE
----------	---------------

Definition	Computes any portions of regions from the second argument that overlap regions in the first argument and discards from both. Returns the remaining portions of regions from both arguments.
Example	

UNION

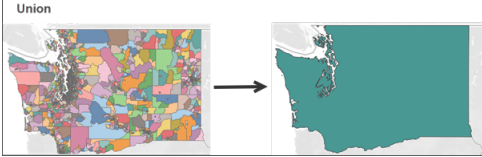
Operator	UNION
Definition	Returns spatial data points, polygons, and lines that overlap or intersect as an outline of the whole.
Example	

Geocode Locations Tableau Does Not Recognize and Plot Them on a Map

If you have locations that Tableau can't map, such as street addresses, you can custom geocode those locations. Custom geocoding means that you assign latitude and longitude coordinates to your locations so Tableau can plot them accurately. It also allows you to create custom geographic roles that you can use as you create map views in Tableau.

For example, if your data contains country, state/province, and street address data, Tableau Desktop geocodes your data to the country and state/province level, but won't recognize the street address data. In this case, you can create a custom geographic role for the street address data so that you can plot it on a map view in Tableau.

Follow the following steps to learn how to custom geocode your data.

Before you start: Custom geocoding your data can be tricky. We recommend that you check out the [Assign Geographic Roles on page 1727](#) topic to learn more about geographic roles and the types of data Tableau recognizes before you get started.

Step 1: Create a CSV file with your location data

The first step to custom geocoding your data is creating a CSV file to import into Tableau. The contents of this file differ depending on whether you're [extending an existing geographic hierarchy](#), [adding a new geographic role](#), or [adding a new hierarchy](#) to Tableau.

However, the following applies to all custom geocoding files:

- The .csv file must contain Latitude and Longitude columns.
- The latitude and longitude values you add must be real numbers. Make sure to include at least one decimal place when specifying these values.

Extend an Existing Role

The built-in geographic roles in Tableau contain hierarchies that can be extended to include locations relevant to your data. For example, the existing hierarchy of Country > State/Province may not contain all of the states or provinces in your data. You can extend this level to include missing states or provinces.

The import file for this type of geocoding should contain every level of the hierarchy above the level you are extending. For example, if you're extending (adding data to) the State/Province geographic role, the existing State/Province hierarchy has a column for Country and State/Province, along with Latitude and Longitude.

	A	B	C	D
1	Country (Name)	State/Province	Latitude	Longitude
2	England	United Kingdom	51.5000	0.1167
3	Scotland	United Kingdom	55.9500	3.1833
4	Wales	United Kingdom	51.4833	3.1833
5	Northern Ireland	United Kingdom	54.6000	5.9167

In the import file, the names of the columns define the geographic roles. When extending an existing role, the column names must match the existing geographic roles in the hierarchy that you're extending. This ensures that the new locations are added to the proper roles and hierarchies.

See the following table for information on how to organize hierarchies in your import file.

Built-In Hierarchy	Columns to include in the .csv file (in order; left to right)

Country (Name)	Country (Name) Latitude Longitude
Country (Name), State/Province	Country (Name) State/Province Latitude Longitude
Country (Name), State/Province, City	Country (Name) State/Province City Latitude Longitude
Country (Name), State/Province, County	Country (Name) State/Province County Latitude Longitude
Country (Name), ZIP Code/Post-code	Country (Name) ZIP Code/Postcode Latitude Longitude
Country (Name), Area Code	Country (Name) Area Code Latitude Longitude
Country (Name), CBSA	Country (Name)

	CBSA
	Latitude
	Longitude

In addition to the Country (Name) column, you can optionally include the following columns: Country 2 char (ISO 3166-1), Country 3 char (ISO 3166-1), and Country (FIPS 10). If you include these columns, they should be just to the right of the Country (Name) column in any order.

Note: The highest level in the hierarchy is Country and can't be extended to include higher levels such as Continent, etc.

Add New Roles

To add new geographic roles to the existing geographic hierarchy in Tableau, format your import file to include the new roles along with their parent roles.

When adding new roles to an existing hierarchy, the import file for those roles needs to contain the columns for each level in the existing hierarchy. For more information on the columns to include in each geographic hierarchy, see the [built-in hierarchy table](#) in the Extend An Existing Role section.

The following table is an example of an import file containing the locations of crater impacts in North America. Importing the following file would add the geographic role Crater Name to the existing Country (Name), State hierarchy. Notice that the column name for country matches the existing Country (Name) geographic role.

A	B	C	D	E
Crater Name	State	Country (Name)	Latitude	Longitude
Ames	Oklahoma	U.S.A.	35.007752	-97.092877
Asak	Alaska	U.S.A.	64.200841	-149.493673
Barringer	Arizona	U.S.A.	34.048928	-111.093731
Beaverhead	Montana	U.S.A.	46.879682	-110.362566
Brent	Ontario	Canada	51.253775	-85.323214
Calvin	Michigan	USA	44.314844	-85.602364
Carswell	Saskatchewan	Canada	52.939916	-106.450864
Charlevoix	Quebec	Canada	46.813878	-71.207981
Chesapeake Bay	Virginia	U.S.A.	37.431573	-78.656894
Chicoutub	Yucatan	Mexico	20.709879	-89.094338

After you've created your import file, save the file as a Comma Delimited (.csv) file (Windows Comma Separated if on a Mac) in a folder on your computer.

Step 2 (Optional): Create a schema.ini file

Sometimes when you attempt to import custom geographic information in Tableau using a .csv file, you may see a ".csv could not be used because it does not contain a unique column" error message.

This is because your .csv file might contain numerical data, such as numeric postcodes. Tableau will only accept text fields for new geographic roles. However, you can create a schema.ini file to tell Tableau that the numeric field you want to import should be treated as a text field.

To learn how to create a schema.ini file, see [Create a schema.ini File](#) on page 1718.

Step 3: Import custom geocoding files into Tableau Desktop

After you've created a .csv file with custom geocoding you can import that file into Tableau.

1. Open Tableau Desktop and navigate to a new or existing worksheet.
2. Select **Map > Geocoding > Import Custom Geocoding**.
3. In the Import Custom Geocoding dialog box, click the button to the right of the text field to browse to the folder your import file is saved in. All files in the folder will be imported into Tableau.

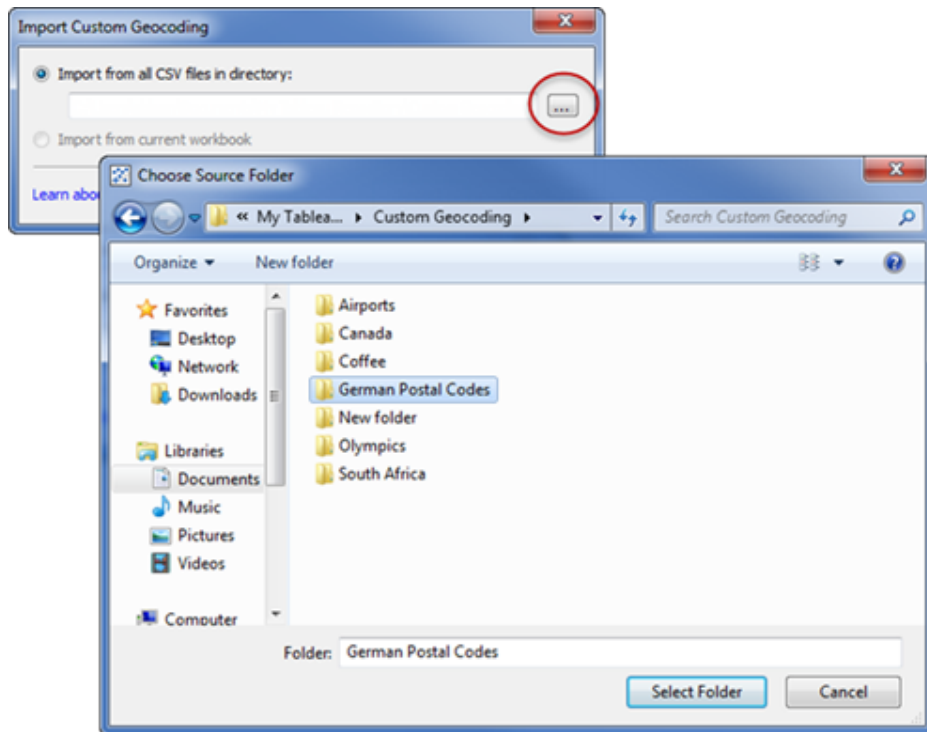

4. Click **Import**.

The custom geocoding data is imported into the workbook and the new geographic roles become available.

Where does Tableau store my custom geocoding data?

When you import custom geocoding, the data is stored in the Local Data folder in your Tableau Repository. To import custom geocoding, your Tableau Repository must be on a local hard drive. The custom geocoding is then available for all workbooks.

Save custom geocoding files in a separate folder on your local computer. If you have several different sets of custom geocoding files, save each of them under their own folder names.

You can remove the custom geocoding stored in your Tableau Repository by clicking **Map > Geocoding > Remove Custom Geocoding**. This won't remove the geocoding from a packaged workbook, but it will remove it from the Local Data folder in your My Tableau Repository.

What happens to my custom geocoding data when I save my workbook?

When you save your workbook as a packaged workbook, the custom geocoding data is packaged with the workbook. When you open a packaged workbook you can import the custom geocoding from that workbook into your own Tableau Repository.

Note: Importing a new custom geocoding file will replace any custom geographic roles previously imported into Tableau.

Step 4: Assign geographic roles to your fields

After you import custom geocoding into your workbook, the custom geographic roles become available. The next step is to assign those geographic roles to fields in your data source.

For example, if you decided to add a new geographic role that lists the latitude and longitude coordinates of crater impacts in North America, you can assign that geographic role to a field in your data source that lists the names of craters so when you create a map view with that field, the crater impacts are plotted in the correct locations on the map view.

To assign a custom geographic role to a field, in the Data pane, click the data type icon next to the field and select **Geographic Role**. Next, select a custom geographic role from the list.

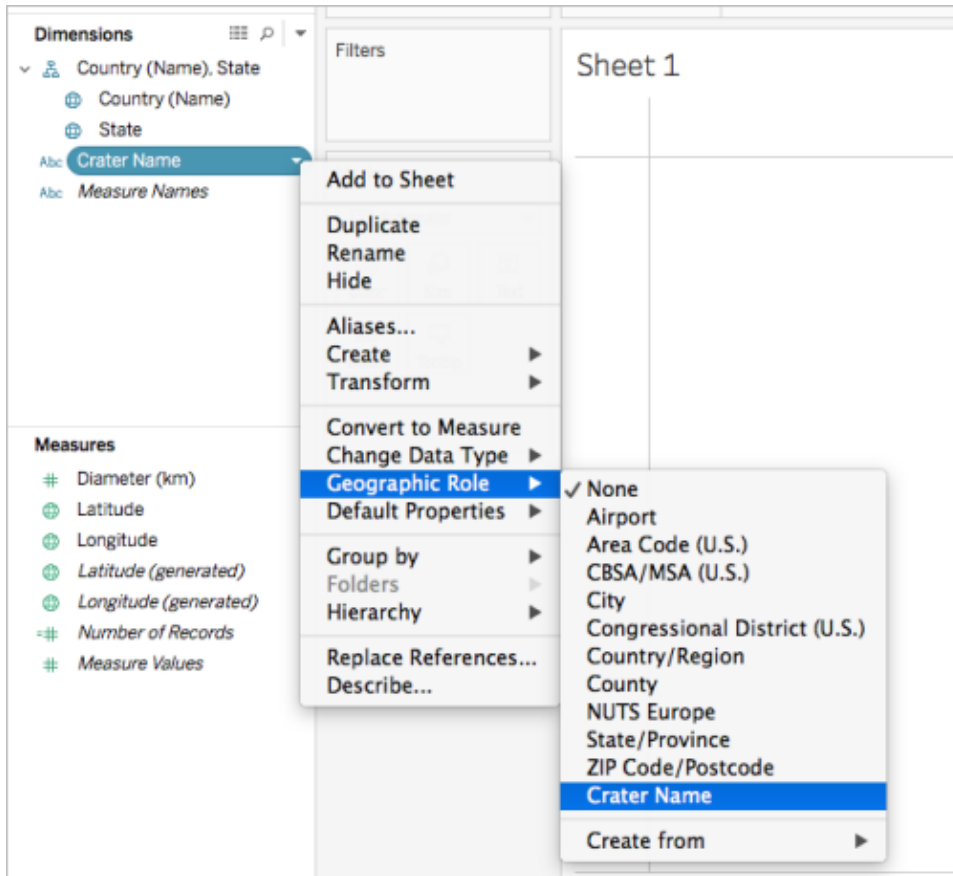

You're now ready to start building a map view with your custom geographic roles. For more information on how to build a map view, see [Mapping Concepts in Tableau](#) on page 1673.

See also

[Data Blending vs. Custom Geocoding](#) on page 1725

[Blend Geographic Data](#) on page 1720

Create a schema.ini File

Sometimes when you attempt to import custom geographic information in Tableau using a .csv file, you may see a ".csv could not be used because it does not contain a unique column" error message.

This is because your .csv file might contain numerical data, such as numeric postcodes. Tableau will only accept text fields for new geographic roles. However, you can create a schema.ini file to tell Tableau that the numeric field you want to import should be treated as a text field.

A schema.ini file is a Microsoft configuration file associated with the Microsoft JET engine. It tells JET how to interpret the contents of text files, including data structure, date formats, and other settings. For example, creating a schema.ini file that specifies that the numeric postcodes in your import file should be treated as text will allow you to plot the postcodes on a map.

To create a schema.ini file

1. Open a text file.
2. In the text file, using the following syntax, specify the names and data types for each column in your import file:

```
[YOURCSVFILENAME.csv]
ColNameHeader=True
Format=CSVDelimited
Col1="Name of 1st Column Header in your .csv file" Dataype
Col2="Name of 2nd Column Header in your .csv file" Dataype
Col3="Name of 3rd Column Header in your .csv file" Dataype
Col4="Name of 4th Column Header in your .csv file" Dataype
```

For example, if your import (.csv) file contained the columns **German Post Code**, **Latitude**, and **Longitude**, and was named **German Postal Codes.csv**, your schema.ini file would look like the following:

```
[German Postal Codes.csv]
ColNameHeader=True
Format=CSVDelimited
Col1="German Post Code" Text
Col2="Latitude" Double
Col3="Longitude" Double
```

3. Save the file as **schema.ini** in the same folder as your.csv file.

You're now ready to import your .csv and schema.ini files into Tableau.

See also

[Geocode Locations Tableau Does Not Recognize and Plot Them on a Map](#) on page 1711

Blend Geographic Data

This example demonstrates how to blend geographic data in Tableau using two small sample data sources. Follow the steps in this topic to learn how to create a file that defines your geographic data, blend two data sources, and build the map view below using the two data sources.

The embedded view below shows famous theaters around the world, and was created by blending geographic data with another data source. Hover over the marks in the view to see information about each theater. If you would like to follow along with the steps in this topic, click **Download** in the view below, and then select **Tableau Workbook**. This will open the view in Tableau Desktop.

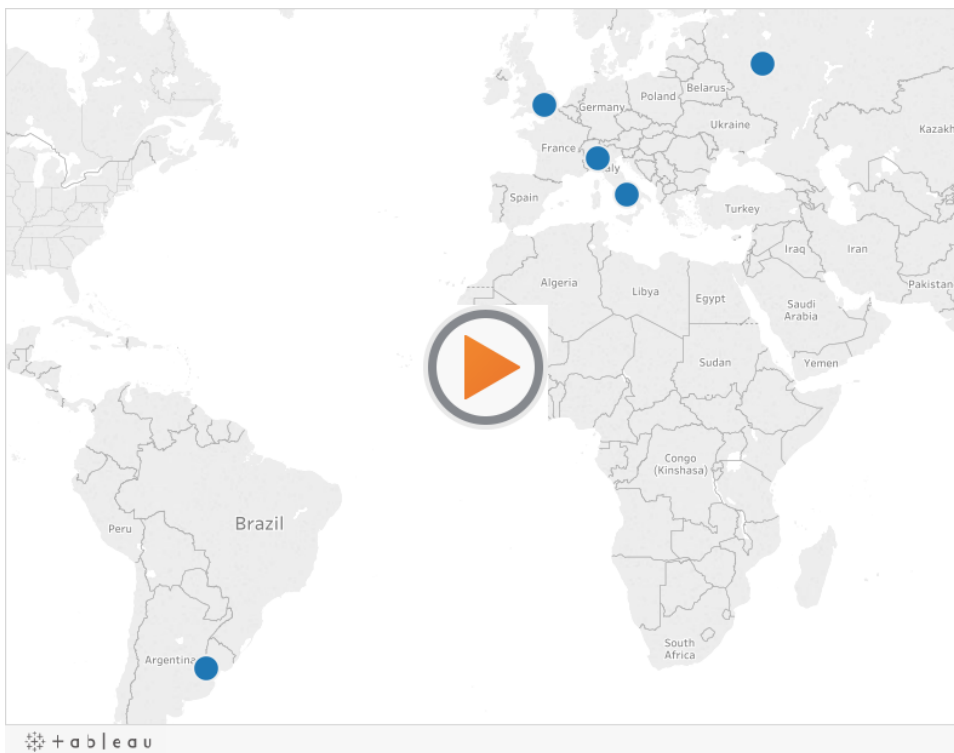

Step 1: Create a file that defines your geographic data

When you have a data source that contains geographic information that is not automatically geocoded in Tableau, the first step is to create a second data source that defines the latitudinal and longitudinal values for that information. You will later connect to this file in Tableau Desktop and blend it with your original data source.

Create a second data source with the following information:

- **Geographic name column:** This column includes any geographic information you want to plot on a map view and typically matches a geographic column name in your original data. For example, if your original data source has a column called Street Address, your second data source should also have a column called Street Address. The data in this column would then be all of the street addresses you want to plot on a map view.

If the column does not match a geographic column name in your original data source, you may need to edit the relationships between your two data sources in Tableau Desktop. For more information, see [Step 3](#).

Finally, this column should not match the names of any geographic roles already in Tableau, such as **County**, **Area Code**, or **CBSA/MSA**.

Note: The data in these columns can be strings or numbers. However, if your locations are numbers, especially numbers with leading zeros (for example, 00501), make sure the data type of the field is set to **String** in Tableau. For more information, see [Data Types on page 157](#).

- **Latitude and Longitude columns:** The values in these columns need to be in decimal degrees (for example, 47.651808, -122.356881).

Below is an example of an original data source with geographic locations, and a second data source that defines those geographic locations.

Original data source

Second data source

	A	B		A	B
1	Name	Estimated Seats	1	Street Address	latitude
2	La Scala	3,000	2	Via Filodrammatici, 2 20121 Milan, Italy	45.46731
3	Teatro di San Calo	1,397	3	Via San Carlo, 98 80132 Naples, Italy	40.83832
4	Teatro Colon	2,500	4	Cerrito 628 Buenos Aires Ciudad Autónoma de Buenos Aires	-34.6011
5	The Royal Opera House	2,256	5	Bow St London WC2E 9DD	51.5137
6	The Bolshoi	2,200	6	Theatre Square, 1 Moscow 125009	55.76016

Step 2: Connect to the data sources

1. Connect to the original data source.
2. Connect to the data source that defines your geographic data.

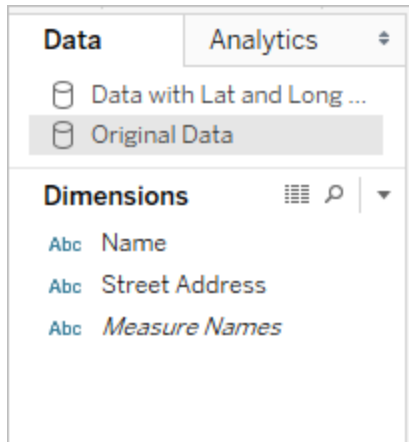

Step 3: Edit Relationships

(Optional) If the two data sources share the same column names, your data should blend automatically when you add fields to the view. However, if the file you created to define your geographic data does not share the same column name as the geographic data in your original data source, you will need to create a relationship between those two fields using the **Edit Relationships** option. For information about how to edit relationships, see [Blend Your Data on page 816](#).

Step 4: Plot the data on a map view

1. In the **Data** pane, select the second data source that defines your geographic data. Under **Measures**, assign the **Latitude** geographic role to the **Latitude** field and the **Longitude** geographic role to the **Longitude** field. For more information, see [Assign Geographic Roles on page 1727](#).

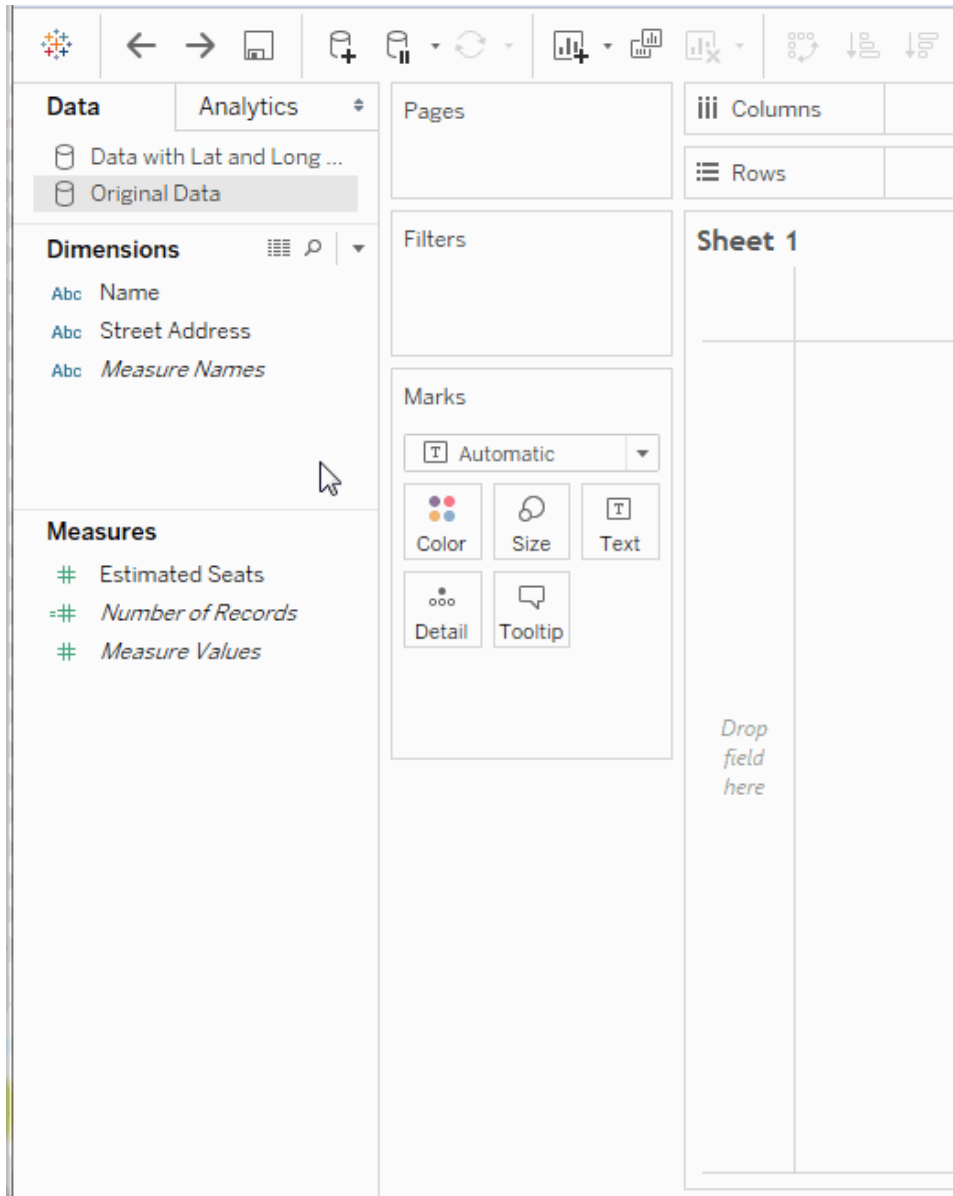

2. In the **Data** pane, select the original data source, and then drag the field you want to plot on a map to **Detail** on the **Marks** card.

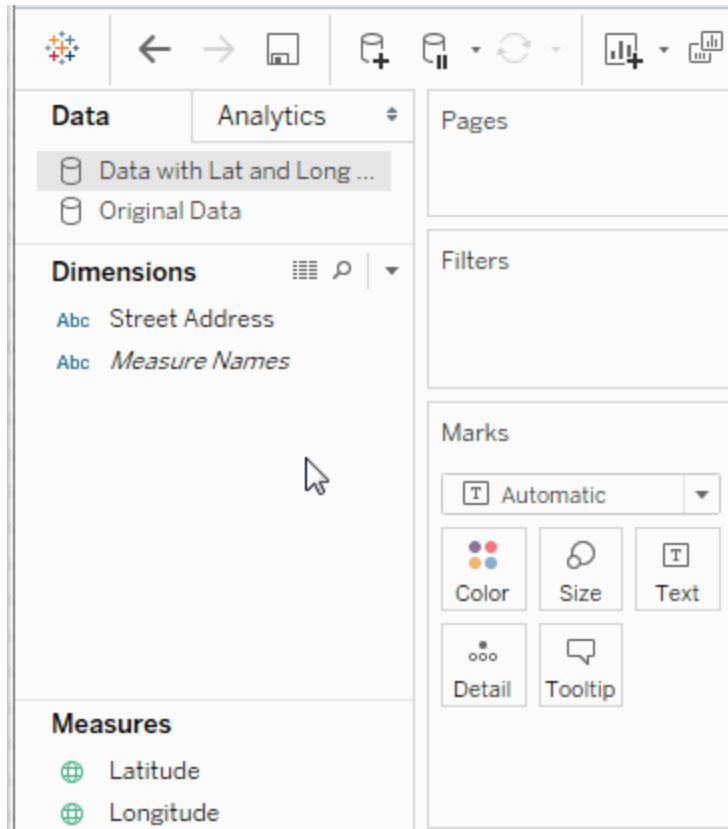

Note: This field should have a data type of String, and should be a dimension. For more information on how to change the data type of a field, see [Data Types on page 157](#).

3. In the **Data** pane, select the second data source, and then double-click **Latitude** and **Longitude** to add them to the **Columns** and **Rows** shelves.

The link icon  indicates that the **Street Address** field is blended with the **Street**

Address field in the original data source. A broken link icon  indicates that the **Street Address** field is not blended with the **Street Address** field in the original data source.

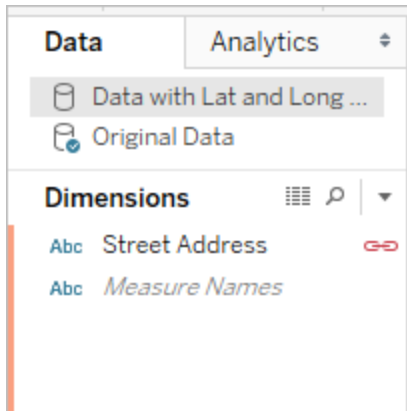

The view is now complete. Each mark represents an address from the original data source.

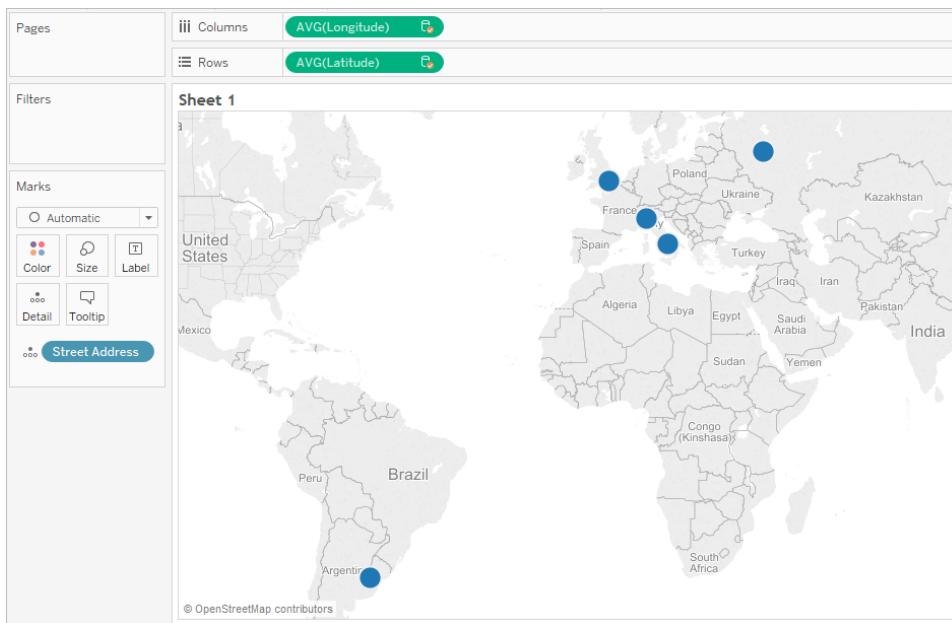

See also

[Data Blending vs. Custom Geocoding](#) below

Data Blending vs. Custom Geocoding

If you have geographic locations in your data that are not automatically geocoded in Tableau, there are two ways to plot them on a map view—data blending and custom geocoding. Both data blending and custom geocoding allow you to plot your own locations on a map. Data blending is easier to set up and you can work with data from any data source. Custom geocoding lets you

add to existing roles, and create hierarchies. Custom geocoding can be easier to use once it is set up and imported.

This topic explains the difference between blending geographic information with another data source and importing custom geocoding data into Tableau.

The following is a quick comparison of data blending and custom geocoding.

Capability	Data Blending	Custom Geocoding
Plot your own locations on a map view	Yes	Yes
Use any data	Yes	No, text files only
Add new geographic roles	No	Yes
Add to an existing geographic role	No	Yes
Create new geographic hierarchies	No	Yes
Can be reused for other workbooks	No	Yes

Data Blending

Data blending is the easiest way to plot your data on a map view. Data blending works great if you are adding a single level of geographic information with a latitude and longitude. You can use any data source, unlike Custom geocoding where you can only use text files. You can share the geographic data source with other workbooks on Tableau Server. You can also speed up your map performance by creating an extract that contains only your geocoding data.

The following is a high-level procedure for blending geographic data. For a more detailed example, see [Blend Geographic Data](#) on page 1720.

To blend geographic data

1. Create a data source that defines your geographic data.
2. In Tableau Desktop, connect to the original data you want to map, and then connect to the data source that defines your geographic data.
3. Blend the two data sources together. For more information, see [Blend Your Data](#) on page 816.
4. Plot the data on a map view.

Custom Geocoding

Custom geocoding is a more flexible way to plot your data on a map. Custom geocoding is available for all workbooks on a computer once the custom geocoding data is imported. The custom geocoding data will be copied into any packaged workbook (.twbx) or published workbook that uses a custom geographic role. This will make the workbooks about 40 MB larger.

If you upgrade Tableau Desktop, you may need to refresh your custom geocoding to take advantage of any fixes made to the geocoding data in Tableau.

In custom geocoding, you can use additional columns to define larger geographic locations. For instance, if you are creating a set of US census tracts, you may need to define which US county they fall in. You can include additional columns to define larger geographic locations in the import file.

You can also use multiple files for multiple geographic roles that have a matching relationship, meaning they share larger geographic data, such as country or state/province. Once the custom geocoding data is imported, you will see additional geographic roles that can be assigned to your geographic data.

Finally, custom geocoding lets you add additional places to an existing geographic role, such as adding new cities to the city role. It also allows you to define a hierarchy of geographic roles that extends the built-in hierarchies (e.g. census tracts in counties) or defines a new hierarchy (e.g. sub-territories in territories).

For more information about custom geocoding, see [Geocode Locations Tableau Does Not Recognize and Plot Them on a Map](#) on page 1711.

See also

[Assign Geographic Roles](#) below

[Create a schema.ini File](#) on page 1718

Assign Geographic Roles

This article describes how to assign a geographic role to a field in Tableau so you can use it to create a map view.

A *geographic role* associates each value in a field with a latitude and longitude value. When you assign a geographic role to a field, Tableau assigns latitude and longitude values to each location in your data based on data that is already built in to the Tableau map server.

Assign a geographic role to a field

Assigning a geographic role based on the type of location (such as state versus postcode) helps ensure that your data is plotted correctly on your map view. For example, you can assign the City geographic role to a field that contains a list of city names.

When a field is assigned a geographic role, Tableau creates a map view when you add the field to **Detail** on the **Marks** card. In other words, Tableau *geocodes* the information in that field.

To assign a geographic role to a field:

- In the Data pane, click the data type icon next to the field, select **Geographic Role**, and then select the geographic role you want to assign to the field.

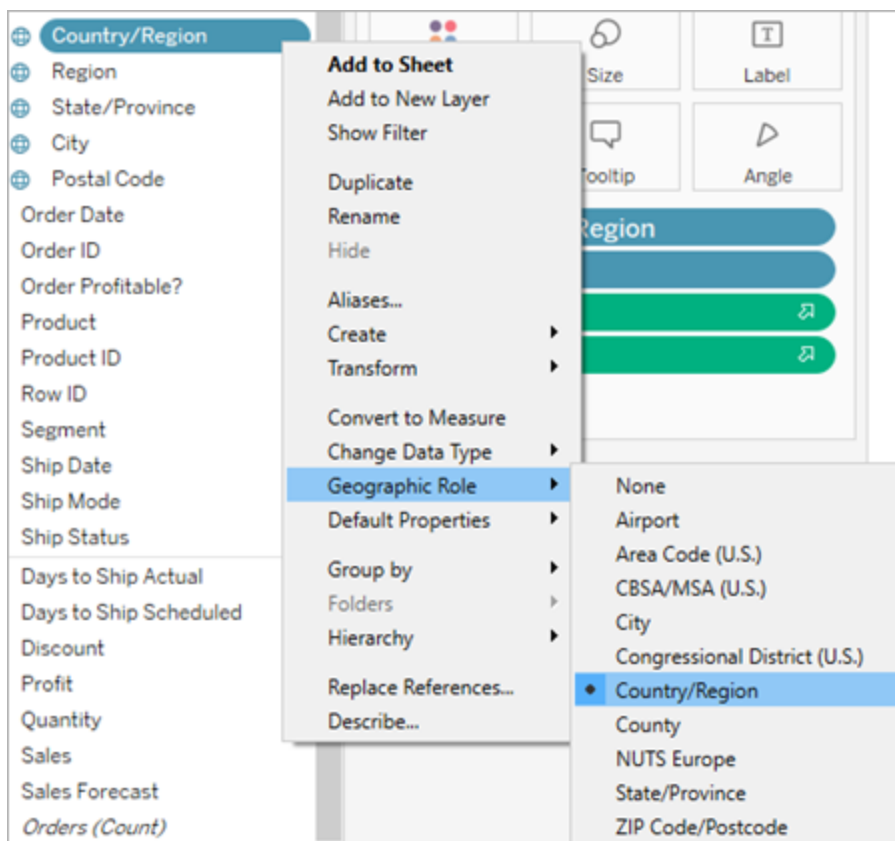

When you assign a geographic role to a field, Tableau adds two fields to the measures area of the Data pane: Latitude (generated) and Longitude (generated).

These fields contain latitude and longitude values and are assigned the Latitude and Longitude geographic roles. If you double-click each of these fields, Tableau adds them to the Columns

and Rows shelves and creates a map view using the Tableau background map.

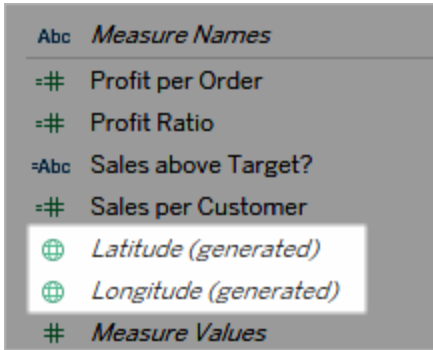

Types of geographic roles in Tableau

The following table describes the geographic roles available in Tableau. Many of the roles are international, but some are limited to the US only.

You can assign geographic roles to your fields based on the type of geographic data they contain. For example, you can assign the Airport geographic role to a field that contains International Air Transport Association (IATA) codes.

If your location data does not fit into one of these roles, you may have to import custom geocoding to plot the data on a map. For more information, see [Geocode Locations Tableau Does Not Recognize and Plot Them on a Map](#) on page 1711.

Geographic Role	Assign this role to a field if it contains:
Airport	International Air Transport Association (IATA) or International Civil Aviation Organization (ICAO) airport codes.
Area Code (US)	US telephone area codes; numbers only.
CBSA/MSA (US)	US Core Based Statistical Areas (CBSA), which includes Metropolitan Statistical Areas (MSA), as defined by the US Office of Management and Budget. CBSA/MSA Codes and Names are recognized.
City	Worldwide cities with population of 15,000 or more. Names are in English (UK or US), French, German, Spanish, Brazilian-Portuguese, Japanese, Korean, and Chinese (Simplified and Traditional).

Congressional District (US)	US congressional districts.
Country/Region	Worldwide countries, regions, and territories. Names are in English (UK or US), French (Canada and France), German, Spanish, Brazilian-Portuguese, Japanese, Korean, and Chinese (Simplified and Traditional), Swedish, and Thai. Tableau also recognizes, FIPS 10, ISO 3166-1 alpha 2, and ISO 3166-1 alpha 3. Names are included in various forms, including long, short, and various abbreviations.
County	<p>Second-level administrative divisions for select countries. For example, US counties, French départements, German kreise, etc.</p> <p>Note: Second-level administrative division definitions vary by country. In Tableau, all second-level administrative divisions are geocoded with the County geographic role. For more information, see the Location Data that Tableau Supports for Building Map Views on page 1687 section.</p>
NUTS Europe	NUTS (Nomenclature of Territorial Units for Statistics) levels 1–3 codes. Codes and names, including synonyms, are supported.
Latitude	Latitude in decimal degrees. Only available for numeric fields.
Longitude	Longitude in decimal degrees. Only available for numeric fields.
State/Province	Worldwide state, province, and other first-level administrative divisions. Names are in English (UK or US), French, German, Spanish, Brazilian-Portuguese, Japanese, Korean, and Chinese (Simplified and Traditional). Note: Some names are available only in their local form.
ZIP Code/Post-code	ZIP codes and postcodes for select countries. For example, US five-digit zip codes, Australian four-digit postcodes, German five-digit postcodes, etc. For more information, see the Location Data that Tableau Supports for Building Map Views on page 1687 section.

See also:

[Location Data that Tableau Supports for Building Map Views](#) on page 1687

[Geocode Locations Tableau Does Not Recognize and Plot Them on a Map](#) on page 1711

[Blend Geographic Data](#) on page 1720

[Create Tableau Maps from Spatial Files](#) on page 1745

[Edit Unknown or Ambiguous Locations](#) below

Edit Unknown or Ambiguous Locations

Sometimes Tableau will not recognize one or more of the location names in your data. When this happens those values are marked as **unknown** in the lower right corner of the map view. This may happen if there is a location or abbreviation that Tableau does not recognize, or if the location is ambiguous and could exist in multiple places.

When this happens, you can add additional information to the view to define locations, or can edit the unknown location names to map to known locations.

Add more fields to view

If your data set includes ambiguous locations (for example, "Aberdeen," which could appear in multiple states or countries), adding another geographic field, like State or Country, to the view defines the correct location for that data. If there is a hierarchy in the data pane, Tableau will automatically use the appropriate levels of the hierarchy to solve location ambiguities.

Edit locations in the Special Values menu

Sometimes, unknown locations can be prompted because there's a misspelling or another issue. When this happens, you can correct the unknown or ambiguous locations in your data using the **Special Values** menu. To do this:

1. In the bottom right corner of the view, click the special values indicator that lists the number of unknown locations in your map. This opens the Special Values menu.

2. In the Special Values dialog box, select **Edit Locations**.

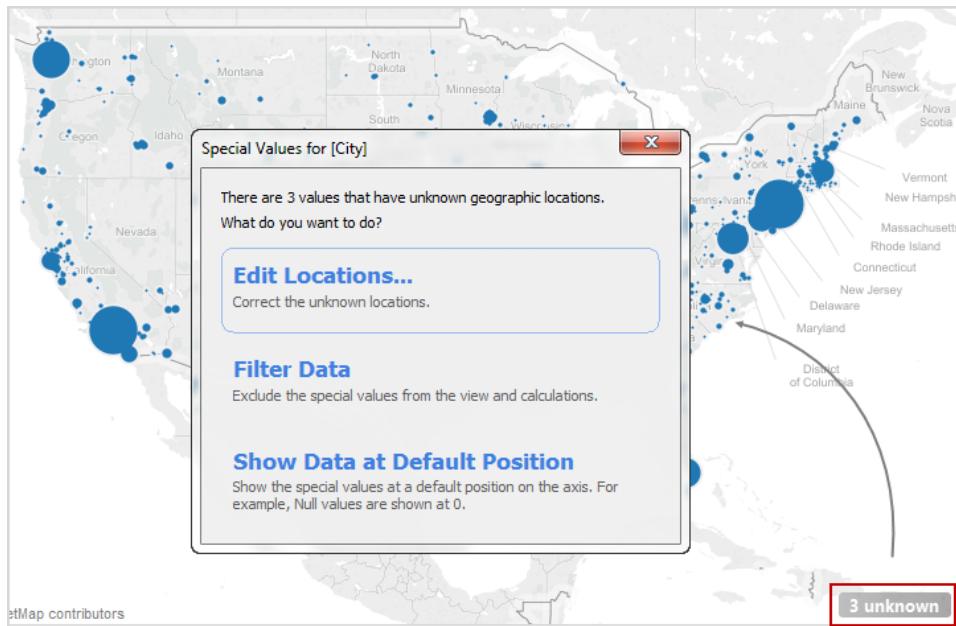

Note: If the special values indicator is not visible, you can also select **Map > Edit Locations**

The Edit Locations dialog lets you clarify unrecognized and ambiguous values to locations in Tableau.

Edit ambiguous locations

Both unrecognized and ambiguous locations can be listed in the Edit Locations dialog box.

You can fix some ambiguous locations by specifying the **Country/Region** and/or **State/Province** for each city from a specific field in your data, either by hard-coding a value if your data only spans one state or country, or by telling Tableau which fields to refer to for that information. This option is in the Geographic Roles section of the Edit Locations dialog box. For example, if you have several cities that are ambiguous, you can specify a State/Province to fix them.

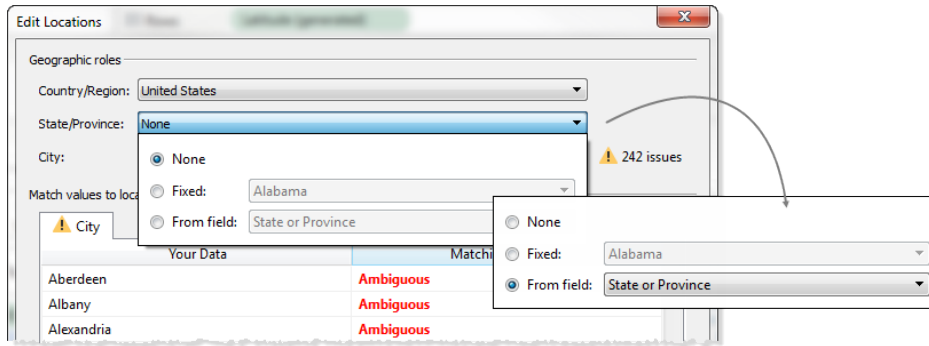

If there are ambiguous or unknown locations in the Country/Region or State/Province tabs in the Edit Locations menu, fixing those first may resolve some ambiguous locations in smaller geographic roles, such as cities.

Edit unknown locations

In the Edit Locations dialog box, click on one of the **Unrecognized** cells to match a known location to your unknown data. When you click on an unrecognized cell, a search box appears. As you begin typing in the search box, Tableau generates a list of possible locations. Select a location from the list.

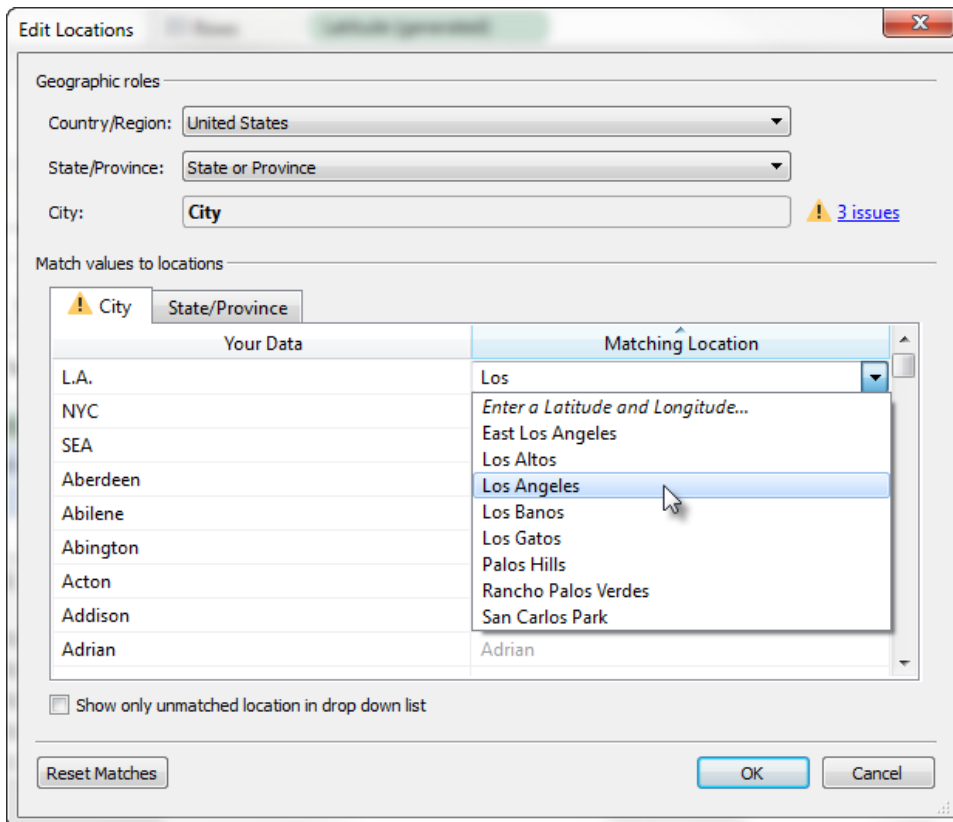

Alternatively, you can enter latitude and longitude to manually map a value to a point location on the map. To do this, begin typing into the unrecognized cell and select **Enter Latitude and Longitude** from the drop-down menu.

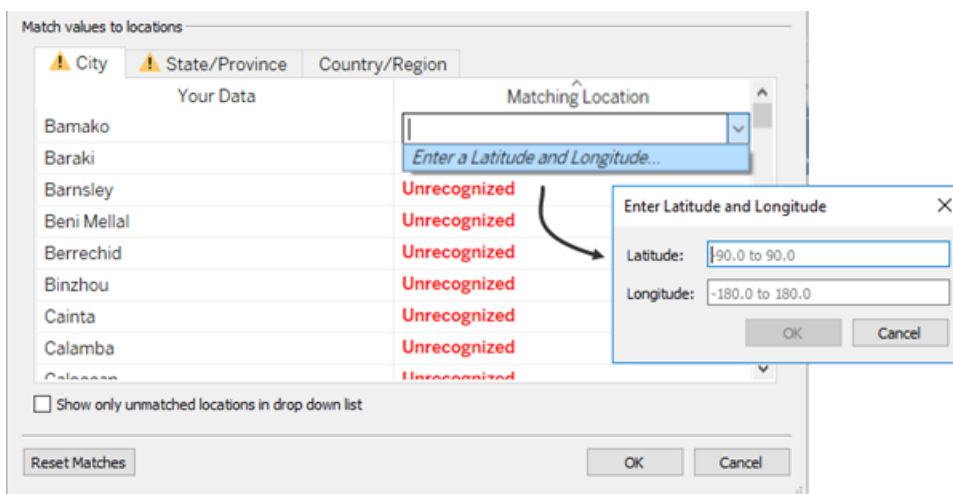

Note: When you type a latitude and longitude, enter the values in decimal format. For example, Addis Ababa is Latitude: 9.033140, Longitude: 38.750080.

Restrict Locations in the List

By default, all possible locations are listed in the drop-down menu. To restrict the list to locations that have not yet been matched to your data, select the **Show only unmatched locations in drop-down list** option in the bottom left corner of the Edit Locations dialog box.

See also:

[Assign Geographic Roles](#) on page 1727

[Location Data that Tableau Supports for Building Map Views](#) on page 1687

Build Maps in Tableau

What type of map do you want to create?

Simple Map

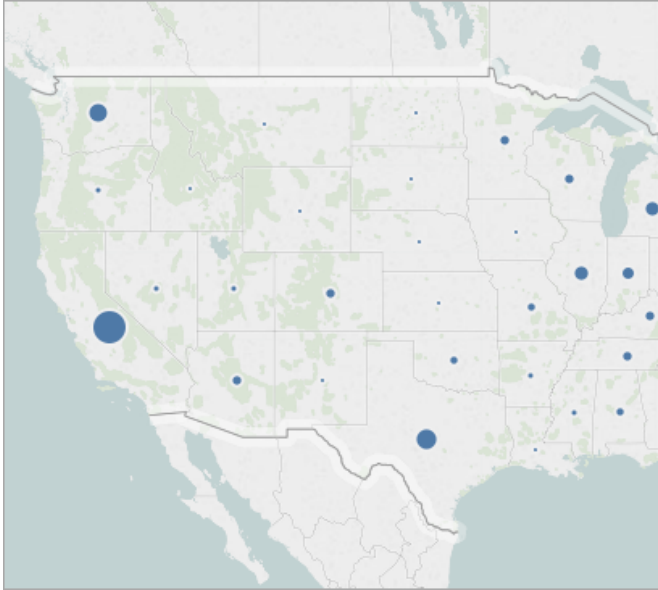

Map from Spatial Files



Proportional Symbol Map

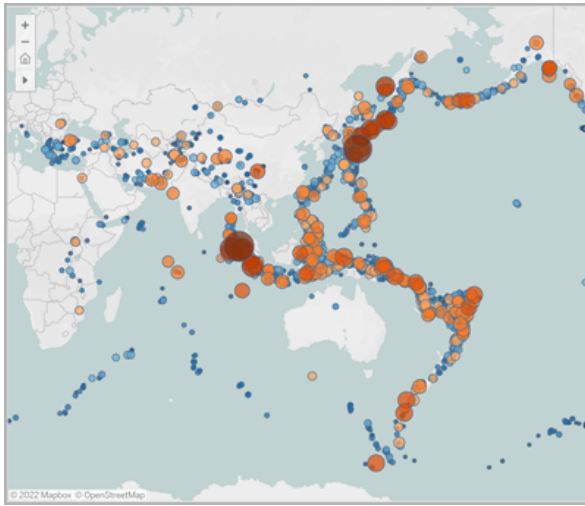

Point Distribution Map

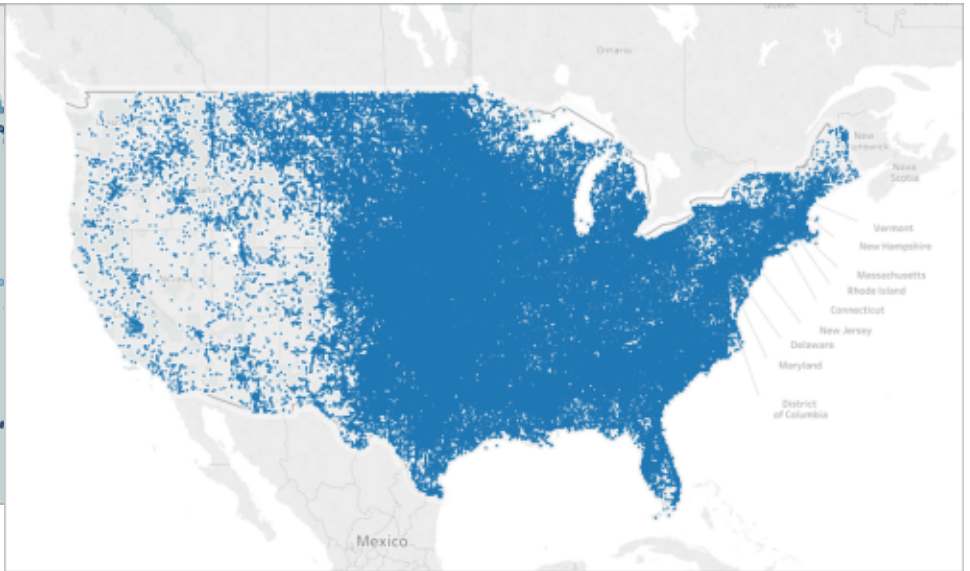

Heatmap (Density Map)

Filled (Choropleth) Map

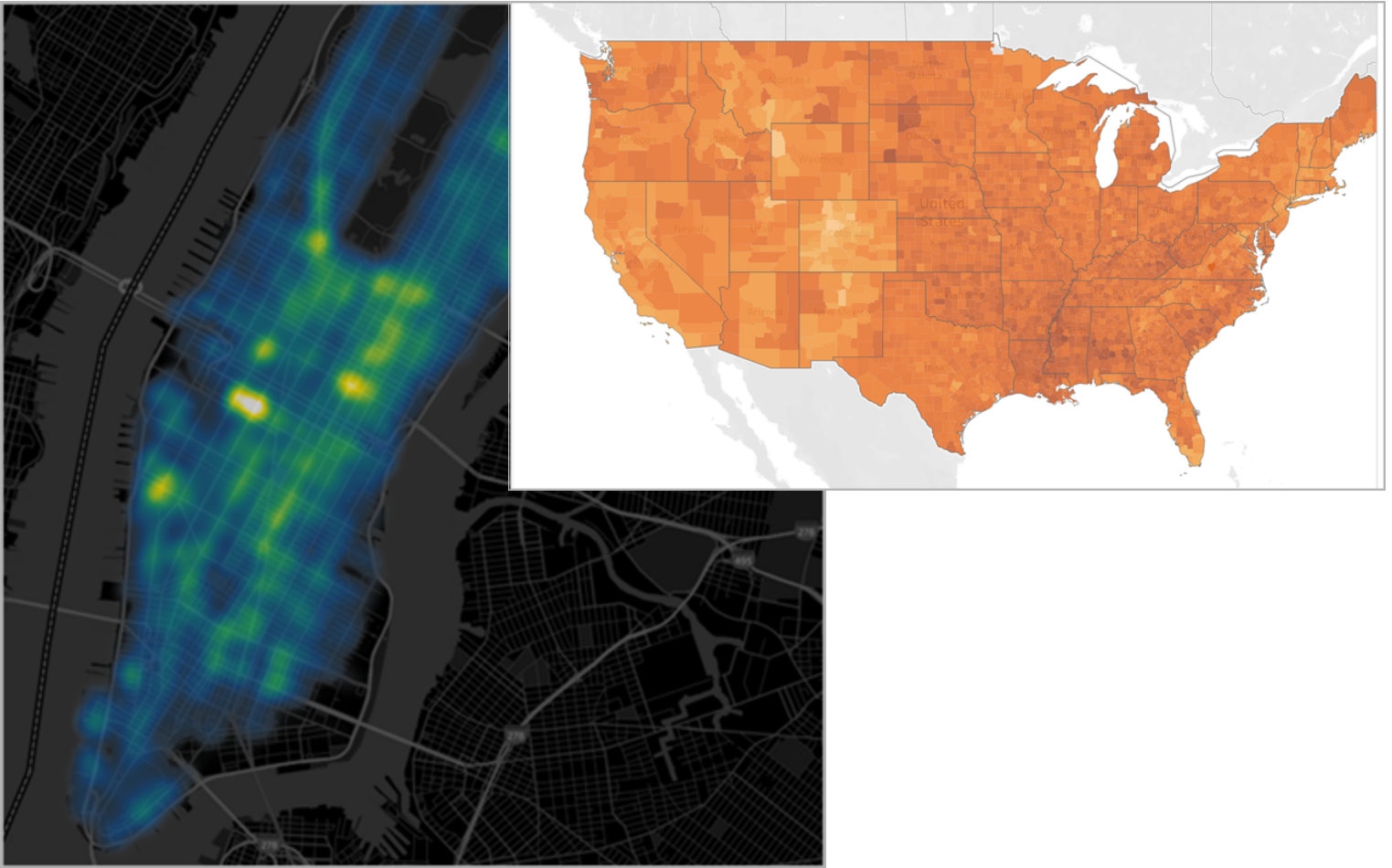

Flow (Path) Map

Origin-Destination Map

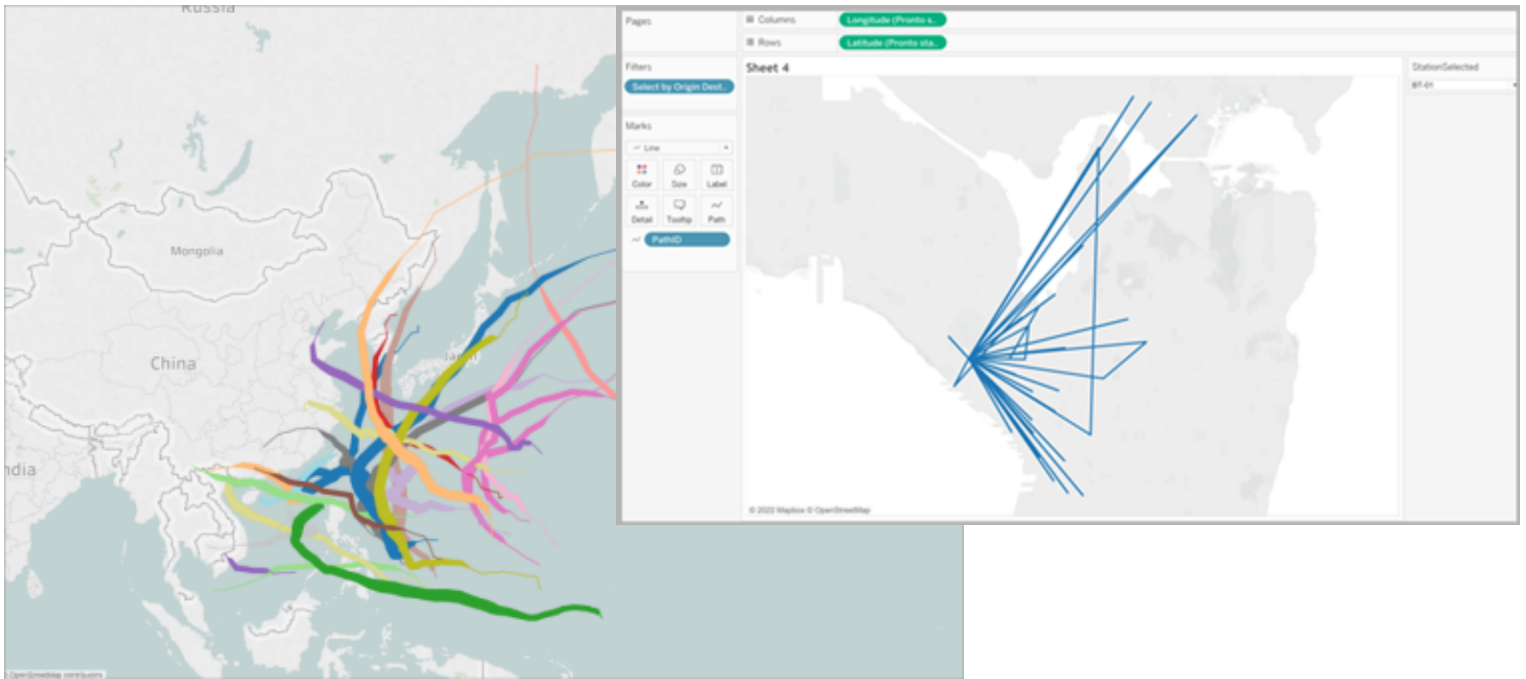

Dual Axis (Layered) Map

Filled Map with Pie Charts

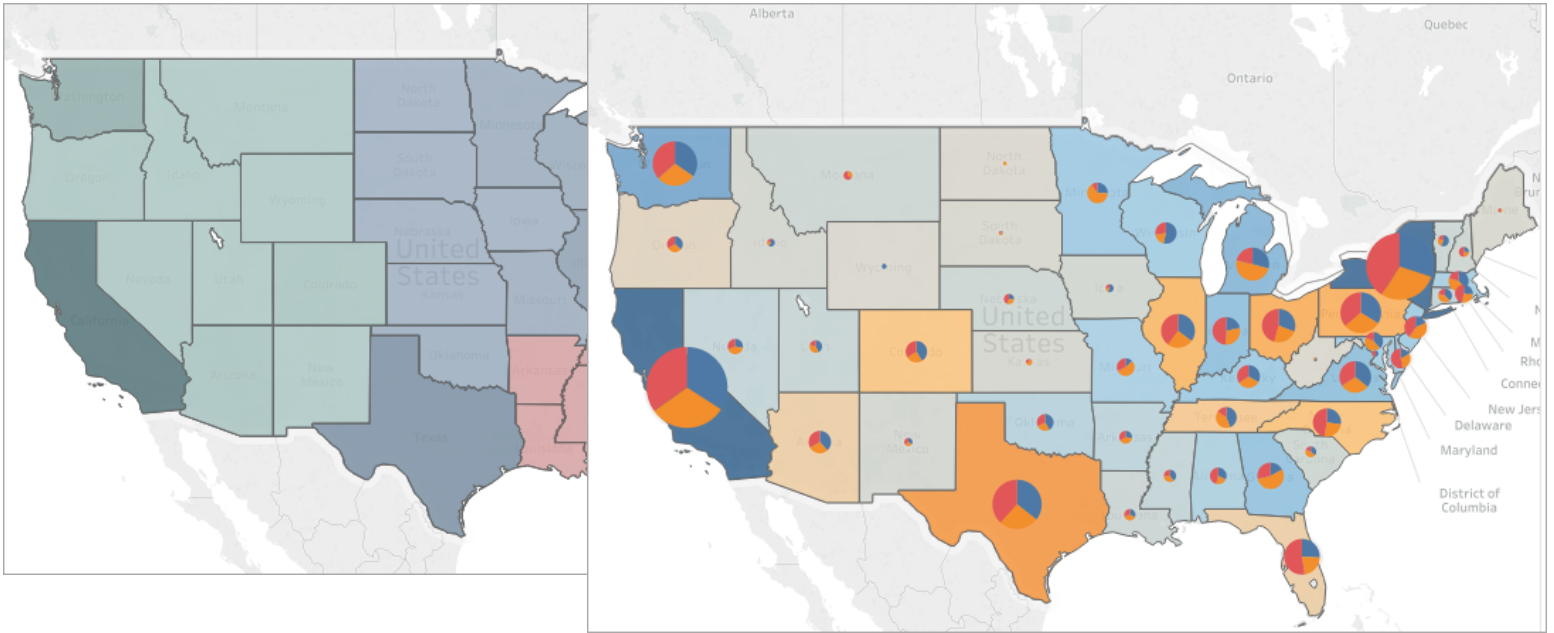

Build a Simple Map

You can build several different types of maps for your geographic analysis in Tableau. If you're new to maps, or simply want to take advantage of the built in mapping capabilities that Tableau provides, you can create a simple point or filled (polygon) map similar to the examples below.

Prerequisites: To build a simple map, your data source must contain location data (for example, location names or latitude and longitude coordinates). If your data source doesn't contain location data, see the [Map Data](#) section for ways you can connect to location data.

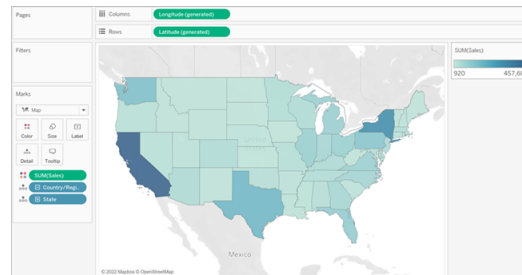
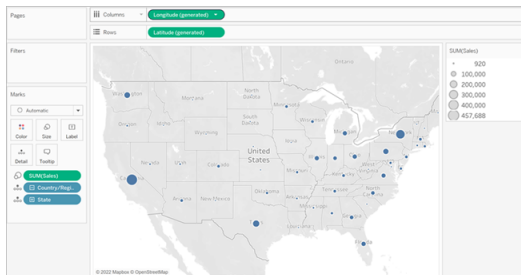

This topic illustrates how to create a simple map using an example. To follow along with the example below, open Tableau Desktop and connect to the **Sample-Superstore** data source, which comes with Tableau.

Build a simple point map

1. Navigate to a worksheet.
2. In the **Data** pane, open the Location folder and double-click **State**.

A map view is automatically created because the State field is a geographic field. To learn more about geographic fields and how to create them, see [Assign a geographic role to a field](#) on page 1728.

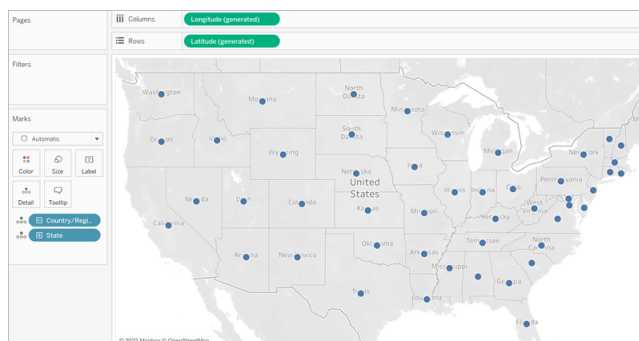

3. From the Orders table in the **Data** pane, drag **Sales** to **Size** on the Marks card. The data points on the map update to show the amount of sales proportionally.

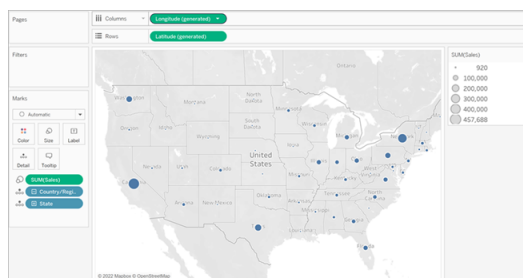

4. Select **Maps > Background Layers**.
5. In the Background pane, click the **Style** drop-down and select **Normal**.

- Under **Background Map Layers**, clear **Country/Region Names**. The background map updates with the new settings.

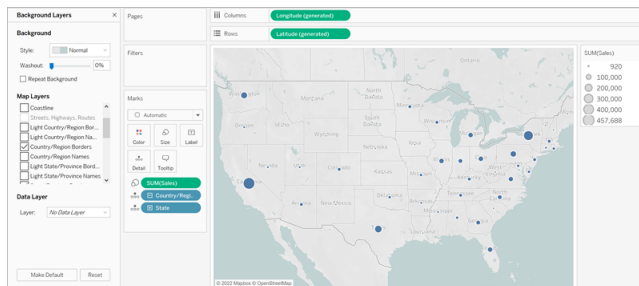

Build a simple filled (polygon) map

- Navigate to a new worksheet.
- In the **Data** pane, open the Location folder and double-click **State**.

A map view is automatically created.

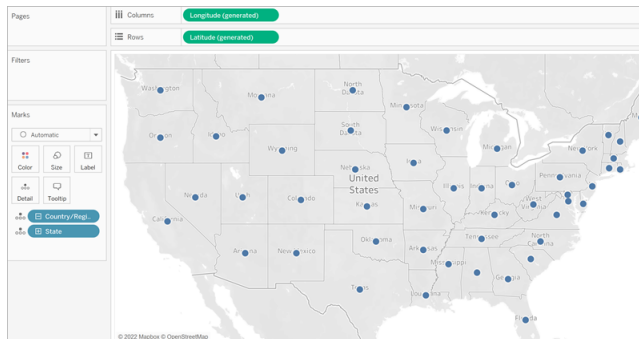

- On the **Marks** card, click the Mark Type drop-down and select **Map**.

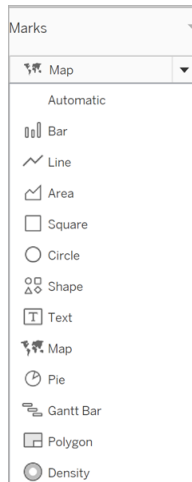

The map view updates to a filled (polygon) map.

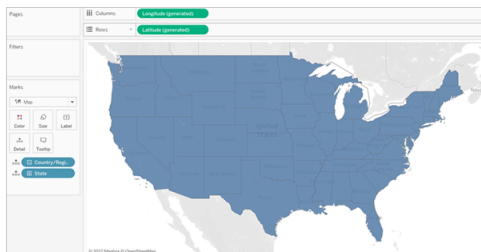

4. From the Orders table in the **Data** pane, drag **Sales** to **Color** on the Marks card.

The polygons on the map update to show the amount of sales using color.

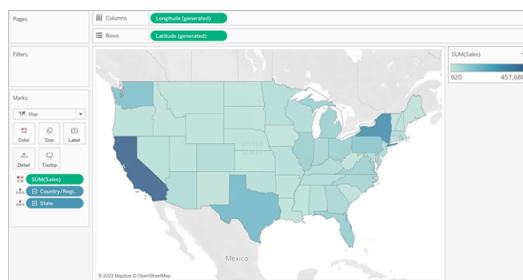

Build a heatmap (density map)

Heatmaps, also known as Density Maps, help you identify locations with greater or fewer numbers of data points. Heatmaps are most effective when working with a data set containing many data points where there is substantial overlap between the marks on the map.

To learn more about Heatmaps and find out how to create and customize them, see [Create Heatmaps that Show Trends or Density in Tableau](#) on page 1800.

To follow along with this example, download the [heatmap_taxi_howto example workbook](#). (Click Download in the upper right hand corner) and open it in Tableau Desktop.

1. Navigate to a new worksheet.
2. From the **Data** pane, drag both Pickup Latitude and Pickup Longitude onto the canvas.

A map view is automatically created.

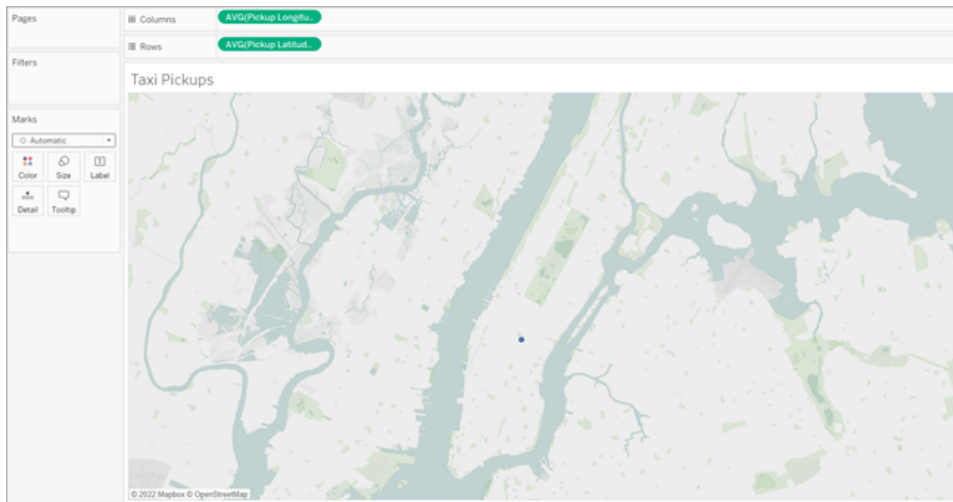

Note: Because Tableau is averaging the latitude and longitude of the data, there is only one mark on the canvas. This will update when you add a measure.

3. Drag a measure field, such as ID, to **Detail** on the Marks card.
4. On the Marks card, click the Mark Type drop-down and select **Density**.

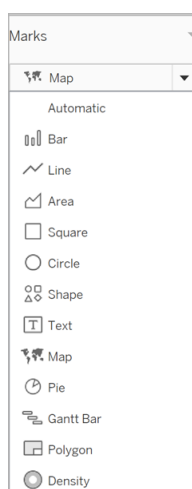

The marks update on the map to show the concentration of taxi pickups per location. The darker colors indicate locations with more pickups, and the lighter colors indicate locations with fewer pickups.

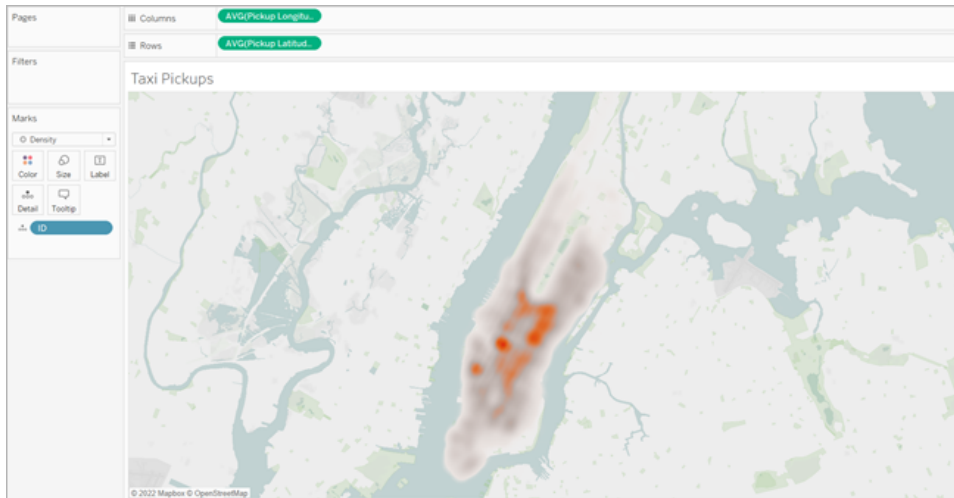

See also:

[Mapping Concepts in Tableau](#) on page 1673

[Build Maps in Tableau](#) on page 1735

[Customize How Your Map Looks](#) on page 1854

Create Tableau Maps from Spatial Files

In Tableau Desktop, you can connect to the following spatial file types: Shapefiles, MapInfo tables, KML (Keyhole Markup Language) files, GeoJSON files, TopoJSON files, and Esri File Geodatabases. You can then create point, line, or polygon maps using the data in those files.

With a Creator license in Tableau Cloud or Tableau Server, you can upload spatial file formats that only require one file (KML, GeoJSON, TopoJSON, Esri shapefiles packaged in a `.zip`, and Esri File Geodatabases with the extension `.gdb.zip`) in the Files tab when you create a new workbook and connect to data.

Note: In current versions of Tableau, you can only connect to point geometries, linear geometries, or polygons. You cannot connect to mixed geometry types.

Where to find spatial files

If you do not already have spatial files, you can find them at many open data portals. You can also find them on websites for your city or for a particular organization, if they provide them.

Here are some examples:

- [LONDON DATASTORE](#)
- [EGIS South Africa](#)
- [U.S. Energy Information Administration](#)
- [USGS Water Resources](#)
- [Geospatial Information Authority of Japan](#)
- [Data.gov](#)
- [Census.gov](#)

Connect to spatial files

1. In Tableau Desktop: click the New Data Source icon and select **Spatial file**.
In Tableau Cloud or Tableau Server (Creator role): Select **Create > Workbook**. Select the **Files** tab.
2. Navigate to the folder that contains your spatial data, select the spatial file you want to connect to, and then click **Open**.

Note: To connect to spatial files, you must include all of the following files in the same directory:

- **For Esri shapefiles:** The folder must contain `.shp`, `.shx`, `.dbf`, and `.prj` files as well as `.zip` files. When connecting to Esri shapefiles in Tableau Cloud or Tableau Server, the file must be packaged in a `.zip`.
- **For Esri File Geodatabases:** The folder must contain the File Geodatabase's `.gdb` or the `.zip` of the File Geodatabases's `.gdb`. When connecting to Esri shapefiles in Tableau Cloud or Tableau Server, the Esri File Geodatabase must be packaged with the extension `.gdb.zip`.
- **For MapInfo tables** (Tableau Desktop only): The folder must contain `.TAB`, `.DAT`, `.MAP`, and `.ID` or `.MID` and `.MIF` files.
- **For KML files:** The folder must contain the `.kml` file. (No other files are required.)
- **For GeoJSON files:** The folder must contain the `.geojson` file. (No other files are required.)
- **For TopoJSON files:** The folder must contain the `.json` or `.topojson` file. (No other files are required.)

How Tableau interprets your spatial data

As soon as you connect to your spatial data, Tableau reads the spatial reference information of the data set and transforms the data into latitude and longitude coordinates. All data, regardless of the spatial reference system, is transformed to **WGS84 (EPSG:4326)**.

Note: If your data does not display diacritics (accent marks on characters) properly, check to make sure the file is **UTF-8** encoded.

The Geometry field

When you connect to spatial data, Tableau creates a Geometry field for your point geometries or your polygons. You use the Geometry field to create a map with your spatial data.

The values in this field display the geometry primitive—for example, **Point** for point geometries, **Linestring** or **Multilinestring** for linear geometries, and **Polygon** or **Multipolygon** for polygons. But this is simply an alias for the underlying spatial data.

For more information on how to build a map with the Geometry field, see the [Build a map view from spatial data below](#) section.

Join spatial data

Sometimes your spatial data includes only the geometry information, and does not include any demographic or other information. In this case, you can join a spatial data source with another data source type, or even another spatial file that includes the additional data you need for your analysis, as long as the files have a column (or field) in common.

For example, you can join a KML file that contains custom geographies for school districts in Oregon, U.S. with an Excel spreadsheet that contains demographic information about those school districts.

For more information on the different ways to join spatial data, see [Join Spatial Files in Tableau on page 1704](#).

Build a map view from spatial data

1. Open a new worksheet.
2. In the Data pane, under Measures, double-click the **Geometry** field.

The Geometry field is added to Detail on the Marks card, and the Latitude (generated) and Longitude (generated) fields are added to the Columns and Rows shelves. A map view is created.

Filter geometries to improve view performance

When working with large spatial data sets, your view might take a long time to render. If this is the case, you can filter the number of geometries being added to the view using another dimension in your data source. For more information about filtering data, see [Filter Data from Your Views](#) on page 1308.

For example, in the image below, the view has been filtered down to a small subset of polygons using a dimension (Family Nam). The data source, from the [IUCN List of Threatened Species](#), contains data on endangered mammals around the world. Therefore, the dimension Family Nam contains a list of mammal family names. This view has been narrowed down to one family name: rhinoceroses. Polygons for only rhinoceroses are shown in the view.



Without the filter, the polygons for every mammal in the data source are shown around the world, and the view takes a long time to render every time you perform an action, such as select a mark in the view.

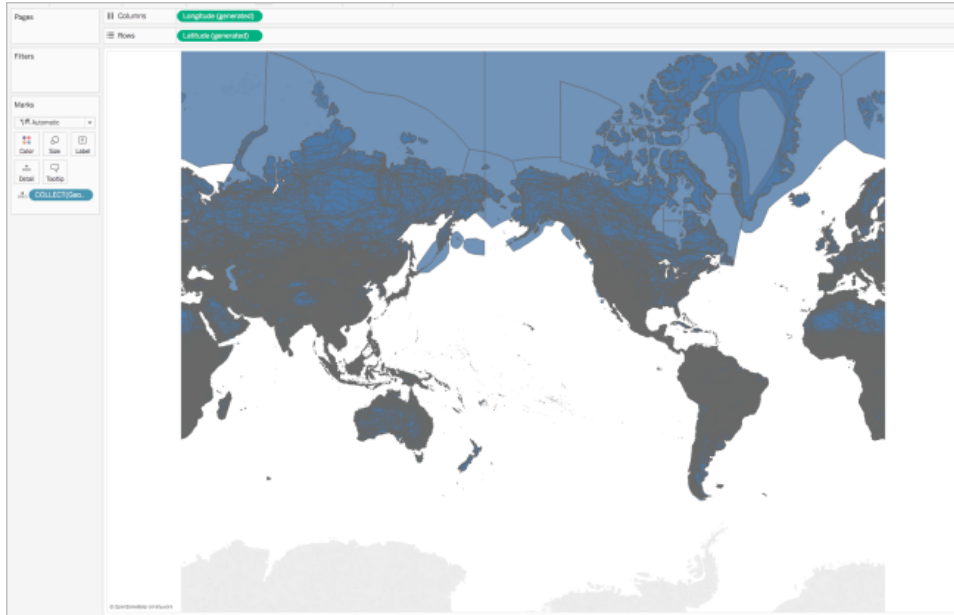

Add levels of detail to the view

The Geometry field is a measure, and by default, is aggregated into a single mark using the COLLECT aggregation when it is added to the view. All of your polygons or marks will be in the view, but they will operate as a single mark. You therefore need to :

- Add additional levels of detail to the view to break it up into separate marks (based on the level of detail you specify)
- or
- Dissaggragate the data all together so every single mark (polygon or data point) is separate.

To add additional levels of detail to the view:

- From Dimensions, drag one or more fields to **Detail** on the Marks card.

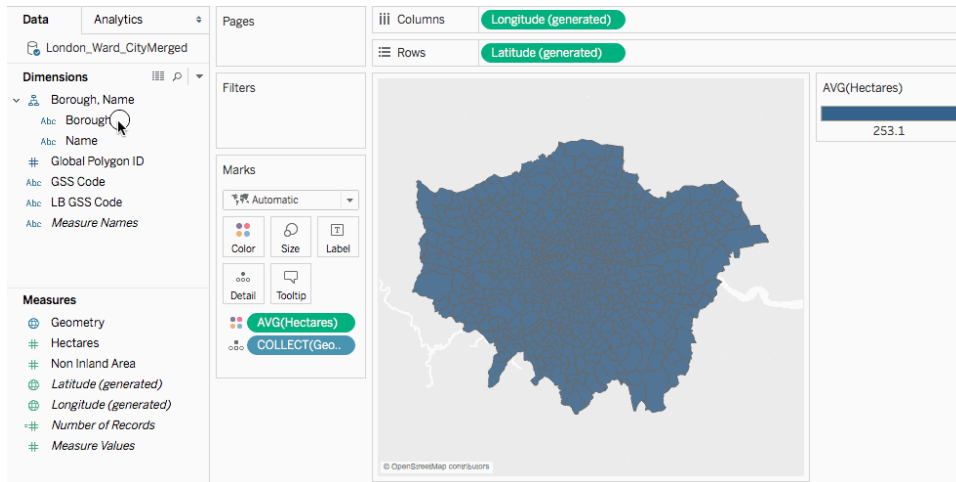

To disaggregate the data:

- Click **Analysis**, and then clear **Aggregate Measures**.

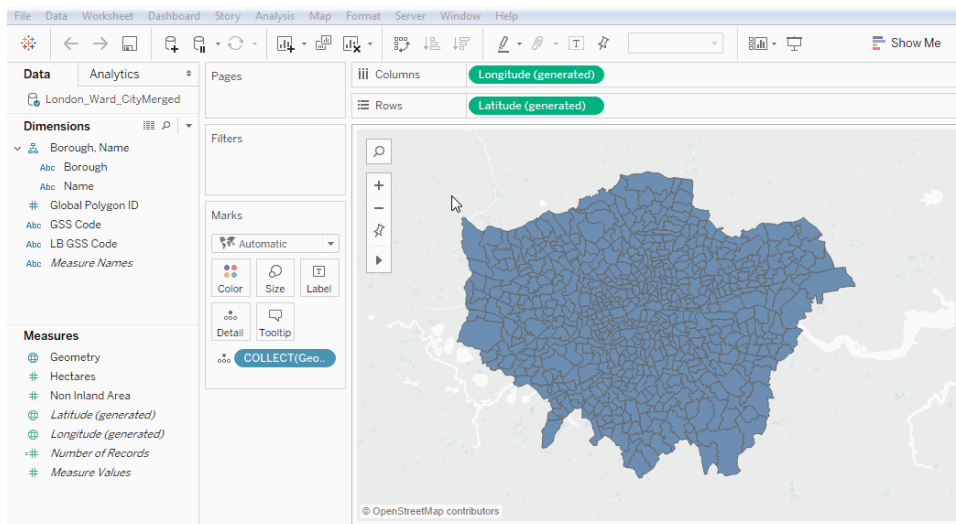

Customize the appearance of geometries

You can customize the appearance of points, polygons, and lines by adding color, hiding polygon lines, specifying which polygons or data points appear on top, and adjusting the size of your data points.

Add color

To add color to your data points or polygons, drag a dimension or measure to **Color** on the Marks card.

For example, in the images above, the dimension (Presence), is placed on Color to represent the presence of an animal in a particular area.

Hide polygon lines

By default, polygon lines are shown when you create a polygon map from spatial data. If you want a cleaner view, you can remove them.

Take the following images, for example. The first image shows polygon lines. The second image does not show polygon lines.



Polygon lines shown by default.



Polygon lines removed.

To hide polygon lines:

1. On the Marks card, click **Color**.
2. Under Effects, select the **Border** drop-down, and then click **None**.

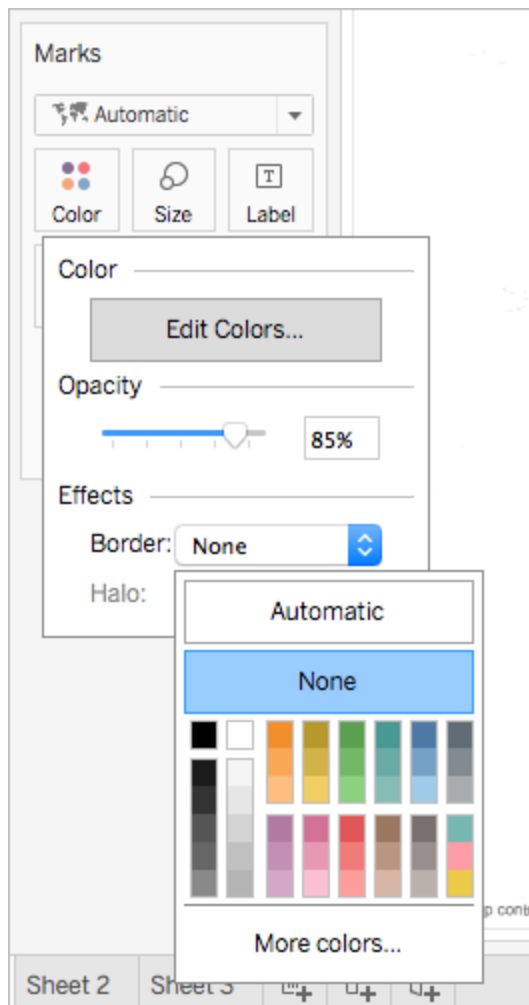

Specify which polygons or data points appear on top

Your polygons or data points might overlap or cover each other. You can specify which polygons or data points appear on top if you have a color or size legend in the view.

For example, in the image below, notice that there is a smaller polygon hidden behind the larger teal polygon in southern Africa.

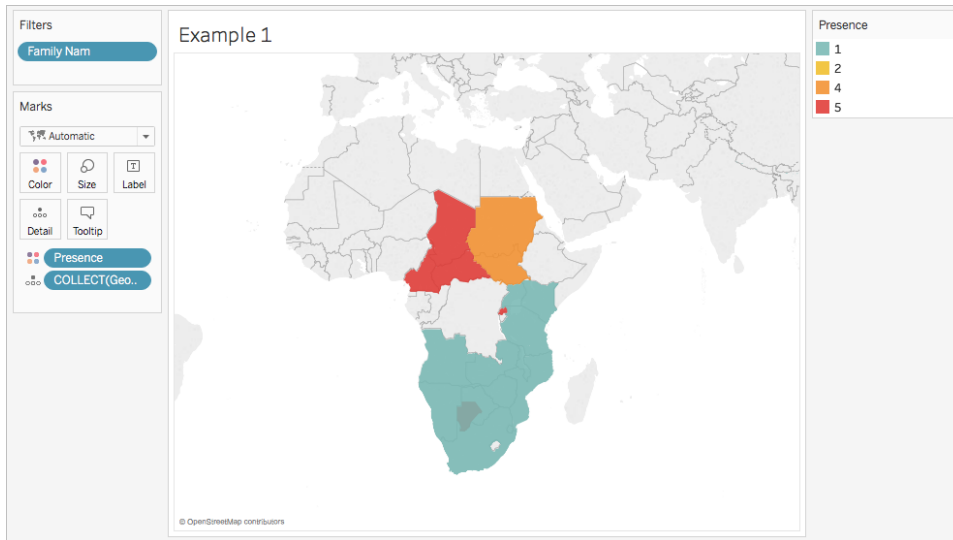

You can rearrange the items in your legend to control which data points or polygons appear on top. To do so, in the legend, select the item you want to be on top, and then drag it to the top of the list.

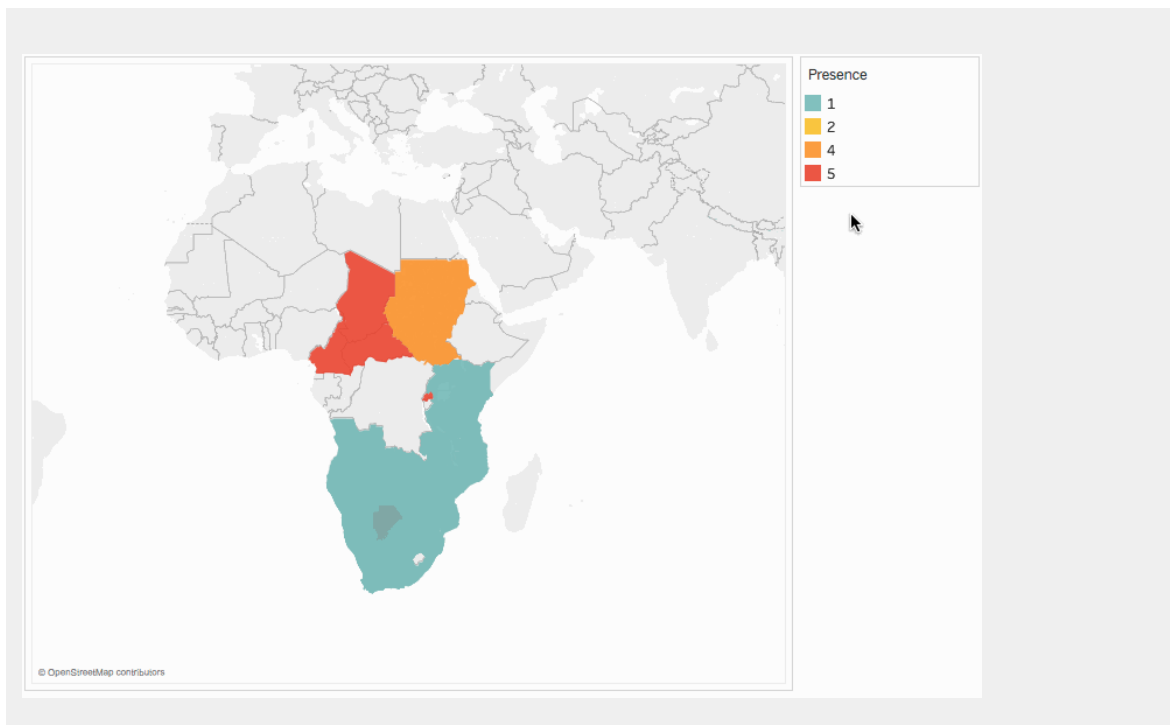

Adjust the size of data points

If you're using point geometries, you can adjust the size of the points on the map view. This is useful if you want to proportion your data points by quantitative values, such as by average

sales, or profit.

To adjust the size of your data points:

1. From the **Data** pane, drag a measure to **Size** on the Marks card.
2. On the Marks card, click the Mark Type drop-down and select **Circle**.
3. Optional: From the **Data** pane, drag one or more dimensions to **Detail** on the Marks card to add more data points to your view.

Note: The level of detail determines which data points are sized. Add additional dimensions to Detail on the Marks card to add levels of detail (more data points), otherwise you might end up with one large data point.

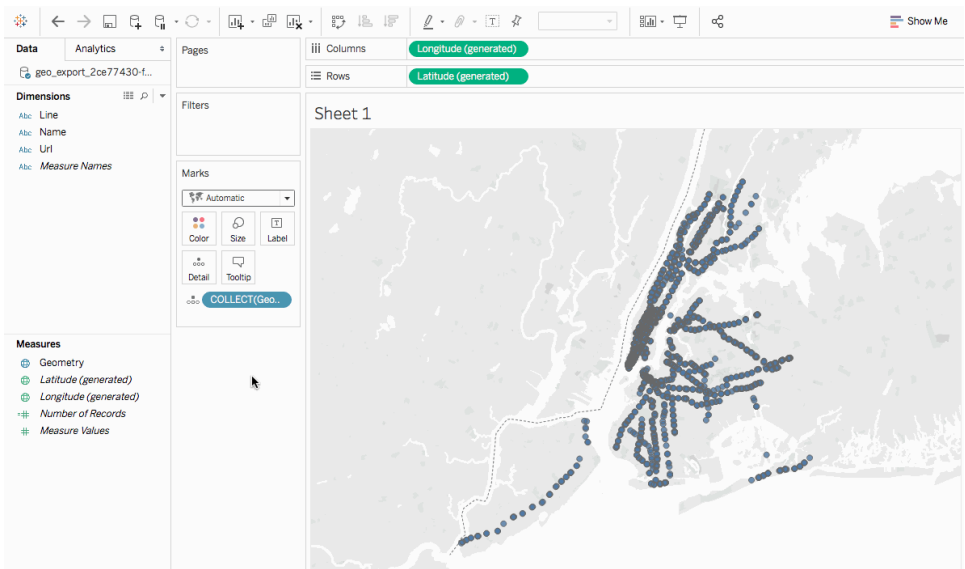

For more information about how to add levels of detail to the view, see the [Add levels of detail to the view on page 1749](#) section.

Build a dual-axis map from spatial data

If you join a spatial file either with another spatial file, or a different file type, you can create a dual-axis map using the geographic data from those files. This enables you to create more than one layer of your data on a map.

For example, the following is a dual-axis map view that was created using two spatial files. It contains two maps; one map shows the boroughs of New York City as polygons, and the other

shows data points for subway entrances around the city. The subway entrance data is layered over top of the city boroughs polygons.

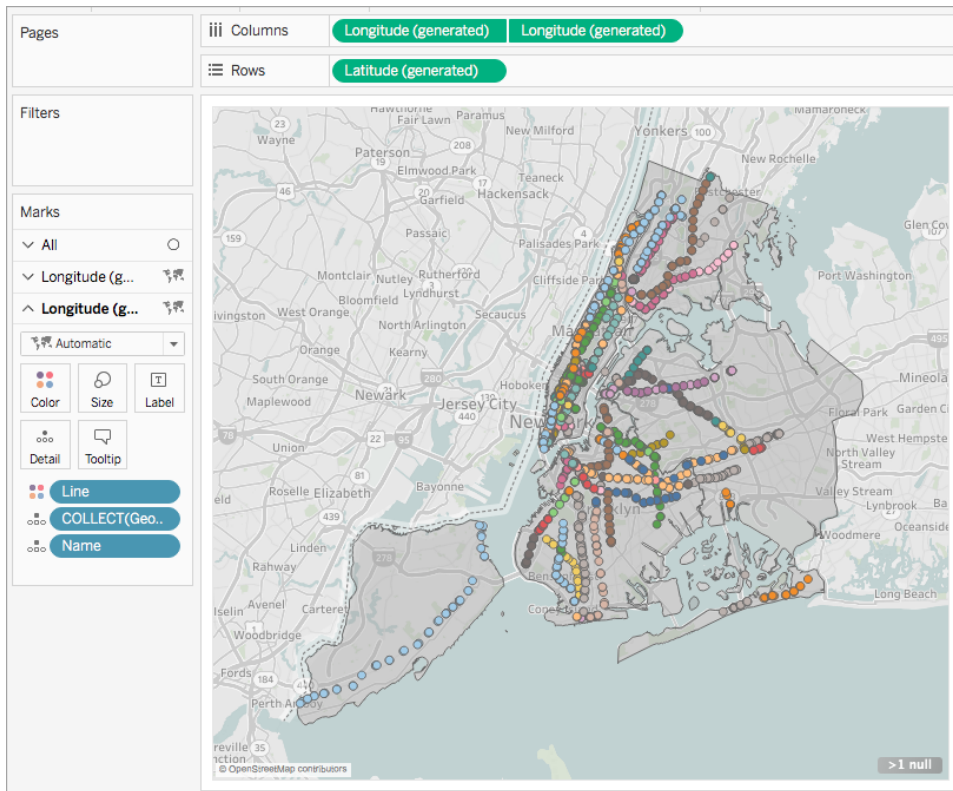

1. In Tableau Desktop, open a new worksheet.
2. Connect to your data sources.
3. Create the first map view.

See [Build a map view from spatial data](#) on page 1747 above for how to build a map view from spatial files.

4. On the Columns shelf, control-drag (command-drag on a Mac) the **Longitude** field to copy it, and place it to the right of the first **Longitude** field.

Important: This example uses the Latitude (generated) and Longitude (generated) fields that Tableau creates when you connect to spatial data. If your data source contains its own Latitude and Longitude fields, you can use them instead of the Tableau generated fields, or in combination with the Tableau generated fields. For

more information, see [Create Dual-Axis \(Layered\) Maps in Tableau](#) on page 1821.

You now have two identical map views. There are now three tabs on the Marks card: one for each map view, and one for both views (All). You can use these to control the visual detail of the map views. The top Longitude tab corresponds to the map on the left of the view, and the bottom Longitude tab corresponds to the map on the right of the view.

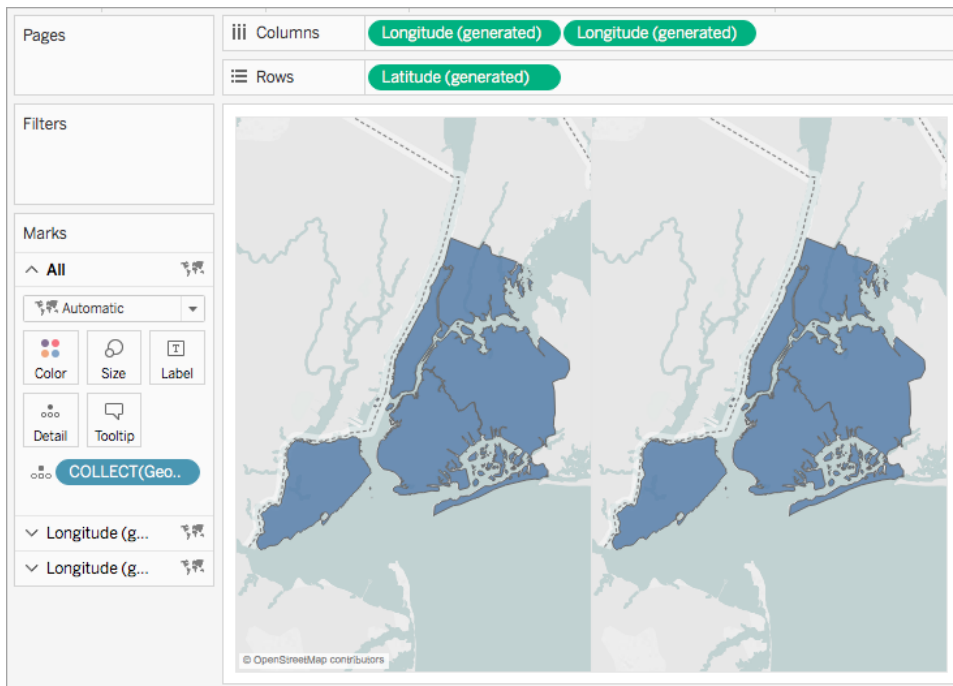

5. On the Marks card, click one of the **Longitude** tabs, and then remove all fields on that tab. One of your map views is now blank.
6. Create the second map view by dragging the appropriate fields from the Data pane to the blank **Longitude** tab on the Marks card.

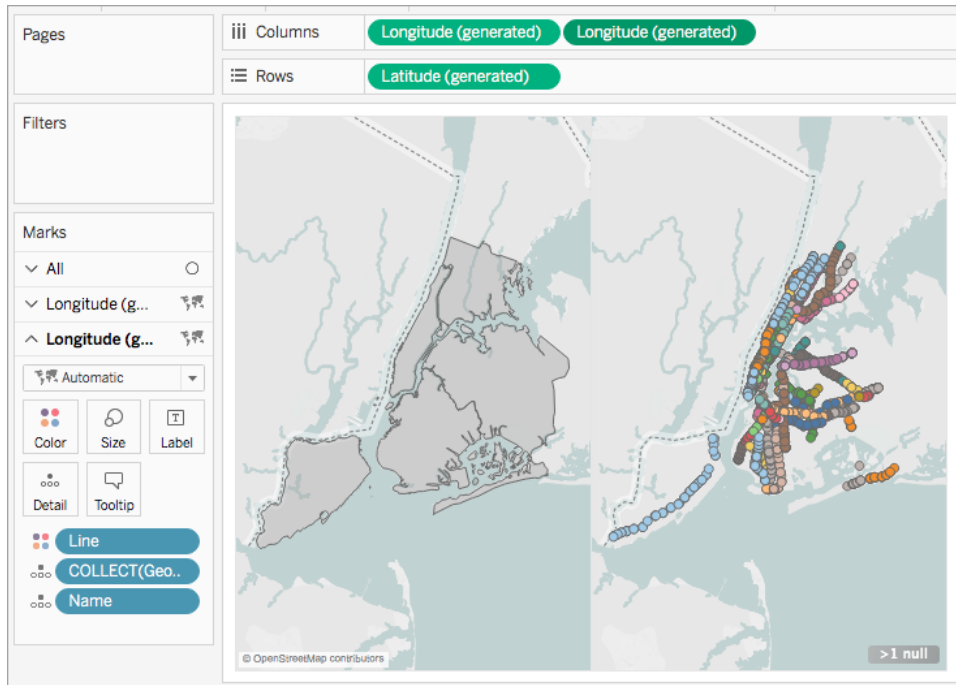

- When your two map views are finished, on the Columns shelf, right-click the **Longitude** field on the right and select **Dual Axis**.

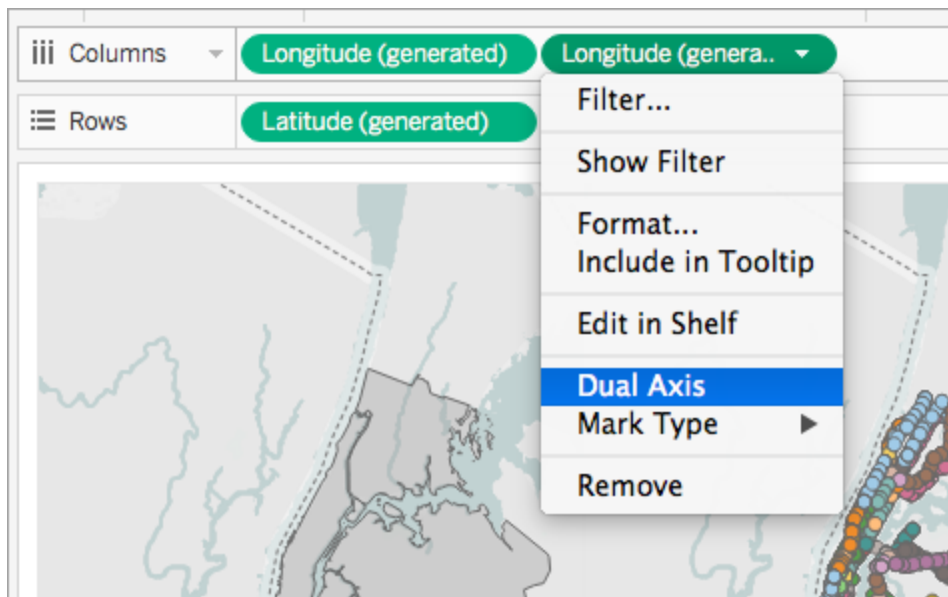

Your map data is now layered on one map view.

To change which data appears on top, on the Columns shelf, drag the **Longitude** field on the right, and place it in front of the **Longitude** field on the left.

See also

[Spatial File](#) on page 1688

[Tackle your geospatial analysis with ease in Tableau 10.2](#) (Tableau blog post)

[Join Spatial Files in Tableau](#) on page 1704

[Mapping Concepts in Tableau](#) on page 1673

[Create Dual-Axis \(Layered\) Maps in Tableau](#) on page 1821

Create Geographic Layers for Maps

When you need to add multiple layers of geographic data to a map, use marks layers in the Marks card. Marks layers act like transparent overlays. Each layer functions independently and can have its own mark type, captions, and color.

Note:

- Marks layers can be used only with geographic data.
- Fields can be shared between marks layers, but any filters that you apply to a field will apply to all marks layers

Build a view using marks layers

As you build a map, options for creating marks layers become available when you add more geographic fields to the view.

Add a marks layer

1. Build your first map in the view. Think of this as the base layer.
2. Drag a geographic field into the view. Notice the Add a Marks Layer control becomes available in the top left corner of the view.
3. Drop the geographic field on the Add a Marks Layer control. A new marks layer is added to

the Marks card and the layer is displayed in the view.

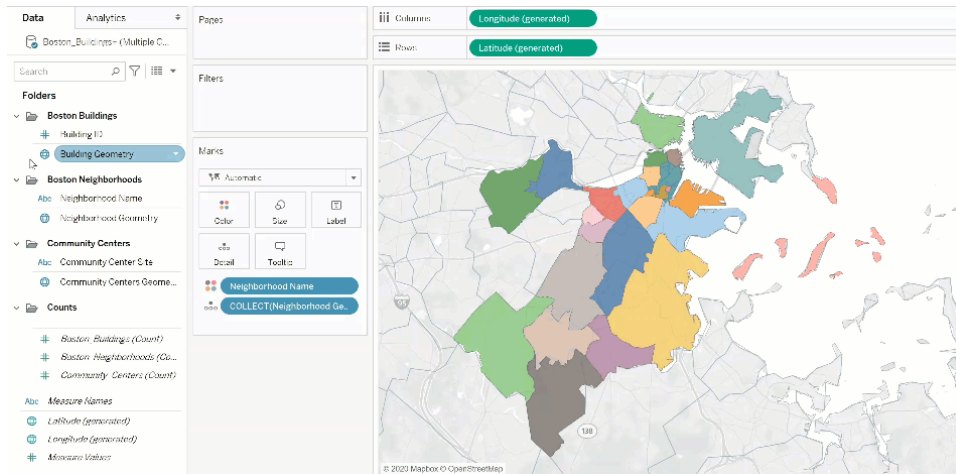

Example: Working with mark layers

The following walk through uses the sample workbook [Marks Layers Example](#).

1. Open the Marks Layers Example workbook. It uses a connection to a geographic data source.
2. Drag the Neighborhood Geometry field to the view. This creates a map in the view.
3. Drag the Neighborhood Names field to Color on Marks card.
4. Drag the Building Geometry field to the view. The Add a Marks Layer drop target displays in the top left corner of the view.

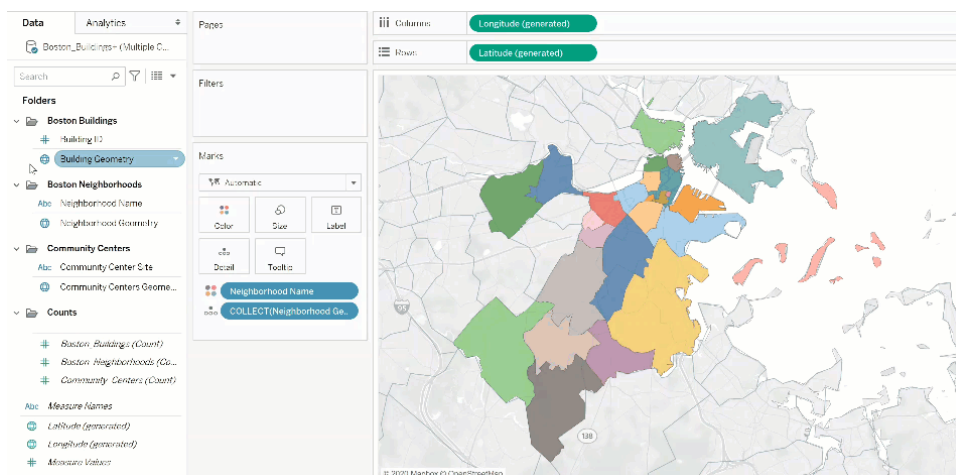

Notice that the Marks card now includes two layers labeled Boston_Buildings.Building Geometry and Boston_Neighborhoods.Neighborhood Geometry.

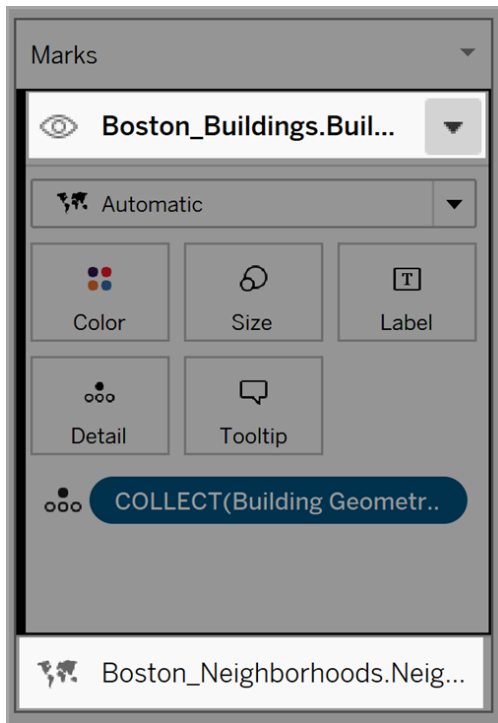

5. Add another layer of data to the view. Drag Community Centers Geometry to the view.
Note: As a shortcut, you can right click a geographic field and click Add to New Layer in the drop-down menu.

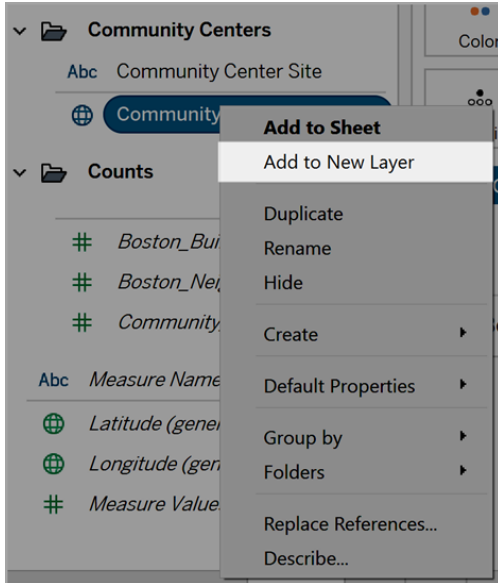

6. In the sample workbook, click the new layer to open its Marks options, and then drag the Community Centers Name field to Color.
7. To change the mark type, click the mark type drop-down arrow, and then select Shape. Click Shape field on the Marks card for this layer, and then select the heavy 'X'.

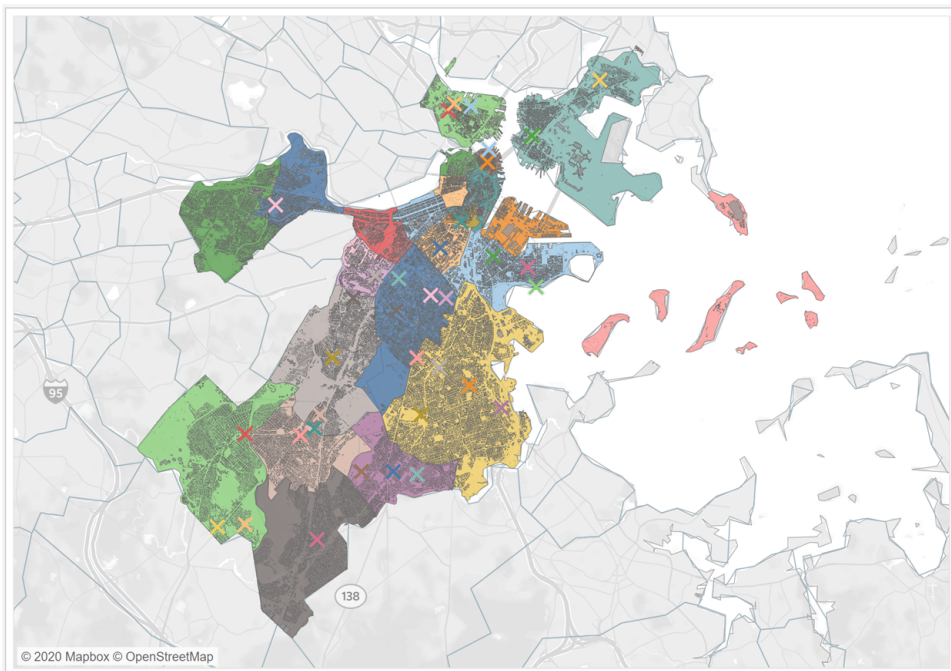

Each layer's mark type, color, and formatting can be configured independently. To change the look of any layer, click that layer to expand its Marks card, and then drag a geographic field to one of the Marks card properties such as Color.

Control mark selection in layers

After you add layers to the view, you may want to control how the user interacts with the layers. With one layer, it is easy to select a single mark to get extra information, such as a caption or text label. However, with multiple layers, it might not be the best user experience to allow your audience to select all marks on all layers. You can control how your users interact with layers in the marks layers settings.

There are two ways to control how a user selects layers in the view.

Disable mark selection

In the Marks card, click the drop-down arrow for a layer, and then select Disable Selection. This prevents users from selecting marks from that layer in the view.

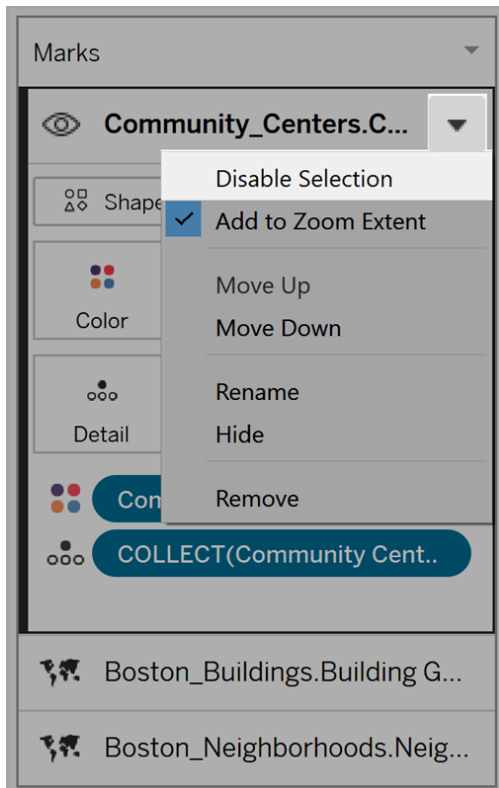

Hide a layer

To hide all marks on a layer

1. In the Marks card, click the Control Layer Visibility icon to the left of the layer name.

The icon becomes visible when you select the layer in the Marks card, and stays visible when layer visibility is disabled.

2. To show a layer, click the icon again.

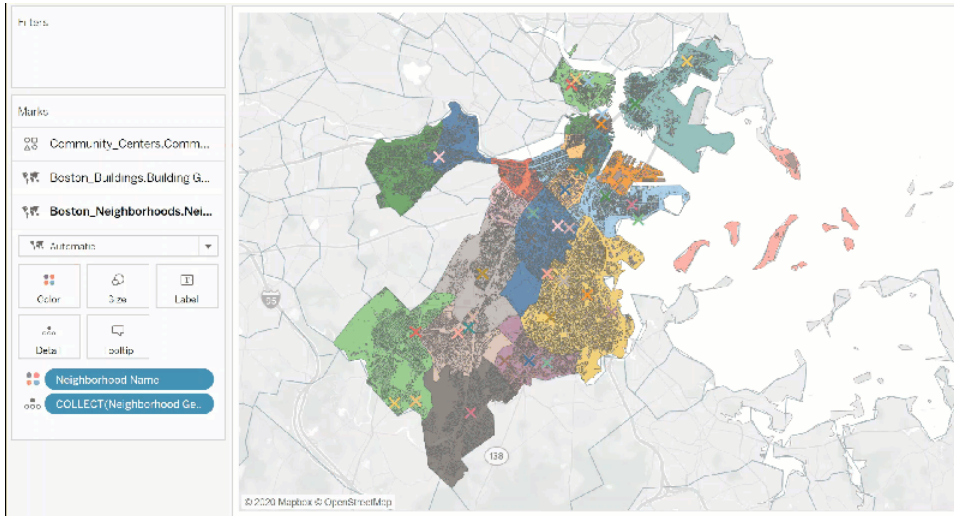

Change layer settings

After you create a map with multiple layers, you can change layer order, rename layers, remove layers, or hide layers.

Change layer order

Tableau renders the layers based on their order in the Marks card. Marks in layers at the top of the list will be displayed over marks in layers at that are lower in the list. To change the layer order

1. In the Marks card, click a layer name and drag it until the orange indicator arrow appears. Orange indicates where the layer can be moved to.
2. Drop the layer in the new order location. Note: To cancel the move while you are dragging the layer, drop the layer in a different part of the view (wherever the orange indicator arrow isn't displayed).

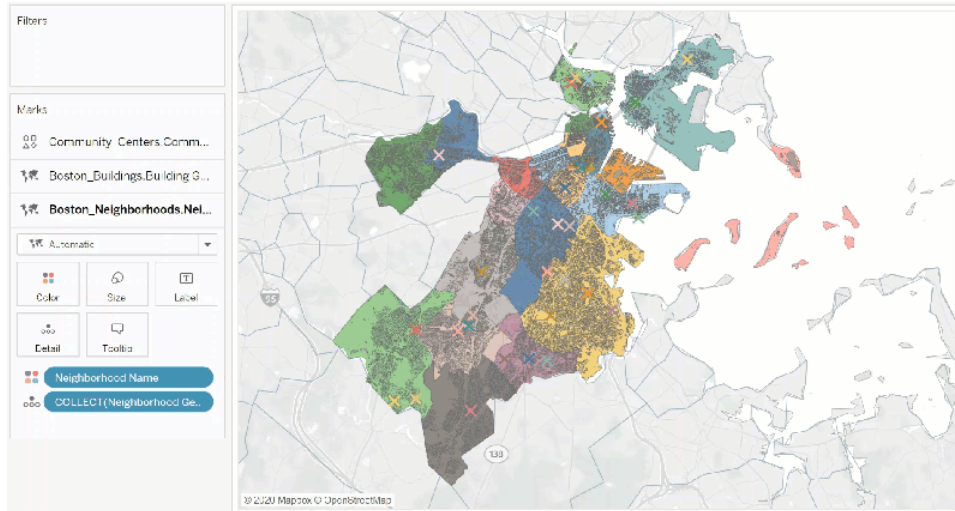

Rename layers

When a new layer is created, Tableau assigns a name automatically based on the table name and field name. With large data sources, it can become difficult to manage many different layers. You can make this easier by renaming the layers and giving each layer a distinct name. To rename a layer

1. In the Marks card, click a layer, and then click the drop-down arrow to the right of the layer name.
2. Select Rename, type the new name, and then press Enter.

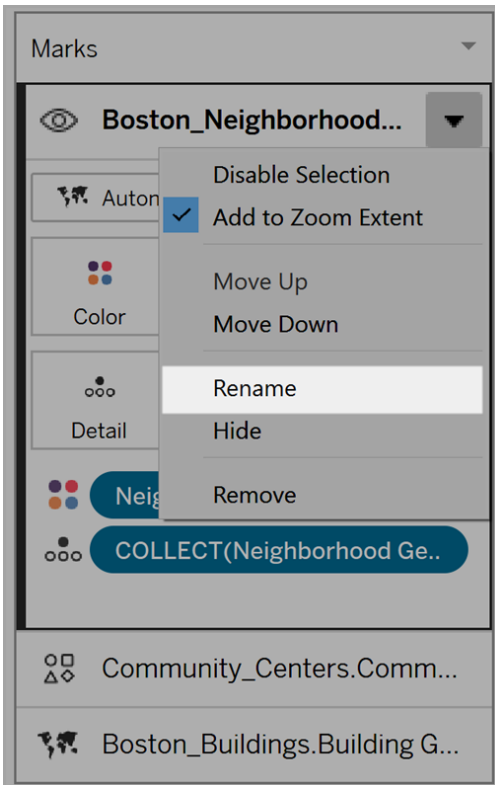

Remove layers

If a layer is not useful anymore, you can remove it.

To remove a layer:

1. In the Marks card, click a layer.
2. Click the drop-down arrow to the right of the layer name, and then select Remove.

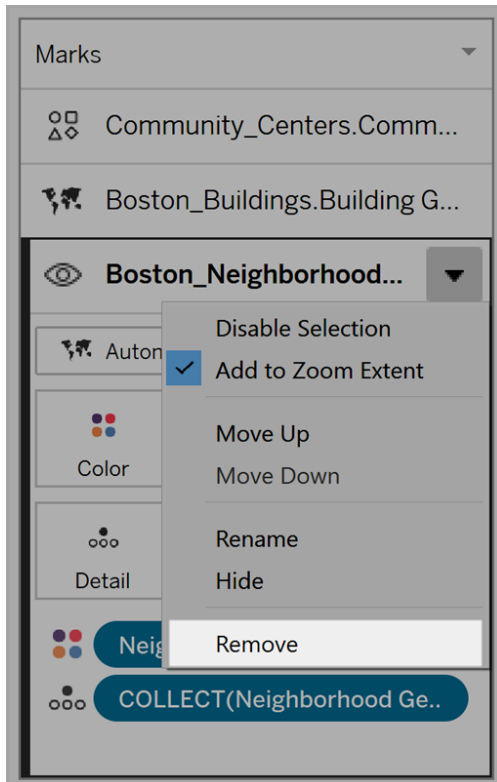

Add to Zoom Extent

By default, when you add a new layer to a map, Tableau will include all marks in the view. If there is a large difference between the scale of marks—for example, one layer showing all streetlights in a neighborhood and the other layers showing the whole country’s electrical grid—the desired detail can be lost.

To resolve this, we can disable this feature on a per-layer basis by selecting the drop-down arrow on the layer name then deselect **Add to Zoom Extent**.

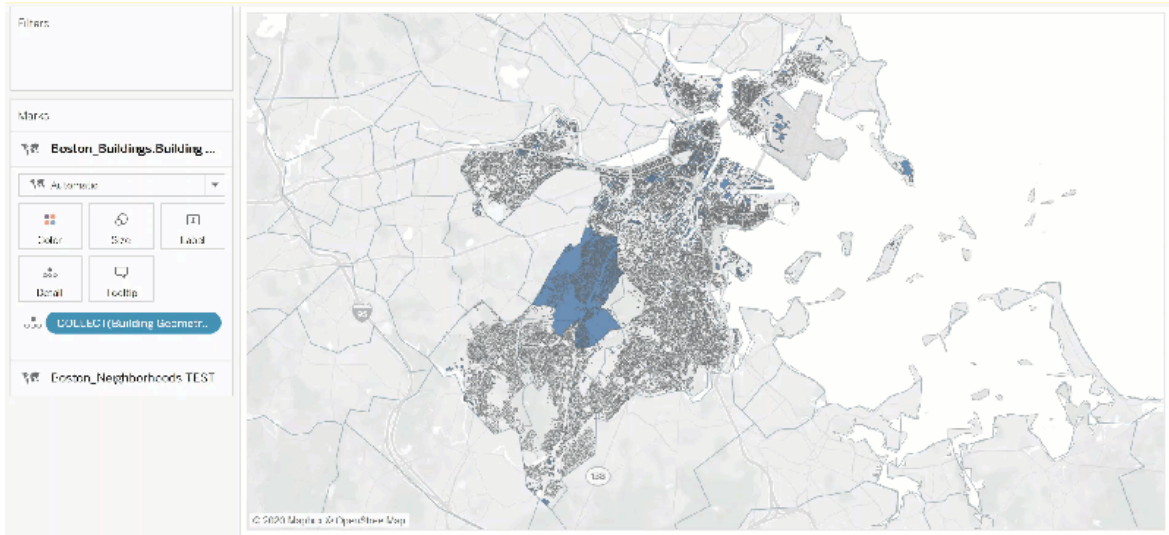

Let users customize views with the Layer Control

With the advent of Geographic Layers for Maps, you have the ability to create dense and information rich views. However, these views may become difficult to navigate as the number of layers and marks increases.

The Layer Control is a panel that expands in the view when selected, displaying all the geographic data layers, and giving you quick access to each marks layer.

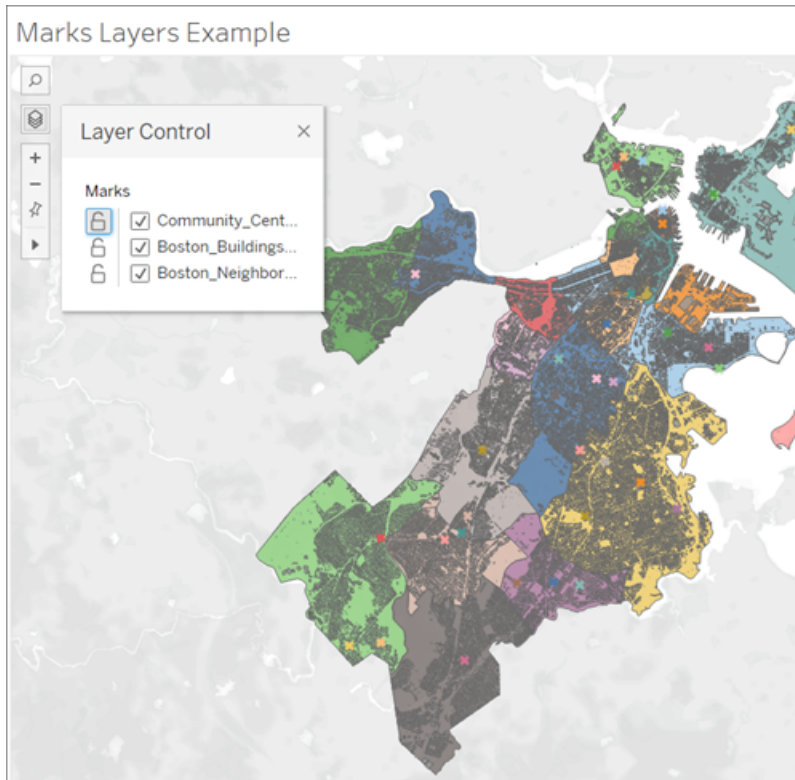

By using the Layer Control, you can hide or disable interactions on each layer, as well as save that selection as a custom view if you are working with a published workbook.

Enable the Layer Control

As the author, you can enable the Layer Control prior to publishing the workbook.

- Select **Maps > Map Options** > Check or Uncheck **“Layer Control”**

By default, Layer Control is checked, so when a workbook is published, users will be able to access the panel and hide or show mark layers.

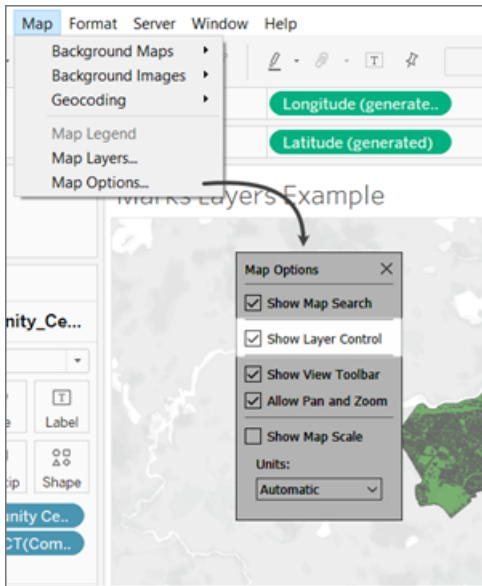

Using the Layer Control

If the Layer Control is enabled, the Layer Control icon will appear in the Map Controls on the upper left hand side of the view. Clicking on the icon will expand a panel where we can see all of the mark layers in the view.

Marks Layers Example

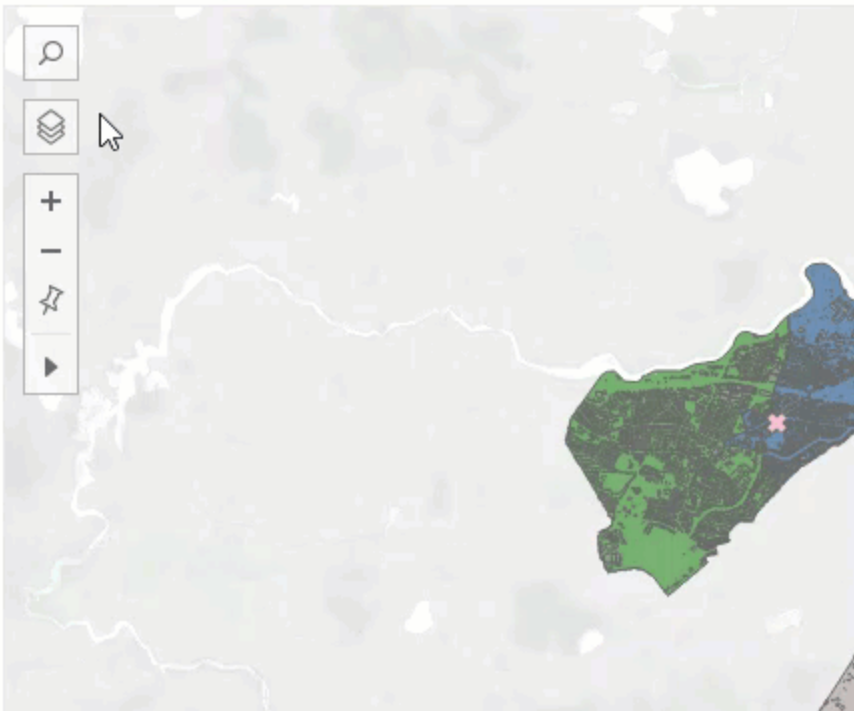

The Layer Control can be dragged around the view freely, but the position will reset each time the view is reloaded.

Each layer in the panel has a pair of icons next to it: the Interaction icon and the Visibility toggle. Any changes you make using the Control will be reflected in the Marks Layers. Hiding a layer using the Control functions exactly the same as hiding a layer in the Marks Layers card.

Selecting the Interaction icon will turn off the ability to select or interact with marks on that layer. This can be very useful for keeping background elements from being selected when doing a lasso selection, for example.

Marks Layers Example

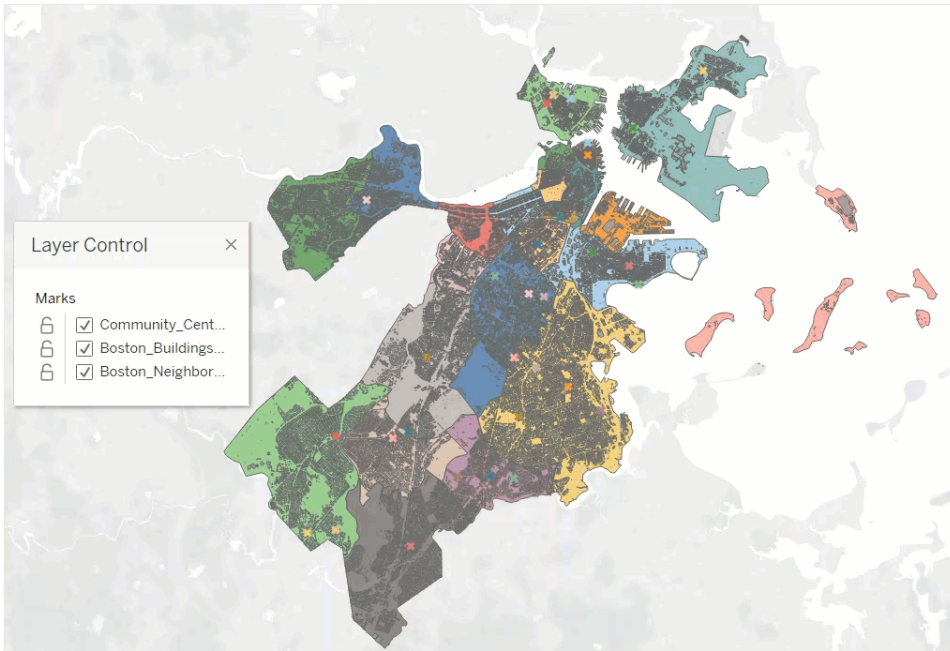

toggling Visibility off will hide all the marks on a layer, while toggling it on will show all the marks in the layer. Note that marks that are hidden are also removed from any selections.

Marks Layers Example

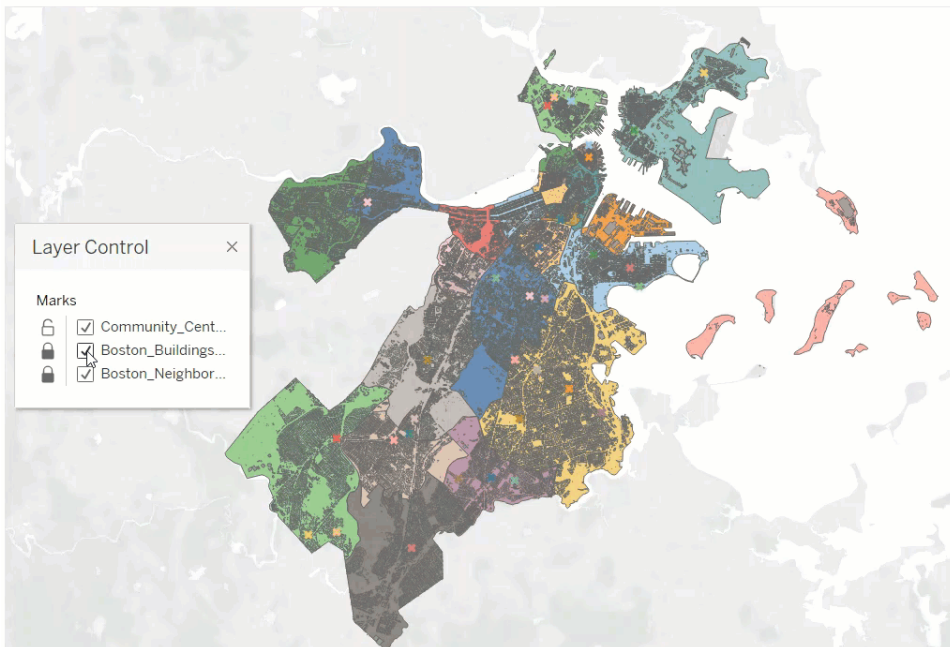

Custom views with the Layer Control

When you publish a view with the Layer Control enabled, any changes a user makes to the layers with the Layer Control won't be retained. However, the user can [Use Custom Views on page 3323](#) to keep their changes intact.

Create Maps that Show Quantitative Values in Tableau

You can create maps in Tableau Desktop that show quantitative values. These types of maps are called proportional symbol maps.

Proportional symbol maps are great for showing quantitative values for individual locations. They can show one or two quantitative values per location (one value encoded with size, and, if necessary, another encoded with color). For example, you can plot earthquakes recorded between 1981 to 2014 around the world, and size them by magnitude. You can also color the data points by magnitude for additional visual detail.

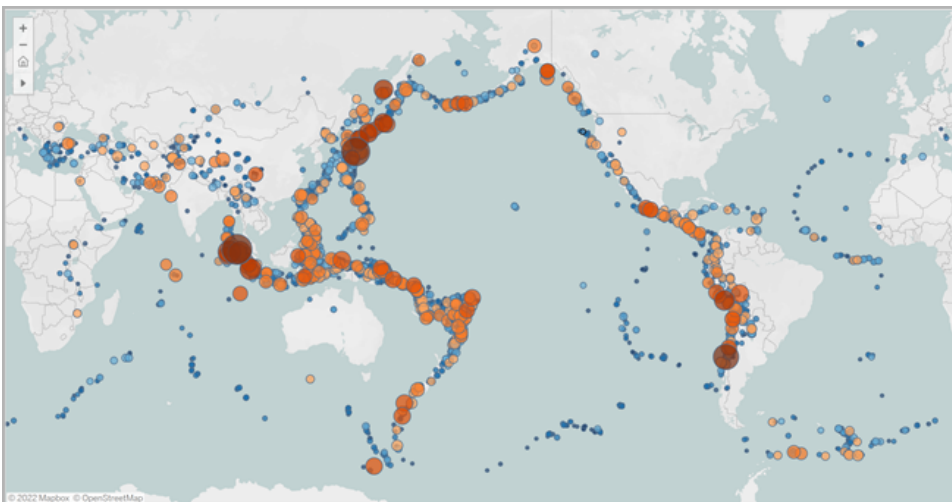

This topic illustrates how to create a proportional symbol map using an example. Follow the example to learn how to set up your data source and build the view for a proportional symbol map.

Your data source

To create a proportional symbol map, your data source should include the following types of information:

- Quantitative values
- Latitude and Longitude coordinates or location names (if recognized by Tableau)

It's also recommended that your data contain a large variation of values; otherwise, your symbols will appear approximately the same size in the view.

The following table is a snippet of the Earthquake data source, which is included in the [Create Proportional Symbol Maps in Tableau Example Workbook](#) on Tableau Public. It contains columns for earthquake magnitude and magnitude to the power of ten, and columns for latitude and longitude values. It also contains a column for the date and earthquake ID for added clarity and organization.

Earth-quake Date Time	ID	Mag-nitude	Mag-nitude^10	Latitude	Lon-gitude
1/1/73	centennial19730101114235	6.00000	17,488,747.0-4	-35.570	-15.427
1/2/73	pde1973010200532030-0_66	5.50000	25,329,516.2-1	-9.854	117.427
1/3/73	pde1973010302294280-0_33	4.80000	6,492,506.21	1.548	126.305
1/4/73	pde1973010400314200-0_33	4.50000	3,405,062.89	41.305	-29.272
1/5/73	pde1973010500394820-0_36	4.70000	5,259,913.22	0.683	-80.018
1/6/73	pde1973010606185230-0_83	4.90000	7,979,226.63	-22.354	-69.310

Basic map building blocks:

Columns shelf:	<i>Longitude</i> (continuous measure, longitude geographic role assigned)
Rows shelf:	<i>Latitude</i> (continuous measure, latitude geographic role assigned)
Detail:	One or more dimension fields
Size:	A measure field (aggregated)
Mark type:	<i>Automatic</i>

Build the map view

To follow along with this example, download the [Create Proportional Symbol Maps in Tableau Example Workbook](#) from Tableau Public, and open it in Tableau Desktop.

1. Open a new worksheet.
2. In the Data pane, double-click **Latitude** and **Longitude**.

Latitude is added to the Rows shelf, and Longitude is added to the Columns shelf. A map view with one data point is created.

3. From the Data pane, drag **ID** to **Detail** on the Marks card. If a warning dialog appears, click **Add all members**.

A lower level of detail is added to the view.

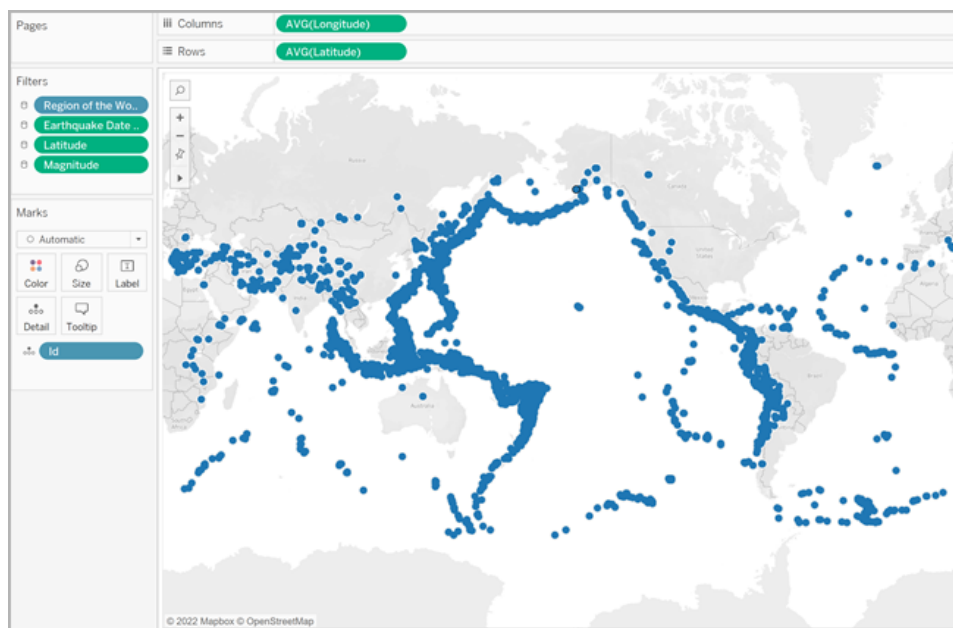

4. From the Data pane, drag **Magnitude¹⁰** to **Size** on the Marks card.

Note that the **Magnitude¹⁰** field is used to encode size instead of the **Magnitude** field. This is because **Magnitude¹⁰** contains a wider range of values, so the differences between values can be seen visually.

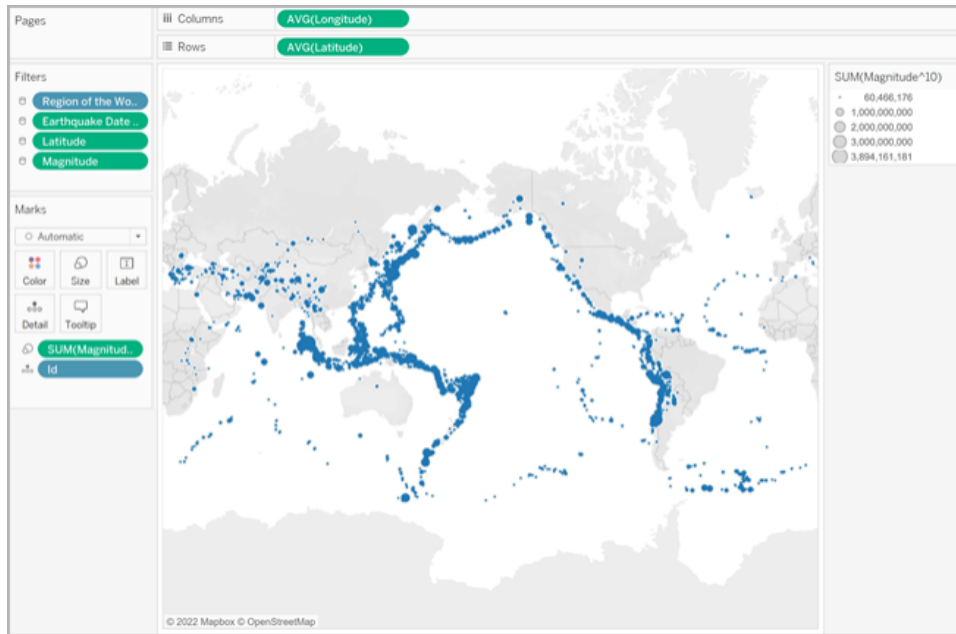

You now have a proportional symbol map. The larger data points represent earthquakes with larger magnitudes, and the smaller data points represent earthquakes with smaller magnitudes.

In most cases, this is as far as you need to go to show quantitative values for single locations. However, in this case, since there are so many data points in the view, more visual detail is needed to help you differentiate between the earthquake magnitudes and to help you spot any trends.

5. From the Data pane, drag **Magnitude** to **Color** on the Marks card.
6. On the Marks card, click **Color > Edit Colors**.
7. In the Edit Colors dialog box, do the following:
 - Click the color drop-down and select the **Orange-Blue Diverging** palette from the list.
 - Select **Stepped Color**, and then enter **8**.
This creates eight colors: four shades of orange, and four shades of blue.
 - Select **Reversed**.
This reverses the palette so that orange represents a higher magnitude than blue.
 - Click **Advanced**, select **Center**, and then enter **7**.

This shifts the color palette and ensures that any earthquake over 7.0 magnitude will appear orange in color, and any earthquake under 7.0 magnitude will appear blue in color.

- Click **OK**.
8. On the Marks card, click **Color** again, and then do the following:
- For **Opacity**, enter **70%**.
 - Under Effects, click the **Border** drop-down menu and select a dark blue border color.

The map view updates with new colors. The dark orange data points represent earthquakes with higher magnitudes, while the dark blue data points represent earthquakes with lower magnitudes. The opacity of the marks is at 70% so you can see where the data points overlap.

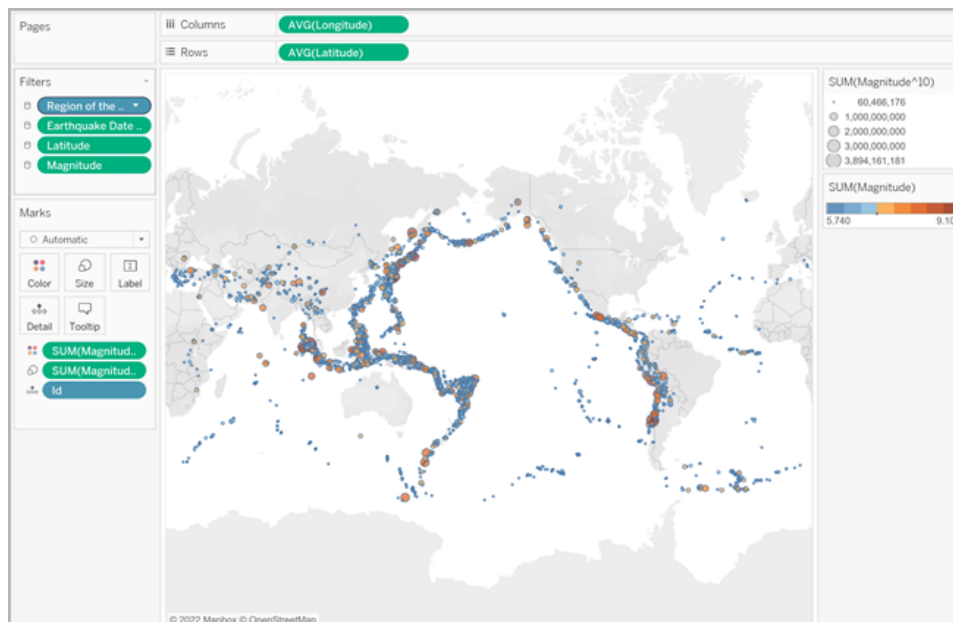

9. On the Marks card, right-click the **ID** field and select **Sort**.
10. In the Sort dialog box, do the following:
- For Sort By, select **Field**, and then click the drop-down and select **Magnitude**.
 - For Sort Order, select **Descending**.
 - Click **OK**.

This sorts the data points in the view so that the larger magnitudes appear on top.

Your proportional symbol map is now complete.

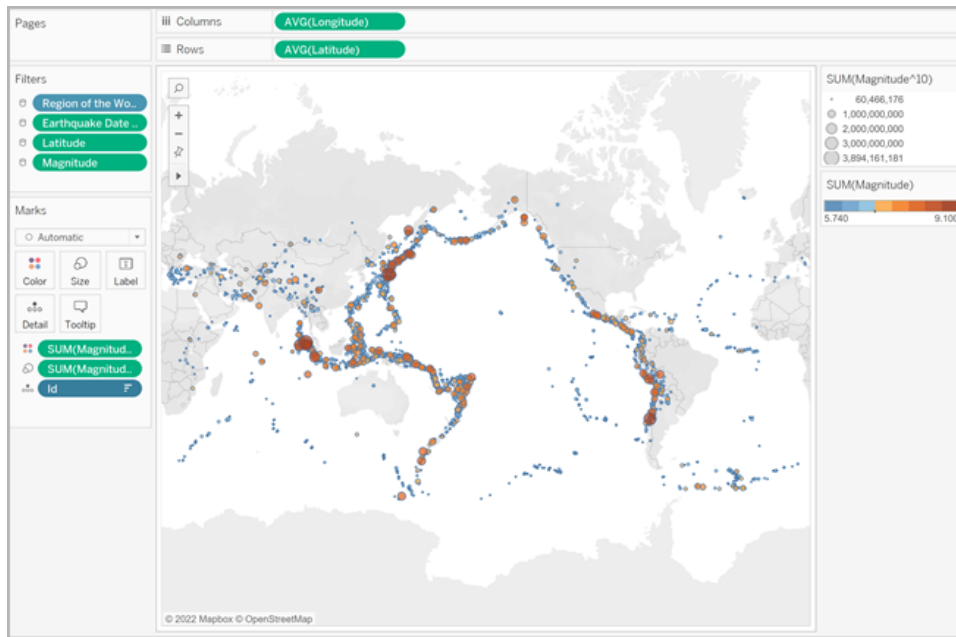

Point location and attribute meaning

It's important to note that symbols on a map can sometimes be misinterpreted as representing actual ground area. For example, if you have a map view that plots earth impact craters across North America, and sizes each symbol by the diameter (in kilometers) of the impact area, you might get a map view that looks like this:

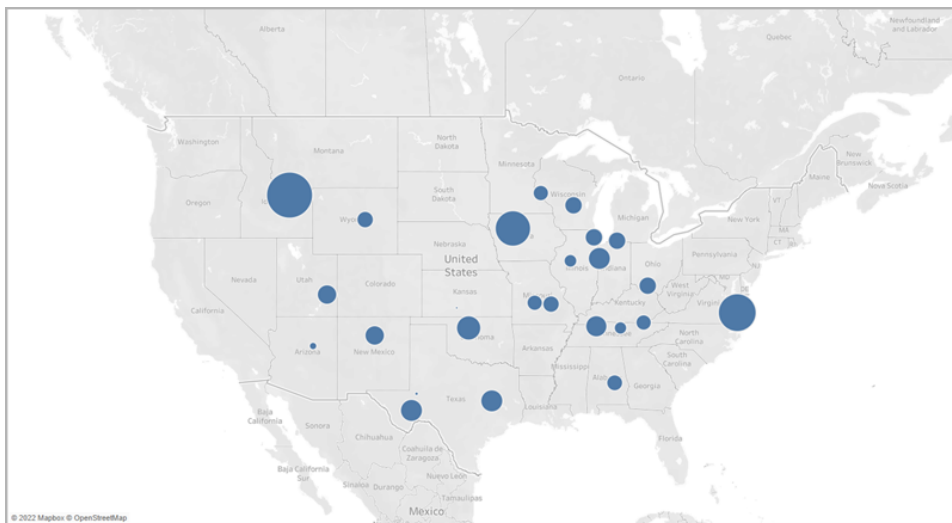

In this particular case, it could be very easy to interpret the size of these data points as representing the actual ground area of the craters. Your audience might assume that most of southwestern Montana, a state in the US, was destroyed by a crater, which is not accurate. In reality, the crater in Montana was simply one of the larger craters in the data source and has been sized accordingly.

To avoid misinterpretations, it might be helpful to include annotations or explanations of what the size actually represents. Even if it seems obvious.

See Also:

[Mapping Concepts in Tableau](#) on page 1673

[Assign Geographic Roles](#) on page 1727

Create Maps that Highlight Visual Clusters of Data in Tableau

You can create maps in Tableau Desktop that help you spot visual clusters, similar to the example below. These types of maps are called point distribution maps.

Point distribution maps are great for showing the how locations of your data points are distributed.

This topic illustrates how to create a point distribution map using an example. Follow the example in this topic to learn how to set up your data source, and build the view for a point distribution map.

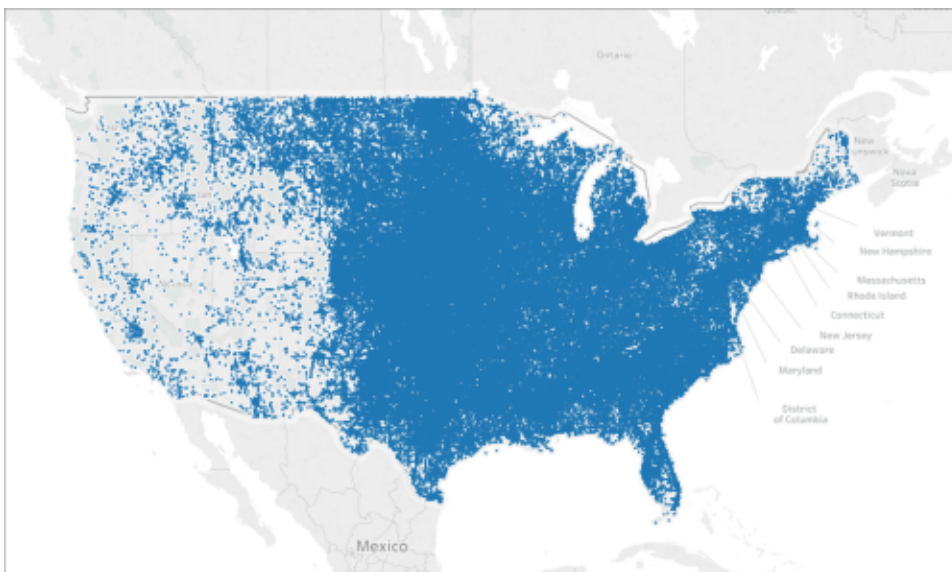

Your data source

To create a point distribution map, your data source should include the following types of information:

- Latitude and longitude coordinates for all of your locations

For example, the following table is a snippet of the Hail data source, which is included in the [Create Point Distribution Maps in Tableau Example Workbook](#) on Tableau Public. It contains columns for the latitude and longitude coordinates of hail storms across the United States from 1955 to the 2013.

Latitude	Longitude
32.2000	-101.5000
38.5800	-92.5800
41.2000	-89.6800
39.2800	-87.4000
41.7800	-87.7800
39.5000	-90.0800

Basic map building blocks

Columns shelf:	<i>Longitude</i> (continuous dimension, longitude geographic role assigned)
Rows shelf:	<i>Latitude</i> (continuous dimension, latitude geographic role assigned)
Mark type:	<i>Automatic</i>

Build the map view

To follow along with this example, download the [Create Point Distribution Maps in Tableau Example Workbook](#) from Tableau Public, and open it in Tableau Desktop.

1. Open a new worksheet.
2. Ensure that the **Latitude** geographic role is assigned to your latitude field, and the **Longitude** geographic role is assigned to your longitude field.

For more information, see [Assign a geographic role to a field](#) on page 1728.

3. In the Data pane, double-click **Latitude** and **Longitude** to add them to the view.

The Latitude and Longitude fields are added to the Columns and Rows shelves, and a map view with one data point is created.

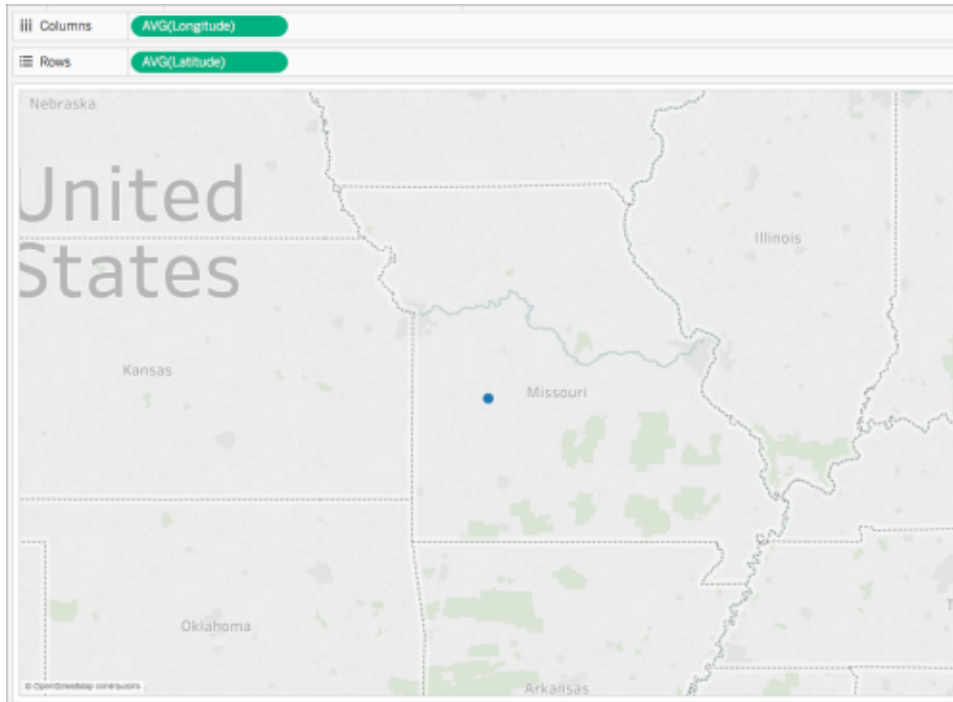

4. On the Columns shelf, right-click **Longitude** and select **Dimension**.

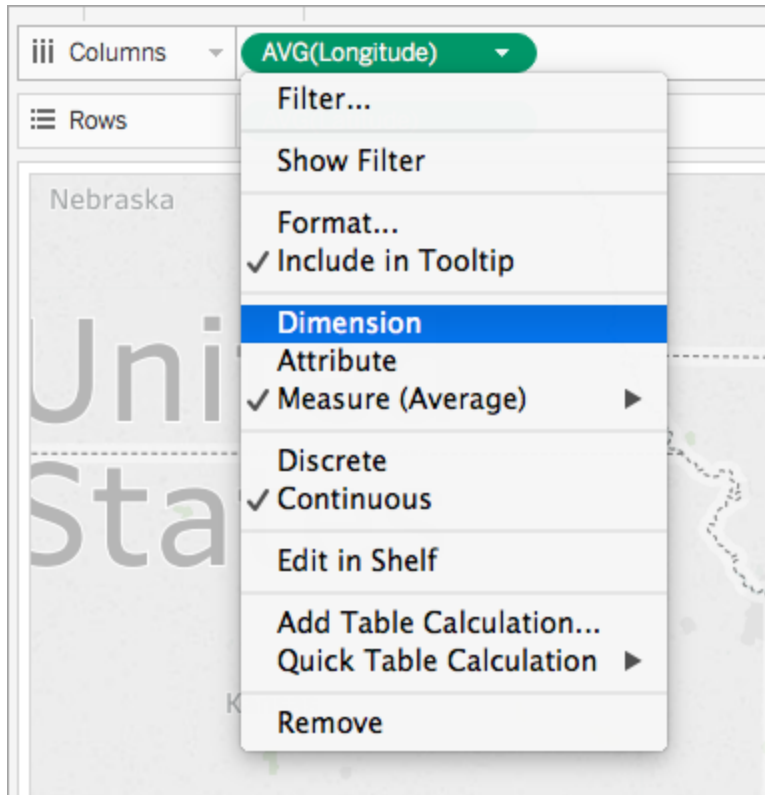

5. On the Rows shelf, right-click **Latitude** and select **Dimension**.

The map view updates with every location in your data source.

Note: You might need to filter some data points from the view.

6. On the Marks card, click **Size**, and then move the slider to the left.

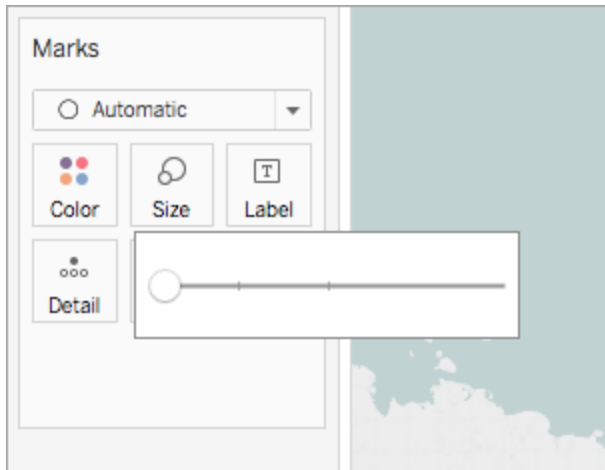

Your point distribution map is now complete. A data point for every location in your data source is now plotted on the map (minus any you filtered from the view). You can now see that a majority of hailstorms occur in the eastern half of the United States.

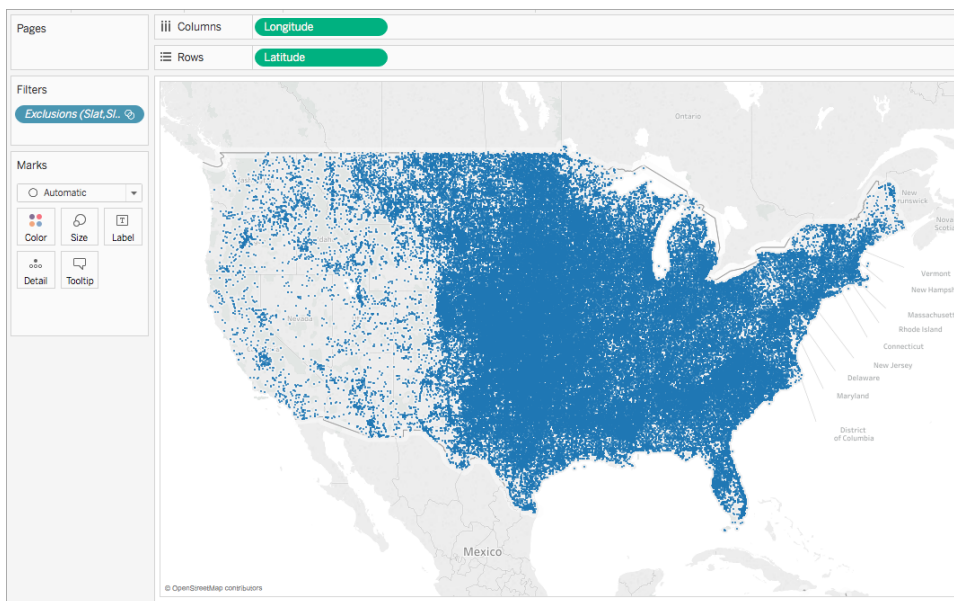

See also:

[Mapping Concepts in Tableau](#) on page 1673

[Create Maps that Show Quantitative Values in Tableau](#) on page 1773

Create Maps that Show Ratio or Aggregated Data in Tableau

You can create maps in Tableau Desktop that show ratio or aggregated data, similar to the example below. These types of maps are called choropleth maps, or filled maps.

Choropleth maps are best for showing ratio or aggregated data for polygons. These polygons can be counties, regions, states, or any area or region that can be geocoded in Tableau. They can even be custom territories created in Tableau. For more information, see [Create Territories on a Map](#) on page 1870.

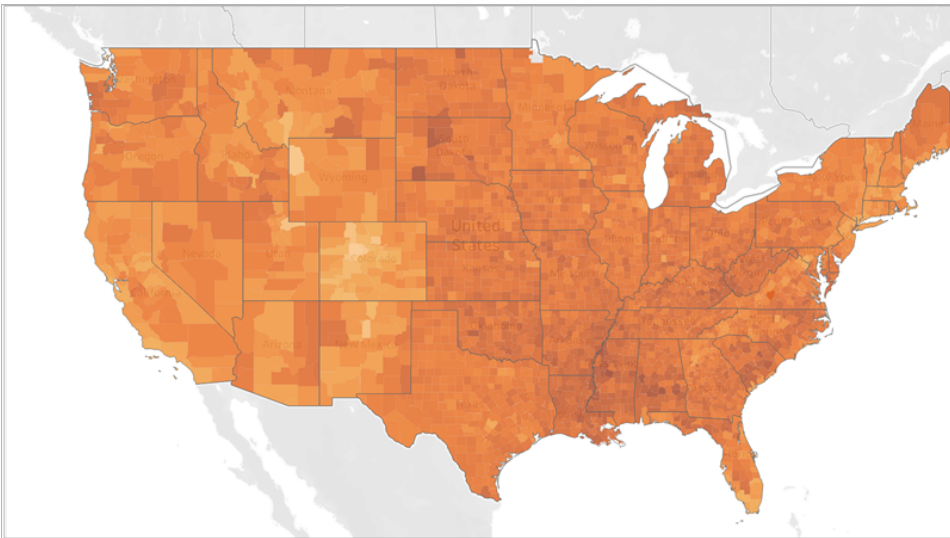

Note: When using aggregated data, be careful when using counts. Counts are often related to size or population for regions. For example, you are likely to have a higher count for sales in regions with a higher count of people.

This topic illustrates how to create a choropleth map using an example. Follow the example in this topic to learn how to set up your data source and build the view for a choropleth map.

Your data source

To create a choropleth map, your data source should include the following types of information:

- Quantitative or qualitative values.
- Location names (if recognized by Tableau), or custom polygons. For more information, see [Create Tableau Maps from Spatial Files](#) on page 1745.

The following table is a snippet of the countyObesity + (Obesity_State_County) data source, which is included in the [Create Choropleth Maps in Tableau Example Workbook](#) on Tableau Public. It contains columns for State, County, and Obesity Percent - 2012.

State	County	Obesity Percent - 2012
Alabama	Autauga County	30.9000
Alabama	Baldwin County	26.7000
Alabama	Barbour County	40.8000
Alabama	Bibb County	40.1000
Alabama	Blount County	32.4000
Alabama	Bullock County	44.5000

Basic map building blocks:

Columns shelf:	<i>Longitude</i> (continuous measure, longitude geographic role assigned)
Rows shelf:	<i>Latitude</i> (continuous measure, latitude geographic role assigned)
Detail:	One or more <i>geographic units</i> (dimensions with geographic roles assigned)
Color:	<i>Measure or dimension</i>
Mark type:	<i>Automatic or Map</i>

Build the map view

To follow along with this example, download the [Create Choropleth Maps in Tableau Example Workbook](#) from Tableau Public, and open it in Tableau Desktop.

1. Open a new worksheet.
2. In the **Data** pane, under the **State, County** folder, double-click **State**.

State is added to Detail on the Marks card and Longitude and Latitude are added to the Columns and Rows shelves. A map view is created with a data point for each state in your data source.

3. In the map view, select the **Alaska** and **Hawaii** data points, and then click **Exclude** on the tooltip that appears.

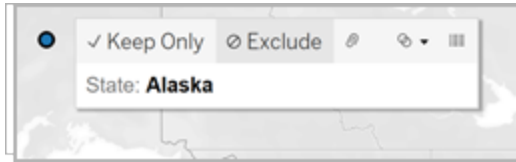

- On the Marks card, click the plus icon on the **State** field to drill down to the County level of detail.

There is now a data point for every county in your data source.

- From the Data pane, under the countyObesity\$ folder, drag **Percent-2012** to **Color** on the Marks card.

The map view changes to a filled map mark type and the polygons are colored green. Note that the default aggregation for the Percent-2012 measure is SUM by default.

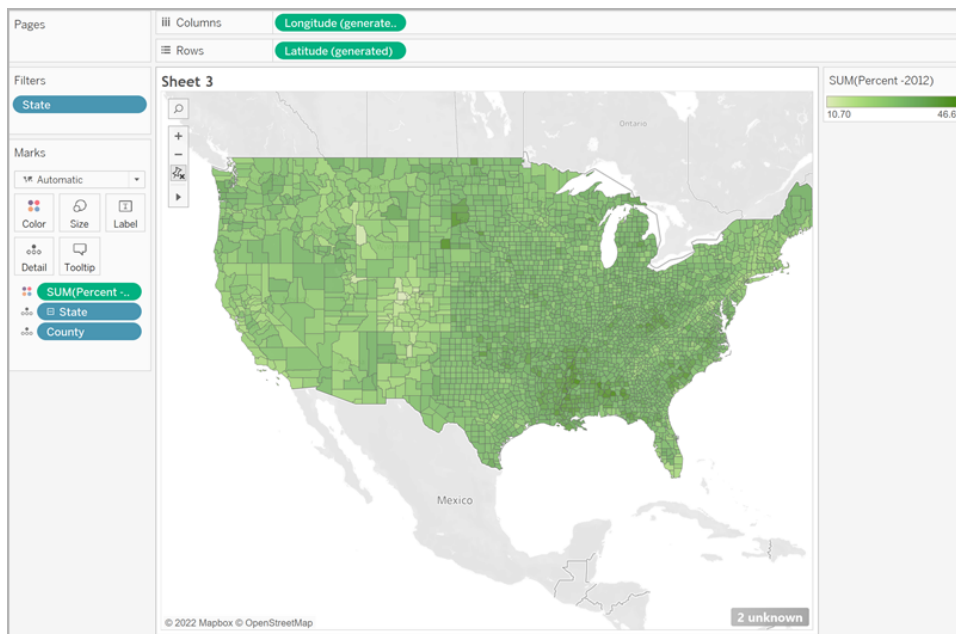

- On the Marks card, right-click the **Percent-2012** field and select **Attribute**.

Since the data in this field is already a percentage, it does not make sense to aggregate it as a sum.

7. On the Marks card, click **Color** and select **Edit Colors**.

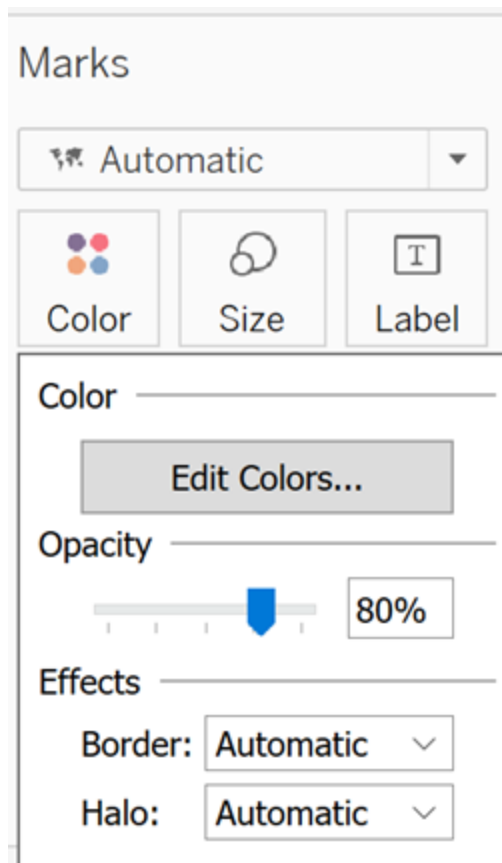

8. In the Edit Color dialog box, click the color drop-down, select **Orange**, and then click **OK**.
9. On the Marks card, click **Color** and then, under Effects, click the **Border** drop-down and select **None**.

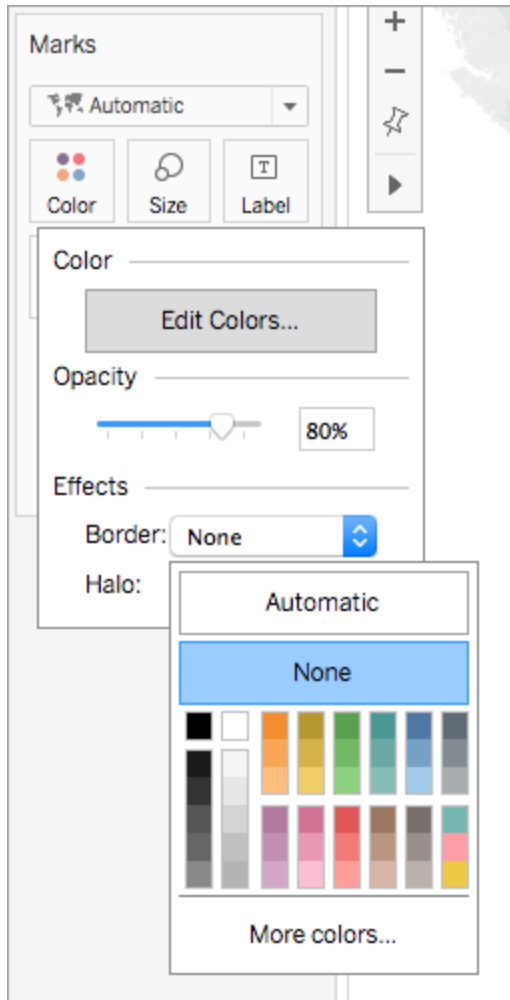

Your choropleth map is now complete. There is an obesity percentage for each polygon (county) on the map view.

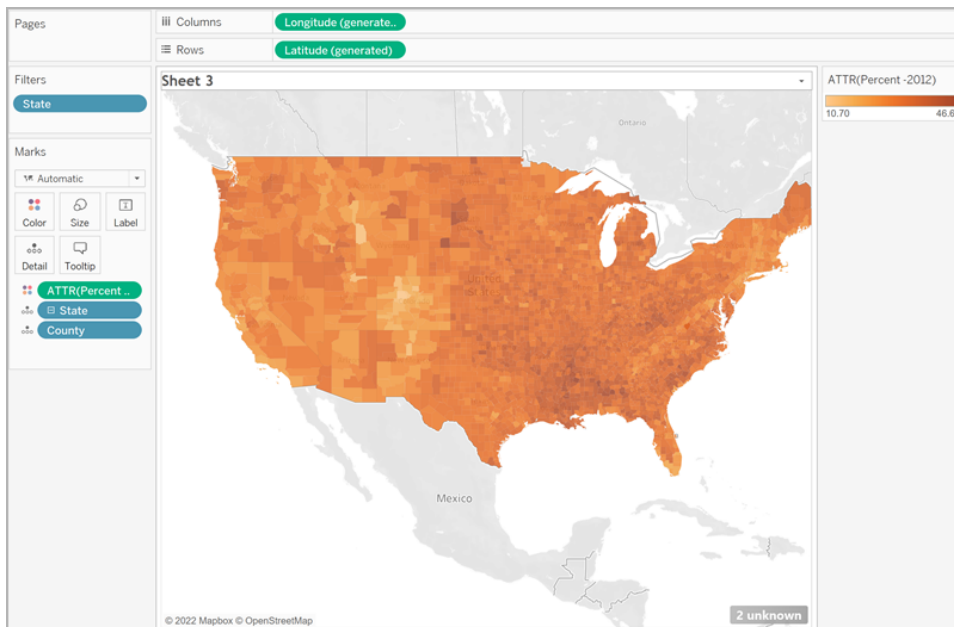

Add additional spatial context

You can add additional spatial context, such as state boundaries, by adding another layer to your map.

1. From the Data pane, drag **State** to the worksheet and drop it on to **Add a Marks Layer**.



Now you can see two layers on your Marks card: State and Country.

2. From the State layer on your Marks card, set the mark type to **Map**.

3. Click **Color**, and then drag the opacity percentage from 80% to 0%.

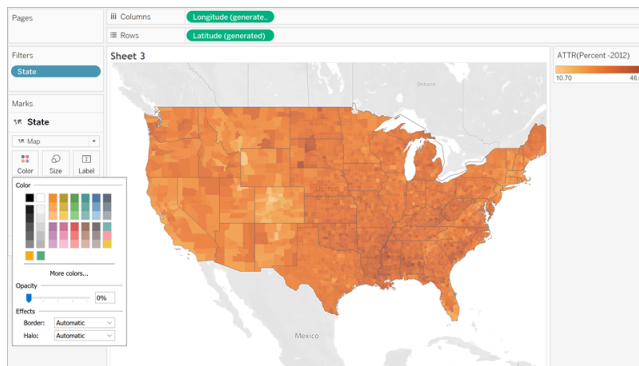

Your map updates to show state boundaries for additional context over the county data.

Note about color distribution

The distribution you specify for the color of the polygons highly affects how people interpret your data. For example, the map you created in the [Build the map view on page 1785](#) section used the Tableau default color distribution. Color was distributed evenly across all values. The map view looked like this:

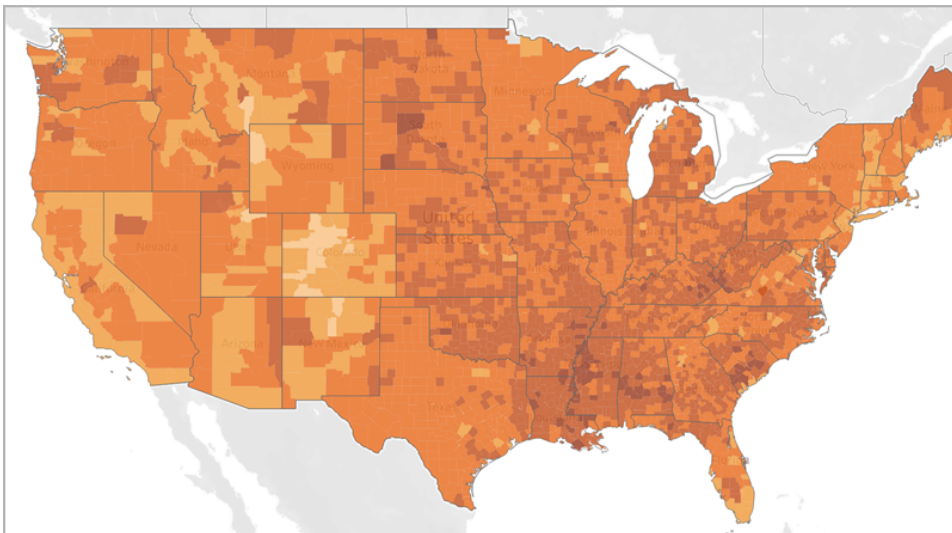

However, if you decide to distribute the values across five colors (stepped color, in Tableau), the map view might look like this:

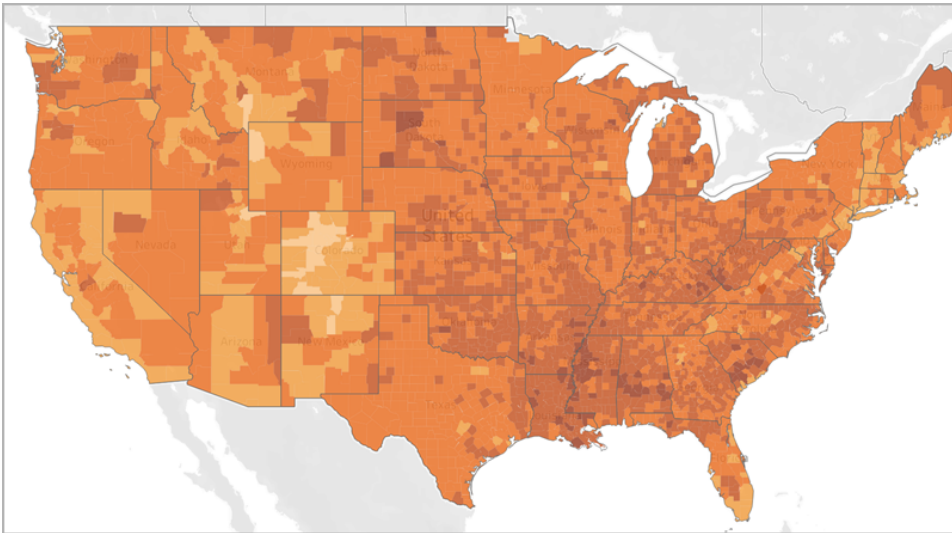

Or maybe you want to see quartiles. If you use percentiles in your data and then use stepped colors for four steps, each step will have 25% of the data and might look like this:

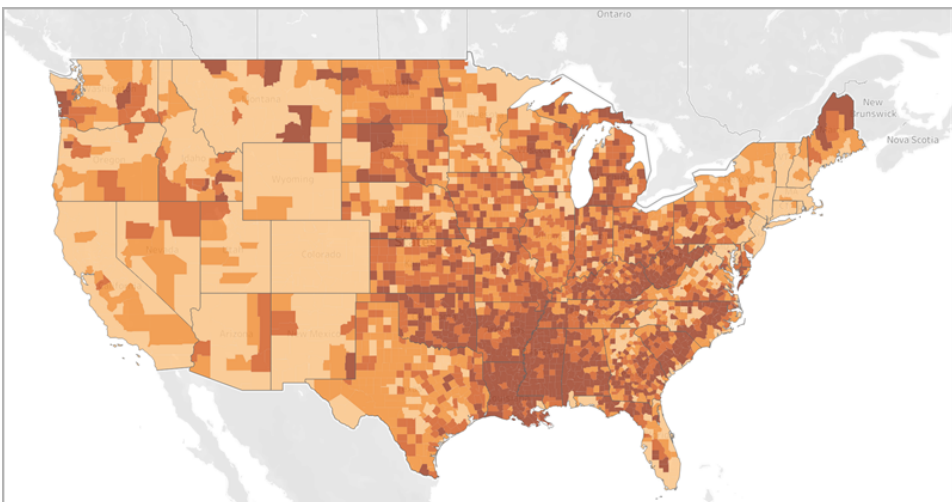

Notice how the high obesity rates in the South are more visible when you use quartiles?

The color distribution you choose depends on the information you're trying to show.

For example, if you wanted to show that obesity rates are higher in the South, you might choose the quartile example. However, if you want to show that obesity rates are high in the United States in general, you might choose the first example, which distributed color evenly. Neither map is right or wrong; they just tell different stories.

Note about level of detail

The level of detail you specify in a choropleth map determines the patterns you want to see in the data. If you want to see a simplified pattern, consider aggregating up to a higher level of detail. If you want to dig in to find smaller trends, consider aggregating down to a lower level of detail.

For example, the map view you created in the [Build the map view on page 1785](#) section was aggregated at the County level of detail. The county level of detail was the lowest level of detail in the data source. If it's appropriate for your dataset, you could aggregate to a higher level of detail, such as state.

See also:

[Mapping Concepts in Tableau on page 1673](#)

[Assign Geographic Roles on page 1727](#)

[Create Maps that Show Quantitative Values in Tableau on page 1773](#)

[Create Territories on a Map on page 1870](#)

Create Maps that Show a Path Over Time in Tableau

You can create maps in Tableau Desktop that show a path over time, similar to the example below. These types of maps are called flow maps, or path maps.

Flow maps are great for when you want to show where something went over time, such as the path of a storm.

This topic illustrates how to create a flow map using an example. Follow the example below to learn how to set up your data source, and build the view for a flow map.



Your data source

Note: Starting in Tableau version 10.4, you can connect to spatial files that contain linear geometries. If you have spatial data with linear geometries, you may not need to perform the steps below. To learn how to create a map using spatial data with linear geometries, see [Create Tableau Maps from Spatial Files](#) on page 1745

To create a flow map, your data source should include the following types of information:

- Latitude and longitude coordinates for each data point in a path
- A column to define the order to connect the points (this can be date information, or manually applied numbers, such as 1, 2, 3, 4, 5)
- A unique ID for each path
- Enough data points to shape each path into a line

For example, the following table is a snippet of the Storm data source, which is included in the [Create Flow Maps in Tableau Example Workbook](#) on Tableau Public. It contains data on the paths of storms, and has columns for **Latitude** and **Longitude**, **Date**, and **Storm Name**. In this example, the Date column is used as an order to connect the data points, and the Storm Name column is used as a unique ID for each path.

Though only a few data points for the storm PAKHAR are shown in this example, the actual data source has enough entries to provide a detailed path for every storm recorded in 2012.

Note that the table also includes two optional columns: Basin and Wind Speed. These fields can be used to quickly filter and add visual detail to the view. You'll see how in the section, [Build the map view](#) below.

Storm Name	Date	Latitude	Longitude	Basin	Wind Speed (kt)
PAKHAR	3/26/12 12:00:00 AM	9.5000	115.700	West Pacific	0
PAKHAR	3/26/12 6:00:00 AM	9.5000	115.400	West Pacific	0
PAKHAR	3/26/12 12:00:00 PM	9.5000	115.100	West Pacific	0
PAKHAR	3/26/12 6:00:00 PM	9.4000	114.800	West Pacific	0
PAKHAR	3/27/12 12:00:00 AM	9.4000	114.500	West Pacific	0
PAKHAR	3/27/12 6:00:00 AM	9.4000	114.300	West Pacific	35

Basic map building blocks:

Columns shelf:	<i>Longitude</i> (continuous measure, longitude geographic role assigned)
Rows shelf:	<i>Latitude</i> (continuous measure, latitude geographic role assigned)
Detail:	<i>Dimension</i> (unique ID for each path)
Path:	<i>Date field</i> or <i>order field</i> to define order to connect the data points
Mark type:	<i>Line</i>

Build the map view

To follow along with this example, download the [Create Flow Maps in Tableau Example Workbook](#) from Tableau Public, and open it in Tableau Desktop.

1. Open a new worksheet.
2. In the **Data** pane, under Measures, double-click **Latitude** and **Longitude**.
The Latitude and Longitude fields are added to the Columns and Rows shelves, and a map view with one data point is created.
3. From Dimensions, drag **Storm Name** to **Detail** on the Marks card.
The map view updates with a data point for every storm in the data source. In the next steps, you will narrow the storms down to only those that occurred in the western Pacific Ocean in 2012.
4. From Dimensions, drag **Date** to the **Filters** shelf.
5. In the Filter Field [Date] dialog box that appears, select **Years**, and then click **Next**.
6. In the Filter [Year of Date] dialog box that appears, click **2012**, and then click **OK**.
The map view updates to show only the storms that occurred in 2012.
7. From Dimensions, drag **Basin** to the **Filters** shelf.
8. In the Filter Field [Basin] dialog box that appears, select **West Pacific**, and then click **OK**.
The map view updates to show only storms that occurred in the western part of the Pacific Ocean.

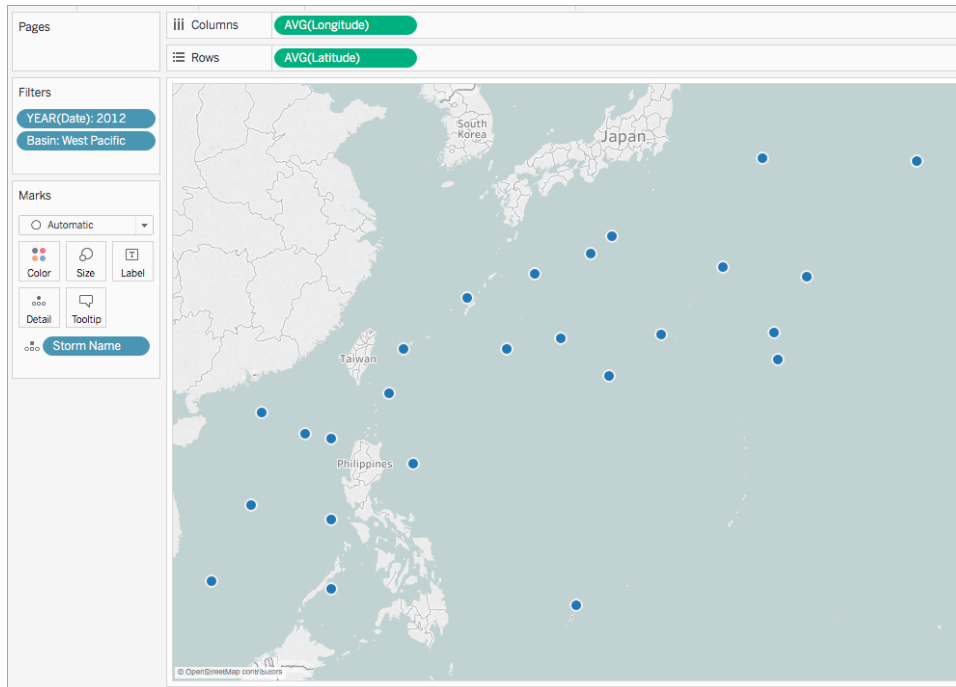

9. On the Marks card, click the mark-type drop-down and select **Line**.

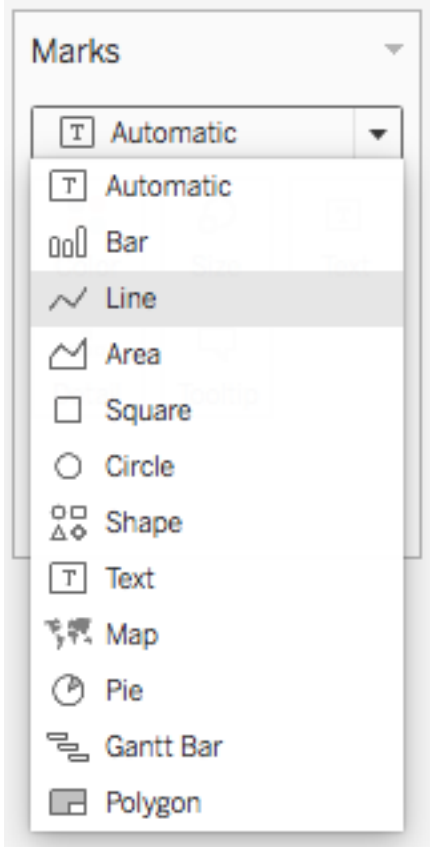

A Path button appears on the Marks card, and the map view updates with a line connecting every data point.

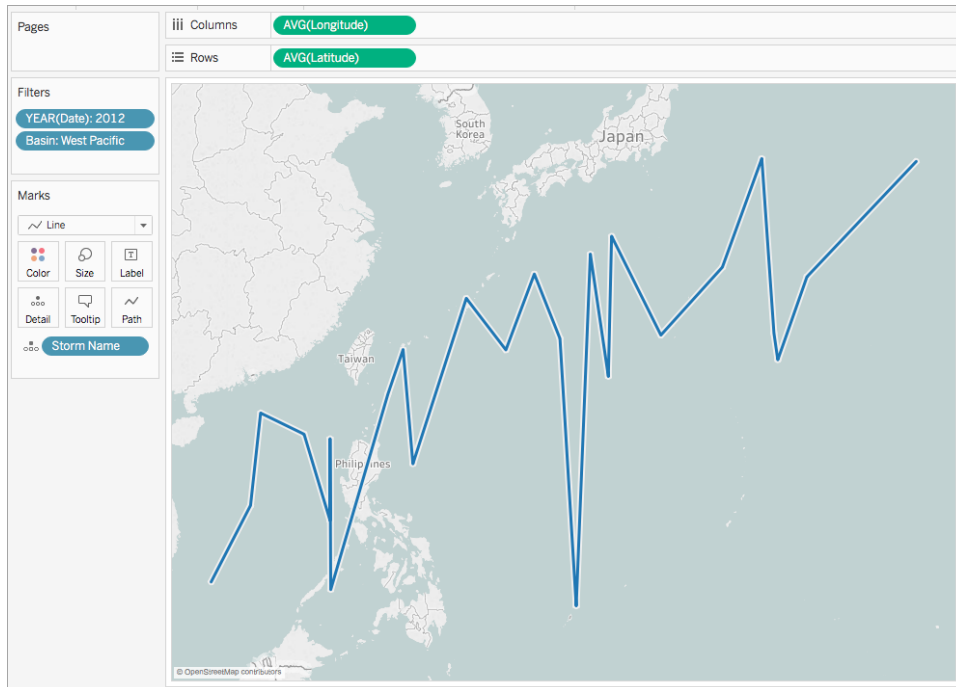

- From Dimensions, drag **Date** to **Path** on the Marks card.

The line disappears. This is because the Date field is set to discrete years. Since the date field in the Storm data source includes day, month, year, and time, this is not the correct level of detail for this field.

- On the Marks card, right-click the **YEAR(Date)** field and select **Exact Date**.

Now the map view updates with a data point for every recorded date and time. You can now see the individual paths of each storm.

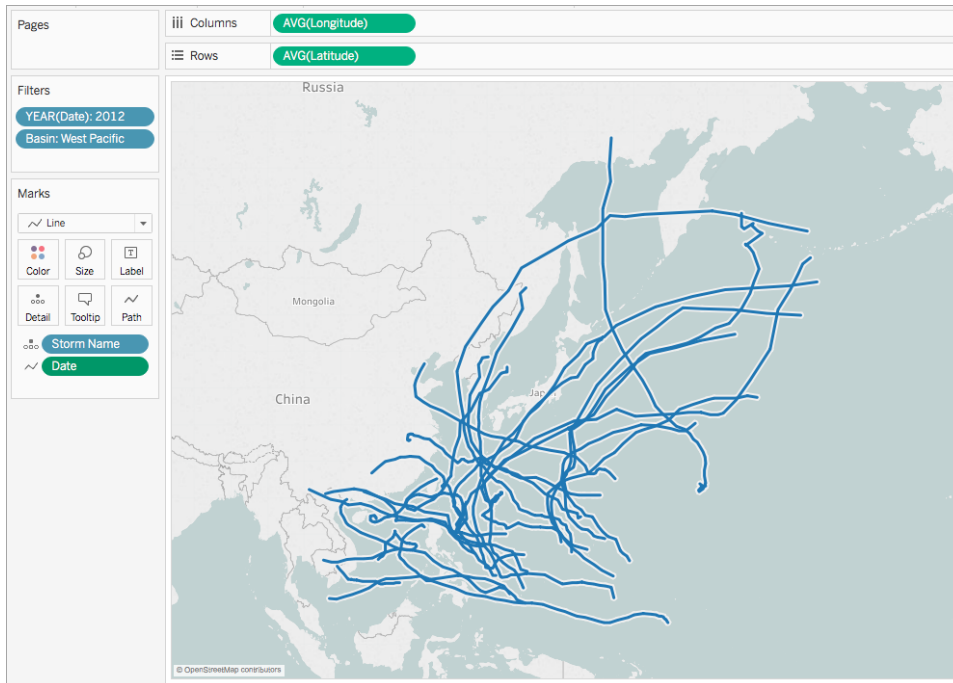

12. From Measures, drag **Wind Speed** to **Size** on the Marks card.

The map view updates to show the varying wind speeds along each storm path.

13. On the Marks card, right-click the **SUM(Wind Speed)** field and select **Measure > Average**.

14. From Dimensions, drag **Storm Name** to **Color** on the Marks card.

Each storm path is assigned a color and the flow map is now complete.

You can now see the paths for every recorded storm that occurred in the West Pacific basin in 2012. You can also see at what point in their path their wind speeds were strongest.

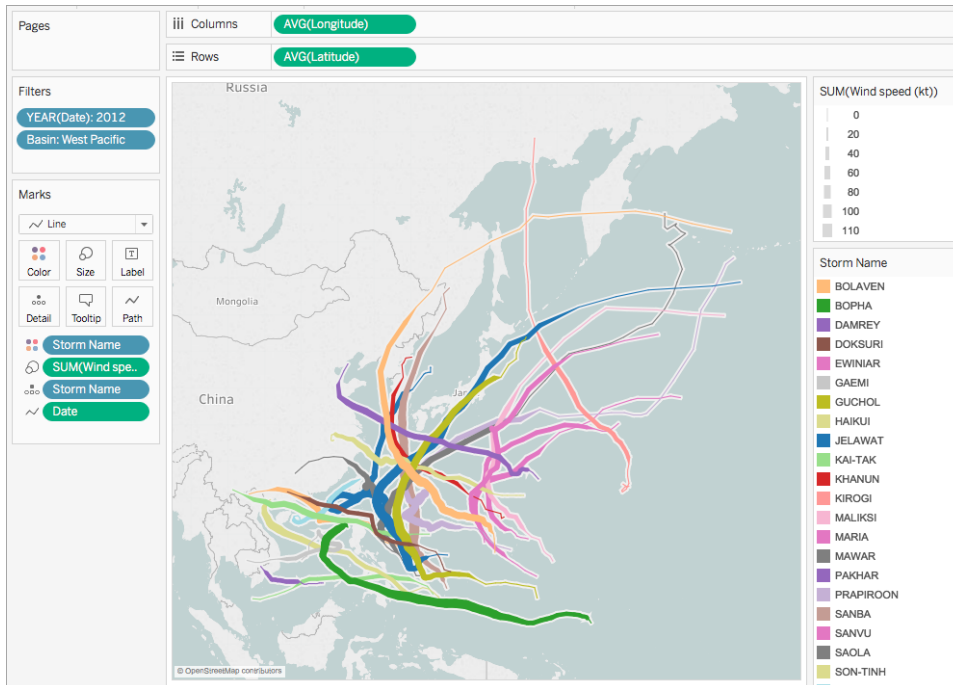

See also:

[Mapping Concepts in Tableau](#) on page 1673

[Create Maps that Show Paths Between Origins and Destinations in Tableau](#) on page 1806

Tableau Community post: [Origin-Destination Maps \(or Flow Maps\)](#)

Create Heatmaps that Show Trends or Density in Tableau

You can create maps in Tableau that reveal patterns or relative concentrations that might otherwise be hidden due to overlapping marks on a map. One common map type for this is a density map, also called a heatmap. Tableau creates density maps by grouping overlaying marks and color-coding them based on the number of marks in the group.

Density maps help you identify locations with greater or fewer numbers of data points. They are most effective when working with a data set containing many data points where there's substantial overlap between the marks on the map.

Your data source

To create a density map, your data source should contain point geometry, latitude and longitude coordinates, or location names (if recognized as location names by Tableau).

Tableau can recognize location names and create a density map using the point locations assigned to Tableau geocoding locations, but density maps are most effective when the location data is very precise, such as location coordinates in a limited space. Density marks work best where the specific locations change continuously and smoothly across space, rather than values constrained to discrete locations like borough or neighborhood.

Basic map building blocks:

Columns shelf:	<i>Longitude</i> (continuous dimension, longitude geographic role assigned)
Rows shelf:	<i>Latitude</i> (continuous dimension, latitude geographic role assigned)
Detail:	One or more fields with many underlying data points
Mark type:	<i>Density</i>

Build the map view

You can choose **Density** from the mark type drop-down and Tableau will compute a density surface on your view. The density surface recomputes as you zoom or filter data on the remaining marks. When using Pages or a small multiples view, the Density is computed across the full domain of the data for comparative analysis.

To follow along with this example, download the [Create Heatmaps in Tableau Example Workbook](#) (click Download in the upper right hand corner), and open it in Tableau Desktop.

1. Open a new worksheet and connect to your data source.

In the data source used in this example, the fields are named Pickup Latitude and Pickup Longitude. Ensure that the Pickup Latitude geographic role is assigned to your latitude field, and the Pickup Longitude geographic role is assigned to your longitude field.

For more information, see [Assign a geographic role to a field](#).

2. In the Data pane, select both Pickup Latitude and Pickup Longitude and drag them onto the canvas.

The Latitude and Longitude fields are added to the Columns and Rows shelves, and a map view with one data point is created.

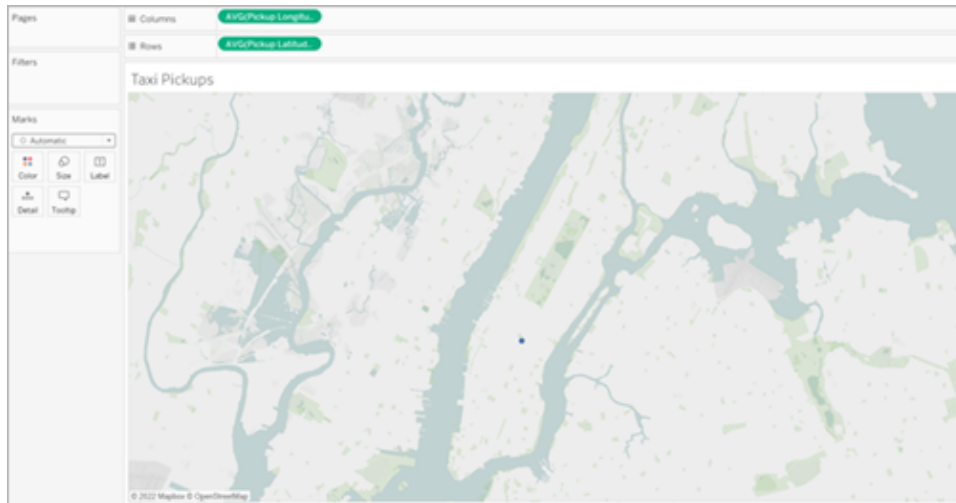

- Next, add distinct marks to the view. Right-click (Control-click on Mac) ID and drag it onto **Detail** on the Marks card. Because each pickup has its own ID, this action breaks up the marks and distinguishes one pickup from another on our map.

There will be a warning letting you know that the field added may contain more than the recommended maximum of 1000. Select **Add all members**.

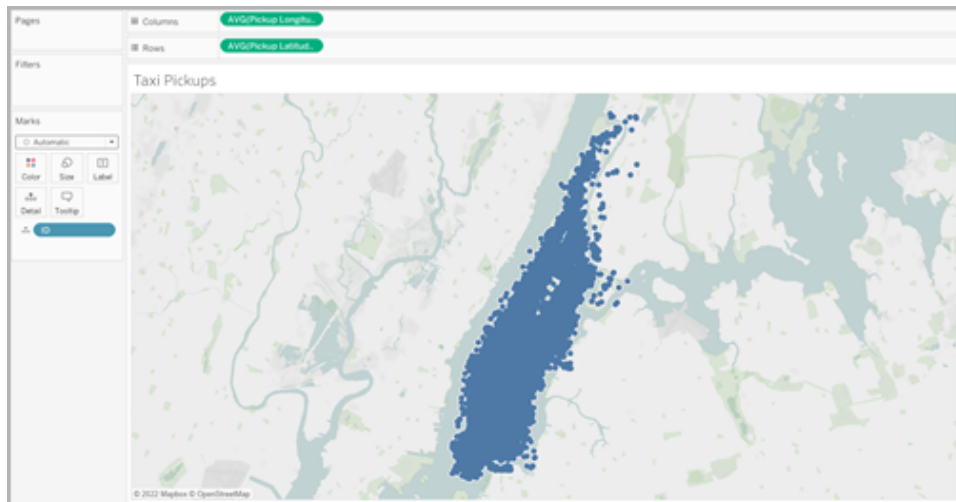

The map view updates to show marks for every pickup location in your data source. Since every location is within Manhattan, the map will zoom to focus on Manhattan in New York City.

Note: You might need to filter some data points from your view to create the level of zoom desired.

- 4. On the Marks card, change the mark type to density by selecting the drop-down menu to the right of Automatic and select **Density**.

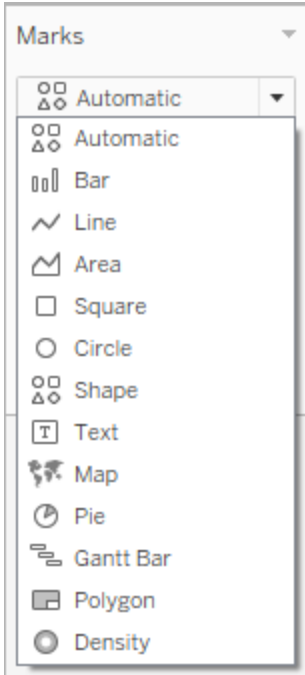

- 5. Your basic density map is created.

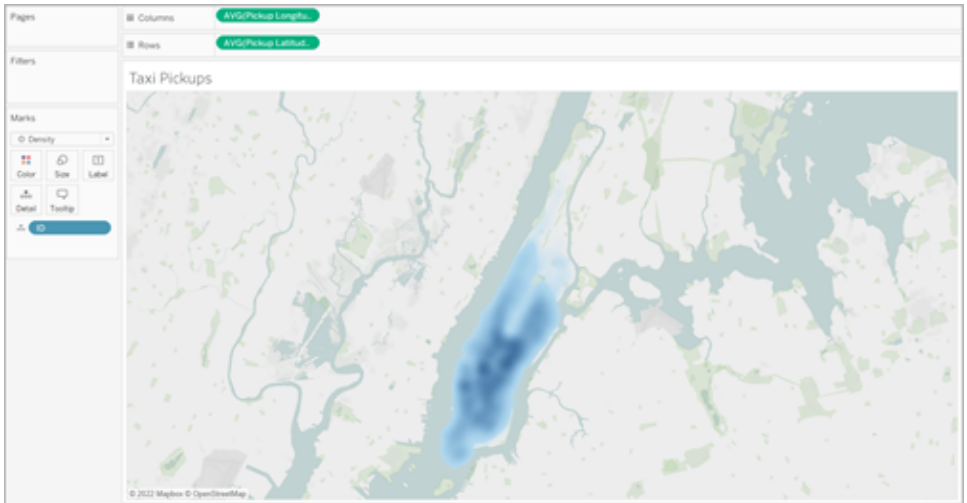

You can see that midtown is the most popular area for taxi pickups, and you can adjust the

focus further by using the zoom tool. Density will recompute as you zoom in or out.

You can select an individual data point from anywhere in your density map. These marks have size (10 pixels) and color (blue) applied by default. Size and color are not adjustable for underlying marks.

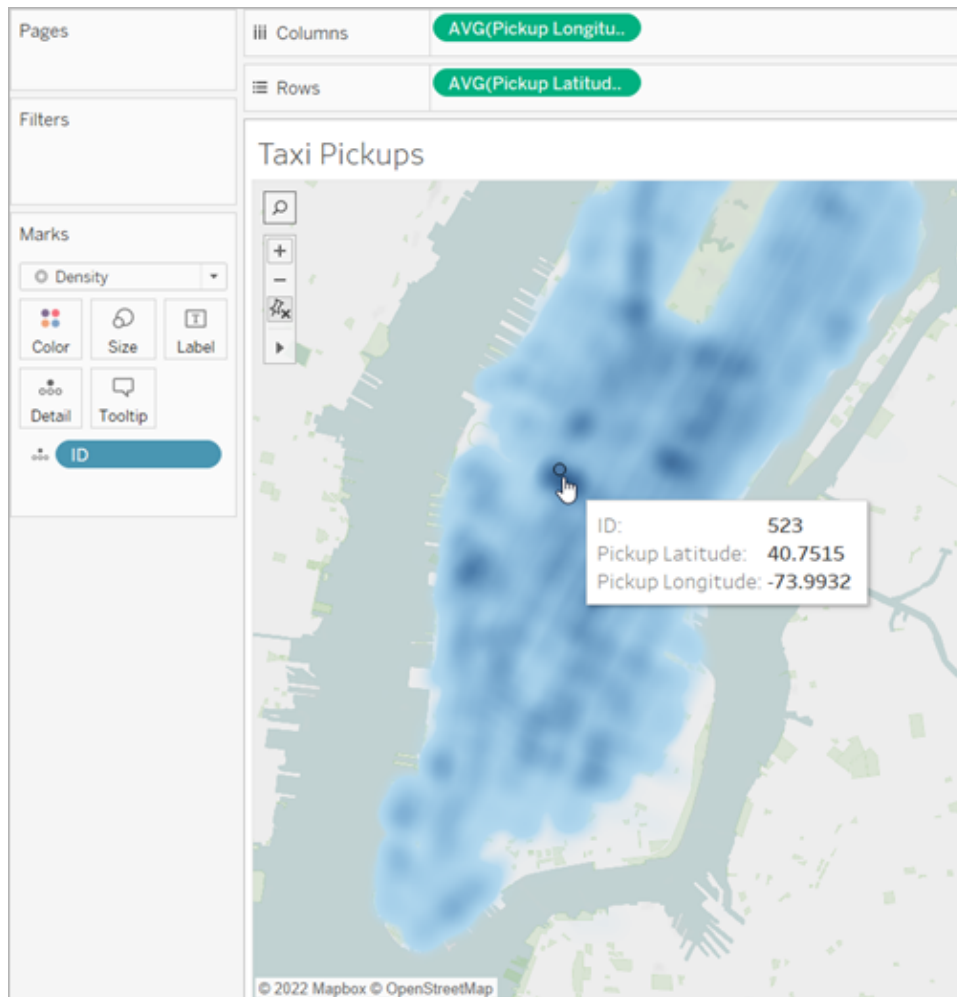

Zoom around the map to analyze your data. Selection, tooltips, labels, and hovering all work based on the marks in the zoom of the view. Density maps have no fixed or constant display and will always recompute as you zoom.

Adjust the appearance

You can adjust the color, intensity, and size of your marks to help you analyze the data on your density map.

Color: Adjust the colors of your density map by selecting **Color** from the Marks card. Choose from ten density color palettes or any of the existing color palettes. The density color palettes are tailored for working on either light or dark base maps.

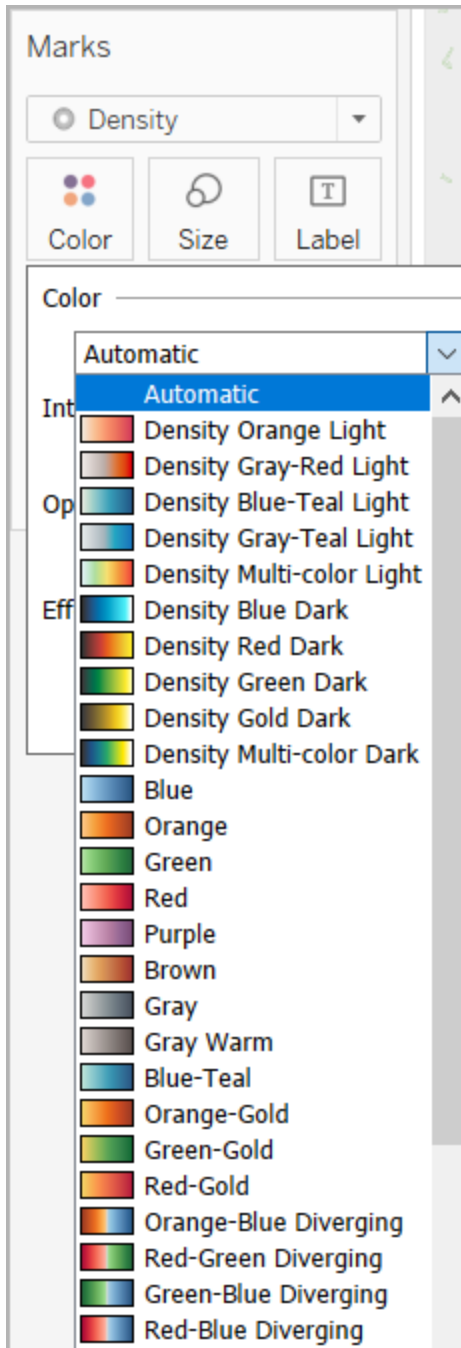

Note: If your data source contains negative values, those values will also appear when a measure field is added to **Color**. Use a diverging color palette to make a clear distinction between positive and negative values.

Intensity: In the Color menu, use the **Intensity** slider to increase or decrease the vividness of your map. For example, increasing density lowers the "max heat" spots in your data, so that more appear.

In the following image, the low intensity map is set at 50%, and the high intensity map is set at 75%.

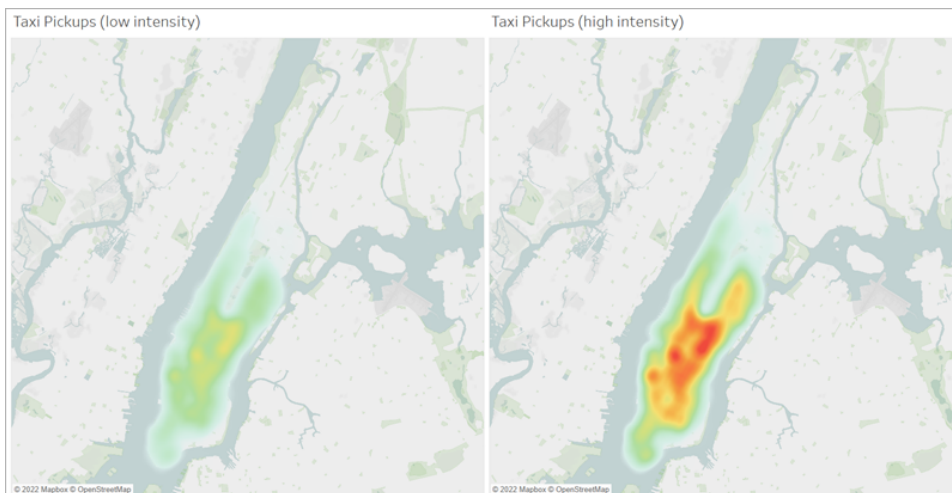

Size: You can use the **Size** shelf to adjust the size of the density marks. Click the **Size** to show the size slider. Adjust the slider to increase or decrease the size of the marks group that makes your density map.

Create Maps that Show Paths Between Origins and Destinations in Tableau

You can create maps in Tableau Desktop that show paths between origins and destinations. These types of maps are called spider maps, or origin-destination maps.

Spider maps are great for when you're working with hubs that connect to many surrounding points. They are an excellent way to show the path between an origin and one or more destination locations.

There are several ways to create spider maps in Tableau. This topic illustrates how to create a spider map using two examples. Follow the examples in this topic to learn how to set up your data source and build the view for two different spider maps.

For other examples that might fit closer to your data, see the following workbooks on Tableau Public:

- [Puget Sound Radio Tower Bandwidth](#)
- [Recruitment Strategies in the English Premier League](#)
- [2014 U.S. Flight Departure Delays](#)

Note: In the following examples, the data source has points that each have a unique path ID and are each on a different row. If your origin and destination data are on the same row, you can use the MAKELINE function to generate a line mark between two spatial points. See [Create a visualization using MAKELINE on page 2185](#).

Example 1: Metro station traffic in Paris, France

Learn how to build it

Set up your data source

To create this type of spider map in Tableau, your data source should include the following information:

- A path ID for every unique path. See [The Line Group \(Path ID\) column on the next page](#) below for more information.
- Numbers to define the drawing order of each data point (location). See [The Order of Points column on the next page](#) below for more information.
- Latitude and longitude coordinates for every location. See the example table below.
- A column with your location names (recommended, but not required).

The following table is a snippet of the Transports data source, which is included in the [Create Spider Maps in Tableau Example 1 Workbook](#) on Tableau Public. It contains metro traffic data for all metro lines in Paris, France. The first three metro stations for two metro lines are included in this example, and it contains the required columns **Line Group (Path ID)**, **Order of Points**, **Latitude**, and **Longitude**. It also contains the additional columns **Line**, **Station**, and **Traffic** for added clarity and organization, but they're not required to build the map view.

Line	Line Group (Path ID)	Order of Points	Station	Latitude	Longitude	Traffic
1	1	1	La Défense (Grande Arche)	48.891934	2.237883	14,275,382
1	1	2	Esplanade de la Défense	48.887843	2.250442	9,843,051
1	1	3	Pont de Neuilly	48.884509	2.259892	6,902,931
10 BOUCLE	10	1	Boulogne-Jean-Jaurès	48.842222	2.238836	3,847,782
10 BOUCLE	10	2	Porte d'Auteuil	48.848074	2.258648	687,237
10 BOUCLE	10	3	Michel-Ange-Auteuil	48.847740	2.264297	2,222,709

The Line Group (Path ID) column

For each path, there is a unique key or string, which is added to every location in that path.

In this example, the Line Group (Path ID) column is used to identify each unique path. You will use this column to create your spider map.

For example, in the table above, there are two metro lines (1 and 10 Boucle), and each of those metro lines have a unique path ID listed in the **Line Group (Path ID)** column. For metro line 1, the Line Group is 1. For metro line 10 Boucle, the Line Group is 10. Every location in line one contains the line group 1, and every location in line 10 Boucle contains the line group 10.

The Order of Points column

This column defines the point order and the direction in which the line is drawn from the first data point to the last data point on your map, which, in this example is the start and end of the metro

line. This field is very important if you have more than two locations in a path, because it draws your paths in the desired order (you can think of it like connecting the dots).

In the example table above, there are three stations on line 1. They are listed in order from La Défense (Grande Arche) to Pont de Neuilly using the numbers **1** through **3** in the **Order of Points** column. The same is true for line 10 Boucle.

Basic map building blocks:

Columns shelf:	<i>Longitude</i> (continuous measure, longitude geographic role assigned)
Rows shelf:	<i>Latitude</i> (continuous measure, latitude geographic role assigned)
Detail:	<i>Path ID field</i> (discrete dimension)
Path:	<i>Order field</i> (continuous dimension)
Mark type:	<i>Line</i>

Build the map view

To follow along with this example, download the [Create Spider Maps in Tableau Example 1 Workbook](#) from Tableau Public, and open it in Tableau Desktop.

1. In the **Create Spider Maps in Tableau Example Workbook**, click the New Worksheet icon.
2. In the new worksheet, from Measures, drag **Longitude** to the **Columns** shelf, and **Latitude** to the **Rows** shelf.
3. From the Data pane, drag **Line Group (Path ID)** to **Detail** on the Marks card.
4. On the Marks card, click the Mark Type drop-down and select **Line**.

The map view updates with a line connecting all of the points. The Path button should appear on the Marks card.

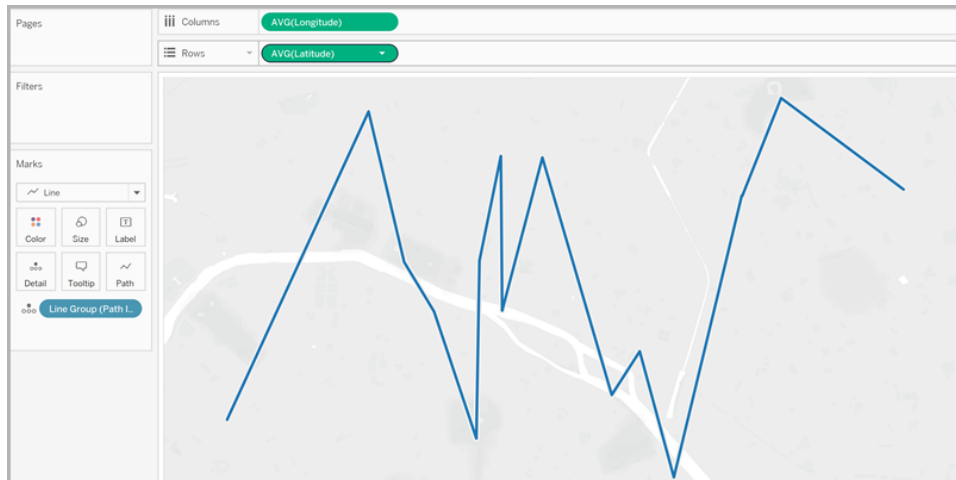

5. From the Data pane, drag **Point Order** to **Path** on the Marks card.
Point Order is aggregated as a sum.
6. On the Marks card, right-click the **SUM(Point Order)** field and select **Dimension**.
The map view updates with a line for every metro line.

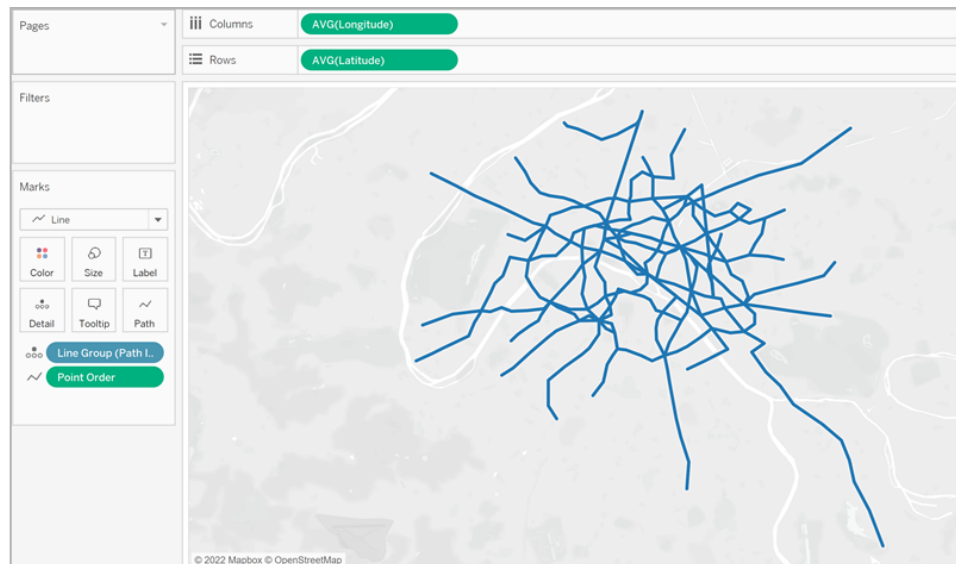

7. From the Data pane, drag **Line Group (Path ID)** to **Color** on the Marks card.
Each line now has its own color associated with it, and a color legend is added to the view.
8. From the Data pane, drag **Longitude** to the **Columns** shelf and place it to the right of the first Longitude field.

There are now two Longitude fields on the columns shelf. The view updates with two identical maps. The Marks card updates with two tabs: one for the map on the left, and one for the map on the right. You can customize each of these tabs to change the visual detail of each map view. There is an All tab to control the visual detail in both maps at the same time.

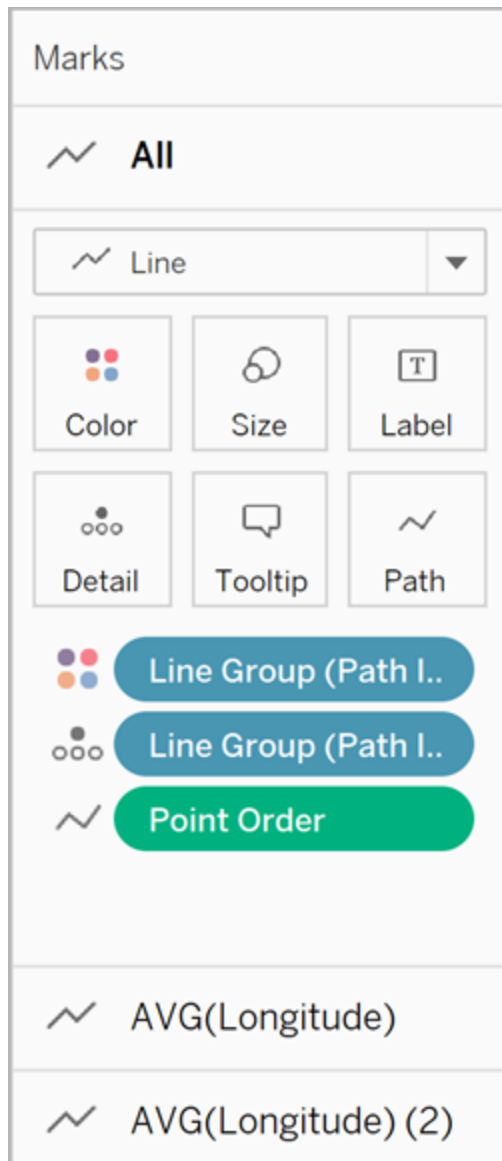

9. On the Marks card, click the bottom **AVG(Longitude) (2)** tab.
10. On the Marks card, under the bottom AVG (Longitude) tab, click the Mark type drop-down and select **Automatic**.

The map view on the right updates to a point map.

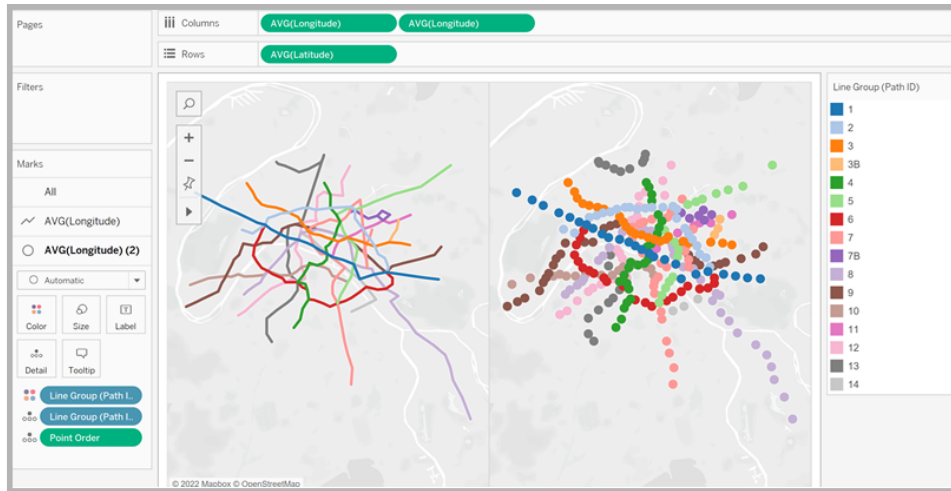

11. On the Columns shelf, right-click the second **AVG (Longitude)** field (on the right), and select **Dual Axis**.

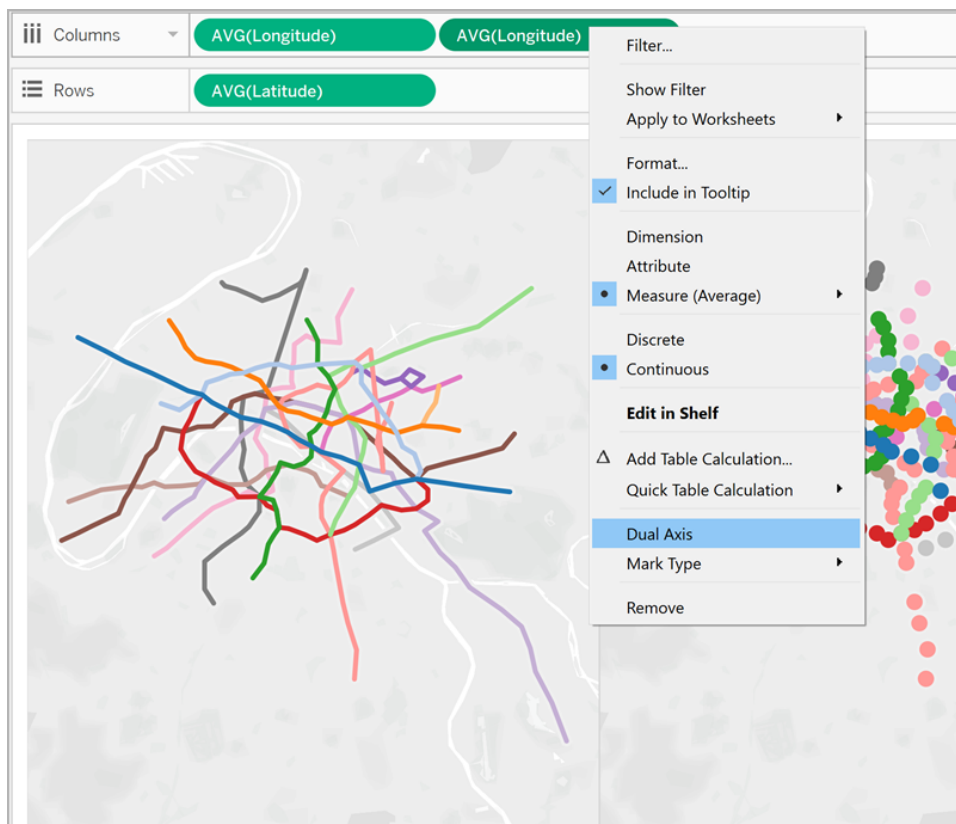

Your map views are now layered on top of one another.

12. From the Data pane, drag **Traffic** to **Size** on the bottom AVG (Longitude) Marks card.

The size of the data points update to show the amount of traffic per station.

13. On the Marks card, click **Size** and move the slider to the right.
14. On the Marks card, click **Color**, and then, under Effects, click the **Border** drop-down and select a color.

The view is now complete. You can quickly find the stations on each metro line with the most traffic.

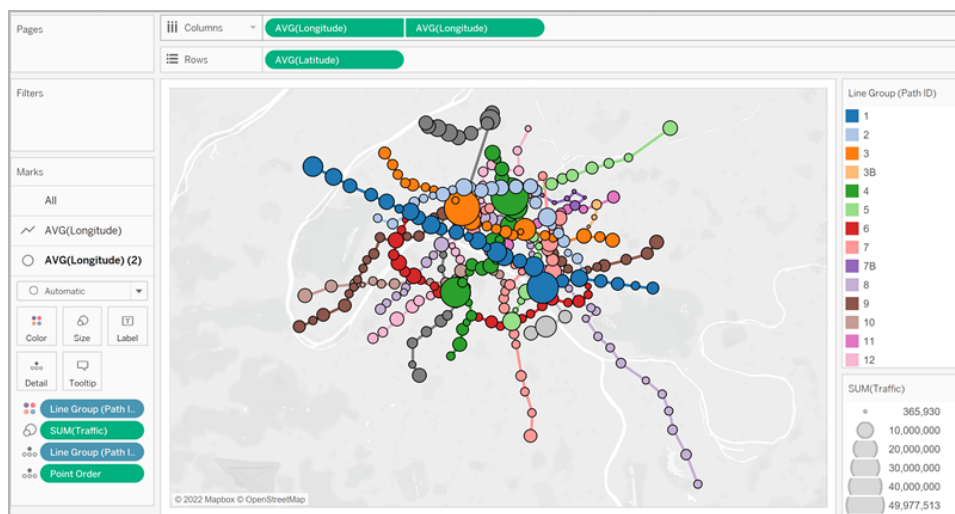

Filter the amount of information in the view

If you want to filter the amount of lines you see in the view:

- From the Data pane, drag **Line Group** to the Filters shelf.

You can also right-click the **Line Group** field and select **Show Filter** to show a filter card in the view.

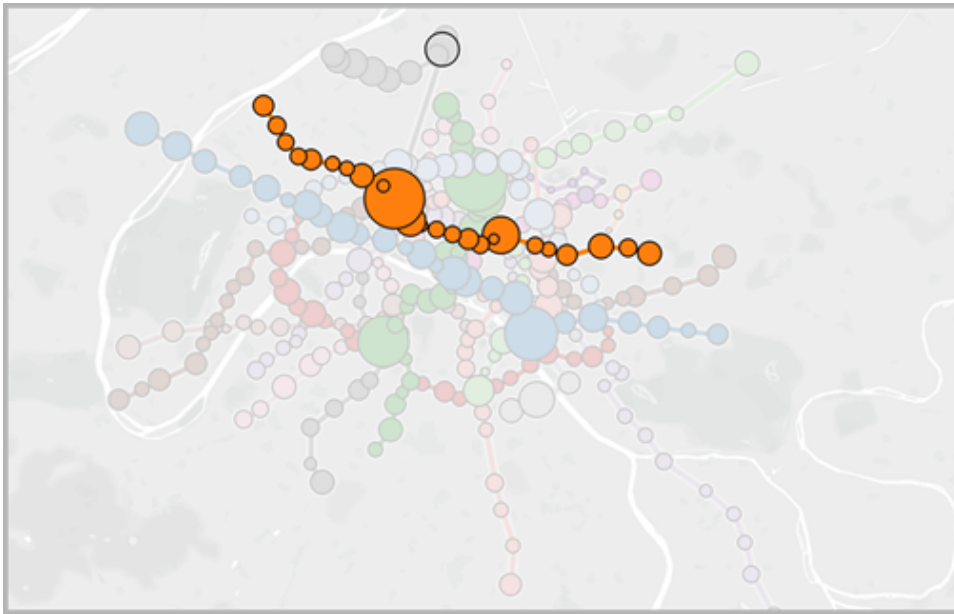

Example 2: Bike share data in Seattle, Washington

Learn how to build it

Set up your data source

Similar to the first example, for this type of spider map, your data source should contain the following information:

- A Path ID for every unique path. See [The Path ID column on the facing page](#) below for more information.
- Latitude and longitude coordinates for every location. See the example table below.
- Two rows in your data source for each path. You should have one row for your origin location data, and one row for your destination location data, repeated for every path. This is a crucial step that enables Tableau to draw your paths correctly. See [Origin-destination rows on the facing page](#) below for more information.
- A column with your location names (recommended, but not required).

This example is a snippet of the Seattle bike share data source, which is included in the [Create Spider Maps in Tableau Example 2 Workbook](#). It has a column for **Origin-Destination**, **Station**, **Path ID**, **Latitude**, and **Longitude**. Only the last three columns in this data source are required to create a spider map, but the Origin-Destination and Location Name columns provide further clarity and organization.

Origin-Destination	Station	Path ID	Latitude	Longitude
Origin	BT-01	BT-01_BT-01	47.61841	-122.35101
Destination	BT-01	BT-01_BT-01	47.61841	-122.35101
Origin	BT-01	BT-01_BT-03	47.61841	-122.35101
Destination	BT-03	BT-01_BT-03	47.61576	-122.34843
Origin	BT-01	BT-01_BT-04	47.61841	-122.35101
Destination	BT-04	BT-01_BT-04	47.61613	-122.34108
Origin	BT-01	BT-01_BT-05	47.61841	-122.35101
Destination	BT-05	BT-01_BT-05	47.61303	-122.34410

Origin-destination rows

For each unique path you want to create, you need a row for your origin location, and a row for you destination location in your data source. This means your origin location will be paired with every destination location.

For example, when showing the path between an origin bike share location and several destination locations in a city, you need a row for the origin location, and a row for the destination location for *every single path*.

In the example above, the origin station BT-01 is paired with several different destination locations (BT-01, BT-03, BT-04, BT-05) to show that bikes were checked out of the BT-01 location and returned either to the same location or to a different location. Each origin-destination pair is color-coded to show that they make up one path. There is a column for Origin-Destination to further illustrate this concept, but this column is not required.

The Path ID column

The Path ID column is used to identify each unique origin-to-destination path. You will use this column to create your spider map.

For each origin and destination location, there is a unique key or string that identifies them as a pair.

In the example below, for the first origin-destination path, the Path ID is BT-01_BT-01. For the second origin-destination path, the Path ID is BT-01_BT-03. Each path ID is listed twice, once for the origin location, and once for the destination location. Again, each pair is color-coded to indicate that they make up one path.

Origin-Destination	Location Name	Path ID	Latitude	Longitude
Origin	BT-01	BT-01_BT-01	47.61841	-122.35101
Destination	BT-01	BT-01_BT-01	47.61841	-122.35101
Origin	BT-01	BT-01_BT-03	47.61841	-122.35101
Destination	BT-03	BT-01_BT-03	47.61576	-122.34843

Note: Your path ID can be anything you want. However, if you want to create complex calculated fields to help filter the locations later on, it helps if your path IDs are consistent across all paths. A great way to do this is to create Path IDs that are a combination of your origin and destination location names, separated by a delimiter. For example, the Path ID for the origin location BT-01 and the destination location BT-03 is BT-01_BT-03. For an example of why you might want to do this, see the [Option 2: Create a dynamic filter: on page 1819](#) section.

Basic map building blocks:

Columns shelf:	<i>Longitude</i> (continuous dimension, longitude geographic role assigned)
Rows shelf:	<i>Latitude</i> (continuous dimension, latitude geographic role assigned)
Detail:	<i>Path ID field</i> (discrete dimension)
Mark type:	<i>Line</i>

Build the map view

After you set up your data source, you can connect to it in Tableau Desktop and build a spider map. To follow along with this example, download the [Create Spider Maps in Tableau Example](#)

2 Workbook from Tableau Public.

1. From the Data pane, drag **Longitude** to the **Columns** shelf, and **Latitude** to the **Rows** shelf.
2. On the Columns shelf, right-click the **Longitude** field and select **Dimension**. Do the same for the **Latitude** field on the **Rows** shelf.

This will ensure Tableau does not aggregate your origin and destination locations.

You should see all the locations in the data source as data points on your map. In this example, there is a data point for every bike share location in the data source.

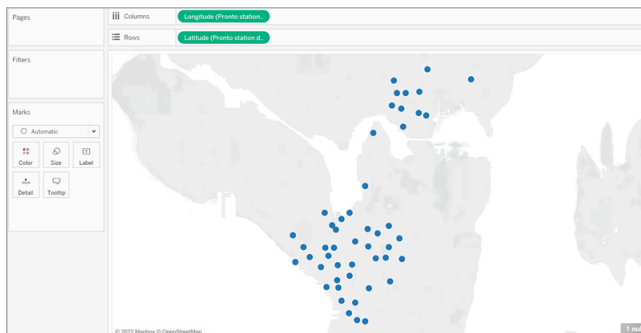

3. On the Marks card, click the Marks Type drop-down, and select **Line**. The view updates to show a line connecting each data point, and the Marks card updates with a Path button.

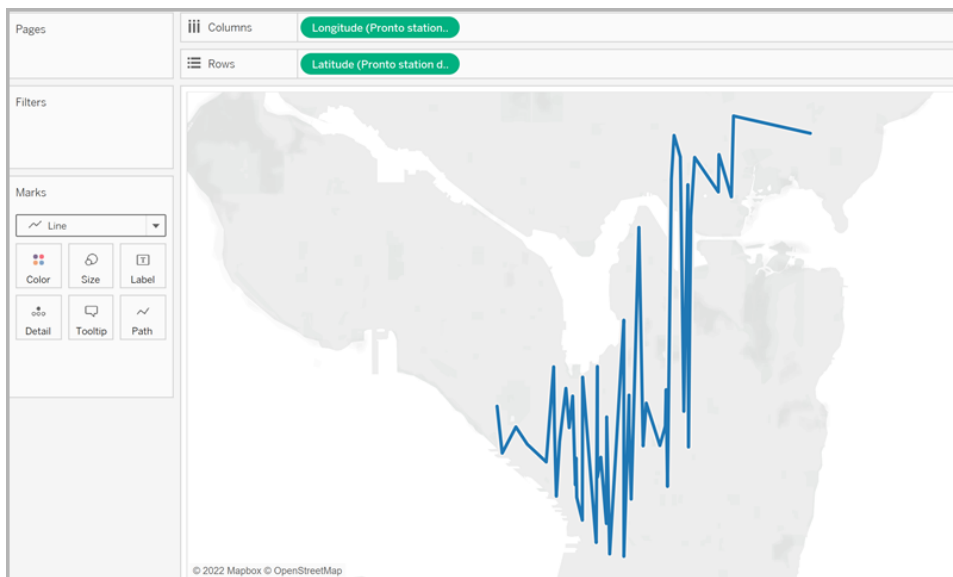

4. From the Data pane, drag **Path ID** to **Detail** on the Marks card.

If you have only a few origin-destination pairs, your view might look something like the following:

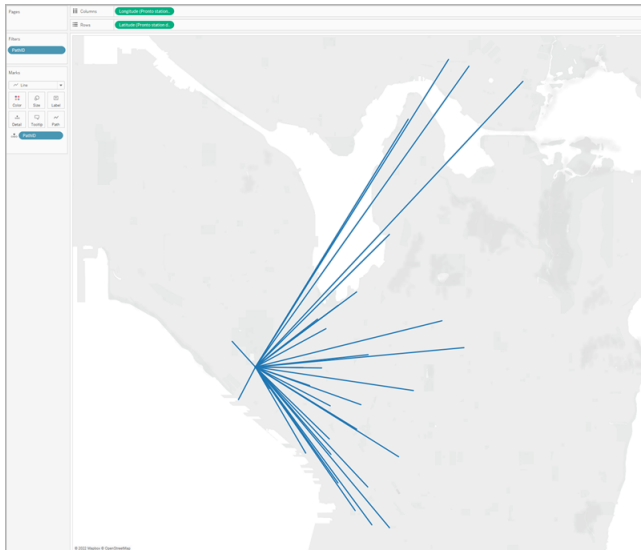

However, if you have many origin-destination pairs, your view might look more like this:

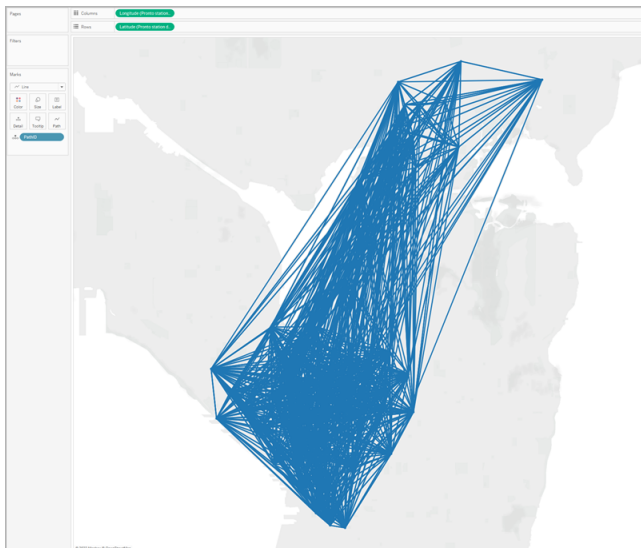

This is very common, and can be fixed by filtering a large portion of your paths from the view. Continue to the following section to learn a couple of ways to do so.

Filter the amount of information in the view

If your data source contains a lot of origin-destination pairs, you can filter most of them from the view.

Option 1: Create a simple filter:

1. From the Data pane, drag **Path ID** to the Filters shelf.
2. In the Filter dialog box that opens, do the following:
 - Under the **General** tab, select **None**.
 - Click the **Wildcard** tab.
 - Under the **Wildcard** tab, for **Match Value**, enter **BT-01**, and then click **Starts With**.
 - Click **OK**.

This filters the view down to only the paths that start with BT-01.

Option 2: Create a dynamic filter:

You can also create a calculated field and combine it with a parameter so you can switch between the paths you want to see right in the view. Follow the steps below to learn how.

Step 1: Create the parameter

1. On the Data pane, click the Data pane drop-down and select **Create Parameter**.
2. In the Create Parameter dialog box, do the following:
 - Name the parameter **StationSelected**.
 - For **Data type**, select **String**
 - For **Allowable values**, click **List**, select **Add from field**, and then select the **Location Names** field.
 - Click **OK**.

Step 2: Create the calculated field

1. Select **Analysis > Create Calculated Field**.
2. In the calculation editor, name the calculated field, **Select by Origin-Destination**, and then enter the following formula:

```
IF
```

```

LEFT([Path ID], FIND([Path ID], "_") - 1) =
[StationSelected] THEN "Origin"

ELSEIF

RIGHT([Path ID], LEN([Path ID]) - FIND([Path ID], "_")) =
[StationSelected] THEN "Destination"

ELSE

"Unselected stations"

END

```

In the [table above](#), each Path ID (for example BT-01_BT-03) contains an underscore (_) as a delimiter to separate the origin location name (BT-01) from the destination location name (BT-03). This delimiter is used in the formula to tell Tableau which locations (selected in the parameter you created in step 1 of this procedure) are origin locations, and which are destination locations. The parameter you created above is also used in the formula (StationSelected).

3. Check that the calculation is valid, and then click **OK**.

Step 3: Add the calculated field to the Filters shelf

1. From the Data pane, drag the calculated field to the **Filters** shelf.
2. In the Filter dialog box, select **Origin**, and then click **OK**.

Step 4: Show the parameter control

In the Data pane, right-click the parameter you created and select **Show Parameter Control**.

You can now select an origin from the parameter control in the view, and the marks on your map view will update.

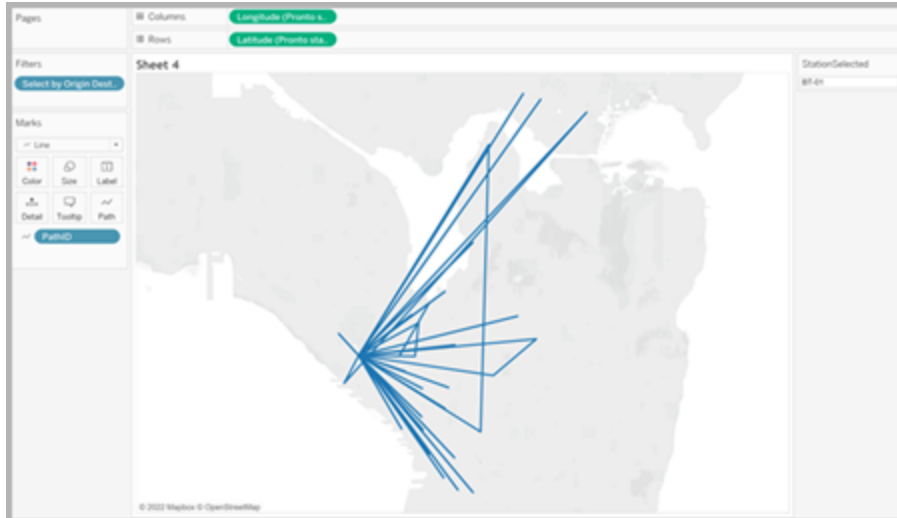

See also:

Tableau Community post: [Origin-Destination Maps \(or Flow Maps\)](#)

[Create Maps that Show a Path Over Time in Tableau](#) on page 1792

[Mapping Concepts in Tableau](#) on page 1673

[Create Parameters](#) on page 1122

[Filter Data from Your Views](#) on page 1308

Create Dual-Axis (Layered) Maps in Tableau

This article demonstrates how to create dual axis (layered) maps in Tableau using several examples. A dual-axis map is a map with two sets of geographic data overlaid on top of one another. For example, a filled map of U.S. states with data points for each city layered on top.

There are three ways to create a dual-axis map in Tableau:

- [By using Tableau Latitude\(Generated\) and Longitude\(Generated\) fields](#)
- [By using custom latitude and longitude fields](#)
- [By using a combination of Tableau Latitude\(Generated\) and Longitude \(Generated\) fields, and custom latitude and longitude fields](#)

Follow the steps below to learn how to create a dual-axis map using each of these methods.

Create a dual-axis map from Tableau Latitude (generated) and Longitude (generated) fields

1. Open Tableau Desktop.
2. In the Connect pane, under Saved Data Sources, connect to the **Sample-Superstore** data source.
3. In the **Data** pane, under Dimensions, double-click **State**.

A map view is created.

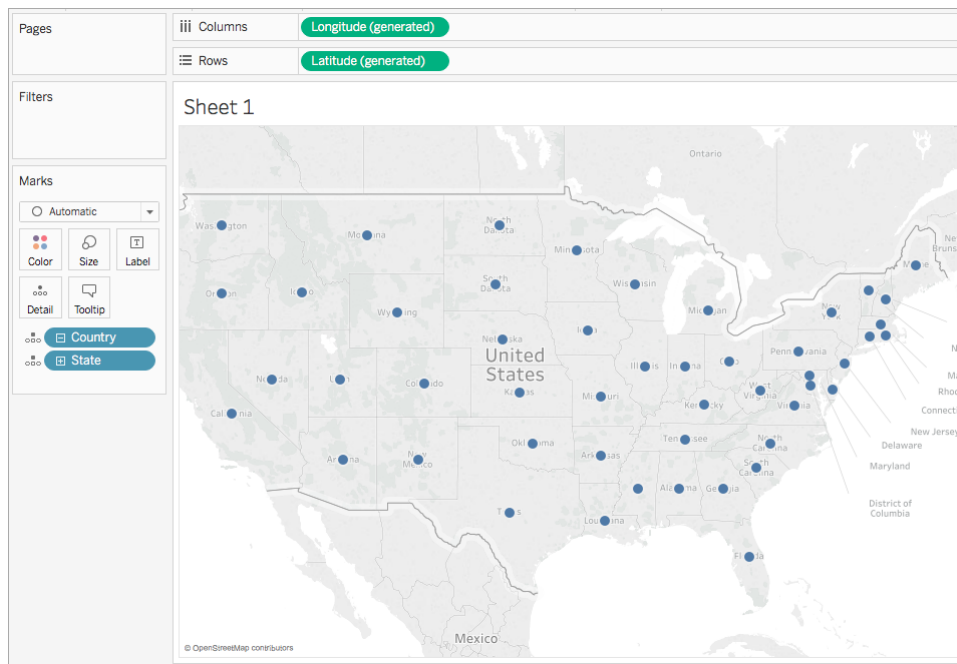

4. On the Marks card, click the Mark Type drop-down and select **Map**.

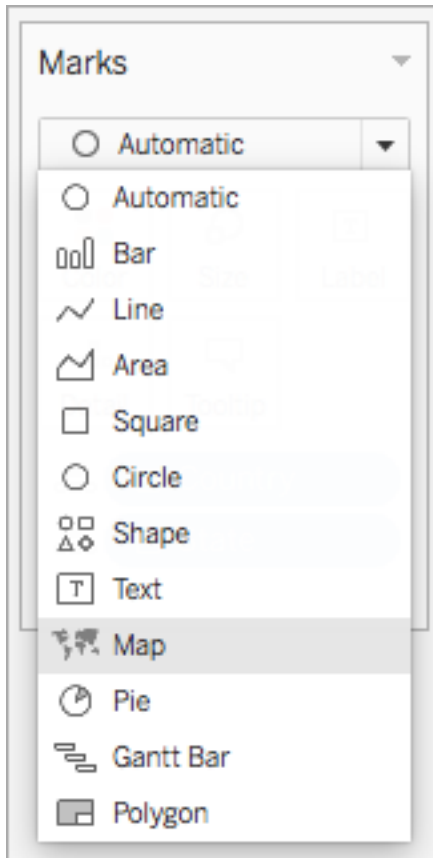

5. From the **Data** pane, under Measures, drag **Sales** to **Color** on the Marks card.

The map updates to show the sum of sales by state. The states with higher sales are darker blue, and the states with fewer sales are lighter blue.

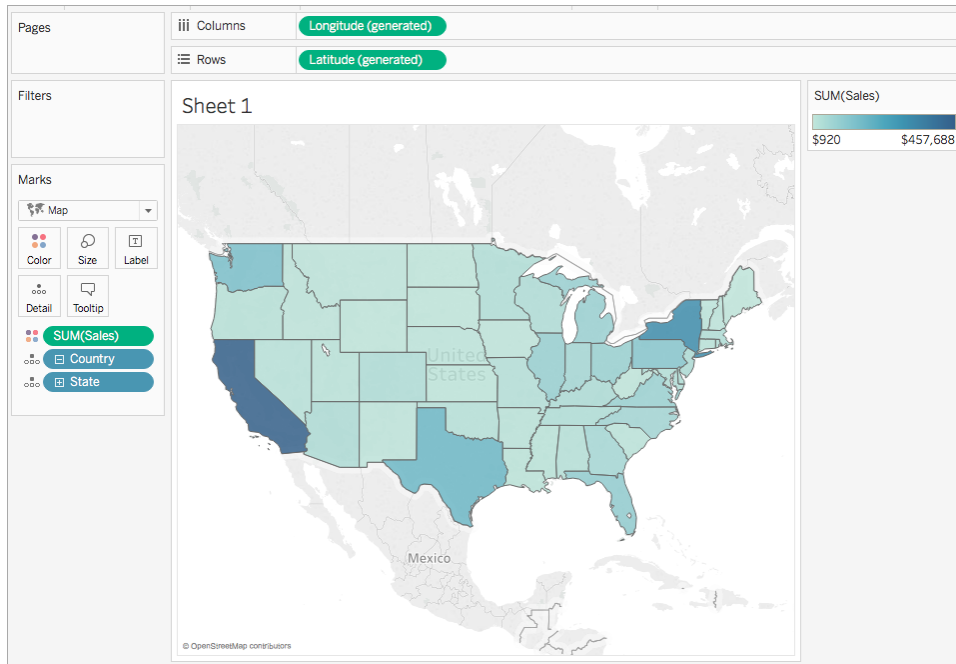

6. On the **Columns** shelf, control-drag (command-drag on a Mac) the **Longitude (generated)** field to copy it, and place it to the right of the first Longitude field.

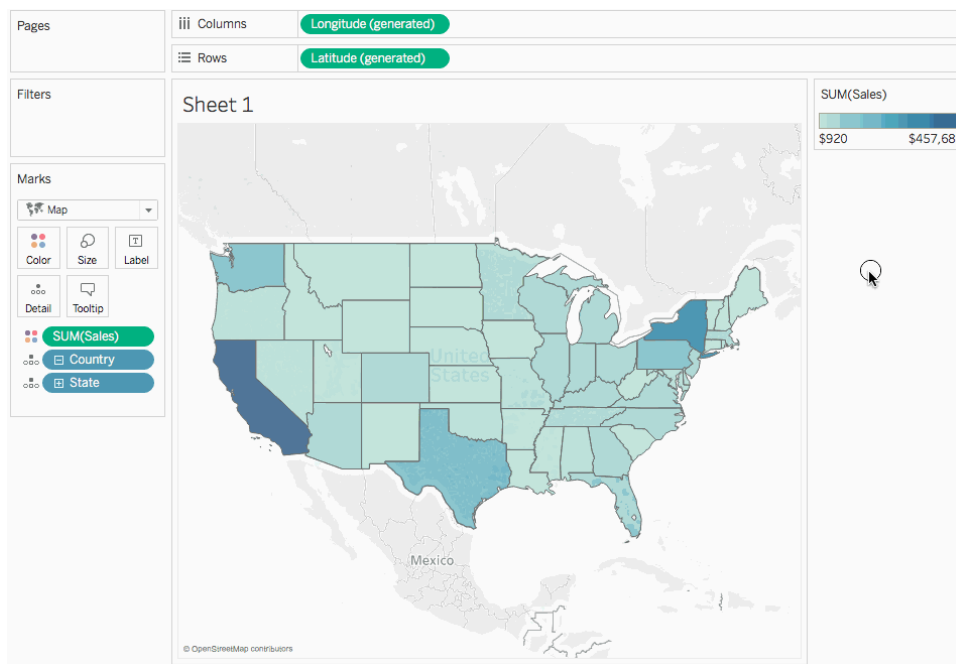

7. On the Marks card, select the top **Longitude (generated)** tab.

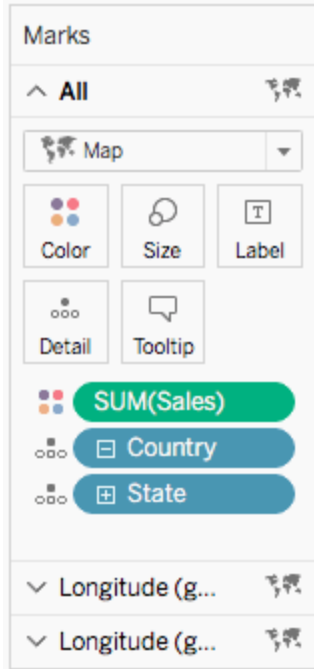

- From the **Data** pane, under Dimensions, drag **Region** to **Color** on the Marks card. The map view on the left updates.

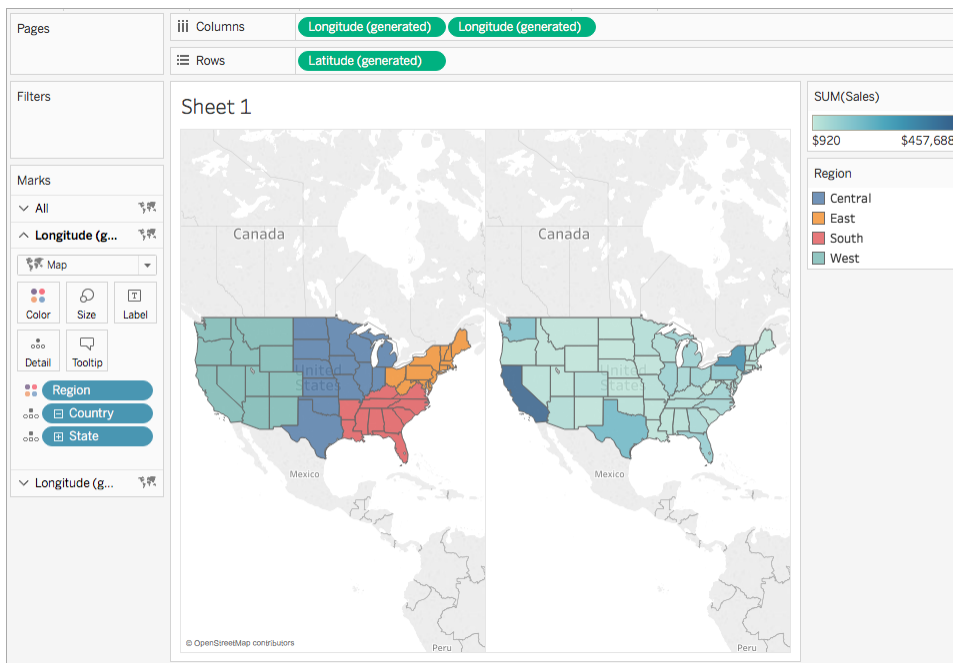

- On the Columns shelf, right-click the **Longitude (generated)** field on the right and select **Dual Axis**.

The map views are now overlapping each other. You might not be able to see the map on the bottom layer.

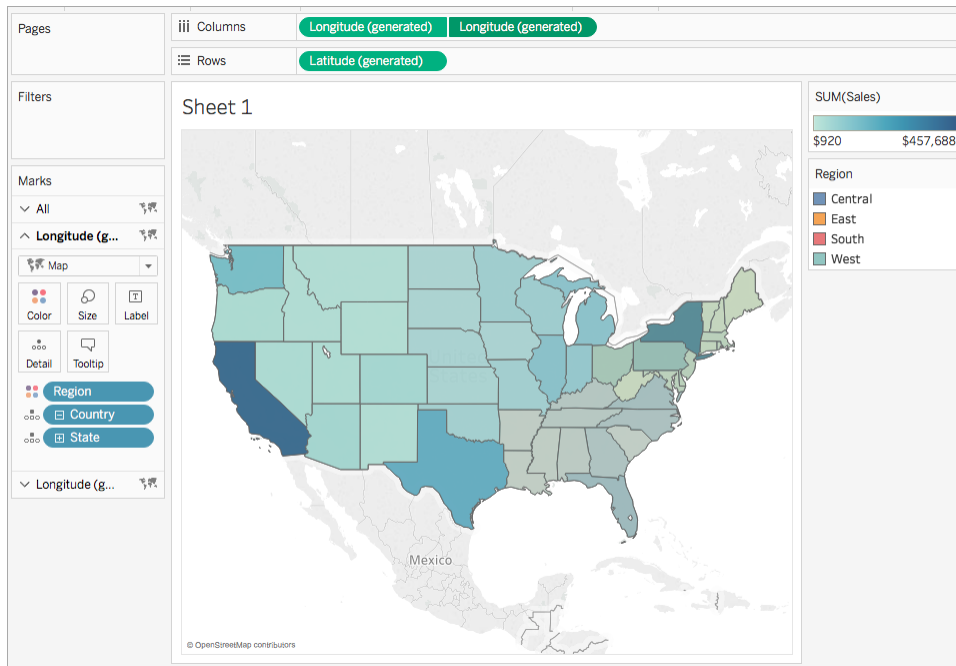

- On the Marks card, ensure that the bottom Longitude (generated) tab is selected, and then click **Color > Edit Colors**.
- In the Edit Colors dialog box that opens, click the Palette drop-down, select **Gray**, and then click **OK**.

Notice that the colors of the map update.

Tableau Desktop and Web Authoring Help

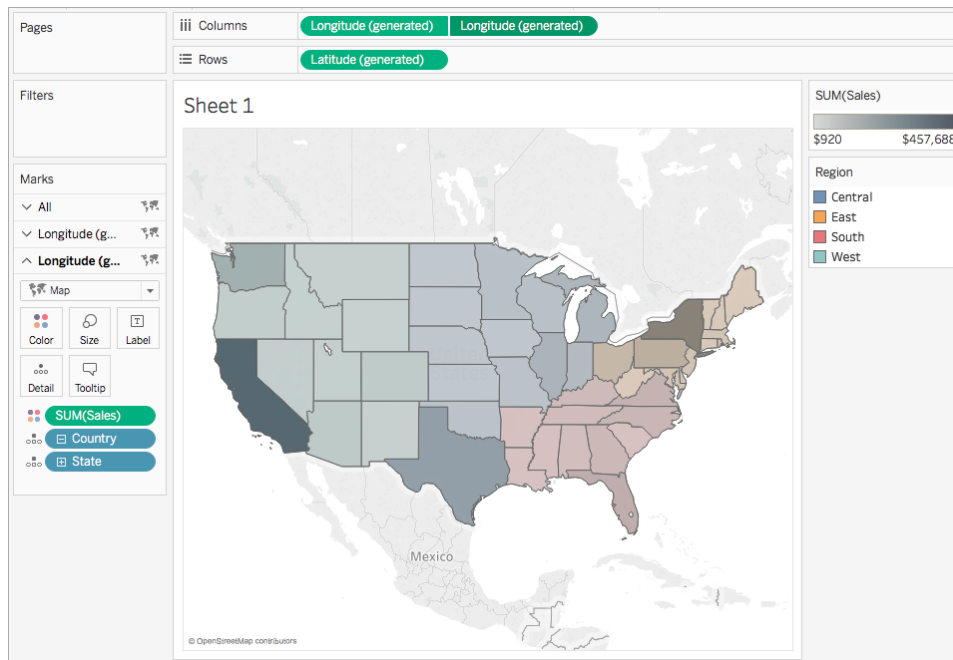

12. On the Marks card, click **Color** again.
13. In the Color pop-up dialog box, under Opacity, move the slider to approximately 75%.

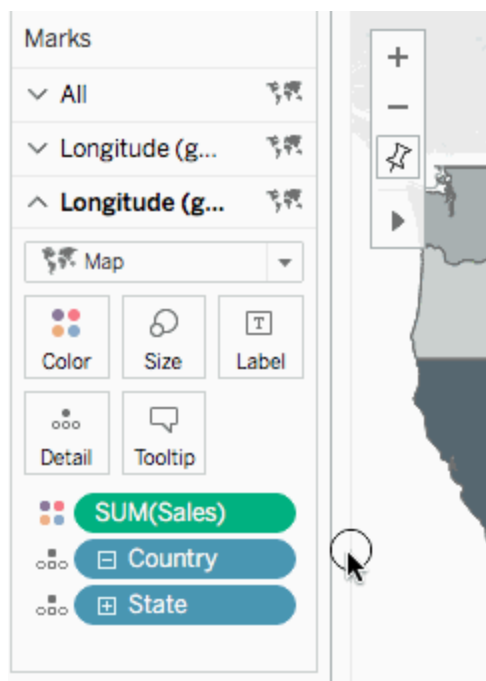

The dual axis (layered) map is now complete. For each region, you can now see which states has the most sales.

Tip: To change which map is on top, rearrange the Longitude (generated) fields on the Columns shelf.

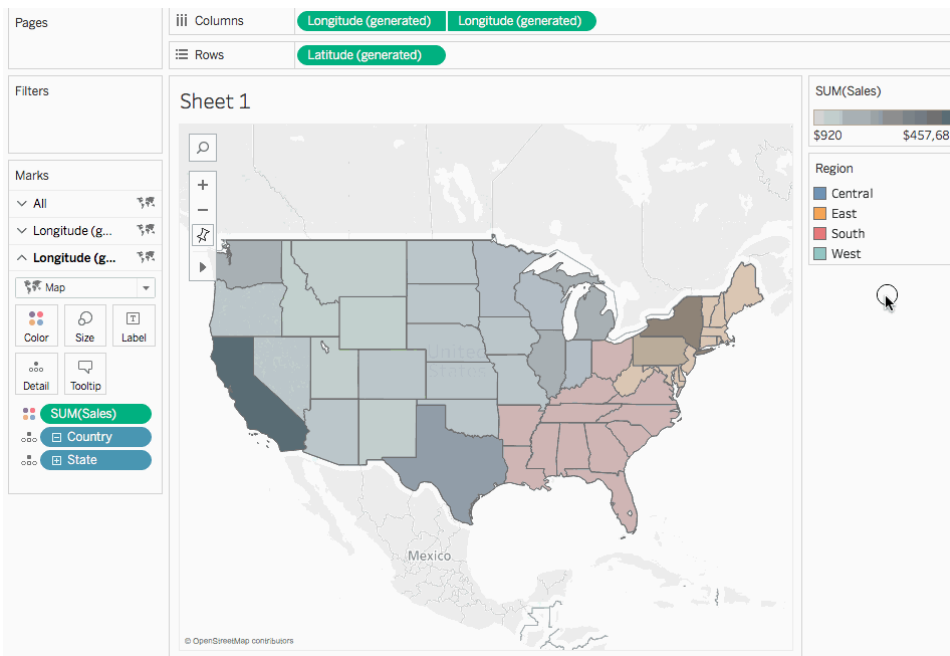

Create a dual-axis map from custom latitude and longitude fields

If your data source contains custom latitude and longitude fields, you can use them instead of the Tableau Latitude (generated) and Longitude (generated) fields to create a dual-axis map. Follow the steps below to learn how.

1. Open Tableau and connect to a data source with custom latitude and longitude values.
2. Navigate to a new worksheet.
3. In the **Data** pane, right-click the custom latitude field and select **Geographic Role > Latitude**.

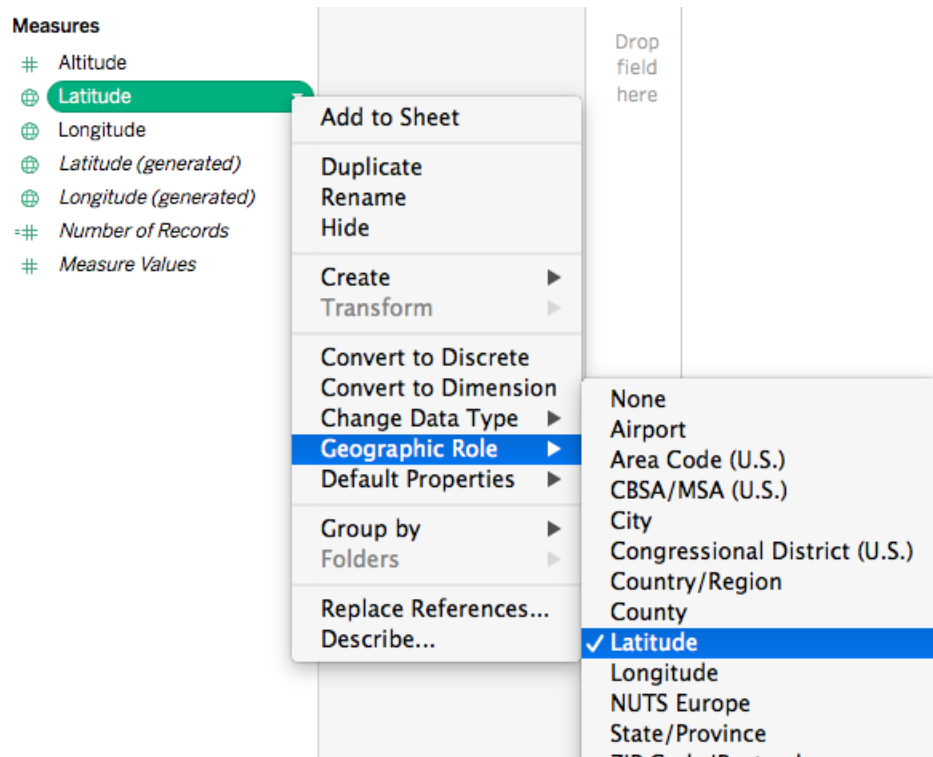

Note that the Latitude geographic role may already be assigned to the field.

4. In the **Data** pane, right-click the custom longitude field and select **Geographic Role > Longitude**.

Note that the Longitude geographic role may already be assigned to the field.

5. From the **Data** pane, drag the custom latitude field to the **Rows** shelf.
6. From the **Data** pane, drag the custom longitude field to the **Columns** shelf.
7. From the **Data** pane, under Dimensions, drag a geographic field to **Detail** on the Marks card.

In this example, the geographic field, Country (Name), is used.

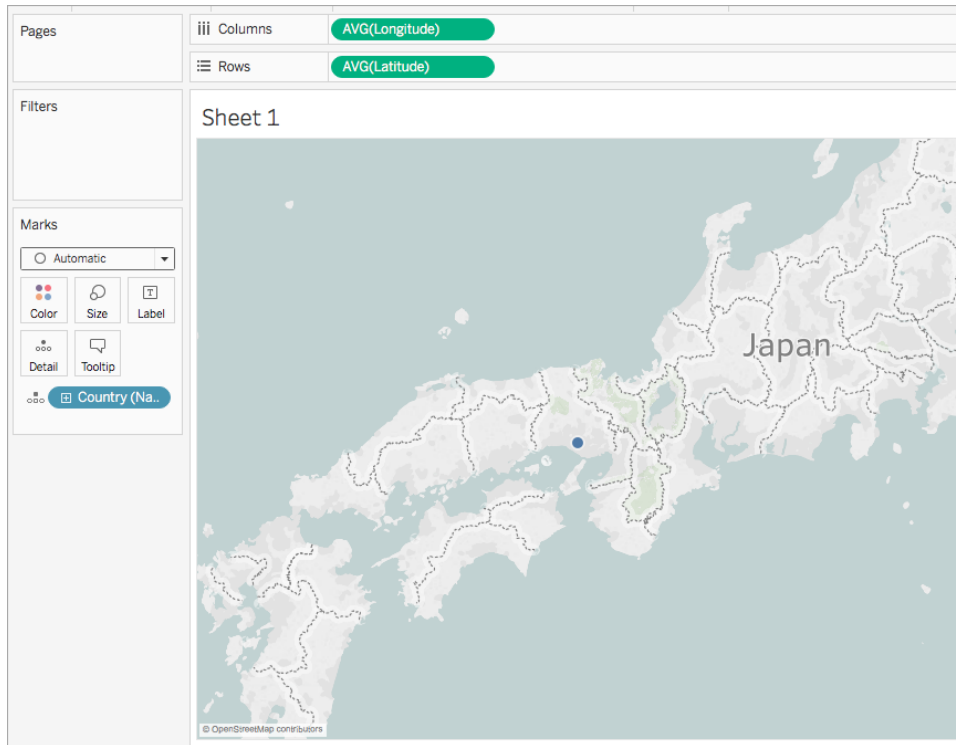

8. On the Marks card, click the Mark Type drop-down and select **Map**.

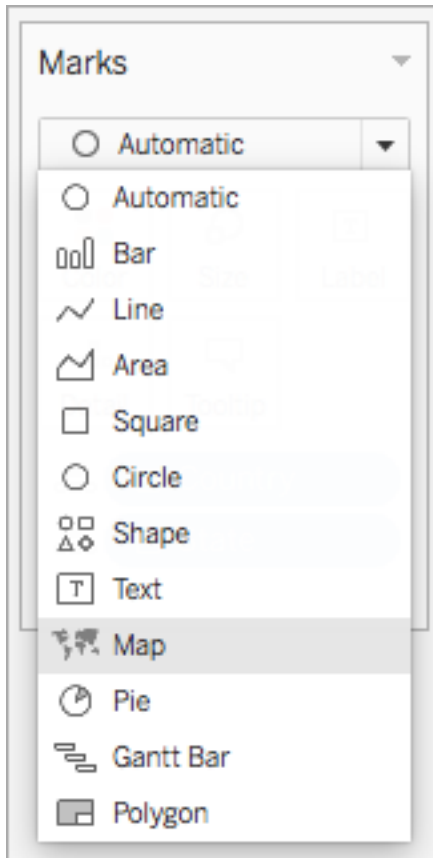

The map updates to a filled map.

9. On the Rows shelf, Ctrl-click (Command-click on a Mac) and drag the custom latitude field to the right. This copies the field.

A second, identical map is created and the Marks card updates to include three tabs. The middle tab is for the top map, and the bottom tab is for the bottom map.

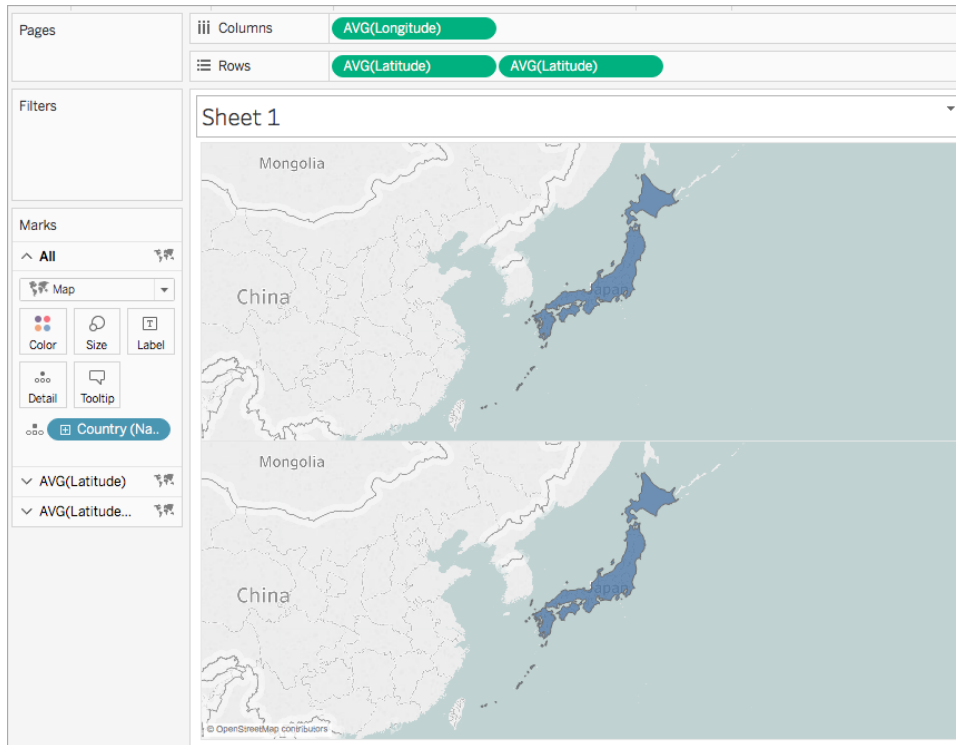

10. On the Marks card, click the bottom tab and remove the geographic field by dragging it off.
11. From the **Data** pane, drag a new geographic field to **Detail** on the Marks card.
In this example, Airport (City) is used.

Tableau Desktop and Web Authoring Help

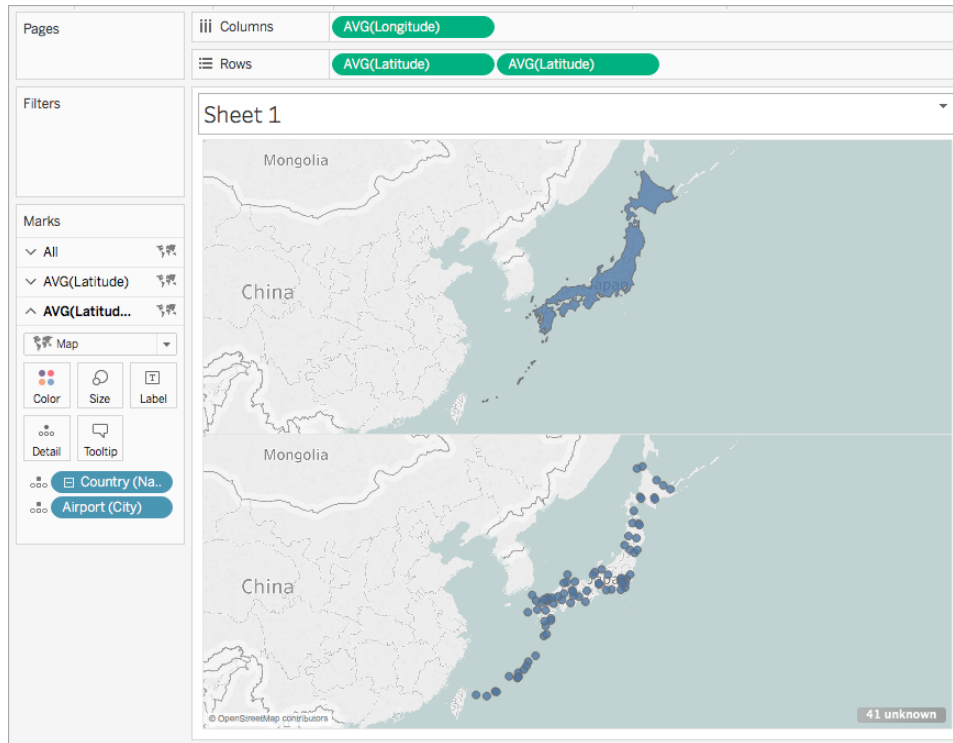

12. On the Marks card, click **Color** and select a color for the marks. In this example, the color orange is used.
13. On the Rows shelf, right-click the custom latitude field on the right and select **Dual Axis**.
The two maps are now combined.

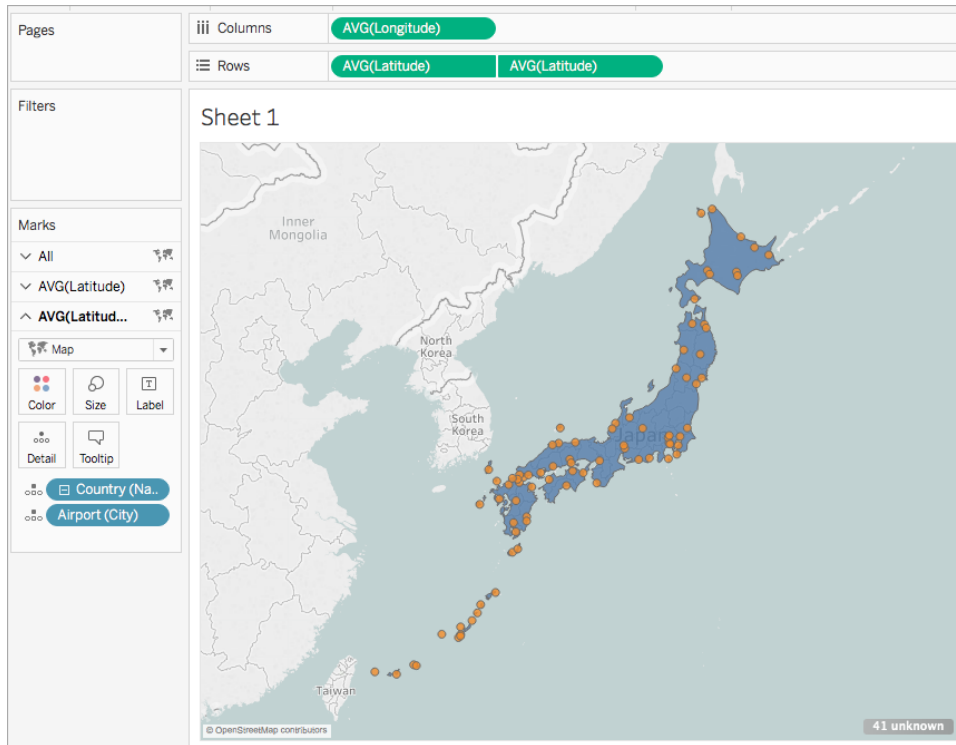

Create a dual-axis map from a combination of generated and custom latitude and longitude fields

Follow the steps in each scenario to learn how to create a dual-axis map from generated and custom latitude and longitude fields.

Best practices for creating dual-axis maps with two sets of latitude and longitude fields:

- The Latitude(generated) and Longitude(generated) fields must be placed on the Columns and Rows shelves.
- The custom latitude and longitude fields must be placed on Detail on the Marks card, and then converted to dimensions. For more information, see [steps 11 and 12](#) in Scenario 1.
- The custom latitude and longitude fields must be assigned the Latitude and Longitude geographic roles. For more information, see [Assign Geographic Roles](#) on page 1727.
- When joining data sources, use a Full Outer join. For more information, see [Join Your Data](#) on page 791.

Scenario 1: Use generated and custom latitude and longitude fields from a single data source

1. Open Tableau Desktop and connect to a data source.

In this example, an excel spreadsheet that contains country and city names, as well as custom latitude and longitude columns for airport locations around the world, is used.

Airports Airport (IATA)	Airports Airport (Name)	Airports Airport (City)	Airports Country (Name)	Airports Latitude	Airports Longitude
GKA	GOROKA	GOROKA	PAPUA NEW GUINEA	-6.0817	145.392
LAE	<i>null</i>	LAE	PAPUA NEW GUINEA	0.0000	0.000
MAG	MADANG	MADANG	PAPUA NEW GUINEA	-5.2069	145.789
HGU	MOUNT HAGEN	MOUNT HAGEN	PAPUA NEW GUINEA	-5.8261	144.296
LAE	NADZAB	NADZAB	PAPUA NEW GUINEA	-6.5697	146.726
POM	PORT MORESBY JAC...	PORT MORESBY	PAPUA NEW GUINEA	-9.4433	147.220
RAB	<i>null</i>	RABAUL	PAPUA NEW GUINEA	0.0000	0.000

2. Navigate to a new worksheet.

Notice that, in the Data pane, under Measures, there are two sets of latitude and longitude fields: the custom latitude and longitude fields from the data source, and the generated latitude and longitude fields that Tableau creates from your geographic fields.

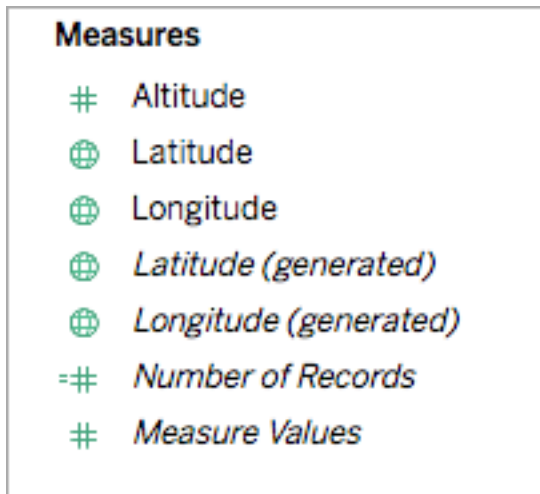

3. From the **Data** pane, under Measures, drag **Longitude(generated)** to the **Columns** shelf.
4. From the **Data** pane, under Measures, drag **Latitude(generated)** to the **Rows** shelf.

- From the **Data** pane, under Dimensions, drag a geographic location to **Detail** on the Marks card.

In this example, **Country (Name)** is used. A map view with a data point for every country in the data source is created.

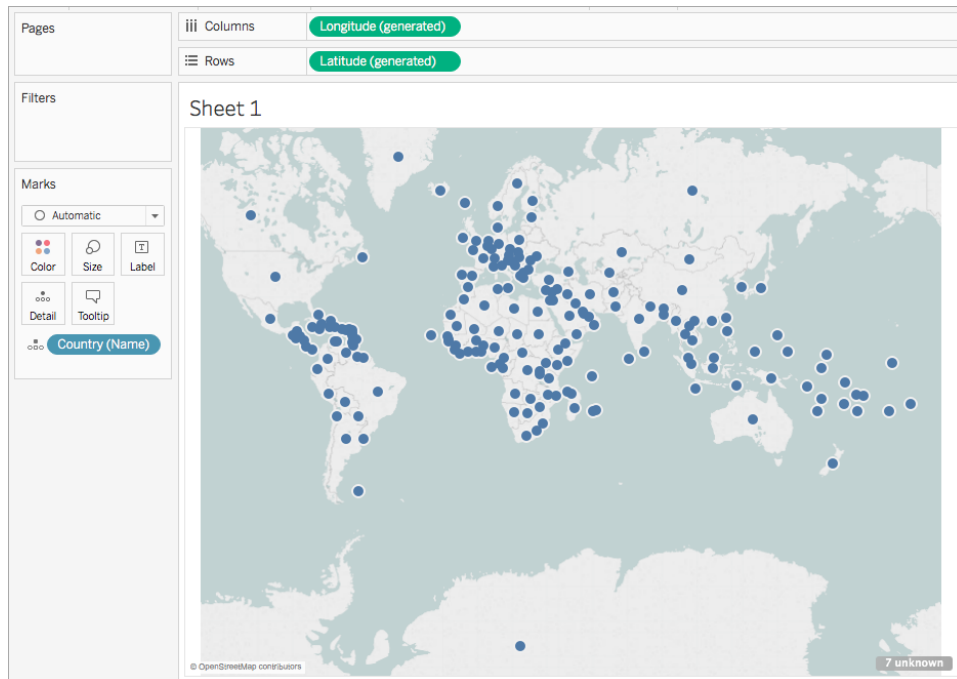

- On the Marks card, click the Mark type drop-down and select **Map**.

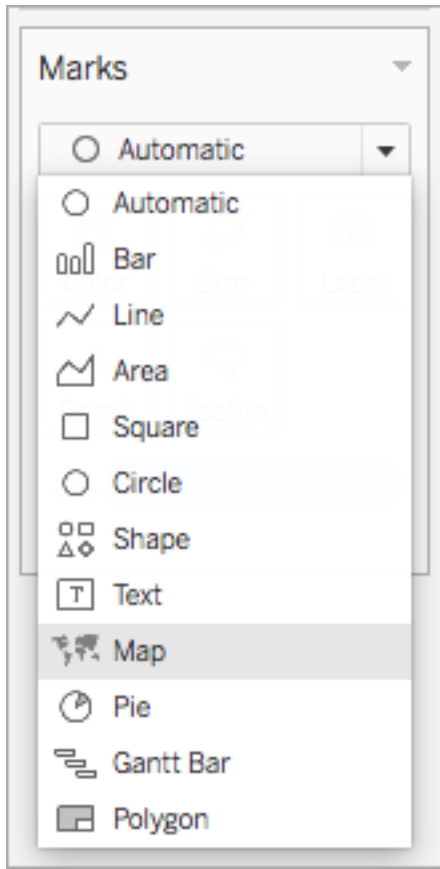

7. On the Rows shelf, Ctrl-click (Command-click on Mac) and drag the **Latitude(generated)** field to the right. This copies the field.

A second, identical map is created and the Marks card updates to include two tabs labeled Latitude(generated). The top tab is for the top map, and the bottom tab is for the bottom map.

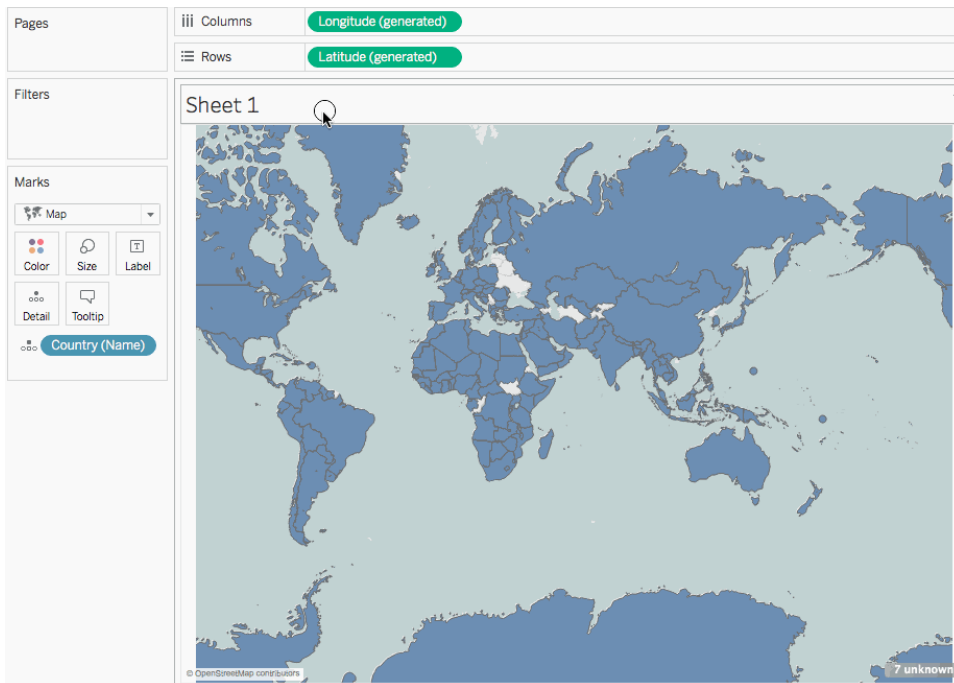

- On the Marks card, click the bottom **Latitude(generated)** tab and remove **Country (name)**.

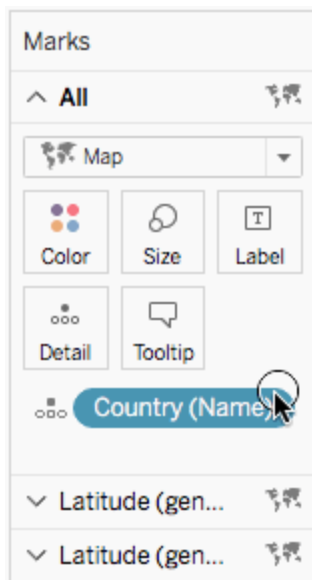

- From the Data pane, under Measures, drag the custom **Latitude** field to **Detail** on the Marks card.

10. From the Data pane, under Measures, drag the custom **Longitude** field to **Detail** on the Marks card.
11. On the Marks card, right-click the custom **Latitude** field and select **Dimension**.
12. Repeat step 11 for the custom **Longitude** field.

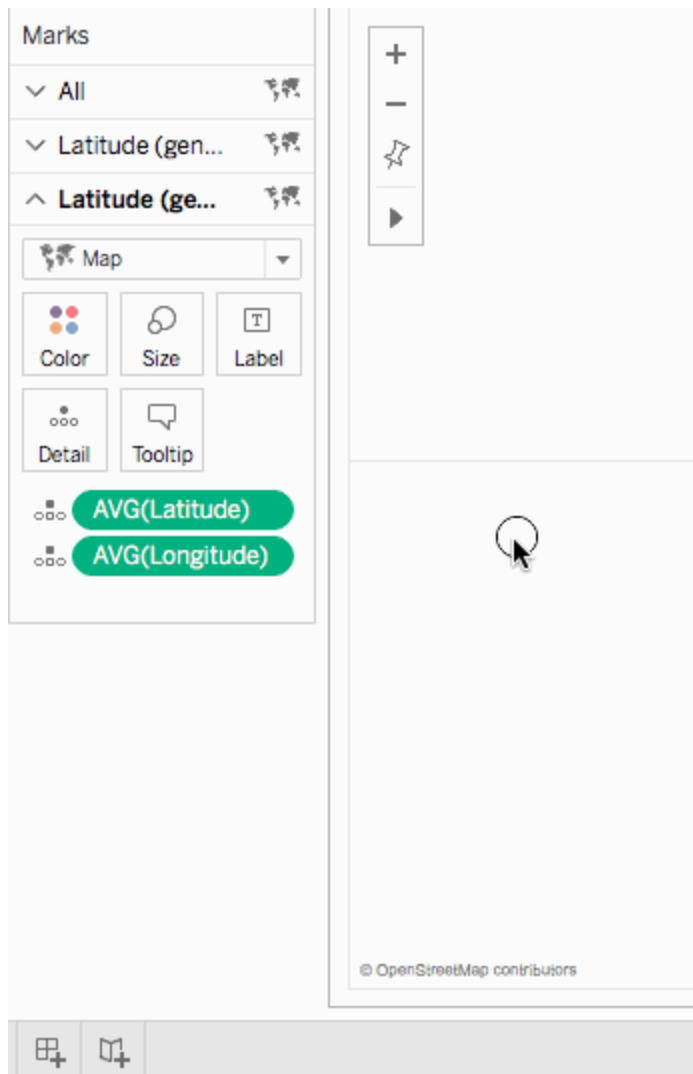

13. On the Marks card, click **Color**, and then select a new color.
In this example, the color orange is used.
14. On the Rows shelf, right-click the **Latitude(generated)** field on the right and select **Dual Axis**.

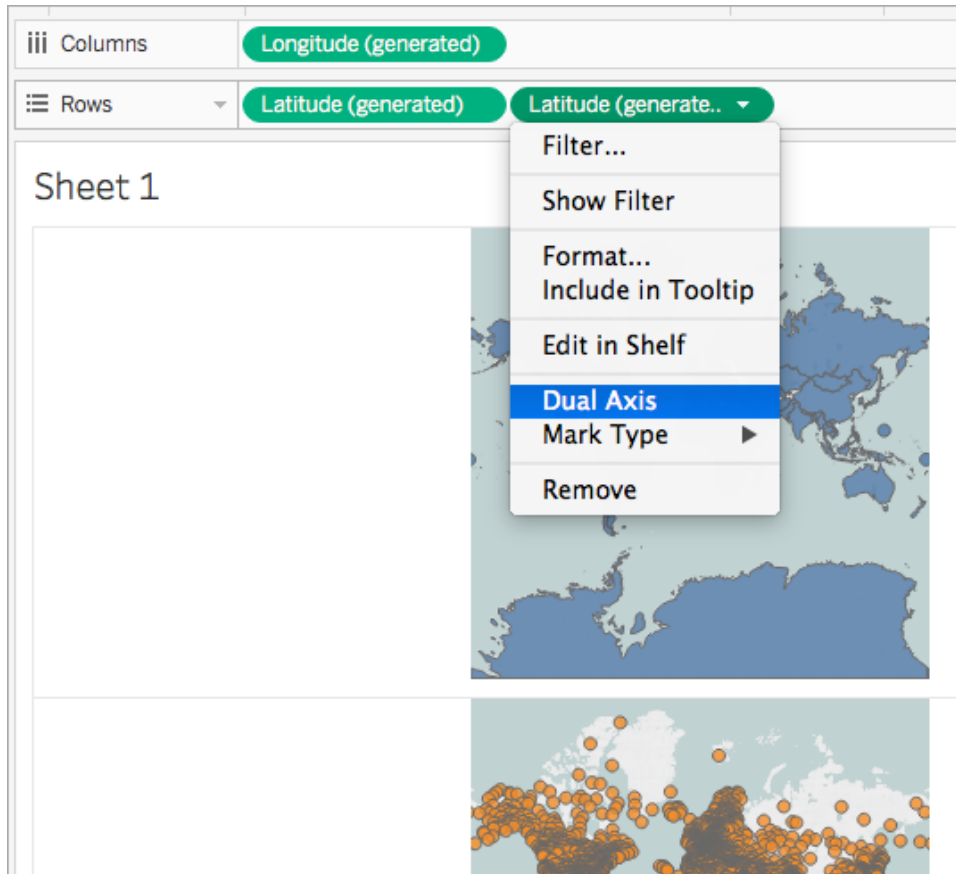

The two maps are now combined. You can filter the view as needed or zoom in to a particular area.

Tableau Desktop and Web Authoring Help

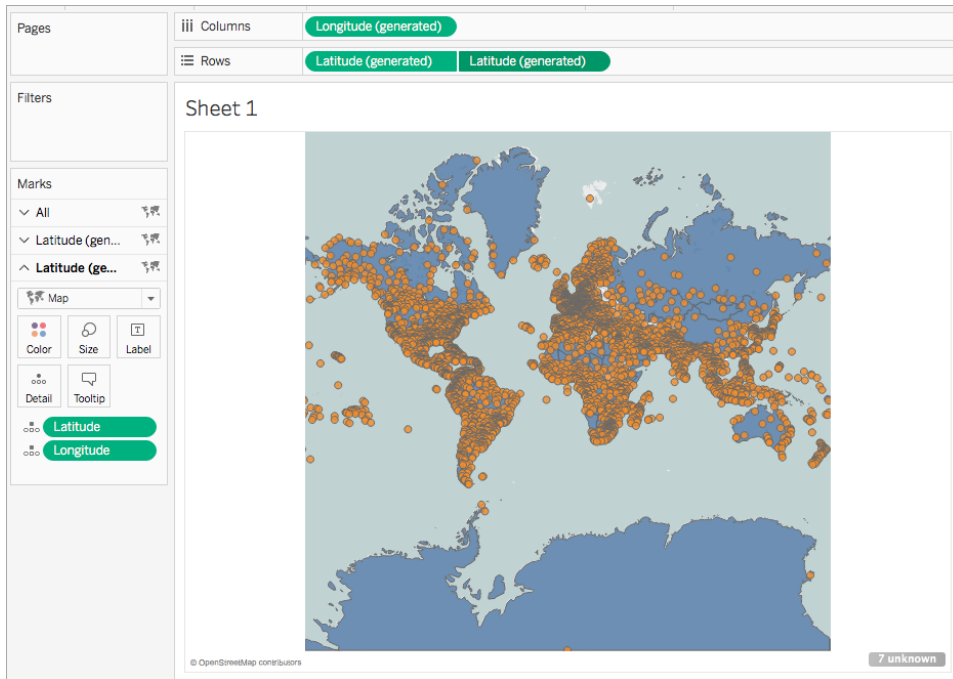

Check your work! Watch steps 2 - 14 below:

Airports (Airports) Connection: Live Extract Filters: 0 | Add

Sort fields: Data source order Show aliases Show hidden fields 1,000 rows

Airport (IATA)	Airport (Name)	Airport (City)	Country (Name)	Latitude	Longitude	Altitude
GKA	GOROKA	GOROKA	PAPUA NEW GUINEA	-6.0817	145.392	5,282
LAE	<i>null</i>	LAE	PAPUA NEW GUINEA	0.0000	0.000	0
MAG	MADANG	MADANG	PAPUA NEW GUINEA	-5.2069	145.789	20
HGU	MOUNT HAGEN	MOUNT HAGEN	PAPUA NEW GUINEA	-5.8261	144.296	5,388
LAE	NADZAB	NADZAB	PAPUA NEW GUINEA	-6.5697	146.726	239
POM	PORT MORESBY JAC...	PORT MORESBY	PAPUA NEW GUINEA	-9.4433	147.220	146
RAB	<i>null</i>	RABAUL	PAPUA NEW GUINEA	0.0000	0.000	0
WWK	WEWAK INTERNATIO...	WEWAK	PAPUA NEW GUINEA	-3.5836	143.669	19
N/A	<i>null</i>	ANGMAGSSALIK	GREENLAND	0.0000	0.000	0
N/A	<i>null</i>	ANGISSOQ	GREENLAND	0.0000	0.000	0

Scenario 2: Join spatial data with an independent data source and plot the data from both on the same map

1. Open Tableau Desktop and connect to spatial data. For more information, see [Connect to spatial files](#) on page 1746.

In this example, a shape file with polygon data for U.S. states is used.

2. On the Data Source page, in the Connections pane, click **Add**.
3. Connect to another data source.

In this example, an excel spreadsheet with custom latitude and longitude columns is used.

4. Join the new data source to the spatial data using a Full Outer join. For more information on how to join data, see [Join Your Data](#) on page 791.

In this example, the excel spreadsheet is joined to the shape file using columns that contain state names from each data source.

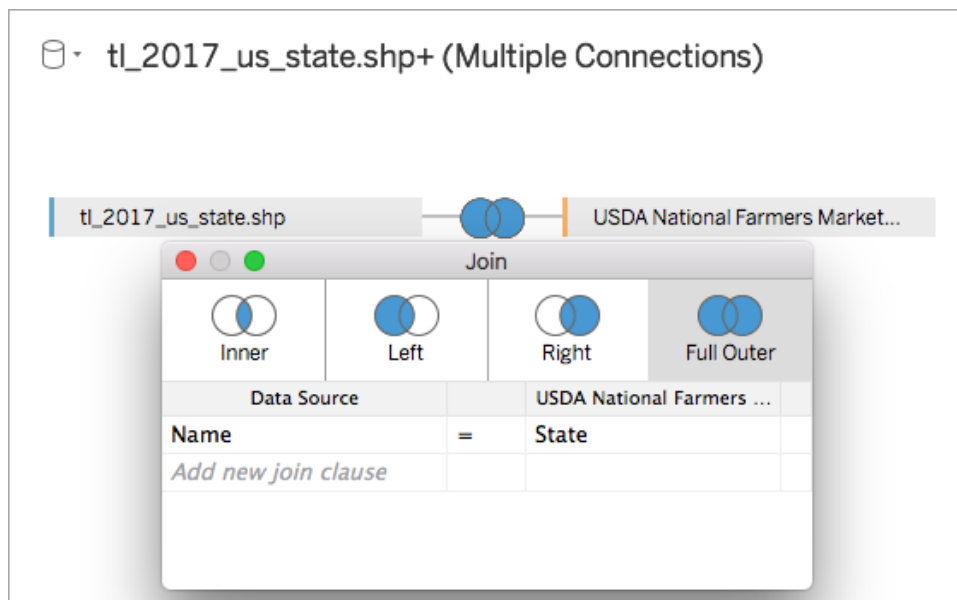

5. Navigate to a new worksheet.

Notice that, in the Data pane, there are two sets of Dimensions and two sets of Measures: one for each of your data sources.

6. From the **Data** pane, under Measures, drag **Latitude(generated)** to the **Rows** shelf.

7. From the **Data** pane, under Measures, drag **Longitude(generated)** to the **Columns** shelf.

A blank map is created.

8. From the **Data** pane, drag either the Geometry field from your spatial data source, or a geographic field from your excel data source, to **Detail** on the Marks card.

The field you choose is for your bottom layer of data. For example, if you have polygon data in your spatial file, use the Geometry field so that the bottom layer will be filled polygons. If you have linear geometries in your spatial file, use a geographic field from your excel data source and format the map to be a filled or point map.

In this example, the **Geometry** field from the shape file is used. The map updates to a filled map of the United States.

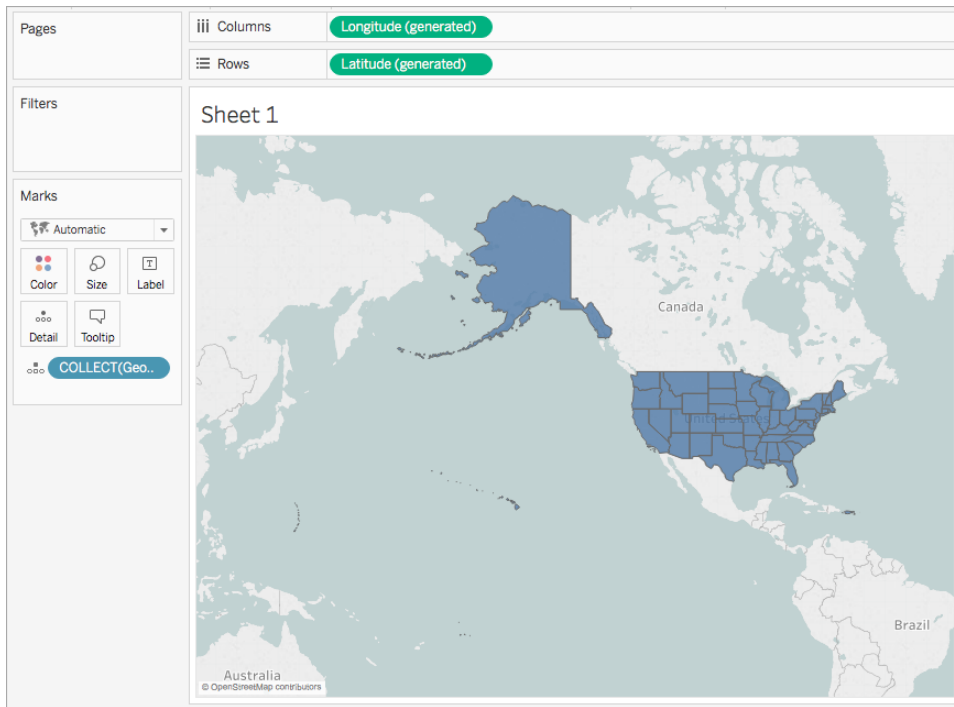

9. On the Rows shelf, Ctrl-click (Command-click on a Mac) and drag the **Latitude (generated)** field to the right. This copies the field.

A second, identical map is created and the Marks card updates to include two tabs labeled Latitude(generated). The top tab is for the top map, and the bottom tab is for the bottom map.

- On the Marks card, click the bottom **Latitude(generated)** tab and remove the geographic field.

In this example, COLLECT(Geometry) is removed.

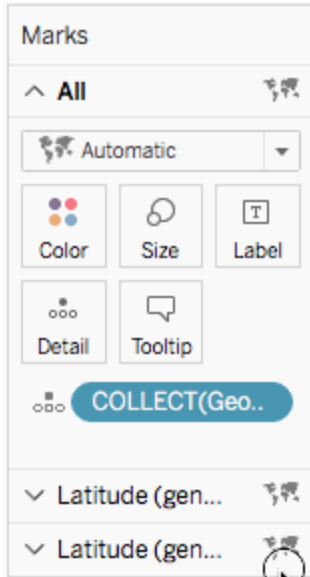

- In the **Data** pane, under Measures, right-click the custom latitude field and select **Geographic Role > Latitude**. For more information, see [Assign Geographic Roles](#) on page 1727.
- In the **Data** pane, under Measures, right-click the custom longitude field and select **Geographic Role > Longitude**.
- From the **Data** pane, under Measures, drag the custom latitude field to **Detail** on the Marks card.
In this example, the custom latitude field is named Y.
- From the **Data** pane, under Measures, drag the custom longitude field to **Detail** on the Marks card.
In this example, the custom longitude field is named X.

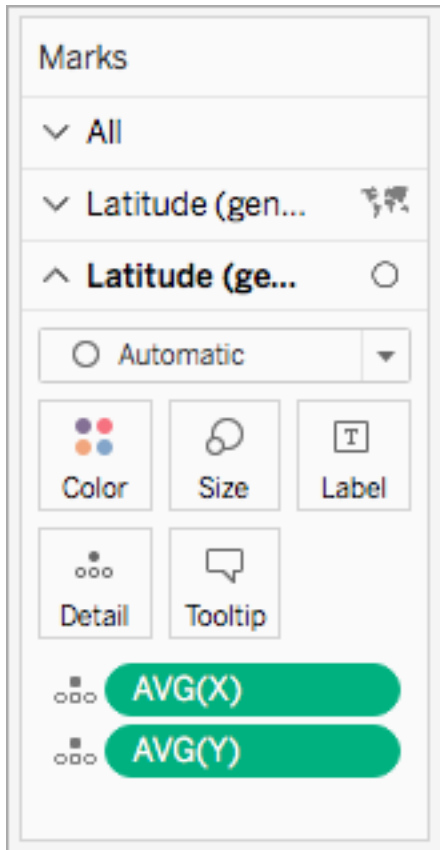

15. On the Marks card, right-click the custom latitude field and select **Dimension**.
16. Repeat step 13 for the custom longitude field.

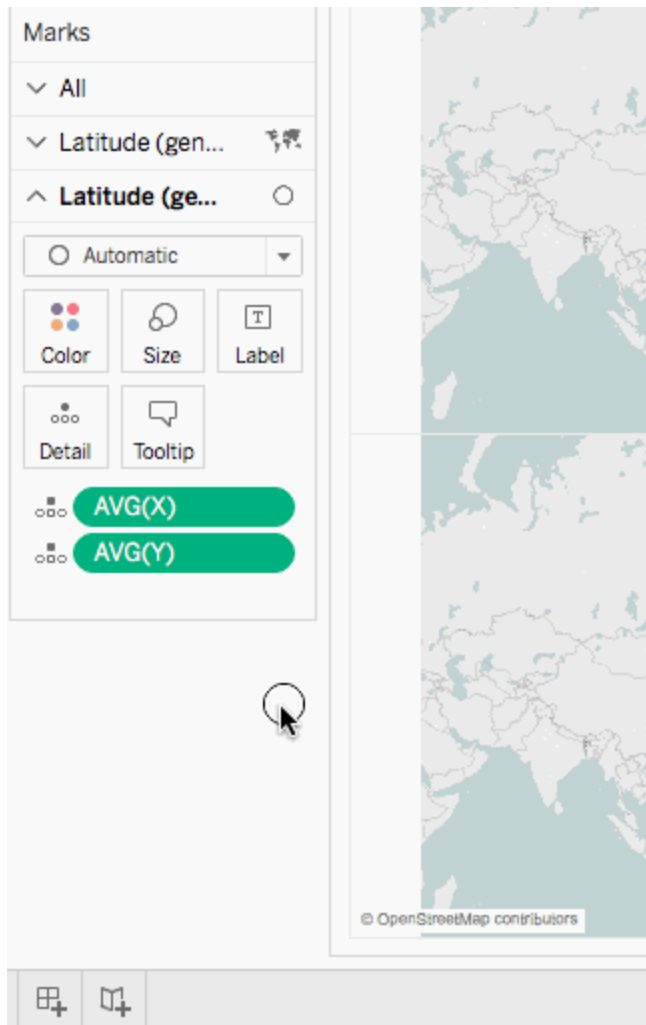

17. On the Marks card, click **Color**, and then select a new color.
In this example, the color orange is used.
18. On the Rows shelf, right-click the **Latitude(generated)** field on the right and select **Dual Axis**.
The two maps are now combined. You can filter the view as needed or zoom in to a particular area.

Tableau Desktop and Web Authoring Help

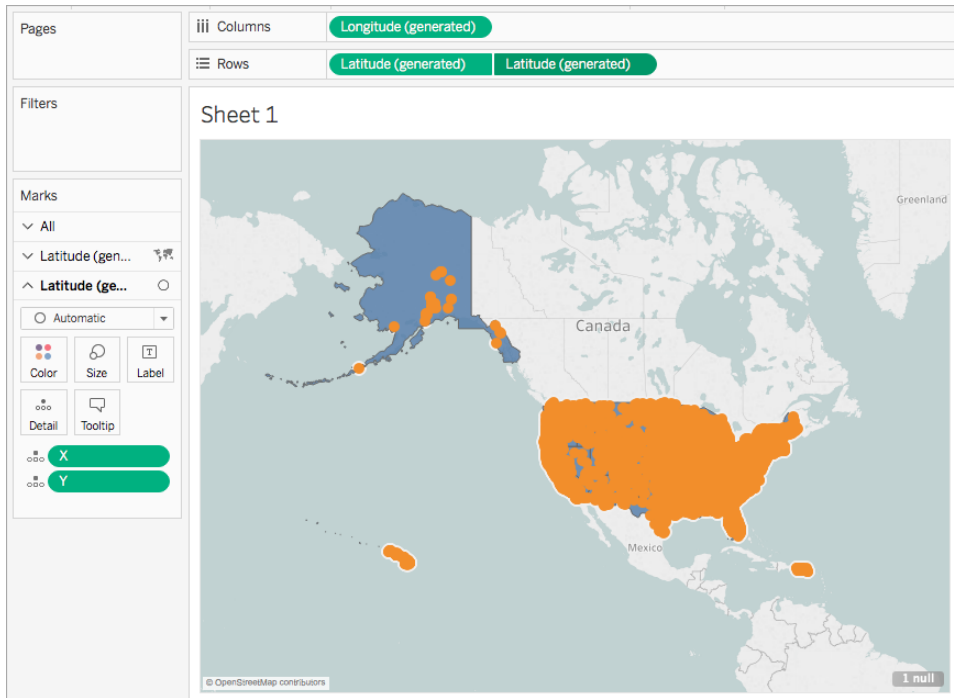

Check your work! Watch steps 1- 18 below:

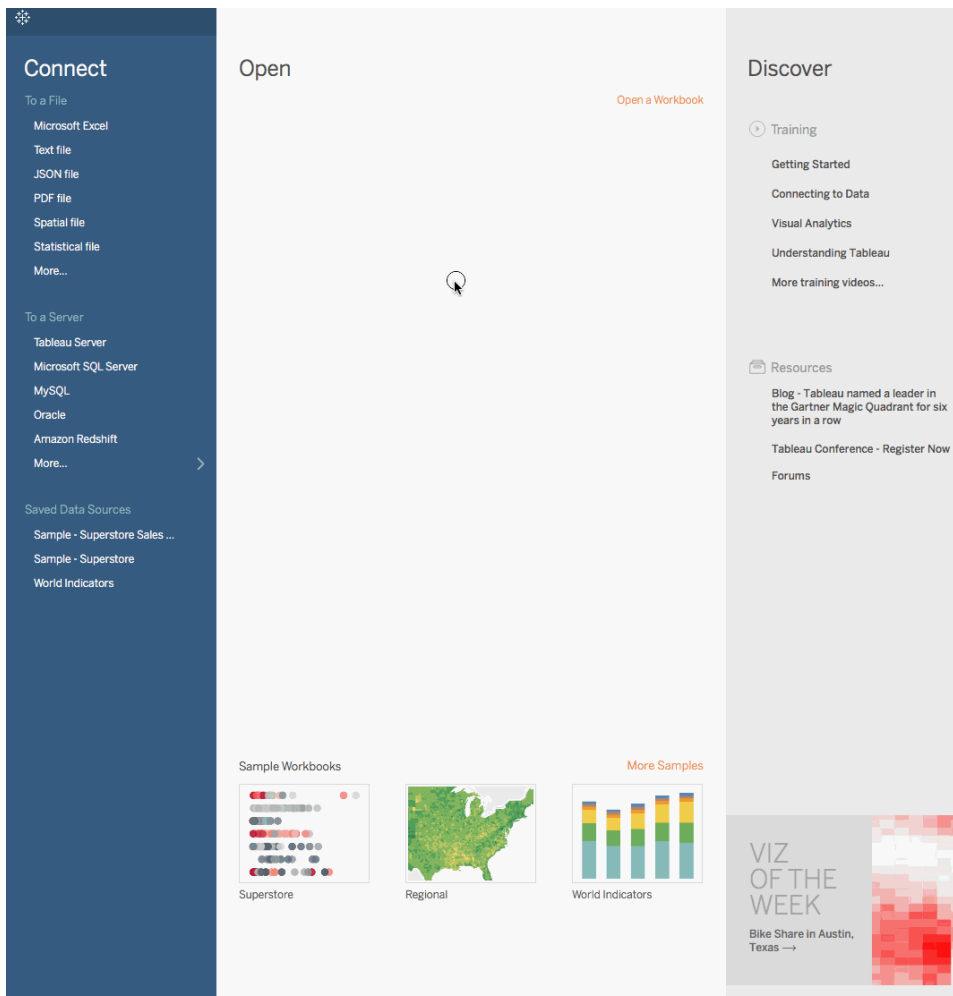

See Also

[Build a dual-axis map from spatial data](#) on page 1755

[Join Your Data](#) on page 791

[Spatial File](#) on page 1688

[Assign Geographic Roles](#) on page 1727

Create Filled Maps with Pie Charts in Tableau

The pie mark type can be useful to show simple proportions to a relative whole. For example, pie marks might be effective when you want to show the percentage of profit for a product by

geographic location.

In this example, the pie mark type is used with the filled maps mark type to show the percentage of profit for office supplies, furniture, and technology, relative to the total profits by state. It uses the Sample-Superstore data source that comes with Tableau Desktop.

Build the map view using layers

1. In Tableau, open a new workbook and connect to the Sample-Superstore data source.
2. On the Data Source page, click **Sheet 1** to go to a new worksheet.
3. In the Data pane, under the Orders table, open the Location folder and double-click **State**.

Tableau creates a symbol map with a data point for each state in the Sample-Superstore data source.

4. On the Marks card, click the Mark type drop-down and select the **Map** mark type.

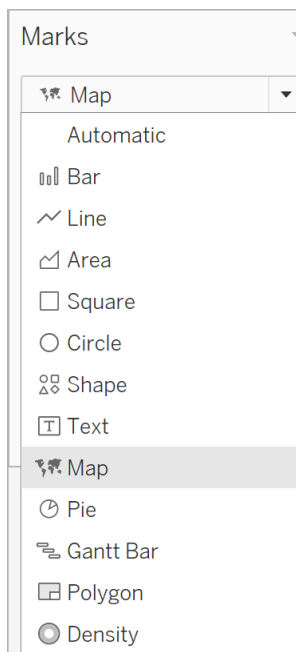

5. From the Data pane, drag **Profit** to **Color** on the Marks card.
6. From the Data pane, under the Orders table, open the Location folder and drag **State** to the map. When the field is over the map, you'll see an option to **Add a Marks Layer**. Drop **State** here to make a new layer.

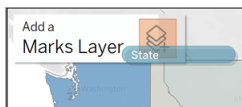

You now have a map with two layers: filled state polygons showing Profit and point locations in the middle of each state. We'll turn these points into pie charts in the next steps.

- If you'd like to organize and name your layers, click the drop-down arrow to the right of the layer name, select **Rename**, and rename the layer to a name that reflects its content, for example, "Pie Chart."
- On the Pie Chart layer, click the Mark type drop-down and select the **Pie** mark type.

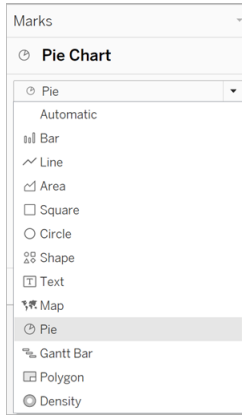

- From the Orders table in the Data pane, drag **Sales** to **Size** on the Marks card on the Pie Chart layer.

The sum of sales for each state is shown in a proportionally sized circle.

- Under the Orders table in the Data pane, open the Product folder and drag **Category** to **Color** on the Marks card.

Tip: If pie charts are too small, click **Size** on the Marks card and adjust the size.

The map updates to show the sum of profit and the sum of sales for each category and state.

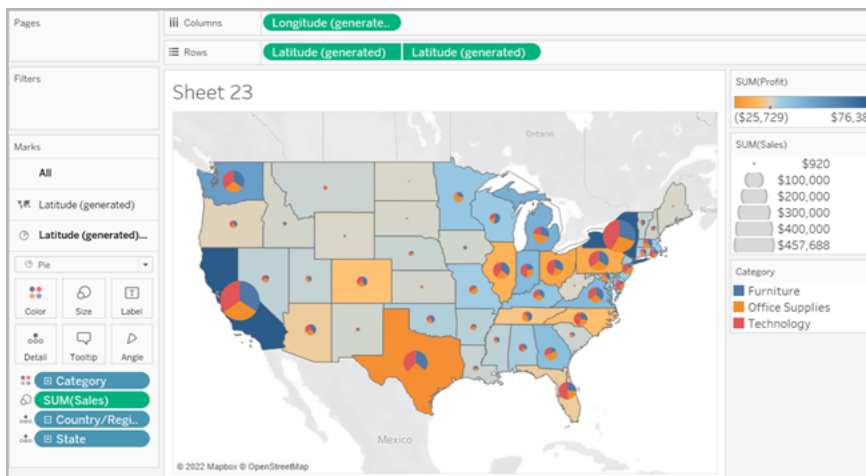

Build the map view using a dual axis

1. In Tableau, open a new workbook and connect to the Sample-Superstore data source.
2. On the Data Source page, click **Sheet 1** to go to a new worksheet.
3. In the Data pane, under the Orders table, open the Location folder and double-click **State**.

Tableau creates a symbol map with a data point for each state in the Sample-Superstore data source.

4. On the Marks card, click the Mark type drop-down and select the **Map** mark type.

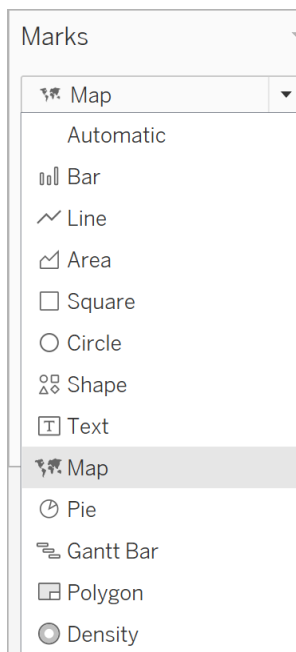

5. From the Data pane, drag **Profit** to **Color** on the Marks card.
6. From the Data pane, drag **Latitude (generated)** to the **Rows** shelf, and place it to the right of the other Latitude field.

You now have two identical map views.

7. On the Rows shelf, right-click the second **Latitude** field and select **Dual Axis**.

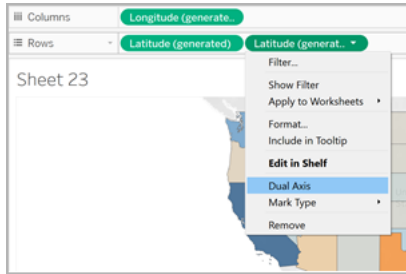

The second map is now layered on top of the first map. There are now three drop-downs on the Marks card: one for each map view, and one for both views (All). These are three separate marks cards that you can use to control the visual detail for each of the map views.

8. On the Marks card, click one of the **Latitude (generated)** tabs, and then click the Mark type drop-down and select the **Pie** mark type.
9. From the Orders table in the Data pane, drag **Sales** to **Size** on the Latitude (generated) Marks card you selected.

The sum of sales for each state is shown in a proportionally sized circle.

10. Under the Orders table, open the Product folder and drag **Category** to **Color** on the same Marks card.

Tip: If the pie charts are too small, click **Size** on the Marks card to adjust the size.

The map view now shows the sum of profit, as well as the sum of sales for each category, for each state.

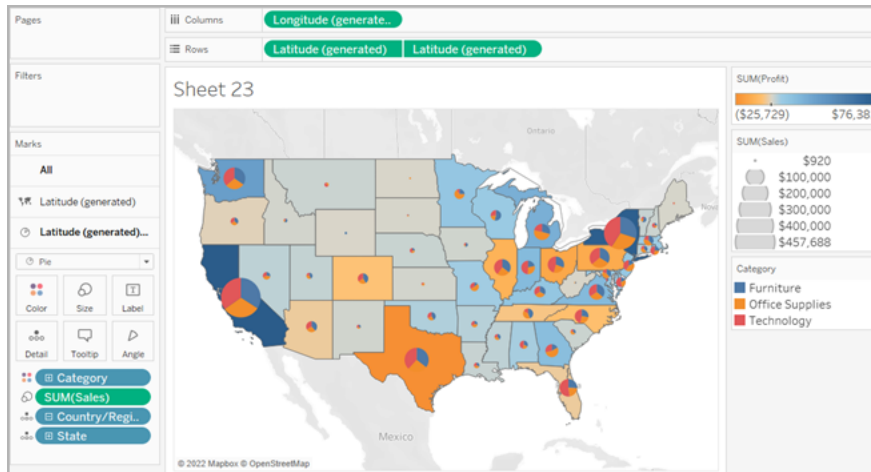

See also:

[Mapping Concepts in Tableau](#) on page 1673

[Get Started Mapping with Tableau](#) on page 1647

Customize Maps

Customize How Your Map Looks

This article describes how you can customize the appearance of a map view in Tableau.

Note: Many of the tasks in this article make use of the **Map Layers** pane. To open this pane, select **Map > Map Layers**. In older versions of Tableau, select **Map > Map Options**.

Select a Tableau background map style

When you are connected to the Tableau background map, you can choose between six built-in background map styles: Normal, Light, Dark, Streets, Outdoors, and Satellite. You can see these styles below:

Normal

Light

Dark

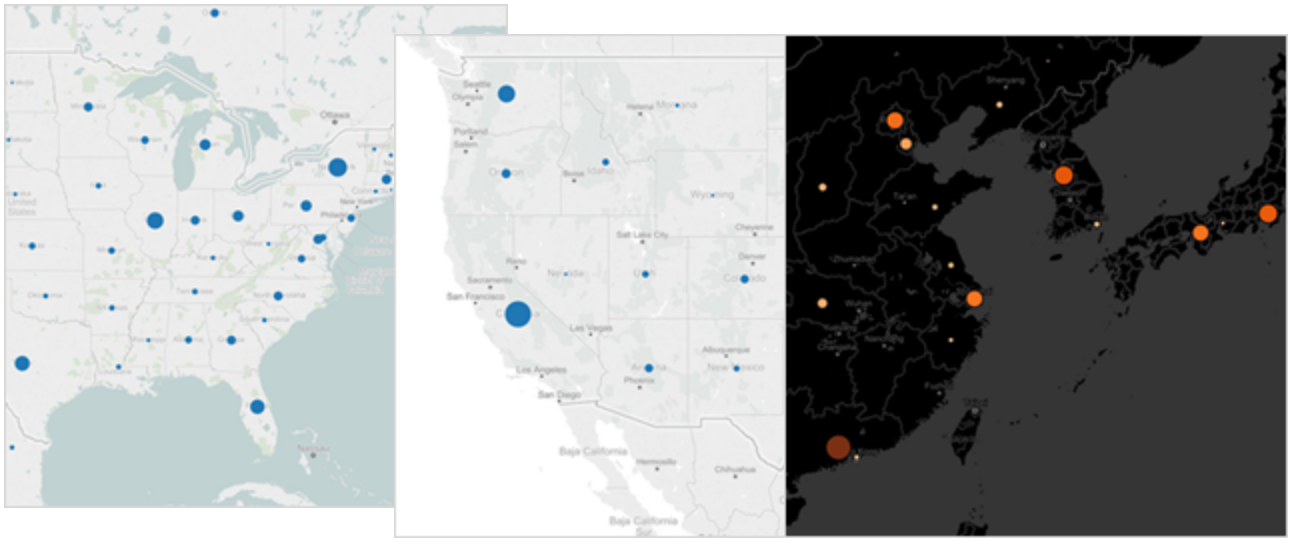

Streets

Outdoors

Satellite



To select a Tableau background map style:

1. Select **Map > Map Layers**.
2. In the Map Layers pane on the left-hand side of the workspace, under Background, click the **Style** drop-down menu, and then select a background map style.

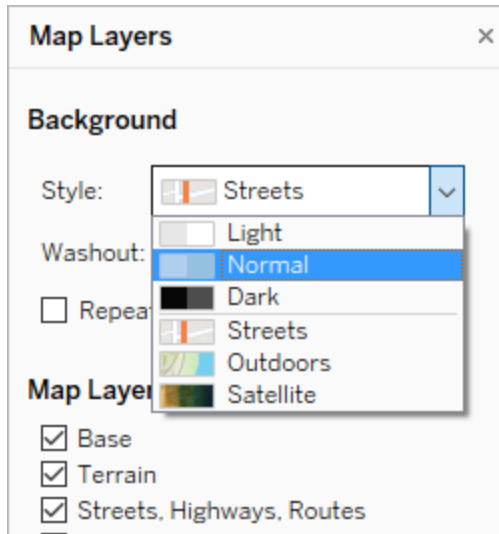

For more information about the built-in Tableau background maps, see [Select Background Maps](#) on page 1880.

Import your own background map

If the built-in Tableau background map styles don't meet your needs, you can import your own background map from a Web Map Service (WMS) server or a Mapbox map.

To import your own background map:

1. Select **Map > Background Maps > Map Services**.
2. In the Map Services dialog box, click **Add**, and then select to add WMS servers or Mapbox maps.
3. Follow the prompts to connect Tableau to the map service of your choice.

For more information, see [Use Web Map Service \(WMS\) Servers](#) on page 1885 or [Use Mapbox Maps](#) on page 1882.

4. When finished, click **Close**.
5. Select **Map > Background Maps**, and then select the background map you want to use.

The map updates to include the background map you choose.

Add a static background image

In addition to importing your own background map, you can add a static background image to your workbook and plot your data on it. For example, you can take a Google Map image and plot your data on it.

For more information, see the following topics:

- [Use Background Images in Your Views](#) on page 1901
- [Add Images of Google Maps and OpenStreetMap as Background Images in Tableau](#) on page 1911
- [Find Background Image Coordinates](#) on page 1913

Show or hide map layers

If you are using the Tableau background map, or a WMS map or Mapbox map that contains custom layers, you can show or hide layers on your background map to customize the background elements that frame your geospatial data. For example, you can overlay streets and highways or county boundaries on the map to give your data context.

To add or subtract map layers:

1. Select **Map > Map Layers**.
2. In the Map Layers pane, under the Map Layers section, select one or multiple map layers.

Note: Some map layers are only visible at specific zoom levels. If a map layer is unavailable at your current level of zoom, it will appear grayed out.

To use layers that are not available, zoom further in to the view.

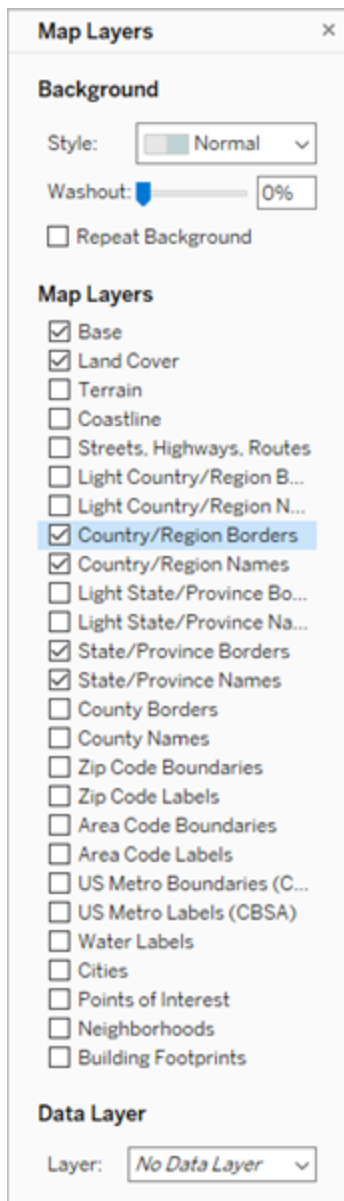

Some map layers are built to work with certain styles. What follows is a description of the different map layers available. Some of these layers are only available when using certain map styles.

Layer Name	Description	present in map style
Base	Shows the base map including water and land areas.	All
Land Cover	Shades wilderness areas and parks to give the map more depth.	All except Satellite
Terrain	Displays a relief of vertical elevation changes.	All except Satellite
Coastlines	Displays coastlines.	Light, Dark, Normal
Streets, Highways, Routes	Marks freeways and highways as well as small city streets. This layer includes the highway and street names as well.	All
Light Country/Region Borders	Shows a light gray outline of country/region borders and names.	Light, Dark, Normal
Light Country/Region Names	Shows country and region names in a light gray.	Light, Dark, Normal
Country/Region Borders	Highlights country and region borders in a darker gray.	All
Country/Region Names	Highlights country and region names in a darker gray.	All
Light State/Province Borders	Shows a light gray outline of state borders and names.	Light, Dark, Normal
Light State/Province Names	Shows state and province names in a light gray.	Light, Dark, Normal
State/Province	Highlights state and province borders in a darker gray.	All

Layer Name	Description	present in map style
Borders		
State/Province Names	Highlights state and province names in a darker gray.	All
County Borders	Highlights second-level administration borders and US county borders.	Light, Dark, Normal
County Names	Highlights second-level administration names and US county names.	Light, Dark, Normal
Zip Code Boundaries	Marks zip code and postcodes boundaries for US and select countries. You must zoom in to see this layer.	Light, Dark, Normal
Zip Code Labels	Shows labels of zip code and postcodes boundaries for US and select countries. You must zoom in to see this layer.	Light, Dark, Normal
Area Code Boundaries	Marks US area code boundaries. You must zoom in to see this layer.	Light, Dark, Normal
Area Code Labels	Shows labels for the US area codes. You must zoom in to see this layer.	Light, Dark, Normal
US Metro Boundaries (CBSA)	Marks US Metropolitan Statistical Areas and Micropolitan area boundaries.	Light, Dark, Normal
US Metro Labels (CBSA)	Shows labels for the U.S. Metropolitan Statistical Areas and Micropolitan areas.	Light, Dark, Normal
Water Labels	Shows labels for bodies of water.	All

Layer Name	Description	present in map style
Cities	Shows labels for cities.	All
Points of Interest	Displays labels for points of interest such as schools, parks, cemeteries, businesses, and important buildings. This layer is dependent on the zoom level.	All
Neighborhoods	Shows labels for neighborhoods in cities. You must zoom in to see this layer.	All
Subway and Train Stations	Displays the names of subway and train stations. You must zoom in to see this layer.	All except Satellite
Building Footprints	Shows the outline of buildings, where available. You must zoom in to see this layer.	Satellite, Streets, Outdoors
House Numbers	Displays the house numbers of buildings, with and without building footprints. You must zoom in to see this layer.	Streets, Outdoors
Contour Lines	Displays lines indicating vertical elevation change in meters. This layer is dependent on zoom level.	Outdoors

Add layers for U.S. demographic data

If you are using the Tableau background map, you can turn on a variety of predefined data layers that show U.S. census information. The data in these layers is for demographic data collected from the U.S. ACS Census.

Note: Map data layers are only available for locations in the U.S.

To add data layers for locations outside the U.S. you can connect to a WMS server that contains the desired demographic information. For more information, see [Use Web Map Service \(WMS\) Servers on page 1885](#).

To add a U.S. data layer to your map view:

1. Select **Map > Map Layers**
2. In the **Map Layers** pane, under **Data Layer**, do the following:
 - Click the **Layer** drop-down menu and select a data layer.
 - Click the **By** drop-down menu, and then select to layer the data by **State**, **County**, **Zip Code** or **Block Group**.
 - Click the **Using** drop-down menu to select a color scheme.

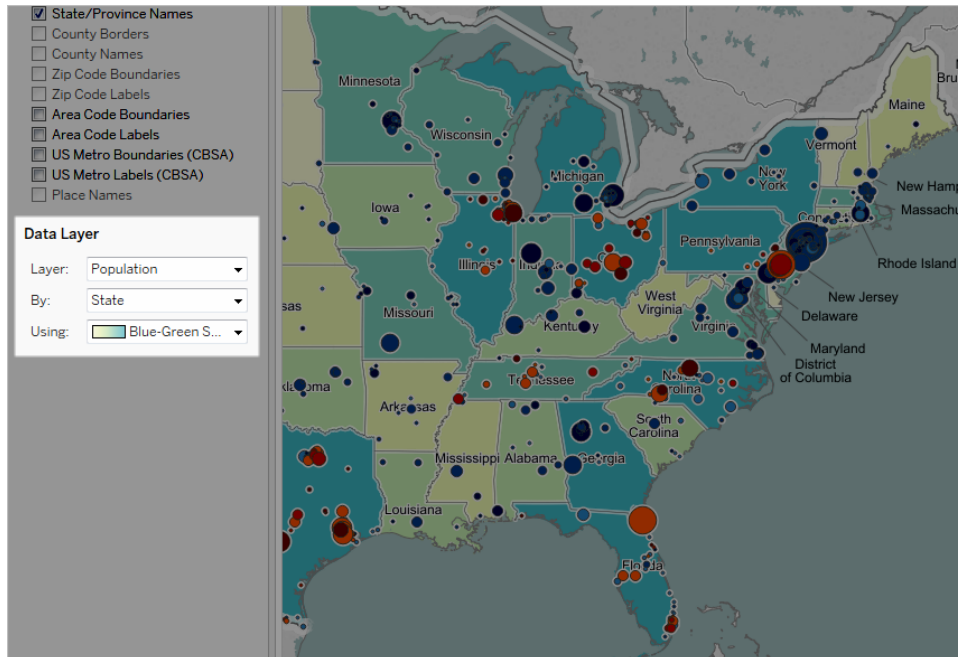

Once you select a data layer, it is added as shading to the map and a legend is shown to explain the colors of the layers. To hide or show this legend at any time, select **Map > Map Legend**.

Change the mark type

By default, when you add a geographic field to the view, Tableau creates a point map. You can change this to a polygon (filled) map, a line map, or a density map (heatmap).

Note: Filled maps are not available at the city or postcode level.

To change a point map to a filled or line map:

- On the Marks card, click the Mark Type drop-down and select **Map**.

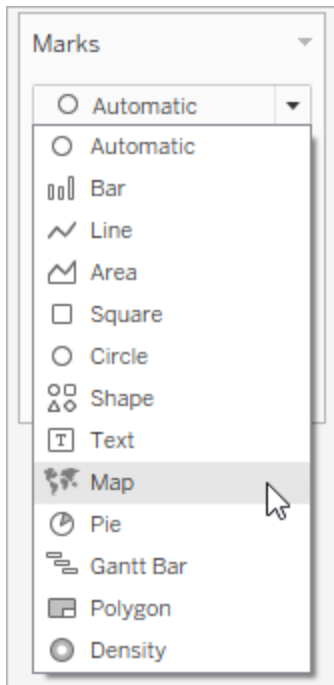

To change a point map to a heatmap (density map):

- On the Marks card, click the Mark Type drop-down and select **Density**.

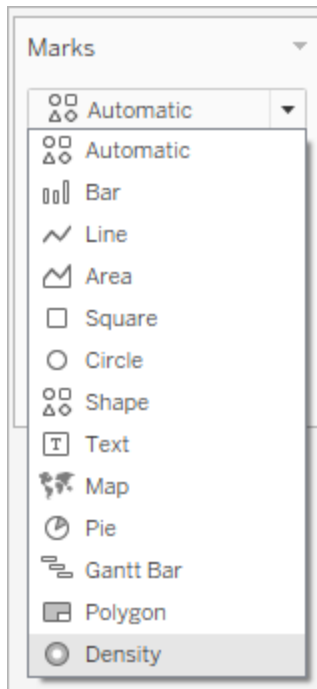

Add levels of detail

With maps, for each level of detail you add, the more granular your data becomes. For example, you might look at obesity rates at the state level, or you could drill down into the county level, like the examples below. Adding or subtracting levels of detail changes the make up of your map.

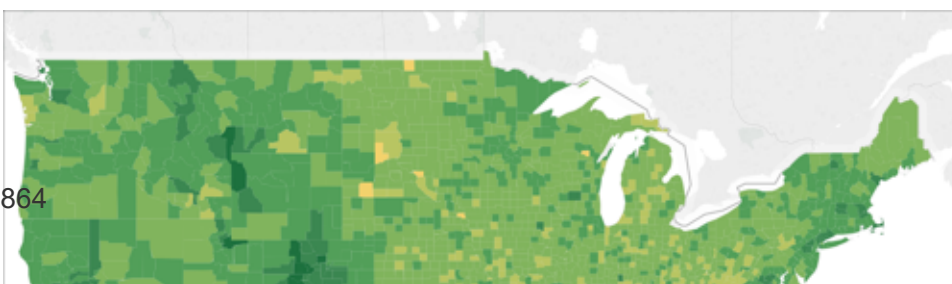
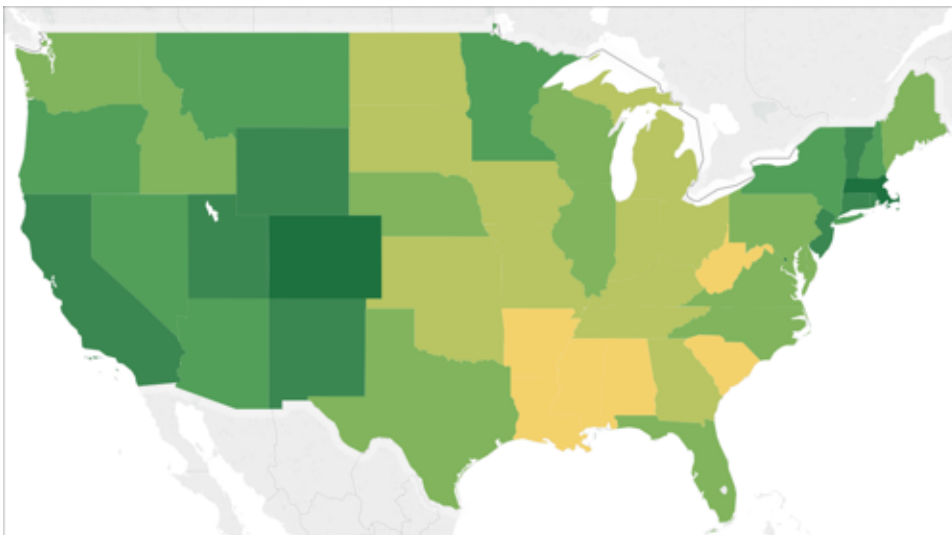

To add levels of detail to the view:

- From Dimensions, drag a geographic field to **Detail** on the Marks card.

Add color

There are two ways you can add color to your map view: You can color locations categorically, or you can color locations quantitatively.

To color locations on your map categorically:

- From the **Data** pane, drag a dimension to **Color** on the Marks card.

The image below shows each state in the U.S. colored by region: West, Central, South, and East. The dimension, Region, is on Color on the Marks card.

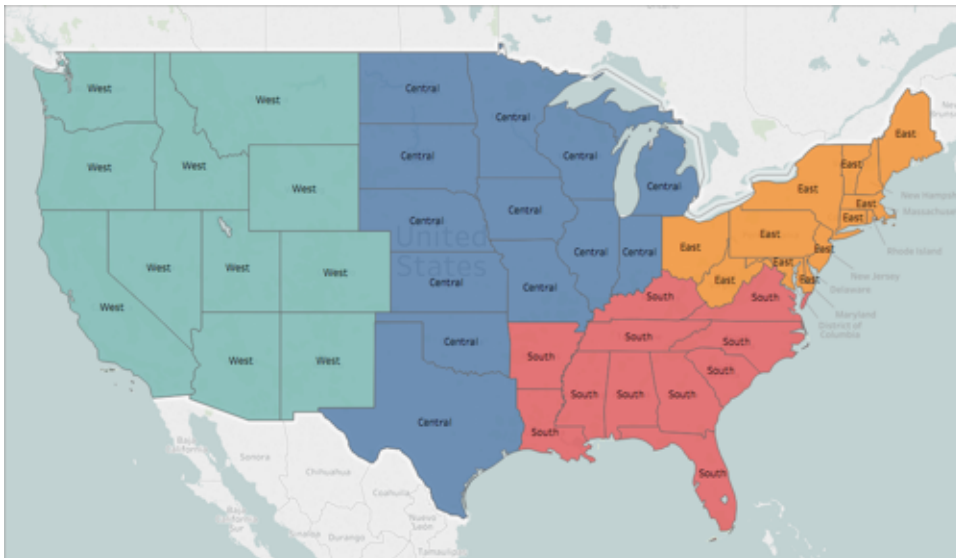

To color each location on your map quantitatively:

- From the **Data** pane, drag a measure to **Color** on the Marks card.

The image below shows each state in the U.S. colored by the amount of sales they

achieved. The measure, Sales, is on Color on the Marks card.

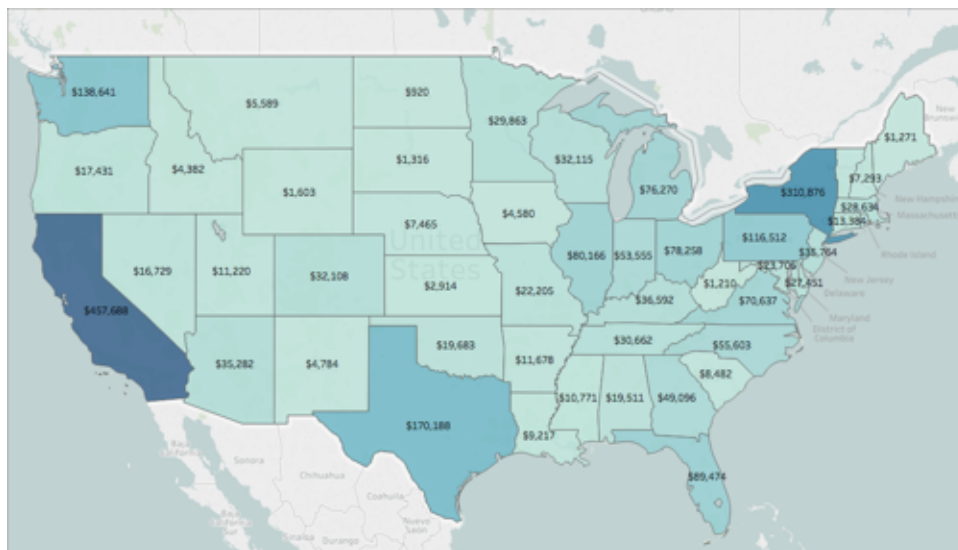

For more information about color, see [Color Palettes and Effects](#) on page 1293.

Add labels

You can add labels to your locations to provide extra context. For example, you can add labels for location name and sales.

To add labels to your data, from the **Data** pane, drag a dimension or measure to **Label** on the Marks card.

A label appears in the center of your location (if a polygon), or to the side of your location (if a data point).

You can add multiple labels.

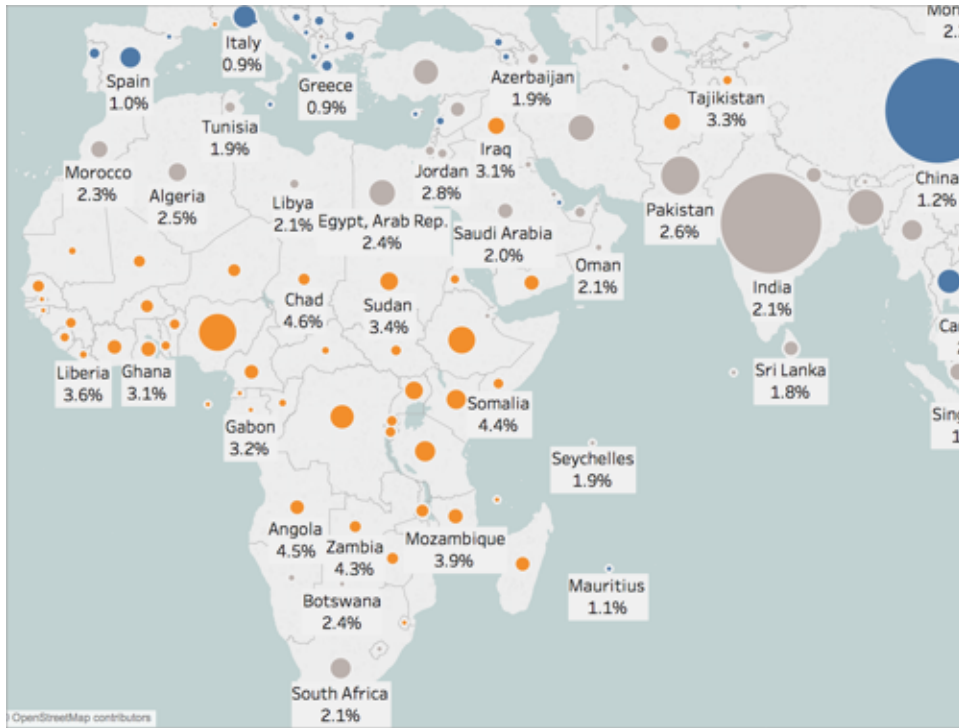

Adjust the size of your data points

You can adjust the size of your data points to compare and contrast them, or make smaller data points easier to see.

To uniformly adjust the size of your data points:

- On the Marks card, click **Size**, and then adjust the slider to the left or right.

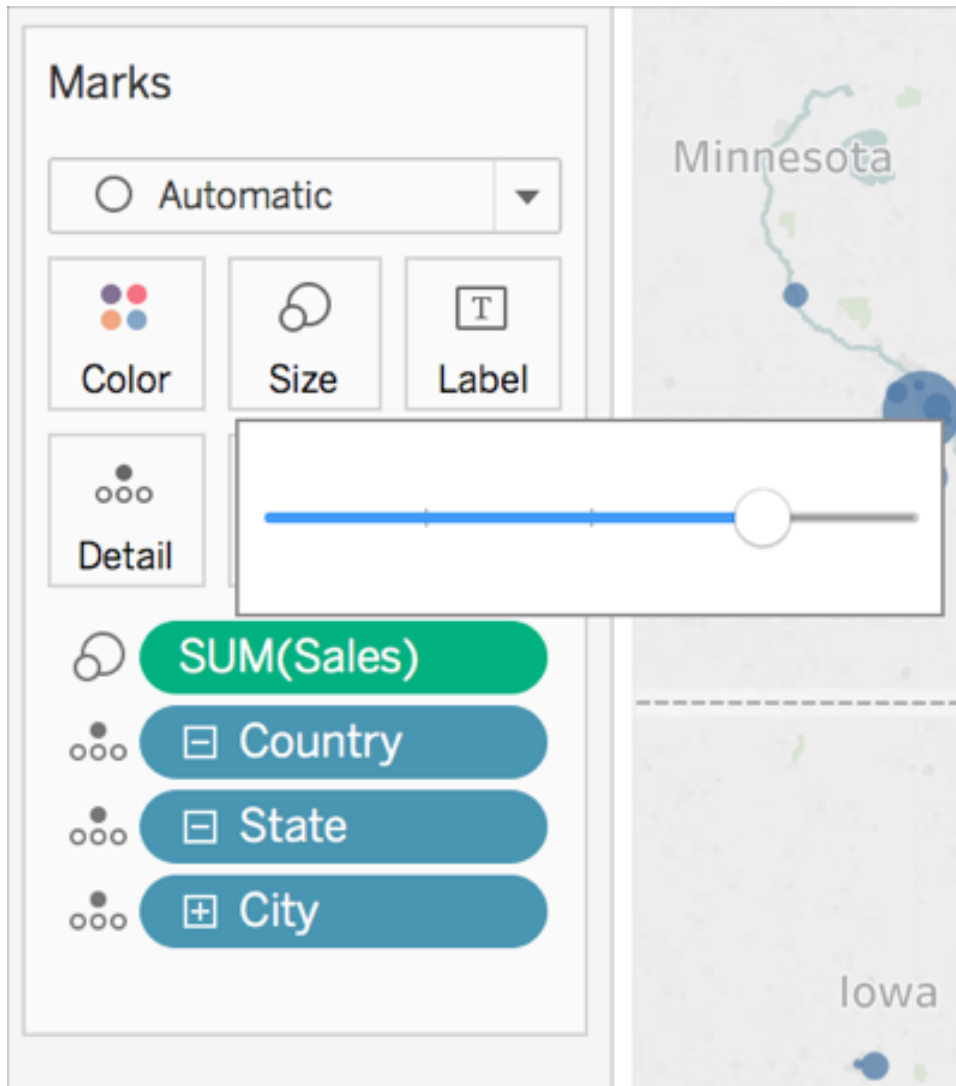

To size your data points quantitatively:

- From Measures, drag a field to **Size** on the Marks card.

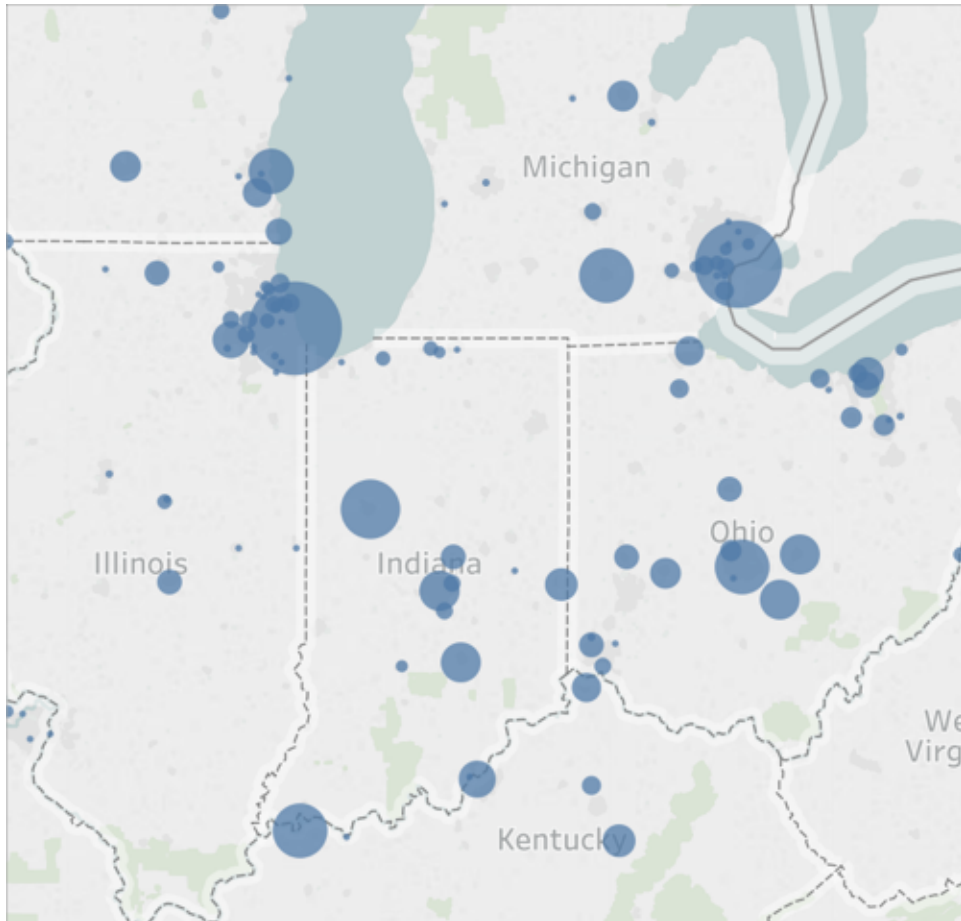

Create custom tooltips

You can create custom tooltips to show additional information about your locations when your audience hovers or clicks on them. You can type in your own information to appear for all marks, or add a field that will update with information specific to each mark.



To add a field to a tooltip:

- From the Data pane, drag the field to **Tooltip** on the Marks card.

To edit a tooltip:

1. On the Marks card, click **Tooltip**.
2. In the Edit Tooltip dialog box, format the tooltip how you would like it to appear.

For more information about customizing tooltips, see [Format tooltips](#) on page 2995 and [Add tooltips to marks](#) on page 1271.

See also:

[Mapping Concepts in Tableau](#) on page 1673

[Use Web Map Service \(WMS\) Servers](#) on page 1885

[Use Mapbox Maps](#) on page 1882

[Select Background Maps](#) on page 1880

Create Territories on a Map

When you're analyzing data on a map view, you might want to group *existing* locations together to create your own territories or regions, such as sales territories for your organization.

In Tableau, there are several ways to create territories:

- [Option 1: Select and group locations on a map](#) on the facing page
- [Option 2: Create a territory from a geographic field](#) on page 1874

- [Option 3: Geocode a territory field using another geographic field](#) on page 1874

Option 1: Select and group locations on a map

If you have created a map view, you can select and group locations (marks) on the map to create your territories.

For example, the following map view shows the total sales by postcode for a company with sales across Australia.

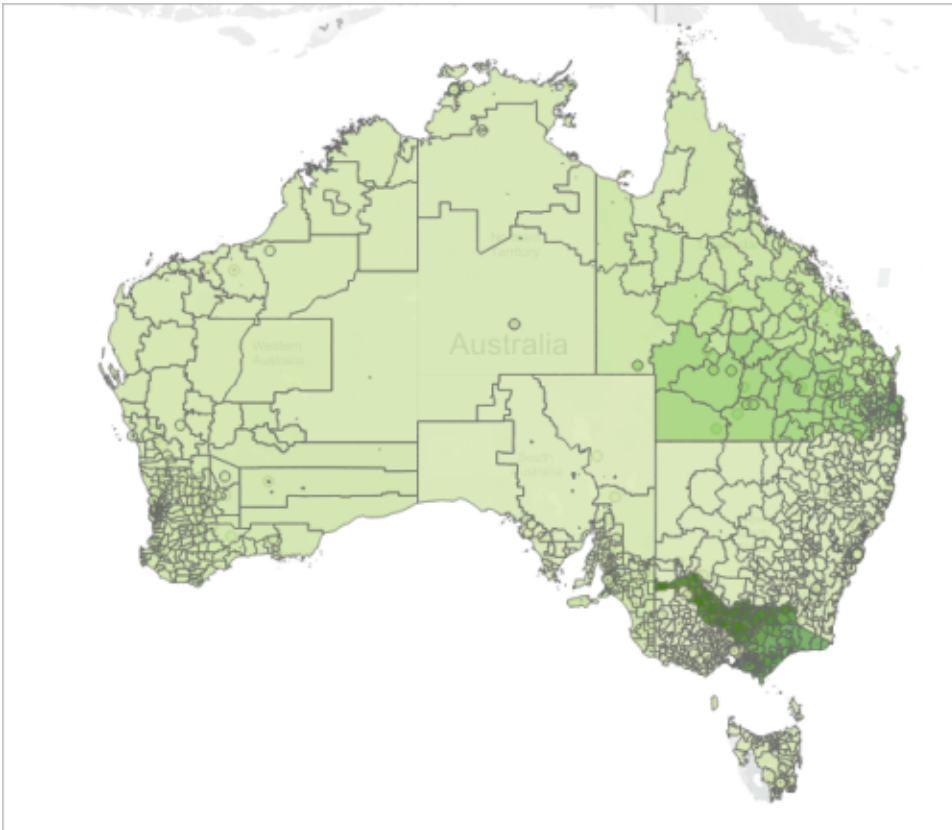

The first thing you might be thinking is: That's a lot of postcodes! In fact, there is a mark in this map view for every single 4-digit postcode in Australia, and each of those marks has an aggregation for SUM of Sales. If you're looking for sales information for every single postcode in Australia, then this is the view for you.

However, you might not want to analyze every individual location in your map view. Instead you might have your own areas, regions, or territories that you want to analyze as a whole. For example, maybe your organization splits Australia into five different sales territories, and you want to analyze the total sales for each of them.

In this case, because you've already created a map view, you can select locations directly on the map and group them to create your own territories. Follow the steps below to learn how.

Step 1: Select locations on the map to group into a territory

On the map view, select the locations (marks) that you want to group into your own territory. For more information about how to select marks, see [Select marks on page 1995](#).

Step 2: Create the first group (your first territory)

When you select marks in the view, or hover over a selection, a tooltip appears. On that tooltip, click the Group icon, and then select the level of detail you want to group the locations by.

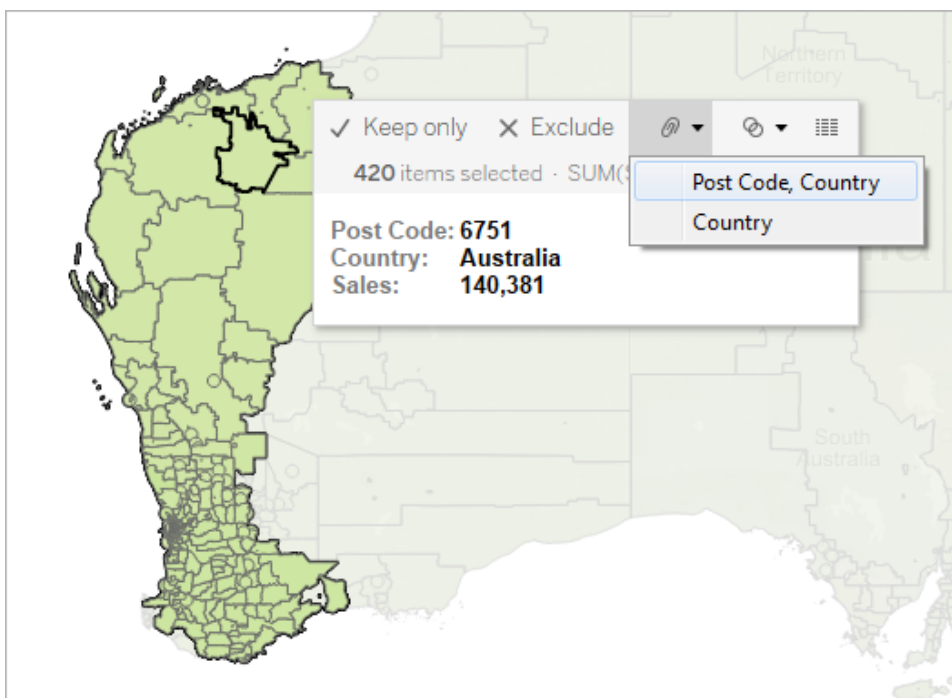

A new group field is added in the **Data** pane with a group icon next to it. To change the locations within the group at any time, right-click the group field in the **Data** pane and select **Edit group**.

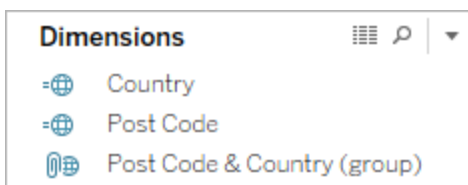

The new field is also added to **Color** on the **Marks** card.

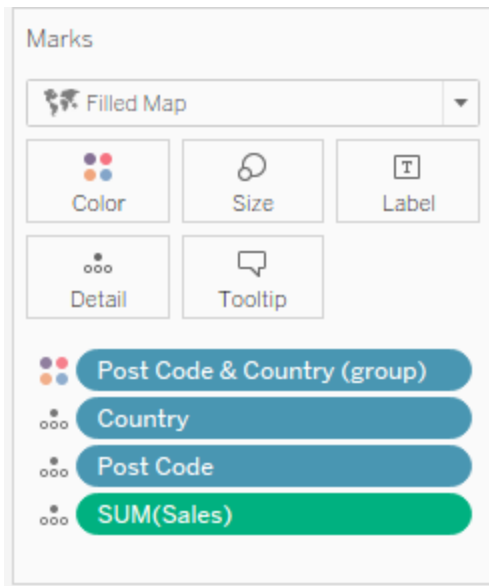

Notice that the marks you selected are now all the same color.

Step 3: Continue grouping data to add territories

Repeat steps 1 and 2 to create additional territories. Each territory is added as a group within the group field you created in step 2. You can create as many territories as you want.

Step 4: Add the group field to the view

From the **Data** pane, drag the newly created group field to **Detail** on the **Marks** card. Next, to make each territory appear as a single mark, you must also remove the related geographic field (s) from the view.

For example, if you grouped postcodes at the **Post Code, Country** level, you must remove the **Post Code** and **Country** fields from the view.

In the image below, notice that the **Post Code** and **Country** fields are no longer on **Detail** on the **Marks** card because they have been replaced by the **Post Code & Country (group)** field.

In this example, there are five groups within the Post Code & Country (group) field, so five territories appear on the map. Aggregations, such as SUM (Sales), are computed at the level of the territory, rather than separately for each location within the territory.

You can now see the SUM (Sales) for each territory by color. Territory 5 has the most sales.

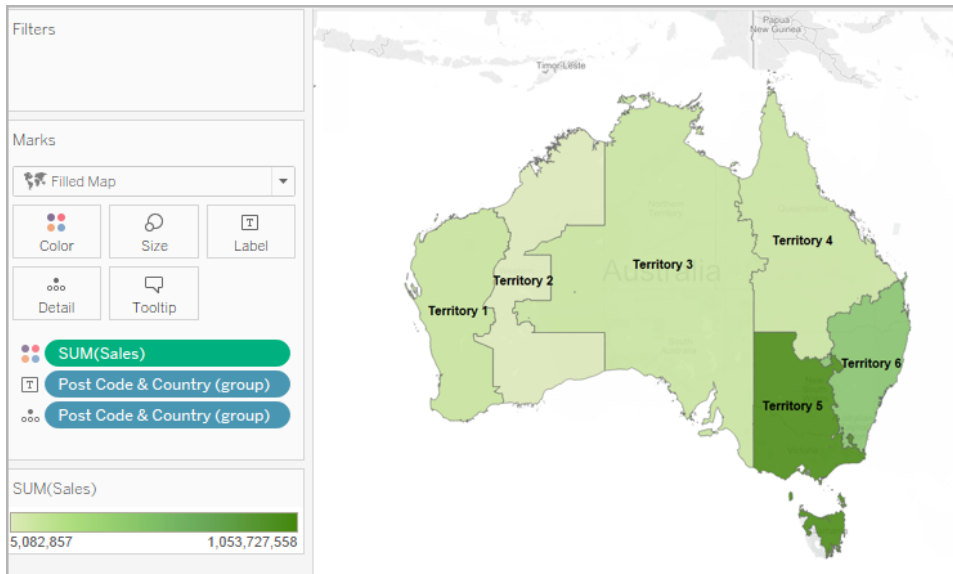

Option 2: Create a territory from a geographic field

You can also create territories by creating groups in the **Data** pane.

1. In the **Data** pane, right-click a geographic field (such as City or State) and select **Create > Group**.
2. In the Create Group dialog box, select the locations you want in your first territory and click **Group**. Each group you create represents a territory.
3. Repeat step 2 until you've created all of your territories, and then click **OK**.

The new group field is added to the **Data** pane.

4. From the **Data** pane, drag the newly created group field to **Detail** on the **Marks** card.

You can also drag the field to **Color** or **Label** on the **Marks** card to help differentiate between each territory.

Change locations in your territory groups

If you want to change the locations in your territory groups at any time, right-click the group field in the **Data** pane and select **Edit group**.

Option 3: Geocode a territory field using another geographic field





If your data source already contains a custom territory field, you can quickly geocode it to make a map in Tableau using an existing geographic field in your data source.

For example, the following data source contains a custom territory field for geographic areas called **Zone géographique**. It contains the values, **North**, **Central** and **South**.

If you were to bring this field into Tableau by itself, Tableau would not be able to recognize it as geographic data.

However, this data source also contains three geographic fields that Tableau *does* recognize: **Country**, **Region**, and **City**.

Each row in this data source contains a value for country, region, city and geographic zone. Therefore, each location is assigned a value from the custom territory field.

 Achats Ville	 Achats Région	 Achats Pays	 Achats Zone géographique
Leeds	Angleterre	Royaume-U...	Nord
Leeds	Angleterre	Royaume-U...	Nord
West Bromwich	Angleterre	Royaume-U...	Nord
West Bromwich	Angleterre	Royaume-U...	Nord
West Bromwich	Angleterre	Royaume-U...	Nord
Le Bouscat	Aquitaine	France	Centre
Le Bouscat	Aquitaine	France	Centre
Le Bouscat	Aquitaine	France	Centre

Because the Zone géographique field is included in the workbook with other geographic fields that contain locations that Tableau recognizes, you can geocode it at the level of detail of one of those fields.

Follow the steps below to geocode a territory field using another geographic field:

Step 1: Assign a geographic role to the territory field

On the data source page, click the data type icon for the custom territory field and select **Geographic Role > Create from**, and then select a level of detail to aggregate the field.

Achats	Achats
Pays	Zone géographique
Royaume-U...	Nord
Royaume-U...	Nord
Royaume-U...	Nord
Royaume-U...	Nord
Royaume-U...	Nord
Royaume-U...	Nord

The options you see are based on the available geographic fields in your data source. Choose the level of aggregation you want in the view. If you're unsure how they will affect your view, try several different levels of detail. You can always undo and try again.

After you assign a geographic role to the territory field, it's added to its respective place in the location hierarchy. You can see it in the **Data** pane when you go to any worksheet.

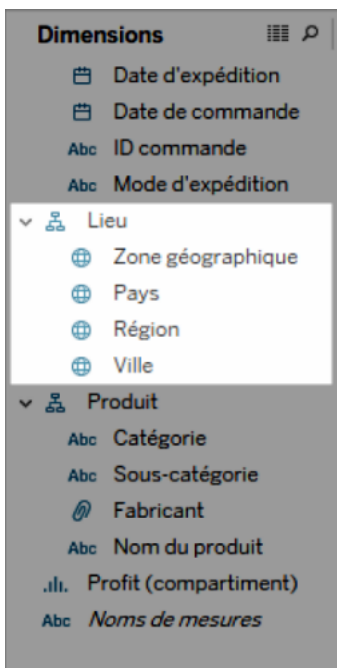

Note: You can also click the data type icon next to the field in the **Data** pane to geocode a territory field using the above procedure.

Step 2: Add the territory field to the view

Create a map view and add the newly geocoded territory field to the **Marks** card. You can place it on **Detail**, **Color**, **Label**, or **Tooltip**. Note that fields on **Detail** determine the level of aggregation in the view.

The custom territory field functions similar to your other geographic fields.

In the example below, the custom territory field (Zone géographique) is on **Detail** and **Color** on the **Marks** card. The average profit is shown for each territory (since the lowest level of detail is the territory field).

If you add another geographic field to **Detail** on the **Marks** card, such as the country field (Pays), the aggregation will update to show information for that level of detail.

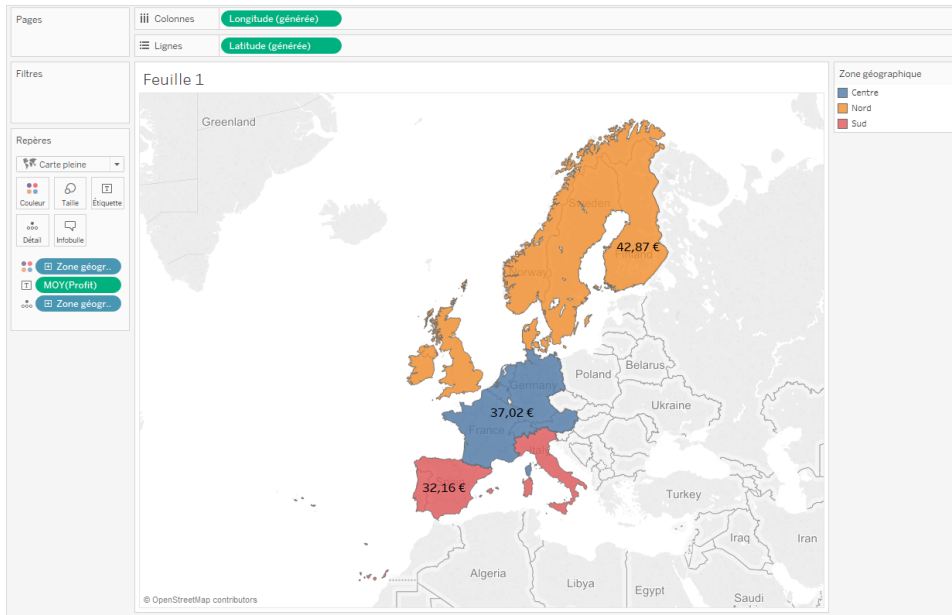

Blend custom territory data

If your data source does not contain a territory field, you can blend a territory field with another geographic field in your data source. For more information, see [Blend Geographic Data on page 1720](#). After you have blended your custom territory field with another field, follow the procedure in [Step 1: Assign a geographic role to the custom territory field](#) to geocode your territory field.

Customize How People Interact with your Map

When you create a map view, there are several default ways you can explore and interact with the view. You can zoom in and out of the view, pan, select marks, and even search for locations worldwide with map search.

However, sometimes you want to limit some of the ways your audience can interact with your map.

You can customize how your audience interacts with your view in the following ways using the **Map Options** dialog box.

Show a map scale

You can display a scale on your map so that your audience can understand distances between your data points. This scale appears in the bottom-right corner of the view, and updates as you zoom in and out of the map.

Note: A map scale will not display on non-Web Mercator projections, such as a WMS using Plate Carrée.

To show a map scale on your map:

1. Select **Map > Map Options**.
2. In the Map Options dialog box that appears in the view, select **Show Map Scale**.
3. Under Units, click the drop-down and select the units of measurement you want.
 - If you want the scale to show measurements in meters and kilometers, select **Metric**.
 - If you want the scale to show measurements in feet and miles, select **U.S.**
 - If you want the units of measurement to be determined by your workbook locale, select **Automatic**.

Note: This setting also determines the units that the Radial tool uses to measure distances. For more information, see [Change the units of measurement on page 1900](#) in the Measure Distances between Data Points and Locations on a Map View topic.

Hide map search

You can hide the map search icon so your audience cannot search for locations in your map view.

To hide the map search icon:

1. Select **Map > Map Options**.
2. In the Map Options dialog box that appears in the view, clear **Show Map Search**.

Note: When you hide the map search icon, you also hide the locate me button for views published on the web. For more information about the locate me button, see [Explore Data in Maps](#) on page 1892.

Hide the view toolbar

You can hide the view toolbar in a map view so your audience cannot lock the map in place or zoom the map to all of your data.

To hide the view toolbar:

1. Select **Map > Map Options**.
2. In the Map Options dialog box that appears in the view, clear **Show View Toolbar**.

Note: When you hide the view toolbar, you can still use keyboard shortcuts to zoom in and out of the view, pan, and select marks. For more information, see [Shortcuts for selecting and navigating marks](#) on page 3465.

Turn off pan and zoom

You can turn off pan and zoom in your map view, as well as in background images, so your audience cannot pan, or zoom in or out of the view.

To turn off pan and zoom:

1. Select **Map > Map Options**.
2. In the Map Options dialog box that appears in the view, clear **Allow Pan and Zoom**.

When you turn off pan and zoom, the pan tool and all zoom controls are removed from the view toolbar, and the rectangular tool becomes the default tool. Keyboard shortcuts for zooming in and

out of the view, or panning, no longer work. If the map search icon is not hidden, you can still navigate the view by searching for locations with the map search box.

See also:

[Search for Locations in Your Map](#) on page 1895

[Zoom and Pan Views, and Select Marks](#) on page 1992

Select Background Maps

Tableau comes installed with a set of background maps that you can access to create map views.

By default, Tableau maps appear with a **Light** background layer provided by Mapbox maps.

The eight background maps that come installed with Tableau are described in this table.

Background Map	Description
Light	A subtle map that puts the emphasis on the marks while providing geographic context. All areas without data appear in white or light gray.
Normal	A general-purpose map similar to Light. Land areas without data appear in white or light gray, and bodies of water appear in light blue.
Dark	A subtle map that puts the emphasis on marks while providing geographic context. The inverse of the Light map; areas without data appear in black or dark gray.
Streets	A general-purpose map that includes major road and transit networks.
Outdoors	A general-purpose map that includes terrain and natural features, including bodies of water and parks.
Satellite	A stylized map with global satellite imagery.
Offline	A map that you can use while not connected to the internet. This background map stores the images that make up the map in a cache on your machine for improved performance and offline access. For more information, see the offline maps section.
None	A visualization that displays data between latitude and longitude on a viz type

**Background
Map**

Description

other than a map.

Change your background map:

In Tableau select **Map > Background Maps** and then select the background map you want to use.

Change your default background map in Tableau Desktop (feature deprecated)

Note: Changing your default background map is a legacy feature that only works with WMS maps on Tableau Desktop. We don't recommend using this feature.

You can choose to set your default background map to a Web Map Service (WMS) or offline map. To learn more about using a WMS map, see [Use Web Map Services \(WMS\) Servers](#).

To specify a default background map:

1. In Tableau Desktop, select **Map > Background Maps > Add WMP Map... or Offline**.
2. Select **Map > Background Maps > Set as Default** to set the selected background map to the default.

The background map is automatically saved as a Tableau Map Source (.tmsd) file and placed in the Mapsources folder of your My Tableau

Repository. It's now the default background map for all new worksheets.

Use the Offline background map

You can create and inspect data in a map view offline using the offline background map that comes with Tableau Desktop.

To use the offline background map:

- In Tableau, select **Map > Background Maps > Offline**

Note: The offline background map uses map images stored on your machine. You can find these images in the following locations:

- **On Windows:** C:\Program Files\Tableau\\Local\Maps
- **On Mac:** //Applications/<Tableau Version>.app/Contents/install/local/maps

There are several actions, however, that require Tableau to retrieve a map image that may not be stored. If the new map image isn't stored on your machine, you won't be able to load the map until you reconnect to the online map that comes with Tableau.

You may need to reconnect to the online map if you would like to do one or more of the following:

- **Turn layers on or off** - if you decide to turn on a layer that isn't stored in the cache, Tableau needs to connect to retrieve the necessary information.
- **Zoom in or out** - zooming in or out on a map requires different map images. If the images at the specified zoom level don't exist in the cache, Tableau needs to retrieve the updated maps.
- **Pan** - panning sometimes requires new map images. If you're working offline and don't have the necessary map images and legends stored in the cache, the new images and legends won't load.

To reconnect to the Tableau map:

- On Tableau Desktop, select **Map > Background Maps > Tableau**

Note: If you set a map to Offline and then publish the workbook, the published workbook will still use the Offline, stored maps, with all of the functionality and limitations of Offline maps noted earlier.

Use Mapbox Maps

If you have access to Mapbox maps, you can add them to your workbooks or use them to create map views in Tableau Desktop. For a list of country-specific data available, see [Supported Map Data](#).

When you publish a view that uses Mapbox maps to Tableau Server, Tableau Cloud, or Tableau Public, your audience can view your data and your Mapbox map without having a Mapbox account.

Starting in Tableau Desktop 2019.2, Mapbox styles Streets, Outdoors, and Satellite are available by default in Tableau in the Map Layers pane. For more information on map styles and map layers, see [Customize How Your Map Looks on page 1854](#).

Add a Mapbox map to your workbook

In Tableau Desktop, you can add a Mapbox map to your workbook and use it as a background map.

After you add a Mapbox map to your workbook, the map is saved with the workbook and available to anyone with whom you share the workbook. You can also save a Mapbox map as a Tableau Map Source (.tms) file that you can share with others so they can quickly connect to it and use it in their own workbooks. For more information, see [Save a Map Source](#) on page 1890. To add a Mapbox map:

1. In Tableau Desktop, select **Map > Background Maps > Add Mapbox Map**.
2. In the Add Mapbox Map dialog box, add:
 - **Style name:** Enter a name for the Mapbox map. This name can be anything you want, and will appear in the Background maps menu after you add the map.
 - **URL:** Enter a style URL for the Mapbox map you want to add.

This URL contains the style ID for your Mapbox map, your access token, and your username. It might look similar to the following:

```
https://api.mapbox.com/styles/v1/<username>/<styleid>?access_token=<access token>
```

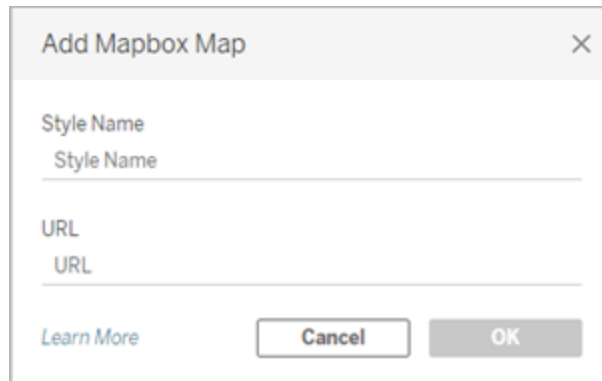

For more information about any of the above items, see the [Access Tokens](#), [Maps](#), and [Styles](#) sections of the Mapbox API Help.

3. When finished, click **OK** to exit the Add Mapbox Map dialog box, and then click **Close** to return to the view.

Create a map view using a Mapbox map

To create a map view using a Mapbox map, select **Map > Background Maps**, and then select the Mapbox map you want to use. Next, build the map view. For more information, see [Mapping](#)

Concepts in Tableau on page 1673.

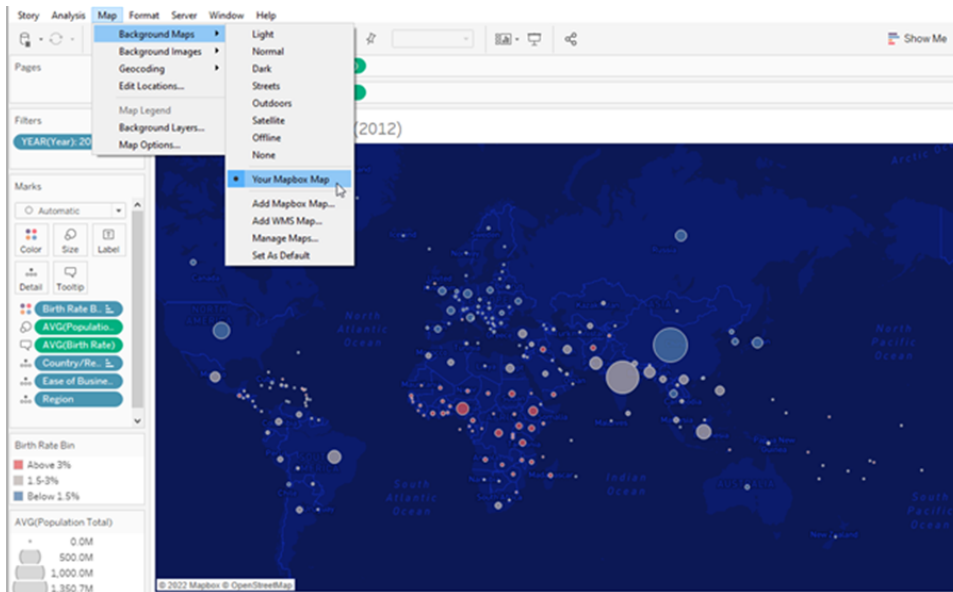

Add or subtract map layers from the view

When you add a Mapbox Studio map to Tableau, all the map's layers are added, too. Layer groups and single layers in Mapbox Studio will display as individual layers in the Map Layers Pane in Tableau, and will retain the layer configuration set in Mapbox Studio.

If a layer group in Mapbox Studio includes sublayers that are turned off, those sublayers will also be turned off when the map is added to Tableau, and the layer group will appear as a single layer in the Map Layers pane. If the layer group is turned off in Tableau, then back on, all of that layer group's sublayers will be turned on.

Map layers are different from data layers in Tableau. In Tableau, Data Layers are pre-built tiles that include demographic information by various levels, like State and County. Data layers and Mapbox are independent of one another in Tableau. For more information about how data layers work, see [Customize How Your Map Looks](#) on page 1854.

Note: When you add a custom map from Mapbox Studio, Tableau imports the data for every layer, even if the layer is turned off. Your map's performance could be affected if it includes many layers and sublayers. To improve performance, add or remove layers and sublayers in Mapbox Studio before adding your map to Tableau.

See also:

[Use Web Map Service \(WMS\) Servers](#) below

[Save a Map Source](#) on page 1890

[Import a Map Source](#) on page 1891

[Select Background Maps](#) on page 1880

[Customize How Your Map Looks](#) on page 1854

Use Web Map Service (WMS) Servers

In Tableau Desktop, you can connect to map servers with the Web Map Service (WMS) protocol. WMS is a standard protocol for requesting and receiving geographically referenced imagery.

You can connect to any WMS server that supports the WMS 1.0.0, 1.1.0, or 1.1.1 standards.

Connect to a WMS server

1. In Tableau Desktop, select **Map > Background Maps > WMS Servers**.
2. In the Add WMS Servers dialog box, type the URL for the server you want to connect to in Tableau, and then click **OK**.

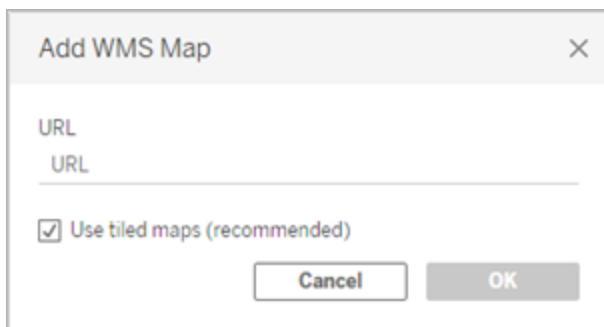

You can add as many map servers as you want to a workbook. Each WMS server you add appears as a background map in the **Background Maps** menu.

Save a WMS server as a Tableau map source

After you add a WMS server to your workbook, it is saved with the workbook and available to anyone you share the workbook with. You can also save a WMS server as a Tableau Map

Source (.tms) file, which you can share with others so they can quickly connect to it and use it in their own workbooks.

For more information about how to save a map as a Tableau map source, see [Save a Map Source](#) on page 1890.

Use a WMS background map

After you connect to a WMS server, you can create a map view using the WMS background map that Tableau creates.

To create a map view using a WMS server:

1. In Tableau Desktop, select **Map > Background Maps**, and then select a WMS background map to use in the view.

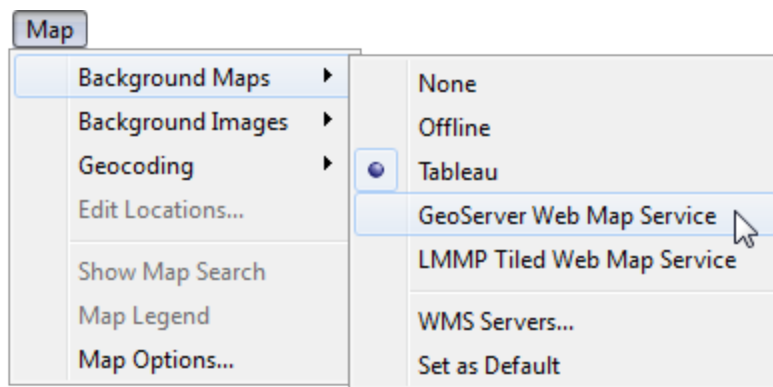

2. Add a geographic field to the view.

For more information, see [Mapping Concepts in Tableau](#) on page 1673.

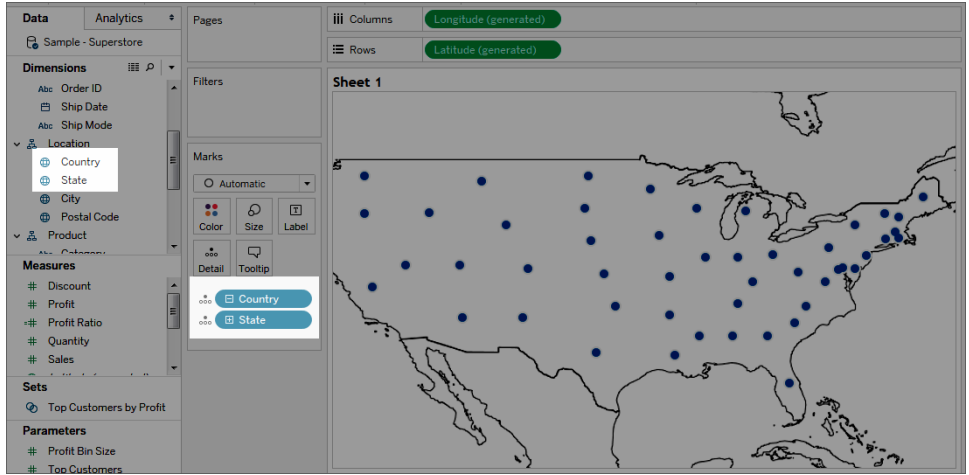

3. Select **Map > Map Layers**, and then select the map layers you want to show in the view.

For more information, see [Customize How Your Map Looks](#) on page 1854.

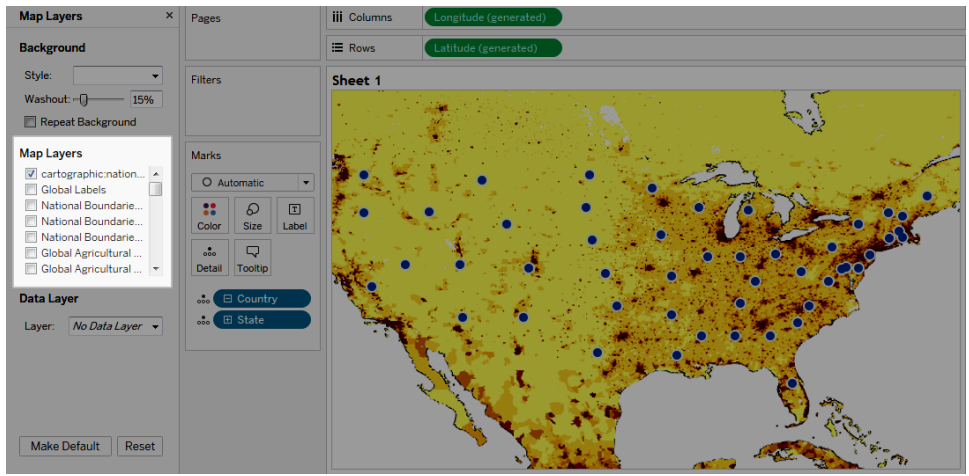

Performance considerations

The content, speed, and performance of a WMS server is reliant on the network and WMS provider. If your Internet connection is interrupted or if you're working behind a restrictive firewall, you can use the Offline background map that comes installed with Tableau Desktop to avoid any performance issues while you build your map view. You can switch back to your WMS server at any time.

Note: With the offline background map, you might only be able to access up to four levels of zoom. For more information, see [Select Background Maps](#) on page 1880.

Supported Spatial Reference Systems

Tableau automatically supports the following list of Spatial Reference Systems (SRS) / European Petroleum Survey Group (EPSG) codes. WMS servers must support at least one of the following spatial reference systems to be compatible with Tableau mapping features.

Supported SRS/EPSS Codes in Tableau:

3857 - WGS 84 / Pseudo-Mercator [DEFAULT]

4326 - WGS 84

4269 - NAD83

3824 - TWD97

3889 - IGRS

4019 - Unknown datum based on the GRS 80 ellipsoid

4023 - MOLDREF99

4030 - Unknown datum based upon the WGS 84 ellipsoid

4031 - Unknown datum based upon the GEM 10C ellipsoid

4046 - RGRDC 2005

4075 - SREF98

4081 - REGCAN95

4126 - LKS94 (ETRS89)

4130 - Moznet

4140 - NAD83(CSRS98)

4148 - Hartebeesthoek94

4151 - CHTRF95

4152 - NAD83(HARN)

4163 - Yemen NGN96

4166 - Korean 1995

4167 - NZGD2000

4170 - SIRGAS 1995

4171 - RGF93
4172 - POSGAR
4173 - IRENET95
4176 - Australian Antarctic
4180 - EST97
4189 - REGVEN
4190 - POSGAR 98
4258 - ETRS89
4283 - GDA94
4319 - KUDAMS
4612 - JGD2000
4617 - NAD83(CSRS)
4619 - SWEREF99
4627 - RGR92
4640 - RRAF 1991
4645 - RGNC 1991
4659 - ISN93
4661 - LKS92
4667 - IKBD-92
4669 - LKS94
4670 - IGM95
4674 - SIRGAS 2000
4686 - MAGNA-SIRGAS
4687 - RGPF
4693 - Nakhl-e Ghanem
4694 - POSGAR 94
4702 - Mauritania 1999

4737 - Korea 2000
4742 - GDM2000
4747 - GR96
4749 - RGNC91-93
4755 - DGN95
4756 - VN-2000
4757 - SVY21
4758 - JAD2001
4759 - NAD83(NSRS2007)
4761 - HTRS96
4762 - BDA2000
4763 - Pitcairn 2006
4764 - RSRGD2000
4765 - Slovenia 1996
102100 - WGS 84 Web Mercator (Auxiliary Sphere)

See also:

[Use Mapbox Maps](#) on page 1882

[Save a Map Source](#) below

[Import a Map Source](#) on the facing page

[Select Background Maps](#) on page 1880

[Customize How Your Map Looks](#) on page 1854

Save a Map Source

After you add a Mapbox map or WMS server to your workbook, you can save it as a Tableau map source (.tms).

Saving a Mapbox map or WMS server as a Tableau Map Source allows you to share your map with others so they can quickly import it into their own workbooks and use it to create new map

views. For more information about importing a Tableau Map Source into a workbook, see [Import a Map Source](#) below.

1. Select **Map > Background Maps > Map Services**. This opens the Map Services dialog box.
2. Select the map that you want to save as a Tableau map source, and then click **Export**. This opens the Export Connection dialog box.
3. Type a name for the file, choose a location, and then click **Save**.

The Tableau map source includes any default map layer settings you have specified in the workbook. For example, the map source will include any custom set of map layers you have specified to show by default. For more information, see [Customize How Your Map Looks on page 1854](#) in the Set Map Layers topic.

Note: If you change the default settings for the map layer options, you should export the map again to include the new settings in the Tableau map source file.

See also:

[Select Background Maps on page 1880](#)

Import a Map Source

You can import a Tableau Map Source (.tms) that someone has shared with you into a workbook, and then use it to create custom map views.

1. Select **Map > Background Maps > Map Services**. This opens the Map Services dialog box.
2. Click **Import**. This opens the Import Connection dialog box.
3. Navigate to the saved Tableau map source file (.tms) that you want to import, select it, and then click **Open**. This closes the Import Connection dialog box and adds the Tableau map source to the list of maps in the Map Services dialog box.

If you want to edit the newly added Tableau map source, select it from the list, and then click **Edit**. Otherwise, click **Close** to return to the view.

You can import as many Tableau map sources as you want into a workbook. Each Tableau map source you add appears as a background map in the **Background Maps** menu and is automatically selected as the default background map until another Tableau map source is

imported, until you connect to a WMS server or Mapbox map, or until you select to use a different background map.

Note: When you create a new map view, the background map that is selected in the **Background Maps** menu is used to create the map for that view.

See also:

[Save a Map Source](#) on page 1890

[Select Background Maps](#) on page 1880

Explore Data in Maps

Tableau maps can help you quickly find locations and analyze data worldwide. There are many ways you can explore and interact with map views. You can zoom in and out, pan, and select marks with the view toolbar, and even search for locations worldwide with map search.

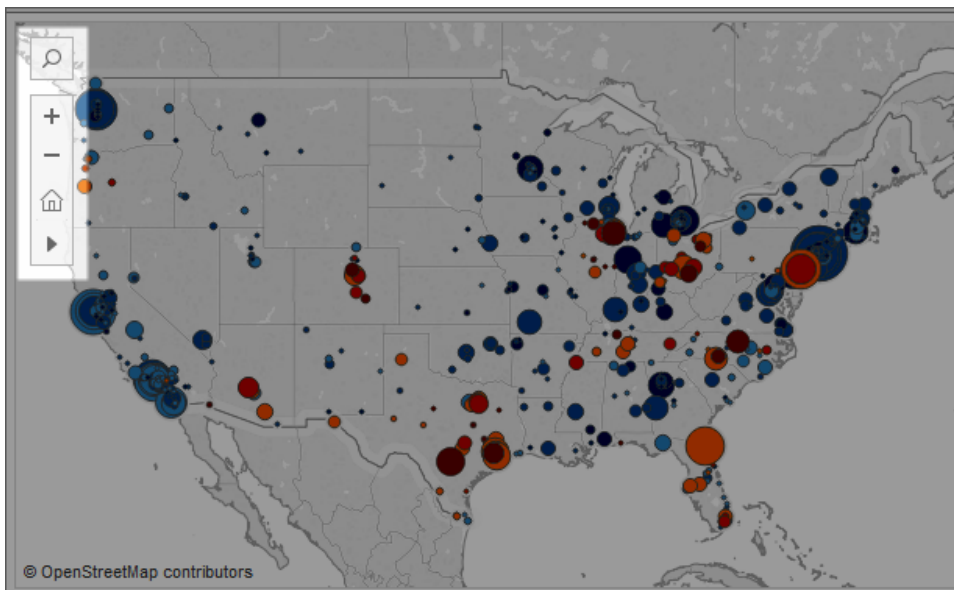

If you don't see the view toolbar or the map search icon, or if you can't pan or zoom, it's probably because the workbook author has chosen to customize how others can interact with the view.

The workbook author can choose to hide the view toolbar and the map search icon so they do not appear in the view. Similarly, the workbook author can choose to turn off pan and zoom to control how you interact with the view.

For more information, see [Customize How People Interact with your Map](#).

Select marks, pan, and zoom

You can use the view toolbar in the upper left corner of the view to select marks, pan, and zoom in and out of a map view. For more information, see [Zoom and Pan Views, and Select Marks on page 1992](#).

Search for locations

You can use the map search icon  to search for locations in your map view. For more information, see [Set Map Search Options](#).

Find your current location

If you're exploring a map view on Tableau Server or Tableau Cloud, you can use the locate me button to quickly pan and zoom to your current location. To do so, click the map search icon in the top-left corner of the view, and then, next to the search box that appears, click the locate me button.

Note: Finding your current location is not supported on Tableau Desktop.

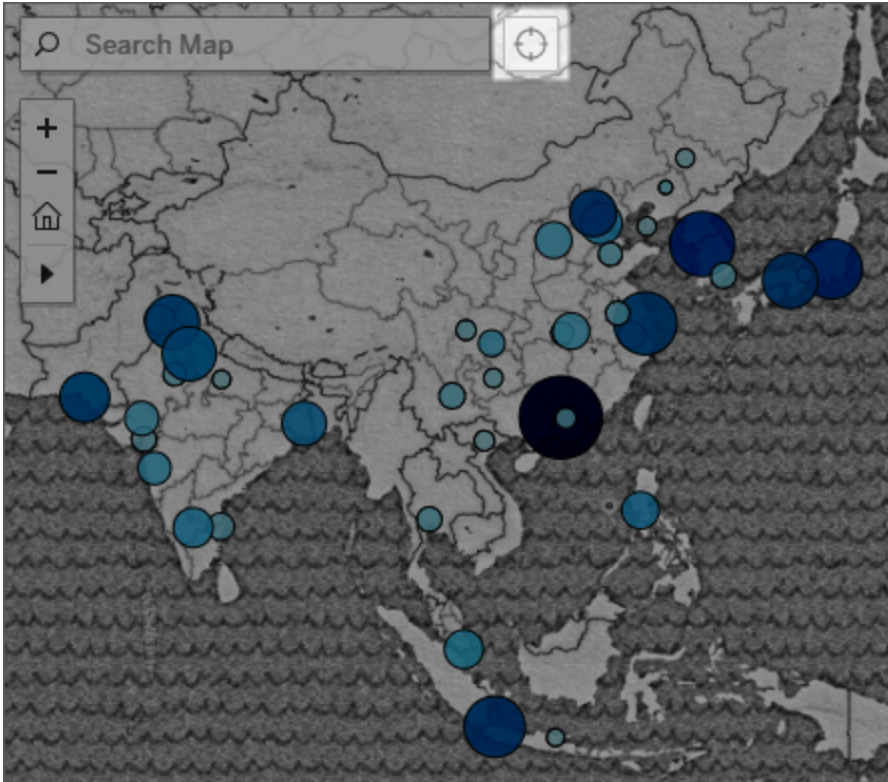

Note: When you click the locate me button, you might be prompted by your web browser to allow Tableau access to find your current location. If you block access, Tableau will be unable to zoom to your current location.

Return to the initial view

After zooming in and out of the view, or panning to a new location, you can return to the initial view of your map. To do so:

On Tableau Desktop, click the reset axes button  on the view toolbar.

On Tableau Server or Tableau Cloud, click the zoom home button  on the view toolbar.

Search for Locations in Your Map

Map search helps you find locations in a map view so you can quickly explore and inspect data.

The map search icon appears in the top left corner of the view. When you click the search icon, a search box appears.

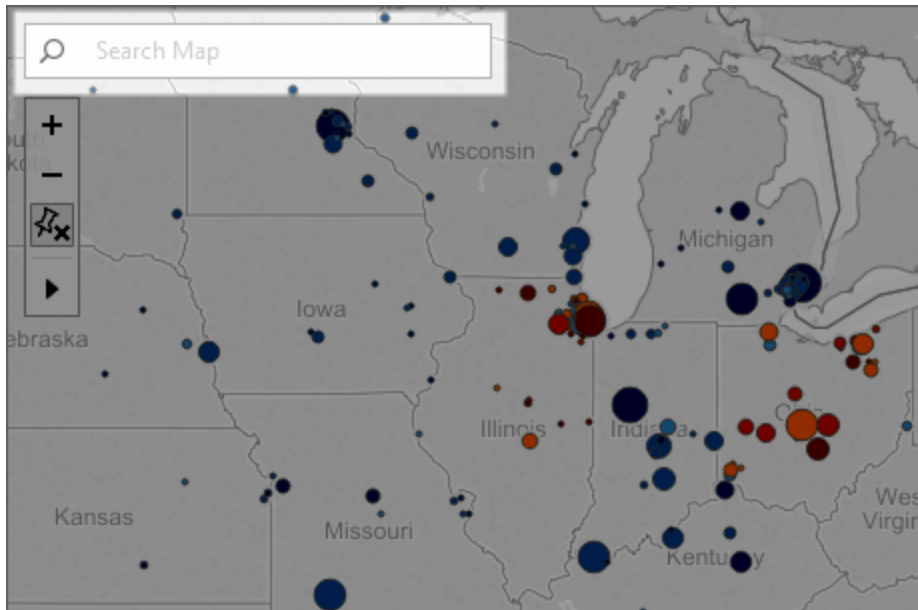

When you begin to type in the search box, map search suggests possible locations that are in your map view. The suggestions are based on location names and text in your data source.

You can search for the following location types:

- Continent
- Country
- State or province
- County
- City
- Postcode

Select a location from the list of suggestions to pan and zoom to that location on the map.

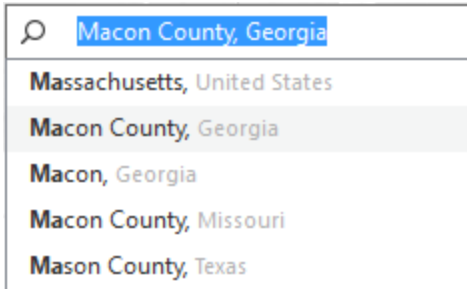

Hide Map Search

By default, the map search icon appears in the top left corner of the view. When you publish a view to Tableau Server or Tableau Cloud, or share the view through Tableau Reader, the map search icon remains in the view. If you do not want viewers to search for locations in your map view, you can hide the map search icon.

For more information about showing and hiding map search, see [Customize How People Interact with your Map](#) on page 1878.

Measure Distances Between Data Points and Locations in a Map

While exploring data in a map view, you might have questions about how that data relates to its surrounding geography, locations, or landmarks. To answer these types of questions, you can use the Radial tool to measure approximate distances in your map view.

The following view shows the number of earthquakes of magnitude 6.0 and higher that have occurred around the world between January, 1994 and February, 2014.

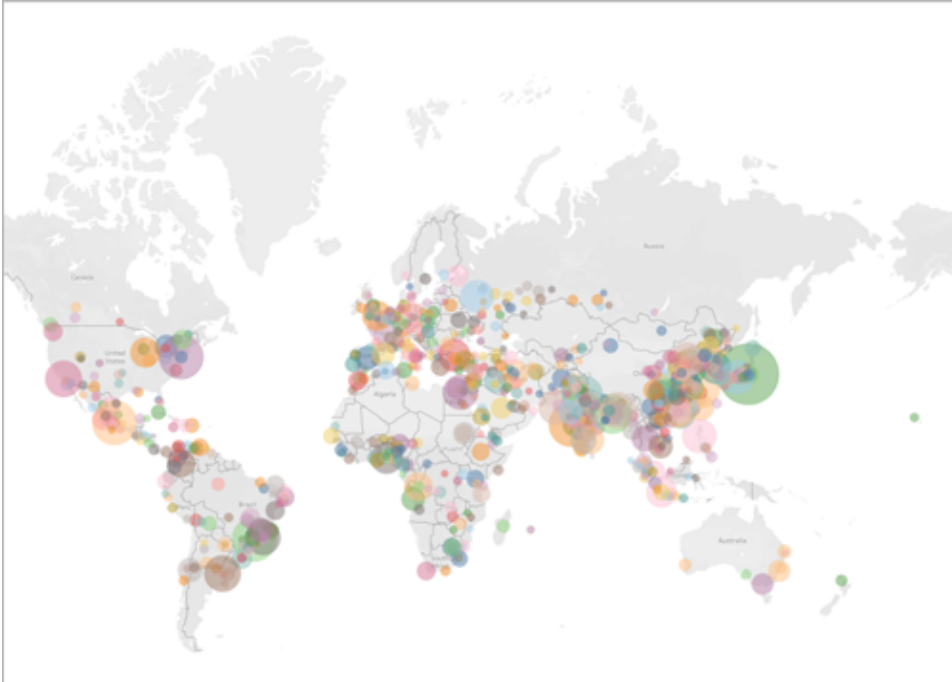

At a global scale, this view is very powerful, but you or your audience might want to zoom in and explore certain areas more closely. For example, maybe you want to see how many earthquakes have occurred in Indonesia in the past 10 years, specifically within 100 miles of its capital, Jakarta.

To do so, you can use the Radial tool to find all the earthquakes within approximately 100 miles of the capital city.

Follow the steps below to learn how to measure distance with the Radial tool.

Step 1: Zoom in to an area or location

The first step to measuring distance in maps with the Radial tool is to zoom in to an area or location in the map view. For more information about how to zoom in and out of the view, see [Zoom and Pan Views, and Select Marks](#) on page 1992.

You can also use map search to quickly navigate to a location in your map. For more information about how to use map search, see [Search for Locations in Your Map](#) on page 1895.

Note: You must zoom in to the map several times before you can measure distance with the Radial tool. The measured distance will not appear if you are zoomed too far out of the map. For more information, see the [Measurement accuracy](#) on page 1900 section.

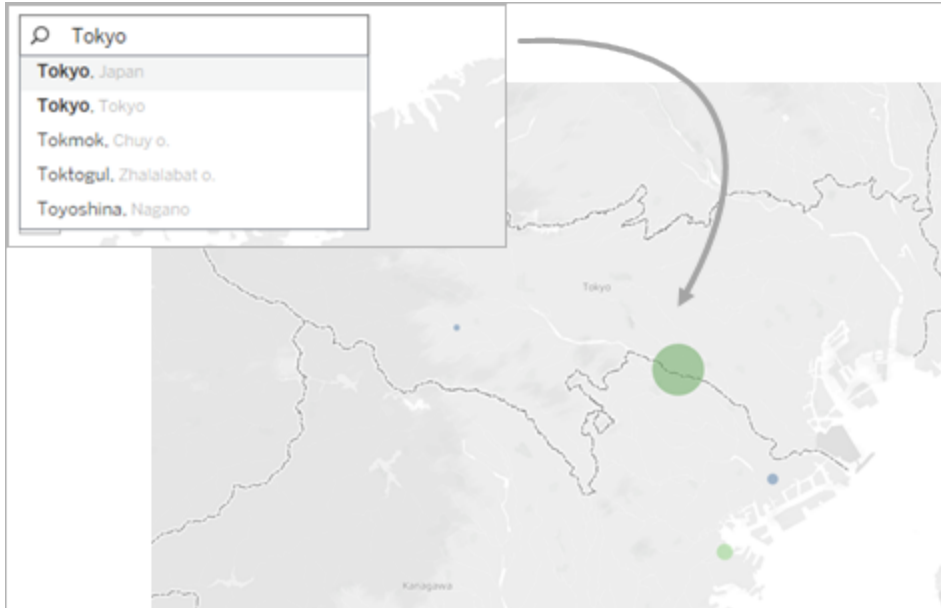

Step 2: Select the Radial tool

After you have zoomed in to a particular area or location in your view, select the Radial tool on the view toolbar, and then click and drag across the view. The measured distance appears to the right of the circle that appears when you drag across the view.

For more information about how to use the Radial tool, see [Select marks on page 1995](#).

Note: If you do not see a measured distance, you must zoom in further to a location or area in the view.

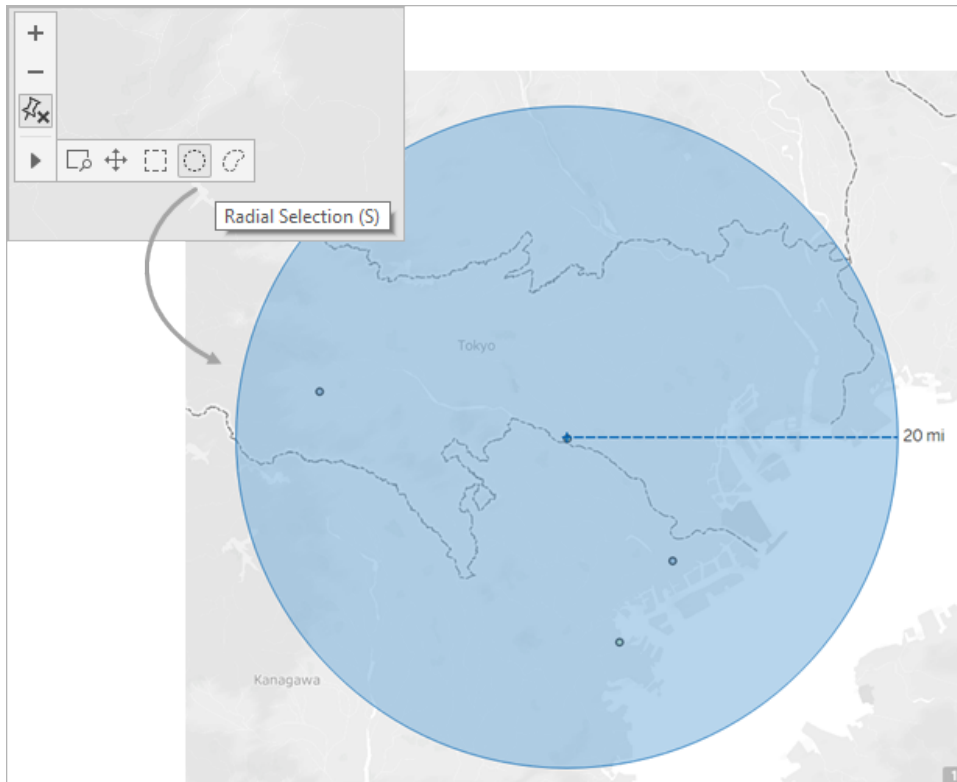

Note: If the view toolbar is hidden, press **S** on your keyboard to use the Radial tool.

As you drag, the Radial tool selects marks that are located within the radius of the circle. In this example, the radius is 100 miles, and it is centered over Jakarta. This means that, according to this data, all of the selected earthquakes (25) have occurred within approximately 100 miles of Jakarta in the past 10 years.

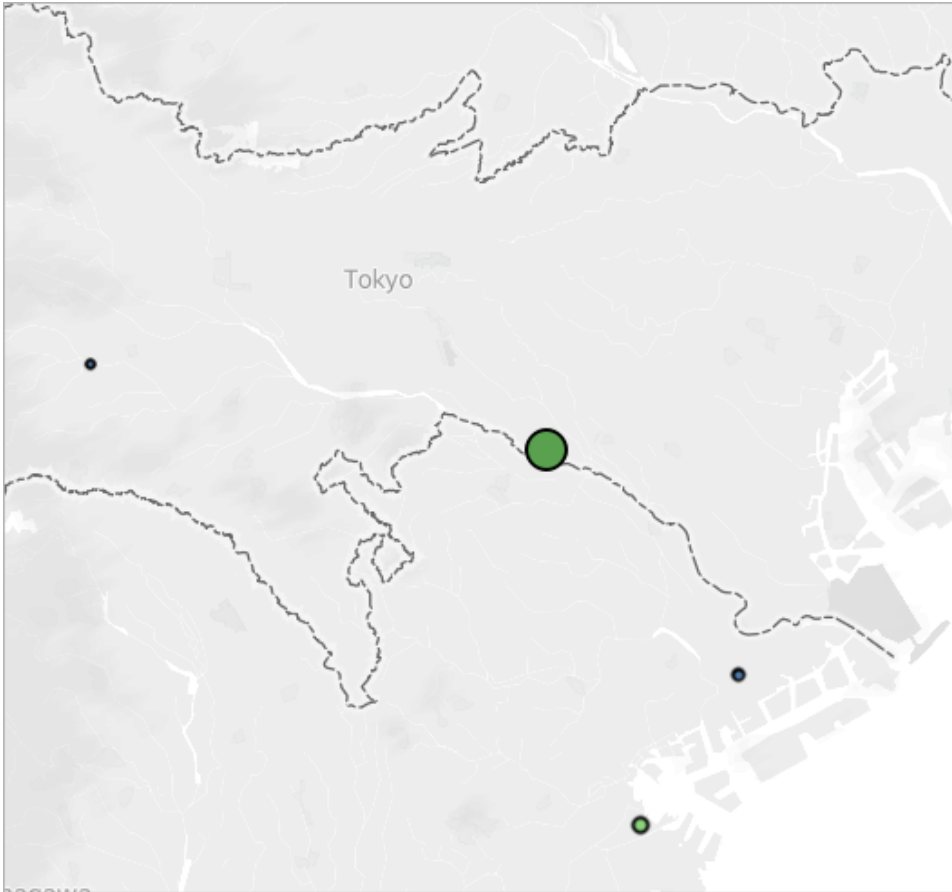

Measurement accuracy

By default, Radial tool measurements have a small margin of error because, in the map projection, distances become exaggerated and stretch as you move away from the equator. This means that the Radial tool can only measure approximate distances.

The Radial tool can measure distance more accurately the closer you are to the equator, and the further you zoom in to the view.

Note: By design, the Radial tool does not display a measured distance when you are zoomed too far out of the view, because the measurement might be inaccurate.

Change the units of measurement

By default, your workbook locale determines which units the Radial tool uses to measure distance. If your workbook locale is set to a country that uses the Imperial system, the Radial tool measures distance in feet and miles. If your workbook locale is set to a country that uses the Metric system, the Radial tool measures distance in meters and kilometers.

You can change the units the Radial tool uses to measure distance for any map view in your workbook.

To do so, select **Map > Map Options**. Next, under **Units**, click the drop-down menu and choose from the following:

- If you want to measure distances in meters and kilometers, select **Metric**.
- If you want to measure distances in feet and miles, select **U.S.**
- If you want the units of measurement to be determined by your workbook locale, select **Automatic**.

The units you choose will be saved with the workbook and will remain if you publish the map view to Tableau Server, Tableau Cloud, or Tableau Public.

See also:

[Show a map scale on page 1878](#)

Map Storing

When you create map views using the online map provider, Tableau stores the images that make up the map in a cache. That way, as you continue your analysis you don't have to wait for the maps to be retrieved. In addition, by storing the maps, you can do a certain amount of work when you are offline. For more information, see [Select Background Maps on page 1880](#).

The cache for the maps are stored with your temporary internet files and can be cleared at any time by deleting the temporary files from your browser.

Stored map images and legends remain valid for about thirty days. After that time, Tableau will not use the stored image; instead, it will require you to reconnect and fetch an updated map. This is to prevent the map images from becoming outdated.

Use Background Images in Your Views

Background images are images that you display underneath your data in order to add more context to the marks in the view. A common use of background images is adding custom map images that correspond to a coordinate system in your data.

For example, you might have data that corresponds to several floors in a building. You can use background images to overlay that data on the actual floor plan of the building to give more

context. Other examples of using background images include showing a model of the sea floor, images of web pages for analyzing web logs, and even levels from video games to visualize player statistics.

While Tableau allows you to load dynamic maps from the online and offline provider, background images allow you to use your own custom images whether they are special maps or any other image that corresponds to your data.

Add background images to your workbook

When you add a background image to the view, you need to specify a coordinate system by mapping both the X and Y axes to the values of fields in your database. If you are adding a map, the X and Y axes should be longitude and latitude expressed as a decimal. However, you can map the axes to any relevant fields based on your own coordinate system.

To add a background image:

1. Select **Map > Background Images** and then select a data source.

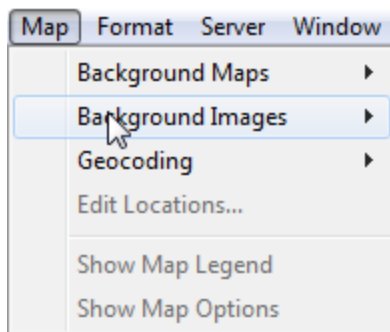

2. In the Background Images dialog box, click **Add Image**.

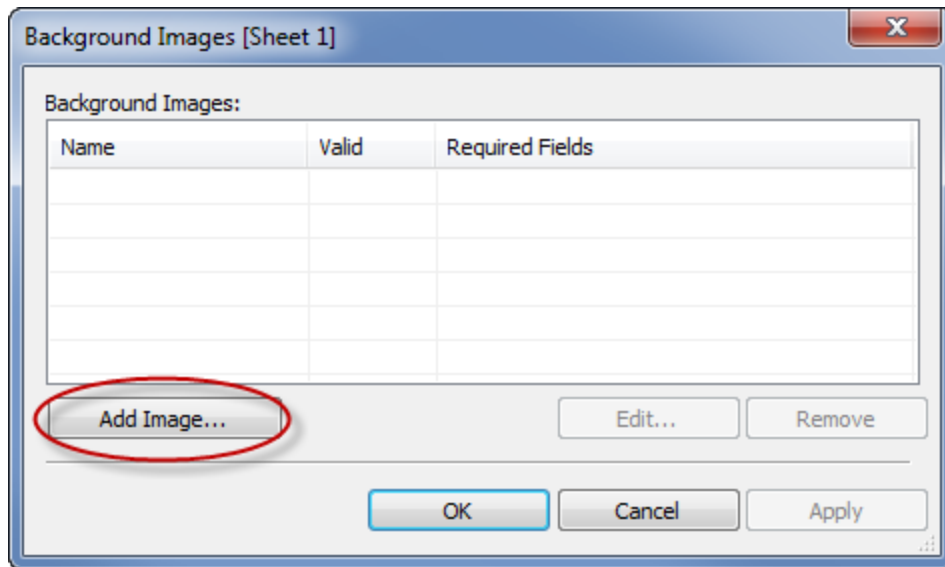

3. In the Add Background Image dialog box do the following:
 - Type a name for the image into the **Name** text box.
 - Click **Browse** to navigate to and select the image you want to add to the background. You can also type a URL to link to an image hosted online.
 - Select the field to map to the x-axis of the image and specify the left and right values. When adding a map, the longitude values should be mapped to the x-axis using decimal values (instead of degrees/minutes/seconds or N/S/E/W).
 - Select the field to map to the y-axis of the image and specify the top and bottom values. When adding a map, the latitude values should be mapped to the y-axis using decimal values (instead of degrees/minutes/seconds or N/S/E/W).
 - You can adjust the intensity of the image using the Washout slider. The farther the

slider moves to the right, the more faded the image will appear behind your data.

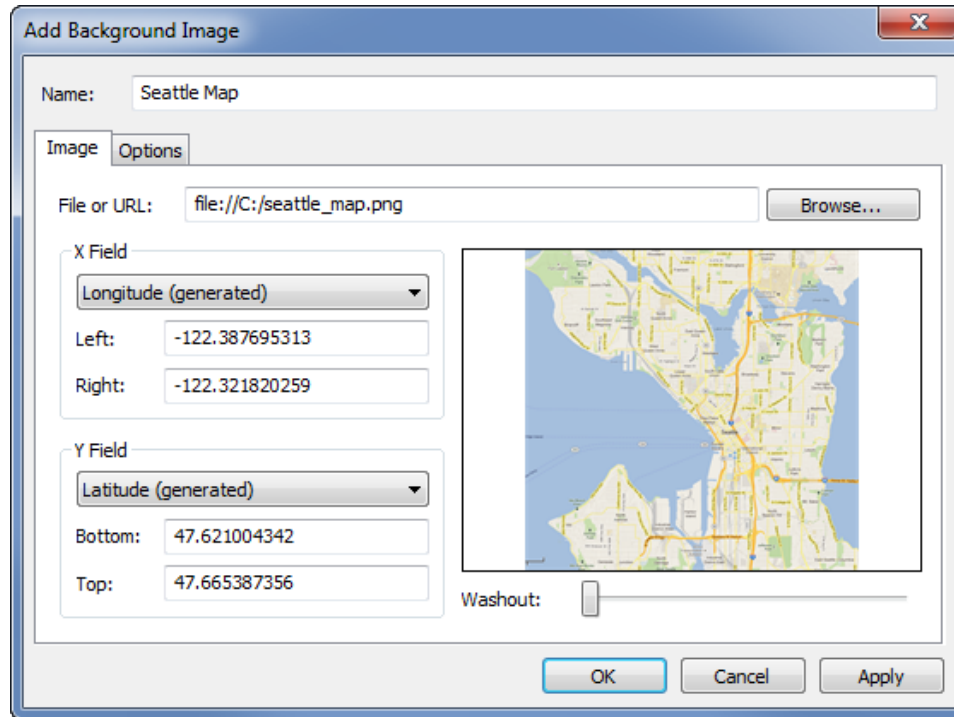

4. You can specify the following options using the **Options** tab:

- **Lock Aspect Ratio** - select this option to maintain the original dimensions of the image for any manipulations of the axes. Deselecting this option allows the image's shape to be distorted.
- **Always Show Entire Image** - select this option to avoid cropping the image when the data encompasses only a portion of the image. If you lock both the axis in a view, this option may be negated.
- Add conditions for when to show the image. Refer to [Filter Data from Your Views](#)

on page 1308 to learn more about defining conditions.

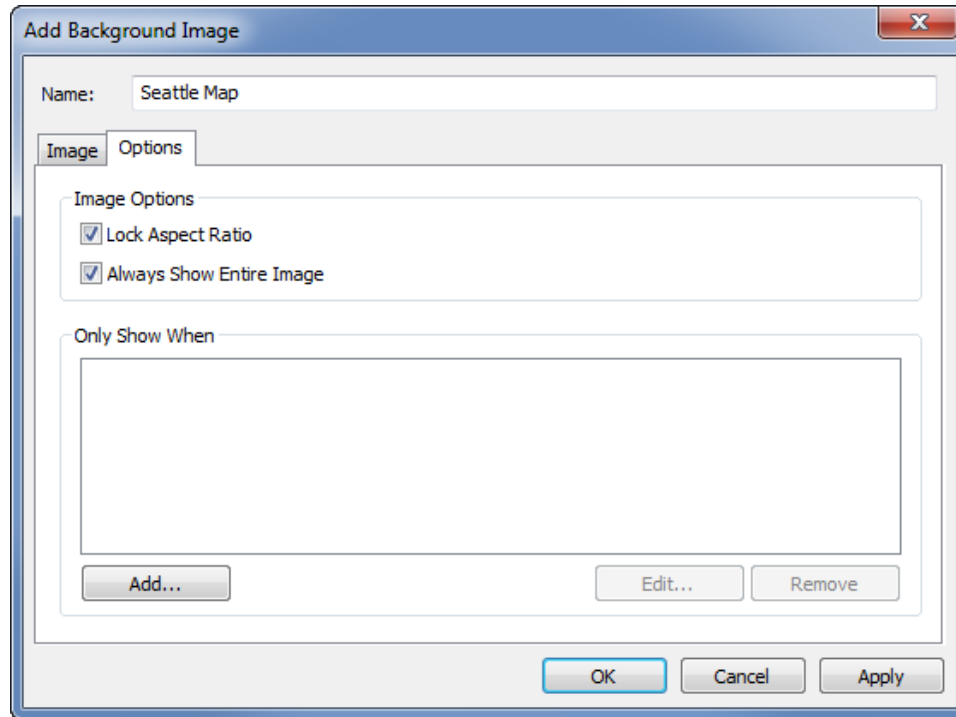

5. Click **OK**.

When you add the x and y fields to the Rows and Columns shelf in the view, the background image displays behind the data. If the background image does not display, make sure that you are using the disaggregated measures for the x and y fields. To disaggregate all measures, select **Analysis > Aggregate Measures**. To change each measure individually, right-click the field on the shelf and select **Dimension**. Finally, if you've used the generated Latitude and Longitude fields for the x and y fields, you'll need to disable the built in maps before your background image will display. Select **Map > Background Maps > None** to disable the built-in maps.

In order to make the marks in a view more visible when placed on top of a background image, each mark is surrounded by a solid contrasting color called a halo. You can turn mark halos off by selecting **Format > Show Mark Halos**.

Build a view with a background image

After you add a background image, you need to build the view in a way that matches the x and y mappings you specified for the image. That is, the fields you specified as x and y must be on the

proper shelves. Follow the steps below to set up the view correctly:

1. Place the field mapped to the x-axis on the **Columns** shelf.

If you are working with maps, the longitude field should be on the columns shelf. It may seem backward at first, however, the fields on the columns shelf determine the values distributed across the x-axis.

2. Place the field mapped to the y-axis on the **Rows** shelf.

If you are working with maps, the latitude field should be on the rows shelf. It may seem backward at first, however, the fields on the rows shelf determine the values distributed across the y-axis.

Edit a background image

After adding a background image, you can always go back and edit the x and y field mappings as well as any of the options on the Options tab.

To edit an image:

1. Select **Map > Background Images**.
2. In the Background Images dialog box, select the image you want to edit and click **Edit** (you can also just double-click the image name).

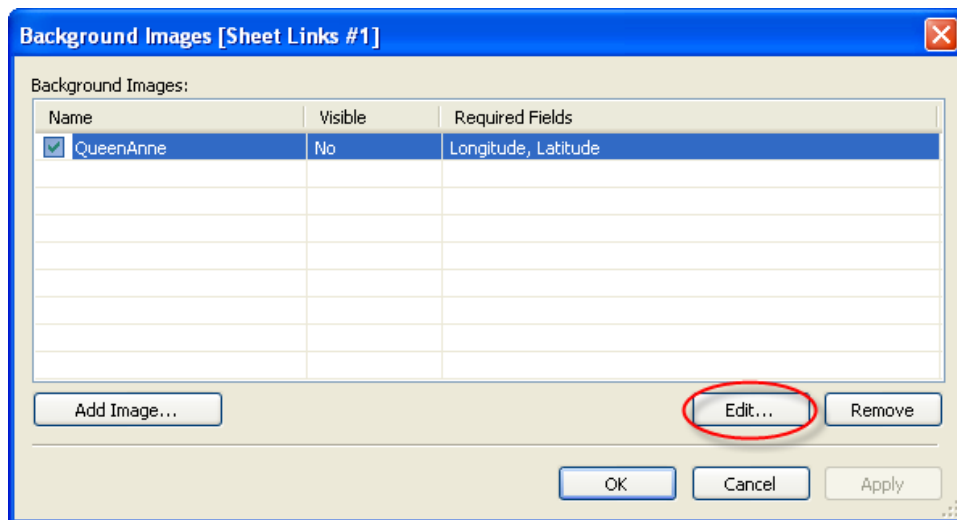

3. In the Edit Background Image dialog box, make the changes to the image and click **OK**.

Enable or disable background images

Although you can add multiple images to a workbook, you may want to only use a subset of the images for a particular set of worksheets. For example, you may want to show a map of the entire United States of America on one view, and maps of individual states in other views.

Use the check boxes in the Background Images dialog box to enable and disable the images for the current worksheet. You can show several images by enabling multiple images on a single worksheet. For example, you may have several images that you want to tile in the background to make a larger background image.

To enable or disable a background image:

1. Select **Map > Background Images**.
2. In the Background Images dialog box, select the check boxes next to the images you want enabled.

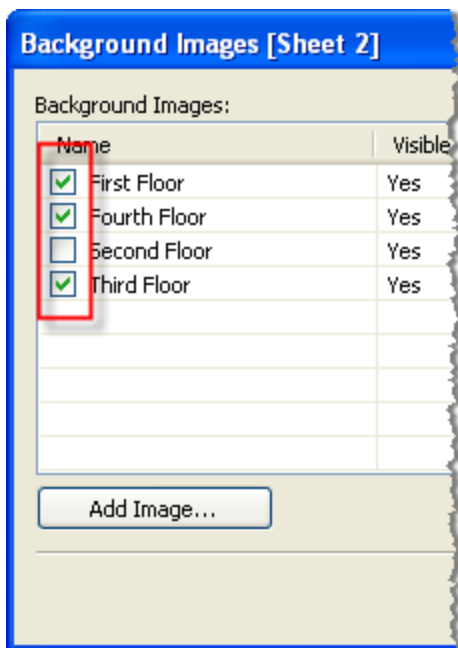

3. Click **OK**.

Add show and hide conditions to background images

When you add a background image and enable it, the image will be shown automatically on any worksheet that has the required fields used in the view. To avoid showing an image on all the worksheets, you can specify show/hide conditions. Show/Hide conditions are conditional statements that you define to specify when to show the image. For example, you may have a floor

plan image for a multi-story building. While each image is associated with the same coordinates (the corners of the building), you do not want to show the first floor map when looking at the third floor information. In this case, you can specify a condition to only show the first floor image when the Floor field is equal to one.

To specify show/hide conditions:

1. Select **Map > Background Images** and then select a data source.
2. In the Background Images dialog box, select the image you want to add a condition to and click **Edit**.
3. In the subsequent dialog box, select the **Options** tab.
4. Click the **Add** button at the bottom of the dialog box.

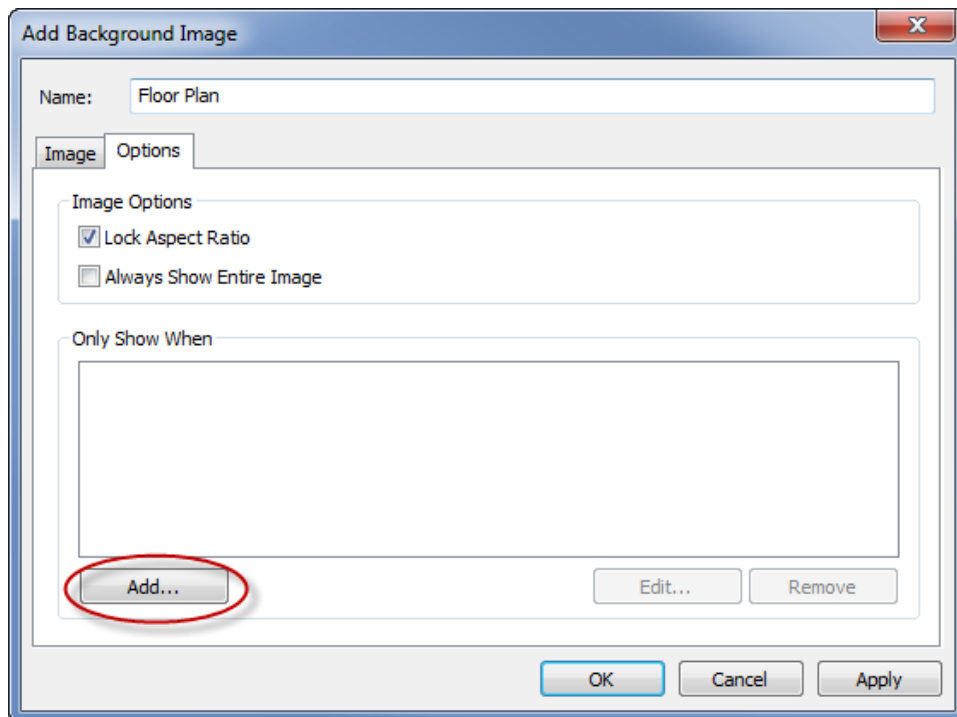

5. Select a field to base the condition on. In the example described above, the field is Floor.

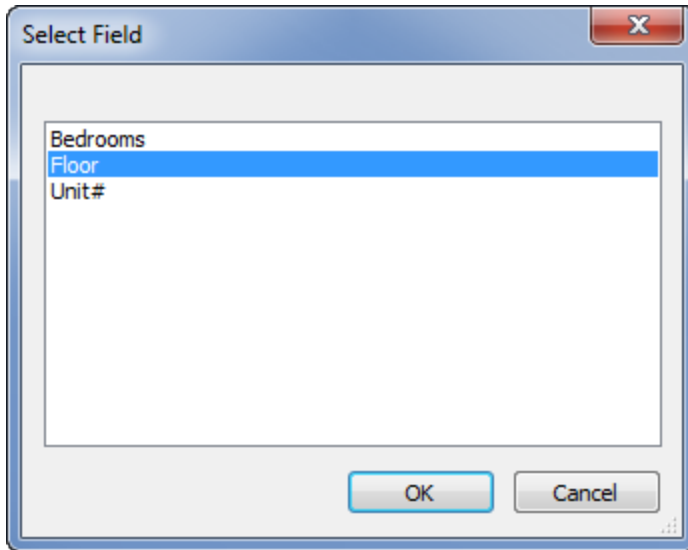

6. Specify when you want to show the image by selecting a value of the field. For this example, one is selected.

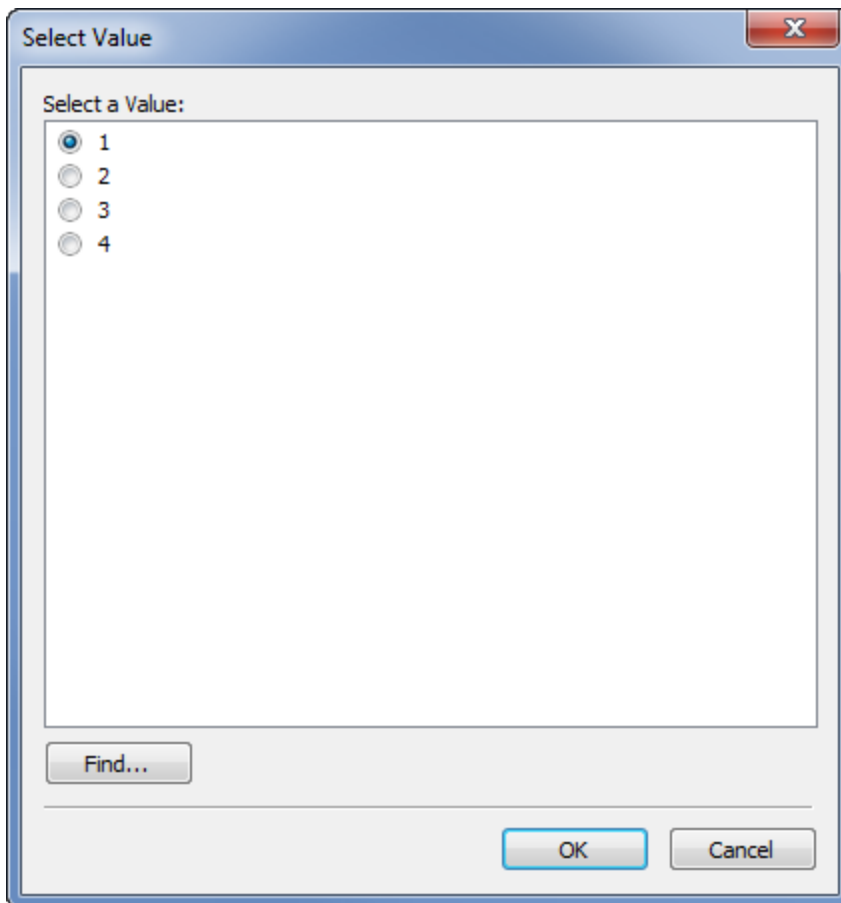

7. Click **OK**.

A condition statement is added to the image. In the building floor plan example, the condition statement is Only show the image when Floor is equal to One.

8. Click **OK** twice to close the Background Image dialog boxes and apply the changes.

When you add multiple conditions, the background image will only show when all conditions are met. For example, if a background image has two conditions on Property Name and Floor, it will only show when Property is Greenwood Estates and Floor is 3.

Remove a background image

When you no longer want to use a background image you can either disable it or remove it, making it unavailable to all worksheets.

To remove an image:

1. Select **Map > Background Images**.
2. In the Background Images dialog box, select the image you want to remove and click **Remove**.

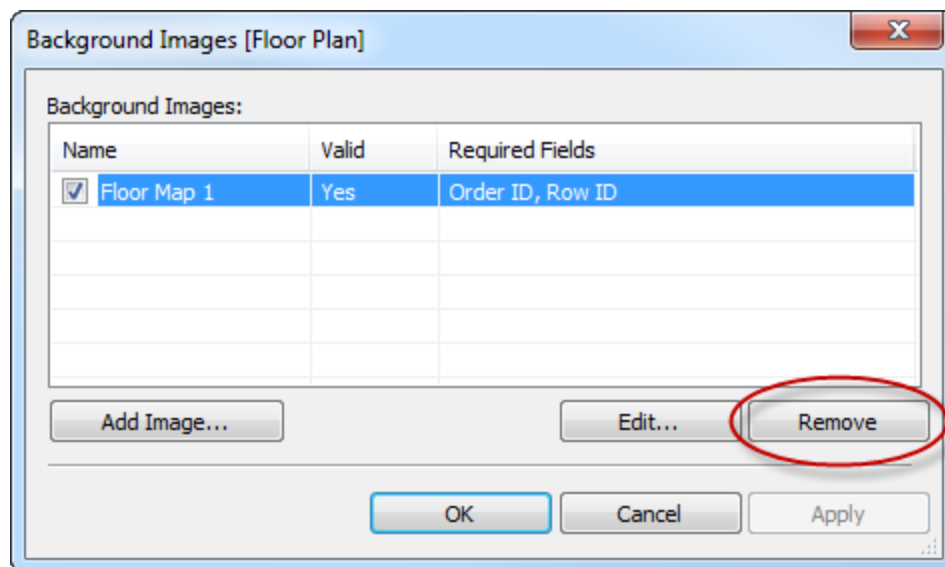

3. Click **OK**.

See Also

- [Maps and Geographic Data Analysis in Tableau](#) on page 1647

Add Images of Google Maps and OpenStreetMap as Background Images in Tableau

You can add images of Google Maps or OpenStreetMap as static background images in Tableau, and then plot data points onto them. To plot data points onto a background image of GoogleMaps or OpenStreetMap, you need both latitude and longitude coordinates of your data.

This topic describes how to obtain latitude and longitude coordinates for Google Maps and OpenStreetMap, as well as how to plot them on a background image in Tableau.

Step 1: Find your map coordinates

Follow the steps below to find map coordinates for Google Maps or OpenStreetMaps.

Option 1: Map data points onto Google Maps

1. Go to <http://www.gorissen.info/Pierre/maps/googleMapLocation.php> and locate the geographic area that you want to plot data points.
2. Once you have located the area you want, hover over the easternmost side of the area and write down the longitude coordinate (displayed in the bottom-right corner of the map). Do the same for the westernmost side of the area.
3. Hover over the northernmost part of the area and write down latitude coordinate. Do the same for the southernmost part of the area.

You should now have two latitude coordinates (one top and one bottom) and two longitude coordinates (one east and one west).

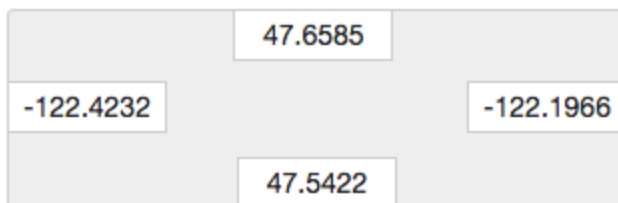

You will use these coordinates to define the scale of your background image in Tableau, and to ensure that you can plot data points onto the image using latitude and longitude coordinates.

4. Take a screenshot of your map and save it to your computer.
5. Follow the steps in "[Step 2: Add your map image as a background image below](#)" to add the image as a background image in Tableau.

Option 2: Map data points onto a map in OpenStreetMap

1. Go to <http://www.openstreetmap.org> and zoom in on the geographic area you want to plot data points.
2. On the top menu bar, click **Export**.

The Export pane provides the latitude and longitude coordinates of the area in the view. You can edit these coordinates to select a different area.
3. Write down the coordinates displayed in the box.
4. On the right side of the page, click the share icon, and then click the **Download** button.
5. Follow the steps listed in "[Step 2: Add your map image as a background image below](#)" to add the image as a background image in Tableau.

Step 2: Add your map image as a background image

1. Open Tableau Desktop and connect to the data you want to plot on the map image.
2. Select **Maps > Background Images**, and select the data source you want to use to plot data on your background image.
3. In the Background Images dialog box, click **Add Image**.
4. In the Add Background Image dialog box, click **Browse**, and then navigate to the location of the map image you created earlier in Step 1: Find your map coordinates.
5. In the Add Background Image dialog box, do the following:
 - For the **X Field** drop-down list, select **Longitude (generated)**.
 - In the **Left** box, type the easternmost longitude in your map image.
 - In the **Right** box, type the westernmost longitude in your map image.
 - For the **Y Field** drop-down list, select **Latitude (generated)**.
 - In the **Bottom** box, type the southernmost latitude in your map image.
 - In the **Top** box, type the northernmost latitude in your map image.

6. When finished, click **OK** in both the Add Background Image and Background Images dialog boxes.
7. Select **Maps>Background Maps>None**.
The background image shows up only if there is no background map.
8. From the Measures pane, drag **Latitude (generated)** to the **Row** shelf and **Longitude (generated)** to the **Column** shelf.
Your background image should appear in the view. If it does not, or if it appears at the wrong scale, complete the following steps to fix your axes.
 9. In the view, double-click the Y axis.
 10. In the Edit Axis dialog box, under Range, select **Fixed**.
 11. In the **Fixed start** text box, enter the bottom most longitude in your map image.
 12. In the **Fixed end** text box, enter the top most longitude in your map image.
 13. Click **OK**.
 14. Repeat steps 9 - 13 for the other axis.

To learn how to plot your data on the background image, see steps 1, 2, and 4 in [Find Background Image Coordinates](#) below.

See also:

[Use Background Images in Your Views](#) on page 1901

[Find Background Image Coordinates](#) below

[Use Mapbox Maps](#) on page 1882

[Use Web Map Service \(WMS\) Servers](#) on page 1885

[Select Background Maps](#) on page 1880

Find Background Image Coordinates

In many scenarios, you might want to map your data onto a background image instead of on a Tableau map. This article explains how to plot data points on a background image.

There are several steps to this process:

1. Create a table in your data source for X and Y coordinates.
2. Connect to your data source in Tableau Desktop and join the coordinate table with the rest of your data.
3. Import your background image and build the view.
4. Annotate points on the background image.
5. Add coordinates to the coordinates table in your data source.
6. Refresh your data source in Tableau.

Step 1: Create the coordinate table

Create a table in your data source that contains columns to identify a unique mark. In this example, there are three columns:

- The first column holds the unique identifier for each mark.
- The other two columns are for the X and Y coordinates.

After you create your columns, you join the new coordinate table to the original data source. The join is based on the unique identifier used in both the original data source and the coordinate table (the identifier that represents a single mark).

1. Select a scale that is appropriate for your background image. If the image is wider than it is tall, use X: 0-100 and Y: 0-50.
2. For this example, open the Sample Superstore Excel file from your Tableau repository in Excel and select a new sheet tab.
3. On the new tab, put a single row in a table that contains one of the unique identifiers and the X and Y end points you selected for your two scales.

In this case, **Product Sub-category** is a column in Sample Superstore, and one of its members is **Tables**. The **X** endpoint is **100**, and the **Y** endpoint is **50** because that is the scale for the background image.

	A	B	C	D
1	Product Sub-category	X	Y	
2	Tables	100	50	
3				
4				
5				

4. Change the tab name to **Coords** and save the file.

Step 2: Connect to the coordinate table

1. In a new Tableau workbook, select **Connect to Data**.
2. In the **Connect to Data** dialog box, select **Microsoft Excel** and then click **Next**.
3. On the data source page, do the following:
 - Drag the Orders sheet to the Join area.
 - Drag the Coords sheet to the Join area.
 - Click the join icon to modify the existing join.
 - In the Join dialog box that opens, select **Left**, and then select **Product Sub-Category** for the **Data Source** column, and **Product Name (Coords)** for the **Coords** column.

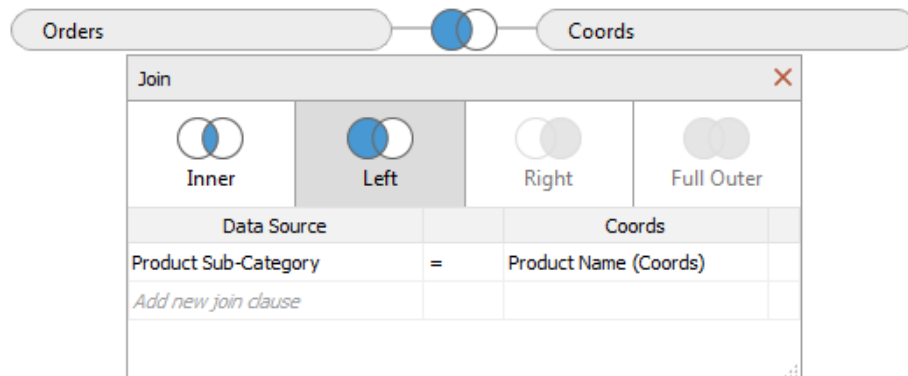

4. Close the Join dialog box, and then select the sheet tab to go to a worksheet.

Step 3: Import the background image

1. In the new worksheet, select **Maps > Background Images, Sample - Superstore**. This opens the Background Images dialog box.

2. In the **Background Images** dialog box, click **Add Image**.
3. In the **Add Background Image** dialog box, browse to and select the file.
4. For **X Field**, select **X** in the list.

Note: If you do not see the X field in the list, it means that you need to change the X field to be a continuous number.

To change the field to be a number, right-click the **X** field in the Data pane, and select **Change Data Type > Number (Whole)**. To convert the field to be continuous, right-click the **X** field in the Data pane, and select **Convert to Continuous**.

Repeat these steps for the **Y** field.

5. In the **Right** text box, type **100** (100 is the number you used in the coordinate table).
6. For **Y Field**, select **Y** in the list.
7. In the **Top** text box, type **50** (50 is the number you used in the coordinate table). Be sure to type in the correct text box.

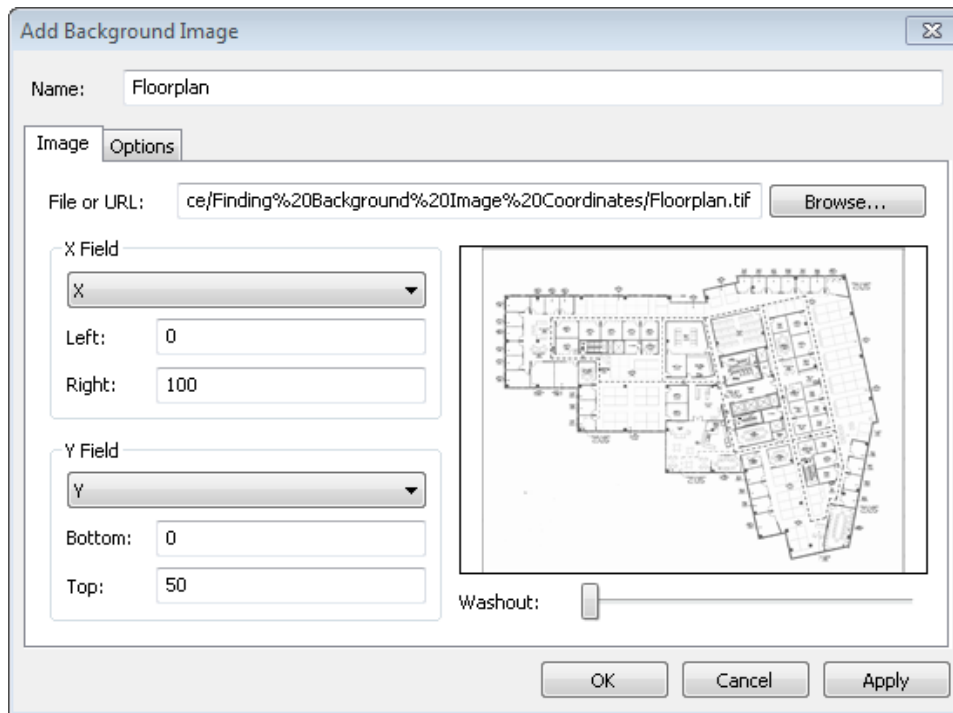

8. Click **OK**, and then click **OK** in the **Background Images** dialog box. (Disregard the **Valid** setting of **No** in the **Background Images** dialog box.)

Step 4: Find the coordinates

1. From the Data pane, drag **X** to the **Columns** shelf and **Y** to the **Rows** shelf.
2. On the **Columns** shelf, right-click **X** and select **Dimension**.
3. On the **Rows** shelf, right-click **Y** and select **Dimension**.

Note: This step is only necessary if the X and Y fields were brought in to Tableau as Measures.

The background image appears in the view.



4. Right-click the X axis and select **Edit Axis**.

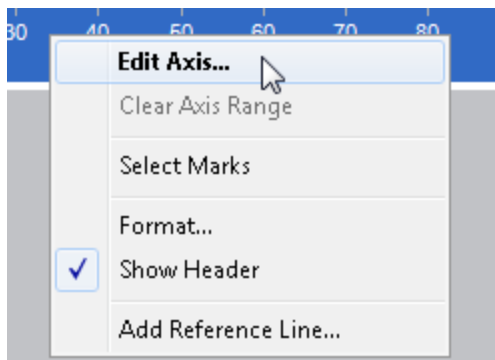

5. In the **Edit Axis** dialog box, select **Fixed**, and then in the **Start** text box, type **0**, and in the **End** text box, type **100**.
6. Click **OK**.
7. Right-click the Y axis and select **Edit Axis**.

- In the **Edit Axis** dialog box, select **Fixed**, and then in the **Start** text box, type **0**, and in the **End** text box, type **50**.
- Click **OK**.

Now the axes start at zero.

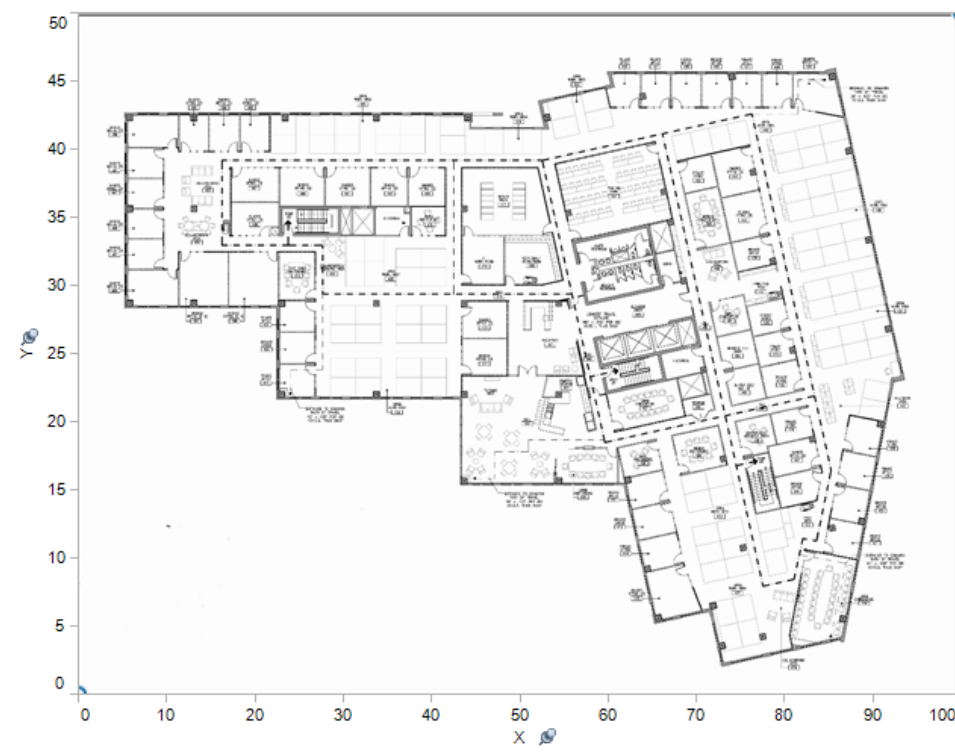

- Right-click anywhere on the image where you want to find the coordinates, and select **Annotate > Point**.

For more information about annotating marks or points in the view, see the [Add Annotations](#) on page 1362 topic in the Tableau Help.

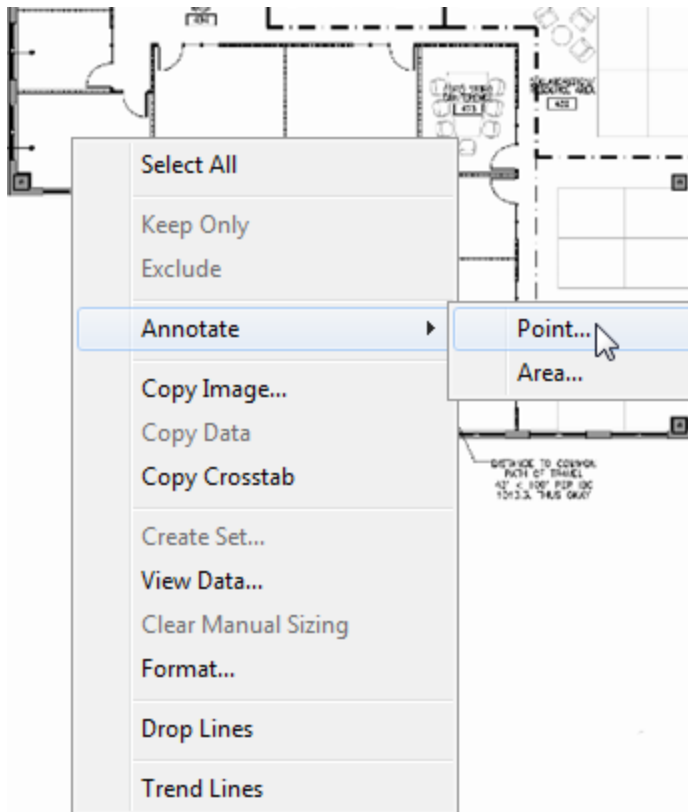

11. In the **Edit Annotation** dialog box, click **OK**.
12. Repeat steps 10 and 11 for each point you want to annotate.

The coordinates appear on the background image as a callout. You can move a callout to a location where it shows up better; just click and drag it. You can also resize the callout by dragging one of the size handles. You can move a coordinate point to a new location by clicking and dragging the arrowhead; the coordinates in the callout change to reflect the new location.

	A	B	C	D
1	Product Sub-category	X	Y	
2	Tables	100	50	
3	Labels	17.16	41.42	
4	Paper	9.00	29.81	
5	Bookcases	23.95	23.21	
6	Office machines	32.27	22.77	
7				
8				

14. In Tableau, select **Data > Sample - Superstore > Refresh**.

The refreshed view displays marks at the coordinate locations.

If you don't want to continue to display the callouts, you can select and remove them on the background image.

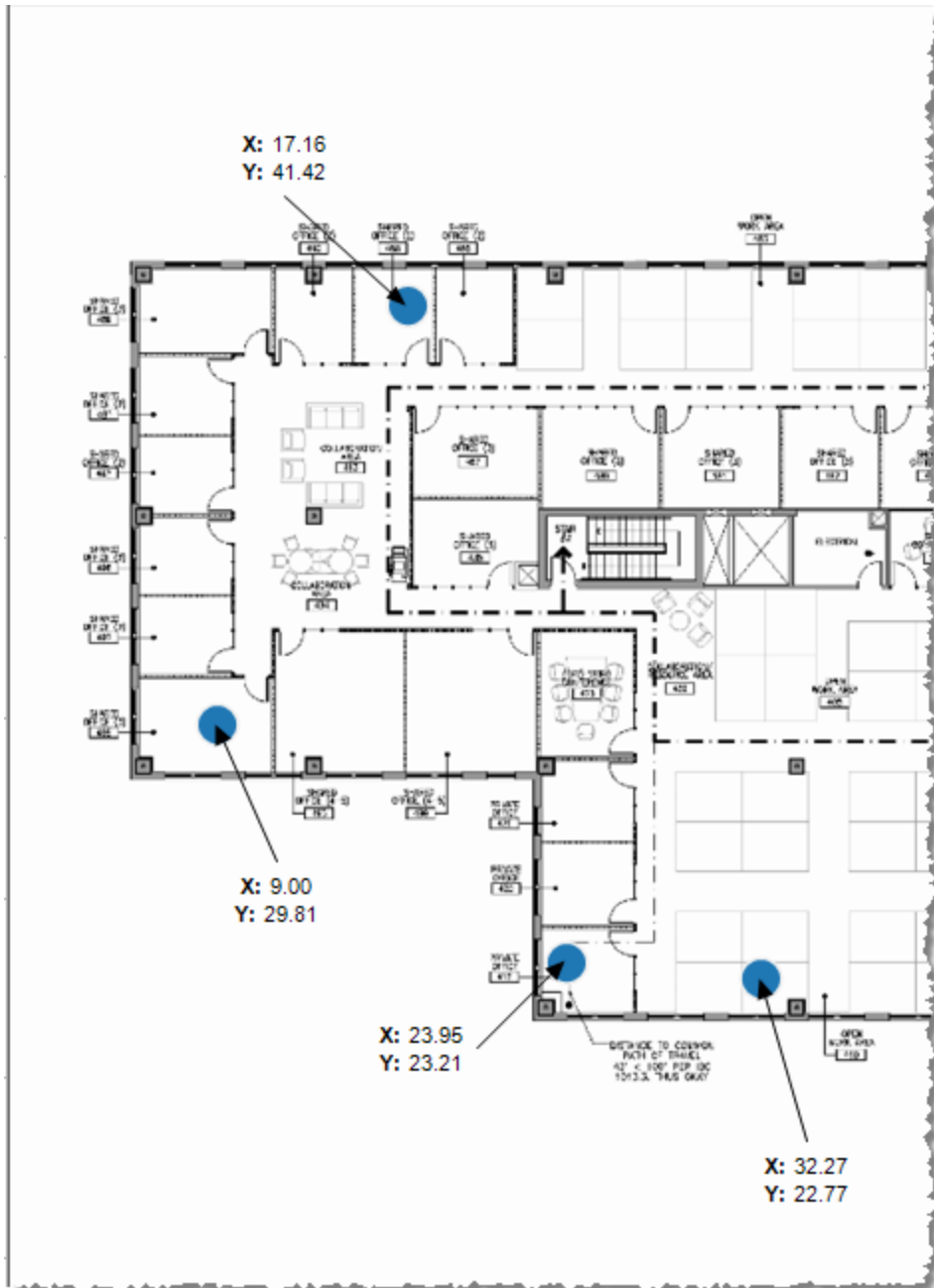

Other Ideas

Try placing another Measure on the Size shelf and put either a Dimension or Measure on Color on the Marks card. Add your own custom shapes. Develop powerful and unique analyses by creating Actions between this view and your other analyses.

If you want to hide the X and Y scales, right-click the respective field on the Columns or Rows shelf and clear **Show Header**.

See also

- [Use Background Images in Your Views](#) on page 1901
- [Maps and Geographic Data Analysis in Tableau](#) on page 1647

Add Viz Extensions to Your Worksheet

Viz Extensions are web applications that can extend the native visual capabilities of Tableau. Viz Extensions give users the ability to interact with custom viz types on their worksheets.

Tableau Extensions expand worksheet functionality with the help of web applications created by Tableau, Tableau Partners, and third-party developers in our community. If you're a developer and want to create your own extensions, see the [Tableau Extensions API](#) documentation on GitHub.

A Viz Extension is similar to a [dashboard extension](#) in that it's a web application that is hosted on the [Tableau Exchange](#). It's different from a dashboard extension in that you add it to a worksheet while building the viz, rather than adding it to a dashboard as an object.

Add a Viz Extension to a worksheet

There are two ways to add a Viz Extension to your worksheet via the Marks card. If you've already downloaded it through the Tableau Exchange, you can add it as a local file. Or you can download it from the Tableau Exchange in the flow of authoring your Viz.

Add a Viz Extension as a local file

If you've already selected and downloaded a Viz Extension from the Tableau Exchange, it will be saved on your computer as a .trex file.

1. Open a Tableau workbook and connect to your data source.
2. In a worksheet, on the Marks card, expand the Mark type dropdown menu.
3. Under Viz Extensions, select **Add Extension**.

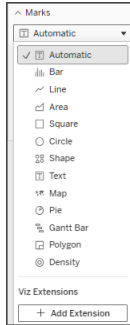

4. In the Add an Extension dialog box that appears, select **Access Local Viz Extensions**.

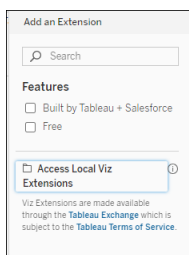

5. Navigate to and open the saved .trex file.
6. If prompted, allow or deny the Viz Extension access to data in the workbook.

The Viz Extension loads in the view, and the mark type changes to the name of the Viz Extension.

Add a Viz Extension while authoring your viz

If you haven't already selected and downloaded a Viz Extension, you can do so in the flow of authoring a viz.

1. Open a Tableau workbook and connect to your data source.
2. In a worksheet, on the Marks card, expand the Mark type dropdown menu.
3. Under Viz Extensions, select **Add Extension**.

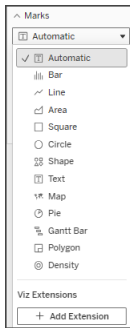

4. In the Add an Extension dialog box that appears, select the Viz Extension that you'd like to load onto your worksheet. In this example, we're loading a Sankey diagram built by Tableau.

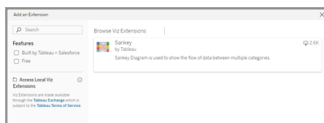

5. If prompted, allow or deny the Viz Extension access to data in the workbook. For more information, see Data security, Network-enabled, and Sandboxed extensions.
6. Select **Open**.

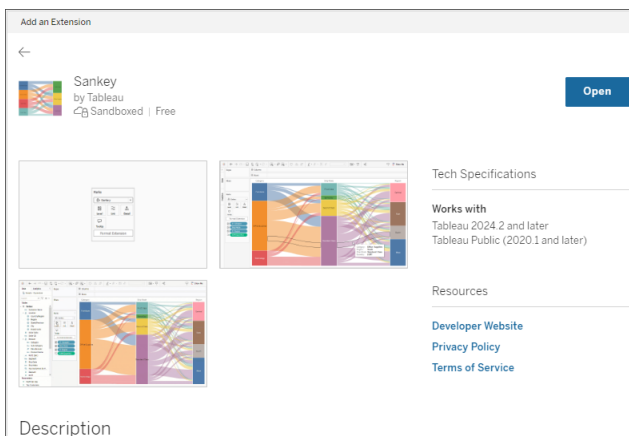

The Viz Extension loads in the view, and the mark type changes to the name of the Viz Extension.

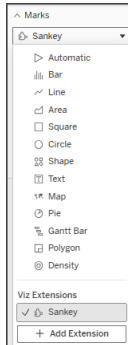

Use the Marks card to encode your marks

Drag fields onto the encoding boxes on the Marks card to build the viz. The Mark encoding boxes and formatting options are determined by the developer. Check the extension description on the Tableau Exchange for information on the Viz Extension you're loading.

To follow along with the Sankey extension, follow these encoding instructions:

The Sankey extension is built to use extension-specific encoding for **Levels** and **Links**. These can be used with the built-in Marks encoding boxes Tooltip and Details to build the Sankey on the worksheet.

- **Level** - Sankey levels represent the categorical dimensions that are related by the Sankey. In this extension, you can include up to 5 discrete dimensions as Levels.
- **Link** - Sankey links connect the categories across the Sankey. This encoding will size the width of each link based on a numeric measure.

Ensure that extensions are allowed on Tableau Cloud

If you're not able to add a Viz Extension, check to see if extensions have been allowed on your site. A Tableau administrator must allow extensions to run on a site and add Network-enabled extensions to an allow list. Administrators should only allow extensions that you have tested and trust.

To learn more about adding Network-enabled extensions to an allow list, see [Tableau Help: Change the default settings for a site.](#)

Data security, Network-enabled, and Sandboxed extensions

Extensions are web applications that come in two forms:

- *Network-enabled extensions* run on web servers located outside of your local network.
- *Sandboxed extensions* run in a protected environment without access to any other resource or service on the web.

Before adding a Network-enabled extension, be certain that you trust the website that hosts it. By default, extensions use the HTTPS protocol, which guarantees an encrypted channel for sending and receiving data, and ensures some privacy and security.

For more information about data security when using extensions, see [Extension Security - Best Practices for Deployment](#).

Allow or deny data access to a Network-enabled extension

Depending on how an extension is designed, it can access either visible data in a view, or full underlying data, table and field names from data sources, and information about data source connections. When you add an extension, you're given an opportunity to allow or deny the extension to run and access this data.

Reset data access for your extension

If you need to reset the data access permissions for your extension, you can simply reload the extension by selecting Add Extension on the Marks card, and then re-adding the extension to the worksheet. These steps kick off the process to allow or deny access to the extension.

Ensure that JavaScript is enabled in Tableau Desktop

Viz extensions interact with data using the Tableau Extensions API library, a JavaScript library. If you want to use extensions, be sure that JavaScript is enabled in the security settings:

Choose **Help > Settings and Performance > Set Dashboard Web View Security > Enable JavaScript**.

Get support for Viz Extensions

To get help for an extension, you'll need to contact the developer or company who created it through the Tableau Exchange.

Note: Tableau doesn't provide support for extensions or for other programs that interface with the Extensions API. However, you can submit questions and ask for help in the [Tableau developer community](#).

Analyze Data

This section describes the various ways you can perform more advanced analysis in Tableau. Read the following articles for information on how to create calculated fields, find clusters in data, calculate percentages, and use various tools to explore and inspect data.

Discover Insights Faster with Explain Data

Explain Data in the Data Guide helps you to inspect, uncover, and dig deeper into the marks in a viz as you explore your data. You can use Explain Data to analyze dashboards, sheets, or selected marks for possible outliers and correlations in the underlying data. Explain Data builds statistical models and proposes possible explanations for individual marks in a viz, including potentially related data from the data source that isn't used in the current view.

For information on running Explain Data and exploring explanations, see [Get Started with Explain Data](#) on the next page.

Note: This topic describes how Explain Data works in Tableau 2021.2 and later versions. If you have a previous version of Tableau, read this topic in [version 2021.1 of Explain Data help](#).

As you build different views, use Explain Data as a jumping-off point to help you explore your data more deeply and ask better questions. For more information, see [How Explain Data helps to augment your analysis](#) on the next page. For information on what characteristics make a data source more interesting for use with Explain Data, see [Requirements and Considerations for Using Explain Data](#) on page 1959.

Access to Explain Data

Explain Data is enabled by default at the site level. Server administrators (Tableau Server) and site administrators (Tableau Cloud) can control whether Explain Data is available for a site. For more information, see [Disable or Enable Explain Data for a Site](#) on page 1978.

Authors who can edit workbooks and have the Run Explain Data permission capability for a workbook can run Explain Data in editing mode. All users with the Run Explain Data capability can run Explain Data in viewing mode in Tableau Cloud and Tableau Server.

When allowed by site administrators, explanations can be shared in viewing mode via email or Slack with other Tableau Cloud and Tableau Server users. For more information, see [Configure Tableau to allow users to share explanations via email and Slack](#) on page 1966.

Authors can use Explain Data Settings to control which explanation types are displayed in the Data Guide pane.

For information on controlling access to Explain Data, explanation types, and fields, see [Control Access to Explain Data](#) on page 1961.

How Explain Data helps to augment your analysis

Explain Data is a tool that uncovers and describes relationships in your data. It can't tell you what is causing the relationships or how to interpret the data. **You are the expert on your data.** Your domain knowledge and intuition are key in helping you decide what characteristics might be interesting to explore further using different views. For related information, see [How Explain Data Works](#) on page 1967 and [Requirements and Considerations for Using Explain Data](#) on page 1959.

For more information on how Explain Data works and how to use Explain Data to augment your analysis, see these Tableau Conference presentations:

- [From Analyst to Statistician: Explain Data in Practice \(1 hour\)](#)
- [Leveraging Explain Data \(45 minutes\)](#)

Get Started with Explain Data

Use Explain Data in your flow of analysis as you are exploring the marks in a viz. Explain Data runs automatically when the Data Guide pane is open and updates based on the current selection (dashboard, sheet, or mark).

Use Explain Data

- [Run Explain Data on a dashboard, sheet, or mark](#) on the facing page
- [Drill into explanations](#) on page 1934
- [View analyzed fields](#) on page 1934

Author Workbooks and Control Access

- [Requirements and Considerations for Using Explain Data](#)
- [Change Explain Data Settings \(Authors-only\)](#)

- **Terms and concepts in explanations** on page 1936
- **Explanation Types**
- **Control Access to Explain Data** on page 1961
- **Disable or Enable Explain Data for a Site** on page 1978
- **How Explain Data Works** on page 1967

Run Explain Data on a dashboard, sheet, or mark

These are the basic steps to run Explain Data in Tableau Desktop, Tableau Cloud, and Tableau Server:

1. Open a dashboard or sheet in a workbook.
2. In the view toolbar, select **Data Guide** to open the Data Guide pane.
3. If you open a dashboard, Explain Data will analyze it for outliers.

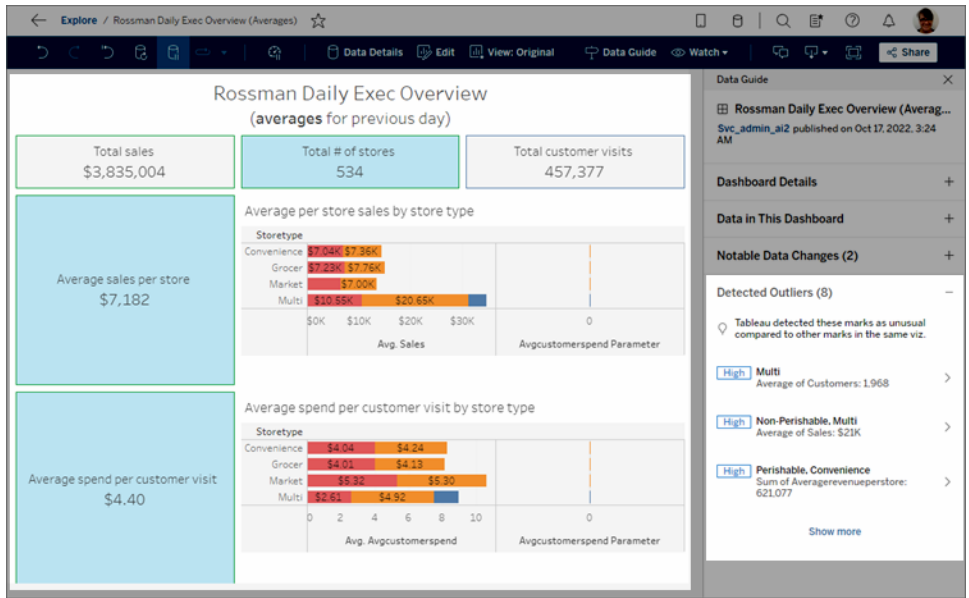

If you select a sheet in the dashboard, Explain Data analyzes the marks in that sheet for outliers.

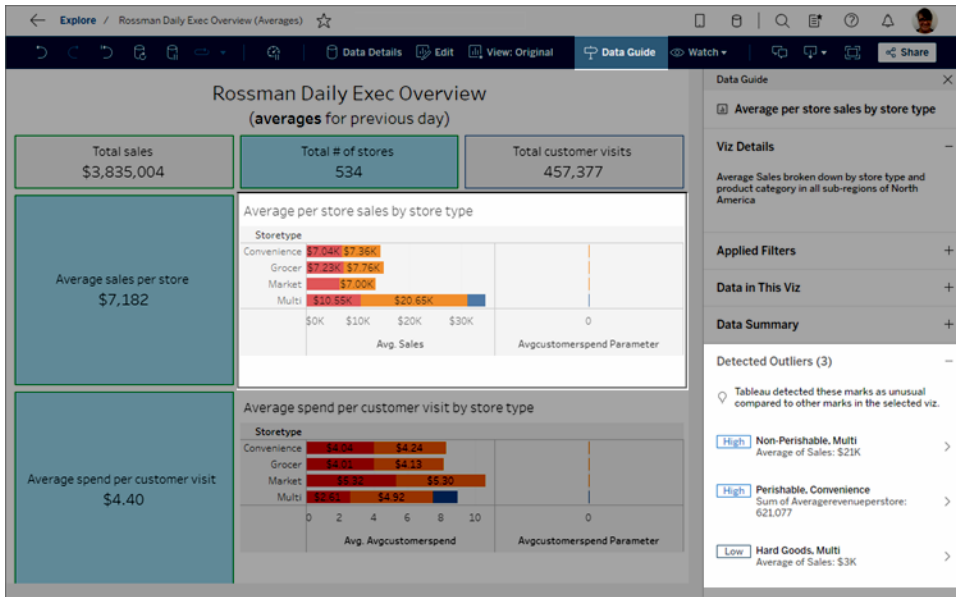

If you select a mark in the dashboard, Explain Data specifically analyzes that mark for explanations.

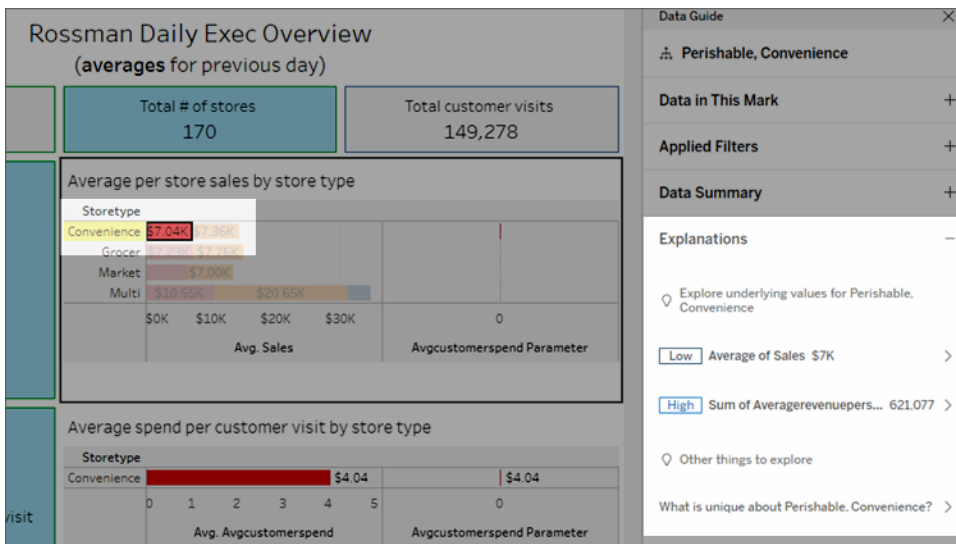

The marks that are being explained are highlighted in the viz as you select corresponding explanations.

Optionally, you can select a mark in a viz, hover the cursor over the mark. In the tooltip menu, select **Data Guide**.

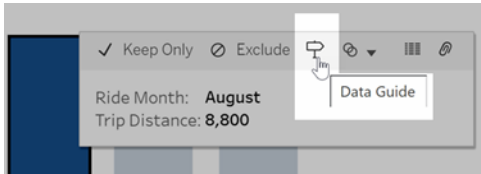

In Tableau Public, select the lightbulb in the tooltip menu to run Explain Data.

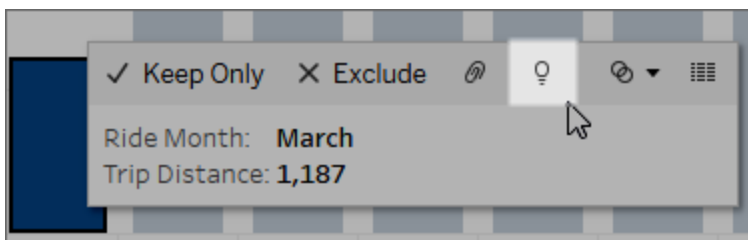

Possible explanations for the value of the analyzed mark are displayed in the Data Guide pane. Select different explanation names to expand the details and start exploring.

Explain Data permissions required for seeing explanations

If you see Detected Outliers with a note to contact the owner of the viz, it is because you need permission to see these types of explanations. Select the owner name to go to their Tableau content page with their email address. Contact the owner to ask them to give you Explain Data permissions for the workbook or view.

If you are the owner of the workbook, for more information on setting permissions, see [Control who can use Explain Data and what they can see on page 1962](#).

Tips for using Explain Data

- Multiple marks can't be selected for comparison with each other.
- The view must contain marks that are aggregated using SUM, AVG, COUNT, COUNTD, or AGG (a calculated field).
- When Explain Data cannot analyze the type of mark selected, a message is displayed to indicate why. For more information, see [Situations where Explain Data is not available](#).



- The data you analyze must be drawn from a single, primary data source. Explain Data does not work with blended or cube data sources.
- For information on what characteristics make a data source more interesting for use with Explain Data, see [Requirements and Considerations for Using Explain Data on page 1959](#).

Drill into explanations

1. In the Data Guide pane, select an explanation name to see more details.
Select an explanation to expand or contract its details.
2. Scroll to see more explanation details.
3. Hover over charts in the explanations to see details on different data points. Select the **Open**  icon to see a larger version of the visualization.

Creators or Explorers who open the view for editing can select the **Open**  icon to open the visualization as a new worksheet and explore the data further.

Note: Creators and Explorers who have editing permissions can also control Explain Data Settings. For more information, see [Control Access to Explain Data on page 1961](#).

4. Hover over a Help icon  to see tooltip help for an explanation. Select the Help icon  to keep the tooltip open. Select a **Learn More** link to open the related help topic.

View analyzed fields

1. [Run Explain Data on a dashboard, sheet, or mark on page 1931](#).

2. In the Data Guide pane, under **Explore underlying values for**, select a target measure name.

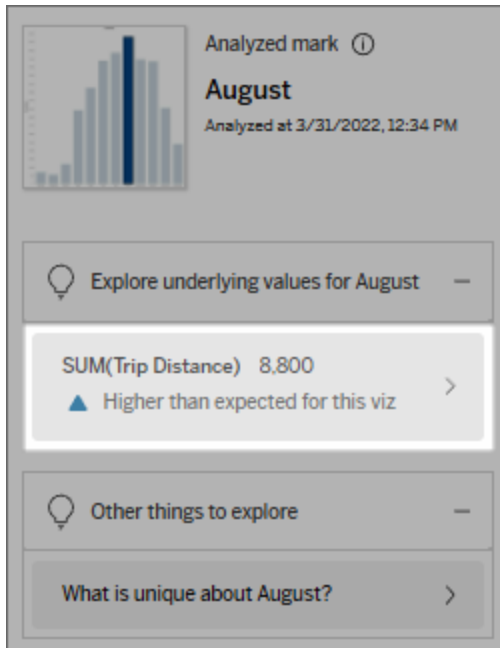

3. Select the *number-of-fields* link at the bottom of the pane.

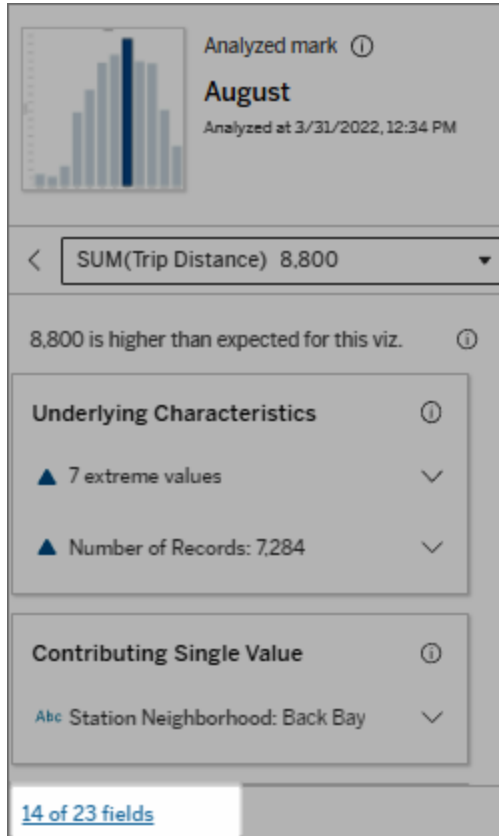

Authors have the option to open Explain Data Settings to control which fields are included in the analysis. For more information, see [Change fields used for statistical analysis](#).

Terms and concepts in explanations

The following terms and concepts appear frequently in explanations. You may find it helpful to become acquainted with their meaning in the context of using Explain Data.

What is a mark?

A mark is a selectable data point that summarizes some underlying record values in your data. A mark can be made of a single record or multiple records aggregated together. Marks in Tableau can be displayed in many different ways such as lines, shapes, bars, and cell text.

Tableau gets the records that make up the mark based on the intersection of the fields in the view.

The **analyzed mark** refers to a mark in a dashboard or sheet that was analyzed by Explain Data.

For more information on marks, see [Marks](#).

What does expected mean?

The expected value for a mark is the median value in the expected range of values in the underlying data in your viz. The expected range is the range of values between the 15th and 85th percentile that the statistical model predicts for the analyzed mark. Tableau determines the expected range each time it runs a statistical analysis on a selected mark.

If an expected value summary says the mark is *lower than expected* or *higher than expected*, it means the aggregated mark value is outside the range of values that a statistical model is predicting for the mark. If an expected value summary says the mark is *slightly lower* or *slightly higher* than expected or *within the range of natural variation*, it means the aggregated mark value is within the range of predicted mark values, but is lower or higher than the median.

For more information, see [What is an expected range?](#)

What are dimensions and measures?

Each column name in a database is a field. For example, Product Name and Sales are each fields. In Tableau, fields like Product Name that categorize data are called dimensions; fields with quantifiable data like Sales are called measures. Tableau aggregates measures by default when you drag them into a view.

Some explanations describe how the underlying record values and the aggregations of those values may be contributing to the value of the analyzed mark. Other explanations may mention the distribution of values across a dimension for the analyzed mark.

When you run Explain Data on mark, the analysis considers dimensions and measures in the data source that aren't represented in the view. These fields are referred to as unvisualized dimensions and unvisualized measures.

For more information on dimensions and measures, see [Dimensions and Measures](#).

What is an aggregate or aggregation?

An aggregate is a value that is a summary or total. Tableau automatically applies aggregations such as SUM or AVG whenever you drag a measure onto Rows, Columns, a Marks card option, or the view. For example, measures are displayed as SUM(Sales) or AVG(Sales) to indicate how the measure is being aggregated.

To use Explain Data, your visualization must use a measure that is aggregated with SUM, AVG, COUNT, COUNTD, or AGG.

For more information about aggregation, see [Data Aggregation in Tableau](#).

What is a record value?

A record is a row in a database table. A row contains values that correspond to each field. In this example, Category, Product Name, and Sales are fields (or columns). Furniture, Floor Lamp, and \$96 are the values.

Category	Product Name	Sales
Furniture	Floor Lamp	\$96.00

What is a distribution?

A distribution is a list of all the possible values (or intervals) of the data. It also indicates how often each value occurs (frequency of occurrence).

Explanation Types in Explain Data

Each time you select a new mark in a viz or dashboard and run Explain Data, Tableau runs a new statistical analysis considering that mark and the underlying data in the workbook. Possible explanations are displayed in expandable sections for the Data Guide pane. For information about how Explain Data analyzes and evaluates explanations, see [How Explain Data Works on page 1967](#).

Explore underlying values

This section lists explanations for each measure that can be explained (referred to as *target measures*). Each explanation listed here describes a relationship with the values of the target measure that are tested on the analyzed mark. Use your real-world, practical understanding of

the data to determine if the relationships found by Explain Data are meaningful and worth exploring.

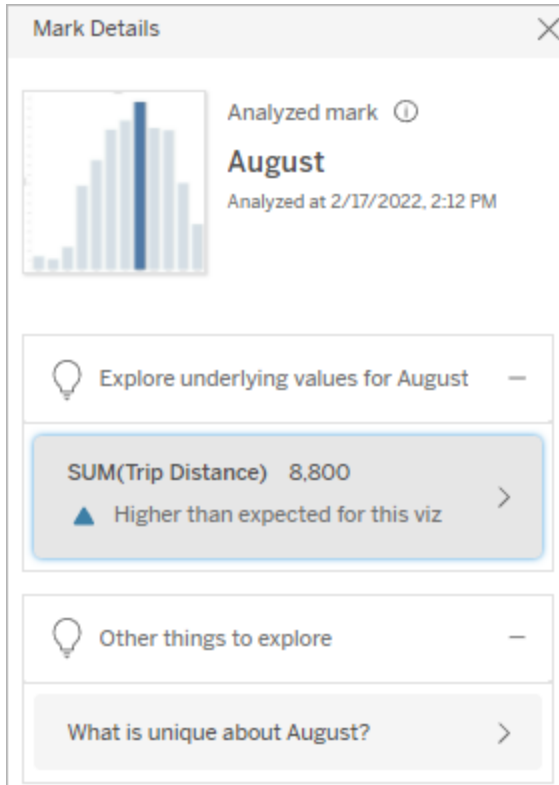

In this example, Trip Distance is the target measure

Underlying Characteristics

These explanations describe how underlying records of the marks in the view may be contributing to the aggregated value of the measure being explained. Mark attributes can include **Extreme Values**, **Null Values**, **Number of Records**, or the **Average Value** of the mark.

Note: For definitions of common terms used in explanations, see [Terms and concepts in explanations](#) on page 1936.

Extreme Values

This explanation type indicates if one or more records have values that are significantly higher or lower than most records. If the explanation is supported by a model, it indicates the extreme value is affecting the target measure of the analyzed mark.

When a mark has extreme values, it doesn't automatically mean it has outliers or that you should exclude those records from the view. That choice is up to you depending on your analysis. The explanation is simply pointing out an extreme value in the mark. For example, it could reveal a mistyped value in a record where a banana cost 10 dollars instead of 10 cents. Or, it could reveal that a particular sales person had a great quarter.

Note: This explanation must be enabled by the author to be visible in viewing mode for a published workbook. For more information, see [Control Access to Explain Data on page 1961](#).

This explanation shows:

- The number of underlying records in the analyzed mark.
- The extreme value or values contributing to the value of the target measure.
- The distribution of values in the mark.
- The record details that correspond to each distribution value.

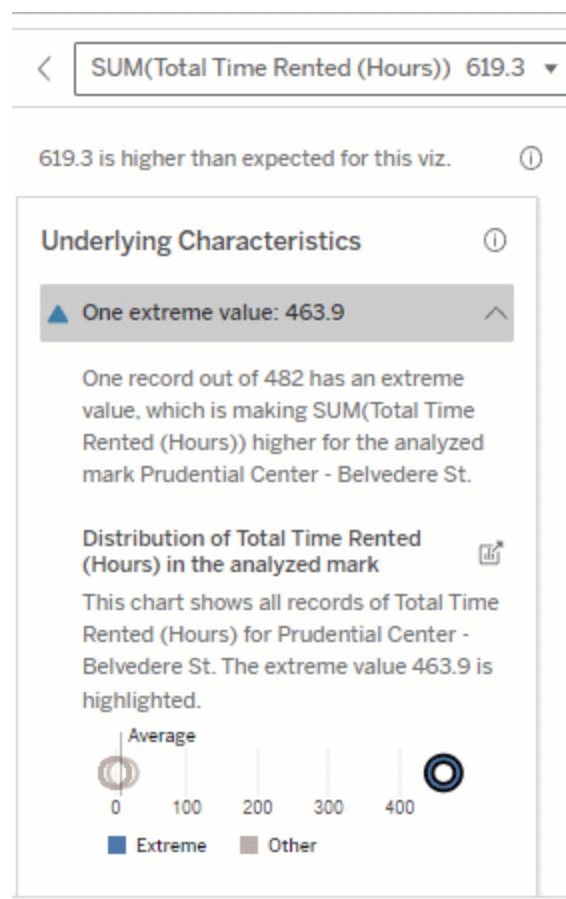

In this example, a single extreme value of 463 hours rented is contributing to the higher than expected sum of Total Time Rented of 613 hours.

A likely reason for this high value could be that someone forgot to

Exploration options:

- Hover over a circle in the chart to see its corresponding value.
 - Select the left or right arrow below the details list to scroll through record details.
 - If available, select **View Full Data**, and then select the **Full Data** tab to see all records in a table.
 - Select the **Open**  icon to see a larger version of the visualization.
- dock the bike when they returned it. In this case, the author might want to exclude this value for future analysis.

Next steps for analysis:

- If the number of records is low, examine these values

compared to the extreme value.

- If the extreme value is significantly higher or lower than the other record values, exclude it and consider how it changes the value of the analyzed mark.
- When considering the data with and without the extreme value, use this as an opportunity to apply your practical knowledge about the data.

Visualize the Difference

This section shows:

- How the analyzed mark value changes when the extreme value is excluded.

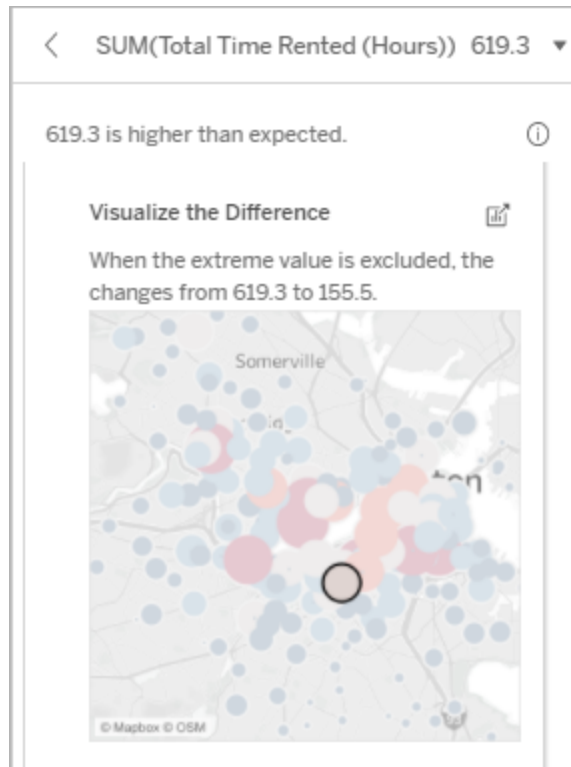

Exploration options:

- Select the **Open** icon to see a larger version of the visualization.
- Explore the difference with and without the

extreme value (or values).

- Authors can open the view as a new sheet and apply a filter to exclude the extreme value.

Next steps for analysis:

- If the extreme value is significantly higher or lower than the other record values, exclude it and see how it changes the value of the analyzed mark.
- When considering the data with and without the extreme value, use

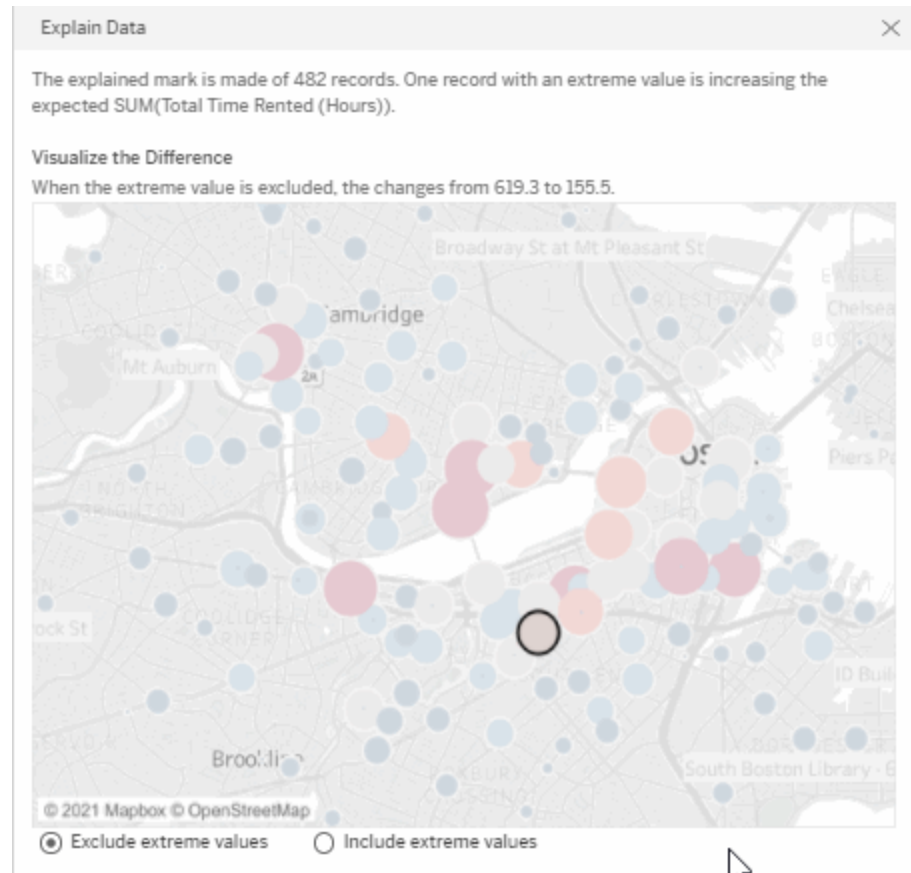

In this example, when the extreme value of 483 is excluded, the analyzed mark is no longer high compared to other marks in the view. Other marks now stand out. The author might want to explore the other marks to consider why these other locations have higher hours for bike rentals.

this as an opportunity to apply your practical knowledge about the data.

Null Values

The Null Values explanation type calls out situations where there is a higher than expected amount of missing data in a mark. It indicates the fraction of target measure values that are null and how the null values might be contributing to the aggregate value of that measure.

This explanation shows:

- The percent of values that are null in the target measure for the analyzed mark (blue circle).

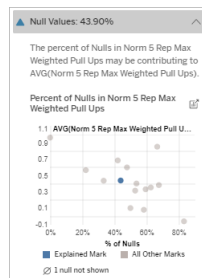

In this example, the percent of null values in the target measure is shown as a blue circle.

Exploration options:

- Hover over each circle in the scatter plot to see its details.
- Scroll to see more of the chart.
- Select the

Open  icon

to see a larger version of the visualization.

Next steps for analysis:

- Optionally exclude null values in the mark for further analysis.

Number of Records

This explanation type describes when the count of the underlying records is correlated to the sum. The analysis found a relationship between the number of records that are being aggregated in a mark and the mark's actual value.

While this might seem obvious, this explanation type helps you explore whether the mark's value is being affected by the magnitude of the values in its records or simply because of the number of records in the analyzed mark.

This explanation shows:

- The number of records in the target measure for the analyzed mark (dark blue bar).
- The number of records in the target measure for other marks in the source visualization (light blue bar).

Exploration options:

- Hover over each bar to see its details.
- Scroll to see more of the chart.
- Select the **Open** icon to see a larger version of the visualization.

Next steps for analysis:

- Compare

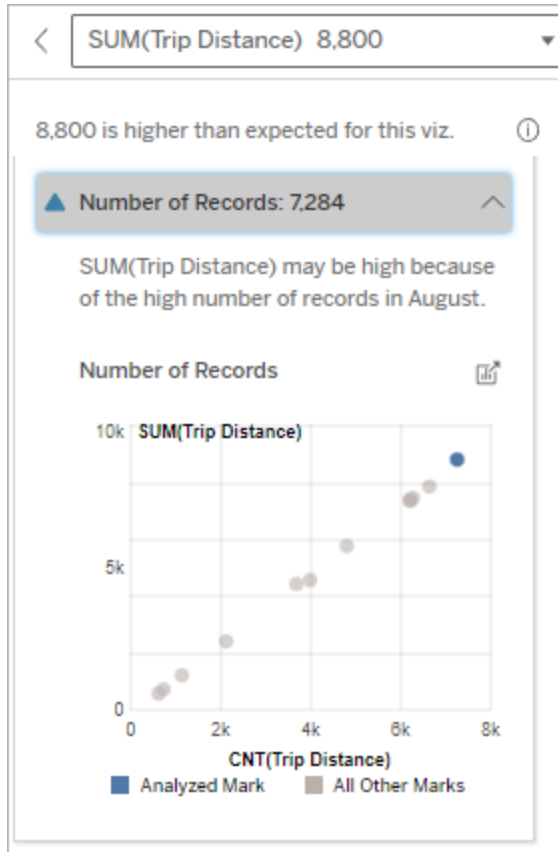

In this example, the number of records for Trip Distance is listed for each value of Ride Month, which is a dimension in the original visualization. August has the highest total trip distance value.

You might explore whether August has the highest value for trip distance because more rides occurred in August, or if it has the highest trip distance because some rides were longer.

whether the individual values of records are low or high, or the number of records in the analyzed mark is low or high.

- Authors, if you are surprised by a high number of records, you might need to normalize the data.

Average Value of Mark

This explanation type describes when the average of a measure is correlated to the sum. Compare whether the average value is low or high, or the number of records is low or high.

This explanation shows:

- The average of the target measure for each value of a dimension used in the source visualization.

Exploration options:

- Hover over each bar to see its details.
- Scroll to see more of the chart.
- Select the

Open  icon to see a larger version of the visualization.

Next steps for analysis:

- Compare whether the average value is low or high, or the number of records is low or high. For example,

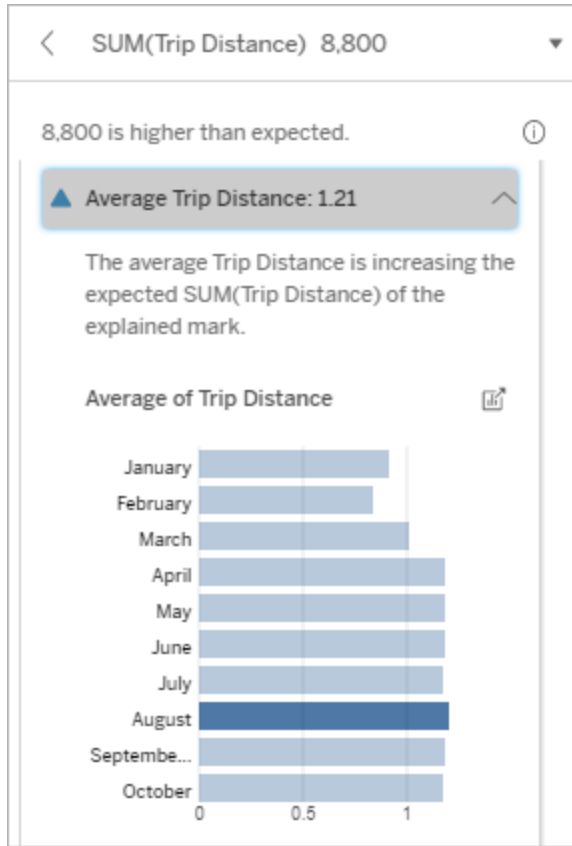

In this example, the average trip distance for August is not significantly higher or lower than most months. This suggests that trip distance is higher for August because there were more rides in August, rather than from people taking longer rides.

- are profits high
because you
sold a lot of
items or
because you
sold expensive
items?
- Try to figure out why the analyzed mark has a significantly higher or lower average value.

Contributing Single Value

Use this explanation to understand the composition of the record values that make up the analyzed mark.

This explanation type identifies when a single value in an unvisualized dimension may be contributing to the aggregate value of the analyzed mark. An unvisualized dimension is a dimension that exists in the data source, but isn't currently being used in the view.

This explanation indicates when every underlying record of a dimension has the same value, or when a dimension value stands out because either many or few of the records have the same single value for the analyzed mark.

Note: For definitions of common terms used in explanations, see [Terms and concepts in explanations](#) on page 1936.

This explanation shows:

- The percent of the number of records for a single value of a dimension for the analyzed mark (blue bar) versus all marks (gray bar) in the source visualization.
- The percent of the number of records for all other values of a dimension for the analyzed mark (blue bar) versus all marks (gray bar) in the source visualization.
- The average of the target measure for the single value of a dimension in the analyzed

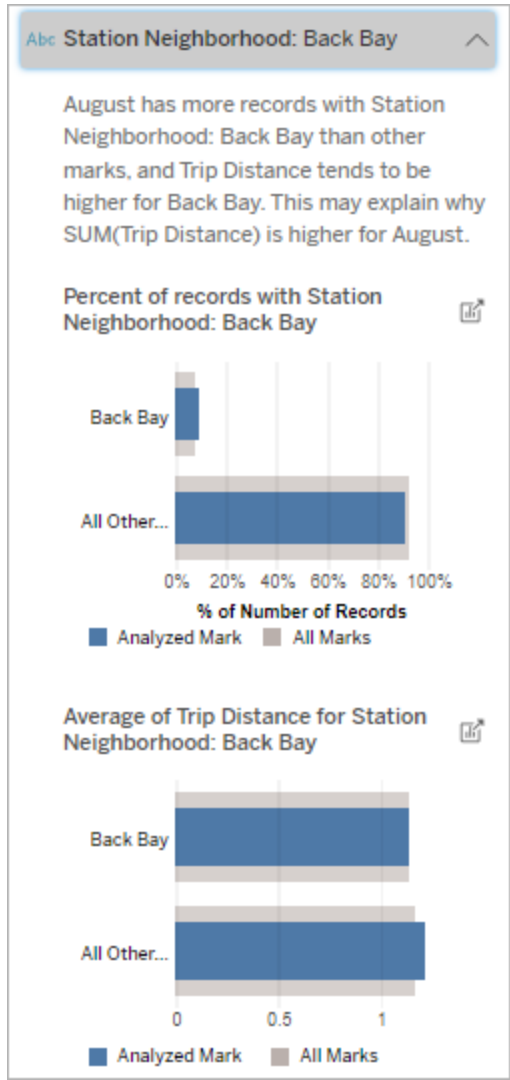

In this example, the statistical analysis has exposed that many of the rides come from the station neighborhood of Back Bay. Note that Station Neighborhood is an unvisualized dimension that has some relationship to Trip Distance in the underlying data for the source visualization.

mark (blue bar) versus all marks (gray bar).

- The average of the target measure for all other values of a dimension for the analyzed mark (blue bar) versus all marks (gray bar) in the source visualization.

Exploration

options:

- Hover over each bar to see its details.
- Select the

Open  icon to see a larger version of the visualization.

Next steps for

analysis:

- Use this explanation to understand the composition of

the record values that make up the analyzed mark.

- Authors might want to create a new visualization to explore any unvisualized dimension surfaced in this explanation.

Top Contributors

Use this explanation to see the values that make up the largest fraction of the analyzed mark.

For a COUNT aggregation, the top contributors show dimension values with the most records. For SUM, this explanation shows dimension values with the largest partial sum.

Contributing Dimensions

Use this explanation to understand the composition of the record values that make up the analyzed mark.

This explanation type shows that the distribution of an unvisualized dimension may be contributing to the aggregate value of the analyzed mark. This type of explanation is used for target measure sums, counts, and averages. An unvisualized dimension is a dimension that exists in the data source, but isn't currently being used in the view.

Note: For definitions of common terms used in explanations, see [Terms and concepts in explanations](#) on page 1936.

This explanation shows:

- The percent of the number of records for all values of a dimension for the analyzed mark (blue bar) versus all values of a dimension for all marks (gray bar) in the source visualization.
- The average of the target measure for all values of a dimension for the analyzed mark (blue bar) all values of a dimension for all marks (gray bar).

Exploration options:

- Hover over each bar to see its details.
- Scroll to see more of the chart.

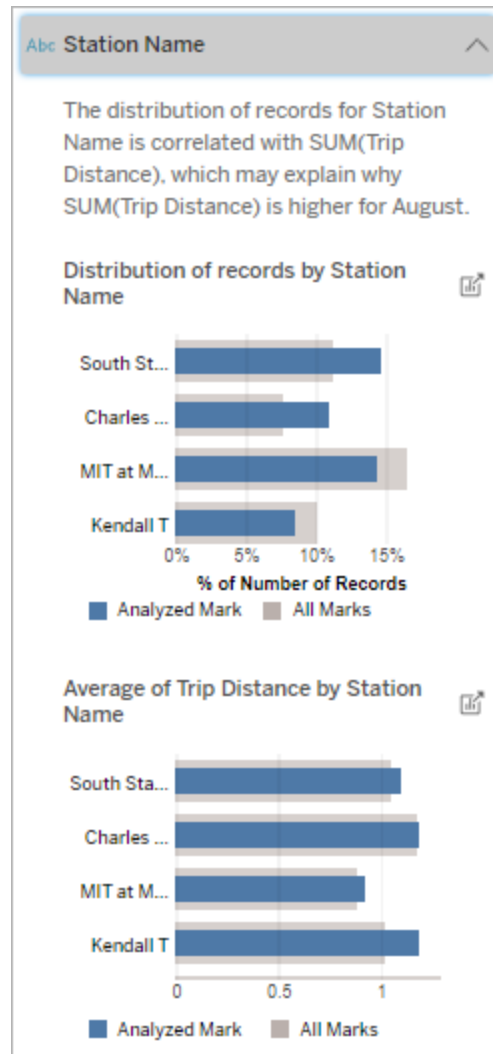

In this example, the statistical analysis has exposed that more rides were taken from South Station and MIT and fewer rides were taken from Charles Circle and Kendall, compared to rides taken for marks overall.

Note that Station Name is an unvisualized dimension that has some relationship to Trip Distance in the underlying data for the source visualization.

- Select the

Open  icon

to see a larger version of the visualization.

Next steps for analysis:

- Use this explanation to understand the composition of the record values that make up the analyzed mark.
- Authors might want to create a new visualization to explore any unvisualized dimensions surfaced in this explanation.

Contributing Measures

This explanation type shows that the average of an unvisualized measure may be contributing to the aggregate value of the analyzed mark. An unvisualized measure is a measure that exists in the data source, but isn't currently being used in the view.

This explanation can reveal a linear or quadratic relationship between the unvisualized measure and the target measure.

Note: For definitions of common terms used in explanations, see [Terms and concepts in explanations](#) on page 1936.

This explanation shows:

- The relationship between the sum of the target measure and the average of an unvisualized measure for the analyzed mark (blue circle) and all marks (gray circles) in the view.
- If the sum of the target measure is high or low because the average value of the unvisualized measure is high or low.

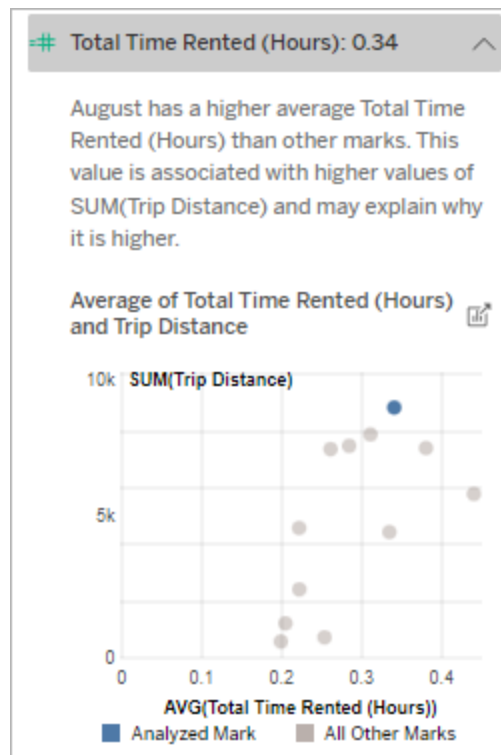

In this example, one possible reason why trip distance is high is because the average total time rented is also high.

Exploration options:

- Hover over each circle to

- see its details.
- Select the

Open  icon

to see a larger version of the visualization.

Next steps for analysis:

- Authors might want to create a new visualization to explore any unvisualized measures surfaced in this explanation.

Other things to explore

This section provides possible reasons why the analyzed mark is unique or unusual. These explanations:

- Do not explain why the value of this mark is what it is.
- Are not related in any way to the value of the measures in the source visualization.
- Do not take any target measures into account.

Other Dimensions of Interest

Use this explanation to understand the composition of the record values that make up the analyzed mark.

The distribution of an unvisualized dimension in the analyzed mark is unusual compared to the distribution of values for all other marks in the view. An unvisualized dimension is a dimension that exists in the data source, but isn't currently being used in the view.

Note: For definitions of common terms used in explanations, see [Terms and concepts in explanations](#) on page 1936.

This explanation shows:

- The percent of the number of records for all values of a dimension for the analyzed mark (blue bar) versus all values of a dimension for all marks (gray bar) in the source visualization.

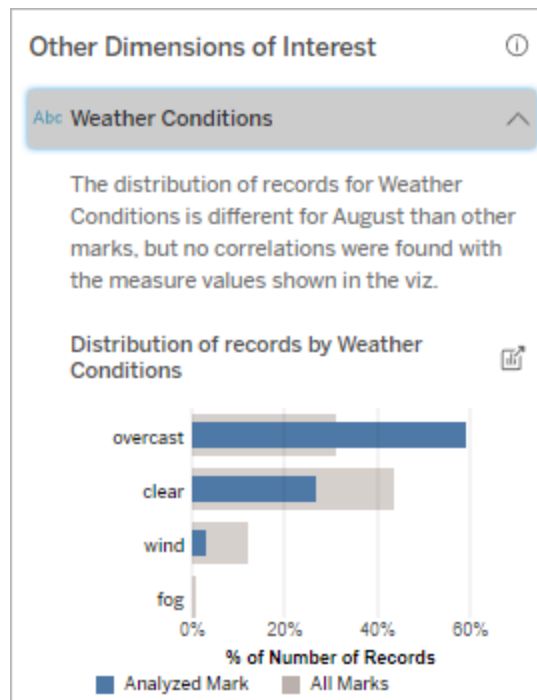

Exploration options:

- Hover over each bar to see its details.
- Scroll to see more of the chart.
- Select the

Open  icon to see a larger version of the visualization.

In this example, a high percentage of records are associated with overcast weather. Because the data is about bike rentals in Boston, and the analyzed mark is Trip Distance for August, we can assume that the weather is typically warm and humid. People might have rented bikes more often on overcast days to avoid the heat. It's also possible there were more overcast days in August.

Next steps for

analysis:

- Use this explanation to understand the composition of the record values that make up the analyzed mark.
- Authors might want to create a new visualization to explore any unvisualized dimensions surfaced in this explanation.

Requirements and Considerations for Using Explain Data

Explain Data is always available to authors in Tableau Desktop.

For Tableau Cloud and Tableau Server: When Explain Data is enabled for a site, Creators and Explorers with the appropriate permissions can run Explain Data when editing a workbook. All users with the appropriate permissions can run Explain Data in viewing mode in published workbooks. For more information, see [Control Access to Explain Data on page 1961](#).

What makes a viz a good candidate for Explain Data

Explain Data works best on visualizations that require deeper exploration and analysis, rather than infographic-style, descriptive vizzes that communicate summarized data.

- Row-level data is necessary for Explain Data to create models of your data and generate explanations. Vizzes with underlying, row-level data, where relationships might exist in unvisualized fields are good candidates for running Explain Data.

- Vizires based on pre-aggregated data without access to row-level data are not ideal for the statistical analysis performed by Explain Data.

What data works best for Explain Data

When you are using Explain Data in a worksheet, remember that Explain Data works with:

- **Single marks only**—Explain Data analyzes single marks. Multiple mark analysis is not supported.
- **Aggregated data**—The view must contain one or more measures that are aggregated using SUM, AVG, COUNT, or COUNTD. At least one dimension must also be present in the view.
- **Single data sources only**—The data must be drawn from a single, primary data source. Explain Data does not work with blended or cube data sources.

When preparing a data source for a workbook, keep the following considerations in mind if you plan to use Explain Data during analysis.

- Use a data source with underlying data that is sufficiently wide. An ideal data set has at least 10-20 columns in addition to one (or more) aggregated measures to be explained.
- Give columns (fields) names that are easy to understand.
- Eliminate redundant columns and data prep artifacts. For more information, see [Change fields used for statistical analysis on page 1974](#).
- Don't discard unvisualized columns in the data source. Explain Data considers fields in the underlying data when it analyzes a mark.
- Low cardinality dimensions work better. The explanation of a categorical dimension is easier to interpret if its cardinality is not too high (< 20 categories). Dimensions with more than 500 unique values will not be considered for analysis.
- Don't pre-aggregate data as a general rule. But if the data source is massive, consider pre-aggregating the data to an appropriate level of detail.
- Use extracts over live data sources. Extracts run faster than live data sources. With live data sources, the process of creating explanations can create many queries (roughly one query per each candidate explanation), which can result in explanations taking longer to be generated.

Situations where Explain Data is not available

Sometimes Explain Data will not be available for a selected mark, depending on the characteristics of the data source or the view. If Explain Data cannot analyze the selected mark, the Explain Data icon and context menu command will not be available.

Explain Data can't be run in views that use:

- Map coordinate filters
- Blended data sources
- Data sources with parameters
- Data sources that don't support COUNTD or COUNT(DISTINCT ...) syntax, such as Access.
- Filters on aggregate measures
- Disaggregated measures

Explain Data can't be run if you select:

- Multiple marks
- Axis
- Legend
- Grand total
- Trend line or reference line
- A mark in a view that contains a very low number of marks

Explain Data can't be run when the measure to be used for an explanation:

- Isn't aggregated using SUM, AVG, COUNT, COUNTD
- Is a table calculation
- Is used in measure values

Explain Data can't offer explanations for a dimension when it is:

- A calculated field
- A parameter
- Used in Measure Names and Measure Values
- A field with more than 500 unique values. Dimensions with more than 500 unique values will not be considered for analysis.

Control Access to Explain Data

Your access to Explain Data will vary depending on your site role and content permissions. Explain Data is always available to authors in Tableau Desktop. Authors with appropriate permissions can run Explain Data in editing mode in Tableau Cloud and Tableau Server.

Authors can also control whether Explain Data is available in viewing mode in published workbooks and which explanation types are displayed.

Be aware that Explain Data can surface values from dimensions and measures in the data source that aren't represented in the view. As an author, you should run Explain Data and test the

resulting explanations to make sure that sensitive data isn't being exposed in your published workbooks.

Who can access Explain Data

Explain Data is enabled by default at the site level. Server administrators (Tableau Server) and site administrators (Tableau Cloud) can control whether Explain Data is available for a site. For more information, [Disable or Enable Explain Data for a Site on page 1978](#).

Mode	Who Can Access
Viewing mode	Tableau Viewers , Explorers , and Creators who have the Run Explain Data permission capability can run and explore Explain Data explanations in viewing mode.
Editing mode	<p>Tableau Creators can run Explain Data when editing a view in Tableau Desktop, Tableau Cloud, or Tableau Server. Explorers who have the Run Explain Data permission capability and editing permissions can run Explain Data when editing a workbook in Tableau Cloud or Tableau Server.</p> <p>Creators and Explorers who have editing permissions can open new worksheets for further analysis.</p> <p>They also can use Explain Data Settings to control who can use Explain Data and what they can see.</p>

Control who can use Explain Data and what they can see

A combination of settings must be enabled to make Explain Data available in editing mode and viewing mode in Tableau Cloud and Tableau Server.

Editing mode

Requirements for authors to run Explain Data or edit Explain Data settings in editing mode:

- Site setting: **Availability of Explain Data** set to **Enable**. Enabled by default.
- Site role: Creator, Explorer (can publish)
- Permissions: **Run Explain Data** capability set to **Allowed**. Unspecified by default. If you open a workbook (Tableau version 2022.1 or earlier) that used this permission in Tableau version 2022.2 or later, you will need to reset the Run Explain Data capability to Allowed.

Note: The **Download Full Data** capability for a Creator or Explorer (can publish) controls whether they see the View Full Data option in Extreme Values explanations. Viewers are always denied the Download Full Data capability. However, all users can see record-level details when the Extreme Values explanation type is enabled in Explain Data settings.

Creators and Explorers with editing permissions and the Run Explain Data permission capability can access **Explain Data Settings**, which provide options for controlling:

- The **explanation types that are displayed** in the Data Guide pane.
- The **fields that are included in, or excluded from** statistical analysis.

These options are set for the entire workbook and can only be set in the Explain Data Settings dialog box.

Viewing mode

Requirements for all users to run Explain Data in viewing mode:

- Site setting: **Availability of Explain Data** set to **Enable**. Enabled by default.
- Site role: Creator, Explorer, or Viewer
- Permissions: **Run Explain Data** capability set to **Allowed**. Unspecified by default. If you open a workbook (Tableau version 2022.1 or earlier) that used this permission in Tableau version 2022.2 or later, you will need to reset the Run Explain Data capability to Allowed.

Note: To see explanations of Detected Outliers in the Data Guide, users of a viz must have the Explain Data permission allowed for the workbook or view. The owner of the workbook will need to open the permissions settings for this workbook in Tableau Server or Tableau Cloud and allow the Explain Data permission to that user.

Open the Explain Data Settings dialog box

1. From the **Analysis** menu, choose **Explain Data Settings**. Or, in the Data Guide pane, click the settings icon (bottom right).

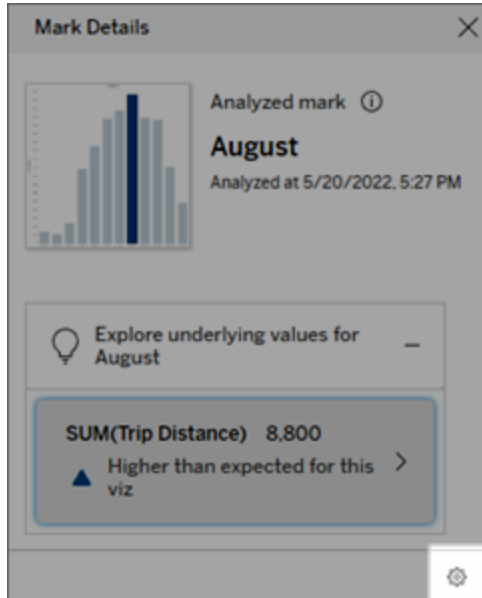

Include or exclude explanation types displayed by Explain Data

Creators and Explorers who have editing permissions can choose to exclude (or include) explanation types displayed for all workbook users.

1. In the **Explain Data Settings** dialog box, click the **Explanation Types** tab.

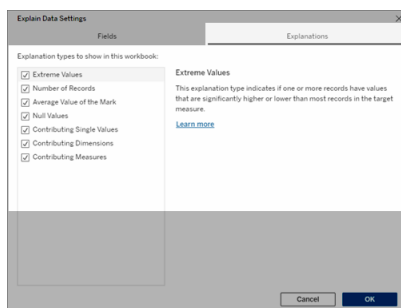

2. In the list of explanation types, select or clear an explanation type.
3. Click **OK**.

Test the setting by saving and closing the published workbook, and then opening a view from the workbook in viewing mode. Select a mark that typically has Extreme Value explanations, and then run Explain Data to check the explanation results.

Include or exclude fields used for statistical analysis

Creators or Explorers who have editing permissions can choose to exclude (or include) fields that are eligible for analysis.

1. In the Data Guide pane (bottom right), choose the settings icon. Or, choose the **Edit** button in the [Analyzed Fields view](#).

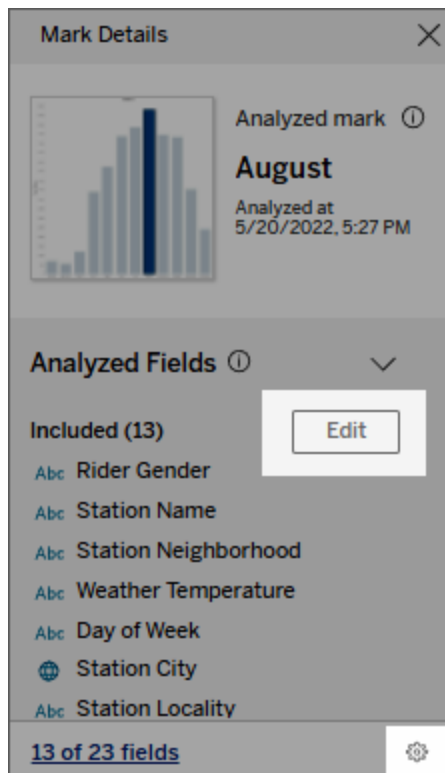

2. In the [Explain Data Settings](#) dialog box, click the **Fields** tab.
3. In the list of fields under **Include**, click the drop-down arrow and select **Automatic** to include an eligible field every time Explain Data runs for that workbook.

Note that fields must have less than 500 unique values to be included in the analysis.

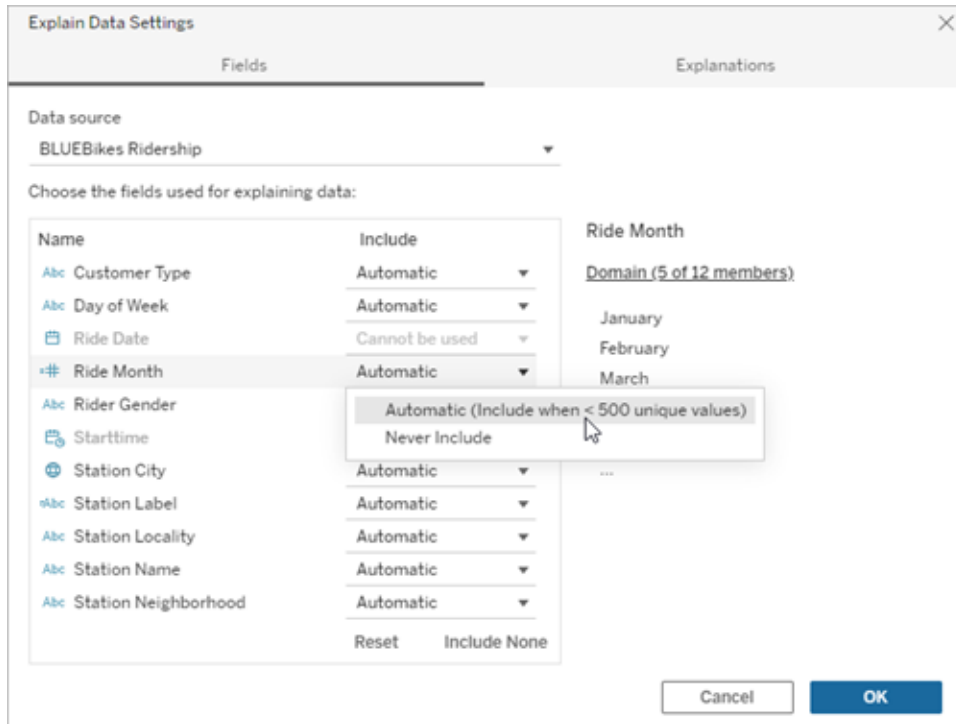

Select **Never Include** to explicitly exclude the field.

Select **Include None** to run a statistical analysis on the data without considering fields.

Select **Reset** to return to the default settings.

4. Click **OK**.

Test the setting by saving the published workbook. Select a mark, and then run Explain Data to check the explanation results.

Configure Tableau to allow users to share explanations via email and Slack

Tableau administrators can control whether explanations can be shared in viewing mode via email or Slack to other Tableau users.

Follow these steps to allow notifications and sharing via email and Slack in Tableau Cloud or Tableau Server:

1. Click **Settings**.
2. On the General tab, scroll down to **Manage Notifications**.
3. For Collaboration, select **Share** for **On Tableau**, **Email**, and **Slack**.

To share explanations via Slack, the Tableau app must be set up for your Slack workspace. Sharing explanations with Slack is enabled by default in Tableau Cloud.

In Tableau Server, an administrator will need to set up the Tableau app for Slack. For more information, see [Integrate Tableau with a Slack Workspace](#).

How Explain Data Works

Use Explain Data as an incremental, jumping-off point for further exploration of your data. The possible explanations that it generates help you to see the different values that make up or relate to an analyzed mark in a view. It can tell you about the characteristics of the data points in the data source, and how the data might be related (correlations) using statistical modeling. These explanations give you another tool for inspecting your data and finding interesting clues about what to explore next.

Note: Explain Data is a tool that uncovers and describes relationships in your data. It can't tell you what is causing the relationships or how to interpret the data. **You are the expert on your data.** Your domain knowledge and intuition is key in helping you decide what characteristics might be interesting to explore further using different views.

For related information on how Explain Data works, and how to use Explain Data to augment your analysis, see these Tableau Conference presentations:

- [From Analyst to Statistician: Explain Data in Practice \(1 hour\)](#)
- [Leveraging Explain Data \(45 minutes\)](#)

What Explain Data is (and isn't)

Explain Data is:

- A tool and a workflow that leverages your domain expertise.
- A tool that surfaces relationships in your data and recommends where to look next.
- A tool and a workflow that helps expedite data analysis and make data analysis more accessible to a broader range of users.

Explain Data is not:

- A statistical testing tool.
- A tool to prove or disprove hypotheses.
- A tool that is giving you an answer or telling you anything about causality in your data.

When running Explain Data on marks, keep the following points in mind:

- **Consider the shape, size, and cardinality of your data.** While Explain Data can be used with smaller data sets, it requires data that is sufficiently wide and contains enough marks (granularity) to be able to create a model.
- **Don't assume causality.** Correlation is not causation. Explanations are based on models of the data, but are not causal explanations.

A correlation means that a relationship exists between some data variables, say A and B. You can't tell just from seeing that relationship in the data that A is causing B, or B is causing A, or if something more complicated is actually going on. The data patterns are exactly the same in each of those cases and an algorithm can't tell the difference between each case. Just because two variables seem to change together doesn't necessarily mean that one causes the other to change. A third factor could be causing them both to change, or it may be a coincidence and there might not be any causal relationship at all.

However, you might have outside knowledge that is not in the data that helps you to identify what's going on. A common type of outside knowledge would be a situation where the data was gathered in an experiment. If you know that B was chosen by flipping a coin, any consistent pattern of difference in A (that isn't just random noise) must be caused by B. For a longer, more in-depth description of these concepts, see the article [Causal inference in economics and marketing](#) by Hal Varian.

How explanations are analyzed and evaluated

Explain Data runs a statistical analysis on a dashboard or sheet to find marks that are outliers, or specifically on a mark you select. The analysis also considers possibly related data points from the data source that aren't represented in the current view.

Explain Data first predicts the value of a mark using only the data that is present in the visualization. Next, data that is in the data source (but not in the current view) is considered and added to the model. The model determines the range of predicted mark values, which is within one standard deviation of the predicted value.

What is an expected range?

The expected value for a mark is the median value in the expected range of values in the underlying data in your viz. The expected range is the range of values between the 15th and 85th percentile that the statistical model predicts for the analyzed mark. Tableau determines the expected range each time it runs a statistical analysis on a selected mark.

Possible explanations are evaluated on their explanatory power using statistical modeling. For each explanation, Tableau compares the expected value with the actual value.

value	Description
Higher than expected / Lower than expected	If an expected value summary says the mark is <i>lower than expected</i> or <i>higher than expected</i> , it means the aggregated mark value is outside the range of values that a statistical model is predicting for the mark. If an expected value summary says the mark is <i>slightly lower</i> or <i>slightly higher</i> than expected, or <i>within the range of natural variation</i> , it means the aggregated mark value is within the range of predicted mark values, but is lower or higher than the median.
Expected Value	If a mark has an expected value, it means its value falls within the expected range of values that a statistical model is predicting for the mark.
Random Variation	When the analyzed mark has a low number of records, there may not be enough data available for Explain Data to form a statistically significant explanation. If the mark's value is outside the expected range, Explain Data can't determine whether this unexpected value is being caused by random variation or by a meaningful difference in the underlying records.
No Explanation	When the analyzed mark value is outside of the expected range and it does not fit a statistical model used for Explain Data, no explanations are generated.

Models used for analysis

Explain Data builds models of the data in a view to predict the value of a mark and then determines whether a mark is higher or lower than expected given the model. Next, it considers additional information, like adding additional columns from the data source to the view, or flagging record-level outliers, as potential explanations. For each potential explanation, Explain Data fits a new model, and evaluates how unexpected the mark is given the new information. Explanations are scored by trading off complexity (how much information is added from the data source) against the amount of variability that needs to be explained. Better explanations are simpler than the variation they explain.

Explanation type	Evaluation
Extreme values	<p>Extreme values are aggregated marks that are outliers, based on a model of the visualized marks. The selected mark is considered to contain an extreme value if a record value is in the tails of the distribution of the expected values for the data.</p> <p>An extreme value is determined by comparing the aggregate mark with and without the extreme value. If the mark becomes less surprising by removing a value, then it receives a higher score.</p> <p>When a mark has extreme values, it doesn't automatically mean it has outliers, or that you should exclude those records from the view. That choice is up to you depending on your analysis. The explanation is simply pointing out an interesting extreme value in the mark. For example, it could reveal a mistyped value in a record where a banana cost 10 dollars instead of 10 cents. Or, it could reveal that a particular sales person had a great quarter.</p>
Number of records	<p>The number of records explanation models the aggregate sum in terms of the aggregate count; average value of records models it in terms of the aggregate average. The better the model explains the sum, the higher the score.</p> <p>This explanation describes whether the sum is interesting because the count is high or low, or because the average is high or low.</p>
Average value of the mark	<p>This type of explanation is used for aggregate marks that are sums. It explains whether the mark is consistent with the other marks because in terms of its aggregate count or average, noting the relation $SUM(X) = COUNT(X) * AVG(X)$.</p> <p>This explanation describes whether the sum is interesting because the count is high or low, or because the average is high or low.</p>
Contributing Dimensions	<p>This explanation models the target measure of the analyzed mark in terms of the breakdown among categories of the unvisualized dimension. The analysis balances the complexity of the model with how well the mark is explained.</p> <p>An <i>unvisualized dimension</i> is a dimension that exists in the data source, but isn't currently being used in the view. This type of</p>

Explanation type

Evaluation

explanation is used for sums, counts and averages.

The model for unvisualized dimensions is created by splitting out marks according to the categorical values of the explaining column, and then building a model with the value that includes all of the data points in the source visualization. For each row, the model attempts to recover each of the individual components that made each mark. The analysis indicates whether the model predicts the mark better when components corresponding to the unvisualized dimension are modeled and then added up, versus using a model where the values of the unvisualized dimension are not known.

Aggregate dimension explanations explore how well mark values can be explained without any conditioning. Then, the model conditions on values for each column that is a potential explanation. Conditioning on the distribution of an explanatory column should result in a better prediction.

Contributing Measures

This explanation models the mark in terms of this unvisualized measure, aggregated to its mean across the visualized dimensions. An *unvisualized measure* is a measure that exists in the data source, but isn't currently being used in the view.

A Contributing Measures explanation can reveal a linear or quadratic relationship between the unvisualized measure and the target measure.

Analyzed Fields in Explain Data

Explain Data runs a statistical analysis on a dashboard or sheet to find marks that are outliers, or specifically on a mark you select. The analysis also considers possibly related data points from the data source that aren't represented in the current view.

Explain Data might not include every column from the data source in the analysis. In many cases, certain types of fields will be automatically excluded from the analysis. For more information, see [Fields excluded by default on page 1977](#).

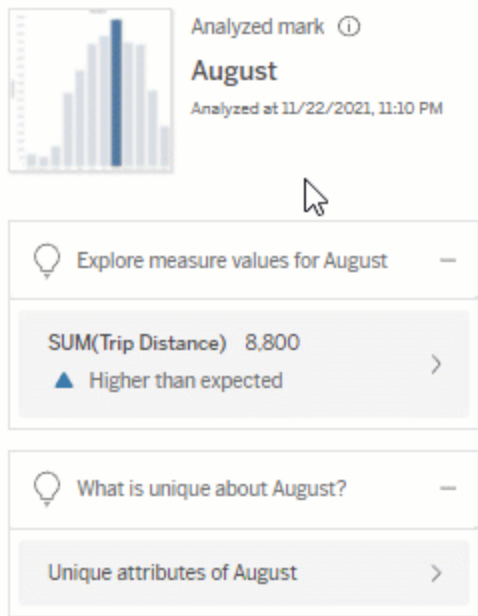

Note: Dimensions with more than 500 unique values won't be considered for analysis (unless allowed by the author in Explain Data Settings).

All users can view information on which fields are included or excluded in the current analysis. Creators and Explorers who have editing permissions can edit the fields used by Explain Data for statistical analysis.

View fields analyzed by Explain Data

When you expand an explanation for a measure that is contributing to the value of the mark, a link that indicates the number of fields considered in the analysis is displayed at the bottom of the Data Guide pane.

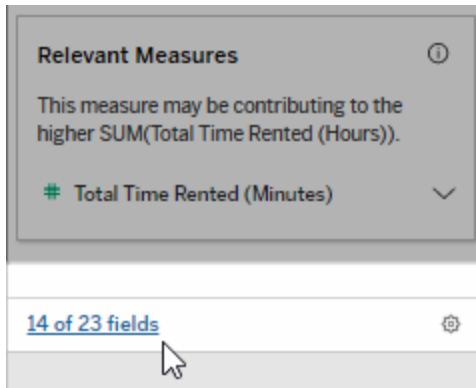

Click the link to see the list of fields included in or excluded from the current statistical analysis.

When a data source contains more than 1000 unvisualized dimensions or measures, you might see an alert asking if you want Explain Data to consider more fields. Click **Explain All** to run an analysis that includes more fields. The analysis may take longer to complete.

To view fields used by Explain Data for statistical analysis

1. Run Explain Data on dashboard, sheet, or mark.
2. In the Data Guide pane, under **Contributing to the value of**, click a measure name.

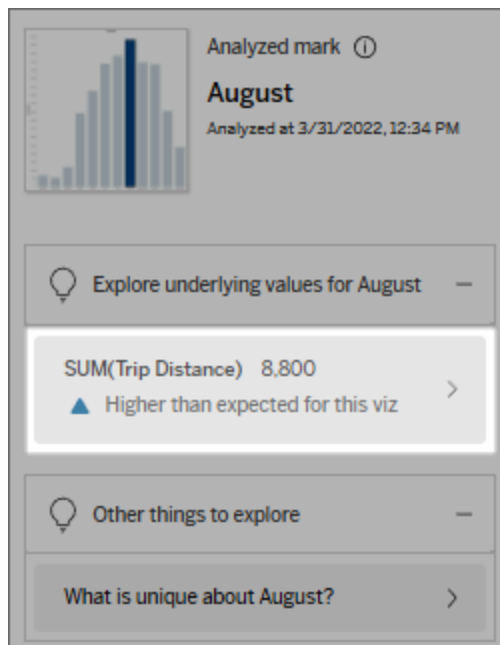

3. Click the *number-of-fields* link at the bottom of the pane.

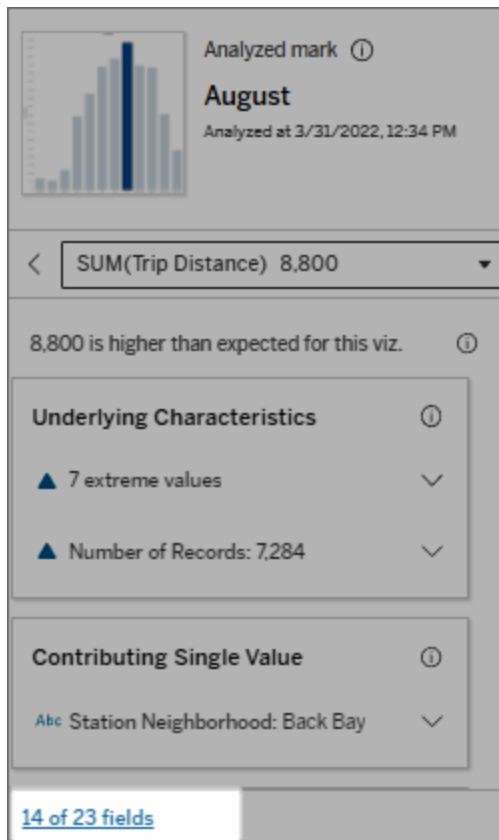

Change fields used for statistical analysis

Creators and Explorers who have editing permissions can select fields to be included or excluded from the statistical analysis in the Fields tab of the Explain Data Settings dialog box.

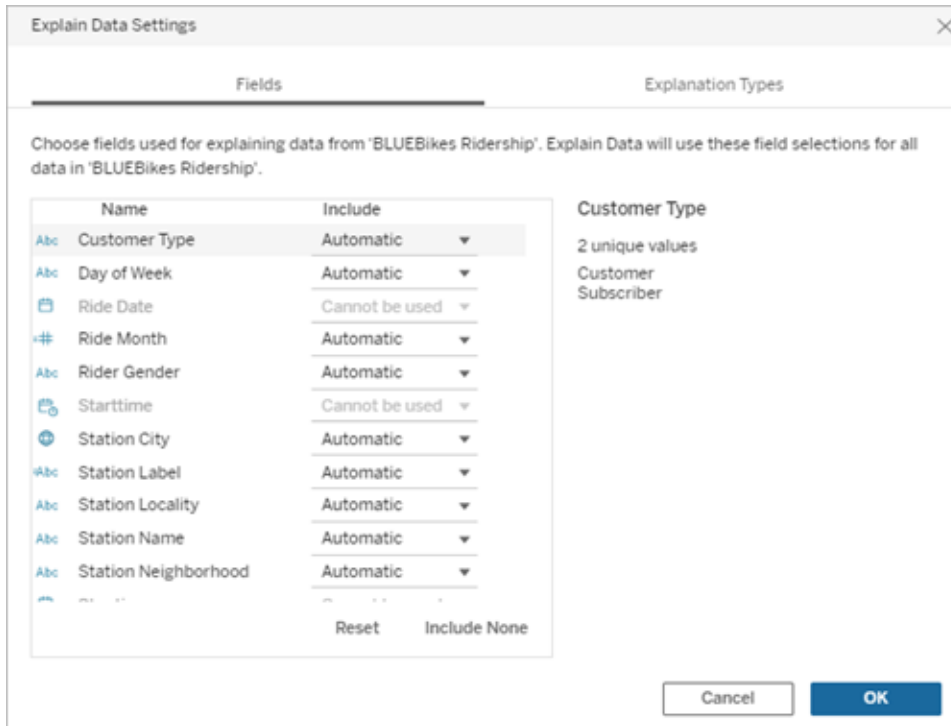

When a data source contains dimensions with a large number of unique values (up to 500), those fields won't be considered for analysis.

To edit the fields used by Explain Data for statistical analysis

Settings for analyzed fields are applied at the data source level.

1. Run Explain Data on a mark when editing a view.
2. In the Data Guide pane, click the settings icon at the bottom of the pane. Or, click the **Edit** button in the Analyzed Fields view ([how to open analyzed fields](#)).

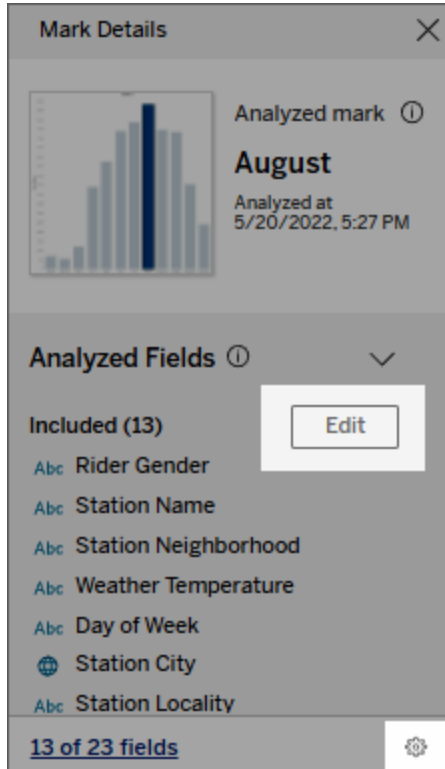

3. In the Explain Data Settings dialog box, click the **Fields** tab.
4. Click a drop-down arrow next to a field name, select **Automatic** or **Never Include**, and then click **OK**.

Note that fields must have less than 500 unique values to be included in the analysis.

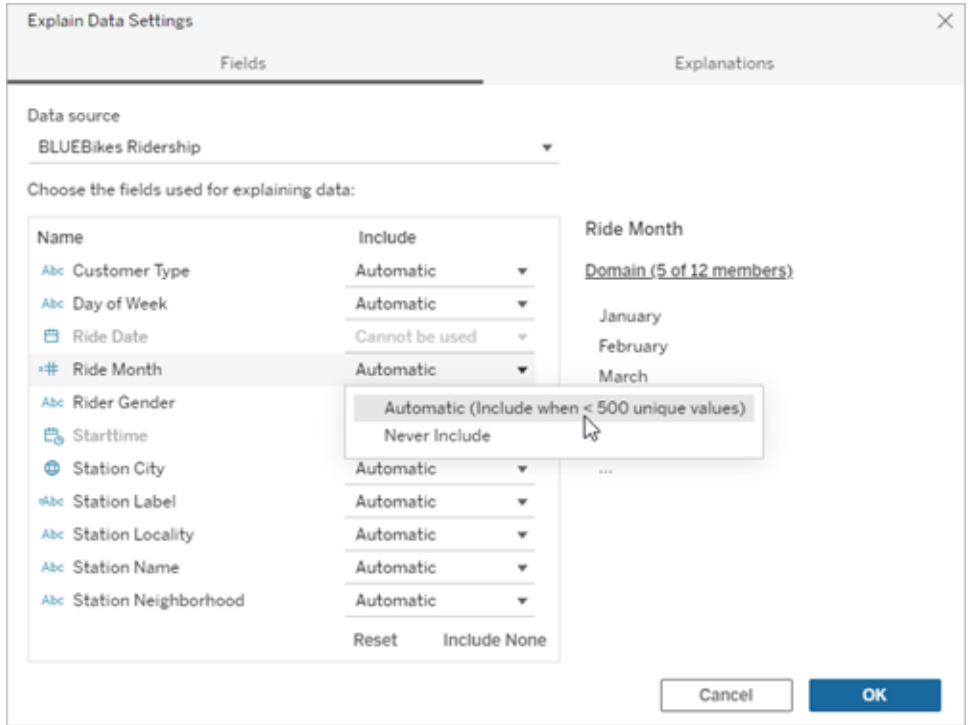

Fields excluded by default

Fields excluded by default

All unvisualized measures when there are more than 1,000 measures in the data source.

All unvisualized dimensions when there are more than 1,000 dimensions in the data source.

Fields that use geometry, latitude, or longitude

Reasons for exclusion

Computing explanations for more than 1000 unvisualized measures or dimensions can take longer to compute, sometimes several minutes. These fields are excluded by default for initial analysis, but you can choose to include them for further analysis.

In this situation, you might see an alert asking if you want Explain Data to consider more fields. Click the alert link to get more information. Click **Explain All** to run an analysis that includes more fields.

Geometry, latitude, or longitude by themselves can never be explanations. It is highly likely that an explanation that calls out the latitude or the lon-

Fields excluded by default	Reasons for exclusion
Dimensions with high cardinality (dimensions with > 500 members)	<p>High cardinality dimensions take longer to compute. Dimensions with more than 500 unique values will not be considered for analysis.</p>
Groups, bins, or sets	Not currently supported.
Table calculations	Table calculations cannot be analyzed when table calculations are at a different level of detail than the view.
Unvisualized measures that can't be averaged	Unvisualized measures that can't be averaged include measures that are calculated fields where the calculation expression includes aggregations (display as AGG() fields when added to the sheet).
Discrete measures and continuous dimensions	Not currently supported.
Hidden fields	Not available.
Calculated fields with errors	No values present to analyze.

Disable or Enable Explain Data for a Site

Explain Data is enabled for sites by default, but Tableau administrators may disable it.

1. Go to the **General** site settings.
2. (Tableau Server only) In the **Web Authoring** section, select **Let users edit workbooks in their browser**.
3. In the **Availability of Explain Data** section, select from these options:
 - **Enable** lets Creators and Explorers with the appropriate permissions run Explain Data in editing mode. Lets all users with appropriate permissions run Explain Data when it is enabled for viewing mode.
 - **Disable** prevents all users from running Explain Data or accessing Explain Data settings in workbooks.

4. In Tableau Cloud and Tableau Server 2023.3 or later, to use Explain Data:
 - In the **Availability of Data Guide** section, select **Show**. For more information about Data Guide, see [Explore Dashboards with Data Guide](#) on page 2714.

Explore and Inspect Data in a View

When you are ready to explore and analyze your view, Tableau offers a selection of dynamic data inspection tools that help you isolate the data of interest. For example, if you have a dense data view, you can focus on a particular region, select a group of outliers, and view the underlying data source rows for each mark.

Select marks to highlight data points in the view

The simplest way to add highlighting to a view is to select the marks you want to highlight. When you manually select a mark in the view, all other marks are dimmed to draw attention to the selection. Your selection is saved with the workbook.

For more information on how to use selection tools, see [Select marks on page 1995](#). Also see [Legend Highlighting on page 1394](#), [Highlight Data Points in Context on page 1397](#), [Highlight Toolbar Button on page 1400](#), and [Highlight Actions on page 1393](#).

You can select multiple marks by holding down the Ctrl key on your keyboard (Command key on Mac) while you select each mark. You can also use one of the advanced selection tools to select marks within a specific shape.

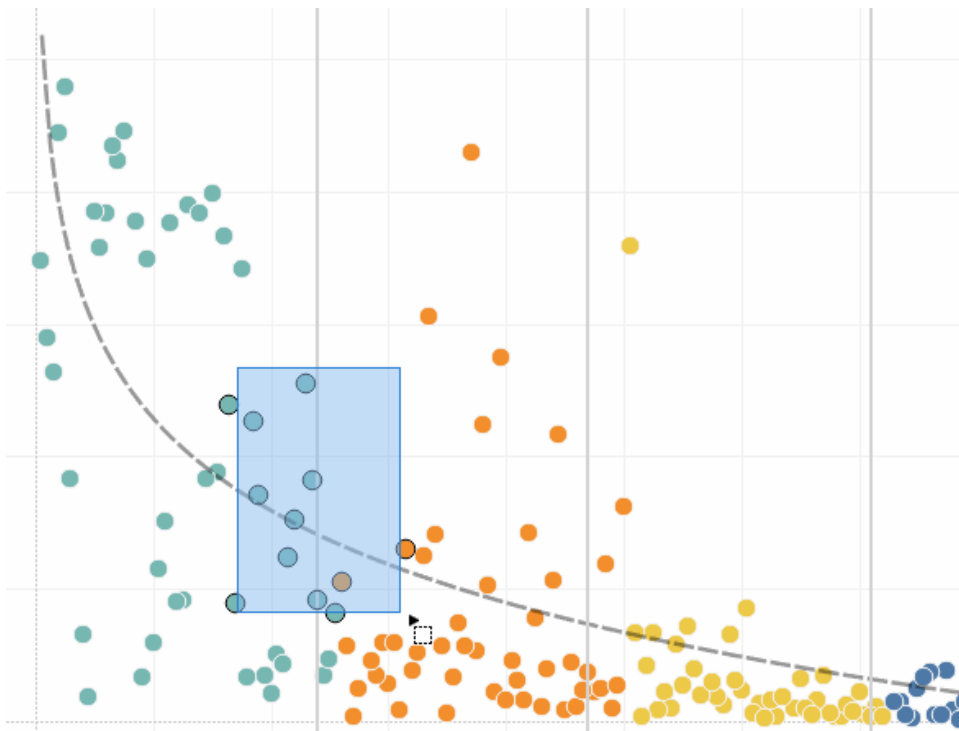

You can also select marks and headers to filter what is being displayed in the view. For more details, see [Select to keep or exclude data points in your view on page 1309](#) and [Select headers to filter data on page 1310](#).

Analyze selected marks using tooltips

When you select one or multiple marks in a view, and then continue to hover in the same spot, several options for inspecting your data are available in the tooltip.

Tableau Desktop version

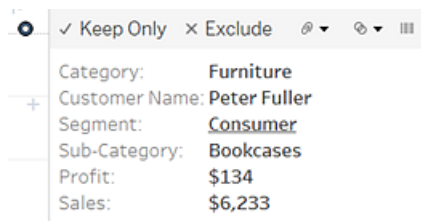

✓ Keep Only × Exclude @ ▾	
Category:	Furniture
Customer Name:	Peter Fuller
Segment:	Consumer
Sub-Category:	Bookcases
Profit:	\$134
Sales:	\$6,233

Web version

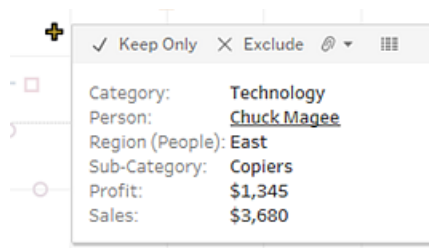

✓ Keep Only × Exclude @ ▾	
Category:	Technology
Person:	Chuck Magee
Region (People):	East
Sub-Category:	Copiers
Profit:	\$1,345
Sales:	\$3,680

Tooltips provide additional information about the marks in your view, and provide the following data analysis options:

- Keep only the selected marks in the view. ✓ Keep Only
For more information, see [Select to keep or exclude data points in your view on page 1309](#).
- Exclude the selected marks from the view. × Exclude
For more information, see [Select to keep or exclude data points in your view on page 1309](#).
- Create a group based on the selected marks. @ ▾ For more information, see [Correct Data Errors or Combine Dimension Members by Grouping Your Data on page 1090](#).
- Create a set that contains the selected marks (Tableau Desktop only). @ ▾ For more information, see [Create Sets on page 1092](#).

- View the underlying data of the marks selected.  For more information, see [View Underlying Data](#) on page 2001.

For related information on Tooltips, see [Tooltips](#) on page 84.

For details on related analysis tools, see [Zoom and Pan Views, and Select Marks](#) on page 1992, [Undo and Redo](#) on page 1998, and [Drop Lines](#) on page 2518.

Highlight data by category in tooltips

If you include discrete (categorical) dimensions or measures in your tooltip, you can use them to select marks in the view that have the same values. If Tooltip selection is turned on for your worksheet, then these fields show as underlined text when you mouse over them. Clicking on the tooltip selects all the marks in the view that have the same value.

In the example below, when you click on Bill Shonely (the value for Customer Name) in the tooltip, any mark in the view that also includes Bill Shonely as a customer is selected and all other marks are dimmed.

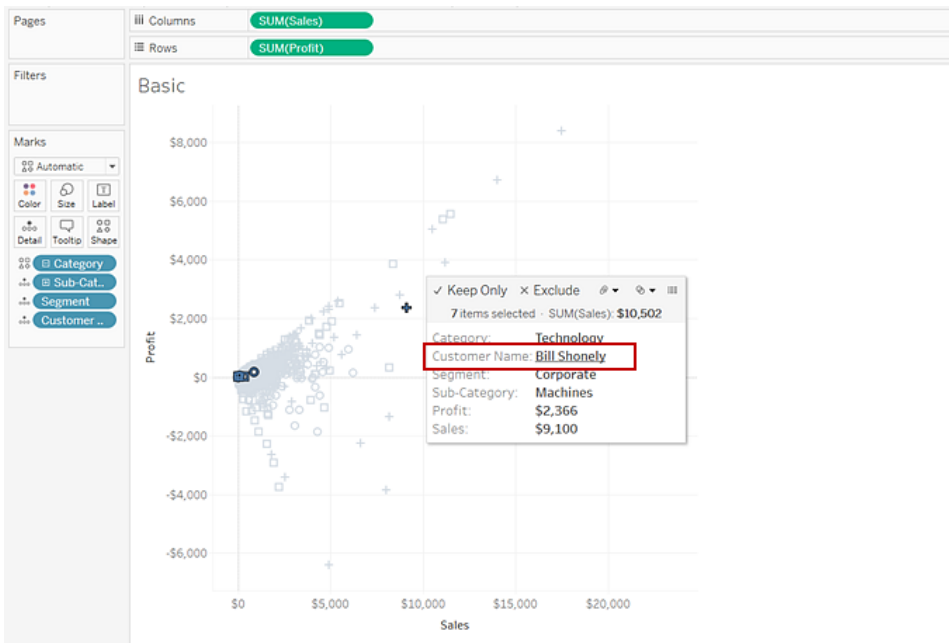

To turn this functionality off or on, select the **Allow selection by category** check box in the Edit Tooltips dialog box. For more information about setting tooltip properties, see [Add tooltips to marks](#) on page 1271.

Explore data in maps

Tableau maps can help you quickly find locations and analyze data worldwide. There are many ways you can explore and interact with map views. You can zoom in and out, pan, and select marks with the view toolbar, and even search for locations worldwide with map search.

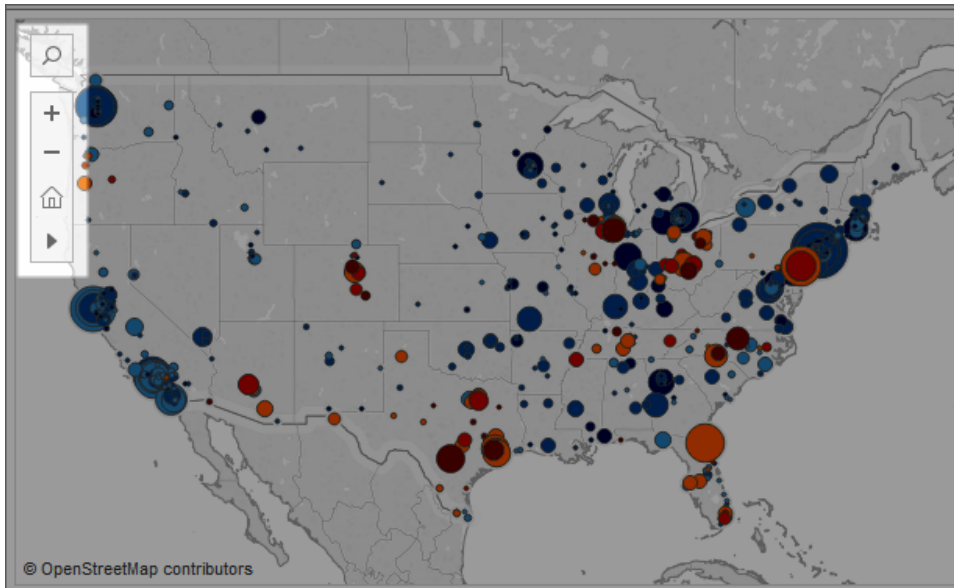

For more details, see [Explore Data in Maps](#) on page 1892, [Search for Locations in Your Map](#) on page 1895, and [Measure Distances Between Data Points and Locations in a Map](#) on page 1896.

Add analytics objects to the view (trend lines, forecasts, reference lines and bands)

Drag reference lines, box plots, trend lines forecasts, and other items into your view from the **Analytics** pane, which appears on the left side of the workspace. Toggle between the **Data** pane and the **Analytics** pane by clicking the tabs at the top of the side bar. For more details, see [Apply Advanced Analysis to a View \(Analytics Pane\)](#) on page 48.



Tableau Desktop Analytics pane

In Tableau Desktop, options for adding Analytics objects to the view are available the **Analytics** pane or menu, or in context in the view. For example, reference lines and bands are available when you edit an axis, and trend lines and forecasts are available from the Analysis menu.

The **Analytics** pane provides drag-and-drop access for the various options.

On the web, most Analytics objects are available from the Analytics pane.

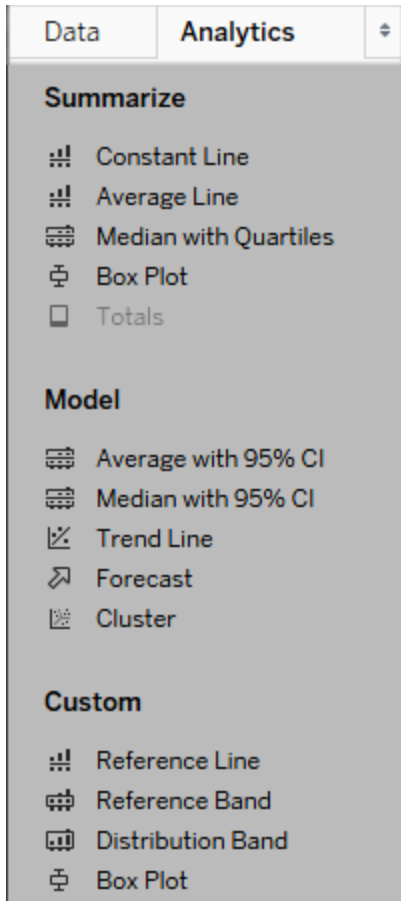
Compare marks data with recalculated lines

If there is an analytics object in your view, such as an average line, constant line, trend line, reference line or distribution line or band, selecting one or multiple marks in the view lets you instantly compare the analytical data for the selected marks to all data in the view.

For example, selecting marks in a view that contains a trend line creates a second, recalculated trend line, the value of which is determined by the selected marks only, so you can compare that trend to the overall trend.

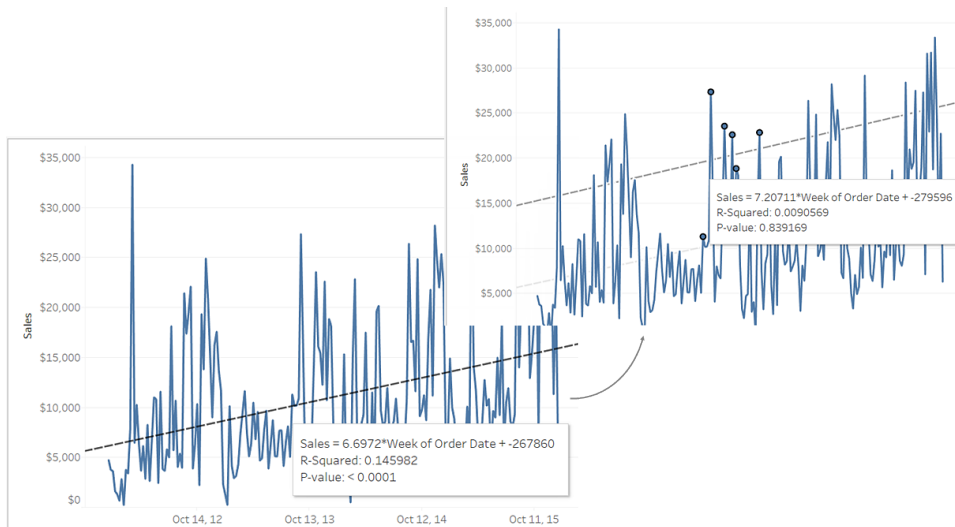

Recalculated lines are displayed by default when you select marks in a view that already contains analytics objects. In Tableau Desktop, if you don't want recalculated lines to be created you can turn them off.

Turn off recalculated lines (Tableau Desktop only):

1. Select an analytics object in the view, such as a trend line, and click **Edit**.
2. In the **Edit** dialog box, clear **Show recalculated line for highlighted or selected data points**.

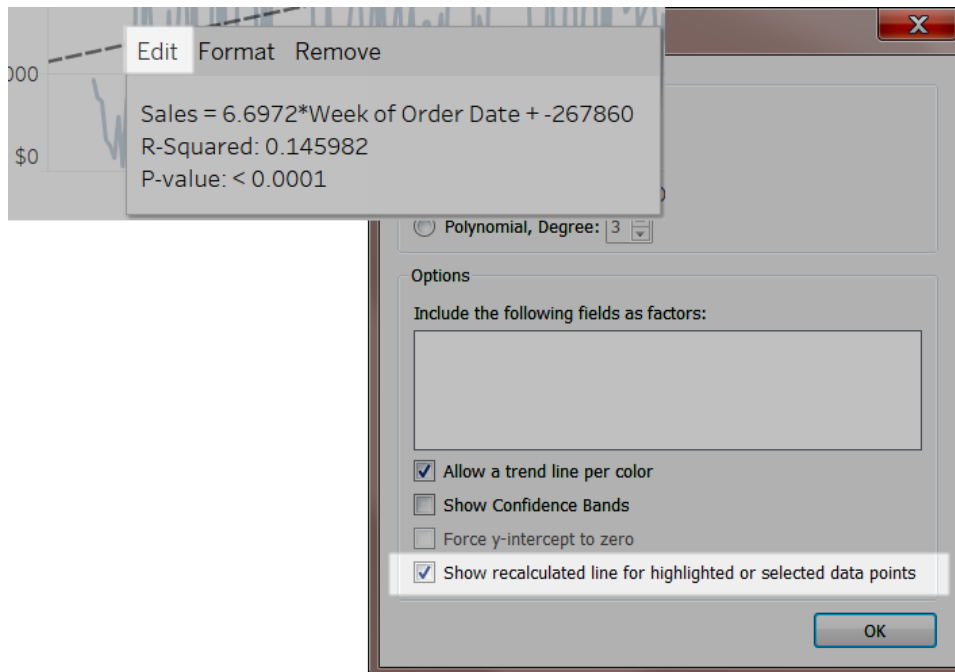

Alternatively, you can right-click (control-click on Mac) an analytics object in the view and clear **Show Recalculated Line**.

When you return to the view and select or highlight marks, recalculated lines will not appear. For more information, see [Highlight Actions](#) on page 1393.

Recalculated lines and highlight actions

Recalculated lines also work with highlighting actions, both in worksheets and dashboards.

For example, if you create a highlight action in a dashboard, selecting marks in one sheet will highlight marks in the other sheets in the dashboard. If those other sheets have trend lines, reference lines, or other analytics objects, recalculated lines will appear as the views update.



Use Data Details to see visualization information

Starting in 2019.3, Tableau Catalog is available as part of the Data Management offering for Tableau Server and Tableau Cloud. When the Tableau Catalog is enabled in your environment, you can use the Data Details pane to see visualization information. For more information about Tableau Catalog, see "About Tableau Catalog" in the [Tableau Server](#) or [Tableau Cloud](#) Help.

When you're looking at a published view and Tableau Catalog is enabled in your environment, you can see information about the data used in the view by selecting **Data Details** in the toolbar above the view in workbooks and dashboards. Details include:

- A sparkline that shows the number of times a sheet or dashboard was viewed over the last 12 weeks.
- Information about the workbook (name, project, author, date modified, data quality warnings).
- The data sources used in the sheet or dashboard.
- A list of the fields in use. Select a field to see the field metadata, such as a description or calculation.

Tableau Desktop and Web Authoring Help

The screenshot shows the Tableau Desktop interface with the **Data Details** pane open. The main view displays a dashboard with the following components:

- Summary Metrics:**

Metric	Value
Profit per Order	\$57.19
Sales per Customer	\$2,908.17
Avg. Discount	15.54%
Quantity	38,654
- Map:** A map of North America with a color scale for Profit Ratio ranging from -50.0% (dark red) to 50.0% (dark blue).
- Filters:** Region (All), Order Date (1/3/2019 to 12/30/2022), Profit Ratio (-21.7% to 37.0%).
- Chart:** Monthly Sales by Product Category - States/Provinces: All. The chart shows sales for Furniture, Office Supplies, and Technology from 2019 to 2023. Furniture sales are consistently the highest, followed by Office Supplies and Technology.

The **Data Details** pane on the right contains the following information:

- Views of this dashboard:** A line chart showing views over the last 12 weeks, with a peak of 12 views and a recent drop to 11.
- Metadata:** Workbook: Superstore, Project: Tableau, Author: Sam Moore, Modified: Sep 21, 2022, 12:31 PM.
- Data Sources (1):** Sample - Superstore, connects to Sample - Superstore.xls, last refreshed via Live Connection.
- Fields in Use (18):** Measure Names, Category, Discrete Text Field, Description, Category of order.
- Data Quality Warning:** 1 data quality warning.

The links in the **Data Details** pane take you to that item, which opens in a separate window.

If there's a data quality warning in the lineage of any of the data used in a view, workbook, or dashboard, the **Data Details** tab shows a blue circle with a white exclamation mark in it. Click the **Data Details** tab, then click the data quality warning to see the details of the warning.

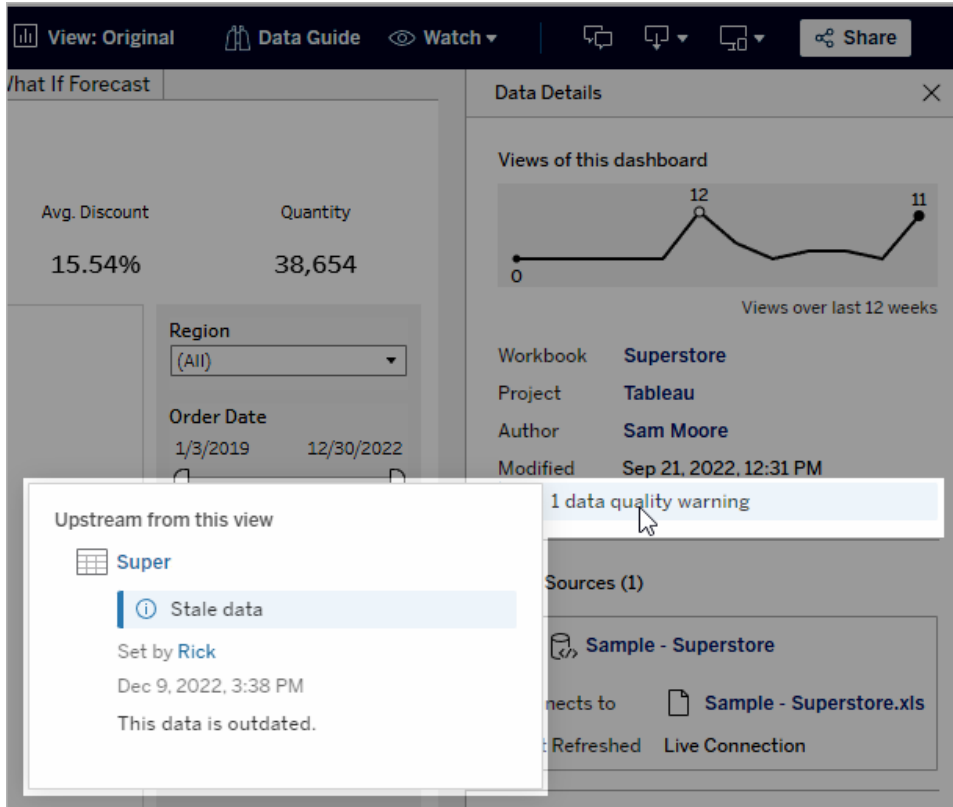

High visibility data quality warnings

When a data quality warning is tagged as important by, for example, the data item owner or an admin:

- A notification appears when anyone opens a published view that uses the affected data, with a link to the Data Details pane:

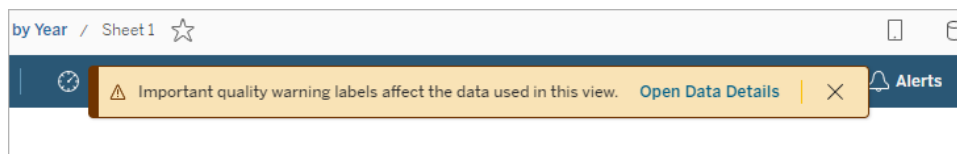

- On the Data Details pane (and elsewhere in Tableau), the warning's visibility is raised by using a yellow warning symbol:

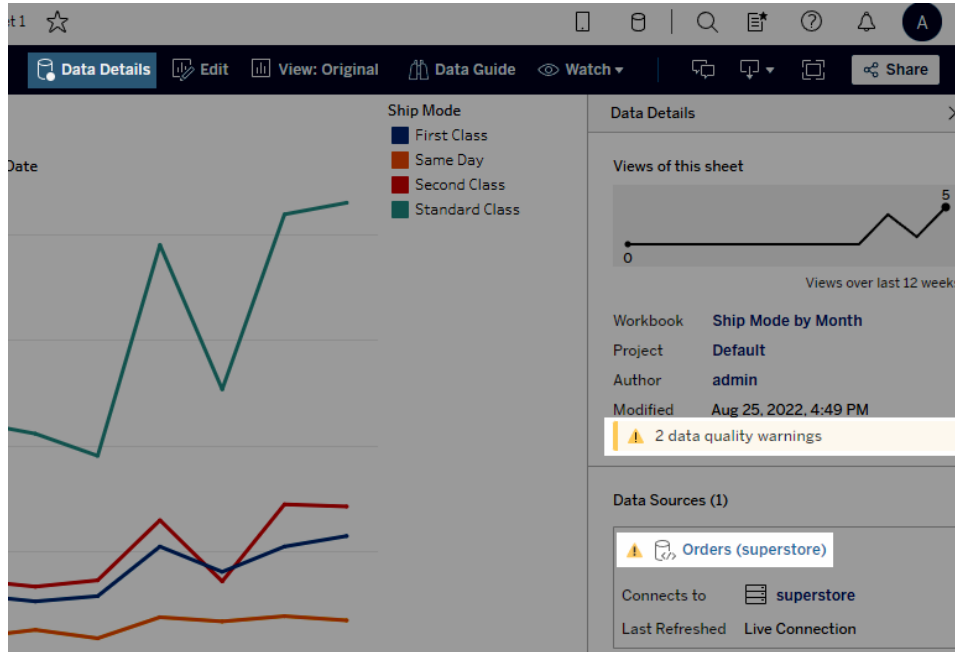

Fields can show upstream descriptions

If a field used in a view doesn't have a description in the workbook, Catalog can look up and display the description from the field or column upstream from it, if one exists. If a published data source is upstream and has a description for this field, the Data Details pane displays that field description. If not, this field shows the description from the column that the field references in the upstream table.

When a field get its description from an upstream source, an information icon appears next to **Description**, telling where the description came from.

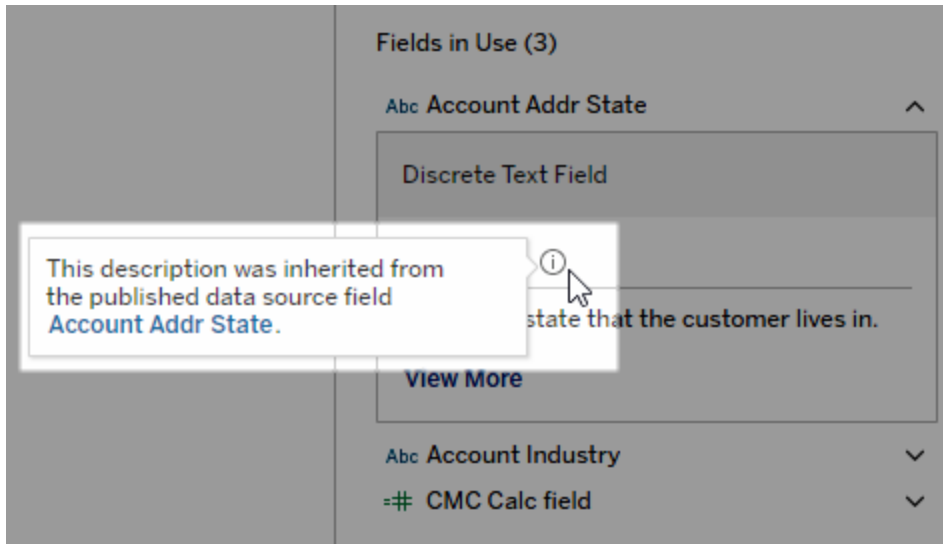

Some fields, such as a calculated field, group field, or set field, don't support showing a description from an upstream source. Also, workbooks and data sources don't support displaying upstream field or column descriptions.

For information about adding descriptions, see "Add or edit descriptions" in [Manage Web Content](#) on page 3301.

Zoom and Pan Views, and Select Marks

In the upper-left corner of a view, the view toolbar lets you zoom in and out, pan the view, and select data marks.

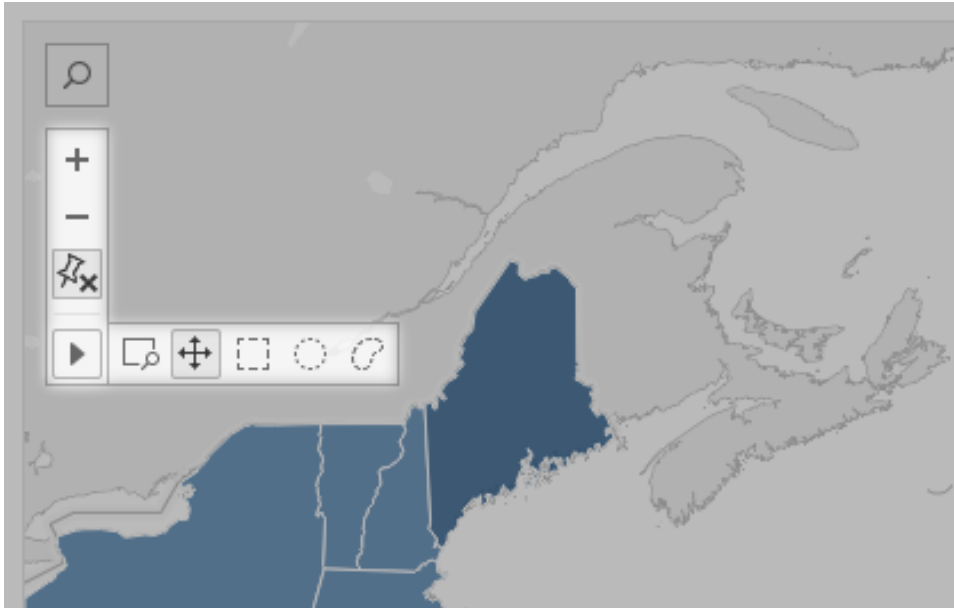

Show or hide the view toolbar

Tip: If you don't see the view toolbar in Tableau Cloud or Tableau Server, ask the content owner to show it using these instructions. Or [use keyboard shortcuts](#) to zoom, pan, and select marks.

When you hover over a map view, the view toolbar appears by default, but you can change that behavior. For more information, see [Customize How People Interact with your Map on page 1878](#). You can also show the toolbar in other types of views, such as scatter or box plots.

1. If you're working with a dashboard, select the zone on which you'd like to show or hide the toolbar.
2. From the top menu, select **Worksheet > Show View Toolbar**. Then select one of the following options:
 - **Automatic** shows the toolbar when you hover over a map view.
 - **Show on hover** shows the toolbar when you hover over any type of view.
 - **Hide** doesn't show the toolbar on the selected view. (To improve usability on mobile devices, however, the toolbar will appear when users interact with scrollable views or multiple selections.)

Tip: In Tableau Desktop, you can quickly toggle the toolbar on or off. Right-click anywhere in a view, and select **Show View Toolbar** or **Hide View Toolbar**.

Zoom and pan

The view toolbar provides zoom controls and a pan tool that lets you see a different areas of a zoomed view.

Zoom in and out

On the view toolbar, click the Zoom In button  to zoom in and the Zoom Out button  to zoom out.

If the view toolbar is hidden, double-click the view to zoom in; to zoom out, hold down Shift, and then double-click the view.



Zoom to a specific area

To zoom in to a specific area of the view, click the Zoom Area tool button  on the view toolbar, and then drag in the view.

If the view toolbar is hidden, hold down Ctrl + Shift (Windows) or Command+ Shift (macOS) to use the Zoom Area tool.

Reset the view

After you zoom in or out, the axes in the view are fixed to a specific range. To quickly reset the axes so they automatically zoom the view to all of your data, do one of the following:

- In Tableau Desktop, click the Reset button  on the view toolbar.
- In Tableau Server or Tableau Cloud, click the Zoom Home button  on the view toolbar.

Pan a view

To pan, do one of the following:

- Hold down Shift, and then drag across the view.
- On the view toolbar, hover over the arrow, select the Pan tool , and then drag across the view.

Select marks

Select marks to see information about them in tooltips that appear. You can also quickly view underlying data or filter selected marks from a view. For more information, see [Tooltips on page 84](#).

When you select marks in the view, all other marks are dimmed to draw attention to the selection. Your selection is saved with the workbook.

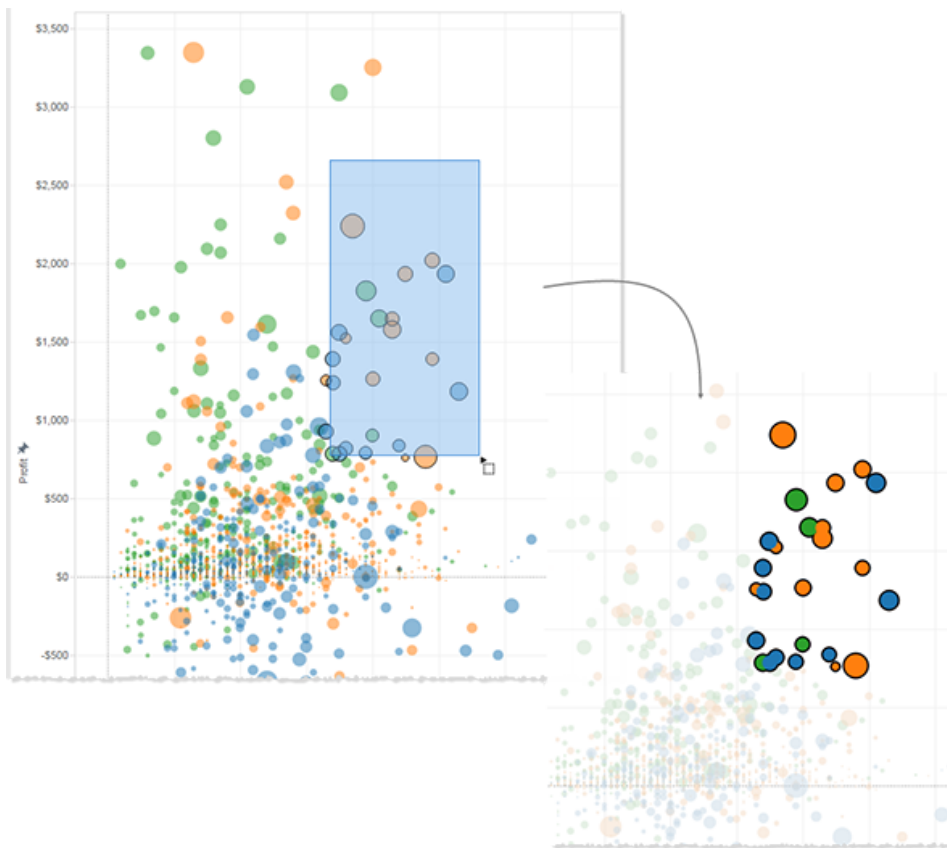

Select individual or multiple marks

To select an individual mark, click it. To add more individual marks to a selection, hold down the Ctrl key (Windows) or the Command key (macOS).

To select multiple marks at once, drag across the view while using the Rectangular, Radial, and Lasso tools on the view toolbar.

Make rectangular selections

The Rectangular tool selects marks within a rectangular shape. To use the Rectangular tool,

hover over the arrow on the view toolbar, click the Rectangular tool button , and then drag across the view.

Note: The Rectangular tool is the default tool in most views and may not appear in the view toolbar. In this case, simply drag across the view to use the rectangular tool.

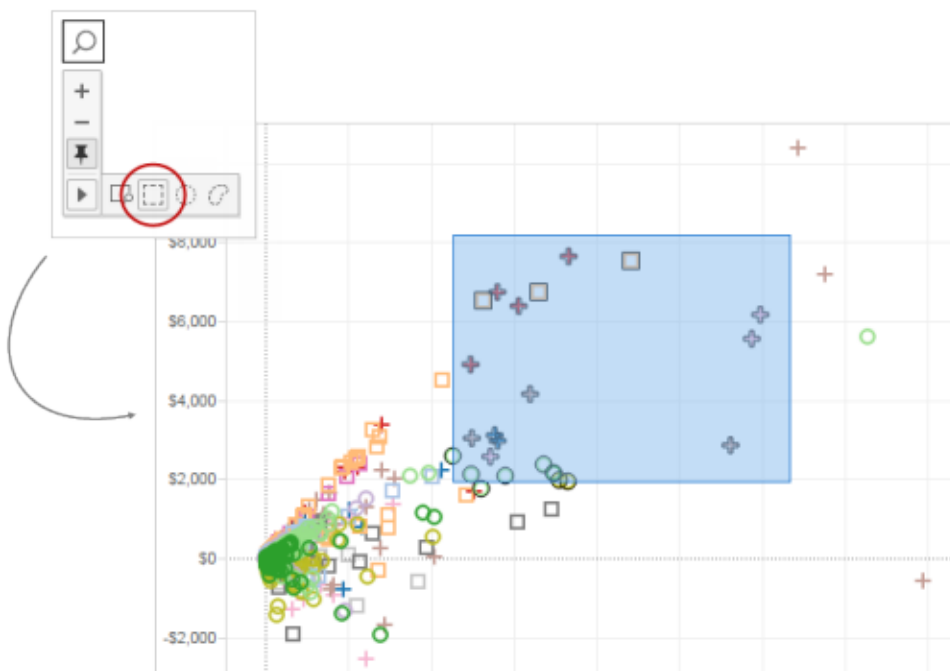

Make radial selections

The Radial tool selects marks within a circular area. To use the Radial tool, hover over the arrow

on the view toolbar, click the Radial tool button , and then drag across the view.

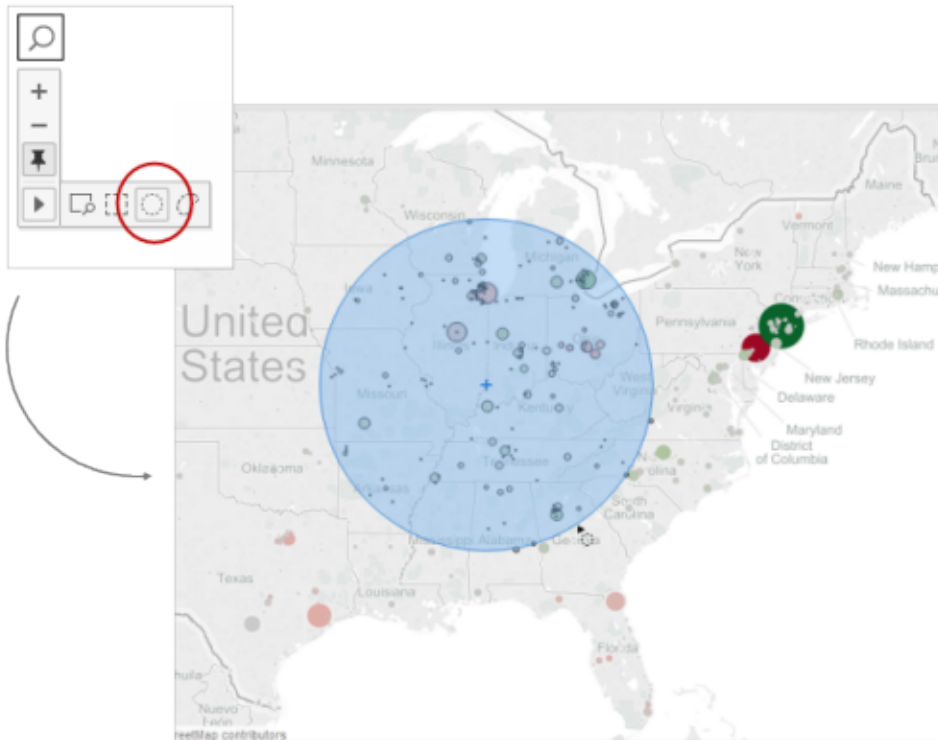

You can also measure distance in a map view with the Radial tool. For more information, see [Measure Distances Between Data Points and Locations in a Map](#) on page 1896.

Make lasso selections

With the Lasso tool, you can select multiple marks by drawing a freehand shape around them. This tool is useful when you want to include only certain marks, and exclude others around them.

To use the Lasso tool, hover over the arrow on the view toolbar, click the Lasso tool button , and then draw a freehand shape around the marks you want to select.

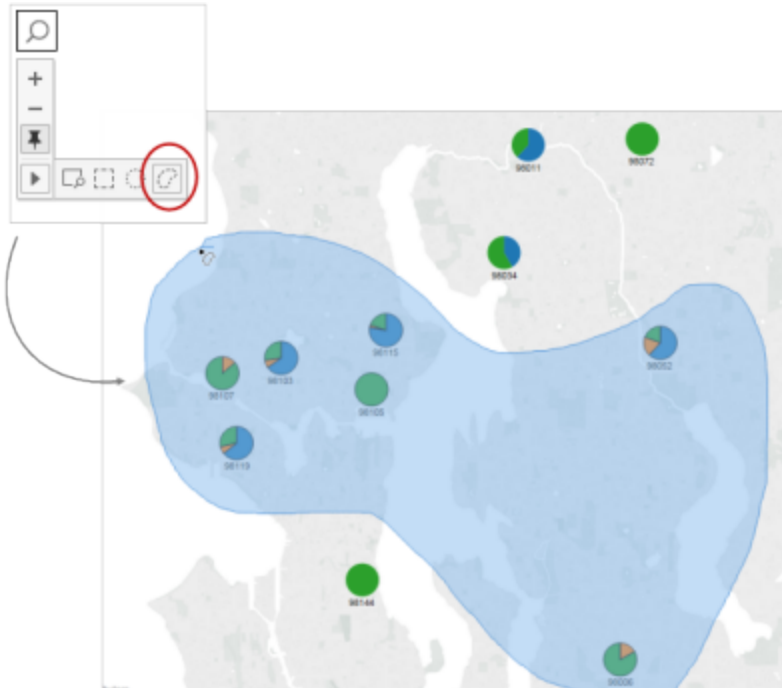

Undo and Redo

You can perform unlimited undo and redo of almost all actions in Tableau Desktop, as well as the content viewing and authoring modes of Tableau Cloud and Tableau Server. For example, you can quickly return to a sheet you were just viewing, or you can cycle through changes to a data source you're editing.

Tableau saves your undo and redo history across all worksheets until you exit; the history isn't saved between sessions.

Keyboard shortcuts

To quickly undo or redo changes, use these keyboard shortcuts:

- On Windows, press Ctrl+Z to undo and Ctrl+Y to redo.
- On macOS, press Command+Z to undo and Command+Shift+Z to redo.

Undo and Redo buttons

In the upper-left corner of Tableau Desktop, Tableau Cloud, and Tableau Server, you can click Undo and Redo buttons.

Here's how those buttons appear in Tableau Desktop:

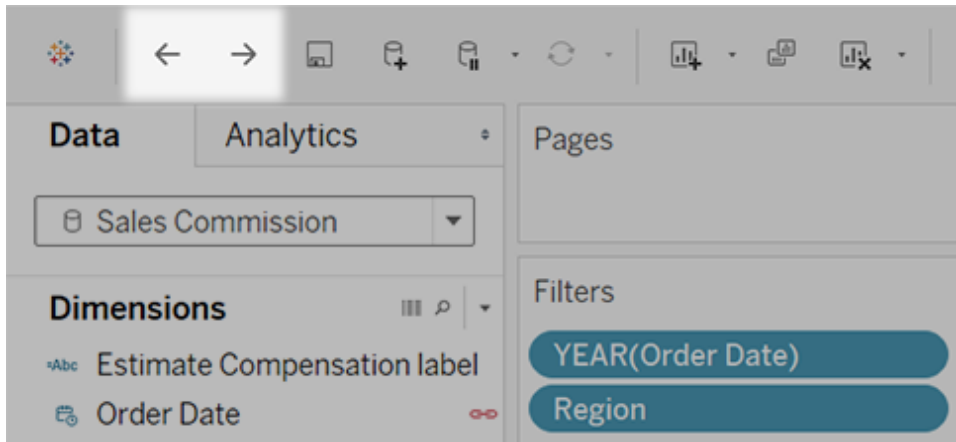

And here's how they appear in Tableau Cloud and Tableau Server:

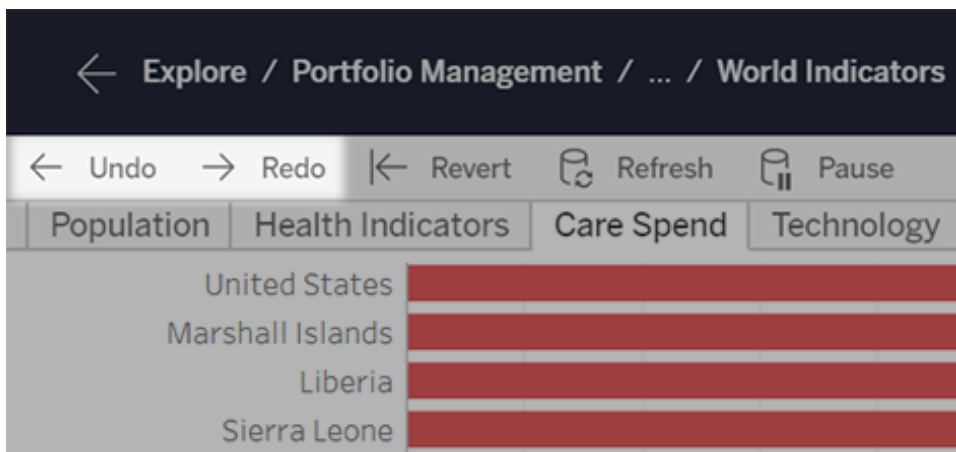

If your browser window is more narrow, the buttons appear like so:

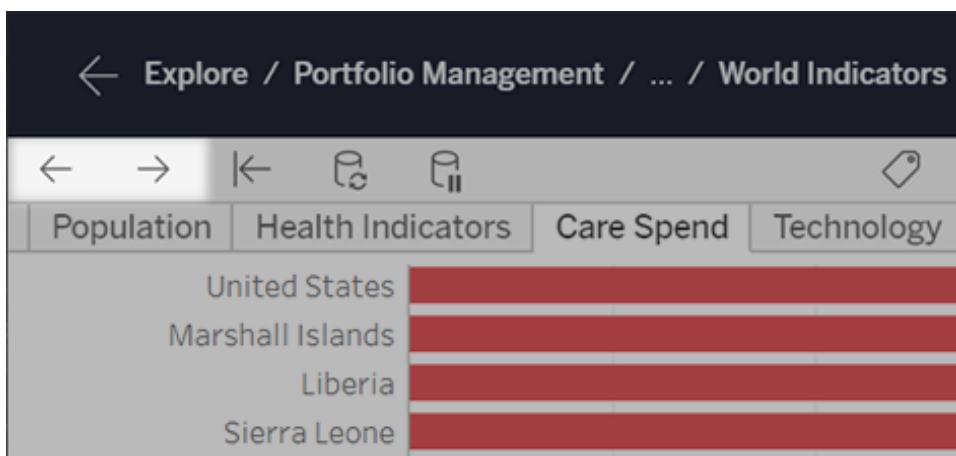

I don't see the toolbar for these buttons

Well, you've got a few options. Either use the [keyboard shortcuts](#) above, or do the following:

- For Tableau Desktop, select **Window > Show Toolbar**.
- For an embedded view from Tableau Cloud or Tableau Server, ask the content owner to unhide the toolbar using the “toolbar” [URL parameter](#).

Now start making some wild changes in Tableau so you can undo and redo them to your heart's content!

Summary Card

The **Summary Card**, available on the **Show/Hide Cards** toolbar menu , provides a quick view of information about a selection or the entire data source.

When you select data in the view, the **Summary Card** updates to show you information only for the data within the selection:

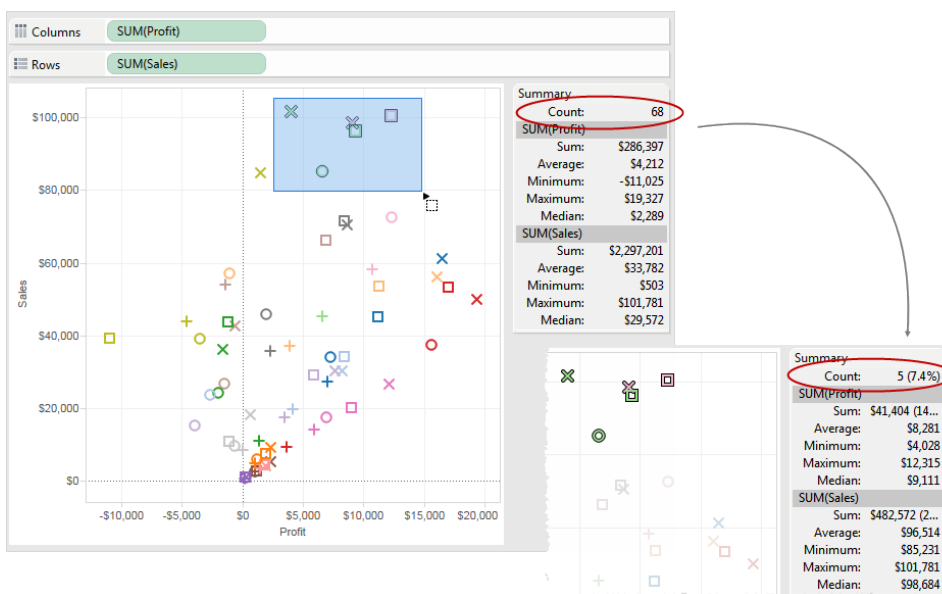

By default, the **Summary Card** shows Sum, Average, Minimum, Maximum, and Median values for the data in the view. The summary card values update to show these values for the current selection of data points. (Average is computed by summing all relevant values and then dividing by the total number of values. Median is computed by sorting values from lowest to highest and

then selecting the middle value.) The Count value at the top of the card indicates the number of marks in the view or selection.

You can use the drop-down menu for the **Summary Card** to show additional statistics:

- **Standard Deviation**

A measure of data spread around its average, measured in the same units as the data itself. The sample standard deviation is an unbiased estimate of the population standard deviation given a slight correction. This standard deviation includes the correction.

- **First Quartile**

A measure of location that is commonly used with other quartiles to provide a robust measure of spread. Robust in this case means not as sensitive to outliers as the standard deviation. The first quartile is the 25th percentile, typically the lower line in a boxplot.

- **Third Quartile**

A measure of location that is commonly used with other quartiles to provide a robust measure of spread. Robust in this case means not as sensitive to outliers as the standard deviation. The third quartile is the 75th percentile, typically the upper line in a boxplot.

- **Skewness**

A measure of the tendency of your data to have extreme values to one side. Positive skewness means the extreme values are to the right, while negative skewness means the extreme values are to the left.

- **Excess Kurtosis**

A measure of the tendency of your data to have more extreme or outlying values than a normal distribution. A normal distribution has a kurtosis of 3 so this value is kurtosis minus three.

View Underlying Data

When you see a Tableau visualization, do you wonder what data makes up each mark or even the entire viz? A typical viz contains aggregated measures based on the structure of the dimensions in the view. Every mark you see in a viz has underlying column and row data. The View Data window displays this data in a tabular format, scoped to the current selection or the current view.

If you have the required permissions, you can view underlying data in a worksheet, sheets in a dashboard, or in the Data Source page. In the worksheet, you can **customize** the View Data window and **download** that customized view in CSV format.

Note: Customized sort results aren't included in the downloaded data.

By default, the View Data window displays up to 10,000 rows of data in Tableau Desktop and up to 200 rows of data in Tableau Cloud and Tableau Server.

Note: Starting in Tableau version 2020.2, when you open a data source from Tableau version 2020.1 or earlier, the column order might be different. Columns might be displayed differently in the View Data window, and the column order might be different when you export it to CSV format. In Tableau version 2022.1 and later, you can manually customize the column order before you export the data.

This change in how column order is handled in the View Data window is required to support relationships and logical tables. If you use scripts that depend on a customized column order, we recommend using the Tableau Extensions API for View Data to download underlying data to CSV format.

Where you can open the View Data window

The data you see in the View Data window varies depending on the context of where you open it.

Context	Scope	How
Worksheet: Selected Mark or Marks Tableau Cloud, Tableau Server, Tableau Desktop	In a worksheet, selecting one or more marks and then selecting View Data from the tooltip menu displays underlying data scoped to	Select one or more marks in the view, and then select View Data from the tooltip menu.

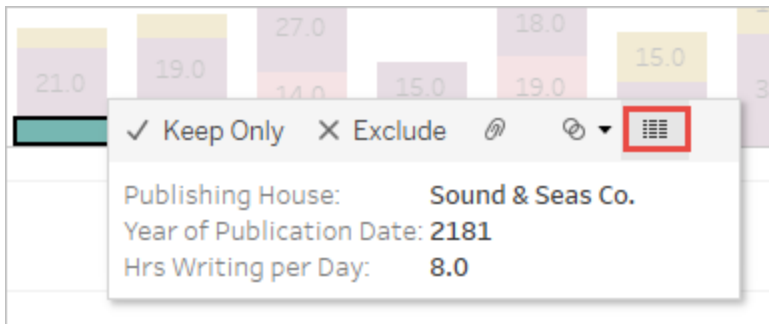

Context	Scope	How
	<p>the individual mark or a group of marks.</p> <p>Note: The Include command buttons option must be selected for tooltips for the View Data button to be available.</p> <p>This view can be customized and downloaded.</p>	
<p>Data Source page: Per Table</p> <p>Tableau Cloud, Tableau Server, Tableau Desktop</p>	<p>In the Data Source page, you can open View Data for each table listed in the data source (left pane).</p> <p>You can move and sort columns in this view, but you can't download the data.</p>	<p>Select View Data next to a table in the left pane of the Data Source page.</p>  <p>You can also display the View Data window for custom SQL by clicking Preview Results in the Custom SQL dialog box.</p>

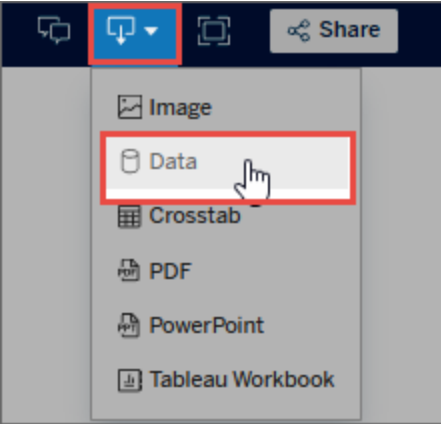
Context	Scope	How
<p>Worksheet: Download button on toolbar</p> <p>Tableau Cloud and Tableau Server</p>	<p>In a worksheet (viewing or editing mode), selecting Data from the Download button menu displays all underlying data used in a viz.</p> <p>In a dashboard, underlying data can be viewed based on the selected worksheet. Select a sheet in the dashboard before you click the Download button to make the Data option available.</p> <p>This view can be customized and downloaded.</p>	<p>From the Download button menu, select Data.</p>  <p>The screenshot shows a dark blue toolbar with several icons. The 'Download' icon (a blue square with a white downward arrow) is highlighted with a red box. A dropdown menu is open below it, listing options: 'Image', 'Data', 'Crosstab', 'PDF', 'PowerPoint', and 'Tableau Workbook'. The 'Data' option is highlighted with a red box and a mouse cursor is pointing at it.</p>

Context	Scope	How
<p>Worksheet: Data pane</p> <p>Tableau Desktop only</p>	<p>In a worksheet, selecting View Data at the top of the Data pane displays tabular data for each field in the data source, listed by table.</p>	<p>In the Data pane, click the View Data button next to the Search field.</p>

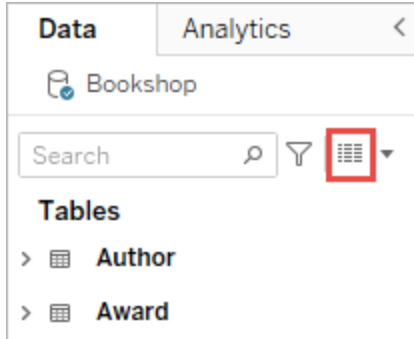

This view can be customized and downloaded.

<p>Worksheet: Analysis menu</p> <p>Tableau Desktop only</p>	<p>In a worksheet, selecting View Data from the Analysis menu displays all underlying data used in a viz. The corresponding table or tables for measures used in the viz are listed in the Tabs pane.</p>	<p>From the Analysis menu, select View Data.</p> <p>In vizzes that aren't text tables, you also can right click the view, and then select View Data.</p>
---	---	--

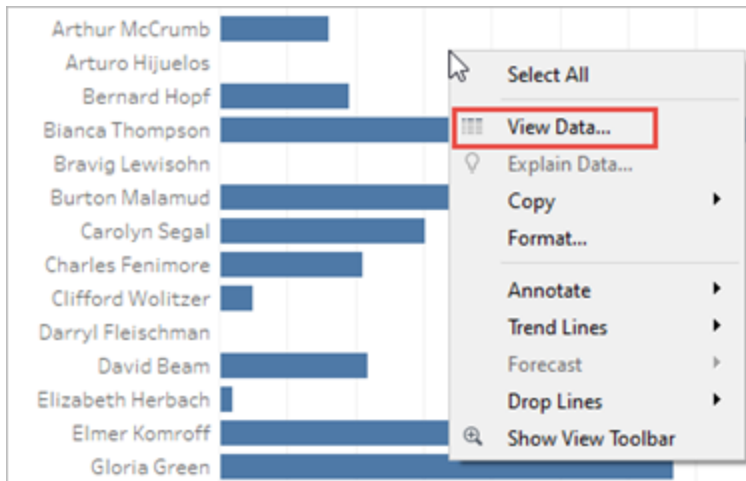

This view can be customized and downloaded.

Open View Data in a worksheet

When you open View Data in a worksheet, you can customize the display of the View Data window and download that customized view.

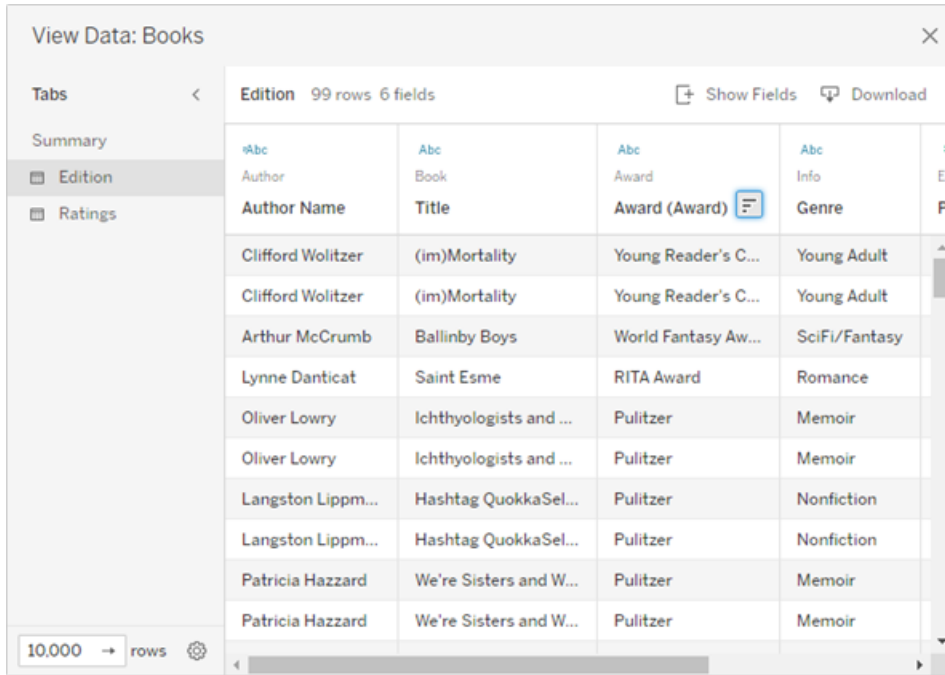

The View Data window displays multiple tabs on the left side of the window. The number of tabs and types of tabs vary depending on the current scope.

- The **Summary** tab displays the dimensions that define the view and the aggregated measure or measures that make up the mark.
When more than one continuous date field is used in a view, the rows for field values won't be merged in the summary data. This behavior applies to continuous dimensions in general, but most commonly will occur with date fields.
- A tab for each table that has a measure present in the view, showing all fields from that table. The **Full Data** tab is displayed for single table data sources.
To show all fields, select **(All)** under **Show Fields**. When **(All)** is selected, each tab shows all dimensions that define the view, regardless of which table they're from.
- Field names are shown as column headers. Hover near the top of a column to display the drop-down menu and Sort button. You can also click anywhere in a column header to display its drop-down menu.

- Some calculations used in the view might be displayed on tabs as well:
 - Calculations that don't belong with a table in the Data pane, such as aggregate calculations or calculations that span tables.
 - LOD calculations (`FIXED` or `INCLUDE` only), even if they reside in a table in the Data pane. Ad hoc LOD calculations aren't shown in View Data.
 - All relevant fields used in the calculation are displayed, regardless of their original table, as well as the value of the calculation itself.

Open View Data in a viz for one or more marks

Click a mark to display its tooltip. In the tooltip menu, click the View Data icon . You can also select multiple marks simultaneously and then click View Data in the tooltip menu to see the combined View Data results.

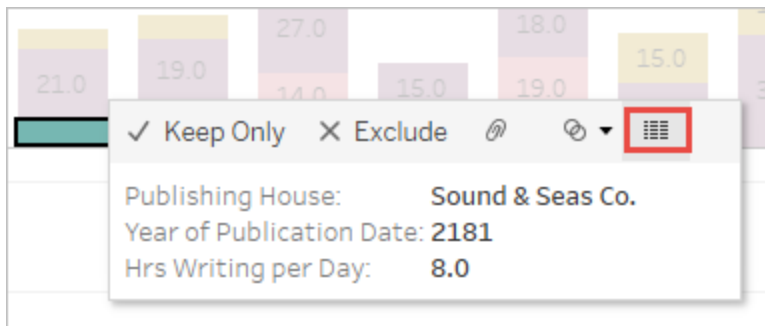

Note: The **Include command buttons** option must be selected for tooltips in the viz for the View Data button to be available.

Open View Data for the entire view

Tableau Cloud and Tableau Server

To see the underlying data for the entire view, in viewing or editing mode, click the **Download** button on the toolbar and then select **Data**. Make sure no marks are selected in the view, otherwise, the data is scoped to your selection.

In a dashboard, underlying data can be viewed based on the selected worksheet. Select a sheet in the dashboard before you click the Download button to make the Data option available.





Tableau Desktop

To see the underlying data for the entire view, from the **Analysis** menu, select **View Data**. The View Data window is displayed with similar results for viewing data for a mark, but instead it displays all of the data in use in the view.

Open View Data for the Data pane

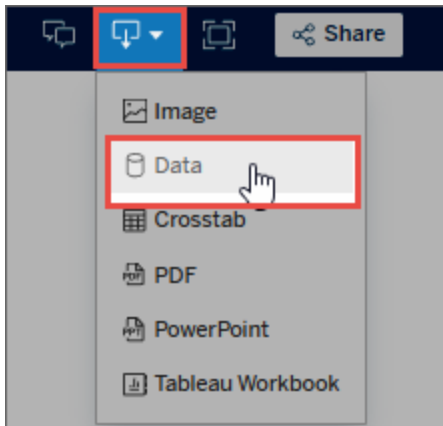
To see the underlying data for each field in the data source, listed by table, click the View Data icon  in the top of the Data pane, next to the Search field.

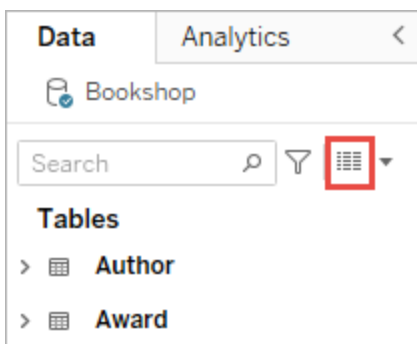

You can open the View Data for the Data pane in Tableau Desktop only.

Open View Data in the Data Source page

The View Data window can be opened per table for the data source. Viewing data for the data source before or during analysis can be useful to give you a sense of the scope of each table, its fields and their values, and general impressions about the data.

When you open View Data in the Data Source page, you can move and sort the field columns in the View Data window, but you can't download the data.

In the Data Source page, hover over a table or sheet in the left pane to display the View Data icon , and then click the icon.



The View Data window displays the data for that table.

Customize the View Data window

All customization options are available when you open View Data in a worksheet and are used for downloaded data.

The customizations you make remain until you close the View Data window. Closing the View Data window discards all customizations.

Note: For the Data Source page, sorting and moving fields are the only options available for View Data.

Option	How
Show or hide field columns	Click Show Fields and check or uncheck a field name. To show all fields, select (All) . Fields are added to the right of the currently

Where

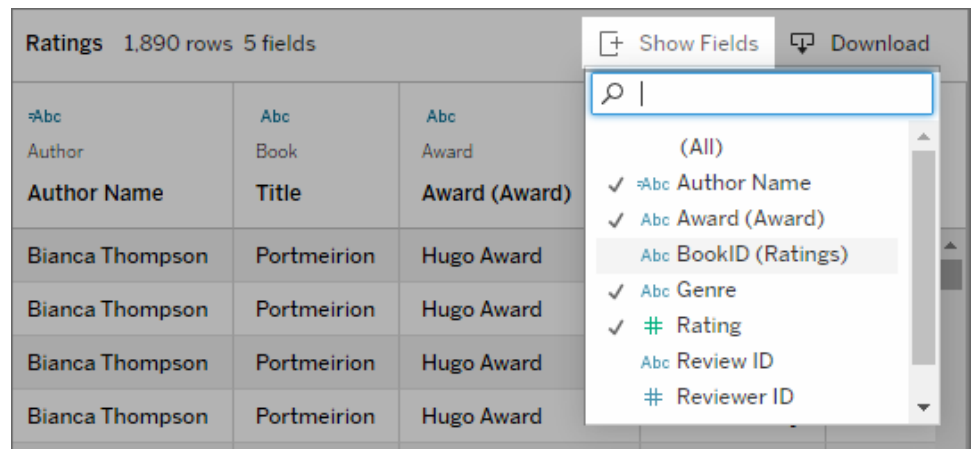

Option	How	Where
--------	-----	-------

	displayed fields.	
--	-------------------	--

Move field columns	Select one or more field columns and then click the right or left arrows at the top of the window. Or, select the drop-down menu and click Move Right and Move Left .	
---------------------------	---	--

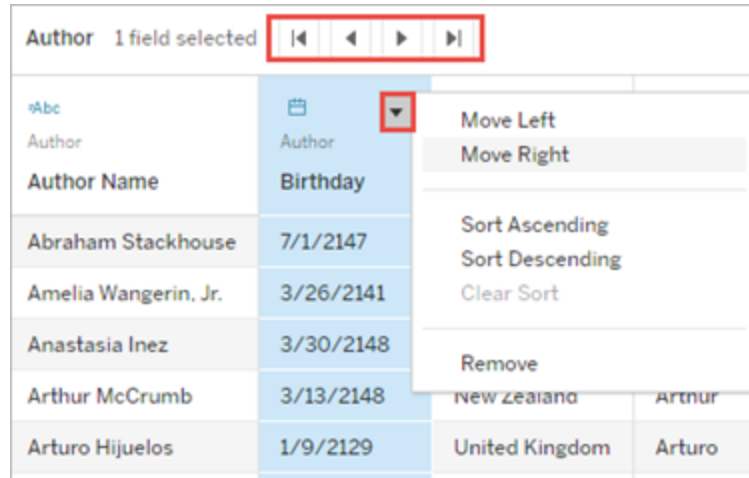

Tip: To group nonadjacent columns together, press Ctrl while selecting the columns, and then move the selected columns to the left or right.

Option **How** **Where**

Remove field columns Select a field column and then select **Remove** from the drop-down menu. Or, click **Show Fields** and uncheck the field to remove its column.

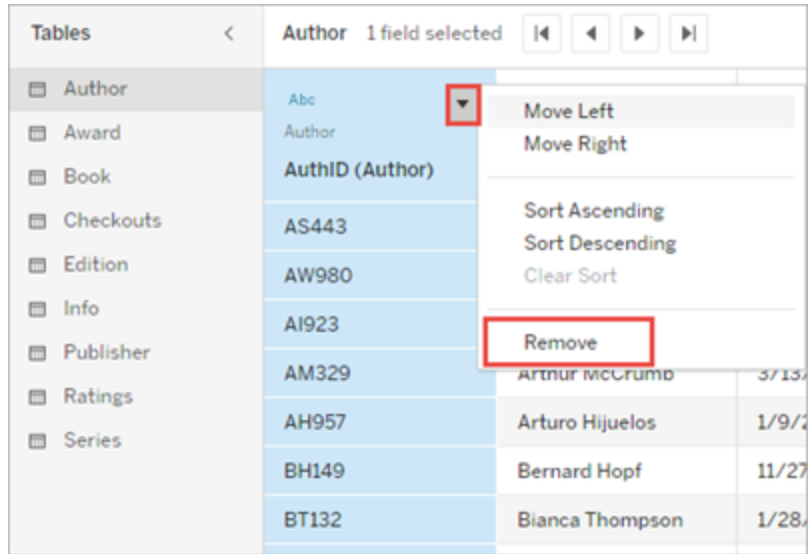

Sort data Hover near the top of a column to display the Sort button. Click the Sort button to change the sort. Optionally, click the drop-down menu and select **Sort Ascending** or **Sort Descending**

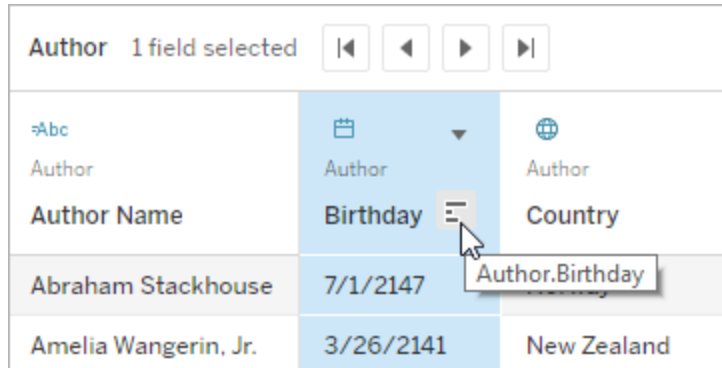

Note:
Customized sort results

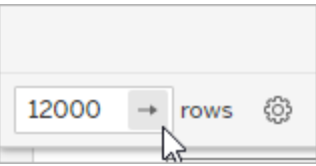
Option	How	Where
	aren't included in downloaded data.	
Edit the maximum number of rows displayed	<p>By default, the View Data window displays up to the first 10,000 rows of data in Tableau Desktop and up to the first 200 rows of data in Tableau Cloud and Tableau Server.</p> <p>You can increase or decrease the maximum number of rows displayed in the View Data window. This setting has no effect on the number of rows exported when you click the Download button.</p>	

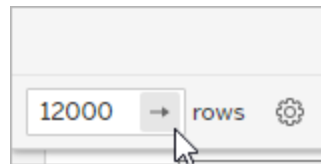

Option	How	Where
	Click in the number of rows field to edit it. Click the arrow button or press Enter on your keyboard to apply the change.	

Show aliases Click the **Settings** button to show or hide aliases for all field names.

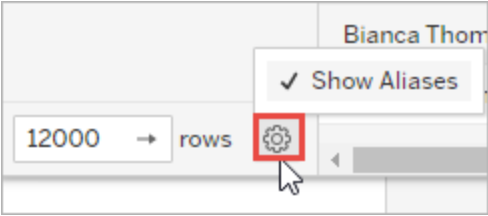

Download data from the View Data window

To export all of the data for the selected tab, click the **Download** button.

The data is exported to a CSV file using the current configuration as the View Data window and isn't limited to the number of rows currently displayed in the View Data window.

Note: Customized sort results aren't included in downloaded data.

Null values are downloaded as empty strings.

Author Name	Birthday	Country	First N
Abraham Stackhouse	7/1/2147	Norway	Abr.
Amelia Wangerin, Jr.	3/26/2141	New Zealand	Am
Anastasia Inez	3/30/2148	New Zealand	Ana
Arthur McCrumb	3/13/2148	New Zealand	Art
Arturo Hijuelos	1/9/2129	United Kingdom	Art
Bernard Hopf	11/27/2122	United States	Ber

Note: If you are a workbook author and want to ensure your audience can't copy or download the underlying data, consider [turning off the command buttons in the tooltips](#) or denying workbook [permissions](#) to download the summary or full data.

Copy data from the View Data window

You can copy portions of the data from the View Data window for use in a spreadsheet or another Tableau workbook (really, anywhere you can paste text). Null values are copied as empty strings.

- Select cells of interest and press Ctrl+C (Windows) or Command+C (Mac), and then paste the data into a spreadsheet, another Tableau workbook, or another destination of your choice.

Note: If you want to download all of the values in the underlying data, click the **Download** button. Selecting and copying a column copies only values that are currently loaded in the View Data window and might not include all of the values in the underlying data.

Why can't I see the View Data icon?

If you can't find the View Data icon for a mark, check that tooltips and tooltip menu command buttons are turned on. Specifically, the **Show tooltips** and **Include command buttons** options must be selected for tooltips in the viz for the View Data button to be available in a tooltip.

Alternatively, right click a mark and select **View Data** from the drop-down menu. This method works when tooltips or command buttons aren't enabled.

There are several reasons why the View Data icon for a mark might not be displayed in a published viz:

- Tooltips aren't enabled.
- Tooltip command buttons have been turned off.
- You might not have the necessary permissions to view data.

Get Details About Fields and Sheets in a Workbook

When you want to see details about the elements in use in a viz, select the **Worksheet** menu, and then click **Describe Sheet**.

For details about a field (such as data role, data type, domain, aggregation, calculation formula), click **Describe** in a field's context menu in the **Data** pane. You can then share those details with someone else by copying that summary text.

Note: For related information, see these blog posts from Tableau Visionaries Ryan Sleeper (PlayfairData) and Bridget Cogley (TableauFit): [3 Ways the Describe Feature Can Help You Use Tableau](#) and [10 Intro Tips to Tableau When You're Handed Someone Else's Workbooks](#).

Display sheet details

Click **Worksheet** > **Describe Sheet** when editing a viz to view a description of the workbook, data source, fields and layout of the current worksheet. This summary includes the Caption in the first line, but provides other important summary information. You can then copy and paste this information into other applications.

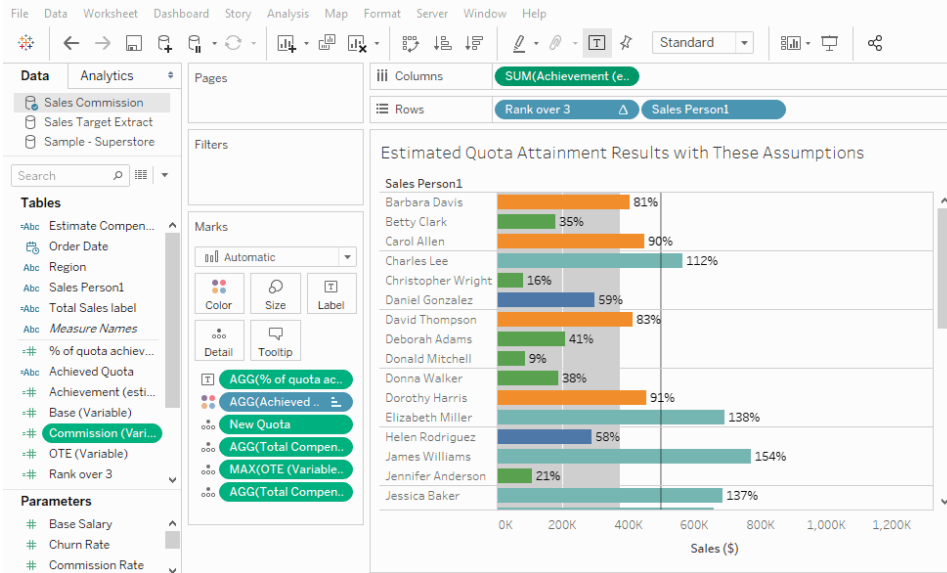

Note: If you have Trend Lines turned on, the Describe Sheet dialog box includes information about the trend line model. For more information, see [Assess Trend Line Significance](#) on page 2515. If you have Forecasting turned on, the Describe Sheet dialog box includes information about estimated data. For more information, see [Forecast Descriptions](#) on page 2562.

Display field details

When you click **Describe** in the context menu of a field in the Data pane, you can view a description of the workbook, data source, fields and layout of the current worksheet. This summary includes the Caption in the first line, but provides other important summary information. You can then copy and paste this information into other applications.

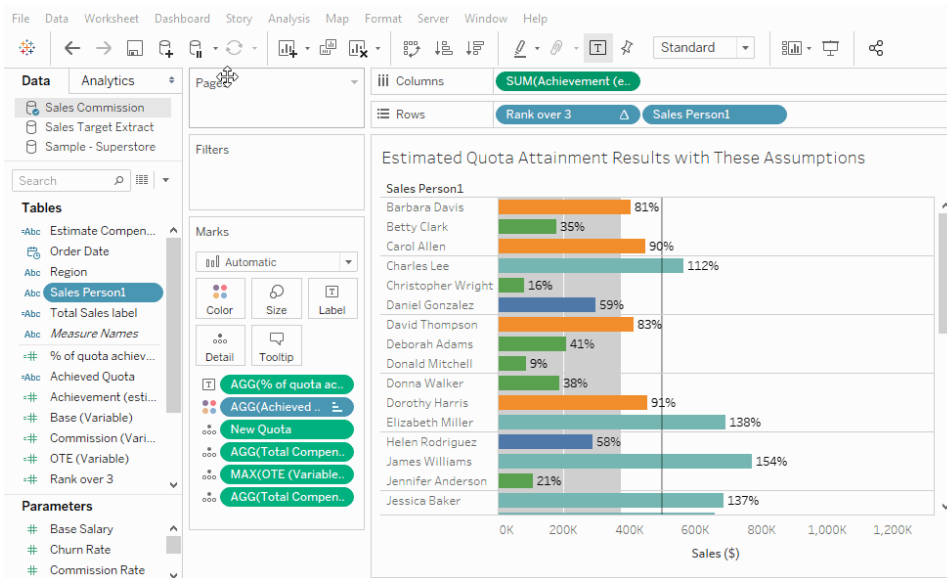

Create Custom Fields with Calculations

If your underlying data doesn't include all of the fields you need to answer your questions, you can create new fields in Tableau using calculations and then save them as part of your data source. These fields are called calculated fields.

This section provides all the documentation you need to get started with calculations in Tableau.

Get Started with Calculations in Tableau

This article describes how to create and use calculated fields in Tableau using an example.

You'll learn Tableau calculation concepts, as well as how to create and edit a calculated field. You will also learn how to work with the calculation editor, and use a calculated field in the view.

If you're new to Tableau calculations or to creating calculated fields in Tableau, this is a good place to start.

Why Use Calculated Fields

Calculated fields allow you to create new data from data that already exists in your data source. When you create a calculated field, you are essentially creating a new field (or column) in your data source, the values or members of which are determined by a calculation that you control. This new calculated field is saved to your data source in Tableau, and can be used to create more robust visualizations. But don't worry: your original data remains untouched.

You can use calculated fields for many, many reasons. Some examples might include:

- To segment data
- To convert the data type of a field, such as converting a string to a date.
- To aggregate data
- To filter results
- To calculate ratios

Types of calculations

You create calculated fields using calculations. There are three main types of calculations you can use to create calculated fields in Tableau:

- **Basic calculations** - Basic calculations allow you to transform values or members at the data source level of detail (a row-level calculation) or at the visualization level of detail (an aggregate calculation).
- **Level of Detail (LOD) expressions** - Just like basic calculations, LOD calculations allow you to compute values at the data source level and the visualization level. However, LOD calculations give you even more control on the level of granularity you want to compute. They can be performed at a more granular level (INCLUDE), a less granular level (EXCLUDE), or an entirely independent level (FIXED) with respect to the granularity of the visualization.

For more information, see [Create Level of Detail Expressions in Tableau on page 2405](#).

- **Table calculations** - Table calculations allow you to transform values at the level of detail of the visualization only. For more information, see [Transform Values with Table Calculations on page 2364](#).

The type of calculation you choose depends on the needs of your analysis and the question you want to answer.

Create a calculated field

Once you have determined the type of calculation you want to use, it's time to create a calculated field. This example uses a basic calculation.

Note: The example in this article uses the **Sample-Superstore** data source that comes with Tableau Desktop. To follow along with the steps in this article, connect to the **Sample-Superstore** saved data source and navigate to **Sheet 1**.

1. In Tableau, select **Analysis > Create Calculated Field**.
2. In the Calculation Editor that opens, do the following:
 - Enter a name for the calculated field. In this example, the field is called, **Discount Ratio**.
 - Enter a formula. This example uses the following formula:

```
IIF([Sales] !=0, [Discount]/[Sales],0)
```

This formula checks if sales is not equal to zero. If true, it returns the discount ratio (Discount/Sales); if false, it returns zero.

Tip: To see a list of available functions, click the triangle icon on the right-side of the Calculation Editor.

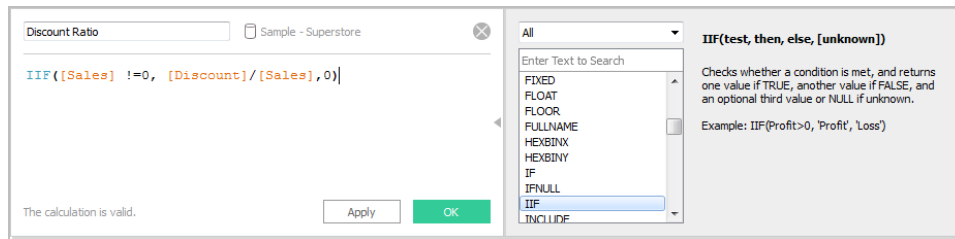

Each function includes syntax, a description, and an example for your reference. Double-click a function in the list to add it to the formula. For more tips, see [Tips for Working with Calculated Fields in Tableau on page 2468](#).

3. When finished, click **OK**. The new calculated field is added to Data pane as a measure because it returns a number. An equal sign (=) appears next to the data type icon. All calculated fields have equal signs (=) next to them in the **Data** pane.

Use a calculated field in the view

Step 1: Build the view

1. From the **Data** pane, drag **Region** to the **Columns** shelf.
2. From the **Data** pane, drag **Category** to the **Rows** shelf.
3. On the **Rows** shelf, click the plus icon (+) on the **Category** field to drill-down to Sub-category.

Step 2: Add the calculated field to the view

1. From the **Data** pane, drag **Discount Ratio** to **Color** on the Marks card. The view updates to highlight table.

- Binders are heavily discounted in the Central region. Notice that Discount Ratio is automatically aggregated as a sum.
2. On the Rows shelf, right-click **SUM(Discount Ratio)** and select **Measure (Sum) > Average**. The view updates to show the average of discount ratio.

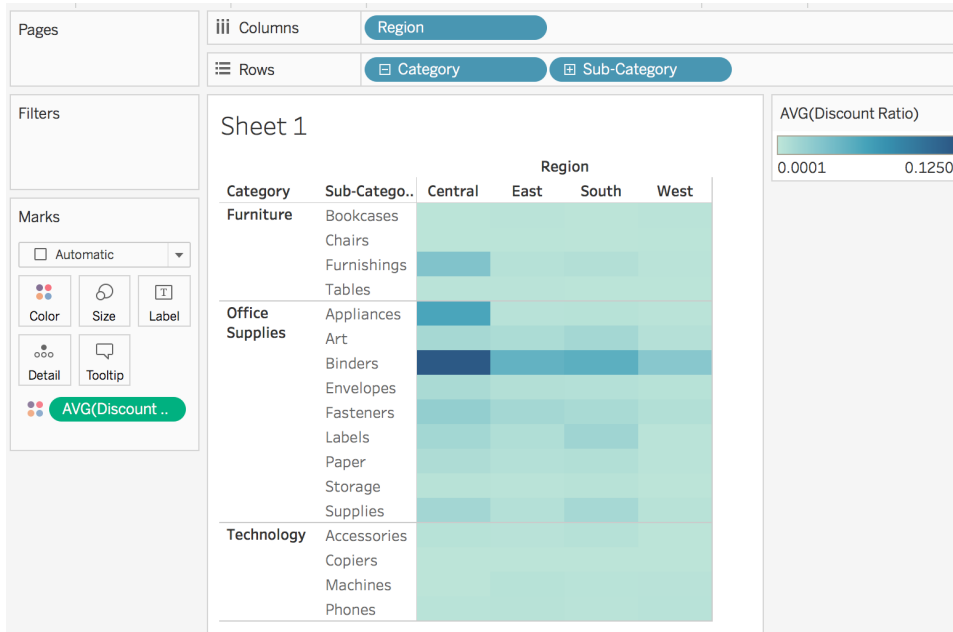

Edit a Calculated Field

If at any time you need to change a calculation, you can edit the calculated field and it will update across your entire workbook.

To edit a calculated field:

1. In the **Data** pane, right-click the calculated field and select **Edit**.
2. In the Calculation Editor that opens, you can do the following:
 - Edit the name of the calculated field.
 - Update the formula.

For this example, the formula is changed to return a discount ratio for orders over 2000 USD in sales:

```
IIF([Sales] > 2000, [Discount]/[Sales],0)
```

3. Click **OK**.

The view updates to reflect the changes automatically. You *do not* need to re-add the updated calculated field to the view.

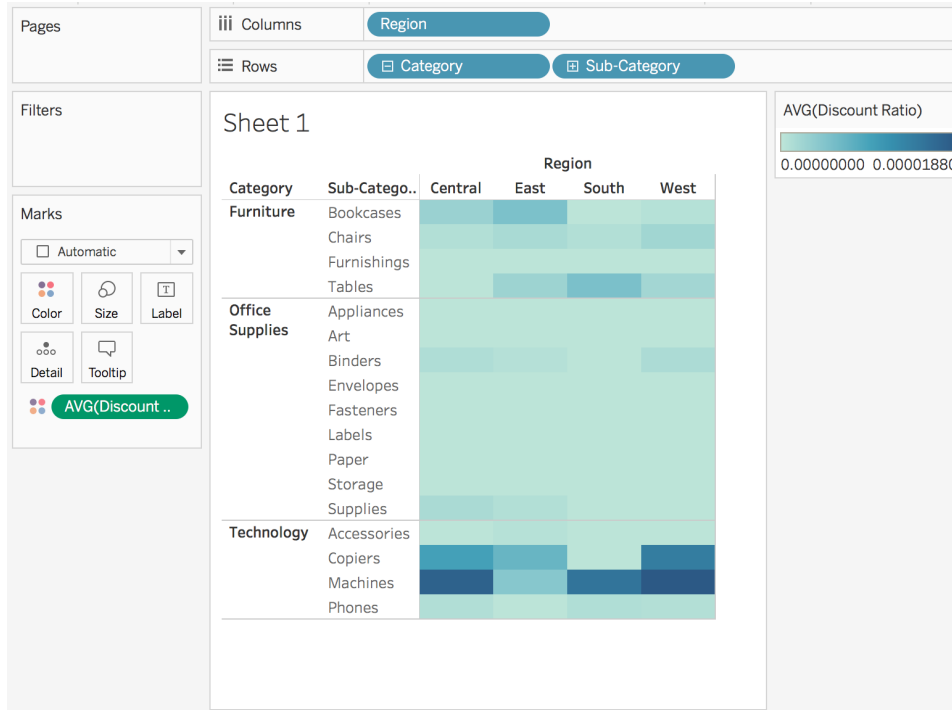

See Also

[Understanding Calculations in Tableau on page 2023](#)

[Formatting Calculations in Tableau on page 2449](#)

[Functions in Tableau on page 2047](#)

[Create Level of Detail Expressions in Tableau on page 2405](#)

[Transform Values with Table Calculations on page 2364](#)

Create a Simple Calculated Field

Sometimes your data source does not contain a field (or column) that you need for your analysis. For example, your data source might contain fields with values for Sales and Profit, but not for Profit Ratio. If this is the case, you can create a calculated field for Profit Ratio using data from the Sales and Profit fields.

This topic demonstrates how to create a simple calculated field using an example.

Step 1: Create the calculated field

1. In a worksheet in Tableau, select **Analysis > Create Calculated Field**.
2. In the Calculation Editor that opens, give the calculated field a name. In this example, the calculated field is called **Profit Ratio**.

Step 2: Enter a formula

1. In the Calculation Editor, enter the following formula:

```
SUM([Profit])/SUM([Sales])
```

Formulas use a combination of functions, fields, and operators. To learn more about creating formulas in Tableau, see [Formatting Calculations in Tableau on page 2449](#) and [Functions in Tableau on page 2047](#).

2. When finished, click **OK**. The new calculated field is added to the Data pane with an = in front of the data type icon to indicate it's a calculated field.

You are now ready to use the calculated field in the view.

Check your work! Watch how to create a simple calculated field in action:

The screenshot shows the Tableau Desktop interface. The Data pane on the left lists dimensions (Ship Mode, Location, Country, State, City, Postal Code, Product, Region) and measures (Discount, Profit, Quantity). A new calculated field, 'Profit (bin)', is being added to the Data pane. The main view shows a table with columns for Category, Sub-Category, and Region (Central, East, South, West). The table data is as follows:

Category	Sub-Catego..	Region			
		Central	East	South	West
Furniture	Bookcases	Abc	Abc	Abc	Abc
	Chairs	Abc	Abc	Abc	Abc
	Furnishings	Abc	Abc	Abc	Abc
	Tables	Abc	Abc	Abc	Abc
Office Supplies	Appliances	Abc	Abc	Abc	Abc
	Art	Abc	Abc	Abc	Abc
	Binders	Abc	Abc	Abc	Abc
	Envelopes	Abc	Abc	Abc	Abc
	Fasteners	Abc	Abc	Abc	Abc
	Labels	Abc	Abc	Abc	Abc
	Paper	Abc	Abc	Abc	Abc
	Storage	Abc	Abc	Abc	Abc
	Supplies	Abc	Abc	Abc	Abc
Technology	Accessories	Abc	Abc	Abc	Abc
	Copiers	Abc	Abc	Abc	Abc
	Machines	Abc	Abc	Abc	Abc
	Phones	Abc	Abc	Abc	Abc

See Also

[Get Started with Calculations in Tableau on page 2017](#)

[Formatting Calculations in Tableau](#) on page 2449

[Functions in Tableau](#) on page 2047

[Create Level of Detail Expressions in Tableau](#) on page 2405

[Transform Values with Table Calculations](#) on page 2364

Understanding Calculations in Tableau

This series introduces the basics of understanding calculations in Tableau. In this topic, you'll learn why and when to use calculations.

Why use calculations

Calculations allow you to create new data from data that already exists in your data source, as well as perform computations on your data. This allows you to perform complex analyzes and add fields to your data source on your own and on the fly.

When to use calculations

The first hurdle to learning calculations in Tableau is to recognize when you actually need to use one. You can use calculations for many, many reasons. Some examples might include:

- To segment data
- To convert the data type of a field, such as converting a string to a date.
- To aggregate data
- To filter results
- To calculate ratios

Some common scenarios might include:

- **The data you need for your analysis is missing from your data source.**

For example, if you have a Sales and Profit field in your data source, but you want to calculate cost, you can *create* a Cost field using a formula similar to the following.

```
[Sales] - [Profit]
```

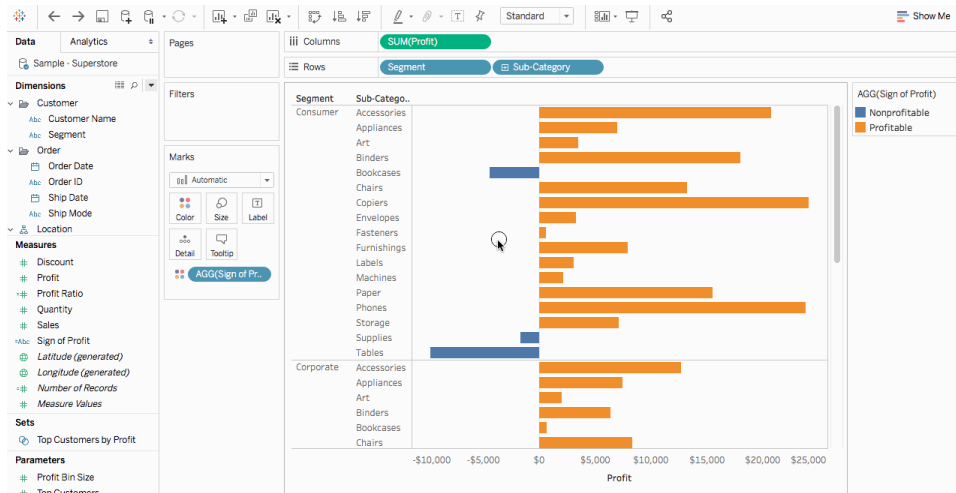

- You want to transform values in your visualization.

For example, you might want to calculate the difference in profit from one year to the other. You can use a quick table calculation to show the difference in profit in the visualization.

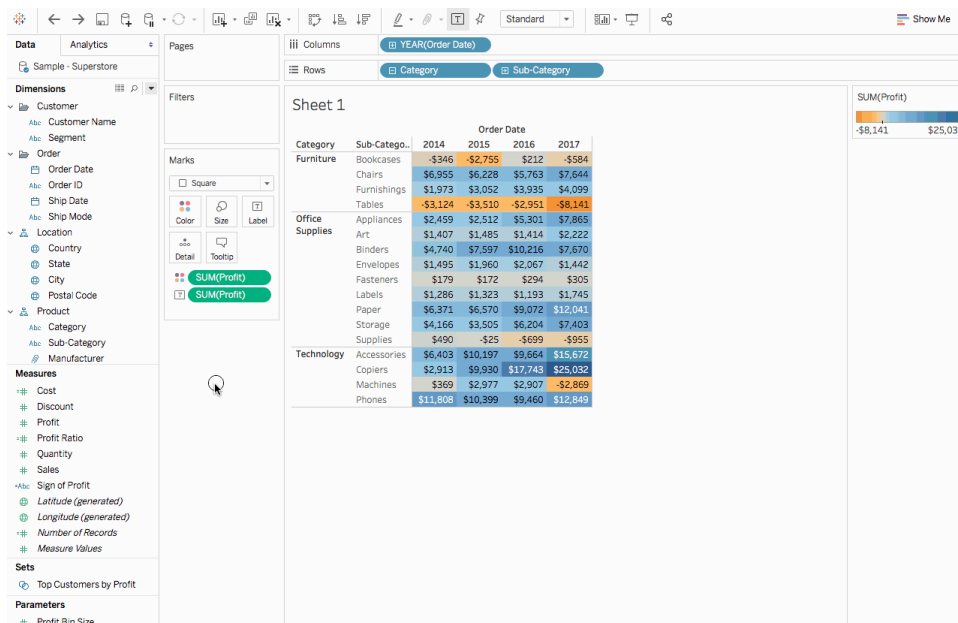

- You want to quickly categorize data.

For example, you might want to quickly color the data in your visualization as profitable or non-profitable. You can create a calculated field using a calculation similar to the following and then add it to Color on the Marks card.

```
IF SUM([Profit]) > 0
THEN "Profitable"
ELSE "Nonprofitable"
END
```

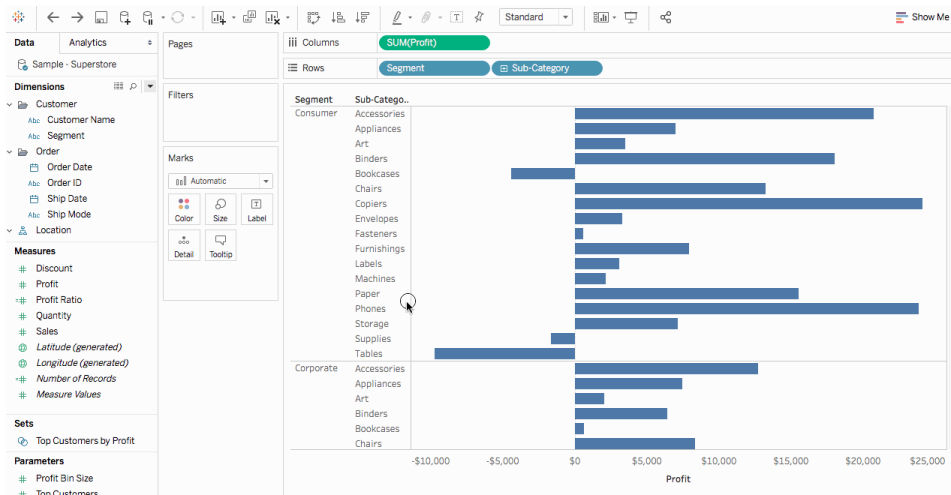

Types of Calculations in Tableau

This article explains the types of calculations you can use in Tableau. You'll learn the difference between each calculation and how they are computed.

There are three main types of calculations you can use to create calculated fields in Tableau:

- **Basic expressions**
- **Level of Detail (LOD) expressions**
- **Table calculations** on page 2032

Basic expressions

Basic expressions allow you to transform values or members at the data source level of detail (a row-level calculation) or at the visualization level of detail (an aggregate calculation).

For example, consider the following sample table, which contains data on two fantasy authors and their books. Perhaps you want to create a column with only the author's last name and a column that displays how many books are in each series.

Book ID	Book Name	Series	Year Released	Author
1	The Lion, the Witch and the Wardrobe	The Chronicles of Narnia	1950	C.S. Lewis
2	Prince Caspian: The Return to Narnia	The Chronicles of Narnia	1951	C.S. Lewis
3	The Voyage of the Dawn Treader	The Chronicles of Narnia	1952	C.S. Lewis
4	The Silver Chair	The Chronicles of Narnia	1953	C.S. Lewis
5	The Horse and His Boy	The Chronicles of Narnia	1954	C.S. Lewis
6	The Magician's Nephew	The Chronicles of Narnia	1955	C.S. Lewis
7	The Last Battle	The Chronicles of Narnia	1956	C.S. Lewis
8	Daughter of the Forest	Sevenwaters	1999	Juliet Maril- lier
9	Son of the Shadows	Sevenwaters	2000	Juliet Maril- lier
10	Child of the Prophecy	Sevenwaters	2001	Juliet Maril- lier
11	Heir of Sevenwaters	Sevenwaters	2008	Juliet Maril- lier
12	Seer of Sevenwaters	Sevenwaters	2010	Juliet Maril- lier
13	Flame of Sevenwaters	Sevenwaters	2012	Juliet Maril- lier

Row-level calculations

To create a column that displays the author's last name for every row in the data source, you can use the following row-level calculation that splits on a space:

```
SPLIT([Author], ' ', 2 )
```

The result can be seen below. The new column, titled **Author Last Name** is shown on the far right. The colors demonstrate the level of detail the calculation is performed at. In this case, the calculation is performed at the row-level of the data source, so each row is colored separately.

Book ID	Book Name	Series	Year Released	Author	Author Last Name
1	The Lion, the Witch and the Wardrobe	The Chronicles of Narnia	1950	C.S. Lewis	Lewis
2	Prince Caspian: The Return to Narnia	The Chronicles of Narnia	1951	C.S. Lewis	Lewis
3	The Voyage of the Dawn Treader	The Chronicles of Narnia	1952	C.S. Lewis	Lewis
4	The Silver Chair	The Chronicles of Narnia	1953	C.S. Lewis	Lewis
5	The Horse and His Boy	The Chronicles of Narnia	1954	C.S. Lewis	Lewis
6	The Magician's Nephew	The Chronicles of Narnia	1955	C.S. Lewis	Lewis
7	The Last Battle	The Chronicles of Narnia	1956	C.S. Lewis	Lewis
8	Daughter of the Forest	Sevenwaters	1999	Juliet Marillier	Marillier
9	Son of the Shadows	Sevenwaters	2000	Juliet Marillier	Marillier

10	Child of the Prophecy	Sevenwaters	2001	Juliet Marillier	Marillier
11	Heir of Sevenwaters	Sevenwaters	2008	Juliet Marillier	Marillier
12	Seer of Sevenwaters	Sevenwaters	2010	Juliet Marillier	Marillier
13	Flame of Sevenwaters	Sevenwaters	2012	Juliet Marillier	Marillier

Aggregate calculations

To create a column that displays how many books are in each series, you can use the following aggregate calculation:

```
COUNT([Series])
```

The result can be seen below. The new column, titled **Number of Books in Series - at Series level of detail** shows how that calculation would be performed at the Series level of detail in the view. The colors help demonstrate the level of detail in which the calculation is being performed.

Series	Number of Books in Series - at Series level of detail
The Chronicles of Narnia	7
The Chronicles of Narnia	
The Chronicles of Narnia	
The Chronicles of Narnia	
The Chronicles of Narnia	
The Chronicles of Narnia	
The Chronicles of Narnia	

Sevenwaters	6
Sevenwaters	
Sevenwaters	
Sevenwaters	
Sevenwaters	
Sevenwaters	

In Tableau, the data looks like this:

The screenshot shows the Tableau interface with a table view. The 'Columns' shelf is empty, and the 'Rows' shelf contains the 'Series' field. The main view displays a table titled 'Number of books in series' with the following data:

Series	
The Chronicles of Narnia	7
Sevenwaters	6

The interface also shows the 'Marks' card with 'AGG(Number ..)' selected, and the 'Filters' and 'Columns' shelves are empty.

But if you drag in **Book Id**, (which is a more granular field), the calculation updates based on that new granularity since aggregate calculations are performed at the visualization level of detail.

The screenshot shows the Tableau Desktop interface. The 'Columns' shelf contains 'Book ID' and 'Series'. The 'Rows' shelf is empty. The 'Marks' shelf is set to 'Automatic' and contains a green pill labeled 'AGG(Number ..)'. The main view displays a table titled 'Number of books in series' with the following data:

Book ID	Series	
1	The Chronicles of Narnia	1
2	The Chronicles of Narnia	1
3	The Chronicles of Narnia	1
4	The Chronicles of Narnia	1
5	The Chronicles of Narnia	1
6	The Chronicles of Narnia	1
7	The Chronicles of Narnia	1
8	Sevenwaters	1
9	Sevenwaters	1
10	Sevenwaters	1
11	Sevenwaters	1
12	Sevenwaters	1
13	Sevenwaters	1

Level of Detail (LOD) expressions

Just like basic expressions, LOD expressions allow you to compute values at the data source level and the visualization level. However, LOD expressions give you even more control on the level of granularity you want to compute. They can be performed at a more granular level (INCLUDE), a less granular level (EXCLUDE), or an entirely independent level (FIXED).

For more information, see [Create Level of Detail Expressions in Tableau](#) on page 2405.

For example, consider the same sample table as [above](#). If you wanted to compute when a book series was launched, you might use the following LOD expression:

```
{ FIXED [Series]:(MIN([Year Released])) }
```

The result can be seen below. The new column, titled **Series Launched**, displays the minimum year for each series. The colors help demonstrate the level of detail in which the calculation is being applied.

Book ID	Book Name	Series	Year Released	Author	Series Launched
1	The Lion, the Witch	The Chronicles	1950	C.S.	1950

Tableau Desktop and Web Authoring Help

	and the Wardrobe	of Narnia		Lewis	
2	Prince Caspian: The Return to Narnia	The Chronicles of Narnia	1951	C.S. Lewis	1950
3	The Voyage of the Dawn Treader	The Chronicles of Narnia	1952	C.S. Lewis	1950
4	The Silver Chair	The Chronicles of Narnia	1953	C.S. Lewis	1950
5	The Horse and His Boy	The Chronicles of Narnia	1954	C.S. Lewis	1950
6	The Magician's Nephew	The Chronicles of Narnia	1955	C.S. Lewis	1950
7	The Last Battle	The Chronicles of Narnia	1956	C.S. Lewis	1950
8	Daughter of the Forest	Sevenwaters	1999	Juliet Marillier	1999
9	Son of the Shadows	Sevenwaters	2000	Juliet Marillier	1999
10	Child of the Prophecy	Sevenwaters	2001	Juliet Marillier	1999
11	Heir of Sevenwaters	Sevenwaters	2008	Juliet Marillier	1999
12	Seer of Sevenwaters	Sevenwaters	2010	Juliet Marillier	1999
13	Flame of Sevenwaters	Sevenwaters	2012	Juliet Marillier	1999

In Tableau, the calculation remains at the Series level of detail since it uses the FIXED function.

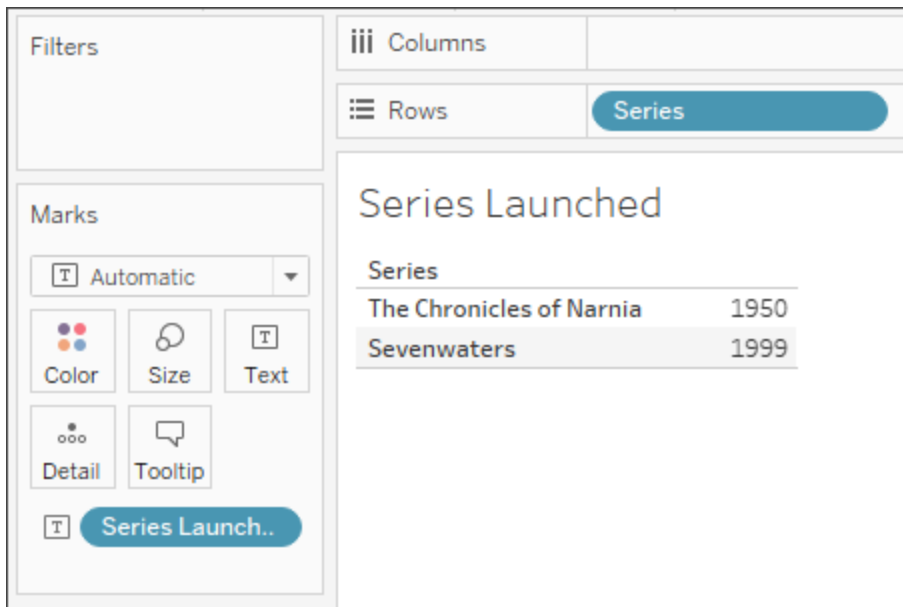

If you add another field to the view (which adds more granularity) the values for the calculation are not affected, unlike an aggregate calculation.

Series	Book Name	Year Released	Year Released
The Chronicles of Narnia	The Lion, the Witch and the Wardrobe	1950	1950
	Prince Caspian: The Return to Narnia	1951	1950
	The Voyage of the Dawn Treader	1952	1950
	The Silver Chair	1953	1950
	The Horse and His Boy	1954	1950
	The Magician's Nephew	1955	1950
	The Last Battle	1956	1950
Sevenwaters	Daughter of the Forest	1999	1999
	Son of the Shadows	2000	1999
	Child of the Prophecy	2001	1999
	Heir to Sevenwaters	2008	1999
	Seer of Sevenwaters	2010	1999
	Flame of Sevenwaters	2012	1999

Table calculations

Table calculations allow you to transform values at the level of detail of the visualization only.

For more information, see [Transform Values with Table Calculations](#) on page 2364.

For example, consider the same sample table as [above](#). If you wanted to compute the number of years since the author released their last book, you might use the following table calculation:

```
ATTR([Year Released]) - LOOKUP(ATTR([Year Released]), -1)
```

The result is shown below. The new column, titled **Years Since Previous Book**, displays the number of years between the book released in that row and the book released in the previous row (on the far right-side of the column) and demonstrates how the table calculation is being computed (on the left-side of the column).

The colors help demonstrate how the table calculation is being computed. In this case, the table calculation is being computed down each pane.

Note: Depending on the table calculation and how it is being computed across the table, the results may vary. For more information, see [Transform Values with Table Calculations](#) on page 2364.

Book ID	Book Name	Series	Year Released	Author	Years Since Previous Book		
1	The Lion, the Witch and the Wardrobe	The Chronicles of Narnia	1950	C.S. Lewis	NULL		
2	Prince Caspian: The Return to Narnia	The Chronicles of Narnia	1951	C.S. Lewis	1951-	1950	1
3	The Voyage of the Dawn Treader	The Chronicles of Narnia	1952	C.S. Lewis	1952-	1951	1
4	The Silver Chair	The Chronicles of Narnia	1953	C.S. Lewis	1953-	1952	1
5	The Horse and His Boy	The Chronicles of Narnia	1954	C.S. Lewis	1954-	1953	1

6	The Magician's Nephew	The Chronicles of Narnia	1955	C.S. Lewis	1955-	1954	1
7	The Last Battle	The Chronicles of Narnia	1956	C.S. Lewis	1956-	1955	1
8	Daughter of the Forest	Sevenwaters	1999	Juliet Marillier	NULL		
9	Son of the Shadows	Sevenwaters	2000	Juliet Marillier	2000-	1999	1
10	Child of the Prophecy	Sevenwaters	2001	Juliet Marillier	2001-	2000	1
11	Heir of Sevenwaters	Sevenwaters	2008	Juliet Marillier	2008-	2001	7
12	Seer of Sevenwaters	Sevenwaters	2010	Juliet Marillier	2010-	2008	2
13	Flame of Sevenwaters	Sevenwaters	2012	Juliet Marillier	2012-	2010	2

In Tableau, the data looks like this:

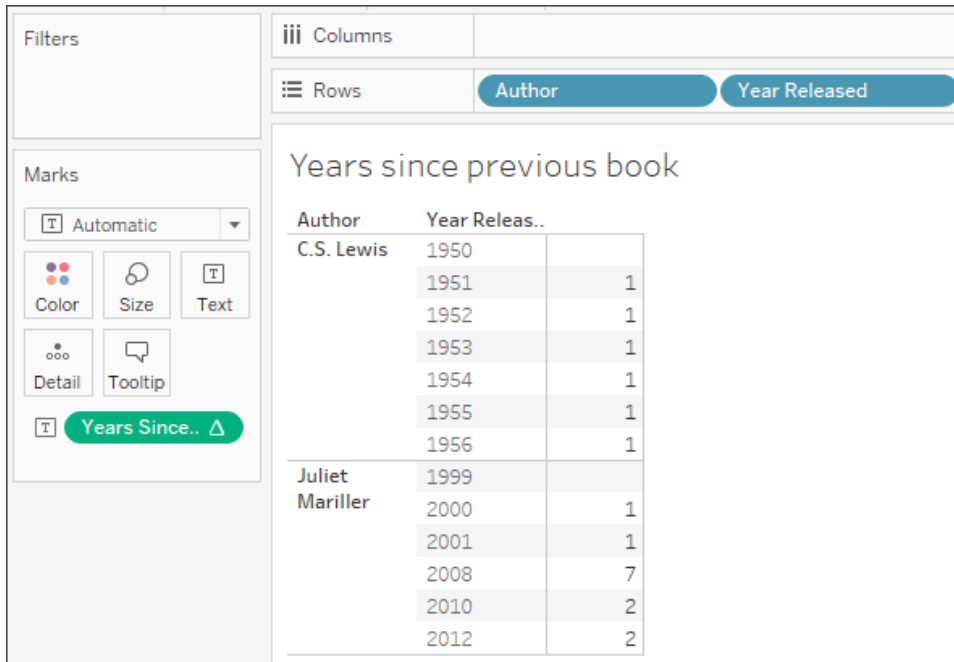

However, if you change the visualization in a way that affects the layout, such as removing a dimension from the view, the calculation values change.

For example, in the image below, **Author** is removed from the viz. Since the table calculation is computed by pane, removing Author changes the granularity and layout of the viz (instead of two panes there is now only one). The table calculation therefore calculates the time between 1956 and 1999.

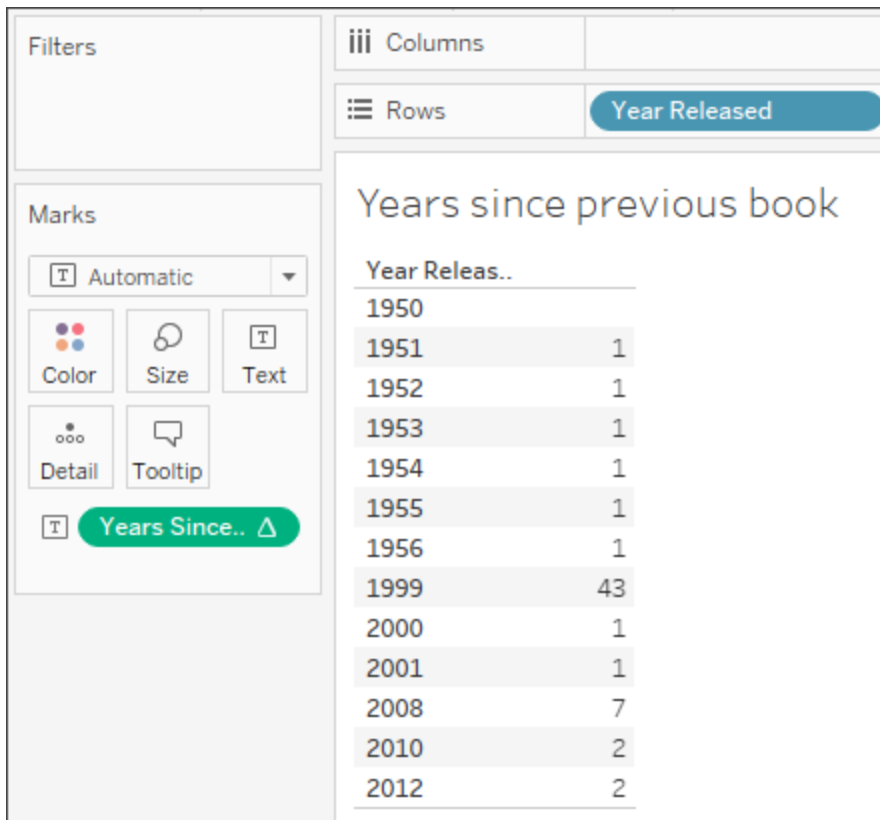

Continue to *Choosing the Right Calculation Type* below

See Also

[Understanding Calculations in Tableau](#)

[Tips for Learning How to Create Calculations](#)

Choosing the Right Calculation Type

The type of calculation you choose depends on the needs of your analysis, the question you want to answer, and the layout of your visualization.

Which calculation is right for your analysis?

Choosing the type of calculation to use for your analysis is not always easy. When trying to decide, consider the following questions and examples.

Note: This content was originally published on the Tableau Blog. See [A Handy Guide to Choosing the Right Calculation for Your Question](#) to read it.

Basic expression or table calculation?

Question 1:

Do you already have all the data values you need on the visualization?

- If the answer is **yes**: You can use a table calculation.
- If the answer is **no**: Use a basic calculation.

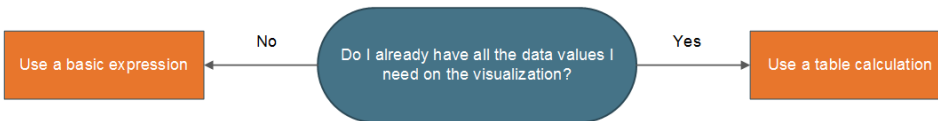

Example:

Consider the following two visualizations. The visualization on the left is a bar chart that shows the total sales per country/region. The visualization on the right also shows sales per country/region, but sales has been disaggregated.

How could you calculate the 90th percentile of sales for each of these visualizations?

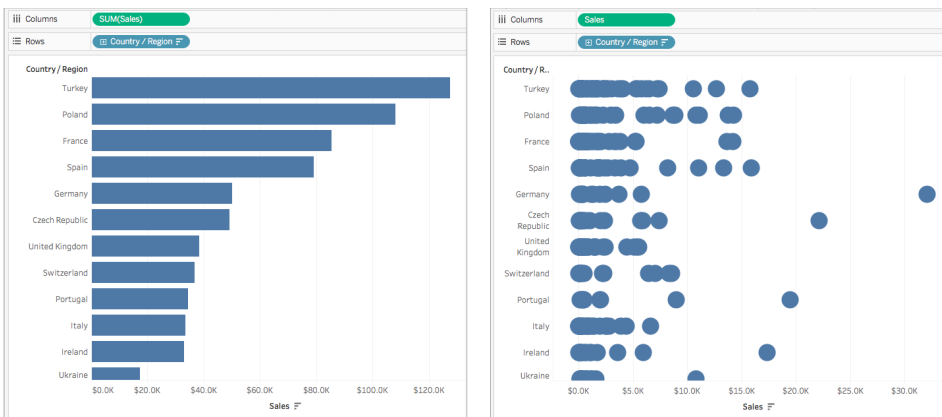

The bar chart on the left is aggregated by SUM. Therefore, there is not enough detail in this view to use a table calculation. You can use a basic aggregate expression to calculate the 90th percentile of sales for each country in this example using the following formula:

```
PERCENTILE ([Sales], .90)
```

This results in a value for 90th percentile per country as a label for each bar.

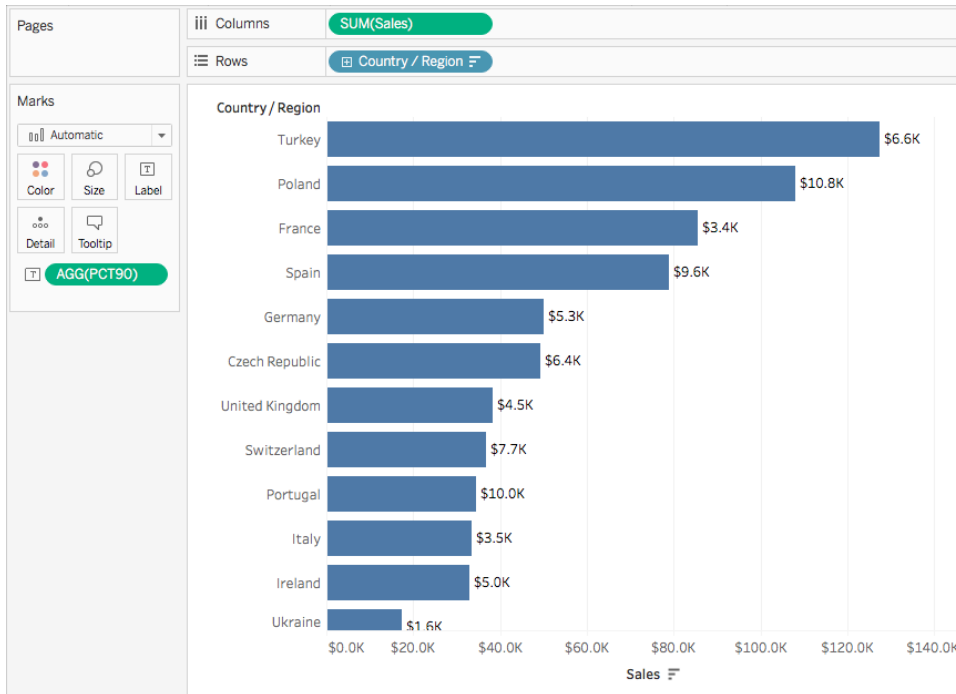

However, the chart on the right includes a data value for every sales order. A larger distribution and outliers are shown. There is enough detail in the view to use a table calculation.

You can calculate the 90th percentile of sales for each country by using a distribution band (equivalent to a table calculation). There is more context in this visualization.

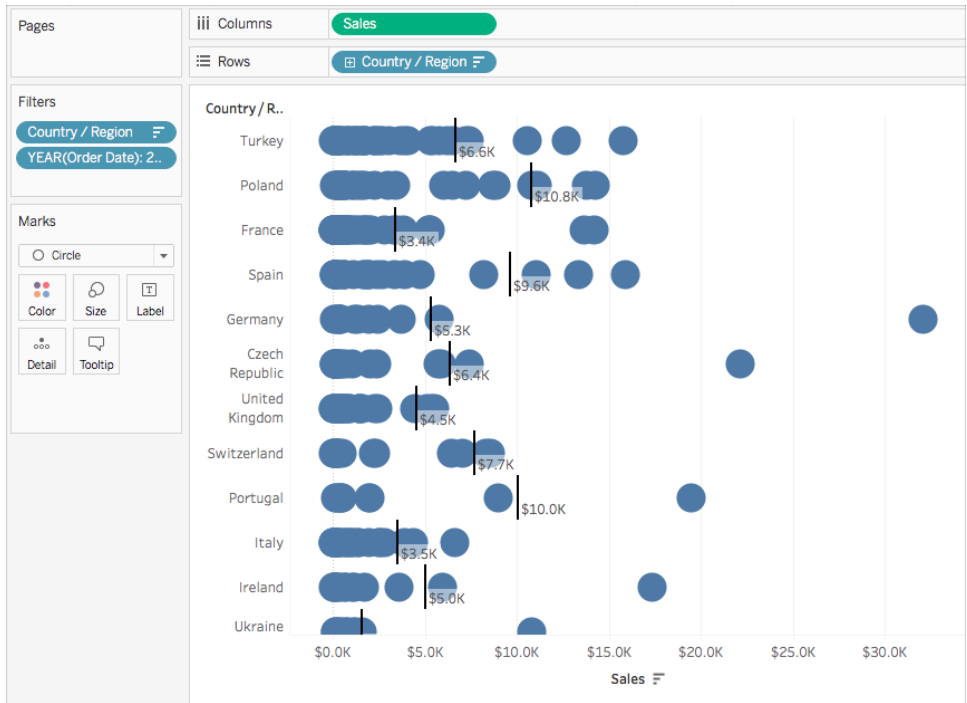

Both calculations achieve the same values, but the insights you gather from each differ based on the level of detail (the amount of data) in the visualization.

Basic expression or Level of Detail (LOD) expression?

If you don't have all the data you need on the visualization, you need your calculation to be passed through to the data source. This means you must use a basic calculation or an LOD Expression.

If you answered **no** to [question 1](#) ask yourself this:

Question 2:

Does the granularity of your question match either the granularity of the visualization or the granularity of the data source?

- If the answer is **yes**: Use a basic expression.
- If the answer is **no**: Use a Level of Detail (LOD) expression.

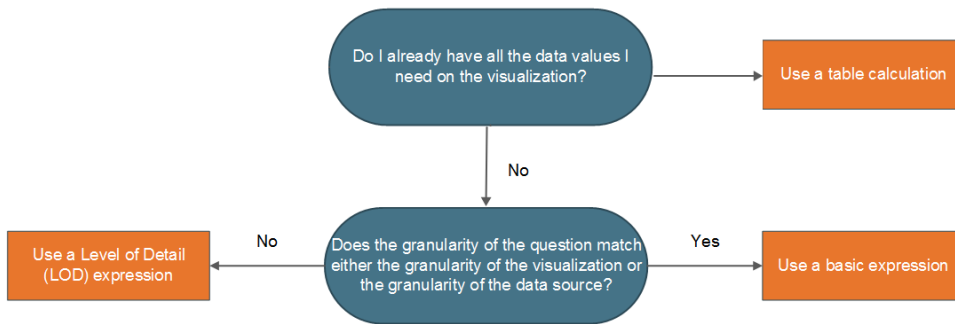

Example

Consider the following visualization. It shows the 90th percentile of sales for all orders in each country.

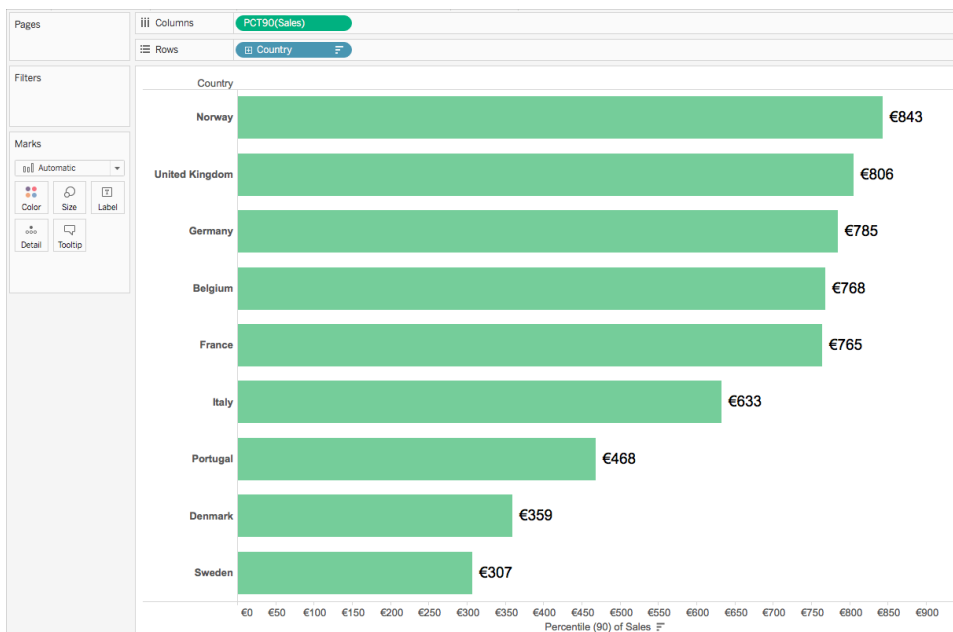

This example uses the Sample-Superstore data source that comes with Tableau. If you are familiar with the Sample-Superstore data source, you might know that there is one row of data per Order ID. Therefore, the granularity of the data source is Order ID. The granularity of the visualization, however, is Country.

If you want to know what the 90th percentile value of sales is for orders in each country at the order ID level of granularity, you can use the following LOD expression:

```
{INCLUDE [Order ID] : SUM([Sales])}
```

You can then change the field to aggregate at the 90th percentile in the view.

To do so, click the field drop-down and select **Measure > Percentile > 90**.

The following diagram demonstrates how the LOD Expression works in this case:

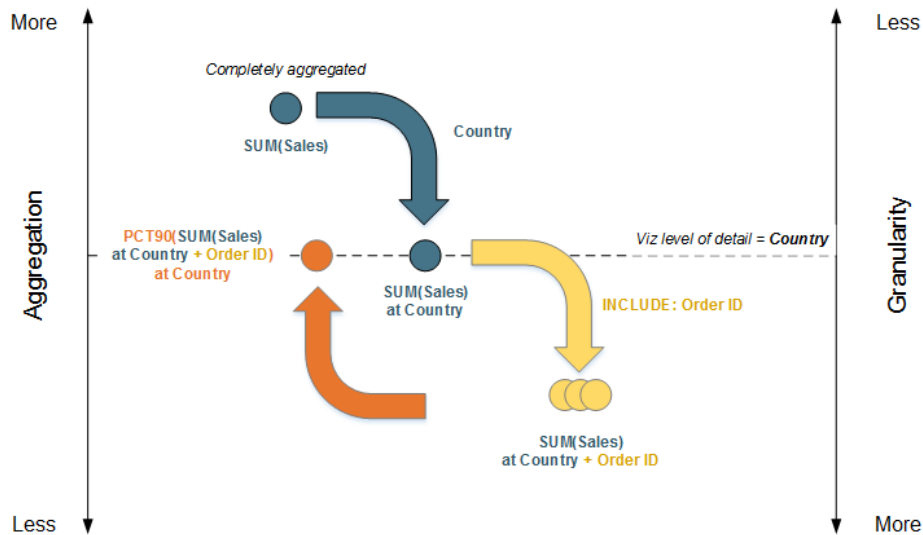

1. The data starts completely aggregated at SUM(Sales) and then moves down to the Country level of detail: SUM(Sales) at Country.
2. The LOD calculation is applied and the data gains more granularity: SUM(Sales) at Country + Order ID.
3. >The LOD calculation is aggregated to the 90th percentile: PCT90(SUM(Sales) at Country + Order ID)

The result is as follows:

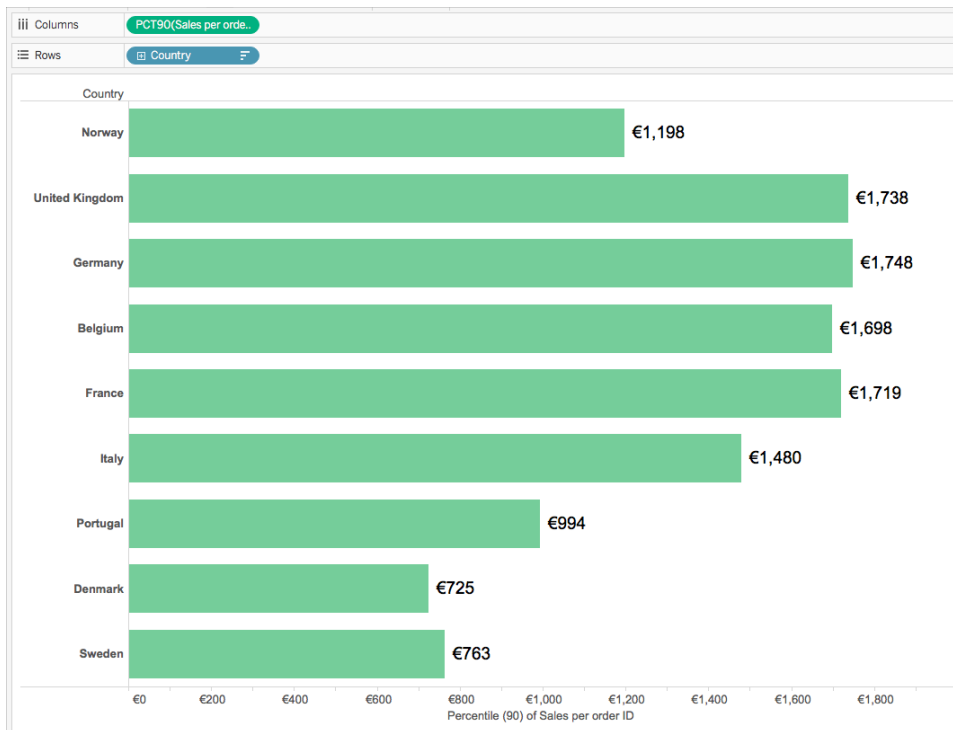

Table calculation or Level of Detail (LOD) expression?

When choosing between a table calculation or an LOD calculation, the process is very similar to choosing between a table calculation and a basic expression. Ask yourself the following questions:

Do you already have all the data values you need on the visualization?

- If the answer is **Yes**, then use a table calculation.
- If the answer is **No**, then ask yourself: *Does the granularity of the question match either the granularity of the visualization or the granularity of the data source?* If the answer is **No**, then use an LOD calculation.

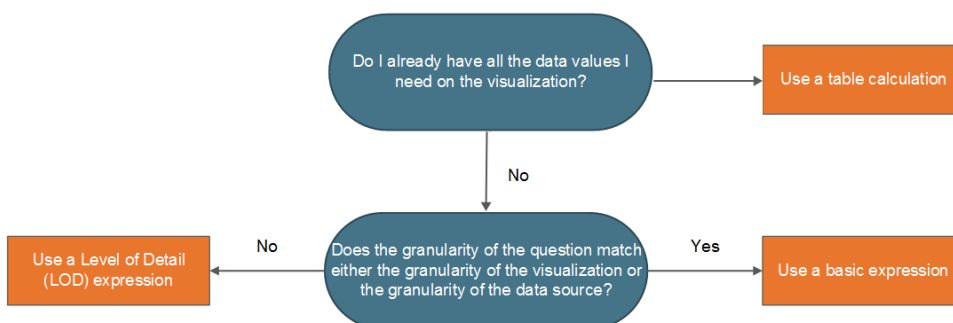
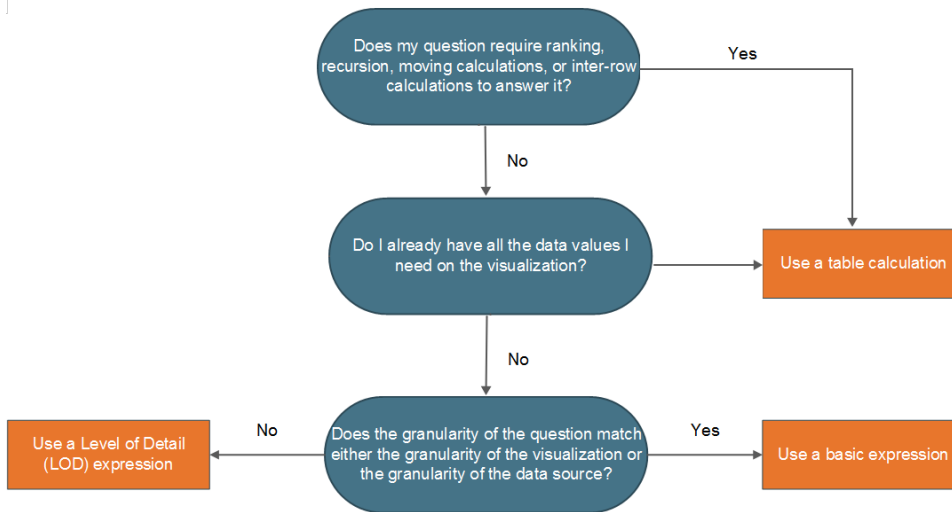

Table calculations only

There are some scenarios where only a table calculation will do. These include:

- Ranking
- Recursion (e.g. cumulative totals)
- Moving calculations (e.g. rolling averages)
- Inter-row calculations (e.g. period vs. period calculations)

If your analysis requires any of these scenarios, use a table calculation.



Example

Consider the following visualization. It shows the average closing price for several stocks between September 2014 and September 2015.

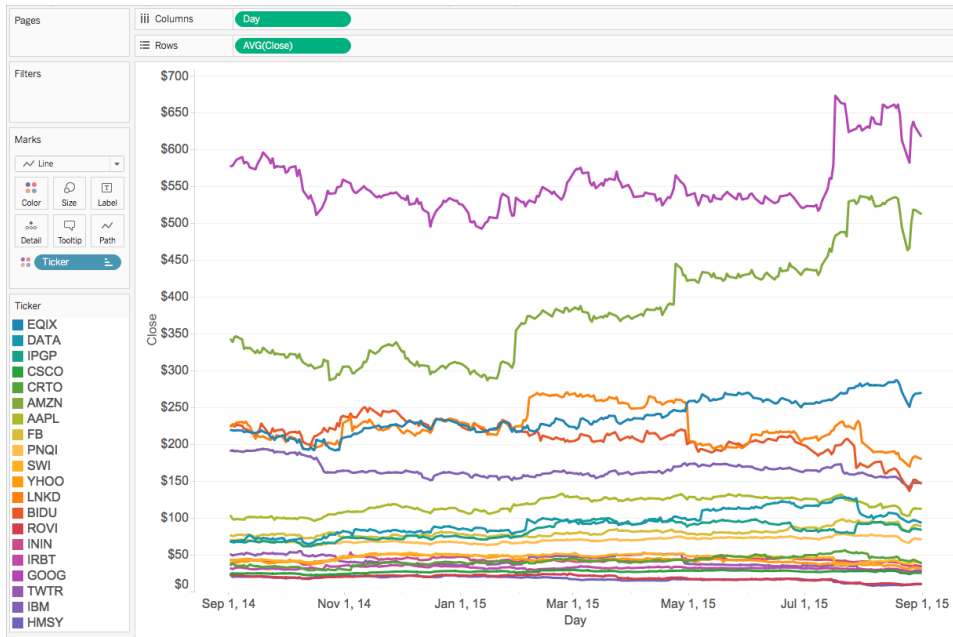

If you want to see the number of times the closing price exceeded its record close value to date, you must use a table calculation, specifically a recursive calculation.

Why? Because table calculations can output multiple values for each partition of data (cell, pane, table), while basic and LOD expressions can only output a single value for each partition or grouping of data.

To calculate the number of times the closing price exceeded its record closing price for each stock, there are a few steps you need to take.

1. You need to consider all the previous values before to tell if you have reached a new maximum close value. You can do this with a `RUNNING_MAX` function. For example, consider the following calculation computed using `Day` (across the table), titled **Record to Date**:

```
RUNNING_MAX(AVG([Close]))
```

2. Next, you can flag the days when the record was broken using the following calculation computed using `Day` (across the table), titled **Count Days Record Broken**:

```
IF AVG([Close]) = [Record to Date]
THEN 1
ELSE 0
END
```

3. Finally, you can count these days using the following calculation computed using Day (across the table):

```
RUNNING_SUM([Count Days Record Broken])
```

When you add the final calculated field to the view in place of Avg(Close), you get something like this:

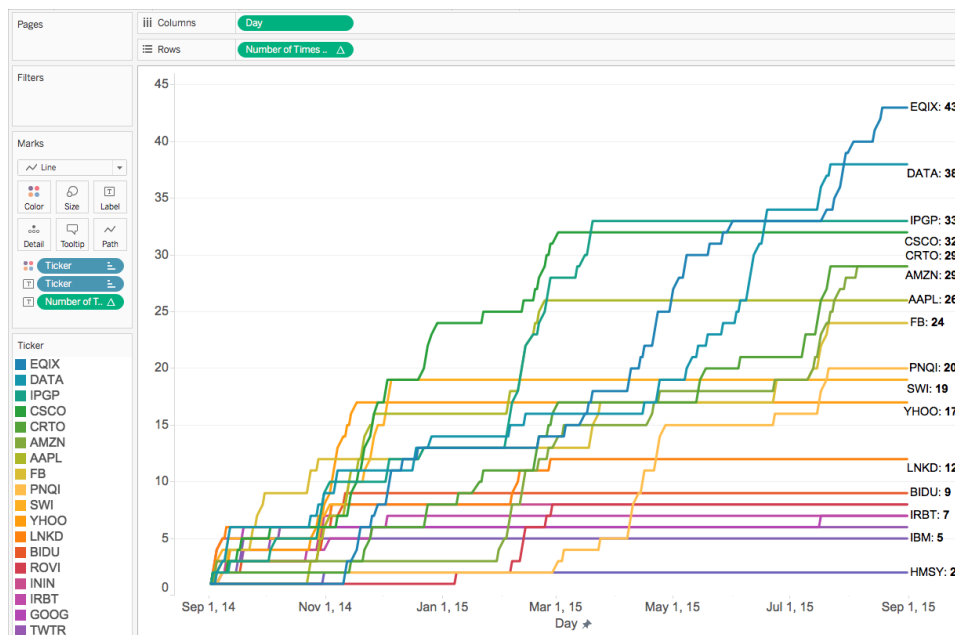

Continue to [Tips for Learning How to Create Calculations](#) below

Also in this series:

[Understanding Calculations in Tableau](#)

[Types of Calculations in Tableau](#)

[Tips for Learning How to Create Calculations](#)

Now that you know the types of calculations and when to use them, how do you actually know how to create the formula for them? This is where things can get tricky.

There's no easy way to know exactly how to create the perfect formula; it takes practice and research. However, here are some ways you can start to learn:

Know your question or purpose

If you know the type of data you need, this can help you choose the correct function and format it properly. For example, if you need to show profit for an order, you might create a formula similar to the following: SUM (Sales) - SUM (Cost).

Learn Tableau functions

There are many different functions available in Tableau. Each type serves a different purpose. To learn more, see [Functions in Tableau on the facing page](#).

Learn how to format calculations

After you're familiar with the different types of Tableau functions and their purpose, make sure to learn how to format calculations using the proper syntax. To learn more, see [Formatting Calculations in Tableau on page 2449](#).

Learn from other examples

Learning by example is effective. Try to collect a list of common calculations to use in your everyday analysis. There are several resources available to you:

- [Tableau Blog: Top 10 Tableau table calculations](#)
- [Tableau Blog: Top 15 LOD Expressions](#)
- [Tableau Blog: Save time and stay consistent with a template of calculated fields](#)

Still having trouble?

[Ask for help on the Tableau Community](#).

Also in this series:

[Understanding Calculations in Tableau](#)

[Types of Calculations in Tableau](#)

[Choosing the Right Calculation Type](#) on page 2036

More calculations content:

[Get Started with Calculations in Tableau](#) on page 2017

[Create a Simple Calculated Field](#) on page 2021

Functions in Tableau

Tableau supports many functions for use in Tableau calculations. To learn more about the functions in Tableau, see the following articles and reference topics:

Number Functions

This article introduces number functions and their uses in Tableau. It also demonstrates how to create a number calculation using an example.

Why use number functions

Number functions allow you to perform computations on the data values in your fields. Number functions can only be used with fields that contain numerical values. For more information, see [Data Types on page 157](#).

For example, you might have a field that contains values for the variance in your budget, titled Budget Variance. One of those values might be -7. You can use the ABS function to return the absolute value of that number, and all the other numbers in that field.

The calculation might look something like this:

```
ABS[Budget Variance]
```

And for that -7 value, the output would be 7.

Number functions available in Tableau

ABS

Syntax	ABS (number)
Output	Number (positive)
Definition	Returns the absolute value of the given <number>.
Example	<pre>ABS (-7) = 7 ABS ([Budget Variance])</pre>

The second example returns the absolute value for all the numbers contained in the Budget Variance field.

Notes See also [SIGN](#) on page 2057.

ACOS

Syntax `ACOS (number)`

Output Number (angle in radians)

Definition Returns the arccosine (angle) of the given `<number>`.

Example `ACOS (-1) = 3.14159265358979`

Notes The inverse function, [COS](#) on the facing page, takes the angle in radians as the argument and returns the cosine.

ASIN

Syntax `ASIN (number)`

Output Number (angle in radians)

Definition Returns the arcsine (angle) of a given `<number>`.

Example `ASIN (1) = 1.5707963267949`

Notes The inverse function, [SIN](#) on page 2057, takes the angle in radians as the argument and returns the sine.

ATAN

Syntax `ATAN (number)`

Output Number (angle in radians)

Definition Returns the arctangent (angle) of a given `<number>`.

Example `ATAN (180) = 1.5652408283942`

Notes The inverse function, [TAN](#), takes the angle in radians as the argument and

returns the tangent.

See also [ATAN2](#) below and [COT](#) on the next page.

ATAN2

Syntax	<code>ATAN2 (y number, x number)</code>
Output	Number (angle in radians)
Definition	Returns the arctangent (angle) between two numbers (x and y). The result is in radians.
Example	<code>ATAN2 (2, 1) = 1.10714871779409</code>
Notes	See also ATAN on the previous page, TAN on page 2058, and COT on the next page.

CEILING

Syntax	<code>CEILING (number)</code>
Output	Integer
Definition	Rounds a <number> to the nearest integer of equal or greater value.
Example	<code>CEILING (2.1) = 3</code>
Notes	See also FLOOR on page 2051 and ROUND on page 2056.
Database limitations	<code>CEILING</code> is available through the following connectors: Microsoft Excel, Text File, Statistical File, Published Data Source, Amazon EMR Hadoop Hive, Amazon Redshift, Cloudera Hadoop, DataStax Enterprise, Google Analytics, Google BigQuery, Hortonworks Hadoop Hive, MapR Hadoop Hive, Microsoft SQL Server, Salesforce, Spark SQL.

COS

Syntax	<code>COS (number)</code>
--------	---------------------------

The number argument is the angle in radians.

Output Number

Definition Returns the cosine of an angle.

Example $\text{COS}(\text{PI}() / 4) = 0.707106781186548$

Notes The inverse function, [ACOS](#) on page 2048, takes the cosine as the argument and returns the angle in radians.

See also [PI](#) on page 2055. To convert an angle from degrees to radians, use [RADIANS](#) on page 2056.

COT

Syntax $\text{COT}(\text{number})$

The number argument is the angle in radians.

Output Number

Definition Returns the cotangent of an angle.

Example $\text{COT}(\text{PI}() / 4) = 1$

Notes See also [ATAN](#) on page 2048, [TAN](#) on page 2058, and [PI](#) on page 2055. To convert an angle from degrees to radians, use [RADIANS](#) on page 2056.

DEGREES

Syntax $\text{DEGREES}(\text{number})$

The number argument is the angle in radians.

Output Number (degrees)

Definition Converts an angle in radians to degrees.

Example $\text{DEGREES}(\text{PI}() / 4) = 45.0$

Notes The inverse function, [RADIANs](#) on page 2056, takes an angle in degrees and returns the angle in radians.
See also [PI](#) on page 2055().

DIV

Syntax `DIV(integer1, integer2)`

Output Integer

Definition Returns the integer part of a division operation, in which <integer1> is divided by <integer2>.

Example `DIV(11,2) = 5`

EXP

Syntax `EXP(number)`

Output Number

Definition Returns e raised to the power of the given <number>.

Example `EXP(2) = 7.389`
`EXP(-[Growth Rate]*[Time])`

Notes See also [LN](#) on page 2053.

FLOOR

Syntax `FLOOR(number)`

Output Integer

Definition Rounds a number to the nearest <number> of equal or lesser value.

Example `FLOOR(7.9) = 7`

Notes	See also CEILING on page 2049 and ROUND on page 2056.
Database limitations	<code>FLOOR</code> is available through the following connectors: Microsoft Excel, Text File, Statistical File, Published Data Source, Amazon EMR Hadoop Hive, Cloudera Hadoop, DataStax Enterprise, Google Analytics, Google BigQuery, Hortonworks Hadoop Hive, MapR Hadoop Hive, Microsoft SQL Server, Salesforce, Spark SQL.

HEXBINX

Syntax	<code>HEXBINX(number, number)</code>
Output	Number
Definition	Maps an x, y coordinate to the x-coordinate of the nearest hexagonal bin. The bins have side length 1, so the inputs may need to be scaled appropriately.
Example	<code>HEXBINX([Longitude]*2.5, [Latitude]*2.5)</code>
Notes	<code>HEXBINX</code> and HEXBINY below are binning and plotting functions for hexagonal bins. Hexagonal bins are an efficient and elegant option for visualizing data in an x/y plane such as a map. Because the bins are hexagonal, each bin closely approximates a circle and minimizes variation in the distance from the data point to the center of the bin. This makes the clustering both more accurate and informative.

HEXBINY

Syntax	<code>HEXBINY(number, number)</code>
Output	Number
Definition	Maps an x, y coordinate to the y-coordinate of the nearest hexagonal bin. The bins have side length 1, so the inputs may need to be scaled appropriately.
Example	<code>HEXBINY([Longitude]*2.5, [Latitude]*2.5)</code>

Notes See also [HEXBINX](#) on the previous page.

LN

Syntax `LN(number)`

Output Number

The output is `Null` if the argument is less than or equal to zero.

Definition Returns the natural logarithm of a `<number>`.

Example `LN(50) = 3.912023005`

Notes See also [EXP](#) on page 2051 and [LOG](#) below.

LOG

Syntax `LOG(number, [base])`

If the optional base argument isn't present, base 10 is used.

Output Number

Definition Returns the logarithm of a number for the given base.

Example `LOG(16,4) = 2`

Notes See also [POWER](#) on page 2056 [LN](#) above.

MAX

Syntax `MAX(expression)` or `MAX(expr1, expr2)`

Output Same data type as the argument, or `NULL` if any part of the argument is null.

Definition Returns the maximum of the two arguments, which must be of the same data type.

`MAX` can also be applied to a single field as an aggregation.

Example

`MAX(4, 7) = 7`

`MAX(#3/25/1986#, #2/20/2021#) = #2/20/2021#`

`MAX([Name]) = "Zander"`

Notes

For strings

`MAX` is usually the value that comes last in alphabetical order.

For database data sources, the `MAX` string value is highest in the sort sequence defined by the database for that column.

For dates

For dates, the `MAX` is the most recent date. If `MAX` is an aggregation, the result will not have a date hierarchy. If `MAX` is a comparison, the result will retain the date hierarchy.

As an aggregation

`MAX(expression)` is an aggregate function and returns a single aggregated result. This displays as `AGG(expression)` in the viz.

As a comparison

`MAX(expr1, expr2)` compares the two values and returns a row-level value.

See also [MIN](#) below.

MIN

Syntax

`MIN(expression)` or `MIN(expr1, expr2)`

Output

Same data type as the argument, or `NULL` if any part of the argument is null.

Definition

Returns the minimum of the two arguments, which must be of the same data type.

`MIN` can also be applied to a single field as an aggregation.

Example

```
MIN(4,7) = 4
MIN(#3/25/1986#, #2/20/2021#) = #3/25/1986#
MIN([Name]) = "Abebi"
```

Notes **For strings**

MIN is usually the value that comes first in alphabetical order.

For database data sources, the MIN string value is lowest in the sort sequence defined by the database for that column.

For dates

For dates, the MIN is the earliest date. If MIN is an aggregation, the result will not have a date hierarchy. If MIN is a comparison, the result will retain the date hierarchy.

As an aggregation

MIN(expression) is an aggregate function and returns a single aggregated result. This displays as AGG(expression) in the viz.

As a comparison

MIN(expr1, expr2) compares the two values and returns a row-level value.

See also [MAX](#) on page 2053.

PI

Syntax PI()

Output Number

Definition Returns the numeric constant pi: 3.14159...

Example PI() = 3.14159

Notes Useful for trig functions that take their input in radians. See also [RADIANs](#) on the next page.

POWER

Syntax	<code>POWER(number, power)</code>
Output	Number
Definition	Raises the <number> to the specified <power>.
Example	<code>POWER(5, 3) = 125</code> <code>POWER([Temperature], 2)</code>
Notes	You can also use the ^ symbol, such as <code>5^3 = POWER(5, 3) = 125</code> See also EXP on page 2051, LOG on page 2053, and SQUARE on page 2058.

RADIANS

Syntax	<code>RADIANS(number)</code>
Output	Number (angle in radians)
Definition	Converts the given <number> from degrees to radians.
Example	<code>RADIANS(180) = 3.14159</code>
Notes	The inverse function, DEGREES on page 2050, takes an angle in radians and returns the angle in degrees.

ROUND

Syntax	<code>ROUND(number, [decimals])</code>
Output	Number
Definition	Rounds <number> to a specified number of digits. The optional <code>decimals</code> argument specifies how many decimal points of precision to include in the final result. If <code>decimals</code> is omitted, <code>number</code> is rounded to the nearest integer.

Example	<code>ROUND(1/3, 2) = 0.33</code>
Notes	<p>Some databases, such as SQL Server, allow specification of a negative length, where -1 rounds number to 10's, -2 rounds to 100's, and so on. This is not true of all databases. For example, it is not true of Excel or Access.</p> <p>Tip: Because <code>ROUND</code> may run into issues due to the underlying floating point representation of numbers—such as 9.405 rounding to 9.40—it may be preferable to format the number to the desired number of decimal points rather than rounding. Formatting 9.405 to two decimal places will yield the expected 9.41.</p> <p>See also CEILING on page 2049 and FLOOR on page 2051.</p>

SIGN

Syntax	<code>SIGN(number)</code>
Output	-1, 0, or 1
Definition	Returns the sign of a <number>: The possible return values are -1 if the number is negative, 0 if the number is zero, or 1 if the number is positive.
Example	<code>SIGN(AVG(Profit)) = -1</code>
Notes	See also ABS on page 2047.

SIN

Syntax	<code>SIN(number)</code>
	The number argument is the angle in radians.
Output	Number
Definition	Returns the sine of an angle.
Example	<code>SIN(0) = 1.0</code> <code>SIN(PI() / 4) = 0.707106781186548</code>
Notes	The inverse function, ASIN on page 2048, takes the sine as the

argument and returns the angle in radians.

See also [PI](#) on page 2055. To convert an angle from degrees to radians, use [RADIAN](#)s on page 2056.

SQRT

Syntax	<code>SQRT (number)</code>
Output	Number
Definition	Returns the square root of a <number>.
Example	<code>SQRT (25) = 5</code>
Notes	See also SQUARE below.

SQUARE

Syntax	<code>SQUARE (number)</code>
Output	Number
Definition	Returns the square of a <number>.
Example	<code>SQUARE (5) = 25</code>
Notes	See also SQRT above and POWER on page 2056.

TAN

Syntax	<code>TAN (number)</code>
	The number argument is the angle in radians.
Output	Number
Definition	Returns the tangent of an angle.
Example	<code>TAN (PI ()/4) = 1.0</code>

Notes See also [ATAN](#) on page 2048, [ATAN2](#) on page 2049, [COT](#) on page 2050, and [PI](#) on page 2055. To convert an angle from degrees to radians, use [RADIAN](#)s on page 2056.

ZN

Syntax `ZN(expression)`

Output Any, or 0

Definition Returns the `<expression>` if it is not null, otherwise returns zero.
Use this function to replace null values with zeros.

Example `ZN(Grade) = 0`

Notes This is a very useful function when using fields that may contain nulls in a calculation. Wrapping the field with `ZN` can prevent errors caused by calculating with nulls.

Create a number calculation

Follow along with the steps below to learn how to create a number calculation.

1. In Tableau Desktop, connect to the **Sample - Superstore** saved data source, which comes with Tableau.
2. Navigate to a worksheet and select **Analysis > Create Calculated Field**.
3. In the calculation editor that opens, do the following:
 - Name the calculated field Minimum Sales transaction
 - Enter the following formula:

```
MIN(Sales)
```

- When finished, click **OK**.

The new number calculation appears under **Measures** in the **Data** pane. Just like your other fields, you can use it in one or more visualizations.

When Minimum Sales is placed on Text on the Marks card in the worksheet, its name is changed to **AGG(Minimum Sales)**, which indicates that it cannot be aggregated any further, since it is already aggregated down to the lowest level of detail (the smallest sales value for all records).

This example shows the minimum sales per category.

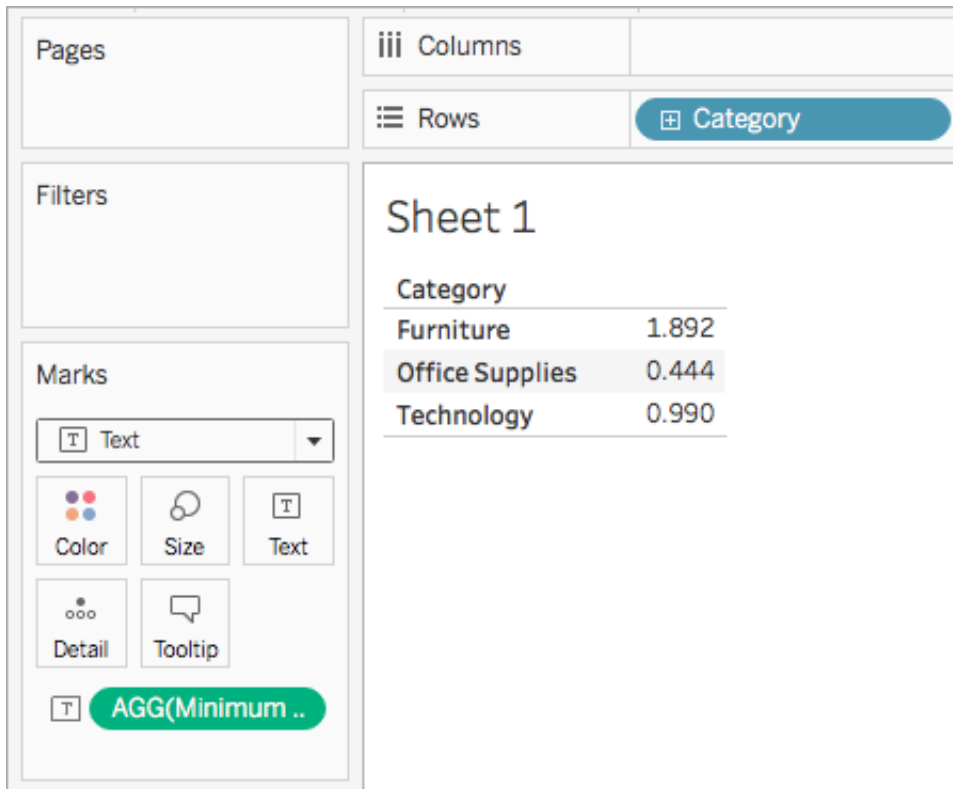

The screenshot shows the Tableau Desktop interface. On the left, the 'Marks' shelf contains 'Text' and 'AGG(Minimum Sales)'. The 'Columns' shelf is empty, and the 'Rows' shelf contains 'Category'. The main view area displays a table titled 'Sheet 1' with the following data:

Category	
Furniture	1.892
Office Supplies	0.444
Technology	0.990

When subcategory is brought into the view, the minimum sales for each subcategory are shown.

Sheet 1

Category	Sub-Catego..	
Furniture	Bookcases	35.490
	Chairs	26.640
	Furnishings	1.892
	Tables	24.368
Office Supplies	Appliances	0.444
	Art	1.344
	Binders	0.556
	Envelopes	1.632
	Fasteners	1.240
	Labels	2.088
	Paper	3.380
	Storage	4.464
	Supplies	1.744
	Technology	Accessories
Copiers		299.990
Machines		11.560
Phones		2.970

See Also

[Functions in Tableau](#) on page 2047

[Tableau Functions \(Alphabetical\)](#) on page 2300

[Tableau Functions \(by Category\)](#) on page 2199

[Formatting Calculations in Tableau](#) on page 2449

String Functions

This article introduces string functions and their uses in Tableau. It also demonstrates how to create a string calculation using an example.

Why use string functions

String functions allow you to manipulate string data (i.e. data made of text). Tableau uses the current International Components for Unicode (ICU) library when comparing strings. The way strings are sorted and compared is based both on language and locale, and it's possible for vizzes to change as the ICU is continuously updated for better language support.

For example, you might have a field that contains all of your customers' first and last names. One member might be: Jane Johnson. You can pull the last names from all your customers into a new field using a string function.

The calculation might look something like this:

```
SPLIT([Customer Name], ' ', 2)
```

Therefore, `SPLIT('Jane Johnson', ' ', 2) = 'Johnson'`.

String functions available in Tableau

ASCII

Syntax	<code>ASCII(string)</code>
Output	Number
Definition	Returns the ASCII code for the first character of a <string>.
Example	<code>ASCII('A') = 65</code>
Notes	This is the inverse of the <code>CHAR</code> function.

CHAR

Syntax	<code>CHAR(number)</code>
Output	String
Definition	Returns the character encoded by the ASCII code <number>.
Example	<code>CHAR(65) = 'A'</code>
Notes	This is the inverse of the <code>ASCII</code> function.

CONTAINS

Syntax	<code>CONTAINS(string, substring)</code>
--------	--

Output	Boolean
Definition	Returns true if the given string contains the specified substring.
Example	<code>CONTAINS("Calculation", "alcu") = true</code>
Notes	See also the logical function IN as well as supported RegEx in the additional functions documentation .

ENDSWITH

Syntax	<code>ENDSWITH(string, substring)</code>
Output	Boolean
Definition	Returns true if the given string ends with the specified substring. Trailing white spaces are ignored.
Example	<code>ENDSWITH("Tableau", "leau") = true</code>
Notes	See also the supported RegEx in the additional functions documentation .

FIND

Syntax	<code>FIND(string, substring, [start])</code>
Output	Number
Definition	Returns the index position of substring in string, or 0 if the substring isn't found. The first character in the string is position 1. If the optional numeric argument <code>start</code> is added, the function ignores any instances of substring that appear before the starting position.
Example	<code>FIND("Calculation", "alcu") = 2</code> <code>FIND("Calculation", "Computer") = 0</code> <code>FIND("Calculation", "a", 3) = 7</code> <code>FIND("Calculation", "a", 2) = 2</code>

```
FIND("Calculation", "a", 8) = 0
```

Notes See also the supported RegEx in the [additional functions documentation](#).

FINDNTH

Syntax `FINDNTH(string, substring, occurrence)`

Output Number

Definition Returns the position of the nth occurrence of substring within the specified string, where n is defined by the occurrence argument.

Example `FINDNTH("Calculation", "a", 2) = 7`

Notes `FINDNTH` is not available for all data sources.

See also the supported RegEx in the [additional functions documentation](#).

LEFT

Syntax `LEFT(string, number)`

Output String

Definition Returns the left-most <number> of characters in the string.

Example `LEFT("Matador", 4) = "Mata"`

Notes See also [MID on page 2066](#) and [RIGHT on page 2069](#).

LEN

Syntax `LEN(string)`

Output Number

Definition Returns the length of the string.

Example	<code>LEN("Matador") = 7</code>
Notes	Not to be confused with the spatial function <code>LENGTH</code> .

LOWER

Syntax	<code>LOWER(string)</code>
Output	String
Definition	Returns the provided <code><string></code> in all lowercase characters.
Example	<code>LOWER("ProductVersion") = "productversion"</code>
Notes	See also UPPER on page 2071 and PROPER on page 2068.

LTRIM

Syntax	<code>LTRIM(string)</code>
Output	String
Definition	Returns the provided <code><string></code> with any leading spaces removed.
Example	<code>LTRIM(" Matador ") = "Matador "</code>
Notes	See also RTRIM on page 2069.

MAX

Syntax	<code>MAX(expression)</code> or <code>MAX(expr1, expr2)</code>
Output	Same data type as the argument, or <code>NULL</code> if any part of the argument is null.
Definition	Returns the maximum of the two arguments, which must be of the same data type. <code>MAX</code> can also be applied to a single field as an aggregation.

Example

```
MAX(4, 7) = 7
MAX(#3/25/1986#, #2/20/2021#) = #2/20/2021#
MAX([Name]) = "Zander"
```

Notes

For strings

MAX is usually the value that comes last in alphabetical order.

For database data sources, the MAX string value is highest in the sort sequence defined by the database for that column.

For dates

For dates, the MAX is the most recent date. If MAX is an aggregation, the result will not have a date hierarchy. If MAX is a comparison, the result will retain the date hierarchy.

As an aggregation

MAX(expression) is an aggregate function and returns a single aggregated result. This displays as AGG(expression) in the viz.

As a comparison

MAX(expr1, expr2) compares the two values and returns a row-level value.

See also [MIN](#) on the facing page.

MID

Syntax (MID(string, start, [length]))

Output String

Definition Returns a string starting at the specified start position. The first character in the string is position 1.

If the optional numeric argument length is added, the returned string includes only that number of characters.

Example MID("Calculation", 2) = "alculation"

```
MID("Calculation", 2, 5) ="alcul"
```

Notes See also the supported RegEx in the [additional functions documentation](#).

MIN

Syntax `MIN(expression)` or `MIN(expr1, expr2)`

Output Same data type as the argument, or `NULL` if any part of the argument is null.

Definition Returns the minimum of the two arguments, which must be of the same data type.

`MIN` can also be applied to a single field as an aggregation.

Example

```
MIN(4,7) = 4
MIN(#3/25/1986#, #2/20/2021#) = #3/25/1986#
MIN([Name]) = "Abebi"
```

Notes **For strings**

`MIN` is usually the value that comes first in alphabetical order.

For database data sources, the `MIN` string value is lowest in the sort sequence defined by the database for that column.

For dates

For dates, the `MIN` is the earliest date. If `MIN` is an aggregation, the result will not have a date hierarchy. If `MIN` is a comparison, the result will retain the date hierarchy.

As an aggregation

`MIN(expression)` is an aggregate function and returns a single aggregated result. This displays as `AGG(expression)` in the viz.

As a comparison

`MIN(expr1, expr2)` compares the two values and returns a row-level value.

See also [MAX](#) on page 2065.

PROPER

Syntax	<code>PROPER(string)</code>
Output	String
Definition	Returns the provided <code><string></code> with the first letter of each word is capitalized and the remaining letters are in lowercase.
Example	<pre>PROPER("PRODUCT name") = "Product Name" PROPER("darcy-mae") = "Darcy-Mae"</pre>
Notes	<p>Spaces and non-alphanumeric characters such as punctuation are treated as separators.</p> <p>See also LOWER on page 2065 and UPPER on page 2071.</p>
Database limitations	PROPER is only available for some flat files and in extracts. If you need to use PROPER in a data source that doesn't otherwise support it, consider using an extract.

REPLACE

Syntax	<code>REPLACE(string, substring, replacement</code>
Output	String
Definition	Searches <code><string></code> for <code><substring></code> and replaces it with <code><replacement></code> . If <code><substring></code> is not found, the string is not changed.
Example	<pre>REPLACE("Version 3.8", "3.8", "4x") = "Version 4x"</pre>
Notes	See also <code>REGEXP_REPLACE</code> in the additional functions documentation .

RIGHT

Syntax	<code>RIGHT(string, number)</code>
Output	String
Definition	Returns the right-most <number> of characters in the string.
Example	<code>RIGHT("Calculation", 4) = "tion"</code>
Notes	See also LEFT on page 2064 and MID on page 2066.

RTRIM

Syntax	<code>RTRIM(string)</code>
Output	String
Definition	Returns the provided <string> with any trailing spaces removed.
Example	<code>RTRIM(" Calculation ") = " Calculation"</code>
Notes	See also LTRIM on page 2065 and TRIM on page 2071.

SPACE

Syntax	<code>SPACE(number)</code>
Output	String (specifically, just spaces)
Definition	Returns a string that is composed of the specified number of repeated spaces.
Example	<code>SPACE(2) = " "</code>

SPLIT

Syntax	<code>SPLIT(string, delimiter, token number)</code>
--------	---

Output	String
Definition	Returns a substring from a string, using a delimiter character to divide the string into a sequence of tokens.
Example	<pre>SPLIT ("a-b-c-d", "-", 2) = "b" SPLIT ("a b c d", " ", -2) = "c"</pre>
Notes	<p>The string is interpreted as an alternating sequence of delimiters and tokens. So for the string <code>abc-defgh-i-jkl</code>, where the delimiter character is '-', the tokens are (1) <code>abc</code>, (2) <code>defgh</code>, (3) <code>i</code>, and (4) <code>jkl</code>.</p> <p><code>SPLIT</code> returns the token corresponding to the token number. When the token number is positive, tokens are counted starting from the left end of the string; when the token number is negative, tokens are counted starting from the right.</p> <p>See also supported REGEX in the additional functions documentation.</p>
Database limitations	<p>The split and custom split commands are available for the following data sources types: Tableau data extracts, Microsoft Excel, Text File, PDF File, Salesforce, OData, Microsoft Azure Market Place, Google Analytics, Vertica, Oracle, MySQL, PostgreSQL, Teradata, Amazon Redshift, Aster Data, Google Big Query, Cloudera Hadoop Hive, Hortonworks Hive, and Microsoft SQL Server.</p> <p>Some data sources impose limits on splitting strings. See <code>SPLIT</code> function limitations later in this topic.</p>

STARTSWITH

Syntax	<code>STARTSWITH(string, substring)</code>
Output	Boolean
Definition	Returns true if <code>string</code> starts with <code>substring</code> . Leading white spaces are ignored.
Example	<code>STARTSWITH("Matador", "Ma") = TRUE</code>

Notes See also [CONTAINS](#) on page 2062, as well as supported REGEX in the [additional functions documentation](#).

TRIM

Syntax `TRIM(string)`

Output String

Definition Returns the provided `<string>` with leading and trailing spaces removed.

Example `TRIM(" Calculation ") = "Calculation"`

Notes See also [LTRIM](#) on page 2065 and [RTRIM](#) on page 2069.

UPPER

Syntax `UPPER(string)`

Output String

Definition Returns the provided `<string>` in all uppercase characters.

Example `UPPER("Calculation") = "CALCULATION"`

Notes See also [PROPER](#) on page 2068 and [LOWER](#) on page 2065.

Create a string calculation

Follow along with the steps below to learn how to create a string calculation.

1. In Tableau Desktop, connect to the **Sample - Superstore** saved data source, which comes with Tableau.
2. Navigate to a worksheet.
3. From the **Data** pane, under Dimensions, drag **Order ID** to the **Rows** shelf.

Order ID	Abc
CA-2011-100006	Abc
CA-2011-100090	Abc
CA-2011-100293	Abc
CA-2011-100328	Abc
CA-2011-100363	Abc
CA-2011-100391	Abc

Notice that every order ID contains values for country (CA and US, for example), year (2011), and order number (100006). For this example, you will create a calculation to pull only the order number from the field.

4. Select **Analysis > Create Calculated Field**.
5. In the calculation editor that opens, do the following:
 - Name the calculated field **Order ID Numbers**.
 - Enter the following formula:

```
RIGHT([Order ID], 6)
```

This formula takes the specified digits (6) from the right of the string and pulls them into a new field.

Therefore, `RIGHT('CA-2011-100006', 6) = '100006'`.

- When finished, click **OK**.

The new calculated field appears under **Dimensions** in the **Data** pane. Just like your other fields, you can use it in one or more visualizations.

- From the **Data** pane, drag **Order ID Numbers** to the **Rows** shelf. Place it to the right of Order ID.

Notice how the fields differ now.

The screenshot shows the Tableau interface with a table on 'Sheet 3'. The table has two columns: 'Order ID' and 'Order ID Numbers'. The 'Order ID' column contains alphanumeric strings, and the 'Order ID Numbers' column contains the numeric part of those strings. The 'Columns' shelf is empty, and the 'Rows' shelf contains 'Order ID' and 'Order ID Numbers'.

Order ID	Order ID Numbers	
CA-2011-100006	100006	Abc
CA-2011-100090	100090	Abc
CA-2011-100293	100293	Abc
CA-2011-100328	100328	Abc
CA-2011-100363	100363	Abc
CA-2011-100391	100391	Abc
CA-2011-100678	100678	Abc

SPLIT limitations by data source

Some data sources impose limits on splitting string. The following table shows which data sources support negative token numbers (splitting from the right) and whether there is a limit on the number of splits allow per data source.

A `SPLIT` function that specifies a negative token number and would be legal with other data sources will return the error with these data sources: *"Splitting from right is not supported by the data source."*

Data Source	Left/Right Constraints	Maximum Number of Splits	Version limitations
Tableau Data Extract	Both	Infinite	
Microsoft Excel	Both	Infinite	

Text file	Both	Infinite	
Salesforce	Both	Infinite	
OData	Both	Infinite	
Google Analytics	Both	Infinite	
Tableau Data Server	Both	Infinite	Supported in version 9.0.
Vertica	Left only	10	
Oracle	Left only	10	
MySQL	Both	10	
PostgreSQL	Left only prior to version 9.0; both for version 9.0 and above	10	
Teradata	Left only	10	Version 14 and later
Amazon Redshift	Left only	10	
Aster Database	Left only	10	
Google BigQuery	Left only	10	
Hortonworks Hadoop Hive	Left only	10	
Cloudera Hadoop	Left only	10	Impala supported starting in version 2.3.0.
Microsoft SQL Server	Both	10	2008 and later

See Also

[Functions in Tableau on page 2047](#)

[Tableau Functions \(Alphabetical\)](#) on page 2300

[Tableau Functions \(by Category\)](#) on page 2199

[Formatting Calculations in Tableau](#) on page 2449

Date Functions

Dates are a common element in many data sources. If a field contains recognizable dates, it will have a **date** or **date time** data type. When date fields are used in the viz they get a special set of functionality, including an automatic date hierarchy drill down, date-specific filter options, and specialized date formatting options. Using dates in calculations often requires the use of date-specific functions.

Gain familiarity with other date concepts

Date functions sometimes reference date-specific elements, including the `date_part` argument, the optional `[start_of_week]` parameter, and date literals (`#`). These are covered in more detail at the end of this topic.

There are several other topics that might be of interest but aren't part of date functions:

- Format how a date is displayed in a viz: [Custom Date Formats](#) on page 1165
- Set default date properties: [Date Properties for a Data Source](#) on page 1151
- Work with fiscal dates: [Fiscal Dates](#) on page 1162
- Use the ISO-8601 calendar: [ISO-8601 Week-Based Calendar](#) on page 1176

Tip: Is your field already recognized as a date (it has a date icon in the Data pane) and you're trying to control how it appears in the viz? You might need to format it rather than use a date function. For example, you want to show 22Sept2024 as 09/24. This is handled through formatting the date, not a calculation.

See [Custom Date Formats](#) on page 1165 and related topics for working with date fields. The date functions on this page allow you to manipulate dates calculated fields, not set their display formatting.

Date functions available in Tableau

DATE

Type conversion function that changes string and number expressions into dates, as long as they are in a recognizable format.

Syntax	<code>DATE (expression)</code>
Output	Date
Definition	Returns a date given a number, string, or date <code><expression></code> .
Example	<pre>DATE([Employee Start Date]) DATE("September 22, 2018") DATE("9/22/2018") DATE(#2018-09-22 14:52#)</pre>
Notes	<p>Unlike DATEPARSE on page 2078, there is no need to provide a pattern as <code>DATE</code> automatically recognizes many standard date formats. If <code>DATE</code> does not recognize the input, however, try using <code>DATEPARSE</code> and specifying the format.</p> <p>MAKEDATE on page 2082 is another similar function, but <code>MAKEDATE</code> requires the input of numeric values for year, month, and day.</p>

DATEADD

Adds a specified number of date parts (months, days, etc) to the starting date.

Syntax	<code>DATEADD (date_part, interval, date)</code>
Output	Date
Definition	Returns the <code><date></code> with the specified number <code><interval></code> added to the specified <code><date_part on page 2088></code> of that date. For example, adding three months or 12 days to a starting date.
Example	<p>Push out all due dates by one week</p> <pre>DATEADD('week', 1, [due date])</pre> <p>Add 280 days to the date February 20, 2021</p> <pre>DATEADD('day', 280, #2/20/21#) = #November 27, 2021#</pre>
Notes	Supports ISO 8601 dates.

DATEDIFF

Returns the number of date parts (weeks, years, etc) between two dates.

Syntax	<code>DATEDIFF(date_part, date1, date2, [start_of_week])</code>
Output	Integer
Definition	Returns the difference between <code><date1></code> and <code><date2></code> expressed in units of <date_part on page 2088> . For example, subtracting the dates someone entered and left a band to see how long they were in the band.
Example	Number of days between March 25, 1986 and February 20, 2021 <code>DATEDIFF('day', #3/25/1986#, #2/20/2021#) = 12,751</code> How many months someone was in a band <code>DATEDIFF('month', [date joined band], [date left band])</code>
Notes	Supports ISO 8601 dates.

DATENAME

Returns the name of the specified date part as a discrete string.

Syntax	<code>DATENAME(date_part, date, [start_of_week])</code>
Output	String
Definition	Returns <date_part on page 2088> of <code><date></code> as a string.
Example	<code>DATENAME('year', #3/25/1986#) = "1986"</code> <code>DATENAME('month', #1986-03-25#) = "March"</code>
Notes	Supports ISO 8601 dates. A very similar calculation is DATEPART on page 2079 , which returns the value of the specified date part as a continuous integer. <code>DATEPART</code> can be faster because it is a numerical operation. By changing the attributes of the calculation's result (dimension or measure,

continuous or discrete) and the date formatting, the results of `DATEPART` and `DATENAME` can be formatted to be identical.

An inverse function is [DATEPARSE](#) below, which takes a string value and formats it as a date.

DATEPARSE

Returns specifically formatted strings as dates.

Syntax	<code>DATEPARSE(date_format, date_string)</code>
Output	Date
Definition	The <code><date_format></code> argument describes how the <code><date_string></code> field is arranged. Because of the variety of ways the string field can be ordered, the <code><date_format></code> must match exactly. For a full explanation and formatting details, see Convert a Field to a Date Field .
Example	<code>DATEPARSE('yyyy-MM-dd', "1986-03-25") = #March 25, 1986#</code>
Notes	<p>DATE on page 2075 is a similar function that automatically recognizes many standard date formats. <code>DATEPARSE</code> may be a better option if <code>DATE</code> does not recognize the input pattern.</p> <p>MAKEDATE on page 2082 is another similar function, but <code>MAKEDATE</code> requires the input of numeric values for year, month, and day.</p> <p>Inverse functions, which take dates apart and return the value of their parts, are DATEPART on the facing page (integer output) and DATENAME on the previous page (string output).</p>
Database limitations	<p><code>DATEPARSE</code> is available through the following connectors: non-legacy Excel and text file connections, Amazon EMR Hadoop Hive, Cloudera Hadoop, Google Sheets, Hortonworks Hadoop Hive, MapR Hadoop Hive, MySQL, Oracle, PostgreSQL, and Tableau extracts. Some formats may not be available for all connections.</p> <p><code>DATEPARSE</code> is not supported on Hive variants. Only Denodo, Drill, and Snowflake are supported.</p>

DATEPART

Returns the name of the specified date part as an integer.

Syntax `DATEPART(date_part, date, [start_of_week])`

Output Integer

Definition Returns [<date_part on page 2088>](#) of <date> as an integer.

Example `DATEPART('year', #1986-03-25#) = 1986`

`DATEPART('month', #1986-03-25#) = 3`

Notes Supports ISO 8601 dates.

A very similar calculation is [DATENAME on page 2077](#), which returns the name of the specified date part as a discrete string. `DATEPART` can be faster because it is a numerical operation. By changing the attributes of the field (dimension or measure, continuous or discrete) and the date formatting, the results of `DATEPART` and `DATENAME` can be formatted to be identical.

An inverse function is [DATEPARSE on the previous page](#), which takes a string value and formats it as a date.

DATETRUNC

This function can be thought of as date rounding. It takes a specific date and returns a version of that date at the desired specificity. Because every date must have a value for day, month, quarter, and year, `DATETRUNC` sets the values as the lowest value for each date part up to the date part specified. Refer to the example for more information.

Syntax `DATETRUNC(date_part, date, [start_of_week])`

Output Date

Definition Truncates the <date> to the accuracy specified by the [<date_part on page 2088>](#). This function returns a new date. For example, when you truncate a date that is in the middle of the month at the month level, this function returns the first day of the month.

Example

```
DATETRUNC('day', #9/22/2018#) = #9/22/2018#
```

```
DATETRUNC('iso-week', #9/22/2018#) = #9/17/2018#
```

(the monday of the week containing 9/22/2018)

```
DATETRUNC(quarter, #9/22/2018#) = #7/1/2018#
```

(the first day of the quarter containing 9/22/2018)

Note: For week and iso-week, the `start_of_week` comes into play. ISO-weeks always start on Monday. For the locale of this example, an unspecified `start_of_week` means the week starts on Sunday.

Notes

Supports ISO 8601 dates.

You shouldn't use `DATETRUNC` to, for example, stop showing the time for a datetime field in a viz. If you want to truncate the way a date displays rather than round its accuracy, [adjust the formatting](#).

For example, `DATETRUNC('day', #5/17/2022 3:12:48 PM#)`, if formatted in the viz to display seconds, would display as 5/17/2022 12:00:00 AM. The value is truncated to day, but the display goes to seconds.

DAY

Returns the day of the month (1-31) as an integer.

Syntax `DAY(date)`

Output `Integer`

Definition Returns the day of the given `<date>` as an integer.

Example `Day(#September 22, 2018#) = 22`

Notes See also [WEEK](#) on page 2087, [MONTH](#) on page 2086, [QUARTER](#) on page 2087, [YEAR](#) on page 2088, and the ISO equivalents.

ISDATE

Checks if the string is a valid date format.

Syntax	<code>ISDATE (string)</code>
Output	Boolean
Definition	Returns true if a given <code><string></code> is a valid date.
Example	<code>ISDATE (09/22/2018) = true</code> <code>ISDATE (22SEP18) = false</code>
Notes	The required argument must be a string. ISDATE cannot be used for a field with a date data type—the calculation will return an error.

ISOQUARTER

Syntax	<code>ISOQUARTER (date)</code>
Output	Integer
Definition	Returns the ISO8601 week-based quarter of a given <code><date></code> as an integer.
Example	<code>ISOQUARTER (#1986-03-25#) = 1</code>
Notes	See also ISOWEEK below, ISOWEEKDAY on the next page, ISOYEAR on the next page, and the non-ISO equivalents.

ISOWEEK

Syntax	<code>ISOWEEK (date)</code>
Output	Integer
Definition	Returns the ISO8601 week-based week of a given <code><date></code> as an integer.
Example	<code>ISOWEEK (#1986-03-25#) = 13</code>
Notes	See also ISOWEEKDAY on the next page, ISOQUARTER above,

[ISOYEAR](#) below, and the non-ISO equivalents.

ISOWEEKDAY

Syntax	ISOWEEKDAY (date)
Output	Integer
Definition	Returns the ISO8601 week-based weekday of a given <date> as an integer.
Example	ISOWEEKDAY (#1986-03-25#) = 2
Notes	See also ISOWEEK on the previous page, ISOQUARTER on the previous page, ISOYEAR below, and the non-ISO equivalents.

ISOYEAR

Syntax	ISOYEAR (date)
Output	Integer
Definition	Returns the ISO8601 week-based year of a given <date> as an integer.
Example	ISOYEAR (#1986-03-25#) = 1,986
Notes	See also ISOWEEK on the previous page, ISOWEEKDAY above, ISOQUARTER on the previous page, and the non-ISO equivalents.

MAKEDATE

Syntax	MAKEDATE (year, month, day)
Output	Date
Definition	Returns a date value constructed from the specified <year>, <month>, and <day>.

Example `MAKEDATE(1986,3,25) = #1986-03-25#`

Notes

Note: Incorrectly entered values will be adjusted into a date, such as `MAKEDATE(2020,4,31) = May 1, 2020` rather than returning an error that there is no 31st day of April.

Available for Tableau Data Extracts. Check for availability in other data sources.

`MAKEDATE` requires numerical inputs for the parts of a date. If your data is a string that should be a date, try the [DATE on page 2075](#) function. `DATE` automatically recognizes many standard date formats. If `DATE` does not recognize the input try using [DATEPARSE on page 2078](#).

MAKEDATETIME

Syntax `MAKEDATETIME(date, time)`

Output Datetime

Definition Returns a datetime that combines a `<date>` and a `<time>`. The date can be a date, datetime, or a string type. The time must be a datetime.

Example `MAKEDATETIME("1899-12-30", #07:59:00#) = #12/30/1899
7:59:00 AM#`

`MAKEDATETIME([Date], [Time]) = #1/1/2001 6:00:00 AM#`

Notes This function is available only for MySQL-compatible connections (which for Tableau are MySQL and Amazon Aurora).

[MAKETIME below](#) is a similar function available for Tableau Data Extracts and some other data sources.

MAKETIME

Syntax `MAKETIME(hour, minute, second)`

Output Datetime

Definition	Returns a date value constructed from the specified <hour>, <minute>, and <second>.
Example	<code>MAKETIME(14, 52, 40) = #1/1/1899 14:52:40#</code>
Notes	<p>Because Tableau does not support a time data type, only datetime, the output is a datetime. The date portion of the field will be 1/1/1899.</p> <p>Similar function to MAKEDATETIME on the previous page, which is only available for MYSQL-compatible connections.</p>

MAX

Syntax	<code>MAX(expression) or MAX(expr1, expr2)</code>
Output	Same data type as the argument, or NULL if any part of the argument is null.
Definition	<p>Returns the maximum of the two arguments, which must be of the same data type.</p> <p>MAX can also be applied to a single field as an aggregation.</p>
Example	<pre>MAX(4, 7) = 7 MAX(#3/25/1986#, #2/20/2021#) = #2/20/2021# MAX([Name]) = "Zander"</pre>
Notes	<p>For strings</p> <p>MAX is usually the value that comes last in alphabetical order.</p>

For database data sources, the MAX string value is highest in the sort sequence defined by the database for that column.

For dates

For dates, the MAX is the most recent date. If MAX is an aggregation, the result will not have a date hierarchy. If MAX is a comparison, the result will retain the date hierarchy.

As an aggregation

`MAX(expression)` is an aggregate function and returns a single aggregated result. This displays as `AGG(expression)` in the viz.

As a comparison

`MAX(expr1, expr2)` compares the two values and returns a row-level value.

See also [MIN](#) below.

MIN

Syntax	<code>MIN(expression)</code> or <code>MIN(expr1, expr2)</code>
Output	Same data type as the argument, or <code>NULL</code> if any part of the argument is null.
Definition	Returns the minimum of the two arguments, which must be of the same data type. <code>MIN</code> can also be applied to a single field as an aggregation.
Example	<code>MIN(4,7) = 4</code> <code>MIN(#3/25/1986#, #2/20/2021#) = #3/25/1986#</code> <code>MIN([Name]) = "Abebi"</code>
Notes	For strings <code>MIN</code> is usually the value that comes first in alphabetical order.

For database data sources, the `MIN` string value is lowest in the sort sequence defined by the database for that column.

For dates

For dates, the `MIN` is the earliest date. If `MIN` is an aggregation, the result will not have a date hierarchy. If `MIN` is a comparison, the result will retain the date hierarchy.

As an aggregation

`MIN(expression)` is an aggregate function and returns a single

aggregated result. This displays as `AGG (expression)` in the viz.

As a comparison

`MIN(expr1, expr2)` compares the two values and returns a row-level value.

See also [MAX](#) on page 2084.

MONTH

Syntax	<code>MONTH(date)</code>
Output	Integer
Definition	Returns the month of the given <code><date></code> as an integer.
Example	<code>MONTH(#1986-03-25#) = 3</code>
Notes	See also DAY on page 2080, WEEK on the facing page, QUARTER on the facing page, YEAR on page 2088, and the ISO equivalents

NOW

Syntax	<code>NOW()</code>
Output	Datetime
Definition	Returns the current local system date and time.
Example	<code>NOW() = 1986-03-25 1:08:21 PM</code>
Notes	<p><code>NOW</code> does not take an argument.</p> <p>See also TODAY on the facing page, a similar calculation that returns a date instead of a datetime.</p> <p>If the data source is a live connection, the system date and time could be in another timezone. For more information on how to address this, see the Knowledge Base.</p>

QUARTER

Syntax	QUARTER (date)
Output	Integer
Definition	Returns the quarter of the given <date> as an integer.
Example	QUARTER (#1986-03-25#) = 1
Notes	See also DAY on page 2080, WEEK below, MONTH on the previous page, YEAR on the next page, and the ISO equivalents

TODAY

Syntax	TODAY ()
Output	Date
Definition	Returns the current local system date.
Example	TODAY () = 1986-03-25
Notes	<p>TODAY does not take an argument.</p> <p>See also NOW on the previous page, a similar calculation that returns a datetime instead of a date.</p> <p>If the data source is a live connection, the system date could be in another timezone. For more information on how to address this, see the Knowledge Base.</p>

WEEK

Syntax	WEEK (date)
Output	Integer
Definition	Returns the week of the given <date> as an integer.

Example `WEEK(#1986-03-25#) = 13`

Notes See also [DAY](#) on page 2080, [MONTH](#) on page 2086, [QUARTER](#) on the previous page, [YEAR](#) below, and the ISO equivalents

YEAR

Syntax `YEAR(date)`

Output Integer

Definition Returns the year of the given <date> as an integer.

Example `YEAR(#1986-03-25#) = 1,986`

Notes See also [DAY](#) on page 2080, [WEEK](#) on the previous page, [MONTH](#) on page 2086, [QUARTER](#) on the previous page, and the ISO equivalents

date_part

Many date functions in Tableau take the argument `date_part`, which is a string constant that tells the function what part of a date to consider, such as day, week, quarter, etc. The valid `date_part` values that you can use are:

date_part	Values
'year'	Four-digit year
'quarter'	1-4
'month'	1-12 or "January", "February", and so on
'dayofyear'	Day of the year; Jan 1 is 1, Feb 1 is 32, and so on
'day'	1-31
'weekday'	1-7 or "Sunday", "Monday", and so on
'week'	1-52
'hour'	0-23

date_part	Values
'minute'	0-59
'second'	0-60
'iso-year'	Four-digit ISO 8601 year
'iso-quarter'	1-4
'iso-week'	1-52, start of week is always Monday
'iso-weekday'	1-7, start of week is always Monday

The [start_of_week] parameter

Some functions have the optional parameter [start_of_week]. The start_of_week parameter can be used to specify what day is considered the first day of the week, such as "Sunday" or "Monday". If it is omitted, the start of week is determined by the data source. See [Date Properties for a Data Source on page 1151](#).

For the examples below, 22 September is a Sunday and 24 September is a Tuesday. The DATEDIFF function is being used to calculate the weeks between these dates.

```
DATEDIFF('week', #2013-09-22#, #2013-09-24#, 'monday') = 1
```

- Because start_of_week is 'monday', these dates are in different weeks.

```
DATEDIFF('week', #2013-09-22#, #2013-09-24#, 'sunday') = 0
```

- Because start_of_week is 'sunday', these dates are in the same week.

The date literal (#)

Examples often use the pound symbol (#) with date expressions. This is the date literal, similar to using quotes for text strings, and it tells Tableau that the value inside the symbols is a date.

Without the date literals, dates may be interpreted as various other data types. For example:

Format	Data Type	Value
'March 25, 1986'	String	'March 25, 1986'
#3/25/1986#	Date	#3/25/1986#
03/25/1986	Floating decimal	0.00006042

1986-03-25	Integer	1,958
March 25, 1986		invalid

-Abc	'March 25, 1986'	
#	#3/25/1986#	
Abc	Measure Names	
-#	03/25/1986	
-#	1986-03-25	
-#	March 25, 1986	!

For more information, see [Literal expression syntax on page 2457](#)

Create a date calculation

Practice creating a date calculation using the Superstore sample data source.

1. In Tableau Desktop, connect to the **Sample-Superstore** saved data source, which comes with Tableau.
2. Open a worksheet.
3. From the **Data** pane, under Dimensions, drag **Order Date** to the **Rows** shelf.
4. On the **Rows** shelf, click the plus icon (+) on the **YEAR(Order Date)** field.

QUARTER(Order Date) is added to the Rows shelf and the view updates.

Columns		
Rows		
Year of Ord..	Quarter of ..	
2011	Q1	Abc
	Q2	Abc
	Q3	Abc
	Q4	Abc
2012	Q1	Abc
	Q2	Abc
	Q3	Abc
	Q4	Abc
2013	Q1	Abc
	Q2	Abc

- On the **Rows** shelf, click the plus icon (+) on the **QUARTER(Order Date)** field to drill down to **MONTH(Order Date)**.

Year of Ord..	Quarter of ..	Month of Order Date	
2011	Q1	January	Abc
		February	Abc
		March	Abc
	Q2	April	Abc
		May	Abc
		June	Abc
	Q3	July	Abc
		August	Abc
		September	Abc
	Q4	October	Abc
		November	Abc
		December	Abc
2012	Q1	January	Abc
		February	Abc

- Select **Analysis > Create Calculated Field**.
- In the calculation editor that opens, do the following:
 - Name the calculated field, **Quarter Date**.
 - Enter the following formula: `DATETRUNC('quarter', [Order Date])`
 - When finished, click **OK**.

The new date calculated field appears under **Dimensions** in the **Data** pane. Just like your other fields, you can use it in one or more visualizations.

- From the **Data** pane, under **Dimensions**, drag **Quarter Date** to the **Rows** shelf and place it to the right of **MONTH(Order Date)**. The visualization updates with year values. This is because Tableau rolls date data up to the highest level of detail.
- On the **Rows** shelf, right-click **YEAR(Quarter Date)** and select **Exact Date**.
- On the **Rows** shelf, right-click **YEAR(Quarter Date)** again and select **Discrete**.

The visualization updates with the exact quarter date for each row in the table.

Year of Ord..	Quarter of ..	Month of Order Date	Quarter Date	
2011	Q1	January	1/1/2011 12:00:00 AM	Abc
		February	1/1/2011 12:00:00 AM	Abc
		March	1/1/2011 12:00:00 AM	Abc
	Q2	April	4/1/2011 12:00:00 AM	Abc
		May	4/1/2011 12:00:00 AM	Abc
		June	4/1/2011 12:00:00 AM	Abc
	Q3	July	7/1/2011 12:00:00 AM	Abc
		August	7/1/2011 12:00:00 AM	Abc
		September	7/1/2011 12:00:00 AM	Abc
	Q4	October	10/1/2011 12:00:00 AM	Abc
		November	10/1/2011 12:00:00 AM	Abc
		December	10/1/2011 12:00:00 AM	Abc
2012	Q1	January	1/1/2012 12:00:00 AM	Abc
		February	1/1/2012 12:00:00 AM	Abc
		March	1/1/2012 12:00:00 AM	Abc

Type Conversion

This article introduces type conversion functions and their uses in Tableau. It also demonstrates how to create a type conversion calculation using an example.

Why use type conversion functions

Type conversion functions allow you to convert fields from one data type to another (this is called "casting"). For example, if you have date information in a field with a string data type, you won't be able to use that field in date calculations unless the field is cast (changed) to a date data type.

For example, to use a string date field in a DATEDIFF function, you'd also need to use a date type conversion:

```
DATEDIFF('day', [Date Field], DATE([String Date Field]) )
```

Without the DATE function changing the data type, you'd get an error that "DATEDIFF is being called with (string, date, string)".

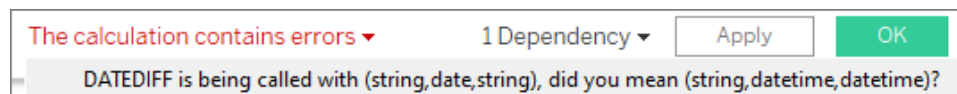

Tip: Fields have default **Data Types** on page 157 in the Data pane. In many instances, you don't need to use a type conversion function at all. You can change the field's data type by clicking the icon. However, in some cases it can be useful to change the data type only for a specific calculation, or Tableau may not be able to correctly cast the field's contents to the desired data

type (such as not recognizing the date format). Then you would need to use a type conversion function like those listed below.

Type conversion functions available in Tableau

DATE

Syntax	<code>DATE (expression)</code>
Output	Date
Definition	Returns a date given a number, string, or date expression.
Example	<pre>DATE ([Employee Start Date]) DATE ("September 22, 2018") DATE ("9/22/2018") DATE (#2018-09-22 14:52#)</pre>
Notes	<p>Unlike DATEPARSE, there is no need to provide a pattern as DATE automatically recognizes many standard date formats. If DATE does not recognize the input, however, try using DATEPARSE and specifying the format.</p> <p>MAKEDATE is another similar function, but MAKEDATE requires the input of numeric values for year, month, and day.</p>

DATETIME

Syntax	<code>DATETIME (expression)</code>
Output	Datetime
Definition	Returns a datetime given a number, string, or date expression.
Example	<code>DATETIME ("April 15, 2005 07:59:00") = April 15, 2005 07:59:00</code>

FLOAT

Syntax	<code>FLOAT(expression)</code>
Output	Floating point number (decimal)
Definition	Casts its argument as a floating point number.
Example	<code>FLOAT(3) = 3.000</code>
Notes	See also <code>INT</code> which returns an integer.

INT

Syntax	<code>INT(expression)</code>
Output	Integer
Definition	Casts its argument as an integer. For expressions, this function truncates results to the closest integer toward zero.
Example	<code>INT(8/3) = 2</code> <code>INT(-9.7) = -9</code>
Notes	When a string is converted to an integer it is first converted to a float and then rounded. See also <code>FLOAT</code> which returns a decimal. See also <code>ROUND</code> , <code>CEILING</code> , and <code>FLOOR</code>

MAKEDATE

Syntax	<code>MAKEDATE(year, month, day)</code>
Output	Date
Definition	Returns a date value constructed from the specified numerical year, month, and date.
Example	<code>MAKEDATE(1986, 3, 25) = #1986-03-25#</code>

Note that incorrectly entered values will be adjusted into a date, such as `MAKEDATE(2020,4,31)` = May 1, 2020 rather than returning an error that there is no 31st day of April.

- Notes** Available for Tableau Data Extracts. Check for availability in other data sources.
- `MAKEDATE` requires numerical inputs for the parts of a date. If your data is a string that should be a date, try the `DATE` function. `DATE` automatically recognizes many standard date formats. If `DATE` does not recognize the input try using `DATEPARSE`.

MAKEDATETIME

- Syntax** `MAKEDATETIME(date, time)`
- Output** Datetime
- Definition** Returns a datetime that combines a date and a time. The date can be a date, datetime, or a string type. The time must be a datetime.
- Example** `MAKEDATETIME("1899-12-30", #07:59:00#) = #12/30/1899 7:59:00 AM#`
- `MAKEDATETIME([Date], [Time]) = #1/1/2001 6:00:00 AM#`
- Notes** This function is available only for MySQL-compatible connections (which for Tableau are MySQL and Amazon Aurora).
- `MAKETIME` is a similar function available for Tableau Data Extracts and some other data sources.

MAKELINE

- Syntax** `MAKELINE(<Spatial Point1>, <Spatial Point2>)`
- Output** Geometry spatial object (line)
- Definition** Generates a line mark between two points.

Example	<code>MAKELINE(OriginPoint, DestinationPoint)</code>
	<code>MAKELINE(MAKEPOINT(OriginLat],[OriginLong]) , MAKEPOINT([DestinationLat],[DestinationLong])</code>
Notes	Useful for building origin-destination maps or, with MAKEPOINT, turning latitude and longitude into spatial objects.

MAKEPOINT

Syntax	<code>MAKEPOINT(<latitude>, <longitude>)</code>
Output	Geometry spatial object (point)
Definition	Converts data from latitude and longitude columns into spatial objects.
Example	<code>MAKEPOINT([AirportLatitude], [AirportLongitude])</code>
Notes	<p>You can use MAKEPOINT to spatially-enable a data source so that it can be joined with a spatial file using a spatial join. For more information, see Join Spatial Files in Tableau on page 1704.</p> <p>To use MAKEPOINT, your data must contain latitude and longitude coordinates.</p>

MAKETIME

Syntax	<code>MAKETIME(hour, minute, second)</code>
Output	Datetime. See Notes.
Definition	Returns a date value constructed from the specified hour, minute, and second.
Example	<code>MAKETIME(14, 52, 40) = #1/1/1899 14:52:40#</code>
Notes	<p>Because Tableau does not support a time data type, only date time, the output is a a datetime. The date portion of the field will be 1/1/1899.</p> <p>Similar function to MAKEDATETIME, which is only available for MYSQL-</p>

compatible connections.

STR

Syntax	<code>STR(expression)</code>
Output	String
Definition	Casts its argument as a string.
Example	<code>STR([ID])</code>

Cast Boolean expressions

A Boolean can be cast to an integer, float, or string, but not a date.

- `True` maps to 1, 1.0, or "1"
- `False` maps to 0, 0.0, or "0"
- `Unknown` maps to `Null`

Create a type conversion calculation

Follow along with the steps below to learn how to create a type conversion calculation.

1. In Tableau Desktop, connect to the **Sample - Superstore** saved data source, which comes with Tableau.
2. Navigate to a worksheet.
3. Select **Analysis > Create Calculated Field**.
4. In the calculation editor that opens, converts the Postal Code field from a number to a string:
 - Name the calculated field, Postal Code String.
 - Enter the following formula:

```
STR([Postal Code])
```

- When finished, click **OK**.

The new calculated field appears under Dimensions in the **Data** pane. Just like your other fields, you can use it in one or more visualizations.

Converting this field from a number to a string ensures that Tableau treats it as a string and not a number (and therefore doesn't aggregate it).

See Also

[Data Types](#) on page 157

[Convert a Field to a Date Field](#) on page 884

[Formatting Calculations in Tableau](#) on page 2449

[Functions in Tableau](#) on page 2047

[Tableau Functions \(Alphabetical\)](#) on page 2300

[Tableau Functions \(by Category\)](#) on page 2199

Logical Functions

This article introduces logical functions and their uses in Tableau. It also demonstrates how to create a logical calculation using an example.

Why use logical calculations

Logical calculations allow you to determine if a certain condition is true or false (Boolean logic). For example, you might want to categorize values based on certain cutoffs.

A logical calculation might look something like this:

```
IF [Profit] > 0
THEN 'Profitable'
ELSEIF [Profit] = 0 THEN 'Break even'
ELSE 'Loss'
END
```

Logical functions and operators available in Tableau

AND

Syntax <expr1> AND <expr2>

Definition Performs a logical conjunction on two expressions. (If both sides are true, the logical test returns true.)

Output	Boolean (true or false)
Example	<pre>IF [Season] = "Spring" AND "[Season] = "Fall" THEN "It's the apocalypse and footwear doesn't matter" END</pre> <p><i>"If both (Season = Spring) and (Season = Fall) are true simultaneously, then return It's the apocalypse and footwear doesn't matter".</i></p>
Notes	<p>Often used with IF on page 2102 and IIF on page 2103. See also NOT on page 2108 and OR on page 2109.</p> <p>If both expressions are TRUE (that is, not FALSE or NULL), then the result is TRUE. If either expression is NULL, then the result is NULL. In all other cases, the result is FALSE.</p> <p>If you create a calculation in which the result of an AND comparison is displayed on a worksheet, Tableau displays TRUE and FALSE. If you would like to change this, use the Format area in the format dialog.</p>

Note: The **AND** operator employs *short circuit evaluation*. This means that if the first expression is evaluated to be **FALSE**, then the second expression is not evaluated at all. This can be helpful if the second expression results in an error when the first expression is **FALSE**, because the second expression in this case is never evaluated.

CASE

Syntax	<pre>CASE <expression> WHEN <value1> THEN <then1> WHEN <value2> THEN <then2> ... [ELSE <default>] END</pre>
Output	Depends on data type of the <then> values.
Definition	Evaluates the <i>expression</i> and compares it to the specified options

(<value1>, <value2>, etc.). When a value that matches expression is encountered, CASE returns the corresponding return. If no match is found, the (optional) default is returned. If there is no default and no values match, then Null is returned.

Example

```
CASE [Season]
WHEN 'Summer' THEN 'Sandals'
WHEN 'Winter' THEN 'Boots'
ELSE 'Sneakers'
END
```

"Look at the Season field. If the value is Summer, then return Sandals. If the value is Winter, then return Boots. If none of the options in the calculation match what is in the Season field, return a Sneakers."

Notes

See also [IF](#) on page 2102 and [IIF](#) on page 2103.

Used with [WHEN](#) on page 2110, [THEN](#) on page 2109, [ELSE](#) below, and [END](#) on page 2102.

Tip: Many times you can use a group to get the same results as a complicated CASE function, or use CASE to replace native grouping functionality, such as in the previous example. You may want to test which is more performant for your scenario.

ELSE

Syntax

```
CASE <expression>
WHEN <value1> THEN <then1>
WHEN <value2> THEN <then2>
...
[ELSE <default>]
END
```

Definition

An optional piece of an IF or CASE expression used to specify a default value to return if none of the tested expressions are true.

Example

```
IF [Season] = "Summer" THEN 'Sandals'
ELSEIF [Season] = "Winter" THEN 'Boots'
```



```

ELSE 'Sneakers'
END

CASE [Season]
WHEN 'Summer' THEN 'Sandals'
WHEN 'Winter' THEN 'Boots'
ELSE 'Sneakers'
END

```

Notes Used with **CASE** on page 2099, **WHEN** on page 2110, **IF** on the next page, **ELSEIF** below, **THEN** on page 2109, and **END** on the next page

ELSE is optional with CASE and IF. In a calculation where ELSE is not specified, if none of the <test>are true, the overall calculation will return null.

ELSE does not require a condition (such as [Season] = "Winter") and can be thought of as a form of null handling.

ELSEIF

Syntax [**ELSEIF** <test2> THEN <then2>]

Definition An optional piece of an IF expression used to specify additional conditions beyond the initial IF.

Example

```

IF [Season] = "Summer" THEN 'Sandals'
ELSEIF [Season] = "Winter" THEN 'Boots'
ELSEIF [Season] = "Spring" THEN 'Sneakers'
ELSEIF [Season] = "Autumn" THEN 'Sneakers'
ELSE 'Bare feet'
END

```

Notes Used with **IF** on the next page, **THEN** on page 2109, **ELSE** on the previous page, and **END** on the next page

ELSEIF can be thought of as additional IF clauses. ELSEIF is optional and can be repeated multiple times.

Unlike ELSE, ELSEIF requires a condition (such as [Season] =

```
"Winter").
```

END

Definition Used to close an **IF** or **CASE** expression.

Example

```
IF [Season] = "Summer" THEN 'Sandals'
ELSEIF [Season] = "Winter" THEN 'Boots'
ELSE 'Sneakers'
END
```

"If Season = Summer, then return Sandals. If not, look at the next expression. If Season = Winter, then return Boots. If neither of the expressions are true, return Sneakers."

```
CASE [Season]
WHEN 'Summer' THEN 'Sandals'
WHEN 'Winter' THEN 'Boots'
ELSE 'Sneakers'
END
```

"Look at the Season field. If the value is Summer, then return Sandals. If the value is Winter, then return Boots. If none of the options in the calculation match what is in the Season field, return a Sneakers."

Notes Used with **CASE** on page 2099, **WHEN** on page 2110, **IF** below, **ELSEIF** on the previous page, **THEN** on page 2109, and **ELSE** on page 2100.

IF

Syntax

```
IF <test1> THEN <then1>
[ELSEIF <test2> THEN <then2>...]
[ELSE <default>]
END
```

Output Depends on data type of the <then> values.

Definition Tests a series of expressions and returns the <then> value for the first

true <test>.

Example

```
IF [Season] = "Summer" THEN 'Sandals'
ELSEIF [Season] = "Winter" THEN 'Boots'
ELSE 'Sneakers'
END
```

"If Season = Summer, then return Sandals. If not, look at the next expression. If Season = Winter, then return Boots. If neither of the expressions are true, return Sneakers."

Notes

See also [IF](#) on the previous page and [IIF](#) below.

Used with [ELSEIF](#) on page 2101, [THEN](#) on page 2109, [ELSE](#) on page 2100, and [END](#) on the previous page

IFNULL

Syntax

IFNULL(expr1, expr2)

Output

Depends on the data type of the <expr> values.

Definition

Returns <expr1> if it's non-null, otherwise returns <expr2>.

Example

```
IFNULL([Assigned Room], "TBD")
```

"If the Assigned Room field isn't null, return its value. If the Assigned room field is null, return TBD instead."

Notes

Compare with [ISNULL](#) on page 2106. IFNULL always returns a value. ISNULL returns a boolean (true or false).

See also [ZN](#) on page 2111.

IIF

Syntax

IIF(<test>, <then>, <else>, [<unknown>])

Output

Depends on the data type of the values in the expression.

Definition Checks whether a condition is met (<test>), and returns <then> if the test is true, <else> if the test is false, and an optional value for <unknown> if the test is null. If the optional unknown isn't specified, IIF returns null.

Example IIF([Season] = 'Summer', 'Sandals', 'Other footwear')

"If Season = Summer, then return Sandals. If not, return Other footwear"

```
IIF([Season] = 'Summer', 'Sandals',
    IIF('Season' = 'Winter', 'Boots', 'Other footwear')
)
```

"If Season = Summer, then return Sandals. If not, look at the next expression. If Season = Winter, then return Boots. If neither are true, return Sneakers."

```
IIF('Season' = 'Summer', 'Sandals',
    IIF('Season' = 'Winter', 'Boots',
        IIF('Season' = 'Spring', 'Sneakers', 'Other footwear')
    )
)
```

"If Season = Summer, then return Sandals. If not, look at the next expression. If Season = Winter, then return Boots. If none of the expressions are true, return Sneakers."

Notes See also [IF](#) on page 2102 and [CASE](#) on page 2099.

IIF doesn't have an equivalent to ELSEIF (like IF) or repeated WHEN clauses (like CASE). Instead, multiple tests can be evaluated sequentially by nesting IIF statements as the <unknown> element. The first (outermost) true is returned.

That is to say, in the calculation below, the result will be Red, not Orange, because the expression stops being evaluated as soon as A=A is evaluated as true:

```
IIF('A' = 'A', 'Red', IIF('B' = 'B', 'Orange', IIF('C' = 'D', 'Yellow', 'Green')))
```

IN

Syntax	<code><expr1> IN <expr2></code>
Output	Boolean (true or false)
Definition	Returns <code>TRUE</code> if any value in <code><expr1></code> matches any value in <code><expr2></code> .
Example	<pre>SUM([Cost]) IN (1000, 15, 200)</pre> <p><i>"Is the value of the Cost field 1000, 15, or 200?"</i></p> <pre>[Field] IN [Set]</pre> <p><i>"Is the value of the field present in the set?"</i></p>
Notes	<p>The values in <code><expr2></code> can be a set, list of literal values, or combined field.</p> <p>See also WHEN on page 2110.</p>

ISDATE

Syntax	<code>ISDATE (string)</code>
Output	Boolean (true or false)
Definition	Returns true if a <code><string></code> is a valid date. The input expression must be a string (text) field.
Example	<pre>ISDATE ("2018-09-22")</pre> <p><i>"Is the string 2018-09-22 a properly formatted date?"</i></p>
Notes	<p>What is considered a valid date depends on the locale of the system evaluating the calculation. For example:</p> <p>In the USA:</p> <ul style="list-style-type: none"> <code>ISDATE ("2018-09-22") = TRUE</code> <code>ISDATE ("2018-22-09") = FALSE</code> <p>In the UK:</p> <ul style="list-style-type: none"> <code>ISDATE ("2018-09-22") = FALSE</code>

- `ISDATE("2018-22-09") = TRUE`

ISNULL

Syntax	<code>ISNULL(expression)</code>
Output	Boolean (true or false)
Definition	Returns true if the <code><expression></code> is NULL (does not contain valid data).
Example	<code>ISNULL([Assigned Room])</code> <i>"Is the Assigned Room field null?"</i>
Notes	Compare with IFNULL on page 2103 . <code>IFNULL</code> always returns a value. <code>ISNULL</code> returns a boolean. See also ZN on page 2111 .

MAX

Syntax	<code>MAX(expression)</code> or <code>MAX(expr1, expr2)</code>
Output	Same data type as the argument, or NULL if any part of the argument is null.
Definition	Returns the maximum of the two arguments, which must be of the same data type. <code>MAX</code> can also be applied to a single field as an aggregation.
Example	<code>MAX(4, 7) = 7</code> <code>MAX(#3/25/1986#, #2/20/2021#) = #2/20/2021#</code> <code>MAX([Name]) = "Zander"</code>
Notes	For strings <code>MAX</code> is usually the value that comes last in alphabetical order.

For database data sources, the `MAX` string value is highest in the sort

sequence defined by the database for that column.

For dates

For dates, the `MAX` is the most recent date. If `MAX` is an aggregation, the result will not have a date hierarchy. If `MAX` is a comparison, the result will retain the date hierarchy.

As an aggregation

`MAX(expression)` is an aggregate function and returns a single aggregated result. This displays as `AGG(expression)` in the viz.

As a comparison

`MAX(expr1, expr2)` compares the two values and returns a row-level value.

See also [MIN](#) below.

MIN

Syntax	<code>MIN(expression)</code> or <code>MIN(expr1, expr2)</code>
Output	Same data type as the argument, or <code>NULL</code> if any part of the argument is null.
Definition	Returns the minimum of the two arguments, which must be of the same data type. <code>MIN</code> can also be applied to a single field as an aggregation.
Example	<code>MIN(4,7) = 4</code> <code>MIN(#3/25/1986#, #2/20/2021#) = #3/25/1986#</code> <code>MIN([Name]) = "Abebi"</code>
Notes	For strings <code>MIN</code> is usually the value that comes first in alphabetical order.

For database data sources, the `MIN` string value is lowest in the sort

sequence defined by the database for that column.

For dates

For dates, the `MIN` is the earliest date. If `MIN` is an aggregation, the result will not have a date hierarchy. If `MIN` is a comparison, the result will retain the date hierarchy.

As an aggregation

`MIN(expression)` is an aggregate function and returns a single aggregated result. This displays as `AGG(expression)` in the viz.

As a comparison

`MIN(expr1, expr2)` compares the two values and returns a row-level value.

See also [MAX](#) on page 2106.

NOT

Syntax	<code>NOT <expression></code>
Output	Boolean (true or false)
Definition	Performs logical negation on an expression.
Example	<pre>IF NOT [Season] = "Summer" THEN 'Don't wear sandals' ELSE 'Wear sandals' END</pre> <p><i>"If Season doesn't equal Summer, then return Don't wear sandals. If not, return Wear sandals."</i></p>
Notes	Often used with IF on page 2102 and IIF on page 2103. See also AND on page 2098 and OR on the facing page.

OR

Syntax <expr1> OR <expr2>

Output Boolean (true or false)

Definition Performs a logical disjunction on two expressions.

Example IF [Season] = "Spring" OR [Season] = "Fall"
THEN "Sneakers"
END

"If either (Season = Spring) or (Season = Fall) is true, then return Sneakers."

Notes Often used with [IF on page 2102](#) and [IIF on page 2103](#). See also [AND on page 2098](#) and [NOT on the previous page](#).

If either expression is TRUE, then the result is TRUE. If both expressions are FALSE, then the result is FALSE. If both expressions are NULL, then the result is NULL.

If you create a calculation which displays the result of an OR comparison on a worksheet, Tableau displays TRUE and FALSE. If you would like to change this, use the Format area in the format dialog.

Note: The OR operator employs *short circuit evaluation*. This means that if the first expression is evaluated to be TRUE, then the second expression is not evaluated at all. This can be helpful if the second expression results in an error when the first expression is TRUE, because the second expression in this case is never evaluated.

THEN

Syntax IF <test1> **THEN** <then1>
[ELSEIF <test2> **THEN** <then2>...]
[ELSE <default>]
END

Definition A required part of an **IF**, **ELSEIF**, or **CASE** expression, used to define what result to return if a specific value or test is true.

Example

```
IF [Season] = "Summer" THEN 'Sandals'
ELSEIF [Season] = "Winter" THEN 'Boots'
ELSE 'Sneakers'
END
```

"If Season = Summer, then return Sandals. If not, look at the next expression. If Season = Winter, then return Boots. If neither of the expressions are true, return Sneakers."

```
CASE [Season]
WHEN 'Summer' THEN 'Sandals'
WHEN 'Winter' THEN 'Boots'
ELSE 'Sneakers'
END
```

"Look at the Season field. If the value is Summer, then return Sandals. If the value is Winter, then return Boots. If none of the options in the calculation match what is in the Season field, return a Sneakers."

Notes Used with **CASE** on page 2099, **WHEN** below, **IF** on page 2102, **ELSEIF** on page 2101, **THEN** on the previous page, **ELSE** on page 2100, and **END** on page 2102

WHEN

Syntax

```
CASE <expression>
WHEN <value1> THEN <then1>
WHEN <value2> THEN <then2>
...
[ELSE <default>]
END
```

Definition A required part of a **CASE** expression. Finds the first <value> that matches <expression> and returns the corresponding <then>.

Example	<pre> CASE [Season] WHEN 'Summer' THEN 'Sandals' WHEN 'Winter' THEN 'Boots' ELSE 'Sneakers' END </pre> <p><i>"Look at the Season field. If the value is Summer, then return Sandals. If the value is Winter, then return Boots. If none of the options in the calculation match what is in the Season field, return a Sneakers."</i></p>
Notes	<p>Used with CASE on page 2099, THEN on page 2109, ELSE on page 2100, and END on page 2102.</p> <p>CASE also supports WHEN IN construction, such as:</p> <pre> CASE <expression> WHEN IN <set1> THEN <then1> WHEN IN <combinedfield> THEN <then2> ... ELSE <default> END </pre> <p>The values that WHEN IN compare to must be a set, list of literal values, or combined field. See also IN on page 2105.</p>

ZN

Syntax	<code>ZN(expression)</code>
Output	Depends on the data type of the <code><expression></code> , or 0.
Definition	Returns <code><expression></code> if it isn't null, otherwise returns zero.
Example	<pre>ZN([Test Grade])</pre> <p><i>"If the test grade isn't null, return its value. If the test grade is null, return 0."</i></p>
Notes	<p>ZN is a specialized case of IFNULL on page 2103 where alternative if the expression is null is always 0 rather than being specified in the calculation.</p> <p>ZN is especially useful when performing additional calculations and a null</p>

would render the entire calculation null. However, use caution interpreting these results as null is not always synonymous with 0 and could represent missing data.

See also [ISNULL](#) on page 2106.

Note: some of these are actually logical operators and appear in black, not blue. For more information, see [Operator syntax](#) on page 2454.

Note on CASE, IF, and IIF

CASE is often easier to use than IF or IIF. In many instances, IF, IIF, and CASE can be used interchangeably. A CASE statement can always be rewritten as an IF statement, although the CASE function will generally be more concise and may be easier to understand. However, not all IF statements can be written as CASE statements, because each ELSEIF could refer to a different field.

Tip: Let's compare an example using the same logic across these three functions:

CASE	IF	IIF
CASE [Region]	IF [Region] = 'West'	IIF([Region] =
WHEN 'West'	THEN 1	'West', 1,
THEN 1	ELSEIF [Region] =	IIF([Region] =
WHEN 'East'	'East' THEN 2	'East', 2,
THEN 2	ELSEIF [Region] =	IIF([Region] =
WHEN 'South'	'South' THEN 3	'South', 3,
THEN 3	ELSEIF [Region] =	IIF([Region] =
WHEN 'North'	'North' THEN 4	'North', 4,
Then 4	ELSE 5	5, 0)
ELSE 5	END)
END)
The CASE	The IF THEN structure permits	The IIF structure handles

structure is very simple and easy to write and understand.

However, the expression (here, [Region]) cannot be a logical operation, unlike with IF or IIF.

Nulls are handled the same for CASE as they are for IF.

multiple ELSEIF clauses, which makes multiple evaluations much easier than with IIF.

Null handling: any unknown (null) results are handled by the same ELSE clause as false results. Here, any region other than the four specified (including null) will be assigned a value of 5.

unknown results differently than false results and has a different syntax than IF. The tradeoff for specific null handling is nesting, as above, which can be clumsy to write and understand.

Null handling: any non-null region other than the four specified will be assigned a value of 5, but a null value will be assigned a 0.

Note: Many times you can use a group to get the same results as a complicated case function. Test to see if one option is more performant than the other.

Examples

CASE functions can be useful for scenarios such as realiasing:

```
CASE LEFT(DATENAME('weekday', [Order Date]), 3)
WHEN 'Sun' THEN 0
WHEN 'Mon' THEN 1
WHEN 'Tue' THEN 2
WHEN 'Wed' THEN 3
WHEN 'Thu' THEN 4
WHEN 'Fri' THEN 5
WHEN 'Sat' THEN 6
END
```

or giving the end user the ability to select which measure to view in a chart when used with a [parameter](#):

```
CASE [Choose a Measure]
WHEN "Sales" THEN SUM([Sales])
WHEN "Profit" THEN AVG([Profit])
```

```
WHEN "Quantity" THEN COUNT([Quantity])
WHEN "Shipping Cost" THEN MEDIAN([Shipping Cost])
END
```

Create a logical calculation

Follow along with the steps below to learn how to create a logical calculation.

1. In Tableau Desktop, connect to the **Sample - Superstore** saved data source, which comes with Tableau.
2. Navigate to a worksheet.
3. From the **Data** pane, drag **State** to the **Rows** shelf.
4. From the **Data** pane, drag **Category** to the **Rows** shelf and place it to the right of State.
5. From the **Data** pane, drag **Sales** to the **Columns** shelf.
6. Select **Analysis > Create Calculated Field**.
7. In the calculation editor that opens, do the following:
 - Name the calculated field KPI.
 - Enter the following formula:

```
SUM([Profit]) > 0
```

This calculation quickly checks if a member is great than zero. If so, it returns true; if not, it returns false.

- When finished, click **OK**.

The new calculated field appears under Measures in the Data pane. Just like your other fields, you can use it in one or more visualizations.

8. From the **Data** pane, drag **KPI** to **Color** on the Marks card.

You can now see which categories are losing money in each state.

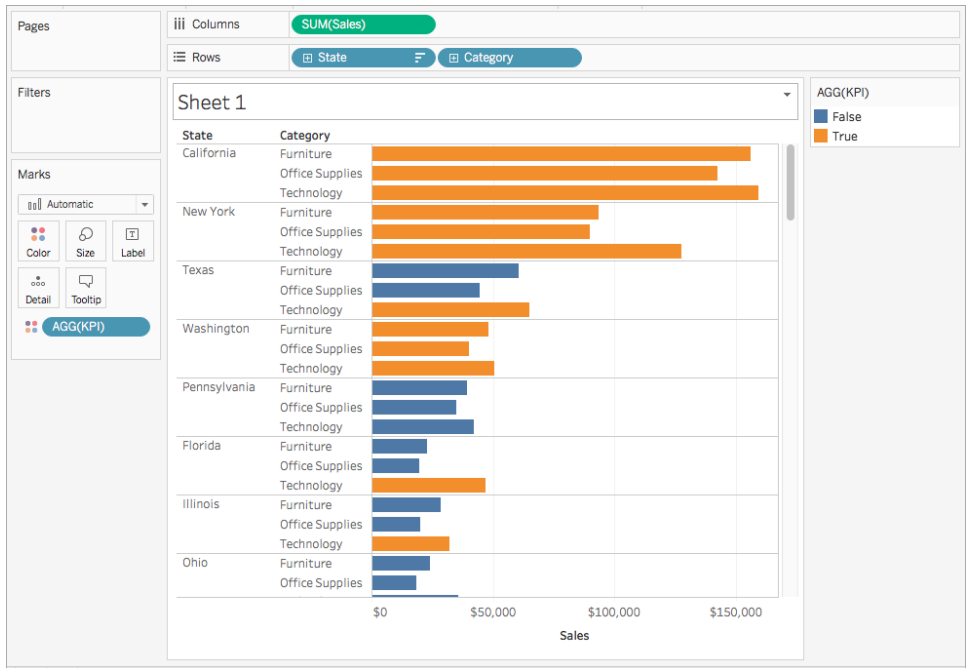

See Also

[Visualize Key Progress Indicators](#) on page 1577

[Functions in Tableau](#) on page 2047

[Tableau Functions \(by Category\)](#) on page 2199

[Tableau Functions \(Alphabetical\)](#) on page 2300

Aggregate Functions in Tableau

This article introduces aggregate functions and their uses in Tableau. It also demonstrates how to create an aggregate calculation using an example.

Why use aggregate functions

Aggregate functions allow you to summarize or change the granularity of your data.

For example, you might want to know exactly how many orders your store had for a particular year. You can use the COUNTD function to tally the exact number of unique orders your company had, and then break the visualization down by year.

The calculation might look something like this:

```
COUNTD(Order ID)
```

The visualization might look something like this:

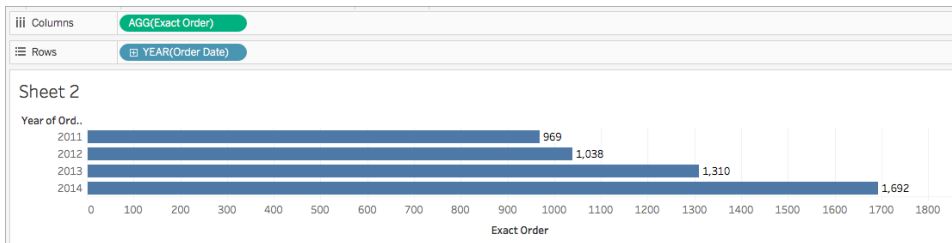

Aggregate functions available in Tableau

Aggregations and floating-point arithmetic: The results of some aggregations may not always be exactly as expected. For example, you may find that the SUM function returns a value such as $-1.42e-14$ for a column of numbers that you know should sum to exactly 0. This happens because the Institute of Electrical and Electronics Engineers (IEEE) 754 floating-point standard requires that numbers be stored in binary format, which means that numbers are sometimes rounded at extremely fine levels of precision. You can eliminate this potential distraction by using the ROUND function (see [Number Functions on page 2047](#)) or by formatting the number to show fewer decimal places.

ATTR

Syntax	ATTR (expression)
Definition	Returns the value of the expression if it has a single value for all rows. Otherwise returns an asterisk. Null values are ignored.

AVG

Syntax	AVG (expression)
Definition	Returns the average of all the values in the expression. Null values are ignored.
Notes	AVG can only be used with numeric fields.

COLLECT

Syntax	<code>COLLECT (spatial)</code>
Definition	An aggregate calculation that combines the values in the argument field. Null values are ignored.
Notes	<code>COLLECT</code> can only be used with spatial fields.

CORR

Syntax	<code>CORR (expression1, expression2)</code>
Output	Number from -1 to 1
Definition	Returns the Pearson correlation coefficient of two expressions.
Example	<code>example</code>
Notes	<p>The Pearson correlation measures the linear relationship between two variables. Results range from -1 to +1 inclusive, where 1 denotes an exact positive linear relationship, 0 denotes no linear relationship between the variance, and -1 is an exact negative relationship.</p> <p>The square of a CORR result is equivalent to the R-Squared value for a linear trend line model. See Trend Line Model Terms.</p> <p>Use with table scoped LOD expressions:</p> <p>You can use CORR to visualize correlation in a disaggregated scatter using a table-scoped level of detail expression. For example:</p> <pre>{CORR (Sales, Profit)}</pre> <p>With a level of detail expression, the correlation is run over all rows. If you used a formula like <code>CORR (Sales, Profit)</code> (without the surrounding brackets to make it a level of detail expression), the view would show the correlation of each individual point in the scatter plot with each other point, which is undefined.</p>
Database lim-	<code>CORR</code> is available with the following data sources: Tableau data extracts,

itations Cloudera Hive, EXASolution, Firebird (version 3.0 and later), Google BigQuery, Hortonworks Hadoop Hive, IBM PDA (Netezza), Oracle, PostgreSQL, Presto, SybaseIQ, Teradata, Vertica.

For other data sources, consider either extracting the data or using WINDOW_CORR. See [Table Calculation Functions](#).

COUNT

Syntax COUNT (expression)

Definition Returns the number of items. Null values are not counted.

COUNTD

Syntax COUNTD (expression)

Definition Returns the number of distinct items in a group. Null values are not counted.

COVAR

Syntax COVAR (expression1, expression2)

Definition Returns the *sample* covariance of two expressions.

Notes Covariance quantifies how two variables change together. A positive covariance indicates that the variables tend to move in the same direction, as when larger values of one variable tend to correspond to larger values of the other variable, on average. *Sample covariance* uses the number of non-null data points $n - 1$ to normalize the covariance calculation, rather than n , which is used by the population covariance (available with the COVARP function). Sample covariance is the appropriate choice when the data is a random sample that is being used to estimate the covariance for a larger population.

If <expression1> and <expression2> are the same, for example

`COVAR([profit], [profit])`, `COVAR` returns a value that indicates how widely values are distributed.

The value of `COVAR(X, X)` is equivalent to the value of `VAR(X)` and also to the value of `STDEV(X)^2`.

Database limitations `COVAR` is available with the following data sources: Tableau data extracts, Cloudera Hive, EXASolution, Firebird (version 3.0 and later), Google BigQuery, Hortonworks Hadoop Hive, IBM PDA (Netezza), Oracle, PostgreSQL, Presto, SybaseIQ, Teradata, Vertica.

For other data sources, consider either extracting the data or using `WINDOW_COVAR`. See [Table Calculation Functions](#).

COVARP

Syntax `COVARP(expression 1, expression2)`

Definition Returns the *population* covariance of two expressions.

Notes Covariance quantifies how two variables change together. A positive covariance indicates that the variables tend to move in the same direction, as when larger values of one variable tend to correspond to larger values of the other variable, on average. *Population covariance* is sample covariance multiplied by $(n-1)/n$, where n is the total number of non-null data points. Population covariance is the appropriate choice when there is data available for all items of interest as opposed to when there is only a random subset of items, in which case sample covariance (with the `COVAR` function) is appropriate.

If `<expression1>` and `<expression2>` are the same, for example `COVARP([profit], [profit])`, `COVARP` returns a value that indicates how widely values are distributed. Note: The value of `COVARP(X, X)` is equivalent to the value of `VARP(X)` and also to the value of `STDEVP(X)^2`.

Database limitations `COVARP` is available with the following data sources: Tableau data extracts, Cloudera Hive, EXASolution, Firebird (version 3.0 and later), Google BigQuery, Hortonworks Hadoop Hive, IBM PDA (Netezza), Oracle, PostgreSQL, Presto, SybaseIQ, Teradata, Vertica

For other data sources, consider either extracting the data or using `WINDOW_COVAR`. See [Table Calculation Functions](#).

MAX

Syntax	<code>MAX(expression)</code> or <code>MAX(expr1, expr2)</code>
Output	Same data type as the argument, or <code>NULL</code> if any part of the argument is null.
Definition	Returns the maximum of the two arguments, which must be of the same data type. <code>MAX</code> can also be applied to a single field as an aggregation.
Example	<code>MAX(4, 7) = 7</code> <code>MAX(#3/25/1986#, #2/20/2021#) = #2/20/2021#</code> <code>MAX([Name]) = "Zander"</code>
Notes	For strings <code>MAX</code> is usually the value that comes last in alphabetical order.

For database data sources, the `MAX` string value is highest in the sort sequence defined by the database for that column.

For dates

For dates, the `MAX` is the most recent date. If `MAX` is an aggregation, the result will not have a date hierarchy. If `MAX` is a comparison, the result will retain the date hierarchy.

As an aggregation

`MAX(expression)` is an aggregate function and returns a single aggregated result. This displays as `AGG(expression)` in the viz.

As a comparison

`MAX(expr1, expr2)` compares the two values and returns a row-level value.

See also [MIN](#) on the facing page.

MEDIAN

Syntax	<code>MEDIAN (expression)</code>
Definition	Returns the median of an expression across all records. Null values are ignored.
Notes	<code>MEDIAN</code> can only be used with numeric fields.
Database limitations	<code>MEDIAN</code> is not available for the following data sources: Access, Amazon Redshift, Cloudera Hadoop, HP Vertica, IBM DB2, IBM PDA (Netezza), Microsoft SQL Server, MySQL, SAP HANA, Teradata. For other data source types, you can extract your data into an extract file to use this function. See Extract Your Data .

MIN

Syntax	<code>MIN (expression)</code> or <code>MIN (expr1, expr2)</code>
Output	Same data type as the argument, or <code>NULL</code> if any part of the argument is null.
Definition	Returns the minimum of the two arguments, which must be of the same data type. <code>MIN</code> can also be applied to a single field as an aggregation.
Example	<code>MIN (4, 7) = 4</code> <code>MIN (#3/25/1986#, #2/20/2021#) = #3/25/1986#</code> <code>MIN ([Name]) = "Abebi"</code>
Notes	For strings <code>MIN</code> is usually the value that comes first in alphabetical order.

For database data sources, the `MIN` string value is lowest in the sort sequence defined by the database for that column.

For dates

For dates, the `MIN` is the earliest date. If `MIN` is an aggregation, the result will not have a date hierarchy. If `MIN` is a comparison, the result will retain the date hierarchy.

As an aggregation

`MIN(expression)` is an aggregate function and returns a single aggregated result. This displays as `AGG(expression)` in the viz.

As a comparison

`MIN(expr1, expr2)` compares the two values and returns a row-level value.

See also [MAX](#) on page 2120.

PERCENTILE

Syntax	<code>PERCENTILE(expression, number)</code>
Definition	Returns the percentile value from the given expression corresponding to the specified <code><number></code> . The <code><number></code> must be between 0 and 1 (inclusive) and must be a numeric constant.
Example	<code>PERCENTILE([Score], 0.9)</code>
Database limitations	This function is available for the following data sources: Non-legacy Microsoft Excel and Text File connections, Extracts and extract-only data source types (for example, Google Analytics, OData, or Salesforce), Sybase IQ 15.1 and later data sources, Oracle 10 and later data sources, Cloudera Hive and Hortonworks Hadoop Hive data sources, EXASolution 4.2 and later data sources. For other data source types, you can extract your data into an extract file to use this function. See Extract Your Data .

STDEV

Syntax	<code>STDEV(expression)</code>
--------	--------------------------------

Definition Returns the statistical standard deviation of all values in the given expression based on a sample of the population.

STDEVP

Syntax STDEVP (*expression*)

Definition Returns the statistical standard deviation of all values in the given expression based on a biased population.

SUM

Syntax SUM(*expression*)

Definition Returns the sum of all values in the expression. Null values are ignored.

Notes SUM can only be used with numeric fields.

VAR

Syntax VAR (*expression*)

Definition Returns the statistical variance of all values in the given expression based on a sample of the population.

VARP

Syntax VARP (*expression*)

Definition Returns the statistical variance of all values in the given expression on the entire population.

Create an aggregate calculation

Follow along with the steps below to learn how to create an aggregate calculation.

1. In Tableau Desktop, connect to the **Sample - Superstore** saved data source, which comes with Tableau.
2. Navigate to a worksheet and select **Analysis > Create Calculated Field**.
3. In the calculation editor that opens, do the following:
 - Name the calculated field **Margin**.
 - Enter the following formula:

```
IIF(SUM([Sales]) !=0, SUM([Profit])/SUM([Sales]), 0)
```

Note: You can use the function reference to find and add aggregate functions and other functions (like the logical IIF function in this example) to the calculation formula. For more information, see [Use the functions reference in the calculation editor on page 2469](#).

- When finished, click **OK**.

The new aggregate calculation appears under **Measures** in the **Data** pane. Just like your other fields, you can use it in one or more visualizations.

Note: Aggregation calculations are always measures.

When **Margin** is placed on a shelf or card in the worksheet, its name is changed to **AGG (Margin)**, which indicates that it is an aggregate calculation and cannot be aggregated any further.

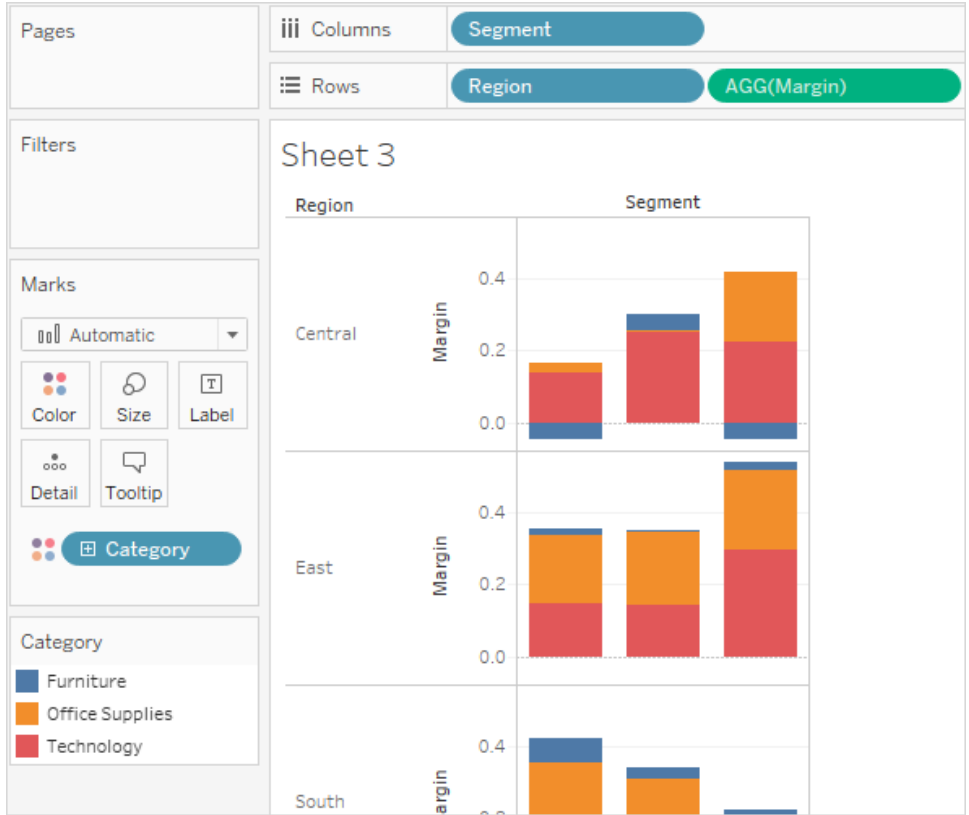

Rules for aggregate calculations

The rules that apply to aggregate calculations are as follows:

- For any aggregate calculation, you cannot combine an aggregated value and a disaggregated value. For example, $SUM(Price) * [Items]$ is not a valid expression because $SUM(Price)$ is aggregated and $Items$ is not. However, $SUM(Price * Items)$ and $SUM(Price) * SUM(Items)$ are both valid.
- Constant terms in an expression act as aggregated or disaggregated values as appropriate. For example: $SUM(Price * 7)$ and $SUM(Price) * 7$ are both valid expressions.
- All of the functions can be evaluated on aggregated values. However, the arguments to any given function must either all be aggregated or all disaggregated. For example: $MAX(SUM(Sales), Profit)$ is not a valid expression because $Sales$ is aggregated and $Profit$ is not. However, $MAX(SUM(Sales), SUM(Profit))$ is a valid expression.
- The result of an aggregate calculation is always a measure. This includes expressions like $ATTR(Dimension)$ or $MIN(Dimension)$.
- Like predefined aggregations, aggregate calculations are computed correctly for grand totals. Refer to Grand Totals for more information.

See also

[Understanding Calculations: Aggregate Calculations](#)

[Data Aggregation in Tableau](#) on page 171

[Functions in Tableau](#) on page 2047

[Tableau Functions \(by Category\)](#) on page 2199

[Tableau Functions \(Alphabetical\)](#) on page 2300

Pass-Through Functions (RAWSQL)

These RAWSQL pass-through functions can be used to send SQL expressions directly to the database, without first being interpreted by Tableau. If you have custom database functions that Tableau doesn't know about, you can use these pass-through functions to call these custom functions.

Your database usually will not understand the field names that are shown in Tableau. Because Tableau does not interpret the SQL expressions you include in the pass-through functions, using the Tableau field names in your expression may cause errors. You can use a substitution syntax to insert the correct field name or expression for a Tableau calculation into pass-through SQL. For example, if you had a function that computed the median of a set of values, you could call that function on the Tableau column [Sales] like this:

```
RAWSQLAGG_REAL("MEDIAN(%1)", [Sales])
```

Because Tableau does not interpret the expression, you must define the aggregation. You can use the RAWSQLAGG functions described below when you are using aggregated expressions.

RAWSQL pass-through functions will not work with published data sources or with Tableau extracts.

These functions may return different results starting in Tableau Desktop 8.2 than they did in earlier versions of Tableau Desktop. This is because Tableau now uses ODBC for pass-through functions instead of OLE DB. ODBC truncates when returning real values as integer; OLE DB rounds when returning real values as integer.

RAWSQL Functions

The following RAWSQL functions are available in Tableau.

RAWSQL_BOOL("sql_expr", [arg1], ...[argN])

Returns a Boolean result from a given SQL expression. The SQL expression is passed directly to the underlying database. Use %n in the SQL expression as a substitution syntax for database values.

Example

In the example, %1 is equal to [Sales] and %2 is equal to [Profit].

```
RAWSQL_BOOL("%1 > %2", [Sales], [Profit])
```

RAWSQL_DATE("sql_expr", [arg1], ...[argN])

Returns a Date result from a given SQL expression. The SQL expression is passed directly to the underlying database. Use %n in the SQL expression as a substitution syntax for database values.

Example

In this example, %1 is equal to [Order Date].

```
RAWSQL_DATE("%1", [Order Date])
```

RAWSQL_DATETIME("sql_expr", [arg1], ...[argN])

Returns a Date and Time result from a given SQL expression. The SQL expression is passed directly to the underlying database. Use %n in the SQL expression as a substitution syntax for database values. In this example, %1 is equal to [Delivery Date].

Example

```
RAWSQL_DATETIME("%1", [Order Date])
```

RAWSQL_INT("sql_expr", [arg1], ...[argN])

Returns an integer result from a given SQL expression. The SQL expression is passed directly to the underlying database. Use %n in the SQL expression as a substitution syntax for database values. In this example, %1 is equal to [Sales].

Example

```
RAWSQL_INT("500 + %1", [Sales])
```

RAWSQL_REAL("sql_expr", [arg1], ...[argN])

Returns a numeric result from a given SQL expression that is passed directly to the underlying database. Use %n in the SQL expression as a substitution syntax for database values. In this example, %1 is equal to [Sales]

Example

```
RAWSQL_REAL("-123.98 * %1", [Sales])
```

RAWSQL_SPATIAL

Returns a Spatial from a given SQL expression that is passed directly to the underlying data source. Use %n in the SQL expression as a substitution syntax for database values.

Example

In this example, %1 is equal to [Geometry].

```
RAWSQL_SPATIAL("%1", [Geometry])
```

RAWSQL_STR("sql_expr", [arg1], ...[argN])

Returns a string from a given SQL expression that is passed directly to the underlying database. Use %n in the SQL expression as a substitution syntax for database values. In this example, %1 is equal to [Customer Name].

Example

```
RAWSQL_STR("%1", [Customer Name])
```

RAWSQLAGG_BOOL("sql_expr", [arg1], ...[argN])

Returns a Boolean result from a given aggregate SQL expression. The SQL expression is passed directly to the underlying database. Use %n in the SQL expression as a substitution syntax for database values.

Example

In the example, %1 is equal to [Sales] and %2 is equal to [Profit].

```
RAWSQLAGG_BOOL("SUM( %1) > SUM( %2)", [Sales], [Profit])
```

RAWSQLAGG_DATE("sql_expr", [arg1], ...[argN])

Returns a Date result from a given aggregate SQL expression. The SQL expression is passed directly to the underlying database. Use %n in the SQL expression as a substitution syntax for database values. In this example, %1 is equal to [Order Date].

Example

```
RAWSQLAGG_DATE("MAX(%1)", [Order Date])
```

RAWSQLAGG_DATETIME("sql_expr", [arg1], ...[argN])

Returns a Date and Time result from a given aggregate SQL expression. The SQL expression is passed directly to the underlying database. Use %n in the SQL expression as a substitution syntax for database values. In this example, %1 is equal to [Delivery Date].

Example

```
RAWSQLAGG_DATETIME("MIN(%1)", [Delivery Date])
```

RAWSQLAGG_INT("sql_expr", [arg1,] ...[argN])

Returns an integer result from a given aggregate SQL expression. The SQL expression is passed directly to the underlying database. Use %n in the SQL expression as a substitution syntax for database values. In this example, %1 is equal to [Sales].

Example

```
RAWSQLAGG_INT("500 + SUM(%1)", [Sales])
```

RAWSQLAGG_REAL("sql_expr", [arg1,] ...[argN])

Returns a numeric result from a given aggregate SQL expression that is passed directly to the underlying database. Use %n in the SQL expression as a substitution syntax for database

values. In this example, %1 is equal to [Sales]

Example

```
RAWSQLAGG_REAL("SUM( %1)", [Sales])
```

RAWSQLAGG_STR("sql_expr", [arg1,] ...[argN])

Returns a string from a given aggregate SQL expression that is passed directly to the underlying database. Use %n in the SQL expression as a substitution syntax for database values. In this example, %1 is equal to [Discount].

Example

```
RAWSQLAGG_STR("AVG(%1)", [Discount])
```

User Functions

This article introduces user functions and their uses in Tableau. It also demonstrates how to create a user calculation using an example.

Why use user functions

User functions can be used to create user filters or row-level security filters that affect visualizations published to Tableau Server or Tableau Cloud, so that only certain people can see your visualization.

For example, if you have a visualization that shows the sales performance for each employee in your department published on Tableau Server or Tableau Cloud, you might want to only allow employees to see their own sales numbers when they access that visualization.

In this case, you can use the ISMEMBEROF function to create a field that returns true if the username of the person signed in to the server is a member of a specified group (on the server), such as the "Managers" group, for example. Then when you filter the view using this calculated field, only a person who is part of that group can see the data.

The calculation in this case might look something like the following:

```
ISMEMBEROF('Managers')
```

Note: If your group or user names contain certain non-alphanumeric you must use HTML URL Encoding for the special characters when using the functions below.

Some special characters are permitted without HTML URL encoding, such as underscores, parentheses, and exclamation points. `_ () !` Many other characters must be encoded.

For example, the function `ISMEMBEROF ("USERS+")` needs to be written as `ISMEMBEROF ("USERS%2B")`, because the `'%2B'` is the HTML URL Encoding for the `'+'` symbol. For information on HTML URL encoding, please see [HTML URL Encoding Reference](#) at the W3schools Web Developer site.

For embedding workflows in Tableau Cloud only

Among the user functions, a subset of user attribute functions can be used with [Tableau connected apps](#). The user attribute functions (**USERATTRIBUTE** and **USERATTRIBUTEINCLUDES**) allow user attributes to be captured by Tableau at runtime as part of the authentication workflow. When user attributes are passed from JSON Web Tokens (JWTs), embedded content authored with these functions can control and customize data displayed to users.

Notes:

- Check the [Embedding API v3 Help](#) for *known issues* that might affect your workflow.
- User attribute functions can be included in content authored in Tableau Desktop or Tableau Cloud.
- Preview of the content with these functions is not available when authoring in Tableau Desktop or Tableau Cloud. User attribute functions will return NULL or FALSE values. To ensure user attribute functions work as expected, we recommend you review the content after embedding in your external application. For more information about embedding workflows that include these user functions, see the [Embedding API v3 Help](#).

User functions available in Tableau

FULLNAME()

Syntax	<code>FULLNAME ()</code>
Output	String
Definition	Returns the full name for the current user.
Example	<code>FULLNAME ()</code>

This returns the full name of the signed in user, such as "Hamlin Myrer".

```
[Manager] = FULLNAME ( )
```

If manager "Hamlin Myrer" is signed in, this example returns TRUE only if the Manager field in the view contains "Hamlin Myrer".

Notes

This function checks:

- Tableau Cloud and Tableau Server: the full name of the signed-in user
- Tableau Desktop: the local or network full name for the user

User filters

When used as a filter, a calculated field such as [Username field] = FULLNAME () can be used to create a user filter that only shows data that is relevant to the person signed in to the server.

ISFULLNAME

Syntax	ISFULLNAME("User Full Name")
Output	Boolean
Definition	Returns TRUE if the current user's full name matches the specified full name or FALSE if it does not match.
Example	ISFULLNAME("Hamlin Myrer")
Notes	<p>The <"User Full Name"> argument must be a literal string, not a field.</p> <p>This function checks:</p> <ul style="list-style-type: none"> • Tableau Cloud and Tableau Server: the full name of the signed-in user • Tableau Desktop: the local or network full name for the user

ISMEMBEROF

Syntax	<code>ISMEMBEROF("Group Name")</code>
Output	Boolean or null
Definition	Returns <code>TRUE</code> if the person currently using Tableau is a member of a group that matches the given string, <code>FALSE</code> if they're not a member, and <code>NULL</code> if they're not signed in.
Example	<code>ISMEMBEROF('Superstars')</code> <code>ISMEMBEROF('domain.lan\Sales')</code>
Notes	<p>The <code><"Group Full Name"></code> argument must be a literal string, not a field.</p> <p>If the user is signed in to Tableau Cloud or Tableau Server, group membership is determined by Tableau groups. The function will return <code>TRUE</code> if the given string is "All Users"</p> <p>The <code>ISMEMBEROF()</code> function will also accept Active Directory domains. The Active Directory domain must be declared in the calculation with the group name.</p> <p>If a change is made to a user's group membership, the change in the data that is based on the group membership is reflected in a workbook or view with a new session. The existing session will reflect stale data.</p>

ISUSERNAME

Syntax	<code>ISUSERNAME("username")</code>
Output	Boolean
Definition	Returns <code>TRUE</code> if the current user's username matches the specified username or <code>FALSE</code> if it does not match.
Example	<code>ISUSERNAME("hmyrer")</code>
Notes	<p>The <code><"username"></code> argument must be a literal string, not a field.</p> <p>This function checks:</p>

- Tableau Cloud and Tableau Server: the username of the signed-in user
- Tableau Desktop: the local or network username for the user

USERDOMAIN()

Syntax	USERDOMAIN ()
Output	String
Definition	Returns the domain for the current user .
Notes	This function checks: <ul style="list-style-type: none"> • Tableau Cloud and Tableau Server: the user domain of the signed-in user • Tableau Desktop: the local domain if the user is on a domain

USERNAME()

Syntax	USERNAME ()
Output	String
Definition	Returns the username for the current user.
Example	<p>USERNAME ()</p> <p>This returns the username of the signed in user, such as "hmyrer".</p> <pre>[Manager] = USERNAME ()</pre> <p>If manager "hmyrer" is signed in, this example returns TRUE only if the Manager field in the view contains "hmyrer".</p>
Notes	This function checks: <ul style="list-style-type: none"> • Tableau Cloud and Tableau Server: the username of the signed-in user • Tableau Desktop: the local or network username for the user

User filters

When used as a filter, a calculated field such as `[Username field] = USERNAME ()` can be used to create a user filter that only shows data that is relevant to the person signed in to the server.

USERATTRIBUTE

Note: For embedding workflows in Tableau Cloud only. For more information, see [Authentication and Embedded Views](#).

Syntax	<code>USERATTRIBUTE('attribute_name')</code>
Output	String or null
Definition	<p>If <code><'attribute_name'></code> is part of the JSON web token (JWT) passed to Tableau, the calculation returns the first value of <code><'attribute_name'></code>. Returns null if <code><'attribute_name'></code> does not exist.</p>
Example	<p>Suppose "Region" is the user attribute included in the JWT and passed to Tableau (using the connected app already configured by your site admin).</p> <p>As the workbook author, you can set up your visualization to filter data based on a specified region. In that filter, you can reference the following calculation.</p> <pre>[Region] = USERATTRIBUTE("Region")</pre> <p>When User2 from the West region views the embedded visualization, Tableau shows the appropriate data for the West region only.</p>
Notes	You can use the <code>USERATTRIBUTEINCLUDES</code> function if you expect <code><'attribute_name'></code> to return multiple values.

USERATTRIBUTEINCLUDES

Note: For embedding workflows in Tableau Cloud only. For more information, see [Authentication and Embedded Views](#).

Syntax	<code>USERATTRIBUTEINCLUDES('attribute_name', 'expected_value')</code>
Output	Boolean
Definition	<p>Returns <code>TRUE</code> if both of the following are true:</p> <ul style="list-style-type: none"> • <code><'attribute_name'></code> is part of the JSON web token (JWT) passed to Tableau • one of <code><'attribute_name'></code> values equals <code><'expected_value'></code>. <p>Returns <code>FALSE</code> otherwise.</p>
Example	<p>Suppose "Region" is the user attribute included in the JWT and passed to Tableau (using the connected app already configured by your site admin).</p> <p>As the workbook author, you can set up your visualization to filter data based on a specified region. In that filter, you can reference the following calculation.</p> <pre>USERATTRIBUTEINCLUDES('Region', [Region])</pre> <p>If User2 from the West region accesses the embedded visualization, Tableau checks if the Region user attribute matches one of [Region] field values. When true, the visualization shows the appropriate data.</p> <p>When User3 from the North region accesses the same visualization, she's unable to see any data because there's no match with [Region] field values.</p>

Create a user calculation

User calculations work directly with the users and groups you have set up on Tableau Server or Tableau Cloud. You can create user calculations to use as filters so users only see the data that is relevant to them.

Tableau Desktop and Web Authoring Help

For example, if you have a map viz similar to the following, which shows sales data for 48 US states, you can create a user calculation to show only parts of the map that are relevant to each user, such as data relevant for a regional manager versus a national manager. (A national manager should be able to see data for the entire country, while a regional manager should only be able to see data for the region they manage).

When the national manager is signed in, they see the following visualization:

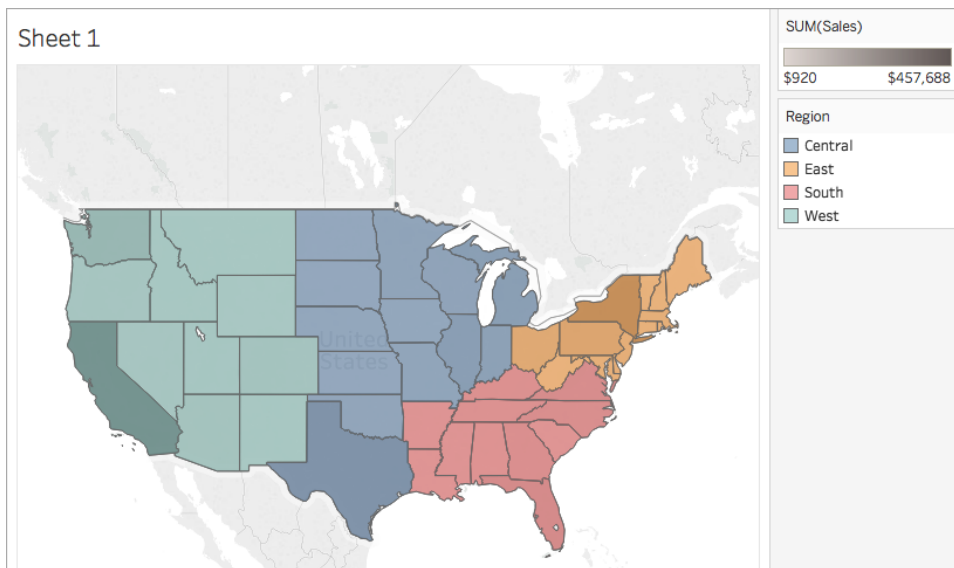

When the western regional manager is signed in, they see only sales for their region:

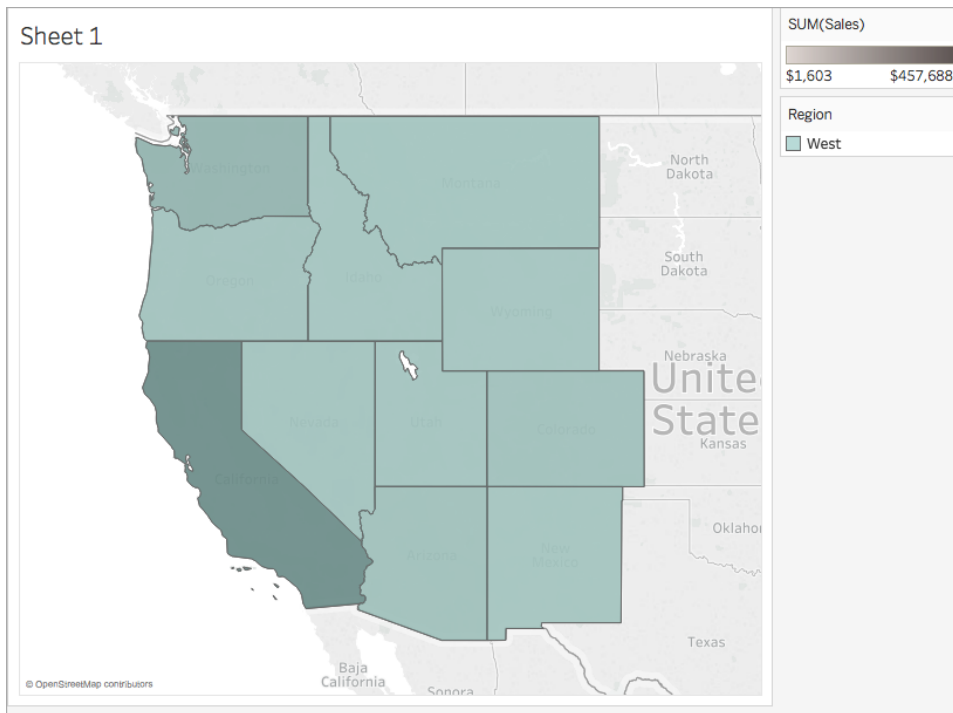

To create a user function that performs similarly to this example, follow the steps below.

Before you begin

To follow along with this example you must have access to Tableau Server or Tableau Cloud. You must also be a Server or Site Administrator.

Step 1: Create the users and groups

1. Sign in to Tableau Server or Tableau Cloud.
2. In Tableau Server or Tableau Cloud, add the following users:
 - Sadie Pawthorne
 - Chuck Magee
 - Fred Suzuki
 - Roxanne Rodriguez

For more information, see [Add Users to a Site](#) in the Tableau Server Help.

3. Create a new group called **National Managers**.

For more information, see [Create a Local Group](#) in the Tableau Server Help.

4. Add yourself to the National Managers group.

For more information, see [Add Users to a Group](#) in the Tableau Server Help.

Step 2: Create the visualization

1. Open Tableau Desktop, and connect to the **Sample-Superstore** data source, which comes with Tableau.
2. In the bottom left corner of the workspace, click the Data Source tab.
3. On the Data Source page, from the Connections pane on the left, drag the People sheet to the join area.
4. Click the join icon and select **Left**.

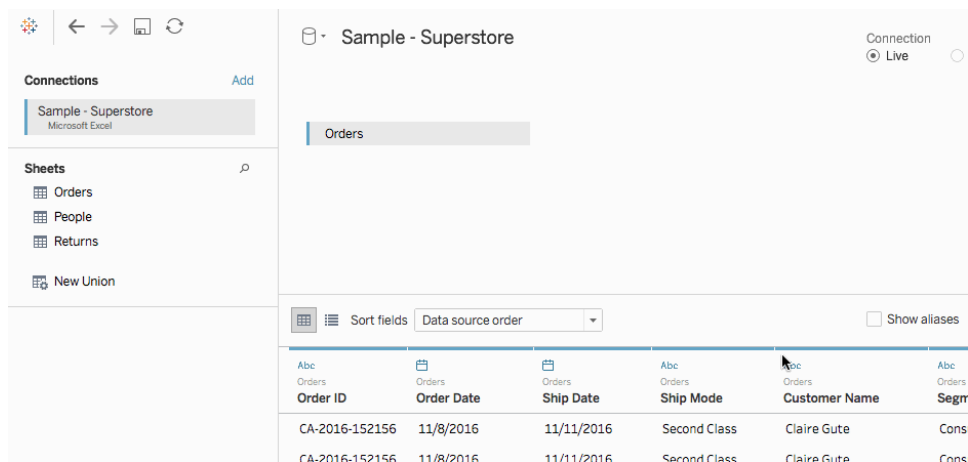

5. Navigate to a new worksheet.
6. In the **Data** pane, under Dimensions, double-click **State**.
A map view is created.
7. From the **Data** pane, under Measures, drag **Sales** to **Color** on the Marks card.
8. On the Columns shelf, select the Longitude field and hold down Control (Command on Mac) on your keyboard to copy it. Drag the copy to the right of the original on the Columns shelf.

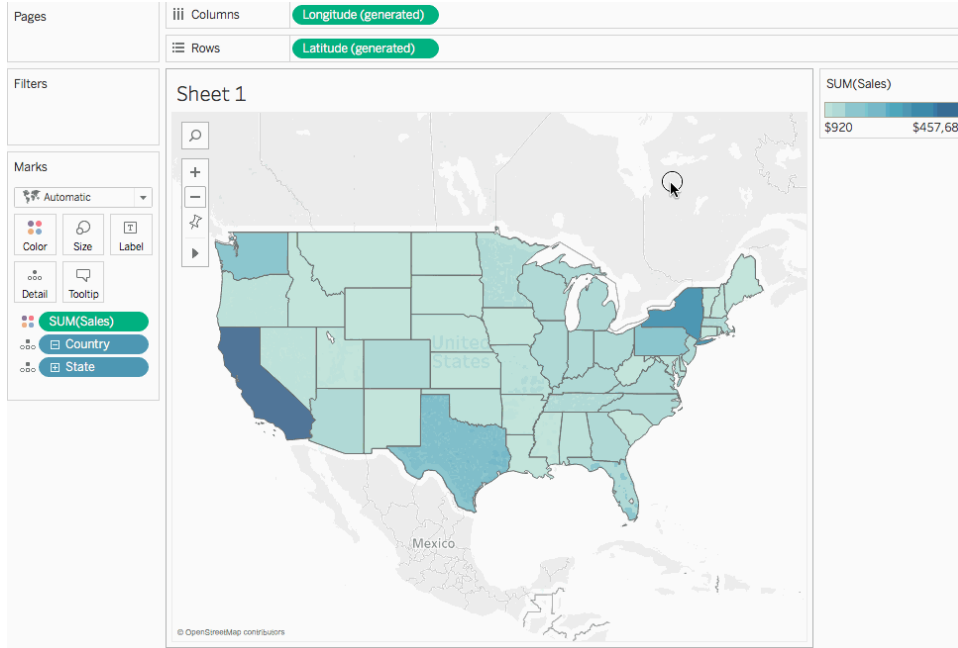

9. On the Marks card, click the second (bottom) **Longitude** tab.
10. From the **Data** pane, drag **Region** to **Color** on the Marks card.
The map view on the right updates with new colors.

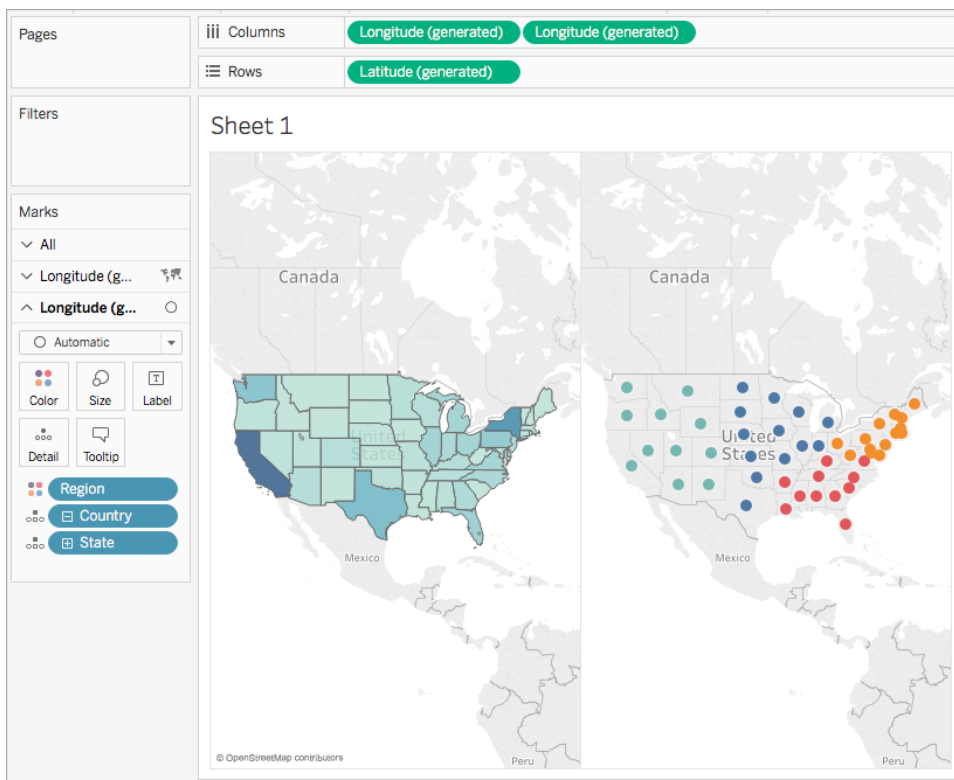

11. On the Marks card, click the mark type drop-down and select **Map**.

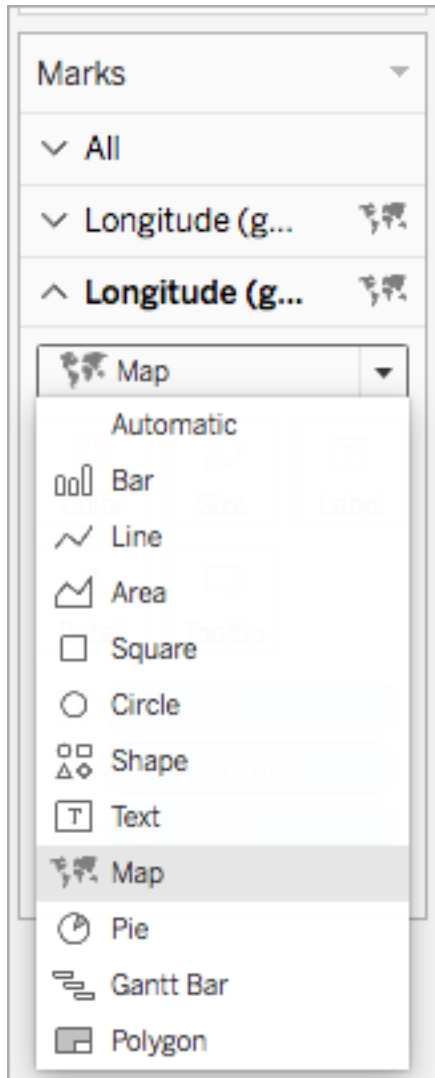

12. On the Marks card, click **Color**, and, under Opacity, adjust the slider to **50%**.
13. On the Marks card, click the first **Longitude** tab.
14. On the Marks card, click **Color > Edit Colors**, and then select **Gray** from the color palette drop-down list.

The map view on the left updates.

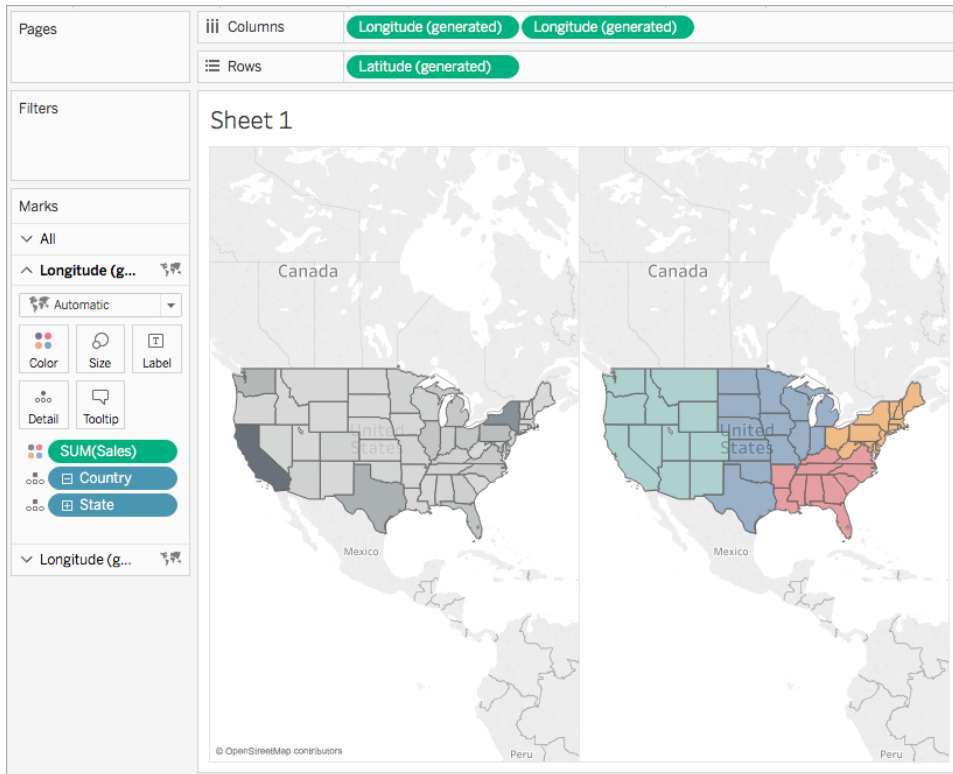

15. On the Columns shelf, right-click the **Longitude** field on the right and select **Dual Axis**.

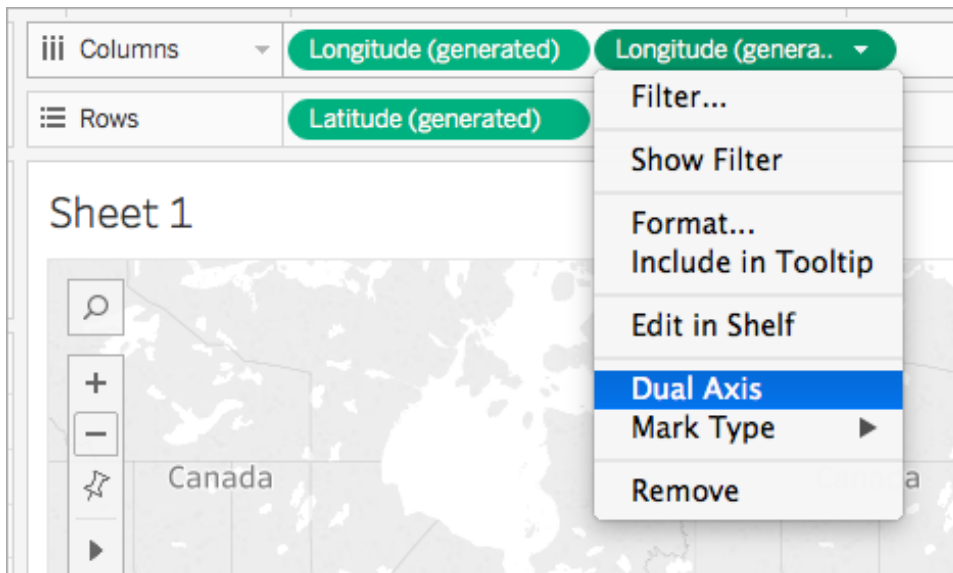

The map looks like the following:

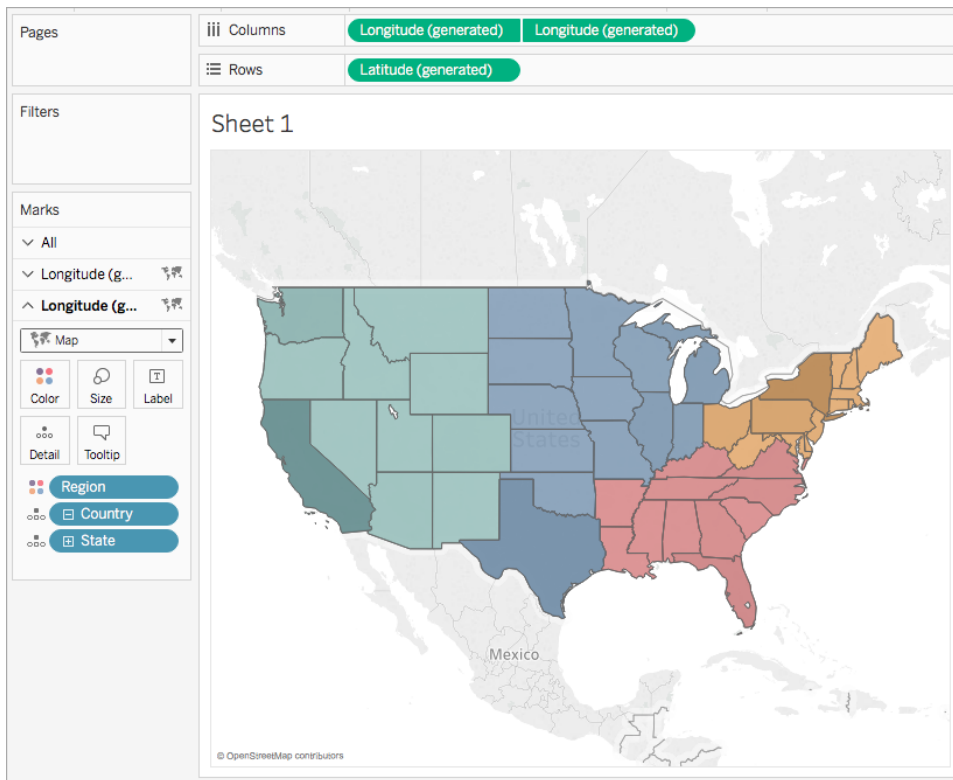

Step 3: Create the User Calculation

1. Select **Analysis > Create Calculated Field**.
2. In the calculation editor that opens, do the following:
 - Name the calculated field, User Filter.
 - Enter the following formula:

```
[Regional Manager] = USERNAME() OR ISMEMBEROF("National Managers")
```

This calculation checks if a person is included in the Region (People) field, or if a person is included in the National Managers group. If so, it returns true.

- When finished, click **OK**.

The new user calculation appears under Dimensions in the Data pane. Just like your other fields, you can use it in one or more visualizations.

Step 4: Add the user calculation to the Filters shelf

1. From the Data pane, under Dimensions, drag User Filter to the Filters shelf.
2. In the Filter dialog box that opens, select **True**, and then click **OK**.

Note: If you are not signed in to Tableau Server or Tableau Cloud, the True option is not visible. In Tableau Desktop, sign in to Tableau Server or Tableau Cloud to select it. See [Sign in to Tableau Server or Tableau Cloud](#) on page 193 for more information.

Step 5: Test the calculation

1. In Tableau Desktop, in the bottom-right corner of the workspace, click the Filter as User drop-down and change the user to **Sadie Pawthorne**.

The map updates to show only the West region of the United States because Sadie is assigned to the West region in the People sheet.

2. Select the Filter as User drop-down again and change the user to Roxanne Rodriguez.

The map updates to show only the Central region of the United States because Roxanne is assigned to the Central region in the People sheet.

3. Select the Filter as User drop-down again and change the user to Chuck Magee.

The map updates to show only the East region of the United States because Chuck is assigned to the East region in the People sheet.

4. Select the Filter as User drop-down again and change the user to Fred Suzuki.

The map updates to show only the South region of the United States because Fred is assigned to the South region in the People sheet.

5. Select the Filter as User drop-down one more time and change the user back to yourself.

The map updates to show all data because you are a part of the National Managers group on the server.

This behavior persists when you publish the view to Tableau Server or Tableau Cloud. Users not listed in the National Managers group, or in the People sheet in the Sample Superstore data source see only a blank visualization.

See Also

[Functions in Tableau](#) on page 2047

[Tableau Functions \(by Category\)](#) on page 2199

[Tableau Functions \(Alphabetical\)](#) on page 2300

Table Calculation Functions

This article introduces table calculation functions and their uses in Tableau. It also demonstrates how to create a table calculation using the calculation editor.

Why use table calculation functions

Table calculation functions allow you to perform computations on values in a table.

For example, you can calculate the percent of total an individual sale is for the year, or for several years.

Table calculation functions available in Tableau

These are the native table calculation functions that can be used in Tableau without an external Analytics Extension.

FIRST()

Returns the number of rows from the current row to the first row in the partition. For example, the view below shows quarterly sales. When `FIRST()` is computed within the Date partition, the offset of the first row from the second row is -1.

Year of Order Date	Quarter of Order Date	Region			
		Central	East	South	West
2009	Q1	\$160,877	\$231,411	\$133,934	\$185,961
	Q2	\$197,213	\$204,914	\$337,813	\$213,507
	Q3	\$302,678	\$165,201	\$283,806	\$206,512
	Q4	\$297,208	\$226,983	\$214,845	\$230,291
2010	Q1	\$180,609	\$180,123	\$273,943	\$251,145
	Q2	\$195,785	\$224,882	\$251,391	\$195,976
	Q3	\$116,613	\$50,363	\$194,601	\$102,731

First()	
\$160,877	0
\$197,213	-1
\$302,678	-2
\$297,208	-3
\$180,609	-4
\$195,785	-5
\$116,613	-6

Example

When the current row index is 3, `FIRST()` = -2.

INDEX()

Returns the index of the current row in the partition, without any sorting with regard to value. The first row index starts at 1. For example, the table below shows quarterly sales. When INDEX() is computed within the Date partition, the index of each row is 1, 2, 3, 4..., etc.

Year of Order Date	Quarter of Order Date	Region			
		Central	East	South	West
2009	Q1	\$160,877	\$231,411	\$133,934	\$185,961
	Q2	\$197,213	\$204,914	\$337,813	\$213,507
	Q3	\$302,678	\$165,201	\$283,806	\$206,512
	Q4	\$297,208	\$226,983	\$214,845	\$230,291
2010	Q1	\$180,609	\$180,123	\$273,943	\$251,145
	Q2	\$195,785	\$224,882	\$251,391	\$195,976
	Q3	\$116,613	\$50,363	\$194,601	\$102,731

INDEX()	
\$160,877	1
\$197,213	2
\$302,678	3
\$297,208	4
\$180,609	5
\$195,785	6
\$116,613	7

Example

For the third row in the partition, INDEX () = 3.

LAST()

Returns the number of rows from the current row to the last row in the partition. For example, the table below shows quarterly sales. When LAST() is computed within the Date partition, the offset of the last row from the second row is 5.

Year of Order Date	Quarter of Order Date	Region			
		Central	East	South	West
2009	Q1	\$160,877	\$231,411	\$133,934	\$185,961
	Q2	\$197,213	\$204,914	\$337,813	\$213,507
	Q3	\$302,678	\$165,201	\$283,806	\$206,512
	Q4	\$297,208	\$226,983	\$214,845	\$230,291
2010	Q1	\$180,609	\$180,123	\$273,943	\$251,145
	Q2	\$195,785	\$224,882	\$251,391	\$195,976
	Q3	\$116,613	\$50,363	\$194,601	\$102,731

LAST()	
\$160,877	6
\$197,213	5
\$302,678	4
\$297,208	3
\$180,609	2
\$195,785	1
\$116,613	0

Example

When the current row index is 3 of 7, LAST () = 4.

LOOKUP(expression, [offset])

Returns the value of the expression in a target row, specified as a relative offset from the current row. Use `FIRST() + n` and `LAST() - n` as part of your offset definition for a target relative to the first/last rows in the partition. If `offset` is omitted, the row to compare to can be set on the field menu. This function returns NULL if the target row cannot be determined.

The view below shows quarterly sales. When `LOOKUP (SUM(Sales), 2)` is computed within the Date partition, each row shows the sales value from 2 quarters into the future.

Year of Order Date	Quarter of Order Date	Region			
		Central	East	South	West
2009	Q1	\$160,877	\$231,411	\$133,934	\$185,961
	Q2	\$197,213	\$204,914	\$337,813	\$213,507
	Q3	+2 \$302,678	\$165,201	\$283,806	\$206,512
	Q4	\$297,208	\$226,983	\$214,845	\$230,291
2010	Q1	\$180,609	\$180,123	\$273,943	\$251,145
	Q2	\$195,785	\$224,882	\$251,391	\$195,976
	Q3	\$116,613	\$50,363	\$194,601	\$102,731

Year of Order Date	Quarter of Order Date	Region			
		Central	East	South	West
2009	Q1	\$302,678	\$165,201	\$283,806	\$206,512
	Q2	\$297,208	\$226,983	\$214,845	\$230,291
	Q3	\$180,609	\$180,123	\$273,943	\$251,145
	Q4	\$195,785	\$224,882	\$251,391	\$195,976
2010	Q1	\$116,613	\$50,363	\$194,601	\$102,731
	Q2				
	Q3				

Example

`LOOKUP (SUM([Profit]), FIRST() + 2)` computes the `SUM(Profit)` in the third row of the partition.

MODEL_EXTENSION functions

The model extension functions:

- MODEL_EXTENSION_BOOL
- MODEL_EXTENSION_INT
- MODEL_EXTENSION_REAL
- MODEL_EXTENSION_STRING

are used to pass data to a deployed model on an external service such as R, TabPy, or Matlab. See [Analytics Extensions](#).

MODEL_PERCENTILE(target_expression, predictor_expression(s))

Returns the probability (between 0 and 1) of the expected value being less than or equal to the observed mark, defined by the target expression and other predictors. This is the Posterior Predictive Distribution Function, also known as the Cumulative Distribution Function (CDF).

This function is the inverse of MODEL_QUANTILE. For information on predictive modeling functions, see [How Predictive Modeling Functions Work in Tableau on page 2571](#).

Example

The following formula returns the quantile of the mark for sum of sales, adjusted for count of orders.

```
MODEL_PERCENTILE(SUM([Sales]), COUNT([Orders]))
```

MODEL_QUANTILE(quantile, target_expression, predictor_expression(s))

Returns a target numeric value within the probable range defined by the target expression and other predictors, at a specified quantile. This is the Posterior Predictive Quantile.

This function is the inverse of MODEL_PERCENTILE. For information on predictive modeling functions, see [How Predictive Modeling Functions Work in Tableau on page 2571](#).

Example

The following formula returns the median (0.5) predicted sum of sales, adjusted for count of orders.

```
MODEL_QUANTILE(0.5, SUM([Sales]), COUNT([Orders]))
```

PREVIOUS_VALUE(expression)

Returns the value of this calculation in the previous row. Returns the given expression if the current row is the first row of the partition.

Example

`SUM([Profit]) * PREVIOUS_VALUE(1)` computes the running product of SUM(Profit).

RANK(expression, ['asc' | 'desc'])

Returns the standard competition rank for the current row in the partition. Identical values are assigned an identical rank. Use the optional 'asc' | 'desc' argument to specify ascending or descending order. The default is descending.

With this function, the set of values (6, 9, 9, 14) would be ranked (4, 2, 2, 1).

Nulls are ignored in ranking functions. They are not numbered and they do not count against the total number of records in percentile rank calculations.

For information on different ranking options, see [Rank calculation on page 2388](#).

Example

The following image shows the effect of the various ranking functions (RANK, RANK_DENSE, RANK_MODIFIED, RANK_PERCENTILE, and RANK_UNIQUE) on a set of values. The data set contains information on 14 students (Student A through Student N); the **Age** column shows the current age of each student (all students are between 17 and 20 years of age). The remaining columns show the effect of each rank function on the set of age values, always assuming the default order (ascending or descending) for the function.

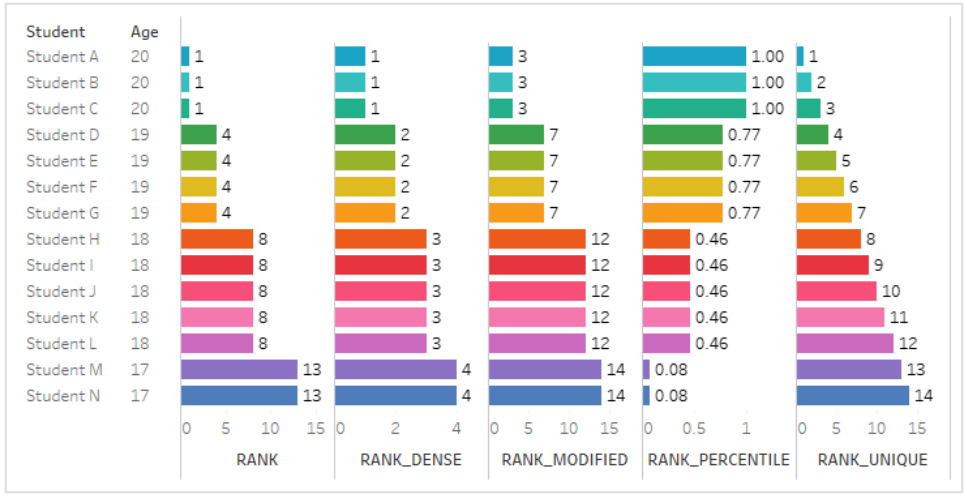

RANK_DENSE(expression, ['asc' | 'desc'])

Returns the dense rank for the current row in the partition. Identical values are assigned an identical rank, but no gaps are inserted into the number sequence. Use the optional 'asc' | 'desc' argument to specify ascending or descending order. The default is descending.

With this function, the set of values (6, 9, 9, 14) would be ranked (3, 2, 2, 1).

Nulls are ignored in ranking functions. They are not numbered and they do not count against the total number of records in percentile rank calculations.

For information on different ranking options, see [Rank calculation on page 2388](#).

RANK_MODIFIED(expression, ['asc' | 'desc'])

Returns the modified competition rank for the current row in the partition. Identical values are assigned an identical rank. Use the optional 'asc' | 'desc' argument to specify ascending or descending order. The default is descending.

With this function, the set of values (6, 9, 9, 14) would be ranked (4, 3, 3, 1).

Nulls are ignored in ranking functions. They are not numbered and they do not count against the total number of records in percentile rank calculations.

For information on different ranking options, see [Rank calculation on page 2388](#).

RANK_PERCENTILE(expression, ['asc' | 'desc'])

Returns the percentile rank for the current row in the partition. Use the optional 'asc' | 'desc' argument to specify ascending or descending order. The default is ascending.

With this function, the set of values (6, 9, 9, 14) would be ranked (0.00, 0.67, 0.67, 1.00).

Nulls are ignored in ranking functions. They are not numbered and they do not count against the total number of records in percentile rank calculations.

For information on different ranking options, see [Rank calculation on page 2388](#).

RANK_UNIQUE(expression, ['asc' | 'desc'])

Returns the unique rank for the current row in the partition. Identical values are assigned different ranks. Use the optional 'asc' | 'desc' argument to specify ascending or descending order. The default is descending.

With this function, the set of values (6, 9, 9, 14) would be ranked (4, 2, 3, 1).

Nulls are ignored in ranking functions. They are not numbered and they do not count against the total number of records in percentile rank calculations.

For information on different ranking options, see [Rank calculation on page 2388](#).

RUNNING_AVG(expression)

Returns the running average of the given expression, from the first row in the partition to the current row.

The view below shows quarterly sales. When `RUNNING_AVG(SUM([Sales]))` is computed within the Date partition, the result is a running average of the sales values for each quarter.

Year of Order Date	Quarter of Order Date	Region			
		Central	East	South	West
2009	Q1	\$160,877	\$231,411	\$133,934	\$185,961
	Q2	\$197,213	\$204,914	\$337,813	\$213,507
	Q3	\$302,678	\$165,201	\$283,806	\$206,512
	Q4	\$297,208	\$226,983	\$214,845	\$230,291
2010	Q1	\$180,609	\$180,123	\$273,943	\$251,145
	Q2	\$195,785	\$224,882	\$251,391	\$195,976
	Q3	\$116,613	\$50,363	\$194,601	\$102,731

\$160,877	\$197,213	\$302,678	\$297,208
\$180,609	\$195,785	\$116,613	

Average = \$179,045

Year of Order Date	Quarter of Order Date	Region			
		Central	East	South	West
2009	Q1	160,877	231,411	133,934	185,961
	Q2	179,045	204,914	337,813	213,507
	Q3	220,256	200,509	251,851	201,993
	Q4	239,494	207,127	242,599	209,068
2010	Q1	227,717	201,726	248,868	217,483
	Q2	222,395	205,586	249,289	213,899
	Q3	207,283	183,411	241,476	198,018

Example

`RUNNING_AVG(SUM([Profit]))` computes the running average of `SUM(Profit)`.

RUNNING_COUNT(expression)

Returns the running count of the given expression, from the first row in the partition to the current row.

Example

`RUNNING_COUNT(SUM([Profit]))` computes the running count of `SUM(Profit)`.

RUNNING_MAX(expression)

Returns the running maximum of the given expression, from the first row in the partition to the current row.

Year of Order Date	Quarter of Order Date	Region			
		Central	East	South	West
2009	Q1	\$160,877	\$231,411	\$133,934	\$185,961
	Q2	\$197,213	\$204,914	\$337,813	\$213,507
	Q3	\$302,678	\$165,201	\$283,806	\$206,512
	Q4	\$297,208	\$226,983	\$214,845	\$230,291
2010	Q1	\$180,609	\$180,123	\$273,943	\$251,145
	Q2	\$195,785	\$224,882	\$251,391	\$195,976
	Q3	\$116,613	\$50,363	\$194,601	\$102,731

Year of Order Date	Quarter of Order Date	Region			
		Central	East	South	West
2009	Q1	160,877	231,411	133,934	185,961
	Q2	197,213	231,411	337,813	213,507
	Q3	302,678	165,201	283,806	206,512
	Q4	302,678	231,411	337,813	230,291
2010	Q1	302,678	231,411	337,813	251,145
	Q2	302,678	231,411	337,813	251,145
	Q3	302,678	231,411	337,813	251,145

Example

`RUNNING_MAX(SUM([Profit]))` computes the running maximum of `SUM(Profit)`.

RUNNING_MIN(expression)

Returns the running minimum of the given expression, from the first row in the partition to the current row.

Year of Order Date	Quarter of Order Date	Region			
		Central	East	South	West
2009	Q1	\$160,877	\$231,411	\$133,934	\$185,961
	Q2	\$197,213	\$204,914	\$337,813	\$213,507
	Q3	\$302,678	\$165,201	\$283,806	\$206,512
	Q4	\$297,208	\$226,983	\$214,845	\$230,291
2010	Q1	\$180,609	\$180,123	\$273,943	\$251,145
	Q2	\$195,785	\$224,882	\$251,391	\$195,976
	Q3	\$116,613	\$50,363	\$194,601	\$102,731

Year of Order Date	Quarter of Order Date	Region			
		Central	East	South	West
2009	Q1	160,877	231,411	133,934	185,961
	Q2	160,877	204,914	133,934	185,961
	Q3	160,877	165,201	133,934	185,961
	Q4	160,877	165,201	133,934	185,961
2010	Q1	160,877	165,201	133,934	185,961
	Q2	160,877	165,201	133,934	185,961
	Q3	116,613	50,363	133,934	102,731

Example

`RUNNING_MIN(SUM([Profit]))` computes the running minimum of `SUM(Profit)`.

RUNNING_SUM(expression)

Returns the running sum of the given expression, from the first row in the partition to the current row.

Year of Order Date	Quarter of Order Date	Region			
		Central	East	South	West
2009	Q1	\$160,877	\$231,411	\$133,934	\$185,961
	Q2	\$197,213	\$204,914	\$337,813	\$213,507
	Q3	\$302,678	\$165,201	\$283,806	\$206,512
	Q4	\$297,208	\$226,983	\$214,845	\$230,291
2010	Q1	\$180,609	\$180,123	\$273,943	\$251,145
	Q2	\$195,785	\$224,882	\$251,391	\$195,976
	Q3	\$116,613	\$50,363	\$194,601	\$102,731

Year of Order Date	Quarter of Order Date	Region			
		Central	East	South	West
2009	Q1	160,877	231,411	133,934	185,961
	Q2	358,090	436,325	471,747	399,469
	Q3	660,768	601,526	755,553	605,980
	Q4	957,976	828,508	970,398	836,272
2010	Q1	1,138,585	1,008,631	1,244,341	1,087,417
	Q2	1,334,369	1,233,513	1,496,732	1,283,392
	Q3	1,450,982	1,283,877	1,690,333	1,386,123

Example

`RUNNING_SUM(SUM([Profit]))` computes the running sum of `SUM(Profit)`

SIZE()

Returns the number of rows in the partition. For example, the view below shows quarterly sales. Within the Date partition, there are seven rows so the `Size()` of the Date partition is 7.

Year of Order Date	Quarter of Order Date	Region			
		Central	East	South	West
2009	Q1	\$160,877	\$231,411	\$133,934	\$185,961
	Q2	\$197,213	\$204,914	\$337,813	\$213,507
	Q3	\$302,678	\$165,201	\$283,806	\$206,512
	Q4	\$297,208	\$226,983	\$214,845	\$230,291
2010	Q1	\$180,609	\$180,123	\$273,943	\$251,145
	Q2	\$195,785	\$224,882	\$251,391	\$195,976
	Q3	\$116,613	\$50,363	\$194,601	\$102,731

\$160,877
\$197,213
\$302,678
\$297,208
\$180,609
\$195,785
\$116,613

Size = 7

Example

`SIZE () = 5` when the current partition contains five rows.

SCRIPT_ functions

The script functions:

- `SCRIPT_BOOL`
- `SCRIPT_INT`
- `SCRIPT_REAL`
- `SCRIPT_STRING`

are used to pass data to an external service such as R, TabPy, or Matlab. See [Analytics Extensions](#).

TOTAL(expression)

Returns the total for the given expression in a table calculation partition.

Example

Assume you are starting with this view:

Year of Orde..	Quarter of O..	Region			
		Central	East	South	West
2011	Q1	\$8,601	\$6,579	\$44,262	\$15,006
	Q2	\$17,407	\$21,064	\$22,524	\$25,543
	Q3	\$44,171	\$33,443	\$16,061	\$49,957
	Q4	\$33,659	\$67,594	\$20,998	\$57,377
2012	Q1	\$11,768	\$17,146	\$16,444	\$23,493
	Q2	\$23,979	\$22,703	\$16,254	\$26,188
	Q3	\$24,486	\$50,777	\$21,460	\$33,537
	Q4	\$42,641	\$65,706	\$17,202	\$56,748
2013	Q1	\$20,212	\$24,134	\$23,934	\$24,317
	Q2	\$25,709	\$52,807	\$17,079	\$39,774
	Q3	\$33,428	\$37,528	\$22,939	\$50,720
	Q4	\$68,080	\$66,060	\$29,588	\$72,165
2014	Q1	\$40,278	\$17,341	\$9,882	\$51,395
	Q2	\$26,606	\$29,978	\$33,137	\$44,302
	Q3	\$34,042	\$67,712	\$23,894	\$74,786
	Q4	\$46,172	\$98,209	\$56,064	\$80,150

You open the calculation editor and create a new field which you name **Totality**:

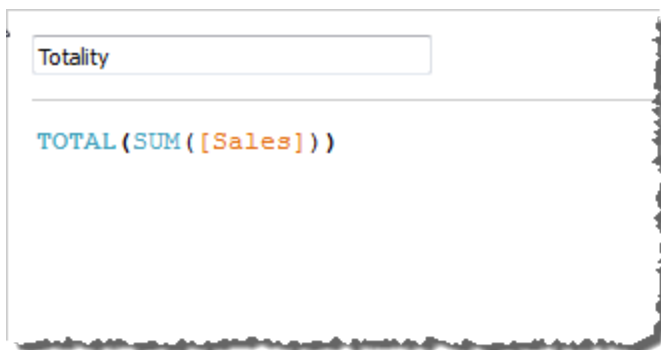

You then drop **Totality** on Text, to replace **SUM(Sales)**. Your view changes such that it sums values based on the default **Compute Using** value:

		Region			
Year of Orde..	Quarter of O..	Central	East	South	West
2011	Q1	74,448	74,448	74,448	74,448
	Q2	86,539	86,539	86,539	86,539
	Q3	143,633	143,633	143,633	143,633
	Q4	179,628	179,628	179,628	179,628
2012	Q1	68,852	68,852	68,852	68,852
	Q2	89,124	89,124	89,124	89,124
	Q3	130,260	130,260	130,260	130,260
	Q4	182,297	182,297	182,297	182,297
2013	Q1	92,596	92,596	92,596	92,596
	Q2	135,370	135,370	135,370	135,370
	Q3	144,614	144,614	144,614	144,614
	Q4	235,893	235,893	235,893	235,893
2014	Q1	118,896	118,896	118,896	118,896
	Q2	134,023	134,023	134,023	134,023
	Q3	200,433	200,433	200,433	200,433
	Q4	280,595	280,595	280,595	280,595

This raises the question, What is the default **Compute Using** value? If you right-click (Control-click on a Mac) **Totality** in the Data pane and choose **Edit**, there is now an additional bit of information available:

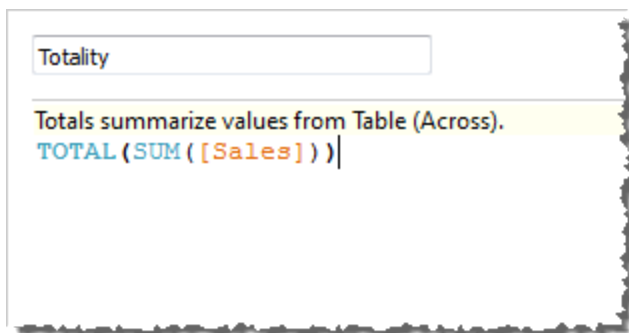

The default **Compute Using** value is **Table (Across)**. The result is that **Totality** is summing the values across each row of your table. Thus, the value that you see across each row is the sum of the values from the original version of the table.

The values in the 2011/Q1 row in the original table were \$8601, \$6579, \$44262, and \$15006. The values in the table after **Totality** replaces **SUM(Sales)** are all \$74,448, which is the sum of the four original values.

Notice the triangle next to **Totality** after you drop it on **Text**:

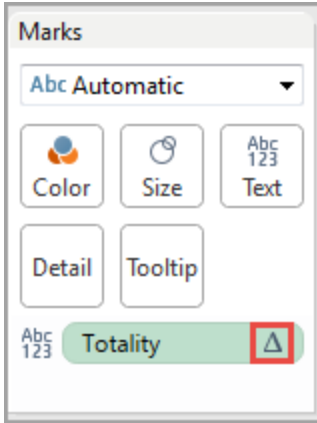

This indicates that this field is using a table calculation. You can right-click the field and choose **Edit Table Calculation** to redirect your function to a different **Compute Using** value. For example, you could set it to **Table (Down)**. In that case, your table would look like this:

The image shows a Tableau table view. The Columns shelf contains 'Region' and the Rows shelf contains 'YEAR(Order Date)' and 'QUARTER(Order Date)'. The table displays sales data for four years (2011-2014) and four quarters (Q1-Q4) for each year, broken down by region (Central, East, South, West). The 'Totality' field is calculated for each row. The interface includes a Marks card on the left and a Columns/Rows shelf at the top.

		Region			
Year of Orde..	Quarter of O..	Central	East	South	West
2011	Q1	501,240	678,781	391,722	725,458
	Q2	501,240	678,781	391,722	725,458
	Q3	501,240	678,781	391,722	725,458
	Q4	501,240	678,781	391,722	725,458
2012	Q1	501,240	678,781	391,722	725,458
	Q2	501,240	678,781	391,722	725,458
	Q3	501,240	678,781	391,722	725,458
	Q4	501,240	678,781	391,722	725,458
2013	Q1	501,240	678,781	391,722	725,458
	Q2	501,240	678,781	391,722	725,458
	Q3	501,240	678,781	391,722	725,458
	Q4	501,240	678,781	391,722	725,458
2014	Q1	501,240	678,781	391,722	725,458
	Q2	501,240	678,781	391,722	725,458
	Q3	501,240	678,781	391,722	725,458
	Q4	501,240	678,781	391,722	725,458

TOTAL(expression)

Returns the total for the given expression in a table calculation partition.

Example

Assume you are starting with this view:

The screenshot shows the Tableau Desktop interface with a pivot table. The Columns shelf contains 'Region' and the Rows shelf contains 'YEAR(Order Date)' and 'QUARTER(Order Date)'. The Marks shelf is set to 'SUM(Sales)'. The table displays sales data for the years 2011 through 2014, broken down by quarter (Q1-Q4) and region (Central, East, South, West).

Year of Order	Quarter of O.	Region			
		Central	East	South	West
2011	Q1	\$8,601	\$6,579	\$44,262	\$15,006
	Q2	\$17,407	\$21,064	\$22,524	\$25,543
	Q3	\$44,171	\$33,443	\$16,061	\$49,957
	Q4	\$33,659	\$67,594	\$20,998	\$57,377
2012	Q1	\$11,768	\$17,146	\$16,444	\$23,493
	Q2	\$23,979	\$22,703	\$16,254	\$26,188
	Q3	\$24,486	\$50,777	\$21,460	\$33,537
	Q4	\$42,641	\$65,706	\$17,202	\$56,748
2013	Q1	\$20,212	\$24,134	\$23,934	\$24,317
	Q2	\$25,709	\$52,807	\$17,079	\$39,774
	Q3	\$33,428	\$37,528	\$22,939	\$50,720
	Q4	\$68,080	\$66,060	\$29,588	\$72,165
2014	Q1	\$40,278	\$17,341	\$9,882	\$51,395
	Q2	\$26,606	\$29,978	\$33,137	\$44,302
	Q3	\$34,042	\$67,712	\$23,894	\$74,786
	Q4	\$46,172	\$98,209	\$56,064	\$80,150

You open the calculation editor and create a new field which you name **Totality**:

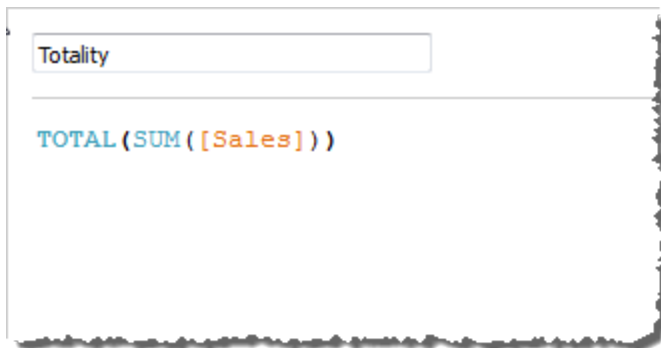

You then drop **Totality** on Text, to replace **SUM(Sales)**. Your view changes such that it sums values based on the default **Compute Using** value:

		Region			
Year of Orde..	Quarter of O..	Central	East	South	West
2011	Q1	74,448	74,448	74,448	74,448
	Q2	86,539	86,539	86,539	86,539
	Q3	143,633	143,633	143,633	143,633
	Q4	179,628	179,628	179,628	179,628
2012	Q1	68,852	68,852	68,852	68,852
	Q2	89,124	89,124	89,124	89,124
	Q3	130,260	130,260	130,260	130,260
	Q4	182,297	182,297	182,297	182,297
2013	Q1	92,596	92,596	92,596	92,596
	Q2	135,370	135,370	135,370	135,370
	Q3	144,614	144,614	144,614	144,614
	Q4	235,893	235,893	235,893	235,893
2014	Q1	118,896	118,896	118,896	118,896
	Q2	134,023	134,023	134,023	134,023
	Q3	200,433	200,433	200,433	200,433
	Q4	280,595	280,595	280,595	280,595

This raises the question, What is the default **Compute Using** value? If you right-click (Control-click on a Mac) **Totality** in the Data pane and choose **Edit**, there is now an additional bit of information available:

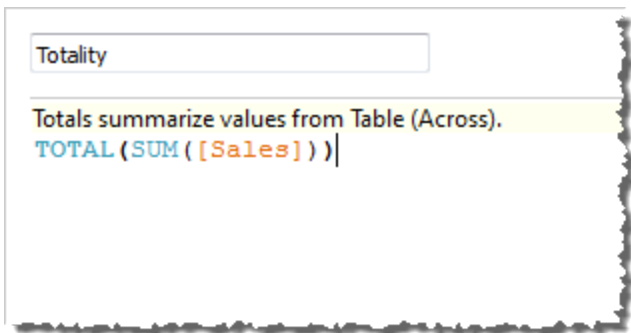

The default **Compute Using** value is **Table (Across)**. The result is that **Totality** is summing the values across each row of your table. Thus, the value that you see across each row is the sum of the values from the original version of the table.

The values in the 2011/Q1 row in the original table were \$8601, \$6579, \$44262, and \$15006. The values in the table after **Totality** replaces **SUM(Sales)** are all \$74,448, which is the sum of the four original values.

Notice the triangle next to **Totality** after you drop it on **Text**:

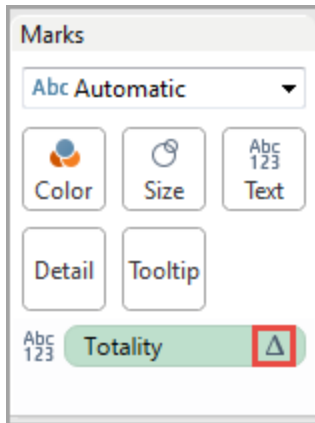

This indicates that this field is using a table calculation. You can right-click the field and choose **Edit Table Calculation** to redirect your function to a different **Compute Using** value. For example, you could set it to **Table (Down)**. In that case, your table would look like this:

 A screenshot of a Tableau view showing a table. The Columns shelf contains 'Region' and the Rows shelf contains 'YEAR(Order Date)' and 'QUARTER(Order Date)'. The table displays sales data for four years (2011-2014) across four quarters (Q1-Q4) for four regions (Central, East, South, West). The 'Totality' field is visible in the Marks card on the left.

Year of Orde..	Quarter of O..	Region			
		Central	East	South	West
2011	Q1	501,240	678,781	391,722	725,458
	Q2	501,240	678,781	391,722	725,458
	Q3	501,240	678,781	391,722	725,458
	Q4	501,240	678,781	391,722	725,458
2012	Q1	501,240	678,781	391,722	725,458
	Q2	501,240	678,781	391,722	725,458
	Q3	501,240	678,781	391,722	725,458
	Q4	501,240	678,781	391,722	725,458
2013	Q1	501,240	678,781	391,722	725,458
	Q2	501,240	678,781	391,722	725,458
	Q3	501,240	678,781	391,722	725,458
	Q4	501,240	678,781	391,722	725,458
2014	Q1	501,240	678,781	391,722	725,458
	Q2	501,240	678,781	391,722	725,458
	Q3	501,240	678,781	391,722	725,458
	Q4	501,240	678,781	391,722	725,458

WINDOW_CORR(expression1, expression2, [start, end])

Returns the Pearson correlation coefficient of two expressions within the window. The window is defined as offsets from the current row. Use FIRST()+n and LAST()-n for offsets from the first or last row in the partition. If start and end are omitted, the entire partition is used.

The Pearson correlation measures the linear relationship between two variables. Results range from -1 to +1 inclusive, where 1 denotes an exact positive linear relationship, as when a positive

change in one variable implies a positive change of corresponding magnitude in the other, 0 denotes no linear relationship between the variance, and -1 is an exact negative relationship.

There is an equivalent aggregation function: CORR. See [Tableau Functions \(Alphabetical\)](#) on page 2300.

Example

The following formula returns the Pearson correlation of **SUM(Profit)** and **SUM(Sales)** from the five previous rows to the current row.

```
WINDOW_CORR(SUM([Profit]), SUM([Sales]), -5, 0)
```

WINDOW_COUNT(expression, [start, end])

Returns the count of the expression within the window. The window is defined by means of offsets from the current row. Use FIRST()+n and LAST()-n for offsets from the first or last row in the partition. If the start and end are omitted, the entire partition is used.

Example

`WINDOW_COUNT(SUM([Profit]), FIRST()+1, 0)` computes the count of SUM(Profit) from the second row to the current row

WINDOW_COVAR(expression1, expression2, [start, end])

Returns the *sample covariance* of two expressions within the window. The window is defined as offsets from the current row. Use FIRST()+n and LAST()-n for offsets from the first or last row in the partition. If the start and end arguments are omitted, the window is the entire partition.

Sample covariance uses the number of non-null data points $n - 1$ to normalize the covariance calculation, rather than n , which is used by the population covariance (with the WINDOW_COVARP function). Sample covariance is the appropriate choice when the data is a random sample that is being used to estimate the covariance for a larger population.

There is an equivalent aggregation function: COVAR. See [Tableau Functions \(Alphabetical\)](#) on page 2300.

Example

The following formula returns the sample covariance of **SUM(Profit)** and **SUM(Sales)** from the two previous rows to the current row.

```
WINDOW_COVAR(SUM([Profit]), SUM([Sales]), -2, 0)
```

WINDOW_COVARP(expression1, expression2, [start, end])

Returns the *population covariance* of two expressions within the window. The window is defined as offsets from the current row. Use FIRST()+n and LAST()-n for offsets from the first or last row in the partition. If start and end are omitted, the entire partition is used.

Population covariance is sample covariance multiplied by $(n-1)/n$, where n is the total number of non-null data points. Population covariance is the appropriate choice when there is data available for all items of interest as opposed to when there is only a random subset of items, in which case sample covariance (with the WINDOW_COVAR function) is appropriate.

There is an equivalent aggregation function: COVARP. [Tableau Functions \(Alphabetical\) on page 2300](#).

Example

The following formula returns the population covariance of **SUM(Profit)** and **SUM(Sales)** from the two previous rows to the current row.

```
WINDOW_COVARP(SUM([Profit]), SUM([Sales]), -2, 0)
```

WINDOW_MEDIAN(expression, [start, end])

Returns the median of the expression within the window. The window is defined by means of offsets from the current row. Use FIRST()+n and LAST()-n for offsets from the first or last row in the partition. If the start and end are omitted, the entire partition is used.

For example, the view below shows quarterly profit. A window median within the Date partition returns the median profit across all dates.

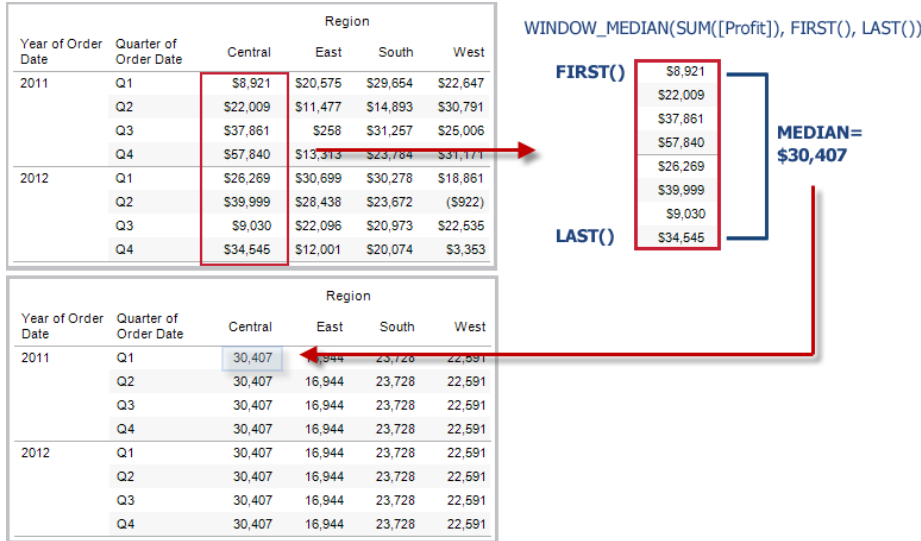

Example

`WINDOW_MEDIAN(SUM([Profit]), FIRST()+1, 0)` computes the median of `SUM(Profit)` from the second row to the current row.

WINDOW_MAX(expression, [start, end])

Returns the maximum of the expression within the window. The window is defined by means of offsets from the current row. Use `FIRST()+n` and `LAST()-n` for offsets from the first or last row in the partition. If the start and end are omitted, the entire partition is used.

For example, the view below shows quarterly sales. A window maximum within the Date partition returns the maximum sales across all dates.

Year of Order Date	Quarter of Order Date	Region			
		Central	East	South	West
2009	Q1	\$160,877	\$231,411	\$133,934	\$185,961
	Q2	\$197,213	\$204,914	\$337,813	\$213,507
	Q3	\$302,678	\$165,201	\$283,806	\$206,512
	Q4	\$297,208	\$226,983	\$214,845	\$230,291
2010	Q1	\$180,609	\$180,123	\$273,943	\$251,145
	Q2	\$195,785	\$224,882	\$251,391	\$195,976
	Q3	\$116,613	\$50,363	\$194,601	\$102,731

Year of Order Date	Quarter of Order Date	Region			
		Central	East	South	West
2009	Q1	302,678	231,411	337,813	251,145
	Q2	302,678	231,411	337,813	251,145
	Q3	302,678	231,411	337,813	251,145
	Q4	302,678	231,411	337,813	251,145
2010	Q1	302,678	231,411	337,813	251,145
	Q2	302,678	231,411	337,813	251,145
	Q3	302,678	231,411	337,813	251,145

WINDOW_MAX(SUM([Sales]), FIRST(), LAST())

FIRST()	\$160,877
	\$197,213
	\$302,678
	\$297,208
LAST()	\$180,609
	\$195,785
	\$116,613

MAX = \$302,678

Example

`WINDOW_MAX(SUM([Profit]), FIRST()+1, 0)` computes the maximum of `SUM(Profit)` from the second row to the current row.

WINDOW_MIN(expression, [start, end])

Returns the minimum of the expression within the window. The window is defined by means of offsets from the current row. Use `FIRST()+n` and `LAST()-n` for offsets from the first or last row in the partition. If the start and end are omitted, the entire partition is used.

For example, the view below shows quarterly sales. A window minimum within the Date partition returns the minimum sales across all dates.

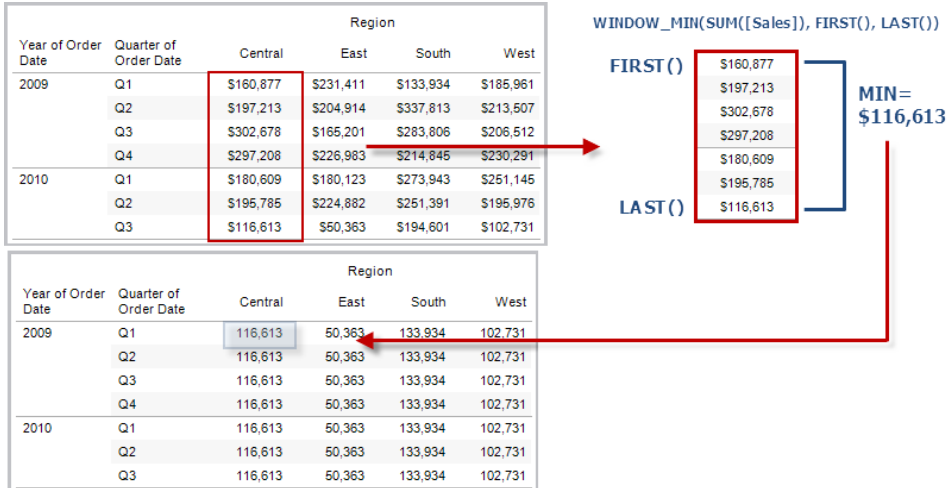

Example

`WINDOW_MIN(SUM([Profit]), FIRST()+1, 0)` computes the minimum of `SUM(Profit)` from the second row to the current row.

WINDOW_PERCENTILE(expression, number, [start, end])

Returns the value corresponding to the specified percentile within the window. The window is defined by means of offsets from the current row. Use `FIRST()+n` and `LAST()-n` for offsets from the first or last row in the partition. If the start and end are omitted, the entire partition is used.

Example

`WINDOW_PERCENTILE(SUM([Profit]), 0.75, -2, 0)` returns the 75th percentile for `SUM(Profit)` from the two previous rows to the current row.

WINDOW_STDEV(expression, [start, end])

Returns the sample standard deviation of the expression within the window. The window is defined by means of offsets from the current row. Use `FIRST()+n` and `LAST()-n` for offsets from the first or last row in the partition. If the start and end are omitted, the entire partition is used.

Example

`WINDOW_STDEV(SUM([Profit]), FIRST()+1, 0)` computes the standard deviation of `SUM(Profit)` from the second row to the current row.

WINDOW_STDEVP(expression, [start, end])

Returns the biased standard deviation of the expression within the window. The window is defined by means of offsets from the current row. Use `FIRST()+n` and `LAST()-n` for offsets from the first or last row in the partition. If the start and end are omitted, the entire partition is used.

Example

`WINDOW_STDEVP(SUM([Profit]), FIRST()+1, 0)` computes the standard deviation of `SUM(Profit)` from the second row to the current row.

WINDOW_SUM(expression, [start, end])

Returns the sum of the expression within the window. The window is defined by means of offsets from the current row. Use `FIRST()+n` and `LAST()-n` for offsets from the first or last row in the partition. If the start and end are omitted, the entire partition is used.

For example, the view below shows quarterly sales. A window sum computed within the Date partition returns the summation of sales across all quarters.

Year of Order Date	Quarter of Order Date	Region			
		Central	East	South	West
2009	Q1	\$160,877	\$231,411	\$133,934	\$185,961
	Q2	\$197,213	\$204,914	\$337,813	\$213,507
	Q3	\$302,678	\$165,201	\$283,806	\$206,512
	Q4	\$297,208	\$226,983	\$214,846	\$230,291
2010	Q1	\$180,609	\$180,123	\$273,943	\$251,145
	Q2	\$195,785	\$224,882	\$251,391	\$195,976
	Q3	\$116,613	\$50,363	\$194,601	\$102,731

WINDOW_SUM(SUM([Sales]), FIRST(), LAST())				
FIRST()	\$160,877	SUM= \$1,450,982	}	LAST()
	\$197,213			
	\$302,678			
	\$297,208			
	\$180,609			
	\$195,785			
	\$116,613			

Year of Order Date	Quarter of Order Date	Region			
		Central	East	South	West
2009	Q1	1,450,982	1,283,877	1,690,333	1,386,123
	Q2	1,450,982	1,283,877	1,690,333	1,386,123
	Q3	1,450,982	1,283,877	1,690,333	1,386,123
	Q4	1,450,982	1,283,877	1,690,333	1,386,123
2010	Q1	1,450,982	1,283,877	1,690,333	1,386,123
	Q2	1,450,982	1,283,877	1,690,333	1,386,123
	Q3	1,450,982	1,283,877	1,690,333	1,386,123

Example

`WINDOW_SUM(SUM([Profit]), FIRST()+1, 0)` computes the sum of `SUM(Profit)` from the second row to the current row.

WINDOW_VAR(expression, [start, end])

Returns the sample variance of the expression within the window. The window is defined by means of offsets from the current row. Use `FIRST()+n` and `LAST()-n` for offsets from the first or last row in the partition. If the start and end are omitted, the entire partition is used.

Example

`WINDOW_VAR((SUM([Profit])), FIRST()+1, 0)` computes the variance of `SUM(Profit)` from the second row to the current row.

WINDOW_VARP(expression, [start, end])

Returns the biased variance of the expression within the window. The window is defined by means of offsets from the current row. Use `FIRST()+n` and `LAST()-n` for offsets from the first or last row in the partition. If the start and end are omitted, the entire partition is used.

Example

`WINDOW_VARP(SUM([Profit]), FIRST()+1, 0)` computes the variance of `SUM(Profit)` from the second row to the current row.

Analytics Extension table calculation functions available in Tableau

Analytic Extensions are connections between Tableau and an external service such as TabPy for python, Matlab, and R. To use Analytics Extensions in your analysis, you must first [configure a connection](#) between Tableau and an external service such as a TabPy server. Then you can use scripts inside specific table calculations (`MODEL_EXTENSION_` for using published named models, or `SCRIPT_` for passing an expression to the external service). The data in the viz (the "table" of the table calc) is passed securely to the external server, the script is run, and the results are passed back as the output of the calculation.

Model extension functions

For use with named models deployed on a TabPy external service.

MODEL_EXTENSION_BOOL (model_name, arguments, expression)

Returns the boolean result of an expression as calculated by a named model deployed on a TabPy external service.

Model_name is the name of the deployed analytics model you want to use.

Each argument is a single string that sets the input values that the deployed model accepts, and is defined by the analytics model.

Use expressions to define the values that are sent from Tableau to the analytics model. Be sure to use aggregation functions (SUM, AVG, etc.) to aggregate the results.

When using the function, the data types and order of the expressions must match that of the input arguments.

Example

```
MODEL_EXTENSION_BOOL ("isProfitable","inputSales", "inputCosts", SUM  
([Sales]), SUM([Costs]))
```

MODEL_EXTENSION_INT (model_name, arguments, expression)

Returns an integer result of an expression as calculated by a named model deployed on a TabPy external service.

Model_name is the name of the deployed analytics model you want to use.

Each argument is a single string that sets the input values that the deployed model accepts, and is defined by the analytics model.

Use expressions to define the values that are sent from Tableau to the analytics model. Be sure to use aggregation functions (SUM, AVG, etc.) to aggregate the results.

When using the function, the data types and order of the expressions must match that of the input arguments.

Example

```
MODEL_EXTENSION_INT ("getPopulation", "inputCity", "inputState", MAX  
([City]), MAX ([State]))
```

MODEL_EXTENSION_REAL (model_name, arguments, expression)

Returns a real result of an expression as calculated by a named model deployed on a TabPy external service.

Model_name is the name of the deployed analytics model you want to use.

Each argument is a single string that sets the input values that the deployed model accepts, and is defined by the analytics model.

Use expressions to define the values that are sent from Tableau to the analytics model. Be sure to use aggregation functions (SUM, AVG, etc.) to aggregate the results.

When using the function, the data types and order of the expressions must match that of the input arguments.

Example

```
MODEL_EXTENSION_REAL ("profitRatio", "inputSales", "inputCosts", SUM  
([Sales]), SUM([Costs]))
```

MODEL_EXTENSION_STRING (model_name, arguments, expression)

Returns the string result of an expression as calculated by a named model deployed on a TabPy external service.

Model_name is the name of the deployed analytics model you want to use.

Each argument is a single string that sets the input values that the deployed model accepts, and is defined by the analytics model.

Use expressions to define the values that are sent from Tableau to the analytics model. Be sure to use aggregation functions (SUM, AVG, etc.) to aggregate the results.

When using the function, the data types and order of the expressions must match that of the input arguments.

Example

```
MODEL_EXTENSION_STR ("mostPopulatedCity", "inputCountry",
"inputYear", MAX ([Country]), MAX([Year]))
```

Script functions

Instead of using a defined external model like MODEL_EXPRESSION functions, SCRIPT functions are used to specify the expression directly in the table calculation.

SCRIPT_BOOL

Returns a Boolean result from the specified expression. The expression is passed directly to a running analytics extension service instance.

In R expressions, use `.argn` (with a leading period) to reference parameters (`.arg1`, `.arg2`, etc.).

In Python expressions, use `_argn` (with a leading underscore).

Examples

In this R example, `.arg1` is equal to `SUM([Profit])`:

```
SCRIPT_BOOL("is.finite(.arg1)", SUM([Profit]))
```

The next example returns True for store IDs in Washington state, and False otherwise. This example could be the definition for a calculated field titled `IsStoreInWA`.

```
SCRIPT_BOOL('grepl(".*_WA", .arg1, perl=TRUE)', ATTR([Store ID]))
```

A command for Python would take this form:

```
SCRIPT_BOOL("return map(lambda x : x > 0, _arg1)", SUM([Profit]))
```

SCRIPT_INT

Returns an integer result from the specified expression. The expression is passed directly to a running analytics extension service instance.

In R expressions, use `.argn` (with a leading period) to reference parameters (`.arg1`, `.arg2`, etc.)

In Python expressions, use `_argn` (with a leading underscore).

Examples

In this R example, `.arg1` is equal to `SUM([Profit])`:

```
SCRIPT_INT("is.finite(.arg1)", SUM([Profit]))
```

In the next example, k-means clustering is used to create three clusters:

```
SCRIPT_INT('result <- kmeans(data.frame(.arg1,.arg2,.arg3,.arg4),  
3);result$cluster;', SUM([Petal length]), SUM([Petal width]),SUM  
([Sepal length]),SUM([Sepal width]))
```

A command for Python would take this form:

```
SCRIPT_INT("return map(lambda x : int(x * 5), _arg1)", SUM([Profit]))
```

SCRIPT_REAL

Returns a real result from the specified expression. The expression is passed directly to a running analytics extension service instance. In

R expressions, use `.argn` (with a leading period) to reference parameters (`.arg1`, `.arg2`, etc.)

In Python expressions, use `_argn` (with a leading underscore).

Examples

In this R example, `.arg1` is equal to `SUM([Profit])`:

```
SCRIPT_REAL("is.finite(.arg1)", SUM([Profit]))
```

The next example converts temperature values from Celsius to Fahrenheit.

```
SCRIPT_REAL('library(udunits2);ud.convert(.arg1, "celsius", "degree_  
fahrenheit")',AVG([Temperature]))
```

A command for Python would take this form:

```
SCRIPT_REAL("return map(lambda x : x * 0.5, _arg1)", SUM([Profit]))
```

SCRIPT_STR

Returns a string result from the specified expression. The expression is passed directly to a running analytics extension service instance.

In R expressions, use `.argn` (with a leading period) to reference parameters (`.arg1`, `.arg2`, etc.)

In Python expressions, use `_argn` (with a leading underscore).

Examples

In this R example, `.arg1` is equal to `SUM([Profit])`:

```
SCRIPT_STR("is.finite(.arg1)", SUM([Profit]))
```

The next example extracts a state abbreviation from a more complicated string (in the original form `13XSL_CA, A13_WA`):

```
SCRIPT_STR('gsub(".*_", "", .arg1)', ATTR([Store ID]))
```

A command for Python would take this form:

```
SCRIPT_STR("return map(lambda x : x[:2], _arg1)", ATTR([Region]))
```

Create a table calculation using the calculation editor

Follow along with the steps below to learn how to create a table calculation using the calculation editor.

Note: There are several ways to create table calculations in Tableau. This example demonstrates only one of those ways. For more information, see [Transform Values with Table Calculations](#) on page 2364.

Step 1: Create the visualization

1. In Tableau Desktop, connect to the **Sample-Superstore** saved data source, which comes with Tableau.
2. Navigate to a worksheet.
3. From the **Data** pane, under Dimensions, drag **Order Date** to the **Columns** shelf.
4. From the **Data** pane, under Dimensions, drag **Sub-Category** to the **Rows** shelf.
5. From the **Data** pane, under Measures, drag **Sales** to **Text** on the Marks card.

Your visualization updates to a text table.

Sheet 2

Sub-Catego..	Order Date			
	2014	2015	2016	2017
Accessories	\$25,014	\$40,524	\$41,896	\$59,946
Appliances	\$15,314	\$23,241	\$26,050	\$42,927
Art	\$6,058	\$6,237	\$5,961	\$8,863
Binders	\$43,488	\$37,453	\$49,683	\$72,788
Bookcases	\$20,037	\$38,544	\$26,275	\$30,024
Chairs	\$77,242	\$71,735	\$83,919	\$95,554
Copiers	\$10,850	\$26,179	\$49,599	\$62,899
Envelopes	\$3,856	\$4,512	\$4,730	\$3,379
Fasteners	\$661	\$545	\$960	\$858
Furnishings	\$13,826	\$21,090	\$27,874	\$28,915
Labels	\$2,841	\$2,956	\$2,827	\$3,861
Machines	\$62,023	\$27,764	\$55,907	\$43,545
Paper	\$14,835	\$15,288	\$20,662	\$27,695
Phones	\$77,391	\$68,314	\$78,962	\$105,341
Storage	\$50,329	\$45,048	\$58,789	\$69,678
Supplies	\$14,394	\$1,952	\$14,278	\$16,049
Tables	\$46,088	\$39,150	\$60,833	\$60,894

Step 2: Create the table calculation

1. Select **Analysis > Create Calculated Field**.
2. In the calculation editor that opens, do the following:
 - Name the calculated field, Running Sum of Profit.
 - Enter the following formula:

```
RUNNING_SUM(SUM([Profit]))
```

This formula calculates the running sum of profit sales. It is computed across the entire table.

- When finished, click **OK**.

The new table calculation field appears under Measures in the Data pane. Just like your other fields, you can use it in one or more visualizations.

Step 3: Use the table calculation in the visualization

1. From the Data pane, under Measures, drag **Running Sum of Profit** to **Color** on the Marks card.
2. On the Marks card, click the Mark Type drop-down and select **Square**.

The visualization updates to a highlight table:

Sheet 2

Sub-Catego..	Order Date			
	2014	2015	2016	2017
Accessories	\$25,014	\$40,524	\$41,896	\$59,946
Appliances	\$15,314	\$23,241	\$26,050	\$42,927
Art	\$6,058	\$6,237	\$5,961	\$8,863
Binders	\$43,488	\$37,453	\$49,683	\$72,788
Bookcases	\$20,037	\$38,544	\$26,275	\$30,024
Chairs	\$77,242	\$71,735	\$83,919	\$95,554
Copiers	\$10,850	\$26,179	\$49,599	\$62,899
Envelopes	\$3,856	\$4,512	\$4,730	\$3,379
Fasteners	\$661	\$545	\$960	\$858
Furnishings	\$13,826	\$21,090	\$27,874	\$28,915
Labels	\$2,841	\$2,956	\$2,827	\$3,861
Machines	\$62,023	\$27,764	\$55,907	\$43,545
Paper	\$14,835	\$15,288	\$20,662	\$27,695
Phones	\$77,391	\$68,314	\$78,962	\$105,341
Storage	\$50,329	\$45,048	\$58,789	\$69,678
Supplies	\$14,394	\$1,952	\$14,278	\$16,049
Tables	\$46,088	\$39,150	\$60,833	\$60,894

Step 4: Edit the table calculation

1. On the Marks card, right-click **Running Sum of Profit** and select **Edit Table Calculation**.

- In the Table Calculation dialog box that opens, under Compute Using, select **Table (down)**.

The visualization updates to the following:

Sub-Catego..	Order Date			
	2014	2015	2016	2017
Accessories	\$25,014	\$40,524	\$41,896	\$59,946
Appliances	\$15,314	\$23,241	\$26,050	\$42,927
Art	\$6,058	\$6,237	\$5,961	\$8,863
Binders	\$43,488	\$37,453	\$49,683	\$72,788
Bookcases	\$20,037	\$38,544	\$26,275	\$30,024
Chairs	\$77,242	\$71,735	\$83,919	\$95,554
Copiers	\$10,850	\$26,179	\$49,599	\$62,899
Envelopes	\$3,856	\$4,512	\$4,730	\$3,379
Fasteners	\$661	\$545	\$960	\$858
Furnishings	\$13,826	\$21,090	\$27,874	\$28,915
Labels	\$2,841	\$2,956	\$2,827	\$3,861
Machines	\$62,023	\$27,764	\$55,907	\$43,545
Paper	\$14,835	\$15,288	\$20,662	\$27,695
Phones	\$77,391	\$68,314	\$78,962	\$105,341
Storage	\$50,329	\$45,048	\$58,789	\$69,678
Supplies	\$14,394	\$1,952	\$14,278	\$16,049
Tables	\$46,088	\$39,150	\$60,833	\$60,894

See Also

- [Create a table calculation on page 2373](#)
- [Table Calculation Types on page 2376](#)
- [Customize Table Calculations on page 2403](#)
- [Quick Table Calculations on page 2397](#)
- [Functions in Tableau on page 2047](#)
- [Tableau Functions \(by Category\) on page 2199](#)
- [Tableau Functions \(Alphabetical\) on page 2300](#)

Spatial Functions

Spatial functions allow you to perform advanced spatial analysis and combine spatial files with data in other formats like text files or spreadsheets. For example, you might have a spatial file of city council districts, and a text file containing latitude and longitude coordinates of reported potholes. You can use a spatial calculation when creating your data source to join these files and analyze which district takes the longest to repair potholes.

You can also create a line that connects two data points for origin-destination maps. For example, you might have a spreadsheet of public transportation data that tells you where commuters began and ended their trips. You can use a spatial calculation to see what paths commuters are taking.

Spatial functions available in Tableau

AREA

Syntax	<code>AREA(Spatial Polygon, 'units')</code>
Output	Number
Definition	Returns the total surface area of a <code><spatial polygon></code> .
Example	<code>AREA([Geometry], 'feet')</code>
Notes	Supported unit names (must be in quotation marks in the calculation, such as 'miles'): <ul style="list-style-type: none"> • <i>meters</i>: meters, metres, m • <i>kilometers</i>: kilometers, kilometres, km • <i>miles</i>: miles, mi • <i>feet</i>: feet, ft

BUFFER

Syntax	<code>BUFFER(Spatial Point, distance, 'units')</code> <code>BUFFER(Linestring, distance, 'units')</code> <ul style="list-style-type: none"> • <i>meters</i>: meters, metres, m • <i>kilometers</i>: kilometers, kilometres, km
--------	---

- *miles*: miles, mi
- *feet*: feet, ft

Output	Geometry
Definition	<p>For spatial points, returns a polygon shape centered over a <spatial point>, with a radius determined by the <distance> and <unit> values.</p> <p>For linestrings, computes the polygons formed by including all points within the radius distance from the linestring.</p>
Example	<pre> BUFFER([Spatial Point Geometry], 25, 'mi') BUFFER(MAKEPOINT(47.59, -122.32), 3, 'km') BUFFER(MAKELINE(MAKEPOINT(0, 20), MAKEPOINT(30, 30)), 20, 'km') </pre>
Notes	<p>Supported unit names (must be in quotation marks in the calculation, such as 'miles'):</p> <ul style="list-style-type: none"> • <i>meters</i>: meters, metres, m • <i>kilometers</i>: kilometers, kilometres, km • <i>miles</i>: miles, mi • <i>feet</i>: feet, ft

DIFFERENCE

Syntax	<code>DIFFERENCE(Spatial, Spatial)</code>
Output	Spatial Polygon
Definition	<p>Computes the portions of regions remaining when all regions in the second argument are carved out of the first argument in areas that overlap. Discards regions from the second argument in areas that don't overlap.</p>
Example	<code>DIFFERENCE(Spatial Polygon1, Spatial Polygon2)</code>
Notes	Supports spatial polygons and multipolygons, not spatial points or lines.

DISTANCE

Syntax	<code>DISTANCE(SpatialPoint1, SpatialPoint2, 'units')</code>
Output	Number
Definition	Returns the distance measurement between two points in the specified <unit>.
Example	<code>DISTANCE([Origin Point],[Destination Point], 'km')</code>
Notes	Supported unit names (must be in quotation marks in the calculation, such as 'miles'): <ul style="list-style-type: none"> • <i>meters</i>: meters, metres, m • <i>kilometers</i>: kilometers, kilometres, km • <i>miles</i>: miles, mi • <i>feet</i>: feet, ft
Database limitations	This function can only be created with a live connection but will continue to work if the data source is converted to an extract.

INTERSECTION

Syntax	<code>INTERSECTION (spatial, spatial)</code>
Output	Polygon
Definition	Computes and returns the portions of regions in the second argument that overlap regions in the first argument.
Example	<code>INTERSECTION (Spatial Polygon1, Spatial Polygon2)</code>
Notes	Supports spatial polygons and multipolygons, not spatial points or lines.

INTERSECTS

Syntax	<code>INTERSECTS (geometry1, geometry2)</code>
--------	--

Output	Boolean
Definition	Returns true or false indicating if two geometries overlap in space.
Notes	Supported combinations: point/polygon, line/polygon, and polygon/polygon.

MAKELINE

Syntax	<code>MAKELINE(SpatialPoint1, SpatialPoint2)</code>
Output	Geometry (line)
Definition	Generates a line mark between two points
Example	<code>MAKELINE(MAKEPOINT(47.59, -122.32), MAKEPOINT(48.5, -123.1))</code>
Notes	Useful for building origin-destination maps.

MAKEPOINT

Syntax	<code>MAKEPOINT(latitude, longitude, [SRID])</code>
Output	Geometry (point)
Definition	<p>Converts data from <latitude> and <longitude> columns into spatial objects.</p> <p>If the optional <SRID> argument is added, the inputs can be other projected geographic coordinates.</p>
Example	<code>MAKEPOINT(48.5, -123.1)</code> <code>MAKEPOINT([AirportLatitude], [AirportLongitude])</code> <code>MAKEPOINT([Xcoord], [Ycoord], 3493)</code>
Notes	<code>MAKEPOINT</code> can't use the automatically generated latitude and longitude fields. The data source must contain the coordinates natively.

SRID is a spatial reference identifier that uses [ESPG reference system codes](#) to specify coordinate systems. If SRID is not specified, WGS84 is assumed and parameters are treated as latitude/longitude in degrees.

You can use `MAKEPOINT` to spatially-enable a data source so that it can be joined with a spatial file using a spatial join. For more information, see [Join Spatial Files in Tableau](#) on page 1704.

LENGTH

Syntax	<code>LENGTH(geometry, 'units')</code>
Output	Number
Definition	Returns the geodetic path length of the line string or strings in the <code><geometry></code> using the given <code><units></code> .
Example	<code>LENGTH([Spatial], 'metres')</code>
Notes	The result is <code><NaN></code> if the geometry argument has no linestrings, though other elements are permitted.

OUTLINE

Syntax	<code>OUTLINE(spatial polygon)</code>
Output	Geometry
Definition	Converts a polygon geometry into linestrings.
Notes	Useful for creating a separate layer for an outline that can be styled differently than the fill. Supports polygons within multipolygons.

SHAPETYPE

Syntax	<code>SHAPETYPE(geometry)</code>
--------	----------------------------------

Output	String
Definition	Returns a string describing the structure of the spatial <geometry>, such as Empty, Point, MultiPoint, LineString, MultiLinestring, Polygon, MultiPolygon, Mixed, and unsupported.
Example	<code>SHAPETYPE (MAKEPOINT (48.5, -123.1)) = "Point"</code>

SYMDIFFERENCE

Syntax	<code>SYMDIFFERENCE (spatial, spatial)</code>
Output	Geometry
Definition	Computes any portions of regions from the second argument that overlap regions in the first argument and discards from both. Returns the remaining portions of regions from both arguments.
Example	<code>SYMDIFFERENCE (Spatial Polygon1, Spatial Polygon2)</code>

VALIDATE

Syntax	<code>VALIDATE (spatial geometry)</code>
Output	Geometry
Definition	Confirms topological correctness of the geometry in your spatial value. If the value cannot be used for analysis due to problems such as a polygon's perimeter intersecting itself, then the result will be a null. If the geometry is correct, the result will be the original geometry.
Example	<code>UNION (VALIDATE ([Geometry]))</code>

Use a spatial calculation

Create a spatial data source using MAKEPOINT

You can use MAKEPOINT to spatially-enable a data source so that it can be joined with a spatial file using a spatial join. To use MAKEPOINT, your data must contain latitude and longitude

coordinates.

1. Open Tableau and connect to a spatial data source.
2. Under Connections, click Add to add a second, non-spatial data source.

The two data sources are added to the canvas.

Tip: To get the Join dialog box to appear, double-click (control click on Mac) a data source on the canvas.

3. Drag the non-spatial data source onto the Join dialog box.
4. Click the Join icon.
5. In the Join dialog box that appears, do the following:
 - Select a join type.
 - Under Data Source, select a spatial field from your spatial file to join by. Spatial fields have a globe icon next to them.
6. For the non-spatial data source, select Create Join Calculation as the join clause.

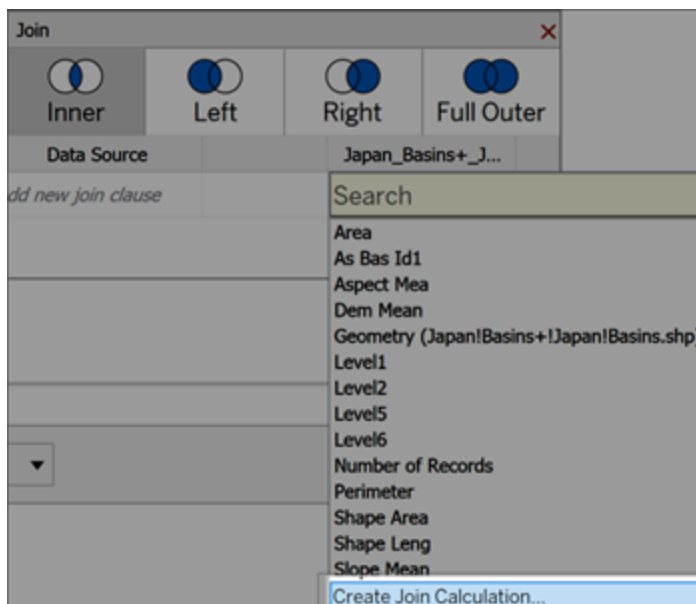

The calculation should look something like this:

```
MAKEPOINT (Latitude, Longitude)
```

7. Select **OK**.
8. Select the Intersects join clause operator to create a data source for spatial analysis.
9. When finished, close the Join dialog box.

For more information on spatial joins, see [Join Spatial Files in Tableau](#) on page 1704.

Create a visualization using MAKELINE

In Tableau Desktop, download the Flight Path workbook from Tableau Public, [available here](#).

1. Navigate to a new worksheet.
2. Select Analysis > Create Calculated Field.
3. In the calculation that opens, do the following:
 - Name the calculated field Flight Paths
 - Enter the following formula

```
MAKELINE(MAKEPOINT([Lat],[Lng]),MAKEPOINT([Dest Lat],[Dest  
Lng]))
```

This formula takes latitude and longitude coordinates from your origin and destination cities and turns them into geographic points for spatial analysis. Those coordinates are used to build two-point lines between origin and destination.

4. When finished, click **OK**.

The new calculated field appears under Dimensions in the Data pane. Just like your other fields, you can use it in one or more visualizations.

5. From the Data pane, double-click Flight Paths to add it to your visualization, which should automatically render as a map.

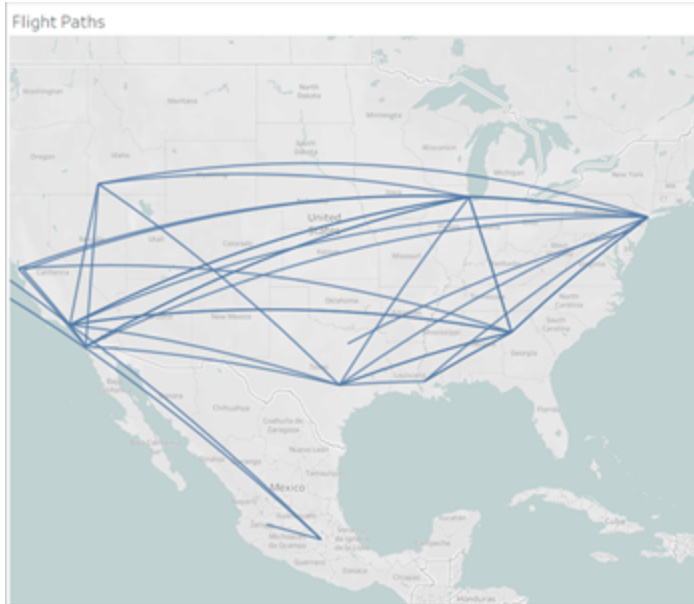

The calculation automatically produces curved geodesic lines when the lines span longer expanses of the globe.

Visualize an area with BUFFER

In Tableau Desktop, download the Flight Path workbook from Tableau Public, [available here](#).

1. Navigate to a new worksheet.
2. Right-click the Data pane and select **Create Parameter**.
3. In the Parameter dialog that opens, set the options below:
 - Name the parameter Buffer Distance
 - Set the Data Type to Integer
 - Set Allowable values to Range
 - Set the Minimum range to 100, the Maximum range to 1000, and the step size to 100.

4. When finished, click **OK**.

This parameter allows us to customize the radius of our buffer, ranging from 100 to 1000 miles. Right-click the parameter and select **Show Parameter**.

5. Select **Analysis > Create Calculated Field**.
6. In the calculation that opens, do the following:
 - Name the calculated field Buffer
 - Enter the following formula

```

BUFFER(MAKEPOINT([Dest Lat],[Dest Lng]),[Buffer
Distance],"miles")

```

The BUFFER calculation takes point spatial data and converts it into shapes with a radius in miles determined by the Buffer Distance parameter.

Note: Because BUFFER can only be used with point spatial data, we're converting the latitude and longitude data into a point with Makepoint, as demonstrated in the previous example.

- When finished, click **OK**.

The new calculated field appears in the Data pane. Just like your other fields, you can use it in one or more visualizations.

- From the Data pane, double-click **Buffer** to add it to your visualization, which should automatically render as a map.
- Drag **Destination** to the Color panel on the Marks card to complete the visualization.

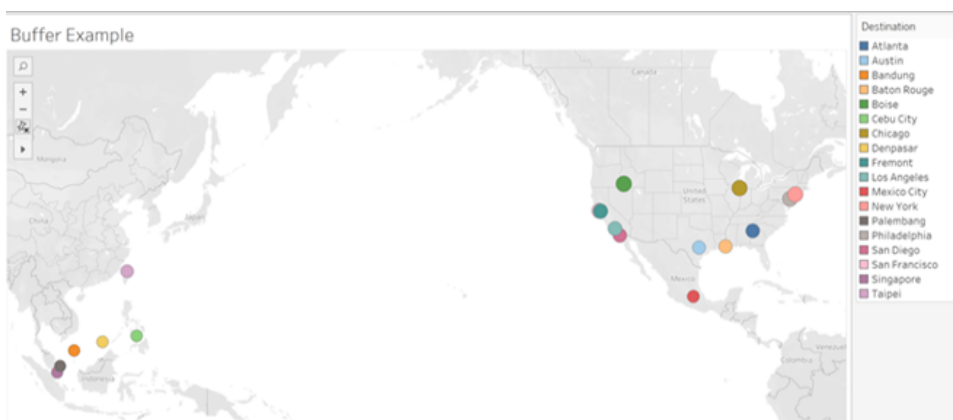

Note: If your view does not look like the image above, make sure that the Mark type is set to **Map** and not **Circle**. For more information on Marks type, see [Change the Type of Mark in the View on page 1238](#).

Predictive Modeling Functions

This article introduces predictive modeling functions and their uses in Tableau. It also demonstrates with an example how to create table calculations using the predictive modeling functions.

Why use predictive modeling functions

Predictive modeling functions can help you quickly generate predictions that can be manipulated, visualized, and exported like data using [table calculations](#).

Before, you may have had to integrate Tableau with R and Python in order to perform advanced statistical calculations and visualize them in Tableau. Now, you can select targets and predictors

by updating the variables and visualizing multiple models with different combinations of predictors. The data can be filtered, aggregated, and transformed at all levels of detail, with inputs and predictions automatically recalculated to match the data in the view.

For more information about predictive modeling functions in Tableau, see [How Predictive Modeling Functions Work in Tableau on page 2571](#)

Predictive modeling functions available in Tableau

MODEL_PERCENTILE

Syntax	<code>MODEL_PERCENTILE (model_specification (optional), target_expression, predictor_expression(s))</code>
Definition	Returns the probability (between 0 and 1) of the expected value being less than or equal to the observed mark, defined by the target expression and other predictors. This is the Posterior Predictive Distribution Function, also known as the Cumulative Distribution Function (CDF).
Example	<code>MODEL_PERCENTILE (SUM([Sales]), COUNT([Orders]))</code>

MODEL_QUANTILE

Syntax	<code>MODEL_QUANTILE (model_specification (optional), quantile, target_expression, predictor_expression(s))</code>
Definition	Returns a target numeric value within the probable range defined by the target expression and other predictors, at a specified quantile. This is the Posterior Predictive Quantile.
Example	<code>MODEL_QUANTILE (0.5, SUM([Sales]), COUNT([Orders]))</code>

Create a prediction calculation

Follow along with the steps below to learn how to create a simple prediction calculation using the MODEL_QUANTILE function. For a more detailed example, see [Example - Explore Female Life Expectancy with Predictive Modeling Functions](#) on page 2601

Step 1: Create a Visualization

1. In Tableau Desktop, connect to the **Sample - Superstore** saved data source, which comes with Tableau.
2. Navigate to a worksheet.
3. From the **Data** pane, drag the **Order Date** dimension to the Columns shelf.
4. Open the measure's context menu to change its list level to Month and Year:

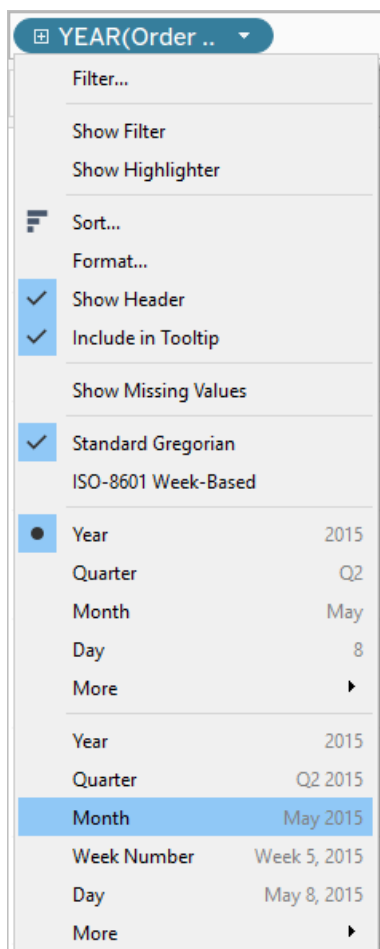

5. Drag **Sales** to the Rows shelf.

Step 2: Create the Calculated Field

1. Click to open the **Analysis** menu at the top, and then select **Create Calculated Field**.
2. In the Calculation Editor, do the following:

- Name the calculation: **Predict Median Sales**.
- Enter the following formula:

```
MODEL_QUANTILE(0.5, SUM([Sales]), ATTR(DATETRUNC('month',  
[Order Date])))
```

Remember: The MODEL_QUANTILE function takes a given quantile and predicts values based on the predictors you input.

Let's break this down:

- In this case, the quantile = 0.5, which predicts the median.
 - We want to predict sales, so the target expression is SUM([Sales]).
 - We want to base the prediction on past performance, so we include date as a predictor, which is the last argument in the calculation.
3. When finished, click **OK**.

The prediction calculation is now added as a calculated field in the Data pane.

Step 3: Add the Prediction Calculation to the View

1. Drag the prediction calculation to the Rows shelf, to the right of SUM(Sales).
2. Right-click (Control-click on Mac) the measure and select **Dual Axis**.
3. To align the two axes in a dual axes chart to use the same scale, right-click (Control-click on Mac) the secondary axis, in this case **Predict Median Sales**, and select **Synchronize Axis**. This aligns the scale of the two axes.

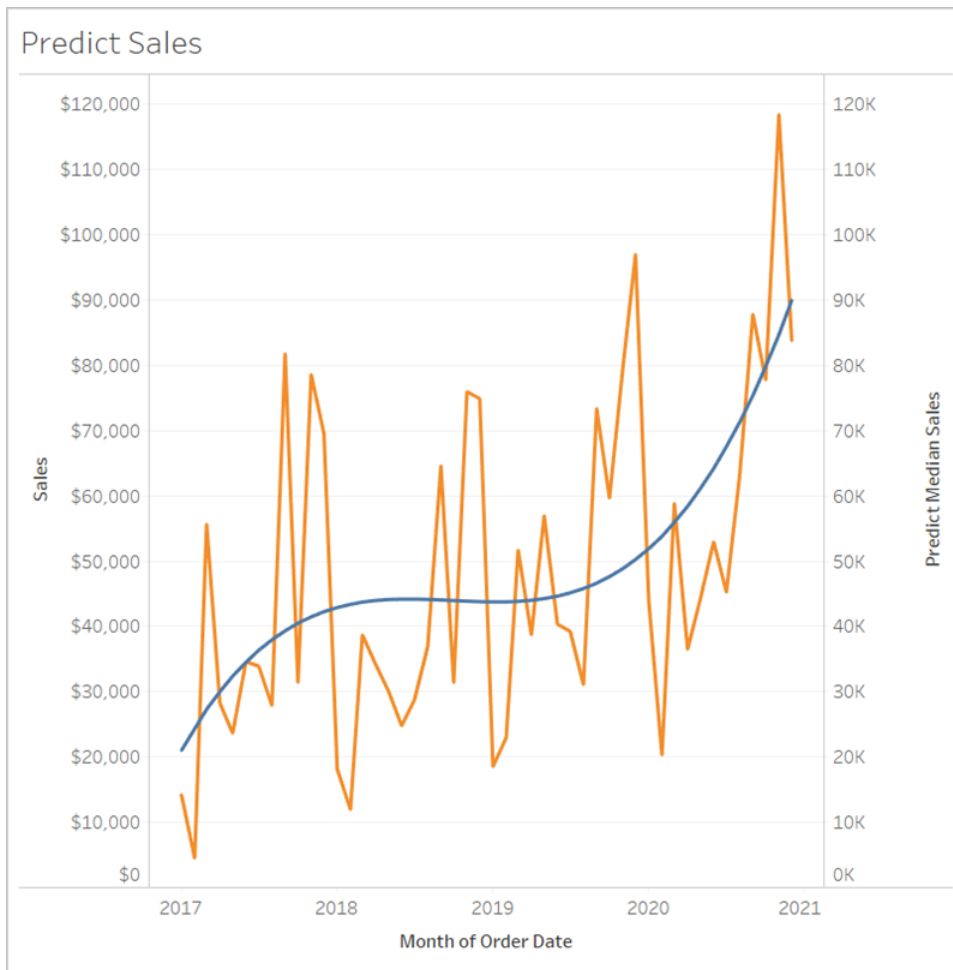

That's all there is to it. To find out how you can extend a date axis and predict the future, see [Predictive Modeling Functions in Time Series Visualizations](#) on page 2613.

Rules for Prediction Calculations

- You can't mix aggregate and non-aggregate arguments. If the target expression is an aggregate, so must the predictor.
- The functions are best used to predict values for individual records, on vizs where each mark represents a discrete entity, such as a person, a product, a sale, etc.
- The functions are best used to predict values for aggregated target expressions using SUM and COUNT.
- The functions aren't recommended to predict values for aggregated target expressions using AVG, MEDIAN, MIN, or MAX.
- The functions should use predictors that are at the same level of detail or higher than the viz.

Additional Functions

REGEXP_REPLACE(string, pattern, replacement)

Returns a copy of the given string where the regular expression pattern is replaced by the replacement string. This function is available for Text File, Hadoop Hive, Google BigQuery, PostgreSQL, Tableau Data Extract, Microsoft Excel, Salesforce, Vertica, Pivotal Greenplum, Teradata (version 14.1 and above), Snowflake, and Oracle data sources.

For Tableau data extracts, the pattern and the replacement must be constants.

For information on regular expression syntax, see your data source's documentation. For Tableau extracts, regular expression syntax conforms to the standards of the current International Components for Unicode (ICU), an open source project of mature C/C++ and Java libraries for Unicode support, software internationalization, and software globalization. See the [Regular Expressions](#) page in the online ICU User Guide.

Example

```
REGEXP_REPLACE('abc 123', '\s', '-') = 'abc-123'
```

REGEXP_MATCH(string, pattern)

Returns true if a substring of the specified string matches the regular expression pattern. This function is available for Text File, Google BigQuery, PostgreSQL, Tableau Data Extract, Microsoft Excel, Salesforce, Vertica, Pivotal Greenplum, Teradata (version 14.1 and above), Impala 2.3.0 (through Cloudera Hadoop data sources), Snowflake, and Oracle data sources.

For Tableau data extracts, the pattern must be a constant.

For information on regular expression syntax, see your data source's documentation. For Tableau extracts, regular expression syntax conforms to the standards of the current International Components for Unicode (ICU), an open source project of mature C/C++ and Java libraries for Unicode support, software internationalization, and software globalization. See the [Regular Expressions](#) page in the online ICU User Guide.

Example

```
REGEXP_MATCH('- ([1234] . [The.Market])-', '\s*(\w*\.) (\w*\s*\)') = true
```

REGEXP_EXTRACT(string, pattern)

Returns the portion of the string that matches the regular expression pattern. This function is available for Text File, Hadoop Hive, Google BigQuery, PostgreSQL, Tableau Data Extract, Microsoft Excel, Salesforce, Vertica, Pivotal Greenplum, Teradata (version 14.1 and above), Snowflake, and Oracle data sources.

For Tableau data extracts, the pattern must be a constant.

For information on regular expression syntax, see your data source's documentation. For Tableau extracts, regular expression syntax conforms to the standards of the current International Components for Unicode (ICU), an open source project of mature C/C++ and Java libraries for Unicode support, software internationalization, and software globalization. See the [Regular Expressions](#) page in the online ICU User Guide.

Example

```
REGEXP_EXTRACT('abc 123', '[a-z]+\s+(\d+)') = '123'
```

REGEXP_EXTRACT_NTH(string, pattern, index)

Returns the portion of the string that matches the regular expression pattern. The substring is matched to the nth capturing group, where n is the given index. If index is 0, the entire string is returned. This function is available for Text File, PostgreSQL, Tableau Data Extract, Microsoft Excel, Salesforce, Vertica, Pivotal Greenplum, Teradata (version 14.1 and above), and Oracle data sources.

For Tableau data extracts, the pattern must be a constant.

For information on regular expression syntax, see your data source's documentation. For Tableau extracts, regular expression syntax conforms to the standards of the current International Components for Unicode (ICU), an open source project of mature C/C++ and Java libraries for Unicode support, software internationalization, and software globalization. See the [Regular Expressions](#) page in the online ICU User Guide.

Example

```
REGEXP_EXTRACT_NTH('abc 123', '([a-z]+)\s+(\d+)', 2) = '123'
```

Hadoop Hive Specific Functions

Note: Only the `PARSE_URL` and `PARSE_URL_QUERY` functions are available for Cloudera Impala data sources.

`GET_JSON_OBJECT(JSON string, JSON path)`

Returns the JSON object within the JSON string based on the JSON path.

`PARSE_URL(string, url_part)`

Returns a component of the given URL string where the component is defined by `url_part`. Valid `url_part` values include: 'HOST', 'PATH', 'QUERY', 'REF', 'PROTOCOL', 'AUTHORITY', 'FILE' and 'USERINFO'.

Example

```
PARSE_URL('http://www.tableau.com', 'HOST') = 'www.tableau.com'
```

`PARSE_URL_QUERY(string, key)`

Returns the value of the specified query parameter in the given URL string. The query parameter is defined by the key.

Example

```
PARSE_URL_QUERY('http://www.tableau.com?page=1&cat=4', 'page') = '1'
```

`XPATH_BOOLEAN(XML string, XPath expression string)`

Returns true if the XPath expression matches a node or evaluates to true.

Example

```
XPATH_BOOLEAN('<values> <value id="0">1</value><value id="1">5</value>', 'values/value[@id="1"] = 5') = true
```

`XPATH_DOUBLE(XML string, XPath expression string)`

Returns the floating-point value of the XPath expression.

Example

```
XPATH_DOUBLE('<values><value>1.0</value><value>5.5</value>
</values>', 'sum(value/*)') = 6.5
```

XPATH_FLOAT(XML string, XPath expression string)

Returns the floating-point value of the XPath expression.

Example

```
XPATH_FLOAT('<values><value>1.0</value><value>5.5</value>
</values>', 'sum(value/*)') = 6.5
```

XPATH_INT(XML string, XPath expression string)

Returns the numerical value of the XPath expression, or zero if the XPath expression cannot evaluate to a number.

Example

```
XPATH_INT('<values><value>1</value><value>5</value> </values>', 'sum
(value/*)') = 6
```

XPATH_LONG(XML string, XPath expression string)

Returns the numerical value of the XPath expression, or zero if the XPath expression cannot evaluate to a number.

Example

```
XPATH_LONG('<values><value>1</value><value>5</value> </values>', 'sum
(value/*)') = 6
```

XPATH_SHORT(XML string, XPath expression string)

Returns the numerical value of the XPath expression, or zero if the XPath expression cannot evaluate to a number.

Example

```
XPATH_SHORT('<values><value>1</value><value>5</value> </values>', 'sum
(value/*)') = 6
```

XPATH_STRING(XML string, XPath expression string)

Returns the text of the first matching node.

Example

```
XPATH_STRING('<sites ><url domain="org">http://www.w3.org</url> <url domain="com">http://www.tableau.com</url></sites>', 'sites/url [@domain="com"]') = 'http://www.tableau.com'
```

Google BigQuery Specific Functions

DOMAIN(string_url)

Given a URL string, returns the domain as a string.

Example

```
DOMAIN('http://www.google.com:80/index.html') = 'google.com'
```

GROUP_CONCAT(expression)

Concatenates values from each record into a single comma-delimited string. This function acts like a SUM() for strings.

Example

```
GROUP_CONCAT(Region) = "Central,East,West"
```

HOST(string_url)

Given a URL string, returns the host name as a string.

Example

```
HOST('http://www.google.com:80/index.html') = 'www.google.com:80'
```

LOG2(number)

Returns the logarithm base 2 of a number.

Example

```
LOG2(16) = '4.00'
```

LTRIM_THIS(string, string)

Returns the first string with any leading occurrence of the second string removed.

Example

```
LTRIM_THIS('[-Sales-]', '[-']') = 'Sales-'
```

RTRIM_THIS(string, string)

Returns the first string with any trailing occurrence of the second string removed.

Example

```
RTRIM_THIS('[-Market-]', '[-']') = '[-Market'
```

TIMESTAMP_TO_USEC(expression)

Converts a TIMESTAMP data type to a UNIX timestamp in microseconds.

Example

```
TIMESTAMP_TO_USEC(#2012-10-01 01:02:03#)=1349053323000000
```

USEC_TO_TIMESTAMP(expression)

Converts a UNIX timestamp in microseconds to a TIMESTAMP data type.

Example

```
USEC_TO_TIMESTAMP(1349053323000000) = #2012-10-01 01:02:03#
```

TLD(string_url)

Given a URL string, returns the top level domain plus any country domain in the URL.

Example

```
TLD('http://www.google.com:80/index.html') = '.com'
```

```
TLD('http://www.google.co.uk:80/index.html') = '.co.uk'
```

FORMAT() Function Workarounds in Tableau

Tableau has no FORMAT() function for formatting fields, but it does provide a variety of means to change the structure and appearance of fields in a workbook:

- Geographic fields, see [Assign Geographic Roles](#) on page 1727.
- Date or number fields, see [Set the default number format](#) on page 1065.
 - Custom date formats, see [Custom Date Formats](#) on page 1165.
- Symbols and conventions that you can use to specify field formats, see [Literal expression syntax](#) on page 2457.
- Numbers and null values, see [Format Numbers and Null Values](#) on page 3001.

Tableau also provides a range of string functions that you can use to customize the appearance of string fields in a view. See [String Functions](#) on page 2061.

Tableau Functions (by Category)

The Tableau functions in this reference are organized by category. Click a category to browse its functions. Or press Ctrl+F (Command-F on a Mac) to open a search box that you can use to search the page for a specific function.

Number functions

ABS

Syntax	<code>ABS (number)</code>
Output	Number (positive)
Definition	Returns the absolute value of the given <code><number></code> .
Example	<code>ABS (-7) = 7</code> <code>ABS ([Budget Variance])</code> The second example returns the absolute value for all the numbers contained in the Budget Variance field.
Notes	See also SIGN on page 2209.

ACOS

Syntax	<code>ACOS (number)</code>
--------	----------------------------

Output	Number (angle in radians)
Definition	Returns the arccosine (angle) of the given <number>.
Example	$\text{ACOS}(-1) = 3.14159265358979$
Notes	The inverse function, COS on the facing page, takes the angle in radians as the argument and returns the cosine.

ASIN

Syntax	$\text{ASIN}(\text{number})$
Output	Number (angle in radians)
Definition	Returns the arcsine (angle) of a given <number>.
Example	$\text{ASIN}(1) = 1.5707963267949$
Notes	The inverse function, SIN on page 2209, takes the angle in radians as the argument and returns the sine.

ATAN

Syntax	$\text{ATAN}(\text{number})$
Output	Number (angle in radians)
Definition	Returns the arctangent (angle) of a given <number>.
Example	$\text{ATAN}(180) = 1.5652408283942$
Notes	The inverse function, TAN , takes the angle in radians as the argument and returns the tangent. See also ATAN2 on the facing page and COT on page 2202.

ATAN2

Syntax	<code>ATAN2 (y number, x number)</code>
Output	Number (angle in radians)
Definition	Returns the arctangent (angle) between two numbers (x and y). The result is in radians.
Example	<code>ATAN2 (2, 1) = 1.10714871779409</code>
Notes	See also ATAN on the previous page, TAN on page 2210, and COT on the next page.

CEILING

Syntax	<code>CEILING (number)</code>
Output	Integer
Definition	Rounds a <number> to the nearest integer of equal or greater value.
Example	<code>CEILING (2.1) = 3</code>
Notes	See also FLOOR on page 2203 and ROUND on page 2208.
Database limitations	<code>CEILING</code> is available through the following connectors: Microsoft Excel, Text File, Statistical File, Published Data Source, Amazon EMR Hadoop Hive, Amazon Redshift, Cloudera Hadoop, DataStax Enterprise, Google Analytics, Google BigQuery, Hortonworks Hadoop Hive, MapR Hadoop Hive, Microsoft SQL Server, Salesforce, Spark SQL.

COS

Syntax	<code>COS (number)</code> The number argument is the angle in radians.
Output	Number

Definition	Returns the cosine of an angle.
Example	$\text{COS}(\text{PI}() / 4) = 0.707106781186548$
Notes	The inverse function, ACOS on page 2199, takes the cosine as the argument and returns the angle in radians. See also PI on page 2207. To convert an angle from degrees to radians, use RADIANS on page 2208.

COT

Syntax	$\text{COT}(\text{number})$ The number argument is the angle in radians.
Output	Number
Definition	Returns the cotangent of an angle.
Example	$\text{COT}(\text{PI}() / 4) = 1$
Notes	See also ATAN on page 2200, TAN on page 2210, and PI on page 2207. To convert an angle from degrees to radians, use RADIANS on page 2208.

DEGREES

Syntax	$\text{DEGREES}(\text{number})$ The number argument is the angle in radians.
Output	Number (degrees)
Definition	Converts an angle in radians to degrees.
Example	$\text{DEGREES}(\text{PI}() / 4) = 45.0$
Notes	The inverse function, RADIANS on page 2208, takes an angle in degrees and returns the angle in radians. See also PI on page 2207().

DIV

Syntax	<code>DIV(integer1, integer2)</code>
Output	Integer
Definition	Returns the integer part of a division operation, in which <code><integer1></code> is divided by <code><integer2></code> .
Example	<code>DIV(11,2) = 5</code>

EXP

Syntax	<code>EXP(number)</code>
Output	Number
Definition	Returns e raised to the power of the given <code><number></code> .
Example	<code>EXP(2) = 7.389</code> <code>EXP(-[Growth Rate]*[Time])</code>
Notes	See also LN on the next page.

FLOOR

Syntax	<code>FLOOR(number)</code>
Output	Integer
Definition	Rounds a number to the nearest <code><number></code> of equal or lesser value.
Example	<code>FLOOR(7.9) = 7</code>
Notes	See also CEILING on page 2201 and ROUND on page 2208.
Database limitations	<code>FLOOR</code> is available through the following connectors: Microsoft Excel, Text File, Statistical File, Published Data Source, Amazon EMR Hadoop Hive, Cloudera Hadoop, DataStax Enterprise, Google Analytics, Google BigQuery, Hortonworks Hadoop Hive, MapR Hadoop Hive, Microsoft

SQL Server, Salesforce, Spark SQL.

HEXBINX

Syntax	<code>HEXBINX(number, number)</code>
Output	Number
Definition	Maps an x, y coordinate to the x-coordinate of the nearest hexagonal bin. The bins have side length 1, so the inputs may need to be scaled appropriately.
Example	<code>HEXBINX([Longitude]*2.5, [Latitude]*2.5)</code>
Notes	<code>HEXBINX</code> and <code>HEXBINY</code> below are binning and plotting functions for hexagonal bins. Hexagonal bins are an efficient and elegant option for visualizing data in an x/y plane such as a map. Because the bins are hexagonal, each bin closely approximates a circle and minimizes variation in the distance from the data point to the center of the bin. This makes the clustering both more accurate and informative.

HEXBINY

Syntax	<code>HEXBINY(number, number)</code>
Output	Number
Definition	Maps an x, y coordinate to the y-coordinate of the nearest hexagonal bin. The bins have side length 1, so the inputs may need to be scaled appropriately.
Example	<code>HEXBINY([Longitude]*2.5, [Latitude]*2.5)</code>
Notes	See also <code>HEXBINX</code> above.

LN

Syntax	<code>LN(number)</code>
--------	-------------------------

Output	Number The output is <code>Null</code> if the argument is less than or equal to zero.
Definition	Returns the natural logarithm of a <code><number></code> .
Example	<code>LN(50) = 3.912023005</code>
Notes	See also EXP on page 2203 and LOG below.

LOG

Syntax	<code>LOG(number, [base])</code> If the optional base argument isn't present, base 10 is used.
Output	Number
Definition	Returns the logarithm of a number for the given base.
Example	<code>LOG(16, 4) = 2</code>
Notes	See also POWER on page 2207 LN on the previous page.

MAX

Syntax	<code>MAX(expression)</code> or <code>MAX(expr1, expr2)</code>
Output	Same data type as the argument, or <code>NULL</code> if any part of the argument is null.
Definition	Returns the maximum of the two arguments, which must be of the same data type. <code>MAX</code> can also be applied to a single field as an aggregation.
Example	<code>MAX(4, 7) = 7</code> <code>MAX(#3/25/1986#, #2/20/2021#) = #2/20/2021#</code> <code>MAX([Name]) = "Zander"</code>
Notes	For strings

`MAX` is usually the value that comes last in alphabetical order.

For database data sources, the `MAX` string value is highest in the sort sequence defined by the database for that column.

For dates

For dates, the `MAX` is the most recent date. If `MAX` is an aggregation, the result will not have a date hierarchy. If `MAX` is a comparison, the result will retain the date hierarchy.

As an aggregation

`MAX(expression)` is an aggregate function and returns a single aggregated result. This displays as `AGG(expression)` in the viz.

As a comparison

`MAX(expr1, expr2)` compares the two values and returns a row-level value.

See also [MIN](#) below.

MIN

Syntax	<code>MIN(expression)</code> or <code>MIN(expr1, expr2)</code>
Output	Same data type as the argument, or <code>NULL</code> if any part of the argument is null.
Definition	Returns the minimum of the two arguments, which must be of the same data type. <code>MIN</code> can also be applied to a single field as an aggregation.
Example	<code>MIN(4, 7) = 4</code> <code>MIN(#3/25/1986#, #2/20/2021#) = #3/25/1986#</code> <code>MIN([Name]) = "Abebi"</code>
Notes	For strings <code>MIN</code> is usually the value that comes first in alphabetical order.

For database data sources, the `MIN` string value is lowest in the sort sequence defined by the database for that column.

For dates

For dates, the `MIN` is the earliest date. If `MIN` is an aggregation, the result will not have a date hierarchy. If `MIN` is a comparison, the result will retain the date hierarchy.

As an aggregation

`MIN(expression)` is an aggregate function and returns a single aggregated result. This displays as `AGG(expression)` in the viz.

As a comparison

`MIN(expr1, expr2)` compares the two values and returns a row-level value.

See also [MAX](#) on page 2205.

PI

Syntax	<code>PI()</code>
Output	Number
Definition	Returns the numeric constant pi: 3.14159...
Example	<code>PI() = 3.14159</code>
Notes	Useful for trig functions that take their input in radians. See also RADIAN S on the next page.

POWER

Syntax	<code>POWER(number, power)</code>
Output	Number
Definition	Raises the <code><number></code> to the specified <code><power></code> .

Example `POWER(5,3) = 125`
`POWER([Temperature], 2)`

Notes You can also use the `^` symbol, such as `5^3 = POWER(5,3) = 125`

See also [EXP](#) on page 2203, [LOG](#) on page 2205, and [SQUARE](#) on page 2210.

RADIANS

Syntax `RADIANS(number)`

Output Number (angle in radians)

Definition Converts the given `<number>` from degrees to radians.

Example `RADIANS(180) = 3.14159`

Notes The inverse function, [DEGREES](#) on page 2202, takes an angle in radians and returns the angle in degrees.

ROUND

Syntax `ROUND(number, [decimals])`

Output Number

Definition Rounds `<number>` to a specified number of digits.

The optional `decimals` argument specifies how many decimal points of precision to include in the final result. If `decimals` is omitted, number is rounded to the nearest integer.

Example `ROUND(1/3, 2) = 0.33`

Notes Some databases, such as SQL Server, allow specification of a negative length, where -1 rounds number to 10's, -2 rounds to 100's, and so on. This is not true of all databases. For example, it is not true of Excel or Access.

Tip: Because `ROUND` may run into issues due to the underlying floating

point representation of numbers—such as 9.405 rounding to 9.40—it may be preferable to **format the number** to the desired number of decimal points rather than rounding. Formatting 9.405 to two decimal places will yield the expected 9.41.

See also **CEILING** on page 2201 and **FLOOR** on page 2203.

SIGN

Syntax	<code>SIGN(number)</code>
Output	-1, 0, or 1
Definition	Returns the sign of a <number>: The possible return values are -1 if the number is negative, 0 if the number is zero, or 1 if the number is positive.
Example	<code>SIGN(AVG(Profit)) = -1</code>
Notes	See also ABS on page 2199.

SIN

Syntax	<code>SIN(number)</code> The number argument is the angle in radians.
Output	Number
Definition	Returns the sine of an angle.
Example	<code>SIN(0) = 1.0</code> <code>SIN(PI()/4) = 0.707106781186548</code>
Notes	The inverse function, ASIN on page 2200, takes the sine as the argument and returns the angle in radians. See also PI on page 2207. To convert an angle from degrees to radians, use RADIANS on the previous page.

SQRT

Syntax	<code>SQRT (number)</code>
Output	Number
Definition	Returns the square root of a <number>.
Example	<code>SQRT (25) = 5</code>
Notes	See also SQUARE below.

SQUARE

Syntax	<code>SQUARE (number)</code>
Output	Number
Definition	Returns the square of a <number>.
Example	<code>SQUARE (5) = 25</code>
Notes	See also SQRT above and POWER on page 2207.

TAN

Syntax	<code>TAN (number)</code> The number argument is the angle in radians.
Output	Number
Definition	Returns the tangent of an angle.
Example	<code>TAN (PI () / 4) = 1.0</code>
Notes	See also ATAN on page 2200, ATAN2 on page 2201, COT on page 2202, and PI on page 2207. To convert an angle from degrees to radians, use RADIANS on page 2208.

ZN

Syntax	<code>ZN(expression)</code>
Output	Any, or 0
Definition	Returns the <code><expression></code> if it is not null, otherwise returns zero. Use this function to replace null values with zeros.
Example	<code>ZN(Grade) = 0</code>
Notes	This is a very useful function when using fields that may contain nulls in a calculation. Wrapping the field with <code>ZN</code> can prevent errors caused by calculating with nulls.

String functions

ASCII

Syntax	<code>ASCII(string)</code>
Output	Number
Definition	Returns the ASCII code for the first character of a <code><string></code> .
Example	<code>ASCII('A') = 65</code>
Notes	This is the inverse of the <code>CHAR</code> function.

CHAR

Syntax	<code>CHAR(number)</code>
Output	String
Definition	Returns the character encoded by the ASCII code <code><number></code> .

Example	<code>CHAR(65) = 'A'</code>
Notes	This is the inverse of the <code>ASCII</code> function.

CONTAINS

Syntax	<code>CONTAINS(string, substring)</code>
Output	Boolean
Definition	Returns true if the given string contains the specified substring.
Example	<code>CONTAINS("Calculation", "alcu") = true</code>
Notes	See also the logical function IN as well as supported RegEx in the additional functions documentation .

ENDSWITH

Syntax	<code>ENDSWITH(string, substring)</code>
Output	Boolean
Definition	Returns true if the given string ends with the specified substring. Trailing white spaces are ignored.
Example	<code>ENDSWITH("Tableau", "leau") = true</code>
Notes	See also the supported RegEx in the additional functions documentation .

FIND

Syntax	<code>FIND(string, substring, [start])</code>
Output	Number
Definition	Returns the index position of substring in string, or 0 if the substring isn't found. The first character in the string is position 1.

If the optional numeric argument `start` is added, the function ignores any instances of substring that appear before the starting position.

Example

```
FIND("Calculation", "alcu") = 2
FIND("Calculation", "Computer") = 0
FIND("Calculation", "a", 3) = 7
FIND("Calculation", "a", 2) = 2
FIND("Calculation", "a", 8) = 0
```

Notes See also the supported RegEx in the [additional functions documentation](#).

FINDNTH

Syntax `FINDNTH(string, substring, occurrence)`

Output Number

Definition Returns the position of the nth occurrence of substring within the specified string, where n is defined by the occurrence argument.

Example `FINDNTH("Calculation", "a", 2) = 7`

Notes `FINDNTH` is not available for all data sources.

See also the supported RegEx in the [additional functions documentation](#).

LEFT

Syntax `LEFT(string, number)`

Output String

Definition Returns the left-most <number> of characters in the string.

Example `LEFT("Matador", 4) = "Mata"`

Notes See also [MID on page 2215](#) and [RIGHT on page 2218](#).

LEN

Syntax	<code>LEN(string)</code>
Output	Number
Definition	Returns the length of the string.
Example	<code>LEN("Matador") = 7</code>
Notes	Not to be confused with the spatial function <code>LENGTH</code> .

LOWER

Syntax	<code>LOWER(string)</code>
Output	String
Definition	Returns the provided <code><string></code> in all lowercase characters.
Example	<code>LOWER("ProductVersion") = "productversion"</code>
Notes	See also UPPER on page 2220 and PROPER on page 2217.

LTRIM

Syntax	<code>LTRIM(string)</code>
Output	String
Definition	Returns the provided <code><string></code> with any leading spaces removed.
Example	<code>LTRIM(" Matador ") = "Matador "</code>
Notes	See also RTRIM on page 2218.

MAX

Syntax	<code>MAX(expression)</code> or <code>MAX(expr1, expr2)</code>
--------	--

Output Same data type as the argument, or `NULL` if any part of the argument is null.

Definition Returns the maximum of the two arguments, which must be of the same data type.

`MAX` can also be applied to a single field as an aggregation.

Example

```
MAX(4, 7) = 7
MAX(#3/25/1986#, #2/20/2021#) = #2/20/2021#
MAX([Name]) = "Zander"
```

Notes **For strings**

`MAX` is usually the value that comes last in alphabetical order.

For database data sources, the `MAX` string value is highest in the sort sequence defined by the database for that column.

For dates

For dates, the `MAX` is the most recent date. If `MAX` is an aggregation, the result will not have a date hierarchy. If `MAX` is a comparison, the result will retain the date hierarchy.

As an aggregation

`MAX(expression)` is an aggregate function and returns a single aggregated result. This displays as `AGG(expression)` in the viz.

As a comparison

`MAX(expr1, expr2)` compares the two values and returns a row-level value.

See also [MIN](#) on page 2206.

MID

Syntax `(MID(string, start, [length]))`

Output String

Definition	Returns a string starting at the specified <code>start</code> position. The first character in the string is position 1. If the optional numeric argument <code>length</code> is added, the returned string includes only that number of characters.
Example	<code>MID("Calculation", 2) = "alculation"</code> <code>MID("Calculation", 2, 5) ="alcul"</code>
Notes	See also the supported RegEx in the additional functions documentation .

MIN

Syntax	<code>MIN(expression)</code> or <code>MIN(expr1, expr2)</code>
Output	Same data type as the argument, or <code>NULL</code> if any part of the argument is null.
Definition	Returns the minimum of the two arguments, which must be of the same data type. <code>MIN</code> can also be applied to a single field as an aggregation.
Example	<code>MIN(4, 7) = 4</code> <code>MIN(#3/25/1986#, #2/20/2021#) = #3/25/1986#</code> <code>MIN([Name]) = "Abebi"</code>
Notes	For strings

`MIN` is usually the value that comes first in alphabetical order.

For database data sources, the `MIN` string value is lowest in the sort sequence defined by the database for that column.

For dates

For dates, the `MIN` is the earliest date. If `MIN` is an aggregation, the result will not have a date hierarchy. If `MIN` is a comparison, the result will retain the date hierarchy.

As an aggregation

`MIN(expression)` is an aggregate function and returns a single aggregated result. This displays as `AGG(expression)` in the viz.

As a comparison

`MIN(expr1, expr2)` compares the two values and returns a row-level value.

See also [MAX](#) on page 2205.

PROPER

Syntax	<code>PROPER(string)</code>
Output	String
Definition	Returns the provided <code><string></code> with the first letter of each word is capitalized and the remaining letters are in lowercase.
Example	<pre>PROPER("PRODUCT name") = "Product Name" PROPER("darcy-mae") = "Darcy-Mae"</pre>
Notes	<p>Spaces and non-alphanumeric characters such as punctuation are treated as separators.</p> <p>See also LOWER on page 2214 and UPPER on page 2220.</p>
Database limitations	PROPER is only available for some flat files and in extracts. If you need to use PROPER in a data source that doesn't otherwise support it, consider using an extract.

REPLACE

Syntax	<code>REPLACE(string, substring, replacement</code>
Output	String
Definition	Searches <code><string></code> for <code><substring></code> and replaces it with <code><replacement></code> . If <code><substring></code> is not found, the string is not changed.

Example `REPLACE("Version 3.8", "3.8", "4x") = "Version 4x"`

Notes See also `REGEXP_REPLACE` in the [additional functions documentation](#).

RIGHT

Syntax `RIGHT(string, number)`

Output String

Definition Returns the right-most <number> of characters in the string.

Example `RIGHT("Calculation", 4) = "tion"`

Notes See also [LEFT](#) on page 2213 and [MID](#) on page 2215.

RTRIM

Syntax `RTRIM(string)`

Output String

Definition Returns the provided <string> with any trailing spaces removed.

Example `RTRIM(" Calculation ") = " Calculation"`

Notes See also [LTRIM](#) on page 2214 and [TRIM](#) on page 2220.

SPACE

Syntax `SPACE(number)`

Output String (specifically, just spaces)

Definition Returns a string that is composed of the specified number of repeated spaces.

Example `SPACE(2) = " "`

SPLIT

Syntax	<code>SPLIT(string, delimiter, token number)</code>
Output	String
Definition	Returns a substring from a string, using a delimiter character to divide the string into a sequence of tokens.
Example	<pre>SPLIT ("a-b-c-d", "-", 2) = "b" SPLIT ("a b c d", " ", -2) = "c"</pre>
Notes	<p>The string is interpreted as an alternating sequence of delimiters and tokens. So for the string <code>abc-defgh-i-jkl</code>, where the delimiter character is '-', the tokens are (1) <code>abc</code>, (2) <code>defgh</code>, (3) <code>i</code>, and (4) <code>jkl</code>.</p> <p><code>SPLIT</code> returns the token corresponding to the token number. When the token number is positive, tokens are counted starting from the left end of the string; when the token number is negative, tokens are counted starting from the right.</p> <p>See also supported REGEX in the additional functions documentation.</p>
Database limitations	<p>The split and custom split commands are available for the following data sources types: Tableau data extracts, Microsoft Excel, Text File, PDF File, Salesforce, OData, Microsoft Azure Market Place, Google Analytics, Vertica, Oracle, MySQL, PostgreSQL, Teradata, Amazon Redshift, Aster Data, Google Big Query, Cloudera Hadoop Hive, Hortonworks Hive, and Microsoft SQL Server.</p> <p>Some data sources impose limits on splitting strings. See <code>SPLIT</code> function limitations later in this topic.</p>

STARTSWITH

Syntax	<code>STARTSWITH(string, substring)</code>
Output	Boolean
Definition	Returns true if <code>string</code> starts with <code>substring</code> . Leading white spaces are

ignored.

Example `STARTSWITH("Matador, "Ma") = TRUE`

Notes See also [CONTAINS on page 2212](#), as well as supported REGEX in the [additional functions documentation](#).

TRIM

Syntax `TRIM(string)`

Output String

Definition Returns the provided <string> with leading and trailing spaces removed.

Example `TRIM(" Calculation ") = "Calculation"`

Notes See also [LTRIM on page 2214](#) and [RTRIM on page 2218](#).

UPPER

Syntax `UPPER(string)`

Output String

Definition Returns the provided <string> in all uppercase characters.

Example `UPPER("Calculation") = "CALCULATION"`

Notes See also [PROPER on page 2217](#) and [LOWER on page 2214](#).

Date functions

Note: Date functions do not take account of the configured fiscal year start. See [Fiscal Dates on page 1162](#).

DATE

Type conversion function that changes string and number expressions into dates, as long as they are in a recognizable format.

Syntax	<code>DATE(expression)</code>
Output	Date
Definition	Returns a date given a number, string, or date <code><expression></code> .
Example	<pre>DATE([Employee Start Date]) DATE("September 22, 2018") DATE("9/22/2018") DATE(#2018-09-22 14:52#)</pre>
Notes	<p>Unlike DATEPARSE on page 2223, there is no need to provide a pattern as <code>DATE</code> automatically recognizes many standard date formats. If <code>DATE</code> does not recognize the input, however, try using <code>DATEPARSE</code> and specifying the format.</p> <p>MAKEDATE on page 2228 is another similar function, but <code>MAKEDATE</code> requires the input of numeric values for year, month, and day.</p>

DATEADD

Adds a specified number of date parts (months, days, etc) to the starting date.

Syntax	<code>DATEADD(date_part, interval, date)</code>
Output	Date
Definition	Returns the <code><date></code> with the specified number <code><interval></code> added to the specified <code><date_part on page 2233></code> of that date. For example, adding three months or 12 days to a starting date.
Example	<p>Push out all due dates by one week</p> <pre>DATEADD('week', 1, [due date])</pre>

Add 280 days to the date February 20, 2021

```
DATEADD('day', 280, #2/20/21#) = #November 27, 2021#
```

Notes Supports ISO 8601 dates.

DATEDIFF

Returns the number of date parts (weeks, years, etc) between two dates.

Syntax `DATEDIFF(date_part, date1, date2, [start_of_week])`

Output Integer

Definition Returns the difference between <date1> and <date2> expressed in units of [<date_part on page 2233>](#). For example, subtracting the dates someone entered and left a band to see how long they were in the band.

Example Number of days between March 25, 1986 and February 20, 2021

```
DATEDIFF('day', #3/25/1986#, #2/20/2021#) = 12,751
```

How many months someone was in a band

```
DATEDIFF('month', [date joined band], [date left band])
```

Notes Supports ISO 8601 dates.

DATENAME

Returns the name of the specified date part as a discrete string.

Syntax `DATENAME(date_part, date, [start_of_week])`

Output String

Definition Returns [<date_part on page 2233>](#) of <date> as a string.

Example `DATENAME('year', #3/25/1986#) = "1986"`

```
DATENAME('month', #1986-03-25#) = "March"
```

Notes	<p>Supports ISO 8601 dates.</p> <p>A very similar calculation is DATEPART on the next page, which returns the value of the specified date part as a continuous integer. DATEPART can be faster because it is a numerical operation.</p> <p>By changing the attributes of the calculation's result (dimension or measure, continuous or discrete) and the date formatting, the results of DATEPART and DATENAME can be formatted to be identical.</p> <p>An inverse function is DATEPARSE below, which takes a string value and formats it as a date.</p>
-------	--

DATEPARSE

Returns specifically formatted strings as dates.

Syntax	<code>DATEPARSE (date_format, date_string)</code>
Output	Date
Definition	The <code><date_format></code> argument describes how the <code><date_string></code> field is arranged. Because of the variety of ways the string field can be ordered, the <code><date_format></code> must match exactly. For a full explanation and formatting details, see Convert a Field to a Date Field .
Example	<code>DATEPARSE ('yyyy-MM-dd', "1986-03-25") = #March 25, 1986#</code>
Notes	<p>DATE on page 2221 is a similar function that automatically recognizes many standard date formats. DATEPARSE may be a better option if DATE does not recognize the input pattern.</p> <p>MAKEDATE on page 2228 is another similar function, but MAKEDATE requires the input of numeric values for year, month, and day.</p> <p>Inverse functions, which take dates apart and return the value of their parts, are DATEPART on the next page (integer output) and DATENAME on the previous page (string output).</p>
Database limitations	DATEPARSE is available through the following connectors: non-legacy Excel and text file connections, Amazon EMR Hadoop Hive, Cloudera Hadoop, Google Sheets, Hortonworks Hadoop Hive, MapR Hadoop Hive, MySQL,

Oracle, PostgreSQL, and Tableau extracts. Some formats may not be available for all connections.

`DATEPARSE` is not supported on Hive variants. Only Denodo, Drill, and Snowflake are supported.

DATEPART

Returns the name of the specified date part as an integer.

Syntax `DATEPART(date_part, date, [start_of_week])`

Output Integer

Definition Returns [<date_part on page 2233>](#) of `<date>` as an integer.

Example `DATEPART('year', #1986-03-25#) = 1986`

`DATEPART('month', #1986-03-25#) = 3`

Notes Supports ISO 8601 dates.

A very similar calculation is [DATENAME on page 2222](#), which returns the name of the specified date part as a discrete string. `DATEPART` can be faster because it is a numerical operation. By changing the attributes of the field (dimension or measure, continuous or discrete) and the date formatting, the results of `DATEPART` and `DATENAME` can be formatted to be identical.

An inverse function is [DATEPARSE on the previous page](#), which takes a string value and formats it as a date.

DATETRUNC

This function can be thought of as date rounding. It takes a specific date and returns a version of that date at the desired specificity. Because every date must have a value for day, month, quarter, and year, `DATETRUNC` sets the values as the lowest value for each date part up to the date part specified. Refer to the example for more information.

Syntax `DATETRUNC(date_part, date, [start_of_week])`

Output	Date
Definition	Truncates the <date> to the accuracy specified by the < date_part on page 2233 >. This function returns a new date. For example, when you truncate a date that is in the middle of the month at the month level, this function returns the first day of the month.
Example	<pre>DATETRUNC('day', #9/22/2018#) = #9/22/2018#</pre> <pre>DATETRUNC('iso-week', #9/22/2018#) = #9/17/2018#</pre> <p>(the monday of the week containing 9/22/2018)</p> <pre>DATETRUNC(quarter, #9/22/2018#) = #7/1/2018#</pre> <p>(the first day of the quarter containing 9/22/2018)</p>

Note: For week and iso-week, the `start_of_week` comes into play. ISO-weeks always start on Monday. For the locale of this example, an unspecified `start_of_week` means the week starts on Sunday.

Notes	<p>Supports ISO 8601 dates.</p> <p>You shouldn't use <code>DATETRUNC</code> to, for example, stop showing the time for a datetime field in a viz. If you want to truncate the way a date displays rather than round its accuracy, adjust the formatting.</p> <p>For example, <code>DATETRUNC('day', #5/17/2022 3:12:48 PM#)</code>, if formatted in the viz to display seconds, would display as 5/17/2022 12:00:00 AM. The value is truncated to day, but the display goes to seconds.</p>
-------	---

DAY

Returns the day of the month (1-31) as an integer.

Syntax	<code>DAY (date)</code>
Output	Integer

Definition	Returns the day of the given <date> as an integer.
Example	Day(#September 22, 2018#) = 22
Notes	See also WEEK on page 2233, MONTH on page 2231, QUARTER on page 2232, YEAR on page 2233, and the ISO equivalents.

ISDATE

Checks if the string is a valid date format.

Syntax	ISDATE(string)
Output	Boolean
Definition	Returns true if a given <string> is a valid date.
Example	ISDATE(09/22/2018) = true ISDATE(22SEP18) = false
Notes	The required argument must be a string. ISDATE cannot be used for a field with a date data type—the calculation will return an error.

ISOQUARTER

Syntax	ISOQUARTER(date)
Output	Integer
Definition	Returns the ISO8601 week-based quarter of a given <date> as an integer.
Example	ISOQUARTER(#1986-03-25#) = 1
Notes	See also ISOWEEK on the facing page, ISOWEEKDAY on the facing page, ISOYEAR on the facing page, and the non-ISO equivalents.

ISOWEEK

Syntax	ISOWEEK (date)
Output	Integer
Definition	Returns the ISO8601 week-based week of a given <date> as an integer.
Example	ISOWEEK (#1986-03-25#) = 13
Notes	See also ISOWEEKDAY below, ISOQUARTER on the previous page, ISOYEAR below, and the non-ISO equivalents.

ISOWEEKDAY

Syntax	ISOWEEKDAY (date)
Output	Integer
Definition	Returns the ISO8601 week-based weekday of a given <date> as an integer.
Example	ISOWEEKDAY (#1986-03-25#) = 2
Notes	See also ISOWEEK above, ISOQUARTER on the previous page, ISOYEAR below, and the non-ISO equivalents.

ISOYEAR

Syntax	ISOYEAR (date)
Output	Integer
Definition	Returns the ISO8601 week-based year of a given <date> as an integer.
Example	ISOYEAR (#1986-03-25#) = 1,986
Notes	See also ISOWEEK above, ISOWEEKDAY above, ISOQUARTER on the previous page, and the non-ISO equivalents.

MAKEDATE

Syntax	<code>MAKEDATE(year, month, day)</code>
Output	Date
Definition	Returns a date value constructed from the specified <code><year></code> , <code><month></code> , and <code><day></code> .
Example	<code>MAKEDATE(1986, 3, 25) = #1986-03-25#</code>

Notes

Note: Incorrectly entered values will be adjusted into a date, such as `MAKEDATE(2020, 4, 31) = May 1, 2020` rather than returning an error that there is no 31st day of April.

Available for Tableau Data Extracts. Check for availability in other data sources.

`MAKEDATE` requires numerical inputs for the parts of a date. If your data is a string that should be a date, try the [DATE](#) on page 2221 function. `DATE` automatically recognizes many standard date formats. If `DATE` does not recognize the input try using [DATEPARSE](#) on page 2223.

MAKEDATETIME

Syntax	<code>MAKEDATETIME(date, time)</code>
Output	Datetime
Definition	Returns a datetime that combines a <code><date></code> and a <code><time></code> . The date can be a date, datetime, or a string type. The time must be a datetime.
Example	<code>MAKEDATETIME("1899-12-30", #07:59:00#) = #12/30/1899 7:59:00 AM#</code> <code>MAKEDATETIME([Date], [Time]) = #1/1/2001 6:00:00 AM#</code>
Notes	This function is available only for MySQL-compatible connections (which for Tableau are MySQL and Amazon Aurora).

[MAKETIME](#) below is a similar function available for Tableau Data Extracts and some other data sources.

MAKETIME

Syntax	<code>MAKETIME(hour, minute, second)</code>
Output	Datetime
Definition	Returns a date value constructed from the specified <hour>, <minute>, and <second>.
Example	<code>MAKETIME(14, 52, 40) = #1/1/1899 14:52:40#</code>
Notes	<p>Because Tableau does not support a time data type, only datetime, the output is a datetime. The date portion of the field will be 1/1/1899.</p> <p>Similar function to MAKEDATETIME on the previous page, which is only available for MYSQL-compatible connections.</p>

MAX

Syntax	<code>MAX(expression) or MAX(expr1, expr2)</code>
Output	Same data type as the argument, or NULL if any part of the argument is null.
Definition	<p>Returns the maximum of the two arguments, which must be of the same data type.</p> <p>MAX can also be applied to a single field as an aggregation.</p>
Example	<pre>MAX(4, 7) = 7 MAX(#3/25/1986#, #2/20/2021#) = #2/20/2021# MAX([Name]) = "Zander"</pre>
Notes	<p>For strings</p> <p>MAX is usually the value that comes last in alphabetical order.</p>

For database data sources, the `MAX` string value is highest in the sort sequence defined by the database for that column.

For dates

For dates, the `MAX` is the most recent date. If `MAX` is an aggregation, the result will not have a date hierarchy. If `MAX` is a comparison, the result will retain the date hierarchy.

As an aggregation

`MAX(expression)` is an aggregate function and returns a single aggregated result. This displays as `AGG(expression)` in the viz.

As a comparison

`MAX(expr1, expr2)` compares the two values and returns a row-level value.

See also [MIN](#) on page 2206.

MIN

Syntax	<code>MIN(expression)</code> or <code>MIN(expr1, expr2)</code>
Output	Same data type as the argument, or <code>NULL</code> if any part of the argument is null.
Definition	Returns the minimum of the two arguments, which must be of the same data type. <code>MIN</code> can also be applied to a single field as an aggregation.
Example	<code>MIN(4, 7) = 4</code> <code>MIN(#3/25/1986#, #2/20/2021#) = #3/25/1986#</code> <code>MIN([Name]) = "Abebi"</code>
Notes	For strings <code>MIN</code> is usually the value that comes first in alphabetical order.

For database data sources, the `MIN` string value is lowest in the sort sequence defined by the database for that column.

For dates

For dates, the `MIN` is the earliest date. If `MIN` is an aggregation, the result will not have a date hierarchy. If `MIN` is a comparison, the result will retain the date hierarchy.

As an aggregation

`MIN(expression)` is an aggregate function and returns a single aggregated result. This displays as `AGG(expression)` in the viz.

As a comparison

`MIN(expr1, expr2)` compares the two values and returns a row-level value.

See also [MAX](#) on page 2205.

MONTH

Syntax	<code>MONTH(date)</code>
Output	Integer
Definition	Returns the month of the given <code><date></code> as an integer.
Example	<code>MONTH(#1986-03-25#) = 3</code>
Notes	See also DAY on page 2225, WEEK on page 2233, QUARTER on the next page, YEAR on page 2233, and the ISO equivalents

NOW

Syntax	<code>NOW()</code>
Output	Datetime

Definition	Returns the current local system date and time.
Example	<code>NOW () = 1986-03-25 1:08:21 PM</code>
Notes	<p><code>NOW</code> does not take an argument.</p> <p>See also TODAY below, a similar calculation that returns a date instead of a datetime.</p> <p>If the data source is a live connection, the system date and time could be in another timezone. For more information on how to address this, see the Knowledge Base.</p>

QUARTER

Syntax	<code>QUARTER (date)</code>
Output	Integer
Definition	Returns the quarter of the given <date> as an integer.
Example	<code>QUARTER (#1986-03-25#) = 1</code>
Notes	See also DAY on page 2225, WEEK on the facing page, MONTH on the previous page, YEAR on the facing page, and the ISO equivalents

TODAY

Syntax	<code>TODAY ()</code>
Output	Date
Definition	Returns the current local system date.
Example	<code>TODAY () = 1986-03-25</code>
Notes	<p><code>TODAY</code> does not take an argument.</p> <p>See also NOW on the previous page, a similar calculation that returns a datetime instead of a date.</p>

If the data source is a live connection, the system date could be in another timezone. For more information on how to address this, see [the Knowledge Base](#).

WEEK

Syntax	WEEK (date)
Output	Integer
Definition	Returns the week of the given <date> as an integer.
Example	WEEK (#1986-03-25#) = 13
Notes	See also DAY on page 2225, MONTH on page 2231, QUARTER on the previous page, YEAR below, and the ISO equivalents

YEAR

Syntax	YEAR (date)
Output	Integer
Definition	Returns the year of the given <date> as an integer.
Example	YEAR (#1986-03-25#) = 1,986
Notes	See also DAY on page 2225, WEEK above, MONTH on page 2231, QUARTER on the previous page, and the ISO equivalents

date_part

Many date functions in Tableau take the argument `date_part`, which is a string constant that tells the function what part of a date to consider, such as day, week, quarter, etc. The valid `date_part` values that you can use are:

date_part	Values
'year'	Four-digit year

date_part	Values
'quarter'	1-4
'month'	1-12 or "January", "February", and so on
'dayofyear'	Day of the year; Jan 1 is 1, Feb 1 is 32, and so on
'day'	1-31
'weekday'	1-7 or "Sunday", "Monday", and so on
'week'	1-52
'hour'	0-23
'minute'	0-59
'second'	0-60
'iso-year'	Four-digit ISO 8601 year
'iso-quarter'	1-4
'iso-week'	1-52, start of week is always Monday
'iso-weekday'	1-7, start of week is always Monday

Logical functions

AND

Syntax <expr1> AND <expr2>

Definition Performs a logical conjunction on two expressions. (If both sides are true, the logical test returns true.)

Output Boolean (true or false)

Example IF [Season] = "Spring" AND "[Season] = "Fall"
THEN "It's the apocalypse and footwear doesn't matter"

END

"If both (Season = Spring) and (Season = Fall) are true simultaneously, then return It's the apocalypse and footwear doesn't matter".

Notes Often used with **IF** on page 2238 and **IIF** on page 2239. See also **NOT** on page 2244 and **OR** on page 2244.

If both expressions are **TRUE** (that is, not **FALSE** or **NULL**), then the result is **TRUE**. If either expression is **NULL**, then the result is **NULL**. In all other cases, the result is **FALSE**.

If you create a calculation in which the result of an **AND** comparison is displayed on a worksheet, Tableau displays **TRUE** and **FALSE**. If you would like to change this, use the Format area in the format dialog.

Note: The **AND** operator employs *short circuit evaluation*. This means that if the first expression is evaluated to be **FALSE**, then the second expression is not evaluated at all. This can be helpful if the second expression results in an error when the first expression is **FALSE**, because the second expression in this case is never evaluated.

CASE

Syntax

```
CASE <expression>
WHEN <value1> THEN <then1>
WHEN <value2> THEN <then2>
...
[ELSE <default>]
END
```

Output Depends on data type of the <then> values.

Definition Evaluates the `expression` and compares it to the specified options (<value1>, <value2>, etc.). When a value that matches expression is encountered, **CASE** returns the corresponding `return`. If no match is found, the (optional) default is returned. If there is no default and no values match, then Null is returned.

Example	<pre> CASE [Season] WHEN 'Summer' THEN 'Sandals' WHEN 'Winter' THEN 'Boots' ELSE 'Sneakers' END </pre> <p><i>"Look at the Season field. If the value is Summer, then return Sandals. If the value is Winter, then return Boots. If none of the options in the calculation match what is in the Season field, return a Sneakers."</i></p>
Notes	<p>See also IF on page 2238 and IIF on page 2239.</p> <p>Used with WHEN on page 2246, THEN on page 2245, ELSE below, and END on page 2238.</p> <p>Tip: Many times you can use a group to get the same results as a complicated CASE function, or use CASE to replace native grouping functionality, such as in the previous example. You may want to test which is more performant for your scenario.</p>

ELSE

Syntax	<pre> CASE <expression> WHEN <value1> THEN <then1> WHEN <value2> THEN <then2> ... [ELSE <default>] END </pre>
Definition	An optional piece of an IF or CASE expression used to specify a default value to return if none of the tested expressions are true.
Example	<pre> IF [Season] = "Summer" THEN 'Sandals' ELSEIF [Season] = "Winter" THEN 'Boots' ELSE 'Sneakers' END </pre> <pre> CASE [Season] WHEN 'Summer' THEN 'Sandals' </pre>

```
WHEN 'Winter' THEN 'Boots'  
ELSE 'Sneakers'  
END
```

Notes Used with **CASE** on page 2235, **WHEN** on page 2246, **IF** on the next page, **ELSEIF** below, **THEN** on page 2245, and **END** on the next page

ELSE is optional with **CASE** and **IF**. In a calculation where **ELSE** is not specified, if none of the <test>are true, the overall calculation will return null.

ELSE does not require a condition (such as [Season] = "Winter") and can be thought of as a form of null handling.

ELSEIF

Syntax [**ELSEIF** <test2> THEN <then2>]

Definition An optional piece of an **IF** expression used to specify additional conditions beyond the initial **IF**.

Example

```
IF [Season] = "Summer" THEN 'Sandals'  
ELSEIF [Season] = "Winter" THEN 'Boots'  
ELSEIF [Season] = "Spring" THEN 'Sneakers'  
ELSEIF [Season] = "Autumn" THEN 'Sneakers'  
ELSE 'Bare feet'  
END
```

Notes Used with **IF** on the next page, **THEN** on page 2245, **ELSE** on the previous page, and **END** on the next page

ELSEIF can be thought of as additional **IF** clauses. **ELSEIF** is optional and can be repeated multiple times.

Unlike **ELSE**, **ELSEIF** requires a condition (such as [Season] = "Winter").

END

Definition	Used to close an IF or CASE expression.
Example	<pre>IF [Season] = "Summer" THEN 'Sandals' ELSEIF [Season] = "Winter" THEN 'Boots' ELSE 'Sneakers' END</pre> <p><i>"If Season = Summer, then return Sandals. If not, look at the next expression. If Season = Winter, then return Boots. If neither of the expressions are true, return Sneakers."</i></p> <pre>CASE [Season] WHEN 'Summer' THEN 'Sandals' WHEN 'Winter' THEN 'Boots' ELSE 'Sneakers' END</pre> <p><i>"Look at the Season field. If the value is Summer, then return Sandals. If the value is Winter, then return Boots. If none of the options in the calculation match what is in the Season field, return a Sneakers."</i></p>
Notes	Used with CASE on page 2235, WHEN on page 2246, IF below, ELSEIF on the previous page, THEN on page 2245, and ELSE on page 2236.

IF

Syntax	<pre>IF <test1> THEN <then1> [ELSEIF <test2> THEN <then2>...] [ELSE <default>] END</pre>
Output	Depends on data type of the <then> values.
Definition	Tests a series of expressions and returns the <then> value for the first true <test>.
Example	<pre>IF [Season] = "Summer" THEN 'Sandals'</pre>

```
ELSEIF [Season] = "Winter" THEN 'Boots'  
ELSE 'Sneakers'  
END
```

"If Season = Summer, then return Sandals. If not, look at the next expression. If Season = Winter, then return Boots. If neither of the expressions are true, return Sneakers."

Notes See also [IF](#) on the previous page and [IIF](#) below.

Used with [ELSEIF](#) on page 2237, [THEN](#) on page 2245, [ELSE](#) on page 2236, and [END](#) on the previous page

IFNULL

Syntax `IFNULL(expr1, expr2)`

Output Depends on the data type of the `<expr>` values.

Definition Returns `<expr1>` if it's non-null, otherwise returns `<expr2>`.

Example `IFNULL([Assigned Room], "TBD")`

"If the Assigned Room field isn't null, return its value. If the Assigned room field is null, return TBD instead."

Notes Compare with [ISNULL](#) on page 2242. `IFNULL` always returns a value. `ISNULL` returns a boolean (true or false).

See also [ZN](#) on page 2211.

IIF

Syntax `IIF(<test>, <then>, <else>, [<unknown>])`

Output Depends on the data type of the values in the expression.

Definition Checks whether a condition is met (`<test>`), and returns `<then>` if the test is true, `<else>` if the test is false, and an optional value for `<unknown>` if the test is null. If the optional unknown isn't specified, `IIF` returns null.

Example `IIF([Season] = 'Summer', 'Sandals', 'Other footwear')`

"If Season = Summer, then return Sandals. If not, return Other footwear"

```
IIF([Season] = 'Summer', 'Sandals',
    IIF('Season' = 'Winter', 'Boots', 'Other footwear')
)
```

"If Season = Summer, then return Sandals. If not, look at the next expression. If Season = Winter, then return Boots. If neither are true, return Sneakers."

```
IIF('Season' = 'Summer', 'Sandals',
    IIF('Season' = 'Winter', 'Boots',
        IIF('Season' = 'Spring', 'Sneakers', 'Other footwear')
    )
)
```

"If Season = Summer, then return Sandals. If not, look at the next expression. If Season = Winter, then return Boots. If none of the expressions are true, return Sneakers."

Notes See also [IF](#) on page 2238 and [CASE](#) on page 2235.

`IIF` doesn't have an equivalent to `ELSEIF` (like `IF`) or repeated `WHEN` clauses (like `CASE`). Instead, multiple tests can be evaluated sequentially by nesting `IIF` statements as the `<unknown>` element. The first (outermost) true is returned.

That is to say, in the calculation below, the result will be Red, not Orange, because the expression stops being evaluated as soon as `A=A` is evaluated as true:

```
IIF('A' = 'A', 'Red', IIF('B' = 'B', 'Orange', IIF('C' = 'D', 'Yellow', 'Green')))
```

IN

Syntax `<expr1> IN <expr2>`

Output Boolean (true or false)

Definition	Returns <code>TRUE</code> if any value in <code><expr1></code> matches any value in <code><expr2></code> .
Example	<code>SUM([Cost]) IN (1000, 15, 200)</code> <i>"Is the value of the Cost field 1000, 15, or 200?"</i> <code>[Field] IN [Set]</code> <i>"Is the value of the field present in the set?"</i>
Notes	The values in <code><expr2></code> can be a set, list of literal values, or combined field. See also WHEN on page 2246.

ISDATE

Syntax	<code>ISDATE (string)</code>
Output	Boolean (true or false)
Definition	Returns true if a <code><string></code> is a valid date. The input expression must be a string (text) field.
Example	<code>ISDATE ("2018-09-22")</code> <i>"Is the string 2018-09-22 a properly formatted date?"</i>
Notes	What is considered a valid date depends on the locale of the system evaluating the calculation. For example: In the USA: <ul style="list-style-type: none"><code>ISDATE ("2018-09-22") = TRUE</code><code>ISDATE ("2018-22-09") = FALSE</code> In the UK: <ul style="list-style-type: none"><code>ISDATE ("2018-09-22") = FALSE</code><code>ISDATE ("2018-22-09") = TRUE</code>

ISNULL

Syntax	ISNULL (expression)
Output	Boolean (true or false)
Definition	Returns true if the <expression> is NULL (does not contain valid data).
Example	ISNULL ([Assigned Room]) <i>"Is the Assigned Room field null?"</i>
Notes	Compare with IFNULL on page 2239 . IFNULL always returns a value. ISNULL returns a boolean. See also ZN on page 2211 .

MAX

Syntax	MAX (expression) or MAX (expr1, expr2)
Output	Same data type as the argument, or NULL if any part of the argument is null.
Definition	Returns the maximum of the two arguments, which must be of the same data type. MAX can also be applied to a single field as an aggregation.
Example	MAX (4, 7) = 7 MAX (#3/25/1986#, #2/20/2021#) = #2/20/2021# MAX ([Name]) = "Zander"
Notes	For strings MAX is usually the value that comes last in alphabetical order.

For database data sources, the MAX string value is highest in the sort sequence defined by the database for that column.

For dates

For dates, the `MAX` is the most recent date. If `MAX` is an aggregation, the result will not have a date hierarchy. If `MAX` is a comparison, the result will retain the date hierarchy.

As an aggregation

`MAX(expression)` is an aggregate function and returns a single aggregated result. This displays as `AGG(expression)` in the viz.

As a comparison

`MAX(expr1, expr2)` compares the two values and returns a row-level value.

See also [MIN](#) on page 2206.

MIN

Syntax	<code>MIN(expression)</code> or <code>MIN(expr1, expr2)</code>
Output	Same data type as the argument, or <code>NULL</code> if any part of the argument is null.
Definition	Returns the minimum of the two arguments, which must be of the same data type. <code>MIN</code> can also be applied to a single field as an aggregation.
Example	<code>MIN(4,7) = 4</code> <code>MIN(#3/25/1986#, #2/20/2021#) = #3/25/1986#</code> <code>MIN([Name]) = "Abebi"</code>
Notes	For strings <code>MIN</code> is usually the value that comes first in alphabetical order.

For database data sources, the `MIN` string value is lowest in the sort sequence defined by the database for that column.

For dates

For dates, the `MIN` is the earliest date. If `MIN` is an aggregation, the result

will not have a date hierarchy. If `MIN` is a comparison, the result will retain the date hierarchy.

As an aggregation

`MIN (expression)` is an aggregate function and returns a single aggregated result. This displays as `AGG (expression)` in the viz.

As a comparison

`MIN (expr1, expr2)` compares the two values and returns a row-level value.

See also [MAX](#) on page 2205.

NOT

Syntax	<code>NOT <expression></code>
Output	Boolean (true or false)
Definition	Performs logical negation on an expression.
Example	<pre>IF NOT [Season] = "Summer" THEN 'Don't wear sandals' ELSE 'Wear sandals' END</pre> <p><i>"If Season doesn't equal Summer, then return Don't wear sandals. If not, return Wear sandals."</i></p>
Notes	Often used with IF on page 2238 and IIF on page 2239. See also DATE on page 2221 and OR below.

OR

Syntax	<code><expr1> OR <expr2></code>
Output	Boolean (true or false)
Definition	Performs a logical disjunction on two expressions.

Example

```
IF [Season] = "Spring" OR [Season] = "Fall"
THEN "Sneakers"
END
```

"If either (Season = Spring) or (Season = Fall) is true, then return Sneakers."

Notes Often used with [IF on page 2238](#) and [IIF on page 2239](#). See also [DATE on page 2221](#) and [NOT on the previous page](#).

If either expression is `TRUE`, then the result is `TRUE`. If both expressions are `FALSE`, then the result is `FALSE`. If both expressions are `NULL`, then the result is `NULL`.

If you create a calculation which displays the result of an `OR` comparison on a worksheet, Tableau displays `TRUE` and `FALSE`. If you would like to change this, use the Format area in the format dialog.

Note: The `OR` operator employs *short circuit evaluation*. This means that if the first expression is evaluated to be `TRUE`, then the second expression is not evaluated at all. This can be helpful if the second expression results in an error when the first expression is `TRUE`, because the second expression in this case is never evaluated.

THEN

Syntax

```
IF <test1> THEN <then1>
[ELSEIF <test2> THEN <then2>...]
[ELSE <default>]
END
```

Definition A required part of an `IF`, `ELSEIF`, or `CASE` expression, used to define what result to return if a specific value or test is true.

Example

```
IF [Season] = "Summer" THEN 'Sandals'
ELSEIF [Season] = "Winter" THEN 'Boots'
ELSE 'Sneakers'
END
```

"If Season = Summer, then return Sandals. If not, look at the next expression. If Season = Winter, then return Boots. If neither of the expressions are true, return Sneakers."

```
CASE [Season]
WHEN 'Summer' THEN 'Sandals'
WHEN 'Winter' THEN 'Boots'
ELSE 'Sneakers'
END
```

"Look at the Season field. If the value is Summer, then return Sandals. If the value is Winter, then return Boots. If none of the options in the calculation match what is in the Season field, return a Sneakers."

Notes Used with [CASE](#) on page 2235, [WHEN](#) below, [IF](#) on page 2238, [ELSEIF](#) on page 2237, [THEN](#) on the previous page, [ELSE](#) on page 2236, and [END](#) on page 2238

WHEN

Syntax

```
CASE <expression>
WHEN <value1> THEN <then1>
WHEN <value2> THEN <then2>
...
[ELSE <default>]
END
```

Definition A required part of a `CASE` expression. Finds the first `<value>` that matches `<expression>` and returns the corresponding `<then>`.

Example

```
CASE [Season]
WHEN 'Summer' THEN 'Sandals'
WHEN 'Winter' THEN 'Boots'
ELSE 'Sneakers'
END
```

"Look at the Season field. If the value is Summer, then return Sandals. If the value is Winter, then return Boots. If none of the options in the

calculation match what is in the Season field, return a Sneakers."

Notes Used with **CASE** on page 2235, **THEN** on page 2245, **ELSE** on page 2236, and **END** on page 2238.

CASE also supports **WHEN IN** construction, such as:

```
CASE <expression>
WHEN IN <set1> THEN <then1>
WHEN IN <combinedfield> THEN <then2>
...
ELSE <default>
END
```

The values that **WHEN IN** compare to must be a set, list of literal values, or combined field. See also **IN** on page 2240.

ZN

Syntax `ZN(expression)`

Output Depends on the data type of the `<expression>`, or 0.

Definition Returns `<expression>` if it isn't null, otherwise returns zero.

Example `ZN([Test Grade])`

"If the test grade isn't null, return its value. If the test grade is null, return 0."

Notes **ZN** is a specialized case of **IFNULL** on page 2239 where alternative if the expression is null is always 0 rather than being specified in the calculation.

ZN is especially useful when performing additional calculations and a null would render the entire calculation null. However, use caution interpreting these results as null is not always synonymous with 0 and could represent missing data.

See also **ISNULL** on page 2242.

Aggregate functions

ATTR

Syntax	<code>ATTR (expression)</code>
Definition	Returns the value of the expression if it has a single value for all rows. Otherwise returns an asterisk. Null values are ignored.

AVG

Syntax	<code>AVG (expression)</code>
Definition	Returns the average of all the values in the expression. Null values are ignored.
Notes	<code>AVG</code> can only be used with numeric fields.

COLLECT

Syntax	<code>COLLECT (spatial)</code>
Definition	An aggregate calculation that combines the values in the argument field. Null values are ignored.
Notes	<code>COLLECT</code> can only be used with spatial fields.

CORR

Syntax	<code>CORR (expression1, expression2)</code>
Output	Number from -1 to 1
Definition	Returns the Pearson correlation coefficient of two expressions.
Example	<code>example</code>
Notes	The Pearson correlation measures the linear relationship between two variables. Results range from -1 to +1 inclusive, where 1 denotes an exact positive linear relationship, 0 denotes no linear relationship between the

variance, and -1 is an exact negative relationship.

The square of a CORR result is equivalent to the R-Squared value for a linear trend line model. See [Trend Line Model Terms](#).

Use with table scoped LOD expressions:

You can use CORR to visualize correlation in a disaggregated scatter using a [table-scoped level of detail expression](#). For example:

```
{CORR(Sales, Profit)}
```

With a level of detail expression, the correlation is run over all rows. If you used a formula like `CORR(Sales, Profit)` (without the surrounding brackets to make it a level of detail expression), the view would show the correlation of each individual point in the scatter plot with each other point, which is undefined.

Database limitations

CORR is available with the following data sources: Tableau data extracts, Cloudera Hive, EXASolution, Firebird (version 3.0 and later), Google BigQuery, Hortonworks Hadoop Hive, IBM PDA (Netezza), Oracle, PostgreSQL, Presto, SybaseIQ, Teradata, Vertica.

For other data sources, consider either extracting the data or using `WINDOW_CORR`. See [Table Calculation Functions](#).

COUNT

Syntax `COUNT(expression)`

Definition Returns the number of items. Null values are not counted.

COUNTD

Syntax `COUNTD(expression)`

Definition Returns the number of distinct items in a group. Null values are not counted.

COVAR

Syntax	<code>COVAR(expression1, expression2)</code>
Definition	Returns the <i>sample</i> covariance of two expressions.
Notes	<p>Covariance quantifies how two variables change together. A positive covariance indicates that the variables tend to move in the same direction, as when larger values of one variable tend to correspond to larger values of the other variable, on average. <i>Sample covariance</i> uses the number of non-null data points $n - 1$ to normalize the covariance calculation, rather than n, which is used by the population covariance (available with the <code>COVARP</code> function). Sample covariance is the appropriate choice when the data is a random sample that is being used to estimate the covariance for a larger population.</p> <p>If <code><expression1></code> and <code><expression2></code> are the same, for example <code>COVAR([profit], [profit])</code>, <code>COVAR</code> returns a value that indicates how widely values are distributed.</p> <p>The value of <code>COVAR(X, X)</code> is equivalent to the value of <code>VAR(X)</code> and also to the value of <code>STDEV(X)^2</code>.</p>
Database limitations	<p><code>COVAR</code> is available with the following data sources: Tableau data extracts, Cloudera Hive, EXASolution, Firebird (version 3.0 and later), Google BigQuery, Hortonworks Hadoop Hive, IBM PDA (Netezza), Oracle, PostgreSQL, Presto, SybaseIQ, Teradata, Vertica.</p> <p>For other data sources, consider either extracting the data or using <code>WINDOW_COVAR</code>. See Table Calculation Functions.</p>

COVARP

Syntax	<code>COVARP(expression 1, expression2)</code>
Definition	Returns the <i>population</i> covariance of two expressions.
Notes	Covariance quantifies how two variables change together. A positive covariance indicates that the variables tend to move in the same direction,

as when larger values of one variable tend to correspond to larger values of the other variable, on average. *Population covariance* is sample covariance multiplied by $(n-1)/n$, where n is the total number of non-null data points. Population covariance is the appropriate choice when there is data available for all items of interest as opposed to when there is only a random subset of items, in which case sample covariance (with the `COVAR` function) is appropriate.

If `<expression1>` and `<expression2>` are the same, for example `COVARP([profit], [profit])`, `COVARP` returns a value that indicates how widely values are distributed. Note: The value of `COVARP(X, X)` is equivalent to the value of `VARP(X)` and also to the value of `STDEVP(X)^2`.

Database limitations `COVARP` is available with the following data sources: Tableau data extracts, Cloudera Hive, EXASolution, Firebird (version 3.0 and later), Google BigQuery, Hortonworks Hadoop Hive, IBM PDA (Netezza), Oracle, PostgreSQL, Presto, SybaseIQ, Teradata, Vertica

For other data sources, consider either extracting the data or using `WINDOW_COVAR`. See [Table Calculation Functions](#).

MAX

Syntax `MAX(expression)` or `MAX(expr1, expr2)`

Output Same data type as the argument, or `NULL` if any part of the argument is null.

Definition Returns the maximum of the two arguments, which must be of the same data type.

`MAX` can also be applied to a single field as an aggregation.

Example

```
MAX(4, 7) = 7
MAX(#3/25/1986#, #2/20/2021#) = #2/20/2021#
MAX([Name]) = "Zander"
```

Notes **For strings**

`MAX` is usually the value that comes last in alphabetical order.

For database data sources, the `MAX` string value is highest in the sort sequence defined by the database for that column.

For dates

For dates, the `MAX` is the most recent date. If `MAX` is an aggregation, the result will not have a date hierarchy. If `MAX` is a comparison, the result will retain the date hierarchy.

As an aggregation

`MAX(expression)` is an aggregate function and returns a single aggregated result. This displays as `AGG(expression)` in the viz.

As a comparison

`MAX(expr1, expr2)` compares the two values and returns a row-level value.

See also [MIN](#) on page 2206.

MEDIAN

Syntax	<code>MEDIAN(expression)</code>
Definition	Returns the median of an expression across all records. Null values are ignored.
Notes	<code>MEDIAN</code> can only be used with numeric fields.
Database limitations	<code>MEDIAN</code> is not available for the following data sources: Access, Amazon Redshift, Cloudera Hadoop, HP Vertica, IBM DB2, IBM PDA (Nettezza), Microsoft SQL Server, MySQL, SAP HANA, Teradata.
	For other data source types, you can extract your data into an extract file to use this function. See Extract Your Data .

MIN

Syntax	<code>MIN(expression)</code> or <code>MIN(expr1, expr2)</code>
Output	Same data type as the argument, or <code>NULL</code> if any part of the argument is null.
Definition	Returns the minimum of the two arguments, which must be of the same data type.

`MIN` can also be applied to a single field as an aggregation.

Example	<code>MIN(4, 7) = 4</code> <code>MIN(#3/25/1986#, #2/20/2021#) = #3/25/1986#</code> <code>MIN([Name]) = "Abebi"</code>
---------	--

Notes

For strings

`MIN` is usually the value that comes first in alphabetical order.

For database data sources, the `MIN` string value is lowest in the sort sequence defined by the database for that column.

For dates

For dates, the `MIN` is the earliest date. If `MIN` is an aggregation, the result will not have a date hierarchy. If `MIN` is a comparison, the result will retain the date hierarchy.

As an aggregation

`MIN(expression)` is an aggregate function and returns a single aggregated result. This displays as `AGG(expression)` in the viz.

As a comparison

`MIN(expr1, expr2)` compares the two values and returns a row-level value.

See also [MAX](#) on page 2205.

PERCENTILE

Syntax	<code>PERCENTILE(expression, number)</code>
Definition	Returns the percentile value from the given expression corresponding to the specified <code><number></code> . The <code><number></code> must be between 0 and 1 (inclusive) and must be a numeric constant.
Example	<code>PERCENTILE([Score], 0.9)</code>
Database limitations	<p>This function is available for the following data sources: Non-legacy Microsoft Excel and Text File connections, Extracts and extract-only data source types (for example, Google Analytics, OData, or Salesforce), Sybase IQ 15.1 and later data sources, Oracle 10 and later data sources, Cloudera Hive and Hortonworks Hadoop Hive data sources, EXASolution 4.2 and later data sources.</p> <p>For other data source types, you can extract your data into an extract file to use this function. See Extract Your Data.</p>

STDEV

Syntax	<code>STDEV(expression)</code>
Definition	Returns the statistical standard deviation of all values in the given expression based on a sample of the population.

STDEVP

Syntax	<code>STDEVP(expression)</code>
Definition	Returns the statistical standard deviation of all values in the given expression based on a biased population.

SUM

Syntax	<code>SUM(expression)</code>
Definition	Returns the sum of all values in the expression. Null values are ignored.
Notes	<code>SUM</code> can only be used with numeric fields.

VAR

Syntax	<code>VAR(expression)</code>
Definition	Returns the statistical variance of all values in the given expression based on a sample of the population.

VARP

Syntax	<code>VARP(expression)</code>
Definition	Returns the statistical variance of all values in the given expression on the entire population.

User functions

FULLNAME()

Syntax	<code>FULLNAME ()</code>
Output	String
Definition	Returns the full name for the current user.
Example	<code>FULLNAME ()</code> This returns the full name of the signed in user, such as "Hamlin Myrer".

```
[Manager] = FULLNAME ( )
```

If manager "Hamlin Myrer" is signed in, this example returns TRUE only if the Manager field in the view contains "Hamlin Myrer".

Notes

This function checks:

- Tableau Cloud and Tableau Server: the full name of the signed-in user
- Tableau Desktop: the local or network full name for the user

User filters

When used as a filter, a calculated field such as `[Username field] = FULLNAME ()` can be used to create a user filter that only shows data that is relevant to the person signed in to the server.

ISFULLNAME

Syntax

```
ISFULLNAME("User Full Name")
```

Output

Boolean

Definition

Returns TRUE if the current user's full name matches the specified full name or FALSE if it does not match.

Example

```
ISFULLNAME("Hamlin Myrer")
```

Notes

The <"User Full Name"> argument must be a literal string, not a field.

This function checks:

- Tableau Cloud and Tableau Server: the full name of the signed-in user
- Tableau Desktop: the local or network full name for the user

ISMEMBEROF

Syntax

```
ISMEMBEROF("Group Name")
```

Output	Boolean or null
Definition	Returns <code>TRUE</code> if the person currently using Tableau is a member of a group that matches the given string, <code>FALSE</code> if they're not a member, and <code>NULL</code> if they're not signed in.
Example	<code>ISMEMBEROF('Superstars')</code> <code>ISMEMBEROF('domain.lan\Sales')</code>
Notes	<p>The <code><"Group Full Name"></code> argument must be a literal string, not a field.</p> <p>If the user is signed in to Tableau Cloud or Tableau Server, group membership is determined by Tableau groups. The function will return <code>TRUE</code> if the given string is "All Users"</p> <p>The <code>ISMEMBEROF()</code> function will also accept Active Directory domains. The Active Directory domain must be declared in the calculation with the group name.</p> <p>If a change is made to a user's group membership, the change in the data that is based on the group membership is reflected in a workbook or view with a new session. The existing session will reflect stale data.</p>

ISUSERNAME

Syntax	<code>ISUSERNAME("username")</code>
Output	Boolean
Definition	Returns <code>TRUE</code> if the current user's username matches the specified username or <code>FALSE</code> if it does not match.
Example	<code>ISUSERNAME("hmyrer")</code>
Notes	<p>The <code><"username"></code> argument must be a literal string, not a field.</p> <p>This function checks:</p> <ul style="list-style-type: none"> • Tableau Cloud and Tableau Server: the username of the signed-in user • Tableau Desktop: the local or network username for the user

USERDOMAIN()

Syntax	USERDOMAIN ()
Output	String
Definition	Returns the domain for the current user .
Notes	<p>This function checks:</p> <ul style="list-style-type: none"> • Tableau Cloud and Tableau Server: the user domain of the signed-in user • Tableau Desktop: the local domain if the user is on a domain

USERNAME()

Syntax	USERNAME ()
Output	String
Definition	Returns the username for the current user.
Example	<p>USERNAME ()</p> <p>This returns the username of the signed in user, such as "hmyrer".</p> <pre>[Manager] = USERNAME ()</pre> <p>If manager "hmyrer" is signed in, this example returns TRUE only if the Manager field in the view contains "hmyrer".</p>
Notes	<p>This function checks:</p> <ul style="list-style-type: none"> • Tableau Cloud and Tableau Server: the username of the signed-in user • Tableau Desktop: the local or network username for the user <p>User filters</p> <p>When used as a filter, a calculated field such as [Username field] = USERNAME () can be used to create a user filter that only shows data that is relevant to the person signed in to the server.</p>

USERATTRIBUTE

Note: For embedding workflows in Tableau Cloud only. For more information, see [Authentication and Embedded Views](#).

Syntax	<code>USERATTRIBUTE('attribute_name')</code>
Output	String or null
Definition	If <code>'attribute_name'</code> is part of the JSON web token (JWT) passed to Tableau, the calculation returns the first value of <code>'attribute_name'</code> . Returns null if <code>'attribute_name'</code> does not exist.
Example	Suppose "Region" is the user attribute included in the JWT and passed to Tableau (using the connected app already configured by your site admin). As the workbook author, you can set up your visualization to filter data based on a specified region. In that filter, you can reference the following calculation. <pre>[Region] = USERATTRIBUTE("Region")</pre> When User2 from the West region views the embedded visualization, Tableau shows the appropriate data for the West region only.
Notes	You can use the <code>USERATTRIBUTEINCLUDES</code> function if you expect <code>'attribute_name'</code> to return multiple values.

USERATTRIBUTEINCLUDES

Note: For embedding workflows in Tableau Cloud only. For more information, see [Authentication and Embedded Views](#).

Syntax	<code>USERATTRIBUTEINCLUDES('attribute_name', 'expected_value')</code>
Output	Boolean

Definition	<p>Returns <code>TRUE</code> if both of the following are true:</p> <ul style="list-style-type: none"> • <code><'attribute_name'></code> is part of the JSON web token (JWT) passed to Tableau • one of <code><'attribute_name'></code> values equals <code><'expected_value'></code>. <p>Returns <code>FALSE</code> otherwise.</p>
Example	<p>Suppose "Region" is the user attribute included in the JWT and passed to Tableau (using the connected app already configured by your site admin).</p> <p>As the workbook author, you can set up your visualization to filter data based on a specified region. In that filter, you can reference the following calculation.</p> <pre>USERATTRIBUTEINCLUDES('Region', [Region])</pre> <p>If User2 from the West region accesses the embedded visualization, Tableau checks if the Region user attribute matches one of [Region] field values. When true, the visualization shows the appropriate data.</p> <p>When User3 from the North region accesses the same visualization, she's unable to see any data because there's no match with [Region] field values.</p>

Table calculations

FIRST()

Returns the number of rows from the current row to the first row in the partition. For example, the view below shows quarterly sales. When `FIRST()` is computed within the Date partition, the offset of the first row from the second row is -1.

Year of Order Date	Quarter of Order Date	Region			
		Central	East	South	West
2009	Q1	\$160,877	\$231,411	\$133,934	\$185,961
	Q2	\$197,213	\$204,914	\$337,813	\$213,507
	Q3	\$302,678	\$165,201	\$283,806	\$206,512
	Q4	\$297,208	\$226,983	\$214,845	\$230,291
2010	Q1	\$180,609	\$180,123	\$273,943	\$251,145
	Q2	\$195,785	\$224,882	\$251,391	\$195,976
	Q3	\$116,613	\$50,363	\$194,601	\$102,731

First()	
\$160,877	0
\$197,213	-1
\$302,678	-2
\$297,208	-3
\$180,609	-4
\$195,785	-5
\$116,613	-6

Example

When the current row index is 3, `FIRST () = -2`.

INDEX()

Returns the index of the current row in the partition, without any sorting with regard to value. The first row index starts at 1. For example, the table below shows quarterly sales. When `INDEX()` is computed within the Date partition, the index of each row is 1, 2, 3, 4..., etc.

Year of Order Date	Quarter of Order Date	Region			
		Central	East	South	West
2009	Q1	\$160,877	\$231,411	\$133,934	\$185,961
	Q2	\$197,213	\$204,914	\$337,813	\$213,507
	Q3	\$302,678	\$165,201	\$283,806	\$206,512
	Q4	\$297,208	\$226,983	\$214,845	\$230,291
2010	Q1	\$180,609	\$180,123	\$273,943	\$251,145
	Q2	\$195,785	\$224,882	\$251,391	\$195,976
	Q3	\$116,613	\$50,363	\$194,601	\$102,731

INDEX()	
\$160,877	1
\$197,213	2
\$302,678	3
\$297,208	4
\$180,609	5
\$195,785	6
\$116,613	7

Example

For the third row in the partition, `INDEX () = 3`.

LAST()

Returns the number of rows from the current row to the last row in the partition. For example, the table below shows quarterly sales. When `LAST()` is computed within the Date partition, the offset of the last row from the second row is 5.

Year of Order Date	Quarter of Order Date	Region			
		Central	East	South	West
2009	Q1	\$160,877	\$231,411	\$133,934	\$185,961
	Q2	\$197,213	\$204,914	\$337,813	\$213,507
	Q3	\$302,678	\$165,201	\$283,806	\$206,512
	Q4	\$297,208	\$226,983	\$214,845	\$230,291
2010	Q1	\$180,609	\$180,123	\$273,943	\$251,145
	Q2	\$195,785	\$224,882	\$251,391	\$195,976
	Q3	\$116,613	\$50,363	\$194,601	\$102,731

LAST()	
\$160,877	6
\$197,213	5
\$302,678	4
\$297,208	3
\$180,609	2
\$195,785	1
\$116,613	0

Example

When the current row index is 3 of 7, `LAST()` = 4.

LOOKUP(expression, [offset])

Returns the value of the expression in a target row, specified as a relative offset from the current row. Use `FIRST() + n` and `LAST() - n` as part of your offset definition for a target relative to the first/last rows in the partition. If `offset` is omitted, the row to compare to can be set on the field menu. This function returns NULL if the target row cannot be determined.

The view below shows quarterly sales. When `LOOKUP (SUM(Sales), 2)` is computed within the Date partition, each row shows the sales value from 2 quarters into the future.

Year of Order Date	Quarter of Order Date	Region			
		Central	East	South	West
2009	Q1	\$160,877	\$231,411	\$133,934	\$185,961
	Q2	\$197,213	\$204,914	\$337,813	\$213,507
	Q3	\$302,678	\$165,201	\$283,806	\$206,512
	Q4	\$297,208	\$226,983	\$214,845	\$230,291
2010	Q1	\$180,609	\$180,123	\$273,943	\$251,145
	Q2	\$195,785	\$224,882	\$251,391	\$195,976
	Q3	\$116,613	\$50,363	\$194,601	\$102,731

Year of Order Date	Quarter of Order Date	Region			
		Central	East	South	West
2009	Q1	\$302,678	\$165,201	\$283,806	\$206,512
	Q2	\$297,208	\$226,983	\$214,845	\$230,291
	Q3	\$180,609	\$180,123	\$273,943	\$251,145
	Q4	\$195,785	\$224,882	\$251,391	\$195,976
2010	Q1	\$116,613	\$50,363	\$194,601	\$102,731
	Q2				
	Q3				

Example

LOOKUP(SUM([Profit]), FIRST()+2) computes the SUM(Profit) in the third row of the partition.

MODEL_EXTENSION functions

The model extension functions:

- MODEL_EXTENSION_BOOL
- MODEL_EXTENSION_INT
- MODEL_EXTENSION_REAL
- MODEL_EXTENSION_STRING

are used to pass data to a deployed model on an external service such as R, TabPy, or Matlab. See [Analytics Extensions](#).

MODEL_PERCENTILE(target_expression, predictor_expression(s))

Returns the probability (between 0 and 1) of the expected value being less than or equal to the observed mark, defined by the target expression and other predictors. This is the Posterior Predictive Distribution Function, also known as the Cumulative Distribution Function (CDF).

This function is the inverse of MODEL_QUANTILE. For information on predictive modeling functions, see [How Predictive Modeling Functions Work in Tableau on page 2571](#).

Example

The following formula returns the quantile of the mark for sum of sales, adjusted for count of orders.

```
MODEL_PERCENTILE(SUM([Sales]), COUNT([Orders]))
```

MODEL_QUANTILE(quantile, target_expression, predictor_expression(s))

Returns a target numeric value within the probable range defined by the target expression and other predictors, at a specified quantile. This is the Posterior Predictive Quantile.

This function is the inverse of MODEL_PERCENTILE. For information on predictive modeling functions, see [How Predictive Modeling Functions Work in Tableau on page 2571](#).

Example

The following formula returns the median (0.5) predicted sum of sales, adjusted for count of orders.

```
MODEL_QUANTILE(0.5, SUM([Sales]), COUNT([Orders]))
```

PREVIOUS_VALUE(expression)

Returns the value of this calculation in the previous row. Returns the given expression if the current row is the first row of the partition.

Example

`SUM([Profit]) * PREVIOUS_VALUE(1)` computes the running product of `SUM(Profit)`.

RANK(expression, ['asc' | 'desc'])

Returns the standard competition rank for the current row in the partition. Identical values are assigned an identical rank. Use the optional 'asc' | 'desc' argument to specify ascending or descending order. The default is descending.

With this function, the set of values (6, 9, 9, 14) would be ranked (4, 2, 2, 1).

Nulls are ignored in ranking functions. They are not numbered and they do not count against the total number of records in percentile rank calculations.

For information on different ranking options, see [Rank calculation on page 2388](#).

Example

The following image shows the effect of the various ranking functions (RANK, RANK_DENSE, RANK_MODIFIED, RANK_PERCENTILE, and RANK_UNIQUE) on a set of values. The data set contains information on 14 students (Student A through Student N); the **Age** column shows the current age of each student (all students are between 17 and 20 years of age). The remaining columns show the effect of each rank function on the set of age values, always assuming the default order (ascending or descending) for the function.

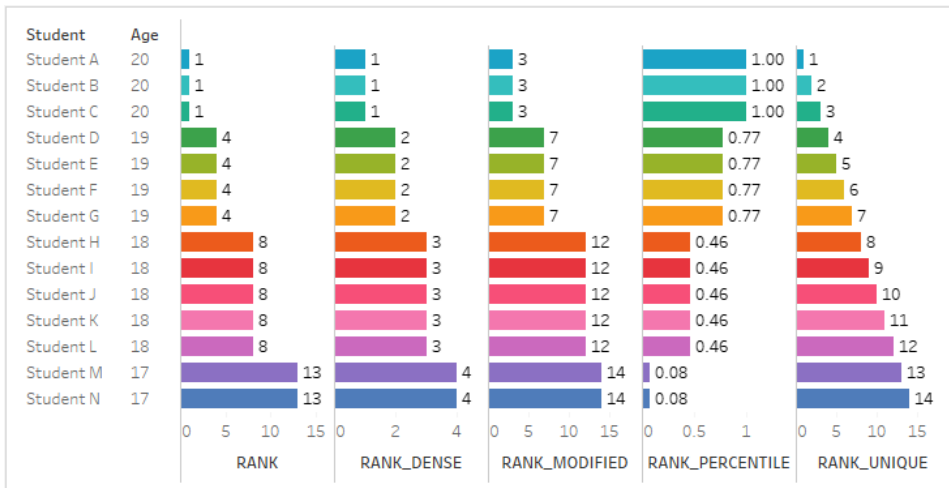

RANK_DENSE(expression, ['asc' | 'desc'])

Returns the dense rank for the current row in the partition. Identical values are assigned an identical rank, but no gaps are inserted into the number sequence. Use the optional 'asc' | 'desc' argument to specify ascending or descending order. The default is descending.

With this function, the set of values (6, 9, 9, 14) would be ranked (3, 2, 2, 1).

Nulls are ignored in ranking functions. They are not numbered and they do not count against the total number of records in percentile rank calculations.

For information on different ranking options, see [Rank calculation on page 2388](#).

RANK_MODIFIED(expression, ['asc' | 'desc'])

Returns the modified competition rank for the current row in the partition. Identical values are assigned an identical rank. Use the optional 'asc' | 'desc' argument to specify ascending or descending order. The default is descending.

With this function, the set of values (6, 9, 9, 14) would be ranked (4, 3, 3, 1).

Nulls are ignored in ranking functions. They are not numbered and they do not count against the total number of records in percentile rank calculations.

For information on different ranking options, see [Rank calculation on page 2388](#).

RANK_PERCENTILE(expression, ['asc' | 'desc'])

Returns the percentile rank for the current row in the partition. Use the optional 'asc' | 'desc' argument to specify ascending or descending order. The default is ascending.

With this function, the set of values (6, 9, 9, 14) would be ranked (0.00, 0.67, 0.67, 1.00).

Nulls are ignored in ranking functions. They are not numbered and they do not count against the total number of records in percentile rank calculations.

For information on different ranking options, see [Rank calculation on page 2388](#).

RANK_UNIQUE(expression, ['asc' | 'desc'])

Returns the unique rank for the current row in the partition. Identical values are assigned different ranks. Use the optional 'asc' | 'desc' argument to specify ascending or descending order. The default is descending.

With this function, the set of values (6, 9, 9, 14) would be ranked (4, 2, 3, 1).

Nulls are ignored in ranking functions. They are not numbered and they do not count against the total number of records in percentile rank calculations.

For information on different ranking options, see [Rank calculation on page 2388](#).

RUNNING_AVG(expression)

Returns the running average of the given expression, from the first row in the partition to the current row.

The view below shows quarterly sales. When `RUNNING_AVG(SUM([Sales]))` is computed within the Date partition, the result is a running average of the sales values for each quarter.

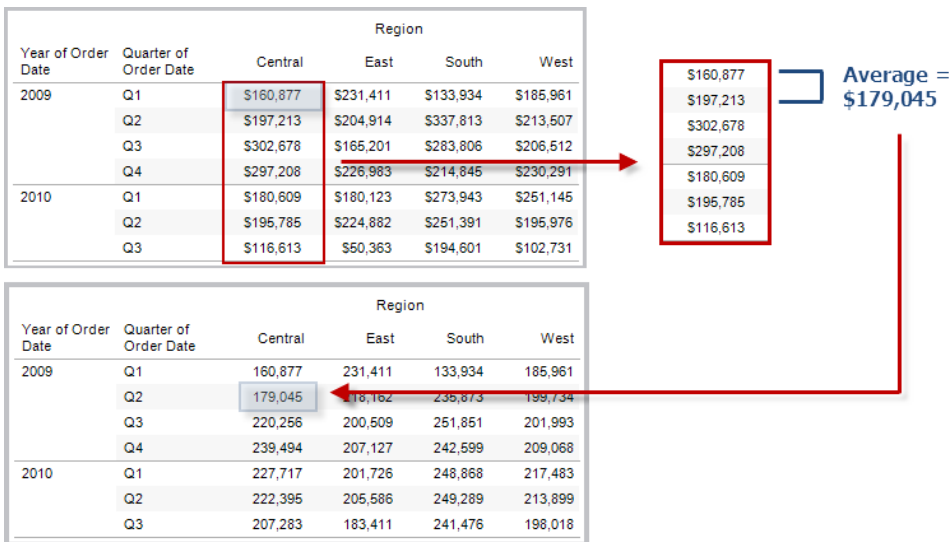

Example

`RUNNING_AVG(SUM([Profit]))` computes the running average of `SUM(Profit)`.

RUNNING_COUNT(expression)

Returns the running count of the given expression, from the first row in the partition to the current row.

Example

`RUNNING_COUNT(SUM([Profit]))` computes the running count of `SUM(Profit)`.

RUNNING_MAX(expression)

Returns the running maximum of the given expression, from the first row in the partition to the current row.

Year of Order Date	Quarter of Order Date	Region			
		Central	East	South	West
2009	Q1	\$160,877	\$231,411	\$133,934	\$185,961
	Q2	\$197,213	\$204,914	\$337,813	\$213,507
	Q3	\$302,678	\$165,201	\$283,806	\$206,512
	Q4	\$297,208	\$226,983	\$214,845	\$230,291
2010	Q1	\$180,609	\$180,123	\$273,943	\$251,145
	Q2	\$195,785	\$224,882	\$251,391	\$195,976
	Q3	\$116,613	\$50,363	\$194,601	\$102,731

Year of Order Date	Quarter of Order Date	Central	East	South	West
2009	Q1	160,877	231,411	133,934	185,961
	Q2	197,213	231,411	337,813	213,507
	Q3	302,678	165,201	283,806	206,512
	Q4	297,208	226,983	214,845	230,291
2010	Q1	180,609	180,123	273,943	251,145
	Q2	195,785	224,882	251,391	195,976
	Q3	116,613	50,363	194,601	102,731

\$160,877
\$197,213
\$302,678
\$297,208
\$180,609
\$195,785
\$116,613

Max = \$302,678

Example

`RUNNING_MAX(SUM([Profit]))` computes the running maximum of `SUM(Profit)`.

RUNNING_MIN(expression)

Returns the running minimum of the given expression, from the first row in the partition to the current row.

Year of Order Date	Quarter of Order Date	Region			
		Central	East	South	West
2009	Q1	\$160,877	\$231,411	\$133,934	\$185,961
	Q2	\$197,213	\$204,914	\$337,813	\$213,507
	Q3	\$302,678	\$165,201	\$283,806	\$206,512
	Q4	\$297,208	\$226,983	\$214,845	\$230,291
2010	Q1	\$180,609	\$180,123	\$273,943	\$251,145
	Q2	\$195,785	\$224,882	\$251,391	\$195,976
	Q3	\$116,613	\$50,363	\$194,601	\$102,731

Year of Order Date	Quarter of Order Date	Region			
		Central	East	South	West
2009	Q1	160,877	231,411	133,934	185,961
	Q2	160,877	204,914	133,934	185,961
	Q3	160,877	165,201	133,934	185,961
	Q4	160,877	165,201	133,934	185,961
2010	Q1	160,877	165,201	133,934	185,961
	Q2	160,877	165,201	133,934	185,961
	Q3	116,613	50,363	133,934	102,731

Example

`RUNNING_MIN(SUM([Profit]))` computes the running minimum of `SUM(Profit)`.

RUNNING_SUM(expression)

Returns the running sum of the given expression, from the first row in the partition to the current row.

Year of Order Date	Quarter of Order Date	Region			
		Central	East	South	West
2009	Q1	\$160,877	\$231,411	\$133,934	\$185,961
	Q2	\$197,213	\$204,914	\$337,813	\$213,507
	Q3	\$302,678	\$165,201	\$283,806	\$206,512
	Q4	\$297,208	\$226,983	\$214,845	\$230,291
2010	Q1	\$180,609	\$180,123	\$273,943	\$251,145
	Q2	\$195,785	\$224,882	\$251,391	\$195,976
	Q3	\$116,613	\$50,363	\$194,601	\$102,731

Year of Order Date	Quarter of Order Date	Region			
		Central	East	South	West
2009	Q1	160,877	231,411	133,934	185,961
	Q2	358,090	436,325	471,747	399,469
	Q3	660,768	11,526	755,559	605,980
	Q4	957,976	828,508	970,398	836,272
2010	Q1	1,138,585	1,008,631	1,244,341	1,087,417
	Q2	1,334,369	1,233,513	1,495,732	1,283,392
	Q3	1,450,982	1,283,877	1,690,333	1,386,123

Example

`RUNNING_SUM(SUM([Profit]))` computes the running sum of `SUM(Profit)`

SIZE()

Returns the number of rows in the partition. For example, the view below shows quarterly sales. Within the Date partition, there are seven rows so the `Size()` of the Date partition is 7.

Year of Order Date	Quarter of Order Date	Region			
		Central	East	South	West
2009	Q1	\$160,877	\$231,411	\$133,934	\$185,961
	Q2	\$197,213	\$204,914	\$337,813	\$213,507
	Q3	\$302,678	\$165,201	\$283,806	\$206,512
	Q4	\$297,208	\$226,983	\$214,845	\$230,291
2010	Q1	\$180,609	\$180,123	\$273,943	\$251,145
	Q2	\$195,785	\$224,882	\$251,391	\$195,976
	Q3	\$116,613	\$50,363	\$194,601	\$102,731

Example

`SIZE()` = 5 when the current partition contains five rows.

SCRIPT_ functions

The script functions:

- `SCRIPT_BOOL`
- `SCRIPT_INT`
- `SCRIPT_REAL`
- `SCRIPT_STRING`

are used to pass data to an external service such as R, TabPy, or Matlab. See [Analytics Extensions](#).

TOTAL(expression)

Returns the total for the given expression in a table calculation partition.

Example

Assume you are starting with this view:

The screenshot shows the Tableau Desktop interface. The Columns shelf contains 'Region'. The Rows shelf contains 'YEAR(Order Date)' and 'QUARTER(Order Date)'. The Marks shelf is set to 'SUM(Sales)'. The view displays a pivot table with the following data:

Year of Orde..	Quarter of O..	Region			
		Central	East	South	West
2011	Q1	\$8,601	\$6,579	\$44,262	\$15,006
	Q2	\$17,407	\$21,064	\$22,524	\$25,543
	Q3	\$44,171	\$33,443	\$16,061	\$49,957
	Q4	\$33,659	\$67,594	\$20,998	\$57,377
2012	Q1	\$11,768	\$17,146	\$16,444	\$23,493
	Q2	\$23,979	\$22,703	\$16,254	\$26,188
	Q3	\$24,486	\$50,777	\$21,460	\$33,537
	Q4	\$42,641	\$65,706	\$17,202	\$56,748
2013	Q1	\$20,212	\$24,134	\$23,934	\$24,317
	Q2	\$25,709	\$52,807	\$17,079	\$39,774
	Q3	\$33,428	\$37,528	\$22,939	\$50,720
	Q4	\$68,080	\$66,060	\$29,588	\$72,165
2014	Q1	\$40,278	\$17,341	\$9,882	\$51,395
	Q2	\$26,606	\$29,978	\$33,137	\$44,302
	Q3	\$34,042	\$67,712	\$23,894	\$74,786
	Q4	\$46,172	\$98,209	\$56,064	\$80,150

You open the calculation editor and create a new field which you name **Totality**:

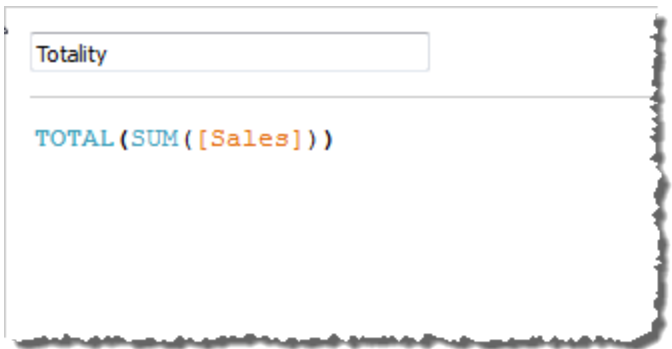

You then drop **Totality** on Text, to replace **SUM(Sales)**. Your view changes such that it sums values based on the default **Compute Using** value:

		Region			
Year of Orde..	Quarter of O..	Central	East	South	West
2011	Q1	74,448	74,448	74,448	74,448
	Q2	86,539	86,539	86,539	86,539
	Q3	143,633	143,633	143,633	143,633
	Q4	179,628	179,628	179,628	179,628
2012	Q1	68,852	68,852	68,852	68,852
	Q2	89,124	89,124	89,124	89,124
	Q3	130,260	130,260	130,260	130,260
	Q4	182,297	182,297	182,297	182,297
2013	Q1	92,596	92,596	92,596	92,596
	Q2	135,370	135,370	135,370	135,370
	Q3	144,614	144,614	144,614	144,614
	Q4	235,893	235,893	235,893	235,893
2014	Q1	118,896	118,896	118,896	118,896
	Q2	134,023	134,023	134,023	134,023
	Q3	200,433	200,433	200,433	200,433
	Q4	280,595	280,595	280,595	280,595

This raises the question, What is the default **Compute Using** value? If you right-click (Control-click on a Mac) **Totality** in the Data pane and choose **Edit**, there is now an additional bit of information available:

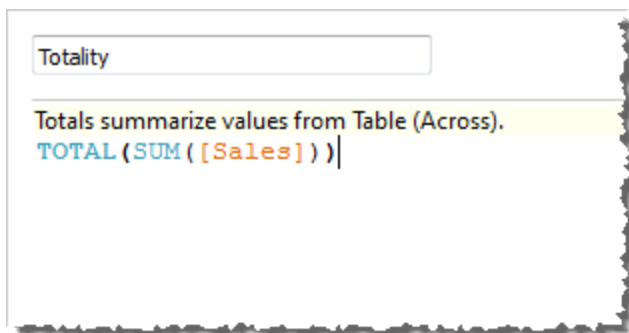

The default **Compute Using** value is **Table (Across)**. The result is that **Totality** is summing the values across each row of your table. Thus, the value that you see across each row is the sum of the values from the original version of the table.

The values in the 2011/Q1 row in the original table were \$8601, \$6579, \$44262, and \$15006. The values in the table after **Totality** replaces **SUM(Sales)** are all \$74,448, which is the sum of the four original values.

Notice the triangle next to **Totality** after you drop it on **Text**:

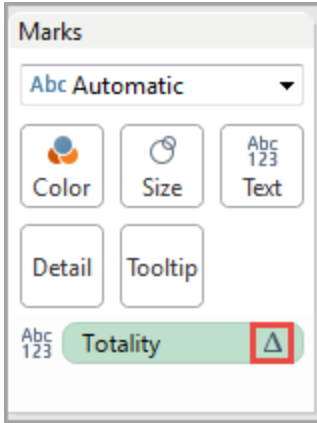

This indicates that this field is using a table calculation. You can right-click the field and choose **Edit Table Calculation** to redirect your function to a different **Compute Using** value. For example, you could set it to **Table (Down)**. In that case, your table would look like this:

The image shows a Tableau dashboard with a table. The Columns shelf contains 'Region' and the Rows shelf contains 'YEAR(Order Date)' and 'QUARTER(Order Date)'. The table displays sales data by year and quarter, broken down by region. The 'Totality' pill is visible in the Marks card on the left.

Year of Orde..	Quarter of O..	Region			
		Central	East	South	West
2011	Q1	501,240	678,781	391,722	725,458
	Q2	501,240	678,781	391,722	725,458
	Q3	501,240	678,781	391,722	725,458
	Q4	501,240	678,781	391,722	725,458
2012	Q1	501,240	678,781	391,722	725,458
	Q2	501,240	678,781	391,722	725,458
	Q3	501,240	678,781	391,722	725,458
	Q4	501,240	678,781	391,722	725,458
2013	Q1	501,240	678,781	391,722	725,458
	Q2	501,240	678,781	391,722	725,458
	Q3	501,240	678,781	391,722	725,458
	Q4	501,240	678,781	391,722	725,458
2014	Q1	501,240	678,781	391,722	725,458
	Q2	501,240	678,781	391,722	725,458
	Q3	501,240	678,781	391,722	725,458
	Q4	501,240	678,781	391,722	725,458

TOTAL(expression)

Returns the total for the given expression in a table calculation partition.

Example

Assume you are starting with this view:

The screenshot shows the Tableau Desktop interface. The Columns shelf contains 'Region' and the Rows shelf contains 'YEAR(Order Date)' and 'QUARTER(Order Date)'. The Marks shelf is set to 'SUM(Sales)'. The main view displays a pivot table with the following data:

Year of Order	Quarter of Order	Region			
		Central	East	South	West
2011	Q1	\$8,601	\$6,579	\$44,262	\$15,006
	Q2	\$17,407	\$21,064	\$22,524	\$25,543
	Q3	\$44,171	\$33,443	\$16,061	\$49,957
	Q4	\$33,659	\$67,594	\$20,998	\$57,377
2012	Q1	\$11,768	\$17,146	\$16,444	\$23,493
	Q2	\$23,979	\$22,703	\$16,254	\$26,188
	Q3	\$24,486	\$50,777	\$21,460	\$33,537
	Q4	\$42,641	\$65,706	\$17,202	\$56,748
2013	Q1	\$20,212	\$24,134	\$23,934	\$24,317
	Q2	\$25,709	\$52,807	\$17,079	\$39,774
	Q3	\$33,428	\$37,528	\$22,939	\$50,720
	Q4	\$68,080	\$66,060	\$29,588	\$72,165
2014	Q1	\$40,278	\$17,341	\$9,882	\$51,395
	Q2	\$26,606	\$29,978	\$33,137	\$44,302
	Q3	\$34,042	\$67,712	\$23,894	\$74,786
	Q4	\$46,172	\$98,209	\$56,064	\$80,150

You open the calculation editor and create a new field which you name **Totality**:

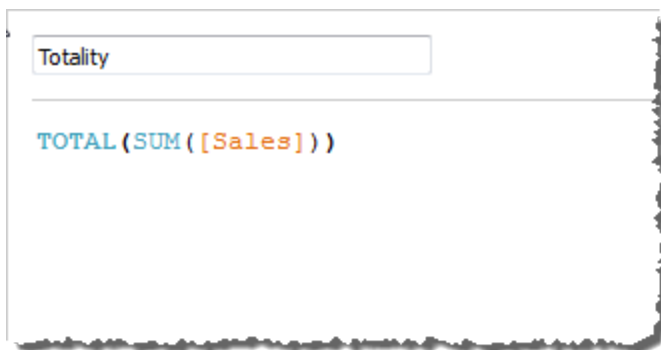

You then drop **Totality** on Text, to replace **SUM(Sales)**. Your view changes such that it sums values based on the default **Compute Using** value:

		Region			
Year of Orde..	Quarter of O..	Central	East	South	West
2011	Q1	74,448	74,448	74,448	74,448
	Q2	86,539	86,539	86,539	86,539
	Q3	143,633	143,633	143,633	143,633
	Q4	179,628	179,628	179,628	179,628
2012	Q1	68,852	68,852	68,852	68,852
	Q2	89,124	89,124	89,124	89,124
	Q3	130,260	130,260	130,260	130,260
	Q4	182,297	182,297	182,297	182,297
2013	Q1	92,596	92,596	92,596	92,596
	Q2	135,370	135,370	135,370	135,370
	Q3	144,614	144,614	144,614	144,614
	Q4	235,893	235,893	235,893	235,893
2014	Q1	118,896	118,896	118,896	118,896
	Q2	134,023	134,023	134,023	134,023
	Q3	200,433	200,433	200,433	200,433
	Q4	280,595	280,595	280,595	280,595

This raises the question, What is the default **Compute Using** value? If you right-click (Control-click on a Mac) **Totality** in the Data pane and choose **Edit**, there is now an additional bit of information available:

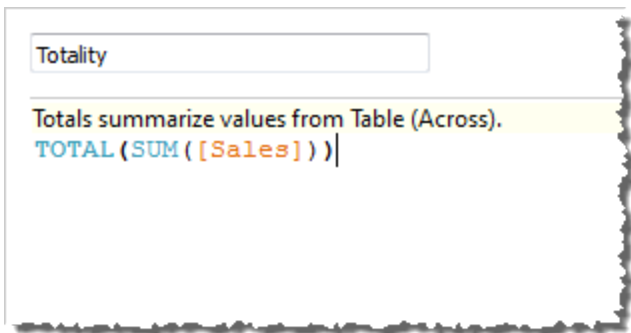

The default **Compute Using** value is **Table (Across)**. The result is that **Totality** is summing the values across each row of your table. Thus, the value that you see across each row is the sum of the values from the original version of the table.

The values in the 2011/Q1 row in the original table were \$8601, \$6579, \$44262, and \$15006. The values in the table after **Totality** replaces **SUM(Sales)** are all \$74,448, which is the sum of the four original values.

Notice the triangle next to **Totality** after you drop it on **Text**:

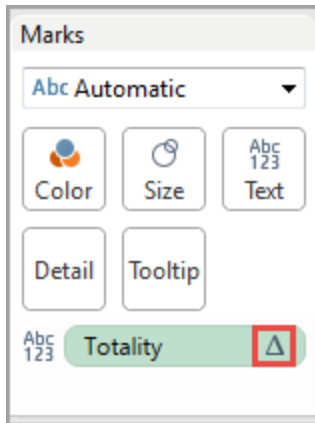

This indicates that this field is using a table calculation. You can right-click the field and choose **Edit Table Calculation** to redirect your function to a different **Compute Using** value. For example, you could set it to **Table (Down)**. In that case, your table would look like this:

 A screenshot of a Tableau view showing a table. The Columns shelf contains 'Region' and the Rows shelf contains 'YEAR(Order Date)' and 'QUARTER(Order Date)'. The table displays sales data for four years (2011-2014) across four quarters (Q1-Q4) for four regions (Central, East, South, West). The 'Totality' field from the previous image is visible in the Marks card on the left.

Year of Orde..	Quarter of O..	Region			
		Central	East	South	West
2011	Q1	501,240	678,781	391,722	725,458
	Q2	501,240	678,781	391,722	725,458
	Q3	501,240	678,781	391,722	725,458
	Q4	501,240	678,781	391,722	725,458
2012	Q1	501,240	678,781	391,722	725,458
	Q2	501,240	678,781	391,722	725,458
	Q3	501,240	678,781	391,722	725,458
	Q4	501,240	678,781	391,722	725,458
2013	Q1	501,240	678,781	391,722	725,458
	Q2	501,240	678,781	391,722	725,458
	Q3	501,240	678,781	391,722	725,458
	Q4	501,240	678,781	391,722	725,458
2014	Q1	501,240	678,781	391,722	725,458
	Q2	501,240	678,781	391,722	725,458
	Q3	501,240	678,781	391,722	725,458
	Q4	501,240	678,781	391,722	725,458

WINDOW_CORR(expression1, expression2, [start, end])

Returns the Pearson correlation coefficient of two expressions within the window. The window is defined as offsets from the current row. Use FIRST()+n and LAST()-n for offsets from the first or last row in the partition. If start and end are omitted, the entire partition is used.

The Pearson correlation measures the linear relationship between two variables. Results range from -1 to +1 inclusive, where 1 denotes an exact positive linear relationship, as when a positive

change in one variable implies a positive change of corresponding magnitude in the other, 0 denotes no linear relationship between the variance, and -1 is an exact negative relationship.

There is an equivalent aggregation function: CORR. See [Tableau Functions \(Alphabetical\)](#) on page 2300.

Example

The following formula returns the Pearson correlation of **SUM(Profit)** and **SUM(Sales)** from the five previous rows to the current row.

```
WINDOW_CORR(SUM([Profit]), SUM([Sales]), -5, 0)
```

WINDOW_COUNT(expression, [start, end])

Returns the count of the expression within the window. The window is defined by means of offsets from the current row. Use FIRST()+n and LAST()-n for offsets from the first or last row in the partition. If the start and end are omitted, the entire partition is used.

Example

`WINDOW_COUNT(SUM([Profit]), FIRST()+1, 0)` computes the count of SUM(Profit) from the second row to the current row

WINDOW_COVAR(expression1, expression2, [start, end])

Returns the *sample covariance* of two expressions within the window. The window is defined as offsets from the current row. Use FIRST()+n and LAST()-n for offsets from the first or last row in the partition. If the start and end arguments are omitted, the window is the entire partition.

Sample covariance uses the number of non-null data points $n - 1$ to normalize the covariance calculation, rather than n , which is used by the population covariance (with the WINDOW_COVARP function). Sample covariance is the appropriate choice when the data is a random sample that is being used to estimate the covariance for a larger population.

There is an equivalent aggregation function: COVAR. See [Tableau Functions \(Alphabetical\)](#) on page 2300.

Example

The following formula returns the sample covariance of **SUM(Profit)** and **SUM(Sales)** from the two previous rows to the current row.

```
WINDOW_COVAR(SUM([Profit]), SUM([Sales]), -2, 0)
```

WINDOW_COVARP(expression1, expression2, [start, end])

Returns the *population covariance* of two expressions within the window. The window is defined as offsets from the current row. Use FIRST()+n and LAST()-n for offsets from the first or last row in the partition. If start and end are omitted, the entire partition is used.

Population covariance is sample covariance multiplied by $(n-1)/n$, where n is the total number of non-null data points. Population covariance is the appropriate choice when there is data available for all items of interest as opposed to when there is only a random subset of items, in which case sample covariance (with the WINDOW_COVAR function) is appropriate.

There is an equivalent aggregation function: COVARP. [Tableau Functions \(Alphabetical\) on page 2300](#).

Example

The following formula returns the population covariance of **SUM(Profit)** and **SUM(Sales)** from the two previous rows to the current row.

```
WINDOW_COVARP(SUM([Profit]), SUM([Sales]), -2, 0)
```

WINDOW_MEDIAN(expression, [start, end])

Returns the median of the expression within the window. The window is defined by means of offsets from the current row. Use FIRST()+n and LAST()-n for offsets from the first or last row in the partition. If the start and end are omitted, the entire partition is used.

For example, the view below shows quarterly profit. A window median within the Date partition returns the median profit across all dates.

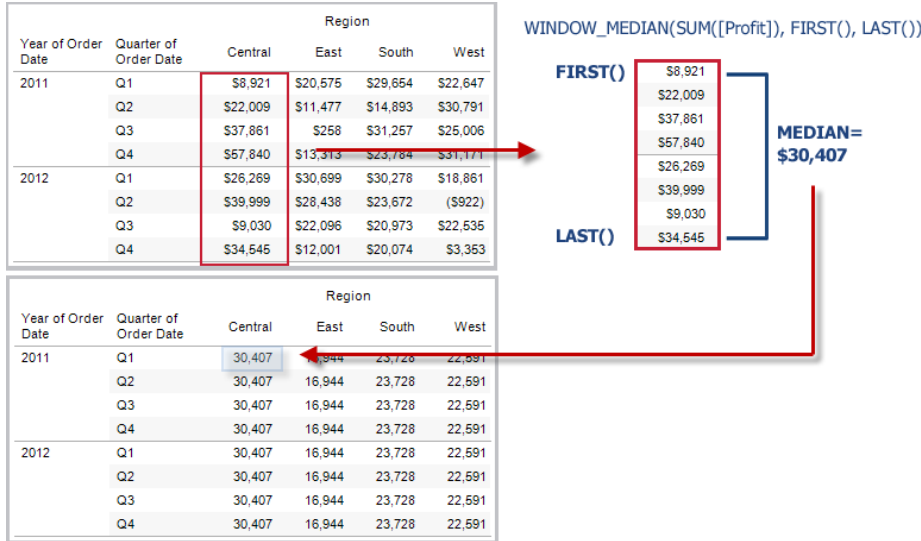

Example

WINDOW_MEDIAN(SUM([Profit]), FIRST()+1, 0) computes the median of SUM(Profit) from the second row to the current row.

WINDOW_MAX(expression, [start, end])

Returns the maximum of the expression within the window. The window is defined by means of offsets from the current row. Use FIRST()+n and LAST()-n for offsets from the first or last row in the partition. If the start and end are omitted, the entire partition is used.

For example, the view below shows quarterly sales. A window maximum within the Date partition returns the maximum sales across all dates.

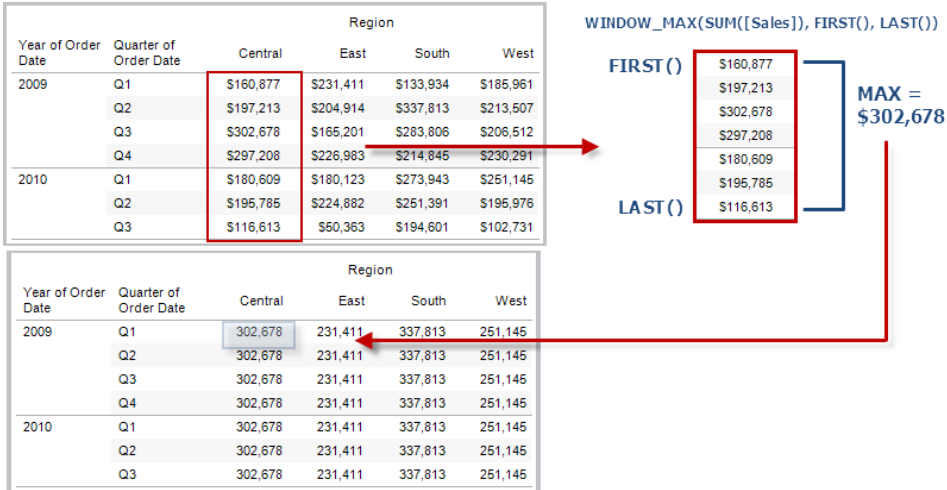

Example

`WINDOW_MAX(SUM([Profit]), FIRST()+1, 0)` computes the maximum of `SUM(Profit)` from the second row to the current row.

WINDOW_MIN(expression, [start, end])

Returns the minimum of the expression within the window. The window is defined by means of offsets from the current row. Use `FIRST()+n` and `LAST()-n` for offsets from the first or last row in the partition. If the start and end are omitted, the entire partition is used.

For example, the view below shows quarterly sales. A window minimum within the Date partition returns the minimum sales across all dates.

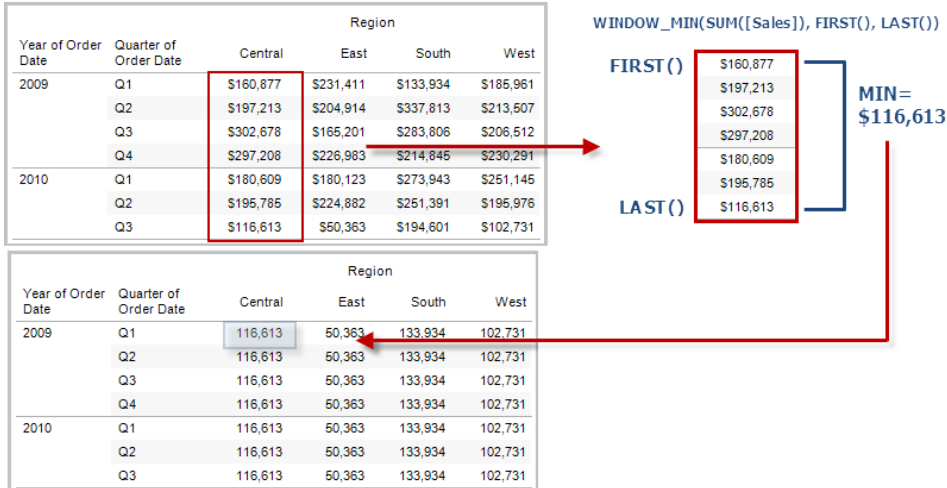

Example

`WINDOW_MIN(SUM([Profit]), FIRST()+1, 0)` computes the minimum of `SUM(Profit)` from the second row to the current row.

WINDOW_PERCENTILE(expression, number, [start, end])

Returns the value corresponding to the specified percentile within the window. The window is defined by means of offsets from the current row. Use `FIRST()+n` and `LAST()-n` for offsets from the first or last row in the partition. If the start and end are omitted, the entire partition is used.

Example

`WINDOW_PERCENTILE(SUM([Profit]), 0.75, -2, 0)` returns the 75th percentile for `SUM(Profit)` from the two previous rows to the current row.

WINDOW_STDEV(expression, [start, end])

Returns the sample standard deviation of the expression within the window. The window is defined by means of offsets from the current row. Use `FIRST()+n` and `LAST()-n` for offsets from the first or last row in the partition. If the start and end are omitted, the entire partition is used.

Example

`WINDOW_STDEV(SUM([Profit]), FIRST()+1, 0)` computes the standard deviation of `SUM(Profit)` from the second row to the current row.

WINDOW_STDEVP(expression, [start, end])

Returns the biased standard deviation of the expression within the window. The window is defined by means of offsets from the current row. Use `FIRST()+n` and `LAST()-n` for offsets from the first or last row in the partition. If the start and end are omitted, the entire partition is used.

Example

`WINDOW_STDEVP(SUM([Profit]), FIRST()+1, 0)` computes the standard deviation of `SUM(Profit)` from the second row to the current row.

WINDOW_SUM(expression, [start, end])

Returns the sum of the expression within the window. The window is defined by means of offsets from the current row. Use `FIRST()+n` and `LAST()-n` for offsets from the first or last row in the partition. If the start and end are omitted, the entire partition is used.

For example, the view below shows quarterly sales. A window sum computed within the Date partition returns the summation of sales across all quarters.

Year of Order Date	Quarter of Order Date	Region			
		Central	East	South	West
2009	Q1	\$160,877	\$231,411	\$133,934	\$185,961
	Q2	\$197,213	\$204,914	\$337,813	\$213,507
	Q3	\$302,678	\$165,201	\$283,806	\$206,512
	Q4	\$297,208	\$226,983	\$214,846	\$230,291
2010	Q1	\$180,609	\$180,123	\$273,943	\$251,145
	Q2	\$195,785	\$224,882	\$251,391	\$195,976
	Q3	\$116,613	\$50,363	\$194,601	\$102,731

WINDOW_SUM(SUM([Sales]), FIRST(), LAST())				
FIRST()	\$160,877	SUM= \$1,450,982		
	\$197,213			
	\$302,678			
	\$297,208			
	\$180,609			
LAST()	\$116,613			

Year of Order Date	Quarter of Order Date	Region			
		Central	East	South	West
2009	Q1	1,450,982	1,283,877	1,690,333	1,386,123
	Q2	1,450,982	1,283,877	1,690,333	1,386,123
	Q3	1,450,982	1,283,877	1,690,333	1,386,123
	Q4	1,450,982	1,283,877	1,690,333	1,386,123
2010	Q1	1,450,982	1,283,877	1,690,333	1,386,123
	Q2	1,450,982	1,283,877	1,690,333	1,386,123
	Q3	1,450,982	1,283,877	1,690,333	1,386,123

Example

`WINDOW_SUM(SUM([Profit]), FIRST()+1, 0)` computes the sum of `SUM(Profit)` from the second row to the current row.

WINDOW_VAR(expression, [start, end])

Returns the sample variance of the expression within the window. The window is defined by means of offsets from the current row. Use `FIRST()+n` and `LAST()-n` for offsets from the first or last row in the partition. If the start and end are omitted, the entire partition is used.

Example

`WINDOW_VAR((SUM([Profit])), FIRST()+1, 0)` computes the variance of `SUM(Profit)` from the second row to the current row.

WINDOW_VARP(expression, [start, end])

Returns the biased variance of the expression within the window. The window is defined by means of offsets from the current row. Use `FIRST()+n` and `LAST()-n` for offsets from the first or last row in the partition. If the start and end are omitted, the entire partition is used.

Example

`WINDOW_VARP(SUM([Profit]), FIRST()+1, 0)` computes the variance of `SUM(Profit)` from the second row to the current row.

Pass-Through functions (RAWSQL)

These RAWSQL pass-through functions can be used to send SQL expressions directly to the database, without first being interpreted by Tableau. If you have custom database functions that Tableau doesn't know about, you can use these pass-through functions to call these custom functions.

Your database usually will not understand the field names that are shown in Tableau. Because Tableau does not interpret the SQL expressions you include in the pass-through functions, using the Tableau field names in your expression may cause errors. You can use a substitution syntax

to insert the correct field name or expression for a Tableau calculation into pass-through SQL. For example, if you had a function that computed the median of a set of values, you could call that function on the Tableau column [Sales] like this:

```
RAWSQLAGG_REAL("MEDIAN(%1)", [Sales])
```

Because Tableau does not interpret the expression, you must define the aggregation. You can use the RAWSQLAGG functions described below when you are using aggregated expressions.

RAWSQL pass-through functions may not work with extracts or published data sources if they contain relationships.

RAWSQL Functions

The following RAWSQL functions are available in Tableau.

RAWSQL_BOOL("sql_expr", [arg1], ...[argN])

Returns a Boolean result from a given SQL expression. The SQL expression is passed directly to the underlying database. Use %n in the SQL expression as a substitution syntax for database values.

Example

In the example, %1 is equal to [Sales] and %2 is equal to [Profit].

```
RAWSQL_BOOL("IIF( %1 > %2, True, False)", [Sales], [Profit])
```

RAWSQL_DATE("sql_expr", [arg1], ...[argN])

Returns a Date result from a given SQL expression. The SQL expression is passed directly to the underlying database. Use %n in the SQL expression as a substitution syntax for database values.

Example

In this example, %1 is equal to [Order Date].

```
RAWSQL_DATE("%1", [Order Date])
```

RAWSQL_DATETIME("sql_expr", [arg1], ...[argN])

Returns a Date and Time result from a given SQL expression. The SQL expression is passed directly to the underlying database. Use %n in the SQL expression as a substitution syntax for database values. In this example, %1 is equal to [Delivery Date].

Example

```
RAWSQL_DATETIME("MIN(%1)", [Delivery Date])
```

RAWSQL_INT("sql_expr", [arg1], ...[argN])

Returns an integer result from a given SQL expression. The SQL expression is passed directly to the underlying database. Use %n in the SQL expression as a substitution syntax for database values. In this example, %1 is equal to [Sales].

Example

```
RAWSQL_INT("500 + %1", [Sales])
```

RAWSQL_REAL("sql_expr", [arg1], ...[argN])

Returns a numeric result from a given SQL expression that is passed directly to the underlying database. Use %n in the SQL expression as a substitution syntax for database values. In this example, %1 is equal to [Sales]

Example

```
RAWSQL_REAL("-123.98 * %1", [Sales])
```

RAWSQL_SPATIAL

Returns a Spatial from a given SQL expression that is passed directly to the underlying data source. Use %n in the SQL expression as a substitution syntax for database values.

Example

In this example, %1 is equal to [Geometry].

```
RAWSQL_SPATIAL("%1", [Geometry])
```

RAWSQL_STR("sql_expr", [arg1], ...[argN])

Returns a string from a given SQL expression that is passed directly to the underlying database. Use %n in the SQL expression as a substitution syntax for database values. In this example, %1 is equal to [Customer Name].

Example

```
RAWSQL_STR("%1", [Customer Name])
```

RAWSQLAGG_BOOL("sql_expr", [arg1], ...[argN])

Returns a Boolean result from a given aggregate SQL expression. The SQL expression is passed directly to the underlying database. Use %n in the SQL expression as a substitution syntax for database values.

Example

In the example, %1 is equal to [Sales] and %2 is equal to [Profit].

```
RAWSQLAGG_BOOL("SUM( %1) > SUM( %2)", [Sales], [Profit])
```

RAWSQLAGG_DATE("sql_expr", [arg1], ...[argN])

Returns a Date result from a given aggregate SQL expression. The SQL expression is passed directly to the underlying database. Use %n in the SQL expression as a substitution syntax for database values. In this example, %1 is equal to [Order Date].

Example

```
RAWSQLAGG_DATE("MAX(%1)", [Order Date])
```

RAWSQLAGG_DATETIME("sql_expr", [arg1], ...[argN])

Returns a Date and Time result from a given aggregate SQL expression. The SQL expression is passed directly to the underlying database. Use %n in the SQL expression as a substitution syntax for database values. In this example, %1 is equal to [Delivery Date].

Example

```
RAWSQLAGG_DATETIME("MIN(%1)", [Delivery Date])
```

RAWSQLAGG_INT("sql_expr", [arg1,] ...[argN])

Returns an integer result from a given aggregate SQL expression. The SQL expression is passed directly to the underlying database. Use %n in the SQL expression as a substitution syntax for database values. In this example, %1 is equal to [Sales].

Example

```
RAWSQLAGG_INT("500 + SUM(%1)", [Sales])
```

RAWSQLAGG_REAL("sql_expr", [arg1,] ...[argN])

Returns a numeric result from a given aggregate SQL expression that is passed directly to the underlying database. Use %n in the SQL expression as a substitution syntax for database values. In this example, %1 is equal to [Sales]

Example

```
RAWSQLAGG_REAL("SUM( %1)", [Sales])
```

RAWSQLAGG_STR("sql_expr", [arg1,] ...[argN])

Returns a string from a given aggregate SQL expression that is passed directly to the underlying database. Use %n in the SQL expression as a substitution syntax for database values. In this example, %1 is equal to [Discount].

Example

```
RAWSQLAGG_STR("AVG(%1)", [Discount])
```

Spatial functions

Spatial functions allow you to perform advanced spatial analysis and combine spatial files with data in other formats like text files or spreadsheets.

AREA

Syntax	<code>AREA(Spatial Polygon, 'units')</code>
Output	Number
Definition	Returns the total surface area of a <spatial polygon>.
Example	<code>AREA([Geometry], 'feet')</code>
Notes	Supported unit names (must be in quotation marks in the calculation, such as 'miles'): <ul style="list-style-type: none"> • <i>meters</i>: meters, metres, m • <i>kilometers</i>: kilometers, kilometres, km • <i>miles</i>: miles, mi • <i>feet</i>: feet, ft

BUFFER

Syntax	<code>BUFFER(Spatial Point, distance, 'units')</code> <code>BUFFER(Linestring, distance, 'units')</code> <ul style="list-style-type: none"> • <i>meters</i>: meters, metres, m • <i>kilometers</i>: kilometers, kilometres, km • <i>miles</i>: miles, mi • <i>feet</i>: feet, ft
Output	Geometry

Definition For spatial points, returns a polygon shape centered over a <spatial point>, with a radius determined by the <distance> and <unit> values.

For linestrings, computes the polygons formed by including all points within the radius distance from the linestring.

Example

```

BUFFER([Spatial Point Geometry], 25, 'mi')

BUFFER(MAKEPOINT(47.59, -122.32), 3, 'km')

BUFFER(MAKELINE(MAKEPOINT(0, 20), MAKEPOINT(30, 30)), 20, 'km')

```

Notes Supported unit names (must be in quotation marks in the calculation, such as 'miles'):

- *meters*: meters, metres, m
- *kilometers*: kilometers, kilometres, km
- *miles*: miles, mi
- *feet*: feet, ft

DIFFERENCE

Syntax `DIFFERENCE(Spatial, Spatial)`

Output Spatial Polygon

Definition Computes the portions of regions remaining when all regions in the second argument are carved out of the first argument in areas that overlap. Discards regions from the second argument in areas that don't overlap.

Example `DIFFERENCE(Spatial Polygon1, Spatial Polygon2)`

Notes Supports spatial polygons and multipolygons, not spatial points or lines.

DISTANCE

Syntax `DISTANCE(SpatialPoint1, SpatialPoint2, 'units')`

Output Number

Definition	Returns the distance measurement between two points in the specified <unit>.
Example	<code>DISTANCE([Origin Point],[Destination Point], 'km')</code>
Notes	Supported unit names (must be in quotation marks in the calculation, such as 'miles'): <ul style="list-style-type: none"> • <i>meters</i>: meters, metres, m • <i>kilometers</i>: kilometers, kilometres, km • <i>miles</i>: miles, mi • <i>feet</i>: feet, ft
Database limitations	This function can only be created with a live connection but will continue to work if the data source is converted to an extract.

INTERSECTION

Syntax	<code>INTERSECTION (spatial, spatial)</code>
Output	Polygon
Definition	Computes and returns the portions of regions in the second argument that overlap regions in the first argument.
Example	<code>INTERSECTION (Spatial Polygon1, Spatial Polygon2)</code>
Notes	Supports spatial polygons and multipolygons, not spatial points or lines.

INTERSECTS

Syntax	<code>INTERSECTS (geometry1, geometry2)</code>
Output	Boolean
Definition	Returns true or false indicating if two geometries overlap in space.
Notes	Supported combinations: point/polygon, line/polygon, and polygon/polygon.

MAKELINE

Syntax	<code>MAKELINE(SpatialPoint1, SpatialPoint2)</code>
Output	Geometry (line)
Definition	Generates a line mark between two points
Example	<code>MAKELINE(MAKEPOINT(47.59, -122.32), MAKEPOINT(48.5, -123.1))</code>
Notes	Useful for building origin-destination maps.

MAKEPOINT

Syntax	<code>MAKEPOINT(latitude, longitude, [SRID])</code>
Output	Geometry (point)
Definition	<p>Converts data from <latitude> and <longitude> columns into spatial objects.</p> <p>If the optional <SRID> argument is added, the inputs can be other projected geographic coordinates.</p>
Example	<pre>MAKEPOINT(48.5, -123.1) MAKEPOINT([AirportLatitude], [AirportLongitude]) MAKEPOINT([Xcoord], [Ycoord], 3493)</pre>
Notes	<p><code>MAKEPOINT</code> can't use the automatically generated latitude and longitude fields. The data source must contain the coordinates natively.</p> <p><code>SRID</code> is a spatial reference identifier that uses ESPG reference system codes to specify coordinate systems. If <code>SRID</code> is not specified, WGS84 is assumed and parameters are treated as latitude/longitude in degrees.</p> <p>You can use <code>MAKEPOINT</code> to spatially-enable a data source so that it can be joined with a spatial file using a spatial join. For more information, see Join Spatial Files in Tableau on page 1704.</p>

LENGTH

Syntax	<code>LENGTH(geometry, 'units')</code>
Output	Number
Definition	Returns the geodetic path length of the line string or strings in the <code><geometry></code> using the given <code><units></code> .
Example	<code>LENGTH([Spatial], 'metres')</code>
Notes	The result is <code><NaN></code> if the <code>geometry</code> argument has no linestrings, though other elements are permitted.

OUTLINE

Syntax	<code>OUTLINE(spatial polygon)</code>
Output	Geometry
Definition	Converts a polygon geometry into linestrings.
Notes	Useful for creating a separate layer for an outline that can be styled differently than the fill. Supports polygons within multipolygons.

SHAPETYPE

Syntax	<code>SHAPETYPE(geometry)</code>
Output	String
Definition	Returns a string describing the structure of the spatial <code><geometry></code> , such as <code>Empty</code> , <code>Point</code> , <code>MultiPoint</code> , <code>LineString</code> , <code>MultiLinestring</code> , <code>Polygon</code> , <code>MultiPolygon</code> , <code>Mixed</code> , and <code>unsupported</code> .
Example	<code>SHAPETYPE(MAKEPOINT(48.5, -123.1)) = "Point"</code>

SYMDIFFERENCE

Syntax	<code>SYMDIFFERENCE(spatial, spatial)</code>
Output	Geometry
Definition	Computes any portions of regions from the second argument that overlap regions in the first argument and discards from both. Returns the remaining portions of regions from both arguments.
Example	<code>SYMDIFFERENCE(Spatial Polygon1, Spatial Polygon2)</code>

VALIDATE

Syntax	<code>VALIDATE(spatial geometry)</code>
Output	Geometry
Definition	Confirms topological correctness of the geometry in your spatial value. If the value cannot be used for analysis due to problems such as a polygon's perimeter intersecting itself, then the result will be a null. If the geometry is correct, the result will be the original geometry.
Example	<code>UNION(VALIDATE([Geometry]))</code>

Additional functions

For more information, see [Pass-Through Functions \(RAWSQL\)](#).

- [Regular Expressions](#) below
- [Hadoop Hive Specific Functions](#) on page 2295
- [Google BigQuery Specific Functions](#) on page 2298

Regular Expressions

`REGEXP_REPLACE(string, pattern, replacement)`

Returns a copy of the given string where the regular expression pattern is replaced by the replacement string. This function is available for Text File, Hadoop Hive, Google BigQuery, PostgreSQL, Tableau Data Extract, Microsoft Excel, Salesforce, Vertica, Pivotal Greenplum, Teradata (version 14.1 and above), Snowflake, and Oracle data sources.

For Tableau data extracts, the pattern and the replacement must be constants.

For information on regular expression syntax, see your data source's documentation. For Tableau extracts, regular expression syntax conforms to the standards of the ICU (International Components for Unicode), an open source project of mature C/C++ and Java libraries for Unicode support, software internationalization, and software globalization. See the [Regular Expressions](#) page in the online ICU User Guide.

Example

```
REGEXP_REPLACE('abc 123', '\s', '-') = 'abc-123'
```

REGEXP_MATCH(string, pattern)

Returns true if a substring of the specified string matches the regular expression pattern. This function is available for Text File, Google BigQuery, PostgreSQL, Tableau Data Extract, Microsoft Excel, Salesforce, Vertica, Pivotal Greenplum, Teradata (version 14.1 and above), Impala 2.3.0 (through Cloudera Hadoop data sources), Snowflake, and Oracle data sources.

For Tableau data extracts, the pattern must be a constant.

For information on regular expression syntax, see your data source's documentation. For Tableau extracts, regular expression syntax conforms to the standards of the ICU (International Components for Unicode), an open source project of mature C/C++ and Java libraries for Unicode support, software internationalization, and software globalization. See the [Regular Expressions](#) page in the online ICU User Guide.

Example

```
REGEXP_MATCH('-([1234].[The.Market])-', '\[s*(\w*\.)\(\w*\s*\)')=true
```

REGEXP_EXTRACT(string, pattern)

Returns the portion of the string that matches the regular expression pattern. This function is available for Text File, Hadoop Hive, Google BigQuery, PostgreSQL, Tableau Data Extract, Microsoft Excel, Salesforce, Vertica, Pivotal Greenplum, Teradata (version 14.1 and above), Snowflake, and Oracle data sources.

For Tableau data extracts, the pattern must be a constant.

For information on regular expression syntax, see your data source's documentation. For Tableau extracts, regular expression syntax conforms to the standards of the ICU (International Components for Unicode), an open source project of mature C/C++ and Java libraries for Unicode support, software internationalization, and software globalization. See the [Regular Expressions](#) page in the online ICU User Guide.

Example

```
REGEXP_EXTRACT('abc 123', '[a-z]+\s+(\d+)') = '123'
```

REGEXP_EXTRACT_NTH(string, pattern, index)

Returns the portion of the string that matches the regular expression pattern. The substring is matched to the nth capturing group, where n is the given index. If index is 0, the entire string is returned. This function is available for Text File, PostgreSQL, Tableau Data Extract, Microsoft Excel, Salesforce, Vertica, Pivotal Greenplum, Teradata (version 14.1 and above), and Oracle data sources.

For Tableau data extracts, the pattern must be a constant.

For information on regular expression syntax, see your data source's documentation. For Tableau extracts, regular expression syntax conforms to the standards of the ICU (International Components for Unicode), an open source project of mature C/C++ and Java libraries for Unicode support, software internationalization, and software globalization. See the [Regular Expressions](#) page in the online ICU User Guide.

Example

```
REGEXP_EXTRACT_NTH('abc 123', '([a-z]+\s+(\d+))', 2) = '123'
```

Hadoop Hive Specific Functions

Note: Only the PARSE_URL and PARSE_URL_QUERY functions are available for Cloudera Impala data sources.

GET_JSON_OBJECT(JSON string, JSON path)

Returns the JSON object within the JSON string based on the JSON path.

PARSE_URL(string, url_part)

Returns a component of the given URL string where the component is defined by url_part. Valid url_part values include: 'HOST', 'PATH', 'QUERY', 'REF', 'PROTOCOL', 'AUTHORITY', 'FILE' and 'USERINFO'.

Example

```
PARSE_URL('http://www.tableau.com', 'HOST') = 'www.tableau.com'
```

PARSE_URL_QUERY(string, key)

Returns the value of the specified query parameter in the given URL string. The query parameter is defined by the key.

Example

```
PARSE_URL_QUERY('http://www.tableau.com?page=1&cat=4', 'page') = '1'
```

XPATH_BOOLEAN(XML string, XPath expression string)

Returns true if the XPath expression matches a node or evaluates to true.

Example

```
XPATH_BOOLEAN('<values> <value id="0">1</value><value id="1">5</value>', 'values/value [@id="1"] = 5') = true
```

XPATH_DOUBLE(XML string, XPath expression string)

Returns the floating-point value of the XPath expression.

Example

```
XPATH_DOUBLE('<values><value>1.0</value><value>5.5</value> </values>', 'sum(value/*)') = 6.5
```

XPATH_FLOAT(XML string, XPath expression string)

Returns the floating-point value of the XPath expression.

Example

```
XPATH_FLOAT('<values><value>1.0</value><value>5.5</value> </values>', 'sum(value/*)') = 6.5
```

XPATH_INT(XML string, XPath expression string)

Returns the numerical value of the XPath expression, or zero if the XPath expression cannot evaluate to a number.

Example

```
XPATH_INT('<values><value>1</value><value>5</value> </values>', 'sum(value/*)') = 6
```

XPATH_LONG(XML string, XPath expression string)

Returns the numerical value of the XPath expression, or zero if the XPath expression cannot evaluate to a number.

Example

```
XPATH_LONG('<values><value>1</value><value>5</value> </values>', 'sum(value/*)') = 6
```

XPATH_SHORT(XML string, XPath expression string)

Returns the numerical value of the XPath expression, or zero if the XPath expression cannot evaluate to a number.

Example

```
XPATH_SHORT('<values><value>1</value><value>5</value> </values>', 'sum(value/*)') = 6
```

XPATH_STRING(XML string, XPath expression string)

Returns the text of the first matching node.

Example

```
XPATH_STRING('<sites ><url domain="org">http://www.w3.org</url> <url domain="com">http://www.tableau.com</url></sites>', 'sites/url[@domain="com"]') = 'http://www.tableau.com'
```

Google BigQuery Specific Functions

DOMAIN(string_url)

Given a URL string, returns the domain as a string.

Example

```
DOMAIN('http://www.google.com:80/index.html') = 'google.com'
```

GROUP_CONCAT(expression)

Concatenates values from each record into a single comma-delimited string. This function acts like a SUM() for strings.

Example

```
GROUP_CONCAT(Region) = "Central,East,West"
```

HOST(string_url)

Given a URL string, returns the host name as a string.

Example

```
HOST('http://www.google.com:80/index.html') = 'www.google.com:80'
```

LOG2(number)

Returns the logarithm base 2 of a number.

Example

```
LOG2(16) = '4.00'
```

LTRIM_THIS(string, string)

Returns the first string with any leading occurrence of the second string removed.

Example

```
LTRIM_THIS('[-Sales-]', ['-']) = 'Sales-'
```

RTRIM_THIS(string, string)

Returns the first string with any trailing occurrence of the second string removed.

Example

```
RTRIM_THIS('[-Market-]', '-') = '[-Market'
```

TIMESTAMP_TO_USEC(expression)

Converts a TIMESTAMP data type to a UNIX timestamp in microseconds.

Example

```
TIMESTAMP_TO_USEC(#2012-10-01 01:02:03#)=1349053323000000
```

USEC_TO_TIMESTAMP(expression)

Converts a UNIX timestamp in microseconds to a TIMESTAMP data type.

Example

```
USEC_TO_TIMESTAMP(1349053323000000) = #2012-10-01 01:02:03#
```

TLD(string_url)

Given a URL string, returns the top level domain plus any country/region domain in the URL.

Example

```
TLD('http://www.google.com:80/index.html') = '.com'
```

```
TLD('http://www.google.co.uk:80/index.html') = '.co.uk'
```

Want to learn more about functions?

Read the [functions topics](#).

See also

[Tableau Functions \(Alphabetical\)](#) on the next page

Tableau Functions (Alphabetical)

The Tableau functions in this reference are organized alphabetically. Click a letter to jump to that location in the list. You can also use Ctrl+F (Command-F on a Mac) to open a search box to look for a specific function.

A B C D E F G H I J K L M N O P Q R S T U V W X Y Z

A

ABS

Syntax	<code>ABS (number)</code>
Output	Number (positive)
Definition	Returns the absolute value of the given <code><number></code> .
Example	<pre>ABS (-7) = 7 ABS ([Budget Variance])</pre> <p>The second example returns the absolute value for all the numbers contained in the Budget Variance field.</p>
Notes	See also SIGN on page 2351.

ACOS

Syntax	<code>ACOS (number)</code>
Output	Number (angle in radians)
Definition	Returns the arccosine (angle) of the given <code><number></code> .
Example	<code>ACOS (-1) = 3.14159265358979</code>
Notes	The inverse function, COS on page 2308, takes the angle in radians as the argument and returns the cosine.

AND

Syntax	<code><expr1> AND <expr2></code>
Definition	Performs a logical conjunction on two expressions. (If both sides are true, the logical test returns true.)
Output	Boolean
Example	<pre>IF [Season] = "Spring" AND "[Season] = "Fall" THEN "It's the apocalypse and footwear doesn't matter" END</pre>

"If both (Season = Spring) and (Season = Fall) are true simultaneously, then return It's the apocalypse and footwear doesn't matter."

Notes Often used with [IF on page 2325](#) and [IIF on page 2326](#). See also [NOT on page 2342](#) and [OR on page 2343](#).

If both expressions are `TRUE` (that is, not `FALSE` or `NULL`), then the result is `TRUE`. If either expression is `NULL`, then the result is `NULL`. In all other cases, the result is `FALSE`.

If you create a calculation in which the result of an `AND` comparison is displayed on a worksheet, Tableau displays `TRUE` and `FALSE`. If you would like to change this, use the Format area in the format dialog.

Note: The `AND` operator employs *short circuit evaluation*. This means that if the first expression is evaluated to be `FALSE`, then the second expression is not evaluated at all. This can be helpful if the second expression results in an error when the first expression is `FALSE`, because the second expression in this case is never evaluated.

AREA

Syntax	<code>AREA(Spatial Polygon, 'units')</code>
Output	Number

Definition	Returns the total surface area of a <code><spatial polygon></code> .
Example	<code>AREA([Geometry], 'feet')</code>
Notes	Supported unit names (must be in quotation marks in the calculation, such as 'miles'): <ul style="list-style-type: none">• <i>meters</i>: meters, metres, m• <i>kilometers</i>: kilometers, kilometres, km• <i>miles</i>: miles, mi• <i>feet</i>: feet, ft

ASCII

Syntax	<code>ASCII(string)</code>
Output	Number
Definition	Returns the ASCII code for the first character of a <code><string></code> .
Example	<code>ASCII('A') = 65</code>
Notes	This is the inverse of the <code>CHAR</code> function.

ASIN

Syntax	<code>ASIN(number)</code>
Output	Number (angle in radians)
Definition	Returns the arcsine (angle) of a given <code><number></code> .
Example	<code>ASIN(1) = 1.5707963267949</code>
Notes	The inverse function, SIN on page 2352, takes the angle in radians as the argument and returns the sine.

ATAN

Syntax	<code>ATAN (number)</code>
Output	Number (angle in radians)
Definition	Returns the arctangent (angle) of a given <code><number></code> .
Example	<code>ATAN(180) = 1.5652408283942</code>
Notes	The inverse function, <code>TAN</code> , takes the angle in radians as the argument and returns the tangent. See also ATAN2 below and COT on page 2308.

ATAN2

Syntax	<code>ATAN2 (y number, x number)</code>
Output	Number (angle in radians)
Definition	Returns the arctangent (angle) between two numbers (<code><y number></code> and <code><x number></code>). The result is in radians.
Example	<code>ATAN2(2, 1) = 1.10714871779409</code>
Notes	See also ATAN above, TAN on page 2355, and COT on page 2308.

ATTR

Syntax	<code>ATTR (expression)</code>
Definition	Returns the value of the <code><expression></code> if it has a single value for all rows. Otherwise returns an asterisk. Null values are ignored.

AVG

Syntax	<code>AVG (expression)</code>
--------	-------------------------------

Definition Returns the average of all the values in the `<expression>`. Null values are ignored.

Notes AVG can only be used with numeric fields.

[back to top](#)

B

BUFFER

Syntax `BUFFER(Spatial Point, distance, 'units')`

Output Geometry

Definition Returns a polygon shape centered over a `<spatial point>`, with a radius determined by the `<distance>` and `<unit>` values.

Example

```
BUFFER([Spatial Point Geometry], 25, 'mi')
BUFFER(MAKEPOINT(47.59, -122.32), 3, 'km')
```

Notes Supported unit names (must be in quotation marks in the calculation, such as `'miles'`):

- *meters*: meters, metres, m
- *kilometers*: kilometers, kilometres, km
- *miles*: miles, mi
- *feet*: feet, ft

[back to top](#)

C

CASE

Syntax

```
CASE <expression>
WHEN <value1> THEN <then1>
WHEN <value2> THEN <then2>
...
```

```
[ELSE <default>]
END
```

Output	Depends on data type of the <then> values.
Definition	Evaluates the <code>expression</code> and compares it to the specified options (<value1>, <value2>, etc.). When a <code>value</code> that matches <code>expression</code> is encountered, <code>CASE</code> returns the corresponding <code>return</code> . If no match is found, the (optional) default is returned. If there is no default and no values match, then Null is returned.
Example	<pre>CASE [Season] WHEN 'Summer' THEN 'Sandals' WHEN 'Winter' THEN 'Boots' ELSE 'Sneakers' END</pre> <p><i>"Look at the Season field. If the value is Summer, then return Sandals. If the value is Winter, then return Boots. If none of the options in the calculation match what is in the Season field, return a Sneakers."</i></p>
Notes	<p>See also IF on page 2325 and IIF on page 2326.</p> <p>Used with WHEN on page 2361, THEN on page 2356, ELSE on page 2317, and END on page 2319.</p> <p>Tip: Many times you can use a group to get the same results as a complicated CASE function, or use CASE to replace native grouping functionality, such as in the previous example. You may want to test which is more performant for your scenario.</p>

CEILING

Syntax	<code>CEILING (number)</code>
Output	Integer
Definition	Rounds a <number> to the nearest integer of equal or greater value.
Example	<code>CEILING (2.1) = 3</code>

Notes See also [FLOOR](#) on page 2322 and [ROUND](#) on page 2349.

Database limitations `CEILING` is available through the following connectors: Microsoft Excel, Text File, Statistical File, Published Data Source, Amazon EMR Hadoop Hive, Amazon Redshift, Cloudera Hadoop, DataStax Enterprise, Google Analytics, Google BigQuery, Hortonworks Hadoop Hive, MapR Hadoop Hive, Microsoft SQL Server, Salesforce, Spark SQL.

CHAR

Syntax `CHAR(number)`

Output String

Definition Returns the character encoded by the ASCII code `<number>`.

Example `CHAR(65) = 'A'`

Notes This is the inverse of the `ASCII` function.

COLLECT

Syntax `COLLECT(spatial)`

Definition An aggregate calculation that combines the values in the argument field. Null values are ignored.

Notes `COLLECT` can only be used with spatial fields.

CONTAINS

Syntax `CONTAINS(string, substring)`

Output Boolean

Definition Returns true if the given `<string>` contains the specified `<substring>`.

Example `CONTAINS("Calculation", "alcu") = true`

Notes See also the [logical function IN](#) as well as supported RegEx in the [additional functions documentation](#).

CORR

Syntax `CORR(expression1, expression2)`

Output Number from -1 to 1

Definition Returns the Pearson correlation coefficient of two expressions.

Example `example`

Notes The Pearson correlation measures the linear relationship between two variables. Results range from -1 to +1 inclusive, where 1 denotes an exact positive linear relationship, 0 denotes no linear relationship between the variance, and -1 is an exact negative relationship.

The square of a CORR result is equivalent to the R-Squared value for a linear trend line model. See [Trend Line Model Terms](#).

Use with table scoped LOD expressions:

You can use CORR to visualize correlation in a disaggregated scatter using a [table-scoped level of detail expression](#). For example:

```
{CORR(Sales, Profit)}
```

With a level of detail expression, the correlation is run over all rows. If you used a formula like `CORR(Sales, Profit)` (without the surrounding brackets to make it a level of detail expression), the view would show the correlation of each individual point in the scatter plot with each other point, which is undefined.

Database limitations `CORR` is available with the following data sources: Tableau data extracts, Cloudera Hive, EXASolution, Firebird (version 3.0 and later), Google BigQuery, Hortonworks Hadoop Hive, IBM PDA (Netezza), Oracle, PostgreSQL, Presto, SybaseIQ, Teradata, Vertica.

For other data sources, consider either extracting the data or using `WINDOW_CORR`. See [Table Calculation Functions](#).

COS

Syntax	<code>COS (number)</code> The number argument is the angle in radians.
Output	Number
Definition	Returns the cosine of an angle.
Example	<code>COS (PI () /4) = 0.707106781186548</code>
Notes	The inverse function, ACOS on page 2300, takes the cosine as the argument and returns the angle in radians. See also PI on page 2346.

COT

Syntax	<code>COT (number)</code> The number argument is the angle in radians.
Output	Number
Definition	Returns the cotangent of an angle.
Example	<code>COT (PI () /4) = 1</code>
Notes	See also ATAN on page 2303, TAN on page 2355, and PI on page 2346.

COUNT

Syntax	<code>COUNT (expression)</code>
Definition	Returns the number of items. Null values are not counted.

COUNTD

Syntax	<code>COUNTD(expression)</code>
Definition	Returns the number of distinct items in a group. Null values are not counted.

COVAR

Syntax	<code>COVAR(expression1, expression2)</code>
Definition	Returns the <i>sample</i> covariance of two expressions.
Notes	<p>Covariance quantifies how two variables change together. A positive covariance indicates that the variables tend to move in the same direction, as when larger values of one variable tend to correspond to larger values of the other variable, on average. <i>Sample covariance</i> uses the number of non-null data points $n - 1$ to normalize the covariance calculation, rather than n, which is used by the population covariance (available with the <code>COVARP</code> function). Sample covariance is the appropriate choice when the data is a random sample that is being used to estimate the covariance for a larger population.</p> <p>If <code><expression1></code> and <code><expression2></code> are the same, for example <code>COVAR([profit], [profit])</code>, <code>COVAR</code> returns a value that indicates how widely values are distributed.</p> <p>The value of <code>COVAR(X, X)</code> is equivalent to the value of <code>VAR(X)</code> and also to the value of <code>STDEV(X)^2</code>.</p>
Database limitations	<p><code>COVAR</code> is available with the following data sources: Tableau data extracts, Cloudera Hive, EXASolution, Firebird (version 3.0 and later), Google BigQuery, Hortonworks Hadoop Hive, IBM PDA (Netezza), Oracle, PostgreSQL, Presto, SybaseIQ, Teradata, Vertica.</p> <p>For other data sources, consider either extracting the data or using <code>WINDOW_COVAR</code>. See Table Calculation Functions.</p>

COVARP

Syntax	<code>COVARP(expression 1, expression2)</code>
Definition	Returns the <i>population</i> covariance of two expressions.
Notes	<p>Covariance quantifies how two variables change together. A positive covariance indicates that the variables tend to move in the same direction, as when larger values of one variable tend to correspond to larger values of the other variable, on average. <i>Population covariance</i> is sample covariance multiplied by $(n-1)/n$, where n is the total number of non-null data points. Population covariance is the appropriate choice when there is data available for all items of interest as opposed to when there is only a random subset of items, in which case sample covariance (with the <code>COVAR</code> function) is appropriate.</p> <p>If <code><expression1></code> and <code><expression2></code> are the same, for example <code>COVARP([profit], [profit])</code>, <code>COVARP</code> returns a value that indicates how widely values are distributed. Note: The value of <code>COVARP(X, X)</code> is equivalent to the value of <code>VARP(X)</code> and also to the value of <code>STDEVP(X)^2</code>.</p>
Database limitations	<p><code>COVARP</code> is available with the following data sources: Tableau data extracts, Cloudera Hive, EXASolution, Firebird (version 3.0 and later), Google BigQuery, Hortonworks Hadoop Hive, IBM PDA (Netezza), Oracle, PostgreSQL, Presto, SybaseIQ, Teradata, Vertica</p> <p>For other data sources, consider either extracting the data or using <code>WINDOW_COVAR</code>. See Table Calculation Functions.</p>

[back to top](#)

D

DATE

Type conversion function that changes string and number expressions into dates, as long as they are in a recognizable format.

Syntax	<code>DATE(expression)</code>
Output	Date
Definition	Returns a date given a number, string, or date <code><expression></code> .
Example	<pre>DATE([Employee Start Date]) DATE("September 22, 2018") DATE("9/22/2018") DATE(#2018-09-22 14:52#)</pre>
Notes	<p>Unlike DATEPARSE on page 2313, there is no need to provide a pattern as <code>DATE</code> automatically recognizes many standard date formats. If <code>DATE</code> does not recognize the input, however, try using <code>DATEPARSE</code> and specifying the format.</p> <p>MAKEDATE on page 2335 is another similar function, but <code>MAKEDATE</code> requires the input of numeric values for year, month, and day.</p>

DATEADD

Adds a specified number of date parts (months, days, etc) to the starting date.

Syntax	<code>DATEADD(date_part, interval, date)</code>
Output	Date
Definition	Returns the specified date with the specified number <code><interval></code> added to the specified <code>><date_part</code> of that date. For example, adding three months or 12 days to a starting date.
Example	<p>Push out all due dates by one week</p> <pre>DATEADD('week', 1, [due date])</pre> <p>Add 280 days to the date February 20, 2021</p> <pre>DATEADD('day', 280, #2/20/21#) = #November 27, 2021#</pre>
Notes	Supports ISO 8601 dates.

DATEDIFF

Returns the number of date parts (weeks, years, etc) between two dates.

Syntax	<code>DATEDIFF(date_part, date1, date2, [start_of_week])</code>
Output	Integer
Definition	Returns the difference between <code>date1</code> and <code>date2</code> expressed in units of <code>date_part</code> . For example, subtracting the dates someone entered and left a band to see how long they were in the band.
Example	Number of days between March 25, 1986 and February 20, 2021 <code>DATEDIFF('day', #3/25/1986#, #2/20/2021#) = 12,751</code> How many months someone was in a band <code>DATEDIFF('month', [date joined band], [date left band])</code>
Notes	Supports ISO 8601 dates.

DATENAME

Returns the name of the specified date part as a discrete string.

Syntax	<code>DATENAME(date_part, date, [start_of_week])</code>
Output	String
Definition	Returns <code><date_part></code> of date as a string.
Example	<code>DATENAME('year', #3/25/1986#) = "1986"</code> <code>DATENAME('month', #1986-03-25#) = "March"</code>
Notes	Supports ISO 8601 dates. A very similar calculation is DATEPART on page 2314 , which returns the value of the specified date part as a continuous integer. <code>DATEPART</code> can be faster because it is a numerical operation. By changing the attributes of the calculation's result (dimension or

measure, continuous or discrete) and the date formatting, the results of `DATEPART` and `DATENAME` can be formatted to be identical.

An inverse function is [DATEPARSE](#) below, which takes a string value and formats it as a date.

DATEPARSE

Returns specifically formatted strings as dates.

Syntax	<code>DATEPARSE(date_format, date_string)</code>
Output	Date
Definition	The <code><date_format></code> argument describes how the <code><date_string></code> field is arranged. Because of the variety of ways the string field can be ordered, the <code><date_format></code> must match exactly. For a full explanation, see Convert a Field to a Date Field .
Example	<code>DATEPARSE('yyyy-MM-dd', "1986-03-25") = #March 25, 1986#</code>
Notes	<p>DATE on page 2310 is a similar function that automatically recognizes many standard date formats. <code>DATEPARSE</code> may be a better option if <code>DATE</code> does not recognize the input pattern.</p> <p>MAKEDATE on page 2335 is another similar function, but <code>MAKEDATE</code> requires the input of numeric values for year, month, and day.</p> <p>Inverse functions, which take dates apart and return the value of their parts, are DATEPART on the next page (integer output) and DATENAME on the previous page (string output).</p>
Database limitations	<p><code>DATEPARSE</code> is available through the following connectors: non-legacy Excel and text file connections, Amazon EMR Hadoop Hive, Cloudera Hadoop, Google Sheets, Hortonworks Hadoop Hive, MapR Hadoop Hive, MySQL, Oracle, PostgreSQL, and Tableau extracts. Some formats may not be available for all connections.</p> <p><code>DATEPARSE</code> is not supported on Hive variants. Only Denodo, Drill, and Snowflake are supported.</p>

DATEPART

Returns the name of the specified date part as an integer.

Syntax `DATEPART(date_part, date, [start_of_week])`

Output Integer

Definition Returns <date_part> of date as an integer.

Example `DATEPART('year', #1986-03-25#) = 1986`

`DATEPART('month', #1986-03-25#) = 3`

Notes Supports ISO 8601 dates.

A very similar calculation is [DATENAME](#) on page 2312, which returns the name of the specified date part as a discrete string. `DATEPART` can be faster because it is a numerical operation. By changing the attributes of the field (dimension or measure, continuous or discrete) and the date formatting, the results of `DATEPART` and `DATENAME` can be formatted to be identical.

An inverse function is [DATEPARSE](#) on the previous page, which takes a string value and formats it as a date.

DATETIME

Syntax `DATETIME(expression)`

Output Datetime

Definition Returns a datetime given a number, string, or date expression.

Example `DATETIME("April 15, 2005 07:59:00") = April 15, 2005
07:59:00`

DATETRUNC

This function can be thought of as date rounding. It takes a specific date and returns a version of that date at the desired specificity. Because every date must have a value for day, month,

quarter, and year, `DATETRUNC` sets the values as the lowest value for each date part up to the date part specified. Refer to the example for more information.

Syntax	<code>DATETRUNC (date_part, date, [start_of_week])</code>
Output	Date
Definition	Truncates the <code><date></code> to the accuracy specified by the <code><date_part></code> . This function returns a new date. For example, when you truncate a date that is in the middle of the month at the month level, this function returns the first day of the month.
Example	<pre>DATETRUNC ('day', #9/22/2018#) = #9/22/2018#</pre> <pre>DATETRUNC ('iso-week', #9/22/2018#) = #9/17/2018#</pre> <p>(the monday of the week containing 9/22/2018)</p> <pre>DATETRUNC (quarter, #9/22/2018#) = #7/1/2018#</pre> <p>(the first day of the quarter containing 9/22/2018)</p>

Note: For week and iso-week, the `start_of_week` comes into play. ISO-weeks always start on Monday. For the locale of this example, an unspecified `start_of_week` means the week starts on Sunday.

Notes	<p>Supports ISO 8601 dates.</p> <p>You shouldn't use <code>DATETRUNC</code> to, for example, stop showing the time for a datetime field in a viz. If you want to truncate the <i>display</i> of a date rather than round its accuracy, adjust the formatting.</p> <p>For example, <code>DATETRUNC ('day', #5/17/2022 3:12:48 PM#)</code>, if formatted in the viz to display seconds, would display as 5/17/2022 12:00:00 AM.</p>
-------	---

DAY

Returns the day of the month (1-31) as an integer.

Syntax	DAY (date)
Output	Integer
Definition	Returns the day of the given <date> as an integer.
Example	Day(#September 22, 2018#) = 22
Notes	See also WEEK on page 2360, MONTH on page 2342, Quarter on page 2347, YEAR on page 2363, and the ISO equivalents

DEGREES

Syntax	DEGREES (number) The number argument is the angle in radians.
Output	Number (degrees)
Definition	Converts an angle in radians to degrees.
Example	DEGREES (PI () /4) = 45.0
Notes	The inverse function, RADIAN s on page 2347, takes an angle in degrees and returns the angle in radians. See also PI on page 2346().

DISTANCE

Syntax	DISTANCE (<SpatialPoint1>, <SpatialPoint2>, 'units')
Output	Number
Definition	Returns the distance measurement between two points in the specified units.
Example	DISTANCE ([Origin Point], [Destination Point], 'km')
Notes	Supported unit names (must be in quotation marks in the calculation): <ul style="list-style-type: none"> <i>meters</i>: meters, metres, m

- *kilometers*: kilometers, kilometres, km
- *miles*: miles, mi
- *feet*: feet, ft

Database limitations This function can only be created with a live connection but will continue to work if the data source is converted to an extract.

DIV

Syntax `DIV(integer1, integer2)`

Output Integer

Definition Returns the integer part of a division operation, in which `<integer1>` is divided by `<integer2>`.

Example `DIV(11,2) = 5`

DOMAIN

`DOMAIN(string_url)`

Only supported when connected to Google BigQuery. For more information, see [Additional Functions](#).

[back to top](#)

E

ELSE

Syntax `CASE <expression>`
`WHEN <value1> THEN <then1>`
`WHEN <value2> THEN <then2>`
`...`
`[ELSE <default>]`
`END`

Definition An optional piece of an IF or CASE expression used to specify a default

value to return if none of the tested expressions are true.

Example

```
IF [Season] = "Summer" THEN 'Sandals'
ELSEIF [Season] = "Winter" THEN 'Boots'
ELSE 'Sneakers'
END

CASE [Season]
WHEN 'Summer' THEN 'Sandals'
WHEN 'Winter' THEN 'Boots'
ELSE 'Sneakers'
END
```

Notes

Used with **CASE** on page 2304, **WHEN** on page 2361, **IF** on page 2325, **ELSEIF** below, **THEN** on page 2356, and **END** on the facing page

ELSE is optional with **CASE** and **IF**. In a calculation where **ELSE** is not specified, if none of the <test>are true, the overall calculation will return null.

ELSE does not require a condition (such as [Season] = "Winter") and can be thought of as a form of null handling.

ELSEIF

Syntax

```
[ELSEIF <test2> THEN <then2>]
```

Definition

An optional piece of an **IF** expression used to specify additional conditions beyond the initial **IF**.

Example

```
IF [Season] = "Summer" THEN 'Sandals'
ELSEIF [Season] = "Winter" THEN 'Boots'
ELSEIF [Season] = "Spring" THEN 'Sneakers'
ELSEIF [Season] = "Autumn" THEN 'Sneakers'
ELSE 'Bare feet'
END
```

Notes

Used with **IF** on page 2325, **THEN** on page 2356, **ELSE** on the previous page, and **END** on the facing page

ELSEIF can be thought of as additional IF clauses. ELSEIF is optional and can be repeated multiple times.

Unlike ELSE, ELSEIF requires a condition (such as [Season] = "Winter").

END

Definition Used to close an IF or CASE expression.

Example

```
IF [Season] = "Summer" THEN 'Sandals'  
ELSEIF [Season] = "Winter" THEN 'Boots'  
ELSE 'Sneakers'  
END
```

"If Season = Summer, then return Sandals. If not, look at the next expression. If Season = Winter, then return Boots. If neither of the expressions are true, return Sneakers."

```
CASE [Season]  
WHEN 'Summer' THEN 'Sandals'  
WHEN 'Winter' THEN 'Boots'  
ELSE 'Sneakers'  
END
```

"Look at the Season field. If the value is Summer, then return Sandals. If the value is Winter, then return Boots. If none of the options in the calculation match what is in the Season field, return a Sneakers."

Notes Used with **CASE** on page 2304, **WHEN** on page 2361, **IF** on page 2325, **ELSEIF** on the previous page, **THEN** on page 2356, and **ELSE** on page 2317.

ENDSWITH

ENDSWITH

Syntax	<code>ENDSWITH(string, substring)</code>
Output	Boolean
Definition	Returns true if the given <code><string></code> ends with the specified <code><substring></code> . Trailing white spaces are ignored.
Example	<code>ENDSWITH("Tableau", "leau") = true</code>
Notes	See also the supported RegEx in the additional functions documentation .

EXCLUDE

For more information, see [Level of Detail Expressions](#).

EXP

Syntax	<code>EXP(number)</code>
Output	Number
Definition	Returns e raised to the power of the given <code><number></code> .
Example	<code>EXP(2) = 7.389</code> <code>EXP(-[Growth Rate]*[Time])</code>
Notes	See also LN on page 2334.

[back to top](#)

F

FIND

Syntax	<code>FIND(string, substring, [start])</code>
Output	Number
Definition	Returns the index position of <substring> in <string>, or 0 if the substring isn't found. The first character in the string is position 1. If the optional numeric argument <code>start</code> is added, the function ignores any instances of substring that appear before the starting position.
Example	<pre>FIND("Calculation", "alcu") = 2 FIND("Calculation", "Computer") = 0 FIND("Calculation", "a", 3) = 7 FIND("Calculation", "a", 2) = 2 FIND("Calculation", "a", 8) = 0</pre>
Notes	See also the supported RegEx in the additional functions documentation .

FINDNTH

Syntax	<code>FINDNTH(string, substring, occurrence)</code>
Output	Number
Definition	Returns the position of the nth occurrence of <substring> within the specified <string>, where n is defined by the <occurrence> argument.
Example	<pre>FINDNTH("Calculation", "a", 2) = 7</pre>
Notes	<code>FINDNTH</code> is not available for all data sources. See also the supported RegEx in the additional functions documentation .

FIRST

FIRST ()

For more information, see [Table Calculation Functions](#).

FIXED

For more information, see [Level of Detail Expressions](#).

FLOAT

Syntax	<code>FLOAT (expression)</code>
Output	Floating point number (decimal)
Definition	Casts its argument as a floating point number.
Example	<code>FLOAT (3) = 3.000</code>
Notes	See also INT on page 2328 which returns an integer.

FLOOR

Syntax	<code>FLOOR (number)</code>
Output	Integer
Definition	Rounds a <number> to the nearest integer of equal or lesser value.
Example	<code>FLOOR (7.9) = 7</code>
Notes	See also CEILING on page 2305 and ROUND on page 2349.
Database limitations	FLOOR is available through the following connectors: Microsoft Excel, Text File, Statistical File, Published Data Source, Amazon EMR Hadoop Hive, Cloudera Hadoop, DataStax Enterprise, Google Analytics, Google BigQuery, Hortonworks Hadoop Hive, MapR Hadoop Hive, Microsoft SQL Server, Salesforce, Spark SQL.

FULLNAME

Syntax `FULLNAME ()`

Output **String**

Definition Returns the full name for the current user.

Example `FULLNAME ()`

This returns the full name of the signed in user, such as "Hamlin Myrer".

```
[Manager] = FULLNAME ( )
```

If manager "Hamlin Myrer" is signed in, this example returns TRUE only if the Manager field in the view contains "Hamlin Myrer".

Notes This function checks:

- Tableau Cloud and Tableau Server: the full name of the signed-in user
- Tableau Desktop: the local or network full name for the user

User filters

When used as a filter, a calculated field such as `[Username field] = FULLNAME ()` can be used to create a user filter that only shows data that is relevant to the person signed in to the server.

[back to top](#)

G

GET_JSON_OBJECT

`GET_JSON_OBJECT(JSON string, JSON path)`

Only supported when connected to Hadoop Hive. For more information, see [Additional Functions](#).

GROUP_CONCAT

`GROUP_CONCAT(expression)`

Only supported when connected to Google BigQuery. For more information, see [Additional Functions](#).

[back to top](#)

H

HEXBINX

Syntax	<code>HEXBINX(number, number)</code>
Output	Number
Definition	Maps an x, y coordinate to the x-coordinate of the nearest hexagonal bin. The bins have side length 1, so the inputs may need to be scaled appropriately.
Example	<code>HEXBINX([Longitude]*2.5, [Latitude]*2.5)</code>
Notes	<code>HEXBINX</code> and <code>HEXBINY</code> below are binning and plotting functions for hexagonal bins. Hexagonal bins are an efficient and elegant option for visualizing data in an x/y plane such as a map. Because the bins are hexagonal, each bin closely approximates a circle and minimizes variation in the distance from the data point to the center of the bin. This makes the clustering both more accurate and informative.

HEXBINY

Syntax	<code>HEXBINY(number, number)</code>
Output	Number
Definition	Maps an x, y coordinate to the y-coordinate of the nearest hexagonal bin. The bins have side length 1, so the inputs may need to be scaled appropriately.
Example	<code>HEXBINY([Longitude]*2.5, [Latitude]*2.5)</code>
Notes	See also <code>HEXBINX</code> above.

HOST

HOST(string_url)

Only supported when connected to Google BigQuery. For more information, see [Additional Functions](#).

[back to top](#)

I

IF

Syntax	<pre>IF <test1> THEN <then1> [ELSEIF <test2> THEN <then2>...] [ELSE <default>] END</pre>
Output	Depends on data type of the <then> values.
Definition	Tests a series of expressions and returns the <then> value for the first true <test>.
Example	<pre>IF [Season] = "Summer" THEN 'Sandals' ELSEIF [Season] = "Winter" THEN 'Boots' ELSE 'Sneakers' END</pre> <p><i>"If Season = Summer, then return Sandals. If not, look at the next expression. If Season = Winter, then return Boots. If neither of the expressions are true, return Sneakers."</i></p>
Notes	<p>See also IF above and IIF on the next page.</p> <p>Used with ELSEIF on page 2318, THEN on page 2356, ELSE on page 2317, and END on page 2319</p>

IFNULL

Syntax IFNULL(expr1, expr2)

Output	Depends on the data type of the <expr> values.
Definition	Returns <expr1> if it's non-null, otherwise returns <expr2>.
Example	<pre>IFNULL([Assigned Room], "TBD")</pre> <p><i>"If the Assigned Room field isn't null, return its value. If the Assigned room field is null, return TBD instead."</i></p>
Notes	<p>Compare with ISNULL on page 2330. IFNULL always returns a value. ISNULL returns a boolean (true or false).</p> <p>See also ZN on page 2363.</p>

IIF

Syntax	IIF (<test>, <then>, <else>, [<unknown>])
Output	Depends on the data type of the values in the expression.
Definition	Checks whether a condition is met (<test>), and returns <then> if the test is true, <else> if the test is false, and an optional value for <unknown> if the test is null. If the optional unknown isn't specified, IIF returns null.
Example	<pre>IIF([Season] = 'Summer', 'Sandals', 'Other footwear')</pre> <p><i>"If Season = Summer, then return Sandals. If not, return Other footwear"</i></p> <pre>IIF([Season] = 'Summer', 'Sandals', IIF('Season' = 'Winter', 'Boots', 'Other footwear'))</pre> <p><i>"If Season = Summer, then return Sandals. If not, look at the next expression. If Season = Winter, then return Boots. If neither are true, return Sneakers."</i></p> <pre>IIF('Season' = 'Summer', 'Sandals', IIF('Season' = 'Winter', 'Boots', IIF('Season' = 'Spring', 'Sneakers', 'Other footwear')))</pre>

"If Season = Summer, then return Sandals. If not, look at the next expression. If Season = Winter, then return Boots. If none of the expressions are true, return Sneakers."

Notes See also [IF on page 2325](#) and [CASE on page 2304](#).

IIF doesn't have an equivalent to ELSEIF (like IF) or repeated WHEN clauses (like CASE). Instead, multiple tests can be evaluated sequentially by nesting IIF statements as the <unknown> element. The first (outermost) true is returned.

That is to say, in the calculation below, the result will be Red, not Orange, because the expression stops being evaluated as soon as A=A is evaluated as true:

```
IIF('A' = 'A', 'Red', IIF('B' = 'B', 'Orange', IIF('C' = 'D', 'Yellow', 'Green')))
```

IN

Syntax <expr1> IN <expr2>

Output Boolean (true or false)

Definition Returns TRUE if any value in <expr1> matches any value in <expr2>.

Example SUM([Cost]) IN (1000, 15, 200)

"Is the value of the Cost field 1000, 15, or 200?"

```
[Field] IN [Set]
```

"Is the value of the field present in the set?"

Notes The values in <expr2> can be a set, list of literal values, or combined field. See also [WHEN on page 2361](#).

INCLUDE

For more information, see [Level of Detail Expressions](#).

INDEX

INDEX ()

For more information, see [Table Calculation Functions](#).

INT

Syntax	INT (expression)
Output	Integer
Definition	Casts its argument as an integer. For expressions, this function truncates results to the closest integer toward zero.
Example	<p>INT (8/3) = 2</p> <p>INT (-9.7) = -9</p>
Notes	<p>When a string is converted to an integer it is first converted to a float and then rounded.</p> <p>See also FLOAT on page 2322 which returns a decimal.</p> <p>See also ROUND on page 2349, CEILING on page 2305, and FLOOR on page 2322</p>

INTERSECTS

Syntax	INTERSECTS (<geometry1>, <geometry2>)
Output	Boolean
Definition	Returns true or false indicating if two geometries overlap in space.
Notes	Supported combinations: point/polygon, line/polygon, and polygon/polygon.

ISDATE

Checks if the string is a valid date format.

Syntax	<code>ISDATE (string)</code>
Output	Boolean
Definition	Returns true if a given <code><string></code> is a valid date.
Example	<code>ISDATE (09/22/2018) = true</code> <code>ISDATE (22SEP18) = false</code>
Notes	The required argument must be a string. ISDATE cannot be used for a field with a date data type—the calculation will return an error.

ISFULLNAME

Syntax	<code>ISFULLNAME ("User Full Name")</code>
Output	Boolean
Definition	Returns <code>TRUE</code> if the current user's full name matches the specified full name or <code>FALSE</code> if it does not match.
Example	<code>ISFULLNAME ("Hamlin Myrer")</code>
Notes	The <code><"User Full Name"></code> argument must be a literal string, not a field. This function checks: <ul style="list-style-type: none">• Tableau Cloud and Tableau Server: the full name of the signed-in user• Tableau Desktop: the local or network full name for the user

ISMEMBEROF

Syntax	<code>ISMEMBEROF ("Group Name")</code>
Output	Boolean or null
Definition	Returns <code>TRUE</code> if the person currently using Tableau is a member of a group that matches the given string, <code>FALSE</code> if they're not a member, and <code>NULL</code> if they're not signed in.

Example	<pre>ISMEMBEROF('Superstars')</pre> <pre>ISMEMBEROF('domain.lan\Sales')</pre>
Notes	<p>The <"Group Full Name"> argument must be a literal string, not a field.</p> <p>If the user is signed in to Tableau Cloud or Tableau Server, group membership is determined by Tableau groups. The function will return TRUE if the given string is "All Users"</p> <p>The ISMEMBEROF() function will also accept Active Directory domains. The Active Directory domain must be declared in the calculation with the group name.</p>

ISNULL

Syntax	ISNULL(expression)
Output	Boolean (true or false)
Definition	Returns true if the <expression> is NULL (does not contain valid data).
Example	<pre>ISNULL([Assigned Room])</pre> <p><i>"Is the Assigned Room field null?"</i></p>
Notes	<p>Compare with IFNULL on page 2325. IFNULL always returns a value. ISNULL returns a boolean.</p> <p>See also ZN on page 2363.</p>

ISOQUARTER

Syntax	ISOQUARTER(date)
Output	Integer
Definition	Returns the ISO8601 week-based quarter of a given <date> as an integer.
Example	<pre>ISOQUARTER(#1986-03-25#) = 1</pre>

Notes See also [ISOWEEK](#) below, [ISOWEEKDAY](#) below, [ISOYEAR](#) below, and the non-ISO equivalents.

ISOWEEK

Syntax ISOWEEK (date)

Output Integer

Definition Returns the ISO8601 week-based week of a given <date> as an integer.

Example ISOWEEK (#1986-03-25#) = 13

Notes See also [ISOWEEKDAY](#) below, [ISOQUARTER](#) on the previous page, [ISOYEAR](#) below, and the non-ISO equivalents.

ISOWEEKDAY

Syntax ISOWEEKDAY (date)

Output Integer

Definition Returns the ISO8601 week-based weekday of a given <date> as an integer.

Example ISOWEEKDAY (#1986-03-25#) = 2

Notes See also [ISOWEEK](#) above, [ISOQUARTER](#) on the previous page, [ISOYEAR](#) below, and the non-ISO equivalents

ISOYEAR

Syntax ISOYEAR (date)

Output Integer

Definition Returns the ISO8601 week-based year of a given date as an integer.

Example `ISOYEAR(#1986-03-25#) = 1,986`

Notes See also [ISOWEEK](#) on the previous page, [ISOWEEKDAY](#) on the previous page, [ISOQUARTER](#) on page 2330, and the non-ISO equivalents.

ISUSERNAME

Syntax `ISUSERNAME("username")`

Output Boolean

Definition Returns `TRUE` if the current user's username matches the specified `<username>` or `FALSE` if it does not match.

Example `ISUSERNAME("hmyrer")`

Notes The `<"username">` argument must be a literal string, not a field.

This function checks:

- Tableau Cloud and Tableau Server: the username of the signed-in user
- Tableau Desktop: the local or network username for the user

[back to top](#)

J

[back to top](#)

K

[back to top](#)

L

LAST

`LAST()`

For more information, see [Table Calculation Functions](#).

LEFT

Syntax	<code>LEFT(string, number)</code>
Output	String
Definition	Returns the left-most <number> of characters in the string.
Example	<code>LEFT("Matador", 4) = "Mata"</code>
Notes	See also MID on page 2339 and RIGHT on page 2349 .

LEN

Syntax	<code>LEN(string)</code>
Output	Number
Definition	Returns the length of the <string>.
Example	<code>LEN("Matador") = 7</code>
Notes	Not to be confused with the spatial function LENGTH below.

LENGTH

Syntax	<code>LENGTH(geometry, 'units')</code>
Output	Number
Definition	Returns the geodetic path length of the line string or strings in the <geometry> using the given <units>.
Example	<code>LENGTH([Spatial], 'metres')</code>
Notes	The result is <NaN> if the geometry argument has no linestrings, though other elements are permitted. Not to be confused with the string function LEN above.

LN

Syntax	<code>LN (number)</code>
Output	Number The output is <code>Null</code> if the argument is less than or equal to zero.
Definition	Returns the natural logarithm of a <code><number></code> .
Example	<code>LN(50) = 3.912023005</code>
Notes	See also EXP on page 2320 and LOG below.

LOG

Syntax	<code>LOG (number, [base])</code> If the optional base argument isn't present, base 10 is used.
Output	Number
Definition	Returns the logarithm of a <code><number></code> for the given <code><base></code> .
Example	<code>LOG(16,4) = 2</code>
Notes	See also POWER on page 2346 LN above.

LOG2

`LOG2 (number)`

Only supported when connected to Google BigQuery. For more information, see [Additional Functions](#).

LOOKUP

`LOOKUP (expression, [offset])`

For more information, see [Table Calculation Functions](#).

LOWER

Syntax	<code>LOWER(string)</code>
Output	String
Definition	Returns the provided <code><string></code> in all lowercase characters.
Example	<code>LOWER("ProductVersion") = "productversion"</code>
Notes	See also UPPER on page 2358 and PROPER on page 2346.

LTRIM

Syntax	<code>LTRIM(string)</code>
Output	String
Definition	Returns the provided <code><string></code> with any leading spaces removed.
Example	<code>LTRIM(" Matador ") = "Matador "</code>
Notes	See also RTRIM on page 2350.

LTRIM_THIS

`LTRIM_THIS(string, string)`

Only supported when connected to Google BigQuery. For more information, see [Additional Functions](#).

[back to top](#)

M

MAKEDATE

Syntax	<code>MAKEDATE(year, month, day)</code>
Output	Date

Definition Returns a date value constructed from the specified <year>, <month>, and <day>.

Example `MAKEDATE(1986, 3, 25) = #1986-03-25#`

Notes

Note: Incorrectly entered values will be adjusted into a date, such as `MAKEDATE(2020, 4, 31) = May 1, 2020` rather than returning an error that there is no 31st day of April.

Available for Tableau Data Extracts. Check for availability in other data sources.

`MAKEDATE` requires numerical inputs for the parts of a date. If your data is a string that should be a date, try the [DATE](#) on page 2310 function. `DATE` automatically recognizes many standard date formats. If `DATE` does not recognize the input try using [DATEPARSE](#) on page 2313.

MAKEDATETIME

Syntax `MAKEDATETIME(date, time)`

Output Datetime

Definition Returns a datetime that combines a <date> and a <time>. The date can be a date, datetime, or a string type. The time must be a datetime.

Example `MAKEDATETIME("1899-12-30", #07:59:00#) = #12/30/1899 7:59:00 AM#`

`MAKEDATETIME([Date], [Time]) = #1/1/2001 6:00:00 AM#`

Notes This function is available only for MySQL-compatible connections (which for Tableau are MySQL and Amazon Aurora).

[MAKETIME](#) on page 2338 is a similar function available for Tableau Data Extracts and some other data sources.

MAKELINE

Syntax	<code>MAKELINE(SpatialPoint1, SpatialPoint2)</code>
Output	Geometry (line)
Definition	Generates a line mark between two points
Example	<code>MAKELINE(MAKEPOINT(47.59, -122.32), MAKEPOINT(48.5, -123.1))</code>
Notes	Useful for building origin-destination maps.

MAKEPOINT

Syntax	<code>MAKEPOINT(latitude, longitude, [SRID])</code>
Output	Geometry (point)
Definition	<p>Converts data from <code><latitude></code> and <code><longitude></code> columns into spatial objects.</p> <p>If the optional <code><SRID></code> argument is added, the inputs can be other projected geographic coordinates.</p>
Example	<code>MAKEPOINT(48.5, -123.1)</code> <code>MAKEPOINT([AirportLatitude], [AirportLongitude])</code> <code>MAKEPOINT([Xcoord], [Ycoord], 3493)</code>
Notes	<p><code>MAKEPOINT</code> can't use the automatically generated latitude and longitude fields. The data source must contain the coordinates natively.</p> <p>SRID is a spatial reference identifier that uses ESPG reference system codes to specify coordinate systems. If SRID is not specified, WGS84 is assumed and parameters are treated as latitude/longitude in degrees.</p> <p>You can use <code>MAKEPOINT</code> to spatially-enable a data source so that it can be joined with a spatial file using a spatial join. For more information, see Join Spatial Files in Tableau.</p>

MAKETIME

Syntax	<code>MAKETIME(hour, minute, second)</code>
Output	Datetime
Definition	Returns a date value constructed from the specified <code><hour></code> , <code><minute></code> , and <code><second></code> .
Example	<code>MAKETIME(14, 52, 40) = #1/1/1899 14:52:40#</code>
Notes	<p>Because Tableau does not support a time data type, only datetime, the output is a datetime. The date portion of the field will be 1/1/1899.</p> <p>Similar function to MAKEDATETIME on page 2336, which is only available for MYSQL-compatible connections.</p>

MAX

Syntax	<code>MAX(expression)</code> or <code>MAX(expr1, expr2)</code>
Output	Same data type as the argument, or <code>NULL</code> if any part of the argument is null.
Definition	Returns the maximum of the two arguments, which must be of the same data type.
	<code>MAX</code> can also be applied to a single field as an aggregation.
Example	<code>MAX(4, 7) = 7</code> <code>MAX(#3/25/1986#, #2/20/2021#) = #2/20/2021#</code> <code>MAX([Name]) = "Zander"</code>
Notes	<p>For strings</p> <p><code>MAX</code> is usually the value that comes last in alphabetical order.</p>

For database data sources, the `MAX` string value is highest in the sort sequence defined by the database for that column.

For dates

For dates, the `MAX` is the most recent date. If `MAX` is an aggregation, the result will not have a date hierarchy. If `MAX` is a comparison, the result will retain the date hierarchy.

As an aggregation

`MAX(expression)` is an aggregate function and returns a single aggregated result. This displays as `AGG(expression)` in the viz.

As a comparison

`MAX(expr1, expr2)` compares the two values and returns a row-level value.

See also [MIN](#) on the next page.

MEDIAN

Syntax	<code>MEDIAN(expression)</code>
Definition	Returns the median of an expression across all records. Null values are ignored.
Notes	<code>MEDIAN</code> can only be used with numeric fields.
Database limitations	<code>MEDIAN</code> is not available for the following data sources: Access, Amazon Redshift, Cloudera Hadoop, HP Vertica, IBM DB2, IBM PDA (Netezza), Microsoft SQL Server, MySQL, SAP HANA, Teradata. For other data source types, you can extract your data into an extract file to use this function. See Extract Your Data .

MID

Syntax	<code>(MID(string, start, [length]))</code>
Output	String
Definition	Returns a string starting at the specified <code><start></code> position. The first character in the string is position 1.

If the optional numeric argument `<length>` is added, the returned string includes only that number of characters.

Example `MID("Calculation", 2) = "alculation"`

`MID("Calculation", 2, 5) ="alcul"`

Notes See also the supported RegEx in the [additional functions documentation](#).

MIN

Syntax `MIN(expression)` or `MIN(expr1, expr2)`

Output Same data type as the argument, or `NULL` if any part of the argument is null.

Definition Returns the minimum of the two arguments, which must be of the same data type.

`MIN` can also be applied to a single field as an aggregation.

Example `MIN(4,7) = 4`
`MIN(#3/25/1986#, #2/20/2021#) = #3/25/1986#`
`MIN([Name]) = "Abebi"`

Notes **For strings**
`MIN` is usually the value that comes first in alphabetical order.

For database data sources, the `MIN` string value is lowest in the sort sequence defined by the database for that column.

For dates

For dates, the `MIN` is the earliest date. If `MIN` is an aggregation, the result will not have a date hierarchy. If `MIN` is a comparison, the result will retain the date hierarchy.

As an aggregation

`MIN(expression)` is an aggregate function and returns a single aggregated result. This displays as `AGG(expression)` in the viz.

As a comparison

`MIN(expr1, expr2)` compares the two values and returns a row-level value.

See also [MAX](#) on page 2338.

Model Extensions

For more information, see [Table Calculation Functions](#).

- `MODEL_EXTENSION_BOOL`
- `MODEL_EXTENSION_INT`
- `MODEL_EXTENSION_REAL`
- `MODEL_EXTENSION_STR`

MODEL_PERCENTILE

Syntax `MODEL_PERCENTILE(
 model_specification (optional),
 target_expression,
 predictor_expression(s))`

Definition Returns the probability (between 0 and 1) of the expected value being less than or equal to the observed mark, defined by the target expression and other predictors. This is the Posterior Predictive Distribution Function, also known as the Cumulative Distribution Function (CDF).

Example `MODEL_PERCENTILE(SUM([Sales]),COUNT([Orders]))`

MODEL_QUANTILE

Syntax `MODEL_QUANTILE(
 model_specification (optional),
 quantile,
 target_expression,
 predictor_expression(s))`

Definition Returns a target numeric value within the probable range defined by the target expression and other predictors, at a specified quantile. This is the Posterior Predictive Quantile.

Example `MODEL_QUANTILE(0.5, SUM([Sales]), COUNT([Orders]))`

MONTH

Syntax `MONTH(date)`

Output Integer

Definition Returns the month of the given <date> as an integer.

Example `MONTH(#1986-03-25#) = 3`

Notes See also **DAY** on page 2315, **WEEK** on page 2360, **Quarter** on page 2347, **YEAR** on page 2363, and the ISO equivalents

[back to top](#)

N

NOT

Syntax `NOT <expression>`

Output Boolean (true or false)

Definition Performs logical negation on an expression.

Example

```
IF NOT [Season] = "Summer"
THEN 'Don't wear sandals'
ELSE 'Wear sandals'
END
```

"If Season doesn't equal Summer, then return Don't wear sandals. If not, return Wear sandals."

Notes Often used with **IF** on page 2325 and **IIF** on page 2326. See also **The**

Tableau functions in this reference are organized alphabetically. Click a letter to jump to that location in the list. You can also use **Ctrl+F** (**Command-F** on a Mac) to open a search box to look for a specific function. on page 2300 and **OR** below.

NOW

Syntax `NOW()`

Output Datetime

Definition Returns the current local system date and time.

Example `NOW() = 1986-03-25 1:08:21 PM`

Notes `NOW` does not take an argument.

See also **TODAY** on page 2357, a similar calculation that returns a date instead of a datetime.

If the data source is a live connection, the system date and time could be in another timezone. For more information on how to address this, see [the Knowledge Base](#).

[back to top](#)

O

OR

Syntax `<expr1> OR <expr2>`

Output Boolean (true or false)

Definition Performs a logical disjunction on two expressions.

Example `IF [Season] = "Spring" OR [Season] = "Fall"
THEN "Sneakers"
END`

"If either (Season = Spring) or (Season = Fall) is true, then return Sneakers."

Notes

Often used with **IF** on page 2325 and **IIF** on page 2326. See also **The Tableau functions in this reference are organized alphabetically. Click a letter to jump to that location in the list. You can also use Ctrl+F (Command-F on a Mac) to open a search box to look for a specific function.** on page 2300 and **NOT** on page 2342.

If either expression is `TRUE`, then the result is `TRUE`. If both expressions are `FALSE`, then the result is `FALSE`. If both expressions are `NULL`, then the result is `NULL`.

If you create a calculation which displays the result of an `OR` comparison on a worksheet, Tableau displays `TRUE` and `FALSE`. If you would like to change this, use the Format area in the format dialog.

Note: The `OR` operator employs *short circuit evaluation*. This means that if the first expression is evaluated to be `TRUE`, then the second expression is not evaluated at all. This can be helpful if the second expression results in an error when the first expression is `TRUE`, because the second expression in this case is never evaluated.

OUTLINE

Syntax	<code>OUTLINE(<spatial polygon>)</code>
Output	Geometry
Definition	Converts a polygon geometry into linestrings.
Notes	Useful for creating a separate layer for an outline that can be styled differently than the fill. Supports polygons within multipolygons.

[back to top](#)

P

PARSE_URL

`PARSE_URL(string, url_part)`

Only supported when connected to Cloudera Impala. For more information, see [Additional Functions](#).

PARSE_URL_QUERY

`PARSE_URL_QUERY(string, key)`

Only supported when connected to Cloudera Impala. For more information, see [Additional Functions](#).

PERCENTILE

Syntax `PERCENTILE(expression, number)`

Definition Returns the percentile value from the given `<expression>` corresponding to the specified `<number>`. The `<number>` must be between 0 and 1 (inclusive) and must be a numeric constant.

Example `PERCENTILE([Score], 0.9)`

Database limitations This function is available for the following data sources: Non-legacy Microsoft Excel and Text File connections, Extracts and extract-only data source types (for example, Google Analytics, OData, or Salesforce), Sybase IQ 15.1 and later data sources, Oracle 10 and later data sources, Cloudera Hive and Hortonworks Hadoop Hive data sources, EXASolution 4.2 and later data sources.

For other data source types, you can extract your data into an extract file to use this function. See [Extract Your Data](#).

PI

Syntax	<code>PI()</code>
Output	Number
Definition	Returns the numeric constant pi: 3.14159...
Example	<code>PI() = 3.14159</code>
Notes	Useful for trig functions that take their input in radians.

POWER

Syntax	<code>POWER(number, power)</code>
Output	Number
Definition	Raises the <number> to the specified <power>.
Example	<code>POWER(5,3) = 125</code> <code>POWER([Temperature], 2)</code>
Notes	You can also use the ^ symbol, such as <code>5^3 = POWER(5,3) = 125</code> See also EXP on page 2320, LOG on page 2334, and SQUARE on page 2354.

PREVIOUS_VALUE

`PREVIOUS_VALUE(expression)`

For more information, see [Table Calculation Functions](#).

PROPER

Syntax	<code>PROPER(string)</code>
Output	String

Definition	Returns the provided <code><string></code> with the first letter of each word is capitalized and the remaining letters are in lowercase.
Example	<pre>PROPER("PRODUCT name") = "Product Name" PROPER("darcy-mae") = "Darcy-Mae"</pre>
Notes	Spaces and non-alphanumeric characters such as punctuation are treated as separators. See also LOWER on page 2335 and UPPER on page 2358.

[back to top](#)

Q

Quarter

Syntax	<code>QUARTER (date)</code>
Output	Integer
Definition	Returns the quarter of the given <code><date></code> as an integer.
Example	<pre>QUARTER (#1986-03-25#) = 1</pre>
Notes	See also DAY on page 2315, WEEK on page 2360, MONTH on page 2342, YEAR on page 2363, and the ISO equivalents

[back to top](#)

R

RADIANS

Syntax	<code>RADIANS (number)</code>
Output	Number (angle in radians)
Definition	Converts the given <code><number></code> from degrees to radians.

Example `RADIANS(180) = 3.14159`

Notes The inverse function, [DEGREES](#) on page 2316, takes an angle in radians and returns the angle in degrees.

RANK Table Calculation functions

For more information, see [Table Calculation Functions](#).

- `RANK(expression, ['asc' | 'desc'])`
- `RANK_DENSE(expression, ['asc' | 'desc'])`
- `RANK_MODIFIED(expression, ['asc' | 'desc'])`
- `RANK_PERCENTILE(expression, ['asc' | 'desc'])`
- `RANK_UNIQUE(expression, ['asc' | 'desc'])`

RAWSQL functions

For more information, see [Pass-Through Functions \(RAWSQL\)](#).

- `RAWSQL_BOOL("sql_expr", [arg1], ... [argN])`
- `RAWSQL_DATE("sql_expr", [arg1], ... [argN])`
- `RAWSQL_DATETIME("sql_expr", [arg1], ... [argN])`
- `RAWSQL_INT("sql_expr", [arg1], ... [argN])`
- `RAWSQL_REAL("sql_expr", [arg1], ... [argN])`
- `RAWSQL_SPATIAL`
- `RAWSQL_STR("sql_expr", [arg1], ... [argN])`
- `RAWSQLAGG_BOOL("sql_expr", [arg1], ... [argN])`
- `RAWSQLAGG_DATE("sql_expr", [arg1], ... [argN])`
- `RAWSQLAGG_DATETIME("sql_expr", [arg1], ... [argN])`
- `RAWSQLAGG_INT("sql_expr", [arg1], ... [argN])`
- `RAWSQLAGG_REAL("sql_expr", [arg1], ... [argN])`
- `RAWSQLAGG_STR("sql_expr", [arg1], ... [argN])`

REGEXP functions

For more information, see [Additional Functions](#).

- `REGEXP_EXTRACT(string, pattern)`
- `REGEXP_EXTRACT_NTH(string, pattern, index)`

- `REGEXP_EXTRACT_NTH(string, pattern, index)`
- `REGEXP_MATCH(string, pattern)`
- `REGEXP_REPLACE(string, pattern, replacement)`

REPLACE

Syntax	<code>REPLACE(string, substring, replacement</code>
Output	String
Definition	Searches <string> for <substring> and replaces it with <replacement>. If <substring> is not found, the string is not changed.
Example	<code>REPLACE("Version 3.8", "3.8", "4x") = "Version 4x"</code>
Notes	See also <code>REGEXP_REPLACE</code> in the additional functions documentation .

RIGHT

Syntax	<code>RIGHT(string, number)</code>
Output	String
Definition	Returns the right-most <number> of characters in the string.
Example	<code>RIGHT("Calculation", 4) = "tion"</code>
Notes	See also LEFT on page 2333 and MID on page 2339.

ROUND

Syntax	<code>ROUND(number, [decimals])</code>
Output	Number
Definition	Rounds the <number> to a specified number of digits. The optional <code>decimals</code> argument specifies how many decimal points of precision to include in the final result. If <code>decimals</code> is omitted, number is rounded to the nearest integer.

Example	<code>ROUND(1/3, 2) = 0.33</code>
Notes	<p>Some databases, such as SQL Server, allow specification of a negative length, where -1 rounds number to the tens place, -2 rounds to the hundreds place, and so on. This is not true of all databases. For example, it is not true of Excel or Access.</p> <p>Tip: Because ROUND may run into issues due to the underlying floating point representation of numbers—such as 9.405 rounding to 9.40—it may be preferable to format the number to the desired number of decimal points rather than rounding. Formatting 9.405 to two decimal places will yield the expected 9.41.</p> <p>See also CEILING on page 2305 and FLOOR on page 2322.</p>

RTRIM

Syntax	<code>RTRIM(string)</code>
Output	String
Definition	Returns the provided <string> with any trailing spaces removed.
Example	<code>RTRIM(" Calculation ") = " Calculation"</code>
Notes	See also LTRIM on page 2335 and TRIM on page 2358.

RTRIM_THIS

`RTRIM_THIS(string, string)`

Only supported when connected to Google BigQuery. For more information, see [Additional Functions](#).

RUNNING Table Calculation functions

For more information, see [Table Calculation Functions](#).

- `RUNNING_AVG(expression)`
- `RUNNING_COUNT(expression)`

- `RUNNING_MAX(expression)`
- `RUNNING_MIN(expression)`
- `RUNNING_SUM(expression)`

[back to top](#)

S

SCRIPT Analytics Extensions

For more information, see [Table Calculation Functions](#).

- `SCRIPT_BOOL`
- `SCRIPT_INT`
- `SCRIPT_REAL`
- `SCRIPT_STR`

SHAPETYPE

Syntax	<code>SHAPETYPE(<geometry>)</code>
Output	String
Definition	Returns a string describing the structure of the spatial geometry, such as Empty, Point, MultiPoint, LineString, MultiLinestring, Polygon, MultiPolygon, Mixed, and unsupported
Example	<code>SHAPETYPE(MAKEPOINT(48.5, -123.1)) = "Point"</code>

SIGN

Syntax	<code>SIGN(number)</code>
Output	-1, 0, or 1
Definition	Returns the sign of a <code><number></code> : The possible return values are -1 if the number is negative, 0 if the number is zero, or 1 if the number is positive.
Example	<code>SIGN(AVG(Profit)) = -1</code>

Notes See also [ABS](#) on page 2300.

SIN

Syntax `SIN(number)`

Output Number

Definition Returns the sine of an angle in radians.

Example `SIN(0) = 1.0`
`SIN(PI()/4) = 0.707106781186548`

Notes The inverse function, [ASIN](#) on page 2302, takes the sine as the argument and returns the angle in radians.

See also [PI](#) on page 2346. To convert an angle from degrees to radians, use [RADIANS](#) on page 2347.

SIZE

`SIZE()`

For more information, see [Table Calculation Functions](#).

SPACE

Syntax `SPACE(number)`

Output String (specifically, just spaces)

Definition Returns a string that is composed of the specified number of repeated spaces.

Example `SPACE(2) = " "`

SPLIT

Syntax	<code>SPLIT(string, delimiter, token number)</code>
Output	String
Definition	Returns a substring from a <string>, using a <delimiter> character to divide the string into a sequence of <tokens>.
Example	<pre>SPLIT ("a-b-c-d", "-", 2) = "b" SPLIT ("a b c d", " ", -2) = "c"</pre>
Notes	<p>The string is interpreted as an alternating sequence of delimiters and tokens. So for the string <code>abc-defgh-i-jkl</code>, where the delimiter character is '-', the tokens are (1) <code>abc</code>, (2) <code>defgh</code>, (3) <code>i</code>, and (4) <code>jkl</code>.</p> <p><code>SPLIT</code> returns the token corresponding to the token number. When the token number is positive, tokens are counted starting from the left end of the string; when the token number is negative, tokens are counted starting from the right.</p> <p>See also supported REGEX in the additional functions documentation.</p>
Database limitations	<p>The split and custom split commands are available for the following data sources types: Tableau data extracts, Microsoft Excel, Text File, PDF File, Salesforce, OData, Microsoft Azure Market Place, Google Analytics, Vertica, Oracle, MySQL, PostgreSQL, Teradata, Amazon Redshift, Aster Data, Google Big Query, Cloudera Hadoop Hive, Hortonworks Hive, and Microsoft SQL Server.</p> <p>Some data sources impose limits on splitting strings. See <code>SPLIT</code> function limitations later in this topic.</p>

SQRT

Syntax	<code>SQRT(number)</code>
Output	Number
Definition	Returns the square root of a <number>.

Example	<code>SQRT(25) = 5</code>
Notes	See also SQURE below.

SQUARE

Syntax	<code>SQUARE (number)</code>
Output	Number
Definition	Returns the square of a <code><number></code> .
Example	<code>SQUARE(5) = 25</code>
Notes	See also SQRT on the previous page and POWER on page 2346.

STARTSWITH

Syntax	<code>STARTSWITH(string, substring)</code>
Output	Boolean
Definition	Returns true if <code>string</code> starts with <code>substring</code> . Leading white spaces are ignored.
Example	<code>STARTSWITH("Matador, "Ma") = TRUE</code>
Notes	See also CONTAINS on page 2306, as well as supported REGEX in the additional functions documentation .

STDEV

Syntax	<code>STDEV(expression)</code>
Definition	Returns the statistical standard deviation of all values in the given <code><expression></code> based on a sample of the population.

STDEVP

Syntax	<code>STDEVP (expression)</code>
Definition	Returns the statistical standard deviation of all values in the given <code><expression></code> based on a biased population.

STR

Syntax	<code>STR (expression)</code>
Output	String
Definition	Casts its argument as a string.
Example	<code>STR ([ID])</code>

SUM

Syntax	<code>SUM (expression)</code>
Definition	Returns the sum of all values in the <code><expression></code> . Null values are ignored.
Notes	<code>SUM</code> can only be used with numeric fields.

[back to top](#)

T

TAN

Syntax	<code>TAN (number)</code>
	The <code><number></code> argument is the angle in radians.
Output	Number
Definition	Returns the tangent of an angle.

Example `TAN(PI ()/4) = 1.0`

Notes See also [ATAN](#) on page 2303, [ATAN2](#) on page 2303, [COT](#) on page 2308, and [PI](#) on page 2346. To convert an angle from degrees to radians, use [RADIAN](#)s on page 2347.

THEN

Syntax

```
IF <test1> THEN <then1>
[ELSEIF <test2> THEN <then2>...]
[ELSE <default>]
END
```

Definition A required part of an IF, ELSEIF, or CASE expression, used to define what result to return if a specific value or test is true.

Example

```
IF [Season] = "Summer" THEN 'Sandals'
ELSEIF [Season] = "Winter" THEN 'Boots'
ELSE 'Sneakers'
END
```

"If Season = Summer, then return Sandals. If not, look at the next expression. If Season = Winter, then return Boots. If neither of the expressions are true, return Sneakers."

```
CASE [Season]
WHEN 'Summer' THEN 'Sandals'
WHEN 'Winter' THEN 'Boots'
ELSE 'Sneakers'
END
```

"Look at the Season field. If the value is Summer, then return Sandals. If the value is Winter, then return Boots. If none of the options in the calculation match what is in the Season field, return a Sneakers."

Notes Used with [CASE](#) on page 2304, [WHEN](#) on page 2361, [IF](#) on page 2325, [ELSEIF](#) on page 2318, [THEN](#) above, [ELSE](#) on page 2317, and [END](#) on page 2319

TIMESTAMP_TO_USEC

`TIMESTAMP_TO_USEC (expression)`

Only supported when connected to Google BigQuery. For more information, see [Additional Functions](#).

TLD

`TLD (string_url)`

Only supported when connected to Google BigQuery. For more information, see [Additional Functions](#).

TODAY

Syntax `TODAY ()`

Output `Date`

Definition Returns the current local system date.

Example `TODAY () = 1986-03-25`

Notes `TODAY` does not take an argument.

See also [NOW](#) on page 2343, a similar calculation that returns a datetime instead of a date.

If the data source is a live connection, the system date could be in another timezone. For more information on how to address this, see [the Knowledge Base](#).

TOTAL

`TOTAL (expression)`

For more information, see [Table Calculation Functions](#).

TRIM

Syntax	<code>TRIM(string)</code>
Output	String
Definition	Returns the provided <code><string></code> with leading and trailing spaces removed.
Example	<code>TRIM(" Calculation ") = "Calculation"</code>
Notes	See also LTRIM on page 2335 and RTRIM on page 2350.

[back to top](#)

U

UPPER

Syntax	<code>UPPER(string)</code>
Output	String
Definition	Returns the provided <code><string></code> in all uppercase characters.
Example	<code>UPPER("Calculation") = "CALCULATION"</code>
Notes	See also PROPER on page 2346 and LOWER on page 2335.

USEC_TO_TIMESTAMP

`USEC_TO_TIMESTAMP(expression)`

Only supported when connected to Google BigQuery. For more information, see [Additional Functions](#).

USERDOMAIN

Syntax	<code>USERDOMAIN()</code>
--------	----------------------------

Output	String
Definition	Returns the domain for the current user.
Notes	This function checks: <ul style="list-style-type: none">• Tableau Cloud and Tableau Server: the user domain of the signed-in user• Tableau Desktop: the local domain if the user is on a domain

USERNAME

Syntax	<code>USERNAME ()</code>
Output	String
Definition	Returns the username for the current user.
Example	<code>USERNAME ()</code> This returns the username of the signed in user, such as "hmyrer". <code>[Manager] = USERNAME ()</code> If manager "hmyrer" is signed in, this example returns TRUE only if the Manager field in the view contains "hmyrer".
Notes	This function checks: <ul style="list-style-type: none">• Tableau Cloud and Tableau Server: the username of the signed-in user• Tableau Desktop: the local or network username for the user User filters When used as a filter, a calculated field such as <code>[Username field] = USERNAME ()</code> can be used to create a user filter that only shows data that is relevant to the person signed in to the server.

USER ATTRIBUTE JSON web token functions

- `USERATTRIBUTE('attribute_name')`
- `USERATTRIBUTEINCLUDES('attribute_name', 'expected_value')`

For more information, see [User Functions](#).

[back to top](#)

V

VAR

Syntax	<code>VAR(expression)</code>
Definition	Returns the statistical variance of all values in the given expression based on a sample of the population.

VARP

Syntax	<code>VARP(expression)</code>
Definition	Returns the statistical variance of all values in the given expression on the entire population.

[back to top](#)

W

WEEK

Syntax	<code>WEEK(date)</code>
Output	Integer
Definition	Returns the week of the given <code><date></code> as an integer.
Example	<code>WEEK(#1986-03-25#) = 13</code>
Notes	See also DAY on page 2315, MONTH on page 2342, Quarter on

page 2347, [YEAR](#) on page 2363, and the ISO equivalents

WHEN

Syntax	<pre> CASE <expression> WHEN <value1> THEN <then1> WHEN <value2> THEN <then2> ... [ELSE <default>] END </pre>
Definition	<p>A required part of a CASE expression. Finds the first <value> that matches <expression> and returns the corresponding <then>.</p>
Example	<pre> CASE [Season] WHEN 'Summer' THEN 'Sandals' WHEN 'Winter' THEN 'Boots' ELSE 'Sneakers' END </pre> <p><i>"Look at the Season field. If the value is Summer, then return Sandals. If the value is Winter, then return Boots. If none of the options in the calculation match what is in the Season field, return a Sneakers."</i></p>
Notes	<p>Used with CASE on page 2304, THEN on page 2356, ELSE on page 2317, and END on page 2319.</p> <p>CASE also supports WHEN IN construction, such as:</p> <pre> CASE <expression> WHEN IN <set1> THEN <then1> WHEN IN <combinedfield> THEN <then2> ... ELSE <default> END </pre> <p>The values that WHEN IN compare to must be a set, list of literal values, or combined field. See also IN on page 2327.</p>

Window Table Calcs

For more information, see [Table Calculation Functions](#).

- `WINDOW_AVG(expression, [start, end])`
- `WINDOW_CORR(expression1, expression2, [start, end])`
- `WINDOW_COUNT(expression, [start, end])`
- `WINDOW_COVAR(expression1, expression2, [start, end])`
- `WINDOW_COVARP(expression1, expression2, [start, end])`
- `WINDOW_MAX(expression, [start, end])`
- `WINDOW_MEDIAN(expression, [start, end])`
- `WINDOW_MIN(expression, [start, end])`
- `WINDOW_PERCENTILE(expression, number, [start, end])`
- `WINDOW_STDEV(expression, [start, end])`
- `WINDOW_STDEVP(expression, [start, end])`
- `WINDOW_SUM(expression, [start, end])`
- `WINDOW_VAR(expression, [start, end])`
- `WINDOW_VARP(expression, [start, end])`

[back to top](#)

X

XPATH functions.

Only supported when connected to Hadoop Hive. For more information, see [Pass-Through Functions \(RAWSQL\)](#).

- `XPATH_BOOLEAN(XML string, XPath expression string)`
- `XPATH_DOUBLE(XML string, XPath expression string)`
- `XPATH_FLOAT(XML string, XPath expression string)`
- `XPATH_INT(XML string, XPath expression string)`
- `XPATH_LONG(XML string, XPath expression string)`
- `XPATH_SHORT(XML string, XPath expression string)`
- `XPATH_STRING(XML string, XPath expression string)`

[back to top](#)

Y

YEAR

Syntax YEAR (date)

Output Integer

Definition Returns the year of the given <date> as an integer.

Example YEAR (#1986-03-25#) = 1,986

Notes See also [DAY](#) on page 2315, [WEEK](#) on page 2360, [MONTH](#) on page 2342, [Quarter](#) on page 2347, and the ISO equivalents

[back to top](#)

Z

ZN

Syntax ZN (expression)

Output Depends on the data type of the <expression>, or 0.

Definition Returns <expression> if it isn't null, otherwise returns zero.

Example ZN ([Test Grade])

"If the test grade isn't null, return its value. If the test grade is null, return 0."

Notes ZN is a specialized case of [IFNULL](#) on page 2325 where alternative if the expression is null is always 0 rather than being specified in the calculation.

ZN is especially useful when performing additional calculations and a null would render the entire calculation null. However, use caution interpreting these results as null is not always synonymous with 0 and could represent missing data.

See also [ISNULL](#) on page 2330.

[back to top](#)

See also

[Tableau Functions \(by Category\) on page 2199](#)

[Functions in Tableau on page 2047](#)

Transform Values with Table Calculations

This article explains the basics of table calculations and how to create them in Tableau.

What is a table calculation?

A table calculation is a transformation you apply to the values in a visualization. Table calculations are a special type of calculated field that computes on the local data in Tableau. They are calculated based on what is currently in the visualization and do not consider any measures or dimensions that are filtered out of the visualization.

You can use table calculations for a variety of purposes, including:

- Transforming values to rankings
- Transforming values to show running totals
- Transforming values to show percent of total

For any Tableau visualization, there is a virtual table that is determined by the dimensions in the view. This table is not the same as the tables in your data source. Specifically, the virtual table is determined by the dimensions within the “level of detail,” which means the dimensions on any of the following shelves or cards in a Tableau worksheet:

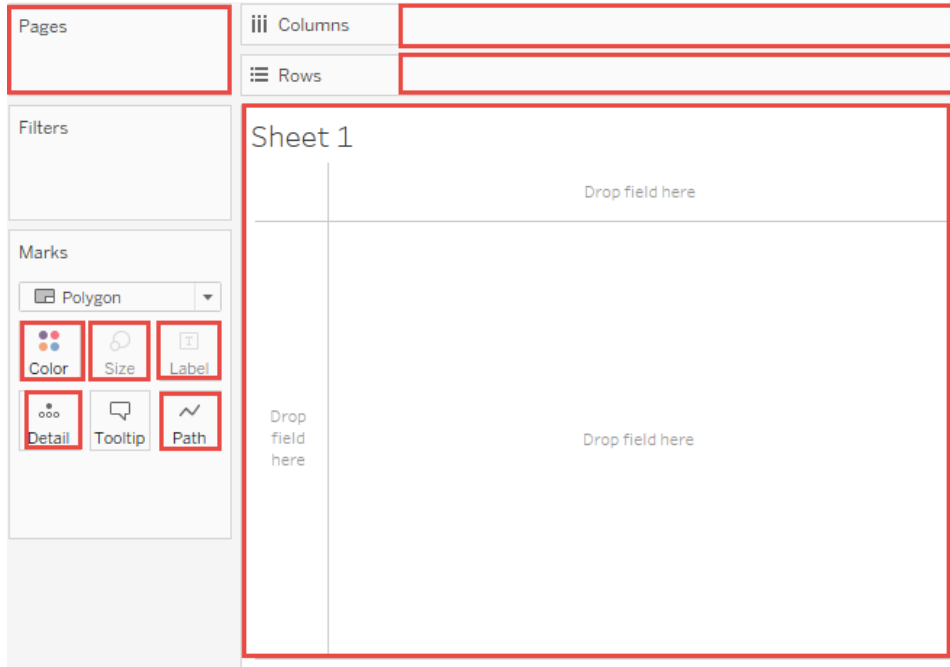

The basics: addressing and partitioning

When you add a table calculation, you must use all dimensions in the level of detail either for partitioning (scoping) or for addressing (direction).

The dimensions that define how to group the calculation (the scope of data it is performed on) are called **partitioning fields**. The table calculation is performed separately within each partition.

The remaining dimensions, upon which the table calculation is performed, are called **addressing fields**, and determine the direction of the calculation.

Partitioning fields break the view up into multiple sub-views (or sub-tables), and then the table calculation is applied to the marks within each such partition. The direction in which the calculation moves (for example, in calculating a running sum, or computing the difference between values) is determined by the addressing fields. So when you order the fields in the Specific Dimensions section of the Table Calculation dialog box from top to bottom, you are specifying the direction in which the calculation moves through the various marks in the partition.

When you add a table calculation using the Compute Using options, Tableau identifies some dimensions as addressing and others as partitioning automatically, as a result of your selections. But when you use Specific Dimensions, then it's up to you to determine which dimensions are for addressing and which for partitioning.

Table (across)

Computes across the length of the table and restarts after every partition.

For example, in the following table, the calculation is computed across columns (YEAR(Order Date)) for every row (MONTH(Order Date)).

The screenshot shows the Tableau interface with a table view. The Columns shelf contains 'YEAR(Order Date)' and the Rows shelf contains 'QUARTER(Order Date)' and 'MONTH(Order Date)'. The Marks card is set to 'SUM(Sales)'. The table data is as follows:

Quarter of Order	Month of Order	Order Date			
		2011	2012	2013	2014
Q1	January	\$4,238	\$368	\$26,134	
	February		\$7,400	\$10,657	-\$2,584
	March		-\$17,224	\$12,719	\$2,723
Q2	April		\$5,900	\$5,053	\$864
	May		\$6,483	\$26,559	-\$11,040
	June		-\$9,798	\$14,633	\$8,829
Q3	July		-\$5,181	\$9,675	\$9,988
	August		\$8,989	-\$3,633	\$28,251
	September		-\$17,181	\$8,312	\$17,581
Q4	October		-\$48	\$25,058	\$21,331
	November		-\$2,656	\$6,220	\$30,134
	December		\$5,374	\$22,318	-\$6,763

Table (down)

Computes down the length of the table and restarts after every partition.

For example, in the following table, the calculation is computed down rows (MONTH(Order Date)) for every column (YEAR(Order Date)).

Tableau Desktop and Web Authoring Help

The screenshot shows the Tableau Desktop interface. The Columns shelf contains 'YEAR(Order Date)'. The Rows shelf contains 'QUARTER(Order Date)' and 'MONTH(Order Date)'. The Marks shelf is set to 'SUM(Sales)'. The main view displays a table with the following data:

Quarter of Order..	Month of Order ..	Order Date			
		2011	2012	2013	2014
Q1	January				
	February	-\$9,136	-\$5,963	\$4,325	-\$24,420
	March	\$50,380	\$26,256	\$28,319	\$33,625
Q2	April	-\$27,396	-\$4,272	-\$11,938	-\$13,797
	May	-\$4,547	-\$4,064	\$17,442	\$5,539
	June	\$10,947	-\$5,334	-\$17,261	\$2,609
Q3	July	-\$549	\$3,968	-\$990	\$169
	August	-\$6,037	\$8,133	-\$5,175	\$13,088
	September	\$53,368	\$27,698	\$39,643	\$28,973
Q4	October	-\$50,324	\$33,191	-\$16,445	-\$12,695
	November	\$47,175	\$44,568	\$25,729	\$34,533
	December	-\$9,983	-\$1,053	\$15,045	-\$21,852

Table (across then down)

Computes across the length of the table, and then down the length of the table.

For example, in the following table, the calculation is computed across columns (YEAR(Order Date)), down a row (MONTH(Order Date)), and then across columns again for the entire table.

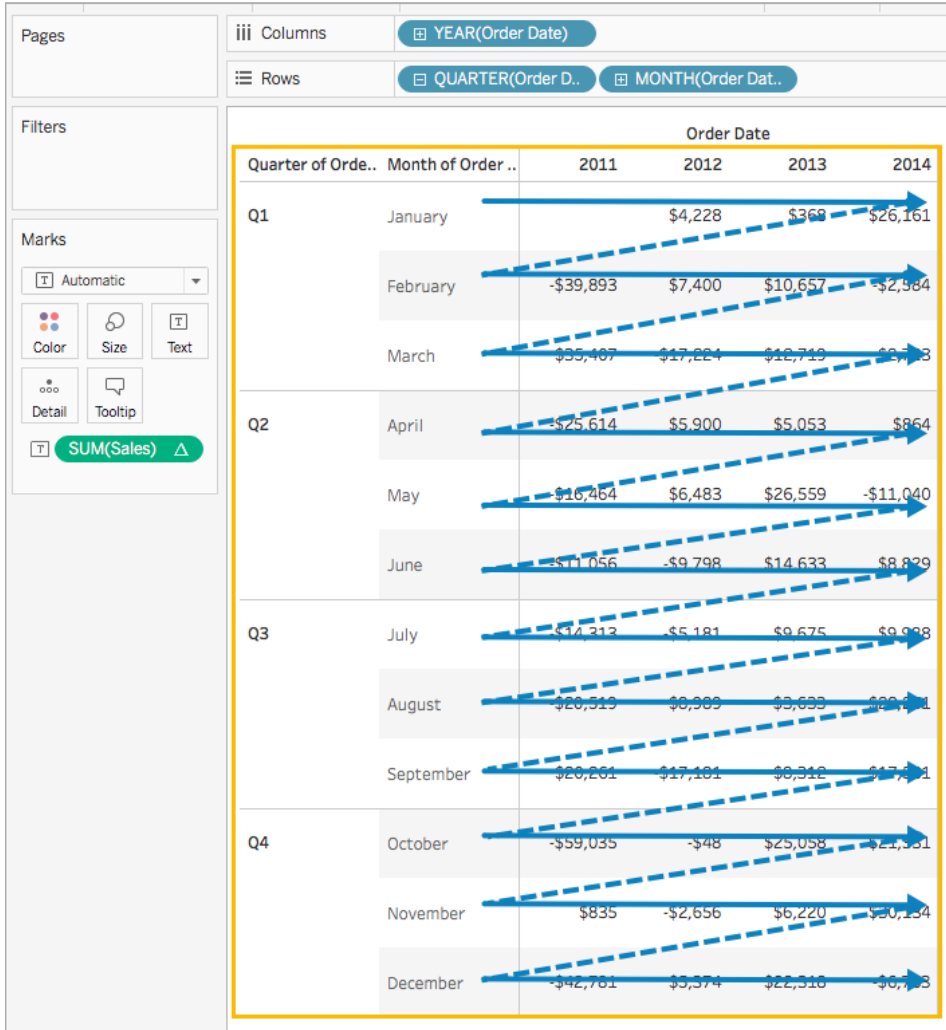

Table (down then across)

Computes down the length of the table, and then across the length of the table.

For example, in the following table, the calculation is computed down rows (MONTH(Order Date)), across a column (YEAR(Order Date)), and then down rows again.

Tableau Desktop and Web Authoring Help

		Order Date			
Quarter of Order..	Month of Order ..	2011	2012	2013	2014
Q1	January		-\$51,372	-\$56,377	-\$52,534
	February	-\$9,136	-\$8,963	\$4,325	-\$24,420
	March	\$50,880	\$26,256	\$28,319	\$33,625
Q2	April	-\$27,396	-\$4,272	-\$11,938	-\$13,797
	May	-\$4,647	-\$4,064	\$17,442	\$5,539
	June	\$10,947	-\$5,334	-\$17,261	\$2,609
Q3	July	-\$649	\$3,968	\$990	\$169
	August	-\$6,037	\$8,133	-\$5,175	\$13,088
	September	\$53,868	\$27,698	\$39,643	\$28,973
Q4	October	-\$50,324	-\$33,151	-\$13,445	-\$12,695
	November	\$47,175	\$44,568	\$25,729	\$34,533
	December	-\$9,083	-\$1,053	\$15,045	-\$21,852

Pane (down)

Computes down an entire pane.

For example, in the following table, the calculation is computed down rows (MONTH(Order Date)) for a single pane.

		Order Date			
Quarter of Order..	Month of Order ..	2011	2012	2013	2014
Q1	January				
	February	-\$9,136	-\$5,963	\$4,325	-\$24,420
	March	\$50,880	\$26,256	\$28,319	\$33,625
Q2	April				
	May	-\$4,647	-\$4,064	\$17,442	\$5,539
	June	\$10,947	-\$5,334	-\$17,261	\$2,609
Q3	July				
	August	-\$6,037	\$8,133	-\$5,175	\$13,088
	September	\$53,868	\$27,698	\$39,643	\$28,973
Q4	October				
	November	\$47,175	\$44,568	\$25,729	\$34,533
	December	-\$9,083	-\$1,053	\$15,045	-\$21,852

Pane (across then down)

Computes across an entire pane and then down the pane.

For example, in the following table, the calculation is computed across columns (YEAR(Order Date)) for the length of the pane, down a row (MONTH(Order Date)), and then across columns for the length of the pane again.

Quarter of Order..	Month of Order..	Order Date			
		2011	2012	2013	2014
Q1	January		\$4,228	\$368	\$26,161
	February	\$35,893	\$7,480	\$10,667	\$2,723
	March	\$35,407	-\$17,224	\$12,719	\$2,723
Q2	April		\$5,900	\$5,053	\$864
	May	-\$16,464	\$6,483	\$26,559	-\$11,040
	June	-\$11,056	-\$9,798	\$14,633	\$8,829
Q3	July		-\$5,181	\$9,675	\$9,988
	August	-\$20,519	\$8,989	-\$3,633	\$28,251
	September	\$20,261	-\$17,181	\$8,312	\$17,581
Q4	October		-\$48	\$25,058	\$21,331
	November	\$835	-\$2,656	\$6,220	\$30,134
	December	-\$42,781	\$5,374	\$22,318	-\$6,763

Pane (down then across)

Computes down an entire pane and then across the pane.

For example, in the following table, the calculation is computed down rows (MONTH(Order Date)) for the length of the pane, across a column (YEAR(Order Date)), and then down the length of the pane again.

Tableau Desktop and Web Authoring Help

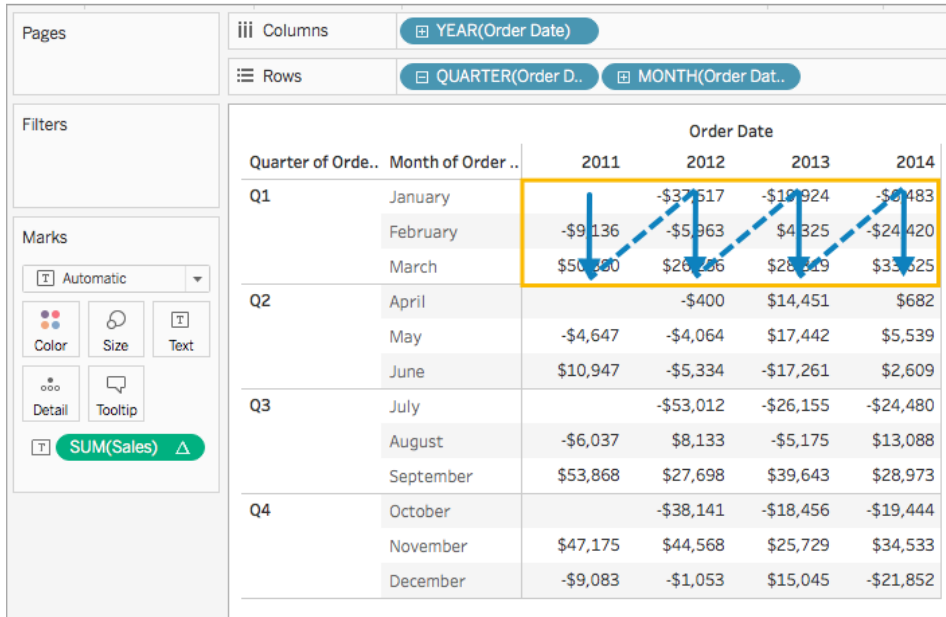

Cell

Computes within a single cell.

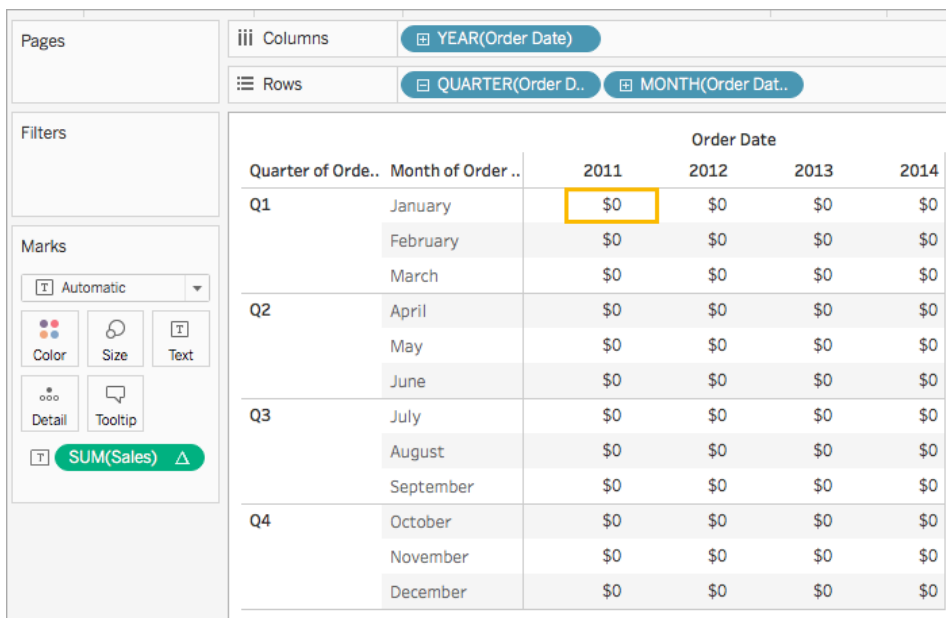

Specific Dimensions

Computes only within the dimensions you specify.

For example, in the following visualization the dimensions, Month of Order Date and Quarter of Order Date, are the addressing fields (since they are selected), and Year of Order Date is the partitioning field (since it is not selected). So the calculation transforms the difference from each month across all quarters within a year. The calculation starts over for every year.

Note that if all dimensions are selected, then the entire table is in scope.

The screenshot shows a Tableau worksheet named 'Sheet 1' with a table calculation. The columns are 'YEAR(Order Date)', 'QUARTER(Order Date)', and 'MONTH(Order Date)'. The rows are grouped by 'Quarter of Order Date' (Q1, Q2, Q3, Q4) and 'Month of Order Date' (January through December). The table shows sales data for the years 2011, 2012, 2013, and 2014. A blue arrow points to the 2011 column, indicating the calculation's scope. The 'Table Calculation' dialog box is open, showing the 'Difference in Sales' calculation type and 'Specific Dimensions' selected for 'Month of Order Date' and 'Quarter of Order Date'. The 'At the level' is set to 'Deepest', 'Relative to' is 'Previous', and 'Sort order' is 'Specific Dimensions'.

Quarter of ..	Month of O..	Order Date			
		2011	2012	2013	2014
Q1	January				
	February	-\$9,136	-\$5,963	\$4,325	-\$24,420
	March	\$50,880	\$26,256	\$28,319	\$33,625
Q2	April	-\$27,396	-\$4,272	-\$11,938	-\$13,797
	May	-\$4,647	-\$4,064	\$17,442	\$5,539
	June	\$10,947	-\$5,334	-\$17,261	\$2,609
Q3	July	-\$649	\$3,968	-\$990	\$169
	August	-\$6,037	\$8,133	-\$5,175	\$13,088
	September	\$53,868	\$27,698	\$39,643	\$28,973
Q4	October	-\$50,324	-\$33,191	-\$16,445	-\$12,695
	November	\$47,175	\$44,568	\$25,729	\$34,533
	December	-\$9,083	-\$1,053	\$15,045	-\$21,852

At the level

The **At the level** option is only available when you select **Specific Dimensions** in the Table Calculations dialog box, and when more than one dimension is selected in the field immediately below the **Compute Using** options—that is, when more than one dimension is defined as an addressing field.

This option is not available when you're defining a table calculation with **Compute Using**, because those values establish partitions by position. But with **Specific Dimensions**, because the visual structure and the table calculation are not necessarily aligned, the **At the level** option is available to let you fine-tune your calculation.

Use this setting to set a break (that is, restart of the calculation) in the view, based on a particular dimension. How is this different from just using that dimension for partitioning? In fact, it is partitioning, but it's partitioning by position rather than by value, which is how partitioning is defined with the **Compute Using** options.

The choices available from the At the level drop-down list in the example above are:

Deepest	Specifies that the calculation should be performed at the level of finest granularity. This is the default option.
Quarter of Order Date	Specifies that the calculation should be performed at the quarter level.
Month of Order Date	Specifies that the calculation should be performed at the month level.

Create a table calculation

To learn how to create a table calculation, follow along with the steps in the example below. To learn how to create quick table calculations, see [Quick Table Calculations on page 2397](#).

Step 1: Build the visualization

1. Open Tableau and connect to the **Sample-Superstore** saved data source.
2. Navigate to a new worksheet.
3. From the **Data** pane, drag **Order Date** to the **Rows** shelf. The dimension updates to **YEAR (Order Date)**.
4. On the Rows shelf, right-click **YEAR(Order Date)** and select **Quarter**.
5. On the Rows shelf, click the **+** icon on **QUARTER(Order Date)**. **MONTH(Order Date)** is added to the shelf.
6. From the **Data** pane, under Dimensions, drag **Order Date** to the **Columns** shelf. The dimension updates to **YEAR(Order Date)** again.
7. From the **Data** pane, drag **Sales** to **Text** on the Marks card.

Sheet 1

Quarter of ..	Month of O..	Order Date			
		2011	2012	2013	2014
Q1	January	\$13,946	\$18,174	\$18,542	\$44,703
	February	\$4,811	\$12,211	\$22,868	\$20,284
	March	\$55,691	\$38,467	\$51,186	\$53,909
Q2	April	\$28,295	\$34,195	\$39,249	\$40,112
	May	\$23,648	\$30,132	\$56,691	\$45,651
	June	\$34,595	\$24,797	\$39,430	\$48,260
Q3	July	\$33,946	\$28,765	\$38,441	\$48,428
	August	\$27,909	\$36,898	\$33,266	\$61,516
	September	\$81,777	\$64,596	\$72,908	\$90,489
Q4	October	\$31,453	\$31,405	\$56,463	\$77,794
	November	\$78,629	\$75,973	\$82,192	\$112,326
	December	\$69,546	\$74,920	\$97,237	\$90,475

Step 2: Add the table calculation

1. On the Marks card, right-click SUM(Sales) and select **Add Table Calculation**.
2. In the Table Calculation dialog box that opens, do the following:
 - For **Calculation Type**: select **Difference From**.
For more information about the types of table calculations you can use in Tableau, and how you can configure them, see [Table Calculation Types](#) on page 2376.
 - For **Compute Using**, select **Table (across)**. Note that as you select how to compute the calculation, the visualization updates with visual indicators to guide you. For more information about these options, see [The basics: addressing and partitioning](#) on page 2365 section.
 - When finished, click the X in the top corner of the Table Calculation dialog box to exit it.

The calculation is applied to the values in the visualization.

Check your work!

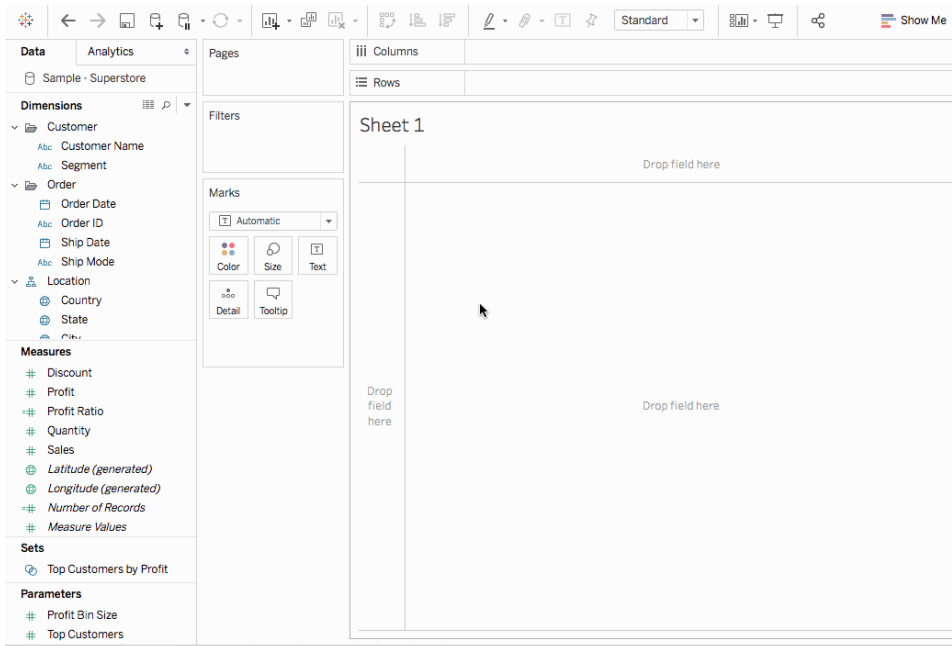

Edit a table calculation

To edit a table calculation:

1. Right-click the measure in the view with the table calculation applied to it and select **Edit Table Calculation**.
2. In the Table Calculation dialog box that appears, make your changes.
3. When finished, click the X in the top corner of the Table Calculation dialog box to exit it.

Remove a table calculation

To remove a table calculation:

- Right-click the measure in the view with the table calculation applied to it and select **Clear Table Calculation**. The table calculation is removed from the measure and the visualization updates with the original values.

See Also

[Table calculations](#) on page 2032

[Quick Table Calculations](#) on page 2397

[Table Calculation Types](#) on the next page

Table Calculation Types

This article describes the types of table calculations available in Tableau and when to use them. It uses simple examples to demonstrate how each calculation transforms data in a table. For more information on how to create and configure table calculations, see [Create a table calculation on page 2373](#).

Difference From calculation

A **Difference From** table calculation computes the difference between the current value and another value in the table for each mark in the visualization.

With a **Difference From**, **Percent Difference From**, or **Percent From** calculation, there are always two values to consider: the current value, and the value from which the difference should be calculated. In most cases, you want to calculate the difference between the current value and the previous value, as in the procedure above. But in some cases you may want something different.

To specify from which value the difference should be calculated:

1. Right-click a measure in the view and select **Add Table Calculation**.
2. In the Table Calculation dialog box, for **Relative to**, select one of the following options:

Previous	Calculates the difference between the current value and the previous value in the partition. This is the default value.
Next	Calculates the difference between the current value and the next value in the partition.
First	Calculates the difference between the current value and the first value in the partition.
Last	Calculates the difference between the current value and the last value in the partition.

Example

Consider the text table below. It shows the total sales per month for 2011, 2012, 2013, and 2014 for a large store chain.

Tableau Desktop and Web Authoring Help

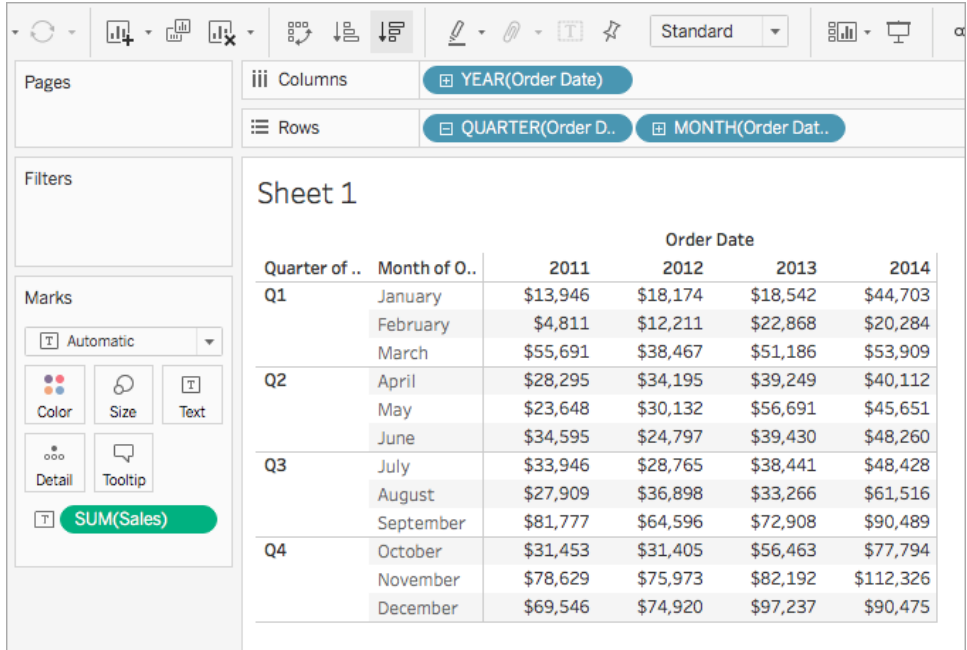

You can use a Difference From table calculation to calculate how sales fluctuate (how much they go up or down) between the years for each month.

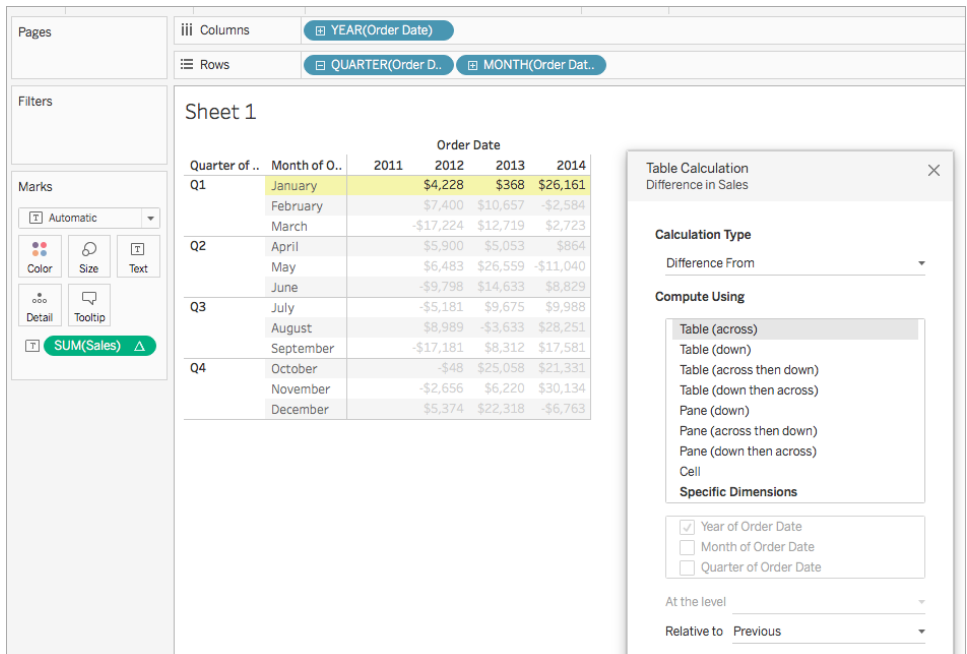

You can see that in January, there was a 368 USD difference between sales in 2012 and 2013, and a 26,161 USD difference between sales in 2013 and 2014.

Tip: When calculating year-over-year growth, the first year doesn't have a previous year to compare to, so the column is left blank. Hide the column that you don't want to show to keep the calculation intact. For details, see [Hide rows and columns on page 60](#).

Why? If you filtered out the first year to remove it from the view, it would also remove it from the calculation so the second year doesn't have a previous year to compare to and is left blank. Instead of filtering, hiding the column keeps the calculation intact.

Moving calculation

For each mark in the view, a **Moving Calculation** table calculation (sometimes referred to as a *rolling* calculation) determines the value for a mark in the view by performing an aggregation (sum, average, minimum, or maximum) across a specified number of values before and/or after the current value.

A moving calculation is typically used to smooth short-term fluctuations in your data so that you can see long-term trends. For example, with securities data there are so many fluctuations every day that it is hard to see the big picture through all the ups and downs. You can use a moving calculation to define a range of values to summarize using an aggregation of your choice.

Example

Consider the text table below. It shows the total sales per month for 2011, 2012, 2013, and 2014 for a large store chain.

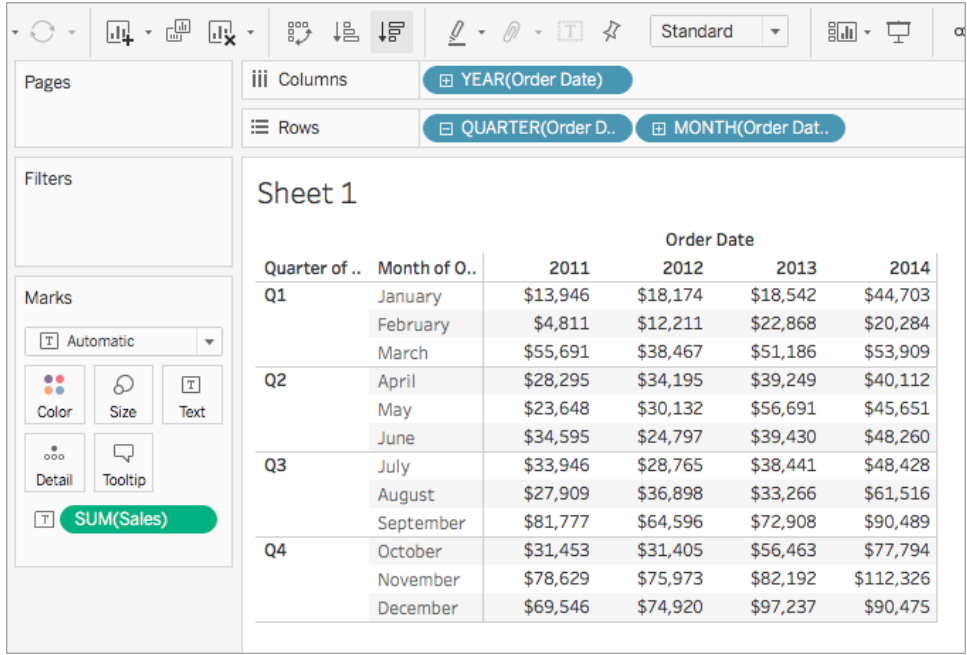

You can use a Moving calculation to find out how sales totals are trending over time. To do this, you can transform each monthly total so that it averages the monthly total for it and the two previous months over time.

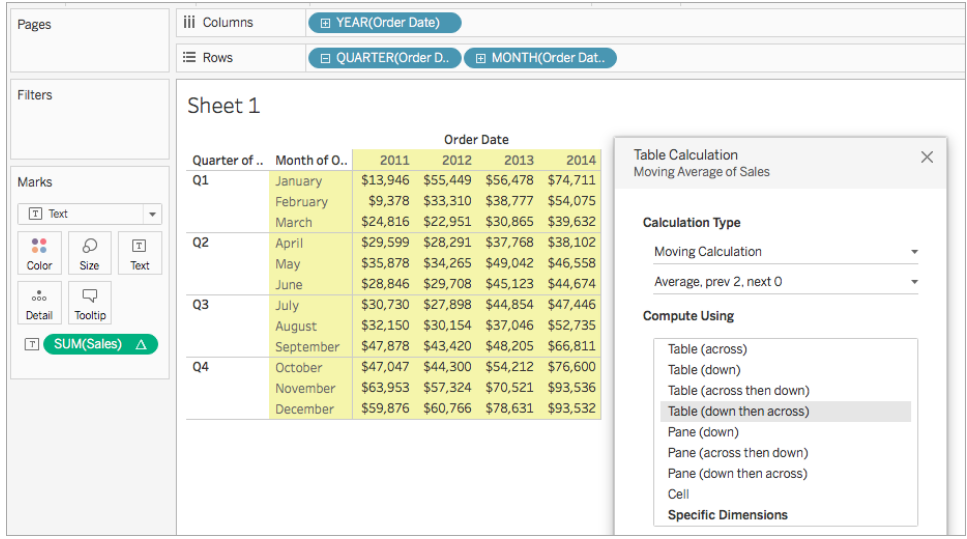

You can see the average sales over time. For example, the value listed for December 2011 is the average sales for October, November, and December, 2011. The value listed for January, 2012 is the average sales for November and December, 2011, and January, 2012.

Add Secondary Calculation

With **Running Total** and **Moving Calculation** table calculations, you have the option to transform values twice to obtain the result you want—that is, to add a secondary table calculation on top of the primary table calculation. For example, you could add an initial table calculation to calculate the running total for sales per month within each individual year, and then a secondary calculation to calculate the year-over-year percent difference for each month from one year to the next.

For an example showing how to create a secondary calculation, see [Running Total calculation on page 2390](#).

Percent Difference From calculation

A **Percent Difference From** table calculation computes the difference between the current value and another value in the table as a percentage for each mark in the visualization.

With a **Difference From**, **Percent Difference From**, or **Percent From** calculation, there are always two values to consider: the current value, and the value from which the difference should be calculated. In most cases, you want to calculate the difference between the current value and the previous value, as in the procedure above. But in some cases you may want something different.

To specify from which value the difference should be calculated:

1. Right-click a measure in the view and select **Add Table Calculation**.
2. In the Table Calculation dialog box, for **Relative to**, select one of the following options:

Previous	Calculates the difference between the current value and the previous value in the partition. This is the default value.
Next	Calculates the difference between the current value and the next value in the partition.
First	Calculates the difference between the current value and the first value in the partition.
Last	Calculates the difference between the current value and the last value in the partition.

Example

Consider the text table below. It shows the total sales per month for 2011, 2012, 2013, and 2014 for a large store chain.

The screenshot shows the Tableau Desktop interface with the following configuration:

- Columns Shelf:** YEAR(Order Date)
- Rows Shelf:** QUARTER(Order Date), MONTH(Order Date)
- Marks Shelf:** SUM(Sales)

The resulting table is as follows:

Quarter of ..	Month of O..	Order Date			
		2011	2012	2013	2014
Q1	January	\$13,946	\$18,174	\$18,542	\$44,703
	February	\$4,811	\$12,211	\$22,868	\$20,284
	March	\$55,691	\$38,467	\$51,186	\$53,909
Q2	April	\$28,295	\$34,195	\$39,249	\$40,112
	May	\$23,648	\$30,132	\$56,691	\$45,651
	June	\$34,595	\$24,797	\$39,430	\$48,260
Q3	July	\$33,946	\$28,765	\$38,441	\$48,428
	August	\$27,909	\$36,898	\$33,266	\$61,516
	September	\$81,777	\$64,596	\$72,908	\$90,489
Q4	October	\$31,453	\$31,405	\$56,463	\$77,794
	November	\$78,629	\$75,973	\$82,192	\$112,326
	December	\$69,546	\$74,920	\$97,237	\$90,475

You can use a Percent Difference From table calculation to calculate how sales fluctuate (how much they go up or down) between the years for each month. Values are calculated as percentages.

Sheet 1

Quarter of ..	Month of O..	2011	2012	2013	2014
Q1	January				
	February	-66%	-33%	23%	-55%
	March	1,058%	215%	124%	166%
Q2	April	-49%	-11%	-23%	-26%
	May	-16%	-12%	44%	14%
	June	46%	-18%	-30%	6%
Q3	July	-2%	16%	-3%	0%
	August	-18%	26%	-13%	27%
	September	193%	75%	119%	47%
Q4	October	-62%	-51%	-23%	-14%
	November	150%	142%	46%	44%
	December	-12%	-1%	18%	-19%

Table Calculation
% Difference in Sales

Calculation Type
Percent Difference From

Compute Using
Table (down)

Specific Dimensions
 Quarter of Order Date
 Month of Order Date
 Year of Order Date

At the level
Relative to Previous

You can see that between January and February, 2011, there was a -66% difference in sales, but between February and March, 2011, there was a huge improvement of 1,058% sales.

Percent From calculation

A **Percent From** table calculation computes a value as a percentage of some other value—typically, as a percentage of the previous value in the table—for each mark in the visualization.

With a **Difference From**, **Percent Difference From**, or **Percent From** calculation, there are always two values to consider: the current value, and the value from which the difference should be calculated. In most cases, you want to calculate the difference between the current value and the previous value, as in the procedure above. But in some cases you may want something different.

To specify from which value the difference should be calculated:

1. Right-click a measure in the view and select **Add Table Calculation**.
2. In the Table Calculation dialog box, for **Relative to**, select one of the following options:

Previous	Calculates the difference between the current value and the previous value in the partition. This is the default value.
Next	Calculates the difference between the current value and the next value in the partition.

First	Calculates the difference between the current value and the first value in the partition.
Last	Calculates the difference between the current value and the last value in the partition.

Example

Consider the text table below. It shows the total sales per month for 2011, 2012, 2013, and 2014 for a large store chain.

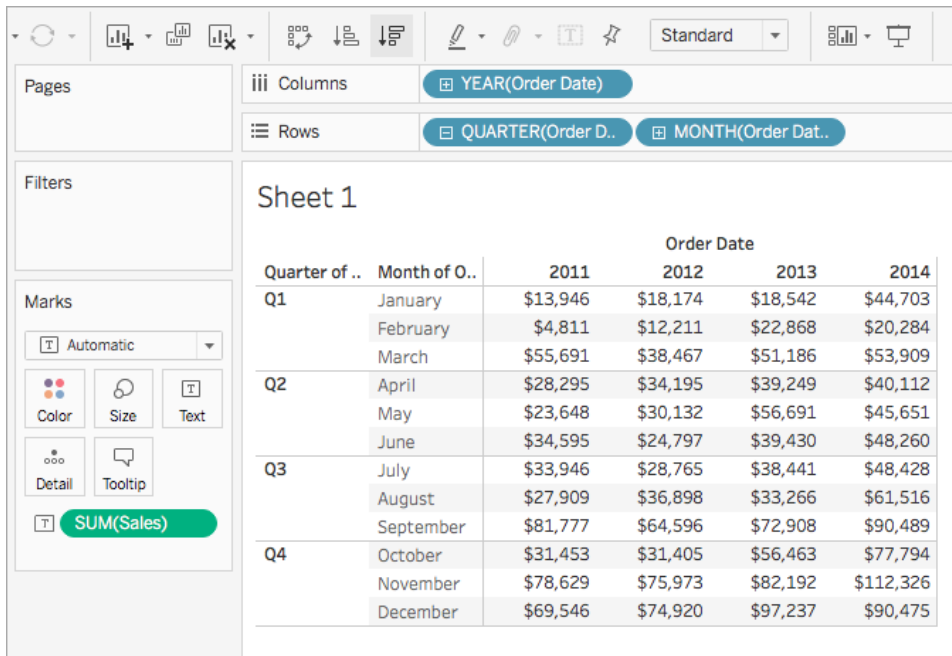

You can use a Percent From table calculation to calculate the percentage of a previous value. For example, you can calculate what percentage of sales in January 2011, was made in February 2011.

Sheet 1

Quarter of ..	Month of O..	2011	2012	2013	2014
Q1	January				
	February	34%	67%	123%	45%
	March	1,158%	315%	224%	266%
Q2	April	51%	89%	77%	74%
	May	84%	88%	144%	114%
	June	146%	82%	70%	106%
Q3	July	98%	116%	97%	100%
	August	82%	128%	87%	127%
	September	293%	175%	219%	147%
Q4	October	38%	49%	77%	86%
	November	250%	242%	146%	144%
	December	88%	99%	118%	81%

Table Calculation
% of Sales

Calculation Type
Percent From

Compute Using
Table (down)

Specific Dimensions
 Quarter of Order Date
 Month of Order Date
 Year of Order Date

At the level
Relative to Previous

You can see that February, 2011 made 34% of the sales made in January, 2011; March, 2011 made 1,158% of the sales made in February, and so on.

Percent of Total calculation

For each mark in the view, a **Percent of Total** table calculation computes a value as a percentage of all values in the current partition.

Example

Consider the text table below. It shows the total sales per month for 2011, 2012, 2013, and 2014 for a large store chain.

Tableau Desktop and Web Authoring Help

The screenshot shows the Tableau Desktop interface with a pivot table. The Columns shelf contains 'YEAR(Order Date)' and the Rows shelf contains 'QUARTER(Order Date)' and 'MONTH(Order Date)'. The Marks shelf is set to 'SUM(Sales)'. The pivot table displays sales data for each quarter and month from 2011 to 2014.

Quarter of ..	Month of O..	Order Date			
		2011	2012	2013	2014
Q1	January	\$13,946	\$18,174	\$18,542	\$44,703
	February	\$4,811	\$12,211	\$22,868	\$20,284
	March	\$55,691	\$38,467	\$51,186	\$53,909
Q2	April	\$28,295	\$34,195	\$39,249	\$40,112
	May	\$23,648	\$30,132	\$56,691	\$45,651
	June	\$34,595	\$24,797	\$39,430	\$48,260
Q3	July	\$33,946	\$28,765	\$38,441	\$48,428
	August	\$27,909	\$36,898	\$33,266	\$61,516
	September	\$81,777	\$64,596	\$72,908	\$90,489
Q4	October	\$31,453	\$31,405	\$56,463	\$77,794
	November	\$78,629	\$75,973	\$82,192	\$112,326
	December	\$69,546	\$74,920	\$97,237	\$90,475

You can use a Percent of Total table calculation to calculate the percentage of total sales each month makes within a quarter. For example, you can see that January, 2011 makes up 18.73% of sales made in Q1.

The screenshot shows the same Tableau Desktop interface as above, but with a 'Table Calculation' dialog box open. The dialog box is titled '% of Total Sales' and shows the 'Calculation Type' set to 'Percent of Total'. The 'Compute Using' section is set to 'Table (down)'. The 'Specific Dimensions' section has 'Month of Order Date' checked. The pivot table in the background now shows percentage values for each cell.

Quarter of ..	Month of O..	Order Date			
		2011	2012	2013	2014
Q1	January	18.73%	26.40%	20.03%	37.60%
	February	6.46%	17.74%	24.70%	17.06%
	March	74.81%	55.87%	55.28%	45.34%
Q2	April	32.70%	38.37%	28.99%	29.93%
	May	27.33%	33.81%	41.88%	34.06%
	June	39.98%	27.82%	29.13%	36.01%
Q3	July	23.63%	22.08%	26.58%	24.16%
	August	19.43%	28.33%	23.00%	30.69%
	September	56.93%	49.59%	50.42%	45.15%
Q4	October	17.51%	17.23%	23.94%	27.72%
	November	43.77%	41.68%	34.84%	40.03%
	December	38.72%	41.10%	41.22%	32.24%

Or you can calculate the percentage of total sales each month makes within a year. For example, you can see that January, 2011 makes up 2.88% of sales made in 2011.

Sheet 1

Quarter of ..	Month of O..	2011	2012	2013	2014
Q1	January	2.88%	3.86%	3.05%	6.09%
	February	0.99%	2.60%	3.76%	2.76%
	March	11.50%	8.18%	8.41%	7.35%
Q2	April	5.84%	7.27%	6.45%	5.47%
	May	4.88%	6.40%	9.32%	6.22%
	June	7.14%	5.27%	6.48%	6.58%
Q3	July	7.01%	6.11%	6.32%	6.60%
	August	5.76%	7.84%	5.47%	8.38%
	September	16.89%	13.73%	11.98%	12.33%
Q4	October	6.50%	6.67%	9.28%	10.60%
	November	16.24%	16.15%	13.51%	15.30%
	December	14.36%	15.92%	15.98%	12.33%

Table Calculation: % of Total Sales

Calculation Type: Percent of Total

Compute Using:

- Table (across)
- Table (down)
- Table
- Pane (down)
- Pane
- Cell
- Specific Dimensions

Specific Dimensions:

- Month of Order Date
- Quarter of Order Date
- Year of Order Date

Percentile calculation

For each mark in the view, a **Percentile** table calculation computes a percentile rank for each value in a partition.

Example

Consider the text table below. It shows the total sales per month for 2011, 2012, 2013, and 2014 for a large store chain.

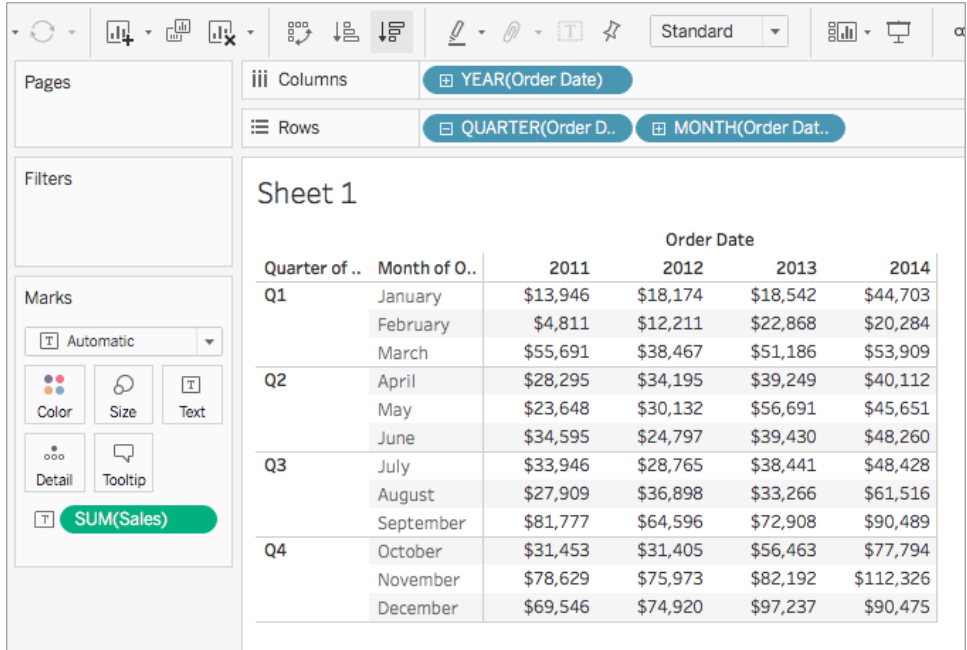

You can use a Percentile table calculation to rank the total sales for each month in a year as a percentage, rather than a whole number (for example, 1 through 10).

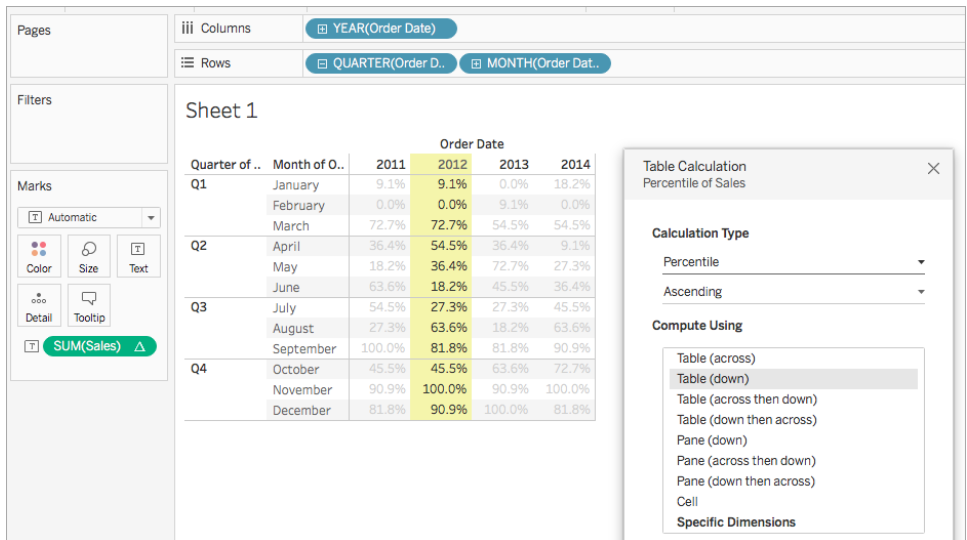

Since February made a very small amount of sales in 2012 compared to the overall total, it is ranked as 0.0% (or number 1 out of 12, since this example is Ascending, and therefore ranked from least to most). Sales in January, 2012 were a bit higher and were therefore ranked as 9.1% (or number 2 out of 12 months). Since November made the most sales in 2012, it is ranked as 100% (or number 12 out of 12).

Descending vs. Ascending

Ascending order ranks values from least to most. **Descending** order ranks values from most to least.

Rank calculation

For each mark in the view, a **Rank** table calculation computes a ranking for each value in a partition.

Example

Consider the text table below. It shows the total sales per month for 2011, 2012, 2013, and 2014 for a large store chain.

Sheet 1

Quarter of ..	Month of O..	Order Date			
		2011	2012	2013	2014
Q1	January	\$13,946	\$18,174	\$18,542	\$44,703
	February	\$4,811	\$12,211	\$22,868	\$20,284
	March	\$55,691	\$38,467	\$51,186	\$53,909
Q2	April	\$28,295	\$34,195	\$39,249	\$40,112
	May	\$23,648	\$30,132	\$56,691	\$45,651
	June	\$34,595	\$24,797	\$39,430	\$48,260
Q3	July	\$33,946	\$28,765	\$38,441	\$48,428
	August	\$27,909	\$36,898	\$33,266	\$61,516
	September	\$81,777	\$64,596	\$72,908	\$90,489
Q4	October	\$31,453	\$31,405	\$56,463	\$77,794
	November	\$78,629	\$75,973	\$82,192	\$112,326
	December	\$69,546	\$74,920	\$97,237	\$90,475

You can use a Rank table calculation to calculate a ranking for each month in a year.

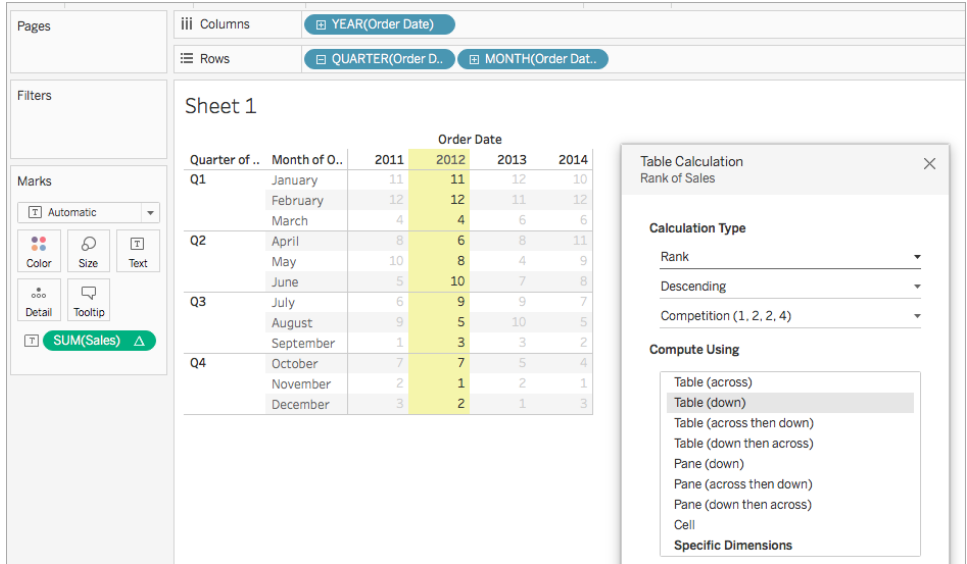

You can see that, since November made the most amount of sales in 2012, it is ranked as number 1 (because the rank is in descending order, meaning it is ordered from most to least). Since February made the least amount of sales in 2012, it is ranked number 12.

Descending vs. Ascending

Ascending order ranks values from least to most. **Descending** order ranks values from most to least. For Rank table calculation, the default value is **Descending**.

Rank Type

One issue with **Rank** calculations is that there may be more than one mark with the same value. What would happen, for example, if Tables in the Central region and Appliances in the South region both had sales of exactly \$36,729? Tableau lets you specify how to handle such cases by including an additional field in the Table Calculation dialog box when you set **Calculation Type** to **Rank**.

The choices are listed below. The number sequence at the beginning of each option show how each option would rank a hypothetical set of four values where two of the values are identical:

Option	Result
Competition (1, 2, 2, 4)	Identical values are assigned an identical rank. The highest value is ranked 1 and then the next two,

	identical values, are both are ranked 2. The next value is then ranked 4.
Modified Competition (1, 3, 3, 4)	Identical values are assigned an identical rank. The highest value is ranked 1 and then the next two, identical values, are both are ranked 3. The next value is then ranked 4.
Dense (1, 2, 2, 3)	Duplicate values are all given the same rank, which is the next number in the ranking sequence. The next value after the duplicate values is computed as though the duplicate values were a single value.
Unique (1, 2, 3, 4)	Duplicate values are given unique rankings, according to the direction in which the ranking is being computed.

Running Total calculation

For each mark in the view, a **Running Total** table calculation aggregates values cumulatively in a partition. It can do this by summing values, averaging values, or replacing all values with either the lowest or highest actual value.

Suppose you are starting with the following text view, which shows sales totals broken out by year (from left to right) and by quarter and month (from top to bottom):

Quarter of O..	Month of Or..	Order Date			
		2011	2012	2013	2014
Q1	January	\$13,946	\$18,174	\$18,542	\$44,703
	February	\$4,811	\$12,211	\$22,868	\$20,284
	March	\$55,691	\$38,467	\$51,186	\$53,909
Q2	April	\$28,295	\$34,195	\$39,249	\$40,112
	May	\$23,648	\$30,132	\$56,691	\$45,651
	June	\$34,595	\$24,797	\$39,430	\$48,260
Q3	July	\$33,946	\$28,765	\$38,441	\$48,428
	August	\$27,909	\$36,898	\$33,266	\$61,516
	September	\$81,777	\$64,596	\$72,908	\$90,489
Q4	October	\$31,453	\$31,405	\$56,463	\$77,794
	November	\$78,629	\$75,973	\$82,192	\$112,326
	December	\$69,546	\$74,920	\$97,237	\$90,475

Instead of absolute sales values, you want to see a running total of sales for each year, such that each month's sales are added to all previous months' sales.

Create the Basic View

1. Connect to the **Sample - Superstore** data source.
2. Click and drag the **Order Date** field in the Data pane and drag it to the Columns shelf.
The default date level is YEAR(Order Date).
3. Click and drag **Order Date** again and drop it this time on the Rows shelf.
4. Click on the right side of the field to open the context menu. Then choose **Quarter**.

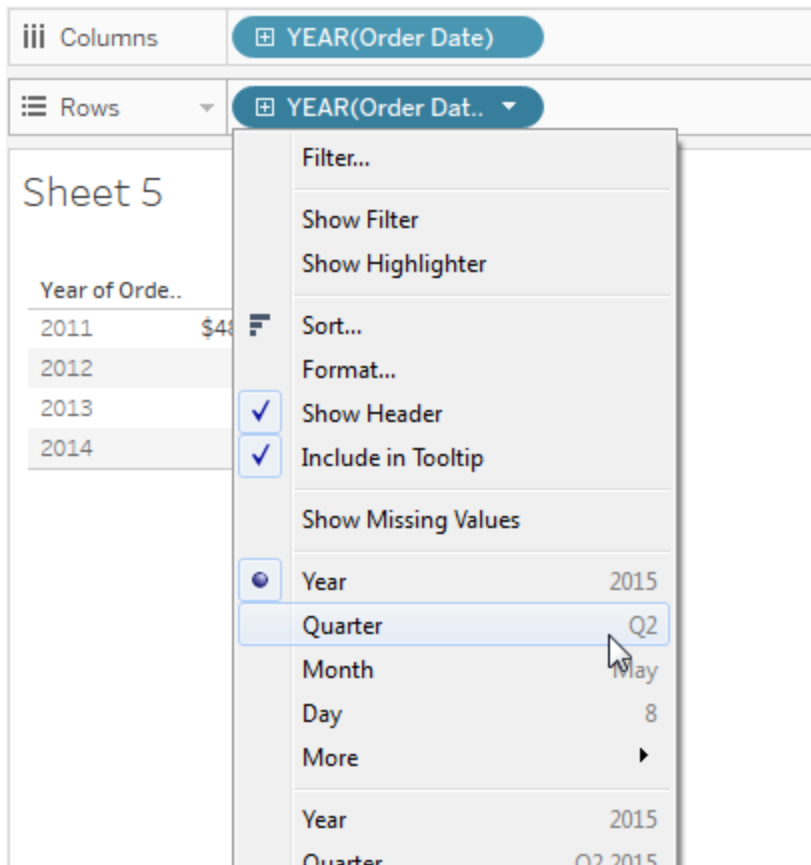

You will see two options named **Quarter**. Be sure to choose the first one.

The field should now read **QUARTER(Order Date)**.

Note: If you are creating the view on the web, the menu looks a bit different.

- Click and drag **Order Date** a third time and drop it on the Rows shelf to the right of **QUARTER(Order Date)**.
- Click on the right side of the field to open the context menu and this time choose **Month** (again, choose the first of two options named **Month**). The field should now read **MONTH (Order Date)**.
- Drag **Sales** from the Data pane and drop it on Text on the Marks card.

You now have the basic view, showing Sales by Order Date over a four-year period, by month, quarter, and year.

Add a Running Total table calculation to the basic view

- Click the **SUM(Sales)** field on the Marks card and choose **Add table calculation**.
- In the Table Calculation dialog box, choose **Running Total** as the **Calculation Type**.
- Choose **Table (Down)** from the **Compute Using** list.

The highlighting in the view shows how this **Compute Using** value sets the scope of the calculation in the view:

Quarter of O..	Month of Or..	Order Date			
		2011	2012	2013	2014
Q1	January	\$13,946	\$18,174	\$18,542	\$44,703
	February	\$18,757	\$30,385	\$41,410	\$64,987
	March	\$74,448	\$68,852	\$92,596	\$118,896
Q2	April	\$102,743	\$103,047	\$131,845	\$159,008
	May	\$126,391	\$133,179	\$188,536	\$204,659
	June	\$160,987	\$157,976	\$227,967	\$252,919
Q3	July	\$194,933	\$186,741	\$266,407	\$301,347
	August	\$222,842	\$223,640	\$299,673	\$362,863
	September	\$304,620	\$288,236	\$372,581	\$453,352
Q4	October	\$336,073	\$319,640	\$429,044	\$531,146
	November	\$414,702	\$395,613	\$511,236	\$643,472
	December	\$484,247	\$470,533	\$608,474	\$733,947

Comparing the values in the original text view with the values in this view shows that the result is correct. The monthly values ascend steadily and the December value (484,247) is the same value you see if you show column grand totals (from the Analysis menu, select **Totals > Show column grand totals**).

4. Click the X in the upper-right corner of the Table Calculations dialog box to close it.

The Running Total doesn't have to be a sum

For a **Running Total** table calculation, Tableau can update values cumulatively in other ways than summing. Choose one of the options from the drop-down list just below the **Calculation Type** field:

Option	Meaning
Sum	Each value is added to the previous value.
Average	The running total averages the current and all previous values.
Minimum	All values are replaced with the lowest value in the original partition.
Maximum	All values are replaced with the highest value in the original partition.

Restarting every option

The **Restarting every** option is only available when you select **Specific Dimensions** in the Table Calculations dialog box and when more than one dimension is selected in the field immediately below the **Compute Using** options—that is, when more than one dimension is defined as an addressing field.

This option is not available when you're defining a table calculation with **Compute Using**.

You can use this setting to set a break (that is, restart of the calculation) in the view, based on a particular dimension.

Restarting every can be useful in the following situations:

- With dates or other hierarchies, if you restart every month, as you bring in Year or Quarter, Tableau knows to partition automatically.

- With non-hierarchies, **Restarting every** affects the sorting. If you want to address on **Products** and partition by **State**, but you want the products sorted by **SUM(Sales)** within each state, you need to include **States** as an addressing field under Specific Dimensions, but then restart every state. Otherwise, the sort by **SUM(Sales)** would be based on each product's sum of sales across all states.

For example, if you take the result of the **Running Total** calculation you added above, you can see the effect of **Restarting every** by doing the following:

1. Click the **SUM(Sales)** field on the Marks card and choose **Edit table calculation**.
2. In the Table Calculation dialog box, choose **Specific Dimensions**.

Notice that two dimensions are now checked in the list box of dimensions: **Quarter of Order Date** and **Month of Order Date**. These are the addressing fields, and because more than one field is being used for addressing, Restarting every is now available.

The choices available from the At the level drop-down list are:

None	Specifies that the calculation should be performed at the level of greatest granularity. This is the default option. This option does not change the view.
Quarter of Order Date	Specifies that the calculation should be performed at the quarter level.

3. If you choose Quarter of Order Date, the view updates to show the effect of this change:

Quarter of O..	Month of Or..	Order Date			
		2011	2012	2013	2014
Q1	January	\$13,946	\$18,174	\$18,542	\$44,703
	February	\$18,757	\$30,385	\$41,410	\$64,987
	March	\$74,448	\$68,852	\$92,596	\$118,896
Q2	April	\$28,295	\$34,195	\$39,249	\$40,112
	May	\$51,944	\$64,327	\$95,940	\$85,764
	June	\$86,539	\$89,124	\$135,370	\$134,023
Q3	July	\$33,946	\$28,765	\$38,441	\$48,428
	August	\$61,856	\$65,664	\$71,706	\$109,944
	September	\$143,633	\$130,260	\$144,614	\$200,433
Q4	October	\$31,453	\$31,405	\$56,463	\$77,794
	November	\$110,082	\$107,377	\$138,655	\$190,120
	December	\$179,628	\$182,297	\$235,893	\$280,595

The calculation now restarts after every quarter. If you click out of the Table Calculations dialog box (to dismiss the highlighting) you can see this more clearly.

4. Click the X in the upper-right corner of the Table Calculations dialog box to close it.

Add Secondary Calculation

With **Running Total** and **Moving Calculation** table calculations, you have the option to transform values twice to obtain the result you want—that is, to add a secondary table calculation on top of the primary table calculation. For example, you could add an initial table calculation to calculate the running total for sales per month within each individual year, and then a secondary calculation to calculate the year-over-year percent difference for each month from one year to the next.

To do this, first add the primary table calculation, as shown above. Then continue as follows:

1. Click the **SUM(Sales)** field on the Marks card and select **Edit table calculation**.
2. In the Table Calculation dialog box, click **Add Secondary Calculation**.

The Table Calculation dialog box expands to show a second panel:

Table Calculation
Difference in Running Sum of Sales

Primary Calculation Type
Running Total
Sum

Secondary Calculation Type
Difference From

Compute Using

Table (across)
Table (down)
Table (across then down)
Table (down then across)
Pane (down)
Pane (across then down)
Pane (down then across)
Cell

Specific Dimensions

Month of Order Date
 Quarter of Order Date
 Year of Order Date

Restarting every **None**

Sort order **Specific Dimensions**

Add secondary calculation
 Show calculation assistance

Compute Using

Table (across)
Table (down)
Table (across then down)
Table (down then across)
Pane (down)
Pane (across then down)
Pane (down then across)
Cell

Specific Dimensions

Year of Order Date
 Month of Order Date
 Quarter of Order Date

At the level

Relative to **Previous**

- In the second panel, choose **Percent Difference From** as the **Secondary Calculation Type**.
- You do not need to change the **Compute Using** selection: **Table (Across)** is the right option.
- Click the X in the upper-right corner to dismiss the Table Calculation dialog box.

Now your view shows what you needed: a year-over-year percent difference of a running total:

Quarter of O..	Month of Or..	Order Date			
		2011	2012	2013	2014
Q1	January		\$4,228	\$368	\$26,161
	February		\$11,628	\$11,025	\$23,576
	March		-\$5,596	\$23,745	\$26,299
Q2	April		\$304	\$28,798	\$27,163
	May		\$6,787	\$55,357	\$16,123
	June		-\$3,011	\$69,991	\$24,952
Q3	July		-\$8,192	\$79,666	\$34,940
	August		\$797	\$76,033	\$63,191
	September		-\$16,384	\$84,345	\$80,771
Q4	October		-\$16,433	\$109,404	\$102,102
	November		-\$19,089	\$115,623	\$132,236
	December		-\$13,715	\$137,941	\$125,473

See Also

[Create a table calculation](#) on page 2373

[The basics: addressing and partitioning](#) on page 2365

Quick Table Calculations

Quick table calculations allow you to quickly apply a common table calculation to your visualization using the most typical settings for that calculation type. This article demonstrates how to apply a quick table calculation to a visualization using an example.

The following quick table calculations are available in Tableau for you to use:

- Running total
- Difference
- Percent difference
- Percent of total
- Rank
- Percentile
- Moving average
- YTD total
- Compound growth rate
- Year of year growth
- YTD growth

For more information about some of these, see [Table Calculation Types](#) on page 2376.

How does a quick table calculation differ from a table calculation?

Quick table calculations are table calculations that you can apply quickly to your visualization in Tableau. They are applied to the visualization with the most typical settings for the calculation type you choose so that you can continue on with your analysis. With traditional table calculations, you can apply the same settings, but you must apply them manually.

Apply a quick table calculation to the visualization

Follow along with the steps below to learn how to apply a quick table calculation to a visualization.

Step 1 Set up the visualization

1. Open Tableau Desktop and connect to the **Sample-Superstore** data source, which comes with Tableau and navigate to a new worksheet.
2. From the **Data** pane, drag **Order Date** to the **Columns** shelf.
3. Drag **State** to the **Rows** shelf.
4. Drag **Sales** to **Text** on the Marks Card.
5. Drag **Profit** to **Color** on the Marks Card.

6. On the Marks card, click the Mark Type drop-down and select **Square**.

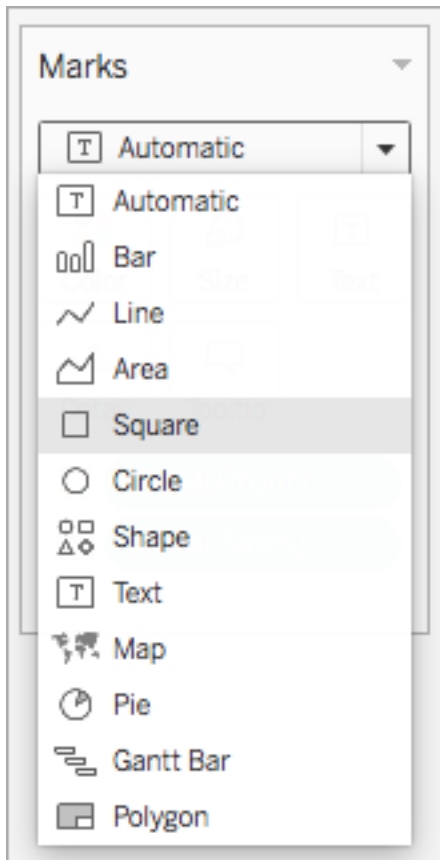

The visualization updates to look like this:

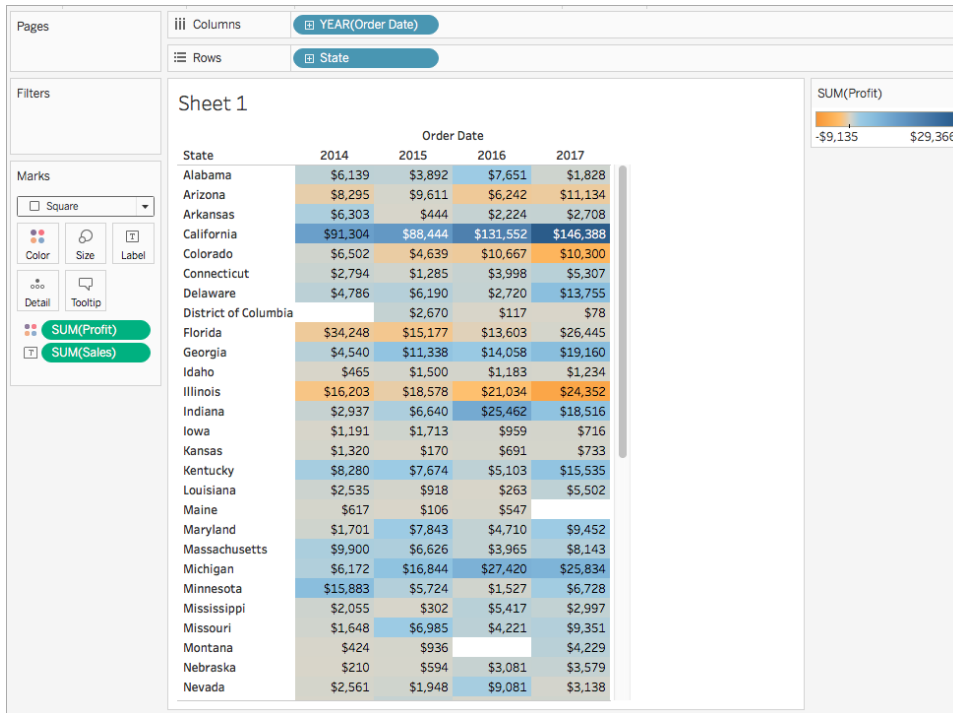

Step 2 Apply the quick table calculation

1. On the Marks card, right-click **SUM(Profit)** and select **Quick Table Calculation > Moving Average**.

Note: You can only perform quick table calculations on measures in the view.

A delta symbol appears on the field to indicate that a quick table calculation is being applied to the field. The colors in the visualization update to show the moving average of profit across the years.

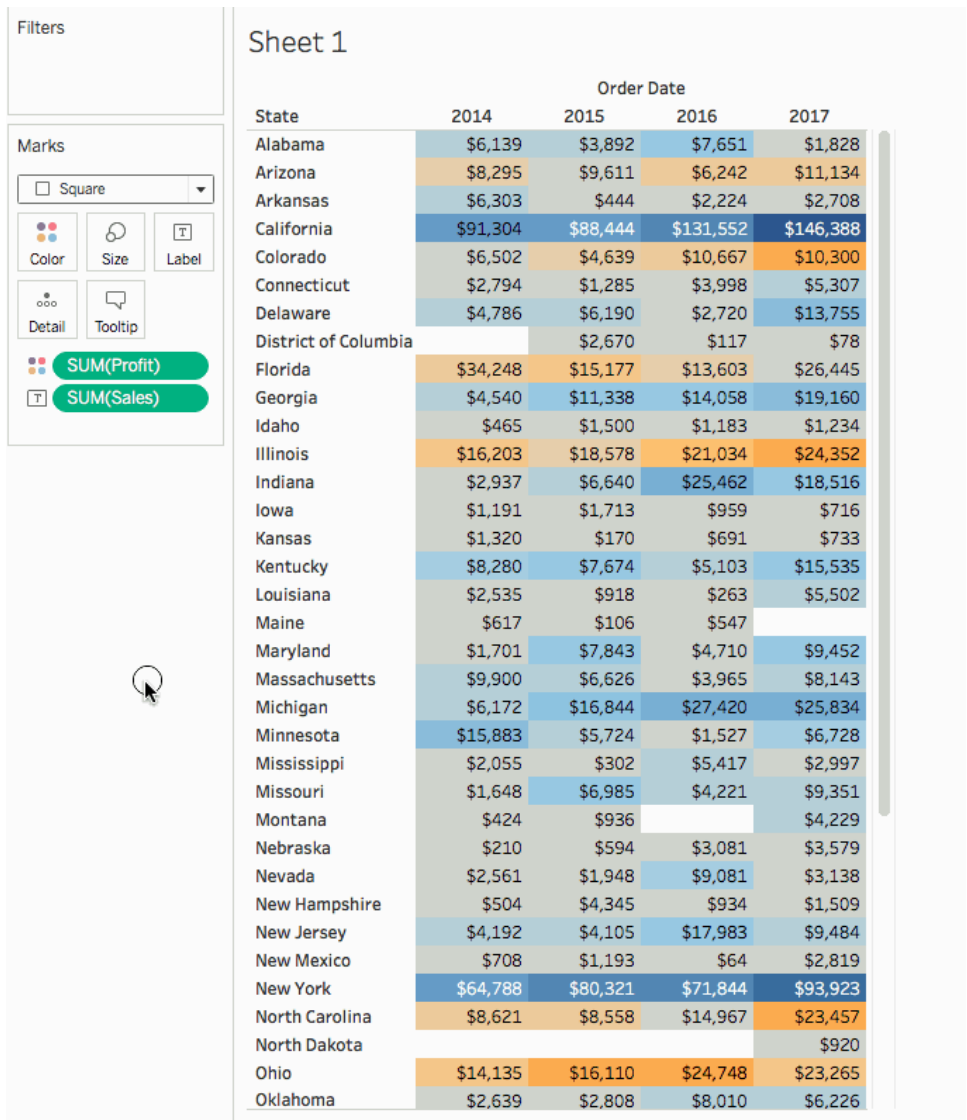

Step 3(Optional) Customize the quick table calculation

1. On the Marks card, right-click **Sum(Profit)** and select **Edit Table Calculation**.
2. In the dialog box that opens, you can configure the following options:
 - The calculation type
 - How to aggregate the values
 - How to compute the calculation (how to address and partition the calculation)

For more information about these options, see [Table Calculation Types](#) on page 2376 and [The basics: addressing and partitioning](#) on page 2365

The visualization updates as you make changes to the calculation. Highlighting and numbering are used to demonstrate how the calculation is being computed. For example, in the following image, the calculation is being computed across the table, for each State.

State	Order Date			
	2014	2015	2016	2017
Alabama	\$6,139 [1]	\$3,892 [2]	\$7,651 [3]	\$1,828 [4]
Arizona	\$8,295 [1]	\$9,611 [2]	\$6,242 [3]	\$11,134 [4]
Arkansas	\$6,303 [1]	\$444 [2]	\$2,224 [3]	\$2,708 [4]
California	\$91,304 [1]	\$88,444 [2]	\$131,552 [3]	\$146,388 [4]
Colorado	\$6,502 [1]	\$4,639 [2]	\$10,667 [3]	\$10,300 [4]
Connecticut	\$2,794 [1]	\$1,285 [2]	\$3,998 [3]	\$5,307 [4]
Delaware	\$4,786 [1]	\$6,190 [2]	\$2,720 [3]	\$13,755 [4]
District of Columbia	[1]	\$2,670 [2]	\$117 [3]	\$78 [4]
Florida	\$34,248 [1]	\$15,177 [2]	\$13,603 [3]	\$26,445 [4]
Georgia	\$4,540 [1]	\$11,338 [2]	\$14,058 [3]	\$19,160 [4]
Idaho	\$465 [1]	\$1,500 [2]	\$1,183 [3]	\$1,234 [4]
Illinois	\$16,203 [1]	\$18,578 [2]	\$21,034 [3]	\$24,352 [4]
Indiana	\$2,937 [1]	\$6,640 [2]	\$25,462 [3]	\$18,516 [4]
Iowa	\$1,191 [1]	\$1,713 [2]	\$959 [3]	\$716 [4]

Table Calculation
Moving Average of Profit

Calculation Type
Moving Calculation
Average, prev 2, next 0

Compute Using

- Table (across)
- Table (down)
- Table (across then down)
- Table (down then across)
- Cell

Specific Dimensions

- Year of Order Date
- State

Add secondary calculation
 Show calculation assistance

If this setting is changed, the visualization and highlighting update to indicate the change.

State	Order Date			
	2014	2015	2016	2017
Alabama	\$6,139 [1]	\$3,892 [1]	\$7,651 [1]	\$1,828 [1]
Arizona	\$8,295 [2]	\$9,611 [2]	\$6,242 [2]	\$11,134 [2]
Arkansas	\$6,303 [3]	\$444 [3]	\$2,224 [3]	\$2,708 [3]
California	\$91,304 [4]	\$88,444 [4]	\$131,552 [4]	\$146,388 [4]
Colorado	\$6,502 [5]	\$4,639 [5]	\$10,667 [5]	\$10,300 [5]
Connecticut	\$2,794 [6]	\$1,285 [6]	\$3,998 [6]	\$5,307 [6]
Delaware	\$4,786 [7]	\$6,190 [7]	\$2,720 [7]	\$13,755 [7]
District of Columbia	[8]	\$2,670 [8]	\$117 [8]	\$78 [8]
Florida	\$34,248 [9]	\$15,177 [9]	\$13,603 [9]	\$26,445 [9]
Georgia	\$4,540 [10]	\$11,338 [10]	\$14,058 [10]	\$19,160 [10]
Idaho	\$465 [11]	\$1,500 [11]	\$1,183 [11]	\$1,234 [11]
Illinois	\$16,203 [12]	\$18,578 [12]	\$21,034 [12]	\$24,352 [12]
Indiana	\$2,937 [13]	\$6,640 [13]	\$25,462 [13]	\$18,516 [13]
Iowa	\$1,191 [13]	\$1,713 [13]	\$959 [13]	\$716 [13]

Table Calculation
Moving Average of Profit

Calculation Type
Moving Calculation
Average, prev 2, next 0

Compute Using

- Table (across)
- Table (down)
- Table (across then down)
- Table (down then across)
- Cell

Specific Dimensions

- State
- Year of Order Date

Add secondary calculation
 Show calculation assistance

See Also

[Understanding Calculations: Table calculations](#)

[Transform Values with Table Calculations](#) on page 2364

[Customize Table Calculations](#) below

Customize Table Calculations

You can always customize a table calculation by editing it in the Table Calculations dialog box, but there are other, more specialized ways to customize a table calculation.

Customizing a Table Calculation Using Its Context Menu

Click any field in the view to see a context menu listing ways to customize the field. For a field in the view that has a table calculation, you can change the **Compute Using** option—that is, the option that determines the direction and scope of the calculation relative to the visual structure of the view. Do this by clicking the field and then choosing an option from the **Compute Using** list.

For **Difference From**, **Percent Difference From**, and **Percent From** table calculations, you can also specify a different field from which the difference should be computed. Do this by clicking the field and then choosing an option from the **Relative to** list. The options are **Previous**, **Next**, **First**, and **Last**.

Customizing a Table Calculation Using the Calculation Editor

You can customize a table calculation by dragging it into the calculation editor:

	March	\$431,205	\$319,390	\$395,631
Q2	April	\$384,124	\$287,534	\$413,242
	May	\$394,564	\$343,181	\$444,287
	June	\$367,140	\$431,925	\$442,346
Q3	July	\$375,946	\$441,334	\$469,588
	August	\$443,993	\$423,132	\$523,288
	September	\$519,485	\$534,675	\$611,887
Q4	October	\$602,802	\$671,275	\$701,403
	November	\$665,546	\$902,301	\$998,147
	December	\$730,577	\$872,136	\$1,048,737

When you edit a table calculation in the calculation editor, you can click **Default Table Calculation** in the lower-right corner of the editor to open the calculation in the Table Calculation dialog box. This will allow you to create a new named calculated field that uses the same table calculation as the one you are basing the calculation on.

Nested Table Calculations

A nested table calculation can be one of two types of calculated fields:

- A calculated field that includes more than one calculated field with a table calculation (as in the example below), or
- A calculated field that itself has a table calculation and includes at least one calculated field with a table calculation.

With nested table calculations, you can set **Compute Using** configurations for individual calculations independently.

Here is a scenario you can try, using the Sample - Superstore data source that is included with Tableau Desktop, which results in a nested table calculation.

1. Drag **Sub-Category** to Columns and **Region** to Rows.
2. Create a calculated field, *1-nest*, with the definition `TOTAL(SUM([Sales]))`.

TOTAL is a table calculation function, so this calculated field automatically has a table calculation—when you use it in the view, the field will have the tell-tale table triangle, indicating a table calculation:



For information on table calculation functions, see [Table Calculation Functions on page 2146](#).

3. Create a second calculated field, *2-nest*, with the definition `TOTAL(SUM([Profit]))`.
4. Create a third calculated field, *3-nest*, with the definition `[1-nest] + [2-nest]`.
5. Drag *3-nest* and drop it to the right of *Sub-Category* on Columns.
6. Click *3-nest* on Columns and choose **Edit Table Calculation**.

In the Table Calculations dialog box, you can now separately configure the underlying table calculations:

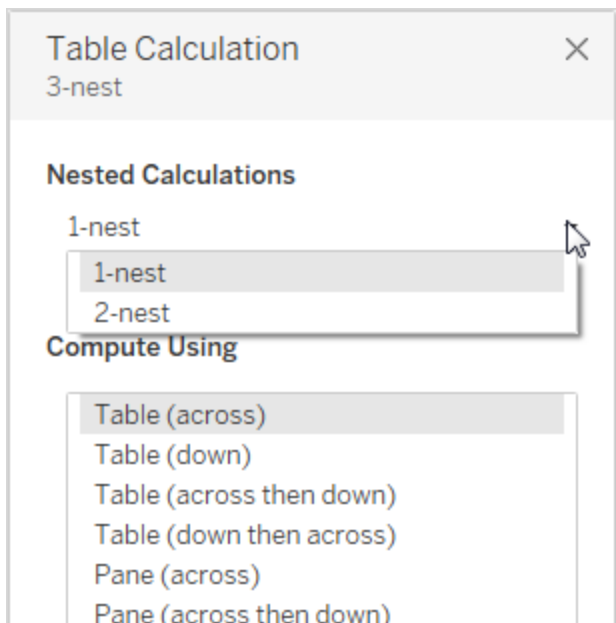

Create Level of Detail Expressions in Tableau

Level of Detail expressions (also known as LOD expressions) allow you to compute values at the data source level and the visualization level. However, LOD expressions let you control the

granularity you want to compute. They can be performed at a more granular level (INCLUDE), a less granular level (EXCLUDE), or an entirely independent level (FIXED).

This article explains the types of LOD expressions you can use in Tableau, when to use them, and how to format them.

How to create LOD expressions

Follow along with the steps to learn how to create and use an LOD expression in Tableau.

Step 1: Set up the Visualization

1. Open Tableau Desktop and connect to the **Sample-Superstore** saved data source.
2. Navigate to a new worksheet.
3. From the **Data** pane, drag **Region** to the **Columns** Shelf.
4. From the **Data** pane, drag **Sales** to the **Rows** Shelf.

A bar chart showing the sum of sales for each region appears.

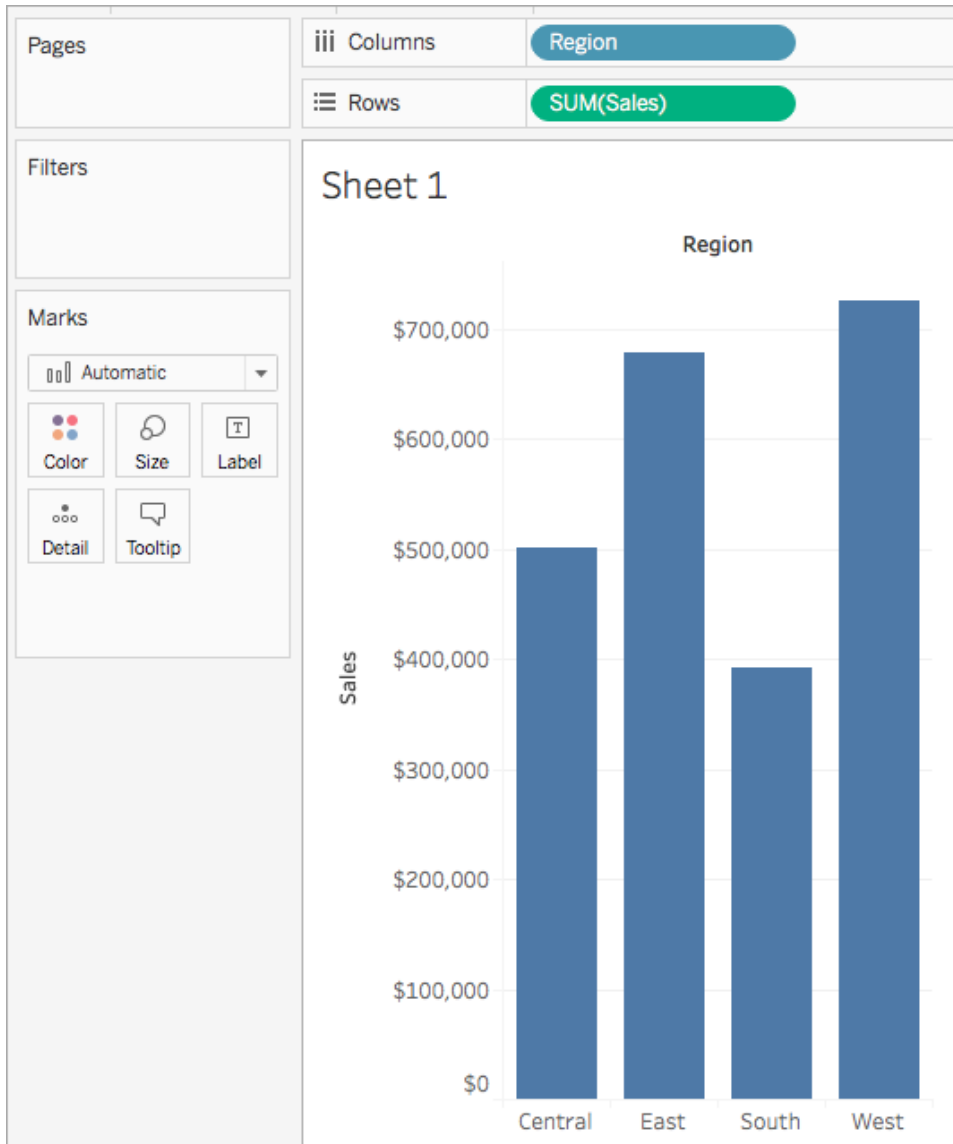

Step 2: Create the LOD expression

Instead of the sum of all sales per region, perhaps you want to also see the average sales per customer for each region. You can use an LOD expression to do this.

1. Select **Analysis > Create Calculated Field**.
2. In the Calculation editor that opens, do the following:
 - Name the calculation, Sales Per Customer.
 - Enter the following LOD expression:

```
{ INCLUDE [Customer Name] : SUM([Sales]) }
```

3. When finished, click **OK**.

The newly created LOD expression is added to the Data pane. To learn more about the types of LOD expressions you can use, see the [Types of LOD expressions on page 2413](#) section.

Step 3: Use the LOD expression in the visualization

1. From the **Data** pane, drag **Sales Per Customer** to the **Rows** shelf and place it to the left of SUM(Sales).
2. On the Rows shelf, right-click **Sales Per Customer** and select **Measure (Sum) > Average**.

You can now see both the sum of all sales and the average sales per customer for each region. For example, you can see that in the Central region, the sales totaled approximately \$500,000 with an average sale for each customer being approximately 800 USD.

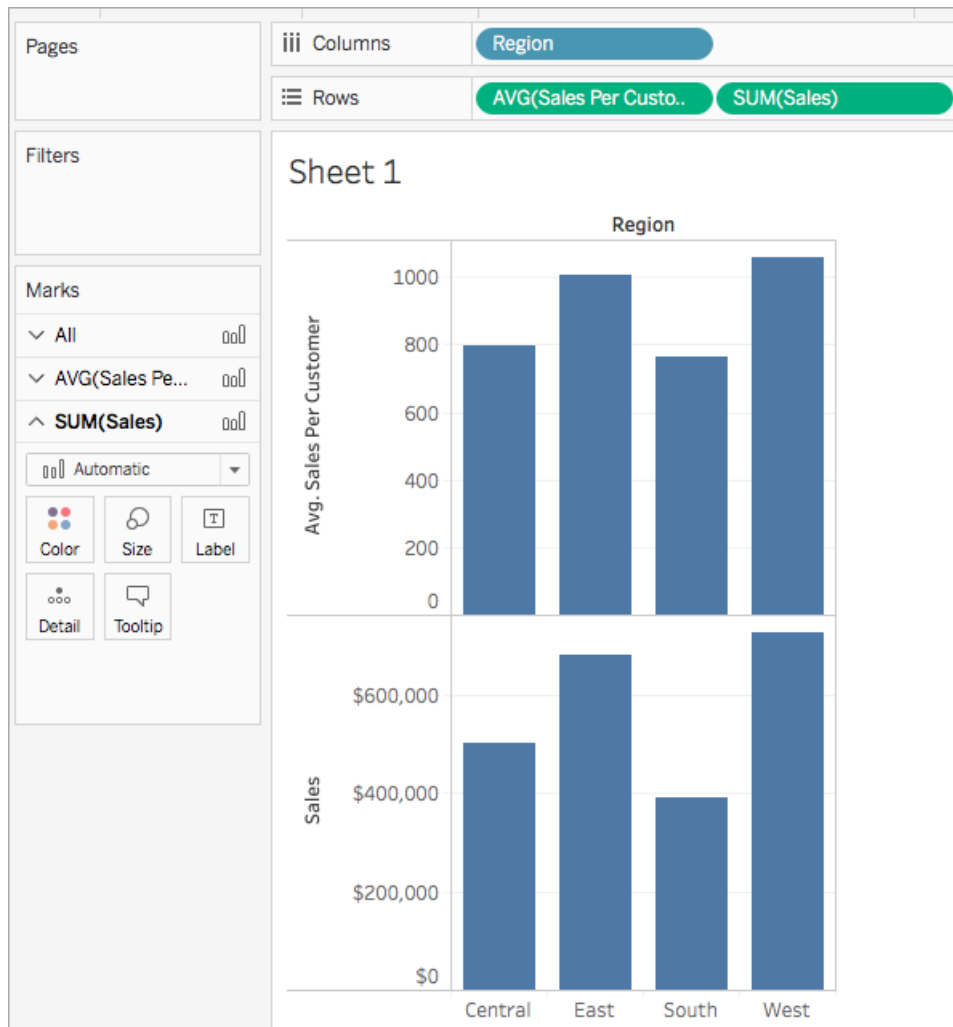

Use a Quick LOD expression

You can create a FIXED LOD expression without needing to enter the full calculation into the calculation dialog.

There are two ways to create a quick LOD calculation.

1. In the **Data pane**, control-click drag the measure you want to aggregate onto the desired dimension. A new field appears as a FIXED LOD calculation.

The aggregation in the aggregate expression will come from the default aggregation on the measure. This is usually SUM. To change the aggregation or otherwise edit the LOD, right click on the new field and edit the calculation.

2. Or, in the **Data pane**, select the measure you want to aggregate and then control-click the dimension you want to aggregate on.

- Right-click on the selected fields and select **Create > LOD Calculation...**
- (Optional) Modify the LOD in the calculation editor.
- Select **OK** .

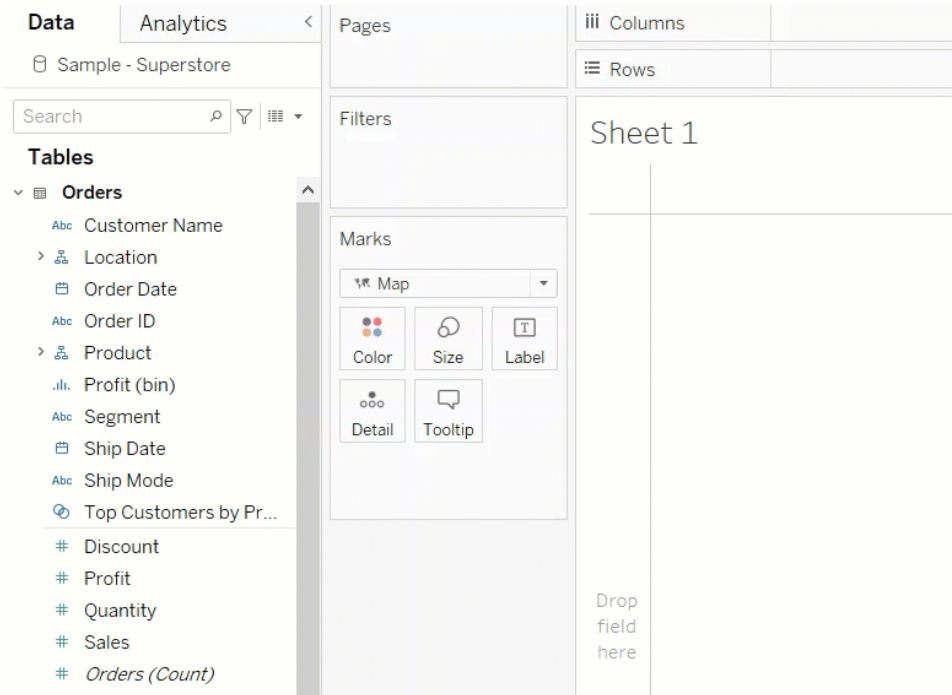

LOD expression syntax

A level of detail expression has the following structure:

```
{[FIXED | INCLUDE | EXCLUDE] <dimension declaration > : <aggregate expression>}
```

```
{ }
```

The entire level of detail expression is enclosed in curly braces.

[FIXED | INCLUDE | EXCLUDE]

The first element after the opening curly brace is one of the following scoping keywords:

FIXED

- **FIXED** level of detail expressions compute values using the specified dimensions without reference to the view level of detail—that is, regardless of other dimensions in the view.

- FIXED level of detail expressions ignore all the filters in the view other than context filters, data source filters, and extract filters.

```
Example: { FIXED [Region] : SUM([Sales]) }
```

For more information about FIXED level of detail expressions, and for some example FIXED level of detail scenarios, see the [FIXED on page 2413](#) section.

INCLUDE

- INCLUDE level of detail expressions compute values using the specified dimensions in addition to whatever dimensions are in the view.
- INCLUDE level of detail expressions are most useful when including a dimension that isn't in the view.

```
Example: { INCLUDE [Customer Name] : SUM([Sales]) }
```

For more information about INCLUDE level of detail expressions, and for some example INCLUDE level of detail scenarios, see the [INCLUDE on page 2415](#) section.

EXCLUDE

- EXCLUDE level of detail expressions explicitly remove dimensions from the expression—that is, they subtract dimensions from the view level of detail.
- EXCLUDE level of detail expressions are most useful for eliminating a dimension in the view.

```
Example: {EXCLUDE [Region]: SUM([Sales])}
```

For more information about EXCLUDE level of detail expressions, and for some example EXCLUDE level of detail scenarios, see the [EXCLUDE on page 2418](#) section.

Table-scoped

- For a table-scoped level of detail expression, no scoping keyword is required. For more information, see the [Table-Scoped on page 2420](#) section.

<dimension declaration>

Specifies one or more dimensions that set the scope of the aggregate expression, according to the keyword.

- `FIXED [Name]`

Use commas to separate multiple dimensions.

- `[Segment], [Category], [Region]`

You can use any expression that evaluates as dimension, including Date expressions.

- `{FIXED YEAR([Order Date]) : SUM(Sales)}` aggregates the sum of **Sales** at the Year level.
- `{INCLUDE DATETRUNC('day', [Order Date]) : AVG(Profit)}` aggregates the sum of **Sales** for **[Order Date]** truncated to the day date part. Because it's an **INCLUDE** expression, it also uses the dimensions in the view to aggregate the value.

Note: It's recommended that you drag fields into the calculation editor when creating dimension declarations, instead of typing them. For example, if you see **YEAR([Order Date])** on a shelf and then type that as the dimension declaration, it won't match the field on the shelf. But if you drag the field from the shelf into the expression, it becomes **DATEPART('year', [Order Date])**, and that matches the field on the shelf.

With calculations saved to the Data pane Tableau can't match the name of a calculation to its contents. For example:

- Create a calculation: **MyCalculation** = `YEAR([Order Date])`
- Create an EXCLUDE level of detail expression `{EXCLUDE YEAR([Order Date]) : SUM(Sales)}`

If you use both calculations in the view, **MyCalculation** isn't excluded. The LOD doesn't understand that `YEAR([Order Date])` is the same thing as **MyCalculation**.

Similarly, if the EXCLUDE expression specified **MyCalculation** (`{EXCLUDE MyCalculation : SUM(Sales)}`), then `YEAR([Order Date])` isn't excluded.

: (a colon)

A colon separates the dimension declaration from the aggregate expression.

<aggregate expression>

The aggregate expression is the calculation that is performed. For example, `SUM(Sales)` or `AVG(Discount)`. The results of the calculation in the aggregate expression depend on the dimension declaration and keyword.

The aggregate expression must be aggregated. The ATTR aggregation isn't supported, however. It doesn't have to be a simple aggregation, it can contain calculations, including other LOD expressions: `{FIXED [Question] : AVG(IF [Answer] = "Red" THEN 1 ELSE 0 END)}`

Table calculations aren't permitted in the aggregate expression.

Table-scoped LODs contain only the aggregate expression inside the braces, such as `{MIN(Grade)}`.

Types of LOD expressions

There are three types of LOD expressions you can create in Tableau:

- **FIXED** below
- **INCLUDE** on page 2415
- **EXCLUDE** on page 2418

You can also scope an LOD expression to the table. This is called a **Table-Scoped** on page 2420 LOD expression.

FIXED

FIXED level of detail expressions compute a value using the specified dimensions, without reference to the dimensions in the view.

Example

The following FIXED level of detail expression computes the sum of sales per region:

```
{FIXED [Region] : SUM([Sales])}
```

This level of detail expression, named **[Sales by Region]**, is then placed on Text to show total sales per region.

The view level of detail is **[Region]** and **[State]**. But FIXED level of detail expressions don't look at the dimensions in the view, only the dimensions specified in the calculation (here, **Region**).

Therefore, the values for the individual states in each region are identical. For more information, see [Aggregation and Level of Detail Expressions](#) on page 2425.

Sheet 5

Region	State	
Central	Illinois	501,240
	Indiana	501,240
	Iowa	501,240
	Kansas	501,240
	Michigan	501,240
	Minnesota	501,240
	Missouri	501,240
	Nebraska	501,240
	North Dakota	501,240
	Oklahoma	501,240
	South Dakota	501,240
East	Texas	501,240
	Wisconsin	501,240
	Connecticut	678,781
	Delaware	678,781
	District of Columbia	678,781
	Maine	678,781
	Maryland	678,781
	Massachusetts	678,781
New Hampshire	678,781	
New Jersey	678,781	

If the keyword had been INCLUDE instead of FIXED, the values would be different for each state. INCLUDE uses the dimension in the expression ([**Region**]) and any additional dimensions in the view ([**State**]) when evaluating the expression.

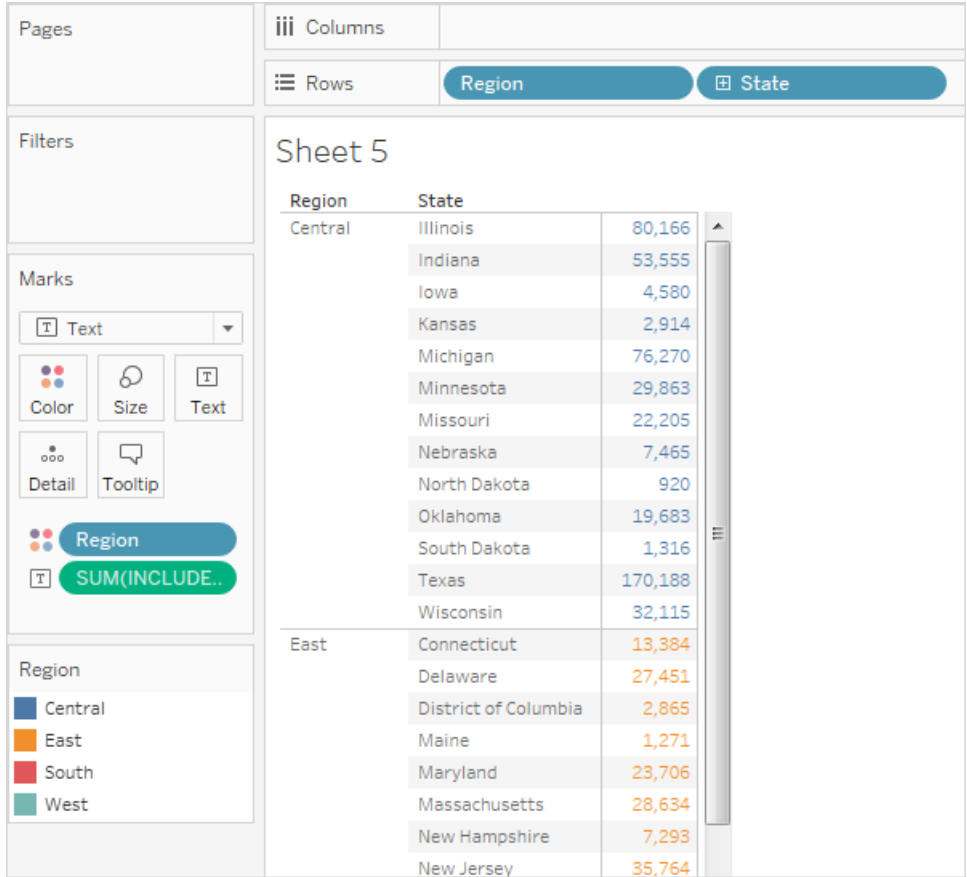

INCLUDE

INCLUDE level of detail expressions compute values using the specified dimensions in addition to whatever dimensions are in the view.

INCLUDE can be useful when you want to calculate at a fine level of detail in the database, but reaggregate at a coarser level of detail in your view. Fields based on INCLUDE level of detail expressions change as you add or remove dimensions from the view.

Example 1

This INCLUDE level of detail expression computes total sales per customer:

```
{ INCLUDE [Customer Name] : SUM([Sales]) }
```

With the LOD on the **Rows** shelf, aggregated as AVG, and **[Region]** on the **Columns** shelf, the view shows the average customer sales amount per region:

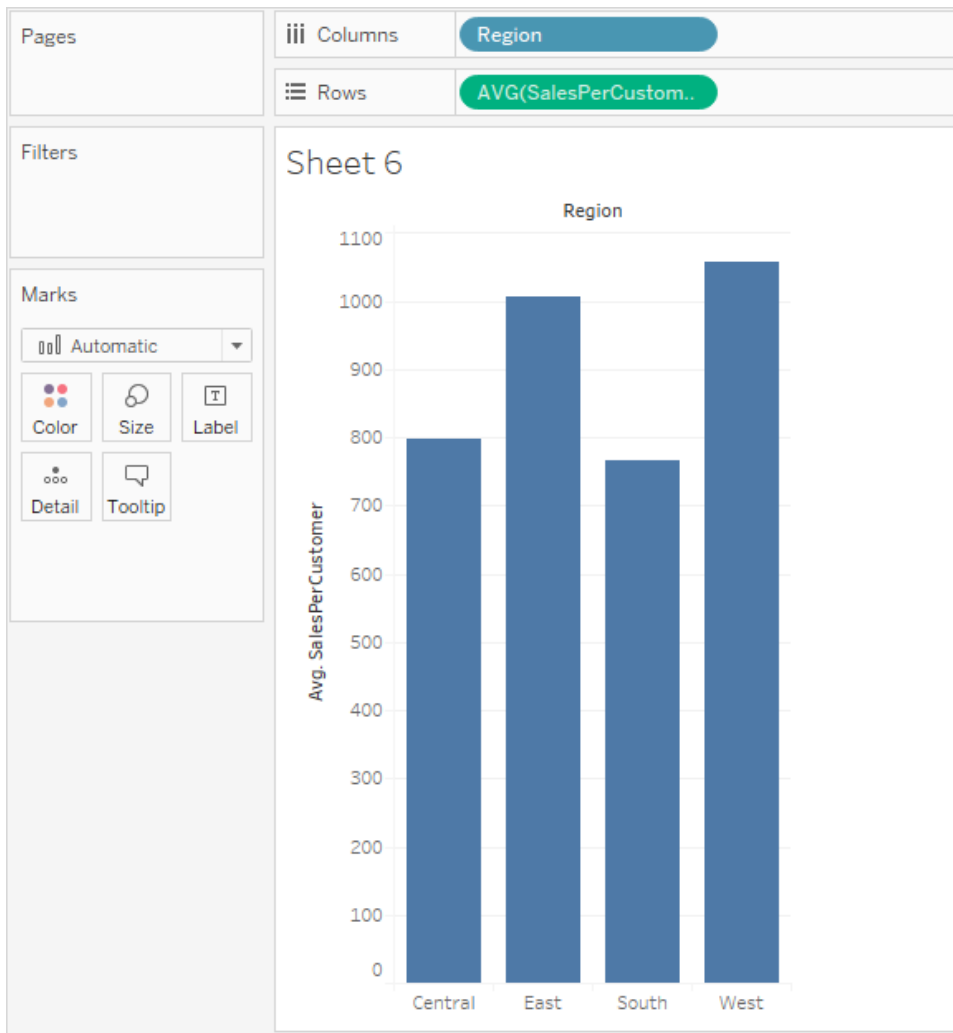

Example 2

This INCLUDE level of detail expression calculates sum of sales on a per-state basis:

```
{ INCLUDE [State] : SUM(Sales) }
```

The calculation is placed on the Rows shelf and is aggregated as an average. The resulting visualization averages the sum of sales by state across categories.

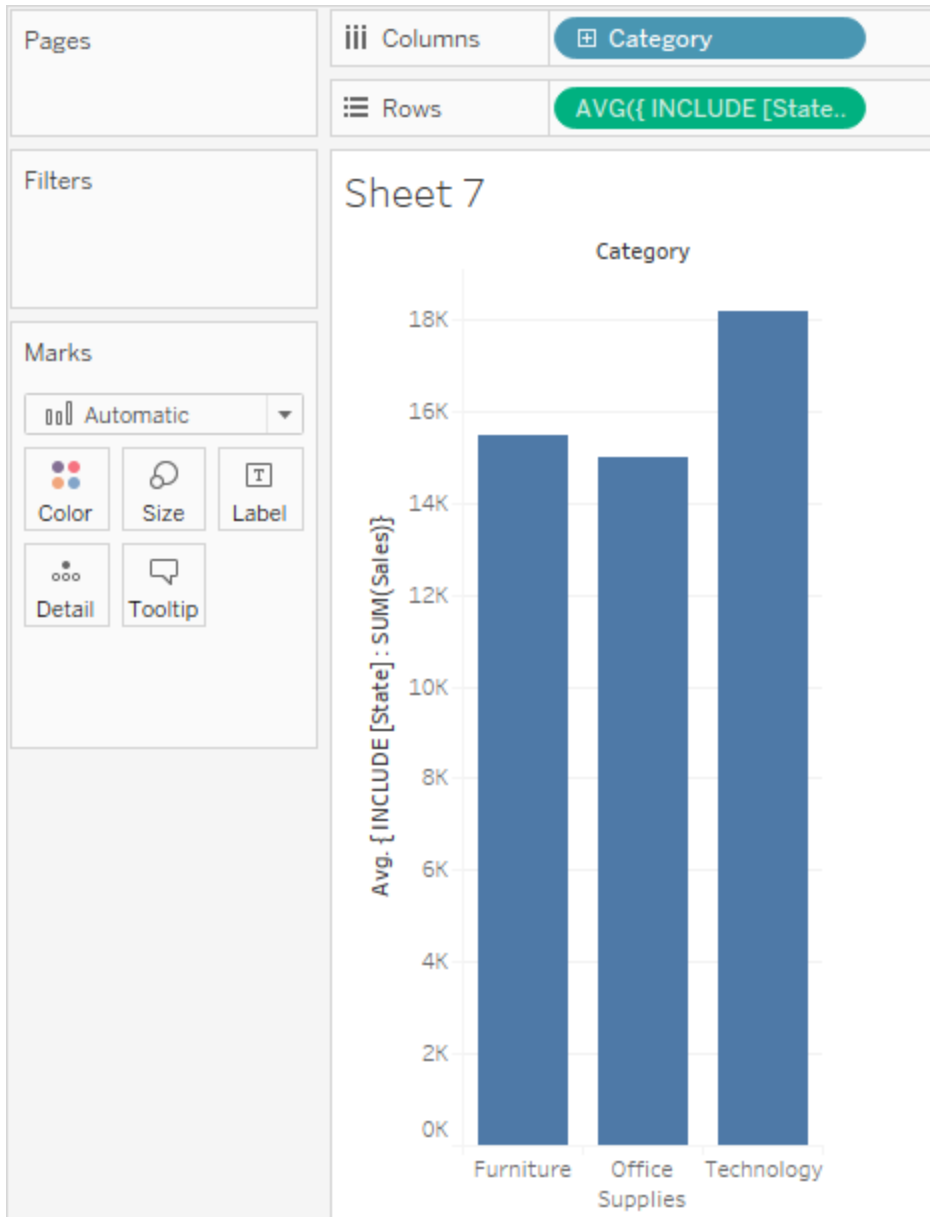

When **Segment** is added to the **Columns** shelf and the calculation is moved to **Label**, the LOD expression results update. Now you can see how the average sum of sales per state varies across categories and segments.

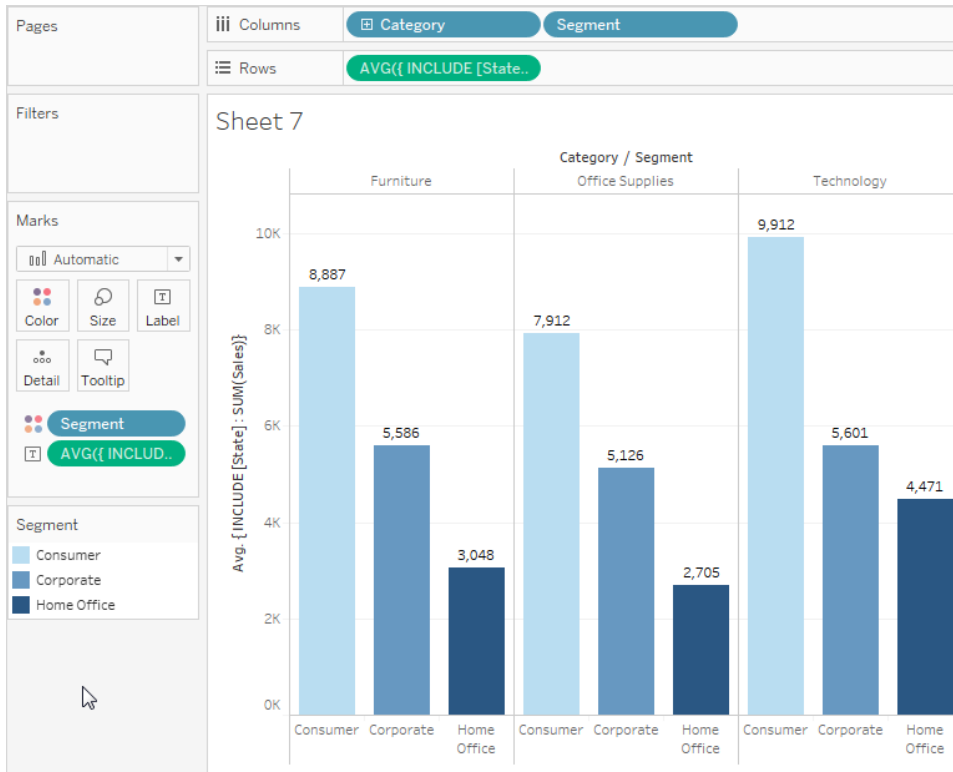

EXCLUDE

EXCLUDE level of detail expressions declare dimensions to omit from the view level of detail.

EXCLUDE is useful for 'percent of total' or 'difference from overall average' scenarios. They're comparable to Totals and Reference Lines.

EXCLUDE can't be used in row-level expressions (where there are no dimensions to omit). They can modify a view-level calculation or other LODs.

Example 1

The following EXCLUDE level of detail expression computes the average sales total per month then excludes the month.

1. First, create a field for Month / Year of Order Date.
 - Right-click "Order Date" in the **Data** pane and select Create > Create Custom Date.
 - From the Detail list, select "Month / Year". Leave the selection as discrete.

- Then, create an LOD expression named "average of sales by month":

```
{EXCLUDE [Order Date (Month / Year)] : AVG({FIXED [Order Date (Month / Year)] : SUM([Sales])})}
```

Notice that this is a nested level of detail expression—that is, a level of detail expression within another level of detail expression.

- The calculation can then be subtracted from the sum of sales per month with an ad-hoc calculation on the **Rows** shelf:



- Put **Month([Order Date])** on the **Columns** shelf

The resulting view that shows the difference between actual sales per month and the average monthly sales for the entire four-year period:

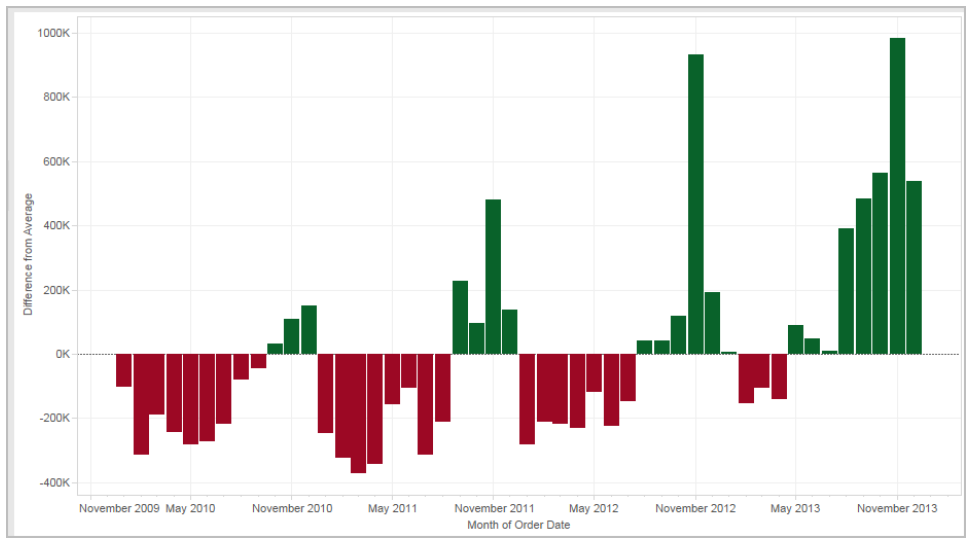

Example 2

Create a level of detail expression, named "ExcludeRegion", that excludes **[Region]** from the sum of **[Sales]**:

```
{EXCLUDE [Region] : SUM([Sales])}
```

Consider the following view, which breaks out the sum of sales by region and by month:

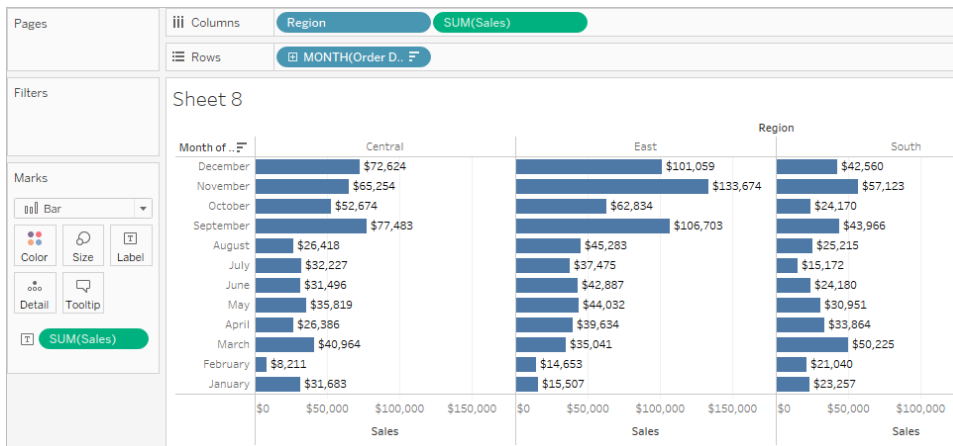

Putting **[ExcludeRegion]** on Color shades the view to show total sales by month without the regional component:

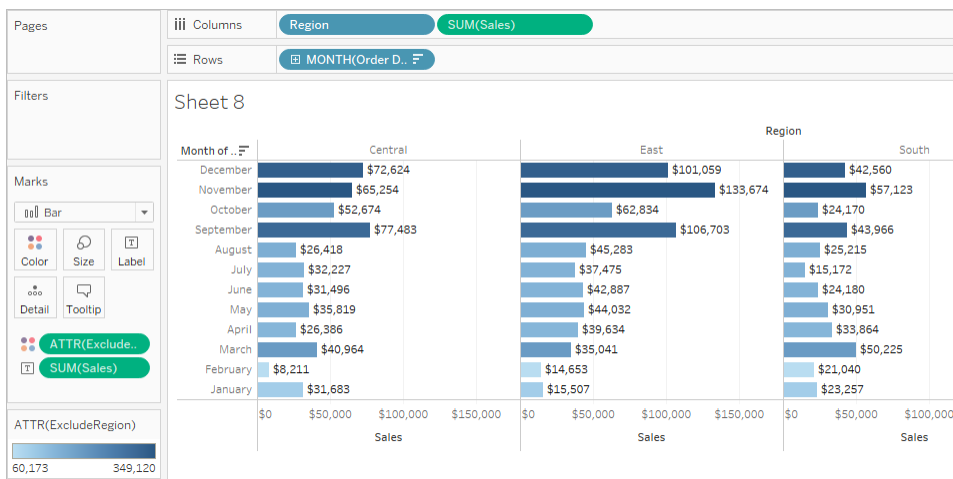

Table-Scoped

It's possible to define a level of detail expression at the table level without using any of the scoping keywords. For example, the following expression returns the minimum (earliest) order date for the entire table:

```
{MIN([Order Date])}
```

This is equivalent to a FIXED level of detail expression with no dimension declaration:

```
{FIXED : MIN([Order Date])}
```

See Also

[Introduction to Level of Detail Expressions](#)

[A Deeper Look at LOD Expressions](#)

[Diving into LOD Expressions](#)

[Top 15 LOD Expressions](#)

[Understanding LOD Expressions](#)

How Level of Detail Expressions Work in Tableau below

How Level of Detail Expressions Work in Tableau

This article explains how level of detail expressions are computed and how they function in Tableau. For more information about LOD expressions and how they work, see the [Understanding Level of Detail \(LOD\) Expressions](#) whitepaper on the Tableau website.

Row Level Expressions and View Level Expressions

In Tableau, expressions referencing **unaggregated** datasource columns are computed for each row in the underlying table. In this case, the dimensionality of the expression is *row level*. An example of a row-level expression is:

```
[Sales] / [Profit]
```

This calculation will be evaluated in each row of the database. For each row, the Sales value in that row will be divided by the Profit value in that row, producing a new column with the result of the multiplication (a profit ratio).

If you create a calculation with this definition, save it with the name **[ProfitRatio]**, and then drag it from the **Data** pane to a shelf, Tableau typically aggregates the calculated field for the view:

```
SUM([ProfitRatio])
```

By contrast, expressions referencing **aggregated** data source columns are computed at the dimensionality defined by the dimensions in the view. In this case, the dimensionality of the expression is view level. An example of a view-level expression is:

```
SUM(Sales) / SUM(Profit)
```

If you drag this calculation to a shelf (or type it directly on a shelf as an ad-hoc calculation), Tableau encloses it in an AGG function:

AGG(SUM(Sales) / SUM(Profit))

This is what is known as an aggregate calculation. For details, see [Aggregate Functions in Tableau](#) on page 2115.

Dimension and set fields placed on any of the locations highlighted in the following image contribute to the view level of detail:

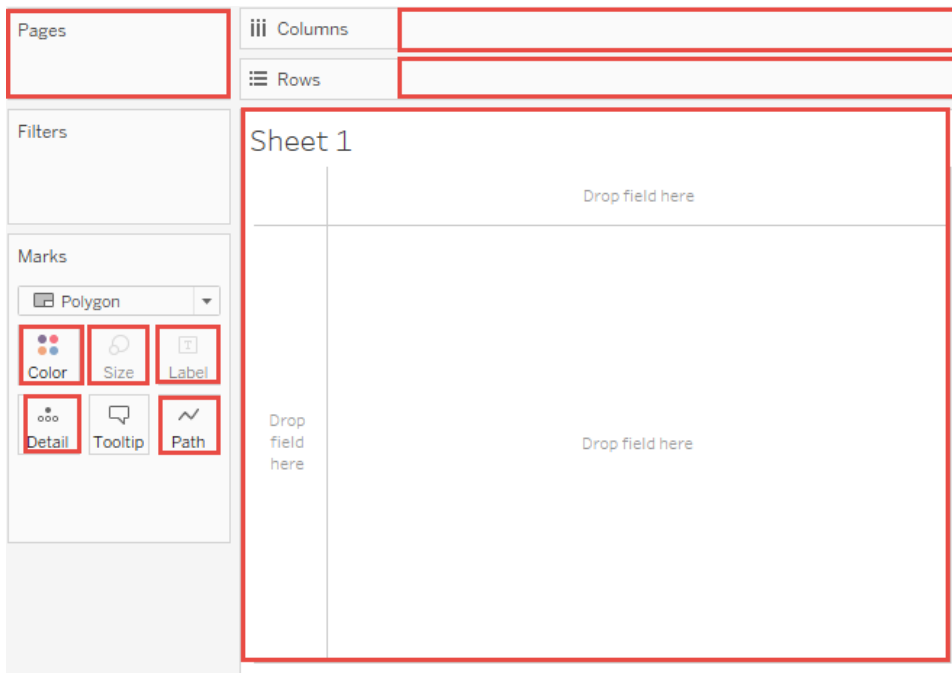

Before level of detail expressions were supported in Tableau, it was not possible to create calculations at a level of detail other than the view level. For example, if you attempt to save the following expression, Tableau displays the error message: “Cannot mix aggregate and non-aggregate arguments with this function”:

```
[Sales] - AVG([Sales])
```

The user’s intent in this case was to compare store sales for each individual store to the average of sales for all stores. This can now be accomplished with a level of detail expression:

```
[Sales] - {AVG([Sales])}
```

This is what is known as a table-scoped level of detail expression. See [Table-Scoped](#) on [page 2420](#)

Limitations for Level of Detail Expressions

The following limitations and constraints apply for level of detail expressions. Also see [Data Source Constraints for Level of Detail Expressions](#) on [page 2427](#).

- Level of detail expressions that reference floating-point measures can behave unreliably when used in a view that requires comparison of the values in the expression. For details, see [Understanding data types in calculations](#) on [page 2459](#).
- Level of detail expressions are not shown on the Data Source page. See [Data Source Page](#) on [page 24](#).
- When referencing a parameter in a dimensionality declaration, always use the parameter name, and not the parameter value.
- With data blending, the linking field from the primary data source must be in the view before you can use a level of detail expression from the secondary data source. See [Troubleshoot Data Blending](#) on [page 836](#).

In addition, some data sources have complexity limits. Tableau will not disable calculations for these databases, but query errors are a possibility if calculations become too complex.

Level of Detail Expressions Can Be Dimensions or Measures

When you save a level of detail expression, Tableau adds it to either the Dimensions or the Measures area in the Data pane.

FIXED level of detail expressions can result in measures or dimensions, depending on the underlying field in the aggregate expression. So `MIN([Date])` will be a dimension because `[Date]` is a dimension, and `{fixed Store : SUM([Sales])}` will be a measure because `[Sales]` is a measure. When a FIXED level of detail expression is saved as a measure you have the option of moving it to dimensions.

INCLUDE and EXCLUDE level of detail expressions are always measures.

Filters and Level of Detail Expressions

There are several different kinds of filters in Tableau and they get executed in the following order from top to bottom.

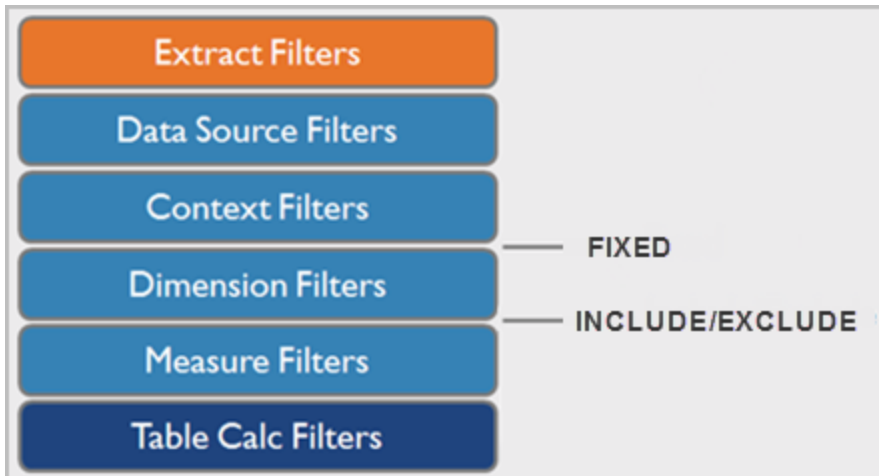

The text on the right shows where level of detail expressions are evaluated in this sequence.

Extract Filters (in orange) are only relevant if you're creating a Tableau Extract from a data source. Table calculations filters (dark blue) are applied after calculations are executed and therefore hide marks without filtering out the underlying data used in the calculations.

If you're familiar with SQL, you can think of measure filters as equivalent to the HAVING clause in a query, and dimension filters as equivalent to the WHERE clause.

FIXED calculations are applied before dimension filters, so unless you promote the fields on your Filter shelf to **Use Context Filters** on page 1337, they will be ignored. For example, consider if you have the following calculation on one shelf in a view, along with **[State]** on a different shelf:

```
SUM([Sales]) / ATTR({FIXED : SUM([Sales])})
```

This calculation will give you the ratio of a state's sales to total sales.

If you then put **[State]** on the Filters shelf to hide some of the states, the filter will affect only the numerator in the calculation. Since the denominator is a FIXED level of detail expression, it will still divide the sales for the states still in the view against the total sales for all states—including the ones that have been filtered out of the view.

INCLUDE and EXCLUDE level of detail expressions are considered after Dimension filters. So if you want filters to apply to your FIXED level of detail expression but don't want to use Context Filters, consider rewriting them as INCLUDE or EXCLUDE expressions.

Aggregation and Level of Detail Expressions

The level of detail of the view determines the number of marks in your view. When you add a level of detail expression to the view, Tableau must reconcile two levels of detail—the one in the view, and the one in your expression.

The behavior of a level of detail expression in the view varies depending on whether the expression's level of detail is coarser, finer, or the same as the level of detail in the view. What do we mean by “coarser” or “finer” in this case?

Level of Detail Expression is Coarser Than View Level of Detail

An expression has a coarser level of detail than the view when it references a subset of the dimensions in the view. For example, for a view that contained the dimensions [**Category**] and [**Segment**], you could create a level of detail expression that uses only one of these dimensions:

```
{FIXED [Segment] : SUM([Sales])}
```

In this case, the expression has a coarser level of detail than the view. It bases its values on one dimension ([**Segment**]), whereas the view is basing its view on two dimensions ([**Segment**] and [**Category**]).

The result is that using the level of detail expression in the view causes certain values to be replicated—that is, to appear multiple times.

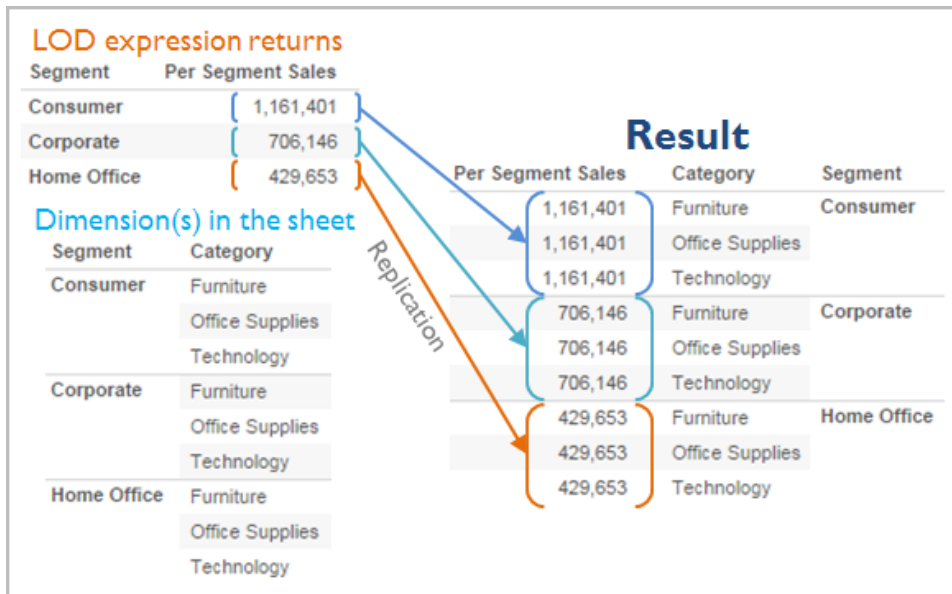

Replicated values are useful for comparing specific values against average values within a category. For example the following calculation subtracts average sales for a customer from the average sales overall:

```
[Sales] - {FIXED [Customer Name] : AVG([Sales])}
```

When values are being replicated, changing the aggregation for the relevant field in the view (for example, from AVG to SUM) will not change the result of the aggregation.

Level of Detail Expression is Finer Than View Level of Detail

An expression has a finer level of detail than the view when it references a superset of the dimensions in the view. When you use such an expression in the view, Tableau will aggregate results up to the view level. For example, the following level of detail expression references two dimensions:

```
{FIXED [Segment], [Category] : SUM([Sales])}
```

When this expression is used in a view that has only [Segment] as its level of detail, the values must be aggregated. Here's what you would see if you dragged that expression to a shelf:

```
AVG({{FIXED [Segment]], [Category]] : SUM([Sales])})
```

An aggregation—in this case, average—is automatically assigned by Tableau. You can change the aggregation as needed.

Adding a Level of Detail Expression to the View

Whether a level of detail expression is aggregated or replicated in the view is determined by the expression type (FIXED, INCLUDE, or EXCLUDE) and whether the expression's granularity is coarser or finer than the view's.

- INCLUDE level of detail expressions will have either the same level of detail as the view or a finer level of detail than the view. Therefore, values will never be replicated.
- FIXED level of detail expressions can have a finer level of detail than the view, a coarser level of detail, or the same level of detail. The need to aggregate the results of a FIXED level of detail depends on what dimensions are in the view.
- EXCLUDE level of detail expressions always cause replicated values to appear in the view. When calculations including EXCLUDE level of detail expressions are placed on a shelf, Tableau defaults to the ATTR aggregation (as opposed to SUM or AVG) to indicate

that the expression is not actually being aggregated and that changing the aggregation will have no effect on the view.

Level of detail expressions are always automatically wrapped in an aggregate when they are added to a shelf in the view unless they're used as dimensions. So if you double-click on a shelf and type

```
{FIXED[Segment], [Category] : SUM([Sales])}
```

and then press Enter to commit the expression, what you now see on the shelf is

```
SUM({FIXED[Segment], [Category] : SUM([Sales])})
```

But if you double-click into the shelf to edit the expression, what you see in edit mode is the original expression.

If you wrap a level of detail expression in an aggregation when you create it, Tableau will use the aggregation you specified rather than assigning one when any calculation including that expression is placed on a shelf. When no aggregation is needed (because the expression's level of detail is coarser than the view's), the aggregation you specified is still shown when the expression is on a shelf, but it is ignored.

Data Source Constraints for Level of Detail Expressions

For some data sources, only more recent versions support level of detail expressions. Some data sources do not support level of detail expressions at all.

In addition, some data sources have complexity limits. Tableau will not disable calculations for these databases, but query errors are a possibility if calculations become too complex.

Data Source	Support
Action Vectorwise	Not supported.
Amazon EMR Hadoop Hive	Supported for Hive 0.13 and later.
Amazon Redshift	Supported.
Aster Database	Supported for version 4.5 and later.
Cloudera Hadoop	Supported for Hive 0.13 and later.
Cloudera Impala	Supported for Impala 1.2.2 and later.

Cubes (multidimensional data sources)	Not supported.
DataStax Enterprise	Not supported.
EXASOL	Supported.
Firebird	Supported for version 2.0 and later.
Generic ODBC	Limited. Depends on the specific data source.
Google Big Query	Supported for standard SQL, not supported for legacy SQL.
Hortonworks Hadoop Hive	Supported for Hive 0.13 and later. On version 1.1 of HIVE level of detail expressions that produce cross joins are not reliable. Cross join occur when there is no explicit field to join on. For example, for a level of detail expression <code>{fixed [Product Type] : sum (sales) }</code> when the view only contains one dimension [Ship Mode] , Tableau creates a cross-join. A cross join produces rows which combine each row from the first table with each row from the second table.
IBM BigInsights	Supported.
IBM DB2	Supported for version 8.1 and later.
MarkLogic	Supported for version 7.0 and later.
Microsoft Access	Not supported.
Microsoft Jet-based connections (legacy connectors for Microsoft Excel, Microsoft Access, and text)	Not supported.
Microsoft SQL	SQL Server 2005 and later.

Server

MySQL	Supported.
IBM PDA (Netezza)	Supported version 7.0 and later.
Oracle	Supported version 9i and later.
Action Matrix (ParAccel)	Supported version 3.1 and later.
Pivotal Greenplum	Supported for version 3.1 and later.
PostgreSQL	Supported version 7 and later.
Progress OpenEdge	Supported.
SAP HANA	Supported.
SAP Sybase ASE	Supported.
SAP Sybase IQ	Supported version 15.1 and later.
Spark SQL	Supported.
Splunk	Not supported.
Tableau Data Extract	Supported.
Teradata	Supported.
Vertica	Supported for version 6.1 and later.

See Also

[Create Level of Detail Expressions in Tableau](#) on page 2405

[Understanding Level of Detail \(LOD\) Expressions](#)

Table-Scoped Level of Detail Expressions

It is possible to define a level of detail expression at the table level without using any of the scoping keywords. For example, the following expression returns the minimum (earliest) order

date for the entire table:

```
{MIN([Order Date])}
```

This is equivalent to a FIXED level of detail expression with no dimension declaration:

```
{FIXED : MIN([Order Date])}
```

FIXED Level of Detail Expressions

FIXED level of detail expressions compute a value using the specified dimensions, without reference to the dimensions in the view.

The following examples can be recreated using the **Sample - Superstore** data source.

Example 1

The following view shows the interval between a customer's first purchase date and any subsequent purchase:

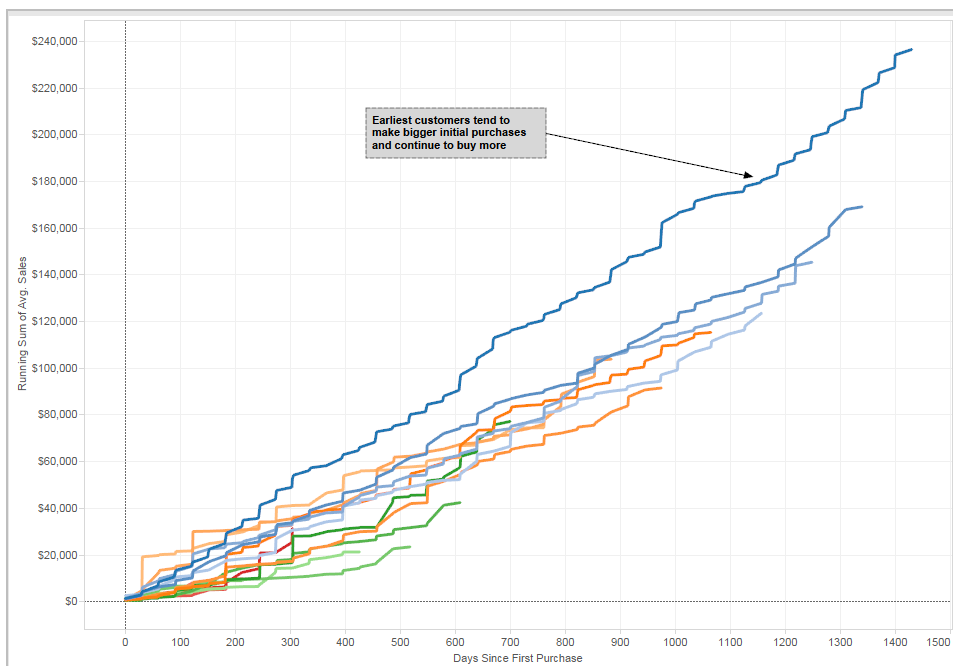

Step-by-Step

Here's how to build the view above, using the Sample - Superstore data source provided with Tableau Desktop.

1. Create two calculated fields: a FIXED level of detail expression, and a date subtraction.

Name	Formula
First Purchase Date	{FIXED [Customer Name] : MIN([Order Date])}
Days Since First Purchase	DATETRUNC('day', [Order Date])-DATETRUNC('day', [First Purchase Date])

2. Drag **Days Since First Purchase** from the Measures area of the Data pane to the Dimensions area.

Because this calculated field contains a subtraction operation, the result is a number, and so Tableau assigns it to the measure category. But you will be using it as a dimension.

3. Drag **Days Since First Purchase** to Columns.
4. Click **Days Since First Purchase** on Columns and choose **Continuous**.
5. Drag **Sales** to Rows.
6. Change the aggregation for **Sales** on Rows from SUM to AVG.
7. Add a quick table calculation to **Sales** on Rows: Running Total.
8. Drag **First Purchase Date** to Color.
9. Click the + in the **YEAR(First Purchase Date)** field on Color to add the next level down in the date hierarchy: **QUARTER(First Purchase Date)**.

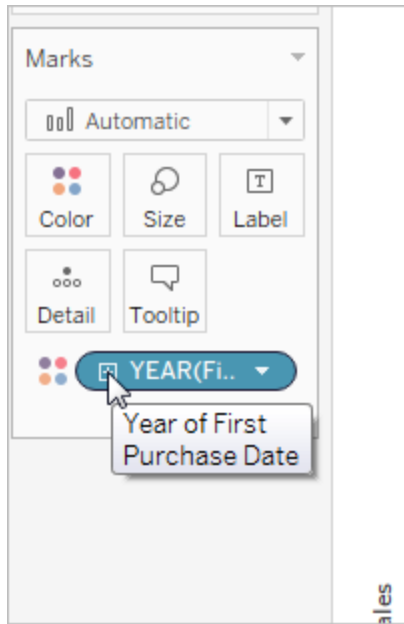

- Tableau won't automatically put two fields on Color, but you can make it happen by clicking the icon to the left of the **QUARTER(First Purchase Date)** field and choosing Color:

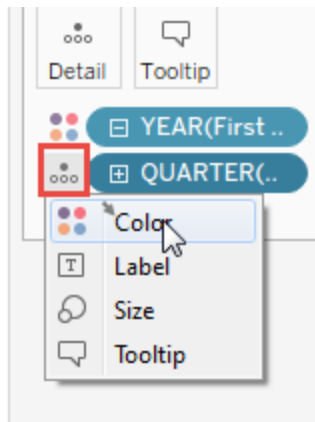

- Drag the Color legend over to the left side of the view, below the Marks card.
Your view should now look like this:

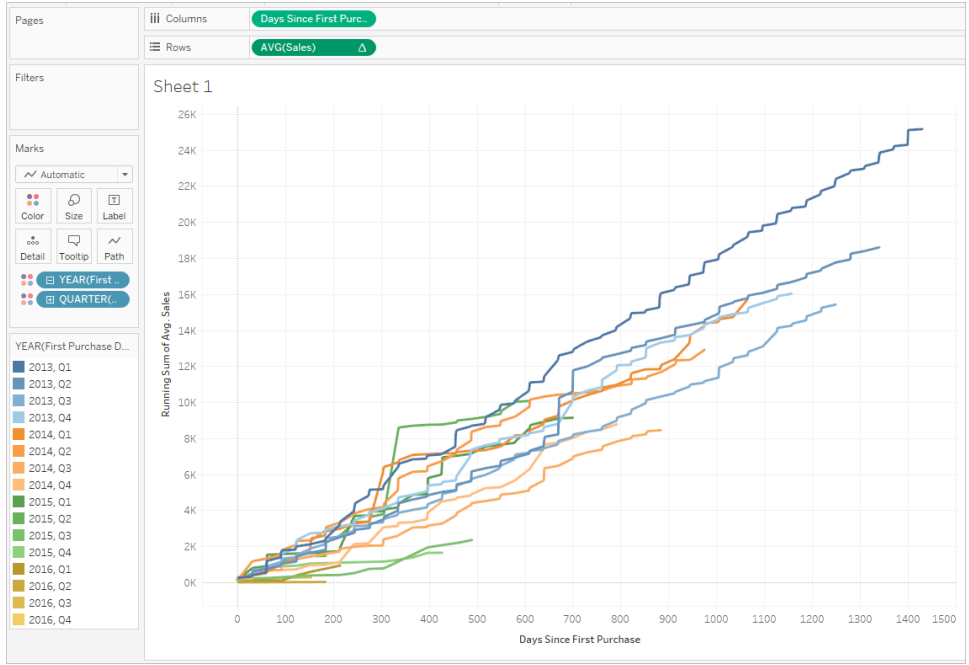

The visualization yields insights as you interact with it. Select individual quarters in the color legend on the left to see how customers acquired in specific individual quarters continued to spend in subsequent quarters. Notice that customers acquired in the early going (2013) tend to spend at a higher rate, even allowing for the fact that they had more time to do so—thus, the blue lines (for 2013) are higher up on the x-axis than other lines. If you had used a standard date value on the y-axis, the view would have been easier to create, but the lines would not all start at the same coordinates and so it would be more difficult to compare acquisition rates.

You can also drag either YEAR(First Purchase Date) or QUARTER(First Purchase Date) off color to see seasonal or annual trends more clearly.

Example 2

The following FIXED level of detail expression computes the sum of sales per region:

```
{FIXED [Region] : SUM([Sales])}
```

This level of detail expression, named **[Sales by Region]**, is then placed on Text to show total sales per region:

The screenshot shows the Tableau Desktop interface with a table view on 'Sheet 5'. The Columns shelf is empty, and the Rows shelf contains 'Region' and 'State'. The Marks card is set to 'Text' and contains a green pill for 'SUM(Sales By ..)'. The Region dimension is placed on the Marks card. The table displays data for two regions: Central and East. Each region lists 11 states, and the numerical value for each state is identical within the region.

Region	State	Value
Central	Illinois	501,240
	Indiana	501,240
	Iowa	501,240
	Kansas	501,240
	Michigan	501,240
	Minnesota	501,240
	Missouri	501,240
	Nebraska	501,240
	North Dakota	501,240
	Oklahoma	501,240
	South Dakota	501,240
Texas	501,240	
Wisconsin	501,240	
East	Connecticut	678,781
	Delaware	678,781
	District of Columbia	678,781
	Maine	678,781
	Maryland	678,781
	Massachusetts	678,781
	New Hampshire	678,781
	New Jersey	678,781

The view level of detail is **[Region]** plus **[State]**, but because **FIXED** level of detail expressions do not consider the view level of detail, the calculation only uses the **[Region]** dimension, and so the values for the individual states in each region are identical. See [Level of Detail Expressions and Aggregation on page 2444](#) for an explanation of why this is so.

If the **INCLUDE** keyword had been used in the level of detail expression instead of **FIXED**, the values would be different for each state, because Tableau would add the dimension in the expression (**[Region]**) with any additional dimensions in the view (**[State]**) in determining values for the expression. The result would be:

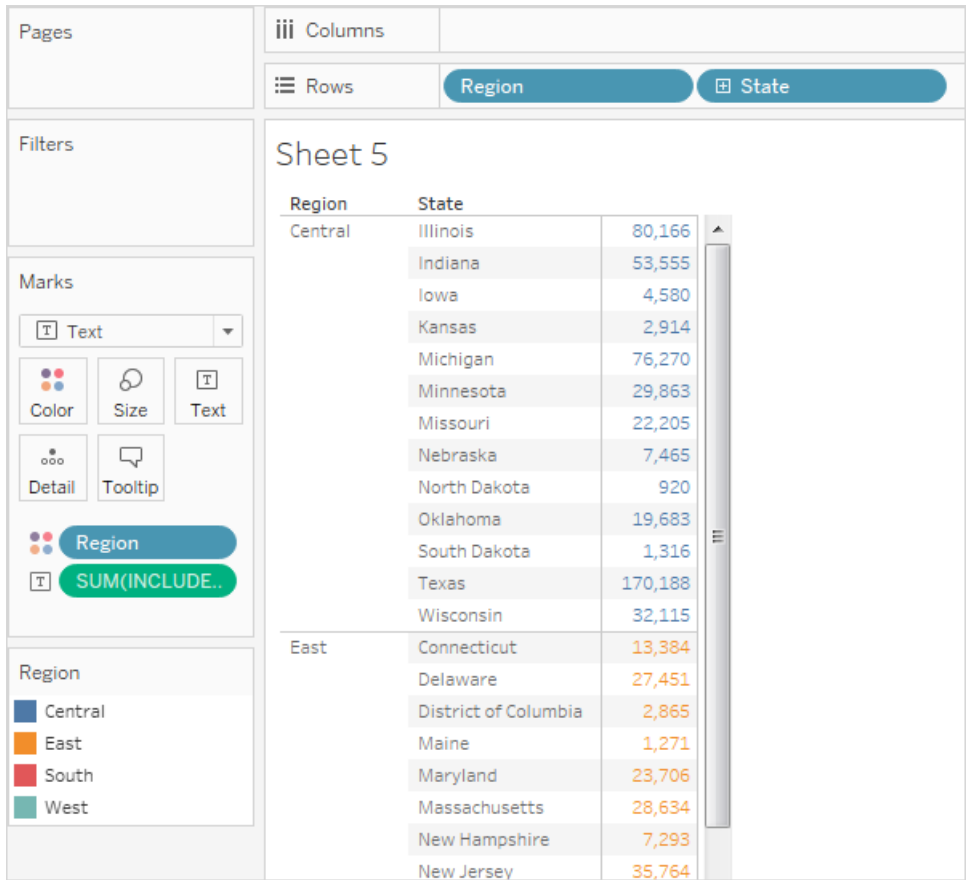

INCLUDE Level of Detail Expressions

INCLUDE level of detail expressions compute values using the specified dimensions in addition to whatever dimensions are in the view.

INCLUDE level of detail expressions can be useful when you want to calculate at a fine level of detail in the database and then re-aggregate and show at a coarser level of detail in your view. Fields based on INCLUDE level of detail expressions will change as you add or remove dimensions from the view.

Example 1

The following INCLUDE level of detail expression computes total sales per customer:

```
{ INCLUDE [Customer Name] : SUM([Sales]) }
```

When that calculation is placed on the **Rows** shelf, aggregated as AVG, and the **[Region]** dimension is placed on the **Columns** shelf, the view shows the average customer sales amount per region:

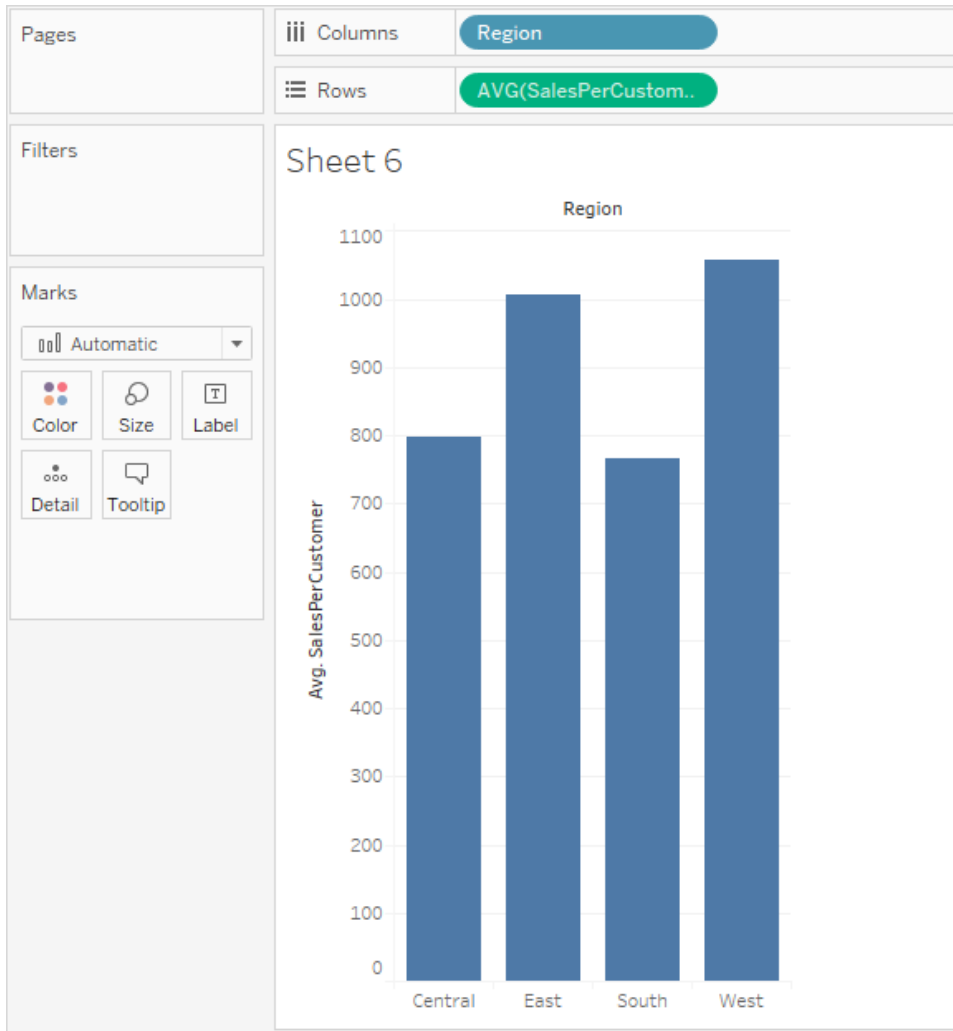

If the **[Sales]** measure is then dragged to the **Rows** shelf, the result illustrates the difference between the sum of sales (somewhere between \$390K and \$700K per region) and the average sales per customer (between \$750 and \$1100 per region):

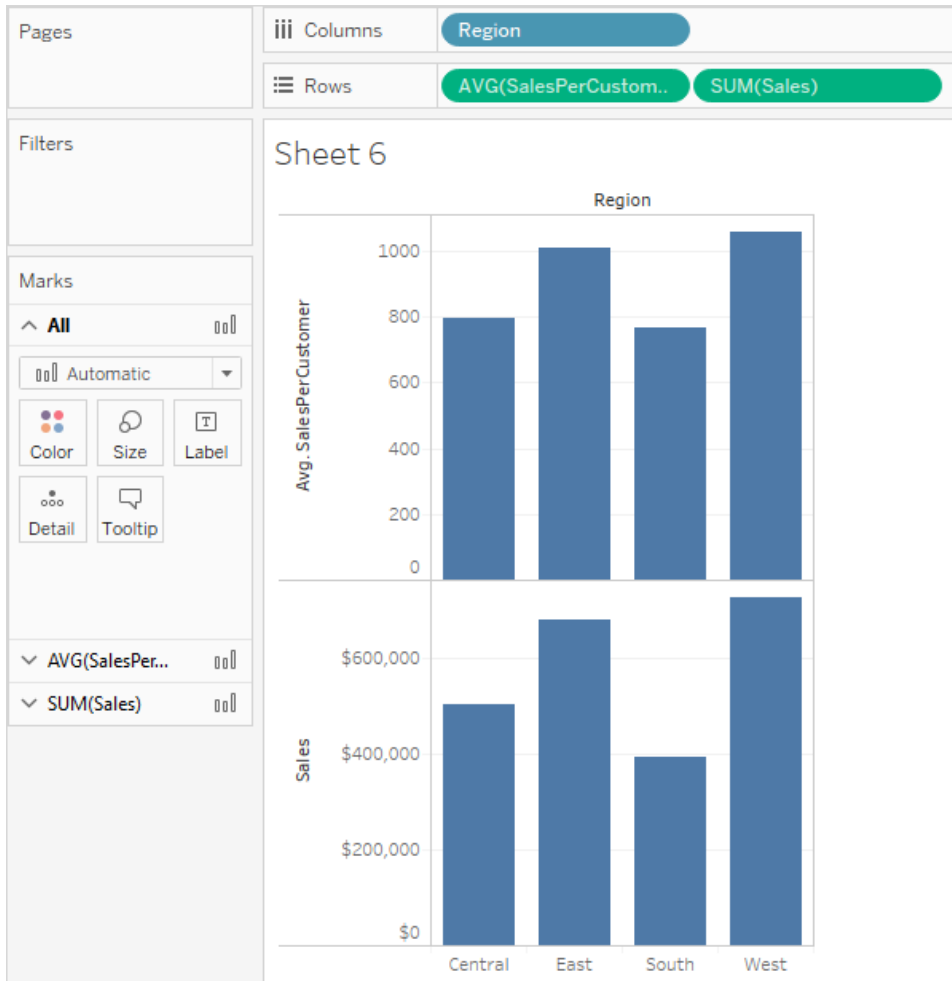

Example 2

The following INCLUDE level of detail expression calculates sum of sales on a per-state basis:

```
{ INCLUDE [State] : SUM(Sales) }
```

Type the calculation directly on the **Rows** shelf, and then change the aggregation to AVG using the field's context menu. The resulting view averages the sum of sales by state across categories.

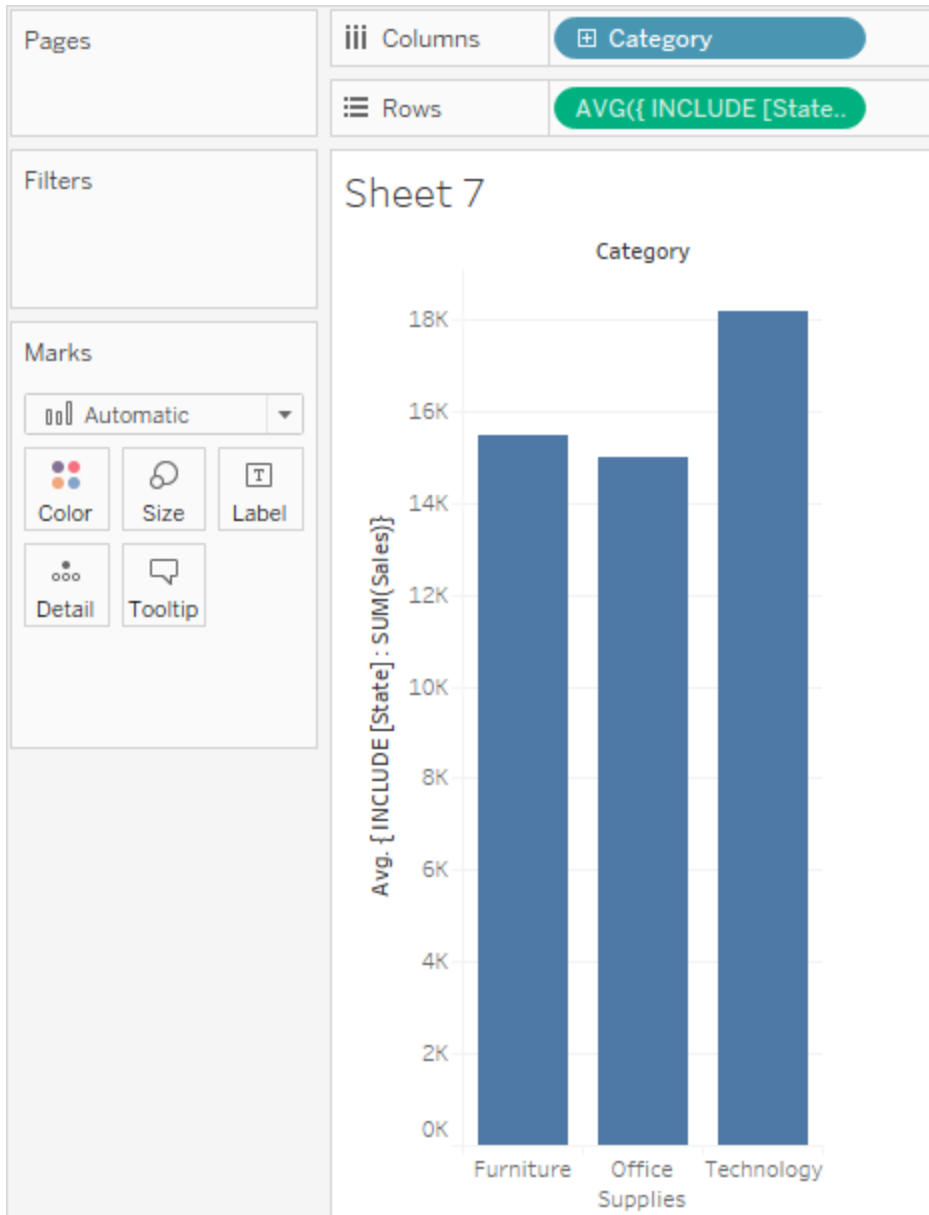

The view can be further enhanced by adding **[Segment]** to **Columns** and then copying the ad-hoc calculation from **Rows** to **Label** (using Ctrl+drag). In the image below we also dragged **Segment** to **Color** and then edited the colors for aesthetic effect. Now we can see how the average sum of sales per state varies across categories and segments.

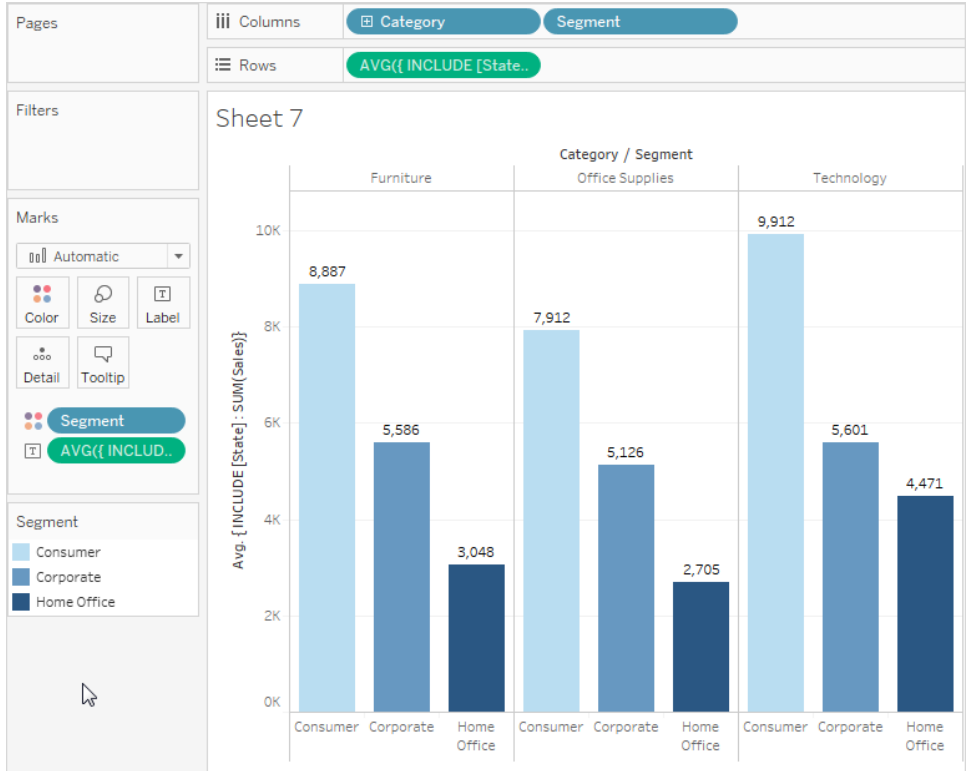

EXCLUDE Level of Detail Expressions

For foundational concepts about level of detail (LOD) expressions, see [Create Level of Detail Expressions in Tableau on page 2405](#) and [How Level of Detail Expressions Work in Tableau on page 2421](#).

Level of detail expressions are used to modify or control the level of detail (granularity) of a calculation. Most fields and calculations are tied to the granularity of the view or of the data source. LOD expressions allow you to set the granularity of a calculation explicitly.

- FIXED LOD expressions establish a specific dimension or dimensions for the rest of the calculation, such as returning the maximum blood pressure for each patient instead of the overall maximum in the data set by fixing the maximum to Patient ID.
- INCLUDE LOD expressions ensure that a dimension that isn't necessarily present in the view is considered in the calculation, such as looking at the average blood pressure for each patient including their sex, displayed in a view that doesn't contain sex information.
- EXCLUDE LOD expressions remove some of the detail from the view for the purposes of the calculation, such as looking at the average blood pressure for patients on a certain medication without considering individual patients, even if the view is by patient.

Note: Whenever a FIXED LOD is used, it will give the same result regardless of the visualization. When an INCLUDE or EXCLUDE LOD is used, the value might change depending on the structure of the view. The INCLUDE keyword takes the context of the view and adds a dimension for the calculation to consider (and the EXCLUDE removes a dimension present in the view from the context of the calculation), so using the calculation in another context can offer different results.

Consider a view (A) built with patient ID, age, and sex, and another view (B) with patient ID, age, and *weight*.

- A FIXED LOD expression will have the same value in both cases because the calculation ignores what is in the view and cares only about the dimension in the LOD expression.
- An INCLUDE LOD that includes *weight* will have a different value in each view, because it adds a dimension to view A but not to view B, which already had weight.
- An EXCLUDE LOD that excludes *weight* will have a different value in each view, because it removes a dimension from view B but doesn't change the context of view A, which already didn't have weight.

EXCLUDE

EXCLUDE level of detail expressions prevent the calculation from using one or more of the dimensions present in the view.

EXCLUDE level of detail expressions are useful for 'percent of total' or 'difference from overall average' scenarios. They are comparable to such features as Totals and Reference Lines.

EXCLUDE level of detail expression cannot be used in row-level expressions (where there are no dimensions to omit), but can be used to modify either a view level calculation or anything in between (that is, you can use an EXCLUDE calculation to remove dimension from some other level of detail expression).

Example 1

The image below shows the change in average blood pressure over time for four countries, broken out by sex.

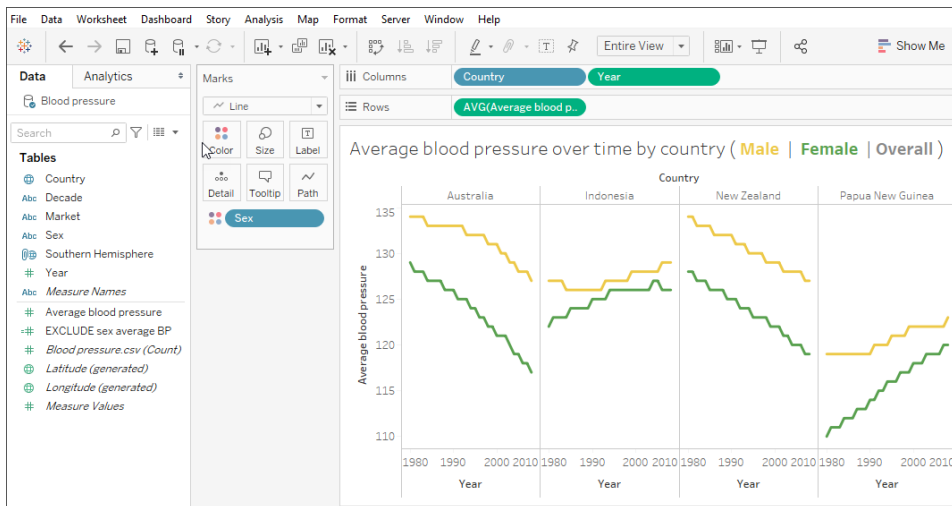
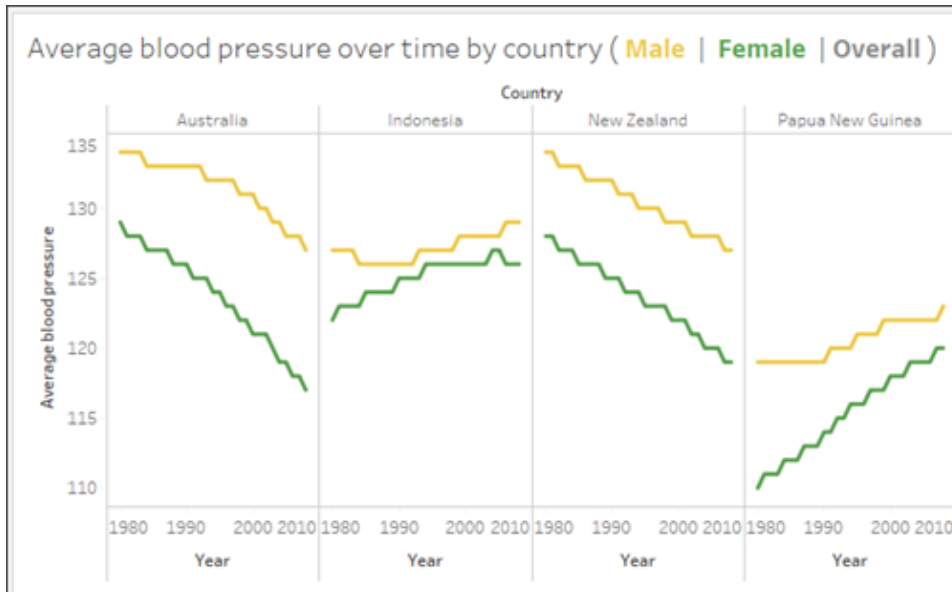

To see the average blood pressure for each country over time but without being split by male and female, use an EXCLUDE level of detail expression `{EXCLUDE [Sex] : AVG[Average blood pressure]}`. This is plotted as the grey line in the viz.

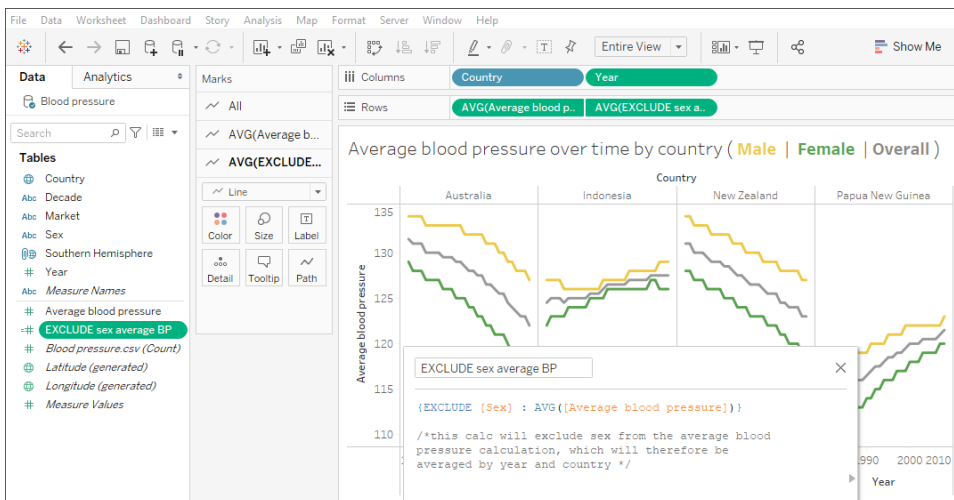
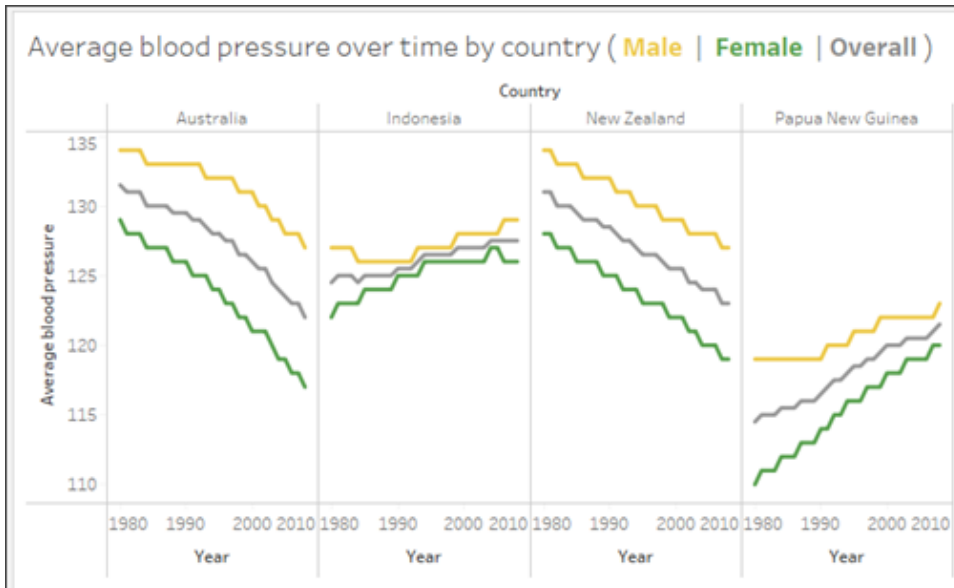

Bringing an average line out from the Analytics pane wouldn't work, because it would simply be a horizontal line for the average blood pressure per country, ignoring sex and year.

Note: This example takes the average of averages which is an incorrect analytical practice. It is done here purely for illustration purposes. No analysis should be made from this visualization.

Example 2

The following level of detail expression excludes **[Region]** from a calculation of the sum of **[Sales]**:

Tableau Desktop and Web Authoring Help

```
{EXCLUDE [Region]: SUM([Sales])}
```

The expression is saved as **[ExcludeRegion]**.

To illustrate how this expression might be useful, first consider the following view, which breaks out the sum of sales by region and by month:

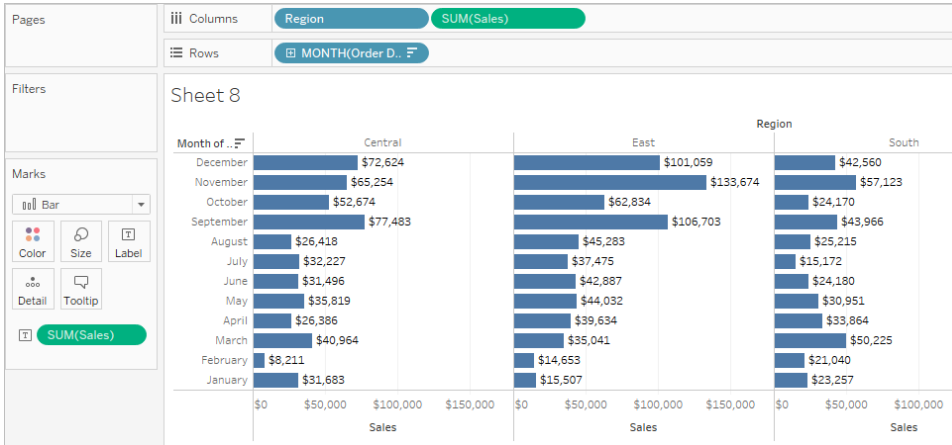

Dropping **[ExcludeRegion]** on Color shades the view to show total sales by month but without the regional component:

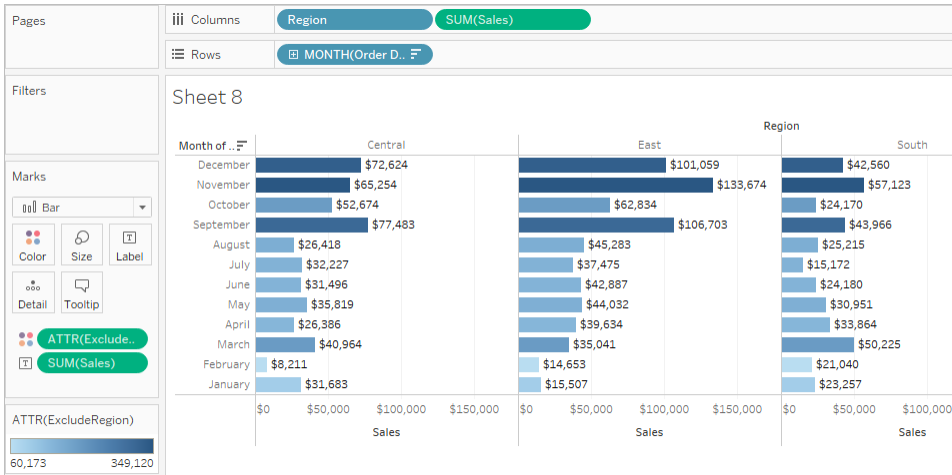

Example 3

The following EXCLUDE level of detail expression computes the average sales total per month and then excludes the month component:

```
{EXCLUDE [Order Date (Month / Year)] : AVG({FIXED [Order Date (Month / Year)] : SUM([Sales])})}
```

Notice that this is a nested level of detail expression—that is, a level of detail expression within another level of detail expression.

Saved as **[average of sales by month]**, the calculation can then be subtracted from the sum of sales per month by means of an ad-hoc calculation on the **Rows** shelf:



With **Month([Order Date])** on the **Columns** shelf, this creates a view that shows the difference between actual sales per month over a four-year period and the average monthly sales for the entire four-year period:

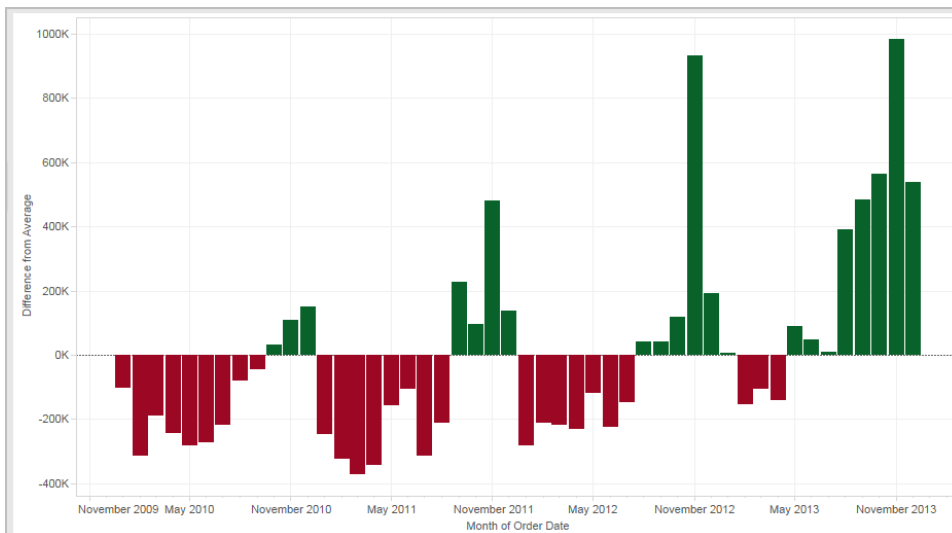

Level of Detail Expressions and Aggregation

The level of detail of the view determines the number of marks in your view. When you add a level of detail expression to the view, Tableau must reconcile two levels of detail—the one in the view, and the one in your expression.

The behavior of a level of detail expression in the view varies depending on whether the expression's level of detail is coarser, finer, or the same as the level of detail in the view. What do we mean by “coarser” or “finer” in this case?

Level of Detail Expression is Coarser Than View Level of Detail

An expression has a coarser level of detail than the view when it references a subset of the dimensions in the view. For example, for a view that contained the dimensions **[Category]** and **[Segment]**, you could create a level of detail expression that uses only one of these dimensions:

```
{FIXED [Segment] : SUM([Sales])}
```

In this case, the expression has a coarser level of detail than the view. It bases its values on one dimension (**[Segment]**), whereas the view is basing its view on two dimensions (**[Segment]** and **[Category]**).

The result is that using the level of detail expression in the view causes certain values to be replicated—that is, to appear multiple times.

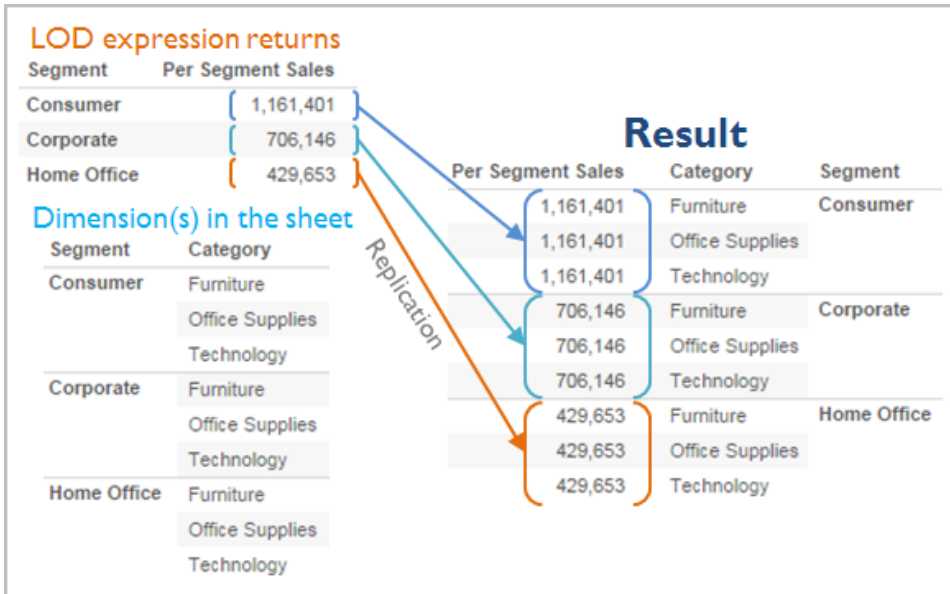

Replicated values are useful for comparing specific values against average values within a category. For example the following calculation subtracts average sales for a customer from the average sales overall:

```
[Sales] - {FIXED [Customer Name] : AVG([Sales])}
```

When values are being replicated, changing the aggregation for the relevant field in the view (for example, from AVG to SUM) will not change the result of the aggregation.

Level of Detail Expression is Finer Than View Level of Detail

An expression has a finer level of detail than the view when it references a superset of the dimensions in the view. When you use such an expression in the view, Tableau will aggregate results up to the view level. For example, the following level of detail expression references two dimensions:

```
{FIXED [Segment], [Category] : SUM([Sales])}
```

When this expression is used in a view that has only [Segment] as its level of detail, the values must be aggregated. Here's what you would see if you dragged that expression to a shelf:

```
AVG({FIXED [Segment]}, [Category] : SUM([Sales]))
```

An aggregation—in this case, average—is automatically assigned by Tableau. You can change the aggregation as needed.

Adding a Level of Detail Expression to the View

Whether a level of detail expression is aggregated or replicated in the view is determined by the expression type (FIXED, INCLUDE, or EXCLUDE) and whether the expression's granularity is coarser or finer than the view's.

- INCLUDE level of detail expressions will have either the same level of detail as the view or a finer level of detail than the view. Therefore, values will never be replicated.
- FIXED level of detail expressions can have a finer level of detail than the view, a coarser level of detail, or the same level of detail. The need to aggregate the results of a FIXED level of detail depends on what dimensions are in the view.
- EXCLUDE level of detail expressions always cause replicated values to appear in the view. When calculations including EXCLUDE level of detail expressions are placed on a shelf, Tableau defaults to the ATTR aggregation (as opposed to SUM or AVG) to indicate that the expression is not actually being aggregated and that changing the aggregation will have no effect on the view.

Level of detail expressions are always automatically wrapped in an aggregate when they are added to a shelf in the view unless they're used as dimensions. So if you double-click on a shelf and type

```
{FIXED[Segment], [Category] : SUM([Sales])}
```

and then press Enter to commit the expression, what you now see on the shelf is

```
SUM({FIXED[Segment], [Category] : SUM([Sales])})
```

But if you double-click into the shelf to edit the expression, what you see in edit mode is the original expression.

If you wrap a level of detail expression in an aggregation when you create it, Tableau will use the aggregation you specified rather than assigning one when any calculation including that expression is placed on a shelf. When no aggregation is needed (because the expression's level of detail is coarser than the view's), the aggregation you specified is still shown when the expression is on a shelf, but it is ignored.

Filters and Level of Detail Expressions

There are several different kinds of filters in Tableau and they get executed in the following order from top to bottom.

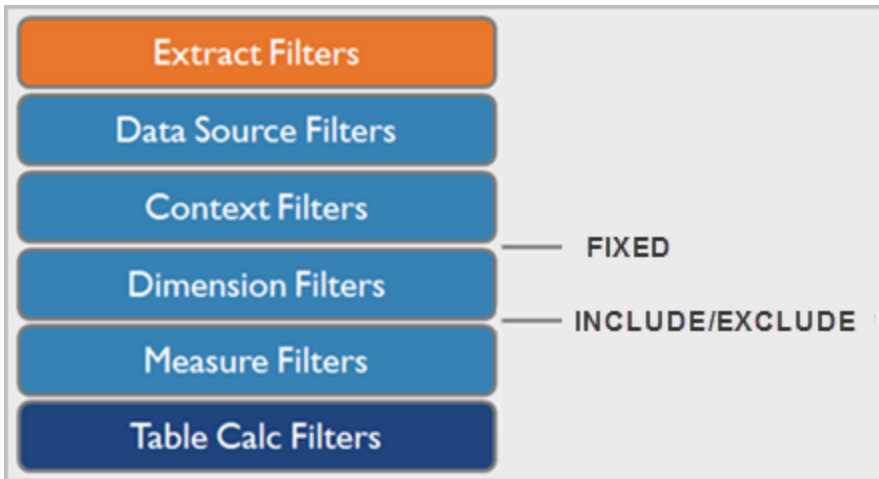

The text on the right shows where level of detail expressions are evaluated in this sequence.

Extract Filters (in orange) are only relevant if you're creating a Tableau Extract from a data source. Table calculations filters (dark blue) are applied after calculations are executed and therefore hide marks without filtering out the underlying data used in the calculations.

If you're familiar with SQL, you can think of measure filters as equivalent to the HAVING clause in a query, and dimension filters as equivalent to the WHERE clause.

FIXED calculations are applied before dimension filters, so unless you promote the fields on your Filter shelf to [Use Context Filters on page 1337](#), they will be ignored. For example, consider if you have the following calculation on one shelf in a view, along with **[State]** on a different shelf:

```
SUM([Sales]) / ATTR({FIXED : SUM([Sales])})
```

This calculation will give you the ratio of a state's sales to total sales.

If you then put **[State]** on the Filters shelf to hide some of the states, the filter will affect only the numerator in the calculation. Since the denominator is a FIXED level of detail expression, it will still divide the sales for the states still in the view against the total sales for all states—including the ones that have been filtered out of the view.

INCLUDE and EXCLUDE level of detail expressions are considered after Dimension filters. So if you want filters to apply to your FIXED level of detail expression but don't want to use Context Filters, consider rewriting them as INCLUDE or EXCLUDE expressions.

Data Source Constraints for Level of Detail Expressions

For some data sources, only more recent versions support level of detail expressions. Some data sources do not support level of detail expressions at all.

In addition, some data sources have complexity limits. Tableau will not disable calculations for these databases, but query errors are a possibility if calculations become too complex.

Data Source	Support
Amazon EMR Hadoop Hive	Supported for Hive 0.13 and later.
Aster Database	Supported for version 4.5 and later.
Cloudera Hadoop	Supported for Hive 0.13 and later.
Cloudera Impala	Supported for Impala 1.2.2 and later.
Cubes (multi-dimensional data sources)	Not supported.
DataStax Enterprise	Not supported.
Firebird	Supported for version 2.0 and later.
Generic ODBC	Limited. Depends on the specific data source.
Google Big Query	Supported for standard SQL, not supported for legacy SQL.
Hortonworks Hadoop Hive	Supported for Hive 0.13 and later. On version 1.1 of HIVE level of detail expressions that produce cross joins are not reliable. Cross join occur when there is no explicit field to join on. For example, for a level of detail expression <code>{fixed [Product Type] : sum (sales)}</code> when the view only contains one dimension [Ship Mode] ,

Tableau creates a cross-join. A cross join produces rows which combine each row from the first table with each row from the second table.

IBM DB2	Supported for version 8.1 and later.
MarkLogic	Supported for version 7.0 and later.
Microsoft Access	Not supported.
Microsoft Jet-based connections (legacy connectors for Microsoft Excel, Microsoft Access, and text)	Not supported.
Microsoft SQL Server	SQL Server 2005 and later.
Mongo DB	Not supported.
IBM PDA (Netezza)	Supported version 7.0 and later.
Oracle	Supported version 9i and later.
Action Matrix (ParAccel)	Supported version 3.1 and later.
Pivotal Greenplum	Supported for version 3.1 and later.
PostgreSQL	Supported version 7 and later.
SAP Sybase IQ	Supported version 15.1 and later.
Splunk	Not supported.
Vertica	Supported for version 6.1 and later.

Formatting Calculations in Tableau

This article describes how to create and format calculations in Tableau. It lists the basic components of calculations and explains the proper syntax for each.

Calculation building blocks

There are four basic components to calculations in Tableau:

- **Functions:** Statements used to transform the values or members in a field.
 - Functions require *arguments*, or specific pieces of information. Depending on the function, arguments can be fields, literals, parameters, or nested functions.
- **Fields:** Dimensions or measures from your data source.
- **Operators:** Symbols that denote an operation.
- **Literal expressions:** Constant values that are hardcoded, such as "High" or 1,500.

Not all calculations need to contain all four components. Additionally, calculations can contain:

- **Parameters:** Placeholder variables that can be inserted into calculations to replace constant values. For more information on parameters, see [Create Parameters on page 1122](#).
- **Comments:** Notes about a calculation or its parts, not included in the computation of the calculation.

For more information about how to use and format each of these components in a calculation, see the following sections.

Example calculation explained

For example, consider the following calculation, which adds 14 days to a date ([Initial Visit]). A calculation like this could be useful for automatically finding the date for a two-week followup.

```
DATEADD('day', 14, [Initial Visit])
```

The components of this calculation can be broken down as:

- **Function:** DATEADD, which requires three arguments.
 - date_part ('day')
 - interval (14)
 - date ([Initial Visit]).
- **Field:** [Initial Visit]
- **Operators:** n/a
- **Literal expressions:**
 - String literal: 'day'
 - Numeric literal: 14

In this example, the hardcoded constant 14 could be replaced with a parameter, which would allow the user to select how many days out to look for a followup appointment.

`DATEADD('day', [How many days out?], [Initial Visit])`

At a glance: calculation syntax

Components	Syntax	Example
Functions	See Tableau Functions (Alphabetical) on page 2300 or Tableau Functions (by Category) on page 2199 for examples of how to format all functions in Tableau.	<code>SUM(expression)</code>
Fields	A field in a calculation is often surrounded by brackets []. See Field syntax on page 2453 for more information.	<code>[Category]</code>
Operators	+, -, *, /, %, ==, =, >, <, >=, <=, !=, <>, ^, AND, OR, NOT, (). See Operator syntax on page 2454 for information on the types of operators you can use in Tableau calculation and the order they are performed in a formula.	<code>[Price] * (1 - [discount])</code>
Literal expressions	Numeric literals are written as numbers. String literals are written with quotation marks. Date literals are written with the # symbol. Boolean literals are written as either true or false. Null literals are written as null. See Literal expression syntax on page 2457 for more information.	1.3567 "Unprofitable" #August 22, 2005# true Null
Parameters	A parameter in a calculation is surrounded by brackets [], like a field. See Create Parameters on page 1122 for more information.	<code>[Bin Size]</code>
Comments	To enter a comment in a calculation, type two forward slashes //. See Add comments to a calculation on page 2459 for more information.	<code>SUM([Sales]) / SUM([Profit])</code>

	Multi-line comments can be added by typing <code>/*</code> to start the comment and <code>*/</code> to end it.	<pre>/*John's calculation To be used for profit ratio Do not edit*/</pre>
--	--	---

Calculation syntax in detail

See the following sections to learn more about the different components of Tableau calculations and how to format them to work in Tableau.

Function syntax

Functions are the main components of a calculation and can be used for various purposes.

Every function in Tableau requires a particular syntax. For example, the following calculation uses two functions, `LEN` and `LEFT`, as well as several logical operators (`IF`, `THEN`, `ELSE`, `END`, and `>`).

```
IF LEN([Name]) > 5 THEN LEFT([Name], 5) ELSE [Name] END
```

- `LEN` takes a single argument, such as `LEN([Name])` which returns the number of characters (that is, the length) for each value in the `Name` field.
- `LEFT` takes two arguments, a field and a number, such as `LEFT([Name], 5)` which returns the first five characters from each value in the `Name` field starting from the left.
- The logical operators `IF`, `THEN`, `ELSE`, and `END` work together to create a logical test.

This calculation evaluates the length of a name and, if it's more than five characters, returns only the first five. Otherwise, it returns the entire name.

In the calculation editor, functions are colored blue.

Use the calculation editor reference pane

You can look up how to use and format a particular function at any time. To open the list of functions in Tableau:

1. Select **Analysis > Create Calculated Field**.
2. In the Calculation Editor that opens, click the expand (triangle) icon located on the right edge of the editor.

A list of functions appears for you to browse. When you select a function from the list, the section on the far right updates with information about that function's required syntax (1), its description (2), and one or more examples (3).

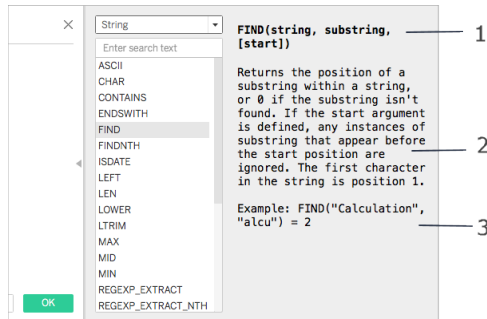

Using multiple functions in a calculation

You can use more than one function in a calculation. For example:

```
ZN(SUM([Order Quantity])) - WINDOW_AVG(SUM([Order Quantity]))
```

There are three functions in the calculation: ZN, SUM, and WINDOW_AVG. The ZN function and the WINDOW_AVG function are separated with the subtraction operator (-).

A function can also be part of another function (or, nested), as is the case with the ZN (SUM ([Order Quantity])) portion of the example above. In this case, the SUM of Order Quantity is computed before the ZN function because it is inside parentheses. For more information on why, see [Parentheses on page 2457](#).

Field syntax

Fields can be inserted into your calculations. Often, a function's syntax indicates where a field should be inserted into the calculation. For example: SUM(expression).

Field names should be encompassed by brackets [] in a calculation when the field name contains a space or is not unique. For example, [Sales Categories].

The type of function you use determines the type of field you use. For example, with the SUM function, you can insert a numerical field, but you cannot insert a date field. For more information, see [Understanding data types in calculations on page 2459](#).

The fields you choose to include in your calculations also depend on the purpose of calculation. For example, if you want to calculate profit ratio your calculation will use the Sales and Profit fields from your data source:

```
SUM([Sales])/SUM([Profit])
```

To add a field to a calculation, do one of the following:

- Drag it from the Data pane or the view and drop it in the calculation editor.
- In the Calculation Editor, type the field name. Note: The Calculation Editor attempts to auto-complete field names.

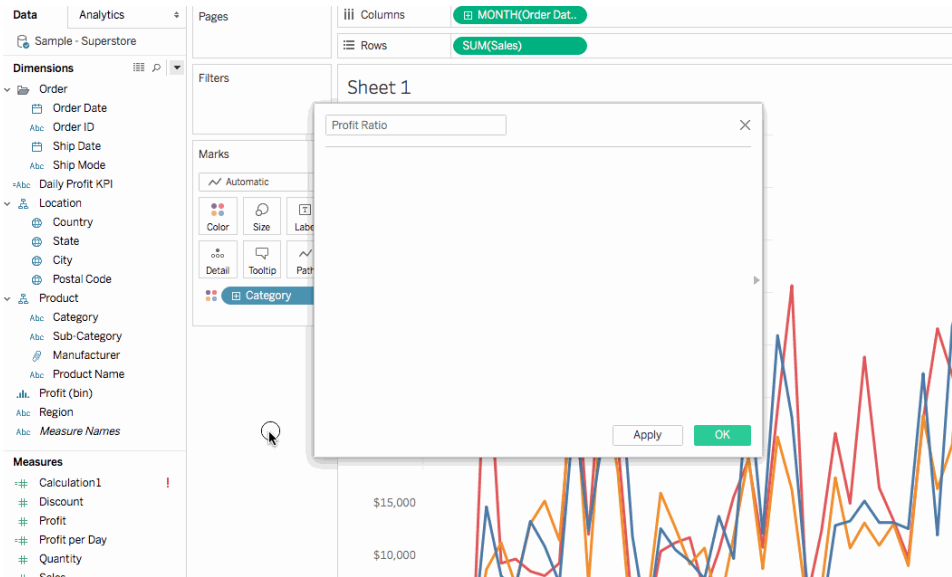

Fields are colored orange in Tableau calculations.

Operator syntax

To create calculations, you need to understand the operators supported by Tableau. This section discusses the basic operators that are available and the order (precedence) they are performed.

Operators are colored black in Tableau calculations.

+ (addition)

The + operator means addition when applied to numbers and concatenation when applied to strings. When applied to dates, it can be used to add a number of days to a date.

For example:

- $7 + 3$
- Profit + Sales
- 'abc' + 'def' = 'abcdef'
- #April 15, 2024# + 15 = #April 30, 2024#

- (subtraction)

The - operator means subtraction when applied to numbers and negation if applied to an expression. When applied to dates, it can be used to subtract a number of days from a date. Hence, it can also be used to calculate the difference in days between two dates.

For example:

- $7 - 3$
- `Profit - Sales`
- $-(7+3) = -10$
- `#April 16, 2024# - 15 = #April 1, 2024#`
- `#April 15, 2024# - #April 8, 2024# = 7`

* (multiplication)

The * operator means numeric multiplication.

For example: $5 * 4 = 20$

/ (division)

The / operator means numeric division.

For example: $20 / 4 = 5$

% (modulo)

The % operator returns the remainder of a division operation. Modulo can only operate on integers.

For example: $9 \% 2 = 1$. (Because 2 goes into 9 four times with a remainder of 1.)

==, =, >, <, >=, <=, !=, <> (comparisons)

These are the basic comparison operators that can be used in expressions. Their meanings are as follows:

- `==` or `=` (equal to)
- `>` (greater than)
- `<` (less than)
- `>=` (greater than or equal to)
- `<=` (less than or equal to)
- `!=` or `<>` (not equal to)

Each operator compares two numbers, dates, or strings and returns either TRUE, FALSE, or NULL.

^ (power)

This symbol is equivalent to the POWER function. It raises a number to the specified power.

For example: $6^3 = 216$

AND

This is a logical operator. An expression or a boolean must appear on either side of it.

For example: `IIF(Profit =100 AND Sales =1000, "High", "Low")`

See **AND** in [Logical Functions on page 2098](#) for more information.

OR

This is a logical operator. An expression or a boolean must appear on either side of it.

For example: `IIF(Profit =100 OR Sales =1000, "High", "Low")`

See **OR** in [Logical Functions on page 2098](#) for more information.

NOT

This is a logical operator. It can be used to negate another boolean or an expression. For example,

```
IIF(NOT(Sales = Profit), "Not Equal", "Equal")
```

Other Operators

CASE, ELSE, ELSEIF, IF, THEN, WHEN, and END are also operators used for [Logical Functions on page 2098](#).

Operator precedence

All operators in a calculation are evaluated in a specific order. For example, $2*1+2$ is equal to 4 and not equal to 6, because multiplication is performed before addition (the * operator is always evaluated before the + operator).

If two operators have the same precedence (such as addition and subtraction (+ or -) they are evaluated from left to right in the calculation.

Parentheses can be used to change the order of precedence. See the [Parentheses](#) below section for more information.

Precedence	Operator
1	– (negate)
2	^ (power)
3	*, /, %
4	+, –
5	==, =, >, <, >=, <=, !=, <>
6	NOT
7	AND
8	OR

Parentheses

Parentheses can be used as needed to force an order of precedence. Operators that appear within parentheses are evaluated before those outside of parentheses, starting from the innermost parentheses and moving outward.

For example, $(1 + (2*2+1)*(3*6/3)) = 31$ because the operators within the innermost parentheses are performed first. The calculation is calculated in the following order:

1. $(2*2+1) = 5$
2. $(3*6/3) = 6$
3. $(1+ 5*6) = 31$

Literal expression syntax

This section describes the proper syntax for using literal expressions in Tableau calculations. A literal expression signifies a constant value that is represented as is. When you are using functions you will sometimes want to use literal expressions to represent numbers, strings, dates, and more.

For example, you may have a function where your input is a date. Rather than type "May 1, 2005", which would be interpreted a string, you would type #May 1, 2005#. This is equivalent to

using a date function to convert the argument from a string to a date (refer to [Date Functions on page 2075](#)).

You can use numeric, string, date, boolean, and null literals in Tableau calculations. Each type, and how to format them, are described below.

Literal expressions are colored black and gray in Tableau calculations.

Numeric Literals

A numeric literal is written as a number. For example, to input the number one as a numeric literal, enter `1`. If you want to input the number 0.25 as a numeric literal, enter `0.25`.

String Literals

A string literal can be written either using 'single quote' or "double quote".

If your string has a single or double quote within it, use the other option for the outermost string literals.

For example, to input the string `"cat"` as a string literal, type `'"cat"'`. For `'cat'` type `"'cat'"`. If you want to type the string `She's my friend` as a string literal, use double quotes for the literals, as in `"She's my friend."`

Date Literals

Date literals are signified by the pound symbol (`#`). To input the date "August 22, 2005" as a literal date, enter the ISO formatted date, `#2005-08-22#`.

Boolean Literals

Boolean literals are written as either true or false. To input "true" as a boolean literal, enter `true`.

Null Literals

Null literals are written as Null. To input "Null" as a Null literal, enter `Null`.

Add parameters to a calculation

Parameters are placeholder variables that can be inserted into calculations to replace constant values. When you use a parameter in a calculation, you can then expose a parameter control in a view or dashboard to allow users to dynamically change the value.

For details, see [Use a parameter on page 1126](#).

Parameters are colored purple in Tableau calculations.

Add comments to a calculation

You can add comments to a calculation to make notes about it or its parts. Comments are not included in the computation of the calculation.

To add a comment to a calculation, type two forward slash (//) characters.

For example:

```
SUM([Sales])/SUM([Profit]) //My calculation
```

In this example, `//My calculation` is a comment.

A comment starts at the two forward slashes (//) and goes to the end of the line. To continue with your calculation, you must start a new line.

A multi-line comment can be written by starting the comment with a forward slash followed by an asterisk (/*), and closed with an asterisk followed by a forward slash (*). For example:

```
SUM([Sales])/SUM([Profit])  
/* This calculation is  
used for profit ratio.  
Do not edit */
```

Comments are colored gray in Tableau calculations.

Understanding data types in calculations

If you create calculated fields, you need to know how to use and combine the different [data types](#) in calculations. Many functions that are available to you when you define a calculation only work when they are applied to specific data types.

For example, the `DATEPART()` function can accept only a date/datetime data type as an argument. You can enter `DATEPART('year', #2024-04-15#)` and expect a valid result: 2024. You cannot enter `DATEPART('year', "Tom Sawyer")` and expect a valid result. In fact, this example returns an error because "Tom Sawyer" is a string, not a date/datetime.

Note: Although Tableau attempts to fully validate all calculations, some data type errors cannot be found until the query is run against the database. These issues appear as error dialogs at the time of the query rather than in the calculation dialog box.

The data types supported by Tableau are described below. Refer to [Type Conversion on page 2092](#) to learn about converting from one data type to another.

String

A sequence of zero or more characters. For example, "Wisconsin", "ID-44400", and "Tom Sawyer" are all strings. Strings are recognized by single or double quotes. The quote character itself can be included in a string by repeating it. For example, 'O' 'Hanrahan'.

Date/Datetime

A date or a datetime. For example "January 23, 1972" or "January 23, 1972 12:32:00 AM". If you would like a date written in long-hand style to be interpreted as a date/datetime, place the # sign on either side of it. For instance, "January 23, 1972" is treated as a string data type but #January 23, 1972# is treated as a date/datetime data type.

Number

Numerical values in Tableau can be either *integers* or *floating-point numbers*.

With floating-point numbers, results of some aggregations may not always be exactly as expected. For example, you may find that the SUM function returns a value such as -1.42e-14 for a field of numbers that you know should sum to exactly 0. This happens because the Institute of Electrical and Electronics Engineers (IEEE) 754 floating-point standard requires that numbers be stored in binary format, which means that numbers are sometimes rounded at extremely fine levels of precision. You can eliminate this potential distraction by formatting the number to show fewer decimal places. For more information, see ROUND in [Number functions available in Tableau on page 2047](#).

Operations that test floating point values for equality can behave unpredictably for the same reason. Such comparisons can occur when using level of detail expressions as dimensions, in categorical filtering, creating ad-hoc groups, creating IN/OUT sets, and with data blending.

Note: The largest signed 64-bit integer is 9,223,372,036,854,775,807. When connecting to a new data source, any column with data type set to **Number (whole)** can accommodate values up to this limit; for larger values, because **Number (whole)** does not use floating-points, Tableau displays "Null." When the data type is set to **Number (decimal)**, larger values can be accommodated.

Boolean

A field that contains the values TRUE or FALSE. An unknown value arises when the result of a comparison is unknown. For example, the expression `7 > Null` yields unknown. Unknown

booleans are automatically converted to Null.

See Also

[Understanding Calculations in Tableau](#) on page 2023

[Create a Simple Calculated Field](#) on page 2021

[Get Started with Calculations in Tableau](#) on page 2017

Best Practices for Creating Calculations in Tableau

This article describes several tips and guidelines for creating efficient calculations in Tableau. These guidelines are meant to help you optimize your workbook performance. For more information about all the ways you can improve workbook performance, see the [Optimize Workbook Performance](#) on page 3041 series.

General Rule: Avoid using a calculated field multiple times in another calculation

Referencing the same calculated field multiple times within another calculation will result in performance issues. If you use a calculated field within a calculation (also known as creating a Nested Calculation), try to reference it only once in the calculation.

Note that referencing a field (terminal field) multiple times in a calculation shouldn't degrade performance.

Example

Let's say you create a calculated field that uses a complicated multiple line calculation to find mentions, or Twitter handles, in tweets. The calculated field is titled, Twitter Handle. Each handle that is returned starts with the '@' sign (for example: @user).

For your analysis, you want to remove the '@' symbol.

To do so, you can use the following calculation to remove the first character from the string:

```
RIGHT([Twitter Handle], LEN([Twitter Handle]) -1)
```

This calculation is quite simple. However, since it references the Twitter Handle calculation twice, it performs that calculation twice for each record in your data source: once for the RIGHT function and again for the LEN function.

In order to avoid calculating the same calculation more than once, you can rewrite the calculation to one that uses the Twitter Handle calculation only once. In this example, you can use MID to accomplish the same goal:

```
MID([Twitter Handle], 2)
```

Tip 1: Convert multiple equality comparisons to a CASE expression or a group

Let's say you have the following calculation, which uses the calculated field, Person (calc), multiple times and employs a series of OR functions. This calculation, though a simple logical expression, will cause query performance issues because it performs the Person (calc) calculation at least ten times.

```
IF [Person (calc)] = 'Henry Wilson'
OR [Person (calc)] = 'Jane Johnson'
OR [Person (calc)] = 'Michelle Kim'
OR [Person (calc)] = 'Fred Suzuki'
OR [Person (calc)] = 'Alan Wang'
THEN 'Lead'
ELSEIF [Person (calc)] = 'Susan Nguyen'
OR [Person (calc)] = 'Laura Rodriguez'
OR [Person (calc)] = 'Ashley Garcia'
OR [Person (calc)] = 'Andrew Smith'
OR [Person (calc)] = 'Adam Davis'
THEN 'IC'
END
```

Instead of using an equality comparison, try the following solutions.

Solution 1

Use a CASE expression. For example:

```
CASE [Person (calc)]
WHEN 'Henry Wilson' THEN 'Lead'
WHEN 'Jane Johnson' THEN 'Lead'
WHEN 'Michelle Kim' THEN 'Lead'
WHEN 'Fred Suzuki' THEN 'Lead'
WHEN 'Alan Wang' THEN 'Lead'

WHEN 'Susan Nguyen' THEN 'IC'
WHEN 'Laura Rodriguez' THEN 'IC'
```

```

WHEN 'Ashley Garcia' THEN 'IC'
WHEN 'Andrew Smith' THEN 'IC'
WHEN 'Adam Davis' THEN 'IC'
END

```

In this example, the calculated field, Person (calc), is only referenced once. Therefore, it is only performed once. CASE expressions are also further optimized in the query pipeline, so you gain an additional performance benefit.

Solution 2

Create a group instead of a calculated field. For more information, see [Group Your Data on page 1079](#).

Tip 2: Convert multiple string calculations into a single REGEXP expression

Note: REGEXP calculations are available only when using Tableau data extracts or when connected to Text File, Hadoop Hive, Google BigQuery, PostgreSQL, Tableau Data Extract, Microsoft Excel, Salesforce, Vertica, Pivotal Greenplum, Teradata (version 14.1 and above), and Oracle data sources. For more information, see [Additional Functions on page 2193](#).

Example 1: CONTAINS

Let's say you have the following calculation, which uses the calculated field, Category (calc), multiple times. This calculation, though also a simple logical expression, will cause query performance issues because it performs the Category (calc) calculation multiple times.

```

IF CONTAINS ([Segment (calc)], 'UNKNOWN')
OR CONTAINS ([Segment (calc)], 'LEADER')
OR CONTAINS ([Segment (calc)], 'ADVERTISING')
OR CONTAINS ([Segment (calc)], 'CLOSED')
OR CONTAINS ([Segment (calc)], 'COMPETITOR')
OR CONTAINS ([Segment (calc)], 'REPEAT')
THEN 'UNKNOWN'
ELSE [Segment (calc)] END

```

You can use a REGEXP expression to get the same results without as much repetition.

Solution

```
IF REGEXP_MATCH([Segment (calc)],
'UNKNOWN|LEADER|ADVERTISING|CLOSED|COMPETITOR|REPEAT') THEN
'UNKNOWN'
ELSE [Segment (calc)] END
```

With string calculations that use a similar pattern, you can use the same REGEXP expression.

Example 2: STARTSWITH

```
IF STARTSWITH([Segment (calc)], 'UNKNOWN')
OR STARTSWITH([Segment (calc)], 'LEADER')
OR STARTSWITH([Segment (calc)], 'ADVERTISING')
OR STARTSWITH([Segment (calc)], 'CLOSED')
OR STARTSWITH([Segment (calc)], 'COMPETITOR')
OR STARTSWITH([Segment (calc)], 'REPEAT')
THEN 'UNKNOWN'
```

Solution

```
IF REGEXP_MATCH([Segment (calc)], '^
(UNKNOWN|LEADER|ADVERTISING|CLOSED|COMPETITOR|REPEAT)') THEN
'UNKNOWN'
ELSE [Segment (calc)] END
```

Note that the '^' symbol is used in this solution.

Example 3: ENDSWITH

```
IF ENDSWITH([Segment (calc)], 'UNKNOWN')
OR ENDSWITH([Segment (calc)], 'LEADER')
OR ENDSWITH([Segment (calc)], 'ADVERTISING')
OR ENDSWITH([Segment (calc)], 'CLOSED')
OR ENDSWITH([Segment (calc)], 'COMPETITOR')
OR ENDSWITH([Segment (calc)], 'REPEAT')
THEN 'UNKNOWN'
ELSE [Segment (calc)] END
```

Solution

```
IF REGEXP_MATCH([Segment (calc)], '
(UNKNOWN|LEADER|ADVERTISING|CLOSED|COMPETITOR|REPEAT)$') THEN
'UNKNOWN'
ELSE [Segment (calc)] END
```

Note that the '\$' symbol is used in this solution.

Tip 3: Manipulate strings with REGEXP instead of LEFT, MID, RIGHT, FIND, LEN

Regular expressions can be a very powerful tool. When doing complex string manipulation, consider using regular expressions. In a lot of cases, using a regular expression will result in a shorter and more efficient calculation. For more information about regular expressions, see the [Become a regex regular and wrangle imperfect data](#) post on the Tableau blog.

Example 1

Let's say you have the following calculation, which removes protocols from URLs. For example: "https://www.tableau.com" becomes "www.tableau.com".

```
IF (STARTSWITH([Server], "http://")) THEN
MID([Server], Len("http://") + 1)
ELSEIF(STARTSWITH([Server], "https://")) THEN
MID([Server], Len("https://") + 1)
ELSEIF(STARTSWITH([Server], "tcp:")) THEN
MID([Server], Len("tcp:") + 1)
ELSEIF(STARTSWITH([Server], "\\\")) THEN
```

```
MID([Server], Len("\\") + 1)
ELSE [Server]
END
```

Solution

You can simplify the calculation and improve performance by using a REGEXP_REPLACE function.

```
REGEXP_REPLACE([Server], "^(\http://|https://|tcp:|\\)\)", "")
```

Example 2

Let's say you have the following calculation, which returns the second part of an IPv4 address. For example: "172.16.0.1" becomes "16".

```
IF (FINDNTH([Server], ".", 2) > 0) THEN
MID([Server],
FIND([Server], ".") + 1,
FINDNTH([Server], ".", 2) - FINDNTH([Server], ".", 1) - 1
)
END
```

Solution

You can simplify the calculation and improve performance by using a REGEXP_EXTRACT function.

```
REGEXP_EXTRACT([Server], "\.([\^\.]*)\.")
```

Tip 4: Do not use sets in calculations

If you are using sets in a calculation, consider replacing them with an alternative, but equivalent calculation.

Example

Let's say you have the following calculation, which uses the set, Top Customers (set).

```
IF ISNULL([Customer Name]) OR [Top customers (set)] THEN  
[Segment] ELSE [Customer Name] END
```

Solution 1

If the set is simple, you can create a calculated field that returns the same result as the set. For example:

```
CASE [Customer Name]  
WHEN 'Henry Wilson' THEN True  
WHEN 'Jane Johnson' THEN True  
WHEN 'Michelle Kim' THEN True  
WHEN 'Fred Suzuki' THEN True  
WHEN 'Alan Wang' THEN True  
ELSE False  
END
```

Note: Using the pattern WHEN TRUE ... ELSE is recommended in this situation to avoid performance issues due to the use of sets. It is not a recommended pattern in most scenarios.

Solution 2

If the set is more complex, consider creating a group that maps all the elements in the set to a given value or attribute, such as 'IN', and then modify the calculation to check for that value/attribute. For example:

```
IF ISNULL([Customer Name]) OR [Top Customers (group)]='IN' THEN  
[Segment] ELSE [Customer Name] END
```

For more information, see [Group Your Data](#) on page 1079 and [Create Sets](#) on page 1092.

Tip 5: Do not use sets to group your data

Sets are meant to make comparisons on subsets of data. Groups are meant to combine related members in a field. Converting sets to groups, such as with the following example, is not recommended:

```
IF [Americas Set] THEN "Americas"  
ELSEIF [Africa Set] THEN "Africa"  
ELSEIF [Asia Set] THEN "Asia"  
ELSEIF [Europe Set] THEN "Europe"  
ELSEIF [Oceania Set] THEN "Oceania"  
ELSE "Unknown"  
END
```

This is not recommended for the following reasons:

- **Sets are not always exclusive.** Some members can appear in multiple sets. For example, Russia could be placed both in the Europe set and the Asia set.
- **Sets cannot always be translated to groups.** If the sets are defined by exclusion, conditions, or limits, it might be difficult or even impossible to create an equivalent group.

Solution

Group your data using the Group feature. For more information, see [Group Your Data on page 1079](#).

See Also

[Create Efficient Calculations on page 3063](#)

[Optimize Workbook Performance on page 3041](#)

[Types of Calculations in Tableau on page 2025](#)

[Functions in Tableau on page 2047](#)

Tips for Working with Calculated Fields in Tableau

To help you become more efficient with creating and editing calculated fields in Tableau, this article lists several tips for working in the calculation editor.

Note: The gifs in this topic show an older version of the UI. The **Data** pane no longer calls out Dimensions and Measures.

Drag and drop fields into the calculation editor

When creating fields in the calculation editor, you can drag existing fields from the Data pane into the editor at any time.

Tableau Desktop and Web Authoring Help

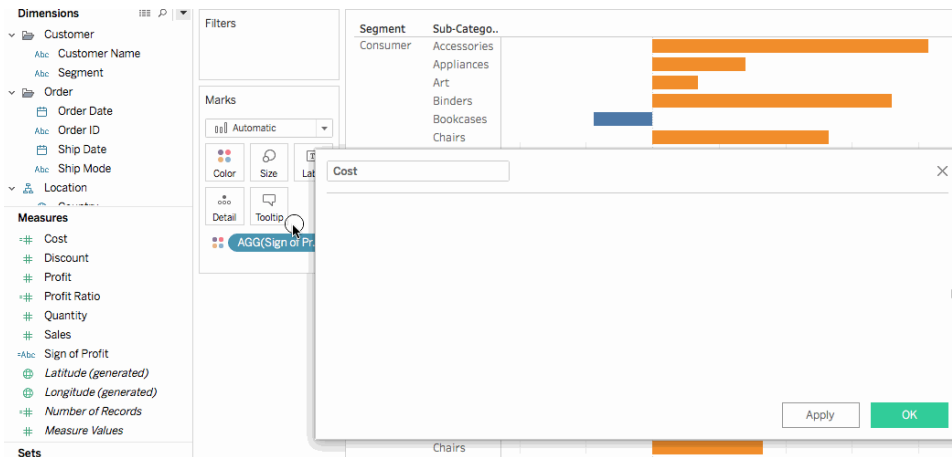

Drag and drop formulas from the calculation editor to the Data pane

When typing a calculation in the calculation editor, you can highlight all or part of the formula and drag it to the Data pane to create a new calculated field. You can then rename the field by typing a name. For more information, see [Ad-Hoc Calculations](#) on page 2472.

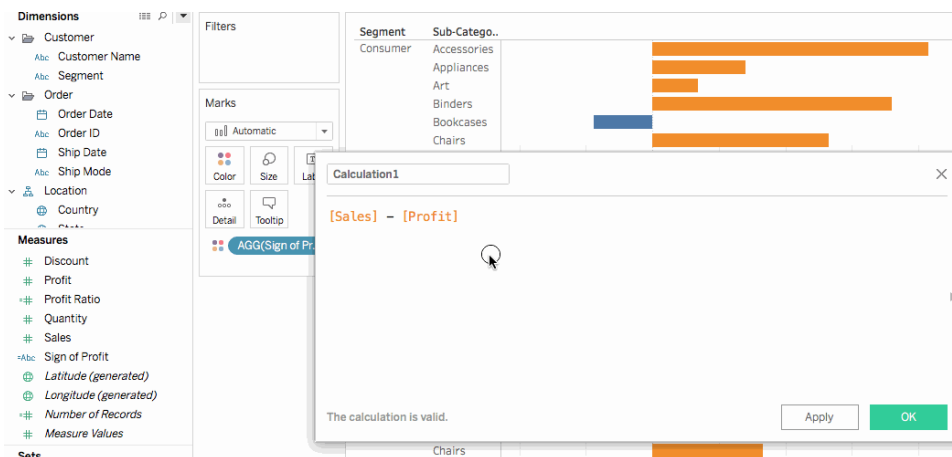

Use the functions reference in the calculation editor

When typing a calculation in the calculation editor, you can use the functions reference to browse all the functions available in Tableau.

To open the functions reference:

In the calculation editor, click the triangle icon on the right-side of the editor.

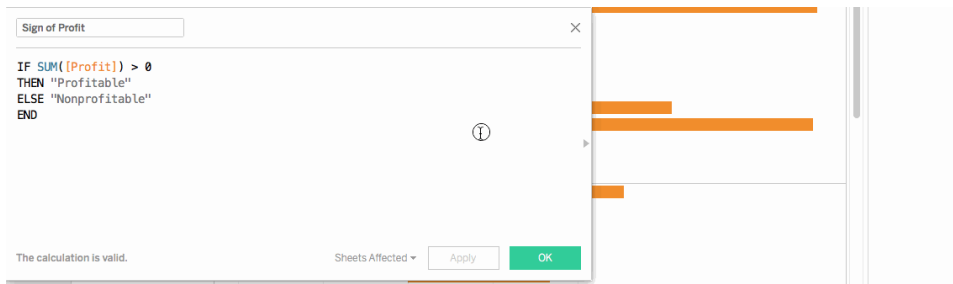

To add a function from the reference to a formula:

In the function reference, double-click a function.

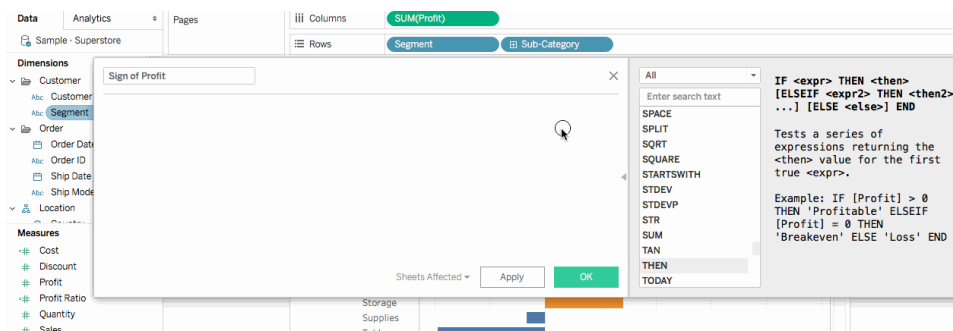

Take advantage of auto-complete for formulas

As you type a formula in the calculation editor, Tableau suggests options to complete items in your formula. Tableau suggests functions, fields in your data source, parameters, sets, and bins that begin with or contain the string you type. The list of suggestions update as you type.

To add an item from auto-complete to a formula:

Press Enter on your keyboard to select the highlighted suggestion. You can use the up and down arrows on your keyboard to move between items in the auto-complete list.

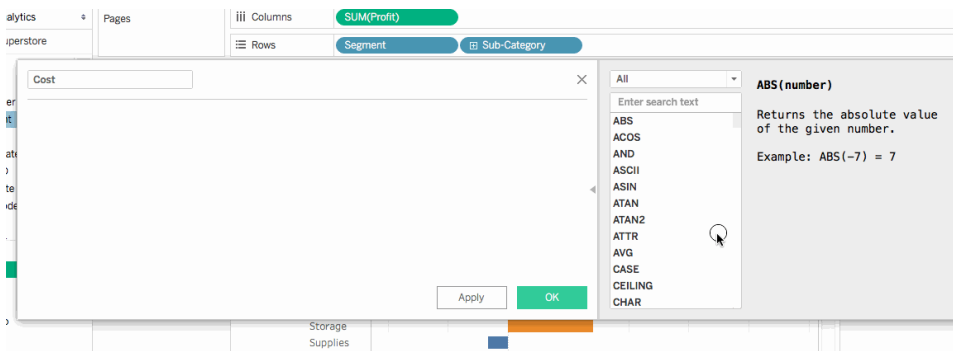

Drag table calculations into the calculation editor to edit them

When you create a table calculation, you can drag it into the calculation editor to review or make changes to the formula.

To edit a table calculation in the calculation editor:

1. In the **Analysis** menu, select **Create Calculated Field...**
2. From the worksheet, drag the table calculation into the calculation editor.
3. When finished, click **OK**.

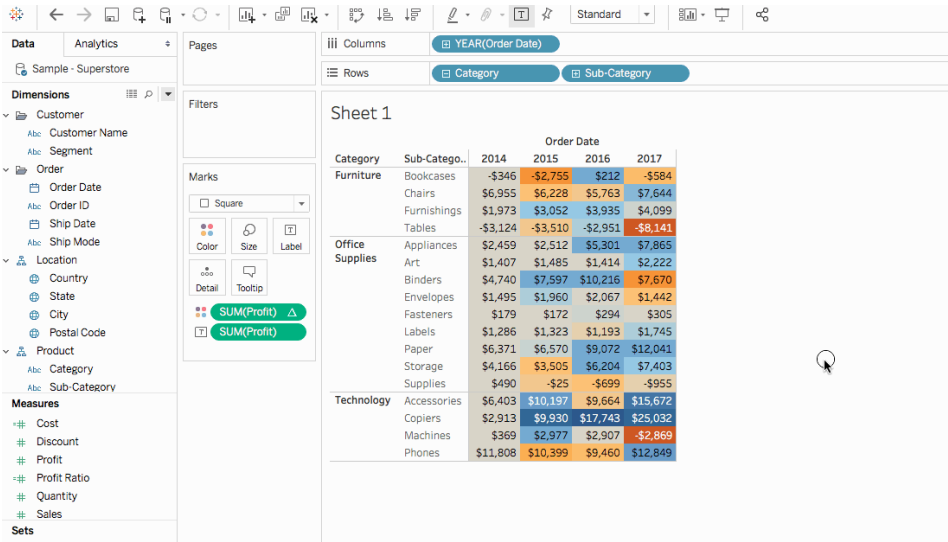

Resize text in the calculation editor

You can adjust the size of the text in the calculation editor as you create or edit calculations.

To increase text size in the calculation editor:

Press the **CTRL** and **+** keys on your keyboard (**Command** + on a Mac)

To decrease text size in the calculation editor:

Press the **CTRL** and **-** keys on your keyboard (**Command** - on a Mac).

Note: Text size persists until you close the editor. The next time you open the editor, text is at the default size.

See which sheets are using a calculated field

As you edit a calculated field, you can click **Sheets Affected** to see which other sheets are using the field. These sheets will also be updated when you commit your changes.

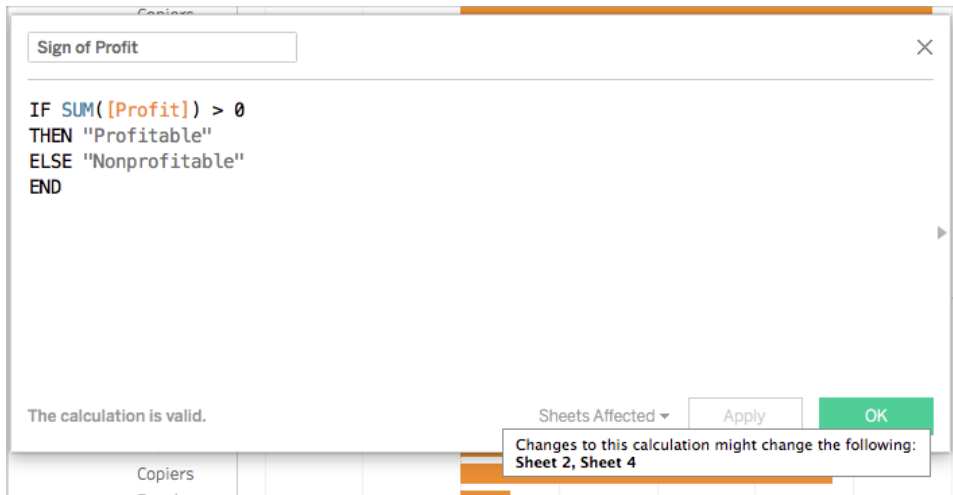

Format numbers and dates

Tip: Sometimes a calculation isn't needed, just some formatting.

There are times that a number or date value will be correct but it doesn't appear how you'd like. For example, a date displaying as 2027/02/02 instead of 2Feb27. This doesn't need a date calculation to fix. Instead, **format the date** to the visual presentation you desire.

Similarly, the results of the `ROUND()` function can sometimes display oddly due to details of the data source. To control how the results appear, **set the number format** to specify the number of decimal points.

Ad-Hoc Calculations

Ad-hoc calculations are calculations that you can create and update as you work with a field on a shelf in the view. Ad-hoc calculations are also known as type-in or in-line calculations.

Create an Ad-Hoc Calculation

Double-click on an existing field to start editing.

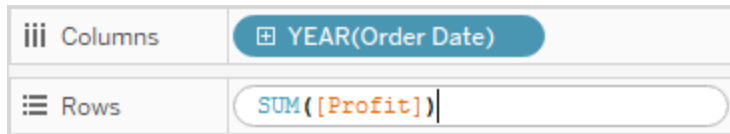

You can also double-click on an empty shelf or on an empty part of a shelf to create a new calculation.

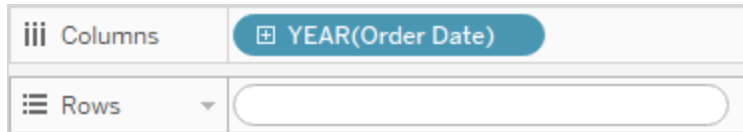

Type to update the expression, or drag new fields into the expression from the **Data** pane or elsewhere in the view.

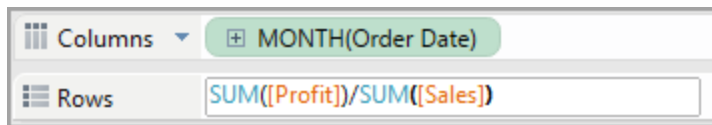

Press Enter, Tab, or click outside the expression to commit the expression, close the calculation, and update the view.

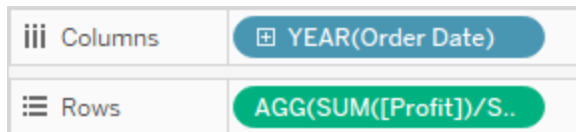

Press Ctrl+Enter (or Command+Enter on a Mac) to commit the expression and update the view without closing the calculation.

Ad-hoc calculations are supported on the **Rows**, **Columns**, **Marks**, and **Measure Values** shelves; they are not supported on the **Filters** or **Pages** shelves.

If you are working in Tableau Desktop, errors in ad-hoc calculations are underlined in red. Hover over the error to see a suggestion for resolving it.

Note: Ad-hoc calculations are not named and stored in the **Data** pane, but they are saved when you close the workbook. If you want to save an ad-hoc calculation for use in other workbook sheets, copy it to the **Data** pane. In Tableau Desktop (but not in the

browser) you will be prompted to name the calculation. Once you name an ad-hoc calculation, it is the same as any calculation you created with the calculation editor, and is available on other sheets in the workbook. See [Get Started with Calculations in Tableau on page 2017](#)

Multi-Line Ad-Hoc Calculations

As you're typing an ad-hoc calculation, you can press Shift+Enter to start a new line. However, only the current line is ever visible in an ad-hoc calculation, so this can be confusing for anyone viewing or editing the calculation who has no way of knowing that it contains multiple lines.

The first line of a multi-line ad-hoc calculation can be a comment that serves as a title for the calculation. This is the only line that is visible on the shelf after the calculation is committed:

```
//City and State
[City] + ', ' + [State]
```

Ad-Hoc Calculations and Aggregation

If Tableau determines that the expression you enter is a measure (that is, returns a number), it automatically adds an aggregation to the expression when you commit the expression. For example, if you type `DATEDIFF('day', [Ship Date], [Order Date])` in an ad-hoc calculation and then press Enter, what you will see is the following:

```
SUM(DATEDIFF('day', [Ship Date], [Order Date]))
```

If you use a field that is already an aggregated field (for example, `SUM([Profit])`) in an ad-hoc calculation, the result is an aggregate calculation. For example, when you commit an ad-hoc calculation `SUM([Profit])/SUM([Sales])`, the result is:

```
AGG(SUM([Profit])/SUM([Sales]))
```

For more information on aggregate calculations, see [Aggregate Functions in Tableau on page 2115](#).

Ad-Hoc Calculations for Insight and Experimentation

Typically you create ad-hoc calculations on-the-fly to do things like

- Test a hunch
- Try a what-if scenario

- Debug a complex calculation

Managing Ad-Hoc Calculations

Use the following keystrokes to manage ad-hoc calculations.

- Double-click in an existing field on the **Rows**, **Columns**, **Marks**, or **Measure Values** shelf to open it as an ad-hoc calculation.
- Double-click elsewhere on any of these shelves to create a new ad-hoc calculation from scratch.
- Press Esc to cancel an ad-hoc calculation.
- Press Enter to commit an ad-hoc calculation, which updates the view and closes the ad-hoc calculation. Press Ctrl+Enter to commit the change and update the view without closing the ad-hoc calculation.
- If you are working in Tableau Desktop, and there is a field to the right of the current ad-hoc calculation on the same shelf, pressing Tab opens that field as an ad-hoc calculation. If there is no field to the right of the current ad-hoc calculation on the shelf, pressing Tab opens a new ad-hoc calculation. Shift+Tab has the same functionality, except it moves to the left.
- When you double-click a named field on a shelf to edit it, you are not changing the original named field.

In addition, the following rules govern the use of ad-hoc calculations.

- Only one ad-hoc calculation can be open at a time.
- If a field that has a geographic role or a fiscal year setting associated with it is added to an ad-hoc calculation, the ad-hoc calculation inherits that role or setting.
- The right-click context menu for an ad-hoc calculation supports the same options that would be available for any other field in the view of the same type, including the ability to change aggregation or format.
- Ad-hoc calculations are not available when you create groups, sets, hierarchies, or parameters.
- Ad-hoc calculations are valid for creating trend lines, forecasts, and reference lines, bands, and distributions.

Example - Spotlighting Using Calculations

Spotlighting is a technique for showing discrete thresholds based on the values of a measure. For instance, you might want to color-code sales so that those over 10,000 appear green and those below 10,000 appear red. A spotlighting calculation is just a special case of a calculation that results in a discrete measure. A discrete measure is a calculation that is a dependent variable

(and therefore a measure), but which results in a discrete result (as opposed to a continuous result). Thus the name discrete measure. Here is an example:

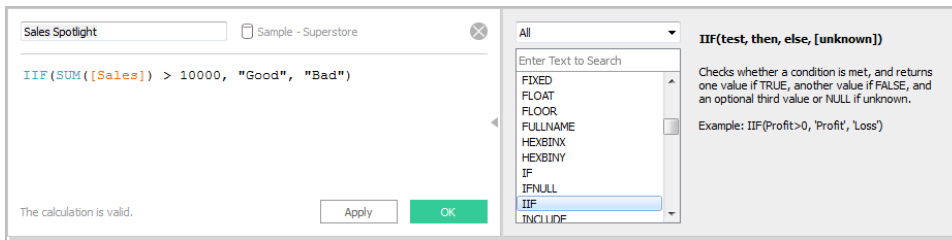

The formula in this example defines a discrete measure named **Sales Spotlight**. Discrete measures always appear with a blue **abc** icon in the **Data** pane. **Sales Spotlight** is classified as a measure in Tableau because it is a function of another measure; it is discrete because it produces discrete values (“Good” and “Bad”). Here is an example of this categorical measure in use:

The screenshot shows a Tableau dashboard titled "Sheet 4". The columns are "Segment" (Consumer, Corporate, Home Office) and the rows are "Category" (Furniture, Office Supplies, Technology) and "Sub-Category". The data is presented as a pivot table with sales values. The legend indicates that blue represents "Bad" and orange represents "Good".

		Segment		
Category	Sub-Category	Consumer	Corporate	Home Office
Furniture	Bookcases	\$68,633	\$34,006	\$12,241
	Chairs	\$172,863	\$99,141	\$56,445
	Furnishings	\$49,620	\$25,001	\$17,084
	Tables	\$99,934	\$70,872	\$36,160
Office Supplies	Appliances	\$52,820	\$36,589	\$18,124
	Art	\$14,252	\$8,590	\$4,276
	Binders	\$118,161	\$51,560	\$33,691
	Envelopes	\$7,771	\$5,943	\$2,763
	Fasteners	\$1,681	\$783	\$560
	Labels	\$6,709	\$4,102	\$1,675
	Paper	\$36,324	\$23,883	\$18,272
	Storage	\$100,492	\$79,791	\$43,560
Technology	Supplies	\$25,741	\$19,435	\$1,497
	Accessories	\$87,105	\$48,191	\$32,085
	Copiers	\$69,819	\$46,829	\$32,880
	Machines	\$79,543	\$60,277	\$49,419
	Phones	\$169,933	\$91,153	\$68,921

Here, **Sales Spotlight** is on Color in the Marks card. It appears with the **AGG** prefix because it is an aggregate calculation. Values above 10,000 and below 10,000 are assigned different colors.

Spot Trends

Reference Lines, Bands, Distributions, and Boxes

You can add a reference line, band, distribution, or box plot to identify a specific value, region, or range on a continuous axis in a Tableau view. For example, if you are analyzing the monthly sales for several products, you can include a reference line at the average sales mark so you can see how each product performed against the average.

Tableau lets you add as many reference lines, bands, distributions, and box plots to a view as you require.

Types of Reference Lines, Bands, Distributions, and Boxes

You can add reference lines, bands, distributions, or (in Tableau Desktop but not on the web) box plots to any continuous axis in the view.

- **Reference Lines** - You can add a reference line at a constant or computed value on the axis. Computed values can be based on a specified field. You can also include confidence intervals with a reference line.

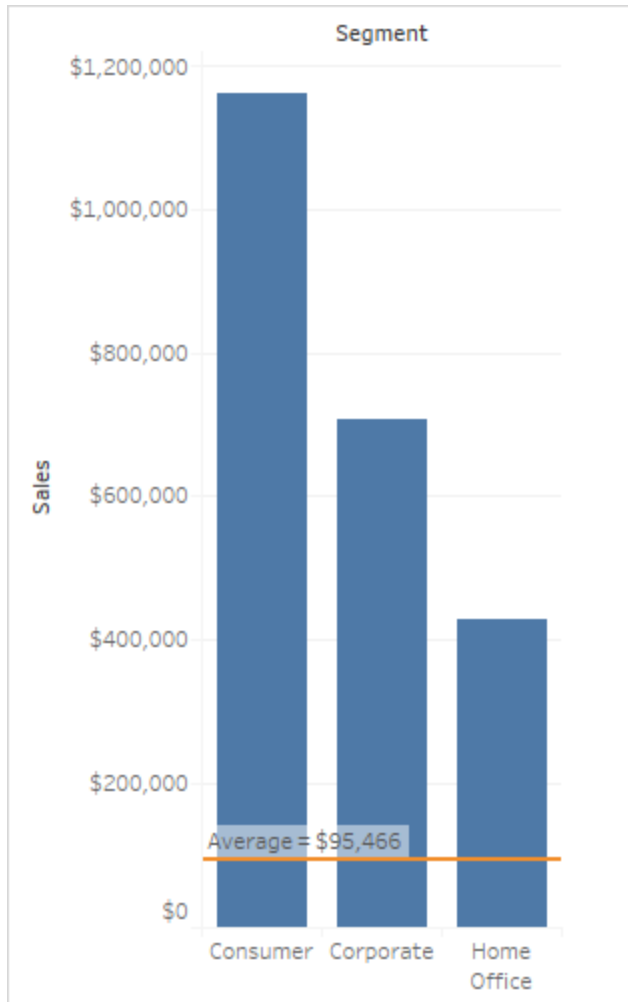

- **Reference Bands** - Reference bands shade an area behind the marks in the view between two constant or computed values on the axis.

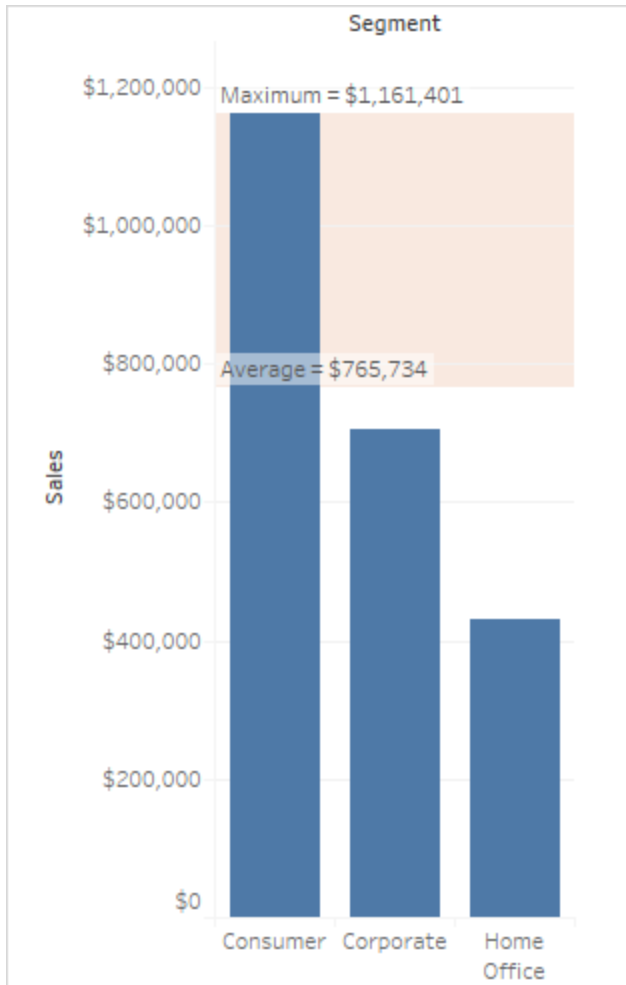

- **Reference Distributions** - Reference distributions add a gradient of shading to indicate the distribution of values along the axis. Distribution can be defined by percentages, percentiles, quantiles (as in the following image), or standard deviation.

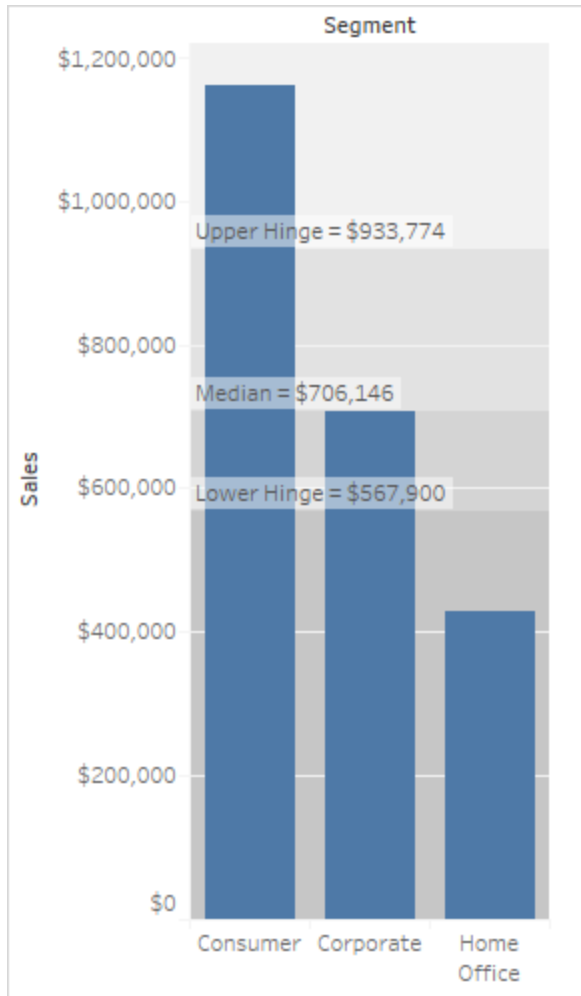

Reference distributions can also be used to create bullet charts. See [Add a Bullet Graph on page 2495](#) later in this article for specifics.

- **Box Plots** - Box plots (also known as box and whisker charts) are a standardized graphic for describing the distribution of values along an axis. Box plots show quartiles (also known as hinges) and whiskers. Tableau provides different box plot styles, and allows you to configure the location of the whiskers and other details.

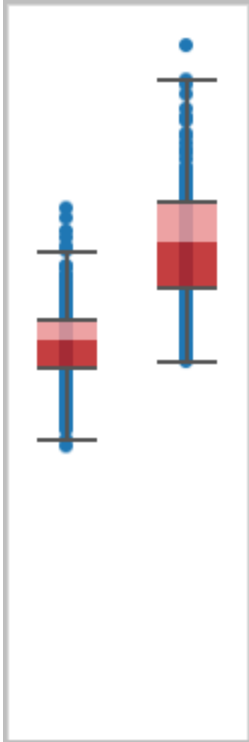

Add a Reference Line

You can add a reference line to any continuous axis in the view.

To add a reference line:

1. Drag **Reference Line** from the **Analytics** pane into the view. Tableau shows the possible destinations. The range of choices varies depending on the type of item and the current view.

In a simple case, the drop target area offers three options:

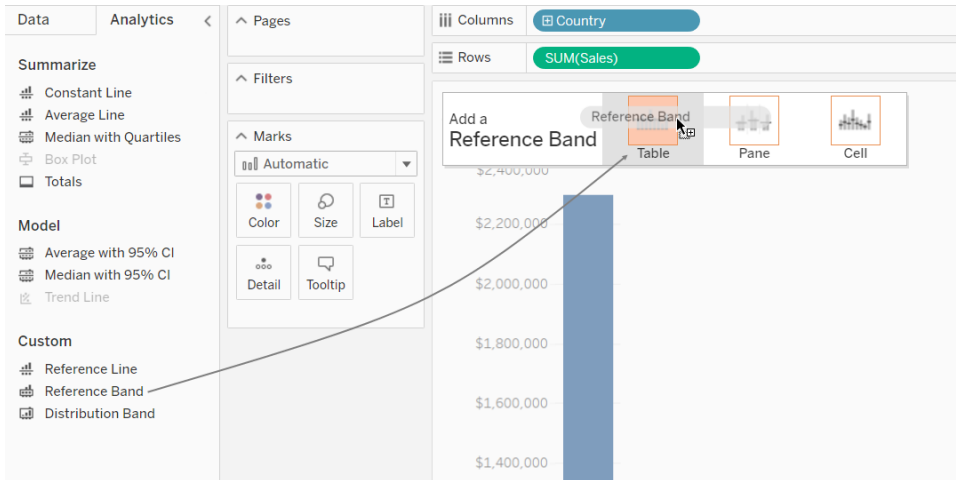

The view above is from a web editing session. In Tableau Desktop, the process is the same but the user interface looks a bit different. The terms **Table**, **Pane** and **Cell** define the scope for the item:

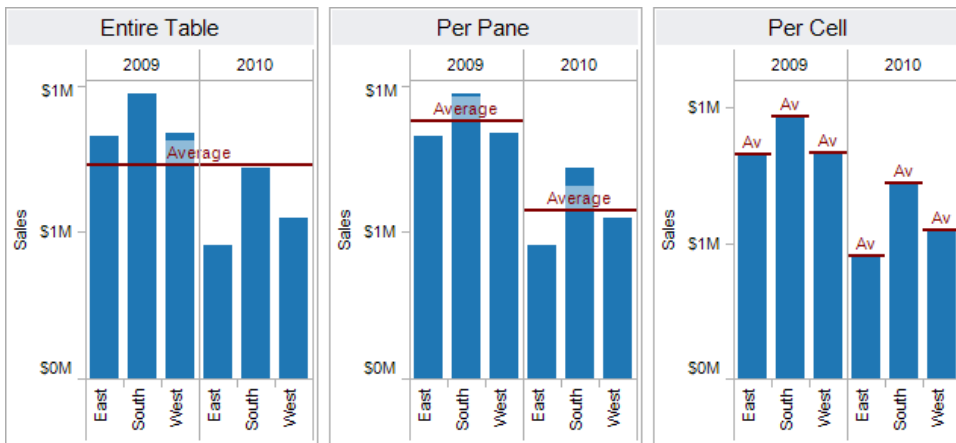

Adds a reference line to the entire table across all panes.

Adds a reference line on a per pane basis. Computed reference lines are recalculated for each pane in the view.

Adds a reference line within each cell. Computed reference lines are recalculated for each cell in the view.

For a more complicated view—for example, if the view contains a line chart with multiple or dual axes—Tableau shows you an expanded drop target area:

Add a Reference Line	Table	Pane	Cell
SUM(Profit)	<input type="text"/>	<input type="text"/>	<input type="text"/>
SUM(Sales)	<input type="text"/>	<input type="text"/>	<input type="text"/>

If you drop the item in one of the three larger boxes in the header (for example, the **Table** box), a separate reference line is added for each continuous field in the view:

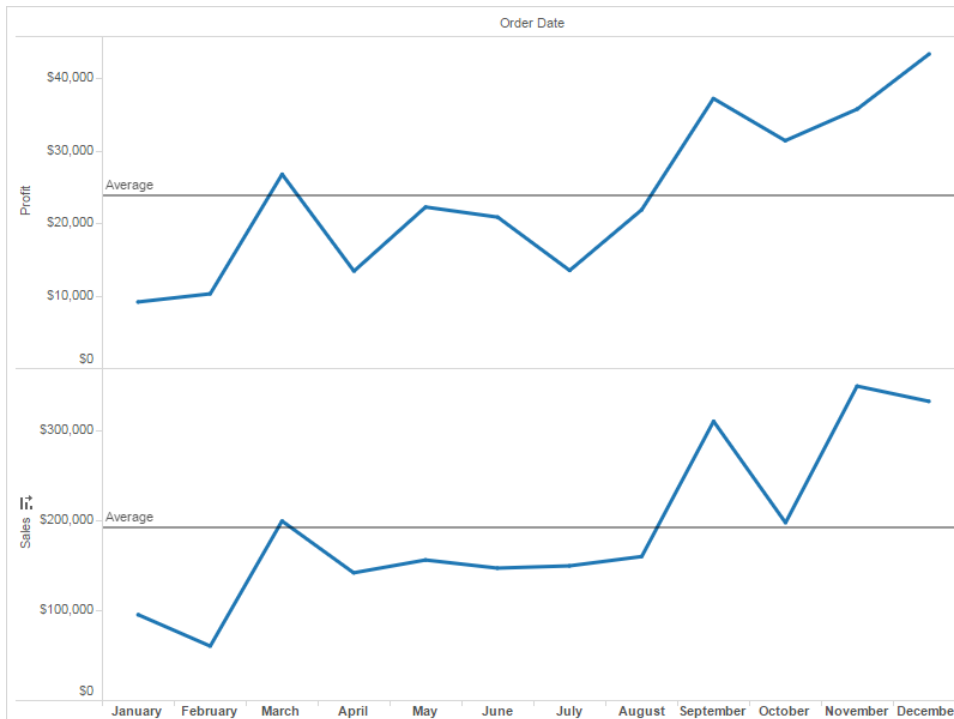

But if you drop the item in any of the lower boxes that are aligned with a specific continuous field, the line is added on the corresponding axis, with the specified scope.

When you drop the line in the target area, Tableau displays a dialog box:

Tableau Desktop version

Web version

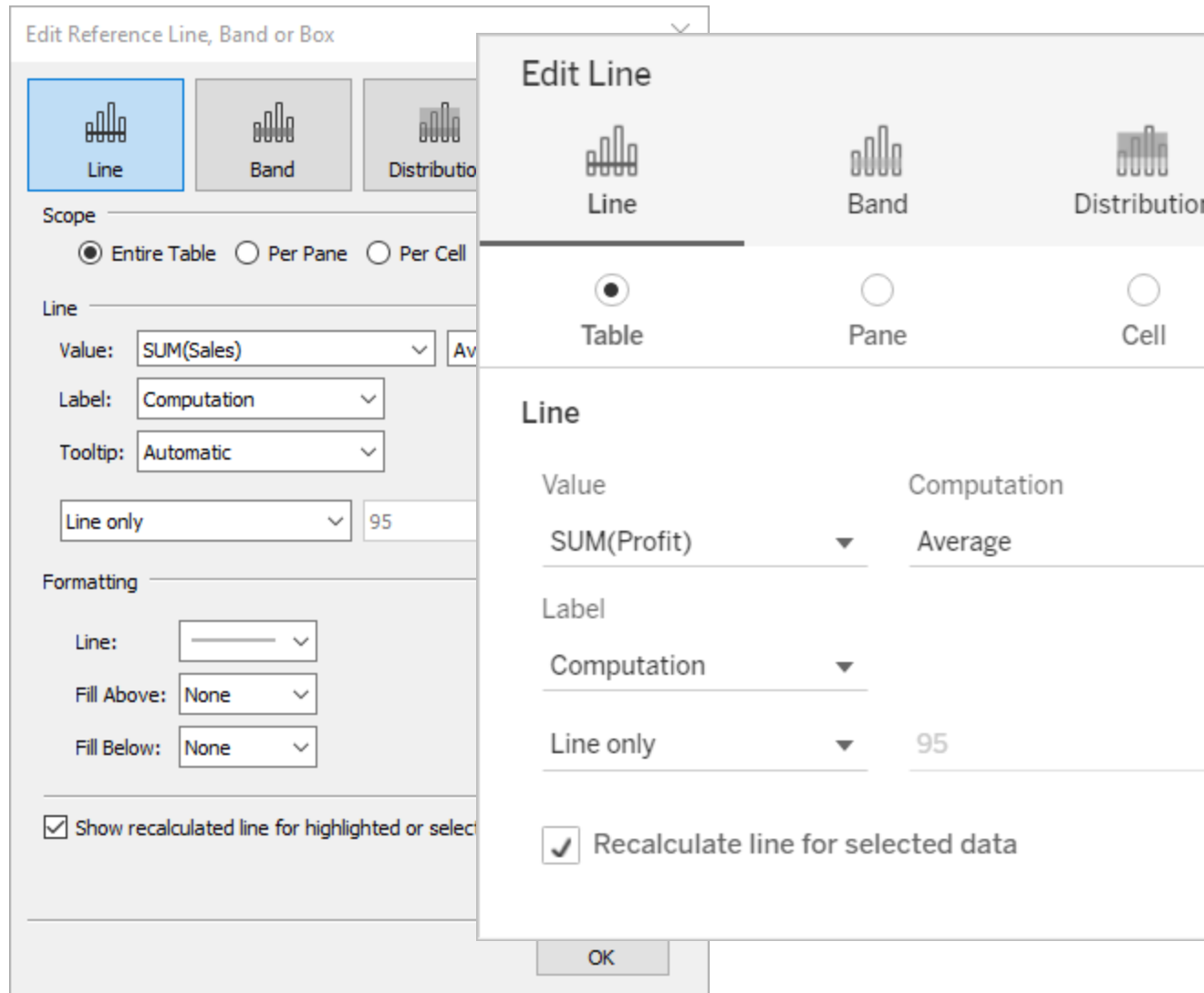

2. The **Line** option is already selected at the top of the dialog box.
3. Select a continuous field from the **Value** field to use as the basis for your reference line. You can also select a parameter.

You cannot select a continuous field that isn't currently in the view as the basis for your reference line. If you want to use such a continuous field, do the following:

- a. Drag the continuous field from the Data pane to the Details target on the Marks card.
- b. Change the continuous field's aggregation if necessary.

This will not change the view, but it will allow you to use that continuous field as the basis for your reference band.

- c. Click on the reference line in the view and choose **Edit** to re-open the **Edit Line** dialog box.
4. Select an aggregation. The aggregations that are displayed depend on the continuous field you select:
 - **Total** - places a line at the aggregate of all the values in either the cell, pane, or the entire view. This option is particularly useful when computing a weighted average rather than an average of averages. It is also useful when working with a calculation with a custom aggregation. The total is computed using the underlying data and behaves the same as selecting one of the totals option the Analysis menu.
 - **Sum** - places a line at the SUM of all the values in either the cell, pane, or entire view.
 - **Constant**- places a line at the specified value on the axis.
 - **Minimum** - places a line at the minimum value.
 - **Maximum** - places a line at the maximum value.
 - **Average** - places a line at the average value along the axis.
 - **Median**- places a line at the median value.
5. Select how you want to label the line:
 - **None** –select this option to not show a label for the reference line.
 - **Value** – select this option to show a label corresponding to the line's value on the axis.
 - **Computation** – select this option to display the name of the continuous field that is the basis for your reference line and any computation that is performed.
 - **Custom** – select this option to build a custom label in the text box. You can use the menu to the right of the text box to insert values such as the computation or the value. You can also type text directly into the box, so you could create a value such as `<Field Name> = <Value>`.
6. Select how you want the tooltip to appear.
 - **None** –select this option to not show a tooltip for the reference line.
 - **Automatic** – select this option to show the default tooltip for the reference line.

- **Custom** – select this option to build a custom label in the tooltip. You can use the menu to the right of the text box to insert values such as the computation or the value. You can also type text directly into the box, so you could create a value such as `<Field Name> = <Value>`.

7. Specify whether to display the line with a confidence interval, just the line, or just the confidence interval.

Confidence interval distribution bands shade the region in which the population average will fall n of the time, where n is the value you select in the drop-down on the right. You can choose one of the listed numeric values or select a parameter:

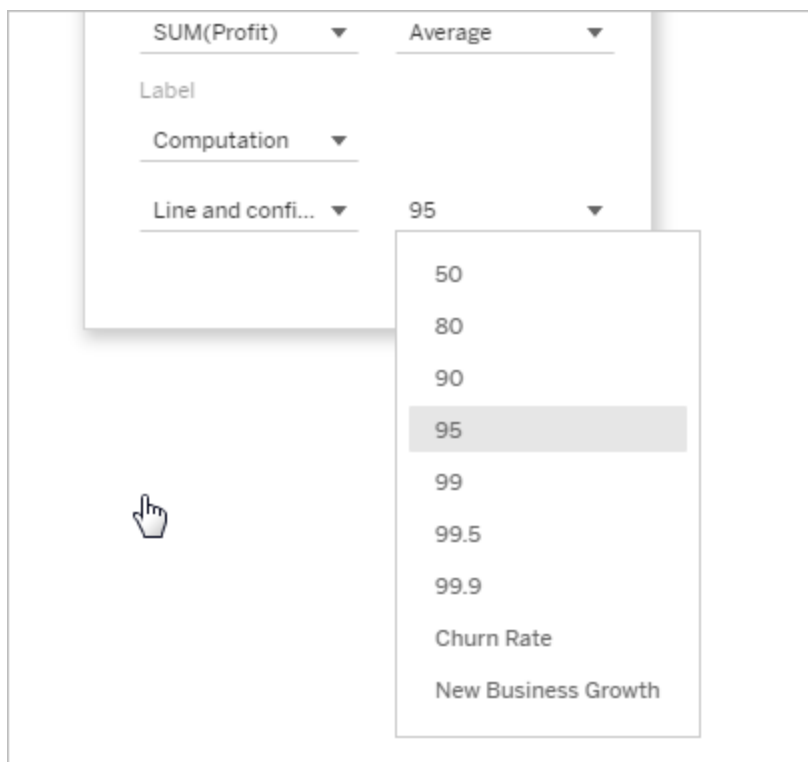

The higher the value you select, the wider the bands will be.

8. In Tableau Desktop, you can also specify formatting options for the line.

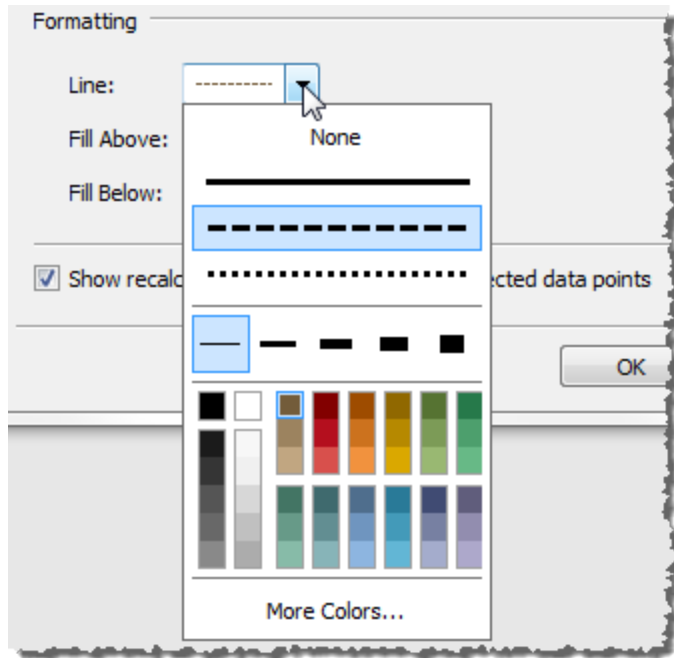

9. Optionally, add a fill color above and below the line.

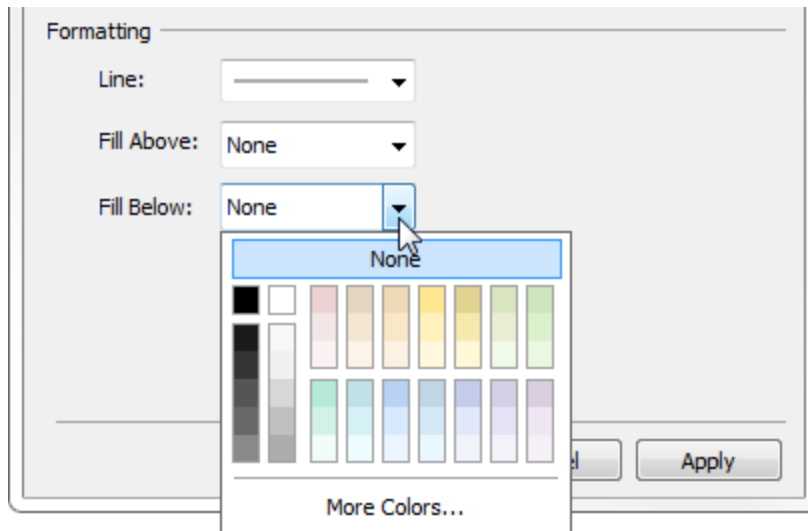

When you are displaying a line and a confidence interval, the shading will be darker within the confidence interval, and lighter beyond it:

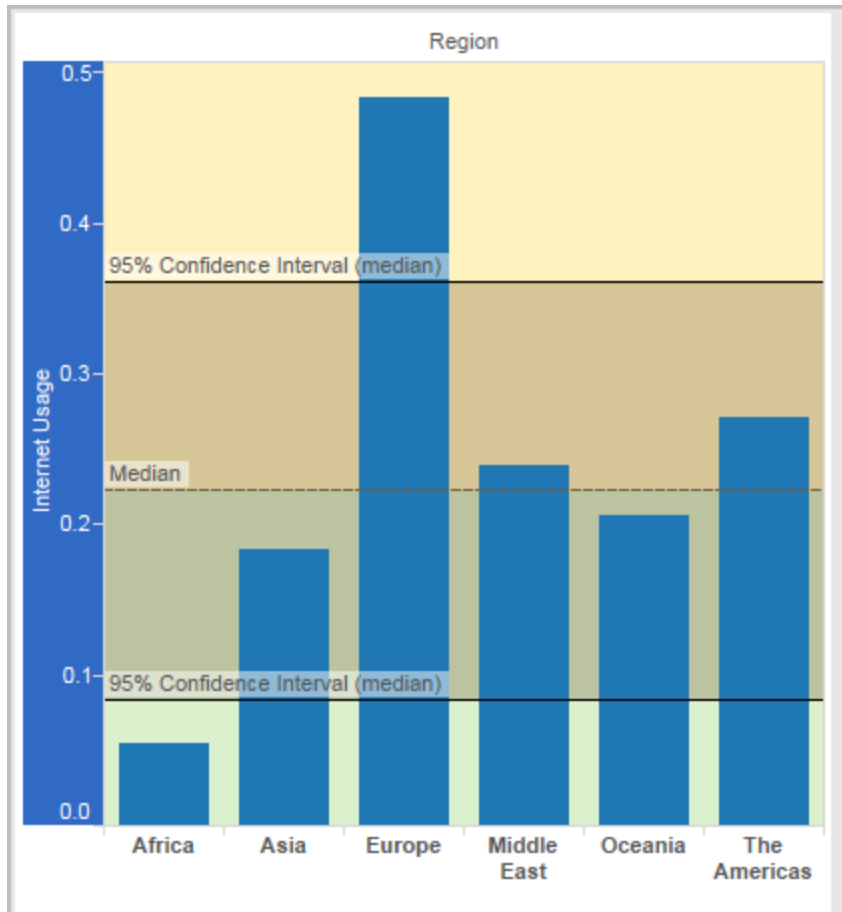

When you are displaying a confidence interval without a line, the fill colors are disregarded, though your settings are retained and then applied if you decide later to show a line.

- Specify whether to **Show recalculated line for highlighted or selected data points**. For more information, see [Compare marks data with recalculated lines](#) on page 1985.

Add Reference Bands

Reference bands are shaded areas behind the marks in the view between two constant or computed values on the axis. You can add reference bands to any continuous axis in the view.

To add a reference band:

- Drag **Reference Band** from the **Analytics** pane into the view. Tableau shows the possible destinations. The range of choices varies depending on the type of item and the current view.

In a simple case, the drop target area would offer just three options:

Tableau Desktop and Web Authoring Help

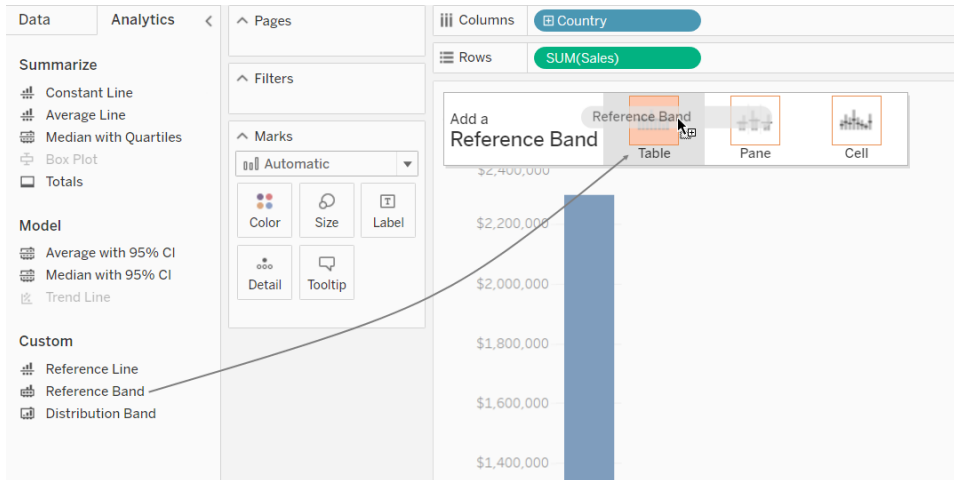

The terms **Table**, **Pane**, and **Cell** define the scope for the item:

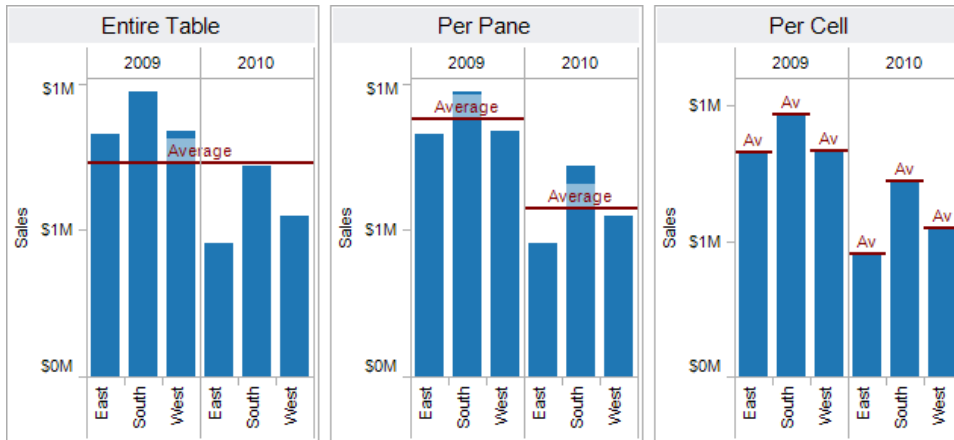

Adds a reference line to the entire table across all panes.

Adds a reference line on a per pane basis. Computed reference lines are recalculated for each pane in the view.

Adds a reference line within each cell. Computed reference lines are recalculated for each cell in the view.

For a more complicated view—for example, if the view contains multiple or dual axes—Tableau shows you an expanded drop target area that looks like this:

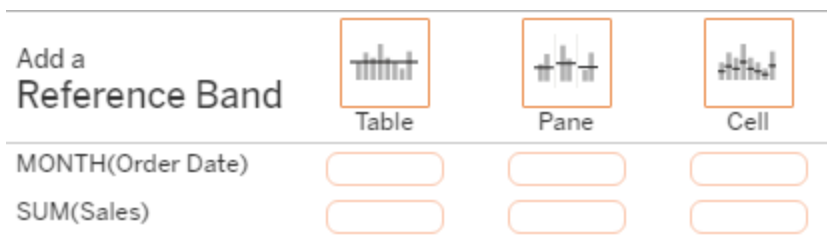

If you drop the item in one of the three larger boxes in the header (for example, the **Table** box), a separate set of bands is added for each continuous field in the view:

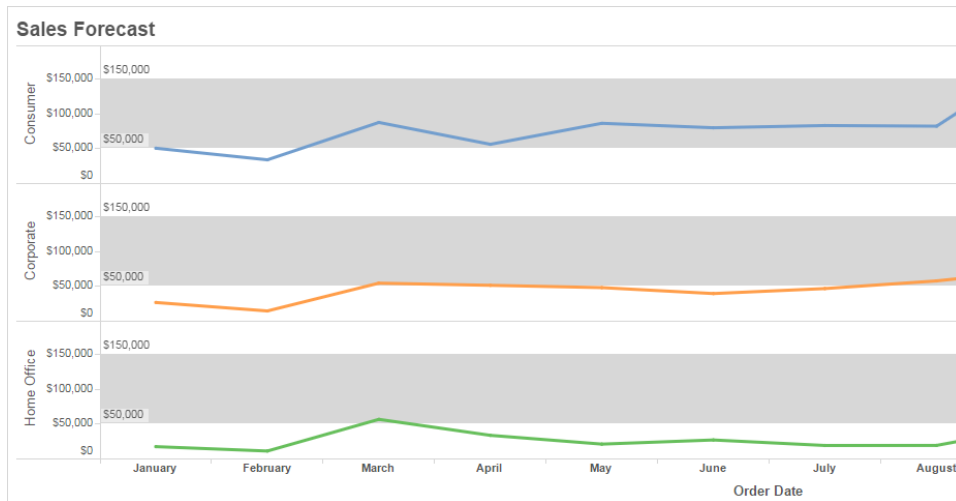

But if you drop the item in any of the lower boxes aligned with a specific continuous field, the band is added on the corresponding axis, with the specified scope.

When you drop the band in the target area, Tableau displays a dialog box:

Tableau Desktop version

Web version

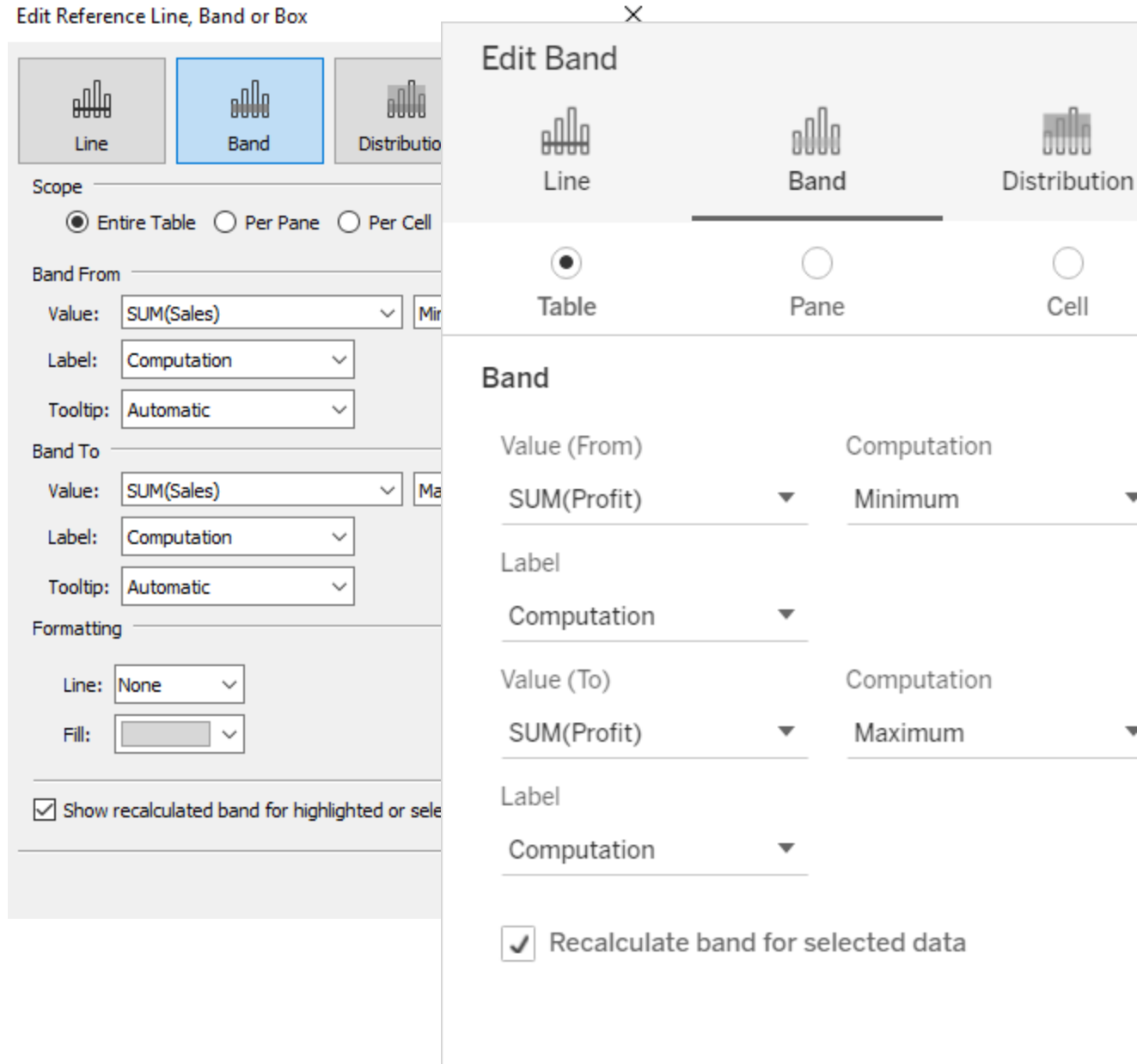

2. The **Band** area is already selected at the top of the dialog box.
3. Select two continuous fields to use as the basis for your reference band one in each **Value** field. You can also select a parameter from the drop-down lists. Do not select the same continuous field and aggregation in both areas.

You cannot select a continuous field that isn't currently in the view as the basis for your reference band. If you want to use such a continuous field, do the following:

- a. Drag the continuous field from the Data pane to the Details target on the Marks card.
 - b. Change the continuous field's aggregation if necessary.

This will not change the view, but it will allow you to use that continuous field as the basis for your reference band.
 - c. Click on the reference band in the view and choose **Edit** to re-open the **Edit Band** dialog box, and select the continuous field in in the **Value (From)** area and one in the **Value (To)** area.
4. Select a computation for each value. The aggregations that are displayed depend on the continuous field you select:
- **Total** - extends the band to a value that is at the aggregate of all the values in either the cell, pane, or the entire view. This option is particularly useful when computing a weighted average rather than an average of averages. It is also useful when working with a calculation with a custom aggregation. The total is computed using the underlying data and behaves the same as selecting one of the totals option the Analysis menu.
 - **Sum** - extends the band to a value that is at the SUM of all the values in either the cell, pane, or entire view.
 - **Constant**- extends the band to a value that is at the specified value on the axis.
 - **Minimum** - extends the band to a value that is at the minimum value.
 - **Maximum** - extends the band to a value that is at the maximum value.
 - **Average** - extends the band to a value that is at the average value along the axis.
 - **Median**- extends the band to a value that is at the median value.
5. Select how you want to label the bands:
- **None** –select this option to not show a label for the reference band.
 - **Value** – select this option to show a label corresponding to the band's value on the axis.
 - **Computation** – select this option to display the name of the continuous field that is the basis for your reference band and any computation that is performed.

- **Custom** – select this option to build a custom label in the text box. You can use the menu to the right of the text box to insert values such as the computation or the value. You can also type text directly into the box, so you could create a value such as `<Field Name> = <Value>`.
6. Select how you want the tooltip to appear.
 - **None** –select this option to not show a tooltip for the reference band.
 - **Automatic** – select this option to show the default tooltip for the reference band.
 - **Custom** – select this option to build a custom label in the tooltip. You can use the menu to the right of the text box to insert values such as the computation or the value. You can also type text directly into the box, so you could create a value such as `<Field Name> = <Value>`.
 1. In Tableau Desktop, you can also specify formatting options for the bands. You can mark the two values with a line or select a shading color for the band.



2. Specify whether to **Show recalculated line for highlighted or selected data points**. For more information, see [Compare marks data with recalculated lines](#) on page 1985.

Add Reference Distributions

When you add a reference distribution, you specify one, two, or more values. With one value, the result is a line; with two or more values the result is a set of one, two, or more bands.

To add a reference distribution:

1. Drag **Distribution Band** from the **Analytics** pane into the view. Tableau shows the possible destinations. The range of choices varies depending on the type of item and the current view.
2. Select a scope for the distribution. The terms **Table**, **Pane**, and **Cell** define the scope for the item:

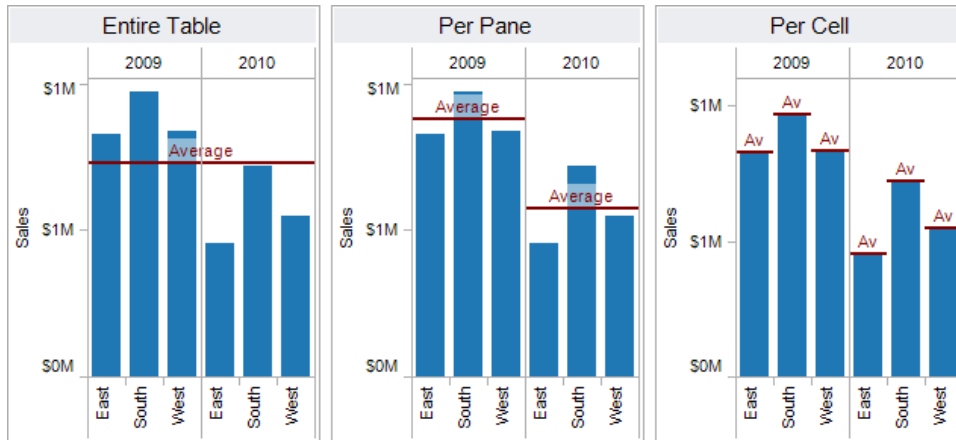

Adds a reference line to the entire table across all panes.

Adds a reference line on a per pane basis. Computed reference lines are recalculated for each pane in the view.

Adds a reference line within each cell. Computed reference lines are recalculated for each cell in the view.

3. Select the computation that will be used to create the distribution:

- **Percentages** - shades the interval between the specified percentage values. Use a comma to separate two or more percentage values (for example, 60, 80), and then specify which measure and aggregation to use for the percentages.

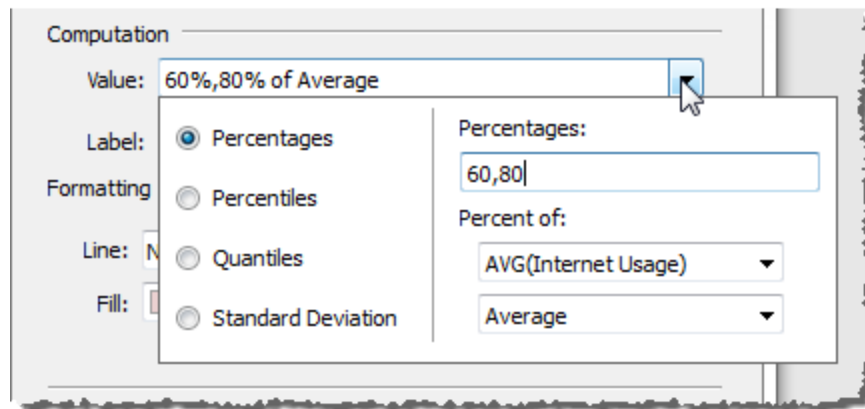

- **Percentiles** - shades intervals at the specified percentiles. Choose *Enter a value* from the **Value** drop-down list, and then enter two or more numerical values, delimited by commas (for example, 60, 80 or 25, 50, 75).
- **Quantiles** - breaks the view into the specified number of tiles using shading and lines. When you select this computation, you must also specify the number of tiles (from 3 to 10, inclusive). For example, if you select 3, Tableau calculates the

boundaries between the first, second and third terciles by calling the general quantile function and asking for the 33.33 and the 66.66 quantiles. It then shades the three terciles differently.

Tableau uses estimation type 7 in the R standard to compute quantiles and percentiles.

- **Standard Deviation** - places lines and shading to indicated the specified number of standard deviations above and below the mean. When you select this option you must specify the factor, which is the number of standard deviations and whether the computation is on a sample or the population.
4. Specify how you want to label the distribution bands:
 - **None** –select this option to not show a label for the distribution bands.
 - **Value** – select this option to show a label corresponding to each distribution band's value on the axis.
 - **Computation** – select this option to display the name of the continuous field that is the basis for your distribution bands and any computation that is performed.
 - **Custom** – select this option to build a custom label in the text box. You can use the menu to the right of the text box to insert values such as the computation or the value. You can also type text directly into the box, so you could create a value such as `<Field Name> = <Value>`.
 5. Specify whether to **Show recalculated band for highlighted or selected data points**. For more information, see [Compare marks data with recalculated lines on page 1985](#) in the Tableau Desktop online help.

Add a Bullet Graph

Reference distributions can also be used to create bullet graphs. A bullet graph is a variation of a bar graph developed to replace dashboard gauges and meters. The bullet graph is generally used to compare a primary measure to one or more other measures in the context of qualitative ranges of performance such as poor, satisfactory, and good. You can create a bullet graph by adding a distribution to indicate the qualitative ranges of performance, and a line to indicate the target. The following procedure uses Show Me to make this process easier.

1. Select one or more dimensions, and two measures in the **Data** pane. The bullet graph will compare measure values. For example, budget vs. actual; actual vs. target; etc. Select multiple fields in the **Data** pane by holding down the Ctrl key as you click fields. If you are

using the Superstore sample workbook, you can select the fields show below:

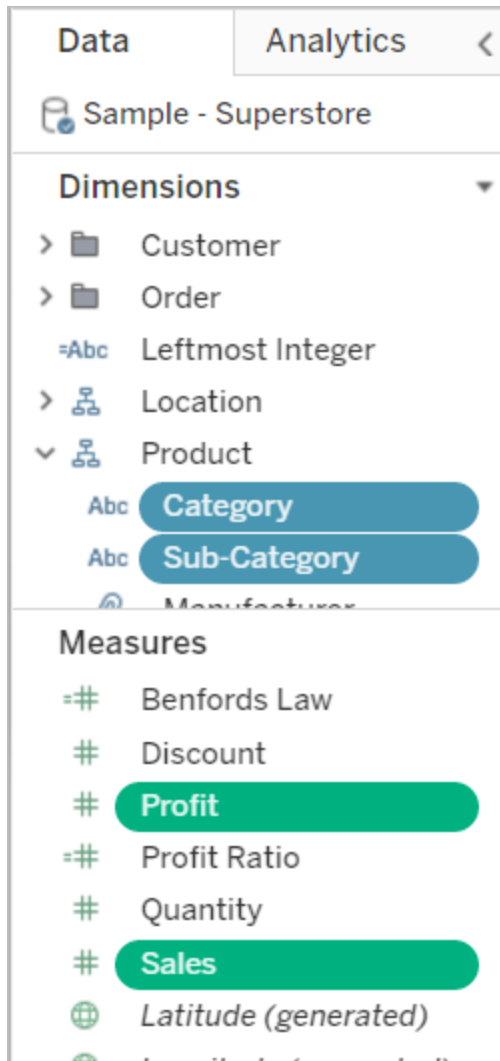

2. Click the **Show Me** button in the toolbar.

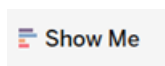

3. Select **Bullet Graph** in the Show Me pane.



Tableau adds a reference distribution that is defined at 60% and 80% of the Average of the measure on Detail. It also adds a reference line that marks the Average of that same measure. The other measure is placed on the Rows shelf.

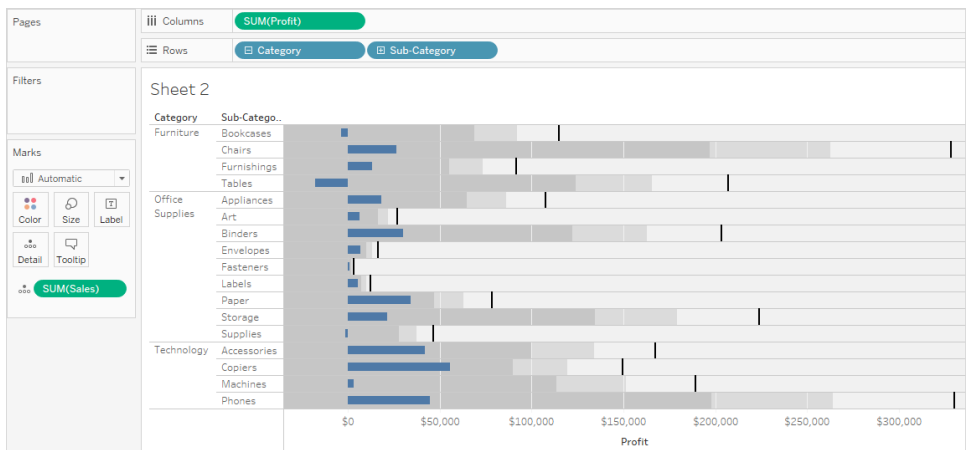

You can edit either of these to change its definition. For example, you may want to add 100% to the set of distribution band values, or draw a line at a constant value. Click on the outer edge or a distribution band, or on the line, and choose **Edit**.

Add a Box Plot

In Tableau Desktop, but not on the web, you can add box plots to a continuous axis.

Use box plots, also known as box-and-whisker plots, to show the distribution of values along an axis.

Boxes indicate the middle 50 percent of the data (that is, the middle two quartiles of the data's distribution).

You can configure lines, called *whiskers*, to display all points within 1.5 times the interquartile range (in other words, all points within 1.5 times the width of the adjoining box), or all points at the maximum extent of the data, as shown in the following image:

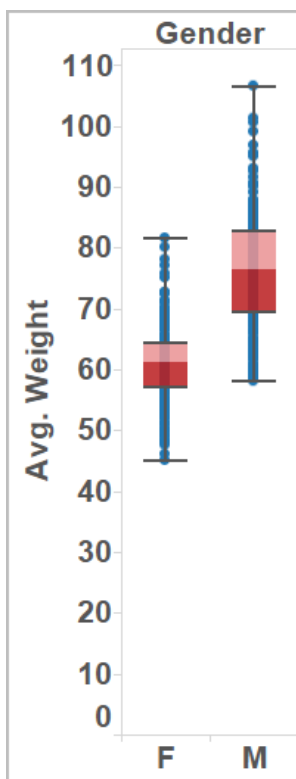

Boxplots are also available from the Show Me pane when you have at least one measure in the view:



For information on Show Me, see [Use Show Me to Start a View](#) on page 1229

To add a box plot:

1. Right-click (Control-click on a Mac) on a quantitative axis and select **Add Reference Line**.

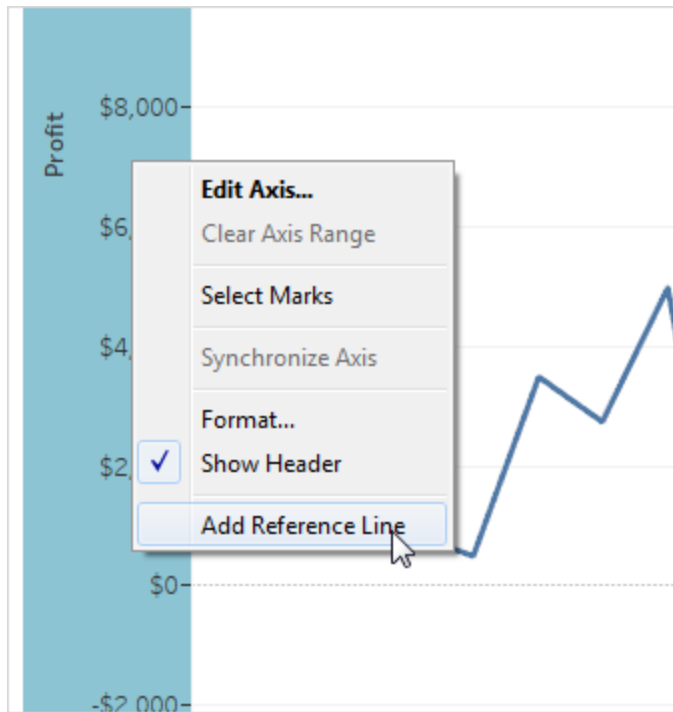

2. In the Add Reference Line, Band, or Box dialog box, select **Box Plot**.

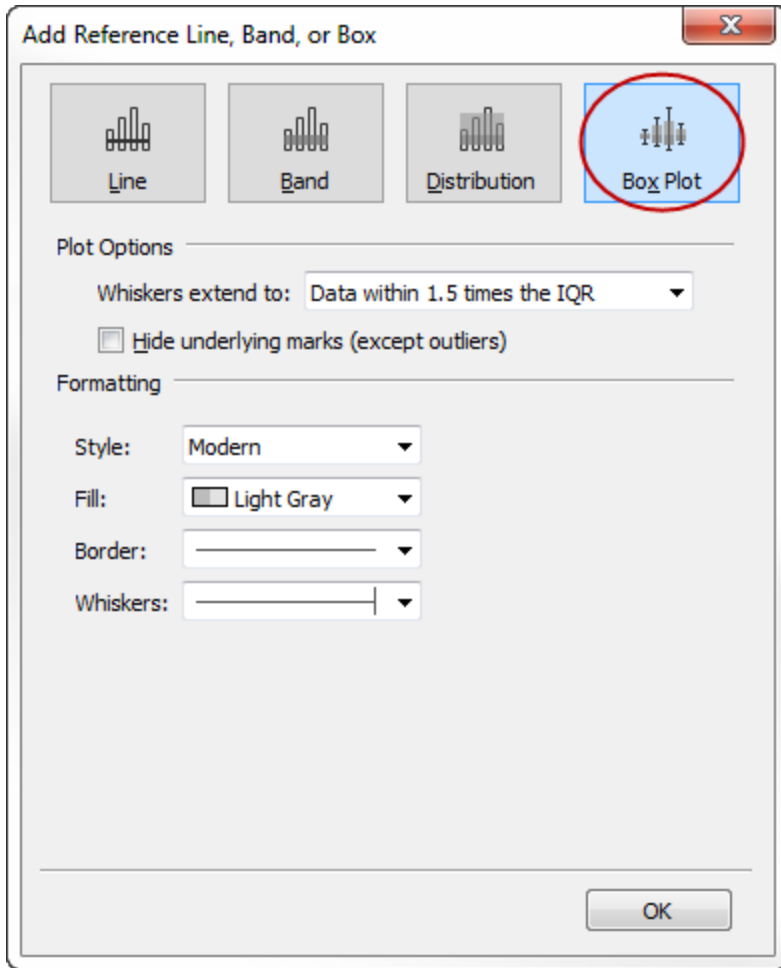

3. Under Plot Options, specify placement for the whiskers:
 - **Data within 1.5 times the IQR** - places whiskers at a location that is 1.5 times the interquartile range—that is, 1.5 times further out than the width of the adjoining box. This is also known as a schematic box plot.
 - **Maximum extent of the data** - places whiskers at the farthest data point (mark) in the distribution. This is also known as a skeletal box plot.
4. Specify whether to **Hide underlying marks (except outliers)**—that is, whether to hide all marks except those beyond the whiskers.
5. Configure the appearance of the plot by selecting a **Style**, **Fill**, **Border**, and **Whiskers**.

Box Plot Alternatives: Show Me Vs. Add Reference Line, Band, or Box

The difference between adding a box plot using Show Me and adding a box plot using Add Reference Line is that with Show Me, the box plot is your visualization, whereas with Add

Reference Line, Band, or Box, you are adding a box plot to an existing visualization. For example, you could create the following view by first selecting a circle view in Show Me, and then adding a box plot from Add Reference Line:



Edit Existing Reference Lines, Bands, and Distributions

You can edit existing lines, bands, or distributions. To do this, click on a line or on the outer edge of a band and choose **Edit** to reopen the edit dialog box for that object.

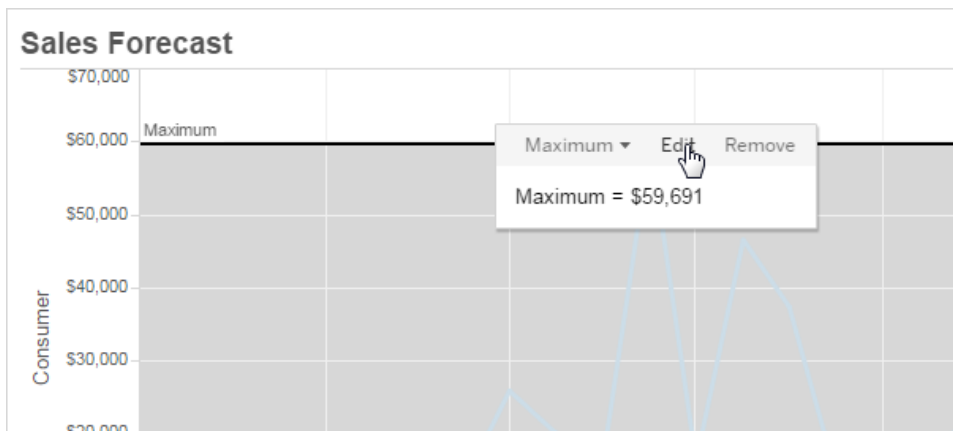

Remove Reference Lines, Bands, or Distributions

To remove a reference line, band, or distribution, click on a line or on the outer edge of a band and choose **Remove**. You can also drag a line or band off the view.

Add Trend Lines to a Visualization

You can show trend lines in a visualization to highlight trends in your data. You can publish a view that contains trend lines, and you add trend lines to a view as you edit it on the web.

When you add trend lines to a view, you can specify how you want them to look and behave.

Add trend lines to a view

To add a trend line to a visualization:

1. Select the Analytics pane.
2. From the Analytics pane, drag **Trend Line** into the view, and then drop it on the Linear, Logarithmic, Exponential, Polynomial, or Power model types.

For more information on each of these model types, see [Trend Line Model Types](#) on page 2510.

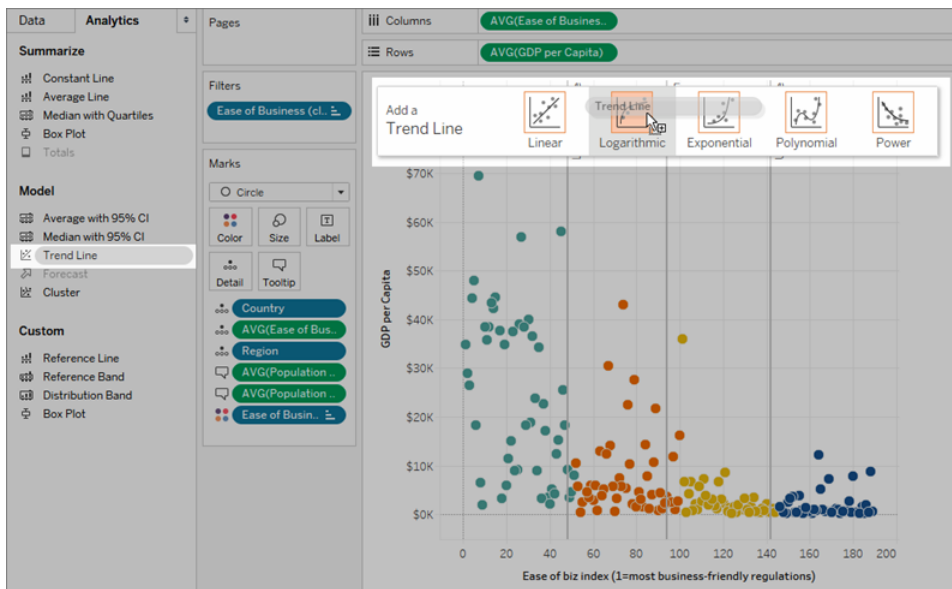

About adding trend lines (and when you can't add them)

To add trend lines to a view, both axes must contain a field that can be interpreted as a number. For example, you cannot add a trend line to a view that has the Product **Category** dimension, which contains strings, on the **Columns** shelf and the **Profit** measure on the **Rows** shelf. However, you can add a trend line to a view of sales over time because both sales and time can be interpreted as numeric values.

For multidimensional data sources, the date hierarchies actually contain strings rather than numbers. Therefore, trend lines are not allowed. Additionally, the 'm/d/yy' and 'mmmm yyyy' date formats on all data sources do not allow trend lines.

If you have trend lines turned on and you modify the view in a way where trend lines are not allowed, the trend lines do not show. When you change the view back to a state that allows trend lines, they reappear.

Tableau automatically stacks bar marks in many cases. However, trend lines cannot be turned on for stacked bars. You can turn off stacked marks by clearing the **Analysis > Stack Marks** option.

Edit a trend line

Once you add a trend line to the visualization, you can edit it to fit your analysis.

To edit a trend line:

In Tableau Desktop: Right-click a trend line in the visualization, and select **Edit Trend Lines**.

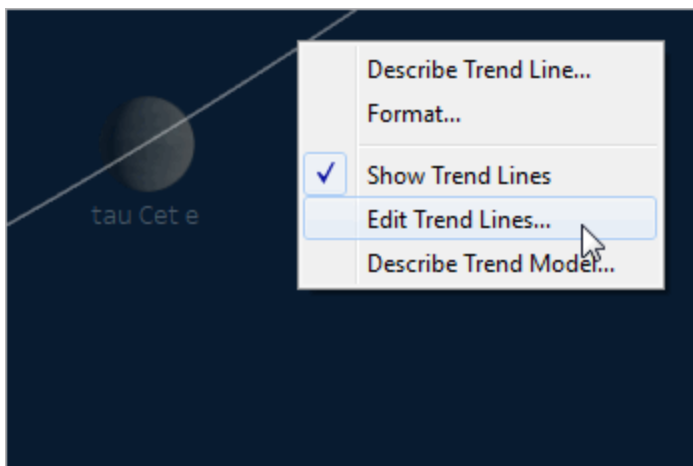

In web editing mode:

1. In the visualization, click the trend line, and then hover your cursor over it.
2. In the tooltip that appears, select **Edit** to open the **Trend Line Options** dialog box.

Note: To edit a trend line in Tableau Cloud or Tableau Server, you must have web editing permissions.

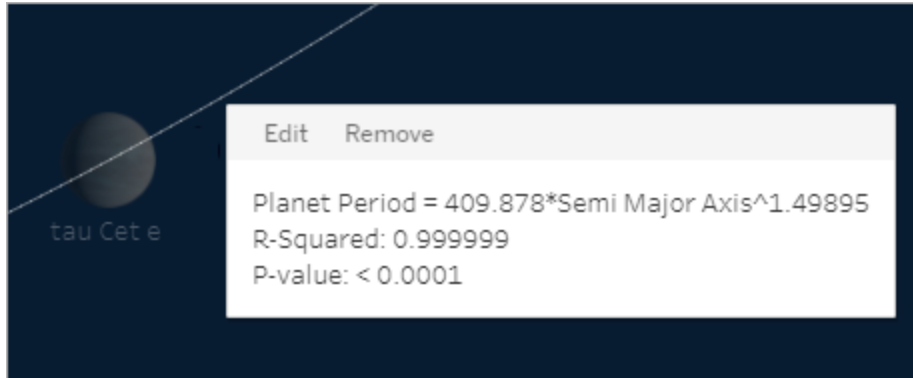

You can configure the following options in the Trend Line Options dialog box:

- Select a model type. For more information, see [Trend Line Model Types](#) on page 2510.
- Select which fields to use as factors in the trend line model. For more information, see [Choose which fields to use as factors in the trend line model](#) below.
- Decide whether to exclude color, using the **Allow a trend line per color** option. When you have color encodings in your view, you can use this option to add a single trend line that models all of the data, ignoring the color encoding.
- Decide whether to **Show Confidence Bands**. Tableau confidence bands show upper and lower 95% confidence lines by default when you add trend lines. Confidence lines are not supported for Exponential models.
- Select whether to **Force the y-intercept to zero**. This option is useful when you know that you want your trend line to begin at zero. This option is available only when both the **Rows** shelf and the **Columns** shelf contain a continuous field, as with a scatterplot.
- Decide whether to **show recalculated lines** when you select or highlight data in the visualization.

Choose which fields to use as factors in the trend line model

For trend models that are considering multiple fields, you can eliminate specific fields as factors in the trend line model.

Often you will want to remove factors because you want the trend line model to be based on the entire row in the table rather than broken up by the members or values of a field. Consider the following example. The view below shows the monthly sales for various products categories, broken out by region.

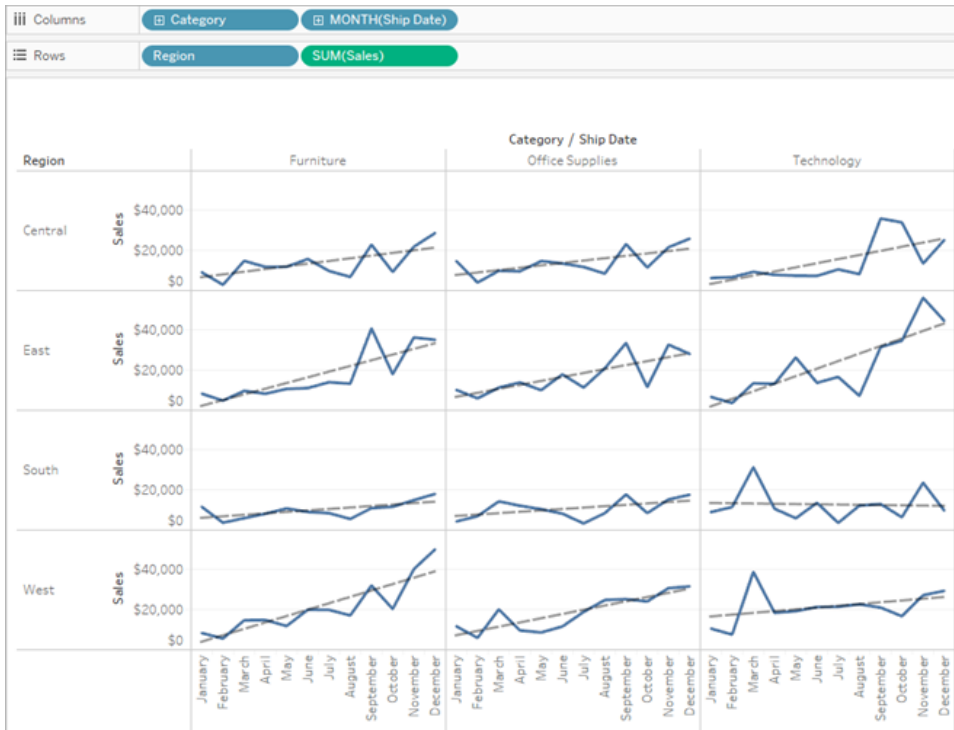

You can see that a separate model is created for each region.

Now remove **Region** as a factor in the model by deselecting it in the Trend Lines Options dialog box.

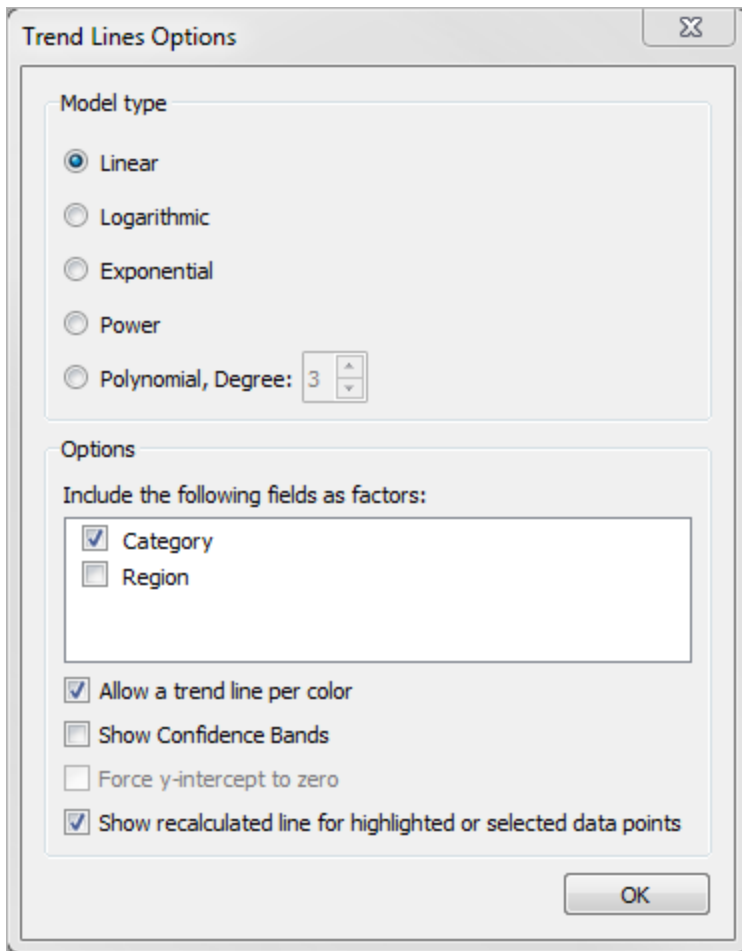

You can see that the trend line model within a category is now the same across all regions. This allows you to compare actual sales against a trend line that is the same for all regions.

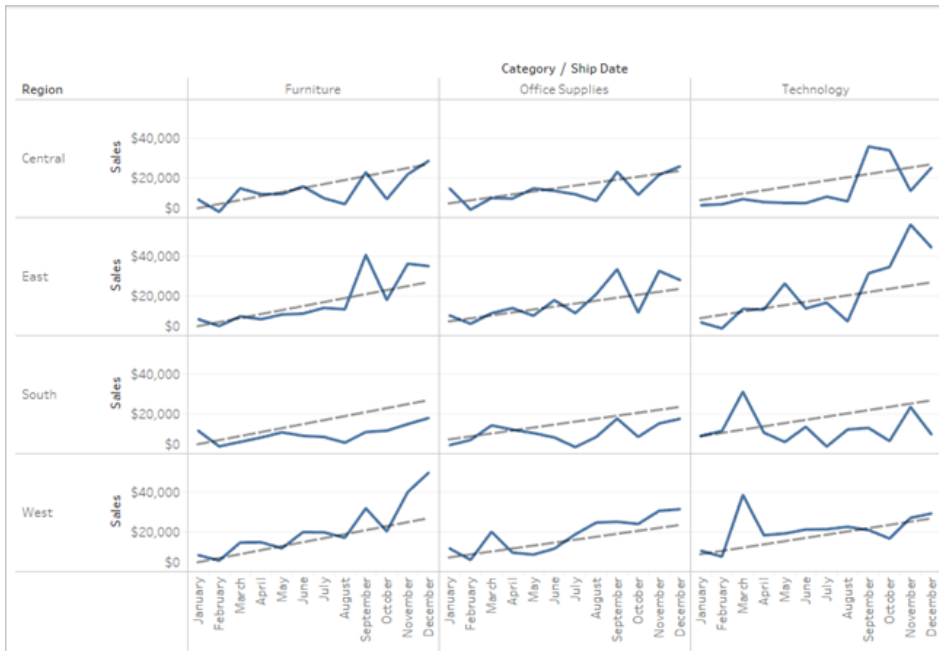

Remove Trend Lines

To remove a trend line from a visualization, drag it off of the visualization area. You can also click a trend line and select **Remove**.

To remove all trend lines from the view, select **Analysis > Trend Lines > Show Trend Lines**.

Note: In Tableau Desktop, trend line options are retained so that if you choose **Show Trend Lines** again from the Analysis menu, the options are as you last set them. However, if you close the workbook with trend lines turned off, trend line options revert to defaults.

See a description of a trend line or trend line model

After you add trend lines, you can display statistics on the trend line. For example, you can see the formula as well as r-squared and p values. For more information on the model types and terms used in the descriptions, see the [Trend Line Model Terms](#) on page 2512 and [Trend Line Model Types](#) on page 2510 sections.

To see a description of a trend line:

- Hover over any part of a trend line to see its description.



Tableau Desktop only

- Right-click the trend line in the visualization , and then select **Describe Trend Line**.

The "Describe Trend Line" dialog box displays the following information:

P-value: 0.0009758
Equation: Sales = 27.8111*Month of Order Date + -1.10259e+06

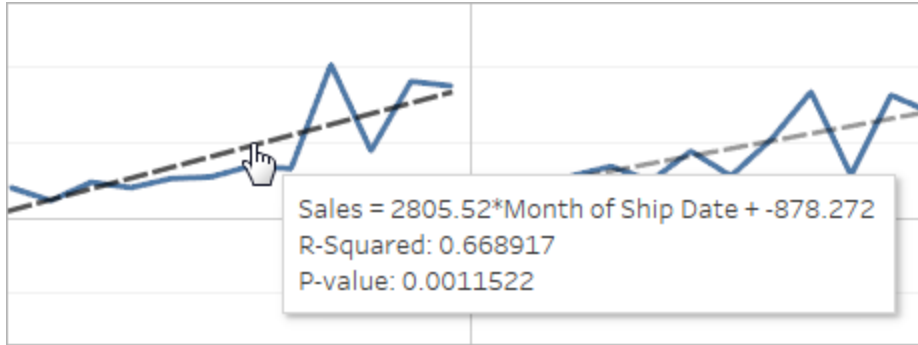
Coefficients

<u>Term</u>	<u>Value</u>	<u>StdErr</u>	<u>t-value</u>	<u>p-value</u>
Month of Order Date	27.8111	7.89364	3.52323	0.0009758
intercept	-1.10259e+06	325699	-3.38532	0.0014632

Buttons: Copy, Close

To view a full description of the model being used in the current view:

- Right-click a trend line in the visualization, and then select **Describe Trend Model**.

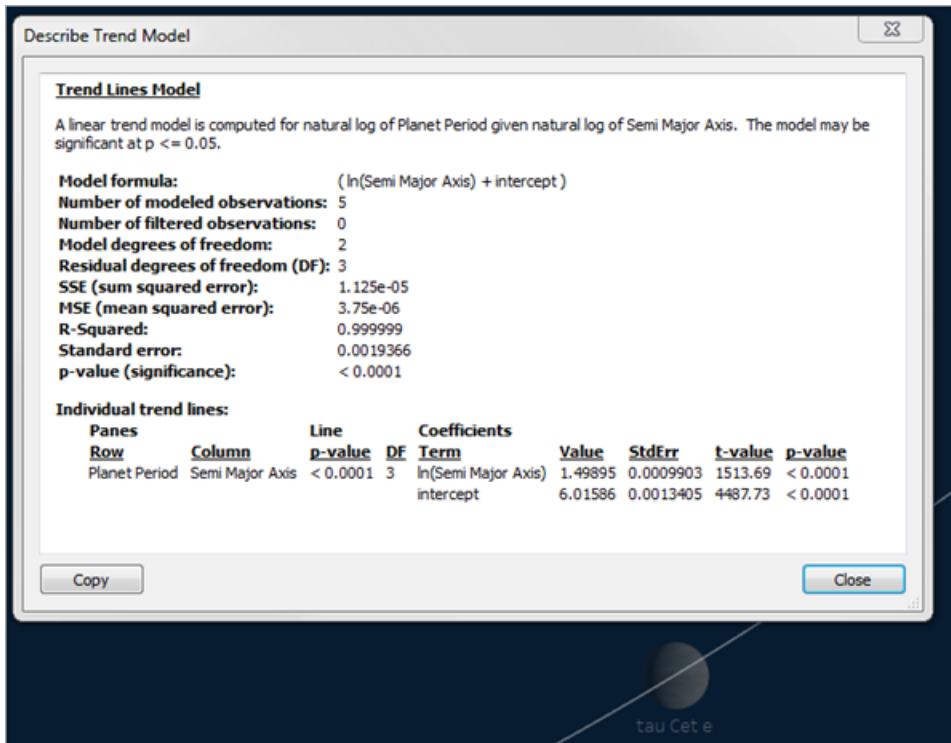

Trend Line Model Types

These model types are available for trend lines: **Linear** below, **Logarithmic** below, **Exponential** on the facing page, **Power** on the facing page, and **Polynomial** on the facing page.

In the following formulas, X represents the explanatory variable, and Y the response variable.

Linear

With the linear model type the formula is:

$$Y = b_0 + b_1 * X$$

where b_1 is the slope and b_0 is the intercept of the line.

Logarithmic

With the logarithmic model type, the formula is:

$$Y = b_0 + b_1 * \ln(X)$$

Because a logarithm is not defined for number less than zero, any marks for which the explanatory variable is negative are filtered before estimation of the model. Avoid using a model

that discards some data unless you know that the data being filtered out is invalid. The trend line description reports how many marks were filtered before model estimation.

Exponential

With the exponential model type, the formula is:

$$Y = \exp(b_0) * \exp(b_1 * X)$$

With an exponential model, the response variable is transformed by the natural log before estimation of the model so the marks plotted in your view are found by plugging in various explanatory values to find values of $\ln(Y)$.

$$\ln(Y) = b_0 + b_1 * X$$

These values are then exponentiated to plot the trend line. What you see is the exponential model in the following form:

$$Y = b_2 * \exp(b_1 * X)$$

Where b_2 is the value of $\exp(b_0)$. Because a logarithm is not defined for numbers less than zero, any marks for which the response variable is negative are filtered before model estimation.

Power

With the power model type, the formula is:

$$Y = b_0 * X^{b_1}$$

With a power model, both variables are transformed by the natural log before estimation of the model resulting in this formula:

$$\ln(Y) = \ln(b_0) + b_1 * \ln(X)$$

These values are then exponentiated to plot the trend line.

Because a logarithm is not defined for numbers less than zero, any marks for which the response variable or explanatory variable is negative are filtered before model estimation.

Polynomial

With the polynomial model type, the response variable is transformed into a polynomial series of the specified degree. The formula is:

$$Y = b_0 + b_1 * X + b_2 * X^2 + \dots$$

With a polynomial model type, you must also select a **Degree** between 2 and 8. The higher polynomial degrees exaggerate the differences between the values of your data. If your data increases very rapidly, the lower order terms may have almost no variation compared to the

higher order terms, rendering the model impossible to estimate accurately. Also, more complicated higher order polynomial models require more data to estimate. Check the model description of the individual trends line for a red warning message indicating that an accurate model of this type is not possible.

Trend Line Model Terms

When you view the description for a trend line model, there are several values listed. This section discusses what each of these values means.

Model formula

This is the formula for the full trend line model. The formula reflects whether you have specified to exclude factors from the model.

Number of modeled observations

The number of rows used in the view.

Number of filtered observations

The number of observations excluded from the model.

Model degrees of freedom

The number of parameters needed to completely specify the model. Linear, logarithmic, and exponential trends have model degrees of freedom of 2. Polynomial trends have model degrees of freedom of 1 plus the degree of the polynomial. For example a cubic trend has model degrees of freedom of 4, since we need parameters for the cubed, squared, linear and constant terms.

Residual degrees of freedom (DF)

For a fixed model, this value is defined as the number of observations minus the number of parameters estimated in the model.

SSE (sum squared error)

The errors are the difference between the observed value and the value predicted by the model. In the Analysis of Variance table, this column is actually the difference between the SSE of the simpler model in that particular row and the full model, which uses all the factors. This SSE also corresponds to the sum of the differences squared of the predicted values from the smaller model and the full model.

MSE (mean squared error)

The term MSE refers to "mean squared error" which is the SSE quantity divided by its corresponding degrees of freedom.

R-Squared

R-squared is a measure of how well the data fits the linear model. It is the ratio of the variance of the model's error, or unexplained variance, to the total variance of the data.

When the y-intercept is determined by the model, R-squared is derived using the following equation:

$$1 - \frac{\sum_{i=1}^n (y_i - \hat{y}_i)^2}{\sum_{i=1}^n (y_i - \bar{y})^2}$$

When the y-intercept is forced to 0, R-squared is derived using this equation instead:

$$1 - \frac{\sum_{i=1}^n (y_i - \hat{y}_i)^2}{\sum_{i=1}^n y_i^2}$$

In the latter case, the equation will not necessarily match Excel. This is because R-squared is not well defined in this case, and Tableau's behavior matches that of R instead of that of Excel.

Note: The R-Squared value for a linear trend line model is equivalent to the square of the result from the CORR function. See [Tableau Functions \(Alphabetical\)](#) on page 2300 for syntax and examples for CORR.

Standard error

The square root of the MSE of the full model. An estimate of the standard deviation (variability) of the "random errors" in the model formula.

p-value (significance)

The probability that an F random variable with the above degrees of freedom exceeds the observed F in this row of the Analysis of Variance table.

Analysis of Variance

This table, also known as the ANOVA table, lists information for each factor in the trend line model. The values are a comparison of the model without the factor in question to the entire model, which includes all factors.

Individual trend lines

This table provides information about each trend line in the view. Looking at the list you can see which, if any, are the most statistically significant. This table also lists coefficient statistics for each trend line. A row describes each coefficient in each trend line model. For example, a linear model with an intercept requires two rows for each trend line. In the Line column, the p-value and the DF for each line span all the coefficient rows. The DF column under the shows the residual degrees of freedom available during the estimation of each line.

Terms

The name of the independent term.

Value

The estimated value of the coefficient for the independent term.

StdErr

A measure of the spread of the sampling distribution of the coefficient estimate. This error shrinks as the quality and quantity of the information used in the estimate grows.

t-value

The statistic used to test the null hypothesis that the true value of the coefficient is zero.

p-value

The probability of observing a t-value that large or larger in magnitude if the true value of the coefficient is zero. So, a p-value of .05 gives us 95% confidence that the true value is not zero.

Assess Trend Line Significance

To see relevant information for any trend line in the view, hover the cursor over it:

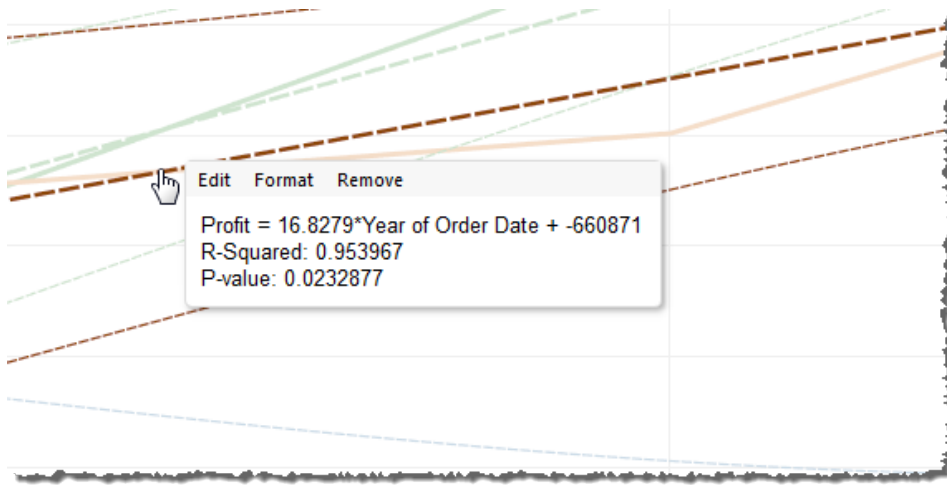

The first line in the tooltip shows the equation used to compute a value of **Profit** from a value of **Year of Order Date**.

The second line, the R-Squared value, shows the ratio of variance in the data, as explained by the model, to the total variance in the data. For more details, see [Trend Line Model Terms on page 2512](#).

The third line, the P-value, reports the probability that the equation in the first line was a result of random chance. The smaller the p-value, the more significant the model is. A p-value of 0.05 or less is often considered sufficient.

Entire Model Significance

Once you've added a trend line to a view, you typically want to know the goodness of fit of the model, which is a measure of the quality of the model's predictions. In addition, you may be interested in the significance of each factor contributing to the model. To view these numbers, open the Describe Trend Model dialog box, right-click (Control-click on a Mac) in the view and select **Trend Lines >Describe Trend Model**.

When you are testing significance, you are concerned with the p-values. The smaller the p-value, the more significant the model or factor is. It is possible to have a model that has statistical significance but which contains an individual trend line or a term of an individual trend line that does not contribute to the overall significance.

Under Trend Lines Model, look for the line that shows the p-value (significance) of the model: The smaller the p-value, the less likely it is that the difference in the unexplained variance between models with and without the relevant measure or measures was a result of random chance.

Describe Trend Model

Trend Lines Model

A linear trend model is computed for sum of Sales given Ship Date Month. The model may be significant at $p \leq 0.05$. The factor Category may be significant at $p=0.05$.

Model formula: Category*(Month of Ship Date + intercept)

Number of modeled observations: 204

Number of filtered observations: 0

Model degrees of freedom: 34

Residual degrees of freedom (DF): 170

SSE (sum squared error): 6.32245e+011

MSE (mean squared error): 3.71909e+009

R-Squared: 0.850309

Standard error: 60984.4

p-value (significance): < 0.0001

Analysis of Variance:

Field	DF	SSE	MSE	F	p-value
Category	32	3.08378e+012	9.6368e+010	25.9117	< 0.0001

Individual trend lines:

Panes	Row	Column	Line		Coefficients				
			p-value	DF	Term	Value	StdErr	t-value	p-value
Sales Appliances			0.0221712	10	Month of Ship Date	11355.9	4200.11	2.70372	0.0221712
					intercept	52856.9	30912	1.70992	0.118073
Sales Binders and Binder Accessories			0.0048827	10	Month of Ship Date	21028.2	5848.16	3.5957	0.0048827
					intercept	38108.4	43041.3	0.885391	0.396736
Sales Bookcases			0.0582459	10	Month of Ship Date	12823	5998.1	2.13785	0.0582459

This p-value for a model compares the fit of the entire model to the fit of a model composed solely of the grand mean (the average of data in the data view). That is, it assesses the explanatory power of the quantitative term $f(x)$ in the model formula, which can be linear, polynomial, exponential, or logarithmic with the factors fixed. It is common to assess significance using the "95% confidence" rule. Thus, as noted above, a p-value of 0.05 or less is considered good.

Significance of Categorical Factors

In the Analysis of Variance table, sometimes referred to as the ANOVA table, each field that is used as a factor in the model is listed. For each field, among other values, you can see the p-value. In this case, the p-value indicates how much that field adds to the significance of the entire model. The smaller the p-value the less likely it is that the difference in the unexplained variance between models with and without the field was a result of random chance. The values displayed for each field are derived by comparing the entire model to a model that does not include the field in question.

The following image shows the Analysis of Variance table for a view of quarterly sales for the past two years of three different product categories.

Analysis of Variance:					
Field	DF	SSE	MSE	F	p-value
Category	160	1.65811e+012	1.03632e+010	20.9732	< 0.0001
Region	136	2.64345e+012	1.94371e+010	39.3372	< 0.0001

As you can see, the p-values for **Category** and **Region** are both quite small. Both of these factors are statistically significant in this model.

For information on specific trend line terms, see [Trend Line Model Terms on page 2512](#).

For ANOVA models, trend lines are defined by the mathematical formula:

$$Y = \text{factor 1} * \text{factor 2} * \dots * \text{factorN} * f(x) + e$$

The term Y is called the *response variable* and corresponds to the value you are trying to predict. The term x is the *explanatory variable*, and e (epsilon) is random error. The factors in the expression correspond to the categorical fields in the view. In addition, each factor is represented as a matrix. The $*$ is a particular kind of matrix multiplication operator that takes two matrices with the same number of rows and returns a new matrix with the same number of rows. That means that in the expression $\text{factor 1} * \text{factor 2}$, all combinations of the members of factor 1 and factor 2 are introduced. For example, if factor 1 and factor 2 both have three members, then a total of nine variables are introduced into the model formula by this operator.

Trend Line Assumptions

The p-values reported in Tableau trend lines depend on some assumptions about the data.

The first assumption is that, whenever a test is performed, the model for the mean is (at least approximately) correct.

The second assumption is that the "random errors" referred to in the model formula (see [Trend Line Model Types on page 2510](#)) are independent across different observations, and that they all have the same distribution. This constraint would be violated if the response variable had much more variability around the true trend line in one category than in another.

Assumptions Required to Compute Trend Lines

The Assumptions required to compute (using Ordinary Least Squares) each individual trend line are:

- Your model is an accurate functional simplification of the true data generating process (for example, no linear model for a log linear relationship).

- Your errors average to zero and are uncorrelated with your independent variable (for example, no error measuring the independent variable).
- Your errors have constant variance and are not correlated with each other (for example, no increase in error spread as your independent variable increases).
- Explanatory variables are not exact linear functions of each other (perfect multicollinearity).

Commonly Asked Questions About Trend Lines

This section describes some commonly asked questions regarding trend lines in Tableau.

How do I change the confidence level used in the model?

Tableau does not enforce a confidence level. It simply reports the significance of the whole model, or of a specific field, by showing the p-value. The p-value will measure the probability of obtaining the same trend result without taking the dimensions into account. For example, a trend of sales per time p-value of 0.05 means that there is 5% chance that the same value could be obtained without taking the time into consideration.

What does it mean if the p-value for the model is significant but the p-value for the specific field in the Analysis of Variance table is not significant?

The p-value in the Analysis of Variance table indicates whether the field adds or detracts from the significance of the entire model. The smaller the p-value the less likely it is that the difference in the unexplained variance between models with and without the field was a result of random chance. The values displayed for each field are derived by comparing the entire model to a model that does not include the field in question. So, for the situation where the p-value for the model is significant but the p-value for the specific field is not, you know that the model is statistically significant, but you cannot be confident that the specific field in question adds anything to it. Consider whether you might not be better off removing the factor from the model.

What does it mean if the p-value for the specific field in the Analysis of Variance table is significant but the p-value for the model is not significant?

This could happen in a case when there is no "trend" within each pane. For example, the lines are flat, but the mean varies across a given factor.

Drop Lines

Use drop lines to distinguish marks and call out their position in the view. For example, in a view that is dense with scatter marks, you can turn on drop lines to show the position of a particular

data point. When you add drop lines, a line is extended from the marks to one of the axes. You can show drop lines all the time or only when a mark is selected.

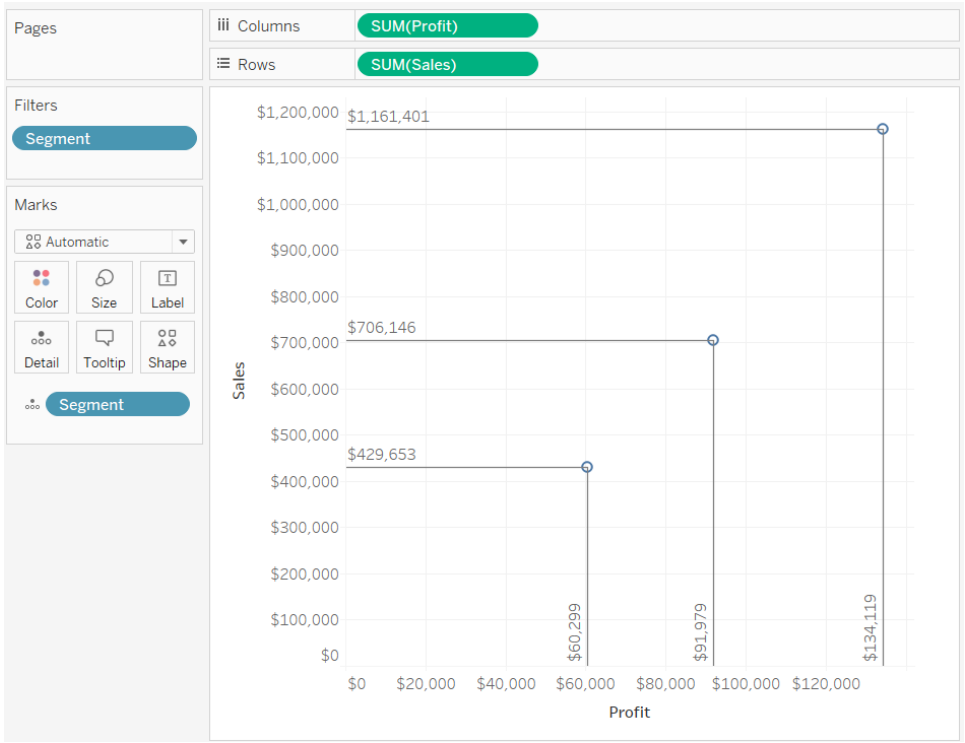

Note: Drop lines do not display when you publish a view to Tableau Server or Tableau Cloud.

To add drop lines to the view, right-click (control-click on Mac) the pane and select **Drop Lines > Show Drop Lines**.

By default, drop lines are set to only show when the mark is selected. You can change this setting and specify other options in the Drop Lines dialog box.

Right-click (Control-click on Mac) the pane and select **Drop Lines > Edit Drop Lines** to open the Drop Lines dialog box.

In the Drop Lines dialog box select an axis to draw the line to, whether to always show the drop lines, and whether to show labels.

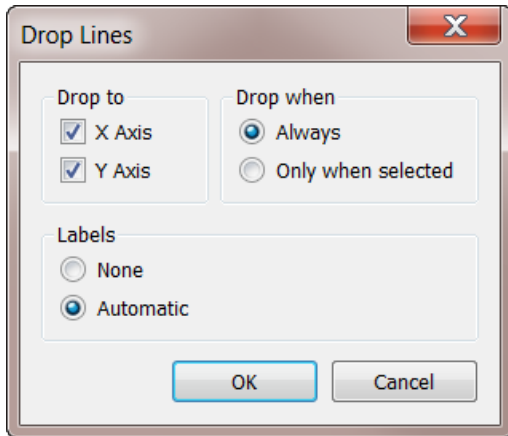

Find Clusters in Data

Cluster analysis partitions marks in the view into clusters, where the marks within each cluster are more similar to one another than they are to marks in other clusters.

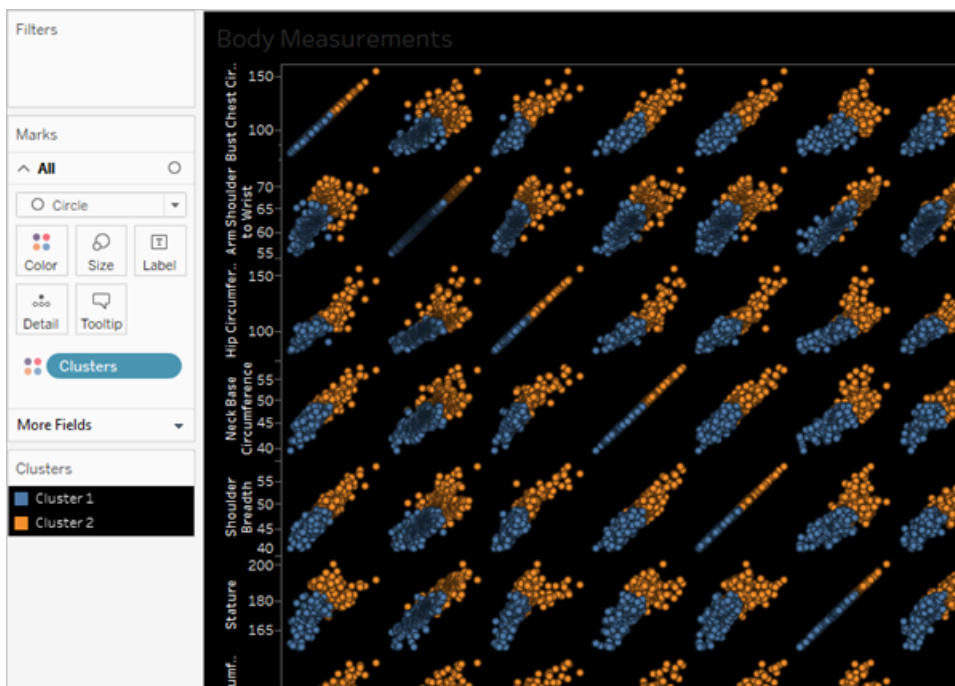

For an example that demonstrates the process of creating clusters with sample data, see [Example: Create clusters using World Economic Indicators data on page 2536](#).

Create clusters

To find clusters in a view in Tableau, follow these steps.

1. Create a view.
2. Drag **Cluster** from the **Analytics** pane into the view, and drop it on in the target area in the view:

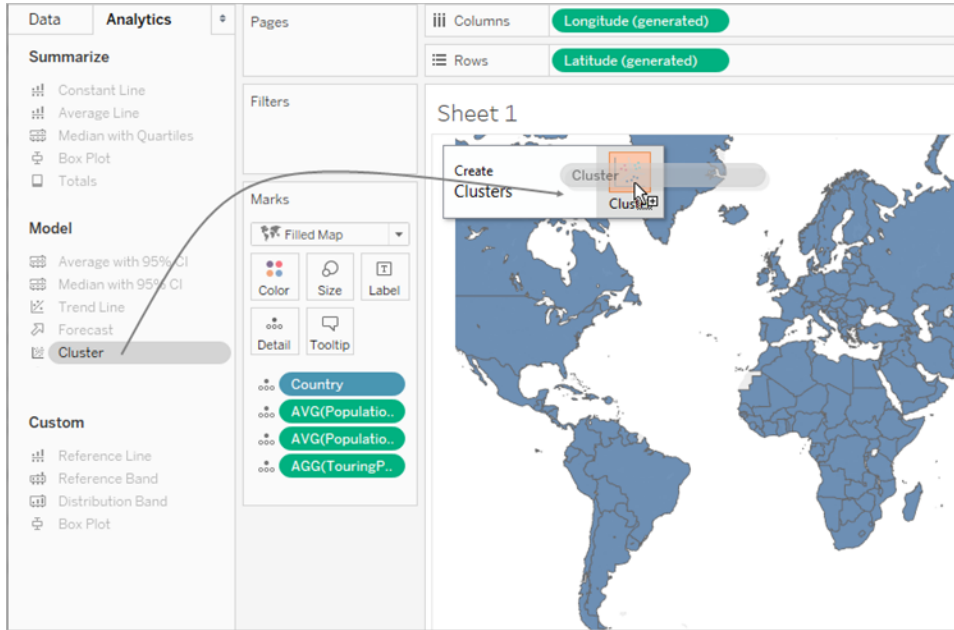

You can also double-click **Cluster** to find clusters in the view.

When you drop or double-click **Cluster**:

- Tableau creates a **Clusters** group on **Color**, and colors the marks in your view by cluster. If there is already a field on **Color**, Tableau moves that field to **Detail** and replaces it on **Color** with the clustering results.

Tableau assigns each mark in the view to one of the clusters. In some cases, marks that do not fit well into a cluster are assigned to a "Not Clustered" cluster.

- Tableau displays the Clusters dialog box, where you can customize the cluster.

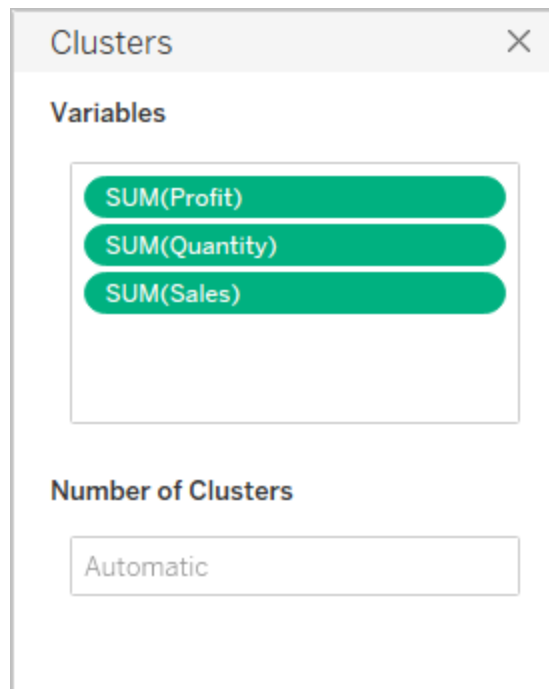

3. Customize the cluster results by doing either of the following in the Clusters dialog box.
 - Drag new fields from the **Data** pane into the Variables area of the Clusters dialog box. You can also drag fields out of the Variables area to remove them.

When you add variables, measures are aggregated using the default aggregation for the field; dimensions are aggregated using ATTR, which is the standard way that Tableau aggregates dimensions.

To change the aggregation for a variable, right-click it.

- Specify the number of clusters (between 2 and 50). If you do not specify a value, Tableau will automatically create up to 25 clusters.
4. When you finish customizing the cluster results, click the X in the upper-right corner of the Clusters dialog box to close it:

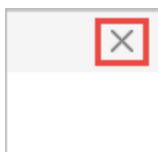

Note: You can move the cluster field from Color to another shelf in the view. However, you cannot move the cluster field from the **Filters** shelf to the **Data** pane.

To rename the resulting clusters, you must first save the cluster as a group. For details, see [Create a group from cluster results](#) on page 2526 and [Edit clusters](#) below.

Clustering constraints

Clustering is available in Tableau Desktop, but is not available for authoring on the web (Tableau Server, Tableau Cloud). Clustering is also not available when any of the following conditions apply:

- When you are using a cube (multidimensional) data source.
- When there is a blended dimension in the view.
- When there are no fields that can be used as variables (inputs) for clustering in the view.
- When there are no dimensions present in an aggregated view.

When any of those conditions apply, you will not be able to drag **Clusters** from the Analytics pane to the view.

In addition, the following field types cannot be used as variables (inputs) for clustering:

- Table calculations
- Blended calculations
- Ad-hoc calculations
- Generated latitude/longitude values
- Groups
- Sets
- Bins
- Parameters
- Dates
- Measure Names/Measure Values

Edit clusters

To edit an existing cluster, right-click (Control-click on a Mac) a **Clusters** field on **Color** and select **Edit clusters**.

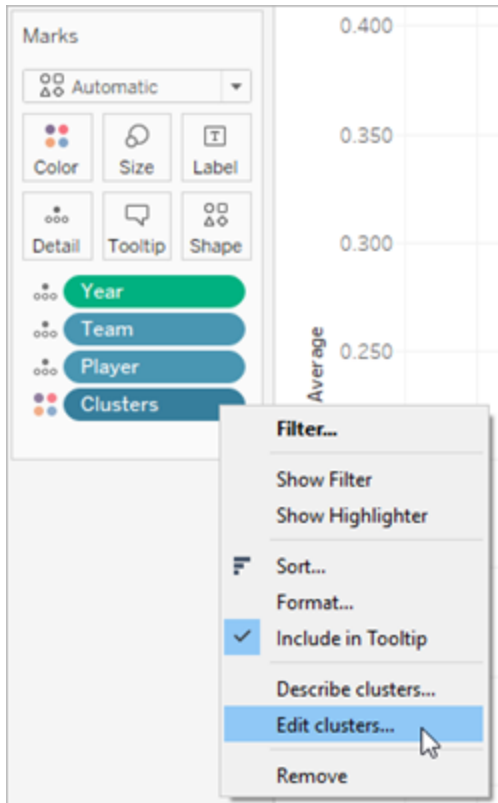

To change the names used for each cluster, you will first need to drag the Clusters field to the **Data** pane and save it as a group. For details, see [Create a group from cluster results on page 2526](#).

Right-click the cluster group and select **Edit Group** to make changes to each cluster.

Tableau Desktop and Web Authoring Help

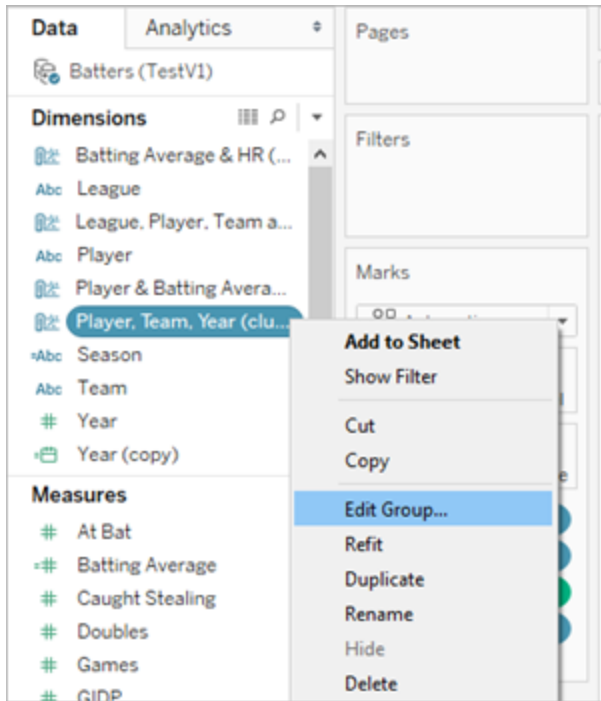

Select a cluster group in the list of Groups and click **Rename** to change the name.

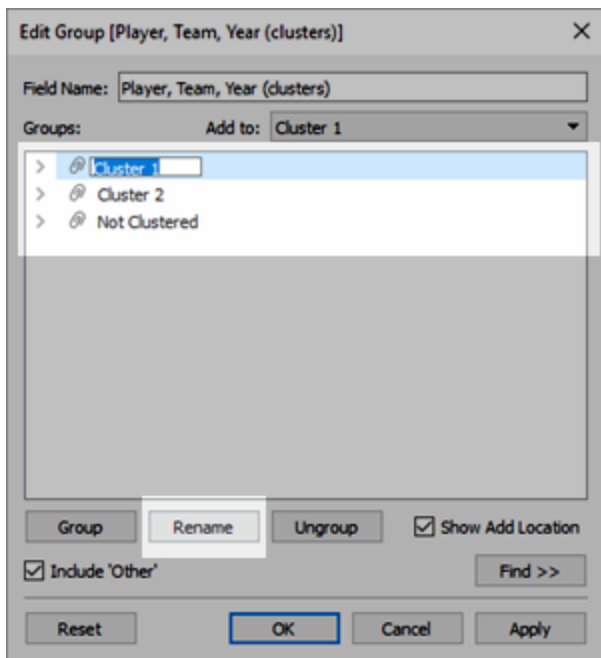

Create a group from cluster results

If you drag a cluster to the **Data** pane, it becomes a group dimension in which the individual members (Cluster 1, Cluster 2, etc.) contain the marks that the cluster algorithm has determined are more similar to each other than they are to other marks.

After you drag a cluster group to the **Data** pane, you can use it in other worksheets.

Drag **Clusters** from the **Marks** card to the **Data** pane to create a Tableau group:

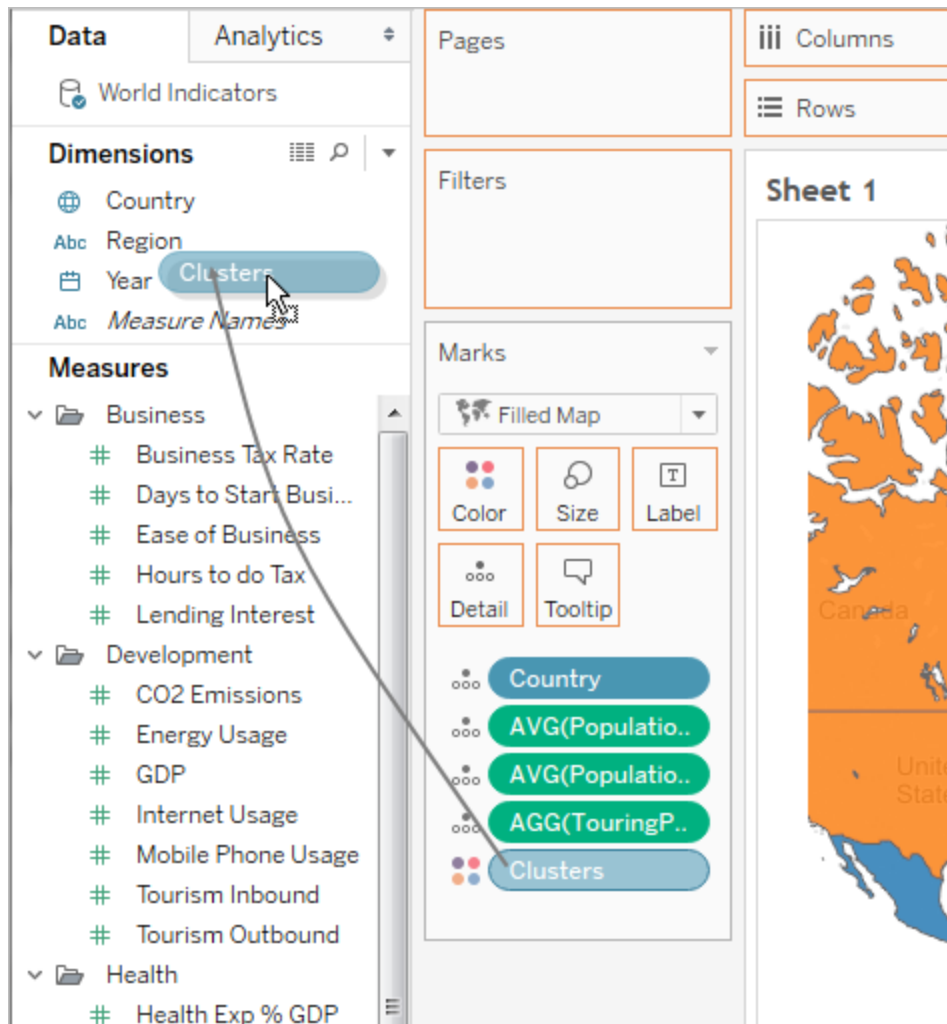

After you create a group from clusters, the group and the original clusters are separate and distinct. Editing the clusters does not affect the group, and editing the group does not affect the cluster results. The group has the same characteristics as any other Tableau group. It is part of the data source. Unlike the original clusters, you can use the group in other worksheets in the workbook. So if you rename the saved cluster group, that renaming is not applied to the original

clustering in the view. See [Correct Data Errors or Combine Dimension Members by Grouping Your Data](#) on page 1090.

Constraints on saving clusters as groups

You will not be able to save Clusters to the **Data** pane under any of the following circumstances:

- When the measures in the view are disaggregated and the measures you are using as clustering variables are not the same as the measures in the view. For details, see [How to Disaggregate Data](#) on page 180.
- When the Clusters you want to save are on the **Filters** shelf.
- When **Measure Names** or **Measure Values** is in the view.
- When there is a blended dimension in the view.

Refit saved clusters

When you save a Clusters field as a group, it is saved with its analytic model. You can use your cluster groups in other worksheets and workbooks, however, they don't automatically refresh.

In this example, a saved cluster group and its analytic model has been applied to a different worksheet. As a result, some of the marks are not included in the clustering yet (indicated by gray marks).

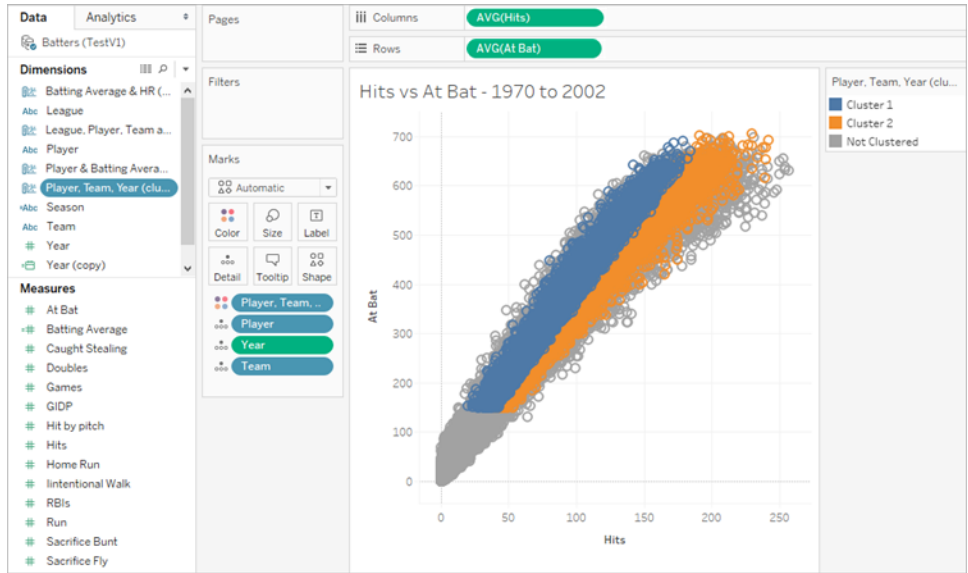

If the underlying data changes, you can use the **Refit** option to refresh and recompute the data for a saved clusters group.

To refit a saved cluster

- Right-click a clusters group in the Data pane, and then click **Refit**.

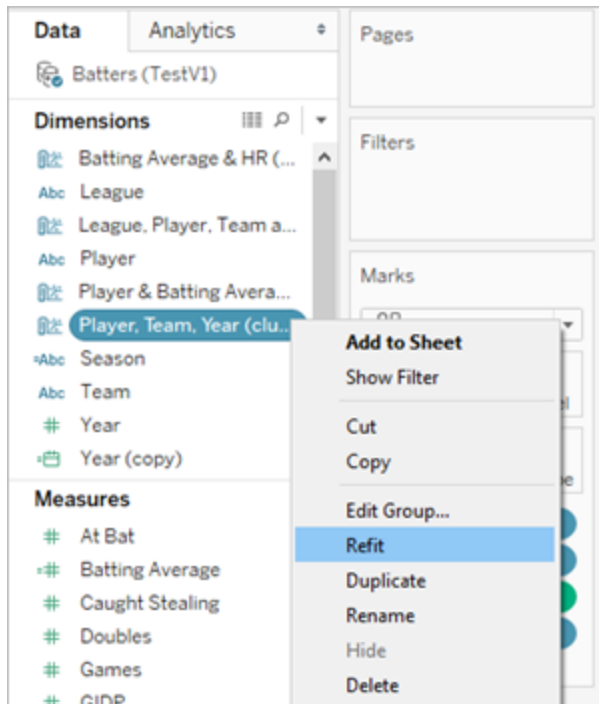

Here's an example of updated clustering after refitting the saved cluster:

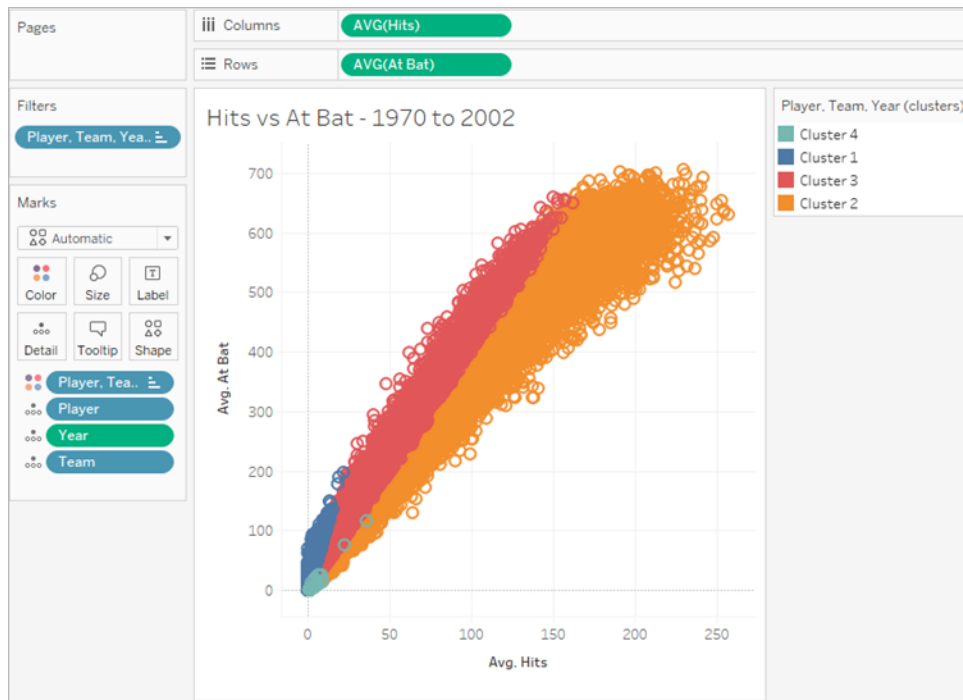

When you refit saved clusters, new clusters will be created and existing aliases for each cluster group category will be replaced with new, generic cluster aliases. Be aware that refitting saved clusters may alter your visualizations that use existing clusters and aliases.

How clustering works

Cluster analysis partitions the marks in the view into clusters, where the marks within each cluster are more similar to one another than they are to marks in other clusters. Tableau distinguishes clusters using color.

Note: For additional insight into how clustering works in Tableau, see the blog post [Understanding Clustering in Tableau 10](#).

The clustering algorithm

Tableau uses the k-means algorithm for clustering. For a given number of clusters k , the algorithm partitions the data into k clusters. Each cluster has a center (centroid) that is the mean value of all the points in that cluster. K-means locates centers through an iterative procedure that minimizes distances between individual points in a cluster and the cluster center. In Tableau, you can specify a desired number of clusters, or have Tableau test different values of k and suggest

an optimal number of clusters (see [Criteria used to determine the optimal number of clusters](#) on page 2532).

K-means requires an initial specification of cluster centers. Starting with one cluster, the method chooses a variable whose mean is used as a threshold for splitting the data in two. The centroids of these two parts are then used to initialize k-means to optimize the membership of the two clusters. Next, one of the two clusters is chosen for splitting and a variable within that cluster is chosen whose mean is used as a threshold for splitting that cluster in two. K-means is then used to partition the data into three clusters, initialized with the centroids of the two parts of the split cluster and the centroid of the remaining cluster. This process is repeated until a set number of clusters is reached.

Tableau uses Lloyd's algorithm with squared Euclidean distances to compute the k-means clustering for each k . Combined with the splitting procedure to determine the initial centers for each $k > 1$, the resulting clustering is deterministic, with the result dependent only on the number of clusters.

The algorithm starts by picking initial cluster centers:

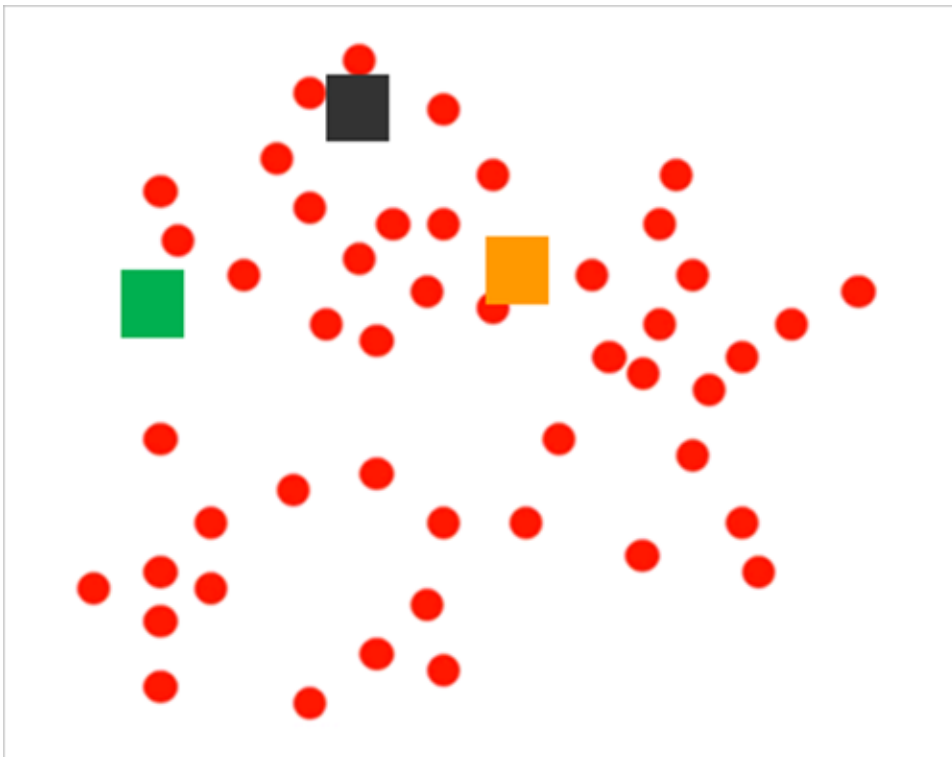

It then partitions the marks by assigning each to its nearest center:

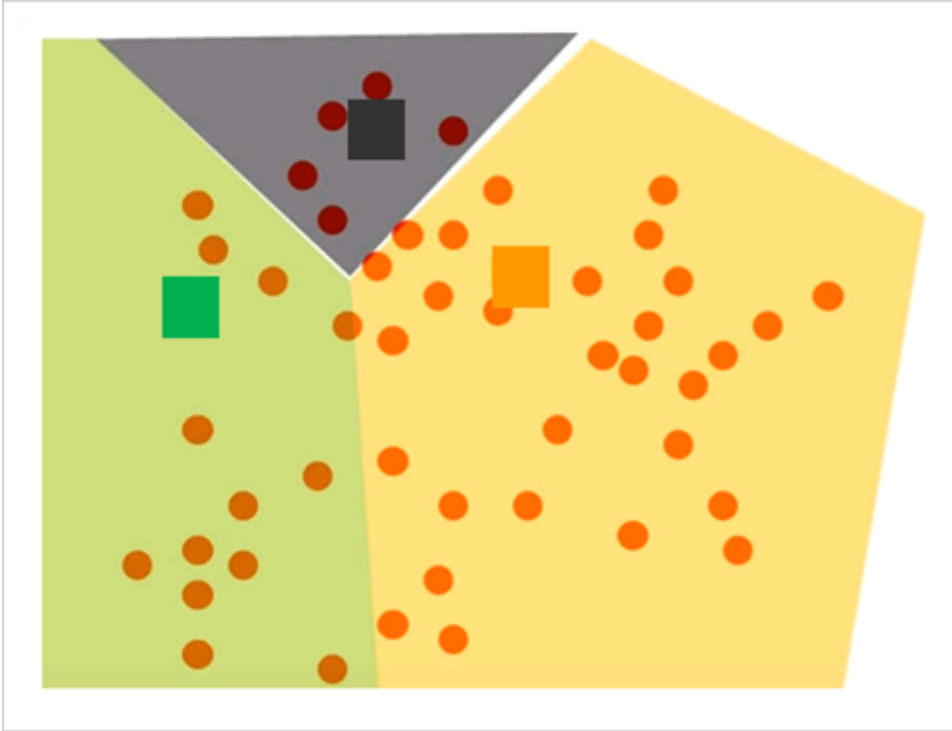

Then it refines the results by computing new centers for each partition by averaging all the points assigned to the same cluster:

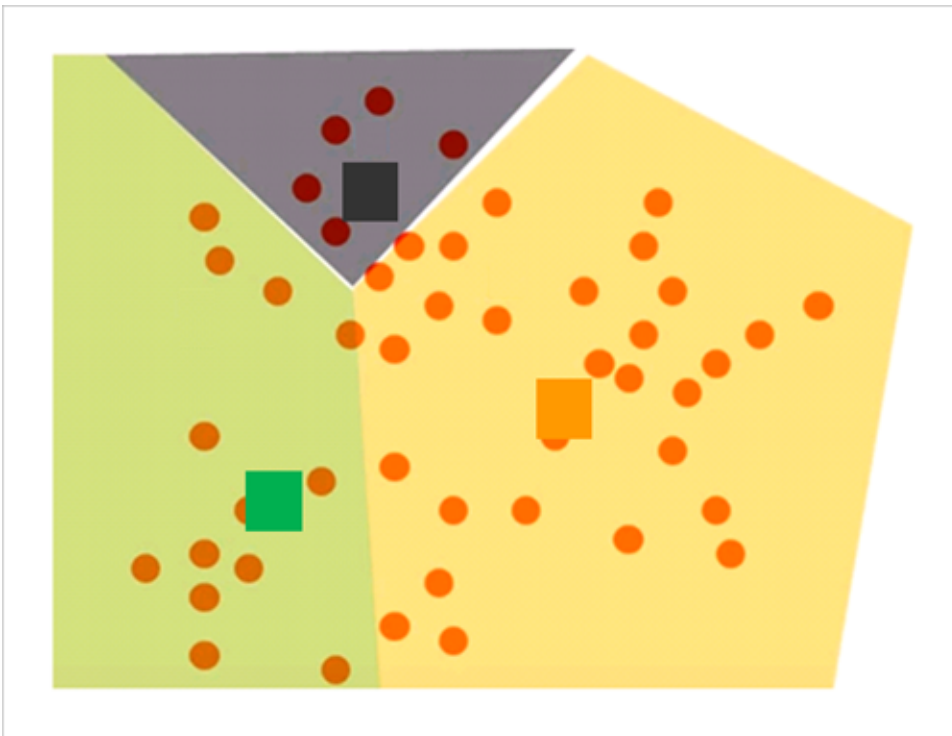

It then reviews the assignment of marks to clusters and reassigns any marks that are now closer to a different center than before.

The clusters are redefined and marks are reassigned iteratively until no more changes are occurring.

Note: Due to underlying differences in the technologies, there may be slight differences between clusters created on x64 or arm64 CPUs for the same data.

Criteria used to determine the optimal number of clusters

Tableau uses the Calinski-Harabasz criterion to assess cluster quality. The Calinski-Harabasz criterion is defined as

$$\frac{SS_B}{SS_W} \times \frac{(N-k)}{(k-1)}$$

where SS_B is the overall between-cluster variance, SS_W the overall within-cluster variance, k the number of clusters, and N the number of observations.

The greater the value of this ratio, the more cohesive the clusters (low within-cluster variance) and the more distinct/separate the individual clusters (high between-cluster variance).

Since the Calinski-Harabasz index is not defined for $k=1$, it cannot be used to detect one-cluster cases.

If a user does not specify the number of clusters, Tableau picks the number of clusters corresponding to the first local maximum of the Calinski-Harabasz index. By default, k-means will be run for up to 25 clusters if the first local maximum of the index is not reached for a smaller value of k . You can set a maximum value of 50 clusters.

Note: If a categorical variable (that is, a dimension) has more than 25 unique values, then Tableau will disregard that variable when computing clusters.

What values get assigned to the "Not Clustered" category?

When there are null values for a measure, Tableau assigns values for rows with null to a **Not Clustered** category. Categorical variables (that is, dimensions) that return * for ATTR (meaning

that all values are not identical) are also not clustered.

Scaling

Tableau scales values automatically so that columns having a larger range of magnitudes don't dominate the results. For example, an analyst could be using inflation and GDP as input variables for clustering, but because GDP values are in trillions of dollars, this could cause the inflation values to be almost completely disregarded in the computation. Tableau uses a scaling method called *min-max normalization*, in which the values of each variable is mapped to a value between 0 and 1 by subtracting its minimum and dividing by its range.

Information on statistics models used for clusters

The Describe Clusters dialog box provides information about the models that Tableau computed for clustering. You can use these statistics to assess the quality of the clustering.

When the view includes clustering, you can open the Describe Clusters dialog box by right-clicking **Clusters** on the **Marks** card (Control-clicking on a Mac) and choosing **Describe Clusters**. The information in the Describe Clusters dialog box is read-only, though you can click **Copy to Clipboard** and then paste the screen contents into a writeable document.

Describe Clusters - Summary Tab

The Summary tab identifies the inputs that were used to generate the clusters and provides some statistics that characterize the clusters.

Inputs for Clustering

Variables

Identifies the fields Tableau uses to compute clusters. These are the fields listed in the Variables box in the Clusters dialog box.

Level of Detail

Identifies the fields that are contributing to the view's level of detail—that is, the fields that determine the level of aggregation. For details, see [How dimensions affect the level of detail in the view on page 151](#).

Scaling

Identifies the scaling method used for pre-processing. Normalized is currently the only scaling method Tableau uses. The formula for this method, also known as min-max normalization, is $(x - \min(x)) / (\max(x) - \min(x))$.

Summary Diagnostics

Number of Clusters

The number of individual clusters in the clustering.

Number of Points

The number of marks in the view.

Between-group sum of squares

A metric quantifying the separation between clusters as a sum of squared distances between each cluster's center (average value), weighted by the number of data points assigned to the cluster, and the center of the data set. The larger the value, the better the separation between clusters.

Within-group sum of squares

A metric quantifying the cohesion of clusters as a sum of squared distances between the center of each cluster and the individual marks in the cluster. The smaller the value, the more cohesive the clusters.

Total sum of squares

Totals the between-group sum of squares and the within-group sum of squares. The ratio $(\text{between-group sum of squares})/(\text{total sum of squares})$ gives the proportion of variance explained by the model. Values are between 0 and 1; larger values typically indicate a better model. However, you can increase this ratio just by increasing the number of clusters, so it could be misleading if you compare a five-cluster model with a three-cluster model using just this value.

Cluster Statistics

For each cluster in the clustering, the following information is provided.

Items

The number of marks within the cluster.

Centers

The average value within each cluster (shown for numeric items).

Most Common

The most common value within each cluster (only shown for categorical items).

Describe Clusters - Models Tab

Analysis of variance (ANOVA) is a collection of statistical models and associated procedures useful for analyzing variation within and between observations that have been partitioned into groups or clusters. In this case, analysis of variance is computed per variable, and the resulting analysis of variance table can be used to determine which variables are most effective for distinguishing clusters.

Relevant analysis of variance statistics for clustering include:

F-statistic

The F-statistic for one-way, or single-factor, ANOVA is the fraction of variance explained by a variable. It is the ratio of the between-group variance to the total variance.

The larger the F-statistic, the better the corresponding variable is distinguishing between clusters.

p-value

The p-value is the probability that the F-distribution of all possible values of the F-statistic takes on a value greater than the actual F-statistic for a variable. If the p-value falls below a specified significance level, then the null hypothesis (that the individual elements of the variable are random samples from a single population) can be rejected. The degrees of freedom for this F-distribution are $(k - 1, N - k)$, where k is the number of clusters and N is the number of items (rows) clustered.

The lower the p-value, the more the expected values of the elements of the corresponding variable differ among clusters.

Model Sum of Squares and Degrees of Freedom

The Model Sum of Squares is the ratio of the between-group sum of squares to the model degrees of freedom. The between group sum of squares is a measure of the variation between cluster means. If the cluster means are close to each other (and therefore close to the overall mean), this value will be small. The model has $k-1$ degrees of freedom, where k is the number of clusters.

Error Sum of Squares and Degrees of Freedom

The Error Sum of Squares is the ratio of within-group sum of squares to the error degrees of freedom. The within-group sum-of-squares measures the variation between observations within

each cluster. The error has $N-k$ degrees of freedom, where N is the total number of observations (rows) clustered and k is the number of clusters.

The Error Sum of Squares can be thought of as the overall Mean Square Error, assuming that each cluster center represents the "truth" for each cluster.

Example: Create clusters using World Economic Indicators data

The Tableau clustering feature partitions marks in the view into clusters, where the marks within each cluster are more similar to one another than they are to marks in other clusters. This example shows how a researcher might use clustering to find an optimal set of marks (in this case, countries/regions) in a data source.

The objective

As life expectancy increases around the world, and as older people remain more active, senior tourism can be a lucrative market for companies that know how to find and appeal to potential customers. The World Indicators sample data set that comes with Tableau contains the kind of data that might help companies identify the countries or regions where there are enough of the right kind of customers.

Finding the right countries/regions

Here is an example of how Tableau clustering could help such a company identify the countries/regions where a senior tourism business could succeed. Imagine you are the analyst. Here is how you might proceed.

1. Open the **World Indicators** sample data source in Tableau Desktop.
2. Double-click **Country/Region** in the **Data** pane.

Tableau automatically creates a map view, with a mark in each country/region.

3. On the **Marks** card, change the mark type to **Map**:

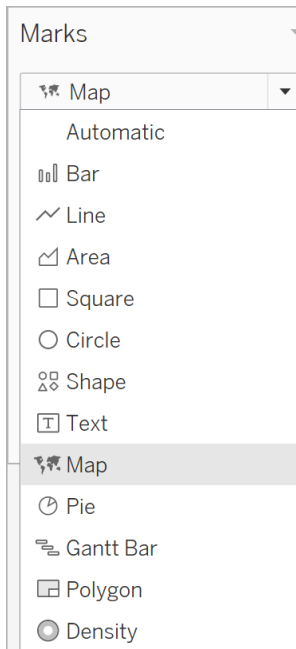

You should now see a map projection where all countries/regions are filled with a solid color:



4. The next step is to identify the fields that you will use as variables for clustering. Here are the fields you choose:

Field	Reason for inclusion
Life Expectancy Female and Life Expectancy Male	Where people are living longer, there are more likely to be people who are interested in traveling later in life.
Population Urban	It is easier to market services in areas with greater population density.
Population 65+	The target population is older residents with the time and funds to travel.
TourismPerCapita	This is a measure that you must create as a named calculated field. The formula is: $\text{SUM}([\text{Tourism Outbound}]) / \text{SUM}([\text{Population Total}])$

Tourism Outbound aggregates the money (in US dollars) that residents of a country/region spend annually on international travel. But this total must be divided by the population of each country/region to determine the average amount each resident spends on international travel.

There is no guarantee that these are the ideal fields to choose, or that these fields will produce cluster results that are clear and unambiguous. Clustering is an iterative process—experimentation leads to discovery which leads, in turn, to more experimentation.

5. Drag these five fields from the **Data** pane to **Detail** on the **Marks** card.
6. Click to open the **Analytics** pane:

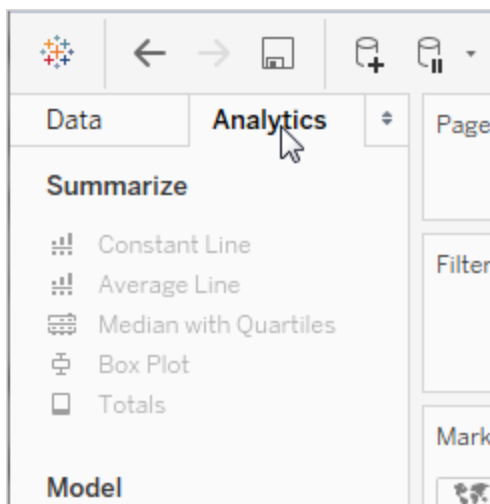

7. Drag **Cluster** from the **Analytics** pane and drop it in the view:



Tableau displays the Clusters dialog box and adds the measures in the view to the list of variables:



It also updates the view by adding clusters to **Color**. In this case, Tableau finds two distinct clusters, and is unable to assign certain countries/regions (colored reddish-pink) to either cluster:

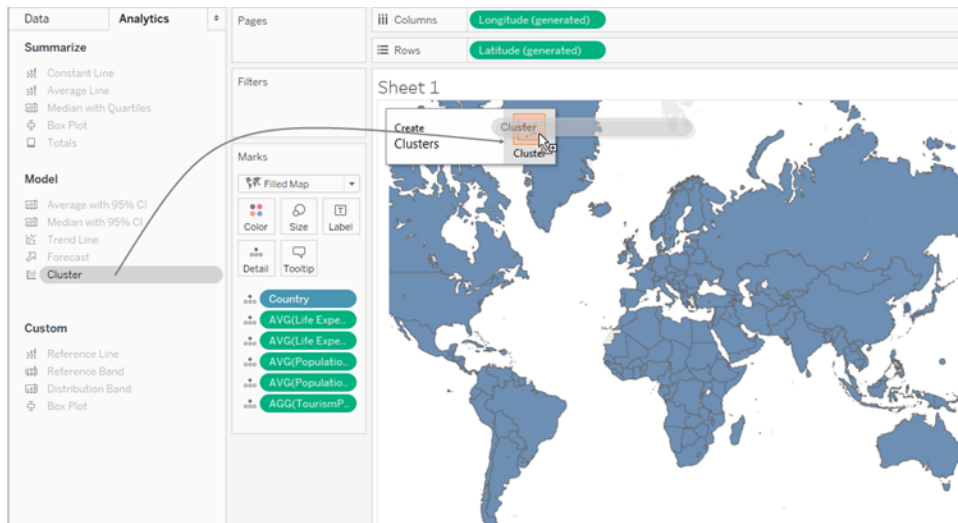
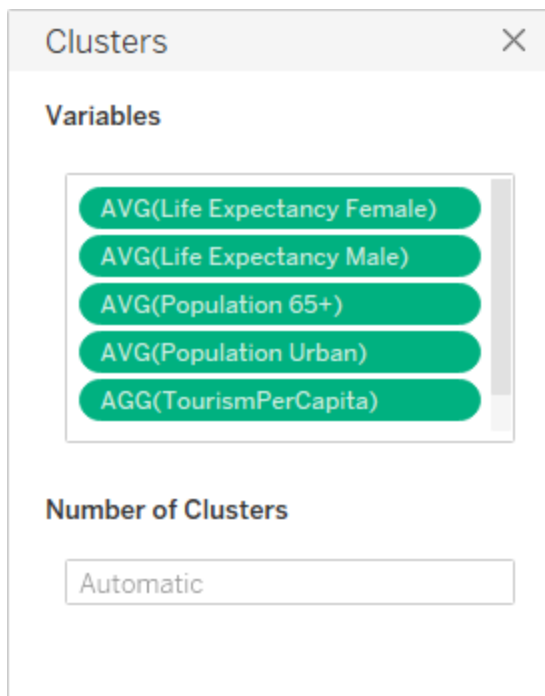
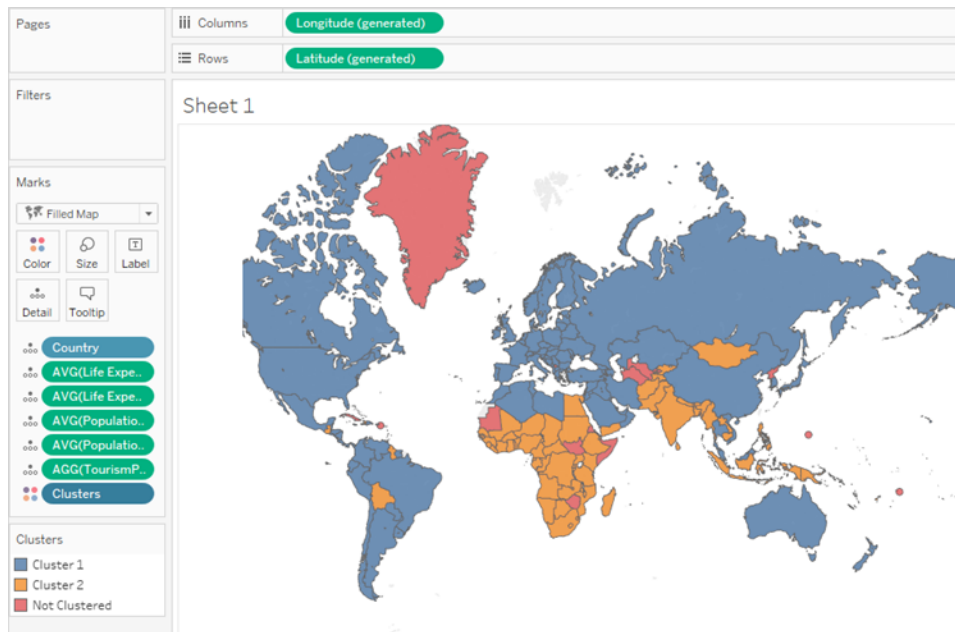

Note: See [How clustering works](#) on page 2529 for details on data that Tableau assigns to "Not clustered."

8. You decide that two clusters isn't enough—you don't have the resources to set up shop in half the countries/regions in the world. So you type 4 in the **Number of Clusters** field in the Clusters dialog box.

The map becomes more interesting:

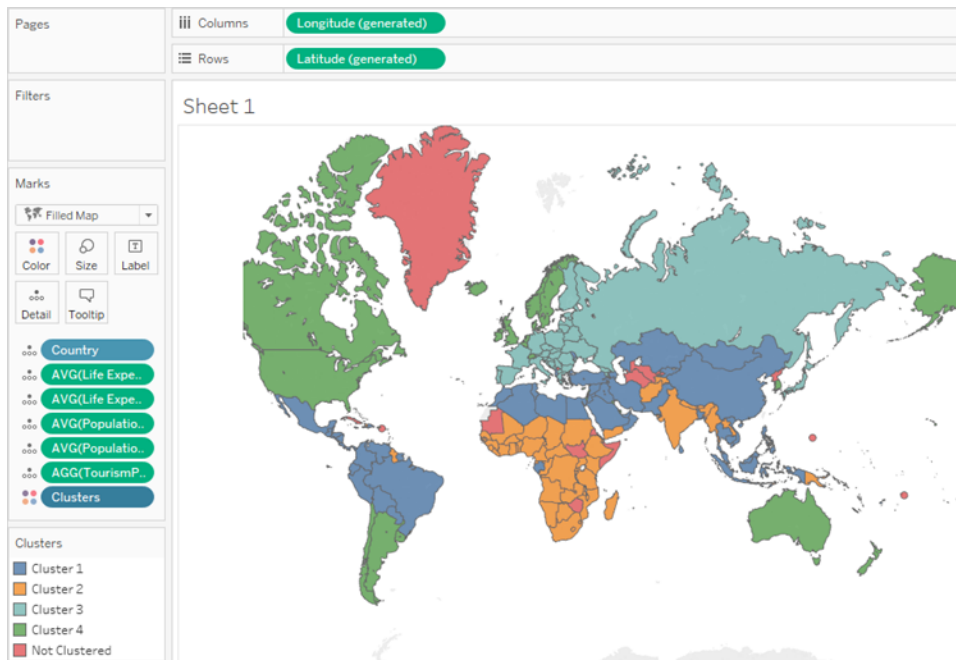

But how do these clusters relate to the variables you have chosen? Which one correlates best with the factors that support senior tourism? It's time to look at the statistics behind the clusters.

9. Close the Clusters dialog box by clicking the X in its upper-right corner:



10. Click the **Clusters** field on the **Marks** card and choose **Describe Clusters**.

The table at the bottom of the **Models** tab in the Describe Clusters dialog box shows the average value for each variable in each cluster:

Clusters	Number of Items	Centers				
		Avg. Life Expectancy Female	Avg. Life Expectancy Male	Avg. Population 65+	Avg. Population Urban	TourismPerCapita
Cluster 1	69	74.216	69.003	0.054943	0.5325	197.12
Cluster 2	52	56.75	54.429	0.031889	0.33127	20.775
Cluster 3	29	79.164	71.706	0.15493	0.65532	320.92
Cluster 4	30	81.287	76.355	0.11606	0.87123	1360.4
Not Clustered	28					

Cluster 4 has the highest life expectancy (both male and female), the highest concentration of urban population, and the highest expenditure for international tourism: \$1360.40 per capita. The only variable for which Cluster 4 does not have the highest

value is **Population 65+**, where Cluster 3 has the advantage: 0.15493 (just under 16%) to 0.11606 (just over 11%) in Cluster 4.

The clustering algorithm does not know whether you are looking for the maximum value for these variables, the minimum value, or something in the middle—it just looks for correlation. But you know that higher values for these variables is the signal you're looking for, and Cluster 4 is the best choice.

11. You could attempt to pick out the Cluster 4 countries/regions from the map, but there is an easier way. Close the **Describe Clusters** dialog box and then click **Cluster 4** on the Color legend and choose **Keep Only**.

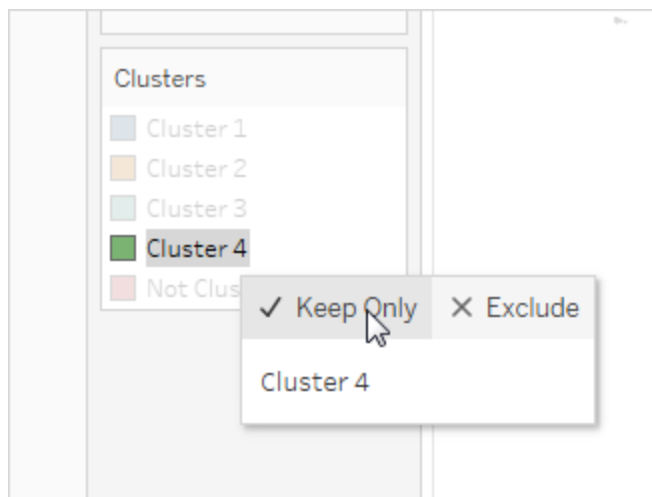

12. Choose Text Table from ShowMe.

You now see a list of the countries/regions in Cluster 4:

Clusters	Country	
Cluster 4	Argentina	Abc
	Australia	Abc
	Bahamas, The	Abc
	Belgium	Abc
	Canada	Abc
	Chile	Abc
	Curacao	Abc
	Cyprus	Abc
	Denmark	Abc
	Hong Kong SAR, China	Abc
	Iceland	Abc
	Ireland	Abc
	Israel	Abc
	Korea, Rep.	Abc
	Kuwait	Abc
	Lebanon	Abc
	Luxembourg	Abc
	Macao SAR, China	Abc
	Malta	Abc
	Netherlands	Abc
	New Zealand	Abc
	Norway	Abc
	Puerto Rico	Abc
	Qatar	Abc
	Singapore	Abc
	Sweden	Abc
	Switzerland	Abc
	United Kingdom	Abc
United States	Abc	
Uruguay	Abc	

This list is not the end of the process. You might try clustering again with a somewhat different set of variables and maybe a different number of clusters, or you might add some countries/regions to the list and remove others, based on other factors. For example, if your tours are mostly to tropical locales, you might remove countries/regions like Curacao and the Bahamas from the list, because tropical tours might not appeal to residents of those countries/regions.

Another option is to filter your data before you re-cluster, to only show countries/regions with populations above a certain threshold, or to target countries/regions in a particular geographical area.

Forecasting

You can add a forecast to a view when there is at least one date dimension and one measure in the view. If you're interested in predictive modeling, also available in Tableau, see [How Predictive Modeling Functions Work in Tableau on page 2571](#).

To turn forecasting on, right-click (control-click on Mac) on the visualization and choose **Forecast >Show Forecast**, or choose **Analysis >Forecast >Show Forecast**.

When no date dimension is present, you can add a forecast if there is a dimension field in the view that has integer values. For details, see [Forecasting When No Date is in the View on page 2556](#).

You can forecast quantitative time-series data using exponential smoothing models in Tableau Desktop. With exponential smoothing, recent observations are given relatively more weight than older observations. These models capture the evolving trend or seasonality of your data and extrapolate them into the future. Forecasting is fully automatic, yet configurable. Many forecast results can become fields in your visualizations.

When a forecast is showing, future values for the measure are shown next to the actual values.

Forecasting Constraints

Forecasting is not supported for Multidimensional data sources. In Tableau Desktop, multidimensional data sources are supported only in Windows.

You can publish a view that contains a forecast, and see the forecast when you view or edit the view on the web, but you cannot modify or add a forecast when you are editing a view on the web.

In addition, you cannot add a forecast to a view if it contains any of the following:

- Table calculations
- Disaggregated measures
- Percent calculations
- Grand Totals or Subtotals
- Date values with aggregation set to Exact Date

How Forecasting Works in Tableau

Forecasting in Tableau uses a technique known as exponential smoothing. Forecast algorithms try to find a regular pattern in measures that can be continued into the future. If you're interested in predictive modeling, also available in Tableau, see [How Predictive Modeling Functions Work in Tableau on page 2571](#).

You typically add a forecast to a view that contains a date field and at least one measure. However, in the absence of a date, Tableau can create a forecast for a view that contains a dimension with integer values in addition to at least one measure.

For details on creating a forecast, see [Create a Forecast on page 2552](#). For details on forecasting using an integer dimension, see [Forecasting When No Date is in the View on page 2556](#).

Overview

All forecast algorithms are simple models of a real-world data generating process (DGP). For a high quality forecast, a simple pattern in the DGP must match the pattern described by the model reasonably well. Quality metrics measure how well the model matches the DGP. If the quality is low, the precision measured by the confidence bands is not important because it measures the precision of an inaccurate estimate.

Tableau automatically selects the best of up to eight models, the best being the one that generates the highest quality forecast. The smoothing parameters of each model are optimized before Tableau assesses forecast quality. The optimization method is global. Therefore, choosing locally optimal smoothing parameters that are not also globally optimal is not impossible. However, initial value parameters are selected according to best practices but are not further optimized. So it is possible for initial value parameters to be less than optimal. The eight models available in Tableau are among those described at the following location on the OTexts web site: [A taxonomy of exponential smoothing methods](#).

When there is not enough data in the visualization, Tableau automatically tries to forecast at a finer temporal granularity, and then aggregates the forecast back to the granularity of the visualization. Tableau provides prediction bands which may be simulated or calculated from a closed form equation. All models with a multiplicative component or with aggregated forecasts have simulated bands, while all other models use the closed form equations.

Exponential Smoothing and Trend

Exponential smoothing models iteratively forecast future values of a regular time series of values from weighted averages of past values of the series. The simplest model, *Simple*

Exponential Smoothing, computes the next level or smoothed value from a weighted average of the last actual value and the last level value. The method is exponential because the value of each level is influenced by every preceding actual value to an exponentially decreasing degree—more recent values are given greater weight.

Exponential smoothing models with trend or seasonal components are effective when the measure to be forecast exhibits trend or seasonality over the period of time on which the forecast is based. *Trend* is a tendency in the data to increase or decrease over time. *Seasonality* is a repeating, predictable variation in value, such as an annual fluctuation in temperature relative to the season.

In general, the more data points you have in your time series, the better the resulting forecast will be. Having enough data is particularly important if you want to model seasonality, because the model is more complicated and requires more proof in the form of data to achieve a reasonable level of precision. On the other hand, if you forecast using data generated by two or more different DGPs, you will get a lower quality forecast because a model can only match one.

Seasonality

Tableau tests for a seasonal cycle with the length most typical for the time aggregation of the time series for which the forecast is estimated. So if you aggregate by months, Tableau will look for a 12-month cycle; if you aggregate by quarters, Tableau will search for a four-quarter cycle; and if you aggregate by days, Tableau will search for weekly seasonality. Therefore, if there is a six-month cycle in your monthly time series, Tableau will probably find a 12-month pattern that contains two similar sub-patterns. However, if there is a seven-month cycle in your monthly time series, Tableau will probably find no cycle at all. Luckily, seven-month cycles are uncommon.

Tableau can use either of two methods for deriving season length. The original temporal method uses the natural season length of the temporal granularity (TG) of the view. Temporal granularity means the finest unit of time expressed by the view. For example, if the view contains either a continuous green date truncated to month or discrete blue year and month date parts, the temporal granularity of the view is month. The new non-temporal method, introduced with Tableau 9.3, uses periodic regression to check season lengths from 2 to 60 for candidate lengths.

Tableau automatically selects the most appropriate method for a given view. When Tableau is using a date to order the measures in a view, if the temporal granularity is quarterly, monthly, weekly, daily or hourly, the season lengths are almost certainly 4, 12, 13, 7 or 24, respectively. So only the length natural to the TG is used to construct the five seasonal exponential smoothing models supported by Tableau. The AIC of the five seasonal models and the three non-seasonal models are compared and the lowest returned. (For an explanation of the AIC metric, see Forecast Descriptions.)

When Tableau is using an integer dimension for forecasting, the second method is used. In this case there is no temporal granularity (TG), so potential season lengths must be derived from the data.

The second method is also used if the temporal granularity is yearly. Yearly series rarely have seasonality, but, if they do, it must also be derived from the data.

The second method is also used for views with temporal granularity of minute or second. If such series have seasonality, the season lengths are likely 60. However, when measuring a regular real world process, the process may have a regular repetition which does not correspond to the clock. So, for minutes and seconds, Tableau also checks for a length different from 60 in the data. This does not mean that Tableau can model two different season lengths at the same time. Rather, ten seasonal models are estimated, five with a season length of 60 and another five with the season length derived from the data. Whichever of the ten seasonal models or three non-seasonal models has the lowest AIC, that model is used to compute the forecast.

For series ordered by year, minute, or second, a single season length from the data is tested if the pattern is fairly clear. For integer ordered series, up to nine somewhat less clear potential season lengths are estimated for all five seasonal models, and the model with the lowest AIC is returned. If there are no likely season length candidates, only the non-seasonal models are estimated.

Since all selection is automatic when Tableau is deriving potential season lengths from the data, the default Model Type of “Automatic” in the Forecast Options Dialog Model Type menu does not change. Selecting “Automatic without seasonality” improves performance by eliminating all season length searching and estimation of seasonal models.

The heuristic that Tableau uses to decide when to use season lengths derived from the data depends on the distribution of errors for the periodic regression of each candidate season length. Since the assembly of season length candidates by periodic regression usually produces one or two clear winning lengths if seasonality actually exists in the data, the return of a single candidate indicates likely seasonality. In this case, Tableau estimates seasonal models with this candidate for year, minute and second granularity. The return of less than the maximum of ten candidates indicates possible seasonality. In this case, Tableau estimates seasonal models with all returned candidates for integer ordered views. The return of the maximum number of candidates indicates that errors for most length are similar. Therefore, the existence of any seasonality is unlikely. In this case, Tableau estimates only non-seasonal models for an integer-ordered or yearly ordered series, and only the seasonal models with a natural season length for other temporally ordered views.

For Model Type “Automatic” in integer-, year-, minute- and second-ordered views, candidate season lengths are always derived from the data whether or not they are used. Since model estimation is much more time consuming than periodic regression, the performance impact should be moderate.

Model Types

In the Forecast Options dialog box, you can choose the model type Tableau users for forecasting. The **Automatic** setting is typically optimal for most views. If you choose **Custom**, then you can specify the trend and season characteristics independently, choosing either **None**, **Additive**, or **Multiplicative**:

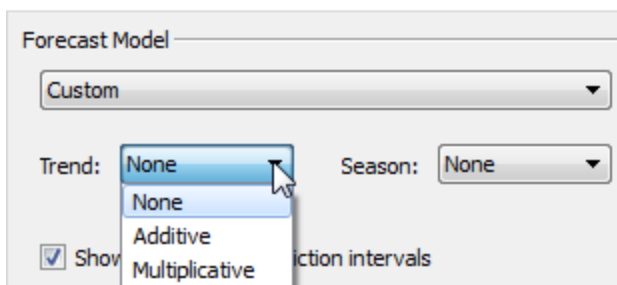

An additive model is one in which the contributions of the model components are summed, whereas a multiplicative model is one in which at least some component contributions are multiplied. Multiplicative models can significantly improve forecast quality for data where the trend or seasonality is affected by the level (magnitude) of the data:

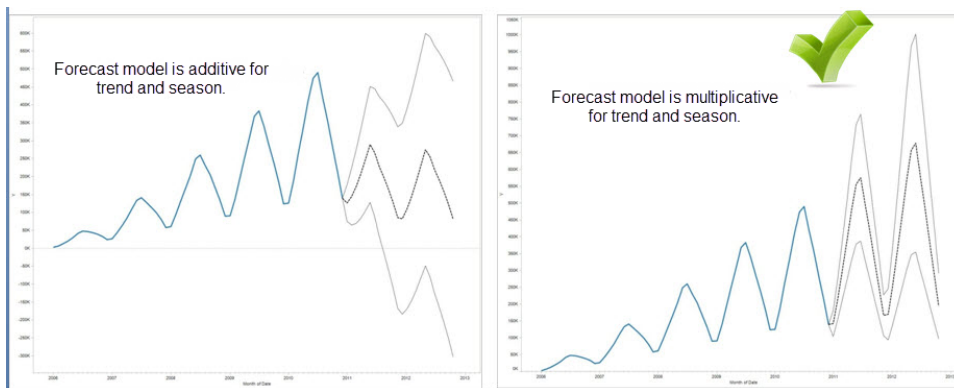

Keep in mind that you do not need to create a custom model to generate a forecast that is multiplicative: the **Automatic** setting can determine if a multiplicative forecast is appropriate for your data. However, a multiplicative model cannot be computed when the measure to be forecast has one or more values that are less than or equal to zero.

Forecasting with Time

When you are forecasting with a date, there can be only one base date in the view. Part dates are supported, but all parts must refer to the same underlying field. Dates can be on **Rows**, **Columns**, or **Marks** (with the exception of the Tooltip target).

Tableau supports three types of dates, two of which can be used for forecasting:

- Truncated dates reference a particular point in history with specific temporal granularity, such as February 2017. They are usually continuous, with a green background in the view. Truncated dates are valid for forecasting.
- Date parts refer to a particular member of a temporal measure such as February. Each date part is represented by a different, usually discrete field (with a blue background). Forecasting requires at least a Year date part. Specifically, it can use any of the following sets of date parts for forecasting:
 - *Year*
 - *Year + quarter*
 - *Year + month*
 - *Year + quarter + month*
 - *Year + week*
 - *Custom: Month/Year, Month/Day/Year*

Other date parts, such as *Quarter* or *Quarter + month*, are not valid for forecasting. See [Convert Fields between Discrete and Continuous on page 1070](#) for more details about different date types.

- Exact dates refer to a particular point in history with maximum temporal granularity such as February 1, 2012 at 14:23:45.0. Exact dates are invalid for forecasting.

It is also possible to forecast without a date. See [Forecasting When No Date is in the View on page 2556](#).

Granularity and Trimming

When you create a forecast, you select a date dimension that specifies a unit of time at which date values are to be measured. Tableau dates support a range of such time units, including Year, Quarter, Month, and Day. The unit you choose for the date value is known as the *granularity* of the date.

The data in your measure typically does not align precisely with your unit of granularity. You might set your date value to quarters, but your actual data may terminate in the middle of a quarter—for example, at the end of November. This can cause a problem because the value for this fractional quarter is treated by the forecasting model as a full quarter, which will typically have a lower value than a full quarter would. If the forecasting model is allowed to consider this data, the resulting forecast will be inaccurate. The solution is to trim the data, such that the trailing periods that could mislead the forecast are ignored. Use the Ignore Last option in the Forecast Options dialog box to remove—or *trim*—such partial periods. The default is to trim one period.

Getting More Data

Tableau requires at least five data points in the time series to estimate a trend, and enough data points for at least two seasons or one season plus five periods to estimate seasonality. For example, at least nine data points are required to estimate a model with a four quarter seasonal cycle ($4 + 5$), and at least 24 to estimate a model with a twelve month seasonal cycle ($2 * 12$).

If you turn on forecasting for a view that does not have enough data points to support a good forecast, Tableau can sometimes retrieve enough data points to produce a valid forecast by querying the datasource for a finer level of granularity:

- If your view contains fewer than nine years of data, by default, Tableau will query the data source for quarterly data, estimate a quarterly forecast, and aggregate to a yearly forecast to display in your view. If there are still not enough data points, Tableau will estimate a monthly forecast and return the aggregated yearly forecast to your view.
- If your view contains fewer than nine quarters of data, by default Tableau will estimate a monthly forecast and return the aggregated quarterly forecast results to your view.
- If your view contains fewer than nine weeks of data, by default, Tableau will estimate a daily forecast and return the aggregated weekly forecast results to your view.
- If your view contains fewer than nine days of data, by default, Tableau will estimate an hourly forecast and return the aggregated daily forecast results to your view.
- If your view contains fewer than nine hours of data, by default, Tableau will estimate an minutely forecast and return the aggregated hourly forecast results to your view.
- If your view contains fewer than nine minutes of data, by default, Tableau will estimate an secondly forecast and return the aggregated minutely forecast results to your view.

These adjustments happen behind the scene and require no configuration. Tableau does not change the appearance of your visualization, and does not actually change your date value.

However, the summary of the forecast time period in the Describe Forecast and Forecast Options dialog will reflect the actual granularity used.

Tableau can only get more data when the aggregation for the measure you are forecasting is SUM or COUNT. See [Data Aggregation in Tableau on page 171](#) for information on available aggregation types and information on how to change the aggregation type.

Create a Forecast

To create a forecast, your view must be using at least one date dimension and one measure.

To turn forecasting on, right-click (control-click on Mac) on the visualization and choose **Forecast >Show Forecast**, or choose **Analysis >Forecast >Show Forecast**.

Each of the following examples indicate the structure that supports creating a forecast.

- The field you want to forecast is on the **Rows** shelf and a continuous date field is on the **Columns** shelf.
- The field you want to forecast is on the **Columns** shelf and a continuous date field is on the **Rows** shelf.
- The field you want to forecast on either the **Rows** or **Columns** shelf, and discrete dates are on either the **Rows** or **Columns** shelf. At least one of the included date levels must be Year.
- The field you want to forecast is on the Marks card, and a continuous date or discrete date set is on **Rows**, **Columns** or **Marks**.

Note: You can also create a forecast when no date dimension is present if there is a dimension in the view that has integer values. See [Forecasting When No Date is in the View on page 2556](#).

With forecasting on, Tableau visualizes estimated future values of the measure, in addition to actual historical values. The estimated values are shown by default in a lighter shade of the color used for the historical data:

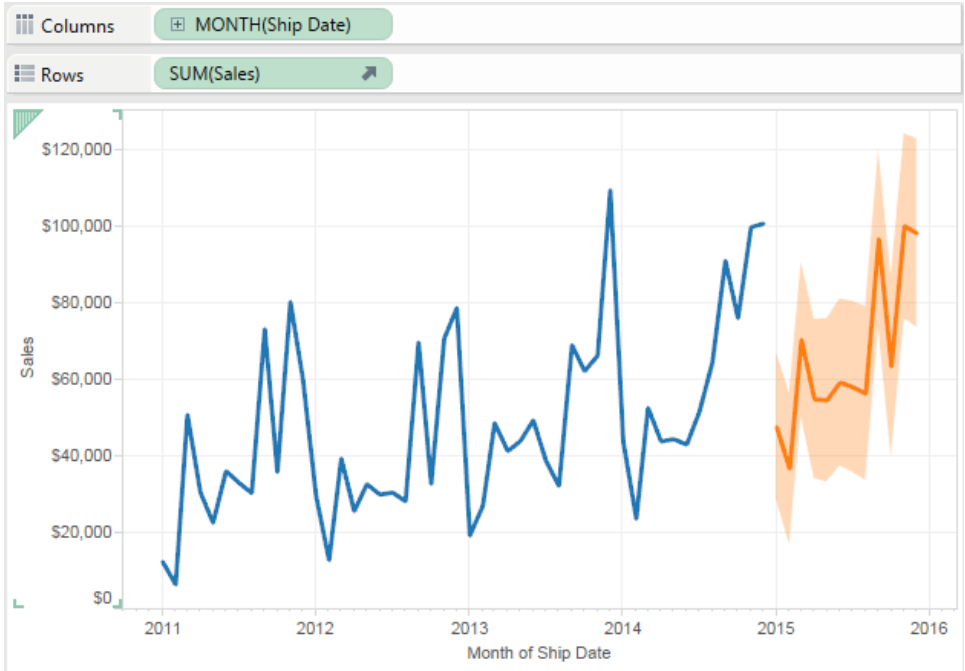

Prediction Intervals

The shaded area in the image above shows the 95% prediction interval for the forecast. That is, the model has determined that there is a 95% likelihood that the value of sales will be within the shaded area for the forecast period. You can configure the confidence level percentile for the prediction bands, and whether prediction bands are included in the forecast, using the **Show prediction intervals** setting in the Forecast Options dialog box:

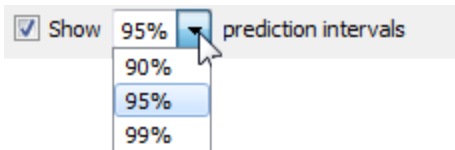

Clear the check box if you do not want to display prediction bands in forecasts. To set the prediction interval, select one of the values or enter a custom value. The lower the percentile you set for the confidence level, the narrower the prediction bands will be.

How your prediction intervals are displayed depends on the mark type of your forecasted marks:

Forecast mark type	Prediction intervals displayed using
Line	Bands
Shape, square, circle, bar, or pie	Whiskers

In the following example, forecast data is indicated by lighter shaded circles, and the prediction intervals are indicated by lines ending in whiskers:

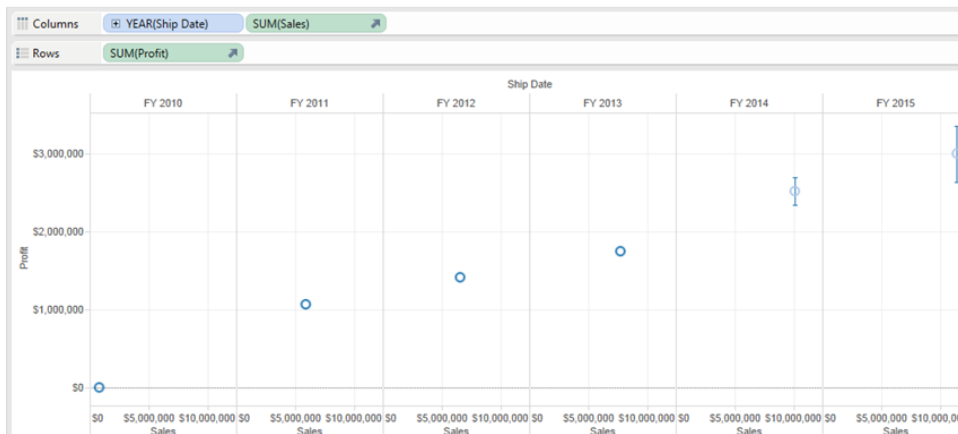

Enhancing Forecasts

For each forecast value, consider verifying the quality or precision of your forecast by dragging another instance of the forecast measure from the **Data** pane to the Detail shelf on the Marks card and then after right-clicking the field to open the content menu, choosing one of the available options:

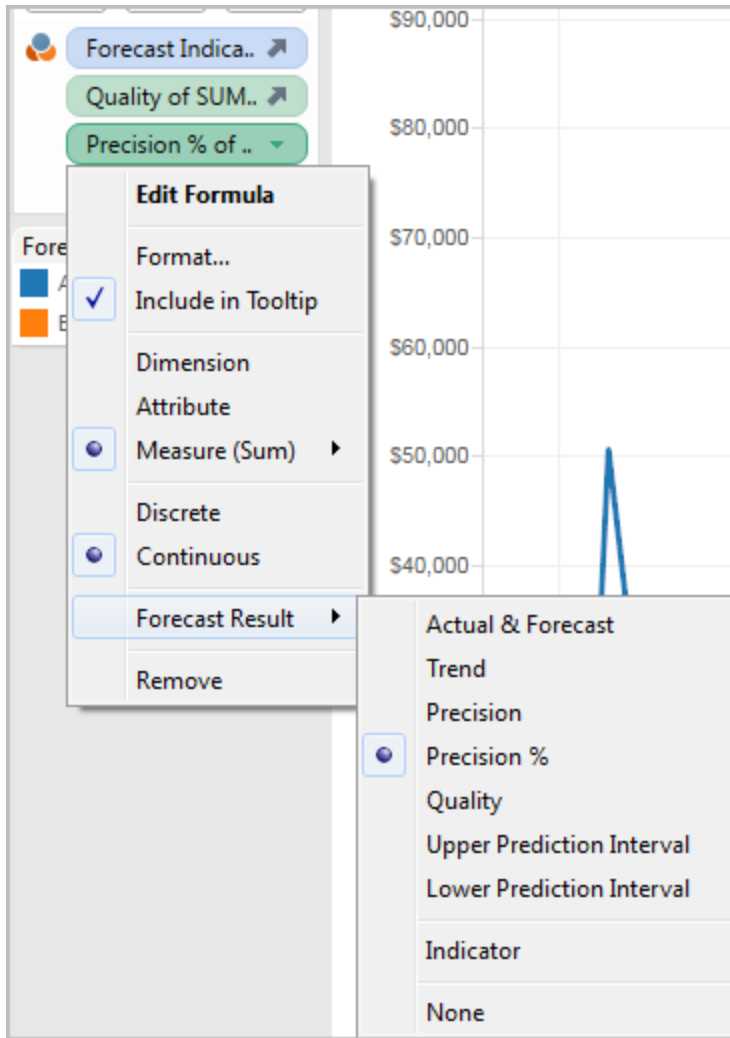

For descriptions of these options, see [Forecast Field Results](#) on the next page.

You can repeat the process to add additional result types for each forecast value. See "Changing the Forecast Result" type in [Forecast Field Results](#) on the next page for information on changing the result type.

By adding such result types to the Details shelf, you add information about the forecast to tooltips for all marks that are based on forecasted data.

Forecast Indicator:	Estimate
Month of Ship Date:	April 2015
Precision % of Sales:	±38.00%
Quality of Sales:	64
Sales:	\$54,753

Forecasting When No Date is in the View

If a valid date is not in the view, Tableau will look for a dimension in the view that has integer values. If it finds such a dimension it will use that to forecast additional values for measures in the view. As with a date, when an integer dimension is selected to order the measures to be forecast, it is no longer used to partition the data. If there is more than one such integer dimension, Tableau will go in this order:

- An integer dimension on the Columns shelf. If there is more than one such dimension, it will use the first one (farthest to the left on the shelf).
- An integer dimension on the Rows shelf.
- An integer dimension on the Pages shelf.
- An integer dimension on the Marks card.

When Tableau is using an integer dimension to forecast, the Forecast Option and Forecast Description dialog boxes will automatically specify that forecasting is aggregating by periods:

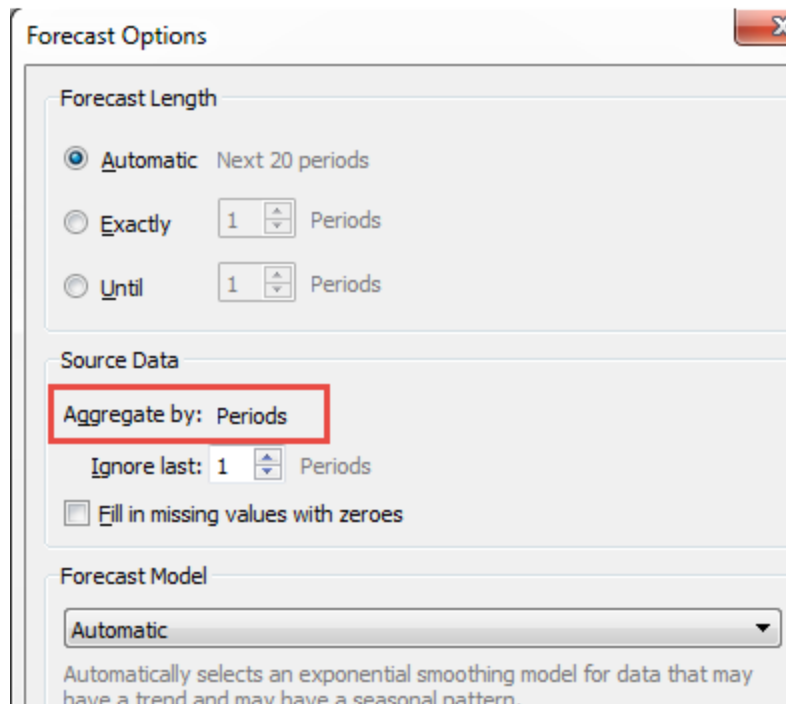

Forecast Field Results

Tableau provides several types of forecast results. To view these result types in the view, right-click (control-click on Mac) on the measure field, choose **Forecast Result**, and then choose one

of the options.

The options are:

- **Actual & Forecast**—Show the actual data extended by forecasted data.
- **Trend**—Show the forecast value with the seasonal component removed.
- **Precision**—Show the prediction interval distance from the forecast value for the configured confidence level.
- **Precision %**—Show precision as a percentage of the forecast value.
- **Quality**—Show the quality of the forecast, on a scale of 0 (worst) to 100 (best). This metric is scaled MASE, based on the MASE (Mean Absolute Scaled Error) of the forecast, which is the ratio of forecast error to the errors of a naïve forecast which assumes that the value of the current period will be the same as the value of the next period. The actual equation used for quality is:

$$100 * \text{MAX}(1 - \text{MASE}, 0)$$

The quality for a naïve forecast would be 0. The advantage of the MASE metric over the more common MAPE is that MASE is defined for time series which contain zero, whereas MAPE is not. In addition, MASE weights errors equally while MAPE weights positive and/or extreme errors more heavily.

- **Upper Prediction Interval**—Shows 90, 95, or 99 confidence level above the forecast value (that is, if the confidence level is 90, the true future value will be above the upper prediction interval 10% of the time) assuming a high quality model. The confidence level percentage is controlled by the **Prediction Interval** setting in the Forecast Options dialog box. See [Configure Forecast Options on the next page](#).
- **Lower Prediction Interval**—Shows 90, 95, or 99 confidence level below the forecast value. The actual interval is controlled by the **Prediction Interval** setting in the Forecast Options dialog box.
- **Indicator**—Show the string **Actual** for rows that were already on the worksheet when forecasting was inactive and **Estimate** for rows that were added when forecasting was activated.
- **None**—Do not show forecast data for this measure.

Forecast description information is also included in the worksheet description. See [Get Details About Fields and Sheets in a Workbook on page 2015](#).

Forecasting a New Measure

When you add a new measure to a visualization that already has forecasting enabled, Tableau attempts to forecast future values.

Changing the Forecast Result Type

To change the forecast result type for a measure, right-click (control-click on Mac) on the measure field, select **Forecast Result**, and then choose a result type.

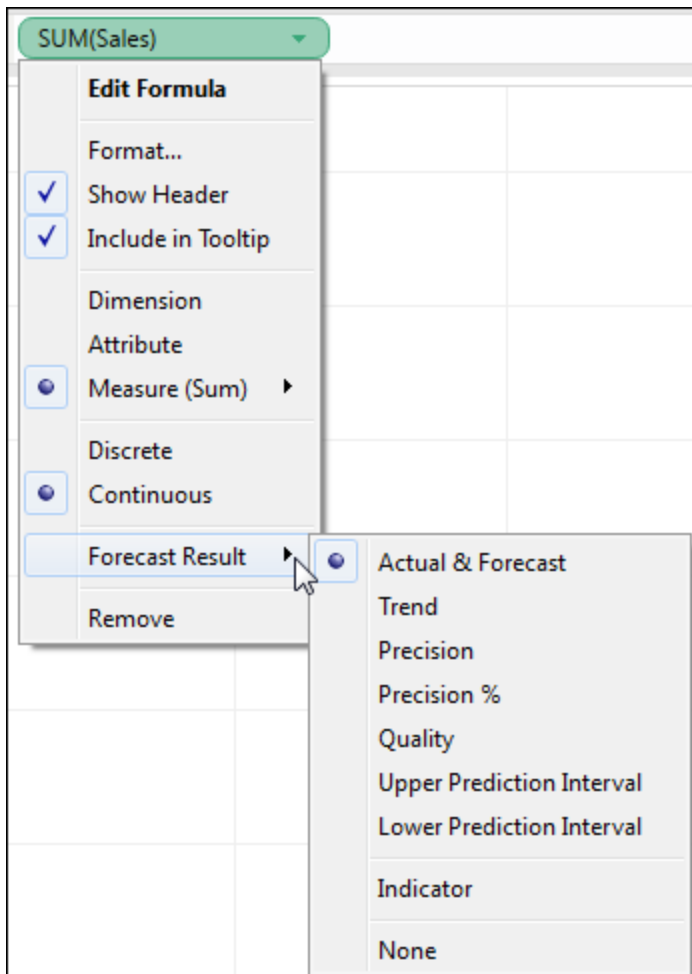

Configure Forecast Options

Use the Forecast Options dialog box to configure forecast options, including:

- The length of the forecast
- The range and temporal aggregation of source data from which to generate the forecast
- The forecast model
- Prediction intervals

When forecasting is enabled, you can open the Forecast Options dialog box by choosing **Analysis > Forecast > Forecast Options**.

Forecast Length

The **Forecast Length** section determines how far into the future the forecast extends. Select one of the following:

- **Automatic:** Tableau determines the forecast length based on the data.
- **Exactly:** Extends the forecast for the specified number of units.
- **Until:** Extends the forecast to the specified point in the future.

Source Data

Use the **Source Data** section to specify.

- **Aggregate by:** Specifies the temporal granularity of the time series. With the default value (**Automatic**), Tableau chooses the best granularity for estimation. This will typically match the temporal granularity of the visualization (that is, the date dimension that the forecast is based on). However, it is sometimes possible and desirable to estimate the forecast model at a finer granularity than the visualization when the time series in the visualization is too short to allow estimation.

Note: When you are using an integer dimension instead of a date dimension for forecasting, the Aggregate by value is always Periods. See [Forecasting When No Date is in the View on page 2556](#).

- **Ignore last:** Specifies the number of periods at the end of the actual data that should be ignored in estimating the forecast model. Forecast data is used instead of actual data for these time periods. Use this feature to trim off unreliable or partial trailing periods which could mislead the forecast. When the estimation granularity specified in the **Source Data** section is finer than in the visualization, the trimmed periods are estimation periods. As a result, the trailing actual visualization period may become a forecast period, which is an aggregate of both actual and forecast periods of estimation granularity. In contrast, null

values are not filled with zeros and must be filtered to allow forecast.

- **Fill in missing values with zeros:** If there are missing values in the measure you are attempting to forecast, you can specify that Tableau fill in these missing values with zero.

Forecast Model

The **Forecast Model** section specifies how the forecast model is to be produced.

Use the drop down to specify whether Tableau selects what it determines to be the best of all models (**Automatic**), the best of those with no seasonal component (**Automatic without seasonality**), or the model you specify (**Custom**).

When you choose the **Custom** option, two new fields appear in the Forecast Options dialog box, which you use to specify the trend and season characteristics for your model:

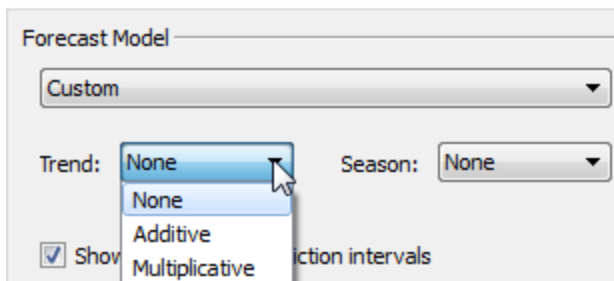

The choices are the same for both fields:

- **None:** When you select **None** for Trend, the model does not assess the data for trend. When you select **None** for Season, the model does not assess the data for seasonality.
- **Additive:** An additive model is one in which the combined effect of several independent factors is the sum of the isolated effects of each factor. You can assess the data in your view for additive trend, additive seasonality, or both.
- **Multiplicative :** A multiplicative model is one in which the combined effect of several independent factors is the product of the isolated effects of each factor. You can assess the data in your view for multiplicative trend, multiplicative seasonality, or both.

If there is more than one time series in your visualization, the Custom option forces them all to be forecast using the same custom model. Constraining the models in this way usually results in lower quality models than would be produced by automatic model selection.

Constraints on Multiplicative Models

- You cannot use a multiplicative model when the measure to be forecast has one or more values that are less than or equal to zero, or even when some of the data points are too close to zero, relative to other data points.
- You cannot specify a model with multiplicative trend and additive season because the result may be numerically unstable.

Prediction Interval

You can set the prediction interval to 90, 95, or 99 percent, or enter a custom value. This value is used in two locations:

- In the prediction bands displayed with a forecast.
- For the prediction interval options (**Upper Prediction Interval** and **Lower Prediction**

Interval) that are available as forecast result types for a measure in the view:

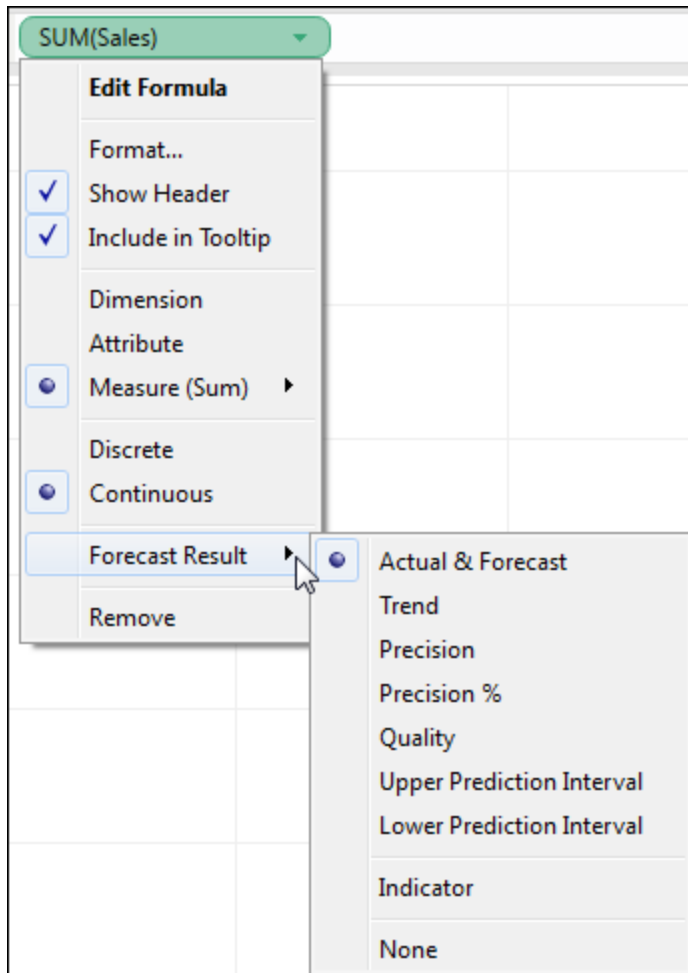

Forecast Summary

The text box at the bottom of the Forecast Options dialog box provides a description of the current forecast. The forecast summary updates whenever you change any of the forecast options above. If there is a problem with the forecast, the text box provides an error message that may help you resolve the issue. See [Resolving Forecasting Errors](#) on page 2568.

Forecast Descriptions

The **Describe Forecast** dialog box describes the forecast models that Tableau computed for your visualization.

When forecasting is enabled, you can open this dialog by selecting **Analysis > Forecast > Describe Forecast**.

The information in the Describe Forecast dialog box is read-only, though you can click **Copy to Clipboard** and then paste the screen contents into a document.

The **Describe Forecast** dialog box has two tabs: a **Summary** tab and a **Models** tab.

Describe Forecast - Summary Tab

The **Summary** tab describes the forecast models Tableau has created, as well as the general patterns Tableau discovered in the data.

Options Used To Create Forecasts

This section summarizes the options Tableau used to create forecasts. These options were either picked automatically by Tableau or specified in the Forecast Options dialog box.

- **Time series**—The continuous date field used to define the time series. In some cases this value might not actually be a date. See [Forecasting When No Date is in the View on page 2556](#).
- **Measures**—The measures for which values are estimated.
- **Forecast forward**—The length and date range of the forecast.
- **Forecast based on**—The date range of the actual data used to create the forecast.
- **Ignore last**—The number of periods at the end of the actual data that are disregarded--forecast data is displayed for these periods. This value is determined by the **Ignore Last** option in the Forecast Options dialog box.
- **Seasonal pattern**—The length of the seasonal cycle that Tableau found in the data, or None if no seasonal cycle was found in any forecast.

Forecast Summary Tables

For each measure that is forecasted, a summary table is displayed describing the forecast. If the view is broken into multiple panes using dimensions, a column is inserted into each table that identifies the dimensions. The fields in summary forecast tables are:

- **Initial**—The value and prediction interval of the first forecast period.
- **Change From Initial**—The difference between the first and the last forecast estimate points. The interval for those two points is shown in the column header. When values are shown as percentages, this field shows the percentage change from the first forecast period.

- **Seasonal Effect**—These fields are displayed for models identified as having seasonality—that is, a repeating pattern of variation over time. They show the high and low value of the seasonal component of the last full seasonal cycle in the combined time series of actual and forecast values. The seasonal component expresses the deviation from the trend and so varies around zero and sums to zero over the course of a season.
- **Contribution**—The extent to which Trend and Seasonality contribute to the forecast. These values are always expressed as percentages and add up to 100%.
- **Quality**—Indicates how well the forecast fits the actual data. Possible values are GOOD, OK, and POOR. A naïve forecast is defined as a forecast that estimates that the value of the next period will be identical to the value of the current period. Quality is expressed relative to a naïve forecast, such that OK means the forecast is likely to have less error than a naïve forecast, GOOD means that the forecast has less than half as much error, and POOR means that the forecast has more error.

Describe Forecast - Models Tab

The **Models** tab provides more exhaustive statistics and smoothing coefficient values for the Holt-Winters exponential smoothing models underlying the forecasts. For each measure that is forecasted, a table is displayed describing the forecast models Tableau created for the measure. If the view is broken into multiple panes using dimensions, a column is inserted into each table that identifies the dimensions. The table is organized into the following sections:

Model

Specifies whether the components **Level**, **Trend**, or **Season** are part of the model used to generate the forecast. The value for each component is one of the following:

- **None**—The component is not present in the model.
- **Additive**—The component is present and is added to the other components to create the overall forecast value.
- **Multiplicative**—The component is present and is multiplied by the other components to create the overall forecast value.

Quality Metrics

This set of values provides statistical information about the quality of the model.

Value	Definition
-------	------------

<p>RMSE: Root mean squared error</p>	$\sqrt{\left(\frac{1}{n}\right) \sum e(t)^2}$
<p>MAE: Mean absolute error</p>	$\frac{1}{n} \sum e(t) $
<p>MASE: Mean absolute scaled error.</p> <p>MASE measures the magnitude of the error compared to the magnitude of the error of a naive one-step ahead forecast as a ratio. A naive forecast assumes that whatever the value is today will be same value tomorrow. So, a MASE of 0.5 means that your forecast is likely to have half as much error as a naive forecast, which is better than a MASE of 1.0, which is no better than a naive forecast. Since this is a normalized statistic that is defined for all values and weighs errors evenly, it is an excellent metric for comparing the quality of different forecast methods.</p> <p>The advantage of MASE over the more common MAPE metric is that MASE is defined for time series that contain zero, whereas MAPE is not. Also, MASE weights errors equally, whereas MAPE weights positive and/or extreme errors more heavily.</p>	$\frac{\frac{1}{n} \sum e(t) }{\frac{1}{(n-1)} \sum \frac{n}{2} Y(t) - Y(t-1) }$
<p>MAPE: Mean absolute percentage error.</p> <p>MAPE measures the magnitude of the error compared to the magnitude of your data, as a percentage. So, a MAPE of 20% is better than a MAPE of 60%. Errors are the differences between the response values, which the model estimates, and the actual response values for each</p>	$100 \frac{1}{n} \sum \left \frac{e(t)}{A(t)} \right $

explanatory value in your data. Since this is a normalized statistic, it can be used to compare the quality of different models computed in Tableau. However, it is unreliable for some comparisons because it weights some kinds of error more heavily than others. Also, it is undefined for data with values of zero.

AIC: Akaike information criterion.

AIC is a model quality measure, developed by Hirotugu Akaike, that penalizes complex models to prevent overfitting. In this definition, k is the number of estimated parameters, including initial states, and SSE is the sum of the squared errors.

$$n * \log(SSE/n) + 2 * (k + 1)$$

In the preceding definitions, the variables are as follow:

Variable	Meaning
t	Index of a period in a time series.
n	Time series length.
m	Number of periods in a season/cycle.
A(t)	Actual value of the time series at period t.
F(t)	Fitted or forecast value at period t.

Residuals are: $e(t) = F(t) - A(t)$

Smoothing Coefficients

Depending on the rate of evolution in the level, trend, or seasonal components of the data, smoothing coefficients are optimized to weight more recent data values over older ones, such that within-sample one-step-ahead forecast errors are minimized. Alpha is the level smoothing coefficient, beta the trend smoothing coefficient, and gamma the seasonal smoothing coefficient. The closer a smoothing coefficient is to 1.00, the less smoothing is performed, allowing for rapid component changes and heavy reliance on recent data. The closer a

smoothing coefficient is to 0.00, the more smoothing is performed, allowing for gradual component changes and less reliance on recent data.

Troubleshooting Forecasting

This topic discusses some issues that may arise as you use forecasting in Tableau.

Null Forecasts

A null forecast results when you are using forecasting and modify the view in a manner that is incompatible with forecasting. The most obvious indication that you have a null forecast is that no forecast data is displayed in your view and the text No Forecast is displayed. Hover the cursor over this message to see why Tableau is unable to create a forecast:

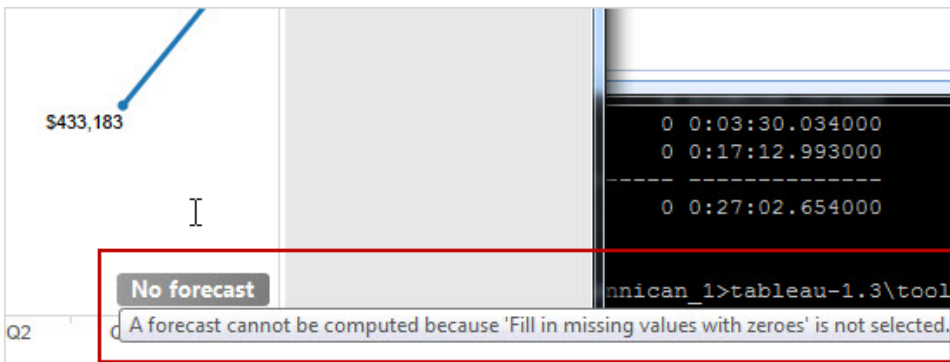

Another indication is that the **Forecast Indicator** field on the Marks card shows Actual values, but no Estimate values:

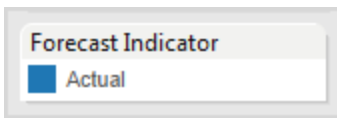

To diagnose a null forecast, open the Describe Forecast dialog box from the Analysis menu (**Analysis > Forecast > Describe Forecast**) to see the error message. Then see [Resolving Forecasting Errors on the next page](#) for a suggested resolution.

Tableau also displays the error message in the Forecast Options dialog box (**Analysis > Forecast > Forecast Options**).

Because a forecast cannot be computed for a time series with null date values in the middle, actions that filter data, either explicitly or implicitly can trigger a null forecast. The **Keep Only** and

Exclude commands on tooltips are examples of actions that can filter data implicitly—in some cases, these commands are removed when a forecast is shown. For example, if you have a time series of sales for each quarter from 2008 until 2012 and you exclude the Sales value for the second quarter of 2010, you will get a Null forecast because the time series is irregular. If, instead, you exclude the first quarter of 2008, you have shortened the time series but it remains regular. So, a valid forecast is still possible.

Resolving Forecasting Errors

If Tableau is unable to provide a forecast for your view, the problem can often be resolved by changing the Date value in the view (see [Change Date Levels on page 1153](#)).

Forecasting errors can result when the aggregation level of the time series (months, weeks, etc.) is either too fine or too coarse for the data to be forecast. This can lead to the "too much data" or "too little data" errors described below. Date aggregation can trigger a "too many Nulls" scenario when forecasting attempts to extract more data from the measure than is possible. For example, if the underlying granularity of the sales data is months but you aggregate by weeks, the result may be a significant number of Null values.

Other problems arise when the view's aggregation and the aggregation specified for the forecast (using the **Aggregate by** field in the Forecast Options dialog box) are not compatible. Tableau can create a forecast when the forecast aggregation is a finer level of detail than the view's aggregation, but not when it is at a coarser level of detail; even when it is finer, the two values are only compatible if there is a strict hierarchy that Tableau can use (for example, quarters can be evenly divided into three months, but months can't be evenly divided into weeks). Avoid these scenarios by setting **Aggregate by** to Automatic.

The following list shows errors that can be result from invalid forecasts in Tableau, and provides advice on how to resolve them.

Error message	Suggestion for Resolution
A continuous date cannot be derived from the date fields in the view.	<p>Forecasting requires a date field that can be interpreted continuously. If the date field is not explicitly continuous, then one of the included date levels must be Year.</p> <p>This error is returned if there are no dates in the view, or if the dates in the view don't constitute a full hierarchy (for example, the date includes Year and Day, but not Month), or if they constitute a hierarchy that is not supported (for example, Year, Week, Day).</p>

<p>The time series is too short to forecast.</p>	<p>Expand the time series in your view to include more date values.</p> <p>This error is returned if there are fewer than four data points after trimming off unreliable or partial trailing periods which could mislead the forecast.</p>
<p>A forecast cannot be computed for a time series with Null date values.</p>	<p>Eliminate any Null values from the date field or fields in the view, either by filtering the date field or by using a less detailed date granularity (for example, by switching from months to quarters).</p>
<p>A forecast cannot be computed when the view contains multiple distinct date fields.</p>	<p>This error is returned if there are multiple date fields in the view. For example, if both Order Date and Ship Date are in the same view, forecasting is not supported.</p>
<p>The selected 'Aggregate by' value in Forecast Options is not compatible with the visualization.</p>	<p>The date in the view must be compatible with the value of Aggregate by in the Forecast Options dialog box. For example, if Aggregate by is set to Weeks and the date in the view is set to Months, this error occurs.</p> <p>Change one of the dates so that the two are compatible, or set Aggregate by to Automatic.</p>
<p>A forecast cannot be computed because there are too many missing values.</p>	<p>This error is returned if more than 40% of the data in a pane is missing.</p> <p>Selecting Fill in missing values with zeros in the Forecast Options dialog box will not resolve this error. Aggregate your data to a higher level of detail by removing dimensions or changing the date level, for example from 'weeks' to 'months'.</p> <p>Otherwise, you must modify the source data or use data from a different source.</p>
<p>There is no measure to forecast.</p>	<p>This error is returned if no measure that can be forecast is present in the view. Forecast measures must be on the Rows or Columns shelf, or on the Marks card.</p>
<p>The measure to forecast</p>	<p>Some measures cannot be interpreted numerically and there-</p>

must be a number.	fore cannot be forecast.
A forecast cannot be computed for a dimension.	The value to be forecast must be a measure, and not a dimension.
There is too much data to compute a forecast.	Forecasting is not possible when the result set from the query is too large. The limit is about 10,000 rows. To fix the forecast, aggregate the time series value at a higher level (for example, Month instead of Week) or filter the data.
A forecast cannot be computed because the data is divided into too many rows, columns, or colors.	Simplify the view to resolve the error by filtering or removing some of the dimensions.
A forecast cannot be computed because the view contains table calculations.	Create a version of the view that does not contain table calculations.
A forecast cannot be computed because there is a measure on the Filters shelf.	Remove the measure from the Filters shelf.
A forecast cannot be computed because Aggregate Measures is not selected.	Aggregate Measures is an option on the Analysis menu. See Data Aggregation in Tableau on page 171 and How to Disaggregate Data on page 180.
A forecast cannot be computed because the view contains percent calculations.	Percentage of is an option on the Analysis menu. See Calculate Percentages in Tableau on page 2686.
A forecast cannot be computed because Grand Totals or Subtotals is enabled.	These options are controlled from the Totals command in the Analysis menu. See Show Totals in a Visualization on page 1354.
A multiplicative model cannot be computed because the measure to be forecast	You have created a custom model with Trend or Seasonality set to Multiplicative . Change this value, or set the Forecast Model to Automatic .

has one or more values that are less than or equal to zero.	
A model with multiplicative trend and additive season is not allowed because it is numerically unstable.	You have created a custom model configured as described in the error message. Change the settings for the custom model, or set the Forecast Model to Automatic .
A seasonal model cannot be computed because the time series is too short.	Expand the time series in your view to include more date values.
The selected multiplicative model cannot be computed because some of the data is too close to zero relative to the rest of the data.	You have created a custom model configured as described in the error message. Change the settings for the custom model, or set the Forecast Model to Automatic .

Predictive Modeling

Predictive modeling functions in Tableau use linear regression to build predictive models and generate predictions about your data. Two [table calculations](#), MODEL_PERCENTILE and MODEL_QUANTILE, can generate predictions and surface relationships within your data. These can be used to identify outliers, estimate values for sparse or missing data, and predict values for future time periods.

This section provides all the documentation you need to get started with predictive modeling functions in Tableau.

How Predictive Modeling Functions Work in Tableau

You can already add [trend lines](#) and [forecasts](#) to a visualization, but now you can go beyond this, using the power of a statistical engine to build a model that understands how your data is distributed around such a trend line, or line of best fit. Previously, users had to integrate Tableau with R and Python in order to perform advanced statistical calculations and visualize them in Tableau. Now, you can use the predictive modeling functions to make predictions from your data by including them in a table calculation. For more information about table calculations, see [Transform Values with Table Calculations](#).

With these predictive modeling functions, you can select targets and predictors by updating the variables and visualizing multiple models with different combinations of predictors. The data can be filtered, aggregated, and transformed at any level of detail, and the model—and thus the prediction—will automatically recalculate to match your data.

For a detailed example that shows how to create prediction calculations using these functions, see [Example - Explore Female Life Expectancy with Predictive Modeling Functions](#) on page 2601.

Predictive modeling functions available in Tableau

MODEL_PERCENTILE

Syntax	<code>MODEL_PERCENTILE (model_specification (optional), target_expression, predictor_expression(s))</code>
Definition	Returns the probability (between 0 and 1) of the expected value being less than or equal to the observed mark, defined by the target expression and other predictors. This is the Posterior Predictive Distribution Function, also known as the Cumulative Distribution Function (CDF).
Example	<code>MODEL_PERCENTILE (SUM([Sales]), COUNT([Orders]))</code>

MODEL_QUANTILE

Syntax	<code>MODEL_QUANTILE (model_specification (optional), quantile, target_expression, predictor_expression(s))</code>
Definition	Returns a target numeric value within the probable range defined by the target expression and other predictors, at a specified quantile. This is the Posterior Predictive Quantile.
Example	<code>MODEL_QUANTILE(0.5, SUM([Sales]), COUNT([Orders]))</code>

The power of predictive modeling functions

Let's look at an example using salary data, starting with MODEL_QUANTILE.

In the example below, MODEL_QUANTILE has been used to display the 10th percentile and the 90th percentile of the expected distribution for the same data set. Based on the existing data and using a linear regression model, the statistical engine has determined that there is a 90% probability that the maximum salary for each tenure will be below the green line, and a 10% probability that the minimum salary for each tenure will be below the blue line.

In other words, with the quantile set at 0.9, the model predicts all salaries will fall at or below the green line 90% of the time. The blue line is set at .1 or 10%, so only 10% of salaries will fall at or below the blue line, with the inverse of that (90%) above the blue line.

Effectively, this gives us a band that we can predict 80% of potentially generated future points or unobserved data will fall inside.

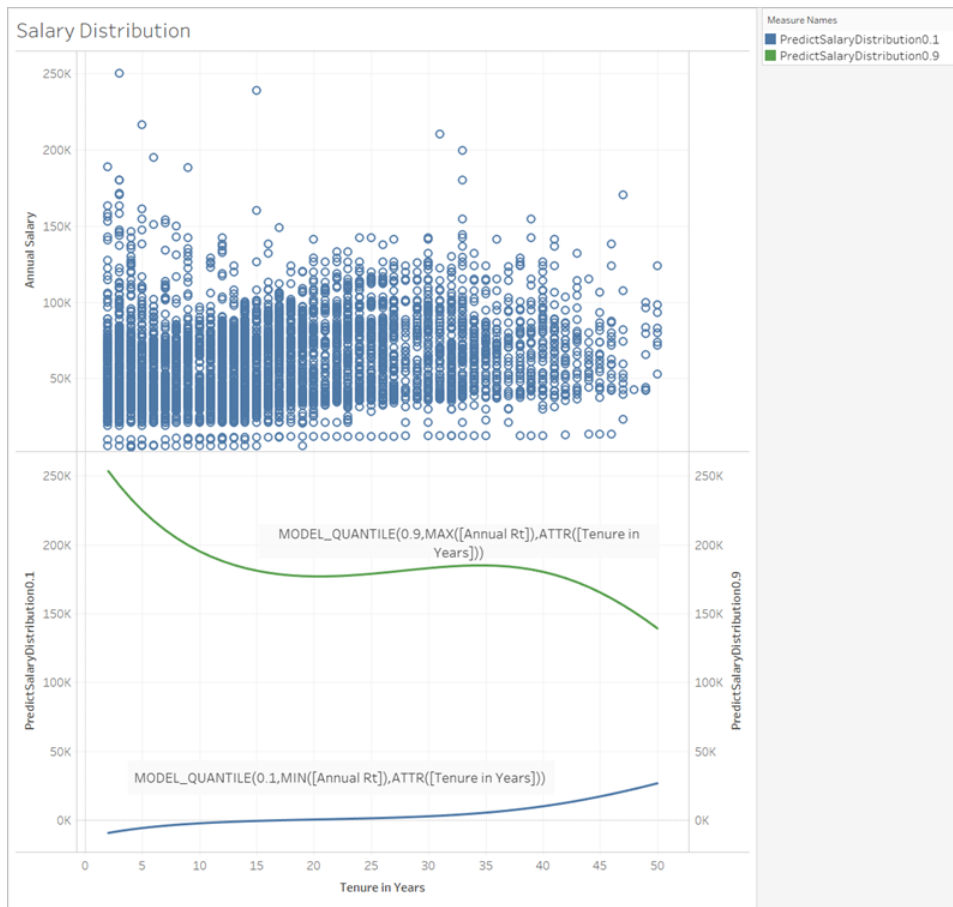

Next, let's see how MODEL_PERCENTILE, the inverse of MODEL_QUANTILE, can help us understand the data further.

You can identify the outliers of the data set by using the MODEL_PERCENTILE function. MODEL_PERCENTILE tells you, as a percentile, where the observed mark falls within a range of probable values for each mark. If the percentile is very close to 0.5, the value observed is very close to the median value predicted. If the percentile is close to 0 or 1, the value observed is at the lower or upper boundaries of the model range and is relatively unexpected.

Below, we have applied MODEL_PERCENTILE as color to the salary visualization in the top half of the image, to help us understand which values are most expected.

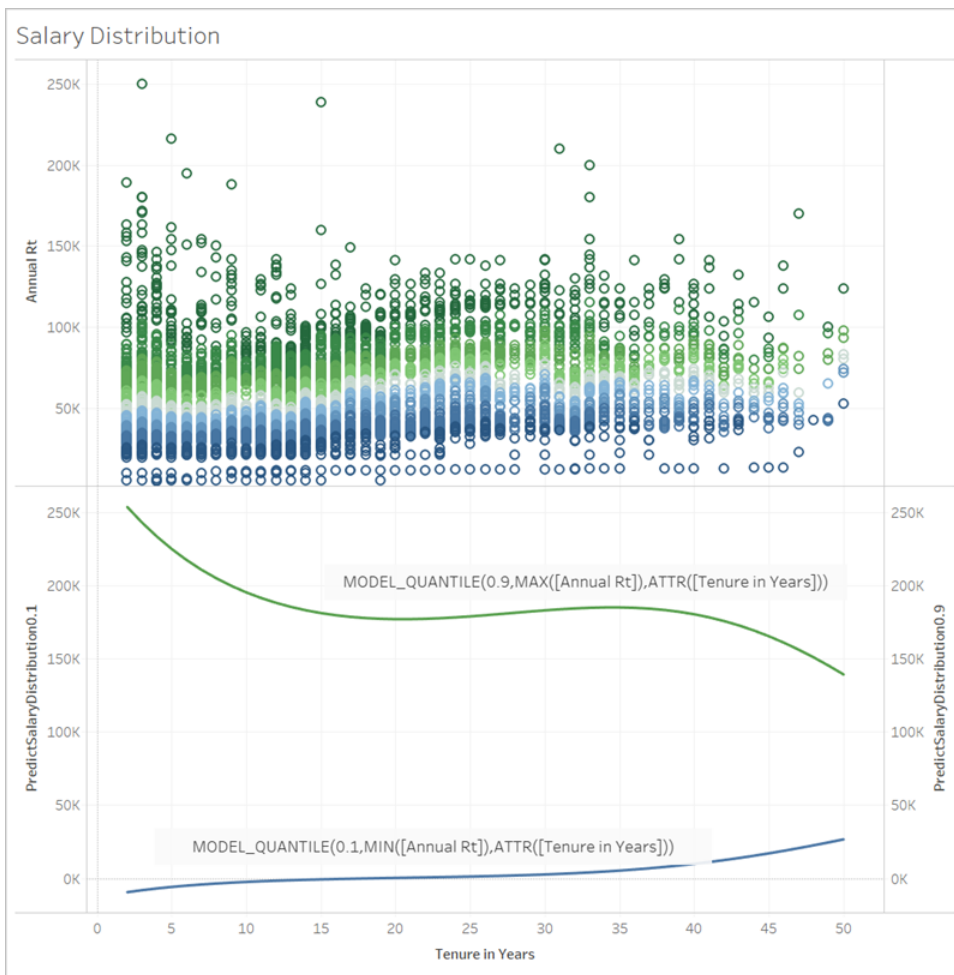

Syntax of predictive modeling functions in detail

What is MODEL_QUANTILE?

MODEL_QUANTILE calculates the posterior predictive quantile, or the expected value at a specified quantile.

- **Quantile:** The first argument is a number between 0 and 1, indicating what quantile should be predicted. For example, 0.5 specifies that the median will be predicted.
- **Target expression:** The second argument is the measure to predict or “target.”
- **Predictor expression(s):** The third argument is the predictor used to make the prediction. Predictors can be dimensions, measures, or both.

The result is a number within the probable range.

You can use MODEL_QUANTILE to generate a confidence interval, missing values such as future dates, or to generate categories that don't exist in your underlying data set.

What is MODEL_PERCENTILE?

MODEL_PERCENTILE calculates the posterior predictive distribution function, also known as the Cumulative Distribution Function (CDF). This calculates the quantile of a particular value between 0 and 1, the inverse of MODEL_QUANTILE.

- **Target expression:** The first argument is the measure to target, identifying which values to assess.
- **Predictor expression(s):** The second argument is the predictor used to make the prediction.
- Additional arguments are optional and are included to control the prediction.

Notice that the calculation syntax is similar, with MODEL_QUANTILE having the extra argument of a defined quantile.

The result is the probability of the expected value being less than or equal to the observed value expressed in the mark.

You can use MODEL_PERCENTILE to surface correlations and relationships within your database. If MODEL_PERCENTILE returns a value close to 0.5, the observed mark is near the median of the range of predicted values, given the other predictors that you've selected. If MODEL_PERCENTILE returns a value close to 0 or to 1, the observed mark is near the lower or upper range of what the model expects, given the other predictors that you've selected.

Note: Dimensions used as predictors can be *ordered* or *unordered*. An ordered dimension is any whose values can be sequenced, such as MONTH. An unordered dimension is any whose

values don't have an inherent sequence, such as gender or color. This distinction matters when using Gaussian process regression. For more information on this model and others, see [Choosing a Predictive Model](#) on page 2579.

For advanced users, there are two other optional arguments you can include to control the prediction. For more information, see [Regularization and Augmentation in Predictive Modeling](#) on page 2623.

What's being computed?

The input used to build the model is a matrix where each mark is a row, and the columns are the target expression and predictor expressions evaluated for each mark. Whatever row is specified on the viz is what defines the row for the data set being computed by the statistical engine.

Let's look at the example below, where rows (and thus marks) are defined by job titles, and columns are the target expression MEDIAN([Annual Rt]). These are followed by the optional additional predictors MEDIAN([Tenure in Months (Measure)]) and ATTR([Department Generic (group)]).

Jobtitle	Actual Median Annual Rt	Median Tenure in Months (Measure)	Department
911 Lead Operator	60,425	287	Fire Department
911 Operator	53,134	141	Fire Department
911 Operator Supervisor	66,537	423	Fire Department
Account Executive	60,700	35	M-R
Account Executive Supervisor	73,900	70	M-R
Accountant I	52,268	75	*
Accountant II	61,451	102	*
Accountant Supervisor	71,300	225	*
Accounting Assistant I	32,003	113	*
Accounting Assistant II	34,011	61	*
Accounting Assistant III	46,758	206	*
Accounting Asst II	32,271	58	M-R
Accounting Asst III	41,810	60	M-R
Accounting Manager	88,100	123	*
Accounting Systems Admin	68,136	137	Finance

Note: Several job titles have an asterisk listed under Department. This is because those job titles exist in several departments but Tableau treats all of them as though they are in the same department. In addition, the statistical engine doesn't consider the number of records, and treats each mark as equally likely. This is because Tableau can't perform table calculations on unaggregated data, and can't aggregate the results of table calculations. For more information on aggregation, see [Data Aggregation in Tableau](#).

For more information on the data used to build a model and generate predictions, see [Compute Using and Data Partitioning in Predictive Modeling](#) on page 2592.

What models are supported?

Predictive modeling functions support linear regression, regularized linear regression, and Gaussian process regression. These models support different use cases and prediction types, as well as have different limitations. For more information, see [Choosing a Predictive Model on page 2579](#).

Choosing your predictors

A predictor can be any field in your data source—measure or dimension—including calculated fields.

Note: If using a dimension as a predictor, you must use a ATTR wrapper (e.g. ATTR([State]) rather than just [State]). This is because dimensions will generally only work if they are in the level of detail in the visualization either directly, or above it in a hierarchy.

For example, suppose you have a data set that includes the fields [City], [State], and [Region], where multiple [City] records exist within a [State], and multiple [State] records within a [Region].

In a visualization that uses [State] as a mark, the predictor ATTR([State]) or ATTR([Region]) will both work as predictors. However, the predictor ATTR([City]) will revert to *, since multiple cities exist within a visualized state and so cannot be used as predictors. In other words, including a predictor that's at a lower level of detail than the viz adds no value to the predictions. In most cases, a predictor at a lower level of detail than the viz will evaluate to * and so will all be treated identically.

However, if the same data set is used to generate a viz that uses [City] as a mark, ATTR([City]), ATTR([State]), and ATTR([Region]) can all be used successfully as predictors. For more information about the use of ATTR functions, see [When to Use the Attribute \(ATTR\) Function](#).

Dimensions and measures do not need to be visualized (in the view or viz) in order to be included as predictors. For more detailed guidance, see [Choosing Predictors on page 2581](#).

Recommendations

Prediction calculations are best used as follows:

- To predict values for individual records, where each mark in your viz represents a discrete entity such as a product, sale, person, etc., rather than aggregated data. This is because Tableau regards each mark as equally likely, even if one mark is made up of 100 records and the other marks are made up of one record each. The statistical engine does not weigh marks based on the number of records that make it up.
- To predict values for aggregated target expressions using SUM and COUNT.

Note: MODEL_QUANTILE and MODEL_PERCENTILE aren't recommended to predict values for aggregated target_expressions using AVG, MEDIAN, MIN, and MAX.

Limitations

- You must use a calculated field to extend a time series into the future. For more information, see [Predicting the Future](#).
- Predictors should be at the same or higher level of detail than the view. That is, if your view aggregates by state, you should use state or region as a predictor, but not city. For more information, see [Choosing Predictors on page 2581](#).

When will prediction calculations break?

Regardless of the model you're using, you must have at least three data points within each partition for the model to return a response.

If you have specified Gaussian process regression as your model, it can be used in predictive calculations with one **ordered** dimensional predictor and any number of **unordered** dimensional predictors. Measures aren't supported as predictors in Gaussian process regression calculations, but can be used in linear and regularized linear regression calculations. For more information on model selection, see [Choosing a Predictive Model on the facing page](#).

If your calculation used ATTR[State] as a predictor and your viz also included State as a mark but no other field at a lower level of detail, such as City, then you would return an error. To prevent this, simply ensure there is not a one-to-one relationship between marks and predictor categories.

For more information on these and other prediction problems, see [Resolve Errors in Predictive Modeling Functions](#).

FAQ

What about marks in multiple predictor-groups?

If a row is aggregated from data that exists within multiple predictor-groups, the value of the ATTR function is a special value of multiple values. For instance, all cities that exist in multiple states will have the same predicted value (unless there are other predictors that are distinct). When selecting your predictors, it's best to use predictors that are at the same level of detail as the viz or or higher. Again, for more information on ATTR functions, see [When to Use the Attribute \(ATTR\) Function](#).

What if ATTR Aggregation returns a * value?

* is treated as a distinct value. If ATTR returns * for all marks, then you, in essence, have a predictor with a constant value, which will be ignored. This is the same as not including that predictor at all.

If ATTR returns * for some but not all marks, then it will be treated as a category where all the * values are considered to be the same. This scenario is identical to the above scenario, in which marks exist in multiple predictor-groups.

What about the "Compute Using" table calculation menu options?

This functions identically to Compute Using in other table calculations. For more information, see [Compute Using and Data Partitioning in Predictive Modeling on page 2592](#).

Why am I getting an error?

There are several reasons why you might be encountering an error when using predictive modeling functions. For detailed troubleshooting steps, see [Resolve Errors in Predictive Modeling Functions](#).

Choosing a Predictive Model

Predictive modeling functions support linear regression, regularized linear regression, and Gaussian process regression. These models support different use cases and prediction types, as well as have different limitations.

Supported models

Linear regression

[Linear regression](#) (also known as ordinary least squares regression, or OLS) is best used when there are one or more predictors that have a linear relationship between the prediction and the prediction target, they aren't affected by the same underlying conditions, and they don't represent two instances of the same data (for example, sales expressed in both dollars and euros). Linear regression is the default model for predictive modeling functions in Tableau; if you don't specify a model, linear regression will be used. You can explicitly specify this model by including **"model=linear"** as the first argument in your table calculation.

Example:

```

MODEL_QUANTILE (
  "model=linear",
  0.5,
  SUM([Sales]),
  ATTR(DATETRUNC('month', ([Order Date])))
)

```

Regularized linear regression

Regularized linear regression is best used when there's an approximate linear relationship between two or more independent variables—also known as **multicollinearity**. This is frequently observed in real-world data sets. To use this model instead of the default linear regression, include **"model=rl"** as the first argument in your table calculation.

Example:

```

MODEL_QUANTILE (
  "model=rl",
  0.5,
  SUM([Sales]),
  ATTR(DATETRUNC('month', ([Order Date])))
)

```

Gaussian process regression

Gaussian process regression is best used when generating predictions across a continuous domain, such as time or space, or when there is a nonlinear relationship between the variable and the prediction target. Gaussian process regression in Tableau must have a single **ordered** dimension as a predictor but may include multiple **unordered** dimensions as predictors. Note that measures can't be used as predictors in Gaussian process regression in Tableau. To use this model instead of the default linear regression, include **"model=gp"** as the first argument in your table calculation.

Note: An *ordered* dimension is any whose values can be sequenced, such as MONTH. An *unordered* dimension is any whose values don't have an inherent sequence, such as gender or color.

Example:

```
MODEL_PERCENTILE (  
  "model=gp",  
  AVG([Days to Ship Actual]),  
  ATTR(DATETRUNC('month', ([Order Date])))  
)
```

As a simple heuristic, you can use the below criteria for selecting your model:

- **Linear regression (default):** Use when you have only one predictor, and that predictor has a linear relationship with your target metric.
- **Regularized linear regression:** Use when you have multiple predictors, especially when those predictors have a linear relationship to the target metric and those predictors are likely affected by similar underlying relationships or trends.
- **Gaussian process regression:** Use when you have time or space predictors, or when you're using predictors that might not have a linear relationship with the target metric.

Choosing Predictors

When creating prediction calculations using the [predictive modeling functions](#) in Tableau, you'll need to choose predictors. As a reminder, a predictor is an input variable whose value is used to predict an outcome variable, also known as the target or response. Often, you'll be working with data you have extensive domain knowledge of and will already have a good sense of which fields are strongly correlated with your prediction target, and would make good predictors. However, it's still a good idea to take the time to evaluate your predictors and ensure that you're choosing them wisely. You will *always* want to include at least one predictor, and usually more than one.

First, select your target. This sounds obvious, but making sure that you're selecting your predictors *based on what you want to predict* is a critical first step. For example, the fields that are most correlated with female life expectancy might be very different from the fields most correlated with male life expectancy. Similarly, the fields most correlated with sales could be very different from the fields most correlated with profit.

Another thing to keep in mind is that by default, the predictive modeling functions use [linear regression](#) as the underlying statistical model. With this model, the most correlated predictors are those that have a linear relationship with the target. For information on using another supported model, see [Choosing a Predictive Model on page 2579](#).

To better understand how to choose the best predictors for the questions you're aiming to answer, let's look at female life expectancy data. To follow along, download the following workbook from Tableau Public: [Choosing Predictors for Your Predictions](#).

Measures as predictors

When using a measure as a predictor, you can evaluate its correlation with your target using Tableau. One way is to build a [scatter plot](#). Below, we compare a country's median female life expectancy with a variety of other measures.

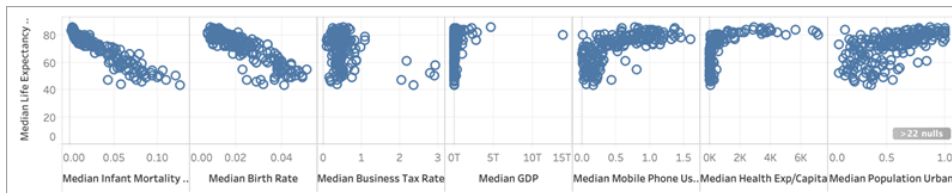

For some measures, like **Infant Mortality** and **Birth Rate**, there's a clear negative correlation with **Female Life Expectancy**, as seen in the negative slope of the scatter plot. For others, it's less clear. However, one thing that we can clearly see is an L-shaped distribution for **Median GDP**, **Median Mobile Phone Usage**, and **Median Health Exp/Capita**. This L-shaped distribution often indicates that using a [log transformation](#) can help you analyze your data more accurately. Another clue is if all a column's values are positive. In Tableau, you can use a log transformation by editing the pill and wrapping the expression in a [LOG function](#):

```
LOG(MEDIAN([GDP]))
```

This takes us from the L-shaped distribution—where it's hard to differentiate between the extremes of the scale—to a more even distribution less compressed by the extremes of the scale.

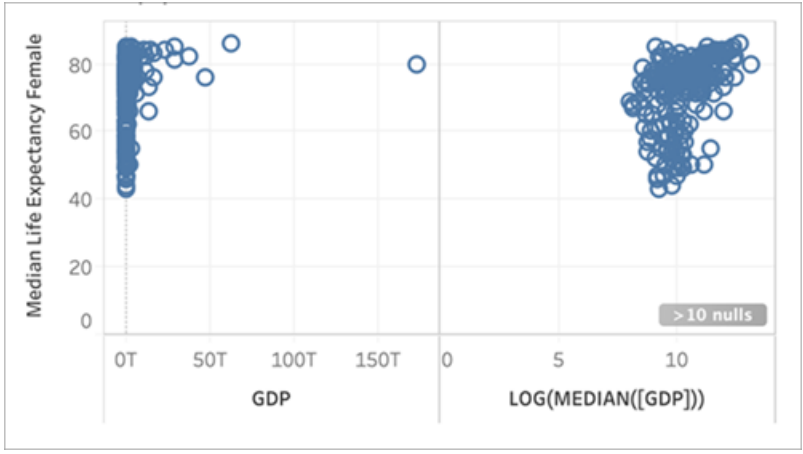

Repeating this with the other L-shaped distributions gives us the following:

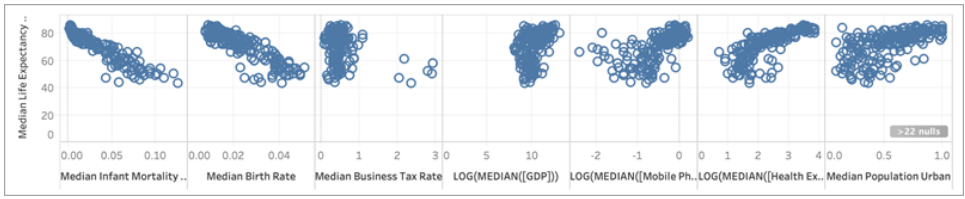

Coefficient of determination, or R-squared value

The closer the marks are to lying on a straight line, the higher the correlation between the two measures. To help evaluate the correlation, you can add **trend lines**. From the **Analytics** pane, drag **Trend Line** into the view and drop it on **Linear**. Hovering your cursor over the trend line will tell you the **R-squared** value, or coefficient of determination, which indicates how much of the dependent variable (the target) is explained by the independent variable (the predictor). Predictors with R-squared values closer to 1 are better than predictors with R-squared values closer to 0.

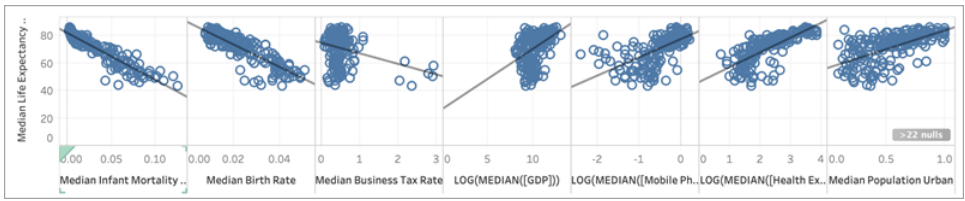

Looking at our scatter plots, we can see that the best predictor for median female life expectancy is median infant mortality, which has an R-squared value of 0.87:

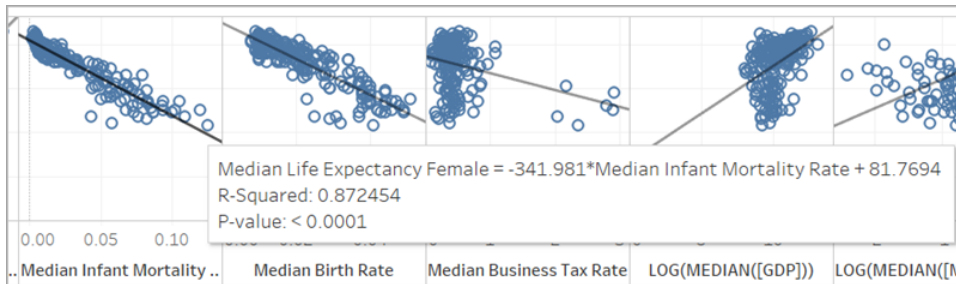

Other good predictors are **Median Birth Rate** (R-squared=0.76) and the log transformation of **Median Health Expenditure/Capita** (R-squared=0.56).

Note: The slope of the line does *not* clearly show you which predictors have the highest R-squared value. Since the scale of the x-axis is determined by the range of the specific variable selected, the slope of the line is greatly affected by the specific variables used.

In the below image, we've visualized **Median Female Life Expectancy** against **Median Female Life Expectancy**, with the resulting viz being a perfectly straight line on a 45° angle: as expected, there is a perfect correlation between the value on the x-axis and the value on the y-axis, with an R-squared value of 1:

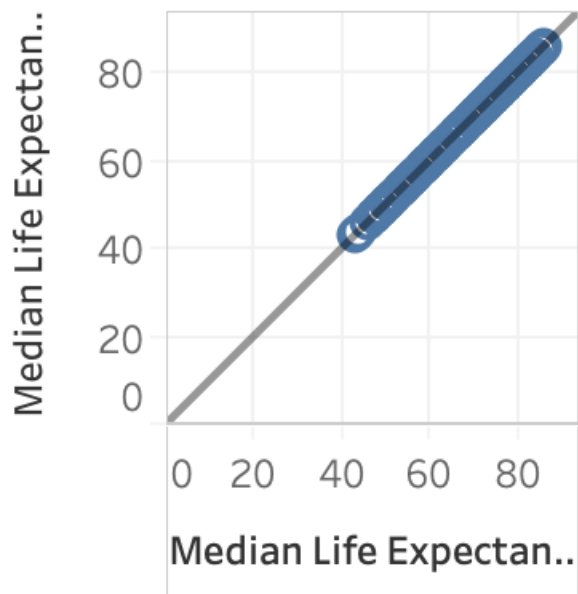

However, as shown below, even though LOG(MEDIAN([GDP])) has a steeper sloped trend line than the others, it has a low R-squared score of only 0.169. This is due to the scale of the x-axis for that pane:

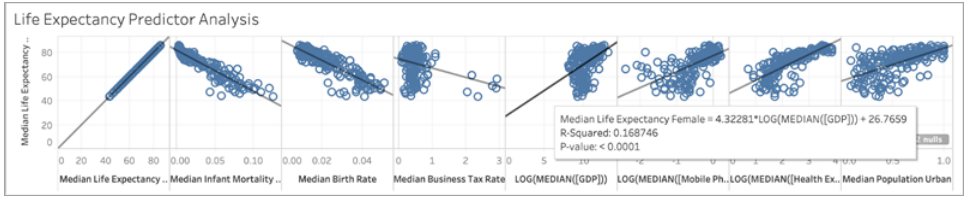

Furthermore, let's take a look at how a few marks can significantly affect the slope of a trend line. Zooming in on the scatter plot for **Median Business Tax Rate** we can see that the majority of the marks have a tax rate between 0 and about 1, with six countries having much higher rates, between 2 and 3. The R-squared value for all marks is 0.0879:

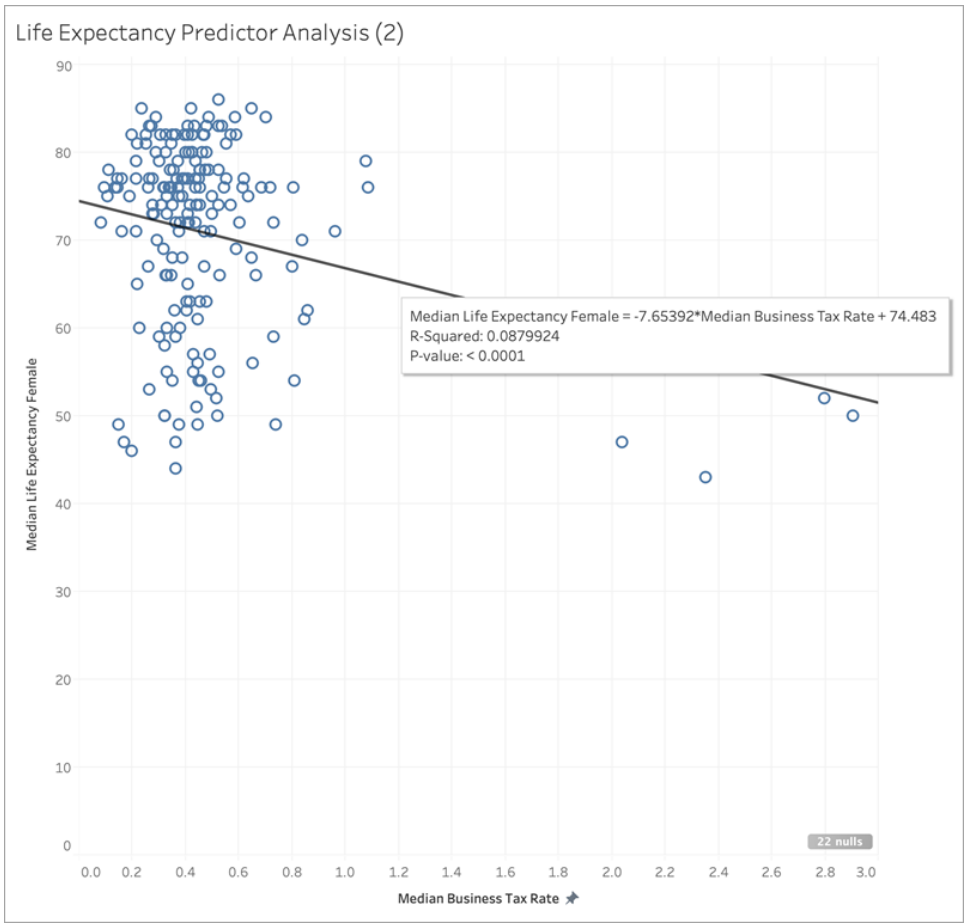

However, let's see what happens if we remove that cluster of six marks:

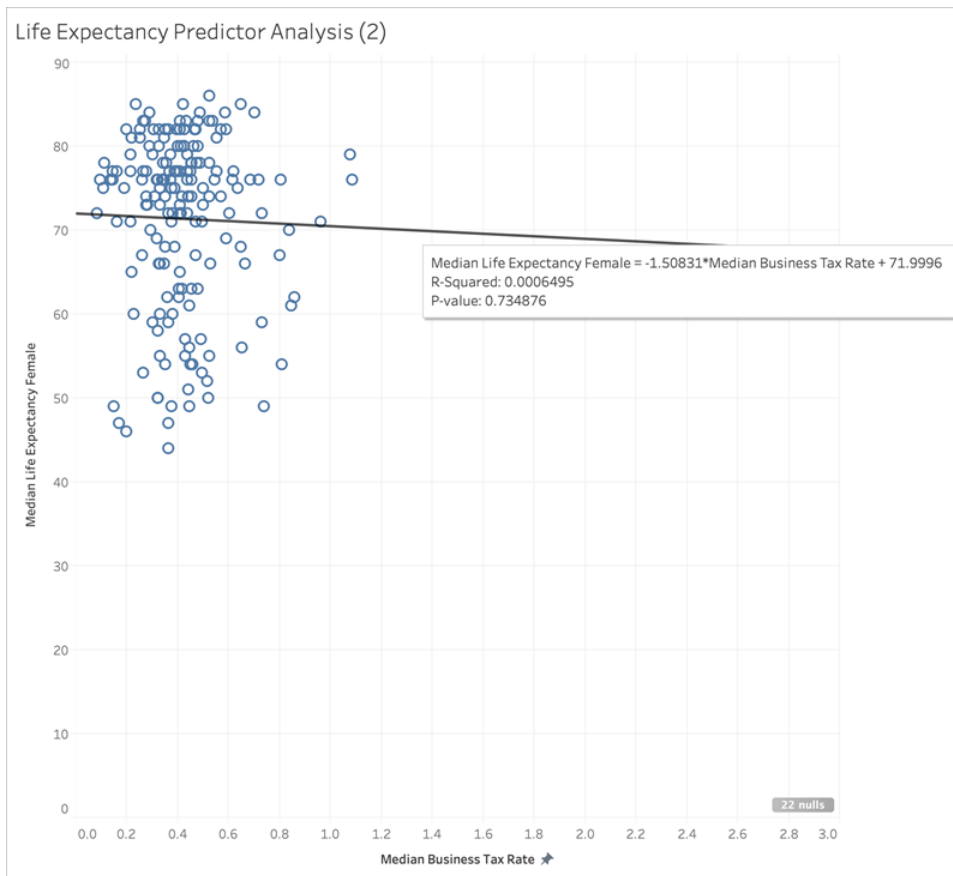

The trend line goes nearly flat, and the R-squared value drops to 0.0006—indicating that there's essentially no correlation between **Median Business Tax Rate** and **Median Female Life Expectancy**. As you visualize your data and use good statistical methods to select your predictors, it's important to carefully consider whether there are any outliers or other data characteristics that could affect your conclusions.

Note: For more examples of how summary statistics might not give you the full picture, read up on [Anscombe's quartet](#).

Dimensions as predictors

When using dimensions as predictors, you can use a similar procedure to determine correlation. However, you may find that there's a significant discrepancy between different dimensions in their level of relationship to the target. For example, when subdividing by **Region**, one region may be a very good predictor for the target, but another region may have significantly less correlation. This doesn't mean that you shouldn't use that dimension as a predictor, but you may want to consider whether using additional measures or dimensions will help improve your model, and in turn, your predictions.

Since we've determined the best predictors for our data set are **Median Infant Mortality**, **Median Birth Rate**, and the log transformation of **Median Health Expenditure/Capita**, let's limit the viz to these three variables:

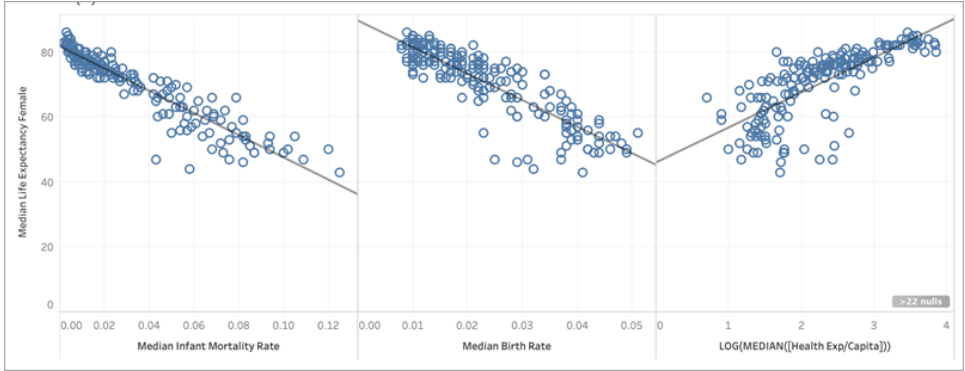

Next, let's partition the data by adding **Region** to Color on the Marks card and see what happens to the viz:

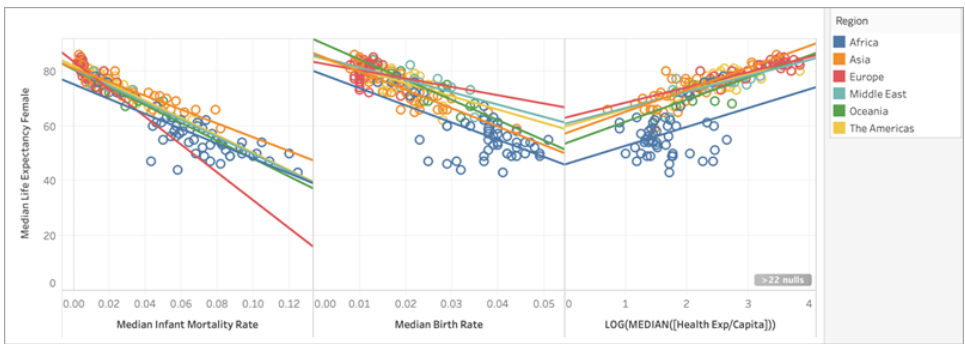

Comparing R-squared values across predictors

Let's see how the R-squared values compare for each of the **Region** trend lines for each predictor:

Region	Median Infant Mortality Rate	Median Birth Rate	LOG(Median(Health Exp/Capita))
Africa	0.659	0.407	0.131
Asia	0.813	0.701	0.618
Europe	0.547	0.036	0.755
Middle East	0.859	0.491	0.459
Oceania	0.756	0.747	0.656
The Americas	0.797	0.396	0.528

In the table above, the lowest R-squared value for each predictor is highlighted in red, and the second-lowest in yellow.

Europe has the lowest R-squared values for Median Infant Mortality and Median Birth Rate and Africa has the lowest R-squared value for the log transformation of Median Health Expenditure/Capita (highlighted in red). Africa also has lower R-squared values for both Median Infant Mortality Rate and Median Birth Rate.

Adding a dimension can provide your model with more information, and adding more information can improve the quality of your prediction. However, within a given subdivision (a Region, in this case), the prediction quality could either improve or decline. In some cases, you may want to build an individual model for each subdivision based on the measures that are the best predictors for that specific group.

In this case, Infant Mortality has a reasonably strong correlation with Female Life Expectancy for all regions, although it's somewhat weaker in Africa and Europe; Median Birth Rate is a good predictor for Oceania and Asia, but has almost no correlation with Female Life Expectancy in Europe, and the log transformation of Median Health Expenditure is a reasonable predictor for all regions except Africa. We can expect that the model built with all four predictors (Infant Mortality, Birth Rate, Log(Health Expenditure), and Region) will have the least accurate predictions for countries in Europe and Africa; we may want to do some deeper dives into the data to see if there are additional or alternative predictors we could use to build models that are better fits for Europe and Africa.

Building your predictive modeling function

Now that we've found good predictors, we can build and apply a predictive modeling function to see it in action.

1. Open the **Analysis** menu at the top, and then select **Create Calculated Field**.
2. In the Calculation Editor, name the calculation, do the following:
 - Name the calculation: **Quantile_LifeExpFemale_HealthExpend,BirthRate,Mortality,Region**
 - Enter the following formula:

```
MODEL_QUANTILE(0.5,MEDIAN([Life Expectancy Female]),
LOG(MEDIAN([Health Exp/Capita])),
MEDIAN([Birth Rate]),
```



```
MEDIAN([Infant Mortality Rate]),
ATTR([Region])
```

This calculation will return the median value (0.5) of the range of modeled median female life expectancies, based on the predictors we selected: **Health Expenditure, Birth Rate, Infant Mortality, and Region.**

Next, let's build a scatter plot that shows both the *actual* median female life expectancy and the *predicted* median female life expectancy:

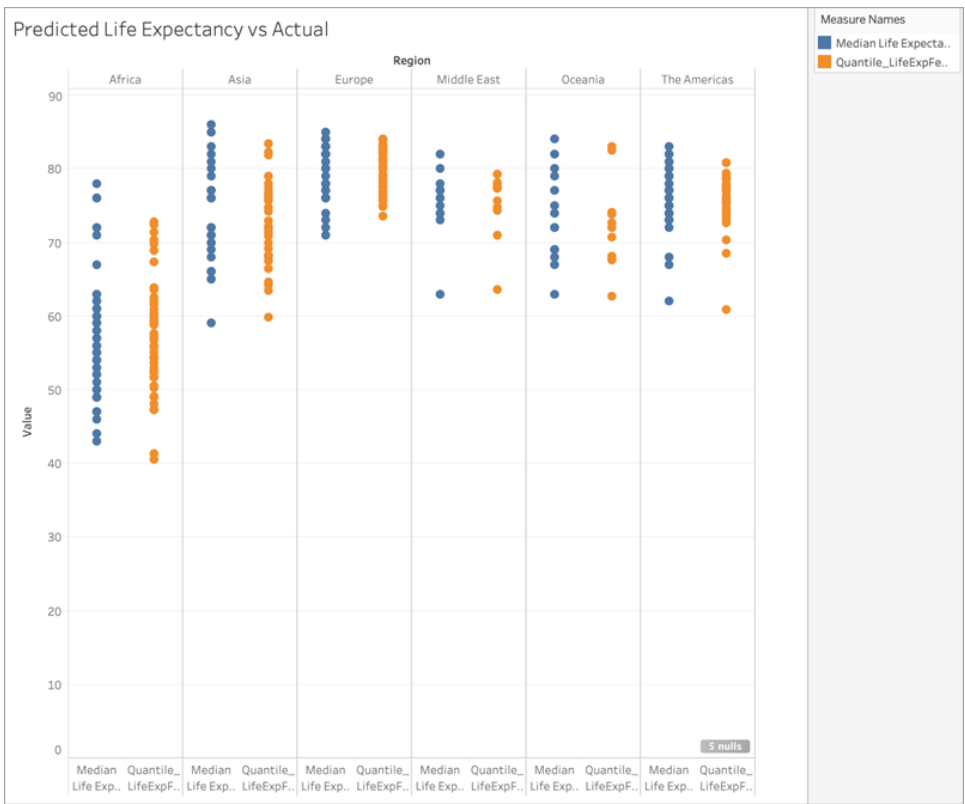

Nice! The predictions are pretty much in line with the actual values for each region.

But let's do another pass to figure out where the predictions are furthest off the mark. Create another calculation called **Residual_LifeExpFemale_HealthExpend,BirthRate,Mortality,Region**, as follows:

```
MEDIAN([Life Expectancy Female]) - [Quantile_LifeExpFemale_HealthExpend,BirthRate,Mortality,Region]
```

This residual calculation will return the difference between the *predicted* median and the *actual* median, helping us see the countries where there's the biggest discrepancy between the actual and predicted median female life expectancy.

Next, let's apply this residual calculation to **Color**:

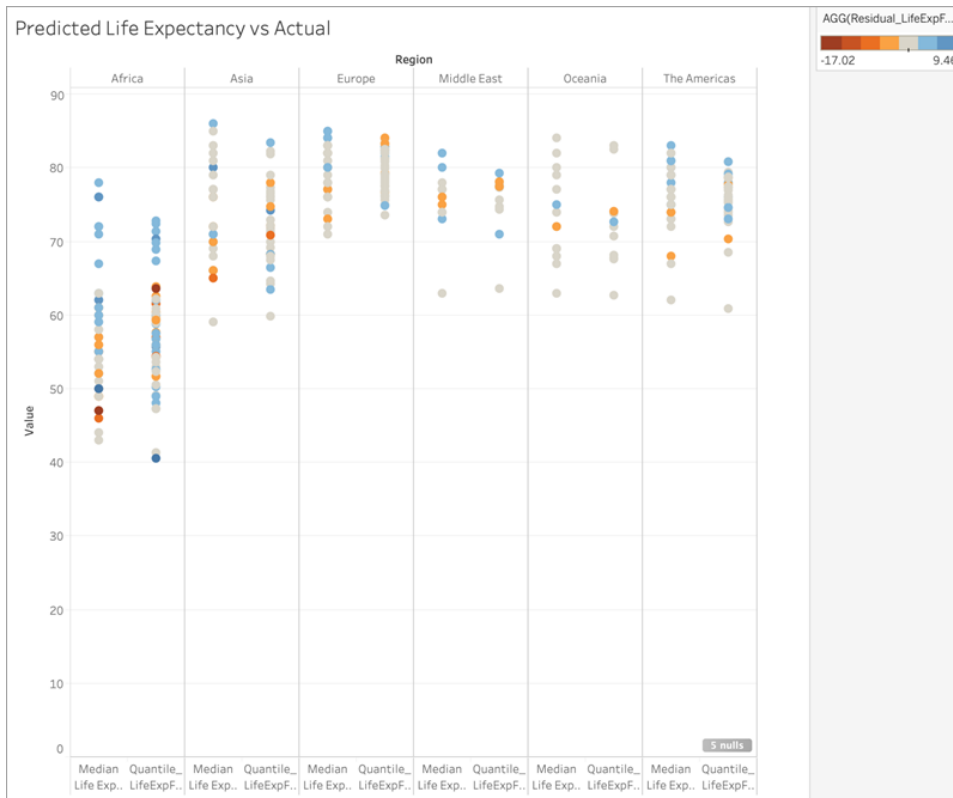

You can see in the above viz that most countries, across most regions, have low discrepancies between predictions and actual values. Africa is the region with the largest number of countries with significant discrepancies, but let's do one more round to see what kind of differences we're looking at.

You can see that the differences range between -17 and +9, so let's divide the viz into groups where there's less than ± 3 years difference, less than ± 5 years difference, less than ± 10 years difference, and more than ± 10 years difference.

Create one more calculation, called **Grouped_Residual_LifeExpFemale_HealthExpend,BirthRate,Mortality,Region**, as follows:

Tableau Desktop and Web Authoring Help

```
IF [Residual_LifeExpFemale_HealthExpend, BirthRate, Mortality, Region] <= 3
AND [Residual_LifeExpFemale_HealthExpend, BirthRate, Mortality, Region] >= -3
THEN "±3"
ELSEIF [Residual_LifeExpFemale_HealthExpend, BirthRate, Mortality, Region] <= 5
AND [Residual_LifeExpFemale_HealthExpend, BirthRate, Mortality, Region] >= -5
THEN "±5"
ELSEIF [Residual_LifeExpFemale_HealthExpend, BirthRate, Mortality, Region] <= 10
AND [Residual_LifeExpFemale_HealthExpend, BirthRate, Mortality, Region] >= -10
THEN "±10"
ELSE
"> ±10"
END
```

Again, let's add the calculation to **Color**:



Notice that the vast majority of predictions are incorrect by less than 3 years, and that only a small handful are off by more than 10 years. Overall, pretty good!

This means that using this model would allow us to accurately identify those countries with median female life expectancies that are outliers, or to provide the modeled female life expectancy for a country where this data was missing.

Compute Using and Data Partitioning in Predictive Modeling

You make predictions from your data by including the [predictive modeling functions](#), MODEL_QUANTILE or MODEL_PERCENTILE, in a table calculation.

Remember that all table calculations must have a **Compute Using** direction specified. For an overview of how different addressing and partitioning dimensions can affect your results, see [Transform Values with Table Calculations](#) on page 2364.

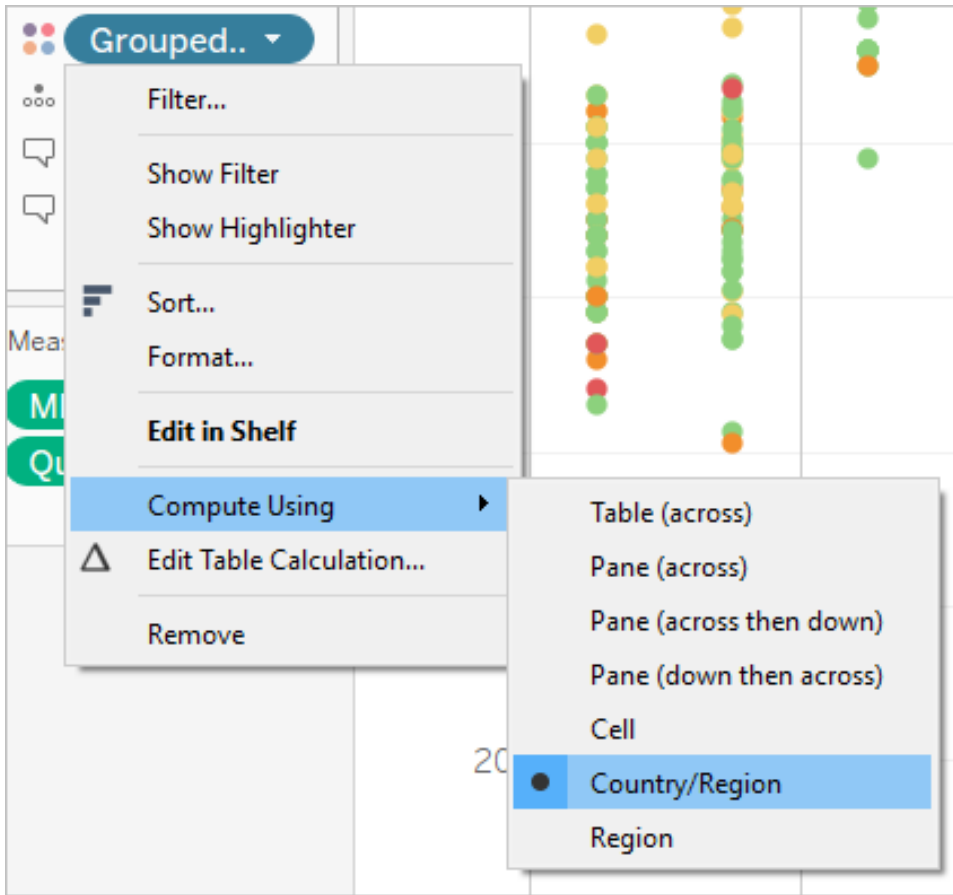

Note: When you add a table calculation, you must use all dimensions in the level of detail either for partitioning (scoping) or for addressing (direction). The dimensions that define how to group the calculation (the scope of data it is performed on) are called partitioning fields. The table calculation is performed separately within each partition. The remaining dimensions, upon which the table calculation is performed, are called addressing fields, and determine the direction of the calculation. For more details, see [The basics: addressing and partitioning](#).

In predictive modeling functions, the **Compute Using** option is used to partition (scope) the data set that will be used to build the predictive model.

Predictive modeling functions *do not* have a concept of addressing (direction), since the model returns a distinct result for each mark based on the predictors selected. That is, unlike **Running Total**, where the addressing dimension determines the order in which fields are added and results are returned, predictive modeling functions are inherently non-sequential. They calculate results using a model from the data defined by the function's target and predictors, at the level of detail specified by the visualization. Within that data, there's no concept of sequencing unless an ordered predictor, such as a date dimension, is used.

Additionally, the level of detail of the visualization is always used when defining the data used to build the model. All table calculations operate at the same level of detail as the viz itself, and predictive modeling functions are no exception.

Recommendations for predictive modeling functions

It's recommended you select a specific dimension to partition on when using predictive modeling functions. Since you may have multiple prediction calculations in a single viz or dashboard, selecting a specific partitioning dimension ensures that you're building models using the same underlying data set for each individual function, and so comparing results from like models.

When working with predictive modeling functions in Tableau, it's critical to ensure that you maintain consistency across the different instantiations, both in different iterations of your model (e.g., as you select different predictors), and in different vizs. Using the directional Compute Using options opens up the possibility that a small change in your visualized data will significantly affect the data being used to build the model, thus affecting its validity and its consistency across different vizs.

Choosing dimensions

The following examples use the **Sample - Superstore** data source, which is included with Tableau Desktop.

When choosing a dimension, remember that Tableau will build a predictive model *across* that dimension. That is, if you select **Order Date** as your partitioning dimension, Tableau will use data *within* any other established partition, but *along* values of **Order Date**.

The image below shows the data that is used to build the model highlighted in yellow, and the model output highlighted in orange. In this case, since there aren't any predictors, all responses are identical within a given **Sub-Category**; selecting optimal predictors will help you generate more meaningful results. For more information on optimal predictors, see [Choosing Predictors on page 2581](#).

Order Date		Order Date / Month of Order Date											
Category	Sub-Catego...	Sales						MODEL_QUANTILE nopred along Order Date					
		Q1			Q2			Q1			Q2		
		January 2016	February 2016	March 2016	April 2016	May 2016	June 2016	January 2016	February 2016	March 2016	April 2016	May 2016	June 2016
Furniture	Bookcases	\$1,010		\$1,706	\$308	\$641	\$760	\$885	\$885	\$885	\$885	\$885	\$885
	Chairs	\$4,188	\$190	\$5,713	\$3,211	\$3,675	\$6,456	\$3,906	\$3,906	\$3,906	\$3,906	\$3,906	\$3,906
	Furnishings	\$712	\$393	\$480	\$984	\$780	\$433	\$630	\$630	\$630	\$630	\$630	\$630
	Tables	\$333	\$1,256	\$6,674	\$3,442	\$1,817	\$5,558	\$3,180	\$3,180	\$3,180	\$3,180	\$3,180	\$3,180
Office Supplies	Appliances	\$313	\$90	\$503	\$533	\$919	\$2,275	\$772	\$772	\$772	\$772	\$772	\$772
	Art	\$177	\$74	\$413	\$568	\$288	\$686	\$368	\$368	\$368	\$368	\$368	\$368
	Binders	\$815	\$339	\$1,526	\$986	\$4,372	\$4,276	\$2,052	\$2,052	\$2,052	\$2,052	\$2,052	\$2,052

Similarly, if **Sub-Category** had been selected as a partitioning dimension, Tableau would use the data *within* a given month but *along* multiple subcategories, as below. If the data is further subdivided into panes, the pane boundaries would be respected when building a model.

Sub-Category		Order Date / Month of Order Date											
Category	Sub-Catego..	Sales						MODEL_QUANTILE nopred along Sub-Category					
		Q1			Q2			Q1			Q2		
		January 2016	February 2016	March 2016	April 2016	May 2016	June 2016	January 2016	February 2016	March 2016	April 2016	May 2016	June 2016
Furniture	Bookcases	\$1,010		\$1,706	\$308	\$641	\$760	\$1,561	\$613	\$3,643	\$1,986	\$1,728	\$3,302
	Chairs	\$4,188	\$190	\$5,713	\$3,211	\$3,675	\$6,456	\$1,561	\$613	\$3,643	\$1,986	\$1,728	\$3,302
	Furnishings	\$712	\$393	\$480	\$984	\$780	\$433	\$1,561	\$613	\$3,643	\$1,986	\$1,728	\$3,302
	Tables	\$333	\$1,256	\$6,674	\$3,442	\$1,817	\$5,558	\$1,561	\$613	\$3,643	\$1,986	\$1,728	\$3,302
Office Supplies	Appliances	\$313	\$90	\$503	\$533	\$919	\$2,275	\$606	\$134	\$956	\$1,239	\$793	\$1,439
	Art	\$177	\$74	\$413	\$568	\$288	\$686	\$606	\$134	\$956	\$1,239	\$793	\$1,439

A note on partitioning

Note that partitioning your data visually has significant effects on the data that's used to build a model and generate your predictions. Adding a higher level of detail (for example, including both **State** and **City** on a single shelf) will partition your data by the higher LOD. This is true regardless of the order in which the pills are placed on the shelf. For instance, these will return identical predictions:



Adding a pill that modifies the level of detail will partition your data if it's added to either the Rows or Columns shelf, or to Color, Size, Label, Detail, or Shape on the Marks card. Adding a pill at a different level of detail to Tooltip will *not* partition your data.

In the below example, the model is automatically partitioning by **Category** since the **Category** and **Sub-Category** pills are both on Rows. The prediction calculation is being computed across **Sub-Category** within the boundaries of the higher-level pill, **Category**.

Sub-Category		Order Date / Month of Order Date											
Category	Sub-Catego..	Sales						MODEL_QUANTILE nopred along Sub-Category					
		Q1			Q2			Q1			Q2		
		January 2016	February 2016	March 2016	April 2016	May 2016	June 2016	January 2016	February 2016	March 2016	April 2016	May 2016	June 2016
Furniture	Bookcases	\$1,010		\$1,706	\$308	\$641	\$760	\$1,561	\$613	\$3,643	\$1,986	\$1,728	\$3,302
	Chairs	\$4,188	\$190	\$5,713	\$3,211	\$3,675	\$6,456	\$1,561	\$613	\$3,643	\$1,986	\$1,728	\$3,302
	Furnishings	\$712	\$393	\$480	\$984	\$780	\$433	\$1,561	\$613	\$3,643	\$1,986	\$1,728	\$3,302
	Tables	\$333	\$1,256	\$6,674	\$3,442	\$1,817	\$5,558	\$1,561	\$613	\$3,643	\$1,986	\$1,728	\$3,302
Office Supplies	Appliances	\$313	\$90	\$503	\$533	\$919	\$2,275	\$606	\$134	\$956	\$1,239	\$793	\$1,439
	Art	\$177	\$74	\$413	\$568	\$288	\$686	\$606	\$134	\$956	\$1,239	\$793	\$1,439

This has implications for how your predictors are applied. Let's look at the example below. In this case, we have three MODEL_QUANTILE table calculations being applied:

Predict_Sales_City	Predict_Sales_State	Predict_Sales_Region
MODEL_QUANTILE (0.5, sum([Sales]), ATTR([City]))	MODEL_QUANTILE (0.5, sum([Sales]), ATTR([State]))	MODEL_QUANTILE (0.5, sum([Sales]), ATTR([Region]))

For all three, we've selected **Compute Using > City**. Let's take a look at some cities in North Carolina:

Region	State	City	Sales	Predict_Sales_City along City	Predict_Sales_State along City	Predict_Sales_Region along City
South	North Carolina	Asheville	\$1,475	2,926	2,926	2,926
		Burlington	\$12,681	2,926	2,926	2,926
		Cary	\$505	2,926	2,926	2,926
		Chapel Hill	\$14	2,926	2,926	2,926
		Charlotte	\$13,693	2,926	2,926	2,926
		Concord	\$5,112	2,926	2,926	2,926
		Durham	\$880	2,926	2,926	2,926
		Fayetteville	\$3,183	2,926	2,926	2,926
		Gastonia	\$895	2,926	2,926	2,926
		Goldsboro	\$35	2,926	2,926	2,926
		Greensboro	\$2,407	2,926	2,926	2,926
		Greenville	\$2,118	2,926	2,926	2,926
		Hickory	\$41	2,926	2,926	2,926
		Jacksonville	\$5,580	2,926	2,926	2,926
		Monroe	\$1,213	2,926	2,926	2,926
		Raleigh	\$4,508	2,926	2,926	2,926
		Thomasville	\$151	2,926	2,926	2,926
		Wilmington	\$743	2,926	2,926	2,926
	Wilson	\$369	2,926	2,926	2,926	
	South Carolina	Columbia	\$6,168	1,414	1,414	1,414
		Florence	\$1,065	1,414	1,414	1,414
Mount Pleasant		\$546	1,414	1,414	1,414	
North Charleston		\$284	1,414	1,414	1,414	
Rock Hill		\$12	1,414	1,414	1,414	
Summerville		\$407	1,414	1,414	1,414	
Tennessee	Bartlett	\$89	2,044	2,044	2,044	
	Bristol	\$437	2,044	2,044	2,044	
	Chattanooga	\$989	2,044	2,044	2,044	
	Clarksville	\$2,218	2,044	2,044	2,044	
	Columbia	\$5,163	2,044	2,044	2,044	
	Franklin	\$948	2,044	2,044	2,044	

Notice that the results from all three calculations are identical within a given state, despite using different predictors.

If we remove **Region** from the Rows shelf, nothing happens to our results—they're still all identical within a given state:

Tableau Desktop and Web Authoring Help

State	City	Sales	Predict_Sales_City along City	Predict_Sales_State along City	Predict_Sales_Region along City
North Carolina	Asheville	\$1,475	2,926	2,926	2,926
	Burlington	\$12,681	2,926	2,926	2,926
	Cary	\$505	2,926	2,926	2,926
	Chapel Hill	\$14	2,926	2,926	2,926
	Charlotte	\$13,693	2,926	2,926	2,926
	Concord	\$5,112	2,926	2,926	2,926
	Durham	\$880	2,926	2,926	2,926
	Fayetteville	\$3,183	2,926	2,926	2,926
	Gastonia	\$895	2,926	2,926	2,926
	Goldsboro	\$35	2,926	2,926	2,926
	Greensboro	\$2,407	2,926	2,926	2,926
	Greenville	\$2,118	2,926	2,926	2,926
	Hickory	\$41	2,926	2,926	2,926
	Jacksonville	\$5,580	2,926	2,926	2,926
	Monroe	\$1,213	2,926	2,926	2,926
	Raleigh	\$4,508	2,926	2,926	2,926
	Thomasville	\$151	2,926	2,926	2,926
Wilmington	\$743	2,926	2,926	2,926	
Wilson	\$369	2,926	2,926	2,926	
North Dakota	Fargo	\$920			
Ohio	Akron	\$2,730	3,261	3,261	3,261
	Bowling Green	\$1,866	3,261	3,261	3,261
	Cincinnati	\$1,612	3,261	3,261	3,261
	Cleveland	\$6,346	3,261	3,261	3,261
	Columbus	\$15,901	3,261	3,261	3,261

But when we remove **State** from the Rows shelf, we see different results for each calculation:

City	Sales	Predict_Sales_City along City	Predict_Sales_State along City	Predict_Sales_Region along City
Burbank	\$3,247	4,326	6,260	4,667
Burlington	\$21,668	4,326	9,366	9,647
Caldwell	\$456	4,326	875	4,667
Camarillo	\$1,468	4,326	6,260	4,667
Cambridge	\$502	4,326	1,038	6,574
Canton	\$818	4,326	3,507	2,528
Carlsbad	\$419	4,326	683	4,667
Carol Stream	\$1,306	4,326	2,926	2,528
Carrollton	\$2,201	4,326	3,102	2,528
Cary	\$505	4,326	2,084	2,465
Cedar Hill	\$122	4,326	3,102	2,528
Cedar Rapids	\$278	4,326	431	2,528
Champaign	\$152	4,326	2,926	2,528
Chandler	\$1,077	4,326	2,828	4,667
Chapel Hill	\$14	4,326	2,084	2,465
Charlotte	\$13,693	4,326	2,084	2,465
Charlottesville	\$103	4,326	3,607	2,465

What's going on?

In the first example, **Region** and **State** on the Rows shelf are partitioning the cities. Therefore, the models for **Predict_Sales_City**, **Predict_Sales_State**, and **Predict_Sales_Region** are receiving the same data and generating the same predictions.

Since we've already visually partitioned the data within **State** and **Region**, none of our predictors add any value to the model and have no impact on the results:

Region	State	City	Sales	Predict_Sales_City along City	Predict_Sales_State along City	Predict_Sales_Region along City
South	North Carolina	Asheville	\$1,475	2,926	2,926	2,926
		Burlington	\$12,681	2,926	2,926	2,926
		Cary	\$505	2,926	2,926	2,926
		Chapel Hill	\$14	2,926	2,926	2,926
		Charlotte	\$13,693	2,926	2,926	2,926
		Concord	\$5,112	2,926	2,926	2,926
		Durham	\$880	2,926	2,926	2,926
		Fayetteville	\$3,183	2,926	2,926	2,926
		Gastonia	\$895	2,926	2,926	2,926
		Goldsboro	\$35	2,926	2,926	2,926
		Greensboro	\$2,407	2,926	2,926	2,926
		Greenville	\$2,118	2,926	2,926	2,926
		Hickory	\$41	2,926	2,926	2,926
		Jacksonville	\$5,580	2,926	2,926	2,926
		Monroe	\$1,213	2,926	2,926	2,926
		Raleigh	\$4,508	2,926	2,926	2,926
	Thomasville	\$151	2,926	2,926	2,926	
	Wilmington	\$743	2,926	2,926	2,926	
	Wilson	\$369	2,926	2,926	2,926	
	South Carolina	Columbia	\$6,168	1,414	1,414	1,414
		Florence	\$1,065	1,414	1,414	1,414
		Mount Pleasant	\$546	1,414	1,414	1,414
		North Charleston	\$284	1,414	1,414	1,414
		Rock Hill	\$12	1,414	1,414	1,414
		Summerville	\$407	1,414	1,414	1,414
	Tennessee	Bartlett	\$89	2,044	2,044	2,044
		Bristol	\$437	2,044	2,044	2,044
		Chattanooga	\$989	2,044	2,044	2,044
		Clarksville	\$2,218	2,044	2,044	2,044
		Columbia	\$5,163	2,044	2,044	2,044
Franklin		\$948	2,044	2,044	2,044	

When we remove **Region** from the Rows shelf, we're still partitioning by **State**—so there's no change to the data used to build the model. Again, since we've already visually partitioned the data within **State**, none of our predictors add any value to the model or have any impact on results:

State	City	Sales	Predict_Sales_City along City	Predict_Sales_State along City	Predict_Sales_Region along City
North Carolina	Asheville	\$1,475	2,926	2,926	2,926
	Burlington	\$12,681	2,926	2,926	2,926
	Cary	\$505	2,926	2,926	2,926
	Chapel Hill	\$14	2,926	2,926	2,926
	Charlotte	\$13,693	2,926	2,926	2,926
	Concord	\$5,112	2,926	2,926	2,926
	Durham	\$880	2,926	2,926	2,926
	Fayetteville	\$3,183	2,926	2,926	2,926
	Gastonia	\$895	2,926	2,926	2,926
	Goldsboro	\$35	2,926	2,926	2,926
	Greensboro	\$2,407	2,926	2,926	2,926
	Greenville	\$2,118	2,926	2,926	2,926
	Hickory	\$41	2,926	2,926	2,926
	Jacksonville	\$5,580	2,926	2,926	2,926
	Monroe	\$1,213	2,926	2,926	2,926
	Raleigh	\$4,508	2,926	2,926	2,926
Thomasville	\$151	2,926	2,926	2,926	
Wilmington	\$743	2,926	2,926	2,926	
Wilson	\$369	2,926	2,926	2,926	
North Dakota	Fargo	\$920			
Ohio	Akron	\$2,730	3,261	3,261	3,261
	Bowling Green	\$1,866	3,261	3,261	3,261
	Cincinnati	\$1,612	3,261	3,261	3,261
	Cleveland	\$6,346	3,261	3,261	3,261
	Columbus	\$15,901	3,261	3,261	3,261

However, when we remove **State**, the data is de-partitioned and we see different predictions for each calculation. Let's take a closer look at what's happening there:

City	Sales	Predict_Sales_City along City	Predict_Sales_State along City	Predict_Sales_Region along City
Burbank	\$3,247	4,326	6,260	4,667
Burlington	\$21,668	4,326	9,366	9,647
Caldwell	\$456	4,326	875	4,667
Camarillo	\$1,468	4,326	6,260	4,667
Cambridge	\$502	4,326	1,038	6,574
Canton	\$818	4,326	3,507	2,528
Carlsbad	\$419	4,326	683	4,667
Carol Stream	\$1,306	4,326	2,926	2,528
Carrollton	\$2,201	4,326	3,102	2,528
Cary	\$505	4,326	2,084	2,465
Cedar Hill	\$122	4,326	3,102	2,528
Cedar Rapids	\$278	4,326	431	2,528
Champaign	\$152	4,326	2,926	2,528
Chandler	\$1,077	4,326	2,828	4,667
Chapel Hill	\$14	4,326	2,084	2,465
Charlotte	\$13,693	4,326	2,084	2,465
Charlottesville	\$103	4,326	3,607	2,465

For **Predict_Sales_City**, we're using **ATTR([City])** as a predictor. Since this is at the same level of detail as the viz, it adds no value and is disregarded. We are aggregating **Sales** for all cities, passing them to the statistical engine, and computing the predicted sales. Since no other predictors are included, we see the same result for each city; if we had included one or more measures, we'd see variation in the results.

City	Sales	Predict_Sales_City along City	Predict_Sales_State along City	Predict_Sales_Region along City
Burbank	\$3,247	4,326	6,260	4,667
Burlington	\$21,668	4,326	9,366	9,647
Caldwell	\$456	4,326	875	4,667
Camarillo	\$1,468	4,326	6,260	4,667
Cambridge	\$502	4,326	1,038	6,574
Canton	\$818	4,326	3,507	2,528
Carlsbad	\$419	4,326	683	4,667
Carol Stream	\$1,306	4,326	2,926	2,528
Carrollton	\$2,201	4,326	3,102	2,528
Cary	\$505	4,326	2,084	2,465
Cedar Hill	\$122	4,326	3,102	2,528
Cedar Rapids	\$278	4,326	431	2,528
Champaign	\$152	4,326	2,926	2,528
Chandler	\$1,077	4,326	2,828	4,667
Chapel Hill	\$14	4,326	2,084	2,465
Charlotte	\$13,693	4,326	2,084	2,465
Charlottesville	\$103	4,326	3,607	2,465

For **Predict_Sales_State**, we're using ATTR([State]) as a predictor. The *predictor* is partitioning all the **City** data by **State**. We expect to see identical results *within* a state, but different results for *each* state.

But notice that isn't quite what we get. The cities of Cary, Chapel Hill, and Charlotte all have identical predictions of \$2,084, as we expect. Burlington, however, shows us a different prediction of \$9,366:

City	Sales	Predict_Sales_City along City	Predict_Sales_State along City	Predict_Sales_Region along City
Burbank	\$3,247	4,326	6,260	4,667
Burlington	\$21,668	4,326	9,366	9,647
Caldwell	\$456	4,326	875	4,667
Camarillo	\$1,468	4,326	6,260	4,667
Cambridge	\$502	4,326	1,038	6,574
Canton	\$818	4,326	3,507	2,528
Carlsbad	\$419	4,326	683	4,667
Carol Stream	\$1,306	4,326	2,926	2,528
Carrollton	\$2,201	4,326	3,102	2,528
Cary	\$505	4,326	2,084	2,465
Cedar Hill	\$122	4,326	3,102	2,528
Cedar Rapids	\$278	4,326	431	2,528
Champaign	\$152	4,326	2,926	2,528
Chandler	\$1,077	4,326	2,828	4,667
Chapel Hill	\$14	4,326	2,084	2,465
Charlotte	\$13,693	4,326	2,084	2,465
Charlottesville	\$103	4,326	3,607	2,465

That's because a city named "Burlington" exists within multiple states (Iowa, North Carolina, and Vermont). Therefore, **State** resolves to *, meaning "more than one value." All marks where **State** resolves to * are evaluated together, so any other city that also exists in multiple states would also have a prediction of \$9,366.

For **Predict_Sales_Region**, we're using ATTR([Region]) as a predictor. The *predictor* is partitioning all the **City** data by **Region**. You expect to see identical results *within* a region, but different results for *each* region:

City	Sales	Predict_Sales_City along City	Predict_Sales_State along City	Predict_Sales_Region along City
Burbank	\$3,247	4,326	6,260	4,667
Burlington	\$21,668	4,326	9,366	9,647
Caldwell	\$456	4,326	875	4,667
Camarillo	\$1,468	4,326	6,260	4,667
Cambridge	\$502	4,326	1,038	6,574
Canton	\$818	4,326	3,507	2,528
Carlsbad	\$419	4,326	683	4,667
Carol Stream	\$1,306	4,326	2,926	2,528
Carrollton	\$2,201	4,326	3,102	2,528
Cary	\$505	4,326	2,084	2,465
Cedar Hill	\$122	4,326	3,102	2,528
Cedar Rapids	\$278	4,326	431	2,528
Champaign	\$152	4,326	2,926	2,528
Chandler	\$1,077	4,326	2,828	4,667
Chapel Hill	\$14	4,326	2,084	2,465
Charlotte	\$13,693	4,326	2,084	2,465
Charlottesville	\$103	4,326	3,607	2,465
Chattanooga	\$989	4,326	2,115	2,465
Chesapeake	\$5,997	4,326	3,607	2,465
Chester	\$1,968	4,326	16,471	6,574
Cheyenne	\$1,603	4,326	1,603	4,667
Chicago	\$48,540	4,326	2,926	2,528

Again, since Burlington exists within multiple regions (Central, East, and South), **Region** resolves to *. Burlington's predictions will match only those cities that also exist within multiple regions.

As you can see, it's very important to ensure that any dimensional predictors are correctly aligned with both your visualization's level of detail and your partitioning. Subdividing your visualization by any dimension could have unintended effects on your predictions.

Example - Explore Female Life Expectancy with Predictive Modeling Functions

This example uses the World Indicators saved data source, which comes with Tableau. We'll use the MODEL_QUANTILE and MODEL_PERCENTILE **predictive modeling functions** to explore the relationships between health spending per capita, female life expectancy, birth rate.

Let's start with a visualization that compares each country's health spending with its female life expectancy. To follow along and access the pre-built views and dashboards, or to view the solution, download the following workbook from Tableau Public: [Predictive Modeling of Female Life Expectancy](#).

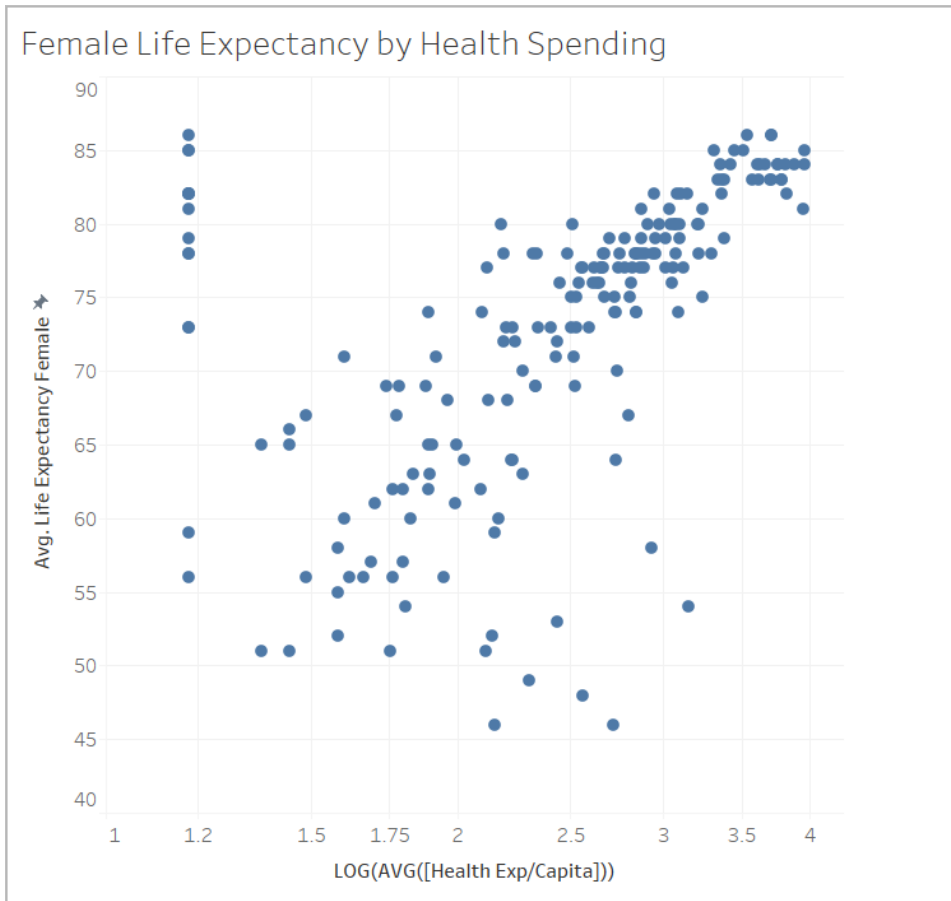

Using MODEL_PERCENTILE

First we'll evaluate the life expectancy and health expenditures for all visible marks. This will allow Tableau to build a model from those marks and return the percentile for each within the model.

Step 1: Create the prediction calculation

If you also have Tableau Server or Tableau Cloud and you want to do your authoring on the web instead of in Tableau Desktop, publish the workbook to your Tableau server, click **Workbooks**, select the workbook, then under Actions, choose **Edit Workbook**.

Once you open the workbook, you'll see that it has several sheets. You'll be using those sheets to build your views.

1. In the starter workbook, click the **Percentile Starter** sheet.
2. Open the **Analysis** menu at the top, and then select **Create Calculated Field**.
3. In the Calculation Editor, do the following:

- Name the calculation: **Percentile Expectancy vs Spending**
Note: If you're following along in the starter workbook, you'll see different names for the calculations used throughout this example. This is so you'll be able to name the fields as described here, without creating duplicates. Your solution may have different names, but the visualizations should look the same.
- Enter the following formula:

```
MODEL_PERCENTILE(AVG([Life Expectancy Female]), LOG(MEDIAN  
([Health Exp/Capita])))
```

This calculation uses average life expectancy as the target expression, and median health expenditure as the predictor. In this case, we used a logarithmic transformation on the health spending axis, as well as for the predictor.

Note: Because this data set skews toward very large values, we transformed our data using a **logarithmic scale**, which is useful when analyzing data with a few values that are much higher than the rest, and will make it easier to identify trends and relationships in our data set.

4. Click **OK**.

The prediction calculation is now added as a calculated field in the Data pane.

Step 2: Add the prediction calculation to the view

In the viz above, you can see each country's health spending against its female life expectancy, filtered to 2012.

Now, let's add the MODEL_PERCENTILE calculation to the view and see what insights we can gain.

1. Drag **Percentile Expectancy vs Spending** to Color on the Marks card.
2. Click the drop-down arrow on the pill and select **Compute Using > Country/Region**.
3. Click **Color** on the Marks card, and then click **Edit Colors**.
 - Under Palette, select **Orange-Blue Diverging**.
 - Select the **Stepped Color** checkbox.
 - Select the **Reversed** checkbox.
4. Click **OK**.

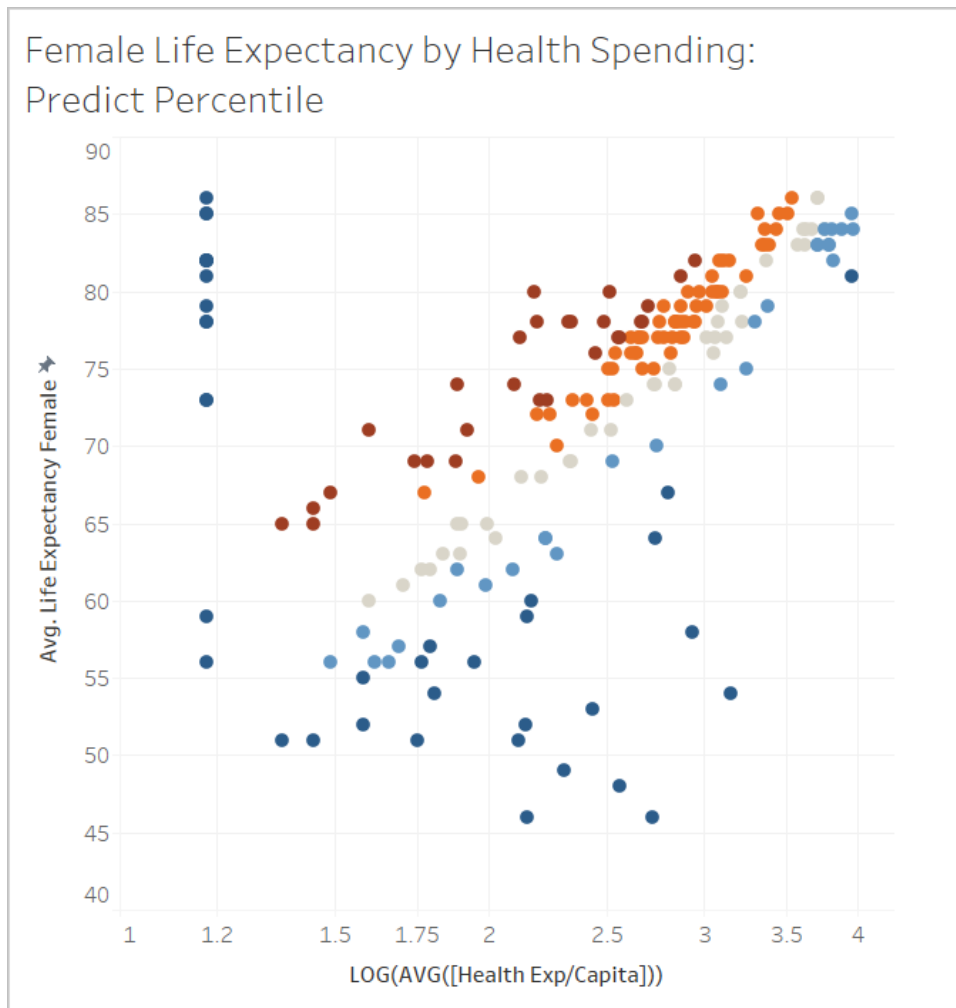

You can see the distribution of countries where health expectancy is both higher and lower than expected based on the level of spending. Notice that generally, the dark red marks indicate that life expectancy is high relative to healthcare spending, dark blue means that life expectancy is low relative to healthcare spending, and grey means that life expectancy is close to what the model expects, based on the level of healthcare spending.

Step 3: Group the results by color

To simplify analysis, let's use the prediction calculation within a new calculation to group the results. We'll build groups so that marks above the 90th percentile and below the 10th percentile are grouped together, marks in the 80th-90th percentile range and 10th-20th percentile range are grouped together, and so on. We'll also highlight marks with a null value and address those later using the other predictive modeling function, `MODEL_QUANTILE`.

1. In the Calculation Editor, do the following:
 - Name the calculation: **Percentile by Color**.
 - Enter the following formula:

```
IF
ISNULL([Percentile Expectancy vs Spending])
THEN "Null"
ELSEIF [Percentile Expectancy vs Spending] >=0.9 OR
[Percentile Expectancy vs Spending] <=0.1
THEN "<10th & >90th percentile"
ELSEIF [Percentile Expectancy vs Spending] >=0.8 OR
[Percentile Expectancy vs Spending] <=0.2
THEN "<20th & >80th percentile"
ELSEIF [Percentile Expectancy vs Spending] >=0.7 OR
[Percentile Expectancy vs Spending] <=0.3
THEN "<30th & >70th percentile"
ELSEIF [Percentile Expectancy vs Spending] >=0.6 OR
[Percentile Expectancy vs Spending] <=0.4
THEN "<40th & >60th percentile"
ELSE "50th percentile +/-10"
END
```

2. Add the new calculation to **Color** on the Marks card.
3. Click the drop-down arrow on the pill and select **Compute Using > Country/Region**.
4. Click **Color** on the Marks card, and then click **Edit Colors**.
 - Adjust the colors to better see the trend. In this case, let's use the **Traffic Light** color palette, and use gray for Nulls.
5. Click **OK**.

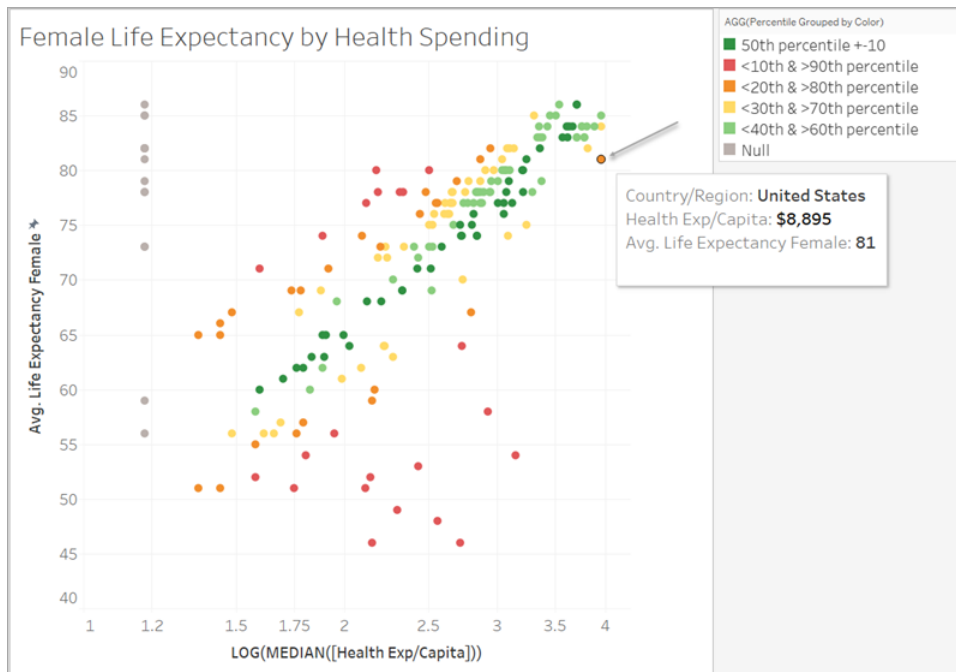

Looking at the orange mark in the corner, notice that the U.S. spends \$8,895 per female for a life expectancy of 81 years. Moving along the X-axis to the left, you can see that other countries spend less and have the same life expectancy.

The model evaluates the strength of the relationship at each point, where the U.S. is close to the upper end of the model's expected range.

Step 4: Compare life expectancy with birth rate

Next, let's look at a viz that compares female life expectancy with birth rate. Notice that there is a negative correlation between birth rates and female life expectancy; however, this does not mean that higher birth rates cause lower female life expectancy. There are likely additional factors that affect both birth rates and female life expectancy that are not visible in this view of the data. But let's add the model and see where the model expects female life expectancy to be higher or lower given health expenditures.

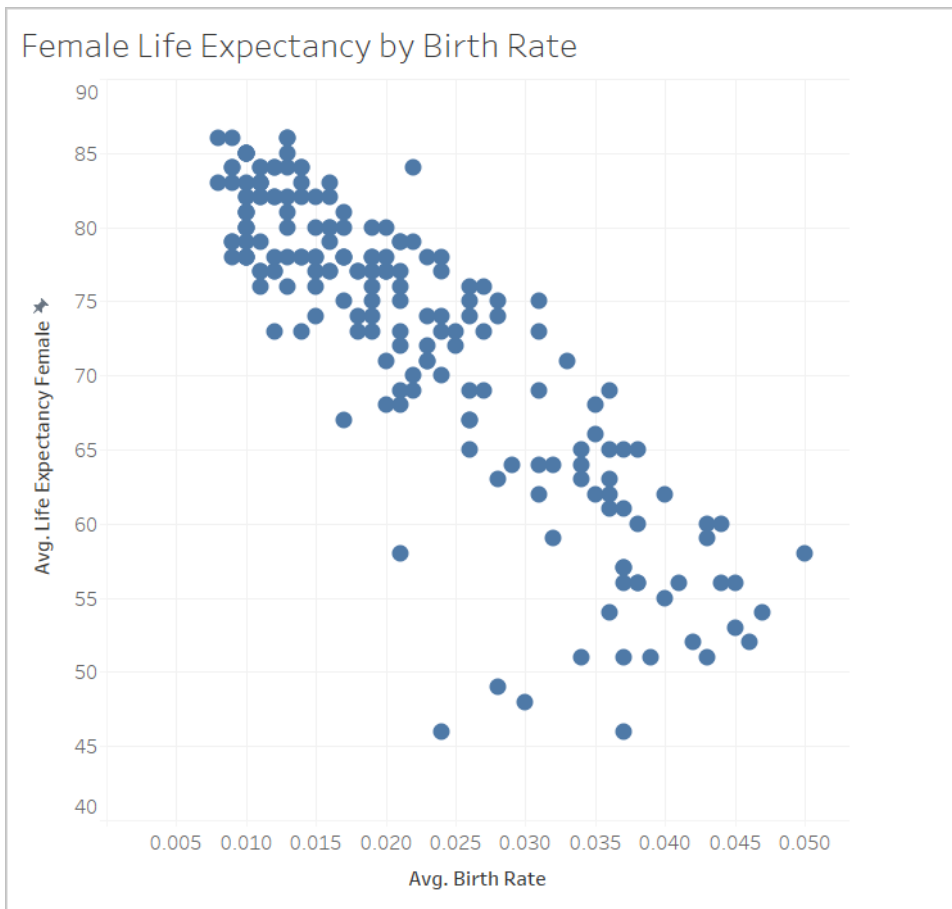

1. On the **Birth Rate** sheet, add the **Percentile by Color** prediction calculation to **Color** on the Marks card to bring it into the view.
2. Click the drop-down arrow on the pill and select **Compute Using > Country/Region**.
3. Click Color on the Marks card, and click **Edit Colors**. Edit the colors as before, using the **Traffic Light** palette and gray for Null.
4. Click **OK**.

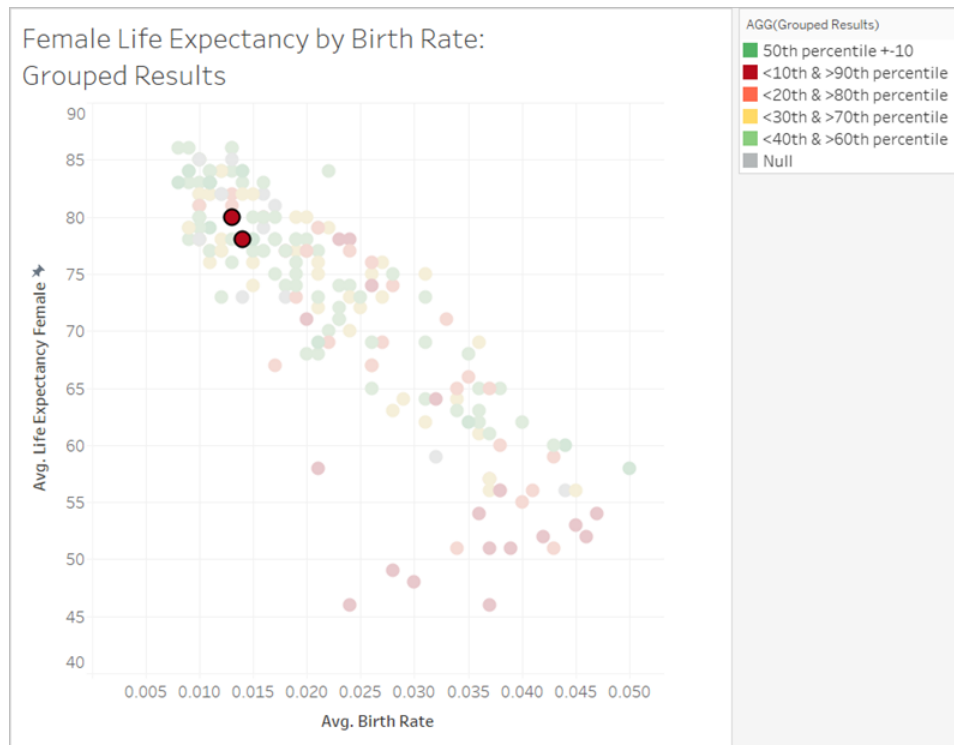

Now the data is much more distributed. The red band in the lower right corner is where life expectancy is lowest but the birth rate is highest, and healthcare spending relative to life expectancy is low. Singling out the two red marks in the top left quadrant, which pertain to Albania and Armenia, you'll notice that both countries have high female life expectancy, lower birth rates, and low health expenditures.

As you can see, we were able to use MODEL_PERCENTILE to identify that these two countries are outliers: Even though they both had relatively low healthcare spending, they still have relatively high life expectancies, placed in the context of birth rate.

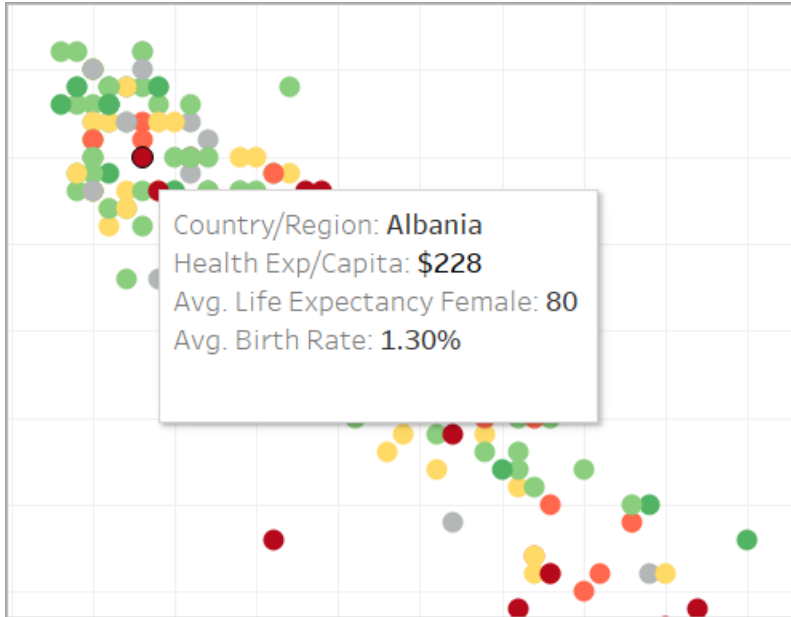

Now, let's see how you can use the other predictive modeling function, `MODEL_QUANTILE`, to continue your analysis.

Using `MODEL_QUANTILE`

`MODEL_QUANTILE` is used to generate numeric predictions, given a target percentile, target expression, and predictors. It's the inverse of `MODEL_PERCENTILE`.

Recall that we have several null values in our results, meaning that some countries don't have health expenditure data. We'll use `MODEL_QUANTILE` to estimate those missing values.

Step 1: Create the prediction calculations

We've been working with this calculation:

```
MODEL_PERCENTILE(AVG([Life Expectancy Female]), LOG(MEDIAN([Health  
Exp/Capita])))
```

First, we want to invert this function in order to get a prediction for healthcare expenditure based on female life expectancy.

1. In the starter workbook, click the **Quantile Starter** sheet.
2. Open the **Analysis** menu at the top, and then select **Create Calculated Field**.
3. In the Calculation Editor, do the following:
 - Name the calculation: **Quantile of Life Expectancy vs Spending**
 - Enter the following formula:

```
POWER(10, MODEL_QUANTILE(0.5, LOG(MEDIAN([Health Exp/Capita])), AVG([Life Expectancy Female])))
```

Let's break this calculation down to better understand it:

- We start with MODEL_QUANTILE, where the first argument is 0.5, specifying what percentile to predict.
- The target expression is median health expenditure per capita.
- The predictor is average female life expectancy.
- In addition, we wrapped the function inside a POWER function to convert the log-transformed target expression back into dollars.

4. Click **OK**.

The prediction calculation is now added as a calculated field in the Data pane.

Step 2: Add the prediction calculation to the view

1. Drag **Quantile of Life Expectancy vs Spending** to Tooltip on the Marks card.
2. Click the drop-down arrow on the pill and select **Compute Using > Country/Region**.
3. Click **Tooltip** on the Marks card and add a row for the MODEL_QUANTILE prediction:
 - Name the tooltip row: **Predicted Health Spend from Female Life Expectancy:**
 - Click **Insert** and select the calculation to ensure the tooltip will dynamically show the mark's unique prediction as you interact with the viz.
4. Click **OK**.

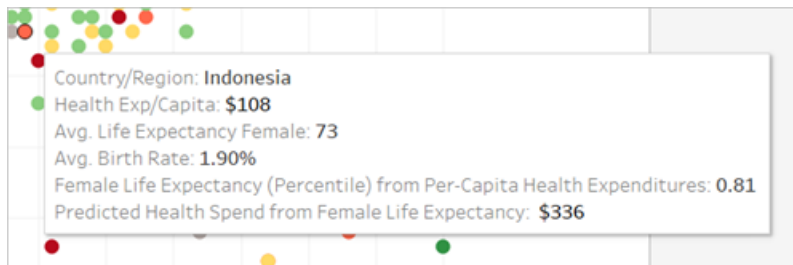

Right now our MODEL_QUANTILE calculation only has one predictor: female life expectancy. Notice as you move from left to right, viewing the tooltip for marks with the same life expectancy, that each one has the same predicted health spend. Indonesia's predicted health spend from life expectancy is \$336, but so is Fiji's, Egypt's, and other countries that have the same female life expectancy.

This is because the model provides the same estimated expenditure for each mark. Since we're only using one predictor (female life expectancy), the model returns the same results for all marks where the predictor has the same value. You can add more nuance to the model by adding predictors.

Step 3: Add a prediction with a second predictor

As you build your predictions, you should consider which fields will be good predictors for your target values and include them in your calculations. You can combine any number of dimensions and measures. For example, we could add GDP, population, and other fields as predictors to improve our predictions. In this case, let's add **Region**.

1. In the Calculation Editor, do the following:
 - Name the calculation: **Quantile Spend vs Expectancy & Region**
 - Enter the following formula, which is the same as the previous calculation, but adds **Region** as a predictor:

```
POWER(10, MODEL_QUANTILE(0.5, LOG(MEDIAN([Health Exp/Capita])), AVG([Life Expectancy Female]), ATTR([Region])))
```

2. Click **OK**.
3. Next, add the new calculation to Tooltip on the Marks card.
4. Click **Tooltip**, and add another line to describe the new prediction, such as **Predicted Health Spend from Female Life Expectancy & Region:**

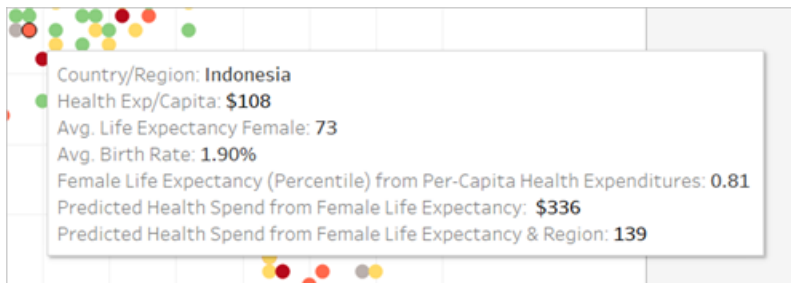

Now the tooltip shows both predictions.

Step 4: Compare actual values to predicted values

As a final step in your analysis, you can also build prediction calculations that combine actual and predicted values. In our example, let's show the actual health expenditures where available and

the estimated expenditures where unavailable.

1. In the Calculation Editor, do the following:
 - Name the calculation: **Health Spend Actual vs Prediction Value**
 - Enter the following formula, which will return the numeric value of the prediction::

```
ROUND(IFNULL(AVG([Health Exp/Capita]),[Quantile_HE/Cap_
LEF,Region]),0)
```
2. Click **OK**.
3. Create another calculation as follows:
 - Name the calculation: **Health Spend Actual vs Prediction Tag**
 - Enter the following formula, which will act as a label for the above calculation:

```
STR(IF ISNULL(AVG([Health Exp/Capita])) THEN "(Estimate)"
ELSE "(Actual)" END)
```
4. Click **OK**.
5. Next, add both calculations to **Tooltip** on the Marks card.
6. Click **Tooltip**, and add another line to describe the new calculations:
 - **Per Capita Health Expenditure (Actual or Estimated):**
 - Insert the new calculations, one after the other.
7. Click **OK**.

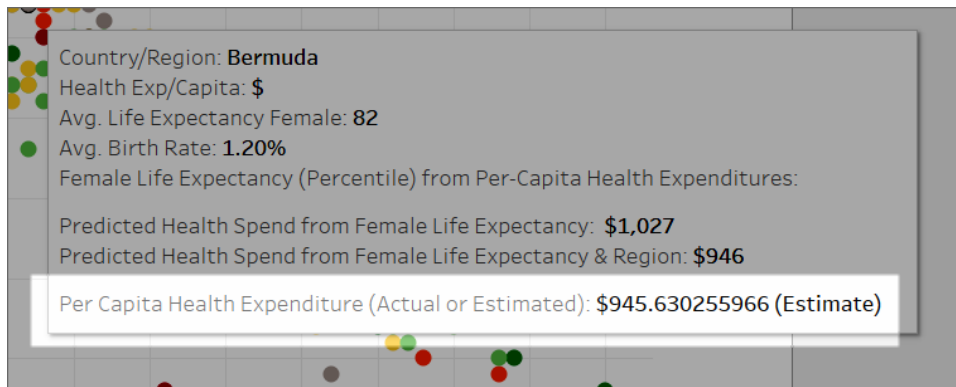

Now, as you interact with the viz, you can see each country's per capita health spending, or view an estimate if the actual value was missing (null) from the data.

Just like that, you can use predictive modeling functions in Tableau to gain insights into your data.

Predictive Modeling Functions in Time Series Visualizations

This document describes the steps required to extend a time axis into the future, so that you can make predictions for future dates using predictive modeling functions.

To see how, follow along with the below example.

Step 1: Create a visualization

1. In Tableau Desktop, connect to the **Sample - Superstore** saved data source, which comes with Tableau.
2. Navigate to the **Sheet 1** worksheet.
3. From the Data pane, drag the **Order Date** dimension to the Columns shelf.
4. Open the measure's context menu to change its list level to Month and Year:

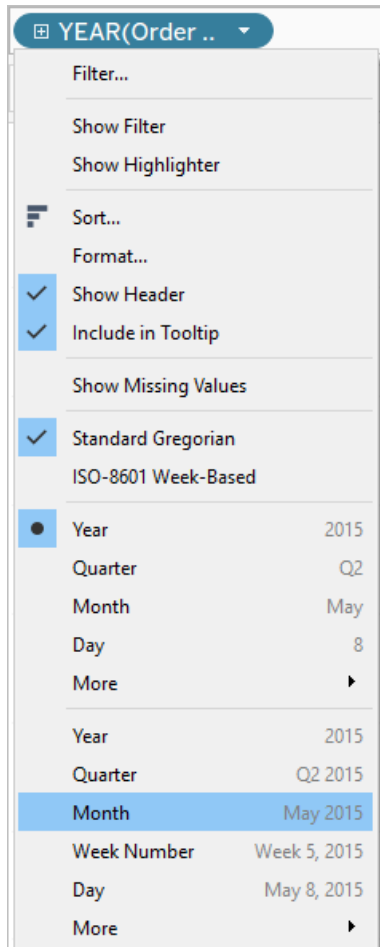

5. Drag **Profit** to the Rows shelf.

Step 2: Create a prediction calculation

1. Click to open the **Analysis** menu at the top, and then select **Create Calculated Field**.
2. In the Calculation Editor, do the following:
 - Name the calculation: **Quantile Predict Median Profit**.
 - Enter the following formula:

```
MODEL_QUANTILE(0.5, SUM([Profit]),ATTR(DATETRUNC('month', [Order Date])))
```

The MODEL_QUANTILE function takes a given quantile and predicts values based on the predictors you input. In this case, the quantile = 0.5, which predicts the median. We

want to predict profit, so the target expression is SUM([Profit]). And since we want to base the prediction on past performance, we need to include date as a predictor.

Note: With Predictive Modeling functions, you cannot mix aggregate and non-aggregate arguments. Since the target expression must be an aggregate, so must the predictor. In this case, we used ATTR(DATETRUNC('month', [Order Date])). For more information about the use of ATTR functions, see [When to Use the Attribute \(ATTR\) Function](#).

3. When finished, click **OK**.

The prediction calculation is now added as a calculated field in the Data pane.

Step 3: Add the prediction calculation to the view

1. Drag the prediction calculation to the Rows shelf, to the right of SUM(Profit).
2. Right-click (Control-click on Mac) the measure and select **Dual Axis**.
3. To align the two axes in a dual axes chart to use the same scale, right-click (Control-click on Mac) the secondary axis, in this case **Quantile Predict Median Profit**, and select **Synchronize Axis**. This aligns the scale of the two axes.

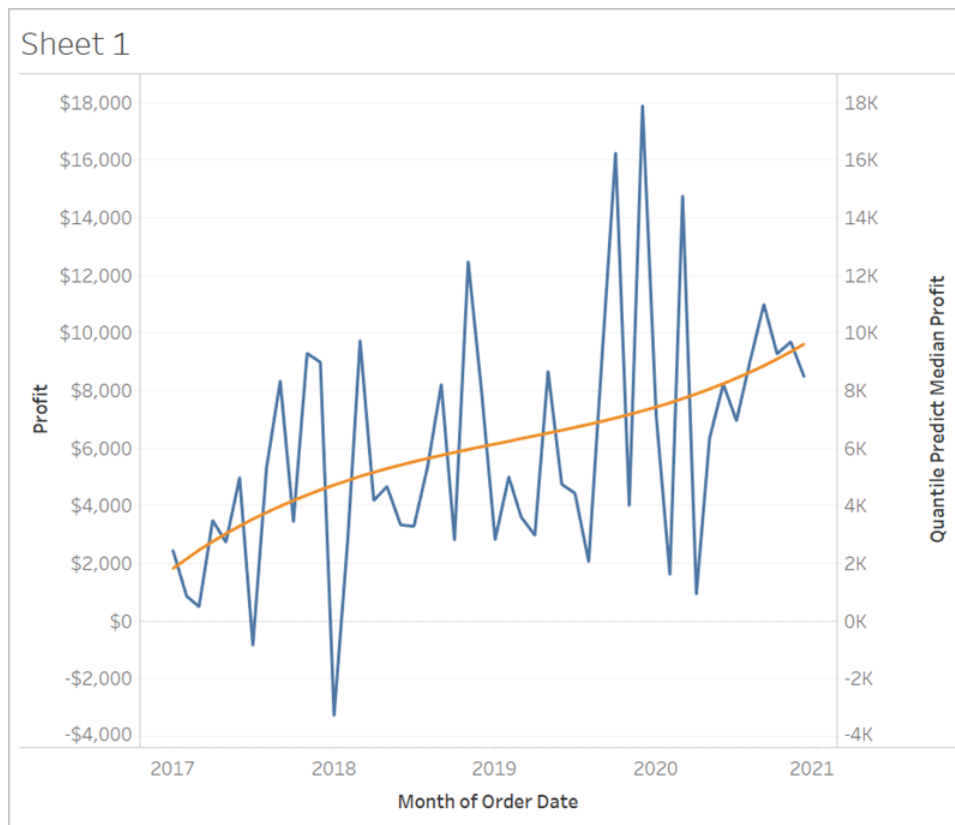

Step 4: Extend the date range and densify the data

The final step is to extend the horizontal axis into the future so that you can add marks beyond the current date range.

1. To do this, open the context menu of the MONTH(Order Date) pill, and select **Extend Date Range**.
2. In the Extend Date Range dialog, let's extend the axis by 16 months:



Tableau has automatically updated the view by extending the horizontal axis and includes predictions on these future dates:



Notice that the blue **Profit** line doesn't extend to the end of the graph. However, the orange line representing the prediction calculation, **Quantile Predict Median Profit**, *does* extend to the end of the graph. Computing the predicted profit on future dates is an example of data densification, which occurs when Tableau creates additional marks in the view to compensate for **missing values**. Data is not added to the underlying data source; marks are simply generated and added to the view.

Note: When you extend a date range into the future, Tableau automatically enables the **Infer Properties from Missing Values** option in the **Analysis** menu. This ensures that your prediction calculation will work on the missing values. For more detail on this menu option, see [Predictive Modeling with Generated Marks](#) below.

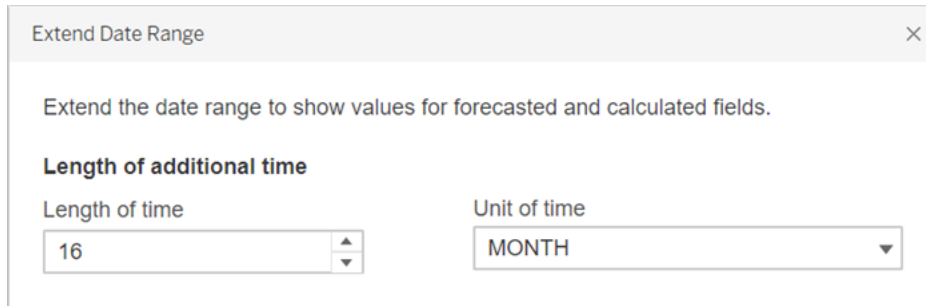
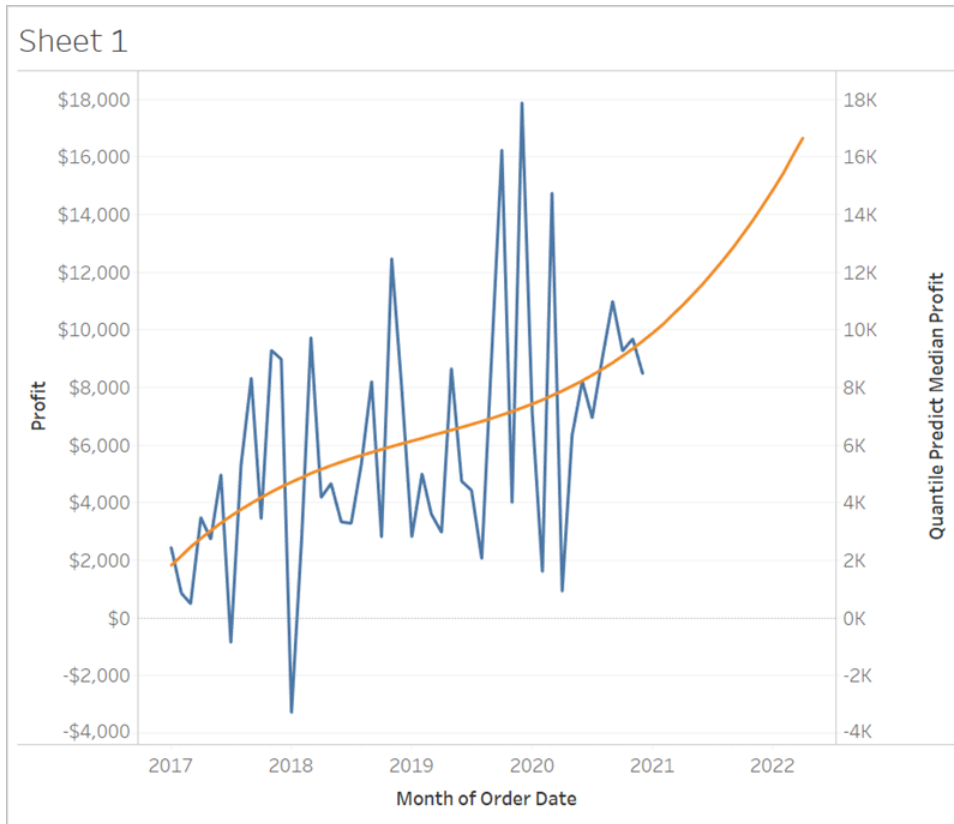
For more information on data densification, see this [data densification post](#) from [Data Plus Science](#).

Predictive Modeling with Generated Marks

If you've been using Tableau for a while, you may have heard of the phrase "data densification." This refers to a process in which marks are generated by Tableau and added to the view, even

though those marks aren't supported by records in the underlying data source. This might be done to extend a date axis, or if you're working with [predictive modeling functions](#), to show predictions.

Watch a video: For an in-depth discussion on densifying data, check out this presentation from TC19: [You Did What to Your Data? A Deep Dive into Imputing and Densifying Data](#).

Learn more: See this blog post on [data densification](#) from [Data Plus Science](#).

Calculate predictions on missing values

For example, you might want to add predictions for future dates. By default, [missing values](#) in Tableau aren't shown, but you can generate these marks as follows:

1. Right-click (control-click on Mac) the date or bin header.
2. Select **Show Missing Values**.

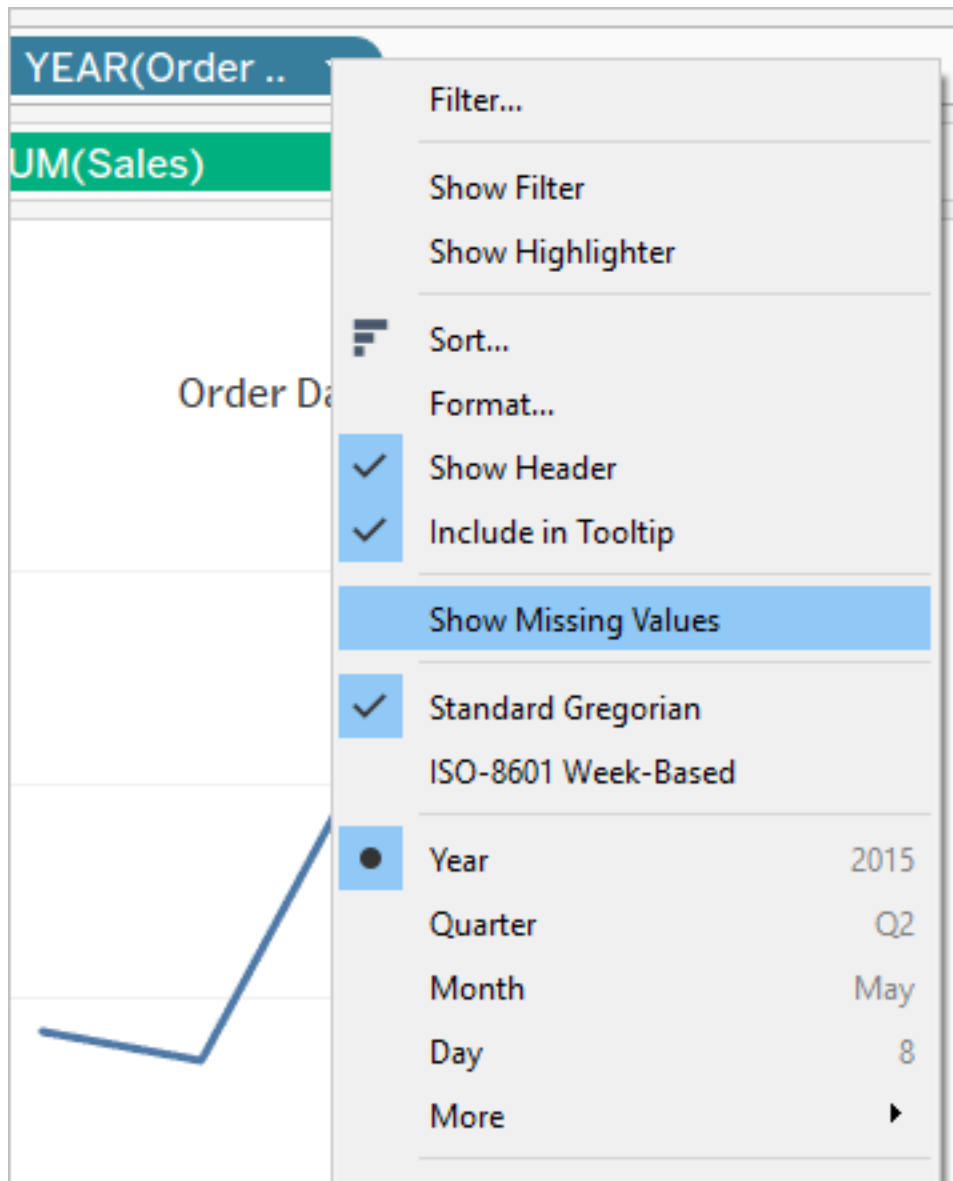

But this isn't enough to let you make predictions on those generated marks. If you tried to perform a calculation on them (whether that's a prediction calculation or not), Tableau would return **null values**. This is expected, since those marks are based on missing values that don't exist.

To make predictions on those missing values, open the **Analysis** menu at the top, and then select **Infer Properties from Missing Values**.

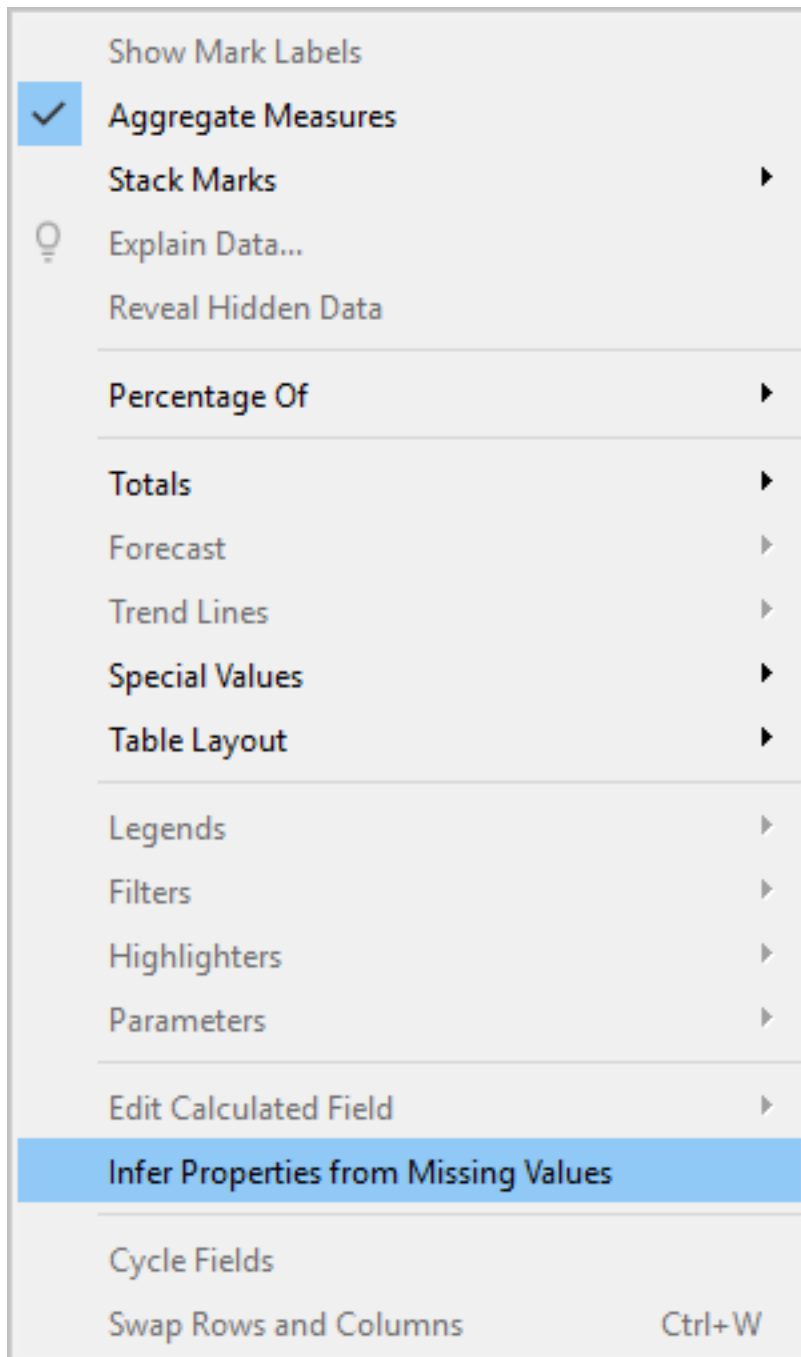

Note: The default setting is that **Infer Properties from Missing Values** is turned off, even when **Show Missing Values** is turned on. Any field or axis that can be expanded using **Show Missing Values** can have this setting applied.

Example of predictions on generated marks

Now let's explore this behavior further. We'll compare three different illustrations showing how the **Show Missing Values** and **Infer Properties from Missing Values** settings can affect your visualization, depending on whether one or both are turned on or off. To follow along, download the following workbook from Tableau Public: [Predictions on Missing Values](#).

We've included predictions using `ATTR(DAY([Order Date]))` as a predictor. This isn't the best predictor for the data (and yields inadequate predictions), but for the purposes of this article, it's a good illustration of **Infer Properties from Missing Values**.

Each viz includes the same four measures on the Rows shelf, as outlined below:

- Row 1: `SUM([Profit])`
- Row 2: `RUNNING_SUM(SUM([Profit]))`
- Row 3: `ATTR(DAY([Order Date]))`
- Row 4: `MODEL_QUANTILE(0.5, SUM([Profit]), ATTR(DAY([Order Date])))`

Illustration 1

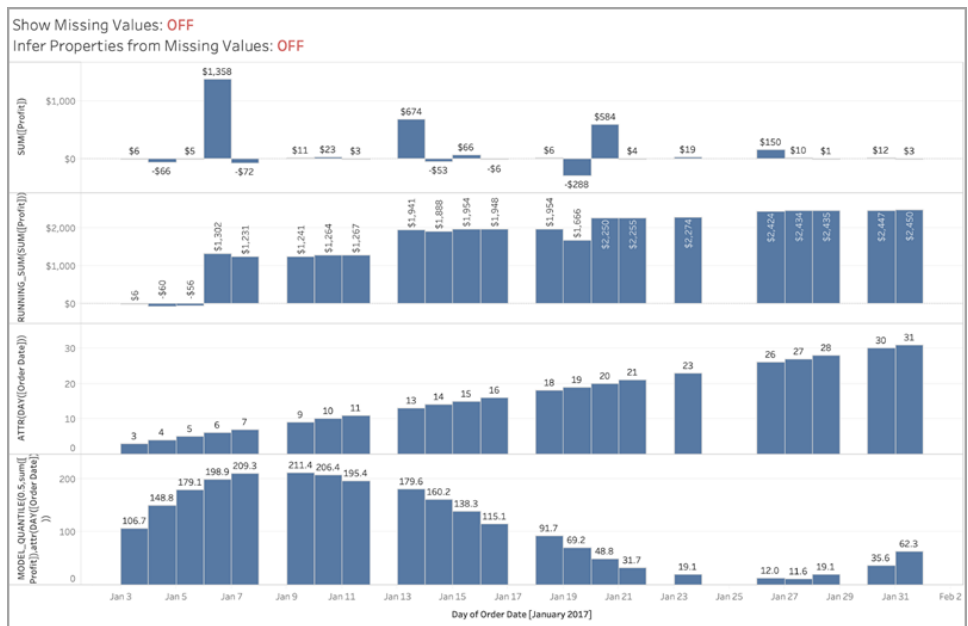

In the above image, both **Show Missing Values** and **Infer Properties from Missing Values** are turned off, which are the default settings in Tableau.

You would see the same viz if **Infer Properties from Missing Values** was turned on and **Show Missing Values** was turned off. This is because **Infer Properties from Missing Values** depends on **Show Missing Values** being turned on.

Illustration 2

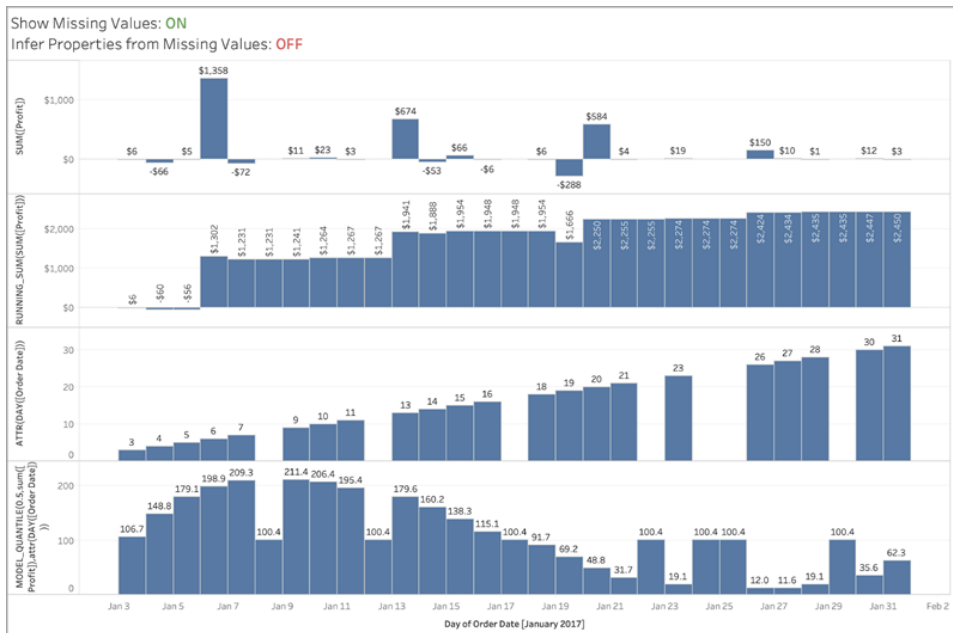

In the above image, **Show Missing Values** is turned on and **Infer Properties from Missing Values** is turned off. The default setting is that **Infer Properties from Missing Values** is turned off, even when **Show Missing Values** is turned on.

Note that in this situation, we do not compute a value for **ATTR** on **DAY**([Order Date]) for the missing values (Row 3). We do generate a prediction for the densified dates, but they are identical for all missing dates, since we're not able to infer the actual **ATTR**(**DAY**([Order Date])) as shown in Row 3. Effectively, those marks are being computed as if **DAY**([Order Date]) is null.

Illustration 3

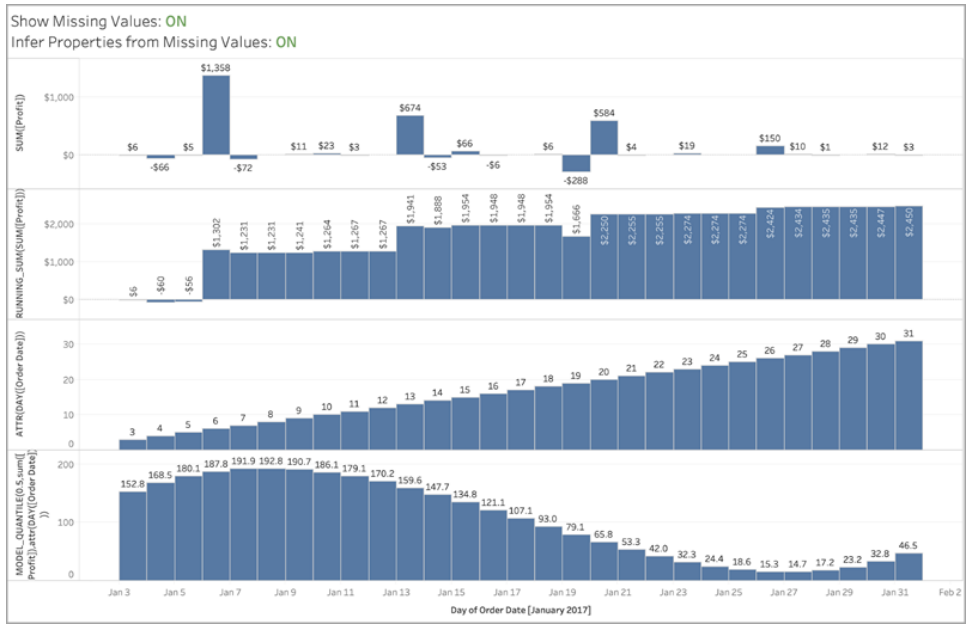

In this image, both **Show Missing Values** and **Infer Properties from Missing Values** are turned on, illustrating the **Infer Properties from Missing Values** setting in action.

As you can see, since we're able to infer the `ATTR(DAY([Order Date]))` (Row 3), we're able to use it in predictions in Row 4, returning a nice smooth curve of predictions.

Regularization and Augmentation in Predictive Modeling

Many people who use Tableau may not use **predictive modeling**, let alone look for ways to improve a predictive model's fit and prediction quality. This article is for advanced users who are interested in this area of data science.

In addition to the default arguments such as target expression (the measure to predict) and predictor expression (the measure and/or dimensions used to make the prediction), you can add two more arguments to fine-tune your predictions: *lambda*, a regularization parameter, and *augmentation*. This involves adding the new arguments to the **syntax** of your calculation.

Which models work with regularization and augmentation?

As a reminder, predictive modeling functions in Tableau support three models: linear regression (also known as ordinary least squares regression, or OLS), regularized linear regression (or ridge regression), and Gaussian process regression. If you're using linear or ridge regression, then augmentation allows you to increase the ability of your models to pick up non-linear patterns. If

you're using ridge regression, then the regularization parameter is a scalar you can use to adjust the regularization effect on your model.

Regularization and augmentation are not applicable to [Gaussian process regression](#).

Before discussing regularization and augmentation further, let's review these two models:

Linear regression is best used when there are one or more predictors that have a linear relationship between the prediction and the prediction target, they aren't affected by the same underlying conditions, and they don't represent two instances of the same data (for example, sales expressed in both dollars and euros).

Regularized linear regression is used to improve stability, reduce the impact of collinearity, and improve computational efficiency and generalization. In Tableau, L2 regularization is used. For more information on L2 regularization, see this lesson on [Ridge Regression](#).

What is regularization?

Ridge regression is a specific kind of regularized linear regression. Regularization imposes a penalty on the size of the model's coefficients. The strength of the regularization is controlled by [lambda](#), a scalar used to fine-tune the overall impact of regularization. The higher the value, the heavier the penalty (i.e. the greater the regularization).

Ridge regression addresses some of the problems of linear regression:

- It removes pathologies introduced by multicollinearity among predictors.
- If the least-square problem is ill-conditioned, such as if the number of data points is less than the number of features, then lambda will select a unique solution.
- It provides a way of improving the generalization of the linear model.

By default, ridge regression in Tableau has **lambda=0.5** because this value works well in many cases. To change the lambda value, simply edit the table calculation (examples below).

What is augmentation?

Augmentation in MODEL_QUANTILE and MODEL_PERCENTILE is a simple example of [data augmentation](#): predictors are expanded to higher order polynomials. In Tableau, there are a couple types of polynomial augmentations built in to the predictive modeling functions.

- For **ordered dimensions**, [Legendre polynomials](#) up to order 3 allow the linear model to pick up quadratic and cubic relations between the augmented predictor and response.
- For **measures**, 2nd degree [Hermite polynomials](#) allow the linear model to pick up quadratic relations between the augmented predictor and response.

In linear regression, only ordered dimensions are augmented by default with **augmentation=on**; in ridge regression where **model=rl**, only measures are augmented by default. To override the setting and disable augmentation for each predictor in your calculation, use **augmentation=off**; no higher order polynomials will be added.

Turning off augmentations is advantageous when the data set is very small because the augmentations could overfit any noise present in the original data, and also because the resulting relationship is simpler and more intuitive.

Note: Augmentation is turned on/off on a per-predictor basis (i.e. within the predictor argument of your calculation). Lambda (and model) are applied at the higher level (outside any predictor expressions).

Configuring lambda and augmentation in your calculation

Now that you know about the regularization parameter (or lambda) and data augmentation, let's see them in the context of a prediction calculation:

```
MODEL_QUANTILE("model=rl, lambda=0.05", 0.5, SUM([Profit]),  
"augmentation=off", SUM([Sales]))
```

Below is a table that quickly summarizes if changing the augmentation and lambda from the default affects the linear models:

	Augmentation	Lambda
Ridge regression	Yes	Yes
Linear regression	Yes	Not applicable

Considerations for regularization and augmentation

- If you have the wrong model for your data, then changing the regularization parameter or augmentation isn't likely to produce significantly better results. Consider reviewing if the data types are correct (measures vs. dimensions). If the underlying data is a time series, for instance, consider using **Gaussian process regression** instead, by changing the model in your table calculation with **model=gp**.
- Because OLS is not regularized, there is no lambda value that can be changed.

- If your data set is extremely small and you have dimensions (especially high cardinality dimensions), then consider using ridge regression by adding `model=rl` to your table calculation.
- All things being equal (for the same data set, given augmentation is on or off), a low lambda may improve fit, but hurt generalization (cause overfitting).
- Conversely, a high lambda may push the fit to be a constant model, with no dependence on any of the predictor. This will reduce the model capacity (cause underfitting).

Example 1

This example shows the relationship between average cholesterol and heart disease in males and females, where males are represented by square marks and females are represented by circles.

In the first visualization, the blue marks indicate the prediction target and the orange marks are the modelled values. You can see that the data is very noisy, and that with augmentation turned on and a small lambda value of 0.01, we see unrealistic heart disease rates greater than 1. There is far too steep of a dependence, probably due to all the outliers in the noisy data.

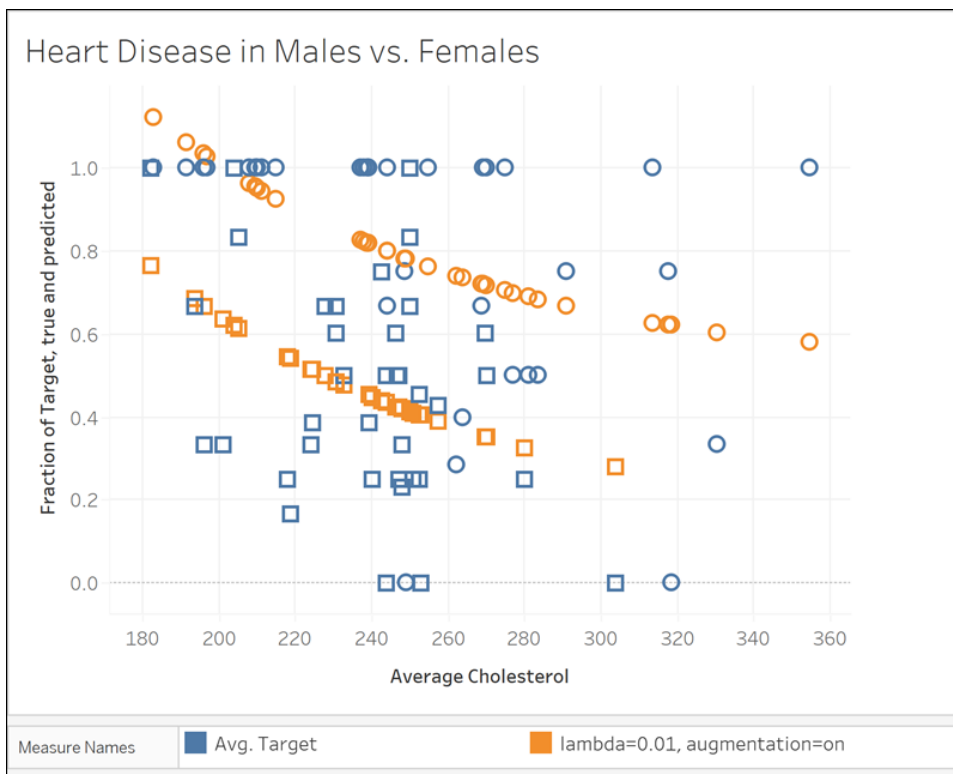

```
MODEL_QUANTILE("model=rl, lambda=0.01", 0.5, AVG([Target]), ATTR([Sex]), "augmentation=on", AVG([Chol]))
```

In the next visualization, we compare the prediction target with a different model, with augmentation turned off and a lambda value off 10. Notice that this model is more realistic, and no marks exceed a disease rate of 1.

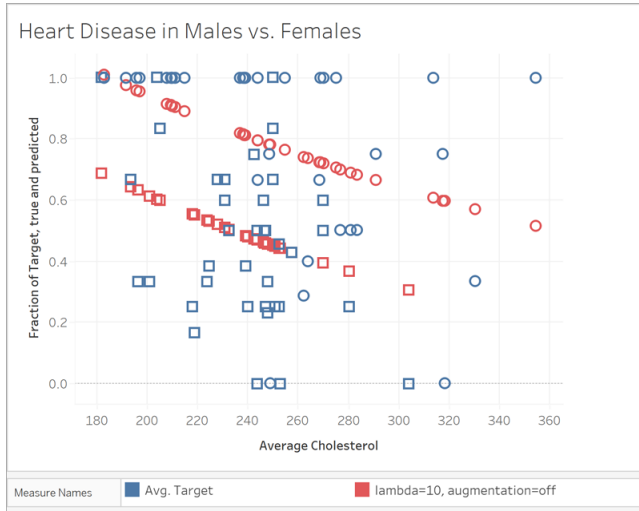

`MODEL_QUANTILE("model=rl, lambda=10", 0.5, AVG([Target]), ATTR([Sex]), "augmentation=off", AVG([Chol]))`

Example 2

Next, let's look at another real-world example using ridership data for Boston's Bluebikes (formerly Hubway) bike sharing system. In this case, linear regression works well. Compare the following visualizations, aggregated to quarters of 2017:

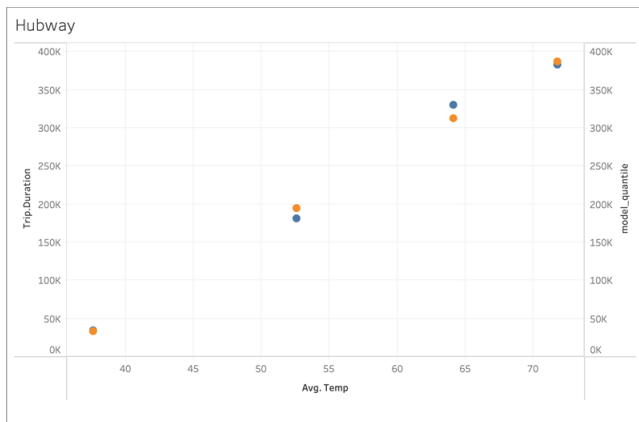

`MODEL_QUANTILE('model=rl, lambda=0.05', 0.5, sum([Trip.Duration]), AVG([Temp]))`

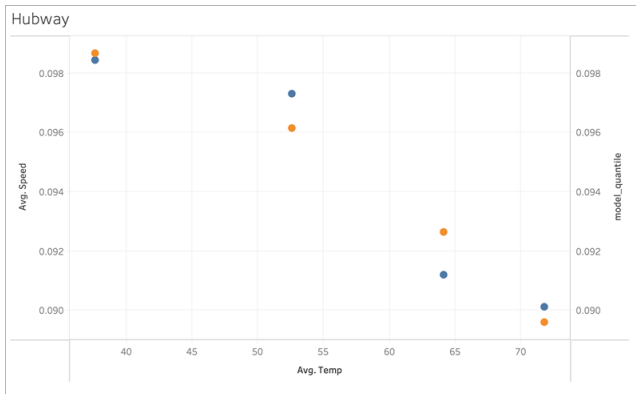

`MODEL_QUANTILE('model=rl, lambda=0.05', 0.5, AVG([Speed]), AVG([Temp]))`

Neither is prone to overfitting much, so the dependence on lambda is weak for a small lambda.

Now look at this last visualization:

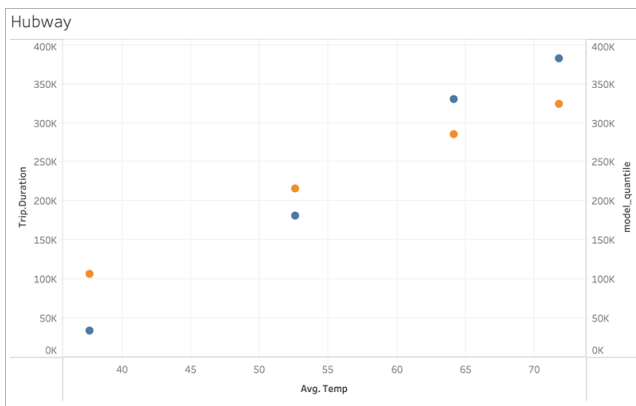

`MODEL_QUANTILE('model=rl, lambda=2', 0.5, sum([Trip.Duration]), AVG([Temp]))`

Notice that as lambda increases, the fit flattens to no slope (that is, becomes over-regularized or “underfit”).

Resolve Errors in Predictive Modeling Functions

When using **predictive modeling functions** in Tableau, you may encounter errors when trying to add the calculations to a viz. Often, this is due to the combination of predictors and visualized elements, leading to a mathematically invalid computation.

Generally, the first thing to try is to double check your **Compute Using** dimension. Next, verify there isn't a mismatch between the level of detail specified in your predictors and the level of detail in the view. Also verify that your predictors provide relevant data to the model, given the current visualization.

In this article, we describe several common issues in detail, and the ways in which you can address them.

Errors with predictive modeling functions are usually caused by one or more of the following issues, depending on the model used.

General errors

- [Invalid Compute Using dimension](#) below
- [Dimension predictors conflict with level of detail visualized](#) on the next page
- [Multiple predictors conflict with each other](#) on page 2631
- [There's not enough data to build a model](#) on page 2631
- [A successful model couldn't be constructed from the data provided](#) on page 2631

Gaussian process regression errors

- [Gaussian process regression requires exactly one ordered dimension predictor](#) on page 2632
- [Gaussian process regression only supports dimensions as predictors](#) on page 2633
- [There's no training data for one or more prediction targets](#) on page 2634
- [There are more than 5,000 marks](#) on page 2634

Invalid Compute Using dimension

When visualizing a predictive modeling function, a Compute Using dimension must be specified. It's recommended you select a specific dimension (such as **Region** or **Category**) rather than a directional dimension (such as **Table Across Then Down** or **Pane Across**).

Since you may have multiple predictive modeling functions included in a viz or dashboard, selecting a specific partitioning dimension will help ensure you're building models using the same underlying data set for each individual function—in other words, comparing results from like to like models.

For more information on addressing and partitioning, see [Transform Values with Table Calculations](#) on page 2364.

When working with predictive modeling functions, you must ensure you maintain consistency across the different instantiations, both in different iterations of your model (e.g., as you select different predictors), and in different vizzes. Using the directional Compute Using dimensions opens up the possibility that a trivial change in your visualized data will significantly affect the data being used to build the model, thus affecting its validity and consistency across different vizzes.

You may see **null values** if no Compute Using dimension has been specified, or if an invalid Compute Using dimension has been selected.

Invalid Compute Using dimensions include:

- Cell: This dimension will always result in a single data point being used to build a model and will not be successful.
- A higher-level nested dimension (e.g., if **Region** and **State** are both visualized on an axis, where marks are generated for **State** but grouped by **Region**.) If **Region** is selected as the partitioning dimension, it will return null values, since there are no marks formalized for **Region** in this view.

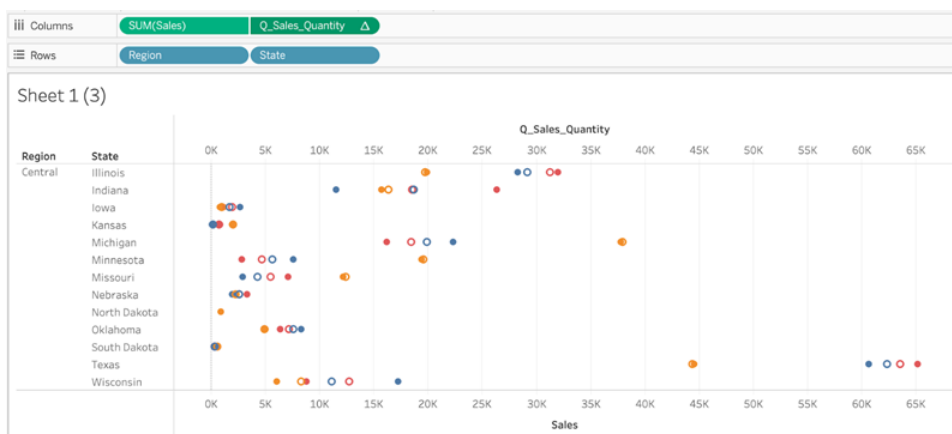

In the above viz, valid Compute Using dimensions are **State** and **Category**. Partitioning the data by **State** or by **Category** yields multiple valid marks that can be used to build a model.

Region, while listed as a Compute Using option, doesn't generate any marks on this view's level of detail, and can't be used to partition the data.

For more information, see [Compute Using and Data Partitioning in Predictive Modeling on page 2592](#).

Dimension predictors conflict with level of detail visualized

Dimension predictors must be at the same level of detail being visualized or *higher*. That is, if you're visualizing data by **State**, you can use **State**, **Region**, or **Country** as predictors, but using **City** as a predictor will cause an error. Since multiple cities exist within a state, this predictor will resolve to * for all marks and won't return meaningful information; as such, Tableau ignores it.

Each dimensional predictor must be enclosed within an **ATTR function**, for example:

```
MODEL_PERCENTILE(SUM([Sales]), ATTR([State]), ATTR([Category]))
```

Multiple predictors conflict with each other

Each predictor used within a given predictive modeling function must provide independent information to the calculation. If two predictors are selected that are exactly equivalent, scaled versions, or inverses of each other, the predictive modeling function will return an error when it's visualized.

For example, a data set that tracks weather conditions over time might have two fields: **IsRain** and **IsClear**. These two fields are inverses of each other; that is, **IsClear** = True when **IsRain** = False, and vice versa. Including both **IsClear** and **IsRain** as predictors on a single predictive modeling function will return an error.

The above is true for both measures and dimensions as predictors.

In both cases, the error can be resolved by modifying your predictors to remove the highly correlated predictors. For more information, see [Choosing Predictors on page 2581](#).

There's not enough data to build a model

There must be at least three marks within a partition to allow predictive modeling functions to build a model and generate predictions. If there are two or fewer marks in the data set defined by the viewed data and the Compute Using dimension, then the predictive modeling function will return null results.

To resolve this issue, revise your level of detail, your data filtering parameters, or your Compute Using dimension so that each partition has more than two marks.

A successful model couldn't be constructed from the data provided

This error appears if there's a conflict between the predictor(s) selected, the visualized level of detail, and/or the selected Compute Using dimension, such that it is impossible to use the predictors to build a rational model.

For example, let's look at this MODEL_QUANTILE calculation:

```
MODEL_QUANTILE(0.5, MEDIAN([Profit]), ATTR(MONTH([Order Date])))
```

Applying this calculation to a viz where each mark represents a **State** value will return the below error:

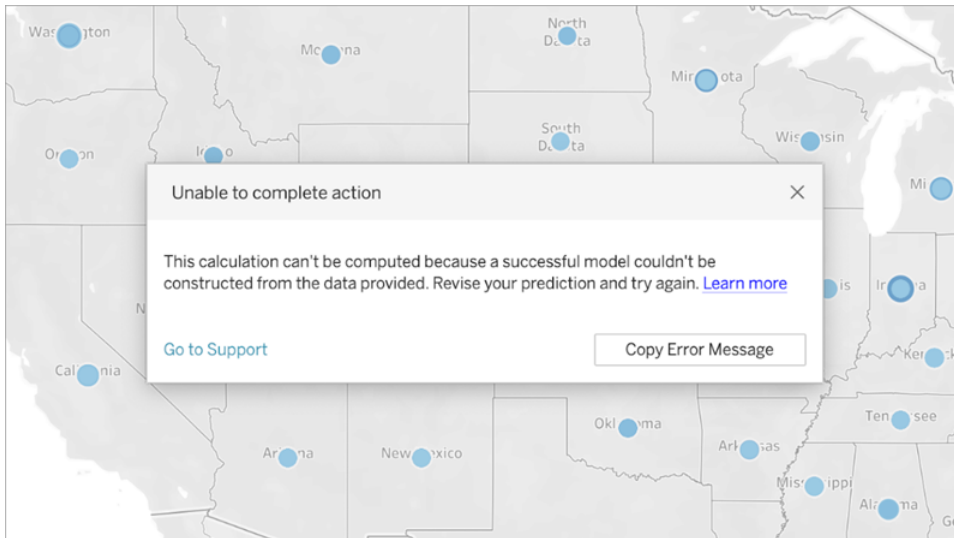

Since **Order Date** is not used to visualize or segment the data, the predictive modeling function can't use the predictor specified to build a model.

To resolve this:

- Update your visualization to include the predictor as a dimension.
- Update your function to remove the non-viable predictor.

It's worth noting that this error reflects a mismatch between the visualization and the table calculation's specific predictors. This same calculation would work without issue if applied to a visualization that included **Order Date** as a dimension.

Gaussian process regression requires exactly one ordered dimension predictor

To use Gaussian process regression, you must include exactly one ordered dimension as a predictor. You can include additional *unordered* dimensions as predictors. Measures can't be used as predictors with Gaussian process regression.

If you encounter this error, add an ordered dimension predictor to your table calculation, remove the excess ordered dimension predictor, or specify that one of the ordered dimensions should be treated as an unordered dimension.

As Gaussian process regression is best used on time-series data, this will usually take the form of a time-based predictor such as `ATTR(DATETRUNC('month',[Order Date]))`. Any **date_part** can be used in the `DATETRUNC` expression, but the `date_part` must be at the same or higher level of detail as the viz. That is, if the viz uses `WEEK([Order Date])` as the level of aggregation,

the `date_part` must be 'week','month','quarter', etc.; it can't be 'dayofyear', 'day', 'weekday', 'hour', etc.

Note that since `ATTR(MONTH([Date]))` returns string values, it will not function as an ordered dimensional predictor unless it is manually specified. This is done by including **"ordered"** immediately before the predictor, as below:

```
MODEL_PERCENTILE (
  "model=gp",
  SUM([Sales]),
  "ordered",ATTR(MONTH([Order Date]))
)
```

If you want to include multiple time dimensions in your predictors, you must specify which ones you wish to use as unordered dimensions. This can be done by including **"unordered"** directly before that dimension, as below:

```
MODEL_PERCENTILE (
  "model=gp",
  SUM([Sales]),
  ATTR(DATETRUNC('month',[Order Date]))
  "unordered",ATTR(DATETRUNC('year',[Order Date]))
)
```

Attempting to use the above calculation without specifying **"unordered"** in front of `ATTR(DATETRUNC('year',[Order Date]))` will return an error.

Additionally, the addressing direction (or "Compute Using") for Gaussian process regression must be set to the same field as the ordered dimension predictor.

Only one addressing direction (or "Compute Using") can be selected for all models.

Gaussian process regression only supports dimensions as predictors

You can't use any measures as predictors in Gaussian process calculations. Remove the measure predictor.

This limitation only applies to predictive modeling functions that specify Gaussian process regression. Linear regression (or OLS, the default) and regularized linear regression functions both support measures as predictors.

There's no training data for one or more prediction targets

Gaussian process regression requires that each data partition has at least n data points in order to build a predictive model and return predictions. If you encounter this error, revise your predictions.

There are more than 5,000 marks

Gaussian process regressions are only supported on vizs with fewer than 5,000 marks. To resolve this issue, update your level of detail to decrease the number of marks, or select a different statistical model.

Integrate Einstein Discovery Predictions in Tableau

Reveal dynamic predictions from Einstein Discovery in your Tableau views and dashboards. In Tableau 2021.1 and later, you can access the power of Einstein Discovery predictions in these ways:

- Connect to the [Einstein Discovery analytics extension](#) to interact with Einstein Discovery-powered predictive models from Tableau.
- Embed predictions in a Tableau workbook by pasting generated [table calculation scripts from Einstein Discovery](#) into calculated fields in Tableau.
- Give users dynamic, on-demand predictions based on their Tableau data using the [Einstein Discovery dashboard extension](#).
- In Tableau Prep, [add Einstein Discovery prediction steps to flows](#) to enrich your flow output with predictions and, optionally, improvements and top factors.

Note: For an introduction to Einstein Discovery in Tableau, see the [Einstein Discovery in Tableau](#) page and [demo](#) on [tableau.com](#).

What is Einstein Discovery?

Einstein Discovery is an analytics tool that augments your data analysis with the power of artificial intelligence using machine learning models and comprehensive statistical analysis. Einstein Discovery quickly sifts through millions of rows of data to find important correlations, predict outcomes, and suggest ways to improve those predicted outcomes.

For more information about Einstein Discovery, see [Gain Insight with Einstein Discovery](#) trail in [Trailhead](#).

Note: Einstein Discovery in Tableau is powered by [salesforce.com](https://www.salesforce.com). Consult your agreement with [salesforce.com](https://www.salesforce.com) for applicable terms.

Requirements for access

To configure and use Einstein Discovery predictions in Tableau, you and anyone who will be viewing predictions in a Tableau workbook will need certain licenses, access, and permissions in Salesforce and Tableau.

Salesforce Requirements

Tableau integration with Einstein Discovery is supported in Tableau version 21.1 or later. Integration requires:

requirement	description
Salesforce license	<p>One of the following licenses:</p> <ul style="list-style-type: none">• Einstein Discovery in Tableau license• Tableau CRM Plus license• Einstein Predictions license <p>These licenses are available for an extra cost.</p>
Salesforce user account	<p>Account that is configured to access Einstein Discovery.</p> <p>If you use the Einstein Discovery in Tableau license, your user account must have the View Einstein Discovery Recommendations Via Connect API system permission assigned to it.</p> <p>If you use either the Tableau CRM Plus license or Einstein Predictions license:</p> <ul style="list-style-type: none">• To get predictions using already deployed Einstein Discovery predictions, the account must have the View Einstein Discovery Recommendations system permission assigned to it.• To build, deploy, and manage predictions in Einstein Discovery, the account must have the Manage Einstein Discovery permission assigned to it.

requirement	description
	To configure user accounts, see Set Up Einstein Discovery in Salesforce help.
Administrator settings	Salesforce administrators will need to: <ul style="list-style-type: none"> • Analytics Extension: Configure Salesforce to create a connected app for Tableau Server (basic). Required for Tableau Server only. • Dashboard Extension: Add the Tableau Server or Tableau Cloud website domain to the Salesforce Cross-Origin Resource Sharing (CORS) allowlist.

Tableau Requirements

requirement	description
Tableau license and permissions	Authors who need to configure the Einstein Discovery dashboard extension will need a Creator or Explorer license and permissions that allow them to edit and save workbooks. Creators, Explorers, and Viewers will need to be signed in to the Salesforce org account to access predictions in the Einstein Discovery dashboard extension in Tableau.
Tableau user account	In Tableau Cloud and Tableau Server, users can save Salesforce user account credentials along with their Tableau user account.
Administrator settings	Tableau Server administrators will need to configure Tableau Server for OAuth (enables access to predictions from Tableau). For more information, see Configure Einstein Discovery Integration in Tableau Server help. To let users see predictions in published table calculations, Tableau Server administrators need to enable analytics extensions for the site. For more information, see Configure Connection with Analytics Extensions in Tableau Server help. For more information on Tableau Server configuration, see

requirement

description

[Configure Einstein Discovery Integration \(Tableau Server\)](#).

For more information on Tableau Cloud configuration, see [Configure Einstein Discovery Integration \(Tableau Cloud\)](#).

Analytics extension support for Einstein Discovery predictions

Einstein Discovery in Tableau brings trusted, intuitive predictions and improvements from Einstein Discovery to every Tableau user across your organization. Workbook authors can build and share visualizations and dashboards that dynamically integrate predictions from predictive models deployed in Salesforce [Einstein Discovery](#).

Authors set up the Einstein Discovery analytics extension for use in a workbook, and then can embed Einstein Discovery-powered predictions directly in Tableau using calculated fields.

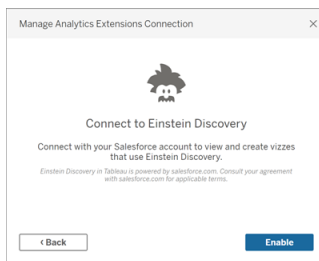

Access Einstein Discovery predictions in Tableau calculated fields

With Tableau connected to the Einstein Discovery analytics extension, you can embed predictions directly in calculated fields. In Salesforce, use Model Manager to auto-generate a Tableau table calculation script, and then paste that script into a calculated field for use in a Tableau workbook. The table calculation script accesses predictive models deployed in Salesforce by calling the prediction ID and passing the data required for the model.

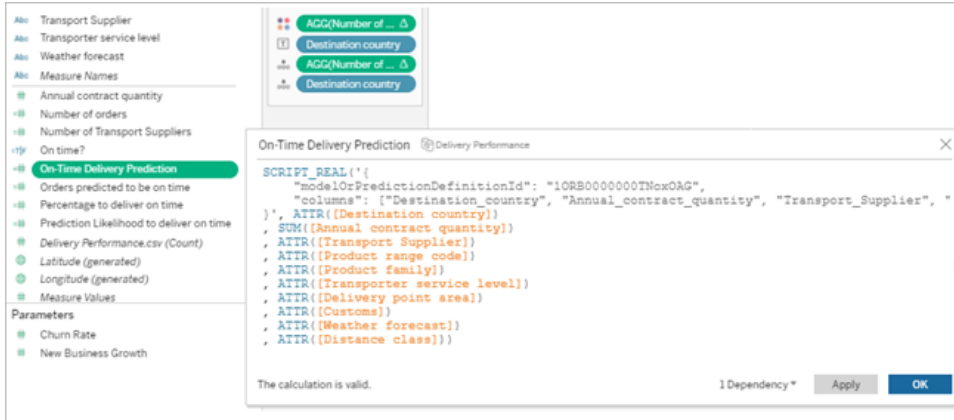

You can create prediction-enhanced visualizations in Tableau Desktop, Tableau Cloud, or Tableau Server, or publish them to the web.

For more details, see [Einstein Discovery on page 2655](#) in [Pass Expressions with Analytics Extensions on page 2653](#).

Einstein Discovery dashboard extension in Tableau

Integrate on-demand, interpretable predictions from Einstein Discovery in Tableau dashboards. Authors create worksheets and the dashboard, and then configure the Einstein Discovery dashboard extension to use a selected Einstein Discovery prediction definition, which uses source data available in the dashboard to derive predictions. Dashboard viewers and users can click different marks in the Tableau visualization to explore predictions.

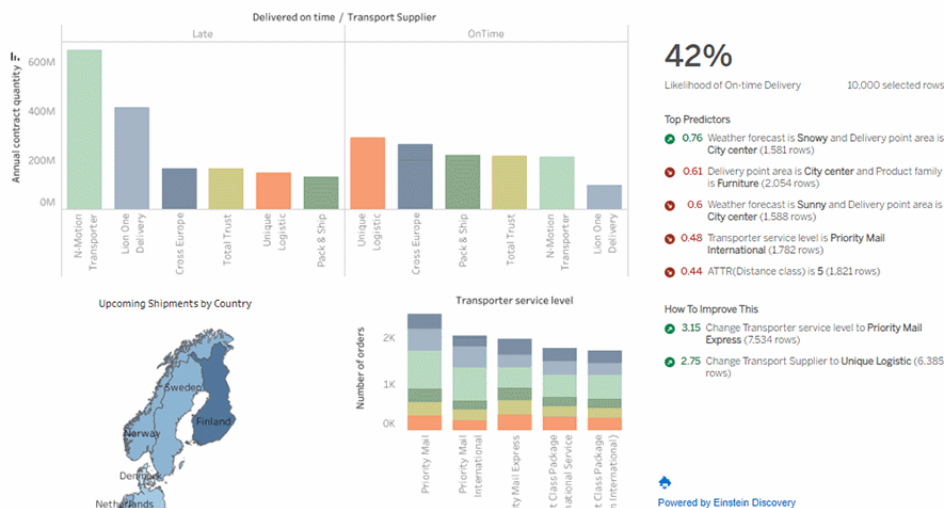

For more information, see [Explore Predictions in Tableau with the Einstein Discovery Dashboard Extension](#) below.

Explore Predictions in Tableau with the Einstein Discovery Dashboard Extension

Use the Einstein Discovery dashboard extension to surface real-time predictions in Tableau. The dashboard extension generates predictions interactively, on-demand, using an Einstein Discovery predictive model on source data in your Tableau workbook.

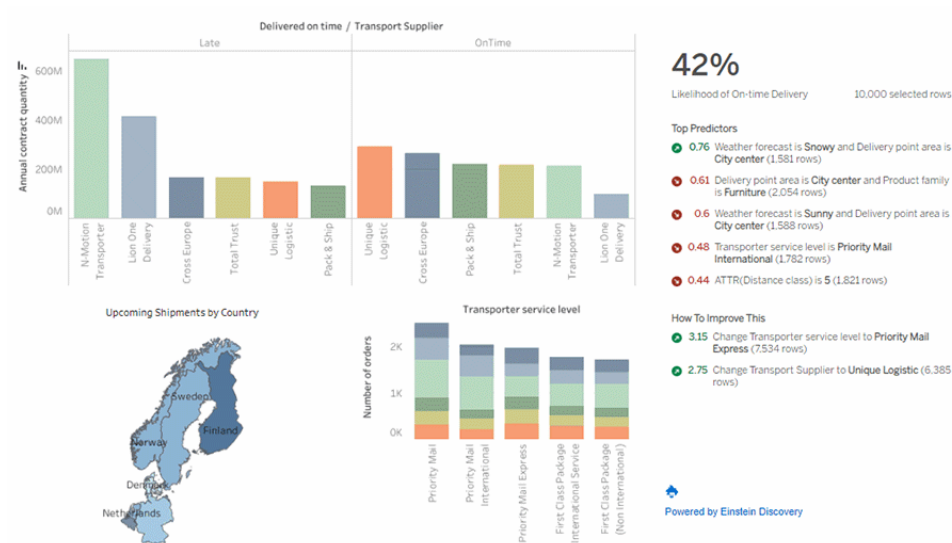

Click marks in the dashboard to see dynamic predictions, key drivers, and possible ways to improve predictions based on an Einstein Discovery predictive model

Dashboard authors can configure the dashboard extension to run predictions on aggregated data in a worksheet, as demonstrated in the image above, or use parameters to let dashboard users explore "what-if" scenarios based on a single set of input values.

For information on how to add the Einstein Discovery dashboard extension, see [Add and configure the Einstein Discovery dashboard extension](#) on page 2642 in this topic. Also see [Requirements for access](#) on page 2635.

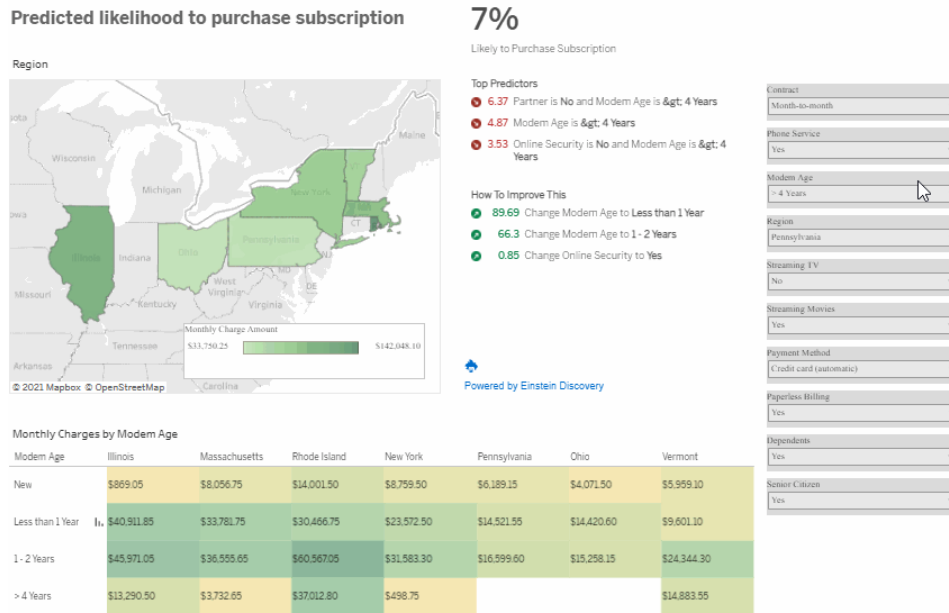

Select inputs in parameters to see how those values might affect predictions

For more information about Einstein Discovery, see [Introduction to Einstein Discovery](#), and [Enhanced Analytics with Einstein Discovery](#) in Salesforce help. You can also expand your knowledge with the [Gain Insight with Einstein Discovery](#) trail in [Trailhead](#).

Note: Einstein Discovery in Tableau is powered by [salesforce.com](#). Consult your agreement with [salesforce.com](#) for applicable terms.

Use the Einstein Discovery dashboard extension

To explore predictions in a dashboard that uses the Einstein Discovery dashboard extension, select different marks or parameter values in the view. Predictions update based on the data in your selection.

You might need to sign into the Salesforce org account that has access to the prediction definition used by the dashboard extension.

In Tableau Desktop, you will need to sign in to your Salesforce account every time you use the Einstein Discovery dashboard extension. If Salesforce signs you out of your session automatically, you may need to reload the dashboard extension (click the drop-down arrow on the Extension object and then select **Reload**).

In Tableau Cloud and Tableau Server, you should need to sign in only once if your credentials are being saved with your Tableau account settings.

For related information, see [Use Dashboard Extensions](#) in Tableau help.

How to read Einstein Discovery predictions

The dashboard extension has three sections:

- **Prediction**—The predicted outcome
- **Top Predictors:** Conditions that affect the predicted outcome
- **How To Improve This:** Suggested actions to take to improve the predicted outcome

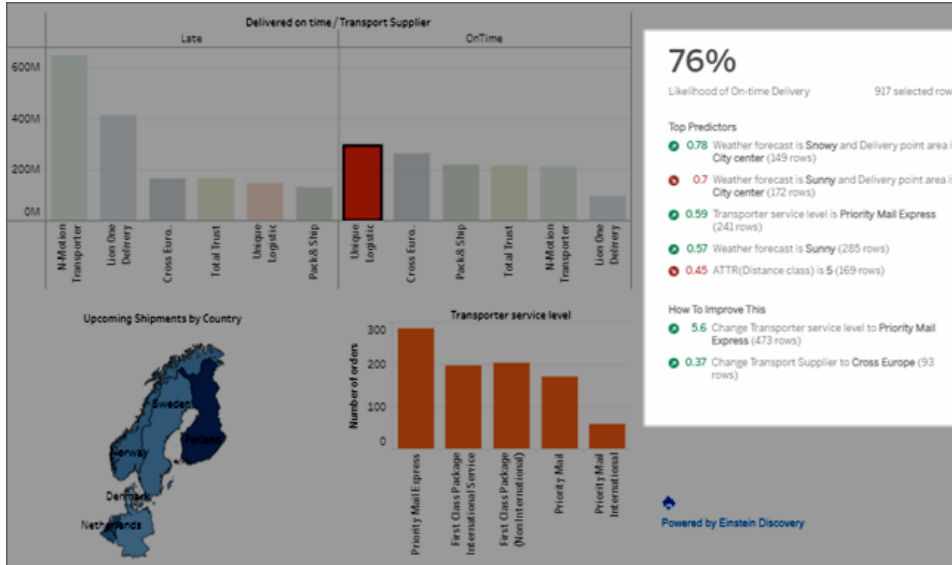

Section	Description	Example
<p>Prediction</p> <p>The prediction reflects the goal of the use case.</p>	<p>The goal is to either maximize or minimize the outcome. For example, your goal can be to minimize shipping time or to maximize the average sales revenue per shipment.</p>	<p>74%</p> <p>Likelihood of On-time Delivery</p> <p>165 selected rows</p>

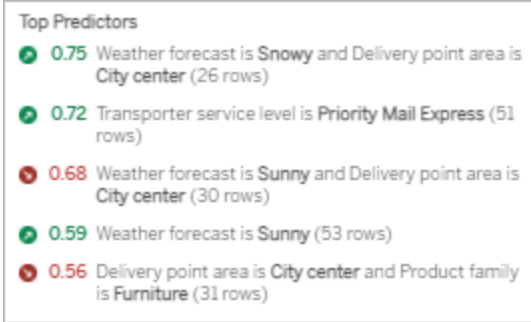
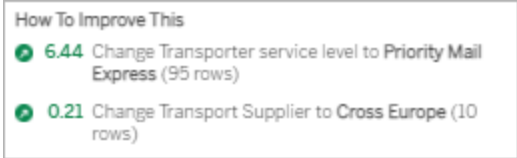
Section	Description	Example
<p>Top Predictors</p> <p>Conditions that most significantly affect the predicted outcome, in decreasing order of magnitude.</p>	<p>A condition is a data value associated with a field.</p> <p>A predictor consists of one or two conditions. If two conditions are shown, they are joined by <i>and</i> to represent the intersection of those conditions.</p> <p>Green (arrow up) indicates that the predictor improves the predicted outcome.</p> <p>Red (arrow down) indicates that the predictor worsens the predicted outcome.</p>	 <p>Top Predictors</p> <ul style="list-style-type: none"> 0.75 Weather forecast is Snowy and Delivery point area is City center (26 rows) 0.72 Transporter service level is Priority Mail Express (51 rows) 0.68 Weather forecast is Sunny and Delivery point area is City center (30 rows) 0.59 Weather forecast is Sunny (53 rows) 0.56 Delivery point area is City center and Product family is Furniture (31 rows)
<p>How To Improve This</p> <p>Suggested actions the user can take to improve the predicted outcome.</p>	<p>Improvements are associated with factors over which users can possibly control, such as the shipping method or a subscriber's membership level.</p>	 <p>How To Improve This</p> <ul style="list-style-type: none"> 6.44 Change Transporter service level to Priority Mail Express (95 rows) 0.21 Change Transport Supplier to Cross Europe (10 rows)

Add and configure the Einstein Discovery dashboard extension

To configure and use the Einstein Discovery dashboard extension in Tableau, you will need:

- Access to a Salesforce org and Tableau Desktop, Tableau Server, or Tableau Cloud.
- An Einstein Discovery prediction definition that is deployed in Salesforce.
- Source data in Tableau with fields that match the model fields required by the Einstein Discovery prediction definition.
- A worksheet in Tableau that contains the source data for the prediction.
- Additional worksheets that can be used as filters in the dashboard.
- The Einstein Discovery dashboard extension in a dashboard.

To configure and use Einstein Discovery predictions in Tableau, you and anyone who will be viewing predictions in a Tableau workbook will need certain licenses, access, and permissions in Salesforce and Tableau. For more information, see [Requirements for access on page 2635](#).

Prepare the model and the workbook

1. Build and deploy the Einstein Discovery prediction definition that you want to use. You can also use a prediction definition that someone else has built and deployed. For more information, see [Build, Deploy, and Manage Models](#) in Salesforce help.
2. Create a Tableau workbook that uses a data source with fields that can be mapped to all model fields required by the Einstein Discovery prediction definition.
3. Create a worksheet that contains the source data for the dashboard extension.

This source data must include all of the fields required by the Einstein Discovery prediction definition to predict an outcome. Also, the source data must match the granularity that the Einstein Discovery prediction definition expects. For example, if the prediction definition expects sales per individual order, then your Tableau data must include fields at the level of detail of individual orders.

- **Worksheets** support predictions for multiple rows of data (bulk predictions). The worksheet can contain the necessary fields in the Rows or Columns shelves, or on Marks card properties. The worksheet will not be visible in the dashboard; a simple view will suffice. For example, you could create a text table.

Delivery poi..	Order Id	Delivered o...	Customs	Priority	Product fa..	Product ran..	Transport S...	Transporte...	Weathe
Agricultural	50399	OnTime	False	1	Technology	Stockholm	N-Motion T...	Priority Mai...	Rainy
	50644	OnTime	False	1	Furniture	Helsinki	Total Trust	Priority Mai...	Snowy
	51349	Late	False	1	Furniture	Brussels	Lion One De...	First Class ...	Sunny
	51594	OnTime	True	1	Technology	Stockholm	N-Motion T...	First Class ...	Rainy
	51649	Late	True	2	Furniture	Copenhagen	Total Trust	Priority Mai...	Snowy
	52935	OnTime	False	1	Office Supp...	Oslo	Total Trust	Priority Mai...	Sunny
	53289	OnTime	False	1	Office Supp...	Oslo	Cross Europe	First Class ...	Snowy
	53443	Late	True	1	Furniture	Helsinki	Lion One De...	Priority Mail	Rainy
	53475	OnTime	False	1	Office Supp...	Copenhagen	Unique Logi...	Priority Mai...	Sunny
	53978	OnTime	False	1	Furniture	Stockholm	Pack & Ship	Priority Mai...	Rainy
	54512	Late	True	2	Furniture	Copenhagen	Pack & Ship	Priority Mai...	Snowy
	54798	OnTime	False	2	Technology	Brussels	Cross Europe	Priority Mai...	Snowy
	55215	OnTime	False	2	Technology	Oslo	Total Trust	Priority Mail	Sunny
	55249	OnTime	True	2	Technology	Brussels	N-Motion T...	First Class ...	Sunny
	55252	Late	False	1	Furniture	Helsinki	N-Motion T...	Priority Mai...	Rainy
	55421	Late	True	2	Furniture	Helsinki	Total Trust	Priority Mai...	Rainy
	56184	Late	True	1	Furniture	Oslo	N-Motion T...	Priority Mai...	Snowy
	56675	OnTime	False	1	Furniture	Helsinki	Total Trust	Priority Mai...	Sunny
	56831	Late	True	1	Furniture	Stockholm	Unique Logi...	Priority Mail	Sunny
	57177	OnTime	False	1	Office Supp...	Copenhagen	Unique Logi...	Priority Mai...	Snowy
	57629	Late	False	2	Technology	Stockholm	Lion One De...	Priority Mai...	Rainy
	57694	OnTime	True	2	Technology	Brussels	Pack & Ship	Priority Mai...	Sunny
	58356	OnTime	True	1	Office Supp...	Copenhagen	N-Motion T...	Priority Mai...	Rainy
	58377	OnTime	True	2	Office Supp...	Oslo	Cross Europe	Priority Mai...	Rainy
	58506	Late	False	2	Furniture	Amsterdam	N-Motion T...	First Class ...	Snowy
	59547	Late	True	2	Office Supp...	Copenhagen	N-Motion T...	First Class ...	Rainy
	59608	OnTime	False	1	Office Supp...	Brussels	Total Trust	First Class ...	Rainy

Or a basic bar chart.

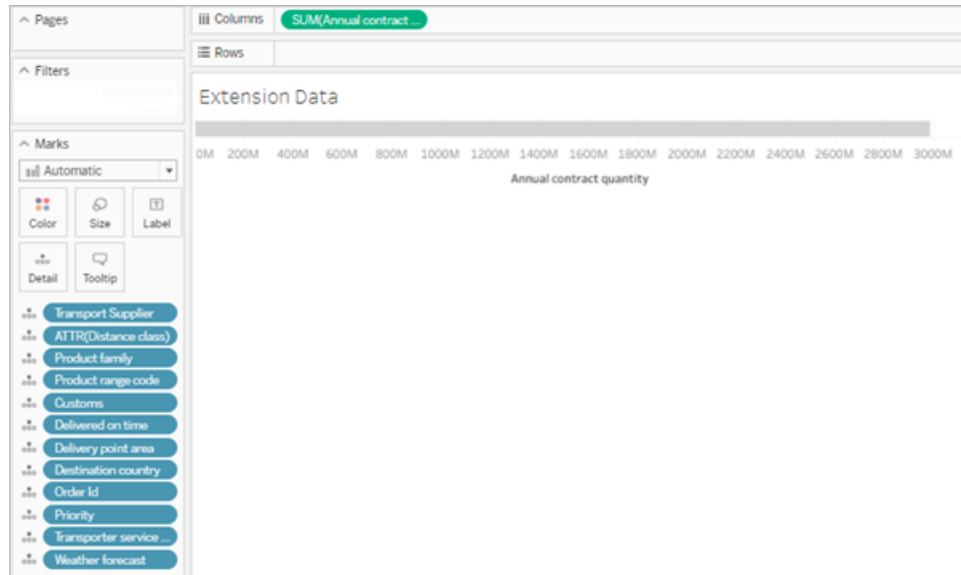

The worksheet used as source data for the model cannot exceed 50,000 rows of data. Fields in the view can't be Measure Names or Measure Values.

- **Parameters** support single-row predictions. To set up the worksheet, show the parameters in the view. You don't need to add fields to the view for this worksheet. For example:

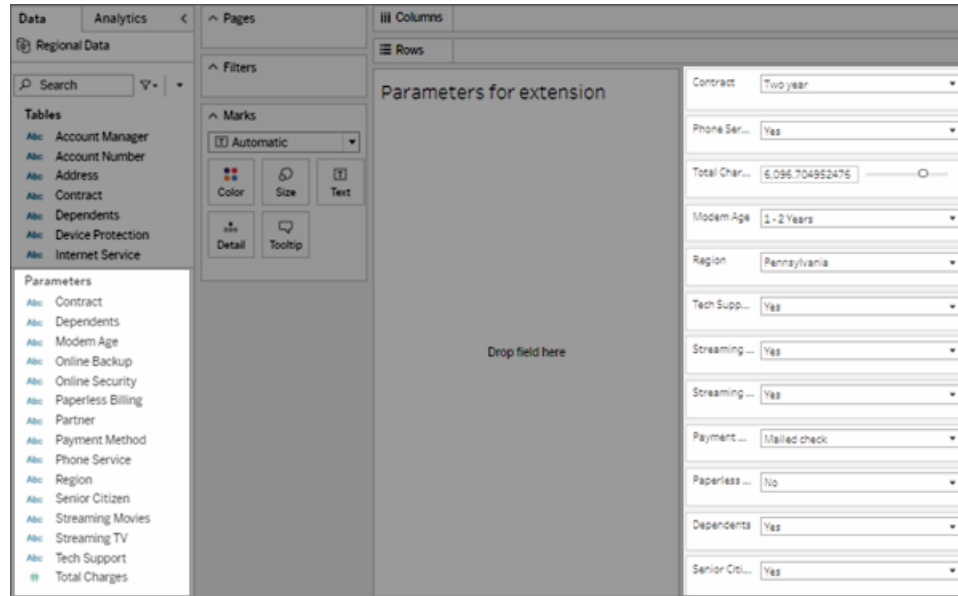

4. Create one or more worksheets with visualizations that you can set to **Use as Filter** in the dashboard.

The visualization can use a subset of the fields used by the model. Clicking marks in these views in the dashboard will refresh the predictions in the dashboard extension.

5. Create the dashboard. In the **Objects** section, click **Floating**. From the **Sheets** section, drag the source data worksheet to the canvas. Resize and hide that sheet so users won't see it in the dashboard. Also drag one or more sheets to the canvas to serve as filters in the dashboard.

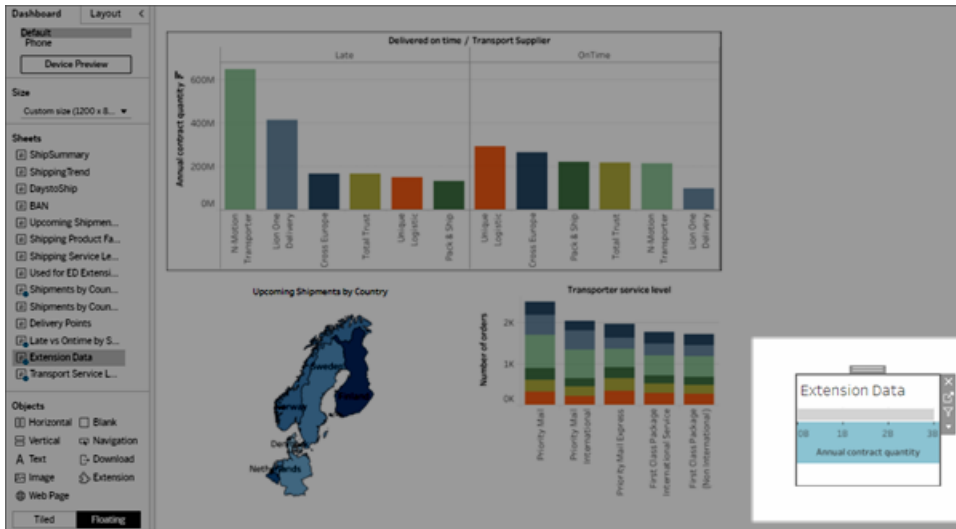

In the Sheet object menu, set at least one worksheet with a visualization to **Use as Filter**.

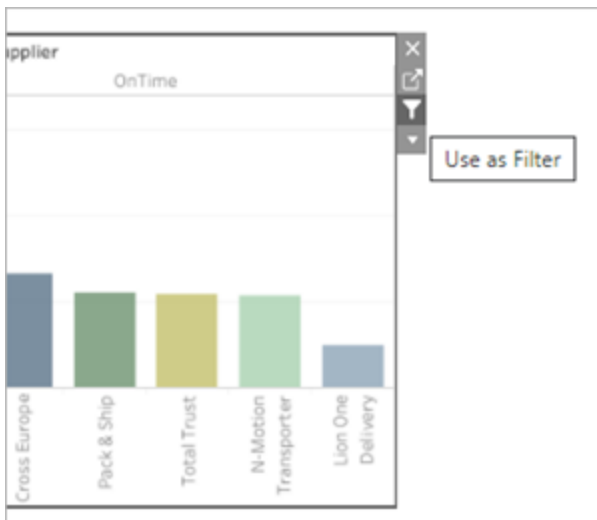

Configure the extension

1. From the **Objects** section, select **Floating**, and then drag the **Extension** object to the dashboard canvas. In the Tableau Exchange, select **Einstein Discovery**.

Sign in to your Salesforce account. After you sign in, a web page opens asking if you want to allow your Salesforce account to access Tableau. Click **Allow** to continue, and then close the resulting tab in your browser.

On Tableau Desktop, you will need to sign in to your Salesforce account every time you use the Einstein Discovery dashboard extension. If Salesforce signs you out of your session automatically, you may need to reload the dashboard extension (click the drop-down arrow on the Extension object and then select **Reload**). This time-out setting is configurable. For more information, see [Edit Session Settings in Profiles](#) in Salesforce help.

In Tableau Cloud and Tableau Server, you should need to sign in only once if your credentials are being saved with your Tableau account settings.

2. Configure the dashboard extension.

For **Prediction Definition**, click *Search Predictions* and then select the name of a prediction model deployed in Salesforce.

Select **Worksheet** or **Parameters** to be the source data for the predictions. Worksheet provides predictions based on a selected mark with aggregated values. Parameters supports interactive, “what if” predictive analysis on a single set of input values.

For **Worksheet**, click **Select an Option**, and then select the name of the worksheet with the source data. For **Parameters**, no other setting is needed.

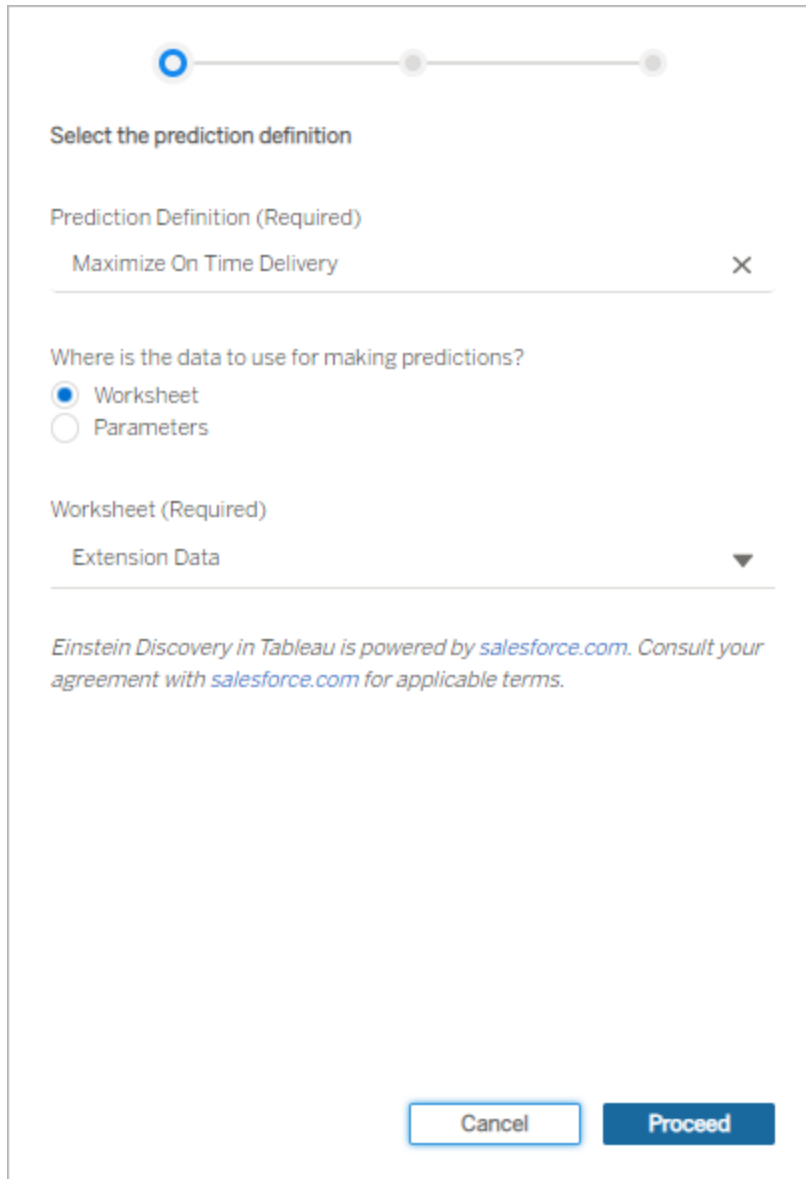

The screenshot shows a configuration dialog box for Einstein Discovery. At the top, there is a progress indicator with three circles, the first of which is highlighted in blue. Below this, the text "Select the prediction definition" is displayed. A dropdown menu labeled "Prediction Definition (Required)" is open, showing the selected option "Maximize On Time Delivery" with a close button (X) to its right. Below the dropdown, the question "Where is the data to use for making predictions?" is followed by two radio button options: "Worksheet" (which is selected) and "Parameters". Another dropdown menu labeled "Worksheet (Required)" is open, showing the selected option "Extension Data" with a downward arrow to its right. At the bottom of the dialog, there is a disclaimer: "Einstein Discovery in Tableau is powered by [salesforce.com](https://www.salesforce.com). Consult your agreement with [salesforce.com](https://www.salesforce.com) for applicable terms." At the very bottom, there are two buttons: "Cancel" and "Proceed".

Click **Proceed**.

3. Map the fields from the model to the fields in the worksheet. The extension will automatically map fields based on names when possible.

To add or change mappings, click in the search box next to a prediction field and select a name from the list of available worksheet fields or parameters.

Map fields between the prediction and the worksheet

Model Field		Worksheet Field
# Annual contract q...	✓	# SUM(Annual contrac X
Abc Distance class	→	Abc [Search] X
Abc Product range code	✓	Abc Product range code X
Abc Weather forecast	✓	Abc Weather forecast X
Abc Transporter servic...	✓	Abc Transporter service I X
Abc Customs	✓	Abc Customs X
Abc Delivery point area	✓	Abc Delivery point area X
Abc Product family	✓	Abc Product family X
Abc Destination country	✓	Abc Destination country X
Abc Transport Supplier	→	Abc [Search] X

Back Next

You must map all of the fields to continue to the next set of configuration settings. If you don't see a matching field listed, [try these troubleshooting steps](#).

Click **Next** to continue.

4. Select options for how predictions are displayed.

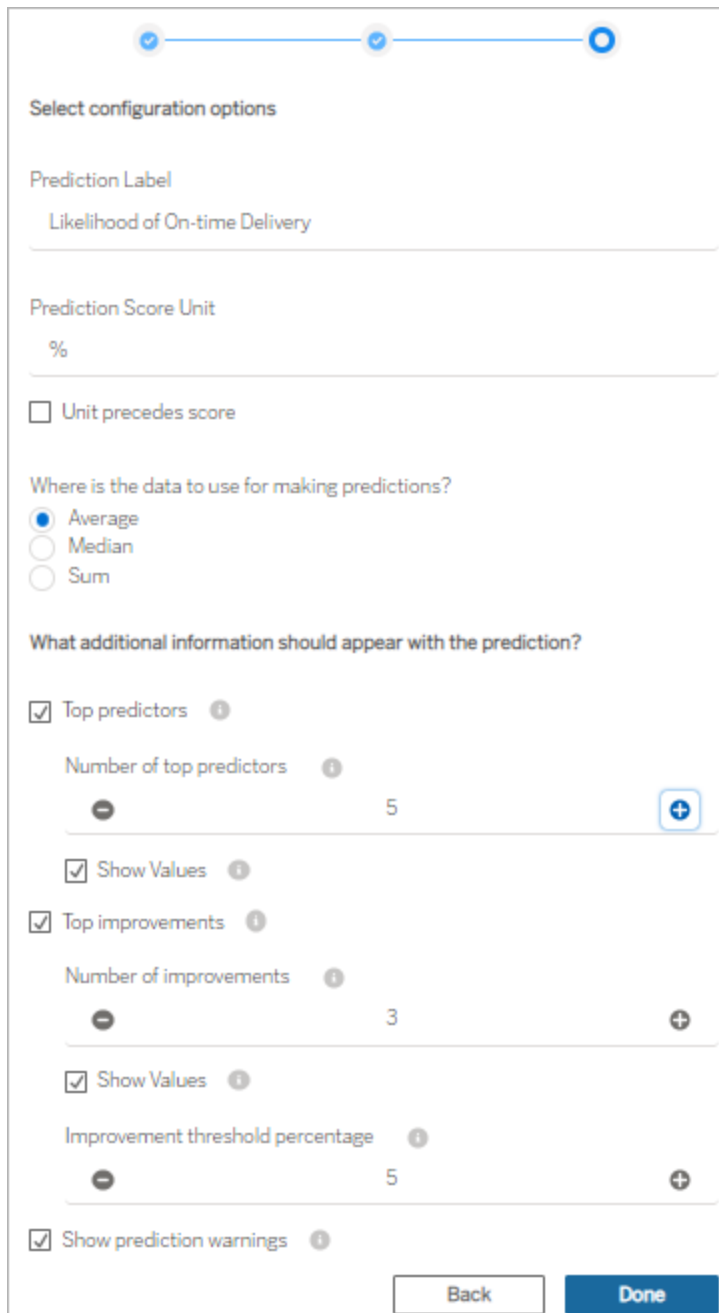

The screenshot shows a configuration dialog box for predictions. At the top, there are three progress indicators: the first two are checked (blue circles with checkmarks) and the third is not (white circle). The dialog is titled "Select configuration options".

Prediction Label
Likelihood of On-time Delivery

Prediction Score Unit
%

Unit precedes score

Where is the data to use for making predictions?
 Average
 Median
 Sum

What additional information should appear with the prediction?

Top predictors ⓘ
Number of top predictors ⓘ
5

Show Values ⓘ

Top improvements ⓘ
Number of improvements ⓘ
3

Show Values ⓘ
Improvement threshold percentage ⓘ
5

Show prediction warnings ⓘ

Buttons: Back, Done

Prediction Label: Click the field and type a label that represents the outcome that you

are predicting, for example, *Likelihood of On Time Delivery*. The deployed model name is displayed by default.

Prediction Score Unit: Type a symbol or text that indicates the unit for the prediction score. For example, %. If the unit should be displayed before the score, select **Unit precedes score**. For example, a currency symbol (such as \$) would precede a currency amount.

Aggregation: Specify how you want to aggregate the selected records (**Average**, **Median**, or **Sum**) in the source data worksheet. Tableau aggregates your selected data into a single set of values, which it submits to the Einstein Discovery prediction definition as input. The granularity must match the granularity expected for the model.

Top predictors: Specify whether to display top predictors that impact the prediction. You can also specify the number of top predictors displayed, and whether the impact values are displayed next to each predictor.

Top improvements: Specify whether to display information on ways to improve the probability of the predicted outcome. You can also specify the number of improvements displayed, and whether the impact values are displayed next to each improvement. For **Improvement threshold percentage**, specify a percentage number (0-99) to display improvements only if they improve the prediction by that percentage.

Show prediction warnings: Specify whether to show warnings about the predictive model, such as missing values in required fields or out-of-bounds values.

Consider showing everything to start with and then fine tuning what you end up sharing with your dashboard audience.

5. Click **Done**. Tableau submits the data immediately to the target Einstein Discovery prediction definition, and then displays the result.
6. In the dashboard, make sure at least one worksheet is set to **Use as Filter**. Every worksheet in the dashboard that is set to **Use as Filter** will drive the extension to update the predictions based on the current selection.

Test your dashboard by clicking and selecting different marks and areas in the dashboard (or by selecting different parameter values) to see what outcome Einstein Discovery predicts for that subset of the data.

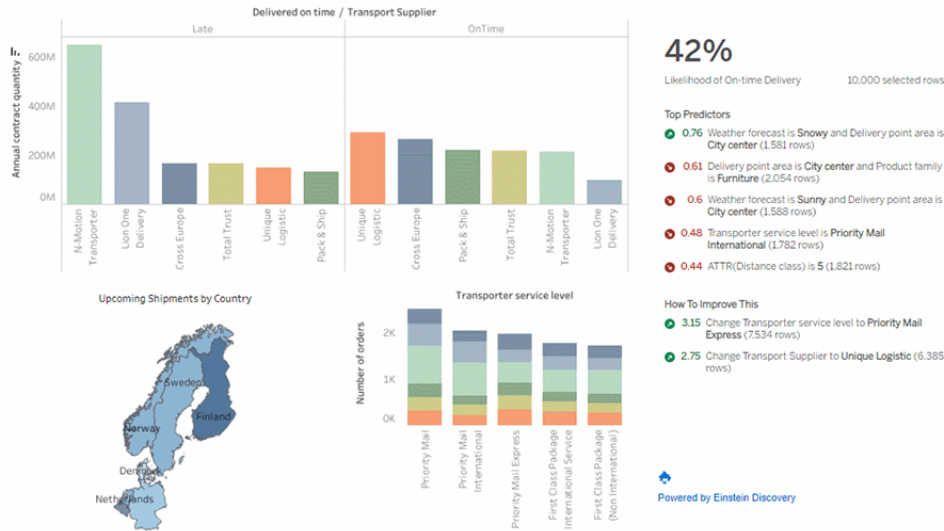

Save the workbook in Tableau Cloud or Tableau Server. Or, publish the dashboard from Tableau Desktop to your Tableau Cloud or Tableau Server site to share it with more people. Explorers and Viewers with access to the same Salesforce org and an Einstein Discovery in Tableau license, a Tableau CRM Plus license, or an Einstein Predictions license will be able to use the extension.

Troubleshoot field mapping

If a field you are expecting to use is not in the list of available fields, you might need to check the data type for the field in Tableau.

Einstein Discovery and Tableau do not always recognize dimensions, measures, and data types in the same way, so you might have to change the data type and role (dimension or measure) in the Data pane of the worksheet to match how Einstein Discovery interprets the field.

1. Close the **Extension: Einstein Discovery** window.
2. Go to the source data worksheet. In the Data pane, change the data type and role of a problematic field in Tableau to match the Einstein Discovery field data type and role in the mapping settings. After you change the data type or role, you will need to replace incorrect fields in the view with the updated fields from the Data pane.
3. In the dashboard, click the drop-down menu for the extension, and then select **Configure**. Proceed to the field mapping settings and select the fields from the list.
4. If you still don't see the fields you expect in the list, go back to the source data worksheet. Remove the fields that are missing for mapping from the Marks card, or the Rows, or Columns shelves.

Next, drag the missing fields from the Data pane to Tooltip on the Marks card.

5. Repeat Step 3 to select the fields for mapping.

Pass Expressions with Analytics Extensions

Beginning with version 2021.2, you can create multiple analytics extensions connections for any site. Versions prior to 2021.2 are limited to a single analytics extension for any site.

After you create a connection to an analytic extension, you can communicate with your external service through calculated fields. Each calculated field uses the **SCRIPT functions for expressions** on page 2662, operating as a table calculation.

Configure an analytics extension

Tableau allows connections to analytics extensions via a set of SCRIPT functions. Before you can pass any SCRIPT functions to your analytics extension, you need to configure your connection to the service.

1. In Tableau Desktop, click the **Help** menu, and then select **Settings and Performance > Manage Analytics Extension Connection**.

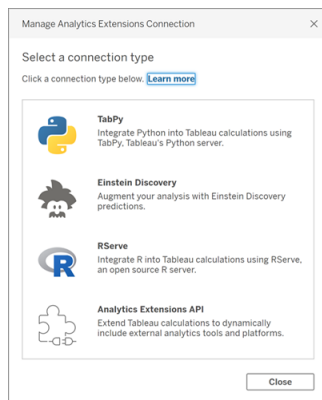

Select the analytics extension you want to connect to. **MATLAB** connections are managed by the Analytics Extension API.

2. Select and configure your analytics service.
 - If you are using **Einstein Discovery**, select Enable. Your default browser will open, allowing you to authorize the connection to Salesforce. After connecting, go to the **Einstein Discovery** on page 2655 section of this help topic to continue.

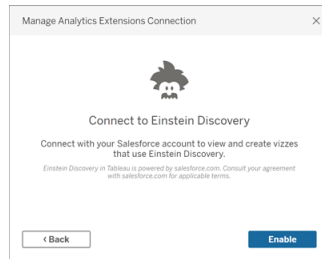

- For all other services (Tabpy, Matlab, and RServe), the following dialog will appear.

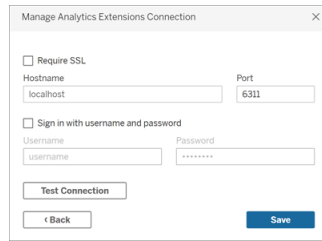

3. Enter or select a server name using a domain or an IP address.

If your server is using SSL encryption, select the **Require SSL** option. Tableau will read certificates installed in the operating system key store to establish the secured connection.

Note: Tableau only supports **PEM** encoded certificates when connecting to **TabPy** or **RServe**.

4. Specify a port.

- Port 6311 is the default port for plaintext RServe servers.
- Port 4912 is the default port for SSL-encrypted RServe servers.
- Port 9004 is the default port for TabPy.

5. Click **Test Connection**.

6. Click **Save**.

If no connection can be established, an error message is displayed. Click **Show Details** in the message to see any diagnostic information returned by the server.

Using Analytics Extensions in Web Authoring

When you are using **web authoring** to create or edit a workbook, select **Analysis > Manage Analytics Extension Connections** and select the analytics extension you want to use for the

workbook. Only one analytics extension can be used per workbook.

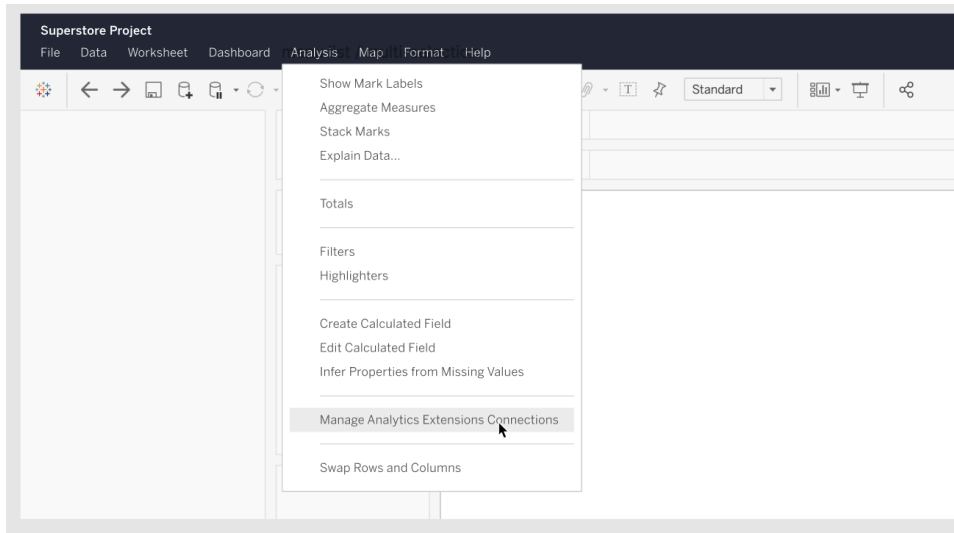

- For Tableau Server, see "Configure Connection with Analytics Extension" ([Windows](#) | [Linux](#)).

Einstein Discovery

Einstein Discovery is a powerful analytics tool in Salesforce that makes use of machine learning to provide insights and predictions. Einstein Discovery requires the Einstein Analytics Plus license, Tableau CRM Plus license, or the Einstein Predictions license, which are available for an extra cost. For related information, see [Requirements for access on page 2635](#).

For more information about Einstein Discovery, see [Getting Started with Discovery](#), and [Explain, Predict, and Take Action with Einstein Discovery](#) in Salesforce help. You can also expand your knowledge with the [Gain Insight with Einstein Discovery](#) trail in [Trailhead](#).

Note: Einstein Discovery in Tableau is powered by [salesforce.com](#). Consult your agreement with [salesforce.com](#) for applicable terms.

Integrate Einstein Discovery models into Tableau

With Tableau connected to the Einstein Discovery analytics extension, you can embed predictions directly in calculated fields and Tableau Table Extensions. In Salesforce, use Model Manager to auto-generate a Tableau table calculation script, and then paste that script into a calculated field for use in a Tableau workbook. The table calculation script accesses predictive models deployed in Salesforce by calling the prediction ID and passing the data required for the model.

Note: You can optionally include additional parameters in the script that has been generated by Model Manager for use with table calculations or Tableau Table Extensions. For more information, see [Add optional parameters to the script generated by Model Manager](#) on page 2658.

Embed a prediction in a calculation

1. Open your Einstein Discovery Salesforce account and navigate to the Model Manager. Select a model to integrate into Tableau. On the model tab, select **Edit Settings** > **Create Tableau Table Calculation**.

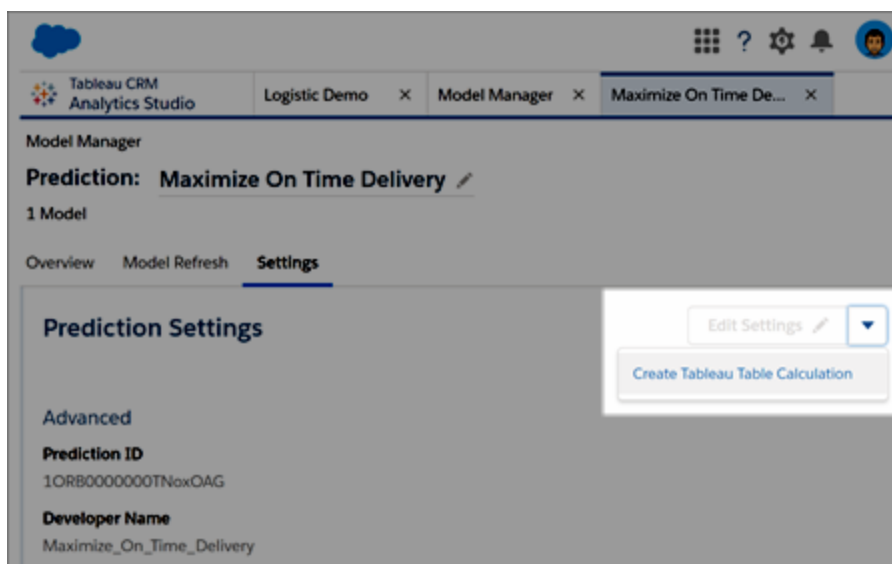

Model Manager generates a script containing the ID of the prediction definition you want to use, the fields (variables) used in the model, and the corresponding source fields in Tableau.

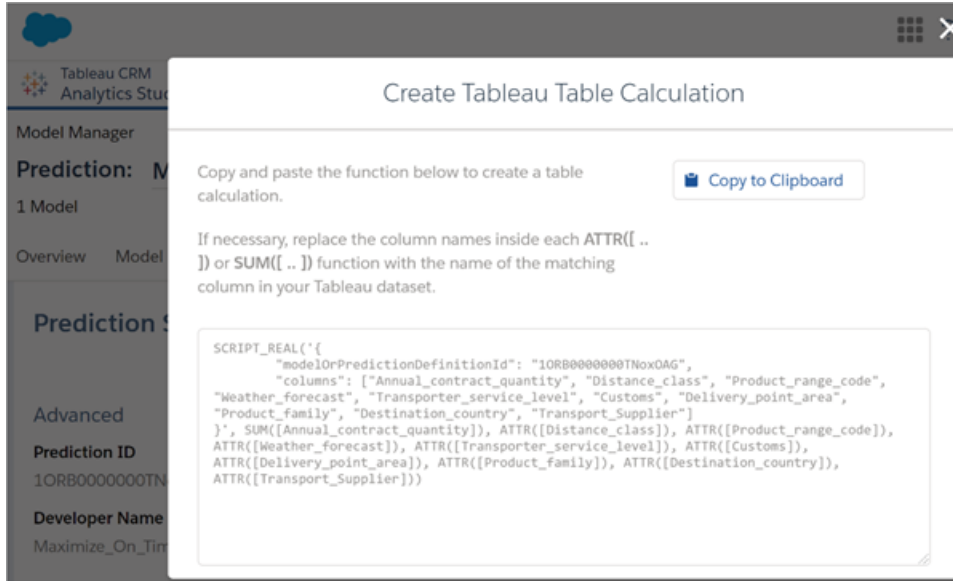

2. Click **Copy to Clipboard**.
3. In a Tableau workbook, select **Analysis > Create Calculated Field**, and then paste the generated script in the Calculation Editor.

Replace the fields names inside each ATTR or SUM function with the name of the matching field in your Tableau data, then save the calculated field.

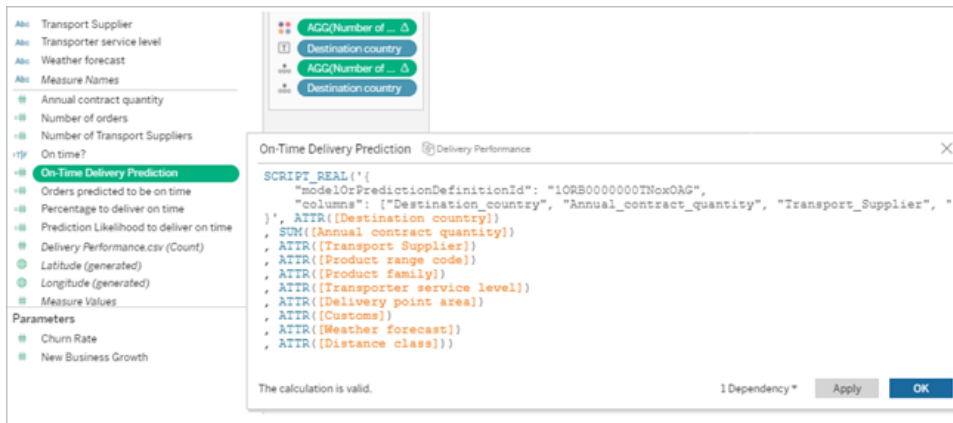

The calculation can be used just like any other Tableau calculation. For more information, see [SCRIPT functions for expressions](#) on page 2662 below.

When the script runs, it sends a prediction request (with the input data) to the prediction definition in Salesforce. Einstein Discovery returns the results to Tableau, where it appears in your worksheet or dashboard.

Embed a prediction in a Tableau Table Extension

The script generated by Model Manager can also be used to create a Tableau Table Extension. To use a script generated by Model Manager for a table extension, remove the SCRIPT_REAL portion of the script and include only the request body that is contained in the curly braces.

Add optional parameters to the script generated by Model Manager

You can optionally include additional parameters in the script that has been generated by Model Manager. These parameters are completely optional; the script will work with or without them. These optional parameters can be used with either a calculated field or with a table extension.

Optional Parameters	Syntax	Description
maxMiddleValues	<code>"maxMiddleValues": integer</code>	<p>Specifies the number of top predictors to return in the response.</p> <p>Set to an integer number.</p> <p>Can only be used with Regression and Binary Classification Models.</p>
maxPrescriptions	<code>"maxPrescriptions": integer</code>	<p>Specifies the maximum number of improvements to return in the response.</p> <p>Set to an integer number.</p> <p>Can only be used with</p>

Optional Parameters	Syntax	Description
showMultiClassProbabilities	"showMultiClassProbabilities": boolean	<p>Regression and Binary Classification Models.</p> <p>Choose whether to show the probabilities for a Multi-class Classification Model.</p> <p>Set to true or false.</p> <p>Can be only be used with Multi-class Classification Models.</p>

The following example script shows how you might use these optional parameters in a script for a calculated field.

```
SCRIPT_REAL(
  '{ "modelOrPredictionDefinitionId": "1ORB0000000HC3KOAW",
  "columns": ["Postal_Code", "City", "Ship_Mode", "Row_ID", "Profit",
  "Category", "Sub_Category", "Order_Date",
    "Quantity", "Ship_Date", "Region", "Sales", "State", "Segment"],
  "maxMiddleValues": 3,
  "maxPrescriptions": 5,
  "showMultiClassProbabilities": false }',
  SUM([Postal Code]), ATTR([City]), ATTR([Ship Mode]), SUM([Row ID]),
  SUM([Profit]), ATTR([Category]), ATTR([Sub-Category]),
    ATTR([Order Date]), SUM([Quantity]), ATTR([Ship Date]), ATTR
  ([Region]), SUM([Sales]), ATTR([State]), ATTR([Segment])
)
```



The next example shows use of this script with a table extension. For a table extension, include only the script in the curly braces. Don't include the SCRIPT_REAL function and attributes outside of the curly braces.

```
{
"modelOrPredictionDefinitionId": "10RB000000HC3KOAW",
"columns": ["Postal_Code", "City", "Ship_Mode", "Row_ID", "Profit",
"Category", "Sub_Category", "Order_Date",
"Quantity", "Ship_Date", "Region", "Sales", "State", "Segment"],
"maxMiddleValues": 3,
"maxPrescriptions": 5,
"showMultiClassProbabilities": false
}
```

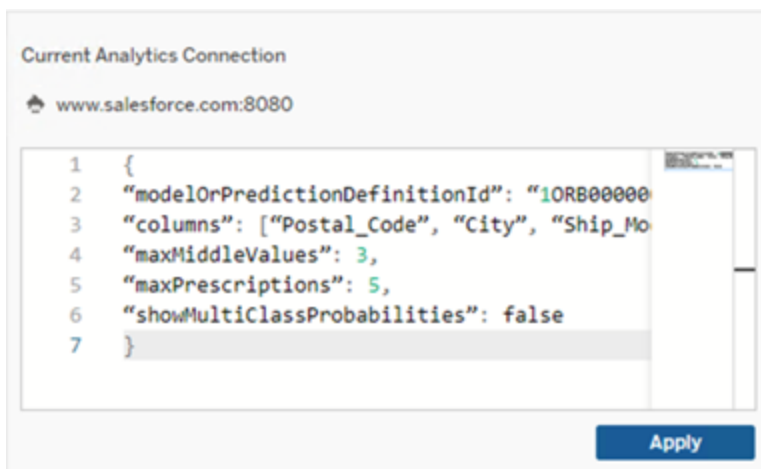

RServe

R is an open source software programming language and a software environment for statistical computing and graphics.

Implementing RServe connections

Tableau Desktop can connect to R via either plaintext or SSL-encrypted traffic. For direction on which type to use, consult your system administrator.

Note: For R integration, Tableau has been tested with R versions 3.4.4 through 3.5.1, and with RServe versions 0.6-8 through 1.7.3.

Intermediate certificate chain for RServe analytics extension

Note: Users don't have to use Tableau Server to connect Tableau Desktop to RServe.

As of Tableau Server version 2020.1, you must install a full certificate chain on Tableau Desktop computers (Windows and Mac) that are connecting to a Rserve external connection through Tableau Server. This requirement is due to how Rserve manages the handshake on secure connections.

Importing a root certificate on the Tableau Desktop is not sufficient, the entire certificate chain must be imported onto the client computer.

MATLAB

MATLAB is a high-level language that connects through the **Analytics Extension API** that enables you to perform computationally intensive tasks faster than with traditional programming languages such as C, C++, and Fortran. You can use MATLAB in a wide range of applications, including signal and image processing, communications, control design, test and measurement, financial modeling and analysis, and computational biology. For information on how to configure your MATLAB server to work with Tableau please contact [MATLAB support](#).

To read more about the possibilities of MATLAB in Tableau, see [Put your MATLAB models and algorithms to work in Tableau](#).

TabPy

Python is a widely used high-level programming language for general-purpose programming. By sending Python commands to an analytics extension, you can do things like predicting customer

churn or running sentiment analysis.

Tableau Python Server (TabPy) is part of Tableau's expanding range of extensibility options. To install TabPy, visit this [GitHub page](#). To read more about the possibilities of Python in Tableau, see [Building advanced-analytics applications with TabPy](#).

SCRIPT functions for expressions

In Tableau Desktop, a set of four SCRIPT functions are available for passing expressions to analytics extensions and obtaining a result. The functions are:

SCRIPT_BOOL

SCRIPT_INT

SCRIPT_REAL

SCRIPT_STR

See [SCRIPT_ functions on page 2156](#) for details and examples.

Because connecting to an analytics extension involves some network overhead, it is often most efficient to pass data all at once rather than as individual row values whenever possible. For example if you set addressing to **Cell** (for example, by clicking the field in the view and choosing **Compute Along > Cell**), Tableau will make a separate call per row (created by each mark in the visualization) to the analytics extension. Depending on the size of the data, this can result in a very large number of individual calls.

The easiest way to ensure efficient calls are made to the analytics extension is to navigate to **Edit Table Calculation** and select **Specific Dimensions** then check the box next to each dimension to put that dimension on addressing. This will generate a single analytics extension call for the entire visualization. Any dimension left un-checked will be partitioned on, generating a separate call for each member in the visualization. If there are many marks in the visualization, it may be advantageous to select **Pause Auto Updates** while selecting dimensions to prevent frequent runs of the calculation before it is properly computed.

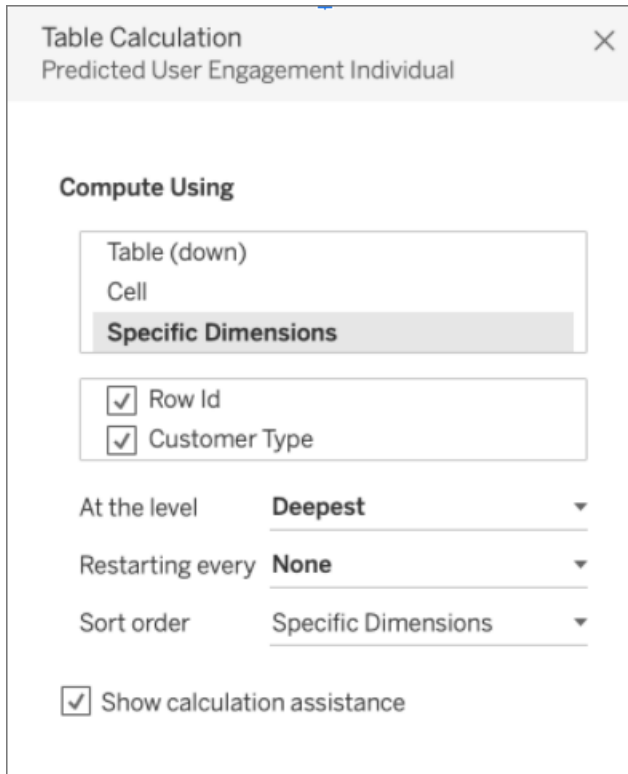

Directly query external analytics models

A series of four functions can directly query a deployed model in your analytics extension. This can keep you from having to write lengthy calculations into a script function. Collectively, these are known as the `MODEL_EXTENSION` functions, and just like the above mentioned Script functions, there are four iterations:

`MODEL_EXTENSION_BOOL`

`MODEL_EXTENSION_INT`

`MODEL_EXTENSION_REAL`

`MODEL_EXTENSION_STR`

The four functions differ only by what values they return. A `MODEL_EXTENSION_BOOL` function returns a Boolean value, for example. In order to use the `MODEL_EXTENSION` functions, you need to have a deployed model in your external analytics service, and the external analytics service must allow for direct queries of that model.

Note: Currently, only **TabPy** models support `MODEL_EXTENSION` functions.

Parts of the MODEL_EXTENSION function

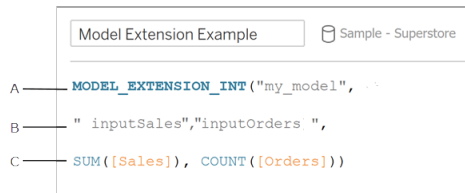

- A.** The model you are invoking. The model name must match the deployed model.
- B.** The model's inputs. Talk to your administrator to learn what inputs are expected by the model you are using.
- C.** The values passed from Tableau to the model.

See [Table Calculation Functions](#) on page 2146 for details and examples.

Because these SCRIPT functions are table calculations, addressing and partitioning concepts apply. (For an explanation of these concepts, see [The basics: addressing and partitioning](#) on page 2365.) Tableau makes one call to an the analytics extension per partition. This means that for each dimension the calculation is partitioning on, one call will be made for every member of that dimension present in the visualization. For this reason, it is recommended to put dimensions on addressing unless partitioning is necessary.

Custom Functions Explorer for deployed models

Deployed models can contain schema information that includes a description, the type of arguments they take, what their output is, and similar documentation. The Custom Function Explorer in Tableau Desktop can read that schema and provide point-in-time documentation for those using the model in Tableau Desktop.

For example, a deployed model `translateToEnglish` may look like this:

```
"translateToEnglish": {
  "description": "Translates a given input to English",
  "type": "model",
  "version": 2,
  "dependencies": [],
  "target": null,
  "creation_time": 1726765000,
  "last_modified_time": 1726777904,
  "schema": "{ 'input': { 'type': 'object',
    'properties': { 'phrase': { 'type': 'string', 'descript
```

Tableau Desktop and Web Authoring Help

```
'phrase which we would like to translate'}},  
    'required': ['phrase']},  
    'sample': {'phrase': 'Danke'},  
    'output': {'type': 'string', 'description': 'translated  
phrase'}}",  
    "is_public": true
```

The Custom Functions Explorer displays that information and show the user exactly what the model is for and what needs to be updated to bring in their data.

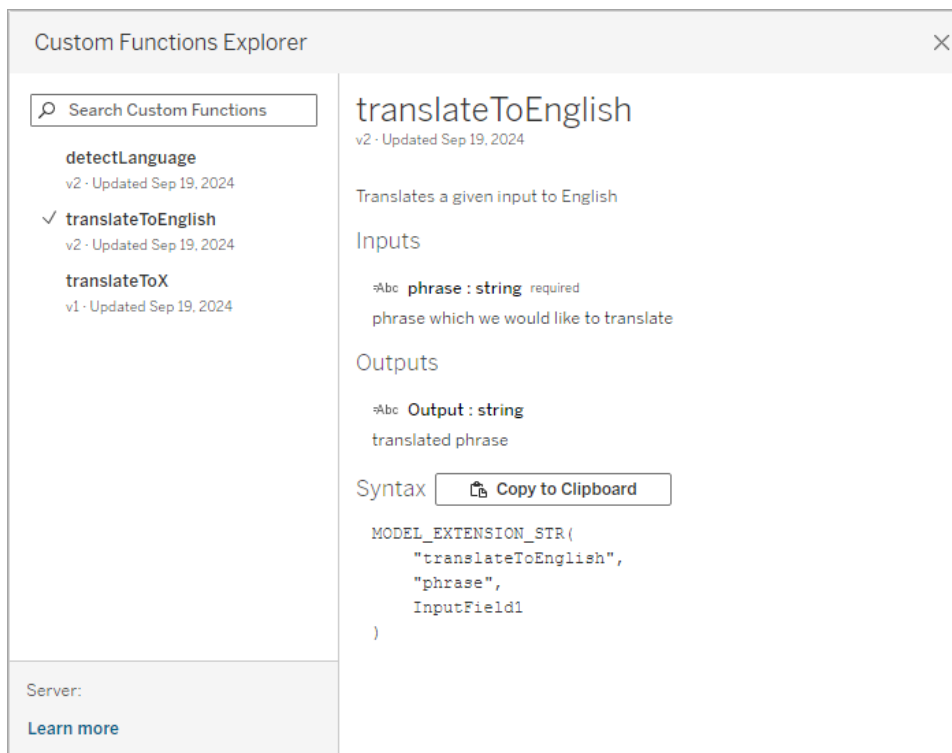

Use the Custom Functions Explorer in Tableau Desktop

You may need to perform some or all of these steps, depending on your current configuration:

1. Deploy a TabPy server. See the [TabPy documentation on GitHub](#) for details.
2. Turn on the Analytics Extension Connection.
 - a. **Help** menu > **Settings and Performance** > **Manage Analytics Extension Connection...**
 - b. Enter the **Hostname** and **Port**.
3. Open a new workbook and connect to your data.

Once you're in a workbook with a data connection and Analytics Extensions connected to a running TabPy instance, you can use the Custom Functions Explorer:

1. On a worksheet with the data source already connected, go to the **Analysis** menu > **Analytics Extension Custom Functions Explorer**.
2. Select the one you want and click the **Copy to Clipboard** button.
 - Only models with the parameter `is_public=True` appear in the list. This parameter is `False` by default. Models where `is_public=False` are still available to use as model extension calculations, they just don't appear in the Custom Functions Explorer.
 - If the Custom Functions Explorer appears empty or is missing a deployed model you want to use, verify `is_public` is set to `True` for the deployed model. See the [TabPy documentation on GitHub](#) for details.
 - If a deployed model doesn't have a schema, the Custom Functions Explorer is less useful but still has the **Copy to Clipboard** option.
3. Create a new calculation and, for the function, paste in the syntax copied to clipboard.
4. Replace any **InputField** placeholder with the field in your data source you'd like to use in the model.
 - Note that as for all table calcs, you'll need to aggregate the input. For strings, MIN, MAX, and ATTR are possible aggregations.

Share a workbook that requires an analytics extension connection

You might need to send a workbook that contains analytics extension functionality to other users, who may be using different copies of Tableau Desktop on other computers. Or, users may download a workbook from Tableau Server that contains analytics extension functionality. If you share your workbook with someone, they must configure analytics extension connections on their computers.

Publish a workbook that requires an analytics extension connection

- For Tableau Server, see "Configure Connection with Analytics Extension" ([Windows](#) | [Linux](#)).

Upon successfully publishing, you must select which of the configured analytics extensions to associate with the workbook.

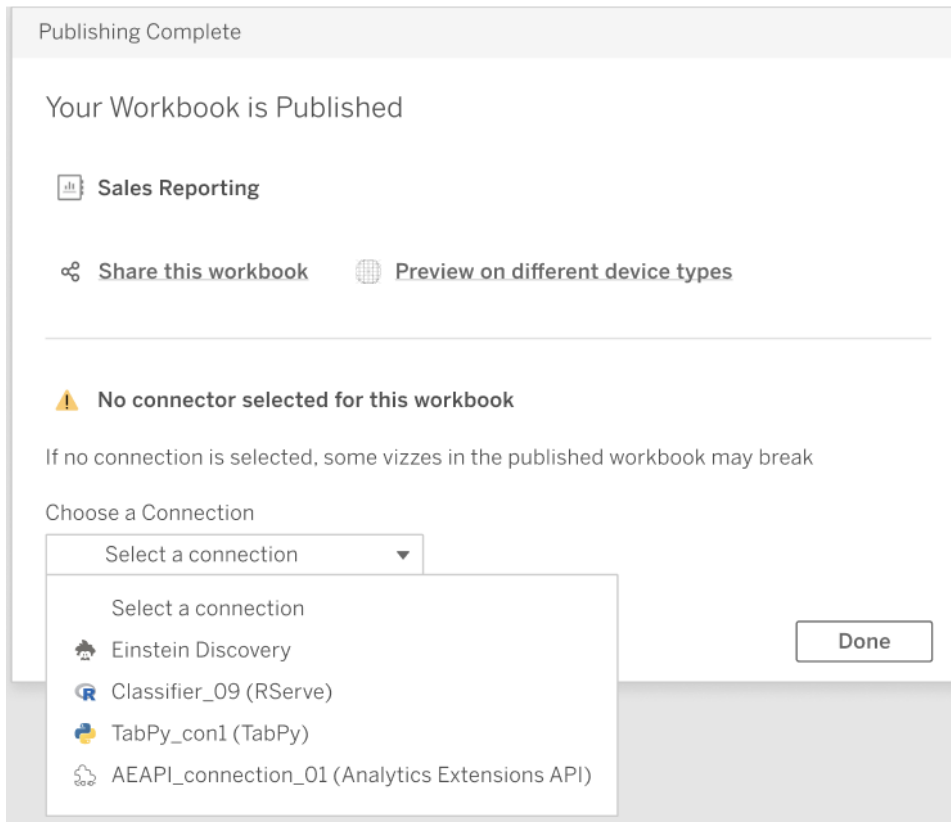

Troubleshooting Analytics Extensions Connections

This topic describes errors you can receive when Tableau is connected to an external analytics extension service.

Note: Tableau technical support cannot assist with writing, troubleshooting, or debugging external scripts.

Errors that can occur when communicating with any analytics extension

Error Message	Comments
Unsupported type passed as an argument to SCRIPT func-	Tableau can only export the following Tableau data types to R: <ul style="list-style-type: none"> Number (Decimal)

tion.	<ul style="list-style-type: none"> • Number (Whole) • Boolean • String • Date • Date/Time
<p>Unexpected number of results returned by SCRIPT function. Function expected %2 values; %1 values were returned.</p>	<p>The script result must be either a scalar or vector of length one that is replicated for all rows, or a vector of length equal to the number of rows in the Tableau result table.</p>
<p>Certificate file is not valid for the specified connection (%1 %2:%3). Check that the same certificate is used for both server and client, the certificate file is not corrupted and has valid dates.</p>	<p>Verify that the certificate you are using to connect to the external service is encoded and formatted correctly. You must connect with a valid PEM-encoded x509 certificate with the extension .crt.</p>
<p>The result returned by the SCRIPT function is of an unexpected type.</p>	<p>Occurs when an invalid data type is received. Tableau can only import the following data types from an Rserve server:</p> <ul style="list-style-type: none"> • RDouble • RInteger • RLogical • RCharacter <p>For TabPy, Tableau can import the following data types:</p>

	<ul style="list-style-type: none"> • List of floating point numbers • List of integers • List of Booleans • List of strings <p>This error is also reported if the result is null or if there was a script execution error for which Tableau could not collect an explanation from the external server.</p>
<p>An error occurred while communicating with the external service.</p>	<p>Tableau runs all external scripts inside of the "try" external function. This error is displayed along with an external-service-generated error message when the "try" function traps an evaluation error.</p>
<p>This external service connection does not support authentication. Try connecting without specifying a password.</p>	
<p>Authentication failed. Please provide a valid external service username and password.</p>	
<p>An unsupported authentication type is enabled in the external service.</p>	<p>Either disable external service authentication or change to plaintext password authentication.</p>
<p>No external service connection con-</p>	<p>See Pass Expressions with Analytics Extensions on page 2653.</p>

<p>figured. Specify a server name and try again.</p>	
<p>The calculation '%1' contains a SCRIPT_ function that requires an internal service connection. Configure your external service connection to enable custom scripts.</p>	<p>See Pass Expressions with Analytics Extensions on page 2653.</p>
<p>The workbook you are attempting to publish contains SCRIPT_ functions that require an external service connection. Custom scripts are not allowed in public workbooks.</p>	<p>You cannot publish workbooks containing external service scripts to Tableau Public.</p>
<p>Tableau Public does not support running custom scripts that require external services. To take advantage of external services, upgrade to Tableau Desktop Professional Edition.</p>	<p>The "Tableau Public" in this error refers to Tableau Desktop Public.</p>

<p>Tableau Reader does not support running custom scripts that require external services. To take advantage of external services, upgrade to Tableau Desktop Professional Edition.</p>	<p>You cannot view workbooks containing external service scripts in Tableau Reader.</p>
--	---

Errors that can occur only with an Rserve Server

Error Message	Comments
Unrecognized Rserve signature.	The Rserve header signature must be "Rsrv".
Unrecognized Rserve version.	The Rserve header version must be "0103".
Unrecognized Rserve protocol.	The Rserve header protocol must be "QAP1".
Authentication failure when connecting to R.	Tableau attempted and failed to authenticate with Rserve. Verify that you entered a valid password.
Incorrect number of bytes in parameter/body.	
The length of data which Tableau read does not equal the length promised by	

the header.	
Unrecognized response type.	The transport protocol type when reading a result was not SEXP as expected.
Excessively long <type>vector.	Unreasonably large number measuring the length of data sent to or from Rserve possibly indicating a corrupt protocol header.
Invalid Rserve command.	Tableau may have improperly implemented the Rserve protocol.
Response from server was Error " << (uint32_t)status << ". See Rsrv.h for details.	Various error conditions are documented in the comments in Rsrv.h.
Excessively long header offset.	This may be due to a garbled header with an unreasonable offset to response data.
Rserve socket failed.	A login, script evaluation, read pending check, result read, or Tableau field to R script argument assignment threw a non-standard exception.
The external service uses an unsupported authentication type.	To support running both SSL-enabled and plaintext connections to an Rserve instance, the Rserve Server administrator must add the following entry to the Rserve configuration file on the Rserve Server: <code>plaintext enable</code>
A crypto-system error has occurred on RServe.	An error has occurred with RServe's encryption system. Check the RServe logs for more details.
RServe has initiated closing due to a security violation.	RServe closed the connection due to a security violation. Check the RServe logs for more details.

<p>The External Service Configuration is set for a secure connection but missing a certificate.</p>	<p>When establishing a secure connection to an External Service, you are required to upload the certificate with which you expect this External Service to be signed. Connections to servers that are not signed by this certificate will be refused. This ensures that you are only sending your data to trusted servers.</p>
<p>Certificate file is not valid for the specified connection (%1 %2:%3). Check that the same certificate is used for both server and client, the certificate file is not corrupted and has valid dates</p>	<p>The certificate provided is not valid for this connection configuration. Check to see that it matches the certificate signing the External Service server, that it is PEM encoded, and that it is valid for today's date.</p>
<p>External service connection certificate is invalid</p>	<p>The certificate provided is invalid. Check to see that the certificate is PEM encoded, and that it is valid for today's date.</p>
<p>External service connection failed to create SSL/TLS context</p>	<p>Tableau failed to initialize a secure environment for this given External Service configuration. Check to see that the host and port are correct, and that the certificate is valid.</p>
<p>External service failed to connect with SSL/TLS</p>	<p>Tableau failed to establish a secure connection to the External Service. Verify that the External Service is configured to support secure connection, and that the certificate provided matches the one signing the External Service.</p>
<p>External service server protocol is unrecognized</p>	<p>A protocol was prepended to the host that is not recognized or supported by Tableau. If connecting to RServe, no protocol is expected. If connecting to TabPy, the HTTP protocol is expected when establishing a plaintext connection, and the HTTPS protocol is expected when establishing a secure connection.</p>

Other issues

SCRIPT functions run even in logical statements that evaluate as false

A function that sends an expression to a running external service instance will be executed even when it is within a logical statement that would otherwise prevent it from being executed. This is true for logical functions such as IF, IIF, and CASE. For example:

```
IF 1==0 THEN
  [[R script code]]
ELSE
  "1 does not equal 0"
END
```

Integrate External Actions

Note: External Actions in Tableau rely on functionality provided by Salesforce Flow. The feature sends your selected data to Salesforce Flow, which runs on separate Salesforce infrastructure. Use of Salesforce Flow and other Salesforce products and services is subject to your agreement with Salesforce.

After seeing and understanding your data in Tableau, what's next? Typically, taking action from data insights involves pivoting from one application to another, often copying and pasting data and losing context along the way. With the Tableau External Actions feature, you can create and interact with data-driven workflows directly from Tableau dashboards and automate your next steps using Salesforce Flow.

About Salesforce Flow

If you're not familiar with [Salesforce Flow](#), it's a no-code tool that provides time-saving process automations. A flow is a component of Salesforce Flow that collects data and performs actions in your Salesforce org. There are several [flow types available in Salesforce Flow](#), but External Actions workflows in Tableau are only compatible with autolaunched flows.

Note: To learn more about flows, check out [Build Flows with Flow Builder](#) on Trailhead.

How External Actions work



When an External Actions workflow is configured for a viz on a Tableau dashboard, a customized button appears on the corresponding viz in an unavailable (grayed out) state. When you select a relevant mark on the viz (1), the button becomes available. Then, when you click the button (2), data from the selected mark is sent directly to a flow that was built and configured in [Salesforce Flow](#) (3).

As the author of an External Actions workflow, you determine:

- Which flow the data is sent to
- Which dashboard the data comes from
- The text and appearance of the dashboard button that triggers the workflow

Note: You can add multiple External Actions workflows to a dashboard, but each of the corresponding flows must be deployed in the same Salesforce org.

Ways to use External Actions workflows

There are endless ways to use External Actions workflows to automate existing processes in your organization. For example, think of the effort saved by a workflow that lets accounting team members send customer invoices directly from the same dashboard they use to track unpaid orders. Or maybe you're looking for ways to streamline your support team's case management. A workflow that lets support team members escalate cases directly from the dashboard they use to track cases could be a significant time-saver. External Actions workflows help keep users in the flow of work, and enables your organization to benefit from increased efficiencies.

When you create an External Actions workflow, you're essentially building a bridge that connects any type of data source in Tableau with a flow at Salesforce. Your data source doesn't need to be connected to a Salesforce database because the workflow itself creates that connection. This is particularly useful when there are multiple groups using separate data sources to complete different steps of the same process.

For example, think about the different teams and tools involved when a customer places an order at an ecommerce site. Ecommerce sales reps might use Salesforce to track the sale while supply chain managers use a supply chain management tool to deduct the purchased item from overall product inventory. Support teams that help the customer troubleshoot any issues that arise when they receive their product might be logged in Salesforce or analyzed in a Tableau dashboard. With an External Actions workflow, you can connect all of this data from each of these teams to streamline processes and even automate some of the existing steps.

Best practices for External Actions workflow authors

Important: Dashboard authors using the External Actions feature to connect dashboard data with flows built in Salesforce Flow should closely collaborate with the Salesforce admins and architects who created the flows.

Flows built in Salesforce Flow are sophisticated business automation programs. Although your organization can greatly benefit from these automations, it's important to understand how flows work before deploying External Actions workflows that use them. Be sure to complete the [Salesforce Flow training on Trailhead](#) and review the [Flows documentation](#). Consider [Flow Best Practices](#) in your design, and keep [Flow Limits and Considerations](#) in mind.

Note: There are several [flow types](#) available in Salesforce Flow, but External Actions workflows are only compatible with autolaunched flows.

External Actions workflows must be carefully implemented to align with the architectural constraints of flows built in Salesforce Flow. Flows are powerful, but they can also be resource-intensive and complex. There are potential licensing, execution throttling, and concurrency issues to consider, and database read/write limits that must be evaluated and tested.

There are also important security considerations related to flows. Users with the Manage Flows permission can view and change all data and resources in the corresponding Salesforce org. Users with the Run Flows permission can run nearly any active flow in the Salesforce org. To restrict access to only those users who require it (such as dashboard authors and workflow users), your Salesforce admin can enable the override default behavior setting for a flow. For more information, see [How Does Flow Security Work?](#)

Dashboard authors who are creating External Actions workflows should communicate with their Salesforce admins before implementing workflows to prevent undesired results.

Create a workflow

Before creating an External Actions workflow, dashboard authors should collaborate with their Salesforce admins to find or create a flow that meets their needs. For example, perhaps your goal is to help your accounting team send invoices directly from an unpaid orders dashboard. To accomplish this goal, you need a flow that can retrieve the customer contact information and order details from the dashboard and populate the invoices.

After you decide which flow to use, the next step is identifying a dashboard to connect it to. It's likely that your users are already interacting with an existing dashboard that would work well. However, if necessary, you can [create a new dashboard](#).

With the right flow and the right dashboard in mind, it's time to think about the compatibility of the data types in the dashboard with the flow's required input fields (known as variables). For example, your unpaid orders dashboard must contain a viz with all of the relevant order details needed to send customer invoices. These details might include information such as order date, customer name and contact information, item descriptions and amounts, and payment amount due.

When your dashboard contains all of the required components, add the Workflow object:

1. In a Tableau workbook, open an existing dashboard or [create a new one](#).
2. From the **Objects** section of the **Dashboard** pane, drag **Workflow** to a viz in the dashboard.

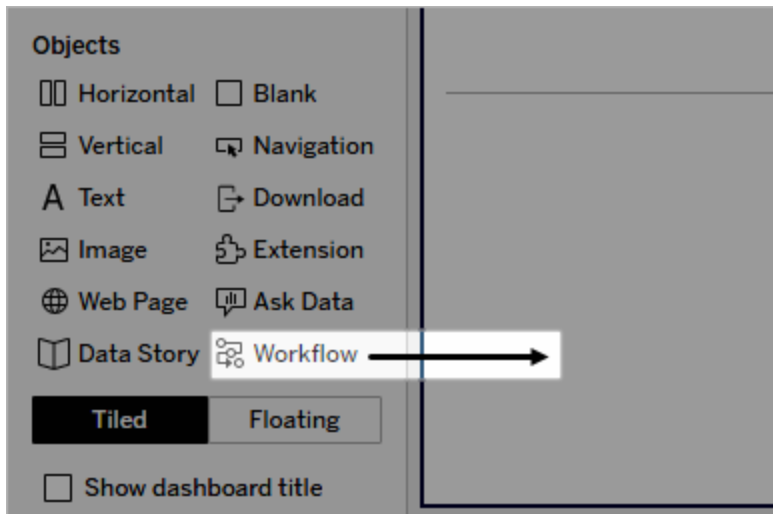

3. When prompted, enter your log-in credentials for the Salesforce org associated with your flow.

Note: When users access the dashboard where you set up your workflow, they must enter their Salesforce credentials. If their Salesforce credentials expire while viewing the dashboard, they're prompted to reauthenticate.

4. Click **Configure Workflow**.
5. In the **Add Workflow** dialog, search for a flow by flow name or flow author.
6. Select a flow to view its details, including the required inputs (Salesforce variables) it needs from the viz. Click **Back** to select a different flow, or click **Next** to continue.
7. From the **Select Sheet** drop-down, select a sheet (worksheet, dashboard, or story) that contains the marks your users will select and send to the flow.

Note: Be sure to select a sheet that has marks with the encoded fields you want to map to the flow's required inputs. For example, if you want to map the `forecast_revenue` variable in the flow to the `SUM(Sales)` field in Tableau, you must select a sheet with marks that are encoded with the `Sum(Sales)` field.

8. Click **Next**.
9. For each of the flow's required inputs (Salesforce variables), select an appropriate field from the Tableau sheet you chose in the Select Sheet step.

Note: For each input, the data type of the Salesforce variable and Tableau field must match.

10. Click **Next**.
11. Configure the appearance of the button that users click to trigger the External Actions workflow. Specify a button title, background color, and border color. Check the preview to confirm the button's appearance.

Note: Remember that users must select a mark from the viz that you chose in the **Select Sheet** step. Until a mark is selected, the button isn't available. Consider adding guiding text to the dashboard so users know exactly what viz to interact with and what will happen when they click the button.

12. Click **Done** to create the workflow and add the corresponding button to the viz in the dashboard.

Use a workflow

To get started as a workflow user, open the dashboard where your dashboard author has added a workflow. You can confirm that a workflow is available if a workflow button displays. The dashboard author customizes the name and format of the button, and it should clearly indicate the action triggered when you click it (such as "Send Data" or "Update Record"). Select a relevant mark from a viz in the dashboard, and then click the button to start the workflow.

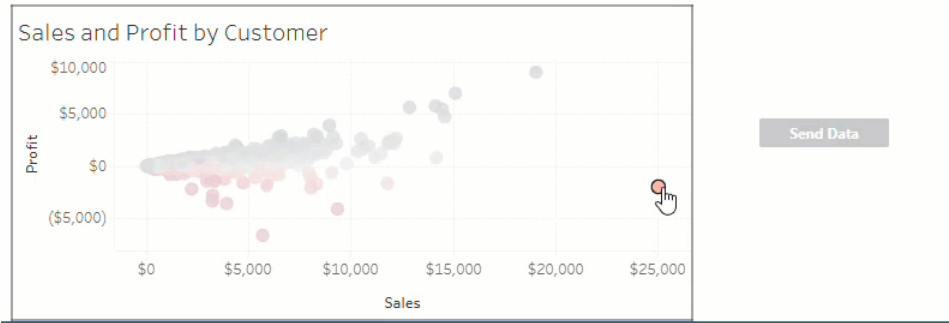

Clicking the workflow button triggers the transmission of data, and the mark you select determines what data is sent. For that reason, the button is unavailable (grayed out) until you select a mark. If you've selected a mark but the button is still unavailable, verify that you've selected a mark on a valid viz for the workflow. If you aren't sure which vizzes are valid, check with the dashboard author.

Depending on their configuration, some workflows might be long-running operations that don't complete immediately. If you're unable to determine whether the workflow you selected is working as expected, check with the dashboard author or your Salesforce admin.

Troubleshoot a workflow

For help resolving issues with an External Actions workflow, see the following troubleshooting guidance.

Access issues

- **For dashboard authors using Tableau Desktop:** If the Workflow object doesn't appear in the Objects section of the Dashboard pane, confirm that you're signed in to a Tableau Server or Tableau Cloud site. If you aren't signed in, you won't be able to access the Workflow extension.

- **For dashboard authors:** If the Workflow object doesn't appear in the Objects section of the Dashboard pane, check with your Tableau admin to ensure that the extension is turned on.
- **For all users:**
 - If your Salesforce admin hasn't created a connected app, the External Actions feature won't work. Ask your Salesforce admin to [create a connected app](#) in Salesforce for Tableau Server.
 - If you're unable to click a workflow button that displays on a dashboard, confirm that you've selected a mark on a valid viz for the workflow. If you aren't sure which vizzes are valid, check with the dashboard author.

Authentication issues

- **For Tableau Cloud or Tableau Server users:** Refresh the dashboard in your browser.
- **For all users:** Confirm that you've signed in to the Salesforce org where the External Actions workflow was added. If necessary, check with your dashboard author to confirm the correct Salesforce org.

Error messages

Error Message	Explanation and Resolution
Workflow is turned off on this site. For more information, contact your Tableau administrator.	Your Tableau admin has turned off the Workflow dashboard extension for your site, so it isn't available for your use. Contact your Tableau admin to discuss turning on access to the extension.
Workflow isn't supported by Tableau Reader	The Workflow dashboard extension and External Actions feature can only be used to send data to a flow using Tableau Cloud , Tableau Desktop , or Tableau Server versions 2022.3 and later.
Flow contains one or more unsupported data types. Go back to select a different flow, or contact your Salesforce Flow administrator to remove unsupported data types from this flow.	The selected flow requires a data type input that isn't available in Tableau dashboards, or is otherwise incompatible with External Actions workflows. Select a different flow if a suitable alternative exists, or check with your Salesforce admin for next steps.

Error Message	Explanation and Resolution
One or more data type mismatches exist in the mapping of input fields.	The data type for one or more of the dashboard values mapped to the input variable fields aren't identical. For example, the flow might require a numeric variable for Revenue, but the mapped value from the dashboard was a text string. Depending on your scenario, you have two options to fix this. You can change the data type of the Revenue field in Tableau from a text string to a numerical value. Or, you edit the workflow configuration to map a different field from the dashboard that has a numerical data type.
Unable to submit data to Salesforce Flow.	An unknown error occurred while the External Actions workflow attempted to send data from the dashboard to the flow. Contact your dashboard author to troubleshoot.
Error occurred: <exception code>. Contact your Salesforce Flow administrator.	The flow interview (running instance of the flow) failed. Share the exception code with your Salesforce admin so they can find the corresponding error email and troubleshoot accordingly.
Workflow failed. Contact your Salesforce Flow administrator.	The data from the selected mark in the dashboard was sent to the flow, but there was an issue in translating that data to the flow. Contact your Salesforce admin to troubleshoot.
Unable to submit data to flow. Contact your workflow author.	The data from the selected mark in the dashboard wasn't sent to the flow. Contact your dashboard author to troubleshoot.

Flow issues

- Some flows run asynchronously, so you may not immediately know whether a flow that's part of an External Actions workflow ran successfully. At times, a flow might fail and roll-back changes without immediately providing detailed feedback. However, when a flow fails, a detailed error email is sent to the workflow user, dashboard author, and Salesforce admin. Workflow users should contact their dashboard authors when they receive a [flow error email](#). Dashboard authors and Salesforce admins can then work together to troubleshoot and resolve the error. For more information on troubleshooting flow issues, see [Troubleshoot Flows](#).

Licensing issues

- **For dashboard authors:** On the Tableau side, no special permissions are required to add a workflow to a dashboard (as long as External Actions are enabled for the site). On the Salesforce side, you'll need the [Manage Flows permission](#) added to your Salesforce profile.
- **For workflow users:** On the Tableau side, any user who can access a dashboard with a workflow can run it. From the Salesforce side, you'll need the [Run Flows permission](#) added to your Salesforce profile.

Turn External Actions On or Off

In Tableau 2022.3 and later, the External Actions feature is turned on by default. For more information on how Tableau admins can configure org-wide access to Tableau External Actions, see [Configure External Actions Workflow Integration](#).

Table Extensions

Table extensions allow you to create data tables with an analytics extensions script. You can write a custom TabPy or Rserve script and optionally add one or more input tables.

Note: A table extension refreshes every time you open up a workbook or refresh a data source.

Benefits

Table extensions have the following benefits for both new and experienced users.

- Easily integrate scripts or advanced functions into Tableau
- Easily drag data from Tableau data connections as input into scripts
- A low code editor makes adding code to data sources easy
- Integrates with [Data Guide](#) and [Explain Data](#)
- Integrates with TabPy, Rserve, and other analytics extensions
- Results can be used to construct dashboards or visualizations

Prerequisites

Before you can use table extensions, you must complete the following list.

- Open a data source in Desktop or Web Authoring.
- Configure an analytics extension
 - For steps to configure analytics extension connections, see [Pass Expressions with Analytics Extensions](#).

Create a Table Extension

To create a table extension, complete the following steps.

1. Open a workbook.
2. Open a data source or create a one.
3. Under **Connections**, choose **New Table Extension**.
4. Drag the sheet into the data model.
5. *(Optional)* Drag tables from the data connection into the table extension pane to use as input into your analytics extensions script or function.

By default, data from Tableau is passed to the analytics extension and defined as the variable `_arg1`, a dictionary-like structure such as: `{ 'column_name' : [1,2,3], 'column_name_2' : [3,4,5]`

- **Python input data:** The input data could be converted to a pandas dataframe using the following: `import pandas as pddf = (pd.DataFrame(_arg1))`
- **RServe input data:** The input data is defined as the `variable._arg1` and the data type are a named list of lists.
- **Custom SQL input data:** For supported relational data sources, you can use Custom SQL as an input into a table extension. When parameters are used in the Custom SQL query, changing the parameter causes the query to rerun and the script to recompute. This creates a path to dynamically update parameters in a dashboard and filter or otherwise pass values to the table extension script.

Note: If a parameter is used in a table extension, that parameter can't be deleted until it's removed from the extension. Deleting a parameter called in table extension can trigger a fatal error.

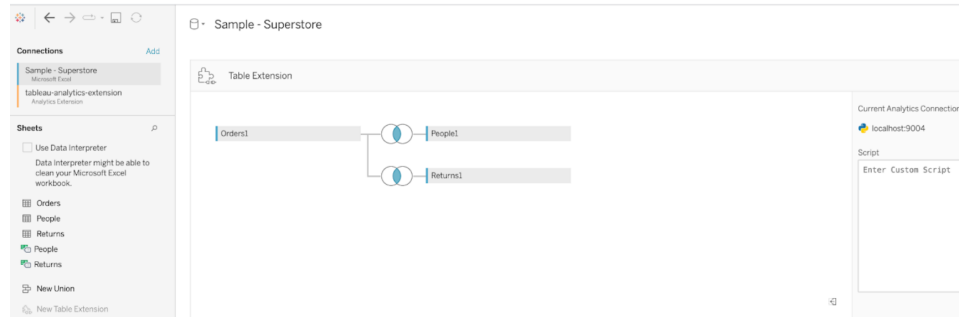

- Under **Script**, enter your script or function call. The script must return a dictionary or list of lists, such as a JSON object. A script for RServe must return a data.frame or list of named lists. A script for Python must return a dictionary.

- **Python example:** Use the following explicit return command: `return df.to_dict(orient='list')`

Note: Table extensions don't support directly calling TabPy endpoints if `TABPY_EVALUATE_ENABLE` is disabled in TabPy.

- Select **Apply** to run the script.

Name	Table Extension	Input Table	Output Table
COGS	Tableau_33_7789106... COGS	Tableau_33_7789106... COGS	Tableau_33_7789106... COGS
Category	Tableau_33_7789106... Cateq...	Tableau_33_7789106... Category	Tableau_33_7789106... Category
City	Tableau_33_7789106... City	Tableau_33_7789106... City	Tableau_33_7789106... City

COGS	Category	City	Country/Region	Customer ID	Customer Name
10.90	Office Supplies	Houston	United States	DP-13000	Darrer
9.03	Office Supplies	Naperville	United States	PO-19195	Phillin
7.51	Office Supplies	Naperville	United States	PO-19195	Phillin
337.51	Office Supplies	Naperville	United States	PO-19195	Phillin
14.65	Office Supplies	Philadelphia	United States	MB-18085	Mick E

- (Optional) If you're relating the table extension to another table in the data model, define the relationship between at least one field in each table.
- In the data grid under **Output Table**, choose **Update Now**. The results appear in the Out-

put Table tab.

Table Extension 22 fields 10194 rows

Name: Table Extension

Type	Field Name	Physical Table	Rem...
#	COGS	Tableau_52_819F189...	COGS
Abc	Category	Tableau_52_819F189...	Categ...
🌐	City	Tableau_52_819F189...	City
🌐	Country/Region	Tableau_52_819F189...	Count...
Abc	Customer ID	Tableau_52_819F189...	Custo...

Input Table Output Table

COGS	Category
10.90	Office Supplies
9.03	Office Supplies
7.51	Office Supplies
337.51	Office Supplies
14.65	Office Supplies
1,827.41	Furniture
4.00	Office Supplies

Note: If you don't define a relationship to a table in the data model, the Input Table tab is empty and displays the message 'Data preview unavailable'.

- (Optional) In the **Name** field, enter a unique name for your new table extension.
- Go to the **Sheet** tab to start exploring and visualizing the data.
- Publish the workbook to share it. The publishing destination must have an analytics extension of the appropriate type enabled and configured.

Troubleshooting tip: If your table extension is hitting an error, first ensure all code and formatting is correct. Then try using the circular Refresh Data Source button in the toolbar or click Apply again.

Compare extension types

While some of the following products aren't related, table extensions and analytics extensions share several features. The table extensions feature relies on a connection with analytics extensions to work. Let's break down each feature.

Dashboard Extensions

Dashboard extensions allow custom web applications to be added to dashboards using the Dashboard Extension SDK.

Table Extensions

Table extensions let you create a table in a data source that can send data and a script to your analytics extension and return a full table as a result. The returned results are displayed as a table in the data model and as measures and dimensions in a workbook.

Analytics Extensions

The **Analytics extensions** feature allows you to extend Tableau calculations with programming languages like Python, external tools, and external platforms.

After you create a connection to an analytics extension, you can communicate with your external server through calculated fields called `SCRIPT_X` or `MODEL_EXTERNAL_X`, where `X` is the data type of the expected return values. For more information, see [Pass Expressions with Analytics Extensions](#).

Calculate Percentages in Tableau

Any analysis in Tableau can be expressed in terms of percentages. For example, rather than viewing sales for every product, you might want to view each product's sales as a percentage of the total sales for all products.

About percentages

There are two factors that contribute to the percentage calculation:

1. The data to which you compare all percentage calculations

Percentages are a ratio of numbers. The numerator is the value of a given mark. The denominator depends on the type of percentage you want, and is the number to which you compare all your calculations. The comparison can be based on the entire table, a row, a pane, and so on. By default, Tableau uses the entire table. Other percentage calculations are available via the **Percentage of** menu item. See [Percentage options on page 2689](#).

The figure below is an example of a text table with percentages. The percentages are calculated with the **Sales** measure aggregated as a summation, and are based on the entire table.

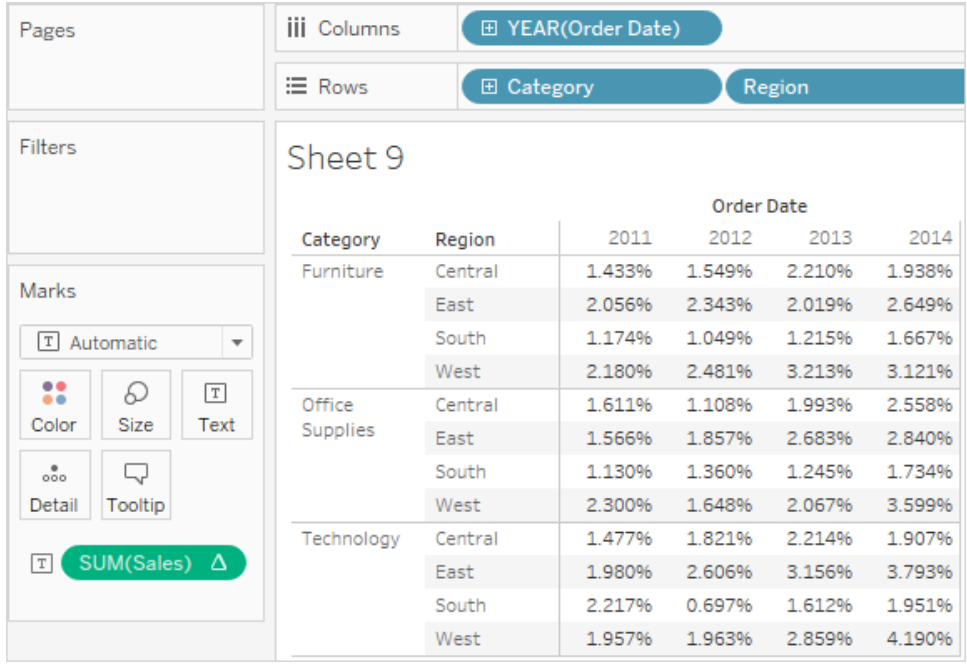

2. The aggregation

Percentages are computed on the basis of the aggregation for each measure. Standard aggregations include summation, average, and several others. See [Data Aggregation in Tableau on page 171](#) for more information.

For example, if the aggregation applied to the **Sales** measure is a summation, then the default percentage calculation (percent of table) means that each number displayed is the SUM(Sales) for that mark divided by the SUM(Sales) for the entire table.

In addition to using predefined aggregations, you can use custom aggregations when calculating percentages. You define your own aggregations by creating a calculated field. Once the new field is created, you can use percentages on the field as you would any other field. See [Aggregate Functions in Tableau on page 2115](#) for more information.

Percent calculations can also be applied to disaggregated data. In this case, all values are expressed as the percentage of a summation. You cannot choose any other aggregation.

Example

The view below shows a nested bar chart created using two dimensions and a measure that is aggregated as a maximum. Additionally, the data are color-encoded by a dimension and the default percentage calculation has been applied. Notice that the axis labels are modified to reflect the percent calculation.

The tooltip reveals that the maximum sales for furniture in the east in 2011 is 17.70% of the maximum for the entire table. What is the maximum for the table? If you recreate the view you'll see that the maximum occurs in the South, in the Technology category, in the year 2011. The tooltip for this bar segment would reveal a maximum sales of 100%.

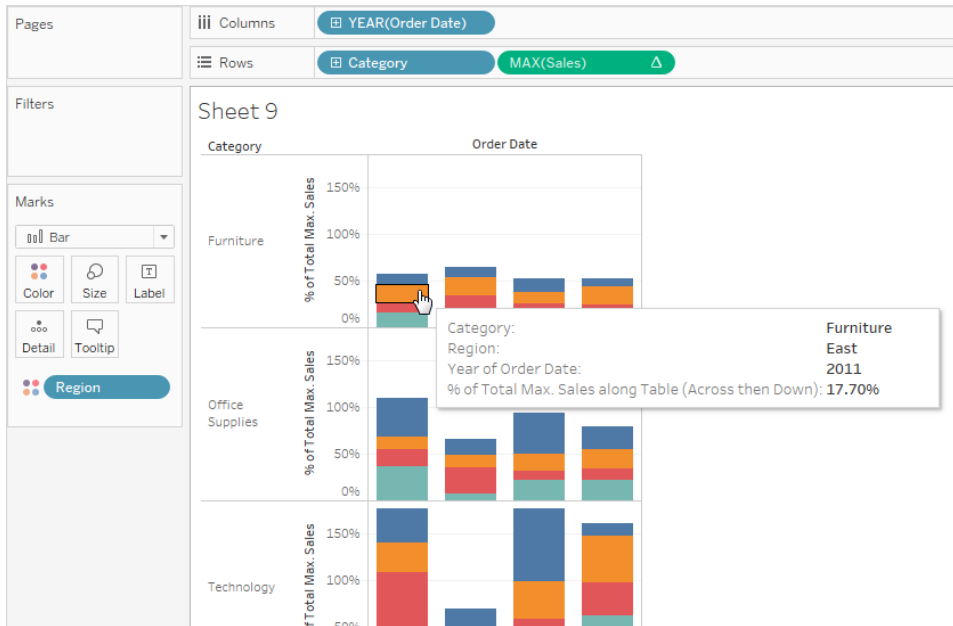

The next view displays two disaggregated measures as a scatter plot. Again, the default percentage calculation has been applied as reflected by the modified axis labels.

The tooltip shows that the selected data point constitutes -0.475 percent of total profit and a 0.3552 percent of total sales. Percentage calculations are based on the entire data source.

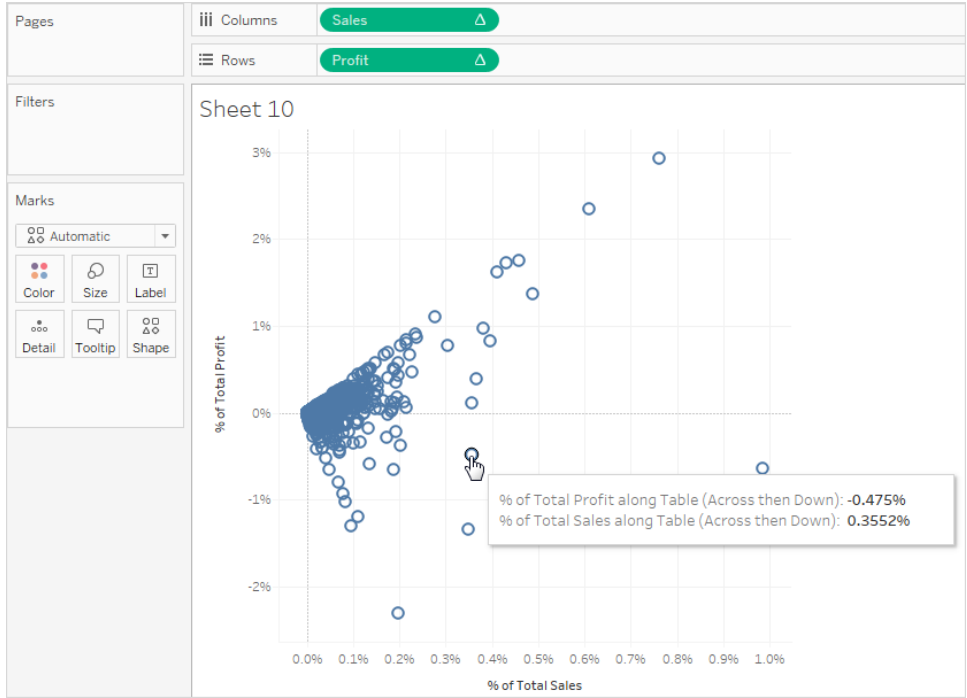

How to calculate percentages

To calculate percentages in your visualization:

- Select **Analysis > Percentages Of**, and then select a percentage option.

Percentage options

Computing a percentage involves specifying a total on which the percentage is based. The default percentage calculation is based on the entire table. You can also choose a different option.

The option you choose is applied uniformly to all measures that appear on a worksheet. You cannot choose **Percent of Column** for one measure and **Percent of Row** for another.

The percentage options on the Analysis menu correspond to the percentage table calculations. When you select a percentage option, you are actually adding a Percent of Total table calculation. See [Transform Values with Table Calculations](#) on page 2364 for more information.

If you are unsure what the current percentage calculation means, display the grand totals. This provides more information about each row and column. For example, if you select **Percent of**

Row while displaying grand totals, you will see that the total for each row is exactly 100%. See [Show Totals in a Visualization on page 1354](#) for more information on grand totals.

The percent calculation options are described in the following sections. In each case, the grand totals are displayed as well.

Percent of Table

When you select **Percentage Of > Table** from the **Analysis** menu, each measure on the worksheet is expressed as a percentage of the total for the entire worksheet (table). For example, Technology in the East region accounts for 3.79% of total sales in 2014. The grand totals for rows show that 2014 accounts for 31.95% of the total sales. Summing the grand totals for rows or for columns yields 100% of the total.

		Order Date			
Category	Region	2011	2012	2013	2014
Furniture	Central	1.433%	1.549%	2.210%	1.938%
	East	2.056%	2.343%	2.019%	2.649%
	South	1.174%	1.049%	1.215%	1.667%
	West	2.180%	2.481%	3.213%	3.121%
Office Supplies	Central	1.611%	1.108%	1.993%	2.558%
	East	1.566%	1.857%	2.683%	2.840%
	South	1.130%	1.360%	1.245%	1.734%
	West	2.300%	1.648%	2.067%	3.599%
Technology	Central	1.477%	1.821%	2.214%	1.907%
	East	1.980%	2.606%	3.156%	3.793%
	South	2.217%	0.697%	1.612%	1.951%
	West	1.957%	1.963%	2.859%	4.190%

Percent of Column

When you select **Percentage of > Column** from the **Analysis** menu, each measure on the worksheet is expressed as a percentage of the total for the column. The values within the red box add up to 100%.

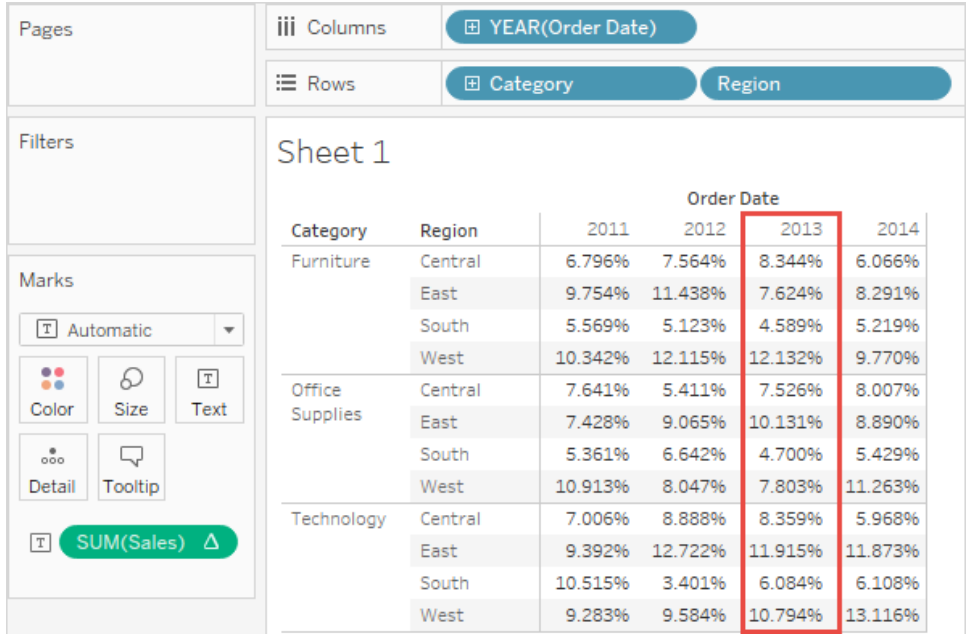

Percent of Row

When you select **Percentage of Row**, each measure on the worksheet is expressed as a percentage of the total for the row. The values within the red box add up to 100%.

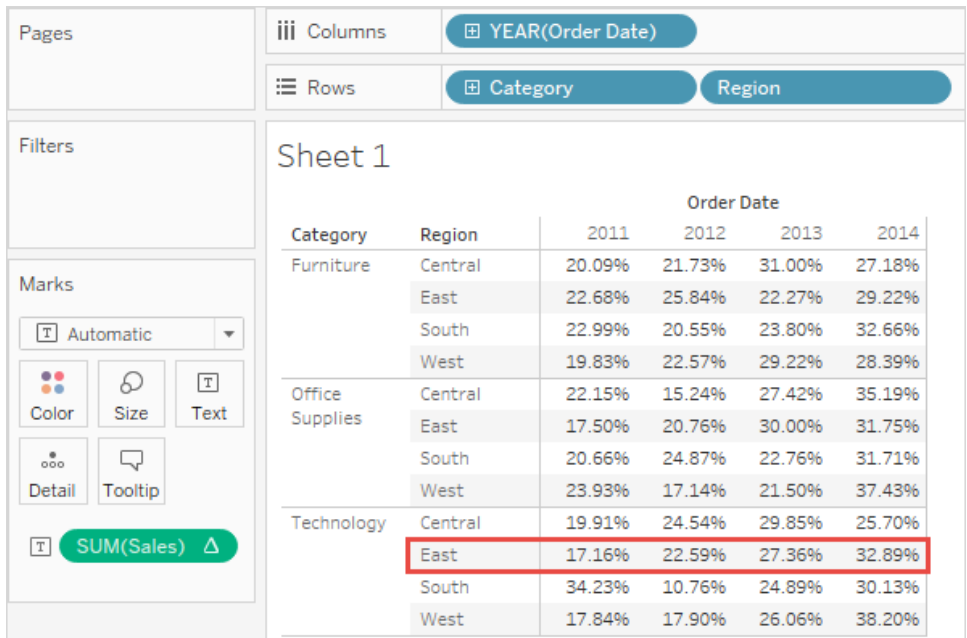

Percent of Pane

When you select **Percentage of > Pane** from the **Analysis** menu, each measure on the worksheet is expressed as a percentage of the total for the panes in the view. This option is equivalent to **Percent of Table** when the table consists of only a single pane.

In the following view, the red box constitutes a single pane; the values within the red box add up to 100%.

The screenshot shows the Tableau Desktop interface. The Columns shelf contains 'YEAR(Order Date)' and the Rows shelf contains 'Category' and 'Region'. The Marks card is set to 'Automatic' with 'SUM(Sales)' as the measure. The view displays a table with the following data:

Category	Region	Order Date			
		2011	2012	2013	2014
Furniture	Central	4.435%	4.797%	6.843%	6.000%
	East	6.366%	7.253%	6.252%	8.201%
	South	3.635%	3.248%	3.763%	5.162%
	West	6.750%	7.683%	9.949%	9.664%
Office Supplies	Central	5.146%	3.541%	6.369%	8.173%
	East	5.002%	5.932%	8.573%	9.074%
	South	3.610%	4.346%	3.977%	5.541%
Technology	Central	4.057%	5.002%	6.083%	5.239%
	East	5.439%	7.159%	8.670%	10.421%
	South	6.090%	1.914%	4.428%	5.361%
	West	5.376%	5.393%	7.855%	11.512%

Percent of Row in Pane

When you select **Percentage of > Row in Pane** from the **Analysis** menu, each measure on the worksheet is expressed as a percentage of the total for a row within a pane. This option is equivalent to as **Percent of Row** when the table is only a single pane wide.

In the following view, the red box constitutes a row within a pane; the values within the red box add up to 100%.

Tableau Desktop and Web Authoring Help

Sheet 1

Region	Order Date / Category											
	2011			2012			2013			2014		
	Furniture	Office Supplies	Technol...	Furniture	Office Supplies	Technol...	Furniture	Office Supplies	Technol...	Furniture	Office Supplies	Technol...
Central	31.69%	35.63%	32.67%	34.60%	24.75%	40.65%	34.44%	31.06%	34.50%	30.27%	39.95%	29.78%
East	36.71%	27.95%	35.34%	34.43%	27.29%	38.29%	25.70%	34.15%	40.16%	28.54%	30.60%	40.86%
South	25.97%	25.00%	49.03%	33.78%	43.80%	22.43%	29.85%	30.57%	39.58%	31.15%	32.40%	36.45%
West	33.87%	35.74%	30.40%	40.73%	27.05%	32.22%	39.48%	25.39%	35.13%	28.61%	32.98%	38.41%

Note: If you place **Measure Names** as the inner dimension on the **Columns** shelf (that is, the dimension farthest to the right), Tableau will return 100% for each mark because you cannot total up the values for multiple measure names. For example, you can't total up the values for SUM(Sales) and SUM(Profit).

Percent of Column in Pane

When you select **Percentage of > Column in Pane** from the **Analysis** menu, each measure in the worksheet is expressed as a percentage of the total for a column within a pane. This option is equivalent to as **Percent of Column** when the table is only a single pane high.

In the following view, the red box constitutes a column within a pane; the values within the red box add up to 100%.

Columns: YEAR(Order Date)

Rows: Category, Region

Marks: SUM(Sales)

Sheet 1

Category	Region	Order Date			
		2011	2012	2013	2014
Furniture	Central	20.94%	20.87%	25.53%	20.67%
	East	30.05%	31.56%	23.32%	28.25%
	South	17.16%	14.14%	14.04%	17.78%
	West	31.86%	33.43%	37.11%	33.29%
Office Supplies	Central	24.38%	18.55%	24.95%	23.84%
	East	23.70%	31.08%	33.59%	26.47%
	South	17.10%	22.77%	15.58%	16.16%
Technology	West	34.82%	27.59%	25.87%	33.53%
	Central	19.36%	25.69%	22.50%	16.10%
	East	25.95%	36.77%	32.07%	32.03%
	South	29.05%	9.83%	16.38%	16.48%
West	25.65%	27.70%	29.05%	35.39%	

If you place **Measure Names** as the inner dimension on the **Rows** shelf (that is, the dimension farthest to the right on the shelf), Tableau will return 100% for each mark because you cannot total up the values for multiple measure names. For example, you can't total up the values for SUM(Sales) and SUM(Profit).

Percent of Cell

When you select **Percentage Of > Cell** from the Analysis menu, each measure on the worksheet is expressed as a percentage of the total for each individual cell in the view. Most views show only one value per cell, in which case all cells show a percentage of 100%. But in some cases, as, for example, when you disaggregate data, a single cell can contain multiple values:

Tableau Desktop and Web Authoring Help

Tableau interface showing a pivot table on Sheet 2. The Columns shelf contains YEAR(Order Date) and Country. The Rows shelf contains QUARTER(Order Date) and MONTH(Order Date). The Marks shelf contains Profit. The pivot table displays data for the United States, grouped by quarter and month, with columns for 2013, 2014, and 2015. The cell for Q1 January 2013 is highlighted with a red border.

		Order Date / Country					
Quarter of ..	Month of O..	2013		2014		2015	
		United States		United States		United States	
Q1	January	30.5%	11.2%	56.8%	29.0%	22.5%	14.4%
		10.6%	9.7%	13.3%	11.4%	14.4%	12.4%
		9.2%	8.3%	9.5%	7.4%	5.1%	5.0%
Q1	February	23.9%	12.0%	45.2%	9.5%	56.0%	4.5%
		10.0%	8.7%	7.0%	6.7%	3.5%	3.4%
		6.2%	5.8%	5.6%	5.2%	3.2%	2.7%
Q1	March	182.5%	83.4%	32.6%	15.2%	66.2%	10.4%
		67.0%	57.1%	6.3%	3.9%	10.0%	8.2%
		50.6%	35.6%	3.6%	3.6%	7.0%	6.7%
Q2	April	9.1%	8.4%	45.5%	15.5%	80.0%	12.8%
		7.6%	6.2%	11.6%	10.0%	12.7%	11.4%
		4.7%	4.3%	7.6%	7.1%	9.9%	6.2%

See Also

[Transform Values with Table Calculations](#) on page 2364

Dashboards

A dashboard is a collection of several views, letting you compare a variety of data simultaneously. For example, if you have a set of views that you review every day, you can create a dashboard that displays all the views at once, rather than navigate to separate worksheets.

Like worksheets, you access dashboards from tabs at the bottom of a workbook. Data in sheets and dashboards is connected; when you modify a sheet, any dashboards containing it change, and vice versa. Both sheets and dashboards update with the latest available data from the data source.

Best Practices for Effective Dashboards

A well-designed dashboard can align your organization's efforts, help uncover key insights, and speed up decision-making. Use this topic for tips on best practices for creating effective dashboards in Tableau.

What's your goal?

Know your purpose and audience

The best visualizations have a clear purpose and work for their intended audience. What will you be trying to say with this dashboard? Are you presenting a conclusion or a key question?

In addition to knowing what you're trying to say, it's important to know who you're saying it to. Does your audience know this subject matter extremely well or will it be new to them? What kind of cues will they need? Thinking about these questions before you head into the design phase can help you create a successful dashboard.

Leverage the most-viewed spot

Most viewers scan web content starting at the top left of a web page. Once you know your dashboard's main purpose, be sure to place your most important view so that it occupies or spans the upper-left corner of your dashboard. In the dashboard below, the author decided that the map view holds the key message.

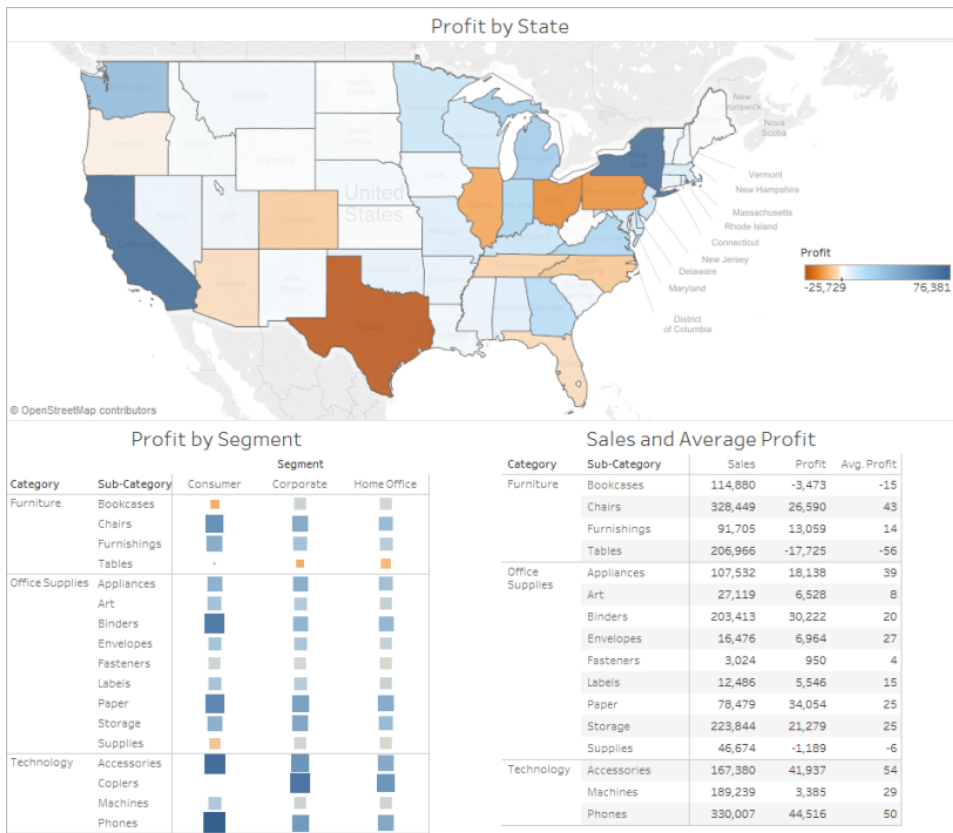

Design for the real world

Author at your final display size

By default, Tableau dashboards are set to use a fixed size and if you keep this setting, be sure to construct your visualization at the size it will be viewed at. You can also set **Size** to **Automatic**, which makes Tableau automatically adapt the overall dimensions of a visualization based on screen size. This means that if you design a dashboard at 1300 x 700 pixels, Tableau will resize it for smaller displays—and sometimes this results in scrunched views or scrollbars. The **Range** sizing feature is helpful for avoiding this.

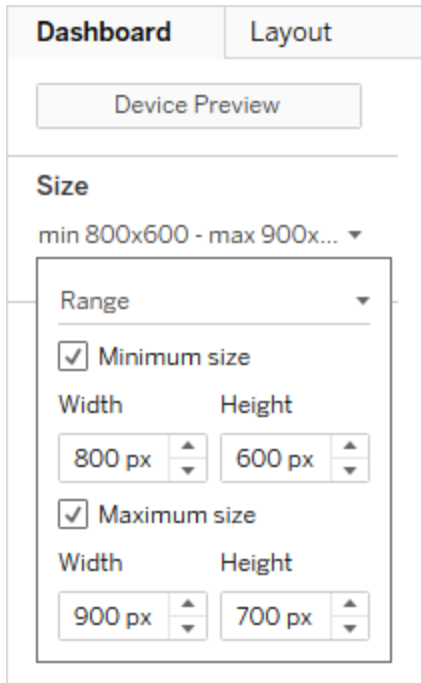

If you're using Tableau Desktop to create dashboards, you can also design for specific device layouts, so that on tablets, for example, your dashboard contains one set of views and objects, and on phones it displays another. See [Create Dashboard Layouts for Different Device Types](#) on page 2788 for steps.

Limit the number of views

In general, it's a good idea to limit the number of views you include in your dashboard to two or three. If you add too many views, visual clarity and the big picture can get lost in the details. If you find that the scope of your story needs to grow beyond two or three views, you can always create more dashboards.

Too many views can also interfere with the performance of your dashboard after it's published. See [Make Visualizations Faster](#) on page 3066 for more details on performance.

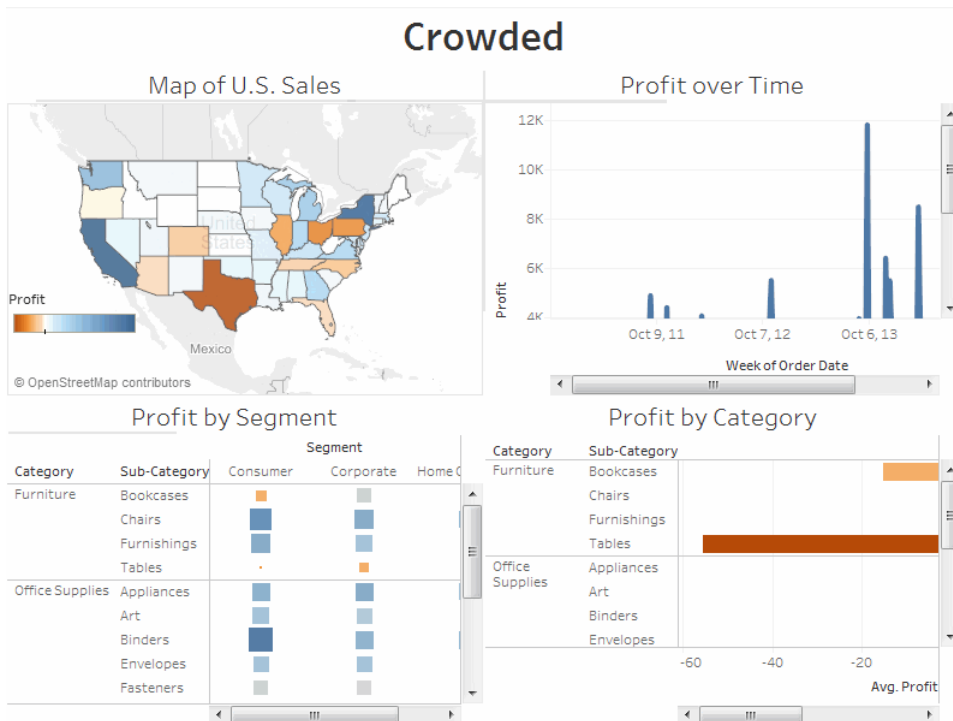

Click the image to replay it.

Add interactivity to encourage exploration

Show filters

Filters help users specify which data is shown in the view.

To turn on filters for a field:

- In Tableau Desktop—Right-click the field in the Data window and select **Show Filter**.
- In Tableau Server or Tableau Cloud—In the toolbar click **Show/Hide Cards > Filters**.

You can customize each filter for different types of data. For example, you can show filters as multi-select check boxes, single select radio buttons, or drop-down lists, etc. You can include a search button, the option to show all fields, null controls, and more. You can also edit the title of a filter to give your viewers clear instructions for interacting with the data.

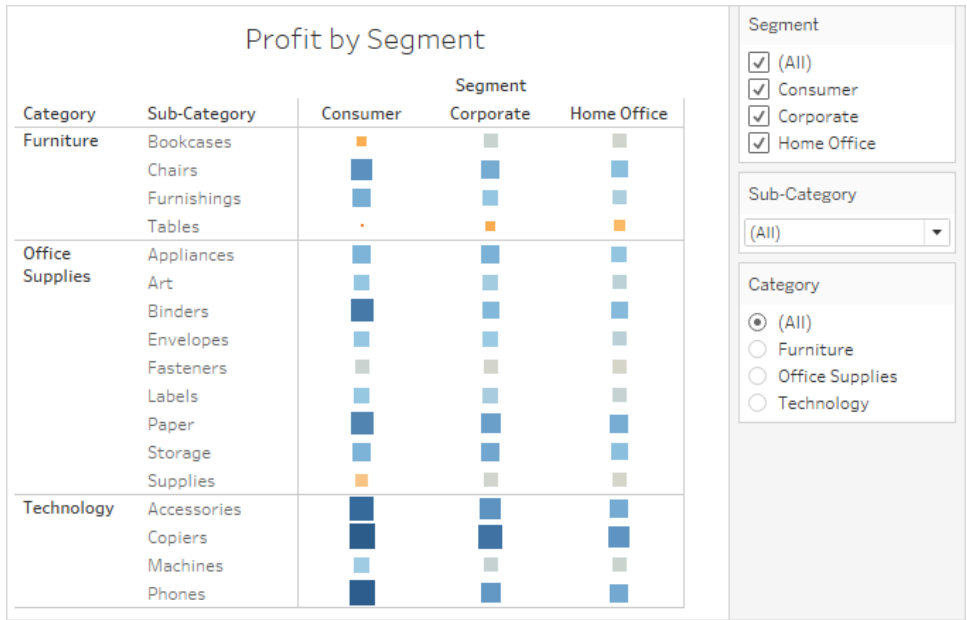

Enable highlighting

You can use the **Highlight** button on the toolbar to set up highlighting between views. When highlighting is turned on, a selection in one view will highlight related data in the other views. You can turn on highlighting for all fields or select specific fields. For more information about the different methods you can use to highlight data, see [Highlight Actions](#).

You can also display a highlighter that allows your customers to highlight parts of a view based on what they enter or select.

To display a highlighter:

1. Go to the worksheet where the view is (or select **Go to Sheet** from the dashboard).
2. Right-click the field you want to highlight—it must be a discrete field—and choose **Show Highlighter**:

The screenshot shows a Tableau Desktop interface with a pivot table titled "Profit by Segment". The columns are "Segment" (Consumer, Corporate) and the rows are "Category" (Furniture, Office Supplies) and "Sub-Category". A context menu is open over the "Show Highlighter" option, which is highlighted by a mouse cursor. The menu includes options like "Edit Filter...", "Show Filter", "Sort...", "Format...", "Show Header", "Include in Tooltip", "Edit Aliases...", "Dimension", "Attribute", "Measure", "Edit in Shelf", and "Remove".

Category	Sub-Category	Consumer	Corporate
Furniture	Bookcases	■	■
	Chairs	■	■
	Furnishings	■	■
	Tables	■	■
Office Supplies	Appliances	■	■
	Art	■	■
	Binders	■	■
	Envelopes	■	■
	Fasteners	■	■
	Labels	■	■
	Paper	■	■
	Storage	■	■

In the highlighter, your users will be able to select or enter terms to highlight data in the view:

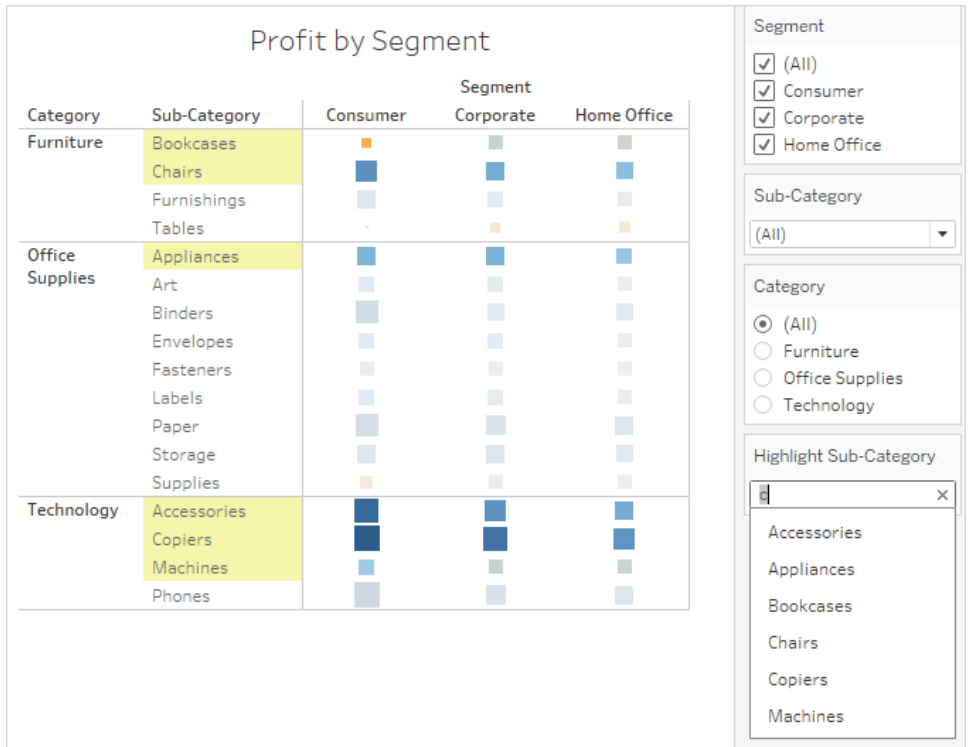

Create a Dashboard

After you've created one or more sheets, you can combine them in a dashboard, add interactivity, and much more.

Tip: To quickly get up and running, see [Use Accelerators to Quickly Visualize Data on page 2721](#).

Create a dashboard, and add or replace sheets

You create a dashboard in much the same way you create a new worksheet.

1. At the bottom of the workbook, click the **New Dashboard** icon:

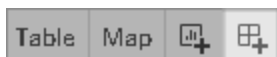

- From the **Sheets** list at left, drag views to your dashboard at right.

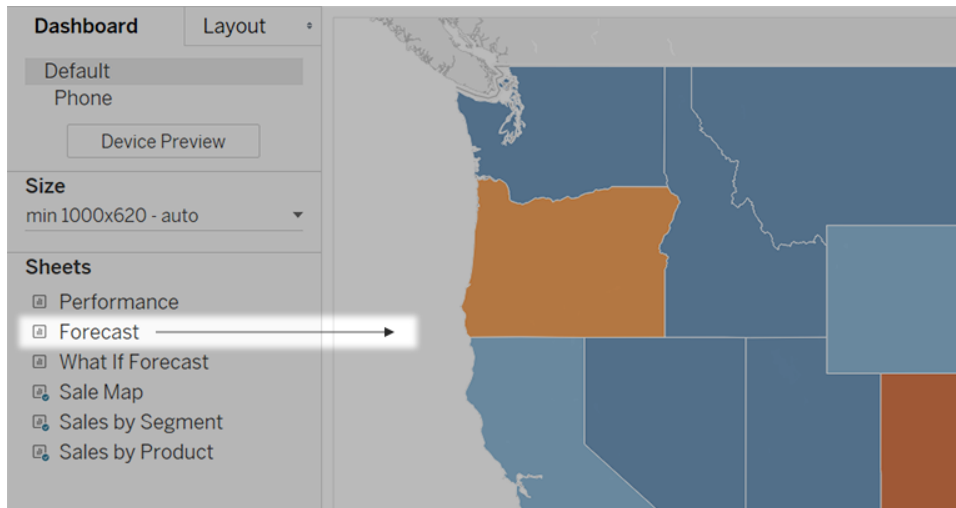

- To replace a sheet, select it in the dashboard at right. In the Sheets list at left, hover over the replacement sheet, and click the **Swap Sheets** button.

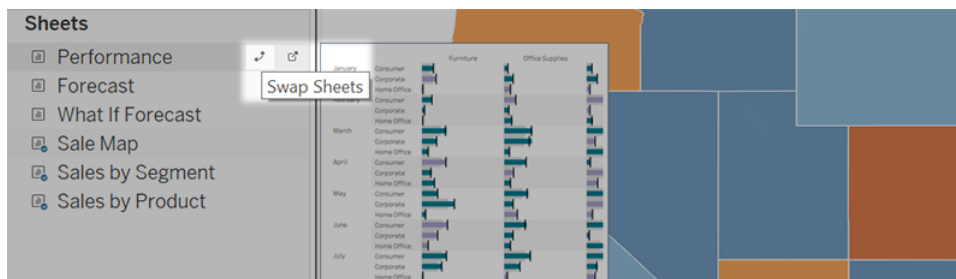

Note: When you replace a sheet, Tableau retains any padding, border, or background color. However, you may need to adjust sheet size if content differs significantly. You may also need to delete dashboard items specific to the previous sheet, such as filters, which become blank.

Add interactivity

You can add interactivity to dashboards to enhance users' data insights. Try these techniques:

- In the upper corner of sheet, enable the **Use as Filter** option to use selected marks in the sheet as filters for other sheets in the dashboard.

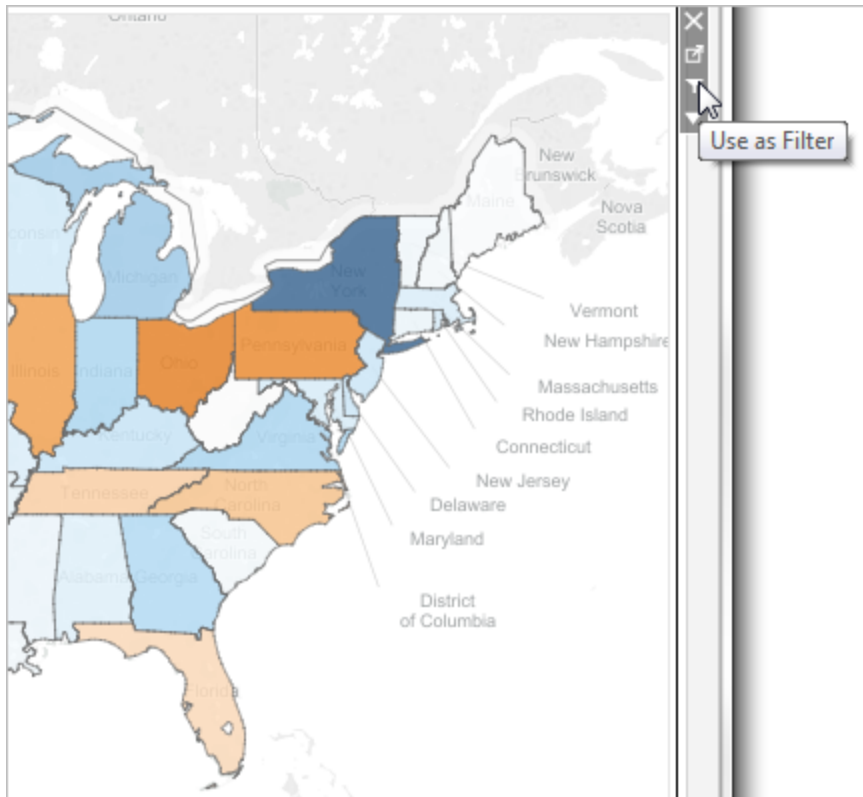

- When authoring in Tableau Desktop, add actions to use multiple sheets as filters, navigate from one sheet to another, display web pages, and more. For details, see [Actions and Dashboards](#) on page 1462.

Add dashboard objects and set their options

In addition to sheets, you can add dashboard objects that add visual appeal and interactivity. Here's guidance about each type:

- **Horizontal** and **Vertical** objects provide [layout containers](#) that let you group related objects together and fine-tune how your dashboard resizes when users interact with them.
- **Text** objects can provide headers, explanations, and other information.
- **Image** objects add to the visual flavor of a dashboard, and you can link them to specific target URLs. (While Web Page objects can also be used for images, they are better for complete web pages. The Image object provides image-specific fitting, linking, and alt-text options.)
- **Web Page** objects display target pages in the context of your dashboard. Be sure to review [these web security options](#), and be aware that some web pages don't allow themselves to be embedded—Google is one example.

Note: For security reasons, your Tableau administrator may prevent Web Page and Image objects from displaying target URLs.

- **Blank** objects help you adjust spacing between dashboard items.
- **Navigation** objects let your audience navigate from one dashboard to another, or to other sheets or stories. You can display text or an image to indicate the button's destination to your users, specify custom border and background colors, and provide informational tool-tips.
- **Download** objects let your audience quickly create a PDF file, PowerPoint slide, or PNG image of an entire dashboard, or a crosstab of selected sheets. Formatting options are similar to Navigation objects.

Note: Crosstab download is possible only after publishing to Tableau Cloud or Tableau Server.

- **Extension** objects let you add unique features to dashboards or integrate them with applications outside Tableau.
- **Pulse Metric** objects let you embed existing metric cards in your dashboard. The metrics that you can add are connected to the same published data sources that are used by the workbook.

Add an object

From the **Objects** section at left, and drag an item to the dashboard on the right:

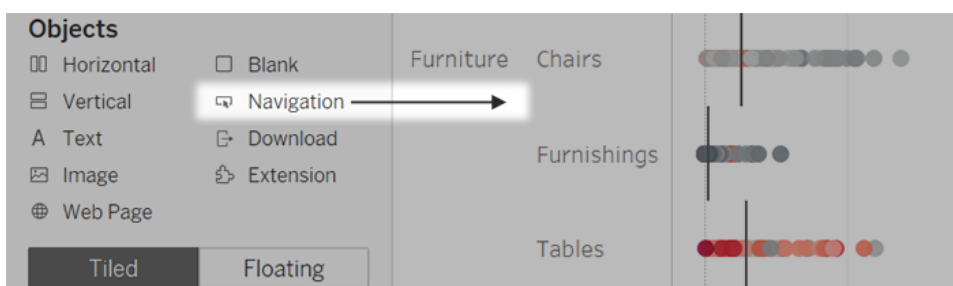

Copy objects

You can copy and paste objects either within the current dashboard, or from dashboards in other sheets and files. You can even copy objects between Tableau Desktop and Tableau in your web browser.

You can't, however, copy the following:

- Sheets in a dashboard
- Items that rely on a specific sheet, such as filters, parameters, and legends
- Layout containers with something you can't copy inside them, like a sheet or filter
- Objects on a device layout
- Dashboard titles

Tip: In addition to the menu commands described below, you can also use the standard keyboard shortcuts for copying and pasting on your operating system.

1. Select a dashboard object, and from the object menu, select **Copy Dashboard Item**. Or from the main menu, select **Dashboard > Copy Selected Dashboard Item**.

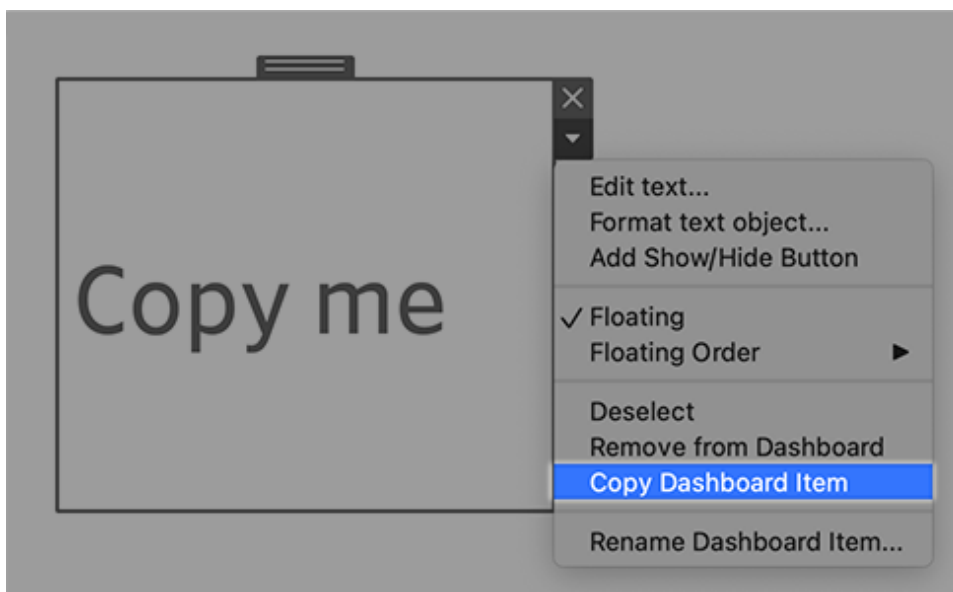

2. Go to the dashboard where you want to paste the object. Then either select nothing to paste in the upper-left corner of the dashboard, or select an existing item to paste next to.
3. In Tableau Desktop, choose **File > Paste**. In a browser, either choose **Edit > Paste** or use the keyboard shortcut for pasting.
4. The object is pasted 10 pixels below and to the right of the upper-left corner of the dash-

board or the selected object. To move the pasted object, drag the handle at the top.

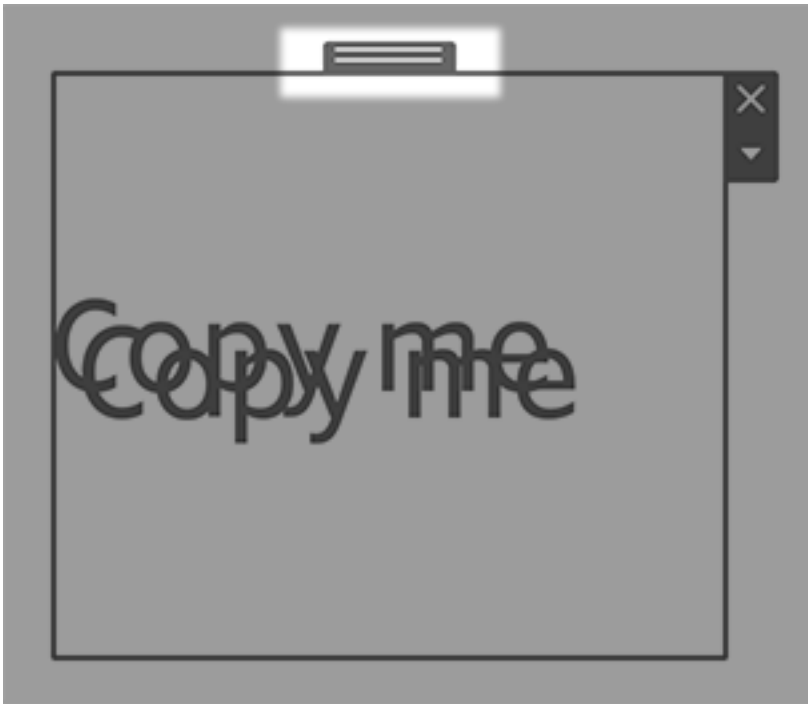

Note: Copied Show/Hide buttons may target the original object or be disabled. For instructions on how to fix this, see [Show and hide objects by clicking a button on page 2711](#).

Set options for objects

Click the object to select it. Then click the arrow in the upper corner to open the shortcut menu. (The menu options vary depending on the object.)

Sales by Product Category		Jan	Mar	Apr	May	Jun	Jul
Furniture	Bookcases	\$5,352	\$7,352	\$4,720	\$6,290	\$9,148	\$8,148
	Chairs	\$11,285	\$21,344	\$18,527	\$25,894	\$21,523	\$23,148
	Furnishings	\$3,980	\$5,159	\$7,538	\$6,893	\$5,923	\$7,148
	Tables	\$10,952	\$16,913	\$9,913	\$9,288	\$16,405	\$10,148

Detailed options for Image objects

With the Image object, you can either insert image files into dashboards or link to images posted on the web. In either case, you can specify a URL the image opens when clicked, adding interactivity to your dashboard.

Note: URLs for web-based images require the HTTPS prefix for improved security. For image URLs with other prefixes, use the Web Page object.

1. From the Objects section at left, drag an Image object to your dashboard at right. Or, on an existing Image object in a dashboard, click the pop-up menu in the upper corner, and choose **Edit Image**.
2. Click either **Insert Image File** to embed an image file into the workbook or **Link to Image** to link to a web-based image.

Consider linking to a web-based image when:

- The image is very large and your dashboard audience will view it in a browser. (Unlike web-based images, inserted images must be downloaded every time a sheet opens, slowing performance.)
- The image is an animated GIF file. (Inserted images don't support animated GIFs.)

Edit Image Object

Insert Image File | **Link to Image**

https://example.com/uploads/globe_image.png

Options

Fit Image
 Center Image

URL Opened When Image Is Clicked

www.tableau.com

Alt Text

Opens Tableau's website

Apply | **OK**

3. If you're inserting an image, click **Choose** to select the file. If you're linking to an image, enter its web URL.
4. Set remaining image fitting, URL linking, and alt text options. (Alt text describes the image in screen-reading applications for improved accessibility.)

Detailed options for Navigation and Download objects

Navigation and Download objects have several unique options that help you visually indicate a navigation destination or file format.



A navigation button using text for the button style

1. In the upper corner of the object, click the object menu, and choose **Edit Button**.

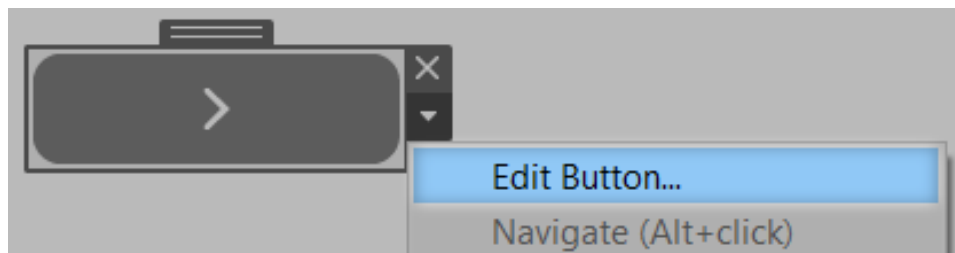

2. Do one of the following:
 - From the **Navigate to** menu, choose a sheet outside the current dashboard.
 - From the **Export to** menu, choose a file format.
3. Choose image or text for **Button Style**, specify the image or text you want to appear, and then set related formatting options.
4. For **Tooltip text**, add explanatory text that appears when viewers hover over the button. This text is optional and typically best used with image buttons. (For example, you might enter "Open Sales viz" to clarify the destination for a navigation button that appears as a miniature sales chart.)

Note: When viewing a published dashboard, simply clicking a button navigates or exports. When authoring a dashboard, however, you need to Alt-click (Windows) or Option-click (macOS).

Show and hide objects by clicking a button

Show/Hide buttons let dashboard viewers toggle the visibility of dashboard objects, revealing them only when necessary.

How hidden objects affect layouts

When a floating object is hidden, it simply reveals any objects beneath it. Show/Hide buttons can be particularly helpful when you want to temporarily hide a floating group of filters to reveal more of a visualization.

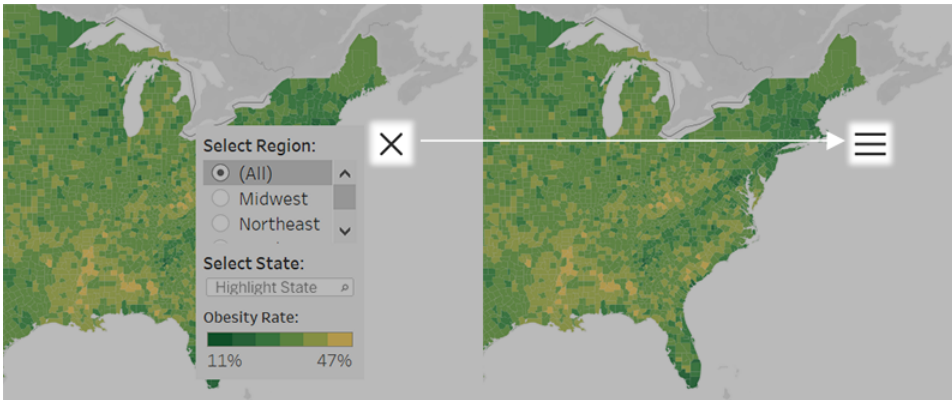

When a tiled object is hidden, the results depend on the object's level in the layout hierarchy.

- In most cases, you'll want to place objects you plan to hide in a Horizontal or Vertical layout container, because hidden objects will have their space filled in by other objects in the container.
- By contrast, in the Tiled layout container at the very top of the layout hierarchy, a hidden object leaves blank space behind.

Add and configure a Show/Hide button

1. Select a dashboard object.
2. From the pop-up menu in the upper corner of the object, select **Add Show/Hide Button**.

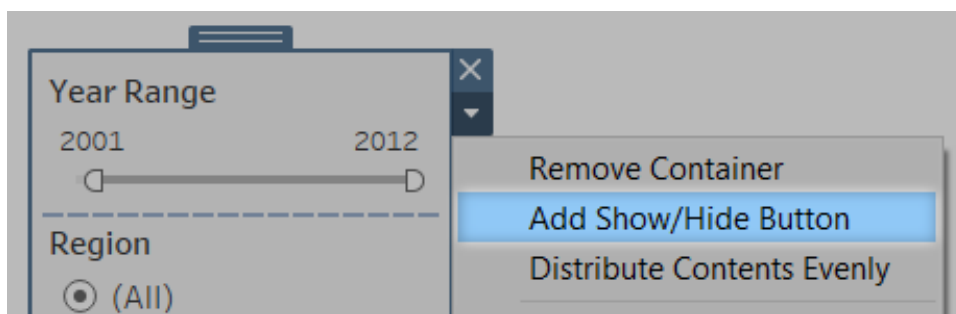

3. From the button menu, choose **Edit Button**.

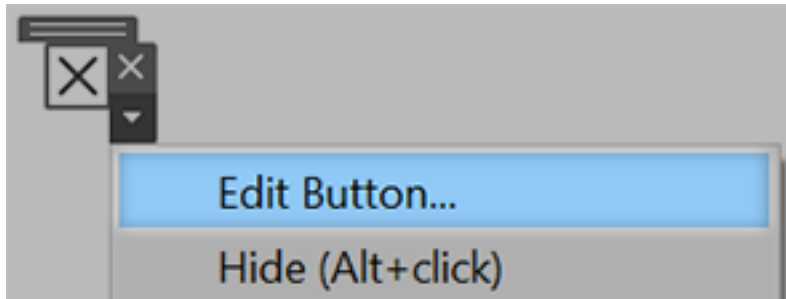

4. Set these options:
 - **Dashboard Item to Show/Hide** specifies the target object. (An object can be the target of only one Show/Hide button at a time. Choose **None** if you want to target the object with another Show/Hide button.)
 - **Button Style** specifies whether image or text displays for the button.
 - **Button Appearance** specifies how the button looks when the item is both shown and hidden. Click **Item Shown** and **Item Hidden** to choose different images or text for each state.
 - **Tooltip text** provides explanatory text that appears when viewers hover over the button. (For example, you might enter "Show or hide filters" for a container with filter menus.)
5. If necessary, drag the button to a different location or resize it to better fit your layout.

Note: When viewing a published dashboard, simply clicking a Show/Hide button toggles object visibility. When authoring a dashboard, however, you need to Alt-click (Windows) or Option-click (macOS).

Security for Web Page objects

If you include Web Page objects in your dashboard, you can optimize security by doing the following.

Use HTTPS protocol when possible

As a best practice, use HTTPS (<https://>) in your URLs. This ensures that the connection from your dashboard to the web page is encrypted. Also, if Tableau Server is running HTTPS and you use HTTP in the URL, your users' browsers won't be able to display the web page that the URL points to. If you don't specify a protocol, HTTP will be assumed.

Security options for Web Page objects (Tableau Desktop only)

Choose **Help > Settings and Performance > Set Dashboard Web View Security**, and set the options below. (In some organizations, these options are controlled across all machines by a Tableau administrator.)

Note: Any changes you make to these security options apply to both existing and newly created web page objects.

- **Enable JavaScript** Allows JavaScript support in the web view. Clearing this option may cause some web pages that require JavaScript to function improperly in the dashboard.
- **Enable Plug-ins** Enables any plug-ins the web page uses, such as an Adobe Flash or QuickTime player.
- **Block Pop-ups** When selected, blocks pop-ups.
- **Enable URL Hover Actions** Allows URL hover actions. For more information, see [URL Actions on page 1404](#).
- **Enable Web Page Objects and Web Images** Allows the display of target URLs in Web Page and Image objects. If you deselect this option, Web Page objects and Image objects that link to the web remain in the dashboard but show no content.

Explore Dashboards with Data Guide

Have you ever discovered a new Tableau dashboard and wondered what data means or how to use it? Or, have you ever published a new dashboard and wished that you could include instructions about how to use your dashboard?

Data Guide provides helpful information about a dashboard and insights about the data behind it. Data Guide allows dashboard creators to provide more explanatory context for end users—like descriptions and links to resources—directly in the dashboard. And Data Guide automatically surfaces insights powered by [Explain Data](#) to help users find outliers and learn about explanations for a mark. Explain the Viz (powered by Explain Data) identifies outlier measures and potential key drivers behind them.

These contextually relevant details can help dashboard users navigate and use new dashboards more easily, allowing users to find insights faster, trust that they're looking at the right data, provide context for data, and establish confidence in their understanding of the viz.

Customize Data Guide as an author

1. From your dashboard, choose the **Edit** button.
2. Choose **Data Guide** in the toolbar.
3. In the Data Guide pane, type a description to help your end users understand the purpose of your dashboard.
4. Select **Add link**, and enter a descriptive label for your link text and the URL.
5. Choose **OK**.
6. Select a viz (a sheet in the dashboard). Data Guide updates automatically so you can add a description and resources that are relevant to each viz in your dashboard.
7. Type a description, and add links relevant to the viz.
8. Choose **OK**.

Tip: To use Data Guide to write custom alt text to improve the accessibility of your vizzes, see [Show more text and make it helpful](#).

Explore Data Guide as a dashboard user

1. From the dashboard, choose **Data Guide** in the toolbar.
2. Read the description of the dashboard and explore resources provided by the dashboard author.
3. Expand **Data in This Dashboard** and **Detected Outliers** to learn more about the underlying data used in the dashboard.
4. Select a viz (an object in the dashboard).
5. Read the description of the viz and explore resources provided by the dashboard author.
6. Expand **Data Summary** and **Detected Outliers** to learn more about data in that viz.
7. Select a mark or multiple marks, such as a bar on a chart or a region on a map, to see information about **Data in This Mark** and **Applied Filters**. Select a single mark to see possible **Explanations** for its value.

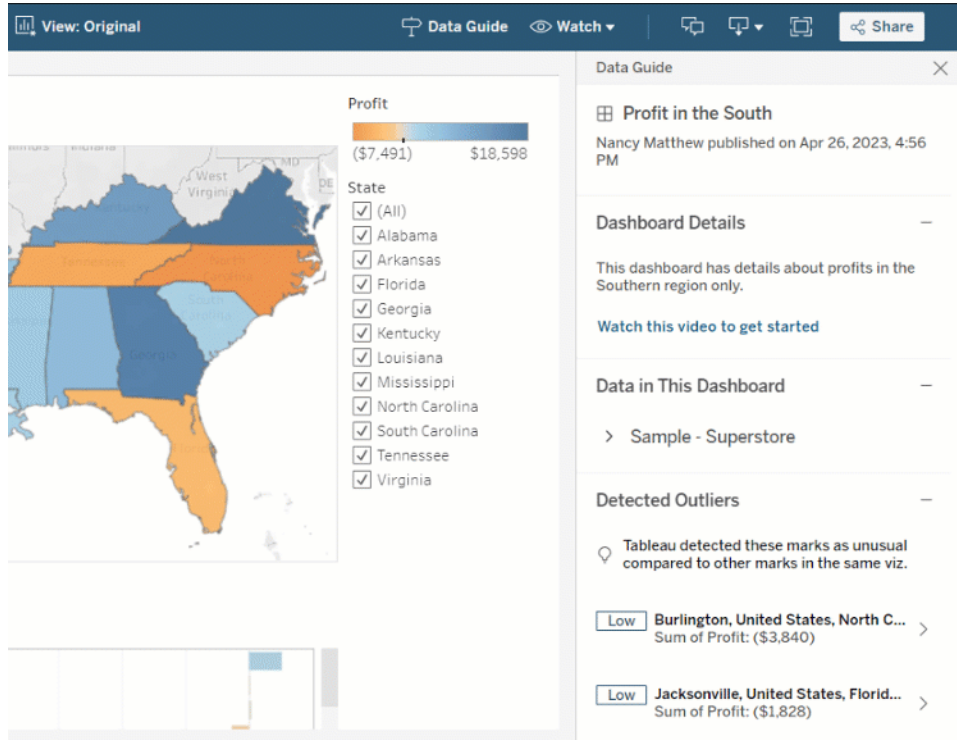

Explore Data Guide at different levels

By default, Data Guide is closed when you open a workbook. And you can open Data Guide in the toolbar. At the top of the Data Guide pane, you see the name of the dashboard or viz that you selected. As a dashboard author, you can write descriptions for both the dashboard and for individual vizzes that make up your dashboard.

Understand dashboard-level details

At the dashboard level, Data Guide:

- Displays the dashboard's name, author, and last published date.
- Can include a description written by the dashboard author and links to related resources, such as videos or wiki pages.
- Lists the data sources used by the dashboard and details about the data, such as which dimensions and measures are used.

- Reveals detected outliers in the dashboard that are identified by Explain Data. For more information, see [Get Started with Explain Data](#) on page 1930.

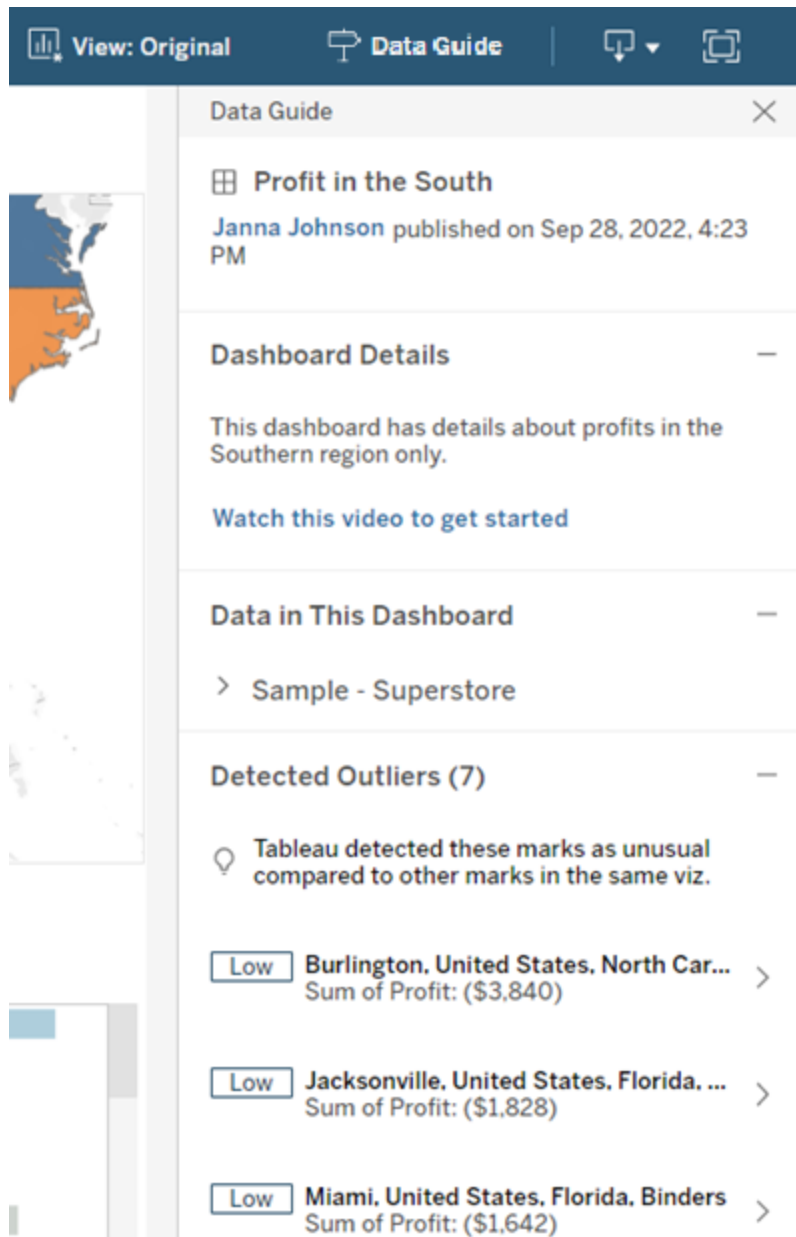

Understand viz-level details

When a user selects a specific viz (dashboard object), Data Guide:

- Displays the viz's name.
- Can include a description written by the dashboard author and links to related resources, such as videos or wiki pages.
- Lists the data sources used by the dashboard, including the dimensions and measures used.
- Lists applied filters and data used in the viz, so you can identify how the data is being influenced by filters that users interact with. Only filters that a user can change are shown.
- Has a summary of the data used in the viz, including the number of data points and sorting details.
- Reveals detected outliers in the viz that are identified by Explain Data. For more information, see [Get Started with Explain Data](#) on page 1930.

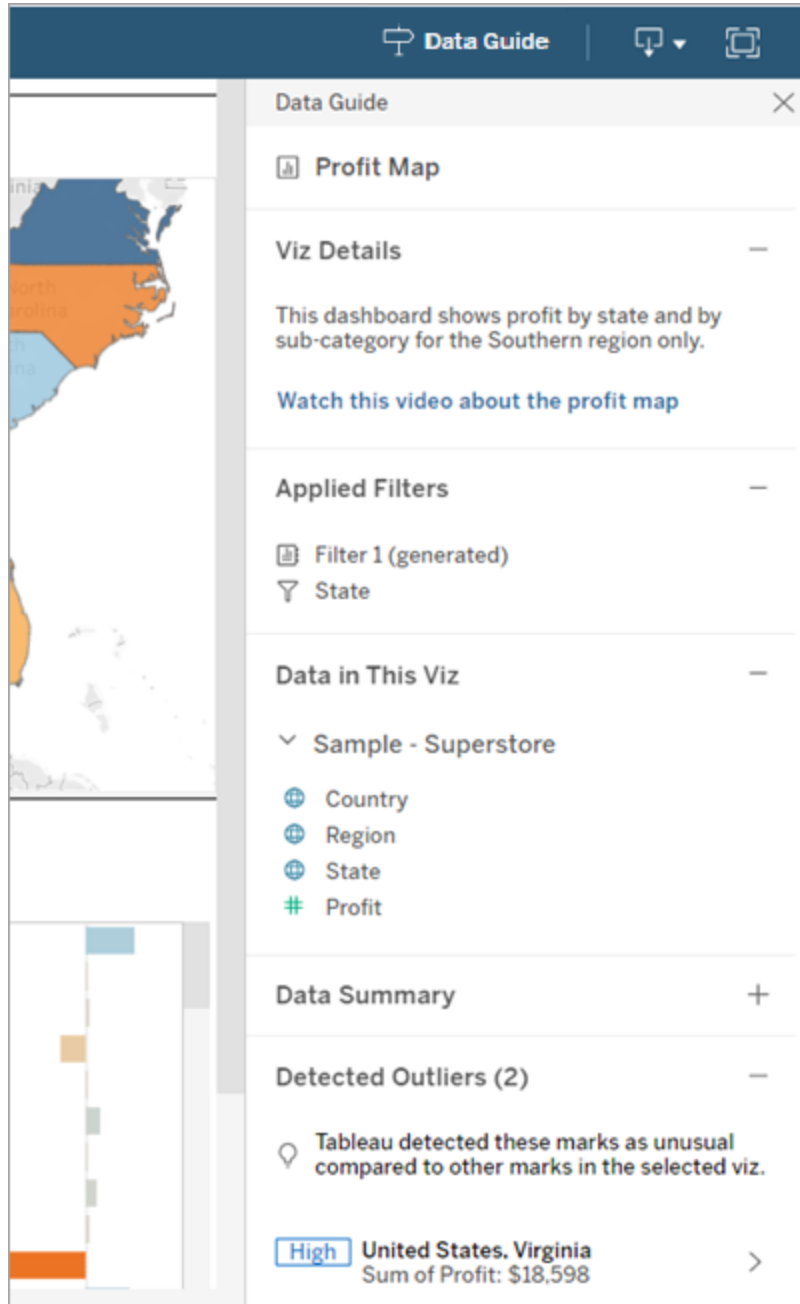

Understand mark-level details

When a user selects a mark (or marks) such as region on a map, Data Guide:

- Displays the name of the mark.
- Lists applied filters and data used in the viz, so you know what's included and what's excluded.
- Reveals detected outliers in the viz that are identified by Explain Data. For more information, see [Get Started with Explain Data](#) on page 1930.

The screenshot shows the Tableau Data Guide interface. On the left, there is a map of the United States with North Carolina highlighted in orange. Below the map is a vertical legend with colored bars. The main panel on the right is titled "Data Guide" and contains the following sections:

- Data Guide** (with a close button)
- United States, North Carolina** (with a location icon)
- Data in This Mark** (with a minus sign)
 - Sample - Superstore
 - Country: United States
 - State: North Carolina
 - Profit: (\$7,491)
- Applied Filters** (with a minus sign)
 - Filter 1 (generated)
 - State
- Explanations for This Mark** (with a minus sign)
 - Explore underlying values for United States, North Carolina
 - Low Sum of Profit (\$7,491) (with a right arrow)
 - Other things to explore
 - What is unique about United States, North Carolina? (with a right arrow)

Control Data Guide visibility

By default, Data Guide is closed when you open a workbook. When you open or close Data Guide, it remains in this state for all workbooks on the site. In 2023.1 or later, a can hide Data Guide for all users. This removes the Data Guide button from the Tableau toolbar on all workbooks on the site. To hide Data Guide:

1. From the left pane, choose **Settings**.
2. From the **General** tab, scroll to **Availability of Data Guide**.
3. Choose **Hide**.
4. Choose **Save**.

Use Accelerators to Quickly Visualize Data

Tableau Accelerators are pre-built dashboards designed to help you get a jumpstart on data analysis. Tailored to specific industries and enterprise applications, Accelerators are built with sample data that you can swap out for your own data, allowing you to discover insights with minimal setup.

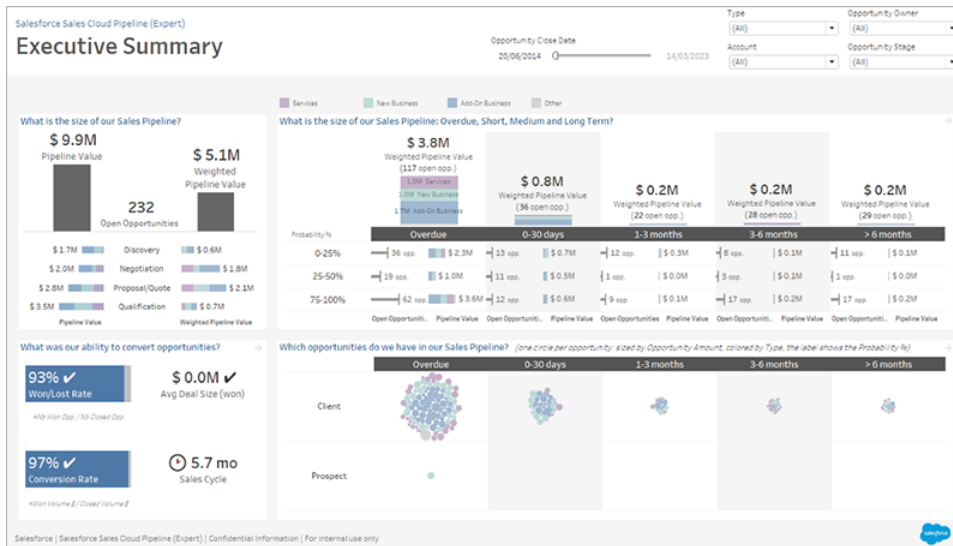

Salesforce Sales Cloud Pipeline Accelerator

Where to find Accelerators

You can access the complete set of Accelerators on the [Tableau Exchange](#) and in Tableau Desktop. Additionally, select Accelerators are available to use when you create a workbook in

Tableau Cloud.

On the Tableau Exchange website

1. Visit the [Accelerators page](#) on the Tableau Exchange website. You can filter to find Accelerators based on the industry they are applicable to and the type of data they connect to.
2. Sign in to the Tableau Exchange website. If you don't have an account, create one.
3. When you find an Accelerator you want to use, select **Download** to get the TWBX file.

Because Accelerators are simply packaged workbooks, you can open the downloaded file in Tableau Desktop or upload it to your site on Tableau Cloud or Tableau Server. For information about uploading workbooks, see [Upload Workbooks to a Tableau Site](#).

In Tableau Desktop

1. On the Start Page in Tableau Desktop, select **More Accelerators**.

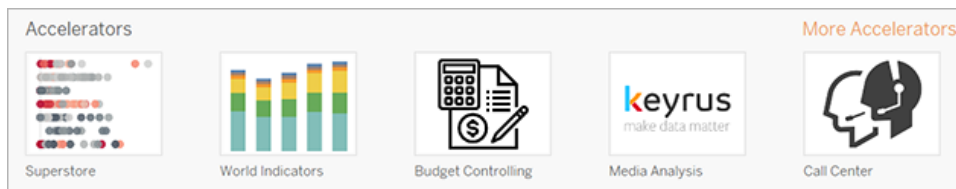

2. The Accelerators in this list are the same as those shown on the Tableau Exchange website, with the added convenience that you can open the Accelerators without leaving Tableau Desktop.
3. When you find an Accelerator you want to use, select **Open** to start working with it.

In Tableau Cloud

A limited number of Accelerators are available for you to use when you create a workbook in Tableau Cloud. These Accelerators connect to cloud-based data like Salesforce, ServiceNow ITSM, LinkedIn Sales Navigator, Marketo, and Oracle Eloqua.

1. If you're a Creator in Tableau Cloud, navigate to the Home or Explore page, then select the **New** button and select **Workbook**.

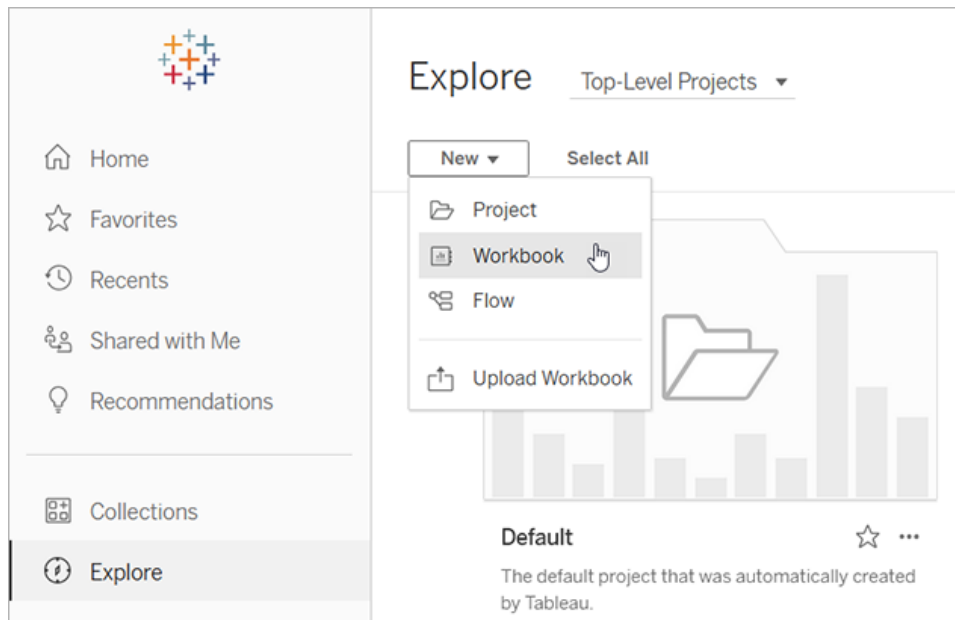

Note: Site administrators can also access Accelerators from the Home page, under the section labeled Accelerators.

2. At the top of the Connect to Data window, select **Accelerator** to browse the Accelerators available to connect to on Tableau Cloud.

You can upload Accelerators from the Tableau Exchange to Tableau Cloud and use them as you would in Tableau Desktop. However, you will need to follow the Tableau Desktop instructions to get your data into the Accelerator instead of the Tableau Cloud instructions.

Use an accelerator from the Tableau Exchange

Follow the instructions in this section to use an Accelerator that you have downloaded from the Tableau Exchange website or opened from within Tableau Desktop. For instructions on using Accelerators when you create a workbook in Tableau Cloud, see [Use an Accelerator directly in Tableau Cloud](#) on page 2732.

Add your data to the Accelerator in Tableau Desktop

Use the data mapper

Data mapping was introduced for a limited number of Accelerators in Tableau Desktop in 2023.1.

Starting in 2023.2, the data mapper now:

- Saves your selections, if you close it, so that you can pick up where you left off
- Allows you to switch between different connected data sources
- Supports a larger number of Accelerators

The data mapper helps you connect to data and map the fields in your data to those required for the Accelerator. If the Accelerator you have downloaded supports the data mapper, a prompt will appear to help you get started. To find Accelerators that support the data mapper, select the filter **Data Mapping enabled** on the [Tableau Exchange website](#).

For Accelerators that don't support the data mapper, follow the instructions to **Manually add your data** on page 2726.

1. When you open an Accelerator, the data mapper opens. Select **Get Started**.

If you close the data mapper, you can reopen it at any time by selecting **Open Data Mapper** from the Data menu.
2. If you've already connected to data, select the data source to use for mapping. Otherwise, select **Connect to Data**, then select the file or cloud-based data to use with the Accelerator.
3. For unpublished data sources with more than one table, you must add data to the canvas so that Tableau can access the fields. If you see a prompt to set up your data, drag one or more tables or sheets to the data source canvas. The data you add will be available to map to the Accelerator.

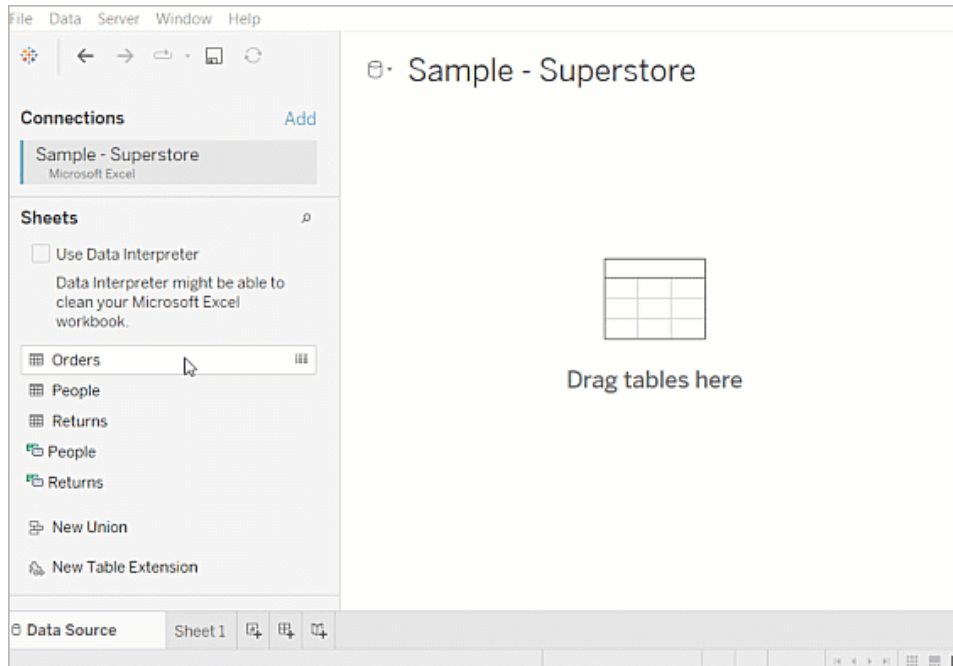

For more information about building a data source, see [Use Relationships for Multi-table Data Analysis](#).

4. After you add your data, your fields appear in the **To** column on the data mapper. For each Accelerator field, select a field of the same data type from your data. Mouse over fields to see details about them.

If you notice that a field in your data is marked as the wrong type, change the data type so that it can be mapped. To learn how, see [Data Types](#).

If you want to switch the data source you're using for data mapping, select the data source name after **To**, then select any other data sources you have connected, or select **New Data Source**. Switching the data source clears any selections you have made.

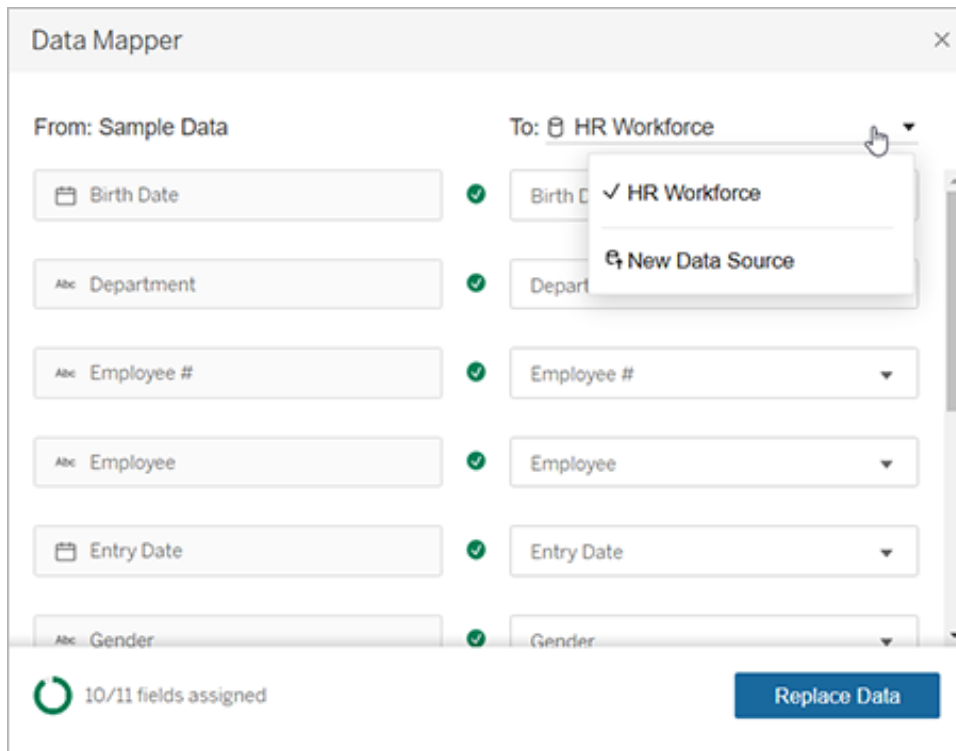

5. The indicator in the lower left of the data mapper shows how many fields you have assigned. After you complete your assignments, select **Replace Data**.

Any fields you leave unmapped will cause the dashboards that use those fields to break. This is because all sample data is removed from the Accelerator when you replace the data.

6. Your data replaces the sample data in the Accelerator. Before you close the data mapper, check the dashboards to make sure that the data was mapped as you expected. If you notice issues with the data, select **Make Changes** to return to the assignment screen. Make your adjustments, then replace the data again.

Starting in Tableau Desktop 2023.2, if you want to make adjustments after you've closed the data mapper, select **Data > Open Data Mapper** to refine your selections. In Tableau Desktop 2023.1, the selections you made don't persist, and if you reopen the data mapper, you'll need to repeat the process of adding a data source and making assignments for each field.

Manually add your data

There are two methods by which you can add your data to the Accelerator: replace the data source with a new data source (method 1) or add a new connection to the existing data source (method 2).

Method 1

Works with data sources that have more than one table.

Allows you to change field names in Tableau Desktop to match the Accelerator.

Doesn't preserve the folder structure in the Accelerator.

Method 2

Data sources must have only one physical table.

Doesn't allow you to change field names in Tableau Desktop, which means that the field names in your data source must match the fields in the Accelerator.

Preserves the folder structure, which keeps the fields used by the Accelerator organized.

Method 1: Replace the data source

Use this method if you're adding a data source with multiple tables.

1. With the Accelerator open in Tableau Desktop, select **Data > New Data Source**.

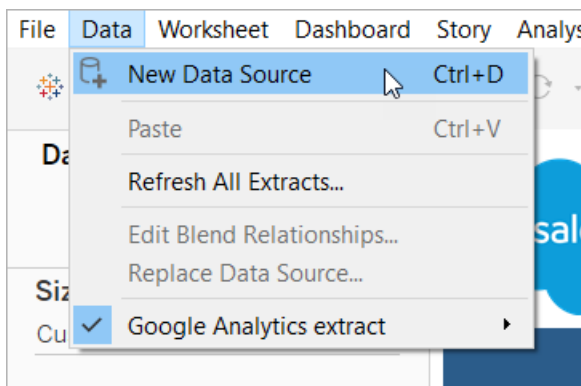

2. Connect to the data you want to use. For more information, see [Connect to Your Data](#). If you're using a Salesforce Accelerator, make sure your account has API access to your Salesforce instance.
3. On the Data Source tab, drag tables onto the canvas to build your new data source. For more information, see [Use Relationships for Multi-table Data Analysis](#).

- Navigate to a dashboard, then select the Go to Sheet icon for one of the sheets listed.

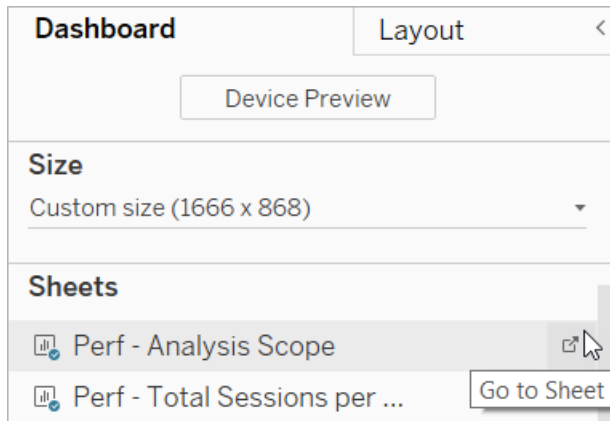

You can only replace data from a worksheet, not from a dashboard or story tab. For more information about the types of sheets in a workbook, see [Workbooks and Sheets](#).

- Select **Data > Replace Data Source**. For more information, see [Replace Data Sources](#).

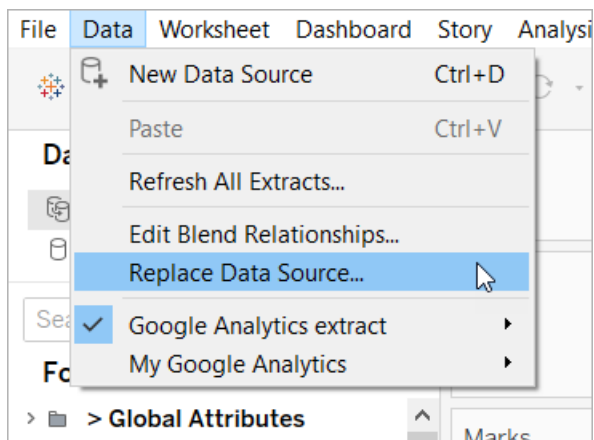

- Under **Replacement**, select the data source you added, then select **OK**.
- In the Data pane, right-click the original data source, then select **Close**. For more information, see [Close Data Sources](#).

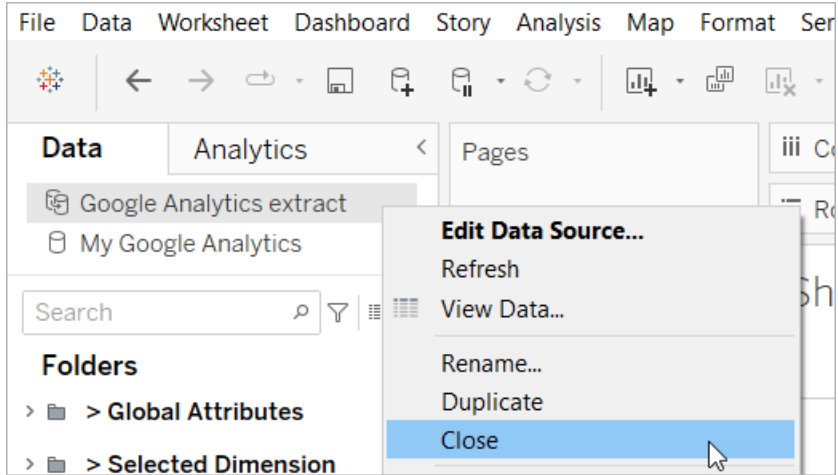

Fix broken references

If the new data source doesn't have the same field names as the original, parts of the Accelerator will be blank. Replace the broken references so that they use the correct fields from your new data source.

1. Navigate to a dashboard, then select the Go to Sheet icon for one of the sheets listed.

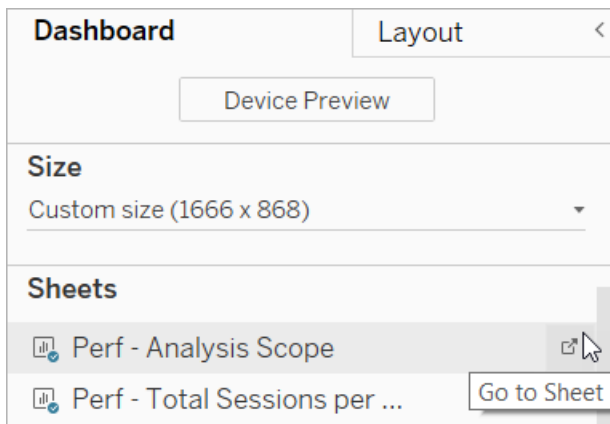

2. In the Data pane, identify the required fields for the Accelerator. The Accelerator page on the [Tableau Exchange](#) should list these fields in the description section.

3. Replace the field references for any fields that are marked with a red exclamation point.

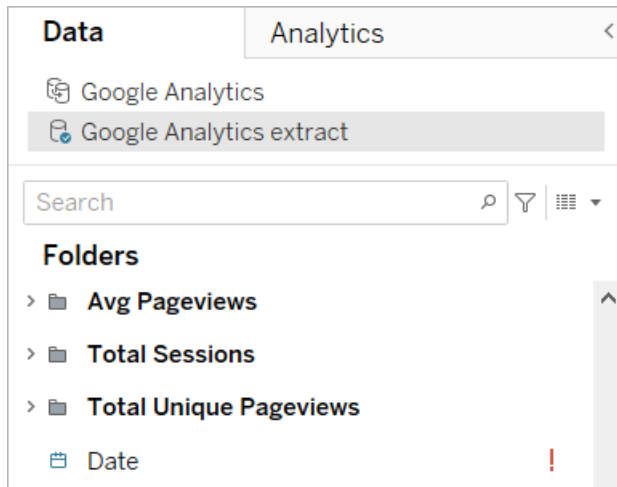

For more information, see [Replace Field References](#).

Method 2: Edit the data source

Use this method if you have a data source with only one physical table that can directly replace the physical table in the Accelerator.

1. With the Accelerator open in Tableau Desktop, select the **Data Source** tab.

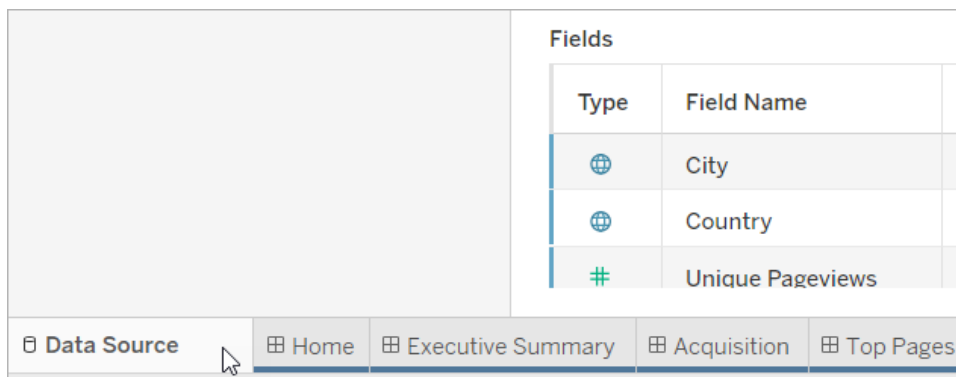

2. Next to Connections, select **Add**. Connect to the data you want to use. For more information, see [Connect to Your Data](#).

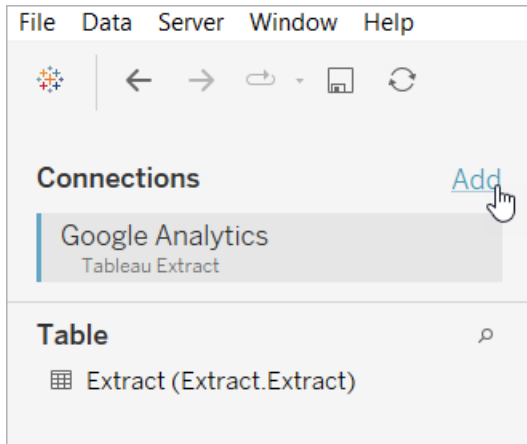

3. On the data source canvas, double-click the logical table to open the physical table. For information about logical and physical tables, see [Layers of the data model](#).

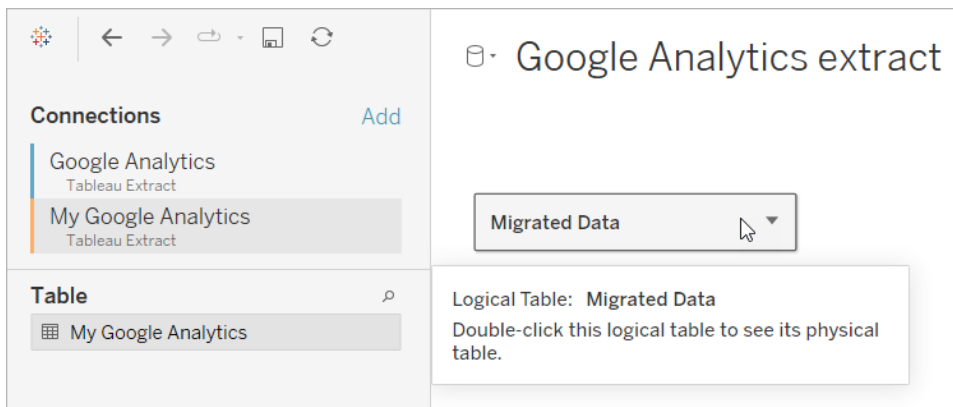

4. Drag the table from the data source you added and drop it onto the existing physical table to replace the sample data. Your data source must be only one physical table.

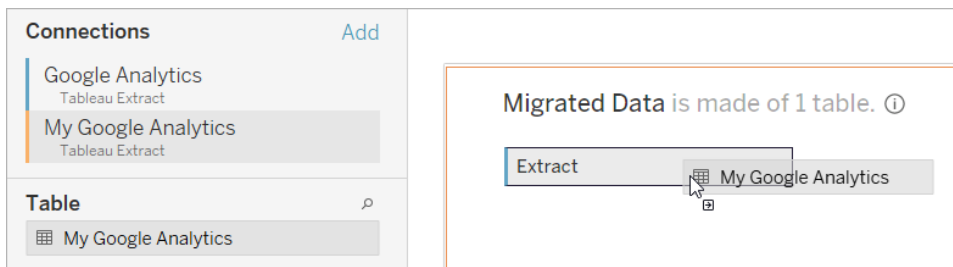

- Under connections, right-click the connection for the sample data, then select **Remove**.

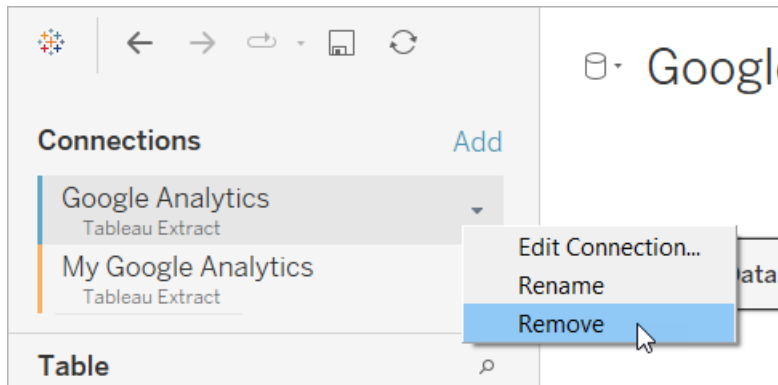

Use an Accelerator directly in Tableau Cloud

A limited number of Accelerators are available for you to use when you create a workbook in Tableau Cloud. These Accelerators prompt you to connect directly to a cloud-based data source, rather than requiring you to add data manually.

- On Tableau Cloud, create a new workbook.
- At the top of the Connect to Data window, select **Accelerator**.
- From the list of pre-built designs, find an option that reflects the data source and business metrics you need, and select **Use Dashboard**.
- To quickly see how a workbook looks with sample data, select **Continue without signing in**. Or select **Continue** to create a workbook with your data.
- Specify a name and containing project for the workbook.
- If you chose to create a workbook with your data, connect to your data source. While Tableau prepares an extract of your data, sample data appears so you can explore the layout.

Note: If you download an Accelerator from the Tableau Exchange with the intention of uploading it to Tableau Cloud, you will need to replace the data by following the instructions under [Use an accelerator from the Tableau Exchange on page 2723](#).

Change permissions to share Accelerators with colleagues

To avoid exposure of confidential data, workbooks for Accelerators are visible only to authors and administrators by default. To share a Accelerator with your colleagues, follow these steps:

1. In Tableau Cloud, [navigate to the workbook](#) for the Accelerator.
2. On the workbook, select **Actions > Permissions**.
3. Give **View** permissions to any user or group you want to see the dashboard. For more information, see [Edit Permissions](#) in Tableau Cloud Help.

Replace sample data with your data

If you chose to use sample data in a dashboard, you can replace it with your data at any time.

1. In Tableau Cloud, [navigate to the workbook](#) for the Accelerator.
2. On the **Data Sources** tab, select the data source. From the Actions menu, choose **Edit Connection**.
3. For authentication, select **Embedded credentials in the connection**, and either choose an existing user account or add a new one. Then select **Save**.
4. On the **Refresh Schedules** tab, select the schedule. From the Actions menu, select **Run Now**.

Fix grayed-out views by replacing field names

If your organization has customized the data structure for a cloud-based system, you may need to match those changes in Accelerators after your data loads in them. For example, if your organization has renamed the Salesforce “Account” field to “Customer”, you'll need to make a corresponding change in Accelerators to avoid grayed-out views like this:

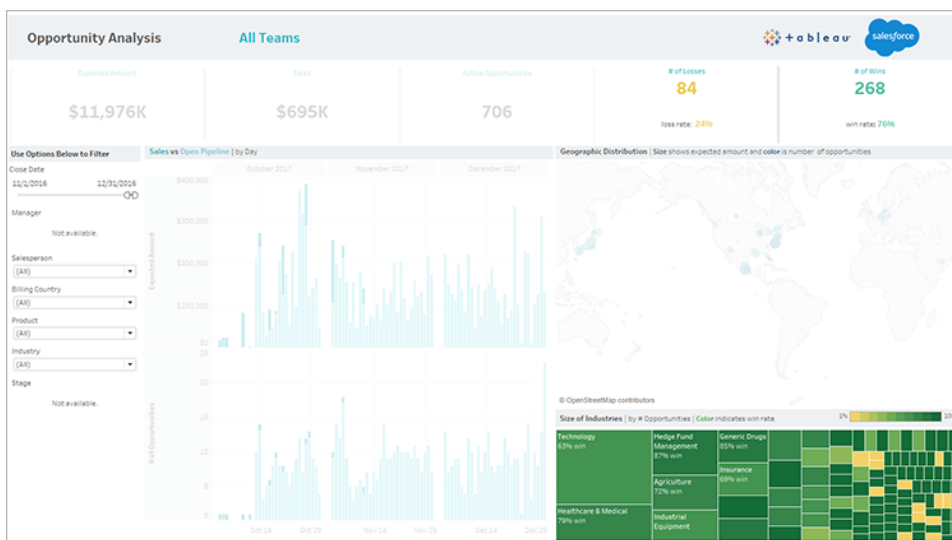

Replace the field references to fix the broken fields.

1. On the dashboard, select **Edit**.
2. [Navigate directly to the grayed-out sheet.](#)
3. In the Data pane at left, look for red exclamation points (!) next to field names, which indicate that your organization uses different names.
4. Right-click each of those fields, and select **Replace References**. Then select the correct field name from the list.

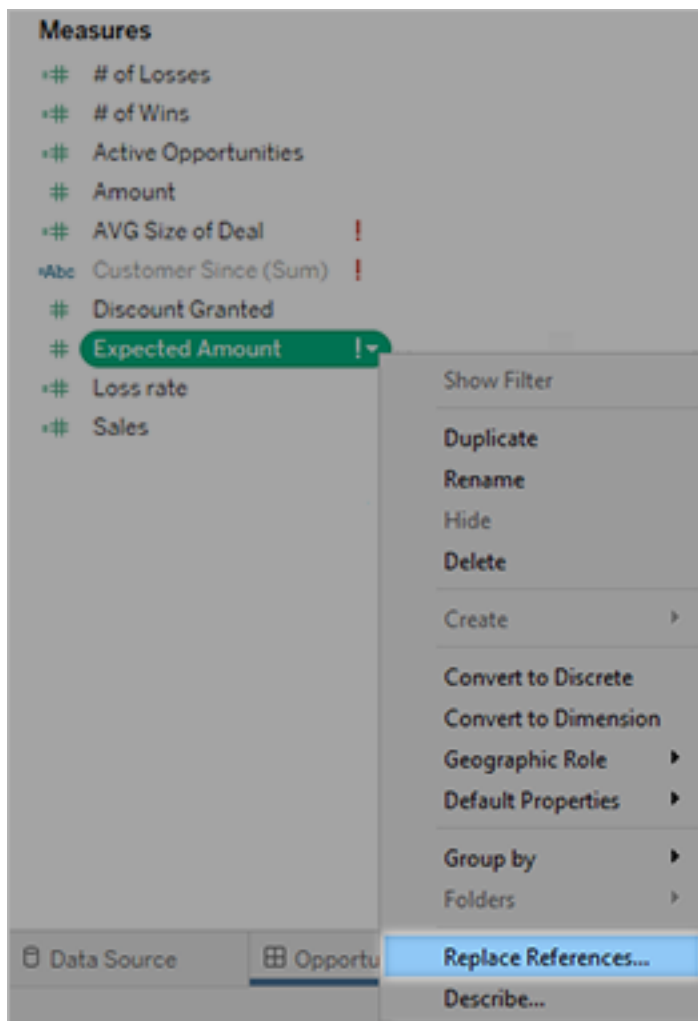

Fix empty dashboards by changing default date ranges

If a dashboard looks completely empty, the likely cause is a default date range that doesn't correspond to the dates in your source data.

1. [Download the workbook](#), then open it in Tableau Desktop.
2. Select the **Data Source** tab.
3. In the upper-left corner, select the arrow next to the data source name, and select **Edit Connection**. Then sign in.

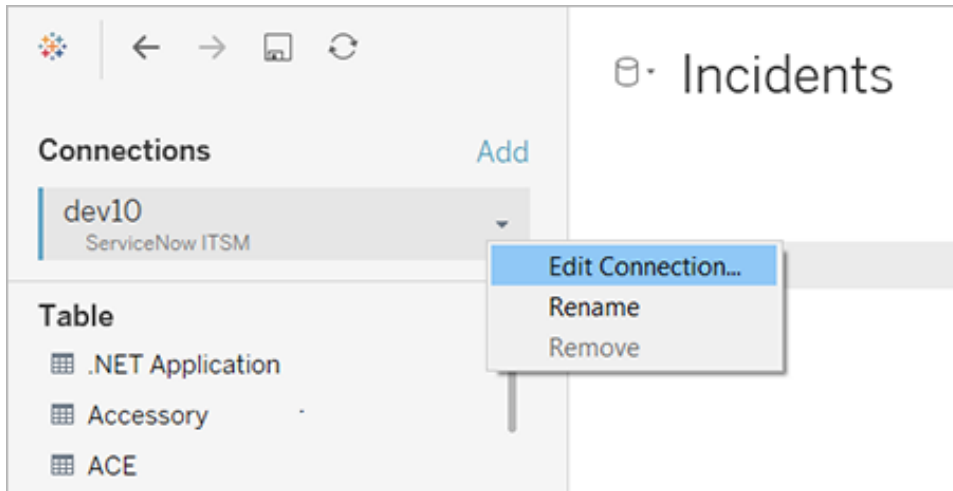

4. Specify a date range that reflects the dates in your data, then select **Connect**.
5. Choose **Server > Publish Data Source** to update extracts of the data on Tableau Cloud.

Build an Accelerator for the Tableau Exchange

Tableau Accelerators are pre-built dashboards that help users jumpstart their analysis in Tableau. With an Accelerator, users can connect their own data to a robust dashboard that is designed specifically for their industry or application and use it to investigate their data. A good Accelerator tells a story that provides insight into business problems and helps users answer questions about their data.

Accelerators are available for download on the [Tableau Exchange](#) and, in a limited subset, on the [Salesforce AppExchange](#). Accelerators are free to use, and users don't need to share their information in order to download an Accelerator. For information about using an Accelerator, see [Use Accelerators to Quickly Visualize Data](#) on page 2721.

Who can build an Accelerator

Only managed [Salesforce partners](#) can contribute Accelerators to the Tableau Exchange. For information about becoming a Salesforce partner, explore the [Salesforce Partner Program](#). If you

aren't a partner, you can still create a workbook that functions like an Accelerator and publish it on [Tableau Public](#), but you aren't eligible to have it included on the Tableau Exchange.

Building an Accelerator doesn't guarantee that it will be listed on the Tableau Exchange. Accelerators built by partners must be approved, and the content of the Accelerator must be relevant to Tableau users. You'll work with a partner account manager to understand the specific requirements for Accelerators and to get yours ready for the Tableau Exchange.

Use Dynamic Axis Ranges

It's key that your users understand the range represented in a viz so that they can correctly analyze the data. Especially when analyzing multiple vizzes in a dashboard or multiple worksheets at the same time, it can be easy for users to misinterpret data when the range of the axes is different between vizzes. For example, when two bar charts appear next to each other, the bars in both charts might appear to be equivalent sizes. However, the axes might have very different ranges, making the charts misleading.

To help users understand the range of the axis, in 2023.3 and later, authors can use Dynamic Axis Ranges to set the minimum and maximum values of an axis range by using numeric parameters or date parameters. Then, as users navigate across vizzes, the axes update synchronously. This makes it easier for your users to analyze data across vizzes easily and accurately. And by limiting the range of the data, you can view a subset of data without filtering the underlying data or impacting the moving average of your data.

Dynamic Axis Ranges can also be used to extend or shorten the range of an axis without filtering out the underlying data. This is ideal for showing progress against a goal or showing a moving average.

Supported field types

Dynamic Axis Ranges support any parameter that is compatible with the selected continuous axis, for example:

- Numeric parameters
- Temporal parameters (date or dateTime)

Configure a dynamic axis range

1. From a Tableau sheet, **create a parameter** for your axis.
2. Right-click the axis, and choose **Edit Axis**.
3. For the Range, choose **Custom**. Then, select the parameter that you created for either the start or end axis extent.
4. Close the dialog box.
5. If you're using multiple sheets on a dashboard, repeat these steps for the axes across the different sheets.

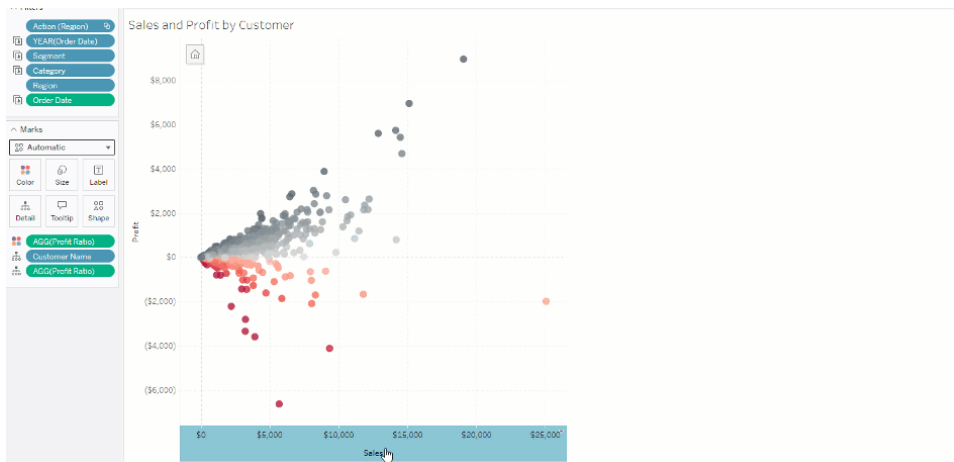

Understand limitations and edge cases

Dynamic Axis Ranges aren't updated within **Stories**. If the parameter used for the axis is deleted, then the most recent parameter value remains as the axis extent. The next time you edit the axis, an error message will prompt you to choose a new parameter to be used.

Use Dynamic Axis Titles

Tableau's flexibility empowers authors to quickly analyze different data sets and visualize data differently for deeper analysis. But with that flexibility, comes the responsibility to communicate accurately the data that is used in a viz. For example, it's critical to communicate the units of measure that change based on a parameter value. Imagine that you're looking at a viz of the weather that shows a forecast of 25 degrees. In Fahrenheit, that forecast might be a great ski trip. But in Celsius, that forecast might call for a trip to the beach.

As an author, you can use Dynamic Axis Titles to update the axis title based on the value of a parameter or a single-value field (for example, an LOD calculation). If you use [swap parameters](#), the axis titles update to match the data being used.

Supported field types

To be used as a Dynamic Axis Title, fields must be:

- A single-valued and a [fixed LOD calculation](#)
- A parameter
- A constant calculated field
- A top 1 set

Configure a dynamic axis title

1. From a Tableau sheet, drag a continuous field onto a shelf.
2. Double-click the axis to open the **Edit Axis** dialog.
3. Under the **Axis Titles** section, choose the field you want to use for your axis title from the list.
4. Close the **Edit Axis** dialog.

For a more complex use case, first follow the steps in [Example: Swap Measures Using Parameters](#). Then, follow these steps:

1. Double-click the X axis to open the **Edit Axis** dialog.
2. Under the **Axis Titles** section, select **Parameter**, and then choose the Placeholder 2 selector.
3. Close the **Edit Axis** dialog.
4. Repeat these steps for the Y axis using Placeholder 1.

Now, when the parameters are changed, the axes titles update to reflect the data being displayed.

Understand limitations and edge cases

Dynamic axis titles are cleared when the viz type is changed using Show Me. Also if you use subtitles, then the subtitle appears after the Dynamic Axis Title, just as it does for custom titles. Automatic subtitles are populated only when you have a continuous date value axis that is filtered to a single year with at least two time periods. The dynamic axis title functionality doesn't

work when using the worksheet in a story (a sequence of visualizations that work together to convey information).

Use Dynamic Zone Visibility

Dashboard space is valuable, especially when you want to progressively reveal insights about data. With Dynamic Zone Visibility, you can hide or reveal zones (tiled or floating dashboard elements) based on the value of a field or parameter. As you interact, zones on your dashboard appear or disappear. The result is a dynamic dashboard that doesn't compromise your desired layout.

While you can [show or hide objects by clicking a button on a dashboard](#), Dynamic Zone Visibility allows you to show and hide objects automatically. This is ideal for dashboards that are used by different user groups. For example, you might want to show different user groups different zones when they visit your dashboard.

And you can use Dynamic Zone Visibility with [Parameter Actions](#). For example, when a user clicks a mark on a viz, a previously hidden zone appears. This is ideal for complex dashboards because it allows you to choose when deeper levels of data are revealed.

Supported field types

To be used for Dynamic Zone Visibility, a field or parameter must be:

- Boolean.
- Single value.
- Independent of the viz, meaning the field returns a constant value independent of the structure of the viz, such as a fixed level of detail (LOD) calculation.

Configure a dynamic dashboard zone

The following example has two sheets that use [Superstore data](#): the first sheet has a bar chart with Sales by Category, and the second sheet has a bar chart with Sales by Sub-Category. By using Dynamic Zone Visibility, the second sheet is visible only after a mark is clicked in the Sales by Category zone. This example relies on a boolean calculated field, which is used as the source field for a parameter action. For the calculation to be used as the source field for the parameter action, the calculation must be added to the marks card.

1. From the Sales by Category sheet, [create a parameter](#). In this example, the parameter **Data type** must be set to **Boolean**.
2. From the Sales by Category sheet, [create a calculated field](#). This example uses the following calculation: `True`
3. On the Sales by Category sheet, drag the calculation that you created to **Details** on the marks card.
4. Create a dashboard.
5. Drag the sheet that you always want to be visible onto your dashboard. In our example, we want Sales by Category to be visible.
6. From your dashboard, click the Sales by Category zone (dashboard object). Then, from the Worksheet menu on your dashboard, [create a parameter action](#). This example uses the following **Change Parameter** action:

The source sheet is set to use the dashboard you created and the Category Sales sheet.

The **Target Parameter** is the parameter you created.

The **Source Field** is the calculation you created.

Add Parameter Action

Name
Dynamic zone action Insert ▼

Source Sheets

- Dynamic product sales dashboard ▼
- Category Sales
- Subcategory Sales

Run action on

- Hover
- Select
- Menu

Target Parameter
Hide zone with parameter ▼

Clearing the selection will

- Keep current value
- Set value to

Source Field Aggregation

Calc for dy... ▼ None ▼

False ▼

Cancel OK

7. Drag the Sales by Sub-Category worksheet onto your dashboard.
8. Click the Sales by Category zone. From the upper right corner, click the dropdown arrow and select **Use as Filter**.
9. Click the Sales by Sub-Category zone, and then click the **Layout** tab.
10. Check the box for **Control visibility using value**.
11. From the dropdown, choose the parameter you created to control zone visibility.

Note: If the option to Control visibility using value doesn't contain the field you want to use, be sure that the field is a supported field type.

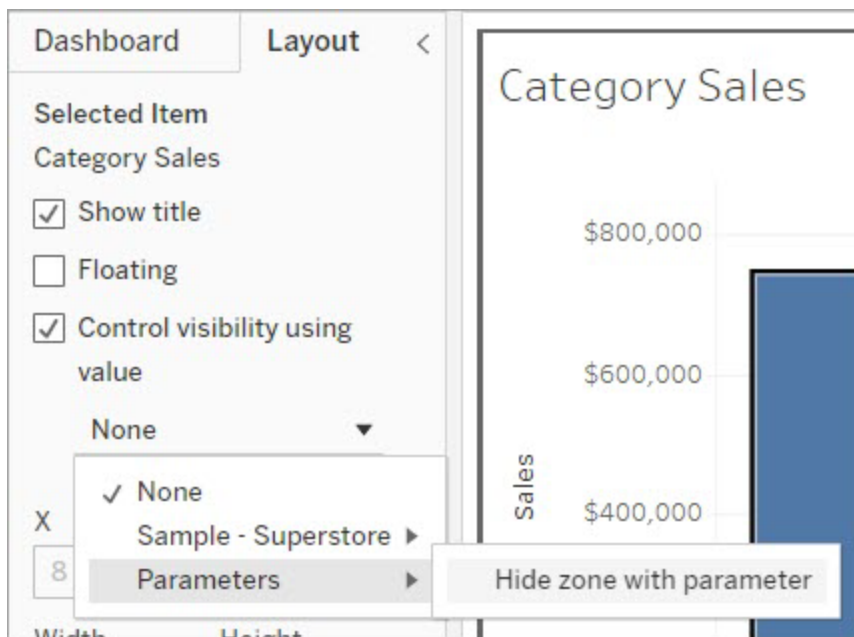

Now, when you click a category mark in the Sales by Category zone, the Sales by Sub-Category zone appears in your dashboard.



Size and Lay Out Your Dashboard

After you create a dashboard, you can resize and reorganize it to work better for your users.

Control overall dashboard size

A best practice is to start with setting the size so any layout work starts at the correct size.

Dashboard size options



Fixed size (default): The dashboard remains the same size, regardless of the size of the window used to display it. If the dashboard is larger than the window, it becomes scrollable. You can pick from a preset size or specify a custom size.

Fixed size dashboards let you specify the exact location and position of the content on the dashboard, which can be useful if there are floating objects.

Published dashboards that use a fixed size can load faster because they're more likely to use a cached version on the server. For other performance tips, see [Optimize Workbook Performance](#) on page 3041.

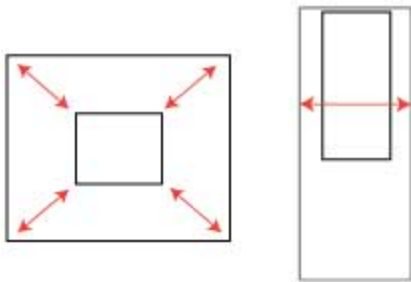

Range: The dashboard scales between the minimum and maximum sizes that you specify. If the window used to display the dashboard is smaller than the minimum size, scroll bars are displayed. If it's larger than the maximum size, white space is displayed.

Use this setting when you're designing for two different display sizes that need the same content and have similar shapes—such as small- and medium-sized browser windows. Range also works well for mobile dashboards with vertical layouts. (The width is allowed to change for different mobile device widths, but the height is fixed for vertical scrolling.)

Automatic: The dashboard automatically resizes to fill the window used to display it.

Use this setting if you want Tableau to take care of any resizing. For best results, use a tiled (rather than floating) dashboard layout. Automatic sizing can lead to unpredictable results on different screens, so use this setting with caution if you don't know where the dashboard will be consumed.

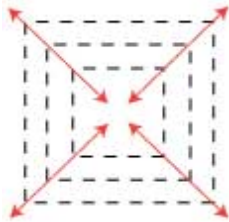

Dashboards with variable sizes must be freshly rendered for every browser request, which can have a performance impact.

Tip: If you use Tableau Desktop, see [Create Dashboard Layouts for Different Device Types on page 2788](#) to create unique layouts optimized for desktop computers, tablets, and phones. In addition to adapting to different screen sizes, each device layout can contain different items.

Set overall dashboard size

- Under **Size** on the Dashboard pane, select the dashboard's dimensions (such as **Desktop Browser**) or sizing behavior (such as **Fixed size**).

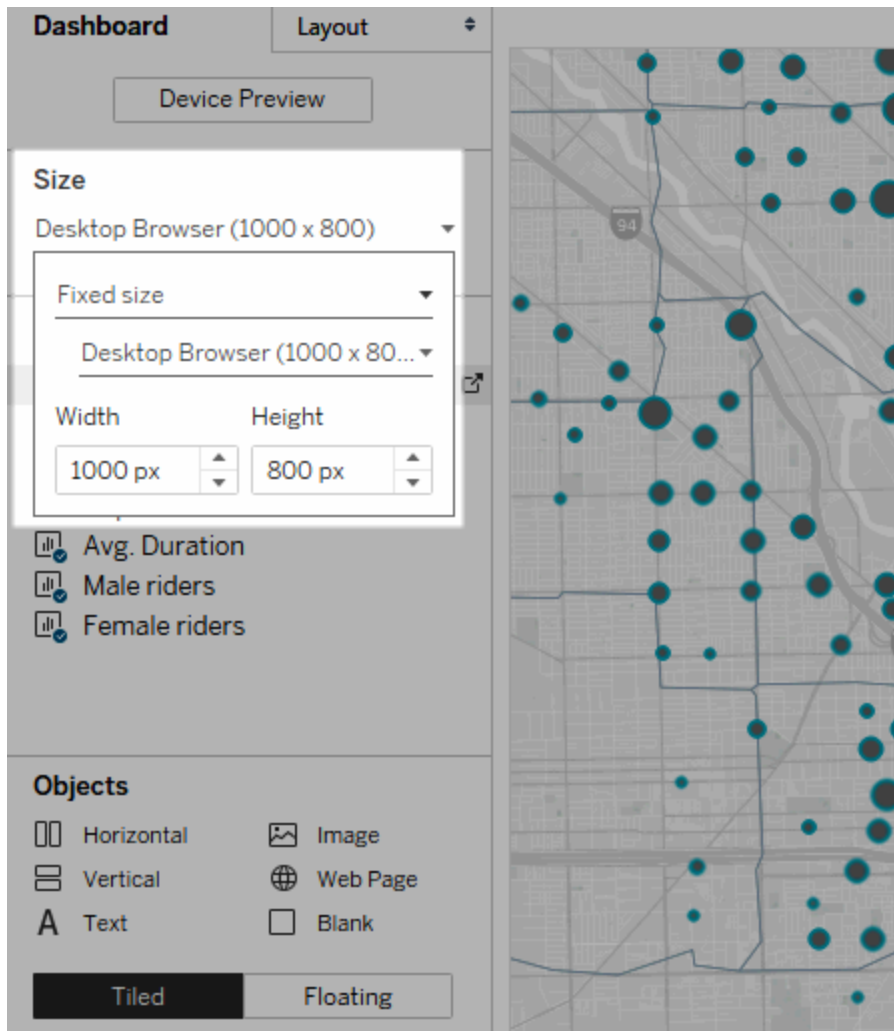

Group items using layout containers

Layout containers let you group related dashboard items together so you can quickly position them. As you change the size and placement of items inside a container, other container items automatically adjust. Layout containers can also be used for formatting.

Layout container types

A horizontal layout container resizes the width of the views and objects it contains; a vertical layout container adjusts height.

Horizontal layout container

Vertical layout container

The two views are arranged in a horizontal layout container.

The three views are stacked in a vertical layout container.

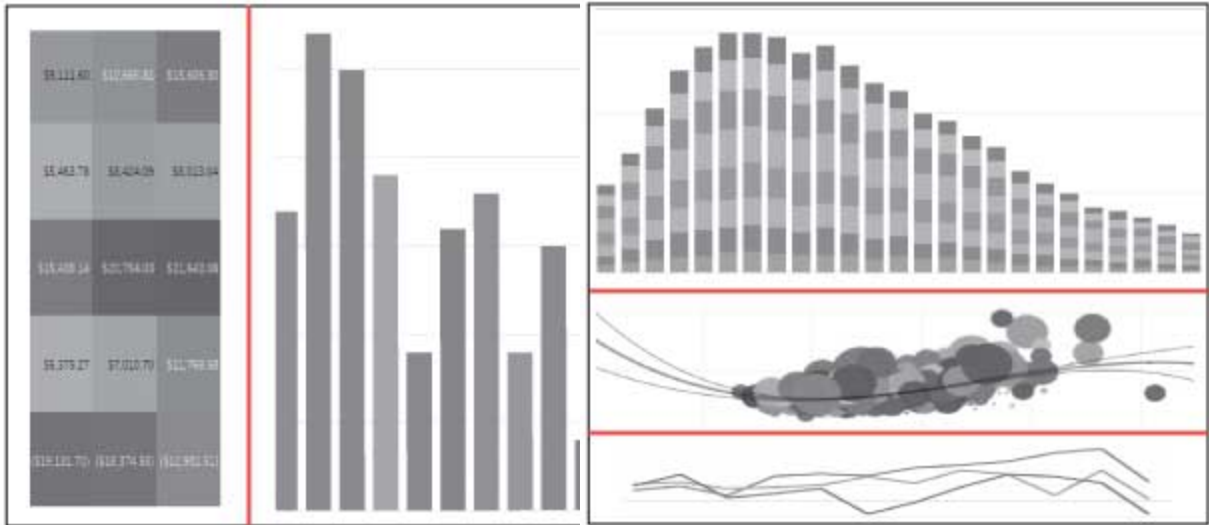

Add a layout container

1. Under **Objects** on the Dashboard pane, select **Horizontal** or **Vertical**.
2. Drag the container to the dashboard.

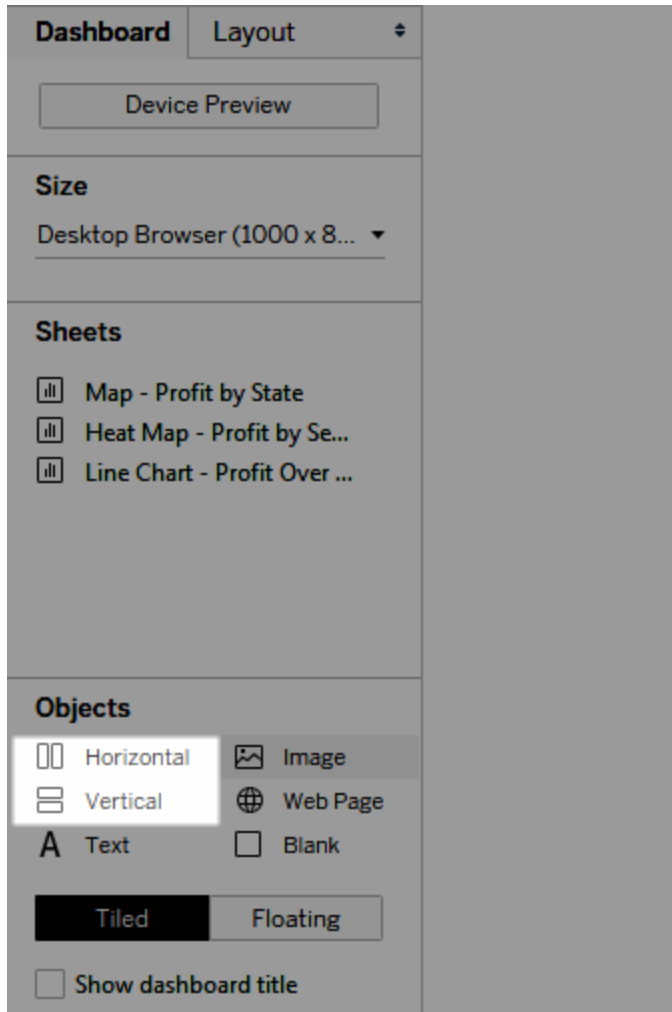

3. Add views and objects to the layout container.

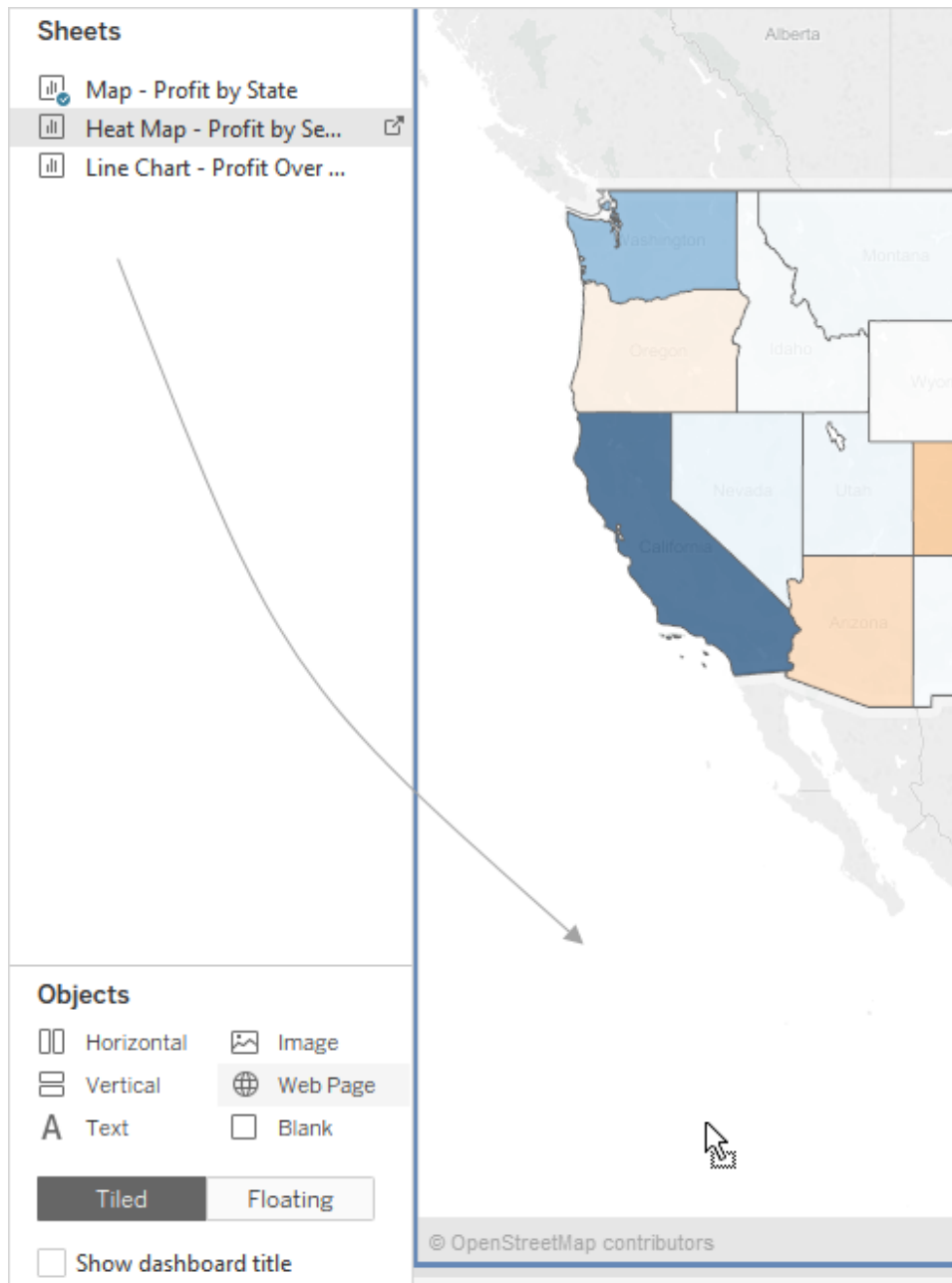

Evenly distribute a layout container's items

1. Select the layout container. If you have trouble making the selection, select an individual item within the container and choose **Select Container** from its shortcut menu.
2. With the layout container selected, choose **Distribute Evenly** from its shortcut menu:

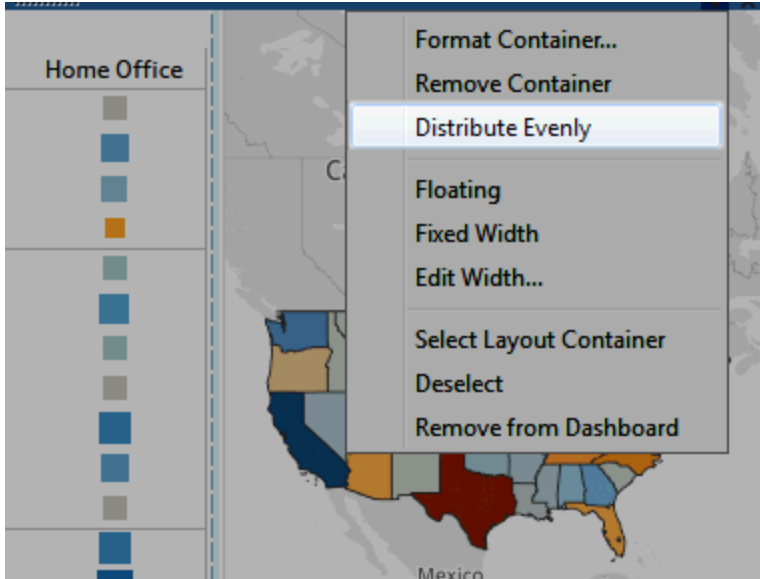

Items that are already within the layout container arrange themselves evenly; any items you add do the same.

Automatically resize sheets in layout containers

If you add multiple sheets with related data to a layout container, whenever marks are selected in one sheet, you can automatically resize related sheets.

In this example, when a mark is selected in the map, the bar chart updates to display profit and sales for that mark. When no marks are selected in the map, it automatically expands to fill the layout container.

With mark selected

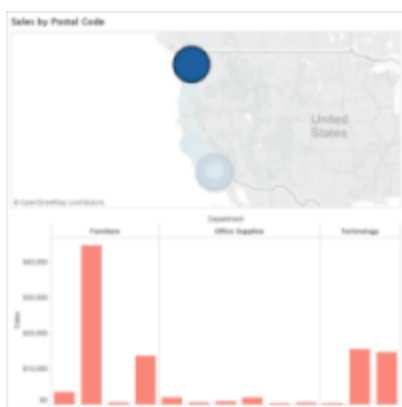

Without a selection

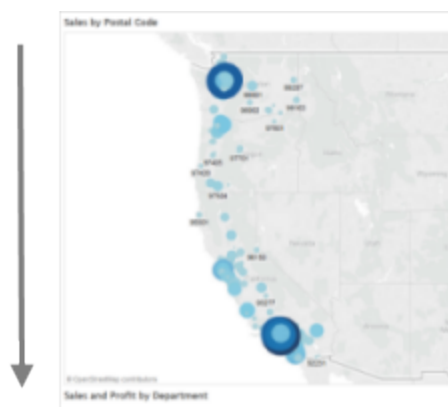

1. Add multiple sheets with related data to a layout container.
2. From the drop-down menu of the sheet you want to expand, choose **Use as Filter**.

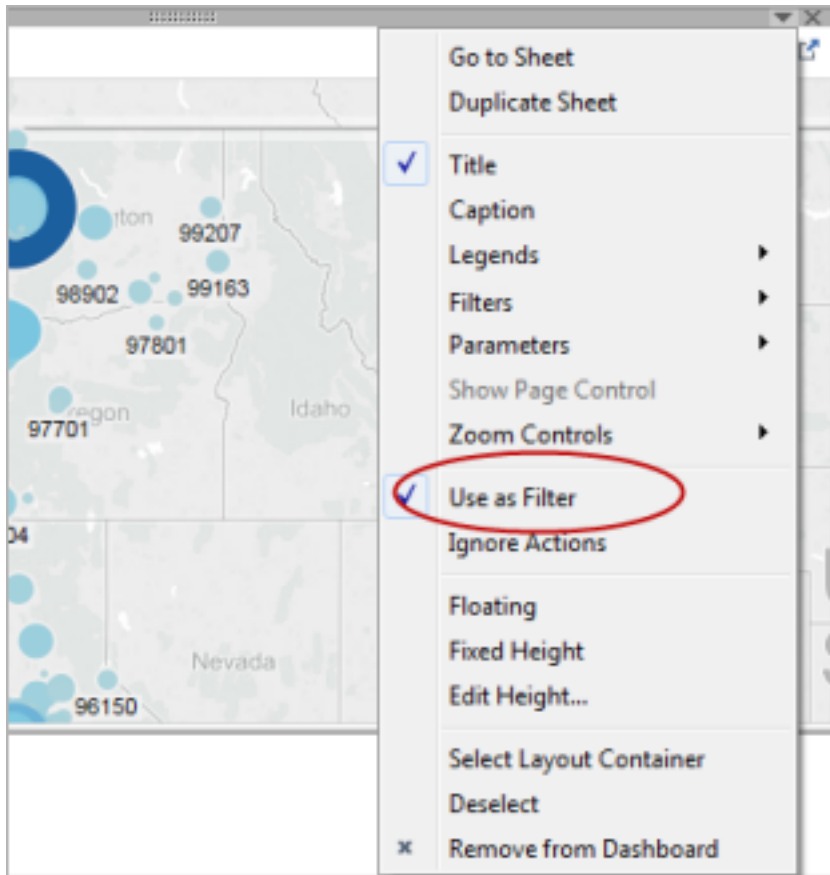

3. Choose **Dashboard > Actions**, and double-click the generated filter you created.
4. In the **Target Sheets** section of the Edit Filter Action dialog box, select the other sheets in the layout container.
5. To control how target sheets resize when no marks are selected in the source sheet, select one of the following:
 - **Show all values** returns target sheets to their original size, showing all data.
 - **Exclude all values** collapses target sheets under their titles, hiding all data.

Remove a layout container to independently edit items it contains

1. Select the container either on the dashboard or in the **Item hierarchy** area of the Layout pane.
2. From the drop-down menu at the top of the container, select **Remove Container**.

Tile or float dashboard items

Tiled vs. floating layouts

Each object, layout container, and view that you place on a dashboard is either tiled (the default) or floating.

Tiled layout

Tiled items don't overlap; they become part of a single-layer grid that resizes based on the overall dashboard size.

Floating layout

Floating items can be layered over other objects. In the example below, a map floats over tiled views.



For best results, give floating objects and views a fixed size and position on a fixed size dashboard.

Float or tile a new item

1. Under **Objects** in the Dashboard pane, click the layout option you want to use: **Floating** or **Tiled**.

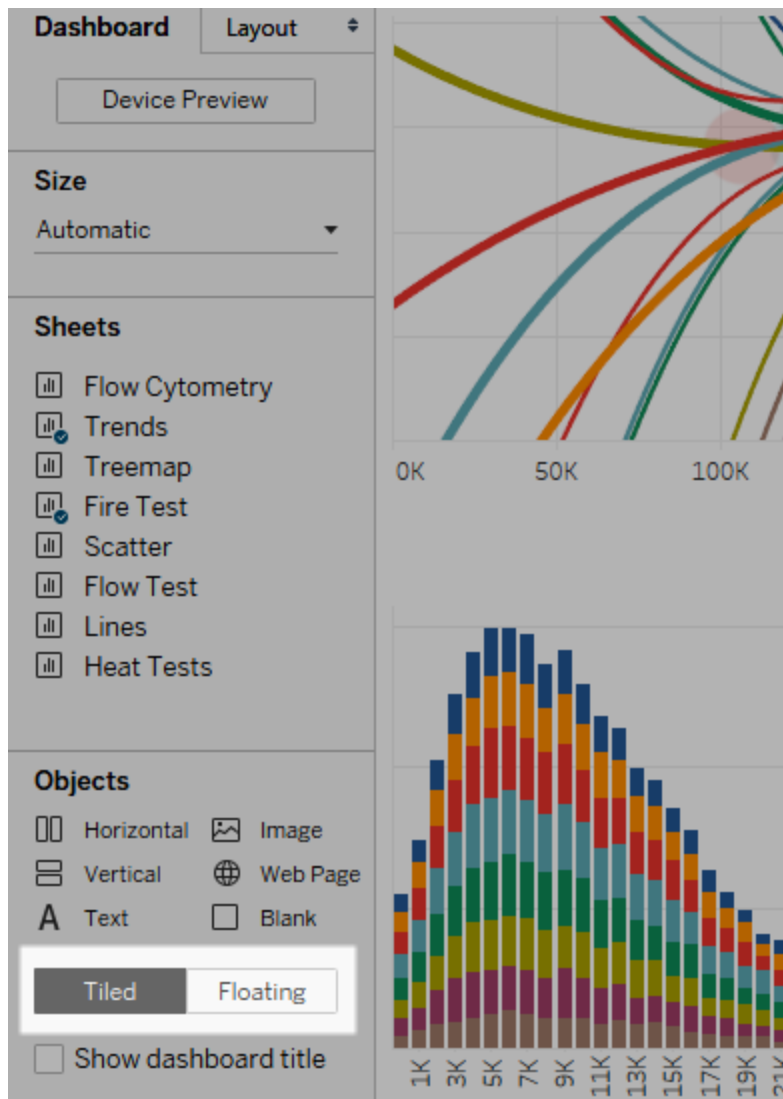

2. Drag the view or object onto the dashboard on the right.

Tip: You can also assign a floating layout to an item by holding down **Shift** on your keyboard as you drag it onto the dashboard.

Switch an existing item from tiled to floating

1. Select the item in the dashboard.
2. In the item's shortcut menu, select **Floating**:

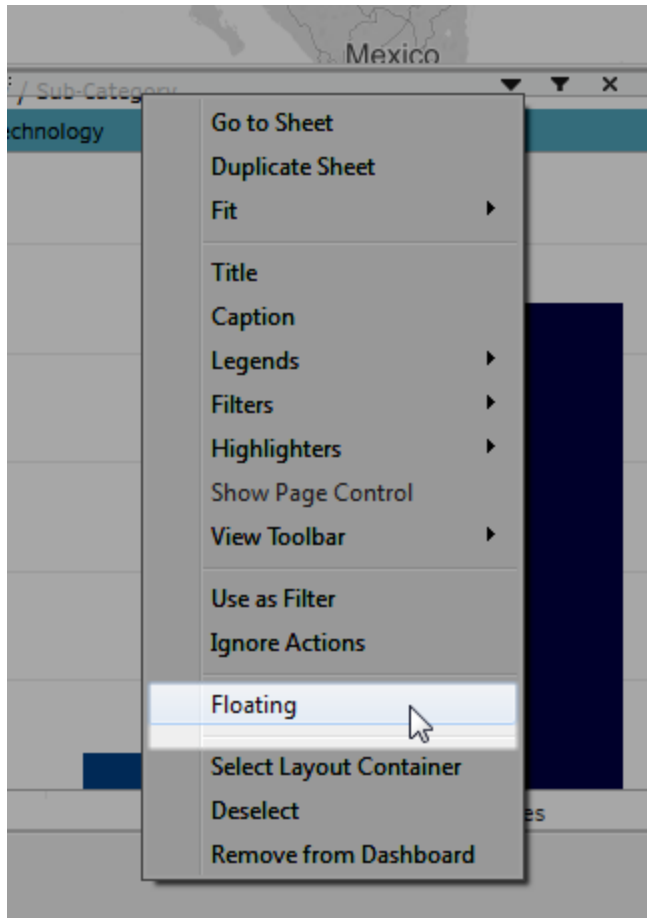

Size, position, reorder, and rename individual dashboard items

Set an item's size and position

If you want a high degree of control over the placement, choose **Fixed size** then set each item's size and position using the Layout pane.

1. Select the dashboard item you want to position and size. In the Layout pane, the item's name appears under **Selected item**.

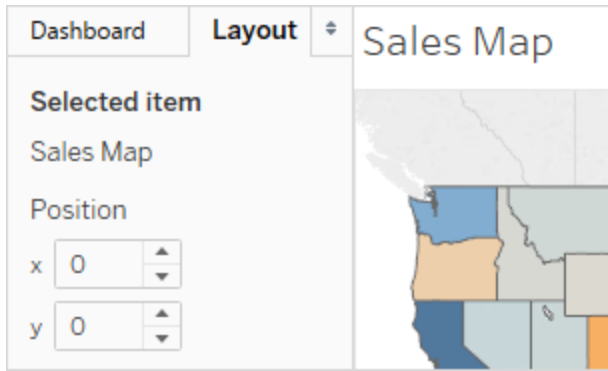

Tip: To quickly switch between the Dashboard and Layout panes, press the T key.

2. Define the item's position **x** and **y** position in pixels as an offset from the top-left corner of the dashboard. For example, to place an object in the top-left corner of the dashboard, specify $x = 0$ and $y = 0$.

The values you enter can be positive or negative but must be whole numbers.

3. To resize an item, click and drag it in the dashboard. You can also use the settings under **Size**.
4. To hide the title of the item you've selected, clear the **Show title** check box. (The similar **Show dashboard title** check box on the Dashboard pane controls the overall dashboard title.)

Tip: To quickly position floating items, press arrow keys to move 1 pixel, or Shift+arrow keys to move 10 pixels. To quickly resize items, add Alt (Windows) or Option (macOS) to these shortcuts.

Align items with a grid

To present a visually consistent design, arrange and size dashboard items over a grid.

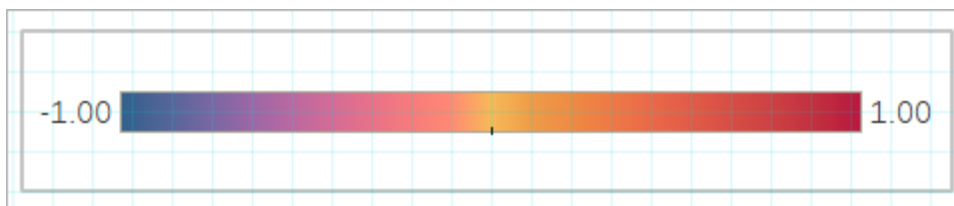

1. Choose **Dashboard > Show Grid**.
2. To change the grid size, choose **Dashboard > Grid Options**.

Tip: To quickly switch the grid on and off, press the G key.

Reorder objects

The **Item hierarchy** area on the Layout pane lets you quickly change how objects are layered and grouped on your dashboard. Items at the top of the list appear in the front, while items at the bottom appear in back.

Reorder any object in Tableau Cloud or Tableau Server

In Tableau Cloud and Tableau Server, you can reorder both tiled and floating objects in the hierarchy. You can also drag items both within their current containers, and into other containers at any level. This lets you nest items with more flexibility than editing on the canvas, which limits you to placing objects in the innermost container.

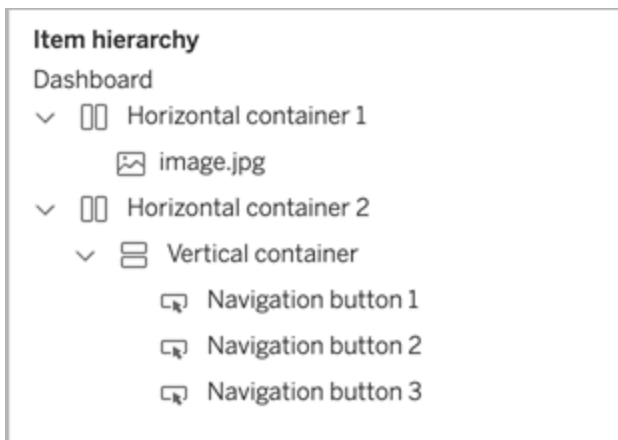

Reorder floating objects in Tableau Desktop

In Tableau Desktop, you can drag floating items at the top level of the hierarchy to change how they layer over each other.

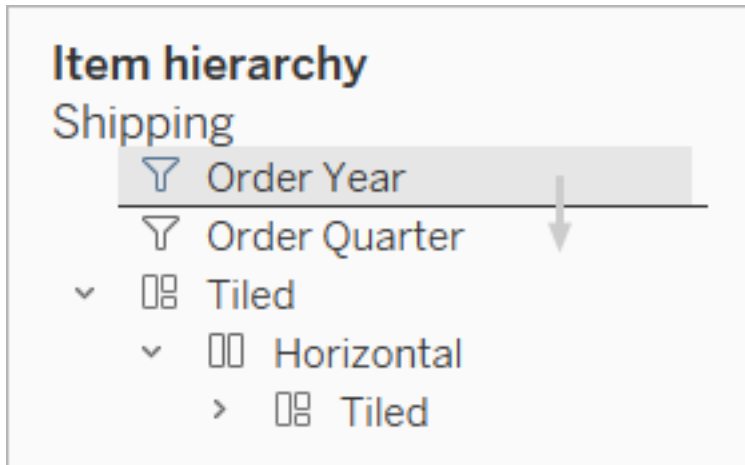

Rename items

To better distinguish between dashboard items, you can rename them.

In the **Item hierarchy** area of the Layout pane, right-click an item, and choose **Rename Dashboard Item**. On the dashboard itself, this command is also available from the drop-down menu for each object.

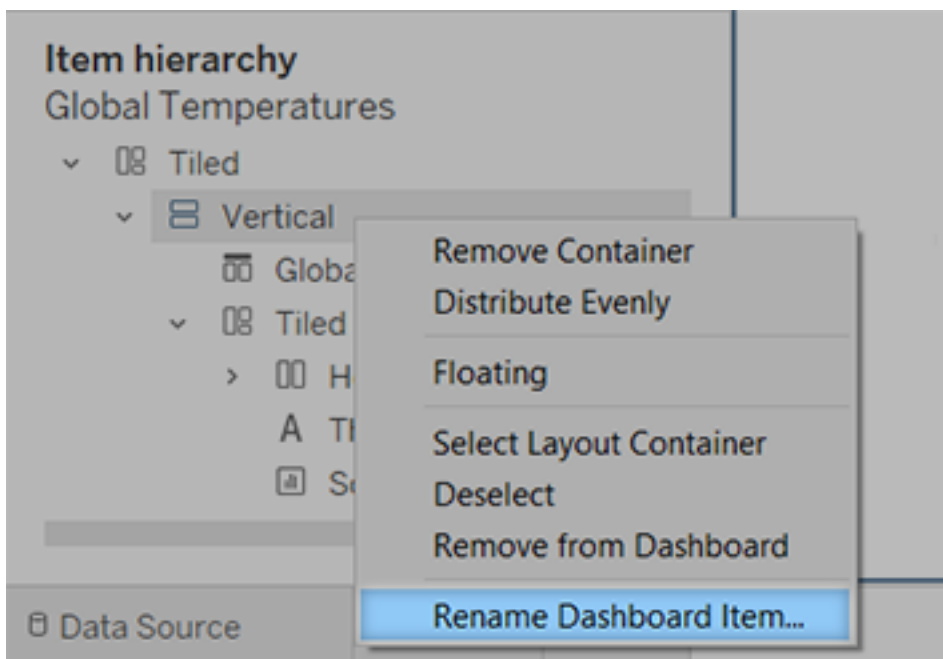

Add padding, borders, and background colors around items

Padding lets you precisely space items on the dashboard, while borders and background colors let you visually highlight them. Inner padding sets the spacing between item contents and the perimeter of the border and background color; outer padding provides more spacing beyond the border and background color.

Note: If you can't change the border or background color for a particular dashboard item, change its formatting [at the worksheet level](#).

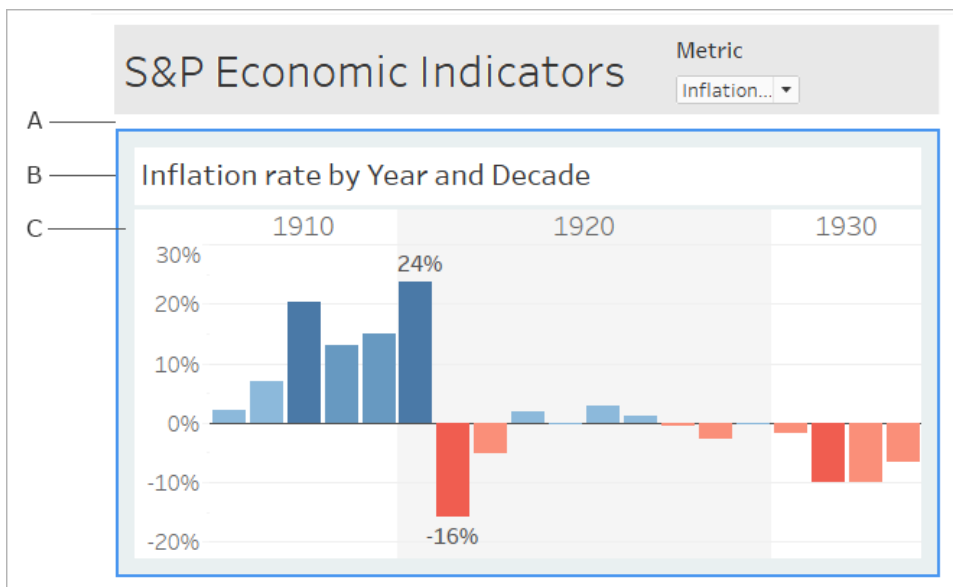

A. Outer padding B. Blue border C. Inner padding with light blue background

1. Select an individual item, or your entire dashboard.
2. On the **Layout** tab at left, specify border style and color, background color and opacity, or

padding size in pixels.



Here are some handy dashboard spacing tips:

- To precisely align one dashboard item with another, deselect **All sides equal**, and adjust padding for only one side.

- To create seamless designs, specify zero outer padding for adjoining items.

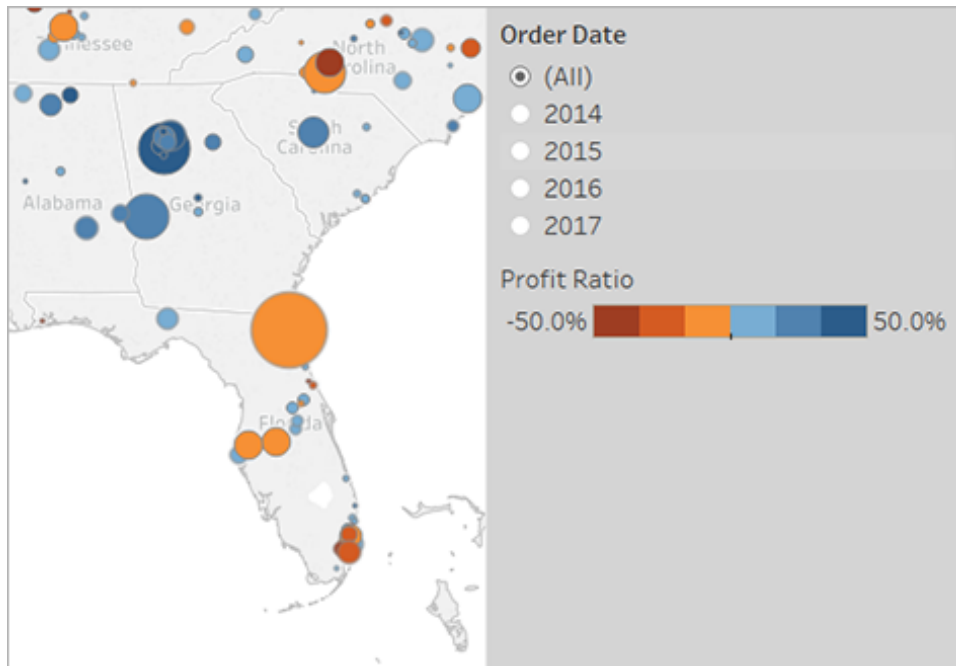

Visually integrate elements with transparency

Transparent elements create a seamless visual look for your dashboards, revealing underlying objects and images.

Tip: To create a background image that shows through floating transparent elements, add an image object as the only tiled item. **Fixed-size dashboards** ensure that the floating elements maintain a consistent visual relationship with the image, regardless of screen size.

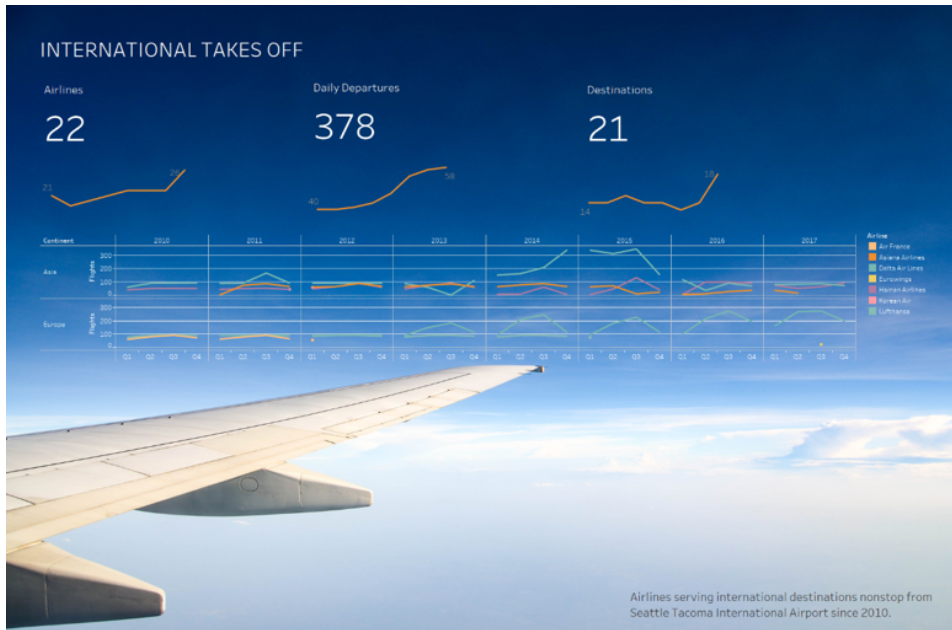

Make worksheet backgrounds transparent

1. In your dashboard, select the sheet.
2. Choose **Format > Shading**, click the **Worksheet** menu, and choose **None** for the background color.

If the sheet appears opaque, change the background color to None for the underlying dashboard, object, or layout container. You can quickly adjust these items on the Layout tab for the dashboard.
3. To smoothly integrate the transparent sheet with other dashboard items, choose **Format > Borders** and **Format > Lines**, and either remove borders and lines or change their colors.

More steps for transparent maps

1. Choose **Format > Shading**, click the **Pane** menu, and choose **None** for the color.
2. Choose **Map > Map Layers**, and deselect the opaque **Base** layer. Then, to make transparent maps more distinct when zoomed out, select the **Coastline** layer.

Depending on the map style, you may also need to experiment with turning other layers on or off.

Make a sheet partially transparent

1. In the **Layout** pane for the dashboard, select the sheet.
2. Click the **Background** color, and set the color and opacity.

Float transparent legends, filters, highlighters, and parameters

To visually connect filters, parameters, and highlighters to related data, float these items, which are transparent by default. Text always remains fully opaque, maintaining legibility.

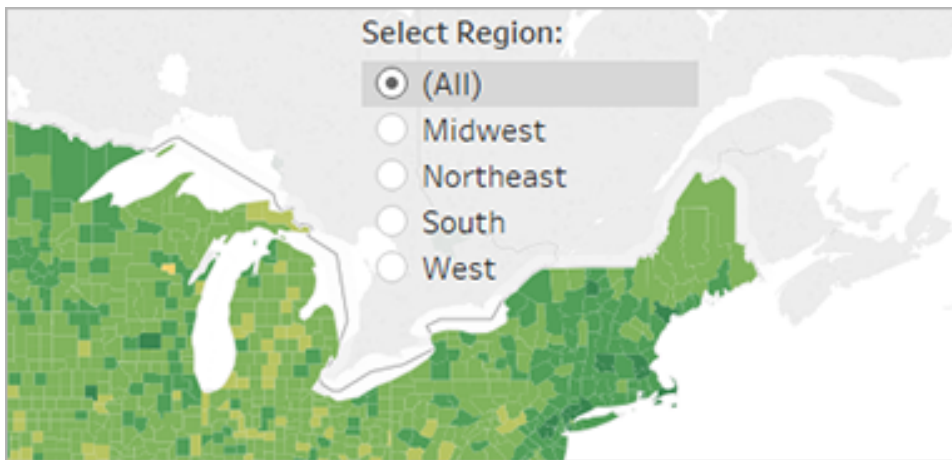

If a floating object continues to display a color, check these object- and worksheet-level settings:

- Select the object, and on the **Layout** tab, click the **Background** color, and choose **None**.
- Click the **Format** menu, and then choose **Legends**, **Filters**, **Highlighters**, or

Parameters. Then, in the Format pane at left, choose **Shading > None**.

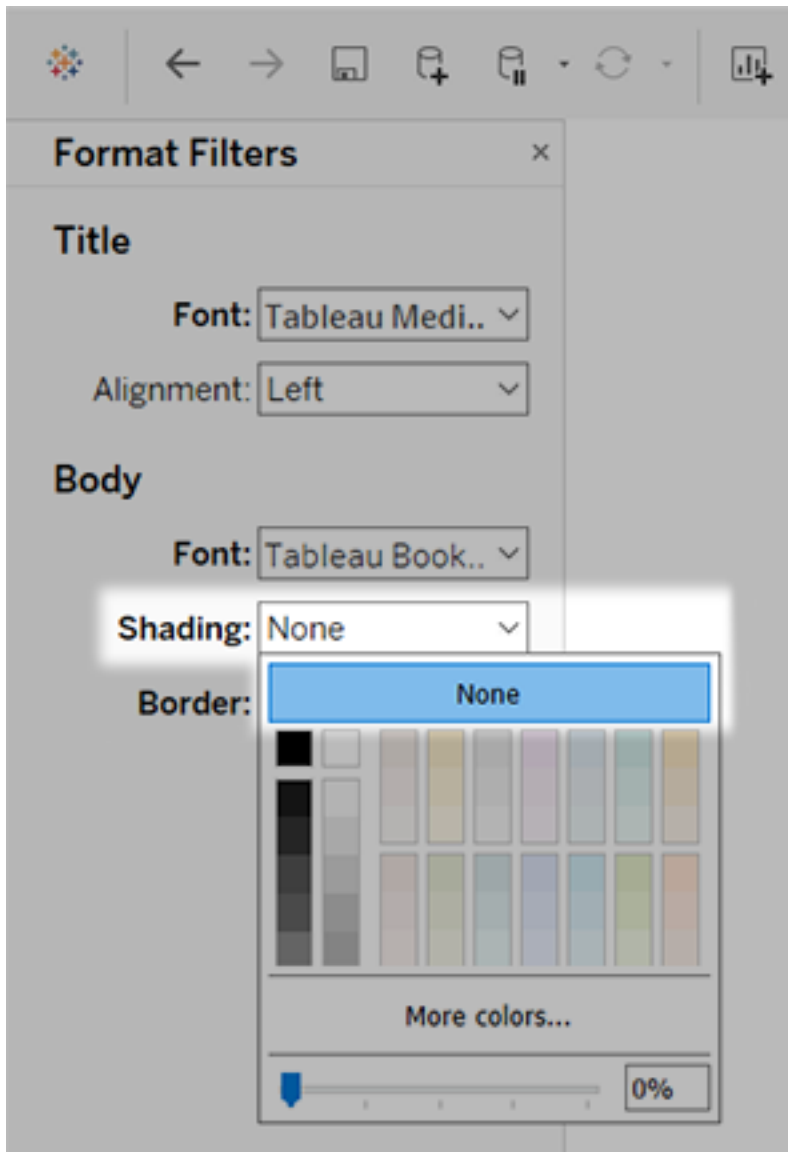

For more information, see [Format at the Worksheet Level](#) on page 2942.

Refine Your Dashboard

After you've created and laid out your dashboard, take a moment to step back and evaluate it. This topic lists some areas to check and refine.

Is everything in the right spot?

Confirm placement

Make sure that the view with your key finding or main question spans or occupies the upper-left corner of your dashboard. In your views, the most important data should be on the X or Y axis and your less important data should be on color, size, or shape.

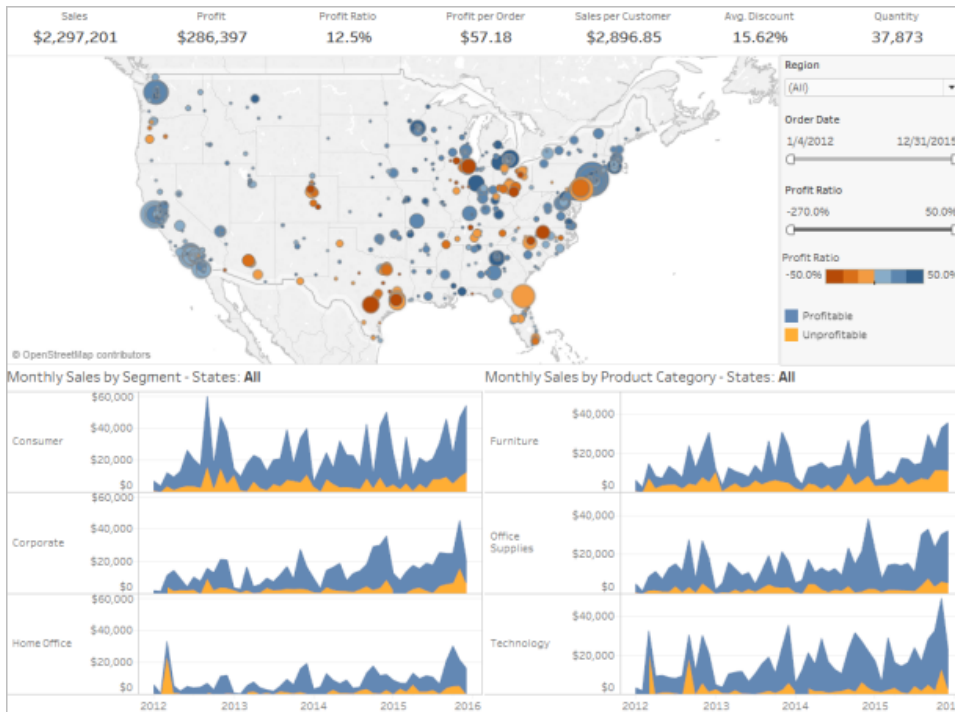

Check label orientation and readability

Important labels should be horizontal so that your viewers can easily read them.

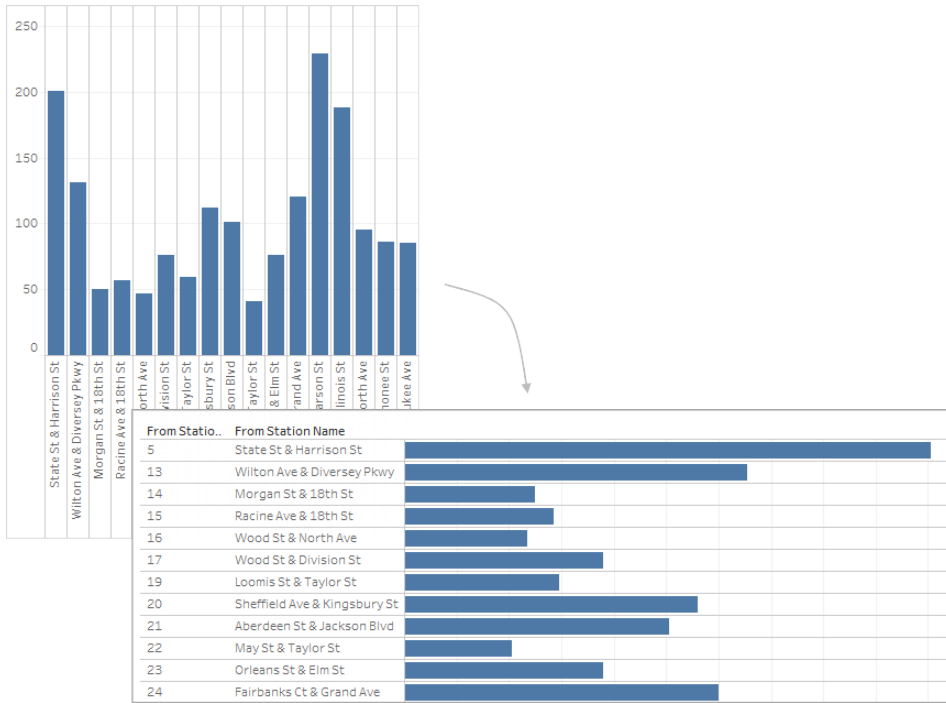

Review sizing and layout

Test your work and adjust sizing

Once you finish your dashboard, it's a best practice to test it and experience it as your users will. For example, will they be using Tableau Reader on a laptop to view your dashboard, will the dashboard be published on Tableau Server, or will it be embedded in a web application and viewed from a tablet?

After you test your dashboard, you'll probably find some things to change—sizing and how and where items are positioned are usually among them.

Tableau dashboards are set to a fixed default size that's intended to work well on a typical desktop. However, when you publish (to the web, in a blog, for a presentation, etc.) you may find yourself more limited.

You can specify the overall size of the dashboard using the settings under **Size** in the **Dashboard** area on the left. Select a new size using the drop-down menu.

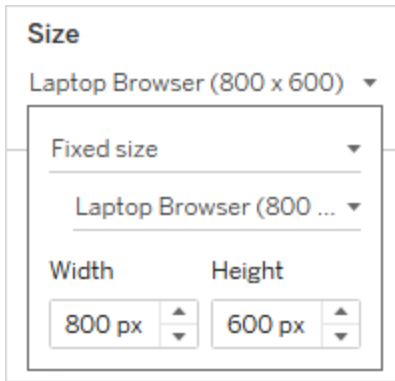

- **Automatic** - The dashboard automatically resizes to fill the window it's displayed in.
- **Fixed size** - The dashboard always remains a specific size. If the dashboard is larger than the window the dashboard becomes scrollable.
- **Range** - The dashboard scales between minimum and maximum sizes that you specify, after which scroll bars or white space display.

Customize image display (Tableau Desktop only)

When you add an **Image** object to a dashboard, you can customize how the image displays by selecting an option on the image's menu. For example, you can select whether to **Fit Image**, which scales the image to the size of image object on the dashboard.

By default, any high-resolution images that you use in a dashboard are displayed in standard resolution and will maintain the same size whether they're viewed on standard or Retina displays.

To take advantage of high-resolution images in a dashboard that are intended to be viewed on a Retina display, you can use the @2x naming convention:

1. Navigate to the high-resolution image on your computer with Retina display.
2. Rename your high-resolution image to include the @2x modifier by using `<image-name>@2x<file-extension>` format. For example, `logo@2x.png`.
3. In your workbook, click and drag an **Image** object onto your dashboard.
4. When you're prompted, select the image you just renamed using the @2x naming convention and then click **Open**.

Note: EMF image file formats are not compatible with Tableau Desktop on the Mac.

Use a layout container

A layout container can create a smoother experience for your users by helping dashboard objects reposition and resize when one view is filtering another.

The image below shows how a dashboard behaves when two views are placed in a vertical layout container versus how they behave when they are not placed in a layout container. Notice how, in the dashboard that uses a layout container, the views adjust vertically as different filters are applied.

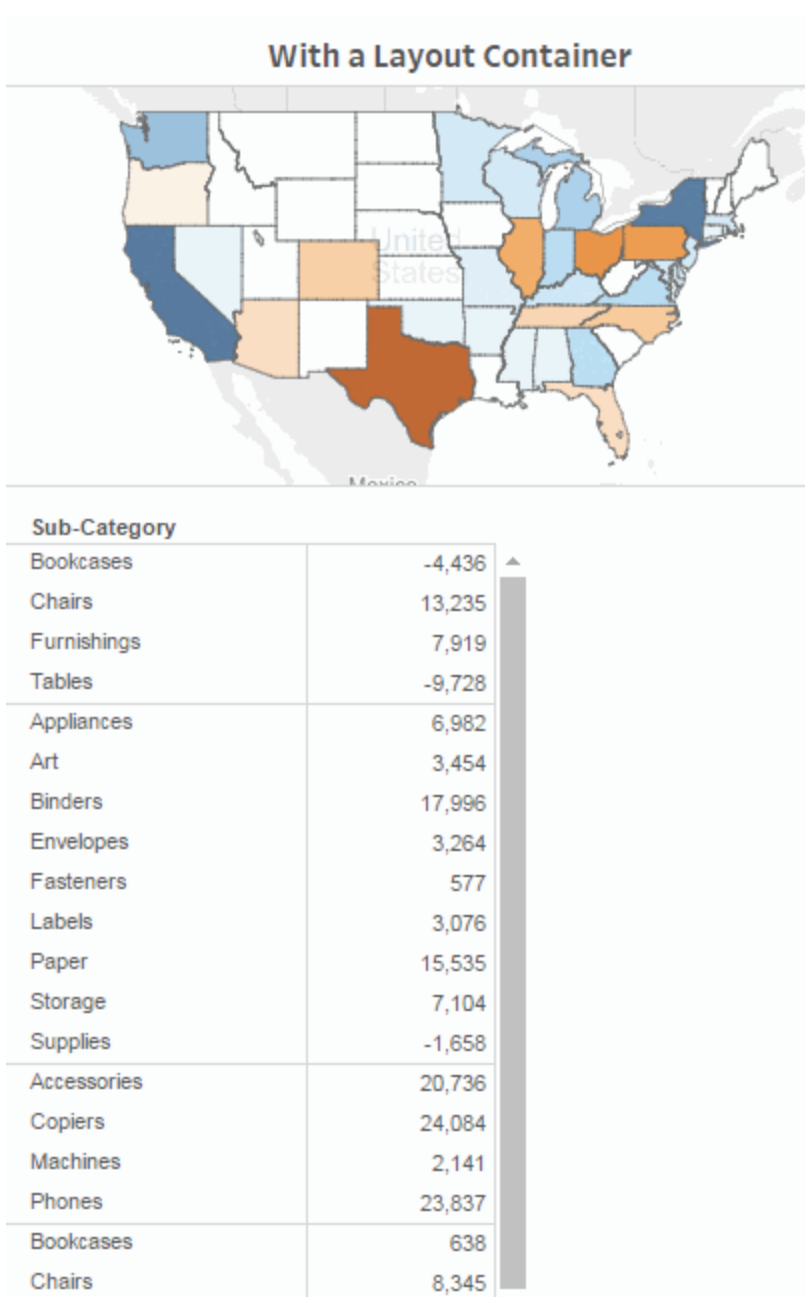

[Click the image to replay it.](#)

To add a layout container

1. Drag a horizontal or vertical layout container to the dashboard.

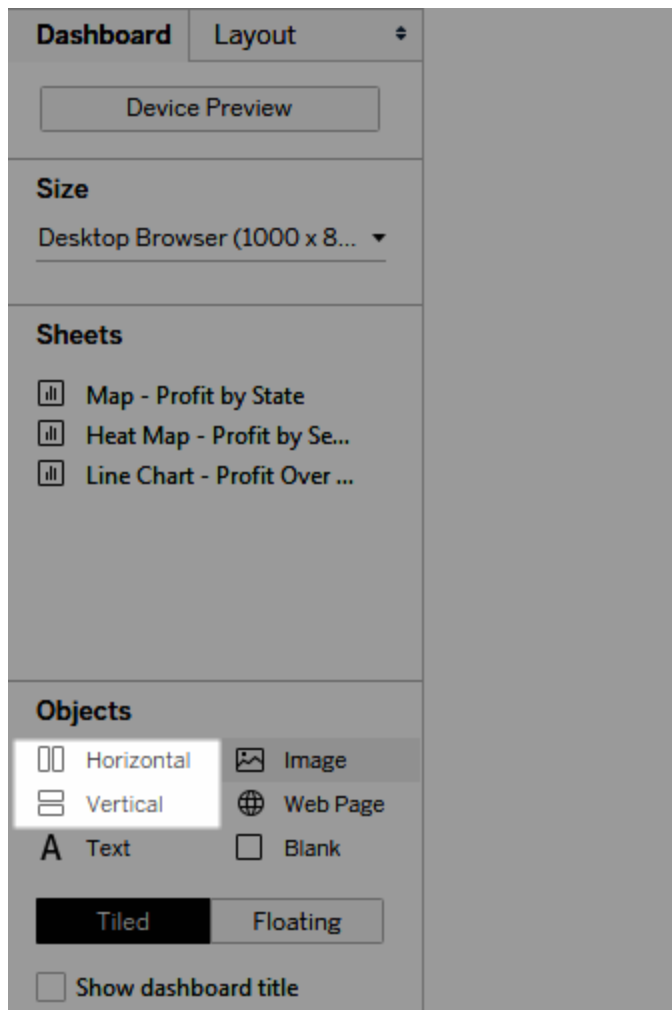

2. Add sheets and objects to the layout container. As you hover over the layout container, a blue box indicates that the object is being added to the flow of the layout container.

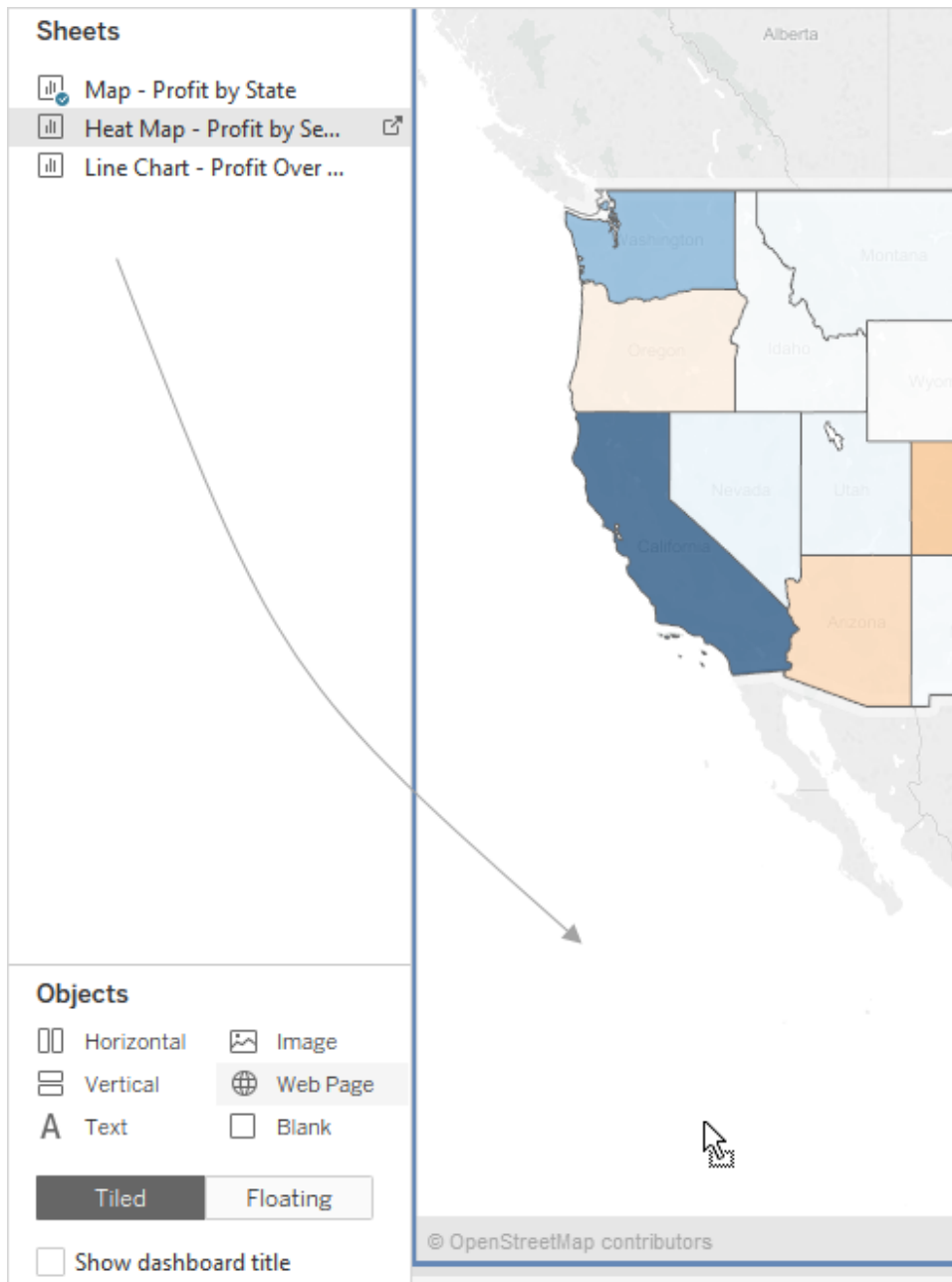

3. To position items evenly, choose **Distribute Evenly** from the layout container's shortcut menu:

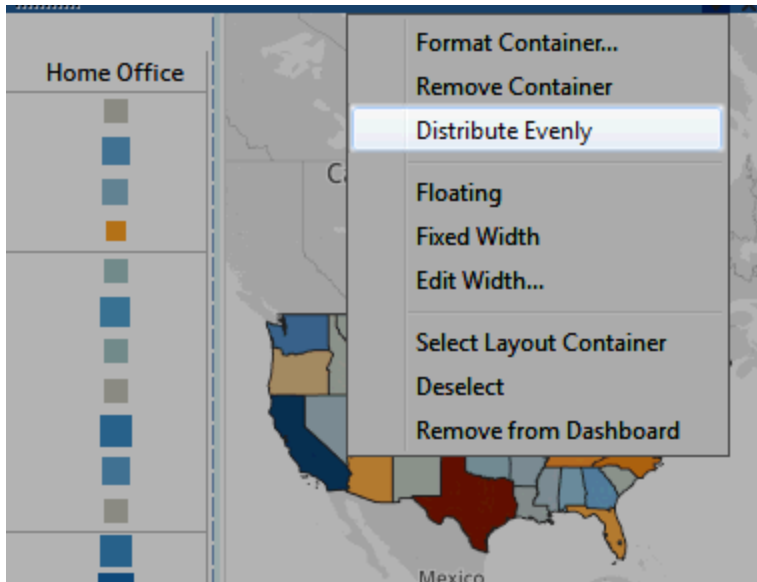

The **Distribute Evenly** command is only available for layout containers that you explicitly add to a dashboard. It's not available for layout containers that are automatically added when you add items.

Buy space with a floating layout

Tableau uses a tiled layout by default in dashboards, which means that each view, legend, and object is arranged in a single-layer grid, similar to a tiled floor.

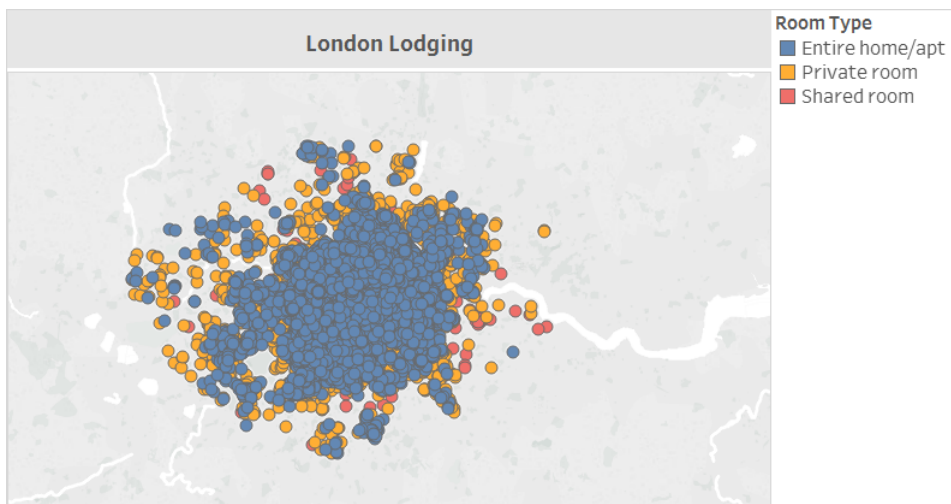

If you want an item to overlap another, you can use a **Floating** layout for one or more items instead:

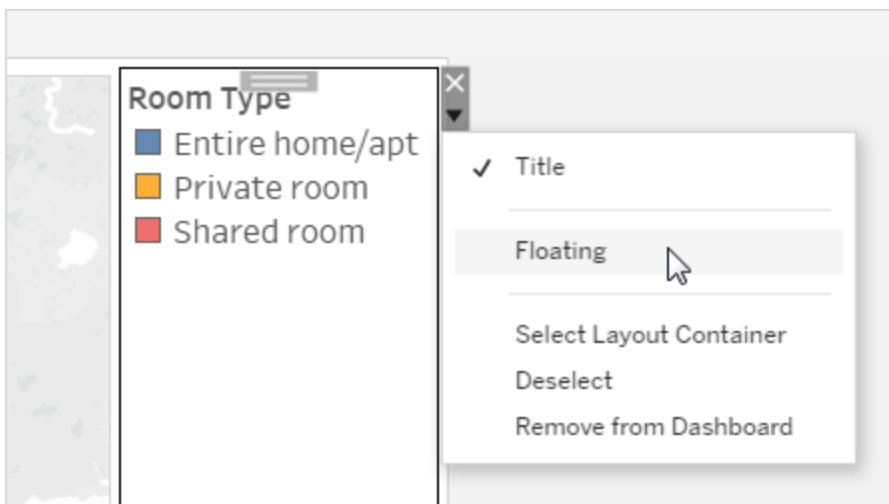
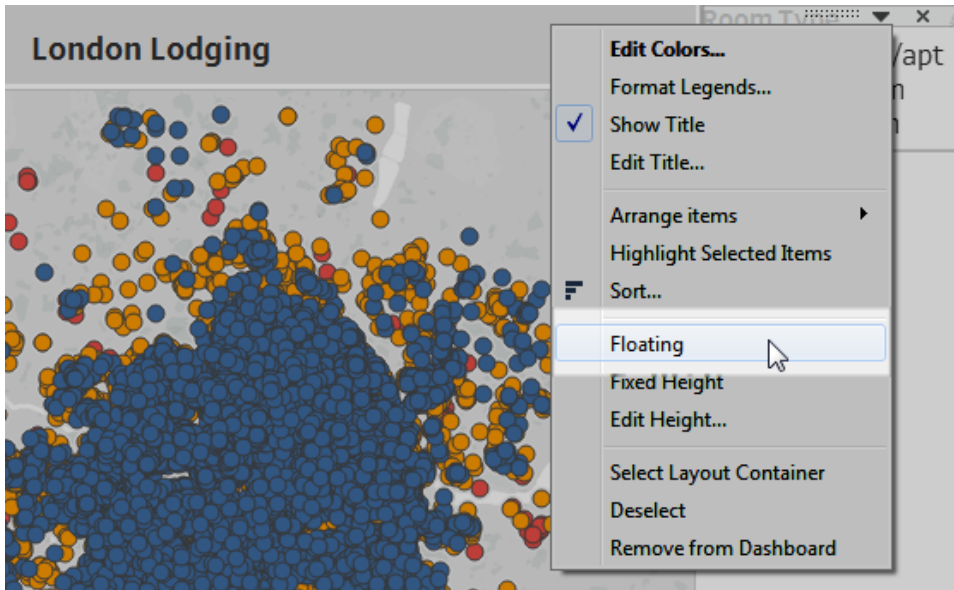

Legends can sometimes be floated over other items instead of remaining tiled.

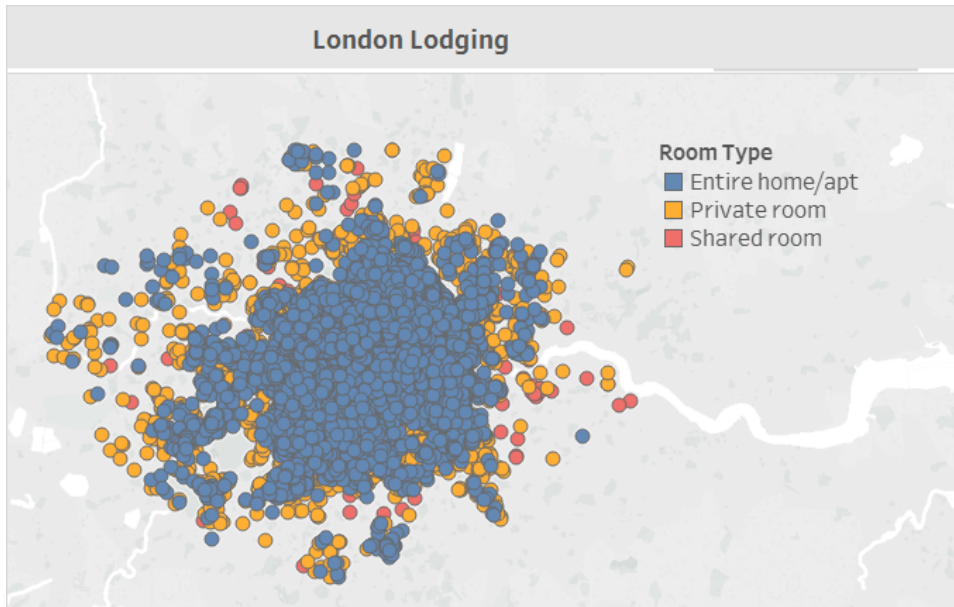

See [Size and Lay Out Your Dashboard](#) on page 2742 for more details.

Tableau Desktop only: If you create device layouts for a dashboard, use a **Tiled** layout. It will give you the most control over where objects appear. See [Create Dashboard Layouts for Different Device Types](#) on page 2788 for steps.

Highlight the essentials

Show just what your users need

Legends, titles, captions, and filters can be helpful for your viewers. Make sure you give your users what they need and no more.

To change what's displayed for your users:

1. Select a view in the dashboard.
2. Click the drop-down menu in the upper-right corner of the selected view and select the items you want to show. For example, you can show the title, caption, legends, and a variety of filters.

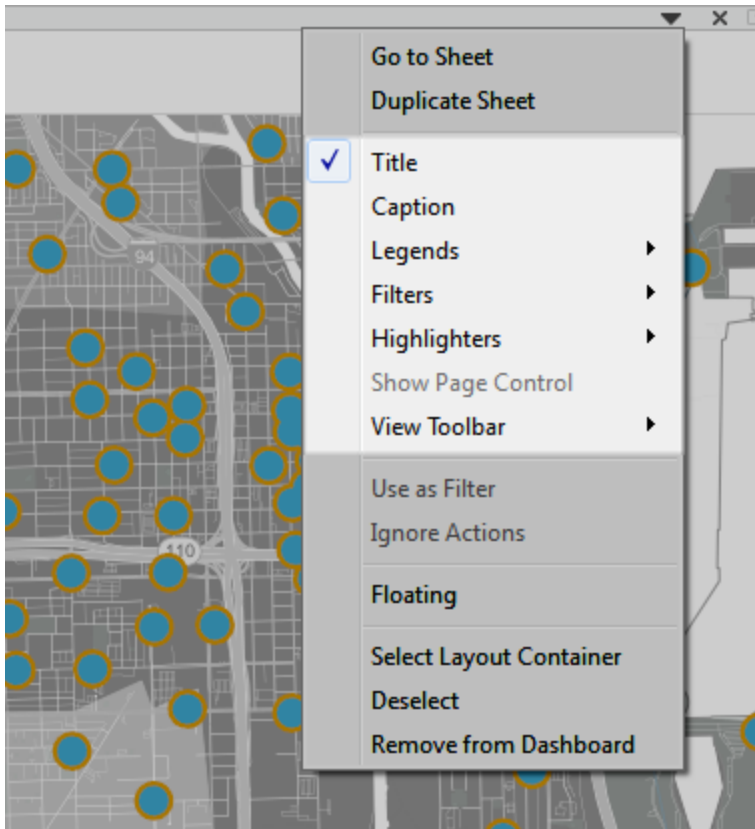

Alternatively, you can right-click an item in the **Layout** section of the **Dashboard** pane to access all of these same commands.

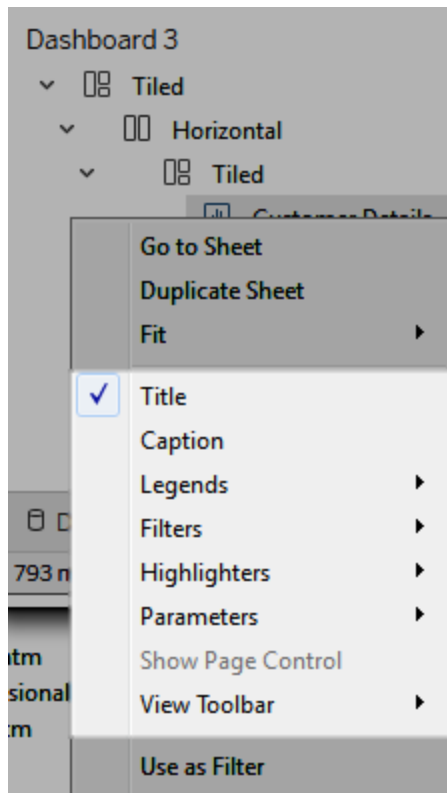

Note: Filters are only available for the fields used in the original view.

Eliminate clutter

In general, you should try to use no more than two color palettes in a single dashboard, and ideally, just one palette if your data is quantitative. Remove unnecessary text, lines, or shading that don't provide actionable information for your viewers. Make sure every legend you provide is really needed, remembering to take into account the final, published size of your dashboard.

Cluttered

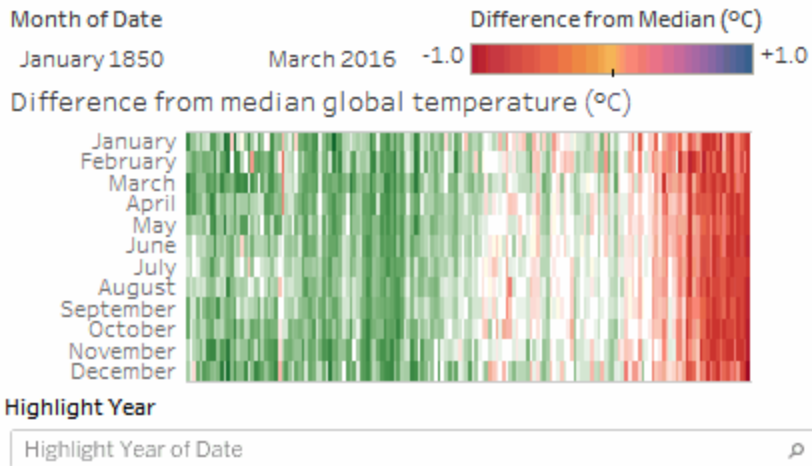

Scatter Plot

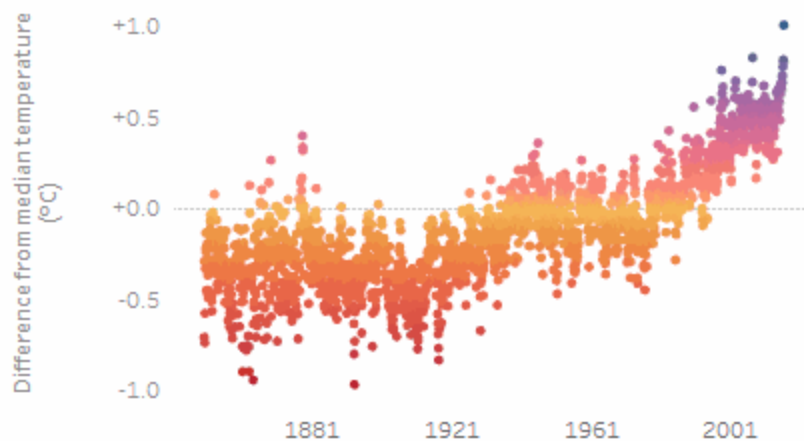

The trend of Median for Date. Color shows Median. Details are shown for Year of Date and Month of Date. The data is filtered on Month of Date, which ranges from January 1850 to March 2016 and keeps Null values. The view is filtered on Year of Date, which excludes 2016. The trend of Median for Date.

[Click the image to replay it.](#)

Create a Sheet Selection Menu for a Dashboard

Using a combination of a parameter and a calculated field, you can create a drop-down menu that lets users select an individual view that automatically expands to fill a dashboard.

Tip: To show sheets using separate buttons rather than a single menu, instead use **Show/Hide buttons**. This is a much simpler approach, though each button will reveal a separate object. To leave a dashboard and open a completely different sheet, use **Navigation objects**.

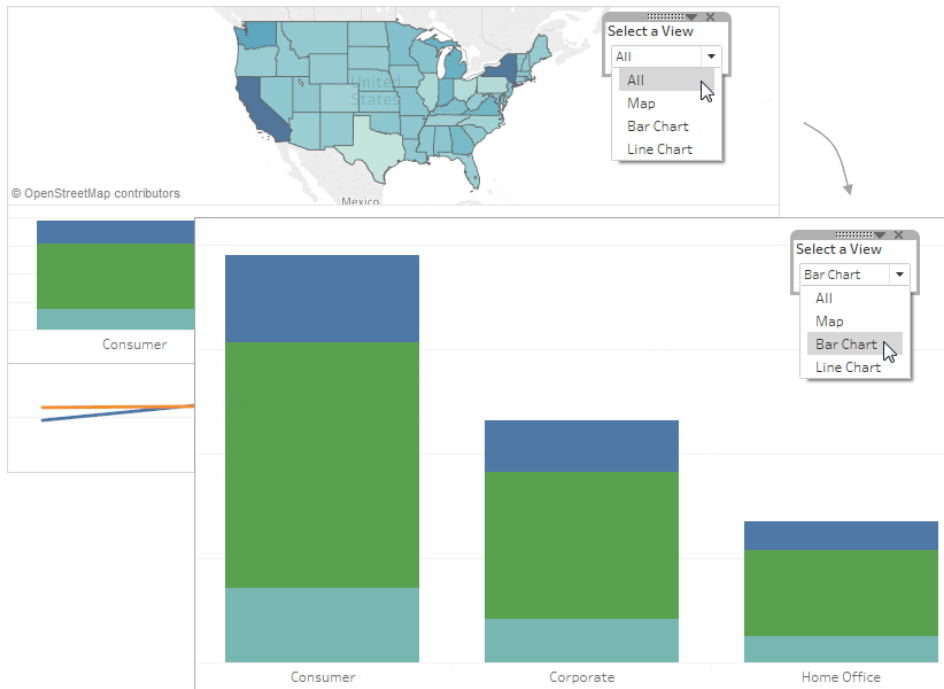

1. On an individual worksheet, right-click an empty area of the **Data** pane at left, and select **Create Parameter**.

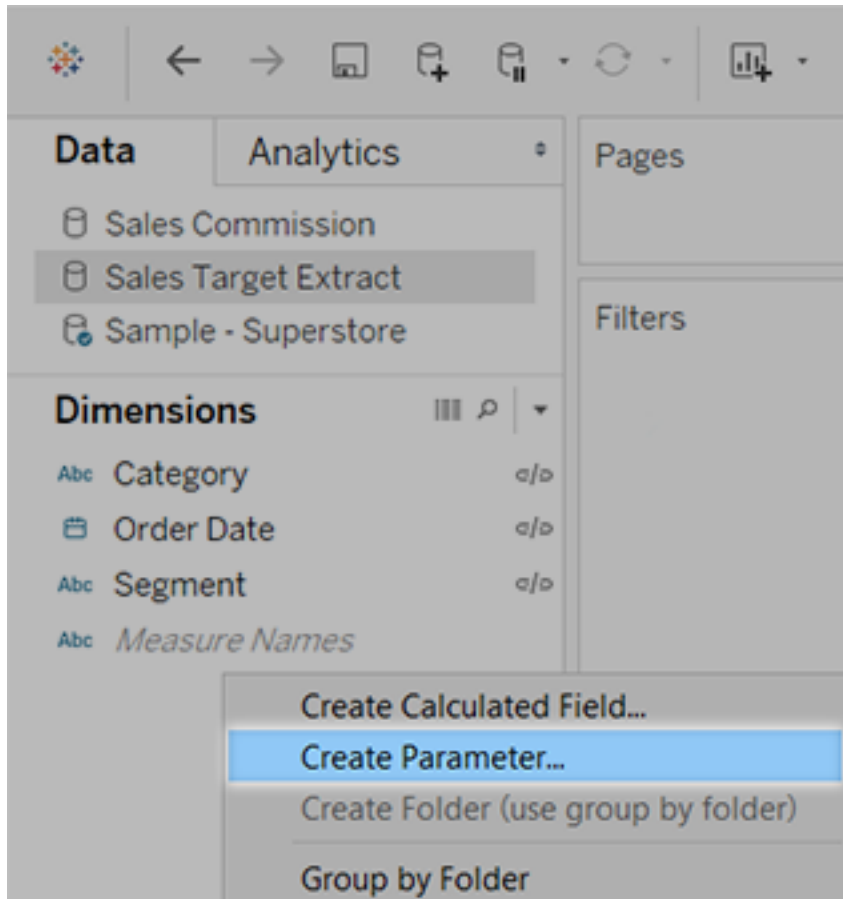

2. In the Create Parameter dialog box, do the following:
 - Enter a name that will appear above the menu, like **Select a View**.
 - For **Data type**, select **String**.
 - For **Allowable values**, select **List**.
 - Under **List of values**, type **All** for the first value, and then add values with the

name of each view in the dashboard.

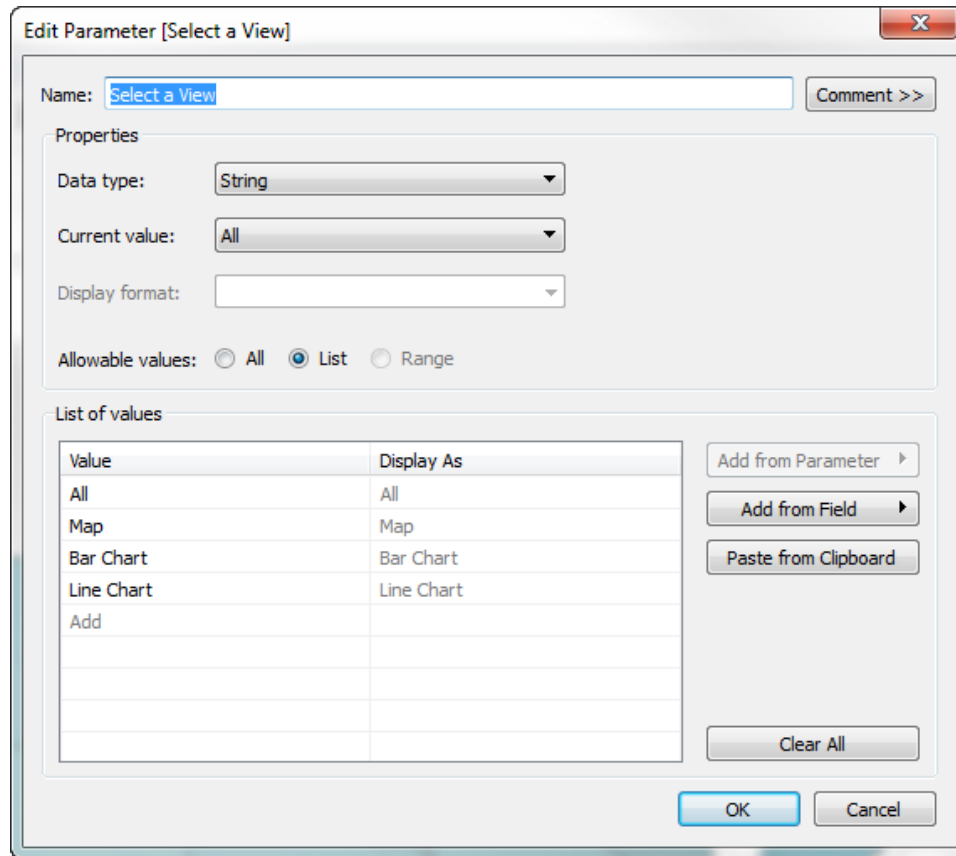

3. Click **OK**.
4. On any sheet, right-click an empty area of the Data pane at left, and select **Create Calculated Field**.
5. Give the calculation a descriptive name like **Display sheet**. In the formula text box, enter the name of the parameter you created above. Then click **OK**.

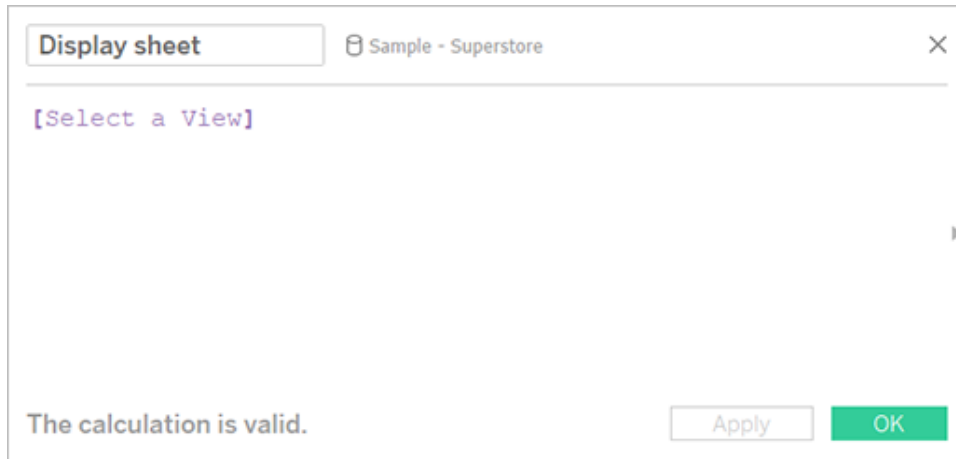

6. Open a sheet you plan to add to your dashboard, and drag the new calculation to the Filters shelf. Then do the following in the Filter dialog box:
 - Select **Custom Value List**.
 - Type **All** in the text box, and click the **Add Item** button.
 - Type the current view's name (like "Map") in the text box, and click the **Add Item** button.

When you're done, click **OK**.

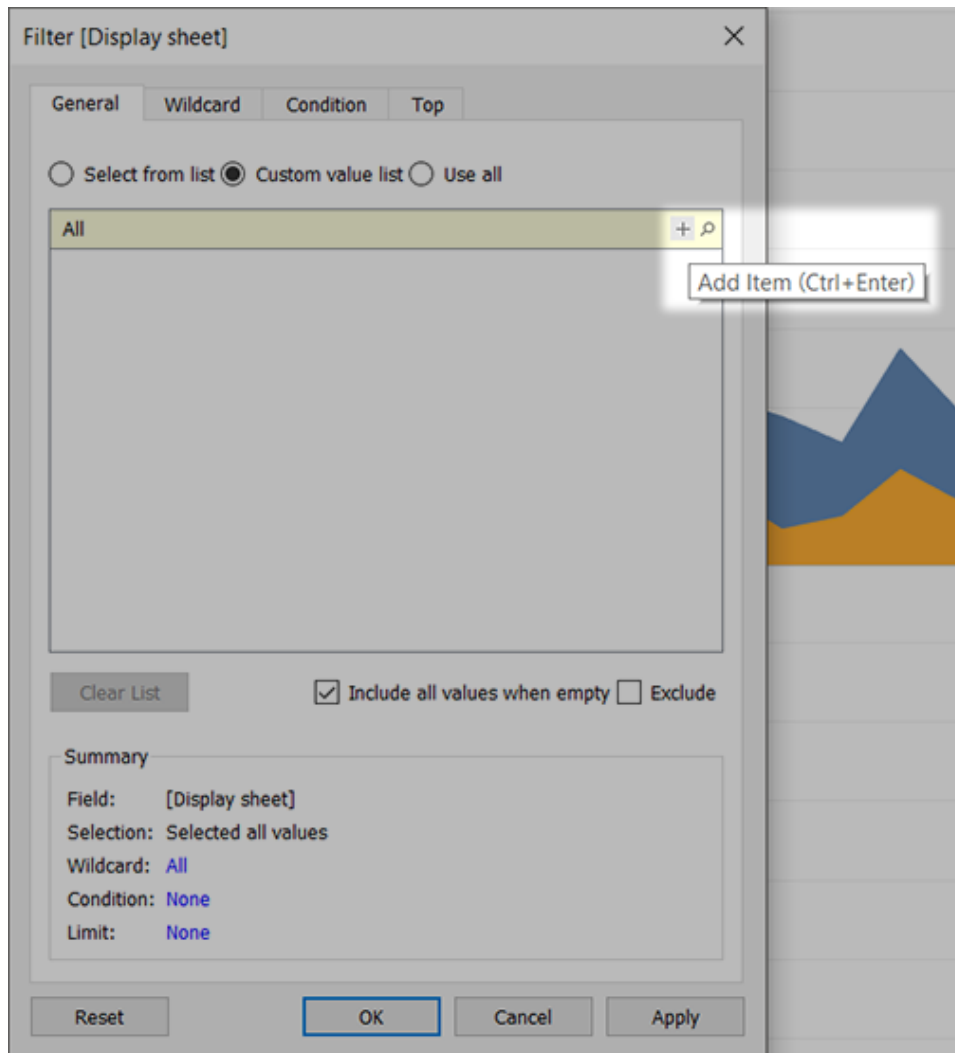

7. Repeat step 6 for every sheet you plan to add to your dashboard.
8. Select **Dashboard > New Dashboard**.
9. From the **Objects** section at lower left, drag a **Vertical** or **Horizontal** layout container to the dashboard.



- Now drag each sheet to the layout container, identified by the dark blue outline.

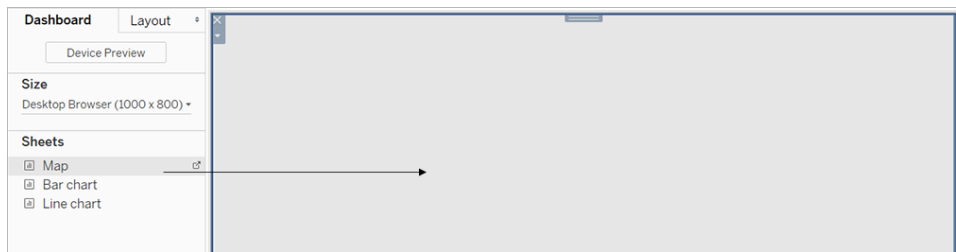

- To display the sheet selector, from the drop-down menu at the top of a view, choose **Parameters** > [new parameter name].

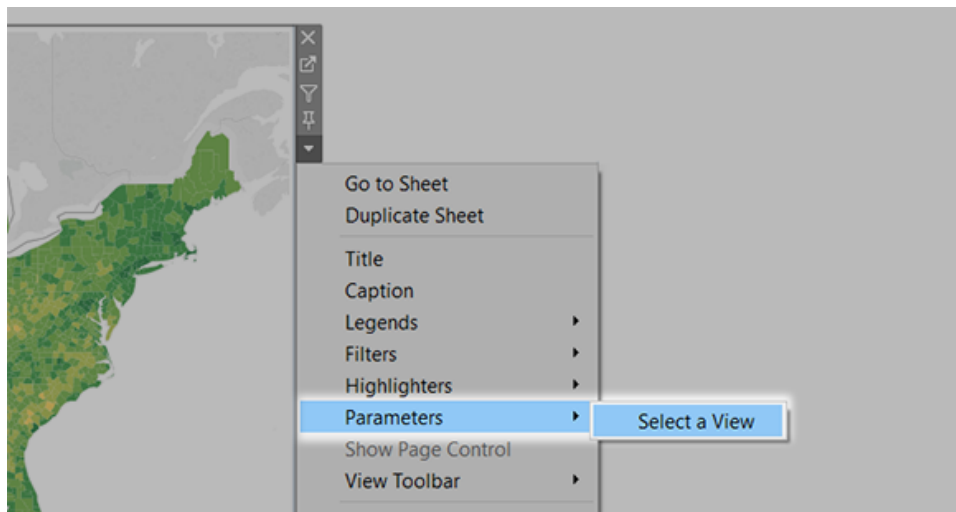

- To ensure that selected views fill the dashboard, do the following:

- From the drop-down menu at the top of each view, ensure that **Fix Width** is *not* selected.
- Right-click the title area of each view in the dashboard, and select **Hide Title**.

Your sheet selector is ready to go! For similar examples, see [Use Parameters to Make Views More Interactive](#) on page 1131.

Rebrand a Dashboard

Tableau Desktop builds visual best practices into its default formatting settings so that your visualizations look great from the start. But you might want to change formatting settings for a dashboard—for example, to align them with your organization's brand.

This article steps you through a dashboard rebranding process for a fictitious organization called Citywide Bike Share. Its brand includes turquoise, orange, and gray for its colors and Century Gothic for its font. The overall look is light and uncluttered and, of course, it's all about bikes!

Before

After

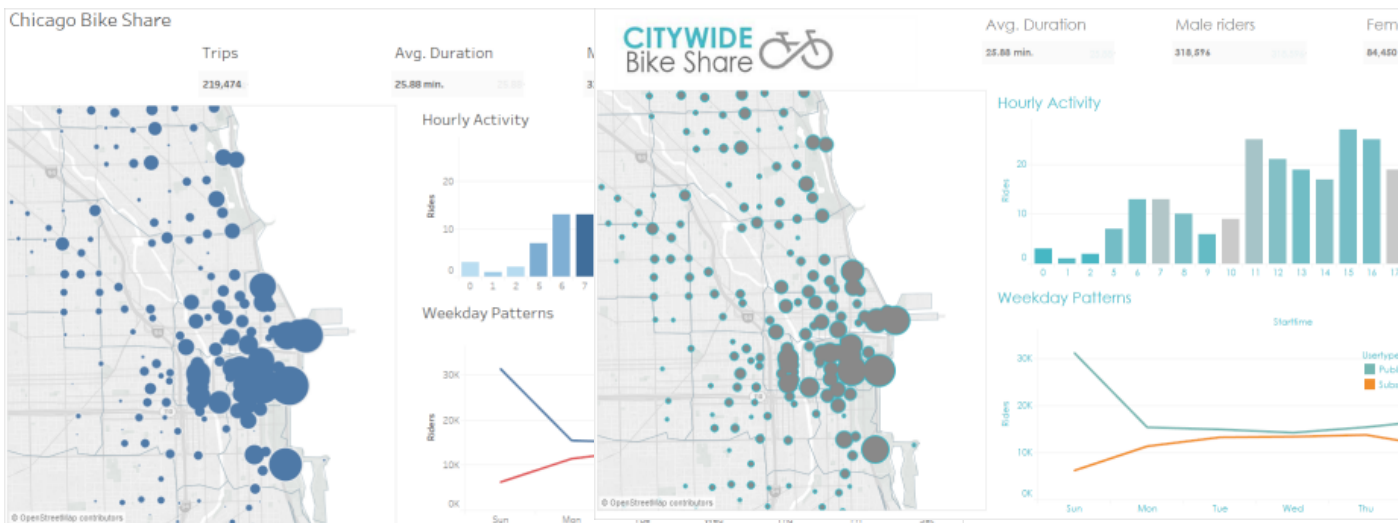

Change the fonts and font color of your titles

Fonts and colors are usually an important part of an organization's brand. The quickest way to make a fast, large-scale change to all the titles in your dashboard is to change them at the workbook level. A workbook is the largest possible container for formatting settings.

1. Click **Format > Workbook**.
2. Make your changes under **Fonts**, in the **Format Workbook** pane.

Here we've changed the font to Century Gothic and the font color to turquoise. We've chosen to change every title in the workbook, but you could also change the look of individual titles.

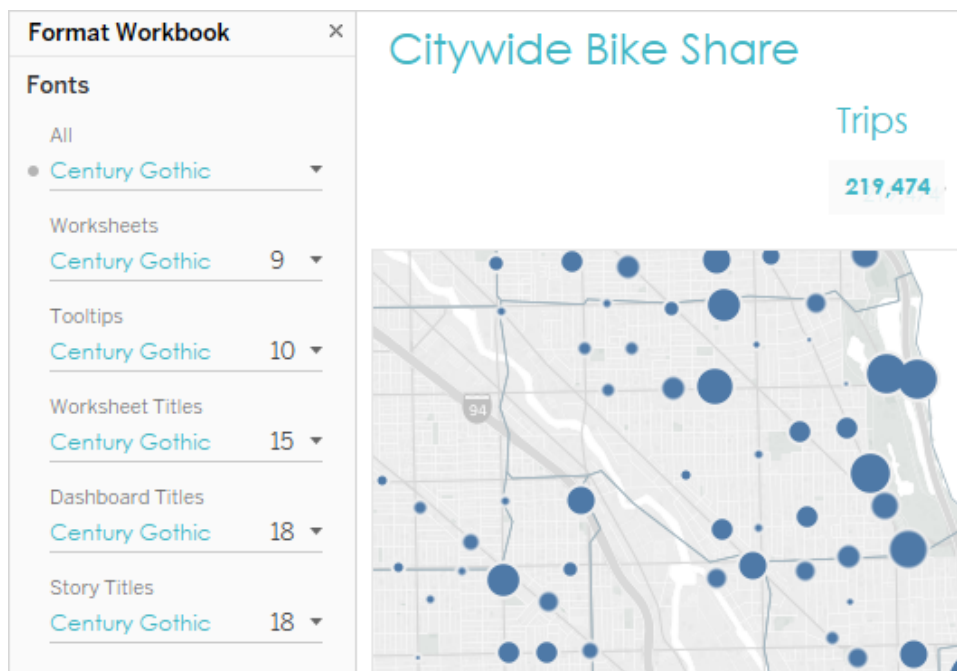

If the font you want to use doesn't exist in Tableau by default, you can add it. See [Use Custom Fonts](#) on page 2990 for details.

Change the marks colors

Marks represent data in a view. In this rebranding scenario, the marks show bike share locations. Changing marks colors is another way to communicate your organization's brand to your audience. For certain types of marks, you can also add and format halos, which is a colored ring around a mark.

1. Go a view on your dashboard and click **Go to Sheet** from the view's shortcut menu.
2. In the view, click **Color** on the **Marks** card.
3. Make your new color selection.

Here we've changed the marks in the Chicago Ride Share map to use gray with a turquoise halo:

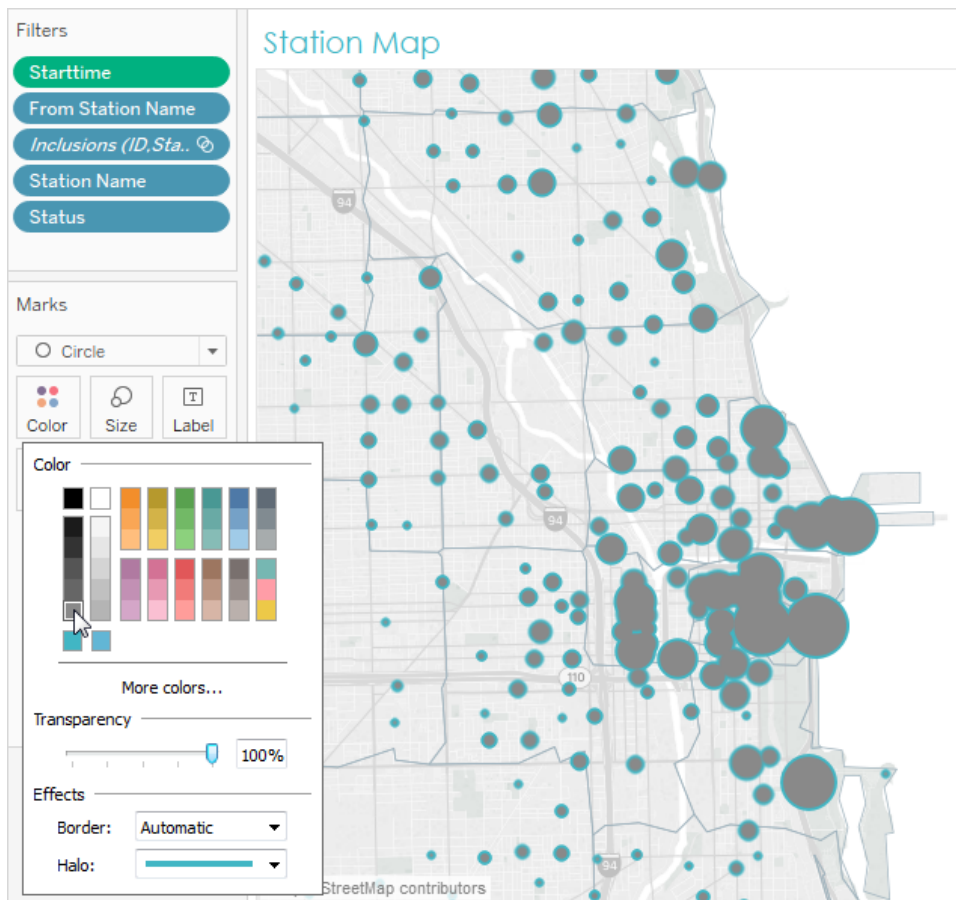

4. Repeat the above steps for every view in your dashboard.

If a color you want to use isn't available, you can create your own custom palette. See [Create Custom Color Palettes](#) on page 3021 for details. For example, here we've changed the colors in the bar chart by created a custom diverging palette.

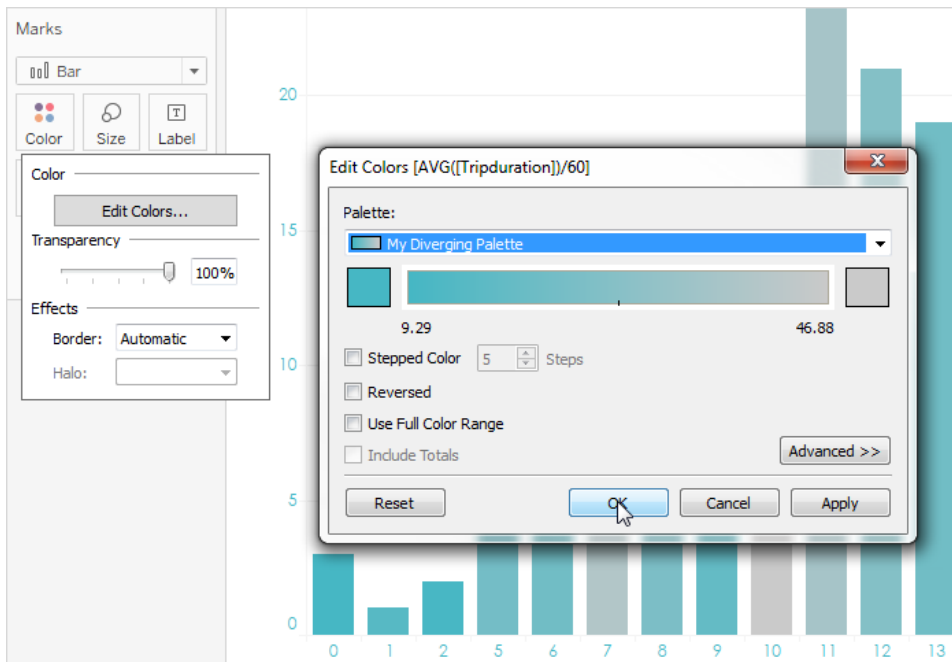

Now, with just a few changes to fonts and marks colors, the dashboard branding is already taking shape.

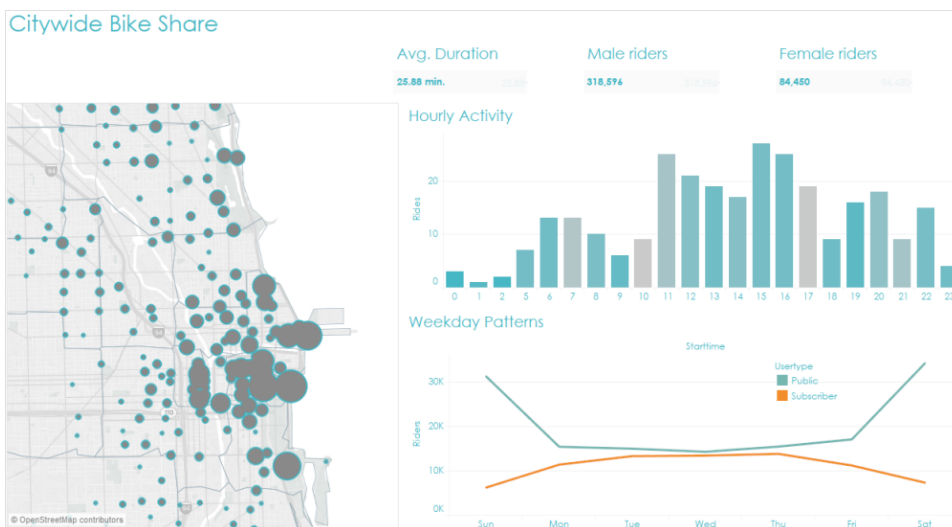

Customize your tooltips

Tooltips appear when you hover the mouse pointer over a mark. Tooltips appear by default for most views. They're a great way to reinforce your brand and tell a better story.

Here's what the map tooltips looked like by default:

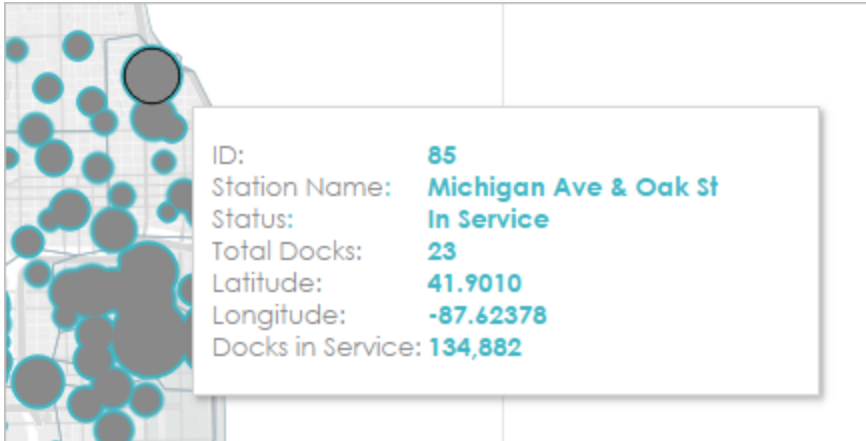

1. Go to the view's worksheet and click **Worksheet > Tooltip**.
2. Confirm that the tooltip has the details you want to display. You can change fonts, order, wording, alignment, and color.

For this rebranding scenario, we reduced the number of items displayed in the tooltip so that it's easier for users to quickly see what they're most interested in. We also reworded a few items and added the color orange as a contrasting, brand-appropriate color:

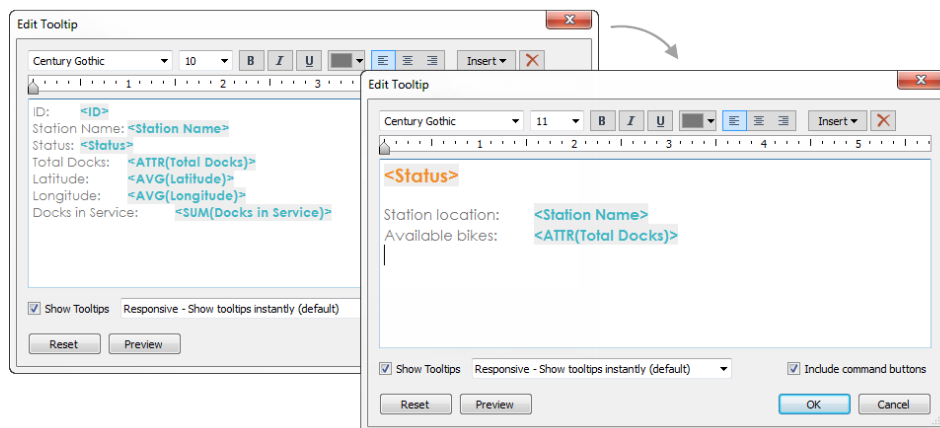

Here's what the map tooltips look like now:

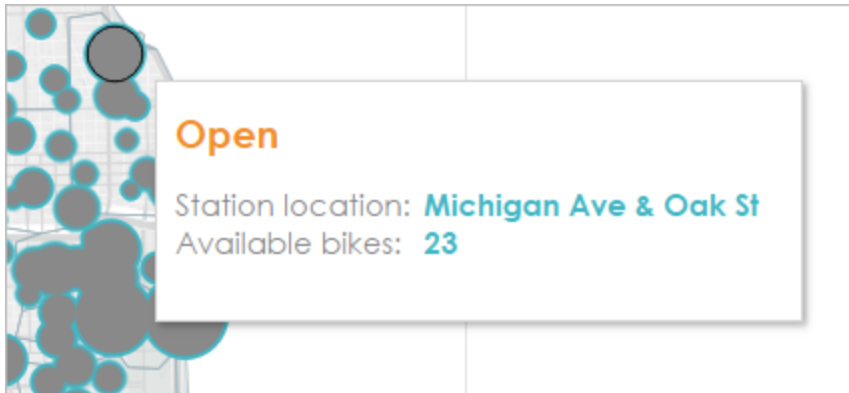

Add an image or logo

Adding your own images can also be a way to bring your organization's brand into a workbook. For example, you can import a logo and use it at the top of your dashboard instead of displaying the default dashboard title.

To remove the title and add an image:

1. In the Dashboard pane, stop displaying the dashboard title by clearing the **Show dashboard title** check box in the lower left corner.

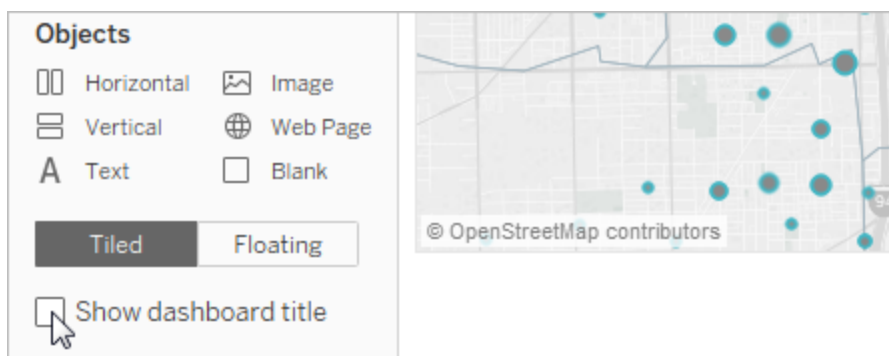

2. Drag the **Image** object to the area where you want to display your logo. You may also need to adjust or remove other dashboard objects.

Tableau Desktop and Web Authoring Help

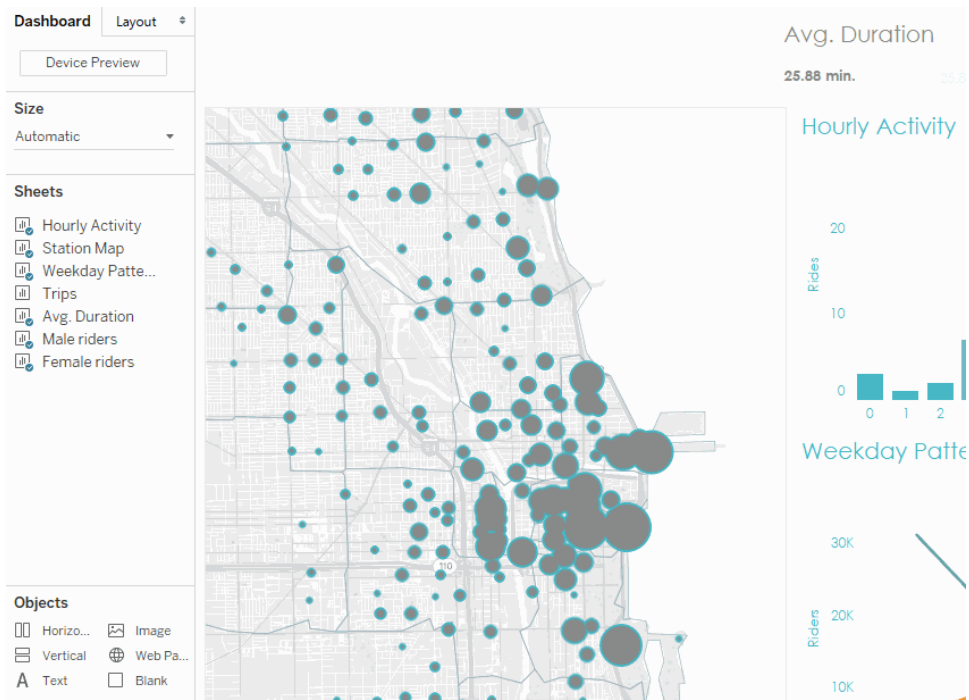

Click the image to replay it.

Here's our final, rebranded workbook:

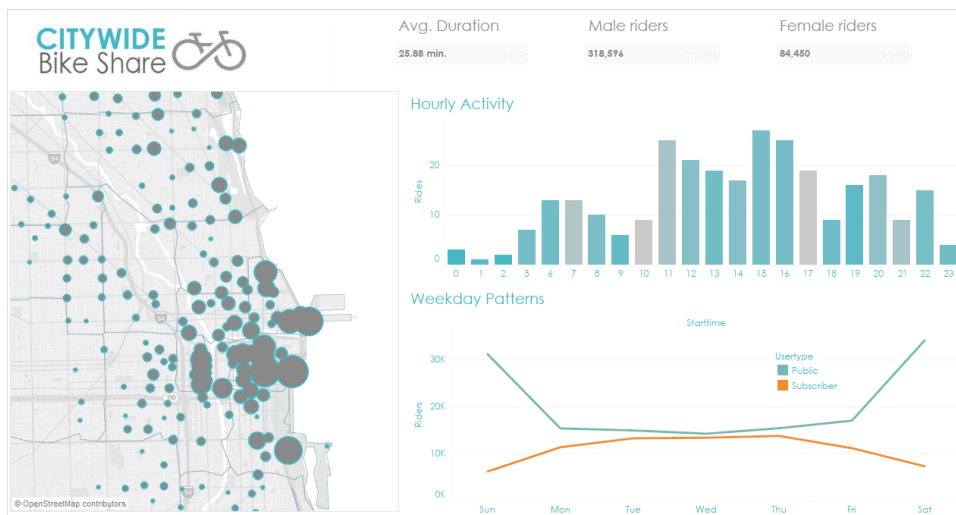

Create Dashboard Layouts for Different Device Types

Dashboards can include layouts for different types of devices that span a wide range of screen sizes. When you publish these layouts to Tableau Server or Tableau Cloud, people viewing your dashboard experience a design optimized for their phone, tablet, or desktop. As the author, you only have to create a single dashboard and deliver a single URL.

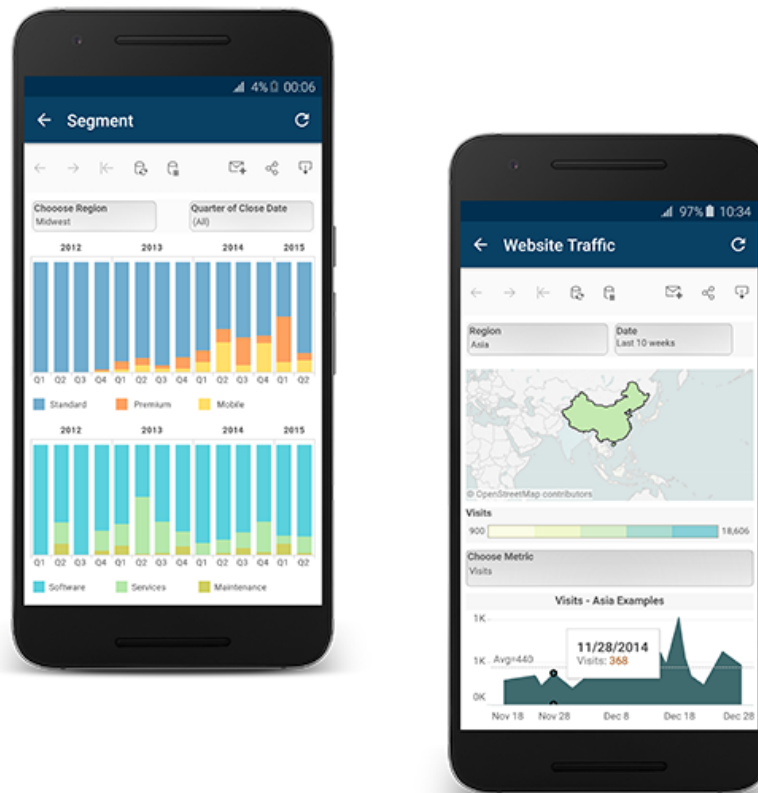

Tip: In addition to optimizing layouts for mobile, [Optimize Workbook Performance on page 3041](#) to better meet the needs of mobile users, who often have limited bandwidth and are in a hurry.

How the Default dashboard relates to device layouts

Device layouts appear on the Dashboard tab, under Default. Initially, each device layout contains every item in the Default dashboard and derives its size and layout from Default as well.

Think of the Default dashboard as the parent, and the device layouts (desktop, tablet, and phone) as its children. Any view, filter, action, legend or parameter that you want to add to a device layout must first exist in the Default dashboard.

Phone layouts and the Default dashboard

To save time with a unique Phone layout option that automatically reflects changes to the Default dashboard, either click the open lock icon , or choose **Auto-Generate Layout** from the pop-up menu.

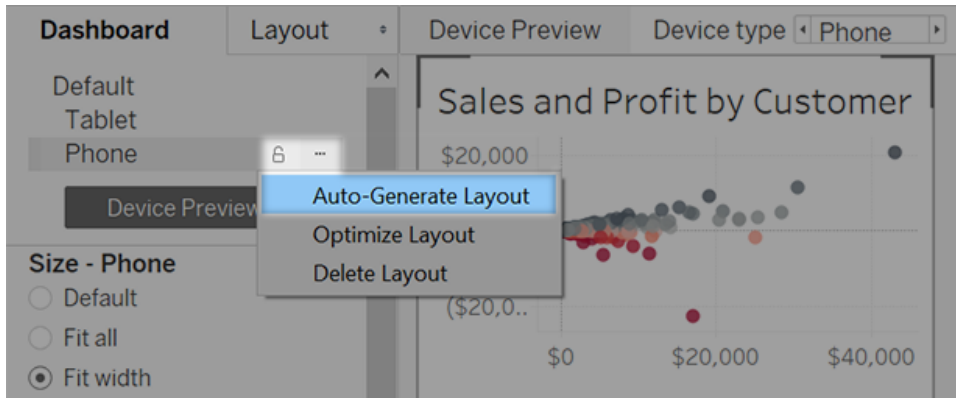

If you instead click the closed lock icon  or choose **Edit Layout** from the menu, the Phone layout becomes fully independent, so you'll need to manually add and arrange items to reflect changes to the Default dashboard.

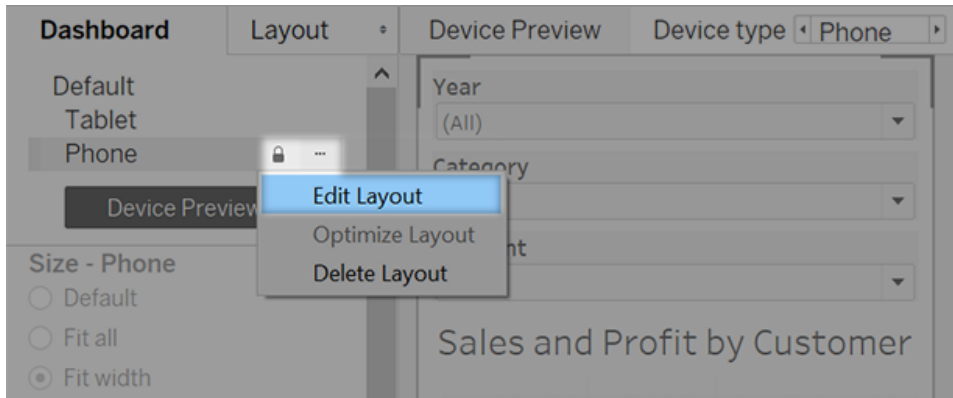

Desktop and Tablet layouts and the Default dashboard

Unlike Phone layouts, you need to manually add Desktop and Tablet layouts to a dashboard. Desktop and Tablet layouts are always fully independent from the Default dashboard, so each device layout can contain a unique arrangement of objects.

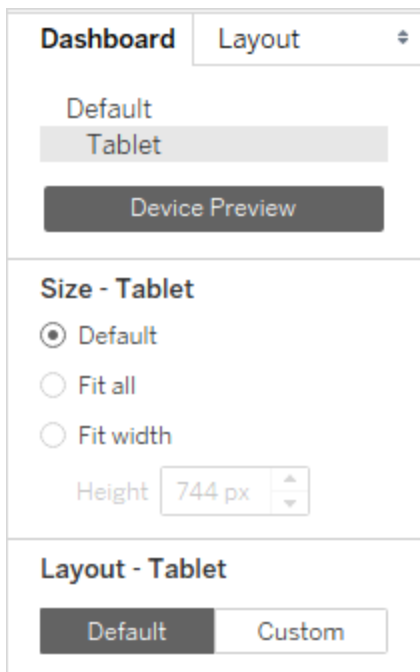

Automatically add phone layouts

Two options let you automatically add phone layouts:

- To create phone layouts whenever you open old dashboards that lack them, choose **Dashboard > Add Phone Layouts to Existing Dashboards**
- To create phone layouts whenever you create a new dashboard, choose **Dashboard > Add Phone Layouts to New Dashboards**. (This option is on by default.)

Preview and manually add device layouts

1. Open a dashboard.
2. On the **Dashboard** tab on the left, click **Device Preview**.

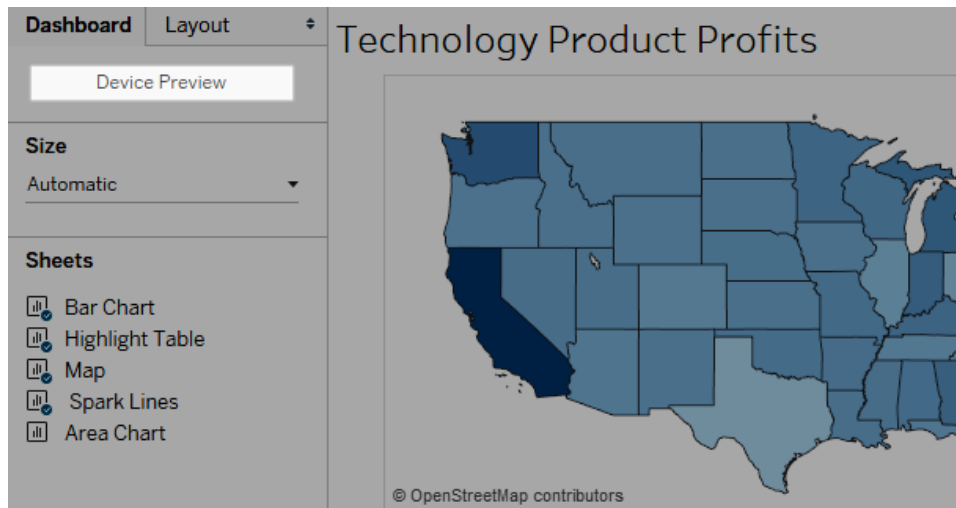

In device preview mode, these options appear above the dashboard:



3. Take a moment to click through the **Device types** and **Models** and explore the different screen sizes. Then set these options:
 - To see how the dashboard will look in landscape vs. portrait mode, click . Usually, landscape is optimal for tablets and portrait is best for phones.
 - Select **Tableau Mobile app** to see how the dashboard will look with the app instead of the browser. This option is available for iOS or Android devices and shrinks the dashboard slightly, leaving space for the app controls.
4. Choose a **Device type**, such as **Tablet**.

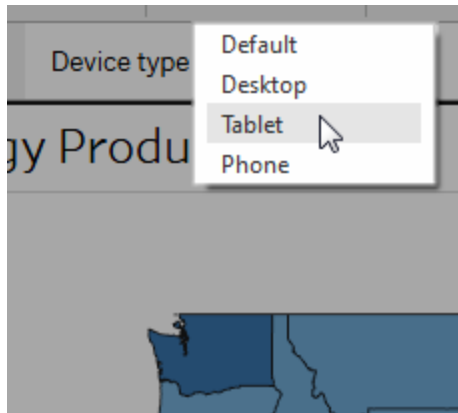

5. In the upper-right corner, click the **Add Layout** button for the device type you selected (for example, **Add Tablet Layout**).

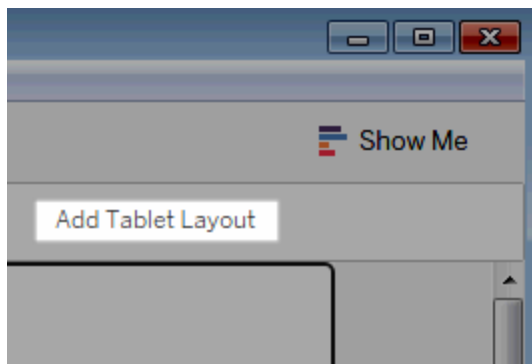

6. Add an additional layout by selecting a new **Device type** and clicking **Add Layout**.

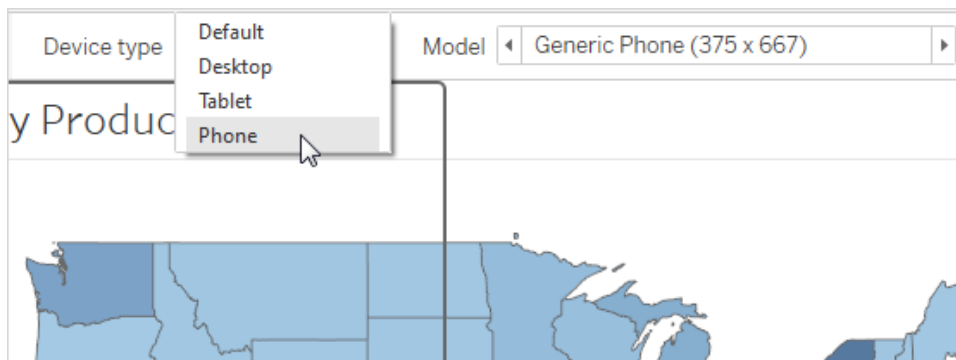

Creating a layout for each device type gives you the most control over your users' experience as they view your dashboard from different devices. After you publish a

dashboard with all three layouts, users won't see the default dashboard layout; instead, they'll always see the appropriate device-specific layout.

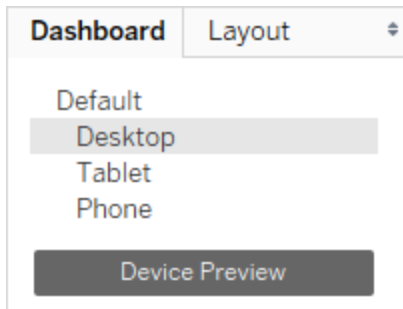



Note: If you make changes to a view, double-check related devices layouts to ensure that they look as you expect.

Customize a device layout

After you've added a device layout to your dashboard, you can start rearranging objects to create the look you want.

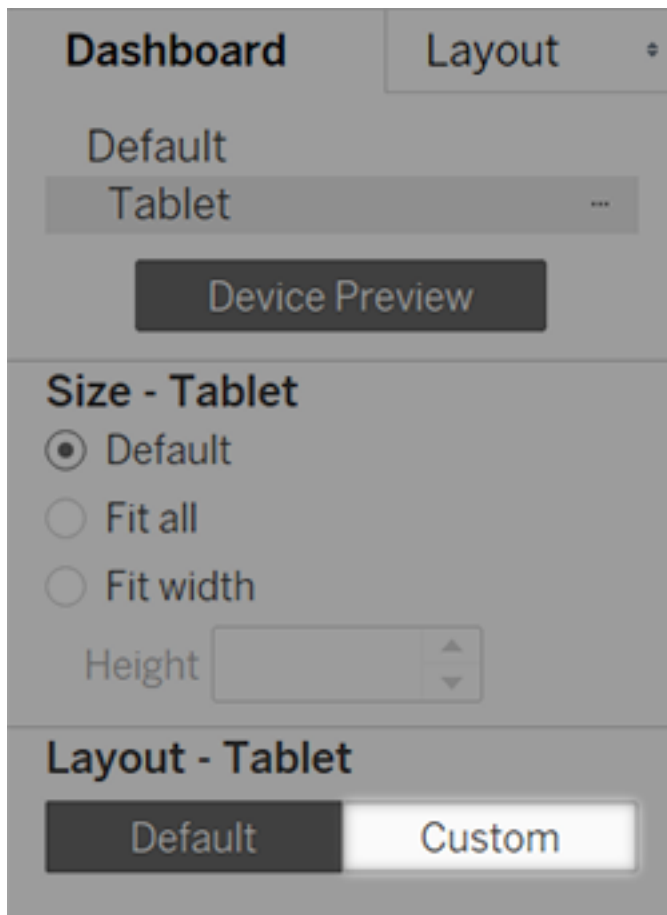
1. For Desktop and Tablet layouts, click **Custom**:



For Phone layouts, either click the lock icon , or choose **Edit Layout** from the pop-up menu:

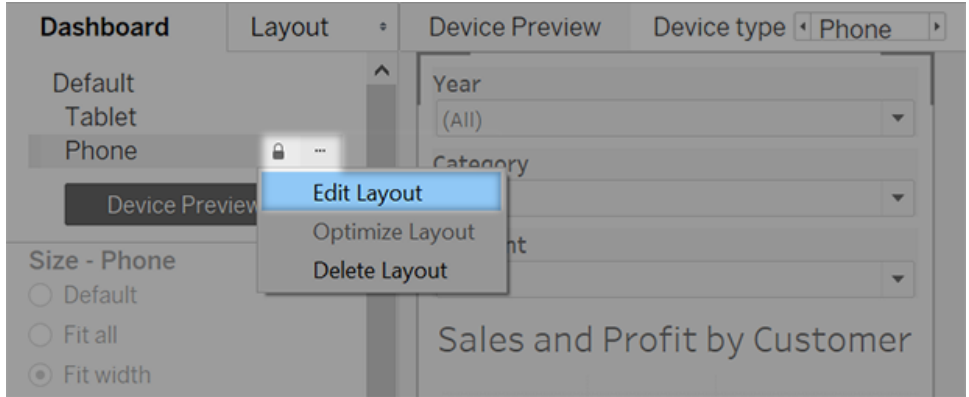

2. Anything you can add to your layout is listed on the left, under **Layout**. If an item has a blue check mark, it means that it's part of the device layout that you're currently working on.

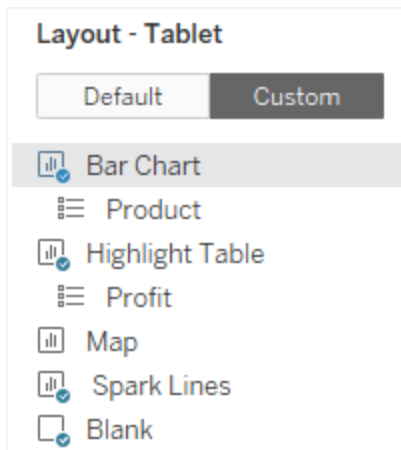

3. If you remove an item, it's only removed from the current device layout. It still exists on the default dashboard and can be added to the device layout again.

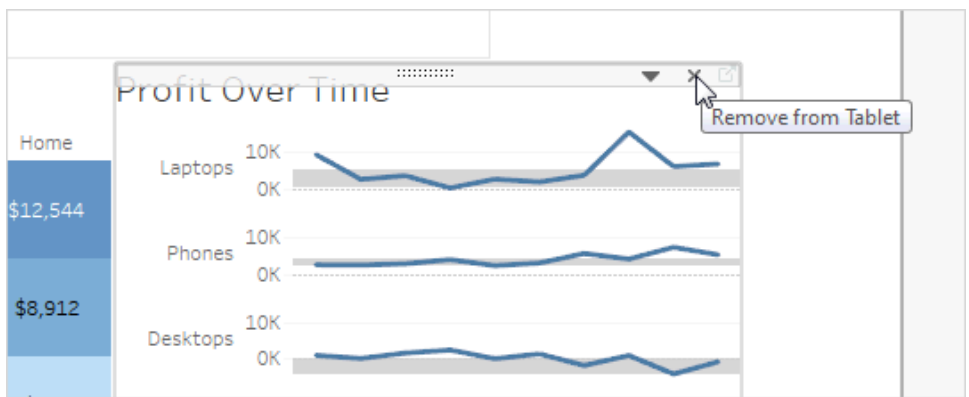

- Click through the **Device model** options to see how the layout will appear on different models.

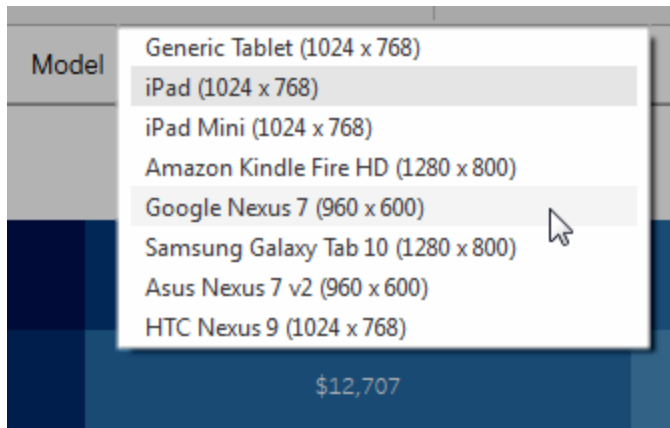

Ultimately, it's the size of the web browser that loads the dashboard that determines which layout appears on the device. For details, see [Confirm which layout a device will display](#) on page 2800.

- At left, explore the options under **Size**.

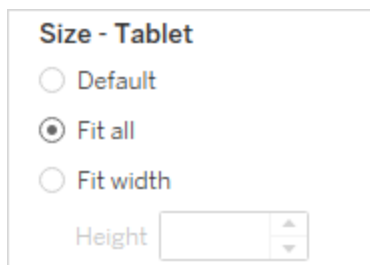

Default: The height and width of the device layout mimics whatever the default dashboard is using. For example, if you're creating a tablet layout and the default dashboard is set to a fixed size of Desktop Browser (1000 x 800), setting Size to Default for the tablet layout will make it use 1000 x 800 as well.

Fit all: All items are automatically resized to fit the device frame size. The device frame size is determined by the Device type, Model, and orientation (portrait or landscape) settings.

Fit width (recommended for phones): Items are automatically resized to fit the width of the device frame, but the height is fixed. This is a great option for phone layouts and vertical scrolling.

Optimize for phones

The small screens of mobile phones benefit from further optimization. Try these techniques.

Optimize manual phone layouts

If you've chosen to edit a phone layout yourself, you can quickly optimize the placement of filters, remove white space, and more. On the **Dashboard** tab, click the pop-up menu to the right of **Phone**, and select **Optimize Layout**.

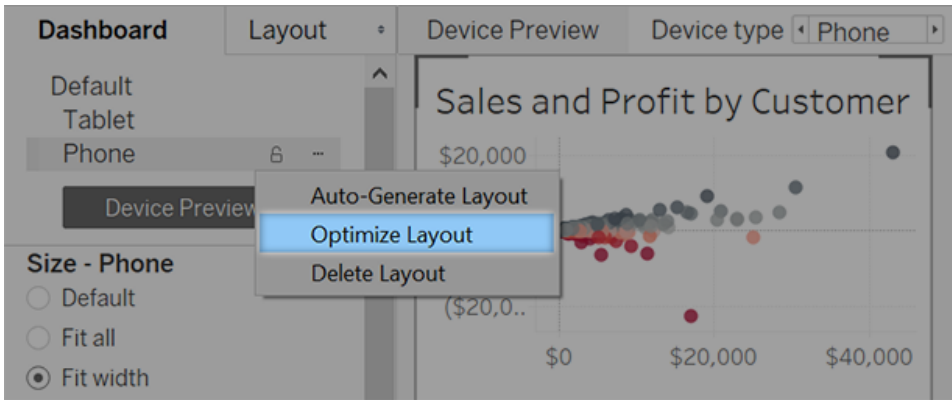

Be aware that this command only rearranges items currently in the phone layout. If you want to continuously update the phone layout to reflect all changes to the default dashboard, select **Auto-Generate Layout**.

Add links that trigger instant messages and phone calls

To let phone users quickly contact key people about dashboard content, add **URL actions** to objects that automatically trigger SMS messages and telephone calls. Use the link format `sms:phone-number` or `tel:phone-number`. Be sure to include country and area codes if necessary.

Create phone-specific versions of views

Create duplicates of certain views in the default dashboard—one optimized for desktop viewing and a second optimized for phones.

1. Go to the worksheet for a view, click its tab, and select **Duplicate Sheet**.

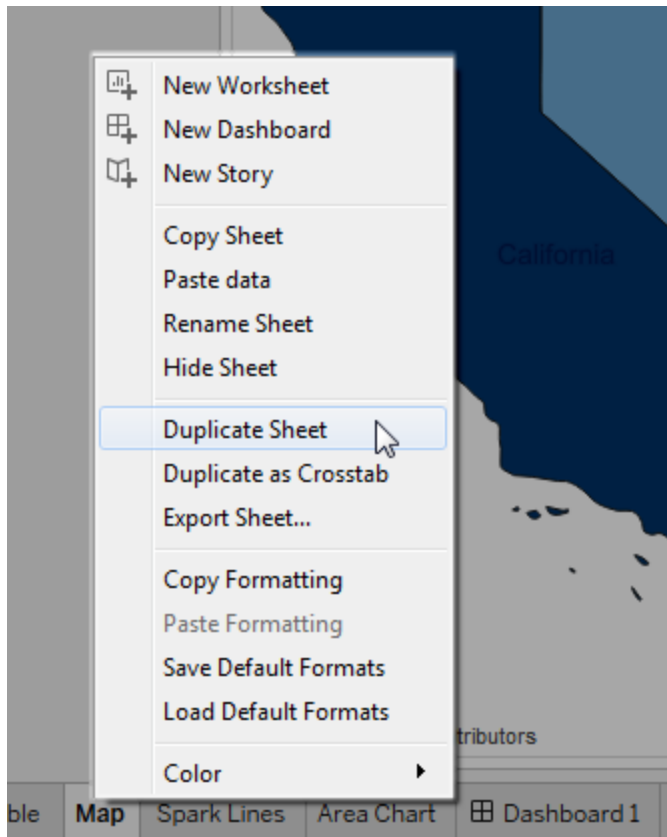

2. Customize the view for mobile viewing.

For maps for example, you may want to zoom in to a specific region by default, or you may want to disable panning, zooming, and other functionality. See [Customize How People Interact with your Map](#) on page 1878.

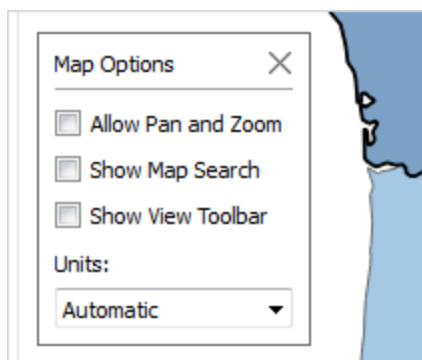

3. Now add the new view to the default dashboard so that it can be available to the device layouts you're creating.

Shorten titles

Short titles work best for mobile viewing. To edit a title, double-click it.

Optimize white space

White space is another visual element to consider. While screen real estate on a phone is scarce and you want to make the most of it, you may also want to provide additional safe places for your users to tap or initiate scrolling, so they don't select filters and other items unintentionally.

To add white space, use padding or Blank objects. For more information, see [Size and Lay Out Your Dashboard](#) on page 2742.

Publish the dashboard

1. Click **Server > Publish Workbook**. If you're not already signed in, you're prompted for your credentials.
2. In the Publish Workbook to Tableau Server dialog box, make sure the **Show sheets as tabs** check box is cleared.

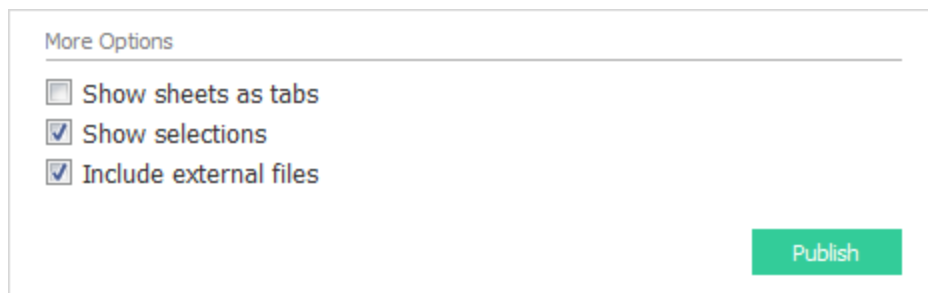

When this check box is selected for device-specific dashboards, the tabs' sizing requirements interfere with the server's ability to correctly detect the size of the web browser and load the correct layout.

3. Click **Publish**.

Test the dashboard

After you publish the dashboard to Tableau Server or Tableau Cloud, test the dashboard by viewing it from different browser sizes.

1. Open the dashboard on Tableau Server or Tableau Cloud.
2. In the upper-right corner of the page, click **Share** and copy the contents of the **Link** text box.

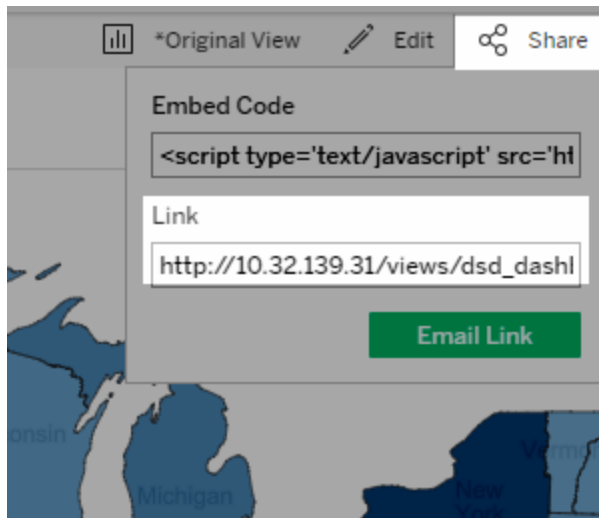

3. Paste the string into a web browser URL. The string should include the following:
embed=y
4. With the embed code string as your browser URL, test the different layouts by changing the size of your web browser window and refreshing it.

Confirm which layout a device will display

The dashboard layout a device displays is based on the smallest dimension (height or width) of the iframe in which the Tableau view appears. Sometimes Desktop, Tablet, or Phone layouts may appear on other types of devices. For example, a Tablet layout may appear on a desktop computer if the display or browser window is small.

If the smallest iframe dimension is ...

500 pixels or less

This device layout appears ...

Phone

Between 501 and 800 pixels

Tablet

Greater than 800 pixels

Desktop

If Tableau Cloud and Tableau Server users find a Phone or Tablet layout too limiting, they can use the display settings button in the toolbar to view the Desktop layout. This button is a toggle that allows you to switch between Desktop and Mobile layouts. The button placement varies depending on the device you are viewing the dashboard on.

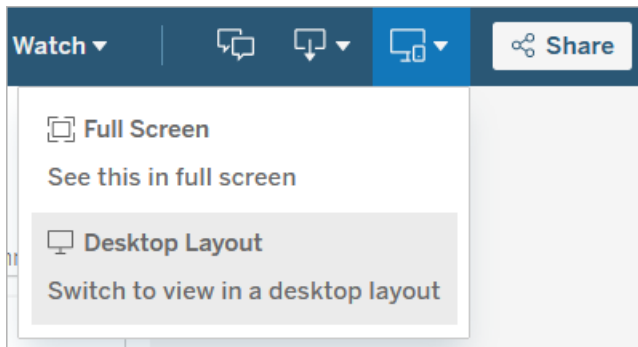

Display settings on a desktop device

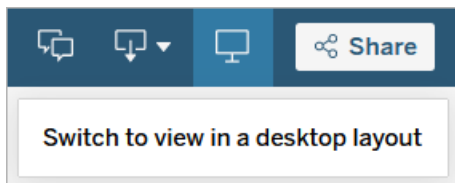

Display settings on a tablet

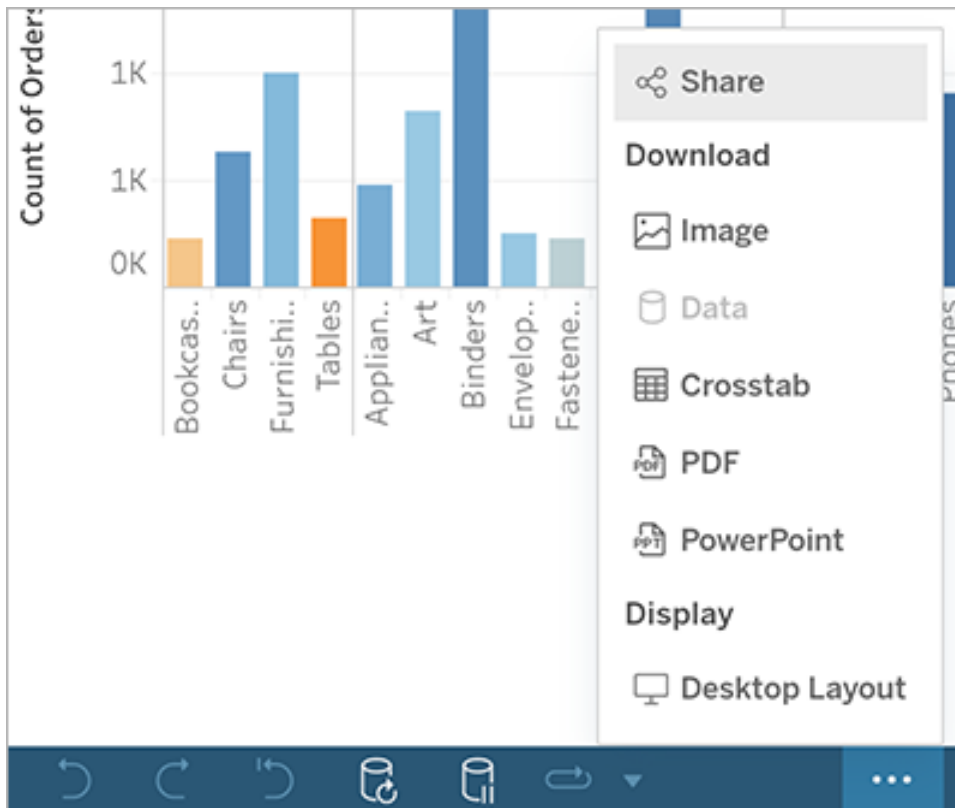

Display settings on a phone

Build Accessible Dashboards

If you want to make your dashboards accessible to as many people as possible, or if you work in an environment that is subject to [US Section 508](#) requirements, other accessibility-related laws and regulations, you can use Tableau to create dashboards that conform to the [Web Content Accessibility guidelines \(WCAG 2.0 AA\)](#).

To make an accessible dashboard:

1. Create a dashboard in either Tableau Desktop or in web authoring on Tableau Server or Tableau Cloud
2. Publish and embed that dashboard into a web page that conforms to Web Content Accessibility guidelines (WCAG 2.0 AA)

This topic explains how screen readers help users to navigate dashboards, the order that screen readers read objects or views in a dashboard, what items in a dashboard are accessible, and how to take an existing dashboard and make it more accessible for all users.

Dashboard keyboard navigation and focus order

Tableau contains keyboard shortcuts that helps users navigate using only a keyboard. For more information, see [Keyboard Accessibility for Tableau Views on page 3257](#).

When creating a dashboard, note that screen readers read views or objects in a dashboard in the order in which they were added. For example, if your dashboard contains a text object containing information that helps explain the dashboard, add this object to your dashboard first.

You can also edit the dashboard hierarchy directly by editing the XML directly. For more information, see the Tableau community post [How can I set the focus order of the views and objects in a dashboard?](#)

Create accessible dashboards

Many items and objects in the Tableau workspace support keyboard navigation and are compatible with assistive technologies like screen reading software. You can use the following items on a dashboard you want to be accessible:

- [Add dashboard objects and set their options on page 2705](#)
 - Text objects
 - Web page objects
 - Button objects
 - Image objects
- Toolbar
- Dashboard titles
- Views, specifically:
 - Title
 - Workbook tabs
 - View Data window
 - Captions (when visible)
 - Categorical legends

Single and multi-value filters

The screenshot displays a Tableau workspace with a scatter plot titled "Profit Ratio versus Discount". The plot shows data points categorized by Customer Segment (Great, Good, Terrible) and Region (Central, East, South, West). The y-axis represents Profit Ratio (from -5% to 25%) and the x-axis represents Discount (from 3.8% to 6.2%).

Numbered callouts (1-8) point to various accessibility features:

- 1:** The main view area, including the plot and its descriptive text.
- 2:** The "Customer Segment" and "Region" filter panels on the right.
- 3:** The "Viz Details" panel, which includes a "Viz description" field for accessibility.
- 4:** A tooltip for a data point, showing details like "Color and shape show details about Quadrant" and "Size of mark shows sum of Sales".
- 5:** The "Accessibility" panel, which provides an "Alt text description" field for the visualization.
- 6:** The "Accessibility" panel's "Reset" and "OK" buttons.
- 7:** The "Select Color Palette" dialog box, showing a "Color Blind" palette.
- 8:** The data source table at the bottom, showing columns for Region, Customer Segment, Profit Ratio, and Discount.

For more information about views, see [Build Data Views for Accessibility](#) on page 1601

Note: Interactivity within a view (mark selection, tooltips, etc) is not accessible.

Walkthrough: make existing dashboards more accessible

Let's start with a finished workbook and work backward to make it more accessible.

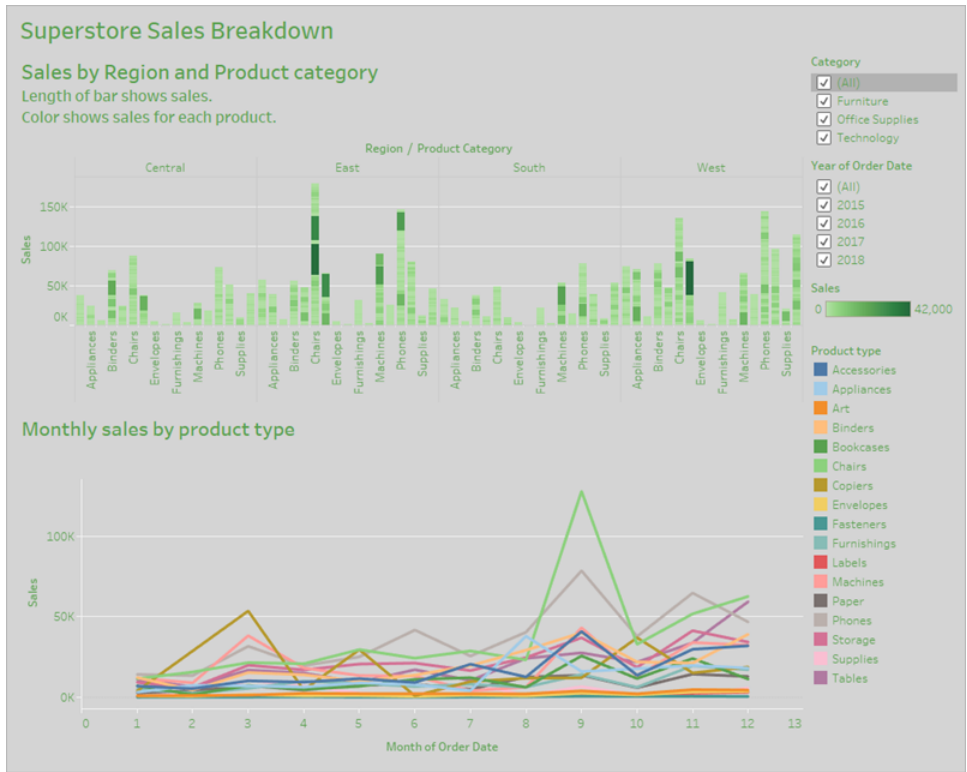

For this workbook to be more accessible, we will:

1. **Format for accessibility at the dashboard and workbook level** on the next page
2. **Aggregate and reduce marks** on page 2808
3. **Eliminate redundant information** on page 2810
4. **Use color and shape to differentiate marks** on page 2810
5. **Use filters to reduce the number of marks in a view** on page 2815
6. **Add captions and legends** on page 2819

This dashboard is designed to show total sales for each sales region and product type. The line chart at the bottom shows monthly sales by product type. The author of this dashboard wanted to use color to brand the dashboard in the Superstore company's colors of green and gray.

Unfortunately, this dashboard has several features that pose accessibility problems for users, including the company color scheme. The steps that follow show a few ways to make this dashboard more accessible.

Format for accessibility at the dashboard and workbook level

The green text on a gray background does not have a high enough contrast ratio to work for users with visual contrast sensitivity loss. To make this workbook accessible to all users and make the contrast ratio as high as possible, we're going to make the background white and change the text colors on our chart to black.

To update the dashboard shading color, change **Dashboard Shading** in the **Format>Dashboard** menu to **None**.

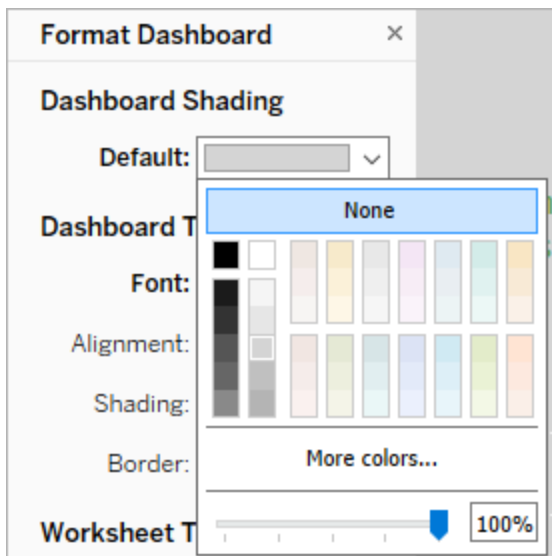

For text formatting changes, we could manually change the formatting on each worksheet. But that will take a lot of time. This dashboard only has two views, but dashboards often contain more.

To update the text on our dashboard to black, select **Format>Workbook** and change **Fonts>All** to **Black**.

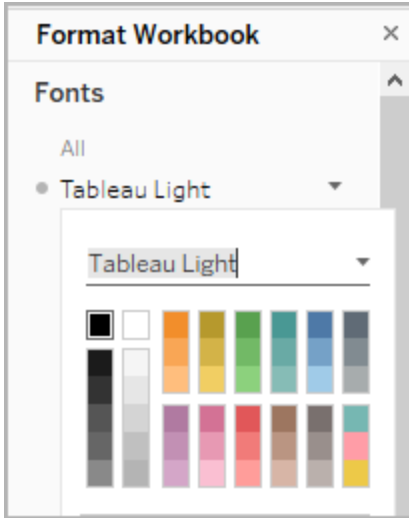

This changes the font color in every sheet of our workbook to black, which is then applied to the views included in the dashboard. For external information on color contrast, see [Color Contrast and Why You Should Rethink It](#).

Less accessible - low contrast

More accessible - higher contrast

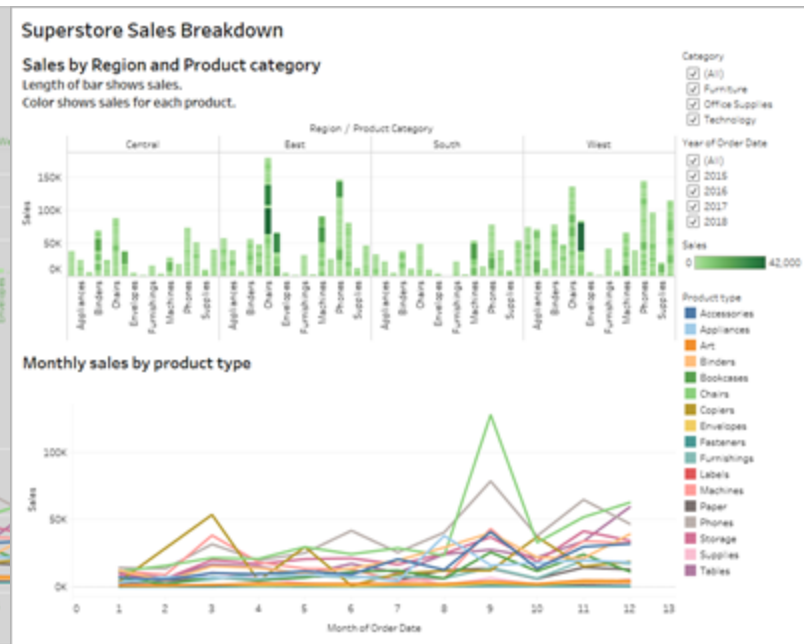
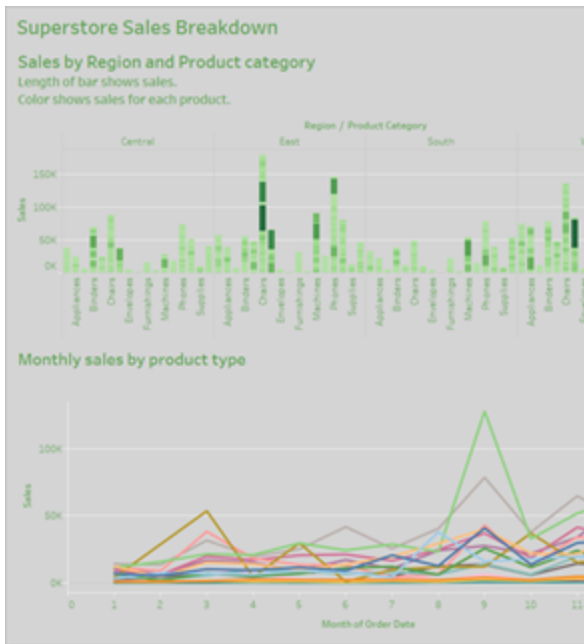

For more information about adding background colors around items, see [Add padding, borders, and background colors around items](#).

Aggregate and reduce marks

You might have a lot of information that you want to communicate with your dashboard or view. However, a dense view with a lot of marks, like the bar chart at the top of our view, can be difficult to understand using a screen reader or keyboard.

The top view in our dashboard displays over 5000 marks because each bar in the chart contains the name of each product in that category. If a view uses more than 1000 marks, it causes the view to be rendered on the server instead of the browser, and server-rendered views are not supported for WCAG conformance. Limit the number of marks to only those that emphasize the most important data points.

To make this view more accessible, make the stacked bar chart into a bar chart by removing the field **Product Name** from **Details** in the **Marks** card. This reduced the number of marks in the view from over 5000 to 68.

Less accessible - too many marks

More accessible - aggregated view

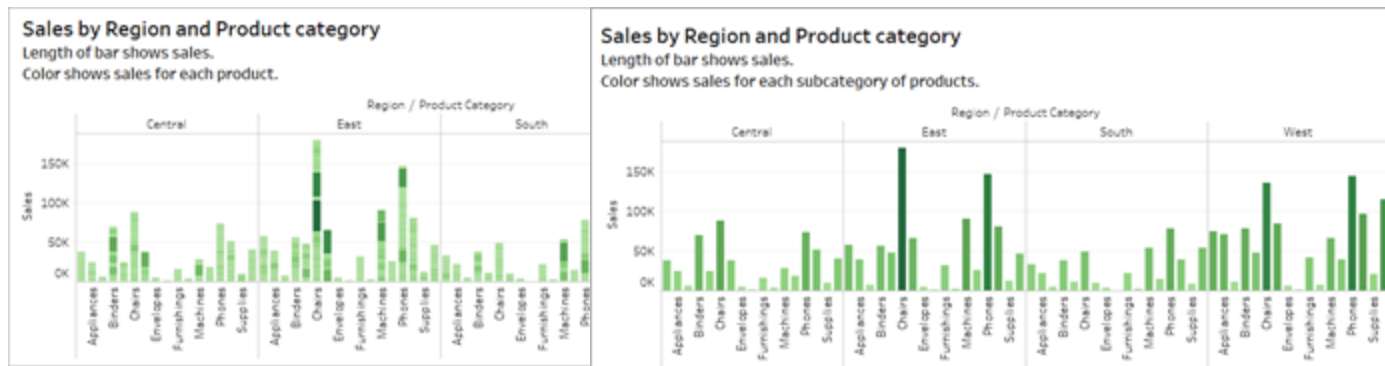

Users can also access the **View Data** window (enabled by default) to review the underlying data for the marks or can download the data from that page to an accessible application to view it that way.

To reduce cognitive overload and reduce the numbers of marks in our field even further, we can create groups of related members in a field. To create a group of similar products:

1. Right click on the field and select **Create > Group**.

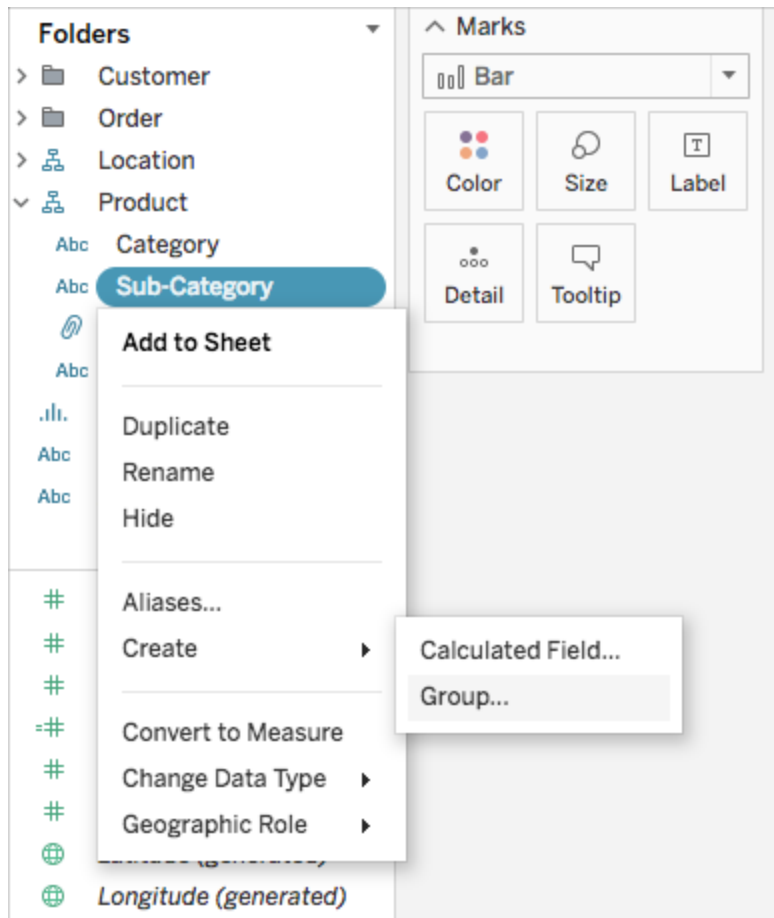

2. In the Create Group dialog box, select several members that you want to group, and then click **Group**.

For more information on grouping, see [Group Your Data on page 1079](#). Here's what the view looked like before grouping and aggregating, compared to after:

Less accessible - too many marks

More accessible - aggregated and grouped view

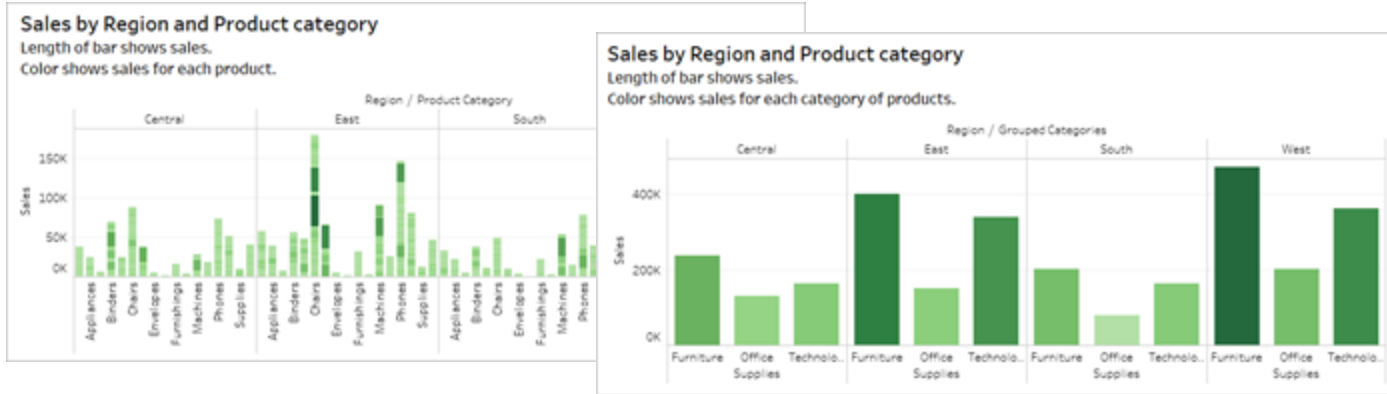

For information and examples about how to build this type of view, see [Keep it simple on page 1611](#) in [Author Views for Accessibility on page 1610](#).

Eliminate redundant information

The aggregated and grouped bar chart reduces cognitive overload for users, but still uses color to convey meaning when color isn't necessary. Since the size of each bar already represents sales numbers, color can be removed from the chart by removing the sales field from Color in the **Marks** card. Removing color also removes the color legend that the screen reader reads.

Less accessible - unnecessary marks

More accessible - unnecessary marks removed

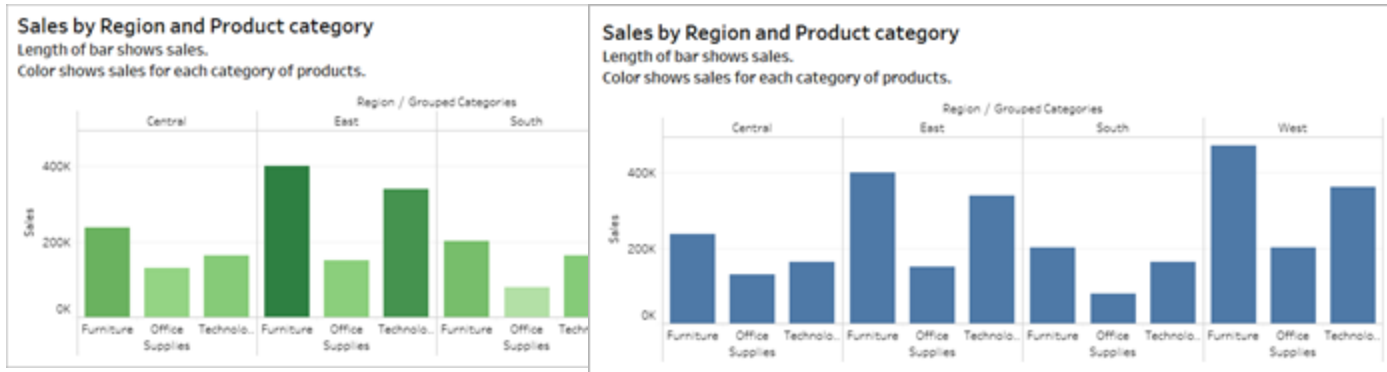

Use color and shape to differentiate marks

The line chart in this dashboard contains marks that are only distinguished by color, which makes it impossible or nearly impossible for people with colorblindness to distinguish marks

from one another. The line path provides helpful position information, but the colors do not provide clear distinction between the line marks.

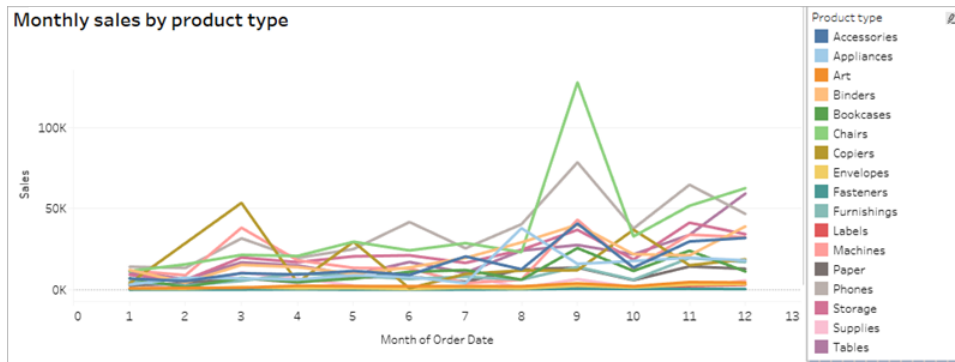

Make this line chart more accessible by applying the **Color Blind** palette and adding shapes to reinforce what is being shown in color.

To apply the Color Blind palette:

1. Select **Color** on the **Marks** card.
2. Select **Color Blind** from the **Color Palette** menu.

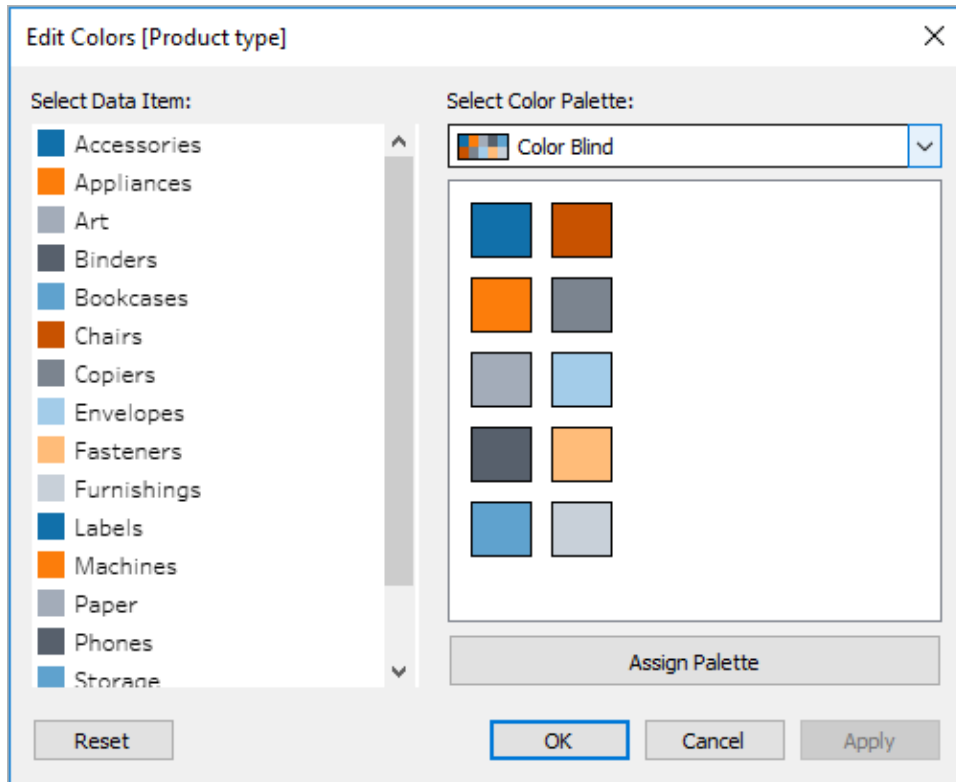

3. Select **Assign Palette** and **Apply** to apply it to the view.

To add shapes in addition to color to your line chart, create a combination chart, or dual axis chart:

1. Control-drag (command-drag on a Mac) the field in the **Rows** shelf to copy it and place it to the right of the first field. This creates two tabs in your Marks card, one for each field in the Rows shelf.

2. On the marks card, select the bottom tab, titled **[Field Name (2)]**. Select **Shape** from the drop down menu in the Marks card.

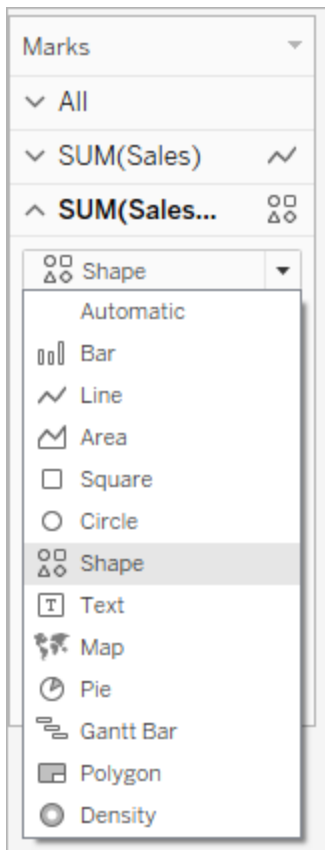

3. Select the Color mark to the right of the field name and select Shape.

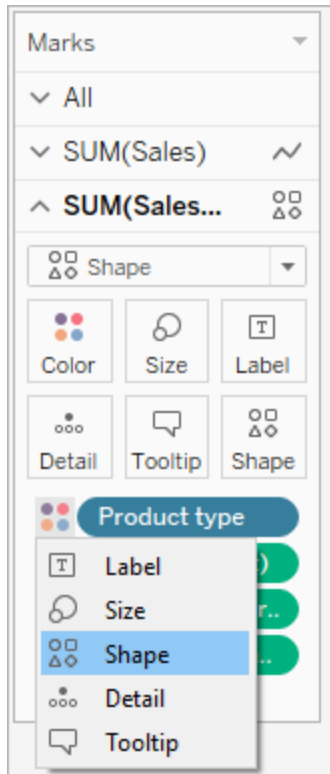

4.

This creates separate shapes for each of the marks in the field. At this point, there are two different charts; one a line chart of colors, another a scatter plot with shapes.

To merge these two charts together into a dual axis chart, in the Rows shelf, select the field on the right and select **Dual Axis**. For more information on combination charts, see [Build a Combination Chart](#) on page 1561.

Not easily accessible

More accessible - Color Blind palette and shapes

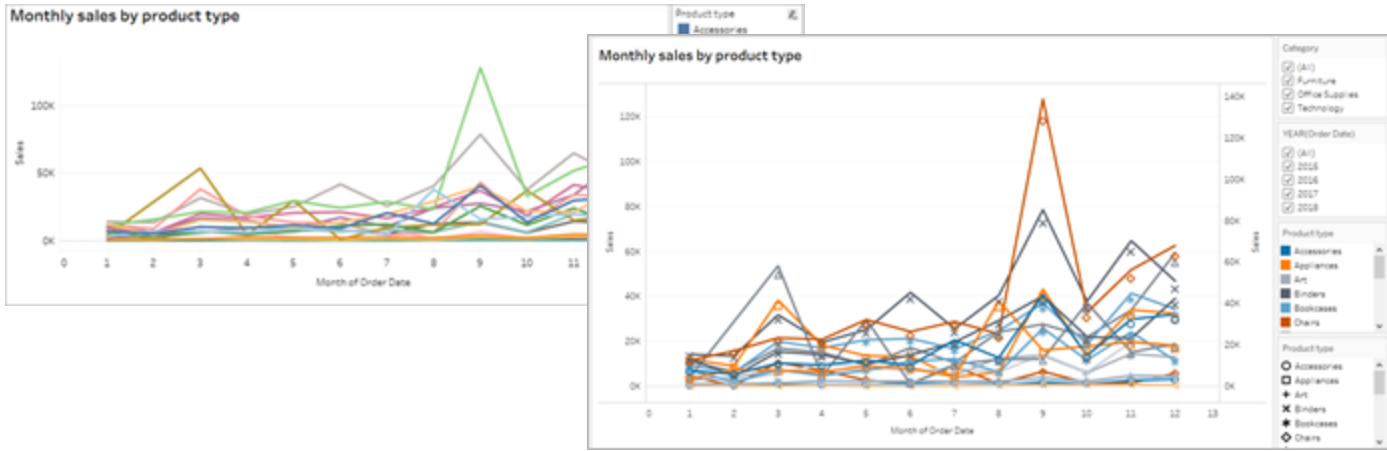

The chart is improved, but the line colors and shapes have started repeating after the 10th mark applied. This makes the view look busy and hard to make sense of, leading to cognitive overload. Let's fix it by adding filters and legends.

Use filters to reduce the number of marks in a view

Using filters helps to focus the number of marks in the view to only what you want users to see.

You can show the following filter modes to allow users to control what data is in the view. The filter modes that Tableau currently supports for WCAG conformance are:

- **Single Value (list):** a filter with radio buttons. Only one item can be selected at a time. Giving your users single-value filters is a great way to reduce the number of marks in the view.
- **Multiple Values (list):** a filter with a list of items (with check boxes) that can be selected at the same time. Multiple-value filters will allow more marks to be shown at the same time.

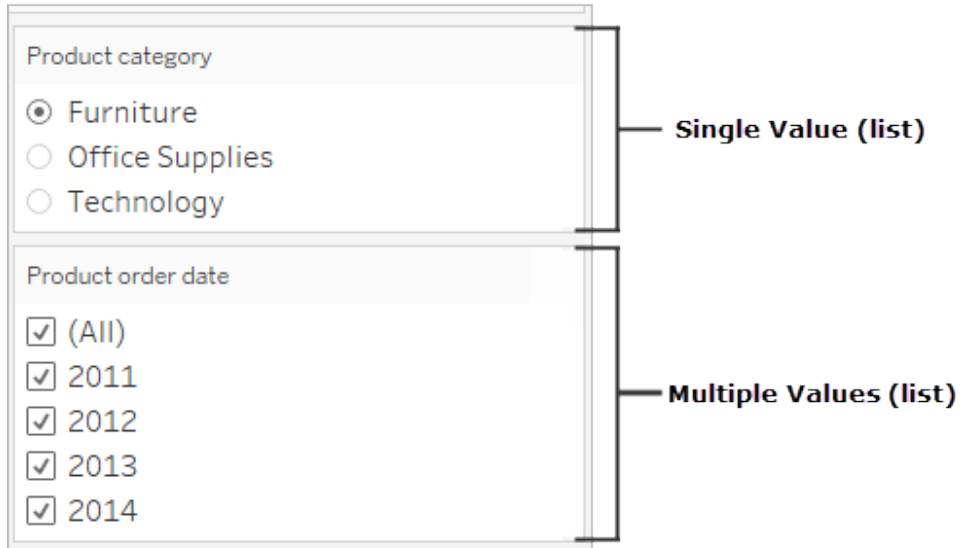

- **Single Value (drop-down)**: a filter with a dropdown list of items. Only one item can be selected at a time. Giving your users single-value filters is a great way to reduce the number of marks in the view.
- **Multiple Values (drop-down)**: a filter with a dropdown list of items that can be selected at the same time. Multiple-value filters will allow more marks to be shown at the same time.

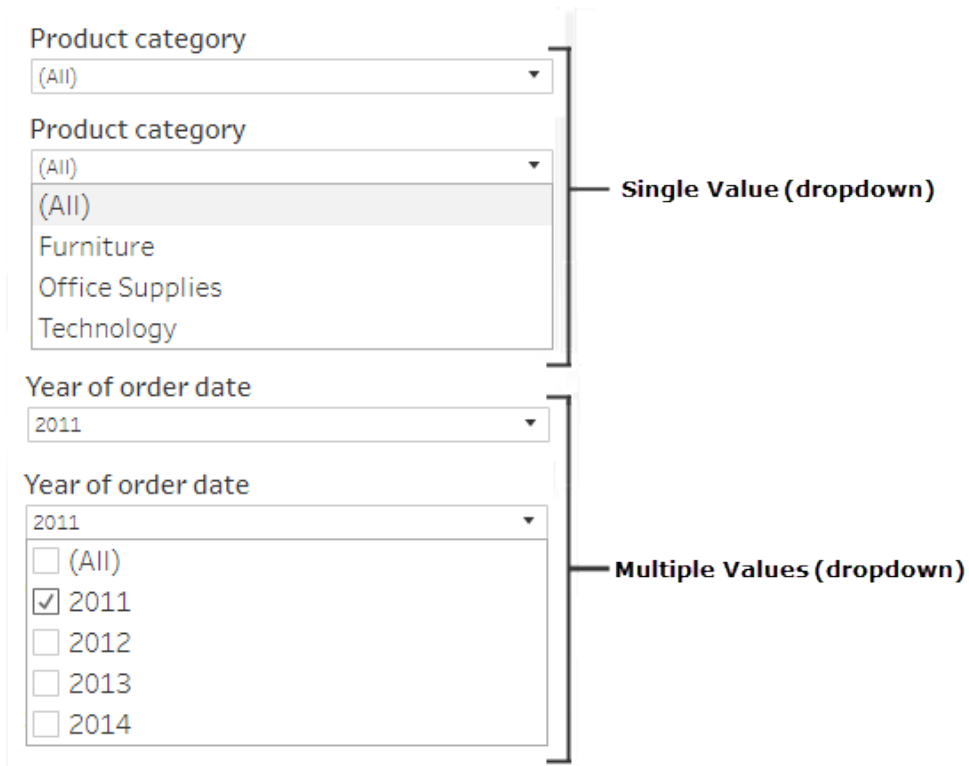

To show a filter, right-click the field you want to use as a filter, and then select **Show Filter**.

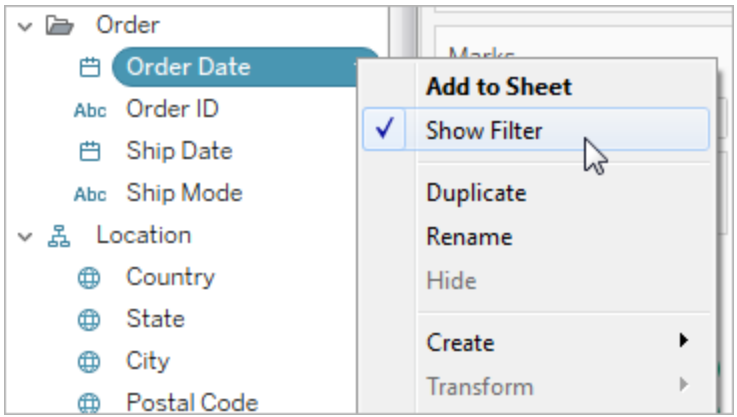

To select the filter mode, in the drop-down menu for a filter, select a **Single Value (list)**, **Single Value (dropdown)**, **Multiple Values (list)**, or **Multiple Values (dropdown)** filter.

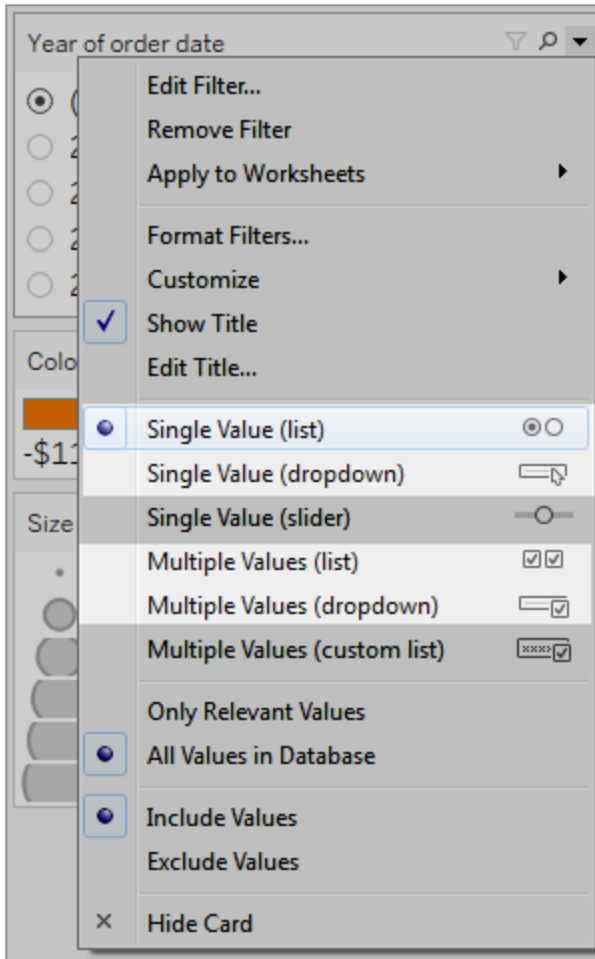

Because the line chart is a Single Value list, we can remove the **All** option from the filter. In the drop-down menu for the filter, select **Customize** and then clear the **Show "All" Value** option.

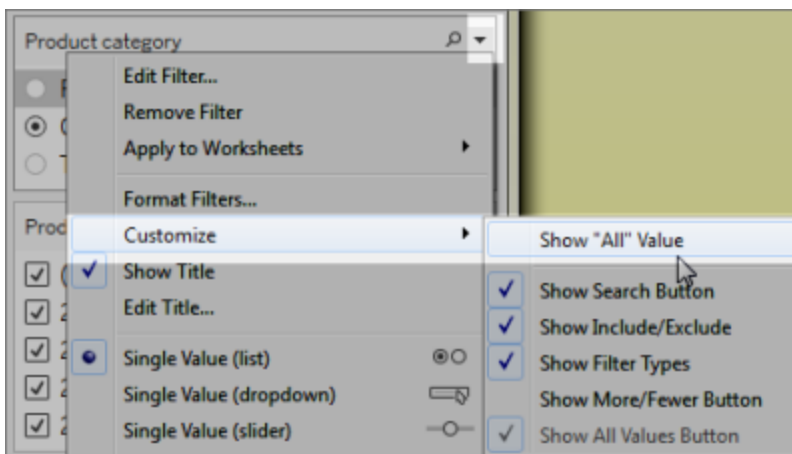

This reduces the level of marks in the view to prevent cognitive overload for dashboard consumers.

Less accessible - too many marks

More accessible - less marks in the view

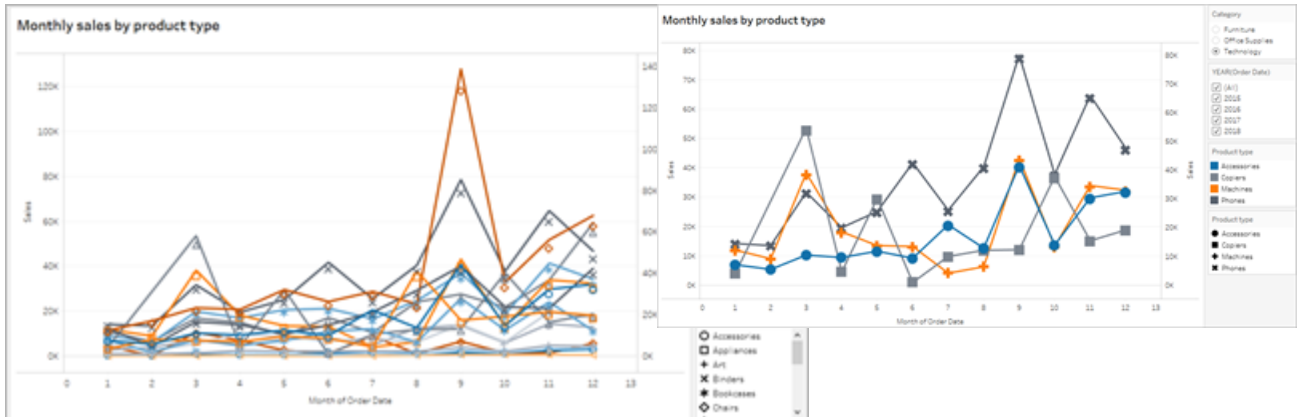

To learn more, see [Use filters to reduce the number of marks in a view.](#)

Another way to make the viz easier to consume is to

Add captions and legends

To add clarity for our users, we can add a **Text object** with a description of the dashboard and instructions about how to filter and use each view in the dashboard, including how to use the filters and categorical legends that we've added. To add a text object:

1. Grab Text from the Objects menu and drag it onto the dashboard.

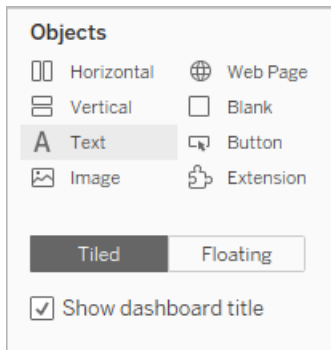

2. Use **Edit Text** window to add text that explains the dashboard's purpose and how to use it.

You can also add chart captions to the dashboard. The default caption text gives a summary of what is shown in the view, but you can add or edit this text to provide better context. To do this, click on a chart in the dashboard and select **Caption** from the **More Options** drop-down menu.

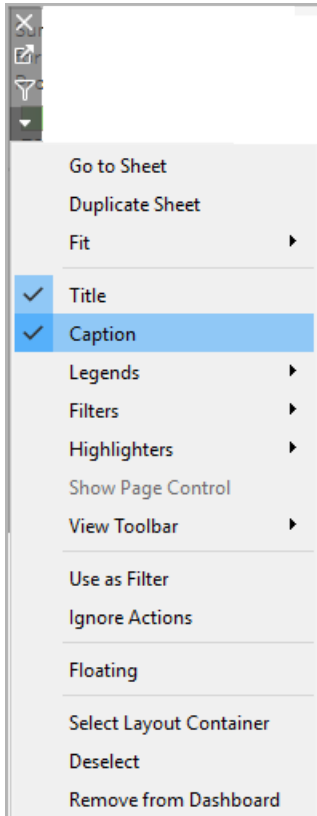

Last, we can update the titles of our legends to reference their associated charts and reduce the amount of redundant text that screen readers consume. To do this, double-click on the legend title, or right-click and select **Edit Title** to add or edit text in the **Edit Filter Title** window.

The result is a dashboard that includes an explanation of the dashboard and chart captions and eliminates redundant text for users.

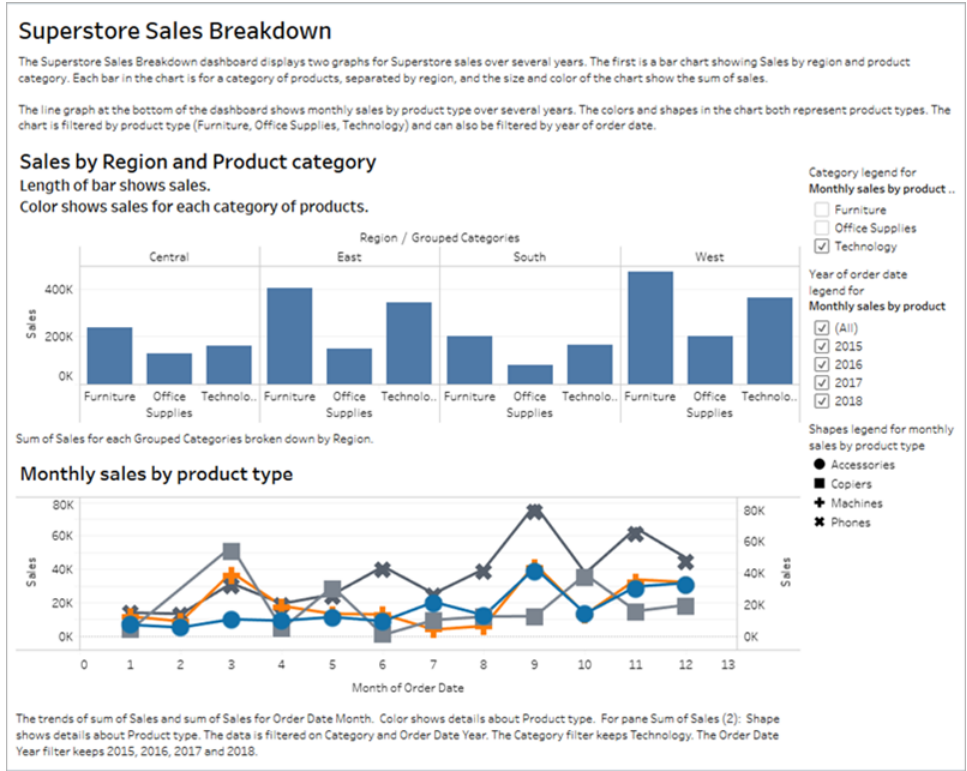

Publish and embed the dashboard

After you create your views, to make them WCAG-conformant, you must:

- Publish views to Tableau Server or Tableau Cloud, and then embed the view in a WCAG-compliant web page. For information about how to publish a view, see [Comprehensive Steps to Publish a Workbook](#) on page 3118.
- Web editing is not supported in WCAG-conformant views, so Web Edit permissions must be turned off in the published workbook.
- In the embedded views, hide the Custom Views, Subscriptions, and Alerts buttons in the toolbar.
- Make sure users have permissions to access to the embedded views and are able to view the underlying data in the View Data window.

For information about each of these steps, see [Publish and embed the view](#) in Author Views for Accessibility.

Manage Sheets in Dashboards and Stories

Hiding, showing, and navigating to sheets helps you more easily manage workbooks and design dashboards.

Hide and show sheets

To streamline the editing process for large workbooks, hide and show sheets as you work.

For Viz in Tooltip, see [Hide or show a Viz in Tooltip worksheet on page 1379](#).

What sheets can I hide?

While editing a workbook, you can hide any sheet contained in a dashboard or story. (That includes dashboard sheets in stories.)

Sheets that aren't in a dashboard or story are always visible while editing workbooks. However, you can hide any sheet in workbooks you publish to Tableau Cloud or Tableau Desktop. See [Comprehensive Steps to Publish a Workbook on page 3118](#).

Hide or unhide all sheets

To hide all of a dashboard or story's sheets, right-click (Windows) or Control-click (macOS) the dashboard's tab at the bottom of the screen, and select **Hide All Sheets**. You can later select **Unhide All Sheets** if needed.

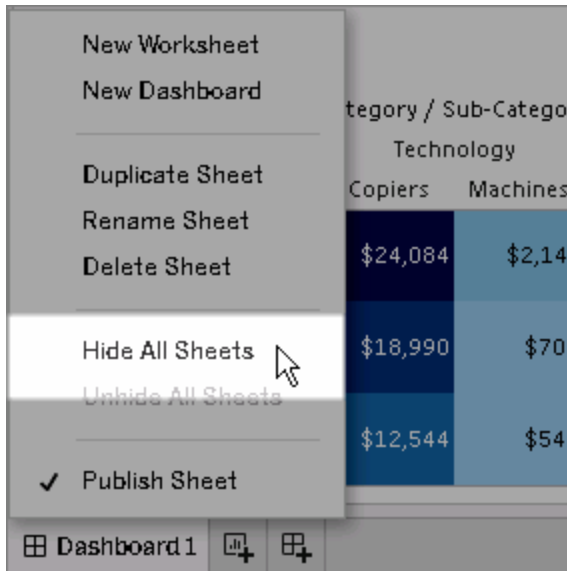

Hide an individual sheet

1. Look for the sheet in the tabs at the bottom of the screen. Or, if you're viewing a dashboard or story, look in the **Sheets** list at left:

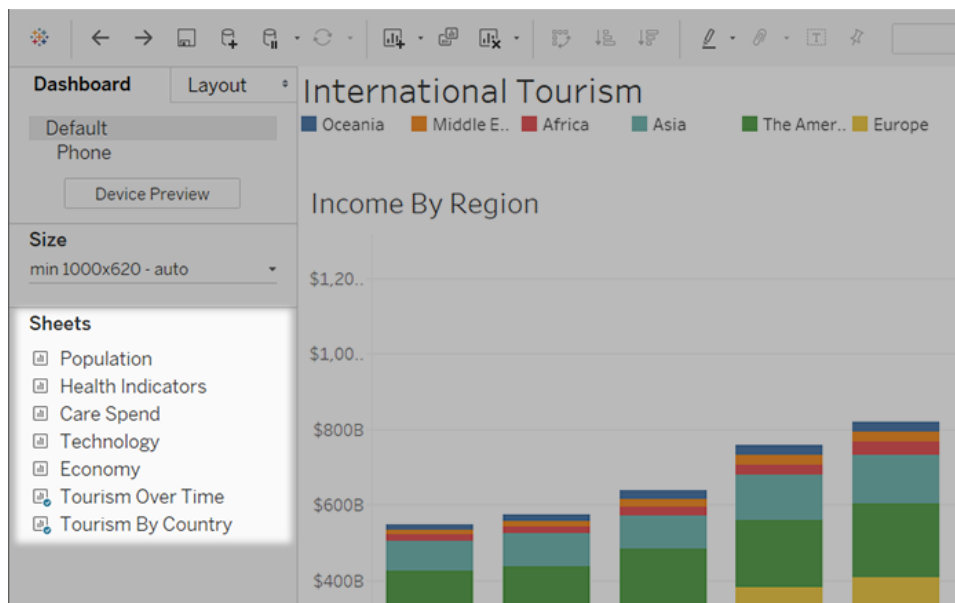

2. Right-click (Windows) or Control-click (macOS) the sheet name, and select **Hide Sheet**.

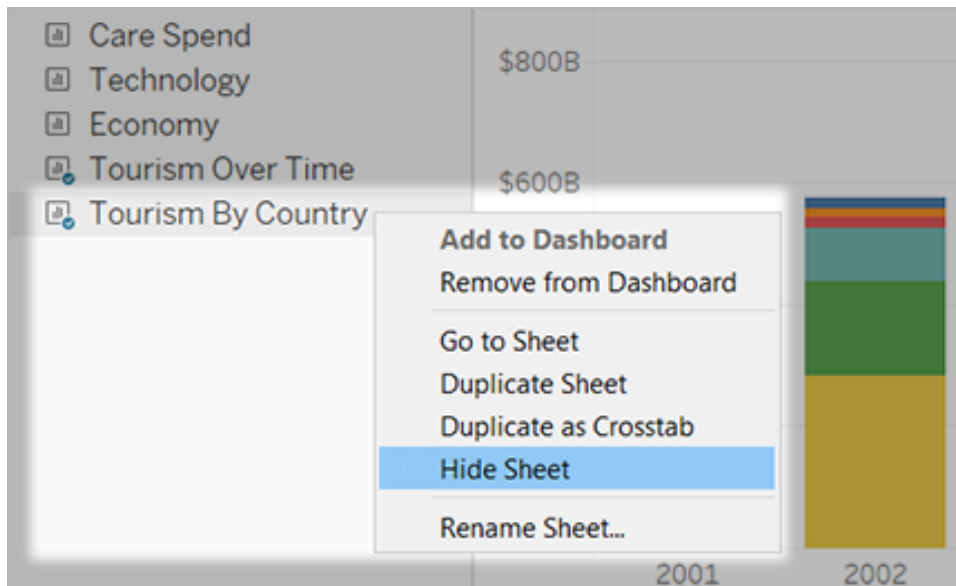

Note: From the sheets list to the left of a dashboard or story, you can hide only sheets used in that particular dashboard or story. You can identify these sheets by the blue checkmark on the sheet icon.

Unhide an individual sheet

1. At the bottom of the screen, click the tab for the dashboard or story that contains the sheet. You can identify dashboards and stories by grid and book icons, respectively.

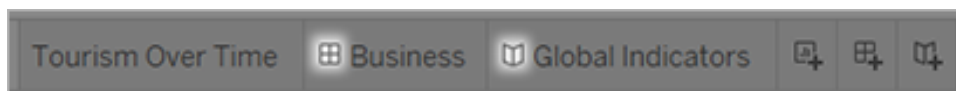

Note: If a story has a hidden dashboard that in turn has a hidden sheet, first go to the hidden dashboard from the story, and then to the hidden sheet from the dashboard.

2. In the list at left, right-click (Windows) or Control-click (macOS) the sheet, and clear the

Hide Sheet checkbox.

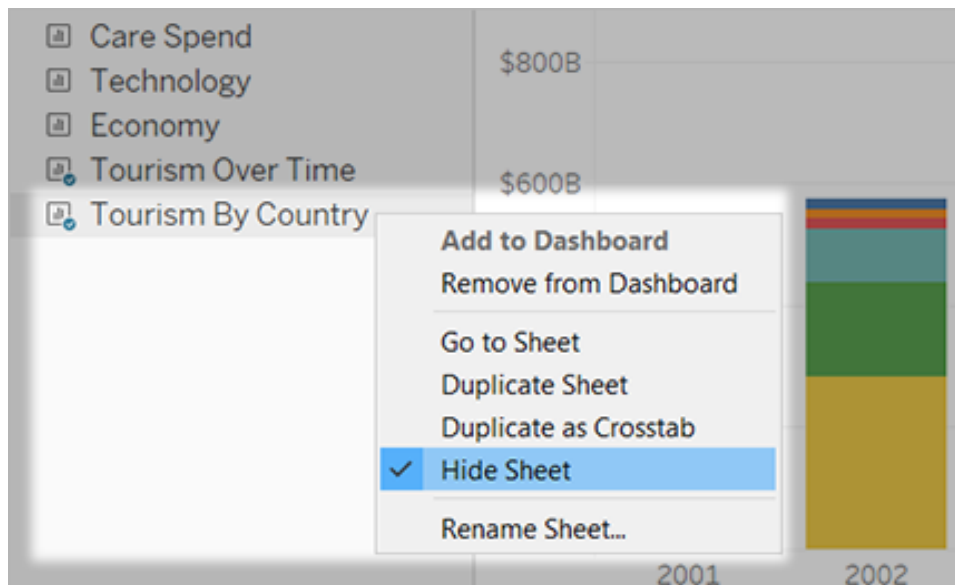

Navigate between sheets, dashboards, and stories

Tableau lets you quickly navigate back and forth between sheets and related dashboards and stories, helping you better optimize the design of each.

Go from a dashboard or story to a sheet it contains

Tip: If a sheet is hidden, this technique temporarily shows it so you can get a closer look at it. The sheet is hidden again when you switch to another sheet.

Do either of the following:

- On the dashboard itself, select the item that references the hidden sheet. Then click the drop-down arrow in the top left or right corner, and select **Go to Sheet**.

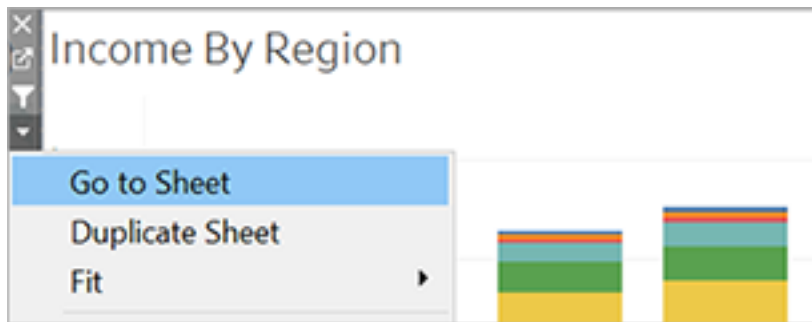

- In the **Sheets** list to the left of the dashboard, click the icon to the right of the sheet name.

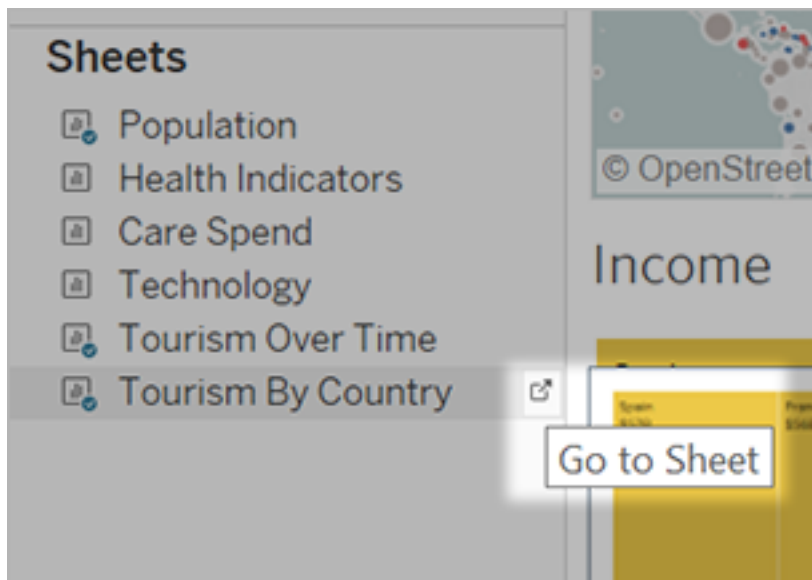

Go from a sheet to related dashboards and stories

To quickly go to dashboards and stories a sheet appears in, right-click the sheet tab and open the **Used in** menu.

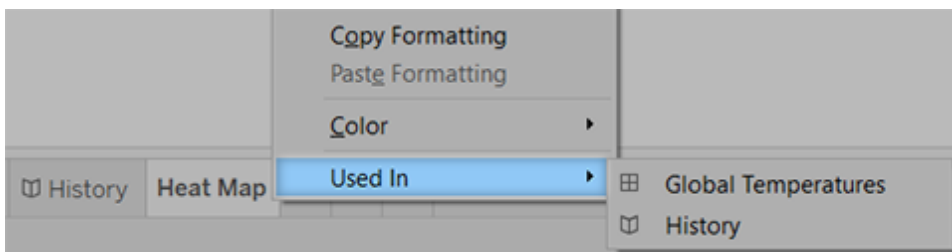

Use Dashboard Extensions

Extensions let you add unique features to dashboards or directly integrate them with applications outside Tableau. Adding extensions is easy; you incorporate them into dashboard layouts just like other dashboard objects.

Extensions expand dashboard functionality with the help of web applications created by third-party developers. If you're a developer and want to create your own extensions, see the [Tableau Extensions API documentation](#) on GitHub.

Note: Tableau administrators can turn off dashboard extensions for [Tableau Desktop](#), [Tableau Server](#), and [Tableau Cloud](#).

Add an extension to a dashboard

1. In a Tableau workbook, open a dashboard sheet.
2. From the **Objects** section, drag **Extension** to the dashboard.

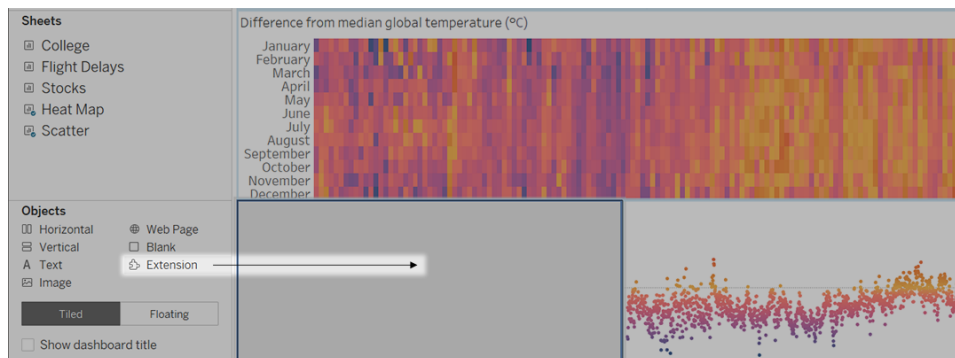

3. In the “Add an Extension” dialog box, do either of the following:
 - Search for and select an extension.
 - Click **Access Local Extensions**, and navigate to a .trex file you previously downloaded.
4. If prompted, allow or deny the dashboard extension access to data in the workbook. For more information, see [Data security, Network-enabled, and Sandboxed extensions on page 2829](#).

If you allow access, follow any on screen instructions for configuring the extension.

Note: If you're using Tableau Server or Tableau Cloud, Extension objects will appear blank in prints, PDFs, and images of dashboards (including images in subscription emails).

Configure a dashboard extension

Some dashboard extensions provide configuration options that let you customize features.

1. Select the extension in the dashboard, and from the drop-down menu in the upper-right corner, choose **Configure**.
2. Follow the on-screen instructions to configure the extension.

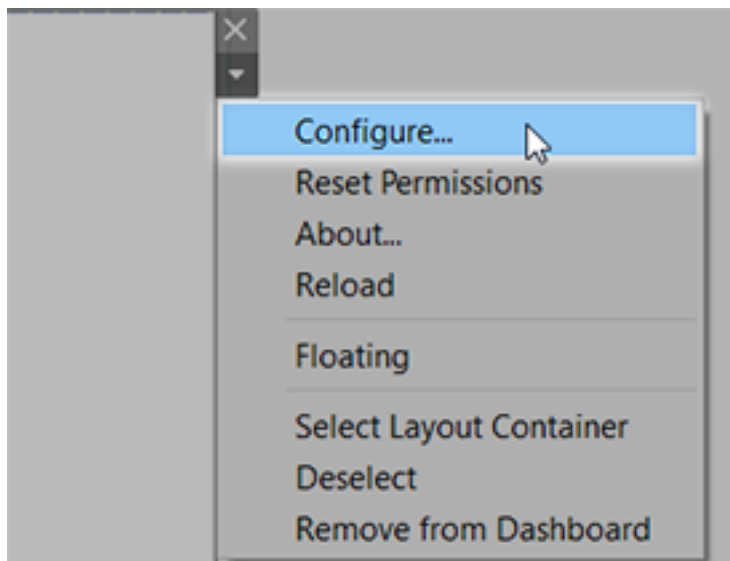

Reload a dashboard extension

If a dashboard extension becomes unresponsive, you might need to reload it, which is similar to refreshing a web page in a browser.

1. Select the extension in the dashboard, and from the drop-down menu in the upper-right corner, choose **Reload**.

The dashboard extension is refreshed and set to its original state.

2. If reloading the extension fails to return it to a useable state, try removing it from the dashboard and adding it again.

Data security, Network-enabled, and Sandboxed extensions

Dashboard extensions are web applications that come in two forms:

- *Network-enabled extensions* run on web servers located outside of your local network.
- *Sandboxed extensions* run in a protected environment without access to any other resource or service on the web.

Before adding a Network-enabled extension or viewing a dashboard with one, be certain that you trust the website that hosts it. By default, dashboard extensions use the HTTPS protocol, which guarantees an encrypted channel for sending and receiving data, and ensures some privacy and security.

For more information about data security when using dashboard extensions, see [Extension Security - Best Practices for Deployment](#).

Allow or deny data access to a Network-enabled extension

Depending on how an extension is designed, it can access either visible data in a view, or full underlying data, table and field names from data sources, and information about data source connections. When you add an extension, or view a dashboard with one, you're given an opportunity to allow or deny the extension to run and access this data.

If you're viewing a dashboard with an extension that requires full data access, and that access has been denied, a message appears in place of the extension. If you trust the extension and want to use it, you can reset permissions and allow the extension to run.

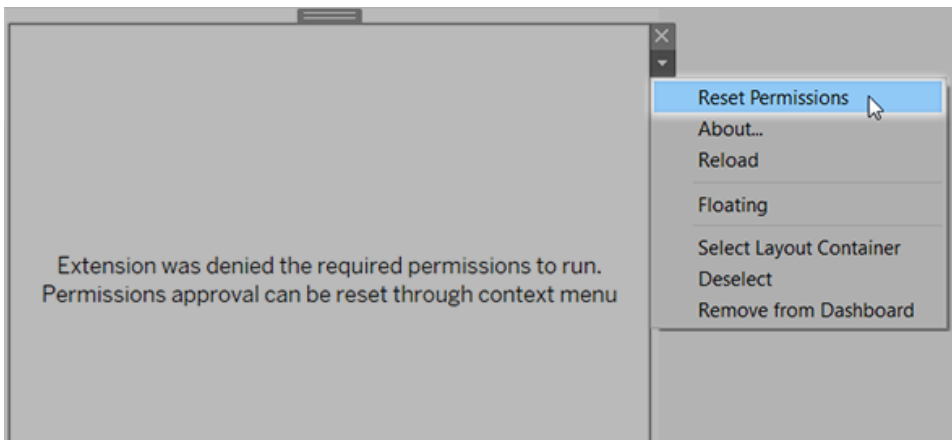

1. Select the extension in the dashboard, and from the drop-down menu in the upper-right corner, choose **Reset Permissions**.

2. Click either **Allow** to let the extension run and access data, or **Deny** to prevent the extension from running.

Ensure that JavaScript is enabled in Tableau Desktop

Dashboard extensions interact with data using the Tableau Extensions API library, a JavaScript library. If you want to use extensions, be sure that JavaScript is enabled in the dashboard security settings:

Choose **Help > Settings and Performance > Set Dashboard Web View Security > Enable JavaScript**.

Ensure that extensions run on Tableau Cloud or Tableau Server

You can add extensions to workbooks you publish from Tableau Desktop or directly in the web-authoring mode of Tableau Cloud and Tableau Server. A Tableau administrator must allow extensions to run on a site and add Network-enabled extensions to a safe list. Administrators should only allow extensions that you have tested and trust.

If you want to use a dashboard extension on Tableau Cloud or Tableau Server, direct your administrator to [Manage Dashboard Extensions in Tableau Cloud](#) or [Manage Dashboard Extensions in Tableau Server](#).

Supported web browsers for Sandboxed extensions

Sandboxed extensions run in all browsers supported [Tableau Server](#) and [Tableau Cloud](#) except Internet Explorer 11.

Supported versions of Tableau Server for Sandboxed extensions

You can use Sandboxed extensions in Tableau Server 2019.4 and later.

Get support for dashboard extensions

To get help for an extension, you'll need to contact the developer or company who created it.

1. Select the extension in the dashboard, and from the drop-down menu in the upper-right corner, choose **About**.
2. Click **Get Support** to go to the support page of the extension developer.

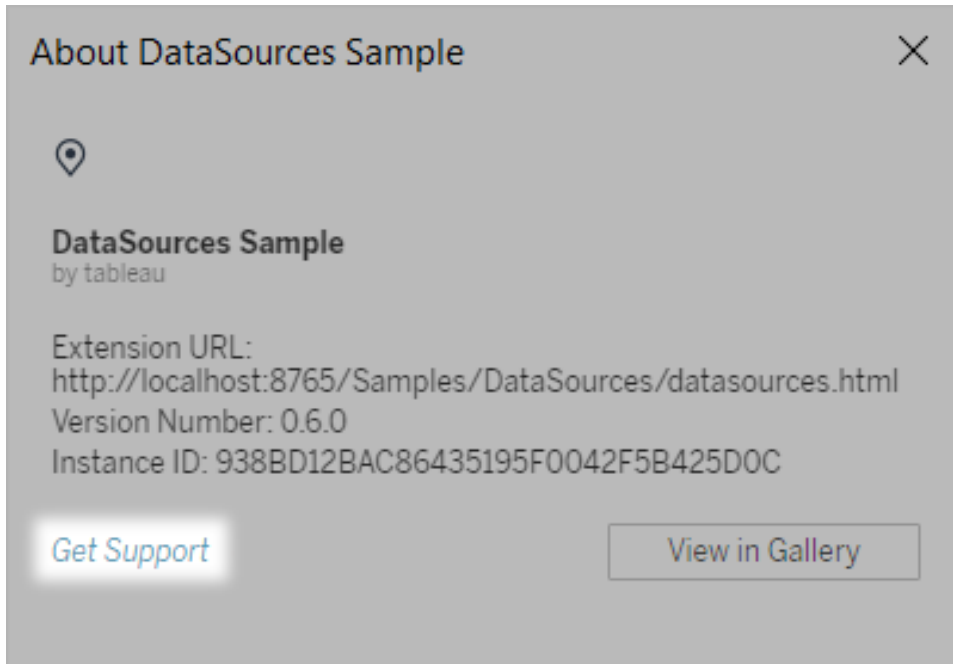

Note: Tableau doesn't provide support for extensions or for other programs that interface with the Extensions API. However, you can submit questions and ask for help in the [Tableau developer community](#).

Stories

In Tableau, a **story** is a sequence of visualizations that work together to convey information. You can create stories to tell a data narrative, provide context, demonstrate how decisions relate to outcomes, or to simply make a compelling case.

A story is a sheet, so the methods you use to create, name, and manage worksheets and dashboards also apply to stories (for more details, see [Workbooks and Sheets on page 95](#)). At the same time, a story is also a collection of sheets, arranged in a sequence. Each individual sheet in a story is called a **story point**.

When you share a story—for example, by publishing a workbook to Tableau Public, Tableau Server, or Tableau Cloud—users can interact with the story to reveal new findings or ask new questions of the data.

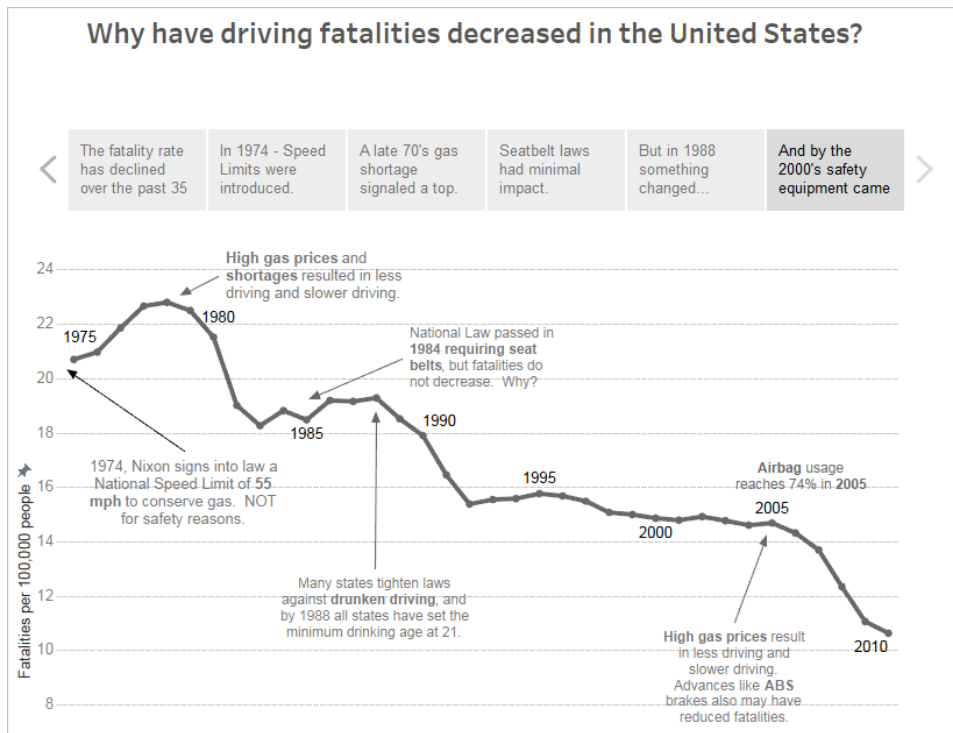

The Story Workspace

As you work on a story, you can use the following controls, elements, and features.

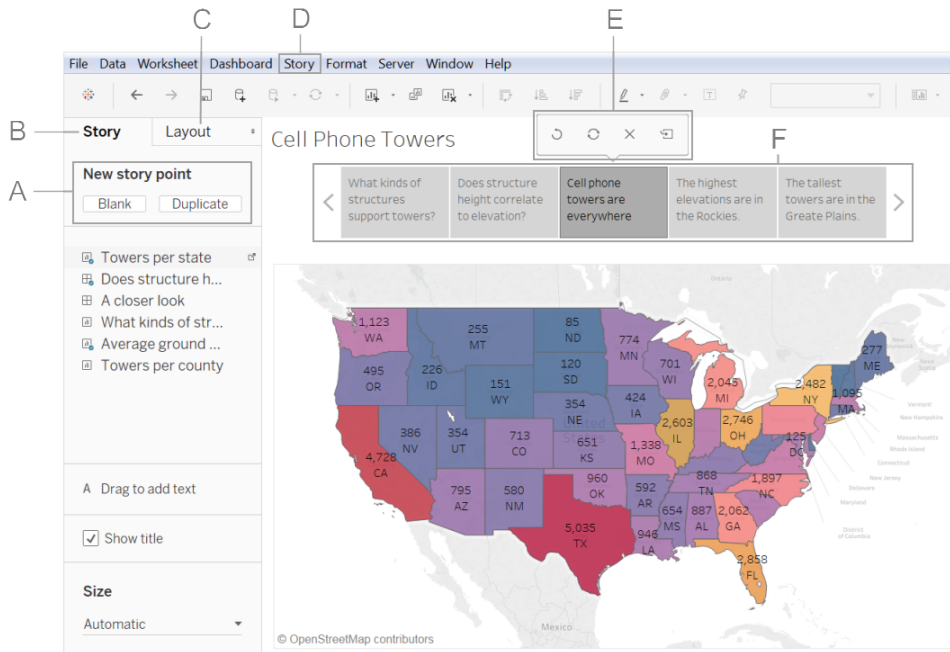

A. Options for adding a new story point: Choose **Blank** to add a new point or **Duplicate** to use the current story point as the starting place for your next point.

B. The Story pane: Use this pane to drag dashboards, sheets, and text descriptions to your story sheet. This is also where you set the size of your story and display or hide the title.

C. The Layout pane: This is where you choose your navigator style and display or hide the forward and back arrows.

D. The Story menu: Use this menu in Tableau Desktop to format the story or copy or export the current story point as an image. You can also clear the entire story here or show or hide the navigator and story title.

E. The Story toolbar: This toolbar appears when you mouse-over the navigator area. Use it to revert changes, apply updates to a story point, delete a story point, or create a new story point out of the current, customized one.

F. The navigator: The navigator allows you to edit and organize your story points. It's also how your audience will step through your story. To change the style of the navigator, use the Layout pane.

For more information on these options, see [Create a Story](#) on page 2840.

Best Practices for Telling Great Stories

A good data story brings data and facts to life. Use this article for tips on best practices to use with Tableau's story points feature.

What's your story's purpose?

Before you start to build your story, take some time to think about the purpose of your story and what you want your viewers' journey to be. Is it a call to action, is it a simple narrative, or are you presenting a case?

If you're presenting a case, decide whether you want to present data points that lead up to a conclusion at the end, or start with a conclusion then show the supporting data points. The latter approach works well for a busy audience.

Finally, sketching out your story first on paper or a whiteboard can help you quickly identify problems with your sequence.

The seven types of data stories

When you use the story feature, you are building a sequence of points. Each point can contain a view, dashboard, or even just text. Some stories show the same view throughout the story, with text annotations and different filters applied to different points to support the narrative arc.

The following table describes seven different data story approaches you can take and provides an example for each. Each data story type is also illustrated in the [Data Story Examples Workbook](#) on Tableau Public. A single story can also use more than one approach—see [Example - A Story That Examines a Trend](#) on page 2848.

Data Story Type	Description
 Change Over Time	<p>What it does: Uses a chronology to illustrate a trend.</p> <p>Discussions it starts: Why did this happen, or why does it keep happening? What can we do prevent or make this happen?</p>

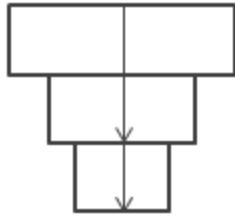

Drill Down

What it does: Sets context so that your audience better understands what's going on in a particular category.

Discussions it starts: Why is this person, place or thing different? How does the performance of this person, place, or thing compare?

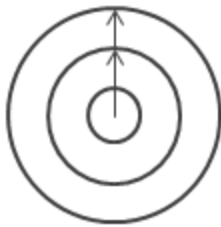

Zoom Out

What it does: Describes how something your audience cares about relates to the bigger picture.

Discussion it starts: How does something you care about compare to the bigger picture? What effect does one area have on the bigger picture?



Contrast

What it does: Shows how two or more subjects differ.

Discussions it starts: Why are these items different? How can we make A perform like B? Which area should we focus on and which area is doing fine?

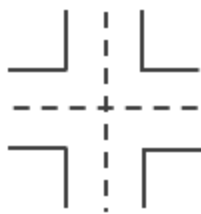

Intersections

What it does: Highlights important shifts when one category overtakes another.

Discussions it starts: What causes these shifts? Are these shifts good or bad? How do these shifts affect other aspects of our plan?

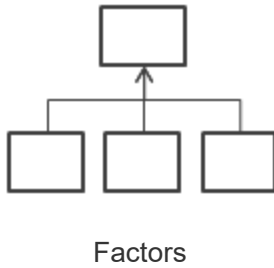

What it does: Explains a subject by dividing it into types or categories.

Discussions it starts: Is there a particular category we should focus on more? How much do these items affect the metric we care about?



What it does: Shows anomalies or where things are exceptionally different.

Discussions it starts: Why is this item different?

Keep it simple

A common error is trying to cram too many views and dashboards into a single story. The result is too many points for your viewers to take in.

The clarity of each story point is also important. Take a step back and consider your story from the perspective of someone who's never seen it. Every element should serve a purpose. If captions, titles, legends, or grid lines aren't necessary, get rid of them!

Before

After

A Case Study on Tables

← Sales are strong, but profits are weak in some areas of the
Here's our product profitability by category, notice
Look at the map again with just tables selected, interesting
Which profit

Least Profitable Tables

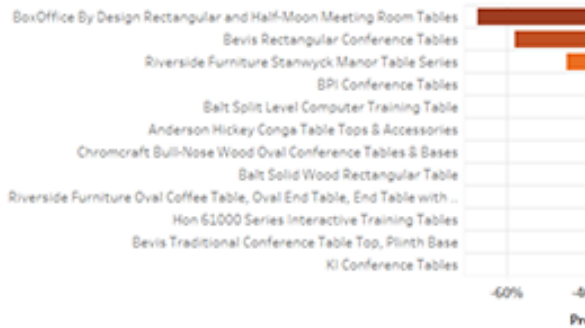

Most Profitable Tables



A Case Study on Tables

← Sales are strong, but profits are weak in some states
Here's our profitability by product
Here are profits for just tables
Which are our most and least profitable tables?

Least Profitable Tables

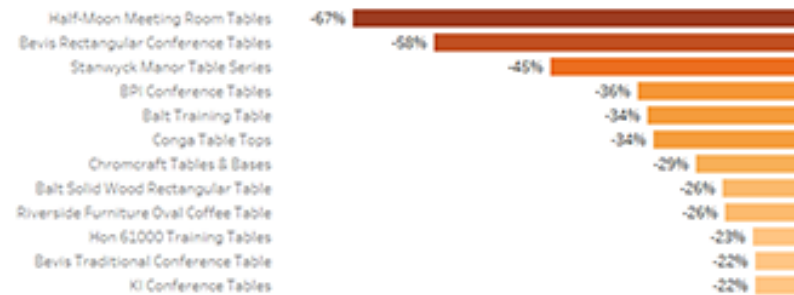

Most Profitable Tables

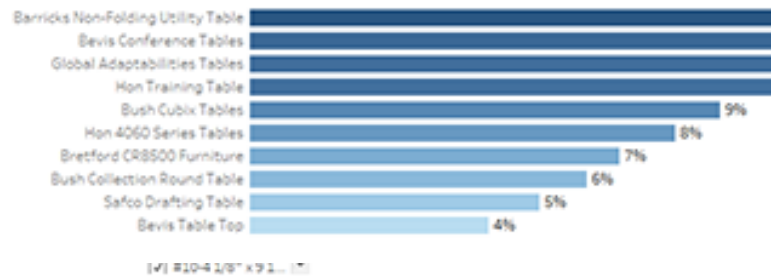

Use 'Fit to' in your dashboards

Dashboards are a common ingredient in Tableau stories. For dashboards that you plan to include in your story, you can use the **Fit to** option under **Size** on the Dashboard pane. It will resize your dashboard so that it's the right size for the story you're creating.

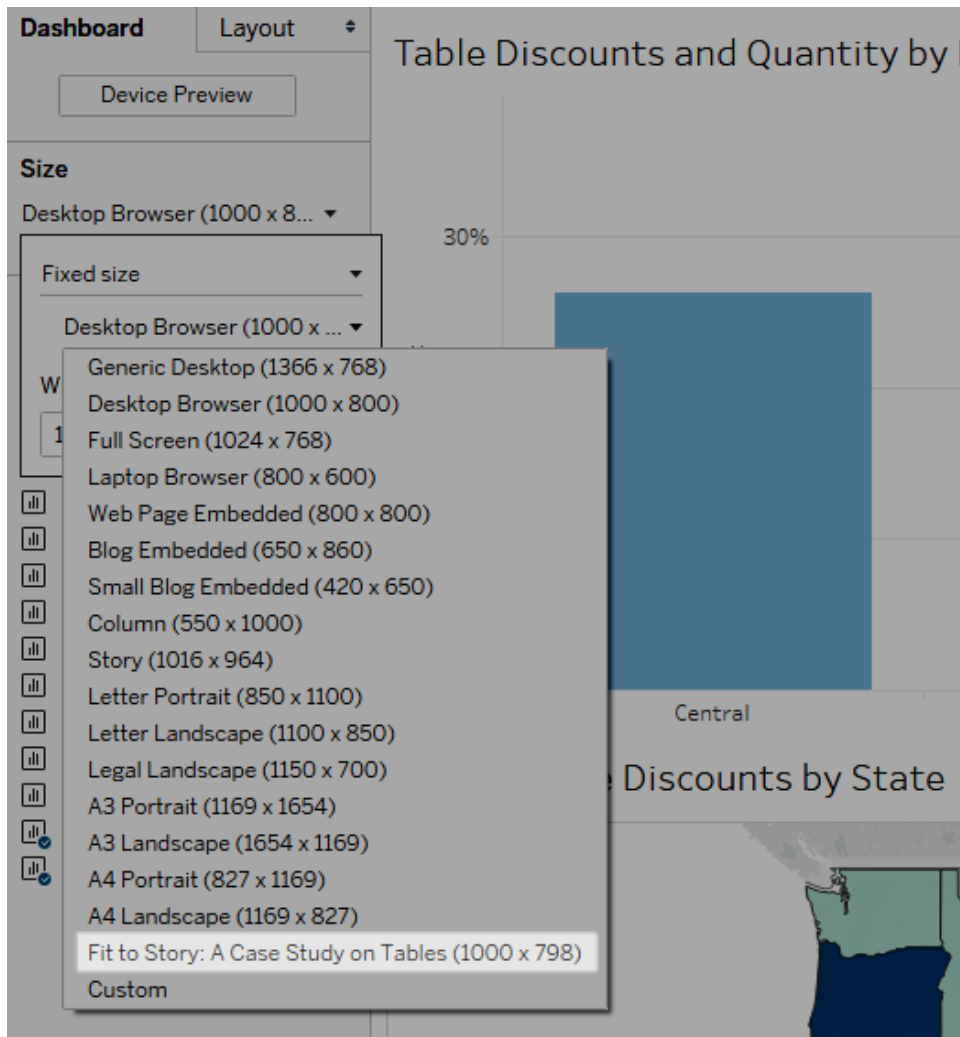

Plan for fast load times

The most wonderful story in the world won't have much impact if it takes too long to load once it's published. People find long waits frustrating.

Filtering is a common culprit for slow load times. Although filters are effective in restricting the amount of data being analyzed, they also impact query performance. For example, **Exclude** filters tend to be slower than **Keep Only** filters. This is because **Exclude** filters load all of the data for a dimension instead of just what you want to keep. Knowing [Tableau's Order of Operations on page 161](#) can also shave time off your load times.

Some of the most critical performance decisions you make as an author begin before you even create your first view or story, in the data preparation stage. Take a moment to familiarize yourself with the data you're working with. See [Know Your Data at the Database Level on](#)

page 3058 and [Test Your Data and Use Extracts](#) on page 3059 in the Tableau Desktop online help for tips on what to look for and smart ways to work with your data.

Create a Story

Use stories to make your case more compelling by showing how facts are connected, and how decisions relate to outcomes. You can then publish your story to the web, or present it to an audience.

Each story point can be based on a different view or dashboard, or the entire story can be based on the same visualization seen at different stages, with different filters and annotations.

Create a story point

1. Click the **New Story** tab.



Tableau opens a new story as your starting point:



2. In the lower-left corner of the screen, choose a size for your story. Choose from one of the predefined sizes, or set a custom size, in pixels:

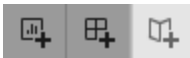
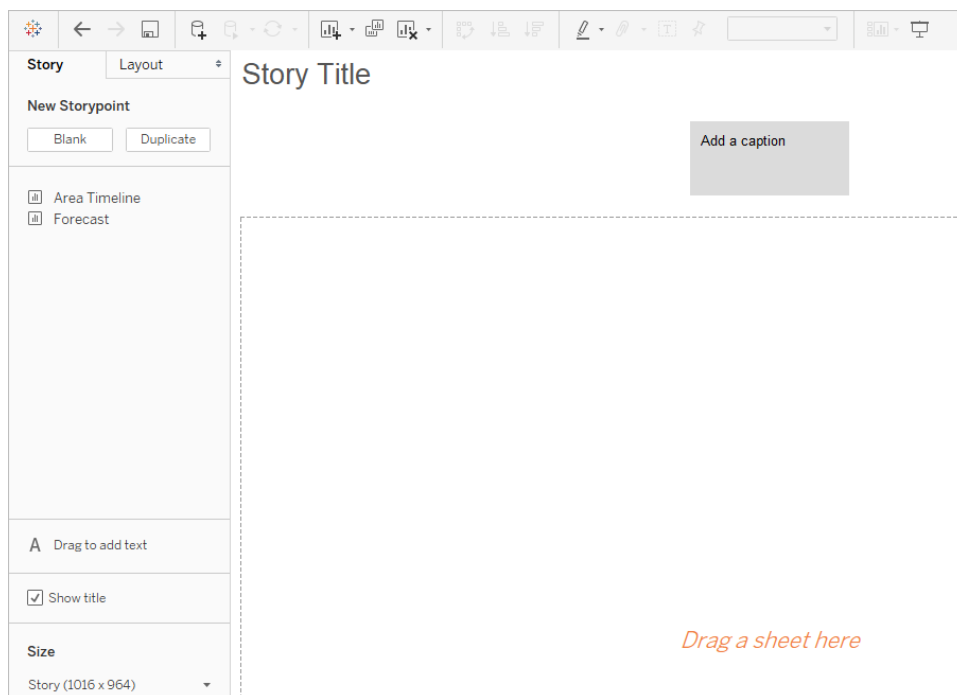
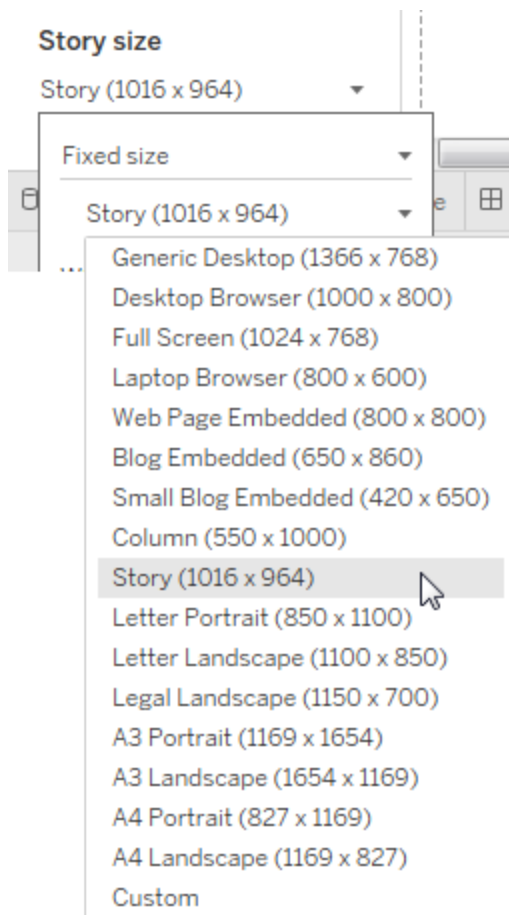

Note: Choose the size your story will be viewed at, not the size you're authoring in.

3. By default, your story gets its title from the sheet name. To edit it, right-click the sheet tab, and choose **Rename Sheet**.

If you're using Tableau Desktop, you can also rename a story by double-clicking the title.

4. To start building your story, double-click a sheet on the left to add it to a story point.

In Tableau Desktop, you can also drag sheets into your story point.

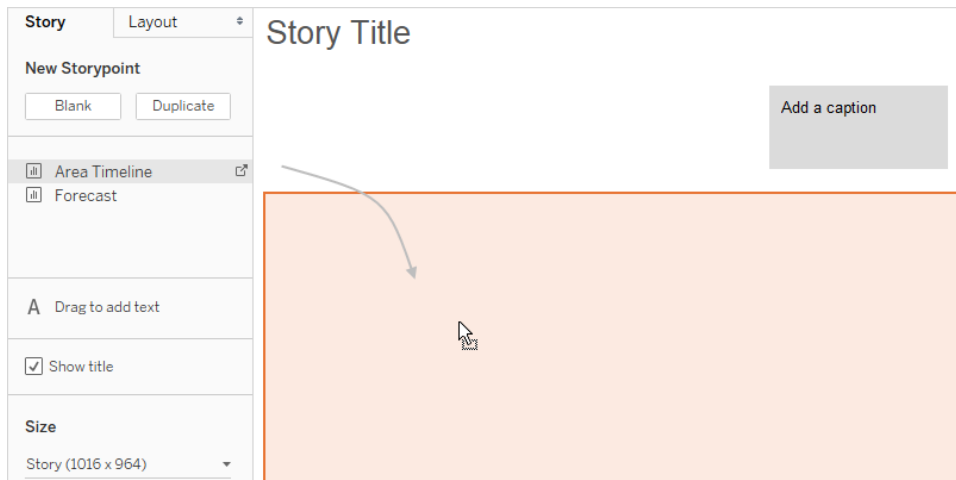

When you add a sheet to a story point, that sheet remains connected to the original sheet. If you modify the original sheet, your changes will automatically be reflected on the story points that use it.

If you are using Tableau Cloud to author on the web and the original sheet has **Pause Auto Updates** enabled, the story sheet will be blank until auto-updates are resumed.

5. Click **Add a caption** to summarize the story point.

In Tableau Desktop, you can highlight a key takeaway for your viewers by dragging a text object to the story worksheet and typing a comment.

6. To further highlight the main idea of this story point, you can change a filter or sort on a field in the view. Then save your changes by clicking **Update** on the story toolbar above the navigator box:

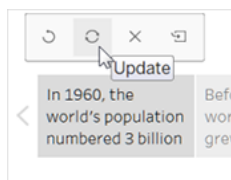

7. Add another story point by doing one of the following:
 - Click **Blank** to use a fresh sheet for the next story point.

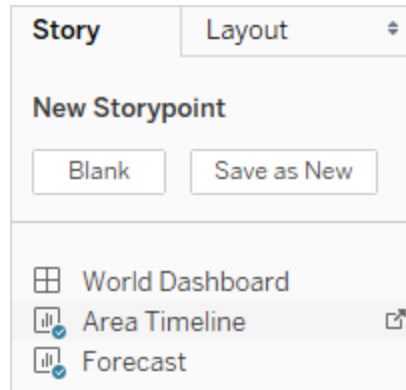

- Start customizing a story point and click **Save as New** on the toolbar above the navigator box.

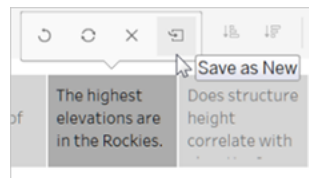

- Click **Duplicate** to use the current story point as the basis for a new one.

Explore layout options

You can refine the look of your story using the options on the **Layout** tab.

1. Click the **Layout** tab.
2. Choose a navigator style that best suits your story, and show or hide the next and previous arrows.



Format a story

Resize captions (Tableau Desktop only)

Sometimes the text in one or more of your captions is too long to fit inside the height of the navigator. In this case, you can re-size the captions vertically and horizontally.

1. In the navigator, select a caption.
2. Drag the border left or right to resize the caption horizontally, down to resize vertically, or select a corner and drag diagonally to resize the caption both horizontally and vertically.

All captions in the navigator update to the new size.

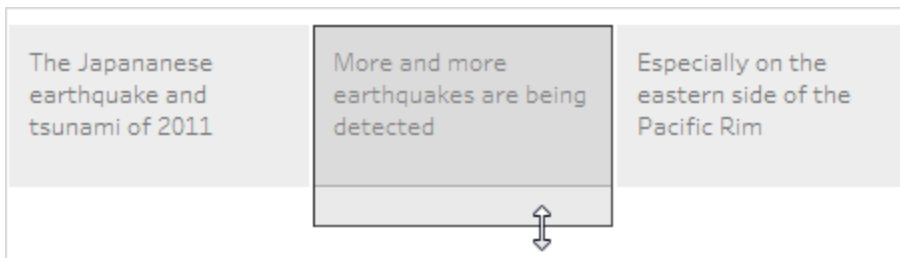

When you resize a caption, you can only select the left, right, or bottom border of the caption.

Fit a dashboard to a story

You can fit a dashboard to the exact size of a story. For example, if your story is exactly 800 by 600 pixels, you can shrink or expand a dashboard to fit inside that space.

Click the **Size** drop-down menu and select the story you want the dashboard to fit inside.

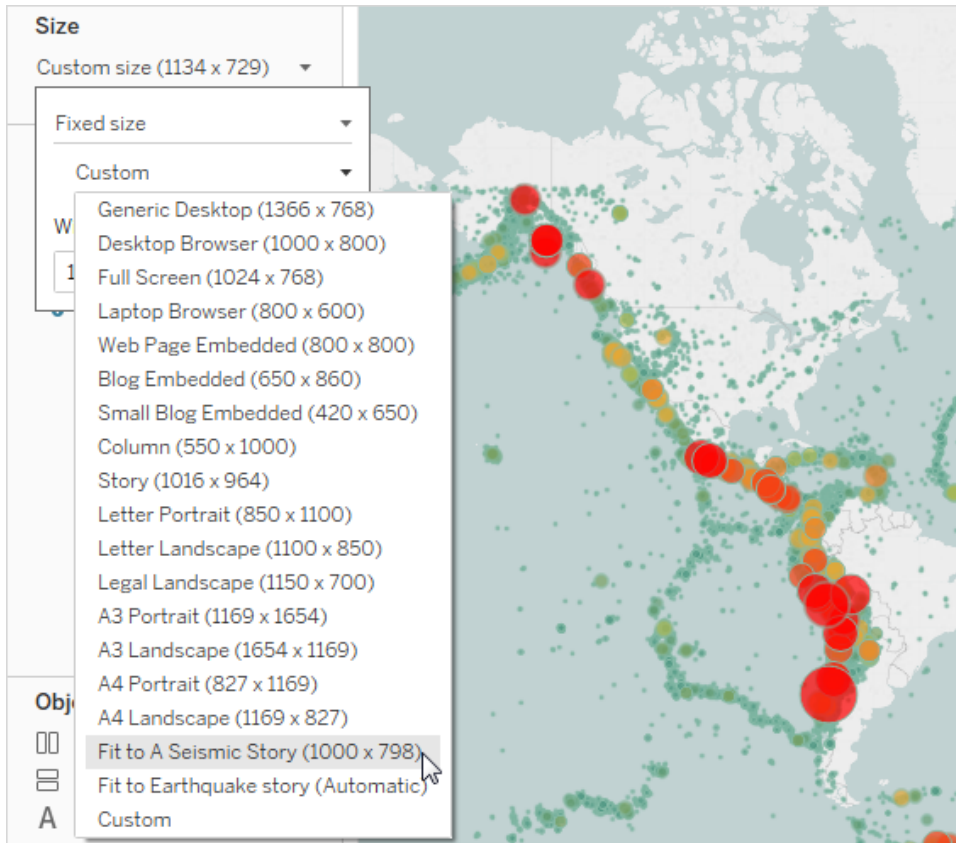

•

Format a story's shading, title, and text objects (Tableau Desktop only)

To open the **Format Story** pane, select **Format > Story**.

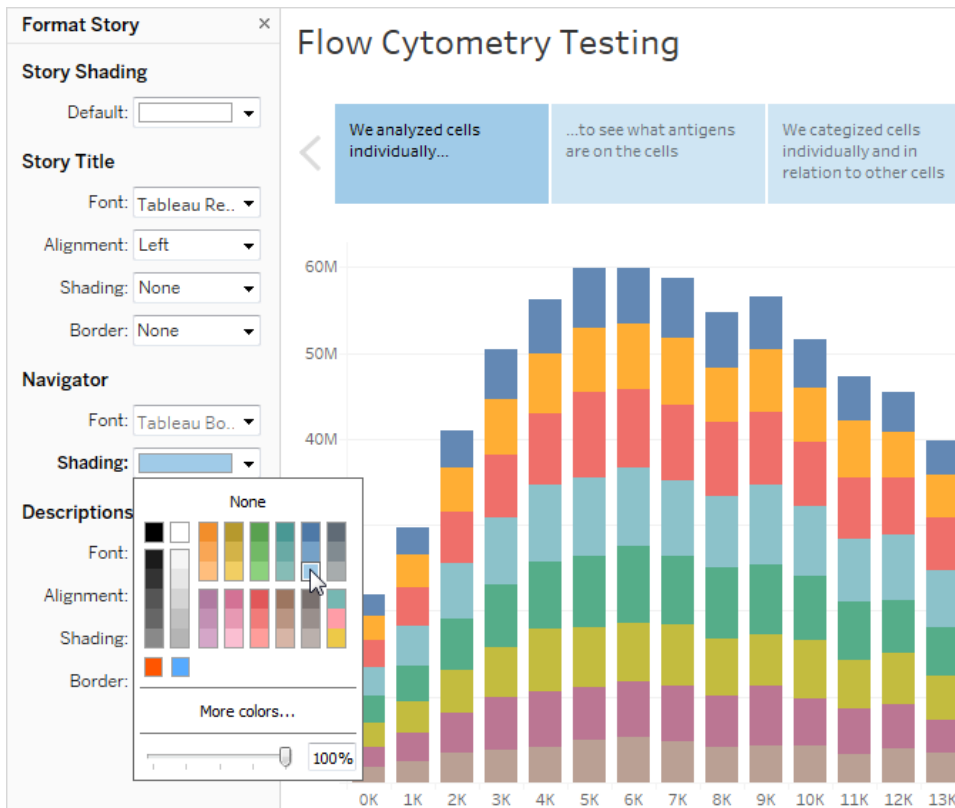

Clear all formatting (Tableau Desktop only)

- To reset a story to its default format settings, click the **Clear** button at the bottom of the **Format Story** pane.
- To clear a single format setting, right-click (Windows) or control-click (macOS) the format setting you want to undo in the **Format Story** pane. Then select **Clear**.

For example, if you want to clear the alignment of the story title, right-click (control-click on

Mac) **Alignment** in the **Title** section, and then select **Clear**.

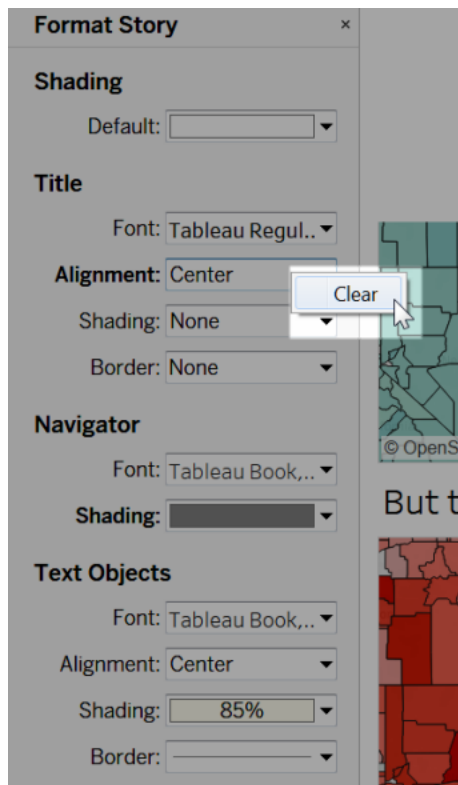

Delete a story point

Click the X in the toolbar above the point's caption:

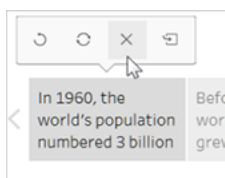

Present your story

1. In Tableau Desktop, click the **Presentation Mode** button  on the toolbar. Or, **publish the story** to Tableau Cloud or Tableau Server, and click the **Full Screen** button in the upper-right corner of the browser.

2. To step through your story, click the arrow to the right of the story points. Or, in Tableau Desktop, use the arrow keys on your keyboard.
3. To exit Presentation or Full Screen mode, press **Esc**.

Example - A Story That Examines a Trend

The example in this article walks you through building a story about earthquake trends over time.

The story feature in Tableau is a great way to showcase this type of analysis because it has a step-by-step format which lets you move your audience through time.

Rather than showing you how to create all the views and dashboards from scratch, this example starts from an existing workbook. What you'll do is pull the story together. To follow along and access the pre-built views and dashboards, download the following workbook from Tableau Public: [An Earthquake Trend Story](#).

Frame the story

A successful story is well-framed, meaning its purpose is clear. In this example, the story's purpose is to answer the following question: Are big earthquakes becoming more common?

There are several approaches you could take—see [Best Practices for Telling Great Stories on page 2835](#) for a list—but the one used here as an overall approach is Change over Time, because it works especially well for answering questions about trends. As you build the story you'll notice that other data story types, such as Drill Down and Outliers, are blended in to support the overall approach.

Build the story

Create a story worksheet

1. Use Tableau Desktop to open the Earthquake Trend Story workbook that you downloaded.

If you also have Tableau Server or Tableau Cloud and you want to do your authoring on the web instead of in Tableau Desktop, publish the workbook to your Tableau server, click **Workbooks**, select the workbook, then under **Actions** choose **Edit Workbook**.

Once you open the workbook, you'll see that it has three dashboards. You'll be using those dashboards to build your story. The workbook also has a finished version of the story.

Tip: To see the individual views that are in a dashboard, right-click the dashboard's tab and select **Unhide all Sheets**.

2. Click the **New Story** tab.



Tableau opens a new worksheet as your starting point.

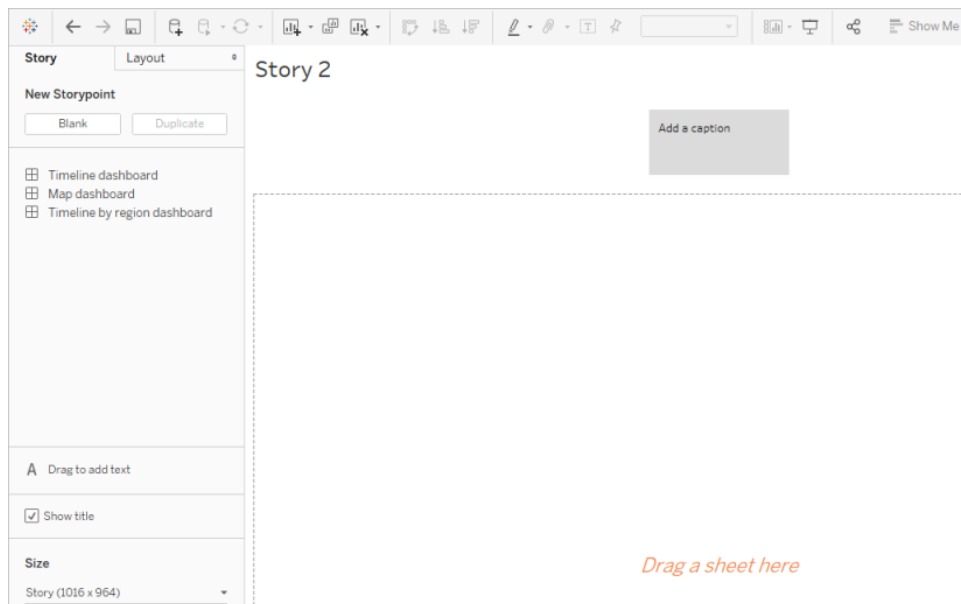

3. Right-click the **Story 2** tab, choose **Rename Sheet**, and type **Earthquake story** as the worksheet name.

State the question

Story titles are in view at all times and they're a handy way to keep your story's purpose front and center. By default, Tableau uses the worksheet name as the story title. In Tableau Desktop you can override that by doing the following:

1. Double-click the title.
2. In the Edit Title dialog box, replace **<Sheet Name>** with the following:

Are big earthquakes on the rise?

3. Click **OK**.

If you're authoring in Tableau Server or Tableau Cloud, the story tab is the only place where you can change the title.

Start big

To help orient your audience, the first story point you create will show the broadest possible viewpoint—all earthquakes, across the entire planet.

1. On the Story pane, double-click **Map dashboard** to place it on the story sheet. If you're using Tableau Desktop, you can also use drag-and-drop to add views and dashboards to a story sheet.

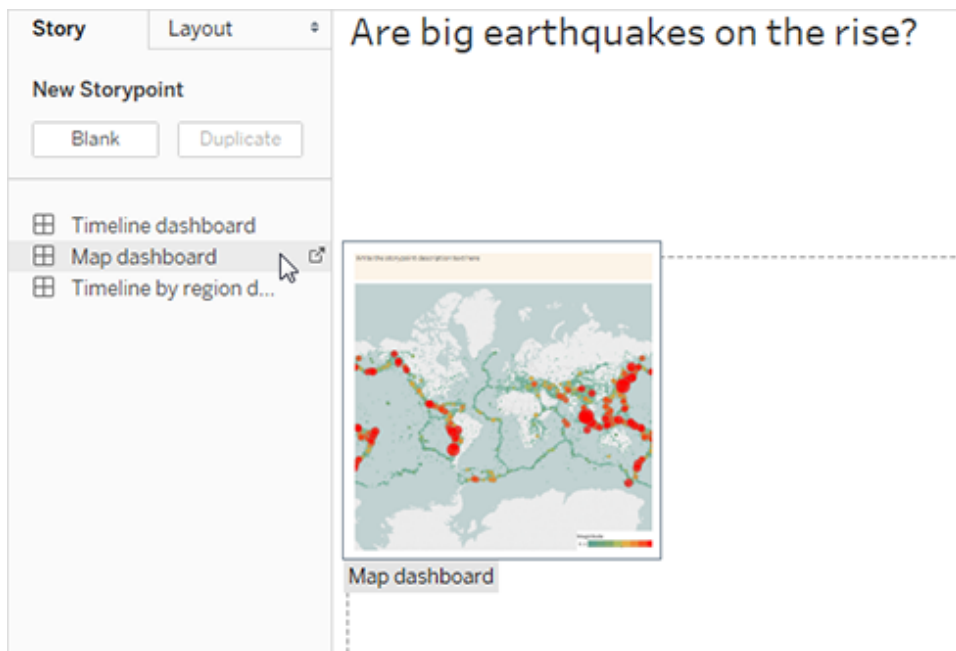

Notice how there's a horizontal scroll bar and the legend isn't fully displayed.

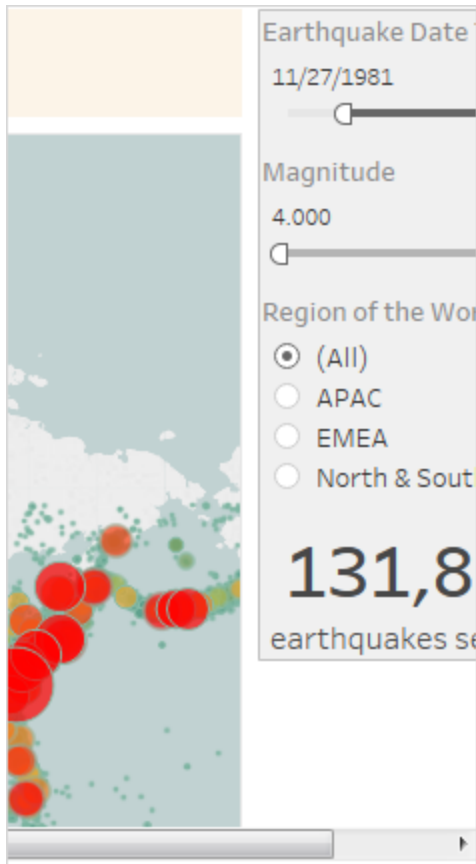

There's a special setting you can use on your dashboards to prevent this from happening.

2. Select **Map dashboard** and under **Size** on the Dashboard pane, select **Fit to Earthquake story**. This setting is designed to make dashboards the perfect size for a story.

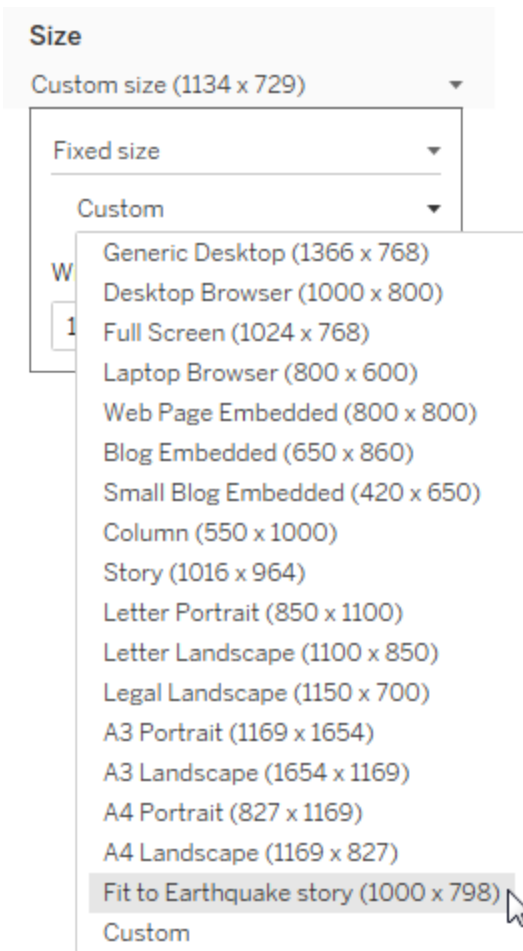

Look at the Earthquake story again. You see that its size has been adjusted and the scroll bars are gone.

3. If you're using Tableau Desktop, add a description for this story point, such as *Exactly 131,834 earthquakes of magnitude 4.0 or greater have been recorded since 1973.*
4. Add caption text by clicking the area that reads **Write the story point description text here.**
5. Click **Update** on the caption to save your changes to the story point.

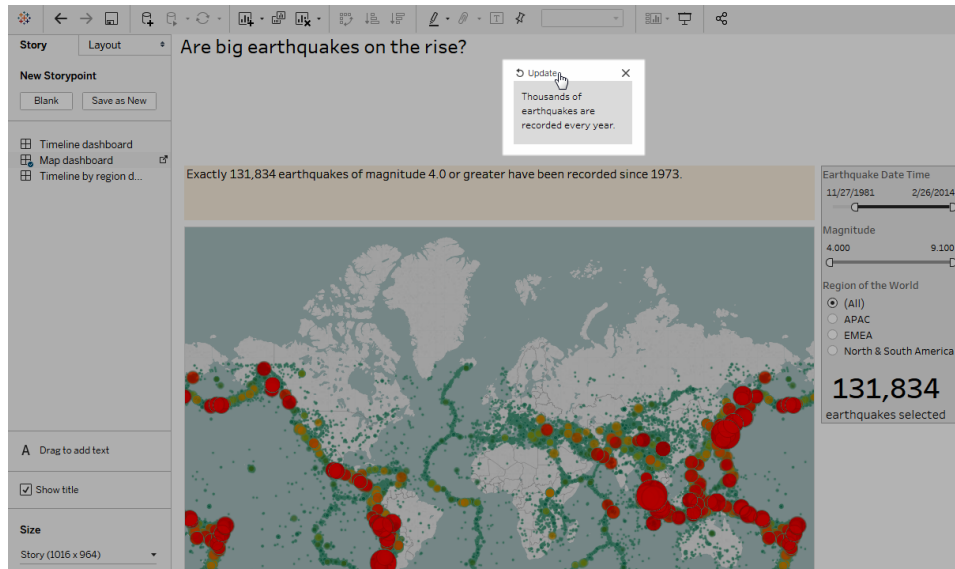

Drill down

Just like the plot of a good novel needs to move the action along, so does a data story. Starting with your next story point, you'll use the drill-down technique in order to narrow down the scope of the story and keep the narrative moving.

1. To use your first story point as a baseline for your next, click **Duplicate** under **New Storypoint** on the left.

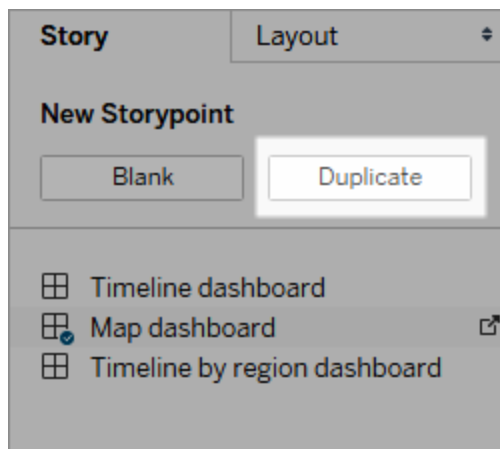

2. Change the **Magnitude** filter to **7.000 – 9.100** so that the map filters out smaller earthquakes. The map pans to show the Pacific "Ring of Fire," where the majority of the large earthquakes occurred.
3. Add a caption, such as *About two quakes each year qualify as "major"*

- If you're using Tableau Desktop, edit the description to describe what you've done in this story point. For example: *Out of over 130,000 earthquakes since 2004, only 174 were of magnitude 7.0 or greater—about two major earthquakes each year. But many people wonder, "Are earthquakes happening more often?"*
- Click **Update** in the story toolbar above the caption to save your changes.

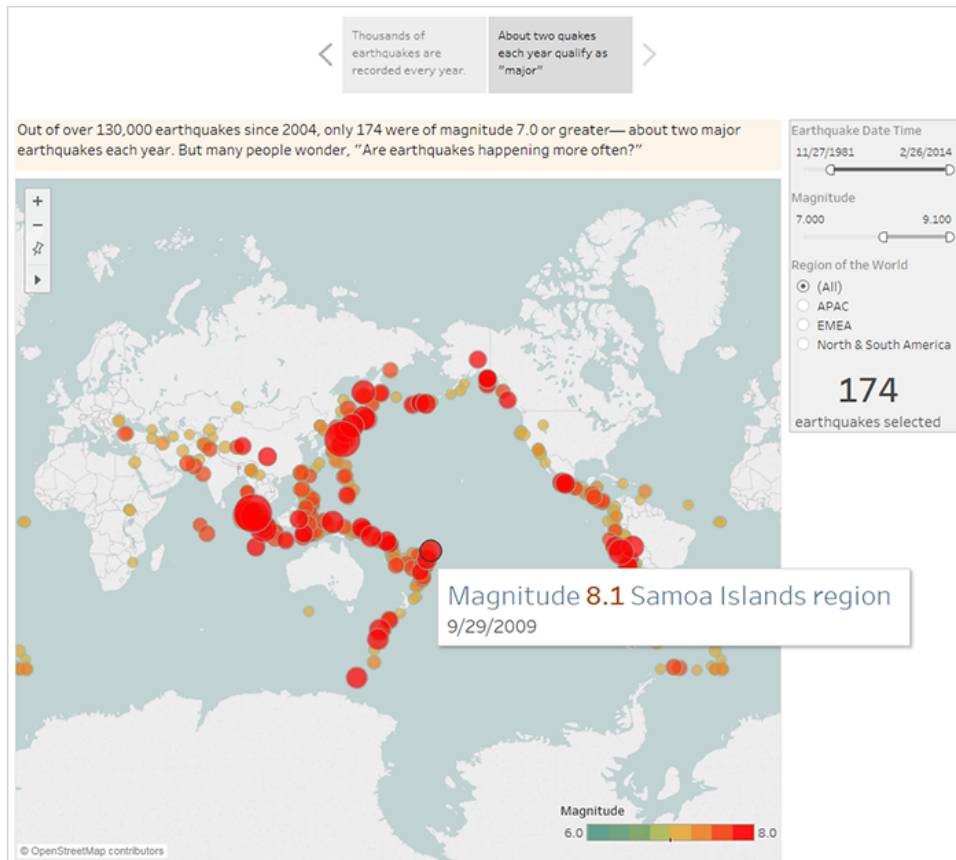

In the next story point, you're going to drill down further, narrowing the story's focus so that a specific type of earthquake—the "megaquake"—comes into view.

- Click **Duplicate** in your second story point to use it as the baseline for your third story point.
- Change the **Magnitude** filter to **8.000 – 9.100** so that the map filters out everything except the megaquakes.
- Add the caption and description text.

- Caption: *These megaquakes have drawn a lot of attention*
- Description (Tableau Desktop only): *Recent megaquakes of magnitude 8.0 and higher have often caused significant damage and loss of life. The undersea megaquakes near Indonesia and Japan have also caused tsunamis that have killed many thousands of people.*

4. Click **Update** to save your changes.

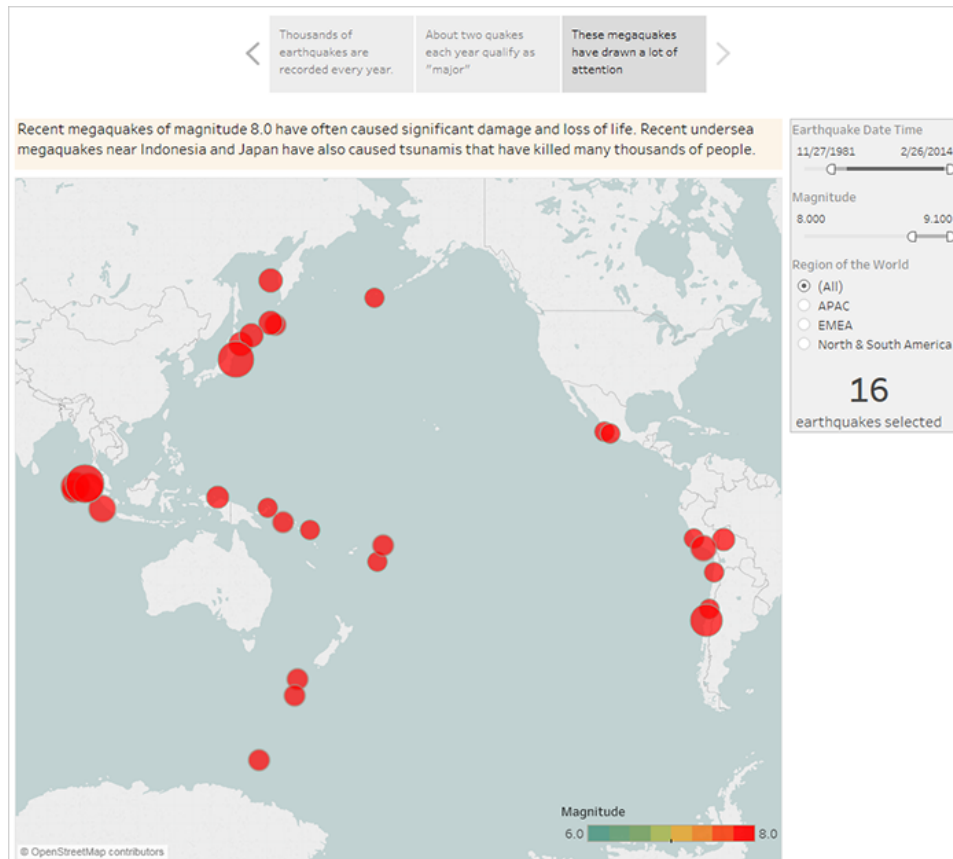

Highlight outliers

In the next two story points, you're going to further engage your audience by examining data points at the far end of the scale: the two most deadly earthquakes in recent history.

1. As you've done before, use **Duplicate** to create a new story point as your starting point.
2. Adjust **Magnitude** to **9.000–9.100** and you'll see just two data points.

3. Select one of the marks, such as the Indian Ocean earthquake and tsunami of 2004 that had a magnitude of 9.1.
4. Use the pan tool on the maps menu to center it in your story point.

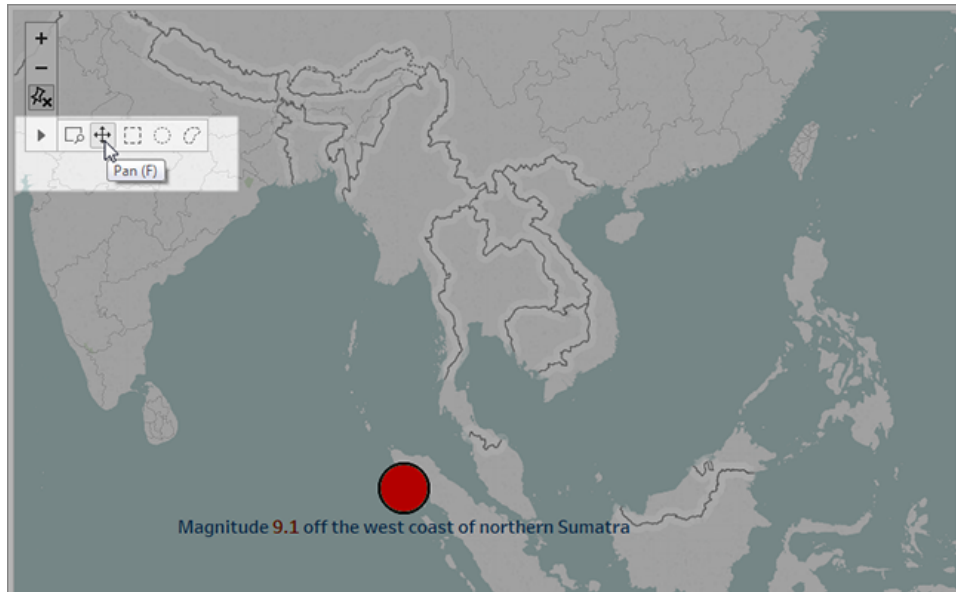

5. Add caption and description text. For example:
 - Caption: *The Indian Ocean earthquake and tsunami of 2004*
 - Description (Tableau Desktop only): *The 2004 Indian Ocean earthquake was an undersea megathrust earthquake that occurred on December 26, 2004. It is the third largest earthquake ever recorded and had the longest duration of faulting ever observed, between 8.3 and 10 minutes.*
6. Click **Update** to save your changes.
7. Repeat the preceding steps for the Japanese earthquake and tsunami of 2011, using the following as caption and description text.
 - Caption: *The Japanese earthquake and tsunami of 2011*
 - Description (Tableau Desktop only): *The 2011 quake off the coast of Tōhoku was a magnitude 9.0 undersea megathrust earthquake. It was the most powerful known earthquake ever to have hit Japan, and the 5th most powerful earthquake ever recorded.*

Notice that you've already created a compelling visual story using just a single dashboard—all by filtering the data and zooming and panning the map.

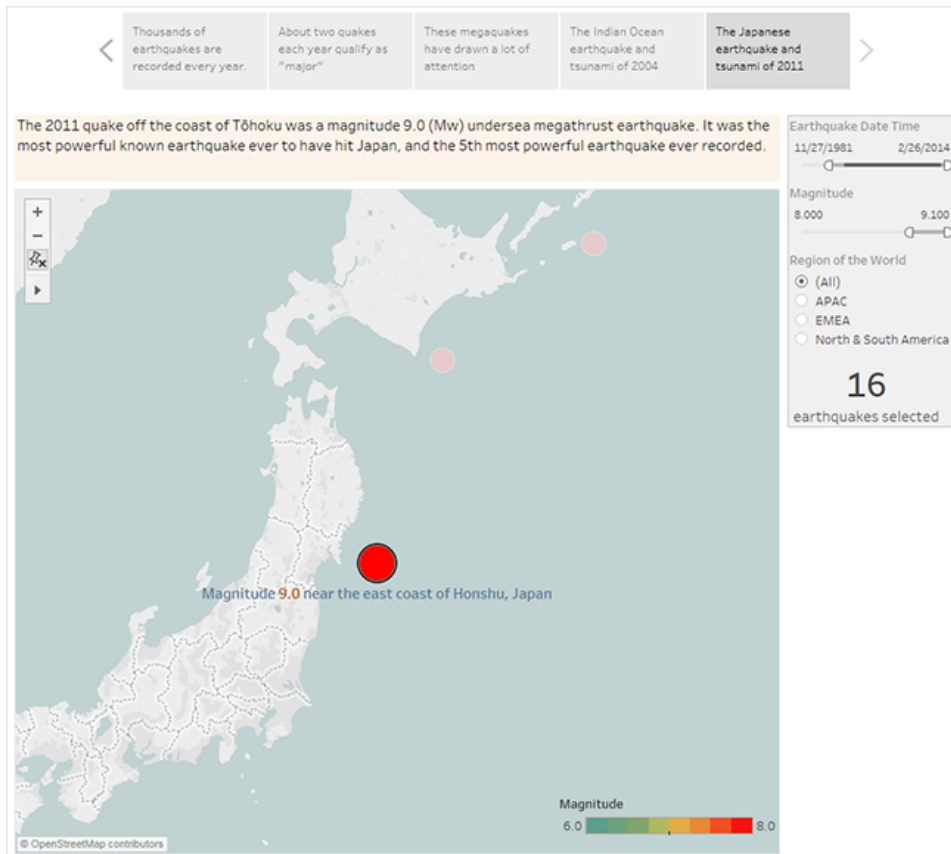

We still haven't answered the key question, however: Are big earthquakes on the rise? The next story points will dig in to that angle.

Show a trend

In the next story point, you'll switch to a line chart (the Timeline dashboard) to show your audience a trend you spotted when you were initially creating views and dashboards.

1. Switch from the story you're building to **Timeline dashboard**.

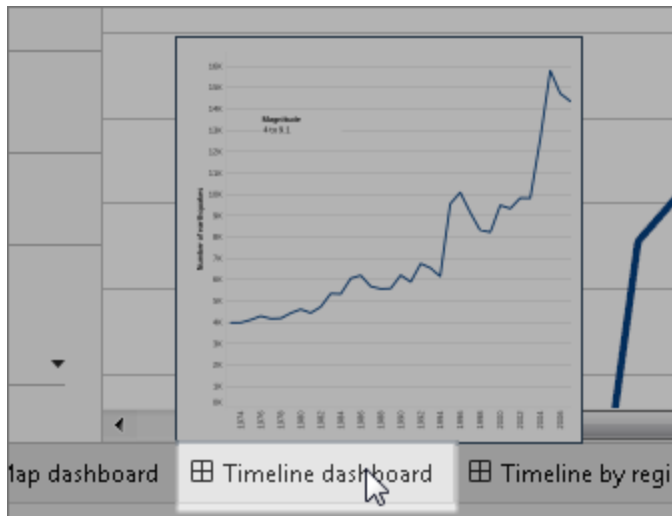

2. On the Timeline dashboard, set size to **Fit to Earthquake story**.
3. Go back to your story and click **Blank** to create a fresh story point.
4. Double-click the **Timeline dashboard** to add it to your story sheet.

More earthquakes are being reported over time since 1973. In fact, it's increased significantly!

5. Add a caption, such as: *More and more earthquakes are being detected*
6. Use **Drag to add text** to add a description of the trend (Tableau Desktop only): *Since 1973, there's been a steady increase in the number of earthquakes recorded. Since 2003, the trend has accelerated.*

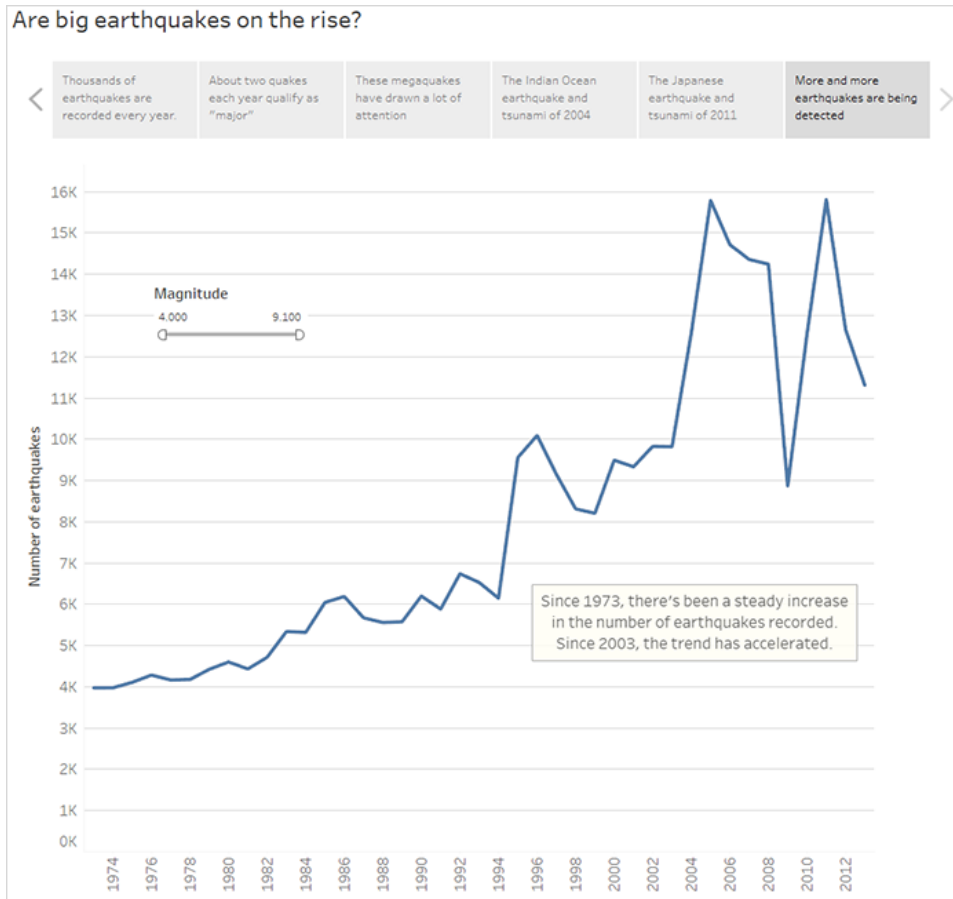

Offer your analysis

From your earlier work in this story with the **Map dashboard** you know that there are regional differences in earthquake frequency. In your next story point, you'll pull in the **Timeline by region dashboard**, which breaks out earthquakes by region, and adds trend lines, which help reduce the variability in the data.

1. Click **Blank** to create a new story sheet.
2. Double-click the **Timeline by region dashboard** to the story sheet. The APAC region clearly stands out.
3. Add a caption then use **Drag to add text** to add a comment that points out the large number of earthquakes in the APAC region.
 - Caption: *Especially on the eastern side of the Pacific Rim*
 - Description (Tableau Desktop only): *A rough categorization of earthquakes into*

geographic regions (by longitude) shows that the most significant increase in recorded earthquakes has occurred around the Pacific Rim.

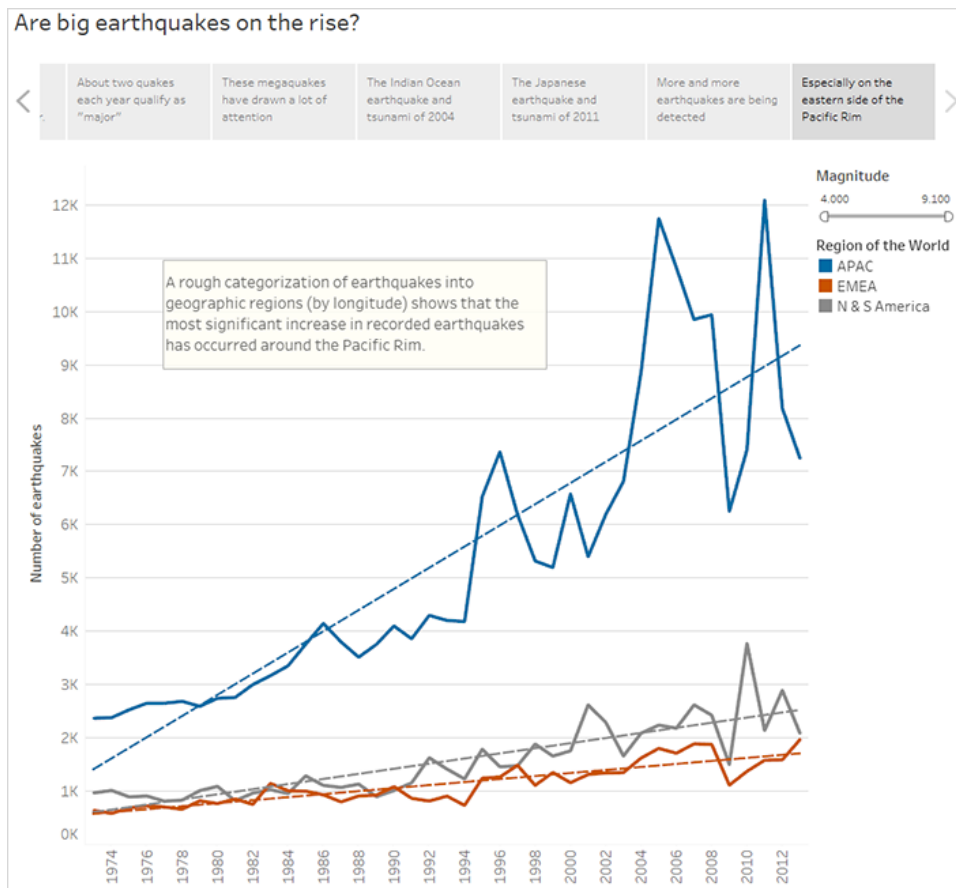

Answer the question

Thus far, your data story has concluded that earthquake frequency in the Pacific Rim has increased since 1973, but your original question was about whether big earthquakes are becoming more frequent.

To answer this question, in your final story point, you'll filter out weaker earthquakes and see what the resulting trend line is.

1. Click **Duplicate** to create a new story sheet.
2. Set the **Magnitude** filter to **5,000–9,100**. Notice how the trend lines have flattened out but there's still a slight increase.
3. Add a caption then use **Drag to add text** to add your answer to the story point.

Caption: *But the trend in big quakes is not as clear*

Description (Tableau Desktop only): *It appears that big earthquakes are increasing slightly. There should be more investigation, however, on whether this trend is real or the result of a small number of exceptionally strong recent earthquakes.*

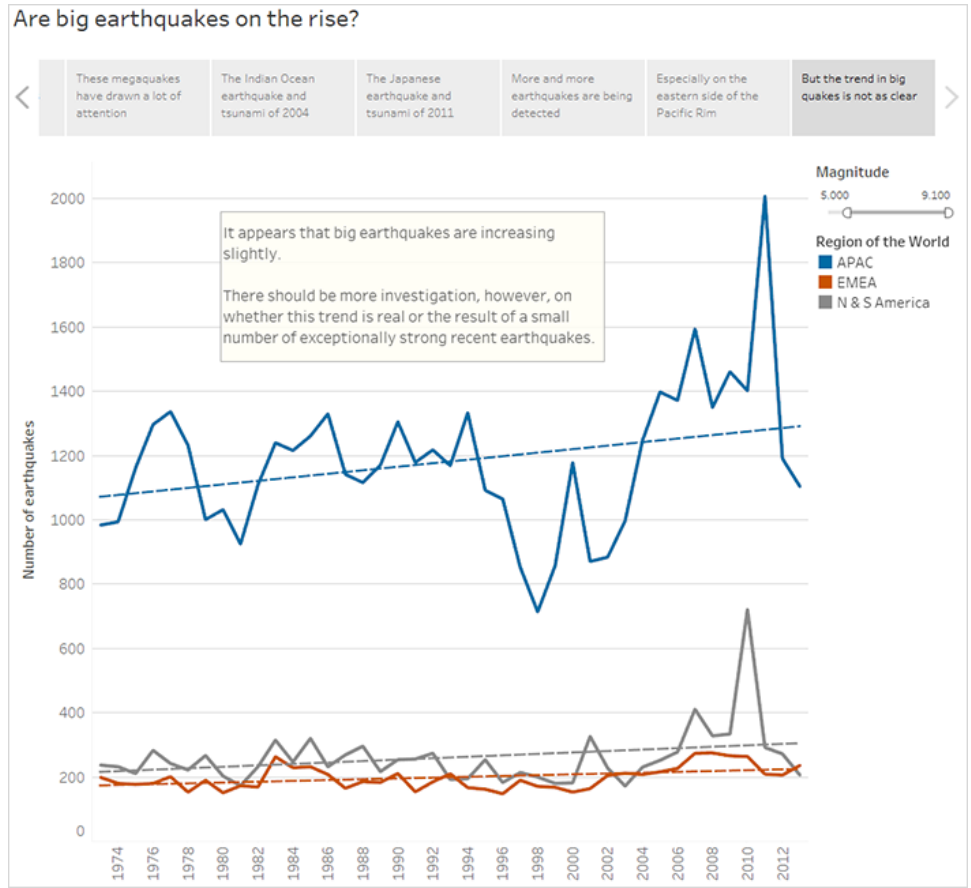

As is often the case with a data story, the story ends with additional questions.

Yes, there's a trend, but it's slight. More big earthquakes (magnitude 5.000 - 9.100) have been reported in recent years, especially in the Asia-Pacific region, but could that be natural variation? That might be a good topic for another story.

Create a Tableau Data Story (English Only)

Important changes for Tableau Data Stories

Tableau Data Stories will be retired in Tableau Desktop, Tableau Cloud, and Tableau Server in January of 2025 (2025.1). With advances in natural language technologies, we're developing an improved interface that will make it easier to ask questions of your data and stay on top of changes. For more information, see [How Tableau Pulse powered by Tableau AI is Reimagining the Data Experience](#).

If you've ever written an executive summary of your Tableau dashboard, then you know it can be time-consuming. It takes time to choose which insights to share, and you have to rewrite your summaries each time the data is updated. Tableau Data Stories automatically generates narrative insights within your dashboard, saving time and surfacing relevant insights. As you explore the vizzes in your dashboard, the stories written by Data Stories adjust, allowing you to dive deeper into data and identify key insights faster.

From where you're already working in Tableau, you can quickly add the **Data Story** object to your dashboard. And you can customize the terms and metrics used in your story, so Data Stories speaks the language used by your business.

Today, you can write and view a Tableau Data Story anywhere you use Tableau. After you create your story, you can also view your Data Story in Tableau Mobile. However, Data Stories aren't included if you export your dashboard, for example to a PDF.

Understand how Data Stories handles data

To write Data Stories, Tableau uses a service hosted in your Tableau Cloud or Tableau Server environment. When you [Add a Tableau Data Story to a Dashboard on the facing page](#) or view a Data Story from a dashboard, Tableau sends associated worksheet data to the environment that you're logged in to (i.e., your Tableau Cloud site or your Tableau Server instance), using the security standards outlined in [Security in the Cloud](#) and [Security in Tableau Server](#). Data Stories can be written and viewed from anywhere you use Tableau.

Learn about how Data Stories are written

Tableau Data Stories is powered by rules-based templated natural language generation (NLG). Data Stories performs automated analytics to determine relevant and accurate facts about the underlying data—from basic calculations to more advanced statistics. To write a story, Data Stories uses a library of predefined language templates to synthesize these facts into natural language insights. Data Stories processes these templates at run-time, using the most up-to-date summary data from the Tableau worksheet it is connected to. You can leverage the [custom language feature](#) to generate your own language templates, add functions, and define business rules, helping you build a more relevant and contextual Data Story.

Note: Data Stories doesn't use generative AI, large language models (LLMs), or machine learning to write insights and stories.

Manage Data Stories for your site

Tableau administrators can choose whether Tableau Data Stories are available for their site. Data Stories are turned on by default.

1. Sign in to your Tableau site.
2. From the left pane, choose **Settings**.
3. From the **General** tab, scroll to the **Availability of Data Stories** section.
4. Choose whether you want to **Turn on** or **Turn off** Data Stories.

Note: If Data Stories are turned off, then turning the feature back on restores Data Stories that were already in dashboards.

Add a Tableau Data Story to a Dashboard

Important changes for Tableau Data Stories

Tableau Data Stories will be retired in Tableau Desktop, Tableau Cloud, and Tableau Server in January of 2025 (2025.1). With advances in natural language technologies, we're developing an improved interface that will make it easier to ask questions of your data and stay on top of changes. For more information, see [How Tableau Pulse powered by Tableau AI is Reimagining the Data Experience](#).

After you [Create a Dashboard](#), you can add the **Data Story** object to your dashboard to display insights about your viz that are written in natural language. Today, Tableau Data Stories are written in English only and are available in Tableau Cloud, Tableau Server (version 2023.1 and later), and Tableau Desktop. There is no data size limit when creating **Data Stories**. However, story generation times out after 45 seconds if it's trying to analyze a lot of data. We recommend using **Data Stories** with visualizations that have 1,000 or fewer data points.

Note: Tableau Data Stories opens in a pop-up window, so be sure to allow pop-ups. If you're using full screen mode, then Data Stories can open in a new tab.

1. Drag the **Data Story** object into your Tableau dashboard. If you haven't already, add a sheet to your dashboard to use Tableau Data Stories.

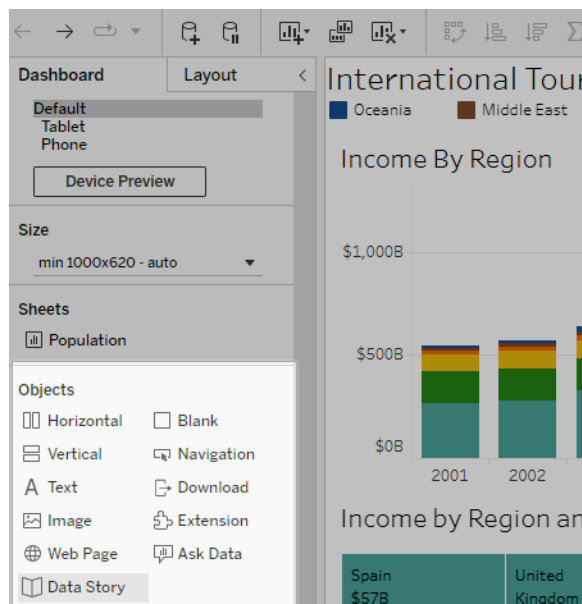

2. In the Data Story dialog box, configure your story by first choosing the worksheet to write about. When you click **Next**, Tableau sends all associated workbook data to the Tableau

Cloud or Tableau Server instance that you are logged in to.

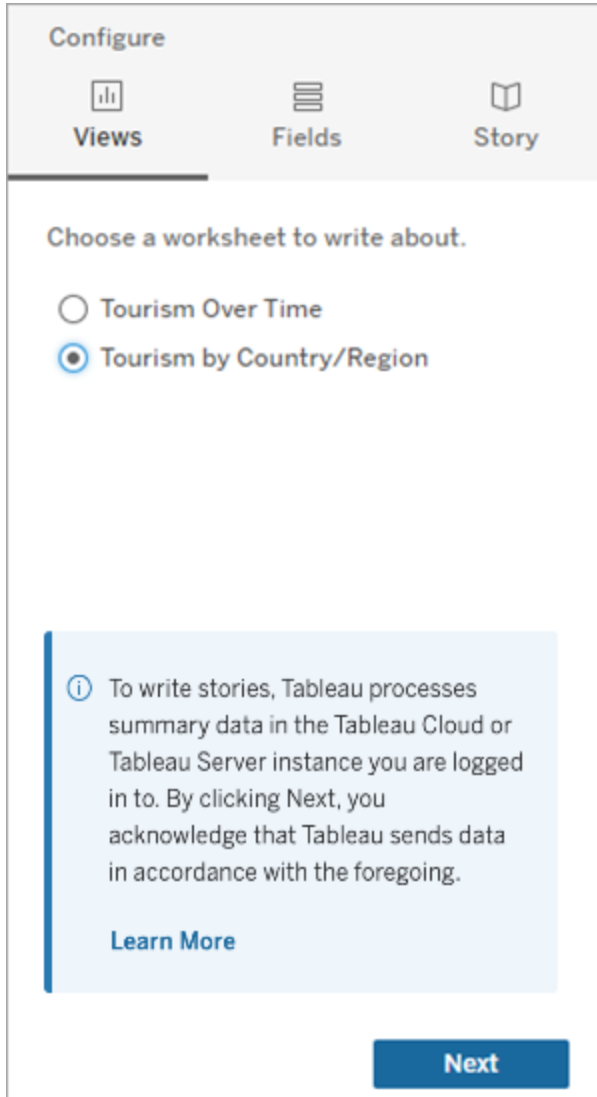

3. Choose the dimensions and measures to include in your story.

Configure

Views Fields Story

Drag and drop fields to include in your narrative.

Dimensions

Country/Region ¹ Region ²

Measures

AVG(GDP) ¹ AVG(Tourism Inbound) ²
AVG(Tourism Outbound) ³

Ignored

Back Next

4. Choose the type of story that best describes your data:

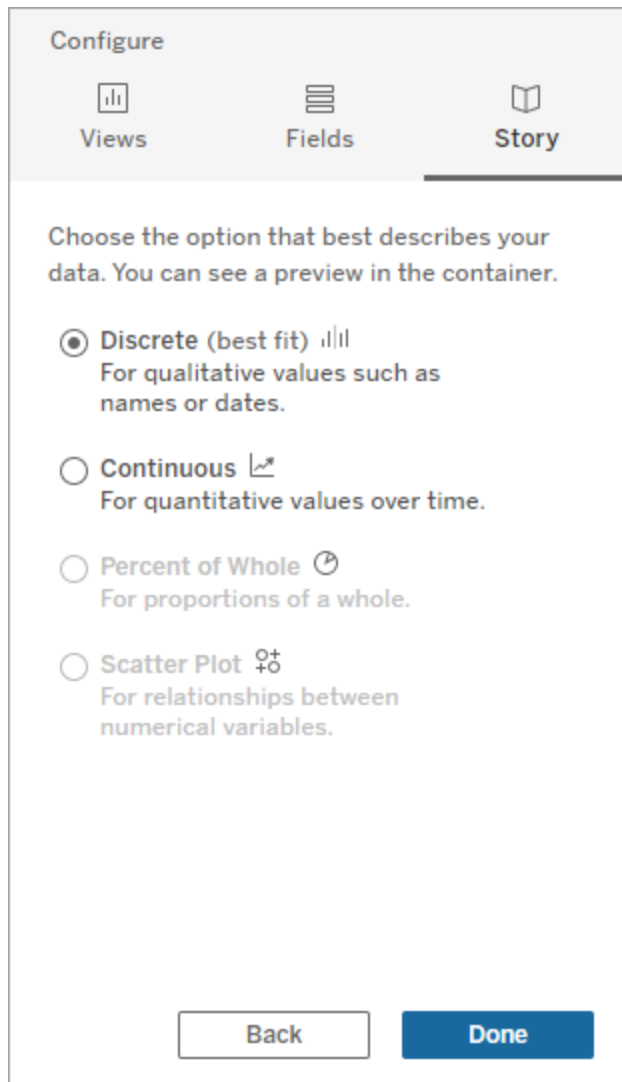

Discrete is best for qualitative values such as names or dates, such as in bar or column charts.

Continuous is best for quantitative values over time, such as a plotted in a line chart.

Percent of Whole is best for proportions of a whole, such as a pie chart.

Scatter Plot is best for relationships between numerical values, such as a scatter plot chart.

5. Click **Done**.

To filter your Data Story by clicking different sections on your visualization, open the menu on your visualization and click **Use as filter**.

After your story is generated, click **Settings** at the top of your **Data Story** object for a guided experience that helps you personalize and contextualize your story. For more information, see [Configure Settings for a Tableau Data Story on page 2871](#).

Note: If you experience a discrepancy in your Tableau Data Story (for example, if the numbers in your story are different than in your visualization), it may be caused by way your visualization is set up. Try creating a new visualization on a different sheet, and then add a new Data Story with the [Use a hidden sheet on page 2913](#) technique to uncover the underlying issue.

Choose the Right Story Type for Your Tableau Data Story

Important changes for Tableau Data Stories

Tableau Data Stories will be retired in Tableau Desktop, Tableau Cloud, and Tableau Server in January of 2025 (2025.1). With advances in natural language technologies, we're developing an improved interface that will make it easier to ask questions of your data and stay on top of changes. For more information, see [How Tableau Pulse powered by Tableau AI is Reimagining the Data Experience](#).

When you [Add a Tableau Data Story to a Dashboard on page 2863](#), it's important to choose the right type of story for your data. Do you want your story about trends over time? Or do you want your story about two values that you're comparing? To help you tell the right story, this topic describes the different types of stories, including an example of each story type.

Continuous

Continuous stories are best for analyzing trends or progress over time.

When you create a continuous story, it includes content for performance, segments, volatility, and trend lines. The story also includes contribution analysis and correlation for stories that use more than one dimension. To use a continuous story, your worksheet must have:

- 1 dimension that has between 1-10 measures
- 2 dimensions and up to 3 measures

The following example is a continuous story for a line chart that has a single dimension and multiple measures:

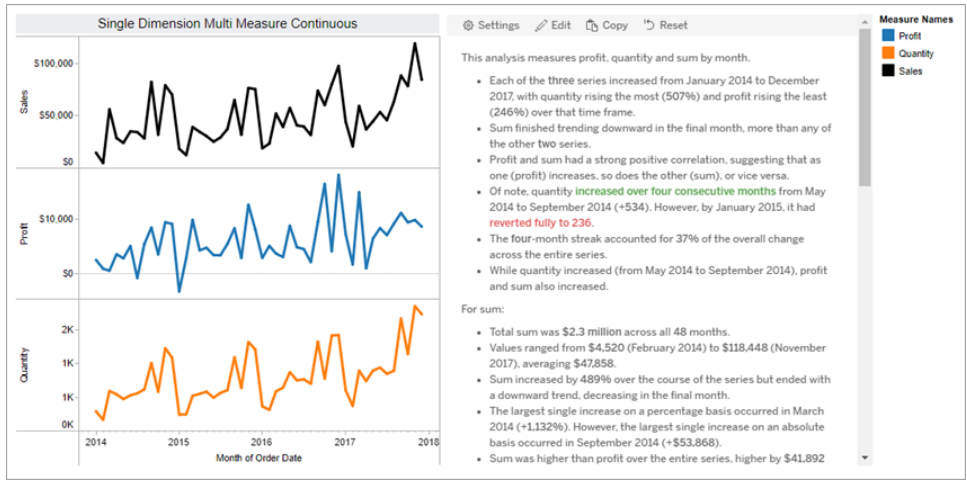

Discrete

Discrete stories are best for comparing values and understanding the distribution of data in each value. When you create a discrete story, the story includes content about the distribution and groupings or clusters across the data. And the story includes contribution analysis for worksheets that use multiple dimensions.

Consider using a discrete story when you want to:

- Understand drivers of your key performance indicators (KPIs) in sales reports.
- Identify and understand outliers quickly during data discovery.
- Identify trends that aren't easily observable in the visual when performing an audit.
- Uncover complex utilization insights instantly for geographic analysis.
- Identify and call out key relationships, for example, between sales and profit.

To use a discrete story, your worksheet must have:

- 1 dimension that has between 1-10 measures
- 2 dimensions and up to 3 measures

The following example is a discrete story for a bar chart that has a single dimension and two measures:

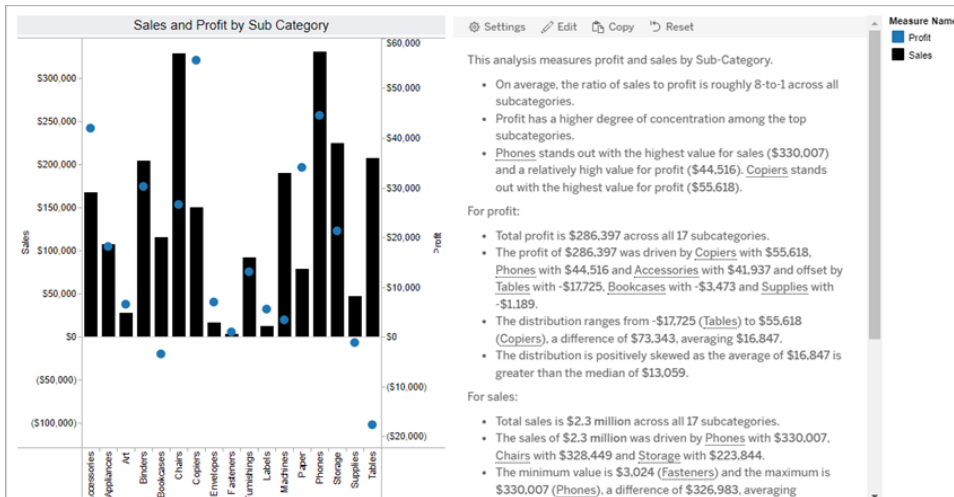

Percent of whole

Percent of whole stories are best for pie charts. To use a percent of whole story, your worksheet must have:

- 1 dimension
- 1 measure

The following example is a percent of whole story that uses a pie chart with a single dimension and a single measure:

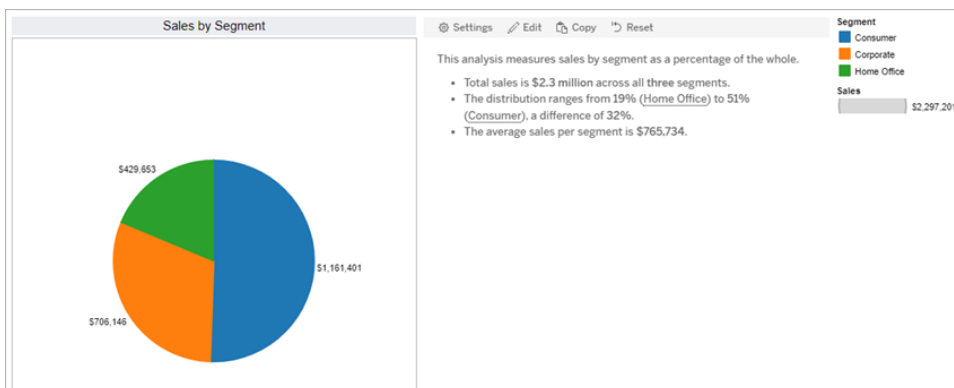

Scatter plot

Scatter plot stories are best for understanding the relationship between two measures. When you create a scatter plot story, the story includes content about the relationship (regression)

between two measures. And the story includes content about groups (clusters) within the data, when they exist.

Consider using a scatter plot story when you want to:

- Call out relationships between two measures to identify impact (regression analysis).
- Identify and understand outliers that are above or below defined thresholds.
- Analyze how your data is distributed.

To use a scatter plot story, your worksheet must have:

- 1 dimension
- 2 or 3 measures

Note: When you create your scatter plot story, the first measure you select is treated as the independent variable and the second measure is the dependent variable.

The following example is a scatter plot story that uses a scatter plot that has a single dimension and two measures:



Configure Settings for a Tableau Data Story

Important changes for Tableau Data Stories

Tableau Data Stories will be retired in Tableau Desktop, Tableau Cloud, and Tableau Server in January of 2025 (2025.1). With advances in natural language technologies, we're developing an improved interface that will make it easier to ask questions of your data and stay on top of

changes. For more information, see [How Tableau Pulse powered by Tableau AI is Reimagining the Data Experience](#).

After you [Add a Tableau Data Story to a Dashboard](#) on page 2863, you can configure and edit your Tableau Data Story so it's tailored to your needs—use language specific to your data, specify which analytics are written about, and customize how your Tableau Data Story is displayed.

Configure Tableau Data Story Settings: Analytics

Important changes for Tableau Data Stories

Tableau Data Stories will be retired in Tableau Desktop, Tableau Cloud, and Tableau Server in January of 2025 (2025.1). With advances in natural language technologies, we're developing an improved interface that will make it easier to ask questions of your data and stay on top of changes. For more information, see [How Tableau Pulse powered by Tableau AI is Reimagining the Data Experience](#).

Within your Tableau Data Story, you can choose which analytics to write about and when those analytics are written about. Different types of analytics are available depending on your story type and how many dimensions and measures your story has. However, analytics aren't currently supported for scatter plot story types. For more information, see [Choose the Right Story Type for Your Tableau Data Story](#) on page 2868.

Configure analytics for your story

1. [Add a Tableau Data Story to a Dashboard](#) on page 2863.
2. From your dashboard, click the **Settings** icon at the top-left corner of your **Data Story** object.
3. In the Data Story dialog box, click the **Analytics** tab.
4. Click the switches to turn on different types of analytics.
5. For **Segments** and **Trend line**, expand **Settings** to set thresholds for performing those analytics.
6. Click **Save**.

Understand different types of analytics

Correlation

Use **Correlation** to identify true statistical correlations between two series. If you have more than two series, then all combinations are analyzed for correlations. For example, you might turn

on **Correlation** to identify when two products are often purchased together.

Clustering

Use **Clustering** to identify distinct groups of data points (clusters) using a single statistical analysis. For example, you might turn on **Clustering** to identify when a product is very popular in a specific geographic region.

Distribution

Use **Distribution** to rank data points relative to each other using nonstatistical observations, such as mean, median, skew, etc. For example, you might turn on **Distribution** to identify which product has the highest profit ratio.

Segments

Use **Segments** to highlight noteworthy changes to data points within a series. First, set the minimum percentage of change that you want to be written about in a segment. Changes that fall below your defined threshold aren't written about. For example, if you set your segment threshold for changes that are greater than 60%, then your story doesn't write about a trough in a time series that features a 30% decrease.

After you've set your threshold, choose whether to **Apply formatting**, and set the minimum percentage of change that you want formatted.

Trend line

Use **Trend line** to calculate a linear best fit line and identify data that falls within a defined percentage of confidence. Data that has high variability has a lower confidence level than data that's more consistent, and that confidence level affects whether trend lines are written about. You can use trend lines for stories that have one dimension and one measure, or you can use trend lines in a drilldown. For more information about drilldowns, see [Configure Tableau Data Story Settings: Narrative on page 2885](#).

Set the minimum percentage of confidence for your trend line. If you set your threshold at 95%, but a trend line could be drawn at 90% confidence, then your story doesn't write about trend lines. After you've set your threshold, choose whether to **Apply formatting**. Then set the minimum percentage of change that you want formatted.

Tableau Data Stories about trend lines communicate the absolute change over a period. The story written about your trend line varies depending on the level of verbosity you set for your story. If your story uses high verbosity, then your story writes about the R-squared value, which is a statistical concept that quantifies how well your data fits the trend line. For more information

about verbosity settings, see [Configure Tableau Data Story Settings: Narrative on page 2885](#).

Within the **Trend line** settings, you can also choose how many periods into the future for which you want your story to write predictions. When you use predictions, your story uses the slope and intercept of the trend line to calculate predicted values for future periods. The confidence of the prediction adds upper and lower bounds to the confidence threshold you set for trend lines. You can use predictions when your story has at least 30 data points that are linear.

Volatility

Use **Volatility** to analyze standard deviations over time. For example, use **Volatility** when you want your story to write about values that fall outside the average range for your data.

Break down how analytics are used to generate stories

At this point, you might be wondering how the analytics for different story types work. Let's take a look at an example for each story type and break down each sentence in the story.

Understand analytics for discrete stories

Because continuous stories measure trends over time, Data Stories writes about performance, progression, averages, totals, streaks, volatility, segments, and predictions.

The following example of a continuous story is about sales per month:

This analysis measures Sales by month.

- Average Sales was **\$47,858** across all **48** months.
- The minimum value was **\$4,520** (February 2014) and the maximum was **\$118,448** (November 2017).
- Sales increased by **489%** over the course of the series but ended with a downward trend, decreasing in the final month.
- The largest single increase on a percentage basis occurred in March 2014 (**+1,132%**). However, the largest single increase on an absolute basis occurred in September 2014 (**+\$53,868**).
- Sales experienced cyclical, repeating each cycle about every **12** months. There was also a pattern of smaller cycles that repeated about every **three** months.
- Sales had a **significant positive peak between October 2014 (\$31,453) and February 2015 (\$11,951), rising to \$78,629 in November 2014.**
- The **overall linear trend of the series rose at \$902 per month** for an absolute change of **\$42,394** over the course of the series.

Example story	Story breakdown
<ul style="list-style-type: none"> • Average Sales was \$47,858 across all 48 months. • The minimum value was \$4,520 (Febru- 	<p>The first two sentences use average and range functions to write about the average, maximum, and minimum values across the</p>

<p>ary 2014) and the maximum was \$118,448 (November 2017).</p>	<p>period you're analyzing.</p>
<ul style="list-style-type: none"> • Sales increased by 489% over the course of the series but ended with a downward trend, decreasing in the final month. 	<p>The third sentence is about overall performance of the measure over the period. For example, a sentence can be about whether sales increased, decreased, or trended differently during a specific period.</p>
<ul style="list-style-type: none"> • The largest single increase on a percentage basis occurred in March 2014 (+1,132%). However, the largest single increase on an absolute basis occurred in September 2014 (+\$53,868). 	<p>The fourth sentence uses progression analysis. This sentence writes about the largest increase and decrease based on the measure during the period using both a percentage basis and absolute basis.</p>
<ul style="list-style-type: none"> • Of the three series, the strongest relationship was between Corporate and Home Office, which had a moderate positive correlation, suggesting that as one (Corporate) increases, the other (Home Office) generally does too, or vice versa. 	<p>This sentence is a Correlation insight. This type of analytic insight writes about notable correlations between different series in your data.</p>
<ul style="list-style-type: none"> • Sales experienced cyclicity, repeating each cycle about every 12 months. There was also a pattern of smaller cycles that repeated about every three months. • Sales had a significant positive peak between October 2014 (\$31,453) and February 2015 (\$11,951), rising to \$78,629 in November 2014. 	<p>This sentence is a Segment insight. This type of analytic insight writes about noteworthy increases and decreases over time.</p>
<ul style="list-style-type: none"> • The overall linear trend of the series rose at \$902 per month for an absolute change of \$42,394 over the course of the series. If this trend continued for the next one month, Sales is predicted to be about \$69,958. 	<p>This sentence is a Trend line insight. This type of insight writes about how well trends fit your data with a certain percentage of confidence, and trend lines allow you to make predictions based on historic trends.</p>

Understand analytics for discrete stories

Because discrete stories allow you to compare values and understand the distribution of the data, the story writes about distribution, averages, totals, and groupings or clusters across the data.

The following example of a discrete story is about sales by product:

This analysis measures Sales by product.

- Total Sales is **\$2.3 million** across all **17** products.
- The Sales of **\$2.3 million** was driven by Phones with **\$330,007**, Chairs with **\$328,449** and Storage with **\$223,844**.
- The distribution ranges from **\$3,024** (Fasteners) to **\$330,007** (Phones), a difference of **\$326,983**, averaging **\$135,129**.
- The distribution is positively skewed as the average of **\$135,129** is greater than the median of **\$114,880**.
- Sales is somewhat concentrated with **eight** of the **17** products (**47%**) representing **78%** of the total.
- The top **two** products represent over a quarter (**29%**) of overall Sales.
- Phones (**\$330,007**) is more than **two** times bigger than the average across the **17** products.

Example story	Story breakdown
<ul style="list-style-type: none"> • Total Sales is \$2.3 million across all 17 products. 	The first sentence calculates the total value of your measure.
<ul style="list-style-type: none"> • The Sales of \$2.3 million was driven by <u>Phones</u> with \$330,007, <u>Chairs</u> with \$328,449, and <u>Storage</u> with \$223,844. 	The second sentence writes about the dimension drivers. In this example, the dimension drivers are the products that contributed the most to total sales.
<ul style="list-style-type: none"> • The distribution is positively skewed as the average of \$135,129 is greater than the median of \$114,880. • Sales is relatively concentrated with 78% of the total represented by eight of the 17 products (47%). 	The third and fourth sentences analyze the distribution of the data. This analyzes the averages, medians, concentration of data (if any exist), and how the data is skewed. This helps identify how balanced these grouped variables are compared to one another.
<ul style="list-style-type: none"> • The top two products combine for over a quarter (29%) of overall Sales. 	This sentence uses Clustering to write about measures that can be grouped. This helps identify whether there are distinct groups that stand out in the data.
<ul style="list-style-type: none"> • <u>Phones</u> (\$330,007) is more than two 	The final sentence writes about notable out-

times bigger than the average across the 17 products.	liers.
--	--------

Understand analytics for scatter plot stories

Scatter plot story types are best used to understand the relationship between two measures, and for that reason, scatter plot stories require 2–3 measures. The scatter plot analysis writes about the relationship (regression) between two measures, and it writes about groups (clusters) within the data, if they exist.

The following example of a scatter plot story is about profit and sales across a dimension:

<p>This analysis measures profit, quantity and sales across 793 customer.</p> <ul style="list-style-type: none"> As quantity increased and profit increased, sales increased based on the data provided. Specifically, when quantity increased by 1, sales increased \$49.55, and when profit increased by \$1.00, sales increased \$1.20. Few customers deviated from this general relationship, indicating a good fit. When organized into groups of similar profit, quantity and sales values, one distinct group stands out. There were 651 customers that had values of profit between -\$6,626 and \$1,488, quantity between 2 and 122 and sales between \$4.83 and \$5,690. <u>Tamara Chand</u>, <u>Raymond Buch</u> and <u>Sanjit Chand</u>, among others were outliers with high profit and sales values. <u>Sean Miller</u> stood out with a low profit and high sales value. The minimum value for profit is -\$6,626 (<u>Cindy Stewart</u>) and the maximum value is \$8,981 (<u>Tamara Chand</u>), a difference of \$15,608. The average profit per customer is \$361 and the median is \$228. The minimum value for quantity is 2 (<u>Anthony O'Donnell</u>) and the maximum value is 150 (<u>Jonathan Doherty</u>), a difference of 148. The average quantity per customer is 47.76 and the median is 44. The distribution of sales ranges from \$4.83 (<u>Thais Sissman</u>) to \$25,043 (<u>Sean Miller</u>), a difference of \$25,038. The average sales per customer is \$2,897 and the median is \$2,256.

Example story	Story breakdown
<ul style="list-style-type: none"> As quantity increased and profit increased, sales increased based on the data provided. Specifically, when quantity increased by 1, sales increased \$49.55, and when profit increased by \$1.00, sales increased \$1.20. Few customers deviated from this general relationship, indicating a good fit. 	<p>The first two sentences are powered by regression analytics. Regression shows how one measure affects another. Notice that in the first sentence, the story has identified a relationship between profit and sales.</p>

<ul style="list-style-type: none"> When organized into groups of similar profit, quantity and sales values, one distinct group stands out. There were 651 customers that had values of profit between -\$6,626 and \$1,488, quantity between 2 and 122 and sales between \$4.83 and \$5,690. 	<p>The third sentence is derived from clustering. Clustering analytics tries to identify key groups or clusters across all the variables in the data.</p>
<ul style="list-style-type: none"> <u>Tamara Chand</u>, <u>Raymond Buch</u>, and <u>Sanjit Chand</u>, among others were outliers with high profit and sales values. Sean Miller stood out with a low profit and high sales value. 	<p>The fourth sentence is written about outliers—values that fall significantly above or below the average.</p>
<ul style="list-style-type: none"> The minimum value for profit is -\$6,626 (<u>Cindy Stewart</u>) and the maximum value is \$8,981 (<u>Tamara Chand</u>), a difference of \$15,608. The average profit per customer is \$361 and the median is \$228. The minimum value for quantity is 2 (<u>Anthony O'Donnell</u>) and the maximum value is 150 (<u>Jonathan Doherty</u>), a difference of 148. The average quantity per customer is 47.76 and the median is 44. The distribution of sales ranges from \$4.83 (<u>Thais Sissman</u>) to \$25,043 (<u>Sean Miller</u>), a difference of \$25,038. The average sales per customer is \$2,897 and the median is \$2,256. 	<p>The remaining sentences for scatter plot stories use range and average analysis to write insights.</p>

Understand analytics for percent of whole stories

Percent of whole story types are best for understanding what part of a whole a dimension or measure represents.

The following example of a percent of whole story is about sales by segment:

This analysis measures sales by segment as a percentage of the whole.

- Total sales is \$2.3 million across all three segments.
- The minimum value is 19% (Home Office) and the maximum is 51% (Consumer), a difference of 32%.
- The average sales per segment is \$765,734.

Example story	Story breakdown
<ul style="list-style-type: none"> • Total SUM(Sales) is 2.3 million across all three entities. 	The first sentence calculates the total value of your measure.
<ul style="list-style-type: none"> • The SUM(Sales) of 2.3 million was driven by Consumer with 1.2 million, Corporate with 706,146 and Home Office with 429,653. 	The second sentence writes about drivers. In this example, the drivers are segments that contributed the most to total sales.
<ul style="list-style-type: none"> • The minimum value is 429,653 (Home Office) and the maximum is 1.2 million (Consumer), a difference of 731,748, averaging 765,734. 	The final sentence analyzes the distribution of the data.

Configure Tableau Data Story Settings: Characteristics

Important changes for Tableau Data Stories

Tableau Data Stories will be retired in Tableau Desktop, Tableau Cloud, and Tableau Server in January of 2025 (2025.1). With advances in natural language technologies, we're developing an improved interface that will make it easier to ask questions of your data and stay on top of changes. For more information, see [How Tableau Pulse powered by Tableau AI is Reimagining the Data Experience](#).

Within your Tableau Data Story, you can configure the characteristics settings to give context to your data, so you get more insightful stories. For example, in your story you can specify that in the context of sales, a higher number is good. But in the context of customer complaints, a higher number is bad.

Use dimension and measure characteristics

Your story and number formatting adjusts based on what the measure is. By default, your story writers all measure values as numbers, and your story won't perform any additional calculations

or apply any special rendering rules.

1. [Add a Tableau Data Story to a Dashboard on page 2863](#).
2. From your dashboard, click the **Settings** icon at the top-left corner of your Data Story object.
3. In the Data Story dialog box, click the **Characteristics** tab.
4. Configure your formatting, such as number type, decimal places, and negative values.
5. Click **Save**.

Learn more about measure characteristics

Formatting

If values are formatted as **Percentages**, then the story writes about percentage point differences, rather than percent changes as a story would for number values. When you format a number as a **Percentage** in the **Characteristics** tab, the **Data Story** multiplies the value of the number by 100 to create the percentage that shows in your story.

If values are formatted as **Currency**, then you can specify your preferred currency. You can also specify how you want large values (numbers greater than one million) formatted, for example \$1.3 million instead of \$1,300,000.00.

For both **Numbers** and **Currency**, you can specify how you want large values and negative values to be written about. If you choose to have negative values written about in parentheses, you might see nested parentheses in your story when the negative value is written about in a parenthetical phrase.

When you choose **Number** formatting, you can also specify whether you want numbers less than or equal to 10 to be spelled out (rather than using a numeral) in your story.

For decimal places, **Dynamic** is the default option. This means that the story rounds to different decimal places depending on how large or small the number is. If the percent value is less than 10, then the number has two decimal places. If the percent value is greater than 10, then the number rounds to the nearest whole number. You can also specify how many decimal places you want used, which is used consistently throughout your story.

Content

You can assign meaning to larger values. For example, larger values for sales are good, but larger values for losses are bad.

In addition, you can choose how to aggregate values by sum or average. It's a best practice to choose the same aggregation method that you're using in the viz. For ratio measures, choose

Average and then define the ratio by selecting the component measures of that ratio measure. Measures that are components of a ratio must be summable.

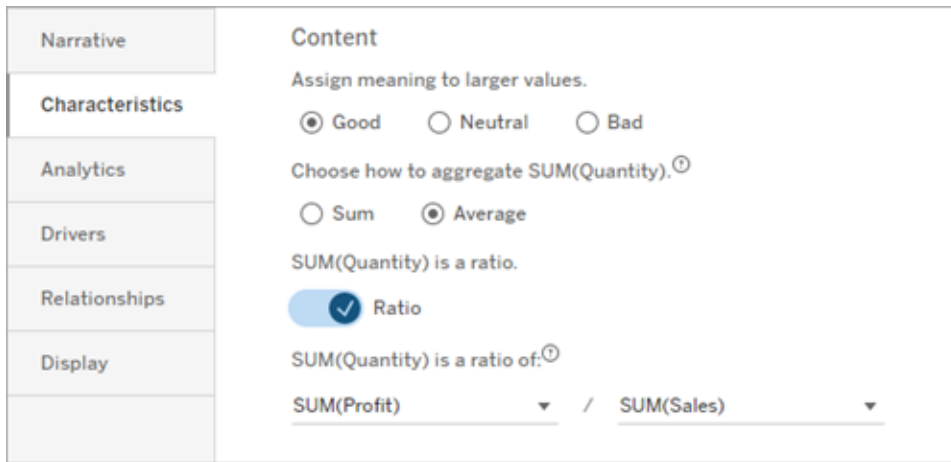

For cumulative measures (available for continuous stories only), choose **Sum** and then specify that the measure is already cumulative. Continuous stories write about the total of the measure across the series.

Sorting

To sort dimension values, click the arrow up/down icon to sort based on the oldest or newest time values in your dimension.

Note: Sorting dimension values is available for only continuous stories.

Configure Tableau Data Story Settings: Display

Important changes for Tableau Data Stories

Tableau Data Stories will be retired in Tableau Desktop, Tableau Cloud, and Tableau Server in January of 2025 (2025.1). With advances in natural language technologies, we're developing an improved interface that will make it easier to ask questions of your data and stay on top of changes. For more information, see [How Tableau Pulse powered by Tableau AI is Reimagining the Data Experience](#).

You can configure how the text in your Tableau Data Story is displayed, such as font color and size. You can also choose whether your story uses bulleted lists or paragraphs.

Configure the display for your story

1. [Add a Tableau Data Story to a Dashboard on page 2863](#).
2. From your dashboard, click the **Settings** icon at the top-left corner of your Data Story object.
3. In the Data Story dialog box, click the **Display** tab.
4. Choose whether you want your story structure to be **Bullets** or **Paragraphs**.
5. Choose your **Font Size**.
6. Pick colors to represent good and bad changes (available for continuous stories).
7. Choose whether to use **Dynamic Ordering**.
8. Choose whether to use a **Condensed View**.
9. Click **Save**.

Understand when to use story display settings

To use color, your story must be continuous. When using color, you can choose colors from the palette to represent good changes and bad changes. For your story to know whether a change is good or bad, you must assign meaning to larger values in the **Characteristics** tab. For more information, see [Configure Tableau Data Story Settings: Characteristics on page 2879](#).

After you configure your display, the styles and colors are applied in your story based on thresholds for trend line or segment analytics.

If you turn on **Dynamic Ordering**, then the insights for measures in a story are dynamically ordered from the best to the worst average value. If you already have an order you want to maintain, turn off **Dynamic Ordering**.

If you turn on **Condensed View**, then additional space is removed from your story. This is helpful if you don't have much extra space in your dashboard or when you have multiple Data Story objects in a dashboard.

Configure Tableau Data Story Settings: Drivers

Important changes for Tableau Data Stories

Tableau Data Stories will be retired in Tableau Desktop, Tableau Cloud, and Tableau Server in January of 2025 (2025.1). With advances in natural language technologies, we're developing an improved interface that will make it easier to ask questions of your data and stay on top of changes. For more information, see [How Tableau Pulse powered by Tableau AI is Reimagining the Data Experience](#).

Hypothetically, let's say your month-over-month sales increased significantly. What drove that increase in sales? And what might have detracted from (offset) those increased sales? Setting up drivers in your Data Story can answer those questions.

In Data Stories, drivers contribute toward a total value. Offsetters detract from a total value. You'll find insights about drivers and offsetters in discrete and continuous stories. And these insights make it easy to understand exactly what's going on in the data and why.

Set dimension drivers

1. [Add a Tableau Data Story to a Dashboard on page 2863.](#)
2. From your dashboard, click the **Settings** icon at the top-left corner of your Data Story object.
3. In the Data Story dialog box, click the **Drivers** tab.
4. From the **Dimension Drivers** section, select the type of driver that has the greatest impact on your analysis:
 - For **Count**, set the maximum number of contributors and offsetters.
 - For **Individual %**, set thresholds for writing about individual contributors and offsetters.
 - For **Cumulative %**, set thresholds for writing about contributors and offsetters based on their collective value.
5. Click **Save**.

Understand dimension driver types

- **Count** specifies the number of entities (contributors and offsetters) called out in your story. For example, use **Count** to see the top three contributors and offsetters in your data.
- **Individual %** sets a threshold, and values higher than that threshold are included in your story. For example, use **Individual %** to specify that you want to write about only entities that represent more than 5% of the total value.
- **Cumulative %** sets a percentage threshold of the total value that included entities collectively account for. For example, use **Cumulative %** to specify that you want to write about the entities that contributed to at least 90% of that total value. In this example, entities are written about in order of magnitude until the cumulative value of those entities account for 90% of the total value.

Use secondary contributors

To use secondary contributors, you must have a second dimension that isn't time. When you use secondary contributors, each driver that is written about also has details about and drivers for its secondary contributor. For example, if you are analyzing store sales, a secondary contributor

would be a class within a department. Secondary contributors allow for deeper analysis. But secondary contributors can also contain a lot of information to fit into a single sentence in your story.

Set metric drivers

For measures that are composed of other subcategory measures, driver analysis can explain the impact that each measure had on the top-level value. For example, material costs and operating costs contribute to total cost.

To use metric drivers, you must have multiple measures for metric analysis. Then, you can specify the relationships between each measure.

1. [Add a Tableau Data Story to a Dashboard on page 2863](#).
2. From your dashboard, click the **Settings** icon at the top-left corner of your Data Story object.
3. In the Data Story dialog box, click the **Drivers** tab.
4. From the **Metric Drivers** section, first choose the measure that is a subcategory of another measure.
5. Then, choose the measure that is the primary category.
6. Click **Save**.

Tip: The verbosity setting also applies to drivers. By changing your story's verbosity setting, you can adjust the way insights are written. If you use high verbosity, then you'll see more information in parentheses. If you use low verbosity, then you'll get a more concisely written insight about your drivers. For more information, see [Configure Tableau Data Story Settings: Narrative on the facing page](#).

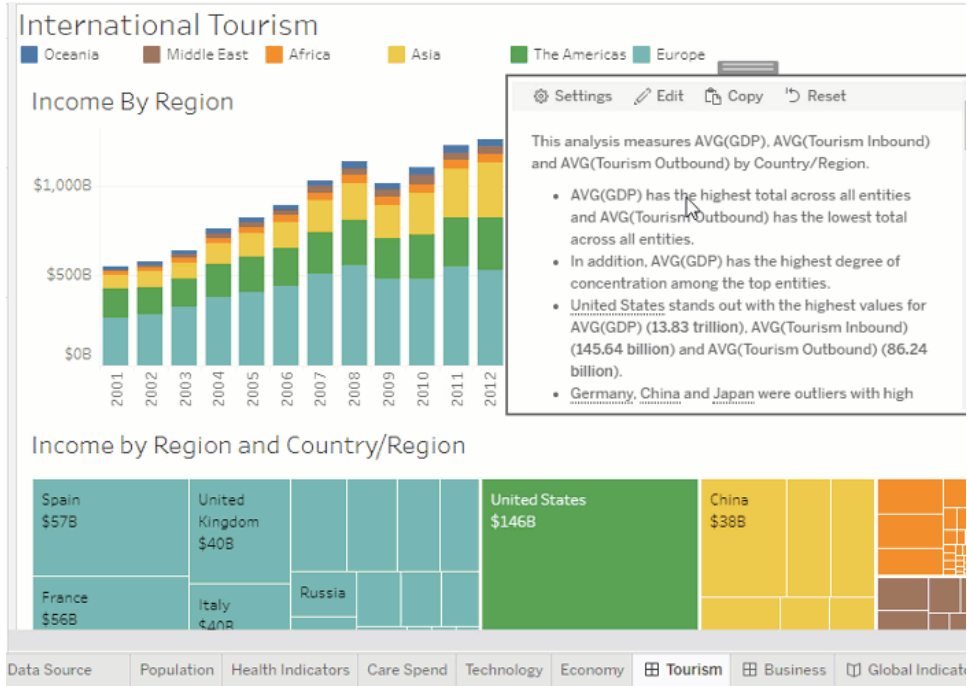

Configure Tableau Data Story Settings: Narrative

Important changes for Tableau Data Stories

Tableau Data Stories will be retired in Tableau Desktop, Tableau Cloud, and Tableau Server in January of 2025 (2025.1). With advances in natural language technologies, we're developing an improved interface that will make it easier to ask questions of your data and stay on top of changes. For more information, see [How Tableau Pulse powered by Tableau AI is Reimagining the Data Experience](#).

You can customize the narrative settings of your Tableau Data Story. Specifically, you can specify the verbosity and level of analytical detail in your story, and you can add terms that are unique to your data. These settings help you write a story that uses the right language and speaks to the right level of detail for your dashboard.

Set verbosity

Verbosity specifies the length and analytical detail written in your story. If you choose high, then your story has longer insights with more analytic analysis. If you choose low, then your story is more concise with fewer details.

If you allow viewers to change verbosity, then viewers of published dashboards can change the level of verbosity in the Data Story object. This is helpful when your dashboard is used by a broader audience with viewers who want varying levels of detail from your story.

Set drilldowns

A drilldown includes two dimensions, and drilldowns describe figures associated with each dimension of your dashboard.

Let's say you have a dashboard that has monthly sales by product category. Your story is configured to write about both the **Time** and **Category** dimensions. In this case, this story includes an insight for each Category that describes its performance in and across the **Time** dimension.

By setting the maximum number of drilldowns, you can control how many insights are included in your story. Drilldown insights are also ranked based on the meaning assigned to the measure characteristics. As the number of drilldowns is reduced, the lowest performing measures (measures that are assigned a Bad meaning) are eliminated.

Add dimension terms

By adding terms, you can define the way each of your measures and dimensions are labeled and referenced in your story.

1. [Add a Tableau Data Story to a Dashboard on page 2863](#).
2. From your dashboard, click the **Settings** icon at the top-left corner of your Data Story object.
3. In the Data Story dialog box, click the **Narrative** tab.
4. Expand the dimension to see how it will be written about in both singular and plural form.
5. Click **Add Term** to add another variation for your story to use to describe your dimension.
6. Click **Save**.

Your story uses (at random) the terms you've added when writing about a dimension.

Manage measure labels

Similarly to dimensions, you can manage labels used for measures in your story.

1. From the **Narrative** tab, expand the measure to see its label.
2. Enter the new label that you want used for your measure.
3. Click **Save**.

Configure Tableau Data Story Settings: Relationships

Important changes for Tableau Data Stories

Tableau Data Stories will be retired in Tableau Desktop, Tableau Cloud, and Tableau Server in January of 2025 (2025.1). With advances in natural language technologies, we're developing an improved interface that will make it easier to ask questions of your data and stay on top of changes. For more information, see [How Tableau Pulse powered by Tableau AI is Reimagining the Data Experience](#).

The **Relationships** setting allows you to assign relationships between measures in a Tableau Data Story that has multiple measures. To configure Relationships, your story must have one dimension and multiple measures. For more information, see [Create Custom Measure Relationships in Your Tableau Data Story](#) on page 2918.

There are two types of relationships:

- Actual vs. Benchmark
- Current/Most Recent vs Previous Period

Use **Actual vs. Benchmark** when you want to know if you're performing above or below your performance benchmarks, for example, when performing quota reporting. This type of relationship is also helpful for identifying data points that require additional analysis because they're significantly above or below your benchmark. To use **Actual vs. Benchmark**, the measures you're comparing must have the same value type.

Use **Current/Most Recent vs. Previous Period** when you want to see if your key performance indicators (KPIs) are increasing, decreasing, or remaining consistent over time. To use **Current/Most Recent vs. Previous Period**, you must use a discrete story type. For more information, see [Choose the Right Story Type for Your Tableau Data Story](#) on page 2868.

Additionally, you can use **Actual vs. Benchmark** and **Current/Most Recent vs. Previous Period** relationships simultaneously. Measures in your viz that aren't part of the configured relationships are written about in separate paragraphs.

Create Actual vs. Benchmark relationship for continuous or discrete stories

Use the **Actual vs. Benchmark** relationship when one measure is a benchmark for other measures. For example, you could compare actual sales to a sales target, so your story writes insights about whether you outperformed or underperformed your goal. When you use this type of relationship, the story removes unnecessary content and focuses on what's most important—comparing a metric to its associated benchmark.

1. [Add a Tableau Data Story to a Dashboard on page 2863.](#)
2. From your dashboard, click the **Settings** icon at the top-left corner of your Data Story object.
3. In the Data Story dialog box, click the **Relationships** tab.
4. Check the box for **Actual vs. Benchmark**.
5. First, select the measure that is the benchmark.
6. Then, select the measure that you want to compare against the benchmark.
7. Click **Save**.

Create Current/Most Recent vs. Previous Period relationship

Use the **Current/Most Recent vs. Previous Period** relationship to compare the performance of two measures over a period. For example, you could compare two products to see which product generated the most revenue over the last year.

1. [Add a Tableau Data Story to a Dashboard on page 2863.](#)
2. From your dashboard, click the **Settings** icon at the top-left corner of your Data Story object.
3. In the Data Story dialog box, click the **Relationships** tab.
4. Check the box for **Current/Most Recent vs. Previous Period**.
5. First select the measure for the previous period.
6. Then, select the measure for the current period.
7. Enter the label for the period that you're measuring, for example, year.
8. Choose the number of periods to measure.
9. Click **Save**.

Customize Your Tableau Data Story

Important changes for Tableau Data Stories

Tableau Data Stories will be retired in Tableau Desktop, Tableau Cloud, and Tableau Server in January of 2025 (2025.1). With advances in natural language technologies, we're developing an improved interface that will make it easier to ask questions of your data and stay on top of changes. For more information, see [How Tableau Pulse powered by Tableau AI is Reimagining the Data Experience](#).

You can use custom language, tailored to your audience, to supplement your Tableau Data Stories with insights specific to your business. Identify the analytics and data from the Data Story that matters most to your audience, and use your own language to create the most

impactful story. As with the overall Tableau Data Story, data and variables used in custom content are dynamic, adjusting along with the dashboard.

Add your own insights

1. In your **Data Story**, click **Edit** to open the Edit dialog box.
2. Find the section you want to write about and click **Add Custom Item**.

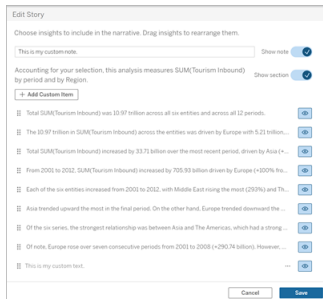

3. Enter your custom text in the field that appears.
4. Click **Save**.

Add headers and footers

You can insert custom text at the top and bottom of your **Data Story**. With headers and footers, you can add your own qualitative analysis to stories, include additional explanations of data trends, or append legal and privacy disclaimers.

1. In your **Data Story**, click **Edit** to open the Edit dialog box.
2. Click the **Show note** switch.
3. Enter your custom note.



4. Click **Save**.

Your note now shows at the top or bottom of your **Data Story**.

Add functions

Using a function in your Data Story is a great way to customize your story and find the insights that are most important to you and your business.

For example, if you want to know the average sum of tourism revenue over a period, select Average as your function and then designate the measure as SUM(Tourism Inbound). This returns the average sum of inbound tourism.

1. In your **Data Story**, click **Edit** to open the Edit dialog box.
2. Click the menu in the right side of the box and select **Add Function**.



3. Select a Data Story Function and fill in the required fields.

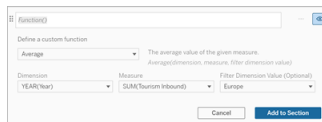

4. Click **Add to Section**.
5. Click **Save**.

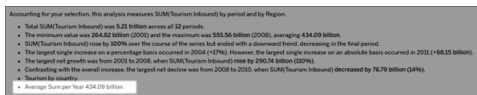

The custom content now shows in your Data Story.

Add conditions

For each custom sentence you write, you can add a condition that determines whether the sentence renders in your **Data Story**. If the condition is met, the custom sentence appears in your story. If the condition isn't met, the custom sentence doesn't appear.

You can apply multiple conditions to each custom sentence, and the conditions can be combined using the **Any** or **All** buttons within the Add a condition dialog box.

Conditional statements are most often used with numerical comparisons, but the function also supports string matching using the equal (=) or not equal (!=) symbols.

1. In your Data Story, click **Edit** to open the Edit dialog box.
2. Enter your custom sentence.
3. Click the menu on the right side of the box and select **Add Condition**.
4. Define the custom function to be used to inform the conditional logic. In this example, the sentence "We have met our quota" shows if the Sum of Tourism Inbound is greater than 5 trillion.

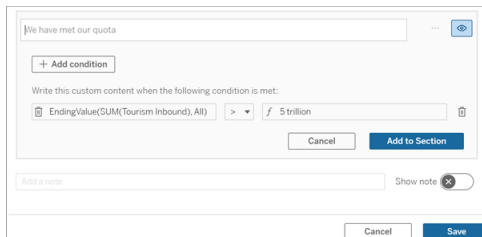

5. Click **Add to Section**.
6. Click **Save**.

The custom sentence now appears in your Data Story only if the conditions are met.

Duplicate custom content

You can easily duplicate custom content added to your Data Story, making it easier to build different variations of a sentence. We recommend copying a fully built custom sentence when applying thresholds, building in language variation, and creating different logical variations.

1. In your Data Story, click **Edit** to open the Edit dialog box.
2. Create a custom sentence, complete with functions and conditions, if desired.
3. In the completed sentence box, Click the menu in the right side of the box and select **Duplicate**.

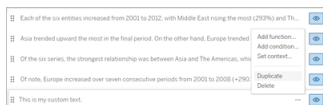

4. Click into your duplicated sentence, update as desired, and click **Add to Section**.
5. Click **Save**.

When you copy a sentence, all functions and conditional statements also copy over. The copied bullet appears directly below the original bullet in the same section.

Note: Copied bullets can only be added to the section that the original bullet is in.

Add custom content in drilldown sections

For stories that have two dimensions, each section after the first section is called a drilldown section. Drilldown sections focus on an individual primary dimension entity (i.e. The Americas in the following example).

Because the drilldown sections have the same content structure, custom content added in the first section (i.e., Europe) are applied to each additional section (i.e., The Americas). You can only create or edit content in the first drilldown section.

1. In your Data Story, click **Edit** to open the Edit dialog box.
2. In the first drilldown section, click **Add Custom Item** to each entity.
3. Enter your custom content.
4. Click **Save**.

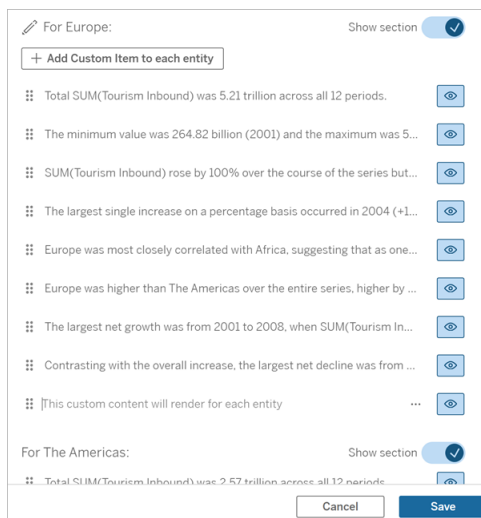

Custom content in drilldown sections already has a context variable called Current Category value (dynamic). This creates a dimension value option called Current Category value (dynamic) which always represents the section that the drilldown section is about.

Tip: To create content that only appears in a single specific drilldown section, you can use conditional logic to ensure it only writes where appropriate.

Customize Your Tableau Data Story: Context Variables

Important changes for Tableau Data Stories

Tableau Data Stories will be retired in Tableau Desktop, Tableau Cloud, and Tableau Server in January of 2025 (2025.1). With advances in natural language technologies, we're developing an improved interface that will make it easier to ask questions of your data and stay on top of changes. For more information, see [How Tableau Pulse powered by Tableau AI is Reimagining the Data Experience](#).

Context variables are functions that can be referenced by other functions. In other words, you can use context variables to nest functions within other functions.

After you define your context variable, it appears as a function that you can use when adding new functions to your Tableau Data Story.

Note: You can have multiple context variables set for each custom sentence, but you must define each context variable separately for each piece of custom content.

Set a context variable

1. In your **Data Story**, click **Edit** to open the Edit dialog box.
2. Click **Add Custom Item**.
3. Click the menu in the right side of your custom content box and select **Set context**.

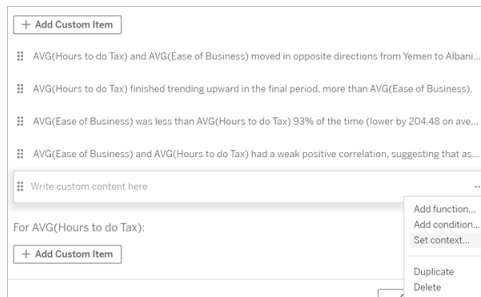

4. Click **Add context**.
5. Name the context variable and click **Set Function**.
6. Define your custom function and choose a dimension.

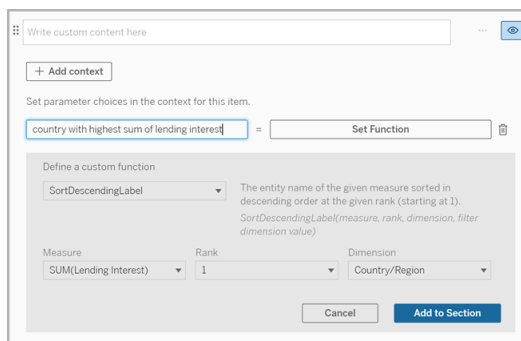

7. Click **Add to Section**.
8. Click back into the sentence where you set your context variable.

9. Follow the steps to **Add functions** on page 2890.

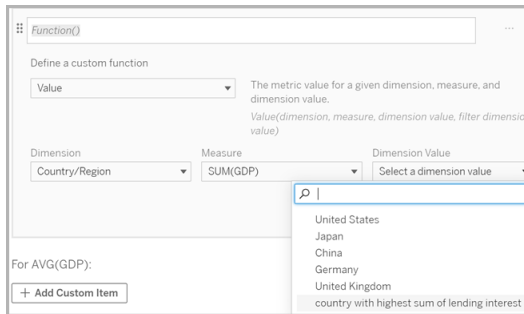

Now, your context variable is listed as an option in the **Dimension Value** drop-down list when adding your function.

When to use a context variable: reference two or more measures

Let's say that you want to refer to two or more measures in one analytical sentence in your **Data Story**. Without a context variable, we can write a sentence for only one measure at a time. But if we use a context variable, we can reference more than one measure in one sentence.

To reference two or more measures with a context variable, your **Data Story** must have:

- 1 dimension
- 2 or more measures

1. In your **Data Story**, click **Edit** to open the Edit dialog box.
2. Click **Add Custom Item**.
3. Click the menu in the right side of your custom content box and select **Set context**.
4. Click **Add context**.
5. Name the context variable and click **Set Function**.
6. Define your custom function and choose a dimension.
7. Click **Add to Section**.

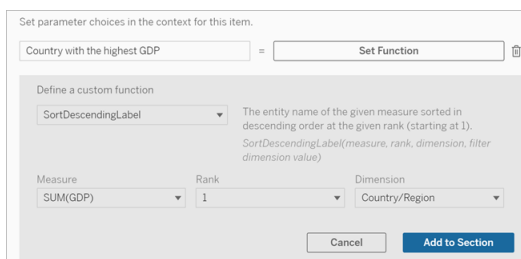

8. Click back into the sentence where you set your context variable.
9. Add your first function and fill in the required fields. In this example, we selected **DimensionValueLabel**, and then chose Country/Region from **Dimension**, and then country with the highest GDP (our context variable) from **Dimension Value**.

Function()

Define a custom function

DimensionValueLabel The label for a dimension value. Most useful in combination with "Current (dynamic)."
DimensionValueLabel(dimension, dimension value)

Dimension: Country/Region Dimension Value: Country with the highest GDP

Cancel Add to Section

10. Click **Add to Section**.
11. Add your second function and fill in the required fields. In this example, we selected **Value**, and then chose Country/Region from **Dimension**, SUM(Lending Interest) from **Measure**, and country with the highest GDP (our context variable) from **Dimension Value**.

DimensionValueLabel(Country/Region, Country with highest GDP), which has the highest AVG (GDP: has a SUM of function)

Define a custom function

Value The metric value for a given dimension, measure, and dimension value.
Value(dimension, measure, dimension value, filter dimension value)

Dimension: Country/Region Measure: SUM(Lending Interest) Dimension Value: Country with highest GDP

Cancel Add to Section

12. Click **Add to Section**.
13. Click **Save**.

Your **Data Story** writes a sentence that gives us insight into a secondary measure (Lending Interest) for the country that we're interested in (the country with the highest GDP).

For AVG(GDP):

- Total AVG(GDP) is **348.03 trillion** across all **five** entities.
- The AVG(GDP) of **348.03 trillion** was driven by United States with 173 trillion, Japan with 62.36 trillion and China with 46.99 trillion.
- The minimum value is **28.48 trillion** (United Kingdom) and the maximum is **173 trillion** (United States), a difference of **144.52 trillion**, averaging **69.61 trillion**.
- United States (173 trillion) is more than **two** times bigger than the average across the **five** entities.
- United States, which has the highest AVG (GDP), has a Lending Interest SUM of 0.7 billion.

When to use a context variable: period-over-period analysis

A context variable is helpful when you want to analyze performance over two different periods in your **Data Story**. You can create a custom sentence that writes about a measure displayed in your drilldown section and compares the measure against different periods, such as year over year or month over month.

To set up a period-over-period analysis, your Data Story must have:

- 2 dimensions: 1 time period dimension (primary) and 1 non-time period dimension (secondary)
 - 1–3 measures
1. Create your **Data Story**.
 2. In the Fields dialog box, make sure your time period dimension is ordered first and click **Next**.
 3. In the Story dialog box, select **Continuous** and click **Done**.
 4. Open the Edit dialog box, and select **Add Custom Item** in the first drilldown area.
 5. Create two context variables that represent your time periods. For example, "Current Quarter" and "Previous Quarter."

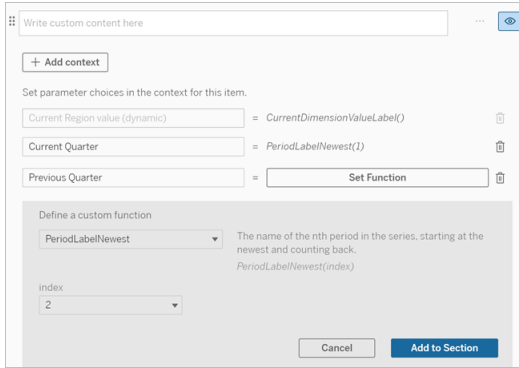

6. Create an *increased* sentence by adding custom language and functions. The content of this sentence results in "[CurrentDimensionValueLabel] increased [X%] over the quarter."
7. Type in the function followed by the word "increased" in the custom text box.
8. Add the function that returns the percent change of your measurement during your time period.

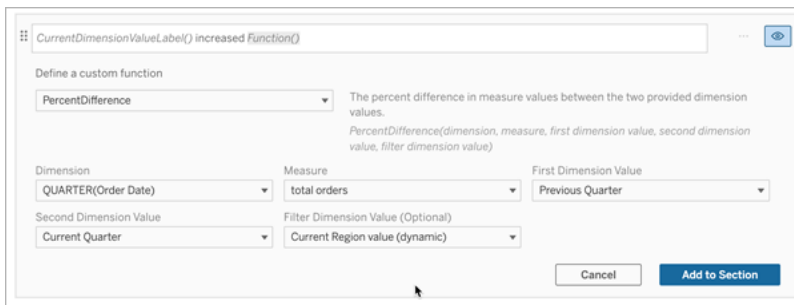

9. Click **Add to Section**.
10. **Duplicate custom content on page 2891** and create a *decreased* version by replacing the word "increased" with "decreased." The functions stay the same.

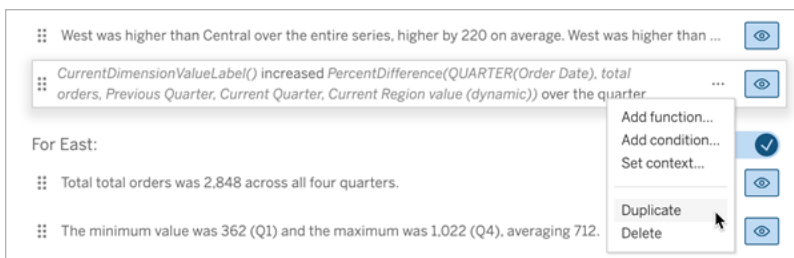

11. **Add conditions** on page 2890 for each sentence so that only one is written, depending on the data.

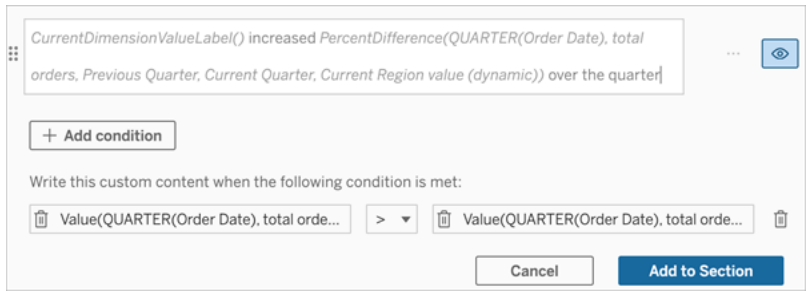

12. For the *increased* sentence, set conditions in line with the following example:

Left Argument = Value function

Dimension = Quarter(OrderDate). Select your time period dimension

Measure = SUM(Total Orders). Select the measure you used for the calculation

Dimension Value = Current Quarter. One of the context variables

Filter Dimension Value = Current Region value (dynamic). This is the preset context variable

Middle Argument = > (greater than)

Right Argument = Value function

Dimension= Quarter(OrderDate). Select your time period dimension

Measure = Total(Total Orders). Select the measure you used for the calculation

Dimension Value = Previous Quarter. One of the context variables

Filter Dimension Value = Current Region value (dynamic). This is the preset context variable

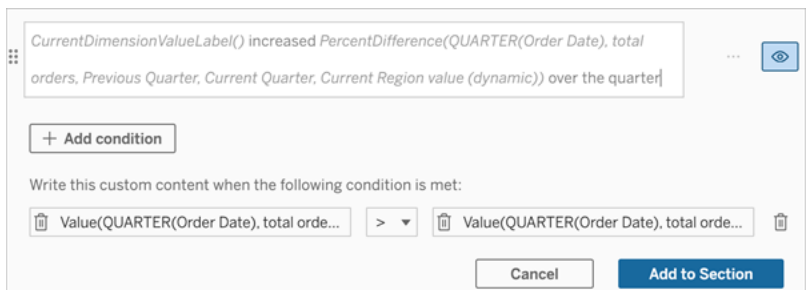

13. For the *decreased* sentence, set the same conditions, but replace the > (greater than) sign with the < (less than) sign. The right and left arguments remain the same.
14. Click **Save**, and your **Data Story** writes a sentence that includes the insights from analyzing the two time periods.

Customize Your Tableau Data Story: Functions

Important changes for Tableau Data Stories

Tableau Data Stories will be retired in Tableau Desktop, Tableau Cloud, and Tableau Server in January of 2025 (2025.1). With advances in natural language technologies, we're developing an improved interface that will make it easier to ask questions of your data and stay on top of changes. For more information, see [How Tableau Pulse powered by Tableau AI is Reimagining the Data Experience](#).

If you'd like to customize your Tableau Data Story with a function, it helps to know what functions you can use, what each function does, and what dimensions and measures you'll need for each function.

Learn how to [Add functions on page 2890](#) to your Data Story.

Click a letter to see functions that begin with that letter. If no functions start with that letter, the functions that start with the next letter in the alphabet are shown. You can also press Ctrl+F (Command-F on a Mac) to open a search box that you can use to search the page for a specific function.

A B C D E F G H I J K L M N O P Q R S T U V W X Y Z

Average

Description: The average value of the given measure.

Syntax: Average(dimension, measure, filterDimensionValue)

Count

Description: The number of dimension values within a given dimension.

Syntax: Count(dimension)

Difference

Description: The difference in measure values between the two provided dimension values.

Syntax: Difference(dimension, measure, firstDimensionValue, secondDimensionValue, filterDimensionValue)

DifferenceFromMean

Description: The difference between the mean and the measure value for the given dimension value.

Syntax: DifferenceFromMean(dimension, measure, firstDimensionValue, filterDimensionValue)

Direction

Description: Language describing the direction (e.g., increase or decrease) between measure values for the two provided dimension values.

Syntax: Direction(dimension, measure, firstDimensionValue, secondDimensionValue, filterDimensionValue, phrase)

Ending Label

Description: The name of the last period in the series.

Syntax: Label(measure)

EndingValue

Description: The value at the last period in the series for the given measure.

Syntax: EndingValue(measure, filterDimensionValue)

Label

Description: The label for the given measure.

Syntax: Label(measure)

LargestNegativeChangeDifference

Description: The value of the largest negative period-over-period difference, on an absolute basis, in the given series.

Syntax: LargestNegativeChangeDifference(measure, filterDimensionValue)

LargestNegativeChangeEndingLabel

Description: The name of the ending period for the largest negative period-over-period difference, on an absolute basis, in the given series.

Syntax: LargestNegativeChangeEndingLabel(measure, filterDimensionValue)

LargestNegativeChangeEndingValue

Description: The ending value of the largest negative period-over-period difference, on an absolute basis, in the given series.

Syntax: LargestNegativeChangeEndingValue(measure, filterDimensionValue)

LargestNegativeChangePercentDifference

Description: The percent change of the largest negative period-over-period difference, on an absolute basis, in the given series.

Syntax: LargestNegativeChangePercentDifference(measure, filterDimensionValue)

LargestNegativeChangeStartingLabel

Description: The name of the starting period for the largest negative period-over-period difference, on an absolute basis, in the given series.

Syntax: LargestNegativeChangeStartingLabel(measure, filterDimensionValue)

LargestNegativeChangeStartingValue

Description: The starting value of the largest negative period-over-period difference, on an absolute basis, in the given series.

Syntax: LargestNegativeChangeStartingValue(measure, filterDimensionValue)

LargestNegativePercentChangeDifference

Description: The value of the largest negative period-over-period difference, on a percentage basis, in the given series.

Syntax: LargestNegativePercentChangeDifference(measure, filterDimensionValue)

LargestNegativePercentChangeEndingLabel

Description: The name of the ending period for the largest negative period-over-period difference, on a percentage basis, in the given series.

Syntax: LargestNegativePercentChangeEndingLabel(measure, filterDimensionValue)

LargestNegativePercentChangeEndingValue

Description: The ending value of the largest negative period-over-period difference, on a percentage basis, in the given series.

Syntax: LargestNegativePercentChangeEndingValue(measure, filterDimensionValue)

LargestNegativePercentChangePercentDifference

Description: The percent change of the largest negative period-over-period difference, on a percentage basis, in the given series.

Syntax: LargestNegativePercentChangePercentDifference(measure, filterDimensionValue)

LargestNegativePercentChangeStartingLabel

Description: The name of the starting period for the largest negative period-over-period difference, on a percentage basis, in the given series.

Syntax: LargestNegativePercentChangeStartingLabel(measure, filterDimensionValue)

LargestNegativePercentChangeStartingValue

Description: The starting value of the largest negative period-over-period difference, on a percentage basis, in the given series.

Syntax: LargestNegativePercentChangeStartingValue(measure, filterDimensionValue)

LargestPositiveChangeDifference

Description: The value of the largest positive period-over-period difference, on an absolute basis, in the given series.

Syntax: LargestPositiveChangeDifference(measure, filterDimensionValue)

LargestPositiveChangeEndingLabel

Description: The name of the ending period for the largest positive period-over-period difference, on an absolute basis, in the given series.

Syntax: LargestPositiveChangeEndingLabel(measure, filterDimensionValue)

LargestPositiveChangeEndingValue

Description: The ending value of the largest positive period-over-period difference, on an absolute basis, in the given series.

Syntax: LargestPositiveChangeEndingValue(measure, filterDimensionValue)

LargestPositiveChangePercentDifference

Description: The percent change of the largest positive period-over-period difference, on an absolute basis, in the given series.

Syntax: LargestPositiveChangePercentDifference(measure, filterDimensionValue)

LargestPositiveChangeStartingLabel

Description: The name of the starting period for the largest positive period-over-period difference, on an absolute basis, in the given series.

Syntax: LargestPositiveChangeStartingLabel(measure, filterDimensionValue)

LargestPositiveChangeStartingValue

Description: The starting value of the largest positive period-over-period difference, on an absolute basis, in the given series.

Syntax: LargestPositiveChangeStartingValue(measure, filterDimensionValue)

LargestPositivePercentChangeDifference

Description: The value of the largest positive period-over-period difference, on a percentage basis, in the given series.

Syntax: LargestPositivePercentChangeDifference(measure, filterDimensionValue)

LargestPositivePercentChangeEndingLabel

Description: The name of the ending period for the largest positive period-over-period difference, on a percentage basis, in the given series.

Syntax: LargestPositivePercentChangeEndingLabel(measure, filterDimensionValue)

LargestPositivePercentChangeEndingValue

Description: The ending value of the largest positive period-over-period difference, on a percentage basis, in the given series.

Syntax: LargestPositivePercentChangeEndingValue(measure, filterDimensionValue)

LargestPositivePercentChangePercentDifference

Description: The percent change of the largest positive period-over-period difference, on a percentage basis, in the given series.

Syntax: LargestPositivePercentChangePercentDifference(measure, filterDimensionValue)

LargestPositivePercentChangeStartingLabel

Description: The name of the starting period for the largest positive period-over-period difference, on a percentage basis, in the given series.

Syntax: LargestPositivePercentChangeStartingLabel(measure, filterDimensionValue)

LargestPositivePercentChangeStartingValue

Description: The starting value of the largest positive period-over-period difference, on a percentage basis, in the given series.

Syntax: LargestPositivePercentChangeStartingValue(measure, filterDimensionValue)

LongestStreakDifference

Description: The difference over the longest streak of consecutive increases or decreases for the given series.

Syntax: LongestStreakDifference(measure, filterDimensionValue)

LongestStreakDirection

Description: The direction (positive or negative) of the longest streak of consecutive increases or decreases for the given series.

Syntax: LongestStreakDirection(measure, filterDimensionValue)

LongestStreakEndingLabel

Description: The name of the ending period for the longest streak of consecutive increases or decreases for the given series.

Syntax: LongestStreakEndingLabel(measure, filterDimensionValue)

LongestStreakEndingValue

Description: The ending value of the longest streak of consecutive increases or decreases for the given series.

Syntax: LongestStreakEndingValue(measure, filterDimensionValue)

LongestStreakLength

Description: The largest number of periods of consecutive increase or decrease for the given series.

Syntax: LongestStreakLength(measure, filterDimensionValue)

LongestStreakPercentDifference

Description: The percent difference over the longest streak of consecutive increases or decreases for the given series.

Syntax: LongestStreakPercentDifference(measure, filterDimensionValue)

LongestStreakStartingLabel

Description: The name of the starting period for the longest streak of consecutive increases or decreases for the given series.

Syntax: LongestStreakStartingLabel(measure, filterDimensionValue)

LongestStreakStartingValue

Description: The starting value of the longest streak of consecutive increases or decreases for the given series.

Syntax: LongestStreakStartingValue(measure, filterDimensionValue)

MaxLabel

Description: The name of the entity with the maximum value for the given measure.

Syntax: MaxLabel(dimension, measure, filterDimensionValue)

MaxValue

Description: The maximum value for the given measure.

Syntax: MaxValue(measure)

Median

Description: The median value for the given measure.

Syntax: Median(dimension, measure, filterDimensionValue)

MinLabel

Description: The name of the entity with the minimum value for the given measure. Syntax:

MinLabel(dimension, measure, filterDimensionValue)

MinValue

Description: The minimum value for the given measure.

Syntax: MinValue(dimension, measure, filterDimensionValue)

PercentDifference

Description: The percent difference in measure values between the two provided dimension values.

Syntax: PercentDifference(dimension, measure, firstDimensionValue, secondDimensionValue, filterDimensionValue)

PercentOfWhole

Description: The percent in measure values for a given dimension value over the total measure values for that dimension.

Syntax: PercentOfWhole(dimension, measure, dimensionvalue, filterDimensionValue)

PeriodLabel

Description: The name of the nth period in the series, starting at 1.

Syntax: PeriodLabel(index)

PeriodLabelNewest

Description: The name of the nth period in the series, starting at the newest and counting back.

Syntax: PeriodLabelNewest(index)

PeriodValue

Description: The value of the given measure at the nth period in the series, starting at 1.

Syntax: PeriodValue(measure, index, filterDimensionValue)

PeriodValueNewest

Description: The value of the given measure at the nth period in the series, starting at the newest and counting back.

Syntax: PeriodValueNewest(measure, index)

Range

Description: The difference between the maximum and minimum values for the given measure.

Syntax: Range(dimension, measure, filterDimensionValue)

SortAscendingLabel

Description: The entity name of the given measure sorted in descending order at the given rank (starting at 1).

Syntax: SortAscendingLabel(measure, rank, dimension, filterDimensionValue)

SortAscendingValue

Description: The value of the given measure sorted in ascending order at the given rank (starting at 1).

Syntax: SortAscendingValue(measure, rank, dimension, filterDimensionValue)

SortDescendingLabel

Description: The entity name of the given measure sorted in descending order at the given rank (starting at 1).

Syntax: SortDescendingLabel(measure, rank, dimension, filterDimensionValue)

SortDescendingValue

Description: The value of the given measure sorted in descending order at the given rank (starting at 1).

Syntax: SortDescendingValue(measure, rank, dimension, filterDimensionValue)

StartingLabel

Description: The name of the first period in the series.

Syntax: StartingLabel()

StartingValue

Description: The value at the first period in the series for the given measure.

Syntax: StartingValue(measure, filterDimensionValue)

StartToFinishDifference

Description: The difference between the values for the first and last periods in the given series.

Syntax: StartToFinishDifference(measure, filterDimensionValue)

StartToFinishPercentDifference

Description: The percent difference between the values for the first and last periods in the given series.

Syntax: StartToFinishPercentDifference(measure, filterDimensionValue)

StdDev

Description: The standard deviation value for the given measure.

Syntax: StdDev(dimension, measure, filterDimensionValue)

Sum

Description: The sum of measure values for the two provided dimension values.

Syntax: Sum(dimension, measure, firstDimensionValue, secondDimensionValue, filterDimensionValue)

Total

Description: The sum total value for the given measure.

Syntax: Total(dimension, measure, filterDimensionValue)

Value

Description: The metric value for a given dimension, measure, and dimension value.

Syntax: Value(dimension, measure, dimension value, filterDimensionValue)

Z-Score

Description: The z-score for the given measure.

Syntax: Z-Score(dimension, measure, firstDimensionValue, filterDimensionValue)

Customize Your Tableau Data Story: Hide and Reorder Content

Important changes for Tableau Data Stories

Tableau Data Stories will be retired in Tableau Desktop, Tableau Cloud, and Tableau Server in January of 2025 (2025.1). With advances in natural language technologies, we're developing an improved interface that will make it easier to ask questions of your data and stay on top of changes. For more information, see [How Tableau Pulse powered by Tableau AI is Reimagining the Data Experience](#).

Customize your Tableau Data Story with the content that is most important to you and your audience by hiding or reordering content within your story.

Hide content and sections

1. Create your **Data Story** and click **Edit** to open the Edit dialog box.
2. Set sections to show or hide by clicking the **Show section** switch to the on or off position.
3. Hover over the blue box to the right of each individual sentence, and click the box to show or hide from view.
4. Click **Save**.

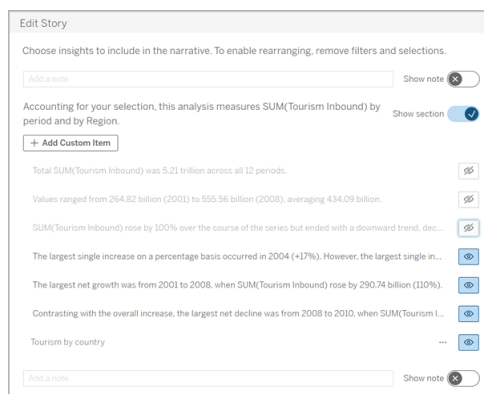

Now, only the sentences and sections that are set to **Show** appear in your Data Story.

Reorder content within a section

1. Create your **Data Story** and click **Edit** to open the Edit dialog box.
2. Hover over the left-side menu of the content you want to reorder. Your cursor turns into a hand icon.
3. Click the item with your cursor and drag it anywhere within the same section.
4. Click **Save**.

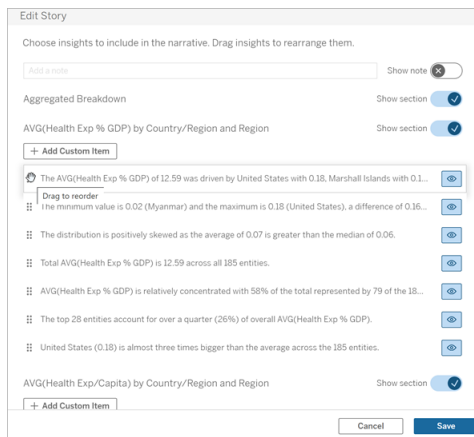

Now, the sentences appear in your **Data Story** in the order that you set them to.

Note: Currently, content can only be moved within the same section. Moving entire sections isn't yet supported.

Add More Data to Your Tableau Data Story

Important changes for Tableau Data Stories

Tableau Data Stories will be retired in Tableau Desktop, Tableau Cloud, and Tableau Server in January of 2025 (2025.1). With advances in natural language technologies, we're developing an improved interface that will make it easier to ask questions of your data and stay on top of changes. For more information, see [How Tableau Pulse powered by Tableau AI is Reimagining the Data Experience](#).

Data Stories currently supports stories with two dimensions and one measure, or one dimension and up to 10 measures. If you'd like to write about data that you don't need to show on your dashboard, then use a hidden sheet to simplify your dashboard. If you'd like to add more than two dimensions to your story, then concatenate dimensions or create multiple data stories and stack them.

Use a hidden sheet

If you have data that you want to include in a Tableau Data Story and don't need to show all the data that drove the insight, you can use a hidden sheet to bring additional measures and dimensions into your story without cluttering the dashboard.

1. Drag the **Data Story** object to your dashboard to see which worksheets you can write about in the Data Story dialog box. In this example, there are two worksheets available to write about.

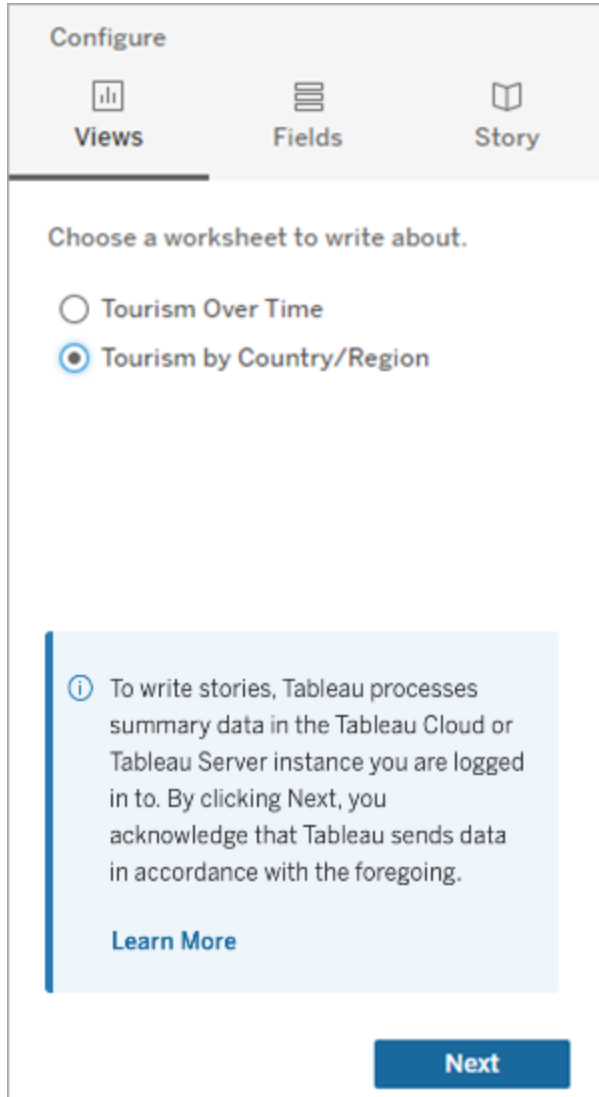

2. Bring in another data source, such as "Population," by navigating to the left-hand menu, selecting **Floating**, and dragging that sheet onto your dashboard.

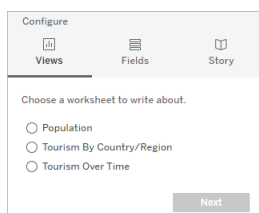

The Data Story dialog box updates with the new available data source.

3. Click into **Layout** and adjust the size to 1 x 1 to hide the sheet but keep the underlying data in your story.

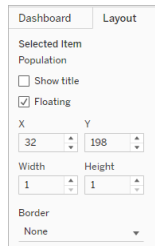

You can now configure your stories using this hidden sheet.

Note: You may need to deselect additional legend elements to keep the sheet hidden.

Concatenate dimensions

If your data contains three dimensions and one measure and is a **Discrete Story**, you can concatenate (link together) two of those dimensions by creating a calculated field.

1. From the worksheet you want to use in your story, click **Analysis** and select **Create Calculated Field**.
2. Name the calculated field and use the following formula to create your calculation, using the + sign to join the dimensions.

[Dimension 1] + [Dimension 2]

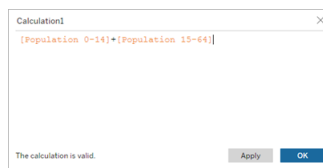

Tip: Drag your dimensions into the **Calculated Field** box and place them in the formula.

3. Click **OK**.
4. Drag your new calculated field into the **Detail** pane to make it accessible in your data story.

Stack multiple data stories

Write about more measures and dimensions by creating multiple **Data Stories** and stacking them vertically or horizontally on your dashboard.

For example, if you wanted to create a story about actual revenue vs benchmark revenue, you could create two different stories—one with the actual revenue and the first benchmark, and another with the actual revenue and the second benchmark—and compare them.

Add a Pop-Up Tableau Data Story to Your Dashboard

Important changes for Tableau Data Stories

Tableau Data Stories will be retired in Tableau Desktop, Tableau Cloud, and Tableau Server in January of 2025 (2025.1). With advances in natural language technologies, we're developing an improved interface that will make it easier to ask questions of your data and stay on top of changes. For more information, see [How Tableau Pulse powered by Tableau AI is Reimagining the Data Experience](#).

You can place a Tableau Data Story in a pop-up window that allows your users to open a story, read it, and then close it when they're done. This is a great way to save space being used by already-established dashboards or to reduce the amount of clutter and information on a dashboard.

1. [Add a Tableau Data Story to a Dashboard on page 2863](#).
2. Set the container to **Floating** by clicking the menu and selecting **Floating**.

Tip: Another way to set the container to **Floating** is by holding the shift key while dragging the container onto your dashboard.

3. Navigate to the **Layout** tab in the left-hand column and set the background color to white.

Tableau Desktop and Web Authoring Help



4. Click the menu that is associated with your floating container to show its settings, and select **Add Show/Hide Button**. This creates an "X" icon that allows you to show or hide your story.

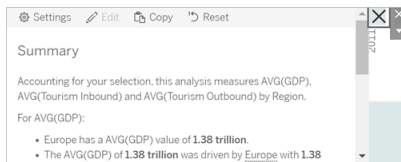

Note: If your story is selected, then your button is partially obscured by the sidebar options that are part of the Data Story object. Click anywhere outside of the story to reveal the button.

5. Hover over the "X" icon to show instructions for opening or closing the story. In this example, you're being prompted to press the Alt key at the same time you click the "X" icon.

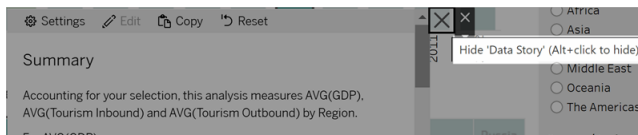

6. Collapse the story by clicking the "X" icon at the same time as pressing the key indicated in your prompt.

The story collapses, but the menu remains on the dashboard so that the user can expand the story when needed. You can move your collapsible, floating story around your dashboard as desired.

Create Custom Measure Relationships in Your Tableau Data Story

Important changes for Tableau Data Stories

Tableau Data Stories will be retired in Tableau Desktop, Tableau Cloud, and Tableau Server in January of 2025 (2025.1). With advances in natural language technologies, we're developing an improved interface that will make it easier to ask questions of your data and stay on top of changes. For more information, see [How Tableau Pulse powered by Tableau AI is Reimagining the Data Experience](#).

You can create a relationship story in your Tableau Data Story to see how data compares to another set of data. To build a relationship story, you must have at least two measures and one dimension. Data that you'd like to compare is often grouped into one column of data named something such as "Year" or "Month," with values such as "2022" or "March."

You can [Create a Simple Calculated Field](#) to separate "2022" from "2021" (or March from February), so that you can compare the two time periods in a relationship story.

1. Start in the sheet that you want to use in your **Data Story**.
2. Click **Analysis**, and select **Create a Calculated Field**.
3. Create a calculated field such as "Current Period."



Tip: Follow the structure of the calculated field shown here, but substitute your own dimension or measure names (orange text).

4. Create a calculated field such as "Previous Period."

Tableau Desktop and Web Authoring Help

```
Previous Period
if DATETRUNC('year', [Year]) = DATEADD('year', -1, (MAX(DATETRUNC('year', [Year]))))
THEN
SUM([Number of Records])
END
```

The calculation is valid. Apply OK

5. Drag the new measures onto the **Detail** mark.
6. From your dashboard, click the story and add the two new measures into your **Data Story**.

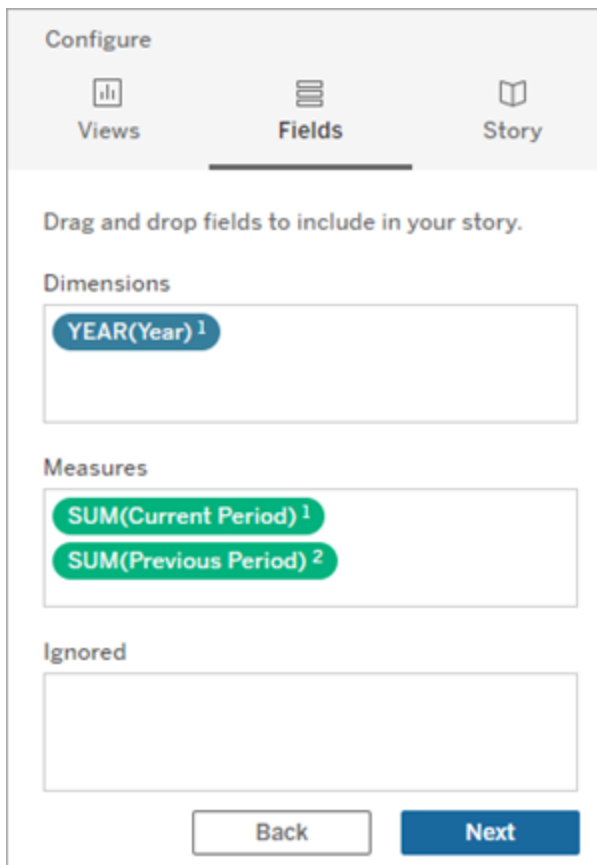

7. From your dashboard, click the **Settings** icon at the top-left corner of your Data Story object.
8. In the Data Story dialog box, click the **Relationships** tab.
9. Set up a relationship story with the two custom measures.

10. Click **Save**.

Your story now writes sentences that compare the custom measures.

Refresh Parameters in a Tableau Data Story

Important changes for Tableau Data Stories

Tableau Data Stories will be retired in Tableau Desktop, Tableau Cloud, and Tableau Server in January of 2025 (2025.1). With advances in natural language technologies, we're developing an improved interface that will make it easier to ask questions of your data and stay on top of changes. For more information, see [How Tableau Pulse powered by Tableau AI is Reimagining the Data Experience](#).

If you've added a parameter to your dashboard and are using Data Stories, you'll notice that clicking the parameter refreshes your visualization, but not the story. This happens because the parameter doesn't refresh the underlying data like a filter does.

To refresh your Tableau Data Story with the parameter data, add a "refresh" button to your dashboard that updates your story to align with your parameter.

1. Create a new sheet in your workbook.
2. Create a **Calculated Field** in the new sheet with the following info:

Name: Refresh

Contents: "refresh"

Tableau Desktop and Web Authoring Help



3. Click **OK**, and then drag the new calculated field (Refresh) onto your new sheet.
4. Right-click the field and click **Show Header** to hide the header.

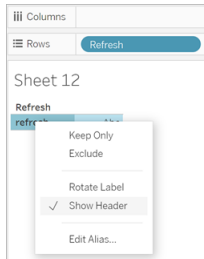

5. Choose a shape for your button.

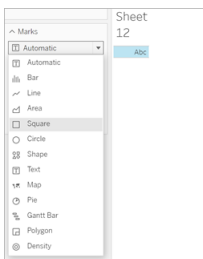

6. Return to your dashboard and drag the sheet containing the refresh button onto your dashboard next to the parameter.
7. Hover over the button, select **More Options**, and click **Title** to hide the title.
8. Hover over the button and click **Use as Filter**.

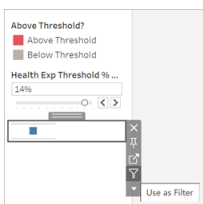

9. Adjust your parameter and then click on the new refresh button. The button updates your story to align with the parameter.

Use a Table Calculation in a Tableau Data Story

Important changes for Tableau Data Stories

Tableau Data Stories will be retired in Tableau Desktop, Tableau Cloud, and Tableau Server in January of 2025 (2025.1). With advances in natural language technologies, we're developing an improved interface that will make it easier to ask questions of your data and stay on top of changes. For more information, see [How Tableau Pulse powered by Tableau AI is Reimagining the Data Experience](#).

You can use a **Table Calculation** as a measure in a Tableau Data Story in addition to the measure that you used to create the table calculation.

1. From the **Marks** card, click the right side of your field to open a menu, and click **Quick Table Calculation**.

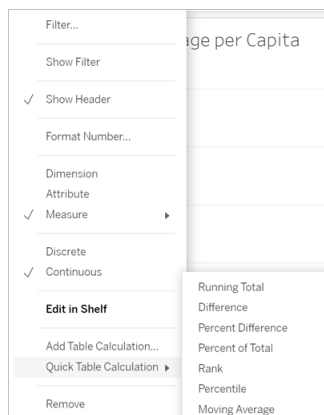

2. After you create your table calculation, drag it to **Measures** in the **Data** pane and rename it.

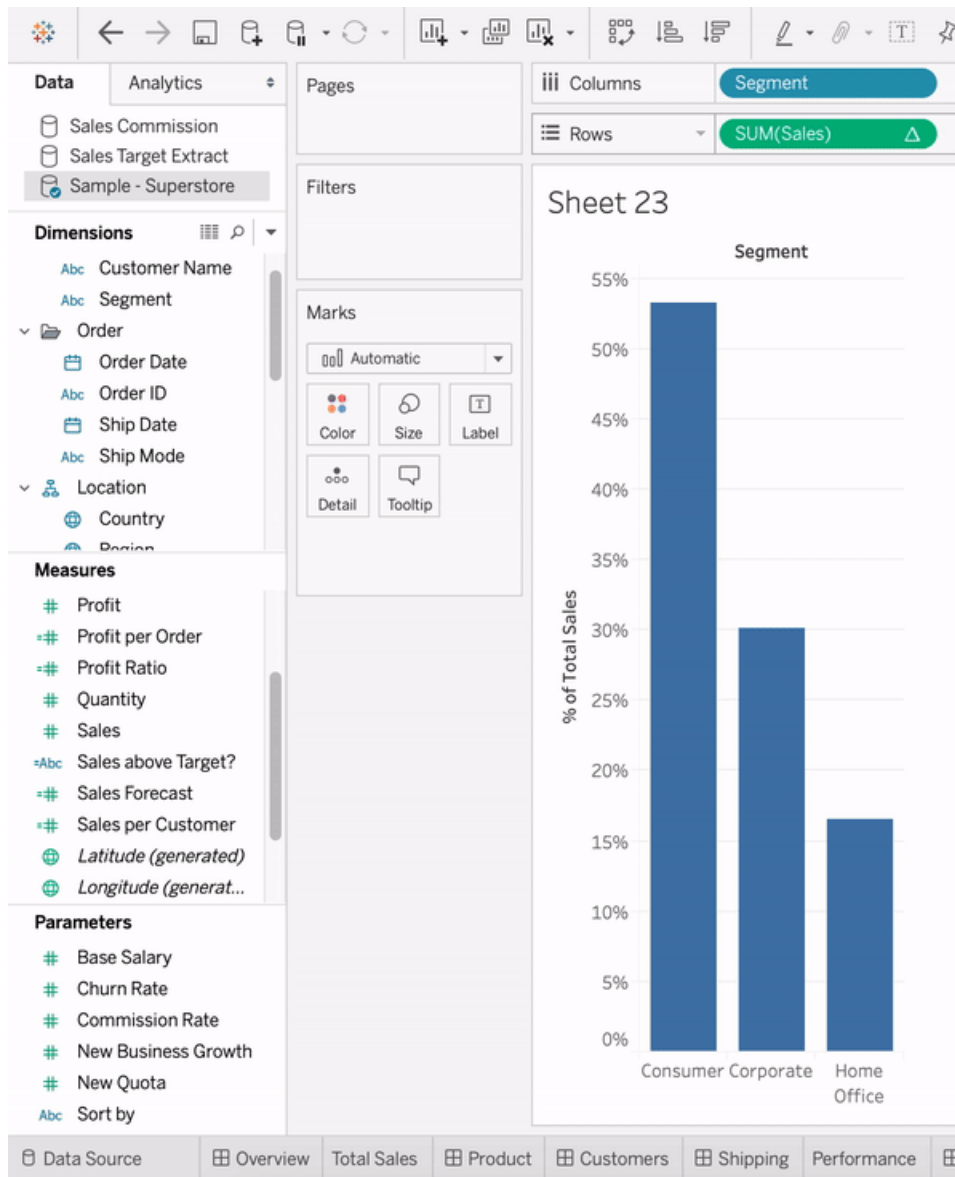

3. Drag your original measure (e.g., Sales) back to the **Rows** shelf, and then drag your new calculation (e.g., Sum of Sales) into the **Tooltip**. Your visualization may remain the same, but you now have access to the new measure.

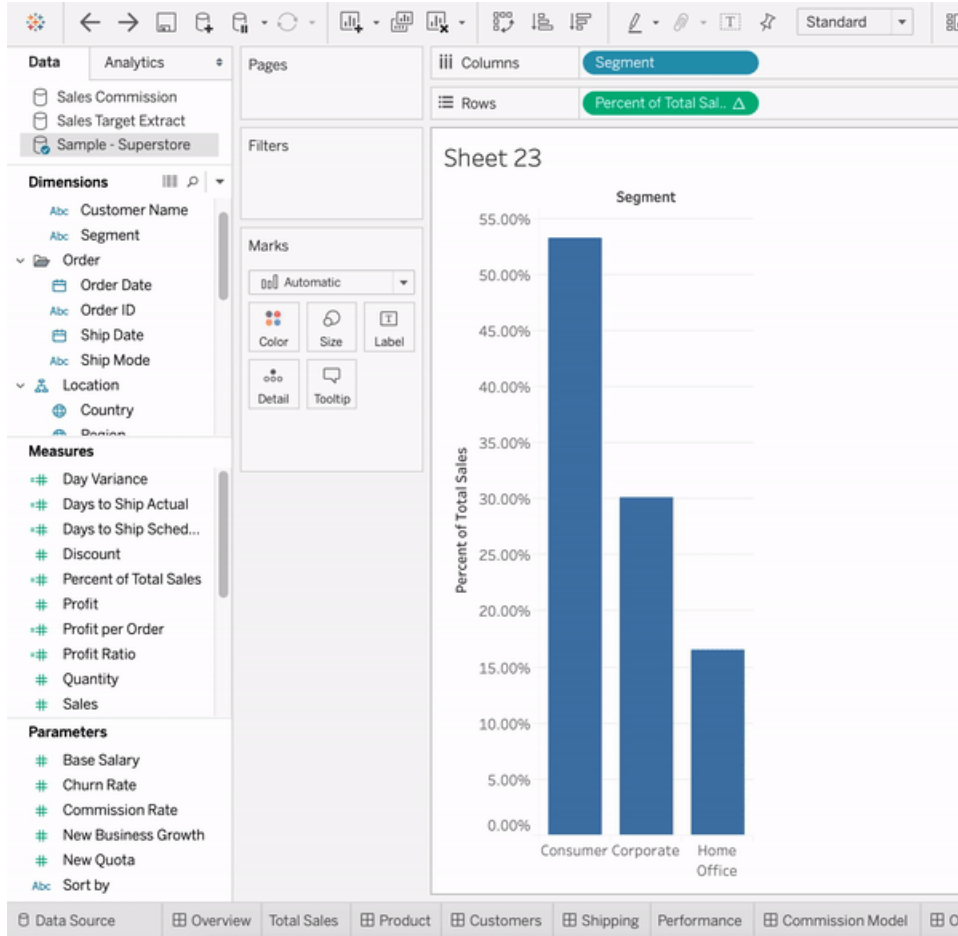

4. Go to your dashboard and drag the **Data Story** object onto the dashboard. Both measures appear when creating your story.

Format Your Work

Choosing the right formatting is important to both your analysis and your presentation. You can change the formatting for almost everything you see on a worksheet, including fonts, shading, alignment, borders, and graph lines. For example, in a text table, you can add banded shading to help you visually separate consecutive groups of rows or fields.

In a scatter view with reference lines, you can change the line thickness and color. All of these settings can be changed using the Format pane. You can specify format settings for the entire worksheet, all rows, or all fields. You can also format individual parts of the view. For example, you can format a single field, resize cells and tables, and edit individual axes.

Visual Best Practices

The fonts, colors, shading, alignment, borders, and grid lines in your visualization are important parts of both your analysis and the story you're telling. Tableau products are designed so that you can create great-looking visualizations that use visual best practices by default, freeing you from the need to think about things like fonts and colors—unless you want to.

If you do want to customize, you can control the look of almost everything you see on a worksheet. This article outlines visual best practices and tips to keep in mind while you customize, from ideal workflow to how to get the most out of tooltips.

Format from largest to smallest

As you change the look and feel of your work, use a biggest to smallest workflow. Start by formatting fonts and titles at the workbook level, then move on to the worksheet level. Save formatting the individual parts of a view for last. A workbook is the largest possible container for formatting changes, and making changes at the workbook level first will save you time.

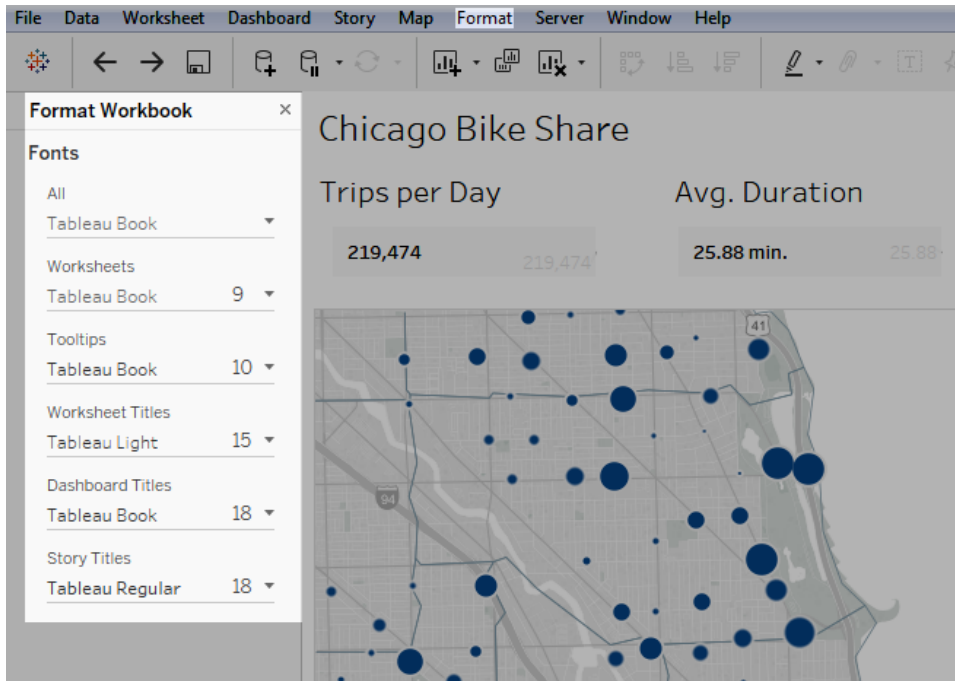

See [Format at the Workbook Level](#) on page 2932, [Format at the Worksheet Level](#) on page 2942, and [Format Text and Numbers](#) on page 2981 for details.

Change color with purpose

If you want to change the colors used by your visualization, Tableau makes it easy: just click the **Color** card, then **Edit Colors**. For example, maybe you want to emphasize a key finding. You can use neutral colors with a single, bright color to highlight what you want your viewers to pay attention to. If you want to match your company's brand, you can create a custom palette. See [Create Custom Color Palettes](#) on page 3021 for steps.

When you change colors, keep the following best practices in mind.

Discrete fields and categorical palettes

Discrete fields are ones where the field's values are unique. One example of this is customer names. Tableau automatically associates discrete fields with *categorical* palettes, which have colors that are designed to be distinct from one another yet also work well together in the visualization as a whole.

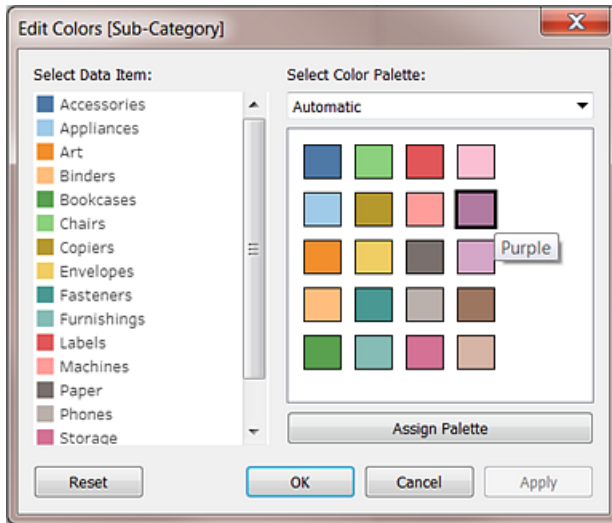

Change colors for individual fields

After you've selected a categorical palette, you can manually change the colors associated with specific fields.

1. From the **Edit Colors** dialog, double-click (Control-Click on Mac) any of the fields in the **Select Data Item** panel.
2. The color palette for your operating system opens, allowing you to define a new color for the item selected.

Continuous fields and quantitative palettes

With continuous fields, the field's values are part of a whole (such as sales over time). Tableau automatically associates these fields with *quantitative* palettes, where colors are along a continuum or range. If the field's values are positive, a single-color range is best:



If there are both positive and negative values, choose a two-color range:

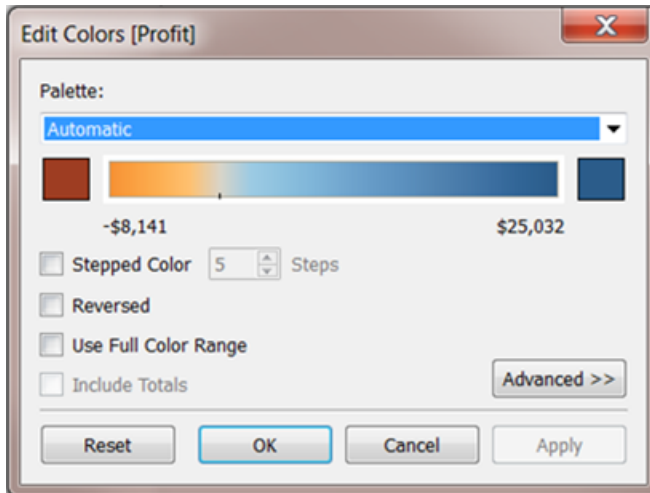

Limit colors

Color used correctly can enhance analysis. Too many colors can create visual overload for your users and impede analysis. In the view below, the stacked bars represent cell phone subscriptions and the trend line is internet usage over time. In the first image, Years is on the **Colors** shelf. Notice how hard it is to pick out the trend line among all the other colors and how easy it is to spot the trend line in the second image, where there are only two colors.

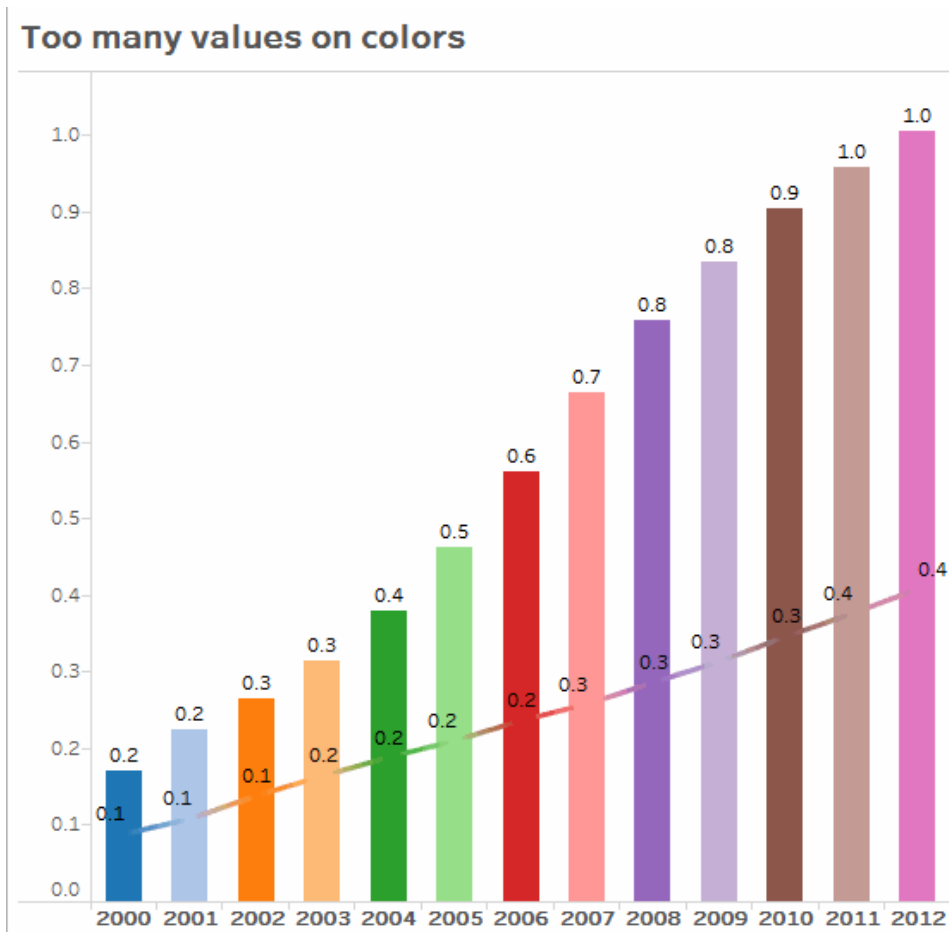

[Click the image to replay it.](#)

Use fonts that optimize online readability

The fonts in the Tableau typeface were designed to be paired with data visualizations and are optimized for legibility at small sizes. Tableau visualizations use them by default.

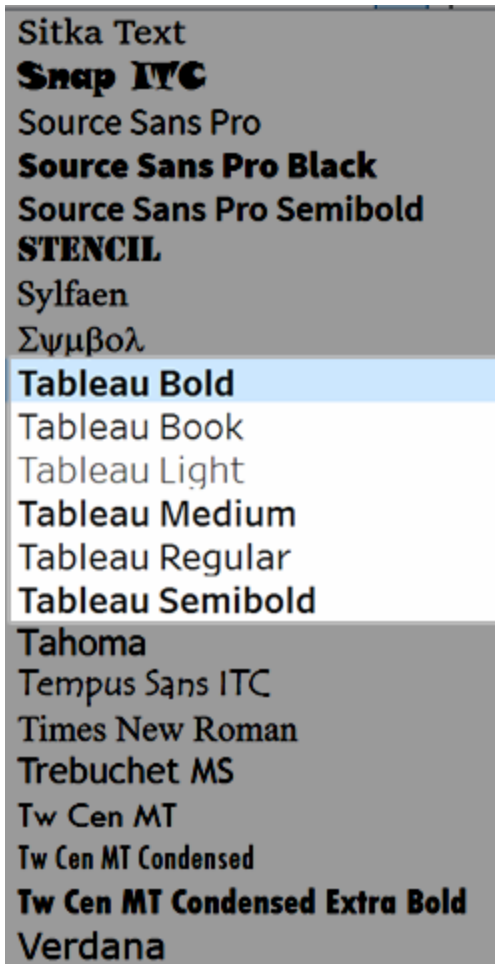

If you need to use a different font, choose one that optimizes readability online, such as the following:

- Arial
- Trebuchet MS
- Verdana
- Times New Roman
- Lucida sans

Reinforce your story with tooltips

People looking at your dashboard will intuitively use their mouse to explore marks, and this makes tooltips appear. Tooltips appear by default for most views, and they are a great way to reinforce your data story. You can customize your tooltips by clicking **Worksheet > Tooltip**.

For example, here's a tooltip for a view on pageviews for a web site:

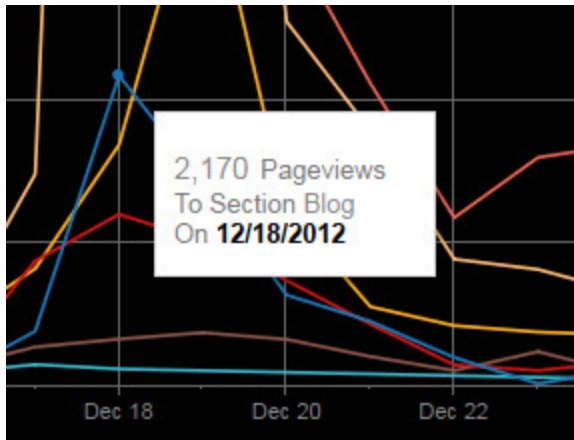

Here's an example of how the above tooltip could be rewritten and formatted to highlight what's important to the people looking at this view:

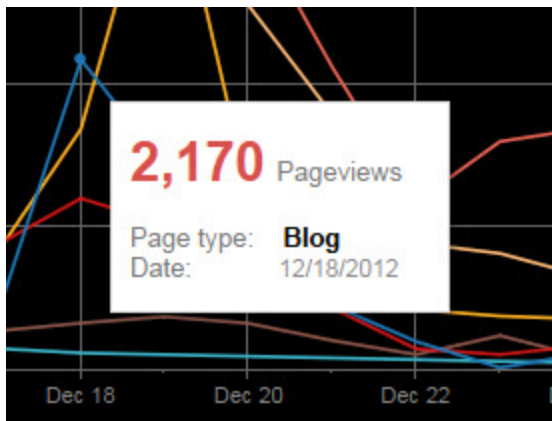

You can also rewrite your tooltips to tell a mini-story. For example, here's a tooltip about the number of oil rigs in Italy.

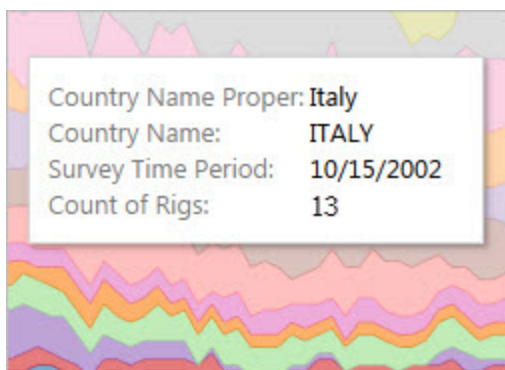

In the following example, the tooltip is rewritten as a sentence, and key elements are bolded to draw the viewer's attention.

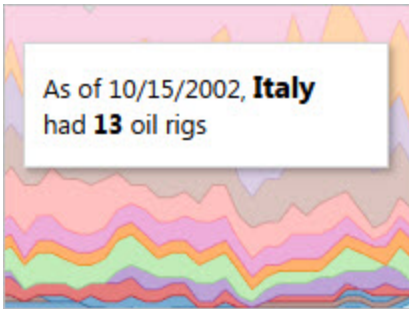

Consider your axes

By default, an axis range in Tableau automatically adjusts based on the data in your visualization. Filtering and other actions can change the axis range. If you are trying to create a specific comparison between two views, changing axes ranges can make analysis difficult for your users. If this is the case, you can set your axes to a specific, fixed range. For steps on how to do this, see [Examples: Use Different Axis Ranges \(Uniform, Independent, Fixed\)](#) on [page 2971](#).

If you're working with data that has a very large range, a fixed axis may not be practical. If this is the case, add grid lines to your visualization. Grid lines can help your users stay oriented when the axis automatically adjusts. See [Format lines](#) on [page 2947](#) for more information.

Format at the Workbook Level

You can quickly change how fonts, titles, and lines look in every view in a workbook by specifying format settings at the workbook level, instead of the worksheet level.

For example, you might want to use a specific font, size, and color so that all views adhere to your company's brand. You might also want to remove grid lines from your views—or make them more noticeable by increasing their pixel size or color.

You can also change the theme used by your workbook. Themes control items like the default font, colors, and line thickness. When you create a new workbook, it automatically uses the Default theme, which uses visual best practices.

Change lines in your workbook

You can change every type of line for all views in your workbook, or you can change just certain types of lines, such as trend lines. You can also turn off certain types of lines, including grid lines.

When you make changes to your workbook's line settings, a gray dot appears next to the setting in the **Format Workbook** pane. You can quickly switch back to default settings using the **Reset to Defaults** button.

In Tableau, line opacity is linked to line color. If you set a line's opacity at the workbook level, all worksheets in the workbook will receive the workbook's color setting for that line as well. If you need to change line opacity and maintain different color settings for a line type, change opacity at the worksheet level instead of at the workbook level.

1. On the **Format** menu, select **Workbook**.
2. The **Format Workbook** pane replaces the **Data** pane on the left and provides a series of drop-down lists where you can change all line settings in a workbook.

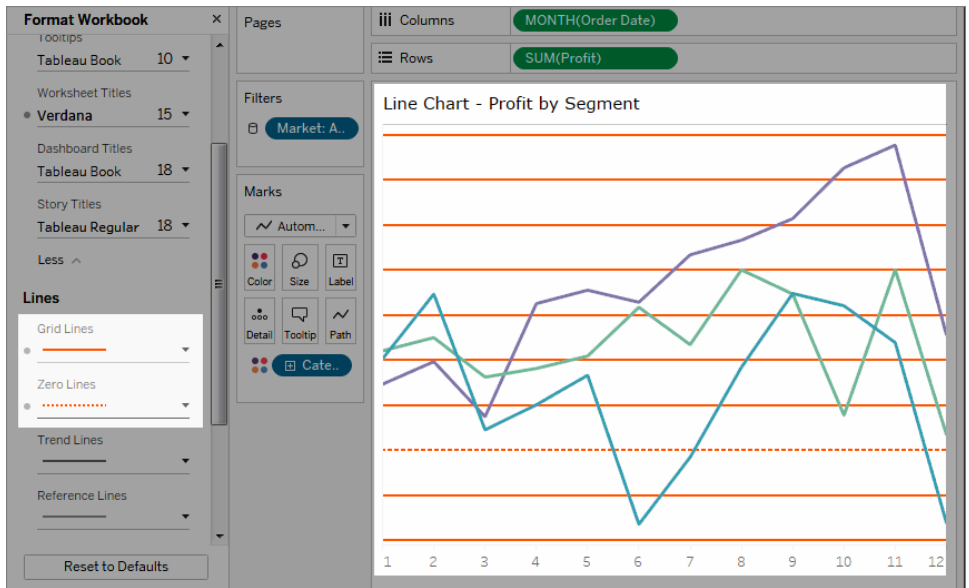

To confirm that your change has been applied to every view in your workbook, you can use thumbnails. Right-click a thumbnail, and select **Refresh All Thumbnails**.

Change fonts in your workbook

You can change all fonts in your workbook or you can change fonts for only certain areas, such as just worksheet titles.

1. On the **Format** menu, select **Workbook**.
2. The **Format Workbook** pane replaces the **Data** pane on the left and provides a series of drop-down lists where you can change all font settings in a workbook, as well as the font settings for titles of worksheets, stories, and dashboards.

Note: If you are editing your workbook online, the **Format Workbook** pane will appear on the right.

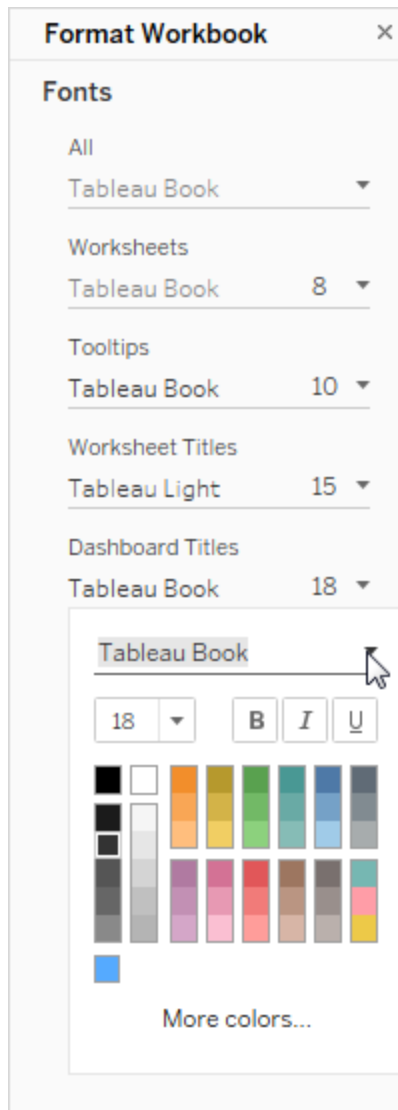

If you have made font changes at the worksheet level, such as on a filter card or a worksheet title, changing the font at the workbook level will overwrite those changes.

Upgrade or change your workbook theme (Tableau Desktop only)

If your workbook is set to a theme other than Default, it will retain that theme when you upgrade from one version of Tableau to another, but you can easily change the theme to Default.

Conversely, you can change your workbook's theme from Default to a different, earlier theme.

If you upgraded from version 9.3 to version 10.x and your theme was set to Default in version 9.3, it will be set to Previous in version 10.x. After you switch to the Default theme, check your workbook to confirm that items are sized appropriately. You might need to make some manual adjustments.

1. On the **Format** menu, select **Workbook Theme**.
2. Choose a theme.

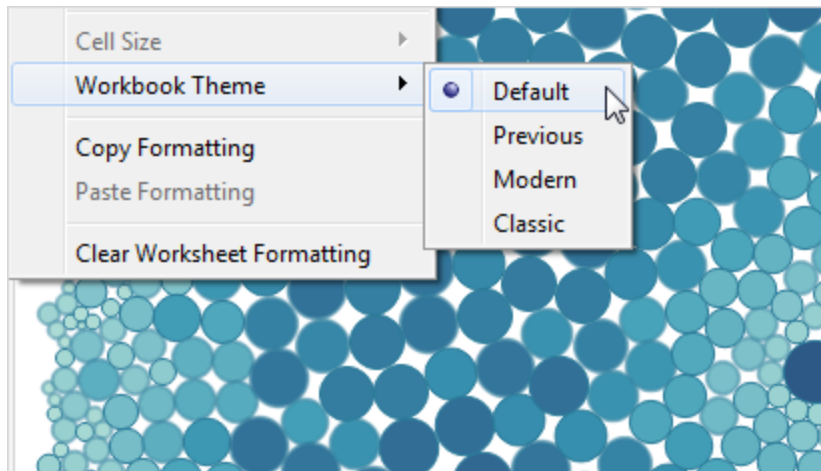

Each theme is associated with a different version of Tableau Desktop.

This workbook theme...	Is associated with these Tableau versions...
Default	Version 10.x
Previous	Versions 8.0.x – 9.3.x
Modern	Versions 3.5 – 7.0.x
Classic	Versions 1.0 – 3.2

Reset a workbook to its default settings

When you make changes to your workbook's font settings, a gray dot appears next to the setting in the **Format Workbook** pane. You can quickly switch back to default settings using the **Reset to Defaults** button.

1. On the **Format** menu, select **Workbook**.
2. In the **Format Workbook** pane, click **Reset to Defaults**.

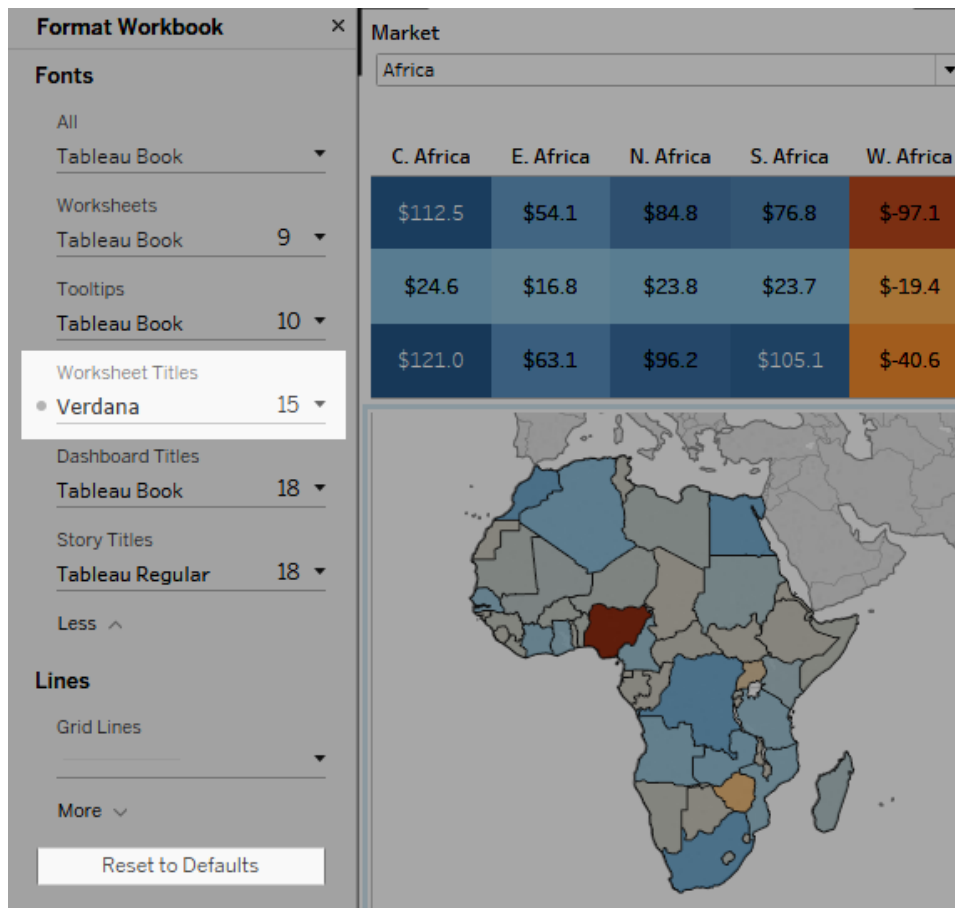

Format Animations

Animate visualizations to better highlight changing patterns in your data, reveal spikes and outliers, and see how data points cluster and separate.

Animations visually transition between filter, sort, and zoom settings, different pages, and changes to filter, parameter, and set actions. As visualizations animate in response to these changes, viewers can more clearly see how data differs, helping them make better informed decisions.

Understanding simultaneous and sequential animations

When you author animations, you can choose between two different styles: simultaneous or sequential. Here are examples of each type.

Simultaneous animations

The default simultaneous animations are faster and work well when showing value changes in simpler charts and dashboards.

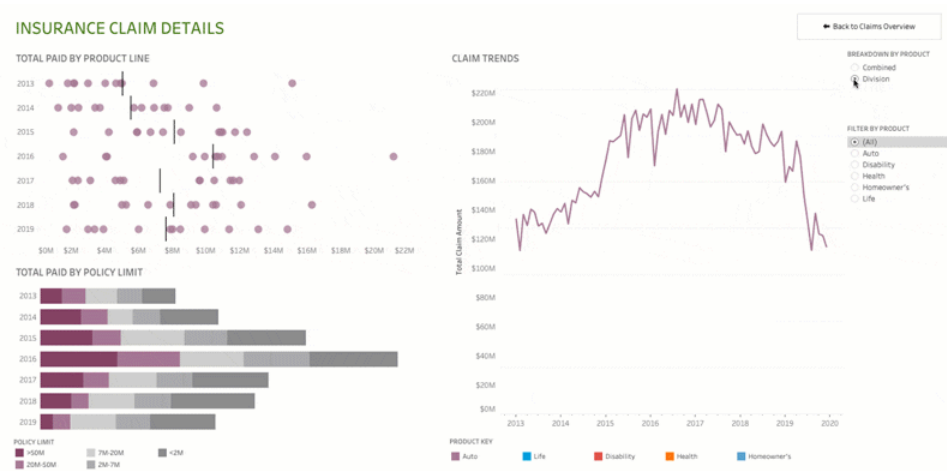

[Click the image above to replay the animation.](#)

Sequential animations

Sequential animations take more time but make complex changes clearer by presenting them step-by-step.

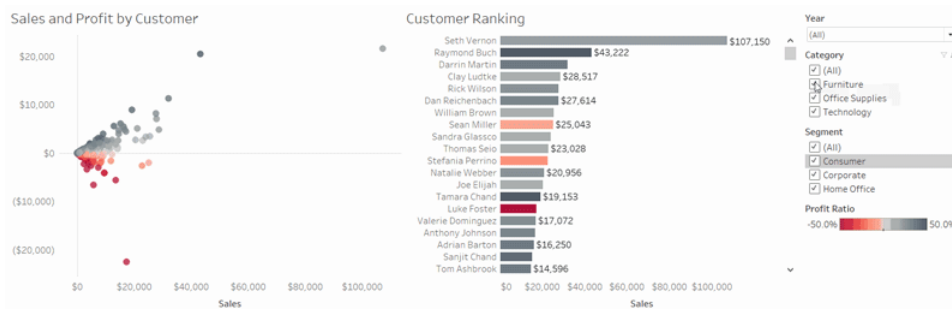

[Click the image above to replay the animation.](#)

Animate visualizations in a workbook

When you create a new workbook, Tableau enables animations for your viz by default. You can turn animations on or off at the user and workbook level.

1. Choose **Format > Animations**.
2. If you want to animate every sheet, under **Workbook Default**, click **On**. Then do the following:
 - For **Duration**, choose a preset, or specify a custom duration of up to 10 seconds.
 - For **Style**, choose **Simultaneous** to play all animations at once or **Sequential** to fade out marks, move and sort them, and then fade them in.
3. To override workbook defaults for a particular sheet, change the settings under **Selected Sheet**.

Note: In the Selected Sheet section, “(Default)” indicates a setting that automatically reflects the related Workbook Default setting.

Animations ×

Workbook Default

On Off

Duration
1.00 seconds (Slow) ▼

Style
Simultaneous ▼

Reset All Sheets

Selected Sheet

Heat Map

Animation
On (Default) ▼

Duration
0.30 seconds (Fast) ▼

Style
Sequential ▼

To replay an animation, click the **Replay** button in the toolbar. From the **Replay** button, you can also choose the speed at which the animation replays: actual speed, 2x speed, or 1/2 speed.

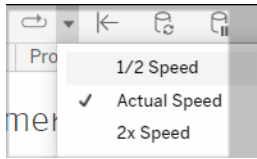

Reset animation settings for a workbook

You can reset animations to return an entire workbook to the default animation settings. Be aware that this turns animations off by default.

1. Choose **Format > Animations**.
2. In the middle of the **Animations** pane, click **Reset All Sheets**.

Completely disable all animations

When you create a new workbook, animations are enabled by default. If you find animations distracting while viewing vizzes, you can completely disable them so they never play. (This isn't a system-wide setting; each user needs to apply it separately.)

- In Tableau Desktop, choose **Help > Settings and Performance**, and deselect **Enable Animations**.
- In Tableau Cloud or Tableau Server, click your profile image or initials in the top right corner of the browser, and choose **My Account Settings**. Then scroll down to the bottom of the page, deselect **Enable animations**, and click **Save Changes**.

Note: When animations are disabled, you can still choose **Format > Animations** in authoring mode and adjust settings—but they will have no effect.

Format decimals for axes animations

If the number of decimal places for a measure is set to the default, then the number of decimals shown during the axis animation might fluctuate during the axes animation. To avoid this, format the number of decimal places displayed for a measure. For more information, see [Format Numbers and Null Values](#).

Why animations won't play

Server rendering

Animations won't play if a viz is server-rendered. To ensure that vizzes render on a client computer or mobile device, use these techniques:

- If you're a viz author, [reduce viz complexity](#).
- If you're a Tableau Server administrator, [increase the complexity threshold for client-side rendering](#).

Note: On computers with lower processing power, animations may appear choppy, but users can continue to interact with vizzes without any delays in responsiveness.

Unsupported browsers and features

Animations are supported by all web browsers except Internet Explorer.

The following Tableau features don't animate:

- Maps, polygons, and density marks in web browsers
- Pie and text marks
- Headers
- Forecasts, trends, and reference lines
- Page history trails (If a viz includes these, turn off animations to avoid unexpected behavior.)

Format at the Worksheet Level

You can format settings for fonts, alignment, shading, borders, lines and tooltips at the worksheet level. For example, you might want to remove all the borders in a text table, or add shading to every other column in a view.

When you make formatting changes at this level, they apply only to the view you're working on. See [Format at the Workbook Level on page 2932](#) for how to make changes that apply to every view in your workbook.

Access worksheet formatting settings from Tableau Desktop

Are you formatting your worksheets on the web? See [Access worksheet formatting settings from Tableau Cloud on page 2950](#)

1. Display a worksheet or dashboard.
2. From the **Format** menu, choose the part of the view that you want to format, such as **Font**, **Borders**, or **Filters**.

Format fonts

For a view, you can specify the font, style, size, and color for either the pane text or header text, or both. For example, in the view below, the header text is set to use the Tableau Bold font.

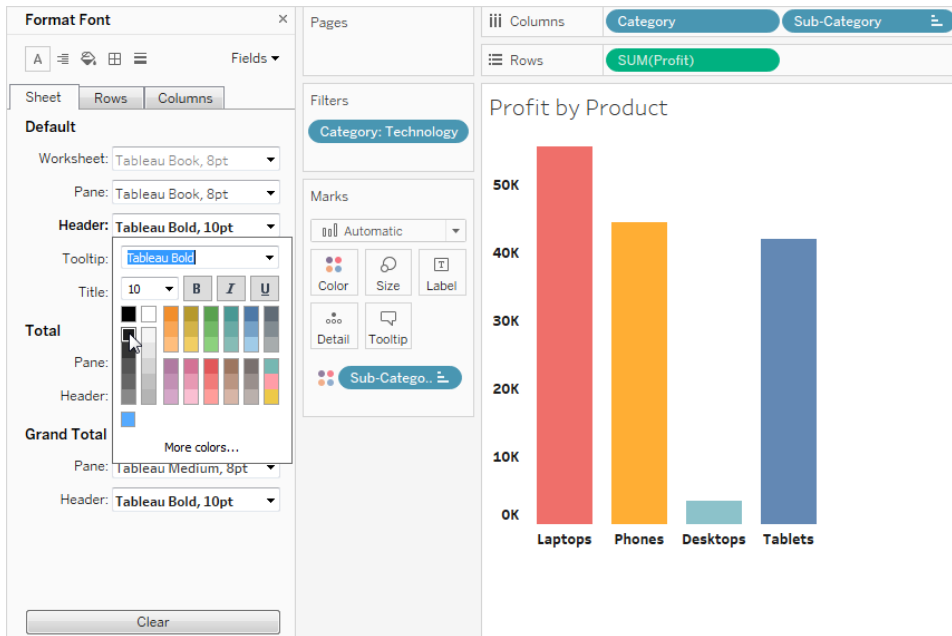

If you have totals or grand totals in the view, you can specify special font settings to make these values stand out from the rest of the data. This is particularly useful when you are working with a text table. The view below shows a text table in which the grand totals are formatted to be dark red.

The screenshot shows the Tableau Desktop interface. On the left, the 'Format font' pane is open, displaying various text formatting options such as font face, size, bold, italic, underline, and color. The main view shows a pivot table titled 'Sheet 7' with columns for 'Sub-Category' and 'Order Date' (years 2011-2014) and rows for 'Sub-Category' (Accessories, Appliances, Art, Binders) and 'Measure Names' (Discount, Number of Records, Profit, Quantity, Sales). The table data is as follows:

Sub-Category	Measure Name	Order Date				Grand Total
		2011	2012	2013	2014	
Accessories	Discount	12	15	15	20	61
	Number of Records	148	166	186	275	775
	Profit	6,403	10,197	9,664	15,672	41,937
	Quantity	580	635	682	1,079	2,976
	Sales	\$25,014.27	\$40,523.96	\$41,895.85	\$59,946.23	\$167,380.32
Appliances	Discount	15	17	16	29	78
	Number of Records	93	94	114	165	466
	Profit	2,459	2,512	5,301	7,865	18,138
	Quantity	314	365	396	654	1,729
	Sales	\$15,313.63	\$23,241.29	\$26,050.32	\$42,926.93	\$107,532.16
Art	Discount	12	13	12	22	60
	Number of Records	164	167	181	284	796
	Profit	1,407	1,485	1,409	2,227	6,528
	Quantity	613	608	673	1,106	3,000
	Sales	\$6,057.98	\$6,236.83	\$5,909.65	\$8,914.32	\$27,118.79
Binders	Discount	109	121	148	189	567
	Number of Records	290	318	413	502	1,523
	Profit	4,740	7,597	10,148	7,737	30,222
	Quantity	1,089	1,215	1,593	2,077	5,974
	Sales					

Format text alignment

Tableau uses visual best practices to determine how text is aligned in a view, but you can also customize text. For example, you can change the direction of header text so that it is horizontal (normal) instead of vertical (up).

Note: Tableau adheres to regional standards when determining when to begin or end line breaks.

Header Text is Vertical

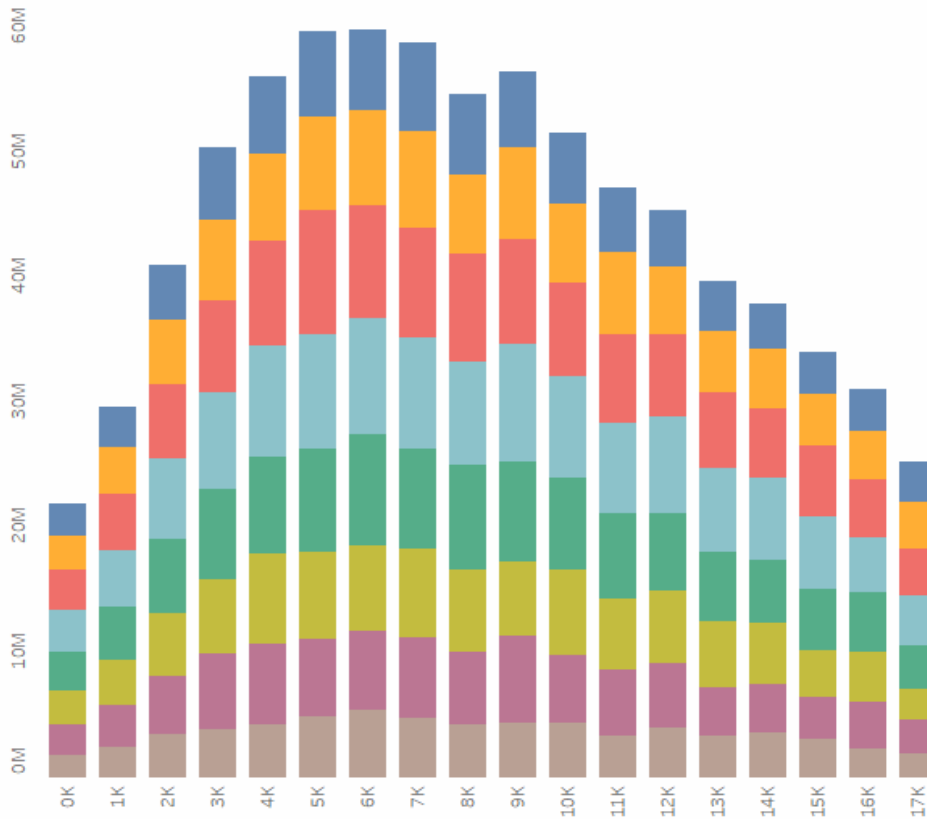

[Click the image to replay it.](#)

For each text area you can specify the following alignment options:

Horizontal - Controls whether text aligns to the left, right, or center.

Vertical Alignment - Controls whether text aligns at the top, middle, or bottom.

Direction - Rotates text so that it runs horizontally (normal), top-to-bottom (up), or bottom-to-top (down).

Wrap - Controls whether long headers wrap to the next line or are abbreviated, but does not control text marks.

Note: If cells are not large enough to show more than one row of text, turning on wrapping will have no visible effect. If this happens, you can hover the cursor over a cell until a double-sided arrow appears, and then click and drag down to expand the cell size.

Format shading

Shading settings control the background color of the pane and headers for totals, grand totals, as well as for the worksheet areas outside those areas.

You can also use shading to add *banding*, alternating color from row to row or column to column. Banding is useful for text tables because the alternating shading helps your eye distinguish between consecutive rows or columns.

Table with Banding

Clinton St & Washington Blvd	1,033	2,873
Canal St & Jackson Blvd	942	2,355
Clinton St & Madison St	994	1,946
Franklin St & Jackson Blvd	1,649	1,829
Daley Center Plaza	1,147	1,772
Michigan Ave & Lake St	2,919	1,522
Dearborn St & Adams St	1,456	1,464
Clark St & Randolph St	956	1,447
Clinton St & Lake St	701	1,370
Dearborn St & Monroe St	838	1,353
State St & Kinzie St	1,957	1,304
Kingsbury St & Erie St	877	1,049

[Click the image to replay it.](#)

For row and column banding, you can use the following options:

Pane and Header- The color the bands use.

Band Size - The thickness of the bands.

Level - If you have nested tables with multiple fields on the rows and columns shelves, this option allows you to add banding at a particular level.

Format borders

Borders are the lines that surround the table, pane, cells, and headers in a view. You can specify the border style, width, and color for the cell, pane, and header areas. Additionally, you can format the row and column dividers. For example, in this view the **Row Divider** borders are formatted to use an orange color:

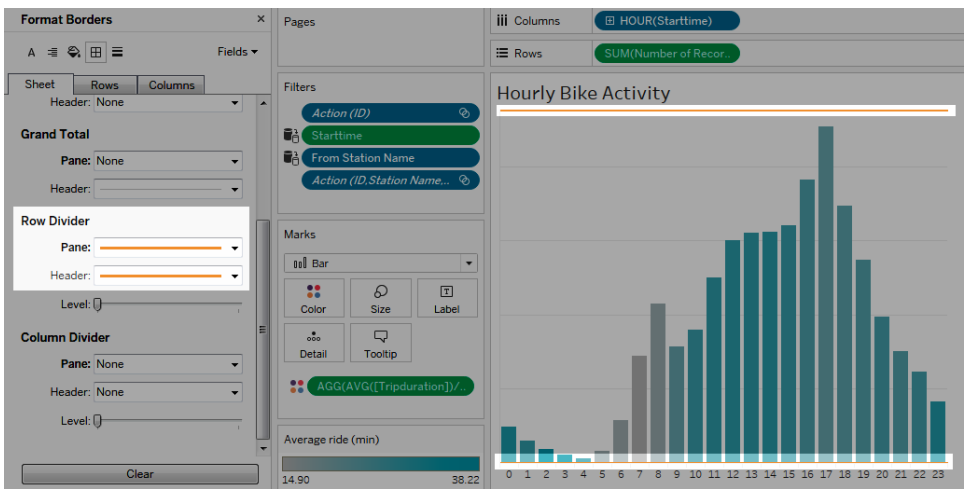

Row and column dividers serve to visually break up a view and are most commonly used in nested text tables. You can modify the style, width, color, and level of the borders that divide each row or each column using the row and column divider drop-downs. The level refers to the header level you want to divide by.

Format lines

You can control the appearance of the lines that are part of the view, such as grid lines and zero lines, as well as lines that help you inspect data, such as trend lines, reference lines, and drop lines.

For example, you can set trend lines to use a red color and an increased thickness:

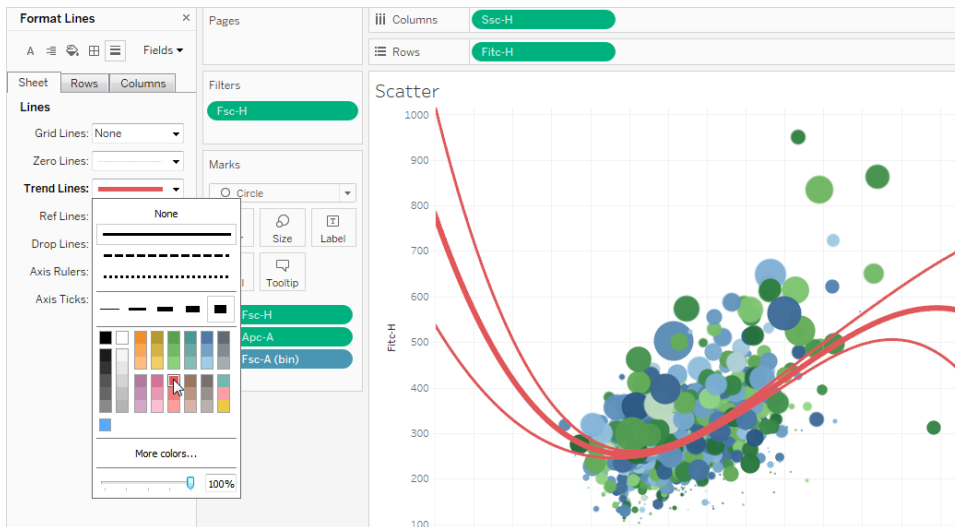

Format highlighters

The highlighter on your worksheet can be formatted to use a different font, style, color, background color, font size, and border. Formatting highlighters allows you to better integrate them into your dashboard or worksheet style. You can also edit the title that displays on each highlighter that shows in the view.

For more information about using highlighters, see [Highlight Data Points in Context on page 1397](#).

Format a filter card

Filter cards contain controls that let users interact with your view. You can change filter cards to use custom formatting. For example, the body text in the filters below is formatted to use the Tableau Bold font, in aqua.

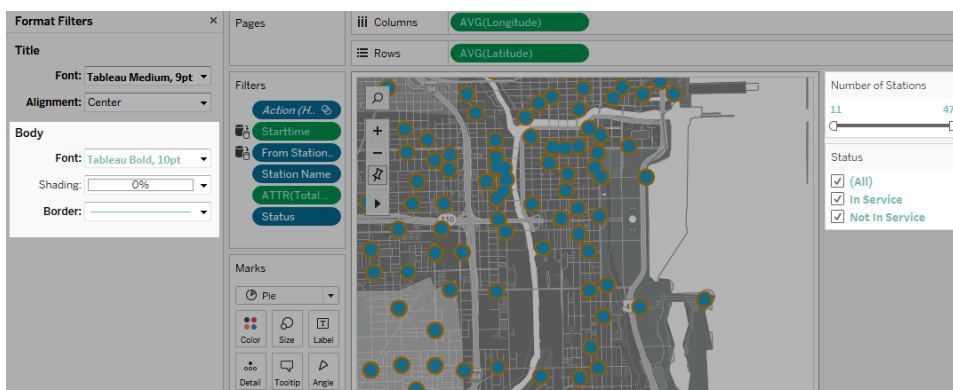

Note: For filters and parameters, title formatting appears only on dashboards or in views published to the web.

Format a parameter control card

Parameter controls are similar to filter cards in that they contain controls that let users modify the view. If you create a parameter control, you can customize how it looks. For example, in the view below, the Sales Range parameter is formatted so that the sales amount appears in orange.

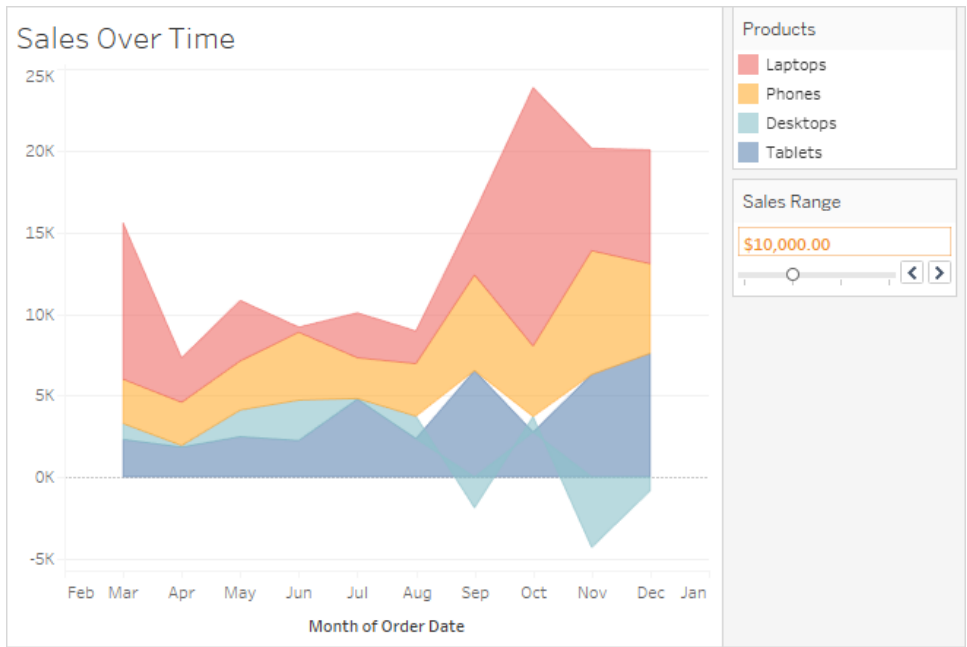

Copy and paste worksheet formatting (Tableau Desktop only)

After you format a worksheet, you can copy its formatting settings and paste them into other worksheets. The settings that you can copy are anything you can set in the **Format** pane, with the exception of reference lines and annotations. Adjustments like manual sizing and level of zoom are not copied.

1. Select the worksheet from which you want to copy formatting.
2. Right-click (control-click on Mac) the worksheet tab and select **Copy Formatting**.
3. Select the worksheet you want to paste the formatting into.
4. Right-click (control-click on Mac) the worksheet tab and select **Paste Formatting**.

Access worksheet formatting settings from Tableau Cloud

Are you formatting your worksheets on Tableau Desktop? See [Access worksheet formatting settings from Tableau Desktop](#) on page 2942.

1. Display a worksheet.
2. From the toolbar, click **Format > Worksheet**, and then choose the part of the view that you want to format, such as Font, Lines, or Borders and Dividers.

Format fonts

For a view, you can specify the font, style, size, and color for your worksheet, pane, header (columns and rows together or separate), and title. In this example, the pane is set to use Tableau Bold, the row header is set to Tableau Medium, the column header is set to Tableau Regular, and the title is set to the Tableau Light font.

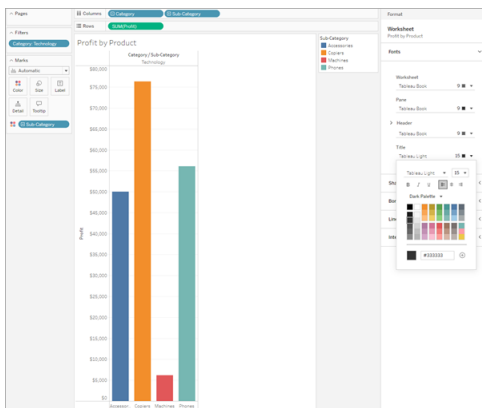

Rotate labels

Tableau uses visual best practices to determine how label text is aligned in a view, but you can also customize your alignment. For example, you can change the direction of label text so that it's horizontal (left to right) or vertical (up and down).

To rotate your labels, right-click (control-click on Mac) on a label and select **Rotate Labels**.

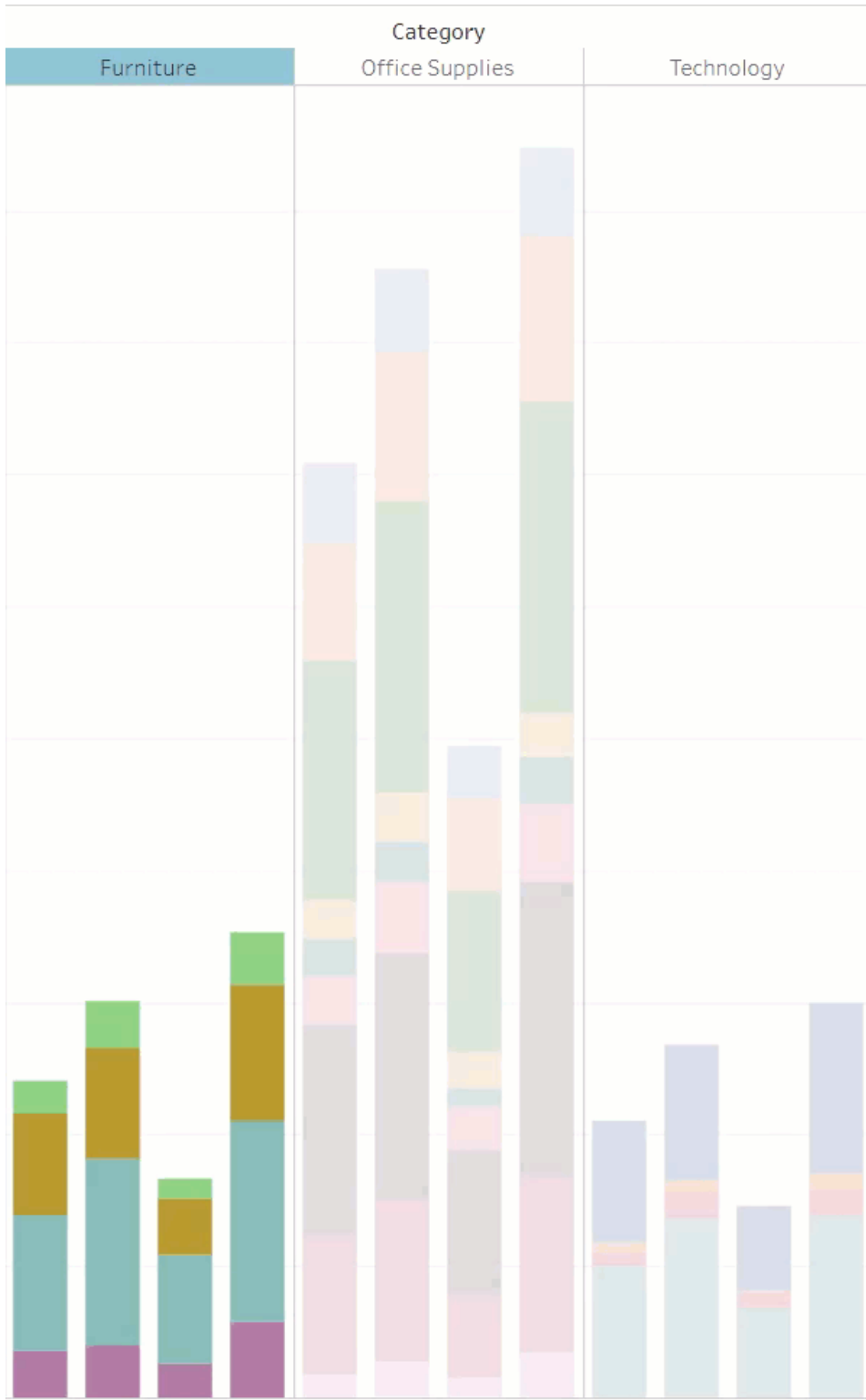

Note: Tableau adheres to regional standards when determining when to begin or end line breaks.

Format shading

Shading settings control the background color of the worksheet, pane, and headers.

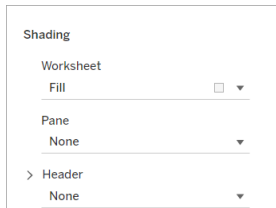

To access these settings, to go **Format > Worksheet > Shading**.

You can also add banding, alternating color from row to row or column to column. Banding is useful for text tables because the alternating shading helps your eye distinguish between consecutive rows or columns.

Table with Banding

Clinton St & Washington Blvd	1,033	2,873
Canal St & Jackson Blvd	942	2,355
Clinton St & Madison St	994	1,946
Franklin St & Jackson Blvd	1,649	1,829
Daley Center Plaza	1,147	1,772
Michigan Ave & Lake St	2,919	1,522
Dearborn St & Adams St	1,456	1,464
Clark St & Randolph St	956	1,447
Clinton St & Lake St	701	1,370
Dearborn St & Monroe St	838	1,353
State St & Kinzie St	1,957	1,304
Kingsbury St & Erie St	877	1,049

Click the image to replay it.

For row and column banding, you can use the following options:

Pane and Header- The color the bands use.

Band Size - The thickness of the bands.

Level - If you have nested tables with multiple fields on the rows and columns shelves, this option allows you to add banding at a particular level.

Format lines

You can control the appearance of the lines that are part of the view, such as grid lines and zero lines. You can turn the lines on or off and format the line type (for example, solid, dotted, or

dashed) and the thickness of the lines. You can also format the color and the opacity of the lines.

For example, you can turn on grid lines to help give quantitative cues to the viewer. In this example, gray dotted grid lines have been added to the viz.

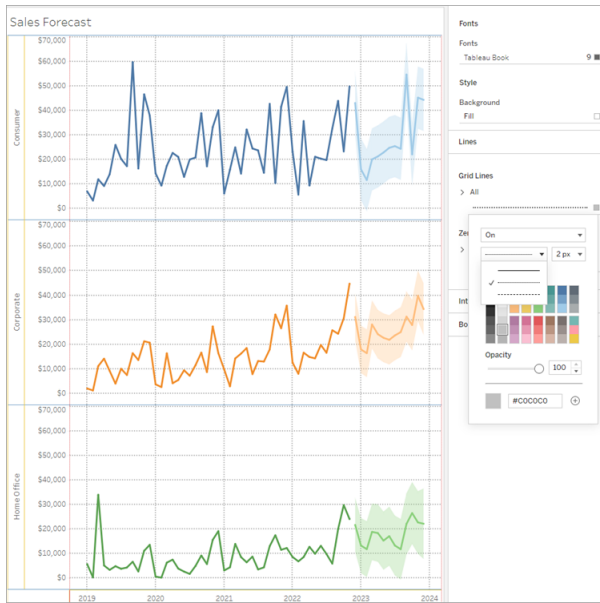

You can also format trend lines, reference lines, and reference bands on the web. You can access these formatting settings by clicking the tooltip on the line, or by clicking on the line while the format pane is open. In this example, the trend line has been formatted to be a solid green line.

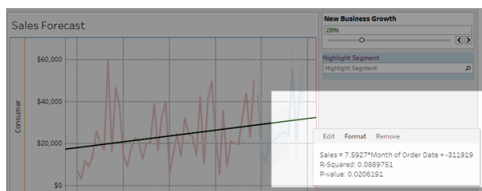

Format interactive controls

You can format all of your interactive controls, including legends, filters, highlighters, and parameters at the same time using the Interactive Controls section of the worksheet format pane.

To access these settings, go to **Format > Worksheet > Interactive Controls**.

If you'd like these controls to have consistent formatting, formatting at this level will save you time. Alternatively, you can format each interactive control individually.

Format legends

If you have a legend on your worksheet, you can customize how it looks. For example, in this example, the *Sales above Budget* legend is formatted so that the title is bolded and the background is light gray.

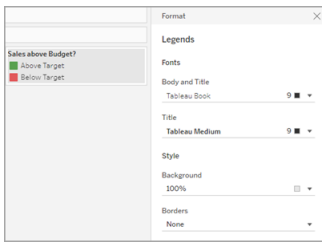

You can access legends formatting by either going into **Format > Legends**, or by clicking into the menu on the legend and selecting **Format Legends**. You can also edit the colors for each of the items in the legend, edit the title, or choose to hide the title or legend through this menu.

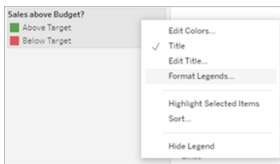

Format filters

Filter cards contain controls that let users interact with your view. You can change filter cards to use custom formatting. For example, the body text in the filter shown is set to Tableau Medium, the title text is set to Tableau Semibold, the background is set to green with 50% opacity, and a black border has been added.

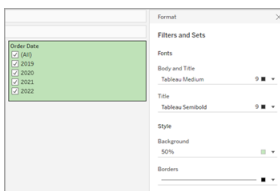

You can access Filters and Sets formatting by either going into **Format > Filters and Sets**, or by clicking into the menu on the Filter card and selecting **Format Filters and Sets**.

Format highlighters

The highlighter on your worksheet can be formatted to customize your font, background color, and border. Formatting highlighters allows you to better integrate them into your dashboard or worksheet style. You can also edit the title that displays on each highlighter that shows in the view.

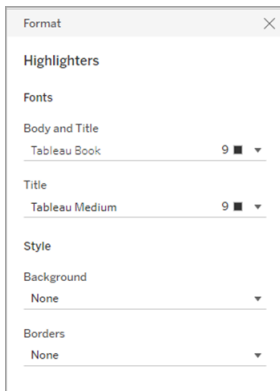

You can access highlighter formatting by either going into **Format > Highlighters**, or by clicking into the menu on the Highlighter card and selecting **Format Highlighters**.

For more information about using highlighters, see [Highlight Data Points in Context on page 1397](#)

Format parameters

Parameter controls are similar to filter cards in that they contain controls that let users modify the view. If you create a parameter control, you can customize how it looks. For example, in the view below, the New Business Growth parameter is formatted so that the growth percentage text appears in green.

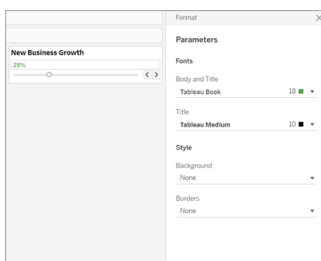

You can access Parameters formatting by either going into **Format > Parameters**, or by clicking into the menu on the parameter card and selecting **Format Parameters**.

Format borders and dividers

Borders are the lines that surround the table, pane, and headers in a view. You can specify the border style, width, and color for the pane and header areas. Additionally, you can format the row and column dividers. For example, in this view the Row Divider borders are formatted to use a blue color.

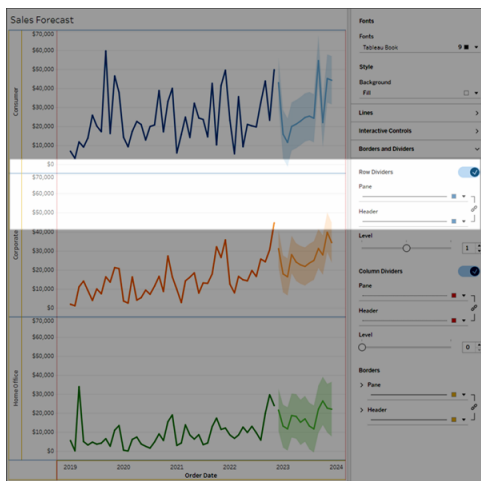

Row and column dividers serve to visually break up a view and are most commonly used in nested text tables. You can modify the style, width, color, and level of the borders that divide each row or each column using the row and column divider drop-downs.

By default, the Pane and Header dividers are formatted simultaneously to save you time. If you'd like the pane and the headers to have different formatting, click the link icon to unlink the formatting and format each member separately.

You can also switch the formatting settings for Row and Column Dividers on or off to hide styling options you don't want to use. In this example, Row Dividers formatting is turned off, and the Column Dividers pane and header formatting is unlinked.

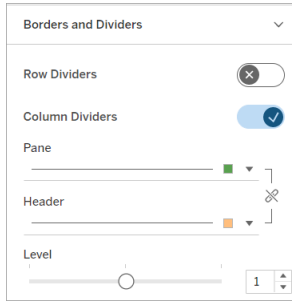

Row and column divider level settings

The level refers to the header level you want to divide by. For example, if you have two fields on your measures column, such as category and sub-category, you can choose to have row dividers just by category (level 1) or by category and sub-category (level 2).

In this example, the row divider is set at level 1.

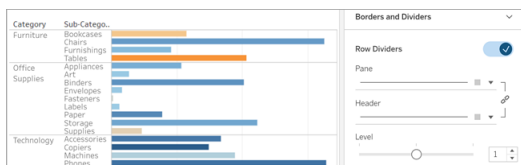

In this example, the row divider is set at level 2.

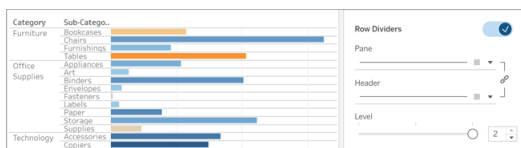

Edit Axes

When you add a continuous field (a field with a green background) to the Columns or Rows shelf, it adds an axis to the view. An axis shows data points that lie within a range of values. For each axis, you can specify the range, scale, and tick mark properties.

Double-click an axis to open the **Edit Axis** dialog box and change the axis configuration and formatting. If you can't edit the axis, see [Why can't I edit my axis? on page 2960](#)

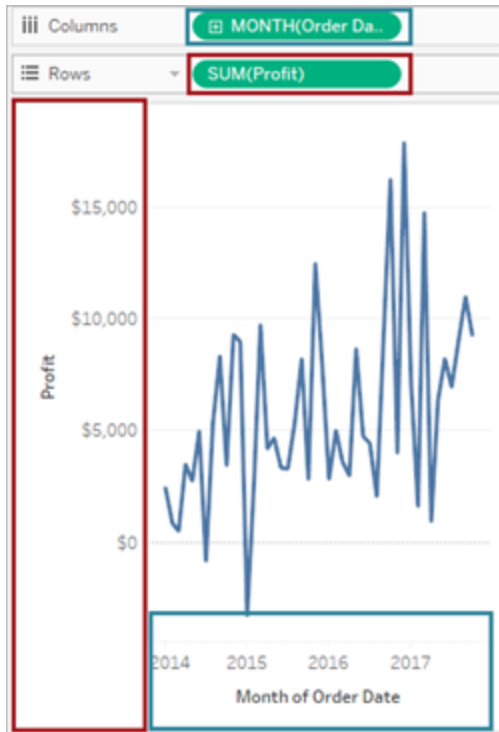

In this example, the Profit field (a continuous measure) on the Rows shelf creates a vertical axis, and the Order Date field (a continuous date dimension) on the Columns shelf creates a horizontal axis.

Note: For more information on formatting headers and field labels, see [Format at the Worksheet Level](#) on page 2942 and [Format Fields and Field Labels](#) on page 2999. For details on continuous and discrete fields, see [Dimensions and Measures, Blue and Green](#) on page 147.

Edit an axis range

To edit an axis range, double-click the axis that you want to edit.

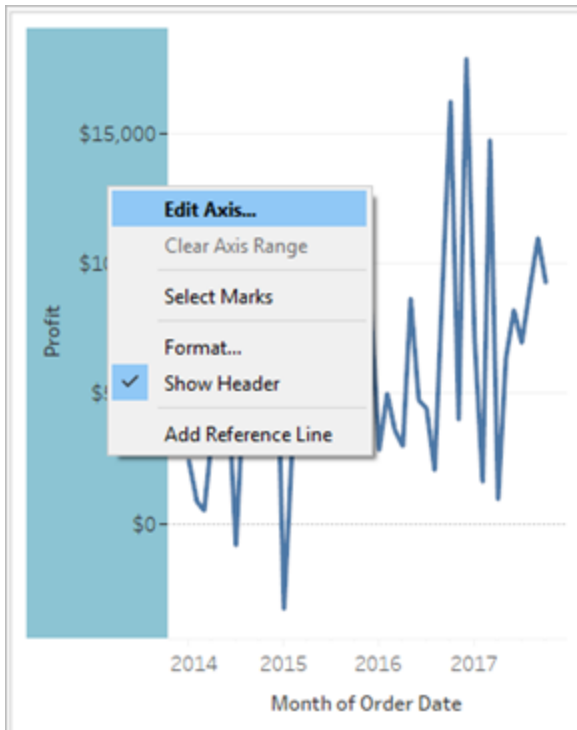

Note: In Tableau Desktop, you can right-click (control-click on Mac) the axis, and then select **Edit Axis**. In web authoring, you can click the arrow button on an axis, and then select **Edit Axis**.

When you select an axis, the marks associated with the axis are not selected so that you can edit and format the axis without modifying the marks.

To select the marks associated with the axis, right-click the axis and select **Select Marks**. You can also select each mark individually. For more information, see [Select marks on page 1995](#).

Why can't I edit my axis?

If you can't edit an axis, it's most likely a header rather than axis.

- Continuous fields (green background) on the Rows and Columns shelves create axes in the view. When you right-click an axis, you will see this menu:

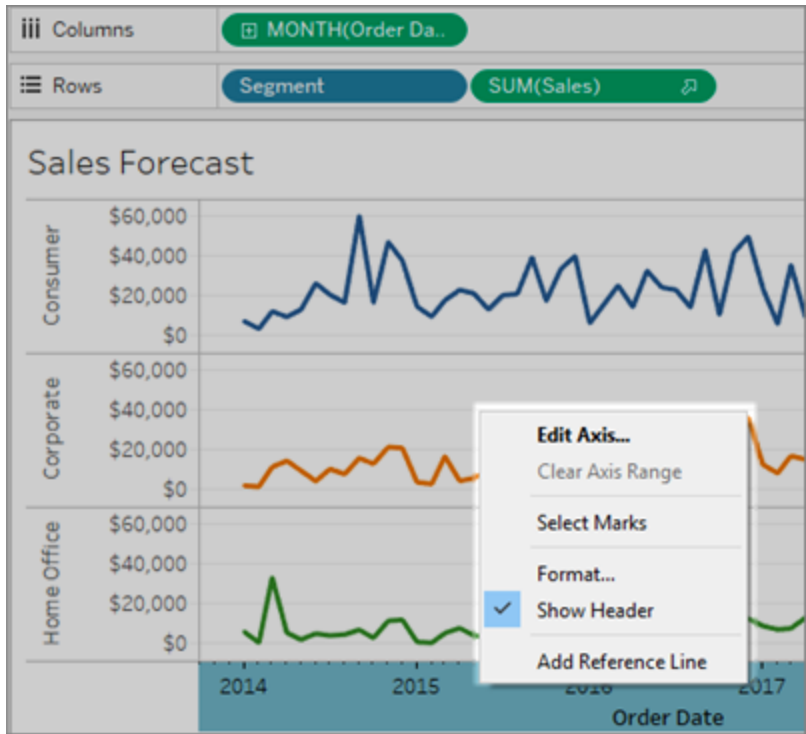

- Discrete fields (blue background) on the Rows and Columns shelves create headers, not axes. When you right-click a header, you will see this menu:

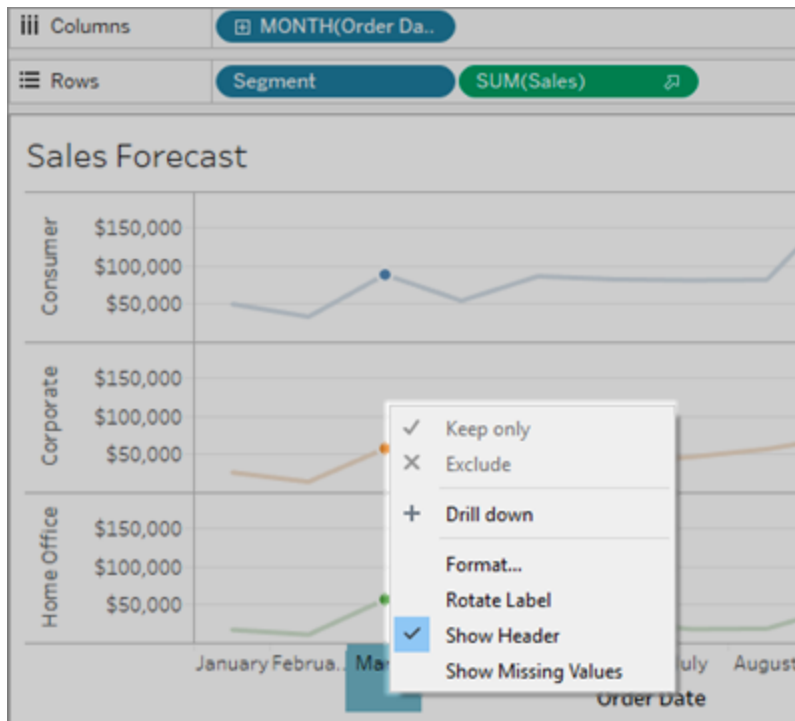

You can edit the formatting of headers by right-clicking a header, and then selecting **Format**.

For more details on formatting headers and field labels, see [Format at the Worksheet Level on page 2942](#) and [Format Fields and Field Labels on page 2999](#). For details on continuous and discrete fields, see [Dimensions and Measures, Blue and Green on page 147](#).

Hide and reshow axes and headers

If you have hidden an axis or a header in the view, you can show it again from its related field in the view.

To hide an axis

Right-click (control-click on Mac) the axis in the view, and then clear the check mark next to the **Show Header** option.

To show a previously hidden axis

Right-click (control-click on Mac) the continuous field in the view that is associated with axis you want to show, click its drop down menu, and then click **Show Header**.

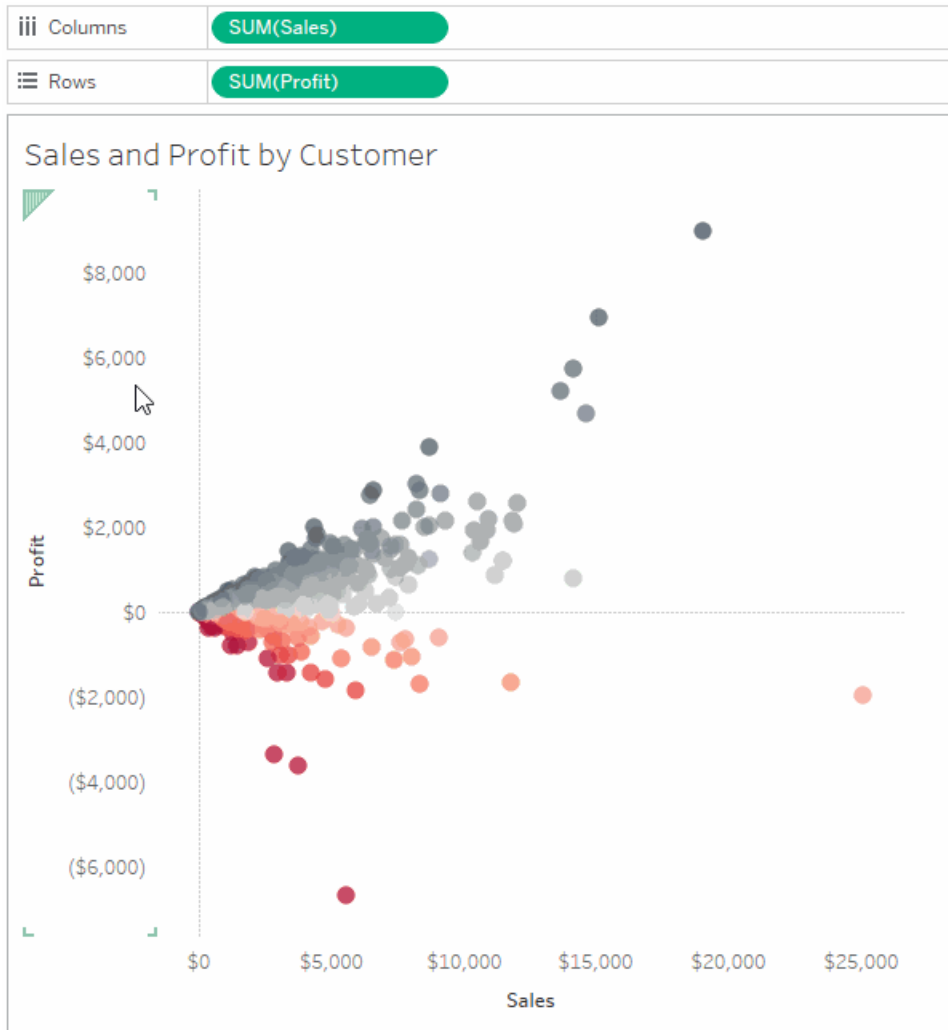

For related details, see [Axes](#) on page 80 in [Parts of the View](#) on page 76.

To hide a header

Right-click (control-click on Mac) a header in the view, and then clear the check mark next to the **Show Header** option.

To show previously hidden header

Right-click (control-click on Mac) the discrete field in the view that is associated with headers that you want to show, click its drop down menu, and then click **Show Header**.

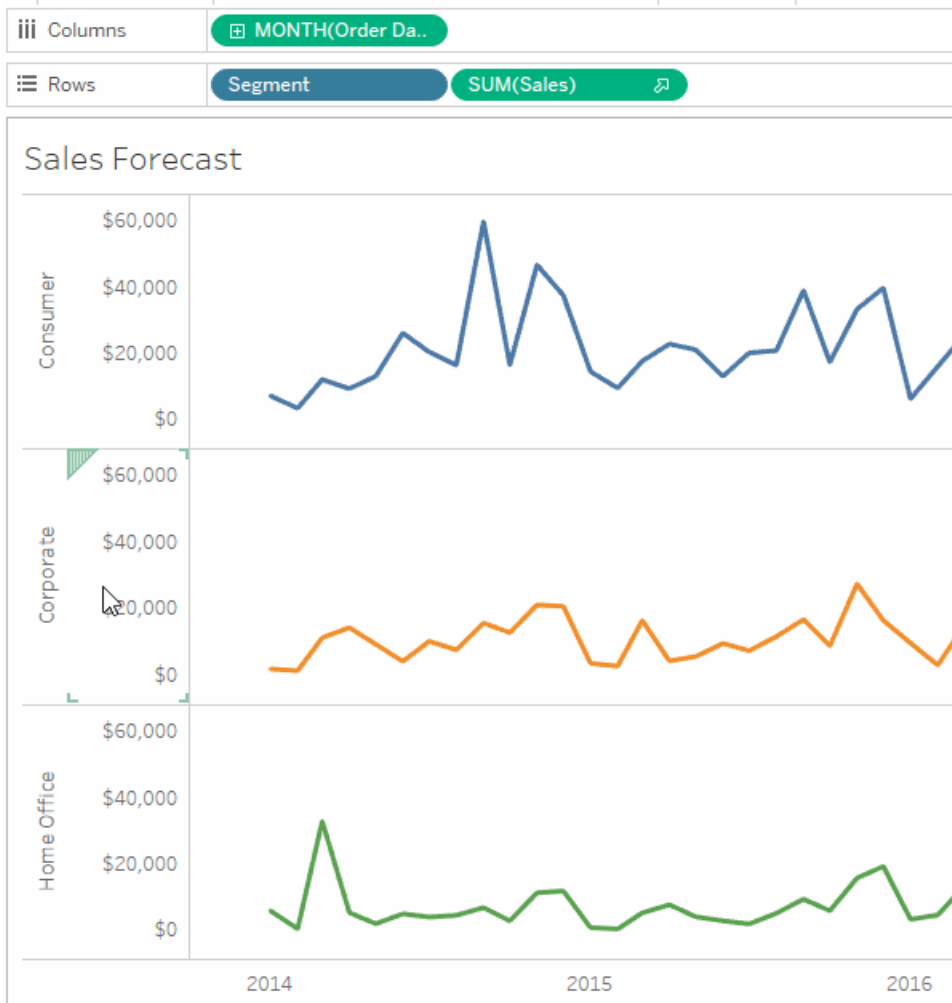

For related details, see [Headers](#) on page 77 in [Parts of the View](#) on page 76.

For details on continuous and discrete fields, see [Dimensions and Measures, Blue and Green](#) on page 147.

Change an axis range

You can limit the axis range to focus the view on certain data points.

For example, assume your view shows sales over four years. The automatic axis might show a range from 0 to \$750,000. If sales never go below \$470,000, you can adjust the axis range to start at \$470,000 to keep the focus on where the data points actually lie.

To change an axis range:

1. Double-click the axis that you want to edit. You can also right-click (control-click on Mac) the axis, and then select **Edit Axis**.
2. In the **Edit Axis** dialog box, select one of the following options:
 - **Automatic.**Automatically bases the axis range on the data used in the view.
 - **Uniform axis range for all rows or columns.**Sets the axis range uniformly to the maximum data range for all panes in the view.
 - **Independent axis ranges for each row or column.** Makes the axis range independent. The axis range varies for each pane in the view, depending on the range of data in each pane.
 - **Fixed.** Specifies to start and/or end the axis at a specific value. You can fix both ends of the axis or only one end. When you fix both ends of the axis, the axis range is determined by the values you specify. When you fix only one end of the axis, you must set the other end of the axis as automatic, uniform, or independent.
3. You can also specify whether to include zero. When you clear the **Include zero** check box, the axis range adjusts to show only the range of values in the data.
4. Click **OK**.

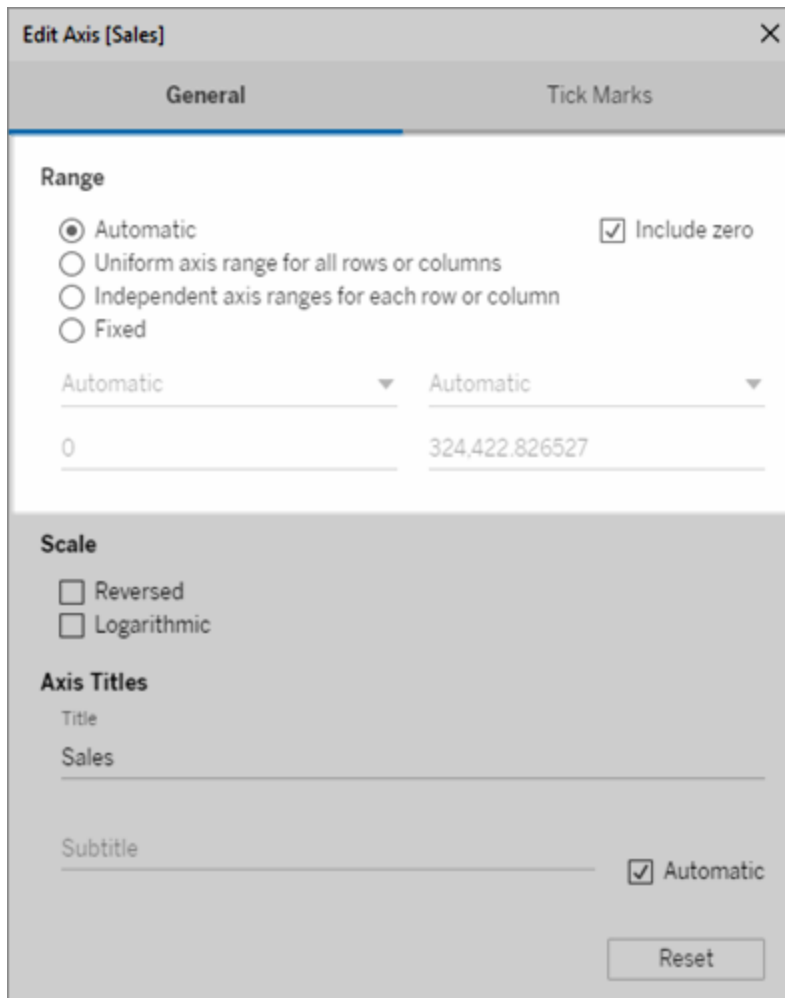

Change the axis scale to reversed or logarithmic

Axis scale options include **Reversed** and **Logarithmic**.

When you select **Logarithmic**, you can then specify **Positive** or **Symmetric**. Symmetric displays data that contains positive, 0, or negative values on a log scale axis, and is best used to visualize large negative values on a logarithmic scale, as well as large positive values, or both. For related details, see [About the symmetric log axis transform](#) on page 2968.

To change the scale of an axis:

1. Double-click the axis that you want to edit. You can also right-click (control-click on Mac) the axis, and then select **Edit Axis**.
2. In the **Edit Axis** dialog box, on the General tab, select **Reversed** or **Logarithmic** for the axis scale.

The option to choose Symmetric or Positive is only available when the axis range extends outside of the closed interval [-10, 10].

Logarithmic: Select **Positive** or **Symmetric** for the log scale. The **Symmetric** option displays data that contains positive, 0, and negative values on a log scale axis. By default, the tick marks are drawn at powers of ten, but you can specify any base that is greater than 1.

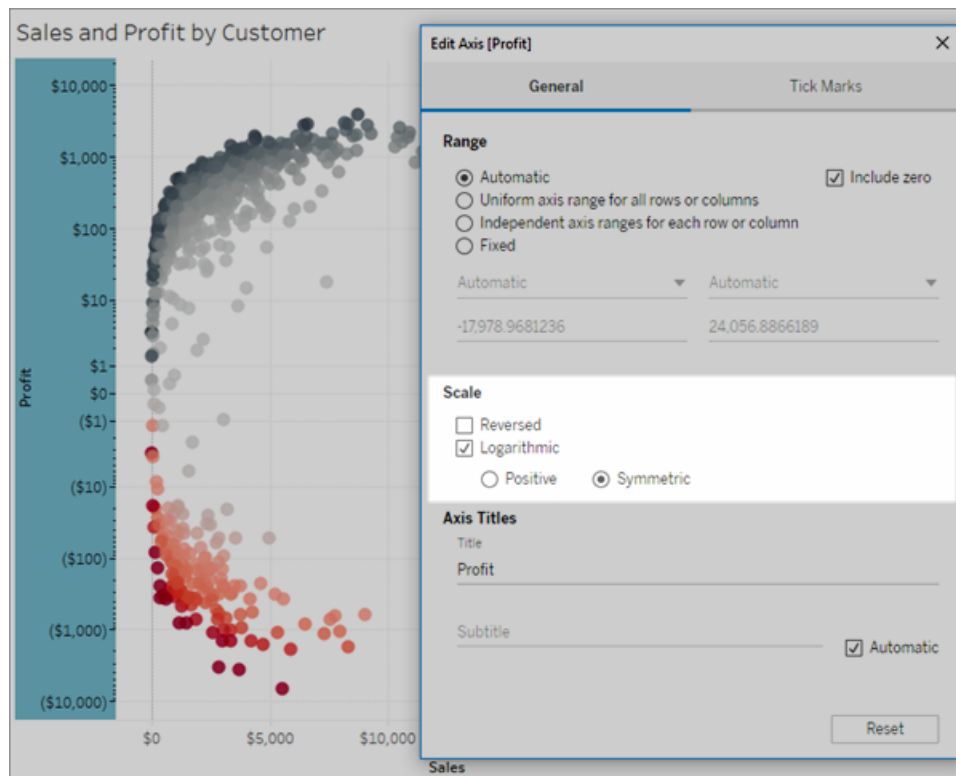

3. Click the **Tick Marks** tab and select one of the following options:
 - **Automatic** - the major tick marks are drawn at powers of 10.
 - **Fixed** - the major tick marks are drawn at a specified exponent. Type a number into the Powers of text box.
 - **None** - major tick marks are not shown.
4. When finished, click **OK**.

You can also reverse the axis by selecting **Reverse** in the Scale area on the General tab of the Edit Axis dialog box.

About the symmetric log axis transform

The symmetric log axis applies an area hyperbolic sine transform to the axis:

$$\text{asinh}(x) = \ln(x + \sqrt{x^2 + 1})$$

For large values ($|x| \gg 1$),

$$\text{asinh}(x) \sim \ln(x), \quad x > 0$$

$$\text{asinh}(x) \sim -\ln(x), \quad x < 0$$

Because *asinh* is defined for all real values (negative numbers in particular) this transform allows you to visualize large negative values on a logarithmic scale, as well as large positive values, or both.

However, while a log axis can be used to visualize the scale of very small values, a symmetric log axis cannot be used to visualize the scale of very small values.

For small values ($|x| < 1$),

$$\text{asinh}(x) \approx x$$

Using a symmetric log axis scale for small values has a similar effect to using a linear scale (i.e., a normal quantitative axis).

Change the appearance of an axis

Every axis has a title that is automatically generated based on the fields in the view. You can specify a custom axis title and add a subtitle using the Edit Axis dialog box. You can also specify the scale of the axis, such as whether to use a logarithmic scale or whether to reverse the axis.

To change the appearance of an axis:

1. Right-click (control-click on Mac) on the axis that you want to edit and select **Edit Axis**.
2. In the Edit Axis dialog box, type a new title in the **Title** text box.

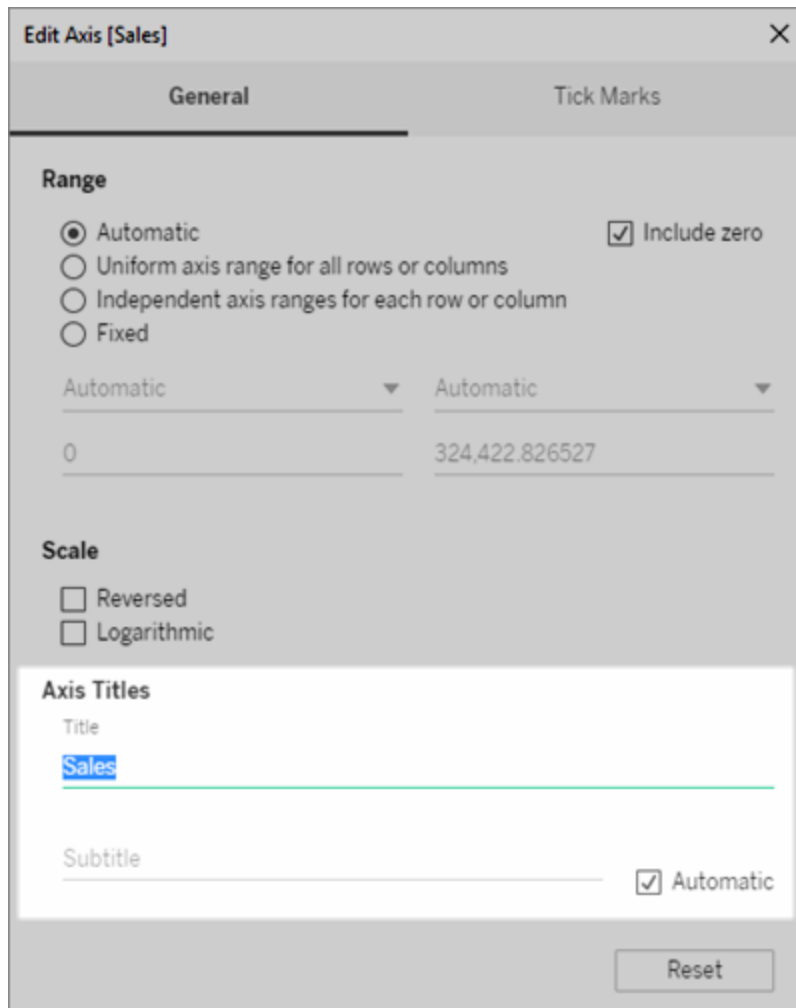

3. To add a custom subtitle, clear the **Automatic** check box.
4. To change the scale of the axis, select one of the following options:
 - **Reversed**- select this option to reverse the order of values on the axis.
 - **Logarithmic** - select this option to use a logarithmic scale on the axis.

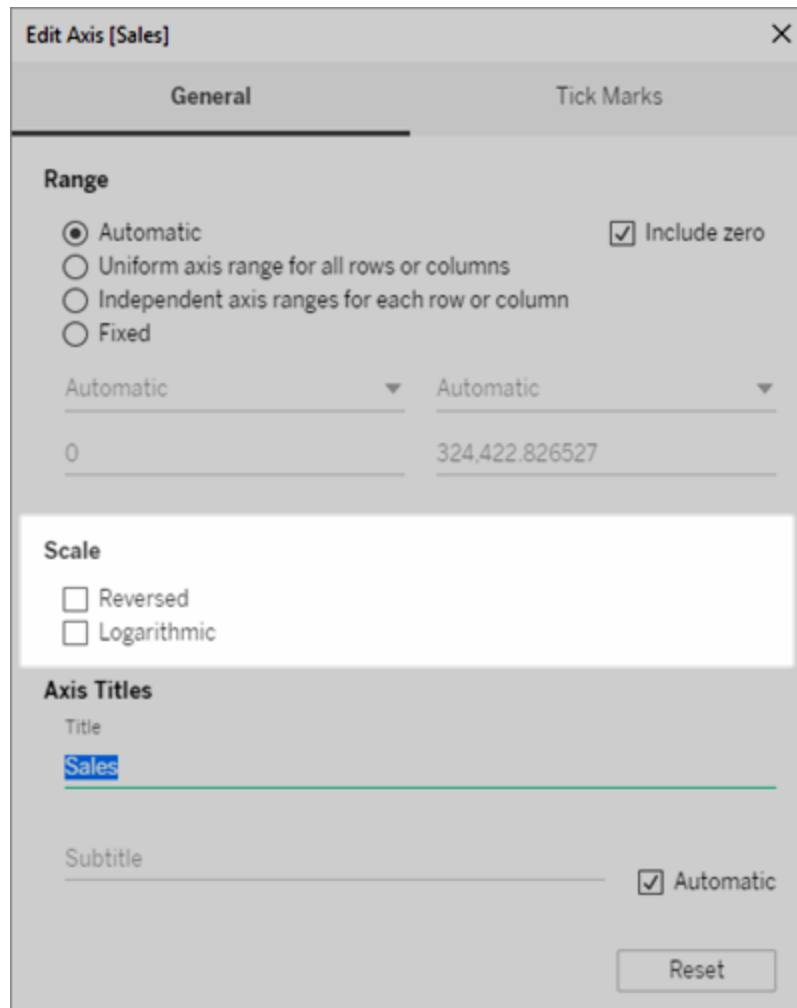

5. Click **OK**.

Format tick marks

You can specify how often the tick marks are displayed along the axis. Tableau allows you to modify both the Major and Minor tick marks. Major tick marks are accompanied by unit labels while Minor tick marks simply represent smaller increments between the major marks. You can choose to use automatic or fixed tick marks or have none at all.

To format tick marks:

1. Right-click (control-click on Mac) the axis you want to edit and select **Edit Axis**.
2. In the Edit Axis dialog box, select the **Tick Marks** tab.
3. For both **Major** and **Minor tick marks**, select from one of the following options:

- **Automatic** - select this option to automatically show tick marks based on the data in the view.
- **Fixed** - select this option to specify how often the tick mark should display and the starting value.
- **None** - select this option to hide the tick marks completely.

4. Click **OK**.

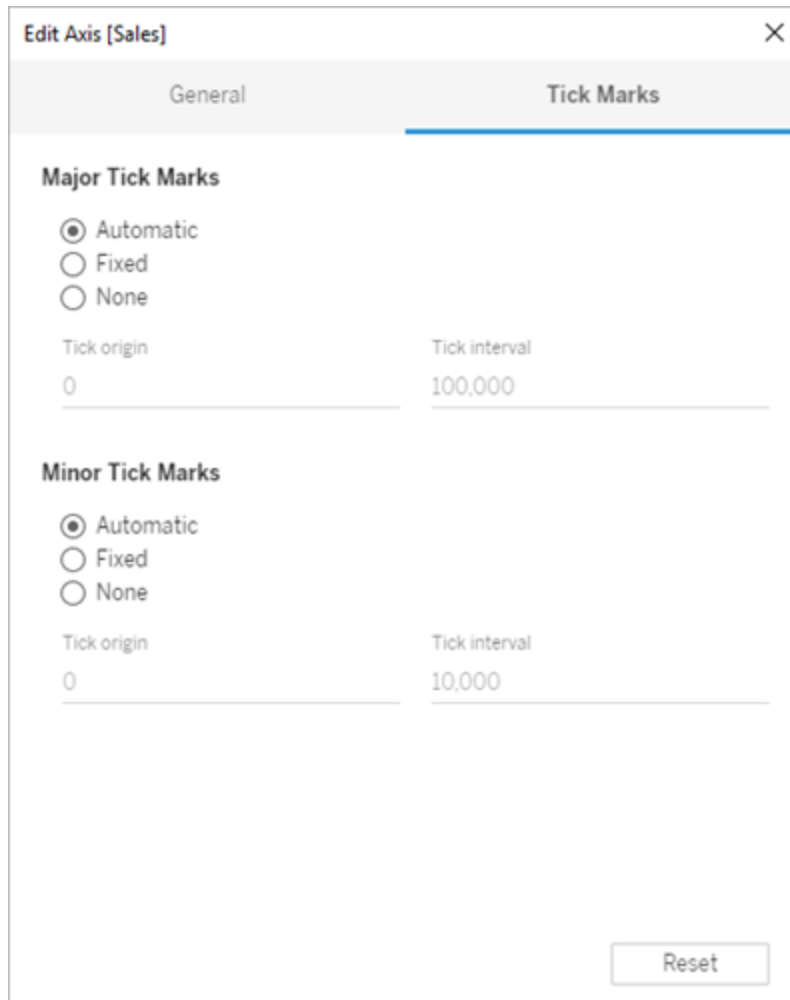

Examples: Use Different Axis Ranges (Uniform, Independent, Fixed)

In this example you will build three views using the same data. However, each view will use a different axis range format. These views use the **Sample-Superstore** data source to display the aggregated total sales for three product categories over the course of four years.

[Build a view with a uniform axis range](#) below
[Build a view using independent axis ranges](#) on page 2974
[Build a view using a fixed axis range](#) on page 2977

Build a view with a uniform axis range

A uniform axis range means that the same range is applied to each row or column in your view. The range is automatically generated based on the underlying data values.

1. Place the **Order Date** dimension on the **Columns** shelf and the **Category** dimension on the **Rows** shelf.
2. Place the **Sales** measure on the **Rows** shelf.

The measure is automatically aggregated as a summation and an axis is added to the view. By default the view uses a uniform axis range. Notice that the axis range is the

same, from zero to 250,000 for each product category.

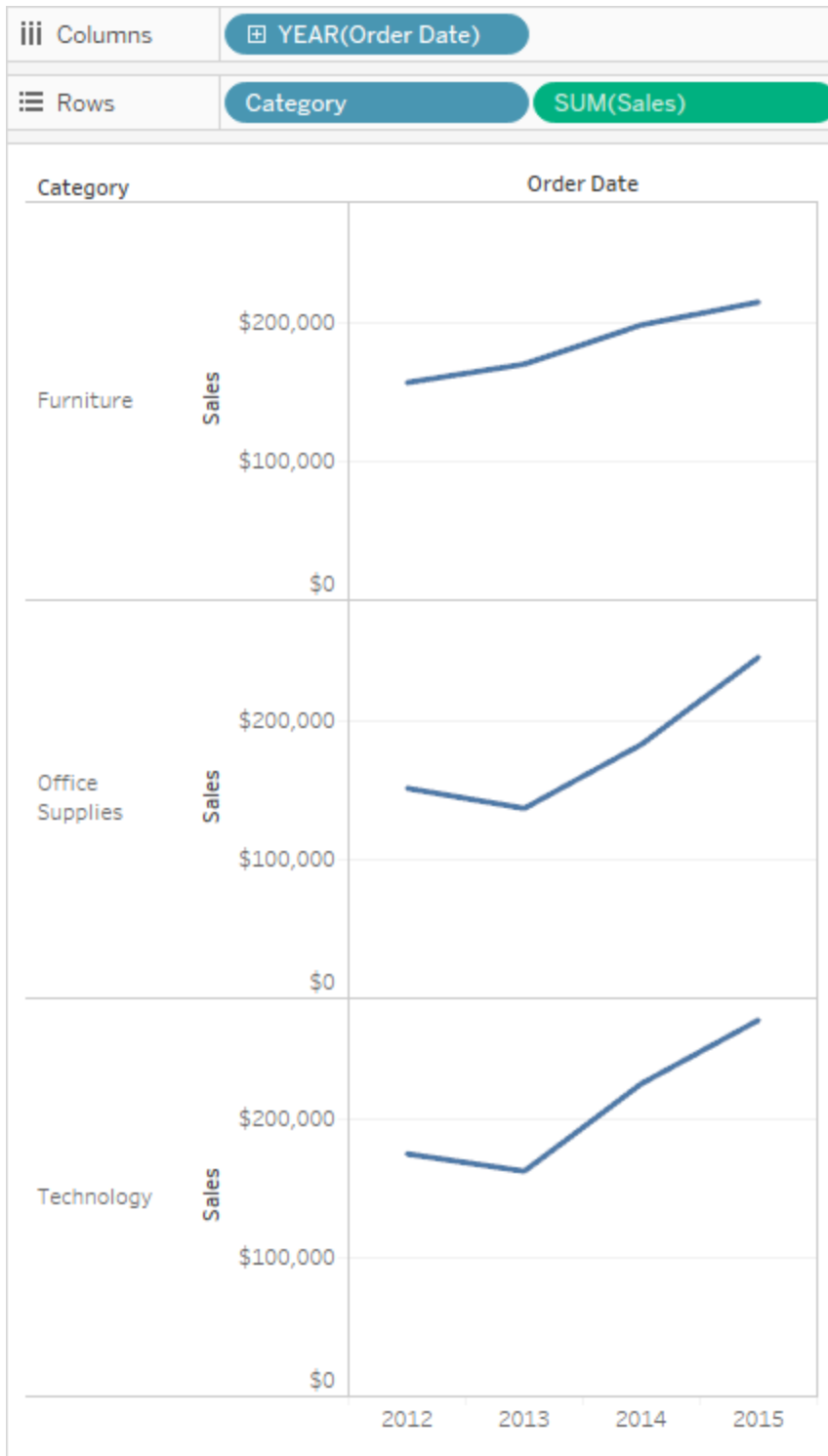

Build a view using independent axis ranges

When you use an independent axis range, each row or column will have its own axis range based on the underlying data values.

1. Right-click (control-click on Mac) the SUM(Sales) axis in the view and select **Edit Axis**.

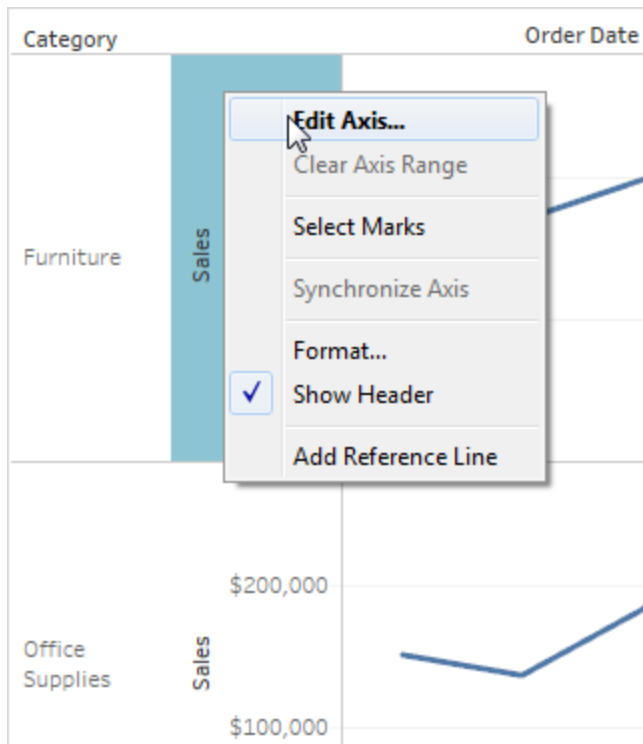

2. In the Edit Axis dialog box, select **Independent axis ranges for each row or column**.

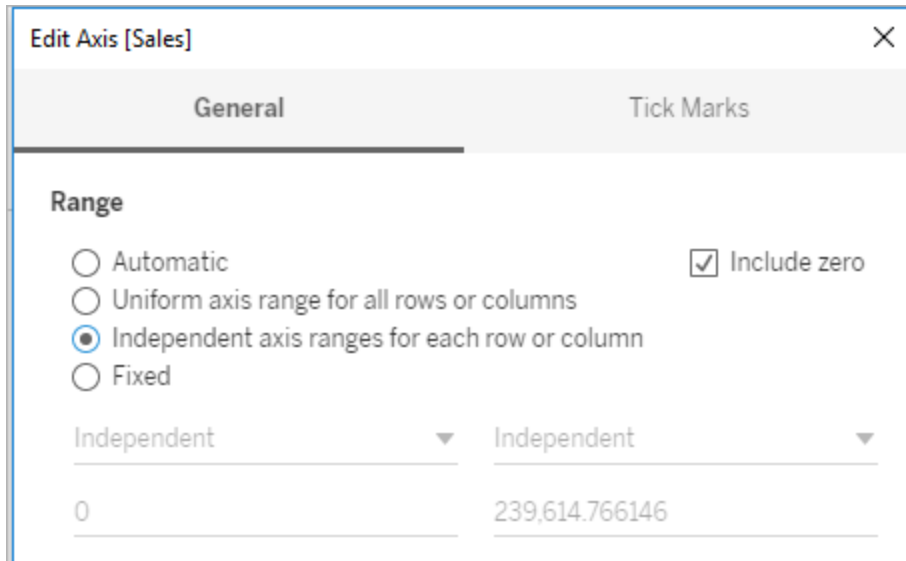

3. Click the X to close the dialog box with the current settings.

The axis range for each product category are now independent from each other. The Technology and Office Supplies categories still range from zero to 250,000, but the Furniture category ranges from zero to a little over 200,000.

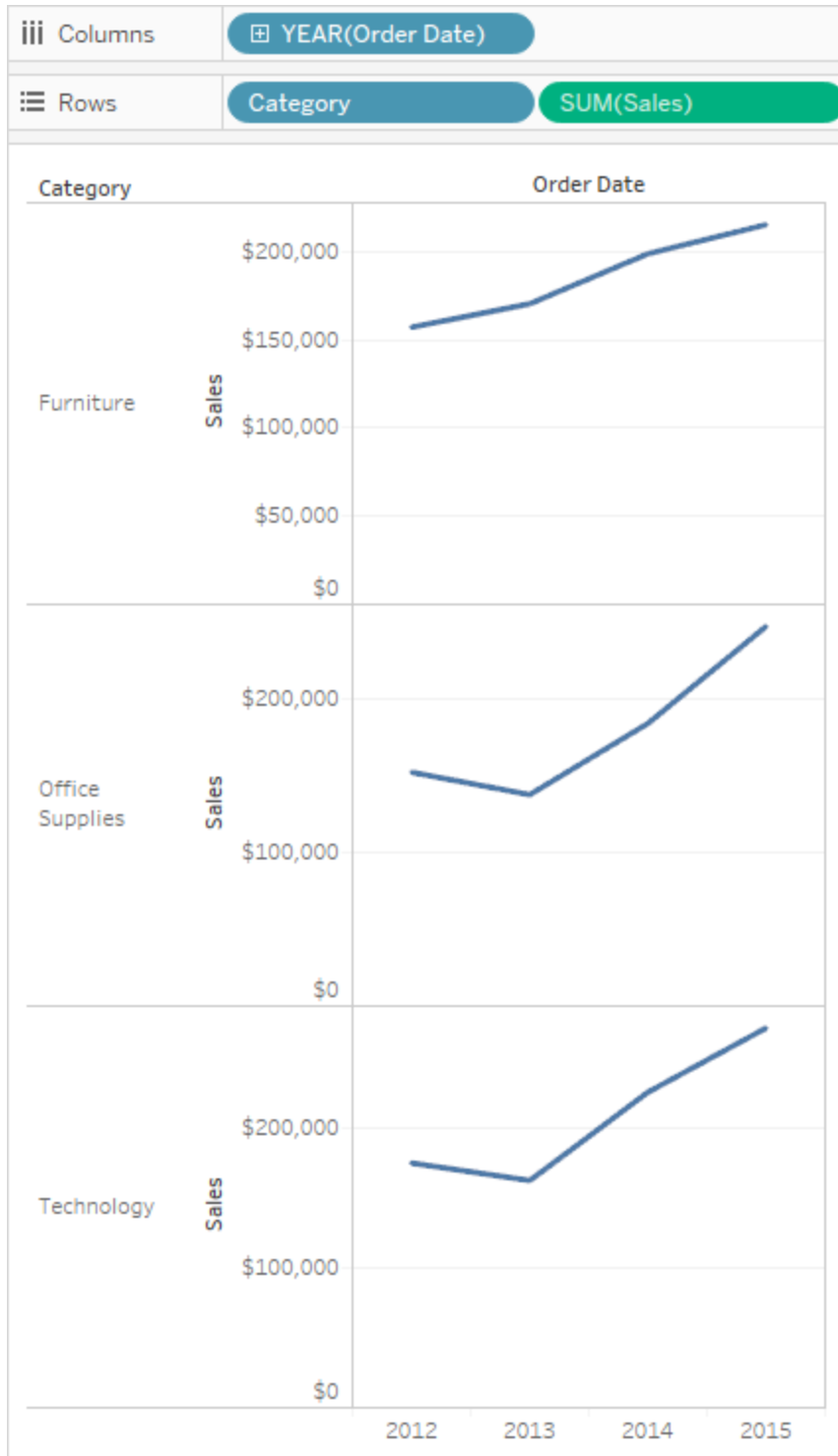

Build a view using a fixed axis range

You can fix one or both ends of an axis in order to customize how much of the data you can see in the view.

The first example shows how to fix both ends of the axis. The second shows how to fix only one end of the axis, and then define the axis range for all panes in the view.

To fix both ends of the axis:

1. Right-click (control-click on Mac) the **SUM(Sales)** axis in the view and select **Edit Axis**.
2. In the Edit Axis dialog box, select **Fixed**, and then define **Start** and **End** values either by typing into the text boxes or by dragging the sliders toward each other. For this example, type **0** for **Start** and **200,000** for **End**.

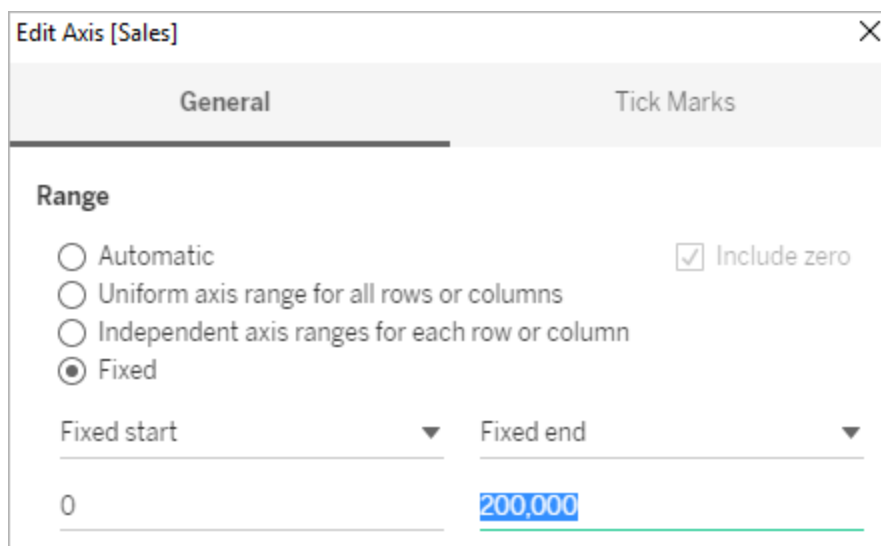

3. Click the X to close the dialog box with the current settings.

The categories now display only up to \$200,000 in sales. The axes are marked with a pin symbol  , which indicates that you have limited the axis range and that some data might

not be displayed.



To fix one end of the axis:

1. Right-click (control-click on Mac) the **SUM(Sales)** axis in the view and select **Edit Axis**.
2. In the Edit Axis dialog box , select **Fixed**, click the **Fixed End** drop-down menu, and then select **Independent**.

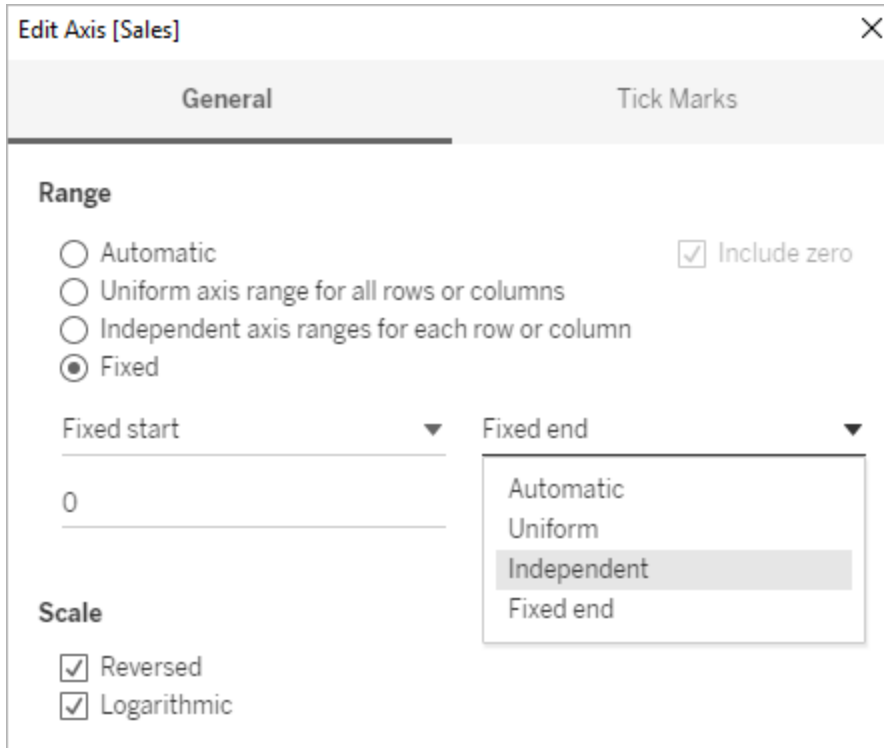

3. Click the X to close the dialog box with the current settings.

Notice that the categories now have slightly different axis ranges. For example, Office Supplies has an axis range from 0 to 250,000 dollars, while Furniture only has a range from 0 to 200,000 dollars.



For more information about the difference between automatic, uniform, and independent axis ranges, see [Edit Axes](#) on page 2958.

Format Text and Numbers

To learn how to format specific items, click the links below.

Format Text

The proper font selection can take your visualization from good to great. Whether you're changing the font size, position, color, or direction, Tableau provides a wide range of customization options for your text.

When you make formatting changes at this level, they apply only to the view you're working on. See [Format at the Workbook Level on page 2932](#) to learn how to make changes that apply to every view in your workbook.

To access worksheet-level format settings, select the **Format** menu, then choose the part of the view, such as **Font** or **Border**, that you want to format.

Format fonts

If you're working in Tableau Server or Tableau Cloud, select **Format** and then choose the element you want to format from the menu. You can choose to format the **Individual Title**, **Caption**, **Legends**, **Filters and Sets**, **Highlighters**, and **Parameters**. You can also **Clear Worksheet Formatting** in the Format menu.

If you're working in Tableau Desktop, select **Format > Font**. A **Format Font** control pane will open. This control pane will let you customize the text in the view.

Worksheet

Editing the font at the worksheet level applies the changes you make to all text fields in view except the Header and Tooltip fields.

Note: Tableau treats Worksheet formatting as a new default, and any changes to any other fields (such as Title, Pane, or Header) will overwrite the Worksheet format.

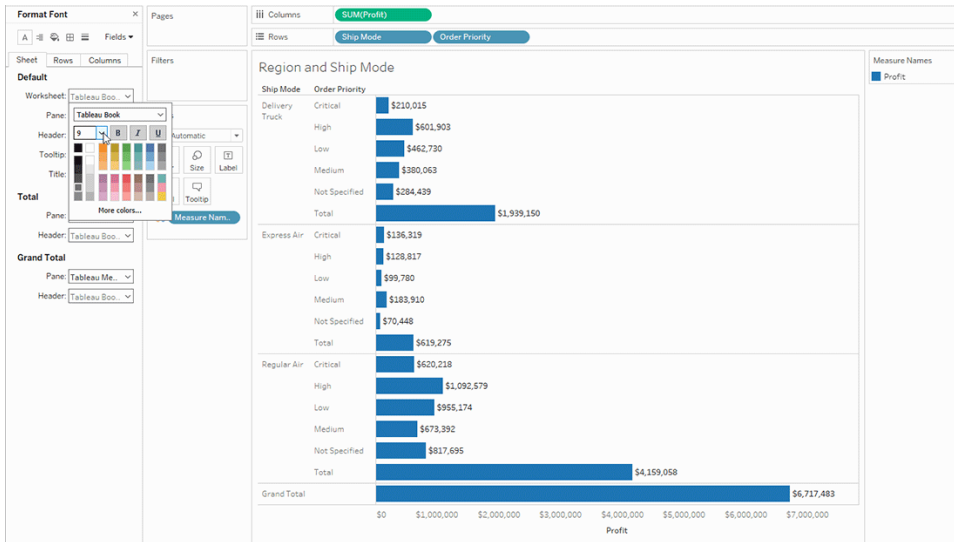

Pane

Adjusting the font here will affect the pane view, which is where Tableau displays the results of your visualizations.

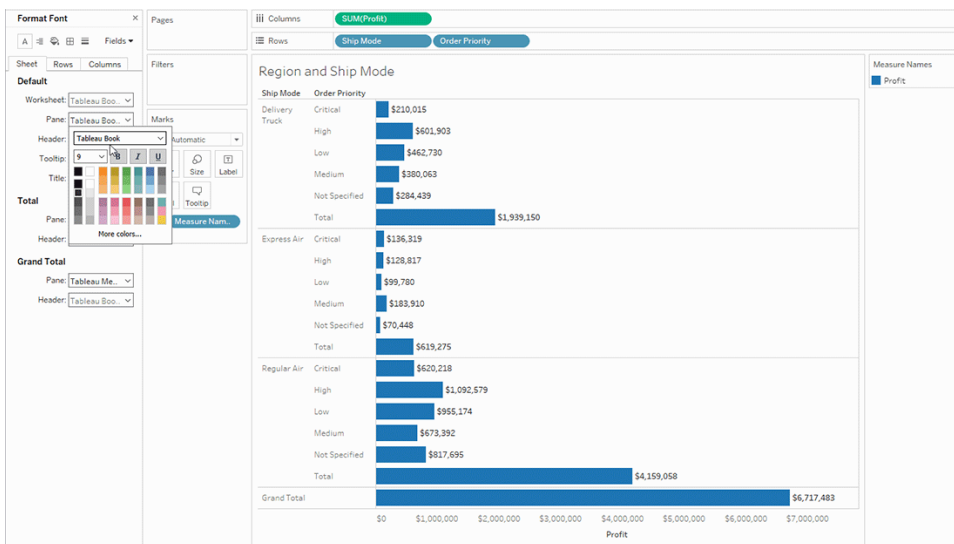

Header

Tableau Desktop and Web Authoring Help

Select this option to adjust font for the headers in your view. Headers display the dimensions used in your viz.

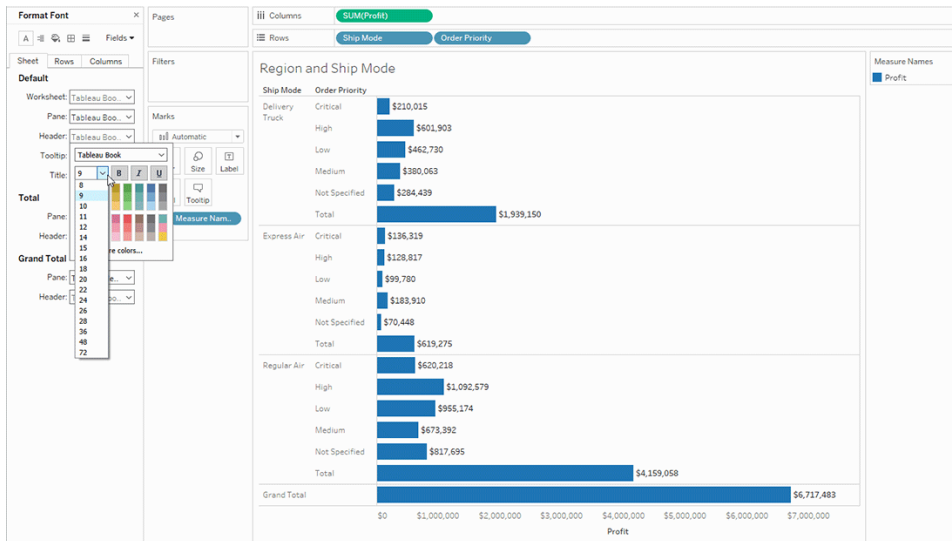

Tooltip

Adjusting the font here will apply changes to all the text in the tooltip, the field that pops up when someone hovers over a mark in your view. If you want more control over the fields in the tooltip, see [Format Text on page 2981](#)

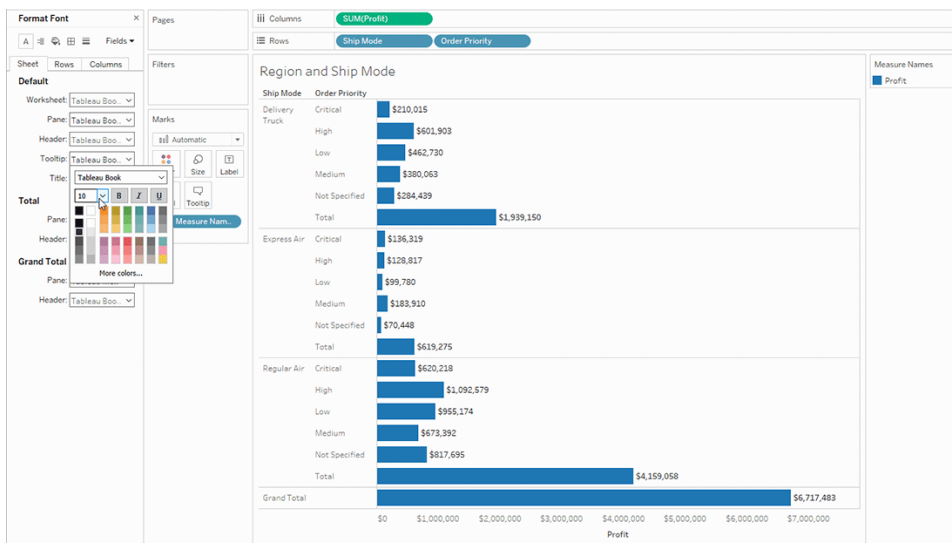

Title

Select this formatting option to quickly adjust the appearance of the Title. For more information, see [Format Text](#) on page 2981

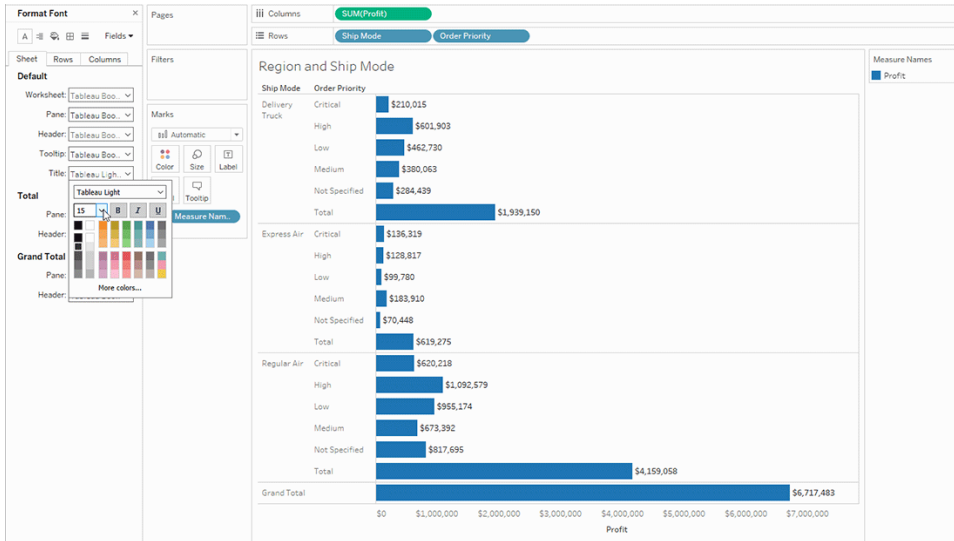

Total Pane

Adjusting the font for totals at the pane level will change both the subtotals and grand totals. For information on setting up totals, see [Show Totals in a Visualization](#) on page 1354.

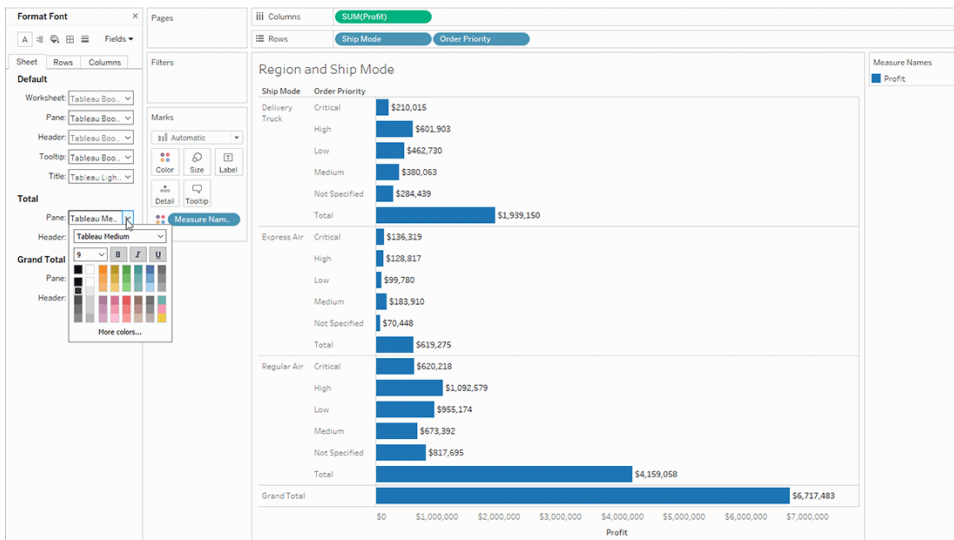

Total Header

Tableau Desktop and Web Authoring Help

Adjusting the font for totals at the header changes the appearance of the **Total** and **Grand Total** label in the view.

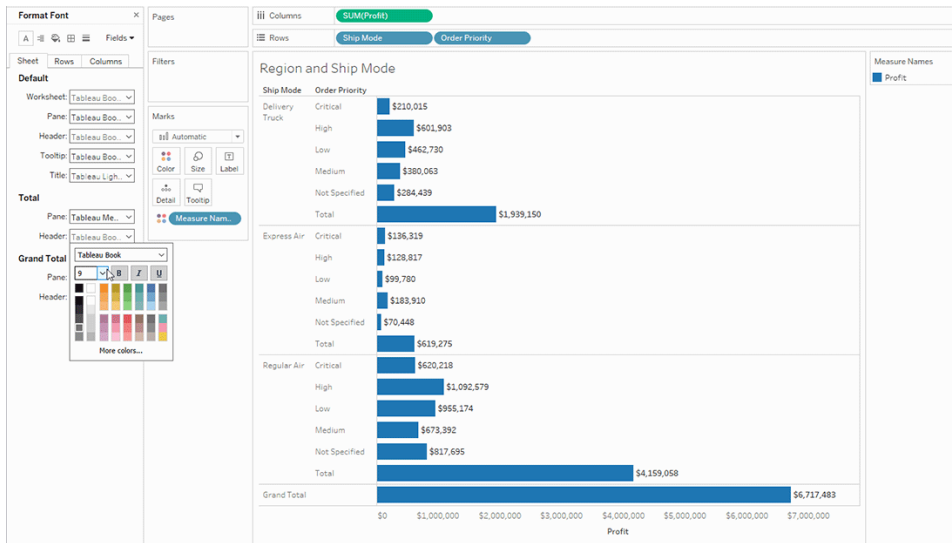

Grand Total Pane

Select this option to adjust the font for the grand total result in your view.

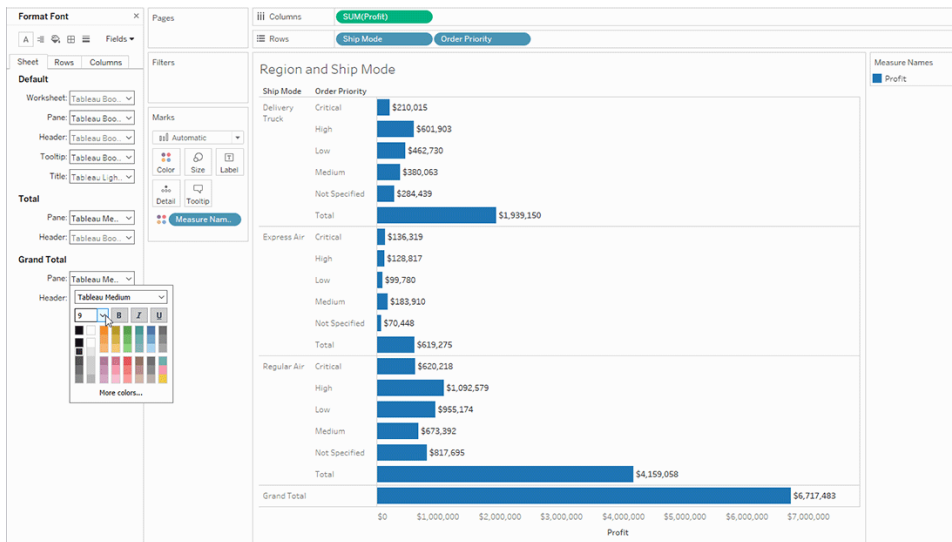

Grand Total Header

Select this option to adjust the font for the grand total label in your view.

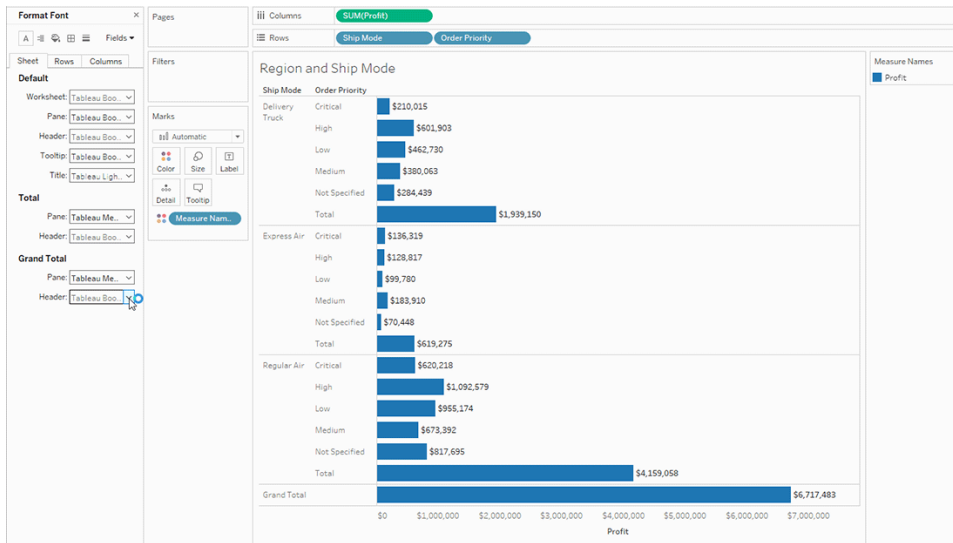

Row and Column Text Formatting

If you have dimensions on both the row and column shelves, you can independently format the fonts through the **Rows** and **Columns** tabs on the Formatting pane.

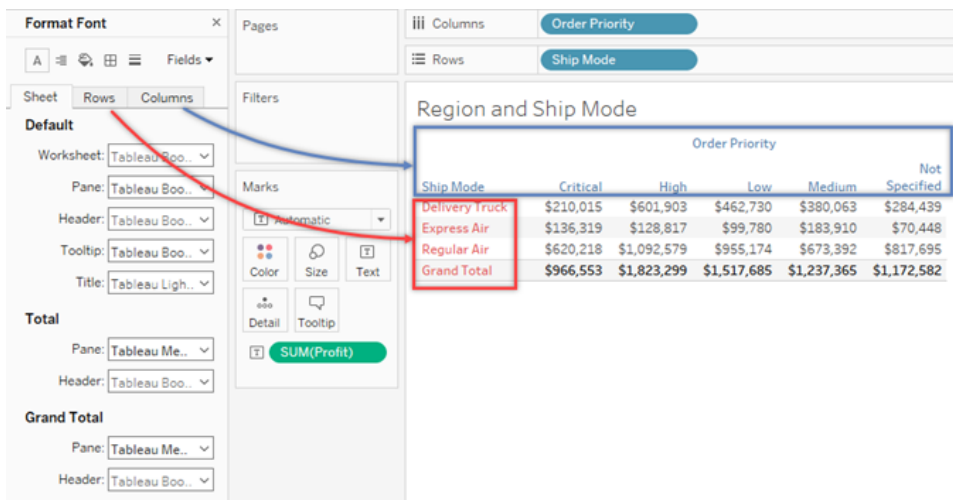

The format font options are limited to the Header, Total, and Grand Total selections.

Format text alignment

Tableau uses visual best practices to determine how text is aligned in a view, but you can also customize your text alignment. For example, you can change the direction of header text so that it is horizontal (default) instead of vertical (up).

To format the text alignment, select **Format > Alignment** to open the text alignment pane.

Header Text is Vertical

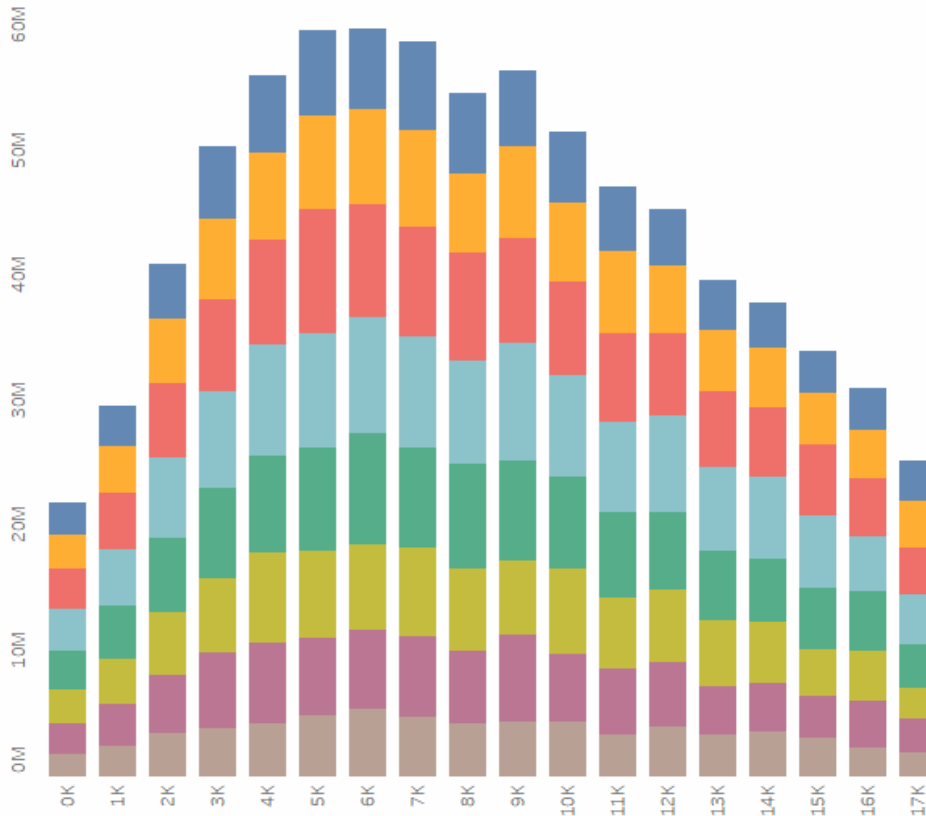

For each text area you can specify the following alignment options:

Horizontal - Controls whether text aligns to the left, right, or center.

Vertical Alignment - Controls whether text aligns at the top, middle, or bottom.

Direction - Rotates text so that it runs horizontally (default), top-to-bottom (up), or bottom-to-top (down).

Wrap - Controls whether long headers wrap to the next line or are abbreviated. It does not control text marks in the visualization.

Note: If cells are not large enough to show more than one row of text, turning on wrapping will have no visible effect. If this happens, you can hover the cursor over a cell until a double-sided arrow appears, and then click and drag down to expand the cell size.

Tableau adheres to regional standards when determining when to begin or end line breaks.

Format tooltips

Tooltips are details that appear when you rest the pointer over one or more marks in the view. Tooltips also offer convenient tools to quickly filter or remove a selection, select marks that have the same value or view underlying data. You can edit the tooltip to include both static and dynamic text. You can also modify which fields are included in the automatic tooltip.

To edit a tooltip:

1. Select **Worksheet > Tooltip**. Tooltips are specified for each sheet and can be formatted using the formatting tools along the top of the Edit Tooltip dialog box. Use the **Insert** menu at the top of the dialog box to add dynamic text such as field values, sheet properties, and more.

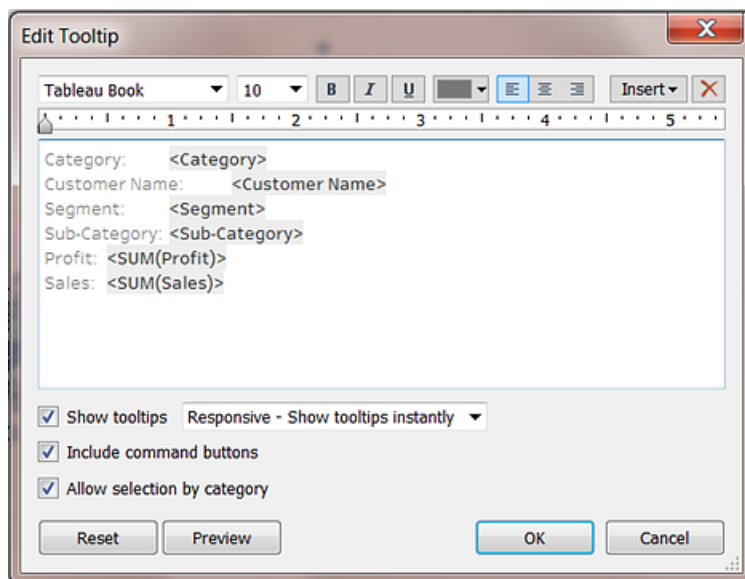

2. Use the formatting tools along the top of the Edit Tooltip dialog box.

3. (Optional) Use the **Insert** drop-down list at the top of the dialog box to add dynamic text such as field values, sheet properties, and more.

The **All Fields** option on the **Insert** menu adds all field names and values that are used in the view. Inserting the All Fields parameter updates the tooltip as you change the view. You can also use the All Fields option to exclude fields.

4. (Optional) Select the **Include command buttons** option to show filtering and view data options in the tooltip. For example, including command buttons will add **Keep Only**, **Exclude**, and **View Data** buttons to the bottom of the tooltip. These command buttons are available both in Tableau Desktop and when the view is published to the web or viewed on a mobile device.
5. (Optional) Select the **Allow selection by category** check box to select marks in a view that have the same value by clicking on a discrete field in a tooltip. For more information see [Tooltips on page 84](#).

Edit worksheet titles, captions, and legend titles

1. Do one of the following:
 - On Tableau Server or Tableau Cloud, double click the item you want to change.
 - On Tableau Desktop, Right-click (control-click on Mac) the item you want to change and select **Edit <item>**, for example, **Edit Title**.
 - On a worksheet, hover on the title, click the drop-down arrow on the right-hand side and select **Edit Title** or **Edit Caption** from the context menu.
2. In the Edit dialog box, modify the text and format the font, size, style, color, and alignment. Use the **Insert** menu to add dynamic text such as sheet properties and field values. Click **OK**.

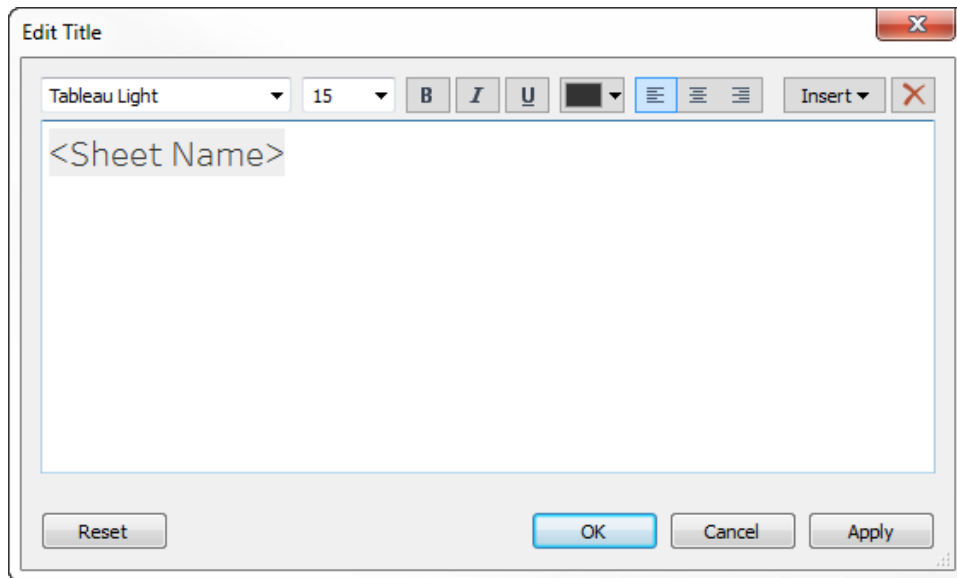

To reset the title back to the default, click **Reset**.

Use Custom Fonts

Tableau provides a variety of fonts for you to use in your visualizations, including the fonts in its default typeface: Tableau. However you might want to use a font other than what's provided. For example, you may want to use a font that's unique to your company's brand.

To use a custom font in Tableau, the first step is to install it on the computers that are running Tableau. This includes Tableau Desktop and, if you're publishing to Tableau Server, any computers running Tableau Server.

Important: If a font specified in Tableau Desktop isn't also installed on all nodes of Tableau Server, Tableau Server substitutes a default font.

To ensure that Tableau Server can render the font correctly, make sure the font is on the list of fonts installed with most browsers. These commonly installed fonts are called "web-safe" fonts, as detailed [here](#).

Note: If you download a workbook from Tableau Server, custom fonts are not downloaded with the workbook.

For more information about installing fonts, see the following links:

- [How to install or remove a font in Windows](#) (Microsoft Knowledge Base)
- [Mac Basics: Font Book](#) (Apple Support)

After you install the font it appears in the formatting pane in Tableau Desktop, where you can use it to change fonts at the workbook or worksheet levels. See [Format at the Workbook Level](#) on page 2932, [Format at the Worksheet Level](#) on page 2942, and [Format Text and Numbers](#) on page 2981 for details.

Publish custom fonts

Publishing a workbook with a custom font correctly depends on knowing how the author and published workbook interact.

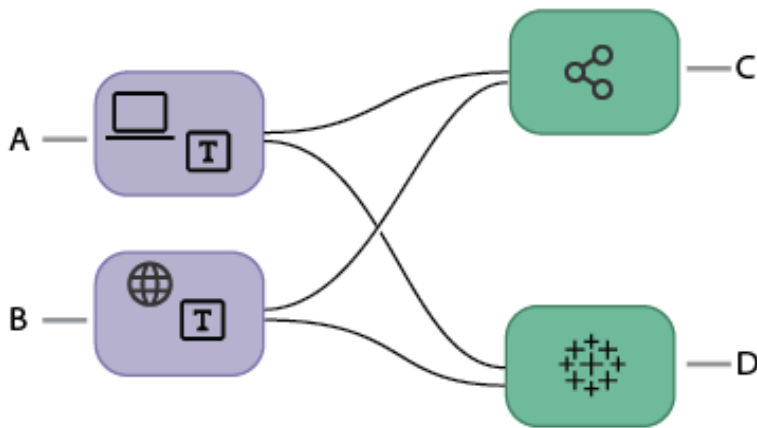

Publishing a custom font work flow

A. Workbook is created in Tableau Desktop.

or

B. Workbook is created using Web Authoring.

then

C. Workbook is published to Tableau Server.

or

D. Workbook is published to Tableau Cloud.

If	Then
A- The workbook is created in Tableau Desktop.	You can use any font installed on your computer in the workbook.
B- The workbook is created using Web Authoring.	Only fonts installed on the Tableau Server or Tableau Cloud are functional when formatting your text.
C- The workbook is published to Tableau Server.	Any custom font must be installed on all server nodes. If the font is not installed on Tableau Server, the uninstall font will be replaced with a substitute font upon publishing.
D- The workbook is published to Tableau Cloud.	Only fonts supported by Tableau Cloud will appear. Any unsupported fonts in the workbook will be replaced with a substitute font upon publishing. For a list of supported fonts, see Knowledge Base: Fonts not displaying as expected .

Troubleshoot custom fonts in published workbooks

Once published, any viewer of the published workbook will need to have the custom fonts installed on their computer. This is why it is a best practice to limit fonts to either Tableau fonts or web safe fonts.

Issue	Possible Solution
Some fonts are accurate in the view, but others are not.	When a view has many marks, the server will render the marks on the server side and display the marks as a static image. This can result in some fonts in the view appearing inconsistent with the rest of the view. To resolve this issue, reduce the number of marks per view.
The spacing on the font appears different for	If the viewer has the custom font installed on their computer, the viewer will see the font displayed accurately. However, each browser uses a slightly different method for rendering fonts, so seeing slight differences in fonts between browsers is expected.

Issue	Possible Solution
different viewers.	
A different font appears for viewers.	If the viewer does not have the custom font installed on their computer, any uninstalled fonts in the workbook will be replaced with a substitute font selected by the browser.

Format Individual Parts of the View

You can format individual parts of the view, including text elements such as titles, captions, and tooltips. You can also format individual controls, including legends, filters, highlighters, and parameter controls.

Text elements

There are several ways that text elements, such as titles, captions, and tooltips, can appear on your view. You can choose to hide or show titles and captions on your worksheet. You can also add tooltips to Marks.

Show titles and captions

If a title or caption isn't showing, open the Worksheet menu and select **Show Title** or **Show Caption**.

For dashboards and stories, there are equivalent options in their respective menus (such as Dashboard > Show Title). There's also a check box to turn the dashboard or story title on or off, available in the left-hand pane.

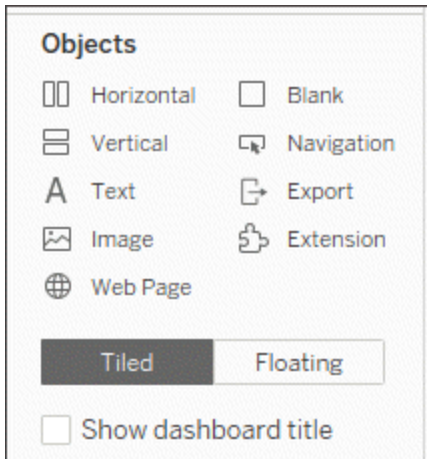

Edit titles and captions

1. On a worksheet, hover on the title to access the context menu, select the dropdown arrow on the right-hand side, and select **Edit Title** or **Edit Caption**. Alternatively:
 - a. Right-click (control-click on Mac) the item you want to change and select **Edit**.
 - b. In Tableau Cloud, double-click the worksheet title.
2. In the Edit Title dialog box, modify the text and format the font, size, style, color, and alignment. If desired, use the **Insert** menu to add dynamic text such as sheet properties and field values. To reset a title or caption back to the default, click **Reset**.

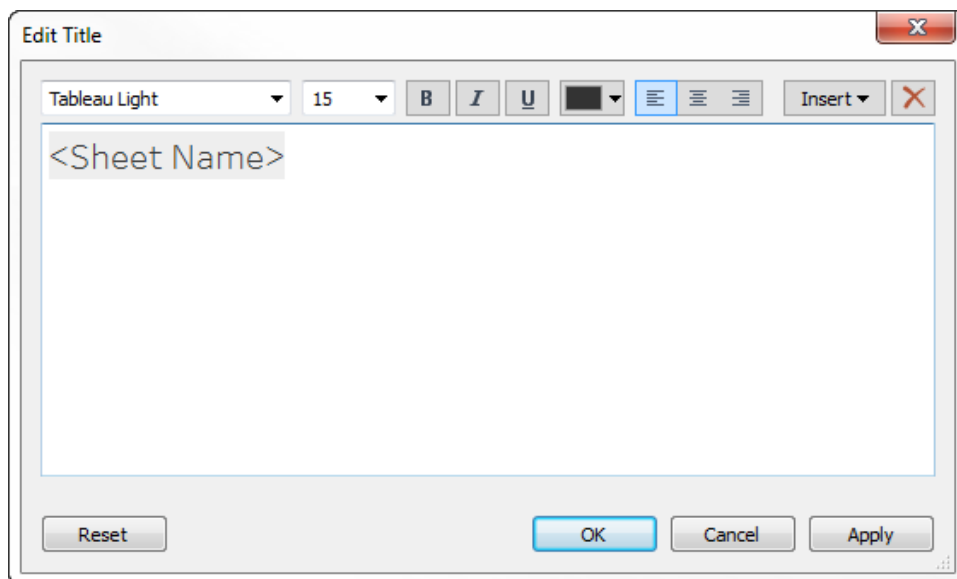

Format titles and captions

For information on showing or hiding a title, see [Titles](#) on page 86.

1. On a worksheet, right-click (control-click on Mac) the title, caption, or legend and select **Format <item>**—for example, **Format Title**.
2. In the **Format** pane, use the drop-down lists to change the default shading or border.

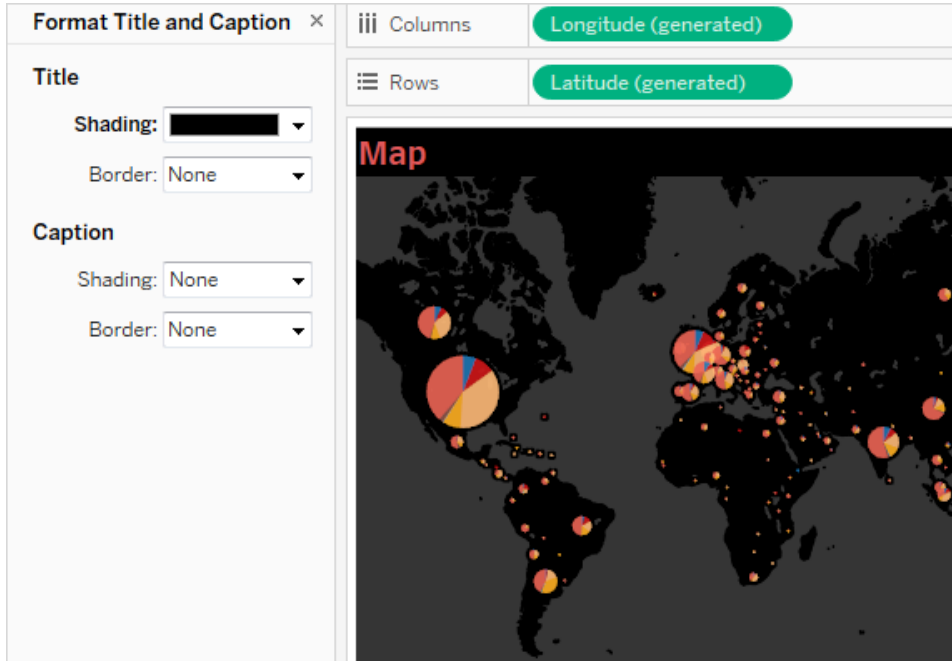

Edit dashboard titles

For information on showing or hiding a title, see [Titles on page 86](#).

1. On a dashboard, double-click the title.
2. In the Edit Title dialog box that appears, format the title as you like. You can enter a new title for the dashboard or a description, and change the font type, size, emphasis, color, and alignment. You can also type in a website URL and Tableau will automatically create a hyperlink.

Note: If you edit the hyperlink, make sure to delete the entire hyperlink and then reenter the new one. If you don't do this, the text of the hyperlink updates, but the URL path won't.

3. When finished, click **OK**. The dashboard title updates with the changes.

Format tooltips

Tooltips are details that appear when you rest the pointer over one or more marks in the view.

Tooltips also offer convenient tools to quickly filter or remove a selection, select marks that have

the same value or view underlying data.

- For more information on tooltips, see [Tooltips on page 84](#).
- To show a visualization in a tooltip, see [Create Views in Tooltips \(Viz in Tooltip\) on page 1371](#).

You can edit the tooltip to include both static and dynamic text. You can also modify which fields are included in the automatic tooltip.

1. On the Marks card select **Tooltip**. Tooltips are specified for each sheet and can be formatted using the formatting tools along the top of the Edit Tooltip dialog box.
2. Use the **Insert** menu at the top of the dialog box to add dynamic text such as field values, sheet properties, and more.
3. Use the formatting tools along the top of the Edit Tooltip dialog box.

There are several optional customizations as well.

Dynamic text values

Use the **Insert** drop-down list at the top of the dialog box to add dynamic text such as field values, sheet properties, and more.

The **All Fields** option on the **Insert** menu adds all field names and values that are used in the view. Inserting the All Fields parameter updates the tooltip as you change the view. You can also use the All Fields option to exclude fields.

Command buttons

Select the **Include command buttons** option to show filtering and view data options in the tooltip.

For example, including command buttons adds **Keep Only**, **Exclude**, and **View Data** buttons to the tooltip. These command buttons are available both in Tableau Desktop and when the view is published to the web or viewed on a mobile device. Unchecking **Include command buttons** will also hide the aggregation summary if multiple marks are selected.

Selection by category

Select the **Allow selection by category** check box to select marks in a view that have the same value by selecting a discrete field in a tooltip. For more information see [Tooltips on page 84](#).

Controls

As of Tableau version 2024.2, you can format controls, including legends, quick filters, highlighters, and parameter controls individually or all together. In Tableau versions 2024.1. and earlier, these controls take on whatever formatting is applied at the worksheet level.

Show Controls

Legends

A legend automatically shows on the worksheet when you encode marks by dropping them on the **Color**, **Shape**, or **Size** cards.

Filters

If you aren't seeing a filter control, hover over the field in the filters box, expand the context menu, and select **Show Filter**.

Highlighters

A highlighter automatically shows on the worksheet when it has been turned on.

To learn more about highlighters, see [Highlight Data Points in Context](#).

Parameters

If you aren't seeing a parameter control, hover over the parameter in the data pane, expand the context menu, and select **Show Parameter**.

To learn more about parameters, see [Create Parameters](#).

Format Controls on Tableau Desktop

1. From the control, expand the context menu by clicking the dropdown arrow on the top right of the box.

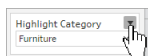

2. Select **Format...**
3. Select **This [Control]...** or **All [Controls]...**

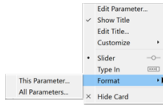

If you select **This [Control]...**, any formatting updates you make will apply to the selected control only. If you select **All [Controls]...**, any formatting you update will apply to all of that type of control, such as all parameters.

4. Make your formatting changes in the formatting pane on the left side of the viz. You can format the Title and Body text, including font, font style, text, and color. You can also format the background shading and border.

Note: On Tableau Desktop, formatting an individual control overrides formatting applied at the worksheet level. If you'd like to make subsequent formatting changes apply to all elements, you must first clear the formatting applied at the individual control level. Some formatting elements, such as borders, may not render on a worksheet, but will show on the viz when added to a dashboard.

Format Controls on Tableau Cloud and Tableau Server

1. From the control, expand the context menu by clicking the down arrow on the top right of the box.
2. Select Format.

A formatting pane appears to the right of the viz.

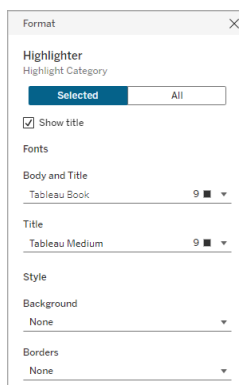

3. By default, changes are set to apply to the **Selected** control only. If you'd like to format all of the types of control for this view, such as all filters, select **All**.
4. Make your formatting changes. You can format the text, including font, font style, text, and color, and you can format the background shading and border. You can also choose to show or hide the title of the control from this pane.

Note: On Tableau Cloud, you can access individual formatting controls on the worksheet; formatting individual controls isn't accessible on a dashboard.

For more information about adding controls, including legends, filters, and parameter controls to a worksheet, see [Additional Shelves, Legends, Cards, and Controls](#).

Format Fields and Field Labels

You can format a specific field in a view, as well as individual field labels. When formatting is done this way, your formatting changes are scoped to only where the field appears in the view, or only an individual label.

Format a field

In the view below, the **Month(Order Date)** field has been formatted so that the headers use the Tableau Semibold font, in blue. Notice that the header values along the Profit axis are not affected.

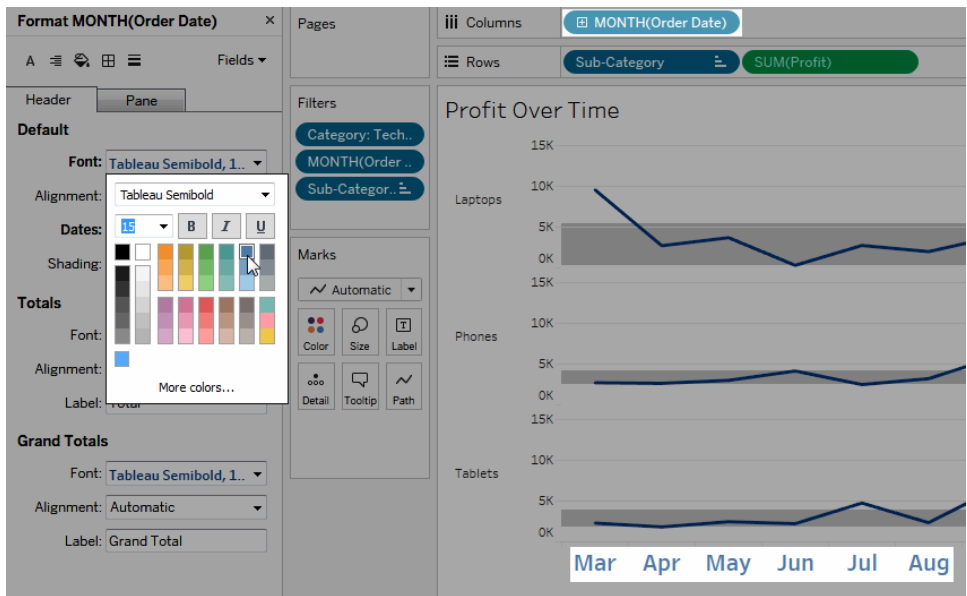

To format a specific field:

1. Right-click (control-click on Mac) the field and select **Format**.

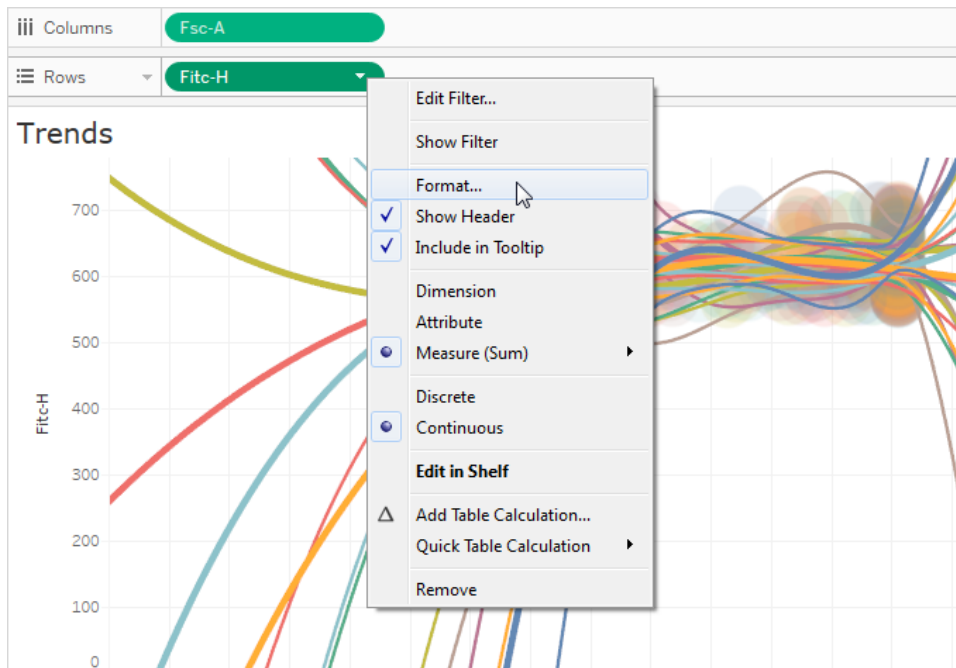

The **Format** pane opens to settings for the selected field.

2. Make your changes in the **Format** pane.

For discrete fields, such as Region or Customer Name, you can specify font and alignment properties for both header and pane areas. For continuous fields, such as Profit or Sales, you can format font properties for the pane and axis as well as number and tick mark colors. For more information about other axis options, see [Edit Axes on page 2958](#). The view is updated as you make changes so you can quickly see the colors and formats that work with your view.

Format a field label

Field labels are row and column headings that indicate the data fields used to create a view. By default, Tableau shows field labels, but you can choose to hide them. When field labels are showing they appear in three different parts of the view: rows, columns, and the corner. The view below shows an example of each of these types of field labels.

Region / Order Date				
East				
Category	2012	2013	2014	2015
Furniture	47,233	53,817	46,387	60,854
Office Supplies	35,969	42,655	61,645	65,247
Technology	45,479	59,859	72,497	87,138

You can format the font, shading, alignment, and separators for each of these types of field labels.

To format a specific field label:

1. Right-click (control-click on Mac) the field label in the view and select **Format**.
2. In the **Format** pane, specify the settings of the font, shading, and alignment field labels.

Note: When you have multiple dimensions on the rows or columns shelves, the field labels appear adjacent to each other in the table. Each field label is separated from the others with a forward slash symbol. Specify a different separator in the **Format** pane.

Format Numbers and Null Values

You can specify the format for numeric values that display in your viz, including measures, dimensions, parameters, calculated fields, and axis labels. When specifying a number format, you can select from a set of standard formats, such as number, currency, scientific, and percentage. You can also define a custom number format with the option to include special characters.

When a measure contains null values, you can use formatting to handle the null values in a different way, such as replacing nulls with zeros or hiding them.

For Tableau Desktop

Specify a number format

1. Right-click (control-click on Mac) a number in the view and select **Format**.
2. In the **Format** pane, click the **Numbers** drop-down menu.
3. Select a number format.

Some formats require additional settings. For example, if you select **Scientific**, you must also specify the number of decimal places.

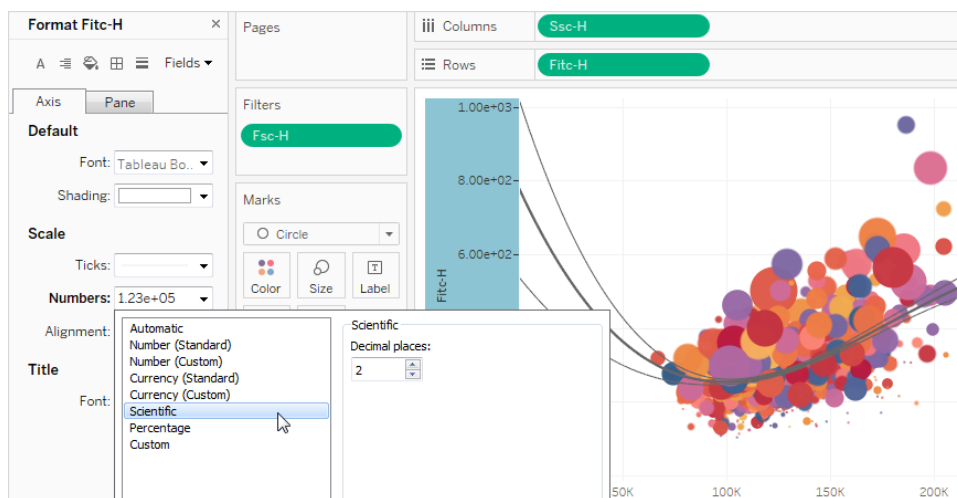

Here are the number formats and associated options available in Tableau.

NUMBER FORMAT

Automatic: format is automatically selected based on either the format specified by the data source or the data contained in the field.

Number (Standard): format is based on locale selected.

Number (Custom): format is customized to your choice.

FORMAT OPTIONS

None.

Locale: number format changes based on the geographical location selected.

Decimal Places: the number of decimal places to display.

Negative Values: how negative values are

Currency (Standard): format and currency symbol is based on locale selected.

Currency (Custom): format and currency symbol is customized to your choice.

Scientific: numbers are displayed in scientific notation.

Percentage: numbers are displayed as a percentage with the percent symbol. The value of 1 is interpreted as 100% and 0

displayed.

Units: the number is displayed using the specified units. For example, if the number is 20,000 and the units are thousands, the number will be displayed as 20K.

Prefix/Suffix: characters that precede and follow each displayed number.

Include thousands separators: whether the number shows separators every thousand (example: 100,000 vs. 100000).

Locale: currency format based on the geographical location selected.

Decimal Places: the number of decimal places to display.

Negative Values: how negative values are displayed.

Units: the number is displayed using the specified units. For example, if the number is 20,000 and the units are thousands, the number is displayed as 20K.

Prefix/Suffix: characters that precede and follow each displayed number.

Include thousands separators: whether the number shows separators every thousand (example: 100,000 vs. 100000).

Decimal: the number of decimal places to display.

Decimal: the number of decimal places to display.

as 0%

Custom: format is based entirely on what is specified in the format options.

Custom: type in the format you want to use, including special characters (optional). See "Define a custom number format" in this topic for details.

Define a custom number format

To apply a custom number format in your viz:

1. Right-click (control-click on Mac) a number in the view and select **Format**.
2. In the **Format** pane, click the **Numbers** drop-down menu and select **Custom**.
3. In the **Format** field, define your formatting preferences using the following syntax: `Positive number format;Negative number format;Zero values.`

When defining your number format code, keep in mind that:

- You can specify the formatting for up to three types of numbers in the following order: positive numbers, negative numbers, and zeros.
- Each number type must be separated by a semicolon (;).
- If you specify only one number type, the format for that type is used for all numbers.
- If you specify two number types, the format for the first type is applied to positive numbers and zeros, while the format for the second type is applied to negative numbers.
- If you skip types in your number format code, you must include a semicolon (;) for each of the missing types.

Custom number format examples

Refer to the following table for examples of commonly used custom number format codes that you can use in your viz.

The syntax has three portions: `<positive number format>;<negative number format>;<zero format>` separated by semicolons.

USE CASE	NUMBER CODE SYNTAX	EXAMPLE OUTPUT
Show only positive values	<code>#,##;</code> (note a blank space after the 2nd and 3rd semicolon)	Positive values: 1,234 Negative values: (only the blank space displays) Zero values: (only the blank

Show only negative values	;-#,##;	space displays) Positive values: (nothing displays) Negative values: -1,234 Zero values: (nothing displays)
Show only zero values	;;0;	Positive values: (nothing displays) Negative values: (nothing displays) Zero values: 0
Hide zero values	#,###;-#,###;;	Positive values: 1,234 Negative values: -1,234 Zero values: (nothing displays)
Show negative values in parentheses	#,###;(#,###);;	Positive values: 1,234 Negative values: (1,234) Zero values: (nothing displays)
Add a character prefix to a value	\$,###.##,-\$,###.##,\$0;	Positive values: \$1,234.56 Negative values: -\$1,234.56 Zero values: \$0
Add a character suffix to a value	#%;-#%;0%;	Positive values: 12% Negative values: -34% Zero values: 0%
Add text descriptors	"\$#,#" Surplus;"\$-##" Shortage"; "\$"0;	Positive values: \$1,234 Surplus Negative values: \$-1,234 Shortage Zero values: \$0

There are several ways to customize your number format to meet your needs. For more code guidance and examples, see [Review guidelines for customizing a number format](#) in the Microsoft Knowledge Base.

Note: There are slight deviations between the options described by Microsoft and those available in Tableau. For example, custom number formats that align text within columns aren't relevant in Tableau. Additionally, custom number formats to color code text aren't applicable because you can apply color to text using the Marks card. (For more information on applying color, see [Control the Appearance of Marks in the View.](#)) Be sure to only use custom number formats that apply in Tableau.

Include special characters in a custom number format

One of the benefits of custom number formatting is the ability to include special characters or symbols. Symbols can make it easier to quickly understand comparisons between measures and calculations in your viz.

For example, let's say you want to show a month-over-month comparison of profits for three of your company's top-selling products. Rather than using the standard label to show that the profit for these products changed +5%, -2%, and 0% label from last month, you can set the custom number format as follows to show these changes as ▲5%, ▼2%, and ►0.

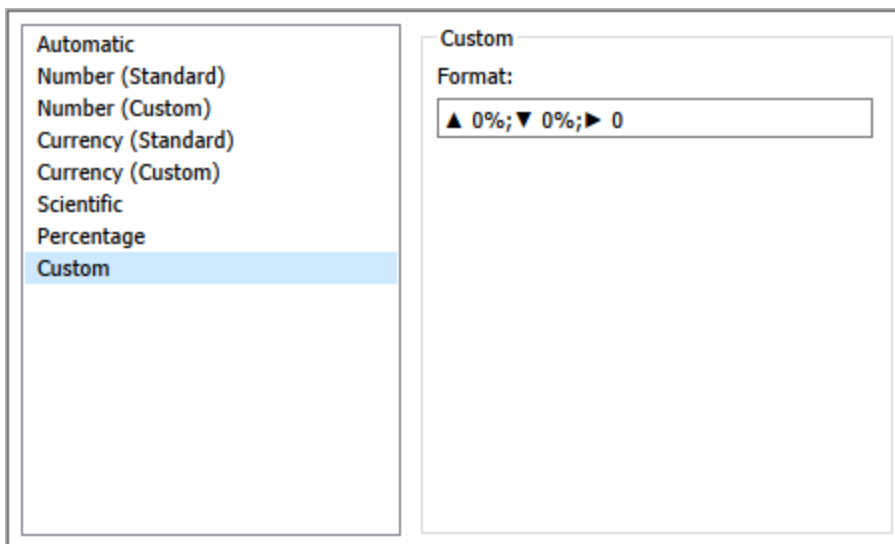

Set the default number format for a field

Right-click (control-click on Mac) the field in the **Data** pane and select **Default Properties > Number Format**.

Tableau Desktop and Web Authoring Help

In the subsequent dialog box, specify a number format to be used whenever the field is added to the view. The default number format is saved with the workbook. It's also exported when you export the connection information.

Note: Formatting numbers using the **Format** pane overrides any number formatting applied elsewhere.

Format a measure as currency

The view in the following image shows profit over time. Notice that the profit figures on the vertical axis aren't formatted as currency.

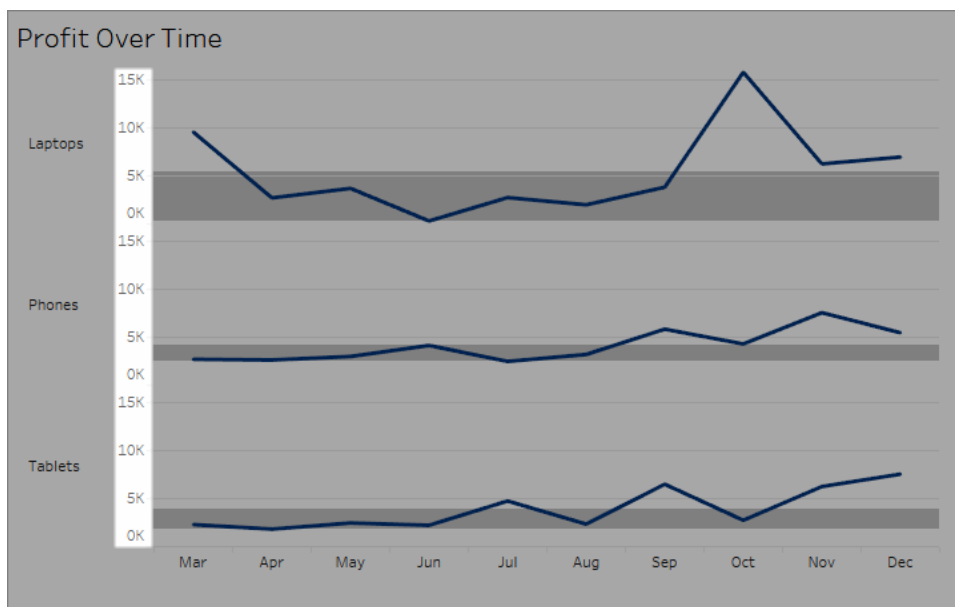

To format the numbers as currency:

1. Right-click the **Profit** axis and choose **Format**.

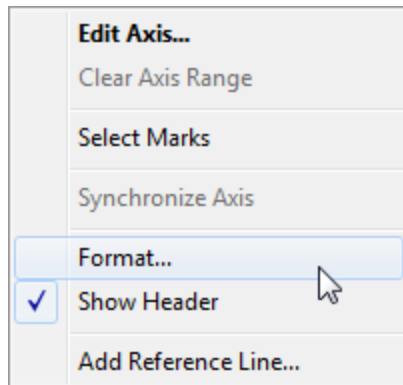

2. On the **Axis** tab in the **Format** pane, under **Scale**, select the **Numbers** drop-down list, and then select one of the following:

Currency (Standard) to add a dollar sign and two decimal places to the figures.

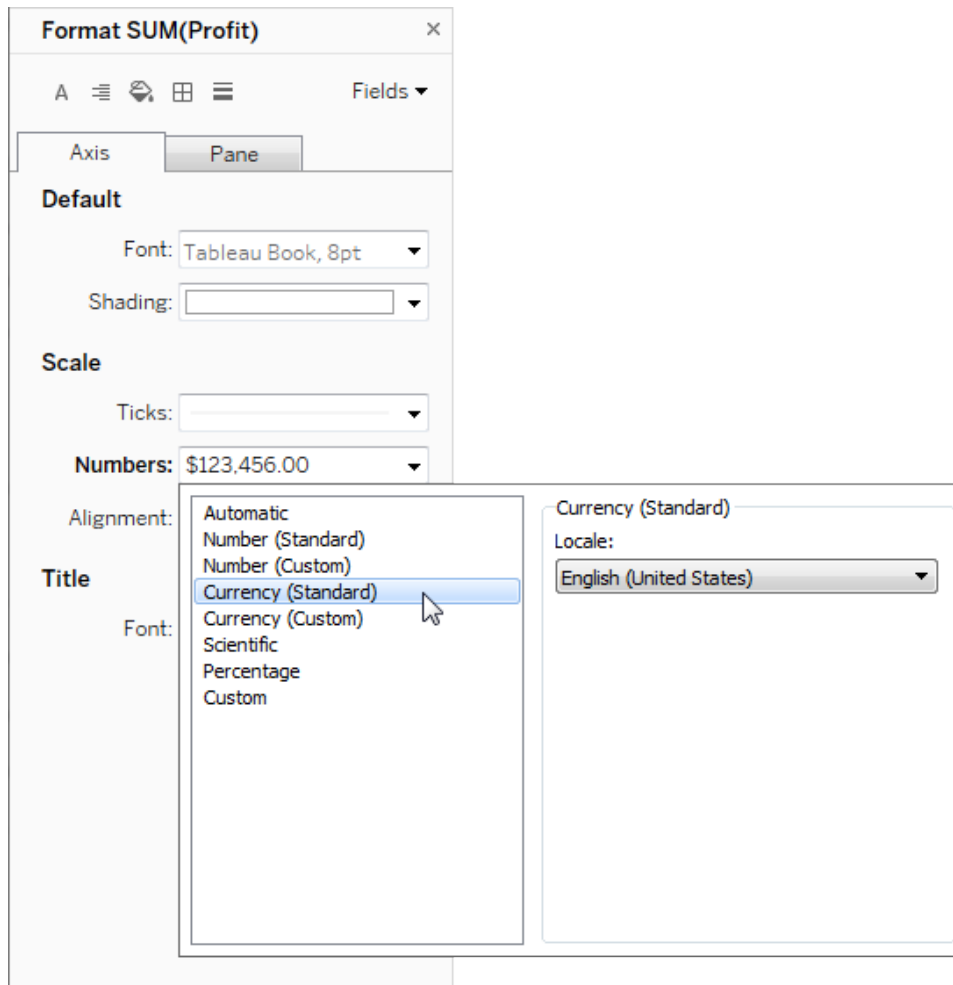

Currency (Custom) to specify the number of decimal places, how to show negative values, the units, whether to include a prefix or suffix, and whether to include a separator character.

Use locale to specify number formats

By default, Tableau uses your computer's locale and language settings to format numbers. But you can explicitly set a different locale in the **Format** pane.

The following steps show how to set Swiss German currency, using the same view as in the previous section.

1. Right-click the **Profit** axis and select **Format**.
2. On the **Axis** tab, under **Scale**, select the **Numbers** drop-down list and then select **Currency (Standard)**.

3. In the **Locale** drop-down list, items appear in a **Language (Country)** format. For this example, select **German (Switzerland)**. The view updates to show the sales figures as Swiss Francs, formatted for the German language.

Tip: You can change the default currency setting so that every time you drag the **Profit** measure to a view it uses the settings you want. In the **Data** pane, right-click **Profit** (or other monetary measure), and select **Default Properties > Number Format**. Then format the field as shown above.

Format null values

When a measure contains null values, they're usually plotted in a view as zero. However, sometimes that changes the view and you'd rather just suppress null values altogether. You can format each measure to handle null values in a unique way.

To format null values for a specific field:

1. Right-click the field in the view that has the null value (Control-click on a Mac) and choose **Format**.
2. Go to the **Pane** tab.
3. In the **Special Values** area, specify whether to show the null value using an indicator in the lower right corner of the view, plot it at a default value (such as zero for number fields), hide the value but connect the line, or hide and break the line to indicate that a null value exists.

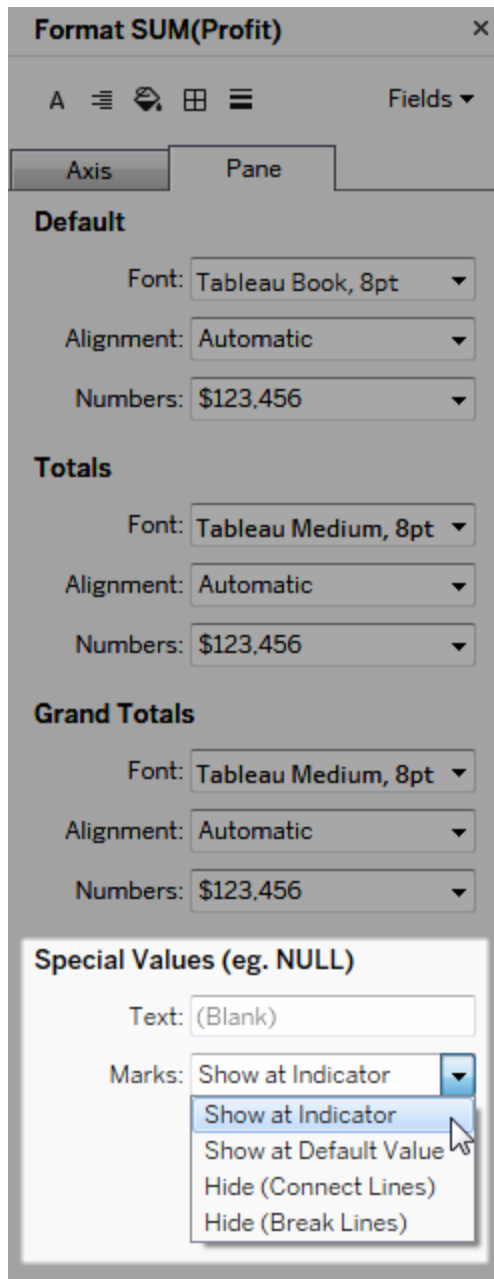

4. If you specify text in the **Text** field, it appears in the view for a null value when mark labels are turned on. See [Show and Hide Mark Labels](#).

Note: The Special Values area isn't available for dimensions or discrete measures.

For Tableau Server or Tableau Cloud

Specify a number format

When authoring a view on the web, you can specify the number format for a field used in the view.

1. In web editing mode, right-click a measure in the view and select **Format Number**.

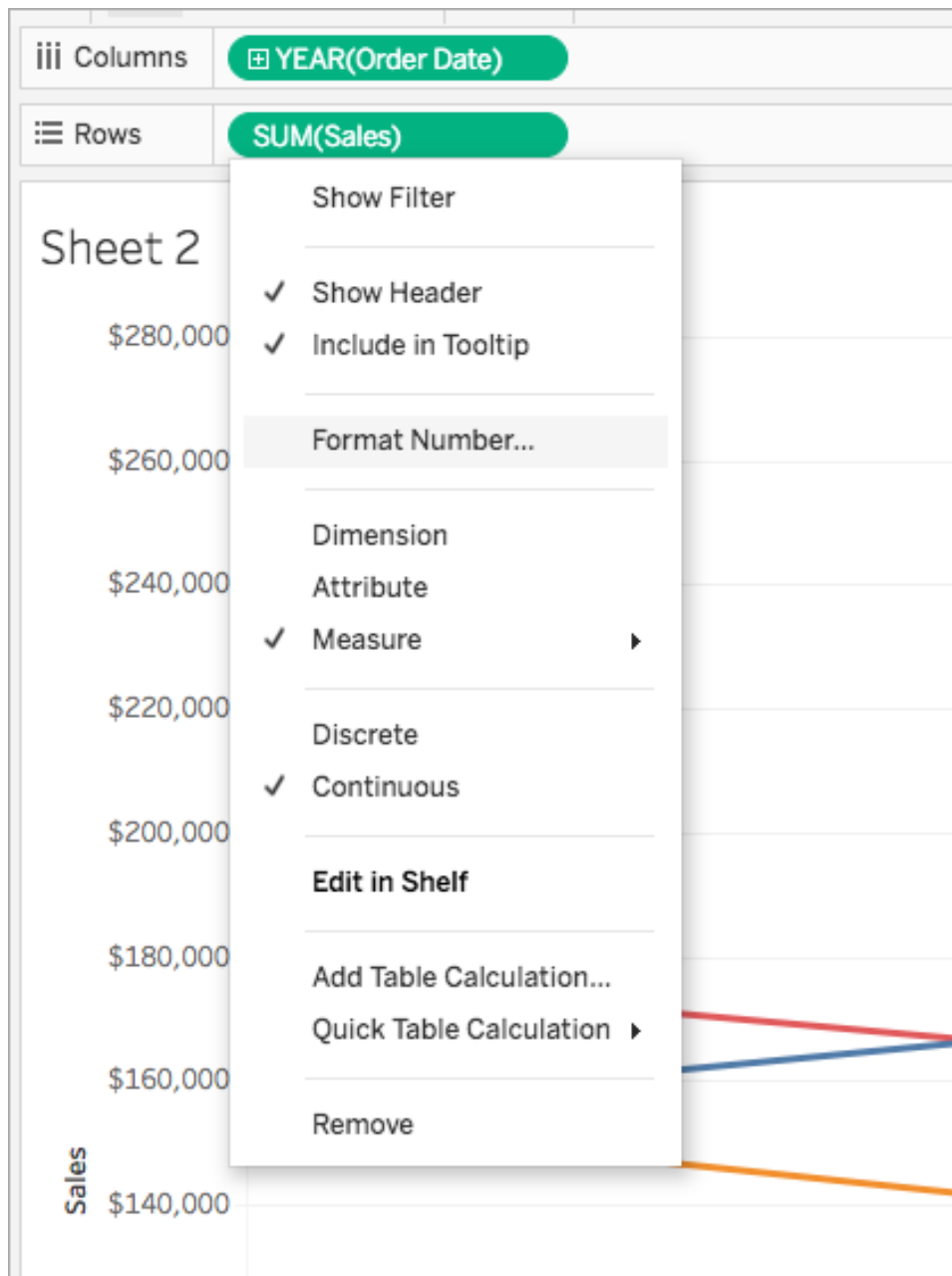

2. In the dialog box that appears, select a number format.

Some formats provide additional settings. For example, if you select **Currency**, you can also specify the number of decimal places, as well as the units, and whether or not to include separators, such as commas.

In this example, Sales is formatted as a Currency with zero decimal places and thousand (k) units. Sales numbers in the view update with these settings. Labels and tooltips update as well.

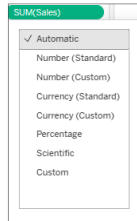

Here are the number formats and associated options available in Tableau.

NUMBER FORMAT

Automatic: format is automatically selected based on either the format specified by the data source or the data contained in the field.

Number (Custom): format is customized to your choice.

Currency (Custom): format and currency symbol is customized to your choice.

FORMAT OPTIONS

None.

Decimal Places: the number of decimal places to display.

Units: the number is displayed using the specified units. For example, if the number is 20,000 and the units are thousands, the number is displayed as 20K.

Include separators: whether the number shows separators every thousand (example: 100,000 vs. 100000).

Decimal Places: the number of decimal places to display.

Units: the number is displayed using the specified units. For example, if the number is 20,000 and the units are thousands, the number is displayed as 20K.

Include separators: whether the number

shows separators every thousand (example: 100,000 vs. 100000).

Percentage (Custom): numbers are displayed as a percentage with the percent symbol. The value of 1 is interpreted as 100% and 0 as 0%

Decimal Places: the number of decimal places to display.

Scientific (Custom): numbers are displayed in scientific notation.

Decimal Places: the number of decimal places to display.

Resize Tables and Cells

You can change the size of the rows, columns, and cells that compose a table. The best way to resize your table depends on the view type and the table components you want to resize.

Use commands to resize rows and columns

1. From a worksheet in Tableau Desktop, Select **Format > Cell Size**.
From a worksheet in Tableau Cloud or Tableau Server, expand the Fit menu and select **Cell Size**.

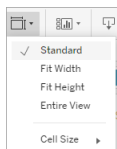

2. Choose the **Taller**, **Shorter**, **Wider**, or **Narrower** command. To quickly apply these commands, see [Shortcuts for resizing rows and columns \(Tableau Desktop\)](#) on page 3465.

For example, in the view below, we used the **Wider** and **Taller** commands to make the view more readable.

		Order Date							
		2011				2012			
Segment	Region	Q1	Q2	Q3	Q4	Q1	Q2	Q3	Q4
Consumer	Central	\$6,116	\$8,324	\$30,149	\$22,727	\$6,759	\$14,559	\$13,726	\$14,619
	East	\$1,683	\$14,985	\$21,136	\$38,700	\$6,477	\$9,486	\$5,035	\$8,402
	South	\$6,570	\$9,416	\$9,847	\$6,477	\$6,570	\$9,416	\$9,847	\$6,477
	West	\$7,596	\$15,126	\$34,972	\$32,272	\$7,596	\$15,126	\$34,972	\$32,272
Corporate	Central	\$235	\$3,856	\$7,446	\$8,364	\$4,351	\$4,079	\$11,558	\$17,652
	East	\$4,351	\$4,079	\$11,558	\$17,652	\$7,008	\$12,443	\$5,747	\$9,486
	South	\$7,008	\$12,443	\$5,747	\$9,486	\$2,397	\$6,866	\$8,241	\$18,704
	West	\$2,397	\$6,866	\$8,241	\$18,704	\$2,249	\$5,227	\$6,576	\$2,568
Home Office	Central	\$2,249	\$5,227	\$6,576	\$2,568	\$545	\$2,000	\$750	\$11,242
	East	\$545	\$2,000	\$750	\$11,242	\$30,684	\$665	\$467	\$5,035
	South	\$30,684	\$665	\$467	\$5,035	\$5,013	\$3,551	\$6,744	\$8,402
	West	\$5,013	\$3,551	\$6,744	\$8,402				

Note: For a given field, all members will have the same width and the same height. You can't resize individual field members.

Manually resize rows and columns

To manually resize the widths or heights of row and column headers or axes:

1. Place your cursor over the vertical or horizontal border of a header or axis.
2. When you see the resize cursor , click and drag the border left and right or up and down.

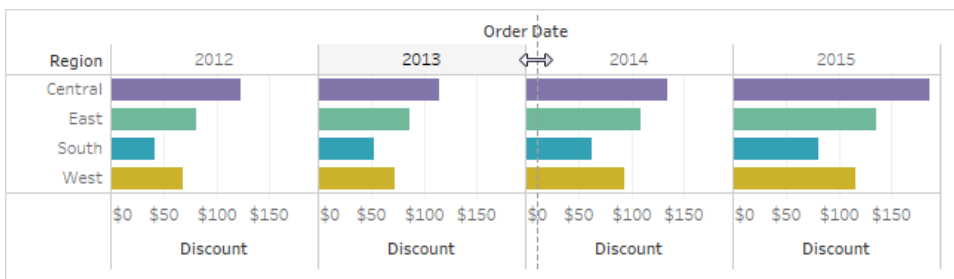

Resize an entire table

You can increase or decrease the size of the entire table by selecting **Bigger** or **Smaller** on the **Cell Size** menu. For example, to increase the width of the columns and the height of the rows for the view shown below, you can select **Cell Size > Bigger**. This option increases both the width

and height of the panes in a visually appropriate way. Notice that the size of the row headers increases horizontally when you resize the table.

Resize cells

Any table you can create in Tableau has the cell as its basic component. For a text table, the cell is what you would expect. It is the intersection of a row and a column, and is where the text is displayed.

However, depending on the view you construct, identifying the cell is not always possible or useful, such as in the case of a scatter plot.

Manipulating cells to enhance your data view is useful when dimensions are the inner fields on both the **Rows** and **Columns** shelves. In this case, there are two shortcuts you can select on the **Format > Cell Size** menu:

- **Square Cell** – Adjusts the view so the cell has a 1:1 aspect ratio. This results in a square cell, which is useful for heatmaps.
- **Text Cell** – Adjusts the view so the cell has a 3:1 aspect ratio. This is useful for text tables.

For example, you can see the text table below with **Square Cell** and **Text Cell** applied. **Text Cell** enforces a cell aspect ratio of 3:1 and results in a compact table that is easy to read.

Square Cell

Text Cell

Segment	2011	2012	2013	2014
Consumer	\$266,097	\$266,536	\$296,296	\$332,473
Corporate	\$128,435	\$128,757	\$206,943	\$242,011
Home Office	\$89,716	\$75,239	\$105,235	\$159,463

The heatmap shown below is modified by selecting **Square Cell** on the **Format > Cell Size** menu. This enforces a cell aspect ratio of 1:1 and results in a compact table that is easy to analyze. You can also use the **Size** slider on the **Marks** card to adjust the size of each mark.

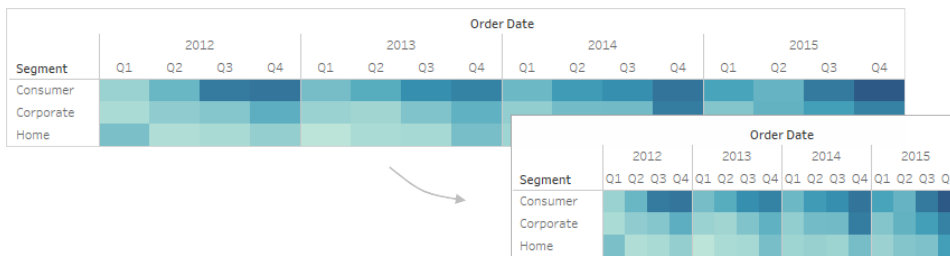

After changing the cell size, you can use **Ctrl+B** and **Ctrl+Shift+B** to decrease or increase the table size while maintaining the cell aspect ratio. On a Mac, the keystrokes are **Command-B** and **Shift-Command-B**.

Define Table Structure

In addition to the standard formatting, there are some other settings that define the table structure. You can modify these settings by selecting **Analysis > Table Layout > Advanced** to open the Table Options dialog box. There you can specify the aspect ratio, the default number format, row and column attributes, and the default label orientation for labels along the bottom of

the view. While these settings apply to the whole view, some can be overridden using the **Format** pane.

Set the aspect ratio

The aspect ratio refers to the ratio of the pane width to the pane height. You can choose to constrain the aspect ratio to a specified amount or not constrain it at all. An unconstrained axis range can be useful because it means that the axes don't have to be the same length.

Anytime you manually resize a row or column, you are unconstraining the aspect ratio. The aspect ratio setting only applies to views containing continuous axes on both the row and column shelves. Nominative axes are not affected by the aspect ratio settings.

Set the default number format

You can define the number of decimal places to appear by default for numbers in the view. If you select **Automatic**, Tableau automatically decides the number of decimal places based on the data in the field. If you select **Manual**, you can decide to show up to 16 decimal places.

Set row attributes

Select from the following row attributes:

- **Maximum levels of row labels:** determines the number of fields that can be added to the Rows shelf before the headers are combined on the same level.

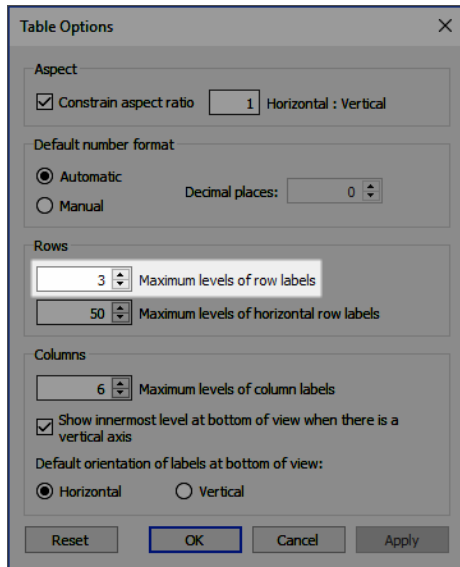

For example, if you set Maximum levels of row labels to 3 and place 5 discrete fields on the Rows shelf, then the first, second, and third row headers will appear in the same header, separated by commas (they will be combined at the same header level).

State	City	Postal Code		
Aaron Bergman, Central, Oklahoma	Oklahoma City	73120		
Aaron Bergman, Central, Texas	Arlington	76017		
Aaron Bergman, West, Washington	Seattle	98103		
Aaron Hawkins, East, New York	New York City	10035		
	Troy	12180		
Aaron Hawkins, East, Pennsylvania	Philadelphia	19134		
Aaron Hawkins, South, Mississippi	Gulfport	39503		
Aaron Hawkins, West, California	Los Angeles	90004		
	San Francisco	94109		
		94122		
Aaron Smayling, Central, Texas	Austin	78745		
Aaron Smayling, East, New York	New York City	10035		
Aaron Smayling, South, North Carolina	Jacksonville	28540		
Aaron Smayling, South, Virginia	Arlington	22204		
Aaron Smayling, West, California	Pasadena	91104		
	San Francisco	94110		

In this example, Customer Name, Region, State, City, and Postal Code are the 5 discrete fields on the Rows shelf. Maximum levels of row labels is set to 3. In the resulting view, Customer Name is combined with Region and State in the first column.

- Maximum levels of horizontal row labels: determines the number of fields that can be placed on the Rows shelf before headers are automatically oriented vertically rather than horizontally when the table doesn't fit the view.

Set column attributes

Select from the following column attributes:

- **Maximum levels of column labels:** determines the number of fields that can be placed on the Columns shelf before Tableau begins to combine the labels. For example, if you set Maximum levels of column labels to 8 and place 9 discrete fields on the Columns shelf, then the first and second column headers will appear in the same header, separated by a comma (they will be combined at the same header level).
- **Show innermost level at bottom of view when there is a vertical axis:** displays the innermost level of column headers at the bottom of the view (as opposed to the top) when a vertical axis is added to the view.
- **Default orientation of labels at bottom of view:** determines whether labels at the bottom of the view are oriented horizontally or vertically by default. You can toggle between the horizontal and vertical options by pressing Ctrl + L on your keyboard (Command-L on a Mac).

Create Custom Color Palettes

Tableau Desktop comes with color palettes that have been carefully designed to work well together and effectively apply color to data in many situations, such as on maps, heatmaps, bar charts, etc. You can also create and use your own custom color palettes by modifying the **Preferences.tps** file that comes with Tableau Desktop. For example, you can create a custom categorical palette that matches your company's brand.

About the preferences file

You can add as many custom palettes as you like to your **Preferences.tps** file, each with as many colors as you want. Although there isn't a limit to how many colors can be added to each custom palette, the Edit colors dialog box only shows 20 colors. If you need to manually assign more than 20 colors to data items, you may want to create several custom palettes with 20 or fewer colors in each palette.

When you modify **Preferences.tps** to add colors, use the standard HTML format for the new colors (hex code #RRGGBB or Red Green Blue format). When you save the workbook and restart Tableau Desktop, the color palette names you added to **Preferences.tps** appear in the **Select Color Palette** drop-down list (Edit Color dialog). You can use a custom palette like you would any other.

Tableau doesn't test or support custom color palettes, so be sure to back up your workbooks before you continue. Also, there is no guarantee that custom color palettes you create will work with future Tableau Desktop upgrades.

Note: When you edit your **Preferences.tps** file, be sure to use straight quotation marks (' ' or " ") to delimit the palette name and type, not curly quotation marks (" " or ' ').

Edit the preferences file

The **Preferences.tps** file is located in the My Tableau Repository folder that is created when you install Tableau Desktop, likely located in Documents. The preferences file is a basic XML file that you can open in a text editor to modify. An unedited preferences file looks like this:

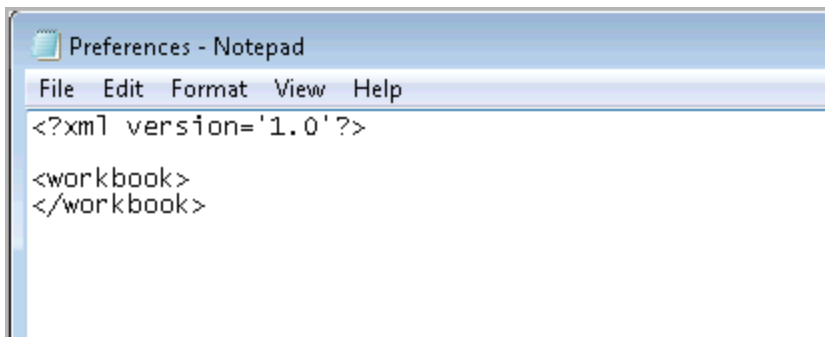

To edit your preferences file:

1. Go to the My Tableau Repository folder in your Documents directory, and open the **Preferences.tps** file with a text editor.
2. Between the opening and closing `workbook` tags, insert opening and closing `preferences` tags so that it looks like this:

```

<?xml version='1.0'?>
<workbook>
<preferences>
</preferences>
</workbook>

```

Note: If your **Preferences.tps** file already has preferences tags, you don't need to add them again.

3. Follow one of the next procedures to create a custom color palette by inserting `color-palette` tags between the `preferences` tags. For example:

```
<?xml version='1.0'?>
<workbook>
<preferences>
<color-palette name="MyColors" type="regular">
<color>#1e4c56</color>
<color>#cba94b</color>
</color-palette>
</preferences>
</workbook>
```

Color palettes can be **categorical** (`type="regular"`), **sequential** (`type="ordered-sequential"`), or **diverging** (`type="ordered-diverging"`).

4. To add more palettes, insert another set of `color-palette` tags.

```
<?xml version='1.0'?>
<workbook>
<preferences>
<color-palette name="MyColors" type="regular">
<color>#1e4c56</color>
<color>#cba94b</color>
</color-palette>
<color-palette name="MoreColors" type="regular">
<color>#ffe96f</color>
<color>#799a0d</color>
</color-palette>
</preferences>
</workbook>
```

5. You must restart Tableau Desktop to see the new color palettes.

Create a categorical palette

A categorical color palette contains several distinct colors that can be assigned to discrete dimension members. For example, when you put a discrete dimension such as **Region** on the **Color** card, the categorical color legend is used.

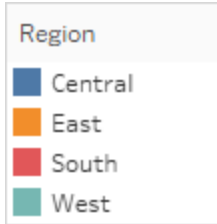

In the preferences file, a categorical palette is `type="regular"`.

Build a custom categorical color palette

The following is an example of what to add between the `preferences` tags to add a categorical color palette. Note that the `type` attribute is specified as `regular`, which identifies this palette as a categorical palette.

To create a custom categorical color palette:

1. In the **Preferences.tps** file, between the "preferences" tags, paste the following. Be sure to use straight quotation marks, not curly quotation marks, to delimit the palette's name and type.

```
<color-palette name="My Categorical Palette" type="regular">
<color>#eb912b</color>
<color>#7099a5</color>
<color>#c71f34</color>
<color>#1d437d</color>
<color>#e8762b</color>
<color>#5b6591</color>
<color>#59879b</color>
</color-palette>
```

2. Save the **Preferences.tps** file and then restart Tableau Desktop.
3. Open a data source, such as the **Superstore - Sample** data source.
4. From the **Data** pane, drag a discrete dimension, such as **Region**, to **Color**.

5. Click the color legend menu arrow and select **Edit Colors**.

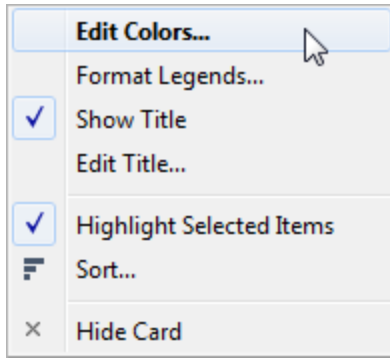

6. In the Edit Colors dialog box, from the palette drop-down list, select your new custom palette.

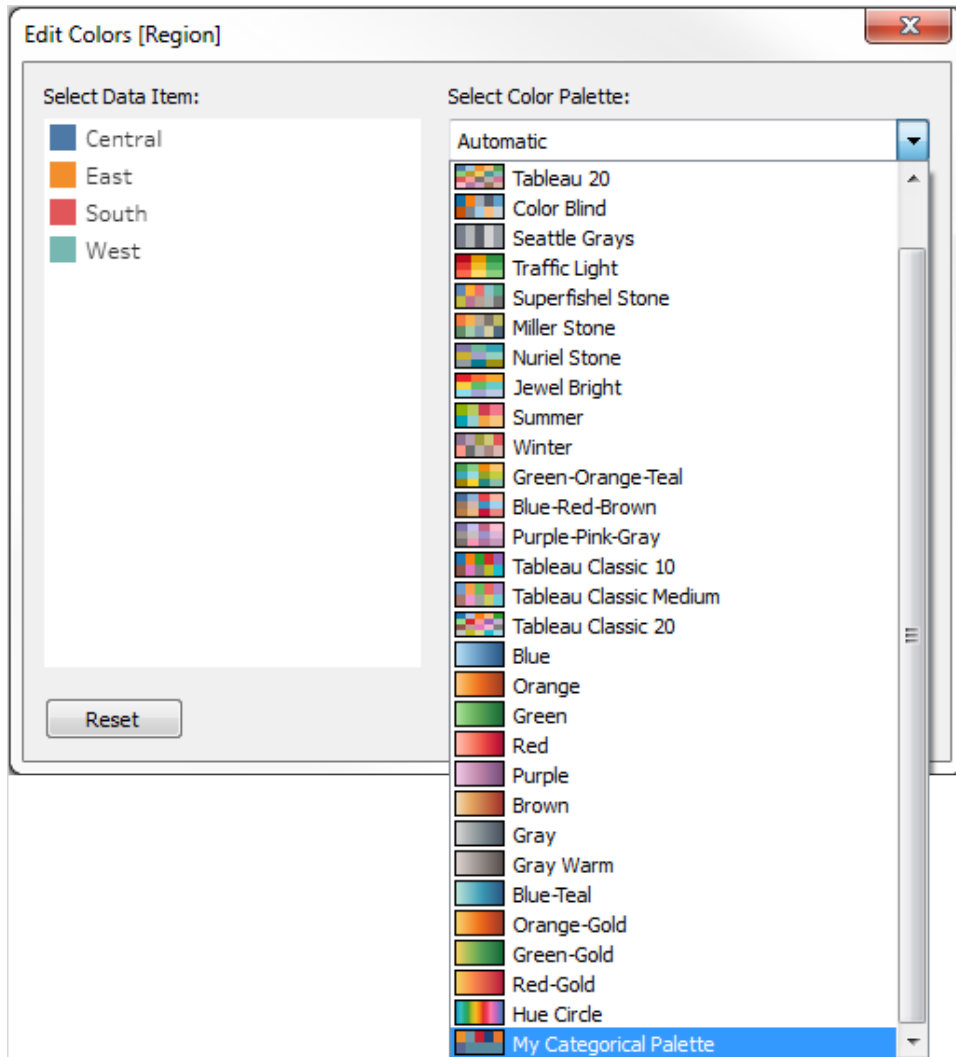

7. Click the **Assign Palette** button to assign the custom colors to each respective field.

8. Click **OK**.

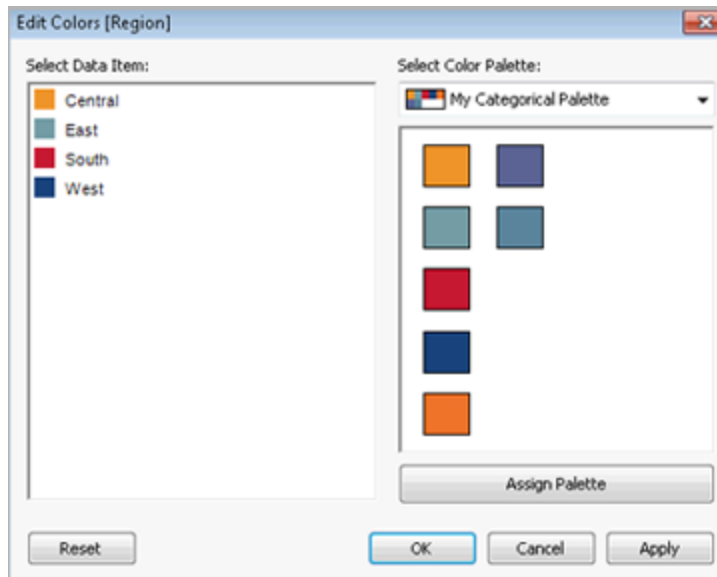

Create a sequential palette

Another type of palette is the sequential color palette. This type of color palette is used for continuous fields, typically for measures. Typically, a sequential palette shows a single color, varying in intensity.

You must specify at least the two end colors in the sequential color range. Tableau will extrapolate the shades in between.

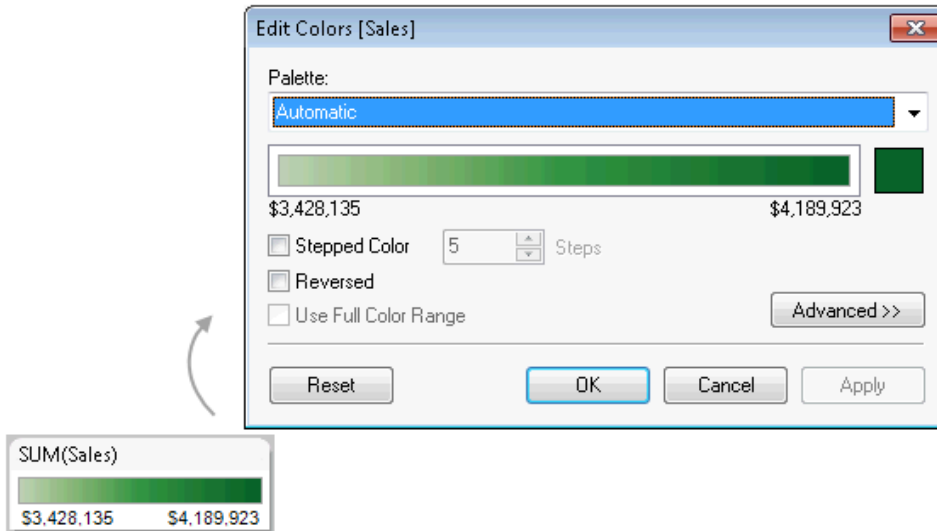

Build a custom sequential color palette

The following is an example of what to add between the `preferences` tags to add a sequential color palette. Note that the `type` attribute is specified as `ordered-sequential`, which identifies this palette as a sequential palette.

To create a custom sequential color palette:

1. In the **Preferences.tps** file, between the `preferences` tags, paste the following. Be sure to use straight quotation marks, not curly quotation marks, to delimit the palette's name and type.

```
<color-palette name="My Sequential Palette" type="ordered-sequential">
```

```
  <color>#eb912b</color>
```

```
  <color>#eb9c42</color>
```

```
  <color>#ebad67</color>
```

```
  <color>#eabb86</color>
```

```
  <color>#eacba8</color>
```

```
  <color>#ebd8c2</color>
```

```
</color-palette>
```

2. Save the **Preferences.tps** file and then restart Tableau Desktop.
3. Open a data source, such as the **Superstore- Sample** data source.

4. From the **Data** pane, drag a measure (such as **Sales**) to **Color**.
5. Click the color legend menu arrow, and select **Edit Colors**.
6. In the Edit Colors dialog box, from the palette drop-down list, select your custom palette.
7. If you want each color gradation to be defined within a box, select the **Stepped Color** check box, and in the **Steps** text box, type the number of color steps you want to display in the bar.
8. Click the **Advanced** button.
9. Select the **Start** check box, and in the text box, type the low end number you want for the continuum.
10. Click the **Apply** button to see the result, and make adjustments as needed. The color will range from high to low intensity (or the reverse) based on the order you specify in the **Preferences.tps** file. The default for sequential color palettes in Tableau is to make the high end of the continuum intense and the low end pale, though selecting the **Reversed** check box will do the opposite.

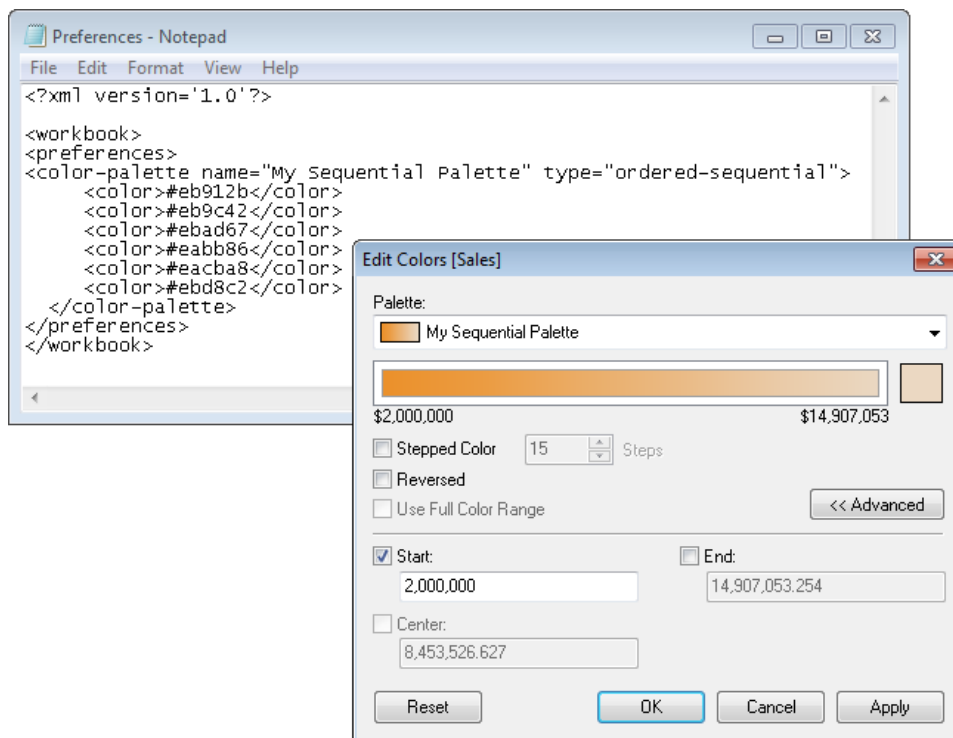

Create a diverging color palette

The third type of color palette is a diverging color palette. Instead of a gradient from one extreme to the other, a diverging palette is like two sequential palettes that share a color in the middle but

have different extremes. This type of palette shows two ranges of values using color intensity (how dark or light) to show the magnitude of the number and the actual color (orange or blue) to show which range the number is from. Diverging palettes are most commonly used to show the difference between positive and negative numbers.

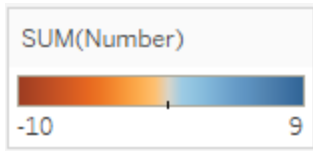

Build a custom diverging color palette

The following is an example of what to add between the `preferences` tags to add a diverging color palette. Note that the `type` attribute is specified as `ordered-diverging`, which identifies this palette as a diverging palette.

To create a custom diverging color palette:

1. In the **Preferences.tps** file, between the `preferences` tags, paste the following. Be sure to use straight quotation marks, not curly quotation marks, to delimit the palette's name and type.

```
<color-palette name="My Diverging Palette" type="ordered-diverging">
<color>#eb912b</color>
<color>#59879b</color>
</color-palette>
```

2. Save the **Preferences.tps** file and then restart Tableau Desktop.
3. Open a data source, such as the **Superstore - Sample** data source.
4. Click the **Assign Palette** button. The colors in the palette are used in the order they appear in the Preferences file.

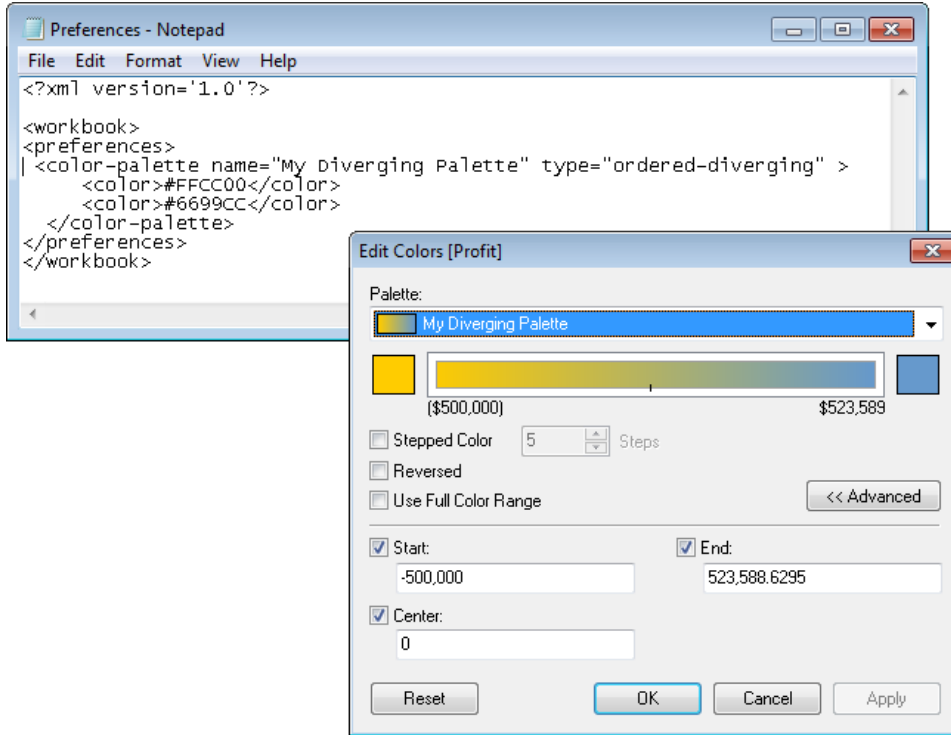

Use discontinued (classic) color palettes

In version 10.0, Tableau created new color palettes, updated some existing ones (such as Tableau 10 and Tableau 20), and discontinued others. If you want to keep using a color palette that was discontinued, you can edit your **Preferences.tps** file to add the hex values for the palette. You can add as many color palettes as you like.





Hex values for discontinued color palettes



The table below lists discontinued color palettes, along with the XML code and hex values you can use in your **Preferences.tps** file to restore them. If you use the code as-is, palette names will start with **Classic** to indicate that they're from before version 10.0. In many cases, there are updated versions of color palettes that have been discontinued.

Version 9.x palette name	Version 9.x HEX Values
Tableau 10	<code><color-palette name="Classic 10" type="regular"></code>





<p>Now called Tableau Classic 10.</p> 	<pre><color>#17becf</color> <color>#bcbd22</color> <col- or>#7f7f7f</color> <color>#e377c2</color> <col- or>#8c564b</color> <color>#9467bd</color> <color>#d62728</color> <color>#2ca02c</color> <col- or>#ff7f0e</color> <color>#1f77b4</color> </color-palette></pre>
<p>Tableau 10 Medium</p> <p>Now called Tableau Classic Medium.</p> 	<pre><color-palette name="Classic 10 Medium" type="regular"> <color>#6dcca</color> <color>#cdcc5d</color> <col- or>#a2a2a2</color> <color>#ed97ca</color> <col- or>#a8786e</color> <color>#ad8bc9</color> <color>#ed665d</color> <color>#67bf5c</color> <col- or>#ff9e4a</color> <color>#729ece</color> </color-palette></pre>
<p>Tableau 10 Light</p> 	<pre><color-palette name="Classic 10 Light" type="regular"> <color>#9edae5</color> <color>#dbdb8d</color> <col- or>#c7c7c7</color> <color>#f7b6d2</color> <col- or>#c49c94</color> <color>#c5b0d5</color> <color>#ff9896</color> <color>#98df8a</color> <col- or>#ffbb78</color> <color>#aec7e8</color> </color-palette></pre>
<p>Tableau 20</p> <p>Now called Tableau Classic 20.</p> 	<pre><color-palette name="Classic 20" type="regular"> <col- or>#9edae5</color> <color>#17becf</color> <col- or>#dbdb8d</color> <color>#bcbd22</color> <color>#c7c7c7</color> <color>#7f7f7f</color> <col- or>#f7b6d2</color> <color>#e377c2</color> <col- or>#c49c94</color> <color>#8c564b</color> <color>#c5b0d5</color> <color>#9467bd</color> <col- or>#ff9896</color> <color>#d62728</color> <col- or>#98df8a</color> <color>#2ca02c</color> <color>#ffbb78</color> <color>#ff7f0e</color> <col- or>#aec7e8</color> <color>#1f77b4</color> </color-palette></pre>

<p>Gray 5</p>  <p>Replaced with Seattle Grays.</p>	<pre><color-palette name="Classic Gray 5" type="regular"> <color>#cfcfcf</color> <color>#8f8782</color> <col- or>#414451</color> <color>#a5acaf</color> <col- or>#60636a</color> </color-palette></pre>
<p>Color Blind 10</p>  <p>Updated as Color Blind.</p>	<pre><color-palette name="Classic Color Blind" type- e="regular"> <color>#cfcfcf</color> <color>#ffbc79</color> <col- or>#a2c8ec</color> <color>#898989</color> <col- or>#c85200</color> <color>#5f9ed1</color> <color>#595959</color> <color>#ababab</color> <col- or>#ff800e</color> <color>#006ba4</color> </color-palette></pre>
<p>Traffic Light</p>  <p>Updated as Traffic Light.</p>	<pre><color-palette name="Classic Traffic Light" type- e="regular"> <color>#9fcd99</color> <color>#ffdd71</color> <col- or>#f26c64</color> <color>#69b764</color> <col- or>#ffc156</color> <color>#d82526</color> <color>#309343</color> <color>#dba13a</color> <col- or>#b10318</color> </color-palette></pre>
<p>Purple-Gray 6</p>  <p>Discontinued.</p>	<pre><color-palette name="Classic Purple-Gray 6" type- e="regular"> <color>#d7d5c5</color> <color>#d098ee</color> <col- or>#995688</color> <color>#94917b</color> <col- or>#dc5fbd</color> <color>#7b66d2</color> </color-palette></pre>
<p>Purple-Gray 12</p>  <p>Updated as Purple-Pink-Gray.</p>	<pre><color-palette name="Classic Purple-Gray 12" type- e="regular"> <color>#dbd4c5</color> <color>#8b7c6e</color> <col- or>#d098ee</color> <color>#ab6ad5</color> <col- or>#d898ba</color> <color>#995688</color> <color>#b4b19b</color> <color>#5f5a41</color> <col-</pre>





	<pre> or>#ffc0da</color> <color>#dc5fbd</color> <col- or>#a699e8</color> <color>#7b66d2</color> </color-palette> </pre>
<p>Green-Orange 6</p>  <p>Discontinued.</p>	<pre> <color-palette name="Classic Green-Orange 6" type- e="regular"> <color>#b85a0d</color> <color>#39737c</color> <col- or>#ffd94a</color> <color>#3cb7cc</color> <col- or>#ff7f0f</color> <color>#32a251</color> </color-palette> </pre>
<p>Green-Orange 12</p>  <p>Updated as Green-Orange-Teal.</p>	<pre> <color-palette name="Classic Green-Orange 12" type- e="regular"> <color>#ccc94d</color> <color>#82853b</color> <col- or>#86b4a9</color> <color>#39737c</color> <col- or>#ffd94a</color> <color>#b85a0d</color> <color>#98d9e4</color> <color>#3cb7cc</color> <col- or>#ffb977</color> <color>#ff7f0f</color> <col- or>#acd98d</color> <color>#32a251</color> </color-palette> </pre>
<p>Blue-Red 6</p>  <p>Discontinued.</p>	<pre> <color-palette name="Classic Blue-Red 6" type- e="regular"> <color>#e9c39b</color> <color>#ea6b73</color> <col- or>#6ba3d6</color> <color>#ac613c</color> <col- or>#f02720</color> <color>#2c69b0</color> </color-palette> </pre>
<p>Blue-Red 12</p>  <p>Updated as Blue-Red-Brown.</p>	<pre> <color-palette name="Classic Blue-Red 12" type- e="regular"> <color>#f4737a</color> <color>#bd0a36</color> <col- or>#ddc9b4</color> <color>#ac8763</color> <col- or>#b5dfdf</color> <color>#6ba3d6</color> <color>#e9c39b</color> <color>#ac613c</color> <col- or>#ffb6b0</color> <color>#f02720</color> <col- or>#b5c8e2</color> <color>#2c69b0</color> </color-palette> </pre>

<p>Cyclic</p>  <p>Updated as Hue Circle.</p>	<pre><color-palette name="Classic Cyclic" type="regular"> <color>#6f63bb</color> <color>#8a60b0</color> <col- or>#ba43b4</color> <color>#c7519c</color> <col- or>#d63a3a</color> <color>#ff7f0e</color> <color>#ffaa0e</color> <color>#ffbf50</color> <col- or>#bcbd22</color> <color>#78a641</color> <col- or>#2ca030</color> <color>#12a2a8</color> <color>#1f83b4</color> </color-palette></pre>
<p>Green</p>  <p>Updated.</p>	<pre><color-palette name="Classic Green" type="ordered- sequential"> <color>#09622a</color> <color>#1a7232</color> <col- or>#27823b</color> <color>#339444</color> <col- or>#69a761</color> <color>#94bb83</color> <color>#bccfb4</color> </color-palette></pre>
<p>Gray</p>  <p>Updated.</p>	<pre><color-palette name="Classic Gray" type="ordered-sequen- tial"> <color>#1e1e1e</color> <color>#282828</color> <col- or>#333333</color> <color>#3f3f3f</color> <col- or>#4b4b4b</color> <color>#585858</color> <color>#666666</color> <color>#747474</color> <col- or>#838383</color> <color>#929292</color> <col- or>#a2a2a2</color> <color>#b2b2b2</color> <color>#c3c3c3</color> </color-palette></pre>
<p>Blue</p>  <p>Updated.</p>	<pre><color-palette name="Classic Blue" type="ordered-sequen- tial"> <color>#26456e</color> <color>#1c5998</color> <col- or>#1c73b1</color> <color>#3a87b7</color> <col- or>#67add4</color> <color>#7bc8e2</color> <color>#b4d4da</color> </color-palette></pre>
<p>Red</p>	<pre><color-palette name="Classic Red" type="ordered-sequen-</pre>

 Updated.	<pre> tial"> <color>#9c0824</color> <color>#b10c1d</color> <col- or>#c21417</color> <color>#cf1719</color> <col- or>#d8392c</color> <color>#e35745</color> <color>#f57667</color> <color>#f89a90</color> <col- or>#eac0bd</color> </color-palette> </pre>
Orange  Updated.	<pre> <color-palette name="Classic Orange" type="ordered- sequential"> <color>#7b3014</color> <color>#a33202</color> <col- or>#d74401</color> <color>#f06511</color> <col- or>#fd8938</color> <color>#fdab67</color> <color>#f0c294</color> </color-palette> </pre>
Area Red  Discontinued.	<pre> <color-palette name="Classic Area Red" type="ordered- sequential"> <color>#bd1100</color> <color>#c92b14</color> <col- or>#d43e25</color> <color>#e04e35</color> <col- or>#ea5e45</color> <color>#f46b55</color> <color>#fd7864</color> <color>#fe8b7a</color> <col- or>#fd9c8f</color> <color>#fbb3ab</color> <col- or>#f5cac7</color> </color-palette> </pre>
Area Green  Discontinued.	<pre> <color-palette name="Classic Area Green" type="ordered- sequential"> <color>#3c8200</color> <color>#4a8c1c</color> <col- or>#569735</color> <color>#60a24d</color> <col- or>#6cae59</color> <color>#7abc5f</color> <color>#8ac765</color> <color>#9ad26d</color> <col- or>#acdc7a</color> <color>#c3e394</color> <col- or>#dbe8b4</color> </color-palette> </pre>
Area Brown	<pre> <color-palette name="Classic Area-Brown" type="ordered- sequential"> </pre>

 <p>Discontinued.</p>	<pre><color>#bb5137</color> <color>#bb6348</color> <col- or>#bb7359</color> <color>#c08262</color> <col- or>#cc8f63</color> <color>#d89c63</color> <color>#e4aa63</color> <color>#f0b763</color> <col- or>#f7c577</color> <color>#f6d29c</color> <col- or>#f3e0c2</color> </color-palette></pre>
<p>Red-Green Diverging</p>  <p>Updated.</p>	<pre><color-palette name="Classic Red-Green" type="ordered- diverging"> <color>#09622a</color> <color>#1e7735</color> <col- or>#2f8e41</color> <color>#69a761</color> <col- or>#a2c18f</color> <color>#cacaca</color> <color>#fc8375</color> <color>#df513f</color> <col- or>#d11719</color> <color>#bd1316</color> <col- or>#9c0824</color> </color-palette></pre>
<p>Red-Blue Diverging</p>  <p>Updated.</p>	<pre><color-palette name="Classic Red-Blue" type="ordered- diverging"> <color>#26456e</color> <color>#1c5998</color> <col- or>#1c73b1</color> <color>#3a87b7</color> <col- or>#67add4</color> <color>#cacaca</color> <color>#fc8375</color> <color>#df513f</color> <col- or>#d11719</color> <color>#bd1316</color> <col- or>#9c0824</color> </color-palette></pre>
<p>Red-Black Diverging</p>  <p>Updated.</p>	<pre><color-palette name="Classic Red-Black" type="ordered- diverging"> <color>#1e1e1e</color> <color>#383838</color> <col- or>#565656</color> <color>#777777</color> <col- or>#9b9b9b</color> <color>#cacaca</color> <color>#fc8375</color> <color>#df513f</color> <col- or>#d11719</color> <color>#bd1316</color> <col- or>#9c0824</color> </color-palette></pre>

<p>Area Red-Green Diverging</p>  <p>Discontinued.</p>	<pre><color-palette name="Classic Area Red-Green" type="ordered-diverging"> <color>#4a8c1c</color> <color>#559633</color> <color>#5ea049</color> <color>#69aa56</color> <color>#75b65d</color> <color>#82c162</color> <color>#90cb68</color> <color>#a0d571</color> <color>#b1de7f</color> <color>#c7e298</color> <color>#e9dabe</color> <color>#fca294</color> <color>#fe8e7e</color> <color>#fd7e6b</color> <color>#f7705b</color> <color>#ef654d</color> <color>#e6583e</color> <color>#dc4930</color> <color>#d23a21</color> <color>#c82912</color> <color>#bd1100</color> </color-palette></pre>
<p>Orange-Blue Diverging</p>  <p>Updated.</p>	<pre><color-palette name="Classic Orange-Blue" type="ordered-diverging"> <color>#26456e</color> <color>#1c5998</color> <color>#1c73b1</color> <color>#3a87b7</color> <color>#67add4</color> <color>#7bc8e2</color> <color>#cacaca</color> <color>#fdab67</color> <color>#fd8938</color> <color>#f06511</color> <color>#d74401</color> <color>#a33202</color> <color>#7b3014</color> </color-palette></pre>
<p>Green-Blue Diverging</p>  <p>Updated.</p>	<pre><color-palette name="Classic Green-Blue" type="ordered-diverging"> <color>#26456e</color> <color>#1c5998</color> <color>#1c73b1</color> <color>#3a87b7</color> <color>#67add4</color> <color>#cacaca</color> <color>#a2c18f</color> <color>#69a761</color> <color>#2f8e41</color> <color>#1e7735</color> <color>#09622a</color> </color-palette></pre>
<p>Red-White-Green</p>	<pre><color-palette name="Classic Red-White-Green" type="ordered-diverging"></pre>

<p>Diverging</p>  <p>Updated.</p>	<pre>="ordered-diverging"> <color>#09622a</color> <color>#297839</color> <col- or>#428f49</color> <color>#74af72</color> <col- or>#b9d7b7</color> <color>#ffffff</color> <color>#fcb4a5</color> <color>#e86753</color> <col- or>#cc312b</color> <color>#b41f27</color> <col- or>#9c0824</color> </color-palette></pre>
<p>Red-White-Black Diverging</p>  <p>Updated.</p>	<pre><color-palette name="Classic Red-White-Black" type= ="ordered-diverging"> <color>#1e1e1e</color> <color>#393939</color> <col- or>#575757</color> <color>#838383</color> <col- or>#bfbfbf</color> <color>#ffffff</color> <color>#fcb4a5</color> <color>#e86753</color> <col- or>#cc312b</color> <color>#b41f27</color> <col- or>#9c0824</color> </color-palette></pre>
<p>Orange-White-Blue Diverging</p>  <p>Updated.</p>	<pre><color-palette name="Classic Orange-White-Blue" type= ="ordered-diverging"> <color>#26456e</color> <color>#2e5f8a</color> <col- or>#3679a8</color> <color>#6a9ec5</color> <col- or>#b7cde2</color> <color>#ffffff</color> <color>#ffc2a1</color> <color>#fb8547</color> <col- or>#d85a13</color> <color>#a84415</color> <col- or>#7b3014</color> </color-palette></pre>
<p>Red-White-Black Light</p>  <p>Discontinued.</p>	<pre><color-palette name="Classic Red-White-Black Light" type="ordered-diverging"> <color>#c6c6c6</color> <color>#d1d1d1</color> <col- or>#dddddd</color> <color>#e8e8e8</color> <col- or>#f3f3f3</color> <color>#ffffff</color> <color>#fff0f0</color> <color>#ffe0e1</color> <col- or>#ffd1d3</color> <color>#ffc2c5</color> </color-palette></pre>

Orange-White-
Blue Light
Diverging



Discontinued.

```
<color-palette name="Classic Orange-White-Blue Light"
type="ordered-diverging">
<color>#c4d8f3</color> <color>#d0e0f6</color> <col-
or>#dce8f8</color> <color>#e8effa</color> <col-
or>#f3f7fd</color> <color>#ffffff</color>
<color>#fff5eb</color> <color>#ffead8</color> <col-
or>#ffe0c5</color> <color>#ffd6b1</color> <col-
or>#ffcc9e</color>
</color-palette>
```

Red-White-
Green Light
Diverging



Discontinued.

```
<color-palette name="Classic Red-White-Green Light"
type="ordered-diverging">
<color>#b7e6a7</color> <color>#c6ebb8</color> <col-
or>#d5f0ca</color> <color>#e3f5db</color> <col-
or>#f1faed</color> <color>#ffffff</color>
<color>#fff0f0</color> <color>#ffe0e1</color> <col-
or>#ffd1d3</color> <color>#ffc2c5</color> <col-
or>#ffb2b6</color>
</color-palette>
```

Red-Green
Light Diverging



Discontinued.

```
<color-palette name="Classic Red-Green Light" type-
="ordered-diverging">
<color>#b7e6a7</color> <color>#c1e6b4</color> <col-
or>#cae6c0</color> <color>#d4e6cc</color> <col-
or>#dde6d9</color> <color>#e5e5e5</color>
<color>#ecdbdc</color> <color>#f2d1d2</color> <col-
or>#f8c7c9</color> <color>#fcbdc0</color> <col-
or>#ffb2b6</color>
</color-palette>
```

Optimize Workbook Performance

When we mention *performance*, we mean the speed with which you can work in Tableau. It might mean the speed of data analysis, such as working in Tableau Desktop on a large corporate database that you are accessing remotely. Or, it could refer to the speed of loading views or dashboards that you access on your desktop from Tableau Server.

If you are working with small data volumes, many of the recommendations in this section are optional for you. Your workbook performance is probably as speedy as you expect. But if you work with hundreds of millions of records, designing an efficient workbook is critically important to the speed at which you can work. We recommend that you review the topics and tips in this section before you start building your first view.

Making performance improvements almost always means making trade-offs. For example: Do you sacrifice speed to make sure you have the most current data? Is it important to include *all* the data for analysis, or will a speedier subset do? The bigger and more complicated the data, the longer it takes to interpret and render. But there are things you can do to accelerate the process. Think of fine-tuning your workbook performance as working on a puzzle with multiple pieces. Pick and choose from the topics in this section to find the pieces that solve your particular puzzle.

The topics in this section on performance discuss the big picture and then drill down to specific functionality. It starts with databases, data, and extracts, and then focuses on things that affect your data source, your workbooks, your calculations, and visualizations. The next set of topics discuss how to record and analyze workbook performance. Finally we look at how to reduce upload times to a Tableau server.

Learn more: For more in-depth and related information beyond this topic, see:

[Designing Efficient Workbooks](#) whitepaper on [tableau.com](#)

[Designing Efficient Workbooks](#) (1 hour) and [Best Practices for Dashboard Performance](#) (50 minutes) free, video presentations

[The Tableau Performance Optimization Flowchart](#), [The Tableau Performance Checklist](#), and the [Tableau Performance Checklist blog series](#) on the [InterWorks blog](#).

General tips

This general list of considerations is a start in learning how to approach optimizing workbooks. It comes from the TL;DR page in the [Designing Efficient Workbooks](#) whitepaper.

- The cleaner your data is and the better it matches the structure of your questions, the faster your workbooks will run and the happier your life will be. Only connect to the data that you need for analysis.
- Extracts are a quick and easy way to make most workbooks run faster. If you don't need real-time data and aren't working over billions of rows of data, you should try them.
- The majority of slow dashboards are caused by poor design – in particular, too many charts on a single dashboard, or trying to show too much data at once. Keep it simple. Allow your users to incrementally drill down to details, rather than trying to show everything then filter (guided analysis).
- Don't work with data you don't need—both in terms of the fields you reference as well as the granularity of the records you return. Use filters, hide unused fields and aggregate.
- While reducing the data, make sure you use filters efficiently.
- Strings and dates are slow, numbers and Booleans are fast.
- There is no silver bullet for inefficient workbooks. Start by looking at the performance recorder to understand where the time is going. Long-running queries? Lots of queries? Slow calculations? Complex rendering? Use this insight to focus your efforts in the right direction.
- Upgrading to the newest version may boost performance without needing anything else.
- If it is slow in the data source, it will be slow in Tableau Desktop. If it is slow in Tableau Desktop, it will (almost always) be slow in Tableau Server.
- Performance tuning is highly individualized to the context of your environment, data, analysis, and workbook. What works in one situation may not work in another--test and iterate to see what works in your specific case.

Workbook Optimizer

The Workbook Optimizer is a tool that identifies if a workbook follows certain performance best practices. These guidelines are limited to what can be parsed from the workbook's metadata and evaluated by a rules engine algorithm. Not all of its recommendations are applicable to or appropriate for every workbook. There are many aspects of performance that aren't captured by the Optimizer, some of which can offer easy wins. For more information, refer to [Streamline your workbook on page 3056](#) and the whitepaper [Designing Efficient Production Workbooks](#).

Run the Workbook Optimizer

In Tableau Desktop

The Workbook Optimizer is available from the Server menu or the publishing dialog.

1. From the **Server** menu, click **Run Optimizer**.
2. The workbook is automatically evaluated against the guidelines and results display in one of three categories: Take action, Needs review, or Passed (or Passed and ignored).
 - You may see fewer than three categories. If no guidelines fall into a category, it doesn't display.
 - Expand each category to see the guidelines. You can also expand each guideline for more information about why it's a recommendation. Some have additional information specific to your workbook.
 - You can choose to address any or none of the guidelines. As running the Optimizer is a voluntary step in the publishing process, it doesn't prevent you from being able to publish.
3. To close the dialog and go back to the workbook, click Close.
4. To close the dialog and go back to (or open) the publishing dialog, click Publish.

In web authoring

The Workbook Optimizer is available from the publishing menu and publishing dialog in web authoring.

Optimizer categories

The Optimizer breaks down its guidelines into three categories: take action, needs review, and passed.

Take action indicates that updating the workbook to follow these best practices have minimal to no impact on the functionality of the workbook. There's probably no reason to avoid making these changes.

Needs review indicates that following these best practices may involve modifying the workbook in more involved ways, such as restructuring a data source or simplifying a dashboard.

- For these guidelines, use your best judgment to determine what is possible or practical to address.

- Some recommendations may involve a lot of effort for minimal performance gain and aren't worth it.
- It may be useful to use the Performance Recorder to get a performance benchmark.
- Some may be deliberate choices you've made.

As the author, you're the final authority on what makes a workbook as efficient as possible. *Remember that some best practices should be broken to effectively deliver content.* Always weigh the goal of the workbook against changes to improve performance.

Passed indicates the guidelines are met and the workbook is already following best practices in that area. But remember, there are many aspects of performance that aren't captured by the Optimizer. This category is renamed **Passed and ignored** if any guidelines are ignored for the workbook.

Ignore a guideline

Guidelines aren't always applicable to your situation. Perhaps you're publishing a template workbook for others to use and need to preserve unused fields and data sources. You don't want the optimizer to continue to notify you about those guidelines.

It's possible to ignore a guideline for a workbook.

1. From a specific guideline, click the **Ignore** button.
 - The guideline is muted and moves to the **Passed and ignored** section. Even if you run the optimizer again, that guideline won't appear in the Take action or Needs review section.
2. To resume evaluating the guideline, find its row in the **Passed and ignored** section and click the **Ignore** button again.
 - The optimizer runs again and the guideline is evaluated. It continues to be checked each time the optimizer runs.

Autofix a guideline

Some suggestions from the workbook optimizer can be implemented without user input. For these guidelines, there's a button to autofix the rule. If the button doesn't appear you must manually address the issue.

From a specific guideline, click the Autofix button.

- The recommended action (such as closing an unused data source) is taken behind the scenes and the guideline moves to the Passed section.
- If the autofix fails for any reason, you'll be notified and prompted to resolve the issue manually.
- If the button isn't available, that guideline cannot be autofixed and must be addressed manually.

The guidelines

Every guideline contains a “consider” statement that suggests a potential way to address the performance impact. These are necessarily general and may not apply in every situation. These suggestions are a starting point only; always frame your decisions in the context of your environment and the goals of your workbook.

Note: Not all suggestions are possible to perform in the browser and may require [editing in Tableau Desktop](#) instead.

Navigate to a guideline by letter: [A](#) . [B](#) . [C](#) . [D](#) . [E](#) . [F](#) . [G](#) . [H](#) . [I](#) . [J](#) . [K](#) . [L](#) . [M](#) . [N](#) . [O](#) . [P](#) . [Q](#) . [R](#) . [S](#) . [T](#) . [U](#) . [V](#) . [W](#) . [X](#) . [Y](#) . [Z](#)

Calculation length

From the Workbook Optimizer

Sample output message: The calculation **My calculation** is 600 characters long

Computing the results of complex calculations can impact performance.

Consider breaking the calculation apart and moving whatever is possible to the database, or using Tableau Prep to create the calculations prior to analysis.

Additional information

Complex and long calculations can either be written in a single calculation or nested (with some components written as standalone calculations that are used in the larger calculation). Building a calculation with nested components may make it easier to troubleshoot and maintain, but it can add complications and additional processing. If possible, pushing these components back to the data source may aid performance.

Comments in calculations count against the length, so this guideline may be triggered by a long comment rather than a long and complex calculation.

Calculation uses multiple data sources

From the Workbook Optimizer

Sample output message: The data source **Supply Chain** includes 17 calculations using fields from another data source.

When calculations use fields from multiple data sources, Tableau can't use any optimizations and must compute the calculation locally.

Consider using Tableau Prep to create the calculation and using an extract.

Additional information

By moving the cross-database calculation to the data layer, the processing can be performed before the user even requests the dashboard. See [Join your data \(Prep\)](#) and [Create level of detail and rank calculations](#) for more information.

Under some conditions a parameter may trigger this guideline. If a calculation is indicated that doesn't use multiple data sources, check to see if it has a parameter and if that parameter can be simplified.

Dashboard size not fixed

From the Workbook Optimizer

Sample output message: The dashboard **Q3 analytics** isn't fixed size.

Fixed sized dashboards can be cached because they're a predictable size. Using automatic dashboard sizing means the results depend on the user's screen, and therefore the dashboard must be rendered every time. Rendering dashboards more often comes with a performance hit.

Consider using fixed dashboard sizing.

Additional information

Although responsive elements are a best practice in web design, letting your dashboard resize can distort the layout of the content in addition to the performance impact of re-rendering. For Tableau visualizations, it's best to use a [fixed dashboard size](#) and use [device-specific dashboards](#) to support different devices and screen sizes.

Filter uses conditional logic

From the Workbook Optimizer

Sample output message: The filter **Sample Type** uses conditional logic.

Dimension filtering can be done in various ways, such as on a list of values, by wildcard matching, or using conditional logic. Conditional logic can be slow.

Consider changing the filter to not use conditional logic. If necessary, make sure your logic tests for the most frequent outcome first and use ELSEIF or CASE when possible.

Additional information

For more information on filtering, see [Filter Your Data](#).

Filter uses "Only Relevant Values"

From the Workbook Optimizer

Sample output message: The filter **Sample Type** uses "Only Relevant Values".

When a filter uses "Only Relevant Values", the interactive filter control only shows options that are applicable given the current state of the view. Every time a change is made to other filters, the list of values to be displayed must be requeryed, which has a performance impact.

Consider using dashboard filter actions instead. If the end-user benefit is valuable enough that this feature should be used, consider extracting the data and optimizing the extract.

Additional information

There are situations where using "Only Relevant Values" is necessary to avoid an unwieldy filter list. Instead of using interactive filters in that situation, try using [action filters](#). For example, consider a dashboard that has cascading filters for Category, Sub-Category, and Product ID, where Product ID is set to show "Only Relevant Values". Removing that restriction would expand the list of products significantly. Rather than using filters, you can build simple visualizations (such as a bar chart of Category and Sub-Category) and use it as a filter. The user clicks on a bar and the action filter is applied to the rest of the visualizations on the dashboard. For more information, see [Dashboard Actions](#).

Live data connections

From the Workbook Optimizer

Sample output message: The data source **Supply Chain** isn't an extract.

Tableau extracts are designed to be as efficient as possible for use with analytics. Using extracts is one of the easiest ways to improve performance due to the data source. Extracts also have many native features for optimization.

Consider extracting the data source.

Additional information

In some instances, taking an extract may put undesirable strain on the Tableau Server or Tableau Site's resources. Work with your Tableau administrator to determine the best course of action.

The whitepaper [Designing Efficient Workbooks](#) has extensive information about extracts and how to use them for performance. (You may need to sign in to access the whitepaper.)

Multiple connections in a data source

From the Workbook Optimizer

Sample output message: The data source **Supply chain** uses multiple data connections.

Data sources that include multiple connections can't be computed locally.

Consider combining the data sources in Tableau Prep and using an extract for analysis.

Additional information

See [Join your data \(Prep\)](#) for more information.

Nested calculations

From the Workbook Optimizer

Sample output message: The calculation **My Calculation** references another calculation.

Nesting calculations can add complications and additional processing, especially with IF statements and other performance intensive functions.

Consider pushing the calculations to the data source or materialize them in an extract.

Additional information

This rule may be triggered for a calculation that isn't in the viz itself but is referenced by a calculation in the viz. For example, imagine four fields:

1. **Points earned** (a field in the data source)
2. **Quiz score** = [Points earned]*10
3. **Curved grade** = [Quiz score]*1.05
4. **Letter grade** = IF [Curved grade] >= 90 THEN "A" ELSEIF [Curved grade] >= 80 THEN "B" ELSEIF [Curved grade] >=70 THEN "C" ELSEIF [Curved grade] >=60 THEN "D" ELSE "F" END

Quiz score is a non-nested calculation that only references a field. Both **Curved grade** and **Letter grade** are nested calculations because they contain references to other calculations. Even if only **Letter grade** is used in the viz, **Curved grade** also triggers the nested calculation rule because it's in use inside **Letter grade**.

For more information on materializing calculations in an extract (Compute Calculations Now), see [Materialize Calculations in Your Extracts on page 944](#).

For more information about building calculations in Tableau Prep, see [Calculations in Tableau Prep](#).

Non-materialized calculations

From the Workbook Optimizer

Sample output message: The data source **Supply Chain** hasn't been pre-computed.

Computing the results of a calculation can impact performance.

Consider pushing calculations to the data source when possible. If using an extract, materialize calculations to pre-compute their results.

Additional information

Pre-compute the data and calculations either in an extract or your back-end data source. By moving this additional processing to the data layer, the processing is completed before the user even requests the dashboard.

Taking an extract of your data often boosts performance, though there are tradeoffs in data freshness and some functionality. See [Extract Your Data on page 919](#) for more information about options for extracts and [Materialize Calculations in Your Extracts on page 944](#) for more information on materializing calculations.

Extract your data: right click on the data source's name at the top of the Data pane and select **Extract Data**. In the configuration dialog, choose **Compute Calculations Now**.

Number of data sources

From the Workbook Optimizer

Sample output message: The workbook contains 17 data sources.

Each data source contributes to the amount of time Tableau spends loading and rendering a workbook.

Consider combining data sources if possible, especially when the level of granularity is the same or they support the same analysis.

Additional information

See [Relate Your Data on page 622](#) for more information on combining data sources, or consider using Tableau Prep.

However, be wary of over-combining data sources. Workbooks perform best when each type of analysis is built off a well-designed data source. If it's hard to combine your data sources, this could be a sign that the analysis should be split into multiple workbooks, each with a more targeted purpose.

To split your analysis across multiple workbooks, try one of these methods:

- Save a copy of the workbook and delete unnecessary sheets, dashboards, and data sources from each one. See [Streamline your workbook](#) for more information.
- Copy specific sheets into a new workbook. This may be more efficient because copying a dashboard into a new workbook carries over only what is needed for that dashboard. However, not all formatting options are transferred. See [Copying Information Between Workbooks on page 3101](#) for more information.

Number of filters

From the Workbook Optimizer

Sample output message: The sheet **Classroom Distribution** contains 17 filters.

Excessive filters on a view create a more complex query.

Consider reducing the number of filters and using filter actions wherever possible. Not all types and formats of filters are created equal in terms of performance, so consider optimizing necessary filters.

Additional information

The whitepaper [Designing Efficient Production Workbooks](#) has an entire section on filters that goes into much more detail. In brief:

- Reduce the overall number of filters
- Filters applied to multiple worksheets trigger multiple queries with every change
- Limit use of **Show only relevant values**. Using an extract helps optimize this feature if it's needed.
- Avoid high cardinality include/exclude filters
- Use the **Apply** button to prevent multiple refreshes as the user interacts with the filter
- Filter on fields that are present in the view
- Use continuous date filters rather than discrete date filters
- Context filters shouldn't be used purely to boost performance

Filter actions are an efficient way to guide the user through a dashboard. See [Filter Actions on page 1388](#) for more information.

Number of layout containers

From the Workbook Optimizer

Sample output message: The dashboard **Q3 analytics** contains 42 layout containers.

Layout containers can complicate dashboard rendering.

Consider removing unnecessary layout containers and simplifying the dashboard design.

Additional information

For more information about layout containers and the Layout pane, see [Group items using layout containers on page 2744](#).

Number of LOD calculations

From the Workbook Optimizer

Sample output message: The workbook contains 42 LOD calculations.

Computing the results of complex calculations can impact performance. Often, LODs are used on the fly to address issues of granularity in the data source that could be handled prior to analysis.

Consider tailoring the data source to the analysis to avoid the need for as many LODs.

Additional information

Level of Detail calculations are powerful tools, but they're expensive. Make sure you're only using them when necessary.

Production databases are designed to handle significant query loads and are a great option for moving processing out of Tableau. FIXED LOD calculations can sometimes be performed by the database. Tableau Prep also supports FIXED LOD calculations. See [Create level of detail and rank calculations](#) for more information.

Number of views in a dashboard

From the Workbook Optimizer

Sample output message: Dashboard **Q3 analytics** contains 17 views

A dashboard must load all elements before it can be displayed. The more views a dashboard contains, the longer it takes to load. Although it often involves a redesign, reducing the number of views in a dashboard is often the best way to boost its efficiency.

Consider streamlining the dashboard to be as effective and simple as possible by reducing the number of views, filters, and other elements. Start with anything that can be removed immediately. See [Streamline your workbook](#) for other ways to reduce clutter in your dashboard

Additional information

If a more substantial redesign is needed, remember that not all views have an equal impact on performance. Focus on sheets with the most marks, filters, or other complexity. A good strategy can be to limit the initial dashboard to summary information and only provide more details when the user requests them. There are many strategies for this sort of guided drill-down, including:

- Use action filters. See [Filter Actions on page 1388](#) for more information.
 - Hide detailed views in a container using a layout container with a show/hide button. See [Show and hide objects by clicking a button on page 2711](#) for more information.
 - Break the dashboard into multiple dashboards and use navigation buttons. See [Detailed options for Navigation and Download objects on page 2710](#) for more information
-

Number of workbook sheets

From the Workbook Optimizer

Sample output message: The workbook contains 42 visible sheets

The overall size of a workbook impacts how long it takes to be processed and displayed. All visible sheets must be loaded before Tableau can display a workbook or view. Reducing the number of sheets can help speed up load time.

Consider reducing the number of sheets in the workbook by closing unneeded sheets, hiding sheets that are used in a dashboard, or splitting the analysis into multiple workbooks.

Additional information

Delete sheets that aren't necessary for the analysis: right click on the sheet tab along the bottom of the workbook and select Delete.

Hide sheets in use: Worksheets used in a dashboard or story can't be deleted, but they can be hidden. See [Manage Sheets in Dashboards and Stories on page 2822](#) for more information.

- Hide all of a dashboard's sheets: right-click the dashboard tab at the bottom of the workbook and select Hide All Sheets.
- Hide a specific sheet: right click the sheet tab at the bottom of the workbook and select Hide.

If all sheets are needed, decide if the analysis can be split into multiple workbooks, each with a more targeted purpose.

- Save a copy of the workbook and delete unnecessary sheets, dashboards, and data sources from each one. See [Streamline your workbook](#) for more information.
 - Copy specific sheets into a new workbook. This may be more efficient because copying a dashboard into a new workbook carries over only what is needed for that dashboard. However, not all formatting options are transferred. See [Copying Information Between Workbooks on page 3101](#) for more information.
-

Unused data sources

From the Workbook Optimizer

Sample output message: The data source **Supply Chain** isn't used in the workbook.

Each data source contributes to the amount of time Tableau spends loading and rendering a workbook.

Consider closing data sources that aren't in use.

Additional information

If any data sources aren't being used, close them: right click on the data source's name at the top of the Data pane and select **Close**.

Unused fields

From the Workbook Optimizer

Sample output message: The data source **Supply Chain** contains 42 fields that aren't being used.

Hiding unused fields prevents them from being unnecessarily queried and reduce the size of extracts.

Consider hiding any fields that aren't being used, regardless of whether the data source is an extract.

Additional information

Hide unused fields

- In Tableau Desktop: open the dropdown menu at the top of the Data pane and select **Hide All Unused Fields**.
 - In web authoring: right click on an unused field and select **Hide**. There's no way to bulk hide unused fields in web authoring. If hiding fields individually is prohibitive, consider [editing in Tableau Desktop](#) instead of working in the browser.
-

Uses data blending

From the Workbook Optimizer

Sample output message: The sheet **Classroom Distribution** uses data blending.

Data blending performance is driven by the number of unique members in the linking fields.

Consider using relationships when possible. If a blend is required, try to use low cardinality linking fields.

Additional information

There are [several ways to combine data](#) from multiple sources. [Data blending](#) sends two separate queries to two separate data sources and displays the results together in the viz. These queries are at the level of the [linking fields](#) and the results are merged in memory in Tableau. Large query results require more processing to generate the final viz.

Tip: If you aren't using data blending but the Workbook Optimizer failed this rule, check if the workbook is using [cross data source filtering](#). Filtering across data sources suffers from similar performance issues around field cardinality.

Uses date calculations

From the Workbook Optimizer

Sample output message: The data source **Supply Chain** contains 17 date calculations.

Date logic can be complicated. Minimize the number of date calculations and conversion you have to do in Tableau.

Consider using DATEPARSE and MAKEDATE before other methods, and try to use built-in functions like DATEDIFF() when possible. If filtering on a date, use relative date filters or a continuous date filter instead of a discrete filter.

Additional information

Computing calculations in Tableau can have a significant performance impact, especially [date functions](#). Consider taking an extract and [materializing calculations](#), or pushing calculations to your data source. For more information about building calculations in Tableau Prep, see [Create Calculations in Tableau Prep](#).

Note: If a date calculation is nested in another calculation, the optimizer flags the nested date calculation, even if the parent calculation is the field used in the viz.

Uses grouping

From the Workbook Optimizer

Sample output message: The data source **Supply Chain** uses 17 grouped fields

Tableau's native grouping functionality loads the entire domain of the field, which can have a performance impact.

Consider using a calculated field with a CASE statement or sets instead of groups.

Additional information

In the testing performed for the [Designing Efficient Workbooks](#) whitepaper, grouping with CASE and sets performed better than the native group functionality.

The **CASE** function can be used to create groups. Imagine a scenario where the data involved a deck of cards. There's a field for the card value (2–10, J, Q, K, A) but the analysis should compare face cards to number cards. The case statement to make that grouping could be

```
CASE [Value]
  WHEN "J" THEN "Face card"
  WHEN "Q" THEN "Face card"
  WHEN "K" THEN "Face card"
  ELSE "Number card"
END
```

Sets have the added benefit of set actions, which make sets more powerful and flexible than traditional grouping. For more information, see [Create Sets on page 1092](#) and [Set Actions on page 1436](#).

Streamline your workbook

Remove what you can

Thoughtfully reducing complexity is key to good performance. A low-impact place to start is to remove elements that aren't in use.

Workbook

- **Delete sheets:** right click on the sheet tab along the bottom of the workbook and select Delete.
- **Hide sheets:** right click on the sheet tab along the bottom of the workbook and select Hide.

Worksheets

- **Remove parameters, sets, groups:** right click on the item in the Data pane and select Delete.
- **Delete calculations:** right click on the calculation in the Data pane and select Delete.
- **Remove filters:** right click on the field on the filter shelf and select Remove. Note that removing the quick filter interface (open the filter menu and select Hide Card) will not delete the filter itself.

Dashboards

- **Remove layout containers:** open the Layout pane and expand the Item hierarchy. Right click on each layout container (tiled, horizontal, or vertical) and select Remove Container.
- **Remove filters or legends:** select a filter or legend and open the dropdown menu and select Remove from Dashboard.
- **Remove device layouts:** on the Dashboard pane, open the menu for the device layout and select Delete Layout.

Data sources

- **Close data sources:** right click on the data source's name at the top of the Data pane and select Close.
- **Hide unused fields:** open the dropdown menu at the top of the Data pane and select Hide All Unused Fields.
- **Use data source filters:** right click on the data source's name at the top of the Data pane and select Edit Data Source Filters > Add
- **Configure the extract:** right click on the data source's name at the top of the Data pane and select Extract Data. In the dialog, you can:
 - Use extract filters to limit how much data is pulled into the extract
 - Aggregate data for visible dimensions to reduce unnecessary granularity
 - Hide all unused fields to drop them from the extract

Break up the workbook

If a workbook contains multiple sheets or dashboards for different analytical purposes, consider splitting it into multiple workbooks, each with a more targeted purpose.

- **Option 1:** save a copy of the workbook and delete unnecessary sheets, dashboards, and data sources from each one. See above for some examples.

- **Option 2:** copy out specific sheets into a new workbook. This may be more efficient because copying a dashboard into a new workbook carries over only what is needed for that dashboard. However, not all formatting options will be transferred. See [Copy Sheets and Data Sources](#) for more information.

General suggestions

These suggestions are pulled from the whitepaper [Designing Efficient Production Workbooks](#).

- **Limit the data** by adding a data source filter, dropping unnecessary columns, or aggregating to the appropriate level.
- **Extracts solve many problems.** Changing from a live connection to an extract will make most workbooks run faster. If you're not running extracts, this is the first place to start, even just as a test to rule out other data issues.
- **Simple is fast.**
- **Move complexity to the data layer.**
 - Use an extract
 - Use a fixed dashboard size
 - Upgrade to the latest version of Tableau
 - Limit the data. Data volume is the single most significant factor in performance.

Know Your Data at the Database Level

Understanding the impact that certain factors in the design of your database have on Tableau performance might give you information you can use to work with your database team to optimize data at the database level.

Enable support for referential integrity

Databases that support referential integrity support the Tableau Assume Referential Integrity feature, which improves the performance of inner joins. Joins cost time and resources to process on the database server. When you join multiple tables in a data source, Tableau uses functionality that is generally invisible to the user, called *join culling*. Join culling queries only the relevant tables instead of all tables defined in your join. Join culling only occurs where referential integrity is defined between tables. For more information, see [Assuming Referential Integrity for Joins](#) on page 807.

Make sure database permissions support creating temp tables

Does your database grant users permission to create and drop temporary tables, also known as temp tables, and does the environment have sufficient spool space for the queries being run? Tableau creates temp tables to help improve performance and add functionality. The temp tables temporarily hold information specific to a connection. If the creation of temp tables in the database is restricted, the overall performance of workbooks and views isn't as fast as it could be.

Create indexes for tables

Index the tables in your relational database. To successfully index your data set, identify the fields that you frequently filter on and add them to the index. If you have a field that you use as a context filter often, consider setting it as your primary index. If you are working with Access tables that have more than 200,000 rows of data, consider setting indexes on the tables. You can learn how to do this by searching for "index" in the Access online help. You can officially store 2 GB of data (approximately 1-2 million rows) in an Access database, but it performs poorly well below this limit.

Many database management system (DBMS) environments have management tools that will look at a query and recommend indexes that would help.

Break up your data

You can often improve performance if you partition a large database table into multiple smaller tables. For example, you can create a cluster of Access tables that addresses specific subsets of your data.

Use a database server

If you have a lot of data, you might consider storing it in a database server, such as Oracle, MySQL, or Microsoft SQL Server. The Professional Edition of Tableau can connect to these larger database servers.

Test Your Data and Use Extracts

You probably have no control over the hardware, processing power, and disk space that your database runs on. Or how many people access the database at any given time, how many services are running, or how robust the network is. But you can test the *raw performance* of the

data before you begin to build a workbook, so that you understand the environment you're working in. And there are things you can do to affect the performance of the workbooks you create, starting with how you choose to connect to your data: the drivers you use, and whether your connection type is *live* or *extract*.

Test as close to the data as possible

A good way to test the raw performance of the data is to install Tableau Desktop on the computer where the data resides and to run some queries. This eliminates external factors such as network bandwidth and latency from performance results, and help you to understand the raw performance of the query in the data source.

Additionally, you can use the *localhost* name for the data instead of the DNS name to help determine if environmental factors such as slow name resolution or proxy servers are slowing performance.

Connect with native database drivers

When you connect to data with native database drivers, you will often experience significantly faster performance than when you connect to the same data with ODBC drivers. When you use native database drivers, make sure that you're using the latest version. Database vendors are always working to improve their drivers. For a list of drivers, see [Drivers and Activation](#) on the Tableau website.

Work with extracts instead of live data

Depending on your data, you can choose between a live or extract connection on the data source page. A *live* connection is a direct connection to your data. A Tableau data *extract* is a compressed snapshot of data stored locally and loaded into memory as required to render a Tableau visualization. Extracts are designed to use all parts of your computer's memory optimally.

There are several reasons to use an extract, but the main performance-related reason is if your query execution is slow. The extract data format is designed to provide a fast response to analytic queries. In this case, you can think of the extract as a query acceleration cache.

For more information about Tableau extracts, see [Extract Your Data on page 919](#). Another reference is a three-part blog post about extracts that starts with the first post, [Understanding Tableau Data Extracts](#).

Reduce the amount of data

When you create an extract, use filters to exclude data that you don't need. Also, ask yourself if you need all of the records in a data source, or if you can limit the extract to a representative sample. For more information, see [Extract Your Data on page 919](#).

Hide unused fields

Hidden fields are not included when you create an extract. Use the **Hide All Unused Fields** option to hide unnecessary fields before you create an extract. This makes the extract smaller, which improves performance. For more information, see [Hide or Unhide Fields on page 1061](#).

Optimize extracts

The **Compute Calculations Now** option materializes calculations in your extract, meaning that certain calculations are computed in advance and their values are stored in the extract.

Depending on the complexity of the calculations used in your extract, this can potentially speed up future queries.

To materialize calculations, select a data source on the **Data** menu and then select **Extract > Compute Calculations Now**. For more information, see [Materialize Calculations in Your Extracts on page 944](#).

Use extracts for file-based data

In general it's best practice to import file-based data—text files such as CSV, Microsoft Excel spreadsheets, and Microsoft Access files, as well as statistical files like SPSS, SAS, and R—into Tableau. This makes queries perform much faster and also results in a much smaller file to store the data values.

If your data is a large text or Excel file, using an extract not only improves performance but also makes more functionality available to you. Note that if you connect Tableau to a large text file, you will be prompted to extract the data if Tableau discovers that the file is too large to perform well.

Avoid using custom SQL

In most cases, custom SQL runs slower than queries created by Tableau. Tableau cannot perform query optimizations on custom SQL. But in cases where you must use custom SQL, use

an extract so that the query runs only once. For more information, see [Connect to a Custom SQL Query](#) on page 863.

Design for Performance While You Build a View

You're connected to your data, and you've built your data source. The next step is to begin building a view in Tableau. There are a few things to keep in mind as you build your workbook so that it will perform faster while you're building it, as well as after it is created.

Use the Describe field to get to know your data

Rather than dragging a dimension out onto the rows shelf so that you can eyeball the data—which requires Tableau to render the data as a crosstab, one of the slowest visualization types—use the **Describe field** option. Right-click the field in the **Data** pane to view a description of the data type as reported by the data source, as well as a sample of the dimension member values.

Keep workbooks a reasonable size

The fewer worksheets and data sources in a workbook, the faster it will perform. If you have a big topic to explore and are tempted to put everything into a single monolithic workbook, reconsider. Notice if your workbook starts to slow down with the addition of a new view and additional queries. If the performance starts to suffer as you enlarge the scope of your workbook, think about breaking your workbook into separate files.

Turn off Automatic Updates

When you place a field on a shelf, Tableau generates the view by automatically querying the data. If you are creating a dense data view, the queries might be time-consuming and significantly degrade system performance. In this case, you can turn off queries in Tableau while you build the view. You can then turn queries back on when you are ready to see the result. For more information, see [Turn off Automatic Updates to Boost Performance](#) on page 3074.

Look for warnings

Tableau displays a performance warning dialog box when you attempt to place a large dimension (with many members) on any shelf. The dialog box provides four choices, as shown

below. If you choose to add all members, then you might experience a significant degradation in performance.

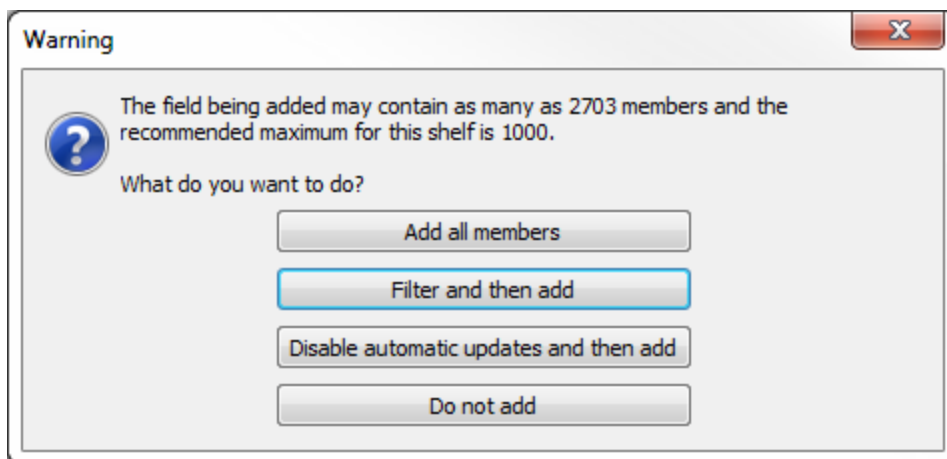

You might also see a warning when you attempt to create too many panes in a table. In this case, Tableau warns you that the requested table "contains more than the recommended maximum number of panes." It is best not to display more than the recommended number of panes, in part because you won't get a useful view.

Create Efficient Calculations

When your data doesn't provide all the information you need to answer your questions, you can create calculated fields to help with your analysis.

Within a calculated field you can define a hardcoded constant (such as a tax rate), do very simple mathematical operations like subtraction or multiplication (for example, revenues minus cost), use more complex mathematical formulas, perform logical tests (IF/THEN, CASE), do type conversions, send expressions to external services such as R, and much more.

There are different calculation types in Tableau:

Basic and aggregate calculations: These types of calculations are generated as part of the query to the underlying data source and are calculated in the database. In general, basic and aggregate calculations scale very well, and there are many database tuning techniques that can improve their performance.

Table calculations: These calculations are calculated by Tableau on the query result set. While this means more work for Tableau, table calculations are generally done over a much smaller set of records than are in the original data source. If table calculation performance is a problem

(possibly because the result set returned to Tableau is very large) consider pushing some aspects of the calculation back to the data source layer. One way to do this is to aggregate the data and then perform the calculation on the aggregated data.

Level of detail (LOD) expressions: LOD expressions are generated as part of the query to the underlying data source and are calculated in the database. They are expressed as a *nested select*, so they are dependent on database performance. A table calculation or blending might perform better than a LOD expression, or vice versa.

If you suspect performance is slow due to a LOD expression, you might try replacing it with a table calculation or a data blend to see if performance improves. For an example, see Example 2 in [Tableau's Order of Operations on page 161](#).

LOD expressions can be affected by join culling, so look at [Assuming Referential Integrity for Joins on page 807](#) if your queries run slowly when you use LOD expressions.

For more information, see the Tableau whitepaper [Understanding Level of Detail \(LOD\) Expressions](#).

Use parameters for conditional calculations

A common technique in Tableau is to show a parameter control so users can select a value that determines how a calculation is performed. Typically, to give the user easy-to-understand options, it makes sense to create the parameter as a string type. But numerical calculations are much faster than string calculations, so take advantage of the **Display As** feature of parameters: that is, show text labels but use underlying integer values for the calculation logic. For more information, see [Create Parameters on page 1122](#).

Convert date fields

Users often have date data that is not stored in native date formats—for example, a date might be a string or a numeric timestamp. You can use the DATEPARSE function if your data supports it—this function is available for non-legacy Microsoft Excel and text file connections, MySQL, Oracle, PostgreSQL, and Tableau data extract data sources. Otherwise, parse the field into a date string such as “2012-01-01”. ISO strings are preferred because they are not locale-specific. Then pass the value to the DATE function. If the originating data is a numeric field, converting it first to a string and then to a date is very inefficient. It is much better to keep the data as numeric and use DATEADD and date literal values to perform the calculation. The performance gains can be significant with large data sets. See [Date Functions on page 2075](#) for more information about these functions.

Use CASE logic statements

When working with complex logic statements, CASE statements may be faster than IF or ELSEIF statements.

Remember that ELSEIF is faster than ELSE IF, because a nested IF computes a second IF statement rather than being computed as part of the first.

For more information, see the whitepaper [Designing Efficient Workbooks](#).

Aggregate measures

If the views you create are slow, make sure you are working with aggregated measures. With disaggregated data, you might be trying to view many rows of data at once. You can reduce the number of rows by aggregating the data. To do this, select **Analysis > Aggregate Measures**.

Calculation tips

There are lots of little things you can do that can improve calculation performance.

- Distinct counting values is one of the slowest aggregation types in almost all data sources. Use the COUNTD aggregation sparingly.
- Using parameters with a wide scope of impact (for example, in a custom SQL statement) can affect cache performance.
- Filtering on complex calculations can potentially cause indexes to be missed in the underlying data.
- Script functions like RAWSQL and SCRIPT_* for integrating with external services can be slow, particularly if there are lots of values that need to be passed back and forth from the DBMS/R server.
- Use NOW only if you need the time stamp level of detail. Use TODAY for date level calculations.
- Remember that all basic calculations are passed through to the underlying data—even literal calculations like label strings. If you need to create labels (for example, for column headers) and your data is very large, create a simple text/Excel file data source with just one record to hold them so they don't add overhead on the big data source.

Make Visualizations Faster

You've put in a lot of work to make your visualization—view, dashboard, or story—make a point or tell a story. You don't want to lose your audience while you wait for the visualization to load. By following the guidelines in this topic, you can improve the speed of your visualizations.

Reduce the scope

Whether you're creating a view, dashboard, or story, it's tempting to pack a lot of information into your visualization because it's so easy to add more fields and calculations to the view and more sheets to the workbook. But the result can be that the visualization becomes slower and slower to render.

Remember that each worksheet runs one or more queries against the data, so the more sheets, the longer it takes to render the visualization.

Take advantage of the fact that Tableau is designed to deliver interactive visualizations to your users, and spread the data out across multiple visualizations, if you can. Be strategic when designing your visualization—the fewer sheets and data sources, the faster your visualization will perform.

Limit the number of filters you show in the view

Filters that you show in your view (formerly called quick filters) are a very powerful feature of Tableau that you can use to create rich, interactive visualizations for your users. See the filters highlighted on the right in the following screenshot:

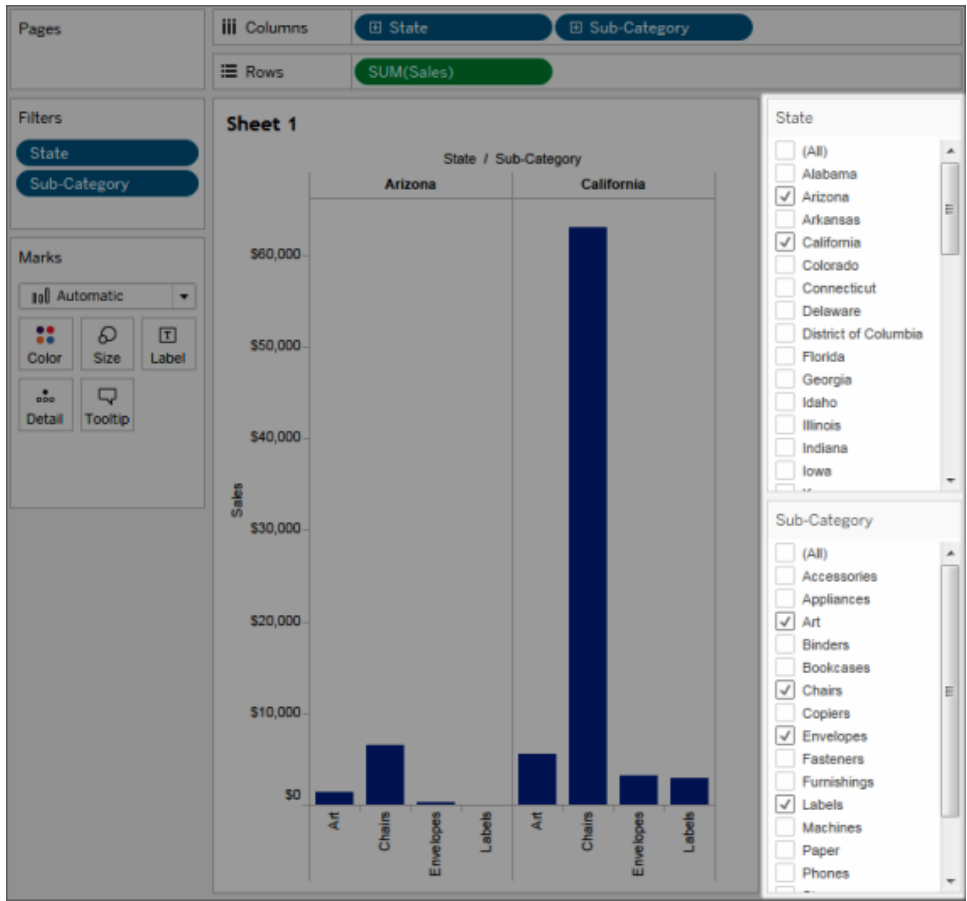

When you add an interactive filter to a view, each filter in the view requires a query in order to populate the options. If you add a lot of interactive filters to your dashboard, it can cause the dashboard to take a long time to render.

Also, when you use “show relevant values” on a filter, it requires a query to update the shown values each time other filters are changed. Use this feature sparingly.

Reduce the number of marks on the view

While there is no hard and fast rule on what defines “too many marks,” be aware that more marks means that more processing power and memory is required to render them. You can find the number of marks by looking at the lower left of the Tableau Desktop window in the status bar. Watch out for large crosstabs and for maps with complex custom polygons. Keep in mind that too many data points on a view can also reduce the visual analytics value by causing information overload.

To avoid this problem, compile related views and connect them with action filters so that you can go from an overview to a more granular view as you explore the data. Make sure that you remove any unneeded dimensions from the **Detail** shelf. You can also try displaying your data in different types of views to see what's most effective.

Zoom without filtering

When users zoom in on a visualization with a large number of marks, Tableau doesn't filter out the marks you can't see. What changes is the view of the data, not the total number of marks. If you only need a subset of the data, filter out the data you don't need.

Record and Analyze Workbook Performance

Your workbook is done and you're wondering if its performance is taking a little longer than it should. To find out what's slowing it down, you can use a performance recording to evaluate your workbook. This is an especially good idea if you plan to share or publish the workbook.

The Performance Recording feature in Tableau records performance information about key events as you interact with a workbook. You can then view performance metrics in a workbook that Tableau creates to analyze and troubleshoot different events that are known to affect performance:

- Query execution
- Compiling query
- Geocoding
- Connections to data sources
- Layout computations
- Extract generation
- Blending data
- Server rendering (Tableau Server only)

Tableau support may ask that you create a performance workbook as they work with you to diagnose performance issues.

Create a performance recording in Tableau Desktop

To start recording performance, follow this step:

Help > Settings and Performance > Start Performance Recording

To stop recording and view a temporary workbook containing results from the recording session, follow this step:

Help > Settings and Performance > Stop Performance Recording

You can now view the performance workbook and begin your analysis.

Click **File > Save** to save the workbook to the location you choose. If you're sending the recording to Tableau Support, save this workbook as a packaged workbook (.twbx) file, and then send it.

Interpret a performance recording workbook

A performance recording workbook contains two main dashboards: Performance Summary and Detailed Views. The Performance Summary dashboard provides a high-level overview of the most time-consuming events. The Detailed Views dashboard provides a lot more detail and is intended to be used by advanced users when building workbooks. The **Detailed Views** dashboard is only visible when the performance recording workbook is opened using Tableau Desktop.

Performance Summary

The **Performance Summary** dashboard contains three views: **Timeline**, **Events**, and **Query**.

Timeline

The uppermost view in the performance summary recording dashboard shows the events that occurred during recording, arranged chronologically from left to right. The bottom axis shows elapsed time since Tableau started, in seconds.

In the Timeline view, the **Workbook**, **Dashboard**, and **Worksheet** columns identify the context for events. The **Event** column identifies the nature of the event, and the final column shows each event's duration and how it compares chronologically to other recorded events:

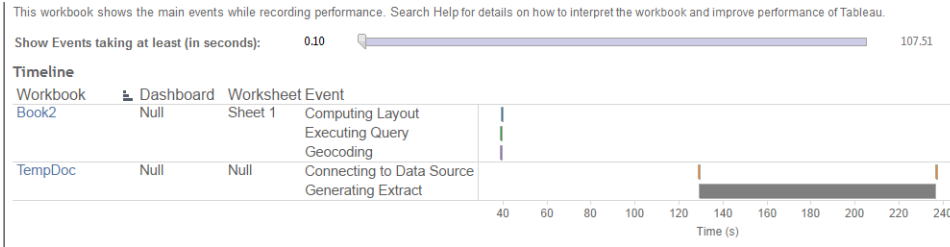

Events

The middle view in a performance summary dashboard shows the events, sorted by duration (greatest to least). Events with longer durations can help you identify where to look first if you want to speed up your workbook.

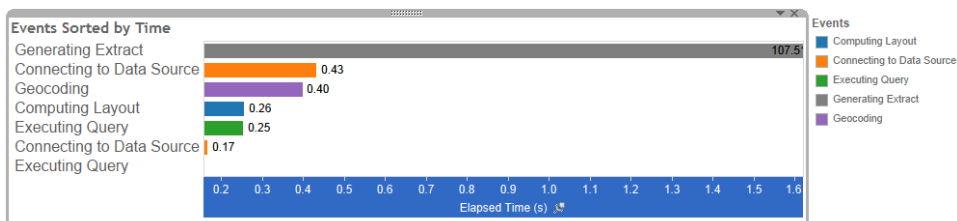

Different colors indicate different types of events. The range of events that can be recorded is:

- Computing layouts

If layouts are taking too long, consider simplifying your workbook.

- Connecting to data source

Slow connections could be due to network issues or issues with the database server.

- Compiling query

This event captures the amount of time spent by Tableau in generating the queries. Long compile query times indicate that the queries generated are complex. The complexity may be due to too many filters, complex calculations, or generally due to a complex workbook. Examples of complex calculations include, lengthy calculations, LOD calculations, or nested calculations. Try simplifying the workbook, using action filters or moving calculations to the underlying database.

- Executing query

- For live connections, if queries are taking too long, it could be because the underlying data structure isn't optimized for Tableau. Consult your database

server's documentation. As an alternative, consider using an extract to speed performance.

- For extracts, if queries are taking too long, review your use of filters. If you have a lot of filters, would a context filter make more sense? If you have a dashboard that uses filters, consider using action filters, which can help with performance.
- Generating extract

To speed up extract generation, consider only importing some data from the original data source. For example, you can filter on specific data fields, or create a sample based on a specified number of rows or percentage of the data.
- Geocoding

To speed up geocoding performance, try using less data or filtering out data.
- Blending data

To speed up data blending, try using less data or filtering out data.
- Server rendering

You can speed up server rendering by running additional VizQL Server processes on additional machines.

Query

If you click on an **Executing Query** event in either the **Timeline** or **Events** section of a performance summary dashboard, the text for that query is displayed in the Query section.

If you are connected to a published data source, the query text is displayed in XML. If you are connected to the data source directly, the query is displayed in SQL like shown below:

Query

```
SELECT "State"."ID" AS "ID",
       "StateSynonyms"."Name" AS "State_Name",
       "State"."ParentID" AS "State_ParentID"
FROM "StateSynonyms"
INNER JOIN "State" ON (("State"."ID" = "StateSynonyms"."ParentID") AND ("State"."MapCode" = "StateSynonyms"."MapCode"
```

If it makes sense, you can use the query text to work with your database team on optimizing at the database level. Sometimes the query is truncated and you'll need to look in the Tableau log to find the full query. Most database servers can give you advice about how to optimize a query by adding indexes or other techniques. See your database server documentation for details.

Sometimes for efficiency, Tableau combines multiple queries into a single query against the data. In this case, you may see an **Executing Query** event for the Null worksheet and zero queries being executed for your named worksheets.

Detailed Timeline

This view is the detailed version of the **Timeline** view that shows all events and separating individual items that were grouped in the **Timeline** view. It is intended to be used by advanced users during workbook designs.

Detailed Views

The **Detailed Views** dashboard contains **Depth**, **Exclusive CPU**, **Inclusive CPU**, and **Elapsed Time** views.

Depth

The **Depth** view is the uppermost view in the **Detailed Views** dashboard and provides insight into what happens when a request is made. This view is the most useful when filtered to a single user request. Examples of user requests are: loading a view, selecting a mark, or changing a filter.

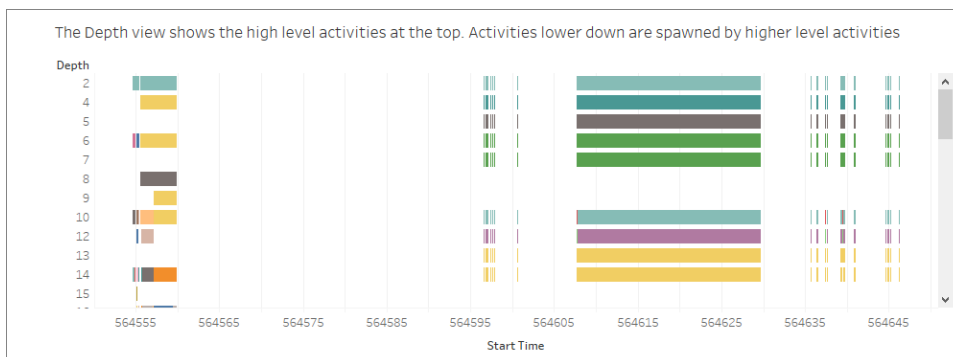

Each bar on the depth view represents a single activity. An activity is a unit of work that is done as part of processing a user request. A single user request results in multiple activities. The length of each bar on the depth view is proportional to the elapsed time for the activity that the bar represents.

High level activities appear at the top of the view. Activities lower down are child activities generated by high level activities.

Hovering over each bar provides additional details about the activity and also highlights the corresponding row in the **CPU** and **Elapsed Time** view described in the next section.

In order to narrow down on what parts of the request took the most time, investigate long running activities at the highest levels.

CPU and Elapsed Time

The **CPU** and **Elapsed Time** views appear lowermost in the **Detailed Views** dashboard. You can toggle between **Exclusive CPU**, **Inclusive CPU** and **Elapsed Time** views by clicking on the radio buttons.

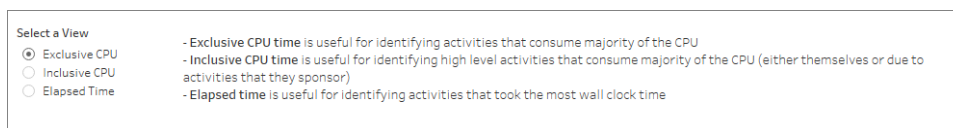

While the **Depth** view can help in quick visual identification of long running activities, it may not necessarily highlight activities that happen multiple times with each instance taking a small amount of time. The **Exclusive CPU**, **Inclusive CPU**, and the **Elapsed Time** views provide aggregate statistics for each activity. The number of times an activity took place is shown in the **Count** column and the total amount of time taken by a single activity is shown using the bar chart.

Reduce Upload Times to Tableau Server

You've created your workbook and analyzed its performance recording to make sure that it's been optimized for speed. Now you're ready to publish the workbook to Tableau Server. It isn't always possible to reduce upload times to Tableau Server, but here are some considerations to keep in mind.

Avoid publishing packaged workbooks

It is a best practice to publish workbooks (.twb files) and data sources separately, rather than publishing them together as packaged workbook (.twbx files). This may not make your initial uploads of workbooks and data sources any faster than publishing them together, but it makes republishing workbooks faster (if you don't have to also republish data sources), and it makes data sources available online for new workbooks. For data sources that are extracts, it also allows you to schedule automated refreshes.

Make extracts smaller

For Tableau extracts, you can help speed uploads by making your extract smaller. As you create extracts, consider:

- Removing unused fields from extracts.
- Making extracts smaller with sampling and filtering.
- Aggregating data for visible dimensions.

See also

[Extract Your Data](#) on page 919

[Publish a Data Source](#) on page 3141

Turn off Automatic Updates to Boost Performance

When you place a field on a shelf, Tableau generates the resulting view by querying the data source. When you create a complex data view that involves many fields, these queries can be time-consuming. To improve performance, you can turn off automatic updates while composing a view, and then query the data source when you're done.

Automatic updates for worksheets

To turn off updates for worksheets, click the **Pause Auto Updates** button  on the toolbar. You can also toggle automatic updates on and off by pressing F10 (Option-Command-0 on a Mac) on your keyboard.

While automatic updates are off, you can update the view at any time by clicking the **Run**

Update  button on the toolbar, or by pressing F9 (Shift-Command-0 on a Mac).

Identifying invalid states when automatic updates are off

It's possible to enter an invalid state when automatic updates are turned off. When this happens, the view is desaturated and invalid commands are disabled. The view and commands become

available again when you click **Run Update** on the toolbar.

For example, the view below has automatic updates turned off. When we changed the aggregation for Profit from a summation to an average, the view became desaturated to indicate that the current view is invalid.

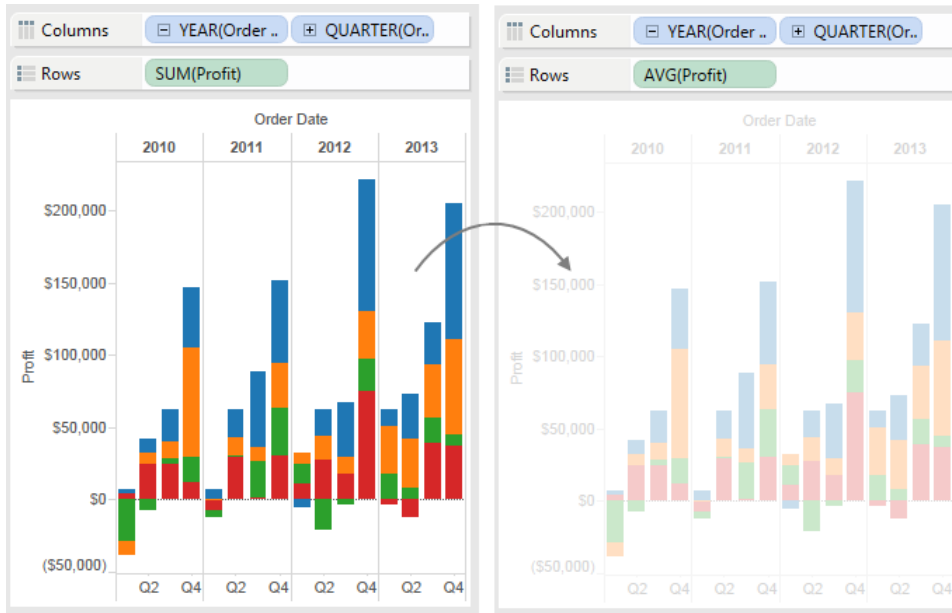

Automatic updates for filters

When you change a filter, even when you turn off automatic updates for worksheets, Tableau continues to query the data source to update the view. When you work with a large data set, this continuous query action can degrade performance, so Tableau also gives you an option to pause automatic updates for filters. If you pause automatic updates for filters, you can make as many changes as you need without having to wait for Tableau to update the filter each time.

To pause automatic updates for filters, click the drop-down arrow on the **Pause Auto Updates** button on the toolbar and select **Auto Update Filters** to clear the check mark .

To resume automatic updates for filters, click the drop-down arrow on the **Pause Auto Updates** button on the toolbar and select **Auto Update Filters** again. You can also click the **Run Update**



button on the toolbar to manually update the view at any time.

How Automatic Updates Affect Dashboards and Stories

You configure automatic updates on a per-view basis. This means that you can have a dashboard where some views update automatically, and others don't. Similarly, you can have a story where some story points update automatically, and others don't. But when dashboards or stories are published to Tableau Server, automatic updates affect either none of the contributing views in a story or dashboard, or all of the views.

Save Your Work

You can save your work at any time while analyzing or interacting with data in Tableau.

For Tableau Desktop

In Tableau Desktop, there are several ways for you to save your work:

- **Automatically save a workbook** - Automatically saves the workbook in the same location as the original file. In the event of a crash, a recovered version is available.
- **Save a workbook** – Saves all open worksheets.
- **Save a packaged workbook** – Saves the workbook along with all referenced local file data sources and images into a single file.
- **Save a bookmark** – Saves the current worksheet.

You can share workbooks and bookmarks with your co-workers, provided they can access the relevant data sources that the workbook uses. If your co-workers do not have access to the data sources, you can save a packaged workbook.

Custom fields such as binned measures, calculated fields, groups, and sets are saved with workbooks and bookmarks.

Automatically save a workbook

Tableau Desktop automatically saves your work for you every few minutes - no more losing hours of work if Tableau Desktop closes unexpectedly. This feature is enabled by default, but you can turn it off from the toolbar under **Help >Settings and Performance>Enable Autosave**.

Note: If you don't see this option, your System Administrator may have disabled this feature.

If Tableau crashes, a recovered version of the workbook is automatically created with a .twbr extension and saved in the same location as the original file or in your **My Tableau Repository/Workbooks** folder. New workbooks are saved with the name "Book1" plus a numeric ID. When you reopen Tableau, a recovery dialog box shows a list of the recovered files that you can select and open to continue in your flow.

You can also delete unwanted files from this same dialog box.

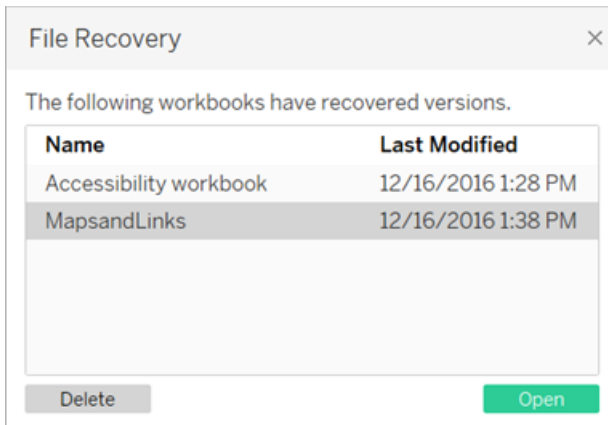

For more information about how to turn this feature on or off during installation, see [Before You Install](#) in the Tableau Desktop Deployment guide.

Save a workbook

When you open Tableau Desktop, it automatically creates a new workbook. Workbooks hold the work you create and consist of one or more worksheets. Each worksheet contains a particular view of your data.

To save a Tableau workbook:

1. Select **File > Save**.
2. Specify the workbook file name in the **Save As** dialog box.

By default, Tableau saves the file with the .twb extension. By default, Tableau saves your workbook in the **Workbooks** folder in your My Tableau Repository. You can find this repository in your Documents folder. However, you can save Tableau workbooks to any directory you choose.

Tableau file names cannot include any of the following characters: forward slash (/), backslash (\), greater-than sign (>), less-than sign (<), asterisk (*), question mark (?), quotation mark ("), pipe symbol (|), colon (:), or semicolon (;).

To save a copy of a workbook you have open:

- Select **File > Save As** and save the file with a new name.

Save a packaged workbook

Packaged workbooks contain the workbook along with a copy of any local file data sources and background images. The workbook is no longer linked to the original data sources and images. These workbooks are saved with a .twbx file extension. Other users can open the packaged workbook using Tableau Desktop or Tableau Reader, and do not need access to the data sources that the workbook includes.

To learn more about how to save your workbook as a packaged workbook, see [Packaged Workbooks](#) on page 3082.

Save a bookmark

You can save a single worksheet as a Tableau bookmark. When you save the bookmark, Tableau creates a snapshot of the worksheet. Bookmarks can be accessed from any workbook using the Bookmarks menu. When you open a bookmarked worksheet, it adds the worksheet to your workbook in the state that it was in when it was bookmarked. It will never update or change automatically. Bookmarks are convenient when you have worksheets that you use frequently.

To save a Tableau bookmark:

1. Select **Window > Bookmark > Create Bookmark**.
2. Specify the bookmark file name and location in the Create Bookmark dialog box.

Tableau saves the file with a .tbm extension. The default location is the Bookmarks folder in the Tableau Repository. However, you can save bookmarks to any location you choose. Bookmarks that are not stored in the Tableau repository do not appear on the **Bookmark** menu.

You can organize bookmarks into folders in the same way you organize files or documents. This can be useful when you have a large number of bookmarks to manage. For example, you might organize bookmarks based on employee name, product types, or sales results. You can organize bookmarks by creating a new folder, renaming an existing folder, renaming existing bookmark files, and so on.

Delete bookmarks the same way you would delete any other file on your computer. After you delete a bookmark from the Bookmarks folder in the Tableau Repository, it is removed from the **Bookmarks** menu the next time you start Tableau.

Note: While bookmarks are generally a snapshot of the worksheet and include the data connection, formatting, etc., a bookmark does not include parameter values and the current page setting on the Pages shelf.

For web authoring

When creating, editing, and interacting with views on Tableau Server or Tableau Cloud, there are a couple of different ways for you to save your work:

- **Save a workbook** - saves a workbook in the project you specify.
- **Save a copy of a workbook** - saves a copy of the workbook in the project you specify.
- **Save changes as a custom view** - saves changes as a custom view, which is related to the original view and updates when the original view is updated.

Save a workbook

When you create a new workbook, or edit an existing workbook on Tableau Server or Tableau Cloud, you can save your work at any time.

To save a workbook:

- In web editing mode, select **File > Save**.

Note: If the workbook has never been saved, you must select **File > Save As**.

Save a copy of an existing workbook

Sometimes you don't want to overwrite an existing view with your changes. In cases like these, you can save a copy of an existing workbook. When you do this, the existing workbook remains unchanged, and a copy of it is created for you to edit as you wish.

Note: When you save a copy of an existing workbook, it is not updated when the original workbook is updated or republished. It is also not deleted when the original view is deleted. If you would like to create a view that updates with the original, see the [Save changes as a custom view on the facing page](#) section

To save a copy of a workbook:

1. In web editing mode, select **File > Save As**.
2. In the Save Workbook dialog box that opens, do the following:
 1. For **Name**: Enter a name for the workbook.
 2. For **Project**: Select the project in which you would like to save the workbook.
 3. (Optional) Select **Show sheets as tabs** to display all worksheets, dashboards, and stories in the workbook as separate tabs.
 4. Click **Save**.

Note: The person who published the data source to Tableau Server or Tableau Cloud may have also set up credentials for accessing the published data source included in the workbook you are about to save. These authentication options should appear in the Save Workbook dialog box. For more information, see the authentication types in the [Set Credentials for Accessing Your Published Data](#) topic.

Save changes as a custom view

If you notice you are making the same changes to a view every time you open it, you might want to consider saving the changes as a custom view. This option is not available in web editing mode, but can be accessed when you open a view to interact with it.

A custom view does not change the original, but is related to it. If the original view is updated or republished, the custom view is also updated.

You can also choose whether your custom views are visible to other users (public), or only to you (private).

For more information about custom views and how to create them, see [Use Custom Views on page 3323](#).

See Also

[Use Custom Views on page 3323](#)

Packaged Workbooks

Workbooks often reference external resources. For example, workbooks might reference background images or local file data sources such as Excel files, Access files, and Tableau extract files (.hyper).

When you save a workbook, links to these resources are also saved. The next time you open the workbook, the views are automatically updated with any changes that may have occurred to the data and images. In most cases, you will want to save the workbook in this way. But if you plan to share the workbook with someone who does not have access to the referenced resources or to Tableau Server, you might want to save a packaged workbook instead.

Packaged workbooks contain the workbook along with a copy of any local file data sources and background images. The workbook is no longer linked to the original data sources and images. These workbooks are saved with a .twbx file extension. Other users can open the packaged workbook using Tableau Desktop or Tableau Reader.

Note: The content of the .twbx file is stored in plain text. All data, including filter values that may give semantic clues to the data, will be readable by anyone who opens the file.

Create a .twbx with file-based data sources

1. Select **File > Save As**.
2. Specify a file name for the packaged workbook in the Save As dialog box.
3. Select **Tableau Packaged Workbooks** on the **Save as type** drop-down list.

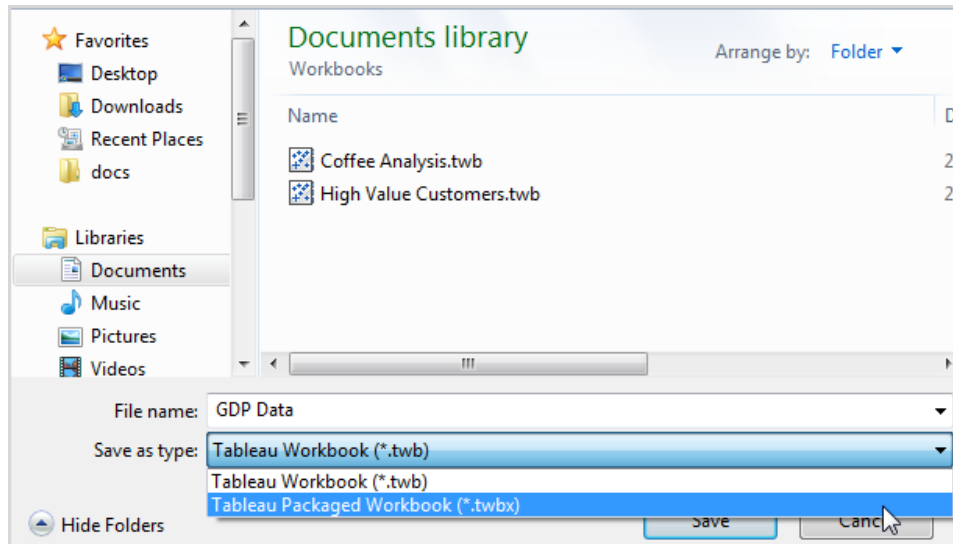

4. Click **Save**.

The default location is the **Workbooks** folder of the Tableau repository. However, you can save packaged workbooks to any directory you choose.

The following files are included in packaged workbooks:

- Background images
- Custom geocoding
- Custom shapes
- Local cube files
- Microsoft Access files
- Microsoft Excel files
- Tableau extract files (.hyper)
- Text files (.csv, .txt, etc.)

If you are sharing packaged workbooks that contain Microsoft Excel or Access 2007 data sources, the people opening the workbook must either have Microsoft Excel and Access 2007 or the Office 2007 Data Connectivity Components installed on their computers. The data connectivity components are available on the Tableau [Tableau Drivers](#) page.

Create a .twbx with non-file-based data sources

If the workbook contains connections to enterprise data sources or other non-file-based data sources, such as Microsoft SQL, Oracle, or MySQL, the data must be extracted from the data sources for it to be included in a packaged workbook (.twbx).

1. In the workbook, right-click the data source in the Data pane and choose **Extract Data**.

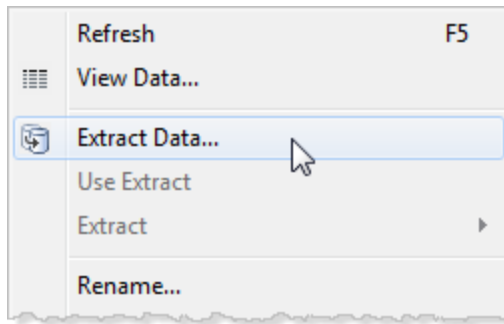

2. In the Extract Data dialog box, click the **Extract** button to extract all data from the data source.

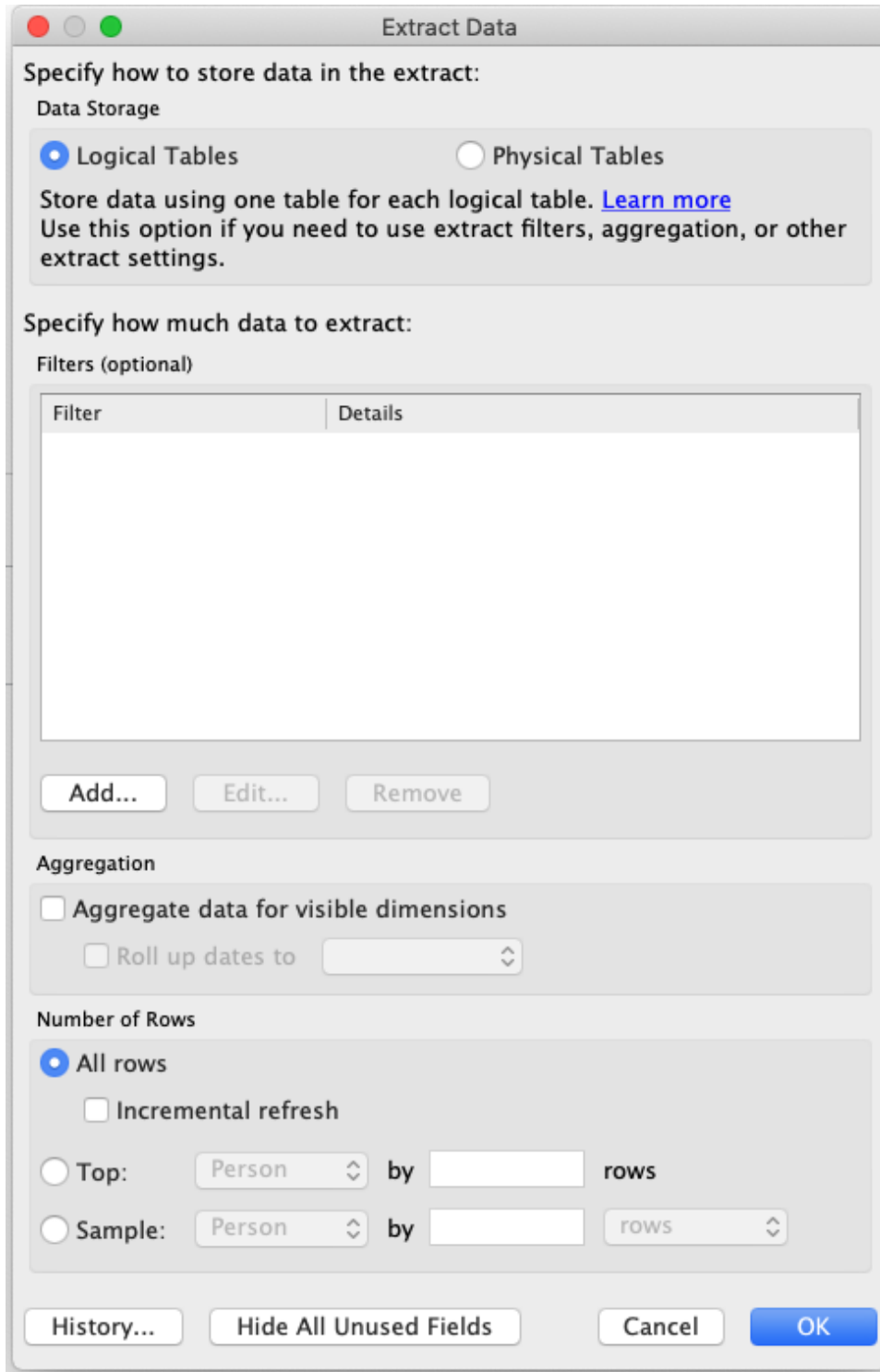

After the extract completes, the data source icon changes to indicate that an extract is active for that data source. Instead of a single cylinder, there are two cylinders connected by an arrow.

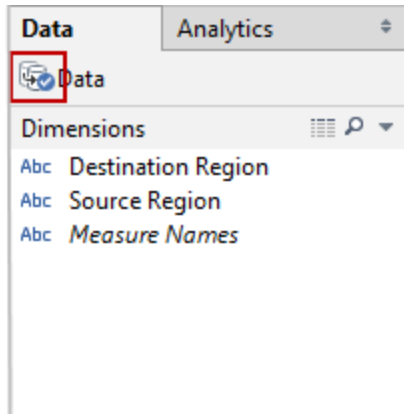

3. **Optional:** Repeat the above steps for each data source in the workbook.
4. Select **File > Save As**.
5. From the **Save as type** drop-down menu, select Tableau Packaged Workbook (*.twbx).

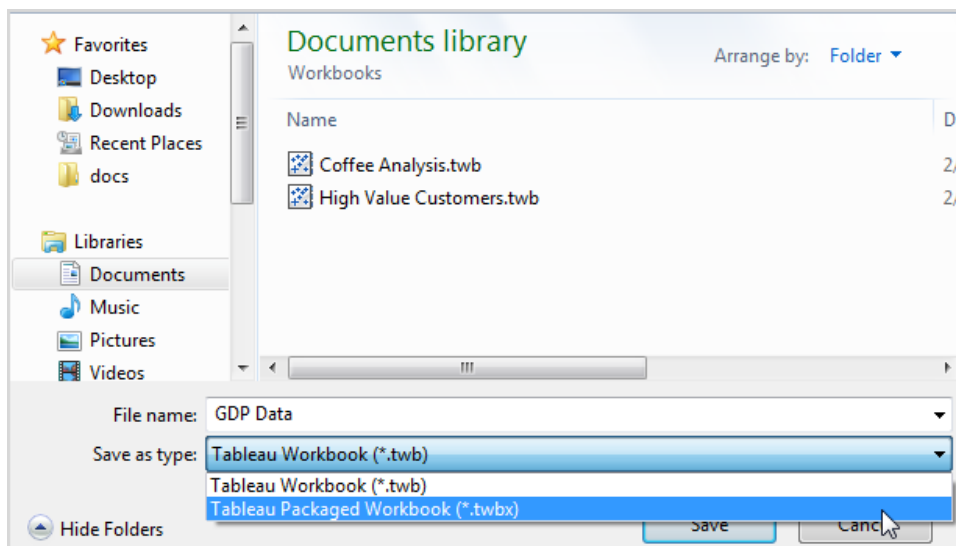

After the extracts have been created for all non-file-based data sources and the packaged workbook has been saved, you can send your workbook.

Create a .twbx with Tableau Server data sources

If the workbook contains connections to a published Tableau Server data source, you must download a local copy of the Tableau Server data source, take an extract of it, and then replace the connection to the local copy for it to be included in a packaged workbook (.twbx).

1. In the workbook, right-click the published data source in the Data pane, and then select **Create Local Copy**.

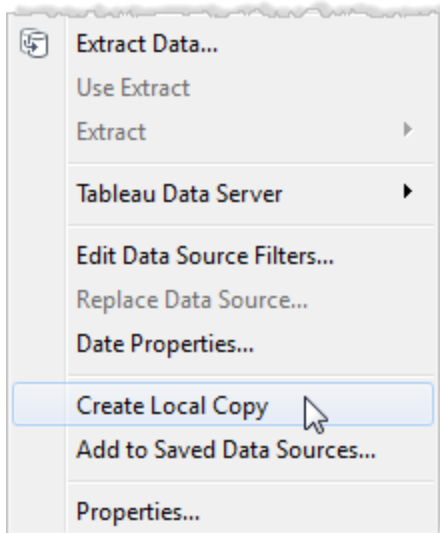

A copy of the published data source is added to the Data pane.

2. Right-click the local copy, and select **Extract Data**.
Note: If the local copy is a published extract you can skip this step.

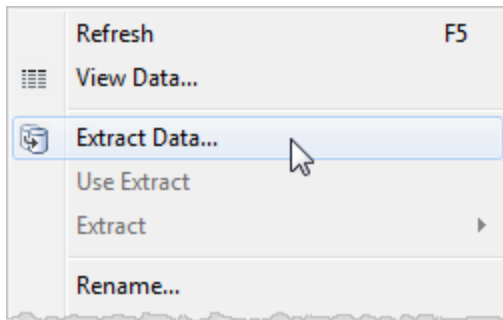

3. In the Extract Data dialog box, click the **Extract** button to extract all data from the data source. Creating an extract of the data source allows the person you are sharing the

workbook with to have access to a copy of the data source.

Extract Data

Specify how to store data in the extract:

Data Storage

Logical Tables Physical Tables

Store data using one table for each logical table. [Learn more](#)
Use this option if you need to use extract filters, aggregation, or other extract settings.

Specify how much data to extract:

Filters (optional)

Filter	Details
--------	---------

Add... Edit... Remove

Aggregation

Aggregate data for visible dimensions

Roll up dates to

Number of Rows

All rows

Incremental refresh

Top: by rows

Sample: by

History... Hide All Unused Fields Cancel **OK**

4. In the Data pane, right-click the published data source, and then select **Replace Data Source**.

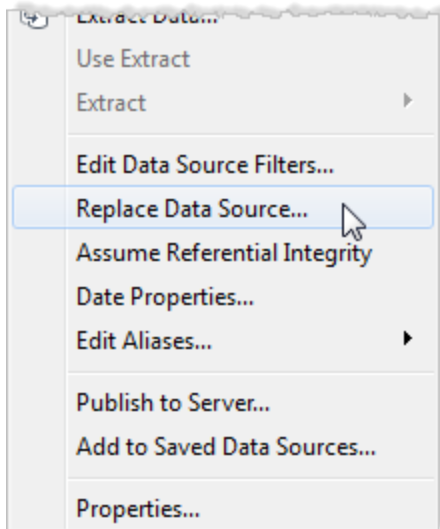

5. Verify that the published data source will be replaced by the local data source, and then click **OK**.

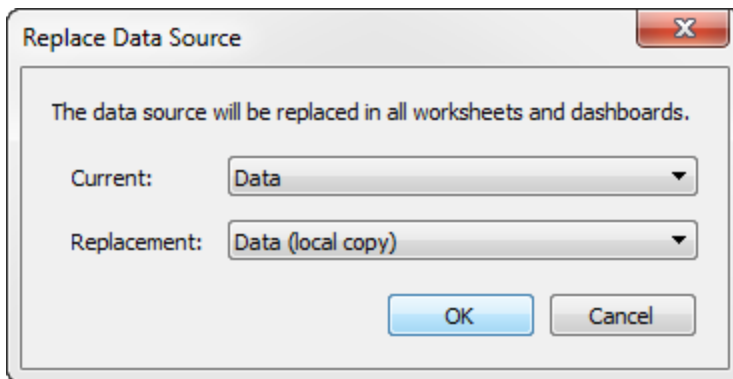

6. Right-click the published data source, and then click **Close**.
7. Select **File > Save As**.
8. From the **Save as type** drop-down menu, select Tableau Packaged Workbook (*.twbx).

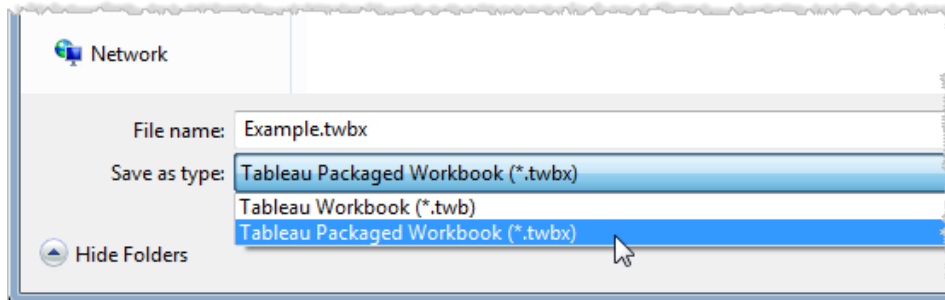

After the local copy and extract of the local copy is created and the packaged workbook saved, you can send your workbook.

Unpackage a .twbx

Packaged workbooks can be unpackaged.

On a Windows or macOS computer, rename the file with a .zip extension (for example, from myfile.twbx to myfile.zip) and then double-click it.

When you unpackage a workbook, you get a regular workbook file (.twb), along with a folder that contains the data sources and images that were packaged with the workbook.

Save Workbooks with Tableau Public

If you want to share your data discoveries with the world outside of your organization, you can save your workbook to Tableau Public, a free cloud service. On Tableau Public, anyone can interact with your views, or download your workbooks or data sources. For information, go to the [Tableau Public website](#).

Important: Workbooks and data published to your Tableau Public profile are not private and are freely accessible to anyone. To work offline or use private data, you can save workbooks locally with the free Tableau Desktop Public Edition.

Save a workbook to Tableau Public

1. With your workbook open in Tableau Desktop Professional or Public Edition, select **Server > Tableau Public > Save to Tableau Public**.

Note: This option is available only if you've created a viz that contains at least one field.

2. Sign in using your Tableau Public account.



If you don't have an account, select the link to create a new one.

3. Type a name for the workbook and click **Save**.

When you save a workbook to Tableau Public, the publishing process creates an extract of the data connection.

Tip: The title becomes part of your view's metadata. Use a unique title that will help others find it when they search. (The title shown in the image is a good example of how *not* to name your workbook.)

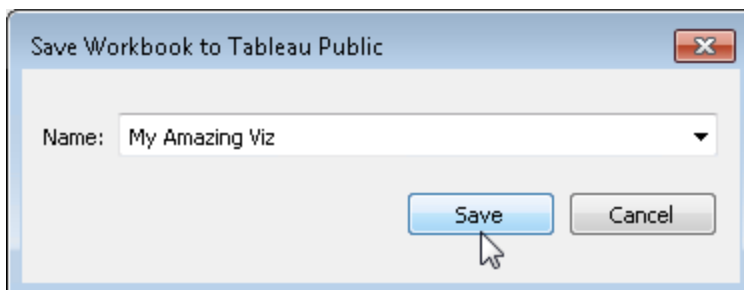

After the workbook is published, you are redirected to your account on the [Tableau Public website](#).

On your profile page on Tableau Public, do any of the following to customize your profile:

- Hover the pointer over a viz to get access to actions such as selecting it as your featured viz, or hiding, downloading, or deleting it.
- Hover the pointer over a viz and then select **View** to open the viz's home page. There you can select **Edit Details** to customize metadata such as workbook name and description, add a permalink, and change other settings.
- To get a link to share on social media or code to embed in a web page, display a view, and then click **Share** at the bottom of the view. (You can get links and embed code for other Tableau Public users' views this way, too.)

Save a workbook locally with Tableau Desktop Public Edition

With the free [Tableau Desktop Public Edition](#), you can choose to either save workbooks to Tableau Public, or save workbooks locally. Local saving allows you to work offline until you're ready to share your work on Tableau Public, and gives you the option to work with private data that can't be shared on Tableau Public.

Revert a Workbook to the Last Saved Version

You can revert a workbook at anytime to undo all of the changes you've made to it since you last saved it.

To revert to the last saved version of a workbook:

- In Tableau Desktop, select **File > Revert to Saved**, and then select **Revert** in the warning dialog box that opens.
- In web authoring mode, select **File > Revert**.

The Revert command is only available for workbooks (.twb) that do not have connections to Extract data sources.

Autosave Workbooks

In Tableau Cloud, Autosave saves the edits that you make to a new or existing workbook while you work.

How does Autosave work?

As soon as you start making changes to a new or existing workbook, we'll start to autosave the changes to a private draft version of your workbook. When you're ready to share your changes with others, use **Publish** to replace the last published revision with your draft.

Note: Autosave doesn't automatically save every type of change, such as specific types of assets. In these cases, you'll see a notification that you must **Publish** your workbook to save your edits.

Workbook file size

Autosave is available for workbooks that are smaller than 5MB. You must **Publish** to manually save changes for larger workbook files.

What if multiple users edit the same workbook?

When more than one user works on the same workbook, each user's edits are associated with and saved to their own private draft. When you begin to edit a workbook, you'll receive a notification if the version you're working from has a published revision from another user. You're then offered a choice to either discard your draft and edit the current revision or to resume editing your private draft.

Warning: You won't receive a notification if another user publishes a revision after you've begun your edits to your private draft. If another user publishes their draft before you publish your version, your changes will overwrite theirs.

You can check the workbook **Revision History** to see when the workbook was last published. From the revision history, you can choose to **Preview** a revision, or **Restore** a previous revision. For more information, see [Work with Content Revisions](#).

If you choose to discard your draft to edit the current revision, the draft and associated asset files that were uploaded are deleted. To retain assets and edits that you made in your private draft, you can manually incorporate the edits of other users into your private draft. Then, publish the workbook with both sets of changes.

Permissions requirement

Autosave is available to Creators and Explorers (can publish) with web editing capabilities at the workbook level. If a user has web editing capabilities at the view level only, Autosave won't be turned on.

Export Views from Tableau Desktop to Another Application

There are several ways to get views and workbooks out of Tableau Desktop and into a presentation, report, or web page.

Note: If you're using Tableau Cloud or Tableau Server, instead see [Download Views and Workbooks](#) on page 3426 and [Link to a PNG, PDF, or CSV of a View](#) on page 3425.

Copy a view as an image

You can quickly copy an individual view as an image and paste it into another application, such as Microsoft Word or Excel. If you're using Tableau Desktop on macOS, a TIFF (Tagged Image File Format) image is copied to the clipboard. On Windows, a BMP (Bitmap) image is copied.

1. Select **Worksheet > Copy > Image**.
2. In the Copy Image dialog box, select the elements you want to include in the image. If the view contains a legend, under Image Options, select the legend layout.
3. Click **Copy**.
4. Open the target application and paste the image from the clipboard.

Export a view as an image file

To create an image file that you can reuse, export the view rather than copy it. You can choose BMP, JPEG, PNG, or SVG image file formats on macOS or Windows. Note, however, that SVG substitutes Tableau fonts (Tableau Regular, Tableau Semibold, etc.) with a similar font.

1. Select **Worksheet > Export > Image**.
2. In the Export Image dialog box, select the elements you want to include in the image. If the view contains a legend, under Image Options, select the legend layout.
3. Click **Save**.
4. In the Save Image dialog box, specify a file location, name, and format. Then click **Save**.

Export as a PowerPoint presentation

When you export a workbook to Microsoft PowerPoint format, selected sheets become static PNG images on separate slides. If you export a story sheet, all story points export as separate slides. Any filters currently applied in Tableau are reflected in the exported presentation.

Tip: To optimize a dashboard for PowerPoint, on the Dashboard tab, choose **Size > Fixed Size > PowerPoint (1600 x 900)**.

To export a workbook to PowerPoint:

1. Select **File > Export as PowerPoint**.
2. Select the sheets you want to include in the presentation. (Hidden sheets can also be included.)

The exported PowerPoint file reflects the file name of your workbook, and the title slide states the workbook name and the date the file was generated.

Tip: Choose **File > Page Setup** to show or hide titles, views, legends, and captions for an individual sheet. (These options in the Show section aren't available for dashboards.)

Export to PDF

To create a vector-based file that embeds the Tableau fonts, print to PDF. After customizing the layout of page elements using the **File > Page Setup** dialog, choose **File > Print to PDF**. For detailed instructions, see [Print Views from Tableau Desktop on page 3105](#)

Export Data from Tableau Desktop

You can export the data in a Tableau data source, including all or part of the records from your original data. Alternatively, you can export only the portion of data used to generate the view.

Note: If you're using Tableau Cloud or Tableau Server, instead see [Download Views and Workbooks](#) on page 3426 and [Link to a PNG, PDF, or CSV of a View](#) on page 3425.

Export data in the data source

After you join tables from one or more connections and make general customizations (for example, create a calculated field, pivot fields, create groups, apply data source or extract filters, etc.) to your Tableau data source, you might want to share or reuse the data in its new form. You can do this by using one of the methods listed below.

- [Export your data to .csv file](#) below
- [Extract your data](#) on the facing page
- [Export the data source](#) on the facing page

Note: The export may exclude some table calculations and level of detail expressions.

Export your data to .csv file

Because the .csv format is one of the most simple structured formats for data, it's supported by a wide range of tools, databases, and programming languages. Exporting your data in the Tableau data source using this format creates an independent data set and can be a convenient and flexible way to share your data with others.

There are two primary ways you can export your data in the data source to a .csv file in Tableau: from the Data Source page and from the view.

- **From the Data Source page:** On the Data Source page, select **Data > Export Data to CSV** to export all the data in your data source to .csv file.
- **From the view:** On the sheet tab, drag a field to the Columns or Rows shelf, click the

View Data icon in the Data pane, and click the **Export All** button.

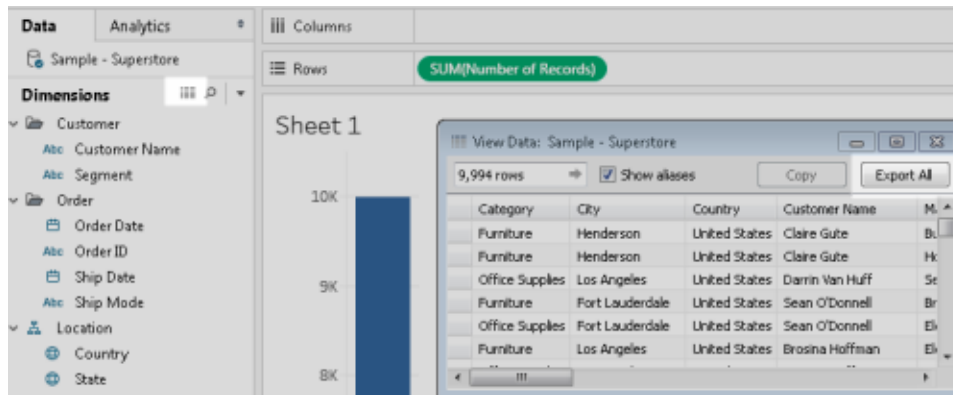

Extract your data

Another way to export all of your data or a subset of your data in the data source is to create an extract (.hyper) file. An extract functions as an independent data set, which you can use to connect directly from Tableau. For more information, see [Extract Your Data on page 919](#).

Export the data source

After you connect to your data, you can export and save your data source as a Tableau data source (.tds) file. Saving the data source creates a shortcut to your remote data and allows you to avoid having to create a new connection to a specific data set each time. For more information, see [Save Data Sources on page 972](#).

Export data used in the view

After you create a view, you can also export just the data used to generate that view.

The fields that are exported come from the fields on the shelves of the sheet. However, fields that function as external filters, in other words, the fields that appear only on the **Filters** shelf, are not included in the export. If you want to include other fields with the exported data without changing the baseline view, you can place those fields on the **Detail** shelf.

The various methods for exporting the data used to generate the view is listed below.

- [Export data in the view to Microsoft Access or .csv on the next page](#)
- [Export crosstab of data in the view to Excel on the next page](#)
- [Copy data in the view to clipboard on page 3099](#)
- [Copy crosstab of data in the view to clipboard on page 3100](#)

Export data in the view to Microsoft Access or .csv

Export the data that is used to generate the view as an Access database (Windows only) or .csv file (Mac only).

1. In Tableau Desktop, select **Worksheet > Export > Data**.
2. Select a location and type a name for your Access database or .csv file.
3. Click **Save**.

If you're on Windows, the Export Data to Access dialog box displays to give you the option to immediately use the new Access database and continue working in Access without interrupting your work flow.

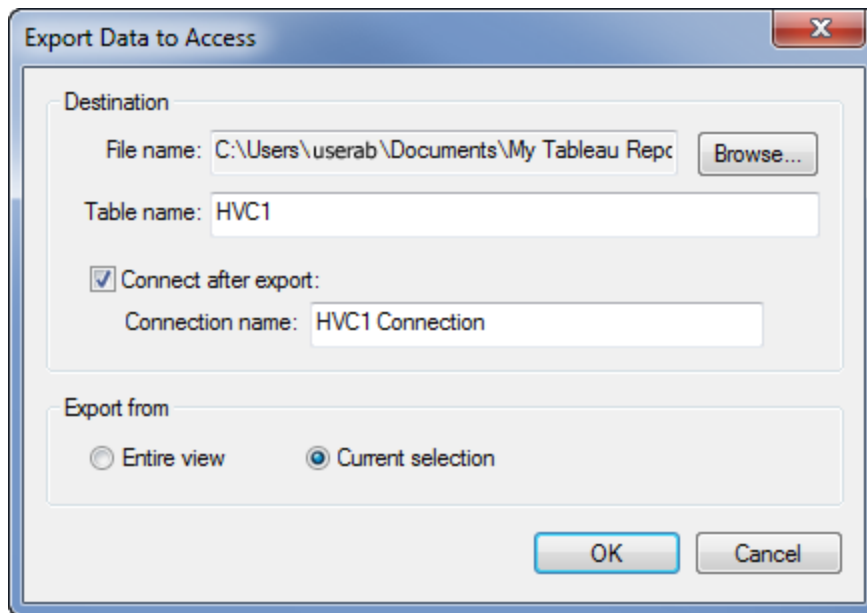

Export crosstab of data in the view to Excel

You can export directly to Excel the data used to generate the view formatted as a crosstab. When you export your view as a crosstab, Tableau automatically opens the Excel application and pastes a crosstab version of the current view into a new Excel workbook.

Although this option provides a direct method for exporting your data to another application, performance of the export can be affected because it is simultaneously copying and formatting the data. If the view you are exporting contains a lot of data, a dialog box opens asking whether you want to export the formatting. In this case, if you choose to exclude the formatting from the export, performance of the export might improve.

- In Tableau Desktop: select **Worksheet > Export > Crosstab to Excel**.
If you're using a Mac, this option opens a dialog box where you can save the file. You must then manually open the file in Excel.
- In Tableau Server or Tableau Cloud, open a view or dashboard and select **Download > Crosstab**.
Select which sheets from the workbook to export data from.

Copy data in the view to clipboard

Copy the data used to generate the view so that you can paste it into another application.

1. Create a view.

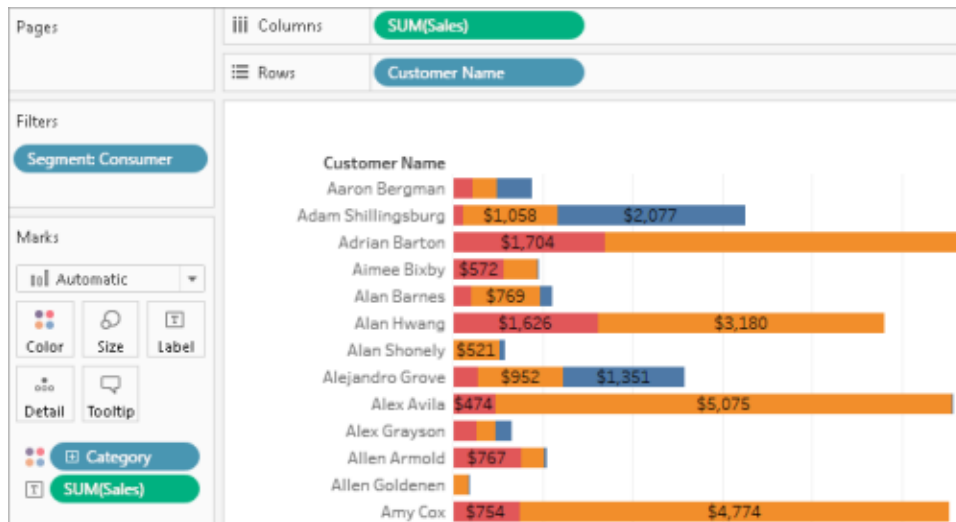

2. Select **Worksheet > Copy > Data**.
3. Open another application, such as Word, and paste the data into the document.

In this example, the fields placed on the Columns, Rows, and Color shelves are copied into the document. However, the **Customer Segment** field is not copied because it is an

external filter because it appears only on the Filters shelf.

Category	Customer Name	Sales
Furniture	Aaron Bergman	\$391
Furniture	Adam Shillingsburg	\$2,077
Furniture	Adrian Barton	\$1,280
Furniture	Aimee Bixby	\$16
Office Supplies	Aaron Bergman	\$274
Office Supplies	Adam Shillingsburg	\$1,058

Copy crosstab of data in the view to clipboard

You can copy a crosstab version of a view so that you can paste or transfer the data into another application. The pasted data always appears as a crosstab, even if the initial view of the data in Tableau did not use a crosstab format.

Copying a crosstab is restricted by some general conditions:

- You must copy all records in the view. You cannot copy a subset of records.
- This option is valid for aggregated views only. It cannot be used on disaggregated views of data because a crosstab is by definition an aggregated view of data. This means the **Aggregate Measures** option on the Analysis menu must be selected in order for copying a crosstab to work properly.
- You cannot copy a crosstab if the view contains continuous dimensions such as continuous dates and times.
- Other restrictions may apply depending on the data in your view.

After the general conditions are met, copy the crosstab.

1. Create a view.

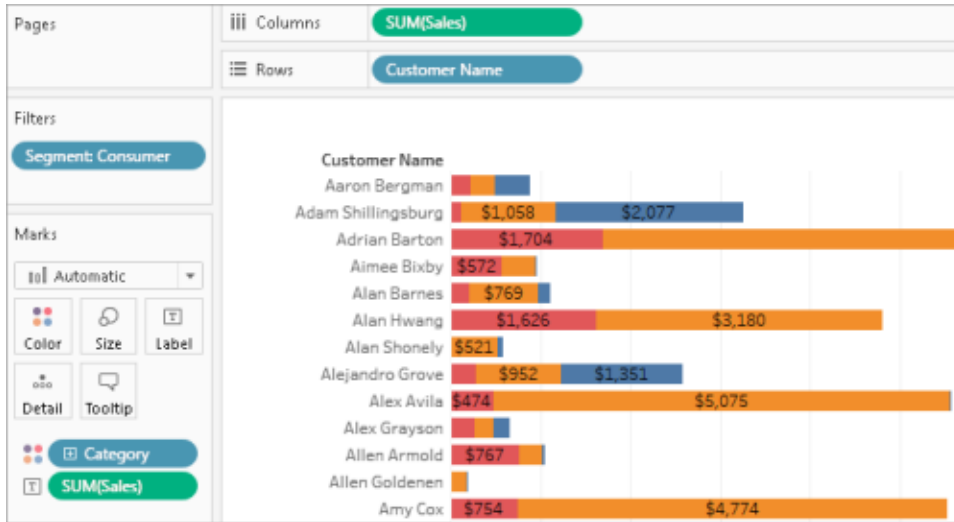

2. Select **Worksheet > Copy > Crosstab**.
3. Open another application, such as Excel, and paste the crosstab.

	A	B	C	D	E
1		Category	Category	Category	
2	Customer Name	Furniture	Office Sup	Technology	
3	Aaron Bergman	\$391	\$274	\$222	
4	Adam Shillingsburg	\$2,077	\$1,058	\$120	
5	Adrian Barton	\$1,280	\$11,489	\$1,704	
6	Aimee Bixby	\$16	\$379	\$572	
7	Alan Barnes	\$131	\$769	\$213	

Copying Information Between Workbooks

Individual sheets, dashboards, and stories can be copied and pasted between workbooks in Tableau Desktop(although not in web authoring). This feature allows you to easily copy an analysis or port a data source into another workbook. It is also possible to import an entire workbook into your current workbook.

What gets copied or saved with selected sheets

When you copy, save, or export selected sheets, the data source or sources that are used on that sheet are also copied. This includes any calculations, parameters, sets, etc. Custom shapes and colors are also included. If the sheet being copied is a dashboard or story, all of the sheets that are used on that dashboard are also copied, whether they are hidden or not.

Custom colors and shapes will be available in the copied or imported sheet but will not be added to your Tableau Repository. If you would like these to persist for other workbooks, refer to [Create Custom Color Palettes](#) on page 3021 and [Use custom shapes](#).

If you are trying to copy formatting between sheets, see [Copy and paste worksheet formatting](#).

How Tableau handles duplicate items

When you paste or import sheets from a different workbook, some items might already exist in the destination workbook, or some items might have the same name in both places. If Tableau encounters an exact duplicate item in the Data pane, such as a calculation, it does not paste or import that item into the destination workbook. However, if an item in the Data pane has the same name but is defined differently, Tableau imports and renames it.

Tableau also pastes or imports sheets and data sources with duplicate names—whether only the name is identical, or their names and contents are identical—and it renames the newer copy.

Copy and paste sheets between workbooks

Copying and pasting sheets is a quick way to combine information from different workbooks or create a new workbook. It is also useful workaround to [replace a data source](#) for a single sheet rather than all sheets that use the data source. You can copy one or more sheets from the tabbed sheet view, filmstrip view or sheet sorter view. Use Shift + click or Ctrl + click to select multiple sheets.

To copy and paste a worksheet using the filmstrip view, do the following:

1. Open a workbook and click the **Filmstrip** button in the status bar.



2. Select the thumbnails of the sheets you want to copy, then right-click (Control-click on Mac) and select **Copy**.



Tableau copies the information in the file format (.twb or .twbx) of the workbook.

3. Open the destination workbook, or create a new workbook. Right-click (Control-click on Mac) on the tab for any sheet, and select **Paste**.

Pasted sheets are placed after existing worksheets, dashboards, and stories.

Note: The **Paste** option is not available when the active sheet is a story.

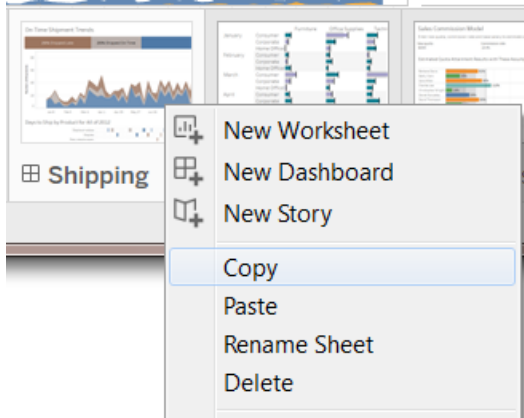
4. Save the changes.

Export and import sheets between workbooks

If you want to extract a subset of information from a larger workbook to maintain as a standalone file, you can export or save selected sheets to a new workbook. You can then import that workbook into an existing one to incorporate its sheets and other objects into the existing workbook.

Note: These steps describe how to share your work among Tableau workbooks. You can also export views to use outside of Tableau. For information, see [Export Views from Tableau Desktop to Another Application](#) on page 3094.

1. Open the workbook that contains the sheets you want to export to a new file.
2. Using the tabbed worksheet, filmstrip view, or sheet sorter view, right-click (Control-click on Mac) the sheet tab or thumbnail view, and then select **Export** to export a single sheet. Use Shift + click or Ctrl + click to select multiple sheets.

3. In the Save As dialog box, specify the file format you want to save (.twb or .twbx), select the location for the new workbook file, give it a name, and then click **Save**.

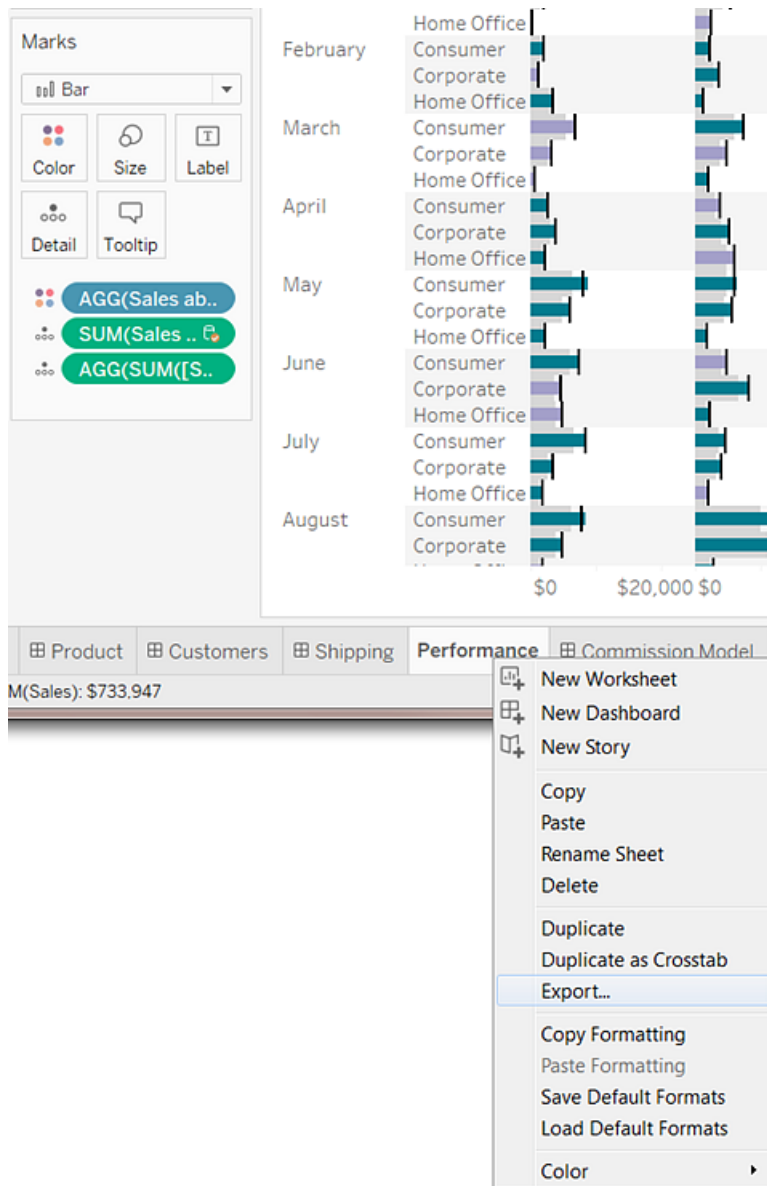

Import an entire Tableau workbook

After you save or export selected sheets to a new workbook (.twb) file, you can import the information into another workbook.

1. With the existing workbook open, select **File > Import Workbook**.
2. Select the workbook that contains the sheets you saved from another workbook, and click **Open**.

The following image shows the result of importing a workbook that contains a sheet with the same name as a sheet in the existing workbook. Tableau adds a number after the name of the imported sheet.

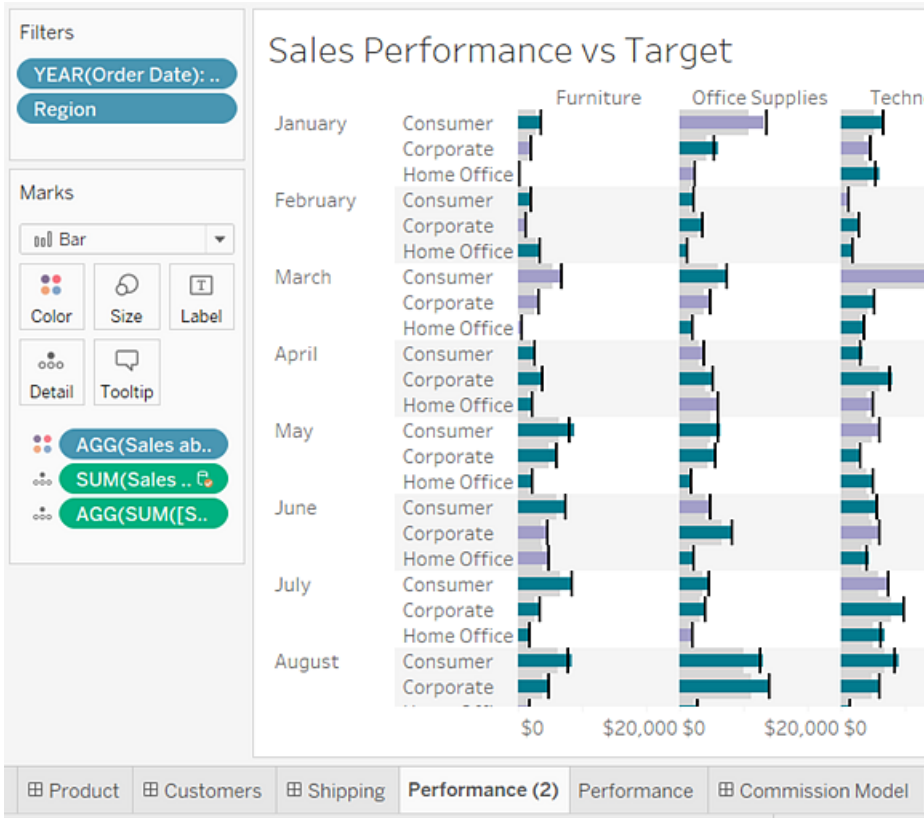

Print Views from Tableau Desktop

Before printing, specify how you want the printed page to look using the Page Setup dialog box. Then print to a printer or PDF.

Set up the page

You can apply different page setup options for each worksheet in a workbook. For example, worksheets can print with titles showing or hidden, with unique page orientation, and more.

To begin, select **File > Page Setup**.

General settings (available for individual sheets, not dashboards)

- **Show** - Show or hide the title, view, caption, color legend, shape legend, size legend, and map legend.
- **Headers and Breaks** - Control the appearance of these table elements.
 - Repeat headers and legends on each page - adds table row and column headers at the top of each printed page when a view breaks across several pages.
 - Break pages on pane boundaries - prevents page breaks in the middle of a table cell.
- **Pages Shelf** - If the view uses the Pages Shelf, specify whether to print the current page or all pages.

Layout settings

- **Legend Layout** - If you include one or more legends, select how you want the legends to appear on the printed page.
- **Margins** - Specify top, bottom, left, and right margins by typing values into the text boxes.
- **Centering** - Optionally, select whether to center the view horizontally or vertically—or both—on the page.

Print Scaling settings

These settings affect only printed documents, not exported images or PDFs. However, the page orientation settings are used as the default when you publish the workbook to Tableau Cloud or Tableau Server.

- **Print Scaling** - Scale a view to fit within a single page or print across multiple pages. Select from the following options:
 - Automatic – Scales the view automatically based on the paper size.
 - Scale to – Scales the view to the specified percentage of its original size.
 - Fit to – Scales the view to fit within the specified area. Select the number of printed pages across and down. For example, if you have a really wide view that is not very tall, you can specify three pages across by one page down.

- **Page Orientation** - Specify how you want the view oriented on the printed page. Select from the following options:
 - Use Printer Setting – Use the page orientation that is already specified by the printer.
 - Portrait – Presents the view so that it is oriented vertically on the printed page.
 - Landscape – Presents the view so that it is oriented horizontally on the printed page.

The following diagram shows the difference between portrait and landscape page orientations.

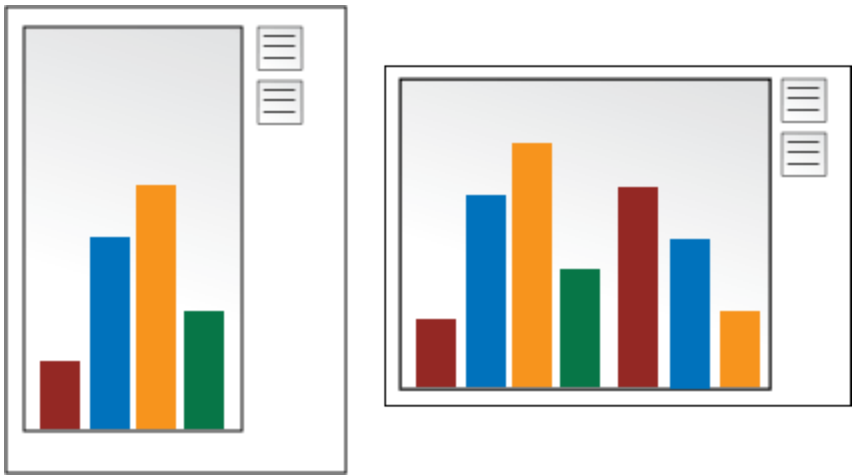

Print a view

After you have configured the [Page Setup](#) settings, select **File > Print**. The following options in the Print dialog box are unique to Tableau.

Show Selections

When this option is selected any selections you've made in the views will be maintained while printing.

Change the Print Range

When you print from a workbook with multiple worksheets, each worksheet represents one or more printed pages, depending on the page setup.

Select from the following print ranges:

- **Entire Workbook** - Prints all the worksheets in the workbook.
- **Active Sheet** - Prints only the sheet currently displayed in the workbook.
- **Selected Sheets** - Prints the selected sheets.

You can select multiple worksheets in a workbook by holding down the CTRL or Shift keys (or the ⌘ key on a Mac) while clicking the worksheet tabs that you want to select.

Print to PDF

Note: If you're using Tableau Cloud or Tableau Server, instead see [Download Views and Workbooks](#) on page 3426 and [Link to a PNG, PDF, or CSV of a View](#) on page 3425.

In Tableau Desktop, you can save views as PDF files rather than printing them as hard copies. You do not need to have Adobe Acrobat installed on your computer.

When you print an individual sheet to PDF, filters in the view are not included. To show filters, create a dashboard containing the sheet and export the dashboard to PDF.

Print to PDF using a Windows computer

1. Specify **page setup** options for each sheet in your workbook.
2. Select **File > Print to PDF**.

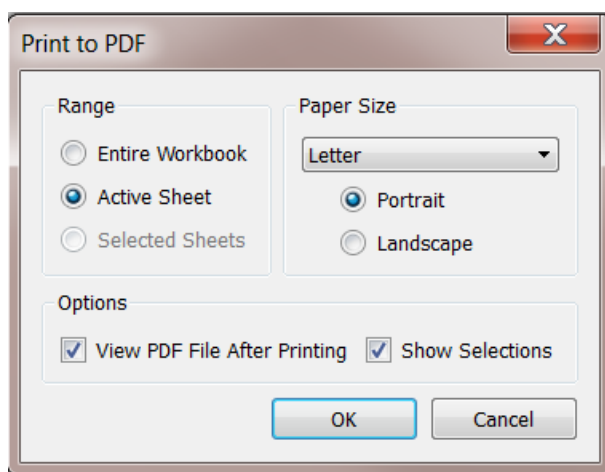

3. In the Print to PDF dialog box, select the print Range:

Tableau Desktop and Web Authoring Help

- Entire Workbook - Publishes all the sheets in the workbook.
 - Active Sheet - Publishes only the sheet currently displayed in the workbook.
 - Selected Sheets - Publishes the selected sheets. To select multiple sheets in a Tableau workbook, hold down the Ctrl key as you select sheet tabs along the bottom of the Tableau workbook.
4. Select a **Paper Size**. If you select Unspecified, the paper size will expand to the necessary size to fit the entire view on a single page.

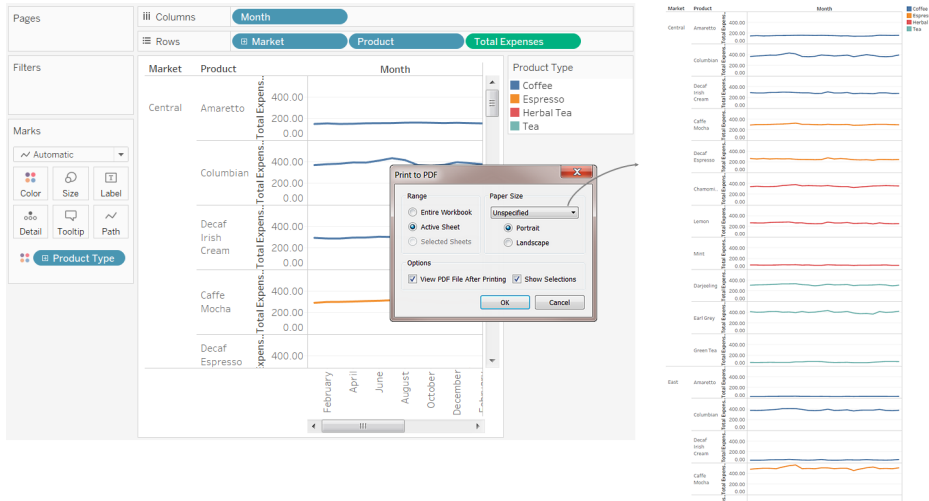

5. Select **View PDF File After Printing** if you want to automatically open the PDF after creating it. This option is only available if you have Adobe Acrobat Reader or Adobe Acrobat installed on your computer.
6. Select whether to **Show Selections**. When this option is selected the selections in the views are maintained in the PDF.
7. Click **OK** and specify where you want to save the PDF. Then click **Save**.

Print to PDF using a Mac computer

1. Specify **page setup** options for each sheet in your workbook.
2. Select **File > Print**.
3. In the Print dialog box, click **Show Details** to select a print range:
 - Entire Workbook - Publishes all the sheets in the workbook.
 - Active Sheet - Publishes only the sheet currently displayed in the workbook.

- Selected Sheets - Publishes the selected sheets. To select multiple sheets in a Tableau workbook, hold down the Command key as you select sheet tabs along the bottom of the Tableau workbook.

4. Click **PDF > Save as PDF**.

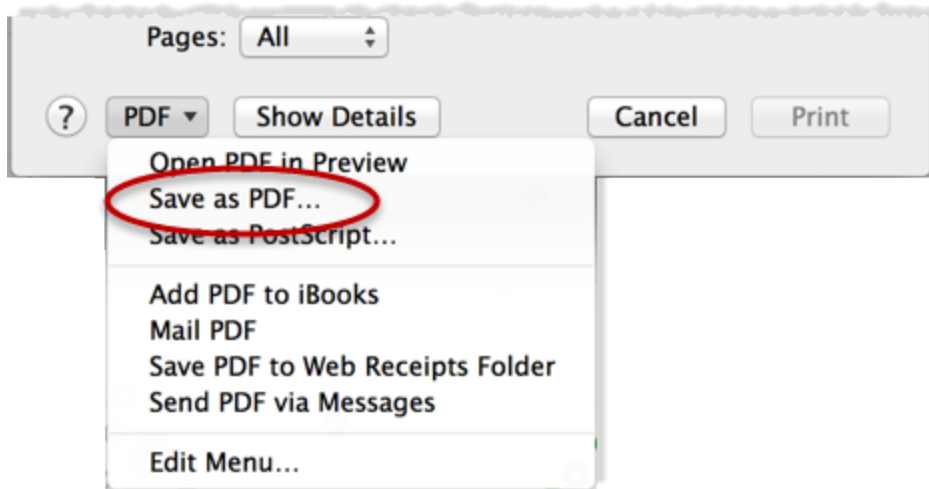

5. Specify where you want to save the PDF , then click **Save**.

Publish Data Sources and Workbooks

Suppose you create a view that exposes a new range of questions in the data you're using, and you want to share this analysis with other people using this data. Or maybe you are your team's Data Steward, in charge of building the data models approved for use by analysts, and meeting your organization's requirements for security, compliance, performance, and so on.

You can share your work with the rest of your team by publishing it to Tableau Server or Tableau Cloud. After it's published, you and your team can access it through your web browser or the Tableau mobile app. Publishing data sources can also help you to centralize data management.

In other resources

For the steps on how to publish, see the following topics:

- [Publish a Data Source](#) on page 3141
- [Comprehensive Steps to Publish a Workbook](#) on page 3118
- [Upload Workbooks to a Tableau Site](#) on page 3229

Note: If you do not have Tableau Cloud or Server, you can share analysis on Tableau Public, a free cloud service. As the name suggests, views published to Tableau Public are publicly accessible. For more information, see public.tableau.com.

Why publish

You can publish data sources and workbooks when you want to widen the audience for your data analysis within your organization. By publishing you can begin to do the following:

- Collaborate and share with others
Allow people in your organization to view, interact with, download, subscribe to, share, edit, and save published views, even if they do not use Tableau Desktop. Incorporate views into blog posts or websites.
- Centralize data and database driver management

Create and publish data models that everyone can use. Centralized data management allows for sharing a single source for your Tableau data. All workbooks connected to the published data reflect updates to it.

In addition, when you publish and connect to data on the server, people connecting to the data from Tableau Desktop do not need to install and maintain database drivers on their own computers.

- Support mobility

Access your data from a different computer or location, through a web browser or the Tableau Mobile iOS app. Sign in to your organization's Tableau Server from a private network offsite.

What you can publish

Content types you can publish include:

- **Data sources:** You can publish data sources that others can use to build new workbooks. A data source can contain a direct (or live) connection to your database or an extract you can refresh on a schedule.

For information, see [Best Practices for Published Data Sources](#) on page 3135.

- **Workbooks:** Workbooks contain your views, dashboards, and stories, and data connection. You can include local resources, such as background images and custom geocoding, if they reside in a location that the server or other Tableau users cannot access.

Who can publish

To publish to Tableau Server or Tableau Cloud, your server or site administrator must grant you the following capabilities:

- A *site role* of **Creator** (formerly Publisher) on the site you're publishing to.
- **View** and **Save** capabilities set to **Allowed** on the project into which you publish.

If you use Tableau Desktop and are not sure whether you can publish to a server, or you are having trouble publishing, see your Tableau administrator. If you're an administrator, see [Content Access and Ownership](#) in the Tableau Server help (or the [Tableau Cloud version](#)) for more information about site roles and permissions.

Prepare for Publishing a Workbook

When you publish a workbook, you need to make a decisions that determine how others will access the views and the data behind them. You also need to take into account the experience you and others will have of interacting with the views on the server. Before you publish your workbook, use the information in this topic to help you make these decisions and improve the workbook's performance.

Note: If you have a Tableau site administrator, check with them on whether your organization already has publishing guidelines that have already answered these questions.

What makes up a typical published workbook

During the publishing process, you select settings that determine how the pieces that make up the workbook interact with each other. The following image shows a simplified overview of a workbook's structure.

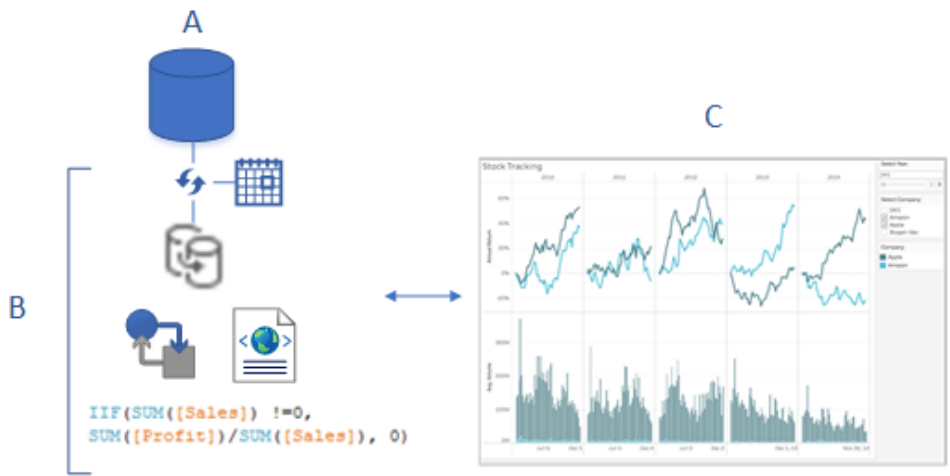

- A. The underlying (original) data that you connected to when you created the workbook. When you publish, you specify whether to include credentials for accessing this data, or whether to require users to enter credentials to access it.
- B. The Tableau data source. This is where the action is. It contains the XML metadata that describes how to access the underlying data (A), field customizations or calculations you made in Tableau, when to refresh the extract if there is one.

In this image, the data is embedded in the workbook, and it contains an extract connection and refresh schedule, some calculations, and so on.

- C. A view showing data from B, which you want to make available for your colleagues to edit or interact with on the server. When you publish, you can select the sheets—which include views, dashboards, and stories—you want to share.

Decide how to access the data and keep it up-to-date

During the publishing steps, you need to answer the following questions about the data connection. For help with the answers, see [Best Practices for Published Data Sources on page 3135](#).

- Will you publish with a live connection to the data, or will you create an extract?

If you publish live connections to Tableau Cloud, see [Authorize Access to Cloud Data Published to Tableau Cloud on page 3154](#).

- Do you want to publish the workbook's connections as separate, standalone Tableau data sources (and then connect the workbook to the published data); or embed the data into the workbook?

Tip: If the workbook already connects to a Tableau data source, you keep the existing connection. That means you've just answered this question.

- Do you want the workbook to show the data when other users open the workbook, or do you want to require them to provide database credentials? (Either way, they must also have access to the site and project you publish to.)

This can be complicated depending on the data the workbook connects to. In many cases, [the simple path to data](#) described below works great. If it doesn't work for you (or you're not sure), see [Set Credentials for Accessing Your Published Data on page 3151](#).

The simple path to data authorization

When you go through the publishing steps, you specify how your workbook users will access the data the workbook connects to. You do this in the **Data Sources** section of the Publish Workbook dialog box.

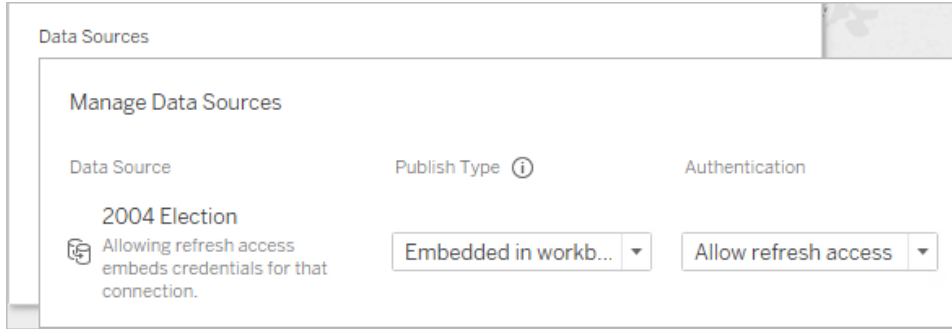

Depending on the connection type, the simple path might work for your environment. You would do one of the following:

For a connection to a Tableau data source: Keep the existing connection and embed the password.

For other data connections:

1. Before you open the Publish Workbook dialog box, create an extract and include only the data you need for the workbook.
2. In the Publish Workbook dialog box, embed the extract in the workbook and select **Allow refresh access**. The latter embeds the credentials in the connection.
3. After you specify remaining settings and click Publish, set up a refresh schedule.

For the complete steps, see [Comprehensive Steps to Publish a Workbook](#) on page 3118.

Scenarios where data authorization requires some extra effort

The simple path doesn't work best for every situation. Some reasons you might need to divert from it include:

- Instead of embedding data into workbooks, your existing policies mandate publishing data sources separately and connecting workbooks to the Tableau published data sources.
This requires a few more steps than embedding the data; however, where there is a choice between the two, publishing data separately and managing it on the server is considered a better practice.
- You added a user filter to enforce row-level security. In this scenario, publishing live connections is more common, and other steps are required to secure the filter.
- You're publishing to Tableau Server, and you use SAP HANA or Impala single sign-on, or your workbook connects to data that can use impersonation-based authorization

(SQL Server or Kerberos-enabled data).

- Other reasons that have to do with your organization's data security or authorization policies, which your IT staff can help you with.

Even if whatever you decide turns out to be not the best path, you can easily correct it by republishing. In some cases, your site administrator can change the settings on the server directly.

Assess the workbook performance and ease of use

Keep performance and interaction best practices in mind as you build workbooks you want to publish. If changes take a long time to display while you're working in Tableau Desktop, they will take as long or longer to display on the server. Simple steps you can take that can have a big impact include limiting the number of marks you add to a view, limiting the number of views you add to a dashboard, and removing unused fields from your data source.

For additional tips, see the following topics:

- [Make Visualizations Faster](#) on page 3066
- [Design for Performance While You Build a View](#) on page 3062
- [Designing Efficient Workbooks](#), starting with "Writing Efficient Workbooks" on page 6. This Tableau white paper requires that you sign in to the Tableau website using a free Tableau ID. This is the same ID you use for the Tableau community forums.

Simple Steps to Publish a Workbook

When you want to share a workbook with your colleagues, you can publish it to Tableau Server or Tableau Cloud with a few simple clicks. There, other people can view it, interact with it, and even edit it if their server permissions allow.

Before you publish your workbook, make sure you know the following:

- The name of the server and how you sign in to it. If your organization uses Tableau Cloud, you can click the Quick Connect link.
- Any publishing guidelines your Tableau administrator might have, such as the name of the project you should publish to.

Publish your workbook

1. With the workbook open in Tableau Desktop, click the **Share** button in the toolbar.



If you aren't already signed in to Tableau Server or Tableau Cloud, do so now. If you don't have a site yet, you can create one on Tableau Cloud.

2. In the Publish Workbook dialog box, select the project to publish to.
3. Name the workbook according to whether you're creating a new one or publishing over an existing one.
4. Under Data Sources, select **Edit**. For **Authentication**, select **Allow refresh access** or **Embed password**.

For some data connections, only one authentication option appears. If **None** shows, leave it set to that.

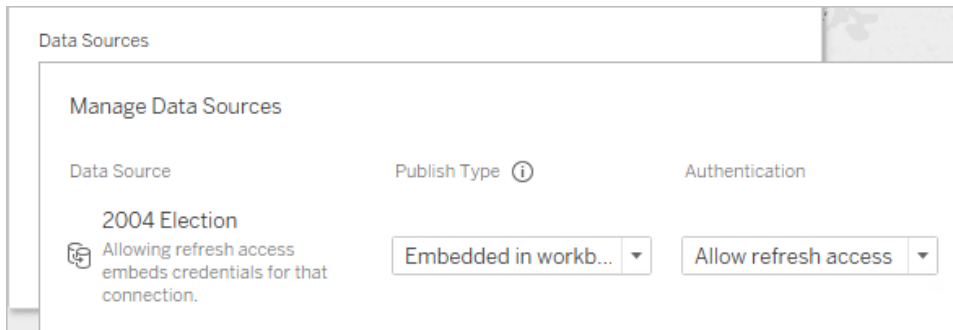

1. Click **Publish**.

If this is your first time publishing a workbook, test it on the server and work out any glitches before letting other users know the workbook is available.

For more details, see these topics:

- [Comprehensive Steps to Publish a Workbook](#) on the next page
- [Publish a Data Source](#) on page 3141
- [Set Credentials for Accessing Your Published Data](#) on page 3151

Let others know the workbook is available on the server

1. Make sure your colleagues can access the site and project you published to.
2. Send them [a direct link to your workbook](#).
3. After they sign in, the workbook opens for viewing, interacting, or editing.

Comprehensive Steps to Publish a Workbook

1. In Tableau Desktop, open the workbook you want to publish.
2. Select **Server > Publish Workbook**.

If the **Publish Workbook** option doesn't appear on the **Server** menu, make sure a worksheet or dashboard tab is active (not the Data Source tab).

If necessary, sign in to a server. For Tableau Cloud, enter <https://online.tableau.com>. For more information, see [Sign in to Tableau Server or Tableau Cloud on page 193](#).

3. In the **Publish Workbook** dialog box, select the project, enter a name for the workbook, and add search tags.

Tags help users find related workbooks when they browse the server. Separate tags using a comma or space. To add a tag that contains a space, put the tag in quotation marks.

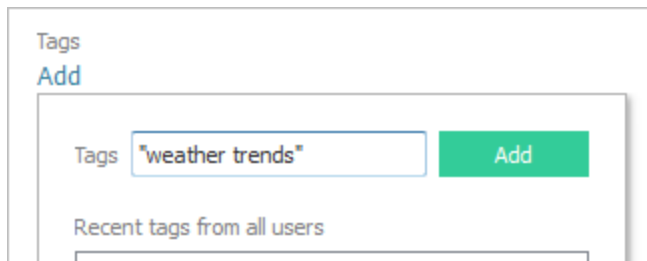

4. For **Permissions**, accept the default project settings.

Generally, a site admin manages permissions on the server. If you think your workbook is an exception, work with your administrator to determine the best course of action. See [Set Permissions as You Publish a Data Source or Workbook on page 3148](#).

5. For **Data Sources**: select **Edit** to change whether the data is embedded in the workbook or published separately, or how people authenticate with data sources.
 - If you're publishing an extract and want to set up a refresh schedule, you must select **Embed password** or **Allow refresh access**.

- If your workbook connects to a Tableau data source, we recommend embedding the password. If you instead choose to prompt users, they need extra permissions on the data source.

For more information, see [Set Credentials for Accessing Your Published Data on page 3151](#).

6. Configure **Variable publishing options** below that are available for this workbook.
7. Click **Publish**.
8. (Optional) Set up a refresh schedule for each extract you published.

The publishing workflow guides you through these steps. For some data types you publish to Tableau Cloud, the publishing process starts Tableau Bridge on your computer.

For more information, see [Schedule Extract Refreshes as You Publish a Workbook on page 3164](#).

Variable publishing options

The following options appear when they're appropriate for the workbook.

Show or hide sheets

By default, Tableau Desktop publishes all sheets in a multiple-sheet workbook. In the **Sheets** section of the Publish Workbook dialog box, you can specify which sheets to include. Hiding sheets is useful when you want to publish a dashboard or story without showing the worksheets that were used to create it.

Important: Hiding sheets isn't a security measure. Anyone who has the **Download Workbook/Save a Copy** capability can access the hidden sheets. Other editing permissions can also allow access to hidden sheets. For more information, see [Content Access and Ownership](#) in Tableau Server Help.

Show sheets as tabs

If you select multiple sheets to show, you can specify how users navigate them.

- Select the **Show Sheets as Tabs** check box to provide tab-based navigation.

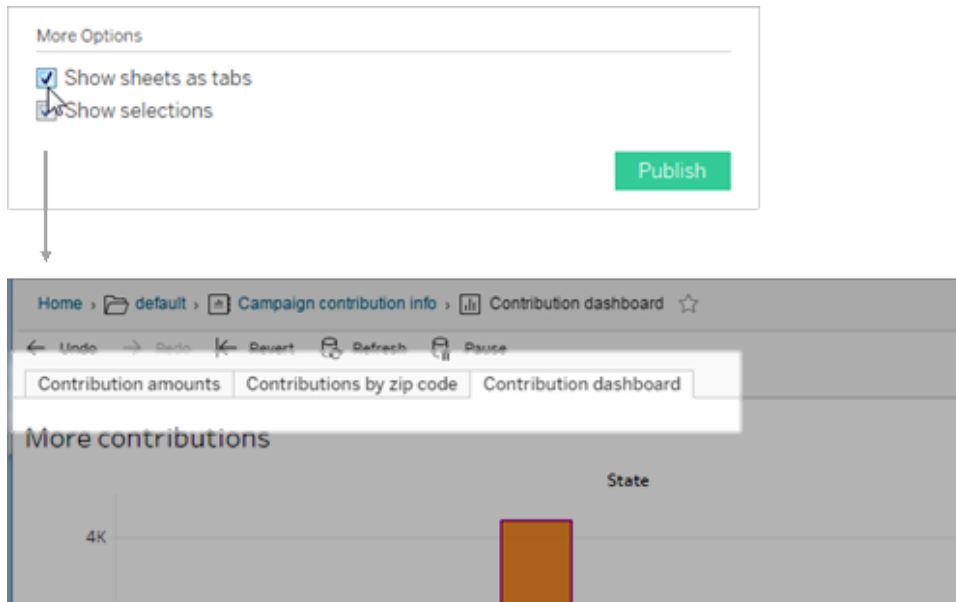

- Clear the check box to allow people to open only one view at a time.

How sheet tabs are configured also impacts permissions. When a workbook shows sheets as tabs, workbook-level permission rules are applied to the sheets. When the sheets aren't shown as tabs, any changes made to workbook permissions don't apply to the individual sheets (aka views). View-level permissions must be set independently. See the [Set Content Permissions](#) tab in the [Permissions](#) topic for more information.

Show selections

Use Show Selections to highlight a particular portion of the view when others open the workbook. Make your selections in Tableau Desktop before you start the publishing process.

Include external files

In general, if your views contain information that isn't available on the server, you can use **Include External Files** during publishing. With this option, you can include a local flat file. However, the availability of this option depends on whether you're publishing to Tableau Server or Tableau Cloud.

For Tableau Server

If you're publishing content that references data or images on a mapped drive, you can select the **Include External Files** when you publish. Alternatively, you can change the connection

information so that the workbook references the UNC path to the data. For example, you could change **D:\datasource.xls** to **\\filesrv\datasource.xls**.

For Tableau Cloud

You can publish a workbook connected to on-premises data, such as Excel or text private network data, such as Excel files and SQL Server data, which Tableau Cloud can't connect to directly. Check to see if the connections in the data source are supported by Tableau Bridge. For more information, see [Supported Connectors](#).

Do one of the following:

- If all the connectors are supported by Tableau Bridge, you can ignore the **Include External Files** check box, but you must use Bridge to keep the data fresh. For more information, see [Use Tableau Bridge to Keep Tableau Cloud Data Fresh](#).
- If one of the connections in the data source isn't supported by Tableau Bridge, you can select the **Include External Files** check box. Tableau Cloud can then refresh the data that can be connected to directly. File-based data can't refresh and its data remains static in this case
- For flat files (Excel, .csv, .txt), you can skip checking Include External Files. A shadow extract is created and the view should display properly.

Preview device layouts

To see how your designs appear on mobile devices, click **Preview device layouts** in the browser when publishing is complete. Then choose a device type above the viz, and a specific dashboard from the menu at the right.

If you don't like a device preview, open the workbook in Tableau Desktop, [adjust device layouts](#), and republish.

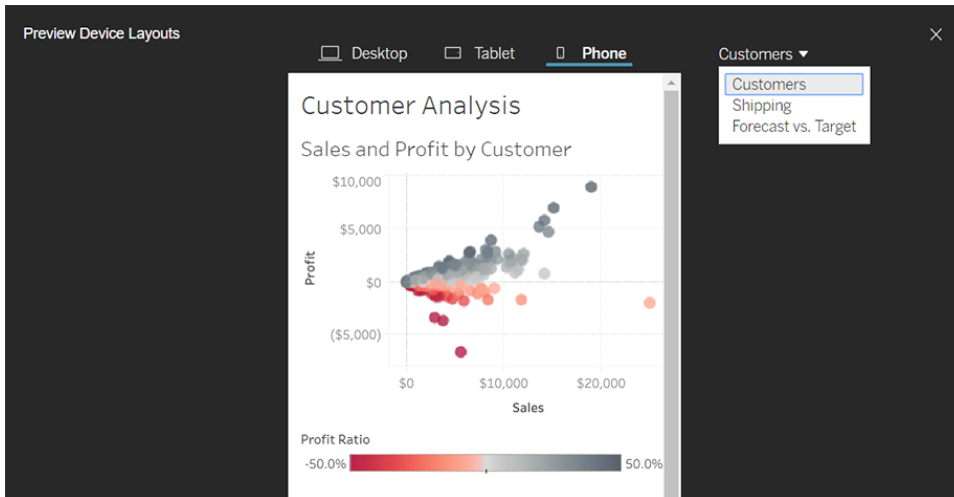

Choose how to generate thumbnails for workbooks with user filters

On the server, users can browse Tableau content with a thumbnail view. These thumbnail images are based on workbook sheets. If your workbook contains user filters, you can specify which user's filter to use when creating the thumbnails. For example, if you want the thumbnail to show all regions of a sales forecast, generate thumbnails based on a user who can see all regions.

In the following scenarios, a generic image appears in place of the view thumbnail.

- The user you select doesn't have permission to see the data.
- The data is from a Tableau Server data source that uses data source filters, user calculations, impersonation, or other user references.

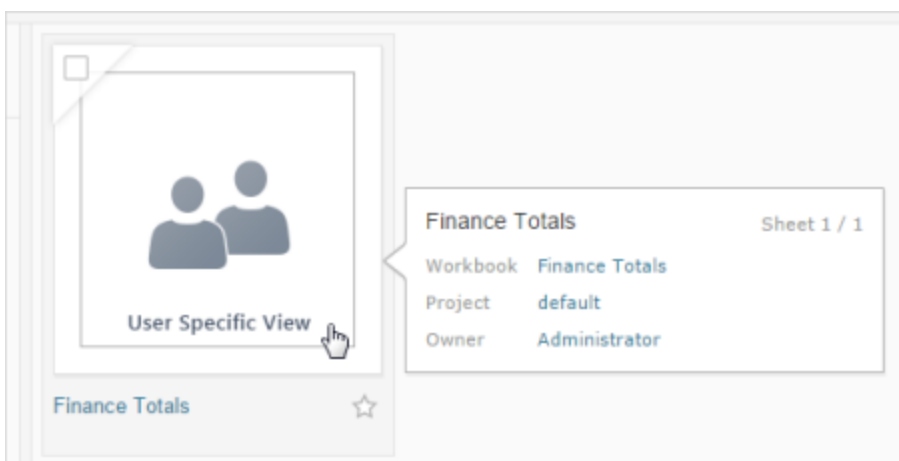

To learn more about user filters, see [Restrict Access at the Data Row Level](#) on page 3165.

Publish Views to Salesforce

Bring your views from Tableau Cloud or Tableau Server right to your Salesforce ecosystem by publishing views to a CRM Analytics app or Salesforce Lightning page.

For more information, see [Publish Tableau Content to CRM Analytics](#) in Salesforce Help.

Prerequisites

See a complete list of [prerequisites](#) in Salesforce Help, including required licenses, account setup, and permissions.

Publish a view to Salesforce

Select one or more views, including dashboards, sheets, and stories. Then, choose a destination from a list of CRM Analytics apps that you have access to edit or manage.

1. Select the view that you want to publish to Salesforce.

Note: You can select a maximum of 25 views at a time to publish to Salesforce.

2. For **Actions**, select **Publish to Salesforce**.
3. Select the Salesforce credentials that you want to use for publishing.
4. Select the destination app that you want to publish to. You can only see apps that you can edit or manage with the signed-in Salesforce user.

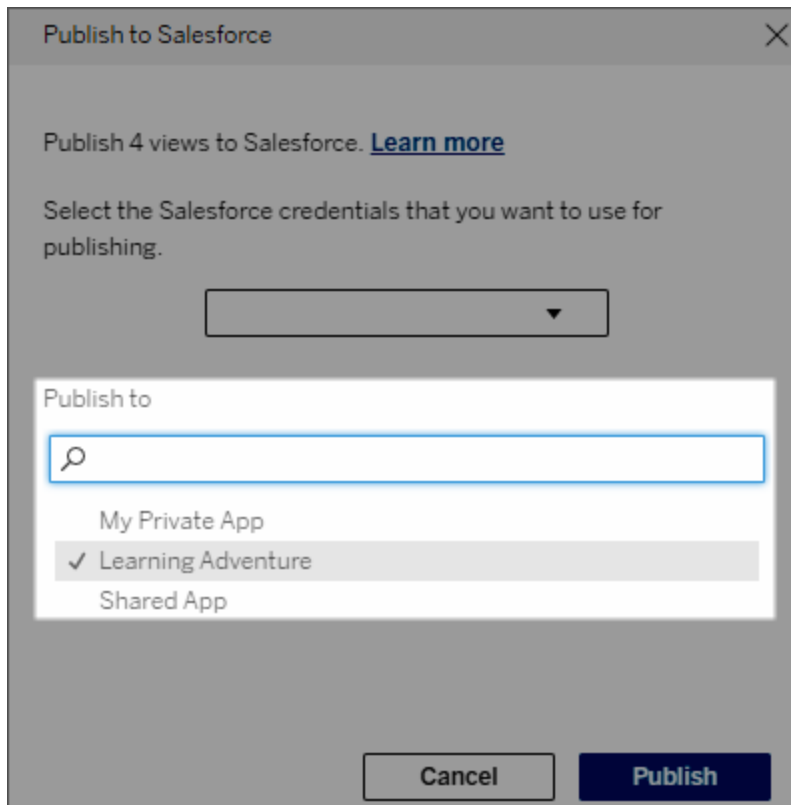

5. Click **Publish**.

Who can see the published view in Salesforce?

When you publish a view to Salesforce, anyone with access to the selected CRM Analytics app or Lightning page can see that the content exists. However, only those signed in with existing Tableau permissions can see the view.

Visual Segment Creation to Data Cloud

Segmentation enables data analysts to curate relevant portions of data from their analyses in Tableau and seamlessly transfer them to [Salesforce Data Cloud](#). Once in Data Cloud, marketing professionals can use various platforms (such as [Data Cloud for Marketing](#)) to quickly take high-impact steps to boost marketing campaigns with ease.

About segmentation

Overview and examples

Segmentation that starts in Tableau provides a way for analysts to visually explore their audience (typically customers) and send data about relevant portions of the target population to Data Cloud. From Data Cloud, marketers can publish to other Salesforce clouds or platforms for further analysis and action.

To better understand the benefits of segmentation and how it works, let's consider a likely use case. A data analyst reviewing an analysis of data about a recent marketing campaign in Tableau identifies a segment with lower engagement than the overall campaign audience. The data analyst knows this is an important subset of the overall data that the marketing team will want to address. So, the data analyst sends this low-engagement segment to Data Cloud.

From Data Cloud, a member of the marketing team (or marketer) can access the segment to get a filtered view of the campaign data related to the low-engagement group. With a focused snippet of the overall data, it's easier for the marketer to determine the actions they need to take to improve engagement.

With an action plan in mind, the marketer publishes the segment on Salesforce Marketing Cloud or a similar platform where they created the original campaign.

In this example and similar scenarios, the data analyst benefits from the robust analysis capabilities in Tableau while efficiently handing off their findings to the marketer. The marketer benefits from accessing a targeted view of data that's relevant to them that they can manage and send to the marketing tools they're already using. Most importantly, the customers benefit from marketing campaigns that effectively reach them.

Workflow

With segmentation, you can streamline the collaboration between data analysts working in Tableau and marketers working in Data Cloud and connected marketing platforms. The typical workflow looks like:

1. The data analyst uses a viz in Tableau to analyze and identify a subset of the customer data that's relevant, meaningful, and actionable to marketers.
2. The data analyst creates a segment of their audience data from their Tableau viz and sends it to Data Cloud.
3. The marketer accesses the segment from Data Cloud. From there, they create a plan for acting on the segment data, and send it to their activation target. The activation target is

typically a marketing platform or tool that the marketing team uses to manage marketing campaigns, such as [Data Cloud for Marketing](#).

4. The marketer launches the marketing campaign from the activation target, and analyzes the campaign results from their platform of choice.

Learn more

To learn more about segmentation, check out these helpful resources:

- [Segmentation](#) (Salesforce Help) - Get a comprehensive review of segmentation and activation on Data Cloud.
- [Segmentation and Activation module](#) (Trailhead) - Learn how to create, filter, and activate marketing segments with Data Cloud.
- [Segmentation Filter Examples](#) (Salesforce Help) - For common use cases for segmentation and get inspiration for creating your own segments.
- [Data Cloud and the Ethical Use of Data trailmix](#) (Trailhead) - Learn how you can use ethical practices when building marketing segments in Data Cloud.

Requirements for segmentation

License requirements

To create a segment in Tableau, data analysts need a Creator license for Tableau Cloud.

To publish a segment in Data Cloud, marketers need:

- Developer, Enterprise, Performance, or Unlimited Salesforce edition
- Segmentation and Activation add-on license for Data Cloud
- Standard Data Cloud permission set and the appropriate marketing-specific permissions (see [Data Cloud Standard Permission Sets](#) for more information)
- (Recommended) [Data Cloud for Marketing](#), for activating segments
- (Optional) The Ad Audiences add-on license for Data Cloud, for activating segments to advertising platforms

Data requirements

Data sources and connections

To create a segment, your [data source](#) must use a single [direct connection to live data](#) (no extracts) and your viz must use a single data source. Published data sources, multiple

connections, and multiple data sources aren't supported.

Data model configuration

When configuring your data model in Data Cloud, be sure to:

- Connect to a Profile DMO, and have the Profile DMO set as the left-most table in the Data Source tab
- Use only one **primary key**

When configuring your data model in Tableau, be sure to:

- Use a table that's used only one time in the data source
- Only use a single table in the logical layer (multiple logical tables aren't supported)
- Avoid including unions or custom SQL tables
- Only use joins between DMOs that match existing Data Cloud relationships
- Use linear joins between DMOs in which each object is only joined to a single object (rather than joining multiple objects to the same object)

For example, instead of:

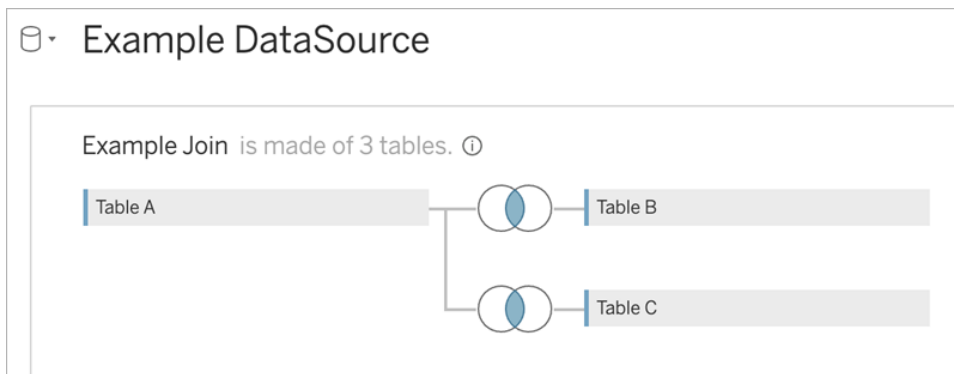

Do this:



- Use join expressions that only include fields (calculations and multiple joins from a single table aren't supported) and the equals operator (other operators aren't supported)

When connecting your data model in Tableau to your data model in Data Cloud, you can recreate any necessary portions of the model using [Tableau joins](#).

Authentication

To create segments in Tableau, you must allow Tableau to connect to Data Cloud using the Salesforce Data Cloud connector. If the Data Cloud connector isn't already configured on your Tableau site, [follow these steps](#).

In the connected app, add the following scopes:

- Perform ANSI SQL queries on Customer Data Platform data (cdp_query_api)
- Manage Customer Data Platform profile data (cdp_profile_api)
- Manage Customer Data Platform Ingestion API data (cdp_ingest_api)
- Perform segmentation on Data Cloud data (cdp_segment_api)

User permissions requirements

To create a segment, work with your Salesforce admin to confirm that you have access to the following application programming interfaces (APIs):

- Write access for the [Create Segment API](#)
- Read access for the [Data Cloud Metadata API](#)

Field requirements

When you create a segment, use fields in your filters that are either existing database fields (rather than fields created by Tableau), or [groups](#). Fields that are cast to other data types might cause errors.

The following types of fields aren't supported in segment filters:

- Measures with MEDIAN, PERCENTILE, or ATTR aggregations
- Table calculations
- Calculations
- Bins
- Groups based on sets, calculations, or combined fields
- Tableau-generated fields, such as:

- Metadata fields (measure names/values)
- Generated map-related fields (latitude and longitude)
- Table type fields (count of object or logical table)
- Calculated insights
- Clusters

Filter requirements

When you create a segment, multiple filters are applied based on your configuration. Segment filters can include a combination of data source filters, context filters, view filters, and filters based on your viz selection.

Use quantitative filters for:

- A measure (with or without aggregation)
- A range of dates

Use categorical filters for segments with individual values selected.

The following types of filters aren't supported in segments:

- Categorical filters with a top, wildcard, or condition filter
- Relative to current date filters with anything other than date and year for next/last N
- Relative to current date filters with anything other than date, month, and year for the current period
- Date filters with Month/Day/Year
- Date filters with date truncation
- Date filters with a datetime exact comparison to another datetime

Relative date filters with a specified anchor date are supported.

Create a segment using engagement data

To create a segment from Tableau to Data Cloud using engagement data, you must configure the correct modeling in Tableau using join clauses.

Use joins within a single logical table and join on the same field as defined in the relationships in the Data Model tab in Data Cloud.

For example, to create a segment using Email Engagement data for the Unified Individual in Tableau, configure your data model and map the relationships as shown.

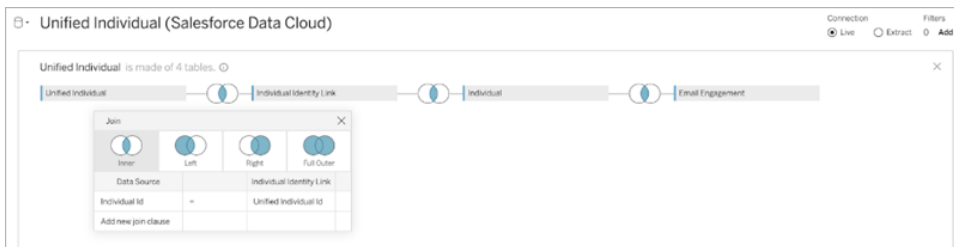

Note: This example is for illustrative purposes only. Data in your Data Cloud instance might use different relationships.

Create a segment in Tableau

1. In Tableau, select the desired portion of the data in your viz, and then right-click and select **Publish Segment to Salesforce**.

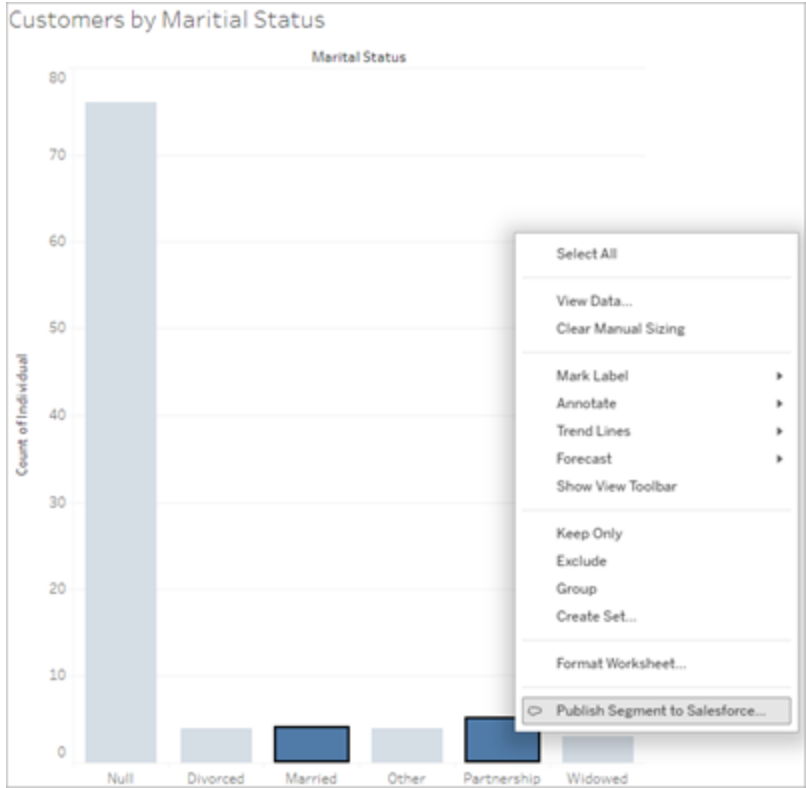

2. Configure your segment in the **Create Segment for Data Cloud** dialog.

Segment name is required. The name must start with a letter and can only contain alphanumeric characters and underscores. The name can't contain consecutive underscores or end with an underscore, and spaces aren't allowed. In Data Cloud, the segment name displays as the name that you specify in the **Segment name** field plus a timestamp of when you create the segment.

When you add filters in the dialog, the filter field names appear under **Rules**.

You can hover over a rule to learn more about it, such as the filter or mark selection that the rule was built on. Multiple rules might filter on the same field, but learning more about a rule's origins can help you identify any duplicates.

As you add each filter, a segment population count displays. The population count represents the count of individual data points (typically customers) who meet your filter criteria. You can use the population count to verify that your segment is working as expected by confirming that the count is the same in Tableau and Data Cloud. Tableau counts all individual records in your viz, but the segment only counts distinct individuals. To

see distinct individuals in a Tableau viz that matches the segment count, use the Count Distinct (COUNTD) aggregated function.

When you add rules, the **Description** is pre-populated with details about them. You can edit the description as needed, but there's a 255 character maximum. A description is optional, but it can make it easier to find the segment in Data Cloud.

3. Click **Create**. When the segment is created, a confirmation message appears with a link to view the segment in Data Cloud.

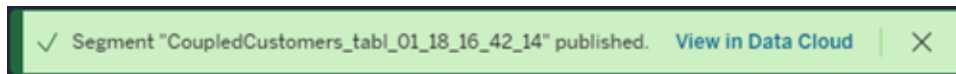

If you receive an error after clicking **Create**, confirm that you meet the [requirements to publish to Data Cloud](#) and [check the status of your organization's Salesforce instance](#).

4. In the confirmation message, click **View in Data Cloud**.

For segments created in Tableau, you can modify the **Segment Name**, **Description**, and **Publish Schedule** in Data Cloud. To do so, click **Edit Properties**.

You can't revise a segment's rules after you publish it. Instead, you must [delete the segment in Data Cloud](#) and create a new one in Tableau.

5. From Data Cloud, your marketing team can [publish the segment to the appropriate activation targets](#).

Make Workbooks Compatible with Older Versions

You can downgrade workbooks to share them with people using older versions of Tableau products.

Important: When you downgrade to an older version, any features or functionality that aren't available in that version are removed for compatibility. Additionally, any calculated fields created in the newer version that use functions unavailable in the older version will have to be manually corrected or removed upon downgrade.

Export to an earlier version from Tableau Desktop

1. In Tableau Desktop select **File > Export As Version** and select the version that you want to downgrade to. (The earliest version you can export is Tableau Desktop 10.5.)

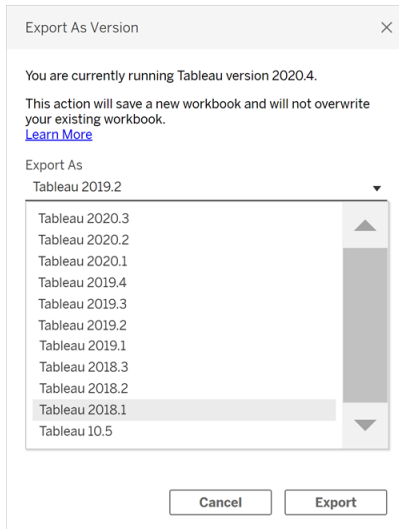

2. Save the workbook to your My Tableau Repository or a selected folder.

Downgrade a workbook when publishing to Tableau Server

If you're using a newer version of Tableau Desktop with an older version of Tableau Server, you can downgrade to the older Tableau Server version when you choose **Server > Publish Workbook**. A warning message appears indicating that workbook will be downgraded when published:

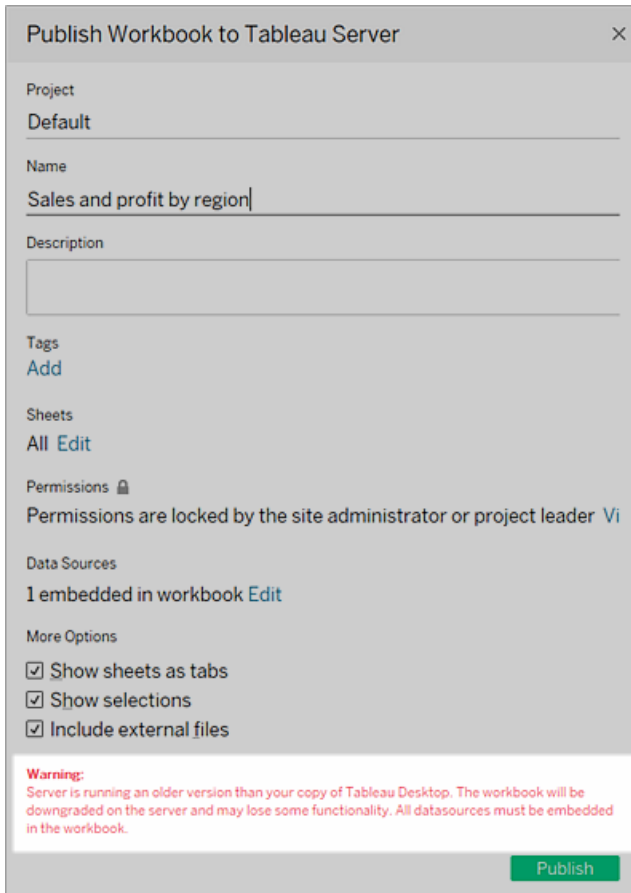

If you later open the downgraded workbook in the newer version of Tableau Desktop, you'll see a message like the one shown below. You may then need to add back the features that were removed when the workbook was downgraded.

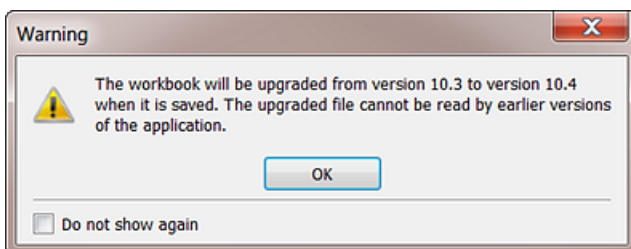

Note: Data sources are not downgraded during publishing.

Download an older version from Tableau Cloud or Tableau Server

If you're using Tableau Cloud or Tableau Server, you can download a workbook to be opened in an older version of Tableau Desktop.

1. To identify which version of Tableau Desktop you're using, select **Help > About Tableau** from the top menu.

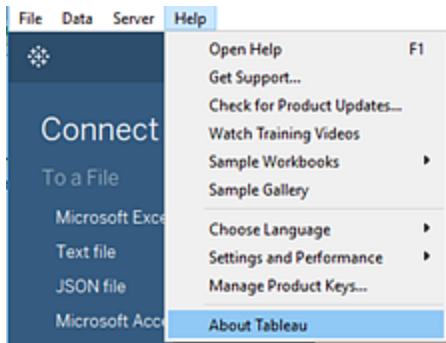

2. In Tableau Server or Tableau Cloud, open the view you'd like to download.
3. Click the **Download** button, and then click **Tableau Workbook**.
4. Select the version that you want to export to. (The earliest version you can download is Tableau Desktop 10.5.)

For more information, see [Download Views and Workbooks](#) on page 3426.

Additional compatibility resources

In the Tableau Deployment Guide, check out [Make Workbooks Compatible Between Versions](#) to learn more about how different versions of Tableau products interact.

Best Practices for Published Data Sources

Publishing data sources to Tableau Cloud or Tableau Server is integral to maintaining a single source for your data. Publishing also enables sharing data among colleagues; including those who don't use Tableau Desktop, but have permission to edit workbooks in the web editing environment.

Updates to a published data source flow to all connected workbooks, whether the workbooks themselves are published or not.

What makes up a published data source

A Tableau data source consists of the following:

The data connection information that describes what data you want to bring in to Tableau for analysis. When you connect to the data in Tableau Desktop, you can create joins, including joins between tables from different data types. You can rename fields on the Data Source page to be more descriptive for the people who work with your published data source.

An extract, if you decide to create one. Guidelines for when to create an extract are included below, as well as in the additional resources.

Information about how to access or refresh the data. The connection also includes access information. Examples of this type of information include:

- The path to an original Excel file.
- Embedded credentials or OAuth access tokens for accessing the data directly.
- Alternatively, no credentials, so that users are prompted to enter them when they want to access the data (whether it's to view a workbook that connects to it, or to connect a new workbook to it).

For more information, see [Set Credentials for Accessing Your Published Data on page 3151](#).

Customization and cleanup that helps you and others use the data source efficiently. When you're working with your view, you can add calculations, sets, groups, bins, and parameters; define any custom field formatting; hide unused fields; and so on.

All of these refinements become part of the metadata contained in the data source that you publish and maintain.

Preparing a data source for publishing

When you publish a data source, consider these best practices:

- Create the connection for the information you want to bring into Tableau and do any customization and cleanup that will help you and others use the data source efficiently.

- If appropriate, create an extract of the data you want to publish. For more information, see the following section, [When to use an extract below](#).
- Develop a data source naming convention.
 - After publishing a data source, you can rename it in Tableau Cloud or Tableau Server. To rename a published data source, choose the **More actions** menu next to the name of your data source. Then, choose **Rename** and enter the new name. You can also use the [Update Data Source REST API](#) to rename a published data source. Be sure to use a well-considered naming convention to help other users of the data deduce which data source to connect to.
 - When a published data source is renamed, all workbooks that use that data source will use the new name after the next data source refresh is complete. Like renaming workbooks, renaming a published data source isn't saved in the revision history of a data source.
 - You can add and edit captions for your data source, but changing the caption doesn't change the name of the underlying published data source. If you edit the underlying published data source name, the caption isn't updated. But don't worry—the correct data source is still referenced. You'll see the updated underlying published data source name in the **Data Source** tab.
- Consider designating the following roles among your Tableau users:
 - A data steward (or team) who creates and publishes the data sources for the Tableau community, which meet your organization's data requirements.
 - A site administrator who manages published content, extract refreshes, and permissions on the server you publish to (Tableau Server or Tableau Cloud).

Central management helps to avoid data source proliferation. Authors who connect to managed data can be confident that the answers they find in it reflect the current state of the business.

When to use an extract

Under the following conditions you might be required or choose to publish an extract instead of connecting live.

Publishing data to Tableau Cloud that it cannot reach directly

Tableau Cloud in the cloud cannot reach data sources that you maintain on your local network. Depending on the connection, you might be required to publish an extract and set up a refresh

schedule using Tableau Bridge.

Some cloud-hosted data sources always require extracts. These include Google Analytics, Salesforce.com, Oracle, OData, and some ODBC data sources. You can set up refresh schedules for some of these data sources directly on Tableau Cloud; for others you use Tableau Bridge.

Web data connector data sources always require extracts. If you connect to the data source using standard user name and password authentication, you can refresh it using Tableau Bridge. If you connect to the WDC data source using OAuth authentication, you will need to use an alternative method to refresh it.

For more about how Tableau Bridge supports both extract and live connections to data Tableau Cloud cannot reach directly, see [Use Tableau Bridge to Expand Data Freshness Options](#) in the Tableau Cloud Help.

Improving performance

Even if the server supports live connections to your data, an extract might make more sense. For example, if the database is large or the connection slow, you can extract a subset that includes only the pertinent information. The extract can be easier and faster to work with than connecting live.

In cases where you can use a live connection or an extract that you refresh on a schedule, you might want to experiment with both options to see which works best for you.

Enabling functionality the data source does not inherently support

For example, suppose you want to use the Median function with SQL Server data.

To learn more about creating data extracts, see [Extract Your Data on page 919](#).

Publishing data separately or embedded in workbooks

You can publish data sources as standalone resources that workbooks connect to, or you can publish workbooks with the data sources included within them.

When you publish a workbook, if any connection specifies anything other than a Tableau data source published to the same project, the data is published as part of the workbook (sometimes referred to as *embedded* in the workbook).

When data is embedded in a workbook:

- Access to the data source is limited to the workbook in which you published it. Neither you nor other users can connect to that data from another workbook.
- You can set up extract refresh schedules as you do for data sources that you publish separately.

Each way of publishing has its advantages. The table below shows a few common points of comparison. It is not a comprehensive list, and these are generalizations. How these and other factors apply to you are specific to your environment.

Published separately	Embedded in workbook
Publishing data sources is a step toward centralizing data management. You can create policies geared toward minimizing data source proliferation and helping people find the right data for the work they do.	Each embedded data source has a separate connection to the data. Each has the potential to show something different than the other at any given time (and data source proliferation is common).
Meant to be shared; becomes available for other Tableau users to connect to.	Data is available only inside the workbook; it is not available for other Tableau Desktop users to connect to.
Without content management and self-service guidelines, seeing a long list of data sources to connect to can be confusing to users who rely on the data to do their work, and is more difficult to manage on the server.	Users create their own connections, and they know exactly what data they're getting.
Someone who changes a shared data source might be uncertain or unaware of the effects that those changes have on connected workbooks.	Changing the data requires opening the workbook, where you can see the result of the change.
Even if effects of data source changes on connected workbooks are planned, updating those connected workbooks is cumbersome.	Same as above; however, if multiple workbooks use similar data and need to be updated, it might be worth connecting to a published data source instead.

Published separately	Embedded in workbook
<p>Extracts can be refreshed on a schedule. You set up one refresh schedule for the extract, and all workbooks that connect to it always show the most current data.</p>	<p>Embedded extracts that aren't refreshed can be useful for showing snapshots in time.</p> <p>If you want to keep the data fresh, each workbook must have its own refresh schedule.</p>
<p>Generally helps you to optimize performance on the server or site.</p>	<p>Performance might be affected when the server contains multiple workbooks that connect to the same original data, and each workbook has its own refresh schedule.</p>

Keeping extracts up-to-date

When you publish a data source with an extract, you can refresh it on a schedule. The way you schedule refreshes depends on the data source type and whether you're publishing to Tableau Server or Tableau Cloud.

For more information, see the following topics:

- [Keep Data Fresh](#) on Tableau Cloud
- [Keep Data Fresh](#) on Tableau Server

Additional resources

- [Understanding Tableau Data Extracts](#)

A version-agnostic, three-part series by Gordon Rose on the Tableau blog. It includes an in-depth look at the extract's file structure, guidelines for when to use extracts, and best practices.

- [O Extract, Where Art Thou?](#) and [TDE or Live? When to Use Tableau Data Extracts \(or not\)](#)

Posts by Tableau Visionary Jonathan Drummey on his blog Drawing with Numbers. Includes tips on extracts, explains the different file types, describes different publishing scenarios. (Read the comments, too.)

- [Tableau Extracts—What / Why / How etc](#)

From the blog maintained by The Information Lab, a Tableau Gold Partner.

Disclaimer: Although we make every effort to ensure these links to external websites are accurate, up to date, and relevant, Tableau cannot take responsibility for the accuracy or freshness of pages maintained by external providers. Contact the external site for answers to questions regarding its content.

Publish a Data Source

When you are ready to make a data source available to other users, you can publish it to Tableau Server or Tableau Cloud. If the data source is in a workbook that you published to Tableau Server or Tableau Cloud, you can make it available by saving it, provided it's an embedded Excel or text file. For details, see [Publish a Data Source on the Web on page 3224](#).

Note: If you haven't yet read about best practices for creating data sources and when to create an extract, see [Best Practices for Published Data Sources on page 3135](#).

General publishing steps

The following steps give an overview of the publishing workflow you will use regardless of the type of data or the server you publish to. Below these steps you can find supplemental information for authentication types and [using Tableau Bridge](#).

1. Select **Server > Publish Data Source**.

If your workbook is connected to multiple data sources, select the one you want from the Publish Data Sources submenu.

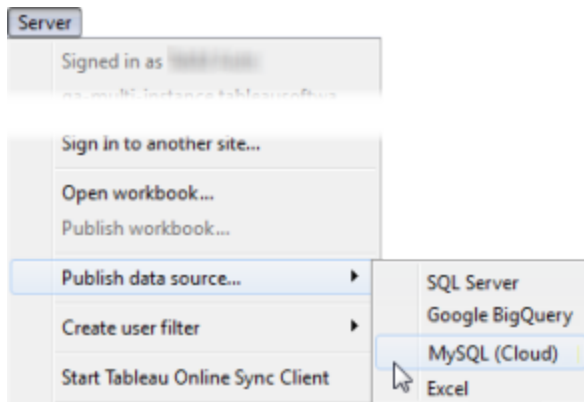

2. If you're not already signed in to Tableau Server or Tableau Cloud, sign in now.

How you sign in depends on how your administrator has set up your environment. For information, see [Sign in to Tableau Server or Tableau Cloud on page 193](#).

3. In the **Publish Data Source** dialog box, do the following:

- For **Project**, select the project you want to publish to and enter the data source name.
- For **Description** and **Tags**, add a description and tags that will help you and other users find it.

Separate tags using either a comma or a space. To add a tag that contains a space, put it in quotation marks (e.g., "Sales Quotes").

- For **Refresh Schedule**, if publishing an extract, you have the option to select a refresh schedule to ensure that your extract data stays fresh. If you choose not to select a schedule here, you can select a schedule from Tableau Server after publishing.

Note: This option is not available when publishing from the Data Source page or to Tableau Cloud.

- For **Permissions**, accept the default project settings.

Generally a site administrator manages permissions on the server. If you think your data source is an exception, work with your administrator to determine the best course of action, and see [Set Permissions as You Publish a Data Source or Workbook on page 3148](#).

- For **Authentication**, if you need to provide credentials to access your data, you can specify how authentication should be handled when the data is published to

the server.

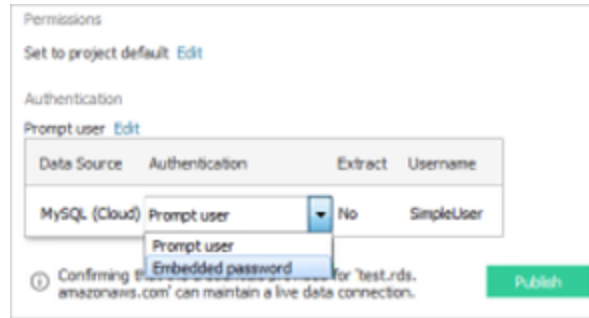

The options available for accessing the data source depend on the type of data you publish and whether you are publishing to Tableau Server or Tableau Cloud.

Information appears at the bottom of the dialog box to let you know whether you need to take further action, such as adding Tableau Cloud to your data provider's authorized list.

For information about the authentication types, see [Set Credentials for Accessing Your Published Data](#) on page 3151.

4. If you are publishing file-based data that is on a Windows mapped drive, or using images that will not be available from the server, select **Include external files**.

When you include external files, copies of the files are put on the server as part of your data source. Copies of files are also put on the server and included as part of the data source when you publish extracts of multi-connection data sources that contain a connection to file-based data such as Excel. For more information about the implications of publishing extracts of multi-connection data sources, see [Join Your Data](#) on page 791

If you do not want to publish the external files to the server, change the connection information so that the data source references a full UNC path. For example, rather than connecting to D:\datasource.xls, you would connect to \\filesrv\datasource.xls.

5. By default, during the publishing process, Tableau updates the workbook connection to use the new published data source. It also closes the local data source.

To continue using the local data source instead, clear the **Update workbook to use the published data source** check box.

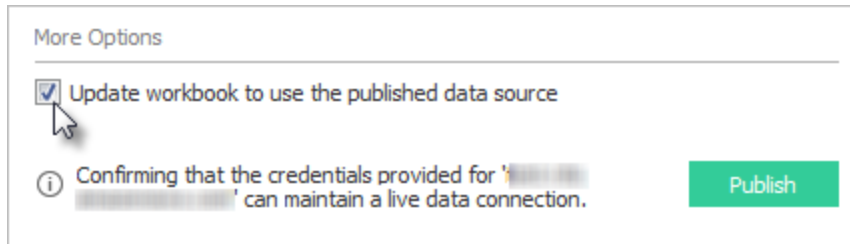

Note: If you select **Undo** after publishing the data source, Tableau will revert to using the local data source, but the data source will remain published. In addition, Tableau does not replace a local data source when you publish a cube (multidimensional) data source to Tableau Server. (Tableau Cloud does not support publishing cube data sources.)

6. Click **Publish**.

After publishing is complete, your web browser opens Ask Data for the data source, where you can ask questions to automatically create vizzes. For more information, see [Automatically Build Views with Ask Data on page 1005](#).

7. (Optional) Set up a refresh schedule on the server. For more information, see the following topics:

- [Schedule Refreshes on Tableau Server](#)
- [Schedule Refreshes on Tableau Cloud](#)
- Schedule Refreshes Using Tableau Bridge - see the section below.

Publish on-premises data (Tableau Cloud only)

To keep data sources that connect to on-premises data fresh after publishing to Tableau Cloud, Tableau Bridge is required. Tableau Cloud relies on Bridge to facilitate the connection between it and data accessible only from inside a private network.

As part of the publishing process, Tableau Cloud will automatically detect if Bridge is needed. If Bridge is needed, your publishing workflow might differ from the publishing process described above.

Refer to one of the following topics depending on the type of data source you're publishing:

- If publishing a data source that uses an extract connection, see [Set up a Bridge Refresh Schedule](#) in the Tableau Cloud Help. If publishing a data source that connects to a private

cloud database, see [Set up schedules for private cloud-based data sources](#).

- If publishing a data source that uses an live connection, see [Publish a Bridge Data Source with a Live Connection](#) in the Tableau Cloud Help. If publishing a data source that connects to a private cloud database, see [Publish private cloud-based data sources](#) to ensure Bridge is used to facilitate the data freshness tasks.

Publish with a Web Data Connector

To publish a web data connector data source, you need to *import* the web data connector to the server before you can set up a refresh schedule. You can do this only on Tableau Server.

You can refresh some web data connector data sources on Tableau Cloud, using Tableau Bridge.

For information, see [Web Data Connectors in Tableau Server](#) in the Tableau Server Help or [Connectivity with Tableau Bridge](#) in the Tableau Cloud Help.

Hidden fields in workbooks

Workbooks connected to a published data source respect the state of hidden fields in the published the data source.

- If you create a new workbook that uses a published data source with hidden fields, those fields remain hidden in the workbook and cannot be used in calculations, sets, groups, and other object creation.
- If you work with an existing workbook that uses a published data source with hidden fields, those hidden fields are displayed in red in the workbook to indicate that the fields, and therefore the views and calculations that use those fields, are invalid.

You can address this issue in one of the following ways:

- Show (unhide) the relevant fields in the data source, and then republish the data source.
- Update the relevant workbooks to exclude the hidden fields.

For information, see [Hide or Unhide Fields](#) on page 1061.

See also

- [Keep Data Fresh](#) (Tableau Cloud)
- [Data Sources](#) (Tableau Server)

Edit a Published Data Source

Imagine that you've published a data source, and your team is using the data source across a number of workbooks. This is a good start, but you have some changes in mind that will make your data source great. Before you implement these changes, you want to see how your proposed changes look in Tableau. And most importantly, you need to test your changes to ensure they won't negatively impact any existing workbooks that use the data source.

Editing a published data source allows you to test changes and make improvements to your data source while maintaining it as a single source of data.

Note: Only users with a site role of Creator can edit publish data sources in the browser.

Edit and test changes

Whether you're creating a new published data source or editing an existing published data source, you can create joins and edit the schema from the Data Source page without leaving your browser. Then use the Scratchpad to test your changes, create folders, organize hierarchies, and rename fields and aliases before publishing your data source. While editing your data source, you'll have all the same features and functionality that you have when authoring in Tableau Cloud. For more information, see [Web Authoring and Tableau Desktop Feature Comparison](#).

To edit a published data source:

1. From the Start or Explore page, navigate to the data source you want to edit.
2. Click **Edit Data Source**.

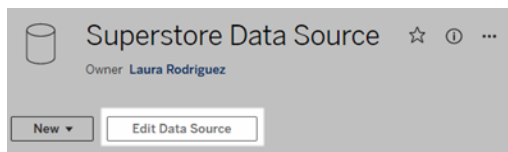

3. Click the **Data Source** page to make joins or edit the schema.

4. Click the **Scratchpad** sheet.
5. From the **Data** pane, create folders, organize hierarchies, rename fields and their aliases, or update metadata that are saved with the published data source.
6. Drag and drop fields onto the scratchpad to make sure your changes are working as expected.
7. Click **Publish**.

Just like you can with workbooks, you can also **Publish As** if you want to make a copy of the data source.

Note: Personal Spaces don't support published data sources.

Roll back changes

To revert to the last version of the published data source:

1. Navigate to the data source that you want to revert.
2. Click **File**.
3. Choose **Revert to Published**.

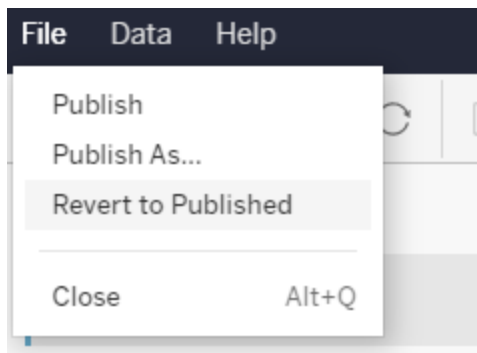

This reverts to the latest published version of that data source.

Understand supported connections

Editing published data sources doesn't support:

- Tableau Bridge connectors in Tableau Cloud.
- Data sources that use embedded passwords in Tableau Cloud and Tableau Server.

Also, the Data Source page isn't available for published data source connection types that aren't supported, including but not limited to .hyper file types. To see which connection types are supported, see [Creators: Connect to Data on the Web on page 3213](#).

Learn about permissions

To edit a published data source, you'll need a Creator license that has Save or Save As permissions for data sources in the respective folder. For more information, see [Permissions](#).

Edit data sources published by a flow

If you make edits to a data source that was published by a flow, the changes will be overwritten during the next scheduled flow. Instead, edit the data source in the flow. For more information, see [Publish a Flow to Tableau Server or Tableau Cloud](#).

Set Permissions as You Publish a Data Source or Workbook

As the publisher of a workbook or data source, you may be able to set permissions as part of the publishing process. Permissions allow or deny other users access to published content on Tableau Server or Tableau Cloud. For example, who can interact with views in a workbook, download a copy of a data source, and so on.

Note that permissions are different than access to the data source. Accessing some data types requires signing in using a database name and password or embedding database credentials into the connection. For information, see [Set Credentials for Accessing Your Published Data on page 3151](#).

When possible, it is best to use the default permission rules for the project where you are publishing your content. If you are publishing to a [locked project](#), you won't be able to modify the permissions. But if you are publishing content into a customizable project and there is a reason your content should have unique permissions, you can set permission rules during publishing.

About setting permissions during publishing

When you start the publishing process, the dialog box shows the permissions that will be applied. By default, the content you publish follows the permission rules of project you are publishing to.

Publish data source to Tableau Online

Project
Default

Name
Sample - World Bank Indicators

Description

Tags
Add

Permissions
Same as project (Default) Edit

More Options

Update workbook to use the published data source

i Requires creating an extract on publish. **Publish**

When you change permissions in the publishing dialog box, you are setting unique permission rules for the content you're publishing. This means changes to the permission rules for the project will not impact your content. Depending on your environment, this might be as you intend, or it might conflict with the guidelines your administrator has set and have unintended consequences.

Tips for deciding whether to set permissions on content

- **Learn your organization's practices**

Consult with your Tableau administrator to learn the guidelines for your organization. It's common (and recommended) practice for an administrator to lock permissions to the project. If you work in such an environment, you will not be able to set unique permissions for your content. And be aware, even if you set permissions during publishing, the person who manages permissions on the server might change these settings afterward.

- **Know the consequences of setting explicit permissions**

In addition to the potential conflicts described earlier, unique permissions on some content requires extra maintenance to keep track of which content has exceptions, and which exceptions are applied.

- **Publish quickly by accepting the default permissions settings**

If necessary, you or your administrator can update permissions on the server afterward, where you have a more comprehensive view into the effects of your changes.

How to set permissions during publishing

1. In the publishing dialog box, next to the summary that indicates the current settings, click **Edit**.

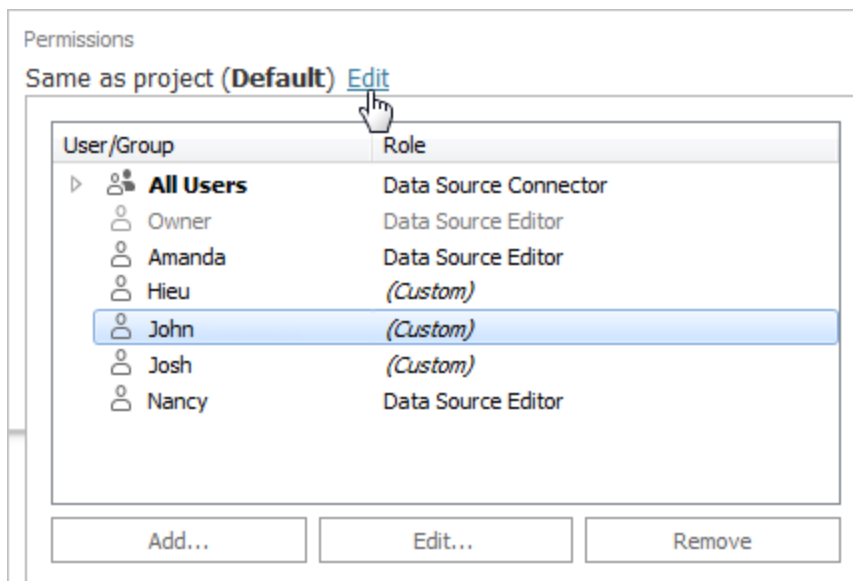

2. In the popup that appears, do one of the following:
 - To set custom capabilities or assign a role explicitly, select an existing user or group and click **Edit**, or click **Add**.
In the **Add/Edit Permissions** dialog box, make your changes.
Click **Apply** to save changes and keep the dialog box open to configure another user or group. Click **OK** to close the dialog box.
 - To remove a permission rule, select the user or group, and then click **Remove**.

Assign permission templates

When you publish content, you can assign any of the following **templates** to a selected user or group:

- **View:** Allows the user basic access to the content, such as filtering a workbook or connecting to a data source.
- **Explore:** Allows the user all capabilities from the View template as well as additional functionality, such as web editing a workbook or downloading a data source.
- **Publish:** Allows the user the ability to overwrite the content (such as via web editing and saving over the original). This will also give them ownership of the content.
- **Administer:** Allows the user the ability to manage the content, such as deleting it and setting permissions.

Set Credentials for Accessing Your Published Data

When you publish a workbook to Tableau Cloud or Tableau Server, you can publish the data source it connects to as part of the workbook (*embedded* into the workbook), or as a separate, standalone data source. In addition, if the data source you're publishing requires authentication, you can customize how credentials are obtained.

The type of authentication to your data source is independent of how people sign in to your Tableau Cloud or Tableau Server site. For example, to give people direct access to the data in a workbook, you would embed a database user's credentials into the data source's connection. But anyone viewing the workbook would still need to be able to sign in to the site on Tableau Cloud or Tableau Server to open your workbook.

This topic describes how to set authentication on data connections as part of the publishing process.

Note: This topic doesn't apply to connections to that don't require authentication, such as text files or Excel files.

Set the authentication type

For many types of connection you can embed a database user's name and password, or use single sign-on (SSO). Specific exceptions are described later in this topic.

The following steps describe how to set authentication as part of publishing a data source or workbook. You can do this for each connection in the data source.

1. In the Publish Workbook dialog box, go to the **Data Sources** area, which lists the workbook's connections, and select **Edit**.
2. In the **Manage Data Sources** popup, after you decide whether to publish the data source separately or as part of the workbook, select an authentication type for each connection in the data source. The available authentication types depend on the connection type, and they can include one or more of the following:
 - **Prompt user:** Users must enter their own database credentials to access the published data when the view or workbook loads.
 - **Embedded password:** The credentials you used to connect to the data will be saved with the connection and used by everyone who accesses the data source or workbook you publish.
 - **Server run as account:** A single Kerberos service account is used to authenticate the user. On Windows this is the account that Tableau Server runs as. On Linux it can be any Kerberos account.
 - **Viewer credentials:** The viewer's credentials are passed through to the database using SSO (usually Kerberos).
 - **Impersonate with embedded account or Impersonate with server Run As service account:** Impersonation using embedded credentials connects with the embedded credentials and then switches to the viewer's identity (only for databases that support this). Impersonation using the Run As service account is similar but first, connects with the Kerberos service account before switching to the viewer's identity.
 - **Refresh not enabled or Allow refresh access:** These options appear when you publish an extract of cloud data such as from Salesforce, and database credentials are needed to access the underlying data. **Allow refresh access** embeds the credentials in the connection, so that you can set up refreshes of that extract on a regular schedule.

Important: How you want to keep extracted data fresh is also a factor:

- If you want to set up an automatic refresh schedule, you must embed the password in the connection.
- If you're publishing a cloud data connection to Tableau Cloud, the publishing steps alert you if you must add Tableau Cloud to the data provider's authorized list.
- You can't publish an extract that's created from a Kerberos-delegated, row-level-secure data source.

Dropbox, OneDrive connections

For Dropbox and OneDrive, when you publish a data source or workbook and select **Embedded password**, Tableau creates a saved credential and embeds it in the data source or workbook.

Workbook connections to Tableau data sources

When you publish a workbook that connects to a Tableau Cloud or Tableau Server data source, rather than setting the credentials to access the underlying data, you set whether the workbook can access the published data source it connects to. Regardless of the original data type, the choice for server data sources is always **Embedded password** or **Prompt users**.

If you select to prompt users, a user who opens the workbook must have **View** and **Connect** permissions on the data source to see the data. If you select embed password, users can see the information in the workbook even if they don't have View or Connect permissions.

Virtual connections

As of Tableau Cloud and Tableau Server 2022.3 and Tableau Desktop 2022.4, when you publish Tableau content like a data source or workbook that uses a virtual connection and select **Embed password** or **Embed credentials**, the viewer of the content will have your permissions to connect to and query the virtual connection. However, any data policies associated with the virtual connection are always evaluated using the viewer's identity—not yours.

For example, you publish a workbook that uses a virtual connection. To let viewers of the workbook connect to and query data by way of the virtual connection, you embed your permissions to connect to and query the virtual connection. Then, any data policies associated with the virtual connection prevent the viewers of the workbook from accessing any sensitive data.

When evaluating whether the tables in a virtual connection can be viewed and accessed, the identity of the content creator is used. However, when evaluating any data policies associated with the tables in a virtual connection, the viewer's identity is used. And the content creator can only ever embed connect permissions to the virtual connection—not edit permissions.

If you choose not to embed permissions, then only users with permissions to access the workbook or data source and with connect permissions to the virtual connection can access the workbook or data source.

The embed password and embed credentials options for virtual connections don't work in Tableau Cloud 2022.2, Tableau Server 2022.1, and Tableau Desktop 2022.3 and earlier. If you select these options before you upgrade to 2022.3 (for Tableau Cloud and Tableau Server) or

2022.4 (for Tableau Desktop), the options will work as expected after you upgrade. Then, you're able to embed your permissions for querying a virtual connection.

See also

- If you publish to Tableau Server, see [Edit Connections](#) in the Tableau Server Help.
- If you publish to Tableau Cloud and the workbook connects to Salesforce, Google Analytics, Google Sheets, Google BigQuery, OneDrive, Dropbox, and QuickBooks Online data, see [Refresh Data Using Saved Credentials](#) in the Tableau Cloud Help.
- If you're a Tableau Server administrator looking for more information about authentication, see the Tableau Server help topics, "Authentication" ([Windows](#) | [Linux](#)) and "Data Connection Authentication" ([Windows](#) | [Linux](#)).

Authorize Access to Cloud Data Published to Tableau Cloud

The information in this topic applies to you if you publish workbooks or data sources to Tableau Cloud that contain live connections to cloud data—for example, Amazon, Google, Salesforce.com.

As a security measure, cloud data providers might require you to supply authorized IP addresses from which external applications request access to your data. A request from an IP address that is not explicitly approved could be rejected. To make sure live connections you publish to Tableau Cloud remain uninterrupted, add Tableau Cloud to your data provider's allowlist.

The table lists IP address ranges Tableau Cloud uses, depending on your site location. You can see its location in the URL that appears after you sign in to Tableau Cloud.

IP addresses are dedicated to and controlled by Salesforce.

Note: In addition to enabling communication over the Tableau Cloud IP range, you might need to enable access over the appropriate database port (for example, 80 or 443) depending on the communication type (HTTP or HTTPS).

Important: From August to December 2024, Tableau Cloud sites will be migrating to Salesforce's [Hyperforce](#), one pod at a time. Because Hyperforce uses different IP addresses, the migration to Hyperforce will require you to update your data provider's allowlist. Going

forward, IP addresses will need to be updated periodically. For more information, see the [New IP addresses \(after Hyperforce migration\)](#) below section below.

For more information about Tableau Cloud's migration to Hyperforce, including when your pod will be moving, see the [Tableau Cloud Migration to Hyperforce](#) knowledge article.

New IP addresses (after Hyperforce migration)

From August to December 2024, Tableau Cloud sites will be migrating to Salesforce's [Hyperforce](#) by pod. After your pod's migration to Hyperforce, your data provider's allowlist will need to be updated to use Hyperforce IP addresses.

IP address process change

Hyperforce IP addresses are updated periodically and will require your data provider's allowlist to be updated. To stay informed about new IP addresses, you have one or both options:

1. **Periodically review the IP address tables below:** At least 30 days before the IP addresses are enabled, the IP address tables below are updated. Site admins will also receive an email notification alerting them of the new IP addresses.
2. **Automate IP address updates using the JSON text file:** Salesforce recommends that your data provider's allowlist mirror the <https://ip-ranges.salesforce.com/ip-ranges.json> text file at all times by automating the IP address updates. New IP addresses are posted to the text file at least 30 days before they're enabled and are denoted by the "Created Date" (in UTC).

In the text file, the IP address and range for your pod are listed by the Hyperforce region that your pod resides in. To determine the Hyperforce region that your pod resides in, refer to the "Pod Name" and the associated "Hyperforce Region Name" in the tables below. For example, if your pod name is "prod-ca-a", your Hyperforce region name is "ca-central-1".

In <https://ip-ranges.salesforce.com/ip-ranges.json> text file, search for "ca-central-1" for the appropriate IP addresses to include in your data provider's allowlist.

Pods migrated to Hyperforce

Pod Name (Host Name)	Location	Hyperforce Region Name	Initial IP Address and Range after Hyperforce Migration
prod-ca-a	Canada - Quebec	ca-central-1	155.226.152.0/23

(prod-ca-a.online.tableau.com)			(Alternatively, search for "ca-central-1" region in https://ip-ranges.salesforce.com/ip-ranges.json)
prod-uk-a (prod-uk-a.online.tableau.com)	Europe - UK	eu-west-2	145.224.200.0/23 (Alternatively, search for "eu-west-2" region in https://ip-ranges.salesforce.com/ip-ranges.json)
useast-1 (us-east-1.online.tableau.com)	US East - Virginia	us-east-1	155.226.144.0/22 (Alternatively, search for "us-east-1" region in https://ip-ranges.salesforce.com/ip-ranges.json)
10AY (10ay.online.tableau.com)	US West - Oregon	us-west-2	155.226.128.0/21 (Alternatively, search for "us-west-2" region in https://ip-ranges.salesforce.com/ip-ranges.json)
DUB01 (dub01.online.tableau.com)	Europe - Germany (formerly Europe - Ireland)	eu-central-1	145.224.208.0/23 (Alternatively, search for "eu-central-1" region in https://ip-ranges.salesforce.com/ip-ranges.json)

Pods not migrated to Hyperforce

Location	Pod Name (Host Name)	Hyperforce Region Name	Initial IP Address and Range after Hyperforce Migration
US East - Virginia	prod-useast-b	us-east-1	155.226.144.0/22 (Alternatively, search for "us-east-1" region in https://ip-ranges.salesforce.com/ip-ranges.json)
US West - Oregon	UW2B	us-west-2	155.226.128.0/21 (Alternatively, search for "us-west-2" region in https://ip-ranges.salesforce.com/ip-ranges.json)
Asia Pacific - Australia	prod-apsouth-east-a	ap-southeast-2	141.163.192.0/23 (Alternatively, search for "ap-southeast-2" region in https://ip-ranges.salesforce.com/ip-ranges.json)
US East - Virginia	prod-useast-a	us-east-1	155.226.144.0/22 (Alternatively, search for "us-east-1" region in https://ip-ranges.salesforce.com/ip-ranges.json)
Europe - Ireland	EW1A	eu-central-1	145.224.208.0/23 (Alternatively, search for "eu-central-1" region in https://ip-ranges.salesforce.com/ip-ranges.json)
Asia Pacific	prod-apnorth-	ap-northeast-	141.163.208.0/23

- Japan	east-a	1	(Alternatively, search for "ap-northeast-1" region in https://ip-ranges.salesforce.com/ip-ranges.json)
US West - Oregon	10AZ	us-west-2	155.226.128.0/21 (Alternatively, search for "us-west-2" region in https://ip-ranges.salesforce.com/ip-ranges.json)

For more information, see one of the following:

- About the Hyperforce migration, see [Tableau Cloud Migration to Hyperforce](#) knowledge article
- About the Hyperforce migration schedule, see the [Schedule for Tableau Cloud Migration to Hyperforce](#) knowledge article

Old IP addresses (before Hyperforce migration)

The IP addresses in the table below only apply if the pod where your Tableau Cloud site resides has not migrated to Hyperforce yet.

For more information, see one of the following:

- About the Hyperforce migration, see [Tableau Cloud Migration to Hyperforce](#) knowledge article
- About the Hyperforce migration schedule, see the [Schedule for Tableau Cloud Migration to Hyperforce](#) knowledge article

Pods and IP addresses (before Hyperforce migration)

Host Name (Pod)	Location	Hyperforce Region Name	IP Addresses or Range
10ax.online.tableau.com	US West -	us-west-2	34.208.207.197

Host Name (Pod)	Location	Hyperforce Region Name	IP Addresses or Range
(10AX)	Oregon		52.39.159.250
10ay.online.tableau.com (10AY)	US West - Oregon	us-west-2	34.248.129.202 52.40.235.24
10az.online.tableau.com (10AZ)	US West - Oregon	us-west-2	34.218.83.207 52.37.252.60
us-west-2b.online.tableau.com (UW2B)	US West - Oregon	us-west-2	34.214.85.34 34.214.85.244
us-east-1.online.tableau.com (useast-1)	US East - Virginia	us-east-1	50.17.26.34 52.206.162.104
prod-useast-a.online.tableau.com (prod-useast-a)	US East - Virginia	us-east-1	3.219.176.16/28
prod-useast-b.online.tableau.com (prod-useast-b)	US East - Virginia	us-east-1	3.219.176.16/28
dub01.online.tableau.com (DUB01)	EU West - Ireland Note: After the move to Hyperforce, region will move to Germany. For more information,	eu-central-1	34.246.74.86 52.215.158.213

Host Name (Pod)	Location	Hyperforce Region Name	IP Addresses or Range
	see Tableau Cloud Migration to Hyperforce knowledge article.		
eu-west-1a.online.tableau.com (EWA1)	EU West - Ireland Note: After the move to Hyperforce, region will move to Germany. For more information, see Tableau Cloud Migration to Hyperforce knowledge article.	eu-central-1	34.246.62.141 34.246.62.203
prod-apnortheast-a.online.tableau.com (prod-apnortheast-a)	Asia Pacific - Japan	ap-south-east-1	18.176.203.96/28
prod-apsoutheast-a.online.tableau.com (prod-apsoutheast-b)	Asia Pacific - Australia	ap-south-east-2	3.25.37.32/28
prod-uk-a.online.tableau.com (prod-	EU West - UK	eu-west-2	18.134.84.240/28

Host Name (Pod)	Location	Hyperforce Region Name	IP Addresses or Range
uk-a)			
prod-ca-a.online.tableau.com (prod-ca-a)	Canada - Quebec	ca-central-1	3.98.24.208/28

Find authorization steps for your data provider

The following links take you to the steps on common data providers' websites for authorizing external applications on their platforms.

Amazon:

- [Redshift](#)
- [RDS](#)
- [EC2](#)

[Microsoft Azure](#)

[Google Cloud Platform](#)

Disclaimer: The links in the list above take you outside of Tableau.com. Although we make every effort to ensure links to external websites are accurate, up to date, and relevant, Tableau cannot take responsibility for the accuracy or freshness of pages maintained by external providers. Contact the external site for answers to questions regarding its content.

Tableau Bridge connections to Tableau Cloud

To facilitate connections between on-premises data and Tableau Cloud, Tableau Bridge uses common port 443 to make outbound requests to Tableau Cloud. For more information, see [Network access](#) section in the Install Tableau Bridge topic.

See also

[Keep Data Fresh](#) (Tableau Cloud Help)

Use Bridge to Keep Data Fresh

For data sources or virtual connections data that Tableau Cloud can't reach directly, you can use Tableau Bridge to keep data fresh. For example, use Bridge when your data source connects to data hosted behind a firewall.

Note: If a data source connects to underlying data hosted in the cloud and is accessible from the public internet, connections run from Tableau Cloud directly.

What is Bridge

Tableau Bridge is client software that runs on a machine in your network. The client works in conjunction with Tableau Cloud to keep data sources that connect to private network data, which Tableau Cloud can't reach directly, up to date. Private network data includes on-premises data and private network cloud data.

How does it work

Tableau Bridge functions like a conduit between private network data, such as Excel files and SQL Server data, and Tableau Cloud. The client communicates with Tableau Cloud through an outbound encrypted connection to enable connectivity between data behind a firewall and your Tableau Cloud site.

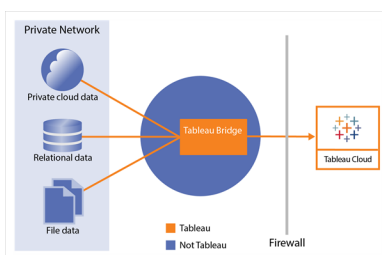

For more information about how Bridge communicates with Tableau Cloud, see [Tableau Bridge Security](#).

Who can use it

Although any authorized user of Tableau Cloud can use Bridge, Bridge is optimized for users that perform the following functions in an organization: site admins and data source owners.

Site admins, or users who have the Site Administrator or Site Administrator Creator role on Tableau Cloud, install and manage Bridge clients. For more information, see [Plan Your Bridge Deployment](#).

Content owners, or users who have the Creator or Explorer (can publish) role on Tableau Cloud, typically publish and manage their own content. Content owners use Bridge to facilitate the live and extract connections between Tableau Cloud and private network data.

- For **live connections**, Bridge is detected automatically as part of the data source or virtual connection publishing process. Support for live connections are enabled through pooling.

More about data sources: Users see the option to publish the data source with a live connection during the publishing process. This option is available when live connections are supported for relational or cloud databases accessible only from inside the network.

After the user publishes the data source, an available client in the pool facilitates the live queries. That's all there is to it.

To get started, users publish a data source to Tableau Cloud, and select the option to maintain a live connection. Or, publish a workbook, then specify a live connection. For more information about publishing data sources, see [Publish a Bridge Data Source with a Live Connection](#).

Note: If publishing a data source that connects to a private cloud database, follow the steps described at [Publish private cloud-based data sources](#) to ensure Bridge is used to facilitate the data freshness tasks.

- For **extract connections**, users can set up refresh schedules for data sources or virtual connections. For more information, see [Set Up a Bridge Refresh Schedule](#).

Note: If publishing a data source that connects to a private cloud database, follow the steps described at [Set up schedules for private cloud-based data sources](#) to use Bridge facilitated refresh schedules.

Schedule Extract Refreshes as You Publish a Workbook

When you publish workbooks that connect to extracts, you can set up a schedule for updates (refreshes) for those extracts, so the views in those workbooks stay current.

The ways you can set up and manage extract refresh schedules depends on where you publish and on the original data type.

- When you publish to **Tableau Server**, the schedule runs and is managed on the server.
- When you publish to **Tableau Cloud**:
 - If extracts are from cloud data (for example, Google Analytics or Salesforce), schedules run and are managed on Tableau Cloud.
 - If extracts are from on-premises or web data connector (WDC) data, you set up and manage refresh schedules using Tableau Bridge.

Note: In many organizations a server content manager or administrator manages all refresh schedules. We recommend that, before you publish, you find out from your administrator whether they have guidelines for these schedules.

Set up a schedule as you publish content

During the publishing process, after you click the **Publish** button, the scheduling options appropriate for your data types and publishing destination appear.

If you are publishing a multi-connection data source, you need to set a refresh schedule for each extract connection in the data source.

To use refresh schedules with connections to a database that requires you to sign in to it, you must store (embed) a database user's credentials with the connection. For more information, see [Set Credentials for Accessing Your Published Data on page 3151](#).

Publish and refresh on Tableau Cloud

For the subtleties around refreshing each type of data you publish to Tableau Cloud, see [Keep Data Fresh](#). Here are examples of things you need to know:

- If your workbook connects to cloud data, add Tableau Cloud to your cloud data provider's authorized list (allowlist). The IP address range for your site location is listed in [Authorize Access to Cloud Data Published to Tableau Cloud](#) on page 3154.
- Tableau Bridge starts during the publishing process if your data source or workbook connects to on-premises data.

Tableau Bridge supports standard database authorization and cannot refresh data you connect to through OAuth. To learn more, see [Use Tableau Bridge to Expand Data Freshness Options](#).

- When you publish a multi-connection data source to Tableau Cloud, if any one connection requires using Tableau Bridge, you must use Bridge to refresh *all* connections in the data source.

For example, say you publish a data source with an extract connection to a MySQL data hosted in the cloud, and a live connection to an on-premises SQL Server database. Although Tableau Cloud supports refreshing hosted MySQL data, in this case, you would need to use the Bridge client to keep both the SQL Server and MySQL connections fresh.

For information about using both live and extract connections in a data source, see [About working with multi-connection data sources](#).

Refreshing web data connector extracts

When you publish a workbook with a web data connector (WDC) data source, you must *import* the web data connector to Tableau Server before you can set up a refresh schedule. You can do this only on Tableau Server. For information, see [Web Data Connectors in Tableau Server](#) in the Tableau Server Help.

For information about refreshing web data connector data sources published to Tableau Cloud, see [Use Tableau Bridge to Expand Data Freshness Options](#) in the Tableau Cloud Help.

Restrict Access at the Data Row Level

When you share workbooks with others by publishing them to Tableau Server or Tableau Cloud, by default, all users who have access to the workbooks can see all of the data shown in the views. You can override this behavior by applying a type of filter that allows you to specify which data "rows" any given person signed in to the server can see in the view.

This approach for securing data at the row level applies to data sources with live connections and extract data sources whose tables are stored as multiple tables. For more information about storing extract data using multiple tables, see [Extract Your Data on page 919](#).

Note: For information on the alternatives you can use to implement row-level security in Tableau, see an [Overview of Row-Level Security Options in Tableau](#) in the Tableau Server Help.

For additional related information, see the whitepaper [Best Practices for Row Level Security with Entitlement Tables](#).

How user-based filtering works

Suppose you created a quarterly sales report for a set of products over several years, in different geographic regions.

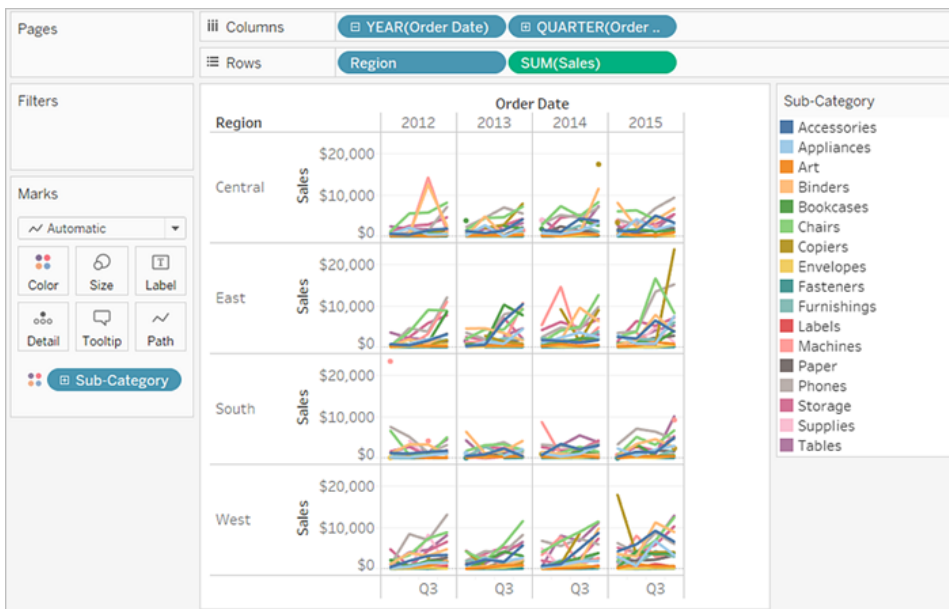

When you publish this report, you want to allow each regional manager to see only the data relevant to his or her region. Rather than creating a separate view for each manager, you can apply a *user filter* that restricts access to the data based on users' characteristics, such as their role.

Restricting access to data in this way is referred to as *row-level security* (RLS). Tableau offers the following approaches to row-level security:

- [Create a user filter and map users to values manually on page 3169.](#)

This method is convenient but high maintenance, and security can be tentative. It must be done per-workbook, and you must update the filter and republish the data source as your user base changes.

- [Create a dynamic filter using a security field in the data on page 3171.](#)

Using this method, you create a calculated field that automates the process of mapping users to data values. This method requires that the underlying data include the security information you want to use for filtering.

The most common way to do this is to use a reference ("look-up," "entitlements," or "security") table that contains this information. For example, if you want to filter a view so that only supervisors can see it, the underlying data must be set up to include user names and specify each user's role.

Because filtering is defined at the data level and automated by the calculated field, this method is more secure than mapping users to data values manually.

Adding user filters to data sources

The two methods in the previous section describe ways to add filters to data embedded in workbooks. If multiple workbooks connect to the same data, instead of wrangling filters on each workbook, you can filter the data source, and then connect the workbooks to the data source after you publish it.

Workbooks that connect to your filtered data source expose only the data the user signed in to the server is allowed to see. In addition, all connected workbooks show data refreshes as they occur.

Extracts vs. live connections with user filters

Generally, when using one of the methods described above, RLS with extracts are faster to create and have better performance than RLS with data sources that use live connections.

Requirements for RLS with extract data sources

As mentioned earlier, the first requirement to using RLS with extracts is that the data in the extract should be stored using multiple physical tables. You can configure your extract to have its data stored using multiple physical tables by following [Extract Your Data on page 919.](#)

In addition to the above requirement, there are some additional considerations to make if you plan to use RLS with your extract. Because extract data stored using multiple tables do not

support extract filters and some other functionality that help reduce the amount of data in the extract, you might consider using one of the following suggestions:

- Connect to data using custom SQL
- Connect to a database view that already has the appropriate level of filtering

For more information about these suggestions, see [Extract Your Data on page 919](#).

Recommended practices for RLS with extract data sources

To effectively perform RLS with extracts, Tableau recommends keeping the number of tables (or database views or custom SQL queries) in your extracts to two. In other words, Tableau recommends that the tables in your extract be comprised of the following types of tables:

- A data table—this is the "object" table that contains all the data you want to show.
- A reference table—this is the "look-up" or "entitlements" table that contains the user information and the security groups the users belong to.

By minimizing the tables in your extract to these two, you ensure that the only join that Tableau has to perform is between these two tables and thus avoid any duplication of data or "join explosion."

About RLS and previous versions of Tableau

Previously, Tableau was unable to support RLS workflows with extracts because of complications around row duplication and performance. Ultimately, these complications derived from the extract whose data could only be stored and queried as a single table. However, beginning in Tableau 2018.3, you can choose to store the data in your extract using multiple tables and thus enabling a workflow for RLS with extracts as you might have previously done with data sources with live connections.

For a comprehensive discussion about RLS with extracts in Tableau, read the blog maintained by a Tableau Sales Consultant who has extensive experience in this area.

- [Multiple Table \(Normalized\) Hyper Extracts](#)
- [Defusing Row Level Security...Part 1](#)
- [Defusing Row Level Security...Part 2](#)

Disclaimer: Clicking these links will take you away from Tableau.com. Although we make every effort to ensure links to external websites are accurate and relevant, Tableau cannot take responsibility or provide support for the external content.

See also

- [Data Security](#) in the Tableau Server Help
- [Overview of Row-Level Security Options](#) in Tableau in the Tableau Server Help

Create a User Filter and Secure it for Publishing

Prerequisites

To implement row-level security (RLS) with a live data source, follow the steps below.

To implement RLS with an extract, there are some extra steps and considerations. For more information see [Requirements for RLS with extract data sources](#) on page 3167.

Note: For information on the alternatives you can use to implement RLS in Tableau, see an [Overview of Row-Level Security Options in Tableau](#).

Create a user filter and map users to values manually

User-based filtering is one option to help secure your data source or workbook using RLS. This procedure is best for a small and fairly static set of users or groups, and only a small number of workbooks that need user filters.

1. In Tableau Desktop, open the workbook and connect to the data you want to filter.
2. Navigate to the worksheet that you want to apply a filter to.
3. Select **Server > Create User Filter**. Then select the field you want to use for filtering the view, such as **Region**.
4. If prompted, sign in to your server or site.
5. In the **User Filter** dialog box, name the filter. We'll use **Regional Managers**.
6. Select a user or group on the left, then indicate which values on the right they should be able to see. Repeat this process for each user or group, and click **OK** when you're done mapping users to values.

For this example, Andrew Allen is set up to see the East region.

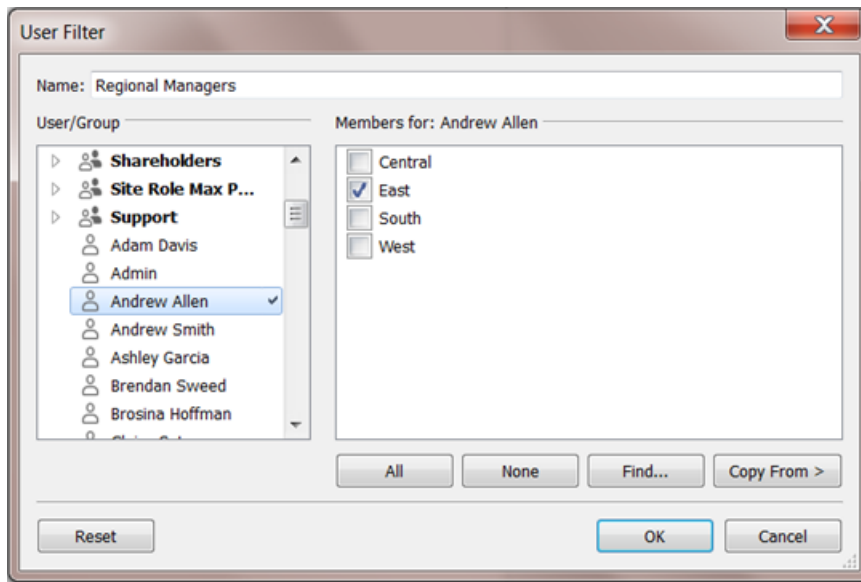

7. After you create the user filter, it appears in the **Sets** area of the Data pane.
8. Drag the user filter to the **Filters** shelf. The filter becomes a context filter, and the view adjusts to show data that you are allowed to see.

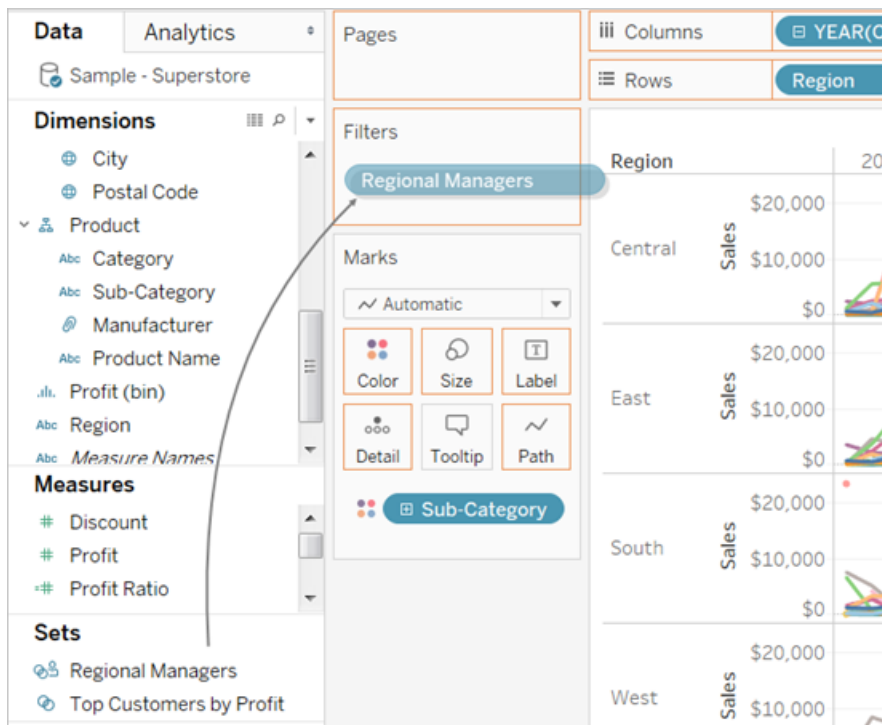

To test or fine-tune the filter:

- If the view appears as a blank canvas, you need to allow yourself or a group you are a member of to see a region. In the **Sets** area of the **Data** pane, open the drop-down menu on the user filter, and then select **Edit Set**.
- To preview how the filter works in the published view, in the lower-right corner of the workbook, open the **Filter as User** menu, and select the user or group from the list.

Note: Previewing is not available if the workbook connects to a published data source.

- To return to viewing the workbook as yourself, in the top right corner of the **Filter as User** menu, select **Reset**.
- To copy the mapping selections you set on one user or group to another (rather than manually mapping the same settings), see [Copy selected field values from one user to another](#) on page 3175.

Known Limitations

If using Tableau Desktop and a published data source, note that calculations containing both an LOD expression and a user function can't be computed properly in Tableau Desktop. These calculations are stripped out.

Important: When you publish the workbook, you need to take additional steps to make sure users cannot edit the workbook and remove the filter. For information, see [Secure user filters on published content](#) on page 3174.

Create a dynamic filter using a security field in the data

The steps below are based on the following view, which shows annual sales performance for a list of regional managers.

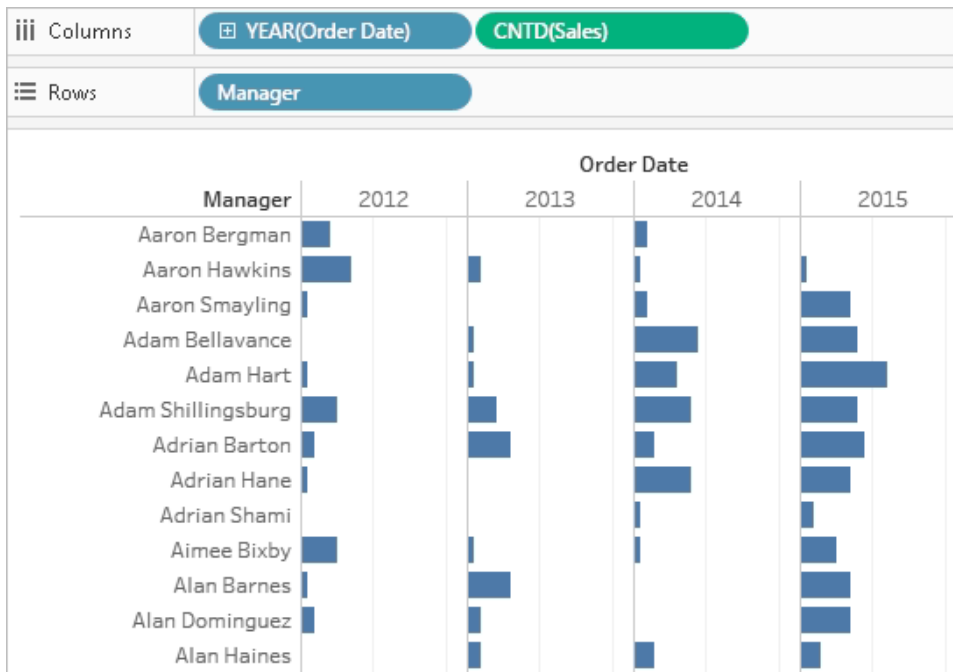

As described in [Restrict Access at the Data Row Level](#) on page 3165, this approach requires the database to contain the field you want to use for filtering.

For this example, the data includes a *reference table* called **People**, which contains two columns: Region and Manager. Names in the Manager field match Tableau Cloud or Tableau Server user names, and we'll use this field for filtering.

You can follow along using the Superstore data that comes with Tableau Desktop, although the fields and values do not match exactly.

Connect to the data and set up the user filter

1. In Tableau Desktop, open the workbook and connect to the data you want to filter. In this example, we use a table called **Orders**.
2. Double click the Orders table to open the join canvas. Add the reference table (**People**) with a left join. For this example, join on the field **Region**.
3. On the worksheet, select **Analysis > Create Calculated Field**, and create the following field, named "User is a manager".

```
USERNAME () = [Manager]
```

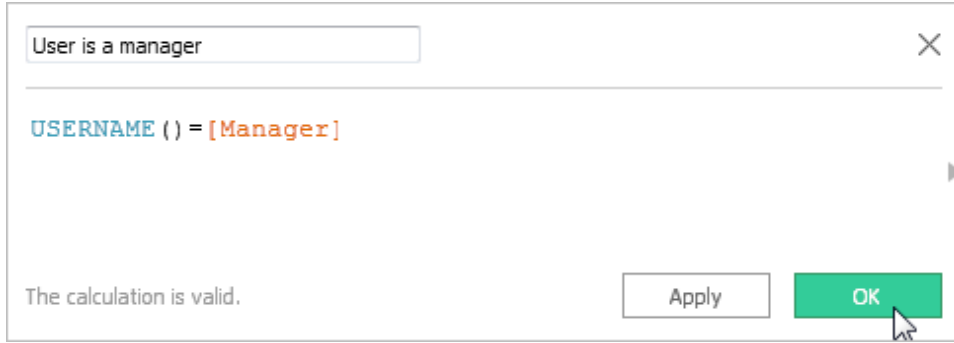
This calculation returns TRUE if the user name of the person signed in to the server exists in the manager column of the People table.

4. Add the **User is a manager** field to the **Filters** shelf.
5. In the **Filter** dialog box, select **True**, and then click **OK**.

This sets the filter so that only people who are managers can see the data in the view. If you are not listed in the Manager field, your view while authoring might appear as a blank canvas.

6. See how the view looks to a particular person: in the lower-right, open the **Filter as User** menu, and select someone you know is a manager.

Important: As with a manual user filter, you need to take steps to [Secure user filters on published content on the next page](#).

Filter a data source

Rather than maintain user filters and special permissions on each published workbook, you can filter a data source, and then publish the data source to make it available as a shared, one-to-many resource for anyone who uses that data.

This procedure builds from the dynamic-filter approach described in this topic.

1. Complete the steps in [Create a dynamic filter using a security field in the data on page 3171](#).
2. In the lower-left area of Tableau Desktop, select the **Data Source** tab.
3. In the upper-right area of the **Data Source** page, under **Filter**, click **Add**.

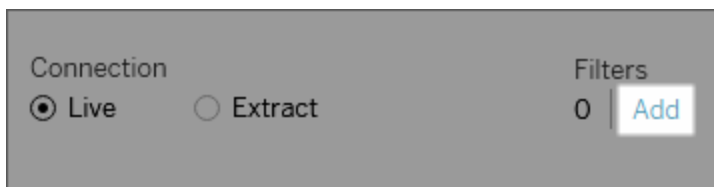

- In the **Edit Data Source Filters** dialog box, click **Add**, add the calculated field you created for the dynamic filter (**User is a manager**), and set the filter to **True**. Click **OK** until you get back to the **Data Source** page.

Global filters and data source filters

When you create a data source filter, any global filters that use that data source are displayed automatically in the **Edit Data Source Filters** dialog box to make it easy for you to promote a global filter to be a data source filter. To promote the global filter to be a data source filter, click **OK**.

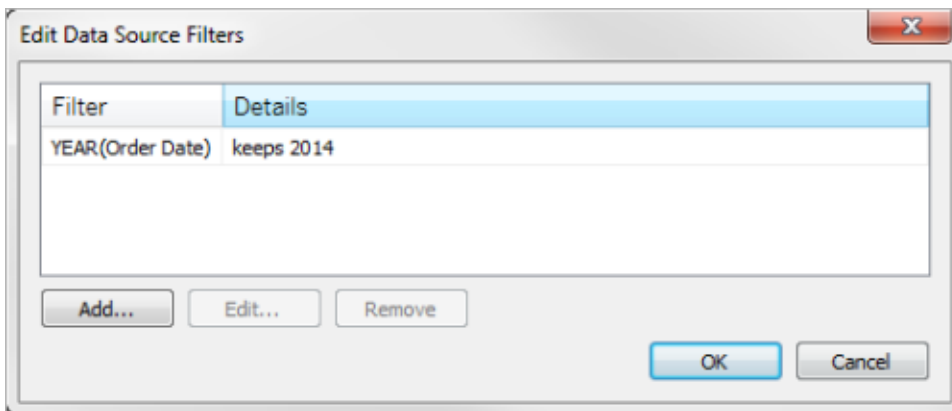

If you promote a global filter to be a data source filter, that global filter will no longer be visible in worksheets of the workbook (because it becomes a data source filter).

Note: Be aware that you do not need to select a global filter in the **Edit Data Source Filters** dialog box to promote it. When you click **OK**, all global filters in the list will be promoted. To prevent a global filter from being promoted to a data source filter, select the global filter in the **Edit Data Source Filters** dialog box, and then click **Remove**.

Secure user filters on published content

When you publish a workbook or data source with user filters, you need to set permissions to make sure that users opening your workbook or connecting to your Tableau Server data source cannot remove the filter, thereby gaining access to all of the data.

Notes

- Before publishing, we recommend that you consult with your Tableau administrator regarding any existing policies in your organization, particularly for setting permissions.

See also [Set Permissions as You Publish a Data Source or Workbook](#) on page 3148.

- This information applies to publishing data sources with live connections and extracts whose data is stored as multiple tables.

Permissions settings

To secure user filters, the following capabilities must be set to **Deny**, either during publishing, or afterward on the server.

Workbooks	Data sources
<ul style="list-style-type: none">• Web Edit• Download/Save a copy• Set Permissions	<ul style="list-style-type: none">• Save• Download• Set Per- missions

Copy selected field values from one user to another

When you're creating a user filter manually, after you map a user or group to data values (members), you might want to map another user or group in the same way. You can do this by copying and pasting the settings.

1. In the **Data** pane, under **Sets**, select a user filter. Click the drop-down arrow and select **Edit Set**.
2. In the **User Filter** dialog box, select the user or group on which you want to paste settings from another user or group.

3. Click **Copy From**, and select the user or group whose settings you want to copy.

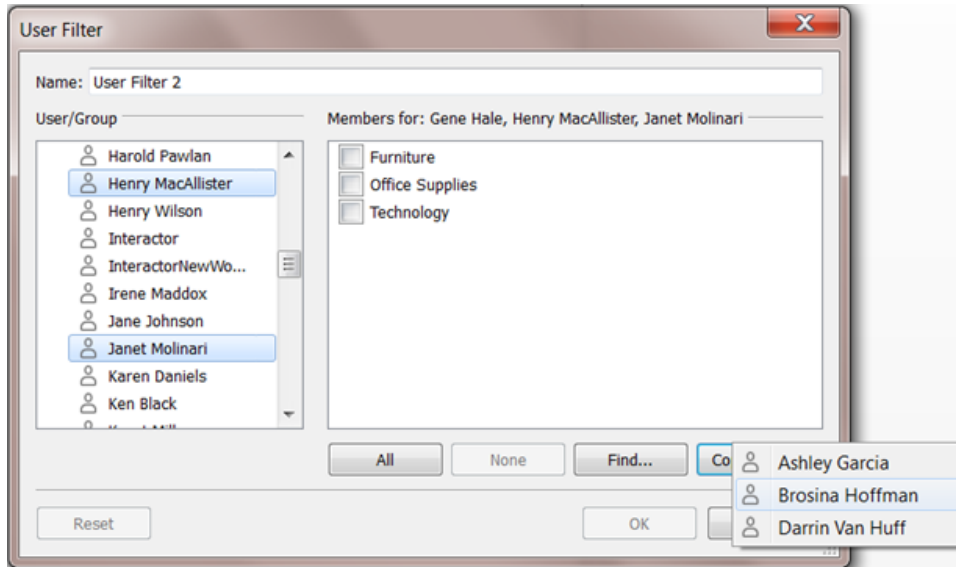

Use Tableau on the Web

Get started

What Can I Do with a Tableau Site? on the next page

Tour Your Tableau Site on page 3180

Creators: Get Started with Web Authoring on page 3197

Viewers: **What Can I Do with a Tableau Web View?** on page 3271

Author web views

Web Authoring and Tableau Desktop Feature Comparison on page 3434

Creators: Connect to Data on the Web on page 3213

Prepare Data on the Web on page 3221

Edit Views on the Web

Upload Workbooks to a Tableau Site on page 3229

Connect to published data sources while web authoring on page 274

Create a Dashboard on page 2703

Create a Story on page 2840

Save your work

Explore and manage content

Explore and Inspect Data in a View on page 1981

Use Custom Views on page 3323

Use Tags on page 3278

Manage Web Content on page 3301

Refresh Data or Pause Automatic Updates on page 3322

Work with Content Revisions on page 3315

Share and collaborate

Share Web Content on page 3345

Create a Subscription to a View or Workbook on page 3351

Send Data-Driven Alerts from Tableau Cloud or Tableau Server on page 3356

Embed Views and Metrics on page 3362

Comment on Views on page 3358

What Can I Do with a Tableau Site?

Your Tableau site is a private workspace on the web where you can share data insights and collaborate with your colleagues. With certain access levels, you can connect to data and create workbooks right on the web, or connect to data sources and workbooks built in Tableau Desktop. Your site role sets what you're able to do in your Tableau site.

What is a site?

A Tableau site is a place for your team to publish data sources and workbooks to share with each other.

In Tableau-speak, we use site to mean a collection of users, groups, and content (workbooks, data sources) that's walled off from other sites (collections of users, groups, and content).

As a site user, you might be able to sign in to one site, or you might be able to sign into multiple sites, depending on the access your administrator gives you. After you sign in, you can see projects and content that you can access.

How does my site work with Tableau Desktop?

Tableau Desktop and your Tableau site are built to work together. In Tableau Desktop, you can connect to data and build workbooks, stories, and dashboards. When you want to share insights with others, you can publish workbooks and data sources to your Tableau site.

In your Tableau site, you can view, interact with, and edit those published views. You can also use your Tableau site to find and edit workbooks in Tableau Desktop.

What can I do on the web?

Your site role and content permissions determine what you can see and do with Tableau on the web. Starting in 2018.1, your Tableau site role can be Creator, Explorer, or Viewer. For in-depth details on each site role, see the capability grid on [Tableau Pricing](#).

Not sure what your site role is? To check, select the icon in the top right corner of the site with your initials or profile picture and select **My Account Settings. Site Role** tells you if you are a a Creator, Explorer, or Viewer.

In general:

Creators can:

- Make new connections to data in the browser
- Upload workbooks (.twb and .twbx files)
- Build and publish data sources and workbooks from the browser or Tableau Desktop
- Open and edit published workbooks in the browser or Tableau Desktop
- Create new data flows and edit an existing flow
- Use Dashboard Starters (Tableau Cloud only)
- Everything else that Explorers and Viewers can do

Explorers* can:

- Connect to published data sources on the site to create new workbooks
- Save new workbooks in Personal Space
- Download workbooks or other content in Personal Space, including data.
- Edit and analyze data in published workbooks (Save and Save As options vary based on permissions. If Save as is available, workbooks can be saved in Personal Space.)
- Create data alerts
- Create subscriptions for others
- Everything that Viewers can do

*The user level Explorer (can publish) is an Explorer who can publish new content from Tableau Desktop to a site and create and publish new content from an existing published data source, but cannot connect to external data or create new data sources.

Viewers can:

- Create custom views and see published and custom views others have created
- Explore the data in a view using filters and legends, sorting, and tooltips
- Share, comment on, and download content (options vary based on permissions)

For more details, see [What Can I Do with a Tableau Web View?](#)

Tour Your Tableau Site

When you sign in to Tableau Server or Tableau Cloud, the first page you see looks similar to the following example.

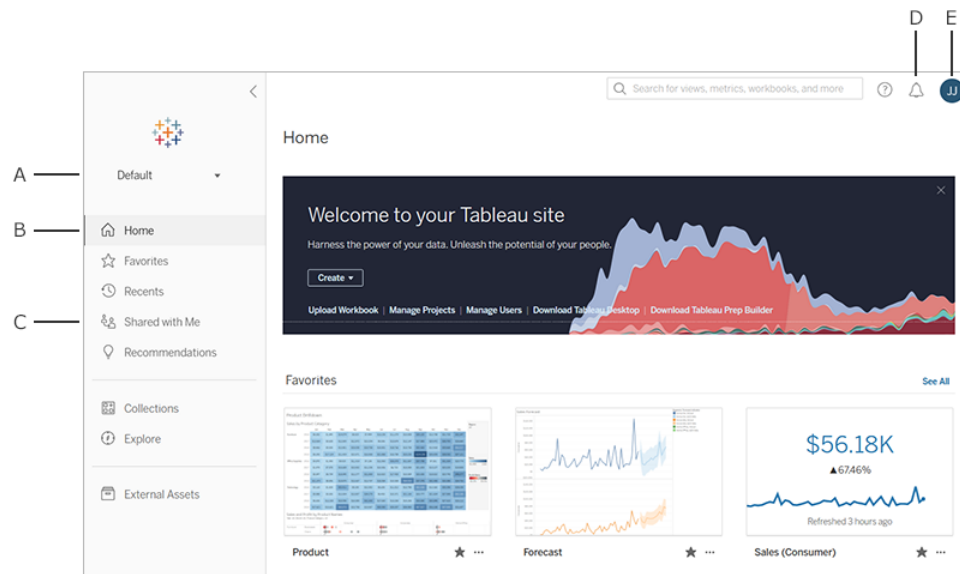

- **A** - [Site picker](#) (if you have access to more than one site)
- **B** - Home
- **C** - Navigation menu
- **D** - Notifications
- **E** - [Your content and account settings](#)

Note: You might see additional features if your site is licensed for Data Management, which includes Tableau Catalog, Tableau Prep Conductor, and other data management features. When Tableau Catalog is enabled, you can see an External Assets page, view data lineage information, and more. You can also see virtual connections listed as another Tableau content type. To learn more, see [Use Data Management in the Tableau Cloud or Tableau Server help](#).

Browse and find content

To see all of the content you have access to across your Tableau site, from the navigation menu, click **Explore**. Your site role and permissions determine the content that you can see and the options that are available.

Tableau Desktop and Web Authoring Help

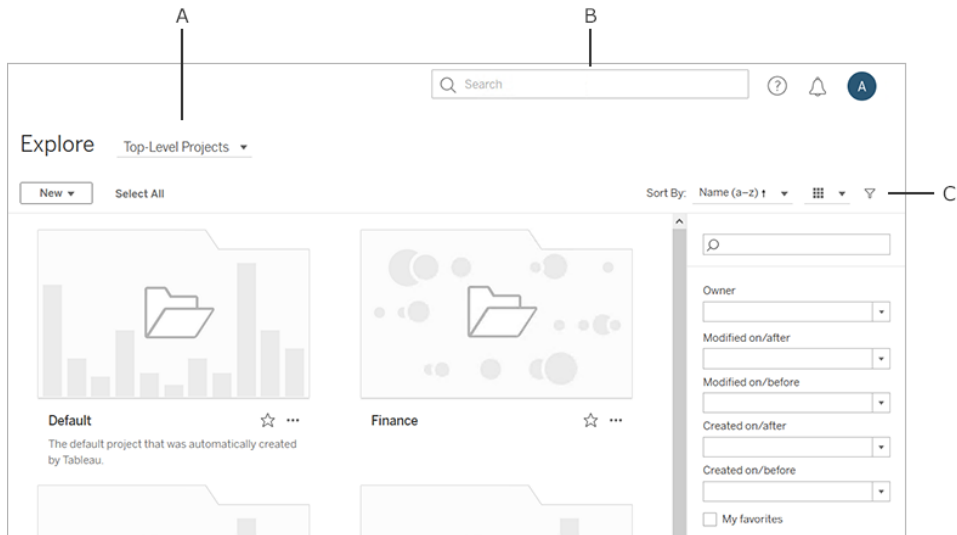

- **A** - Content type menu
- **B** - Quick search
- **C** - Your account and settings

By default, Explore shows **Top-Level Projects**. To see other types of content, select them from the drop-down content type menu.

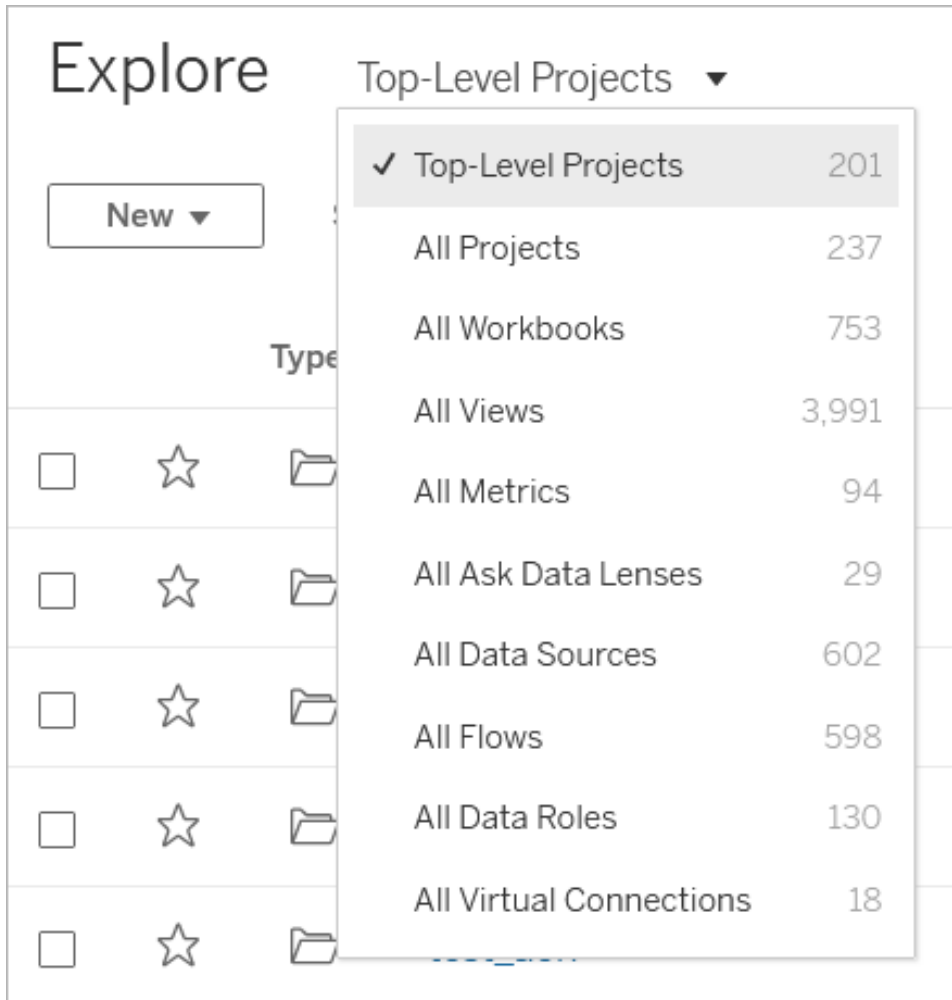

Projects

Projects provide a way to organize the content on your site. Top-level projects can contain other (nested) projects, forming a hierarchy that you navigate like the file system on your computer.

When you open a project, you see all of the content that project contains on a single page, including any nested projects.

Tableau Desktop and Web Authoring Help

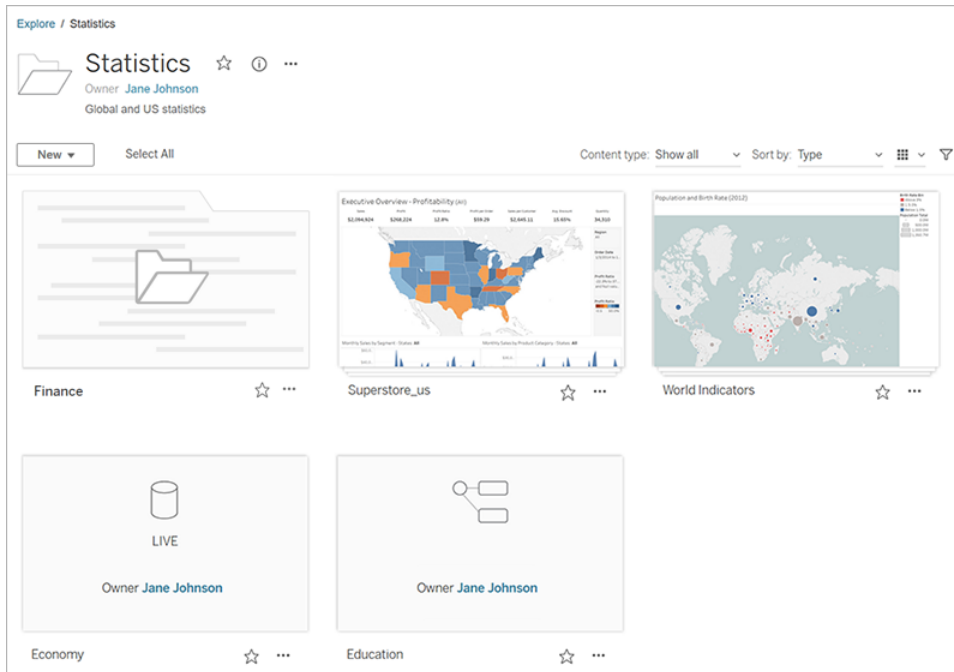

To see only specific content types in a project, click the **Content Type** drop-down menu and select the content types you want to see. You can select the **Show Workbooks as Views** option to see all of the individual views and custom views within a workbook displayed on the project page.

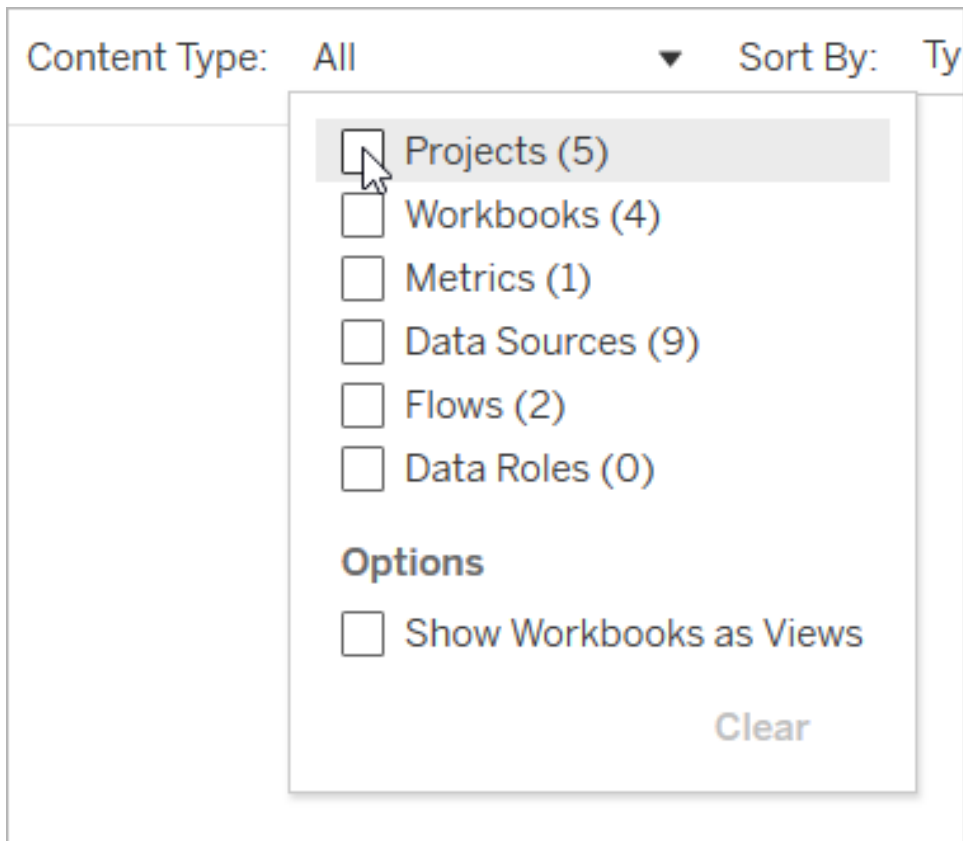

Workbooks

A workbook page shows the views included in the workbook, the data sources used by the workbook, metrics created from the views in the workbook, custom views, user subscriptions to either the workbook or to individual views, lineage data (if Tableau Catalog is enabled), and usage statistics.

Superstore						
Owner Jane Johnson		Modified Jul 5, 2022, 5:28 PM				
Edit Workbook						
Views 7 Data Sources 3 Connected Metrics 2 Custom Views 1 Subscriptions 1 Lineage Usage						
Select All				Sort By: Sheet (first-last) ↑		
Type	Name	Actions	Acceleration	Views (all-time)	Sheet	
<input type="checkbox"/>	Overview	...	Off	570	1	
<input type="checkbox"/>	Product	...	Off	35	2	
<input type="checkbox"/>	Customers	...	Off	29	3	
<input type="checkbox"/>	Commission Model	...	Off	47	4	
<input type="checkbox"/>	Order Details	...	Off	34	5	
<input type="checkbox"/>	Forecast	...	Off	102	6	

For more information about creating workbooks, see [Creators: Get Started with Web Authoring](#) on page 3197.

Views

A view page displays options for interacting with the view, including sharing, subscribing, and editing. The options available in the toolbar vary depending on the site configuration and your permissions.

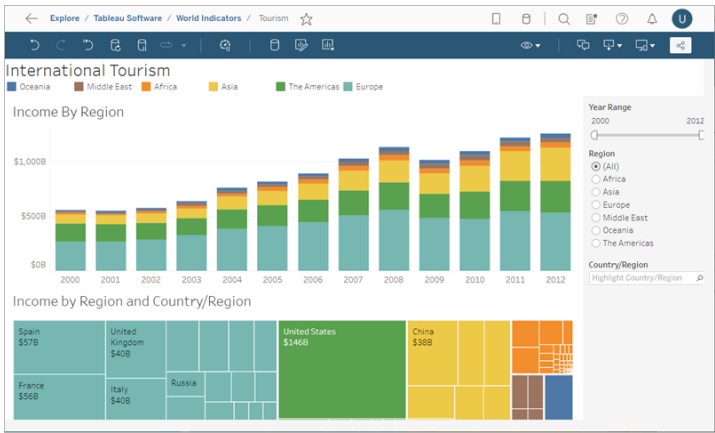

When a workbook is published from Tableau Desktop with the **Show sheets as tabs** option selected, you can see each sheet by clicking the tabs below the view toolbar.

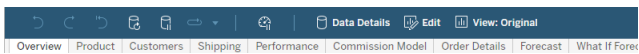

For more information about working with views, see [What Can I Do with a Tableau Web View?](#) on page 3271.

Metrics

A metric page shows the current value for the metric, the time the metric last refreshed, and details about the metric, such as the owner, description, and definition. If the metric has a date dimension as part of its definition, it will show a timeline that displays historical values for the metric.

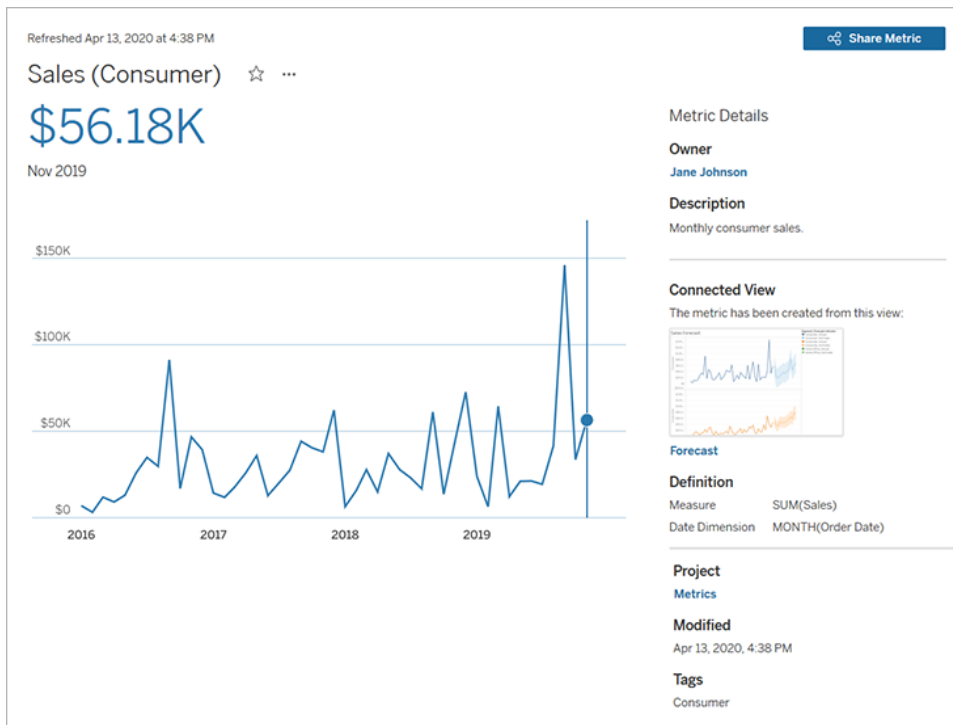

For more information about metrics, see [Create and Troubleshoot Metrics \(Retired\)](#) on page 3234.

Retirement of the legacy metrics feature

Tableau's legacy metrics feature was retired in Tableau Cloud in February 2024 and in Tableau Server version 2024.2. In October 2023, Tableau retired the ability to embed legacy metrics in Tableau Cloud and in Tableau Server version 2023.3. With Tableau Pulse, we've developed an improved experience to track metrics and ask questions of your data. For more information, see [Create Metrics with Tableau Pulse](#) to learn about the new experience and [Create and Troubleshoot Metrics \(Retired\)](#) for the retired feature.

Data sources

A data source page shows connections to databases or file-based data, as well as the workbooks connected to the data source. If the data source is an extract, the page shows scheduled extract refreshes.

You can use **Ask Data** to investigate your data right from the data source page. Type a question and instantly get a visualization as an answer. For more information, see [Automatically Build Views with Ask Data](#) on page 1005.

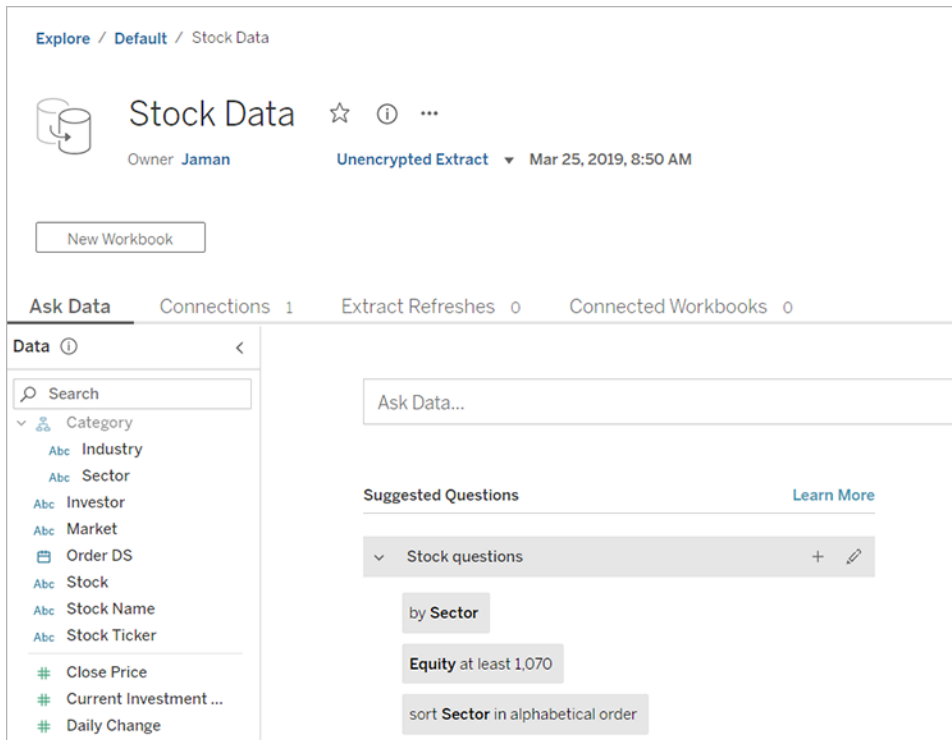

When viewing a list of data sources, to see connection and authentication details, from the **Show As** menu, select **Connections**.

New ▾		Select All	Show as: Data sources ▾		Content type: Data sources ▾	Sort by: Views (All-time) ▾	⌵	⌵
Type	Name	Views (All-time)	Workbooks	Connections	Owner	Live/Last extract...		
<input type="checkbox"/>	Global Temperatures	7	2	Global Temperatures...	Jane Johnson	Live		
<input type="checkbox"/>	Sales Commission	7	2	Sales Commission,hy...	Jane Johnson	Live		
<input type="checkbox"/>	Economy	2	1	Economy,hyper (Data...	Jane Johnson	Live		
<input type="checkbox"/>	Education	2	1	Education,hyper (Dat...	Jane Johnson	Live		
<input type="checkbox"/>	Flight	2	1	Flight,hyper (Data/Re...	Jane Johnson	Live		

Ask Data lenses

An Ask Data lens provides a curated subset of data from a data source, making it easier for you to find relevant answers to your questions. For more information, see [Create Lenses that Focus Ask Data for Specific Audiences](#) on page 1024.

Shipping Analytics ...

Owner **Jared** Modified **Apr 26, 2021, 2:09 PM** Data Source **RetailSample Extract**

A lens for ad-hoc analytics from the logistics team.

Ask Data

Data ⓘ <

Search

- Abc Address
- Abc Brand
- Abc CATEGORY
- Abc Class
- Abc Department
- Abc Distributioncenter
- Abc District
- Abc Division
- Geographic Location
 - Abc Region
 - State
 - City
 - Zip

No fields

No filters

Search fields or values to create a visualization

Recommended Visualizations

- FAQs
- Prices by category
- Shipping Costs over time

Data roles

A data role page shows custom data roles published to your site or server. You can create custom data roles in Tableau Prep Builder using the field values in your data set and publish them to Tableau Server or Tableau Cloud to share with others. You can use data roles to validate field values when cleaning your data.

The screenshot shows a Tableau interface for a data role named 'city-datarole'. At the top, it indicates the user is in the 'Explore / Default' view. The data role is owned by 'Jane Johnson' and was last modified on 'Jun 25, 2019, 5:37 PM'. Below this, there is a 'Definition' section with an 'About' tab selected. Under 'About', there are fields for 'Role Type' (Synonyms), 'Dictionary' (Shipping), and 'Description' (No description available). A 'Values (531)' section includes a search box labeled 'Search Values' and a table listing the first three values: 'Aberdeen', 'Abilene', and 'Akron'.

Name
Aberdeen
Abilene
Akron

For more information about creating and using data roles to clean data, see [Use Data Roles to Validate Your Data](#) in the Tableau Prep online help.

Flows

The flow page enables you to view, edit, monitor, and maintain your flow and run it on demand. If you have a Data Management license with Tableau Prep Conductor enabled, you can schedule your flow to run or set up linked tasks to run multiple flows one after the other.

The screenshot shows the Tableau Prep interface for a project named 'Superstore'. At the top, there are tabs for 'Overview', 'Connections', 'Scheduled Tasks', and 'Run History'. Below this is a 'Description' section with the text 'No description available.' A table lists the tasks:

Run All	Output Step	Output Name	Status	Schedule	Errors
Run	Create 'Annual Regional Performance Id...'	Create 'Annual Regional Performance Id' (no...	Never run	+ Create new task	
Run	Create 'Superstore Sales Id'	Create 'Superstore Sales Id' (not yet published)	Never run	+ Create new task	

Below the table is a flow diagram showing data sources on the left (orders_south..., Orders_East, Orders (West), Orders (Central), Returns (all)) and various transformation steps (Remove Nulls, Fix Data Type, Rename States, Fix Dates, All Orders, Orders + Returns, Clean 2, Quota, Pivot Quotas, Roll Up Sales, Quota = Orders, Create 'Annual...').

For more information about working with flows, see [Keep Flow Data Fresh](#) in the Tableau Prep help.

Virtual connections

Virtual connections provide a central access point to data. You can use a virtual connection to create a data source, workbook, or flow. You can trust that the data is fresh because the extract refresh schedule has already been set. And you can share content freely, knowing that you won't put security at risk because data policies that apply row-level security are always enforced. For more information, see [Use a Virtual Connection in the Tableau Cloud](#) or [Tableau Server](#) help.

The screenshot shows the 'Connect to Data' dialog in Tableau. The 'Content Type' dropdown is set to 'Virtual Connections (38)'. A list of data sources is visible, including 'mysql testv' and 'postgres_vconn'. A dropdown menu is open over the list, showing options: 'Data Sources', 'Virtual Connections', 'Databases and Files', and 'Tables'. The 'Virtual Connections' option is highlighted.

Access important content quickly

In addition to browsing content in projects, take advantage of the following areas of your site to keep track of the items that are important to you:





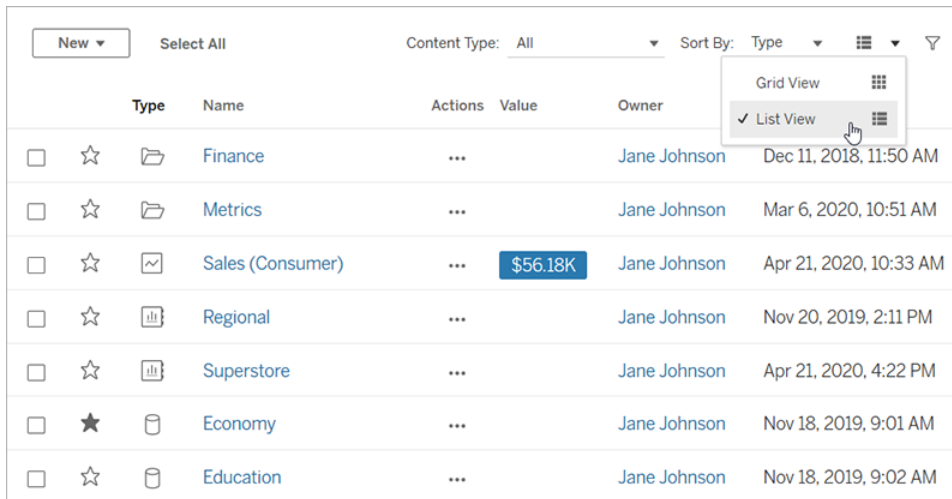

- **Personal Space** - a private location for Explorers and Creators to save or edit work. For more information, see [Create and Edit Private Content in Personal Space on page 3224](#).
- **Favorites** - Add any type of content to your favorites.
- **Recents** - See the views, metrics, and flows you have most recently accessed.
- **Shared with Me** - Find items that other users have sent you.
- **Collections** - Create your own collection of related items, or access collections made by other users. For more information, see [Organize Items in a Collection on page 3293](#).

View content as list or grid



You can display content as a list or as a grid of thumbnails by clicking the **View As** icons.







Here's the list view:



New ▾		Select All	Content Type: All ▾	Sort By: Type ▾	Grid View ▾	Filter ▾
Type	Name	Actions	Value	Owner		
<input type="checkbox"/>	☆  Finance	...		Jane Johnson	Dec 11, 2018, 11:50 AM	
<input type="checkbox"/>	☆  Metrics	...		Jane Johnson	Mar 6, 2020, 10:51 AM	
<input type="checkbox"/>	☆  Sales (Consumer)	...	\$56.18K	Jane Johnson	Apr 21, 2020, 10:33 AM	
<input type="checkbox"/>	☆  Regional	...		Jane Johnson	Nov 20, 2019, 2:11 PM	
<input type="checkbox"/>	☆  Superstore	...		Jane Johnson	Apr 21, 2020, 4:22 PM	
<input type="checkbox"/>	★  Economy	...		Jane Johnson	Nov 18, 2019, 9:01 AM	
<input type="checkbox"/>	☆  Education	...		Jane Johnson	Nov 18, 2019, 9:02 AM	

In list view:

-  indicates a project
-  indicates a workbook

-  indicates a view
-  indicates a metric
-  indicates an Ask Data lens
-  indicates a data source
-  indicates a data role
-  indicates a flow
-  indicates a virtual connection

And here's the grid view:

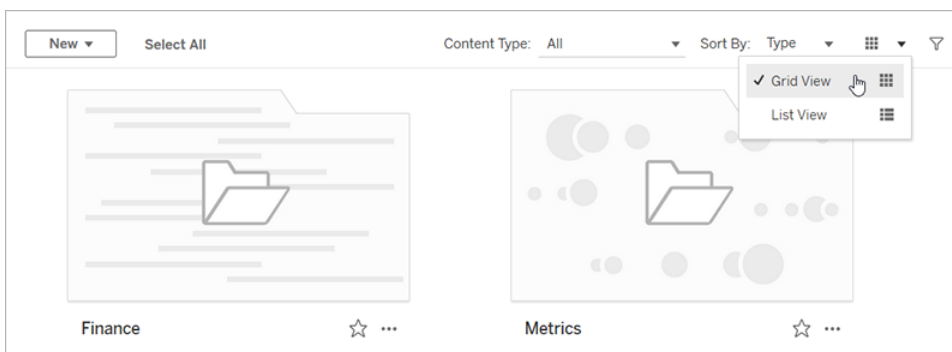

In grid view, you can hover over thumbnails to see details about the content.

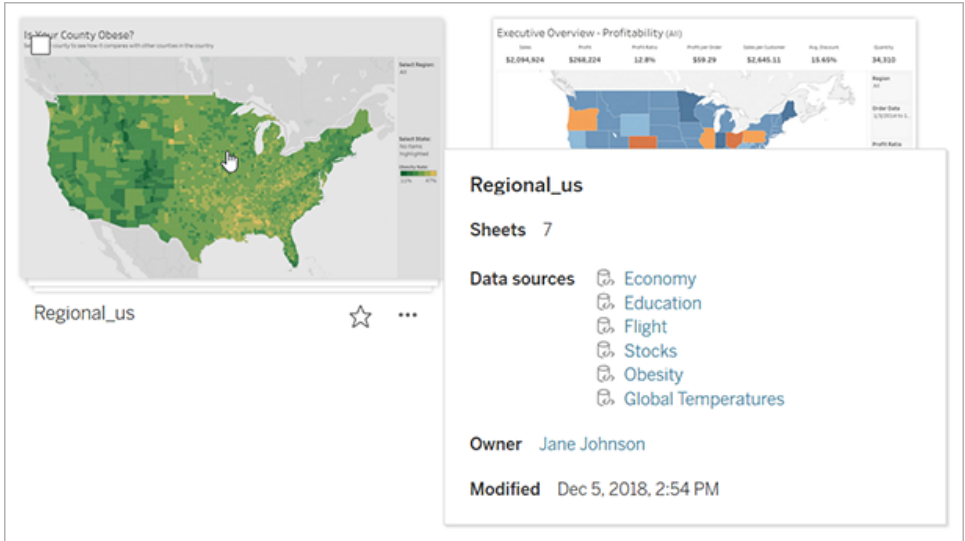

Sort content

To sort items, click the **Sort By** drop-down menu. You can sort by characteristics such as name, owner, number of views, and creation date.

This example shows the sort options for number of page views.

Content type: Views		Sort by: Views (1 month) ↓			
Views (1 month)	Workbook	Sheet	Owner		
6	World Indicators	3	Jane John		2:54 PM
5	World Indicators	7	Jane John		2:54 PM
4	Regional_us	3	Jane John		2:54 PM
3	Superstore_us	6	Jane John		2:53 PM
3	Superstore_us	3	Jane John		2:53 PM
2	Regional_us	6	Jane Johnson	Dec 5, 2018, 2:54 PM	

The table shows a list of content items sorted by 'Views (1 month)' in descending order. A context menu is open over the 'Views (1 month)' column header, showing the following options:

- Order
 - ✓ 1 month
 - 3 months
 - 12 months
 - All-time
- Sort
 - Name
 - ✓ Viewed by users
 - Workbook
 - Sheet
 - Project
 - Owner
 - Modified

You can also sort a list by clicking the column heading. An arrow indicates the order: ascending (up arrow) or descending (down arrow).

↓ Views (1 month) ▾	Workbook	Sheet
6	World Indicat...	3
5	World Indicat...	7
4	Superstore_us	6
3	Regional_us	3
3	Superstore_us	3
2	Regional_us	6

Identify and navigate sites

Each site on Tableau Server and Tableau Cloud has a name and an ID.

On Tableau Server, if only one site exists, that site is named **Default**. When you're signed in to the **Default** site, the browser URL looks something like this:

`https://server-name/#/home`

If you have access to multiple sites, you select one when you sign in.

On Tableau Cloud or an instance of Tableau Server running multiple sites, the browser URL includes **`#/site/`** followed by the site ID. If the URL doesn't include **`/site/`**, then you're signed in to the **Default** site.

The following URL shows an on-premises Tableau Server site whose site ID is **finance**:

`https://localhost/#/site/finance/home`

Once signed in, you can navigate to another site by selecting it from the site picker. If you have access to only one site, you will not see the site picker.



Tableau Pulse

Available for Tableau Cloud, Tableau Pulse helps you to stay up to date with your data by providing insights about metrics. You can follow metrics to receive a digest with changes to your data via email or Slack, and you can visit a metric's details page on Tableau Cloud to ask questions of the data and learn more.



Metrics in Tableau Pulse are based on data sources published to your Tableau site, but Tableau Pulse metrics are separate from the other content on your site and don't appear in projects under Explore. To access Tableau Pulse, from the navigation menu, select **Pulse**. For more information, see [Create Metrics with Tableau Pulse](#).

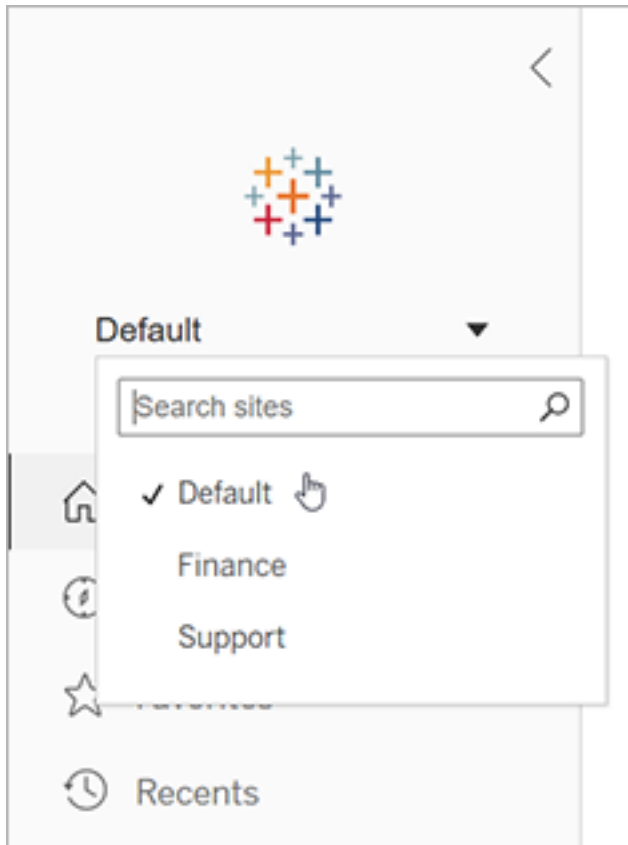
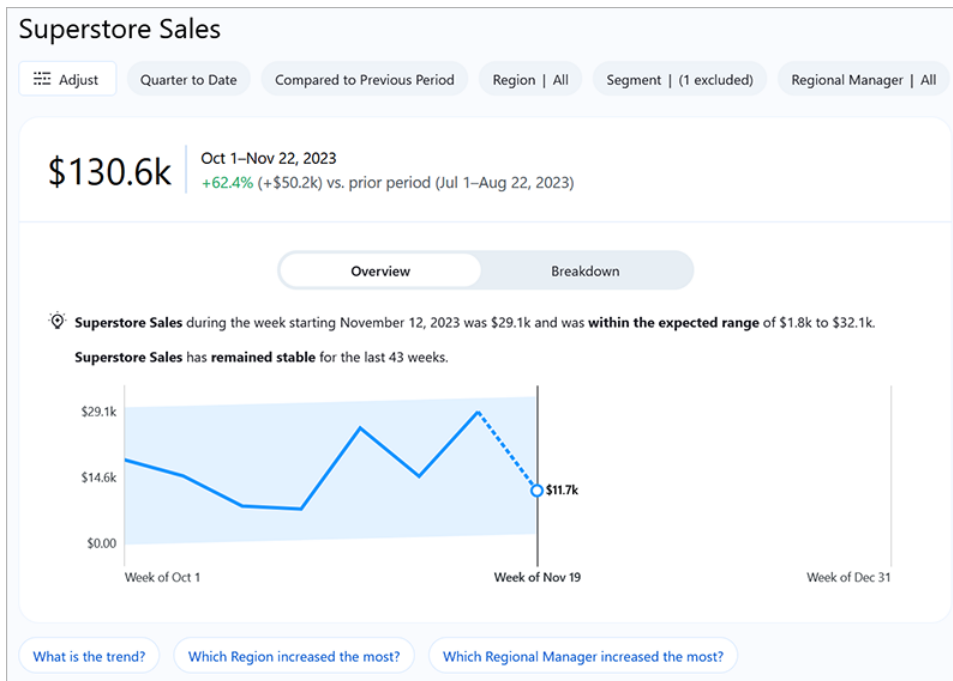
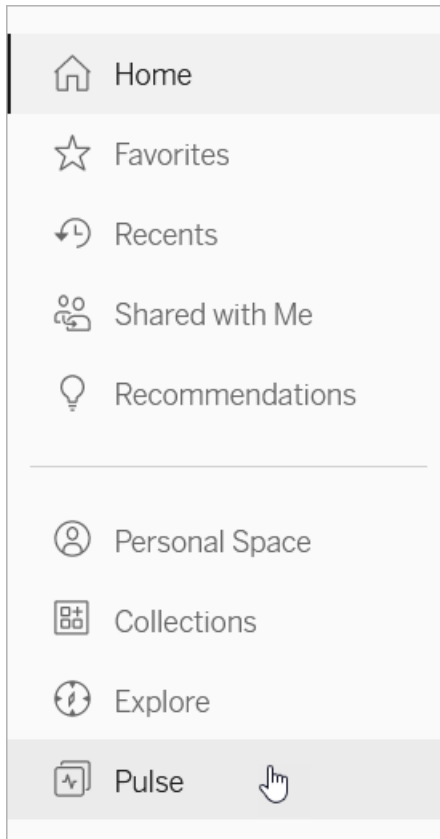

Creators: Get Started with Web Authoring

There's a lot you can do with Tableau on the web. As a Creator, you can connect to data directly to power your analytics, create stunning data visualizations, and share those insights with others. In this guide, we'll cover the Tableau Cloud environment, connecting to and preparing your data for analysis, creating a workbook and sharing those insights with others.

Not sure what your user level is? To check, select the icon in the top right corner of the site with your initials or profile picture and select **My Account Settings**. **Site Role** tells you if you are a Creator, Explorer, or Viewer.

Step 1: Sign in and explore projects on the next page

Step 2: Create a new workbook and connect to data on page 3199

Step 3: Prepare your data on page 3201

Step 4: Author a view on page 3203

Step 5: Present your work on page 3210

Step 6: Save your work on page 3212

Step 7: Collaborate and share your findings on page 3213

Step 1: Sign in and explore projects

To get started, enter your user name and password to sign in to your Tableau site. Then, from the navigation pane, click **Explore** to see all the content you have access to across the site.

Initially, you will see **Top-Level Projects**. You can browse these projects or select other content types.

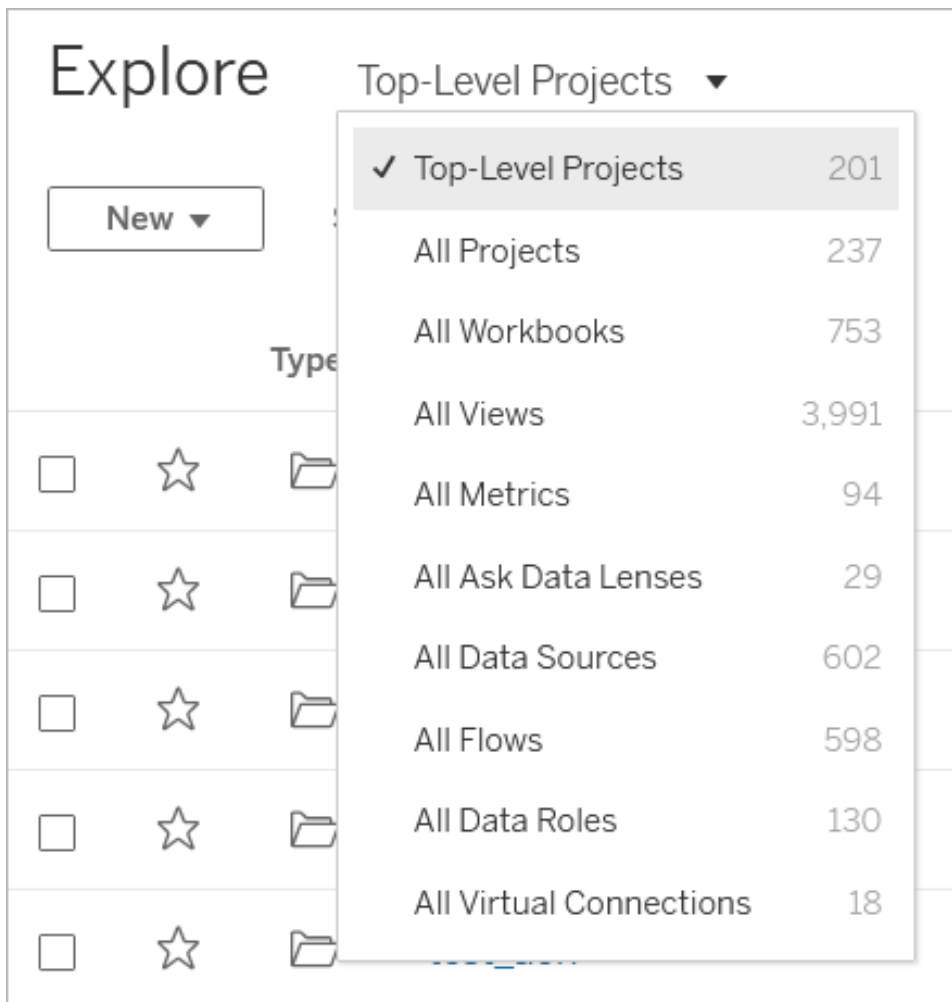

Workbooks, data sources, data roles, and flows can be saved to locations called projects. Projects can also contain nested projects. Much like folders on your desktop, projects are a way to sort and manage content in your site. If you've been invited to an existing site, you may see projects created by your teammates.

In addition to projects, you can privately save workbooks to a location called Personal Space. You can use Personal Space to create or explore workbooks, and move them to a project when you're ready to share with others. For more information, see [Create and Edit Private Content in Personal Space](#) on page 3224.

Both Personal Space and a default project are places for you to use for explorations if other projects are not available to you.

Starting in 2019.3, Tableau Catalog is available with Data Management in Tableau Server and Tableau Cloud. When Tableau Catalog is enabled in your environment, in addition to navigating and connecting to data from Explore, you can navigate and connect to more kinds of data, like databases and tables, from External Assets. For more information about Tableau Catalog, see "About Tableau Catalog" in the [Tableau Server](#) or [Tableau Cloud](#) Help.

Step 2: Create a new workbook and connect to data

In some way, you'll need to connect to data in order to analyze it and build a workbook. As a Creator, Tableau lets you connect to data sources directly on the web, or you can connect to data sources [published to Tableau Cloud through Tableau Desktop](#).

To begin, click the **New** button and select **Workbook**.

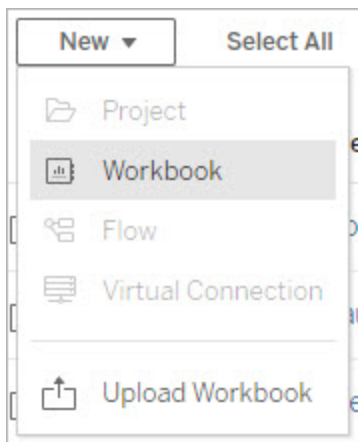

The **Connect to Data** dialog displays a scrollable list of mixed content that's popular. If you have a Data Management license, you can connect to data with a virtual connection, and if you have

Data Management with Tableau Catalog enabled, you can also connect to external assets, like databases, files, and tables.

The responsive search field shows a list of suggestions that updates as you enter text. Filter search results by type of data, certification status, or other filters that depend on the type of data selected. For example, some types of data may allow you to filter based on tags, connection type, data quality warnings, or other criteria. Older versions of the dialog look and function slightly differently, but the overall function is similar.

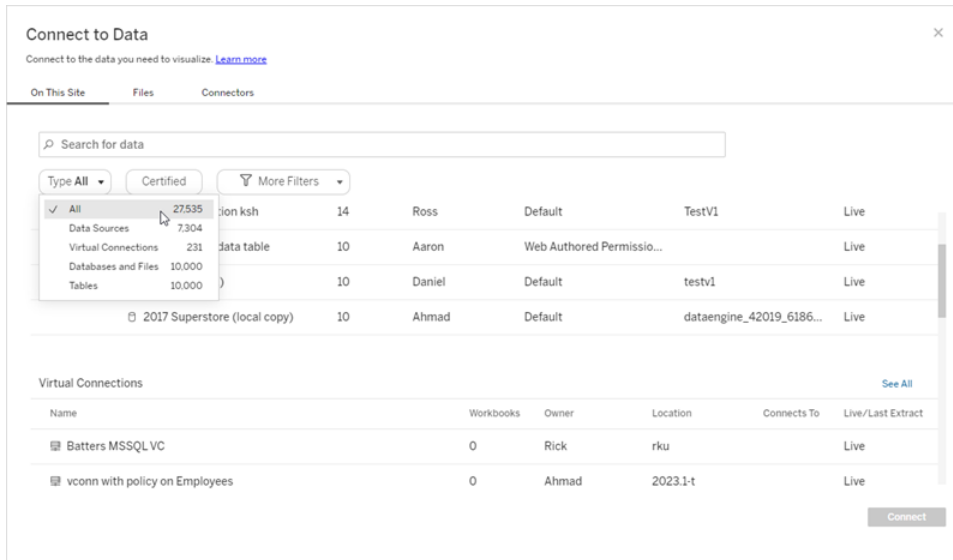

You can connect to the data that will power your workbook in several ways:

- Connect to published data sources from the **On This Site** tab.
If you have a Data Management license, you can connect to data with a virtual connection, and if you have Data Management with Tableau Catalog enabled, you can also connect to external assets, like databases, files, and tables.
- Upload Excel or text-based data sources from the **Files** tab.
- Connect to server or cloud data sources from the **Connectors** tab.
- On Tableau Cloud, quickly author and analyze data from LinkedIn Sales Navigator, Oracle Eloqua, Salesforce, ServiceNow ITSM, and Marketo from the **Dashboard Starters** tab.

To learn more about connecting to data on the web, see [Creators: Connect to Data on the Web](#).

Tableau Catalog users create workbooks from external assets

When you have Data Management with Tableau Catalog enabled, you can create a new workbook when you're making a Catalog-supported connection from the External Assets page:

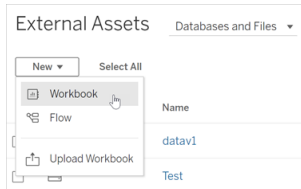

And from database and table pages:

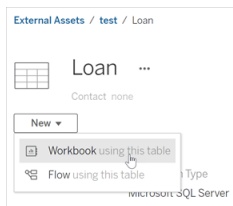

If Catalog doesn't support the connection, **New Workbook** doesn't appear.

Step 3: Prepare your data

After you have connected to data, use the data source page to prepare your data for analysis.

Parts of the data source page

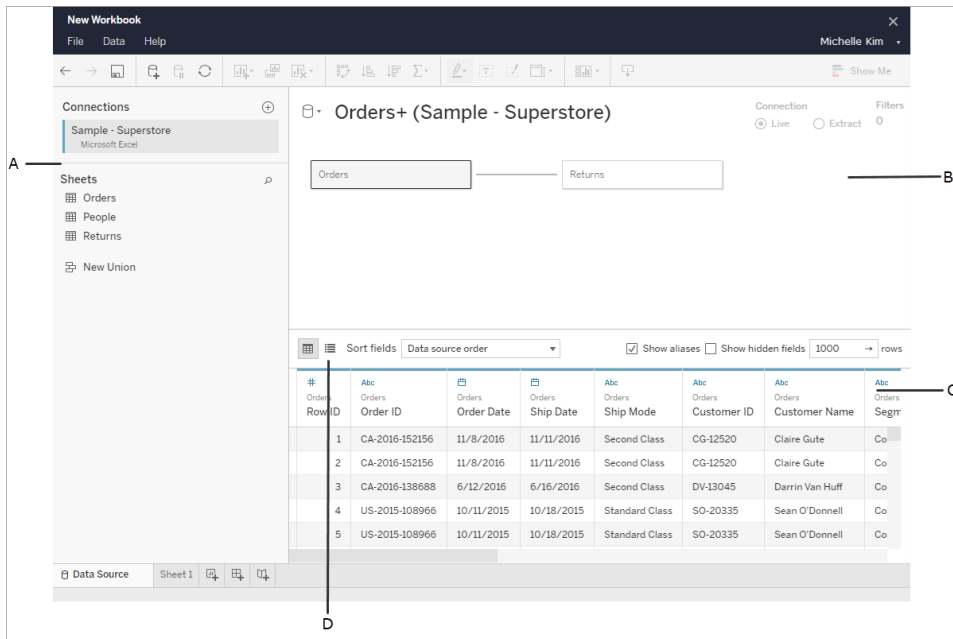

There are four areas of the data source page:

- Left pane:** Displays details about your data. For file-based data, the left pane might display the file name and the worksheets in the file. For relational-based data, the left pane might display the server, the database or schema, and the tables in the database.
- Canvas:** When connected to most relational and file-based data, you can drag one or more tables to the canvas area to set up your Tableau data source for analysis.
- Data grid:** You can use the data grid to review the fields and the first 1,000 rows of the data contained in the Tableau data source.
- Metadata grid:** The button takes you to the metadata grid, which displays the fields in your data source as rows so you can look at its structure.

You can prepare your data for analysis in the data source page by:

- Renaming your data source
- Cleaning your data using the Data Interpreter
- Setting text file options
- Relating your data
- Editing data columns

To learn more about preparing your data for analysis on the web, see [Creators: Prepare your Data on the Web](#).

Once your data is ready for analysis, click on **Sheet 1** at the bottom of the screen to be taken to the Tableau workspace to build a view.

Step 4: Author a view

You've connected to data, you've set it up for analysis, and now you're ready to create a visual analysis of your data. Tableau calls this a **view**. If you've used Tableau Desktop before, the workspace area is very similar.

Workspace area

This is the layout of the Tableau workspace:

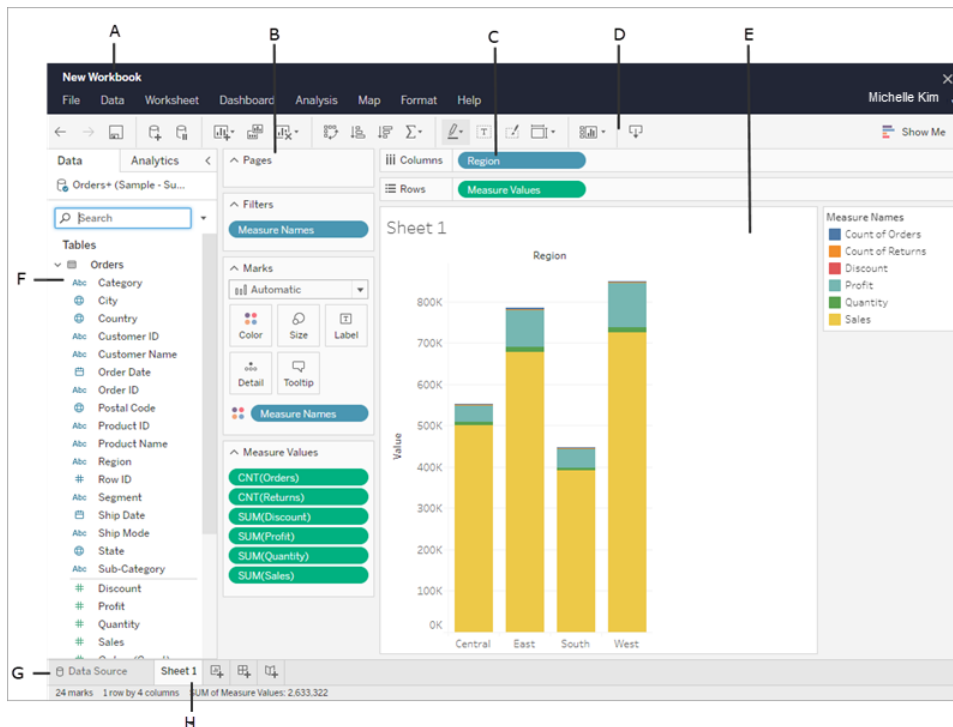

- A. **Workbook name.** A workbook contains sheets. A sheet can be a worksheet, a dashboard, or a story. For more information, see [Workbooks and Sheets](#).
- B. **Pages shelf, Filters shelf, Marks card** - Drag fields to the cards and shelves in the workspace to add data to your view. For more information, see [Shelves and Cards](#).

- C. **Columns and Rows shelf** - Drag fields to the cards and shelves in the workspace to add data to your view. For more information, see [Shelves and Cards](#).
- D. **Toolbar** - Use the toolbar to access commands and analysis and navigation tools. See the [Tableau Toolbar Button reference](#).
- E. **View** - This is the workspace where you create your data visualizations.
- F. **Side Bar** - In a worksheet, the side bar area contains the Data pane and the Analytics pane.
- G. Go to the **data source** page. For more information, see [Creators: Preparing Data on the Web](#).
- H. **Sheet tabs** - Tabs represent each sheet in your workbook. This can include worksheets, dashboards, and stories.

Starting in Tableau 2020.2: For each table or folder in the Data pane, a gray line separates dimensions (above line) and measures (below line). The **Dimensions** and **Measures** labels are no longer used in the Data pane.

Different ways to start building a view

Every time you drag a field into the view or onto a shelf, you are asking a question about that data. The question will vary depending on where you drag various fields, the types of fields, and the order in which you drag fields into the view.

For every question you ask, the view changes to represent the answer visually - with marks (shapes, text, hierarchies, table structures, axes, color).

In the worksheet, the columns from your data source are shown as fields on the left side in the **Data** pane. The **Data** pane contains a variety of different kinds of fields, organized by table.

Tableau Desktop and Web Authoring Help

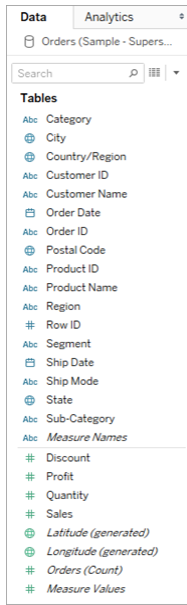

When you build a view, you add fields from the **Data** pane. You can do this in different ways. For example:

- Drag fields from the **Data** pane and drop them onto the cards and shelves that are part of every Tableau worksheet.

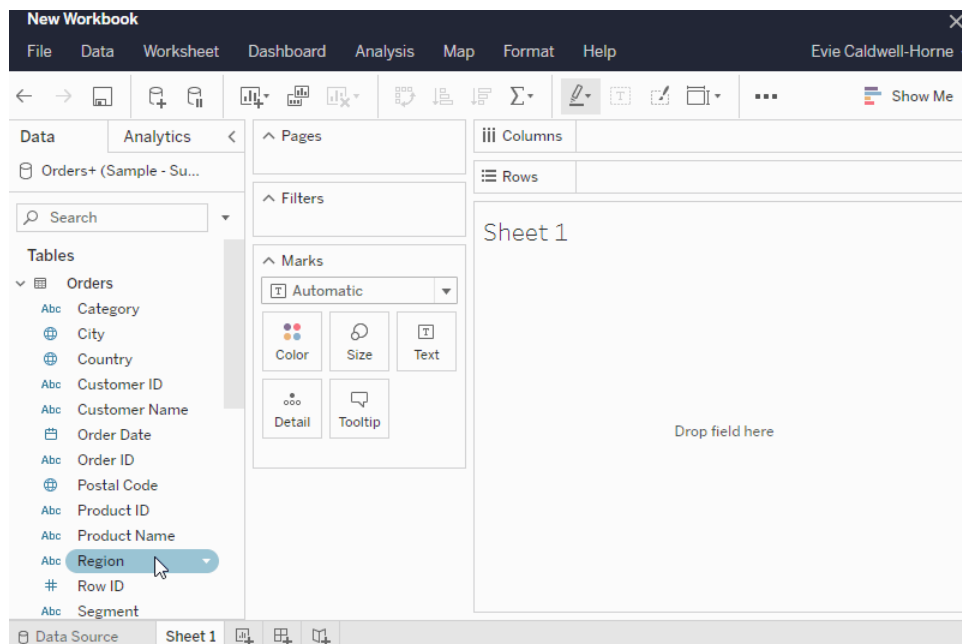

- Double-click one or more fields in the **Data** pane.

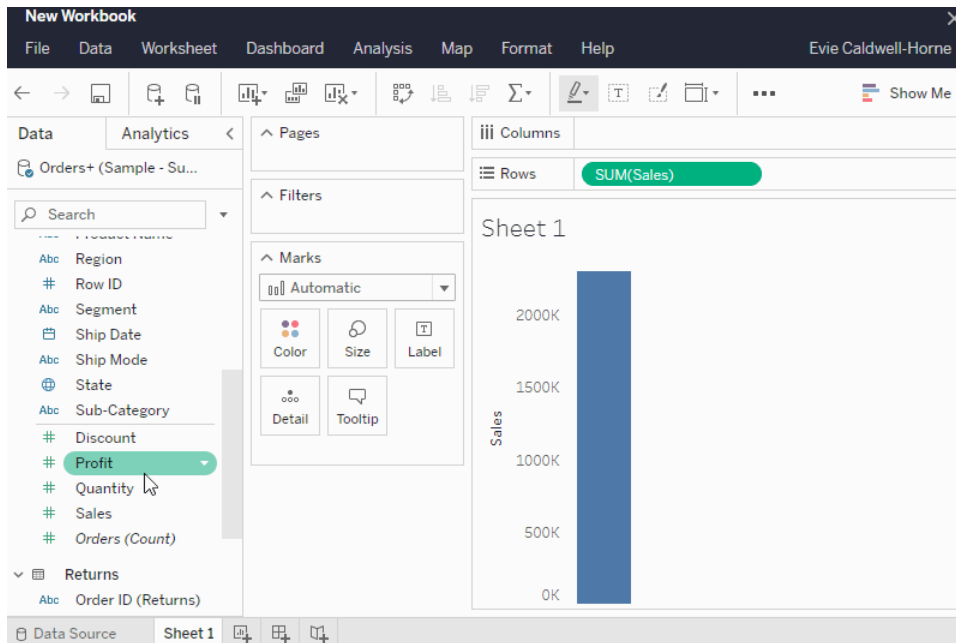

- Select one or more fields in the **Data** pane and then choose a chart type from **Show Me**, which identifies the chart types that are appropriate for the fields you selected. For more information, see [Show Me](#).

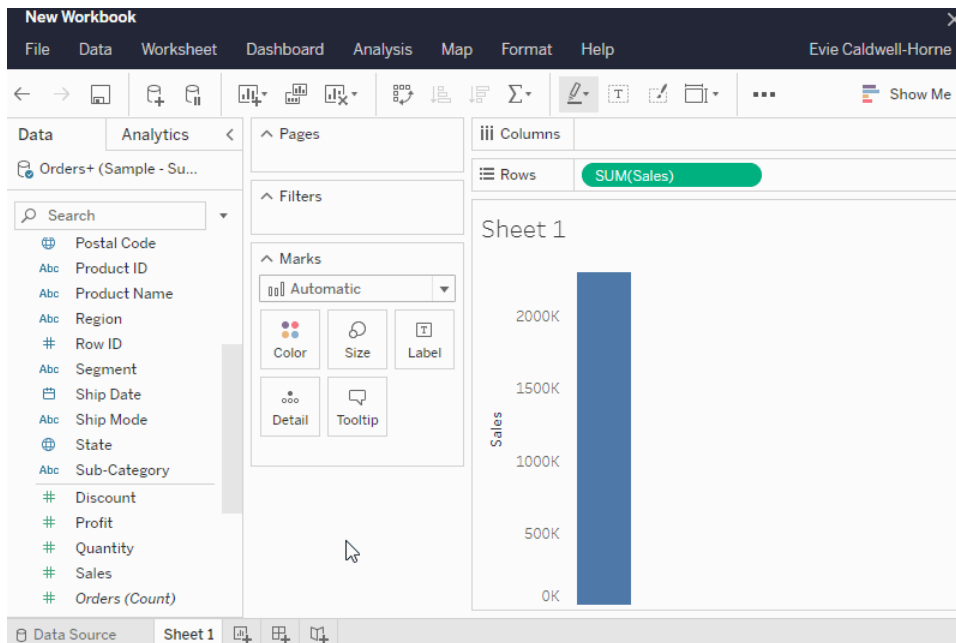

Filtering data

You might want to filter your data to only display a certain amount in your view. You can filter your data in a number of ways, including:

When you add fields to the filter Shelf, an interactive filter appears in the view. You can then select the items you want to include or exclude in the view.

- To create a filter in Tableau on the web, drag a dimension, measure, or date field to the filter shelf.

When you add a field to the filters shelf, an interactive filter appears in the view. You can select items you want to include or exclude from the view, or select a range of values.

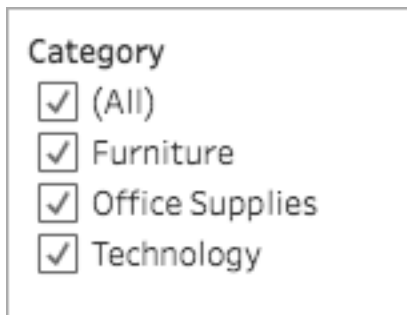

- You can also interact with a published view by selecting a single mark (data point) or click and drag in the view to select several marks. On the tooltip that appears, you can select Keep Only to keep only the selected marks in the view, or select Exclude to remove the selected marks from the view.

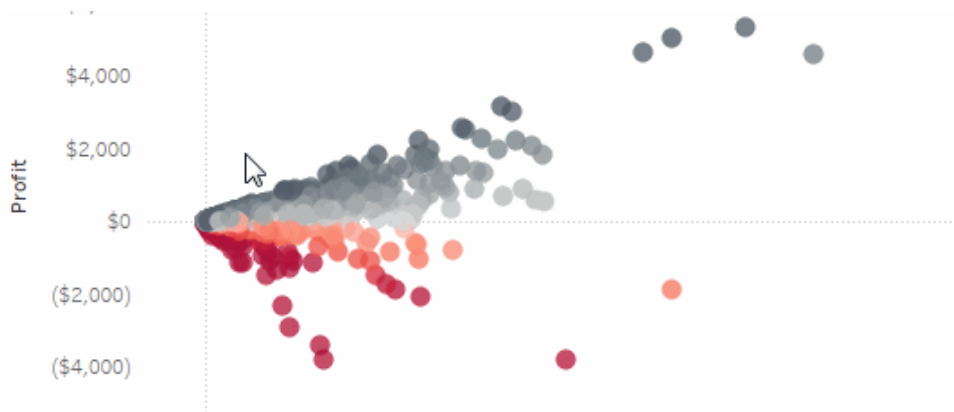

For more information about filtering in Tableau, including Tableau's order of operations, see [Filter Data from Your Views](#).

Using the Marks card

You can use the Marks card to add context and details to the marks in your view. You use the Marks card to set the mark type, and to encode your data with color, size, shape, detail, and text.

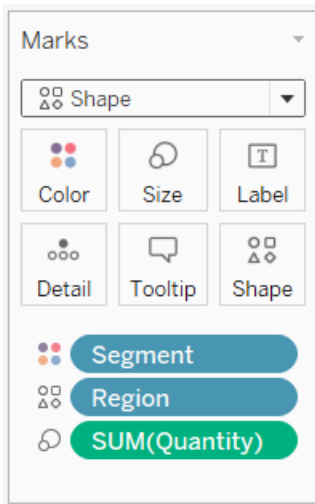

After you add a field to the Marks card, you can click the icon next to the field to change the property it is using. You can also click the property buttons in the Marks card to change those settings.

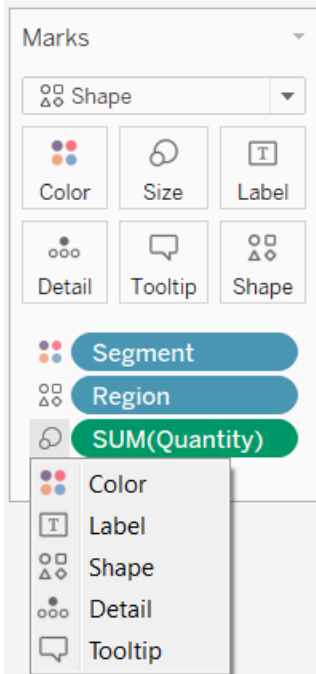

Many properties can have multiple fields. For example, you can add multiple fields to Label, Detail, Tooltip, and Color. Size and Shape can only have one field at a time. For more information, see [Mark Properties Reference](#).

Undo your work

Tableau is extremely flexible and very forgiving. As you build a view, if you ever take a path that isn't answering your question, you can always undo to a previous point in your exploration.

- To undo or redo, click undo ← or redo → on the toolbar.

You can undo all the way back to the last time you opened the workbook. You can undo or redo an unlimited number of times.

Build and edit views on the web

There are many ways to explore data in Tableau. For instructions on building specific chart types on the web, see [Edit Tableau Views on the Web](#) on page 3231, or for more features available to help you build a visualization in Tableau, see [Build and Explore Data Views](#).

Step 5: Present your work

There are several ways to tell a story or persuade others with the data insights you've found in your views.

Format your work

You can format almost everything you see on a workbook, including parts of a view, your workbook's fonts, and graph lines.

- [Learn about visual best practices](#)
- [Format parts of a view](#)
- [Create Custom Color Palettes](#)
- [Format Text and Numbers](#)
- [Format at the workbook level](#)

Dashboards

A **dashboard** is a collection of several worksheets and supporting information shown in a single space so you can compare and monitor different data simultaneously.

To open a new dashboard sheet and start creating a dashboard, click the New Dashboard icon at the bottom of the workbook:



The Dashboard area appears on the left and lists the sheets in your workbook. You can add one or more views to a dashboard, add objects like web pages, blank space, and layout containers, or interactivity to associate different views on your sheet.

Tableau Desktop and Web Authoring Help

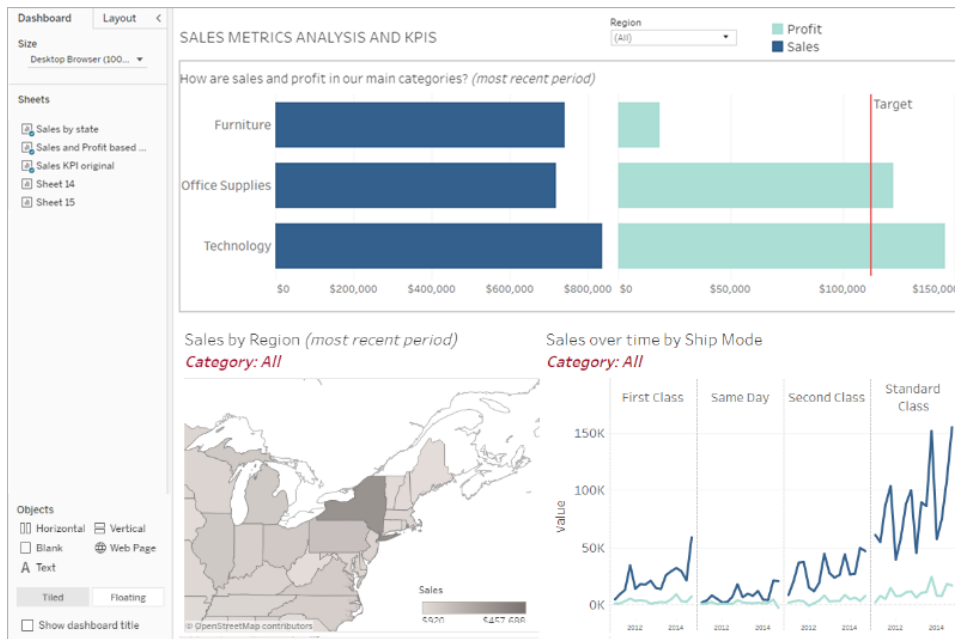

- [Learn more about dashboards](#)
- [Learn about tips and tricks from dashboard experts](#)

Stories

A **story** is a sheet that contains a sequence of worksheets and dashboards that work together to convey information. You can use stories to make a compelling case by showing how facts are connected, and how decisions create stories to tell a data narrative, provide context, demonstrate how decisions relate to outcomes, or make a compelling case with your data.

[Create a story](#) or [learn more about stories](#).

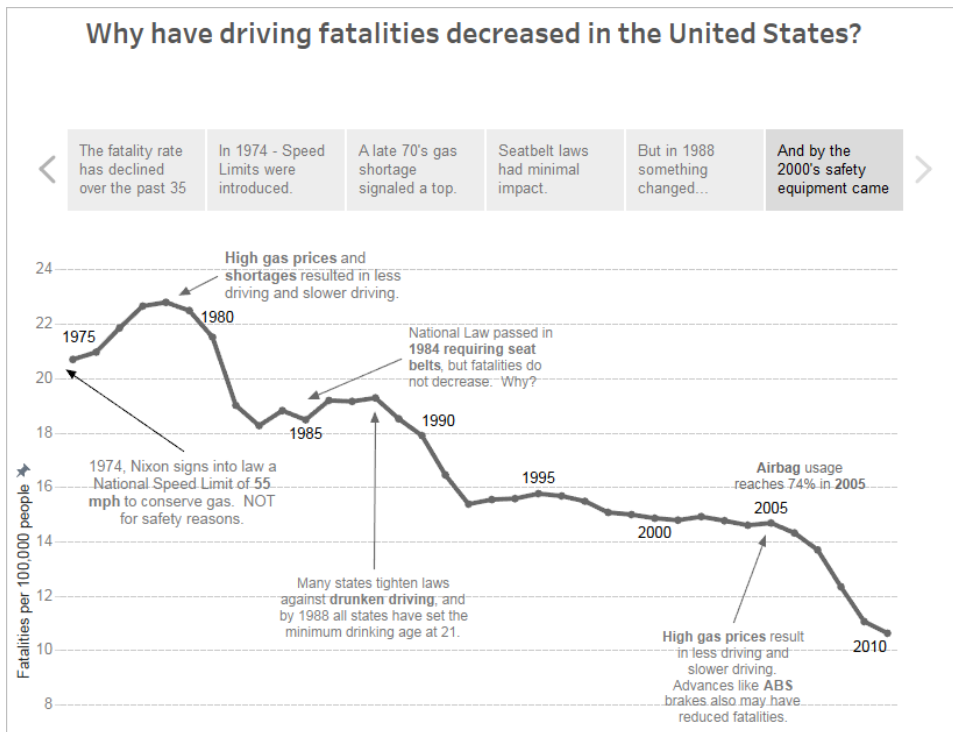

Step 6: Save your work

You can save your workbook at any time by selecting **File > Save As**. Your workbook will save into the folder it was created in.

You can also save your data source to create another workbook later, or enable members of your team to use that data for their own analysis.

To save a data source, hover over the data source name in the Data tab in the workspace until an arrow appears. Select the arrow and select **Save**.

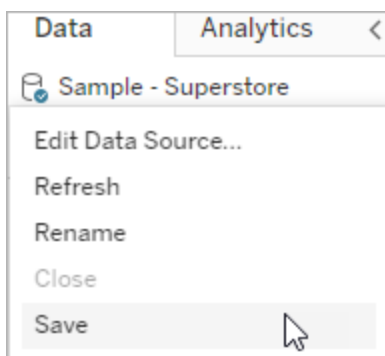

Note: When you save a data source on the web, it will appear as a published data source in the **Connect to Data** window as well as in the **Data Sources** section.

When you're finished, select **File > Close** to exit the workspace.

Step 7: Collaborate and share your findings

There are a number of ways to share your work and stay up-to-date.

Collaborate

Other Creators or Explorers in your organization can edit or update your workbooks and views if they have been given access to the project where the workbook is located. Access is controlled by your site's administrator, who can set project permissions, move content between projects, and change a user's role. If you've saved your data source, those users can connect to your data and use it to create new workbooks.

Share Views and Insights

Every view or workbook saved to your site can be shared via links in email and other applications, or can be embedded directly into web pages, wikis, and web applications.

To see a view, users must have permission to access it in Tableau Server or Tableau Cloud.

Learn how to:

- [Share web views](#) (link to a view or embed a view).
- [Subscribe to Views](#) to receive a snapshot of it by email at regular intervals.
- Create [Data-Driven Alerts](#) to receive email notifications when data reaches important thresholds.
- [Comment on views](#) to share a conversation with other users.
- [Embed views and dashboards](#) into webpages.
- [Download views or workbooks](#).

Creators: Connect to Data on the Web

Before you can create a workbook and build a view on the web to analyze your data on the web, you must connect to your data. Tableau supports connecting to data sources on the web

published through Tableau Desktop, or, connecting to data directly through Tableau Cloud, Tableau Server, or Tableau Public.

Starting in 2019.3, Tableau Catalog is available as part of the Data Management offering for Tableau Server and Tableau Cloud. When Tableau Catalog is enabled in your environment, in addition to navigating and connecting to data from Explore, you can navigate and connect to more kinds of data, like databases and tables, from Tableau Catalog. For more information about Tableau Catalog, see "About Tableau Catalog" in the [Tableau Server](#) or [Tableau Cloud](#) Help. Starting in 2021.4, Data Management includes virtual connections, a central access point to data. For more information, see "About Virtual Connections and Data Policies" in the [Tableau Server](#) or [Tableau Cloud](#) help.

Open the Connect to Data page

On the web, you use the Connect to Data page to access data to connect to. After you sign in to Tableau Server or Tableau Cloud, you can open this page two ways:

- **Home > New > Workbook**
- **Explore > New > Workbook**

If you're on Tableau Public, you can open this page from your author profile:

- **My Profile > Create a Viz**

The **Connect to Data** dialog displays a scrollable list of mixed content that's popular. If you have a Data Management license, you can connect to data with a virtual connection, and if you have Data Management with Tableau Catalog enabled, you can also connect to external assets, like databases, files, and tables.

The responsive search field shows a list of suggestions that updates as you enter text. Filter search results by type of data, certification status, or other filters that depend on the type of data selected. For example, some types of data may allow you to filter based on tags, connection type, data quality warnings, or other criteria. Older versions of the dialog look and function slightly differently, but the overall function is similar.

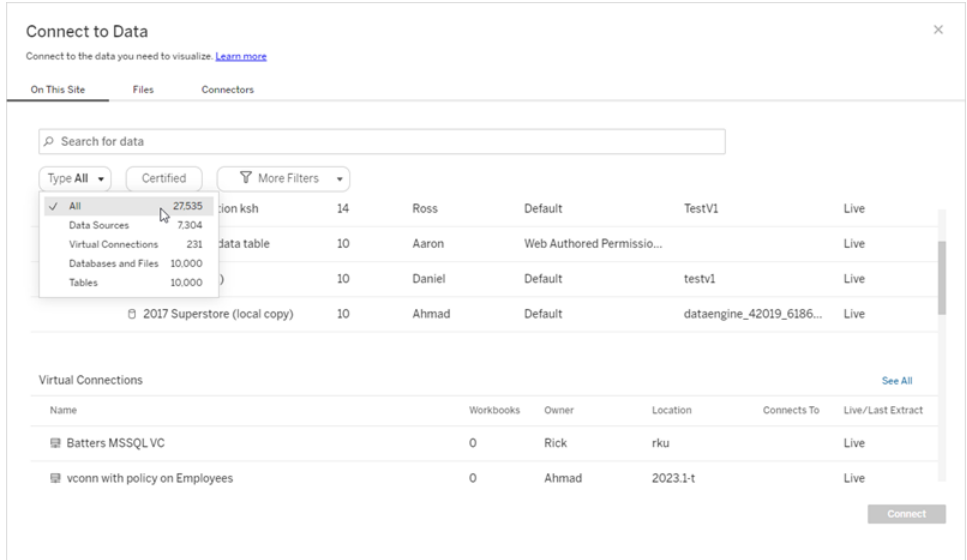

On the Connect to Data page, the tabs you see depend on the product you have.

Tableau Server

On Tableau Server, select from the following tabs to connect to data: On this site, Files, and Connectors.

Connect to data On this site

1. Select **On this site** to browse to or search for published data sources.
2. Select the data source under **Name** and click the **Connect** button.

Note: In addition to connecting to data sources, when you have Data Management, you can use **On this site** to connect to data using a virtual connection. When Tableau Catalog is enabled you can also connect to databases, files, and tables.

Connect to files

Tableau supports uploading Excel, text-based data sources (.xlsx, .csv, .tsv), and spatial file formats that only require one file (.kml, .geojson, .topojson, .json, and Esri shapefiles and Esri File Geodatabases packaged in a .zip) directly in your browser. In the **Files** tab of the **Connect to Data** pane, connect to a file by dragging and dropping it into the field or clicking **Upload from Computer**. The maximum file size you can upload is 1 GB.

Use connectors

From the **Connectors** tab, you can connect to data housed in a cloud database or on a server in your enterprise. You must supply connection information for each data connection that you make. For example, for most data connections, you must supply a server name and your sign-in information.

[Supported Connectors](#) has information on how to connect Tableau to each of these connector types to set up your data source. If the connector you need doesn't appear in the Connectors tab, you can connect to data through Tableau Desktop and publish your data source to Tableau Cloud or Tableau Server for web authoring. Learn more about how to [Publish a Data Source](#) in Tableau Desktop.

When Tableau successfully connects to your data, the Data Source page opens so that you can prepare the data for analysis and begin building your view. To learn more, see [Creators: Prepare Data on the Web](#).

Tableau Server connectors

Action Matrix*	Google BigQuery**‡	OData‡
Alibaba AnalyticDB for MySQL‡	Google BigQuery JDBC**‡	OneDrive‡
Alibaba Data Lake Analytics‡	Google Cloud SQL‡	Oracle‡
Alibaba MaxCompute‡	Google Drive‡	Pivotal Greenplum Database‡
Amazon Athena‡	Impala‡	PostgreSQL‡
Amazon Aurora for MySQL‡	Kognito*	Progress OpenEdge*
Amazon EMR Hadoop Hive‡	Kyvos‡	Presto‡
Amazon EMR Hadoop Hive‡	Hortonworks Hadoop Hive	Qubole Presto‡
Amazon Redshift‡	IBM BigInsights	SAP HANA (for virtual connections only)‡
Apache Drill‡	IBM DB2‡	SAP Sybase ASE*
Aster Database*	IBM PDA (Netezza)*	SAP Sybase IQ*
Azure Data Lake Storage Gen2‡	Kyvos‡	Salesforce‡
	MariaDB‡	SharePoint Lists‡
	MarkLogic*	SingleStore (formerly
	Microsoft Azure SQL	

Box‡	Database‡	MemSQL)‡
Cloudera Hadoop‡	Microsoft Azure Synapse Analytics‡	Snowflake‡
Databricks‡	Microsoft SQL Server‡	Spark SQL‡
Datorama by Salesforce‡	MonetDB*	Teradata***‡
Denodo‡	MongoDB BI Connector‡	Vertica‡
Dremio by Dremio‡	MySQL‡	
Dropbox‡		
Esri Connector‡		
Exasol‡		

*Not available on Linux servers.

**Google BigQuery needs OAuth when creating data sources from the web. Learn more about how server administrators can [Set up OAuth for Google](#).

***Teradata web authoring currently doesn't support query banding functionality. See [Teradata](#) for details.

‡Supports virtual connections if you have Data Management. See [About Virtual Connections and Data Policies](#) in the Tableau Server help for details.

Tableau Catalog Supported Connectors

Tableau Catalog supports making a connection with a subset of the data connectors that Tableau Server supports. If a data source, database, file, or table is grayed out, you can't connect from Tableau Server. You can, however, connect from the Tableau Desktop **Connect** pane, if you have the correct permissions.

Tableau Cloud

On Tableau Cloud, select from the following tabs to connect to data: On this site, Files, Connectors, and Dashboard Starters.

Connect to data On this site

1. Select **On this site** to browse to or search for published data sources.
2. Select the data source under **Name** and click the **Connect** button

Note: In addition to connecting to data sources, when you have Data Management, you can use **On this site** to connect to data using a virtual connection. When Tableau Catalog is enabled you can also connect to databases, files, and tables.

Connect to files

Tableau supports uploading Excel or text-based data sources (.xlsx, .csv, .tsv) directly in your browser. In the **Files** tab of the Connect to Data pane, connect to an Excel or text file by dragging and dropping it into the field or clicking **Upload from Computer**. The maximum file size you can upload is 1 GB.

Use connectors

From the **Connectors** tab, you can connect to data housed in a cloud database or on a server in your enterprise. You must supply connection information for each data connection that you make. For example, for most data connections, you must supply a server name and your sign-in information.

[Supported Connectors](#) has information on how to connect Tableau to your data using connectors. If the connector you need doesn't appear in the Connectors tab, you can connect to data through Tableau Desktop and publish your data source to Tableau Cloud or Tableau Server for web authoring. Learn more about how to [Publish a Data Source](#) in Tableau Desktop.

Note: If you're unable to connect to your data from Tableau Cloud, check to see if the database is publicly accessible. Tableau Cloud can only connect to data that's accessible from the public internet. If your data is behind a private network, you can connect using Tableau Bridge. To learn more, see [Publishers: Use Tableau Bridge to Keep Tableau Cloud Data Fresh](#).

Tableau Cloud Connectors

Alibaba AnalyticsDB for MySQL‡	Dropbox*‡	OData‡
Alibaba Data Lake Analytics‡	Esri Connector‡	OneDrive*‡
Amazon Athena‡	Exasol‡	Oracle‡
Amazon Aurora for MySQL‡	Google BigQuery*‡	Pivotal Greenplum Database‡
Amazon EMR Hadoop Hive‡	Google Cloud SQL (MySQL	

Tableau Desktop and Web Authoring Help

Amazon Redshift‡	compatible)‡§	PostgreSQL‡
Apache Drill‡	Google Drive‡	Presto‡
Azure Data Lake Storage Gen2‡	Hortonworks Hadoop Hive	Qubole Presto‡
Azure Synapse Analytics (SQL Server compatible)	Impala‡	Salesforce‡
Box‡	Kyvos‡	SAP HANA (for virtual connections only)‡
Cloudera Hadoop‡	MariaDB‡	SharePoint Lists‡
Databricks‡	Microsoft Azure SQL Database‡	SingleStore (formerly MemSQL)‡
Datorama by Salesforce‡	Microsoft Azure Synapse Analytics‡	Snowflake‡
Denodo‡	Microsoft SQL Server‡	Spark SQL‡
Dremio by Dremio‡	MongoDB BI Connector‡	Teradata**‡
	MySQL‡	Vertica‡

*For more information about using OAuth 2.0 standard for Google BigQuery, OneDrive, and Dropbox connections in Tableau Cloud, see [OAuth Connections](#).

**Teradata web authoring currently doesn't support query banding functionality. See [Teradata](#) for details.

‡Supports virtual connections if you have Data Management. See [About Virtual Connections and Data Policies](#) in the Tableau Cloud help for details.

§Tableau Cloud doesn't support SSL using Google Cloud SQL.

Tableau Catalog Supported Connectors

Tableau Catalog supports making a connection with a subset of data connectors that Tableau Cloud supports. If a data source, database, file, or table is grayed out, you can't connect from Tableau Cloud. You can, however, connect from the Tableau Desktop **Connect** pane, if you have the correct permissions.

Use Dashboard Starters

On Tableau Cloud, you can author and analyze data from LinkedIn Sales Navigator, Oracle Eloqua, Salesforce, ServiceNow ITSM, and QuickBooks Online using Dashboard Starters. On

the **Dashboard Starter** tab, from the list of pre-built designs, select an option and click **Use Dashboard**. See [Dashboard Starters for Cloud-based Data Sources](#) for details.

Tableau Public

On Tableau Public, you can connect to data by uploading a supported file.

Connect to files

Tableau supports uploading Excel or text-based data sources (.xlsx, .csv, .tsv) directly in your browser. In the **Files** tab of the Connect to Data pane, connect to an Excel or text file by dragging and dropping it into the field or clicking **Upload from Computer**. The maximum file size you can upload is 1 GB.

If you don't have a data set, check out the free [sample data sets](#) on the Tableau Public website.

Use connectors

From the **Connectors** tab, you can connect to data housed in a cloud database. You must supply connection information for each data connection that you make. For example, for most data connections, you must supply your sign-in information.

[Supported Connectors](#) has information on how to connect Tableau to your data using connectors. If the connector you need doesn't appear in the Connectors tab, you can connect to data through Tableau Desktop and create an data extract.

Note: If you're unable to connect to your data from Tableau Public, check to see if the database is publicly accessible. Tableau Public can only connect to data that's accessible from the public internet.

Tableau Public Connectors

Google Drive

OData

After you connect

When Tableau connects to your data, the Data Source page opens so that you can prepare the data for analysis and begin building your view. To learn more, see [Creators: Prepare Data on](#)

the Web.

Keep data fresh in web authoring

Update uploaded files in Tableau Cloud or Tableau Server: If you manually upload a file (Excel or text) for web authoring, Tableau can't refresh the file automatically. To update your data, select "Edit Connection" to upload a new version of the file.

In Tableau Public, go to your viz and click **Request Update**. You can also keep your data fresh automatically by selecting "Keep this data in sync" in Tableau Desktop Public Edition.

Update file-based published data sources in Tableau Cloud: If you have a published data source in Tableau Cloud (published through Tableau Desktop) that uses file-based data, you can keep it fresh using Tableau Bridge. For more information, see [Expand Data Freshness Options by Using Tableau Bridge](#).

Prepare Data on the Web

After you connect to data in Tableau Cloud or Tableau Server, you can use the Data Source page to set up your data source and prepare your data for analysis. Having data that is formatted in a way Tableau likes is crucial to building a view or doing analysis in Tableau, and communicating the right information to the right people.

This article describes preparing your data in the browser with Tableau Cloud or Tableau Server. Although Tableau supports many of the same functionality for preparing your data for analysis in the browser as Tableau Desktop, for specific differences between the two, see [Web Authoring and Tableau Desktop Feature Comparison](#) on page 3434.

Note on keeping your data fresh: If you connect to a published **flat file** (Excel or text), that data will not be refreshed even if it's modified. If your data is in an **on-premises server** and is published to the web through Tableau Desktop, it will be rendered as an extract and won't be refreshed. If you need to keep data published through Tableau Desktop fresh on the web, you can use Tableau Bridge. To learn more about these requirements, see [Keep Data Fresh](#) and [Use Bridge to Keep Data Fresh](#) on page 3162

Tour the Data Source page

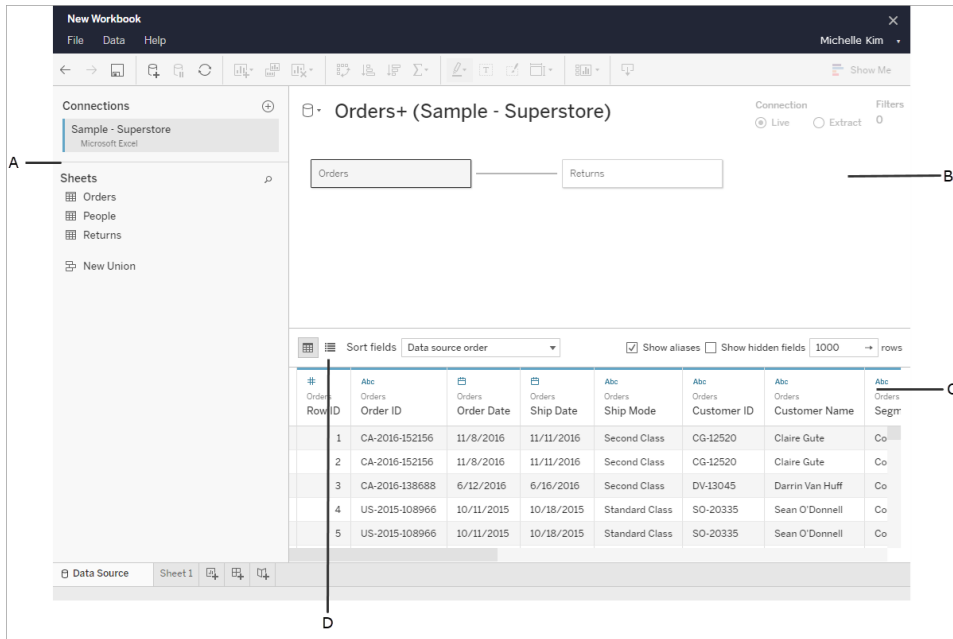

There are four parts of the data source page:

A: Left pane

Displays details about your data connection. For example, for Excel-based data, the left pane shows your Excel workbook name, and sheets contained in that workbook. For databases, the left pane displays the server, the database or schema, and tables in the database.

B: Canvas

When connected to most relational and file-based data, you can drag one or more tables to the canvas area to join tables for analysis.

In the canvas, you can also join tables from the same or multiple data sources

C: Data grid

You can use the data grid to review or rename fields, create calculations, preview your changes, and more.

D: Metadata grid

Select the metadata grid button to see the fields in your data source as rows. This view is helpful in understanding the structure of your data source.

Set up data sources

After you connect to your data, use the Data Source page to set up the data source and prepare your data for analysis. There are many optional configurations that you can make before you begin your analysis. The configurations that you make on the Data Source page creates the data source that Tableau uses to interpret and interact with your data.

[Plan the Data Source on page 596](#)

[Relate Your Data on page 622](#)

[Connect to a Custom SQL Query on page 863](#)

[Join Your Data on page 791](#)

[Union Your Data on page 847](#)

[Convert a Field to a Date Field on page 884](#)

[Pivot Data from Columns to Rows on page 892](#)

[Clean Data from Excel, CSV, PDF, and Google Sheets with Data Interpreter on page 897](#)

Edit and sort fields in the data grid

You can make changes to your fields in the data grid. You can rename your fields, group them, create aliases, create calculated fields, change data type, and convert to a measure.

[Understand Field Type Detection and Naming Improvements](#)

[Get Started with Calculations in Tableau](#)

[Convert a Field to a Date Field](#)

[Data Types](#)

[Field types: Dimensions and Measures, Blue and Green](#)

Manage data sources

[Edit Data Sources on page 957](#)

[Refresh Data Sources](#) on page 968

[Replace Data Sources](#) on page 970

[Close Data Sources](#) on page 980

[Save Data Sources](#) on page 972

[Run Initial SQL](#) on page 591

Publish a Data Source on the Web

You can save data sources to share or reuse from your published workbooks on Tableau Server. To do this, you'll need to have the specific permissions to edit the workbook and publish on Tableau Server. For more about publishing permissions, see [Who can publish content](#) in the Tableau Server Help.

If your data source uses a large extract, this publish step might take a few minutes.

1. On Tableau Server, open a workbook in web authoring.
2. Click the tab for any worksheet.
3. From the **Data** pane, click the drop-down menu for the data source you want to share, and click **Save as Published Data Source**.

Note: After the data source is published to the web, you will not be able to edit or view the data model.

Create and Edit Private Content in Personal Space

Personal Space is a private location for all Explorers and Creators to save content to when working in a Tableau Site. Content saved in Personal Space can't be shared with other users but can be moved to a project when you're ready for others to see it. Within Personal Space, you can create a new workbook or save a workbook to Personal Space as a separate copy. You can also move existing content you own into Personal Space for editing, then move it back to a project later. Explorers can download workbooks in Personal Space, including all data included in the workbook.

Privacy in Personal Space

Content saved to your Personal Space is only visible to you and site administrators. Site administrators can't directly access any user's Personal Space or edit content in someone else's Personal Space, but they can view and manage Personal Space workbooks. Personal Space workbooks appear in administrator search results and as a workbook location on the Explore page. In addition, the permissions menu is unavailable when a workbook is in Personal Space because the workbook is private.

Tableau Catalog and Personal Space

Starting in 2019.3, Tableau Catalog is available with Data Management in Tableau Server and Tableau Cloud. For more information, see "About Tableau Catalog" in the Tableau Server or Tableau Cloud Help.

When Tableau Catalog is enabled in your work environment, the information about workbooks you save in your Personal Space is indexed by Catalog. These workbooks are included in lineage counts, however, only you can see the workbooks. Furthermore, users who browse through the lineage tool see Permissions required instead of information about workbooks in your Personal Space.

Collaboration tools

When a workbook is in Personal Space, some functionality is disabled, including share, metrics, comments, alerts, and subscriptions. Existing alerts and subscriptions to you will continue running, but alerts and subscriptions to others will fail, since the content is now private. Metrics can't be created in Personal Space but will continue to work if a connected workbook is moved there. (The legacy Metrics feature was retired in February 2024 for Tableau Cloud and in Tableau Server version 2024.2. For more information, see [Create and Troubleshoot Metrics \(Retired\)](#).)

These limitations are removed when the workbook is moved or saved to another location. For example, if a workbook contains comments and moves to Personal Space, existing comments are hidden. Comments restore when the workbook is moved to another location.

Extract refreshes in Personal Space

To limit resource consumption, existing extract refreshes continue to run if they've been scheduled, but new extract refreshes can't be scheduled while a workbook is in Personal Space.

Find content in Personal Space

You can access Personal Space from the left navigation menu to see all your Personal Space content or create a new workbook, and you can save to Personal Space when creating or editing a workbook anywhere on the site.

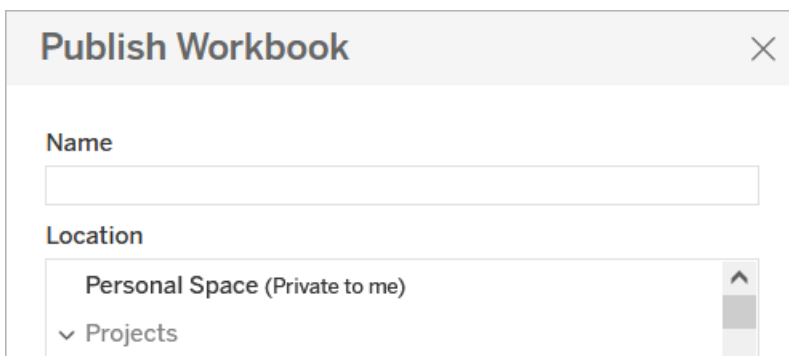
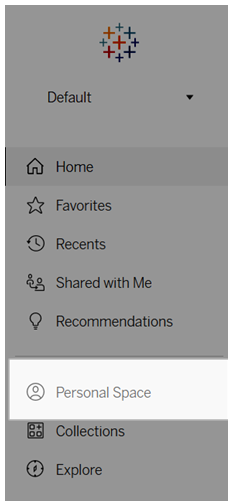

You can also see workbooks in Personal Space from the Explore page when All Workbooks is selected, and you can filter down to Personal Space content.

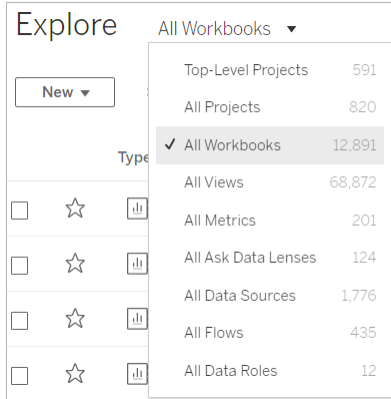

Publish a workbook to Personal Space

Personal Space works much like a private project for you to publish a new or existing workbook to from Tableau Cloud, Tableau Server, or Tableau Desktop.

Publish a workbook to Personal Space on Tableau Server or Tableau Cloud

1. With the workbook open, select **File > Publish As**.
2. Under Location, select **Personal Space**.

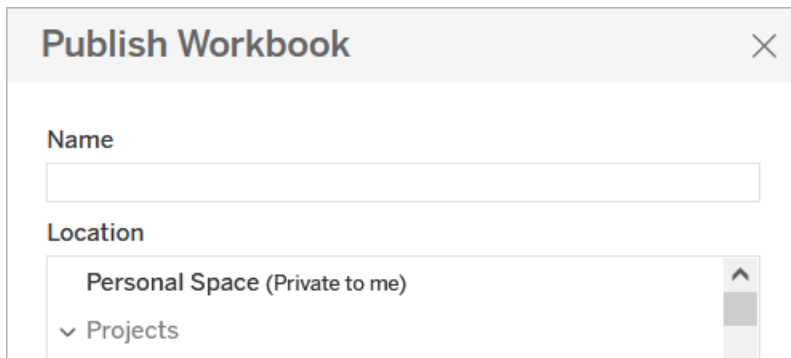

Note: Explorers can only save workbooks to Personal Space and may not see a location selection dialog.

Publish a workbook to Personal Space from Tableau Desktop

Starting in 2023.1, you can publish a workbook to Personal Space from Tableau Desktop.

1. With the workbook you want to publish open in Tableau Desktop, select **Server > Publish Workbook**.
2. Under Project, select **Personal Space**.
3. Under Data Sources, select **Edit**.
4. In the Manage Data Sources popup under Publish type, select **Embedded in workbook** for all data sources. You must embed data sources when publishing from Tableau Desktop, because you can't publish data sources separately to Personal Space.
5. Fill out the remainder of the publishing options as usual. For more information, see [Comprehensive Steps to Publish a Workbook](#).

Move workbooks to Personal Space

You can move an existing workbook to Personal Space if you are the owner of the workbook and there is room in your Personal Space. Personal Space storage limits are set by administrators.

To move a workbook to Personal Space:

- Select a workbook, then click the **Actions** drop-down menu.
- Select **Move**.
- Under Location, Select **Personal Space**.

Note: Explorers can only save workbooks to Personal Space and may not see the move action or location selection dialog.

For more information, see [Perform actions](#) in the Manage Web Content help topic.

When you move an existing workbook or data source to Personal Space, tools like share, alerts, and subscriptions become hidden. Existing extract refreshes continue to run if they've been scheduled, but users can't schedule new extract refreshes within their Personal Space.

Existing subscriptions and alerts also continue but can't be edited from Personal Space and will fail if other users are recipients. Existing connected metrics will continue to refresh, but the connected view will not be visible to other users.

Move workbooks from Personal Space

When you move a workbook out of Personal Space, collaboration tools like share, alerts, and subscriptions become visible, and any existing comments reappear.

Upload Workbooks to a Tableau Site

Most workbooks you encounter in a Tableau Cloud or Tableau Server site are created and published to the web using Tableau Desktop, or are created directly on the web. When Desktop is unavailable, you can upload Tableau workbooks and Tableau packaged workbooks directly to your Tableau Cloud or Tableau Server site if you have a Creator and Explorer (can publish) site role.

Upload a new workbook to a Tableau site

To upload a workbook:

1. Sign in to a site on Tableau Cloud or Tableau Server.
2. From the Home or Explore pages, select **New > Workbook Upload**.

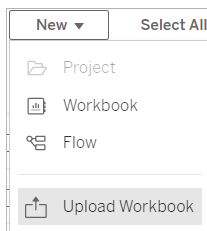

3. In the dialog that opens, do either of the following:
 - Select **Choose a file** to select a .twb or .twbx file from your computer
 - Drag and drop a file into the upload area of the dialog.

Files must be 50 MB or smaller to be uploaded.

4. In the Name field, enter a name for your workbook. By default, the workbook will retain the name of the file.
5. Choose a project where your workbook will be published, or leave as is to publish the workbook to the Default project.

Note: You'll see a warning if the project already contains a workbook with the same name. You can override an existing workbook, or update the **Name** field to something else.

6. Optionally, add a workbook description or select **Show sheets as tabs** to provide tab-based navigation.

How sheet tabs are configured also impacts permissions. When a workbook shows sheets as tabs, workbook-level permission rules are applied to the sheets. When the sheets are not shown as tabs, any changes made to workbook permissions do not apply to the individual sheets (aka views). View-level permissions must be set independently. For more information, see the [Set Content Permissions](#) tab in the [Permissions](#) topic for more information.

7. Select **Upload**.

If the workbook is overwriting an existing workbook, confirm that you'd like to overwrite, or select **Cancel** to rename.

8. When the workbook uploads successfully, you're directed to the first sheet of the workbook.

Note: Uploading publishes every sheet in the workbook. To limit publishing to specific sheets, use Tableau Desktop to upload.

Permissions and data source connections

To upload a workbook, you must have permission to publish to the site and the project.

If your workbook uses an embedded data source that requires a password, you can embed credentials after you publish the workbook.

To edit the data source connection after uploading and publishing a workbook:

- Open the workbook for editing, select the Data Source tab, and select Edit Connection.
- From the Data Sources tab, select the Actions menu (...) and select Edit Connection.

Edit Tableau Views on the Web

If you can see the **Edit** button when you are looking at a view in Tableau Cloud or Tableau Server, that means you can make changes to it. Depending on your access level and permissions, you can:

- Edit an existing published workbook and add worksheets for views, dashboards, and stories.
- Create and edit a new workbook based on a published data source.
- Edit an existing workbook and add worksheets in the browser, or by opening the workbook in Tableau Desktop.
- Connect to different published data sources while editing. For details, see [Connect to Published Data Sources while Web Editing](#).

For more information about how to build different types of charts and views in Tableau, see [Build Charts and Analyze Data on page 1005](#).

Note: Editing a view on a mobile device, either with a mobile web browser or the Tableau Mobile app, is not supported. You must use a desktop web browser.

Edit a published view

1. Sign in to a site, then either open the workbook that contains the view you want to edit, or show **All Views** from the Explore page.
2. Open the view.
3. Click **Edit** in the view toolbar.



When you click **Edit**, the view opens in web authoring mode.

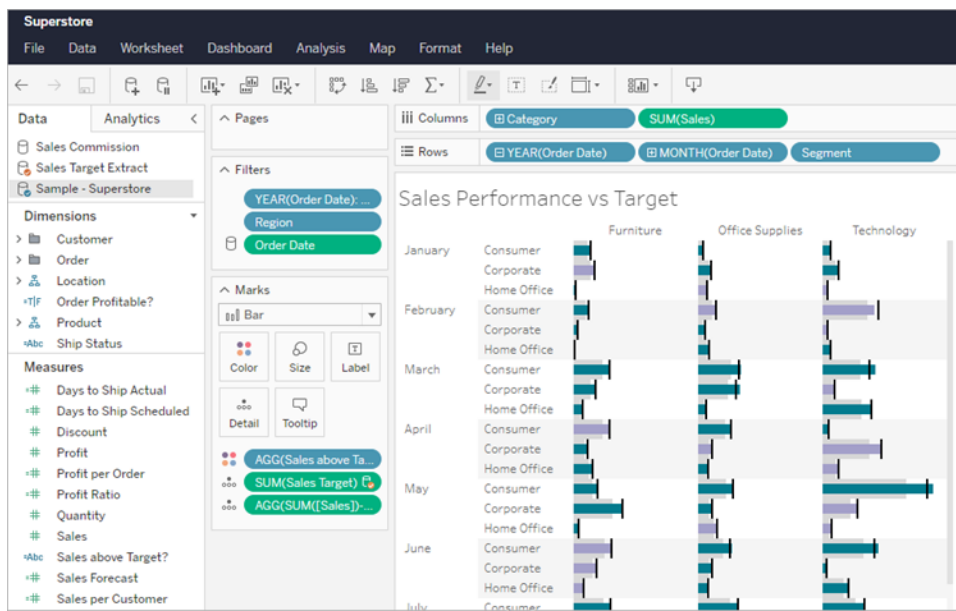

Now you can edit the view.

Note: If you have Tableau Desktop version 2021.2 or later, you can also open the workbook in Tableau Desktop and edit there. Select the Edit in Desktop icon  in the authoring toolbar to open, then publish the workbook to the site when you're finished.

To learn how to build a chart or dashboard, see **Step 4** in [Creators: Get Started with Web Authoring](#) and [Explore and Analyze Data in a View](#).

4. The **Save** options available to you will vary depending on your permissions set by your Tableau site administrator.
 - To close the view without saving your changes, select **File > Close**.
 - To save your work in the current workbook, select **File > Publish**.
 - To save your work as a new workbook, select **File > Publish As**. Creators can select a location to save the workbook, either in a project or to their private Personal Space. Explorers can only save to Personal Space. For more information about Personal Space, see [Create and Edit Private Content in Personal Space on page 3224](#).

Note: If you edited a workbook in Tableau Desktop and want to publish your changes, select **Server > Publish Workbook** and select **Publish**. The workbook's location and name will be populated in the **Publish** dialog.

Create a new workbook on the web from a published data source

1. Sign in to a site on Tableau Cloud or Tableau Server.
2. Either open the project that contains the data source you want to use, or show **All Data Sources**.
3. Click the **...** next to the data source name to open the actions menu, then click **New Workbook**.

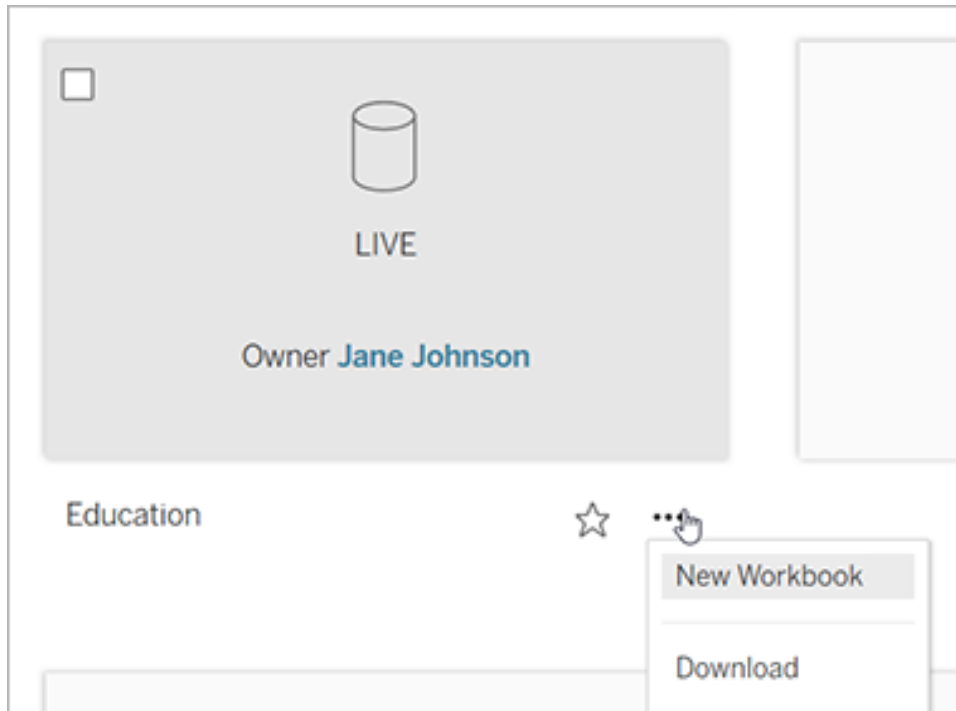

A new, blank workbook opens in the Tableau Server web editing environment.

Create and Troubleshoot Metrics (Retired)

Retirement of legacy metrics

This article is about Tableau's legacy metrics feature, which was retired in Tableau Cloud in February 2024 and in Tableau Server version 2024.2. In October 2023, Tableau retired the ability to embed legacy metrics in Tableau Cloud and in Tableau Server version 2023.3.

Tableau Pulse introduces a new way to track metrics. With Tableau Pulse, the metrics you create are used to generate insights about your data. These data insights are sent directly to users who follow the metrics, so they can learn about changes to their data in their flow of work. For more information, see [Create Metrics with Tableau Pulse](#).

If you have legacy metrics that you want to keep, note the data source, measure, and time dimension for those metrics and recreate them in Tableau Pulse. Legacy metrics won't be automatically migrated to Tableau Pulse.

Metrics provide a fast way to stay informed about your data. Because metrics update automatically and display their current value in the grid and list view of your content, you can check all the key numbers you care about in seconds.

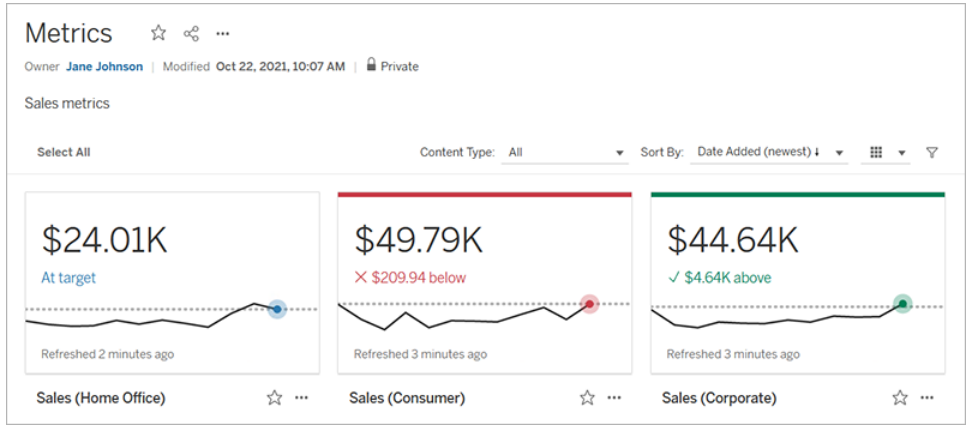

At their most basic level, metrics show the value of an aggregate measure, like the sum of sales. More complex metrics can include timelines, comparisons, and statuses that provide an easy to understand indicator of how you're performing relative to a prior point in time or a value you have defined.

If you have a set of dashboards that you regularly check, create metrics for the numbers that you want to monitor, then track them in one place by adding them to your favorites or a collection, or by creating them in the same project. That way, you don't need to load and filter the dashboards unless you want to dig deeper into your data.

Find metrics on your site

There are a few ways to find metrics on your Tableau site. To browse all the metrics that you have permission to view, navigate to the Explore page, then select **All Metrics** from the content type menu.

If you're looking for metrics related to a particular view or workbook, check the connected metrics for that content. To see connected metrics for a view, open the view, then click **Watch > Metrics** in the view toolbar. The metrics displayed are ordered from the newest creation date to the oldest.

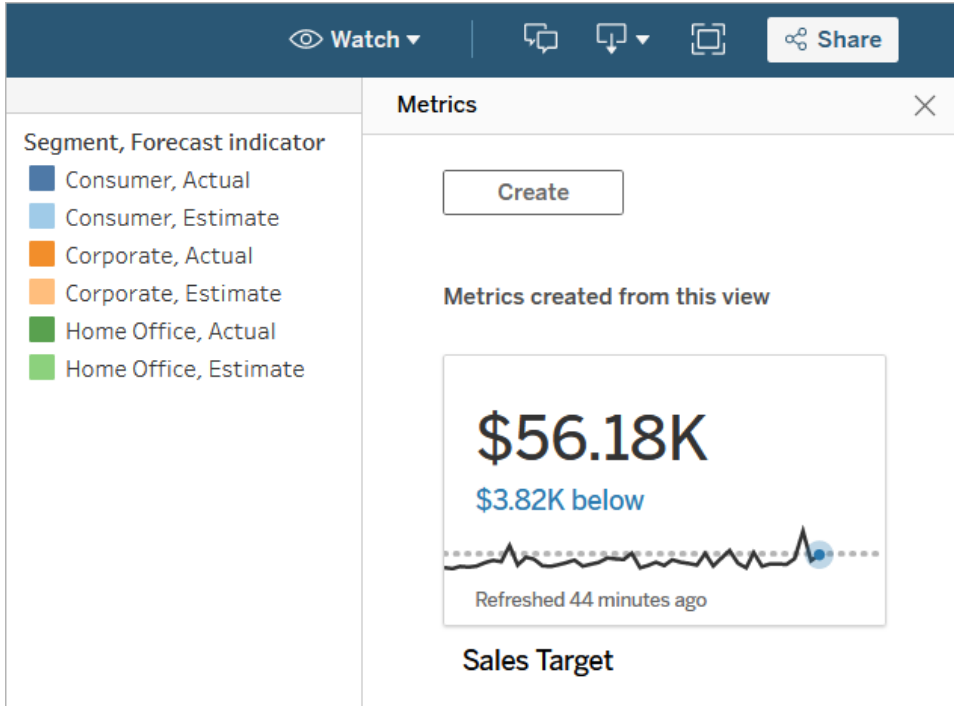

To see connected metrics for all the views in a workbook, navigate to the workbook, then click the **Connected Metrics** tab. You can sort these metrics using the Sort By menu.

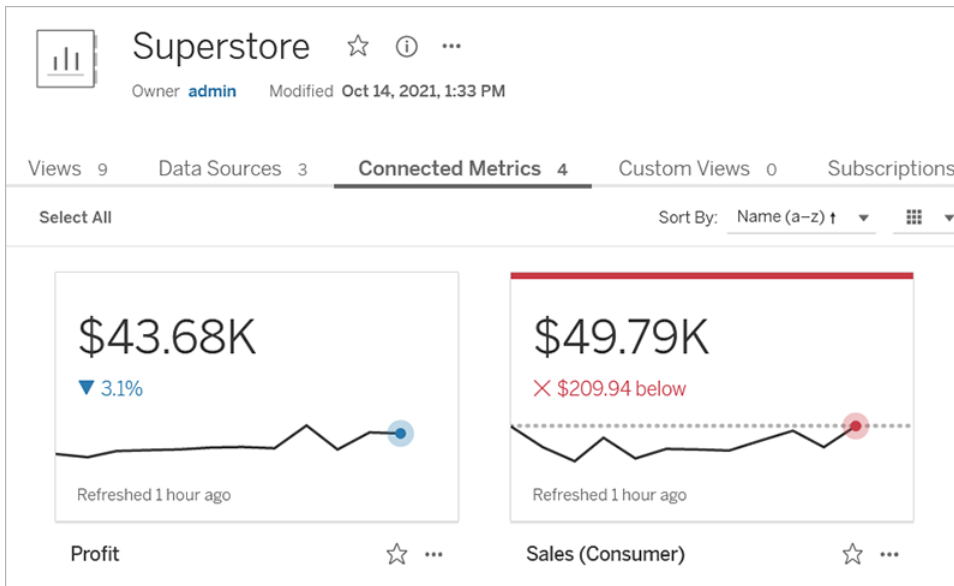

Components of a metric

The only data required to define a metric is an aggregate measure. Metrics are created from a mark in a view, and the measure associated with that mark defines the metric. The measure must be aggregated, because an unaggregated mark will not change over time. For information about dimensions and measures in Tableau, see [Dimensions and Measures, Blue and Green](#).

A metric can optionally be defined by a date dimension, and you can configure a comparison and a status for your metric. Each of these components will add context to the data presented on the metric card.

Metrics that have only a measure defining them will appear as a single number. This number will update when the data updates, but there will be no timeline on the card.

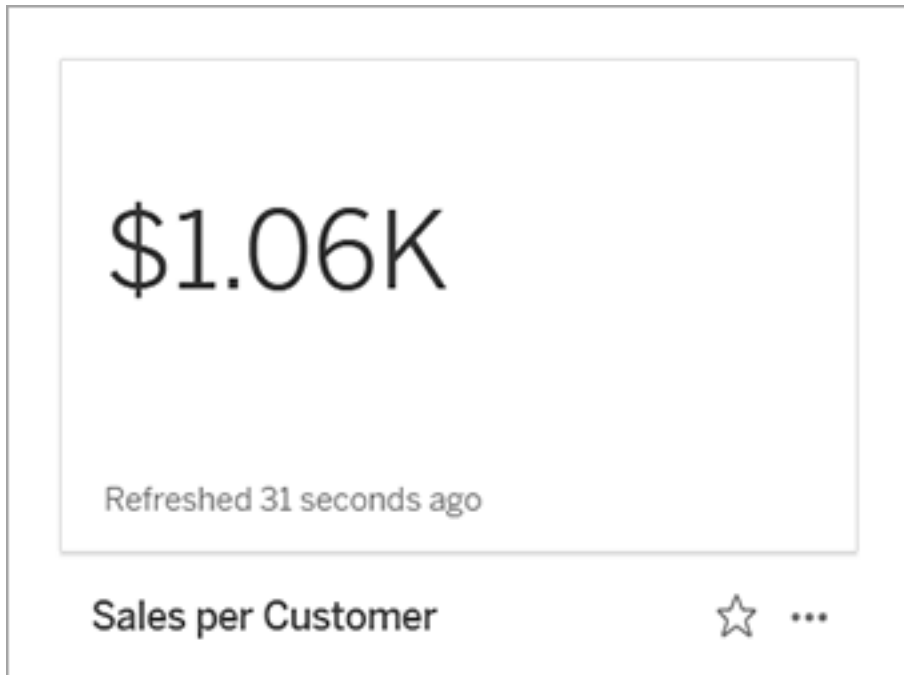

Timeline

When you select a mark to define a metric, if the mark has a date dimension associated with it, that dimension becomes part of the metric definition. Metrics with a date dimension show a timeline, and you can configure the historical comparison for the metric. By default, the historical comparison is to the previous mark.

When you open a metric's details page, the timeline shows the value of the measure based on the granularity of the date dimension, for example, daily sales or monthly users. Hover over the points on the timeline to see historical values.

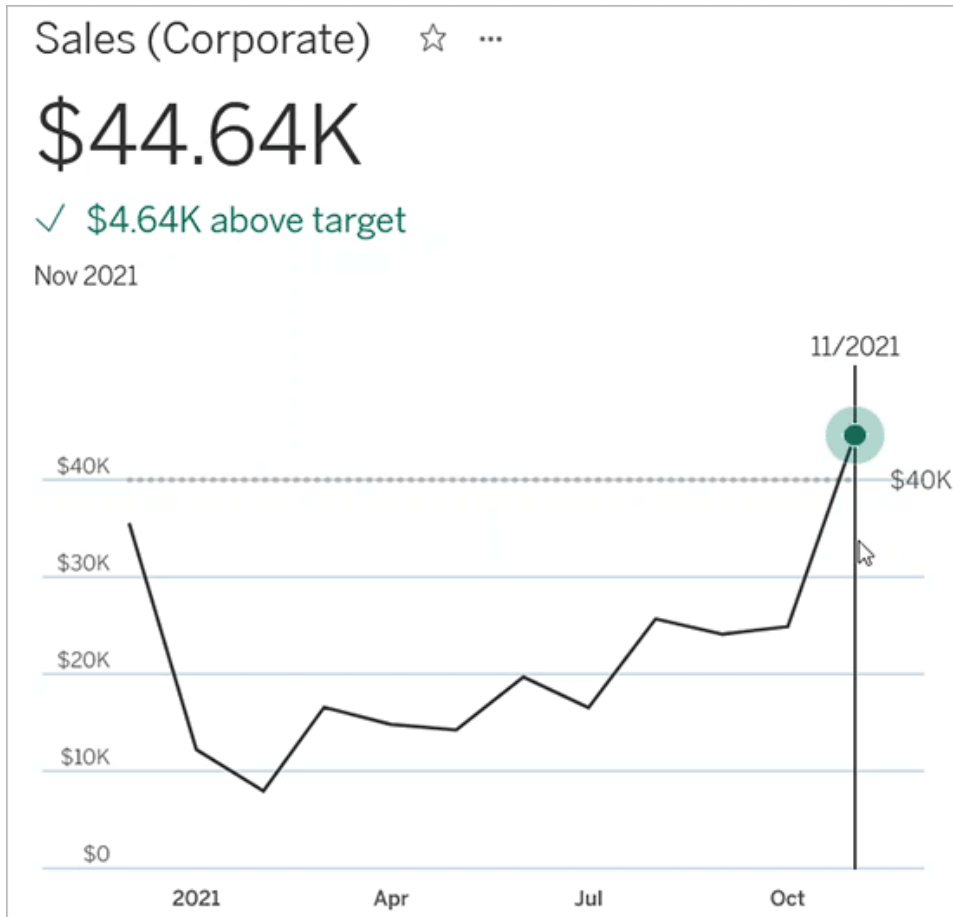

Comparison

There are two types of comparisons that you can configure for metrics: historical comparisons and constant comparisons. You can configure a historical comparison only if a metric has a date dimension associated with it, but constant comparisons can be added for any type of metric.

A historical comparison is a relative comparison between the current value and a specified number of hours, days, or other unit of time previous. For example, you could set a comparison between the current value for monthly sales and the value from 12 months ago. Every time data is added to a metric, the historical comparison will adjust relative to the date or time of the new data.

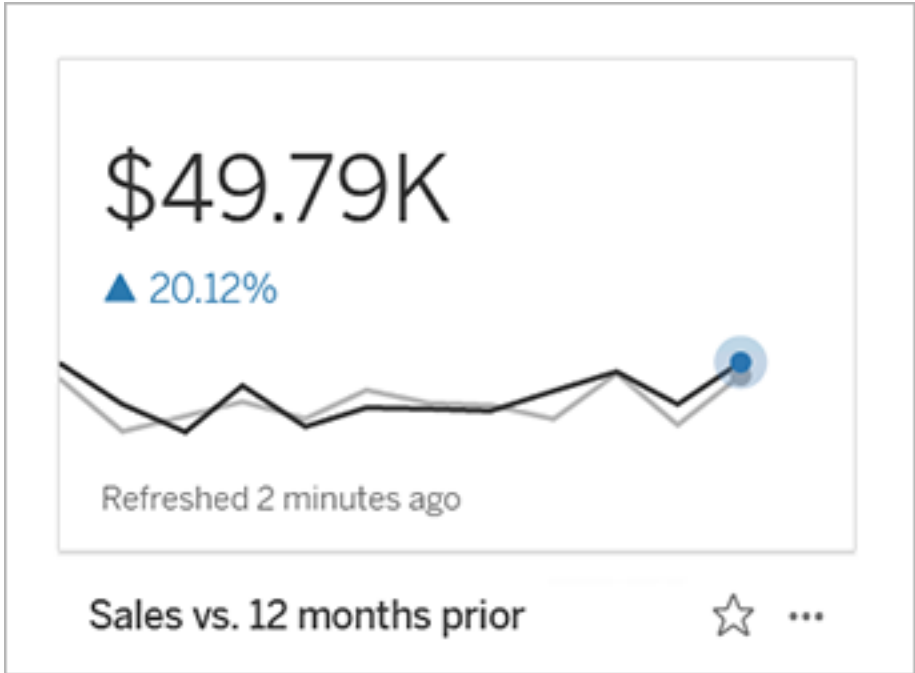

Constant comparisons are to a single value that doesn't change as new data is added. You might set a comparison to represent a threshold to stay above, for example, if you need to maintain a 90% on-time delivery rate. Or you might define a cumulative goal you are working toward, for example, a monthly sales target.

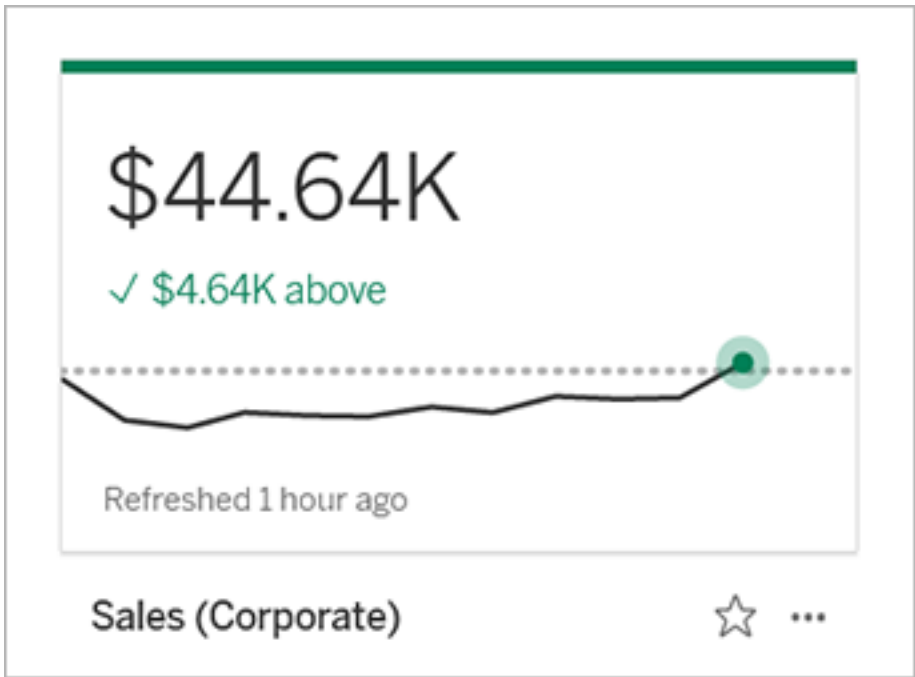

Status

For metrics with a constant comparison, you can define whether being above, below, or at the comparison value is good, bad, or neutral. A metric with a “good” status will display a check mark next to the comparison value, and the metric card will have a green band at the top. A metric with a “bad” status will display an X next to the comparison value, and the metric card will have a red band at the top. Metrics with a “neutral” status appear the same as metrics without a status indicator; there is no icon or color applied to the card.

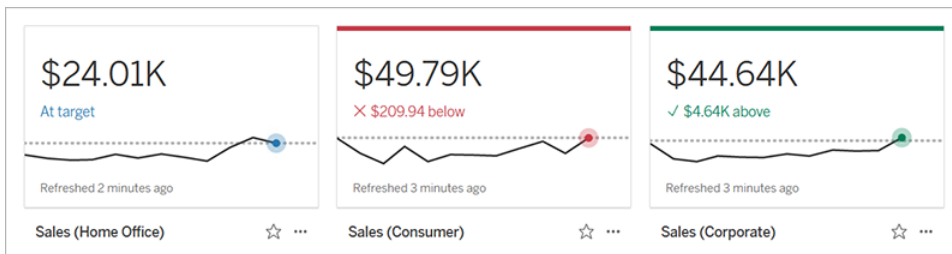

Create a metric from a view

If you have a site role of Creator or Explorer (can publish), and you have the Create/Refresh Metric capability on the relevant workbook, you can create metrics on Tableau Cloud or Tableau Server.

Before you create a metric, check the connected metrics for the view to make sure that the metric you are planning to create doesn't already exist. Instead of creating a duplicate metric, open the existing metric and add it as a favorite.

Select the mark to define your metric

1. Navigate to the view that you want to create a metric from.
2. On the view toolbar, select **Watch > Metrics**.

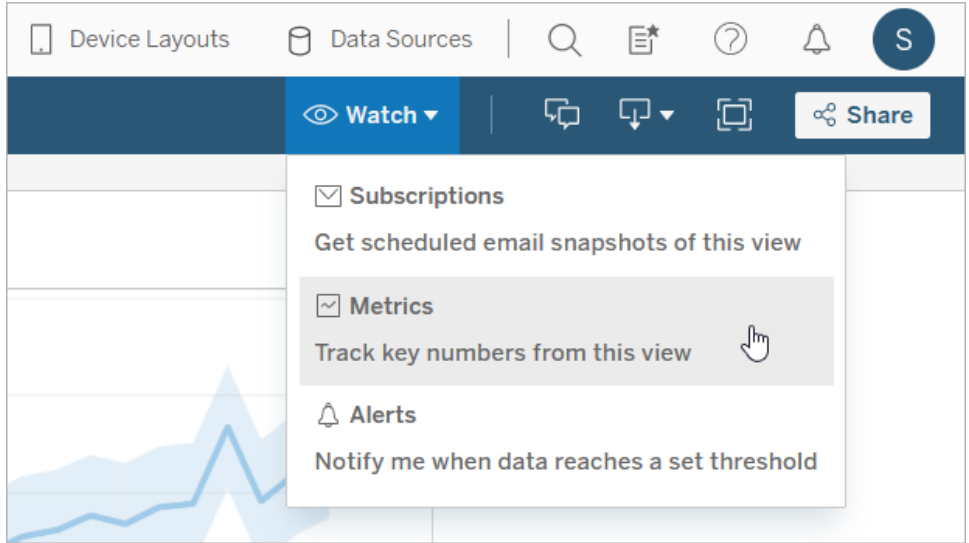

The metrics pane opens.

3. If the pane shows connected metrics, select the **Create** button to enter authoring mode.
4. Select a mark. If you encounter an error, see [When you can't create a metric on page 3244](#).

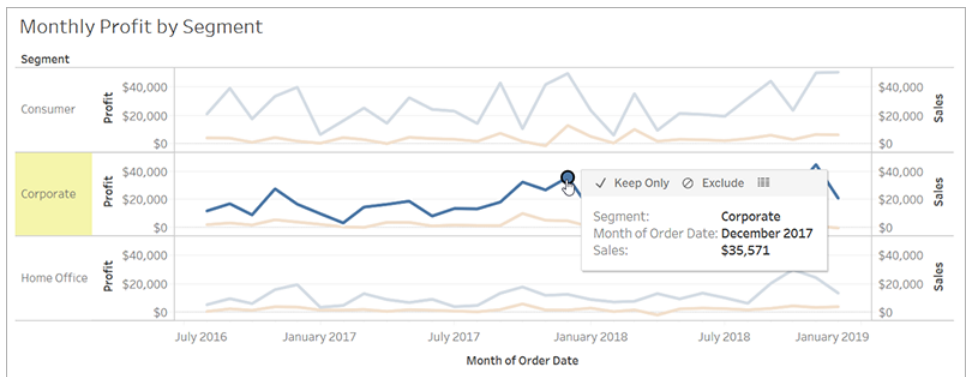

The measure associated with this mark defines your metric. Any filters you apply to the mark are applied to your metric. If this mark has a date dimension associated with it, that date dimension also defines your metric, and your metric will display a timeline.

The metrics pane shows a preview of your metric. The value in the preview is the most recent value for the metric, which may differ from the value of the mark you selected if it was not the most recent in the time series. The preview updates as you try different configurations.

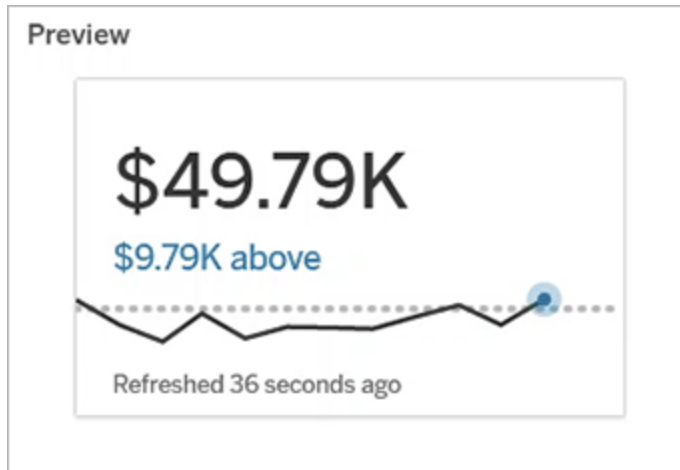

Describe and configure your metric

The options available to configure your metric depend on the mark you select and on the type of comparison you choose.

1. The **Name** field is pre-populated based on the mark you select. You can give the metric a different name. A metric must have a unique name within the project it belongs to.
2. Under **Description**, enter an optional message to help others understand your metric. For example, describe filters applied to the metric or indicate the data source used by the metric.
3. For the **Date Range** (only for metrics with a date dimension), select one of the default options, or set a custom range. If your metric has a large number of marks, limiting the date range can make it easier to read the timeline.
4. Select the **Comparison Type** for the metric: historical or constant.
5. For **Historical** comparisons:
 - Enter how far prior you want to compare against. The unit of time for the comparison is the same as the granularity of your data, such as hours or months.
 - Select **Show Comparison Line** to include a second line for the comparison period on the timeline.
6. For **Constant** comparisons:
 - Enter the value to compare against. Don't include commas or symbols in this field. To enter a percentage, simply type the number without the percent sign, for example, enter 25 instead of 0.25 for a target of 25%. When you enter a valid target value, the preview updates to show how far above or below the target the current

value is.

- Set the **Status** for the comparison to indicate whether being above, at, or below the value is good, bad, or neutral. By default, the status is set to neutral. Check the metric preview to see how different statuses affect your metric.
7. Under **Definition > Measure**, select the measure to use for your definition from the drop-down. This option appears only if the mark you select has more than one measure associated with it.

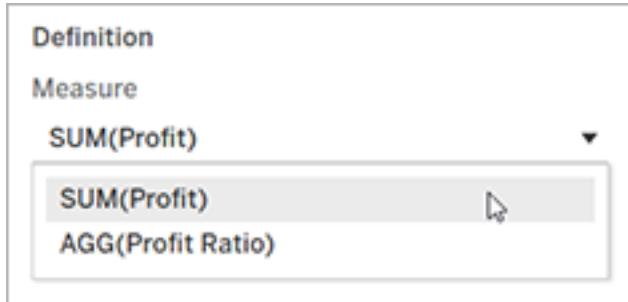

Finalize your metric

1. Under **Project**, select **Change Location** to choose a different project for the metric. By default, your metric will be added to the same project that the view belongs to.

Every metric in a project must have a unique name. Because a metric's name and project are initially set based on the mark you select, you might run into a conflict when you try to save your metric, if another user has already created a metric from that mark. Either choose a different project or name for your metric or, if you want to overwrite the existing metric, see [Overwrite a metric](#).

2. Click the **Create** button.

A message appears with a link to the metric in the project you added it to.



3. Verify that the permissions for your metric are correct, following the guidance in [Set permissions](#).

By default, a metric inherits the permissions of the project it is created in. Anyone with access to your metric will be able to see the metric's data, even if they don't have permission to access the connected view or data source.

Now that you've created a metric, you can manage the metric the same way you manage other independent pieces of content on your Tableau site. Though metrics are created from a view, they exist independently of that view, unlike data driven alerts or subscriptions. You can move the metric to a different project without moving the connected view. For information about managing content on your Tableau site, see [Manage Web Content](#).

Overwrite a metric

Once a metric is created, you can change the name, description, and configuration of the metric, but you can't change how the metric is defined. If you want to change the data that the metric uses, you must overwrite it. In order to overwrite a metric, you need to be the metric owner or be granted the correct permission capability.

1. To overwrite a metric, create a metric with the same name in the same project as the metric you want to overwrite.

The Overwrite Metric dialog appears.

2. Click the **Overwrite** button.

When you overwrite a metric, the metric continues to appear for those who have added it to their favorites, and any changes made to permissions for the previous metric will apply to the new metric.

When you can't create a metric

If you select a mark on a chart that doesn't support metrics, you'll get an error message explaining why you can't create a metric. The table below summarizes these scenarios.

Reason	Scenarios
You don't have the correct permissions.	<ul style="list-style-type: none"> • The workbook owner or an administrator has denied the Create/Refresh Metric capability. For more information, see Permissions.
You can't access the complete data.	<ul style="list-style-type: none"> • Row level security or user filters limit the data you can see. For more information, see Restrict Access at the Data Row Level.

Reason	Scenarios
The password for the workbook's data source is not embedded or is no longer valid.	<ul style="list-style-type: none">• The workbook prompts for a password. For more information, see Set Credentials for Accessing Your Published Data.
The data isn't at the correct level of granularity.	<ul style="list-style-type: none">• The data in the chart isn't aggregated. Metrics use aggregations, such as sum or average. For more information, see Data Aggregation in Tableau.• There are multiple values per cell of data—a result of data blending. For more information, see Troubleshoot Data Blending.
The date dimension is not supported.	<ul style="list-style-type: none">• The chart includes both date parts and date values. For more information, see Change Date Levels.• The date dimension uses the ISO 8601 calendar rather than the standard Gregorian calendar. For more information, see ISO-8601 Week-Based Calendar.• The date dimension is aggregated at the custom level of Month / Year or Month / Day / Year. For more information, see Custom Dates.

Edit a metric's configuration

Starting in 2022.2, you can change the configuration for a metric. A metric's configuration includes the comparison, date range, and status indicator. The configuration options available depend on the type of metric. Metrics with a timeline allow you to set a historical comparison or a constant comparison. Single number metric support only a constant comparison.

A metric's configuration does not include the metric definition (the measure and date dimension that generate the metric value). If you want to change the definition, overwrite the metric with a new metric.

To edit a metric's configuration, you must have the overwrite capability for the metric.

1. Open the metric details page for the metric you want to edit.
2. Mouse over the configuration section. Click anywhere on the section to enter editing mode.

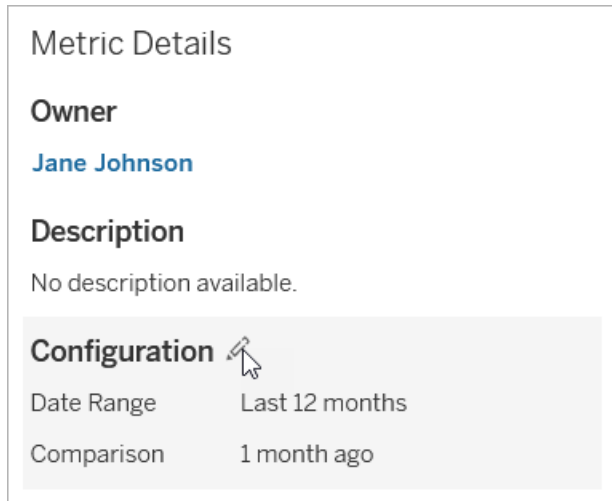

3. For a timeline metric, set the date range to display on the metric card and details.
4. Select the comparison type. For a constant comparison, set a comparison value and status. For a historical comparison, set how far prior you want to compare against and choose whether to show a comparison line on the timeline.
5. Click **Save**. Your configuration changes will appear to anyone who views the metric.

How metrics refresh

When a metric refreshes, it checks the connected view (the view the metric was created from) for new data. A refresh doesn't necessarily update the value of a metric, because there may be no changes to the data.

Metrics refresh at a frequency either based on an extract's refresh schedule or, for live data, every 60 minutes. The time of the last refresh is displayed on the metric.

Fix failing refreshes

If a metric isn't able to access the connected view or its underlying data, the refresh will fail. If the refresh for your metric fails, you'll receive a notification, which notes the time of the failure and the affected metric.

Metric refreshes may fail for one of the following reasons.

- The connected view was deleted or modified.
- Permissions changed for the connected view.
- The password for the data source is no longer embedded or is no longer valid.

- The metric owner doesn't have the required site role to refresh the metric. A site role of Creator or Explorer (can publish) is required.
- There was a temporary connectivity issue, which will resolve itself.

To identify the cause of the failure, look at the metric details. Make sure that the metric owner has the required site role to refresh the metric. Then inspect the **Connected View**.

Metric Details

Owner
Jane Johnson

Connected View
The metric has been created from this view:



Weekly Sales and Profit

Definition

Measure	SUM(Profit)
Date Dimension	WEEK(Order Date)

If the connected view is still listed

Open the view to investigate the cause of the failure.

If the view loads, check that the measure and (optional) date dimension that define the metric are still present in the view.

- If the view appears to be unchanged, you might no longer have permission to refresh metrics from it. The content owner or a Tableau administrator can change the Create/Refresh Metric permission capability. For more information, see [Permissions](#).
- If the measure is no longer present, the view has been modified so the metric can't connect to the data needed to refresh. The content owner or a Tableau administrator can check the revision history and restore previous versions. For more information, see [View Revision History](#).

If the view doesn't load, but instead prompts for a password or displays an error when connecting to the data source, the password for the data source is not embedded or is no longer valid. The content owner or a Tableau administrator can edit the data source connection to embed the password. For more information, see [Edit Connections](#).

If there is no connected view listed

The view was deleted or you no longer have permission to access the view. Contact your Tableau administrator for assistance.

Resume suspended refreshes

If a refresh fails enough times, the refresh is suspended. You'll receive a notification if the refresh for your metric is suspended.

When a metric refresh is suspended, Tableau no longer attempts to get new data for the metric. Metrics with suspended refreshes continue to present historical data.

If the cause of the failure is fixed, you can resume the refresh.

1. Open the affected metric.
2. On the warning message, click **Resume refresh**.

Tableau attempts to perform the refresh. If this attempt succeeds, you'll receive a notification, and the refresh will resume on schedule. If the attempt doesn't succeed, your refresh remains suspended.

Try overwriting the metric if the connected view is still available. For more information, see [Overwrite a metric](#). Otherwise, you can keep the metric to reference past data or delete the metric.

Note: If the metric refresh is suspended because you don't have the required site role for it to refresh, you won't be able to resume the refresh or delete the metric.

Metrics appear in Tableau Catalog

Starting in 2019.3, Tableau Catalog is available with Data Management in Tableau Cloud and Tableau Server. When the Tableau Catalog is enabled in your environment, you can see metrics in the Catalog lineage tool, and metrics affected by data quality warnings display those warnings. For more information about Tableau Catalog, see "About Tableau Catalog" in the [Tableau Server](#) or [Tableau Cloud](#) Help.

When you have metrics defined for the numbers you want to monitor, it's important to know if the data that the metrics rely on are impacted in any way. You can use Catalog in a couple of ways to know this. First, data quality warnings set on the data your metric is based on show on the metric. These warnings appear when you open a metric in Tableau Mobile, and in Tableau Server and Tableau Cloud when you hover over a metric in grid view and on the metric details page, as shown below:

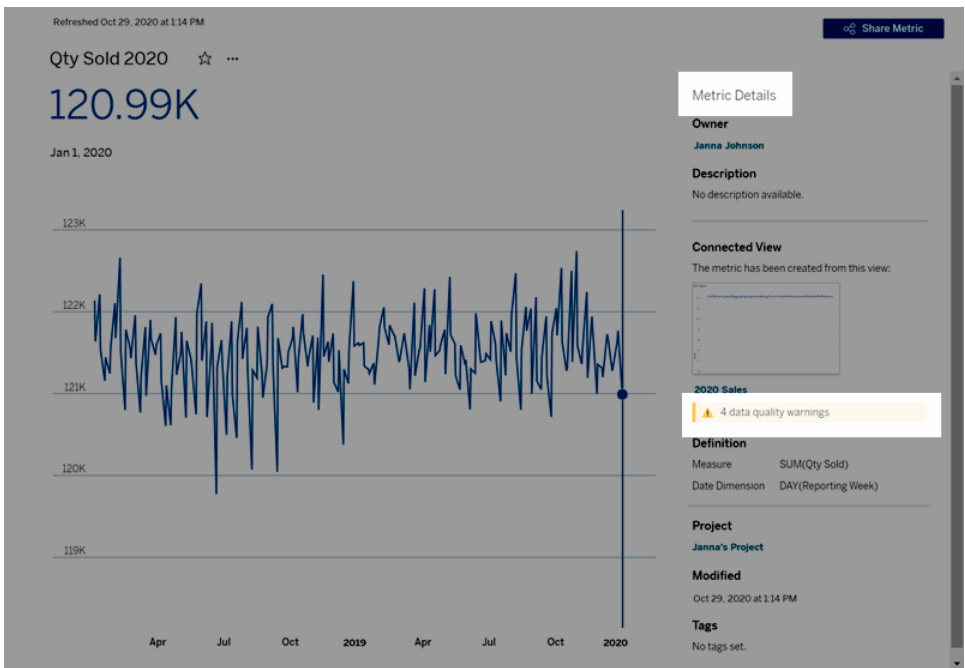

For more information, see "Set a Data Quality Warning" in the [Tableau Server](#) or [Tableau Cloud](#) Help.

You can also use the lineage tool in Tableau Catalog to see the upstream sources that your metric relies on. When doing an impact analysis, you can see which metrics are affected if a certain column or a table is changed or deprecated, or if certain workbooks are removed.

Including metrics in the lineage means that Catalog gives a full picture of the impact changes can have on the assets in your environment.

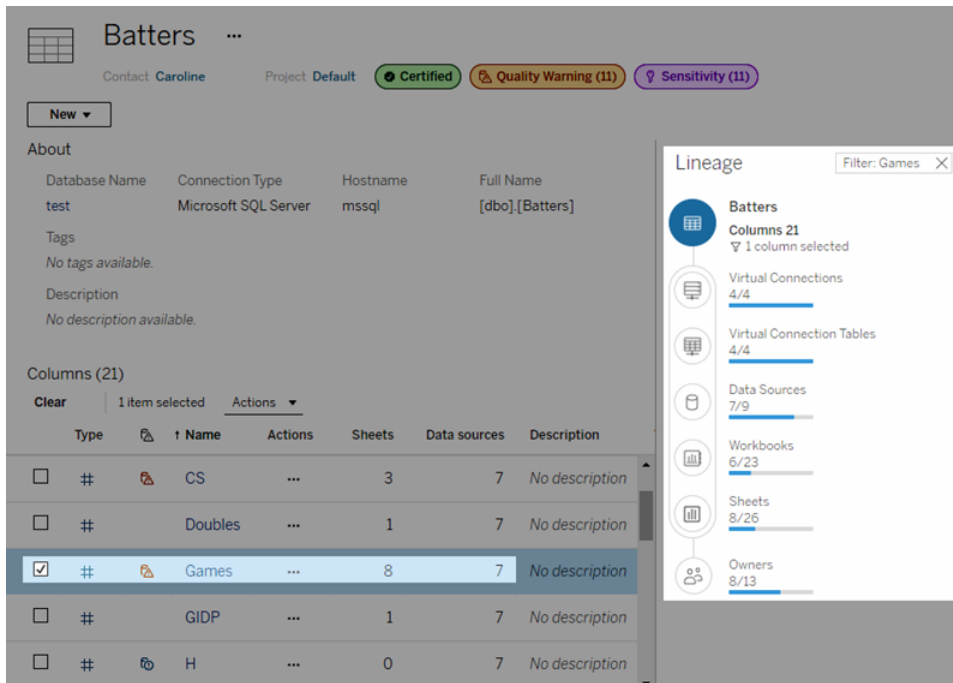

For more information, see "Use Lineage for Impact Analysis" in the [Tableau Server](#) or [Tableau Cloud Help](#).

View Acceleration

Administrators and workbook owners who have Creator or Explorer licenses can accelerate workbooks. Administrators can suspend individual views or turn off acceleration for their site. View Acceleration loads views faster by precomputing and fetching the workbook's data in a background process. There are two potential bottlenecks when loading a view:

1. Querying (fetching data from the data source).
2. Rendering (creating the visuals, such as drawing shapes or rendering a map).

The time it takes to load a workbook depends on the combined time it takes to do these two steps. However, not all views can be accelerated. View Acceleration improves the performance of the first step (querying). If the view is loading slowly for reasons other than querying, View Acceleration won't improve the workbook's performance.

When users create custom views on top of an accelerated view, the ten most used custom views are precomputed automatically. These accelerated custom views don't count against the view limit. Custom views that haven't been accessed in the last 14 days won't be accelerated. If you directly accelerate a custom view, both the original view and the custom view are accelerated.

Accelerate your view

1. Sign in to a site on Tableau Cloud or Tableau Server.
2. From the Home or Explore page, navigate to the view you want to accelerate.
3. Choose the **Accelerate** icon, and select the switch to **Accelerate**.

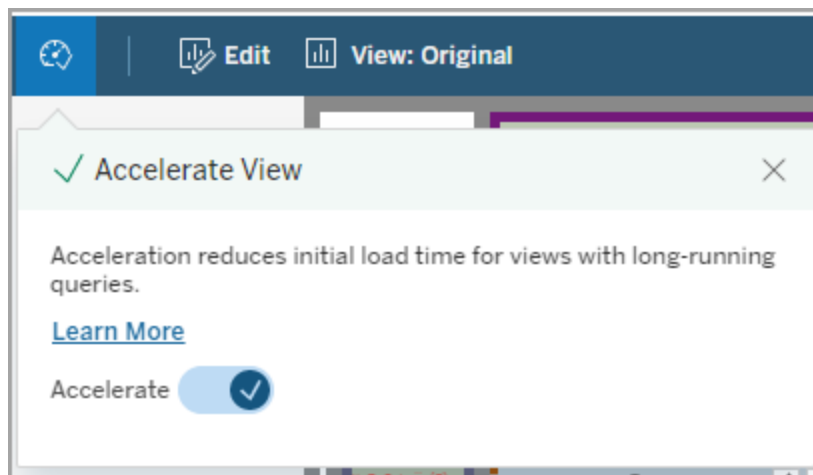

You can also accelerate views from the workbook page in one of three ways:

1. Select the desired view and choose **Acceleration** > **On** from the **Actions** menu.

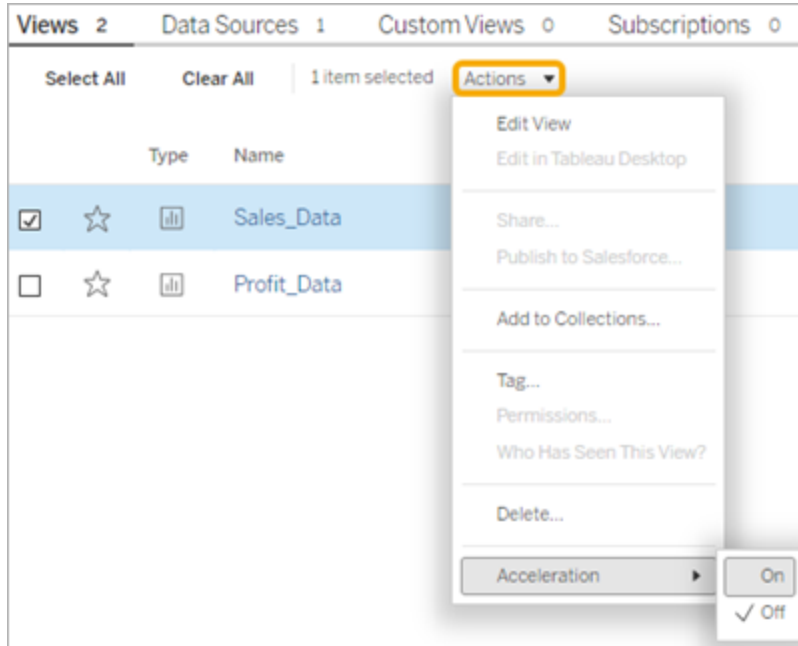

2. Select the **More options(...)** menu for the desired view and choose **Acceleration** > **On**.



3. To accelerate all views in the workbook, choose **Acceleration > On** from the **More options (...)** menu.

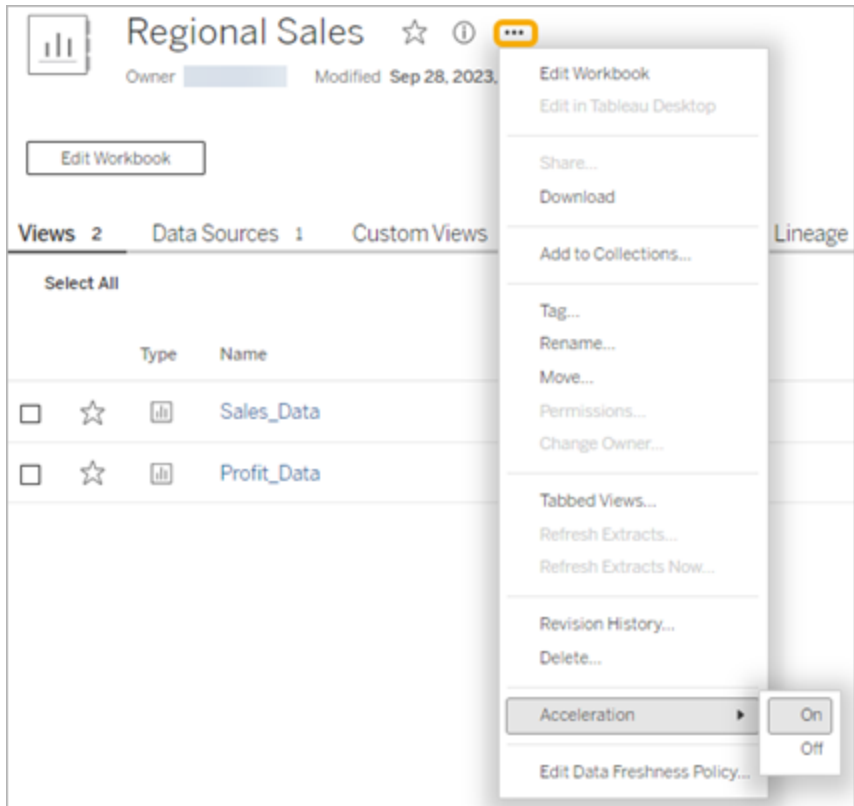

Note: View Acceleration isn't available in Tableau Desktop.

Refresh accelerated views

Event based refresh of accelerated views

In workbooks that have an extract, all accelerated views are refreshed when the extract refresh completes. When a workbook is republished or renamed, all accelerated views in the workbook are refreshed.

Schedule based refresh of accelerated views

Schedules for refreshing accelerated views can only be configured if a workbook has at least one live data source.

Accelerated views for workbooks utilizing live data sources are refreshed based on the workbook's data freshness policies. If there isn't a schedule set for refreshing the data, the

default data freshness policy is used. For more information, see [Edit a workbook data freshness policy](#).

Manage View Acceleration on your site

By default, View Acceleration is allowed.

1. Sign in to your site on Tableau Cloud.
2. From the left pane, choose **Settings**.
3. From the **General** tab, scroll to the **View Acceleration** section.
4. Select the check box to allow creators and explorers to accelerate views in their workbooks. Clear the check box to turn off View Acceleration for the site.

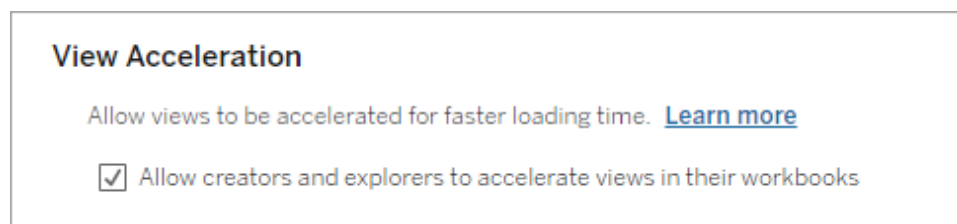

Accelerate recommended views

Based on a workbook's query time and usage, Tableau sometimes recommends acceleration to improve the performance of slower and more popular views and dashboards. If acceleration is available for a view, users can recommend acceleration for a view once every 30 days.

When a user visits a view, they'll see the option to Recommend Acceleration to the site admin or workbook owner.

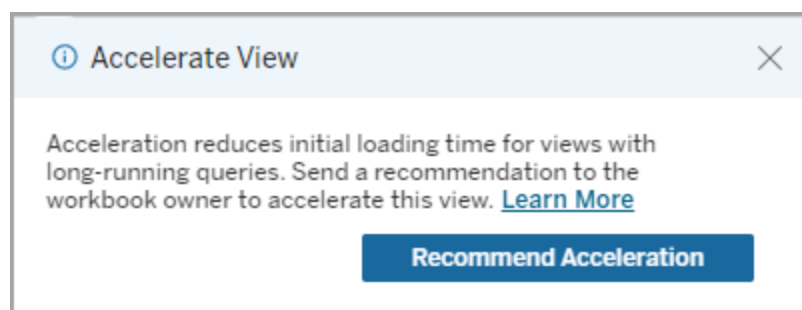

When the site admin or workbook owner visits the same view, they'll see the option to accelerate the view, and they'll see how many users have recommended acceleration.

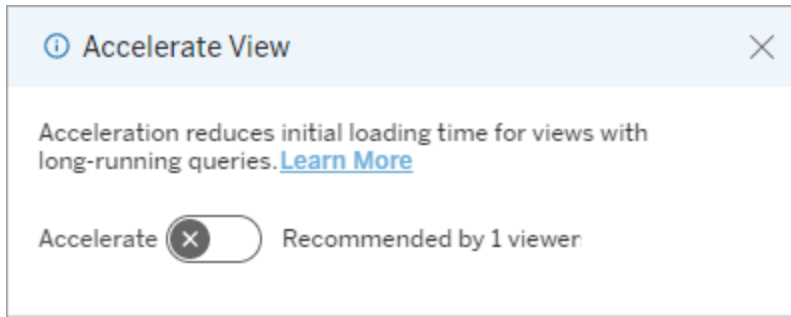

Manage Views recommended for acceleration

As a site admin, you can see when Tableau has recommended acceleration for a view:

1. Sign in to your Tableau site.
2. From the left pane, choose **Tasks**.
3. From the **Acceleration status** column, check for views with a **Recommended** status. You can also use the **Filter** in the right-side pane to filter for views with a **Recommended** status.

Personalized recommendations for acceleration as a workbook owner or admin:

1. Sign in to your Tableau site.
2. From the top-right of the page, choose the account menu icon.
3. Select **My Content**.
4. Select the **Performance** tab.
5. From the **Actions** column, choose **Accelerate**.

Automatically suspend acceleration to save resources

To conserve resources, administrators can automatically suspend acceleration for views that are consistently failing. Administrators can set a threshold for the number of times an acceleration task can fail per day, week, or month before the acceleration is automatically suspended.

1. Sign in to your Tableau site.
2. From the left pane, choose **Settings**.
3. From the **General** tab, scroll to the **View Acceleration** section.
4. Choose **Save**.

View and manage accelerated workbooks

1. Sign in to your Tableau site.
2. From the left pane, choose **Tasks**.

3. Select the **Accelerated Views** tab.
4. Choose the **Actions** menu (...) to Resume or Suspend Acceleration for the selected view or views.

Extract Refreshes 1 Flows 0 Subscriptions 0 Alerts 0 Accelerated Views 4						
Select All						
↓ View name	Actions	Workbook	Location	Owner	Views (1 month)	Average
<input type="checkbox"/> Sheet 24	...	single_query	Default	Jane	0	
<input type="checkbox"/> Sheet 1	...	live	Default	Jane	0	

Manage View Acceleration notifications

Administrators can manage whether to receive notifications for views that are automatically suspended.

1. Sign in to your Tableau site.
2. From the left pane, choose **Settings**.
3. From the **General** tab, scroll to the **Manage Notifications** section.
4. To receive notifications for views that are automatically suspended, check the box for **View Acceleration**.
5. Choose **Save**.

When views are automatically suspended, notifications are sent to site and server administrators. The notification includes information about why the view was suspended and the time that the view was suspended. Select the notification to go to the **Accelerated Views** tab of the **Tasks** page. From this page, administrators can filter the Acceleration Status to find views that were automatically suspended.

Understand user context for precomputation

Precomputation for accelerated workbooks is performed with the user context of only one user.

This user is either:

- The owner of the workbook (if there are no user filters in the workbook or data source, or if there are user filters on the data source but the data source is a published data source).
- or-

- The user that was selected for thumbnail generation the last time the workbook was published (if there are user filters on the workbook and the data source isn't a published data source).

Keyboard Accessibility for Tableau Views

Interact with views

Users sent a link to a WCAG-conformant view or workbook in Tableau Cloud or Tableau Server can interact and explore using commonly supported WAI-ARIA standards for keyboard navigation. The following keyboard navigation also applies to embedded views.

All components

What to do	Keystrokes
Move focus to next navigation component	Tab
Move focus to previous navigation component	Shift+Tab
Button activation	Spacebar or Enter

Navigation panel and toolbar

To skip the navigation panel and toolbar, select **Skip to Content**.

What to do	Keystrokes
Move focus to next component in navigation panel	Tab
Move focus to next item in toolbar	Right
Move focus to previous item in toolbar	Left
Activate the selected toolbar button	Enter
Escape toolbar button window	Esc
In a toolbar button window, move focus between components	Tab
In a toolbar button window, move focus for dropdown menus	Arrow keys

What to do	Keystrokes
Choose a new menu item from dropdown menus	Enter
Move focus between people or groups in a user selection box	Up/Down
Delete or remove additions in a selected toolbar window	Delete

Custom views toolbar window

What to do	Keystrokes
Rename custom view	Ctrl+R
Set default custom view	Ctrl+D
Make visible to others toggle on/off	Ctrl+P
Delete selected custom view	Windows: Delete Mac OS: Fn+Delete

Comments pane

What to do	Keystrokes
Apply comment snapshot to the view	Enter or Spacebar
Delete comment	Delete or Backspace

Sheet tabs

What to do	Keystrokes
Move focus to previous	Left/Up
Move focus to next	Right/Down
Navigate to the focused tab	Enter

Legends

	What to do	Keystrokes
	Move focus to previous	Up
	Move focus to next	Down
	(Single column) move focus to previous, (Multi-column) move focus to left	Left
	(Single column) move focus to next, (Multi-column) move focus to right	Right
	Move focus to first item	Home
	Move focus to last item	End
	Toggle item selection	Spacebar
	Toggle highlighting on and off	Enter
<p>Note: This is the keyboard equivalent of Highlight Selected Items.</p>		
	Clear all item selections	Esc

Note: To view legend item text with more contrast, select individual legend items, and then switch highlighting on and off.

Filters

	What to do	Keystrokes
	Move focus to previous item	Left/Up
	Move focus to next item	Right/Down
	Move focus to first item	Home
	Move focus to last item	End
	Toggle selection (check/clear checkboxes, select/clear radio buttons)	Spacebar
	Apply changes, if Cancel or Apply buttons are available	Enter

What to do	Keystrokes
Revert changes to default settings	Esc

Filter controls and search

What to do	Keystrokes
Move focus from filter item to filter control buttons (search, Single Value (List)/Multiple Values (List), Single Value (Dropdown)/Multiple Values (Dropdown), Include/Exclude Values). Press Spacebar to select a button.	Shift+Tab
Move focus in the dropdown menu	Arrow keys
Choose a menu item	Enter
Press on search button and enter search term	Spacebar
Press to clear search input. Press Esc again to dismiss Search.	Esc

Parameter controls

Single value (list)

What to do	Keystrokes
Move focus to previous item	Left/Up
Move focus to next item	Right/Down
Commit selection and update parameter value	Spacebar

Single value (dropdown)

What to do	Keystrokes
Dropdown list collapsed: Move focus to previous item and commit to value,	Up
Dropdown list open: Move focus to previous item and commit to value; doesn't commit to value	
Dropdown list collapsed: Move focus to next item and commit to value,	Down
Dropdown list open: Move focus to next item and commit to value; doesn't	

What to do	Keystrokes
commit to value	
Dropdown list collapsed: Open or close domain list,	Spacebar
Dropdown list open: Commit selection of focused item	
Dropdown list open: Collapse domain list without making a selection	Esc

Slider

What to do	Keystrokes
See previous item in domain and commit	Left/Up
See next item in domain and commit	Right/Down

View Data window

Note: The View Data keyboard shortcuts are available in Tableau Cloud, Tableau Server, and Tableau Desktop.

What to do	Keystrokes
Move focus to a visualization (viz)	Within a dashboard or workbook, press Enter
With a viz in focus, open the View Data window	Shift+Enter

Note: The screen reader you're using might require some combination of modifier keys (Shift, Ctrl, Alt, Cmd) in conjunction with Enter. See the documentation for your screen reader.

What to do	Keystrokes
Move focus to any cell within the data grid	Arrow keys
Move a column	Within the data grid, use the arrow keys to move focus to a cell in the desired column. Press Enter, use the down arrow key to select Move Left or Move Right , and then press Enter.
Sort by column	Within the data grid, use the arrow keys to move focus to a cell in the desired column. Press Enter, use the down arrow key to select Sort Ascending or Sort Descending , and then press Enter.
Remove a column	Within the data grid, use the arrow keys to move focus to a cell in the desired column. Press Enter, use the down arrow key to select Remove , and then press Enter.
Move focus to another data table	Press Tab to move the focus to the Summary tab. Use the down arrow key to move the focus to the desired data table within the Tabs pane.
Edit number of rows	Press Tab to move the focus to the row count field. Type the desired row number, and then press Enter.
Show or hide aliases	Press Tab to move the focus to the Settings button. Press Enter to show aliases, and press Enter again to hide aliases.
Add or remove fields	Press Tab to move the focus to the Show Fields button. Press Enter to display a list of fields in the data source. Use the arrow keys to move the focus to each field name. Press Enter to remove any undesired fields from the data grid. To add fields back to the data grid, press Enter on the desired field to reselect it.
Download the data as it displays in the View Data window	Press Tab to move the focus to the Download button, and then press Enter. A CSV file containing your customized view of the data downloads in your browser.

What to do

Keystrokes

Close the **View Data** window

Windows: ALT+F4

Mac OS: Cmd+W

In the **View Data** window, there are several tab stops that enable you to customize the data that displays.

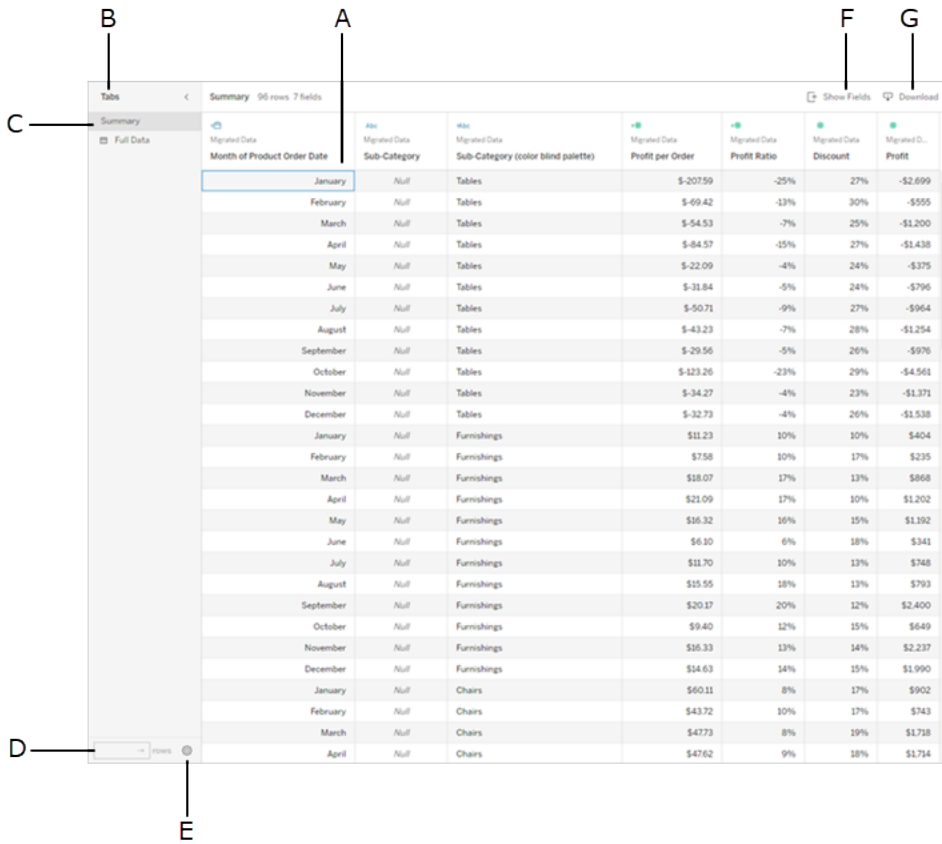

- **A** - Selected cell within the data grid
- **B** - **Tab**s pane, expand/collapse
- **C** - **Tab**s pane, current selection
- **D** - **Row** count field
- **E** - **Settings** button
- **F** - **Show Fields** button
- **G** - **Download** button

Visualization headers

What to do	Keystrokes
Move focus to a visualization (viz)	Within a dashboard or workbook, press Enter
With a viz in focus, move to the left, top, right, or bottom headers	Arrow keys
Navigate into a header	Enter
Navigate within a header or nested header	Arrow keys
Toggle header highlighting on/off	Spacebar
Back out of a header	Esc

Example: Navigate a View in Tableau Cloud or Tableau Server

This example shows how you can navigate and interact with a view using keyboard navigation.

1. Press Tab to move the focus to the visualization.

Note: The **Skip to Content** button lets you skip over the navigation panel and toolbar. To go directly to the view page, press Enter to select **Skip to Content**.



Note: In a workbook that has multiple sheet tabs, press Tab to move the focus to the **Tabs** pane, and use the arrow keys to move focus between tabs. Then press Enter or Spacebar to open a specific sheet.

Tableau Desktop and Web Authoring Help



This image shows the visualization area in a sheet. A blue border indicates the focus.

2. Navigate to filters and legends in the view by pressing Tab.

To change a filter setting, press Tab to move focus to the filter, and then press the arrow keys to move between items.

- Press Spacebar to switch item selections.
- For dropdown filters - Press Enter to apply filter changes. Press Esc to revert changes to the default settings.

To highlight legend items, press Tab to move focus to the legend, and then press the arrow keys to move between items.

- Press Spacebar to switch item selections.

Note: To view legend item text with more contrast, select individual legend items, and then switch highlighting on and off.

- Press Enter to highlight the selected legend items in the view. Press Enter again to turn off highlighting.
- Press Esc to clear all item selections.

See the table of keystrokes at the beginning of this article for the list of keystroke options for legends and filters.

3. To access underlying data that can be read by your screen reader, tab the focus to the visualization area and then press Enter.

Note: Your screen reader may require some combination of modifier keys (Shift, Ctrl, Alt, Cmd) in conjunction with Enter. See the documentation for your screen reader for details.

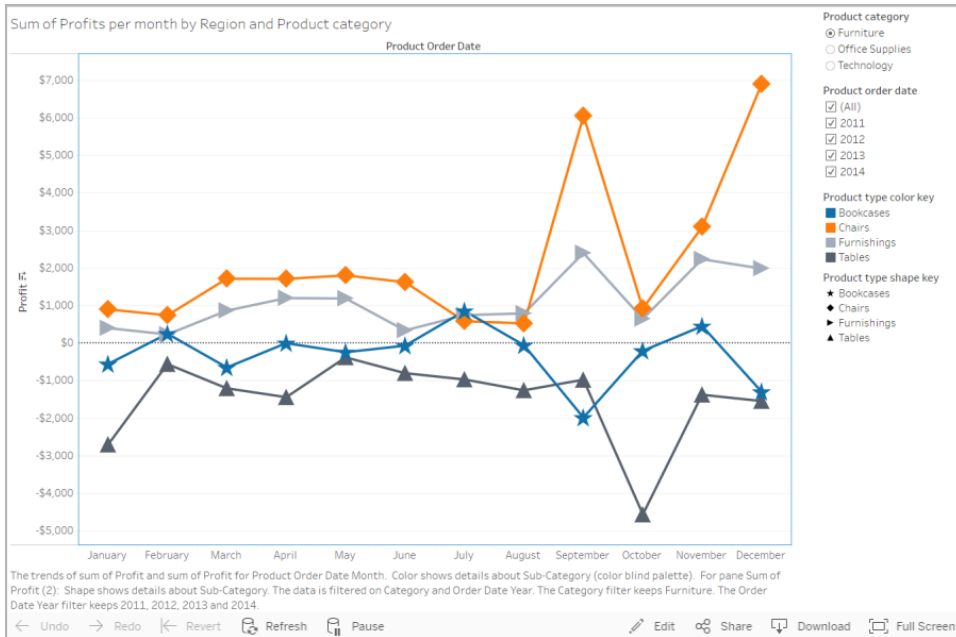

The **View Data** window opens in a new browser window.

Summary 96 rows 7 fields					
Month of Product Order ...	Sub-Category	Sub-Category (color bli...	Profit per Order	Profit Ratio	
January	Null	Tables	\$-207.59	-25%	
February	Null	Tables	\$-69.42	-13%	
March	Null	Tables	\$-54.53	-7%	
April	Null	Tables	\$-84.57	-15%	
May	Null	Tables	\$-22.09	-4%	
June	Null	Tables	\$-31.84	-5%	
July	Null	Tables	\$-50.71	-9%	
August	Null	Tables	\$-43.23	-7%	
September	Null	Tables	\$-29.56	-5%	
October	Null	Tables	\$-123.26	-23%	
November	Null	Tables	\$-34.27	-4%	
December	Null	Tables	\$-32.73	-4%	

In the View Data window, the first cell of the data grid is in focus. Use the arrow keys to move the focus to any cell within the data grid.

With a cell in focus, press Enter to open the context menu to move, sort, or remove a column.

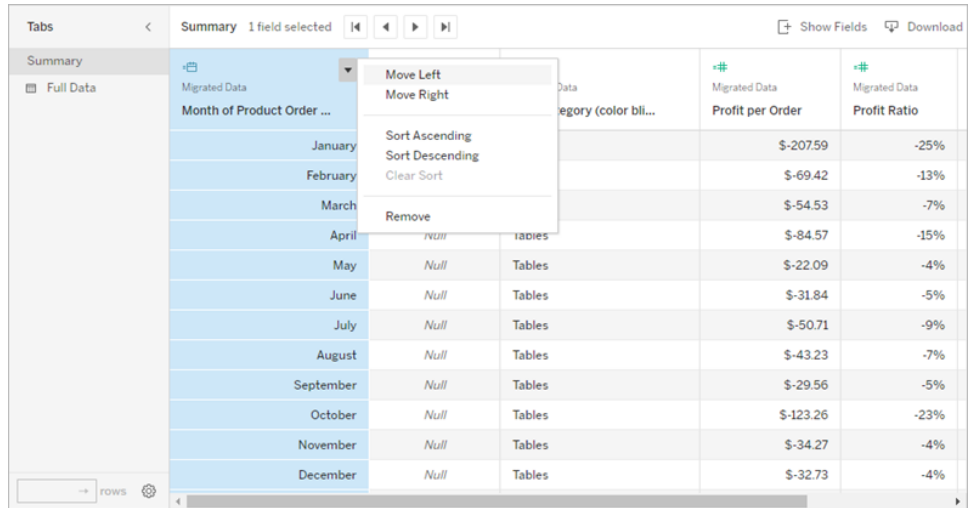

To move the focus to the **Tab**s pane, press Tab. Press Enter to expand or collapse the pane.

To change the data shown within the table, press Tab to move the focus within the **Tab**s pane. Use the arrow keys to move the focus to a specific data table, and press Enter.

Press Tab to move the focus to the **row count** field. To edit the row count, type the desired row number and press Enter.

Press Tab to move the focus to the **Settings** button. Press Enter to **Show Aliases**, and press Enter again to hide aliases.

Press Tab to move the focus to the **Show Fields** button. Press Enter to display a list of fields in the data source. Use the arrow keys to move the focus to each field name. Press Enter to switch the selection of fields in the data grid.

Month of Product Order ...	Sub-Category	Sub-Category (color bl...	Profit p
January	Null	Tables	
February	Null	Tables	
March	Null	Tables	
April	Null	Tables	
May	Null	Tables	\$-22.09 -4%
June	Null	Tables	\$-31.84 -5%
July	Null	Tables	\$-50.71 -9%
August	Null	Tables	\$-43.23 -7%
September	Null	Tables	\$-29.56 -5%
October	Null	Tables	\$-123.26 -23%
November	Null	Tables	\$-34.27 -4%
December	Null	Tables	\$-32.73 -4%

Press Tab to move the focus to the **Download** button. Press Enter. A CSV file containing your customized data is downloaded in your browser.

Note: The web browser you're using might require a different key combination to open downloaded files. See the documentation for your web browser.

Press ALT+F4 (Windows) or Cmd+W (Mac OS) to close the **View Data** window.

- To access buttons in the toolbar, tab the focus to the toolbar area and then use the right arrow to move to the next toolbar button.

Press Enter to activate the Comments button on the toolbar.

Type your comment in the **Add a comment** field. To add a snapshot to your comment, press Tab to move the focus to the snapshot button. Press Enter to add a snapshot. Press Tab to move the focus to the **Post** button. Press Enter to add the comment.

Press Tab to move through options in the button's window, including exiting the window.

Manage Content

Use the following keyboard interactions to manage content on Tableau Server or Tableau Cloud.

Organize Your Favorites or Collections

On your Favorites page or collections that you own, you can move items when content is displayed in grid view. The order you arrange items in appears as the custom order under the Sort By menu. For more information, see [Mark Favorites on page 3290](#).

What to do	Keystrokes
Pick up item	Windows: Alt+Up Mac OS: Option+UP
Move item left	Left
Move item right	Right
Undo move	Esc or Tab
Drop item	Windows: Alt+Down Mac OS: Option+Down

Navigate Visualizations with Assistive Technology

Starting in Tableau version 24.3, you can navigate Marks on all online visualization types on Tableau Cloud using a keyboard and other assistive technologies.

Note: Viz navigation isn't currently supported for server-rendered visualizations. To learn more about server and client-side rendering, see [Configure Client-Side Rendering](#).

Navigate marks in a visualization

1. To activate the experience, navigate to a visualization and press **Enter**.
2. Select **Enter** again to navigate the Marks.
3. Use the **Arrow** keys to navigate between headers, columns, and rows.

If your visualization has a dual axis, or if it's a scatter plot or map, an additional navigation affordance appears. Use the Arrow keys to move the focus to a group of marks and select Enter to navigate the marks in the group.

4. To navigate out of the text table, press **Esc**.

Note: Prior to entering mark-level navigation, you can use the Arrow keys to navigate different areas of the view, such as the header and axis.

Navigate marks in the View Data pane

1. To open the View Data pane, move your focus to the viz and press **Shift + Enter**.
2. Use the **Arrow** keys to navigate between headers, columns, and rows.
3. To close the View Data pane, press **ALT + F4** (Windows) or **Cmd + W** (Mac OS).

To learn more about keyboard navigation on Tableau, see [Keyboard Accessibility for Tableau Views](#).

Explore and Manage Web Content

What Can I Do with a Tableau Web View?

You've seen hundreds of presentations, emails, and documents with data charts. Those things are static and sad. First off, the data is frozen in time. Second, if you have any questions about it, you've got to ask whoever created the chart . . . if you can find them.

Tableau is different. When someone sends you a link to a web view, you're often seeing the freshest data available, and more importantly, you can *interact* with it. Want to dig deeper and answer questions the minute they occur to you? Simply click the view right in your web browser; it's that simple.

What can you do with a Tableau web view? A lot!

Note: We're covering the most popular ways you can interact with views. Sometimes, view creators enable only a subset of these features.

Will I hurt the data?

Not at all. When you interact with a view, you're simply changing how it *looks* for a moment. Next time you or your colleagues open the view, it will look exactly as it originally appeared. The underlying data always remains safe and sound, so feel free to explore!

Filter and sort data

Want to trim or rearrange the visible data so you can focus on stuff you're interested in? You've got a couple easy options:

Filter data

Most view creators add filters that let you limit visible data to specific date ranges, regions, and categories. When you see these, feel free to click or drag them as needed.

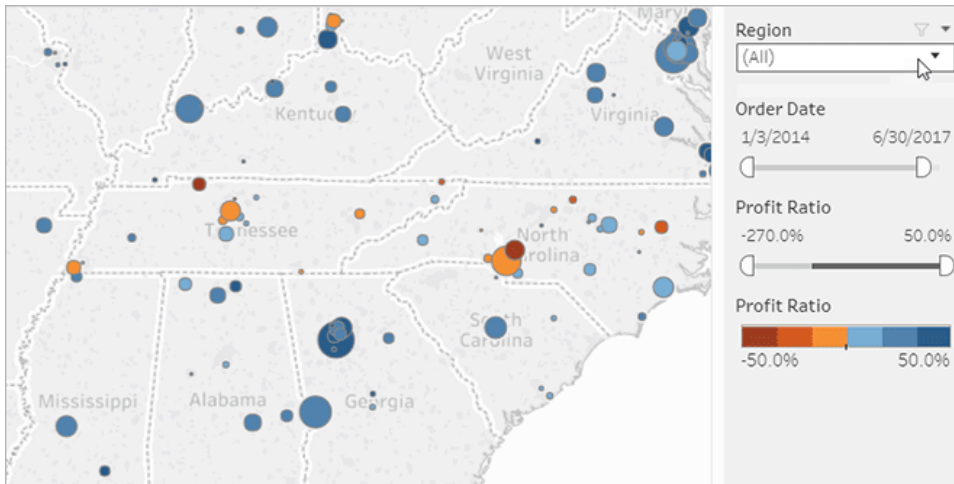

[Click the image above to replay the animation.](#)

Sort data

If you're looking at a table of data and want to sort it alphabetically or numerically, just hover over a column header and click the sort icon.

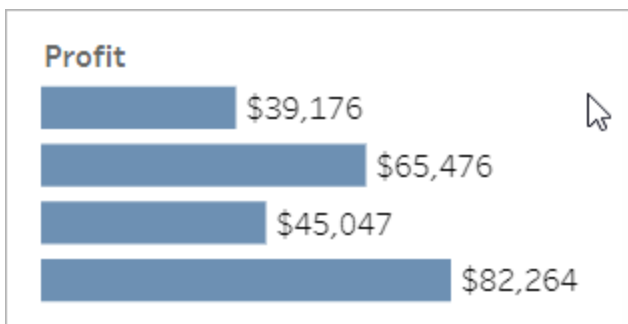

[Click the image above to replay the animation.](#)

See details about specific data points

As you move the mouse across a view, you'll often see tooltips that reveal details about each data point, or *mark*. Marks can take many forms; here's how they look in maps, bar charts, and tables:

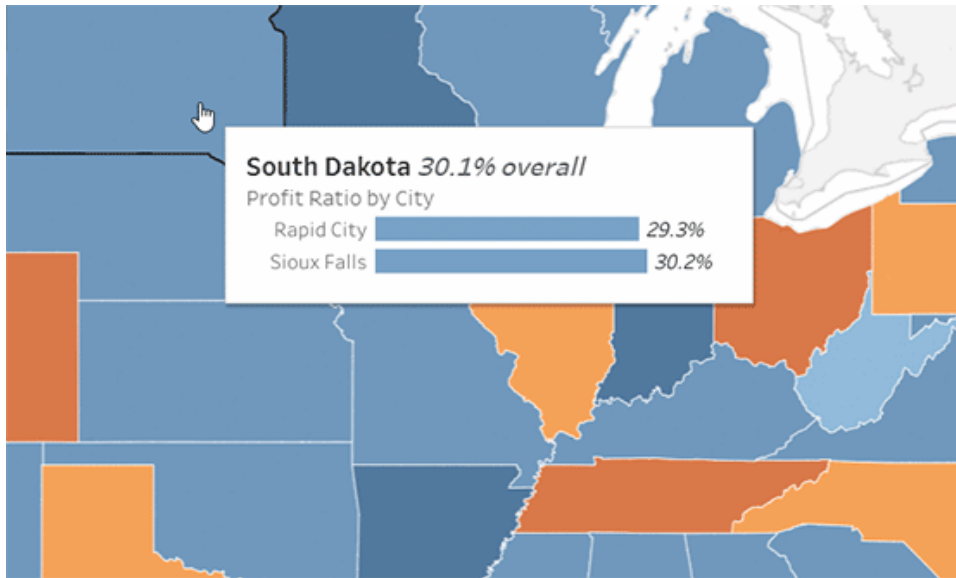

[Click the image above to replay the animation.](#)

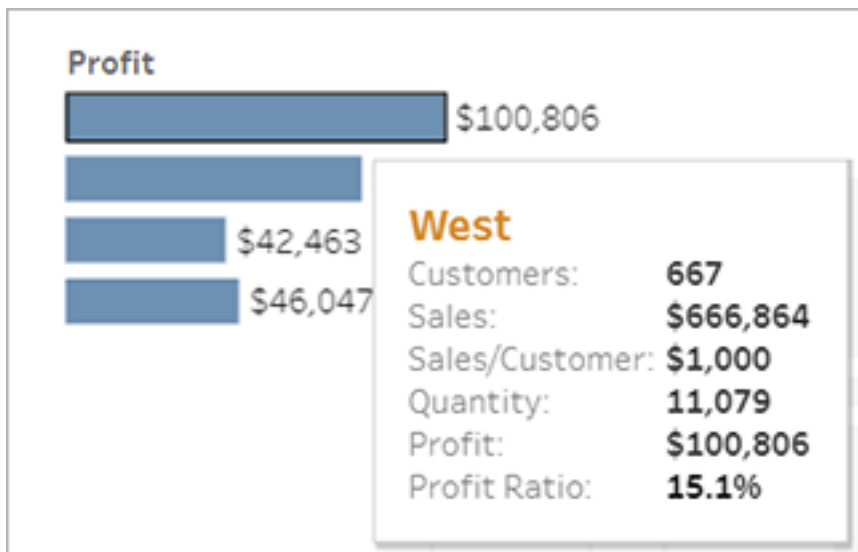

May	Jun	Jul
\$6,913	\$13,206	\$10,821
\$9,375	\$7,714	\$13,674
\$15,120		\$13,069
\$16,958	Furniture	\$1,813
\$7,136	May 2015	\$5,121
\$9,114	Sales: \$9,375	\$4,720
\$13,035	Profit: \$901	\$2,924
\$13,737		\$10,241

View underlying data

If you're the inquisitive type, you might want to see summarized source data to get a better sense of the numbers behind the visuals. If the view creator has given you permission, you can click any mark in the view, and then click the **View Data** icon.

\$18	13.7%	6	4
\$219	43.1%	24	20
\$9	48.0%	3	4
\$20	6.3%	6	5
\$23	7.5%	6	4
\$177	29.2%	18	12
\$123	15.6%	18	15
\$80	48.0%	3	5
(\$6)	-265.0%	1	2
(\$1)	-1.3%	6	5
\$6	48.0%	3	3

[Click the image above to replay the animation.](#)

Collaborate on data

Data becomes more meaningful when you explore it with other people.

Add comments

To quickly ask questions or share insights, click the comments icon in the toolbar. You can pair your remarks with a snapshot of the view that reflects any filters or other changes you made.

Tableau Desktop and Web Authoring Help

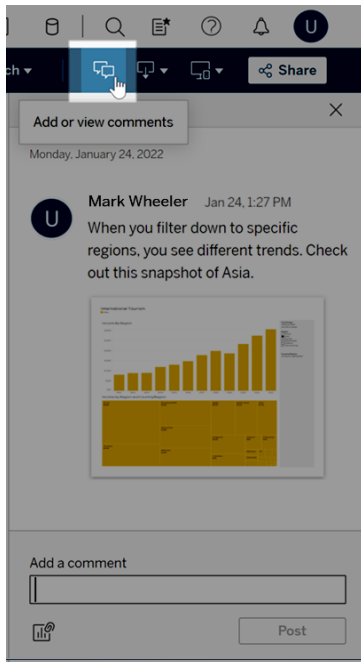

Share links

Want to share the excitement of directly engaging with data? Click **Share** in the toolbar, copy the link to the view, and then email or instant-message it to anyone with a Tableau account at your organization.

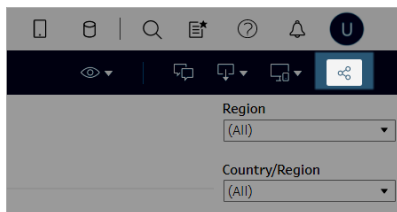

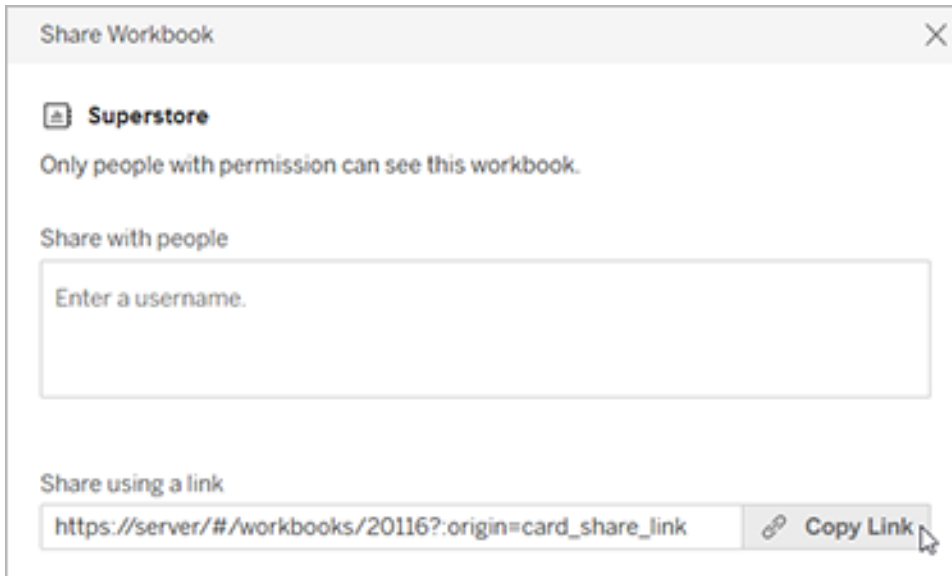

Get views emailed to you on a schedule

To automatically receive emails of a view on a regular schedule (before weekly meetings, for example), click **Watch > Subscriptions** in the toolbar.

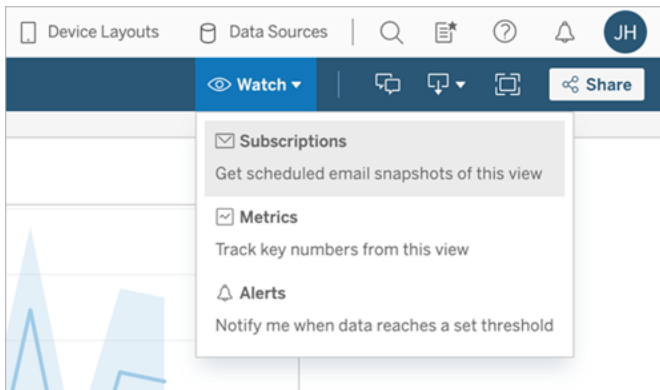

Note: You might also receive emails to views that other people have arranged for you, including data-driven alerts that notify users when data crosses key thresholds for your business.

Download a view

You've seen the power of interactive Tableau web views. But there are times when you want to show off that data outside the browser. If the view creator has given you permission, click the

download icon in the toolbar to create a static .png, .pdf, or .pptx file that reflects the view as it looks right now.

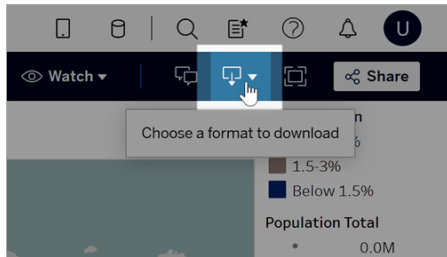

Find a recently accessed view

If you come across an interesting view but later forget where you found it, don't worry. Tableau keeps track for you. You can find your 12 most recently accessed views on the Recents page, which you can open from the navigation panel.

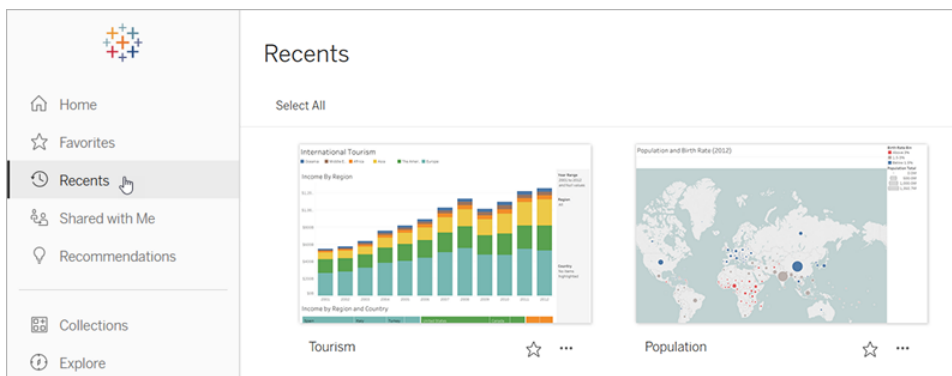

You can also find a smaller selection of your most recently accessed views on the Home page.

Add a view to favorites

As the Tableau content in your organization grows, you'll want to easily find data important to you. To add a view to your favorites, click the star icon in the header.

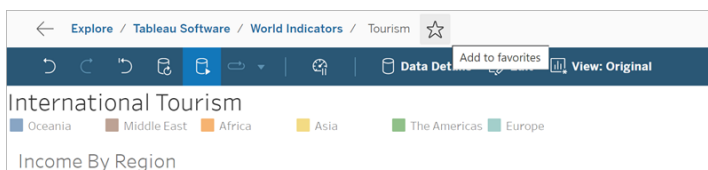

To return to a favorite, open the Favorites page from the navigation panel.

Favorites you choose in Tableau Server or Tableau Cloud also appear in the Tableau Mobile app, and vice versa, giving you instant access to key data wherever you go.

Congratulations, data rockstar!

See how easy that was? Now that you're familiar with web views, start exploring all the Tableau content available at your company. Answer questions. Share insights. You've got this!

See also

[Tour Your Tableau Site](#) on page 3180

[Share and Collaborate on the Web](#) on page 3345

[Zoom and Pan Views, and Select Marks](#) on page 1992

Use Tags

Tags are keywords that you add to items on Tableau Server and Tableau Cloud to categorize them. Tags help users find and filter Tableau content (workbooks, views, metrics, data sources, and flows) and, with Tableau Catalog, external assets (databases, files, and tables). (The legacy Metrics feature was retired in February 2024 for Tableau Cloud and in Tableau Server version 2024.2. For more information, see [Create and Troubleshoot Metrics \(Retired\)](#).)

If you have a site role of Explorer or Creator, you can add tags and delete the tags you have added. Authors can also tag content when they publish from Tableau Desktop or Tableau Prep to a Tableau site.

Note: You can't tag projects, data roles, or Ask Data lenses.

Tableau Catalog, part of Data Management for Tableau Server and Tableau Cloud, is required to be able to tag external assets (databases, files, tables, and columns). For more information about Tableau Catalog, see "About Tableau Catalog" in the [Tableau Server](#) or [Tableau Cloud](#) Help.

See tags for an item

Tags appear in the details for workbooks, metrics, and data sources. Click on a tag to see a list of all items of that type with that tag.

Tableau Desktop and Web Authoring Help

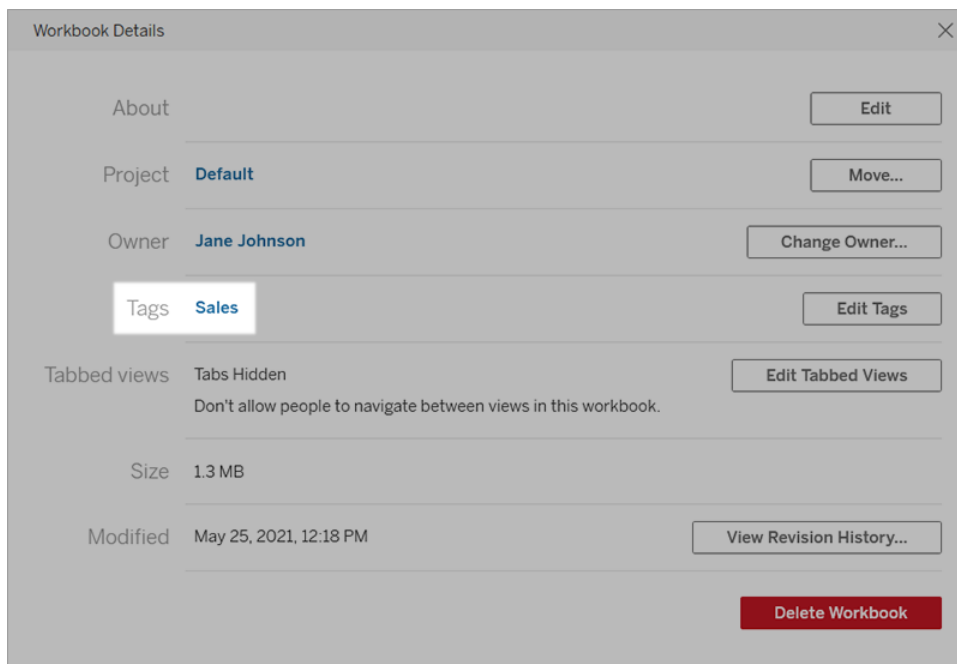

For flows, tags appear at the bottom of the Overview page.

The screenshot shows the Tableau Catalog interface for a table named "Superstore". At the top, there is a navigation bar with the table name "Superstore", a star icon, and a menu icon. Below this, the owner is listed as "Jane Johnson" and the modification date is "May 29, 2020, 1:42 PM". The interface has four tabs: "Overview" (selected), "Connections", "Scheduled Tasks", and "Run History". Under the "Overview" tab, there is a "Description" section with a pencil icon and the text "No description available.". Below that is an "Output Step" section with a sub-step "Create 'Superstore Sales.tde'". A diagram shows a flow from a source icon labeled "orders_south_..." to a target icon labeled "Remove Nulls". At the bottom, there is a "Tags" section with a "Sales" tag and a pencil icon.

When Tableau Catalog is enabled, tags for external assets appear in the About section. Tables also include a Tags column that lists the tags for each column in the table.

Tableau Desktop and Web Authoring Help

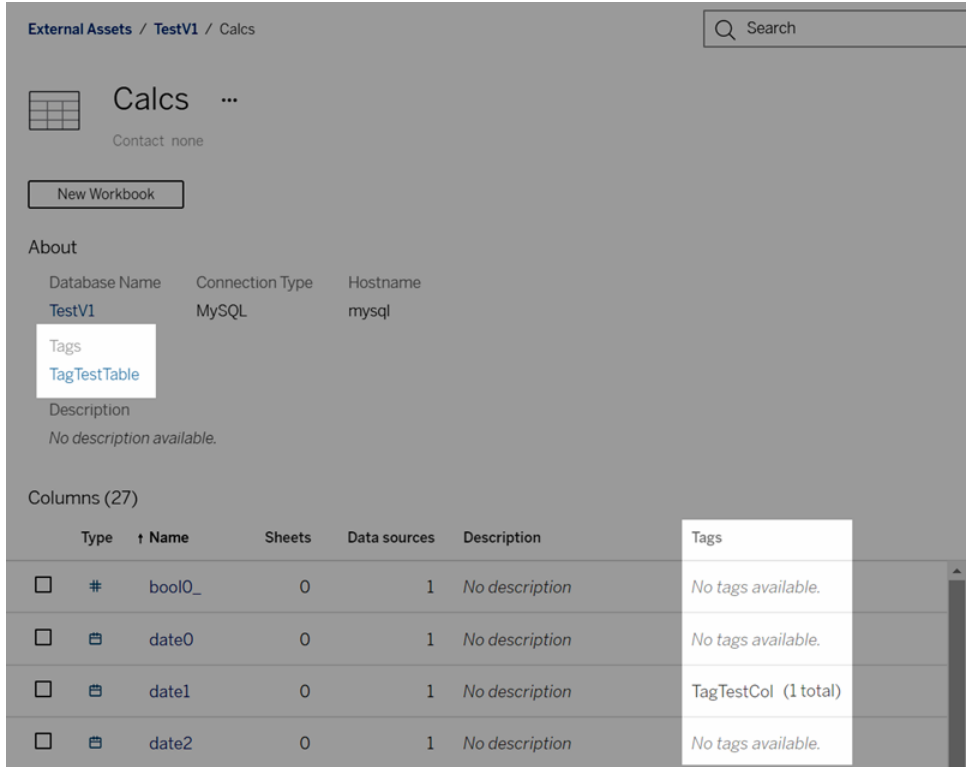

When you browse content in grid view, tags appear in the tooltips shown when you hover over thumbnails. If an item has no tags, the tags section doesn't appear. There is no grid view for external assets.

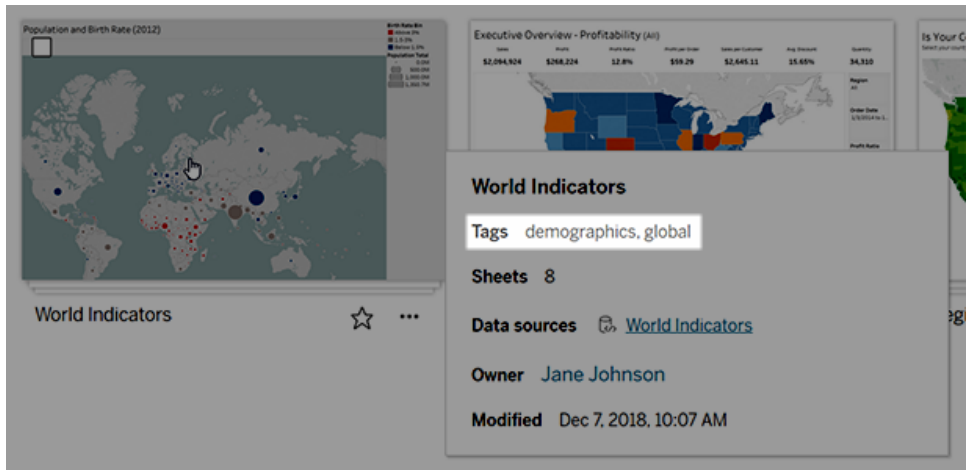

Find tagged content

Use tags to find content with quick search.

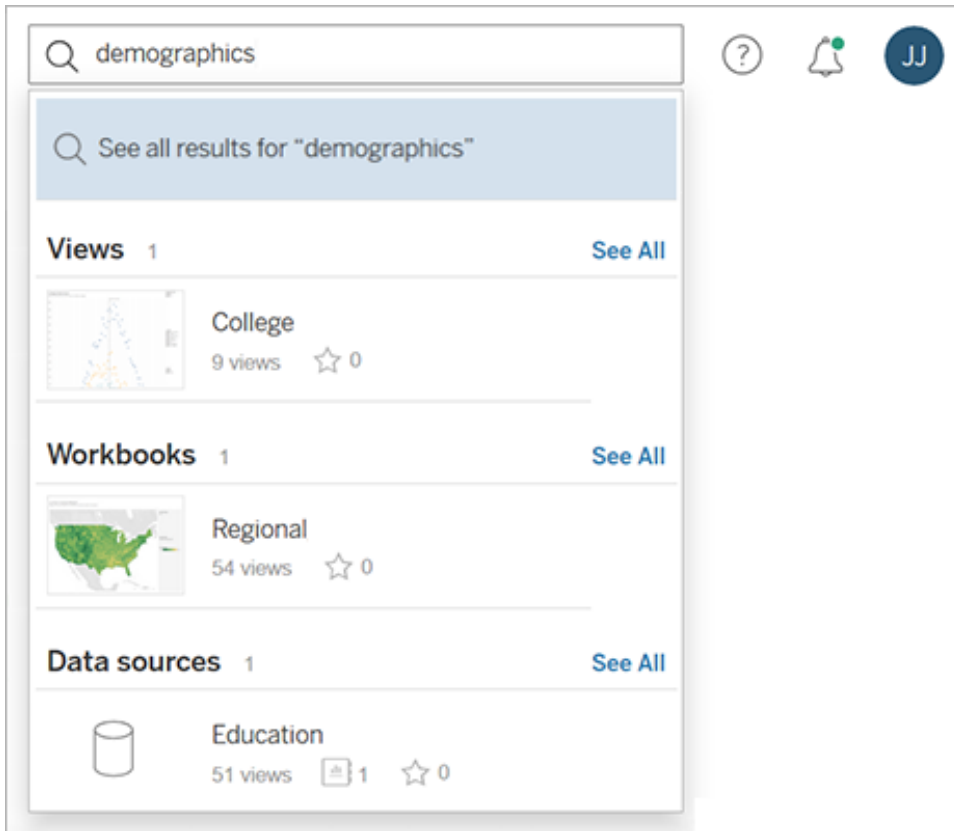

Or use filters to search the list of tags.

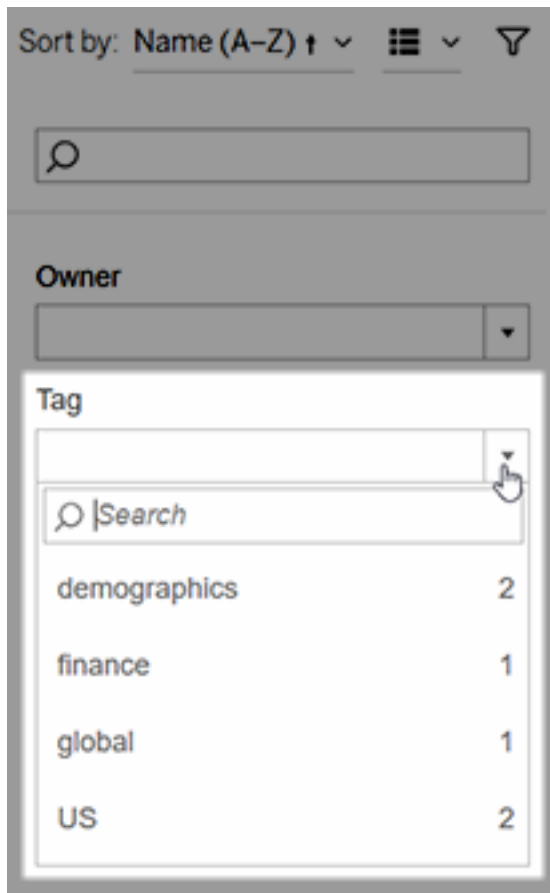

Note: The tag filter doesn't appear if you are looking at multiple types of content in a project. To access the tag filter from within a project, first use the content type selector to display a single type of content that can be tagged, such as workbooks.

When to use and when not to use tags

The purpose of tags is to help users filter content in order to find relevant items. Because any user can add tags, they aren't recommended for scenarios when you need tight control over the categorization of content. For example, don't use the existence of a tag to make decisions around whether to grant access to sensitive content.

Examples of when to use tags:

- Add the tag "Sales" to content located across different projects that is relevant to salespeople, so they can easily find it.

- Add a tag to content created during a particular initiative, so it can be viewed together, regardless of which projects it lives in.

Examples of when not to use tags:

- Don't add tags with the intention of using them to decide how to set permissions for content. Anyone can add these tags to content.
- Don't add a tag about whether data is approved to share with a certain people. Another user can add this tag without approval.

Add tags

If you have a site role of Explorer or Creator, you can add tags to any items that you have permission to access. You don't need to be the owner of an item to tag it. (To add a tag to a column, see [Use Tags on page 3278](#).)

1. Navigate to a list of items.
2. Select one or more items you want to tag, and then select **Actions > Tag**.

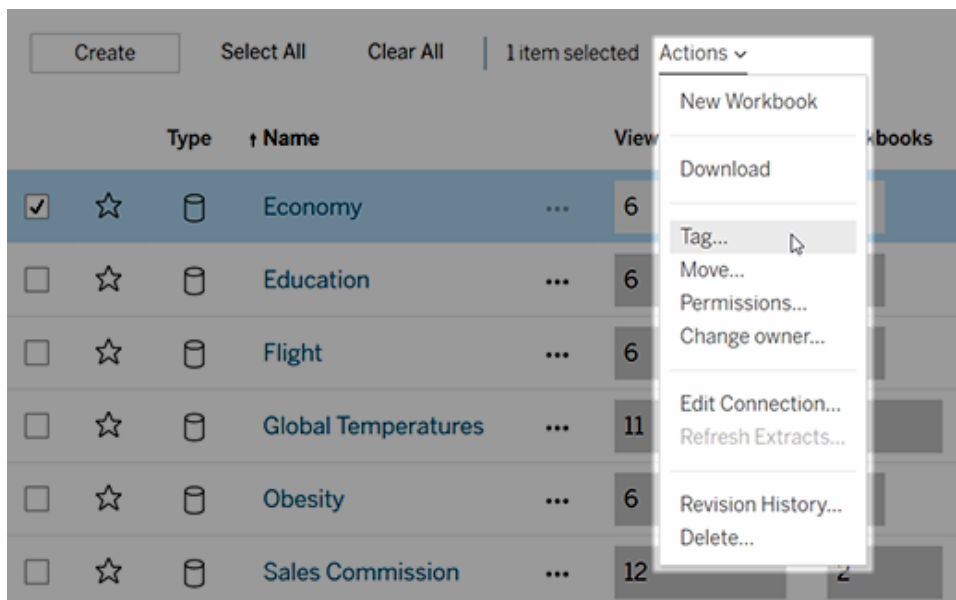

3. Enter one or more tags in the text box, and then click **Save Tags**.

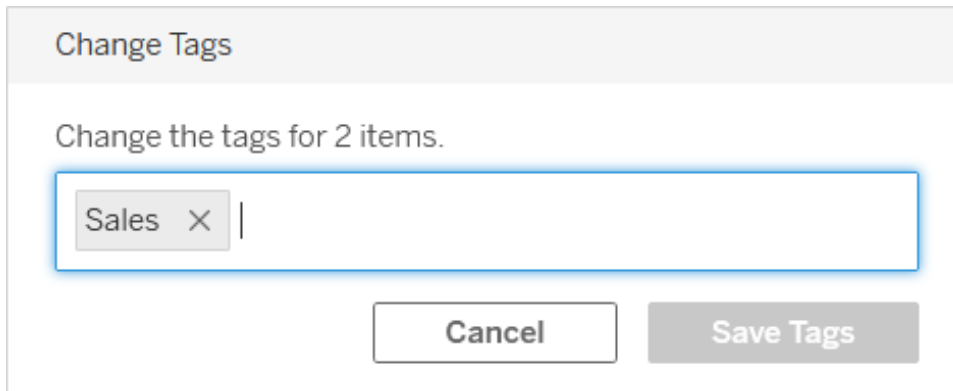

Delete tags

You can delete tags that you have added.

1. Click the Actions menu (...) for an item, then select **Tag**.

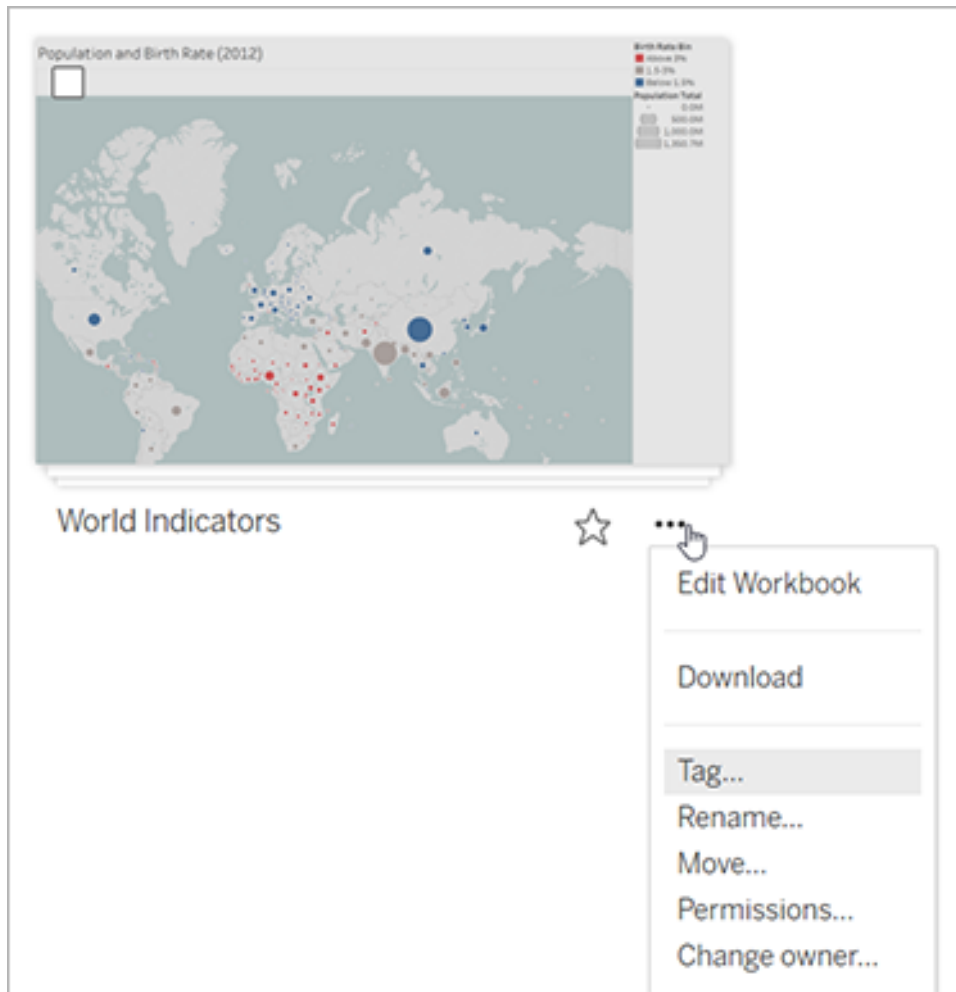

2. Click the 'x' next to the tag you want to remove, and then click **Save Tags**.

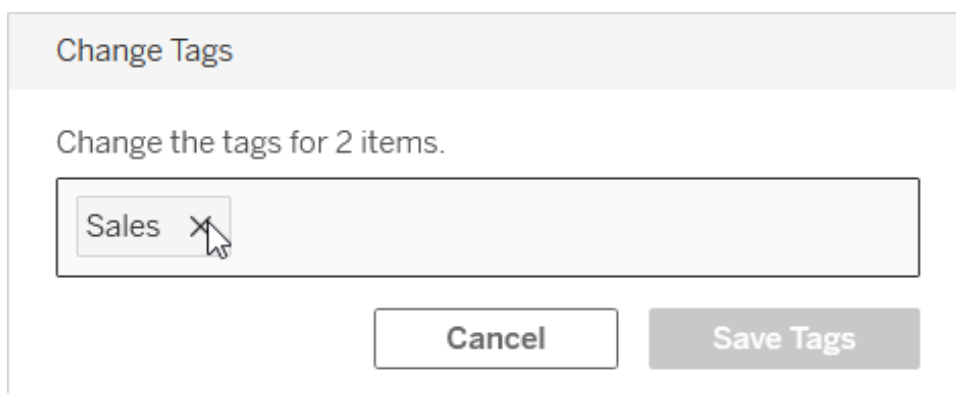

Other places tag information is surfaced

Tags you add are visible to others via auto-complete when users add their own tags.

In addition to seeing tag information in the product ([See tags for an item on page 3278](#)), you can also surface tag information using the REST API or Metadata API to query lineage-related tasks. For more information about these APIs, see [Tableau Metadata API](#) and [Tableau REST API - Metadata Methods](#).

Tag item count mismatch

When you search tags, the item count shown for a tag represents the items you have permission to view. Depending on how your site is configured, when you look at lineage data, the item count shown for a tag might be the total number of items regardless of your permission to view those items. However, all sensitive information about items you don't have permission to view will be obfuscated. For information about sensitive lineage data, see "Access lineage information" in the [Tableau Server](#) or [Tableau Cloud](#) Help.

Search Your Tableau Site

Tableau Server and Tableau Cloud offer search capabilities to help you navigate to and discover the content on your site. Search can retrieve all the content that is available on your Site and in your Personal Space, but it will only show the content that you have access to view. Tableau provides two primary search experiences: quick search and full search.

Quick search

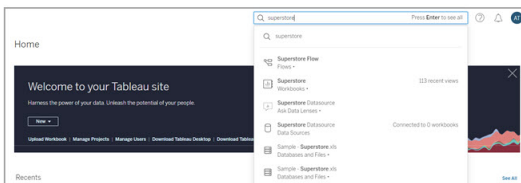

You can access Search by clicking into the search bar in the top right-hand corner of any page on your Tableau Server or Tableau Cloud site. As you type, quick search dynamically renders content suggestions corresponding to the characters you've typed. Quick search matches your query terms to the keywords in content Title or Owner fields, and it ranks results through a combination of quality, popularity, and relevance signals, increasing the likelihood that the content you're looking for shows up at the top of the results page. You can click on these results

to navigate directly to the content, or you can press **Enter**, which will land you on the search results page.

When you click into the search bar, you will also see the past queries you have typed, as well as quick link buttons for a subset of content types and content owners, corresponding to the owners of the content that you've recently viewed. When you click a quick link button, you'll navigate to the search results page with the applied scope of the button you just clicked. From there, you can type a search with that applied scope.

Full search

When you navigate from the quick search experience to the search results page, you are in the full search experience. By default, the results are shown in **Mixed View**, which is a combination of grid and list view, depending on the content type.

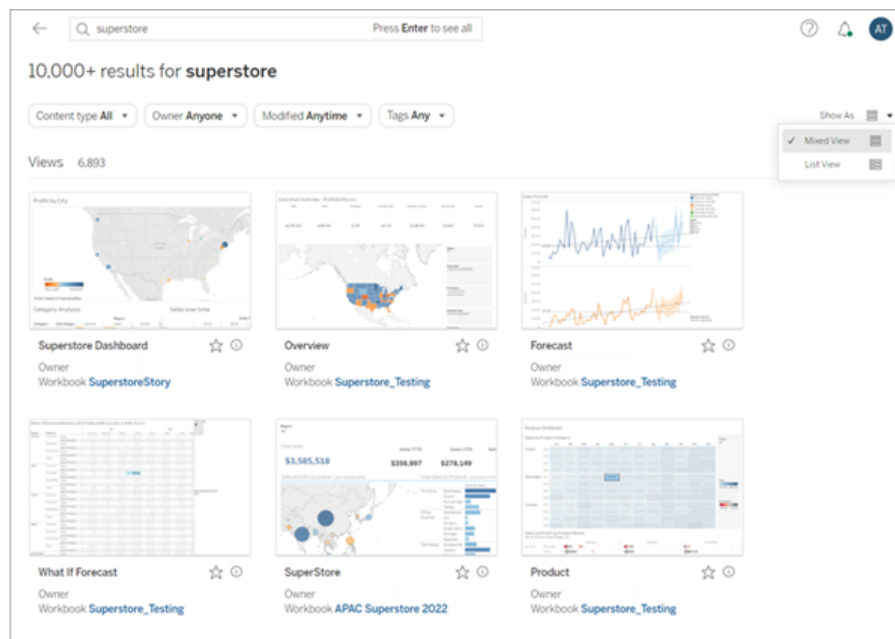

To change the way the results are displayed, select **Show As > List View**. List View provides more field metadata per result.

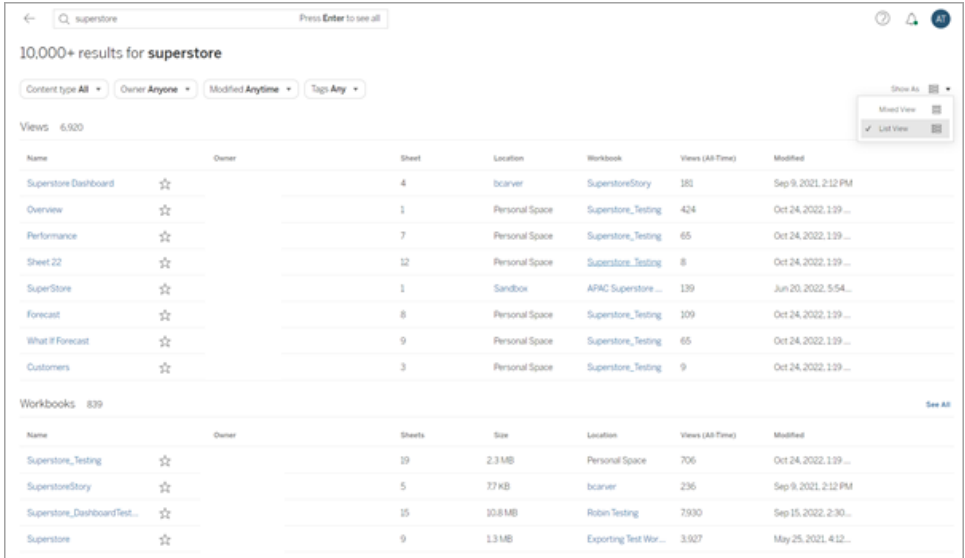

You can filter your results by content type such as All, Views, Workbooks, and Data Sources. You can further refine your search results with the other filters located above the results. To see more results for a given content type, click **See All** or select a particular content type from the content type menu. When you're in the single content type view, you can also change the **Sort By** options. By default, results are sorted by relevance, which ranks results by various usage, quality, and personalization attributes. Some content types can also be sorted by popularity, which uses the frequency and recency of content item views to order the results. For **Data Sources, Tables and Objects**, and **Databases and Files**, sorting by popularity orders the results by the number of connected workbooks.



Tableau Catalog users may see search results for non-embedded databases and tables before ingestion to catalog is finished. When this happens, if you click this entry from the quick search results, a "Showing partial results..." warning message displays. If you review the search results page, the entry is grayed out until ingestion to catalog is complete.

To find tips on making the most of Tableau search, see [Blog: The Evolution of Tableau Search and Best Practices for](#)

Mark Favorites

To make it easy to find your most-used content, you can mark it as a favorite. You can add any type of content to your favorites, except for embedded data sources.

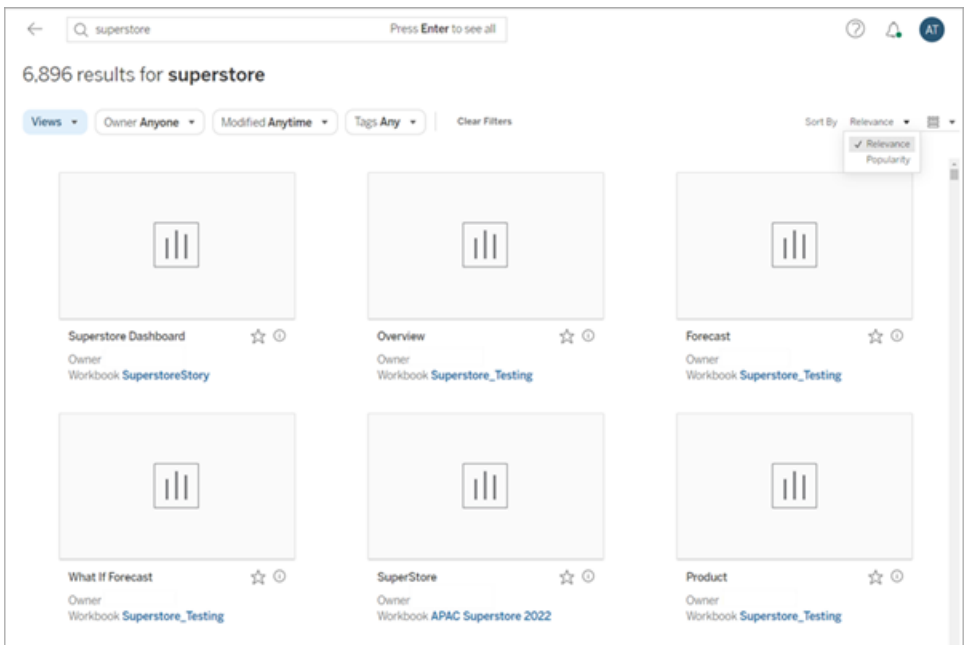
Mark content as a favorite

Click the favorites star near the content name.

In grid view:

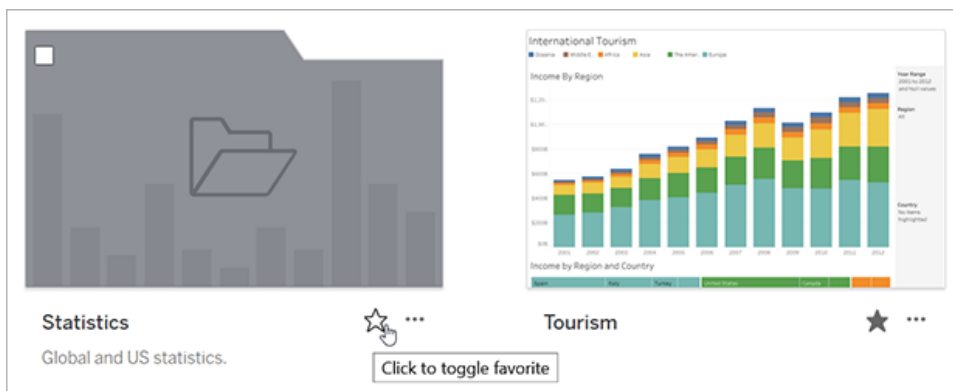

Or in list view:

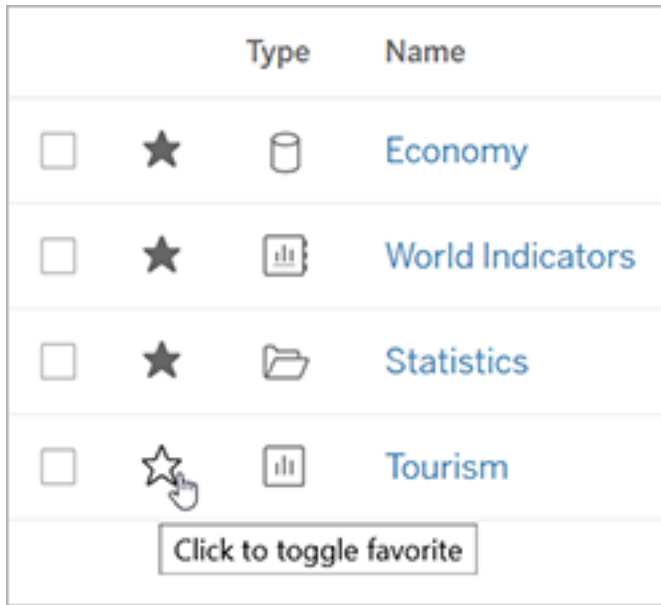

Alternatively, when you have a view open, click the star in the header.

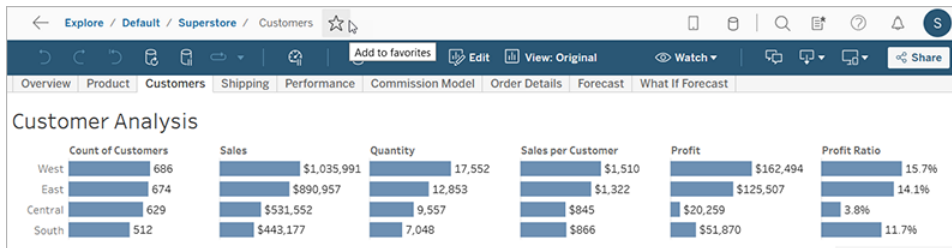

Remove an item from favorites

Click the star that you used to mark the favorite.

Find favorites

To access your Favorites page, from the navigation panel, click **Favorites**.

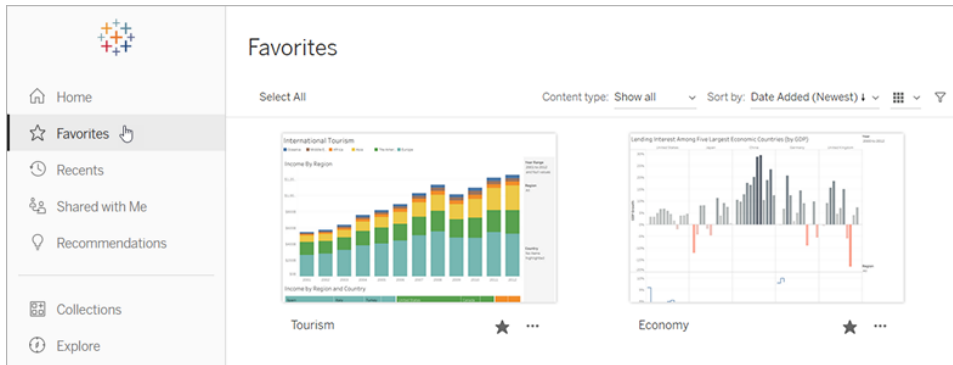

You can filter the content on your Favorites page to find specific items. Filters are helpful if you accumulate a large number of favorites. For more information, see [Filtered search](#).

Note: Your recently added favorites also appear on the Home page.

Organize your favorites

In grid view, drag and drop cards to reorder your favorites.

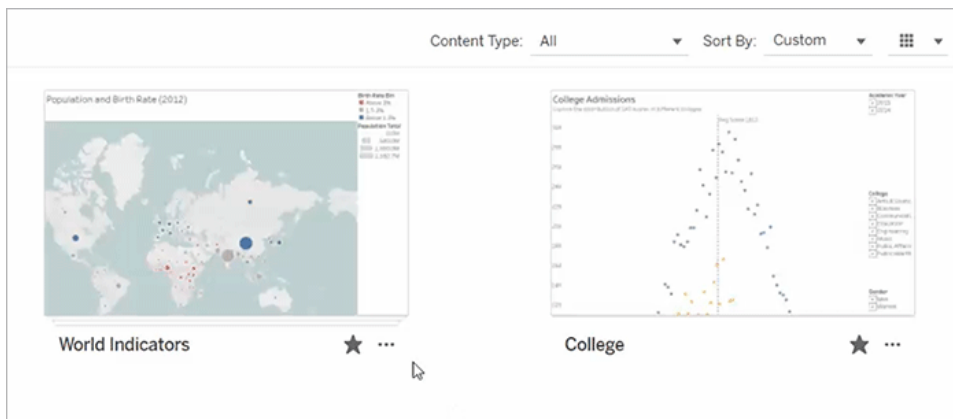

Switch between the custom sorting order you create and other orders like date or name using the **Sort By** menu.

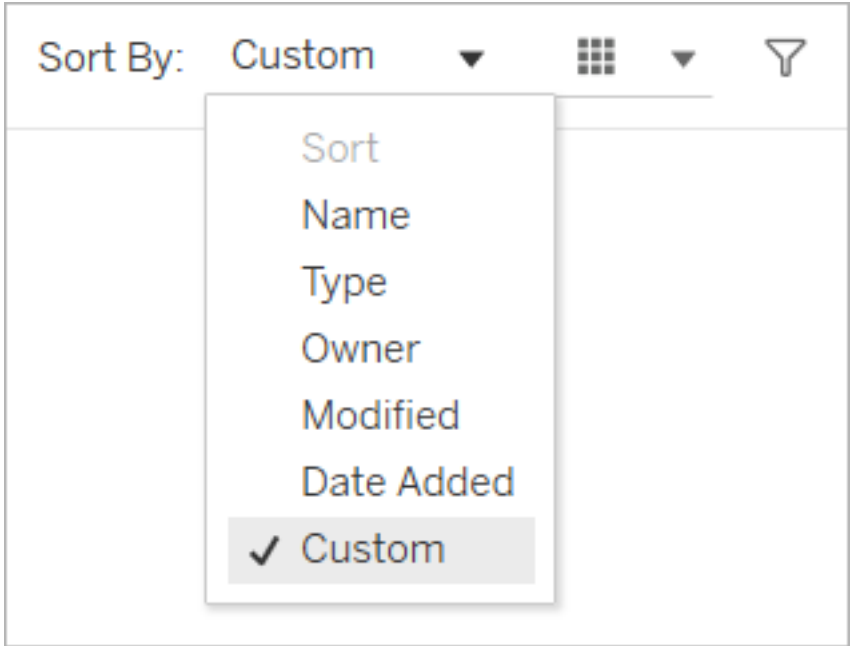

Note: For information about how to organize favorites using a keyboard, see [Keyboard Accessibility for Tableau Views](#) on page 3257.

Access favorites from a view

To access your favorites while looking at a view, click the list icon on the right side of the header. Enter keywords into the search box to find specific items.

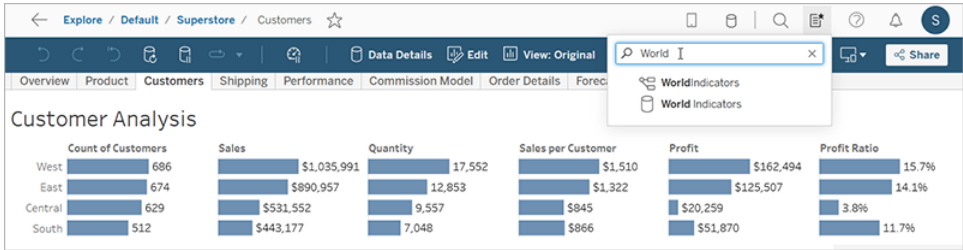

Organize Items in a Collection

Collections let you gather related items into an easy to access list. With a collection, you can organize items in a way that is meaningful to you, without worrying about who owns an item or which project it lives in on your Tableau site.

You can keep a collection private or share it with others. When you give others access to a collection, there's no risk of exposing data, because collections don't affect the permissions for the items they contain. In a collection, users see only the items that they have permission to access.

You might want to build a collection to:

- Onboard new employees with data appropriate for their roles
- Organize the data you frequently use for a project in one place
- Promote certified data and approved dashboards in your organization

Find collections

From the navigation pane, click Collections to see all the collections you have permission to view. The collections that you are the owner of appear under the My Collections tab. Collections aren't included in the Explore section of your site or when you search, but they do appear in Favorites and Shared with Me, if applicable.

When you open a collection, you'll see the items you have permission to view. If there are many items in the collection, filter and sort to find specific items (some filter and sort options are limited in collections). The number of items displayed in a collection may differ from the total number of items listed in the collection details, depending on the permissions for the individual items.

Create a collection

To add items to a collection, you first need to create one. Anyone can create a collection. You don't need a specific role or permission.

1. From the navigation pane, click **Collections**.
2. Click the **New Collection** button.

The collection is created with a default name.

3. To change the name from the default, mouse over the name and click the highlighted text. Enter a new name, and then click **Save**.
4. To add a description, mouse over the description area and click the highlighted text. Enter

a description, and then click **Save**.

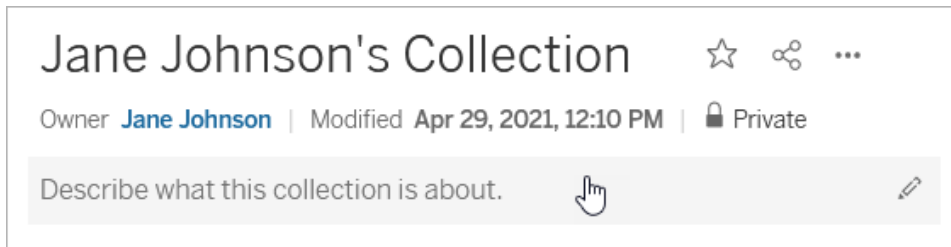

You can also create a collection from the Add to Collections dialog, shown below.

Add items to a collection

If you can view an item on your site, you can add it to your collection, with the exception of external assets (databases, files, and tables), lenses, and other collections. You must own a collection to be able to add items to it. Though the items you collect might belong to different projects, you can add them to a collection without needing to move or copy them.

1. Navigate to the item you want to add to a collection.
2. Click the Actions (...) menu, and then click **Add to Collections**.

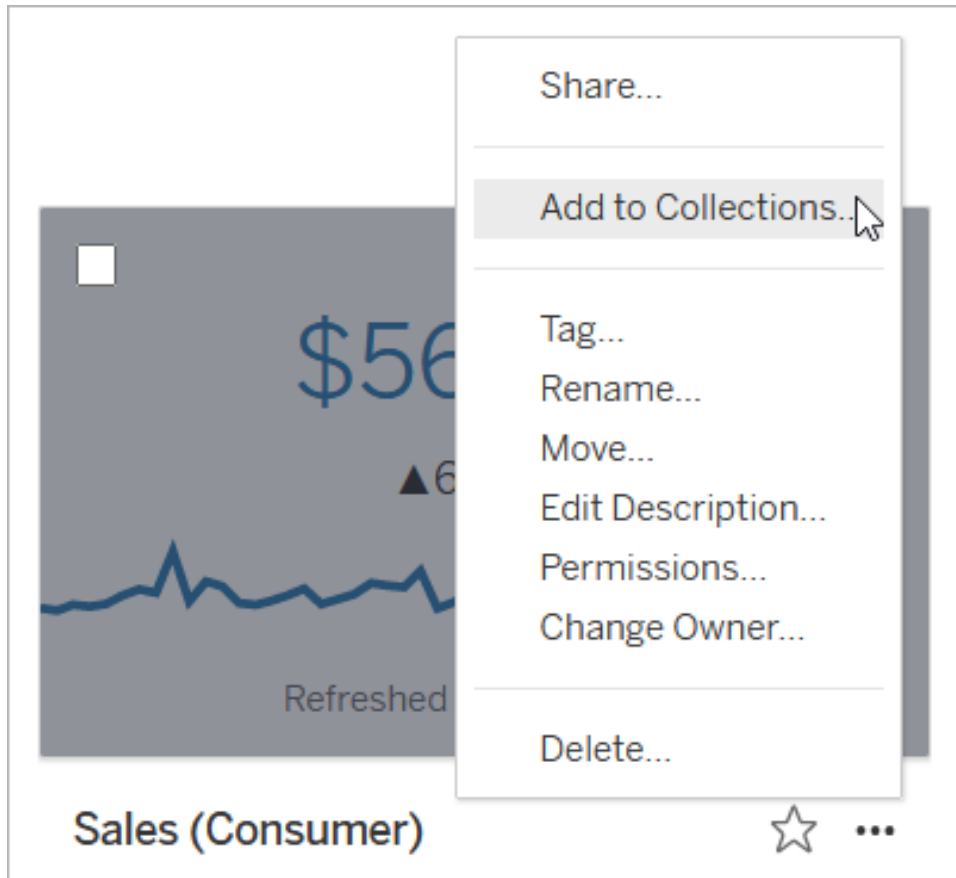

To add multiple items to a collection, select checkboxes for the items, and then click **Actions > Add to Collections**.

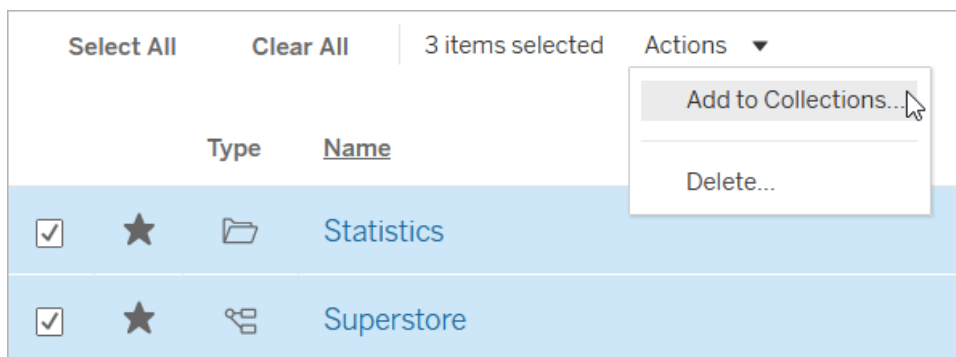

- On the Add to Collections dialog, select the collection you want to add the item or items to. You can select multiple collections. If a collection name isn't selectable, that means that the collection doesn't have enough space to accommodate the items. A collection can contain a maximum of 1000 items.

(Optional) If you want to make a new collection for these items, create one by clicking the **New Collection** button. Once you create it, the new collection will be pre-selected in the dialog.

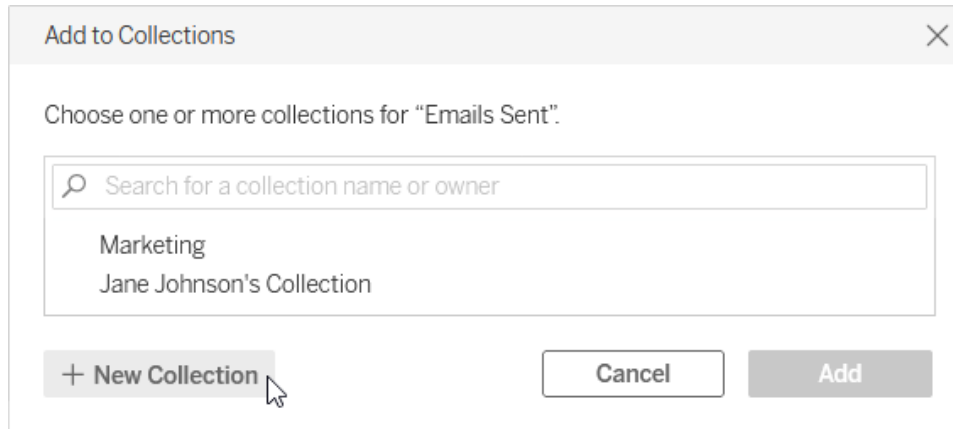

4. Click **Add**.

Remove items from a collection

You can remove items from collections that you own.

1. From the navigation pane, click **Collections**.
2. Click the **My Collections** tab.
3. Open the collection you want to remove items from.
4. To remove a single item, click the Actions (...) menu for that item, and then click **Remove from This Collection**.

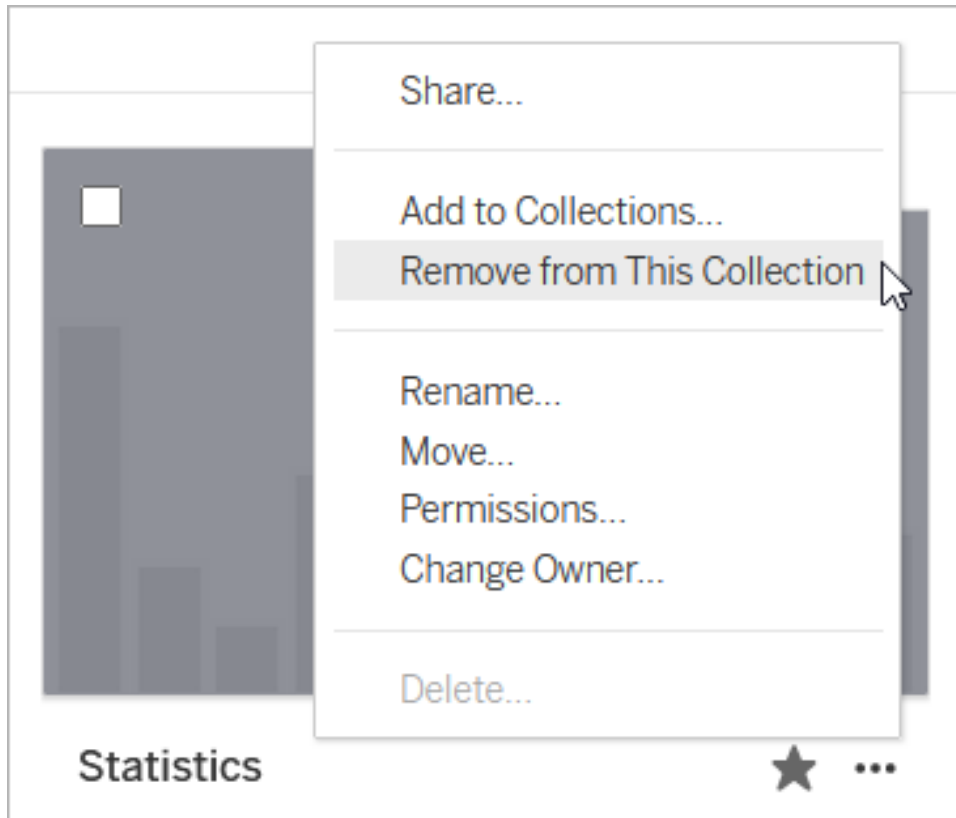

To remove multiple items, select checkboxes for the items, and then click **Actions > Remove from This Collection**.

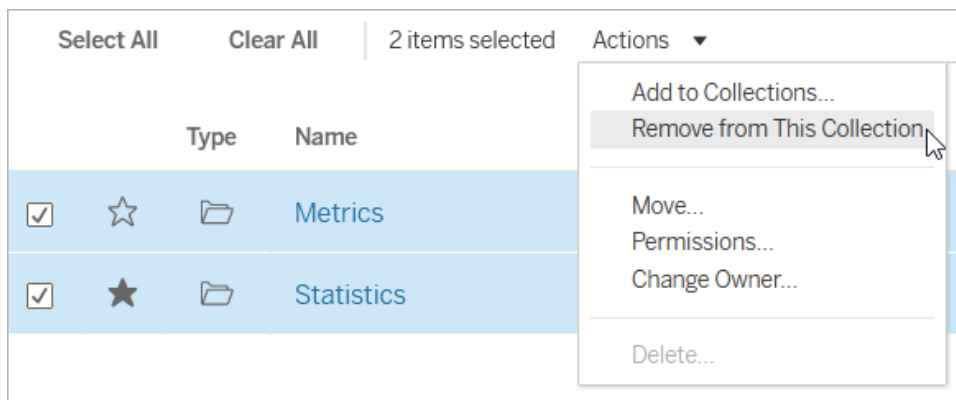

If you accidentally remove an item, don't worry. You can simply navigate back to where it lives and re-add it.

Deleting a collection or removing items from a collection won't delete the actual items, because the link between the collection and the items it contains is like a shortcut. This is different from

deleting a project or an item in a project, where you are managing the actual items. The Delete action is disabled from within a collection, so there is no risk of accidentally deleting an item while managing items in a collection.

Organize your collection

You can reorder items in collections that you own. In grid view, drag and drop an item to move it.

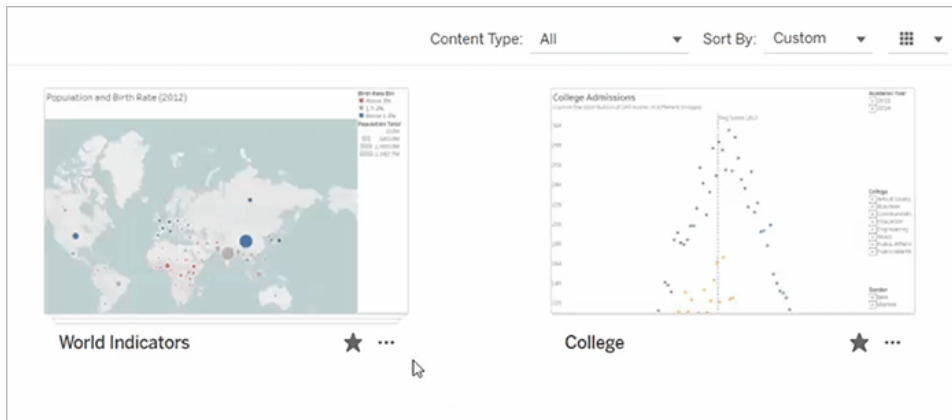

Switch between the custom sorting order you create and other orders like date or name using the **Sort By** menu. The custom order that you create will appear as the default sort order for others who can view your collection as well.

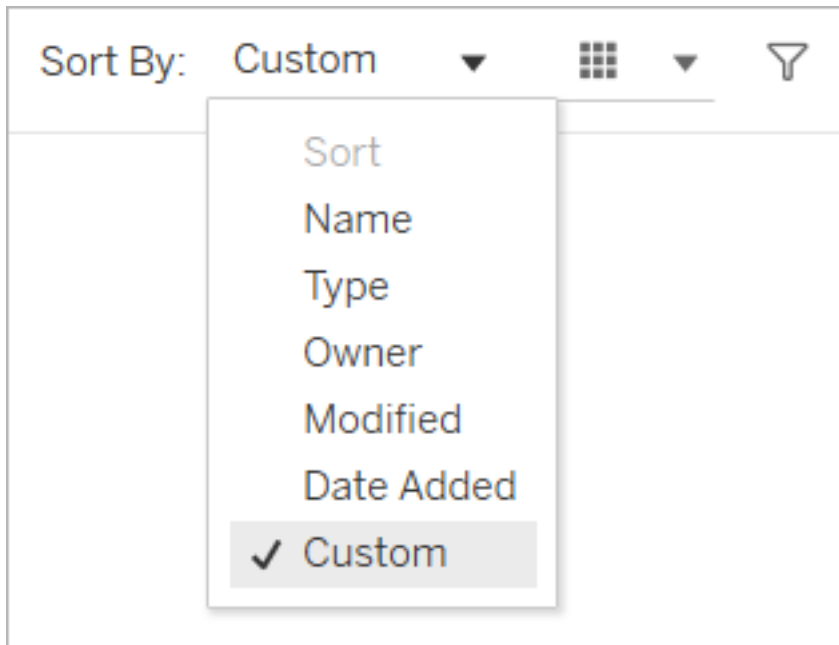

Manage collection permissions

Collections are private by default. You can give other users access to a collection either by configuring the permissions for the collection directly or by granting access after sharing the collection.

Be aware that permissions for a collection do not affect the items in the collection. This means that some users might see fewer items in your collection than you do, because they don't have permission to access all of the items. Contact the content owner or your site administrator for help with permissions for restricted items.

Configure permissions

If you are the owner of a collection, you can configure permissions for the collection. There is only one capability available for collections: View. Giving users the View capability will allow them to see the collection, but they won't be able to add or remove items from the collection. The View capability for a collection doesn't give users access to items in the collection that they don't have permission to. For more information about how permissions work in Tableau, see [Permissions](#).

1. Click the Actions menu (...) for the collection, then click **Permissions**.
2. Under Permission Rules, click **Add Group/User Rule**.
3. Enter a user or group name.
4. Under Template, click **View**.
5. Click **Save**.

The collection will now appear on the Collections page for the users you added. These users won't be notified about the change in permissions, so if you want to make them aware of the collection, share it with them.

Grant access by sharing

The option to grant access appears after you share a collection if you are the collection owner.

1. Click the Share () button for the collection.
2. Enter the name of the user or users you want to share with.
3. Click **Share**.
4. On the Grant Access dialog that appears, click **Grant Access**.

If the people you shared with already have access to the collection, either because you previously configured permissions or because their site role gives them access, you won't see the grant access dialog.

Manage Web Content

Use the options detailed in this topic to edit item descriptions or perform actions like moving or renaming items on your Tableau site. The options available to you are based on your site role and permissions.

Note: If Tableau Catalog is enabled on your site, you can add descriptions to fields on a published data source page. You can also access external assets (databases and tables). Some of the options for external assets differ from the options for Tableau content (project, workbooks, views, data sources, data roles, and flows).

Tableau Catalog is available in the Data Management for Tableau Server and Tableau Cloud. For more information, see "About Tableau Catalog" in the [Tableau Server](#) or [Tableau Cloud](#) Help.

Access options

The top of the page for each item displays the name of the item and the owner or contact. Some pages might show additional information, such as a description of the item or the date the item was last modified.

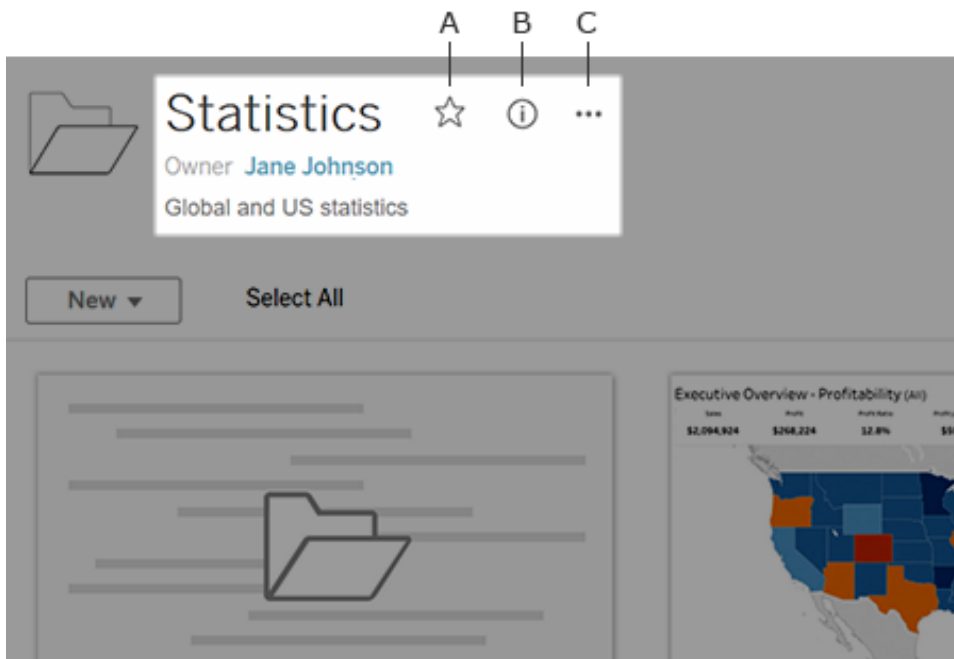

You can use the icons next to the item name to:

- **A** - Add the item to your **favorites**.
- **B** - View the item's details.
- **C** - **Perform actions** on the item.

Add or edit descriptions

Descriptions make it easier for everyone in your organization to find the right items. If you own an item or have the appropriate permissions, you can edit the item's description.

Describe projects, workbooks, and data sources

1. From the navigation pane, select **Explore**.
2. Navigate to the project, workbook, or data source you want to describe.
3. Click the details icon .
4. To the right of **About**, click **Edit**.
5. Enter a description in the **About** field. You can format the text in a message with bold, underline, and italics, and include a link or an image. To see text formatting tips, click **Show formatting hints** under the text box.
6. Click **Save**.

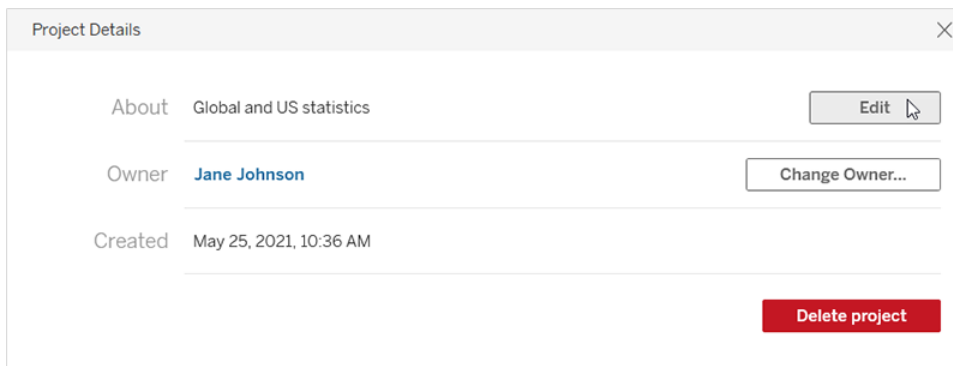

Starting in Tableau Cloud June 2024, if both Tableau Catalog and Tableau AI are turned on, you can have Einstein draft workbook, data source, and table descriptions for you. (For table descriptions, see [Describe Databases and Tables](#).) This feature is only available in Tableau Cloud. For information on enabling Tableau AI, see [Turn On Tableau AI for Your Site](#) in the Tableau Cloud Product Help.

1. Select the Actions (...) menu for the asset, then **Edit Description....**

2. In the **Edit description** dialog, use the **Draft with Einstein** button to generate a suggestion based on metadata, like field names. Click the **Draft with Einstein** button more than once to see alternative suggestions.
3. Adjust the draft if needed. You can change the text, or format it with bold, underline, and italics. You can also include a link or an image. To see text formatting tips, select **Formatting Guide** under the text box.
4. Select **Save**.

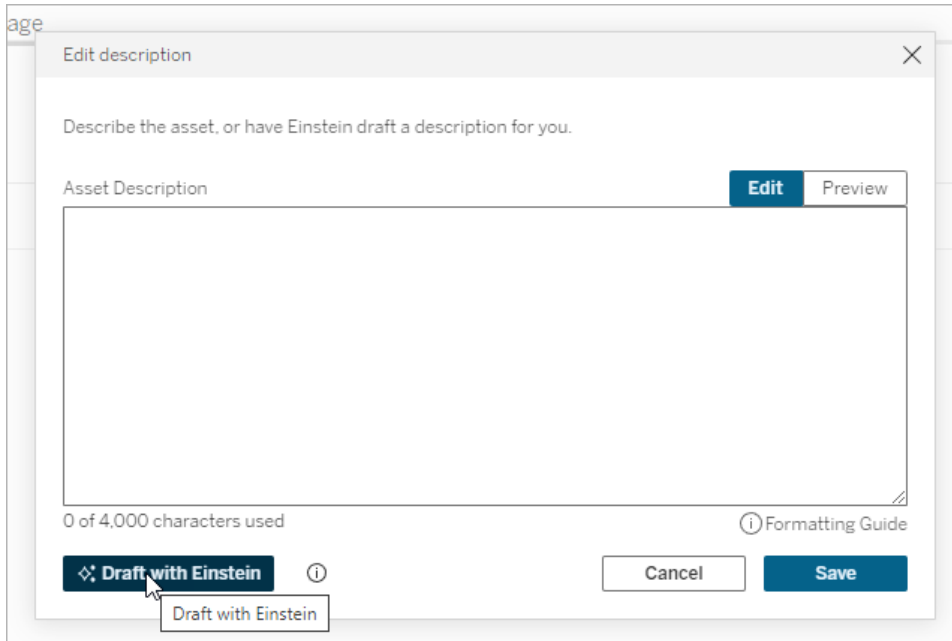

Note: This feature uses generative AI, which is built on the Einstein Trust Layer. Your data stays safe and secure through data and privacy controls that are seamlessly integrated into the user experience. For more information, see [Einstein Trust Layer](#).

Describe metrics, data roles, Ask Data lenses, and collections

1. From the navigation pane, select **Explore**.
2. Navigate to the content you want to describe.
3. For metrics and data roles, mouse over the **Description** header and click anywhere on the gray background that appears. (The legacy Metrics feature was retired in February 2024 for Tableau Cloud and in Tableau Server version 2024.2. For more information, see [Create and Troubleshoot Metrics \(Retired\)](#).)

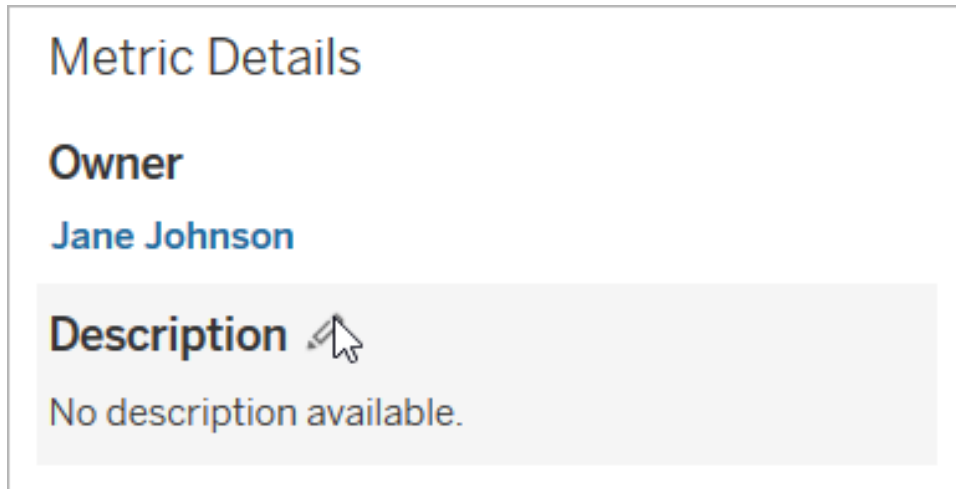

For lenses and collections, mouse over the description text and click anywhere on the gray background appears.

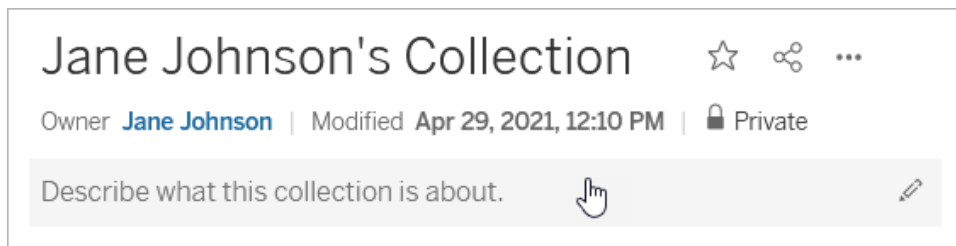

4. Enter a description, then click **Save**.

Describe flows

1. From the navigation pane, select **Explore**.
2. Select **All Flows** from the drop-down menu.
3. In the **Name** column, select the flow you want to describe.
4. On the **Overview** tab, click the edit icon next to **Description**.
5. Enter a description. You can format the text in a message with bold, underline, and italics, and include a link or an image. To see text formatting tips, click **Show formatting hints** under the text box.
6. Click **Save**.

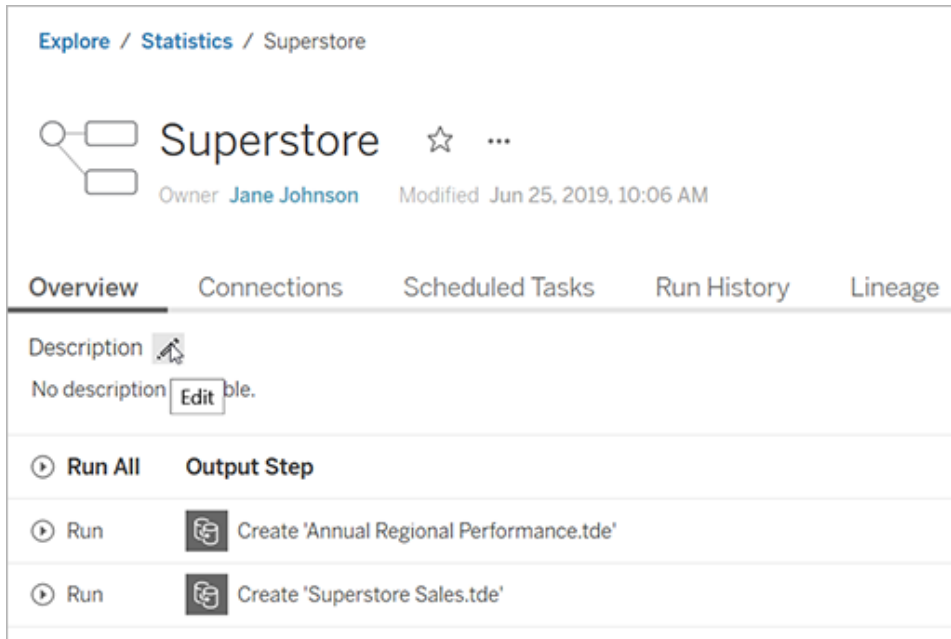

Describe databases and tables (available if Tableau Catalog is enabled)

1. From the navigation pane, select **External Assets**.
2. Select **Databases and Files** or **Tables and Objects**.
3. In the **Name** column, select the asset you want to describe.
4. From the Actions (...) drop-down menu to the right of the asset name, select **Edit Description**.

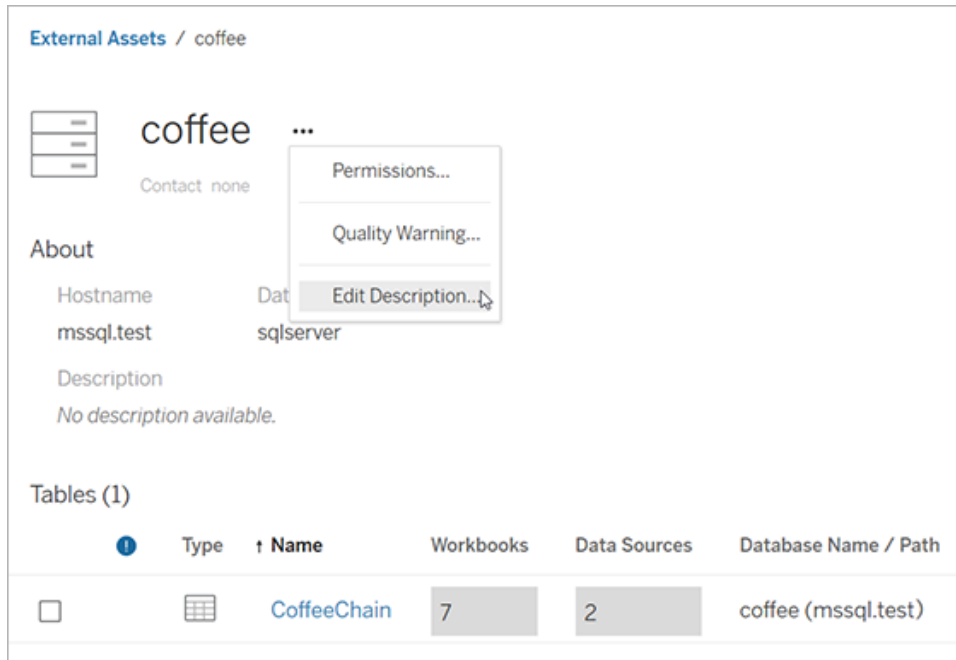

5. In the **Edit Description** dialog box, enter a description. Or, starting in Tableau Cloud June 2024, if Tableau AI is turned on and you're describing a table, you can select the **Draft with Einstein** button to generate a suggestion based on metadata, like table and column names. Click the **Draft with Einstein** button more than once to see alternative suggestions. (This feature is only available in Tableau Cloud. For information on enabling Tableau AI, see [Turn On Tableau AI for Your Site](#) in the Tableau Cloud Product Help.) Adjust the draft if needed. Format the text with bold, underline, and italics, and include a link or an image. To see text formatting tips, click **Formatting Guide** under the text box.
6. Click **Save**.

Note: The **Draft with Einstein** feature uses generative AI, which is built on the Einstein Trust Layer. Your data stays safe and secure through data and privacy controls that are seamlessly integrated into the user experience. For more information, see [Einstein Trust Layer](#).

When you add the description, there might be a delay before you can see your change.

Describe table columns (available if Tableau Catalog is enabled)

1. From the navigation pane, select **External Assets**.
2. Select **Databases and Files** or **Tables and Objects**.
3. From the list, select the name of the asset with the column you want to describe.
4. On the table page, under **Columns**, select the name of the column.

5. In the **Column Details** dialog box, select the edit icon to the right of **Description**.

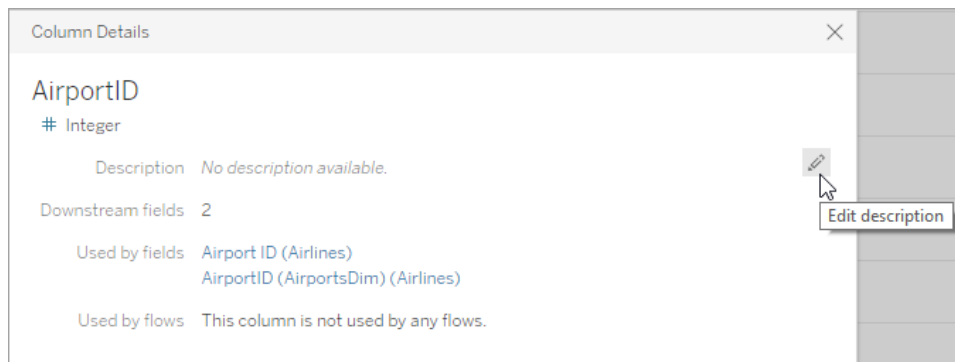

6. Enter a description in the **Description** field. You can format the text in a message with bold, underline, and italics, and include a link or an image. To see text formatting tips, click **Formatting Guide** under the text box.
7. Click **Save**.

When you add the description, there might be a delay before you can see your change. After the description has been applied, you can see it in the **Description** column on the table page **Lineage** tab.

Describe fields in a published data source (available if Tableau Catalog is enabled)

1. From the navigation pane, select **Explore**.
2. Select **All Data Sources** from the drop-down menu.
3. Click the data source name to open the data source page.
4. On the **Lineage** tab, select the field you want to describe.
5. In the **Field Details** dialog box, select the edit icon to the right of **Description**.
6. Enter a description in the **Description** field. You can format the text in a message with bold, underline, and italics, and include a link or an image. To see text formatting tips, click **Formatting Guide** under the text box.
7. Click **Save**.

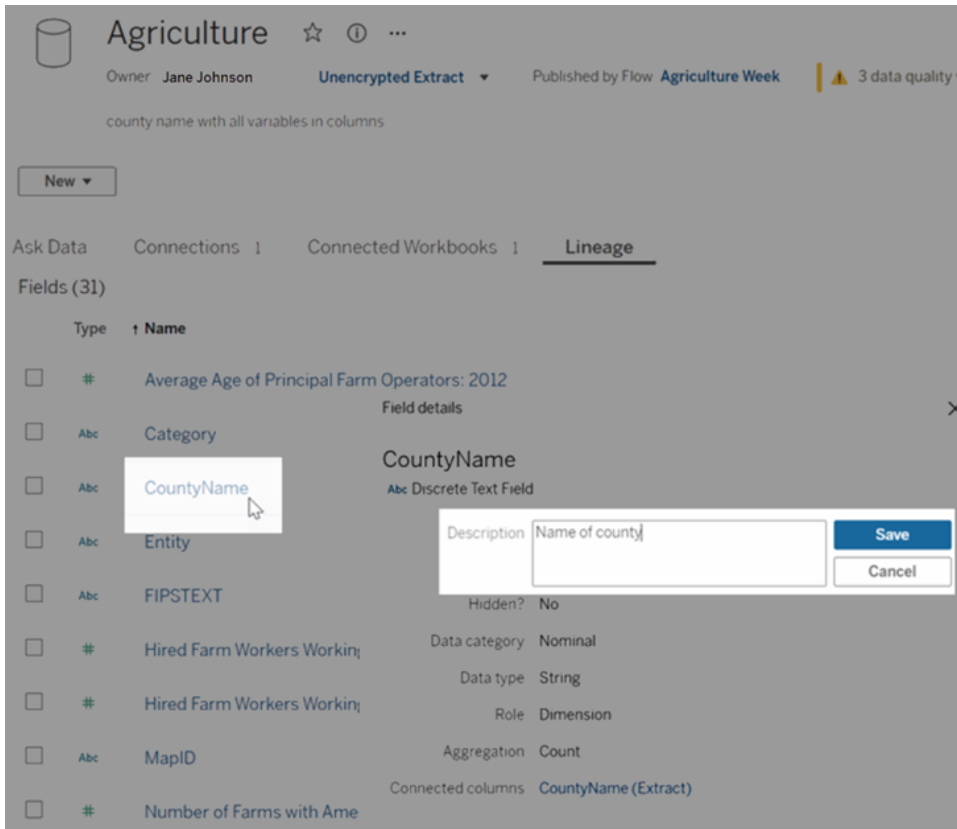

When you add the description, there might be a delay before you can see your change. After the description has been applied, you can see it in the **Description** column on the data source page **Lineage** tab. When you build a visualization, you can see the description on the **Data** tab by hovering your mouse over the field name.

How field descriptions are inherited (if Tableau Catalog is enabled)

When a description exists upstream from a field that has no local description, that field inherits the nearest upstream description. Information about where the description is inherited from also appears.

In web authoring on Tableau Server or Tableau Cloud, inherited descriptions always appear. In Tableau Desktop, inherited descriptions appear only when you're connected to Tableau Server or Tableau Cloud.

Note: Inherited descriptions do not appear when using virtual connections in Tableau Desktop or web authoring.

Tableau Desktop and Web Authoring Help

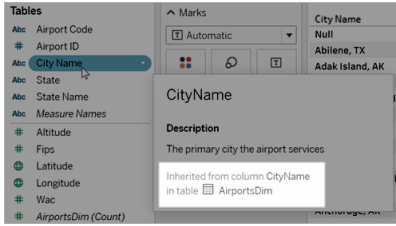

On Tableau Server and Tableau Cloud, inherited descriptions also appear in lineage pages and data details panes.

Type	Name	Sheets	Description
Abc	City Name	0	The primary city the airport services
Abc	CityName (AirportsDim)	0	The primary city the airport services

Description inherited from column [CityName](#) in table [AirportsDim](#).

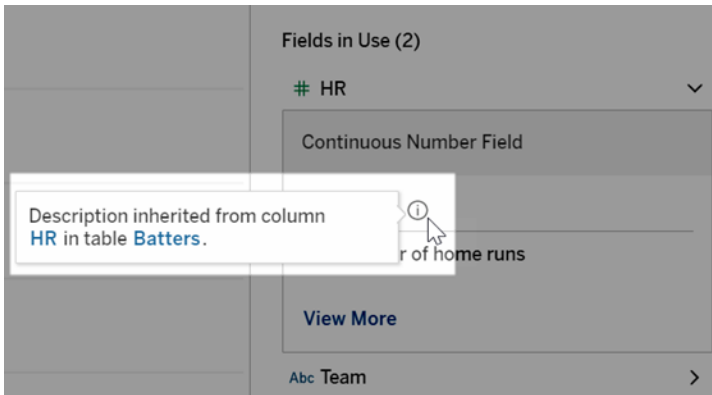

Inherited descriptions have the following caveats. They:

- Don't appear for calculated fields.
- Aren't supported if your data source or workbook has more than 500 fields.
- Aren't supported if your data source or workbook is so large that the inheritance query times out.

Access your content

To see the content you own, click your profile image or initials at the top of the page, and then click **My Content**.

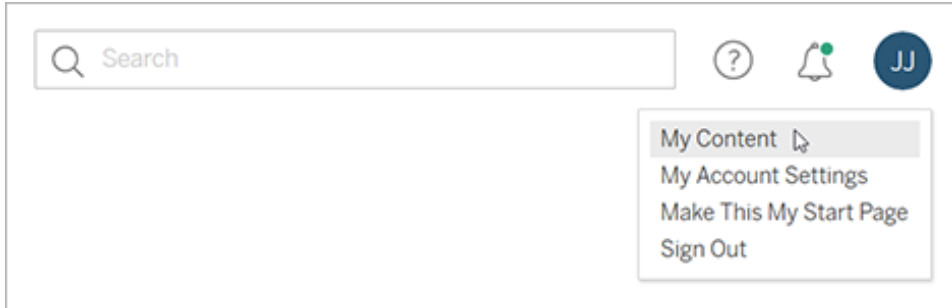

Your content page displays your user information and the content that you own. From this page, you can also access your alerts, subscriptions, and account settings. To learn more, see [Manage Your Account Settings](#) on page 3333.

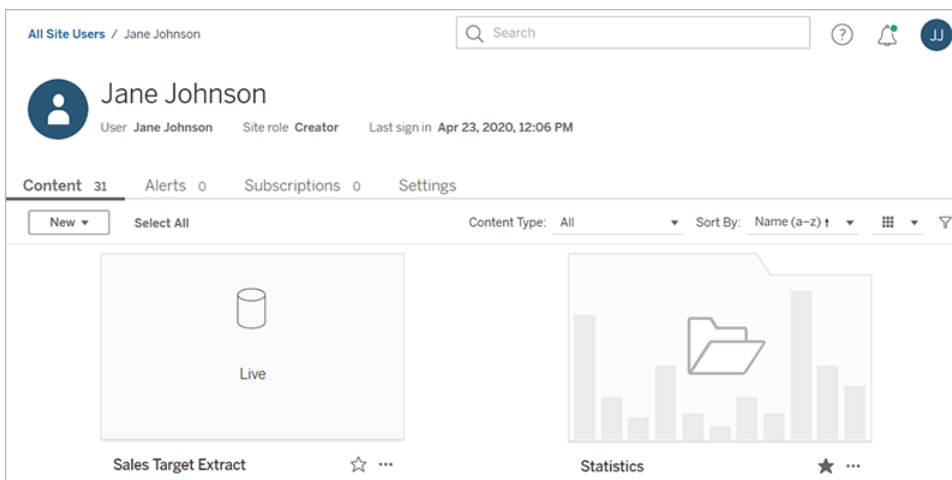

For the views you own, you can see which users have looked at a particular view by selecting **Who Has Seen This View?**.

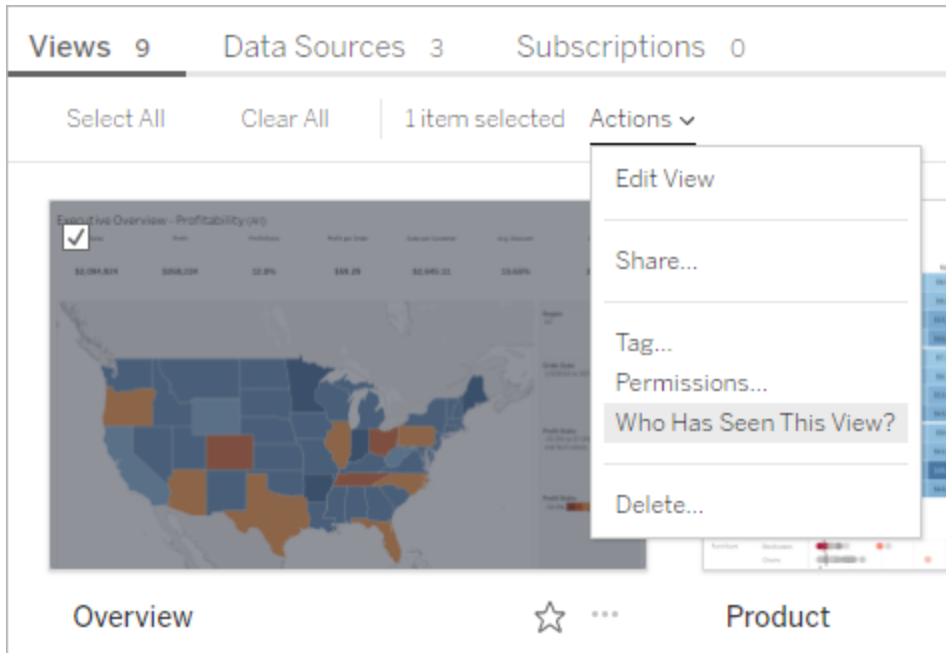

Perform actions

Click check boxes to select items, then click the **Actions** drop-down menu to access commands available for those items.

If you don't have permission to perform an action on the item selected, the action will be disabled. If you select multiple items, and you don't have permission to perform an action on one of the items selected, you will get an error when you try to perform the action on that item.

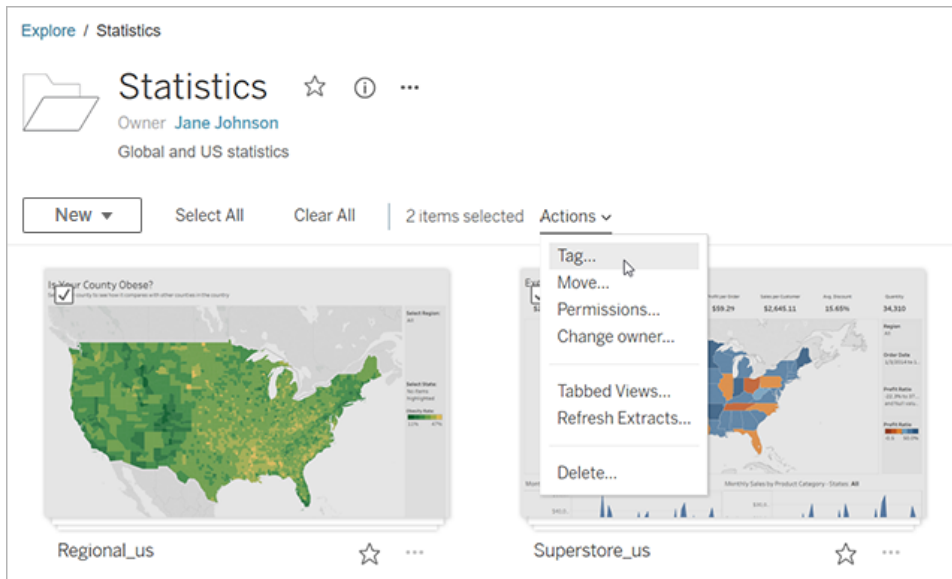

Note: Different types of items have different actions available. If you select more than one type, for example, selecting a workbook and a data source, the actions you see will be limited to those in common between the types.

Access the actions menu for the item you currently have open by clicking the ... at the top of the page. This actions menu is disabled if you have check boxes selected for other items on the page; instead, use the actions menu shown above to modify checked items.

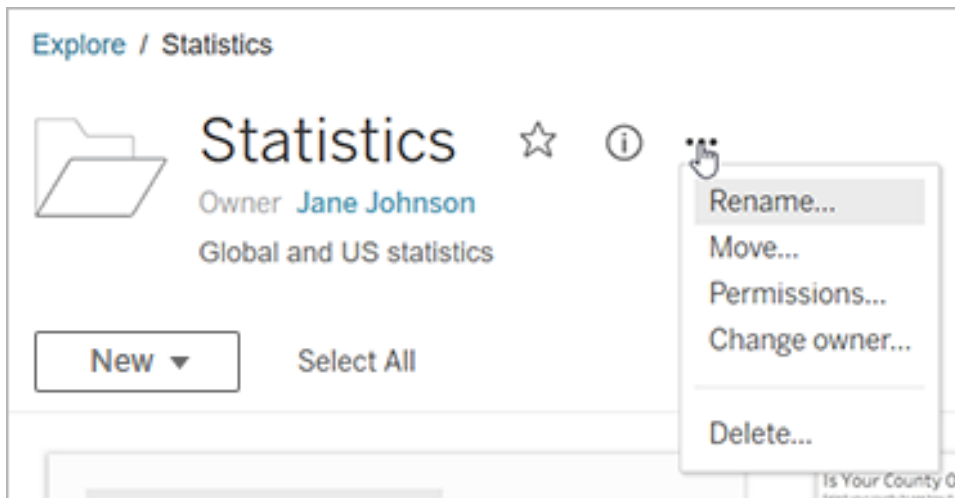

In grid view, access the actions menu from the lower-right corner of a thumbnail.

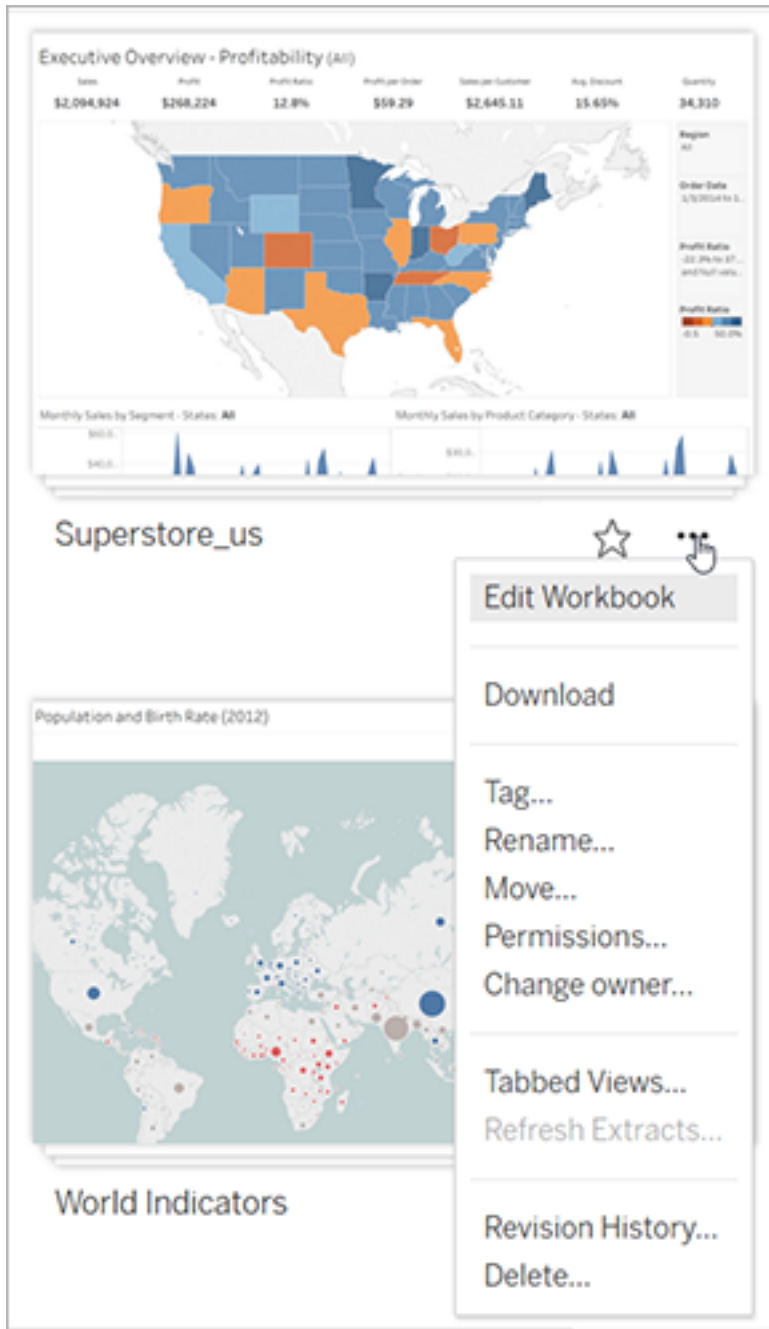

In list view, access the actions menu to the right of the item's name.

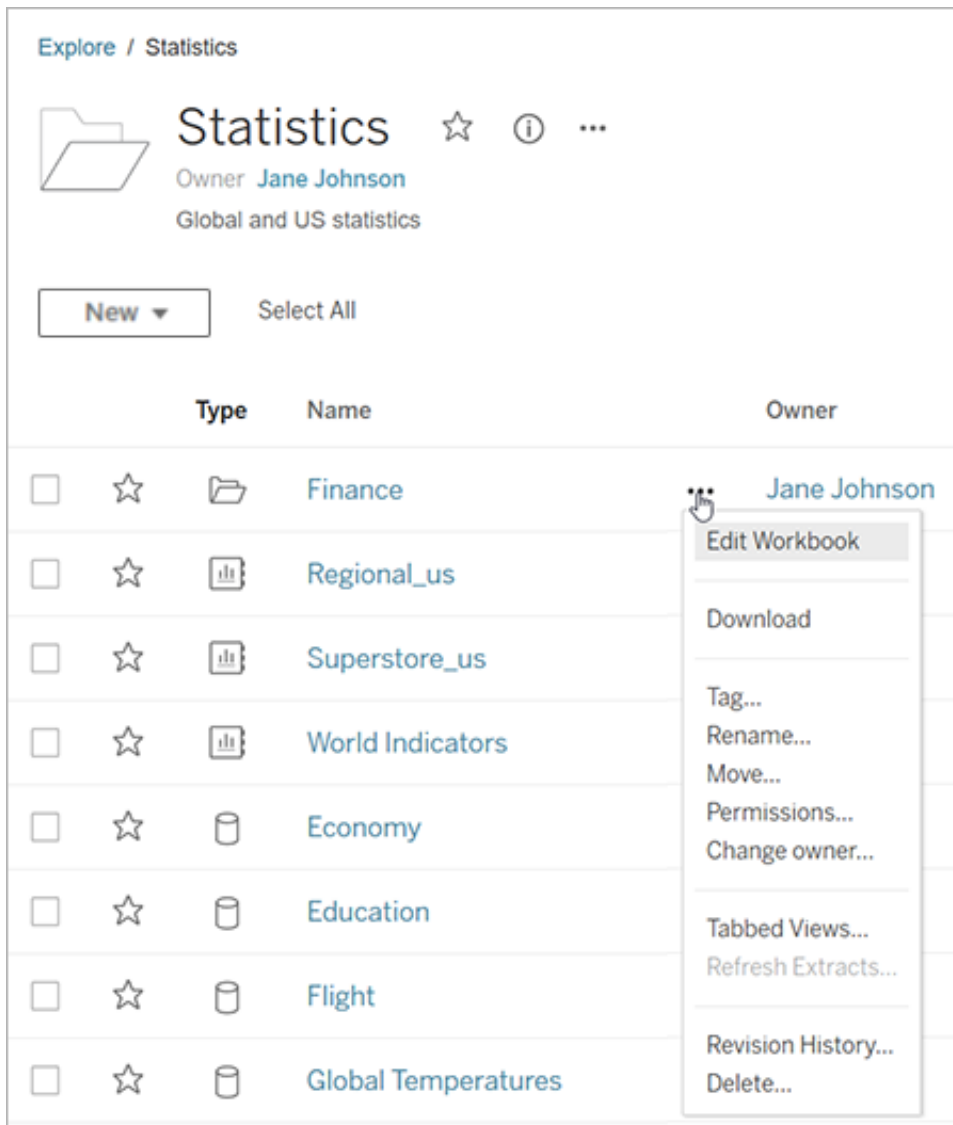

Delete content

In order to delete content, you must meet one of the following criteria:

- Have a site role of Explorer (can publish) or Creator AND have the Delete capability for the content
- Be the content owner
- If the item is in a project and not in Personal Space: Be the project owner or project leader where the content is located.

For more information about how permissions and site roles interact, see [Effective Permissions](#).

Tip: Be careful when deleting content from your site. Deleting is a permanent action for all types of content except for views.

To delete content:

1. From the navigation pane, select **Explore**.
2. Navigate to the content you want to delete.
3. From the Actions (...) drop-down menu, select **Delete**.

Some areas of your site, like collections, recommendations, and external assets, provide links or references to items. These links or references do not affect the items themselves. You can remove an item from a collection or hide a recommendation without worrying about deleting the original item.

Consequences of deleting content

Type of content	Consequence
Workbooks, metrics, flows, and data roles	The content is permanently deleted. You can't undo this action.
Views	The view is removed from the site; however, it is still accessible if you edit or download the workbook. The effect is the same as if the view had been hidden upon publishing. For more information, see Show or hide sheets on page 3119.
Projects	The project, and any Tableau content inside the project, is permanently deleted. External assets are moved to the External Assets Default Project . (In Tableau Server 2022.3 and earlier, external assets are irrelevant since they can't be in a folder to begin with.)
Collections	The collection is permanently deleted, but the items added to the collection are not deleted.

Work with Content Revisions

When you publish a workbook or data source, a version is saved in the revision history for Tableau Server and Tableau Cloud. You can revert to a previous version at any time.

Required permissions for revision history

To access revision history, you must have a site role of **Creator** or **Explorer (Can Publish)**, plus the following permissions, depending on the content type:

- Project: **View** and **Save**
- Workbooks in the project: **View**, **Save**, and **Download Workbook/Save As**
- Data sources in the project: **View**, **Save**, and **Download Data Source**

For virtual connections in the project, you must have a **Creator** site role and the **View** and **Overwrite** permissions. See "Use a Virtual Connection" in the [Tableau Cloud](#) or [Tableau Server](#) help for details. (Virtual connections require Data Management. See [About Data Management](#) for details.)

Publish your content

In Tableau Desktop, click **Server > Publish Workbook** or **Server > Publish Data Source**. Make changes to the workbook or data source, and then publish it again to the same project, with the same name. (You'll need to confirm that you want to overwrite the existing content.)

You can also save workbook revisions by editing and saving a workbook in the web-authoring interface of Tableau Server and Tableau Cloud.

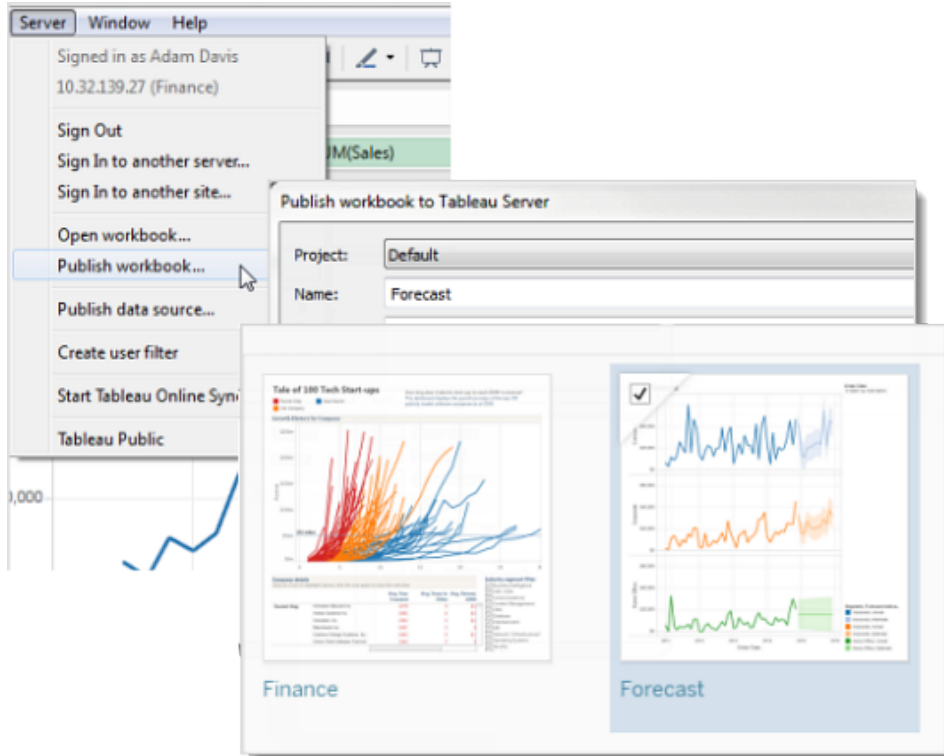

View revision history

- Click the actions menu (. . .) for a workbook or data source, then click **Revision History**.
The following image shows a workbook's revision history.

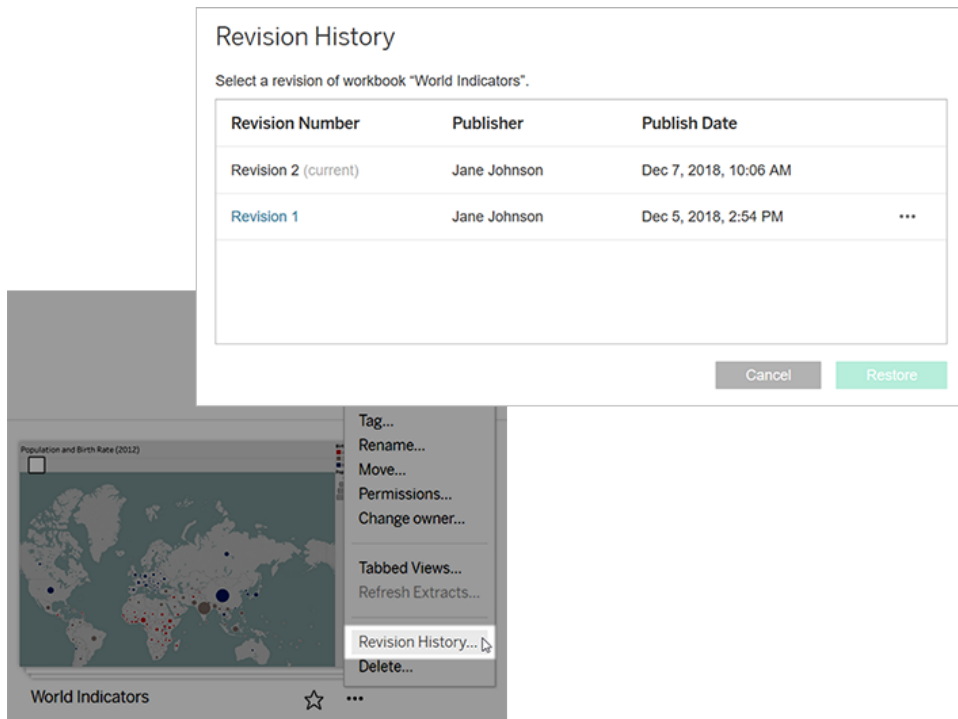

Manage revisions

Preview a workbook revision

- From a revision's actions menu (. . .), click **Preview**.

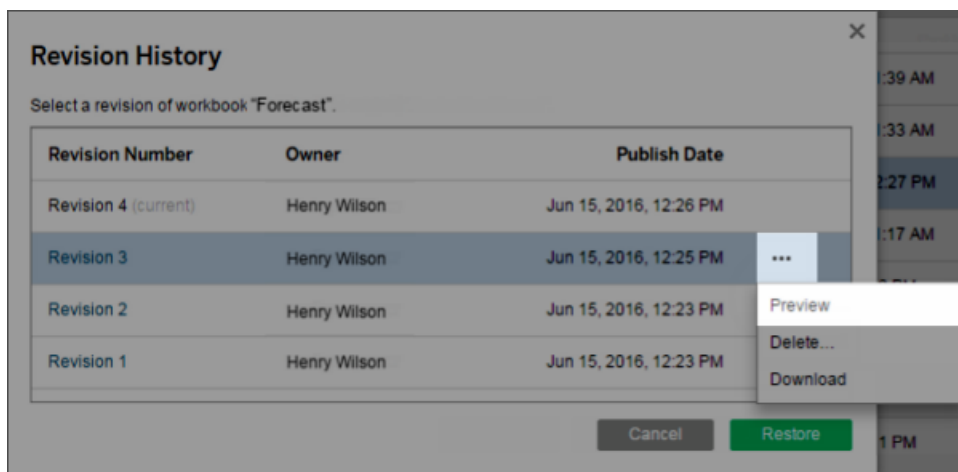

If a preview is available, it opens in a new tab in the browser. For workbooks that you can't preview on the server, such as those with OAuth data connections, you can download the revision and open it in Tableau Desktop.

Download a workbook or data source revision

1. From a revision's actions menu (. . .), click **Download**.

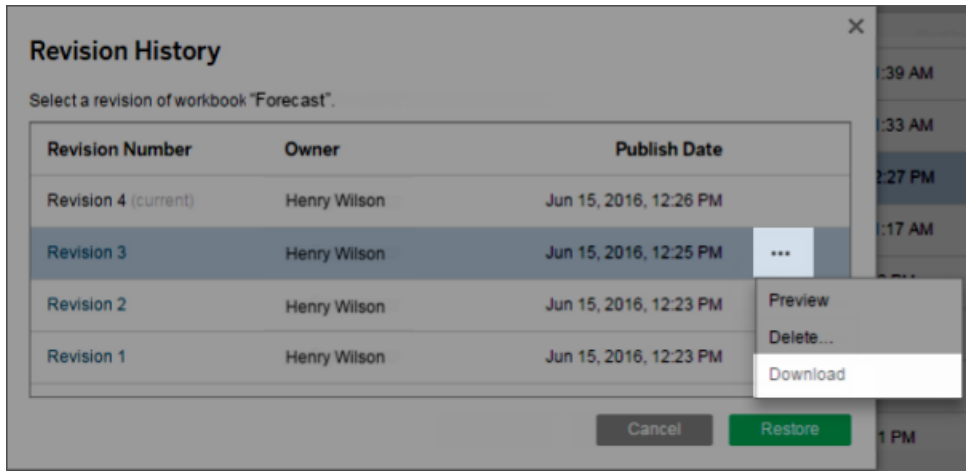

2. Open the downloaded file in Tableau Desktop.

Restore a workbook revision

- In the revision history, select a revision, and then click **Restore**.

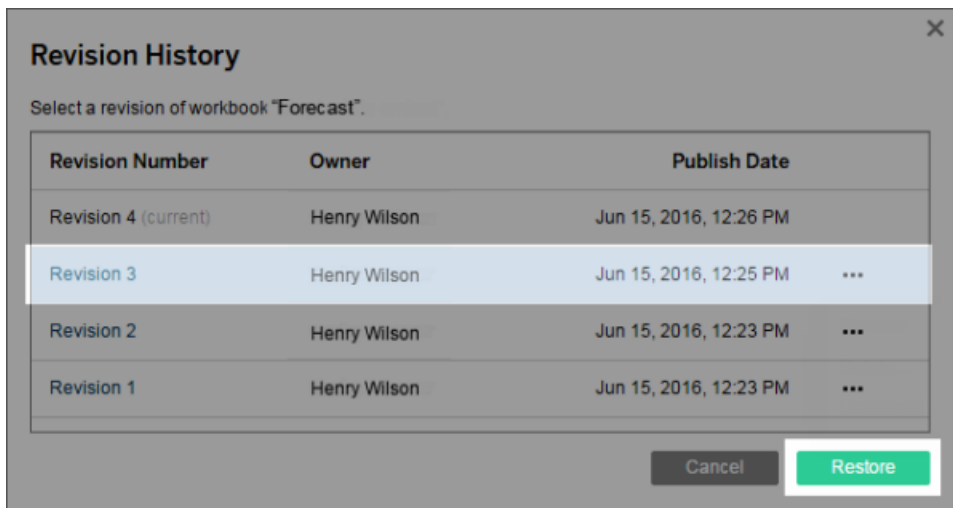

The restored version becomes the current version.

Note: If a revision can't be restored directly on the server, download the revision, open it in Tableau Desktop, and republish it.

Restoring workbooks that require database credentials

If a workbook uses a live data connection that prompts for a user name and password, you have the option to embed credentials for the connection. If the workbook uses a data source with multiple connections, you might need to provide credentials for each one.

If a workbook uses data extracts with scheduled refreshes and embedded credentials, you'll need to edit the data connection to provide the credentials.

Restore a data source revision

For a variety of reasons—for example, extracts commonly are on refresh schedules—a previous revision of a data source will not include the extract as it was published at the time. To restore the extract, you can download the previous revision of the data source (in .tdsx format), open it in Tableau Desktop, and re-publish the extract.

For more information, see [Data changes and deletions on the facing page](#) under **Potential revision history issues on the facing page**.

1. Sign in to the Tableau Server or Tableau Cloud web editing environment, navigate to the data source, and open its revision history.
2. From a revision's actions menu (. . .), click **Download**.

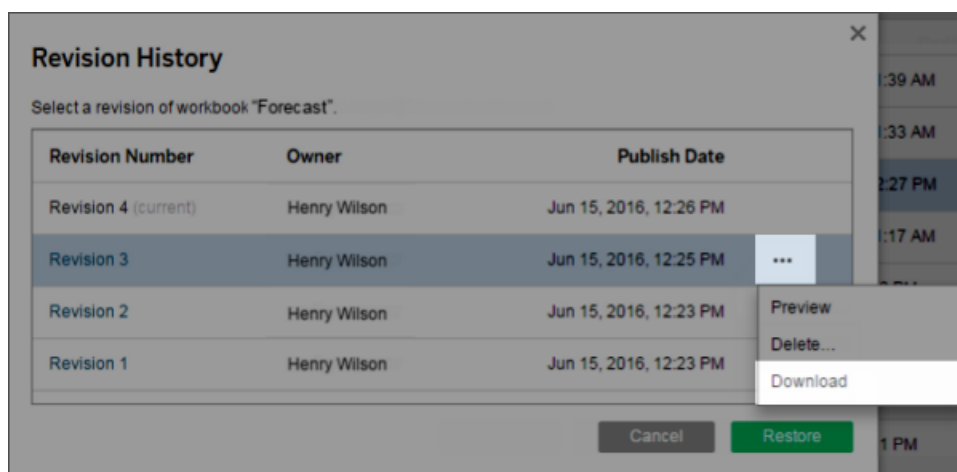

3. Open the downloaded file in Tableau Desktop, and then republish it with the same name, to the same location on your Tableau Server or Tableau Cloud site (confirming that you want to overwrite the existing version).

The uploaded version becomes the most current version.

Delete a workbook or data source revision from history

1. From a revision's actions menu (. . .), click **Delete**.

The revision history list updates to indicate a revision has been deleted.

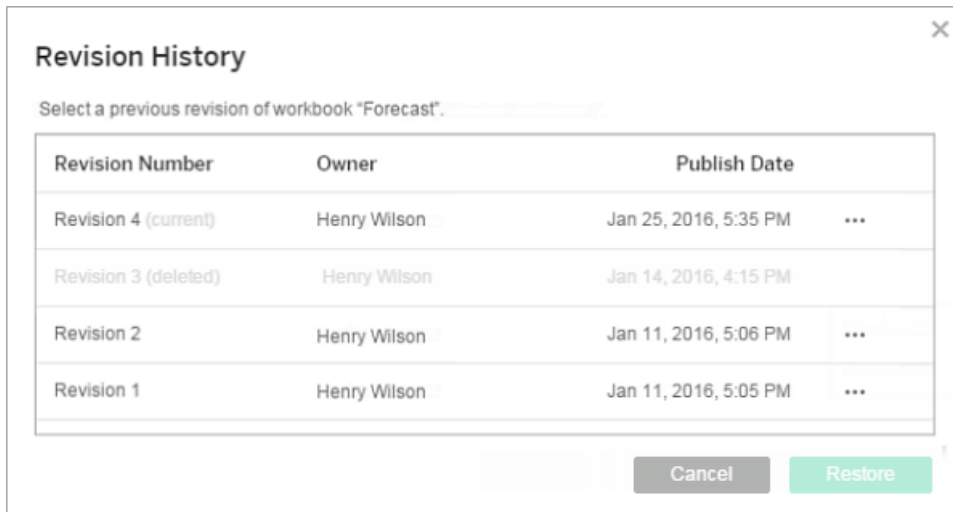

Potential revision history issues

Overwriting content with the same name

If a different author publishes over a workbook or data source with the same name, the most recent author becomes the owner of the content and can see its entire revision history.

Data changes and deletions

- Workbooks and data sources are downloaded with the latest configuration of their extract or data connection. If the data model or data connection has changed between revisions, you might need to update the downloaded workbook or data source.
- Revisions of workbooks and data sources that use .xls or .csv files are saved with an extract of that data.

- Revisions are saved for .hyper files with a direct connection. Revisions are not saved for extracts.
- If a workbook or data source is deleted from a site, all revisions are also deleted.

Turning revision history on and off

On Tableau Server, server administrators can disable revision history for specific sites.

If revision history is turned on and then off, saved revisions are retained, and new versions overwrite the latest version. If revision history is then turned on again, version numbering starts from the last saved revision.

If you're a Tableau Server administrator, see [Enable Users to Save Revision History](#) for more about revision history settings.

Refresh Data or Pause Automatic Updates

Tableau Server and Tableau Cloud let you control how views interact with data sources so you can keep data fresh and improve performance.

Refresh Data

If a data source is changed (for example, with new fields, field names, or data values), the view reflects those changes the next time you load the page. To manually update data while you interact with a view, such as performing several actions at once without updating between each one, click the refresh icon on the toolbar.



When you refresh data, Tableau Server and Tableau Cloud clear any cache and retrieve the latest information from the data source. If you're working with a complex view or a large data source, refreshing data can take a long time.

Pause Automatic Updates

As you interact with a view, the server sometimes has to query the data source to update the view. To temporarily stop updates so you can more quickly interact with a view, click the pause icon on the toolbar.



Click the resume icon to again automatically query the data source as needed.



Stop long-running actions

When an interaction takes a long time to load, a dialog appears that allows you to stop the action. If you stop, the viz goes into a suspended state similar to pausing automatic updates.

After stopping an action, you can choose to:

- Cancel the action and return to the previous state. To do so, use the **Undo** button in the toolbar.
- Allow the action to finish. To do so, use the **Resume Auto Updates** button in the toolbar.
- Continue working but without the viz updating. The behavior is the same as pausing automatic updates. When you're ready for the viz to update, use the **Resume Auto Updates** button in the toolbar.

When you do resume automatic updates, be aware it can take a while to complete the action.

Use Custom Views

A custom view is a shortcut to a specific state of interaction, such as filter selections and sorting, for a published viz. Custom views don't impact the underlying content. They're a good option if you find yourself adjusting the same filters or zooming into the same data every time you look at a viz.

Custom views aren't the same as web editing, which changes the underlying published content itself. See [Edit Tableau Views on the Web](#).

If the custom views are specifically for filter settings, consider using embedding filter parameters in a shared URL. See [Filter a published dashboard by editing the URL](#) from [The Data School](#).

Notes on custom views

- A custom view doesn't modify the content it's built on.
- Deleting the original content deletes its custom views.

- If the original content is updated or republished, the custom view is also updated.

Tip: Some changes to the original content can break the custom view. See [Maintain Content with Custom Views](#) for best practices on modifying content with custom views.

- If a user is removed from the site, any shared custom views they owned are also lost.
- Subscriptions and data-driven alerts based on custom views may be more fragile than those based on the original content.

Note: As of the 2022.3 release, Tableau replaced user names in the custom view URL with IDs. Bookmarked URLs still work but are redirected to the new URL schema. This change is to add more company and user data protection.

Create a custom view

Start by navigating to the individual view. Make whatever changes you want to capture in the custom view, such as selecting marks, filtering data, or changing sorts.

1. When you're ready to save the changes you've made as a custom view, select **Save Custom View** from the toolbar.

Note: The **Save Custom View** button appears in the toolbar after any changes are made to the current view.

2. In the **Save Custom View** dialog, enter a name for the custom view.
3. (Optional) Select **Make it my default**.
4. (Optional) Select **Make visible to others**. This makes the custom view available to everyone who can see the original content. However, there are several instances when this option isn't available:
 - The user is a Viewer site role.
 - The site's [User Visibility setting](#) is set to Limited.
 - The permission capability [Share Customized](#) is denied on the workbook.
5. Click **Save**.

Find a custom view

From a view

When you're looking at a viz, you can change to a different custom view by selecting the View icon in the toolbar. If there's room in the toolbar, the name of the custom view you're looking at is shown.

Any custom views you've made, and all visible custom views made by other users, appear in the list.

From the workbook

When you're looking at content at the workbook level, use the **Custom Views** tab to see all the available custom views for that workbook.

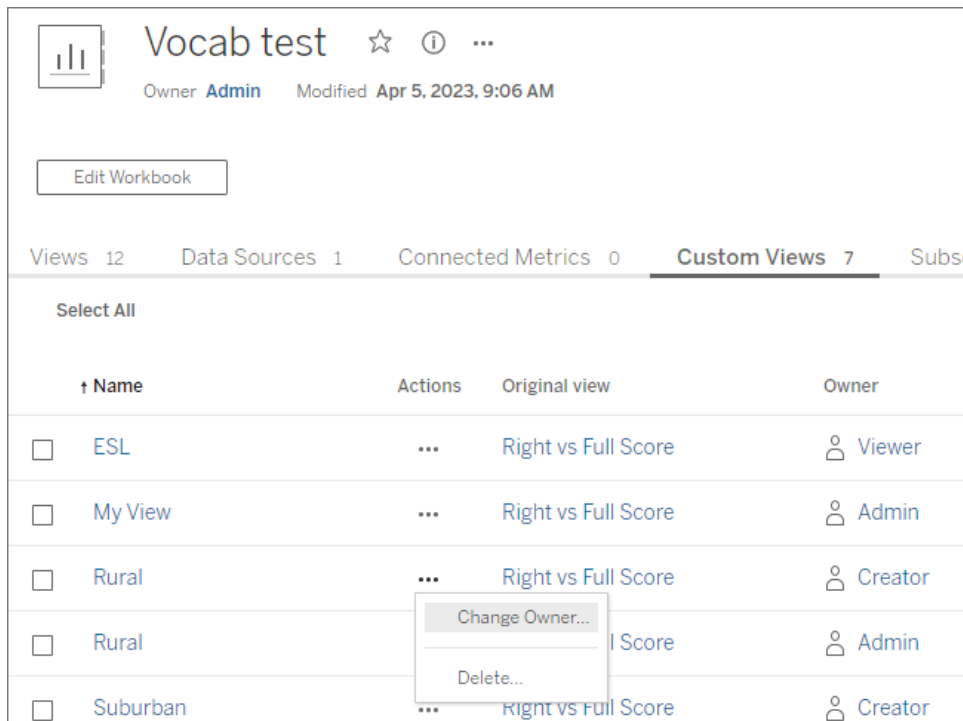

Set a default custom view

After you've found or made a custom view, you make it the default you see when you open that viz.

1. Select the **View** icon in the toolbar.
2. Check the **Set this view a your default** option.
3. Close the dialog to save.

The next time you open that viz, you'll land on that custom view.

Share a custom view



By default, custom views are private and only appear for the user who created them.

Note: Users with a Viewer site role can't make custom views visible to others. However, they can share a custom view by copying and sharing the URL.

Users with a site role of Explorer or higher can set a custom view as visible to others. This setting allows anyone with access to the original content to see the custom view.

To change an existing private custom view to be visible to others (or to make a visible view private):

1. Select the **View** icon in the toolbar.
2. Toggle the eye icon to the view you want to share to the desired state.
3. Close the dialog to save.

The eye with a slash  indicates the view is private to you. The eye  indicates the view is visible to others.

Delete a custom view

To delete a custom view:

1. Select the **View** icon in the toolbar.
2. Select the trash icon of the view you want to delete.
3. Confirm that you want to delete the view.

Take care when deleting

If you're the owner of a custom view that's visible to others, remember it's deleted for everyone if you delete it.

Deleting a custom view also deletes any subscriptions or data-driven alerts based on that custom view.

Manage custom views

Administrators can change ownership for custom views and delete custom views created by other users.

Custom views can be managed for a piece of content or for a specific user.

1. Go to the Custom Views tab for the workbook or user.
2. Use the action menu to change the owner or delete the custom view.

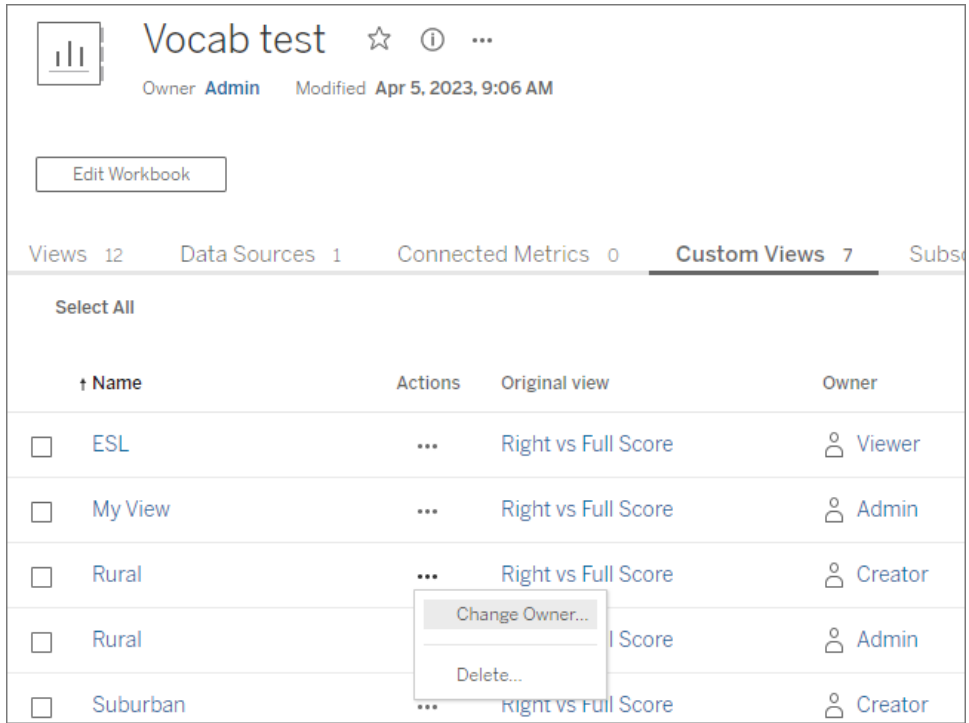

Tip: It's a best practice to change ownership of any custom views belonging to a user before removing them from the site. Deleting a user also deletes their custom views, including public views others may be using.

Safely change content with custom views

If you need to modify a view that has custom views (or the data source the view is built on), be aware that certain changes can break custom views. For more information, see [Maintain Content with Custom Views](#).

Maintain Content with Custom Views

As a content creator, it's important to understand how updates you make to workbooks and data sources can impact the end user. Custom views are a popular way to personalize how vizs are consumed, but custom views can break if their source content changes. Avoid making changes known to impact custom views, if possible. When changes need to be made, follow the steps outlined later in this topic.

In general, there are some best practices when working with content known to use custom views.

- Advise end users to only create custom views on stable content.
 - Use projects or naming systems to identify workbooks that are being modified and recommend users don't create custom views on them.
- Test changes in a staging or development environment. Test custom views that are representative of the expected filters, user actions, parameter settings, and other customizations.
- Proactively notify users before publishing changes that may break custom views. (Retrieve a list of all custom views applied to a workbook [using the custom views methods in Tableau's REST API.](#))

Changes known to impact custom views

While it's best to test any changes to verify their impact on custom views, there are some updates that are known to impact custom views.

This list isn't comprehensive and is intended for guidance only.

Workbook changes

- **Name changes.** Changing the name of the workbook (or the sheet the custom view is associated with) breaks the custom views.
- **Parameters.** Adding or removing a parameter may cause a custom view to break or fail to update as expected.
 - If a parameter is added to the original content, the custom view may break.
 - If a parameter control is removed, calculated fields that used its input retain their last value and are no longer adjustable.
- **Filters.** Removing a filter removes the filter control but leaves the data in a filtered state.
 - In general, if a filter is deleted in the original content, a custom view that used that filter continues to work. However, the data remains filtered with no filter control present. This means users can't change the filter selection from the custom view.
 - Changing the filter control from slider to relative date doesn't adjust the filter to accurately reflect the relative date as expected.
 - If custom views are used to control filter selections, consider using embedding filter parameters in a shared URL instead.
- **Hiding sheets.** Setting a sheet to hidden, even if it's later unhidden, breaks custom views on that sheet.
- **Republishing.** Deleting and republishing a workbook breaks its custom views.

Data source changes

- **Data source changes.** Replacing a data source using the Replace data source functionality or replacing an embedded data source with a published copy of the same data source breaks the custom views.
- **Data type.** Changing the data type of a field relevant to the custom view breaks the custom view.
- **Removing fields.** Removing fields, calculations, groups, or sets that custom views are based on breaks the custom view.

Update content safely

The following is a set of best practices to minimize the risk of breaking existing custom views.

- Edit the workbooks and changes to the data sources separately.
- Don't republish a workbook that has a replaced data source.
- Edit a local version of the workbook or data source and republish it with the same name.

Modify a workbook

These steps assume the workbook uses a live connection to a separately published data source and has existing custom views.

Modify a workbook with web editing

Web editing is the preferred method for modifying a workbook. Only use Tableau Desktop if necessary.

1. Edit a workbook in the browser, avoiding the items addressed earlier that are known to break custom views.
 - If changes need to be made to the data, don't make them now. See the section on modifying a data source.
2. Publish the workbook to the same location with the same name, saving over the existing version.

Modify a workbook with Tableau Desktop

When possible, modify workbooks in the browser. Only use Tableau Desktop if necessary.

1. Open a local version of the workbook (download the workbook first if necessary).
2. Edit the workbook, avoiding the items addressed earlier that are known to break custom views.

- If changes need to be made to the data, don't make them now. See the section on modifying a data source.
3. Publish the workbook to the same location with the same name, replacing the existing version.
 - *Don't* check the option to "Update the workbook to use the published data source".

Modify a data source

1. Open a local version of the data source in Tableau Desktop by downloading the workbook and creating a local copy of the data source:
 - a. Download the workbook and open it in Tableau Desktop.
 - b. Right-click the data source and select "Create Local Copy".
 - c. Right-click the new data source and select "Replace Data Source...".
 - d. Swap the existing connection to the published data source with the newly created local copy.

Note: Using a local version in a workbook is the preferred method because it allows you to verify data source changes directly in the workbook. Alternatively, you can download the data source or use a locally stored copy.

2. Edit to the data source, avoiding the items addressed earlier that are known to break custom views.
3. Publish the data source.
 - a. Use the same name and save over the existing data source.
 - b. Don't check the option to "Update the workbook to use the published data source".
 - c. Don't publish the workbook with the modified data source. If changes need to be made to the workbook contents, see the section on modifying workbooks.

Investigate broken custom views

Note: This section assumes familiarity with XML and basic command-line interactions.

In a .twb workbook file, the XML of a workbook contains identifying tags for elements of the workbook. When a custom view is created, a snapshot is taken of the interactive elements (such as filter or set values, parameters, or selected marks) and their values. When a custom view is accessed, Tableau applies the attribute values stored with the custom view to the relevant element IDs. If the element IDs are changed or the attribute values can't be loaded, the custom view breaks.

It may be possible to identify what changed to break a custom view by comparing a .twb from before and after the change.

1. You need a .twb of the workbook when the custom view is functioning (save a copy of content before making any changes).
2. In another copy of the workbook, make the change thought to cause the custom view to break and save it as a different .twb.
3. In the command line, run the following command (substituting the files from step one as file1.twb and from step two as file2.twb).

```
vdmdiff file1.twb file2.twb
```

4. The results highlight changes between the files.

Some IDs or attribute values (in **[brackets]**) that are known to break custom views if changed:

```
<datasources>
  <datasource name=' [ID] '>

<worksheets>
  <worksheet name=' [ID] '>

<table>
<view>
<datasource-dependencies datasource=' [ID] '>
<column datatype=' [Value] ' name=' [Value] '>

<dashboards>
  <dashboard name=' [ID] '>
```

Discover Recommended Views on Your Tableau Site

Recommendations make it easier to discover relevant content on your Tableau site.

Recommendations for views appear both on the Home page and on the Recommendations page, accessed from the left navigation pane.

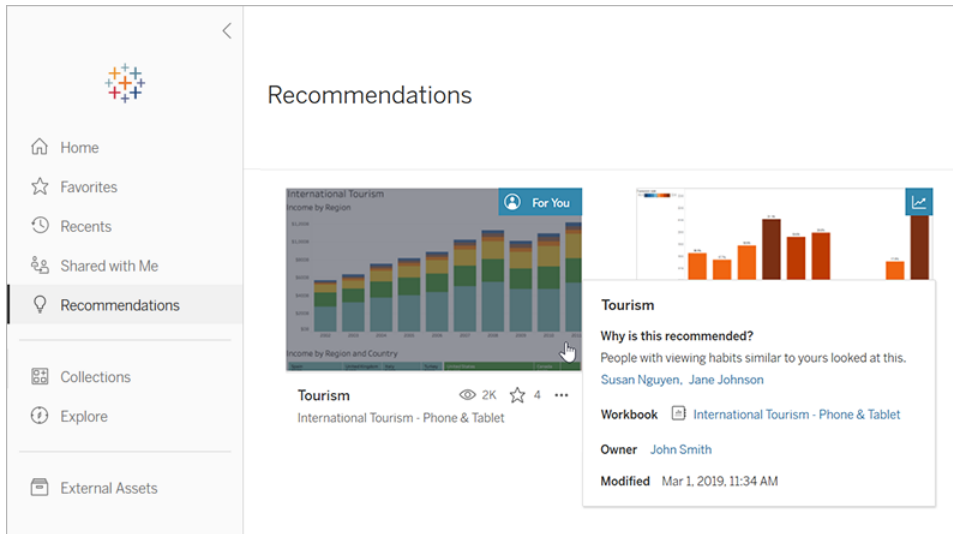

Why are these views recommended?

The model used to recommend content looks at the viewing habits of users and trends in popularity of content on your site. Recommendations that are For You are personalized based on the content you have looked at. Recommendations that are Trending have been popular across your site in the past week.

Tip: If a recommendation isn't useful, you can hide it by selecting the actions menu (...), and then selecting **Hide**.

Whose names are shown?

On recommendations that are For You, you might see the names of other users who have looked at that content. These are users on your site who have viewing habits similar to yours. The names give you an additional indicator of why you might want to investigate a view, because a colleague with similar interests looked at it.

The visibility of names on recommendations is controlled by a site-wide setting. If you don't see names on a recommendation For You, the setting might have been turned off for your site.

Which views appear as recommendations?

You will see recommendations for particular views only if you have the correct permissions to see those views. You can't exclude a view from being recommended to others on your site; however, you or your site administrator can set permissions so that only users who should have access to a workbook or view are able to see it. That way, the view will not show up in recommendations for the wrong users.

Manage Your Account Settings

In Tableau Server and Tableau Cloud, your Account Settings page lets you manage your credentials, email settings, and user interface options in one central place.

Go to your Account Settings page

At the top of a page, click your profile image or initials, and then select **My Account Settings**.



To change your profile image, click the current image or initials on your account settings page.



Manage your credentials and passwords

When you access a workbook or data source that has a live connection to data and requires you to sign in, Tableau offers to save your password for you. If you accept, it stores your credentials in a cookie or an access token, depending on the data type. You can remove these credentials if you no longer use the data, or you have exceeded the maximum number of saved credentials and want to make room for a new one.

Under **Saved Credentials**, do either of the following:

- Select the **Delete** link next to an individual access token.
- Select **Clear All Saved Credentials**.

When you clear all credentials, the following items are removed from your user account:

- Passwords you used to access published data sources or workbooks that connect to them.
- Access tokens for OAuth data connections, such as to Google or Salesforce.com data.

Caution: Removing an access token is effectively like “changing the locks.” If the token is stored with workbooks or data sources you published, deleting the token also removes access to the data from those workbooks and data sources. If the token is embedded in an extract connection, and the extract is refreshed on a schedule, the refreshes will not be able to complete until you embed the new credentials or access token into the connection.

Manage multi-factor authentication verification methods

After [Tableau with MFA](#) has been enabled and you've register your verification method, you use your TableauID credentials and verification method each time you sign in to Tableau Cloud.

To add or remove verification methods, you can click the **Manage My Verification Methods** link to do the following:

- Add additional verification methods for backup purposes
- Delete existing verification methods if you no longer need them

For more information, see [Manage verification methods](#) in Tableau Cloud Help.

Create and manage personal access tokens

Create personal access tokens (PATs) to authenticate automated tasks with the Tableau REST API. We recommend creating a PAT for each automation task that requires authentication. By creating PATs for this purpose, managing many automated tasks is simplified if you need to remove a task. To remove a task immediately, you can just revoke the PAT associated with the task.

Note: If multi-factor authentication (MFA) is enabled with Tableau authentication, PATs are required. You must use a PAT, instead of user name and password, to make a Tableau REST API sign in request to Tableau Cloud. For more information, see [Tableau with MFA](#) in the Tableau Cloud Help.

Create a personal access token

This procedure requires you to copy a secret to a file. The secret is the string that you will include in your automation scripts and will be used to authenticate to Tableau Cloud or Tableau Server.

Handle the secret as you would a password: protect the secret and do not share it with others.

1. Under **Personal Access Tokens**, enter a descriptive name for your token in the **Token Name** field, and then click **Create Token**.
2. In the Personal Access Token dialog box, click the **Copy Secret** button.

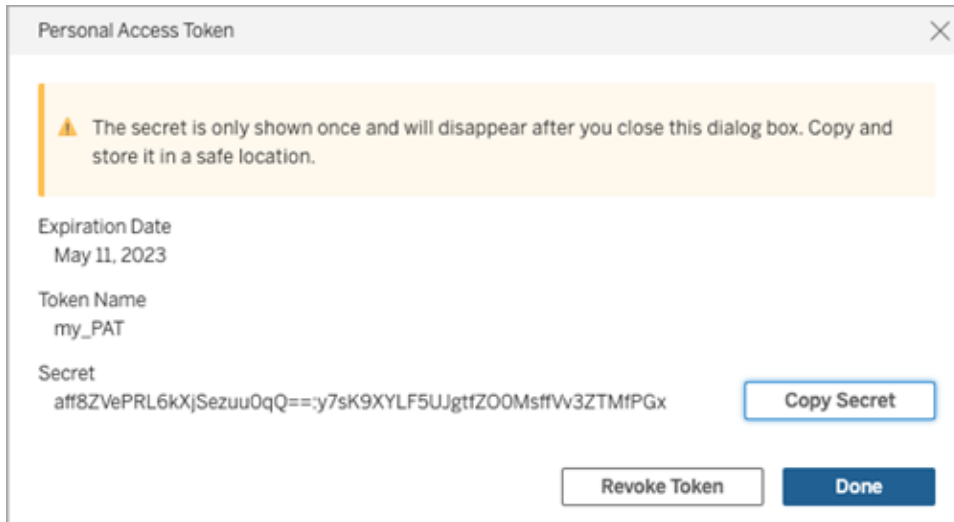

3. Paste the secret to a file and store the file in a safe location.
4. When finished, click the **Close** button.

Note: If using Tableau Sever, you can have up to 10 PATs by default. If using Tableau Cloud, you can have up to 104 PATs.

Check when a personal access token expires

Expiration of PATs in Tableau Cloud depends on the PAT's site setting. Default expiration of PATs created on Tableau Server is one year.

1. Under **Personal Access Tokens**, identify the PAT name.
2. Next to the PAT name, review its expiration date.

Note: When PATs expire, they are removed from your **My Account Settings** page.

Revoke a personal access token

1. Under **Personal Access Tokens**, identify the token name that you want to revoke.
2. Click the **Revoke Token** (in Tableau Cloud) or **Revoke** (in Tableau Server) button next to

the token name.

3. In the Delete dialog box, click the **Delete** button to revoke the PAT.

Remove connected clients

The first time you sign in to Tableau Server or Tableau Cloud from a Tableau *connected client* like Tableau Desktop, Tableau Prep Builder, or Tableau Mobile, a secure refresh token is created and stored in your account. This refresh token allows you to access the site from the connected client, without having to sign in each time.

You can delete a connected client (refresh token) if you no longer use it, or if you want to add a new client but get an error that says you're already using the maximum number of connected clients. After you remove a connected client from your account, you will need to provide your credentials the next time you access Tableau Server or Tableau Cloud from that client.

- In the **Connected clients** section, next to the client you want to remove, click **Delete**.

Change notification settings

Notifications are messages that let you know when something happens to content you own, that is shared with you, or you are @mentioned on.

In the **Notifications** section, you can select the notification types that you want to receive. You can receive notifications as an email, on the Tableau site, or in your Slack workspace if your administrator has connected your site to Slack. The types of notifications you receive, such as data alerts, comment mentions, and share, depend on your site and server settings.

When you enable **On Tableau**, you can see notifications by clicking the bell icon in the upper right corner of your browse and can update your settings by clicking the gear icon.

Notifications			
Preferences	On Tableau	Email	Slack
Collaboration			
Comment mentions	<input checked="" type="checkbox"/>	<input checked="" type="checkbox"/>	<input checked="" type="checkbox"/>
Share	<input checked="" type="checkbox"/>	<input checked="" type="checkbox"/>	<input checked="" type="checkbox"/>
Data alerts		<input checked="" type="checkbox"/>	<input checked="" type="checkbox"/>
Predictive Model	<input checked="" type="checkbox"/>	<input checked="" type="checkbox"/>	
Systems Status			
Flow runs	<input checked="" type="checkbox"/>	<input checked="" type="checkbox"/>	<input checked="" type="checkbox"/>
Extract jobs	<input checked="" type="checkbox"/>	<input checked="" type="checkbox"/>	
Webhooks		<input checked="" type="checkbox"/>	
View Acceleration	<input checked="" type="checkbox"/>		

If grayed out, the notification option is disabled for use.

Note: Recreate your notifications settings when upgrading from 2020.4 or earlier to 2021.1 and later. Older notifications settings are not automatically moved to the Notifications setting.

Change subscription settings

1. Under **Subscription time zone**, select the time zone for schedules you create.
2. To modify subscriptions, click **Subscriptions** at the top of the page, and then select a workbook or view.
3. From the **Actions** drop-down menu, select **Change Schedule**, **Change Subject**, **Change Empty View Mode**, or **Unsubscribe**.

(The empty-view option sends subscription emails only when data exists in a view. It's a good choice for high-priority alerts.)

Enable or disable data alerts

Choose to enable or disable emails for alerts on your site due to repeated failures.

Enable or disable the Data Management features message

(Tableau Cloud only) Choose to hide or show the Data Management features message. If you haven't purchased the Data Management license, information about the available features will be

displayed when you are signed into Tableau Cloud.

Data Management Features	Show messaging about Data Management features.
	<input checked="" type="checkbox"/> Show Tableau Catalog feature overview
	<input checked="" type="checkbox"/> Show Tableau Prep Conductor feature overview

Change your start page

To change the start page that appears when you sign in, navigate to the page you want, click your name in the upper right area of the page, and then click **Make This My Start Page**. Updates to your start page take effect the next time the page loads completely, or after you sign out, and then sign in again.

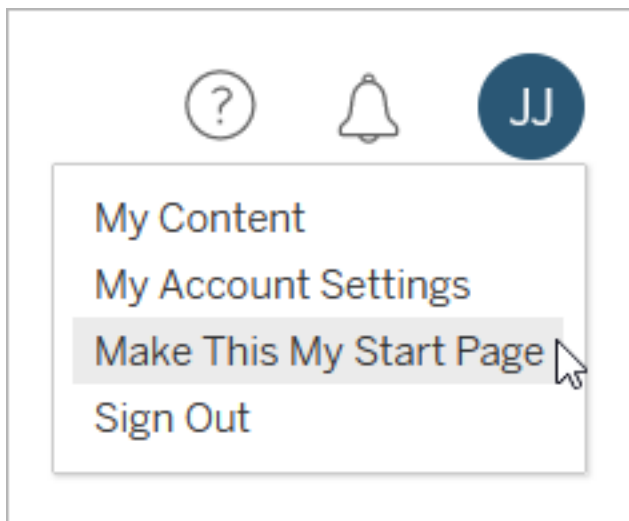

To return to the default start page, click your user name, and then click **My Account Settings**. In the start page section, click **Reset to Default**. (The URL for your current start page is displayed here too; click the link to go to the page.)

Start page	/projects	Reset to Default...
To change your start page, navigate to a page and select "Make This My Start Page" from the drop-down menu in the upper-right corner of the page.		

Change language and locale

The **Language** setting determines the language you see for user interface options. **Locale** affects views, such as how numbers are formatted, or which currency is used.

Change the **Language** and **Locale**, and then click **Save Changes**. The language and locale update immediately.

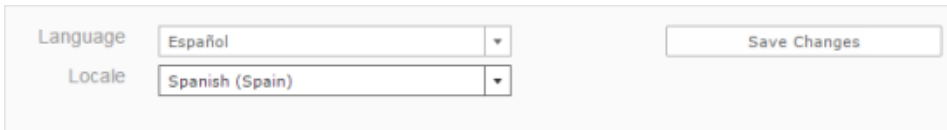

A screenshot of a settings panel. On the left, there are two dropdown menus. The top one is labeled 'Language' and has 'Español' selected. The bottom one is labeled 'Locale' and has 'Spanish (Spain)' selected. To the right of these menus is a button labeled 'Save Changes'.

If you use Tableau Server and want to select a language that isn't currently supported, contact your administrator.

Change your display name, password, or email address for Tableau Server

Change your display name

If the server is configured to use the internal user management system (Local Authentication) instead of Active Directory, you can change your display name. Select the display name text and enter the new display name, and then click **Save Changes**.



A screenshot of a user profile settings panel. It shows three input fields: 'Username' with 'jjohnson', 'Display name' with 'Jane Johnson (Lead)', and 'Email' with 'jjohnson@myco.com'. Below the 'Email' field is a 'Change Password' link. To the right is a 'Save Changes' button. The 'Display name' field is highlighted with a white border.

Change your password

If the server is configured to use the internal user management system (Local Authentication) instead of Active Directory, you can change your password by clicking **Change Password**. Click **Save Password** to save your changes.



A screenshot of the same user profile settings panel as above. The 'Change Password' button is now highlighted with a white border.

Change your email address

If you subscribe to views or receive data-driven alerts, the related email account appears on the Account Settings page. Enter the new email address in the **Email** text box, and then click **Save Changes**.

The screenshot shows a user interface for account settings. It includes the following elements:

- Username:** jjohnson
- Display name:** Jane Johnson (Lead)
- Email:** jjohnson@myco.com
- Save Changes:** A button to save the changes.
- Change Password:** A link to change the password.

Note: Starting with Tableau Server 2022.3.7, you can update your email address if site-specific SAML is configured for your site. In Tableau Server 2022.3.6 and earlier, only admins have the ability to change a user's email address. If you are unable to change your email address, contact your admin to request a change.

Change your display name or password for Tableau Cloud

If your site is not set up for single sign-on (SSO), your Tableau Cloud display name and password are based on your Tableau ID account. Your Tableau ID allows access to Tableau Cloud, the Tableau website, the Customer Portal, and other resources.

If you forgot your password

To reset your password, go to <https://online.tableau.com>, enter your site URI (if prompted), enter the email address you use to sign in to Tableau Cloud, and then click the **Forgot password** link. Then follow the instructions in the email you receive.

If you're signed in to Tableau Cloud

1. Open your **My Account Settings** page, and click **Change Password**.
This redirects you to the Tableau website.
2. If prompted, sign in using your Tableau Cloud credentials, and then select the **Change Password** link at the top.
 - In the fields provided, type your current and new passwords, confirm the new password, and click **Change Password**.

Change Password

Passwords are case sensitive, 8-100 characters long. Requires at least one number (0-9), one uppercase letter, one lowercase letter, and one of the following characters: ! " \# \$ % & ' () * + , - . / : ; < = > ? @ [] ^ _ ` { | } ~. You cannot use previously used passwords.

Current Password

New Password

Confirm New Password

CHANGE PASSWORD

- To change your display name, click **Manage Account**.

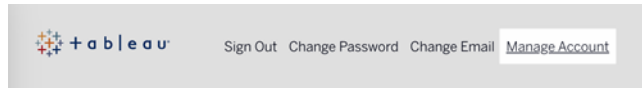

On the User Profile page, change your first or last name, update any other information that might be out of date, and click **Update**.

Note: When you change your display name or password, you're directed outside of Tableau Cloud to your Tableau ID account profile. You can also access your Tableau ID profile by navigating to the [Tableau](#) website and clicking **Sign In**.

Manage Saved Credentials for Data Connections

Saved credentials enable you to connect to a data source without being prompted for your credentials. The credentials saved for your connection can be OAuth access tokens, or other credentials, such as user name and password. You can manage saved credentials on your account settings page.

Note: When editing Tableau Prep flows on the web, you may still be prompted to re-authenticate.

Test connections using saved credentials

If the connector supports test functionality, you can test the connection using saved credentials.

1. While you're signed in to Tableau Server or Tableau Cloud, display your Account Settings page.
2. In the Saved Credentials section, select the **Test** link next to the stored connection that you want to test.

This test confirms that Tableau Cloud or Tableau Server can access your account using this corresponding saved credential. If the test succeeds, but you can't access your data through this managed connection, confirm that the credentials you provided for this connection can access your data.

For example, if you accidentally created the connection using your personal Gmail account, but you use a different account to access a Google Analytics database, you'll need to delete the saved credentials and sign in to the data using the appropriate Gmail account.

Update saved credentials

To help ensure uninterrupted data access from existing Tableau content after a custom OAuth client has been configured for your site, we encourage you to update your saved credentials. To update saved credentials, you can delete the previous saved credentials for a particular connector and then add it again.

When you add saved credentials again, both new and existing Tableau content will access the data using the custom OAuth client configured by your .

1. Sign in to Tableau Server and navigate to your **My Account Settings** page.
2. Under **Saved Credentials for Data Sources**, do the following:
 1. Click **Delete** next to the saved credentials for a connector.
 2. Next to the same connector, click **Add** and follow the prompts to 1) connect to the custom OAuth client that your site admin notified you about and 2) save the latest credentials.

Clear all saved credentials

When you select **Clear All Saved Credentials**, the following items are removed from your user account:

- All saved credentials for connections that are stored in your account.

Caution: If any of these saved credentials are stored with published workbooks or data sources, deleting them also removes access to the data source from those locations. Effectively, this is like "changing the locks" anywhere the affected saved credentials are used.

- Passwords you've used to access published data extracts or workbooks that connect to them.

Remove saved credentials

To remove Tableau access to data, delete the associated saved credentials for that data from your account. After you delete the credentials, you'll need to sign in to the data the next time you access it. This creates new saved credentials.

Your administrator might choose for all users to use the same shared credentials for connecting to a data source. If this is the case, the saved credential is associated with the data connection for all users, and it doesn't appear under Saved Credentials on your Account Settings page.

Note: If you're a Tableau Server user and can't delete saved credentials, ask your administrator if they've cleared the Allow users to save data source access tokens option in the server settings.

Share and Collaborate on the Web

Share Web Content

Share projects, collections, workbooks, views, metrics, data sources, and flows either directly with other users or by copying a link to the content. For views and metrics, you can also copy code to embed them in a webpage. (The legacy Metrics feature was retired in February 2024 for Tableau Cloud and in Tableau Server version 2024.2. For more information, see [Create and Troubleshoot Metrics \(Retired\)](#).)

Share directly with other users

When you share content directly with other users on your site, they receive a notification with a link to that content. The content is also added to their Shared with Me page, so they can easily find it later. Notifications can come by email, in Tableau's in-app notifications center, or in the Tableau for Slack app if the site is connected to a Slack workspace. For more information, see [Manage Your Account Settings](#) on page 3333 and [Receive Notifications, Search, and Share Using the Tableau App for Slack](#) on page 3428.

1. Open the Actions (...) menu for the content you want to share.
2. Select **Share** from the menu.

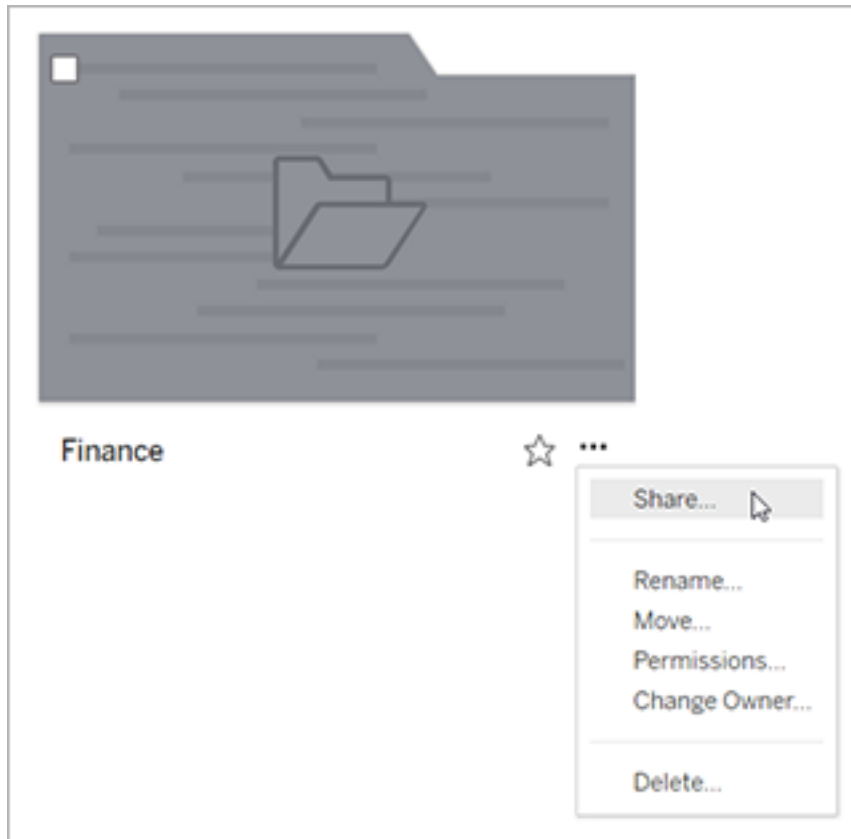

3. Under **Share with people**, enter at least one user name. When you type, names that match your text appear.

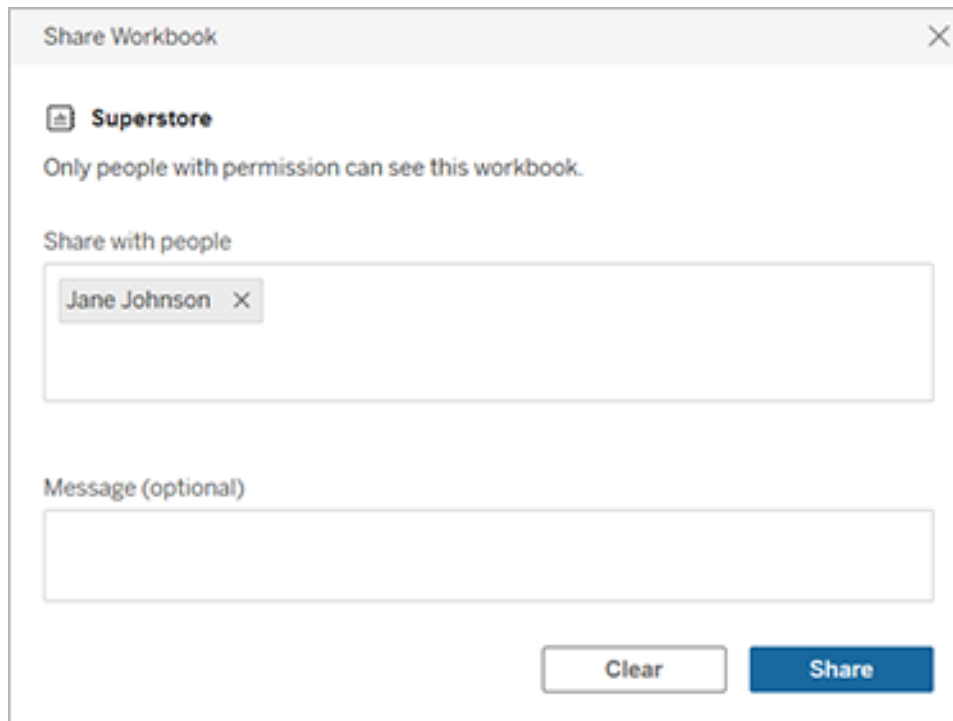

4. Under **Message**, enter an optional note to your recipients.
5. Click the **Share** button.

Grant access to shared content

To access the content you share with them, users must have permission to view that content on Tableau Server or Tableau Cloud.

If you control permissions for the content, you can grant access when you share it. If any of the users you shared with don't have the ability to view the content, the option to grant access will appear automatically after you share. You can only grant the capabilities for the view template via the grant access dialog. To grant users other permission capabilities, follow the instructions on [Set permissions](#).

If you don't have the ability to set permissions for the content, the users you share with will be able to request access upon opening the link to the shared content. Their request for access is sent to the user who controls permissions for the content.

Copy a link to share

Copy the link generated for a piece of content to share without sending an email to specific users.

1. Open the Actions (...) menu for the content you want to share.
2. Select **Share** from the menu.
3. Click the **Copy Link** button, then paste the link into an application to share it with others.

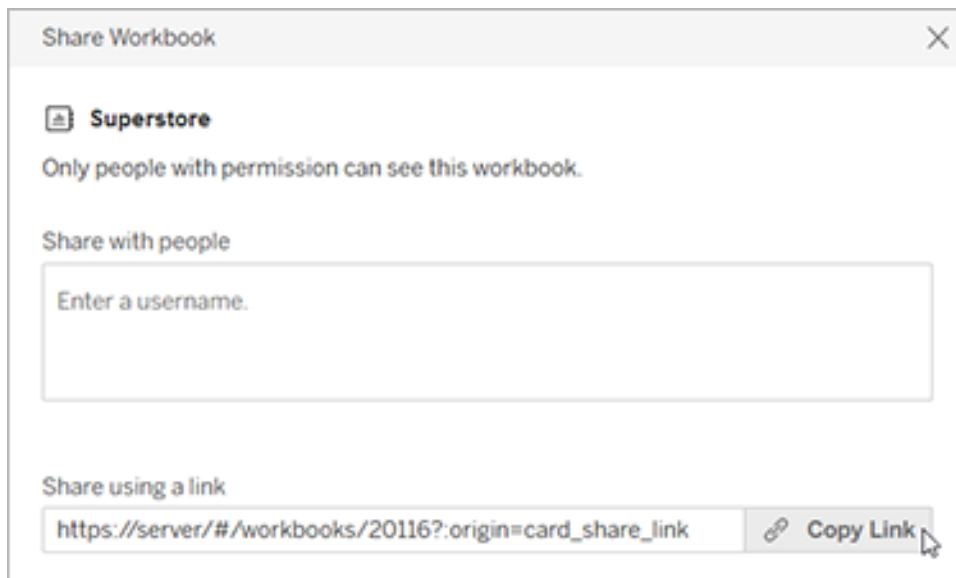

Tip: If you don't see the **Sharing using a link** option, clear any names from under **Share with people**.

Share and embed views and metrics

In addition to the sharing options listed above, views have unique options available when you click the **Share** button on the toolbar for a view. You can share a view that you have modified, and you can get the embed code for a view.

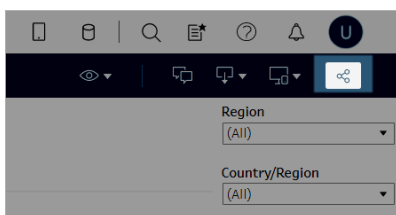

You can also embed metrics by copying the embed code from the share dialog.

Embed views and metrics

1. Click **Share** in the toolbar for the view you want to embed or on the metric you want to embed.
2. Click **Copy Embed Code**, then paste the embed code into the source code for the webpage where you want to embed the view.

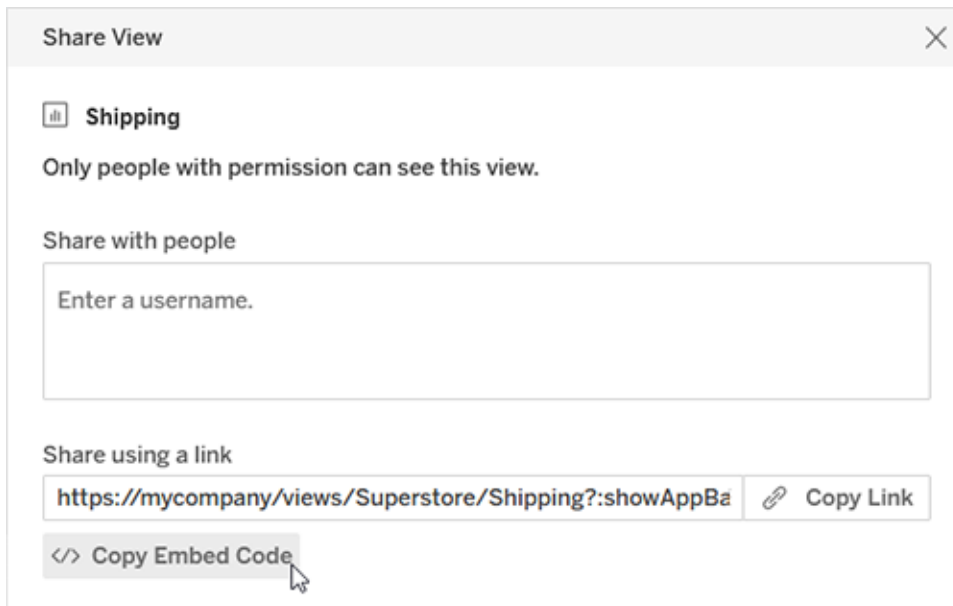

For more information, see [Embed Views into Webpages](#) on page 3362 or [Embed Metrics into Webpages \(Retired\)](#) on page 3364.

Retirement of the legacy metrics feature

Tableau's legacy metrics feature was retired in Tableau Cloud in February 2024 and in Tableau Server version 2024.2. In October 2023, Tableau retired the ability to embed legacy metrics in Tableau Cloud and in Tableau Server version 2023.3. With Tableau Pulse, we've developed an improved experience to track metrics and ask questions of your data. For more information, see [Create Metrics with Tableau Pulse](#) to learn about the new experience and [Create and Troubleshoot Metrics \(Retired\)](#) for the retired feature.

Share modified or custom views

If you modify a view, by selecting marks or filters, Tableau captures these modifications by generating a unique link when you click the Share button. This unique link replaces the link to the original view for all sharing and embedding options. That way, the people you share with will see exactly what you were seeing when you shared.

The link generated for a modified view expires two years after it was last accessed, or two years after it was created if never accessed.

To share a custom view that you have saved, simply open the custom view and use any sharing option.

Find content shared with you

You receive a notification message when someone shares content with you directly, either as an email, on your Tableau site by selecting the bell icon in the upper right corner, or in a connected Slack workspace with the Tableau for Slack app.

The Shared with Me page, accessed from the navigation pane, stores items that have been shared with you. The most recently shared items also appear in the Shared with Me channel on the Home page. Each item shows who it was shared by, the date it was shared, and any message added by the sharer.

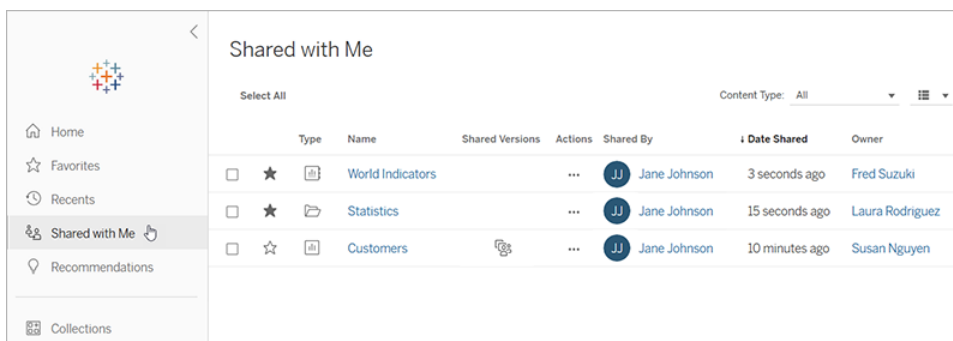

Select All		Content Type: All				
Type	Name	Shared Versions	Actions	Shared By	Date Shared	Owner
<input type="checkbox"/> ★	World Indicators		...	Jane Johnson	3 seconds ago	Fred Suzuki
<input type="checkbox"/> ★	Statistics		...	Jane Johnson	15 seconds ago	Laura Rodriguez
<input type="checkbox"/> ☆	Customers		...	Jane Johnson	10 minutes ago	Susan Nguyen

If an item has been shared with you multiple times, the information shown is for the most recent share. Views include additional information if multiple versions of the view have been shared with you. Custom views, modified views, and the original view all appear with unique details and links under **Shared Versions**.

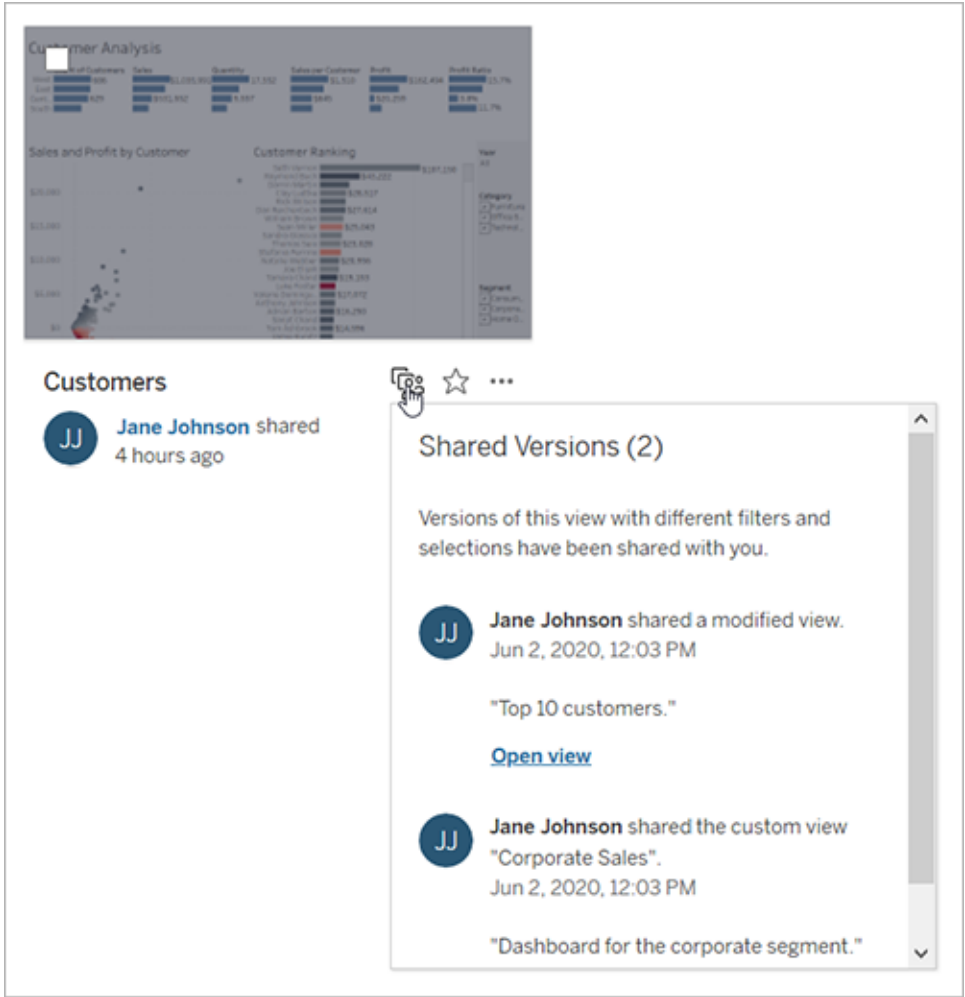

Create a Subscription to a View or Workbook

Subscriptions email you an image or PDF snapshot of a view or workbook at regular intervals—without requiring you to sign in to .

Set up a subscription for yourself or others

When you open a view in , if you see a subscription icon (✉+) in the toolbar, you can subscribe to that view or to the entire workbook. You can subscribe other users who have permission to view the content if you own a workbook, if you are a project leader with an appropriate site role, or if you are an administrator.

1. From the Explore section of your site, select **All Workbooks** or **All Views**, or open the project that contains the view you want to subscribe to.

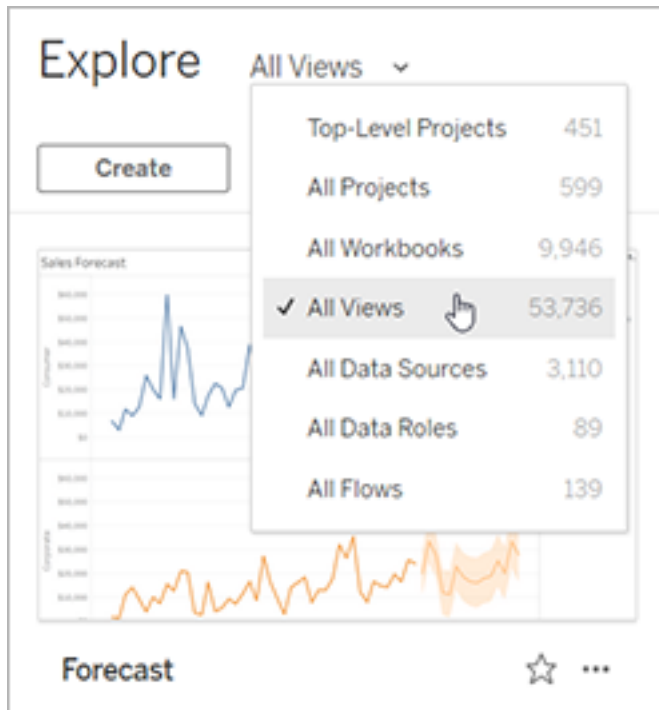

2. Open a view either directly, or after opening the containing workbook.
3. On the view toolbar, select **Watch > Subscriptions**.

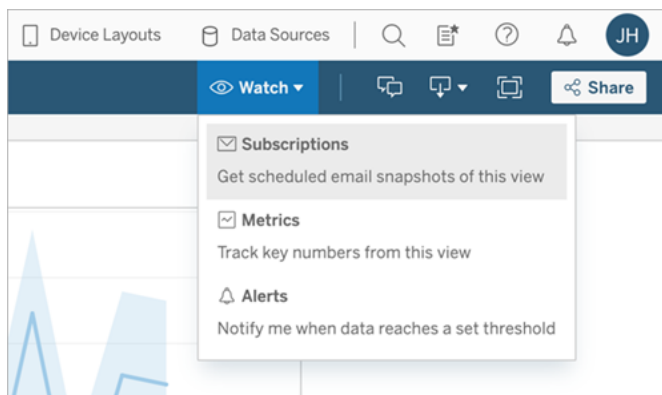

4. If you own the workbook, select **Subscribe me**.

Notes:

- When you subscribe a group, each user is added individually at the time the subscription is created. If more users are added to the group later, you must re-subscribe the group for those new users to receive the subscription. Likewise, users later removed from the group will not have their subscriptions removed automatically unless their permissions to the subscribed view are removed.
 - You can't subscribe a group set.
5. Choose whether subscription emails include the current view or the entire workbook. If the view contains data only when high-priority information exists, select **Don't send if view is empty**.
 6. Choose the format for your snapshot: as a PNG image, a PDF attachment, or both.
 - If PDFs, choose the paper size and orientation you'd like to receive.

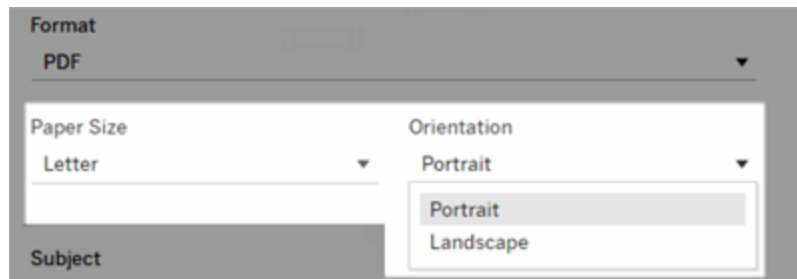

7. To clarify subscription emails, customize the subject line, and add a message.

Note: To update the subscription message, you must unsubscribe from the existing subscription and create a new subscription with a different message. For more information, see [Update or unsubscribe from a subscription](#).

8. When the workbook uses one data extract on a published connection, you can pick a frequency:
 - **When Data Refreshes:** Sends only when data in the view or workbook is refreshed by running refresh schedules.
 - **On Selected Schedule:** Pick a schedule for the subscription.
9. Click **Subscribe**.

When you receive a subscription email, you can select the image (or the link in the message body for PDF subscriptions) to be taken to the view or workbook in .

Update or unsubscribe from a subscription

You can unsubscribe from an existing subscription, or make changes to a subscription's format, schedule, subject, or empty view mode.

1. Access your account settings by doing one of the following:
 - Click **Manage my subscriptions** at the bottom of a subscription email.

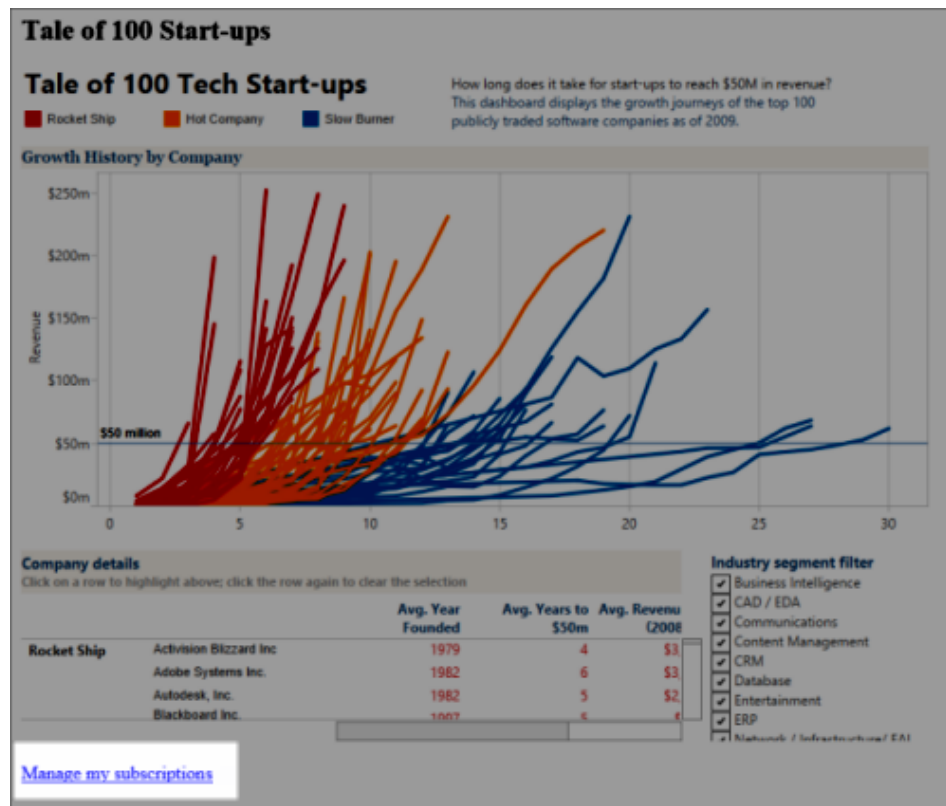

- Sign in to . At the top of the page, select your user icon, and then select **My**

Content.

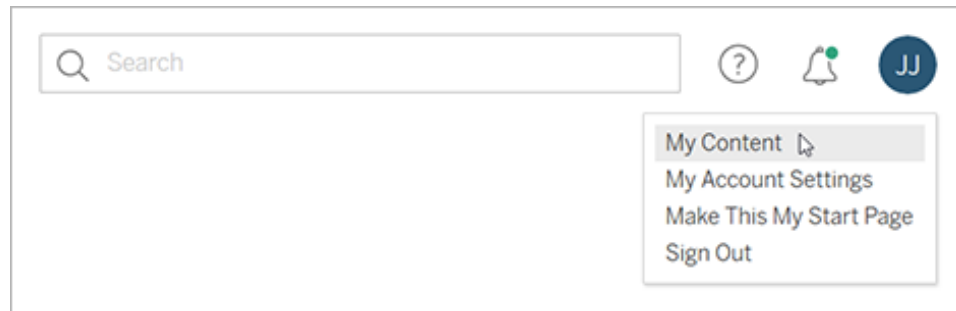

2. Click **Subscriptions**.
3. Select the check box next to the view you want to unsubscribe from, click **Actions**, and then click **Unsubscribe**, or select the subscription option you'd like to change.

Resume or delete suspended subscriptions

Sometimes, subscriptions fail because of an issue with the workbook or a problem loading the view. If a subscription fails more than five times, you'll receive a notification email that your subscription has been suspended. There are a few ways to resume a suspended subscription if you're a subscription owner or administrator:

- From the My Content area of Tableau web pages, an icon appears in the Last update column to indicate that the subscription is suspended. Select ... > **Resume Subscription** to resume.
- From the Subscriptions tab of the affected workbook, an icon appears in the last update column to indicate that the subscription is suspended. Select ... > **Resume Subscription** to resume.

You'll receive an email notification when the subscription is working again.

See also

[Change subscription settings](#) in the Tableau Desktop and Web Authoring Help.

[Project-level administration](#) in the Tableau Cloud Help, to learn which site roles allow full Project Leader capabilities.

Send Data-Driven Alerts from Tableau Cloud or Tableau Server

When data reaches important thresholds for your business, data-driven alerts automatically send notifications to key people you specify. Data alerts can be sent as an email, or as a notification either in your Tableau site or in a connected Slack workspace through the Tableau for Slack application. You can set data-driven alerts on dashboards and views, but not story points.

For time-based charts, use [relative date filters](#) so people automatically receive alerts as new data appears. If you don't own the content, ask the author to make this change.

Create a data-driven alert

1. Select a continuous numeric axis of any chart other than a Gantt chart or map. (Numeric bins and discrete numeric axes aren't supported.)
2. Select **Create** from the Alerts side panel.
3. In the view, a red line shows where the threshold falls relative to your current data.

4. Specify the email subject line, schedule, and recipients. Select **Make visible to others** if you'd like others users to see your alert and add themselves to it For more information, see [Add yourself to an existing data-driven alert](#) below.
5. Click **Create Alert**.

Add yourself to an existing data-driven alert

Anyone with access to a view can see alerts created by others. Select the alert to see its details, including its threshold, schedule, and notification frequency. Add yourself to the alert by selecting **Add Me**.

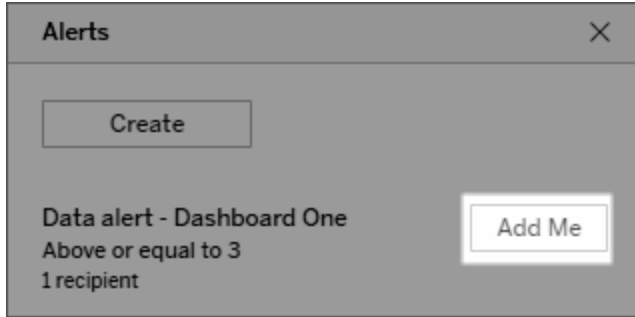

Manage your data-driven alerts

You can manage alerts from the [My Content](#) area of Tableau web pages, but doing so directly from alert emails can be quicker. Click the links below the image to manage all your alerts, or add or remove yourself from the emailed alert. If you're the alert owner, click **Edit this alert** to change alert settings such as threshold, schedule, and recipients.

Tip: To add recipients to an alert you don't own, you can forward an alert email and ask people to click **Add me to this alert**, or ask them to select **Add Me** from the Alert side panel.

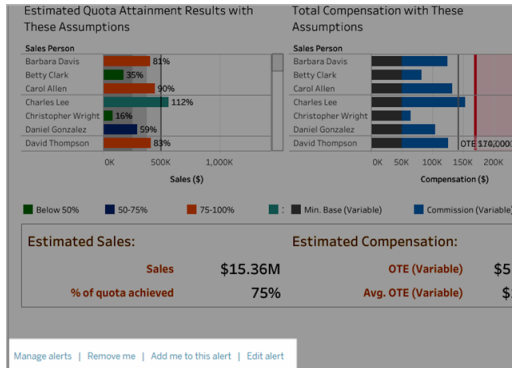

If you are an owner of an alert, you also can manage that alert through the **Actions** menu from the Alerts side panel of the dashboard or view.

Manage your alert notifications

You can receive data-driven notifications as emails, in your Tableau site, and in a connected Slack workspace through the Tableau for Slack app. For more information, see [Change Notification Settings](#) and [See Tableau notifications in Slack](#).

Fix failing data-driven alerts

Alerts can sometimes fail, usually for these reasons:

- Temporary connectivity issues. In this case, the alert will fix itself.
- A data source has been removed
- Credentials to data have expired
- The workbook or sheet that the alert was created on has been removed.

If an alert fails, you'll receive a notification email that tells you which alert failed and when, with a link to your site to fix the problem.

To fix a failing alert if you're the alert owner, click **Edit this alert** to change alert settings such as threshold, schedule, and recipients. A warning will appear to tell you if the workbook or sheet that your alert was created on has been removed.

You'll receive an email notification when the alert is working again.

Resume or delete suspended data-driven alerts

If an alert fails enough times, you'll receive a notification email that your alert has been suspended. There are a few ways to resume a suspended alert if you're an alert owner or administrator:

- From the My Content area of Tableau web pages, an icon appears in the Last checked column to indicate that the alert is suspended. Select ... > **Resume Alert** to resume the alert.
- Click **Resume Alert** in the notification email to resume the alert. A notification will either allow you to resume the alert, or indicate that the view has changed and the alert should be deleted.

You'll receive an email notification when the alert is working again.

Comment on Views

Comments let you share a conversation about data discoveries with other Tableau Server or Tableau Cloud users.

Tip: To keep comments when you republish a workbook, be sure to use the same workbook and view names.

Add comments

1. In the toolbar above a view, click the comments button.

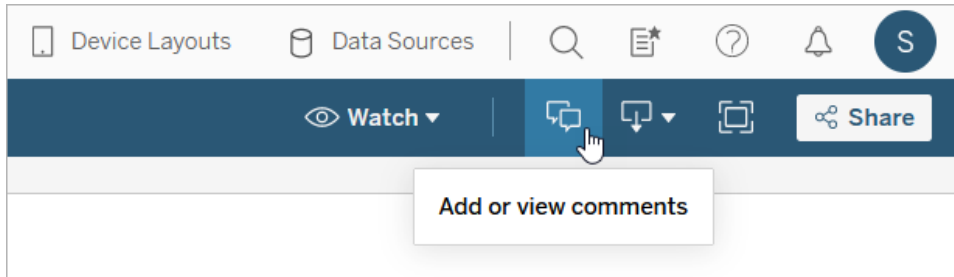

2. In the Comments pane at right, enter your remarks.
3. If you'd like to notify others about the comment, include an @mention. The @mention search shows a maximum of ten users, in alphabetical order. If you have trouble locating someone, try searching for a username instead of a display name, such as, jjohnson instead of Jane Johnson.

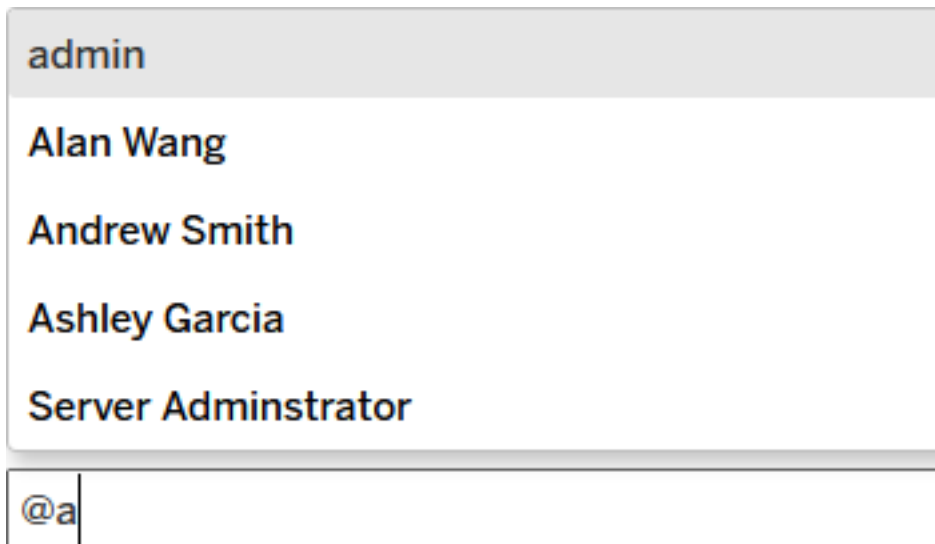

4. If you've filtered the view, click the snapshot icon  to share an interactive image that highlights the data you're describing.

Note: The snapshot icon doesn't appear if a view is **user-filtered**, protecting secure data.

5. Click **Post**.

The screenshot displays a Tableau dashboard with two main components. On the left, there are two stacked bar charts for the years 2011 and 2012, showing data across five categories represented by different colors (teal, orange, yellow, light blue, and green). Below these charts is a treemap visualization showing regional data. The treemap includes labels for 'Hong Kong SAR, China 23.3B', 'Korea, Rep. 13.0B', 'India 12.7B', 'Australia 27.9B', 'Egypt, Arab Rep.', and 'Morocco'. On the right, a social media-style comment interface is overlaid. It features a close button (X) in the top right corner. The first comment is from 'Mark' at 1:49 PM, with the text: 'When you filter down to specific regions, you see different trends. Check out this snapshot of Asia.' Below the text is a thumbnail image titled 'International Tourism' showing a bar chart and a treemap. The second comment is from 'Eriel' at 1:55 PM, with the text: 'Wow! Thanks for highlighting that data! We'll shift our budget around to match.' At the bottom of the interface, there is a text input field labeled 'Add a comment...', a share icon, and a 'Post' button.

6. To filter a view and see a data snapshot in detail, hover over the thumbnail image, and click **View**.

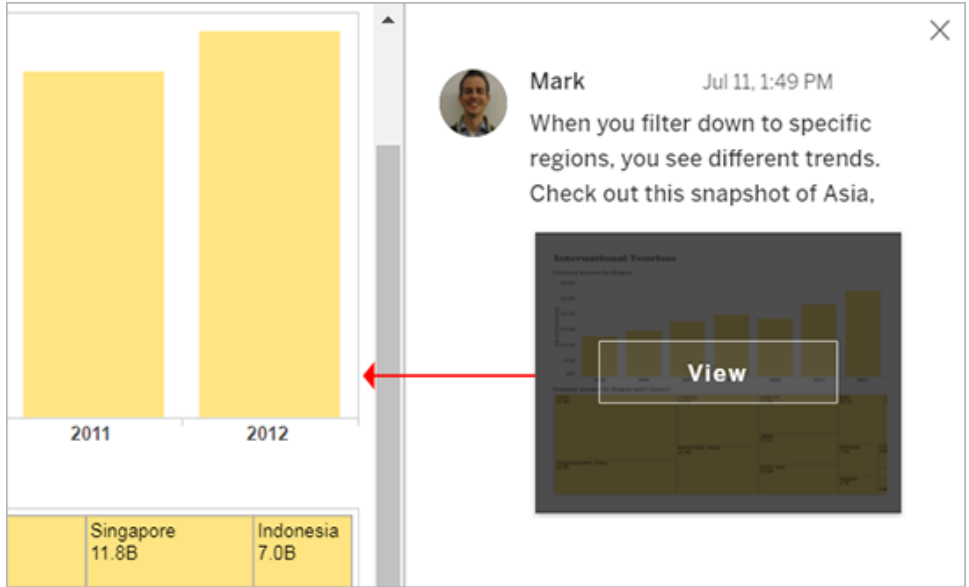

The person you've mentioned will receive a notification about your comment. Notifications can come by email, in Tableau's in-app notifications center, or in the Tableau for Slack app if the site is connected to a Slack workspace. For more information, see [Manage Your Account Settings](#) on page 3333 and [Receive Notifications, Search, and Share Using the Tableau App for Slack](#) on page 3428.

Delete comments

If a comment is unnecessary or inaccurate, you can quickly delete it. Just click the **X** in the upper-right corner.

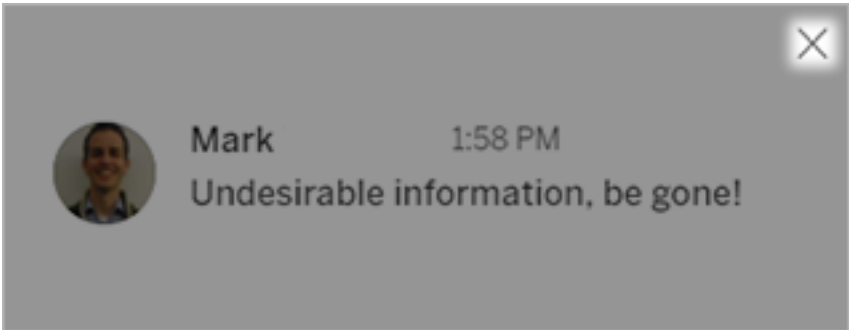

You can delete a comment if you created it, are the content owner, are a project leader with an appropriate site role, or are an administrator. To learn which site roles are required for full project leader access, see [Project-level administration](#) in the Tableau Cloud Help.

Embed Views and Metrics

Retirement of the legacy metrics feature

Tableau's legacy metrics feature was retired in Tableau Cloud in February 2024 and in Tableau Server version 2024.2. In October 2023, Tableau retired the ability to embed legacy metrics in Tableau Cloud and in Tableau Server version 2023.3. With Tableau Pulse, we've developed an improved experience to track metrics and ask questions of your data. For more information, see [Create Metrics with Tableau Pulse](#) to learn about the new experience and [Create and Troubleshoot Metrics \(Retired\)](#) for the retired feature.

Embed Views into Webpages

The embed code for Tableau Server 2022.3 and later and Tableau Cloud has changed to use the Embedding API v3. This topic contains basic information about getting started with embedding. For comprehensive guidance on embedding Tableau views, see the [Tableau Embedding API help](#). For information about switching from an older version of the Embedding API, see [Migrating from Embedding JSAPI v1 or v2 to Embedding API v3](#).

You can embed interactive Tableau views into web pages, blogs, wiki pages, web applications, and intranet portals. Embedded views update as the underlying data changes, or as their workbooks are updated on Tableau Server or Tableau Cloud.

Embedded views follow the same licensing and permission restrictions used on Tableau Server and Tableau Cloud. To see a Tableau view that's embedded in a web page, the person accessing the view must also have an account on the Tableau site it is embedded from. For more information, see [Authentication and Embedded Views](#).

An exception to the account restriction is if your organization uses a core-based license on Tableau Server with a Guest account. This allows people to view and interact with Tableau views embedded in web pages without having to sign in to the server. Contact your Tableau administrator to find out if the Guest user is enabled for your Tableau site.

Note: Your Tableau administrator can limit the sites where embedding is allowed or disable embedding entirely. If your embedded view doesn't load, check with your administrator to make sure that the site where you have embedded it is on the embedding allow list. For more information, see [Tableau Site Settings for Embedding](#).

Copy the embed code

The easiest way to embed a view is to copy the embed code provided by Tableau Server or Tableau Cloud. You can access this code from the share dialog on a view.

1. With a view open, click the Share button in the toolbar.

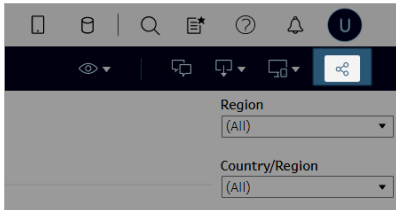

2. Click **Copy Embed Code**, then paste the code into your webpage. To customize your embedded view, use the options documented in the [Tableau Embedding API](#).

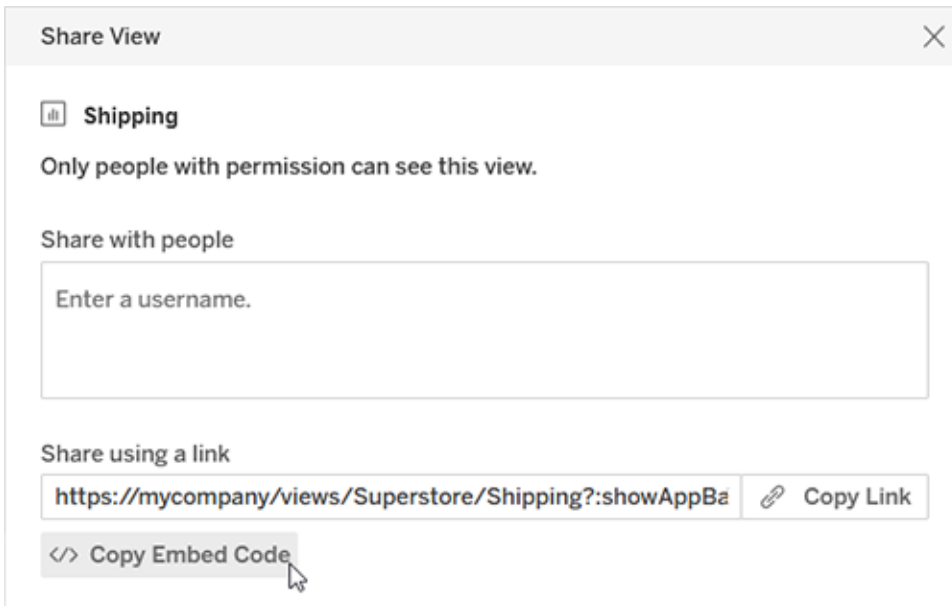

Use the Embedding API

To modify the basic embed code that you copied from the share dialog, or to create custom embedded applications, use the [Tableau Embedding API](#). You can use the API to enable single sign-on (SSO) for embedded content and customize and control user access to data with Tableau connected apps, control toolbar options, apply filters, trigger actions for events, enable embedded web authoring, and more.

Embed Metrics into Webpages (Retired)

Retirement of the legacy metrics feature

Tableau's legacy metrics feature was retired in Tableau Cloud in February 2024 and in Tableau Server version 2024.2. In October 2023, Tableau retired the ability to embed legacy metrics in Tableau Cloud and in Tableau Server version 2023.3. With Tableau Pulse, we've developed an improved experience to track metrics and ask questions of your data. For more information, see [Create Metrics with Tableau Pulse](#) to learn about the new experience and [Create and Troubleshoot Metrics \(Retired\)](#) for the retired feature.

You can embed metrics to display them alongside other web content, in the context where they are most relevant to your viewers. When you load an embedded metric, you get the freshest data available, because you're connecting directly to your data on Tableau Server or Tableau Cloud.

To embed metrics into a webpage, copy the HTML embed code provided on Tableau Server or Tableau Cloud or use the JavaScript example shown below. You can embed multiple metrics on a single page, as long as the metrics come from the same Tableau site.

Embedded metrics work with the same web browsers that are supported by Tableau Cloud and Tableau Server. For a list of supported browsers, see the [Technical Specifications](#). Though embedding is supported by Safari, viewers must turn off "Prevent cross-site tracking" to see embedded content.

The embed code and parameters for embedded metrics differ from those used for embedded views. For information about embedded views, see [Embed Views into Webpages on page 3362](#).

Note: Your Tableau administrator can limit the sites where embedding is allowed or disable embedding entirely. If your embedded metric doesn't load, check with your administrator to make sure that the site where you have embedded it is on the embedding allow list. For more information, see [Tableau Site Settings for Embedding](#).

Copy the embed code

The fastest way to embed a metric is by copying the embed code provided by Tableau.

1. On Tableau Cloud or Tableau Server, navigate to the details page for the metric that you want to embed.
2. Click the **Share Metric** button.

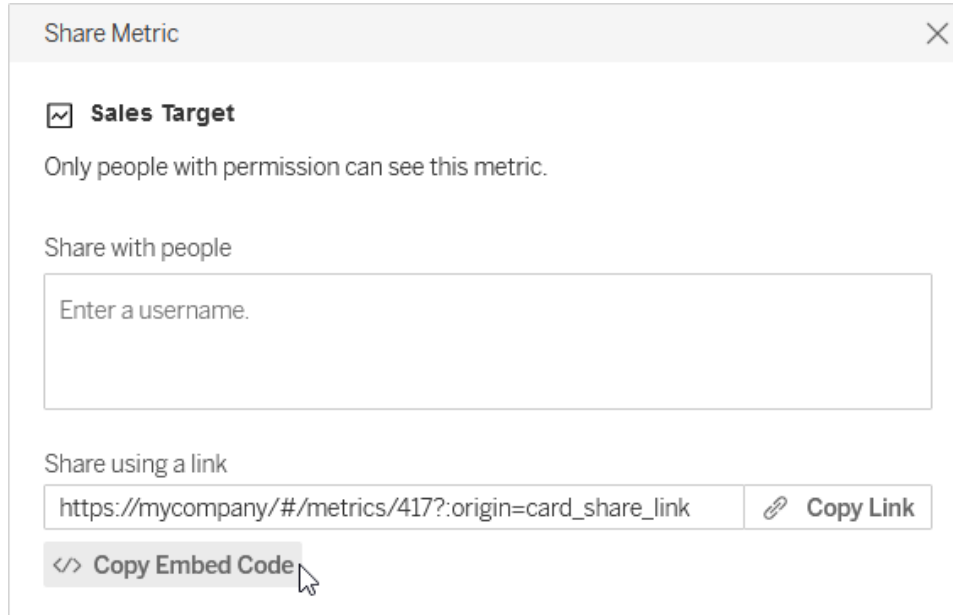
3. Click **Copy Embed Code**.

4. Paste the embed code into the webpage where you want to embed the metric.

Write your own embed code

When you copy the embed code from Tableau Server or Tableau Cloud, you are copying the HTML embed code, without any optional parameters. If you want more control over the embedded metric, you can either customize the HTML or use the JavaScript example to write your own script.

HTML example

```
<tableau-metric
  src='https://mycompany/#/metrics/1'
  link-target='https://example.com'>
</tableau-metric>
<script type='module' src-
='https://mycompany/javascripts/api/tableau.metric.1.latest.min.js'></-
script>
```

JavaScript example

```
<div id='metricDiv' />
<script type='module'>
```

```

import { TableauMetric } from 'https://-
mycompany/javascripts/api/tableau.metric.1.latest.min.js';

let metric = new TableauMetric();

metric.src = 'https://mycompany/#/metrics/1';
metric.linkTarget = 'https://example.com';document.getElementById
('metricDiv').appendChild(metric);
</script>

```

Parameters for embed code

The parameters for the embed code can be used to customize both the HTML and JavaScript embedding options.

Parameter	Values	Description	Example
src (required)	string	The URL of the metric on Tableau Server or Tableau Cloud.	https://mycompany/#/metrics/1
link-target (HTML) linkTarget (JavaScript) (optional)	string	The URL that viewers will be directed to if they click on the metric. If no target is specified, the embedded metric will link to the source URL.	http://example.com

Authentication for embedded metrics

Embedded metrics follow the same licensing and permission restrictions used on Tableau Server and Tableau Cloud. To see an embedded metric, the viewer must sign in to an account on the Tableau site that the metric is embedded from. Unlike embedded views, embedded metrics don't allow for the use of a Guest account to display metrics to viewers who are not signed in.

Viewers who haven't signed in to Tableau Server or Tableau Cloud in another tab will be prompted to sign in from the embedded metric itself. To successfully sign in from an embedded metric, the viewer's browser must be configured to allow third-party cookies.

Embedded metrics support all authentication methods for Tableau Server and Tableau Cloud, with the exception of trusted authentication. For metrics embedded from Tableau Server, the server must use HTTPS to secure communication.

To enable a single sign-on experience for embedded metrics, your Tableau administrator must configure a trust relationship between Tableau Server and an external authorization server (Tableau Server only) or a Tableau connected app and a webpage. For more information, see [Register EAS to Enable SSO for Embedded Content](#) in the Tableau Server help or [Configure Tableau Connected Apps to Enable SSO for Embedded Content](#) in the Tableau Cloud help.

How metric URLs are structured

To embed a metric, you specify the metric URL and the URL of the JavaScript used to render the metric. Metric URLs follow slightly different patterns on Tableau Cloud, Tableau Server environments with a single site, and multi-site Tableau Server environments. If you aren't sure how to format the URL, copy the embed code, as it includes both the metric URL and the JavaScript URL.

Metrics must be hosted on Tableau Server or Tableau Cloud. You can't embed a metric from a local file.

Metric URL structure

- **Tableau Cloud site:** `https://<pod>.online.tableau.com/#/site/<sitename>/metrics/<metric>`
- **Tableau Server single site (or the Default site):** `https://<server-name>/#/metrics/<metric>`
- **Tableau Server multi-site:** `https://<server-name>/#/site/<sitename>/metrics/<metric>`

JavaScript URL structure

The metric URL changes based on the site you are embedding from, but the URL for the JavaScript that renders the metric doesn't change, because it doesn't include the site.

- **Tableau Cloud site:** `https://<pod>.online.tableau.com/javascripts/api/tableau.metric.1.latest.min.js`
- **Tableau Server:** `https://<server-name>/javascripts/api/tableau.metric.1.latest.min.js`

Writing Embed Code for Views

The embed code for Tableau Server 2022.3 and later and Tableau Cloud has changed to use the Embedding API v3. For current information on how to embed a view with the Embedding API v3, see [Basic Embedding](#) in the [Embedding API help](#). The information in this topic is for prior versions of embedding (using the Tableau JavaScript API v1 and v2).

Writing embed code for prior versions of embedding

If you're writing your own embed code, you can take one of two approaches:

- **Use Tableau JavaScript:** This is the preferred approach. Use the embed code that Tableau generates as the starting point for your own code, adding or editing object parameters that control the toolbar, tabs, and more. The default embed code, which relies on a Tableau JavaScript file, is also the only way to control the load order of multiple embedded views.
- **Specify the View URL:** Embed a view using an iframe or image tag, where the source is the URL you get when you click **Share** on a view and then click **Copy Link**. You may want to do this if you can't use JavaScript on your website. There may also be situations when all you can specify is a URL.

When you embed a view, you should define a width and height that the view will be displayed in. Otherwise, the client browser will arbitrarily pick a width and height.

Note: When you need to specify the server name for Tableau Cloud in embed code (for example, to point to the location of the JavaScript API), use the URL <https://online.tableau.com>.

Use Tableau JavaScript

The following code shows an example of embed code that is generated when you click **Share** on a published view. Special characters in the `host_url` parameter are URL encoded, and those in the `site_root` and `name` parameters are notated as HTML numeric character references.

Tableau Server example:

```
<script type='text/javascript' src-  
='http://myserver/javascripts/api/viz_v1.js'></script>
```

```
= 'display:none; '>
```

Tableau Cloud example:

```
<script type='text/javascript' src-
='https://online.tableau.com/javascripts/api/viz_v1.js'></script>

='display:none; '>

value='https%3A%2F%2Fonline.tableau.com%2F' />
```

```
<div class='tableauPlaceholde
<object class='tableauViz' wi

<param name='host_url' value=
<param name='site_root' value
<param name='name' value='MyC
<param name='tabs' value='yes
<param name='toolbar' value='yes' /><

<div class='tableauPlaceholde
<object class='tableauViz' wi

<param name='host_url'

<param name='site_root' value
<param name='name' value='MyC
<param name='tabs' value='yes
<param name='toolbar' value='
</object>

</div>
```

The source for the `<script>` tag is the URL for the Tableau Server and Tableau Cloud JavaScript file, `viz_v1.js`. The JavaScript file handles assembling the full URL of the view that's displayed for your users. The `name` and `site_root` object parameters are the only required parameters; all other parameters are optional.

Specify the View URL

Here's an example of embedding the same view using an `iframe`, where the source is the URL you get when you click **Share** on a view and then click **Copy Link**.

Tableau Server example:

```
<iframe src="http://myserver/t/Sales/views/MyCoSales/SalesScoreCard
?:embed=yes&:tabs=yes&:toolbar=yes" w
t="600"></iframe>
```

Tableau Cloud example:

```
<iframe src-
c="https://online.tableau.com/t/Sales/views/MyCoSales/SalesScoreCard
?embed=yes&:tabs=yes&:toolbar=yes" w
height="600"></iframe>
```

The `embed` URL parameter is required, and you can optionally include parameters that control the toolbar and revert options, among others. You can also add filters to the URL that control the specific data that shows when a view is loaded.

Tip: When using this method, add the HTML attribute `allowfullscreen="true"` to the `iframe` element to enable the Full Screen button on the view.

Embed Code Parameters for Views

The embed code for Tableau Server 2022.3 and later and Tableau Cloud has changed to use the Embedding API v3. For a current list of classes and methods in the Embedding API v3, see the [Embedding API Reference](#) in the [Embedding API help](#). The information in this topic is for prior versions of embedding (using the Tableau JavaScript API v1 and v2).

Parameters for prior versions of embedding

You can configure an embedded view using either of these methods:

- [Object parameters for JavaScript tags](#) below
- [URL parameters for iframe tags](#) on page 3385

Object parameters for JavaScript tags

Object Parameter	Val- ues	Descrip- tion	Examples
<code>dataDetails</code>	no	Hides the Data Details button	<code><param name='dataDetails' value='no' /></code>

Object Parameter	Val- ues	Descrip- tion	Examples
		in the toolbar, which lets users see details about the data used in that view.	
showDataDetails	yes	If Tableau Catalog is enabled, shows the view with the Data Details pane open.	<code><param name='showDataDetails' value='yes' /></code>
alerts	no	Hides the Alerts button in the	<code><param name='alerts' value='no' /></code>

Object Para- meter	Val- ues	Descrip- tion	Examples
		toolbar, which lets users create data- driven alerts.	
cus- tomVi- ews	no	Hides the View button in the toolbar, which lets users save custom views.	<code><param name='customViews' value='no' /></code>
device	de- sk- to- p; ta- bl- e- t; ph- on- e	If a dash- board has lay- outs for mobile device- s, dis- plays a specific layout,	<code><param name='device' value='phone' /></code>

Object Para- meter	Val- ues	Descrip- tion	Examples
		regard- less of screen size. If this para- meter isn't set, Tablea- u Server or Tablea- u Cloud detects screen size and loads a cor- respon- ding layout. See Embed Dash- boards on page 3- 405 for exampl- es.	

Object Parameter	Values	Description	Examples
filter	string	Filters the data displayed when the view opens. You can also filter using URL parameters.	<code><param name='filter' value='Team=Blue' /></code>
host_url	string	Required. The server name as it appears in the URL.	<code><param name='host_url' value='http://myserver.exampleco.com/'></code> <code><param name="host_url" value="http://localhost/"></code>
link-target	string	The target window name for external hyper-	<code><param name="linktarget" value="_blank"/></code>

Object Para- meter	Val- ues	Descrip- tion	Examples
		links.	
load- order	nu- mb- er	When multiple views are embedded, determines the order in which they load on the page. Negative numbers are allowed.	<code><param name="load-order" value="2"/></code>
mobile	ye- s	Displays touch-optimized quick filters for mobile	<code><param name='mobile' value='yes'/></code>

Object Parameter	Values	Description	Examples
name	string	Required object parameter, with this structure: [workbook name]/ [sheet name]/ [optional custom view name] Format optional custom view names like this: username@d	<pre> <param name='name' value='ExampleCoSales/Sales' /> <param name='name' value='ExampleCoSales/Sales/jsmith@example.com/EastRegionSales' /> </pre>

Object Para- meter	Val- ues	Descrip- tion	Examples
		omain/ [custo m view name]	
		If you refer to the Tablea u Server or Tablea u Cloud URL to confirm the value of name, exclud e the session ID (:iid= <n>) at the end of the URL.	
:ori- ginal_ view	ye- s	If the name	<param name='filter' value=':original_view- w=yes' />

Object Para- meter	Val- ues	Descrip- tion	Examples
		parameter refers to a workbook or sheet URL (and does not explicitly refer to a custom view) including this parameter displays the view as the original view.	
path (Tableau Server	stri- ng	For trusted authen-	<pre><param name='path' value='trusted/Etdpsm_Ew6rJY-9kRrALjauU/views/workbookQ4/SalesQ4' /> http://tableauserver/trusted/Etdpsm_Ew6rJY-9kRrALjauU/views/workbookQ4/SalesQ4?:embed=yes&:tabs=yes</pre>

Object Para- meter	Val- ues	Descrip- tion	Examples
only. Not applica- ble to Tableau Cloud.)		tication only, cannot be used with the ticke- t para- meter. Over- rides value of the name para- meter and is used as the URL. For more inform- ation, see Dis- play the View with the Ticket in the Tablea- u	

Object Parameter	Values	Description	Examples
		Server Administrator help.	
showShareOptions	true; false	Controls whether the Share options are displayed in an embedded view.	<code><param name='showShareOptions' value='true' /></code>
site_root	string	Required. The site name. The Default site value is null (value=''). If your server is multi-site	<code><param name='site_root' value='/#/Sales'/></code> <code><param name='site_root' value='' /></code>

Object Para- meter	Val- ues	Descrip- tion	Examples
		<p>and you want to use trusted authentication, see Display the View with the Ticket in the Tableau Server help.</p>	
sub- scrip- tions	no	<p>Hides the Subscriptions button in the toolbar, which lets users set up email</p>	<pre><param name='subscriptions' value='no' /></pre>

Object Parameter	Values	Description	Examples
		subscriptions to receive snapshots of views at regular intervals.	
tabs	yes; no	Displays or hides tabs.	<code><param name='tabs' value='yes' /></code>
(Tableau Server only. Not applicable to Tableau Cloud.)	string	For trusted authentication only, cannot be used with the path object parameter. Must	<pre> <param name='ticket' value='9D1ObyqDQmSIOyQpKdy4Sw==:dg62gCsSE0QRARXNTOp6m-1J5' /> http://tableauserver/trusted/9D1ObyqDQmSIOyQpKdy4Sw==:dg62gCsSE0QRARXNTOp6m1J5/views/workbookQ4/SalesQ4?:embed=yes&:tabs=yes </pre>

Object Para- meter	Val- ues	Descrip- tion	Examples
		be used with name object to construct the trusted ticket redemption URL. For more information, see Display the View with the Ticket in the Tableau Server help.	
tool- bar	ye- s; n- o; to-	The toolbar is displayed	<code><param name='toolbar' value='top' /></code>

Object Para- meter	Val- ues	Descrip- tion	Examples
	p	on the bottom by default. The toolbar is placed above the view when you set this parameter to top and excluded from the embedded view when you set it to no.	
tool- tip	ye- s; no	Tool- tips are dis- played	<code><param name='tooltip' value='no' /></code>

Object Parameter	Values	Description	Examples
		by default. If you set this parameter to no, however, tooltips are excluded from the embedded view.	

URL parameters for iframe tags

Note: Before you add URL parameters, remove `:iid=[#]` at the end of the URL. This is a temporary view counter for your current browser session.

URL Parameter	Values	Description	Examples
<code>:dataDetails</code>	no	Hides the Data Details button in the toolbar, which lets users see details about the data used in that view.	<code>http://tabserver/views/Date-Time/DateCalcs?embed=yes&:dataDetails=no</code>

URL Parameter	Values	Description	Examples
:showData-Details	yes	If Tableau Catalog is enabled, shows the view with the Data Details pane open.	http://tabserver/views/Date-Time/DateCalcs?s?:embed=yes&:showDataDetails=yes
:alerts	no	Hides the Alerts button in an embedded view.	http://tabserver/views/Date-Time/DateCalcs?:embed=yes&:alerts=no
:customViews	no	Remember my changes option.	http://tabserver/views/Date-Time/DateCalcs?s?:embed=yes&:customViews=no
:device	desktop; tablet; smartphone	If a dashboard has layouts for mobile devices, displays a specific layout, regardless of screen size. If this parameter isn't set, Tableau Server or Tableau Cloud detects screen size and loads a corresponding layout. See Embed Dashboards on page 3405 for examples.	http://tabserver/views/sales/sales_dashboard?:device=tablet

URL Parameter	Values	Description	Examples
:display_count (Tableau Public only)	yes	Shows the total number of pageviews when you click the Tableau logo at lower left.	https://public.tableau.com/en-us/s/gallery/what-emoji-say-about-music?:display_count=yes
:embed	yes	Required URL parameter. Hides the top navigation area, better blending the view into your web page.	http://tabserver/views/Date-Time/DateCalcs?:embed=yes
:format	pdf; png	Displays a view as a PDF or .png file.	http://tabserver/views/Sales/Q2?:format=pdf
:highdpi	false	Renders a view using standard DPI (dots per inch) for high-resolution displays and devices.	http://tabserver/views/Sales/Q2?:highdpi=false
:linktarget	string	The target window name for external hyperlinks.	http://tabserver/views/Date-Time/DateCalcs?:embed=yes&:linktarget=_blank
:openid_hd	string	Used when authenticating	http://tabserver/views/Sales/Q2?:openid_hd=example.com

URL Parameter	Values	Description	Examples
:openid_login_hint	string	<p>with OpenID Connect. Specifies the hosted domain to which a user belongs. For example, you might use this option if you do not want to render the domain selection pane. Used in conjunction with :openid_login_hint to specify the full user identifier.</p> <p>Used when authenticating with OpenID Connect. Specifies the full user identifier (email address). Used in conjunction with :openid_hd to specify the hosted domain to which the user belongs.</p>	<p>http://t- abserver/views/Sales/Q2?:openid_login_hint=tara@example.com</p>

URL Parameter	Values	Description	Examples
:record_performance (Tableau Server only. Not applicable to Tableau Cloud.)	yes	Starts a performance recording for a view. Add this at the end of the URL, immediately before the session ID (:iid=<n>). For more information, see Create a Performance Recording in Tableau Server help.	http://tabserver- absolver- /views/Sales2013/Re- gions?:recordperformance=yes
:refresh	yes	Renders the view using the latest data from Tableau Server or Tableau Cloud.	http://tabserver/views/Date- Time/DateCalc- s?:embed=yes&:refresh=yes

Tip: To continually refresh a view, in the <head> section of the web page,

URL Parameter	Values	Description	Examples
:render	true; false; number	<p data-bbox="581 331 695 1014">add <meta http- equiv= "refre sh" conten t="#">, where # is the number of seconds between refreshes.</p> <p data-bbox="545 1087 737 1640">If client-side rendering is enabled (the default), setting this to <code>false</code> forces server-side rendering for the session. Setting this to <code>true</code> forces client-side rendering for the session.</p> <p data-bbox="545 1671 737 1785">A number from 1 to 100 can be entered to set</p>	http://tabserver/views/Date-Time/DateCalcs?:render=false

URL Parameter	Values	Description	Examples
:revert	all; fil- ter- s; sort- s; axe- s; shel- ves	the complexity threshold above which views are rendered by the server. For more information, see About Client-Side Rendering in Tableau Server help. Returns the item to its original state.	http://tabserver/views/Date-Time/DateCalcs?:embed=yes&:revert=all
:showAppBanner	false	Hides the “Open in Tableau Mobile” banner in mobile web browsers.	http://tabserver/views/Date-Time/DateCalcs?:embed=yes&:showAppBanner=false
:showAskData	false	Hides the Ask Data button in the toolbar in an embedded	http://tabserver/views/Date-Time/DateCalcs?:embed=yes&:showAskData=false

URL Parameter	Values	Description	Examples
		view. By default the Ask Data button displays.	
:showShareOptions	true; false	Controls whether the Share options are displayed in an embedded view.	http://tabserver/views/Date-Time/DateCalcs?:embed=yes&:showShareOptions=true
:showVizHome (Tableau Public only)	yes; no	Shows or hides the content navigation interface of Tableau Public. Set to no when embedding vizzes in other web pages.	https://public.tableau.com/en-us/s/gallery/what-emoji-say-about-music?:showVizHome=no
:subscriptions	no	Hides the Subscribe button in an embedded view.	http://tabserver/views/Date-Time/DateCalcs?:embed=yes&:subscriptions=no
:tabs	yes; no	Displays or hides tabs.	http://tabserver/views/Date-Time/DateCalcs?:embed=yes&:tabs=no
:toolbar	yes; no; top	The toolbar is displayed by default on the bottom when this parameter is not set. When no the	http://tabserver/views/Date-Time/DateCalcs?:embed=yes&:toolbar=no

URL Parameter	Values	Description	Examples
		toolbar is excluded from the embedded view. When top, the toolbar is placed above the view.	
:tooltip	yes; no	<p>Tooltips are displayed by default in a view when this parameter is not set. If set to no, tooltips are excluded from the embedded view.</p>	<p>http://t- abserver- /views/- work- bookQ4/SalesQ4?:embed=yes&:tooltip=no</p>

Add Filters to Embed Code for Views

The embed code for Tableau Server 2022.3 and later and Tableau Cloud has changed to use the Embedding API v3. For current information about filtering, see [Filter the View](#) in the [Embedding API help](#). The information in this topic is for prior versions of embedding (using the Tableau JavaScript API v1 and v2).

Filter using prior versions of embedding

You can include filter values in embedded views so they highlight just the data you want. For example, you may want to include a hyperlink from another part of your web application to an embedded sales performance view that shows only a specific region.

Note: Stories don't support embedded filters.

Filter on one field

Passing a filter on one field is a quick way to focus an embedded view on specific data.

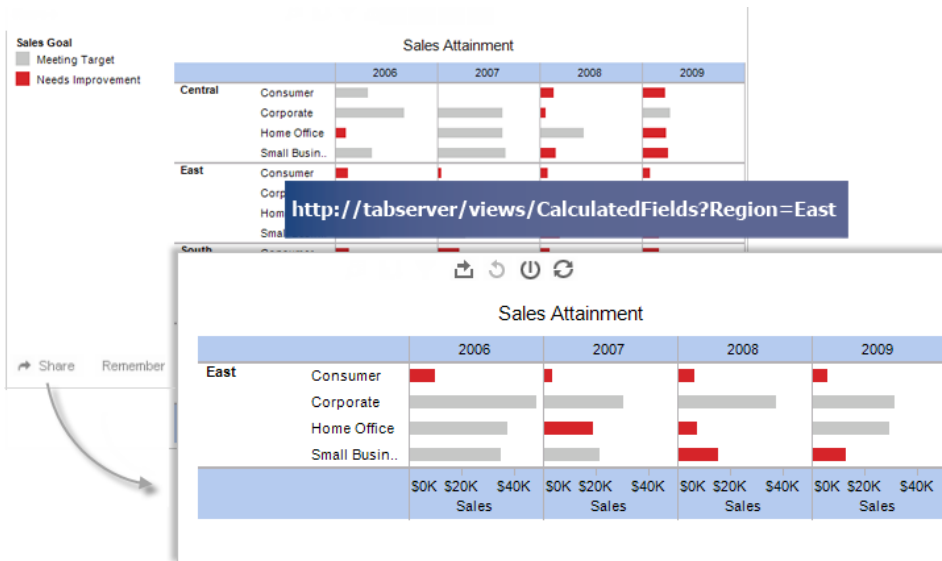

Script tag example:

```
<script type='text/javascript' src-
='http://myserver/javascripts/api/viz_v1.js'>
</script>
<object class='tableauViz' width='800' height='600' style-
='display:none;'>
  <param name='host_url' value='http://myserver/' />
  <param name='site_root' value='' />
  <param name='name' value='Superstore/Product' />
  <param name='filter' value='Region=East' />
</object>
```

To pass through multiple filter values, just separate each with a comma. For example:

```
<param name='filter' value='Region=East,West' />
```

Iframe tag examples:

```
<iframe src-
="h-
```

```
ttp://myserver/views/Superstore/Product?:embed=y&Region=East,West"
width="800" height="600"></iframe>
```

Filter on multiple fields

You can pass filters on as many fields as you want, including fields that are not in visible the original view.

Script tag example:

```
<script type='text/javascript' src-
='http://myserver/javascripts/api/viz_v1.js'>
</script>
<object class='tableauViz' width='800' height='600' style-
='display:none;'>
  <param name='host_url' value='http://myserver/' />
  <param name='site_root' value='' />
  <param name='name' value='Superstore/Product' />
  <param name='filter' value='Region=Central,South&Customer Seg-
ment=Consumer,Home Office' />
</object>
```

Iframe tag example:

```
<iframe src-
="h-
ttp://myserver-
/views/Su-
perstore/Product?:embed=y&Region=Central,South&Segment=Consumer,Home
Office"
width="800" height="600"></iframe>
```

The first image below shows an example of the URL you get when you click **Share** on a view and then click **Copy Link**.

The second image shows how you might modify the URL and add it to an iframe by deleting the `showShareOptions` and `display_count` parameters, adding filter parameters for `Region` and `Segment`, and adding `width` and `height` parameters, to create an embed link that displays only Consumer and Home Office products from the Central and South regions.

The screenshot displays a Tableau Desktop interface with a 'Product Drilldown' view. The main view shows a table of sales data by product category (Furniture, Office Supplies, Technology) from 2014 to 2017, with columns for months (Jan-Dec). A callout box highlights an embedded web view URL: `http://myserver/views/Superstore/Product?:embed=ys:showShareOptions=true&:display_count=no`.

The embedded web view shows a similar table with a callout box containing an `<iframe>` tag: `<iframe src="http://myserver/views/Superstore/Product?:embed=y%Region=Central, South&Segment=Consumer, Home Office" width="800" height="600"></iframe>`.

Below the embedded view, there is a 'Sales and Profit by Product Names' section with a bubble chart showing sales for Furniture (Bookcases, Chairs, Furnishings, Tables) and Office Supplies (Appliances, Art, Binders, Envelopes, Fasteners) across Consumer and Corporate segments.

Note: If a filter value contains a special character, such as a comma, replace the character with the URL encoding sequence for \ (backslash, %5c) followed by the URL encoding sequence for the special character. The backslash is needed to escape the special character. For example, the URL encoding sequence for \, (backslash, comma) is %5c%2c.

Filter dates and times

If you want to filter on a Date/Time field, include the value using the default Tableau format shown below:

```
yyyy-mm-dd hh:mm:ss
```

The time part uses a 24-hour clock. Many databases store all date values as Datetime fields, so you may need to pass a time value along with your date.

Script tag example:

Tableau Desktop and Web Authoring Help

```
<script type='text/javascript' src-
='http://myserver/javascripts/api/viz_v1.js'></script>
<object class='tableauViz' width='800' height='600' style-
='display:none;'>
  <param name='host_url' value='http://myserver/' />
  <param name='site_root' value='' />
  <param name='name' value='Sales/Sales-Performance' />
  <param name='filter' value='Date=2012-12-01' />
</object>
```

This example filters on both a date field and a datetime field:

```
<param name='filter' value='2012-12-01%2022:18:00' />
```

Iframe tag example:

```
<iframe src="http://myserver/Sales/SalesPer-
formance?:embed=yes&Date=2008-12-01%2022:18:00" width="800" height-
t="600"></iframe>
```

To filter multiple dates, separate each date with a comma.

Filter measures

You can filter measures by including one or more values. There is no support for greater than, less than, or ranges. The example below filters to show only \$100 and \$200 sales.

Script tag example:

```
<script type='text/javascript' src-
='http://myserver/javascripts/api/viz_v1.js'>
</script>
<object class='tableauViz' width='800' height='600' style-
='display:none;'>
  <param name='host_url' value='http://myserver/' />
  <param name='site_root' value='' />
  <param name='name' value='Sales/Sales-Performance' />
  <param name='filter' value='Profit=100, 200' />
</object>
```

Iframe tag example:

```
<iframe src="http://myserver/views/Sales/Sales-Per-
formance?:embed=yes&Profit=100,200"
width="800" height="600"></iframe>
```

How View URLs Are Structured

The embed code for Tableau Server 2022.3 and later and Tableau Cloud has changed to use the Embedding API v3. With the Embedding API v3, you no longer add parameters to view URLs to filter when embedding. Instead you filter by adding attributes to a filter web component. For more information, see [Filter the View](#) in the [Embedding API help](#). The information in this topic is for prior versions of embedding (using the Tableau JavaScript API v1 and v2).

To understand how Tableau structures view URLs, let's take a close look at an example in the browser address bar.

The structure of the base URL

- In Tableau Server or Tableau Cloud, the basic URL pattern for a Tableau view is:
`http://<servername>/#/views/<workbook>/<sheet>`
- In a multi-site environment, for views saved to sites other than Default, the site ID is also included in the URL:
`http://<servername>/#/site/<sitename>/views/<workbook>/<sheet>`

Filter with URL parameters using prior versions of embedding

Adding parameters to the base URL

Appending a query string

To create a filtering URL, you append a *query string* to the base URL. In a query string, the view filters are the parameters. To construct a query string:

- Begin the query string with a question mark (?).
- Separate the parameters using ampersands (&).
- Separate multiple values per parameter using commas (,).

For example:

```
http://<servername>/#/views/<workbook>/sheet
?param1=value1,value2&param2=value
```

In addition, any characters in your field or sheet names that cannot appear in URLs are URL-encoded. For example, a space is converted to %20.

Note: Before you add URL parameters, remove `:iid=[#]` at the end of the URL. This is a temporary view counter for your current browser session.

Reflecting the capitalization of field names

URL parameters are case-sensitive. When you append query strings, be sure to precisely reflect the capitalization of field names in your source data.

How query strings affect dashboards

Unlike visible filters in a dashboard, which sometimes affect only one sheet, URL parameters apply to all sheets. Before appending URL parameters, become familiar with the fields shown in each sheet to avoid accidentally filtering out data you'd like to retain.

Select an example view to work with

The examples in this article use the Performance view, in the Superstore sample data that comes with Tableau Server.

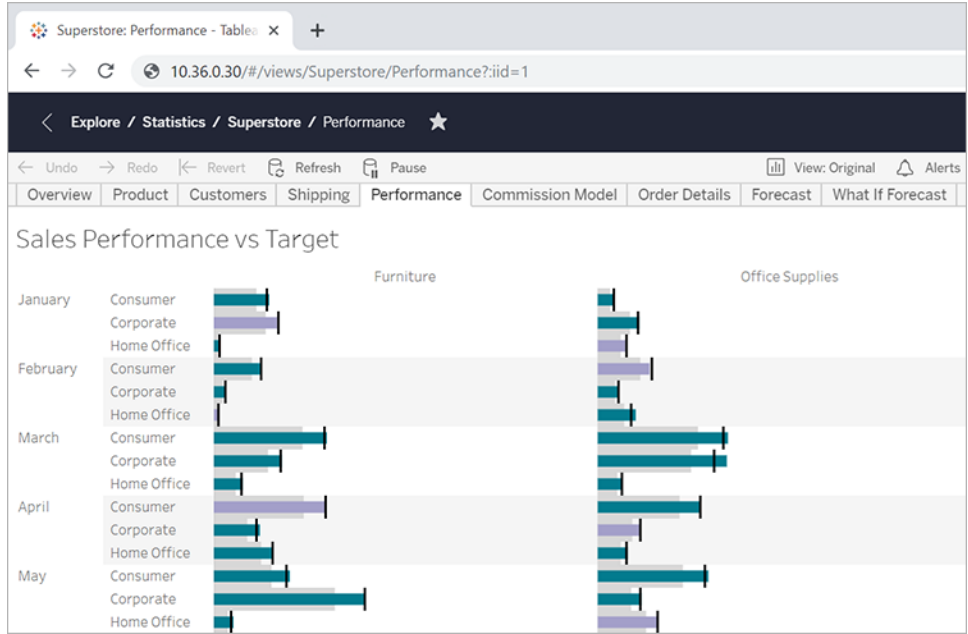

The example URL reflects the following attributes:

- The sheet name is **Performance**
- The workbook name is **Superstore**
- The server name is indicated using a placeholder IP address, where your on-premise server name or `online.tableau.com` would appear.

To follow along with the examples, you can look at a similar view from Superstore, or you can adjust the example URLs to use the field, sheet, and other names from your own environment. If you are using your own view, make sure you first publish it to the server.

Filter the view

For the example view used in this article, the base URL is:

`http:<servername>/#/views/Superstore/Performance`

Furniture only

To display only sales of furniture, at the end of the URL, add the following query string:

`?Category=Furniture`

For example:

`http:<servername>/#/views/Superstore/Performance?Category=Furniture`

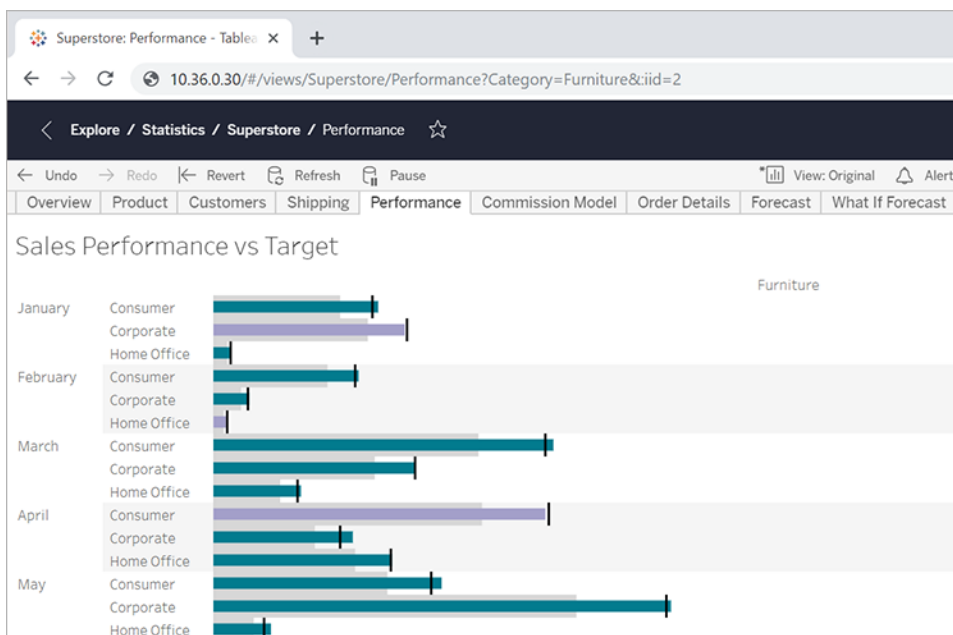

Consumer only

To limit the view to Consumer sales, change the URL to:

`http:<servername>/#/views/Superstore/Performance?Segment=Consumer`

Tableau Desktop and Web Authoring Help

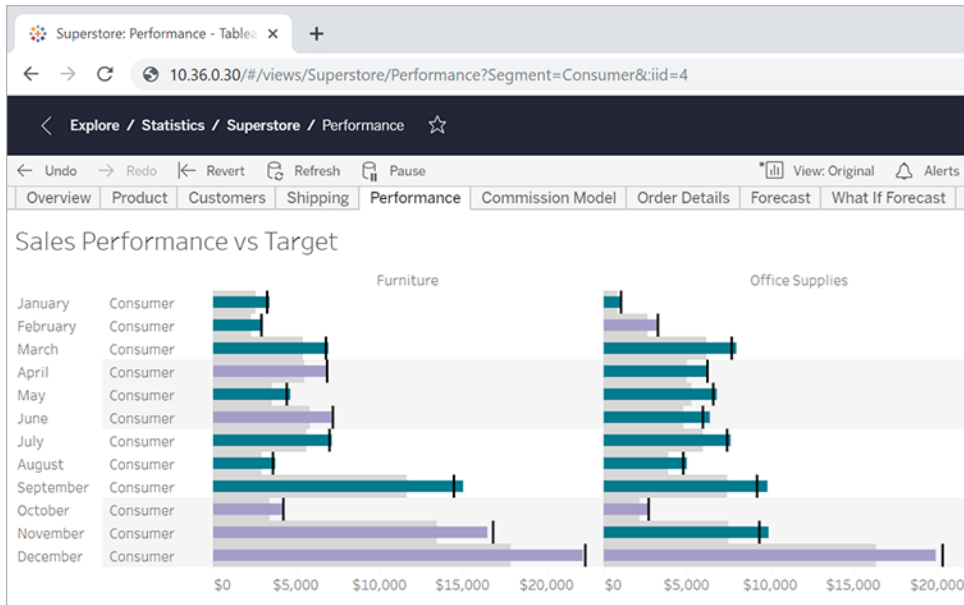

Home Office and Consumer

To show both home office and consumer sales, change the URL to:

```
http:<servername>/#/views/Superstore/Performance  
?Segment=Home%20Office,Consumer
```

Notice that in the field name "Home Office," %20 represents the URL-encoded space character, as described in [Adding parameters to the base URL on page 3398](#).

Here multiple values per parameter are separated with a comma, but not a space.

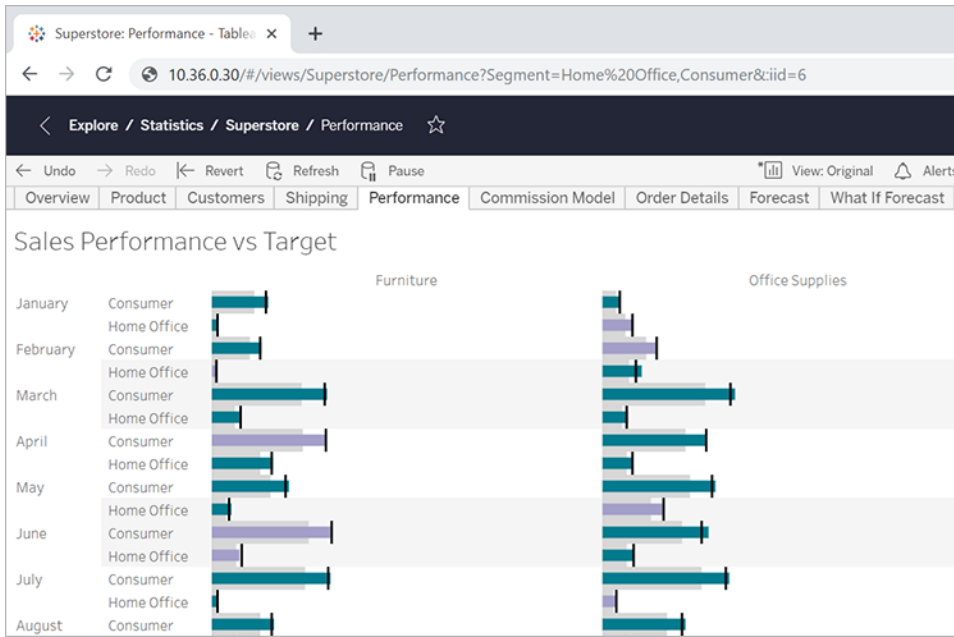

Furniture in the Central

To show multiple field/value pairs, separate them with an ampersand:

`http:<servername>/#/views/Superstore/Performance`

?Region=Central&Category=Furniture

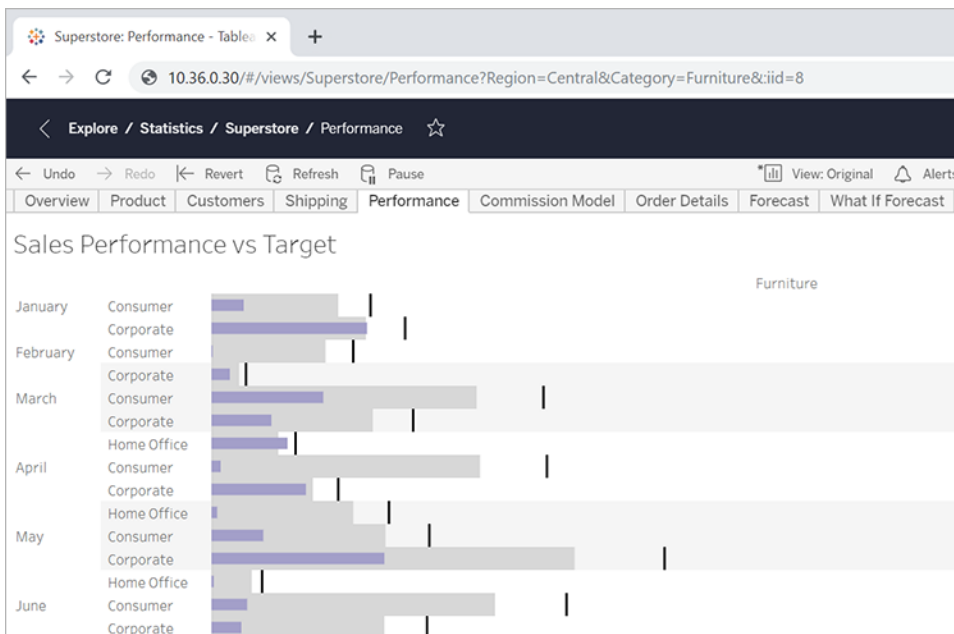

Exclusive filtering

So far, the examples shown in this article display all values for the fields in the resulting views. For more flexibility, you can specify multiple values for a specific filter, and include an additional parameter that displays only particular intersections of those values.

The following URL describes the base, unfiltered view used in this example, showing department sales by region:

```
http://<servername>/#/views/Superstore/Performance
```

Next, to show sales for only the Furniture and Technology departments in the Central and West regions, you would add the following query string to the base URL:

```
?Region=Central,West&Category=Furniture,Technology
```

To show only Furniture sales in the Central region and Technology sales in the West region, add the `~s0` parameter to the query string:

```
?Region~s0=Central,West&Category~s0=Furniture,Technology
```

The final URL looks like this:

```
http://<servername>/#/views/Superstore/Performance?Region~s0=Central,West&Category~s0=Furniture,Technology
```

Special considerations for date filtering

When you want to filter date fields, take into account how dates are formatted and behave in a database environment.

- Date (and time) values passed via URL parameter need to match the following Tableau default format:
`yyyy-mm-dd hh:mm:ss`
- Many databases store dates as datetime values, so you may need to include a time part in the value you provide in the parameter. The time part is based on a 24 hour clock, so 10:18 pm is specified as 22:18:00.

Example date parameters

The following example query strings use a date field called **Order Date**. As in the previous examples in this article, you would add these to the base URL of your view.

- If the Order Date field type includes only the date (with no time of day), and you want to show data only for July 8, 2018, the query string would look something like this:
`?Order%20Date=2018-07-08`

- If Order Date includes the time part, to filter on July 8, 2018 at 10:18 pm, the query string might look like this:

```
?Order%20Date=2018-07-08%2022:18:00
```

- If Order Date is only the date, and you want to filter on multiple dates, you would use commas, as described earlier in this article. For example:

```
?Order%20Date=2018-07-08,2018-07-09,2018-07-10,2018-07-11
```

Parameters as DATEPART filters

To filter by date part, use the same nomenclature as in the default Tableau Desktop date hierarchy. For more information, see [Date Functions](#) in the Tableau Help.

year(Order%20Date)	Integer
quarter(Order%20Date)	Integer between 1 and 4
month(Order%20Date)	Integer between 1 and 12
day(Order%20Date)	Integer between 1 and 31
hour(Order%20Date)	Integer 0–23
minute(Order%20Date)	Integer 0–59
second(Order%20Date)	Integer 0–59
week(Order%20Date)	Integer 1–53
my(Order%20Date)	Six-digit integer: YYYYMM
mdy(Order%20Date)	Eight-digit integer: YYYYMMDD

Control Load Order for Multiple Embedded Views

The embed code for Tableau Server 2022.3 and later and Tableau Cloud has changed to use the Embedding API v3. For current information about embedding, see the [Embedding API help](#). The information in this topic is for prior versions of embedding (using the Tableau JavaScript API v1 and v2).

Control load order using prior versions of embedding

You can control the order in which multiple views load for the people working with your views. This feature can be accessed only using embed code that relies on the Tableau JavaScript file.

In the following example, two views are embedded. The second view loads first, followed by the top view. If you embed multiple views and give them all the same load order value, or if you don't specify load order parameters, they are loaded in the order in which they appear on the page.

Script Tag Example

```
<script type='text/javascript' src-  
='http://myserver/javascripts/api/viz_v1.js'>  
</script>  
<object class='tableauViz' width='600' height='400' style=  
='display:none;'>  
  <param name='host_url' value='http://myserver/' />  
  <param name='site_root' value='' />  
  <param name='name' value='MyCoSales/TopPerformers' />  
  <param name='tabs' value='yes' />  
  <param name='toolbar' value='yes' />  
  <param name='filter' value='Salesperson=Top 5' />  
  <param name='load-order' value='0' />  
</object>  
<script type='text/javascript' src-  
='http://myserver/javascripts/api/viz_v1.js'>  
</script>  
<object class='tableauViz' width='600' height='400' style=  
='display:none;'>  
  <param name='host_url' value='http://myserver/' />  
  <param name='site_root' value='' />  
  <param name='name' value='MyCoSales/SalesScoreCard' />  
  <param name='tabs' value='yes' />  
  <param name='toolbar' value='yes' />  
  <param name='load-order' value='-1' />  
</object>
```

Embed Dashboards

The embed code for Tableau Server 2022.3 and later and Tableau Cloud has changed to use the Embedding API v3. For current information about device specific layouts and dashboard sizing,

see [Configure Embedding Objects and Components](#) in the [Embedding API help](#). The information in this topic is for prior versions of embedding (using the Tableau JavaScript API v1 and v2).

Embed dashboards using prior versions of embedding

You can embed a Tableau dashboard in your own web site or wiki page and you can have it display in different layouts based on the size of the iframe.

- To automatically make the right layout appear for your users, regardless of which device they are using, create device-specific layouts for your dashboard in Tableau Desktop. When you do, Tableau Server and Tableau Cloud automatically display the correct layout based on iframe size, provided you use 100% for the iframe's width and height instead of exact pixel values (see below).
- To always make a certain layout appear, regardless of iframe size, use the `device` parameter in your embed code.

In the following example, the embed code displays a dashboard that's 800 pixels wide by 600 pixels high. Exact width and height values are part of the default embed code you get when you click the **Share** button at the top of a view or dashboard:

```
<script type='text/javascript' src-
='http://mysite.myserver.com/javascripts/api/viz_v1.js'></script>
  <div class='tableauPlaceholder' style='width: 800px; height:
600px;' >
  <object class='tableauViz' width='800' height='600' style-
='display:none;'>
  <param name='host_url' value='http://mysite.myserver.com' />
  <param name='site_root' value='' />
  <param name='name' value='ProfitAnalysis/Sales_Dashboard' />
  <param name='tabs' value='yes' />
  <param name='toolbar' value='yes' />
  <param name='filter' value=':original_view=yes' /></object></div>
```

In this example, where the dashboard uses device-specific layouts, the style attributes for the div class have been removed and the object class values for width and height have been replaced with 100%. In most cases, the correct layout displays; that is, if width and height aren't also being controlled elsewhere in your CSS.

Tableau Desktop and Web Authoring Help

```
<script type='text/javascript' src-  
='http://mysite.myserver.com/javascrpts/api/viz_v1.js'></script>  
  <div class='tableauPlaceholder' >  
    <object class='tableauViz' width='100%' height='100%' style-  
='display:none;'>  
      <param name='host_url' value='http://mysite.myserver.com' />  
      <param name='site_root' value='' />  
      <param name='name' value='ProfitAnalysis/Sales_Dashboard' />  
      <param name='tabs' value='yes' />  
      <param name='toolbar' value='yes' />  
      <param name='filter' value=':original_view=yes' /></object></div>
```

If the correct layout doesn't display, it may be because the HTML page you're using for embedding has a `<!DOCTYPE html>` tag, and that tag is preventing items in the body of the page from resizing to 100% (see [details on Stack Overflow](#)). A workaround is to add the following lines to the body of your HTML page:

```
<style>  
  html, body { height: 100% }  
</style>
```

The following example assumes that the embedded dashboard has device-specific layouts. The `device` parameter is set to `phone`. This means that, no matter which device displays the dashboard, the layout created for phones will be the one that's displayed.

```
<script type='text/javascript' src-  
='http://mysite.myserver.com/javascrpts/api/viz_v1.js'></script>  
  <div class='tableauPlaceholder'>  
    <object class='tableauViz' width='100%' height='100%' style-  
='display:none;'>  
      <param name='host_url' value='http://mysite.myserver.com' />  
      <param name='site_root' value='' />  
      <param name='name' value='ProfitAnalysis/Sales_Dashboard' />  
      <param name='device' value='phone' />  
      <param name='tabs' value='yes' />  
      <param name='toolbar' value='yes' />  
      <param name='filter' value=':original_view=yes' /></object></div>
```

Iframe dimensions and device layouts

The dashboard layout a device displays is based on the smallest dimension (height or width) of the iframe in which the Tableau view appears. Sometimes Desktop, Tablet, or Phone layouts may appear on other types of devices. For example, a Tablet layout may appear on a desktop computer if the display or browser window is small.

If the smallest iframe dimension is ...	This device layout appears ...
500 pixels or less	Phone
Between 501 and 800 pixels	Tablet
Greater than 800 pixels	Desktop

For details on how to create a dashboard that uses device-specific layouts, see [Create Dashboard Layouts for Different Device Types](#) on page 2788.

Embed Code for Custom Views

The embed code for Tableau Server 2022.3 and later and Tableau Cloud has changed to use the Embedding API v3. For current information on embedding custom views, see [Embed Custom Views](#) in the [Embedding API help](#). The information in this topic is for prior versions of embedding (using the Tableau JavaScript API v1 and v2).

Embed custom views using prior versions of embedding

When you embed a custom view of a workbook or sheet, the default view is determined by these factors:

- If the embed code URL specifically refers to a custom view, that view is displayed by default.
- If the embed code URL does not refer to a custom view, the Default custom view is displayed by default.
- If no Default custom view has been defined, the original view is displayed by default.

Note: To ensure the original view will be displayed by default in an embedded view, make sure the embed code URL for the name parameter does not explicitly refer to a custom

view, and include the following `filter` parameter in the embed code: `<param name='filter' value=':original_view=yes' />`.

In the following example, the embed code will always display the original view of the Profit Analysis sheet in the Profit Analysis workbook, because the `filter` parameter is set to `:original_yes`, and the `name` parameter does not refer to a specific custom view in the URL for the sheet.

```
<script type='text/javascript' src-
='http://mysite.myserver.com/javascrpts/api/viz_v1.js'></script>
  <div class='tableauPlaceholder' style='width: 1496px; height:
749px;'>
  <object class='tableauViz' width='1496' height='749' style-
='display:none;'>
  <param name='host_url' value='http://mysite.myserver.com' />
  <param name='site_root' value='' />
  <param name='name' value='ProfitAnalysis/ProfitAnalysis' />
  <param name='tabs' value='yes' />
  <param name='toolbar' value='yes' />
  <param name='filter' value=':original_view=yes' /></object></div>
```

In this example, the setting for the `name` parameter in this example specifically refers to the URL for a custom view named Furniture (in the Profit Analysis sheet in the Profit Analysis workbook).

```
<script type='text/javascript' src-
='http://mysite.myserver.com/javascrpts/api/viz_v1.js'></script>
  <div class='tableauPlaceholder' style='width: 1496px; height:
749px;'>
  <object class='tableauViz' width='1496' height='749' style-
='display:none;'>
  <param name='host_url' value='http://mysite.myserver.com' />
  <param name='site_root' value='' />
  <param name='name' value='ProfitAnalysis/ProfitAnalysis/Furniture'
/>
  <param name='tabs' value='yes' />
  <param name='toolbar' value='yes' /></object></div>
```

In this example, the `name` parameter does not refer to a specific custom view in the URL for the sheet, and the `original_view` parameter has not been specified. The embed code here will display the custom view that has been set to Default in the Profit Analysis sheet in the Profit Analysis workbook. However, if the original view is still the Default (no other custom view has been set to Default), then the original view will be displayed as the default view.

```
<script type='text/javascript' src-
='http://mysite.myserver.com/javascrpts/api/viz_v1.js'></script>
  <div class='tableauPlaceholder' style='width: 1496px; height:
749px;'>
  <object class='tableauViz' width='1496' height='749' style-
='display:none;'>
  <param name='host_url' value='http://mysite.myserver.com' />
  <param name='site_root' value='' />
  <param name='name' value='ProfitAnalysis/ProfitAnalysis' />
  <param name='tabs' value='yes' />
  <param name='toolbar' value='yes' /></object></div>
```

Embed Views into Wikis

You can easily embed a view into a wiki or other web page simply by putting the view inside an `<iframe>` tag.

1. Navigate to the wiki page you want to embed a view into.
2. Edit the page and add an `<iframe>` where the source is the URL you get when you click **Share** on a view and then click **Copy Link**. For example:

```
<iframe src="http://myserver/views/Date-Time/DateCalc-
s?:embed=yes&:toolbar=no"
width="800" height="600"></iframe>
```

3. Save your changes.

If you use Tableau Server and both it and the wiki are configured to use Active Directory to automatically authenticate users, they will immediately see the view. Otherwise, users

will be asked to sign in before they can see the view.



Embed Images of Tableau Server Views

In addition to embedding a view into a `<script>` or `<iframe>` tag you can also embed the view as an image. When you embed an image the view is not interactive; however, it is updated every time the page fully reloads, showing the latest data.

Note: This approach works only if users accessing the embedded image have an active web browser session with Tableau Server and are automatically signed in using Active Directory.

1. Navigate to the page where you want to embed the image.
2. Edit the page and add an `` tag where the source is the URL you get when you click **Share** on a view and then click **Copy Link**. For example:

```

```

Embed Tableau Server Views into SharePoint (Active Directory Authentication)

Note: The following procedure for embedding Tableau views into SharePoint was retired in Tableau 2023.3. You can no longer embed Tableau views following these instructions.

If your Tableau Server is configured to use Active Directory and automatically authenticate users, they can see views you embed in SharePoint pages with the Tableau web part.

If your Tableau Server instead uses Local Authentication to authenticate users, see [Embed Tableau Server Views into SharePoint \(Local Authentication\)](#) on page 3415. If you don't know which type of authentication your Tableau Server uses, ask your administrator.

Requirements

- To embed views, you need SharePoint 2013 or later, and an administrator must deploy the TableauEmbeddedView web part to your SharePoint server. For sample SharePoint code and instructions, look in this folder:

```
C:\Program Files\Tableau\Tableau Server\packages\extras.<version_code>\embedding\sharepoint\
```

The sample code is provided as an example and may require modification to work in your SharePoint deployment.

- To see embedded views, users must have a Tableau Server license and the same user name on SharePoint.

Embedding a View into SharePoint

You can embed the Tableau web part in a new or existing SharePoint page.

1. Open the page where you want to embed a view and switch to edit mode.
2. In the section of the page where you want to embed the view, on the **Insert** tab, click **Web Part**.
3. Under Categories, in the **Custom** (or **Miscellaneous**) folder, select **TableauEmbeddedView**, and then click **Add** in the lower-right corner.

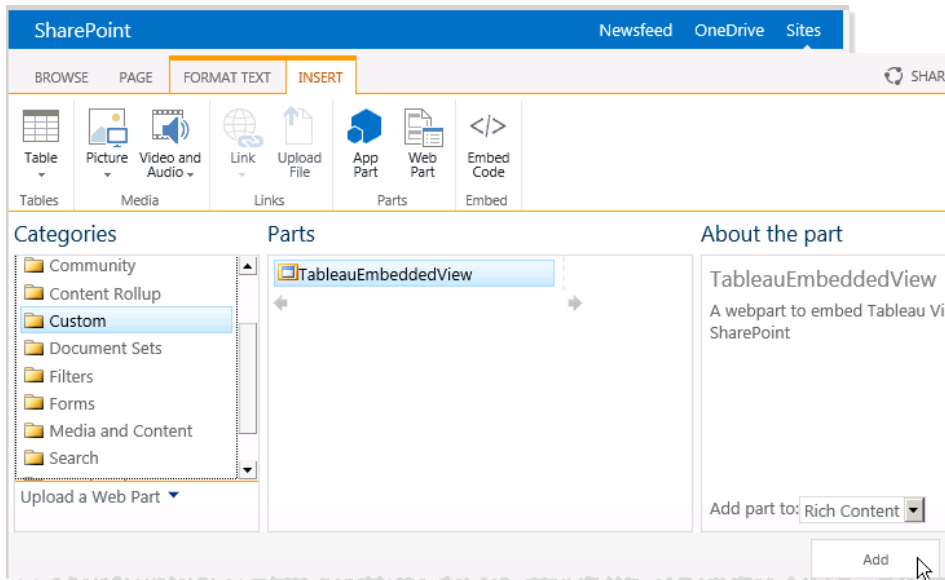

4. Select the TableauEmbeddedView web part, click the drop-down arrow, and then select **Edit Web Part**.

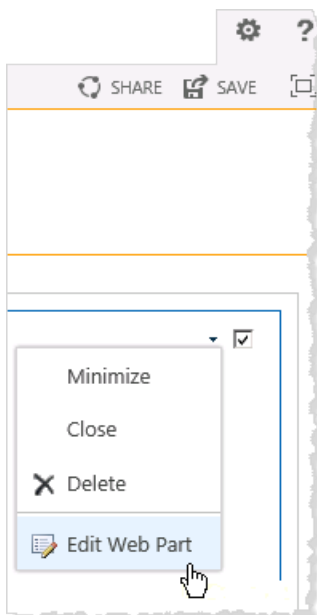

5. On the right side of the page, you can specify the attributes of the TableauEmbeddedView web part.
 - In **Tableau Server Name**, enter the name of your Tableau Server. You do not need to enter "http://" before the Tableau Server name.

- In **View Path**, enter the path to the view you want to embed.
- Specify whether you want to show the toolbar, use Trusted Authentication, use SSL, or if you want to embed the view as an image instead of as an interactive view.
- In the **Appearance** section you can specify a **Title** for the web part, the **Height**, **Width**, **Chrome State**, and **Chrome Type**. In general you should specify a fixed height (for example, 700 Pixels) and adjust the width to fit the zone.

myTableau Stats

Tableau View Settings

Tableau Server Name
YourTableauServerName

View Path
/views/VizName/WorkbookName

Show Toolbar

Use Trusted Authentication

Use SSL

Embed view as an image

Image Width
pixels

Image Height
pixels

Appearance

Title
MyDataDisplayName

Height
Should the Web Part have a fixed height?
 Yes 700 Pixels No. Adjust height to fit zone.

Width
Should the Web Part have a fixed width?
 Yes No. Adjust width to fit zone.

6. Click **OK** to apply the changes and exit edit mode.

The view will be embedded into the web part that you just created. To see the view, your users will be automatically authenticated using Active Directory.

Embed Tableau Server Views into SharePoint (Local Authentication)

Note: The following procedure for embedding Tableau views into SharePoint was retired in Tableau 2023.3. You can no longer embed Tableau views following these instructions.

If your Tableau Server uses Local Authentication to authenticate users, there are some extra steps you need to take so they can see views embedded in SharePoint pages.

If your Tableau Server instead uses Active Directory to authenticate users, see [Embed Tableau Server Views into SharePoint \(Active Directory Authentication\)](#) on page 3411. If you don't know which type of authentication your Tableau Server uses, ask your administrator.

Requirements

- To embed views, you need SharePoint 2013 or later.
- To see embedded views, users must have a Tableau Server license and the same user name on SharePoint.

Edit Security Permissions for TableauEmbeddedView.dll

Edit the security permissions for TableauEmbeddedView.dll so that all users of the operating system can use it.

1. Locate the TableauEmbeddedView.dll and TableauEmbeddedView.wsp files that install with Tableau Server. If Tableau Server is installed on drive C, the files will be in the following directory:

```
C:\Program Files\Tableau\Tableau Server\packages\extras.<version_code>\embedding\sharepoint\
```

2. Copy the files to the root directory of your SharePoint server. The root directory is usually located at C:\Inetpub\wwwroot\wss\VirtualDirectories\<port>\bin, for example:

```
C:\Inetpub\wwwroot\wss\VirtualDirectories\80\bin
```

3. To edit the security permissions on TableauEmbeddedView.dll, right-click **TableauEmbedded.dll** and then select **Properties > Security**.
4. Under **Group or user names**, select **Everyone**, and then click **Edit**.

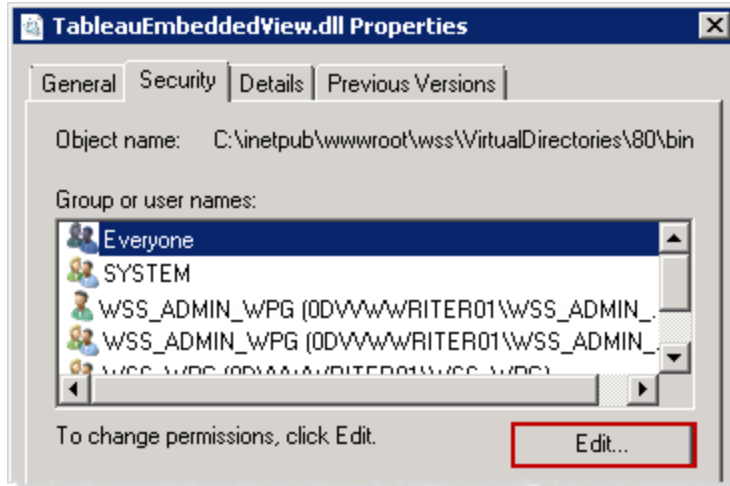

- Under **Permissions for Everyone**, for the **Full control** permission, select **Allow**.

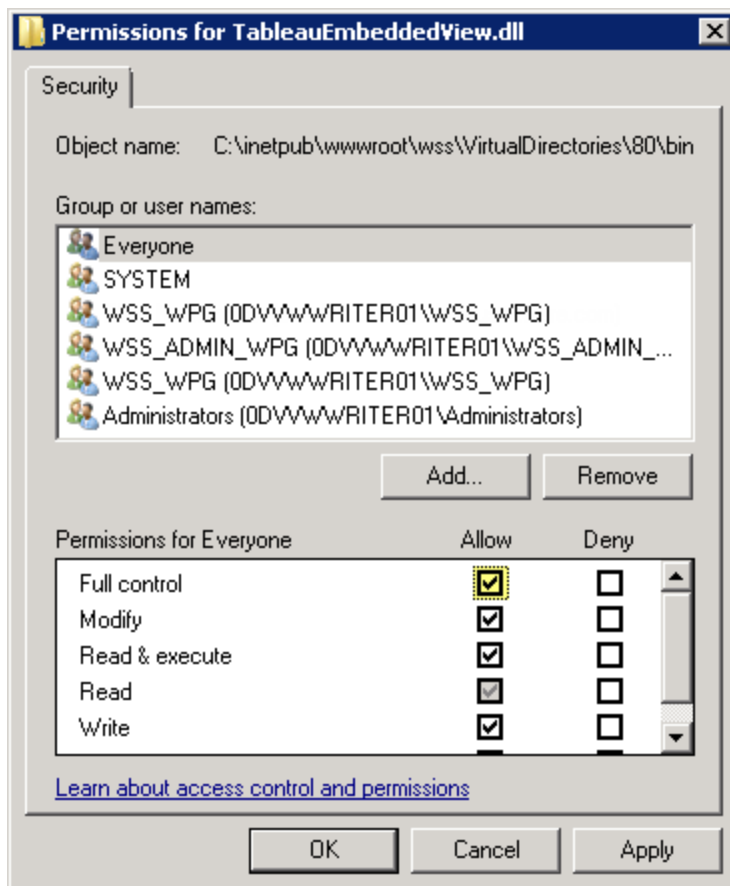

- Click **OK**.

Install and Deploy TableauEmbeddedView.wsp

The TableauEmbeddedView.wsp file gives SharePoint more information about what to do with the .dll file. You copied the TableauEmbeddedView.wsp file to the SharePoint root directory in the previous procedure. To install and deploy the .wsp file, follow these steps:

1. Open SharePoint 2013 Management Shell and enter the following command:

```
Add-SPSolution -LiteralPath  
"C:\Inetpub\wwwroot\wss\VirtualDirectories\80\bin\TableauEmbedded  
View.wsp"
```

2. On the SharePoint Central Administration home page, click **System Settings**.
3. In the **Farm Management** section, click **Manage farm solutions**.
4. On the Solution Management page, click the solution that you want to deploy.
5. On the Solution Properties page, click **Deploy Solution**.
6. On the Deploy Solution page, in the **Deploy When** section, select one of the following options:
 - **Now**
 - **At a specified time**. Specify a time by using the date and time boxes.
7. In the **Deploy To?** section, in the **A specific web application** list, click **All web applications** or select a specific Web application, and then click **OK**.
8. Open your SharePoint site. Click the settings icon, and then select **Site settings**.

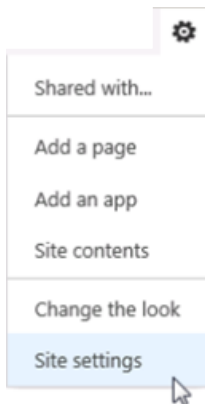

9. Under Site Collection Administration, click **Site collection features**.

10. Scroll to the TableauEmbeddedView feature and then click **Activate** to activate the feature.

Verify the Web Part's Deployment

In the following procedure, you will verify that the Tableau web part is installed.

1. Open your SharePoint site in a web browser.
It may take a few moments for the site to appear.
2. Click the settings icon, and then select **Site settings**.
3. Under **Web Designer Galleries**, click **Web parts**.

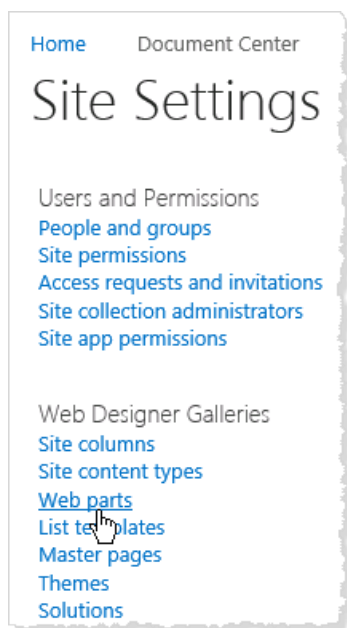

4. Confirm that **TableauEmbeddedView.webpart** is listed.

Embed a View Using the Tableau Web Part

You can embed the Tableau web part in a new or existing SharePoint page.

1. Open the page where you want to embed a view and switch to edit mode.
2. In the section of the page where you want to embed the view, on the **Insert** tab, click **Web Part**.
3. Under Categories, in the **Custom** (or **Miscellaneous**) folder, select **TableauEmbeddedView**, and then click **Add** in the lower-right corner.

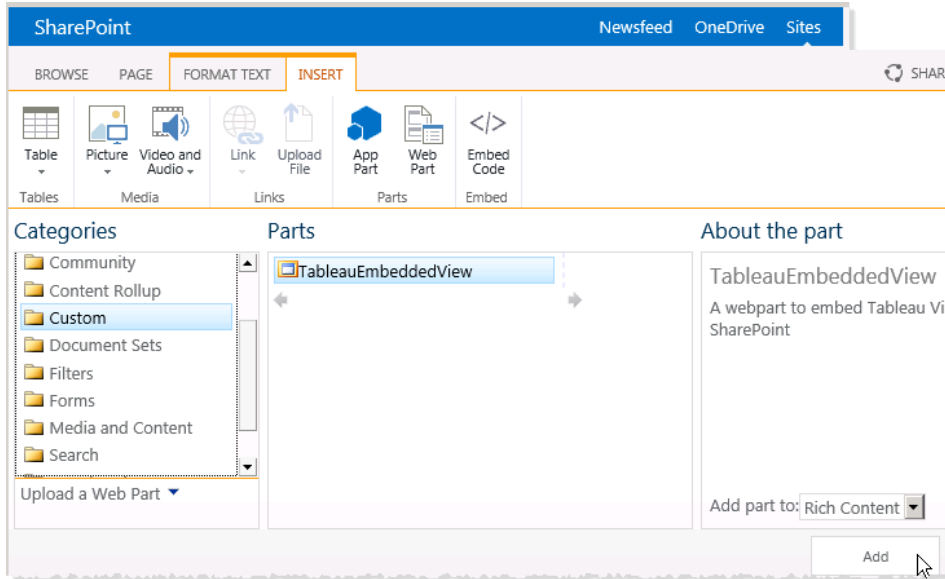

4. Select the TableauEmbeddedView web part, click the drop-down arrow, and then select **Edit Web Part**.

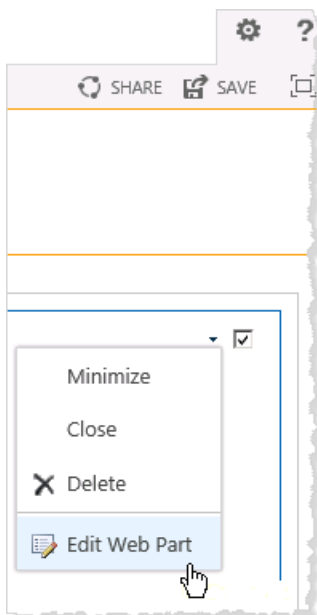

5. On the right side of the page, you can specify the attributes of the TableauEmbeddedView web part.
 - In **Tableau Server Name**, enter the name of your Tableau Server. You do not need to enter "http://" before the Tableau Server name.

- In **View Path**, enter the path to the view you want to embed.
- Specify whether you want to show the toolbar, use Trusted Authentication, use SSL, or if you want to embed the view as an image instead of as an interactive view.
- In the **Appearance** section you can specify a **Title** for the web part, the **Height**, **Width**, **Chrome State**, and **Chrome Type**. In general you should specify a fixed height (for example, 700 Pixels) and adjust the width to fit the zone.

myTableau Stats

Tableau View Settings

Tableau Server Name
YourTableauServerName

View Path
/views/VizName/WorkbookName

Show Toolbar

Use Trusted Authentication

Use SSL

Embed view as an image

Image Width
pixels

Image Height
pixels

Appearance

Title
MyDataDisplayName

Height
Should the Web Part have a fixed height?

Yes 700 Pixels

No. Adjust height to fit zone.

Width
Should the Web Part have a fixed width?

Yes Pixels

6. Click **OK** to apply the changes and exit edit mode.

Now the view is embedded in the page and users who access it will be automatically signed in based on their user name and password for SharePoint.

This is an example of embedding views into SharePoint using the provided .dll file. You can also embed views into other types of web applications. For more information, see the [JavaScript API](#) on the Tableau Developer Portal.

Embed Tableau Views into Salesforce

The Tableau Viz Lightning web component was retired from Salesforce AppExchange in May 2024 and replaced by the Tableau View native component. For more information, see [Configure Tableau Lightning Web Components and Single Sign-On \(SSO\) with Token Authentication](#).

You can easily embed Tableau views into Salesforce Lightning pages using the native Tableau View Lightning web component. When you edit a Lightning page, you simply drag and drop the Tableau View Lightning web component onto the page and then provide the URL for the Tableau view. You can embed Tableau views from Tableau Server, Tableau Cloud, or Tableau Public. The Tableau View Lightning web component supports all versions of Tableau. Using the Tableau View Lightning web component, Salesforce administrators and developers can quickly integrate Tableau dashboard into Salesforce pages.

You can [set up Tableau Server and Tableau Cloud for single sign-on \(SSO\)](#), so that users of the Tableau Lightning web component won't have to sign in to Tableau every time they visit the Salesforce page.

The Tableau Lightning web component includes built-in support for filtering the view based upon the Lightning record page you are embedding the view in. The component lets you configure how the view is displayed in Salesforce, and provides additional filtering capabilities based upon Tableau and Salesforce fields you select.

Requirements and Permissions

- The Tableau View Lightning web component is designed to run on the Salesforce Lightning Experience. Lightning web components are supported in many Salesforce experiences and tools such as Lightning Communities and Salesforce App. Salesforce Classic and Marketing Cloud do not support the Tableau View Lightning web component.
- To configure the Tableau View Lightning component, you need to have administrator privileges for the Salesforce org.
- Context and advanced filtering of the Tableau view is only available on Lightning Experience record pages.

The Tableau View Lightning web component only supports the Salesforce Lightning Experience. If you want to embed a Tableau view into Salesforce Classic, you have other options. You could use the Salesforce Canvas Adapter for Tableau, or create a custom solution using Apex code and Visualforce pages.

Configure single sign-on (SSO)



If you are embedding a Tableau view from Tableau Server or Tableau Cloud, you might want to configure SSO with Salesforce. That way when users sign into Salesforce and open a page that contains an embedded Tableau view they won't need to re-authenticate with Tableau. The Tableau View Lightning web component only supports SAML as the SSO method. The SAML IdP used for Tableau authentication must be either the Salesforce IdP or the same IdP that is used for your Salesforce instance. Configuring Tableau Server or Tableau Cloud requires Tableau administrator permissions.

Note: Users in Tableau Cloud who are configured with [Salesforce Authentication](#) will need to reauthenticate to view embedded visualizations in Tableau Cloud.

- For information about setting up SSO with Tableau Cloud, see [Configure SAML with Salesforce](#) and [Configure SAML for Tableau Viz Lightning Web Component](#).
- For information about setting up SSO with Tableau Server, see [Configure SAML for Tableau Viz Lightning Web Component](#).

Add the Tableau view to the Lightning page

Use the native component to add a Tableau view to Lightning Experience pages.

1. From the App Launcher (), find and select a page to embed the Tableau visualization. (For example, select **Sales** or any other App that provides a home or record page where you can embed the Tableau Lightning web component).
2. Click the Setup gear () and then select **Edit Page**.
3. Drag the **Tableau View** component from the Lightning Components list to the top of the Page Canvas.
4. Select a Tableau view to display by providing the URL for the view in the **Enter the Viz URL** text box.

5. To find the URL for a view on Tableau Server or Tableau Cloud, click **Share** on the toolbar and select **Copy Link** from the Share View dialog box. For Tableau Public, copy the URL for the view from the address bar in your browser.
6. In Salesforce, use the options for the **Tableau View** component to control the height of the view and whether you want to show the Tableau toolbar or any tabs for the view.

You can also control when the Tableau View Lightning web component appears by selecting component visibility filters. For more information about the **Set Component Visibility** options, see [Dynamic Lightning Pages](#) in the Salesforce Help.

For the best experience, you might want to configure Tableau and Salesforce to use SSO. See [Configure single sign-on \(SSO\) on the previous page](#).

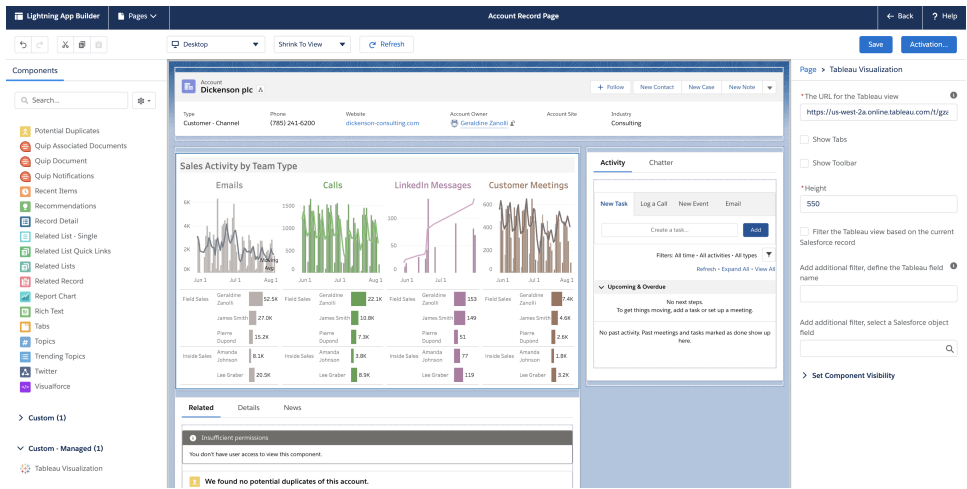

Filter the view based upon the page context

The Tableau Lightning component supports two ways of filtering the Tableau visualization. These methods of filtering only work on Lightning record pages. Filtering is not available for Home pages or App pages. For record pages, you can automatically filter the Tableau visualization based upon the page it is embedded in (*context filtering*), or you can specify the fields to use for filtering in Tableau and in Salesforce to create more sophisticated views.

To have the view filtered based upon the page it is embedded in, the Tableau view needs to have a field that corresponds to the record page ID. For example, if you want to embed a view for sales on a user's page that shows just the sales for that user, the Tableau view should include a field or parameter that holds the record IDs for users.



1. In your Salesforce org, select a record page where you want to embed the viz (for example, Users or Opportunities).
2. Edit the record page and configure the component by entering the URL of the Tableau view that contains the data you want to display. The Tableau visualization must include a field that holds the record IDs (for example, user or account IDs).
3. Select **Filter visualization based on the page** and save your changes to the page.

When the record ID of the page matches the corresponding value in a field in the Tableau view, the Tableau Lightning component applies that filter. For example, if you want to embed a Tableau view on the Account page and filter for the specific account, the Tableau view needs to have a field named **Account ID**. The Tableau Viz Lightning web component uses the default field name when a user connects to Salesforce using Tableau.

Apply filters based upon on Tableau and Salesforce fields

If you want more control over filtering the Tableau visualization on a records page, you can map a field or parameter in Tableau to a specific field in Salesforce. The Tableau field or parameter needs to be on the view that you are embedding. The Salesforce field must be a qualified field on the page where you are embedding the view. When the values of these two fields match, the Tableau Visualization component will automatically filter the Tableau view.

To apply the advanced filtering, add the **Tableau View** component to a record page. For example, if you have a Tableau view that contains Salesforce data that is related to sales information, you can add that view to your opportunity record pages.

1. In your Salesforce org, click the App Launcher () , find and select **Sales** (or any other App that provides a record page where you can embed the Tableau Lightning component). For example, the click Accounts tab. Select an account, for example, Burlington Textiles from the All Accounts list.
2. Click the Setup gear () and then select **Edit Page**.
3. Drag the **Tableau View** component from the Custom area of the Lightning Components list to the top of the Page Canvas.
4. Configure the component.

- Enter the URL of the Tableau view that contains the sales data you want to display.
- Provide the name of the Tableau field to use for filtering. The Tableau field needs to be the name of a field in the view that you are embedding. For example, the view might contain a field for the **User ID**.
- Provide the name of the Salesforce field to use in filtering. You can select the qualified field names for the page from the drop-down list. For example, on the account record page, you could select **Owner ID**.

When the values from these two fields match, the Tableau View component automatically filters the view.

Important: You must enter field names as they are defined in the data source. For example, if the data source is in English, but the data source fields are translated to Japanese for a user, the user must enter the original English field name.

5. Save your changes to the page.

Link to a PNG, PDF, or CSV of a View

Note: To download to these formats rather than link to them, instead see [Download Views and Workbooks on the next page](#) Or, if you're using Tableau Desktop, see [Export Views](#) and [Export Data](#).

If you work with a website or application that doesn't support [embedded, interactive Tableau views](#), you can link to PNG or PDF versions of them.

If you're familiar with scripting, you can also use links to automatically convert multiple views into PNGs, PDFs, or even CSVs. The resulting files can be shared with people who lack Tableau Cloud or Tableau Server accounts, incorporated into presentations, or archived for future reference.

When you link to any of these formats, they always load the latest data available on the server. But be aware that CSVs of dashboards link to only one sheet—the one whose title is first in alphabetical order.

1. With the help of a Tableau content owner or site administrator, ensure that your audience has [permission to access the content](#). (If you're using a script to process multiple files, only you need access.)

- For links to PNG and PDF files, users need the Download Image/PDF permission.
 - For links to CSVs, users need the Download Full Data permission.
2. Replace the end of a view's browser URL with the appropriate file extension.

For example, change

```
http://<servername>/#/views/<workbook>/sheet?:iid=7 to
```

```
http://<servername>/#/views/<workbook>/sheet.png
```

3. If you want to filter a view, add a question mark after the file extension, followed by **URL parameters** that reflect the view's data structure.

For example, change `http://<servername>/#/views/<workbook>/sheet.png` to

```
http://<servername>/#/views/<workbook>/sheet.png
```

```
?Region=South&Department=Sales
```

Download Views and Workbooks

Note: To link to views in other formats rather than download them, instead see [Link to a PNG, PDF, or CSV of a View on the previous page](#). Or, if you're using Tableau Desktop, see [Export Views](#) and [Export Data](#).

1. At the top of a view in Tableau Cloud or Tableau Server, click **Download**. Or, click the download button  wherever it appears on the page.

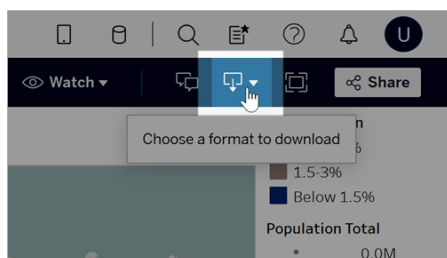

2. Select a download format:

Note: The download formats available to you depend on permissions granted by Tableau content owners and site administrators.

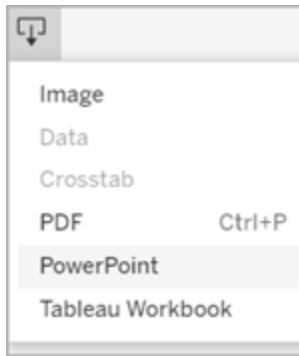

- **Image:** Downloads an image of the view in .png format. Any filters, parameters, or selections currently applied in Tableau are reflected in the downloaded image.
- **Data:** Opens a new tab in the browser window and displays the view's data in summary and detail. You can then download the data as a comma-separated value (.csv) file.

When downloading from a dashboard, first click the specific sheet with data you want.

- **Crosstab:** Opens a dialog window to select download options. If viewing a dashboard, select a sheet from the dashboard to download. Under Select Format, select .csv or Microsoft Excel .xlsx.

For dashboards, all sheets will be listed, including hidden sheets.

Any filters, parameters, or selections currently applied in Tableau are reflected in the downloaded crosstab.

- **PDF:** Opens a dialog window to select download options. Under **Include**, select the the part of the workbook you want to download. Select this view, specific sheets from a workbook or dashboard, or select all. Select Scaling to control the image's appearance on the PDF. Select Paper Size and Orientation.

If you're downloading a dashboard to PDF format, web page objects aren't included.

- **PowerPoint:** Downloads selected sheets as images on individual slides in a PowerPoint presentation. For untabbed views, you can select only currently visible content. However, hidden sheets visible in a dashboard can be selected if you choose **Specific sheets from this workbook**. If you select a story sheet, all story points export as separate slides.

Any filters, parameters, or selections currently applied in Tableau are reflected in the exported presentation. The generated PowerPoint file includes a title slide with the name of your workbook and the date the file was generated. The title is a hyperlink that opens the workbook in Tableau Cloud or Tableau Server.

- **Tableau Workbook:** Downloads a workbook you can open with Tableau Desktop. (As an alternative, you can select **Server > Open Workbook** in Tableau Desktop.)

You have the option of downloading the workbook to different versions of Tableau or keeping the workbook in its current version. For example, if the workbook needs to be opened in Tableau Desktop 2022.2, select Tableau 2022.2. For information about version compatibility, see [Make Workbooks Compatible with Older Versions on page 3132](#).

When downloading workbooks and views, the content of the .twb or .twbx file is stored in plain text. All data, including filter values that may give semantic clues to the data, will be readable by anyone who opens the file.

Note: Downloading extremely large amounts of data can affect server performance and might not complete successfully. If you encounter these issues, try exporting the data directly from the underlying data source.

Receive Notifications, Search, and Share Using the Tableau App for Slack

The Tableau App for Slack lets you work and collaborate right where you work in Slack. In Tableau 2023.1 or later, you can search for views and workbooks, and easily access your favorite and recently viewed Tableau content from the Tableau App for Slack. With the Tableau App for Slack, you can also see snapshots of visualizations, with links back to your Tableau site for further exploration. Some features (such as sharing and searching Tableau content from Slack) aren't yet available in Tableau Server. Currently, Tableau Server users can receive notifications.

In Tableau 2021.3 and later, you can get Tableau notifications in Slack for data-driven alerts, sharing activity, and comment mentions. If the notification contains a view or workbook you have access to, the notification will also contain a visual snapshot.

Administrators can connect their Tableau site to a Slack workspace to enable the Tableau App for Slack for their entire organization. For more information, see "Integrate Tableau with a Slack Workspace" in the [Tableau Cloud](#) or [Tableau Server](#) help.

After your Tableau admin connects your Tableau site to a Slack workspace:

1. Add the Tableau App for Slack.
2. Select **Connect to Tableau**.
3. Log in to your Tableau site.
4. Authorize the app by choosing **Allow**.

Note: For information about privacy, see the [Privacy Policy](#).

Search, share, and access recents and favorites from Slack

From the Tableau App for Slack **Home** tab, you can search for views and workbooks on your Tableau Cloudsite.

After you've found the Tableau content you're looking for, select the name of the Tableau content to open it directly in Tableau or select Share to send the content to an individual or Slack channel. You can also write a custom message to provide context about the Tableau content you're sharing.

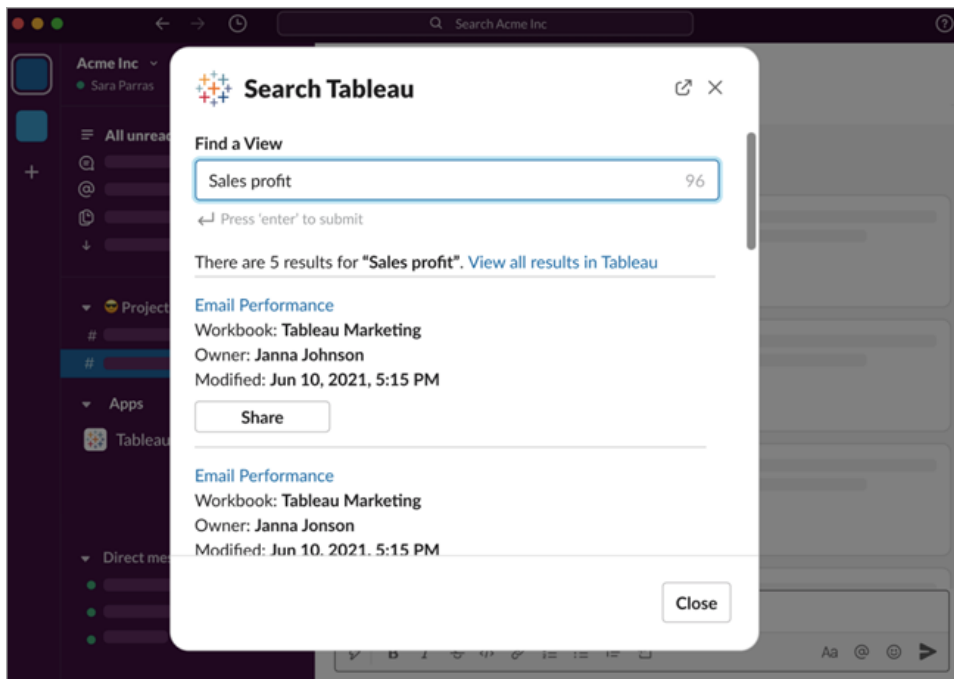

Choose **Share with Snapshot** to include a preview (Slack link unfurling) of the Tableau content in your message. You can share a snapshot if the Tableau content doesn't contain filters that restrict data access (for example, row-level security). The snapshot is visible to all people you share it with, regardless of their access level.

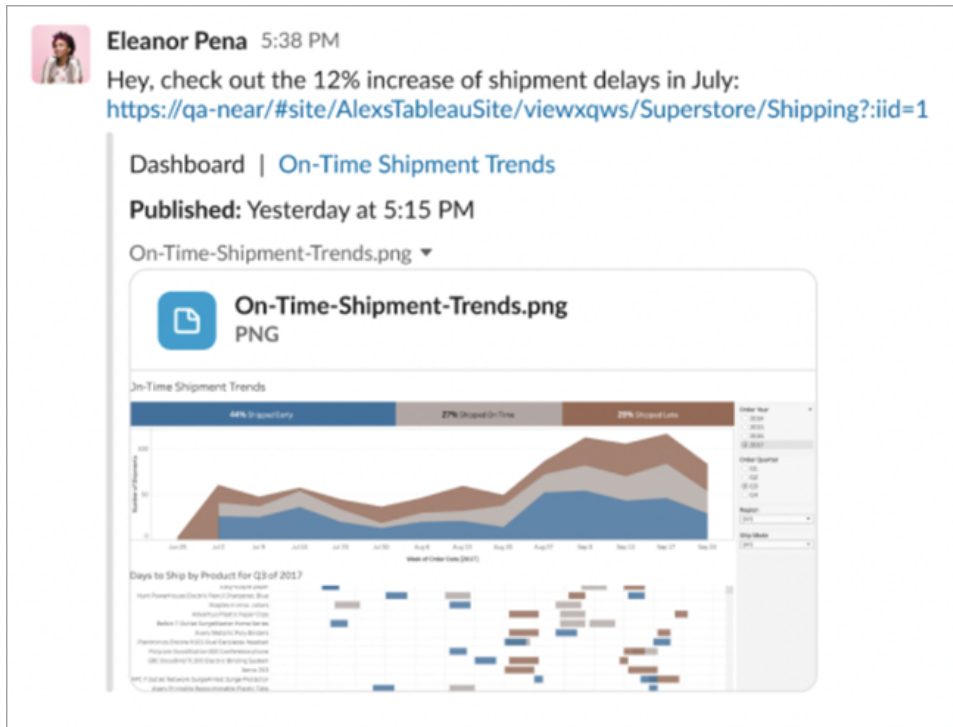

And without leaving Slack, you can access recently viewed Tableau content and your Tableau favorites. From the Tableau App for Slack **Home** tab, you see the five Tableau views or workbooks you visited most recently. You can also access five of your favorite Tableau views or workbooks.

Select the name of the Tableau view or workbook to open it directly in Tableau, or select the more actions menu (...) to share favorite or recently viewed Tableau content.

Receive Tableau notifications in Slack

Comments

Get notified when you're @mentioned in a comment to keep the conversation going. For more information, see [Comment on Views](#).

Tableau Desktop and Web Authoring Help

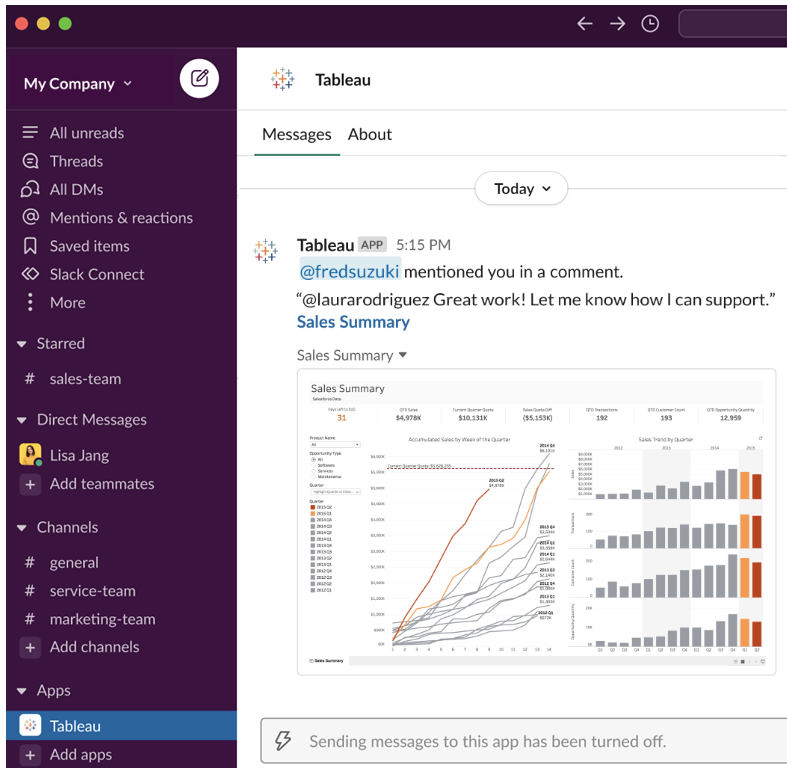

Share

See when a teammate sends a Tableau asset your way, including views, workbooks, and more. For more information about sharing, see [Share Web Content](#).

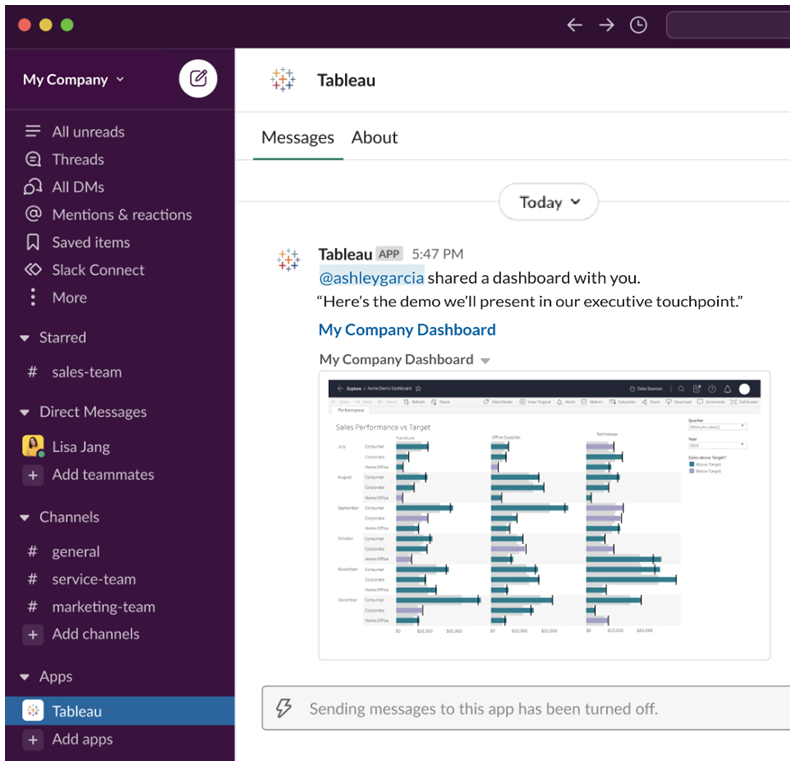

Data-driven Alerts

You can specify a threshold for your data and get alerted when it's met. For more information, see [Send Data-Driven Alerts from Tableau Cloud or Tableau Server](#).

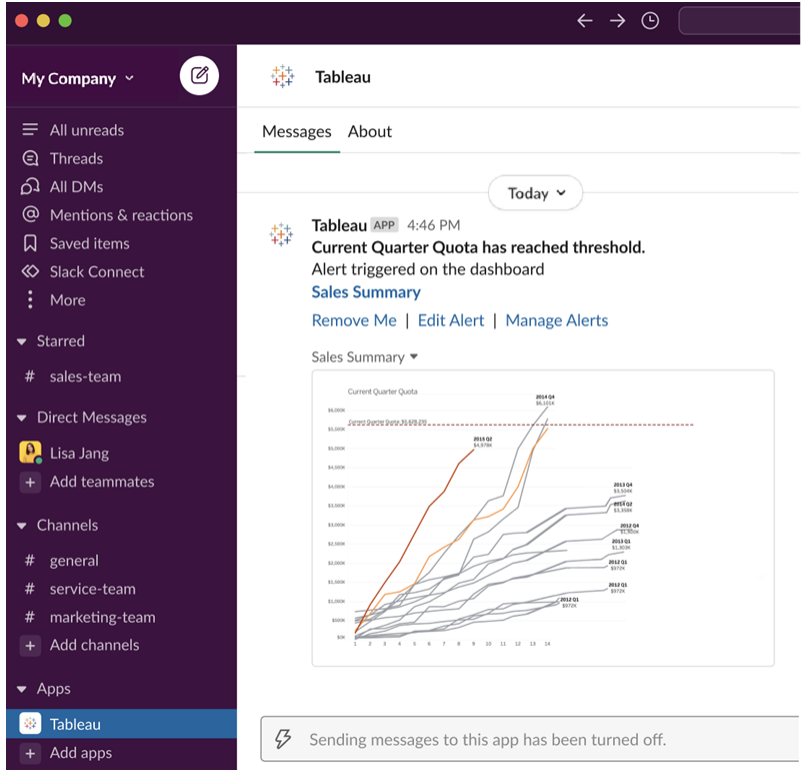

Manage Tableau notifications for Slack

Your Tableau site admin can turn on or off all notifications across the site. Tableau admins and Slack workspace admins integrate your Tableau site with Slack, and control whether site users can receive notifications. If it's enabled and your Tableau site administrator allows notifications, all site users can receive notifications in Slack through the Tableau App for Slack. Sometimes notification preferences aren't available because the site has other settings configured that affect notifications.

To control which notifications appear in your Slack workspace, or to turn off Slack notifications, at the top of a page, click your profile image or initials, and then select **My Account Settings**.



Under Notifications, select or clear the check boxes under **Slack** for comment mentions, share, and data alerts.

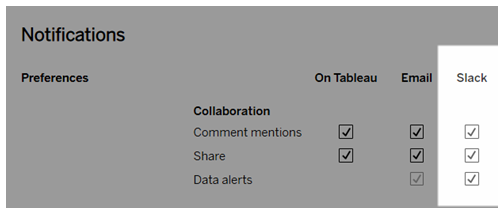

Select **Save Changes**.

For more information, see **Change notification settings** in [Manage Your Account Settings](#).

Web Authoring and Tableau Desktop Feature Comparison

For anyone familiar with Tableau Desktop and new to the web authoring environment in Tableau Server and Tableau Cloud, this topic provides a summary of the web features that you use similarly to the way you do in Tableau Desktop. It also lists some fundamental differences between the two environments.

Note: This topic summarizes core authoring functionality and does not cover every difference between the desktop and web environments.

Features listed by version

For a list of the latest web editing features to be added to each release, see the web authoring sections in [Tableau Desktop and Web Authoring Release Notes](#) and [Tableau Cloud Release Notes](#), or check out the [Release Navigator](#) viz to filter and compare changes by release.

General differences in web authoring

- Your authoring capabilities are determined by your license level. For an overview of what you can do with each license level, see [What can I do with a Tableau site?](#)

- You can access right-click menu actions on fields in the view, but not on every item in the workspace.
- Keyboard shortcuts for web authoring and Tableau Desktop are not the same. For a list of web authoring keyboard shortcuts, see [Shortcuts for web authoring](#).

Web authoring capabilities

In the web environment, you can connect to data and create workbooks from those data sources, or data published through Tableau Desktop. You can edit views created on the web or published from Tableau Desktop.

Administrators can set at the site level what web authoring abilities users can have. Explorers can edit workbooks, create new workbooks from published data sources, connect to published data sources, and create and edit views, dashboards, and stories. Creators have those same capabilities, but can also create new workbooks, connect to data on the web, and use Ask Data and (in Tableau Cloud) Dashboard Starters to quickly dive into analysis.

Data management

- **Creators:** Connect to data sources, upload files (text, excel, and Tableau workbooks), or use pre-built Dashboard Starter templates for certain data sources. For more information, see [Creators: Connect to Data on the Web](#).
- **Creators:** Prepare data on the web in the Data Source page. For more information, see [Creators: Prepare Data on the Web](#).

Note: There is a limitation on the number of rows that can be viewed in the Data Source page when authoring data on the web, determined by browser:

- Internet Explorer: 10,000 rows
- Other browsers: 100,000 rows

Independent of browser, the total number of records (rows by columns) that can be viewed in the Data Source page on the web is **3 million**.

- Run Initial SQL when connecting with some data sources
- Relate your data to combine data from multiple tables

- Join data from different tables in the same data source or from different databases using a multi-connection data source
- Add a join calculation
- Union data
- Pivot data
- Copy values in a grid (Ctrl+C, or Command-C on a Mac)
- [Edit Data Sources](#)
- Clean data using the Data Interpreter
- Create a Custom SQL query
- **Explorers:** Connect to published data sources.
 - Blend published data sources.
 - Save a data source (embedded in a published workbook) as a separate, published data source.
 - Change aggregation of measures in the view. Change the default aggregation of measures in the Data pane.
 - Search for fields in the schema.
 - Duplicate, hide, or rename fields.
 - Change the data type of fields.
 - Convert measures to dimensions or vice versa.
 - Convert a discrete field to continuous and vice versa. This option is available for measures and date dimensions.
 - Assign a geographic role for a field.
 - Create aliases for members of dimensions.
 - Create and edit groups.
 - Create and edit sets (conditioned sets are not available)
 - Create, edit, and remove parameters. Formatting numbers and dates, and adding comments for the parameter are not supported on the web.

Analytics

- Create, edit, rename, duplicate, and clear sheets (views, dashboards, and stories) in a workbook.
- Use [Ask Data](#) to automatically create views.
- Use [Explain Data](#) to automatically create views.
- Search for fields in the Data pane with schema search
- Drag fields to the view, Rows, Columns, and different mark types in the **Marks** card.
- Use **Show Me** to create views. Also, from the Data pane, select and drag a field of interest to the view area to automatically create a "Show Me" view.
- View underlying data (via tooltips).
- Viz in Tooltip works in web views, but must be configured in Tableau Desktop. [Viz in Tooltip worksheets can be hidden](#), the same way you would hide worksheets used in stories or dashboards.
- [Actions](#) work in web views, but must be configured in Tableau Desktop.
- Create and edit calculated fields.
- Create bins from continuous measures, and edit bins.
- Create and edit table calculations, and use quick table calculations.
- Create sets and show set controls. (Note that you cannot create sets from cube data sources in web authoring.)
- Use the **Analytics** pane to drag reference lines, trend lines, and other objects into the view. Edit reference lines, trend lines, and bands. Create and configure reference distributions on a continuous axis. Adding a cluster, and adding and modifying a forecast, are not supported for the web.
- Create groups by selecting marks in the view and then clicking Group Members (paperclip) in the tooltip for that selection. You can also edit existing groups in the Data pane.
- Create hierarchies by dragging one dimension onto another in the Data pane. **Note:** You can't create hierarchies when fields are already grouped within a folder.
- Change options for interacting with maps, including enabling or disabling pan and zoom, or showing map search, the view toolbar, or map scale. Users can also map units.

- Drill up and down a continuous hierarchy in the view. In a view with a continuous hierarchy, hover near the headers on a continuous axis to display the + and - controls. Click to drill down or up.
- Show labels, totals, and subtotals.
- Show, hide, and format mark labels
- Show and hide titles and captions.
- Show and hide cards for filters and highlighters.
- Show, hide, and resize headers in the view.
- Swap X and Y axes. Resize axes in the view.
- Change the view size.
- Show and hide the View Toolbar for any view or dashboard.
- Duplicate a sheet as a crosstab view.

Filtering and sorting

- Use data highlighting.
- Add, edit, and remove filters, and edit filter control layouts.

Note: There is a limitation on the number of results that can be filtered when authoring data on Tableau Cloud or Tableau Server. Only the first 100 results are returned to limit the performance impact one user has when loading a large domain on the server.

- Filter across published data sources.
- Apply filters to multiple sheets
- Create context filters (**Add to Context** option in the Filters shelf) and dependent filters (**Only Relevant Values** option in a filter control shown in a view).
- Apply table calculation filters to totals in the view.
- Show hidden fields, and exclude or remove fields from the view.

- Sort fields in the view in ascending or descending order. Access the **Sort** dialog box by right-clicking a dimension on the Rows or Columns shelf. Nested sorting on dimension values within the context of each pane.
- Drag and drop headers to create a custom sort order within a view.

Formatting

- Resize the width of row headers and the height of column headers.
- Edit workbook formatting, including formatting lines.
- Edit worksheet and dashboard titles.
- Edit axes (double-click an axis in the view). Other options available: **Synchronize dual axes**, clearing the axis range (**Reset**), and tick mark settings. Enable or disable **Dual axis** in a field context menu (right-click a measure field on Rows or Columns shelf). Logarithmic scales can be positive or symmetric (includes 0 and negative values).
- Edit number formatting (decimal places, percentage, thousands separator, units, and currency).
- Create, edit, move, and resize point, mark, and area annotations.
- Add and edit dashboard objects, including: horizontal and vertical layout containers, text, images, navigation buttons, web page links, and dashboard extensions.
- Create transparent worksheet backgrounds (set background color to **None**). Combine transparent worksheets with transparent filters, highlighters, and parameters.
- Change the color palette. For categorical fields you can assign specific colors and custom colors (using a hex code) to data items. For continuous fields, you can set custom colors for start and end colors (using a hex code).
- Create, rearrange, and preview device-specific dashboard layouts
- Set a dashboard item's exact size, position, and spacing.
- Add padding, borders, and background colors around items in dashboards.
- Select a background map in map views.
- Legends per measure. If you create separate color legends for the measures in your view, Tableau assigns the default color palette to each new color legend. To change the color legend for each measure, click the drop-down arrow on the color legend to open the **Edit**

Colors dialog box and select the palette that you want to use. For more details, see [Legends per measure](#).

Related topics

[What can I do with a Tableau site?](#)

[Set a Site's Web Authoring Access](#)

[Getting Started with Web Authoring](#)

[Creators: Connect to Data on the Web](#)

[Creators: Prepare your Data on the Web](#)

[Build Views on the Web](#)

[Grant Web Edit, Save, and Download Permissions](#)

Install or Upgrade Tableau Desktop

For comprehensive installation information, see the [Tableau Desktop and Tableau Prep Deployment Guide](#).

When you install or upgrade you have the option to share usage data with us to help us continually improve our product to better meet your needs. For more information about the data we collect, see [Tableau Product Usage Data](#). For information about how to opt out of sharing usage data see [Turn off usage reporting](#) in the Tableau Desktop and Tableau Prep Deployment Guide.

Accessing the repository from a previous version

When you upgrade to Tableau 2022.4 from previous versions, your repository is upgraded. Any bookmarks, workbooks, and data sources that you had in your old repository will still be accessible by the application. In addition, the new sample data sources and workbooks will replace the old samples unless you have modified them and saved them as your own.

Note: Your recent workbooks are automatically imported and restored to your Start page along with your recent connections list and any organization-specific settings on the Discover pane.

Accessing the repository from a beta version

If you have participated in the Tableau Software Beta program, you also have a beta repository. While this folder will still exist after you install Tableau 2022.4, the application will no longer access it. To make your beta workbooks accessible in Tableau 2022.4, copy the workbooks from the beta repository to your new 2022.4 repository.

Turn Product Updates Off or On

To ensure that you always have the most up-to-date features, security resolutions, and corrected issues, Tableau Desktop includes a product update feature. When you start Tableau Desktop,

product updates prompts you to download an updated maintenance version of Tableau Desktop, if one exists. The update downloads immediately and then installs when you exit Tableau.

You can also choose to postpone or skip the update. If you do this, you can always check for product updates at any time by selecting **Help > Check for Product Updates**.

For more information about how to turn product updates off or on, see the [Control Product Updates](#) article in the Tableau Desktop and Tableau Prep Deployment Guide.

Note the following:

- The product update installers are downloaded to the Downloads/TableauAutoUpdate folder. If the Downloads folder doesn't exist, the installers are downloaded to the TEMP/TableauAutoUpdate folder.
- Updates are not downloaded and installed on your computer if your Product Maintenance has expired. For more information, see the [Renewing your Licenses with Tableau](#).
- You may not be prompted for product updates. There are a number of reasons why this may be so. For details, see the **Troubleshoot maintenance updates** section in the [Troubleshoot Tableau Desktop Installation](#) article in the Tableau Desktop and Tableau Prep Deployment Guide.

Turn off product updates

Product updates is on by default. You can turn off product updates from the Help menu, or on Windows, by running the installer.

Use the Help menu

Select **Help > Settings and Performance > Enable Automatic Product Updates** and clear the check box.

Run the installer (Windows only)

To turn off product updates on Windows, run the Tableau Desktop installer, and then click **Customize**. In the Custom setup dialog box,

1. Clear the **Check for Tableau product updates** check box.
2. Click **Install**.

To turn product updates on again, run the installer, click **Customize**, and select the check box.

Administrators control product updates

As an administrator, you can turn product updates off or on for your users. You can also determine the Tableau Desktop version that your users will update to. Rather than having users update to the version of their choice (or choose not to update), you can make sure that your users update to the version you choose. For more information, see the [Control Product Updates](#) article in the Tableau Desktop and Tableau Prep Deployment Guide.

Maintain Licenses for Tableau Desktop and Tableau Prep

Tableau Desktop and Tableau Prep Builder can be licensed under a term license model. When you purchase a new Tableau Server or a new Tableau Cloud subscription however, product keys are no longer issued for Tableau Desktop or Tableau Prep Builder. Instead, you use login-based license management to activate and sign in to Tableau Server or Tableau Cloud. For more information, see [Activate Tableau using Login-based License Management](#).

Term licenses must be renewed and the product key refreshed to continue providing uninterrupted service. You can continuously renew the term license as each specified period expires. If you don't renew your term license and the term expires, Tableau will stop working and you will no longer have access to the software. For more information about renewing your license, see [How to Renew your Tableau Licenses](#).

Note: Trial licenses for Tableau Desktop or Tableau Prep expire after a set period of time, usually 14 days. After the trial period expires, you'll need to [purchase a license](#) to continue using the product.

View data about your license

After you install Tableau Desktop or Tableau Prep open the application and then navigate to **Help > Manage Product Keys** from the top menu to see information about the type of license you have and when it expires.

You can also activate or deactivate a product key or refresh a maintenance product key from this dialog if you are not using the Virtual Desktop (ATR) option.

Note: Tableau offers term licenses that provide a range of capabilities. The type of license that you have is displayed in the **Product** field. For more information about the different type of user-based licenses that are available, see [User-based licenses](#) in the Tableau Server help.

Existing Tableau Desktop users may have a perpetual (permanent) license. Perpetual licenses don't expire and their **License Expires** field in the **Manage Product Keys** dialog box displays "Permanent". However, to get access to product updates and technical support you must purchase Support and Maintenance services. These services must be renewed to continue receiving the service. Perpetual (permanent) licenses are no longer available for Tableau Desktop.

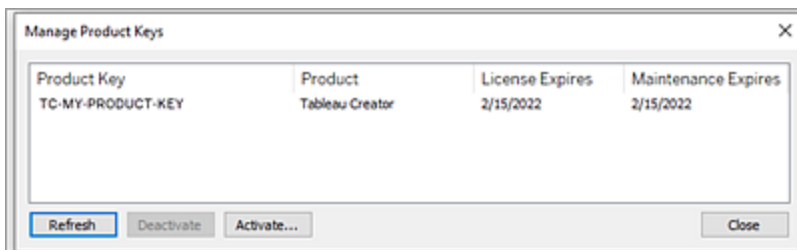

Use the following buttons to take action on your product key:

- **Refresh** (Non-login-based license management and non-Virtual Desktop only): Click the **Refresh** button to refresh a maintenance license that is expiring, then close and restart Tableau Desktop. If the **Maintenance Expires** date doesn't update, check with your license administrator as the key or maintenance agreement may have changed.

A product key whose License Expires value is listed as "Permanent," as shown in the Manage Product Keys dialog box above, is a legacy product key. You can refresh a Permanent product key at any time as long as the maintenance end date listed in the Tableau Customer Portal is higher than the date reflected in the Desktop Manage Product Keys dialog box.

If the product key has reached its expiration date (non-permanent product keys), you cannot refresh the product key. Visit the Tableau Customer Portal to obtain an updated subscription product key and perform a new activation. If the product key has not reached its expiration date, you can refresh the product key. When you refresh a product key that has not yet expired, only the "License Expires" value will change and not the product key. The product key will change when it reaches its expiration date.

To refresh a maintenance key from the command line see [Refresh the product key](#) in the Tableau Desktop and Tableau Prep Deployment guide.

Note: You cannot refresh the product key if Tableau Desktop is offline. If you are activating Tableau Desktop in offline mode, you must obtain and activate a new key from the Tableau Customer Portal.

- **Deactivate** (Non-login-based license management and non-Virtual Desktop only): Select a product key in the list then click **Deactivate** to deactivate the product key. Deactivate a product key if you need to move the product key to another computer or when you no longer need the product key on this computer.

For more information about deactivating a product key, see [Move or Deactivate Product Keys](#) in the Tableau Desktop and Tableau Prep Deployment guide.

- **Activate:** After Tableau Desktop or Tableau Prep is installed, click **Activate** to open the activation dialog and enter your product key. If you get an error and can't activate Tableau Desktop or Tableau Prep using your product key, contact [Tableau Support](#).

For more information about activating a product key, see [Activate and Register your Product](#) in the Tableau Desktop and Tableau Prep Deployment guide.

Automatically refresh product keys using zero downtime licensing

Beginning in Tableau version 2021.1, internet-connected Tableau Desktop and Tableau Prep Builder users may not have to manually refresh product keys. Term licenses are automatically refreshed without requiring any action starting 14 days before subscription expiration if the user is signed onto Tableau Desktop or Tableau Prep Builder. Permanent product keys are not automatically refreshed and must be refreshed manually using the **Manage Product Keys** menu option.

Tableau Desktop and Tableau Prep Builder will attempt to silently refresh an active product key and will warn users 14 days before their license is set to expire if the silent refresh was unsuccessful. Tableau will attempt to refresh a product key three times (at 14 days, 2 days, and 1 day before license expiration) to reflect license end date extensions as a result of your subscription renewal. The product key is not refreshed unless a Tableau Desktop user signs onto Tableau Desktop during those times. For users who do not sign onto Tableau Desktop every day, you must refresh their product keys using the **Manage Product Keys** menu option.

Track Tableau Desktop license usage and expiration data

If you want to track and view license usage and expiration data for Tableau Desktop in Tableau Server you must configure Tableau Desktop to send license data to Tableau Server on a set interval, and then enable reporting on Tableau Server.

This enables server administrators to access two reports:

- **Desktop License Usage:** This report lets server administrators see usage data for Tableau Desktop licenses in your organization.
- **Desktop License Expiration:** This report gives server administrators information about which Tableau Desktop licenses in your organization have expired or need maintenance renewal.

If Tableau Desktop and Tableau Server are configured for license reporting, when signed in to Tableau Server as an Administrator, you will see these two reports listed on the **Server Status** page in the **Analysis** section.

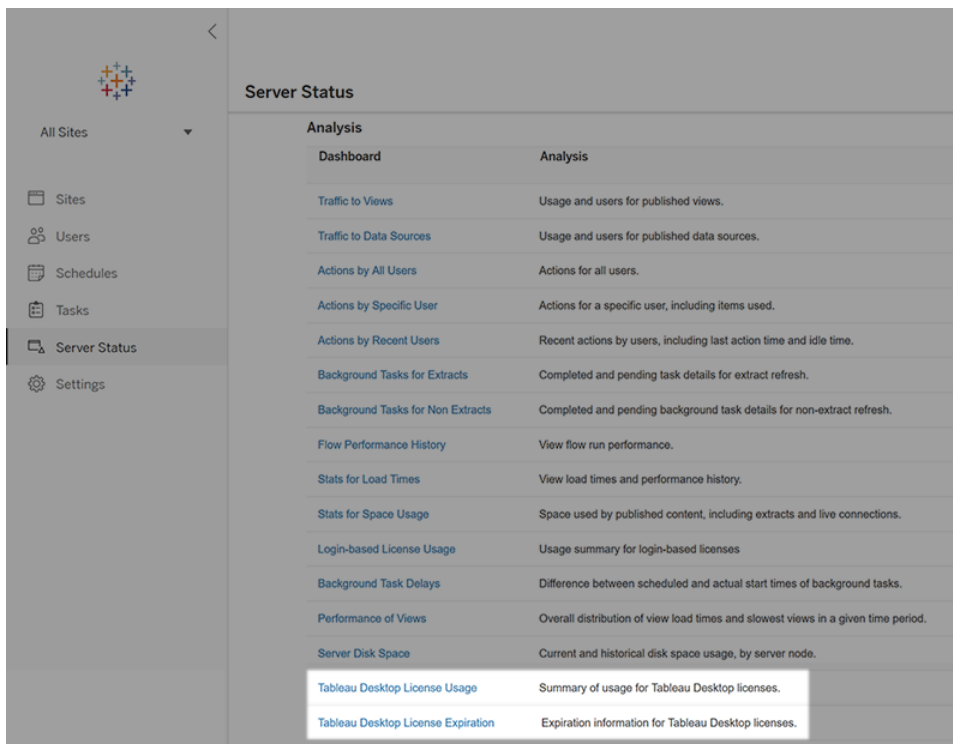

If you don't see these reports listed, then Tableau Desktop and Tableau Server may not be configured for Tableau Desktop usage reporting.

For information about how to configure Tableau Desktop and Tableau Server for usage reporting, see [Manage Tableau Desktop License Usage](#) in the Tableau Desktop and Tableau Prep Deployment guide.

Additional resources

For more information about managing your license refer to the following topics:

- To find your product key and activate Tableau Desktop or Tableau Prep Builder, see [Where's my product key](#).
- To deactivate a product key or move it to another computer, see [Move or Deactivate Tableau Desktop](#).
- To learn more about product keys for non-persistent virtual desktops or for computers that are regularly re-imaged, see [Configure Virtual Desktop Support](#).
- To learn more about product key management for Tableau Server or Tableau Cloud, see [Licensing Overview \(Linux | Windows\)](#)
- To learn more about the license renewal process or to renew a license, see [How to Renew your Tableau Licenses](#).

OAuth Overview

OAuth (Open Authorization) is an authentication protocol that allows users to grant limited access to their resources on one website or application to another website or application, without sharing their actual login credentials.

OAuth acts like a trusted middleman that enables you to give permission for one service to access your data from another service without revealing your username and password. This document includes a technical explanation of the OAuth workflow and a practical OAuth analogy.

OAuth workflow

OAuth provides a secure and standardized way for users to grant access to their data across different websites and applications without sharing their login credentials. It ensures that you have control over which services can access your data and allows you to revoke access at any time.

The following list is a step-by-step explanation of how OAuth works.

You (the user) want to use a website or application (called the "client") that requires access to your data on another website or application (called the "resource server").

The client requests permission to access your data from the resource server. It typically does this by redirecting you to the resource server's login page.

You enter your login credentials on the resource server's login page directly. This step is crucial because your username and password are never shared with the client.

The resource server verifies your credentials and authenticates you. Once authenticated, it generates a unique access token for the client.

The resource server redirects you back to the client application, providing the access token along with the redirection.

The client receives the access token and sends it to the resource server whenever it needs to access your data.

The resource server checks the validity of the access token. If the token is valid, it grants the client access to the requested resources for a limited period.

The client can use the granted access to retrieve or modify your data on the resource server, but only within the scope defined by the access token. The scope determines what actions and data the client can access.

If the access token expires or if the client needs additional permissions, the client can request a new access token by going through the authentication process again.

Practical OAuth analogy

The following is an analogy of how OAuth works using a practical scenario.

Imagine you are throwing a party, and you want to hire a caterer (the client) to handle the food. However, you don't want to give the caterer the keys to your house (your login credentials) because that would give them access to all your personal belongings. So, you use a trusted party organizer (OAuth) to manage the access.

You tell the party organizer that you want to hire a caterer. The party organizer knows how to handle access to your house and the caterer's services.

The party organizer contacts the caterer and sends them to your house for a meeting. You're not home at this point.

The caterer arrives at your house but realizes they can't enter without your permission (access token). They call you to ask for access.

You, as the homeowner, want to verify the caterer's credibility before granting access. So, you ask the caterer some questions to confirm their identity (authentication).

Once you're satisfied with the caterer's credentials, you give them a temporary access code (access token) through the phone. This code allows them to enter your house and prepare the food but only within the scope of their catering duties.

The caterer enters your house using the access code and starts setting up the food. They can access the kitchen and dining area but are restricted from entering other rooms.

After a specified period or when the party ends, the access code expires, ensuring that the caterer can't re-enter your house without your permission.

In this scenario, you (the homeowner) are the user, the caterer is the client application, your house represents your personal data on the resource server, and the party organizer is OAuth.

The access code serves as the access token, allowing the client (caterer) limited access to your resources (house) without compromising your login credentials (house keys).

OAuth acts as a trusted intermediary, facilitating the secure sharing of your data between services while maintaining control over access permissions.

Configure a forward proxy for OAuth authentication

You can configure a forward proxy in Tableau Server and Tableau Desktop to enable OAuth authentication. Forward proxies can help you manage traffic out to the internet for tasks such as load balancing.

Use Windows to connect to Tableau Desktop through a forward proxy

Complete the following steps to configure the proxy server in Windows LAN Settings.

1. Open the Local Area Network (LAN) Settings dialog box.

Tip: A quick way to get to this dialog box is to search for Internet Options in the Windows Start menu.

2. In the Internet Properties dialog box, select the Connections tab.

3. Select LAN settings.

4. Under Proxy server, select Use a proxy server for your LAN.

5. Enter the proxy server address.
6. Enter the server port.
7. Select **Bypass proxy server for local addresses**.

Note: If you've already followed the steps in [Configuring Proxies for Tableau Server](#) and OAuth requests through your proxy aren't working then follow option 2.

Windows configuration option 1: Use system environment variables

You can edit the system-wide environment variables and set `http_proxy` and `https_proxy` to your proxy to enable OAuth authentication.

1. In your Windows computer search box, enter **Advanced system settings**.
2. Tap **Enter** to open the **System Properties** box.
3. On the **Advanced** tab, select **Environment Variables**.
4. Scroll through the **System variables** field.
 - If the field has `http_proxy` or `https_proxy`, verify that the values don't conflict with the proxy server address that you configured in the previous step.
 - If they aren't set, then set them to the values that match the proxy server address configured in the previous step.
5. Restart Tableau Desktop.
6. Attempt to connect to an OAuth connector, and validate it works as expected.

Note: If you see a **OAuth-Client can't be empty** or **SSLHandshake Exception** or **Connection Refused** exception continue to option 2.

Windows configuration option 2: Configure Java net.properties proxy settings

1. In your file directory, locate the version of Java you're using to run Tableau Desktop.
`C:/Program Files/Tableau/Tableau <Version>/bin/jre`
2. In the Java locations directory, select the `conf` folder. If this directory doesn't exist, then create one.
3. In the `conf` folder, locate the `net.properties` file, and open it in an editor. If this file doesn't exist, then create one by the same name.

Note: If you don't have write permissions on this file, use the system file settings to enable them.

4. Modify or create the following values:

- `http.proxyPort=<your proxy port>`
- `http.proxyHost=<your proxy host address>`
- `https.proxyPort=<your proxy port>`
- `https.proxyHost=<your proxy host address>`

Warning: Make sure to only include the host. If your proxy address is `http://myproxy:8888`, then set it to: `http.proxyHost=myproxy`

5. Restart Tableau Desktop, and try to connect through OAuth.

Use Mac to connect to Tableau Desktop through a forward proxy

To use Mac to connect Tableau Desktop through a forward proxy you must configure Java `net.properties` proxy settings.

1. In your file directory, locate the version of Java you're using to run Tableau Desktop.

```
/Applications/Tableau <Version>/Plugins/jre
```

2. In the Java locations directory, select the `conf` folder. If this directory doesn't exist, then create one.

3. In the `conf` folder, locate the `net.properties` file, and open it in an editor. If this file doesn't exist, then create one by the same name.

Note: If you don't have write permissions on this file, use the system file settings to enable them.

4. Modify or create the following values:

- `http.proxyPort=<your proxy port>`
- `http.proxyHost=<your proxy host address>`
- `https.proxyPort=<your proxy port>`
- `https.proxyHost=<your proxy host address>`

Warning: Make sure to only include the host. If your proxy address is `http://myproxy:8888`, then set it to: `http.proxyHost=myproxy`

5. Restart Tableau Desktop, and try to connect through OAuth.

Use Windows to connect through a proxy that requires OAuth authorization

If your proxy requires you to sign in with a username and password, then complete the following steps so OAuth requests connect through the proxy.

1. In your file directory, locate the version of Java that you're using to run Tableau Desktop.

```
C:/Program Files/Tableau/Tableau <Version>/bin/jre
```

2. In the Java locations directory, select the `conf` folder. If this directory doesn't exist, then create one.

3. In the `conf` folder, locate the `net.properties` file, and open it in an editor. If this file doesn't exist, then create one by the same name.

Note: If you don't have write permissions on this file, use the system file settings to enable them.

4. Modify or create the following values:

- `http.proxyUser=<your proxy username>`
- `http.proxyPassword=<your proxy password>`

5. Restart Tableau Desktop, and try to connect through OAuth.

Use Mac to connect through a proxy that requires OAuth authorization

If your proxy requires you to sign in with a username and password, then complete the following steps so OAuth requests connect through the proxy.

1. In your file directory, locate the version of Java that you're using to run Tableau Desktop.

```
/Applications/Tableau <Version>/Plugins/jre
```

2. In the Java locations directory, select the `conf` folder. If this directory doesn't exist, then create one.

3. In the `conf` folder, locate the `net.properties` file, and open it in an editor. If this file doesn't exist, then create one by the same name.

Note: If you don't have write permissions on this file, use the system file settings to enable them.

4. Modify or create the following values:

- `http.proxyUser=<your proxy username>`
- `http.proxyPassword=<your proxy password>`

5. Restart Tableau Desktop, and try to connect through OAuth.

Use Windows to connect to Tableau Server through a forward proxy

You can launch Tableau Server from behind a forward proxy to allow internet access. You can configure the proxy server in Windows LAN Settings to connect to Tableau Server through a forward proxy.

Configure the proxy

Complete the following steps to configure the proxy server.

1. Open the **Local Area Network (LAN) Settings** dialog box.

Tip: A quick way to get to this dialog box is to search for Internet Options in the Windows Start menu.

2. In the **Internet Properties** dialog box, select the **Connections** tab.

3. Select **LAN settings**.

4. Under **Proxy server**, select **Use a proxy server for your LAN**.

5. Enter the proxy server address.

6. Enter the proxy server port.

7. Select **Bypass proxy server for local addresses**.

Add exceptions

You can add exceptions to guarantee that all communications within a local Tableau Server cluster don't route to the proxy server. Complete the following steps to add exceptions.

1. In the **LAN settings** dialog box, select **Advanced**.

Note: This button is available only if you've selected the option to use a proxy server for your LAN.

2. In the **Proxy Settings** dialog box, in the **Exceptions** field, enter the following values.

- localhost
- Server host names

- IP addresses of other Tableau Server computers in the same cluster.

Note: Use semicolons to separate items.

3. Close the **Proxy settings** dialog box.
4. Close the **Local Area Network (LAN) Settings** dialog box.
5. In the **Internet Properties** dialog box, select **OK** to apply the settings.

Note: If you've completed the steps in [Configuring Proxies for Tableau Server](#) and OAuth requests through your proxy aren't working then follow option 2.

Windows configuration option 1: Use system environment variables

You can edit system-wide environment variables and set `http_proxy` and `https_proxy` to your proxy.

1. In the Windows computer search box, enter **Advanced system settings**.
2. Tap **Enter** to open the **System Properties** box.
3. On the **Advanced** tab, select **Environment Variables**.
4. Scroll through the **System variables** field.
 - If the field has `http_proxy` or `https_proxy`, verify that the values don't conflict with the proxy server address that you configured in the previous step.
 - If they aren't set, then set them to the values that match the proxy server address configured in the previous step.
5. Restart Tableau Server.
6. Attempt to connect to an OAuth connector, and validate it works as expected.

Note: If you see a **OAuth-Client can't be empty, SSLHandshake, or Connection Refused** exception continue on to option 2.

Windows configuration option 2: Configure Java net.properties proxy settings

1. In your file directory, locate the version of Java you're using to run Tableau Server.

```
C:\Program Files\Tableau\Tableau Server\packages\repository*\jre
```

2. In the Java locations directory, select the `conf` folder. If this directory doesn't exist, then create one.
3. In the `conf` folder, locate the `net.properties` file, and open it in an editor. If this file doesn't exist, then create one by the same name.

Note: If you don't have write permissions on this file, use the system file settings to enable them.

4. Modify or create the following values:

- `http.proxyPort=<your proxy port>`
- `http.proxyHost=<your proxy host address>`
- `https.proxyPort=<your proxy port>`
- `https.proxyHost=<your proxy host address>`

Warning: Make sure to only include the host. If your proxy address is `http://myproxy:8888`, then set it to: `http.proxyHost=myproxy`

5. The proxy host default value is `http.nonProxyHosts =localhost|127.*|[::1]`. If the default value matches the list of exceptions, bypass the proxy server, and then continue to step 6. If they don't match make sure that it has the following values.

- `localhost`
- Server host names and IP addresses of other Tableau Server computers in the same cluster.
- Each item is separated by “|”

6. Restart Tableau Server and try to connect through OAuth.

Use Linux to connect to Tableau Server through a forward proxy

You can configure Java `net.properties` proxy settings to use Linux to connect Tableau Server through a forward proxy.

1. In your file directory, locate the version of Java you're using to run Tableau Server.

```
opt/tableau/tableau_server/packages/repository*/jre
```

2. In the Java locations directory, select the `conf` folder. If this directory doesn't exist, then create one.
3. In the `conf` folder, locate the `net.properties` file, and open it in an editor. If this file doesn't exist, then create one by the same name.

Note: If you don't have write permissions on this file, use the system file settings to enable them.

4. Modify or create the following values:

- `http.proxyPort=<your proxy port>`
- `http.proxyHost=<your proxy host address>`
- `https.proxyPort=<your proxy port>`
- `https.proxyHost=<your proxy host address>`

Warning: Make sure to only include the host. If your proxy address is `http://myproxy:8888`, then set it to: `http.proxyHost=myproxy`

5. The proxy host default value is `http.nonProxyHosts =localhost|127.*|[::1]`. If the default value matches the list of exceptions, bypass the proxy server, and then continue to step

6. If they don't match make sure that it has the following values.

- localhost
- Server host names and IP addresses of other Tableau Server computers in the same cluster.
- Each item is separated by “|”

6. Restart Tableau Server and try to connect through OAuth.

Use Windows to connect to Tableau Server through a proxy that requires OAuth authorization.

If your proxy requires that you sign in with a username and password, then complete the following steps to allow OAuth requests to connect through the proxy.

1. In your file directory, locate the version of Java you're using to run Tableau Server.

```
C:\Program Files\Tableau\Tableau Server\packages\repository*\jre
```

2. In the Java locations directory, select the `conf` folder. If this directory doesn't exist, then create one.

3. In the `conf` folder, locate the `net.properties` file, and open it in an editor. If this file doesn't exist, then create one by the same name.

Note: If you don't have write permissions on this file, use the system file settings to enable them.

4. Modify or create the following values:

- `http.proxyUser=<your proxy username>`
- `http.proxyPassword=<your proxy password>`

5. Restart Tableau Server, and try to connect through OAuth.

Use Linux to connect to Tableau Server through a proxy that requires OAuth authorization.

If your proxy requires that you sign in with a username and password, then complete the following steps to allow OAuth requests to connect through the proxy.

1. In your file directory, locate the version of Java you're using to run Tableau Server.

```
opt/tableau/tableau_server/packages/repository*/jre
```

2. In the Java locations directory, select the `conf` folder. If this directory doesn't exist, then create one.

3. In the `conf` folder, locate the `net.properties` file, and open it in an editor. If this file doesn't exist, then create one by the same name.

Note: If you don't have write permissions on this file, use the system file settings to enable them.

4. Modify or create the following values:

- `http.proxyUser=<your proxy username>`
- `http.proxyPassword=<your proxy password>`

5. Restart Tableau Server, and try to connect through OAuth.

SSL handshake errors

If you're getting errors, then check to ensure you have put your SSL cert into the correct keystore. On Windows, the keystore is under the system Trusted Certs store. If the keystore is correct, and you're still getting errors, then import your cert directly into the Java keystore. Complete the following steps to import your certificate into the Java keystore.

Export the SSL certificate for your proxy to a file.

Tip: You can find your certificate under Applications, Utilities, Keychain Access, System, Category, Certificates.

1. Locate the version of Java you're using to run Tableau.
2. Open the terminal command prompt.
3. Run the following command from the directory that contains the version of Java you're using to run Tableau.

```
Keytool -import -trustcacerts -file /Users/tableau_  
user/Desktop/SSL.cer -keystore Tableau  
<version>/Plugins/jre/lib/security/cacerts -storepass changeit
```

4. Restart Tableau Server or Tableau Desktop.

Note: If you get a **FileNotFoundException** (Access denied) when running the keytool command, try running the command with elevated permissions.

```
sudo keytool -import -trustcacerts -file /Users/tableau_  
user/Desktop/SSL.cer -keystore Tableau  
2021.3.1/Plugins/jre/lib/security/cacerts -storepass changeit
```

Keyboard Shortcuts

This is a list of keyboard shortcuts for working in Tableau. For information on navigating a view using a keyboard, see [Keyboard Accessibility for Tableau Views](#) on page 3257.

Shortcuts for managing workbooks, sheets, and files (Tableau Desktop)

Description	Windows shortcut	Mac shortcut
New workbook	Ctrl+N	Command+N
New worksheet	Ctrl+M	Command+T
Describe sheet	Ctrl+E	Command+E
Cycle forward through open work-sheets	Ctrl+Tab, Ctrl+F6	Shift+Command+Right bracket
Cycle backward through open work-sheets	Ctrl+Shift+Tab, Ctrl+Shift+F6	Shift+Command+Left bracket
Switch in and out of Presentation Mode	F7 , Ctrl+H	Option+Return
Switch in and out of Full Screen mode		Control+Command+F
Open file	Ctrl+O	Command+O
Save file	Ctrl+S	Command+S
Save file as	Ctrl+Shift+S	Shift+Command+S
Revert workbook to last saved state	F12	Option+Command+E
Close the current workbook	Alt+F4	Command+W

Print	Ctrl+P	Command+P
Open Help	F1	Control+Command+?

Shortcuts for managing workbooks, sheets, and files (Tableau Server, Tableau Cloud)

Description	Windows shortcut	Mac shortcut
New worksheet	Ctrl+Alt+T	Option+Command+T
Switch in and out of Full Screen mode	F11	Control+Command+F
Save file	Ctrl+S	Command+S
Save workbook as	Ctrl+Shift+S	Shift+Command+S
Close the current workbook	Alt+F4	Option+Q
Print (or export as PDF)	Ctrl+P	Command+P
Open Help	F1	Control+Command+/ Control+Command+?

Shortcuts for data (Tableau Desktop)

Description	Windows shortcut	Mac shortcut
Connect to data source	Ctrl+D	Command+D
Activate the find command in the Data pane	Ctrl+F	Command+F
Refresh data source	F5	Command+R
Run data updates on a view	F9	Shift+Command+0
Toggle automatic data updates on and off	F10	Option+Command+0

Shortcuts for data (Tableau Server, Tableau Cloud)

Description	Windows shortcut	Mac shortcut
Connect to data source	Ctrl+D	Command+D
Refresh data source	Alt+F5	Option+F5
Rename data source	Alt+F2	Option+F2
New data source	Ctrl+Alt+D	Control+D
Edit data source	Ctrl+Alt+Shift+D	Control+Shift+D

Shortcuts for authoring views (Tableau Desktop)

Description	Windows shortcut	Mac shortcut
Show Me!	Ctrl+1 , Ctrl+Shift+1	Command+1
Add the selected field to the sheet. (Only works with a single field.)	Enter or double-click	Return or double-click
Place selected field on Columns shelf	Alt+Shift+C	Option+Shift+C
Place selected field on Filters shelf	Alt+Shift+F	Option+Shift+F
Place selected field on Size	Alt+Shift+I	Option+Shift+I
Place selected field on	Alt+Shift+L	Option+Shift+L

Detail

Place selected field on Color	Alt+Shift+O	Option+Shift+O
Place selected field on Pages shelf	Alt+Shift+P	Option+Shift+P
Place selected field on Rows shelf	Alt+Shift+R	Option+Shift+R
Place selected field on Shape	Alt+Shift+S	Option+Shift+S
Place selected field on Text/Label	Alt+Shift+T	Option+Shift+T
Place selected field on Rows shelf	Alt+Shift+X	Option+Shift+X
Place selected field on Columns shelf	Alt+Shift+Y	Option+Shift+Y
Open the Drop Field menu	Right-click+drag to shelf	Option+drag to shelf
Copy a field in the view and place it on another shelf or card	Ctrl+drag	Command+drag
Swap rows and columns	Ctrl+W	Control+Command+W
Flip orientation of column labels at bottom of view	Ctrl+L	
Toggle dashboard grid on and off	G	G
Toggle between Dash-	T	T

board and Layout tabs

Cut text selection (in captions, titles, formulas, etc.)	Ctrl+X	Command+X
Paste clipboard	Ctrl+V	Command+V
Undo	Ctrl+Z	Command+Z
Redo	Ctrl+Y	Command+Shift+Z
Clear the current worksheet	Alt+Shift+Backspace	Option+Shift+Delete
Move floating dashboard object	Arrow key moves 1 pixel, Shift+Arrow moves 10 pixels	Arrow key moves 1 pixel, Shift+Arrow moves 10 pixels
Resize floating dashboard object	Alt+Arrow key resizes in 1-pixel increments, Shift+Alt+Arrow resizes in 10-pixel increments	Option+Arrow key resizes in 1-pixel increments, Shift+Option+Arrow resizes in 10-pixel increments

Shortcuts for authoring views (Tableau Server, Tableau Cloud)

Description	Windows shortcut	Mac shortcut
Add the selected field to the sheet. (Only works with a single field.)	Double-click	Double-click
Copy a field in the view and place it on another shelf or card	Ctrl+drag	Command+drag
Toggle dashboard grid on and off	G	G

Toggle between Dashboard and Layout tabs	T	T
Cut text selection (in captions, titles, formulas, etc.)	Ctrl+X	Command+X
Paste clipboard	Ctrl+V	Command+V
Undo	Ctrl+Z	Command+Z
Redo	Ctrl+Y	Command+Shift+Z
Open current workbook in Tableau Desktop	Ctrl+O	Option+Command+O
Clear the current worksheet	Alt+Shift+Backspace	Option+Shift+Delete
Move floating dashboard object	Arrow key moves 1 pixel, Shift+arrow moves 10 pixels	Arrow key moves 1 pixel, Shift+arrow moves 10 pixels
Resize floating dashboard object	Alt+Arrow key resizes in 1-pixel increments, Shift+Alt+Arrow resizes in 10-pixel increments	Option+Arrow key resizes in 1-pixel increments, Shift+Option+Arrow resizes in 10-pixel increments
Rename column field (when field is selected in the data schema pane)	F2	F2
Rename calculated field (when calculated field editor is open)	F2	F2

Shortcuts for resizing rows and columns (Tableau Desktop)

Smaller cell size	Ctrl+B	Command+B
Bigger cell size	Ctrl+Shift+B	Command+Shift+B
Make rows narrower	Ctrl+Left arrow	Control+Command+Left arrow
Make rows wider	Ctrl+Right arrow	Control+Command+Right arrow
Make columns shorter	Ctrl+Down arrow	Control+Command+Down arrow
Make columns taller	Ctrl+Up arrow	Control+Command+Up arrow

Shortcuts for pages (Tableau Desktop)

Description	Windows shortcut	Mac shortcut
Start or stop forward playback on the Pages shelf	F4	F4
Start or stop backward playback on the Pages shelf	Shift+F4	Shift+F4
Skip forward one page	Ctrl+Period	Command+Period
Skip backward one page	Ctrl+Comma	Command+Comma

Shortcuts for selecting and navigating marks

Description	Windows shortcut	Mac shortcut
Select a mark	Click	Click
Select a group of marks	Drag	Drag
Add individual marks to the selec-	Ctrl+click	Command+click

tion

Add a group of marks to the selection	Ctrl+drag	Command+drag
Use Rectangular Selection tool	A	A
Use Lasso Selection Tool	D	D
Use Radial Selection Tool	S	S
Select all data	Ctrl+A	Command+A
Copy selected data	Ctrl+C	Command+C
Clear the mark selection	Esc	Esc
Pan around the view	Shift+drag	Shift+drag
Zoom in to a point in the view (if not map, requires zoom mode)	Double-click , Ctrl+Shift+click	Double-click, Shift+Command+click
Zoom out from a point on a map (if not map, requires zoom mode)	Ctrl+Shift+Alt+click	Shift+Option+Command+click
Zoom out	Shift+Double-click	Shift+Double+click
Zoom in to an area in the view (requires zoom mode if not map)	Ctrl+Shift+drag	Shift+Command+drag
Zoom in and out on a map	Scroll	Scroll
Drag a row and scroll through a long list simultaneously	Click+drag to bottom of pane+hold	Click+scroll, Command+hold

Shortcuts for flows (Tableau Prep Builder)

Description	Windows shortcut	Mac shortcut
Open file	Ctrl+O	Command+O

Tableau Desktop and Web Authoring Help

New flow	Ctrl+N	Command+N
Save file	Ctrl+S	Command+S
Save file as	Alt+Ctrl+S	Shift+Command+S
Quit	Ctrl+Q	Command+Q
Undo	Ctrl+Z	Command+Z
Redo	Ctrl+Y	Shift+Command+Z
Cut	Ctrl+X	Command+X
Copy	Ctrl+C	Command+C
Paste	Ctrl+V	Command+V
Select All	Ctrl+A	Command+A
Run All	Ctrl+R	Command+R
Publish flow	F10	

Copyright

© 2024 Salesforce, Inc. and its licensors. All rights reserved.

Additional information regarding Tableau's copyrights, patents and trademarks can be found at www.tableau.com/ip.

For information about Third Party Code which may be distributed with the Software, please review the Tableau Software End User License Agreement.