



NVIDIA DGX-1

DU-08033-001 _v15 | May 2018

User Guide



TABLE OF CONTENTS

Chapter 1. Introduction to the NVIDIA DGX-1 Deep Learning System.....	1
1.1. Using the DGX-1: Overview.....	1
1.2. Hardware Specifications.....	2
1.2.1. Components.....	2
1.2.2. Mechanical.....	3
1.2.3. Power Requirements.....	3
1.2.4. Connections and Controls.....	3
1.2.5. Rear Panel Power Controls.....	4
1.2.6. LAN LEDs.....	5
1.2.7. IPMI Port LEDs.....	5
1.2.8. Hard Disk Indicators.....	6
1.2.9. Power Supply Unit (PSU) LED.....	7
Chapter 2. Installation and Setup.....	8
2.1. Registering Your DGX-1.....	8
2.2. Choosing a Setup Location / Site Preparation.....	8
2.3. Unpacking the DGX-1.....	10
2.4. What's In the Box.....	11
2.5. Installing the DGX-1 Into a Rack.....	11
2.5.1. Installing the Rails.....	12
2.5.2. Mounting the DGX-1.....	12
2.6. Attaching the Bezel.....	13
2.7. Connecting the Power Cables.....	14
2.8. Connecting the Network Cables.....	15
2.9. Setting Up the DGX-1.....	16
2.10. Post Setup Instructions for DGX OS Server Software Version 2.x and Earlier.....	17
2.11. Updating the DGX-1 Software.....	19
Chapter 3. Preparing for Using Docker Containers.....	21
3.1. Installing Docker and the Docker Engine Utility for NVIDIA GPUs on DGX OS Server Software 2.x or Earlier.....	21
3.2. Configuring Docker IP Addresses.....	22
3.2.1. Configuring Docker IP Addresses for DGX OS Server Software Version 2.x and Earlier..	23
3.2.2. Configuring Docker IP Addresses for DGX OS Server Software Version 3.1.1 and Later.	23
3.3. Letting Users Issue Docker Commands.....	24
3.3.1. Checking if a User is in the Docker Group.....	25
3.3.2. Creating a User.....	25
3.3.3. Adding a User to the Docker Group.....	25
3.4. Configuring a System Proxy.....	25
3.5. Configuring NFS Mount and Cache.....	26
Chapter 4. Configuring and Managing the DGX-1.....	28
4.1. Using the BMC.....	28

4.1.1. Creating a Unique BMC Password for Remote Access.....	29
4.1.2. Viewing System Information.....	30
4.1.3. Submitting BMC Log Files.....	30
4.1.4. Determining Total Power Consumption.....	30
4.1.5. Accessing the DGX-1 Console.....	31
4.1.6. Powering Off / Power Cycling the System Remotely.....	31
4.1.6.1. From the DGX-1 Console Window.....	31
4.1.6.2. From the BMC UI.....	31
4.2. Configuring a Static IP Address for the BMC.....	32
4.2.1. Configuring a BMC Static IP Address Using ipmitool.....	32
4.2.2. Configuring a BMC Static IP Address Using the System BIOS.....	33
4.2.3. Configuring a BMC Static IP Address Using the BMC Dashboard.....	37
4.3. Configuring Static IP Addresses for the Network Ports.....	38
4.4. Obtaining MAC Addresses.....	39
4.5. Resetting GPUs in the DGX-1.....	42
4.5.1. Stopping Running Applications and Services.....	43
4.5.2. Resetting the GPUs.....	44
4.6. Changing the Mellanox Card Port Type.....	44
4.6.1. Switching the Port from InfiniBand to Ethernet.....	46
4.6.2. Switching the Port from Ethernet to InfiniBand.....	46
Chapter 5. Maintaining and Servicing the NVIDIA DGX-1.....	48
5.1. Problem Resolution and Customer Care.....	48
5.2. Restoring the DGX-1 Software Image.....	48
5.2.1. Obtaining the DGX-1 Software ISO Image and Checksum File.....	49
5.2.2. Re-Imaging the System Remotely.....	49
5.2.3. Creating a Bootable Installation Medium.....	52
5.2.3.1. Creating a Bootable USB Flash Drive by Using the dd Command.....	52
5.2.3.2. Creating a Bootable USB Flash Drive by Using Akeo Rufus.....	53
5.2.4. Re-Imaging the System From a USB Flash Drive.....	55
5.2.5. Retaining the RAID Partition While Installing the OS.....	55
5.3. Updating the System BIOS.....	56
5.4. Updating the BMC.....	59
5.5. Replacing the System and Components.....	61
5.5.1. Replacing the System.....	62
5.5.2. Replacing an SSD.....	62
5.5.3. Recreating the Virtual Drives.....	63
5.5.3.1. Access the BIOS Setup Utility.....	63
5.5.3.2. Clear the Drive Group Configuration.....	66
5.5.3.3. Recreate the OS Virtual Drive.....	70
5.5.3.4. Recreate the RAID0 Virtual Drive.....	78
5.5.4. Recreating the RAID 0 Array.....	90
5.5.5. Replacing the Power Supplies.....	91
5.5.6. Replacing the Fan Module.....	92

5.5.7. Replacing the DIMMs.....	92
5.5.8. Replacing the InfiniBand Cards.....	97
5.5.9. Setting Up the InfiniBand Cards.....	101
Chapter 6. Installing Software on Air-Gapped NVIDIA DGX-1 Systems.....	105
6.1. Installing NVIDIA DGX-1 Software.....	105
6.1.1. Re-Imaging the System.....	105
6.1.2. Creating a Local Mirror of the NVIDIA and Canonical Repositories.....	106
6.2. Installing Docker Containers.....	106
Chapter 7. Customer Support for the NVIDIA DGX-1.....	108
Chapter 8. King Slide - AH61-500 Instructions.....	109
Chapter 9. Safety.....	111
9.1. Safety Warnings and Cautions.....	111
9.2. Intended Application Uses.....	112
9.3. Site Selection.....	112
9.4. Equipment Handling Practices.....	113
9.5. Electrical Precautions.....	113
9.6. System Access Warnings.....	114
9.7. Rack Mount Warnings.....	114
9.8. Electrostatic Discharge.....	115
9.9. Other Hazards.....	116
Chapter 10. Compliance.....	118
10.1. United States.....	118
10.2. United States / Canada.....	118
10.3. Canada.....	119
10.4. CE.....	119
10.5. Japan.....	119
10.6. Australia.....	120
10.7. China.....	120
10.8. Israel.....	122
10.9. South Korea.....	122
10.10. India.....	123

Chapter 1.

INTRODUCTION TO THE NVIDIA DGX-1 DEEP LEARNING SYSTEM

The NVIDIA® DGX-1™ Deep Learning System is the world's first purpose-built system for deep learning with fully integrated hardware and software that can be deployed quickly and easily.



1.1. Using the DGX-1: Overview

The NVIDIA DGX-1 comes with a base operating system consisting of an Ubuntu OS, Docker, Docker Engine Utility for NVIDIA GPUs, and NVIDIA drivers. This system is designed to run a number of NVIDIA-optimized deep learning framework applications packaged in Docker containers. You can use your own scheduling and management software to run jobs, and also build and run your own applications on the DGX-1.

1.2. Hardware Specifications

1.2.1. Components

Component	Qty	Description
Base Server	1	Dual Intel® Xeon® CPU motherboard with x2 9.6 GT/s QPI, 8 Channel with 2 DPC DDR4, Intel®X99 Chipset, AST2400 BMC
	1	GPU Baseboard supporting 8 SXM2 modules (Cube Mesh) and 4 PCIe x16 slots for InfiniBand/Ethernet NICs
	1	Chassis with 3+1 1600W Power supply and support for up to five 2.5 inch drives
	1	10/100BASE-T IPMI Port
	1	RS232 Serial Port
	2	USB 3.0 Ports
Power Supply	4	1600 W each.
CPU	2	Intel® Xeon® E5-2698 v4, 20-core, 2.2GHz, 135W
GPU	8	<p>(Pascal) Tesla P100, featuring</p> <ul style="list-style-type: none"> ▶ 170 teraflops, FP16 ▶ 16 GB memory per GPU ▶ 28,672 NVIDIA CUDA® Cores <p>(Volta) Tesla V100, featuring</p> <ul style="list-style-type: none"> ▶ 1 petaflop, Mixed Precision ▶ 16 GB memory per GPU ▶ 40,960 NVIDIA CUDA® Cores ▶ 5120 NVIDIA Tensor Cores <p>(Volta 32 GB) Tesla V100, featuring</p> <ul style="list-style-type: none"> ▶ 1 petaflop, Mixed Precision ▶ 32 GB memory per GPU ▶ 40,960 NVIDIA CUDA® Cores ▶ 5120 NVIDIA Tensor Cores
System Memory	16	32 GB DDR4 LRDIMM (512 GB total)
SAS Raid Controller	1	8 port LSI SAS 3108 RAID Mezzanine
Storage (RAID 0) (Data)	4	1.92 TB, 6 Gb/s, SATA 3.0 SSD
Storage (OS)	1	480 GB, 6 Gb/s, SATA 3.0 SSD
10 GbE NIC	1	Dual port, 10GBASE-T, network adapter Mezzanine
InfiniBand EDR/100GbE NIC	4	Single port, x16 PCIe, Mellanox ConnectX-4 VPI MCX455A-ECAT

1.2.2. Mechanical

Feature	Description
Form Factor	3U Rackmount
Height	5.16" (13.1 cm)
Width	17.5" (44.4 cm)
Depth	34.1" (86.6 cm)
Gross Weight	134 lbs (61 kg)

1.2.3. Power Requirements

Input		Specification for Each Power Supply	Comments
200-240 V (ac)	3500 W max.	1600 W @ 200-240 V, 8 A, 50-60 Hz	The DGX-1 contains four load-balancing power supplies, with 3+1 redundancy.

1.2.4. Connections and Controls

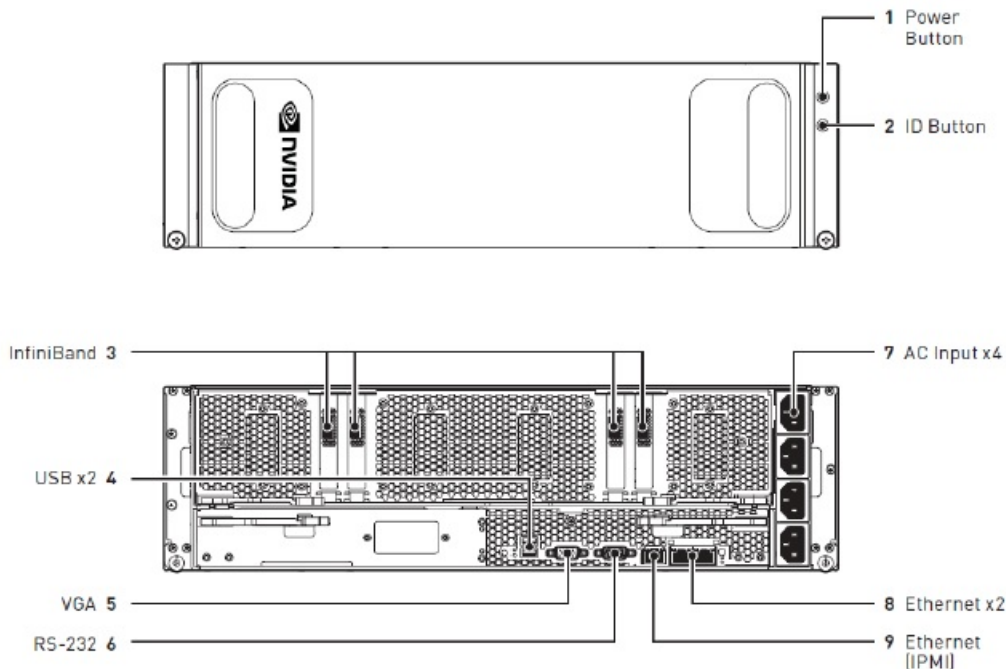

ID	Type	Qty	Description
1	Power button	1	Press to turn the DGX-1 on or off. Blue: System power on

ID	Type	Qty	Description
			Off: System power off Amber (blinking): DC Off and fault Amber and blue (blinking): DC On and fault
2	ID button	1	Press to cause an LED on the back of the unit to flash as an identifier during servicing.
3	InfiniBand/ Ethernet (QSFP28)	4	EDR IB/100GbE
4	USB	2	USB 3.0 ports are available to connect a keyboard.
5	VGA	1	The VGA port connects to a VGA capable monitor for local viewing of the DGX-1 setup console or base OS.
6	DB9	1	RS232 serial port for internal debugging
7	AC input	4	Power supply inputs
8	Ethernet (RJ45)	2	10GBASE-T dual port network adapter Mezzanine
9	IPMI (RJ45)	1	10/100BASE-T Intelligent Platform Management Interface (IPMI) port

1.2.5. Rear Panel Power Controls

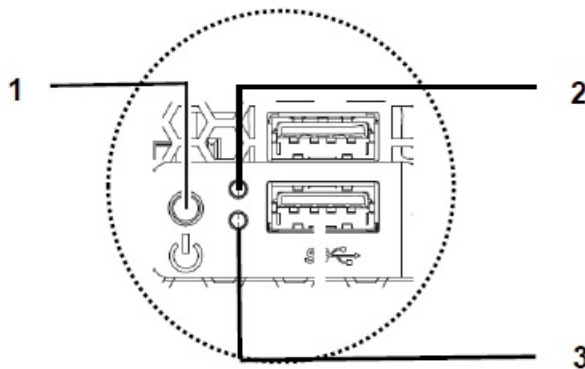
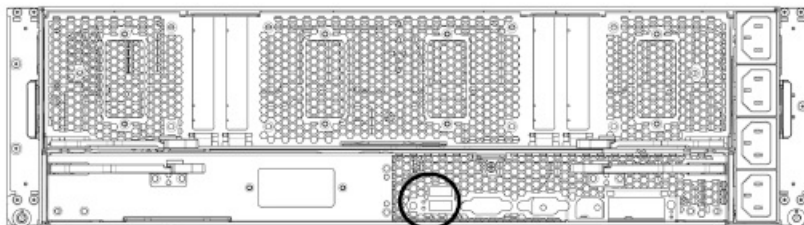

ID	Type	Qty	Description
1	Power button	1	Press and immediately release the power button for a graceful shutdown of the host OS. Press and hold the power button for at least four seconds to shut down the system immediately. The BMC remains live.
2	Power LED	1	Off: Power off

ID	Type	Qty	Description
			Blue (steady): Power on Blue (blinking): BMC reports system health fault.
3	Main Board Status LED	1	Off: Normal Amber (blinking): BMC reports system health fault.

1.2.6. LAN LEDs

LEDs next to each Ethernet port indicate the connection status as described in the table below:

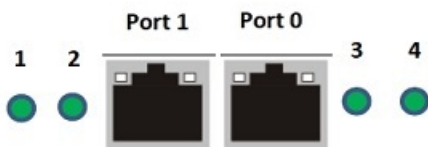

LED	Status	Description
1 (Port 1 Link/Activity)	Amber (steady)	LAN link
	Amber (blinking)	LAN access (off when there is traffic)
	Off	Disconnected
2 (Port 1 Speed)	Green	10 Gb/s
	Amber	1 Gb/s
	Off	100 Mb/s
3 (Port 0 Link/Activity)	Amber (steady)	LAN link
	Amber (blinking)	LAN access (off when there is traffic)
	Off	Disconnected
4 (Port 0 Speed)	Green	10 Gb/s
	Amber	1 Gb/s
	Off	100 Mb/s

1.2.7. IPMI Port LEDs

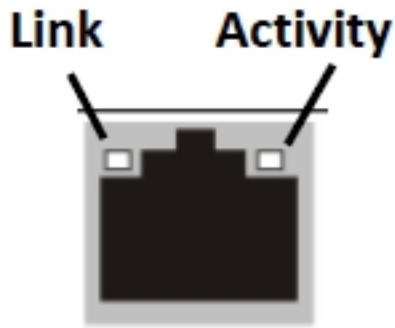

LEDs on the IPMI port indicate the connection status as described in the table below:

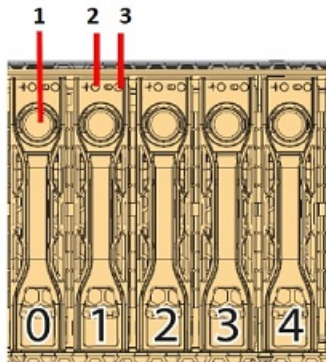

Link	Activity	Description
Off	Off	Unplugged
Green (steady)	Green (blinking)	100M active link
Off	Green (blinking)	10M active link

1.2.8. Hard Disk Indicators



ID	Feature	Description
1	Button and release lever for removing the HDD	
2	 HDD present LED	Blue (Steady): Drive present Blue (Blinking twice/sec): Identification (such as when initializing or locating through the SBIOS) Blue (Blinking once/sec): Rebuilding (such as when creating a RAID array) Amber (Steady): Warning/failure Off: Slot empty
3	 HDD activity LED	Blue: Access

1.2.9. Power Supply Unit (PSU) LED

The PSU LED indicates the operation status of the PSU as described in the table below:

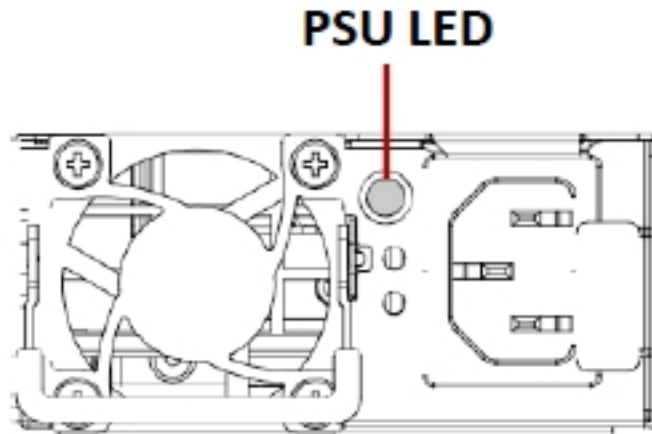

Activity	Description
Green	Normal operation
Amber (blinking)	Power off; Fault
Green (blinking)	Power on; Standby mode

Chapter 2.

INSTALLATION AND SETUP

This chapter provides the basic instructions for installing and setting up the NVIDIA DGX-1.

2.1. Registering Your DGX-1

Be sure to register your DGX-1 with NVIDIA as soon as you receive your purchase confirmation e-mail. Registration enables your hardware warranty and allows you to set up an NVIDIA DGX Container Registry account.

To register your DGX-1, you will need information provided in your purchase confirmation e-mail. If you do not have the information, send an e-mail to NVIDIA Enterprise Support at enterprisesupport@nvidia.com.

1. From a browser, go to the [NVIDIA DGX Product Registration \(http://www.nvidia.com/object/dgx-product-registration\)](http://www.nvidia.com/object/dgx-product-registration) page.
2. Enter all required information and then click **SUBMIT** to complete the registration process and receive all warranty entitlements and, if applicable, DGX-1 support services entitlements.

Refer to the [Customer Support](#) chapter for customer support contact information.

2.2. Choosing a Setup Location / Site Preparation

Decide on a suitable location for setting up and operating the DGX-1. The location should be clean, dust-free, and well ventilated.

General Conditions

- ▶ Prepare a sufficiently wide aisle to accommodate the unboxed chassis (chassis dimensions - 5.16"H x 17.5"W x 34.1"D).
- ▶ The rack must accommodate a 134 lb, 3U rack mount system (chassis dimensions - 5.16"H x 17.5"W x 34.1"D).

- ▶ The rack must have square mounting holes.
- ▶ Leave enough clearance in front of the rack (36" (91.4 cm)) to enable you to install the unit into the rack.
- ▶ Leave approximately 30" (76.2cm) of clearance in the back of the rack to allow for sufficient airflow and ease in servicing.
- ▶ Always make sure the rack is secured and stable before adding or removing the appliance or any other component.
- ▶ Prepare adequate sound-proofing: The equipment fans can generate 72-100 dBA.

Environmental Conditions

- ▶ Operating environment
 - ▶ Temperature: 5 ° C to 35 ° C (41 ° F to 95 ° F)
 - ▶ Relative humidity: 20% to 85% noncondensing
- ▶ Air flow
 - ▶ The chassis fans can produce a maximum of 340 CFM of air flow.
 - ▶ Do not block the ventilation areas at the front and rear of the chassis.
 - ▶ Minimize any restrictions on air flow around the chassis.

Connections

- ▶ Power:
 - ▶ The DGX-1 is powered through four 1600W power supply units, each rated at 200-240VAC, 8A, 50/60 Hz. Total system power requirement: 3500W
 - ▶ C13/C14 cables provided for each power supply to connect to a compatible PDU.

IMPORTANT: Do not use the provided cables with any other product or for any other purpose.

- ▶ Network: Dual 10GBASE-T RJ45 connection
Use industry standard CAT6 Ethernet cables for connecting to the network ports. (Cables not included.)
- ▶ IPMI: 10/100BASE-T RJ45 connection
Use industry standard CAT6 Ethernet cables for connecting to the network ports. (Cables not included.)
- ▶ InfiniBand: Qty 4 - QSFP28 ports, InfiniBand and Ethernet compliant
Use Mellanox-compliant InfiniBand cables for connecting to the InfiniBand ports. (Cables not included.)

Preparing for Network Access

- ▶ The IPMI port and Ethernet ports can be connected to your local LAN.

These ports are configured for DHCP by default.

- ▶ To use DHCP, connect the port to a local DHCP server which should provide an IP address and assign a DNS configuration to the DGX-1.
- ▶ If DHCP is not available, then you will need to set up a static IP for each Ethernet port.
- ▶ NVIDIA recommends that customers follow best security practices for BMC management (IPMI port). These include, but are not limited to, such measures as:
 - ▶ Restricting the DGX-1 IPMI port to an isolated, dedicated, management network
 - ▶ Using a separate, firewalled subnet
 - ▶ Configuring a separate VLAN for BMC traffic if a dedicated network is not available
- ▶ Make sure your network can connect to the following:
 - ▶ <http://us.archive.ubuntu.com/ubuntu/>
 - ▶ <http://security.ubuntu.com/ubuntu>
 - ▶ <http://international.download.nvidia.com/dgx1/repos/> (Base OS Software 2.x or earlier)
 - ▶ <http://international.download.nvidia.com/dgx/repos/> (Base OS Software 3.1 or later)
 - ▶ <https://apt.dockerproject.org/repo>
 - ▶ <https://download.docker.com/linux/ubuntu>
 - ▶ nvcv.io

If access to those URLs requires use of a proxy, refer to [Setting Up a System Proxy](#) for setup instructions.

2.3. Unpacking the DGX-1

1. Remove the shrink wrap.
2. Collapse the yellow "Do not stack" cone, if included.
3. Open the main DGX-1 box, then remove the accessory and rail kit boxes.



CAUTION: At least four people, or a mechanical assist, are required to remove the DGX-1 from the box. To reduce the risk of personal injury or damage to the equipment, always observe local occupational health and safety requirements and guidelines for material handling.



DO NOT use the handles at the front of the DGX-1 to lift the unit. The handles are designed for sliding the unit out of a rack, and not for carrying the full weight of the DGX-1.

4. Remove the protective plastic sheet from the top of the DGX-1.
5. Preserve and retain packaging.

6. Be sure to inspect each piece of equipment shipped in the packing box. If anything is missing or damaged, contact your supplier.

2.4. What's In the Box

The NVIDIA DGX-1 shipping box includes the following:

- ▶ NVIDIA DGX-1
- ▶ Bezel
- ▶ Rail hardware kit
- ▶ Accessory Box
 - ▶ AC Power Cables (qty 4 – IEC 60320 C13/14, 3.3-ft./1-meter, compatible with data center PDUs)

IMPORTANT: Do not use the provided cables with any other product or for any other purpose.
 - ▶ Hard disk bay screws
 - ▶ Toxic Substance Notice & Safety Instructions
 - ▶ Quick Start Guide
 - ▶ DVD containing source files for open source software



The four power cables included in the box are not optional. All power cables are necessary and must be plugged into individual 10 A capable sockets for optimal DGX-1 operation. Failure to do so can result in a reduction in power redundancy, a reduction in performance, or a complete system failure.

2.5. Installing the DGX-1 Into a Rack



CAUTION: To prevent bodily injury when mounting or servicing the DGX-1 in a rack, you must take special precautions to ensure that the system remains stable. The following guidelines are provided to ensure your safety.

- The DGX-1 should be mounted at the bottom of the rack if it is the only unit in the rack.
- When mounting the DGX-1 in a partially filled rack, load the rack from the bottom to the top with the heaviest component at the bottom of the rack.
- If the rack is provided with stabilizing devices, install the stabilizers before mounting or servicing the DGX-1 in the rack.
- The DGX-1 weighs approximately 134 lbs, so an equipment lift is required to safely lift the unit and then accurately align the chassis rails with the rack rails.
- **DO NOT** use the handles at the front of the DGX-1 to lift the unit. The handles are designed for sliding the unit out of a rack, and not for carrying the full weight of the DGX-1.

2.5.1. Installing the Rails



The rail assemblies shipped with the appliance fit into a standard 19" rack between 26-inches and 33.5-inches deep (66 cm to 85 cm). The outer rail is adjustable from approximately 23.5" to 34" (59.7 cm to 86.4 cm)

*Refer to the instructions in the rail packaging for details on installing the rails onto the rack and chassis. The instructions are also provide in the chapter **King Slide - AH61-500** in this document.*

The following are supplemental instructions:

1. Use a Phillips screwdriver to assist in mounting the rails to the rack.
2. If necessary, detach the inner rails from the outer slide rails.
3. Follow any designations on the inner rail (or its outer rail mate) to determine the proper orientation and positioning to connect to the chassis, then secure to the chassis.

IMPORTANT: Make sure that the reinforced hole at the front end of the rail is positioned on the bottom side of the rail, and that it aligns with the thumbscrew on the front of the DGX-1. If the hole is positioned on the top side, then the rail is on the wrong side of the DGX-1 and the DGX-1 will not fit properly in the rack.

4. Follow any designations on the outer slide rail to determine front/back and left-side/right-side positioning against the rack.
5. Secure the back of one of the slide rails to the rack, then extend the rail until it fits securely to the front of the rack.
6. Secure the slide rail to the front of the rack.
7. Repeat steps 4-6 for the other slide rail.

2.5.2. Mounting the DGX-1



CAUTION: Stability hazard – The rack stabilizing mechanism must be in place, or the rack must be bolted to the floor before you slide the DGX-1 out for servicing. Failure to stabilize the rack can cause the rack to tip over.

1. Confirm that the DGX-1 has the inner rails attached and that you have already mounted the outer rails into the rack.
2. With the front of the unit facing away from the rack, use an equipment lift to assist in sliding the unit into the rack as follows:



CAUTION: The DGX-1 weighs approximately 134 lbs, so an equipment lift is required to safely lift the unit and then accurately align the chassis rails with the rack rails.

- a) Align the inner chassis rails with the front of the outer rack rails.

- b) Slide the inner rails into the outer rails, keeping the pressure even on both sides (you may have to depress the locking tabs when inserting).

When the DGX-1 has been pushed completely into the rack, you should hear the locking tabs "click" into the locked position.

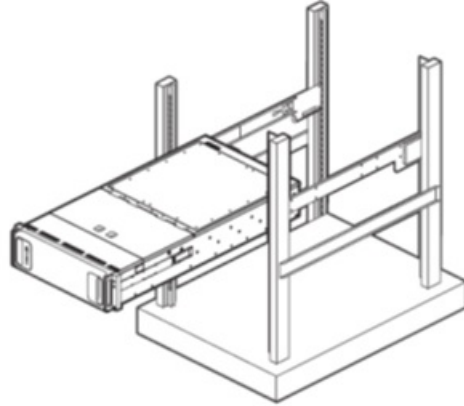

3. Lock the unit in place using the thumb screws located on the front of the unit.



2.6. Attaching the Bezel

The bezel is designed to attach easily to the front of the DGX-1.

1. Prepare the DGX-1 by making sure that the power supply handles (located at the power supply fans) are flipped up.

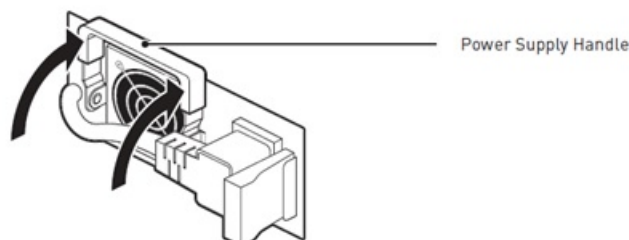

2. Move any other obstructions, such as cable ties, away from the outer edge of the DGX-1.
3. With the bezel positioned so that the NVIDIA logo is visible from the front and is on the left hand side, line up the pins near the corners of the DGX-1 with the holes in back of the bezel, then gently press the bezel against the DGX-1.



CAUTION: Be careful not to accidentally press the power button that is on the right edge of the DGX-1 when removing or installing the bezel.

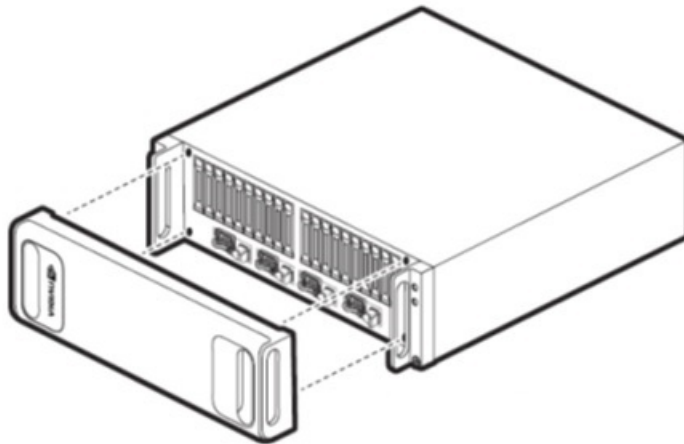

The bezel is held in place magnetically .

2.7. Connecting the Power Cables

1. Open the accessory box and remove the four C13/C14 power cables.
2. Use the cables to connect each of the four plugs at the right-rear of the DGX-1 to a PDU.

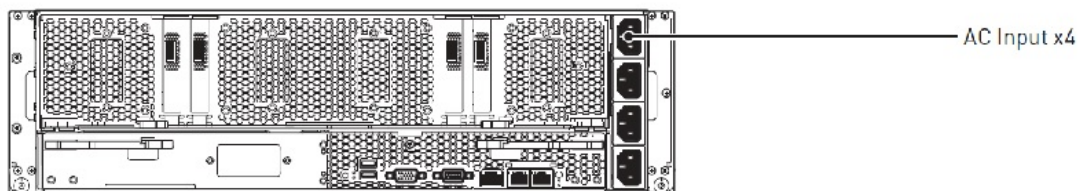

- a) Secure each cable to the DGX-1, using the power cable retention clips attached to the power plugs.
- b) Connect each cable to the PDU.

Ensure that the cables are distributed over at least two circuits and, if using 3-phase PDUs, they are balanced across all phases as much as possible. Ideally, each cable should connect to a different PDU.

- c) Verify that each cable is firmly inserted into the PDU.
There is usually a click to indicate full insertion.

2.8. Connecting the Network Cables

- Using an Ethernet cable, connect one of the dual Ethernet ports (em1 or em2) to your LAN for internet access to the NVIDIA DGX website, remote access to launched application containers on the DGX-1, or to connect to the DGX-1 using SSH.

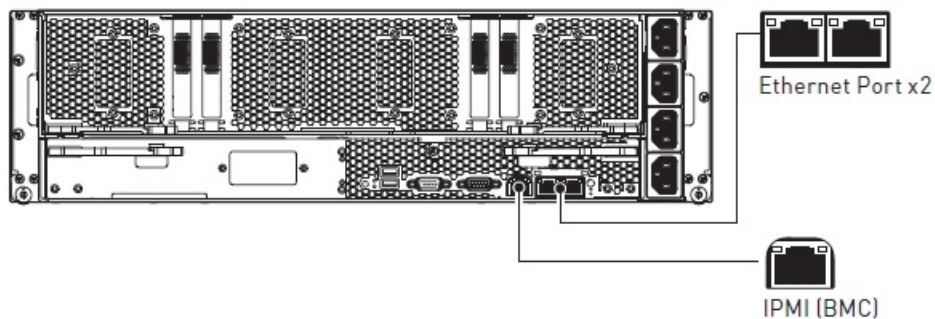

The left-side/right-side ethernet port designation depends on the Base OS software version installed on the DGX-1 as listed in the table below.

Ethernet Port Position	Port Designation: Base OS Software 2.x and earlier	Port Designation: Base OS Software 3.x and later
Right Side	em1	enp1s0f0
Left Side	em2	enp1s0f1



NVIDIA recommends connecting only one of the Ethernet ports to your LAN. If you are connecting both Ethernet ports, they must each be connected to separate networks. The DGX-1 is not configured from the factory to have multiple Ethernet interfaces on the same network.

- Using an Ethernet cable, connect the IPMI (BMC) port to your LAN for remote access to the base management controller (BMC).

Verify that all network cables are firmly inserted into the DGX-1 and the associated network switch.

2.9. Setting Up the DGX-1

These instructions describe the setup process that occurs the first time the DGX-1 is powered on after delivery. Be prepared to accept all EULAs and to set up your username and password.

1. Connect a display to the VGA connector, and a keyboard to any of the USB ports.

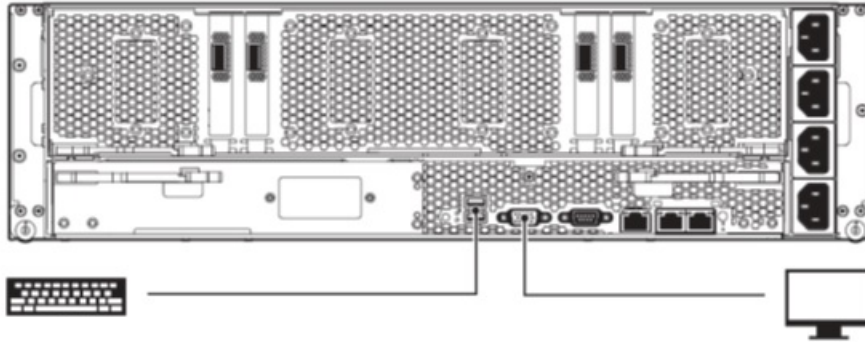

For best display results, use a monitor with a native resolution of 1024x768 or lower.

2. Power on the DGX-1.



The system will take a few minutes to boot.

You may be presented with end user license agreements (EULAs) for the NVIDIA software at this point in the setup, depending on the DGX-1 software version. Accept all EULAs to proceed with the installation.

You are prompted to configure the DGX-1 software.

3. Perform the steps to configure the DGX-1 software.
 - ▶ Select your time zone and keyboard layout.
 - ▶ Create a user account with your name, username, and password.

You will need these credentials to log in to the DGX-1 as well as to log in to the BMC remotely. When logging in to the BMC, enter your username for both the

User ID as well as the password. Be sure to create a unique BMC password at the first opportunity.



The BMC software will not accept "sysadmin" for a user name. If you create this user name for the system log in, "sysadmin" will not be available for logging in to the BMC.

- ▶ Choose a primary network interface for the DGX-1.



After you select the primary network interface, the system attempts to configure the interface for DHCP and then asks you to enter a hostname for the system. If DHCP is not available, you will have the option to configure the network manually. If you need to configure a static IP address on a network interface connected to a DHCP network, select **Cancel** at the *Network configuration - Please enter the hostname for the system* screen. The system will then present a screen with the option to configure the network manually.

- ▶ Choose a host name for the DGX-1.
- ▶ Choose to install predefined software.

Press the space bar to select or deselect the software to install.



By default, the DGX-1 installs only minimal software packages necessary to ensure system functionality. You can deselect the OpenSSH package; however, NVIDIA recommends that you keep this package selected, and uninstall it only if required by your IT security policy.

4. Select **OK** to continue.

You may be presented with end user license agreements (EULAs) for the NVIDIA software at this point in the setup, depending on the DGX-1 software version. Accept all EULAs to complete the installation.

The system completes the installation, reboots, then presents the system login prompt:

```
<hostname> login:
Password:
```

5. Log in.



Before using the DGX-1, check the [DGX OS Server release notes](#) for the availability of important over-the-network software updates, including security updates.

2.10. Post Setup Instructions for DGX OS Server Software Version 2.x and Earlier

These instructions apply if your DGX-1 is installed with software version 2.x or earlier.

To determine the DGX OS Server software version on your system, enter the following command.

```
$ grep VERSION /etc/dgx-release
DGX_SWBUILD_VERSION="2.0.4"
```

1. If your network is configured for DHCP, then make sure that dynamic DNS updates are enabled.

Check whether `/etc/resolv.conf` is a link to `/run/resolvconf/resolv.conf`.

```
$ ls -l /etc/resolv.conf
```

Expected output:

```
lrwxrwxrwx 1 root root 29 Dec 1 21:19 /etc/resolv.conf ->
../run/resolvconf/resolv.conf
```

- ▶ If the expected output appears, then skip to step 2.
- ▶ If this does not appear, then enable dynamic DNS updates as follows:

- a) Launch the *Resolvconf Reconfigure* package.

```
$ sudo dpkg-reconfigure resolvconf
```

The *Configuring resolvconf* screen appears.

- b) Select **<Yes>** when asked whether to prepare `/etc/resolv.conf` for dynamic updates.
- c) Select **<No>** when asked whether to append original file to dynamic file.
- d) Select **<OK>** at the *Reboot recommended* screen.

You do not need to reboot.

You are returned to the command line.

- e) Bring down the interface, where `<network interface>` is `em1` or `em2`, whichever you have set up as your primary network interface.

```
$ sudo ifdown <network interface>
```

Expected output:

```
ifdown: interface <network interface> not configured
```

- f) Bring up the interface, where `<network interface>` is `em1` or `em2`, whichever you have set up as your primary network interface.

```
$ sudo ifup <network interface>
```

Expected output (last line):

```
...
bound to <IP address> -- renewal in ...
```

- g) Repeat step 1 to confirm that `/etc/resolv.conf` is a link to `/run/resolvconf/resolv.conf`.

2. Make sure that the `nvidia-peer-memory` module is installed.

```
$ lsmod | grep nv_peer_mem
```

If the following output appears, then your DGX-1 setup is complete and you do not need to perform the next steps.

```

nv_peer_mem          16384  0
nvidia               11911168 30
nv_peer_mem,nvidia_modeset,nvidia_uv
mib_core             143360 13
rdma_cm,ib_cm,ib_sa,iw_cm,nv_peer_mem,mlx4_ib,mlx5_ib,
ib_mad,ib_ucm,ib_umad,ib_uverbs,rdma_ucm,ib_ipoib

```

3. If there is no output to the `lsmod` command, then build and install the `nvidia-peer-memory` module.
 - a) Get and install the module.

```

$ sudo apt-get update
$ sudo apt-get install --reinstall mlnx-ofed-kernel-dkms nvidia-peer-
memory-dkms

```

Expected output.

```

DKMS: install completed.
Processing triggers for initramfs-tools (0.103ubuntu4.2) ...
update-initramfs: Generating /boot/initrd.img-4.4.0-45-generic

```

- b) Add the module to the Linux kernel.

```

$ sudo modprobe nv_peer_mem

```

There is no expected output for this command.

- c) Repeat step 2 to confirm that the `nvidia-peer-memory` module has been added.

2.11. Updating the DGX-1 Software

You must register your DGX-1 in order to receive software updates. Once registered, you will receive an email notification whenever a new software update is available.

These instructions explain how to update the DGX-1 software through an internet connection to the NVIDIA public repository. The process updates a DGX-1 system image to the latest QA'd versions of the entire DGX-1 software stack, including the drivers.

The instructions apply to a point update from the latest software release – for example, from 3.1.4 to 3.1.6. To upgrade from DGX OS Server release 1.0, 2.0, or 2.1, refer to the release notes for detailed instructions.



Caution These instructions update all software for which updates are available from your configured software sources, including applications that you installed yourself. If you want to prevent an application from being updated, you can instruct the Ubuntu package manager to keep the current version. For more information, see [Introduction to Holding Packages](#) on the Ubuntu Community Help Wiki.

Perform the updates using commands on the DGX-1 console.

1. Run the package manager.

```
$ sudo apt update
```

2. Check to see which software will get updated.

```
$ sudo apt full-upgrade -s
```

To prevent an application from being updated, instruct the Ubuntu package manager to keep the current version. See [Introduction to Holding Packages](#).

3. Upgrade to the latest version.

```
$ sudo apt full-upgrade
```

Answer any questions that appear.

Most questions require a Yes or No response. When asked to select the grub configuration to use, select the current one on the system.

Other questions will depend on what other packages were installed before the update and how those packages interact with the update.

4. Reboot the system.

Chapter 3.

PREPARING FOR USING DOCKER CONTAINERS

This chapter presents an overview of the prerequisites for accessing Docker containers from the command line for use on the NVIDIA® DGX-1™ in base OS mode. These containers include NVIDIA DGX-1 specific software to ensure the best performance for your applications. Using these containers as a basis for your applications should provide the best single-GPU performance and multi-GPU scaling.

- ▶ [Installing Docker and the Docker Engine Utility for NVIDIA GPUs on DGX OS Server Software 2.x or Earlier](#)
- ▶ [Configuring Docker IP Addresses](#)
- ▶ [Letting Users Issue Docker Commands](#)
- ▶ [Configuring a System Proxy](#)
- ▶ [Configuring NFS Mount and Cache](#)

3.1. Installing Docker and the Docker Engine Utility for NVIDIA GPUs on DGX OS Server Software 2.x or Earlier

To enable portability in Docker images that leverage GPUs, NVIDIA developed the Docker Engine Utility for NVIDIA GPUs (**nvidia-docker**), an open-source project that provides a command line tool to mount the user mode components of the NVIDIA driver and the GPUs into the Docker container at launch.

As of DGX OS Server software version 3.1.1 and later, Docker and the **nvidia-docker** utility are part of the base software installation and you do not need to perform the steps in this section. However, if your DGX-1 is installed with software version 2.x or earlier, then follow these instructions to install Docker and **nvidia-docker** on the system.

To determine the DGX OS Server software version on your system, enter the following command.

```
$ grep VERSION /etc/dgx-release
DGX_SWBUILD_VERSION="2.0.4"
```

Ensure your environment meets the prerequisites before installing Docker. For more information, see [Getting Started with Docker](#).

1. Install Docker.

```
$ sudo apt-key adv --keyserver
hkp://p80.pool.sks-keyservers.net:80 --recv-keys
58118E89F3A912897C070ADBF76221572C52609D
$ echo deb https://apt.dockerproject.org/repo ubuntu-trusty main
| sudo tee /etc/apt/sources.list.d/docker.list
$ sudo apt-get update
$ sudo apt-get -y install docker-engine=1.12.6-0~ubuntu-trusty
```

2. Edit the `/etc/default/docker` file to use the Overlay2 storage driver.

- a) Open the `/etc/default/docker` file for editing.

```
$ sudo vi /etc/default/docker
```

- b) Add the following line:

```
DOCKER_OPTS="--storage-driver=overlay2"
```

If there is already a `DOCKER_OPTS` line, then add the parameters (text between the quote marks) to the `DOCKER_OPTS` environment variable.

- c) Save and close the `/etc/default/docker` file when done.
- d) Restart Docker with the new configuration.

```
$ sudo service docker restart
```

3. Install the [NVIDIA Docker Engine Utility for NVIDIA GPUs](#).

The following example installs both `nvidia-docker` and the `nvidia-docker-plugin`.

```
$ wget -P /tmp
https://github.com/NVIDIA/nvidia-docker/releases/download/v1.0.1/nvidia-
docker_1.0.1-1_amd64.deb

$ sudo dpkg -i /tmp/nvidia-docker*.deb && rm
/tmp/nvidia-docker*.deb
```

3.2. Configuring Docker IP Addresses

To ensure that the DGX-1 can access the network interfaces for Docker containers, Docker should be configured to use a subnet distinct from other network resources used by the DGX-1.

By default, Docker uses the `172.17.0.0/16` subnet. Consult your network administrator to find out which IP addresses are used by your network. *If your network*

does not conflict with the default Docker IP address range, then no changes are needed and you can skip this section.

However, if your network uses the addresses within this range for the DGX-1, you should change the default Docker network addresses. The method for accomplishing this depends on the Base OS software version installed on the DGX-1.

1. If you don't know the Base OS software version installed on the DGX-1, then enter the following and inspect the VERSION entry.

```
$ grep VERSION /etc/dgx-release
DGX_SWBUILD_VERSION="3.1.1"
```

2. Follow the instructions in the section appropriate for the software version installed.
 - ▶ [Configuring Docker IP Addresses for DGX OS Server Software Version 2.x and Earlier](#)
 - ▶ [Configuring Docker IP Addresses for DGX OS Server Software Version 3.1.1 and Later](#)

3.2.1. Configuring Docker IP Addresses for DGX OS Server Software Version 2.x and Earlier

1. Open the `/etc/default/docker` file for editing.

```
$ sudo vi /etc/default/docker
```

2. Modify the `/etc/default/docker` file, specifying the correct bridge IP address and IP address ranges for your network. Consult your IT administrator for the correct addresses.

For example, if your DNS server exists at IP address `10.10.254.254`, and the `192.168.0.0/24` subnet is not otherwise needed by the DGX-1, you can add the following line to the `/etc/default/docker` file:

```
DOCKER_OPTS="--dns 10.10.254.254 --bip=192.168.0.1/24 --fixedcidr=192.168.0.0/24"
```

If there is already a `DOCKER_OPTS` line, then add the parameters (text between the quote marks) to the `DOCKER_OPTS` environment variable.

3. Save and close the `/etc/default/docker` file when done.
4. Restart Docker with the new configuration.

```
$ sudo service docker restart
```

3.2.2. Configuring Docker IP Addresses for DGX OS Server Software Version 3.1.1 and Later

You can change the default Docker network addresses by either modifying the `/etc/docker/daemon.json` file or modifying the `/etc/systemd/system/docker.service.d/docker-override.conf` file. These instructions provide an

example of modifying the `/etc/systemd/system/docker.service.d/docker-override.conf` to override the default Docker network addresses.

1. Open the `docker-override.conf` file for editing.

```
$ sudo vi /etc/systemd/system/docker.service.d/docker-override.conf
[Service]
ExecStart=
ExecStart=/usr/bin/dockerd -H fd:// -s overlay2
LimitMEMLOCK=infinity
LimitSTACK=67108864
```

2. Make the changes indicated in bold below, setting the correct bridge IP address and IP address ranges for your network. Consult your IT administrator for the correct addresses.

```
[Service]
ExecStart=
ExecStart=/usr/bin/dockerd -H fd:// -s overlay2 --bip=192.168.127.1/24
--fixed-cidr=192.168.127.128/25

LimitMEMLOCK=infinity
LimitSTACK=67108864
```

Save and close the `/etc/systemd/system/docker.service.d/docker-override.conf` file when done.

3. Reload the `systemctl` daemon.

```
$ sudo systemctl daemon-reload
```

4. Restart Docker.

```
$ sudo systemctl restart docker
```

3.3. Letting Users Issue Docker Commands

To prevent the `docker` daemon from running without protection against escalation of privileges, the NVIDIA Docker software requires `sudo` privileges to run containers.

You can grant the required privileges to users who will run containers on the DGX-1 in one of the following ways:

- ▶ Add each user as an administrator user with `sudo` privileges.
- ▶ Add each user as a standard user without `sudo` privileges and then add the user to the `docker` group.

This section provides instructions for adding users to the `docker` group.



WARNING: Only add users to the `docker` group whom you would trust with root privilege. These instructions make it more convenient for users to access Docker containers; however, the resulting `docker` group is equivalent to the root user, because once a user is able to send commands to the Docker engine, they are able to escalate privilege and run root level operations. This may violate your organization's

security policies. See the [Docker Daemon Attack Surface](#) for information on how this can impact security in your system. Always consult your IT department to make sure the installation is in accordance with the security policies of your data center.



The commands in this section require `sudo` access, and should be performed by a system administrator.

3.3.1. Checking if a User is in the Docker Group

To check whether a user is already part of the `docker` group, enter the following:

```
$ groups username
```

The output shows all the groups of which that user is a member. If `docker` is not listed, then add that user.

3.3.2. Creating a User

To create a new user in order to add them to the `docker` group, perform the following:

1. Add the user.

```
$ sudo useradd username
```

2. Set up the password.

```
$ sudo passwd username
```

Enter a password at the prompts:

```
Enter new UNIX password:
Retype new UNIX password:
passwd: password updated successfully
```

3.3.3. Adding a User to the Docker Group

For each user you want to add to the `docker` group, enter the following command:

```
$ sudo usermod -a -G docker username
```

3.4. Configuring a System Proxy

If you will be using the DGX-1 in base OS mode, and your network requires use of a proxy, then edit the file `/etc/apt/apt.conf.d/proxy.conf` and make sure the following lines are present, using the parameters that apply to your network:

```
Acquire::http::proxy "http://<username>:<password>@<host>:<port>/" ;
Acquire::ftp::proxy "ftp://<username>:<password>@<host>:<port>/" ;
Acquire::https::proxy "https://<username>:<password>@<host>:<port>/" ;
```

To ensure that Docker is able to access the DGX-1 Container Registry through the proxy, Docker uses environment variables. For best practice recommendations on configuring proxy environment variables for Docker, see <https://docs.docker.com/engine/admin/systemd/#http-proxy>.

3.5. Configuring NFS Mount and Cache

The DGX-1 includes four SSDs in a RAID 0 configuration. These SSDs are intended for application caching, so you must set up your own NFS drives for long term data storage. The following instructions describe how to mount the NFS onto the DGX-1, and how to cache the NFS using the DGX-1 SSDs for improved performance.

Make sure that you have an NFS server with one or more exports with data to be accessed by the DGX-1, and that there is network access between the DGX-1 and the NFS server.

1. Check if the cache daemon is installed and configured.

```
$ service cachefilesd status
```

If the output indicates that cachefilesd is disabled, continue with the following steps. Otherwise, skip to step 7.

2. Install the cache daemon.

```
$ sudo apt-get install cachefilesd
```

3. Edit the cache daemon startup file.

```
$ sudo vi /etc/default/cachefilesd
```

Uncomment the "RUN=yes" line in the startup file and then save the file.

4. Configure the cache daemon for the DGX-1.

- a) Open the cache daemon configuration file.

```
$ sudo vi /etc/cachefilesd.conf
```

- b) Edit the contents to match the following, then save the file.

```
dir /raid
tag dgx1cache
brun 25%
bcull 15%
bstop 5%
frun 10%
fcull 7%
fstop 3%
```

These settings are optimized for deep learning workloads, and provide the best throughput for training from large datasets.

5. Start the cache daemon.

```
$ service cachefilesd start
```

6. Verify the cache daemon started properly.

```
$ service cachefilesd status
```

Output should be similar to the following.

```
Apr 02 17:22:27 dvt8 systemd[1]: Starting LSB: CacheFiles daemon...
Apr 02 17:22:27 dvt8 cachefilesd[2342]: * Starting FilesCache daemon
cachefilesd
Apr 02 17:22:27 dvt8 cachefilesd[2510]: About to bind cache
Apr 02 17:22:27 dvt8 cachefilesd[2530]: Daemon Started
Apr 02 17:22:32 dvt8 cachefilesd[2342]: ...done.
Apr 02 17:22:32 dvt8 systemd[1]: Started LSB: CacheFiles daemon.
```

7. Configure an NFS mount for the DGX-1.

a) Edit the filesystem tables configuration.

```
sudo vi /etc/fstab
```

b) Add a new line for the NFS mount, using the local mount point of /mnt.

```
<nfs_server>:<export_path> /mnt nfs
rw,noatime,rsize=32768,wsize=32768,nolock,tcp,intr,fsc,nofail 0 0
```

- ▶ /mnt is used here as an example mount point.
- ▶ Consult your Network Administrator for the correct values for <nfs_server> and <export_path>.
- ▶ The nfs arguments presented here are a list of recommended values based on typical use cases. However, "fsc" must always be included as that argument specifies use of FS-Cache.

c) Save the changes.

8. Verify the NFS server is reachable.

```
ping <nfs_server>
```

Use the server IP address or the server name provided by your network administrator.

9. Mount the NFS export.

```
sudo mount /mnt
```

/mnt is the example mount point used in step 7.

10. Verify caching is enabled.

```
cat /proc/fs/nfsfs/volumes
```

Look for the text FSC=yes in the output.

Upon rebooting, the NFS should be mounted and cached on the DGX-1.

Chapter 4.

CONFIGURING AND MANAGING THE DGX-1

This chapter describes the following DGX-1 configuration and management tasks:

- ▶ Using the BMC
- ▶ Configuring a Static IP Address for the BMC
- ▶ Configuring Static IP Addresses for the Network Ports
- ▶ Obtaining MAC Addresses

4.1. Using the BMC

The DGX-1 includes a baseboard management controller (BMC) that lets you manage and monitor the DGX-1 independently of the CPU or operating system. You can access the BMC remotely through the Ethernet connection to the IPMI port.

This section describes how to access the BMC, and describes a few common tasks that you can accomplish through the BMC. It is not meant to be a comprehensive description of all the BMC capabilities.

To access the BMC remotely:

1. Make sure you have connected the IPMI port on the DGX-1 to your LAN.
2. Open a Java-enabled browser within your LAN and go to `http://<IPMI IP Address>/`. Use Firefox or Internet Explorer. Google Chrome is not officially supported by the BMC.

Baseboard Management Controller

3. Log in.

Your initial log in credentials are based on the ones you created when you first set up the DGX-1. Enter your username for both the User ID as well as the Password.

User ID: <your username>

Password: <your username>.

4. Be sure to change your password immediately to ensure the security of the BMC.
See the next section for instructions on how to change your BMC password.

4.1.1. Creating a Unique BMC Password for Remote Access

When you set up the DGX-1 upon powering it on for the first time, you set up a username and password for the system. These credentials are also used to log in to the BMC remotely, except that the BMC password is the username.

It is strongly recommended that you create a unique password as soon as possible.

Create a unique BMC password as follows:

1. Open a Java-enabled web browser within your LAN and go to `http://<IPMI IP address>/`.

Use Firefox or Internet Explorer. Google Chrome is not officially supported by the BMC.
2. Log in with the username that you created when you first set up the DGX-1.
Enter your username for both the User ID as well as the password:
User ID: <your username>
Password: <your username>
3. From the top menu, click **Configuration** and then select **User**.
4. Select your username and then click **Modify User**.

5. In the *Modify User* dialog, select **Change Password**, and then enter your new password in the *Password* and *Confirm Password* boxes.
6. Click **Modify** when finished.

4.1.2. Viewing System Information

The BMC opens to the dashboard, which shows information about the system and system components, such as temperatures and voltages.

The screenshot shows the NVIDIA BMC dashboard. The top navigation bar includes 'Dashboard', 'Server Information', 'Server Health', 'Configuration', 'Remote Control', 'Maintenance', and 'Firmware Update'. The main content area is divided into three sections: 'Device Information', 'Sensor Monitoring', and 'Event Logs'.

Device Information:

- Firmware Revision: 2.15.00
- Firmware Build Time: Aug 24 2016 20:50:08 CST
- BIOS Version: 52W_3A01
- Expander Firmware Version: 0400
- BMC NIC: Dedicated-NIC
- System MAC:
 - 1 : OCP Mezz: 54:AB:3A:CC:1B:E9
 - 2 : OCP Mezz: 54:AB:3A:CC:1B:EA
- BMC Date & Time: Thu, 03 Nov 2016 17:53:15
- BMC Chipset: AST2400
- PSU1 MFR Revision: 01
- PSU1 Firmware Version: 00.02.05
- PSU2 MFR Revision: 01
- PSU2 Firmware Version: 00.02.05
- PSU3 MFR Revision: 01
- PSU3 Firmware Version: 00.02.05
- PSU4 MFR Revision: 01
- PSU4 Firmware Version: 00.02.05
- GPU0 Market Name: Tesla P100-SXM2-16GB
- GPU0 GPU Part Number: 15F9-800-A1
- GPU0 Firmware version: 36.00.20.00.02
- GPU1 Market Name: Tesla P100-SXM2-16GB
- GPU1 GPU Part Number: 15F9-800-A1
- GPU1 Firmware version: 36.00.20.00.02
- GPU2 Market Name: Tesla P100-SXM2-16GB
- GPU2 GPU Part Number: 15F9-800-A1
- GPU2 Firmware version: 36.00.20.00.02
- GPU3 Market Name: Tesla P100-SXM2-16GB
- GPU3 GPU Part Number: 15F9-800-A1

Sensor Monitoring:

Status	Sensor	Reading	
●	Temp_GPGPU0	34 ° C	🔊
●	Temp_GPGPU1	29 ° C	🔊
●	Temp_GPGPU2	34 ° C	🔊
●	Temp_GPGPU3	33 ° C	🔊
●	Temp_GPGPU4	34 ° C	🔊
●	Temp_GPGPU5	35 ° C	🔊
●	Temp_GPGPU6	33 ° C	🔊
●	Temp_GPGPU7	33 ° C	🔊
●	Power_GPGPU0	30 Watts	🔊
●	Power_GPGPU1	32 Watts	🔊
●	Power_GPGPU2	32 Watts	🔊
●	Power_GPGPU3	30 Watts	🔊
●	Power_GPGPU4	30 Watts	🔊
●	Power_GPGPU5	30 Watts	🔊
●	Power_GPGPU6	30 Watts	🔊
●	Power_GPGPU7	32 Watts	🔊

Event Logs:

- Event Log (0.11%)
- Free Space (99.09%)

4.1.3. Submitting BMC Log Files

The BMC provides automatic logging of system activities and status. The NVIDIA Enterprise Support team uses the log files to assist in troubleshooting. Follow these instructions to obtain the log files to send to NVIDIA Enterprise Support.

1. Log into the BMC, then click **Server Health** from the top menu and select **Event Log**.
2. Make sure that **Text** is selected at *Format of Download Event Logs*.

Format of Download Event Logs: Text Hex

3. Click **Save Event Logs** to download the event logs.

4.1.4. Determining Total Power Consumption

You can use the BMC dashboard to determine total power consumption of the DGX-1 as follows:

1. Log into the BMC.

- From the BMC dashboard, locate the *Sensor Monitoring* area and then scroll down the page until you see the *PSU Input* rows.

●	PSU1 Input	216 Watts	🔍
●	PSU2 Input	216 Watts	🔍
●	PSU3 Input	135 Watts	🔍
●	PSU4 Input	27 Watts	🔍

- Add the values for all the PSUs.
In this example, the total power consumption would be $216+216+135+27 = 594$ watts.

4.1.5. Accessing the DGX-1 Console

- Log into the BMC.
- From the top menu, click **Remote Control** and then select **Console Redirection**.
- Click **Java Console** to open the popup window.

The window provides interactive control of the DGX-1 console.

4.1.6. Powering Off / Power Cycling the System Remotely

4.1.6.1. From the DGX-1 Console Window

If you have opened the Java Viewer (*Remote Control->Console Redirection*) to view the console window, then you can power cycle, reset, or shutdown the DGX-1 as follows:

- From the JViewer top menu, click **Power** and then select from the available options, depending on what you want to do.



- Click **Yes** and then **OK** at the *Power Control* dialog, then wait for the system to perform the intended action.

4.1.6.2. From the BMC UI

- Log into the BMC.
- From the top menu, click **Remote Control** and then select **Server Power Control**.



Refresh Print Logout

Dashboard Server Information Server Health Configuration Remote Control Maintenance Firmware Update HELP

Console Redirection

Server Power Control

Java SOL

The current server power status is shown below. To perform a power control of options below and press "Perform Action".

Host is currently on

- Reset Server
- Power Off Server - Immediate
- Power Off Server - Orderly Shutdown
- Power On Server
- Power Cycle Server

Perform Action

3. Select from the available options according to what you want the system to do, then click **Perform Action**.

4.2. Configuring a Static IP Address for the BMC

This section explains how to set a static IP address for the BMC. You will need to do this if your network does not support DHCP.

Use one of the methods described in the following sections:

- ▶ Configuring a BMC Static IP Address Using the System BIOS
- ▶ Configuring the BMC Static IP Address Using ipmitool
- ▶ Configuring the BMC Static IP Address Using the BMC User Interface

4.2.1. Configuring a BMC Static IP Address Using ipmitool

This section describes how to set a static IP address for the BMC from the Ubuntu command line.



If you cannot access the DGX-1 remotely, then connect a display (1024x768 or lower resolution) and keyboard directly to the DGX-1.

To view the current settings, enter the following command.

```
$ sudo ipmitool lan print 1
Set in Progress      : Set Complete
Auth Type Support    : MD5
Auth Type Enable     : Callback : MD5
                    : User      : MD5
                    : Operator : MD5
```

```

: Admin : MD5
: OEM   : MD5
IP Address Source : DHCP Address
IP Address       : 10.31.241.190
Subnet Mask      : 255.255.255.0
MAC Address      : 54:ab:3a:72:08:a9
SNMP Community String : Quanta
IP Header        : TTL=0x40 Flags=0x40 Precedence=0x00 TOS=0x10
BMC ARP Control  : ARP Responses Enabled, Gratuitous ARP Disabled
Gratuitous ARP Intrvl : 0.0 seconds
Default Gateway IP : 10.31.241.1
Default Gateway MAC : 00:00:00:00:00:00
Backup Gateway IP  : 0.0.0.0
Backup Gateway MAC : 00:00:00:00:00:00
802.1q VLAN ID    : Disabled
802.1q VLAN Priority : 0RMCP+ Cipher Suites : 0,1,2,3,6,7,8,11,12,15,16,17
Cipher Suite Priv Max : XaaaaaaaaaXXX
                   : X=Cipher Suite Unused
                   : c=CALLBACK
                   : u=USER
                   : o=OPERATOR
                   : a=ADMIN
                   : O=OEM

```

To set a static IP address for the BMC, do the following.

1. Set the IP address source to **static**.

```
$ sudo ipmitool lan set 1 ipsrc static
```

2. Set the appropriate address information.

- ▶ To set the IP address (“Station IP address” in the BIOS settings), enter the following and replace the italicized text with your information.

```
$ sudo ipmitool lan set 1 ipaddr 10.31.241.190
```

- ▶ To set the subnet mask, enter the following and replace the italicized text with your information.

```
$ sudo ipmitool lan set 1 netmask 255.255.255.0
```

- ▶ To set the default gateway IP (“Router IP address” in the BIOS settings), enter the following and replace the italicized text with your information.

```
$ sudo ipmitool lan set 1 defgw ipaddr 10.31.241.1
```

4.2.2. Configuring a BMC Static IP Address Using the System BIOS

This section describes how to set a static IP address for the BMC when you cannot access the DGX-1 remotely. This process involves setting the BMC IP address during system boot.

1. Connect a keyboard and display (1024x768 or lower resolution) to the DGX-1, then turn on the DGX-1.
2. When you see the NVIDIA logo, press **Del** to enter the BIOS Utility Setup Screen.



3. At the BIOS Setup Utility screen, navigate to the **Server Mgmt** tab on the top menu, then scroll to **BMC network configuration** and press **Enter**.

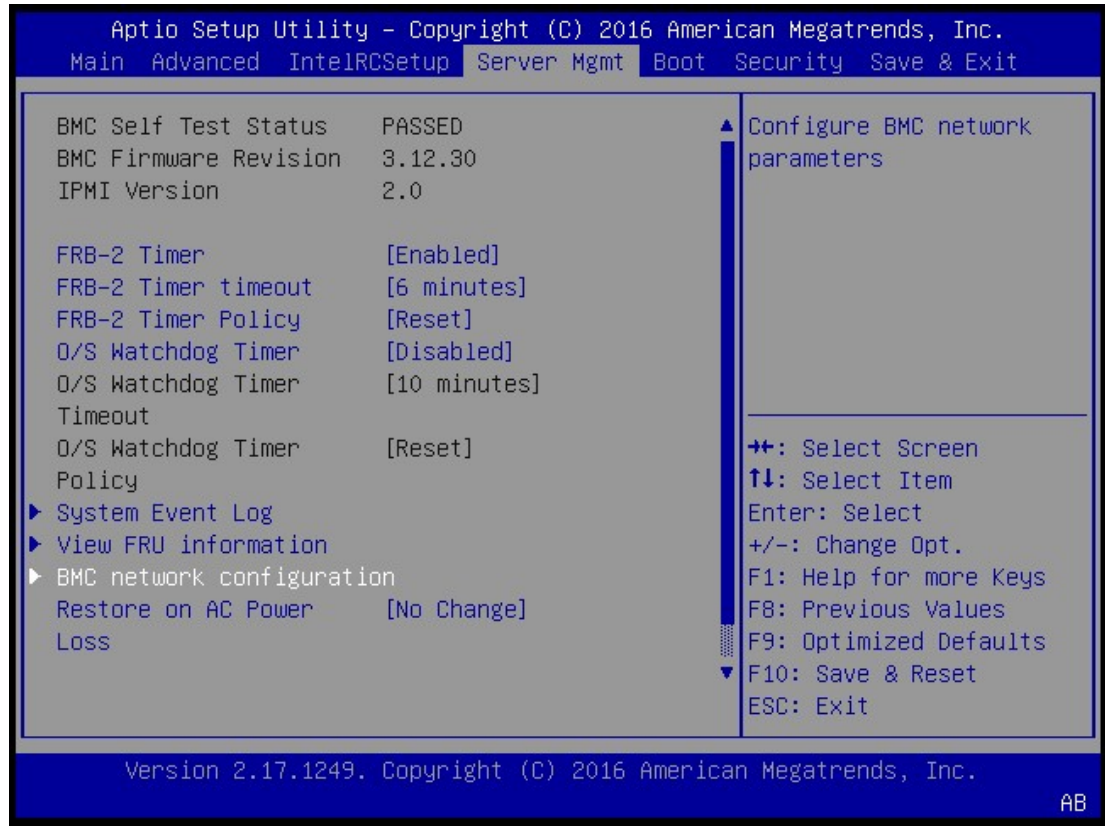

4. Scroll to **Configuration Address Source** and press **Enter**, then at the **Configuration Address source** pop-up, select **Static on next reset** and then press **Enter**.

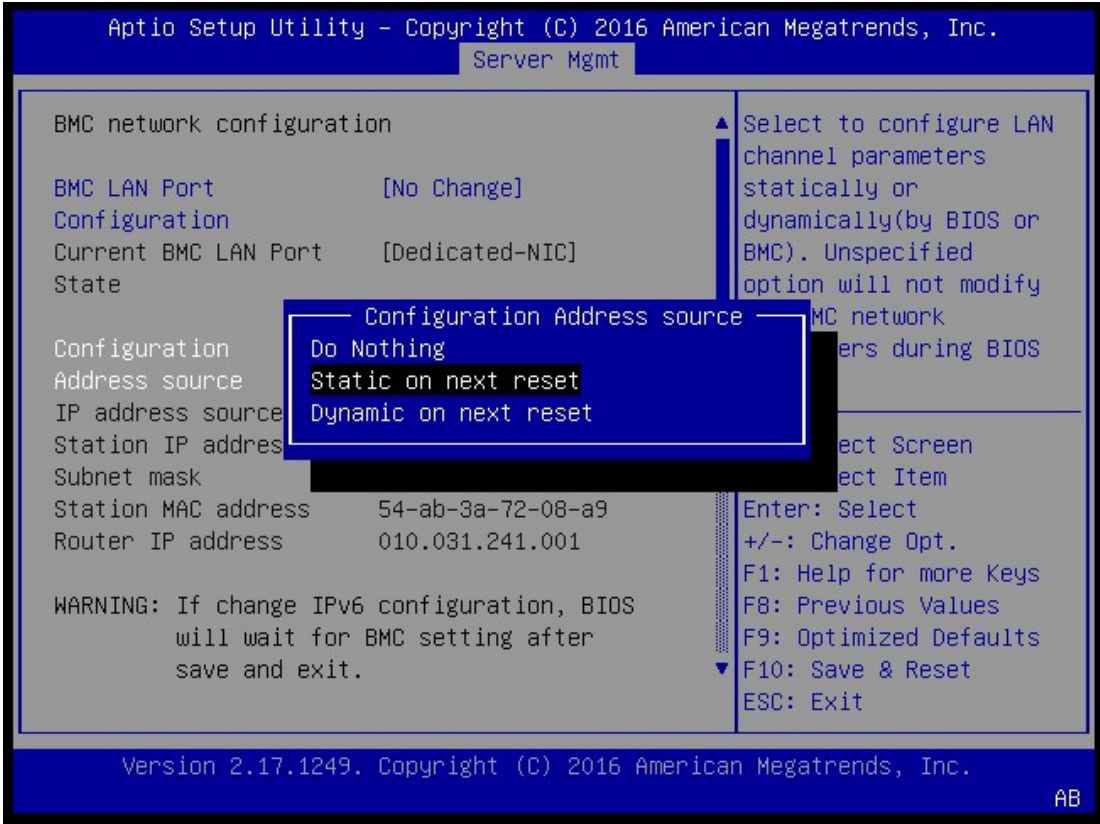

- 5. Set the addresses for the Station IP address, Subnet mask, and Router IP address as needed by performing the following for each:
 - a) Scroll to the specific item and press **Enter**.
 - b) Enter the appropriate information at the pop-up, then press Enter.

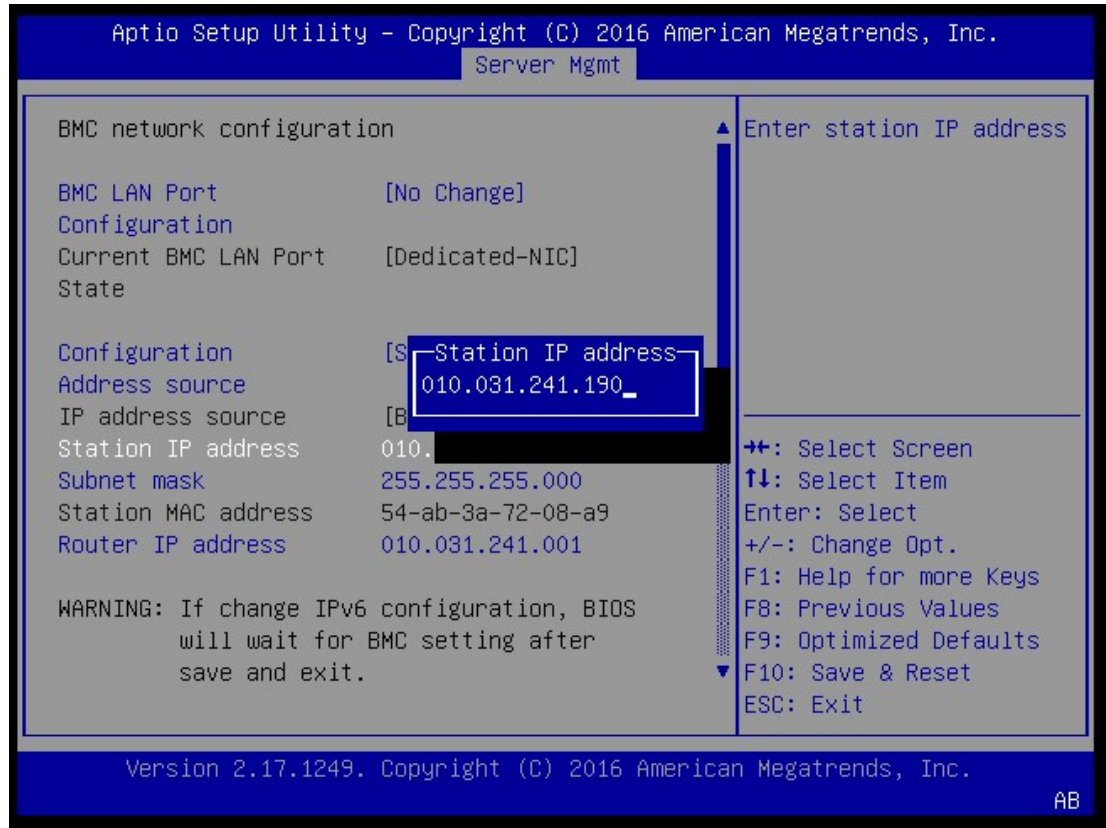

6. When finished making all your changes, press **F10** to Save & Reset, then select **Yes** at the confirmation pop-up and press **Enter**.

You can now access the BMC over the network.

4.2.3. Configuring a BMC Static IP Address Using the BMC Dashboard

1. Log into the BMC, then click **Configuration** from the top menu and select **Network Settings**.
2. In the *IPv4 Configuration* section of the Network Settings page, clear the **Use DHCP** check box, and then enter the appropriate values for the **IPv4 Address**, **Subnet Mask**, and **Default Gateway** fields.



Network Settings

Manage network settings of the device.

LAN Interface	<input type="text" value="bond0"/>
LAN Settings	<input checked="" type="checkbox"/> Enable
MAC Address	<input type="text" value="54:AB:3A:D6:96:11"/>
IPv4 Configuration	
IPv4 Settings	<input checked="" type="checkbox"/> Enable
Obtain an IP address automatically	<input checked="" type="checkbox"/> Use DHCP
IPv4 Address	<input type="text" value="10.31.124.132"/>
Subnet Mask	<input type="text" value="255.255.255.0"/>
Default Gateway	<input type="text" value="10.31.124.1"/>

3. Click **Save** when done.

4.3. Configuring Static IP Addresses for the Network Ports

During the initial boot setup process for the DGX-1, you had an opportunity to configure static IP addresses for the network ports. If you did not set this up at that time, you can configure the static IP addresses from the Ubuntu command line according to the following instructions.



If you cannot access the DGX-1 remotely, then connect a display (1024x768 or lower resolution) and keyboard directly to the DGX-1.

1. Determine the port designation that you want to configure, based on the physical ethernet port that you have connected to your network.

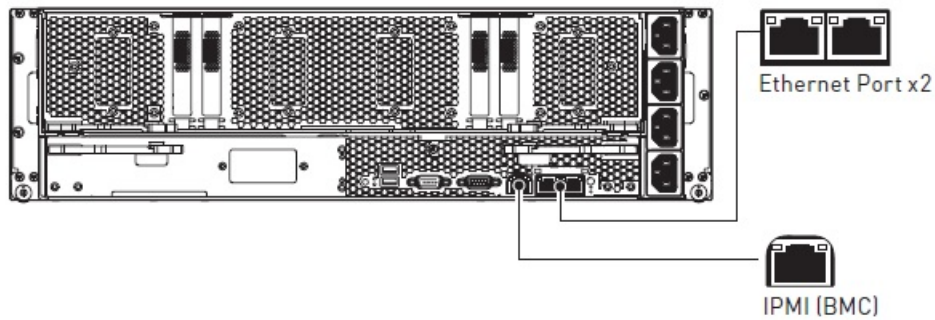

Use the following port designations according to the DGX-1 Base OS software version installed on the DGX-1:

Ethernet Port Position	Port Designation: Base OS Software 2.x and earlier	Port Designation: Base OS Software 3.x and later
Right Side	em1	enp1s0f0
Left Side	em2	enp1s0f1

2. Edit the interfaces file.

```
$ sudo vi /etc/network/interfaces
## Configure a static IP
auto em1
iface em1 inet static
    address 192.168.1.14
    gateway 192.168.1.1
    netmask 255.255.255.0
    network 192.168.1.0
    broadcast 192.168.1.255
```

Consult your network administrator for the appropriate addresses for your network, and use the port designations that you determined in step 1.

3. When finished with your edits, press **ESC** to switch to command mode, then save the file to the disk and exit the editor.

```
:wq
```

4. Restart the network services to put the changes into effect.

```
$ sudo /etc/init.d/networking restart
```

4.4. Obtaining MAC Addresses

These instructions explain how to determine the MAC addresses for the IPMI port (BMC) as well as both ethernet ports of the DGX-1.

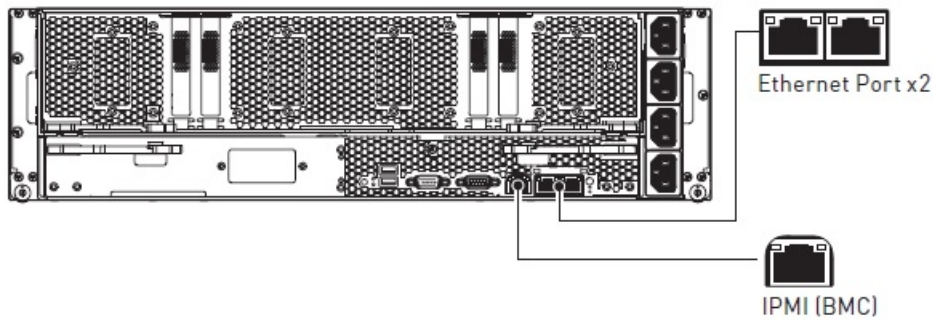

The ports are, from left to right, IPMI (BMC), em2 (or enp1s0f1), em1 (or enp1s0f0).

1. Connect a display (1024x768 or lower resolution) and keyboard to the DGX-1.
2. Turn the DGX-1 on or reboot.
3. At the NVIDIA logo boot screen, press **[F2]** or **[Del]** to enter the BIOS setup screen.

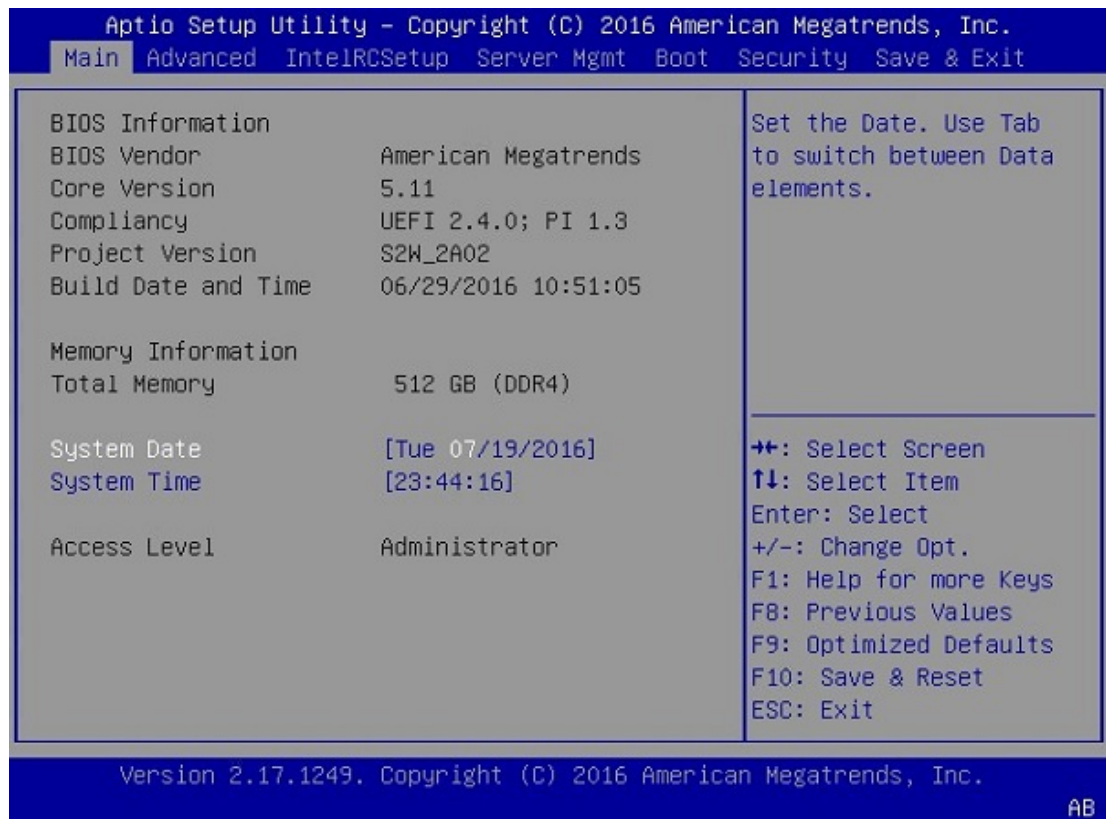

4. Select the **Advanced** tab from the top menu, then scroll down to view the two **Quanta Dual Port 10G BASE-T Mezzanine** items.

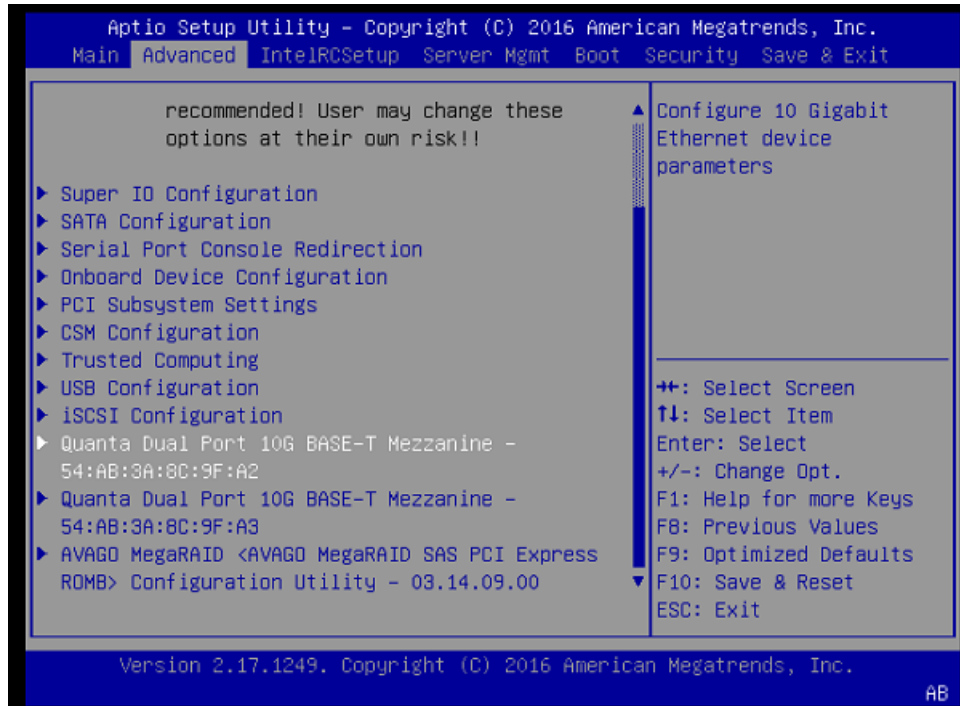

The first item shows the MAC address for ethernet port em1, and the second item shows the MAC address for em2.

5. Navigate to and select **Server Mgmt** from the top menu, then scroll down to and select **BMC network configuration**.

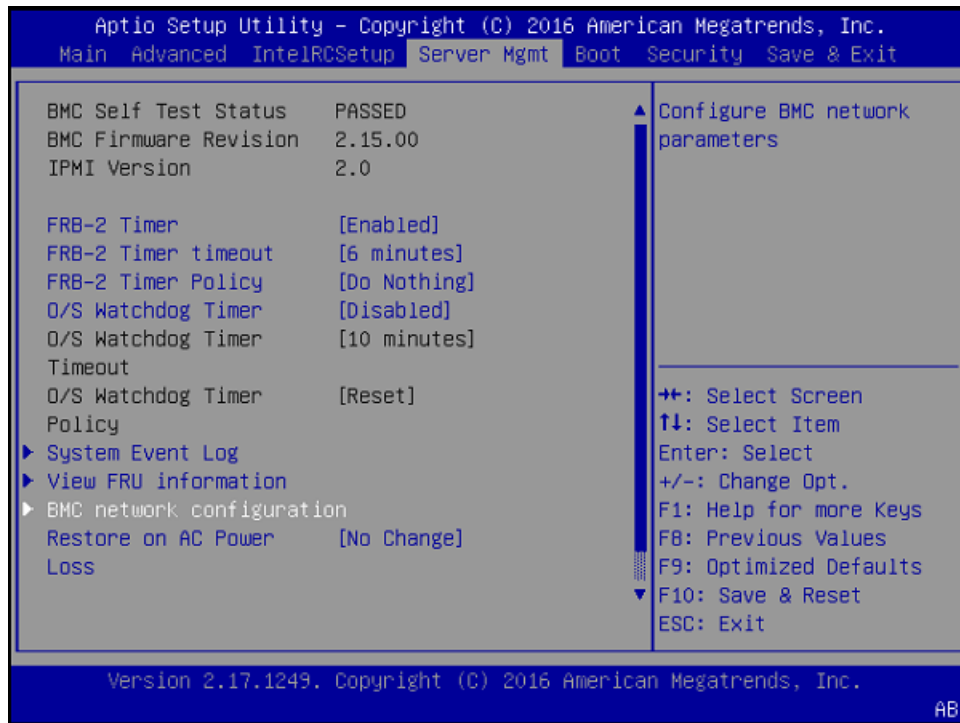

6. Scroll down to view the Station MAC address.

This shows the MAC address for the BMC.

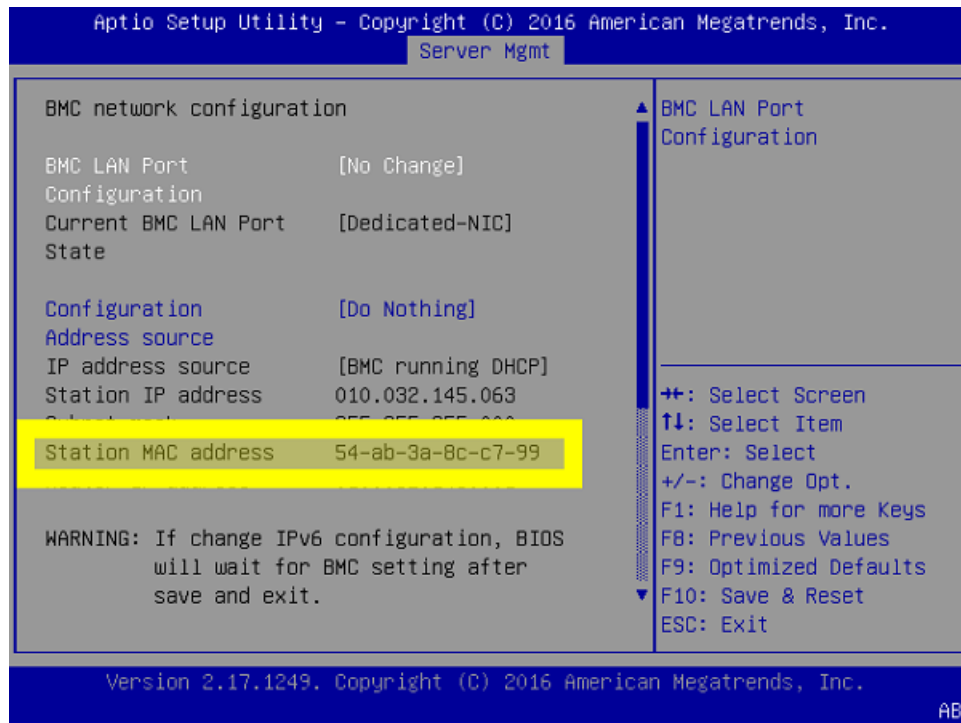

4.5. Resetting GPUs in the DGX-1

The NVIDIA® DGX-1™ GPUs may need to be reset during maintenance or repair work. For example, when a GPU presents Double Bit Errors or repeat Single Bit Errors in the same location, pages are retired. For the retired pages to be blacklisted (unavailable to the user/application), the GPU needs to be reset. In the case of the DGX-1 platforms, individual GPUs cannot be reset because they are linked via NVLink, so all the GPUs must be reset simultaneously.

The simplest way to reset all the GPUs in the system is to reboot the system. If this is too disruptive and you need to keep the system booted, then this section explains how to reset the GPUs without rebooting the system.

GPU Reset Process Overview

To reset the GPUs, all applications running on the GPUs must first be shut down. NVIDIA provides a tool (`nvidia-smi`) to monitor and manage the GPUs on the system. This tool can be used to check for running applications and then to reset the GPUs. The basic process is as follows:

1. Check for running applications, using `nvidia-smi`.
2. Close running applications.

3. Stop NVIDIA processes, using `systemctl`.
4. Reset the GPUs, using `nvidia-smi`.
5. Re-enable NVIDIA processes, using `systemctl`.

4.5.1. Stopping Running Applications and Services

1. Check if there are any applications running on the GPUs.

```
~$ nvidia-smi -q -d PIDS

=====NVSMI LOG=====
Timestamp : Fri Feb 23 11:56:41 2018
Driver Version : 384.111
Attached GPUs : 8
GPU 00000000:06:00.0
  Processes : None
GPU 00000000:07:00.0
  Processes : None
GPU 00000000:0A:00.0
  Processes : None
GPU 00000000:0B:00.0
  Processes : None
GPU 00000000:85:00.0
  Processes : None
GPU 00000000:86:00.0
  Processes : None
GPU 00000000:89:00.0
  Processes : None
GPU 00000000:8A:00.0
  Processes : None ~$
```

2. Close any listed applications.
3. If DCGM is being used to monitor GPUs, make sure to shut down the host engine (daemon).

```
~$ sudo nv-hostengine -t
Host engine successfully terminated.
```

4. If the DGX-1 system is being monitored by any application or agent that is watching the GPUs (for example, Nagios), those applications or agents should also be shut down.
5. Run `nvidia-smi` to confirm the applications have been closed.
6. Once no applications are running on the GPUs, stop the `nvidia-docker` and `nvidia-persistenced` services as follows:

```
~$ sudo systemctl stop nvidia-persistenced
```

```
~$ sudo systemctl stop nvidia-docker
```

7. As a final check, verify that no applications or agents are running on the GPUs.

```
~$ lsof /dev/nvidia*
```

If any processes are listed, be sure stop or kill them before proceeding with the next section.

4.5.2. Resetting the GPUs

To reset the GPUs, do the following.

1. Run the `nvidia-smi` command as follows:

```
~$ sudo nvidia-smi -r
GPU 00000000:06:00.0 was successfully reset.
GPU 00000000:07:00.0 was successfully reset.
GPU 00000000:0A:00.0 was successfully reset.
GPU 00000000:0B:00.0 was successfully reset.
GPU 00000000:85:00.0 was successfully reset.
GPU 00000000:86:00.0 was successfully reset.
GPU 00000000:89:00.0 was successfully reset.
GPU 00000000:8A:00.0 was successfully reset.
All done. ~$
```

2. Enable `nvidia-persistenced`, `nvidia-docker`, and any other monitoring agents and applications that were stopped earlier as described in the previous section.

```
~$ sudo systemctl start nvidia-persistenced
~$ sudo systemctl start nvidia-docker
```

3. Run the following command only if DCGM was being used.

```
~$ sudo nv-hostengine dmon
Started host engine version 1.3.3 using port number: 5555
```

4.6. Changing the Mellanox Card Port Type

Data center environments can vary in the type of network connectivity used. The NVIDIA DGX-1 system is equipped with 4 Single port Mellanox ConnectX-4 VPI MCX455A-ECAT modules. By default these are configured as Infiniband ports, but you have the option to convert these to Ethernet ports.

In order for these changes to work properly, the configured port must connect to a networking switch that matches the port configuration. In other words, if the port configuration is set to Infiniband, then the external switch should be an Infiniband switch with the corresponding Infiniband cables. Likewise, if the port configuration is set to Ethernet, then the switch should also be Ethernet.

Downloading and Starting the Mellanox Software Tools

1. Download http://www.mellanox.com/downloads/MFT/mft-4.6.0-48-x86_64-deb.tgz.
2. Untar the downloaded package.
3. Switch to the download directory `mft-4.6.0-48-x86_64-deb/` and then run the installation script.

```
$ install.sh
```

4. Start the mst driver:

```
$ sudo mst start
```

To verify that the Mellanox Software Tools (MST) services are running, enter the following.

```
~$ sudo mst status
```

- ▶ The following output indicates the services are *not* running.

```
MST modules:
-----
MST PCI module is not loaded
MST PCI configuration module is not loaded

PCI Devices:
-----
05:00.0
84:00.0
0c:00.0
8b:00.0
```

- ▶ The following output indicates the services are running.

```
MST modules:
-----
MST PCI module is not loaded
MST PCI configuration module loaded
MST devices:
-----
/dev/mst/mt4115_pciconf0 - PCI configuration cycles access.
                        domain:bus:dev.fn=0000:05:00.0 addr.reg=88
data.reg=92
                        Chip revision is: 00
/dev/mst/mt4115_pciconf1 - PCI configuration cycles access.
                        domain:bus:dev.fn=0000:0c:00.0 addr.reg=88
data.reg=92
                        Chip revision is: 00
/dev/mst/mt4115_pciconf2 - PCI configuration cycles access.
                        domain:bus:dev.fn=0000:84:00.0 addr.reg=88
data.reg=92
                        Chip revision is: 00
/dev/mst/mt4115_pciconf3 - PCI configuration cycles access.
                        domain:bus:dev.fn=0000:8b:00.0 addr.reg=88
data.reg=92
                        Chip revision is: 00
-1:~$
```

Determining the Current Port Configuration

To determine the current port configuration, enter the following,

```
~$ ibv_devinfo | grep -e "hca_id\|link_layer"
```

- ▶ The following output indicates the ports are configured for InfiniBand.

```
hca_id: mlx5_3 link_layer: InfiniBand
hca_id: mlx5_2 link_layer: InfiniBand
hca_id: mlx5_1 link_layer: InfiniBand
hca_id: mlx5_0 link_layer: InfiniBand
```

- ▶ The following output indicates the ports are configured for Ethernet.

```
hca_id: mlx5_3 link_layer: Ethernet
hca_id: mlx5_2 link_layer: Ethernet
hca_id: mlx5_1 link_layer: Ethernet
hca_id: mlx5_0 link_layer: Ethernet
```

4.6.1. Switching the Port from InfiniBand to Ethernet

Make sure that you have installed the Mellanox Software Tools (MST) services and have started running them as explain in the section [Downloading and Starting the Mellanox Software Tools](#).

1. Change the configuration for all four ports to Ethernet.

```
~$ sudo mlxconfig -y -d /dev/mst/mt4115_pciconf0 set LINK_TYPE_P1=2
~$ sudo mlxconfig -y -d /dev/mst/mt4115_pciconf1 set LINK_TYPE_P1=2
~$ sudo mlxconfig -y -d /dev/mst/mt4115_pciconf2 set LINK_TYPE_P1=2
~$ sudo mlxconfig -y -d /dev/mst/mt4115_pciconf3 set LINK_TYPE_P1=2
```

2. Verify the configuration changes have been applied.

```
~$ sudo mlxconfig query |grep -e "LINK_TYPE\|PCI\ device"
PCI device: /dev/mst/mt4115_pciconf3 LINK_TYPE_P1 ETH(2)
PCI device: /dev/mst/mt4115_pciconf2 LINK_TYPE_P1 ETH(2)
PCI device: /dev/mst/mt4115_pciconf1 LINK_TYPE_P1 ETH(2)
PCI device: /dev/mst/mt4115_pciconf0 LINK_TYPE_P1 ETH(2)
```



These changes will not take place until the server is rebooted.

3. Reboot the DGX-1.
4. After the DGX-1 is back online, make sure that Ethernet is the active link layer.

```
~$ ibv_devinfo |grep -e "hca_id\|link_layer"
hca_id: mlx5_3 link_layer: Ethernet
hca_id: mlx5_2 link_layer: Ethernet
hca_id: mlx5_1 link_layer: Ethernet
hca_id: mlx5_0 link_layer: Ethernet
```

4.6.2. Switching the Port from Ethernet to InfiniBand

Make sure that you have installed the Mellanox Software Tools (MST) services and have started running them as explain in the section [Downloading and Starting the Mellanox Software Tools](#).

1. Change the configuration for all four ports to InfiniBand.

```
~$ sudo mlxconfig -y -d /dev/mst/mt4115_pciconf3 set LINK_TYPE_P1=1
~$ sudo mlxconfig -y -d /dev/mst/mt4115_pciconf2 set LINK_TYPE_P1=1
~$ sudo mlxconfig -y -d /dev/mst/mt4115_pciconf1 set LINK_TYPE_P1=1
~$ sudo mlxconfig -y -d /dev/mst/mt4115_pciconf0 set LINK_TYPE_P1=1
```

2. Verify the configuration changes have been applied.

```
~$ sudo mlxconfig query |grep -e "LINK_TYPE\|PCI\ device"
PCI device: /dev/mst/mt4115_pciconf3 LINK_TYPE_P1 IB(1)
PCI device: /dev/mst/mt4115_pciconf2 LINK_TYPE_P1 IB(1)
PCI device: /dev/mst/mt4115_pciconf1 LINK_TYPE_P1 IB(1)
```

```
PCI device: /dev/mst/mt4115_pciconf0 LINK_TYPE_P1 IB(1)
```



These changes will not take place until the server is rebooted.

3. Reboot the DGX-1.
4. After the DGX-1 is back online, make sure that InfiniBand is the active link layer.

```
~$ ibv_devinfo |grep -e "hca_id\|link_layer"  
hca_id: mlx5_3 link_layer: InfiniBand  
hca_id: mlx5_2 link_layer: InfiniBand  
hca_id: mlx5_1 link_layer: InfiniBand  
hca_id: mlx5_0 link_layer: InfiniBand
```

Chapter 5.

MAINTAINING AND SERVICING THE NVIDIA DGX-1

Be sure to familiarize yourself with the NVIDIA Terms & Conditions documents before attempting to perform any modification or repair to the DGX-1. These Terms & Conditions for the DGX-1 can be found through the [NVIDIA DGX Systems Support \(http://www.nvidia.com/object/dgxsupport.html\)](http://www.nvidia.com/object/dgxsupport.html) page.

5.1. Problem Resolution and Customer Care

Log on to the [NVIDIA Enterprise Services \(https://nvid.nvidia.com/dashboard/\)](https://nvid.nvidia.com/dashboard/) site for assistance with troubleshooting, diagnostics, or to report problems with your DGX-1.

Refer to [Customer Support for the NVIDIA DGX-1](#) for additional contact information.

Refer to [Submitting BMC Log Files](#) for instructions on how to obtain the BMC log files to assist in troubleshooting.

5.2. Restoring the DGX-1 Software Image

If the DGX-1 software image becomes corrupted or the OS SSD was replaced after a failure, restore the DGX-1 software image to its original factory condition from a pristine copy of the image.

The process for restoring the DGX-1 software image is as follows:

1. Obtain an ISO file that contains the image from NVIDIA Support Enterprise Services as explained in [Obtaining the DGX-1 Software ISO Image and Checksum File](#).
2. Restore the DGX-1 software image from this file either remotely through the BMC or locally from a bootable USB flash drive.
 - ▶ If you are restoring the image remotely, follow the instructions in [Re-Imaging the System Remotely](#).

- ▶ If you are restoring the image locally, prepare a bootable USB flash drive and restore the image from the USB flash drive as explained in the following topics:
 - ▶ [Creating a Bootable Installation Medium](#)
 - ▶ [Re-Imaging the System From a USB Flash Drive](#)

5.2.1. Obtaining the DGX-1 Software ISO Image and Checksum File

To ensure that you restore the current version of the DGX-1 software image, obtain the correct ISO image file from NVIDIA Support Enterprise Services. A checksum file is provided for the image to enable you to verify the bootable installation medium that you create from the image file.

1. Log on to the [NVIDIA Enterprise Services \(https://nvid.nvidia.com/dashboard/\)](https://nvid.nvidia.com/dashboard/) site.
2. Click the **Announcements** tab to locate the download links for the DGX-1 software image.
3. Download the ISO image and its checksum file and save them to your local disk.
The ISO image is also available in an archive file. If you download the archive file, be sure to extract the ISO image before proceeding.

5.2.2. Re-Imaging the System Remotely

These instructions describe how to re-image the system remotely through the BMC. For information about how to restore the system locally, see [Re-Imaging the System From a USB Flash Drive](#).

Before re-imaging the system remotely, ensure that the correct DGX-1 software image is saved to your local disk. For more information, see [Obtaining the DGX-1 Software ISO Image and Checksum File](#).

1. Connect to the BMC and change user privileges.
 - a) Open a Java-enabled web browser within your LAN and go to **http://IPMI-IP-address/**, then log in.
Use Firefox or Internet Explorer. Google Chrome is not officially supported by the BMC.
 - b) From the top menu, click **Configuration** and then select **User Management**.
 - c) Select the user name that you created for the BMC, then click **Modify User**.
 - d) In the **Modify User** dialog, select the **VMedia** check box to add it to the extended privileges for the user, then click **Modify**.

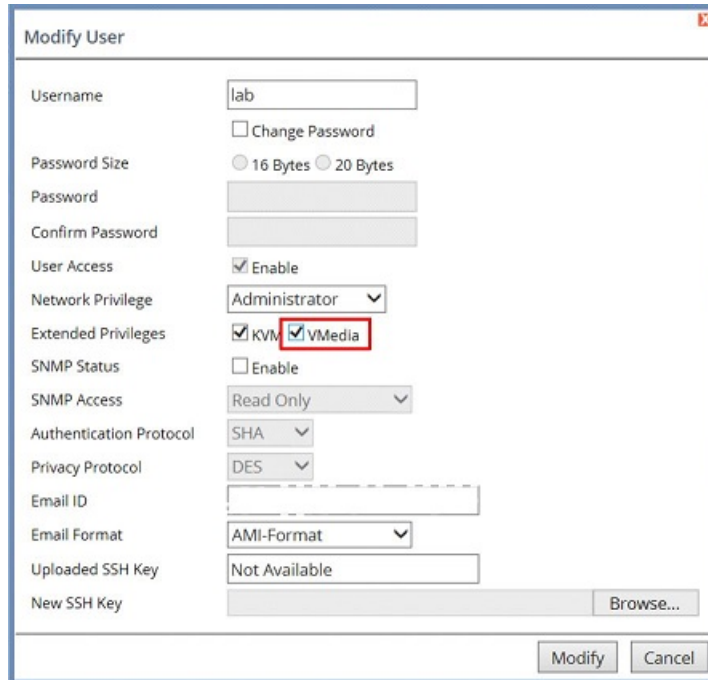

2. Set up the ISO image as virtual media.
 - a) From the top menu, click **Remote Control** and select **Console Redirection**.

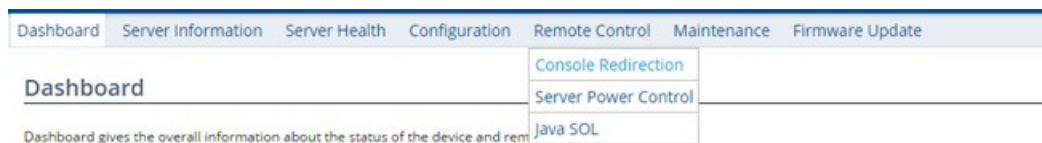

- b) Click **Java Console** to open the remote JViewer window.
Make sure pop-up blockers are disabled for this site.
 - c) From the JViewer top menu bar, click **Media** and then select **Virtual Media Wizard**.

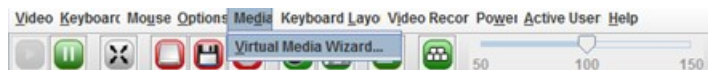

- d) From the **CD/DVD Media: I** section of the **Virtual Media** dialog, click **Browse** and then locate the re-image ISO file and click **Open**.
You can ignore the device redirection warning at the bottom of the **Virtual Media** wizard as it does not affect the ability to re-image the system.
 - e) Click **Connect CD/DVD**, then click **OK** at the **Information** dialog.
The **Virtual Media** window shows that the ISO image is connected.

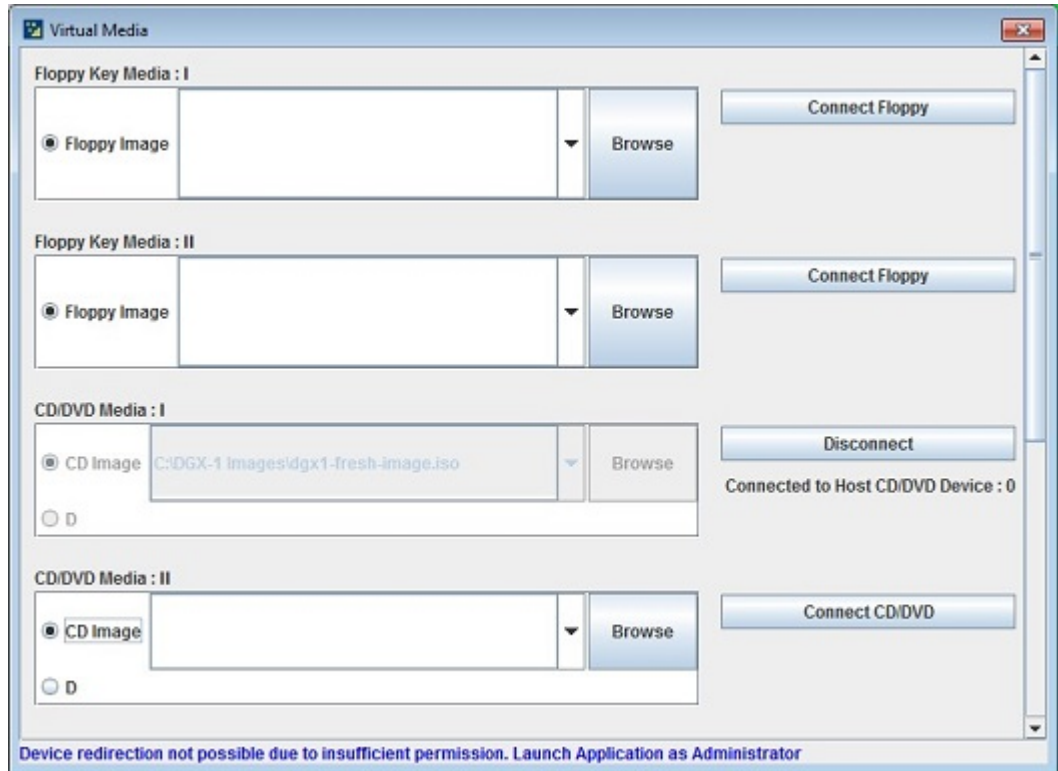

f) Close the window.

The CD ROM icon in the menu bar turns green to indicate that the ISO image is attached.



3. Reboot, install the image, and complete the DGX-1 setup.

a) From the top menu, click **Power** and then select **Reset Server**.



b) Click **Yes** and then **OK** at the **Power Control** dialogs, then wait for the system to power down and then come back online.

c) At the boot selection screen, select **Install DGX Server**.

If you are an advanced user who is not using the RAID disks as cache and want to keep data on the RAID disks, then select **Install DGX Server without**

formatting RAID. See the section [Retaining the RAID Partition While Installing the OS](#) for more information.

d) Press **Enter**.

The DGX-1 will reboot from CDR0M0 1.00, and proceed to install the image. This can take approximately 15 minutes.



The Mellanox InfiniBand driver installation may take up to 10 minutes.

After the installation is completed, the system ejects the virtual CD and then reboots into the OS.

Refer to [Setting Up the DGX-1](#) for the steps to take when booting up the DGX-1 for the first time after a fresh installation.

5.2.3. Creating a Bootable Installation Medium

After obtaining an ISO file that contains the software image from NVIDIA Support Enterprise Services, create a bootable installation medium, such as a USB flash drive or DVD-ROM, that contains the image.



If you are restoring the software image remotely through the BMC, you do not need a bootable installation medium and you can omit this task.

- ▶ If you are creating a bootable USB flash drive, follow the instructions for the platform that you are using:
 - ▶ On a text-only Linux distribution, see [Creating a Bootable USB Flash Drive by Using the dd Command](#).
 - ▶ On Windows, see [Creating a Bootable USB Flash Drive by Using Akeo Rufus](#).
- ▶ If you are creating a bootable DVD-ROM, you can use any of the methods described in [Burning the ISO on to a DVD \(https://help.ubuntu.com/community/BurningIsoHowto#Burning_the_ISO_on_to_a_DVD\)](https://help.ubuntu.com/community/BurningIsoHowto#Burning_the_ISO_on_to_a_DVD) on the Ubuntu Community Help Wiki.

5.2.3.1. Creating a Bootable USB Flash Drive by Using the `dd` Command

On a Linux system, you can use the `dd` (<http://manpages.ubuntu.com/manpages/xenial/en/man1/dd.1.html>) command to create a bootable USB flash drive that contains the DGX-1 software image.



To ensure that the resulting flash drive is bootable, use the `dd` command to perform a device bit copy of the image. If you use other commands to perform a simple file copy of the image, the resulting flash drive may not be bootable.

Ensure that the following prerequisites are met:

- ▶ The correct DGX-1 software image is saved to your local disk. For more information, see [Obtaining the DGX-1 Software ISO Image and Checksum File](#).
 - ▶ The USB flash drive meets these requirements:
 - ▶ The USB flash drive has a capacity of at least 4 GB.
 - ▶ The partition scheme on the USB flash drive is a GPT partition scheme for UEFI.
1. Plug the USB flash drive into one of the USB ports of your Linux system.
 2. Obtain the device name of the USB flash drive by running the `lsblk` (<http://manpages.ubuntu.com/manpages/xenial/man8/lsblk.8.html>) command.

```
lsblk
```

You can identify the USB flash drive from its size, which is much smaller than the size of the SSDs in the DGX-1, and from the mount points of any partitions on the drive, which are under `/media`.

In the following example, the device name of the USB flash drive is `sde`.

```
~$ lsblk
NAME      MAJ:MIN RM   SIZE RO TYPE MOUNTPOINT
sda         8:0    0  1.8T  0 disk
|_sda1     8:1    0  121M  0 part /boot/efi
|_sda2     8:2    0  1.8T  0 part /
sdb         8:16   0  1.8T  0 disk
|_sdb1     8:17   0  1.8T  0 part
sdc         8:32   0  1.8T  0 disk
sdd         8:48   0  1.8T  0 disk
sde         8:64   1   7.6G  0 disk
|_sde1     8:65   1   7.6G  0 part /media/deeplearner/DGXSTATION
~$
```

3. As root, convert and copy the image to the USB flash drive.

```
sudo dd if=path-to-software-image bs=2048 of=usb-drive-device-name
```



Caution The `dd` command erases all data on the device that you specify in the `of` option of the command. To avoid losing data, ensure that you specify the correct path to the USB flash drive.

5.2.3.2. Creating a Bootable USB Flash Drive by Using Akeo Rufus

On a Windows system, you can use the [Akeo Reliable USB Formatting Utility \(Rufus\)](https://rufus.akeo.ie/) (<https://rufus.akeo.ie/>) to create a bootable USB flash drive that contains the DGX-1 software image.

Ensure that the following prerequisites are met:

- ▶ The correct DGX-1 software image is saved to your local disk. For more information, see [Obtaining the DGX-1 Software ISO Image and Checksum File](#).
 - ▶ The USB flash drive has a capacity of at least 4 GB.
1. Plug the USB flash drive into one of the USB ports of your Windows system.

- Download and launch the Akeo Reliable USB Formatting Utility (Rufus) (<https://rufus.akeo.ie/>).

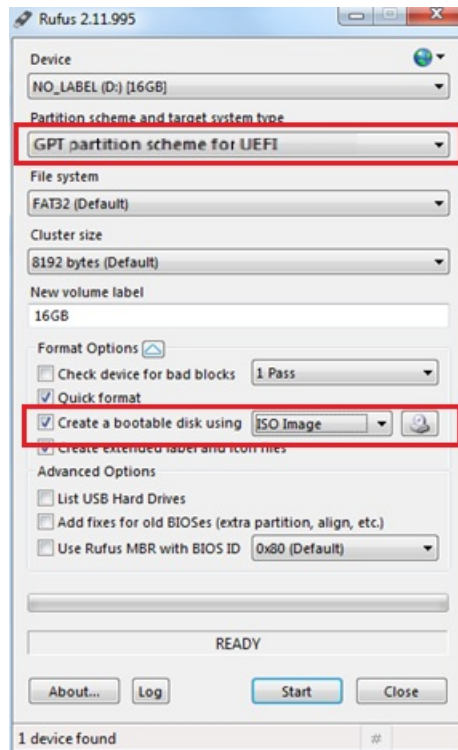

- Under **Partition scheme and target system type**, select **GPT partition scheme for UEFI**.
- Select the **Create a bootable disk using** option and from the dropdown menu, select **ISO image**.
- Click the optical drive icon and open the DGX-1 software ISO image.
- Click **Start**.

Because the image is a hybrid ISO file, you are prompted to select whether to write the image in ISO Image (file copy) mode or DD Image (disk image) mode.

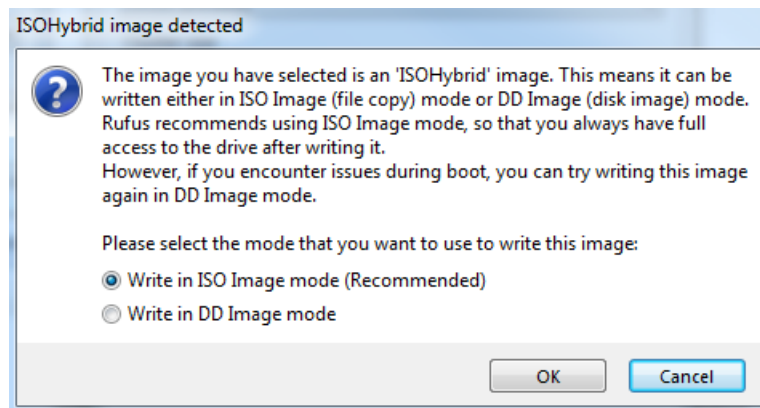

7. Select **Write in ISO Image mode** and click **OK**.

5.2.4. Re-Imaging the System From a USB Flash Drive

These instructions describe how to re-image the system from a USB flash drive. For information about how to restore the system remotely, see [Re-Imaging the System Remotely](#).

Before re-imaging the system from a USB flash drive, ensure that you have a bootable USB flash drive that contains the current DGX-1 software image.

1. Plug the USB flash drive containing the OS image into the DGX-1.
2. Connect a monitor and keyboard directly to the DGX-1.
3. Boot the system and press **F11** when the NVIDIA logo appears to get to the boot menu.
4. Select the USB volume name that corresponds to the inserted USB flash drive, and boot the system from it.
5. When the system boots up, select **Install DGX Server** on the startup screen.

If you are an advanced user who is not using the RAID disks as cache and want to keep data on the RAID disks, then select **Install DGX Server without formatting RAID**. See the section [Retaining the RAID Partition While Installing the OS](#) for more information.

6. Press **Enter**.

The DGX-1 will reboot and proceed to install the image. This can take more than 15 minutes.

 The Mellanox InfiniBand driver installation may take up to 10 minutes.

After the installation is completed, the system then reboots into the OS.

Refer to [Setting Up the DGX-1](#) for the steps to take when booting up the DGX-1 for the first time after a fresh installation.

5.2.5. Retaining the RAID Partition While Installing the OS

This information describes an installation option that is available starting with DGX OS Server 3.1.1.

The re-imaging process creates a fresh installation of the DGX OS. During the OS installation or re-image process, you are presented with a boot menu when booting the installer image. The default selection is **Install DGX Software**. The installation process then repartitions all the SSDs, including the OS SSD as well as the RAID SSDs, and the RAID array is mounted as `/raid`. This overwrites any data or file systems that may exist on the OS disk as well as the RAID disks.

Since the RAID array on the DGX-1 is intended to be used as a cache and not for long-term data storage, this should not be disruptive. However, if you are an advanced user and have set up the disks for a non-cache purpose and want to keep the data on those drives, then select the **Install DGX Server without formatting RAID** option at the boot menu during the boot installation. This option retains data on the RAID disks and performs the following:

- ▶ Installs the cache daemon but leaves it disabled by commenting out the `RUN=yes` line in `/etc/default/cachefilesd`.
- ▶ Creates a `/raid` directory, leaves it out of the file system table by commenting out the entry containing `"/raid"` in `/etc/fstab`.
- ▶ Does not format the RAID disks.

When the installation is completed, you can repeat any configurations steps that you had performed to use the RAID disks as other than cache disks.

You can always choose to use the RAID disks as cache disks at a later time by enabling `cachefilesd` and adding `/raid` to the file system table as follows:

1. Uncomment the `#RUN=yes` line in `/etc/default/cachefiled`.
2. Uncomment the `/raid` line in `etc/fstab`.
3. Run the following:
 - a) Mount `/raid`.

```
sudo mount /raid
```

- b) Reload the systemd manager configuration.

```
systemctl daemon-reload
```

- c) Start the cache daemon.

```
systemctl start cachefilesd.server
```

These changes are preserved across system reboots.

5.3. Updating the System BIOS

You can update the system BIOS remotely through the BMC. Before updating the system BIOS, the system must be turned off through the BMC according to the instructions in this section.

1. Obtain the BIOS image.
 - a) Log on to [NVIDIA Enterprise Services \(https://nvid.nvidia.com/dashboard/\)](https://nvid.nvidia.com/dashboard/) and click the Announcements tab to locate the DGX-1 software image archive.
 - b) Download the image archive and then extract the `.bin` file.
2. Log on to the BMC and shut down the DGX-1.

- a) Open a Java-enabled web browser within your LAN and go to `http://<IPMI-IP-address>/`, then log in.

Use Firefox or Internet Explorer. Google Chrome is not officially supported by the BMC.

- b) From the top menu, click **Remote Control** and then select **Server Power Control**.
- c) At the *Power Control and Status* screen, select the **Power Off Server - Orderly Shutdown** option, then click **Perform Action**.

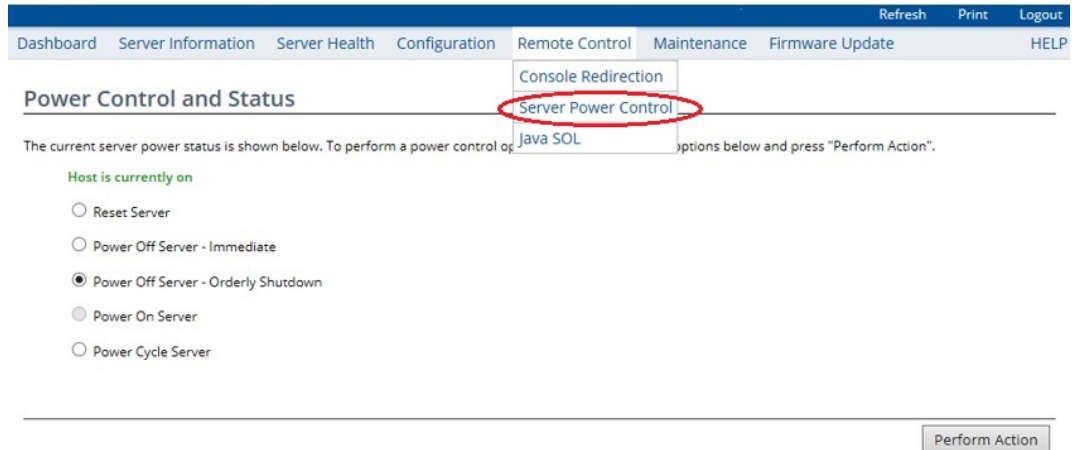

You can verify that the DGX-1 is shut down by noting that all the *Power Control and Status* options are grayed out except for the *Power On Server* option.

3. Update the system BIOS.

- a) From the top menu, click **Firmware Update**, select **BIOS Update**, and then click **Enter Update Mode**.

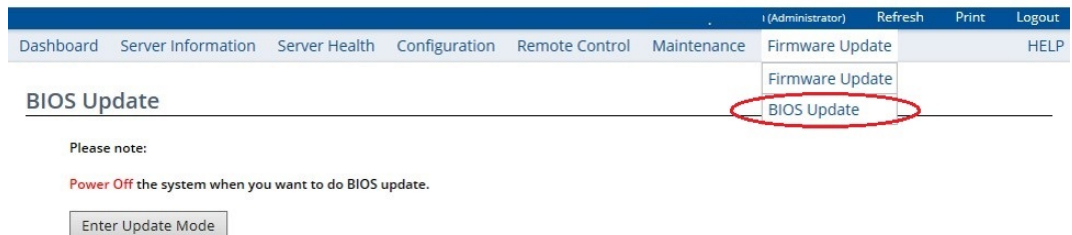

- b) Click **OK** at the *Are you sure to enter update mode?* dialog.
- c) From the *BIOS Upload* screen, click **Browse** at the *Select Firmware to Upload* step, then navigate the explorer windows to locate the file you downloaded and select it.



BIOS Upload

Please specify the filename (*.bin/*.BIN) of the Firmware Image that you want to upgrade to. Clicking on the 'Browse' button will allow you to select the firmware image file. Once you do that, click on the 'Upload' button to upload the image file.

Select Firmware to Upload: C:\DGX-1\BIOS\2016WW30.3_S2W_2A04\52W_2A04.BIN Browse...

Select Preserve Configurations:

Preserve BIOS NVRAM Region

Preserve ME Region

Upload Firmware Cancel

- d) Be sure all the check boxes under *Select Preserve Configuration* are cleared. This ensures that the BIOS reverts to its fail-safe default settings for a reliable update.

- e) Click **Upload Firmware** to start the process of installing the updated BIOS.

You are asked to wait while the image is verified.

- f) Click **OK** at the *Proceed?* dialog to start the actual upgrade process.

The *BIOS Flash Status* screen shows the upgrade progress, which should take a couple of minutes to complete.



Do not interrupt the upgrade process once it has started.

4. After the upgrade process has completed, you can use the top menu to turn the system back on.
 - a) From the top menu, click **Remote Control** and then select **Server Power Control**.
 - b) Select the **Power On Server** option, and then click **Perform Action**.
5. To verify that the BIOS was updated with the proper file, press **[F2]** or **[Del]** to enter the BIOS setup screen when the system reboots, then compare the Project Version with the update filename.

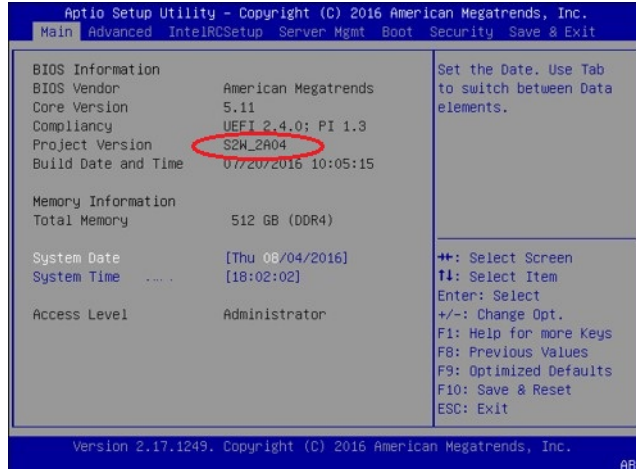

5.4. Updating the BMC

You can update the BMC remotely using the IPMI port. Applications can be left running. Power must be left on.

1. Obtain the BMC image.
 - a) Log on to [NVIDIA Enterprise Services \(https://nvid.nvidia.com/dashboard/\)](https://nvid.nvidia.com/dashboard/) and click the Announcements tab to locate the DGX-1 software image archive.
 - b) Download the image file.
2. Open a Java-enabled web browser within your LAN and go to `http://<IPMI IP address>/`, then log in to the BMC.

Use Firefox or Internet Explorer. Google Chrome is not officially supported by the BMC.

3. If you're using DHCP and choose not to preserve the network configuration, then obtain the MAC address for the BMC.

If the BMC is connected to a network via DHCP, the IP address could change after the update. Follow these substeps to obtain the MAC address in order to connect to the BMC after the update, in case the IP address changes. You can skip these steps if a static IP is used.

- a) From the top menu, click **Configuration** and then select **Network**.
 - b) Note the MAC address.
4. From the top menu, click **Firmware Update** and then select **Firmware Update** from the drop-down menu.
5. Click **Enter Preserve Configuration**, then set the IPMI and Network preserve status to *Preserve* and all others to *Overwrite*.



qct.admin (Administrator) Refresh Print Logout HELP

Dashboard Server Information Server Health Configuration Remote Control Maintenance Firmware Update

Firmware Update

Upgrade firmware of the device. Press 'Enter Update Mode' to put the device in update mode.

The protocol information to be used for firmware image transfer during this update is as follows. To configure, choose 'Protocol Configuration' under Firmware Update menu.
Protocol Type : HTTP/HTTPS

WARNING: Please note that after entering the update mode, the widgets, other web pages and services will not work. All the open widgets will be automatically closed. If the upgradation is cancelled in the middle of the wizard, the device will be reset.

Preserve all Configuration. This will preserve all the configuration settings during the firmware update - irrespective of the individual items marked as preserve/overwrite in the table below. All configuration items below will be preserved as default during the restore configuration operation. Click "Enter Preserve Configuration" to modify the Preserve status settings.

#	Preserve Configuration Item	Preserve Status
1	SDR	Overwrite
2	FRU	Overwrite
3	SEL	Overwrite
4	IPMI	Preserve
5	Network	Preserve
6	NTP	Overwrite
7	SNMP	Overwrite
8	SSH	Overwrite
9	KVM	Overwrite
10	Authentication	Overwrite

Upload Signimage Key **Enter Preserve Configuration** Enter Update Mode

Be sure to set IPMI to *Preserve* in order to preserve your BMC login credentials. If you fail to do this, the BMC username/password will be set to qct.admin/qct.admin. If this happens, then be sure to enter the BMC dashboard and go to Configuration->Users to add a new user account and disable the qct.admin account after updating the BMC.

6. If necessary, click **Firmware Update** again from the top menu and then select **Firmware Update** from the drop-down menu to return to the Firmware Update page.

7. Click **Enter Update Mode**, then click **OK** at the confirmation dialog.

After entering Update Mode, aborting the operation or even resizing the browser windows will terminate the session and reset the BMC. If this happens, you will need to close and then reopen the browser to initiate a new session. You may need to wait several minutes for the BMC to reset.

8. At the *Upload Firmware* prompt, click **Browse** to locate and select the firmware image file.

Upload Firmware

Please select the firmware image to flash

e:\S2W_BMC_v209\S2W_BMC_v209\S2Wv209.ima_enc Browse...

Upload Cancel

Select the encrypted file (the file with the "_enc" suffix on the file extension), as the BMC requires the firmware image to be encrypted.

9. Click **Upload** to transfer the image to the BMC.

10. At the *Select Based Firmware Update* prompt, select **Full Flash** and then click **Proceed**.

Section Based Firmware Update

All the module section versions in the existing image and uploaded image is same.

Version Compare Flash Full Flash

#	Section Name	Existing Version	Uploaded Version	Upgradable/Non-Upgradable
1	boot	2.1.000000	2.1.000000	<input type="checkbox"/>
2	root	2.1.000000	2.1.000000	<input type="checkbox"/>
3	osimage	2.1.000000	2.1.000000	<input type="checkbox"/>
4	www	2.1.000000	2.1.000000	<input type="checkbox"/>
5	ast2400e	2.9.0	2.9.0	<input type="checkbox"/>



IMPORTANT: Do not shut off power to the DGX-1 while updating the BMC. If the BMC update fails, keep the DGX-1 powered on and booted, and then contact NVIDIA Enterprise Support.

- ▶ When the BMC firmware update is completed, the BMC resets and the remote session terminates.
- ▶ To initiate a new BMC session, close and then reopen the browser.
- ▶ The BMC can take as much as 10 minutes to reset itself. During this time, the BMC will be unresponsive.

5.5. Replacing the System and Components

Be sure to familiarize yourself with the NVIDIA Terms & Conditions documents before attempting to perform any modification or repair to the DGX-1. These Terms & Conditions for the DGX-1 can be found through the [NVIDIA DGX Systems Support \(http://www.nvidia.com/object/dgxsystems-support.html\)](http://www.nvidia.com/object/dgxsystems-support.html) page.

Contact NVIDIA Enterprise Customer support to obtain an RMA number for any system or component that needs to be returned for repair or replacement.

The following components are customer-replaceable:

- ▶ Solid State Drives (SSDs)
- ▶ Power Supplies
- ▶ Fan Modules
- ▶ DIMMs

Return the failed components to NVIDIA. Low-cost items such as power supplies and fans do not need to be returned.

5.5.1. Replacing the System

When returning a DGX-1 under RMA, consider the following points.

SSDs

If necessary, you can remove and keep the SSDs prior to shipping the system back for replacement. If you already received a replacement system and you want to keep the original SSDs, install the new SSDs into the defective system when shipping it back.

Bezel

Be sure to include the bezel when returning the system.

5.5.2. Replacing an SSD

Access the SSDs from the front of the DGX-1. You can hot swap the SSDs as follows:

1. If not already removed, remove the bezel by grasping the bezel by the side handles and then pulling the bezel straight off the front of the DGX-1.



CAUTION: Be careful not to accidentally press the power button that is on the right edge of the DGX-1 when removing or installing the bezel.

2. Locate the SSD that you want to replace, then press the round button at the top edge to release the latch.
3. Pull the latch down and then out to unseat the SSD assembly.

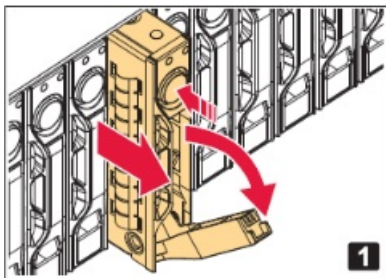

4. Continue pulling the SSD assembly to completely remove it from the unit.
5. Using a phillips screwdriver, remove the four screws attaching the SSD to the hot-swap tray.

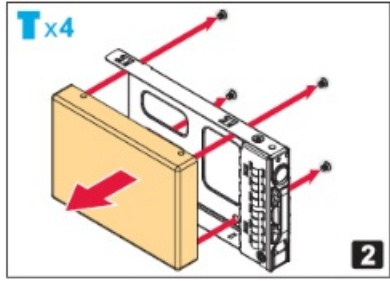

6. Save the screws for the replacement.
7. Mount the replacement SSD to the hot-swap tray using the four screws. Make sure that the connector is on the open edge side of the tray.
8. With the round button at the top, insert the assembly into the appropriate bay, then push the assembly all the way in.
9. Press the latch against the assembly to completely seat the assembly.
10. Reattach the bezel.

With the bezel positioned so that the NVIDIA logo is visible from the front and is on the left-hand side, line up the pins near the corners of the DGX-1 with the holes in back of the bezel, then gently press the bezel against the DGX-1. The bezel is held in place magnetically.



CAUTION: Be careful not to accidentally press the power button that is on the right edge of the DGX-1 when removing or installing the bezel.

5.5.3. Recreating the Virtual Drives

After you have replaced the OS SSD, with or without any of the cache SSDs, you need to recreate the virtual drives and then re-image the system in order to recreate the partitions on all the virtual drives.

The following is an overview of the process:

1. Clear the drive group configuration
2. Recreate the OS Virtual Drive
3. Recreate the Cache Virtual Drive
4. Re-image the System

These instructions apply only if you have replaced the OS SSD, with or without one or more of the cache SSDs. If you have replaced only one or more of the cache SSDs, and not the OS SSD, then follow the instructions in the section [Recreating the RAID 0 Array](#)

5.5.3.1. Access the BIOS Setup Utility

RAID configuration is accomplished through the BIOS setup utility.

1. Connect a display (1024x768 or lower resolution) and keyboard to the DGX-1.
2. Turn the DGX-1 on or reboot.

- At the NVIDIA logo boot screen, press **[F2]** or **[Del]** to enter the BIOS setup screen.

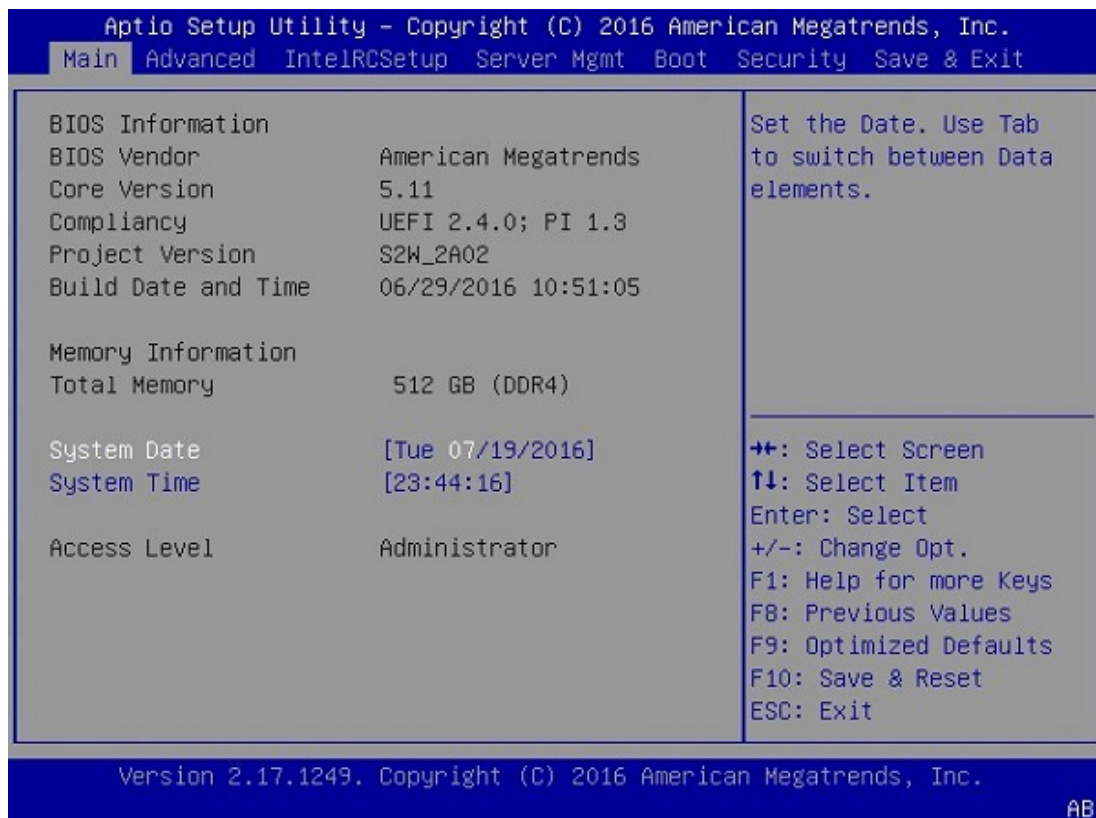

- Select the **Advanced** tab from the top menu and then Scroll down and select the **MegaRAID Configuration Utility**.



The RAID Configuration menu appears.

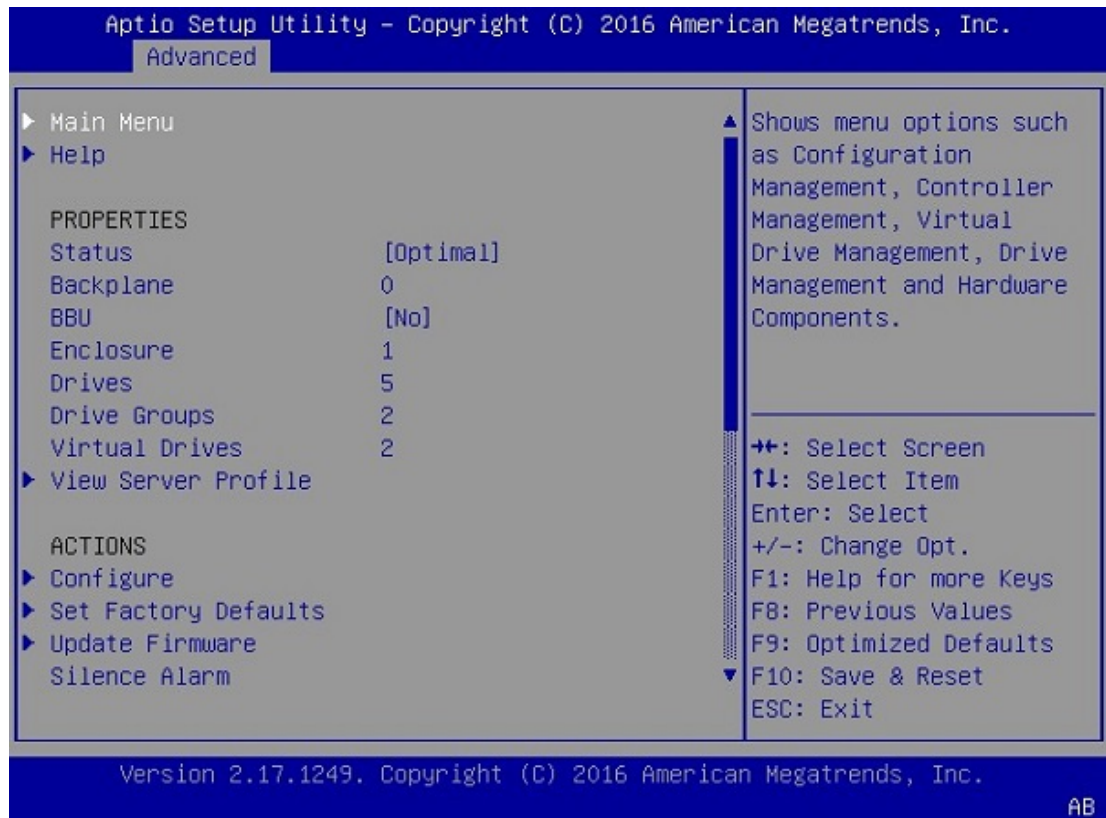

If you replaced the OS drive, follow the instructions in the section [Clear the Drive Group Configuration](#).

5.5.3.2. Clear the Drive Group Configuration

These instructions apply when you have replaced the OS drive.

1. Select **Main Menu**, then select **Configuration Management**.

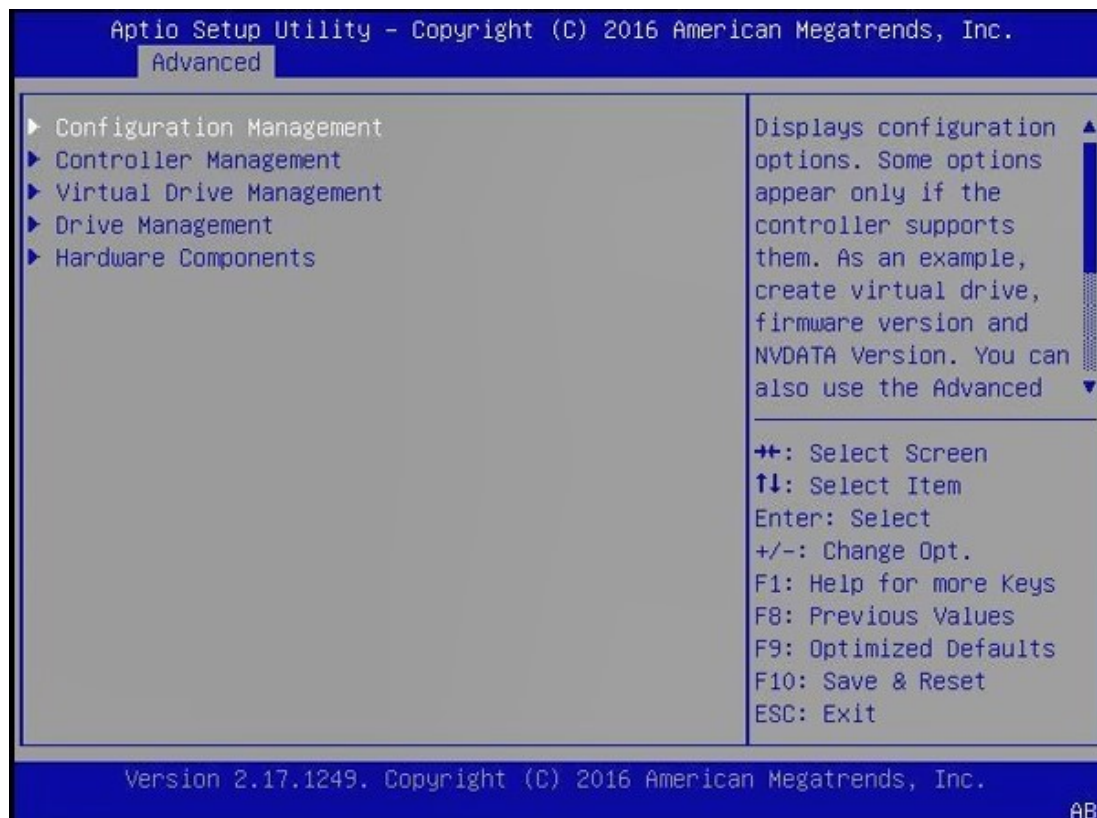

2. Select **Clear Configuration**.

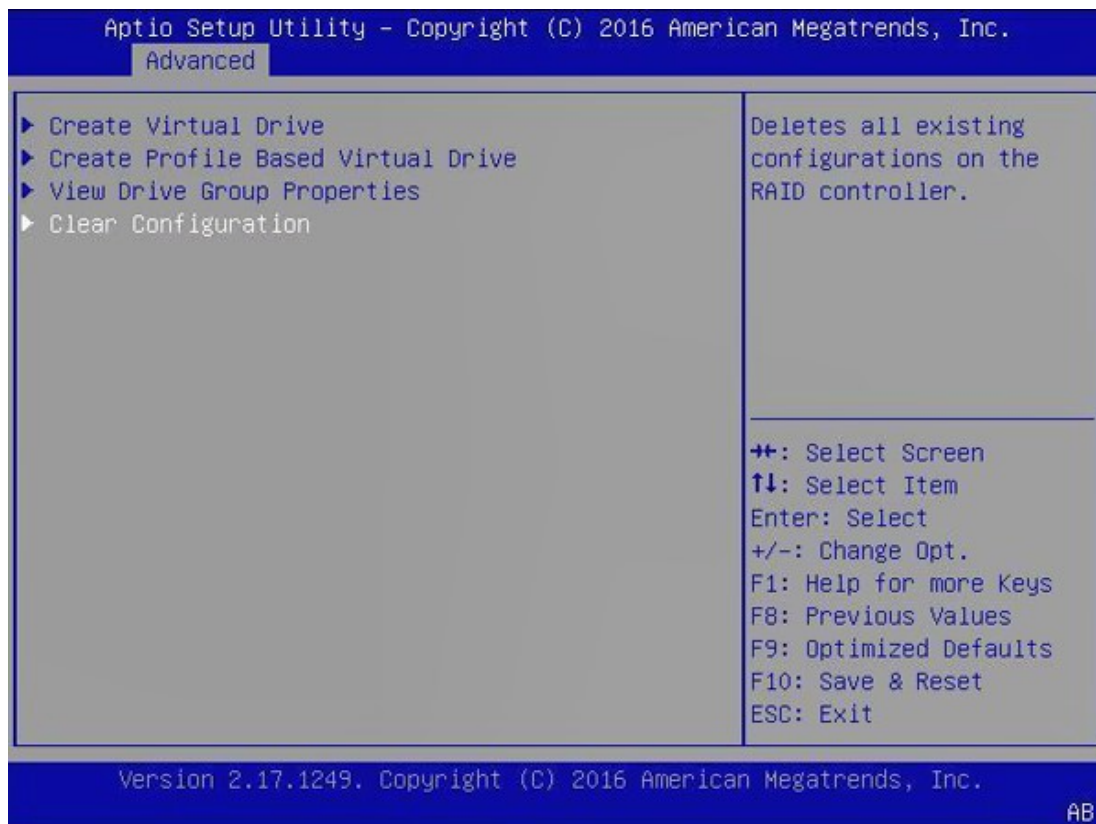

3. Select **Confirm [Disabled]** and then select **Enabled** at the confirmation popup.



4. Select **Yes**, then select **OK** at the success screen.

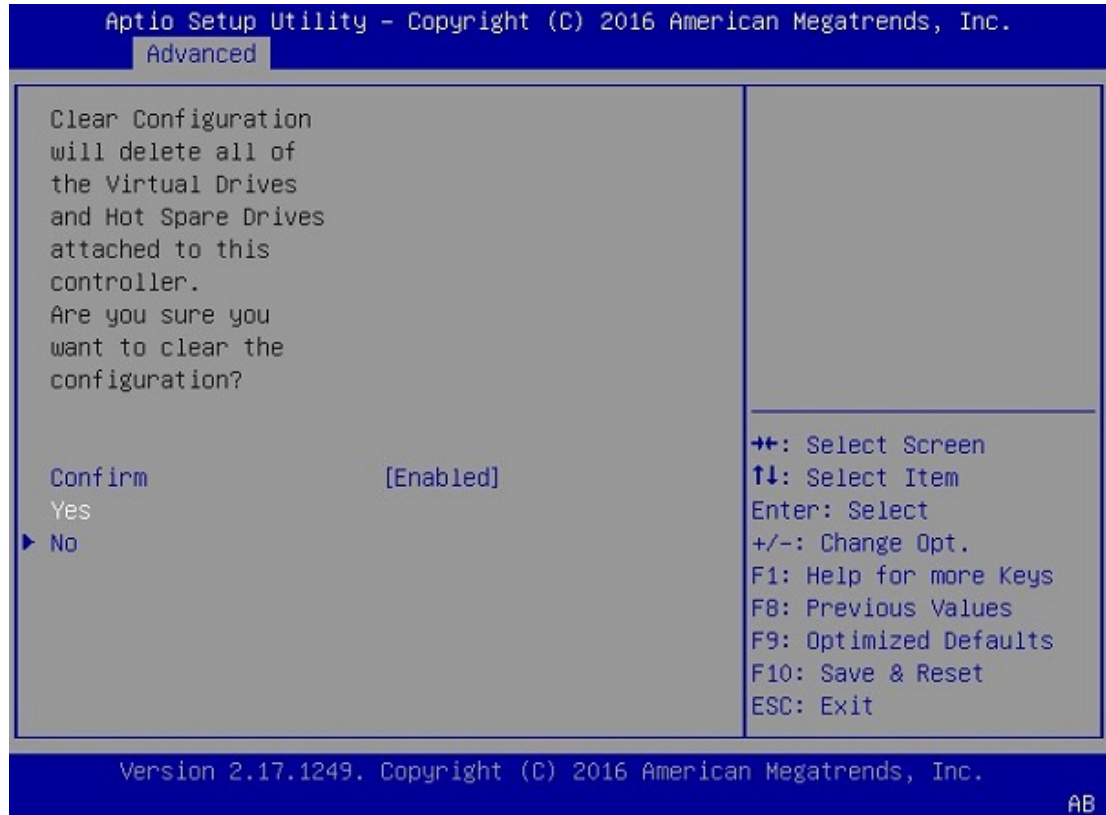

5. Follow the instructions in the sections [Recreate the OS Virtual Drive](#) and then [Recreate the RAID0 Virtual Drive](#) .

5.5.3.3. Recreate the OS Virtual Drive

These instructions apply when you have replaced the OS drive. Be sure to first complete the instructions in the section [Clear the Drive Group Configuration](#).

1. Navigate to the RAID Utility Main Menu, then under Actions, select Configure, then select **Configuration Management**.

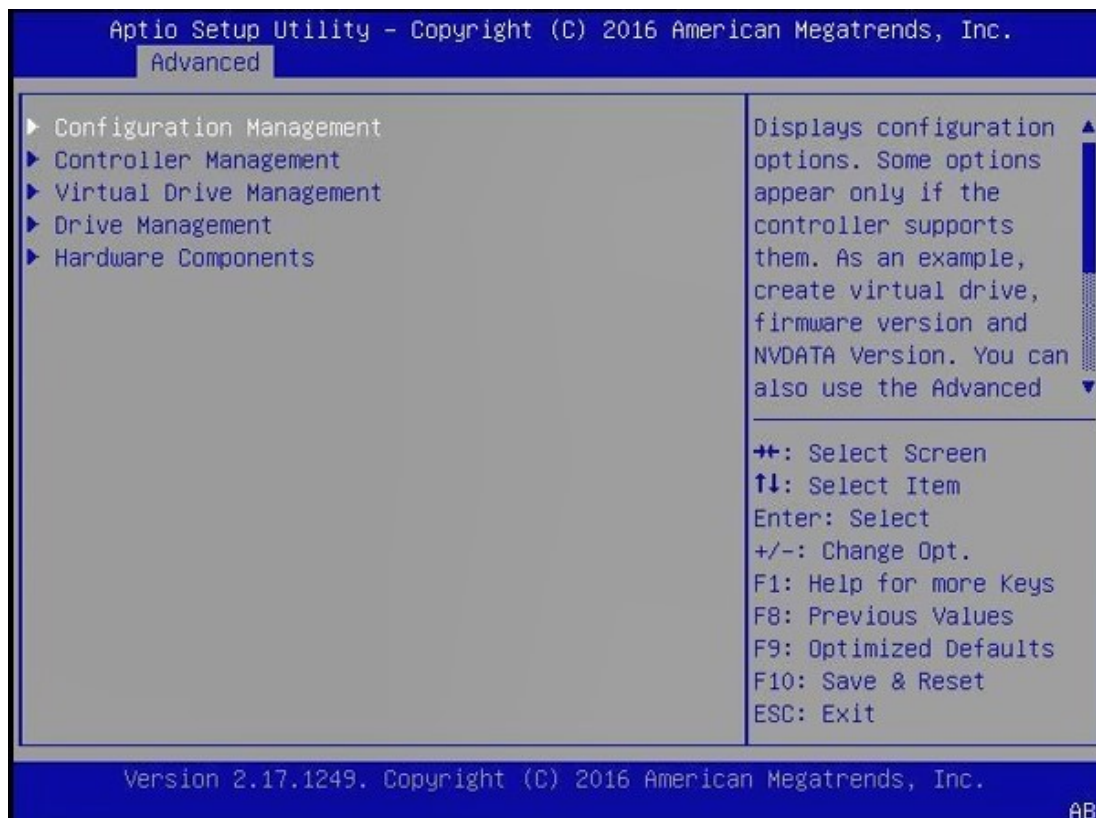

2. Select **Create Virtual Drive**, then select **Select Drives** at the next screen. Leave all other options at their default settings as shown below.

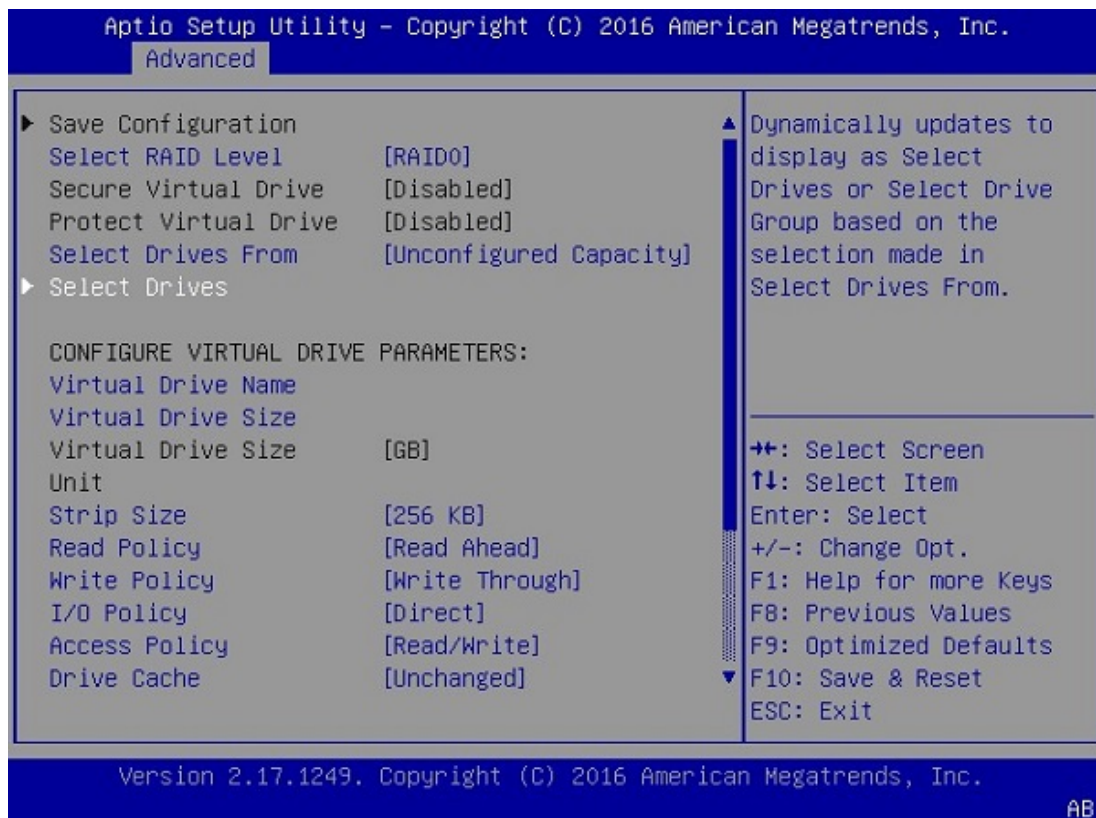

The list of drives under *CHOOSE UNCONFIGURED DRIVES* will initially be empty.

3. To view the available drives, select **Select Media Type [HDD]**, then change to **[SSD]**.

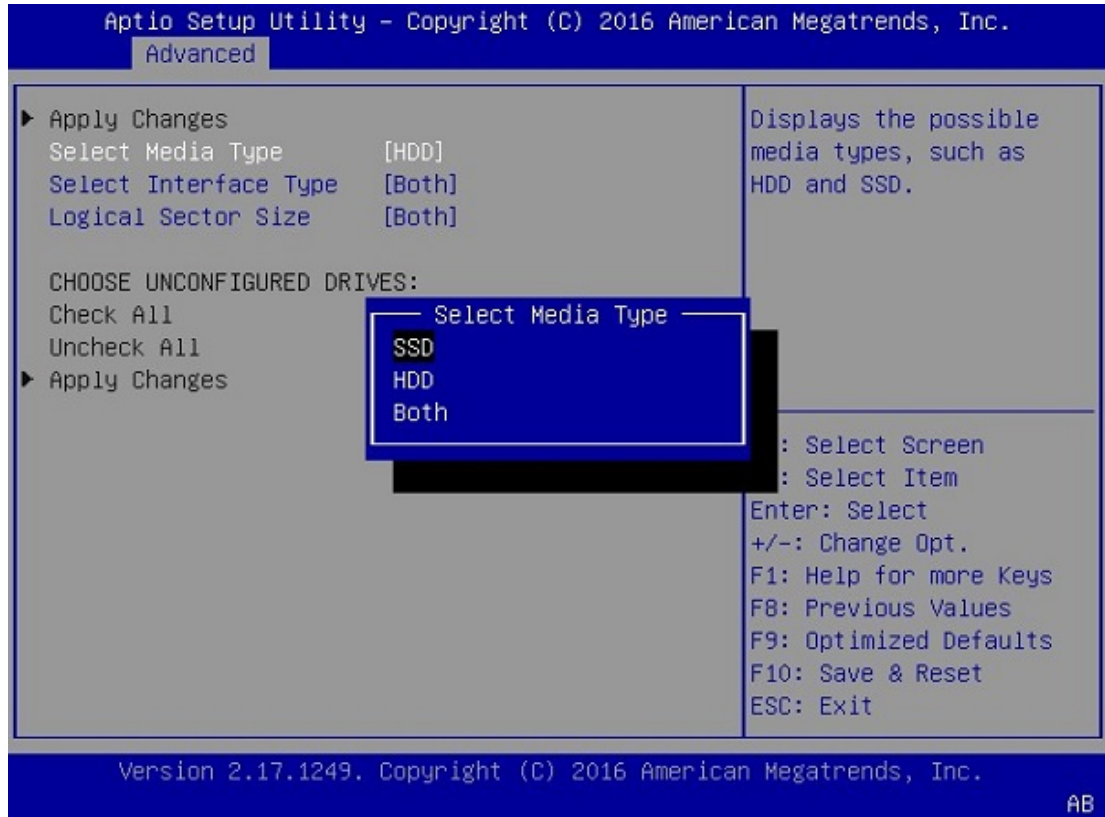

4. Under **CHOOSE UNCONFIGURED DRIVES**, select the 446 GB drive, then change to **[Enabled]** at the pop-up dialog.

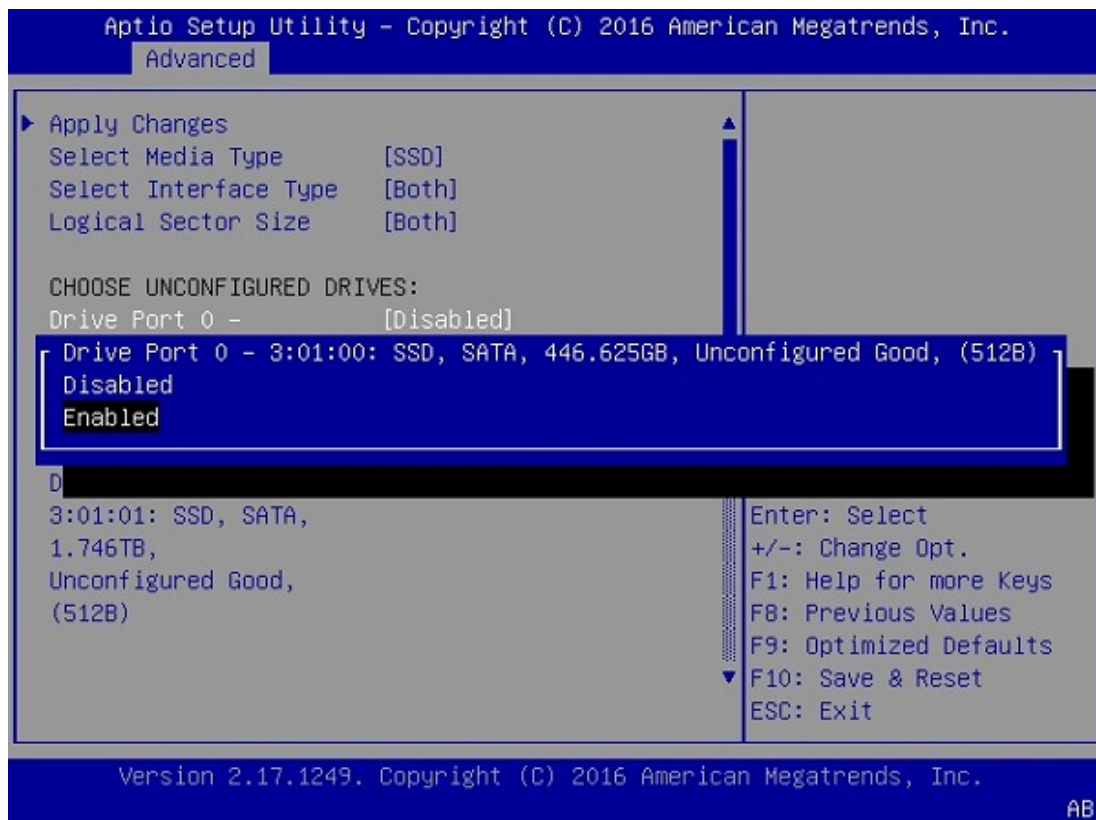

5. Confirm that only the first drive at **Drive Port 0 - 3:01:00** displays as **[Enabled]**.

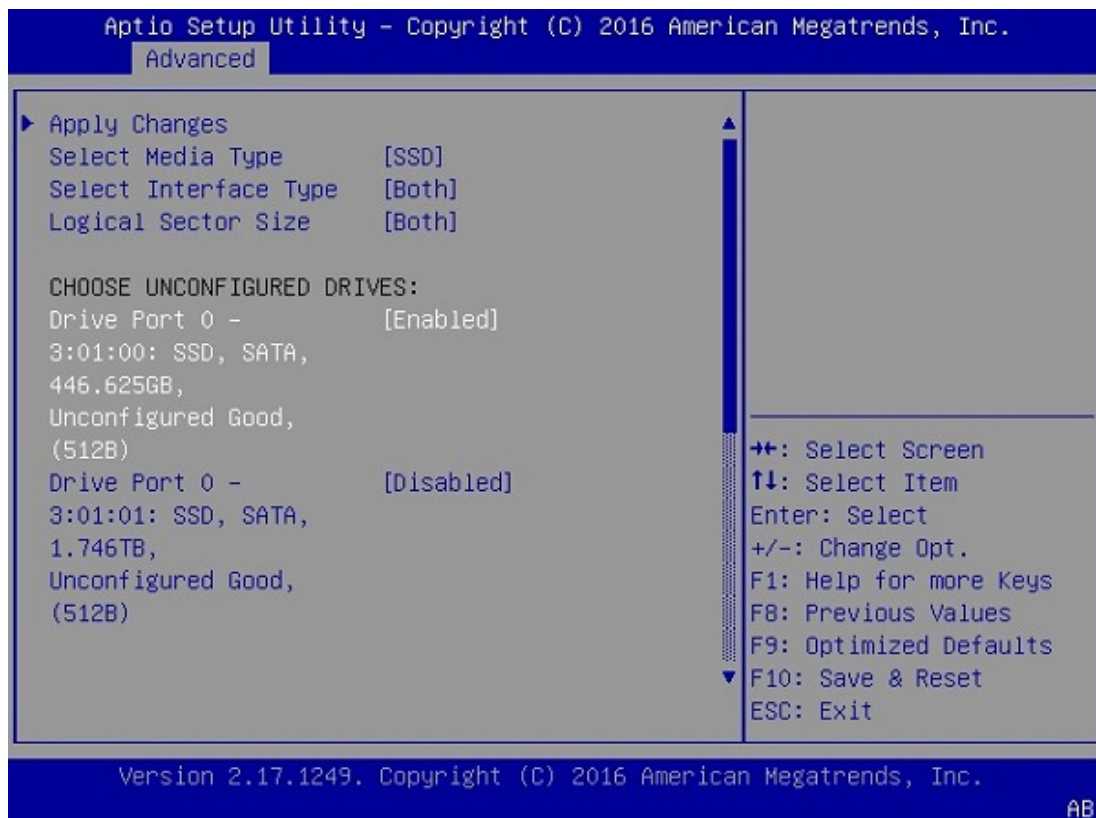

6. Scroll up and select **Apply Changes**.

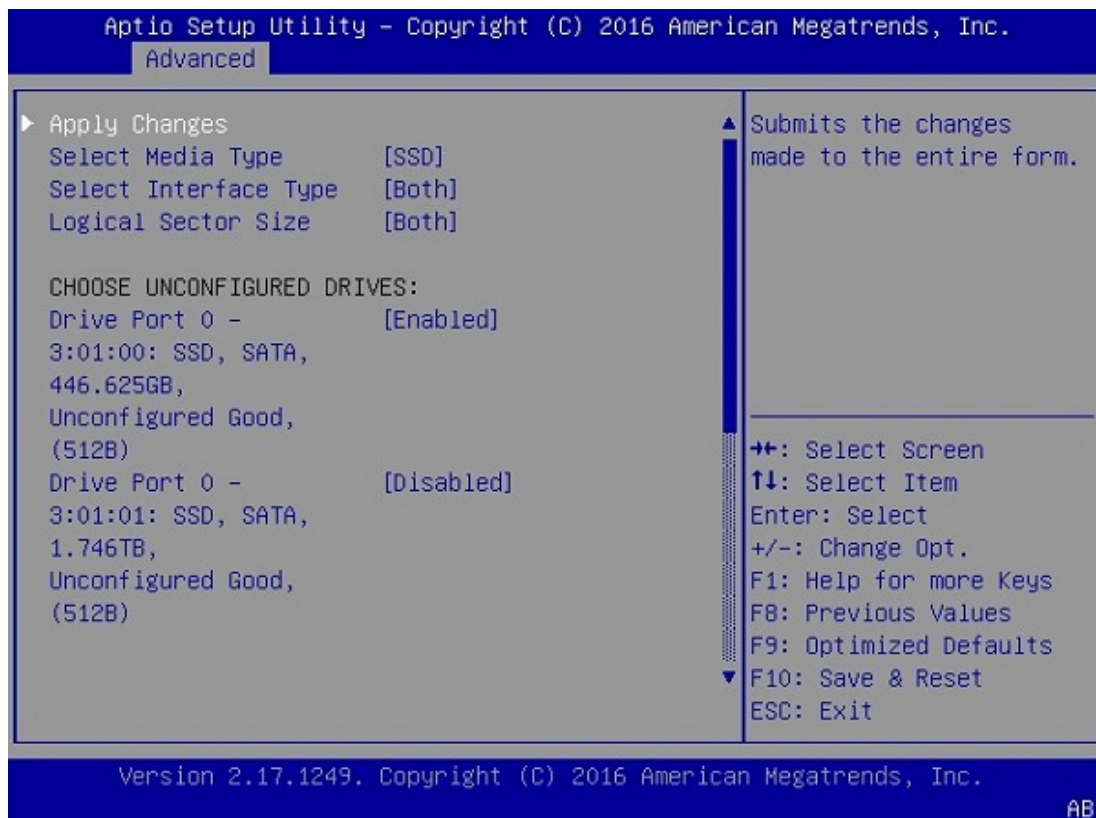

7. Select **OK** at the success screen.

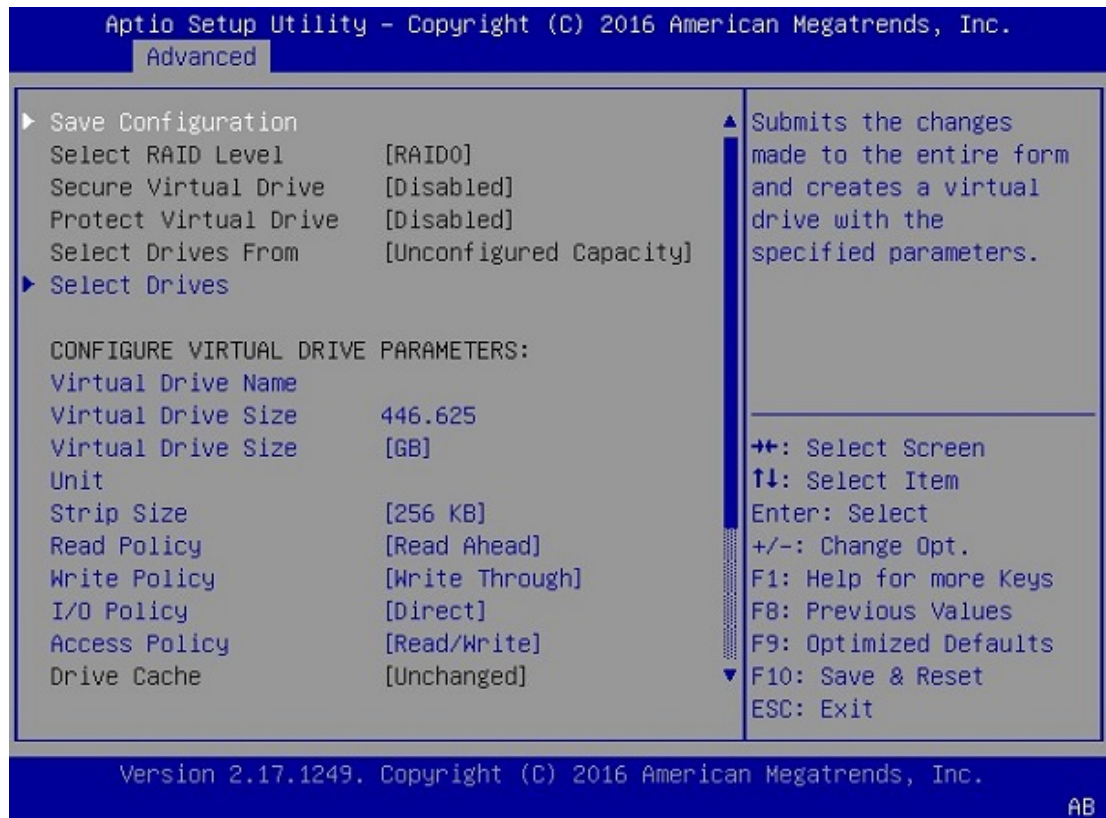

The virtual drive creation page now displays a summary of your selection. The Virtual Drive Size should be approximately 446 GB.

8. Select **Save Configuration** at the top of the menu.
9. Change the **Confirm [Disabled]** field to **[Enabled]** and then select **[Yes]**.

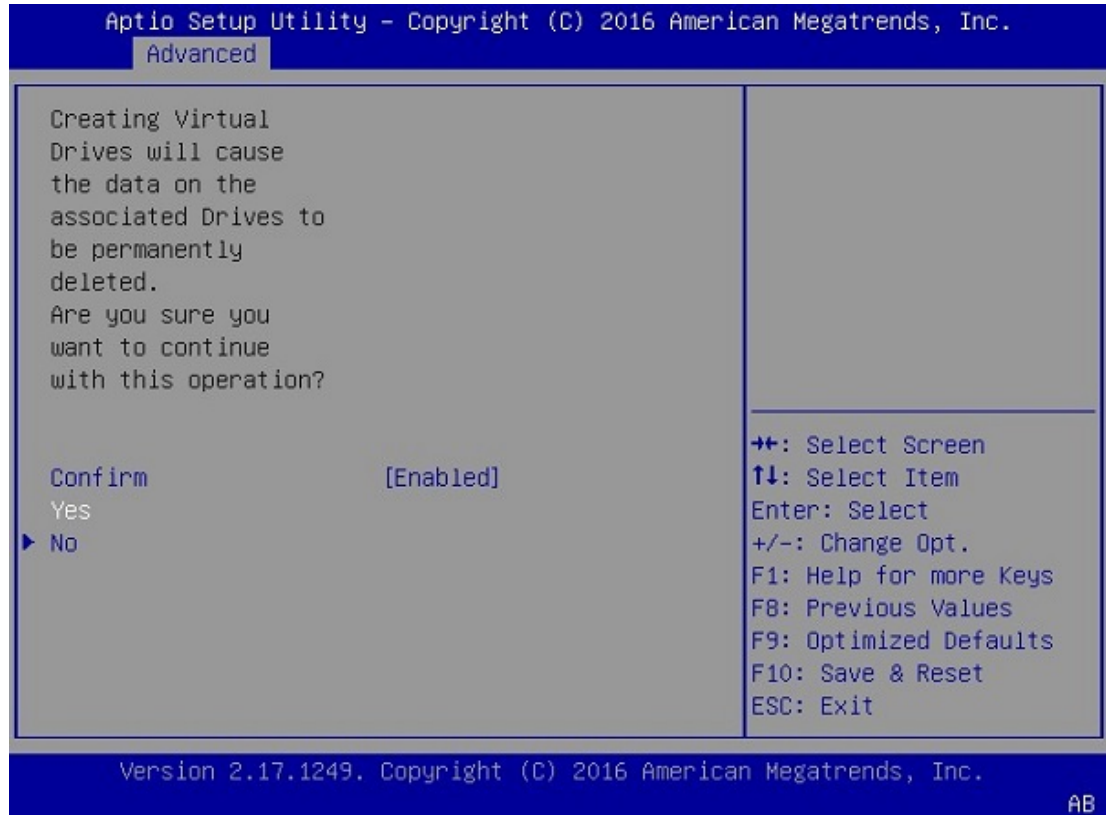

10. Select **[OK]** at the success screen.
You have successfully re-created Virtual Drive 0, where the OS will be installed.
11. Follow the instructions in the section [Recreate the RAID0 Virtual Drive](#)

5.5.3.4. Recreate the RAID0 Virtual Drive

These instructions apply when you have replaced the OS drive and cleared the drive group configuration.

1. Navigate to the RAID Utility Main Menu, then under Action, select Configure, then select **Configuration Management**.

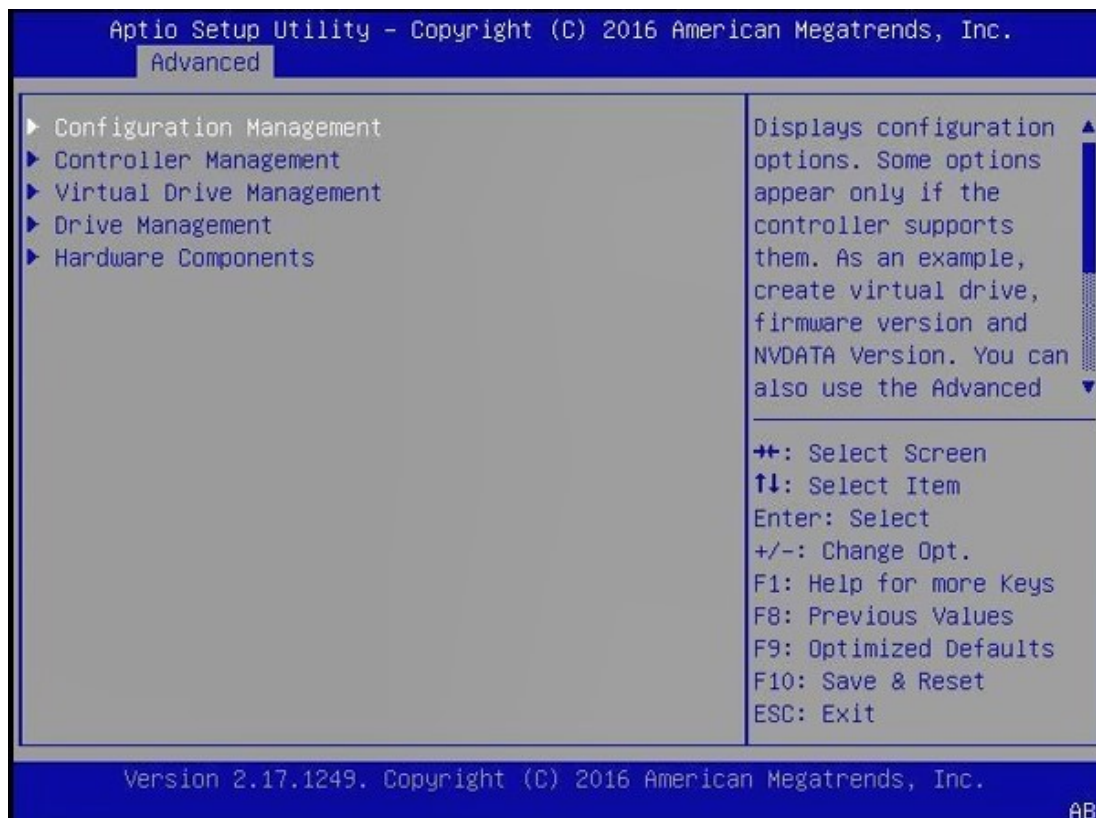

2. Select **Create Virtual Drive**.

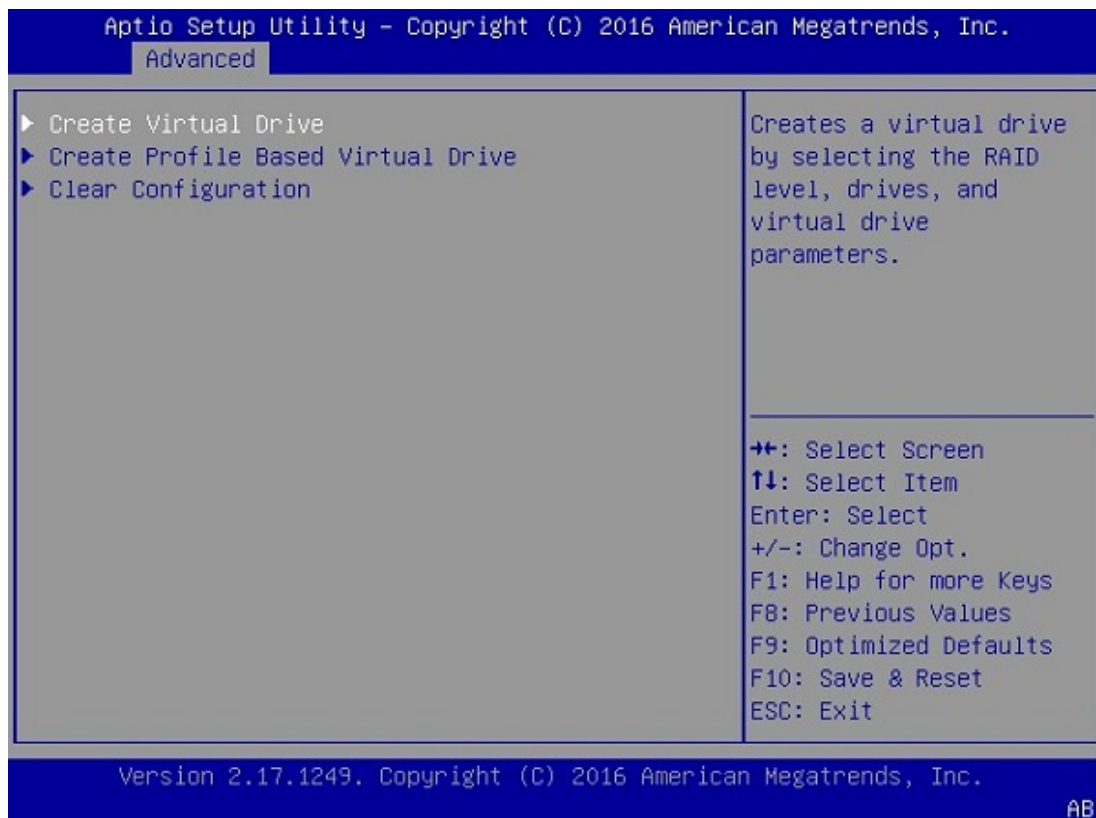

3. Scroll to **Select RAID Level** and switch to **[RAID0]**, if not already set.

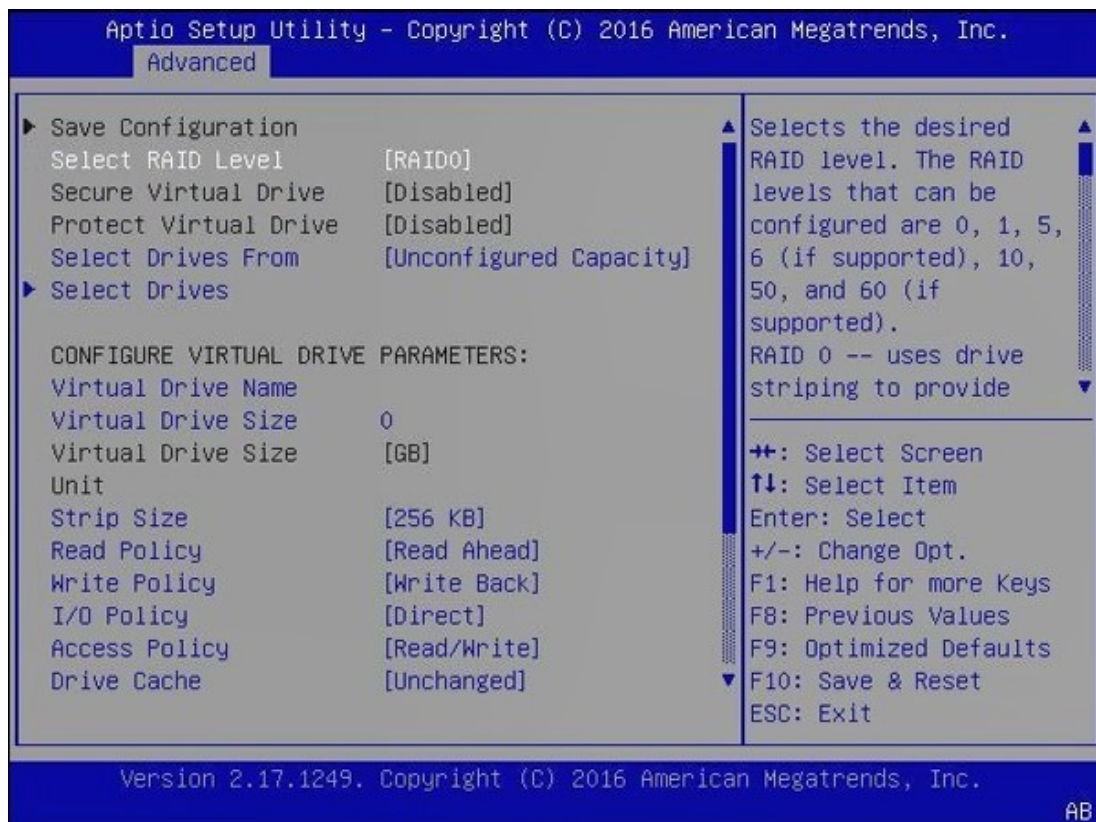

4. Scroll to **Select Media Type** and switch to **[SSD]**.

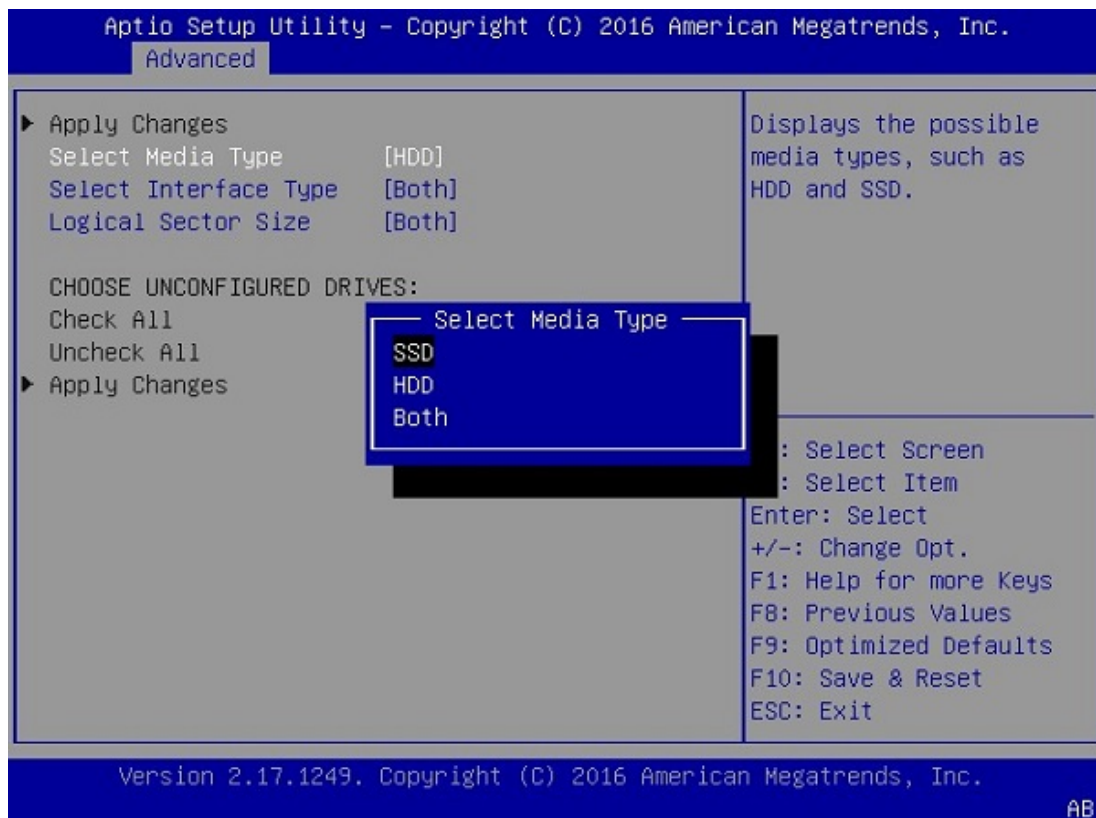

5. Select **Select Drives**.

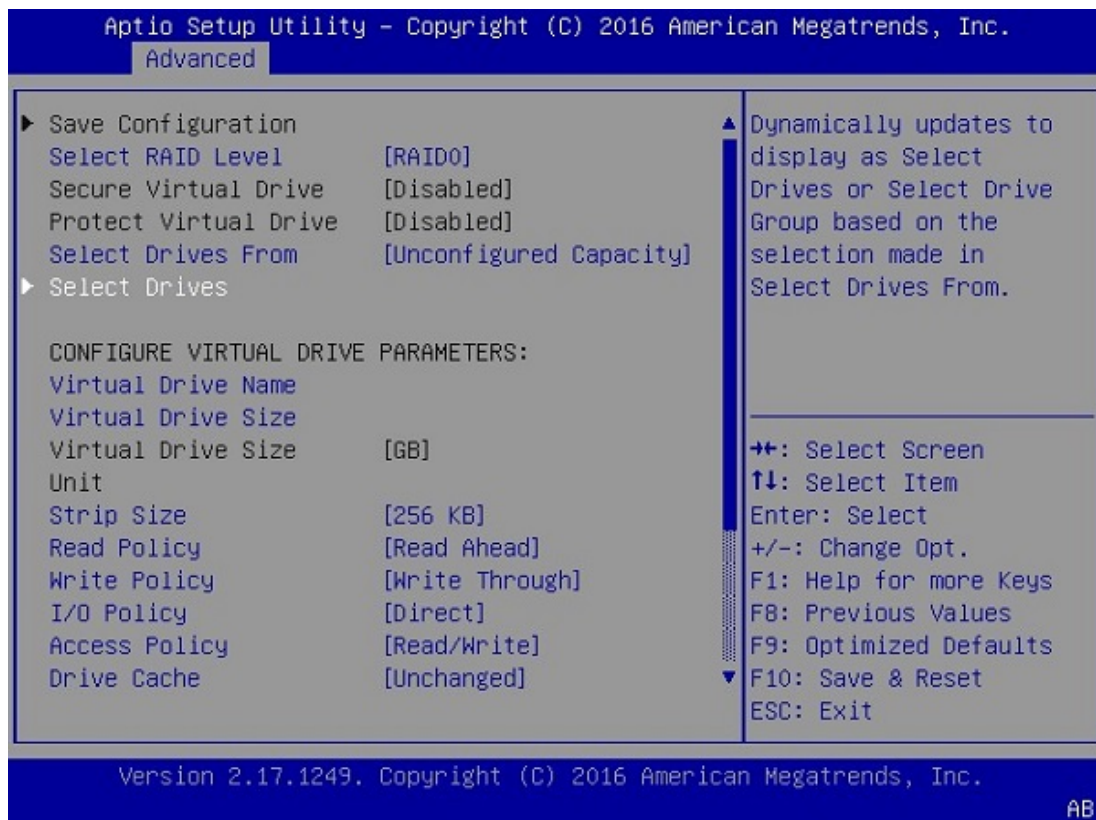

6. Switch all unconfigured 1TB drives to **[Enabled]**.

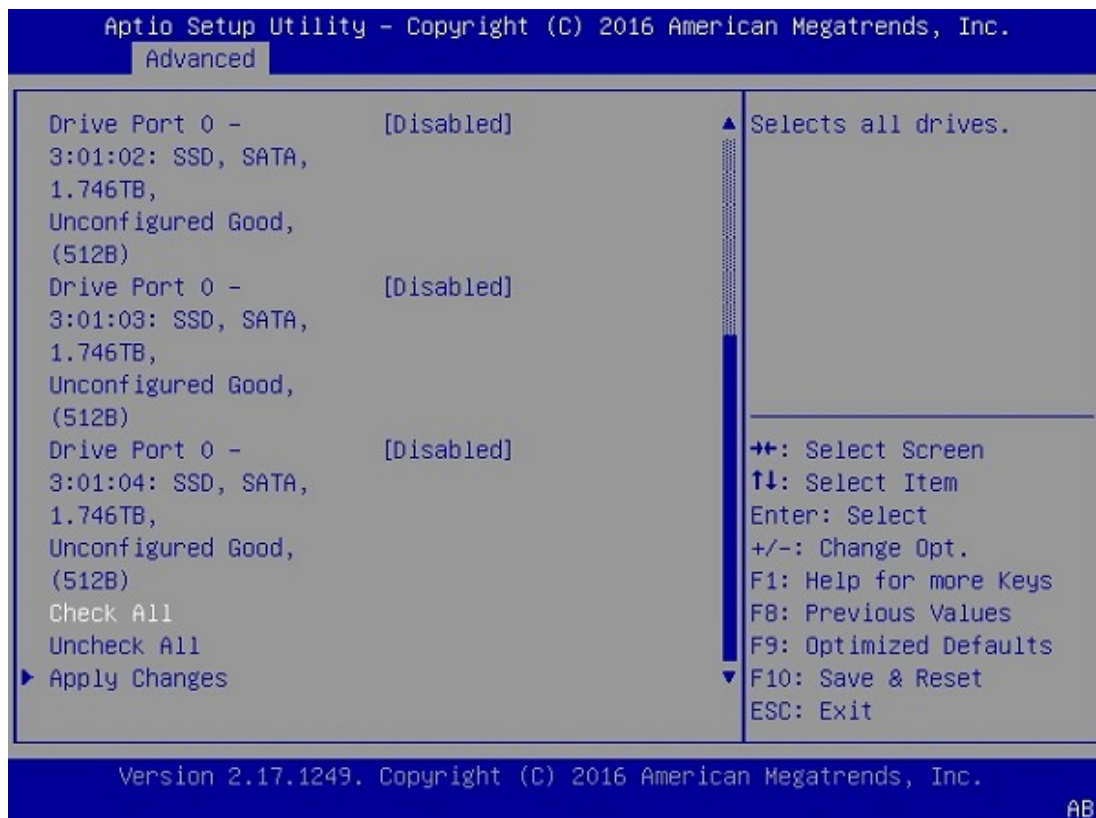

7. Select **Apply Changes**.

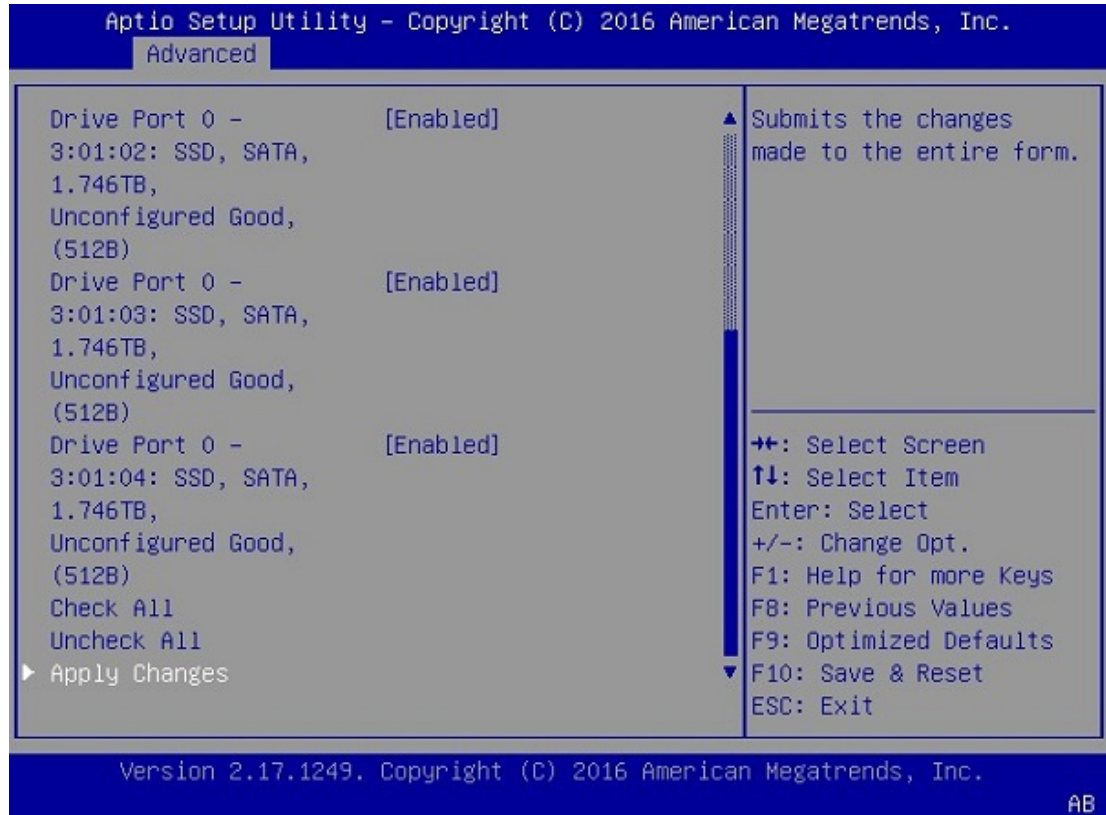

8. Change Confirm to **[Enabled]**, then select **Yes**.
9. Select **OK** at the success screen.
The *Create Virtual Drive* screen displays a summary of your selection.
10. Verify that the summary matches your selection, then select **Save Configuration**.

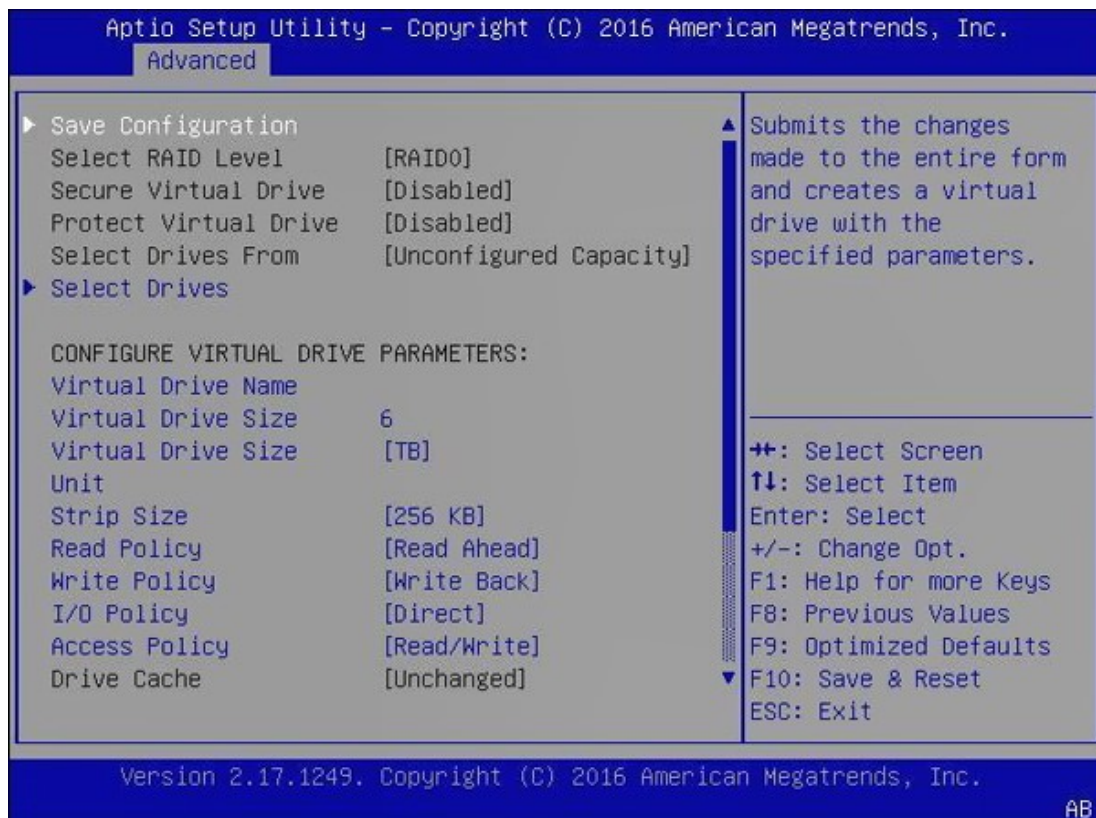

11. Make sure **Confirm** is set to **[Enabled]**, then select **Yes** to confirm the change.

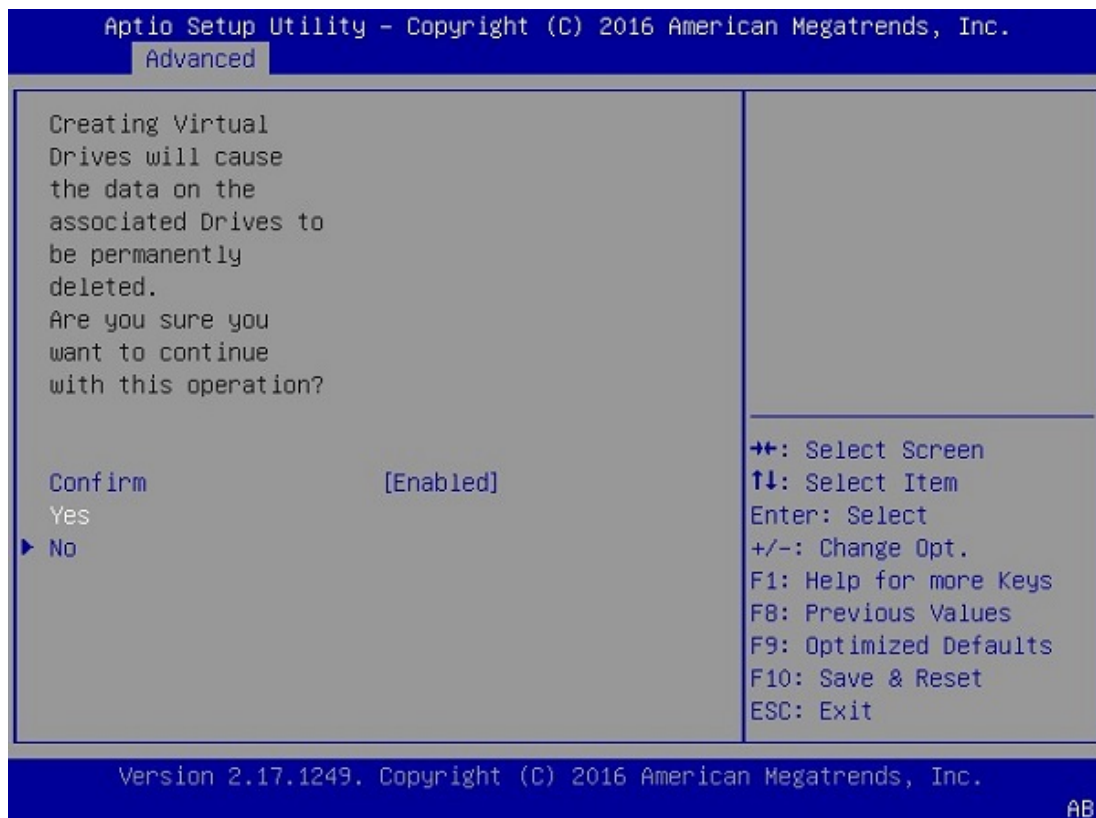

12. Select **OK** at the success screen.
13. Confirm and exit.
 - a) Select **View Drive Group Properties** to confirm the configuration.

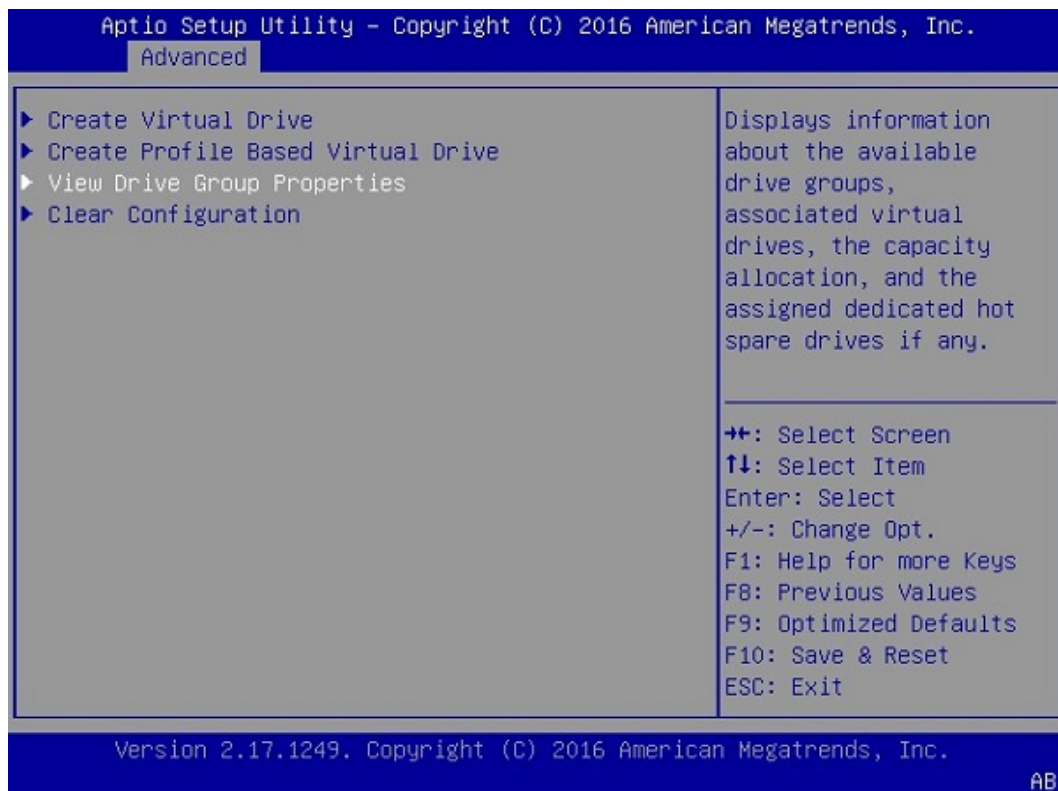

- b) Verify that your configuration screen shows that you have two virtual drives with the following properties:
- Virtual Drive 0 of size 446 GB (or very similar)
 - Virtual Drive 1 of size 7 TB (or very similar).

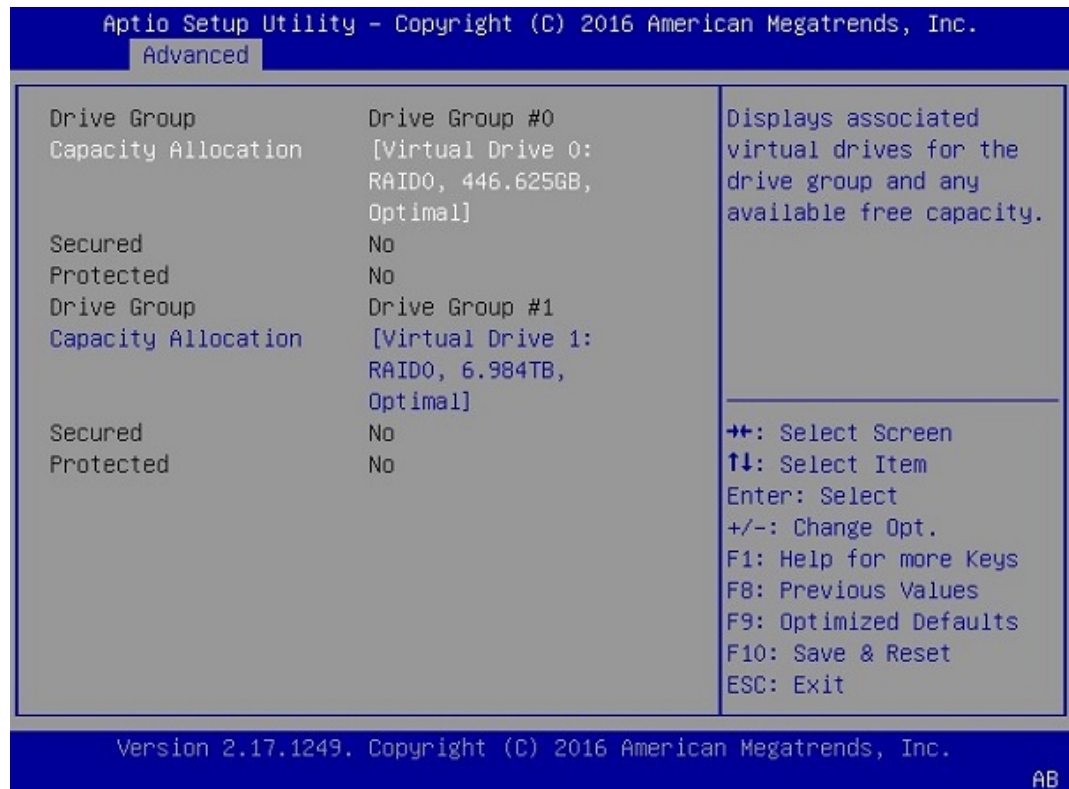

- c) If your Drive Groups match the above, press **[F10]** to save these settings and reset the system.
- d) Select **Save Changes and Reset**, then select **Yes** at the confirmation prompt.

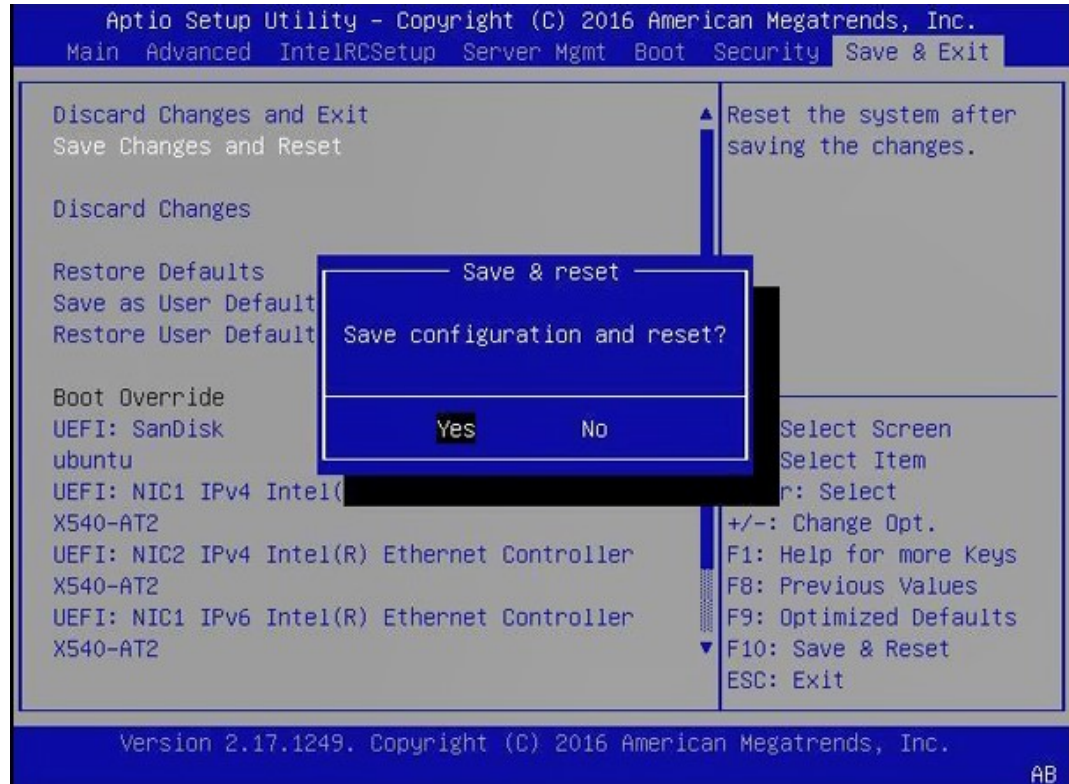

- Follow the instructions in the section [Restoring the DGX-1 Software Image](#) to create the partitions.

5.5.4. Recreating the RAID 0 Array

After replacing one of the RAID 0 cache SSDs, you need to recreate the RAID 0 array. If you replaced only the cache and not the operating system SSD, then you can use a convenient script to recreate the RAID array. The script is part of the DGX-1 software as of version 2.0.4.

The script requires that the Broadcom StorCLI utility is installed on the DGX system. As of DGX OS Server version 3.1.6, StorCLI is included in the DGX software. For instructions on installing the utility on DGX systems with DGX OS Server versions prior to 3.1.6, see the document *Using StorCLI to Recreate the NVIDIA DGX-1 RAID 0 Array*, available from the Enterprise Services site.



Connect a display (1024x768 or lower resolution) and keyboard to the DGX-1 when booting the DGX-1 before recreating the RAID array. This is because the system may halt at the BIOS screen alerting you that the RAID array needs to be configured. Press C (or whichever key allows you to continue) to complete the boot process. You will be able to do this only if you are operating the DGX-1 through a direct display and keyboard connection.

1. Run the script by entering the following on the command line:

```
$ sudo python /usr/bin/configure_raid_array.py -c -f
```

2. After the script has finished recreating the RAID 0 array, reboot the DGX-1 to verify that `/raid` is mounted and usable.

5.5.5. Replacing the Power Supplies

Access the power supplies from the front of the DGX-1. You can hot-swap the power supplies as follows:

1. If not already removed, remove the bezel by grasping the bezel by the side handles and then pulling the bezel straight off the front of the DGX-1.



CAUTION: Be careful not to accidentally press the power button that is on the right edge of the DGX-1 when removing or installing the bezel.

2. Unplug the power cord from the power connector on the fan assembly.
3. Flip the power supply handle out.

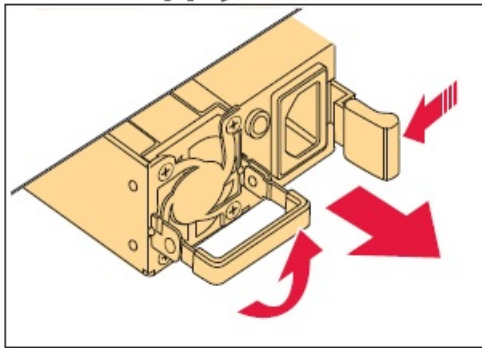

4. Push the green release lever to the left and simultaneously use the power supply handle to pull out the power supply.
5. Slide the replacement power supply into the bay and push until seated.
6. Flip the power supply handle up against the power supply.
7. Reconnect the power cord.



IMPORTANT: Make sure that the end of the power cord cable tie is not inserted into the power supply fan. The cable tie can interfere with normal operation of the fan, resulting in failure of the power supply.

8. Reattach the bezel.

With the bezel positioned so that the NVIDIA logo is visible from the front and is on the left-hand side, line up the pins near the corners of the DGX-1 with the holes in

back of the bezel, then gently press the bezel against the DGX-1. The bezel is held in place magnetically.



CAUTION: Be careful not to accidentally press the power button that is on the right edge of the DGX-1 when removing or installing the bezel.

5.5.6. Replacing the Fan Module

CAUTION: To avoid overheating the system, the fan module should be replaced within 25 seconds after removal.

1. Unscrew the thumbscrews at the front of the DGX-1, then slide the DGX-1 about half way out from the rack.
2. Squeeze together the latches at the square access openings on the top of the chassis, then flip open the top of the chassis to expose the fan modules.

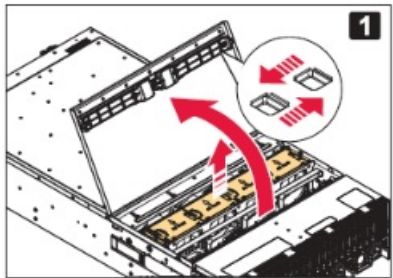

3. Squeeze the release tabs on the outer edge of the fan module you want to replace, then pull up to lift the fan module out of the unit.

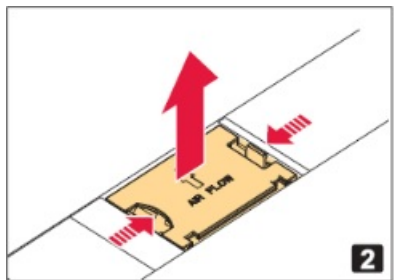

4. Replace with a new fan module using the reverse steps.

5.5.7. Replacing the DIMMs

Before attempting to replace any of the dual inline memory modules (DIMMs), make sure that you know the location of the faulty DIMM needing replacement. The location ID is an alpha-numeric designator, such as A0, A1, B0, B1, etc., and is reported in the BMC log files.



CAUTION: Static Sensitive Devices: - Be sure to observe best practices for electrostatic discharge (ESD) protection. This includes making sure personnel and equipment are connected to a common ground, such as by wearing a wrist strap connected to the chassis ground, and placing components on static-free work surfaces.

The DIMMs are located on the motherboard tray, which is accessible from the rear of the DGX-1.

1. Turn off the DGX-1 and disconnect all network and power cabling.
2. Remove the motherboard tray.
 - a) Locate the locking levers for the motherboard tray at the rear of the DGX-1.
There are two sets of locking levers. The locking levers for the motherboard are the bottom set.

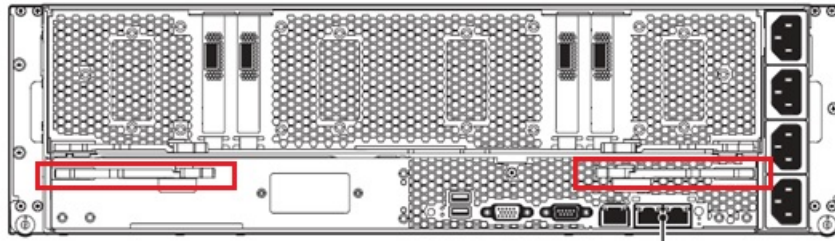

- b) Rotate the retention clasps inward towards the center of the unit.

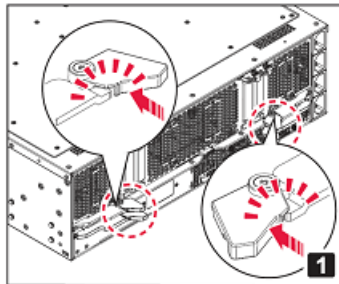

The retention clasps hold the locking levers in place. Rotating the clasps inward releases the locking levers.

- c) Swing the locking levers out and then use them to pull the motherboard tray out of the unit.

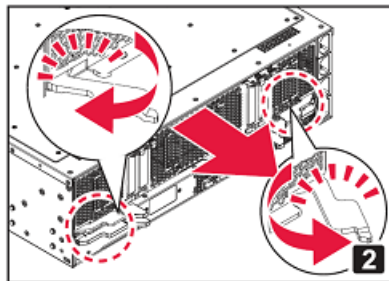

Do not pull the unit by the blue retention clasps; they may break.

- d) Set the motherboard tray on a clean work surface, and position it so that the locking levers are at the top as you look down on the tray.

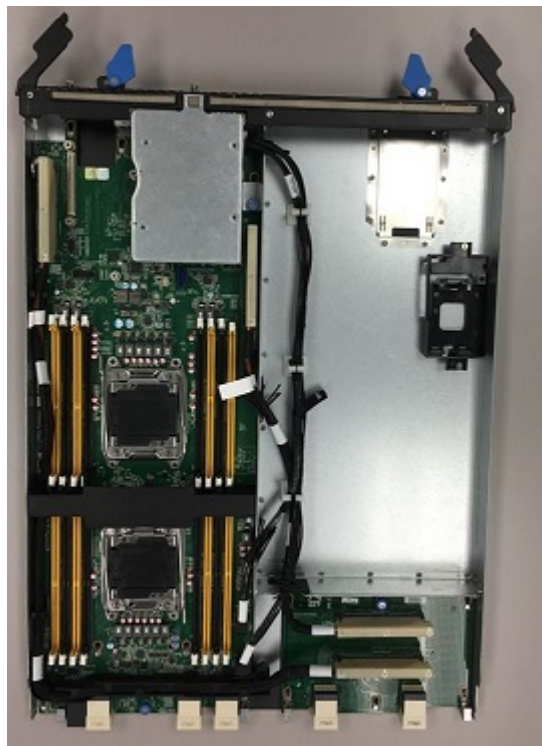

The DIMMs are on a printed circuit board on the left side of the tray.

3. Using the figure below as a guide, locate the DIMM corresponding to the ID of the faulty DIMM as reported in the BMC log.

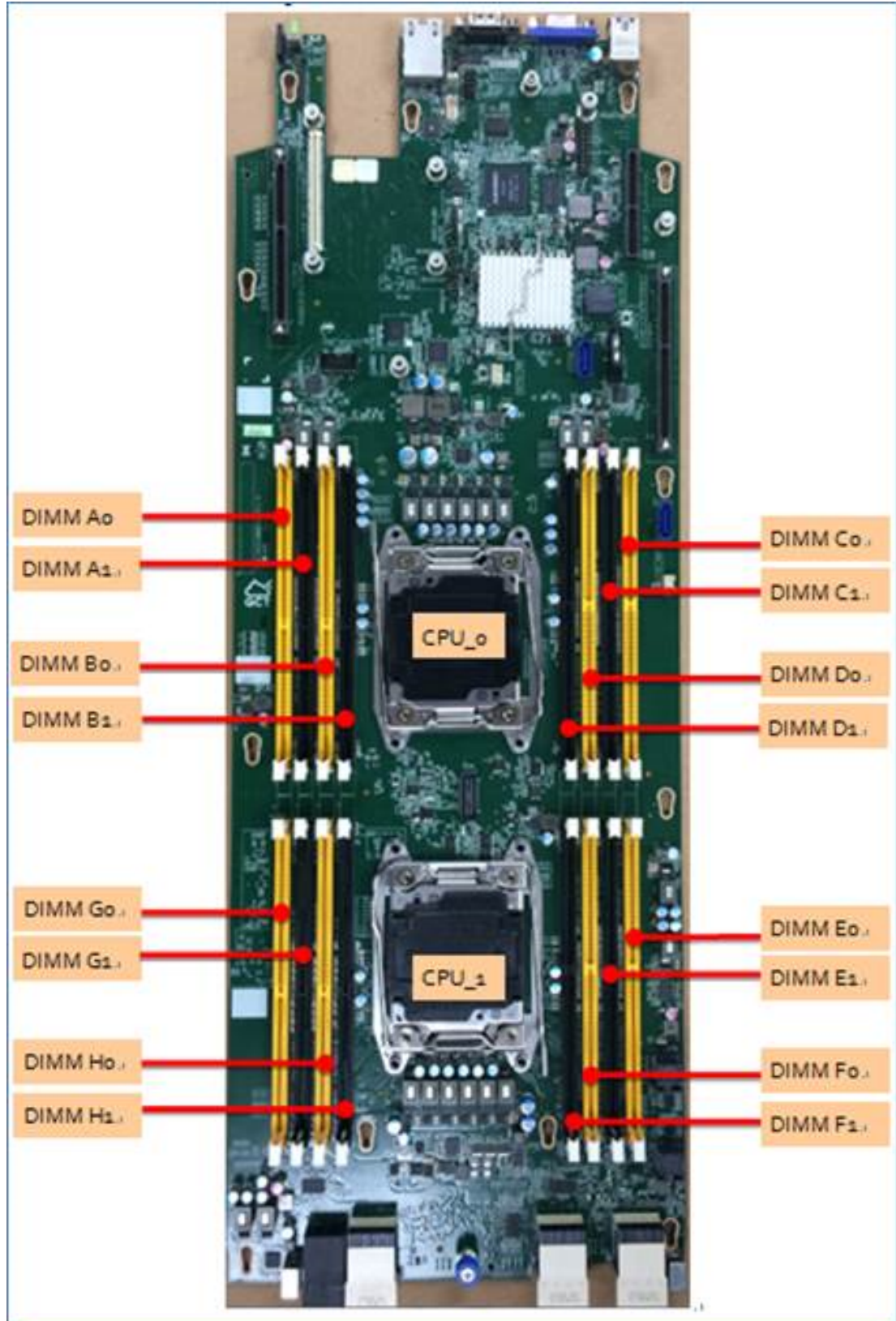

4. Remove the DIMM.

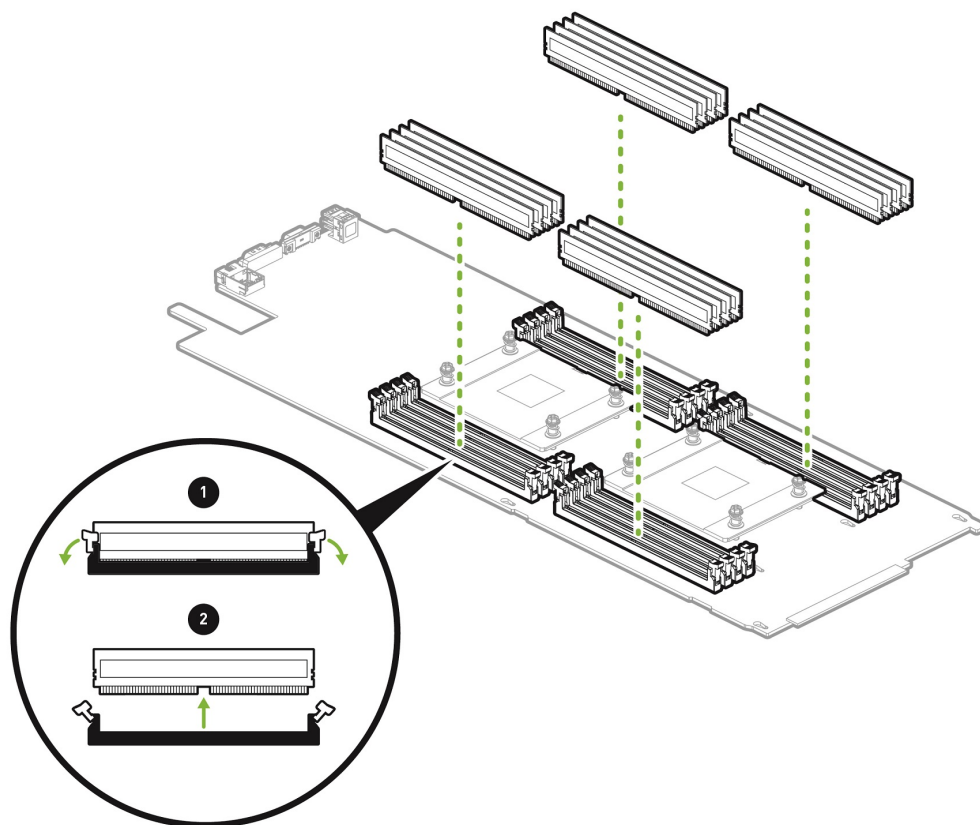

- a) Press down on the side latches at both ends of the DIMM socket to push them away from the DIMM.
This should unseat the DIMM from the socket.
 - b) Pull the DIMM straight up to remove it from the socket.
5. Carefully insert the replacement DIMM.

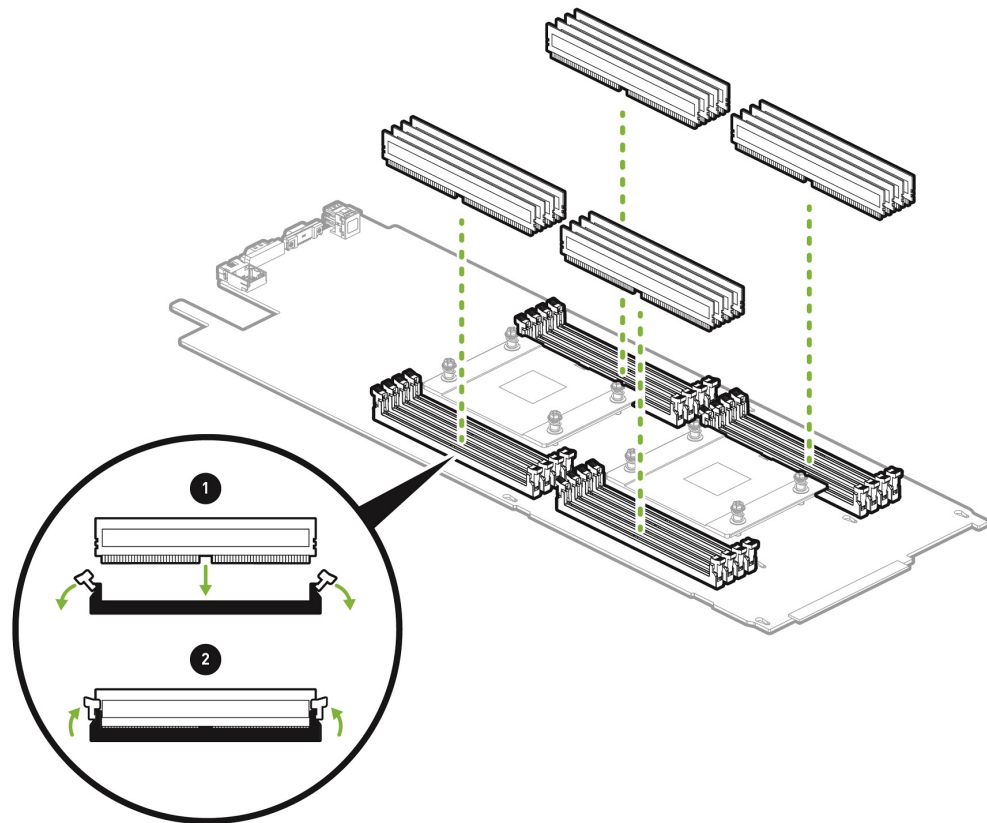

- a) Make sure the socket latches are open.
 - b) Position the DIMM over the socket, making sure that the notch on the DIMM lines up with the key in the slot, then press the DIMM down into the socket until the side latches click in place.
 - c) Make sure that the latches are up and locked in place.
6. Carefully insert the motherboard tray back into the unit, then swing the locking levers flat against the tray and secure them in place with the retention clasps.

5.5.8. Replacing the InfiniBand Cards

The InfiniBand cards are located on the GPU tray which is accessible from the rear of the DGX-1. Be sure you have identified the faulty InfiniBand card needing to be replaced. The slots are identified as indicated in the following image.

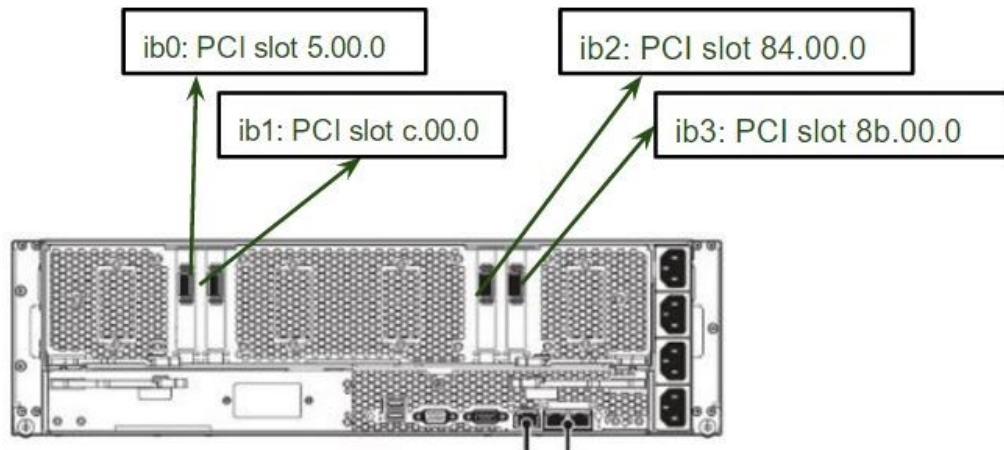

CAUTION: Static Sensitive Devices: - Be sure to observe best practices for electrostatic discharge (ESD) protection. This includes making sure personnel and equipment are connected to a common ground, such as by wearing a wrist strap connected to the chassis ground, and placing components on static-free work surfaces.

1. Turn off the DGX-1 and disconnect all network and power cabling.
2. Remove the GPU tray.
 - a) Locate the locking levers for the GPU tray at the rear of the DGX-1.
There are two sets of locking levers. The locking levers for the GPU tray are the top set.

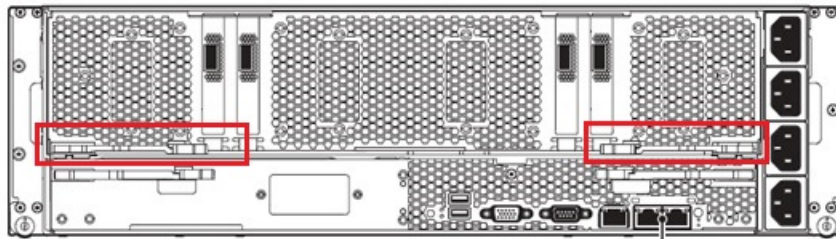

- b) Rotate the retention clasps inward towards the center of the unit.

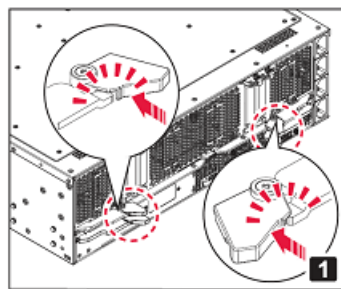

The retention clasps hold the locking levers in place. Rotating the clasps inward releases the locking levers.

- c) Swing the locking levers out and then use them to pull the GPU tray out of the unit.

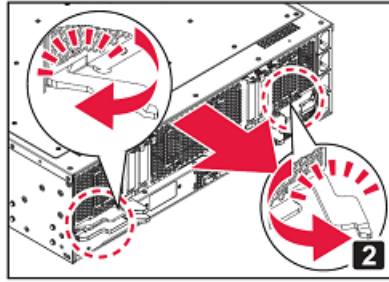

Do not pull the unit by the blue retention clasps; they may break.

3. Set the GPU tray on a clean work surface.

WARNING: Do not attempt to move or lift the GPU tray by grabbing the U-bolts.



To properly move the GPU tray, grab the tray by the outer edges of the assembly and support it from underneath, taking care not to damage any components.

4. At the top edge of the bracket for the InfiniBand card that you want to replace, rotate the retention clasp to free the bracket.

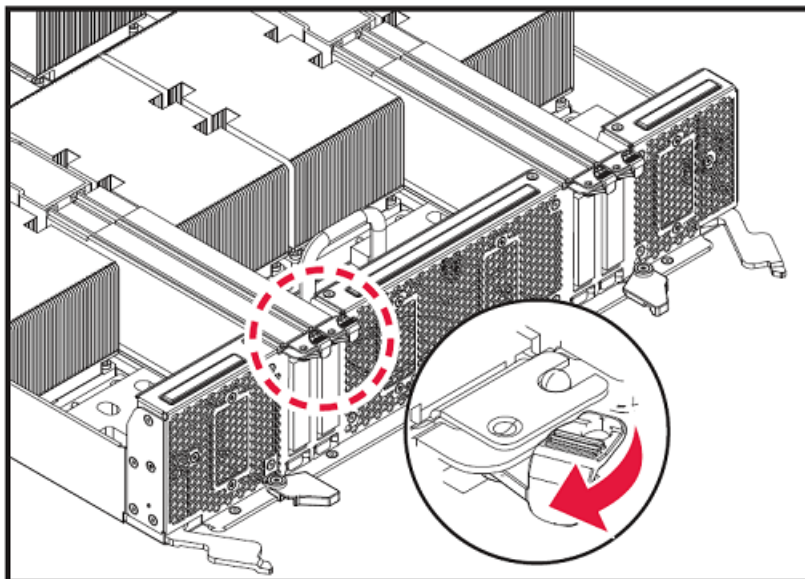

5. Firmly grasp the InfiniBand card and lift it straight up out of the PCIe slot.

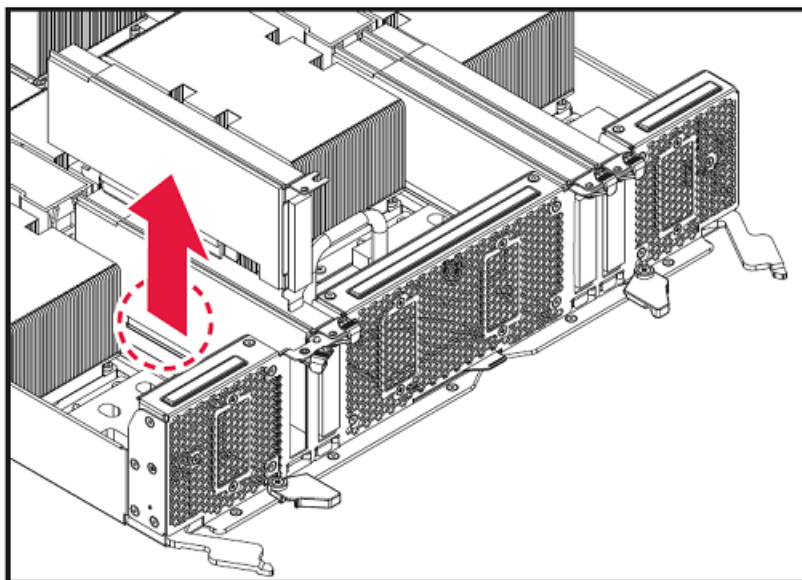

6. Position the replacement InfiniBand card over the empty PCIe slot and insert it into the slot.
7. Swing the retention clasp over the bracket to secure the bracket in place.

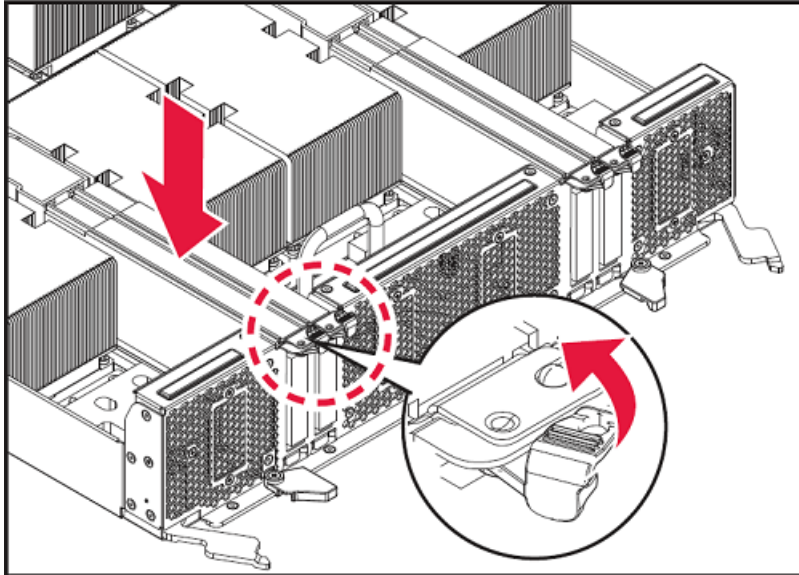

8. Carefully insert the GPU tray back into the unit, then swing the locking levers flat against the tray and secure them in place with the retention clasps.
9. Reconnect all connectors, boot the system, then perform the verification and setup steps described in the next section.

5.5.9. Setting Up the InfiniBand Cards

This section describes the steps needed to verify that the InfiniBand card has been replaced correctly.

1. With the DGX-1 turned on, verify that the card was installed correctly and is recognized by the system.

```
$ lspci | grep -i mellanox
```

The output should show all four InfiniBand cards.

Example:

```
05:00.0 Infiniband controller: Mellanox Technologies MT27700 Family
[ConnectX-4]
0c:00.0 Infiniband controller: Mellanox Technologies MT27700 Family
[ConnectX-4]
84:00.0 Infiniband controller: Mellanox Technologies MT27700 Family
[ConnectX-4]
8b:00.0 Infiniband controller: Mellanox Technologies MT27700 Family
[ConnectX-4]
```

If all four cards are not reported, then the card was not installed properly and should be reseated.

If a card other than the officially supported Mellanox family of adapters appears, contact NVIDIA Enterprise Support.

2. Verify that the InfiniBand drivers are present.

```
$ lsmod | grep -i ib_
```

The output should be a list of `ib_` and `mlx_` driver components.

Example:

```
ib_ucm 20480 0
ib_ipoib 131072 0
ib_cm 45056 3 rdma_cm,ib_ucm,ib_ipoib
ib_uverbs 73728 2 ib_ucm,rdma_ucm
ib_umad 24576 0
mlx5_ib 192512 0
mlx4_ib 192512 0
ib_sa 36864 5 rdma_cm,ib_cm,mlx4_ib,rdma_ucm,ib_ipoib
ib_mad 57344 4 ib_cm,ib_sa,mlx4_ib,ib_umad
ib_core 143360 13
rdma_cm,ib_cm,ib_sa,iw_cm,nv_peer_mem,mlx4_ib,mlx5_ib,ib_mad,ib_ucm,ib_umad,ib_uverbs,rdm
ib_addr 20480 3 rdma_cm,ib_core,rdma_ucm
ib_netlink 16384 3 rdma_cm,iw_cm,ib_addr
mlx4_core 344064 2 mlx4_en,mlx4_ib
mlx5_core 524288 1 mlx5_ib
mlx_compat 16384 18
rdma_cm,ib_cm,ib_sa,iw_cm,mlx4_en,mlx4_ib,mlx5_ib,ib_mad,ib_ucm,ib_netlink,ib_addr,ib_cor
```

3. Verify that the OFED software was installed correctly.

```
$ modinfo mlx5_core | grep -i version | head -1
```

Example output:

```
Version : 3.4-1.0.0
```



DGX OS Server release 1.x should have OFED software 3.2.

DGX OS Server release 2.x should have OFED software 3.4.

DGX OS Server release 3.x should have OFED software 4.0

4. Restart the InfiniBand services so that the new card is recognized.
 - a) Restart the InfiniBand service.

```
$ sudo service openibd restart
```

- b) Verify that the service has started.

```
$ service openibd status
openibd start/running
```

- c) If the services do not start, verify
 - ▶ That the drivers are loaded according to step 3.
 - ▶ That the associated cables are connected to the InfiniBand ports.
 - ▶ The state of `ibstat` (refer to step 7)
 - ▶ Whether errors are reported in `/var/log/syslog`.

If these steps do not indicate a problem and yet the services still do not start, contact NVIDIA Enterprise Support and obtain an RMA for the card.

5. Verify the firmware version.

```
$ cat /sys/class/infiniband/mlx5*/fw_ver
```

Example output:

```
12.17.1010
12.17.1010
12.17.1010
12.17.1010
```

The latest InfiniBand firmware version supported on DGX OS Server release 1.x is 12.16.1020, the latest supported on release 2.x is 12.17.1010, and the latest supported on release 3.x is 12.18.1000.

6. If you need to update the firmware, follow these steps:
 - a) Initiate the firmware update.

```
$ sudo /opt/mellanox/mlnx-fw-updater/mlnx_fw_updater.pl
```

The script will check the firmware version of each card and update where needed. If the firmware is updated for any card, you will need to reboot the system for the changes to take effect.

- b) Reboot the system if instructed.
 - c) After rebooting the system, verify that all the Mellanox InfiniBand cards are using the current firmware.

```
$ cat /sys/class/infiniband/mlx5*/fw_ver
12.17.1010
12.17.1010
12.17.1010
12.17.1010
```

7. Verify the physical port state for the InfiniBand cards.

```
$ ibstat
```

In the output text, verify that the Physical State for each card with a cable connection is **LinkUp** and that the port for the card is configured with a GUID. The following example output shows one card in a non-connected state, and three cards in a connected state. Relevant text is highlighted in bold.

```
CA 'mlx5_0'
CA type: MT4115
Number of ports: 1
Firmware version: 12.17.1010
Hardware version: 0
Node GUID: 0x248a0703000de288
System image GUID: 0x248a0703000de288
Port 1:
    State: Down
    Physical state: Polling
    Rate: 10
    Base lid: 65535
    LMC: 0
    SM lid: 0
    Capability mask: 0x2651e848
    Port GUID: 0x248a0703000de288
    Link layer: InfiniBand
CA 'mlx5_1'
CA type: MT4115
Number of ports: 1
Firmware version: 12.17.1010
Hardware version: 0
Node GUID: 0x248a0703000de26c
System image GUID: 0x248a0703000de26c
Port 1:
```

```

State: Initializing
Physical state: LinkUp
Rate: 100
Base lid: 65535
LMC: 0
SM lid: 0
Capability mask: 0x2651e848
Port GUID: 0x248a0703000de26c
Link layer: InfiniBand
CA 'mlx5_2'
CA type: MT4115
Number of ports: 1
Firmware version: 12.17.1010
Hardware version: 0
Node GUID: 0x248a0703001effde
System image GUID: 0x248a0703001effde
Port 1:
State: Initializing
Physical state: LinkUp
Rate: 100
Base lid: 65535
LMC: 0
SM lid: 0
Capability mask: 0x2651e848
Port GUID: 0x248a0703001effde
Link layer: InfiniBand
CA 'mlx5_3'
CA type: MT4115
Number of ports: 1
Firmware version: 12.17.1010
Hardware version: 0
Node GUID: 0x7cfe900300118f22
System image GUID: 0x7cfe900300118f22
Port 1:
State: Initializing
Physical state: LinkUp
Rate: 100
Base lid: 65535
LMC: 0
SM lid: 0
Capability mask: 0x2651e848
Port GUID: 0x7cfe900300118f22
Link layer: InfiniBand

```

See the section [Changing the InfiniBand Port Type](#) for instructions on switching the port to InfiniBand or Ethernet, if required.

Chapter 6.

INSTALLING SOFTWARE ON AIR-GAPPED NVIDIA DGX-1 SYSTEMS

For security purposes, some installations require that systems be isolated from the internet or outside networks. Since most DGX-1 software updates are accomplished through an over-the-network process with NVIDIA servers, this section explains how updates can be made when using an over-the-network method is not an option. It includes a process for installing Docker containers as well.

6.1. Installing NVIDIA DGX-1 Software

One method for updating DGX-1 software on an air-gapped DGX-1 is to download the ISO image, copy it to removable media and then re-image the DGX-1 from the media. This method is available only for software versions that are available as ISO images for download.

Alternately, you can update the DGX-1 software by performing a network update from a local repository. This method is available only for software versions that are available for over-the-network updates.

6.1.1. Re-Imaging the System



WARNING: This process destroys all data and software customizations that you have made on the DGX-1. Be sure to back up any data that you want to preserve, and push any Docker images that you want to keep to a trusted registry.

1. Obtain the ISO image from the Enterprise Support site.
 - a) Log on to the [NVIDIA Enterprise Services \(https://nvid.nvidia.com/dashboard/\)](https://nvid.nvidia.com/dashboard/) site and click the Announcements tab to locate the DGX-1 Base OS Image ISO file.
 - b) Download the image ISO file.
2. Refer to the instructions in the [Restoring the DGX-1 Software Image](#) section for additional instructions.

6.1.2. Creating a Local Mirror of the NVIDIA and Canonical Repositories

Instructions for setting up a private repository or mirroring the NVIDIA and Canonical repositories are beyond the scope of this document. It is expected that users are knowledgeable about those processes.

1. Create a private repository that mirrors the NVIDIA as well as the Canonical repositories.
Consult `/etc/apt/sources.list` and the contents of `/etc/apt/sources.list.d` on your running DGX-1 for the repository locations.
2. Modify `/etc/apt/sources.list` and appropriate contents of `/etc/apt/sources.list.d` to point to your private repository.
3. Perform the update from the private repository, starting with *Get the new package list* step (`sudo apt-get update`) of the instructions found in the *DGX-1 Software Release Notes and Upgrade Guide*, which you can obtain from the Enterprise Support site.

6.2. Installing Docker Containers

This method applies to Docker containers hosted on the NVIDIA DGX Container Registry, and requires that you have an active DGX account.

1. On a system with internet access, log in to the DGX Container Registry by entering the following command and credentials.

```
$ docker login nvcr.io
Username: $oauthtoken
Password: apikey
```

Type “\$oauthtoken” exactly as shown for the Username. This is a special username that enables API key authentication. In place of `apikey`, paste in the API Key text that you obtained from the DGX website.

2. Enter the docker pull command, specifying the image registry, image repository, and tag:

```
$ docker pull nvcr.io/nvidia/repository:tag
```

3. Verify the image is on your system using `docker images`.

```
$ docker images
```

4. Save the Docker image as an archive. .

```
$ docker save nvcr.io/nvidia/repository:tag > framework.tar
```

5. Transfer the image to the air-gapped system using removable media such as a USB flash drive.

6. Load the NVIDIA Docker image.

```
$ docker load -i framework.tar
```

7. Verify the image is on your system.

```
$ docker images
```

Chapter 7.

CUSTOMER SUPPORT FOR THE NVIDIA DGX-1

There are several options for contacting NVIDIA Customer Support for assistance reporting, troubleshooting, or diagnosing problems with your DGX-1.

NVIDIA Enterprise Support Portal

The best way to file an incident is to log on to

NVIDIA Enterprise Services (<https://nvid.nvidia.com/dashboard/>).

NVIDIA Enterprise Support Email

enterprisesupport@nvidia.com

NVIDIA Enterprise Support - Local Language Phone Numbers

EMEA - Monday – Saturday 9 AM – 7 PM CET

- ▶ **DE:** +49 3030806888
- ▶ **ES:** +34 911880035
- ▶ **FR:** +33 975186797
- ▶ **IT:** +39 0294757110
- ▶ **PL:** +48 223975013
- ▶ **RU:** + 7 (499) 6092527 - 11 AM – 9 PM MSK
- ▶ **JP:** 0120-706-170 9 AM - 6 PM JST
- ▶ **US:** +1 (408) 486-2500 - Monday - Friday 8 AM - 5 PM PST

After-hours emergency, call 24x7 at +1 (800) 797-6530.

Our support team can help collect appropriate information about your issue and involve internal resources as needed.

Chapter 8.

KING SLIDE - AH61-500 INSTRUCTIONS

These are the rail assembly instructions for the rail kit provided with the DGX-1.

1. Release and detach the inner member from the slide.

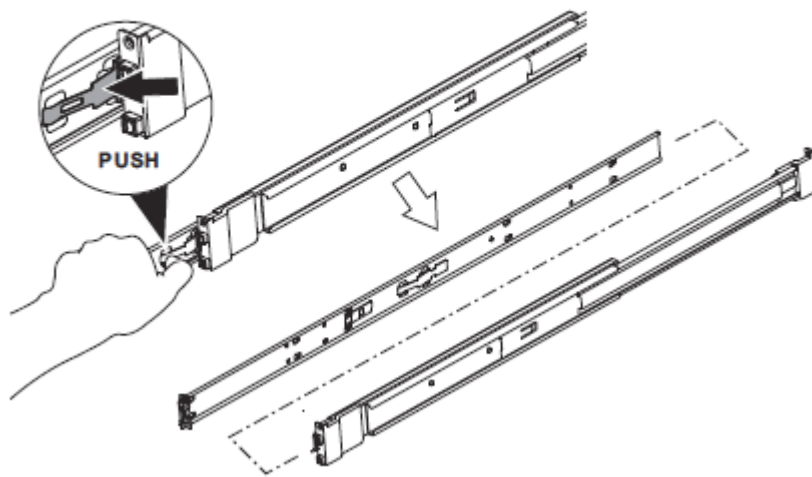

2. Attach inner member to the system.

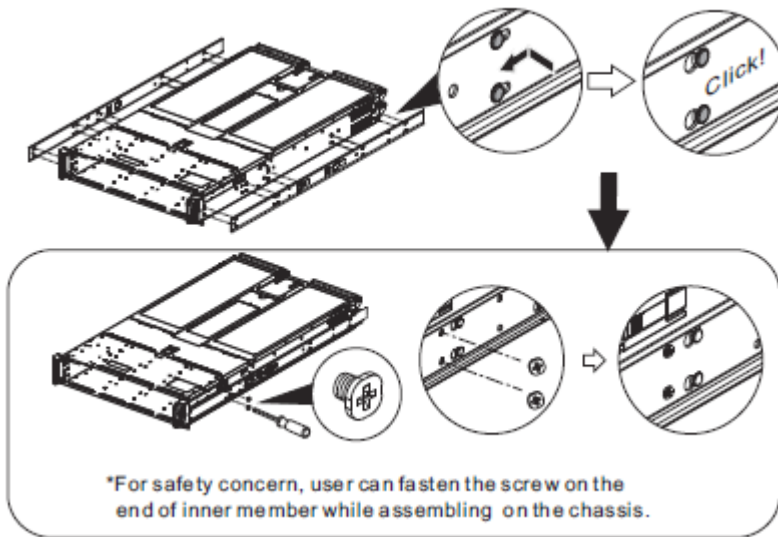

3. Attach outer member to the rack.

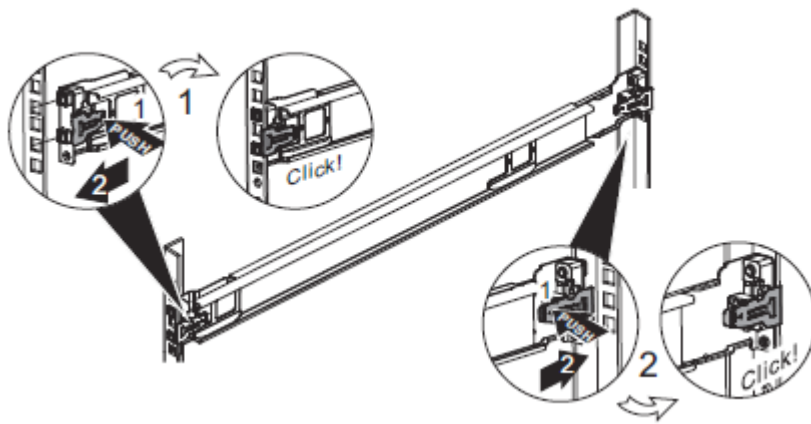

4. Insert the unit to complete the installation.

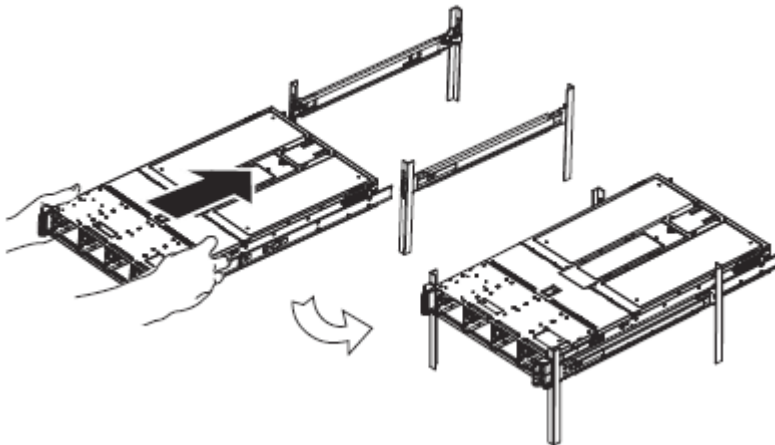

All images copyright 2016 King Slide. All Rights Reserved

Chapter 9.

SAFETY

To reduce the risk of bodily injury, electrical shock, fire, and equipment damage, read this document and observe all warnings and precautions in this guide before installing or maintaining your server product.



In the event of a conflict between the information in this document and information provided with the product or on the website for a particular product, the product documentation takes precedence.







Your server should be integrated and serviced only by technically qualified persons.

You must adhere to the guidelines in this guide and the assembly instructions in your server manuals to ensure and maintain compliance with existing product certifications and approvals. Use only the described, regulated components specified in this guide. Use of other products or components will void the UL Listing and other regulatory approvals of the product, and may result in noncompliance with product regulations in the region(s) in which the product is sold.

9.1. Safety Warnings and Cautions

To avoid personal injury or property damage, before you begin installing the product, read, observe, and adhere to all of the following safety instructions and information. The following safety symbols may be used throughout the documentation and may be marked on the product and I or the product packaging.

Symbol	Meaning
CAUTION	Indicates the presence of a hazard that may cause minor personal injury or property damage if the CAUTION is ignored.
WARNING	Indicates the presence of a hazard that may result in serious personal injury if the WARNING is ignored.
	Indicates potential hazard if indicated information is ignored.
	Indicates shock hazards that result in serious injury or death if safety instructions are not followed

Symbol	Meaning
	Indicates hot components or surfaces.
	Indicates do not touch fan blades, may result in injury.
	Indicates to unplug all AC power cord(s) to disconnect AC power.
	Recycle the battery.
	The rail racks are designed to carry only the weight of the server system. Do not use rail-mounted equipment as a workspace. Do not place additional load onto any rail-mounted equipment.
	Indicates two people are required to safely handle the system

9.2. Intended Application Uses

This product was evaluated as Information Technology Equipment (ITE), which may be installed in offices, schools, computer rooms, and similar commercial type locations. The suitability of this product for other product categories and environments (such as medical, industrial, residential, alarm systems, and test equipment), other than an ITE application, may require further evaluation.

9.3. Site Selection

Choose a site that is:

- ▶ Clean, dry, and free of airborne particles (other than normal room dust).
- ▶ Well-ventilated and away from sources of heat including direct sunlight and radiators.
- ▶ Away from sources of vibration or physical shock.
- ▶ In regions that are susceptible to electrical storms, we recommend you plug your system into a surge suppressor and disconnect telecommunication lines to your modem during an electrical storm.
- ▶ Provided with a properly grounded wall outlet.
- ▶ Provided with sufficient space to access the power supply cord(s), because they serve as the product's main power disconnect.

9.4. Equipment Handling Practices

Reduce the risk of personal injury or equipment damage:

- ▶ Conform to local occupational health and safety requirements when moving and lifting equipment.
- ▶ Use mechanical assistance or other suitable assistance when moving and lifting equipment .

9.5. Electrical Precautions

Power and Electrical Warnings

Caution: The power button, indicated by the stand-by power marking, DOES NOT completely turn off the system AC power, SV standby power is active whenever the system is plugged in. To remove power from system, you must unplug the AC power cord from the wall outlet. Your system may use more than one AC power cord. Make sure all AC power cords are unplugged. Make sure the AC power cord(s) is/are unplugged before you open the chassis, or add or remove any non hot-plug components.

Do not attempt to modify or use an AC power cord if it is not the exact type required. A separate AC cord is required for each system power supply.

Some power supplies in servers use Neutral Pole Fusing. To avoid risk of shock use caution when working with power supplies that use Neutral Pole Fusing.

The power supply in this product contains no user-serviceable parts. Do not open the power supply. Hazardous voltage, current and energy levels are present inside the power supply. Return to manufacturer for servicing.

When replacing a hot-plug power supply, unplug the power cord to the power supply being replaced before removing it from the server.

To avoid risk of electric shock, turn off the server and disconnect the power cord, telecommunications systems, networks, and modems attached to the server before opening it.

Power Cord Warnings

Use certified AC power cords to connect to both the power distribution unit (PDU) and server system installed in your rack.

Do not attempt to modify or use the AC power cord(s) if they are not the exact type required to fit into the grounded electrical outlets.

Caution: To avoid electrical shock or fire, check the power cord(s) that will be used with the product as follows:

- ▶ The power cord must have an electrical rating that is greater than that of the electrical current rating marked on the product.

- ▶ The power cord must have safety ground pin or contact that is suitable for the electrical outlet.
- ▶ The power supply cord(s) is/are the main disconnect device to AC power.
- ▶ The socket outlet(s) must be near the equipment and readily accessible for disconnection.
- ▶ The power supply cord(s) must be plugged into socket-outlet(s) that is /are provided with a suitable earth ground.

9.6. System Access Warnings

Caution: To avoid personal injury or property damage, the following safety instructions apply whenever accessing the inside of the product:

- ▶ Turn off all peripheral devices connected to this product.
- ▶ Turn off the system by pressing the power button to off.
- ▶ Disconnect the AC power by unplugging all AC power cords from the system or wall outlet.
- ▶ Disconnect all cables and telecommunication lines that are connected to the system.
- ▶ Retain all screws or other fasteners when removing access cover(s). Upon completion of accessing inside the product, refasten access cover with original screws or fasteners.
- ▶ Do not access the inside of the power supply. There are no serviceable parts in the power supply. Return to manufacturer for servicing.
- ▶ Power down the server and disconnect all power cords before adding or replacing any non hot-plug component.
- ▶ When replacing a hot-plug power supply, unplug the power cord to the power supply being replaced before removing the power supply from the server.

Caution: If the server has been running, any installed processor(s) and heat sink(s) may be hot.

Unless you are adding or removing a hot-plug component, allow the system to cool before opening the covers. To avoid the possibility of coming into contact with hot component(s) during a hot-plug installation, be careful when removing or installing the hot-plug component(s).

Caution: To avoid injury do not contact moving fan blades. Your system is supplied with a guard over the fan, do not operate the system without the fan guard in place.

9.7. Rack Mount Warnings

Note: The following installation guidelines are required by UL for maintaining safety compliance when installing your system into a rack.

The equipment rack must be anchored to an unmovable support to prevent it from tipping when a server or piece of equipment is extended from it. The equipment rack must be installed according to the rack manufacturer's instructions.

Install equipment in the rack from the bottom up with the heaviest equipment at the bottom of the rack.

Extend only one piece of equipment from the rack at a time.

You are responsible for installing a main power disconnect for the entire rack unit. This main disconnect must be readily accessible, and it must be labeled as controlling power to the entire unit, not just to the server(s).

To avoid risk of potential electric shock, a proper safety ground must be implemented for the rack and each piece of equipment installed in it.

Elevated Operating Ambient- If installed in a closed or multi-unit rack assembly, the operating ambient temperature of the rack environment may be greater than room ambient. Therefore, consideration should be given to installing the equipment in an environment compatible with the maximum ambient temperature (T_{ma}) specified by the manufacturer.

Reduced Air Flow -Installation of the equipment in a rack should be such that the amount of air flow required for safe operation of the equipment is not compromised.

Mechanical Loading- Mounting of the equipment in the rack should be such that a hazardous condition is not achieved due to uneven mechanical loading.

Circuit Overloading- Consideration should be given to the connection of the equipment to the supply circuit and the effect that overloading of the circuits might have on overcurrent protection and supply wiring. Appropriate consideration of equipment nameplate ratings should be used when addressing this concern.

Reliable Earthing- Reliable earthing of rack-mounted equipment should be maintained.

Particular attention should be given to supply connections other than direct connections to the branch circuit (e.g. use of power strips).Topic paragraph

9.8. Electrostatic Discharge

Caution: ESD can damage drives, boards, and other parts. We recommend that you perform all procedures at an ESD workstation. If one is not available, provide some ESD protection by wearing an antistatic wrist strap attached to chassis ground -- any unpainted metal surface -- on your server when handling parts.

Always handle boards carefully. They can be extremely sensitive to ESO. Hold boards only by their edges. After removing a board from its protective wrapper or from the server, place the board component side up on a grounded, static free surface. Use a conductive foam pad if available but not the board wrapper. Do not slide board over any surface.

9.9. Other Hazards

PROPOSITION 65 WARNING

This product contains chemicals known to the State of California to cause cancer and birth defects or other reproductive harm.

CALIFORNIA DEPARTMENT OF TOXIC SUBSTANCES CONTROL

Perchlorate Material – special handling may apply. See www.dtsc.ca.gov/hazardouswaste/perchlorate.

Perchlorate Material: Lithium battery (CR2032) contains perchlorate. Please follow instructions for disposal.

NICKEL



NVIDIA Bezel: The bezel's decorative metal foam contains some nickel. The metal foam is not intended for direct and prolonged skin contact. Please use the handles to remove, attach or carry the bezel. While nickel exposure is unlikely to be a problem, you should be aware of the possibility in case you're susceptible to nickel-related reactions.

Battery Replacement

Caution: There is the danger of explosion if the battery is incorrectly replaced. When replacing the battery, use only the battery recommended by the equipment manufacturer.

Dispose of batteries according to local ordinances and regulations. Do not attempt to recharge a battery.

Do not attempt to disassemble, puncture, or otherwise damage a battery.

Cooling and Airflow

Caution: Carefully route cables as directed to minimize airflow blockage and cooling problems. For proper cooling and airflow, operate the system only with the chassis covers installed. Operating the system without the covers in place can damage system parts. To install the covers:

- ▶ Check first to make sure you have not left loose tools or parts inside the system.
- ▶ Check that cables, add-in cards, and other components are properly installed.

- ▶ Attach the covers to the chassis according to the product instructions.

Chapter 10.

COMPLIANCE

The NVIDIA DGX-1 is compliant with the regulations listed in this section.

10.1. United States

Federal Communications Commission (FCC)

FCC Marking (Class A)

This device complies with part 15 of the FCC Rules. Operation is subject to the following two conditions: (1) this device may not cause harmful interference, and (2) this device must accept any interference received, including any interference that may cause undesired operation of the device.

NOTE: This equipment has been tested and found to comply with the limits for a Class A digital device, pursuant to part 15 of the FCC Rules. These limits are designed to provide reasonable protection against harmful interference when the equipment is operated in a commercial environment. This equipment generates, uses, and can radiate radio frequency energy and, if not installed and used in accordance with the instruction manual, may cause harmful interference to radio communications. Operation of this equipment in a residential area is likely to cause harmful interference in which case the user will be required to correct the interference at his own expense.

10.2. United States / Canada

cULus Listing Mark



10.3. Canada

Industry Canada (IC)

CAN ICES-3(A)/NMB-3(A)

The Class A digital apparatus meets all requirements of the Canadian Interference-Causing Equipment Regulation.

Cet appareil numérique de la class A respecte toutes les exigences du Règlement sur le matériel brouilleur du Canada.

10.4. CE

European Conformity; Conformité Européenne (CE)



This is a Class A product. In a domestic environment this product may cause radio frequency interference in which case the user may be required to take adequate measures.

The product has been marked with the CE Mark to illustrate its compliance.

This device complies with the following Directives:

- ▶ EMC Directive (2014/30/EU) for Class A, I.T.E equipment.
- ▶ Low Voltage Directive (2014/35/EU) for electrical safety.
- ▶ RoHS Directive (2011/65/EU) for hazardous substances.
- ▶ ErP Directive (2009/125/EC) for European Ecodesign.

A copy of the Declaration of Conformity to the essential requirements may be obtained directly from NVIDIA GmbH (Floessergasse 2, 81369 Munich, Germany).

10.5. Japan

VCCI

この装置は、クラス A 情報技術装置です。この装置を家庭環境で使用すると電波妨害を引き起こすことがあります。この場合には使用者が適切な対策を講ずるよう要求されることがあります。 VCCI-A

This is a Class A product.

In a domestic environment this product may cause radio interference, in which case the user may be required to take corrective actions. VCCI-A

10.6. Australia

RCM



10.7. China

RoHS Material Content



产品中有害物质的名称及含量
 The Table of Hazardous Substances and their Content
 根据中国《电器电子产品有害物质限制使用管理办法》
 as required by China's Management Methods for Restricted of Hazardous Substances Used in Electrical and Electronic Products

部件名称 Parts	有害物质 Hazardous Substances					
	铅及其化合物 (Pb and its compounds)	汞及其化合物 (Hg and its compounds)	镉及其化合物 (Cd and its compounds)	六价铬化合物 (Cr(VI) compounds)	多溴联苯 (PBB)	多溴二苯醚 (PBDE)
机箱 Chassis	X	O	O	O	O	O
印刷电路部件 PCA	X	O	O	O	O	O
图形处理器 GPU	X	O	O	O	O	O
中央处理器 CPU	X	O	O	O	O	O
主板 Motherboard	X	O	O	O	O	O
电源设备 Power supply	X	O	O	O	O	O
存储设备 System memory	X	O	O	O	O	O
硬盘驱动器 Hard drive	X	O	O	O	O	O
机械部件 (风扇、散热器、面板等) Mechanical parts (fan, heat sink, bezel...)	X	O	O	O	O	O
线材/连接器 Cables/Connectors	X	O	O	O	O	O
焊接金属 Soldering material	O	O	O	O	O	O
助焊剂, 锡膏, 标签及其他耗材 Flux, Solder Paste, label and other consumable materials	O	O	O	O	O	O

本表格依据SJ/T 11364-2014 的规定编制
The table according to SJ/T 11364-2014

O: 表示该有害物质在该部件所有均质材料中的含量均在GB/T 26572-2011 标准规定的限量要求以下。
O: Indicates that this hazardous substance contained in all of the homogeneous materials for this part is below the limit requirement in GB/T 26572-2011.
X: 表示该有害物质至少在该部件的某一均质材料中的含量超出GB/T 26572-2011 标准规定的限量要求。
X: Indicates that this hazardous substance contained in at least one of the homogeneous materials used for this part is above the limit requirement in GB/T 26572-2011.

此表中所有名称中含“X”的部件均符合欧盟 RoHS 立法。
All parts named in this table with an “X” are in compliance with the European Union’s RoHS Legislation.

注：环保使用期限的参考标识取决于产品正常工作的温度和湿度等条件
Note: The referenced Environmental Protection Use Period Marking was determined according to normal operating use conditions of the product such as temperature and humidity.

10.8. Israel

SII

ודא שלמות ותקינות כבל החשמל והתקע אין להכניס או להוציא את התקע מרשת החשמל בידיים רטובות. אין לפתוח את המכשיר, במקרה של בעיה כלשהי יש לפנות למעבדת השירות הקרובה. יש להרחיק את המכשיר מנוזלים. במקרה של ריח מוזר, רעשים שמקורם במכשיר, יש לנתקו מיידית מרשת החשמל ולפנות למעבדת שירות המכשיר מיועד לשימוש בתוך המבנה, ולא לשימוש חיצוני ולא לשימוש בסביבה לחה. אין לחתוך, לשבור, ולעקם את הכבל החשמל. אין להניח חפצים על הכבל החשמל או להניח לו להתחמם יתר על המידה, שכן עלול לגרום לנזק, דליקה או התחשמלות. יש להקפיד לחזק את התקן הניתוק במצב תפעולי מוכן לשימוש. אזהרה: אין להחליף את כבל הזינה בתחליפים לא מקוריים, חיבור לקוי עלול לגרום להתחשמלות המשתמש. בשימוש על כבל מאריך יש לוודא תקינות מוליך הארקה שבכבל.

10.9. South Korea

KC



MSIP-REM- QCT-P2787 (A)

<p>A급 기기 (업무용 방송통신기자재)</p>	<p>이 기기는 업무용(A급) 전자파적합기기로써 판매자 또는 사용자는 이 점을 주의하시기 바라며, 가정외의 지역에서 사용하는 것을 목적으로 합니다.</p>
--------------------------------	--

Class A Equipment (Industrial Broadcasting & Communication Equipment). This equipment Industrial (Class A) electromagnetic wave suitability equipment and seller

or user should take notice of it, and this equipment is to be used in the places except for home.

10.10. India

BIS

IS 13252 (Part 1)/
IEC 60950-1



R-41067512

Notice

THE INFORMATION IN THIS GUIDE AND ALL OTHER INFORMATION CONTAINED IN NVIDIA DOCUMENTATION REFERENCED IN THIS GUIDE IS PROVIDED “AS IS.” NVIDIA MAKES NO WARRANTIES, EXPRESSED, IMPLIED, STATUTORY, OR OTHERWISE WITH RESPECT TO THE INFORMATION FOR THE PRODUCT, AND EXPRESSLY DISCLAIMS ALL IMPLIED WARRANTIES OF NONINFRINGEMENT, MERCHANTABILITY, AND FITNESS FOR A PARTICULAR PURPOSE. Notwithstanding any damages that customer might incur for any reason whatsoever, NVIDIA’s aggregate and cumulative liability towards customer for the product described in this guide shall be limited in accordance with the NVIDIA terms and conditions of sale for the product.

THE NVIDIA PRODUCT DESCRIBED IN THIS GUIDE IS NOT FAULT TOLERANT AND IS NOT DESIGNED, MANUFACTURED OR INTENDED FOR USE IN CONNECTION WITH THE DESIGN, CONSTRUCTION, MAINTENANCE, AND/OR OPERATION OF ANY SYSTEM WHERE THE USE OR A FAILURE OF SUCH SYSTEM COULD RESULT IN A SITUATION THAT THREATENS THE SAFETY OF HUMAN LIFE OR SEVERE PHYSICAL HARM OR PROPERTY DAMAGE (INCLUDING, FOR EXAMPLE, USE IN CONNECTION WITH ANY NUCLEAR, AVIONICS, LIFE SUPPORT OR OTHER LIFE CRITICAL APPLICATION). NVIDIA EXPRESSLY DISCLAIMS ANY EXPRESS OR IMPLIED WARRANTY OF FITNESS FOR SUCH HIGH RISK USES. NVIDIA SHALL NOT BE LIABLE TO CUSTOMER OR ANY THIRD PARTY, IN WHOLE OR IN PART, FOR ANY CLAIMS OR DAMAGES ARISING FROM SUCH HIGH RISK USES.

NVIDIA makes no representation or warranty that the product described in this guide will be suitable for any specified use without further testing or modification. Testing of all parameters of each product is not necessarily performed by NVIDIA. It is customer’s sole responsibility to ensure the product is suitable and fit for the application planned by customer and to do the necessary testing for the application in order to avoid a default of the application or the product. Weaknesses in customer’s product designs may affect the quality and reliability of the NVIDIA product and may result in additional or different conditions and/or requirements beyond those contained in this guide. NVIDIA does not accept any liability related to any default, damage, costs or problem which may be based on or attributable to: (i) the use of the NVIDIA product in any manner that is contrary to this guide, or (ii) customer product designs.

Other than the right for customer to use the information in this guide with the product, no other license, either expressed or implied, is hereby granted by NVIDIA under this guide. Reproduction of information in this guide is permissible only if reproduction is approved by NVIDIA in writing, is reproduced without alteration, and is accompanied by all associated conditions, limitations, and notices.

Trademarks

NVIDIA, the NVIDIA logo, DGX, DGX-1, and DGX Station are trademarks and/or registered trademarks of NVIDIA Corporation in the United States and other countries. Other company and product names may be trademarks of the respective companies with which they are associated.

Copyright

© 2018 NVIDIA Corporation. All rights reserved.