



Flexible X-Ray Imaging Detectors Using Scintillating Fibers

Scott Wilbur (s.h.wilbur@sheffield.ac.uk)

Kristin Lohwasser (k.lohwasser@sheffield.ac.uk)

University of Sheffield

6/27/2023





The FleX-RAY Project

- ▶ Many X-ray imaging applications use photographic film for flexibility (pipes, airplane wings, etc.)
- ▶ Flat-panel electronic detectors lead to image distortion
- ▶ Project aims to create an electronic detector with the flexibility of film
- ▶ Using flexible scintillating fibers and detecting scintillation at edges
- ▶ Work funded by EU Horizon 2020 grant No. 899634



Benefits of FleX-RAY

- ▶ Can achieve benefits of electronic and film detectors
- ▶ Allows fragile electronics to be out of the beam path (can be more radiation-hard)
- ▶ Capable of self-reporting its flexed shape
- ▶ Can be cheaper than large-area flat panel detector

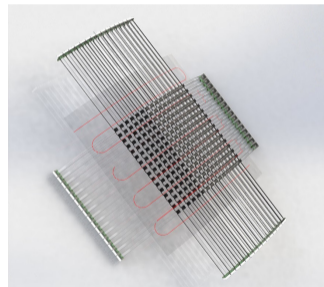



Scintillating Fibers

- ▶ Need bright and fast (few ns) scintillation for detection
- ▶ Size of fibers is principal factor in detector resolution
- ▶ Commercially-available plastic fibers at 250 μm - 1 mm (e.g. Saint-Gobain, 8000 photons/MeV, 2.7 ns scintillation time)
- ▶ Have developed smaller liquid-filled fibers at 50 μm
 - ▶ Comparable to resolution of film and flat-panel electronic detectors
 - ▶ Developed by colleagues at Research Institutes of Sweden
 - ▶ Easily filled in parallel by pressure or capillary action
 - ▶ Spliced to standard optical fiber at end

Custom Liquid-Filled Fibers

- ▶ Flexible glass fiber with 50 μm capillary (120 μm OD)
- ▶ Many commercially-available scintillating liquids
 - ▶ Saint-Gobain BC505, brighter/faster than plastic
 - ▶ High-Z loaded liquids
 - ▶ Choose to optimize efficiency / yield / scintillation time
- ▶ Can potentially be refilled in-place (more radiation-resistant than plastic)

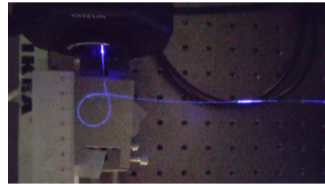

Shape Sensing

- ▶ Waveguides with Bragg gratings reflect light at specific wavelength
- ▶ Reflects longer wavelength when stretched, shorter when compressed
- ▶ Can calculate 3D shape from reflected light

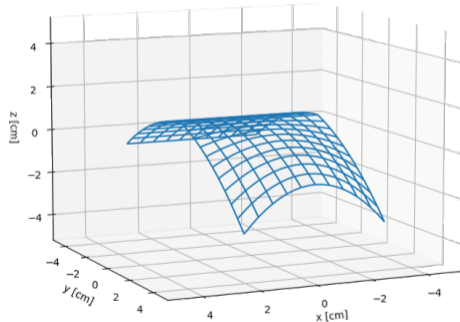
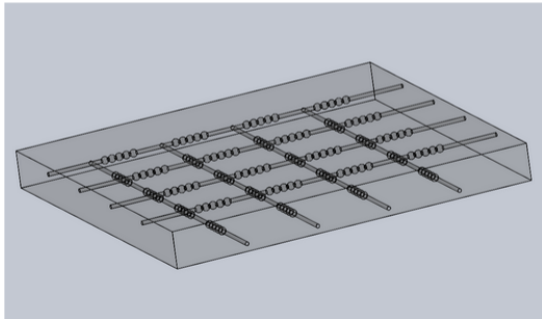

Shape Sensing Technology

- ▶ Developed by colleagues at Fraunhofer HHI
- ▶ Femtosecond pulse laser engraves waveguides and gratings onto thin glass
- ▶ Sensor's response is highly linear and repeatable

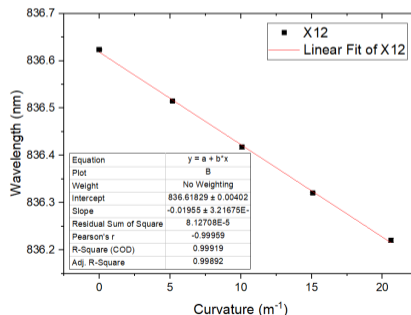
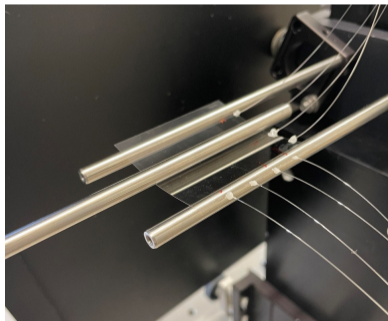

Image Reconstruction (Time-Difference)

- ▶ Detect scintillation light on both ends of one fiber
- ▶ Time-of-flight difference to measure position along fiber
- ▶ Significantly blurred along fiber
- ▶ Custom deconvolution algorithm can take advantage of cross-shaped blur

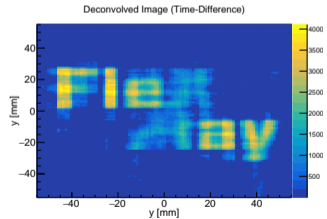
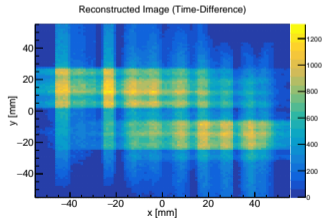
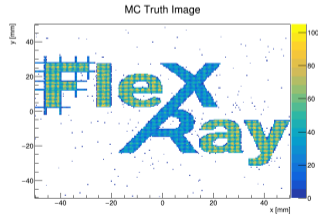
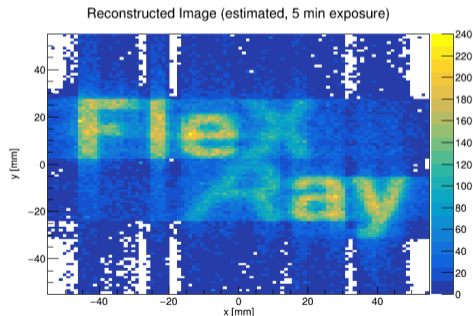
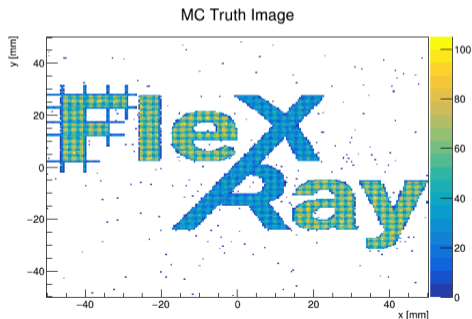

Image Reconstruction (Two-Dimensional)

- ▶ Detect scintillation light on two fibers at once
- ▶ 2D detections rare at X-ray energies, but much more common above ~ 511 keV
- ▶ Can give better image quality if the application uses (for example) a Co-60 source



2D detections with Gamma-Ray Energies

- ▶ Higher-energy gammas transfer more energy to electron
- ▶ Higher-energy electron travels farther, hits both fiber layers
- ▶ Most detections are two-dimensional
- ▶ Exposure time proportional to $1/\sigma^2$ – down from many minutes to seconds

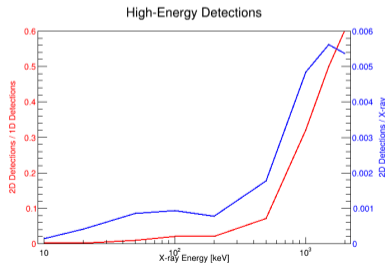
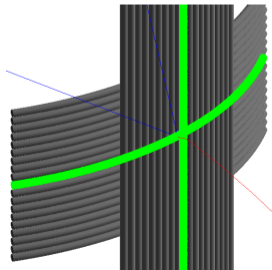

Prototype Preparation

- ▶ Building a proof-of-concept prototype
- ▶ Fibers enclosed in silicone matrix

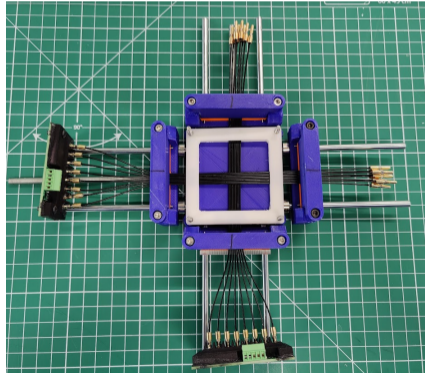
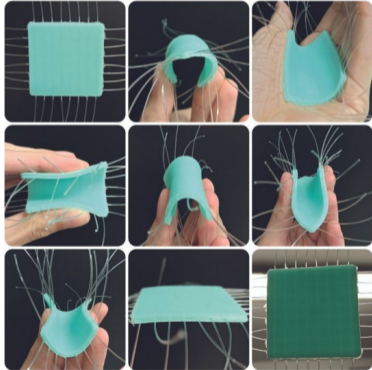

Prototype Electronics

- ▶ Using Hamamatsu S13360-3075CS 3mm SiPMs
- ▶ Fibers coupled to arrays of 8 SiPMs
- ▶ Signals read out by weeroc Petiroc2A board
- ▶ Developing a custom front end with better price and performance



Proof-of-Concept Prototype

- ▶ We have an early 8×8 -fiber prototype
- ▶ All parts are working together and producing images
- ▶ Timing resolution at 200 ps: works for 2d image reconstruction, sufficient for 1d with long exposure and deconvolution

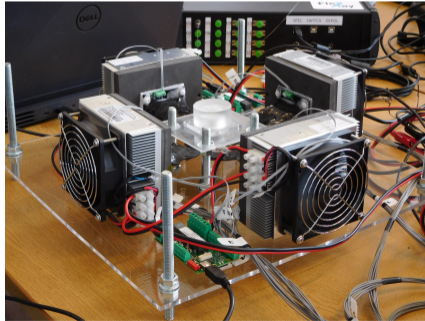
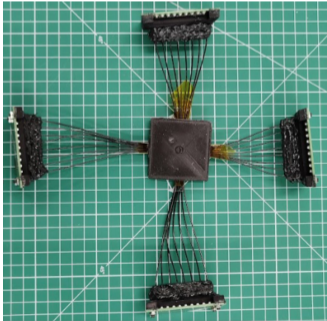

Initial Tests - Images

- ▶ First tests with prototype last month
- ▶ First tests using weak radioactive sources and simple test shapes
- ▶ Iterating and improving prototype, next tests soon with high-intensity X-rays

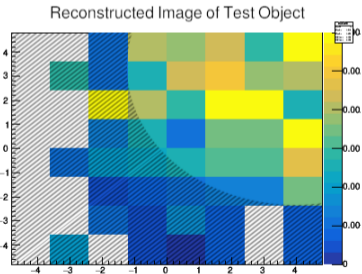

Conclusions

- ▶ FleX-RAY project proving that technology is feasible
- ▶ Needs further development work
- ▶ Now investigating specific applications to target specific benchmarks

Thank You!

FlexRay

This project has received funding from the European Union's Horizon 2020 Research and Innovation Program under grant agreement No. 899634.

