

SEA analysis in the cabin of a regional turboprop with metamaterial lining panels

Original

SEA analysis in the cabin of a regional turboprop with metamaterial lining panels / Cinefra, Maria; Petrone, Giuseppe. - (2019). (Intervento presentato al convegno AIAA Scitech 2019 Forum tenutosi a San Diego nel January 7-11, 2019) [10.2514/6.2019-1806].

Availability:

This version is available at: 11583/2728949 since: 2019-03-20T17:21:37Z

Publisher:

American Institute of Aeronautics and Astronautics

Published

DOI:10.2514/6.2019-1806

Terms of use:

This article is made available under terms and conditions as specified in the corresponding bibliographic description in the repository

Publisher copyright

(Article begins on next page)

SEA analysis in the cabin of a regional turboprop with metamaterial lining panels

Maria Cinefra*

Politecnico di Torino, Turin, Italy

Giuseppe Petrone†

Università degli studi di Napoli Federico II, Naples, Italy

The main goal of this paper is to evaluate the comfort, and hence the interior sound pressure levels, in the cabin of a regional turboprop under Turbulent Boundary Layer flow over the fuselage during cruise flight conditions. In the preliminary work phase, design of the metamaterial and numerical analysis at component level were performed. Then, the CAD model of a fuselage section was created representing the typical features and dimensions of an airplane for regional flights and a Statistical Energy Analysis (SEA) model was built by using Va One software. Investigation of the influence of designed metamaterial on the acoustic behaviour of a fuselage were presented. Results reveal a reduction in Sound Pressure Level of almost 5 dB in overall the frequency range and for all the cavities for the configuration with the application of metamaterial as core for the lining panels.

I. Nomenclature

CAD	=	computer-aided drafting
CUF	=	Carrera unified formulation
MSG	=	mechanics of structure genome
NCT	=	noise control treatment
OASPL	=	overall sound pressure level
PSD	=	power spectral density
Re	=	Reynolds number
SEA	=	statistical energy analysis
SIF	=	semi-fluid infinite system
SPL	=	sound pressure level
TBL	=	turbulent boundary layer
TL	=	transmission loss
V_f	=	volume fraction
δ	=	turbulent boundary layer thickness

II. Introduction

THE purpose of this work is to drive innovative technologies, in terms of processes and materials, suitable for the fuselage of a regional aircraft in order to achieve improvements to the problem of noise and vibrations in the cabin, according to the studies by Rayleigh [1] and Beranek [2].

In general, the aircraft requirements are originated by:

- regulations (i.e. FAR, EASA) issued by the competent Aviation Authority; aircraft design and production must be compliant with them in order for the aircraft to be certified and so to be “airworthy”;
- customer needs, identified by the marketing analysts and forwarded to the design offices;
- benchmarking of competitors.

Moving onto specific noise aspects, it is worth mentioning that regulations like FAR and EASA, in the field of aircraft design and production, mainly consist in safety standards, although the FAR do have a part devoted to environmental

*Professor, Department of Mechanical and Aerospace Engineering, maria.cinefra@polito.it.

†Researcher, Department of Industrial Engineering, giuseppe.petrone@unina.it.

noise, as exposed in the work by Willshire and Stephens [3] and ICAO [4]. Hence, these regulations do not have quantified internal noise requirements, but only qualitative indications, which address safety aspects. For instance, it is requested that vibration and noise of cockpit equipment do not interfere with safe operation of the aircraft; this means that noise levels should allow safe, easy communication among pilots and flight crewmembers, but also that they should not cause distraction, and so on. There are some military regulations that deal with internal noise; anyway, they concern the noise exposure hazard in aircraft cabin and cockpit and the speech intelligibility, but not the comfort aspects, which are mainly relevant in civil transport aviation, as discussed in the work by Beranek [5].

Hence, interior noise requirements in civil transport aircraft [6]) mainly derive from airline requests, which are made directly to aircraft manufacturers and that are based on passengers and cabin crew subjective response collected, for instance, by means of questionnaires as in the work by Pennig et al. [7]. Furthermore, the benchmarking of potential competitors is also very important, since new products are always expected to have a wide range of improved technical characteristics in order to enter the market successfully if compared to competitors already on the market. Nowadays the noise problem is attacking also small aircraft with classical configurations, as result of a lower technological progress in the field compared to the results of big airplanes and for the stringency of the aeronautical rules and local airport authorities which become with the time always more sensitive to the community noise level, as stated in ICAO Working Paper [8] and CleanSky 2 [9].

One more aspect has a fundamental importance to define the internal noise requirements and it is related to the acoustic treatments that are all the means/technical solutions that are installed on board to increase the noise reduction through the fuselage wall and to control the internal noise sources, as anticipated in the paper by Nichols et al. [10]. Some technologies proposed in the past are resumed in the work by Dobrzynski [11]. The following items contribute to reduce internal noise levels and hence may be regarded as noise treatments: thermo-acoustic blankets, skin damping, furnishing panels, mufflers, active noise control systems. The acoustic treatments configuration needs to be optimized taking into account different parameters, particularly the weight and the cost; an example is given by the honeycomb acoustic metamaterial proposed by Sui et al. [12], which possesses lightweight and yet sound-proof properties. In particular, if one refers to a regional turboprop it can be considered that the mass of fuselage blankets, in percentage of the MEW, should be less than 1.4%. For these reasons, an acoustic configuration including a sandwich with composite skins and metamaterial core has been considered in the following analyses.

There is a lack of reliable and useful numerical models, valid for innovative configurations, able to predict the structural response and the radiated acoustic power. One can find some attempts in the automotive field, as presented by Yuksel et al. [13]. Thus, in the most of cases the experimental tests can certify the achievement of the desired performances. Nevertheless, the efforts in literature, directed toward some configurations, emerged during the years also due to the availability of composite materials, cannot be neglected: among them the works by Franco et al. [14], Petrone et al. [15], Arunkumar et al. [16]. A state-of-the-art for the theoretical models able to predict the acoustic performance of the sandwich configurations, as well as the numerical modeling and experimental testing supporting these models, is provided in the article by D'Alessandro et al. [17]. The availability of a numerical tool, especially for regional aircrafts which are subject to very different customer requests, is a fundamental need together with the confidence of the users of such tools who should have the ability for a correct, realistic interpretation of the results produced numerically. The basic assumptions rely on the diffuse acoustic field inside each elemental volume and on the acoustic energy balance among the input source and the exchange output among the different volumes. In parallel, the possibility of studying different materials is a driving factor for approaching the problem of the aircraft interior noise.

This paper will present the results obtained by numerical simulations performed with Va-One, a software based on Statistical Energy Method. This is a powerful tool for the acoustic and vibroacoustic analysis of complex structures, accounting for various geometries, load conditions and materials. Moreover, this software allows different types of analyses to be performed, which have been validated through many applications presented in [18–20].

Different fuselage configurations, in terms of materials used for lining panels, are compared and the most promising solution is identified. Among these, acoustic Metamaterials are proposed in this work. This term refers to materials whose properties are "beyond" those of conventional materials. They are made from assemblies of multiple elements fashioned from composite materials such as metals, foams or plastics. The core concept of metamaterial is to replace the molecules with man-made structures called unit cell. They can be viewed as "artificial atoms", usually arranged in repeating patterns. Metamaterials derive their properties not from the properties of the materials they are composed of, but from their newly designed structures with repeating patterns, hence the need for homogenization. Indeed, if it is possible to treat them like homogeneous materials with outstanding properties, their analysis becomes faster and more convenient as few adaptation to existing codes and softwares are required. An investigation was carried to find a material that obeys several aeronautical criteria, namely:

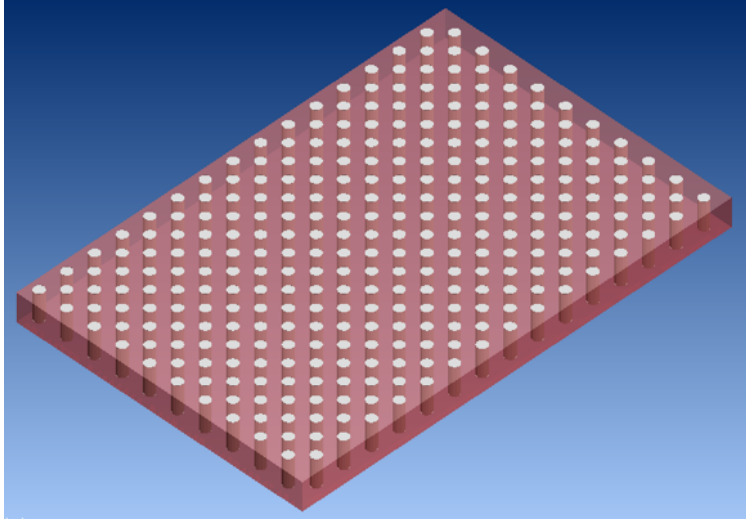

Fig. 1 3D plate of Melamine and Aluminium Inclusions studied as heterogeneous plate in Actran

- Excellent sound-transmission loss properties in the widest range possible
- Light
- Good mechanical strength
- Fire-repellent according to aviation standards
- Easy to manufacture

Materials which respect this set of criteria are viscoelastic foams like Polyurethane, Polyimide or Melamine Foam, with have good acoustic properties in the high-frequency domain. In this work, the melamine foam has been considered. Then, in order to improve the damping properties in the low-frequency range without increasing the thickness of the material, a periodic array of Aluminium cylindrical inclusions has been integrated inside the foam as shown in Fig. 1. Aluminium has been chosen for its good stiffness and lightness and its volume fraction in the metamaterial is chosen so that it adds as little weight as possible.

III. Homogenization of metamaterials

A novel homogenization method based on CUF and MSG has been here extended to the computation of homogenized properties in the metamaterial with poro-elastic matrix. The method is based on novel higher-order Layer-Wise beam theory in the framework of the Carrera Unified Formulation (CUF) and yields very good results for composites and pure elastic metamaterials with few calculations [21, 22]. The main feature of this method, which leads to think it could be used to study acoustic metamaterials, is the fact that the method makes use of the concept of repeating unit cell just like other homogenization methods for metamaterials (Parallel Transfer Matrix Method, [23]). Moreover it is fast and very simple to use, as it is able to homogenize the material only by knowing the unit cell geometry and the material properties of its components.

These features are enabled by the use of the Mechanics of Structure Genome approach, developed by Yu et al. [24]. MSG is very efficient in obtaining the complete effective stiffness matrix of heterogenous materials in a straightforward manner without relying on ad-hoc assumptions and with no need of multiple loadings. In order to do this, the method lays on the concept of Structure Genome, which is identical to the concept of Unit Cells when talking about metamaterials, as it is defined as the smallest mathematical building block of the structure.

Since the melamine foam behaves like a viscoelastic material, also the metamaterial is homogenized as viscoelastic. Knowing that viscoelastic materials can be characterized with frequency-dependent complex parameters, our main assumption is that the behavior of the material related to the real part of the complex moduli can be decoupled from the behavior of the material related to the imaginary part of the complex moduli, as conducted in [25].

A literature study has also been carried to find frequency-dependent complex engineering moduli for melamine foam and, following the numerical approach of Cuenca [26], the properties of melamine have been calculated. The Cuenca's method lies on the assumption that the stiffness matrix can be seen as the sum of a static term - corresponding to the

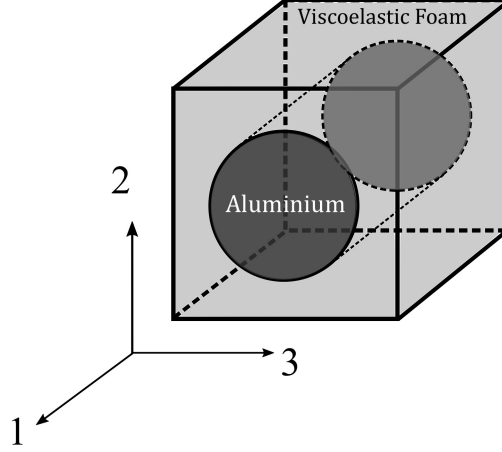

Fig. 2 Periodic Unit Cell of the Metamaterial with matrix of viscoelastic foam and cylindrical inclusions of Aluminium

material's fully relaxed (elastic) state, and a complex, frequency-dependent term related to the (anelastic) relaxation phenomenon. Taking the same assumption, the MSG-CUF homogenized method has been applied twice to homogenize the real and the imaginary parts of complex moduli of metamaterial.

The periodic unit-cell to be homogenized (Fig. Fig. 2) is a cube of melamine filled with an Aluminium cylinder. The properties of Aluminium are: Young modulus $E = 6.75 \times 10^{10}$ Pa, Poisson ratio $\nu = 0.34$ and density $\rho_{Al} = 2700 \text{ kg.m}^{-3}$.

Considering that one of the design constrains in aeronautics is the weight, a maximum volume fraction of Aluminium in the metamaterial is fixed taking as reference value the density of Nomex ($\rho_N = 48 \text{ kg.m}^{-3}$), since it is a classical material adopted for lining panels of aircrafts. The melamine density is approximated to be $\rho_M = 8 \text{ kg.m}^{-3}$ which appears to be the low average for this material. The efficient density ρ_{eff} of the homogenized metamaterial is given by $\rho_{eff} = \rho_M(1 - V_f) + \rho_{Al}V_f$. So the assumption yields a volume fraction $V_f = 0.015$.

The complex frequency-dependent properties found with Cuenca model have been studied in the frequency range 0-500 Hz. 15 frequencies are chosen within this range and the 15 sets of mechanical complex properties are extracted. For each set among the 15 chosen frequencies, the MSG-CUF method was used two times, one time for the real part of the properties and one other time for their imaginary part.

Further investigation using Actran has been carried out to verify if this homogenization model captures the acoustic properties of the metamaterial.

A. Evaluation of Acoustic Properties using Actran

Actran MSC is a commercial software based on finite element method and created to solve vibro-acoustic problems. It is mostly used by automotive manufacturers and suppliers, aerospace and defense companies, and consumer product manufacturers.

Transmission Loss is one of the acoustic properties that can be calculated by this software and it accounts for the percentage of sound intensity that has been transmitted through an obstacle. TL is a frequency-dependent physical property of the material and is calculated by the log ratio of the incident energy to the transmitted energy:

$$TL = 10 \log \frac{I_{incident}}{I_{transmitted}} \quad (1)$$

hence, Transmission Loss quantifies the material's ability to reflect or block sound energy.

A first analysis with Actran was carried for different configurations of metamaterial panels. A spherical acoustic source is set on one side of the panel. Metamaterial panels with 300 and 600 cylindrical inclusions are created as shown in Fig. 3. The plate are 20 mm thick (z-direction), 309 mm long (x-direction) and 206 mm wide (y-direction). The diameter of cylindrical inclusions is 7 mm so, in this validation, the volume fraction is different from the reference value of 0.015. Boundary conditions for the displacement are set so that the plate is clamped. These heterogeneous plates have been analyzed in Actran and compared to the corresponding homogenized plates.

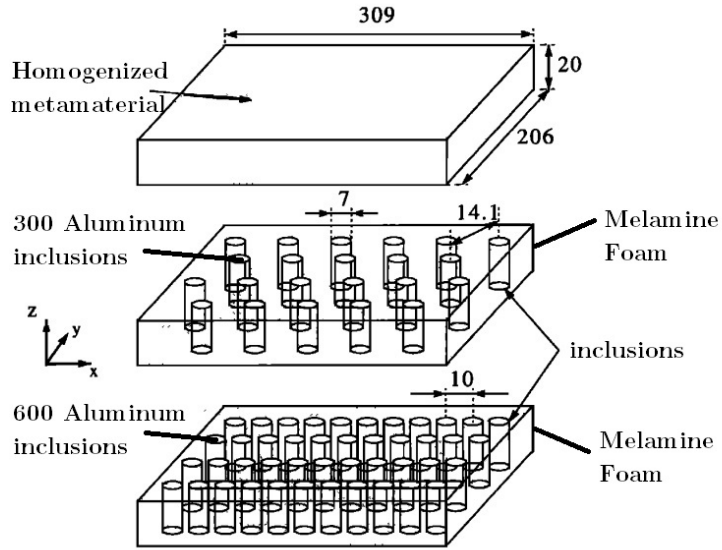

Fig. 3 309x206x20mm plate made of Melamine Foam with 300 or 600 Aluminum inclusions

One big issue that was encountered is the computation time needed for the analysis of the heterogeneous plates. Indeed, each cylinder adds more degrees of freedom than if the plate is studied as homogeneous. Figs. 4 and 5 show results in terms of Transmission Loss.

The results in Fig. 4 show a good agreement between 10 to 500 Hz, except for 50 Hz, which shows a 30 dB difference, while frequencies 60 and 110 Hz shows a 20 dB difference. Also in Fig. 5, related to the plate with 600 inclusions, at 40 Hz we have the same resonance peak, even though a 20 dB difference is shown. In general, both the plates with 300 and 600 inclusions show an average good agreement along the frequencies. Since VA One does not perform analysis of materials with frequency-dependent properties, the metamaterial moduli have been averaged on the frequency range.

IV. Fuselage study case

Exposure to noise inside the aircraft has always been a prevalent problem for pilots. Noise is produced by two principal sources, fuselage boundary layers and turbojet exhaust, and four other relevant noises, turbomachinery, cabin

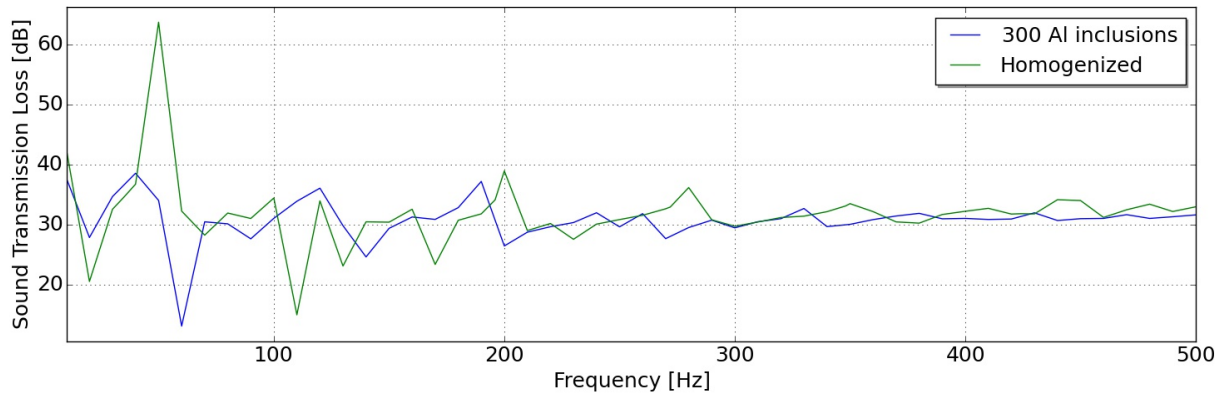

Fig. 4 STL of a simply supported plate, Melamine Foam and 300 Aluminum inclusions (19.2% volume fraction): comparison with equivalent homogenized material

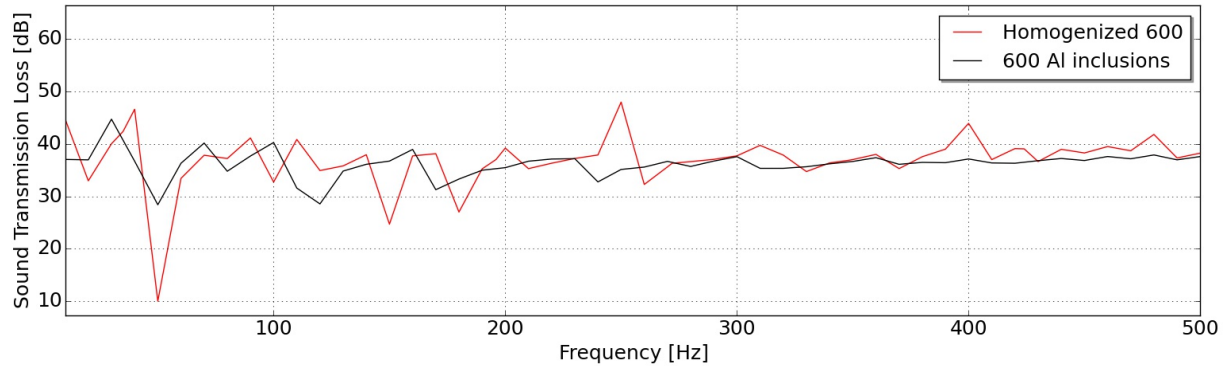

Fig. 5 STL of a simply supported plate, Melamine Foam and 600 Aluminum inclusions (58.2% volume fraction): comparison with equivalent homogenized material

conditioning and pressurization systems, structure-borne noise and aerodynamic flow. Other noise sources are masked by the ones mentioned before, as for example hydraulic and electrical actuators.

Noise is transmitted to the cabin along airborne paths through the fuselage sidewall and along structure borne paths through the engine mounts or the wing structure. Each aircraft has its characteristics sounds used by pilots as a diagnostic system. As a reference value, jet cabins sound pressure level is comprised between 60 and 88dB. Long noise exposure over 85dB could cause hearing lost. Noise inside the cabin must be reduced not only for comfort: hearing damage, fatigue and reduction of concentration must be avoided, not only for the passengers but also for the pilots.

The following section intends to address the noise requirements for a regional turboprop aircraft, with respect to the cabin environment, which should drive future cabin design to provide comfort to the aircraft occupants. Taking into account that for a turboprop aircraft the near field noise excitation is mainly due to the propeller and therefore the major part of the acoustic energy is concentrated in the low frequency range (0-200 Hz), in this paper the Sound Pressure Level of a fuselage under Turbulent Boundary Layer excitation is evaluated in the frequency range 200-10000 Hz. One more aspect which has fundamental importance in defining the internal noise requirements is related to the acoustic treatments, that are all the means/technical solutions adopted to increase the noise reduction of the fuselage wall.

A. Reference turboprop internal noise requirements

A single aisle regional aircraft with a medium capacity of 40-70 seats has been used as a reference to assess the methodologies presented in this work. Basically noise requirements are strongly dependent on the type of aircraft, being linked to the aircraft operating conditions and characteristics (Mach number, flight altitude, type of engine, etc. . .). Typically internal noise requirements for regional turboprop aircrafts address cruise and climb flight phases. Take-off condition can be noisier, but, given its limited time duration, it is usually not considered for noise requirements. Generally, averaged levels are defined at seated passenger ear height and at aisle center. Also different levels are taken into account in different fuselage regions (two or three maximum) at different longitudinal positions with respect to engine. In particular, in view to quantify the interior noise level, the Sound Pressure Level (SPL), which is a logarithmic measure of the effective pressure of a sound relative to a reference value, and the Overall Sound Pressure Level (OASPL, dB), which adds most audible frequency components equally, have been evaluated at different locations and stations.

B. Analysis definition

Having analyzed the parameters for the analysis of the comfort level in the fuselage of regional aircrafts, the model was created in CAD (Fig. 6). A fuselage with a diameter pairs to 2,74 m and a length to 10 m, consisting of 10 lines of seats (4 seats symmetrically located for each line), has been considered.

C. SEA model

Once CAD model of the fuselage trunk was created, the software Va One was used to built the SEA model. An isometric view of SEA plates and cavities are reported in Figure 7, while a view of internal arrangement is reported in Fig. (8).

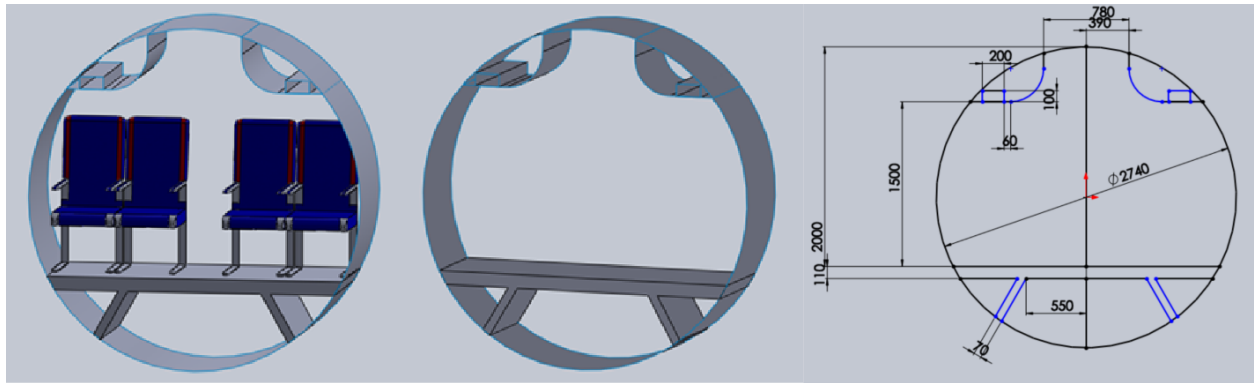

Fig. 6 CAD model of the fuselage trunk (dimensions are given in [mm])

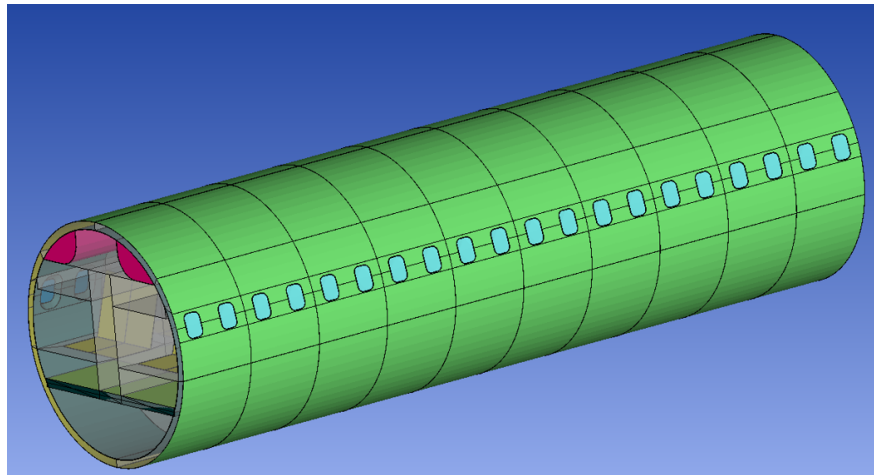

Fig. 7 SEA fuselage.

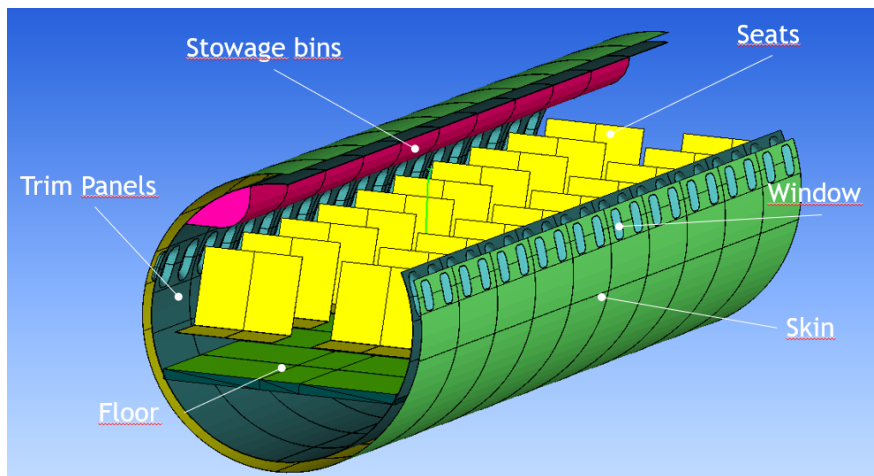

Fig. 8 Details on SEA fuselage section.

The skin (airframe) has been modeled as a ribbed plate made of aluminum with a thickness of 1 mm. The floor has been modeled as a rigid foam with a thickness of 10 mm. Seats were modeled with a 3 mm aluminum frames with a noise control treatment (NCT) applied to upper and front side of seat frame to simulate typical seat cushions (which is a foam material with an average density of $\rho=39 \text{ kg/m}^3$). Each seat has a mass of 14 Kg. The stowage bins and the lining (or trim) panels have been modeled as sandwich structures. Finally the window has been modelled as a 15 mm thick window layout consisting: tempered glass, airgap and plexiglass.// Furthermore, the area between skin and trim panel is modelled as airgap filled with some soundproofing materials, such as aeronautic glasswool fibres, which are characterized by small weight and high sound absorption values. These treatments are named as Noise Control Treatment (NCT) in the software Va One. In this paper the influence on acoustic performances of the investigated fuselage is investigated by replacing the core material (Nomex) of the actual sandwich structure of the lining panel with a metamaterial. The mechanical properties of the investigated core are reported in Table 1.

Table 1 Mechanical properties of Nomex and metamaterial cores.

Core material	E_1	E_2	E_3	G_{12}	G_{31}	G_{23}	ν_{12}	ν_{31}	ν_{23}	ρ
-	[Pa]	[Pa]	[Pa]	[Pa]	[Pa]	[Pa]				$[\text{kg/m}^3]$
Nomex	0.10E06	0.10E06	0.09E09	1.00E05	1.50E07	3.10E07	0.20	0.01	0.01	48
Metamaterial	1.54E06	2.88E05	1.01E09	1.07E05	1.30E05	1.09E05	0.21	0.01	0.49	48

V. Results

Two configurations of fuselage have been investigated: one with lining panel with Nomex core (baseline) and the other one with lining panel with metamaterial core. Analysis have been performed at cruising flight condition (altitude=7600m and flight speed= 177 m/s) in the frequency range 200-10000 Hz. These values have partially characterized the TBL and SIF parameters applied to each panel of the model. Since the symmetry of the fuselage and of the applied TBL, load results will be the same from right side to left one. From first line to the last one, instead, results will be different according to the TBL load that changes with x_0 . The airborne noise generated by the turbulent boundary layer is introduced in the program VA One as a pressure power spectral density (PSD), using the expression proposed by (Cockburn and Roberson 1974). The turbulent boundary layer thickness δ at distance x_0 from the nose of the ATR fuselage was computed from the relation:

$$\delta = 0.37 \frac{x_0}{Re^{0.2}} \quad (2)$$

where Re is the Reynolds number.

The first results report the SPL, measured at “head” cavities, for three different stations in the fuselage: first line, middle and last line (Fig. 9, 10, 11). In overall the frequency range and for all the stations a decrease of SPL for the configuration with application of metamaterial as core in the lining panel can be observed.

Sound pressure levels for each interior acoustic subsystem along with their averaged values are plotted in Figure 12. The grey curves represent the SPL values for all the Head cavities of the fuselage while the red curve is the average value. The highest interior sound pressure levels are in the aft-most cabin subsystem where the turbulent boundary layer thickness is at a maximum. The SPL has been plotted in dBA to better represent the human ear perception of noise.

A comparison of the average SPL and the OASPL, in dB, of the head acoustic cavities are reported respectively in Figures 13 and 14. As can be appreciated the curve representing the configuration with metamaterial core behaves better than Nomex in overall the frequency range (Fig. 13).

In Fig. 14 a comparison of the Overall Sound Pressure Level (OASPL) for the two investigated configurations is reported. On the x axis are reported the stations. Each station refers to a portion of the fuselage between two frames with two windows. Station 1 refers to the one closest to cockpit, station 10 the farthest one. It is evident that the OASPL of the configuration with metamaterial is always lower than the configuration with Nomex and that it increases with distance from leading edge (as confirmed in Fig. 12 and by contour plot of Fig. 13).

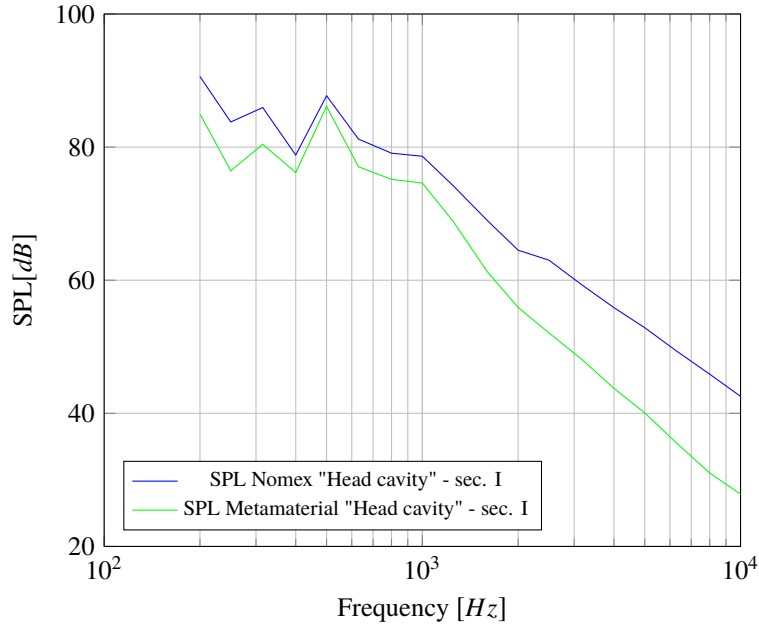

Fig. 9 Sound Pressure Level at head cavity of section I.

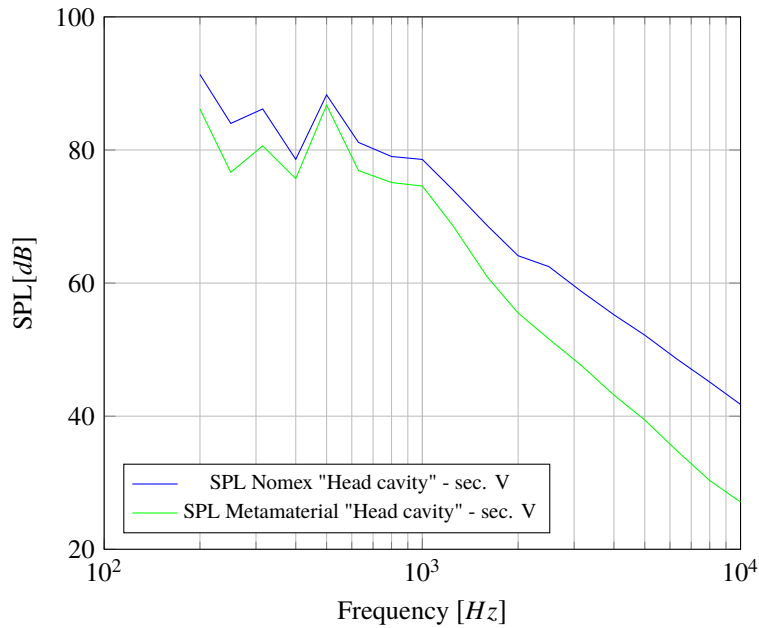

Fig. 10 Sound Pressure Level at head cavity of section V.

VI. Conclusion

The main goal of this paper was to evaluate the comfort, and hence the interior sound pressure levels, in the cabin of a regional turboprop under Turbulent Boundary Layer flow over the fuselage during cruise flight conditions. In particular, different fuselage configurations, in terms of materials used for lining panels, are compared. To this aim, two types of analysis have been performed: the first one at the material level and the second one at the system level. At material level, a new acoustic metamaterial has been here proposed to reduce the noise in the cabin, that is composed of a poro-elastic melamine matrix and cylindrical aluminium inclusions. In order to analyze the metamaterial in commercial softwares, a novel homogenization method based on CUF and MSG has been successfully extended to the

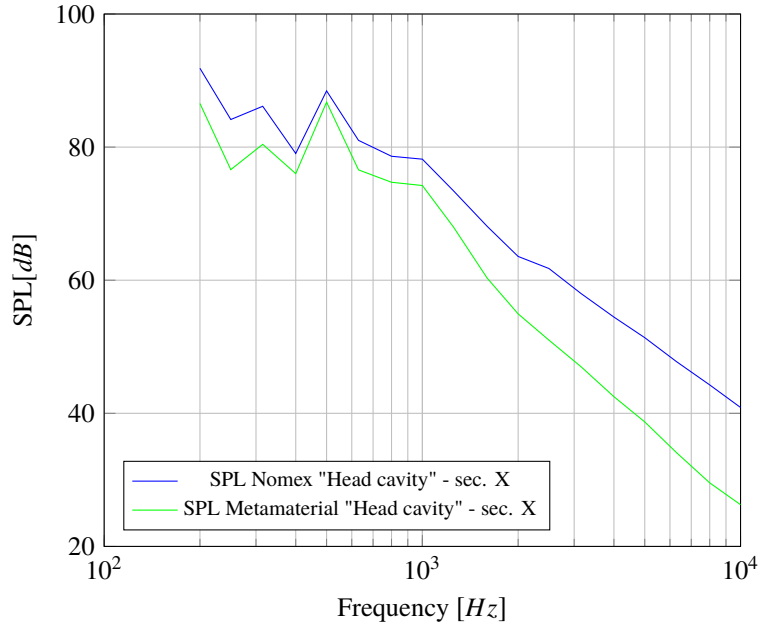

Fig. 11 Sound Pressure Level at head cavity of section X.

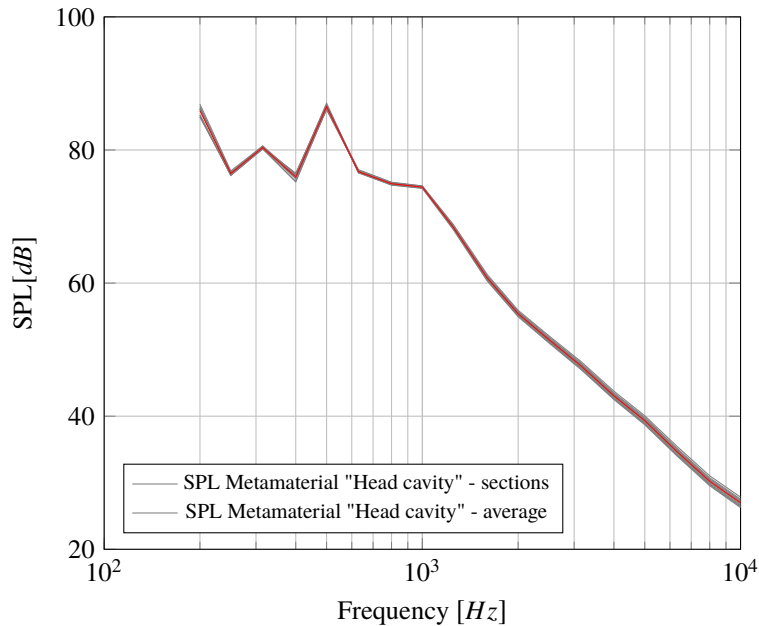

Fig. 12 Sound Pressure Level for all the head acoustic cavities (grey curves) and the average value (red curve) of the fuselage with metamaterial core in lining panels under turbulent Boundary Layer excitation.

computation of homogenized properties of these materials. An investigation has been carried out in Actran to verify if this homogenization model captures the acoustic properties (in terms of Transmission Loss) of the metamaterial. The results obtained by studying the metamaterial as heterogeneous and homogeneous have shown an average good agreement along the frequencies.

At system level, the promising performances of metamaterial have been demonstrated by SEA analysis in VA One of the fuselage of a regional turboprop. Two configurations of fuselage have been considered: one with lining panel with Nomex core (baseline) and the other one with lining panel with metamaterial core. The SPL at the head of the passenger

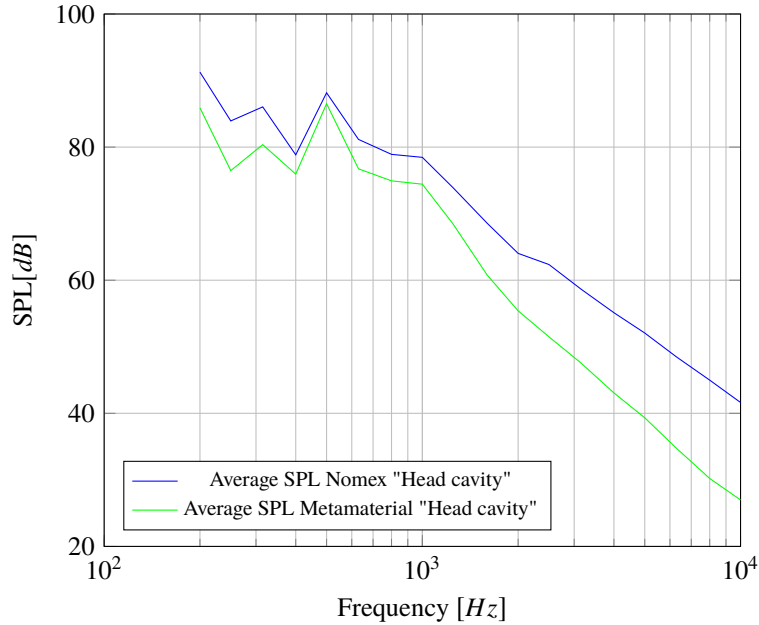

Fig. 13 Comparison of the average Sound Pressure Level (SPL) for all the head acoustic cavities of the fuselage with Nomex and metamaterial core in lining panels under turbulent Boundary Layer excitation.

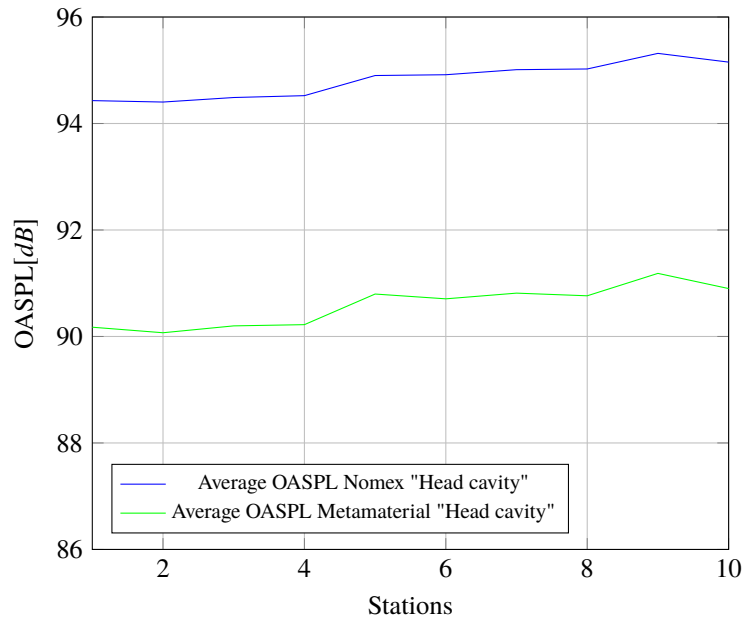

Fig. 14 Comparison of the average Overall Sound Pressure Level (OASPL) for all the head acoustic cavities of the fuselage with Nomex and metamaterial core in lining panels under turbulent Boundary Layer excitation.

and the overall sound pressure level in the cabin have been measured and it has been demonstrated that the configuration with metamaterial core behaves better than Nomex in the overall frequency range: in particular, the OASPL of the configuration with metamaterial was lower than the configuration with Nomex.

Hence, it is possible to conclude that the idea to improve the comfort in the cabin by combining light and strong materials, such as composites, and acoustic metamaterials can be a good compromise for the development of new sound-proofing solutions in aeronautics.

Further analyses will be performed to validate the results here presented. A FEM analysis of the same fuselage model will be carried out in ACTRAN and compared with SEA results. Finally, experimental tests will be conducted to investigate the properties of metamaterials, not only from an acoustical but also mechanical point of view.

References

- [1] Rayleigh, J. W. S., *The Theory of Sound*, Macmillan & Co., London, 1877.
- [2] Beranek, L. L., *Noise Reduction*, McGraw-Hill Book Company Inc., NY, 1960, Chap. p. 258.
- [3] Willshire, W. L., and Stephens, J. D. G., "Aircraft noise technology for the 21st century," *Noise Con*, Vol. 98, Noise Control Foundation, 1998, pp. 7–22.
- [4] "ICAO annex 16," *Vol. I amendment 10 - (implementing CAEP/8 4 March)*, 2011, pp. 175–212.
- [5] Beranek, L. L., *The Noisy Dawn of the Jet Age*, Sound and Vibration Magazine, 2007, Chap. January.
- [6] Wilby, J. F., "Aircraft interior noise", *Journal Of Sound and Vibration*," *Journal of Applied Physics*, Vol. 190, No. 3, 1996, pp. 545–564.
- [7] Pennig, S., Quehl, J., and Rolny, V., "Effects of aircraft cabin noise on passenger comfort," *Ergonomics*, Vol. 55, No. 10, 2012, pp. 1252–1265.
- [8] "ICAO Working Paper," *Present and Future Trends in Aircraft Noise and Emissions*, Assembly – 38th Session, July, 2013.
- [9] 2, C., "Future Trends in Aviation Noise, Workshop," *Present and Future Trends in Aircraft Noise and Emissions*, 1-2 October, 2014.
- [10] Nichols, R. H., Sleeper, H. P. J., Wallace, R. L. J., and Ericson, H. L., "Acoustical materials and acoustical treatments for aircraft," *Journal of the Acoustical Society of America*, Vol. 19, No. 3, 1947, pp. 428–443.
- [11] Dobrzynski, W., "Almost 40 Years of Airframe Noise Research: What Did We Achieve?" *Journal of Aircraft*, Vol. 47, No. 2, 2010, pp. 353–367.
- [12] Sui, N., Yan, X., Huang, T.-Y., Xu, J., Yuan, F.-G., and Jing, Y., "A lightweight yet sound-proof honeycomb acoustic metamaterial," *Applied Physics Letters*, Vol. 106, 2015, p. 171905.
- [13] Yuksel, E., Kamci, G., and Basdogan, I., "Vibro-acoustic design optimization study to improve the sound pressure level inside the passenger cabin," *Journal of Vibration and Acoustics-Transactions of the ASME*, Vol. 134, No. 6, 2012, pp. 061017–9.
- [14] Franco, F., De Rosa, S., and Polito, T., "Finite element investigations on the vibroacoustic performance of plane plates with random stiffness," *Mechanics of Advanced Materials and Structures*, Vol. 18, 2011, pp. 484—497.
- [15] Petrone, G., D'Alessandro, V., Franco, F., and De Rosa, S., "Numerical and experimental investigations on the acoustic power radiated by Aluminium Foam Sandwich panels," *Composite Structures*, Vol. 118, 2014, pp. 170–177.
- [16] Arunkumar, M. P., Jeyaraj, P., Gangadharan, K. V., and Lenin Babu, M. C., "Influence of nature of core on vibro acoustic behavior of sandwich aerospace structures," *Aerospace Science and Technology*, Vol. 56, 2016, pp. 155–167.
- [17] D'Alessandro, V., Petrone, G., Franco, F., and De Rosa, S., "A review of the vibroacoustics of sandwich panels: Models and experiments," *Journal of Sandwich Structures and Materials*, Vol. 15, No. 5, 2013, pp. 541—582.
- [18] Culla, A., D'Ambrogio, W., Fregolent, A., and Milana, S., "Vibroacoustic optimization using a statistical energy analysis model," *Journal of Sound and Vibration*, Vol. 375, 2016, p. 102114.
- [19] Zhang, J., Xiao, X., Sheng, X., Zhang, C., Wang, R., and Jin, X., "SEA and contribution analysis for interior noise of a high speed train," *Applied Acoustics*, Vol. 112, 2016, pp. 158–170.
- [20] Bouhaj, M., von Estorff, O., and Peiffer, A., "An approach for the assessment of the statistical aspects of the SEA coupling loss factors and the vibrational energy transmission in complex aircraft structures: Experimental investigation and methods benchmark," *Journal of Sound and Vibration*, Vol. 403, 2017, pp. 152–172.
- [21] de Miguel, A. G., Pagani, A., Yu, W., and Carrera, E., "Micromechanics of periodically heterogeneous materials using higher-order beam theories and the mechanics of structure genome," *Composite Structures*, Vol. 180, 2017, pp. 484–496.

- [22] Cinefra, M., de Miguel, A. G., Filippi, M., Houriet, C., Pagani, A., and Carrera, E., “Homogenization and free-vibration analysis of elastic metamaterial plates by CUF finite elements,” *Advances in Aircraft and Spacecraft Science*, submitted.
- [23] Doutres, N., Oand Atalla, and Osman, H., “Transfer matrix modeling and experimental validation of cellular porous material with resonant inclusions,” *The Journal of the Acoustical Society of America*, Vol. 137, No. 6, 2015, pp. 3502–3513.
- [24] Yu, W., “A unified theory for constitutive modeling of composites,” *Journal of Mechanics of Materials and Structures*, Vol. 11, No. 4, 2016, pp. 379–411.
- [25] Martinez-Agirre, M., and Elejabarrieta, M. J., “Dynamic characterization of high damping viscoelastic materials from vibration test data,” *Journal of sound and vibration*, Vol. 330, No. 16, 2011, pp. 3930–3943.
- [26] Cuenca, J., Van der Kelen, C., and Goransson, P., “A general methodology for inverse estimation of the elastic and anelastic properties of anisotropic open-cell porous materials—with application to a melamine foam,” *Journal of Applied Physics*, Vol. 115, No. 8, 2014, p. 084904.