

Towards standardised design of wave energy converters: A high-fidelity modelling approach

Original

Towards standardised design of wave energy converters: A high-fidelity modelling approach / Paduano, Bruno; Parrinello, Luca; Niosi, Francesco; Dell'Edera, Oronzo; Sirigu, SERGEJ ANTONELLO; Faedo, Nicolas; Mattiazzo, Giuliana. - In: RENEWABLE ENERGY. - ISSN 0960-1481. - (2024). [10.1016/j.renene.2024.120141]

Availability:

This version is available at: 11583/2985926 since: 2024-02-13T20:38:49Z

Publisher:

Elsevier

Published

DOI:10.1016/j.renene.2024.120141

Terms of use:

This article is made available under terms and conditions as specified in the corresponding bibliographic description in the repository

Publisher copyright

(Article begins on next page)

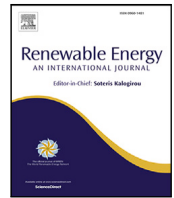

Towards standardised design of wave energy converters: A high-fidelity modelling approach

Bruno Paduano^{*}, Luca Parrinello, Francesco Niosi, Oronzo Dell'Edera, Sergej Antonello Sirigu, Nicolás Faedo, Giuliana Mattiazzo

Marine Offshore Renewable Energy Lab, Politecnico di Torino, Corso Duca degli Abruzzi, 24, Turin 10121, Piedmont, Italy

ARTICLE INFO

Keywords:

Wave energy converter
Extreme events
Fatigue
Design
Standards

ABSTRACT

Within this study, an analysis of the global standard panorama for wave energy converters (WECs) is presented, in order to develop design methodologies as close as possible to the state-of-the-art. In particular, an analysis of such international standards panorama exhibits a lack of information and detail regarding WEC system design, and the specific simulations procedures that shall be followed accordingly.

In the light of this, this study proposes a standardised design process that can be followed to define the design loads which characterise a structural analysis, which are obtained by high-fidelity models. The device assessment in extreme states is analysed on intact and damaged conditions, where the use of a computational fluid dynamics (CFD) software is proposed to encompass any non-linear behaviour related to extreme events. Furthermore, this article also describes a fatigue assessment based on linear system theory, with the inclusion of linearised significant terms, such as, e.g. mooring influence on device dynamics.

1. Introduction

Over the next decades world energy consumption will rise considerably. The energy production via so-called *traditional methods* represents a serious environmental problem, and starting from the last years, governments are pushing to a pollution-free production method [5]. The evolution of renewable energies has paved the way for the development of various technologies, and one emerging area is ocean energy.

Ocean energies can be divided according to several harvesting methods and, amid them, *wave energy* is significantly promising, having the second largest energy potential [6,7]. To define the importance of an energy source, the potential of that source should be related to the capacity of the technology to extract power. According to recent studies, the power extraction could reach 10%–20% of the total potential,¹ which could provide a substantial part of the total energy consumption [8]. In addition, an important factor that could lead to effective development of wave energy technology is related to the predictable behaviour of waves, which can be forecasted (in statistical terms) in 1–2 days in advance [9,10].

Far from being standardised, wave energy converters (WECs) currently developed are categorised according to the working principle, i.e.:

- An oscillating water column (OWC) takes advantage of the air compressibility in order to move a bidirectional turbine and harvest energy.
- A point absorber is relatively small compared to the wave length and operates in pitch, heave or multiple degrees of freedom (DoFs).
- An attenuator, is a wave energy system parallelly-oriented to the incoming wave. In order to tune the attenuators resonance condition, these systems need to have a size that is comparable with the wave length.
- A terminator is a wave energy system perpendicularly-oriented to the incoming wave.

For an exhaustive description of wave energy systems, the reader can refer to [11–14].

Moreover, the levelised cost of wave energy is still high compared to other renewable sources (such as solar or wind) [15,16] and, therefore, the path to a commercial stage of WECs to harvest energy from waves, shall incorporate an effective design process based on reliable mathematical models, facilitating optimal device design for given operating conditions.

^{*} Corresponding author.

E-mail address: bruno.paduano@polito.it (B. Paduano).

¹ Please note that the highlighted quantity pertains to simplified models or the energy available in reachable areas. For a comprehensive understanding of the analysis and the underlying assumptions, we direct the reader to the detailed discussion in [1,1–4].

Nomenclature

ALS	Accidental limit state
BEM	Boundary element method
CAD	Computer-aided design
CDF	Cumulative distribution function
CFD	Computational fluid dynamics
CMA	Conditional model approach
DNV	Det Norske Veritas
DoF	Degree of freedom
EC	Environmental contour
EMEC	European marine energy centre
FD	Frequency domain
FEM	Finite element method
FLS	Fatigue limit state
GL	Germanischer Lloyd
IEC	International electrotechnical commission
ISO	International organisation for standardisation
ITTC	International towing tank conference
MEC	Marine energy converter
MPM	Most probable maximum
PDF	Probability distribution function
PTO	Power take-off
RANS	Reynolds-averaged Navier-Stokes
RAO	Response amplitude operator
SWL	Sea water level
TD	Time domain
ULS	Ultimate limit state
WEC	Wave energy converter
YRP	Year of return period

The design process of a WEC is far from being trivial and can be broadly divided into two main phases [17]:

- Preliminary design: in the first development stage, WECs shall be tested and dimensioned according to the environmental conditions of the site to be deployed. This phase is generally based on a simplified optimisation model [18], to define the best device in terms, for example, of cost of energy. The preliminary design set its focus primarily on effective harvested energy and device cost and, although energy production device characteristics (*i.e.* device power take-off (PTO) and controller synthesis [19]) are defined at this stage, generally, a structural analysis is neglected, or, at least, approximated with simplified models.
- Definitive or detailed design: Based on the site conditions and the overall device characteristics defined by the preliminary design, this stage regards a detailed dimensioning process. The device hull is tested against internal and external actions, and its withstanding capabilities shall be proved within the defined site environmental, extreme, and operative conditions.

The definitive design of a device needs to be computed by effectively demonstrating WECs survivability, which is generally verified defining a sufficiently low risk of failure. Certification societies play an important role in the definition of design processes that should be followed to achieve a certified risk assessment related to a given probability of failure. Clearly, being wave energy a relatively young energy field, there is a notorious lack of standards and guidelines tailored for WEC design. The lack of standards in the design of renewable systems poses challenges in ensuring consistent progress and efficient implementation, as observed in wind-based technologies [20,21]. In details, for wave energy systems:

- Available standards do not fit the WEC purpose and behaviour, and generally strong (and limiting) assumptions are required for their application [22].
- Some standards use semi-empirical equations to define stresses inside a steel hull, though these cannot be used for other materials (*e.g.* concrete, among others) [22].
- A simplified method (*e.g.* based exclusively on linear models [23]) could lead to oversizing issues. Instead, a design via a direct method (not based on an empirical formulation and standard-given loads), can be used to avoid extra costs.

Moreover, the existing standards represent the stem of the traditional Oil&Gas and ships field and, the behaviour of such floating objects is, for purpose and working principle, significantly different from WECs. Accordingly, the main differences between a WEC and traditional floating bodies are, among others:

- In extreme events, the pressures related to waves and currents and, in general, device motion, need to be estimated with a model as accurate as possible [24]. For example, unlike other structures, WECs can be excited from wave forces not only on their draught, but also on their deck. These actions, called wave-in-deck forces [25], are highly non-linear, and traditional models (generally based on mean wetted surface) fail to provide an accurate representation. In fact, within the available literature, it is generally accepted that simplified models are effectively reliable under certain assumptions (*e.g.* small motions, negligible viscous effects, among others [26]), and boundary element method (BEM)-based models (especially those considering linear Froude-Krylov forces), can approximate device dynamics accurately only on small wave conditions [27,28].
- The overall system response can be significantly affected by the mooring system [29,30]. Again, the model fidelity plays a fundamental role, since static and quasi-static models can be reliable only under the assumption of negligible (mooring) inertial forces [31]. Nevertheless, a WEC, in contrast to a offshore structures experiences, for its nature, large motion due to wave excitation forces, defined by significantly high velocities, and a dynamic mooring model can be required.
- Since in operative conditions, a WEC experiences smaller motions and, in a fatigue assessment a significant number of environmental conditions need to be tested which means that, as best trade-off between fidelity and computational time, a BEM-based model can be used. Moreover, also in operative conditions, a resonance-working device has a motion which can be significantly affected by nonlinear actions, such as mooring force [29] and system nonlinear damping.

1.1. Contributions and manuscript position

Motivated by such absence of specific standards, and the inherent differences and complexity of the WEC case with respect to sister renewable energy applications, within this study, a definitive design method is proposed and discussed, with a special focus on the wave-hull interaction and the pressure field definition.

The aim of this study is to propose a high-fidelity *direct*² design method suitable for WEC systems, with the primary objective of reducing devices cost, while minimising the departure of the proposed standard from the current global standards panorama. The methodology described in this paper exploits the use of well-established high-fidelity modelling techniques, such as computational fluid dynamics (CFD), to

² The word *direct* is used herein to refer to a correlation between site environmental conditions, and stress (or load) on the hull, *i.e.* without employing any semi-empirical relation.

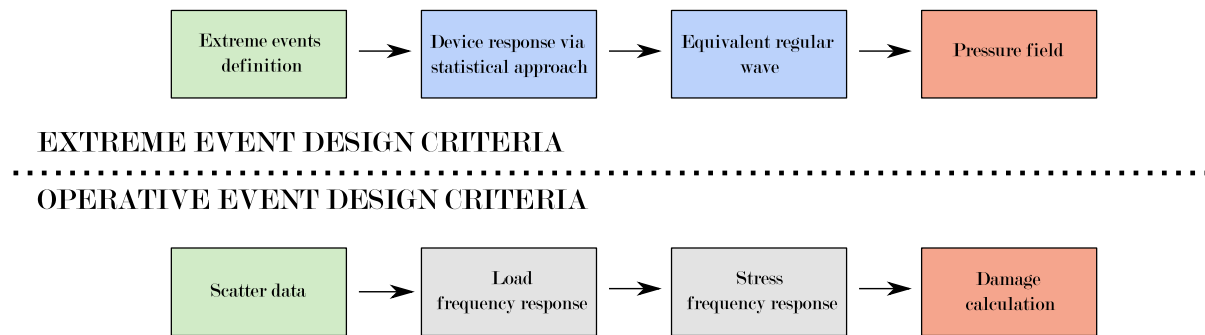

Fig. 1. Design process overview.

provide an accurate evaluation of pressure fields, avoiding potential device oversizing, and hence reducing the associated cost.

Furthermore, the dimensioning process proposed within this paper refers to the definition of the actions, being *independent* on chosen device material and, hence, the proposed procedure can be applied to any potential WEC system and/or offshore structure.

The main contributions of this manuscript can be summarised as follows:

- A review of the existing standards and available reports on the design process is provided, in order to establish the main differences between our study and the currently applied methodologies. Moreover, though fundamentally different due to the nature of the WEC absorption process, the design procedure proposed is deliberately kept as close as possible to the existing standards procedures so as to facilitate the application for current practitioners.
- Although the current design guidelines contemplate the use of high-fidelity tools (such as CFD-based tools), these are used to verify few conditions and the design is carried out by means of models with a lower fidelity. Therefore, a direct method CFD-based is proposed, in which the simulation time can be minimised by leveraging the concept of focused waves.
- Since fatigue assessment can be significantly influenced by non-linearities, the inclusion of these effects in a linear model by means of tailored data-based strategies is proposed.

The remainder of this study is organised as follows. In Section 1.2, an overview of this study is presented. Section 2 reviews the existing standards and guidelines that aim to address the WEC design problem. Section 3 provides an overview of the numerical models that can be used to pursue the proposed design process. Section 4 offers a detailed description of the proposed methodology. In Section 5, the main findings are discussed, analysed, and compared to international standards, while finally, Section 6 outlines the conclusions of this study.

1.2. Study overview

Although the complete dimensioning process is analysed and discussed in Section 4, in this section, an overview of the study is provided, aiming to assist the reader through the structure of the proposed procedure.

We begin by noting that this study describes a design process which can be divided into 2 main parts: Extreme events design criteria, and design process in operative conditions. These are briefly described in the following. Note that load assessment, considering both extreme and operative conditions, can be summarised as described in Fig. 1.

1.2.1. Extreme events design criteria

As discussed in Section 1, offshore devices and structures need to be tested against extreme events. Load assessment in harsh conditions is based on extreme environmental events, which are computed

defining an occurrence level (see Annex) and, hence, environmental data constitutes the starting point of the analysis. Since the definition of the system statistical response needs to be based on an analysis performed in a sufficiently large set of irregular wave conditions (e.g. by using a JONSWAP short-term representation), a computationally sustainable model can be used to perform simulations. Clearly, the model fidelity needs to be verified and tested against experimental data, as suggested and requested by standards [25]. Once the statistical responses of the system under investigation are available, it is possible to build, by leveraging an equivalent regular wave approach, a small set of monochromatic exciting conditions which can be easily tested in a high fidelity CFD environment. The simplified model allows also the generation of regular waves that mimic a given response, such as hydrodynamic forces on the hull, as a long combination of irregular conditions. The last step of the methodology proposed ensures, by leveraging a CFD environment, the evaluation of the pressure field on the hull, including the above waterline hydrodynamics forces, which cannot be evaluated with a linear-BEM method.

1.2.2. Design process in operative conditions

Once the design in extreme events is achieved, each device needs to be tested within operative conditions, to demonstrate its withstanding capability with a fatigue assessment. Within this paper, unlike the extreme event case briefly introduced in Section 1.2.1, the device dimensioning process within its operative state is based on linear assumptions, which are discussed and motivated in Section 4.3. Consequently, after a suitable scatter definition, the stresses map can be defined via a 3D finite element model (FEM).

A stress response amplitude operator (RAO) can be then obtained by a linear combination of pressure and stress frequency-response behaviour. The stresses on the device are calculated for each wave and, taking into account the wave occurrence, the cumulative damage can be correspondingly evaluated.

2. Standards and guidelines: A brief review

In this section, an overview of relevant (and related) available standards is provided, with the primary aim of keeping this paper reasonably self-contained. These are, ultimately, used to guide the definition of the proposed design process, keeping the methodology of this manuscript as close as possible to the standards accepted and adopted in sister applications. Please note that the complete design procedure of a wave energy system requires an analysis of a broader range of aspects, encompassing system performance and associated risk assessment. However, these aspects are beyond the scope of this study, which focuses on analysing the gaps in the current standard landscape concerning survivability conditions only. For a more comprehensive discussion of guidelines on the overall WEC design, interested readers are referred to [32–35].

Standards help to define a design process that certifies device survivability, defining a level of risk with respect to an acceptable probability

of failure of the system. Among renewable energies, wave energy finds less space in standards panorama compared to e.g. offshore wind [36], since it is effectively a younger field.

Although no certification class for WECs has been defined yet by international institutions, some standards and guidelines refer directly to the marine energy field. We recall and report these in the following.

2.1. Wave energy converter standards

Some institutions and certification societies developed specific standards for a generalised class of marine energy converters (MECs) [37]. Among these,³ one can find:

- The European Marine Energy Centre (EMEC) produced guidelines [32] for MECs assessment and design. Guidelines cover a large range of application, from MECs performance, to their manufacturing.
- The International Electrotechnical Commission (IEC) standards are still in a development stage as *technical specification* guidelines for MECs [33–35]. The IEC collaborates strictly with international organisation for standardisation (ISO) hence, the MECs guidelines effectively refer to ISO standards.
- Det Norske Veritas (DNV) and Germanischer Lloyd (GL) (since 2021, DNV), have standards for MECs certification [38].

According to these available standards, WEC (and, in general, MEC) design must be verified against the same ‘challenges’ arising within the oil and gas field and, hence, all the proposed MEC standards refer directly to well-known international guidelines (i.e. [39,40]). Although these guidelines can be useful to define a general workflow, there is a lack of information on the design method that should be *specifically* followed to design a WEC.

As discussed in Section 1, the behaviour of WEC devices in extreme conditions is affected by highly non-linear phenomena like slamming [41], and wave-in-deck effects [42] (also described by the standard [25]) and, therefore, a high-fidelity simulations (e.g. CFD-based) can be used to evaluate these class of actions. Although the use of a CFD model as WEC design tool is contemplated by standards [25,33], the design workflow required when using such a tool is not clearly defined, nor stated.

In the light of this, this study establishes a design method to test WECs survivability in *limit* states. Though the definition of limit states is well-known in literature (see for instance [39,40]), an brief overview is provided in Section 2.2.

2.2. Load assessment and design states

Identification, definition, and assessment of the various loads affecting a floating structure in a marine environment, is essential for design purposes. Note that the evaluation of loads follows the same procedure, regardless of the hull material. International standards that consider all the actions on the hull are briefly described in the following paragraphs, mainly according to DNV, ISO, and IEC international standards. In particular, loads can be divided as follows:

- Permanent (G):
structure, solid ballast and equipment mass,
hydrostatic permanent pressure,
- Variable (Q):
liquid ballast,
power take-off (PTO) loads,

³ The reader is referred to [37] for a complete review of the available standards.

Table 1

ULS and ALS environmental effects. Only wave, current and wind are included in each different combination (according to [40]).

Type of LS	Combination #	Return period (in yr.)		
		Wave	Current	Wind
ULS	1	100	10	100
	2	10	100	10
ALS	1	1	1	1

installation operation loads,
mooring loads.

- Environmental loads (E):
wave, wind, current loads,
ice, earthquake.
- Deformation loads (D):
temperature loads,
mooring pre-tensioning loads.

Clearly, load types are generalised, and partially considering/neglecting a subset of these is strongly linked to the particular case under study.

With respect to the assessment of actions, there are several principles that need to be fulfilled, described in [34,39,40]. Among these, the following requirements are recalled in the following, due to their intrinsic connection with the objectives posed in this study:

- All the loads acting on the device shall be included from internal and external sources.
- All the components which cause a significant load on the device need to be included in the analysis and considered in the internal actions.
- Environmental loads shall include all the events with significant influence on the device according to its location.
- If a correlation of environmental loads and internal actions is difficult to consider, worst internal actions and environmental loads shall be considered as uncorrelated events.
- Variable loads, such as PTO effects, must be included in the considered actions if the device is not in safety mode.

The environmental events are described via a statistical approach, with the so-called return periods (in years). A return period describes (statistically) an estimated average time between events and, hence, the probability that a specific event occurs in the defined time span.

2.2.1. Extreme states assessment

In this section, extreme states are described and discussed. The term *extreme state* is generally referred to a condition formed of a combination of several environmental events (i.e. wave, current, wind, among others). Each environmental event is obtained via a statistical model, able to define the worst-case event that can potentially happen during the device life cycle [25].

The return periods that must be considered, according to [40], are reported in Table 1, both for ultimate limit state (ULS) and accidental limit state (ALS) cases. Within ULS, the environmental events need to be combined considering different returning period and safety factors. Tables 1 and 2 refer to different combinations as suggested by [40].

Data for extreme waves can be computed by means of hindcast data or experimental data for the chosen design site [25]. These data are collected and analysed in order to define an event with a sufficiently low probability of occurrence, and hence to express their occurrence as year of return period (YRP). An explanation of the methodology applied to define events return periods, is reported in Annex. If such environmental data is not available, extreme data given from standards can be potentially used (e.g. [25]).

Table 2
ULS, ALS, and FLS safety factors (according to [40]).

Type of LS	Combination #	Load category			
		G	Q	E	D
ULS	1	1.3	1.3	0.7	1
	2	1	1	1.3	1
ALS	1	1	1	1	1
FLS	1	1	1	1	1

Note that the loads described in Section 2.2 need to be applied to a structural model with a proper safety factor. In particular, the safety factors for ULS and ALS environmental conditions are reported in Table 2. The same considerations adopted for ULS conditions can be applied to ALS conditions. The main difference, which relates to ALS, is that the conditions shall be considered with at least 1 year of return period (as per Table 1), and following a combination of different failures (i.e. mooring line failure, equipment failure, among others), according to [40].

Note that IEC standards define limit states and design categories to obtain a series of design load cases which are not directly comparable to the DNV method. The reader is referred to [34] for further detail.

2.2.2. Fatigue state assessment

Structural elements, if subject to time varying loads, can present untimely breakage even for loads which are not sufficient to induce plastic deformation on the components. This is due to the fact that, under time varying loads, cracks are able to generate and propagate within the loaded elements, leading to a fracture of the stressed structural part. This process is usually referred to as *fatigue*.

WECs fatigue assessment, known as fatigue limit state (FLS), needs to be tested in device operative conditions and, hence, the most occurrent environmental events shall be considered. IEC suggests a higher safety factor for variable loads if the device works in resonance conditions. Otherwise, the safety factors of the FLS are reported in Table 2. Environmental data for the specific installation site are to be considered, both for short-term and long-term statistics, according to [25]. The design of the device may be limited to FLS analysis depending on its shape and material and, also, on the specific working principle of the WEC for effective wave energy harvesting. An detailed description and discussion on this last statement is provided in this paper, in Section 4.3.

3. Numerical models

In Section 2.2, the loads included within in the subsequent analysis are defined and divided considering their source. In this section, the corresponding mathematical models, used for device load assessment, are presented and discussed.

Note that the following analysis should be intended as a guideline, and the use of a *specific* numerical model needs to be evaluated on the basis of the WEC device under analysis. The numerical models proposed in this section, are based on the following hypotheses:

- Extreme conditions shall be tested evaluating loads on the device following a statistical approach and, hence, large pool of simulations are required. As such, the analysis shall be ideally carried out with a computationally efficient model.
- Non-linear effects, such as mooring forces, viscous damping, among others, need to be included in the model, especially in extreme conditions.
- In operative conditions, the device motion tends to be smaller than its corresponding motion in harsh sea-state scenarios and, hence, a fully linear model can be used.

Among the set of loads presented in Section 2.2, the following are considered and discussed in detail:

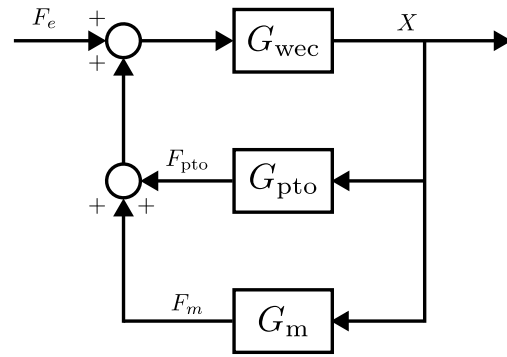

Fig. 2. WECs algebraic block diagram representation.

- Solid ballast, structure and equipment mass, and hydrostatic pressure (G).
- PTO loads and mooring loads (Q).
- Wave, wind and current loads (E).

Though the other actions, listed in Section 2.2, can be of relevance within WEC design procedures, they are not considered within this study, since these are strongly case-dependent.

Generally, a WEC can be summarised under the hypothesis of linear time-invariant system as proposed in Fig. 2. Note that the WEC response (X in Fig. 2) is influenced by the mutual interaction of the associated hydrodynamics (G_{wec}), the power take-off (PTO) (G_{pto}), and the mooring system (G_m). If is not possible to include an omni-comprehensive model considering the totality of the actions, these shall be considered as uncorrelated events, and worst-case loads need to be combined and applied simultaneously in the structural model.

In the proposed design process, three different mathematical models are proposed for the extreme events case⁴:

- Frequency-domain (FD) BEM-based model: These models are generally based on the calculation of the hydrodynamic parameters of the WEC system via BEM, and the equation of motion is solved under the assumption of mean wetted surface and non-viscous incompressible flow, i.e. potential flow theory [26].
- Time domain (TD) BEM-based model: the statistical description of the device response is obtained via a TD model, in order to include (to some extent) non-linear effects (such as mooring forces). These models are generally based on the resolution of radiation forces via the so-called Cummins' equation [43].
- TD CFD model: the pressure evaluation cannot be computed via a BEM-based model, in particular if the non-linear component of wave forces need to be included within the analysis. If the mooring system has a significant influence on device dynamics (and it is included within the TD BEM-based model), a coupled model can be employed [44]. Hence, within the CFD environment, it is possible to evaluate both pressure field, and exerted mooring loads, with a high degree of fidelity.

While the current section introduces and details several mathematical models, it is essential to emphasise that the reliability of a mathematical model requires validation against experimental data. Standards often require the use of experimental data to quantify the reliability of the adopted mathematical model, as exemplified in [45]. In the development of emerging technologies like wave energy systems, experimental data is crucial for evaluating their potential and

⁴ Note that the integration of a mooring solver within a CFD environment, and in a time-domain BEM-based model, is clearly related to the influence of the mooring system on device dynamics, which changes accordingly to the case study.

validating associated mathematical models [46]. In the wave energy domain, the complex behaviour of wave energy systems can often push commonly used numerical models, such as linear BEM-based models, beyond their range of validity due to the inherently adopted modelling assumptions [24]. However, while some models may be based on limiting hypotheses (such as BEM models relying on small motion assumptions), it becomes necessary to quantify model reliability beyond these limitations. For example, in both [47,48], two distinct experimental campaigns and model validation processes are presented. The case study in both instances involves a pitching wave energy converter, chosen as a relevant benchmark case study due to the substantial variation in the waterline resulting from the device pitching motion. In both cases, a BEM-based software model (based on the mean wetted surface) is employed, demonstrating satisfactory results in predicting the real system behaviour.

3.1. Frequency domain BEM-based model

The calculation of hydrodynamic coefficients is usually carried out by means of BEM software. For instance, well-known BEM codes are NEMOH [49], which is open source, or its commercial alternatives AQWA [50], ORCAWAVE [51], and WAMIT [52]. Note that software capable of combining hydrodynamic calculations with structural analysis is also available, such is the case of e.g. SESAM [53].

The hydrodynamic analysis shall be carried out for at least 20 frequencies and 12 wave directions [54,55], in order to obtain a sufficiently discretised frequency-response behaviour. According to [56], the model needs to include the frequencies characterising the main response of the device, as well as those characteristic frequencies of the installation site environment. The BEM software evaluates all the hydrodynamic parameters that describe, for each wave direction, the following frequency-domain equation:

$$\begin{aligned} X(i\omega) &= \left(\frac{G_{\star}(i\omega)}{1 - G_{\star}(i\omega)G_{pto}(i\omega)} \right) F_e(i\omega), \\ G_{\star}(i\omega) &= \frac{G_{wec}(i\omega)}{1 - G_{wec}(i\omega)G_m(i\omega)}, \\ \frac{1}{G_{wec}(i\omega)} &= -\omega^2(M + A(\omega)) + i\omega(B(\omega) + B_{visc}) + K, \end{aligned} \quad (1)$$

where $\{G_{wec}(i\omega), G_{pto}(i\omega), G_m(i\omega)\} \subset \mathbb{C}^{6 \times 6}$ are the WEC, the PTO, and the mooring frequency responses, respectively. $\{M, K\} \subset \mathbb{R}^{6 \times 6}$ are the mass and hydrostatic stiffness matrices, respectively, $F_e(i\omega) \in \mathbb{C}^6$ represents the excitation force applied on the device, and $\{B(\omega), A(\omega)\} \subset \mathbb{R}^{6 \times 6}$ are the damping and added mass matrices, respectively. The vectors $X(i\omega) \in \mathbb{C}^6$ represent the Fourier transform of device displacement.

However, additional parameters may be required to include significant phenomena, e.g. viscous actions due to the shape of the hull itself. In particular, such viscous effects can be characterised by a quadratic function and a viscous damping coefficient, which can include, following linearisation (see e.g. [57]), in Eq. (1) accordingly. Such a coefficient can be obtained by means of e.g. CFD-based simulations, or experimental free-decay tests. In such cases, it is possible to identify a ‘global’ damping for the hull and, if it is sensibly larger than the radiation damping $B(\omega)$ alone, introduce the additional viscous damping $B_{visc} \in \mathbb{R}^{6 \times 6}$ within Eq. (1) [58].

The influence of the mooring system can be obtained with simplified mooring models (i.e. static mooring model [59]) or, in terms of a representative linear model⁶ as follows. First, a TD model of the vessel and its mooring needs to be defined and excited, imposing the device motion. Within this paper, a multisine signal [61] with a box-type frequency spectrum, i.e. a spectrum with compact support and uniform

amplitude distribution, is chosen. The box spectrum must cover at least the same frequency span used for the BEM calculation. It is also important to conduct a sensitivity study on the ‘height’ (peak-to-peak ratio) of the generated input signal. In order to generate a suitable multisine signal, it is important to choose the phase of each component so as to minimise the so-called *crest factor* (see [62]). This can be achieved, for instance, by employing the so-called *Schroeder phases* [61], although other methods are available. To be precise, such a multisine signals can be defined as:

$$\begin{aligned} x(t) &= a \otimes \begin{bmatrix} 1 & \dots & 1 \\ \vdots \\ \cos(\omega_k t + \phi_k) \end{bmatrix}, \\ x(t) &= \begin{bmatrix} x_1(t) \\ \vdots \\ x_6(t) \end{bmatrix}, \quad a = \begin{bmatrix} a_1 \\ \vdots \\ a_6 \end{bmatrix}, \\ \phi_k &= \frac{-k(k+1)}{N_k}, \quad \forall k \in \{1, \dots, N_k\}, \end{aligned} \quad (2)$$

in which $a \in \mathbb{R}^{+6}$ is the constant amplitude of each k th component, ϕ_k is the phase of the k th component, according to [61], and $x(t) \in \mathbb{R}^6$ is the device imposed position.

As already stated, it is important to evaluate the influence of the values of a in the system response, by conducting a sensitivity analysis, bearing in mind that the linearity hypothesis holds only if the amplitude of the multisine is not excessively large. After having conducted the corresponding time domain simulation (with (2) as the wave input), it is possible to characterise the mooring system frequency response calculating, for each wave direction:

$$G_{m_{p,j}}(i\omega) = \frac{F(f_{m_p}(t))}{F(x_j(t))}, \quad \forall j, p \in \{1, 2, \dots, 6\}, \quad (3)$$

where $G_m(i\omega)$ is the mooring frequency response already proposed in Eq. (1) and Fig. 2, $f_m(t) \in \mathbb{R}^6$ is the net mooring force applied to the device CoG, and F being the Fourier transform operator.

Finally, the actions associated with the PTO need to be considered within the model. For the purposes of FLS analysis, a linear model of the PTO system can be developed, in which one takes into account the interaction between the motion of the device, the control system, and the mechanical parameters of the PTO. Otherwise, representative linear model can be computed following the same process described for mooring forces.

The outlined procedure consent to linearise and include in the model described in Eq. (1) nonlinear terms and hence, evaluate the device motion considering the PTO and the mooring influence. Although the generalised forces to the CoG have been discussed and proposed above, the definition of the stress transfer functions (see Section 4.3.3) needs to be defined by means of local (hot spot) transfer function which are referred, for example, in case of the mooring force, to the fairleads:

$$G_{m,n_{p,j}}(i\omega) = \frac{F(f_{m,n_p}(t))}{F(x_j(t))}, \quad \forall j, p \in \{1, 2, \dots, 6\}, \quad (4)$$

with $f_{m,n}(t)$ being the n th fairlead, while $G_{m,n}(i\omega) \in \mathbb{C}^6$ is the mooring frequency response,⁷ Force components shall be calculated for a frame of reference integral with the hull. The data-based frequency responses are usually referred to as an *experimental frequency responses*, since they are directly obtained by operating on acquired time-domain data.

⁵ Note that in the proposed notation $\frac{1}{G(i\omega)}$ is the inverse of the matrix $G(i\omega)$.

⁶ The reader is referred to [60] for the definition of representative linear model.

⁷ Note that, normally, a mooring line is connected to the device with a spherical joint, hence $f_{m,n}(t)$ moments are zero.

3.2. Time domain BEM-based model

Several commercial and open source software can be used as TD models. Among them, ORCAFLEX [51], AQWA [50], SEAFEM [63], and SESAM [53], are the most common commercial TD solvers with a mooring module. Within the open-source side, WEC-SIM [64] is a TD software naturally coupled with MOORDYN [65], a dynamic lumped-mass mooring solver. For an extensive analysis of software possibilities for this task, the reader is referred to [27].

Although the formulation of the equations can slightly change among different software, in general, the device motion is computed in TD solving the integro-differential equation proposed by Cummins [43]:

$$(M + A)\ddot{x}(t) + \int_{\mathbb{R}^+} h(\tau)\dot{x}(t - \tau)d\tau + Kx(t) = F_{ext}(t), \quad (5)$$

where $h(t) \in \mathbb{R}^{6 \times 6}$ is the radiation damping impulse response function, and the other parameters correspond with those already described within Eq. (1). $F_{ext} \in \mathbb{R}^6$, instead, is the sum of all external forces applied to the WEC hull. Considering that the PTO is effectively blocked in extreme conditions (i.e. in safety mode), $F_{ext} = F_m + F_e + F_{2nd} + F_w + F_c$, where $F_m, F_{2nd}, F_2, F_w, F_c$ represent mooring forces, excitation forces (also present in Eq. (1)), 2-nd order forces (also known as sum and difference frequencies forces [26]), wind forces, and current forces. The latter two forces, i.e. wind and current, are generally included by means of the so-called drag formulation [66].

Though the international standard for mooring analysis [45] allows the use of a quasi-static model, WEC systems are generally excited within a relatively large range of frequencies, defined as *wave frequencies*. Hence, the use of a dynamic mooring solver is recommended, in order to accurately model the mooring forces in the high frequency region. Dynamic mooring models can be divided into two main categories:

- FEM: Generally time-consuming, but they can be used to model some particular events like, for example, snap events [67].
- Lumped-mass models: they use a lumped-mass formulation to compute mooring forces [68].

Lumped-mass models are relatively common within the wave energy field [31] and, hence, a simplified formulation of a lumped-mass mathematical model is presented below

$$\ddot{y}_i(t) = \frac{1}{m_i + a_i} (K_m(y_i(t), y_{i-1}(t), y_{i+1}(t)) + B_m(\dot{y}_i(t), \dot{y}_{i-1}(t), \dot{y}_{i+1}(t)) + W_{B,i} + D_i(\dot{y}_i(t))), \quad (6)$$

where $\{y_i(t), \dot{y}_i(t), y_i(t)\} \subset \mathbb{R}^3$ represent the acceleration, velocity, and position of the i th node, respectively, and $\{m_i, a_i, K_m, B_m\}$ are the inertial and added mass terms, spring force, damping force due to the motion of nodes, respectively. Finally, $\{W_{B,i}, D_i\}$ represent node net buoyancy and drag force.

3.3. CFD model

A CFD environment ensures high-fidelity simulation for modelling strongly nonlinear phenomena. Among the available software, STAR-CCM+ [69] and OPENFOAM [70] are the most commonly-used codes, being commercial and open source, respectively. Recommended practices for CFD modelling are provided in [71]. Note that the integration of a moored model in CFD environment is not a novelty, and has been already achieved in e.g. [72].

The mass continuity equation, and the momentum continuity equation, are:

$$\begin{aligned} \nabla \cdot u &= 0, \\ \frac{\partial u}{\partial t} + u \cdot \nabla u &= -\frac{\nabla p}{\rho} + g + \nabla \cdot (\mu \nabla u), \end{aligned} \quad (7)$$

where, $\{u, p, \rho, \mu\}$ are the volume of fluid velocity, pressure, density, and viscosity, respectively, while g represents the constant gravitational acceleration.

The response of the system described herein cannot be analytically solved, but can be computed numerically through domain discretisation into finite volumes. Reynolds Averaged Navier–Stokes equations (RANS) are applied to average flow properties over time. A realisable $k - \epsilon$ turbulence model needs to be employed, with k representing turbulent kinetic energy and ϵ indicating the dissipation rate. This choice of a turbulence model is coupled with wall functions to handle high-gradient regions near walls.

To address the wave transport problem, the simulation environment necessitates the definition of two fluids. The volume-of-fluid model, developed by Muzafferija and Peric in 1998 [73], can be applied for this purpose. This model precisely describes the interface between different fluid phases, allowing for an accurate representation of wave interaction with the WEC.

Adhering to standards [25], the volume-of-fluid method stands out as an effective approach for simulating wave-in-deck loads. This method facilitates the breakup of fluid particles and accommodates changes in the topology of the fluid domain [74].

4. Design process

In this section, the proposed design procedure for a WEC is explained and discussed. This section is divided into 2 main parts, defining a design criteria for extreme and operative conditions, respectively.

4.1. Extreme event design criteria

The procedure to follow in ultimate and accidental limit states, i.e. ULS and ALS respectively, is the same. In ALS, the simulations shall be run considering equipment failure (e.g. the failure of a mooring line). In the definition of the hull thickness, and the steel reinforcement layer, ULS can be considered as the “design stage”, in order to define hull properties. In contrast, any other limit states can be essentially considered as verification stages.

The design process starts with the analysis of the environmental events. Although the simulation shall be carried out setting the short-term climate condition (e.g. a JONSWAP spectrum for waves), for the definition of short-term events, a long-term analysis is required, which consists in the definition of the so-called environmental contour (EC) [25].

The design analysis needs to refer to a proper choice of the climate conditions. Clearly, in extreme limit states (such as ULS and ALS), the definition of the environmental states (wave, wind and current spectra), is defined via a probabilistic model, in order to consider the proper wave (or external events) in the device life cycle.

The methodology which can be used to define the long-term distribution of a phenomenon starting from available data, is described in Annex. Though the long-term description (hereinafter Environmental Contour, EC) of the event is computed, the definition of the sea states from the computed environmental contour is not trivial. Technically, the worst-case sea state (in terms of loads on the device) should be considered as the design sea state, though its definition for non-linear models cannot be assumed in advance. WECs are resonant devices, and hence, both H_s and T_e can affect the device response significantly. RAOs, facilitate the understanding (under linearity assumptions) of the resonance frequency of the device (i.e. as example the PeWEC [75] device RAOs are exposed in Fig. 4) and, hence, the waves that would need to be considered from ECs. RAOs are evaluated via a BEM software that calculates the device response in regular waves although, in irregular sea states, waves are defined by a stochastic panchromatic process. Therefore, in an irregular sea state, the definition of the spectrum period (which can be described by peak, mean, or energy period,

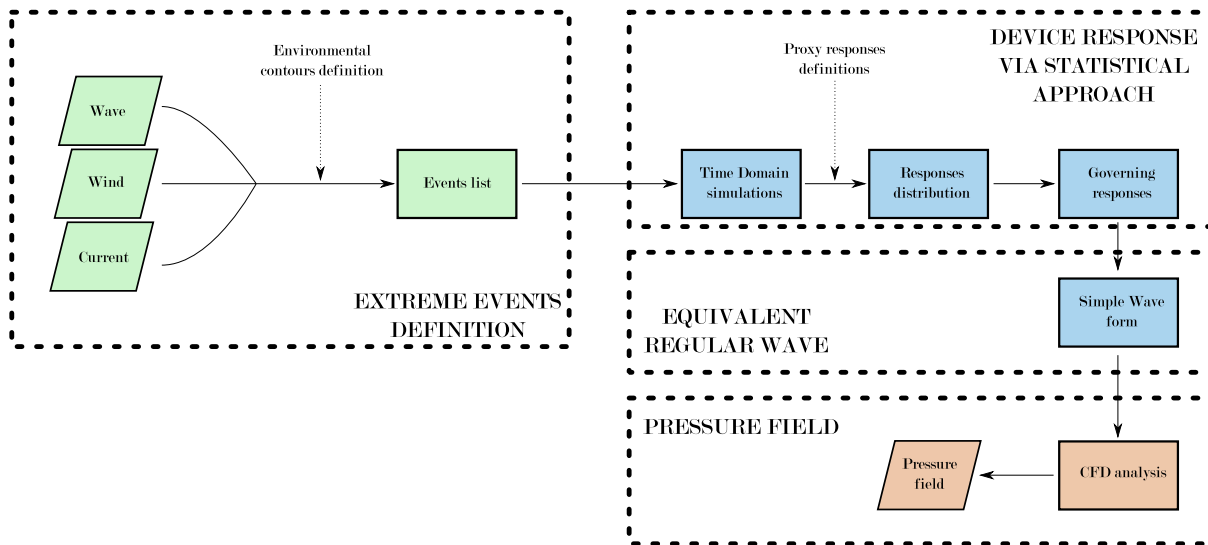

Fig. 3. Extreme condition design process.

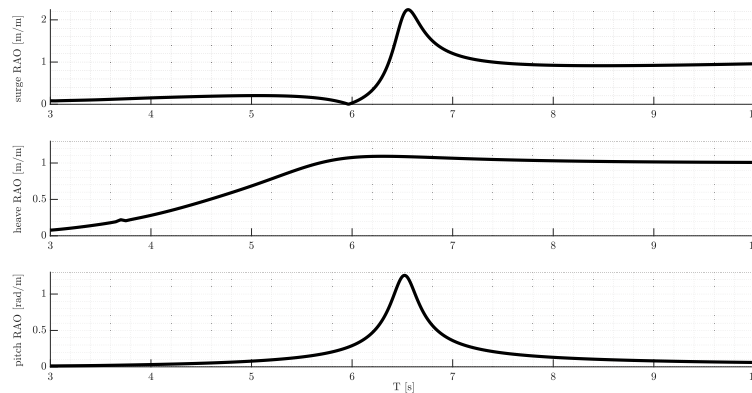

Fig. 4. The PeWEC device RAOs.

among others [76]) is not trivial, and several wave spectra need to be considered in order to encompass the worst-case scenario.

Based on the discussion provided above, the proposed wave selection on the EC can be summarised as follows:

- From EC, an equally spaced array of waves shall be chosen, starting from a period lower than the resonance one, covering from resonant waves, towards the period of the highest wave on the contour.
- The number of waves of each contour should take into account the period variation, in order to effectively consider the WEC response variation.

Therefore, following the examples proposed in Figs. 8 and 4, an equispaced (in period) array of waves can be selected from the environmental contour as highlighted in Fig. 5.

Note that this process can be effectively spread considering wave directionality. For the evaluation of directional contours, the procedure is equivalent to the procedure explained in Annex, dividing the wave data into sectors, and considering exclusively the data from a desired sector. Each individual sector shall contain a sufficiently large set of data, in order to achieve a proper definition of its relative directional environmental contour [25]. Therefore, considering a 30 year set of wave data, a value of angle between sectors of 30° can be potentially sufficient, although this needs to be verified according to the specific site data under consideration.

If the WEC is station-kept by a mono-directional mooring system (*i.e.* a mooring system which does not allow the device to weathervane),

only a quarter (worst-case quarter) of the possible directions can be considered within the analysis. Note that a mono-directional mooring system is essentially a spread mooring system [77], which does not allow the hull to weathervane.

Note that, in addition, current and wind are considered in the definition of the short-term events. As suggested by international standards, the events correlation needs to be defined properly. In particular, the events correlation in collinear and non-collinear cases depends on the possibility of the device to weathervane. In case of a weathervaning unit, for each environmental contour, the following events and directions need to be considered [45]:

- Wave, wind and current shall have the same direction.
- Wave direction shall be set as the environmental contour direction. In contrast, wind and current directions shall be set respectively to 30° and 45°, relative to the wave direction.

For a unit with a mono-directional mooring system, which does not allow the hull to weathervane, current, wind, and wave shall be considered as acting on the same direction.

4.1.1. Device response via a statistical approach

The hydrodynamic non-linearities related to the extreme condition of the sea states, and the large motion of the WEC, can be evaluated with the proposed CFD-moored model (as outlined in Section 3). The main problem related to CFD numerical models is the computational burden required by the solver. As such, a complete wave spectrum

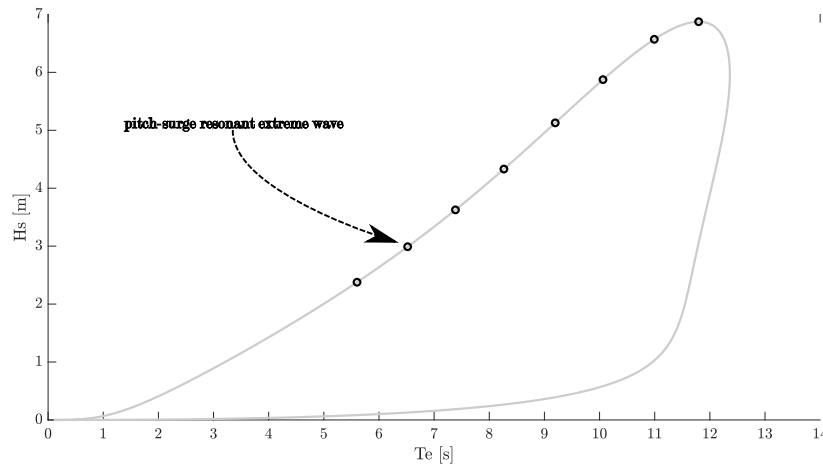

Fig. 5. Environmental contour, and corresponding chosen waves.

cannot be evaluated within a CFD environment (in particular when considering a multi-seed approach) and, hence, particular methodologies, known as *focused wave* approaches, have been developed and proposed in literature [78].

Technically, considering a focused wave, the design is solely defined based on wave related statistics. This means that a focused wave approach is effectively able to describe a wave time series producing the highest peak of wave elevation. Note that, although, the device needs to be designed according to worst-case loads, which does not necessarily correspond with the highest peak of the wave elevation time series.

To avoid this problem, this study proposes a statistical analysis based on the TD model simplified described in Section 3.2. Fig. 3 illustrates the proposed workflow.

Via the combination of wave, current, and wind data, it is possible to define a proper events list, according to standards [45], while also considering the weathervaning capabilities of the unit. Note that, by following the definition of events reported in Annex, an event list is hence available to evaluate the WEC response in time-domain.

For each sea state, at least a 3 h simulation, with 10 seeds, shall be carried out (see [25,45]). Simulations are post-processed to define, via a statistical analysis, the magnitude of relevant parameters (such as device motion and loads acting on hull). These are called *proxy responses*.

The *extreme* magnitude values of proxy responses are used to find an equivalent (in terms of parameter magnitude) regular wave, which can be simulated within a CFD environment. Considering that the aim is the evaluation of pressures and mooring loads on the device, in order to guarantee representative design conditions to the structural model, the parameters that need to be considered in the analysis are:

- Environmental loads (hydrodynamic and hydrostatic forces, current forces, and wind forces).
- Permanent and gravity Loads.
- Variable loads (mooring loads).

Hence the proxy responses can be chosen as follows:

- Wave hydrodynamic forces and moments on device (six parameters).
- Device accelerations (six parameters).
- Mooring net forces applied on device (six parameters).
- Current forces applied on device (six parameters).
- Wind forces applied on device (six parameters).

Note that the proxy responses are chosen considering a general case, and some parameters can be potentially neglected when considering a specific case of study.

For each proxy response, the maximum value of each simulation shall be used to obtain a corresponding probability distribution function (PDF) [45]. Following [79,80], the extreme events can be hence treated in terms of three different distributions:

- Type I extreme value distribution: Gumbel distribution.
- Type II extreme value distribution: Fréchet distribution.
- Type III extreme value distribution: Weibull distribution.

From the combination of these 3 functions, another distribution can be defined, known as *generalised extreme value distribution*. For building PDFs for proxy responses, standards [45] suggest the use of a Gumbel distribution, though the fit between distribution and data needs to be verified accordingly.

Having a PDF for each proxy response, the most probable maximum (MPM) of the distribution can be now defined as the *governing response level* of the proxy response. For example, for a Gumbel distribution the MPM can be evaluated as:

$$MPM_{Gumbel} = \mu - 0.45\sigma,$$

where μ and σ are the mean and standard deviation of the analysed data, respectively.

4.1.2. Equivalent regular wave

Finally, several regular waves can be tested within the TD BEM-based model. These waves can be built randomly, with a fine discretisation in heights and periods. Unlike the irregular case, regular wave simulations are not time consuming, and the steady-state condition is reached after few hundreds of seconds. Note that the regular waves, used within the CFD model, should satisfy the governing response level for each proxy response. As such, the maximum number of regular waves that should be simulated in CFD is given by the number of proxy responses. Nonetheless, the number of waves required is generally lower than the number of proxy responses, since one wave can effectively satisfy the governing response level of multiple proxy responses.

4.1.3. Pressure field

With this process, the number of simulations requested to be evaluated in CFD is reduced significantly, and the simulations need to be ran until the stationary (steady-state) condition is reached, which generally implies a few hundreds seconds of simulation.

Considering the proxy responses presented in Section 4.1.1, less than 30 waves can be simulated via CFD in order to provide a representative characterisation of the pressures forces acting on device. Though the maximum number of waves is equal to the number of proxy responses defined, a single equivalent regular wave can provide

a sufficiently large level of more than one proxy response. Note that, if a mooring solver is included in the CFD environment, this ensures the determination of the mooring loads on fairleads, and the dynamic of device is significantly affected by the mooring system.⁸

The CFD model needs to be set carefully, with a proper definition of the virtual wave tank. For example, the waves radiated from the device move towards the boundaries of the domain, dissipating energy. Hence, the characteristic length of the domain shall be large enough, in order to capture the most energetic part of the wave pattern. For instance, the description of a CFD model for a pitching WEC is provided in [58], while the International Towing Tank Conference (ITTC) developed guidelines regarding virtual tank setting [71].

With regular waves as input for the CFD virtual wave tank, also the output signals (*i.e.* pressures, kinematics, mooring forces, among others) have a regular-like behaviour. As such, it is straightforward to define, with minimal uncertainty, the moment in time in which the maxima of the design parameters (*i.e.* pressures, mooring forces, among others) occur. At these specific moments, it is then possible to evaluate:

- Mooring forces on fairleads, post-processing mooring solver outputs,
- environmental pressures on the device, defined on the CFD device mesh, which can be easily interpolated on the mesh of the structural software and,
- device accelerations, which also describe gravity loads.

Finally, a structural FEM 3D model can be developed and set with the proper loads, in order to evaluate/verify the hull withstanding capability. Detailed information on structural FEM is beyond the scope of this study, and the reader is referred to [23,40,81,82].

4.2. Limitations

In this section, we highlight the primary limitations of the proposed methodology. While the criteria for designing operational events outlined below align with industry standards and model constraints, the extreme conditions may extend numerical models beyond their validity range. As discussed in Section 3, experimental validation of numerical models is imperative in the design phase. Nevertheless, a simplified BEM-based model with only linear terms might fall short in predicting device dynamics. Linear models, as outlined in [24], suffice for operational, small wave conditions. However, incorporating nonlinear terms, like significant mooring forces and second-order drift forces, enables models to faithfully describe device dynamics even in extreme conditions [47]. In summary, two mathematical models with the following limitations are necessary to implement the proposed design procedure:

- A time-domain BEM-based model is required. This model should exhibit computational efficiency to calculate device responses in all extreme irregular tests in which it must be capable of statistically reproducing the device response in extreme irregular conditions.
- A time-domain CFD-based model is required. This model should encompass all relevant dynamics.

4.3. Operative event design criteria

In the field of naval design and, generally, offshore structure design, fatigue is one of the major aspects to be considered, since such objects are subject to a wide series of dynamic loads, *e.g.* wave loads, wind

⁸ Note that in a CFD moored simulation, mooring and pressure forces are correlated. This means that not necessarily the worst-case pressure load acts at the same time of the worst-case mooring force, and hence oversizing issues can be avoided.

loads, loads given by moving cargo (such as tankers), mooring loads, among others. The aim of fatigue design is to ensure that the structure has an adequate fatigue life. Estimated fatigue life also forms the basis for efficient inspection program during fabrication, and the operational life of the structure.

To date, the regulatory framework in terms of standards for fatigue assessment of WECs is not particularly well-defined (with the notable exception of [56]), and the general approach is to adapt the naval standards to the specific design cases [78,83,84].

However, [56] only provides a normative frame of reference regarding WEC design, while the purpose of this study is to describe the step-by-step design of a WEC. In general, the international normative reference for offshore structural design is provided by DNV, which has developed a comprehensive collection of rules, guidelines, standards, classification notes, among others. In particular, the procedure hereby described for FLS is mainly derived from [54,55,85].

The fatigue verification of vessel structures, according to [85], can be performed following one of the alternative methods reported below:

- Prescriptive fatigue assessment: This method is specifically created for steel ship structures, and it is based on the selection of equivalent design waves, which maximise specific wave induced loads on the hull. Such characteristic loads are described in [86]. Within this approach, no structural FEM model is used, and the stress in the structure is calculated based on empirical relations, which take into account inertial and geometrical parameters of the hull. Of course, such relations have been developed specifically for ship-like hulls, and may not be suitable to describe the structural behaviour a WEC geometry in general. Moreover, the actual sea states to which the vessel is subject to are not explicitly taken into account. Since a WEC is a device installed on a specific site, for which it is safe to suppose that the environmental properties (wave, wind, and current) are known when designing the hull, such simplification may be limiting. For these reasons, it is far more preferable to adopt a design method which takes into account the actual environmental conditions to which the system is going to be subject, together with the actual geometry and properties of the hull.
- Direct fatigue assessment: This method is based on direct computation of wave loads for selected loading conditions, and a specific wave environment. This is important to take into account the specific installation site for which the hull is designed, so the direct approach proves to be more reliable than the prescriptive approach. In turn, the direct approach can be subdivided into two different methods:
 - Component stochastic analysis: global environmental actions on the hull are calculated (forces and moments), and converted into structural stress by using empirical coefficients. As for the prescriptive method, the use of empirical coefficients may not be adequate to describe the structural behaviour of WEC, and studies regarding the applicability of such coefficients to the variety geometries that characterise the various WEC concepts are lacking.
 - Full stochastic analysis: this approach requires that the hydrodynamic loads (including pressures), calculated by means of a BEM solver, are directly transferred into a FEM model of the hull, in order to calculate the structural stress in the vessel. This method represents the most versatile and complete alternative for fatigue evaluation, and is not affected by the drawbacks of the methods described above. The main drawback, characteristic of this method, is a higher computational cost compared to the other approaches. Nonetheless, this method has been chosen as the basis for the definition of a procedure for the FLS calculation, proposed below.

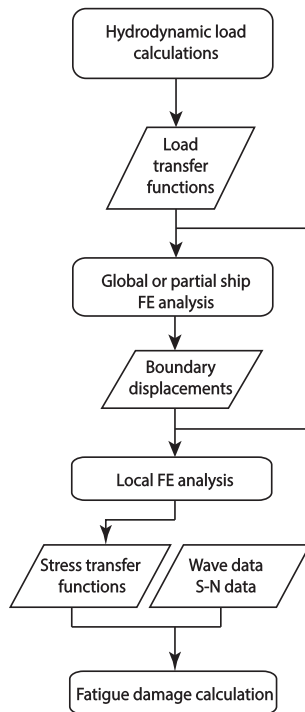

Fig. 6. Full stochastic analysis flow chart diagram from [87].

After having identified the most suitable methodology, we provide a more detailed description of the calculation procedure associated. The algorithm describing the full stochastic analysis, proposed by [87], is shown in Fig. 6. The process workflow, proposed in this study, has been slightly modified from the one proposed within Fig. 6, in order to include some terms neglected in the initial procedure. Such a modified workflow is illustrated in Fig. 7. Note that the proposed method requires the calculation of the hydrodynamic loads, and the derivation of the load frequency response. Such functions are linear maps that relate each regular sea state with the forces and torques exerted on the hull by the sea state itself.

Following the computation of such loads, the global actions are provided to a FEM of the hull, and it is possible to calculate either the stress on the structure, or its displacement. Calculating displacements is useful for evaluating the stress on particular sections of the vessel, by means of a local FEM model. The use of a local FEM model is required in cases of particular geometrical complexity, or when the global model is not accurate enough to describe the stress behaviour in certain areas of the structure.

The frequency response calculated directly relates the sea state (which generates the global actions) to the structural stress. Once the stress frequency response is available, it is possible to combine it with the environmental data of the selected installation site, in order to calculate the load cycle associated to each wave in the scatter, and its associated occurrence.

Having calculated such data, it is possible to combine them with the fatigue characteristic of the materials constituting the hull (concrete, steel, etc.), and verify if the structure satisfies the fatigue life requirements. The main complexity of the proposed method rests in the use of a FEM model for the structural calculation, since automatization may not be easily achievable in the case of non-linear materials. On the other hand, the use of FEM allows a great versatility and flexibility with respect to the materials and constructive solutions that can be described for the FLS calculation.

Such method has the great advantage of being suitable for describing any hull geometry and every hull material, for any chosen installation site. The hypotheses on which the hereby described procedure is based are the following (see [85]):

- Wave climate is represented by scatter diagrams. Each sea state is represented by a wave spectrum.
- Rayleigh distribution applies for stresses within each short term condition.
- Cycle count is according to zero crossing period of short term stress response.
- Miner summation is according to linear cumulative damage.
- Linear load effects and responses.
- Stresses used for fatigue calculation are based on hot spot stress methods using a stochastic approach. The hot spot stress is either calculated using a stress concentration factor model, or derived from nominal stresses combined with associated stress concentration factors.
- Although based upon linear theory, the analysis should include any relevant non-linear effect. If the effect has a significant influence on the overall structural response, and a significant probability⁹ it should be included within the analysis. An example of such effect is the intermittent wetting of the side shell and the resulting effect on the linearised pressure loads. Other load effects, such as slowly varying impact loads, should be included if they influence the fatigue life.
- Non-linear effects due to large amplitude motions and large waves can be neglected in the fatigue analysis, since any stress within lower load levels (intermediate wave amplitudes) contributes relatively more to the cumulative fatigue damage.

The choice of the structural material follows a series of considerations, and several factors need to be included in the evaluation process. Most of the standards for fatigue evaluation of offshore structures are based on steel (see [55,85,88–90]), or both steel and concrete (e.g. offshore wind [91]), and some are specific to concrete [23]. For WEC design using steel or concrete, it is possible to follow the rules and standards mentioned above, while for composite materials, the reference is given in [92,93].

4.3.1. Scatter data

Environmental data need to be calculated for the site of installation of the device, covering two sets of information: Both long-term, data and short-term data are required. The former is usually known as wave scatter, and report the occurrence of each sea state, characterised by significant wave height H_s , energetic period T_e (or related data such as peak period T_p of the spectrum or mean zero-crossing period T_z), wave direction, and possibly spreading [25]. The latter is given by the sea state energy spectrum, which describes the single sea state, and it is function of the frequency ω , and the wave direction. Within the present study, a JONSWAP spectrum has been considered, but further reference is given in [25,87].

Each sea state is usually described by means of a frequency spectrum¹⁰ and a variety of spectral forms have been defined over the course of the decades [95]. The sea states are hence represented using the following (8) relation:

$$S_{\eta}(\omega) = 320 \frac{H_s^2}{T_p^4} \omega^{-5} e^{-\frac{1950}{T_p^4} \omega^{-4}} \gamma_{JS}^A, \quad (8)$$

where $S_{\eta}(\omega) \in \mathbb{R}$ is the wave spectrum, which described the power density of the wave, H_s is the significant wave height, and T_p is the period associated to the highest spectral peak. The parameter γ_{JS} is

⁹ Please note that, the definition of probability of a phenomenon is linked to the failure probability of the system [85]. of occurrence (e.g. exceedance level larger than 1×10^{-4}).

¹⁰ Note that in this formulation the wave spreading can be included, for further information please refer to [94].

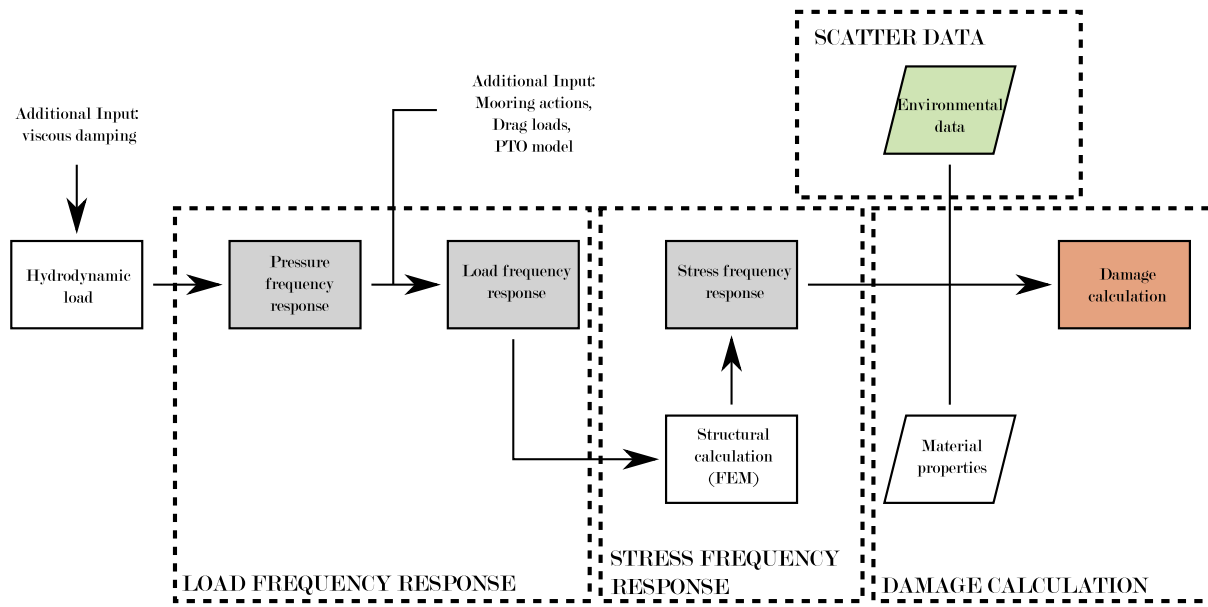

Fig. 7. Operative condition design process.

the so-called peak-enhancement factor. Finally, the value of A is given by

$$A(\omega) = e^{-\left(\frac{\frac{\omega}{\omega_p} - 1}{\sigma_J \sqrt{2}}\right)^2}, \quad (9)$$

where $\omega_p = 2\pi/T_p$ and

$$\sigma_J = \begin{cases} 0.07 & \text{if } \omega \leq \omega_p, \\ 0.09 & \text{if } \omega > \omega_p. \end{cases} \quad (10)$$

4.3.2. Load frequency response

The computation of the hydrodynamic parameters as described in Section 3.1 facilitates the introduction of new components within hydrodynamic calculations. For instance, the displacement RAO can be modified according to the value of the additional viscous damping. This leads to a corrected value of the velocity RAO, which can be used to calculate the viscous drag actions on the hull by means of the drag coefficients, for each of the waves considered within the BEM software. Finally, it is possible to use the RAO associated with the mooring forces at the fairleads, in order to effectively introduce the effect of the mooring in the overall response.

The acceleration RAO $\ddot{x}(i\omega)$ describes an acceleration for each degree of freedom (DoF), and each wave calculated within the BEM software. However, the external actions mentioned above need to be considered properly in Eq. (1), in order to include them in the device acceleration.

From [55], it is possible to introduce a correction term for the wave pressure, to take into account the intermittent wet and dry external surfaces of the WEC. The wave dynamic pressure can be corrected for the splash zone as

$$p_{dyn,sz} = r_p p_{dyn}, \quad (11)$$

in which p_{dyn} is the dynamic pressure on a given location on the hull surface, r_p is a corrective coefficient, and $p_{dyn,sz}$ is the dynamic pressure corrected for the splash zone.

For conducting such correction, it is important to first determine the vertical extent of the splash zone. This can be done by considering a characteristic value of the dynamic pressure p_{WL} on the hull for the mean sea water level (SWL), which is usually located at $z = 0$ in the

global coordinates of the BEM software, and calculating the vertical extent h_W of the splash zone as

$$h_W = \frac{p_{WL}}{\rho g}, \quad (12)$$

with ρ being the sea water density, and g the gravitational acceleration. The significant value of dynamic pressure at the SWL can be defined as the maximum amplitude of the dynamic pressure for $z = 0$ (for a conservative estimate).

Having calculated the extent of the splash zone, it is possible to define the corrective coefficient r_p as

$$r_p(z) = \begin{cases} 1, & \text{if } z \leq -h_W, \\ 0, & \text{if } z \geq h_W, \\ \frac{h_W - z}{2h_W}, & \text{if } -h_W < z < h_W. \end{cases} \quad (13)$$

Note that, defining H_{draft} as the draft of the vessel, and H_{total} as its height, the conditions $-H_{draft} < -h_W$ and $H_{total} - H_{draft} > h_W$ have to be always verified.

4.3.3. Stress frequency response

After the definition of loads on the hull, it is necessary to quantify the structural stress on the device for each regular wave condition, and for a series of significant points on the structure. This allows the calculation of a stress response function, analogous to the one specified in [54,55,85] for the spectral fatigue analysis. The structural assessment of the device (or portions of it) is usually conducted by means of a FEM model.

Although a complete description of the structural calculation method is not included in this study, a reference to FEM analysis for fatigue in offshore structures is provided in [54,85]. In general, the FEM analysis must be conducted including every effect that impacts on the fatigue life of the device. For the case under analysis, such effects are:

- External pressure on the hull, obtained by interpolation of the pressure values calculated for the hydrodynamic mesh (if structural mesh and hydrodynamic mesh are different).
- Inertial loads, computed within the FEM software by imposing the acceleration \ddot{x} , calculated as suggested in Section 3.1. The inertial loads should be defined for each element in the model, and not as a general force applied on the hull [85].
- Mooring forces, calculated for each BEM wave as specified above. The forces are specified by components on each fairlead.

- Viscous loads, proportional to the velocity of the vessel. Such actions can be transferred to the model as line loads along the bilge or as distributed surface loads parallel to the hull (tangential loads).
- PTO loads, which can be calculated for each regular BEM wave by means of a linearised PTO model.

After having transferred the mentioned effects on the model, it is important to verify that the model is in equilibrium, and no unbalanced loads are present, since this could disturb the global response of the structure. This check should be carried out for different wave headings. Having defined both the input and general conditions for the FEM calculation, it is necessary to determine the stress range in a set of significant locations in the structure, based on the two loading conditions calculated for the single BEM wave. For the details of the FEM calculation procedure, such as the evaluation of welds, or the hot-spot stress evaluation, the reader is referred to [55,96].

The information of the single load cycle for the selected BEM sea state can then be used in combination with the results from other BEM waves, in order to evaluate the corresponding stress frequency response, which is of paramount importance for the application of the spectral analysis performed below. The stress frequency response, as previously mentioned, relates a regular sea state characterised by a frequency ω and a wave direction, with the stress range occurring at a specific location on the structure. The process of evaluating the stress range, therefore, is to be repeated for each BEM wave, for the significant set of points in the structure.

4.3.4. Damage calculation

The procedure proposed within this study requires the calculated wave loads for selected loading conditions in a specific installation site. The stress on the structure can be estimated, for each wave condition, by a spectral analysis. The aim of this section of the procedure is therefore to combine the information of the sea state with the stress frequency response, as described in Section 4.3.3. As stated in [56], a linear modelling of the response is in general sufficient for fatigue assessment purposes, meaning that the assumption of linear behaviour between the sea state and the stress condition on the structure is adequate to represent the fatigue problem, thus being consistent with the definition of the aforementioned stress frequency response.

The response of the structure in terms of stress can be therefore described as a linear combination of the response for each regular component constituting the irregular sea state, by means of the superposition principle. This method implies that the simultaneous occurrence of different load effects is maintained through the calculations, and that any uncertainties are effectively reduced with respect to alternative simplified methods. The possibility of superimposing the effects given by each wave component facilitates the use of a frequency-domain analysis, by which the resulting stress on a given point of the structure is obtained as a combination of all contributing dynamic effects.

Nonetheless, as already discussed in Section 4.3, linear theory requires a series of assumptions that are not necessarily satisfied for large waves, so it is clear that linear theory is not adequate to completely describe the behaviour of the system under severe sea states. On the other hand, most of the fatigue damage occurs for moderate wave conditions, for which linear theory is sufficiently precise.

Having provided justification for the calculations below, the first step of the procedure consists in calculating the stress response of the structure for a given sea state. Therefore, the stress response of the structure can be obtained as

$$S_s(\omega, \beta) = |H_s(\omega, \beta)|^2 S_\eta(\omega, \beta), \quad (14)$$

where $H_s(\omega, \beta) \in \mathbb{C}$ is the stresses frequency response, obtained by means of the Fourier transform of the stresses on the hull [97]. The

spectral moment m of order n of the structural stress response process, for a given wave heading β^* , can be described by [97]

$$m_n = \int_{\mathbb{R}} \omega^n S_s(\omega, \beta^*) d\omega. \quad (15)$$

If the stress response is sufficiently narrow-banded, condition that is usually satisfied with sea states described by JONSWAP spectra, the stress range response for the structure has a short-term distribution that can be described by means of a Rayleigh distribution [79], with a cumulative probability function $F_{\Delta s_{ij}} : \mathbb{R} \mapsto [0, 1]$ given by

$$F_{\Delta s_{ij}}(\Delta s) = 1 - e^{-\frac{\Delta s^2}{8m_{0ij}}}, \quad (16)$$

with m_{0ij} being the zeroth-order spectral moment of the stress response for the sea state i , with heading j , and Δs being the stress range. From the short-term stress distributions of each sea state, and each heading analysed, it is possible to define a long-term stress distribution [79] as

$$F_{\Delta s}(\Delta s) = \sum_{i,j} r_{ij} F_{\Delta s_{ij}}(\Delta s) p_{ij}, \quad (17)$$

where p_{ij} is the probability of occurrence of each sea state i combined with heading j , and $r_{ij} = \frac{v_{ij}}{v_0}$ is the ratio between the crossing rates in a given sea state and the average crossing rate. In turn, $v_{ij} = (m_{2ij}/m_{0ij})^{1/2}/(2\pi)$ is the zero-crossing rate for sea state i and direction j , while $v_0 = \sum_{i,j} p_{ij} v_{ij}$.

The long-term stress response can be then fitted using a Weibull distribution, having a shape parameter ξ , and a scale parameter q . The fitting of the Weibull distribution to the sum of Rayleigh distributions should preferably be based on a least square approach, using a number of stress ranges Δs . Such a Weibull distribution is described as

$$F(\Delta s) = 1 - e^{-\left(\frac{\Delta s}{q}\right)^\xi}. \quad (18)$$

As guidance for the definition of the Weibull distribution parameters, the stress levels corresponding to a cumulative probability of 95% and 99% divide the fatigue damage in three approximately equal part damages, indicating the most important range of the response distribution.

Having obtained the stress responses (both short-term and long-term), it is possible to calculate the fatigue damage of the structure using the Miner rule [98], by which

$$D = \sum_{b=1}^{n_{tot}} \frac{n_b}{N_b} \leq \Gamma, \quad (19)$$

in which D is the accumulated fatigue damage, n_{tot} is the total number of stress blocks, with each block being characterised by a value of Δs_b , repeated for n_b stress cycles, while N_b is the number of cycles to failure at the constant stress range Δs_b . Finally, Γ is the maximum acceptable usage factor, being the inverse of the design fatigue factor. For steel structures, the reader is referred to [40], while for concrete structures, [99] can be used. For the characterisation of other materials, the reader can refer to [100–105].

5. Discussion

The degree of novelty in the wave energy sector introduces limitations in applying existing standards, primarily rooted in the O&G field, to wave energy conversion systems. The nature of WECs necessitates a focus on various aspects primarily due to the resonant behaviour of such devices. Combined with harsh sea state conditions, this gives rise to strong nonlinear actions. Furthermore, though challenging to determine a priori which aspects are significant, it is true that the diverse range of WEC types and the associated severe working conditions highlight the need for a direct design process. This process, linked to a direct evaluation of the system response, relies on high-fidelity modelling tools.

The proposed method for extreme sea state design relies on a partially nonlinear model, specifically a BEM-based model developed in a time-domain framework to incorporate relevant external nonlinearities. While such models can replicate device kinematics in extreme conditions [47,48], the evaluation of the associated dynamics involving fluid–structure interaction requires high-fidelity models. In this context, the use of a CFD model is imperative [106,107], given the resonant nature of wave energy systems combined with extreme conditions that result in significant nonlinear terms, as discussed previously in this section. Although standards acknowledge the use of CFD models (e.g. [25]), their direct application is limited by substantial computational demands. Despite the existence of a few standards for wave energy systems (see Section 2.1), these are generally adaptations from other standards, such as those for ship design. In these cases, adhering to such standards results in a forced fit for the wave energy field, where guidelines specify the definition of a symmetrical pressure pattern with predefined values [22,86]. This approach may yield misleading results, especially when considering unconventional materials for the WEC hull (such as concrete-based materials, among others), where asymmetrical loading conditions could represent worst-case scenarios [81].

Although the use of linear-BEM can significantly reduce computational time, it is not possible to include any external nonlinear actions in the evaluation of the pressure field. Furthermore, linear-BEMs are based on the assumption of mean wetted surface, meaning that no actions are considered above the considered waterline. Moreover, a critical question arises: are external nonlinear forces generally significant? While the hydrodynamic interaction of the hull of a floating body can be reproduced by a linear model, a wave energy system, in general, cannot be characterised by such a model [27,106–108]. Additionally, the external forces related to the mooring system are strongly nonlinear [109], and the associated reaction force can have a significant influence on the overall device dynamics [29,30]. On the other hand, the use of CFD relies on an almost prohibitive computational burden. For example, according to [106], a partially nonlinear BEM can be 10^4 times faster than the numerical solution provided by a CFD model. Nevertheless, the simulation framework proposed in Section 4.1 relies on the use of a reduced number of regular waves that are easily evaluable, even considering the CFD computational time.

In operative conditions, a reduction in significant wave height brings the simulation closer to the range of validity of linear models. Hence, the use of a standards-based simulation framework is suggested. Moreover, for a station-kept unit like a WEC, the inclusion of certain forces, such as the influence of viscous damping [58] or the impact of the mooring system [110], can be crucial in determining the overall dynamics.

6. Conclusions

The insertion of a novel technology in a developed energy market is clearly not trivial. For a new technology, such as wave energy, the comparison with a fully-fledged market risks to be limiting and problematic. Although this problem is mainly related to technology optimisation, which has not yet reached the desired outcome in terms of harvested energy, device design plays an important role in cost assessment and, within the state-of-the-art, it needs to be verified following standards and guidelines developed in general for offshore structures. Wave energy converters are moored and confined in a specific site and, in contrast to ships and other offshore structures, are generally characterised by large motions, especially in harsh sea states, experiencing strong nonlinear effects which need to be considered carefully within mathematical models.

Therefore, to avoid device oversizing and reduce devices cost, this study proposes a design workflow for wave energy converters adapted from standards and current literature. Moreover, the proposed design process encompasses the WEC dimensioning and load assessment,

approaching the problem with high-fidelity models, in order to characterise WEC responses with a proper fidelity. In particular, two different methods are proposed for the design of a WEC in extreme and in operative conditions.

The first method describes the design process which needs to be followed in extreme conditions (ultimate and accidental limit states). In contrast to other offshore structures, and due to the generally large motion characterising WEC systems, conventional software (such as BEM-based software) is not able to represent with a proper fidelity the load assessment of the device. To circumnavigate this issue, a CFD model is proposed for the analysis of the pressure field, adopting the definition of an equivalent regular wave. The equivalent regular waves are computed through a statistical analysis employing a partially-nonlinear model. This approach allows for the evaluation of the system response using a sufficiently complex model, ensuring the performance of long simulations within a relatively short computational time. Given the computational time constraints, the external forces applied to the hull cannot be directly assessed in CFD when considering all environmental conditions. However, with the proposed methodology, a comprehensive assessment for defining the design case can be achieved in a few days.

In operative conditions, WECs responses are more conservative compared to extreme conditions. Therefore, the design process is developed following available standards, which are more “WEC-adaptable”. Furthermore, as discussed within out study, nonlinear loads, such as mooring and PTO forces, can have a significant influence on the overall system dynamics and impact the associated fatigue evaluation; therefore, these effects need to be included within load assessment. As such, the proposed methodology is able to integrate these loads accordingly by proposing a tailored linearisation approach, achieving a model that is able to include the relevant dynamics while keeping the computational time significantly low.

Declaration of competing interest

The authors declare that they have no known competing financial interests or personal relationships that could have appeared to influence the work reported in this paper.

Acknowledgements

Project funded under the National Recovery and Resilience Plan (NRRP), Italy, Mission 4 Component 2 Investment 1.3 - Call for tender No. 1561 of 11.10.2022 of Ministero dell'Università e della Ricerca (MUR); funded by the European Union – NextGenerationEU Award Number: Project code PE0000021, Concession Decree No. 1561 of 11.10.2022 adopted by Ministero dell'Università e della Ricerca (MUR), Italy, CUP, Italy E13C22001890001, Project title “Network 4 Energy Sustainable Transition – NEST”.

Annex. Extreme events definition

Note that, according to the process presented herein, wave and current information can be also evaluated. As suggested by [25], the construction of the EC shall be carried out with a conditional model approach (CMA), where the probability distribution of the energy period T_e is *conditioned* on the significant wave height H_s of the sea state. A 3-parameter Weibull distribution is chosen for H_s , where the Weibull distribution location parameter γ , considers the optimum fit of the distribution on the available data, *i.e.*

$$F_{H_s}(h) = P(H_s \leq h) = 1 - e^{-\left(\frac{h-\gamma}{\lambda}\right)^k}, \quad (20)$$

where $F_{H_s} : \mathbb{R} \mapsto [0, 1]$, $h \mapsto F_{H_s}(h)$, is the cumulative distribution function (CDF), $\{h, k, \lambda\} \subset \mathbb{R}^+$ are the probability evaluation point, shape parameter, and scale parameter, respectively.

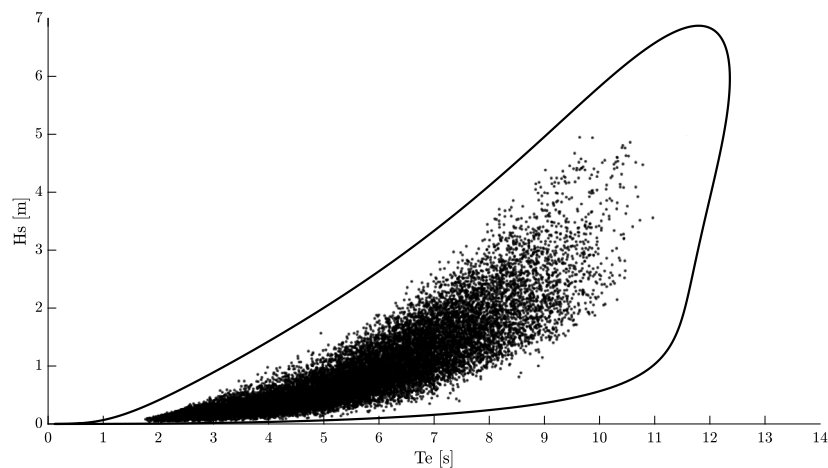

Fig. 8. Alghero environmental contour with 100 YRP.

The wave period, T_e , is described by a lognormal distribution conditioned by H_s [111]

$$F_{T_e|H_s}(t_e) = P(H_s = h|T_e = t_e) = \Phi\left(\frac{\ln t_e - \mu}{\sigma}\right), \quad (21)$$

where $F_{T_e|H_s} : \mathbb{R} \mapsto [0, 1]$, $t_e \mapsto F_{T_e|H_s}(t_e)$, is the conditioned lognormal distribution, $\{\mu, \sigma\} \subset \mathbb{R}^+$ are the mean and standard deviation of the variable natural logarithm, and Φ is the (standard) normal CDF.

The return period $T_r \in \mathbb{R}^+$, defines the radius of circumference in normal Gaussian space and, hence,

$$\beta = -\Phi^{-1}\left(\frac{1}{T_r n}\right), \quad (22)$$

where $\{\beta, n\} \subset \mathbb{R}^+$ represent the radius of the circumference and number of events during one year, respectively. For example, considering a three-hour data samples, $n = 2920$. T_r , therefore, represents the probability of an annual exceedance of the contour. In the present case a return period of 100 years is considered, which is equivalent to an annual exceedance probability of 1×10^{-2} [112].

Thanks to the Rosenblatt transformation [113], it is possible to map the circumference into desired ECs by means of the following equation:

$$H_s = F_{H_s}^{-1}(\Phi(o_1)), \quad T_e = F_{T_e|H_s}^{-1}(\Phi(o_2)), \quad (23)$$

in which $\{o_1, o_2\}$ are the projections of the circumference on the x - and y -axis, respectively. Although the EC is built considering waves, the same procedure (or a even simplified version) can be followed to build current and wind ECs. Note that the computation of the EC (*i.e.* long-term condition) is essential for a proper definition of the environmental events which need to be simulated and analysed (*i.e.* short-term conditions). As example, an EC is computed (Fig. 8) considering the Alghero site (Sardinia, Italy), and the data are obtained from the ERA5 database [114].

References

- [1] M.A. Mustapa, O.B. Yaakob, Yasser M. Ahmed, Chang Kyu Rheem, K.K. Koh, Faizul Amri Adnan, Wave energy device and breakwater integration: A review, *Renew. Sustain. Energy Rev.* 77 (2017) 43–58.
- [2] Joao Cruz, Ocean wave energy: Current status and future perspectives, 2008.
- [3] A. Wahyudie, M.A. Jama, T.B. Susilo, O. Saeed, C.S.A. Nandar, K. Harib, Simple bottom-up hierarchical control strategy for heaving wave energy converters, *Int. J. Electr. Power Energy Syst.* 87 (2017) 211–221.
- [4] Gunnar Mørk, Stephen Barstow, Alina Kabuth, M. Teresa Pontes, Assessing the global wave energy potential, in: *Proceedings of the International Conference on Offshore Mechanics and Arctic Engineering - OMAE*, Vol. 3, 2010, pp. 447–454.
- [5] European Commission, Horizon Europe, Budget : Horizon Europe - the Most Ambitious EU Research and Innovation Programme Ever, Publications Office, 2021.
- [6] T.W. Thorpe, A brief review of wave energy A report produced for the UK department of trade and industry, 1999.
- [7] Arqam Ilyas, Syed A.R. Kashif, Muhammad A. Saqib, Muhammad M. Asad, Wave electrical energy systems: Implementation, challenges and environmental issues, *Renew. Sustain. Energy Rev.* 40 (2014) 260–268.
- [8] EIA, International energy outlook 2021 - U.S. energy information administration (EIA), 2021.
- [9] B. Drew, A.R. Plummer, M.N. Sahinkaya, A review of wave energy converter technology, *J. Power Energy* 223 (2009) 887–902.
- [10] Iraide López, Jon Andreu, Salvador Ceballos, Iñigo Martínez De Alegría, Iñigo Kortabarria, Review of wave energy technologies and the necessary power-equipment, *Renew. Sustain. Energy Rev.* 27 (2013) 413–434.
- [11] Domenico Curto, Vincenzo Franzitta, Andrea Guercio, Sea wave energy. A review of the current technologies and perspectives, *Energies* 14 (2021).
- [12] D. Clemente, P. Rosa-Santos, F. Taveira-Pinto, On the potential synergies and applications of wave energy converters: A review, *Renew. Sustain. Energy Rev.* 135 (2021) 110162.
- [13] Dongsheng Qiao, Rizwan Haider, Jun Yan, Dezhi Ning, Binbin Li, Review of wave energy converter and design of mooring system, *Sustain. (Switzerland)* 12 (2020) 1–31.
- [14] Bingyong Guo, John V. Ringwood, Geometric optimisation of wave energy conversion devices: A survey, *Appl. Energy* 297 (2021) 117100.
- [15] Adrian de Andres, Jérôme Maillat, Jørgen Hals Todalshaug, Patrik Möller, David Bould, Henry Jeffrey, Techno-economic related metrics for a wave energy converters feasibility assessment, *Sustain. (Switzerland)* 8 (2016).
- [16] A. De Andres, E. Medina-Lopez, D. Crooks, O. Roberts, H. Jeffrey, On the reversed LCOE calculation: Design constraints for wave energy commercialization, *Int. J. Mar. Energy* 18 (2017) 88–108.
- [17] Ali Trueworthy, Bryony DuPont, The wave energy converter design process: Methods applied in industry and shortcomings of current practices, *J. Mar. Sci. Eng.* 8 (2020).
- [18] Sergej A Sirigu, Giacomo Vissio, Giovanni Bracco, Ermanno Giorcelli, Biagio Passione, Mattia Raffero, Giuliana Mattiazzo, ISWEC design tool, *Int. J. Mar. Energy* 15 (2016) 201–213.
- [19] Ryan G Coe, Giorgio Bacelli, Sterling Olson, Vincent S Neary, Mathew B R Topper, Initial conceptual demonstration of control co-design for WEC optimization, *J. Ocean Eng. Mar. Energy* 6 (2020) 441–449.
- [20] S.P. Evans, D.R. Bradney, P.D. Clausen, Assessing the IEC simplified fatigue load equations for small wind turbine blades: How simple is too simple? *Renew. Energy* 127 (2018) 24–31.
- [21] M.I. Rakib, S.P. Evans, P.D. Clausen, Measured gust events in the urban environment, a comparison with the IEC standard, *Renew. Energy* 146 (2020) 1134–1142.
- [22] RINA, Rules for the Classification of Pleasure Yachts - Part B, RINA Registro Italiano Navale, 2009.
- [23] DNV, DNV-OS-C502 offshore concrete structures, 2010, October.
- [24] Markel Penalba, Giuseppe Giorgi, John V. Ringwood, A review of non-linear approaches for wave energy converter modelling, in: *Proceedings of the 11th European Wave and Tidal Energy Conference*, Nantes, 2015.
- [25] DNV, DNV-RP-C205: Environmental conditions and environmental loads October 2010 - recommended practice, 2010, pp. 9–123.
- [26] O. Faltinsen, *Sea Loads on Ships and Offshore Structures*, Cambridge University Press, 1993.
- [27] Markel Penalba, Giuseppe Giorgi, John V. Ringwood, Mathematical modelling of wave energy converters: a review of nonlinear approaches, *Renew. Sustain. Energy Rev.* 78 (2017) 1188–1207.

- [28] Mathew B.R. Topper, Guidance for numerical modelling in wave and tidal energy, 2010.
- [29] Bruno Paduano, Edoardo Pasta, Guglielmo Papini, Fabio Carapellese, Giovanni Bracco, Mooring influence on the productivity of a pitching wave energy converter, *Oceans* (2021) 1–6.
- [30] Francesco Niosi, Luca Parrinello, Bruno Paduano, Edoardo Pasta, Fabio Carapellese, Giovanni Bracco, On the influence of mooring in wave energy converters productivity: the PeWEC case, in: 2021 International Conference on Electrical, Computer, Communications and Mechatronics Engineering, ICECCME, 2021, pp. 1–6.
- [31] Josh Davidson, John V. Ringwood, Mathematical modelling of mooring systems for wave energy converters - A review, *Energies* 10 (2017).
- [32] EMEC, Guidelines for Design Basis of Marine Energy Conversion Systems, 2009, p. 56.
- [33] IEC, IEC TS 62600-30, 2019.
- [34] IEC, IEC TS 62600-2, 2019.
- [35] IEC, IEC TS 62600-103, 2019.
- [36] Anne Lene Haukanes, Regulators and legislation for offshore wind in selected countries Norsk Industri AS, 2021.
- [37] Johan Sandström, John Griffiths, Thomas Svensson, Review of standards on reliability for ocean energy and relation to VMEA, 2016.
- [38] DNV, DNV-OSS-312: Certification of tidal and wave energy converters, 2008, p. 26.
- [39] ISO, ISO 19901-7:2013 - Petroleum and natural gas industries — Specific requirements for offshore structures — Part 7: Stationkeeping systems for floating offshore structures and mobile offshore units, 2013.
- [40] DNV, DNV OS C 101 - Design of offshore steel structures, 2018.
- [41] Yong Cheng, Chun yan Ji, Zhi ming Yuan, Atila Incecik, Wave slamming on An OWSC wave energy converter in coupled wave-current conditions with variable-depth seabed, *China Ocean Eng.* 35 (2021) 646–661.
- [42] Li Ma, Chris Swan, An experimental study of wave-in-deck loading and its dependence on the properties of the incident waves, *J. Fluids Struct.* 92 (2020) 102784.
- [43] W.E. Cummins, The impulse response function and ship motions, *Schiffstechnik* 9 (Heft 47) (1962) 101–109.
- [44] Johannes Palm, Claes Eskilsson, G. Moura Paredes, L. Bergdahl, CFD simulation of a moored floating wave energy converter, in: Proceedings of the 10th European Wave and Tidal Energy Conference, Aalborg, 2013.
- [45] DNV, DNV-OS-E301 Position mooring, 2015.
- [46] M. Herrando, A. Coca-Ortegón, I. Guedea, N. Fueyo, Experimental validation of a solar system based on hybrid photovoltaic-thermal collectors and a reversible heat pump for the energy provision in non-residential buildings, *Renew. Sustain. Energy Rev.* 178 (2023) 113233.
- [47] Bruno Paduano, Fabio Carapellese, Edoardo Pasta, Mauro Bonfanti, Sergej Sirigu, Dario Basile, Domenica Pizzirusso, Nicolás Faedo, Giuliana Mattiazzo, Experimental and numerical investigation on the performance of a moored pitching wave energy conversion system, *IEEE J. Oceanic Eng.* (2024).
- [48] F Niosi, E Begovic, C Bertorello, B Rinauro, G Sannino, M Bonfanti, S A Sirigu, Experimental validation of orcaflex-based numerical models for the PEWEC device, *Ocean Eng.* 281 (2023) 114963.
- [49] Technology Drive Canonsburg, Nemoh User Manual, Vol. 3304, 2009, pp. 724–746.
- [50] ANSYS Inc., AQWA Reference Manual, Vol. 15317, 2012, pp. 724–746.
- [51] Orcina, OrcaFlex - Documentation, 10.1b edition, 2020.
- [52] Inc. WAMIT, WAMIT User Manual, 2019.
- [53] DNV, Sesam Software suite for hydrodynamic and structural analysis of renewable, offshore and maritime structures.
- [54] DNV, DNVV-classification note 30.7: "Fatigue assessment of ship structures", 2014.
- [55] DNV, DNVGL-CG-0129: Fatigue assessment of ship structures, 2015, pp. 1–129, October.
- [56] CarbonTrust, Guidelines on design and operation of wave energy converters: A guide to assessment and application of engineering standards and recommended practices for wave energy conversion devices, 2005.
- [57] ITTC, Numerical estimation of roll damping, in: Recommended Procedures, 2011, p. 33.
- [58] Marco Fontana, Pietro Casalone, Sergej Antonello Sirigu, Giuseppe Giorgi, Viscous damping identification for a wave energy converter using CFD-URANS simulations, *J. Mar. Sci. Eng.* 8 (2020) 1–26.
- [59] Josh Davidson, Christian Windt, Giuseppe Giorgi, Romain Genest, John V Ringwood, in: Springer João Nobrega, Hrvóje Jasak (Eds.), Evaluation of Energy Maximising Control Systems for Wave Energy Converters Using OpenFOAM, Springer, Cham, 2019, pp. 157–171.
- [60] N. Faedo, G. Giorgi, J.V. Ringwood, G. Mattiazzo, Optimal control of wave energy systems considering nonlinear Froude–Krylov effects: control-oriented modelling and moment-based control, *Nonlinear Dynam.* 109 (2022) 1777–1804.
- [61] J. Schoukens, Rik Pintelon, Edwin Van Der Ouderaa, Jean Renneboog, Survey of excitation signals for FFT based signal analyzers, *IEEE Trans. Instrum. Meas.* 37 (1988) 342–352.
- [62] Jaan Ojarand, Mart Min, Recent advances in crest factor minimization of multisine, *Elektronika ir Elektrotechnika* 23 (2017).
- [63] Compass, SeaFEM Theory Manual, Compass, 2013.
- [64] Kelley Ruehl, Adam Keester, Nathan Tom, Dominic Forbush, Jeff Grasberger, Salman Husain, David Ogden, Jorge Leon, *Wec-sim v6.0*, 2023, <http://dx.doi.org/10.5281/zenodo.10023797>, <https://doi.org/10.5281/zenodo.10023797>.
- [65] Matthew Hall, MoorDyn user's guide, 2015.
- [66] Oil Companies International Marine Forum, Prediction of Wind and Current Loads on VLCC's, second ed., 1994, pp. 1–56.
- [67] Johannes Palm, Claes Eskilsson, Influence of bending stiffness on snap loads in marine cables: A study using a high-order discontinuous Galerkin method, *J. Mar. Sci. Eng.* 8 (2020) 795.
- [68] Bruno Paduano, Giuseppe Giorgi, Rui P F Gomes, Edoardo Pasta, João C C Henriques, Luís M C Gato, Giuliana Mattiazzo, Experimental validation and comparison of numerical models for the mooring system of a floating wave energy converter, *J. Mar. Sci. Eng.* 8 (2020) 565.
- [69] Siemens, STAR-CCM+ v11.04 User Guide, CD-adapco, 2016.
- [70] OpenFOAM, OpenFOAM the open source CFD toolbox user guide version 3.0.1, 2015.
- [71] ITTC, Practical guidelines for ship CFD applications, in: ITTC – Recommended Procedures and Guidelines ITTC, 2011, pp. 1–8.
- [72] J. Palm, L. Bergdahl, C. Eskilsson, Parametric excitation of moored wave energy converters using viscous and non-viscous CFD simulations, 2018, *Renew.*
- [73] Samir, Perić Milovan, Schreck Eberhard, Seidl Volker Demirdžić Ismet, Muzaferija, Computation of flows with free surfaces, in: Wolfgang, Voß Heinrich, Werther Joachim Keil Frerich, Mackens (Eds.), *Scientific Computing in Chemical Engineering II*, Springer Berlin Heidelberg, Berlin, Heidelberg, 1999, pp. 360–367.
- [74] K M Theresa Kleefsman, Geert Fekken, Arthur E P Veldman, Bogdan Iwanowski, An improved volume-of-fluid method for wave impact problems, 2004, All Days. ISOPE-I-04-070.
- [75] N. Pozzi, M. Bonfanti, G. Mattiazzo, Mathematical modeling and scaling of the friction losses of a mechanical gyroscope, *Int. J. Appl. Mech.* 10 (2018).
- [76] WMO, Guide to Wave Analysis and Forecasting, vol. 1998, 1998, pp. 1–109.
- [77] Barbara Zanuttigh, Luca Martinelli, Mirko Castagnetti, Screening of suitable mooring systems, 2013.
- [78] Jennifer van van Rij, Yi-Hsiang Yu, Yi Guo, Ryan G. Coe, A wave energy converter design load case study, *J. Mar. Sci. Eng.* 7 (2019) 250.
- [79] Isabel Fraga Alves, Cláudia Neves, Extreme Value Distributions, 2011, pp. 493–496.
- [80] Maria Jacob, Cláudia Neves, Danica Vukadinović Greetham, Forecasting and Assessing Risk of Individual Electricity Peaks, 2020, pp. 39–60.
- [81] Costanza Anerdi, Bruno Paduano, Pietro Casalone, Giovanni Bracco, Luca Giordano, Use of concrete as a basic material for a wave energy converter: Load definition and structural feasibility, in: Fib Symposium, 2021, pp. 102–108, Cited by: 0.
- [82] Costanza Anerdi, Bruno Paduano, Pietro Casalone, Giuliana Mattiazzo, Luca Giordano, Design of a reinforced concrete wave energy converter in extreme wave conditions, *Mech. Mach. Sci.* 108 MMS (2022) 70–77.
- [83] Francesco Ferri, Simon Ambühl, Boris Fischer, Jens Peter Kofeod, Balancing power output and structural fatigue of wave energy converters by means of control strategies, *Energies* 7 (2014) 2246–2273.
- [84] Andrew S. Zurkinden, Søren Heide Lambertsen, Lars Damkilde, Zhen Gao, Torgeir Moan, Fatigue analysis of a wave energy converter taking into account different control strategies, in: Proceedings of the International Conference on Offshore Mechanics and Arctic Engineering - OMAE, vol. 8, 2013.
- [85] DNV, DNV-RP-c206 - fatigue methodology of offshore ships, Computer (2007).
- [86] DNV, DNVGL-RU-SHIP Pt.3Ch.3 Structural design principles, 2017.
- [87] DNV, DNVGL-CG-0130 - wave loads, 2018, pp. 1–84.
- [88] DNV, DNV-RP-C203, in: Recommended Practice DNVGL-RP-0005:2014-06, 2005, p. 126.
- [89] ABS, Guide for fatigue assessment of offshore structures, 2020, pp. 1–56, 2003.
- [90] IRLCLASS, Guidelines on spectral fatigue analysis of ship structures, 2020.
- [91] DNV, DNV-OS-J101 design of offshore wind turbine structures, 2014, pp. 212–214, May.
- [92] DNV, DNV-OS-C501 composite components, 2013, p. 250.
- [93] DNV, DNVGL-RU-HSLC Pt3.Ch4 - high speed and light craft, 2017.
- [94] Alexis Merigaud, A harmonic balance framework for the numerical simulation of non-linear wave energy converter models in random seas, 2018.
- [95] J.M.J. Journée, W.W. Massie, *Offshore Hydromechanics*, first ed., Delft University of Technology, 2001.
- [96] DNV, DNVGL-CG-0127 - Finite element analysis, 2015.
- [97] J.B. Roberts, P.D. Spanos, in: J.B. Roberts, P.D. Spanos (Eds.), *Random Vibration and Statistical Linearization*, Courier Corporation, 2003.
- [98] Milton A. Miner, Cumulative damage in fatigue, *J. Appl. Mech.* 12 (2021) A159–A164.
- [99] EN, Eurocode 2: Design of Concrete Structures, Vol. 1, 2011.
- [100] DNV, DNVGL-RU-SHIP Pt.2Ch.3 - rules for classification ships Part 2 materials and welding chapter 2 metallic materials, 2021, p. 198.

- [101] ASTM International, ASTM D6115-97R19 standard test method for mode I fatigue delamination growth onset of unidirectional fiber-reinforced polymer matrix composites, 2019.
- [102] ASTM International, ASTM D3039/D3039M-17 standard test method for tensile properties of polymer matrix composite materials, 2017.
- [103] ASTM International, ASTM D7774-17 standard test method for flexural fatigue properties of plastics, 2018.
- [104] ASTM International, ASTM D6873/D6873M-19 standard practice for bearing fatigue response of polymer matrix composite laminates, 2019.
- [105] ASTM International, ASTM D3479/D3479M-19 standard test method for tension-tension fatigue of polymer matrix composite materials, 2019.
- [106] Benjamin W Schubert, William S P Robertson, Benjamin S Cazzolato, Mergen H Ghayesh, Linear and nonlinear hydrodynamic models for dynamics of a submerged point absorber wave energy converter, *Ocean Eng.* 197 (2020) 1–12.
- [107] Josh Davidson, Ronan Costello, Efficient nonlinear hydrodynamic models for wave energy converter design — A scoping study, 2020, pp. 1–65.
- [108] Rong quan Wang, De zhi Ning, Chong wei Zhang, Qing ping Zou, Zhen Liu, Nonlinear and viscous effects on the hydrodynamic performance of a fixed OWC wave energy converter, *Coast. Eng.* 131 (2018) 42–50.
- [109] Majid A Bhinder, Madjid Karimirad, Sam Weller, Yannick Debruyne, Matthieu Guérinel, Wanan Sheng, Modelling mooring line non-linearities (material and geometric effects) for a wave energy converter using AQWA, SIMA and Orcaflex, in: Proceedings of the 11th European Wave and Tidal Energy Conference, 2015, pp. 1–10.
- [110] Guglielmo Papini, Bruno Paduano, Edoardo Pasta, Fabio Carapellese, Giuliana Mattiazzo, Nicolás Faedo, On the influence of mooring systems in optimal predictive control for wave energy converters, *Renew. Energy* 218 (2023) 119242.
- [111] Edwin L. Crow, Kunio Shimizu, Lognormal distribution - Theory and applications, *Appl. Ecol.* (2018) 303–330.
- [112] T.C. Ude, C.A. Cornell, et al., Environmental Parameters For Extreme Response: Inverse FORM with Omission Factor, Vol. 2, 2001, pp. 142–148.
- [113] Murray Rosenblatt, Remarks on a multivariate transformation, *Ann. Math. Stat.* 23 (1952) 470–472.
- [114] Hans Hersbach, Bill Bell, Paul Berrisford, et al., The ERA5 global reanalysis, *Q. J. R. Meteorol. Soc.* 146 (2020) 1999–2049.