

## Research Article

# 60-GHz Millimeter-Wave Radio: Principle, Technology, and New Results

Nan Guo,<sup>1</sup> Robert C. Qiu,<sup>1,2</sup> Shaomin S. Mo,<sup>3</sup> and Kazuaki Takahashi<sup>4</sup>

<sup>1</sup> Center for Manufacturing Research, Tennessee Technological University (TTU), Cookeville, TN 38505, USA

<sup>2</sup> Department of Electrical and Computer Engineering, Tennessee Technological University (TTU), Cookeville, TN 38505, USA

<sup>3</sup> Panasonic Princeton Laboratory (PPRL), Panasonic R&D Company of America, 2 Research Way, Princeton, NJ 08540, USA

<sup>4</sup> Network Development Center, Matsushita Electric Industrial Co., Ltd., 4-12-4 Higashi-shinagawa, Shinagawa-ku, Tokyo 140-8587, Japan

Received 15 June 2006; Revised 13 September 2006; Accepted 14 September 2006

Recommended by Peter F. M. Smulders

The worldwide opening of a massive amount of unlicensed spectra around 60 GHz has triggered great interest in developing affordable 60-GHz radios. This interest has been catalyzed by recent advance of 60-GHz front-end technologies. This paper briefly reports recent work in the 60-GHz radio. Aspects addressed in this paper include global regulatory and standardization, justification of using the 60-GHz bands, 60-GHz consumer electronics applications, radio system concept, 60-GHz propagation and antennas, and key issues in system design. Some new simulation results are also given. Potentials and problems are explained in detail.

Copyright © 2007 Nan Guo et al. This is an open access article distributed under the Creative Commons Attribution License, which permits unrestricted use, distribution, and reproduction in any medium, provided the original work is properly cited.

## 1. INTRODUCTION

During the past few years, substantial knowledge about the 60-GHz millimeter-wave (MMW) channel has been accumulated and a great deal of work has been done toward developing MMW communication systems for commercial applications [1–16]. In 2001, the Federal Communications Commission (FCC) allocated 7 GHz in the 57–64 GHz band for unlicensed use. The opening of that big chunk of free spectrum, combined with advances in wireless communications technologies, has rekindled interest in this portion of spectrum once perceived for expensive point-to-point (P2P) links. The immediately seen opportunities in this particular region of spectrum include next-generation wireless personal area networks (WPANs). Now a question raises: do we really need to use the 60-GHz band? The answer is yes and in the next section we will explain this in detail. The bands around 60 GHz are worldwide available and the most recent global 60-GHz regulatory results are summarized in Figure 1 and Table 1.

The high frequencies are associated with both advantages and disadvantages. High propagation attenuation at 60 GHz (following the classic Friis formula) actually classifies a set of short-range applications, but it also means dense frequency

reuse patterns. Higher frequencies lead to smaller sizes of RF components including antennas. At MMW frequencies, not only are the antennas very small, but also they can be quite directional (coming with high antenna gain), which is highly desired. The cost concern is mainly related to the transceiver RF front ends. Traditionally, the expensive III–V semiconductors such as gallium arsenide are required for MMW radios [3–5, 12]. In the past few years, alternative semiconductor technologies have been explored [6–10, 13]. According to the reports about recent progress in developing the 60-GHz front-end chip sets [15], IBM engineers have demonstrated the first experimental 60-GHz transmitter and receiver chips using a high-speed alloy of silicon and germanium (SiGe); meanwhile researchers from UCLA, UC Berkeley Wireless Research Center (BWRC), and other universities or institutes are using a widely available and inexpensive complementary metal oxide semiconductor (CMOS) technology to build 60-GHz transceiver components. Each of the two technologies has advantages and disadvantages. But it was claimed by IBM that its SiGe circuit models worked surprisingly well at 60 GHz. It is no doubt that the SiGe versus CMOS debate will continue.

Two organizations that drive the 60-GHz radios are the IEEE standard body [17] and WiMedia alliance, an industrial

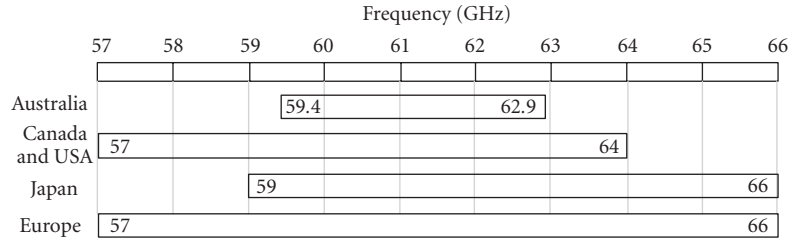

FIGURE 1: Spectra available around 60 GHz.

TABLE 1: Emission power requirements.

Region	Output power	Other considerations
Australia	10 mW into antenna	150 W peak EIRP
Canada and USA	500 mW peak	min. BW = 100 MHz
Japan	10 mW into antenna +50, -70% power change OT and TTR	47 dBi max. ant. Gain
Europe	+57 dBm EIRP	min. BW = 500 MHz

association [18]. The IEEE 802.15.3 Task Group 3c (IEEE 802.15.3c) is developing an MMW-based alternative physical layer (PHY) for the existing 802.15.3 WPAN Standard IEEE-Std-802.15.3-2003. With merging of former multiband OFDM alliance (MBOA), the WiMedia alliance is pushing a 60-GHz WPAN industrial standard, likely based on orthogonal frequency division multiplexing (OFDM) technology. The shooting data rate is 2 Gb/s or higher. Among a large number of proposals, the majority of them can be categorized to either multicarrier (meaning OFDM) or single-carrier types, where the former is expected to support extremely high data rates (say, up to 10 Gb/s; see Section 6.1 for explanation).

The rest of this paper is organized as follows. Section 2 explains why the 60-GHz radio is necessary. Potential applications of the 60-GHz radio are introduced in Section 3. Radio system concept is discussed in Section 4. Section 5 reports recent work on the 60-GHz channel modeling, and identifies an issue of the directional antenna impact on the medium access control (MAC) sublayer. In Section 6, a list of system design issues is discussed, followed by conclusions given in Section 7.

## 2. WHY IS THE 60-GHZ BAND ATTRACTIVE?

The answer is multifold. First of all, data rates or bandwidths are never enough, while the wireless multimedia distribution market is ever growing. Let us take a look at the microwave ultra-wideband (UWB) impulse radio [19–24]. UWB is a revolutionary power-limited technology for its unprecedented system bandwidth in the unlicensed band of 3.1–10.6 GHz allocated by FCC. The low emission and impulsive nature of the UWB radio leads to enhanced security in communications. Through-wall penetration capability makes UWB systems suitable for hostile indoor environments. The UWB impulse radio can be potentially imple-

mented with low-cost and low-power consumption (battery driven) components. UWB is able to deliver high-speed multimedia wirelessly and it is suitable for WPANs. However, one of the most challenging issues for UWB is that international coordination regarding the operating spectrum is difficult to achieve among major countries. In addition, the IEEE standards are not accepted worldwide. This spectral difficulty will deeply shape the landscape of WPANs in the future. Spectrum allocation, however, seems not to be an issue for 60-GHz WPANs. This is one of the reasons for the popularity of 60-GHz MMW.

Inter-system interference is another concern. The UWB band is overlaid over the 2.4- and 5-GHz unlicensed bands used for increasingly deployed WLANs, thus the mutual interferences would be getting worse and worse. This inter-system interference problem exists in Europe and Japan too. In order to protect the existing wireless systems operating in different regions, regulatory bodies in these regions are working on their own requirements for UWB implementation. Worldwide harmonization around 60 GHz is possible, but it is almost impossible for a regional UWB radio to work in another region. Figure 2 shows two spectral masks that set emission power limits in US and Japan. Unlicensed use in Japan is permitted at the 3.4–4.8 GHz and 7.25–10.25 GHz wireless spectra, the latter of which is reserved for indoor products only. Products using the lower 3.4–4.8 GHz spectrum will be required to implement detection and avoidance (DAA) technologies to avoid interference with other services operating at the same frequencies. When spectrum conflict is detected, the UWB signal strength has to be dropped.

Data-rate limitation is also a concern. Currently, the multiband OFDM (MB-OFDM) UWB systems can provide maximum data rate of 480 MB/s. This data rate can only support compressed video. Data rate for uncompressed video for high definition TV, such as high-definition multimedia interface (HDMI), can easily go over 2 Gb/s. Although the

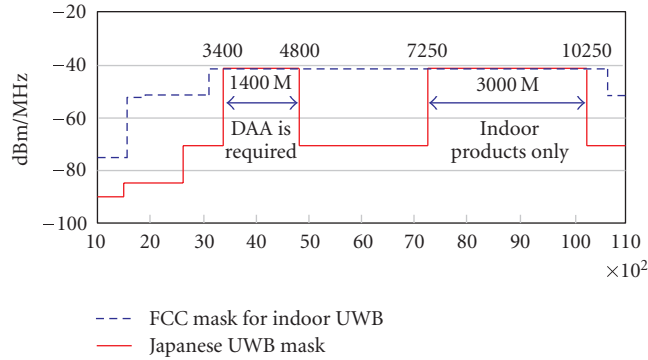

FIGURE 2: Emission power limits in US and Japan.

TABLE 2: Relationship between center frequencies and coverage range.

Band group	Center frequency (MHz)	Range (meter)
1	3,960	10.0
2	5,544	5.10
3	7,128	3.09
4	8,712	2.07
5	10,032	1.56

MB-OFDM UWB can be enhanced to support 2 Gb/s, the complexity, power consumption, and cost will increase accordingly.

Finally, variation of received signal strength over a given spectrum can be a bothering factor. For the MB-OFDM UWB systems, there are 5 band groups covering a frequency range from 3.1 GHz to 10.6 GHz. According to the Friis propagation rule, given the same transmitted power, propagation attenuation is inversely proportional to the square of a group center frequency. If band group 1 can cover 10 meters, coverage range for band group 5 is only 1.56 meters (see Table 2). On the other hand, because of relatively smaller change in frequency, coverage range does not change dynamically for the 60-GHz radio.

Therefore, the 60-GHz band is indeed an underexploited waterfront.

### 3. POTENTIAL CONSUMER ELECTRONICS APPLICATIONS AT 60 GHZ

Similar to the microwave UWB radio, the 60-GHz radio is suitable for high-data-rate and short-distance applications, but it suffers from less chance of inter-system interference than the UWB. People believe that the 60-GHz radio can find numerous applications in residential areas, offices, conference rooms, corridors, and libraries. It is suitable for in-home applications such as audio/video transmission, desktop connection, and support of portable devices. Judging by the interest shown by many leading CE and PC companies, applications can be divided into the following categories:

- (i) high definition video streaming,
- (ii) file transfer,

- (iii) wireless Gigabit Ethernet,
- (iv) wireless docking station and desktop point to multi-point connections,
- (v) wireless backhaul,
- (vi) wireless ad hoc networks.

The first three, that is, high definition video streaming, file transfer, and wireless Gigabit Ethernet, are considered as top applications. In each category, there are different use cases based on (1) whether they are used in residential area or office, (2) distance between the transmitters and receivers, (3) line-of-sight (LOS) or non-line-of-sight (NLOS) connection, (4) position of the transceivers, and (5) mobility of the devices. In [25], 17 use cases have been defined.

High-definition video streaming includes uncompressed video streaming for residential use. Uncompressed HDTV video/audio stream is sent from a DVD player to an HDTV. Typical distance between them is 5 to 10 meters with either LOS or NLOS connection. The high-definition streams can also come out from portable devices such as laptop computer, personal data assistant (PDA), or portable media player (PMP) that are placed somewhere in the same room with an HDTV. In this setting, coverage range might be 3 to 5 meters with either LOS or NLOS connection. NLOS results from that the direct propagation path is temporarily blocked by human bodies or objects. Uncompressed video streaming can also be used for a laptop-to-projector connection in conference room where people can share the same projector and easily connect to the projector without switching cables as in the case of cable connection.

File transfer has more use cases. In offices and residential areas it can happen between a PC and its peripherals including printers, digital cameras, camcorders, and so forth. It may also happen between portable devices such as PDA and PMP. A possible application may be seen in a kiosk in a store that sells audio/video contents. Except for connections between fixed devices, such as a PC and its peripherals, where NLOS may be encountered temporarily, most use cases involving portable devices should be able to have LOS connections because these devices can be moved to adjust aiming.

### 4. SYSTEM CONCEPT OF 60-GHZ RADIO

The system can be described in different ways. The system core is built mainly on physical layer and MAC sublayer. Typical MAC functions include multiple access, radio resource management, rate adaptation, optimization of transmission parameters, and quality of service (QoS), and so forth. When antenna arrays are employed, the MAC needs to support additional functions like probing, link set up, and maintenance.

The physical layer part of a transceiver contains an RF front end and a baseband back end. What should be highlighted in the front end is the multistage signal conversion. Taking an example from IBM's report [16], illustrated in Figure 3 is an MMW receiver front-end architecture with two-stage down conversion, where " $\times 3$ " is a frequency tripler (a type of frequency multiplier) and " $\div 2$ " is a frequency divider with factor 2. The phase lock loop (PLL) with voltage

controlled oscillator (VCO) generates a frequency higher than that of the reference source. The multiplier increases the frequency further. The RF signal is converted from RF to intermediate frequency (IF) and then to baseband. The resulted IF signal after the first down conversion has a lower center frequency thus is easy to handle. The second-stage conversion is quadrature down conversion leading to a pair of baseband outputs. In the transmitter front end, up conversion is achieved in a reversed procedure. Multistage signal conversion is an implementation approach which is associated with insertion loss contributed by multiple mixers. In addition, conversion between baseband and 60 GHz introduces an increased phase noise. If desired frequency at the input of the mixer is  $f$  and the original frequency from the reference source is  $f_0$ , then the final phase noise will be  $20 \log_{10}(f/f_0)$  dB stronger than the original level, without taking into account additional phase noise contributed by circuits. This is why phase noise enlargement could be a problem to the 60-GHz radio.

An antenna array technique called phased array [26–30] has been considered feasible for the 60-GHz radio. The phased array relies on RF phase rotators to achieve beam steering. One benefit of using antenna array is that the requirements for power amplifiers (PAs) can be reduced. According to reports from BWRC, CMOS amplifier gain at 60 GHz is below 12 dB [2], which raises a concern about limited transmitted power. Note that the transmitter-side antenna array automatically achieves spatial power combining [2]. Figure 4 is a transmitter configuration with a phased array and a bank of PAs, where each branch contains a phase rotator, a PA, and an antenna element. If each branch can emit a certain amount of power, an  $M$ -branch transmitter can provide roughly  $20 \log_{10} M$  dB more power at the receiver, compared to the case of a single-antenna transmitter.

To see some quantitative results, a set of simulations have been conducted considering the following setting:

- (i) center frequency: 60 GHz,
- (ii) modulation: OQPSK,
- (iii) symbol duration: 1 nanosecond (bit rate 2 Gb/s),
- (iv) shaping filter: square-root raised cosine (SR-RC) with roll-off factor 0.3,
- (v) PA: Rapp model with gain = 12, smooth factor = 2, and 1 dB compression input power = 7 dBm (assuming 50 ohm input impedance),
- (vi) antenna type: single-directional antenna at both Tx and Rx with 7 dBi gain,
- (vii) channel model: LOS channel with no multipath,
- (viii) transmit power (EIRP): 8.85 dBm,
- (ix) low-noise amplifier gain: 12 dB,
- (x) receiver noise figure: 10 dB,
- (xi) detection method: matched filter.

This setting meets the emission power requirements in all regions. To isolate phase noise issue, it is intentionally to use the one-path channel model and to prevent the signal from being clipped by the PA. The PA's input power is about  $-10.15$  dBm which is far below the assumed 1 dB compression power (7 dBm), implying that the PA's nonlinearity

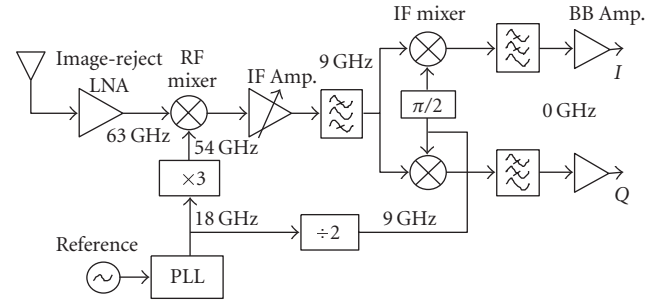

FIGURE 3: A proposed RF front-end architecture [16].

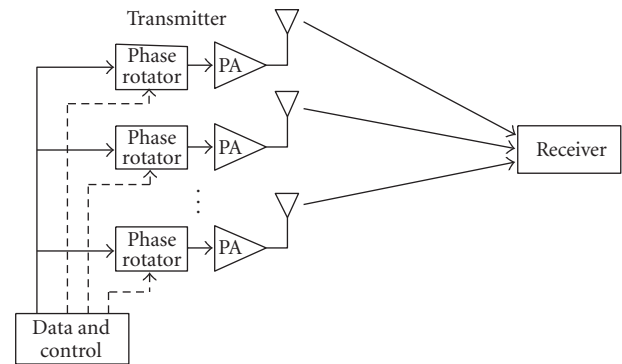

FIGURE 4: BER versus distance for different levels of phase noise.

would be negligible for this specific setting. The impact of phase noise on bit-error rate (BER) can be seen in Figure 5, where the abscissa represents the transmission distance between the transmitter and receiver. Basically, when phase-noise level is above  $-85$  dBc at 1 MHz, it is not able to support a bit rate of 2 Gbps using OQPSK (or QPSK). It can be imaged that higher-order phase modulation or quadrature modulation would be more sensitive to phase noise. These results suggest that phase noise is a big obstacle to increasing data rate or extending distance.

## 5. PROPAGATION AND ANTENNA EFFECT

60-GHz channel characteristics have been well studied in the past. References [31–40] are some of most recent experimental work in uncovering the behavior of the channels. It has been noted that the channels around 60 GHz do not exhibit rich multipath, and the non-line-of-sight (NLOS) components suffer from tremendous attenuation. These channel characteristics are in favor of reducing multipath effect, but makes communications difficult in NLOS environments. With a plenty of measurement contributions, the IEEE 802.15.3c is currently working to set the statistical description of a 60-GHz S-V channel model based upon contributed empirical measurements. Shown in Table 3 is a summary of measured data [40]. Proposed by NICT (Yokosuka, Japan) is an enhanced S-V channel model called TSV model, and in the case of LOS it contains two paths. A set

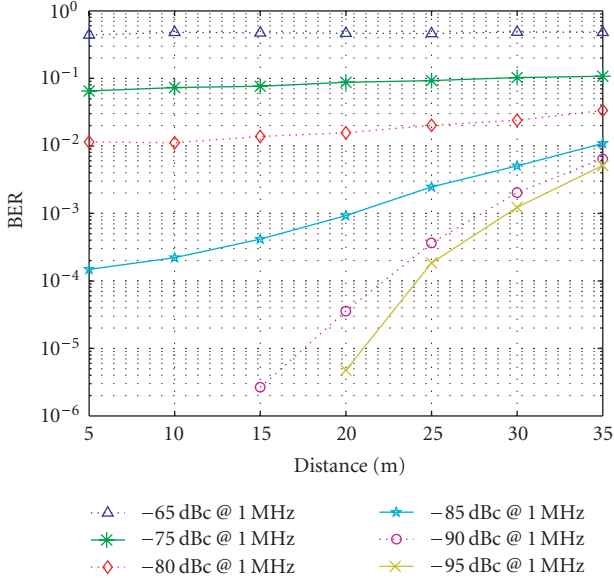

FIGURE 5: BER versus distance for different levels of phase noise.

TABLE 3: Summary of measured data.

Source	Measured environments		AoA
NICTA	Office desktop	(N)LOS <sup>1</sup>	Yes
	Office corridor	(N)LOS <sup>1</sup>	
	Closed office	(N)LOS <sup>1</sup>	
NICT Japan	Empty residential	(N)LOS <sup>1</sup>	Yes
	Open-plan office	NLOS	
University of Massachusetts	Office cubicles	LOS, NLOS	Yes
	Office corridor		
	Closed office		
	Homes		
IMST	Library	LOS, NLOS	Virtual <sup>2</sup>
France Telecom	Cluttered residential	LOS, NLOS	Virtual <sup>2</sup>
	Open-plan office	LOS, NLOS	
	Conference room	LOS, NLOS	
IBM	Library	LOS, NLOS	No
	Office cubicles	LOS, NLOS	
	Cluttered residential	LOS, NLOS	

<sup>1</sup>Inherent NLOS component due to directionality of the antenna.<sup>2</sup>Data measured over linear and grid arrays.

of 10-channel models have been proposed and the mappings between environments and channel models are listed in Table 4 [25].

At 60 GHz, the antennas are in centimeter or sub-centimeter size, and achieving 10 dBi antenna gain is practical, which encourages us to use directional antennas since a high antenna gain (equivalently, narrow antenna pattern or high directivity) is desired to improve the signal-to-noise ratio (SNR) and reduce inter-user interference. However, the 60-GHz radio is sensitive to shadowing due to high attenuation of NLOS propagation, and the directional antennas can

TABLE 4: Mapping of environment to channel model.

Channel model	Scenario	Environment name
CM1	LOS	Office
CM2	NLOS	
CM3	LOS	Desktop
CM4	LOS	Residential
CM5	NLOS	
CM6	LOS	Conference room
CM7	NLOS	
CM8	LOS	Corridor
CM9	LOS	Library
CM10	NLOS	

make it more problematic when the LOS path is blocked and in the scenarios that require mobility without aiming. In order to cover all directions of interest while providing certain antenna gain, two beam steering solutions, antenna switching/selection (simple beam steering method) [41] and phase-array antennas [2, 26–30], have been suggested. To cooperate with beam forming or steering, traditional MAC designed for omni-directional antennas is no longer optimal [42, 43]. One open research topic is cross-layer optimization considering the impact of antenna directivity on the MAC.

## 6. SYSTEM DESIGN ISSUES

This section does not discuss system design systematically, but goes through some issues involved in the system design.

### 6.1. Single carrier versus multicarrier

Here by multicarrier we mean OFDM. OFDM is an effective means to mitigate multipath effect, although it has disadvantages of high peak-to-average power ratio, higher sensitivity to the phase noise [44], and relatively high power consumption at the transmitter. According to some 60-GHz channel measurement reports, the NLOS components suffer from much higher losses than the LOS component. LOS connection appears in many suggested application scenarios. In addition, directional antennas and beam steering are highly recommended for the 60-GHz radio. All these facts suggest that at 60 GHz, mitigation of multipath effect is not the number-one issue, and the single-carrier approach should be comparable to its multicarrier counterpart in terms of spectral efficiency. However, the multicarrier approach indeed has some advantages from implementation point of view: the transceiver can be efficiently implemented using IFFT/FFT, and frequency-domain equalization is rather easy and flexible. At this point, the single-carrier approach is considered for low-end applications. For example, single-carrier transmission with on-off keying (OOK) modulation should have no problem to support data rates up to 2 Gb/s over an LOS link of 2-GHz bandwidth, and it can be chosen to build low-cost wireless devices. Higher data rate can be expected if wider bandwidth or multiband is utilized. If both single

carrier and multicarrier solutions are accepted, compatibility between them is an issue.

### 6.2. Selection of modulation schemes

The following factors need to be considered in selecting modulation scheme: spectral efficiency, linearity of power amplifier (PA), phase-noise level, and scalability, and so forth. Plotted in Figure 6 are spectra of several modulation signals with different pulse shaping, where “SR-RC” stands for “square-root raised cosine,”  $T_S$  is the symbol duration and each symbol contains two bits, and the Gaussian filter for GMSK has a 3-dB bandwidth of  $0.3/T_S$ . Among the modulation schemes considered in Figure 6, only GMSK and OQPSK/QPSK with SR-RC shaping can provide fast spectral roll off. If  $B$  is one-sided bandwidth of modulated signal, the bandwidth efficiency is equal to  $1/(T_S B)$  symbols/s/Hz. Obviously, none of GMSK and OQPSK/QPSK with SR-RC shaping can achieve a 2-bits/s/Hz (or 1-symbol/s/Hz) bandwidth efficiency. Illustrated in Figure 7 is the trajectory of a segment of OQPSK signal with roll-off factor 0.3. It can be seen in Figure 7 that the trajectory is no longer a square (OQPSK with rectangular shaping has a square trajectory). The shaping filter for bandwidth efficiency actually makes the amplitude more fluctuating (a purely constant-envelope modulation scheme, such as MSK, has a circle trajectory). QPSK is convenient to be down scaled to BPSK or up scaled to 8 PSK. Because of relatively high-phase noise at 60 GHz (due to limited Q-value, the achievable phase noise is around  $-85$  dBc/Hz at 1 MHz frequency offset [2]), higher order modulation schemes such as 16 QAM would be too challenging.

Though OOK is not a bandwidth-efficient modulation, it is a very good candidate for low-cost devices since OOK-modulated signal can be noncoherently demodulated using cheap circuit. In addition, OOK does not require linear PA, so that large power back off is not necessary and the PA would be very efficient in terms of power consumption. GMSK is a constant-envelope modulation scheme with fast roll-off property, and it is the best choice for using maximally the PA (assuming single carrier), but its theoretical bandwidth efficiency is around 1.33 bits/s/Hz. Also, at the bit rate of a few Gigabits/s, it is not clear at present whether or not the Viterbi algorithm (for GMSK demodulation) can be implemented at acceptable price.

### 6.3. Other issues

It is desired to reuse IEEE 802.15.3 MAC for the 60-GHz radio. Potential impacts on the MAC come from high-data rate, high-antenna directivity, shadowing, and maybe compatibility between single carrier and multicarrier. Chance of signal blocking is good in indoor LOS-dominated environments, especially when beam forming or steering are employed. In other words, fast acquiring and maintaining a reliable link is critical to the 60-GHz radio. Effectively implementing these functions is very challenging and it needs involvement of both PHY and MAC. Dual-band (microwave and MMW) operation was proposed as a mea-

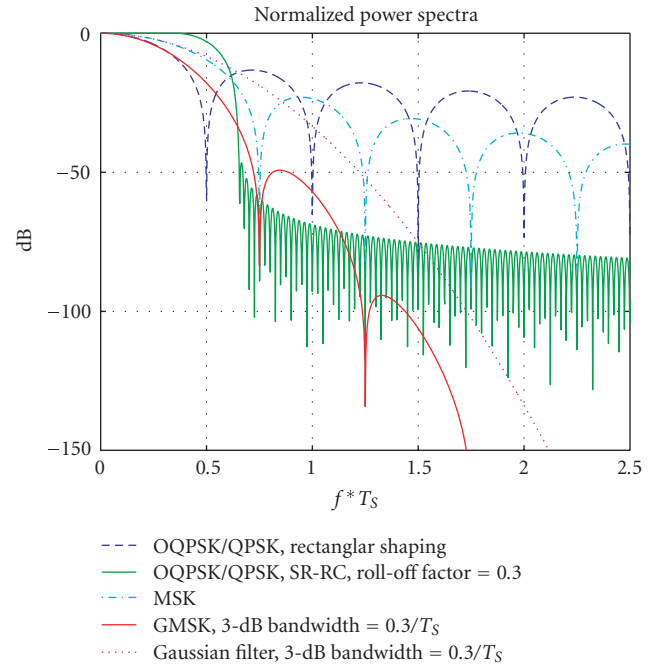

FIGURE 6: Spectra of different modulation schemes.

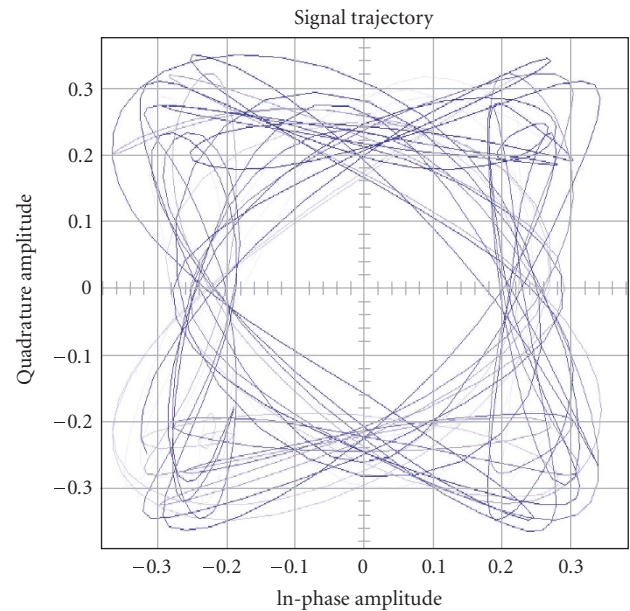

FIGURE 7: Trajectory of OQPSK with square-root raised cosine shaping (roll-off factor = 0.3; based on a simulation of 100 random symbols).

sure against both coverage limitation and severe shadowing [1]. Possible dual-band combinations include WiFi/MMW and UWB/MMW. Obviously, dual-band operation would increase complexity at both PHY and MAC, implying a higher-cost solution. When pulse-based low-duty-cycle signaling is employed, some uncoordinated multiple-access methods can be more efficient than CSMA/CA. Such multiple-access

methods include rate-division multiple access (RDMA) [45] and delay-capture-based multiple access [46–48]. All of these pose challenges for optimal design of MAC.

## 7. CONCLUSIONS

The 60-GHz radio has been discussed in different aspects. Positive moves can be seen in standardization and front-end development. Though potential is clear, there are many problems. Technically, success of the 60-GHz radio will largely depend on the advance of 60-GHz front-end technology. The SiGe versus CMOS debate will continue and it is not clear when we will see high-speed front ends with acceptable price. There are many questions to answer in designing PHY and MAC. Here are some examples: single carrier or multicarrier, or both? what kind of modulation? how to optimally control antennas from MAC? Breakthroughs in beam forming or steering and low-phase-noise local oscillator (LO) are expected. It will be very likely that the future market of the 60-GHz radio will be a mixture of varieties covering a full range of applications from low end to high end.

## ACKNOWLEDGMENT

This work was supported in part by Panasonic R&D Company of America, Panasonic Princeton Laboratory (PPRL).

## REFERENCES

- [1] P. Smulders, "Exploiting the 60 GHz band for local wireless multimedia access: prospects and future directions," *IEEE Communications Magazine*, vol. 40, no. 1, pp. 140–147, 2002.
- [2] C. H. Doan, S. Emami, D. A. Sobel, A. M. Niknejad, and R. W. Brodersen, "Design considerations for 60 GHz CMOS radios," *IEEE Communications Magazine*, vol. 42, no. 12, pp. 132–140, 2004.
- [3] H. Daembkes, B. Adelseck, L. P. Schmidt, and J. Schroth, "GaAs MMIC based components and frontends for millimeterwave communication and sensor systems," in *Proceedings of IEEE Microwave Systems Conference (NTC '95)*, pp. 83–86, Orlando, Fla, USA, May 1995.
- [4] R. L. Van Tuyl, "Unlicensed millimeter wave communications a new opportunity for MMIC technology at 60 GHz," in *Proceedings of the 18th Annual IEEE Gallium Arsenide Integrated Circuit Symposium*, pp. 3–5, Orlando, Fla, USA, November 1996.
- [5] M. Siddiqui, M. Quijije, A. Lawrence, et al., "GaAs components for 60 GHz wireless communication applications," in *Proceedings of GaAs Mantech Conference*, San Diego, Calif, USA, April 2002.
- [6] S. Reynolds, B. Floyd, U. Pfeiffer, and T. Zwick, "60 GHz transceiver circuits in SiGe bipolar technology," in *IEEE International Solid-State Circuits Conference. Digest of Technical Papers (ISSCC '04)*, vol. 1, pp. 442–538, San Francisco, Calif, USA, February 2004.
- [7] C. H. Doan, S. Emami, A. M. Niknejad, and R. W. Brodersen, "Design of CMOS for 60 GHz applications," in *IEEE International Solid-State Circuits Conference. Digest of Technical Papers (ISSCC '04)*, vol. 1, pp. 440–538, San Francisco, Calif, USA, February 2004.
- [8] W. Winkler, J. Borngräber, H. Gustat, and F. Korndörfer, "60 GHz transceiver circuits in SiGe:C BiCMOS technology," in *Proceedings of the 30th European Solid-State Circuits Conference (ESSCIRC '04)*, pp. 83–86, Leuven, Belgium, September 2004.
- [9] S. K. Reynolds, "A 60-GHz superheterodyne downconversion mixer in Silicon-Germanium bipolar technology," *IEEE Journal of Solid-State Circuits*, vol. 39, no. 11, pp. 2065–2068, 2004.
- [10] B. A. Floyd, S. K. Reynolds, U. R. Pfeiffer, T. Zwick, T. Beukema, and B. Gaucher, "SiGe bipolar transceiver circuits operating at 60 GHz," *IEEE Journal of Solid-State Circuits*, vol. 40, no. 1, pp. 156–167, 2005.
- [11] N. Deparis, A. Bendjabballah, A. Boe, et al., "Transposition of a baseband UWB signal at 60 GHz for high data rate indoor WLAN," *IEEE Microwave and Wireless Components Letters*, vol. 15, no. 10, pp. 609–611, 2005.
- [12] S. E. Gunnarsson, C. Kärnfelt, H. Zirath, et al., "Highly integrated 60 GHz transmitter and receiver MMICs in a GaAs pHEMT technology," *IEEE Journal of Solid-State Circuits*, vol. 40, no. 11, pp. 2174–2185, 2005.
- [13] S. Pinel, C.-H. Lee, S. Sarkar, et al., "Low cost 60 GHz Gb/s radio development," in *Progress in Electromagnetics Research Symposium*, pp. 483–484, Cambridge, Mass, USA, March 2006.
- [14] S. Sarkar, P. Sen, S. Pinel, C. H. Lee, and J. Laskar, "Si-based 60GHz 2X subharmonic mixer for multi-Gigabit wireless personal area network application," in *Proceedings of IEEE MTT-S International Microwave Symposium*, San Francisco, Calif, USA, June 2006.
- [15] S. K. Moore, "Cheap chips for next wireless frontier," *IEEE Spectrum*, vol. 43, pp. 12–13, 2006.
- [16] B. Gaucher, "Completely integrated 60 GHz ISM band front end chip set and test results," IEEE 802.15 TG3c document: 15-06-0003-00-003c, January 2006.
- [17] IEEE 802.15 Working Group for WPAN, <http://www.ieee802.org/15/>.
- [18] WiMedia alliance, <http://www.wimedia.org/>.
- [19] R. Scholtz, "Multiple access with time-hopping impulse modulation," in *Proceedings of IEEE Military Communications Conference (MILCOM '93)*, vol. 2, pp. 447–450, Boston, Mass, USA, October 1993.
- [20] M. Z. Win and R. A. Scholtz, "Ultra-wide bandwidth time-hopping spread-spectrum impulse radio for wireless multiple-access communications," *IEEE Transactions on Communications*, vol. 48, no. 4, pp. 679–689, 2000.
- [21] R. C. Qiu, H. Liu, and X. Shen, "Ultra-wideband for multiple access communications," *IEEE Communications Magazine*, vol. 43, no. 2, pp. 80–87, 2005.
- [22] R. C. Qiu, R. A. Scholtz, and X. Shen, "Guest editorial special section on ultra-wideband wireless communications—a new horizon," *IEEE Transactions on Vehicular Technology*, vol. 54, no. 5, pp. 1525–1527, 2005.
- [23] X. Shen, M. Guizani, H.-H. Chen, R. C. Qiu, A. F. Molisch, and L. B. Milstein, "Guest editorial ultra-wideband wireless communications—theory and applications," *IEEE Journal on Selected Areas in Communications*, vol. 24, no. 4, pp. 713–716, 2006, editorial on special issue on UWB.
- [24] R. C. Qiu, X. Shen, M. Guizani, and T. Le-Ngoc, "Introduction," in *UWB Wireless Communications*, X. Shen, M. Guizani, R. C. Qiu, and T. Le-Ngoc, Eds., John Wiley & Sons, New York, NY, USA, 2006.
- [25] A. Sadri, "802.15.3c Usage Model Document (UMD), Draft," IEEE 802.15 TG3c document: 15-06-0055-14-003c, January 2006.

- [26] J. Park, Y. Wang, and T. Itoh, "A 60 GHz integrated antenna array for high-speed digital beamforming applications," <http://www.mwlab.ee.ucla.edu/>.
- [27] A. Hajimiri, A. Komijani, A. Natarajan, R. Chunara, X. Guan, and H. Hashemi, "Phased array systems in silicon," *IEEE Communications Magazine*, vol. 42, no. 8, pp. 122–130, 2004.
- [28] X. Guan, H. Hashemi, and A. Hajimiri, "A fully integrated 24-GHz eight-element phased-array receiver in silicon," *IEEE Journal of Solid-State Circuits*, vol. 39, no. 12, pp. 2311–2320, 2004.
- [29] H. Hashemi, X. Guan, A. Komijani, and A. Hajimiri, "A 24-GHz SiGe phased-array receiver - LO phase-shifting approach," *IEEE Transactions on Microwave Theory and Techniques*, vol. 53, no. 2, pp. 614–626, 2005.
- [30] A. Natarajan, A. Komijani, and A. Hajimiri, "A fully integrated 24-GHz phased-array transmitter in CMOS," *IEEE Journal of Solid-State Circuits*, vol. 40, no. 12, pp. 2502–2514, 2005.
- [31] M. R. Williamson, G. E. Athanasiadou, and A. R. Nix, "Investigating the effects of antenna directivity on wireless indoor communication at 60 GHz," in *Proceedings of the 8th IEEE International Symposium on Personal, Indoor and Mobile Radio Communications (PIMRC '97)*, vol. 2, pp. 635–639, Helsinki, Finland, September 1997.
- [32] D. Dardari and V. Tralli, "High-speed indoor wireless communications at 60 GHz with coded OFDM," *IEEE Transactions on Communications*, vol. 47, no. 11, pp. 1709–1721, 1999.
- [33] H. Xu, V. Kukshya, and T. S. Rappaport, "Spatial and temporal characteristics of 60-GHz indoor channels," *IEEE Journal on Selected Areas in Communications*, vol. 20, no. 3, pp. 620–630, 2002.
- [34] A. G. Siamarou, "Broadband wireless local-area networks at millimeter waves around 60 GHz," *IEEE Antennas and Propagation Magazine*, vol. 45, no. 1, pp. 177–181, 2003.
- [35] C. R. Anderson and T. S. Rappaport, "In-building wideband partition loss measurements at 2.5 and 60 GHz," *IEEE Transactions on Wireless Communications*, vol. 3, no. 3, pp. 922–928, 2004.
- [36] F. Aryanfar and K. Sarabandi, "A millimeter-wave scaled measurement system for wireless channel characterization," *IEEE Transactions on Microwave Theory and Techniques*, vol. 52, no. 6, pp. 1663–1670, 2004.
- [37] S. Collonge, G. Zaharia, and G. El Zein, "Influence of the human activity on wide-band characteristics of the 60 GHz indoor radio channel," *IEEE Transactions on Wireless Communications*, vol. 3, no. 6, pp. 2396–2406, 2004.
- [38] N. Moraitis and P. Constantinou, "Indoor channel measurements and characterization at 60 GHz for wireless local area network applications," *IEEE Transactions on Antennas and Propagation*, vol. 52, no. 12, pp. 3180–3189, 2004.
- [39] T. Zwick, T. J. Beukema, and H. Nam, "Wideband channel sounder with measurements and model for the 60 GHz indoor radio channel," *IEEE Transactions on Vehicular Technology*, vol. 54, no. 4, pp. 1266–1277, 2005.
- [40] A. Mathew, "Channel model status report," IEEE 802.15 TG3c document: IEEE 802.15-06/0037r2, May 2006.
- [41] P. F. M. Smulders, M. H. A. J. Herben, and J. George, "Application of five-sector beam antenna for 60 GHz wireless LAN," <http://www.brabantbreedband.nl/>.
- [42] R. Ramanathan, J. Redi, C. Santivanez, D. Wiggins, and S. Polit, "Ad hoc networking with directional antennas: a complete system solution," *IEEE Journal on Selected Areas in Communications*, vol. 23, no. 3, pp. 496–506, 2005.
- [43] F. Dai and J. Wu, "Efficient broadcasting in ad hoc wireless networks using directional antennas," *IEEE Transactions on Parallel and Distributed Systems*, vol. 17, no. 4, pp. 335–347, 2006.
- [44] T. Pollet, M. Van Bladel, and M. Moeneclaey, "BER sensitivity of OFDM systems to carrier frequency offset and Wiener phase noise," *IEEE Transactions on Communications*, vol. 43, no. 234, pp. 191–193, 1995.
- [45] M. Weisenhorn and W. Hirt, "Uncoordinated rate-division multiple-access scheme for pulsed UWB signals," *IEEE Transactions on Vehicular Technology*, vol. 54, no. 5, pp. 1646–1662, 2005.
- [46] D. H. Davis and S. A. Gronemeyer, "Performance of slotted ALOHA random access with delay capture and randomized time of arrival," *IEEE Transactions on Communications Systems*, vol. 28, no. 5, pp. 703–710, 1980.
- [47] K. Cheun, "Optimum arrival-time distribution for delay capture in spread-spectrum packet radio networks," *IEEE Transactions on Vehicular Technology*, vol. 46, no. 4, pp. 981–991, 1997.
- [48] N. Guo, R. C. Qiu, and B. M. Sadler, "A UWB radio network using multiple delay capture enabled by time reversal," in *Proceedings of Military Communications Conference (MILCOM '06)*, Washington, DC, USA, October 2006.