

GEOHERMAL DISTRICT ENERGY SYSTEM ANALYSIS, DESIGN, AND DEVELOPMENT

by R. Gordon Bloomquist, Ph.D.

1. INTRODUCTION

District energy (DE) may be defined as the heating and/or cooling of two or more structures from a central heat source (Fig. 1). Heat may be provided in the form of either steam or hot water and may be utilized to meet process, space, or hot water requirements. Chilled water or an ice slurry may be distributed to meet the needs for space cooling. The thermal energy is distributed through a network of insulated pipes consisting of delivery and return mains. Heat can be provided through the use of conventional boilers that burn conventional fuels such as oil, natural gas, or coal, or from cogeneration plants that produce both electricity and heat. Cooling can be provided through the use of absorption chillers or centrifugal chillers driven by electricity, steam, or a binary turbine. District energy systems may also utilize renewable resources such as geothermal, biomass, or waste heat resources such as industrial waste heat. Fossil fuel peaking or back-up is often an integral part of district heating systems and thermal storage in the form of chilled water. Brine or ice is often incorporated into the design and generation of most modern district cooling systems.

The delivery of thermal energy from a central source is not a new idea. During Roman times, warm water was circulated through open trenches to provide heating for buildings and baths in Pompeii. In the ruins are the remains of the old heating plants, for example, the one used in conjunction with the so called Thermer (bath). In many places it is still possible to see how the heated water was circulated from home to home through a network of trenches that went through the cellars of the buildings. Hundreds of years later, but several hundred years before our time, in Chaudes Aigues Cantal in France, geothermal water was distributed as early as the 14th Century through wooden pipes. That system is still used today. The French were already at that time utilizing a large main with laterals to provide heat to individual houses.

In 1748, Benjamin Franklin built a fire proof flue system beneath the floor of two row houses in Philadelphia, Pennsylvania, so that they could be provided with heat from a central furnace.

In 1877, Birdsill Holly established the first commercial district heating system in the U.S. in Lockport, New York. He used a boiler in his cellar as the central heat source and built a loop consisting of steam pipes, radiators, and condensate return lines. The system began with 14 customers and by 1880 the system served several factories as well as residential customers and had extended to a three-mile loop.

The New York Steam Company increased summer steam loads by introducing absorption cooling as early as 1885. The Manhattan Refrigerating Company to this day continues to operate a brine system dating back to 1890.

In 1893, the Municipal Council Building in Hamburg, Germany, was receiving heat from a central power station and in 1900, in order to minimize risk of fire damage to valuable art treasures, government buildings in Dresden, Germany, were linked to a central heating system (Swedish District Heating Association, 1986).

In the United States, Seattle, Washington; and Baltimore, Maryland, district energy companies offered cooling service in the last century before entering the district heating business (Pierce, 1995). Thermal energy for many of these systems was provided by the electrical generating plants that were being established throughout the country. Heat was in the form of exhaust steam from these facilities.

The same was true in Europe and Scandinavia. In Denmark, the first district heating system was established in Frederiksberg (a suburb of Copenhagen) in 1891. The heat was provided by the "Hortensiavaerket" electrical generating plant and supplied a hospital and several municipal government buildings.

Throughout the first half of this century, district energy prospered in the U.S. and, to a lesser extent, in Scandinavia and Europe.

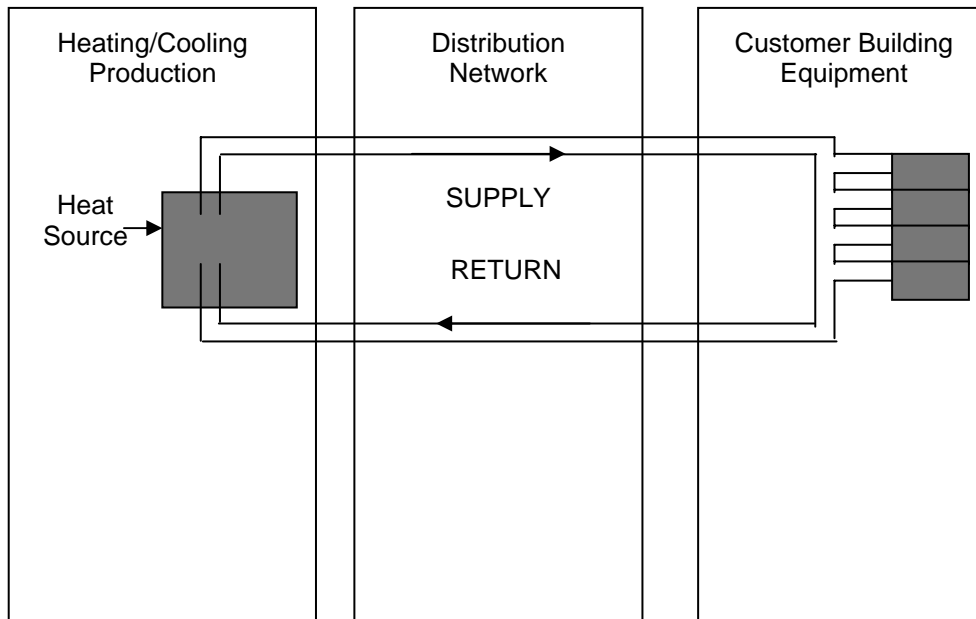

Figure 1: Simplified District Energy System

In the United States, the first geothermal district heating system was built in Boise, Idaho, in 1892. This system, known originally as the Artesian Hot and Cold Water Company and later as the Boise Warm Springs Water District, still serves the Warm Springs district of the city of Boise, Idaho, and has served as the catalyst for the development of the Boise, Idaho, capitol campus system and a municipally-owned system serving the downtown business district (Rafferty 1992a). Throughout the western United States, numerous geothermal district heating systems were developed through the 1980s, and growth of many of these systems continues today. Of these, the systems in Elko, Nevada; San Bernardino, California; Klamath Falls, Oregon; and Boise, Idaho, are probably best known. Many of the systems built in the 1980s were a direct result of the oil crises of the 1970s, and the availability of extensive government programs that supported geothermal exploration, reservoir confirmation studies, and technical and economic feasibility studies. These programs included: U.S. Department of Energy Technical Assistance Grant Program, the Program Research and Development Announcement (PRDA), Program Opportunity Notice (PON), and the Industry-Coupled Program (Bloomquist, 1986). In addition, a number of federal and state programs were in place throughout the late 1970s and early 1980s that also played a role in facilitating the success of geothermal district energy programs (Bloomquist, 1986).

Development of geothermal district energy systems in Europe has been even more dramatic than in the U.S. with major developments taking place in Iceland and France, and with less aggressive development of geothermal district energy systems in such countries as Sweden, Poland, Hungary, Romania, Italy, and Turkey. The Reykjavik, Iceland, geothermal district energy system was begun in 1930, and now supplies over more than 97 percent of space heating requirements of Iceland's capital city (Gunnlaugsson, 1999). In fact, geothermal district energy systems now supply well over 50 percent of Iceland's requirements for space heating. In France, developments of geothermal district energy systems has occurred throughout the Paris Basin over the past 30 years, and the system provides more than 70,000 MWh in L'Almout and Montaign, for example. In the southern Swedish city of Lund, low-temperature geothermal fluids (26°C), used in conjunction with large (20-30 MWt) heat pumps, contribute significant amounts of heat to the city's district energy network. In Poland, a new and extremely modern geothermal district energy system now serves the resort community of Zakopane, significantly improving the air quality of this picturesque mountain community. In Italy, the geothermal district energy system in Ferrara supplies 2.7 million m³ of heated space (Carella, 1999). And in Turkey, systems in Izmir-Balcova and Afyon City are expected to lead the way to the development of as many as 100 geothermal district energy systems throughout the country, some of which may be based on the concept of

combined cooling/heat and power, an evermore attractive use of moderate-temperature geothermal resources (100° - 150°C) (Mertoglu, 1999).

With an ever increasing international demand for energy and with increasing concern for the environment from burning of fossil fuels to meet that demand, geothermal district energy systems can and should play a major role in providing a clean, reliable, and cost-effective supply of thermal energy.

Realizing that development potential, however, requires a well-defined and organized effort that brings together the experience of geothermists, engineers, financiers, marketers, contract specialists, and construction personnel. It also requires close coordination between private and public entities, a will to facilitate and accept change and a commitment to the use of renewable resources and to environmental improvement. And it needs a visionary and a champion who is willing and able to take charge, mediate differences, and hold the course throughout what can be a multi-year development effort.

The renewed interest in district heating internationally has, however, been no guarantee that district heating will become a dominant force in meeting future energy needs. Technical as well as financial, institutional, and regulatory barriers must be addressed if we are to take full advantage of geothermal district energy systems to provide a safe and environmentally-attractive alternative to more conventional fuels and methods of supplying heating and cooling.

2. DISTRICT ENERGY BENEFITS

In order for district energy (DE) to become a serious alternative to existing or future individual heating and/or cooling systems, it must provide significant benefits to both the community in which it is operated and the consumer who purchases energy from the system. In addition, it must provide major societal benefits if federal, state, or local governments are to offer the financial and/or institutional support that is required for successful development.

2.1 Benefits to Society

If it is to endorse district energy, society must be convinced that district energy will provide an overall net socio-economic benefit in comparison to other thermal supply options. Such a determination must be based on a thorough evaluation of many factors including environmental, economic, and employment impacts.

District energy fuel flexibility, coupled with the availability to incorporate indigenous sources of renewable resources such as geothermal, represents an important motivation for district energy development. This ability to use indigenous resources translates directly into a reduction, a reliance on foreign imports and related strategic vulnerability, and an improvement trade imbalance.

District energy can have major impacts on the environment by significantly reducing overall air emissions. Since the need for individual heating and/or cooling systems will be substantially reduced by providing thermal energy from a central source that can more easily control emissions, the emission of sulfur dioxide, nitrous oxide, and dust particulates, will be substantially reduced. For example, if the district energy system relies upon a fossil fuel cogeneration plant for heat, the overall energy efficiency of the plant can increase from approximately 35 to 80 percent, thus emissions per unit of energy produced will be decreased by 50 to 60 percent. If the district energy system can utilize renewable energy such as geothermal or waste heat, emission levels can be even further decreased. In a similar manner, a district cooling system can take full advantage of non-CFC/CHFC technologies such as absorption cooling, ammonia-based refrigerant systems, and thermal storage; technologies that are seldom possible at the individual building level.

Economic impacts of district energy can range from economic revitalization projects to a major incentive for industrial growth.

District energy can often be either a catalyst for, or an adjunct to, urban or neighborhood renewal projects as a central part of a coordinated infrastructure and financial assistance package. It can also provide economic incentives to existing or new industries that are able to increase revenues by selling thermal energy to the district system and at the same time reduce the cost associated with waste heat disposal.

In a less direct but economically as attractive manner, district energy systems result in hundreds of thousands or even millions of dollars of investment in local economics and generate substantial tax revenue.

Employment benefits from district energy include not only temporary and permanent jobs created from system construction and operation and from retrofitting building systems to be compatible with the district energy system, but also from industrial growth.

On a broader scale, employment opportunities will also be created in the industries that supply equipment used to construct district energy systems.

2.2 Community Benefits

A modern district energy system is a useful selling point in retaining and attracting business to a community. District energy can become a catalyst for urban revitalization by providing a reliable, economically-competitive energy source. Systems often allow for the use of energy resources indigenous to the community that cannot be used for other purposes, while at the same time providing increased protection from regional or even international energy market fluctuations and ultimately providing for greater economic stability.

Additional benefits may include: a cleaner environment that makes the community a more desirable place to live, and increased employment opportunities that ultimately result in improving the local tax base.

A community-operated district energy system may also become a significant source of income for the community.

2.3 Customer Benefits

Local residents, businesses, and industrial customers may receive the greatest benefit from a modern district energy system. Not only do they reap the benefits of all other members of the community, as discussed above, but also the direct benefit of a stable, economically attractive energy supply. Some industries may not only benefit from the reduced energy cost, but may also find a new source of revenue by selling waste energy to the district energy system, and at the same time, reduce operating costs associated with waste heat disposal.

Many customers will, however, receive additional benefits from being connected to a district energy system. These may include: 1) reduced operation costs since a subscriber installation is, in most cases, practically maintenance free; 2) safety of operation due to reduced fire hazards as a result of eliminating the need for fuel delivery or fuel storage on the premises; 3) potentially lower insurance rates due to the reduced fire hazard; 4) elimination of CFC or HCFC on-site chillers; 5) more space for other purposes because internal floor space previously devoted to heating and/or cooling equipment will no longer be required and can be rededicated to revenue producing uses; and 6) increased reliability because district energy systems usually consist of several production units and can, thus, provide substantial backup capability.

3. COMMUNITY PLANNING

A district energy system, as with any major element of the infrastructure of an urban area, cannot be thought of as an independent project whose feasibility is solely dependent upon technical and economical parameters. To be successful, district energy must become an integral determinant in the community planning, design, and development process. For example, by expanding a community's comprehensive plan to include thermal planning, a community can create a land-use framework that is more energy-efficient and at the same time more conducive to district energy development and growth.

Although past abundances of inexpensive energy historically allowed many communities to develop with little or no regard for energy efficiency or energy planning, during the 1970s two major oil crises caused a refocusing of attention on achieving an improved balance between energy supplies and demands. Such an improvement can be realized through more efficient land use patterns that require lower amounts of energy input for such functions as space heating and cooling, transportation, and more efficient infrastructure design that facilitates the utilization of alternative energy resources such as renewables and waste heat, and alternative energy technologies such as district energy.

Depending on climate, a majority of a community's energy needs are often required for heating and/or cooling purposes, including space heating and cooling, domestic water heating, and

industrial process heat and refrigeration. Thus, significant improvements in a community's future energy efficiency will depend, in large part, on orderly and timely plans for managing thermal supplies and demands in such a way that the total energy input will be reduced. This can be achieved in several ways including: energy conservation, higher efficiency of fuel utilization as can be achieved through combined heat and power, and the utilization of renewables or industrial waste heat. In addition, a community's dependence on nonindigenous fuel supplies can be greatly reduced through the use of renewable energy resources such as geothermal.

In Europe and Scandinavia, heat supply planning is not only considered to be a good idea, but also a national priority--often, in fact, mandated by law. In Sweden, a National Energy Policy was adopted in 1975, and in 1977, local governments were given the responsibility for energy planning. A typical local energy plan must contain: 1) a conservation component, 2) a supply component, 3) an analysis of the interaction between energy planning and physical planning, and 4) a specific plan of action.

In Denmark, the Parliament passed the Heat Supply Act in 1979. The purpose of the Heat Supply Act was to reduce the dependence on oil and to secure an economic use of energy for heating purposes. The aims of the act were to be achieved primarily through an extensive conversion from individual to public heat supply wherever it was found to be economically advantageous. To achieve these aims, the Danish government can, in fact, require local authorities to initiate the necessary planning and carry through specific projects. The local authorities can, in turn, require consumers to join the public supply system (Enggaard, 1983). Consumers are, however, involved in the heat planning process. Public hearings are mandatory, both in the planning stage and in the subsequent implementation phases. The Danish national energy plan, adopted in 1982 in response to Parliamentary action, resulted in an over 80 percent reduction in the use of oil for space heating, a tremendous increase in the development of combined heat and power, and a significant increase in district energy. In 1997, the plan was 2 percent ahead of the goals set in 1982 despite several changes in political leadership (Mortensen, 1997). In order to ensure that the heat planning effort takes place in as coordinated a fashion as possible, close cooperation among local, regional, and central authorities is imperative. The central Danish government, therefore, is responsible for setting general guidelines for heat planning and for ensuring that the actual planning is in accordance with those guidelines. The task of the local authority is to map local heat supply conditions, work out proposals for future heat supply, and to consult with consumers, supply companies, and regional authorities about the plan.

Thus, as has been demonstrated in Scandinavia, in order to best manage community energy supplies and requirements, a thermal heat plan should be formulated and implemented as an integral part of a community's overall planning and development strategy. Such a plan should be concerned with the following:

Systematic monitoring of current and forecasted thermal supplies and demands.

- Conservation of thermal energy through more rational and efficient land use and building.
- Development of alternate resources such as biomass, geothermal, and cogeneration (combined cooling, heat, and power).
- Optimizing the locational matches between thermal sources and users.
- Integration of thermal energy supply and demand planning with other traditional community planning sectors, such as housing, transportation, and employment in order to make thermal energy a key determinant in the community development process.
- Reduction of the gross fuel requirements of the community through the cumulative efforts of thermal energy plan implementation.

The community thermal energy planning process is shown diagrammatically in Fig. 2.

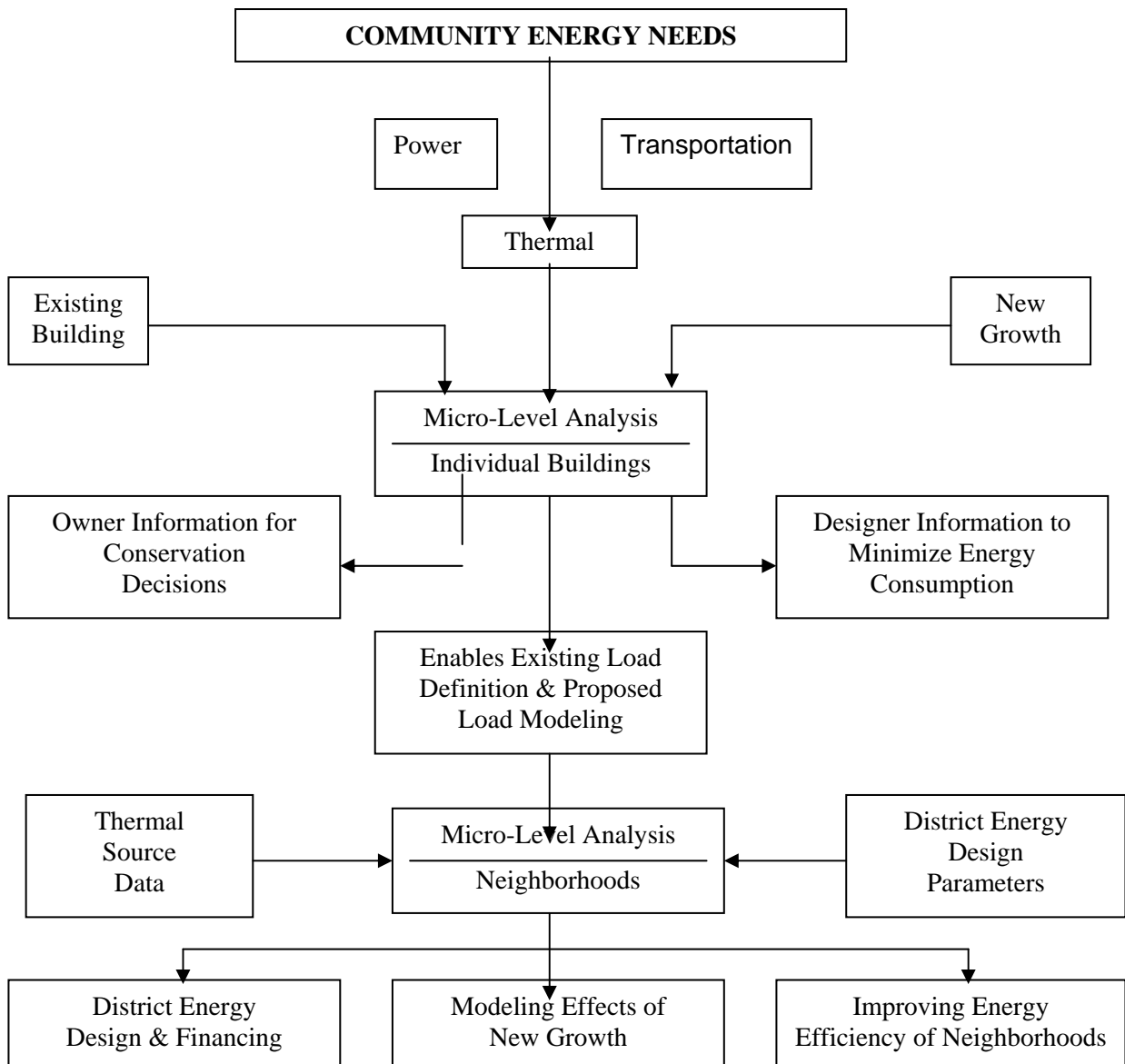

Figure 2: The Community Thermal Energy Planning Process

Community thermal loads are a direct function of land uses. The types, locations, densities, and mixes of land uses will control its suitability for district energy. Moreover, land use locational relationships to energy resource sites will determine the suitability of such thermal sources for district energy.

A community thermal energy plan for purposes of district energy must, therefore, be concerned with thermal resources and thermal loads and their locational relationship to one another. As thermal resource and load data is acquired, it should be plotted on a map or a series of map overlays for analysis.

3.1 Thermal Resources

The thermal resources of a community will include those conventional fuels already in use and those alternate energy resources that have potential for utilization. This portion of the planning process is concerned with identifying which specific fuels and thermal resources are or could be available to the community; in what quantities, qualities, and locations they occur; and what their likely future prices will be. This fuel and resource inventory should also indicate the types of alternative energy technologies that could be integrated with community infrastructures, in particular, a district energy distribution network.

The thermal resource inventory can be prepared from information obtainable from local utility officials, fuel distributors, industrial plant operators, and possibly previous energy studies that

were completed in the area. Information concerning the availability of such resources as geothermal may be much harder to come by and may require the services of an energy resource company that specializes in geothermal exploration and resource characterization. The same may be true for biomass and waste heat resources.

The thermal resource inventory will serve as the basis for future planning efforts that concentrate upon more efficient utilization of fuels in terms of increased utilization per unit of energy input. A prime example would be a conventional thermal electrical generating facility that was converted to cogeneration, thus increasing its net energy output per unit of fuel consumption from 35-40 percent to 75-80 percent. The thermal resource inventory will also provide information that, when integrated with that acquired during the thermal load inventory, will serve to determine the specific locational limitations of future district energy systems.

3.2 Thermal Load

A detailed determination of thermal load must include all thermal energy required to meet space, water, and industrial process heat and cooling demands. These heat demands should be inventoried according to sector, e.g., residential, commercial, institutional, and industrial. The objective is to establish a data base of existing thermal loads and a projection of future thermal needs. A secondary objective of the thermal load survey is the identification of thermal energy users in each sector who have a favorable potential for utilizing district energy.

Ideally, thermal load data should be based upon an audit of every building in the area. However, it is usually impractical to obtain such information directly and instead a method of estimating thermal load from building type, age, construction, and floor space will normally have to suffice.

One methodology has been developed by the Washington State University Energy Program (WSU) and has been incorporated into the computer program HEATMAP[®]. The estimating routine is based on the COMPAC program developed by the Lawrence Berkeley Laboratory for the Electric Power Research Institute. Other routines that could be used include DOE II, developed by the Lawrence Berkeley Laboratory, and BLAST, developed for the U.S. Army by The University of Illinois. Both of these programs require considerable detail on potential consumers, and the added levels of precision in the estimates may not be justified. However, where ever and when ever possible, load data from actual metered data should be used as actual occupancy patterns and use have a tremendous impact on loads.

Industrial loads, however, must be determined from actual data obtained from the individual industries.

The thermal load inventory will provide information critical to determining whether or not district energy could be technically and economically viable, and for developing a strategy for improving community energy efficiency and DE favorability through land use planning.

Thermal load density (load per unit of land area), that can now be determined from the thermal load inventory, is critical to the feasibility of district energy because it is one of the major determinants of the distribution network capital and operating cost. Studies completed by WSU and others indicate that for a district energy system the cost of the distribution network may be the largest single capital expense (up to 60+ percent of the total capital investment). Thus, it is imperative that communities that hope to develop district energy possess a sufficiently high thermal load density to support such a system.

However, a major obstacle to reaching district level thermal load density may be land use plans and regulations administered by many cities. These controls, embodied in comprehensive land use plans, and zoning and subdivision ordinances, are often inconsistent with the thermal load density, load factor, and resource/load proximity prerequisites of modern district energy systems (Allen, 1981).

The thermal load density of a community is determined by the type and arrangement of its land uses in each neighborhood; the space and water heating and cooling loads per unit of building floor space of each neighborhood; the total amount of such floor space in each neighborhood; and any local industrial process heat and refrigeration loads. Thermal load density is commonly expressed as megawatts per hour per square kilometer (MW/hr/km²) or million Btu per hour per acre (MMBtu/hr/ac).

As can be expected, the type and spatial arrangement of a community's land uses has a direct effect on thermal load densities. District energy favorability based upon thermal load

densities has been determined from studies in Sweden and the U.S. (Wahlman, 1978). The relationship between district energy feasibility and thermal load density was recently confirmed during extensive studies conducted by the U.S. Army (Brewer, 1998).

It can be clearly seen from Table 1 that a community's potential for implementing a successful district energy system is linked to its historical land use patterns and dependent upon its zoning and subdivision ordinances and future land use plans.

Another measure of district energy favorability (Table 2) is the ratio of annual heat use (MWh/ha/year) to sales needed for community-wide operation. This may give a more accurate measurement since it is not as affected by peak demand.

In addition to thermal load density, a community's load factor is a major determinant of district energy feasibility. Load factor is the ratio of total annual energy use to the total possible annual consumption if the peak were supplied continuously for a year. As with thermal load density, a high load factor is critical. A high load factor can be most easily obtained through a pattern of mixed land uses. For example, an area that is comprised of both commercial and residential units will have a higher load factor than will either land use separately. Obtaining a high load factor through mixed load uses has been the key to the success of many European and Scandinavian district energy systems.

Table 1: Favorability Based on Thermal Load Density

Type of Land-Use ¹	Thermal Load Density ² (MW/ha)	Desirability for District Energy
Downtown; high rises	Greater than 0.70	Very favorable
Downtown; multi-storied	0.51 - 0.70	Favorable
City core; commercial buildings & multi-family apartments	0.20 - 0.51	Possible
Two-family residential	0.12 - 0.20	Questionable
Single-family residential	Less than 0.12	Not possible

1. Land-use types are categorized to indicate general groups of desirability; local land-uses may have differing thermal load densities and district energy desirability's; for example, improvements in distribution economics may make certain single-family areas eligible for district energy.

2. Based on diversified peak hourly load.

(Wahlman, 1978)

Table 2: Favorability Ratios

Favorability Ratio*	Rating
Less than 1.43	Very favorable
1.04 - 1.43	Favorable
0.41 - 1.04	Possible
0.25 - 0.41	Questionable
More than 0.25	Unfavorable

Favorability Ratio is based upon a comparison of a neighborhood annual heat use (MWh/ha/year) to sales needed for community-wide operation.

(After Allen, 1984)

Communities have used zoning ordinances since the early 20th Century to guide growth and development. Today a community's comprehensive plan provides general land use guidelines while zoning ordinances are used to implement the plan through specific regulatory measures. Zoning ordinances not only specify which land uses can occur in a neighborhood, but also the maximum allowable density of such land uses. In residential neighborhoods, density is frequently controlled through minimum allowable lot sizes for dwelling units or, in some communities, maximum allowable ratios of land area to floor space. Commercial density is often controlled by increments of allowable intensity of use. Commercial densities are also affected by off-street parking requirements and building height limitations. Industrial land uses are generally regulated on the basis of intensity, most commonly through the segregation of small, enclosed uses from large, open-air uses.

In addition, for example, in many American cities, zoning has usually precluded mixed land uses within a single zone, thus limiting load diversity and load factor.

Although most cities have land use patterns and densities that are well established, significant portions of each community are subject to current standards when development of older areas, in-filling of vacant leap-frogged land, or new fringe development occurs. It is thus essential that thermally efficient standards be adopted. Such standards should strive for both a high thermal load density (see Table 1) and a high thermal load factor.

The following is a brief list of land use measures that communities should consider in order to improve the favorability for district energy.

3.3 Land Use Planning Recommendations for Improving District Energy Favorabilities

Comprehensive Plan

- Amend the Comprehensive Plan to incorporate a district energy section or element. Such an amendment will signify the importance of this energy technology and service to the community, and provide a policy framework to guide the nature and extent of future community actions.
- A district energy element in the Comprehensive Plan should include the following: 1) documentation of the alternate thermal source potentials estimated to be available to the community over time, including probable source locations, and needs for site protection; 2) documentation of the community's various demands for heat and cooling, e.g., residential, commercial, industrial; 3) evaluation of alternative courses of action to assure resource conservation, and economic and social gains through resource development; 4) establishment of policies to guide thermal source conservation and district energy development according to preferred alternatives; and 5) identification of implementation measures, such as zoning and subdivision regulations, that can achieve policy objectives in the day-to-day community development process.
- Amend the land use plan to identify the most favorable thermal source areas, e.g., geothermal production fields, and designate them as significant resource sites requiring special development standards for future uses so as to assure protection of the resource's long-term productivity by preventing development of conflicting uses.
- Amend the land use plan to designate areas for uses in proximity to thermal sources according to the relative thermal demands of the land uses, such that the more intensive uses are located closest to thermal sources wherever practical.
- Prohibit strip or linear commercial development that decreases load densities and increases distribution requirements for district energy.
- Discourage annexation and development of energy-inefficient strips or fringe areas that contribute to sprawl and low densities; encourage in-filling of vacant interior lands in targeted thermal zones.

Zoning Ordinance

- Amend the zoning ordinance to address four issues critical to district energy favorabilities: density, diversity, rate of growth, and site standards (each are discussed separately below). Also adopt zone changes consistent with land use plan changes described above.
- Create a district energy (DE) overlay zone. This zone would encompass the boundaries of those neighborhoods considered for ultimate inclusion in a district energy system, regardless of their underlying zones, i.e., residential, commercial, or industrial. Special district energy measures would be applied through this overlay zone, as described below.
- Establish a minimum density standard and density bonus. Within the DE overlay zone, all uses would be required to meet a minimum thermal load density, e.g., 0.36 MW/ha. This would assure that new or redevelopment would result in thermal loads that could be, at least, economically served by district energy. Also, bonuses could be awarded to new or redevelopment that provides above-average thermal load density, e.g., greater than 0.75 0.54 MW/ha, or an above-average load factor, e.g., greater than 25 percent. Bonuses could take the form of increases in maximum density limits, reduced off-street parking requirements, higher height limits, tax abatement, etc.

- Allow mixed uses in one area so as to increase thermal load diversity, and thereby increase the area's load factor. Within the DE overlay zone, uses not otherwise permitted in the underlying zone should be allowed conditionally if they can contribute significantly to an increased load factor for the immediate area, e.g., a 10 percent or greater increase, while still remaining compatible with immediately surrounding uses. Bonus incentives for mixed use developments could also be effectively offered through a planned unit development zone.
- Increase the rate of new growth or redevelopment in district energy target areas. Areas that will benefit the most from land use incentives are the following: the principal thermal source sites; major pipeline corridors; economic development areas or industrial parks; and areas that do not presently meet minimum thermal load densities for district energy. These types of target areas can be delineated within the DE overlay zone, and additional development bonuses offered to new or redevelopment which locates within such areas. Bonuses could take the form of additional reductions or variances in other non-energy standards while still maintaining compatibility with surrounding uses.
- Amend zoning performance standards to require reasonable exterior or service line access to building heating equipment to facilitate future retrofitting to district energy.

Subdivision

- Amend the easement authority to specifically include easements for thermal source operations and district energy pipelines and facilities.
- Amend lot and block design standards to encourage district energy-oriented design, e.g., clustering. Bonuses for such designs could be offered in the form of reductions or variances in non-energy related subdivision standards.
- Amend the list of required utilities to include discretionary power for requiring district energy pipeline and/or pipeline conduit where deemed necessary for future needs.
- Designate multi-family uses to increase thermal loads thermal resource sites, major institutional and commercial uses, and along district energy pipeline corridors.
- Allow alternative uses such as home occupations, or small rentals in large single-family structures, to increase residential load densities and load factors.

Capital Improvement Program

- Although not strictly a land use planning measure, the preparation and use of a long-range capital improvement program for a district energy system will also bolster the community's ability to optimize the benefits of the system. A carefully engineered capital improvement program can serve as an important factual basis for the land use measures described above while also assuring heat source protection and system optimization.

4. PRODUCTION, DISTRIBUTION, AND SYSTEM DESIGN

The ultimate success of a district energy (DE) system will depend upon the use of sound engineering practices in the design and construction of the production and distribution systems. And although they are very different and independent systems, they are intimately associated with one another and a decision on one is sure to have a major impact on the other (Fig. 3). Nowhere is this more true than in the selection of the temperature at which the thermal energy will be distributed. The temperature selection will determine whether or not the system will be steam or hot water, chilled water, brine, or ice slurry; the pressure at which the system will operate; the type of piping which can be used; the ability to incorporate thermal storage into the system design; the ability of the system to meet customer demand; the design of the customer's system; and what thermal sources or production plants can be incorporated into the system. All of these factors will have a profound impact on the capital cost of the system and ultimately on the cost competitiveness of district energy.

For example in the heating mode, by designing the system for a low distribution temperature, the scale and the capital cost of the heat production and/or storage system can, in most instances, be substantially reduced and a wide variety of waste heat sources may be more easily incorporated into the system design.

The Danes have reduced the cost of the customer connection by distributing lower-temperature hot water (70°C/158°F to 90°C/203°F). The lower-temperature and pressure of Danish systems typically allow them to dispense with the heat exchanger and instead the DE system is directly connected to the building's hydronic internal system. British research has revealed that this form of direct connection has a 2.5 to 1 cost advantage over systems where a heat exchanger must be used when capital, energy and pumping costs, and the capitalized value of lost electricity production (cogeneration) are compared (Gleason, 1983).

A cooling system that can generate and store ice allows for low-temperature distribution, reducing distribution piping cost substantially, allows the system to more easily handle peak demand through storage, and can result in significant savings to the business owner from not only savings in energy, but substantial savings in construction costs of the building.

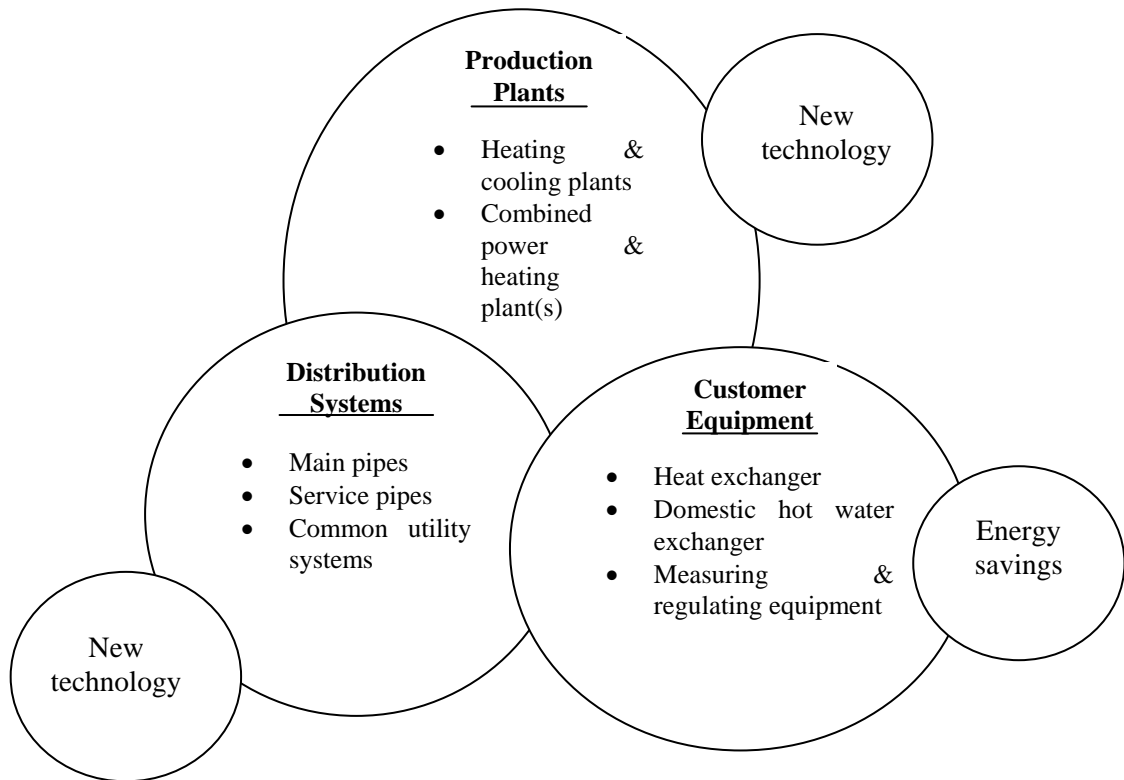

Figure 3: District Energy System Components

4.1 Production

Thermal energy for district energy can be provided by a number of sources in addition to geothermal, including cogeneration plants, fossil fuel boilers, industrial heat rejection systems, biomass boilers, and solar systems.

A major advantage is, in fact, that the production system can consist of a number of production units that utilize a wide variety of fuels and/or renewable resources. This allows for very efficient system operation and a high degree of flexibility in system design, system operation, and fuel selection. Both of these factors are extremely important in that with such flexibility, the production unit or units with the lowest operational cost can always be utilized.

Another very important consideration is whether or not the primary thermal source(s) will meet peak demand or if peak demand can be more efficiently met through the use of a specially dedicated peaking/back up production unit or through thermal storage or a combination of both.

4.1.1 Cogeneration

Cogeneration, or combined heat and power (CHP), is the simultaneous production of both electricity and thermal energy at a common facility. In the United States, a majority of the district heating system built near the turn of the century and up to the 1940s were based on the CHP concept. In Sweden and Denmark, and throughout much of Europe, CHP continues to be the most common source of district heating production.

Because both heat and electricity are produced from the same fuel (e.g., geothermal or natural gas), the overall output per unit of fuel consumed is greatly increased. The efficiency of a thermal energy power generating plant is usually lower than 35 percent. However, most CHP plants operate with an overall efficiency of 80 to 85 percent. Increasing interest in the simultaneous production of electrical and thermal energy from geothermal resources could greatly increase the economic attractiveness of low- to moderate-temperature geothermal sites.

4.1.2 Geothermal Resources

Geothermal energy, capable of being used in DE applications, has been used extensively for district heating. Geothermal resources vary from low temperature, less than 38°C (100°F) to well above 260°C (500°F). Low-temperature resources are usually used in conjunction with a heat pump, while the higher temperature resources may be used directly. Temperatures of 100°C and above are required for thermally-activated cooling applications or for combined heat and power applications.

Geothermal systems, unlike most fossil- and biomass-fired systems, are usually designed as baseload systems with peaking and back up requirements met through the use of thermal storage and fossil fuel boilers. If properly designed, the geothermal portion of the system can provide 80 to 85 percent of annual energy consumption while meeting less than 50 percent of the peak demand. In order to meet peak demand with geothermal, the number of wells would have to be doubled and with a corresponding increase in the diameter of the distribution piping system by up to 30 percent.

4.1.3 Fossil Fuel Boilers

The fossil fuel boiler has long been the primary heat production unit of most district energy systems. Fossil fuel boilers can also play a very important role in the development of geothermal systems by providing peaking, back-up, and, in the initial phase of development, a means to connect large numbers of buildings to the district energy system prior to full development of the well field and/or the distribution system.

The concept of the block central (local district energy system) is one that is ideally suited to the use of a small fossil fuel-fired boiler and ideally suited to the development of a new or expansion of an existing district energy system. Start small... think big... think link has guided energy planners throughout Scandinavia for decades (Eckfield, 1986).

In Sweden, over 6,000 block centrals rely on small fossil fuel boilers. The heating of block centrals with a central boiler allows for new construction to be designed so as to be easily connected to a community-wide district energy system. As a new area is built up, several block centrals can be interconnected, and eventually the entire area can be connected to the central DE system. As load increases, CHP may become increasingly viable.

4.1.4 Heat Pumps

Geothermal heat pumps are capable of boosting the latent thermal energy found in low-temperature sources up to temperatures suitable for space conditioning and water or process heating. Figure 4 is a very simplistic illustration of the "boosting" which occurs in a heat pump. The efficiency of operation or coefficient of performance (COP) is the ratio of driving energy to heat output, and is dependent upon the temperature differential between input temperature and required output temperature. The greater the difference, the lower the COP.

100% Driving

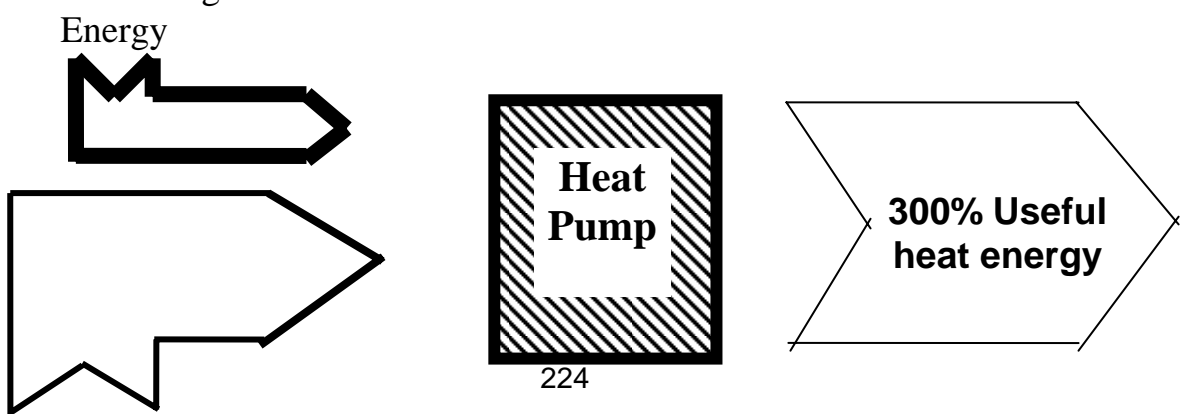

= 3 parts useful heat

**200% Waste
heat**

**2 parts waste energy
+1 part driving energy**

Heat pump C.O.P.=

Figure 4: The Heat Pump Concept

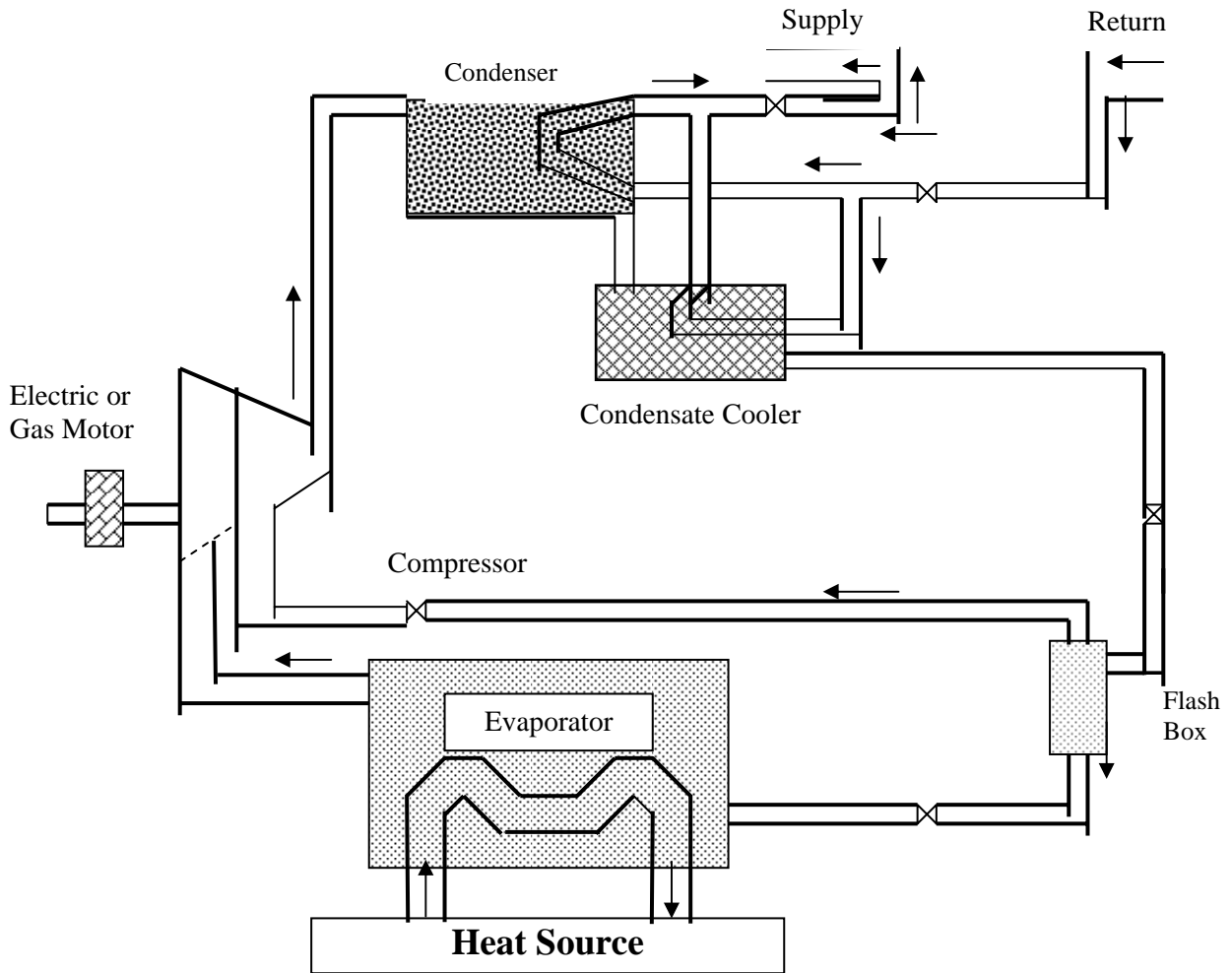

Figure 5: Low-Temperature Water Source Heat Pump

Figure 5 provides a more detailed description of a heat pump's components and operation using hydrothermal sources.

A heat pump operates by transferring the heat in a low-temperature source to, e.g., a refrigerant through an evaporator (heat exchanger). When heated, the refrigerant is converted to a gas and then heated further through compression. The hot gas is then condensed, returning to the liquid state and giving off its heat in the condenser to a secondary fluid, e.g., treated water, that is then circulated for heating. The refrigerant is then returned via a pressure-reducing valve to the evaporator where the process is repeated (Allen, 1986).

In the case of cooling, the use of thermally-activated absorption heat pumps may be more feasible than centrifrically-driven chillers. Figure 6 provides detail of the use of a single effect absorption unit. If high enough temperatures are available, double and even triple effort absorption units should be considered because of their high efficiencies.

Because heat pumps can be used to boost the temperature of low-temperature geothermal sources to temperatures applicable for use in a district energy system, their use has opened up the use of many low-temperature geothermal resources areas. The first major use of heat pump technology for district heating in the United States was in the city of Ephrata, Washington. A 30°C (86°F) geothermal well served as the source for a 1 MWth heat pump installation that supplies heating and cooling to the Grant County Courthouse and the Courthouse Annex. The system operates with a COP of 5.8 while in the heating mode and about 4.0 in the cooling mode.

In Lund, Sweden, a 24°C (76°F) geothermal resource supplies nearly 50 MWth to the city's district heating system. The two heat pumps (18 and 30 MWth) operate with a COP of approximately 3.3 and supply approximately 80°C (176°F) water to the district heating net.

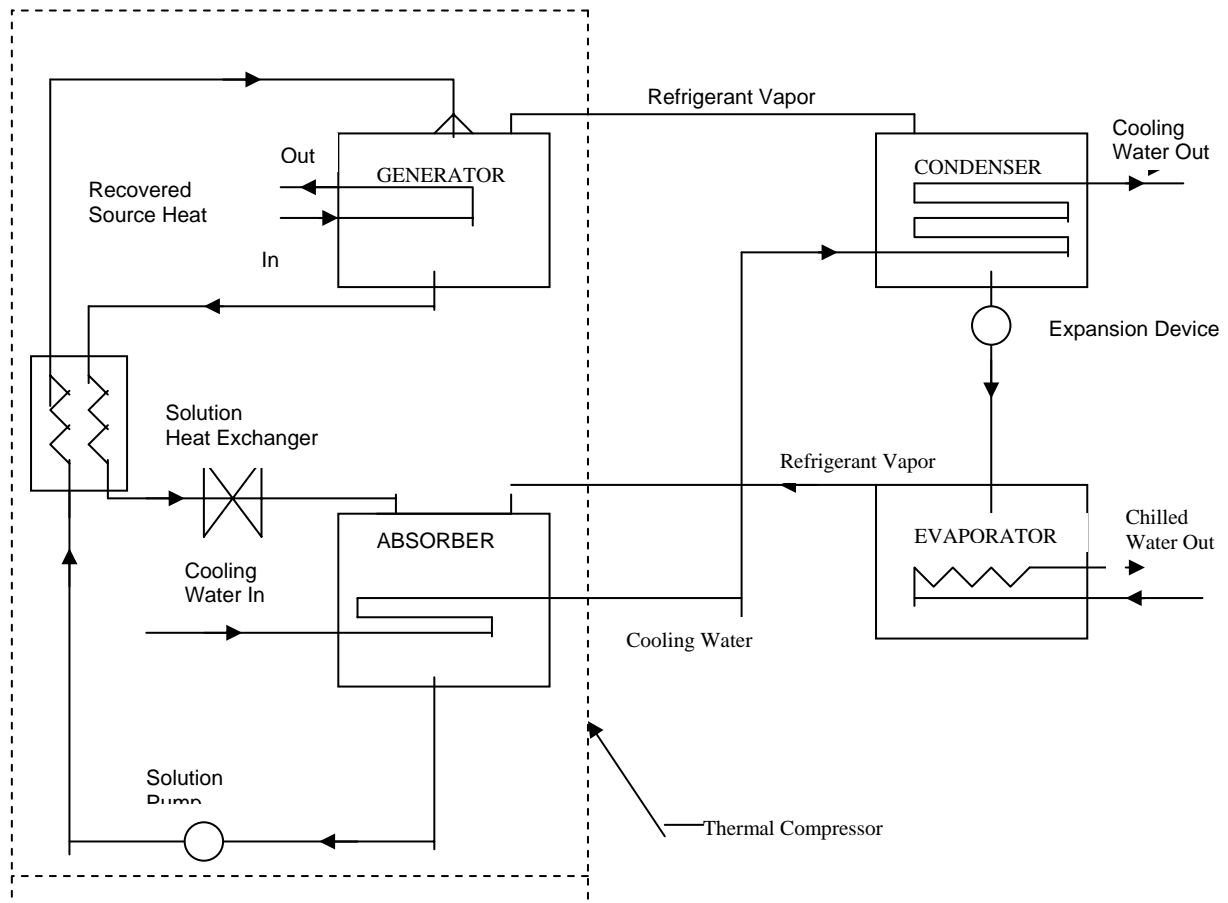

Figure 6: Absorption Refrigeration Cycle Schematic, Single Effect

Because heat pumps operate most efficiently when the differential between the source temperature and the output temperature is as small as possible, most heat pump systems are designed to meet 50 percent or less of peak demand with the remainder being furnished by a fossil fuel or electric boiler which can also serve as an emergency or stand-by unit.

As can be seen from Fig. 7, although the heat pump supplies 50 percent or less of the peak demand, it can supply 80 percent or more of the total annual energy requirement and thereby operate at or near full capacity year round, and thus achieve better efficiency and economy as a result.

4.1.5 Thermal Storage

Thermal storage is rapidly becoming an integral and extremely important aspect of district energy production. Thermal storage can be essential to efficient utilization of geothermal for district energy. Storage is usually in the form of hot water, although other storage mediums are available such as phase change materials, rock, oil, or oil and rock. Both short-term (diurnal, weekend, weekly) and seasonal storage may be used depending upon the requirements of the

district heating or cooling system and the characteristics of the thermal source. With district cooling, chilled water brines, ice slurry, or ice on tube storage is critical in the design of the cooling system in order to reduce both capital and operating costs, e.g., all production can occur during off-peak periods.

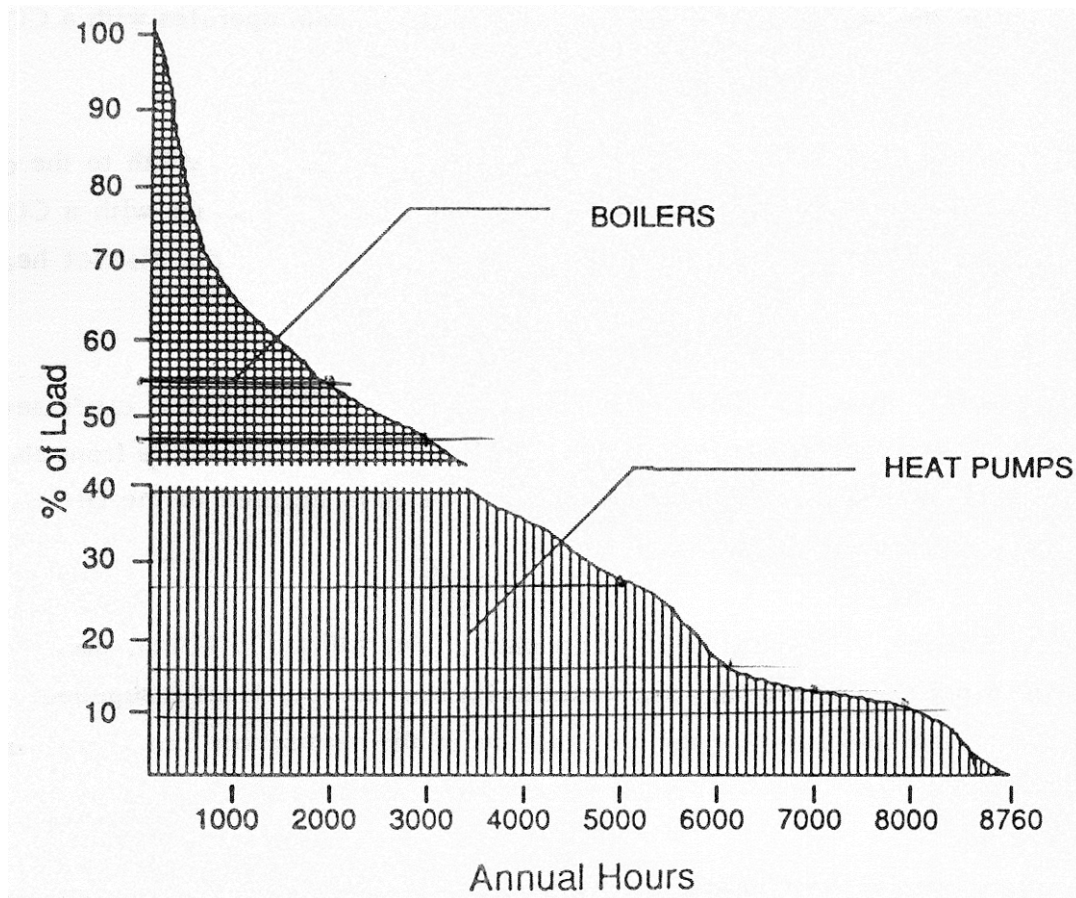

Figure 7: Typical District Heating Annual Duration Curve

Because most district energy systems require large quantities of thermal energy, the storage medium must have a high heat capacity, be environmentally acceptable, and be reasonably inexpensive. Most storage systems therefore rely on water or ice as the storage medium.

Another important characteristic of the storage system is its ability to contain the storage medium by providing boundaries against water and heat flow from the facility. Containment can be provided by above- or below-ground tanks, rock caverns (natural or man made), geologic structures, geologic formations, and lakes or ponds. The containment must provide structural integrity, good thermal insulation, and, as with the storage medium, be inexpensive.

Thermal storage can be used to meet peak demand or to bridge the time gaps between system demand and availability.

Short-term storage can be extremely important to achieving maximum thermal as well as electrical output from a combined cooling, heat, and power facility. Since daily peak demand for electricity and thermal energy often coincide, the availability of sufficient short-term storage, usually in the form of above-ground steel tanks, allows for maximum electrical generation while the thermal peak can be met with thermal energy produced and stored during off peak periods.

The geothermal district heating system in Reykjavik, Iceland, depends upon above-ground storage tanks to meet a major portion of peaking demand.

Long-term storage is usually utilized in order to take advantage of seasonal differences in energy demand and production capability. It can be advantageously utilized when the thermal energy is available sporadically, continuously, or intermittently as can be the case with CHP.

Long-term or seasonal thermal storage usually involves storage in aquifers, glacial layers such as gravel eskers or glacial deltas, open rock caverns, or bore holes in rock. The temperature

at which the energy is stored can vary from 80°-90°C (176°-194°F) for systems based upon, CHP or municipal waste incineration.

In Salt Lake City, Utah, the main office building of the Church of the Latter Day Saints utilizes a four-well, low-temperature, geothermal arrangement to supply both heating and cooling. During the summer months, water is withdrawn from two of the wells and through the use of heat pumps, heat is extracted from the building and transferred to the water, serving as the heat sink, then is returned to the two injection wells. During the winter, the system is reversed and the now somewhat warmer water provides for the space heating of the building.

The development of new mediums for energy storage also shows promise for increasing the benefits of thermal storage and could increase the cost effectiveness of such systems.

The STL (Stockage Thermique par Chaleur Latente) is a thermal storage system that has been developed at the Sophia Antipolis Research Centre at Valkonne in southern France. The system is based on the principal that energy can be stored in saline solutions that have the property of collecting energy when they melt and of releasing energy when they solidify again. The system consists of a water container filled with tennis-sized plastic balls containing identical salt solutions. The balls are made of polythene or polypropylene and contain various saline solutions to meet different temperature requirements.

The STL system is designed for water-borne heat or cold, is connected to a building's central heat and/or cooling system, and can help modify peak demand, especially where heating and cooling demand varies greatly over a diurnal period (Scandinavian Energy, 1984b).

More commonly, thermal energy to meet cooling demand is stored in the form of water: a water salt solution, ice slurry, or ice on tube. All are designed to help meet peak demand at the lowest possible capital and operating cost.

Thermal storage can often be a technically and economically attractive addition to the production system of a district energy system and often a solution to many of the problems associated with thermal demand and availability. In fact, because thermal storage can play a major role in achieving a balance between demand and availability in well-designed DE systems, it can have a significant impact on the design and operation of the distribution system as well as the production system.

4.1.6 Distribution

The distribution system that carries thermal energy from the production unit(s), in the form of steam, hot water, chilled water, or ice slurry to the customer is by far the single most expensive capital item in a district energy system. The distribution system can account for anywhere from 35 to 75 percent of the total system cost dependent upon the length of the net, the customer demand, the temperature at which the thermal energy is transmitted, the piping material selected, and the method of installation.

The distribution net can, for example, be limited to less than 200 meters (656 ft.) of piping to serve two buildings, as is the case in Ephrata, Washington, to the system in the Polish community of Zakopane where the distribution system consists of over 15 km (9 miles) of distribution piping to supply up to 63 MW (Geothermia Podhalanska, 1999). The piping network that supplies Iceland's capitol city of Reykjavik is even more extensive, having a total length of about 1,300 km (Gunnlaugsson, 1999).

The selection of the material for the piping system will depend, to a very large extent upon the temperature at which the thermal energy is transmitted. For steam and high-temperature hot water systems, the predominant material used today is prefabricated plastic culvert with steel as the carrier pipe, a protective jacket of plastic (PE or PVC), and polyurethane foam insulation (IEA, 1986). For hot water systems that operate below 100°C (212°F), the piping system may consist of preinsulated steel, copper, or fiberglass-reinforced plastic (FRP), and for systems that operate at a maximum temperature of 90°C (194°F), both polybutene and polyethylene are also available as preinsulated pipe. Whatever type of piping is selected, it should provide high thermal efficiency, moisture protection, reliability, corrosion protection, and be economical to install.

For cooling systems, both metallic and nonmetallic insulated or noninsulated piping system may be used, depending upon the circumstances.

Preinsulated steel pipe comes in fixed lengths usually 10 meters (33 ft.) in length, but in some diameters, sections up to 20 meters (66 ft.) long are available. Diameters range from 25 mm (1 inch) to 1,000 mm (40 inch) or above.

The sections of steel pipe are welded on-site and the joints are covered by an insulated muffler that forms a water tight seal. The muffler can be either cemented in place or heat welded. Many pipe manufacturers imbed two or three wires in the insulating material that provide leak detection and, in the case of a three-wire system, the control of valves and other equipment by remote control. The wires are connected at the same time the pipe sections are welded together. Because the distribution pipe will expand or contract with temperature, the pipe must be constructed with expansion loops or an internal expansion compensation system. The use of internal expansion compensation will lower both the cost of materials and installation. Direct burial is the preferred method of constructing the network and works extremely well with internal expansion.

One of the most important advances in district energy distribution technology has been the development of flexible district energy distribution culverts. The principal advantage of which is the potential for a major cost reduction in the distribution net. Both metallic and nonmetallic carrier pipe systems are available. The economic advantage is provided by the following factors:

- The speed of installation increases considerably.
- Pipeline lengths up to 100 meters (328 ft.) or more reduces the number of joints.
- There is a very high degree of flexibility and reduced demand for support and filling.
- Obstacles in the ground can be easily circumvented and exact slopes are not required.
- The number of bends is substantially reduced.
- There is no need for expansion elements such as compensators, loop expansion joints, or anchors.
- There is easy handling during transport and laying.
- There is a major decrease in the trenching since trench size can be kept to a minimum, because most of the installment work can be done more simply at the surface instead of in the trench (IEA, 1986; Johansen, 1987).

Flexible district energy culvert is now available in diameters up to 110 mm (4.3 inches) and in materials that will take temperatures up to 130°C (266°F) at 25 bars (378 psi). The most common carrier materials are copper, polybutene, corrugated stainless steel, and polyethylene. The pipe comes preinsulated with polyurethane foam or glass wool and with a corrugated casing of heavy duty polyethylene to resist impact. The parallel corrugated polyethylene casing increases strength and at the same time makes bending easier.

When the carrier pipe is made of plastic, additional advantages include the use of electro fittings for joining the sections with a very high degree of security and the elimination of corrosion problems.

However, the long-term strength of plastic carrier pipe, when exposed to high temperatures and high pressure, may be a problem and the diffusion of oxygen through the plastic pipe wall into the circulating district water may lead to corrosion in other parts of the system, e.g., heat exchangers, radiators, etc. (IEA, 1986; Johansen, 1987).

Despite the possible problems stated above, and the fact that flexible piping is available in sizes only up to about 110 mm (4.3 inches), the use of flexible district energy piping should be given careful consideration whenever long runs of small diameter piping is required to reach new customers, because of its many technical and cost advantages. This is especially true of systems designed to serve residential neighborhoods.

4.2 Geothermal Unique Technical Design Considerations

Geothermal district energy systems present the developer with some uniquely difficult design considerations that are seldom if ever found by developers of other district energy systems.

Both the nature of the geothermal resource, e.g., the potential for scaling and/or corrosion, and locational constraints can dramatically affect design, component selection, and operational strategy.

In its most simplified form, a geothermal system will consist of a production well or wells, including, if needed, pumps, a transmission and distribution network, and a means of disposing of the geothermal fluid, e.g., surface disposal or injection. In this case, the geothermal fluid is supplied directly to the customer's end use equipment. The advantage is minimum capitol cost, simplicity of design, minimum cost to the end user, and simplicity of operation. The disadvantages include high potential for corrosion and/or scaling in the transmission and distribution network as well as the customer's end use equipment; inability to vary distribution temperature, therefore

requiring that both peak demand and back-up must be supplied by the geothermal system; and, if surface disposal is employed or injection is at a considerable distance from the production area, an inability to maintain reservoir pressures and potentially fluid volumes.

A slight variation on the above design would be to install heat exchangers at each individual consumer. This provides a high level of protection for the consumers in building equipment, but will add cost, although those costs may be offset by reductions in maintenance of the in-building system. This type of system is employed by the Oregon Institute of Technology (OIT) in Klamath Falls, Oregon, and has proven to be highly successful and extremely cost effective. The installation of heat exchangers was a design change after 10+ years of operation where the geothermal fluids were circulated through the user's in-building equipment. Back-up and peaking for the OIT system is provided through the use of three wells, of which only one is needed to meet base load demand, and a second for peak requirements, always leaving a third well for back-up.

A more common approach is to separate the geothermal fluids from the circulating loop through the use of a plate and frame heat exchanger prior to transmission or, at a minimum, prior to distribution. Once having passed through the heat exchanger, the spent geothermal fluid is either injected back into the reservoir or disposed of at the surface. The primary advantage is to avoid potential for corrosion or scaling resulting from the circulation of the geothermal fluid. A second major advantage is the ability to site injection wells at an optimum distance from the production wells without the need for an extensive and potentially costly return line. Disadvantages include a slightly more complex system, cost of the primary heat exchanger, and the continued requirement to meet both peaking and back-up requirements with the geothermal fluid. Depending upon the demands of the system and the volume and temperature of the geothermal fluids available, peak demand may require up to twice as many wells as is required for base load supply, and transmission and distribution pipelines may have to be up to 30 percent larger than if peak demand could be met through increases in send-out temperature rather than strictly through increased flow.

The addition of peaking and back-up boilers and potentially thermal storage to the above system design greatly enhances flexibility of design and operation, minimizes the number of production and injection wells required, minimizes transmission and distribution pipeline diameters, and adds security of operation due to the availability of fossil-fueled or electric back-up. Although the boiler will, in all likelihood, require the availability of fossil fuel and possible fossil fuel storage, operating cost will not be greatly affected as the boiler will not be expected to be used more than 5 to 15 percent of the time, although it may meet 50 percent or more of the peak demand.

For larger systems, incorporation of a primary heat exchanger to separate the geothermal fluids from the distribution loop and inclusion of fossil fuel peaking and back-up boiler should always be given serious consideration both as a means of minimizing capital expenditure and as a means of ensuring maximum possible operational flexibility and system security.

If the geothermal resource area is located at some distance from the district energy service area, the cost of a transmission piping loop required to transmit the geothermal fluid to and from the service area may be excessively expensive. In such cases, consideration should be given to instead using a single transmission pipe through which heated surface water or near surface, non-geothermal groundwater is used as the heat transmission medium. A second primary heat exchange could then be accomplished at the service area prior to distribution or the transport medium could be used as the distribution medium as well. Incorporation of storage and fossil fuel boilers to meet peak demand could significantly reduce the required diameter of both the transmission and distribution piping system, minimizing capital cost. The transport medium would then be rejected to some surface water source or injected. Because the temperature of the rejected water will be significantly above the ambient temperature of the receiving water, the risk for significant thermal pollution must be carefully considered and mitigation measures adopted where ever necessary. Consideration of long-distance transmission would only be justified where the customer base justifies the added cost associated with constructing the transmission pipeline.

In Reykjavik, Iceland, heated non-geothermal water is transported some 30 km (18 miles) from the Nesjavellir field through a 900 mm (35 inch) transmission pipe to the outskirts of the city where both storage and fossil fuel-fired peaking is available (Gunnlaugsson, 1999).

Material selection is also a major consideration in the design of a geothermal district energy transmission and/or distribution system. The corrosiveness or high potential for scaling of

many geothermal fluids requires that at least some consideration be given to the use of nonmetallic pipe. When available, asbestos concrete was an ideal choice but, unfortunately, is no longer available, at least in the United States and Canada. Polybutelene and reinforced fiberglass are other possible choices, although both have temperature limitations. Ductile iron is another possible choice, but concerns related to the nature of the mechanical joints make it less than ideal. In its least expensive form, ductile iron is uninsulated, causing concern related to heat loss and possible environmental unacceptability. In most situations, the preferred alternative, at least for large diameter transmission and distribution piping, is preinsulated, jacketed, welded steel pipe with insulated and sealed mufflers at the joints. In smaller diameter, many of the preinsulated and jacketed, nonmetallic, flexible piping systems, primarily available from Europe, should be given careful consideration. The flexibility and nonmetallic nature of the piping system could make it the ideal solution for use in many geothermal systems, especially if the geothermal fluids are used as the distribution medium. Even when the geothermal fluid is not distributed, these flexible piping systems can considerably reduce the cost of installing the distribution network.

Although seldom given serious consideration, geothermal can also serve as a basis for providing cooling, either as a separate district cooling service or as an adjunct to district heating service. Thermally-activated absorption equipment may be located in a central plant and distribution of chilled water provided through a district distribution system or located at each individual user with thermal energy provided through the heat distribution system. Another alternative would be to use centrally-located, steam-driven, centrifugal chillers if the geothermal fluid temperature is adequate for steam production. The turbine drive of a binary system could also serve as a means to drive centrifugal chillers. Incorporation of storage can greatly improve the economics of most cooling systems because of the ability to schedule production during nonpeak power periods. Because cooling is often of greater economic value than heating, where ever cooling is needed and geothermal fluids of adequate temperature are available, it should be evaluated.

5. DISTRICT ENERGY MODELING

New emphasis on the development of district energy has required the development of more sophisticated and comprehensive simulation and optimization models to handle increasingly more complex production and distribution systems. Modern district energy systems may include multiple, geographically-dispersed, production units to meet base as well as peak demand, geographically distributed customers with varying service requirements, and multiple pipelines to connect them.

The models developed to be used in considering feasibility and design studies must be able to handle all of the above and, in addition, complex system and building load calculations, varying climatic conditions, changes in fuel and labor costs, taxation policies, environmental impacts, and multiple financing options.

5.1 Capabilities of an Ideal Model

5.1.1 New System

In determining the technical and economic feasibility of a new district energy system, the key questions are:

- What are the actual building loads; when do these loads occur; and what are the heating and cooling load densities of a given area?
- What are the best technical solutions for providing heating and cooling production, e.g., is the system based on cogeneration or trigeneration with excess steam or hot water used in absorption equipment; are there waste heat streams from industry that can be incorporated; or are there possibilities for direct cooling from, for example, lake or sea water?
- Do daily or seasonal electrical rate schedules or other factors encourage or even necessitate the inclusion of storage?
- Will the system require multiple production plants or can all of the equipment be located in a central facility?

- What is the planned build-out of the system; will it be constructed in phases; what is the likely penetration rate based on marketing surveys?
- What are the economic trade offs in terms of production cost and varying send-out temperatures vs cost of the distribution network?
- What is the most economical routing for the distribution system, taking into account the placement of existing utility services and opportunities to use existing pathways, e.g., through basements or below-ground parking garages?
- How should the distribution system be laid out to provide maximum operational security and customer assurance?
- How are economics affected by using various piping materials, flow rates, and/or send-out and return temperature?
- Are there tax incentives or utility programs that can improve the economics of a system that accomplish certain policy or operational goals?
- In the case of a cooling system, what is the best “mix” between using chilled water sent from a production plant or the alternative of providing steam/hot water for use in decentralized absorption equipment?
- What financing options are available and how can multiple financing options be packaged to obtain the most cost-effective package?

5.1.2 System Expansion

In planning the expansion of an existing district energy system, another set of issues must be considered that are very much dependent upon whether such expansion is being considered to increase the reliability of an already over extended system, to meet the needs of planned new construction, or simply to increase market share.

If the goal is increased reliability, the questions are:

- Should distribution constraints be dealt with by making changes in the production equipment to raise or lower send-out temperature; should new mains be constructed where capacity is constrained; or should new production plants be located so as to avoid the distribution constraints?
- Should production constraints be alleviated through adding production equipment to existing plants; by adding storage; or should additional satellite or peaking plants be built?

If the issue is whether or not to serve new construction, the questions most often asked are:

- Could the area be served from a stand-alone system constructed to meet the new load?
- Can the existing production plant and/or distribution system be expanded and/or extended to serve the new load economically?
- Can the new load be served by the existing system with peaking demand being met locally?

If the goal is to increase market share, the questions are:

- What kinds and levels of investment are most beneficial to improving the overall economy of system operation?
- What are the economic costs and benefits of expanding the distribution and/or production plant to meet the needs of new customers?
- Will an expanded market base allow for major production plant upgrade, e.g., incorporation of thermal storage, cogeneration, trigeneration, or control enhancements?
- Can multiple existing stand-alone systems be interconnected, thus lowering overall production cost as a result of economies of scale and operational flexibility?

5.1.3 System Operation

In operating a district energy system, the goals are to minimize operational cost, maximize equipment and personnel productivity, and maintain system reliability and security. In order to achieve these goals, the model must be able to determine:

- What effect various operational changes will have on system costs and system security?

- What options are available for providing service in the case of a forced or planned outage?
- Does the system provide a reasonable margin of over capacity in both production and distribution to meet unexpected load conditions?

A long list of models to meet the needs of planners and system designers have been developed over the years (see below). The history of district energy model development and capabilities of some of these models are summarized below.

5.2 Modeling Programs: A Historical Review

Although the first serious attempt to develop a model capable of accurately estimating the technical and economic feasibility of geothermal district energy was probably a computer model (known as GeoCity) developed by the Pacific Northwest Laboratory in Richland, Washington. The model was not released for wide-spread use. In truth, HEATPLAN was the first such model to be widely applied.

HEATPLAN

HEATPLAN was developed in the early 1980s in response to the need to better quantify the feasibility of geothermal district heating systems. The primary premise of HEATPLAN was that feasibility was a direct function of heat load density. The program built upon information developed in Sweden where numerous existing district heating systems had been evaluated in an attempt to establish the relationship between district heating viability and heat load density (Whalman, 1978). HEATPLAN allowed for the identification of up to 100 individual user-identified blocks for which the gross area was defined by the user; and the establishment of heating loads in each block based on actual heating requirement. Based on the geography, proposed service area, and heat load, HEATPLAN calculated heat load density. Favorability for district energy was based on the following scale.

$$\text{Favorability Ratio} = \frac{\text{Study Area Net Density of Annual Heat Use (MWh/ha/year)}}{\text{Minimum Heat Sales Needed for System-wide Operation (MWh/ha/year)}}$$

Favorability Ratios

>1.43	Very Favorable
1.04 – 1.43	Favorable
.041 – 1.04	Possible
.025 – 0.41	Questionable
<0.25	Unfavorable

HEATPLAN also allowed for a rough approximation of cost of service based on the user-defined cost for the geothermal system and computer-derived cost for the distribution network based on statistically-derived pipe sizes and lengths needed to serve the calculated load in the defined service area. Original versions of the program assumed that the entire heating load would be satisfied through the use of geothermal energy without supplemental peaking and/or storage. HEATPLAN was, however, significantly improved between 1985 and 1987 through a joint project of the Swedish Council for Building Research and the Washington State Energy Office (now Washington State University Cooperative Extension Energy Program). The most advanced version of the program, HEATPLAN 3.0, completed in 1987, allowed for much greater user input as well as the ability to choose among a number of peaking and/or back-up sources, including gas, oil, biomass, and electric boilers and heat pumps. The program, however, had a number of major limitations primarily due to the lack of geographic control over customers, production plant(s), and distribution system components. Of these, lack of accurate knowledge of the layout of the distribution system and ability to accurately dimension pipes were probably most critical in as much as 60 percent or more of the capital cost of a district energy system is invested in the distribution system. HEATPLAN, however, was an important step toward the development of more robust models and led directly to the development of HEATMAP©.

DERIM

DERIM (District Energy Regional Impact Mode) was developed by WSU (formerly the Washington State Energy Office) for the U.S. Department of Energy (USDOE) Fossil Fuel Division in 1990. DERIM is a microcomputer-based district heating and cooling (DHC) and combined heat and power (CHP) model capable of simulating regional DHC/CHP potentials under various future energy cost and air quality scenarios. The model was primarily intended as a tool to forecast and evaluate the impact of changing technologies, taxes on various air emissions, government incentive programs on DHC/CHP market penetration, and resulting changes in air emissions. Although the model was designed primarily as a tool for in-house USDOE use and specifically directed toward regional analysis, the model could easily be adapted for use at the local community level.

Unfortunately, the DERIM model was never released by USDOE for widespread application by either the public or private sector. Many of the capabilities of the model were, however, later incorporated into the HEATMAP© model. These features include comparative air emissions; impact of tax incentives, including energy taxes; and ability to model technological improvements as, for example, increases in equipment efficiency, enhanced distribution piping insulation, or friction reducing additives.

DETECT

DETECT is a consequence model for assessing the environmental benefits of district heating and cooling. DETECT stands for District Energy, The Environmental Considerations and Taxes. As the name describes, the program has the ability to include environmental considerations in the economic analysis, e.g., as extra expenses for equipment for emission control or graduated taxes on fuels. DETECT is designed to allow for conducting a preliminary feasibility study using a number of economic parameters (investments, energy prices, etc.) and calculating the reduction in emissions compared to a reference alternative (the evolution of energy costs and emissions if development continues without change in energy sources). DETECT is intended to be used to provide an indication of DHC favorably and not to replace the need for detailed feasibility and design studies. DETECT, like HEATPLAN, is non-geographically-based, and thus requires considerable engineering analysis or reliance upon statistically generated distribution system parameters including pipe length, diameter, and costs.

HEATMAP©

HEATMAP© development began in 1988 in a response to the need to improve on HEATPLAN's analytical capabilities relative to district energy distribution systems. HEATMAP© provides a fast and reliable method of modeling district heating and cooling (DHC) systems or central energy plants. The program can effectively model both proposed DHC projects (e.g., to assist in assessing the technical and economic feasibility) and existing systems (e.g., to evaluate system performance and determine the effect of various alternatives for improving operating performance, system expansion, or system modification upgrades). The program has been developed by WSU on behalf of the New York State Energy Research and Development Authority, the Swedish Council for Building Research, the Swedish Trade Office, the United States Navy and Army, the United States Department of Defense, United States Department of Energy, and Public Works and Government Services Canada (Science Directorate).

The latest WINDOWS version provides ease of data manipulation, simplified procedures for performing comparative analyses of multiple scenario alternatives, and the acceptance of hourly consumer load data from DOE II or an ASCII file. Maximum coincident loading on any pipe described in the heating or cooling distribution model can be determined, as well as desired scenario analyses to identify effects of consumer or system loads present during any hourly interval of a model year.

Features include: a graphical analysis package covering analytical procedures; metric (SI) capability; AutoCAD compatibility; international currency units; use of ASHRAE-compatible temperature bin data; insertion of specific pump and valve curve operating data; extensive report generation options; graphical diagnostics; and color plots of distribution system parameters.

The HEATMAP© program allows the user to establish and maintain a project database that stores a structured, detailed description of the target or existing DHC system. The database

and the HEATMAP© software are organized to correspond to the six general categories of information and function that are required to complete a DHC project:

- General project description
- Consumer heating and cooling loads
- Production plants
- Distribution system
- Economics
- Reports
- Library (support data)

The HEATMAP© database is linked to a three dimensional project map that is constructed using AutoCAD. The location of each DHC consumer and production plant in the database is identified on the map. For geothermal systems, this includes production and injection wells and transmission piping as well as the heat exchanger plant and back-up or peaking boilers. Combined heat and power systems can also be modeled as can systems employing thermal storage. The map also contains a representation of the distribution network. Each node and pipe depicted on the map is linked to a corresponding record in the project database. Pumps and/or valves can be inserted at any node in the system.

An additional important feature of the program is its capability to analyze air emissions from existing individual building boiler plants and compare levels of emissions to those that will be present after DHC implementation. In the case of geothermal emissions, levels will be essentially zero unless peaking and/or back-up is provided through the use of fossil fuel-fired boilers.

Consumer Heating or Cooling Loads and Air Emissions. For each consumer added to the project database, HEATMAP© requests annual energy consumption data for space heating, space cooling, and domestic hot water. If the user is unable to provide actual data (e.g., from utility bills), the program estimates the annual load based on the conditioned square footage of the facility and its end use, e.g., offices, school, or residential, etc. The methodology used for estimating consumer load is patterned directly after COMPACT, a software tool developed by Lawrence Berkeley Laboratory under the sponsorship of the Electric Power Research Institute (EPRI). The COMPACT computer program calculates an energy utilization index (EUI), expressed in terms of kWh/square meter/year or kWh/square foot/year. Separate EUIs are established for space heating, space cooling, and domestic hot water. Note: If industrial process loads are present in a facility, users must specify the actual load for each process since its energy use will be a function of the specific application. The user may also specify load data calculated by using such programs as DOE II or BLAST.

After annual loads have been determined for each consumer, HEATMAP© calculates peak loads. The aggregated annual and peak load totals for all DHC consumers serve as inputs to the procedure that calculates the load duration curve. Diversity factor or percentage of coincident peak is also a very important input. This procedure requires a variety of other input data, including load factor, weather (temperature bin table), and distribution system losses.

HEATMAP© also calculates air emissions produced by each consumer, based on the thermal efficiency and the type of fuel used by all of the existing heating and cooling equipment. The program provides estimates for CO₂, SO_x, NO_x, and particulates; totals are aggregated for the emissions produced by all potential or target DHC consumers.

Production Plants The HEATMAP© user can specify heating and/or cooling production equipment to operate in either base load or peak mode. Peak equipment is assumed to be capable of operating over a wide load range, and can be brought on line rapidly. Base load equipment, e.g., a geothermal plant consisting of fluid production equipment, i.e., wells, heat exchangers, and pumps, is assumed to operate with higher turn down ratios and requires additional time to be brought on line. Production equipment fuel sources include geothermal, natural gas, electricity, fuel oil, coal, biomass, municipal solid waste, heat pumps, and recovered waste heat. Cooling equipment includes absorption units, heat pumps, and steam- or electric-driven centrifugal chillers. For a geothermal system, absorption cooling, steam, or binary-driven centrifugal or screw chillers, would be the most logical choices.

The user can provide actual values for equipment performance characteristics such as output capacity and efficiency, or can select default values supplied by the HEATMAP© library.

The cost of energy purchased to operate the production equipment is calculated by HEATMAP© on a seasonal basis for winter, mid season, and summer. Seasonal calculations

allow the effects of varying energy costs and equipment performance to be considered. The seasonal purchased energy costs and the duration of each season may be specified by the user. The CHP version of the program uses a simulated 8,760 hour calculating routine to better assess the value of peak power or peak demand offset attainable through thermal storage.

HEATMAP© calculates estimates of the air emissions produced by the DHC production equipment, including CO₂, SO_x, NO_x, and particulates. By comparing these values to the aggregated consumer totals, HEATMAP© will evaluate emission level reduction benefits for the central plant operation.

Distribution System. The HEATMAP© user designs a complete DHC distribution network on the project map using AutoCAD software. The HEATMAP© program "reads" the CAD drawing of the map, and creates a record in the database for each section of pipe and node (consumer or production plant) in the system. HEATMAP© correlates the input geographical information with heating or cooling load data and passes an output file to the LFLOW-2F program. LFLOW-2F analyzes the entire distribution system (both supply and return) to determine: pressures, temperatures, flow, and thermal energy characteristics for each pipe and node; and pipe sizes if unspecified by input data (e.g., in new systems or expansions). From the results of the LFLOW-2F analysis, HEATMAP© constructs an inventory of technical specifications and costs for all system components, including pumps and valves. In addition, energy cost associated with pump operations are derived.

HEATMAP© also permits interactive use of the LFLOW-2F program so that the effects of modifying various distribution system parameters (i.e., valves, pumps, pipe sizes, heat transfer coefficients, roughness factors, pressures, temperatures, and flow conditions, etc.) can be examined. Hydraulic and thermal analysis of various distribution system scenarios can help designers and system operators in the identification of many functional benefits including: optimization of heat production, pump heads, and system operating temperatures and pressures; and minimization of heat loss, flow circulation, and system energy waste. The program allows for evaluating the effects of meeting peak load and determining flow conditions when new consumers are added to the existing network or if the network is expanded into new geographical areas.

Library. The HEATMAP© library contains a wide variety of information from which default values and assumptions are obtained for use throughout the program. For example, the program requires information about fuel types for the analysis of DHC production units *and* existing consumer heating or cooling equipment. To estimate air emissions, HEATMAP© uses library information on weather data as well as all other pertinent factors needed to perform the necessary calculations.

In most cases, the data in the support library is stored and manipulated in the form of tables. A table consists of rows (records) and columns (fields). The table of fuel data, for example, contains a row for each fuel type recognized by HEATMAP©. Each row consists of seven columns: fuel name, unit name, conversion factor, and levels for each of the four emission categories. Data tables are maintained for six categories of information:

- Weather Data
- Fuel Data
- Statistical EUI Data
- Production Unit Data
- Consumer Heating and Cooling Equipment Data
- Pipe Data

Economics. On the basis of the project conditions specified by the user, HEATMAP© will calculate either the necessary break-even unit sales price for each consumer by mode of operation, i.e., heating production (hot water or steam) and cooling production (chilled water), or allow the user to conduct a more traditional life cycle cost analysis.

Prices are calculated for each year of the project and on a levelized basis throughout the project life. Both public and private ownership's can be considered.

The sales prices are calculated based on the "minimum acceptable revenue requirement" financial model. The general calculation approach involves determining the required revenue stream associated with each production plant's operating expenses (e.g., purchased energy, operating labor, equipment maintenance and repair, debt, taxes, and others). Required return on investment is treated as an expense item. The gross revenue that must be present for the plant to operate profitably is determined from the sum of all revenue streams generated by the plant

operation. By calculating the required gross revenue for each year of the project life, and knowing the annual heating and cooling production send out, HEATMAP© will determine the average sales price.

Special features of the HEATMAP© economic analysis module include: debt financing from bonds or bank loans; equity financing; ability to annually escalate cost factors including capital equipment, fuels, operating labor, and maintenance costs; separate construction and long-term debt financing; income tax calculations including various tax depreciation methods; tax credits; income stream from thermal sales and electrical; consequences or impacts of environmental taxes applied to different fuels or production methods; and a sensitivity analysis of sales price versus key production plant operating expenses.

The model has undergone extensive testing, both in the U.S. and in Europe, and continues to have new features added on a regular basis.

Despite the availability of the best possible models, they are only a tool to be used in a comprehensive program directed toward the development of a commercial or even an institutional district energy system. Other equally valuable tools include a marketing plan and the establishment of a legal and institutional framework conducive to DE development.

6. MARKETING

The development of a comprehensive program will only result in the desired outcome if adequate attention is paid to marketing district energy along every step of the way and developing an institutional and legal framework conducive to development and user confidence.

Marketing is one of the most difficult tasks facing developers of modern district energy (DE) systems. Marketing efforts must begin early in the planning stages and must continue throughout all phases of development.

In order to be successful, marketing must be directed toward community leaders, owners/operators, and customers, and must focus on creating a win, win, win situation. All entities must be comfortable with the concept and convinced of the benefits that district energy will provide. This is because district energy requires major adjustments in traditional attitudes toward energy planning, energy resources and production, delivery mechanisms, and energy consumption equipment and utilization.

Complex questions of ownership, operation, financing, and regulation must all be dealt with in order to successfully market district energy. Who has the legal authorization to engage in the financing, development, ownership, and operation of a district energy system? What degree of regulation will be imposed upon the developer and by what agency or agencies? What contract provisions will be required in order to ensure the adequacy of energy supplies, the financial viability of the system, and customer confidence in service and future costs?

Finally, in order to successfully market district energy, local engineers, architects, and HVAC contractors must be familiar with the benefits that a well designed district energy system can provide to their clients, and the incremental cost of connecting to the district system as opposed to a more conventional heating and/or cooling system must be recoverable within a reasonable period of time.

6.1 Community Leaders

The marketing of district energy to local officials may be the most difficult and potentially the most beneficial in terms of project success. Elected officials, municipal employees, local utility personnel, and various civic and neighborhood groups will all play an important role in defining a doable project and ensuring its viability. However, each group will have its own agendas and priorities. Therefore, to be successful, the marketing effort must not only be directed toward convincing each group of the benefits of district energy, but also to addressing the concerns of each group.

Elected officials will be concerned with their legal authority to become involved with a district energy project. Do they have the legal authority to finance, construct, own, and operate a district energy system? Do their constituents really want it? Should the city become directly involved or should it encourage some other entity--an existing local utility or a company specializing in district energy--to construct and operate the system? If the city decides to encourage another party, what sort of franchise or contractual arrangements are necessary and how should they be structured? Does district energy fit within the framework of an existing

comprehensive plan or would it require major revisions? Can district energy play a major role or contribute in a substantial way toward reaching other municipal goals such as economic development or community revitalization? If the city is interested in entering the district energy field, does district energy fit with other publicly-provided services such as water, sewage, natural gas, or electricity? Does the city already operate an existing electric or natural gas utility that would make it comfortable providing district energy service without the need to establish another department to run such a system, e.g., natural gas? Will district energy service actually compete with other viable services the city already provides? What will be the fiscal impact on municipal finances?

Another major question is whether or not a major renovation or replacement of a potable water or sewer system is required or planned in the city? If so, it will necessitate extensive excavation and as long as streets are being excavated and existing utilities are being repaired, rerouted, or replaced, a modern district energy system could be installed very inexpensively since costs of civil work could be shared among a number of utilities.

Municipal employees will be most concerned with the impact of district energy upon existing and future work loads, and upon ongoing or planned public works projects.

Local utilities will be most interested in how a district energy system will affect their market share. Will they lose customers? Could they add district energy to the list of other services they now provide and actually benefit from the implementation of a modern district energy system?

Civic and neighborhood groups will be most interested in how district energy can contribute to economic development or neighborhood revitalization. They will also be very interested in how construction will disturb access to businesses or residences, how the project will be financed, and whether or not district energy will affect local taxes.

From among the above mentioned groups it is vital to the success of the proposed project that one or more champions of the system emerge. The local champion will be responsible for making contact with city personnel and other affected agencies and organizations to help them gain an understanding of how the system operates and what impact it has in other related areas. The champion(s) is also needed to assure city council members about revenues, costs, impacts of construction, and impacts on existing services. The champion can be an elected official, mayor, or city councilman; a city employee, city manager, or public works director; or an influential businessman. However, someone who has led a successful downtown grass roots movement, whether for or against city programs, will probably be the most effective in enlisting support from small building owners. Finally, personality is often much more important than position in convincing target audiences of the value of district energy and convincing them to join the "band wagon." Whoever he or she may be, providing an opportunity to visit a successfully operating system will be time and money well spent (Bloomquist and Spurr, 1999).

6.2 Owner/Operator

Although strong support from the community, and especially from elected officials, is vital to the success of district energy, municipal government may not be able or willing to take on the added responsibility of actually owning and operating a DE system. The city may wish instead to grant a franchise to an energy company that will, in turn, provide district energy services. Likely candidates would include existing gas and/or electric utilities, and companies that specialize in providing district energy service.

Existing utilities may be interested in providing district energy in order to increase their market share, better utilize existing thermal plant capacity, or as a conservation measure. District energy companies will be most concerned with making a reasonable rate of return or, in the case of a non-profit corporation or cooperative, in supplying reliable, economical district energy service. All potential owner/operators should be kept well informed and, if at all possible, directly involved in the completion of feasibility studies and the review of design options.

Of critical importance to the utility or for-profit corporation will be the extent and potential impacts of state and/or local regulations of district energy activities. Public service or utility commission regulation of district energy suppliers or distributors can result in the loss of tax credits, a restricted rate of return, imposition of administrative and financial burdens disproportionate to the benefits received, or underutilization of resources and restricted development in order to avoid regulation.

A second major issue for private developers of district energy systems will be local municipal franchise provisions. Again, as with utility law, local franchise statutes can, if not properly structured, serve to restrict development. Thus, if local officials are going to be able to successfully market their city to private district energy investors and developers, federal, state, and local statutes and regulations must provide an attractive framework within which district energy can develop and prosper.

For profit, as well as not for profit, or cooperative system developers must all be concerned with the long-term cost and availability of thermal resources. Because of this, contracts between energy suppliers and distributors will be of critical importance and will be a major determinant in the structure of customer contracts.

6.3 Customers

Potential customers of district energy services may present the greatest marketing challenge. The developer of a new district energy system is proposing to sell a product which few people will deem necessary, and which will require customers to make major changes in their energy consumption equipment and patterns. In addition, the cost of conversion may be substantial, and if the customer has recently purchased a new boiler, chiller, or installed a new HVAC system, the thought of another conversion may be a very unwelcome idea.

Potential customers will therefore need to be convinced of the long-term benefits of DE, and will be most concerned with the cost effectiveness of district energy to meet their individual needs. However, they will also be very concerned with contract provisions such as who has responsibility for what equipment, terms of the contract, pricing formulas, and provisions for price escalation. Customers will also have to become comfortable with the district heating supplier's system in terms of its adequacy to meet their needs on a continuing basis. They will also have to be convinced that the company is financially stable and will be able to provide service well into the future at a competitive price. This is especially true if district heating does not fall under the jurisdiction of the state utility or public service commission.

In addition, the total number of potential customers and the diverse array of end use systems, both in terms of fuel type and delivery mechanism, will seriously complicate marketing efforts. It may also be difficult to convince developers of new buildings to design their HVAC system so as to be compatible with the DH system because of unfamiliarity of architects and engineers in the design and operational parameters of district energy systems.

6.4 Marketing Approaches

Marketing to potential customers can be approached in several ways. Incentives as well as intimidation can be used, and the approach can be either direct or indirect.

In Willmar, Minnesota, USA, customers were offered a free heat exchanger and free maintenance; a second heat exchanger for domestic hot water is provided at a nominal cost. In Vancouver, British Columbia, Canada, the district heating company covers a percentage of the retrofit costs dependent upon the term of the contract the customer is willing to sign. In Sweden and Denmark, customers are offered a substantially-reduced connection fee if they join the system when it is initially installed. In addition, low-interest loans are available to cover costs. Those who wish to connect at a later time pay the penalty of a large connection fee.

In Denmark, the Heat Supply Act of 1979 authorized communities to make connection to the district heating system mandatory. And although few communities have had to consider the need to implement mandatory connection, its availability gives a community a strong tool in negotiations. And although connection to the system could be mandated, residential customers would have nine years or until their existing heating system required replacement.

Local government can also play an important role in marketing, especially when it comes to new construction or major renovations of existing buildings, by passing an ordinance that would require that every building in the district energy service area consider district energy as a prerequisite for obtaining a building permit for renovation or new construction.

However, whatever approach or approaches are adopted, economic motivation and a desire to address the concerns of the building owner and/or operator is vital. Simply offering heat and/or cooling at a price lower than that of competitive services is by no means a guarantee of success.

Cost savings to the customer are based not only on the cost of DE service but equally on the cost of retrofitting an existing system to accept DE service. The payback on investment will be

highly dependent upon both factors. Because of this, the cost of retrofitting must be based upon sound engineering and cost estimates, as must the projected cost of thermal energy from the district system. Wherever possible, retrofit costs should be verified by more than one expert. In this regard, the well informed engineer and/or HVAC contractor can become one of the most important marketers of district energy services.

Because many prospective customers are either in the design or building phase or in the process of replacing or upgrading an existing HVAC system, local engineers and HVAC contractors are in an ideal position to market district energy by providing technical guidance. Because it is almost impossible for the district energy company to provide the technical information required by each potential customer, the engineer or HVAC contractor can fill that role especially well if they have been provided with detailed information concerning the benefits of district energy as well as solutions to common retrofit or new construction design problems.

The engineer or HVAC contractor must, however, be convinced not only of the benefits to the customer but also the benefits to his or her own business in terms of the increased revenue to be made from retrofitting or new construction. Because of the importance of the engineer or HVAC contractor to the district energy marketing effort, some cities conduct regular classes aimed at providing complete information concerning the benefits of district energy, system operation, and recommended retrofit or design procedures and equipment.

However, regardless of how well thought out and sophisticated a marketing program might be, the ability to have potential customers visit a demonstration project or an operating system and discuss concerns and benefits with a satisfied building owner will often be the key to increased district energy sales.

In the case of new construction, connecting to a district energy system can result in a significant reduction in the initial cost of the building through eliminating the need for much of the conventional equipment, including boilers and chillers. It can also result in a major reduction in operation and maintenance costs.

In setting up a marketing program, it is extremely risky to simply consider a discount on the price of other competitive fuels, e.g., natural gas. With district energy, you are providing a service, e.g., heating and cooling, not simply selling a commodity, e.g., natural gas or electricity, that must be converted by the building owner/operator to provide heating and/or cooling. In most areas, the value of district energy service can and should be considerably higher than the commodity price of competing fuels.

6.5 Franchise Agreements

Where DE development is being pursued by the private sector, an agreement between the city and the developer to utilize public right-of-way is a vital step in the development process and critical to obtaining financing.

Most local governments are empowered to grant franchises authorizing the use of public streets and rights of way for specified utility purposes, and they establish procedures for doing so. These generally include requirements for public notice and hearing, and sometimes for competitive bidding. The product of this process is normally a municipal ordinance constituting an offer or grant of a franchise agreement between the municipality and the utility provider (referred to below as the "**grantee**" of the franchise, or simply the "**franchisee**").

Franchisees for local utility services are usually conventional investor-owned electric, gas, water, or telephone utilities serving the general public, but they can also be DE suppliers serving limited portions of the community. District energy systems serving institutional or other users entirely through private property rarely need franchises, but most other types of DE systems do.

Franchise agreements set forth conditions for the franchisee's use of public property and describe the parties' rights and obligations surrounding the franchised activities. These agreements are generally similar in form from one local government to another, but specific franchise terms vary with the municipality and the type of utility service. These terms are more or less negotiable, depending on the municipality's interest in new utility services and the needs of prospective suppliers.

Familiarity with alternative franchise approaches should help both municipalities and DE proponents to structure agreements that will serve local needs and assist DE development. Municipalities that have not yet granted district heating franchises are likely to look to their existing gas, electric, and water franchises as models, so the following discussion on franchise terms

covers both district energy and other services. A typical agreement covers some or all of the following subjects, each of which is discussed further below:

- Franchise Grant and Scope
- Duration or Term
- Fee or Compensation to Municipality
- Franchisee Rights and Obligations
- Reservation of Municipal Rights
- Liability for Damages
- Default, Forfeiture, and Termination
- Transfer and Assignment of Franchise
- Municipal Acquisition of Utility

6.5.1 Franchise Grant and Scope

Franchise agreements typically contain a "granting" provision setting forth the activities authorized and the purposes to be served by the franchise. Some confer an exclusive right to undertake those activities within some designated service territory, meaning that the franchisee has a legal right to challenge others who might later seek to provide the same service within the same territory. Other franchises expressly provide for nonexclusive rights, meaning that others who wish to provide similar services in the franchisee's service area are free to do so.

Where the central activities authorized are construction and operation of pipelines and related facilities, an "exclusivity" provision may not be critical, since other suppliers are unlikely to duplicate pipelines already in place to serve the same customers. However, where the authorized activities include construction and operation of production facilities such as geothermal wells or a cogeneration plant, prospective suppliers may need the protection of an "exclusivity" clause to assure their financing sources that the value of the initial investment will have some protection from direct competition by similar central plant heat sources (although not from on-site sources).

6.5.2 Duration or Term

Franchise agreements specify the time period during which the franchisee's rights will continue (subject to its performance and other conditions discussed later). From most DE suppliers' viewpoint, the longer the term, the better. At a minimum, the term must be long enough to recover the supplier's capital costs, including its necessary investment return, from the system's projected revenues.

Franchises are usually granted for a fixed term of years. They may also be granted for indefinite terms or in perpetuity, subject only to termination on specified conditions.

6.5.3 Franchise Fee or Compensation to Municipality

Municipal franchises normally require their grantees to pay the municipality a fee, sometimes described as compensation, for the use of public streets and rights of way. Fees are usually set as a percentage of the franchisee's gross revenues from its franchised activities. Fees normally range from 1-3 percent of revenues, and are usually payable within a specified period following the end of the year. Payment often must be accompanied by the franchisee's sworn statement verifying the revenues upon which the fees are based. Penalties, including forfeiture of the franchise, are usually provided for late payments. Although the fee is usually a fixed percentage of revenues for the life of the franchise, some franchises provide formulas for periodic modifications or adjustments.

6.6 Franchisee Obligations and Conditions

To obtain franchise privileges, utility franchisees must agree to certain obligations and conditions. Among the most common are requirements to proceed diligently to construct and operate the utility system; to excavate, repair, and restore streets and other property so as to minimize interference with its use by the public; to provide adequate service to customers; to meet certain safety standards; and to comply with state and local laws and ordinances.

6.6.1 Reservation of Municipal Rights

Franchise agreements not only grant rights to the franchisee, but also reserve certain rights for the benefit of the municipality. The most common reservation is probably the right to inspect and/or audit the franchisee's books and records to verify the revenues upon which the city's franchise fee depends. Municipalities may also reserve rights to inspect the franchisee's physical plant to ensure its safety and continued maintenance. Many franchise agreements expressly reserve municipal priorities for construction and relocation of streets and public facilities where these might affect the franchisee's system.

6.6.2 Liability for Damages

Municipalities uniformly require protection against any liability that might arise from the conduct of their franchisees' activities. This may be in the form of an indemnity, a "hold harmless" provision, insurance requirements, or all of these.

6.6.3 Default, Forfeiture, and Termination

Municipal franchises for utility services universally establish grounds for default, termination and forfeiture of the franchise. Some agreements limit forfeiture and termination to substantial failures of performance by the franchisee. Others are more draconian, and provide for forfeiture at the municipality's option for any failure by the franchisee to abide by the franchise terms, however inconsequential. Such provisions may or may not be strictly enforceable, but prospective DE developers should certainly try to negotiate less severe terms wherever possible. In addition, clear procedures to determine when a default has occurred and provide opportunities to correct it should be spelled out in the agreement.

6.6.4 Transfer and Assignment of Franchise

Utility franchises generally provide for transfer or assignment to someone other than the original franchisee, but only with the municipality's consent. Since financing sources typically require that the franchisee's assets, including the franchise itself, be assigned to them or to a trustee as security for loans and other financing instruments, some franchises exempt these "technical" transfers from the municipal consent requirement. Where a prospective thermal energy producer desires that some other entity handle transmission and distribution functions, but needs to obtain a municipality's franchise commitment to attract such a partner or obtain financing or customer commitments, it may be prudent to acknowledge that the franchise will or may be transferred with the municipality's consent once such a partner is secured.

6.6.5 Municipal Acquisition of Utility

Municipalities generally reserve the right to acquire the utility systems they franchise. Provisions to this effect often provide for both voluntary acquisition by agreement between the parties and forced acquisition by condemnation and eminent domain proceedings. They may or may not limit the circumstances under which acquisition may proceed, or establish a price formula and/or acquisition procedures.

6.6.6 Summary

The above franchise provisions are typical of those likely to govern DE systems. As suggested earlier, franchise agreements are generally similar in form, but they vary in specifics from one municipality to another. Although most municipalities probably prefer to use franchise terms that they have used with other types of utility services, there is usually room for negotiation between the municipality and the prospective DE supplier.

For a more detailed account of franchise agreements, see *District Heating and Development Guide: Legal, Institutional and Marketing Issues* (Bloomquist, et al., 1988).

6.7 SUPPLIER/CUSTOMER AGREEMENTS

Given the diversity of district energy (DE) systems, no uniform standard contract between thermal energy distributors, public or private, and their customers could effectively address the

concerns of every individual system. But it is possible to identify key issues likely to arise in most DE customer contracts, and to see how existing DE systems have handled them.

Before considering specific contract provisions, it is worth noting that the DE supplier's freedom to structure its customer contracts may be limited by regulatory considerations and/or the type of customer involved. Where the supplier falls under a "public utility" definition and therefore the jurisdiction of a utility commission, the commission may have authority to approve the suppliers' contract terms, and will probably mandate different standards than a municipal or nonregulated supplier would adopt for its contracts.

For example, utility commissions normally set customer rates based on the utility's cost of service, including a low rate of return reflecting the relatively low risks faced by conventional monopoly suppliers. On the other hand, an unregulated supplier operating in competitive heating and cooling markets will probably set its rates based on the market value of its services in relation to competing suppliers, with its cost of service operating only as a floor. In the case of new DE systems, those rates would have to be low enough to attract customers away from existing energy suppliers.

Similarly, where a DE supplier serves one or more large customers (either alone or as "anchor" customers for a system that also serves a number of smaller users), it will negotiate contracts with its large customers that more closely reflect their individual needs. Since the viability of the supplier's system may depend on the continued thermal demands of these customers, it may be willing to agree to terms that it could not offer to smaller users whose individual contributions would not significantly affect the system's success. Examples might include terms covering bulk pricing, back-up requirements, or heat and/or cooling allocation priorities in case of service disruptions.

Apart from these qualifications, the contract provisions set forth below are quite representative of the terms DE suppliers offer their customers. These terms cover the following subjects, each of which is discussed below:

- Contract Duration or Term
- Supplier's Delivery Obligation
- Customer's Purchase Obligation
- Conversion or Retrofit Responsibility
- Rates and Charges
- Billing and Payment
- Resale and Submetering
- Equipment and Maintenance Responsibility
- Inspection Rights and Access
- Termination of Service
- Liability
- Dispute Resolution
- Assignment and Successors

6.7.1 Contract Duration or Term

There is no standard duration for DE customer contracts. Among those reviewed, terms vary from less than one year in the case of one experimental geothermal system, to an indefinite number of years to be selected by the parties in the case of several other systems.

6.7.2 Supplier's Delivery Obligation

The nature of the DE supplier's obligation to deliver heating and/or cooling to its customers is one of the most important terms of any DE customer contract, and can be one of the most complex. This key provision usually defines the minimum or maximum quantity of heat or chilled water the supplier will deliver at specified temperatures and pressures. It may also define allowable service interruptions or conditions which would excuse any failure to deliver the agreed quantity or quality.

6.7.3 Customer's Purchase Obligation

Like conventional utility suppliers, DE suppliers must recover their capital costs and operating expenses (usually including profit) through energy sales to customers. But unlike most conventional utility suppliers, DE suppliers do not enjoy a monopoly in the service they provide. Heating and cooling are available from a variety of local sources, including electricity, gas, coal, oil, propane, wood, and/or solar energy. Whereas conventional gas, electric, and even water utilities historically have been assured that all customers within their service territories will purchase their needs from the utility, this is not true for district heating and cooling suppliers, whose customers may switch from one source to another, or use different heating and cooling sources to satisfy different needs.

To stabilize their sales under these conditions, some DE suppliers seek more certain purchase commitments from their customers. This can be especially important for resources such as geothermal, where it may be difficult or costly to match heat production precisely to customer demand. The most common purchase commitment requires customers to buy all of their heating needs from the DE system, to the extent that it can provide them. Another common customer commitment is to pay for some minimum amount of heating or cooling each month or each year. The customers of some public and nonprofit DE systems agree to pay a prorata share of the system's fixed costs if total demand on the system falls below some specified minimum.

6.7.4 Conversion or Retrofit Responsibility

Buildings served by DE systems must have internal heating or cooling systems capable of receiving, measuring, using, and disposing of the energy stream furnished by the system. Existing buildings previously served by other heating and cooling forms may need to be retrofitted; new buildings need to be designed and equipped to receive and use DE services. DE customer agreements therefore define the parties' rights and obligations concerning these issues. The customer normally installs and pays for the retrofit of its own facilities, sometimes subject to the DE supplier's specifications and approval.

6.7.5 Rates and Charges

Charges for DE services can be calculated in many ways, and customer contracts reflect all of them. Some rate provisions are models of simplicity, while others raise complexity to an art form. Several basic models are available.

The simplest is a flat monthly charge. This infrequent pricing approach can serve well enough for short-term contracts based on geothermal or other renewable heat sources involving capital costs but little or no energy costs, and not subject to major fuel price fluctuations; but it will not adequately protect other suppliers. Another approach, also common to renewable resource-based systems, is to set rates based on the market value of the DE supplier's service in relation to competing heating or cooling services, usually by offering a percentage discount under the customer's cost of heating or cooling with conventional energy sources. A third approach is to set DE rates in much the same way that conventional utilities have, as a function of the supplier's cost of service, including both demand and energy charges.

6.7.6 Billing and Payment

Billing and payment provisions are standard in DE customer contracts. Their terms are not unique to the DE context, or particularly novel.

6.7.7 Resale and Submetering

DE contracts often prohibit the customer from reselling or submetering heating or cooling commodities or services to others, at least without the supplier's consent. Some contracts permit resales only within the customer's building(s), or only if they meet conditions that ensure that the customer will not profit at the supplier's expense or interpose itself as an intermediary utility between the supplier and the ultimate users of its services.

6.7.8 Equipment and Maintenance Responsibilities

District energy systems include not only the supplier's production, transmission, and distribution facilities, but also the customer's building and equipment needed to utilize the system's outputs. DE customer contracts often include terms that define where the supplier's system ends and the customer's begins, and allocate responsibilities for furnishing, installing, maintaining and repairing various components of the system. A common arrangement is for the supplier to be responsible for parts of the system up to the point of connection with the customer's building and for any metering devices, while the customer is responsible for equipment within its own building.

6.7.9 Inspection Rights & Access

DE suppliers need access to their customers' premises and equipment located there for several reasons. When customer rates are based on metered usage, the meters are normally located on the customer's premises, and the supplier is responsible to read them at regular (usually monthly or bimonthly) intervals. In addition, some of the supplier's own equipment may be located on its customers' premises, so access is needed to maintain and repair it. Finally, since the customer's own equipment is an integral part of the supplier's system, the supplier needs to be able to inspect and possibly to service, repair, remove, and/or replace the equipment. DE contracts usually recognize these needs and include provisions defining the parties' rights and responsibilities concerning access and inspections.

6.7.10 Termination and Suspension of Service

Like other forms of service contract, DE customer contracts define the conditions under which the parties can terminate their arrangement and their obligations upon termination. Suppliers are usually entitled to terminate service for conditions such as customer non-payment, customer maintenance failures or safety violations, damage to or destruction of the supplier's facilities or the customer's premises, governmental actions or other events beyond the supplier's control, or customer fraud. Customers are usually entitled to terminate for failure of the supplier to deliver heating or cooling for some specified period, or for damage to or destruction of the supplier's facilities or their own premises. Reasonable notice is normally required prior to termination by either party. Most DE contracts simply end the parties' obligations upon termination, although some require the customer to pay certain costs--sometimes including a portion of the supplier's unamortized system costs -- where the customer terminates the arrangement.

6.7.11 Liability

Most district energy contracts apportion potential liability for loss or damage arising in some way from system operations. Terms range from one-sided liability disclaimers by DE suppliers, to more even-handed allocations of risk between suppliers and their customers. Some suppliers disclaim liability for all loss or damage not caused by their own negligence or willful misconduct, and some include similar provisions for their customers' benefit.

Contracts may apportion liability according to the location of the facilities or equipment causing the problem, with the customer liable for any mishaps within its building and the supplier liable for occurrences within its production, transmission and distribution system. Some contracts also provide for supplier liability for certain consequential losses or damages--such as lost rent--arising from system failures. On the other hand, customers are generally liable for loss or damage to any property of the supplier installed on the customer's premises.

6.7.12 Dispute Resolution

Few of the customer contracts establish any mechanism for resolving supplier/customer disputes. Such provisions can, however, be helpful in directing the parties to solutions that they may be unable to negotiate on their own, while enabling them to avoid costly and wasteful litigation. Arbitration provisions found in many other types of contracts suggest one possibility for unregulated DE systems.

6.7.13 Assignment and Successors

Owners and occupants of buildings served by DE systems can change. So can the owners and operators of the system itself. District heating and cooling customer contracts normally define the rights and obligations of suppliers and customers in these situations, but their terms vary considerably. Most prohibit assignment or transfer of the customer's interest in the contract without the supplier's written consent. Some void any transfer of contract rights and hold the customer responsible for performance unless the successor agrees to assume the original customer's obligations.

Some even purport to limit the customer's right to transfer its property or merge or consolidate its business without the supplier's consent and the successor's assumption of the customer's obligations (although these provisions may not be enforceable in some cases).

6.7.14 Summary

The contract terms presented above represent most of the key terms in DE customer contracts. Individual contracts may, of course, contain additional terms unique to a particular DE system. They will also contain "boilerplate" terms found in many other kinds of contracts (including notice provisions, good faith requirements, specification of what law applies, severability provisions, etc.).

For a more detailed account of Supplier/Customer Agreements, see *District Heating Development Guide: Legal, Institutional and Marketing Issues* (Bloomquist, et al., 1988).

7. PROGRAM TO CATALYZE GEOTHERMAL DISTRICT ENERGY IMPLEMENTATION

There are significant untapped low- to moderate-temperature geothermal resources that are located near communities throughout the world that could be used for geothermal district heating and/or district cooling. This section describes a recommended phased program for catalyzing Geothermal Community Energy Systems (GCES) development in communities located near known geothermal resource sites. Key objectives of this program are to:

1. rank the opportunities for GCES;
2. select communities for detailed assessment;
3. conduct assessments in the highest-ranked communities; and
4. facilitate the implementation of GCES through outreach, technical assistance, and cost-shared feasibility studies and assessments, including drilling and reservoir engineering, and the establishment of legal and institutional framework for successful project development.

Studies of the potential of and barriers to implementation of district energy systems have reached a number of common conclusions, including (Brookhaven National Lab., 1993) (National Planning Committee... , 1992) (Handbook of Alternative Energy Technology... , 1983):

- Many key community leaders, utilities, building owners, and others who could be key stakeholders in implementing geothermal district supplies energy systems are not aware of the potential benefits of these systems;
- Development of a new district energy system, particularly one implemented by the community as a whole, can be a complex undertaking, involving many institutional, technical, legal, and financial issues; and
- Local leaders and stakeholders usually lack important knowledge necessary to effectively implement a geothermal district energy systems.

Key elements of the recommended program are designed to stimulate the use of geothermal energy resources by removing major barriers to implementation by local leaders and private sector developers, including lack of knowledge and experience. By educating them about benefits, providing them the tools to assess their current energy production systems, and helping them build a network of experts and practitioners, the recommended program would remove major road-blocks to successful implementation. This program can be the impetus for may local leaders to develop or facilitate private sector development of GCES in their community, increasing energy

efficiency as well as benefiting the environment and local economy. This has been, for example, a key strategy in the Canadian federal government's successful Community Energy Systems program operated by the CANMET Energy Technology Centre.

The recommended program also addresses the fact that in many cases the potential of the geothermal reservoir must be confirmed through additional drilling before detailed engineering on a GCES can be prudently undertaken.

This recommended program is designed to bring communities to the point where they can confidently embark upon contract negotiations and detailed system design using local and/or private sector funding. Any cost share provided by outside governmental entities could be reimbursed by the community upon financing of the Geothermal District Energy System, similar to the approach taken by the Canadian Community Energy Systems program and recommended as far back as 1985 in the studies made by Argonne National Laboratory: A U.S. Department of Energy Revolving Loan Fund: Analysis of Potential Applications Supporting Integrated Community Energy Systems.

The successes stimulated directly by the recommended program are also expected to stimulate additional action by other communities.

7.1 Program Elements

In order to achieve this goal, the following activities should implement:

1. Rank the identified colocated opportunities in consultation with local, regional, and national geothermal experts.
2. Develop information tools on GCES, including a handbook and video.
3. Conduct screening evaluations of the highest-ranked opportunities to include a computer-generated feasibility analysis.
4. Implement outreach program to educate local leaders in identified communities through workshops focusing on GCES.
5. Give local leaders a first-hand look at GCES via on-site visits to operating systems.
6. Facilitate the implementation of GCES through cost-shared feasibility assessments and assistance in overcoming institutional barriers.
7. Confirm reservoir potential through cost-shared well drilling and assessment.

These activities would ideally be conducted in a phased program over three to five years. Each program element, includes specific program deliverables. Subsequent sections address the program budget and program benefits.

7.2 Refine Ranking

Ranking of known geothermal sites is essential for a well-targeted, cost-effective program. Ranking should be established based on input from local, regional, and national geothermal experts and staff of ongoing geothermal programs. This could involve, for example, application of a model such as GEORANK, and consideration of additional information such as heating and cooling potential and thermal load density as that information becomes available.

The following deliverables should be produced in the formats indicated:

- Report on results of consultation with geothermal experts (print).
- Ranking of sites and summary of ranking methodology (print).

7.3 Information Tools

Community interest in developing a GCES depends on a solid understanding of what a GCES can be, how it can be developed, and what its benefits are. A key element in the program would be the development of information products for getting the message out, effectively and efficiently, to community leaders and stakeholders. The primary products would be a marketing plan, a Geothermal Community Energy Handbook, and a video on geothermal community district energy.

Geothermal Community Energy Handbook. It is essential to create concise information on district energy to gain interest, expand awareness, and convey key information. The year one objective would be to develop a handbook and disseminate it through workshops, information and training sessions, and other avenues, as appropriate. This handbook would have dual uses as a stand-alone product that can be distributed individually, as part of a mailing, during a trade show or

other event, or as part of the workshops and information sessions. The handbook would include information on:

- how Geothermal Community Energy Systems work;
- environmental and economic benefits;
- case studies;
- process for evaluating the potential in any given community; and
- legal and institutional issues.

Video. A brief video should be produced to effectively convey basic information about GCES and the benefits from the community perspective. The video would be created focusing on how community energy systems work, how geothermal energy can be harnessed by communities, and what environmental and economic benefits can result. It could build on existing video information available from, for example, the Washington State University, International District Energy Association, Canadian Ministry for Natural Resources, Gothenburg Energi, the Danish District Heating Association, and others. All of these communication tools could be cost-effectively produced by making maximum use of existing materials.

The following deliverables should be produced in the formats indicated:

- Geothermal Community Energy Handbook (print)
- Geothermal Community Energy Video (video)
- Report on dissemination of the handbook and video (print).

7.4 Screening Evaluations

An initial screening evaluation should be conducted of the top ranked communities. However, based on a strong community interest and/or new information relevant to implementation of GCES in a community, work on communities that are initially unranked may be conducted earlier than anticipated.

The screening evaluation should be designed to assess, quickly and cost-effectively, key variables crucial to the viability of a GCES. The costs of the screening assessments should not exceed 10,000 to 15,000 dollars US per assessment. The assessment should include the following tasks.

Task 1 – Site Visit. The community should be visited in order to:

- Meet with community representatives to provide information about the evaluation and to assess the level of interest and identify major potential stakeholders and key local issues relevant to a potential GCES.
- Obtain data required for the analysis, including a map of the downtown; data on power and fuel prices; data on building floor space; and other relevant information as available.
- Conduct a “windshield survey” of the downtown to gather observational information on building use, the number of floors, and other aspects of major downtown buildings

Task 2 – Loads and Distribution System. Heating and cooling loads and demand density should be identified using a computer model to:

- Estimate the heating and cooling peak demands and annual energy requirements.
- Map the estimated loads and identify areas with the highest development density.
- Develop a preliminary thermal distribution network layout and pipe sizing.

Task 3 – Economic Analysis. The potential financial feasibility of a GCES should be evaluated, using a computer model to:

Estimate capital costs for:

- geothermal production (production and injection wells)
- heat exchanger(s)
- back-up/peaking thermal production unit(s)
- transmission to the community
- distribution within the community
- interface with buildings including retrofits

Estimate operating costs for

- pumping the geothermal wells

- pumping for transmission and distribution
- fuel for thermal production in peaking boilers
- personnel for operations, marketing, and management
- maintenance of production and transmission/distribution systems

Calculate the Internal Rate of Return on the required investment

Calculate the Minimum Revenue Required as a test of economic competitiveness.

The following deliverables would be produced in the formats indicated:

- Report on the evaluation for each screened community, including:
- Assessment of heating and cooling peak demands and annual energy requirements
- Map showing estimated loads and thermal load density
- Estimated capital and operating costs for production, transmission, distribution, and building interface
- Proforma financial analysis.
- Recommended priorities for further assessment

7.5 Outreach

This program element should provide interactive dissemination of information about how GCES work, their environmental and economic development benefits, legal and institutional issues, case studies, and how to evaluate GCES. This can be accomplished through workshops to which all of the target communities would be invited, creating an opportunity for detailed discussion and interactive learning.

Written and video information is essential but not sufficient. A key element in the outreach program should be to compliment the handbook and video with interactive workshops focused on GCES. Objectives would be to annually develop, market, and implement one full-day workshop in each year of the planned program.

The following deliverables should be produced in the formats indicated:

- Detailed plan for implementation of each workshop, including agendas and materials (print).
- Attendance list for each workshop (print).
- Summary of results of evaluations solicited from participants in workshops and information sessions (print).

7.6 Site Visits

Building on the previous elements, this program element places local leaders on the ground at actual GCES sites through study tours. These tours compliment the prior elements by putting a physical image together with the data and raw information. Participants should see the elements of GCES first-hand, examine working systems in action and be prepared to discuss with their local government peers how it was accomplished, how it has benefited other communities, and how it could benefit their own. This element of the program also provides an important opportunity for local leaders to make contacts that will be useful as some participants decide to pursue implementation of GCES in their communities. Visiting successful community energy systems helps local leaders understand the technologies; legal institutional, and environmental issues; the community benefits; and how to make it happen. A study tour should be conducted at least every year of the program.

The following deliverables should be produced in the formats indicated:

- Agenda for each study tour (print).
- Attendance list for each study tour (print).
- Summary of results of evaluations solicited from participants in study tours (print).

7.7 Feasibility Assessments and Local Assistance

This step takes the local official from education and training into partnerships for evaluation and implementation. Based on what they have learned and seen, some local leaders will be prepared to and want to take action to further assess the potential use of district energy in their communities and potentially implement a system based on the detailed evaluation. The program is designed to stimulate this activity by encouraging cost-shared partnerships between

local governments and other entities, and guiding decision-makers through the process of a detailed feasibility study, community outreach, and consideration of financing, franchise, and contractual issues.

The program would aid local leaders build a critical path toward implementation and leverage a resource network to guide them in this process. Communities for this step should be chosen on a competitive basis from among the screened communities.

Implementation of GCES is usually a complex undertaking from an institutional and contractual standpoint because it involves multiple stakeholders and participants. This program should provide comprehensive information and guide and assist communities in evaluating the opportunities and benefits of GCES in their community. This would help them overcome the institutional challenges and perform the essential planning, communications, marketing, engineering, and financing required for successful implementation.

A detailed feasibility study and associated community communications should be conducted if, based on the screening evaluation, a community is interested in exploring the feasibility of a GCES. It is anticipated that the average total cost of a detailed feasibility study and technical assistance would be 75,000 dollars US. The elements of the feasibility study and local assistance should include:

- Quantification of the potential market for heating and cooling service;
 - Assessment of the costs of self-generation of heating and cooling;
 - Assessment of technology alternatives for thermal energy transmission and distribution;
 - Development of a preliminary distribution system lay-out and conceptual design;
 - Conceptual design for back-up thermal storage and peaking capacity for the district heating and cooling system;
 - Capital costs for geothermal production, back-up/peaking thermal production, generation of cooling using geothermal heat (as appropriate), thermal storage (if applicable), transmission to the community, distribution within the community, and interface with buildings
 - operation, maintenance, and management costs for the GCES;
 - Analysis of the economic feasibility based on alternative financing approaches;
 - Identification of legal and/or institutional issues that must be addressed; and
 - Communication with the community, key decision-makers, potential customers, and potential private sector partners regarding the GCES concept and its potential benefits.
- The following deliverables would be produced in the formats indicated:
- Report on each feasibility study and local assistance project (print).

7.8 Resource Confirmation

In some cases, the potential for production and/or reinjection must be confirmed, requiring additional drilling before detailed engineering on a GCES can be prudently undertaken. The costs of such resource confirmation will vary significantly, depending on the site.

7.9 Program Benefits

The benefits of the above detailed program would include reduced fossil fuel consumption, reduced air pollution and greenhouse gas emissions, enhanced local economies, and better utilization of indigenous and sustainable resources.

- Fossil fuel consumption will be significantly reduced because communities will substitute geothermal energy for fuel consumption to meet heating (and potentially cooling) requirements. Fuel consumption reductions include direct fuel consumption at the building and indirect fuel consumption at power plants supplying electricity to buildings.
- Emissions of air pollution, including nitrogen oxides, sulfur dioxide, and particulates, will be greatly reduced as a result of the reduced fuel consumption, as will carbon emissions.

As Geothermal Community Energy Systems are developed, local economies should benefit as a result of the reduction in flow of dollars out of the community to pay for fossil fuels produced elsewhere. The recirculation of these retained funds will multiply the economic benefits in the local and state economies.

REFERENCES

1. Allen, E., 1981. *Institutional and Financial Guide to Geothermal District Heating*, for EG&G Idaho, Inc., and the U.S. Department of Energy, Eliot Allen and Associates, Portland, Oregon.
2. Bloomquist, et al., 1988. *District Heating Development Guide: Legal, Institutional and Marketing Issues*, Washington State University Energy Program, Olympia, Washington.
3. Bloomquist, R.G, and M. Spurr, 1999. *Geothermal District Energy at Colocated Sites*, Washington State University Energy Program, Olympia, Washington.
4. Brewer, M., 1998. Personal communication. U.S. Army Construction Engineering Research Laboratory (CERL), Champaign, Illinois, USA.
5. Brookhaven National Laboratory, 1993. "Renewable Energy for America's Cities: Advanced Community Energy Systems Proposed Research, Development and Demonstration Program."
6. Carella, R., 1999. Italian Geothermal Centralized and District Heating, International Summer School on Direct Application of Geothermal Energy, International Geothermal Days-Oregon, Oregon Institute of Technology, Klamath Falls, Oregon, 11 p.
7. Eckfield, R., 1986. Start Small... Think Big... Think Link, *DHC/CHP in America*, Winter/Spring, pp. 21-27.
8. Engaard, K., 1983. Heat Planning in Denmark Promotes District Heating, *City Currents*, United States Conference of Mayors, January/February, pp. 4-6.
9. Geotermia Podhalanska, 1999. Geotermia on the Podhale Region, Text Translated from the PEC Geotermia Podhalanska S.A. Company Brochure, 7 p.
10. Gunnlaugsson, E., 1999. District Heating in Reykjavik, Iceland, International Summer School on Direct Application of Geothermal Energy, International Geothermal Days-Oregon 1999, Oregon Institute of Technology, Klamath Falls, Oregon, 11 pp.
11. "Handbook of Alternative Energy Technology Development and Policy," Congressional Research Service, Report Number 83-43 SPR, 1983.
12. IEA, 1986. "New Distribution Techniques for Residential Areas on its Way," IEA District Heating Project, Energiplanerarna AB, Stockholm, Sweden, *District Heating R and D Newsletter*, Vol. 2, No.1.
13. Jaudin, F., 1999. Heating in the Paris Region - The Melun Example, International Summer School on Direct Application of Geothermal Energy, International Geothermal Days-Oregon 1999, Oregon Institute of Technology, Klamath Falls, Oregon, pp. 119-121.
14. Johansen, K.B., 1987. Plastic Pipes, *District Heating Research and Technology Development in Denmark*, Danish Ministry of Energy, Copenhagen (ISBN 87-503-6536-3), pp. 35-36.
15. Mertoglu, O., 1999. Technological and Market Developments Concerning Geothermal District Heating System in Turkey, International Summer School on Direct Application of Geothermal Energy, International Geothermal Days-Oregon 1999, Oregon Institute of Technology, Klamath Falls, Oregon, pp. 31-35.
16. Mortensen, H.C., 1997. Personal communication, CTR, Copenhagen, Denmark.
17. National Planning Committee for District Heating, Cooling and Cogeneration, March 1992. "National Action Plan for District Heating, Cooling and Cogeneration, An Industry-Government Partnership."
18. Scandinavian Energy, 1984b. *Plastic Balls Filled with Salt Solution for Storing Energy*, Teknikforlaget AB, Halmstad, Sweden, No. 3, p. 12.
19. Wahlman, E., 1978. *Energy Conservation Through District Heating*, Theorell and Martin AB, Sweden.