

TerraSAR-X

Ground Segment

Basic Product Specification Document

CAF – Cluster Applied Remote Sensing

editors:  09.10.'13
T. Fritz, M. Eineder Date
SAR Product Verification Responsible
& TMSP Team

reviewed:  10.10.13
B. Bräutigam Date
SAR System Performance Responsible

reviewed:  10.10.2013
B. Schättler Date
PGS System Engineer SAR

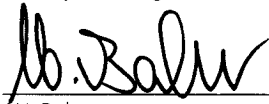
approved:  10.10.2013
W. Balzer Date
PGS Project Manager

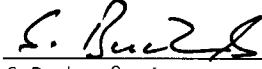
approved:  10.10.2013
S. Buckreiß Date
TS-X Mission Manager

released:  14.10.2013
B. Werninghaus M. R. TS-X Date
TS-X Project Manager



- This page intentionally left blank -



Document Preparation

The document was prepared with contributions from

M. Eineder	IMF
T. Fritz	IMF
J. Mittermayer	IHR
A. Roth	DFD
E. Börner	IMF
H. Breit	IMF
B. Bräutigam	IHR
T. Kraus	IHR

Document Distribution

This document is publicly available.

Document Change Log

Issue	Date	Page	Change Description	Note (i.e. reason of change)
0.5	12.12.2002		Initial Version	
1.0 Draft			Included changes due to RIDs raised at the G/S Preliminary Design Review - Added definitions and estimates for DTAR, ISLR, PSLR in product tables. - Added left looking, full access incidence angle range and 300 MHz - Performed editorial changes - Changed Document ID according to new standards	
1.0	16.3.2004		<ul style="list-style-type: none"> - editorial changes - changed Doc. Number acc. To GS document tree - applicable documents revised - p. 24, 26, 28, 29: increased sampling from 1 to 2 meters - included 10% margin in all geometric resolution values - added incidence angle mask in product size - pp. 24–31: reorganized and compacted product tables - p. 26: increased sampling from 1 to 2 meters - pp. 30-31: increased resolution of ScanSAR products to 15/20 m, reduced radiometric accuracy to 1.5 dB - pp. 30-31: removed undefined dualpol ScanSAR products - reduced criterium for RE products to 1.5 dB (~6 looks) increasing their resolution - allowed arbitrary pixel spacing to reduce product size significantly - Changed product mnemonic to proposed PGS standard, removed polarization to reduce length if identifier - reduced dual pol resolution to 2.4 meters acc. To ASTRIUM Spec. - harmonized, i.e. reduced dual polarization combinations acc. To TX-AED-RS-0001 - introduced values for radiometric stability etc. - inserted incidence angle mask and DEM mask 	Major revision.

			<ul style="list-style-type: none"> - inserted detailed list of parameters 	
1.1	6.7.2004		<ul style="list-style-type: none"> - changed revision of referenced documents and made old RD-1 applicable (WER-R-13/DCR-0079) - pg. 24: Change central meridians from 6° to 9° (UT32) and 9° to 15° (UT33) (SCH-R-2g/DCR-0057) (SCH-R-2d/DCR-0056) - Table 4.1: DTAR of -17 dB was a requirement and pessimistic. Changed to <-20 dB to reflect most cases. - Table 4.2: DTAR value of -16 dB was a requirement. Changed to <-17 dB to reflect all cases. - Explained DTAR (SCH-R-2k/DCR-0058) - Table 4.3: changed DTAR from -17 to <-17 dB. - Table 4.4: changed DTAR from -17 to <-17 dB. (SCH-N-6/DCR-0050) - Table 4.5: changed DTAR from -17 to <-19 dB. - Table 4.6: changed DTAR from -16 to <-17 dB. - Table 4.7: replaced DTAR "unspecified" to <-20 dB reflecting the majority of cases. - ScanSAR access range changed to 15°-60° (SCH-N-7/DCR-0051) - Updated annotation tables in chapter 5.1 (URB-F-2/PGS-DCR-0069). - Clarified avail. Of incidence angle mask (SCH-N-2/DCR-0048) - Explained calculation of product size. (SCH-N-15/DCR-0047) - Changed size of GIM from 1 to 2 bytes, increasing detected product size. - Changed radiometric performance values in 3.3 and tables 4.x acc. To inputs from ICS (MIT-J-8/DCR-0028) - Added size of images (MIT-J-2/DCR-0027) - Editorial changes (MIT-J-1/DCR-0023) - Increased resolution of all detected single pol. Products with Hamming=0.75 to 1.1 meter - Increased resolution of complex single pol. Products with Ham- 	

			<ul style="list-style-type: none"> ming=1.0 to 1.0 meter - Included Hamming coefficient In tables 4.x 	
1.2	9.5.2005		<ul style="list-style-type: none"> - Product format and annotation parameter description transferred to separate document. - Revised Basic Product Data Structure description (chapter 5) - Added NESZ comment (value outdated) 	
1.3	05.10.2005		<ul style="list-style-type: none"> - Editorial changes - Included references to the Level 1b Product Format Specification - Mentioned occurrence of varying PRF - NEBZ will be annotated instead of NESZ - DEM coverage map description added - Increased SC rad. Enhanced. Resolution @45° to theoretical limit of 17.6 meter 	
1.4	06.10.2006		<ul style="list-style-type: none"> - Due to new performance analysis results the dual polarization combination VV/HV is changed to VVVH - Sentence on TxRx polarization scheme definition added - Paragraph on 150 MHz / 100 MHz range bandwidth switches includeed - Assumption of constant 150 MHz bandwidth removed from NESZ section - Pixel localization accuracy of detected products in the product tables replaced by reference to relevant section. - Pixel localization accuracy of complex products changed to 2 m, assuming the rapid orbit accuracy - Annex B inserted indicating the configured MGD, GEC, EEC product variants - Editorial changes 	
1.5	24.02.2008		<ul style="list-style-type: none"> - All product performance values throughout the document and the product tables are (replaced by) the verified ones of the operational products which were adjusted in the commissioning phase to the SAR performance analysis results. Some major changes are: <ul style="list-style-type: none"> o absolute pixel localization accuracy is improved 	<p>Post commissioning phase version. Major revision including in-orbit calibration and product verification results and settings for operational phase</p>

			<p>from 2m to 1m including all signal propagation effects</p> <ul style="list-style-type: none"> ○ absolute radiometric accuracy (SM mode) is improved from 1.1dB (1.4dB worst case) to 0.6 dB including long term stability ○ relative radiometric accuracy (SM mode) is improved from 0.68dB (0.78dB worst case) to 0.3 dB ○ ScanSAR radiometric accuracy improved to 0.7dB (0.4 dB relative) ○ Spotlight azimuth resolution is improved from 2.2m to 1.7m (from 4.4m to 3.4m in dual pol) ○ point target response sidelobe suppression is improved by at least 4dB due to new weighting with a Hamming factor of 0.6 ○ the PTR improvement results in a slight deterioration in slant range resolution of 150 MHz bandwidth products from 1.1m to 1.2m. ○ as a compensation, the experimental 300 MHz bandwidth mode option for the high resolution spotlight acquisitions is introduced – yielding 0.6m slant range resolution at the cost of a reduced scene range extent beyond 30° incidence angle. ○ all specified dual pol resolutions (especially of detected products) strongly improved by selection of nominal range bandwidths (150MHz – instead of originally planned 75MHz). ○ The ScanSAR azimuth resolution is slightly worsened from 17.7 to 18.5m to allow a better burst overlap and a more ho- 	
--	--	--	---	--

			<p>ogeneous radiometry.</p> <ul style="list-style-type: none"> - Annex B is completely revised and all plots are replaced by those derived from the operational filter settings of the TMSP processor. Some product type plots are added. - Annex C is new, containing comprehensive SAR performance plots for operational modes and details on SAR instrument performance and commanding limitations. It also lists the operational elevation beams for the entire data collection range. - A section on product coverage and location is added (including the 300MHz swath extent characterization results) - A section on the new recommended performance range chosen to avoid ambiguities in high contrast scenes is included. - The section on pixel localization accuracy has been revised and a subsection on delivery/latency is added. - The section on geometric resolution has been revised. The resolution class sketch has been replaced by overview plots of the relative resolution of all available product variants. - The radiometric performance section is more specific with respect to the annotated parameters in the products and the noise parameters. - The product examples are now derived from TerraSAR-X acquisitions. - Some wording and details in the chapter on the product structure are changed - Details and editorials changed in Annex A - Restriction of document distribution adapted - Editorial changes 	
1.6	12.03.2009		<ul style="list-style-type: none"> - Introduction of the TDX-1 satellite for the TerraSAR-X mission - Section on radiometry detailed - Noise correction of RE products introduced 	TanDEM-X pre-launch version

			<ul style="list-style-type: none"> - Limitation of all RE product variants to a resolution of worse than 2.5m for SatDSiG handling. Update of the HS300MHz RE product table and plot. - Section on DRA mode updated - Product delivery latency and orbit selection section update (SatDSiG) - Example for use of GIM included - Product name detailed - Editorials 	
1.7	15.10.2010		<ul style="list-style-type: none"> - Results of the TanDEM-X monostatic commissioning phase included in SAR product performance: No change of values. - Section 2.5 on implications of TanDEM-X formation flight on ordering and product repeatability added - Section 2.6 on experimental (DRA) products updated - Editorials 	Post TanDEM-X monostatic commissioning version for start of TerraSAR-X mission data provision by both satellites.
1.8 DRAFT	18.04.2013		<ul style="list-style-type: none"> - New mode identifier ST introduced - New SC mode variant with six beams introduced - Annex D added 	Implementation phase 1 results of Staring Spotlight & 6 beam wide ScanSAR modes included
1.9	09.10.2013		<ul style="list-style-type: none"> - Optimized range bandwidth commanding and new multi-looking strategy yields new resolution and radiometric parameters for the wide 6-beam ScanSAR variant. - Extended azimuth coverage with slightly reduced performance for staring spotlight products with steep incidence angles 	Final implementation phase 2 results of 6 beam wide ScanSAR and Staring Spotlight product parameters included.

Verify that this is the correct revision before use. Check the document server for the latest version. Distributed hardcopies of documents are not automatically updated. In case of uncertainty contact the person who released the document or the documentation manager.

Table of Contents

1	Introduction	12
1.1	Scope	12
1.2	Applicable Documents	12
1.3	Reference Documents	12
1.4	Document Structure	14
1.5	Definition of Basic Products	14
2	The TerraSAR-X Instrument	15
2.1	Imaging Modes	16
2.2	Full Performance and Data Access Range	22
2.3	Recommended Performance Range	23
2.4	Product Coverage and Repeatability	24
2.5	TanDEM-X Formation Flight Implications	26
2.6	Experimental Modes	27
3	Basic Products	28
3.1	Geometric Resolution	28
3.2	Radiometric Performance	34
3.3	Radiometric Accuracy	36
3.4	Pixel Localization Accuracy	36
3.5	Geometric Projections and Data Representation	40
3.6	Map Projections and Grid Formats	45
3.7	Product Identification Scheme	48
4	Basic Product Tables	49
4.1	Single Polarization Stripmap Products (SM)	50
4.2	Dual Polarization Stripmap Products (SM)	51
4.3	High Resolution Single Polarization Spotlight Products (HS)	52
4.4	Single Polarization Staring Spotlight Products (ST), 300 MHz	53
4.5	High Resolution Dual Polarization Spotlight Products (HS)	54
4.6	Single Polarization Spotlight Products (SL)	55
4.7	Dual Polarization Spotlight Products (SL)	56
4.8	ScanSAR Products (SC) – Four Beams	57
4.9	ScanSAR Products (SC) – Six Beams	58
5	Basic Product Data Structure	59
5.1	Annotation	60
5.2	SAR Image Channels	60
5.3	Auxiliary Raster Files	60
5.4	Quicklooks	60
5.5	Administrative Parameter Files	60
	ANNEX A) Definition of Performance Parameters	61
	ANNEX B) Configuration of Detected Product Variants	63
	ANNEX C) SAR Performance Details and Parameters	76
	Polarization Channel Combinations	76
	Improvement of Radiometric Accuracy	76
	TX-RX Bandwidth in Stripmap and ScanSAR Modes	76
	Comment to Radiometric Resolution	78
	NESZ Calculation and BAQ	79
	Stripmap and Spotlight Elevation Beam Definition	80



Product coverage and swath width degradation (terrain, Height Error Map).....	85
High-Resolution and Spotlight Scene Extension	85
Performance Plots	86
Stripmap single	86
Stripmap dual HHVV	89
Stripmap dual HHHV (equivalent VVVH)	92
Spotlight single	96
Spotlight dual HH/VV	98
High-Resolution Spotlight single (HS 150MHz)	102
High-Resolution Spotlight 300MHz single (HS 300MHz)	104
High-Resolution Spotlight dual	106
ScanSAR.....	110
ScanSAR (Completion of Data Collection Angle Range).....	113
ANNEX D) Six Beam ScanSAR and Staring Spotlight Performance	116
ScanSAR (6 Beams).....	116
Staring Spotlight	122
ANNEX E) Acronyms and Abbreviations	126

1 Introduction

TerraSAR-X is a joint project between the German Aerospace Center (DLR) and the German industry (ASTRIUM). Operational data acquisition for the TerraSAR-X mission is executed by the two satellites TSX-1 (in orbit since June 2007) and TDX-1 (launch in June 2010). Both instruments will also fulfill the TanDEM-X mission in a joint operation. DLR owns and operates the satellites and the payload ground segment (PGS) and holds the rights for the scientific exploitation of the TerraSAR-X mission data. ASTRIUM holds the exclusive rights for the commercial exploitation of the TerraSAR-X mission data products.

1.1 Scope

This document specifies the operational TerraSAR-X basic products generated at PGS for scientific and commercial use from data acquired by any of the contributing instruments. In this document, the term TerraSAR-X refers to the mission and not to the individual instrument unless otherwise noted. In the context of the project the products are called basic products because they are the basis for higher level information products. The document summarizes the operation modes of TerraSAR-X and the characteristic parameters. It describes the product design criteria, lists the different product types and introduces their structure.

The document in hand is supplemented by the Level 1b Product Format Specification document [RD 8] specifying the binary data formatting and the detailed annotation parameters of the product.

1.2 Applicable Documents

This document is based on the requirements specified in the following documents.

[AD 1]	TX-PGS-RSD-1005	PGS Requirements Specification Document Issue 2.0
[AD 2]	RD-RE-TerraSAR-DLR/02	TerraSAR-X Ground Segment Requirements Issue 2.0

1.3 Reference Documents

Reference	Document Number	Document Title
[RD 1]	TX-AED-TN-0010	TerraSAR-X System Performance Modeling and Analysis Document, 15.3.2002
[RD 2]		DLR Internal Technical Note: DLR/HR-Comments on TerraSAR-X Performance Specification, J. Mittermayer, 13.3.2002
[RD 3]	ERS-D-TN-22910-A/9/88	Map Projections for SAR Geocoding, Remote Sensing Laboratories, University of Zurich
[RD 4]	TX-AED-RS-0001	TerraSAR-X Mission & System Requirements Specification Issue 5, 14.7.2003
[RD 5]	RD-RE-TerraSAR-DLR/01	TerraSAR-X Space Segment Requirements, Issue 1.0
[RD 6]		A Plea for Radar Brightness, R.K. Raney, T. Freeman, R.W. Hawkins, R. Bamler, IGARSS 1994.
[RD 7]	TX-IOCS-DD-4402	IOCS Instrument Operations Section Design Document, Volume 06, TerraSAR-X Instrument Table Generator Design Document
[RD 8]	TX-GS-DD-3307	Level 1b Product Format Specification, Version 1.3
[RD 9]	TX-SEC-TN-JM-10	Definition of Recommended Target Area
[RD 10]	TX-SEC-TN-JM-11	Inputs to Appendix for TS-X Basic Product Spec from SAR Performance
[RD 11]	TX-SEC-TN-4266	SAR Performance Inputs of Staring Spotlight and Wide Scan-SAR for the Basic Product Specification



1.4 Document Structure

This document is structured as follows:

Chapter 1 introduces the structure and scope of the document.

Chapter 2 gives a description of the TerraSAR-X instruments. The available imaging and polarization modes are characterized and discussed.

Chapter 3 defines those processing parameters influencing the nature and specification of the basic products. This includes product identification, product definition, etc.

Chapter 4 contains tables for summarizing the product characteristics and specifications.

Chapter 5 gives an overview of the data structure and the content of a basic product.

1.5 Definition of Basic Products

TerraSAR-X basic products are the operational products offered by the TerraSAR-X PGS to commercial and scientific customers. These products can be ordered through and will be delivered by the PGS user services at DLR. They are generated by the TerraSAR Multi Mode SAR Processor (TMSP).

2 The TerraSAR-X Instrument

The TerraSAR-X instrument (TSX-1) is a side-looking X-band synthetic aperture radar (SAR) based on active phased array antenna technology. The active antenna allows not only the conventional stripmap imaging mode but additionally spotlight and ScanSAR mode. Fig. 2-1 shows an artists view of the satellite and Table 2-1 summarizes the characteristic values of the platform and the SAR instrument.

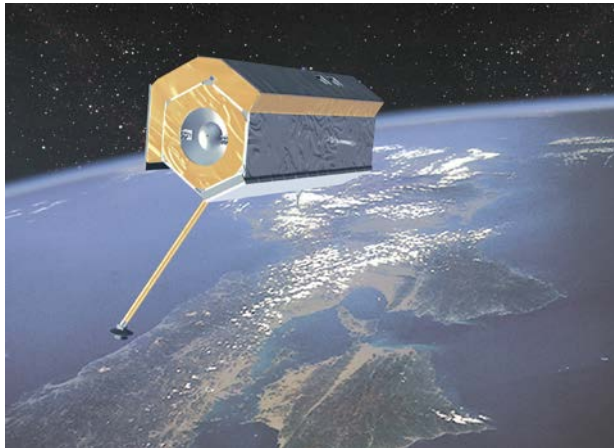

Fig. 2-1: Artists view of TerraSAR-X

Orbit and Attitude Parameters	
Nominal orbit height at the equator	514 km
Orbits / day	15 ² / ₁₁
Revisit time (orbit repeat cycle)	11 days
Inclination	97.44°
Ascending node equatorial crossing time	18:00 ± 0.25 h (local time)
Attitude steering	"Total Zero Doppler Steering"

System Parameters	
Radar carrier frequency	9.65 GHz
Radiated RF Peak Power	2 kW
Incidence angle range for stripmap / ScanSAR	20° – 45° full performance (15°-60° accessible)
Polarizations	HH, VH, HV, VV
Antenna length	4.8 m
Nominal look direction	right
Antenna width	0.7 m
Number of stripmap / ScanSAR elevation beams	12 (full performance range) 27 (access range)
Number of spotlight elevation beams	91 (full performance range) 122 (access range)
Number spotlight azimuth beams	229
Incidence angle range for spotlight modes	20° – 55° full performance (15°-60° accessible)
Pulse Repetition Frequency (PRF)	2.0 kHz – 6.5 kHz
Range Bandwidth	max. 150 MHz (300 MHz experimental)

Table 2-1: Orbit and system parameters of TerraSAR-X

In June 2010, TSX-1 was supplemented in orbit by its twin, the TanDEM-X instrument (TDX-1). In a close formation flight, they will separately acquire data for the TerraSAR-X mission and jointly execute the TanDEM-X mission data collection. With the finalization of its commissioning phase in October 2010, it could be confirmed that the second satellite will provide the SAR data for the TerraSAR-X mission with nearly identical performance parameters and stability as the first one.

2.1 Imaging Modes

The instrument timing and pointing of the electronic antenna can be programmed allowing a numerous combinations. From the many technical possibilities four imaging modes have been designed to support a variety of applications ranging from medium resolution polarimetric imaging to high resolution mapping. Due to the short antenna the system is optimized for high azimuth resolution. Consequently, the pulse repetition frequency (PRF) must be high which limits the maximum width of the swath.

The following imaging modes are defined for the generation of basic products:

- Stripmap mode **SM** in single or dual polarization
- High Resolution Spotlight mode **HS** in single or dual polarization
- Spotlight mode **SL** in single or dual polarization
- Staring Spotlight mode **ST** in single polarization
- ScanSAR mode **SC** in single polarization

In the following chapters the imaging modes are characterized. Detailed parameters of the derived products can be found in the tables in chapter 4. Note that the resolution values given here are typical for nominal complex basic products and include processing bandwidths, weightings and accuracy margins. Residual deviations e.g. from orbit height variations may be found. The values do not necessarily reflect the instrument performance or geometric imaging configurations alone.

2.1.1 Stripmap Mode (SM)

This is the basic SAR imaging mode as known e.g. from ERS-1 and other satellites. The ground swath is illuminated with a continuous sequence of pulses while the antenna beam is pointed to a fixed angle in elevation and azimuth. This results in an image strip with constant image quality in azimuth. In Fig. 2-2 the stripmap mode geometry is illustrated. The characteristic parameters of this mode are listed in Table 2-2. The maximum length of an acquisition is limited by battery power, memory and thermal conditions in the sensor. The latter depend mainly on the PRF and on previous acquisitions.

Note: Because of tight timing margins the pulse repetition frequency (PRF) may vary in a data take in order to maintain the nominal swath width even at varying terrain height. This will be accounted for in the SAR processor and complex Basic Products will be sampled with the highest occurring PRF in the corresponding raw data.

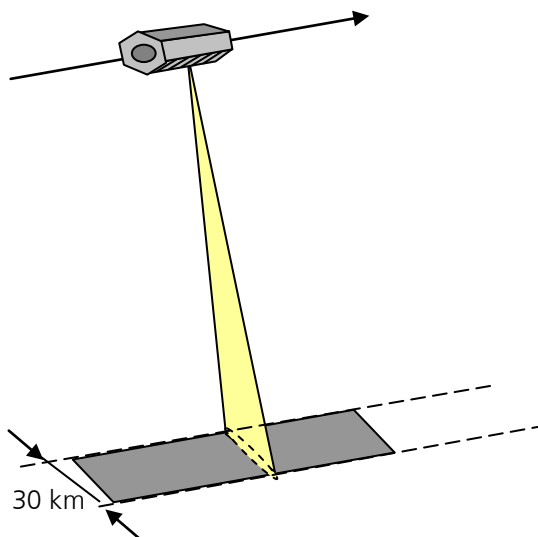

Parameter	Value
Swath width (ground range)	30 km single pol. 15 km dual pol.
Nom. L1b product length	50 km
Full performance incidence angle range	20° - 45°
Data access incidence angle range	15° - 60°
Number of elevation beams	27 (12 full perf.)
Azimuth resolution	3.3 m (6.6 m dual pol.)
Ground range resolution	1.70 m - 3.49 m (@ 45°.. 20° incidence angle)
Polarizations	HH or VV (single) HH/VV, HH/HV, VV/VH (dual)

Fig. 2-2: Imaging geometry in stripmap mode

Table 2-2: Characteristic parameters of SM mode

As listed in Table 2-2, stripmap can be operated in single or in dual polarization mode resulting in one or two image layers, respectively. Each polarization channel is identified by two letters where the first letter denotes the transmit polarization and the second one refers to the receive polarization.

The dual polarization mode is implemented by toggling the transmit and/or receive polarization between consecutive pulses. The effective PRF in each polarimetric channel is thus half of the total PRF. In order to sample the antenna azimuth spectrum properly in each channel, the total PRF has to be increased compared to single polarization mode. Due to the increased PRF the maximum ground swath width is only half of the single polarization mode. For the dual polarization beam with 15km wide swathes have been defined, i.e. stripNear and stripFar. The beams match the corresponding halves of the equally numbered single polarization beams.

Because of an upper total PRF limit of 6.5 kHz, the azimuth ambiguities in the dual polarization channels are higher than in single polarization mode and can only be reduced by limitation of the azimuth bandwidth in the SAR processor. Therefore the azimuth resolution is reduced by a factor of 2 in the product tables.

Unlike in alternating burst mode acquisitions (like the Twin-Pol mode), the same part of the Doppler spectrum is recorded by both polarimetric channels for distributed targets in this line-by-line toggling mode. Any possible deviation of the azimuth spectra (e.g. from slight mispointing) does not exceed a few Hertz. Therefore the polarimetric phase between the channels can be exploited, e.g. for polarimetric interferometry.

2.1.2 Spotlight Modes

As depicted in Fig. 2-3 spotlight mode uses phased array beam steering in azimuth direction to increase the illumination time, i.e. the size of the synthetic aperture. The larger aperture results in a higher azimuth resolution at the cost of azimuth scene size. In the extreme case of starring spotlight (ST) the antenna footprint rests on the scene and the scene length corresponds to the length of the antenna footprint.

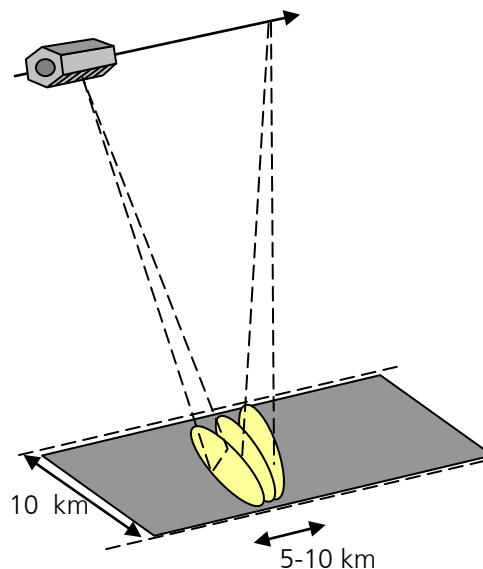

Fig. 2-3: Imaging geometry in spotlight mode

Two variants of a sliding spotlight mode are designed with different values for azimuth resolution and scene size. For the product identification they are named "Spotlight" (SL) and "High Resolution Spotlight" (HS).

Since a spotlight imaging takes only a few seconds and requires simultaneously a precise antenna steering as the sensor passes the scene, hitting the desired area of interest requires precise pointing and timing. TerraSAR-X

offers high flexibility in order to image the user's area of interest. In elevation, 122 spotlight elevation patterns are defined in order to adjust the scene center in small increments so that the required area can be placed in the middle of a scene. In azimuth up to 125 beams from a set of 229 beams are used in one data take to extend the synthetic aperture. The imaging process is started GPS-controlled, i.e. when the satellite reaches a position along the orbit that is calculated from the user's required scene center coordinates. This way the effect of along track orbit prediction errors on the final product location is almost compensated.

2.1.2.1 High Resolution Spotlight Mode (HS)

This mode is designed for an azimuth resolution of 1.1 meter resulting in an azimuth scene size of 5 km. The characteristic values are:

Parameter	Value
Scene extent	5 km (azimuth) x 10 km (ground range)
Full performance incidence angle range	20° - 55°
Data access incidence angle range	15° - 60°
Number of elevation beams	91 (full performance) 122 (data access)
Number of azimuth beams	up to 125 out of 229
Azimuth steering angle	up to $\pm 0.75^\circ$
Azimuth resolution	1.1 m (single polarization) 2.2 m (dual polarization)
Ground range resolution	1.48 m - 3.49 m (@ 55°..20° incidence angle) 0.74 m – 1.77 m (with 300 MHz bandwidth option and reduced swath extent in range)
Polarizations	HH or VV (single) HH/VV (dual)

Table 2-3: Parameters of high resolution spotlight mode

TerraSAR-X may be operated in an experimental mode with 300 MHz range bandwidth instead of the nominal 150 MHz. The sensor performance for this mode is not specified and the derived products may not fulfill all specifications established for 150MHz products. However, the characterization activities in the commissioning phase revealed excellent performance parameters for the **HS 300 MHz single polarization** mode in terms of focusing quality, phase stability and radiometry. The only drawback is that instrument constraints limit the range extent in this mode and it falls below the specified 10km for far range beams. Therefore products from this mode are not specified and only characterized by this document. Nevertheless, they can be ordered as an option for the HS mode by the user. All other *nominal* products mentioned in this document are based on a maximum 150 MHz bandwidth.

2.1.2.2 Spotlight Mode (SL)

In this mode the beam steering velocity is lower than in high resolution spotlight mode resulting in reduced azimuth resolution and increased azimuth scene extension. The characteristic values are:

Parameter	Value
Scene extent	10 km (azimuth) x 10 km (ground range)
Full performance Incidence angle range	20° - 55°
Data access incidence angle range	15° - 60°
Number of elevation beams	91 (full performance) 122 (data access)
Number of azimuth beams	up to 125 out of 229
Azimuth steering angle	up to $\pm 0.75^\circ$
Azimuth resolution	1.7 m (single polarization) 3.4 m (dual polarization)
Ground range resolution	1.48 m - 3.49 m (@ 55°..20° incidence angle)
Polarizations	HH or VV (single) HH/VV (dual)

Table 2-4: Parameters of spotlight mode

Note that reduced margins and newly established commanding sequences which extend the used azimuth beam steering angle range yield an improvement in azimuth resolution from the originally specified 2.2m (4.4m) to 1.7m (3.4m) in SL single (dual) polarization mode. These resolutions are achieved despite the broadening by the improved sidelobe suppression weighting functions while keeping the azimuth scene extent specifications.

2.1.2.3 Staring Spotlight Mode (ST)

The experience gained with the instruments and experimental acquisitions showed that it is possible to operate both instruments stable outside their initial limits. Especially the azimuth beam steering angle range could be widened to 2.2 degrees without significant distortions. Therefore it is possible to acquire scenes with about 6 to 10 seconds aperture length in a staring spotlight configuration. The newly implemented ST mode is designed for an azimuth resolution of 0.24 meter with an azimuth scene extent which corresponds to the width of the processable part of the illuminated antenna footprint on ground which is in the order of 2 to 3km. Since this mode aims for the highest feasible resolution, it is only available as a single polarization, 300MHz range bandwidth variant. The same timing restrictions for the mode – specifically with respect to the instrument buffer and the resulting ground range scene extent - as for the HS 300MHz mode variant apply. They are even further limited by additional commanding constraints with respect to duty cycles and PRF selection. Hence the scene size depends in both directions on the range to the ground area - respectively the incidence angle – and the selected timing parameters. It increases in azimuth with higher incidence angles while it decreases in range. Again, the highly variable nature of the instrument constraints and the sensitivity to the specific geometry of each individual acquisition allow only a characterization of the product performance parameters. The characteristic values are:

Parameter	Value
Scene extent for (20° - 45°)	[2.5 to 2.8 km] azimuth x [6 to 3.8 km] ground range - worst case x [7.5 to 4.6 km] ground range - typical case
Full performance incidence angle range	20° - 45°
Data access incidence angle range	15° - 60°
Number of elevation beams	58 (full performance) 122 (data access)
Number of azimuth beams	Depending on target area
Azimuth steering angle	± 2.2°
Azimuth resolution	0.24 m (single polarization)
Ground range resolution	0.85 m – 1.77 m (45°...20° at 300 MHz)
Polarizations	HH or VV (single)

Table 2-5: Parameters of staring spotlight mode

The long aperture length results in a very strong sensitivity to overall phase stability for processing. Also the reference ranges used for the image positions (i.e. the DEM applied during focusing) influences the focusing quality of targets which are not located at that height. Even smaller variations in X-band signal propagation may cause deviant phase histories and slightly broaden the point target responses by some cm.

One of the biggest advantages of detected products from this mode is that over a wide range of angles one obtains 4 to 5 radiometric looks from azimuth alone while keeping the detected ground range resolution with one look at the best possible value.

Since the azimuth beam pattern is not averaged out by sliding the beam over the ground and targets at the edges of the scenes are hence imaged with reduced antenna gain, the radiometric performance is dependent on the azimuth position within the image. Specifically the NESZ worsens by up to 3.3dB (even more for extended coverage areas) from scene center to the azimuth borders. Due to the nature of a mode operating outside the initial timing, beam definition and squint limits, the azimuth (and range) ambiguity to signal ratios are significantly worse for incidence angles higher than 45°. The full performance range for this spotlight mode is thus limited to 20° - 45° while the data collection range is the same as for the other two spotlight modes. The recommended performance range with optimal product characteristics in terms of ambiguity performance, coverage and ground range resolution for the ST mode is 32° - 45°.

2.1.2.4 ScanSAR Mode (SC)

In ScanSAR mode electronic antenna elevation steering is used to switch after bursts of pulses between swaths with different incidence angles. Due to the switching between the beams only bursts of SAR echoes are received, resulting in a reduced azimuth bandwidth and hence, reduced azimuth resolution. Fig. 2-4 illustrates the ScanSAR imaging geometry. In the designed TerraSAR-X ScanSAR mode 4 stripmap beams are combined to achieve a 100 km wide swath. Since an increasing demand for wider swath coverage products arose, this mode has now been extended to an additional variant with a reduced azimuth resolution, lower range bandwidth and a 200km wide swath consisting of 6 specific beams. The four beam ScanSAR swaths are composed exclusively from stripmap beams, i.e. they use the calibrated stripmap antenna patterns while the six beam ScanSAR variant uses dedicated wide beams.

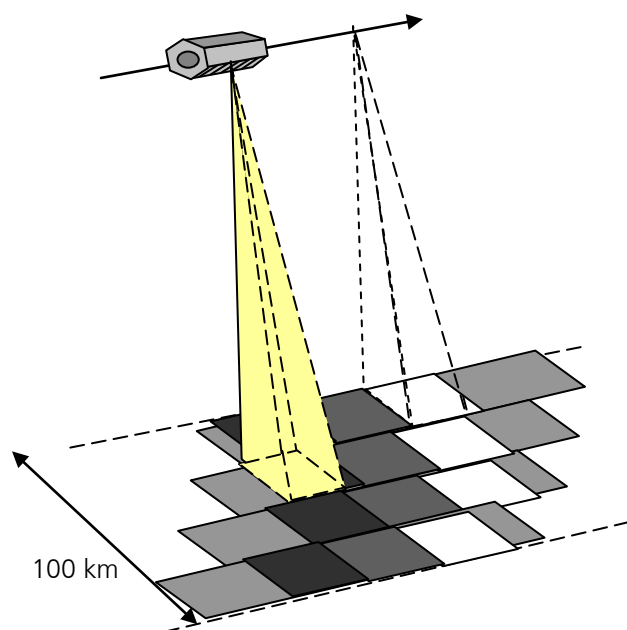

Fig. 2-4: Four beam ScanSAR imaging geometry

In order to obtain a very homogeneous NESZ over the access range, each beam of a six beam wide ScanSAR has an individual transmitted chirp range bandwidth which decreases with increasing incidence angle. The bandwidth is selected to achieve a constant ground range resolution of about 7m in the complex single look data. The range sampling frequency remains the same as for the four beam ScanSAR 100 MHz bandwidth data (i.e. 110 MHz). The six beam wide ScanSAR mode products are available in 5 "wide" beam combinations covering a large incidence angle range each. For this wide ScanSAR mode variant, a restriction to a full performance range is not applied. The limited number of available combined swaths where the first and last beams of the combinations are often located at extreme incidence angles does not allow a meaningful restriction.

Detected four beam ScanSAR products have constant multi-looking parameters for the whole combined swath. This approach would result in a significant variation of (range) resolution, looks and radiometry over a detected image for a wide swath acquisition. Hence the multi-looking is individually adapted to each beam for the six beam variant. This yields a more constant ground range resolution with only slight variations in radiometric looks. Nevertheless, six beam ScanSAR products can only be characterized within certain parameter ranges and the performance parameters are always significantly depending on the range position within an image. Additionally, the radar brightness representation requires a wide dynamic range in the image data from near to far range for six beam ScanSAR products.

Commanding of a six beam ScanSAR is very demanding in terms of usage of instrument settings. If larger terrain variations require many adaptations of these settings for very long datatakes, the commanding of such an acquisi-

tion might not be feasible and the order will not be planned. Hence it is recommended to restrict the length of six beam ScanSAR datatakes over land with significant terrain variations to 60...100 seconds. The length of acquisitions over oceans or flat terrain is only limited by the nominal instrument resources.

Characteristic values are:

Parameter	Four beam ScanSAR	Six beam ScanSAR
Number of sub-swaths	4	6
Swath width (ground range)	100 km	266 to 194 km (wide_001 to wide_005)
Nominal L1b product length	150 km	200 km
Full performance incidence angle range	20° - 45°	15.6° - 49°
Data access incidence angle range	15° - 60°	15.6° - 49°
Number of elevation beams	27 (9 x 4 stripmap beam combinations in full perf. Range)	10 specific wide beams (5 x 6-beam combinations)
Azimuth resolution	18.5 m	40m
Range bandwidth	100 and 150 MHz	100 to 55 MHz
Ground range resolution	1.70 m - 3.49 m (@ 45°..20° incidence angle)	< 7m
Polarizations	HH or VV (single)	HH or VV or experimental HV or VH (single)

Table 2-6: Parameters of ScanSAR Mode

Similar to spotlight imaging, the start of a ScanSAR data take are triggered by GPS when a predefined orbit location is reached. This feature allows repeated ScanSAR acquisitions with synchronized burst patterns which is a prerequisite for ScanSAR interferometry.

2.2 Full Performance and Data Access Range

The TerraSAR-X instrument performance is specified by the manufacturer for incidence angles within the so-called *full performance range* in right-looking mode. The spacecraft may also be operated in left-looking mode or with a wider range of incidence angles defining the *data access range*. These operations improve the access time to a scene. However, due to reduced performance these products are not open for general access.

Imaging Mode	Polarization Mode	Full Performance Beam Configurations	Incidence Angle (Look Angle) Range
Stripmap	single	strip_003- strip_014	19.7° - 45.5° (18.2° - 41.3°)
Stripmap	dual	stripNear_003 – stripFar_014	19.9° - 45.4° (18.3° - 41.3°)
Spotlight & High-Resolution Spotlight	single & dual	spot_010 – spot_100	19.7° - 55.2° (18.2° - 49.5°)
Staring Spotlight	single	spot_010 – spot_067	19.7° - 45° (18.2° - 41°)
ScanSAR	single	scan_003 – scan_011 (4b)	19.7° - 45.5° (18.2° - 41.3°)
		wide_001 – wide_005 (6b)	15.6° - 49° (14.3° - 44°)

Table 2-7: Full performance beams and incidence angle ranges

All elevation beams covering the data access range in single polarization stripmap and ScanSAR mode are listed in the Annex C. They are called strip_01 to strip_27 and the 122 spotlight beams are called spot_001 to spot_122, respectively. The ScanSAR beam configurations scan_xy are composed of 4 consecutive stripmap beams beginning with the corresponding near range one and the wide_xy combination comprise 6 beams starting with wideBeam_xy. The performance specifications in this document refer only to the full performance range, i.e. Strip_3 to Strip_14 in stripmap/ScanSAR modes and Spot_010 to Spot_100 in spotlight modes. The smaller dual polarization swathes in stripmap are adjusted to the single polarization beams with the same numbering.

Basic products with incidence angles outside the full performance range can not be ordered nominally since they may have a degraded performance. The left-looking mode has no guaranteed performance as well and additionally an impact on mission operations (the solar array is turned away from the sun, the SAR antenna is turned into the sun). Thus the ordering of left-looking acquisitions for users is restricted while products from the corresponding left-looking “full performance range” of already acquired data takes may be retrieved from the catalogue.

2.3 Recommended Performance Range

Generally, for TerraSAR-X the ambiguity control and evaluation is a challenge due to the short antenna. Consequence of the antenna dimension is a quite high PRF with minimum values of about 3000 Hz. The initially specified ambiguity ratios are generally meet but in some imaging geometries and instrument settings the ambiguities may dominate the visual impression of images of high contrast scenes (e.g. harbors). In the commissioning phase, the image analysis w.r.t. range and azimuth ambiguities concluded that there should be an indication for the user on the ambiguity quality dependent on the scene context. This resulted in the introduction of an additional performance range, the **Recommended Performance Range** which indicates the range of incidence angles considered preferable for scenes with **very high contrast**, e.g. land sea transitions.

It was also found that a total ambiguity ratio is not significant. Therefore, the ambiguity requirement is applied separately to azimuth and range ambiguities. Based on the results of the performance estimation, the recommended performance range indicates incidence angles, where the azimuth ambiguities are around -20 dB or

better and the range ambiguities are around -25 dB or better. See Annex C for details on the ambiguity performance for each mode and beam.

Mode	Pol Mode	High Contrast Recommended Performance Beams (Criteria Rg -25 dB Az -20 dB)	Incidence Angle (Look Angle) Ranges
Stripmap	Single	strip_003 - strip_014	19.7° - 45.5°
Stripmap	Dual	stripNear_003 - stripFar_011	19.9° - 40.3°
SL & HS	Single	spot_010 - spot_079	19.7° - 49.7°
SL & HS	Dual	spot_010 - spot_059	19.7° - 43.3°
ST	Single	spot_034 – spot_067	32° - 45°
ScanSAR	Single	scan_003 - scan_011	19.7° - 45.5°

Table 2-8: Recommended performance beams and incidence angle ranges for high contrast scenes

2.4 Product Coverage and Repeatability

The location of a product strongly depends on the orbit position, an accurate data take azimuth start time, the correct echo window setting in range (the error of DEM used for commanding) and - especially for spotlight modes - the Doppler centroid used for processing to zero Doppler coordinates.

The orbit tube around the TerraSAR-X reference track of +/- 250m is taken into account by margins in range of more than 1km for the SM swathes in the full performance range. Also the echo window is commanded to follow terrain variations. See the Annex C for details and limitations causing possible swath width degradations due to extreme geometric imaging configurations or reference DEM errors. The TanDEM-X Satellite is flying in different mission phases specific controlled "helix" formations with respect to the reference track. This is taken into account by the satellite commanding (see next section for details).

When ordering a scene from nominal spotlight modes, the user is guaranteed that the delivered product covers at least 10 km x 10 km in SL and 10 km x 5 km in HS mode around the ordered scene centre coordinates. The ST mode has a varying coverage and the product is only checked for the overall minimum extent in range and azimuth. As for all SAR data acquisitions, the Doppler centroid and its variations strongly influence the product azimuth start and stop times. Whereas the duration of data taking in stripmap or ScanSAR configuration can be quite easily extended by considerable margins, the situation is more complex for the spotlight modes due to the azimuth beam steering. Margins are lower in azimuth direction to ensure the high resolution. Nevertheless, the scenes are generally fulfilling the specified 300m margin for product location accuracy. The processor focuses and delivers the entire valid area of an acquired scene. In case that the product exceeds the specified extent, the center coordinate of the product is not necessarily identical to the ordered one but the product covers the specified extent of it. See Fig. 2-5 for examples from the SL and HS coverage location and extent verification.

Important TerraSAR-X system features set the base for this high location accuracy achieved in spotlight data taking: The antenna look direction is accurately measured with star trackers and thus reduces the pointing knowledge on ground to less than 20 m error. The attitude is actively controlled by the Total Zero Doppler Steering law which reduces the Doppler offset to less than 120 Hz. Based on GPS measurements, a data take start time correction value is determined and applied on-board with respect to the assumed predicted value which effectively shifts the acquired scene towards the ordered location. The latter feature is also important for the ScanSAR repeat pass burst overlap required for interferometric use. The commissioning phase analysis verified an along track deviation of repeated acquisitions of below 50m on ground in most cases. This corresponds to less than 10% of four beam ScanSAR burst lengths.

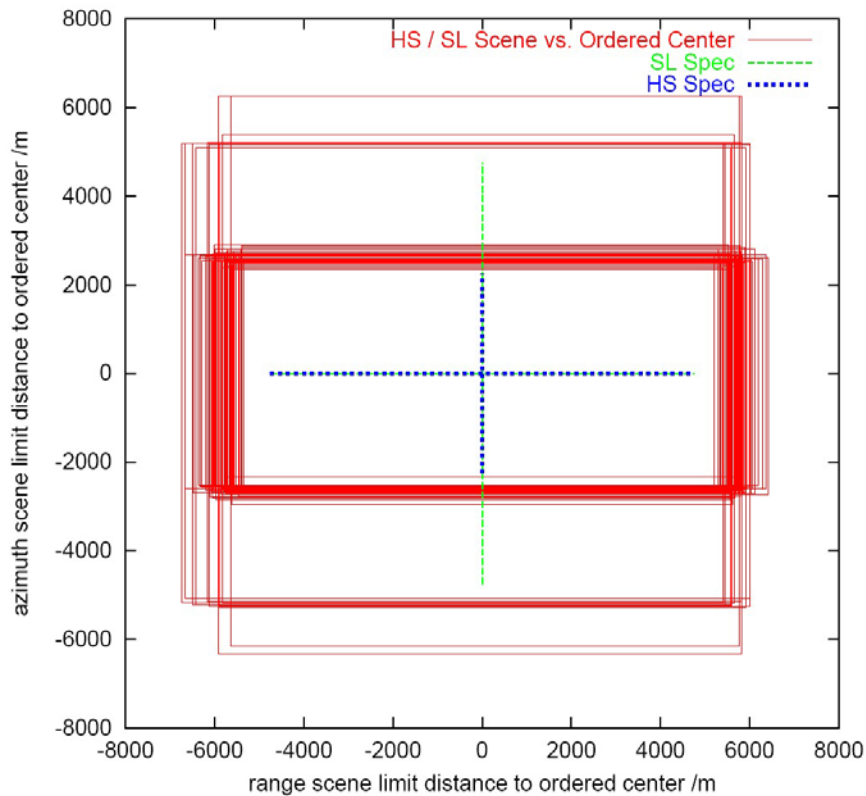

Fig. 2-5: Measured coverages and positioning of HS / SL products (red boxes) w.r.t. user ordered center position and specified scene extents (dotted crosses) taken from the commissioning phase product characterization report.

In some cases also a slightly reduced azimuth extent for HS & SL spotlight modes is encountered due to the timing and Doppler centroid accuracy constraints. The HS products with the experimental 300MHz range bandwidth option show a reduced range extent (still centered on the ordered scene coordinates) due to the on-board echo buffer limitations. See the Fig. 2-6 for measured scene extents of HS 300MHz products (the two different colors for each dimension represent different processing levels). Note further that for HS products with 300 MHz range bandwidth *in dual polarization* mode, the range extent is further reduced while it may exceed the azimuth extent of 5km (which is specified for HS 150MHz products) due to a lower processing bandwidth. *The latter mode combination is not recommended and not specified.*

The ST products have an incidence angle dependent azimuth scene extent corresponding to a fixed part of the projected azimuth beam pattern and a similar range scene extent dependency than the HS 300MHz mode. The timing constraints for steep incidence angles allow to process a wider part of the illuminated patch in azimuth with sufficient ambiguity suppression. Hence the delivered products have an extended azimuth coverage in which the main performance parameters are comparable to the wider scenes with more shallow incidence angles. The trade-off for the wider coverage is a degraded NESZ in these extension areas. See the Fig. 2-7 for details on the nominal coverage.

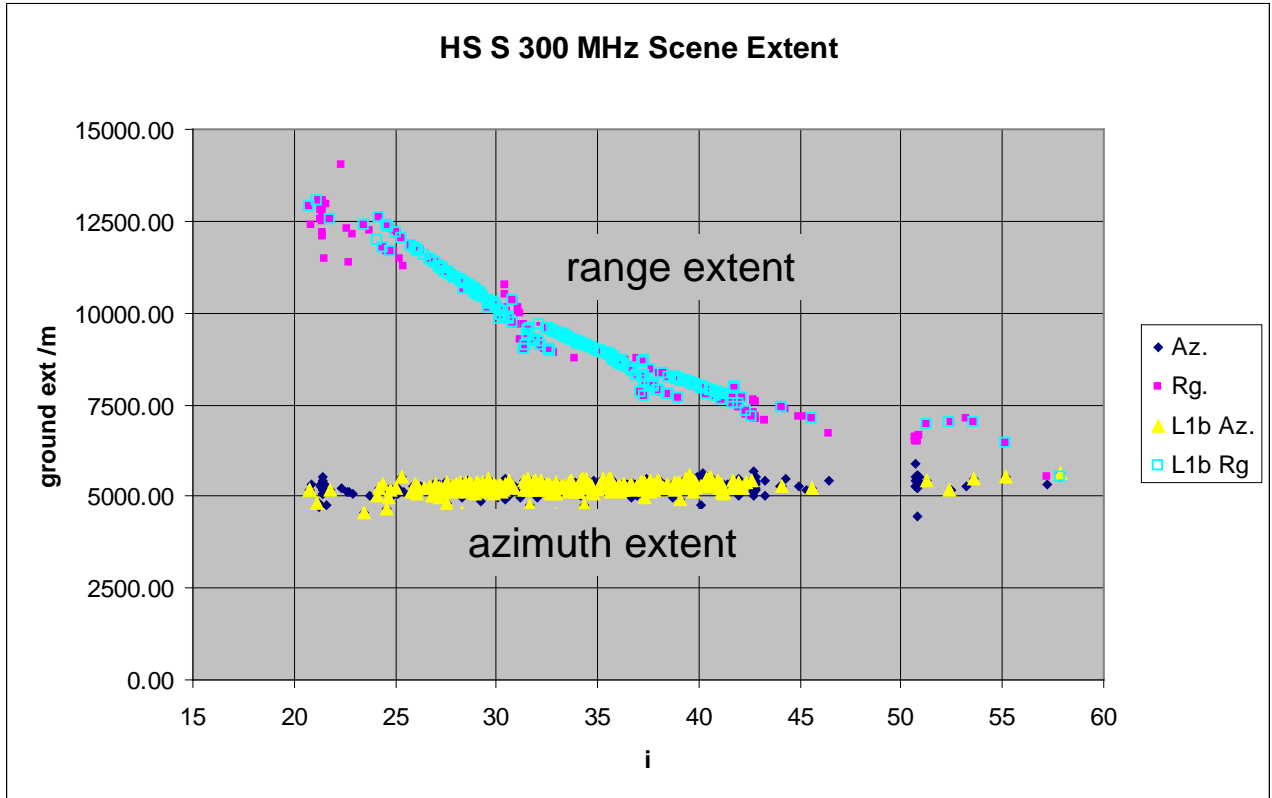

Fig. 2-6: Measured scene extent of High-Resolution Spotlight products in single pol 300 MHz mode for different scene center incidence angles (i) taken from the commissioning phase product characterization report.

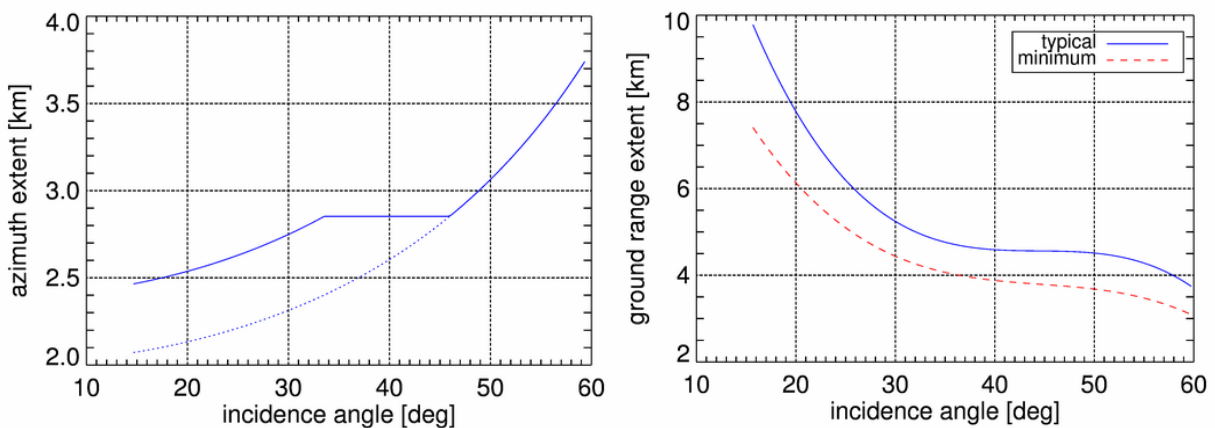

Fig. 2-7: *Nominal* scene extent of Staring Spotlight products in single pol 300 MHz mode for different scene center incidence angles. The lines represent typical values or lower boundaries (dashed line). The dotted line for the azimuth extent indicates the full performance extent, the solid one shows the extended coverage provided in the user products.

2.5 TanDEM-X Formation Flight Implications

With two satellites in orbit, two missions will be conducted. Both instruments will jointly execute bistatic acquisitions for the TanDEM-X mission and share the TerraSAR-X mission data taking. The monostatic commissioning

phase of the TanDEM-X satellite yielded excellent SAR performance results, nearly identical to the ones of TerraSAR-X. Thus both instruments will generate SAR products according to this specification.

The two satellites fly in so-called helix formations to enable bistatic acquisitions and to achieve optimal baselines for different phases of the global DEM acquisition. A typical cross-track distance for such a helix is between 200 and 500m. Although the TanDEM-X orbit itself is very precisely controlled, it will thus be steered out of the nominal tube around the TerraSAR-X orbit for some mission phases. Instrument tasking and commanding take these orbit configurations into account and select specifically adapted instrument settings for TanDEM-X for optimal SAR product performance for these phases. Besides the activated "Total Zero Doppler Steering" for both satellites, a latitude dependent roll steering on the TanDEM-X satellite has been implemented to illuminate the same ground swath as TerraSAR-X with the same beam pattern.

The optimization of timing settings (i.e. the echo window timing) for some geometries is conjoint under specific conditions with acquisition parameters (i.e. the pulse repetition frequency PRF) which differ from the ones selected inside the tube. While different timing parameters are already possible for TerraSAR-X Stripmap and Spotlight products, the different setting may limit the use of ScanSAR datatakes in such cases for interferometric processing. The use of all detected and/or geocoded Stripmap, Spotlight and ScanSAR products from outside the TerraSAR-X tube is not restricted in any aspect.

The geometric helix configuration implies that, during certain segments of one orbit, one satellite might be illuminated by the radar beam of the other satellite. In order to avoid this, the satellite that is "behind" the other one (seen from the ground) must not transmit radar signals. The one in "front" will thus perform the active role in TanDEM-X acquisitions and execute all the TerraSAR-X data takes for that time and region. These segments of the orbits are called "exclusion zones" for the satellite "behind". They will vary over the mission and depend on the looking direction. The selection of the transmitting satellite is performed by the mission planning system.

As a consequence, data stacks from the same region will be acquired by both instruments and may thus exhibit a slightly larger baseline and parameter variation than experienced up to now. Please contact your science or commercial coordinators if you have any specific requirements on the interferometric repeatability – specifically with respect to burst synchronization for interferometric processing of ScanSAR products.

2.6 Experimental Modes

The experimental Dual Receive Antenna (DRA) configuration splits the antenna in to two halves and can be used for fully polarimetric (Quad) polarization imaging or along track interferometric (ATI) imaging. Another experimental acquisition mode for ATI is to switch alternately between the two antenna halves for reception (Aperture Switching). For the very complex DRA configuration which uses redundant electronics, instrument use and ordering is restricted and the products are not included in this document. Results from DRA calibration data takes showed excellent results but the DRA specific instrument characteristics have to be investigated further for full calibration. Experimental DRA data has been acquired, and operationally processed in dedicated campaigns on specific coordinated user requests. Full polarimetric products are not part of this document but characterized in the experimental product specification.

3 Basic Products

In the context of the TerraSAR-X ground segment the SAR raw data are processed to basic products by the TerraSAR-X Multi Mode SAR Processor (TMSP). Given the capabilities of the SAR instrument and the platform, a set of products has been designed by selecting appropriate processing algorithms and parameters, e.g.

- geometric and radiometric resolution
- geometric projection
- auxiliary information and annotation

The following chapter describes the design logic while more details are given in chapter 4. All specified values refer to nominal product generation with the operational processor. They reflect the optimization process that was performed during the commissioning phase which results in different improvements – i.e. wider azimuth steering ranges and improved sidelobe suppression. For fast access to the data (e.g. for crisis management), a near real time (NRT) processing option has been established. Products generated this way are based on input data of reduced accuracy and the specified values generally do not apply to such NRT products.

3.1 Geometric Resolution

The theoretical maximum slant range resolution of TerraSAR-X in single polarization is 0.89 meter based on the range bandwidth of 150 MHz if no spectral weighting is applied. For all products the maximum resolution is deliberately reduced by weighting the range and the azimuth spectrum with a Hamming window (α coefficient 0.6) in order to suppress the sidelobes of the point target response (PTR) function to -25 dB or better. This better side-lobe suppression is specifically important in imaging urban and industrial areas where the high spatial resolution of the system exposes high numbers of extremely strong scatters leading to high image contrasts. As well, the level of azimuth ambiguities is decreased. By enlarging the azimuth processing bandwidth in stripmap mode and the azimuth steering angles in SpotLight mode, the resulting impulse response broadening could be compensated. However, due to the fixed range bandwidth, the range resolution values are slightly worsened, resulting in a slant range resolution of 1.2 meters instead of the formerly specified 1.1m at 150 MHz. The spectral weighting also widens the azimuth resolution w.r.t. to former specified values but this effect is compensated by increased bandwidths, reduced processing and instrument degradation margins and wider azimuth steering angles.

Complex products have the same Hamming window applied as detected ones to ensure a consistent product performance for all types. From the comprehensive product annotation it is principally possible to undo the weighting (which is a complex task especially in spotlight modes). Note that weighting and processing bandwidth are balanced against each other to optimize resolution, sidelobe suppression and ambiguity performance. They cannot be maximized separately.

Depending on the incidence angle the 1.2 meters slant range resolution scales to ground by $1/\sin(\text{incidence angle})$, i.e. to 1.70 meters at 45° incidence angle or to 3.49 m at 20°, respectively. Due to instrument timing limitations, the range bandwidth of 150 MHz cannot be achieved for all incidence angles. Depending on the actual timing parameters, far range beams in Stripmap and ScanSAR mode are operated with a reduced range bandwidth setting of 100 MHz. The specified ground range resolution for detected products is kept this way but the number of radiometric looks is lowered. This limitation may also lead to different range bandwidth settings in the four ScanSAR beams. See the Annex C for details. On the other hand the 300 MHz range bandwidth option can be ordered for the HS mode which fixes the bandwidth to this value but then the instrument buffer limits lead to a reduced scene range extent for higher incidence angles. The ST mode is only available with 300MHz range bandwidth. In the six beam wide ScanSAR configuration, each beam has a predefined fixed chirp bandwidth ranging from 81.25 MHz for near range beams down to 31.25 MHz for far range beams. The ground resolution for complex data and the NESZ performance are kept relatively constant to 10m this way but the multi-looked products are more variable over the full swath. The six beam ScanSAR range sampling rate – also for complex products - is however the one determined by the instrument settings (i.e. 110 MHz).

In azimuth the theoretical resolution in stripmap mode is half the antenna length ($4.8 \text{ m} / 2 = 2.4 \text{ m}$). Due to finite sampling of the $\sin(x)/x$ shaped Doppler spectrum aliasing always occurs. In the processor, bandwidth reduction and spectral shaping is performed in order to reduce the ambiguities caused by aliasing (improving the

signal azimuth ambiguity ratio "SAAR") and to improve the shape of the PTR. A constant resolution of 3.3 meters is a design goal for all stripmap single polarization products. In ScanSAR mode, an additional margin in commanding - required to ensure complete burst overlaps for all geometries - slightly broadens the azimuth PTR from the initially planned 17.6m to 18.5m. The six beam ScanSAR has more than two times the swath extent of the four beam ScanSAR and an azimuth resolution of 40m.

In stripmap dual polarization mode the effective PRF per channel is decreased and the effective resolution of the products will be adjusted to 6.6 meters, i.e. half of the single polarization resolution. The processed Doppler bandwidths in single polarization and dual polarization stripmap mode are hence 2765 Hz and 1380 Hz, respectively. An analogous strategy is applied on dual polarization spotlight data.

Note, that for the complex SSC products the resolution is given in azimuth and slant range (assuming the nominal 150 MHz range bandwidth). For all detected products the geometric resolution is given in ground range.

In the detected product variants the resolution is reduced (the number of looks is increased accordingly) in order to reduce speckle and thermal noise, i.e. to improve the radiometric resolution. In contrast to ERS-1 and ENVISAT/ASAR the range resolution is close to or even better than the azimuth resolution and looks cannot be derived by degrading only the azimuth resolution. Therefore two different strategies have been followed in order to design two variants of detected products. One is optimized for resolution (spatially enhanced, SE) and one is optimized for radiometry (radiometrically enhanced, RE). In both variants a square sized ground resolution cell is implemented.

The filter settings are adjusted and annotated for near range (the worst case). Additionally, the filtering is implemented not to deteriorate the better resolution as long as the azimuth and range resolutions differ in the cm range only. Thus the resolution is in general significantly better than specified for the entire swath and slightly asymmetric PTRs (not pixels) may occur (e.g. 1.1x1.2m). In four beam ScanSAR products, the azimuth resolution always dominates the PTR, allowing for more looks in range than required for RE variants and hence a slight relaxation of the range resolution to better values is performed.

In six beam wide ScanSAR detected products, the multi-looking parameters are adjusted for each beam individually since the range bandwidth is different for each subswath and the combined swath covers extreme incidence angle ranges. This is done in order to keep the ground range resolution in a target range of 30 to 40m for the full swath. As a consequence, the number of range looks varies slightly from beam to beam in the range of 6 to 8 looks. The products are configured to minimize jumps between extreme values and to select an adequate spacing which fulfills the Nyquist sampling requirement (half the resolution) for far range targets.

Also the detected ST mode products follow a different approach in azimuth/range resolution & multi-looking. Since the ST mode is designed for the highest possible resolution, its SE product variants are set up to obtain a ratio of about 2:1 for range to azimuth resolution. The ST SE image pixel spacing is nevertheless identical for both directions (thus oversampling in range).

An additional deviation from the concept of a constant number of looks for RE products is implemented for the HS 300MHz RE product variants: In order to facilitate handling in terms of the German satellite data security regulations, the RE products of far range data taken in this mode are deliberately reduced in resolution to stay above the limit of 2.5m (other product variants are unaltered). Following the currently implemented German law, this in turn allows to deliver to the user *all* RE products of all modes over all regions of the world without any delay (i.e. including in NRT) while the delivery of other product types and variants may be subject to restrictions (e.g. five days of delivery latency or even no delivery for crisis areas). This reduction in RE product resolution is *not* applied to ST mode RE products. Even at 7 to 4 radiometric looks, they are resolved better than 2m (down to 1m) for *all* incidence angles – and hence always subject to the strict limit of the security regulations.

The pixel spacing of detected products is dynamically adjusted to satisfy the Nyquist sampling criterion and to multiples of 25 cm if adequate. Lower values are used for ST mode data, starting with 16cm for 60° incidence angle and increasing in steps of 2cm towards near range beams. In the complex SSC product the pixel spacing is given by the natural sampling of the radar, i.e. the pulse repetition frequency (PRF) and the range sampling frequency (RSF). The exact settings depend on the acquired scene. For the product tables in section 4 these time

intervals have been converted into *approximate* metric pixel spacing in azimuth and in slant range. Note that for Spotlight the sampling frequency in azimuth is higher in the processed image than in the raw data. If PRF changes occurred in the raw data, the SAR processor will deliver the product with the highest constant PRF that occurred in the raw data belonging to that product.

Especially the very high resolution products (SSCs and SE variants) of the ST - and partly also the HS 300 mode - concentrate point target signal energies in very small pixel - hence yielding very high amplitude values. These are often clipped for bright targets due to the limitation of the 16bit data representation. Hence one should consider to order such products with an adequate processor gain attenuation set in the order interface if the user is interested in point targets.

3.1.1 Spatially Enhanced Products (SE)

The spatially enhanced product is designed for the highest possible square ground resolution. Depending on imaging mode, polarization and incidence angle the larger resolution value of azimuth or ground range determines the square pixel size. The smaller resolution value is adjusted to this size and the corresponding reduction of the bandwidth is used for speckle reduction. An exception is made for ST mode products which have square pixels but asymmetric resolution cells where the azimuth resolution is approximately half the one of the ground range resolution or less.



Fig. 3-1: Example for a spatially enhanced stripmap product with 1.2 looks and approx. 3.2 meter resolution of the Oberpfaffenhofen calibration site. The extent is 2.9km x 1.4km (pixel spacing: 1.25m)

3.1.2 Radiometrically Enhanced Products (RE)

The radiometrically enhanced product is optimized with respect to radiometry. The range and azimuth resolution are intentionally decreased to significantly reduce speckle by averaging approximately 6 (5 to 7) looks to obtain a radiometric resolution of about 1.5 dB. The SNR that generally decreases with larger incidence angles is also considered assuming a backscatter of -6 dB at 20° and -12 dB at 50° . Because of the lower resolution, the required pixel spacing can be reduced and the product data size decreases significantly. In the six beam ScanSAR detected products, the far range resolution in the combined wide swath is generally significantly better than the azimuth resolution.



Fig. 3-2: Example for a radiometrically enhanced stripmap product with 5.5 looks and 6.8 meter resolution.

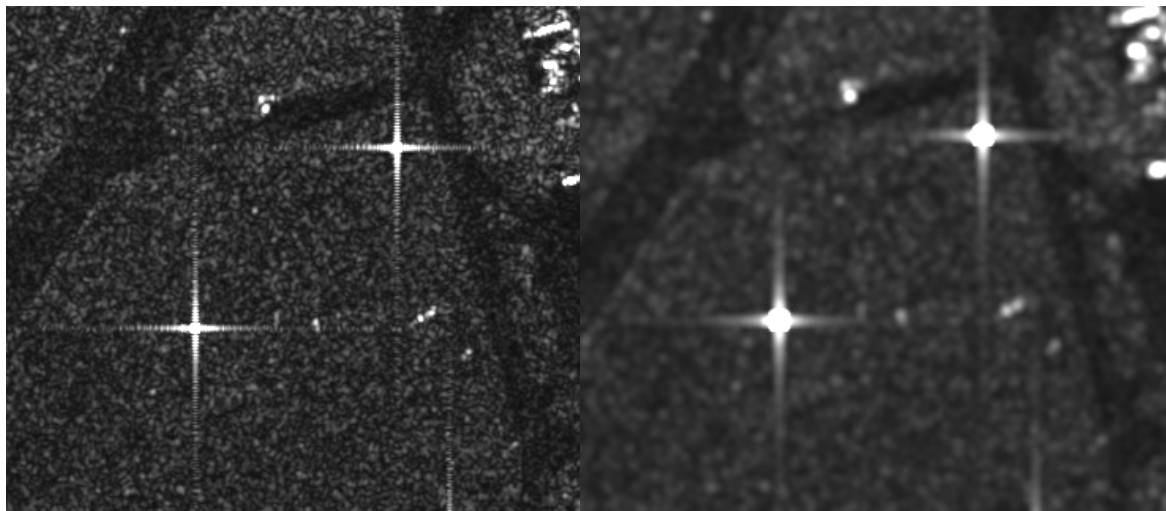

Fig. 3-3: Blow up of the two product variants. The pixel spacing is set to the one of the SE variant for demonstration purposes.

The Fig. 3-4 and Fig. 3-5 below give an overview of the relative resolution cell sizes of the various product variants. Additionally, the more complex incidence angle to resolution dependency *within* six beam wide ScanSAR RE products and characteristic values for ST mode products are shown in the Figures below.

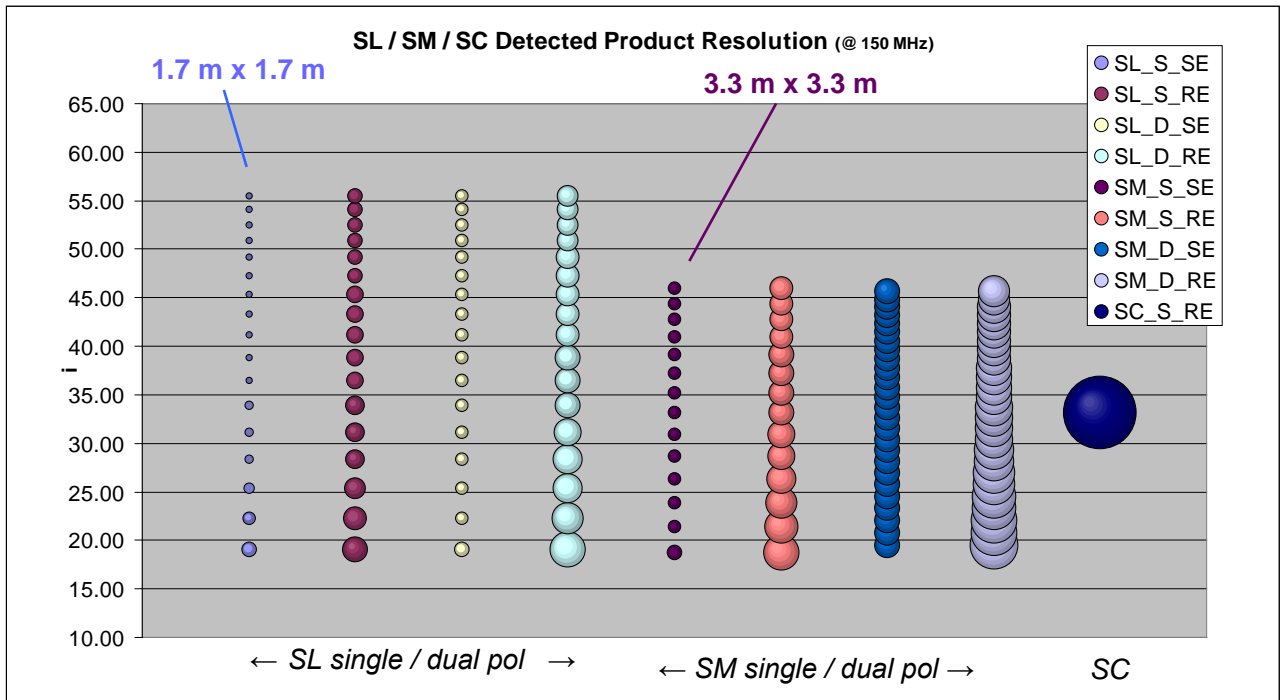

Fig. 3-4: The relative resolutions of detected product variants for all operational SM, SL and SC modes as they depend on the incidence angle.

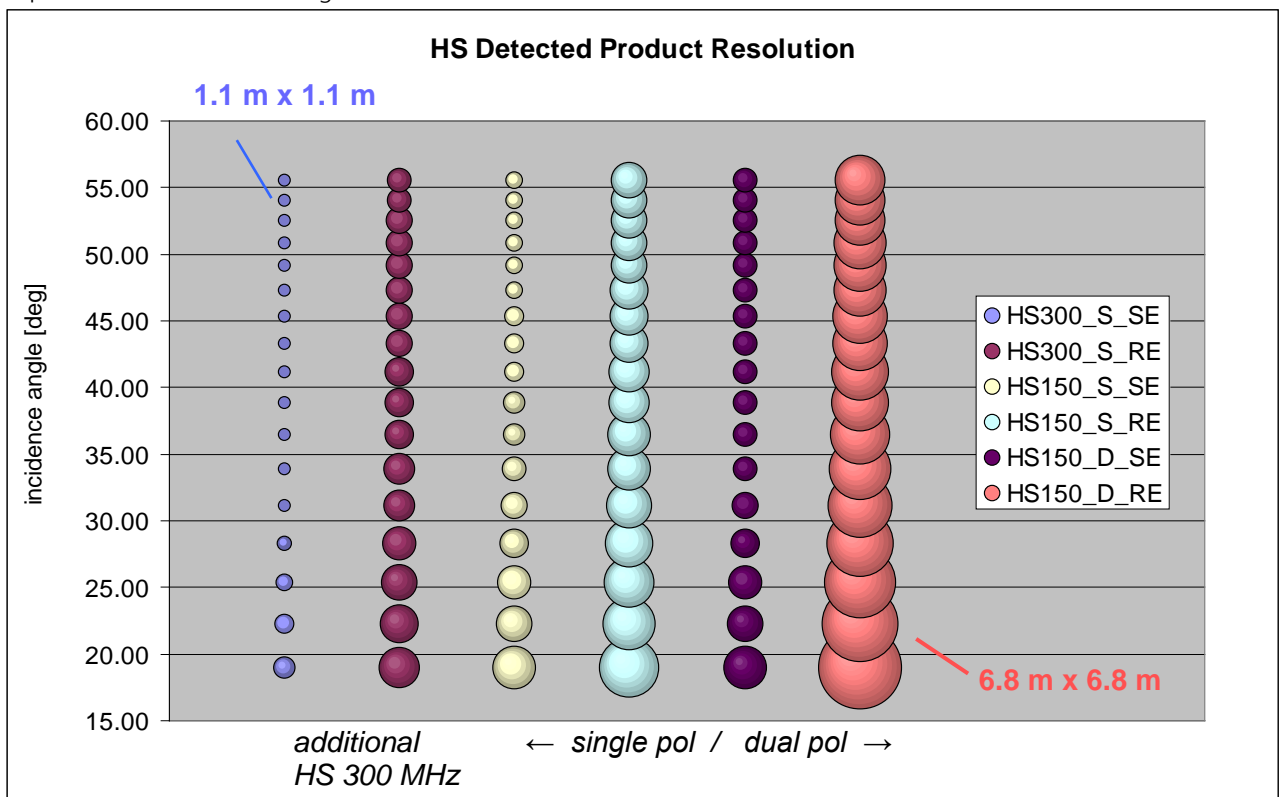

Fig. 3-5: The relative resolutions of detected product variants for the HS modes as they depend on the incidence angle.

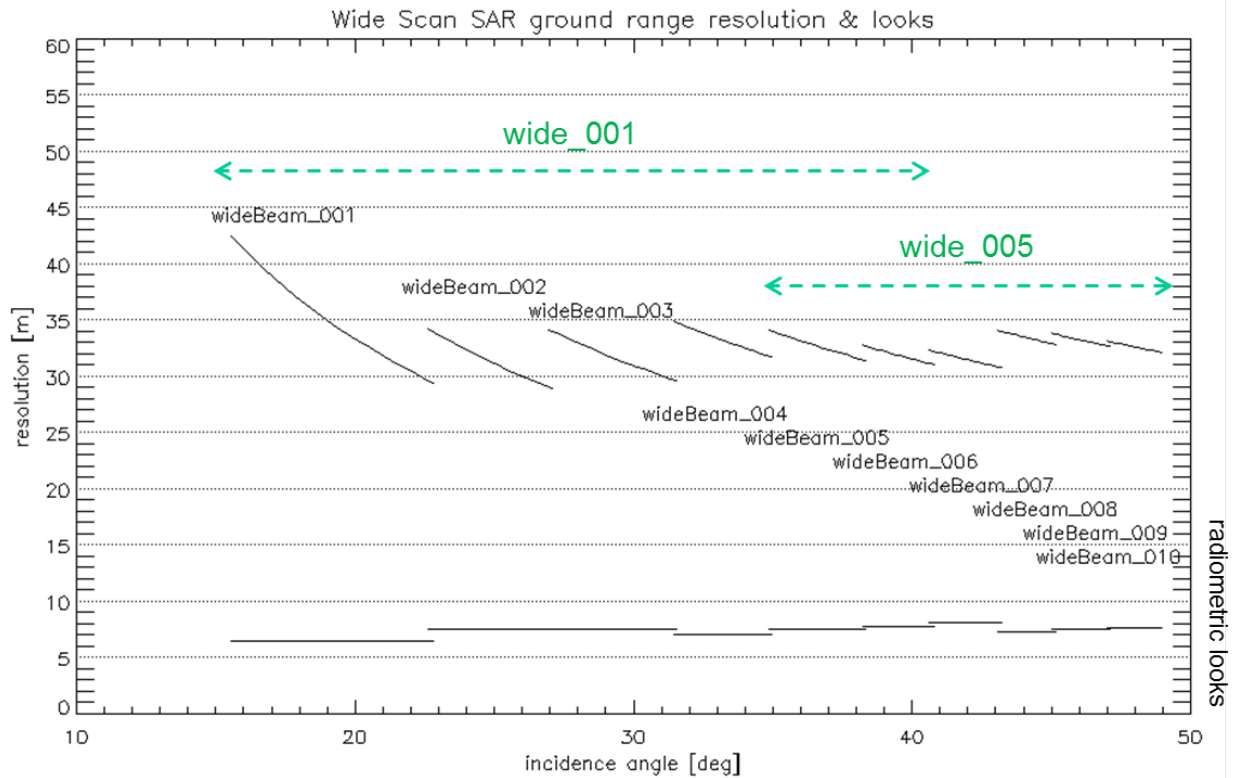
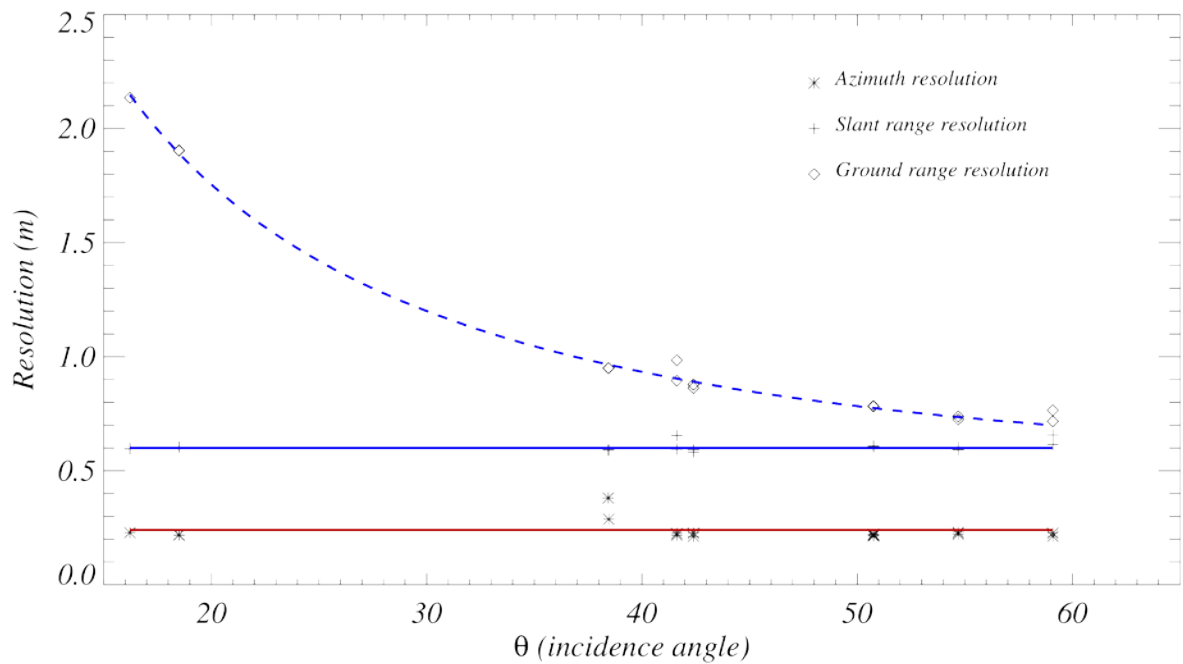

Fig. 3-6: The configured ground range resolution and radiometric looks of targets in detected six beam wide ScanSAR images (only RE variants exist for this product type). The multi-looking parameters are individually optimized for each beam of the 6-beam “wide” configurations yielding only slight variations in resolution and looks.



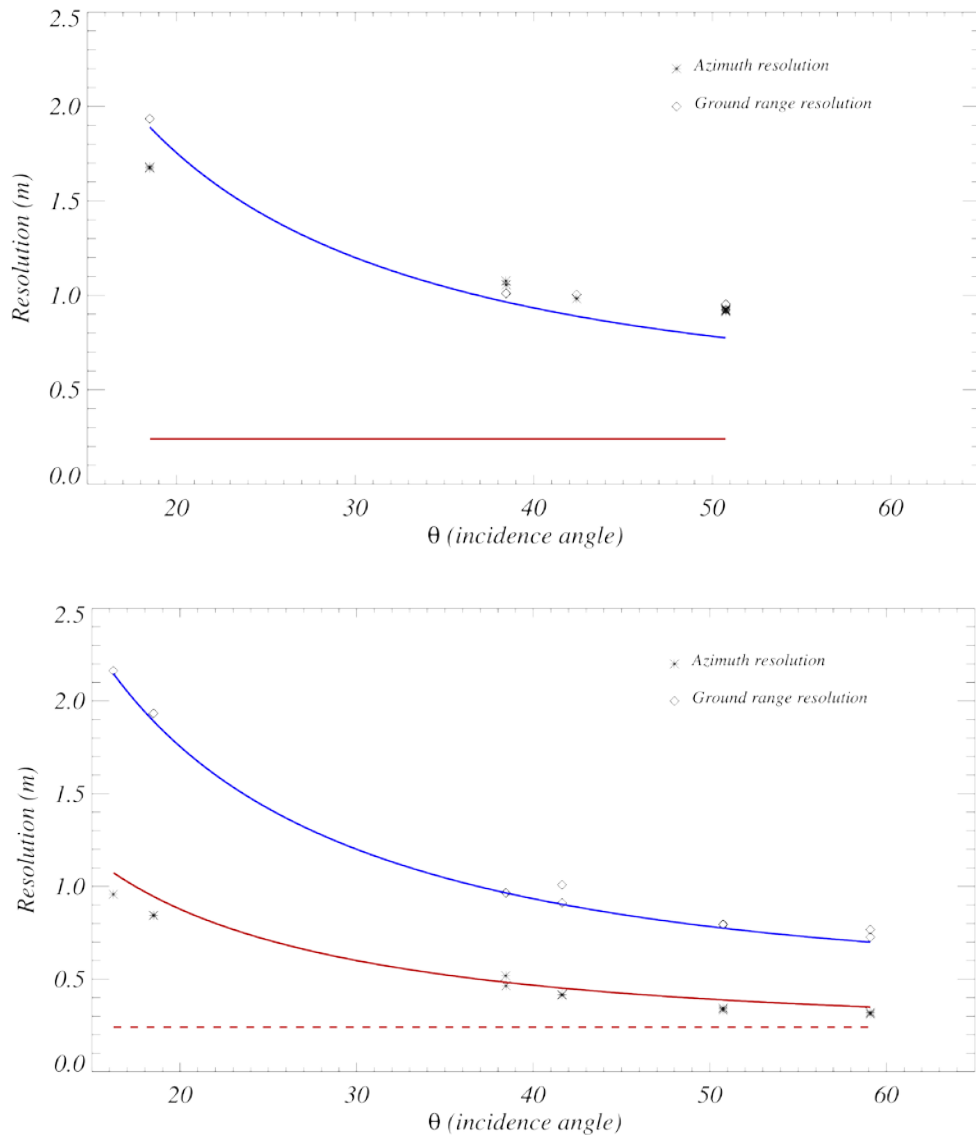

Fig. 3-7: Characteristic measured corner target resolutions in ST mode SSC (upper image) with the theoretical ones, MGD-RE (center) and MGD-SE (lower) products. Blue lines are projected ground and slant range resolutions without multi-looking, azimuth is shown in red. Only in far range detected RE products, a fraction of the range resolution is used to provide a small share of the radiometric looks for the nominal RE approach (thus yielding a lower resolution). In all other products, the azimuth resolution alone is sufficiently small to retrieve the necessary looks.

3.2 Radiometric Performance

3.2.1 Derivation of Backscatter Coefficient for Distributed Targets

All delivered TerraSAR-X products are calibrated to radar brightness β_0 (beta nought), compatible to the detected ground range products from ERS, ENVISAT/ASAR and RADARSAT and following the recommendations in [RD 6]. In contrast to ENVISAT and ERS, also the complex slant range products are delivered in radar brightness. There is thus no correction for ground range projection or illumination effects. This reflects the fact that the calibrated brightness values relate to unit areas in slant range.

The products are thus corrected for any measured or characterized gain variation including the ones of the instrument and e.g. the ones resulting from projected antenna pattern. The TMSP has a normalized signal gain for all modes and a single absolute calibration constant is applicable to all products. The digital representation of the data as 16bit integer values requires however to use the amplitude data and a scaling factor for the numeric values. This scaling can be controlled by the user through selection of a processor gain attenuation in order to prevent clipping of very bright targets (i.e. corner reflectors) at the cost of badly quantized radiometry for low backscatter areas. Due to format limitations, the digital image data pixel value (the digital number DN) itself is hence not a numerical representation of the beta nought floating point value. It is scaled in order to achieve an optimal use of the 16bit dynamic range and has to be converted from the squared image data amplitude values to beta nought using the individual calibration factor k_s annotated for each image layer.

In the SAR processor the following effects are compensated:

- elevation antenna pattern on the local DEM and range spread loss
- azimuth antenna pattern in ScanSAR and spotlight modes (best effort)
- effects of different azimuth and range bandwidths
- sensor settings like receiver gain, transmit power, duty cycle
- instrument temperature dependent gain variations, etc.

Besides the backscatter corrected for the effects listed above, the image data contains an additional thermal noise power which is estimated, subjected to all normalization and gain adjustments of the processor and precisely characterized in the products by annotated profiles. The noise power variation over the image predominantly reflects the antenna gain pattern compensation during processing. The annotated image noise power has to be scaled with the same calibration factor as the according image data to obtain the noise equivalent beta nought NEBN. This local NEBN has to be subtracted from each pixel's β_0 value to obtain a fully calibrated and noise corrected image.

Especially for ScanSAR, the evaluation and projection of the noise profiles to the image domain is a rather complex task. A very precise compensation of the measured noise can be performed inside the TMSP. Since the radiometrically enhanced RE product variants target for precise radiometry, the processor corrects these products for the noise contribution by default. Thus, as a novelty, all RE product variants (this includes all detected ScanSAR products) are corrected for the noise power contribution which is indicated by a "noise correction" flag in the annotation file.

The radiometric representation which allows parameter retrieval independent of the projection geometry is the normalized backscatter σ_0 . It relates to unit areas on the surface and thus requires an illumination correction based on the local incidence angles. Sigma nought is derived from the binary pixel values DN (digital numbers - representing the amplitude) as follows (see [RD 8] for details):

$$\sigma_0 = \left(k_s \langle |DN|^2 \rangle - NEBN \right) \sin(\theta_i),$$

where θ_i is the local incidence angle (contained in the incidence angle mask of EEC products) at the pixel, k_s is the calibration *and processor scaling* factor for SAR signals annotated in each product and the local calibrated noise power $NEBN$, which is only to be used for uncorrected products and derived from the noise profiles (see 3.2.2). For flat terrain or sea surfaces, the incidence angles annotated in the geo grid file are sufficiently accurate for this conversion – otherwise the local slopes from a terrain model have to be taken into account.

Beta naught representation is selected for the description of the noise power because like the radar brightness it is a system parameter that does not depend on the terrain and requires no knowledge of the scatterer. The relationship between the system noise expressed in beta naught and sigma zero is simply

$$NESZ = NEBN \cdot \sin(\theta_i)$$

Note that only the stripmap antenna patterns that are also used for four beam ScanSAR products are calibrated and verified. The large number of spotlight range and azimuth patterns and the ScanSAR azimuth pattern are calibrated using approximations and a “best effort” approach which is based on very precise models.

3.2.2 Noise Equivalent Sigma Zero

The values given for noise equivalent sigma zero in the product tables are estimates based on performance estimations verified by measurements. They are specified in average for the different beams between -19 dB and -26 dB. The NESZ depends on a number of factors, e.g. the antenna pattern (i.e. the position in the scene), the power of the transmitted pulse, the quantization, the receiver noise and the bandwidth. The average value for both the instruments is -21dB within the relevant full performance ranges. See Annex C for details on the NESZ performance for each mode and beam range.

The expected NEBN (not the NESZ) is annotated in the products in form of polynomials over range with azimuth time tags that describe the image data noise power (requiring the identical k_s as the imaging DNs for conversion to beta nought) as a function of range considering the major contributing factors, i.e. elevation antenna pattern, transmitted power and receiver noise.

3.3 Radiometric Accuracy

The radiometric accuracy is defined twofold:

Absolute Radiometric Accuracy

This parameter is the root mean square (RMS) error between the measured and the true radar cross section at different locations within one scene and also over time. The absolute radiometric accuracy for the products (including all errors from calibration devices and processing) derived during the commissioning phases of both instruments and confirmed by TerraSAR-X recalibration campaigns is **0.6 dB**. *This value includes the long term stability.* It is thus much lower than the originally specified 1.1 dB. See the Annex C for details.

Relative Radiometric Accuracy

This parameter is the standard deviation of the radiometric error of known targets within one data take, i.e. over range and within 220 seconds. Contributions come from the antenna pattern, the pointing knowledge of the antenna pattern and drifts of the instrument during operation. The relative radiometric accuracy of both instruments is **0.3 dB** for stripmap data, including long term stability.

3.4 Pixel Localization Accuracy

The pixel localization accuracy defines how accurate a pixel in a TerraSAR-X basic product can be transformed to a ground position.

For complex slant range products no slant to ground projection is performed in the processor and only the system errors are relevant. A major error contribution comes from the GPS orbit determination. Three types of orbits are used for the processing of basic products:

Orbit type	Required Accuracy	Purpose
predicted (PRED)	700 m along track	Processing of near real time products (NRT) only.
rapid (RAPD)	2 m (3D, 1 sigma)	Standard processing of basic products.
science (SCIE)	20 cm (3D, 1 sigma), aiming at 10 cm	Processing for high accuracy purposes, e.g. for interferometry.

Table 3-1: Orbit types used for basic product processing

Note that currently the achieved orbit accuracies are much better and that even the operational *rapid* orbit error is found to be below 20cm, provided that TOR-IGOR GPS measurements are available. This is nominally the case.

However, during solar maximum the accuracy of all orbit types will possibly decrease but is kept well within the specified values.

Former versions of the specification stated that with the timing and orbit information provided in the basic products a user is able to locate his 3D coordinates in the complex slant range SAR image with an accuracy of 2 meters and better. The pixel localization accuracy refers to SSCs in slant range coordinates. The value of 2m was specified for *perfect knowledge* of the signal path. The radar signal is however subject to a path delay due to the different refractive indices of vacuum, ionosphere and troposphere. This results in a slant range error of the order of 2-4 m that depends on the actual conditions in the passed media and on the length of the signal path - hence the incidence angle. The “dry” component of the tropospheric path delay is relatively easy to model and nearly constant in time, while the ionospheric effects are more erratic but of small magnitude in the X band. Average delays for the entire scene are corrected for in the processor. They are approximated by standard models, used for all geo-location & geocoding and annotated in the product. The residual incidence angle dependent differential effects are below 0.5 m. Note that all coordinates used and annotated are hence corrected ones. However, the time tags for the corresponding coordinates annotated in the products are the instrument measurements including electronic delay corrections but excluding these signal path corrections.

A major result of the TerraSAR-X commissioning phase activities is that the achieved absolute geometric accuracy is much better than formerly specified due to the reliable orbit accuracy, the precisely calibrated instrument delays and the accurate delay and timing corrections performed in the processor. Thus the specified accuracy is tightened to **1 m absolute** geometric accuracy and is now valid for all nominal imaging conditions (using science orbits) *including all uncertainties on the signal path and along-track (azimuth) errors*. Same geometry, repeat pass acquisition L1b products of SC, SM, SL and HS modes are found to be “intrinsically” co-registered down to the sub-pixel level. The monostatic commissioning phase of TanDEM-X yielded as precise geo-location performance parameters as for TerraSAR-X. The relative geometric accuracy of both instruments in joint acquisitions is in the centimetre to millimetre range.

3.4.1 Geocoded Product Location Accuracy

Geocoded EEC products are projected to the digital elevation model (DEM) surface and an error in the DEM additionally affects the pixel localization accuracy. This error is given in horizontal northing and easting coordinates. The achievable accuracy depends on the orbit precision, the timing accuracy and specifically the elevation accuracy of the reference DEM. For low incidence angles the DEM accuracy is more significant than for higher ones. The main contribution to the pixel localization accuracy in geocoded products is the height accuracy of the reference DEM used during processing as illustrated in Fig. 3-8.

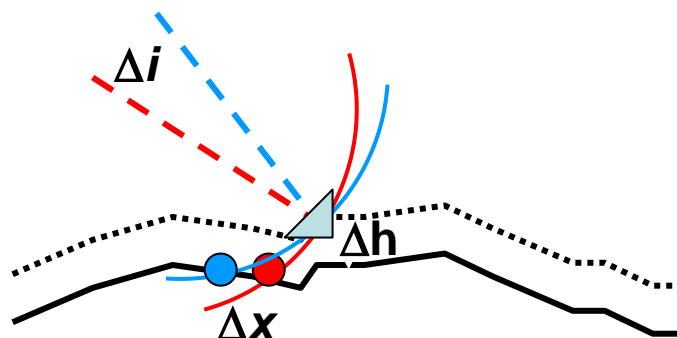

Fig. 3-8: Sketch of DEM height to location error relation for different incidence angles

With perfect knowledge of the terrain, a localization accuracy that corresponds to the pixel spacing is theoretically also achievable for geocoded products. The specified value thus refers to flat terrain and high incidence angles *not* considering the DEM error contributions. It reflects the accuracy of the SAR-processing and ge-

ocoding procedures. As the elevation accuracy of the DEM might locally vary, the effect on the pixel location accuracy can be estimated from the following table:

	20°	23°	26°	29°	32°	35°	38°	41°	44°	47°	48°	50°	incidence angle
DEM elevation error	2,75	2,36	2,05	1,80	1,60	1,43	1,28	1,15	1,03	0,93	0,90	0,83	displacement factor
2 m	5,5	4,7	4,1	3,6	3,2	2,9	2,6	2,3	2,1	1,9	1,8	1,7	resulting location error in meters
6 m	16,5	14,2	12,3	10,8	9,6	8,6	7,7	6,9	6,2	5,6	5,4	4,9	
8 m	22	19	16	14	13	12	11	9	9	8	7	7	
16 m	44	38	33	29	25	23	21	18	17	15	14	13	
30 m	82	71	61	54	48	43	38	34	31	28	27	25	
100 m	275	236	205	180	160	143	128	115	103	93	90	83	

Table 3-2: Pixel localization error resulting from DEM errors at different incidence angles

The table listed above demonstrates the pixel displacement in range that is caused by DEM elevation errors. An elevation range from 2 m to 100 m is listed vs. the incidence angle range of TerraSAR-X. The cotangent of the incidence angle is the factor that converts a height error into a location error.

The DEM-sources used for the operational TerraSAR-X production are listed below:

DEM product	vertical accuracy		grid size	limitations
	relative	absolute		
SRTM / X-SAR	6 m	16 m	1 "	+60° with gaps
SRTM / C-band	8 m	16 m	3 "	+ 60°
ERS-tandem	20 m	30 m	1 "	limited availability
DTED-1	20 m	30 m	3 "	limited availability
GLOBE	varying 10 m – 100s of meters		30 "	no restrictions, poor quality

Table 3-3: Characteristics of DEM sources available for TerraSAR

A DEM map is provided with EEC products in order to indicate the actual DEM used in different areas of an image.

Multi-Look Ground-range Detected (MGD) Products and Geocoded Ellipsoid Corrected (GEC) product types are both generated using *one* average height for projection of the entire scene on ground and are thus very limited in their (range) location accuracy. MGDs additionally are provided in linear azimuth / ground range orientation and are thus not precisely georeferenced. However, using the annotation information and the auxiliary product components (Mapping Grid & Geo Grid), they can be re-projected in to the time domain with an accuracy that is only limited by the interpolation accuracy of the grids. In that sense, they are also accurately localized.

3.4.2 Impact of Orbit Selection on Product Generation and Delivery Latency

The generation latency of an L1b product strongly depends on the availability of the auxiliary data with the desired accuracy. The delivery latencies of the orbit products are specified to within 15 hours after GPS data dump for the rapid orbit and 3 weeks for the science orbit.

Note however that currently the majority of rapid orbit products are available much faster (within 10 hours after image acquisition) and that – depending on the availability of input data – a 5-day latency can be achieved for the science orbit products in many cases. Thus most catalogue orders will use science orbit accuracy (even if rapid accuracy is selected) while future products are generated as soon as the specified orbit is available. Each L1b product is generated upon availability of an orbit product with at least the user ordered accuracy. Nominally, the product could be delivered immediately after processing. But keep in mind that (due to the satellite data security regulations enforced by the German government) “very high resolution data” and specific complex products have to undergo a “quarantine” period of currently five days from *acquisition time* to delivery. High resolution in this context currently refers to data with a resolution of 2.5m or better. As mentioned before, all detected RE product variants of all modes with the exception of the ST mode are limited in resolution to remain above this value. Many other products are also above this limit (e.g. all detected stripmap products).

However, SSCs and SE products of the spotlight modes may be better resolved. Hence selecting science orbit accuracy can be advised for *future scene orders* of such product types since it will usually not *further* delay the delivery of very high resolution or complex products. Users which require fast data access but may be satisfied with coarser resolutions and some cm less in location accuracy should select the rapid orbit and product variants that yield 2.5m or worse resolution for the given beam from the plots in the annex (in doubt, the RE variant is to be selected).

3.5 Geometric Projections and Data Representation

3.5.1 Single Look Slant Range Complex (SSC)

Geometric Projection: Azimuth – Slant Range (time domain)

This product is the basic single look product of the focused radar signal. The pixels are spaced equidistant in azimuth (according to the pulse repetition interval $PRI=1/PRF$) and in slant range (according to the range sampling frequency) and the data are represented as complex numbers. Each image pixel is processed to zero Doppler coordinates, i.e. perpendicular to the flight track. This convention is compatible with the standard slant range products available from ERS-1/2, ENVISAT/ASAR, RADARSAT and from X-SAR/SIRC.

Spotlight products will be processed to zero Doppler coordinates like stripmap products with an artificial PRF selected large enough to hold the total processed Doppler spectrum. The products are therefore widely compatible with complex stripmap products. However, it must be considered that the Doppler centroid varies strongly with azimuth.

The SSC product is intended for scientific applications that require the full bandwidth and the phase information, e.g. SAR interferometry and interferometric polarimetry. Any possible offsets in the antenna phase pattern between TSX-1 and TDX-1 will be compensated and annotated in the product when applicable.

3.5.2 Multi Look Ground Range Detected (MGD)

Geometric Projection: Azimuth – Ground Range (without terrain correction).

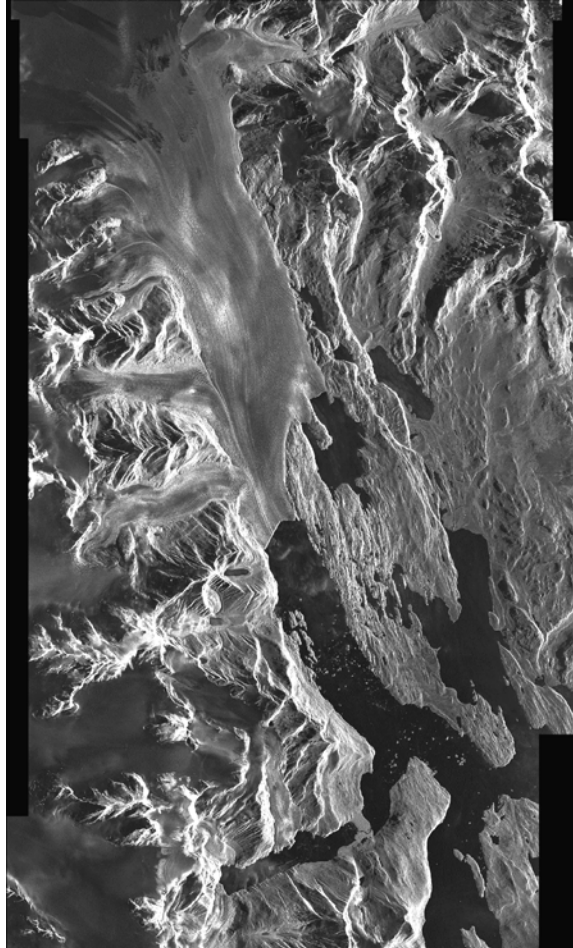

Fig. 3-9: Example for a MGD projection over mountainous terrain where the echo window coarsely follows the DEM variations (TerraSAR-X stripmap product 30x55 km, Upsala glacier in Patagonia).

This product is a detected multi look product with reduced speckle and approximately square resolution cells on ground. The image coordinates are oriented along flight direction and along ground range. The pixel spacing is equidistant in azimuth and in ground range. A simple polynomial slant to ground projection is performed in range using a WGS84 ellipsoid and an average, constant terrain height parameter.

The advantage of this product is that no image rotation to a map coordinate system is performed and interpolation artifacts are thus avoided. Consequently, the pixel localization accuracy is lower than in geocoded products. As for all TS-X L1b products, a coarse grid of coordinates is annotated in the product. The grid coordinates are calculated using a coarse DEM, while the projection of the image data is performed using an ellipsoid with one elevation determined for the scene.

3.5.3 Geocoded Ellipsoid Corrected (GEC)

Geometric Projection: Map geometry with ellipsoidal corrections only (no terrain correction performed).

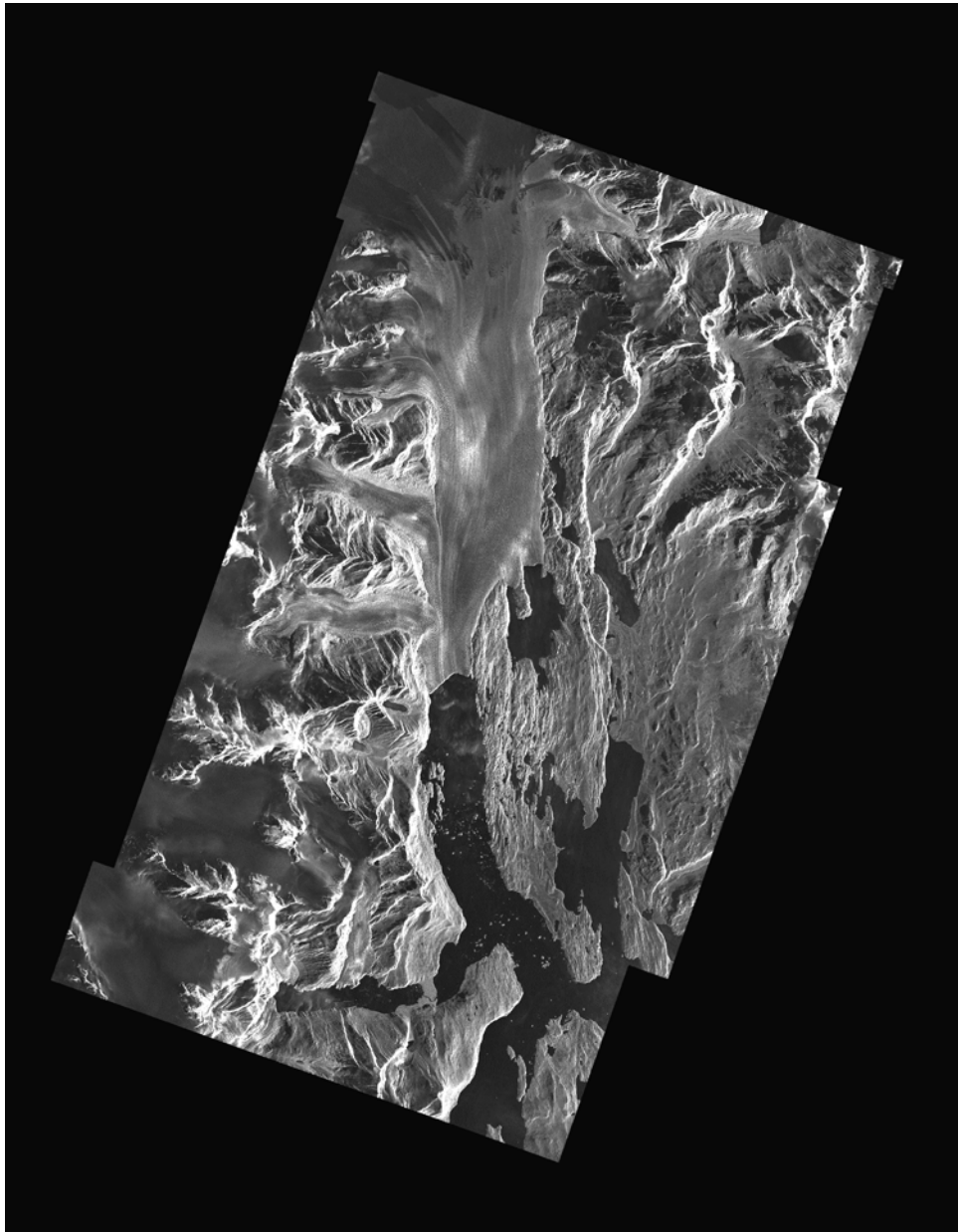

Fig. 3-10: Example for a GEC projection. The image is rotated but not terrain corrected.

The GEC product is a multi look detected product. It is projected and re-sampled to the WGS84 reference ellipsoid assuming one average terrain height. Available grid formats are UTM and UPS (see section 3.6).

As the ellipsoid correction does not consider a DEM, the pixel location accuracy varies due to the terrain. The accuracy measures provided in chapter 4 are valid for flat surfaces. For other types of relief, the terrain induced SAR specific distortions will not be corrected and significant differences can appear in particular for strong relief and steep incidence angles.

3.5.4 Enhanced Ellipsoid Corrected (EEC)

Geometric Projection: Map geometry with terrain correction, using a digital elevation model (DEM).

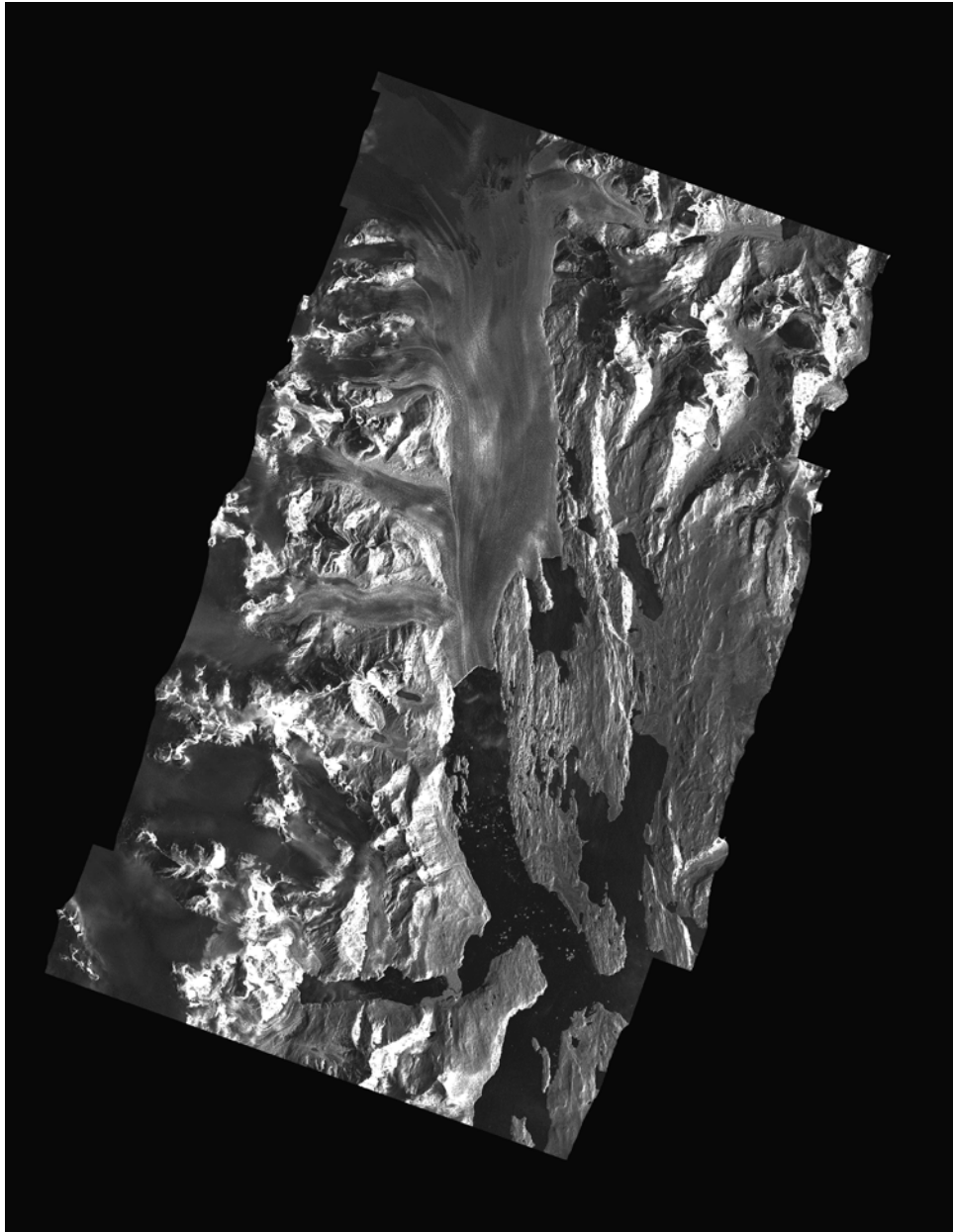

Fig. 3-11: Example for an EEC projection. The image is rotated and terrain corrected.

Like the GEC, the EEC is a multi look detected product. It is projected and re-sampled to the WGS84 reference ellipsoid. The image distortions caused by varying terrain height are corrected using an external DEM. Available grid formats will be either UTM or UPS [see section 3.6].

Terrain induced distortions are corrected using a DEM. Therefore the pixel localization in these products is highly accurate. The accuracy still depends on the type of terrain as well as the quality and resolution of the DEM and on the incidence angle.

The EEC is generated using the best available digital elevation model (DEM) at PGS. These DEMs are compiled from different sources like SRTM/X-SAR, SRTM/C-band, ERS-tandem data, DTED-1 and DTED-2. Remaining gaps are filled with GLOBE-data. SRTM is the best globally available source of elevation data and provides an excellent basis for the rectification of the SM and SC modes. However in case of undulated terrain it is still relatively coarse with respect to the horizontal resolution of the HS and SL modes.

DEM coverage map: The DEM used for rectification is annotated in a matrix delivered with the image. The resolution of the DEM coverage map depends on the best available DEM for the geocoding (e.g. 1 arcsec for SRTM X-band DEM). Each cell of the matrix contains an index that identifies the name(s) of the DEM(s). A lookup table, which describes the index, is part of the delivered product.

The DEM itself is not a TerraSAR-X product and is not delivered with the basic product.

EEC products will optionally be complemented with a geocoded incidence angle mask (GIM). The GIM provides information about the local incidence angle for each pixel of the geocoded SAR scene and about presence of layover and shadow areas.

Local incidence angle: The local incidence angle is the angle between the radar beam and a line perpendicular to the slope at the point of incidence. For its determination it is necessary to know the slant range vector and the local surface normal vector.

Shadow areas: Areas of SAR shadow are determined via the off-nadir angle, which in general increases for a scan line from near to far **range**. Shadow occurs as soon as the off-nadir angle reaches a turning point and decreases when tracking a scan-line from near to far range. The shadow area ends where the off-nadir angle reaches that value again, which it had at the turning point.

The GIM product shows the same cartographic properties like the geocoded output image with regard to output projection and cartographic framing. The content of the GIM product component is basically the local terrain incidence angle and additional flags indicate whether a pixel is affected by shadow and/or layover or not.

The following coding of the incidence angles into the GIM data is specified:

- incidence angles are given as 16bit integer values in tenths of degrees, e.g. 10,1° corresponds to an integer value of 1010.
- The last digit of this integer number is used to indicate shadow and/or layover areas as follows:

1.....	indicates layover	(ex. 1011)
2.....	indicates shadow	(ex. 1012)
3.....	indicates layover and shadow	(ex. 1013)

Deriving the local incidence angle for each image pixel directly from the corresponding GIM pixel is a very convenient way to obtain a terrain illumination correction respectively a ground projection of the calibrated β_0 values (sigma nought (σ_0)) or even gamma nought (γ_0) which is β_0 projected on the unit areas perpendicular to the line of sight via $\tan(i)$. Fig. 3-12 gives an example for such representations and the application of the shadow-and-layover (SLM) flags to invalidate the pixel.

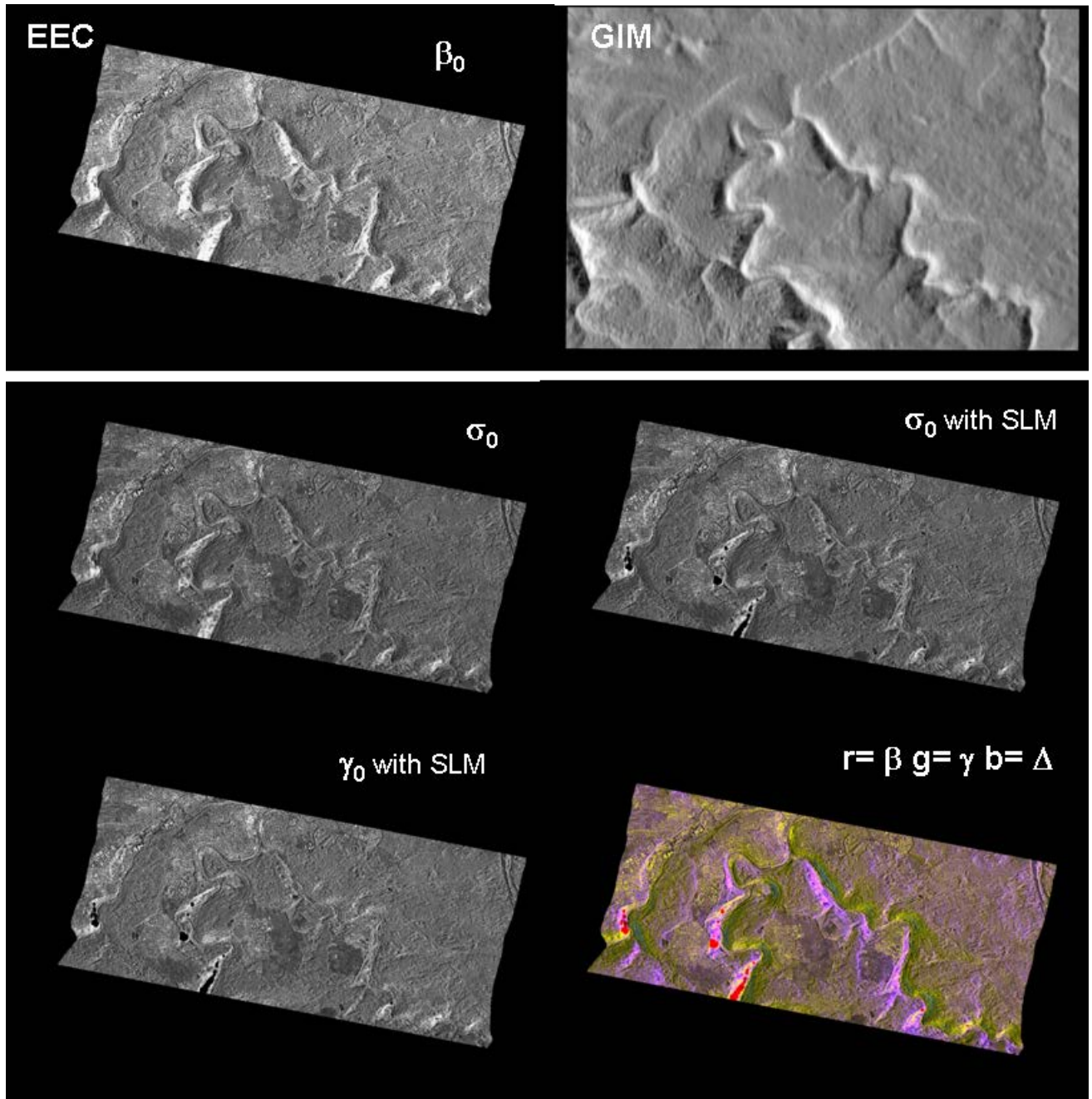

Fig. 3-12: Example for radiometric conversions using the product component GIM of a HS EEC L1b. The RGB composite indicates the differences between the beta nought and the gamma nought representation.

3.6 Map Projections and Grid Formats

3.6.1 Geodetic Datum and Map Projection

In order to be able to produce maps of the earth's surface it is necessary to precisely know its size and shape. Two mathematical descriptions were established – the geoid and the ellipsoid.

The geoid represents the mean sea-level surface which is thought to be continuing underneath the continents. It is the equipotential surface corresponding to an overall absolute elevation of 0 m. The geoid is often used as reference for elevation models.

Usually the earth surface is described by an ellipsoid or a sphere. The ellipsoid can be defined by its semi-major and semi-minor axis. The polar axis is shorter than the equatorial axis and the earth is flattened. However ellipsoid and geoid don't fit very well everywhere. Therefore individual countries use different ellipsoids to minimize deviations between these two surfaces in their area of interest. Additionally the ellipsoids' origins are not necessarily identical with the center of the earth and their shape and size may vary considerably. Ellipsoids that have been defined with size, shape and location in space are referred to as *geodetic datums*.

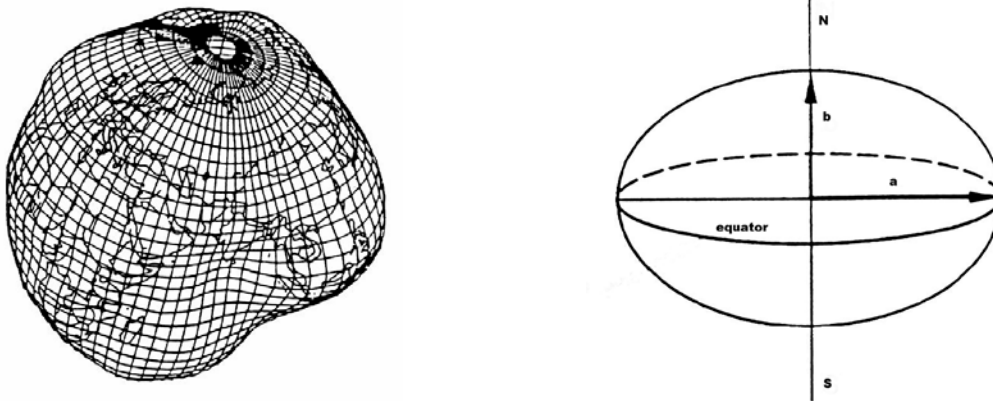

Fig. 3-13: Geoid (left), Ellipsoid (right). Figures taken from [RD 3].

Finally, a map projection needs to be selected in order to represent the curved surface of the ellipsoid on a plane surface. However each of the projections has some kind of distortions. They either preserve angular relationships (conformal projection), distances or area relationships. Usually over land conformal projections are preferred (like Transverse Mercator). Angles on a conformal map are the same as those that would be measured on the earth's surface.

For TerraSAR-X WGS84 is used as geodetic datum. Universal Transverse Mercator (UTM) is the standard projection. For polar regions Universal Polar Stereographic (UPS) will be applied. These projections are supported by all of the common image processing systems and are well established also for other spaceborne missions like ERS and ENVISAT-ASAR.

The projection and zone are derived from the scene center coordinates. Whenever the scene center latitude crosses 84° north or 80° south UPS is selected. The UTM-zones are 6° wide with e.g. 3° (UT31), 9° (UT32), 15° (UT33), ... as central meridians. The scene center longitude determines the zone of the entire scene.

3.6.2 Universal Transverse Mercator (UTM) Grid

The UTM is a conformal cylindrical projection where the surface of the WGS84 ellipsoid is projected onto a cylinder (as shown in Fig. 3-14) that cuts the earth along two lines parallel to the central meridian. The scale is 1 at the cuts and the scale error is mainly a function of the distance from the central meridian. In order to avoid significant distortions UTM is limited in its east-west extent. UTM is a global system consisting of 60 zones each being 6° wide in longitude and providing a rectangular and metric grid.

3.6.3 Universal Polar Stereographic (UPS) Grid

As UTM would produce big distortions in polar regions, the Universal Polar Stereographic Projection is applied for areas between 84° to 90° northern and 80° to 90° southern latitudes thus providing two different "zones".

Universal Polar Stereographic is a conformal azimuthal projection. It is a perspective projection on a plane tangent to either the North or the South Pole as shown in Fig. 3-16. It is conformal free from angular distortions.

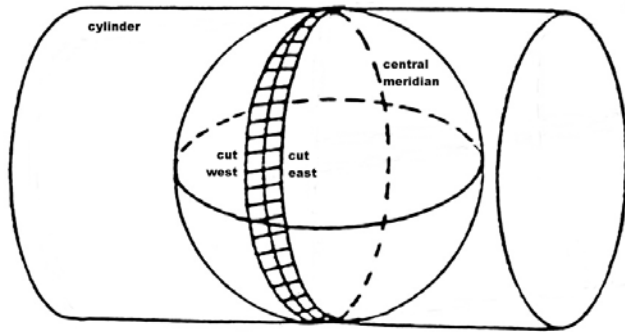

Fig. 3-15: Transverse Mercator Figure taken from [RD 3].

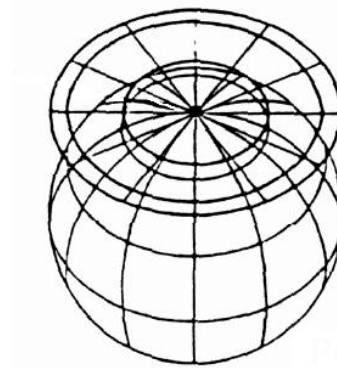

Fig. 3-16: Polar Stereographic Projection. Figure taken from [RD 3].

For compatibility with existing and future standards used in geographic information systems (GIS) and for navigation, all TerraSAR-X products are horizontally referenced to the WGS84 ellipsoid. Depending on the geographical latitude, UTM or UPS grids are used.

3.7 Product Identification Scheme

The different basic products for TerraSAR-X are identified and classified by a mnemonic scheme described in the following. The purpose of this scheme is to enable the identification of products that are compatible with respect to imaging mode or polarization mode. Since the compatibility requirements depend on the intended application, a minimal set of radar and product parameters are used to compose a product identifier:

- the radar imaging mode influencing the resolution and the scene size
- the polarization mode influencing the number of available polarization channels
- the resolution class, a processing parameter
- the geometric projection, a processing parameter

The product identifier follows the standards proposed for the TS-X PGS. It is split into 4 sub-identifiers and the global product name is composed as:

<projection>_<resolution class>_<imaging mode>_<polarization mode>

e.g. **MGD_SE_SM_S** for a spatially enhanced single polarization stripmap product in multi look ground range projection. If a sub-identifier is not applicable, like the resolution class for complex products, it is omitted.

Definition of Product Identifier

3.7.1 Radar Imaging Mode Identifier

Four different imaging modes are currently defined:

Imaging Mode	Identifier
High Resolution Spotlight	HS
Spotlight	SL
Staring Spotlight	ST
Stripmap	SM
ScanSAR	SC

3.7.2 Polarization Mode Identifier

Single Polarization and Dual Polarization are the two standard modes which are possible for each image mode, except ScanSAR, which is restricted to single polarization. Furthermore two more polarization modes, Quad Polarization and Twin Polarization are technically possible. They are currently not available as Basic Products.

Polarization Mode	Identifier
Single	S
Dual	D
Quad	Q
Twin	T

3.7.3 Projection Identifier

The following options for geometrical projection and for data representation will be selectable:

Identifier	Projection, data representation
SSC	<u>S</u> ingle Look <u>S</u> lant Range, <u>C</u> omplex representation
MGD	<u>M</u> ulti Look <u>G</u> round Range, <u>D</u> etected representation
GEC	<u>G</u> eocoded <u>E</u> llipsoid <u>C</u> orrected, detected representation
EEC	<u>E</u> nhanced <u>E</u> llipsoid <u>C</u> orrected, detected representation

4 Basic Product Tables

The following tables list the TerraSAR-X basic products for each radar image mode together with the characteristic parameters. The products have a fixed size in azimuth and range. No framing is applied and the product location along a longer stripmap or ScanSAR data take can be freely selected.

Single and dual polarization variants are sorted in consecutive tables. The given product size should give a minimum estimate for product storage and transport purposes. It is roughly calculated as

$$size = \left(n_{pol} \cdot bps + 2 \cdot n_{inc} \right) \frac{R \cdot A}{\Delta r \cdot \Delta a \cdot 10000000} \text{ [MB]},$$

where

n_{pol} is the number of polarimetric layers,

bps is the number of bytes per sample, i.e. 2 for detected and 4 for complex products,

n_{inc} is the number of incidence angle masks, i.e. 1 for EEC, 0 for all other products,

R is the scene size in range,

A is the scene size in azimuth,

Δr is the pixel spacing in range,

Δa is the pixel spacing in azimuth.

The values given for detected products contain the incidence angle mask which is only provided with geocoded EEC products. The incidence angle mask makes 50% of a single polarization product and 33 % of a dual polarization product. The relative increase in product size due to a slightly tilted flight track is significant only for small products and thus neglected.

The DEM index file additionally increases the product size of EEC products but it is expected that this map can be compressed efficiently.

4.1 Single Polarization Stripmap Products (SM)

Mnemonic	{MGD, GEC, EEC}_SE_SM_S		{MGD, GEC, EEC}_RE_SM_S		SSC_SM_S
Imaging Mode	SM				
Product Type	Detected				Complex
Geometric Projection	{MGD, GEC, EEC}				SSC
Polarization Mode	S				
Resolution Mode	SE		RE		
Number of Polarimetric Channels	1				
Polarization Mode	{HH, VV}				
Data collection range	15°-60°				
Full Performance range	20°-45°				
Recomm. Performance range	20°-45°				
Range Scene Size [km]	30				
Azimuth scene size [km]	50				
Abs. Radiometric Accuracy [dB]	0.6				
Relative Radiom. Accuracy [dB]	0.30				
NESZ [dB]	-19				
Ambiguity Ratio [dB]	< -17				
PSLR [dB]	-25				
ISLR [dB]	-18				
Num. of Inc. Angle Masks	1				0
Bit per Pixel	16				32
Hamming coefficient	0.6				0.60
Incidence angle (20°-45°)	20	45	20	45	
Slant range resolution [m]					1.2
Ground Range Resolution [m]	3.5	3.3	8.0	7.0	
Azimuth Resolution [m]	3.5	3.3	8.0	7.0	3.3
Approx. Range Pixel Spacing [m]	1.5	1.25	4	3.25	0.9
Appr. Azimuth Pixel Spacing [m]	1.5	1.25	4	3.25	2.0
Effective number of looks	1.0	1.3	6.1	6.4	
Pixel localization accuracy [m]					1.0
Radiometric resolution [dB]	3.1	2.9	1.5	1.5	
Product Size (MB)	2667	3840	375	568	3300

Table 4-1: Single polarization stripmap products for 20° and 45° beams

Notes:

- SM = stripmap
 - SE = Spatially enhanced (high resolution), RE = Radiometrically enhanced (high radiometry)
 - S = Single polarization
- all values for detected products at 20° and SSCs are based on 150 MHz range bandwidth, for 45° 100 MHz is used

4.2 Dual Polarization Stripmap Products (SM)

Mnemonic	{MGD, GEC, EEC}_SE_SM_D		{MGD, GEC, EEC}_RE_SM_D		SSC_SM_D
Imaging Mode	SM				
Product Type	Detected				Complex
Geometric Projection	{MGD, GEC, EEC}				SSC
Polarization Mode	D				
Resolution Mode	SE		RE		
Number of Polarimetric Channels	2				
Polarization Mode	{HH/VV, HH/HV, VV/VH}				
Data collection range	15°-60°				
Full Performance range	20°-45°				
Recomm. Performance range	20°-40°				
Range Scene Size [km]	15				
Azimuth scene size [km]	50				
Abs. Radiometric Accuracy [dB]	0.6				
Rel. Radiometric Accuracy [dB]	0.30				
NESZ [dB]	-19				
Ambiguity Ratios [dB]	< -16				
PSLR [dB]	-25				
ISLR [dB]	-18				
Inc. Angle Masks	1				0
Bit per Pixel	16				32
Hamming coefficient	0.6				0.60
Incidence angle (20°-45°)	20	45	20	45	
Slant range resolution [m]					1.2
Ground Range Resolution [m]	6.6	6.6	11.8	9.9	
Azimuth Resolution [m]	6.6	6.6	11.8	9.9	6.6
Range Pixel Spacing [m]	3	3	5.5	4.5	0.9
Azimuth Pixel Spacing [m]	3	3	5.5	4.5	2.5
Effective number of looks	1.8	2.8	6.5	6.6	
Pixel localization accuracy [m]					1.0
Radiometric resolution [dB]	2.5	2.1	1.5	1.5	
Product Size (MB)	500	500	149	222	2667

Table 4-2: Dual polarization stripmap products for 20° and 45° beams

Notes:

- SM = stripmap
- SE = Spatially enhanced (high resolution), RE = Radiometrically enhanced (high radiometry)
- D = Dual polarization

4.3 High Resolution Single Polarization Spotlight Products (HS)

Mnemonic	{MGD, GEC, EEC}_SE_HS_S		{MGD, GEC, EEC}_RE_HS_S		SSC_HS_S
Imaging Mode	HS				
Product Type	Detected				Complex
Geometric Projection	{MGD, GEC, EEC}				SSC
Polarization Mode	S				
Resolution Mode	SE	RE			
Number of Polarimetric Channels	1				
Polarization Mode	{HH, VV}				
Data collection range	15°-60°				
Full Performance range	20°-55°				
Recomm. Performance range	20°-50°				
Range Scene Size [km]	10				
Azimuth scene size [km]	5				
Abs. Radiometric Accuracy [dB]	unspecified				
Rel. Radiometric Accuracy [dB]	unspecified				
NESZ [dB]	-19				
Ambiguity Ratios [dB]	< -17				
PSLR [dB]	-25				
ISLR [dB]	-18				
Inc. Angle Masks	1				0
Bit per Pixel	16				32
Hamming coefficient	0.6				0.60
Incidence angle (20°-55°)	20	55	20	55	
Slant range resolution [m]					1.2
Ground Range Resolution [m]	3.5	1.4	4.7	3.1	
Azimuth Resolution [m]	3.5	1.4	4.7	3.1	1.1
Range Pixel Spacing [m]	1.5	0.5	2	1.5	0.9
Azimuth Pixel Spacing [m]	1.5	0.5	2	1.5	0.8
Effective number of looks	3.0	1.3	6.3	5.9	
Pixel localization accuracy [m]					1.0
Radiometric resolution [dB]	2.1	3.0	1.5	1.7	
Product Size (MB)	89	800	50	89	275
	HS 300 MHz (Characterisation only)				
Range Scene Size [km]	10 ... 5				
Slant range resolution [m]					0.6
Ground Range Resolution [m]	1.8	1.1	3.4	3.0	
Azimuth Resolution [m]	1.8	1.1	3.4	3.0	1.1
Range Pixel Spacing [m]	0.75	0.5	1.5	1.25	0.5
Azimuth Pixel Spacing [m]	0.75	0.5	1.5	1.25	0.8
Effective number of looks	1.5	1.2	5.0	9.0	
Radiometric resolution [dB]	2.7	3.1	1.7	1.4	
Product Size (MB)	356	800	89	128	500

Table 4-3: Tables of single polarization high resolution spotlight products for 20° and 55° beams

Notes: HS = High Resolution Spotlight, SE = Spatially enhanced (high resolution), RE = Radiometrically enhanced (high radiometry), S = Single polarization

4.4 Single Polarization Staring Spotlight Products (ST), 300 MHz

Mnemonic	{MGD, GEC, EEC} SE ST S	{MGD, GEC, EEC} RE ST S	SSC ST S	
Imaging Mode	ST			
Product Type	Detected			Complex
Geometric Projection	{MGD, GEC, EEC}			SSC
Polarization Mode	S			
Resolution Mode	SE	RE		
Number of Polarimetric Channels	1			
Polarization Mode	{HH, VV}			
Data collection range	15°-60°			
Full Performance range	20°-45°			
Recomm. Performance range	32°-45°			
Range Scene Size [km]	approx. 7.5 - 4.6 (in full perf. range)			
Azimuth scene size [km]	approx. 2.5 – 2.8 (extended coverage in full perf. range)			
Abs. Radiometric Accuracy [dB]	unspecified			
Rel. Radiometric Accuracy [dB]	unspecified			
NESZ [dB]	-18 (degraded by azimuth pattern)			
Ambiguity Ratios [dB]	< -20 / < -17 (RASR / AASR)			
PSLR [dB]	-25 / -20 (range / azimuth)			
ISLR [dB]	-18 / -16 (range / azimuth)			
Inc. Angle Masks	1			0
Bit per Pixel	16			32
Hamming coefficient	0.6			0.60
Incidence angle (20°-45°)	20	45	20	45
Slant range resolution [m]	0.6			
Ground Range Resolution [m]	1.8	0.9	1.8	0.9
Azimuth Resolution [m]	0.9	0.45	1.8	0.9
Range Pixel Spacing [m]	0.4	0.2	0.8	0.4
Azimuth Pixel Spacing [m]	0.4	0.2	0.8	0.4
Effective number of looks	3.7	1.9	7.5	4
Pixel localization accuracy [m]	1.0			

Table 4-4: Table of characteristic values for single polarization staring spotlight products for 20° and 45° beams

4.5 High Resolution Dual Polarization Spotlight Products (HS)

Mnemonic	{MGD, GEC, EEC}_SE_HS_D	{MGD, GEC, EEC}_RE_HS_D	SSC_HS_D	
Imaging Mode	HS			
Product Type	Detected			Complex
Geometric Projection	{MGD, GEC, EEC}			SSC
Polarization Mode	D			
Resolution Mode	SE	RE		
Number of Polarimetric Channels	2			
Polarization Mode	HH/VV			
Data collection range	15°-60°			
Full Performance range	20°-55°			
Recomm. Performance range	20°-43°			
Range Scene Size [km]	10			
Azimuth scene size [km]	5			
Abs. Radiometric Accuracy [dB]	unspecified			
Rel. Radiometric Accuracy [dB]	unspecified			
NESZ [dB]	-19			
Ambiguity Ratios [dB]	< -16 (-9 above 45°)			
PSLR [dB]	-25			
ISLR [dB]	-18			
Inc. Angle Masks	1			0
Bit per Pixel	16			32
Hamming coefficient	0.6			0.6
Incidence angle (20°-55°)	20	55	20	55
Slant range resolution [m]				1.2
Ground Range Resolution [m]	3.3	2.2	7.2	4.4
Azimuth Resolution [m]	3.3	2.2	7.2	4.4
Range Pixel Spacing [m]	1.5	1	3	2
Azimuth Pixel Spacing [m]	1.5	1	3	2
Effective number of looks	1.5	1.5	6.5	6.0
Pixel localization accuracy [m]				1.0
Radiometric resolution [dB]	2.7	2.8	1.5	1.6
Product Size (MB)	133	300	33	75
			75	333

Table 4-5: Table of high resolution dual polarization spotlight products for 20° and 55° beams

Notes:

- HS = High Resolution Spotlight
- SE = Spatially enhanced (high resolution), RE = Radiometrically enhanced (high radiometry)
- D = Dual polarization

4.6 Single Polarization Spotlight Products (SL)

Mnemonic	{MGD, GEC, EEC}_SE_SL_S		{MGD, GEC, EEC}_RE_SL_S		SSC_SL_S
Imaging Mode	SL				
Product Type	Detected				Complex
Geometric Projection	{MGD, GEC, EEC}				SSC
Polarization Mode	S				
Resolution Mode	SE	RE			
Number of Polarimetric Channels	1				
Polarization Mode	{HH, VV}				
Data collection range	15°-60°				
Full Performance range	20°-55°				
Recomm. Performance range	20°-50°				
Range Scene Size [km]	10				
Azimuth scene size [km]	10				
Abs. Radiometric Accuracy [dB]	unspecified				
Rel. Radiometric Accuracy [dB]	unspecified				
NESZ [dB]	-19				
Ambiguity Ratios [dB]	< -17				
PSLR [dB]	-25				
ISLR [dB]	-18				
Inc. Angle Masks	1				0
Bit per Pixel	16				32
Hamming coefficient	0.6				0.60
Incidence angle (20°-55°)	20	55	20	55	
Slant range resolution [m]					1.2
Ground Range Resolution [m]	3.5	1.7	6.1	3.8	
Azimuth Resolution [m]	3.5	1.7	6.1	3.8	1.7
Range Pixel Spacing [m]	1.5	0.75	3	1.75	0.9
Azimuth Pixel Spacing [m]	1.5	0.75	3	1.75	1.3
Effective number of looks	2.0	1.2	6.0	6.1	
Pixel localization accuracy [m]					1.0
Radiometric resolution [dB]	2.4	3.1	1.5	1.6	
Product Size (MB)	178	400	44	131	338

Table 4-6: Table of single polarization spotlight products for 20° and 55° beams

Notes:

- SL = spotlight
- SE = Spatially enhanced (high resolution), RE = Radiometrically enhanced (high radiometry)
- S = Single polarization

4.7 Dual Polarization Spotlight Products (SL)

Mnemonic	{MGD, GEC, EEC}_SE_SL_D	{MGD, GEC, EEC}_RE_SL_D	SSC_SL_D	
Imaging Mode	SL			
Product Type	Detected			Complex
Geometric Projection	{MGD, GEC, EEC}			SSC
Polarization Mode	D			
Resolution Mode	SE	RE		
Number of Polarimetric Channels	2			
Polarization Mode	HH/VV			
Data collection range	15°-60°			
Full Performance range	20°-55°			
Recomm. Performance range	20°-43°			
Range Scene Size [km]	10			
Azimuth scene size [km]	10			
Abs. Radiometric Accuracy [dB]	Unspecified			
Rel. Radiometric Accuracy [dB]	Unspecified			
NESZ [dB]	-19			
Ambiguity Ratios [dB]	< -16 (-9 above 45°)			
PSLR [dB]	-25			
ISLR [dB]	-18			
Inc. Angle Masks	1			0
Bit per Pixel	16			32
Hamming coefficient	0.6			0.60
Incidence angle (20°-55°)	20	55	20	55
Slant range resolution [m]				1.2
Ground Range Resolution [m]	3.5	3.4	8.5	5.5
Azimuth Resolution [m]	3.5	3.4	8.5	5.5
Range Pixel Spacing [m]	1.5	1	4	2.5
Azimuth Pixel Spacing [m]	1.5	1	4	2.5
Effective number of looks	1.0	2.4	5.8	6.4
Pixel localization accuracy [m]				1.0
Radiometric resolution [dB]	3.1	2.4	1.6	1.6
Product Size (MB)	267	600	38	96

Table 4-7: Table of dual polarization spotlight products for 20° and 55° beams

Notes:

- SL = spotlight
- SE = Spatially enhanced (high resolution), RE = Radiometrically enhanced (high radiometry)
- D = Dual polarization

4.8 ScanSAR Products (SC) – Four Beams

Mnemonic	{MGD, GEC, EEC}_RE_SC_S		SSC_SC_S
Imaging Mode			SC
Product Type	Detected		SSC
Polarization Mode			S
Geometric Projection	{MGD, GEC, EEC}		
Resolution Mode	RE		
Number of Beams			4
Number of Polarimetric Channels			1
Polarization Mode			{HH, VV}
Data collection range			15°-60°
Full Performance range			20°-45°
Recomm. Performance range			20°-45°
Range Scene Size [km]			100
Azimuth Scene Size [km]			150
Abs. Radiometric Accuracy [dB]			0.7
Rel. Radiometric Accuracy [dB]			0.4
NESZ [dB]			-19
Ambiguity Ratios [dB]			< -15
PSLR [dB]			unspecified
ISLR [dB]			unspecified
Inc. Angle Masks	1		0
Bit per Pixel	16		32
Hamming coefficient	0.6		0.6
Incidence angle (20°-45°)	20	45	
Slant Range Resolution [m]			1.2 (at 150 MHz)
Ground Range Resolution [m]	19.2	17.0	
Azimuth Resolution [m]	19.2	18.5	18.5
Range Pixel Spacing [m]	8.25	8.25	0.9
Azimuth Pixel Spacing [m]	8.25	8.25	13 (mean)
Effective number of looks	5.6	11.1	
Pixel localization accuracy [m]			1
Radiometric resolution [dB]	1.6	1.2	3
Product Size (MB)	882	882	5940

Table 4-8: Table of ScanSAR products (4 beam), samples for 20° and 45°

Notes:

- SC = ScanSAR
- RE = Radiometrically Enhanced (High Radiometry)
- S = Single Polarization

4.9 ScanSAR Products (SC) – Six Beams

Mnemonic	{MGD, GEC, EEC}_RE_SC_S		SSC_SC_S
Imaging Mode	SC		
Product Type	Detected		SSC
Polarization Mode	S		
Geometric Projection	{MGD, GEC, EEC}		
Resolution Mode	RE		
Number of Beams	6		
Number of Polarimetric Channels	1		
Polarization Mode	{HH, VV, HV, VH}		
Data collection range	15.6°-49°		
Full Performance range	15.6°-49°		
Recomm. Performance range	n.a.		
Range Scene Size [km]	266 - 194		
Azimuth Scene Size [km]	200		
Abs. Radiometric Accuracy [dB]	not specified		
Rel. Radiometric Accuracy [dB]	not specified		
NESZ [dB]	< -15		
Ambiguity Ratios [dB]	< -17		
PSLR [dB]	unspecified		
ISLR [dB]	unspecified		
Inc. Angle Masks	1		0
Bit per Pixel	16		32
Hamming coefficient	0.6		0.6
Incidence angle (20°-45°)	20	45	
Slant Range Resolution [m]			Depending on range bandwidth 1.7 – 3.3
Ground Range Resolution [m]	Depending on beam 42 - 30	Depending on beam 34 - 31	< 7
Azimuth Resolution [m]	40	40	40
Range Pixel Spacing [m]	15.0	15.0	1.4
Azimuth Pixel Spacing [m]	15.0	15.0	
Effective number of looks	6 - 7	7 - 8	
Pixel localization accuracy [m]			1

Table 4-9: Table of ScanSAR product (6 beam), characteristic samples for 20° and 45°

5 Basic Product Data Structure

For each ordered Basic Product a standard set of components will be delivered to the user. In the following the structure of a Basic Product is described while the detailed parameters and the detailed format and contents are defined in the separate annex document [RD 8]. For the purpose of storage on a media and for shipping to the customer, more than one product may be bundled.

Basic Product	
Annotation Parameter Files	
Annotation File Header	General information on the main annotation file.
Product Components Directory	Pointers to all product components.
Product Information Parameters	General generation, mission, scene and imaging mode related parameters. Image data description. <i>Basic information on the product.</i>
Product Specific Parameters	Specific information for SSCs, detected and geocoded products
Processing Setup Parameters	Screening and processing chain setup and control parameters.
SAR Processing Parameters	Processor and product configuration parameters and parameters of the data determined and used during screening and processing.
Instrument Parameters	Sensor specific parameters at the time of the image acquisition.
Calibration Parameters	The base for the application of radiometric and other data corrections. Nominal performance of the product.
Noise annotation.	Polynomials characterizing the expected noise in the image layers.
Platform Parameters	Orbit and attitude data of the platform used for the processing.
Product Quality Parameters	Assessment of the signal data and summary of the image and processing quality flags.
Georeference Grid (add. file)	Parameters related to geolocation of (SSC) image layers.
Image Raster Files	
HH-Layer	Containing one or more polarimetric channels in separate binary data matrices. For DRA mode geometric layers are contained. Data format is 16 bit integer for geocoded products and 16 / 16 bit integer complex for SSCs.
VV-Layer	
HV-Layer	
...	
Auxiliary Raster Files (optional, only for MGD, GEC, EEC)	
Incidence Angle Mask	Incidence angle for each image pixel derived from DEM (EEC only).
DEM Map	Map indicating which DEM is used for geocoding.
Mapping Grid	Coarse grid which correlates pixel of projected images with range/azimuth times.
Image Preview Files	
Quicklook & Browse Images	Rescaled images readable with common tools for cataloguing and quality control purposes.
Map Plot	Geographical map showing the image footprint.
Administrative Parameter File (in delivery package, not part of the L1b user product))	
Delivery Package and Processing Facility Related Information	Uniquely identifies the delivered product and describes the product package structure. Characterizes the processing facility and mode.

Table 5-1: Data structure of a Basic Product

5.1 Annotation

The product annotation is provided in XML format, see document [RD 8] for details. Since every delivered level 1b product is at least based on an intermediate complex product in slant range geometry (SSC) and all calibration is performed on that one, the characteristics of that SSC are annotated even for detected or geocoded products. This approach of a modular annotation structure which includes the history of parameters allows to trace (and to reverse if wished) the corrections applied during processing. Such a flexible and extendable annotation also facilitates the use of one product model for the large variety of product variants. The basic annotation is thus supplemented by product variant specific information (e.g. SSC processing parameters or map projection parameters for geocoded products). Even the inclusion of additional components from further processing steps is thus a straight-forward process.

Different product types may extend the annotation. However, for all product variants there is a common annotation segment containing the product parameters that describe the basic characteristics of the product.

5.2 SAR Image Channels

Contains one or more polarimetric channels in separate binary data matrices. As detailed in [RD 8], detected images will be delivered in GeoTIFF format while complex data are provided in the COSAR file format.

5.3 Auxiliary Raster Files

The incidence angle mask and the DEM mask contain for EEC products the slope dependent local incidence angle for each image pixel (including a flag for shadow or layover conditions) and the reference to the DEM used for this pixel. The mapping grid gives range and azimuth times for coarsely sampled image points of projected and geocoded products.

5.4 Quicklooks

5.4.1 Quicklook Image

Image quicklooks rescaled to a resolution class of approximately 5-10 times the original one (pixel spacing is for SC: 50m, SM: 25m, SL: 10m, HS: 5m), in TIFF format readable with common display tools. Additionally, a RGB color composite quicklook of the polarization layers and a smaller browse image with half the resolution are contained. Further quicklook files may be supplemented in the future.

5.4.2 Map Plot

A coarse geographical map showing the footprint of the image.

5.5 Administrative Parameter Files

The product and processing facility identifiers as well as the data set descriptors are generated by the product library data base for the delivered product package. The L1b product name is not to be confused with the delivery package identifier (dims*). It consists of components describing the mode, product type and time coverage:

{satID}_SAR_{type}_{variant}_{mode}_{pol}_{startTime}_{stopTime}

e.g. TDX1_SAR_EEC_RE__SL_S_SRA_20110830T121814_20110830T121816. Details are given in [RD 8].

ANNEX A) Definition of Performance Parameters

Measures for the Point Target Response Function

The point target response (PTR), or impulse response function (IRF) of a SAR system (sensor and processor) is the 2-D image of a point target in either slant range or ground range representation. As the SAR principle exhibits an approximate separability in range and azimuth, often only the 1-D slices in range and azimuth are used to characterize the 2-D IRF.

Quantitative analysis of a PTR of real world SAR data necessitates interpolation (oversampling) of the image by a factor of at least 16. Care has to be taken that the interpolation kernel does not alter the shape of the IRF.

- *Peak Sidelobe Ratio (PSLR)*

The peak sidelobe ratio is the worst case measure of the SAR ability to identify a weak target from a nearby strong target. The PSLR is defined as the ratio of the peak intensity in the mainlobe of the IRF to the peak intensity of the most intense sidelobe. It is calculated as

$$\text{PSLR} = 10 \log_{10} [I_{\text{peak}} / I_{\text{side}}]$$

For general image quality and for detection purposes a spatially compact IRF is desirable. However, there is a trade-off between resolution, i.e. compactness of the IRF and sidelobes, ambiguous responses that are spatially separated from the main response.

Assuming an ideal SAR sensor with rectangular range spectra and a sinc shaped azimuth pattern, the shape of the PTR is essentially a function of processing parameters, i.e. bandwidth and spectral shaping. Generally reduction of sidelobes results in degradation of resolution and a trade-off between sharpness and low sidelobes has to be performed. Further deterioration of the sidelobes may be caused by errors of the real SAR sensor. From the commissioning phase analysis, a compromise between resolution and sidelobe suppression has been found by using a Hamming coefficient of 0.6.

- *Integrated Sidelobe Ratio (ISLR)*

The integrated side lobe ratio characterizes the ability to detect weak targets in the neighbourhood of bright targets. The ISLR is defined as the ratio of energy of the mainlobe to that in the sidelobes and is calculated as:

$$\text{ISLR} = 10 \log_{10} [E_{\text{main}} / E_{\text{side}}]$$

The ISLR can be measured both in a one-dimensional and a two-dimensional way. In the one-dimensional case, the mainlobe is defined to be of width $2X$ in azimuth and $2Y$ in the range directions, centered on the IRF peak. The spatial resolutions in range and azimuth are referred to as the range resolution Y and azimuth resolution X , respectively. The sidelobe region is defined to extend to a total length of $20X$ in the azimuth and $20Y$ in the range directions, centered at the peak of the IRF, but excluding the mainlobe region just defined.

In the two-dimensional case, the mainlobe is defined as the area enclosed within a contour obtained enlarging the -3 dB contour by a factor of 2 in each direction, centered on the peak of the IRF, while the sidelobe region is the area obtained by enlarging the -3 dB contour by a factor 20 in each direction and excluding the mainlobe area.

The values given for PSLR and ISLR in the product tables are estimates based on verified performance estimations and include a very small deterioration by the SAR processor.

Signal to Azimuth Ambiguity Ratio (SAAR) & Azimuth Ambiguity to Signal Ratio (AASR)

The SAAR is defined as the ratio between the mean image intensity of a distributed target within a given resolution cell and the sum of the mean image intensities observed in the same resolution cell but originating from distributed targets within the azimuth ambiguous zones, that is:

$$SAAR = 10 \cdot \log_{10} \frac{\int_{-PBW/2}^{PBW/2} |S_a(f - \Delta fDC)|^2 df}{\sum_{m=-\infty, m \neq 0}^{\infty} \int_{-PBW/2}^{PBW/2} |S_a(f - \Delta fDC - m \cdot PRF)|^2 df}$$

where ΔfDC is the Doppler centroid estimation error, PBW the processing bandwidth, S_a the azimuth amplitude spectrum and m an integer. The SAAR is directly related to the shape of the azimuth antenna pattern, so it is often estimated substituting S_a with the antenna pattern. While the SAAR is given by the antenna pattern and PRF, it can be improved in the processor at the cost of azimuth resolution. The inverse is the AASR used herein.

Geometric Resolution

The spatial resolution of an imaging system is a measure for its ability to distinguish between adjacent targets and is defined as the IRF width measured at 3 dB (half of the intensity) below the peak value. The spatial resolutions in range and azimuth are referred to as the range resolution Y and azimuth resolution X , respectively. The values given in the product tables and plots are estimates based on verified performance predictions and measurements. The maximum geometric azimuth resolution is fixed for a given radar imaging mode and can be reduced in the processor to enhance the radiometric resolution.

Radiometric Resolution

The radiometric resolution describes the expected residual radiometric variation per pixel depending on the number of looks N_L and the signal to noise ratio SNR [RD 2].

$$\gamma = 10 \cdot \log_{10} \left(1 + \frac{1 + \text{SNR}^{-1}}{\sqrt{N_L}} \right)$$

The SNR depends mainly on the thermal noise power and the reflected signal power. Therefore, the SNR depends on the incidence angle and on the physical properties of the target. For the product tables in chapter 4 different backscatter estimates of -6 dB, -9 dB and -12 dB for incidence angles of 20°, 45° and 55° have been assumed.

Distributed Target Ambiguity Ratio (DTAR)

The DTAR is the average ratio between signal power and the aliased power caused by azimuth and range ambiguities for one pixel. Note that the values in the tables now give typical upper limits for the individual azimuth and range contributions that can be derived in detail from the performance plots in Annex C.

Noise Equivalent Sigma Zero (NESZ)

NESZ is the normalized backscatter which is equivalent to the background noise observed in a SAR image. It is caused by thermal noise, analog digital converter quantization noise and, to a negligible extent, processing noise. Typically, the spatial distribution and the spectral properties of noise differ from the SAR signal. Hence, the noise power depends on the spectral and spatial weighting in the processor. Especially compensation of the range spreading loss $1/R^3$ and of the antenna pattern in the processor cause a spatial variation of the noise level in the product.

Noise Equivalent Beta Zero (NEBZ)

NEBZ is a system parameter that is better suited to describe the background noise of the SAR system than NESZ, because it does not depend on the local incidence angle. Because it depends on system parameters like range spreading loss and antenna pattern, it can be described in the form of polynomials. The NEBZ is related to the NESZ via the local incidence angle θ_i by

$$NESZ = NEBN \cdot \sin(\theta_i)$$

ANNEX B) Configuration of Detected Product Variants

The following figures exemplary represent the configured quadratic resolution cell sizes and radiometric looks of **detected** products over the incidence angle range (note, that information on six beam wide ScanSAR products and ST mode products is found in Annex D). These are adjustable in the processing system due to the flexible time domain incoherent averaging and are optimized for the two spatially enhanced (**SE** – best quadratic resolution) and radiometrically enhanced (**RE** – constant number of looks) product variants. The exact values depend on the actual instrument commanding (e.g. the selected range bandwidth) and processing parameters (e.g. azimuth processing bandwidth).

The range looks, azimuth looks and the resulting equivalent number of looks (ENL) shown here are derived from simulations using the real filter settings in the processor. The latter are iteratively optimized during processing and the depicted values are thus only approximations of what to expect for typical products.

Note that the figures for Stripmap and ScanSAR (4 beam) mode refer to either the nominal 150 MHz or 100 MHz range bandwidth which is not always selected uniformly for all beams due to instrument buffer limitations (see Annex on performance for details). Incidence angle ranges where the depicted setting is unlikely to be selected by commanding are shaded. The spotlight 100 MHz variants are included here for completeness but nominally not used in commanding since the highest possible nominal bandwidth is selected (i.e. 150 MHz). In the HS mode, the 300 MHz range bandwidth option may be ordered by the user to increase range resolution while trading off some scene range extent due to the buffer limitations.

In the ScanSAR mode, there is only one resolution variant since the azimuth resolution always limits the best achievable quadratic resolution cell still allowing for several range looks. The ENL even surpasses the targeted 6-7 looks for far range beams by allowing more range looks at this fixed resolution. For ScanSAR products with combinations of 100 & 150 MHz beams, the worst of the 4 beams resolution is used for the entire swath – thus increasing the number of looks accordingly.

Stripmap Products

SM S 150MHz SE Products : Resolution & Equivalent Number of Looks

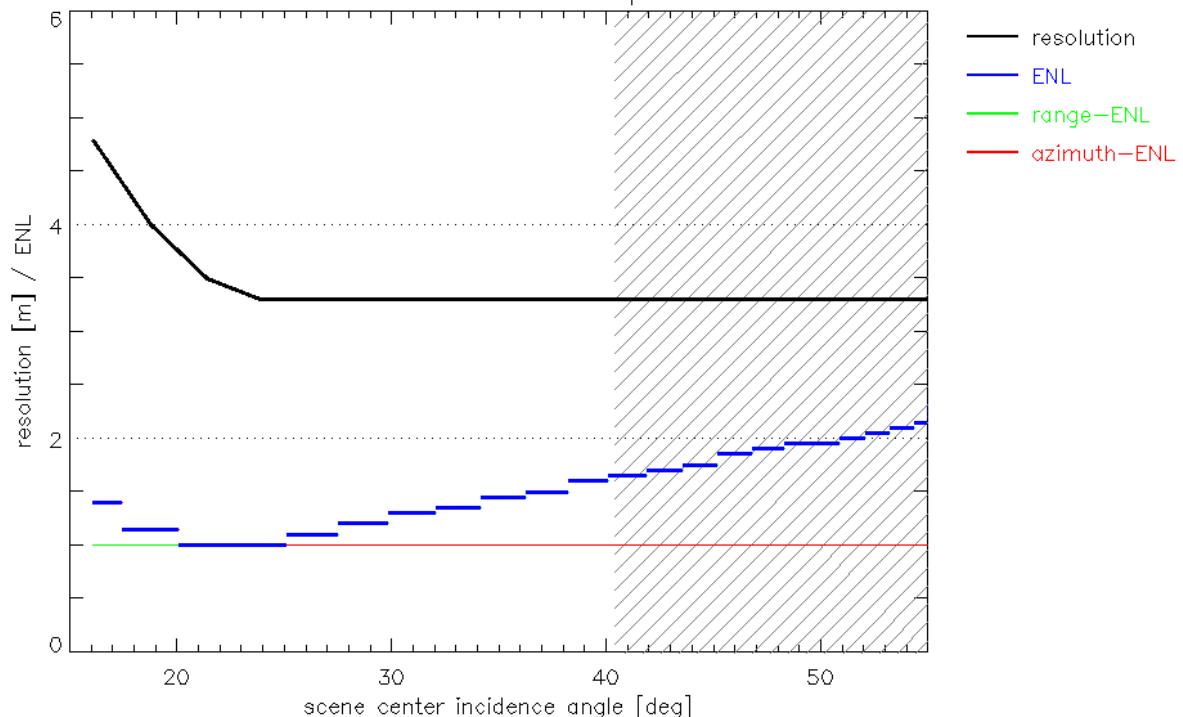

Fig. 1: Stripmap single polarization SE product variant for 150 MHz range bandwidth.

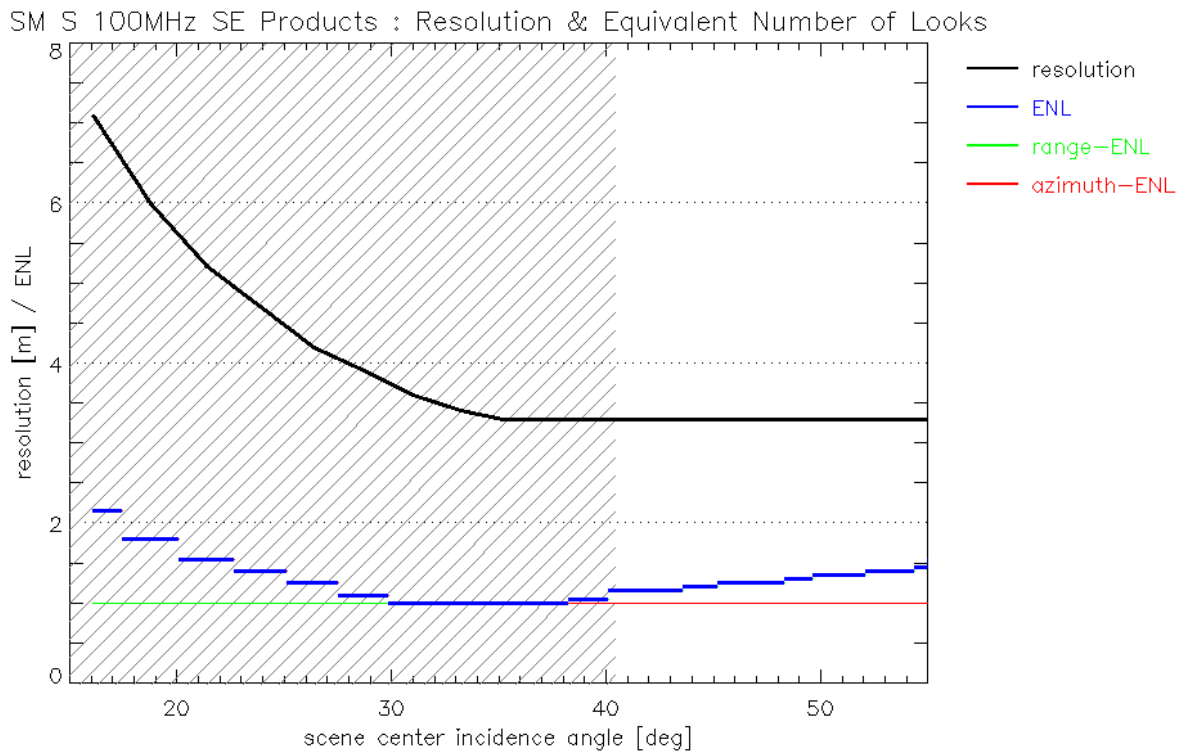

Fig. 2: Stripmap single polarization SE product variant for 100 MHz range bandwidth.

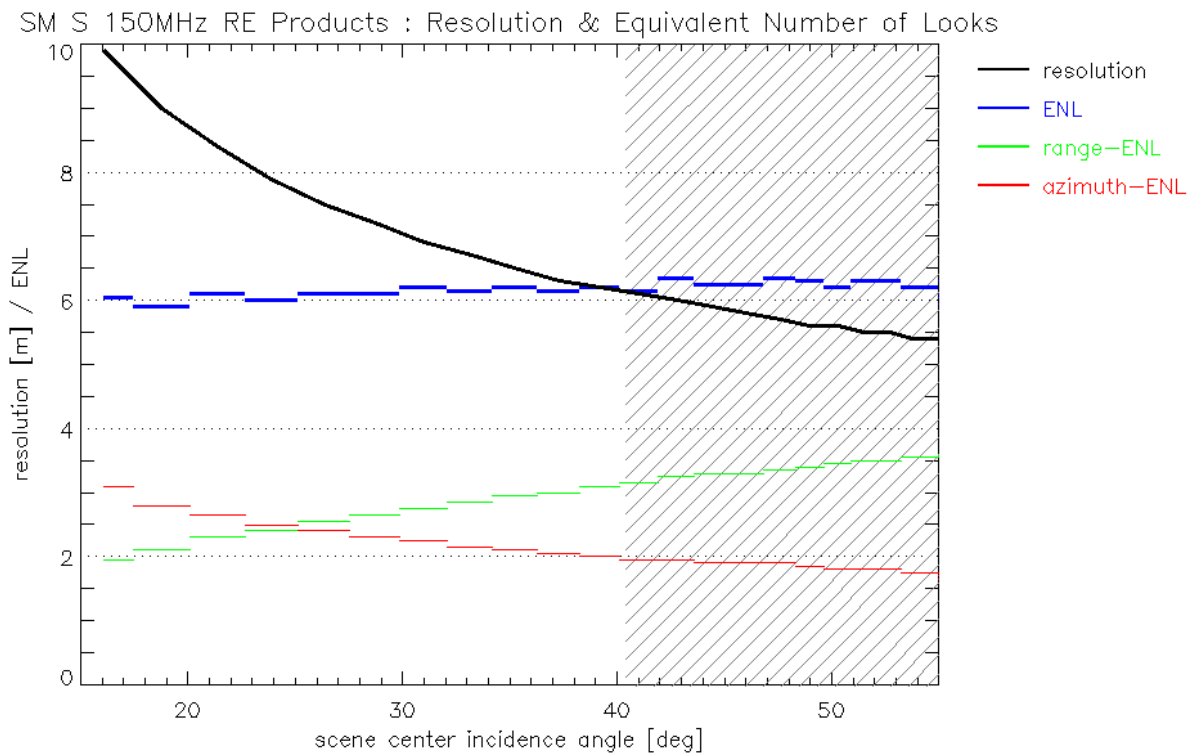

Fig. 3: Stripmap single polarization RE product variant for 150 MHz range bandwidth.

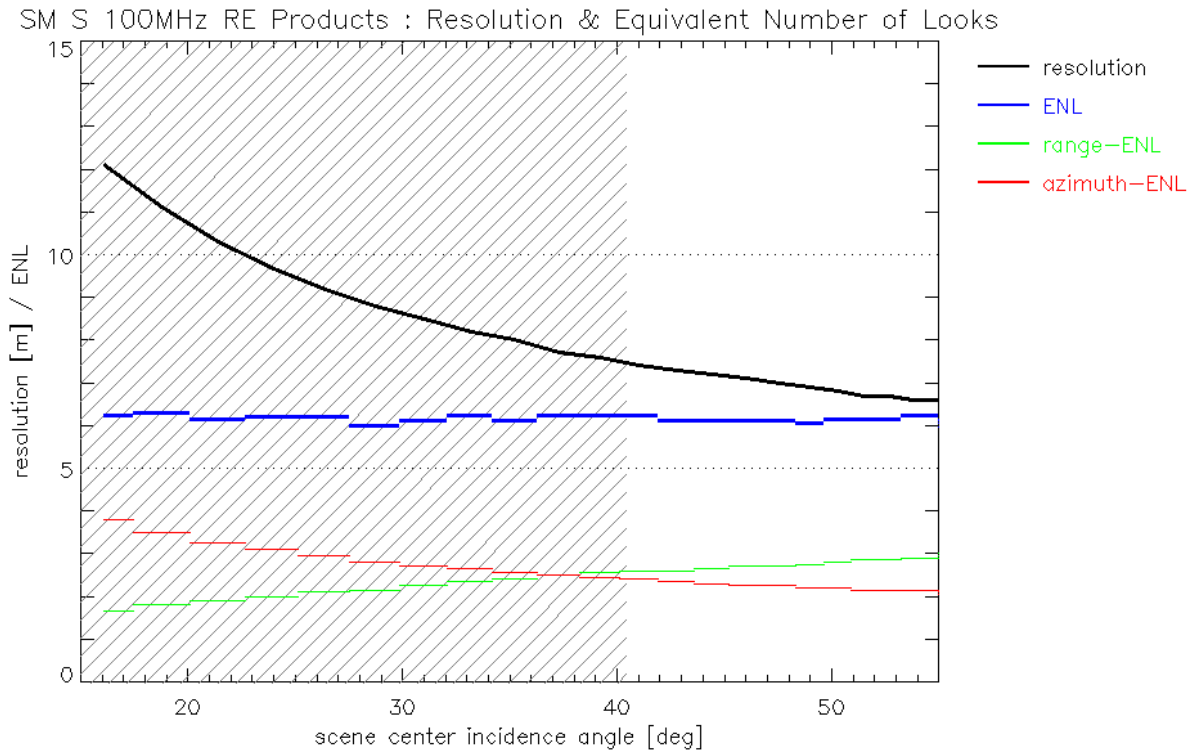

Fig. 4: Stripmap single polarization RE product variant for 100 MHz range bandwidth.

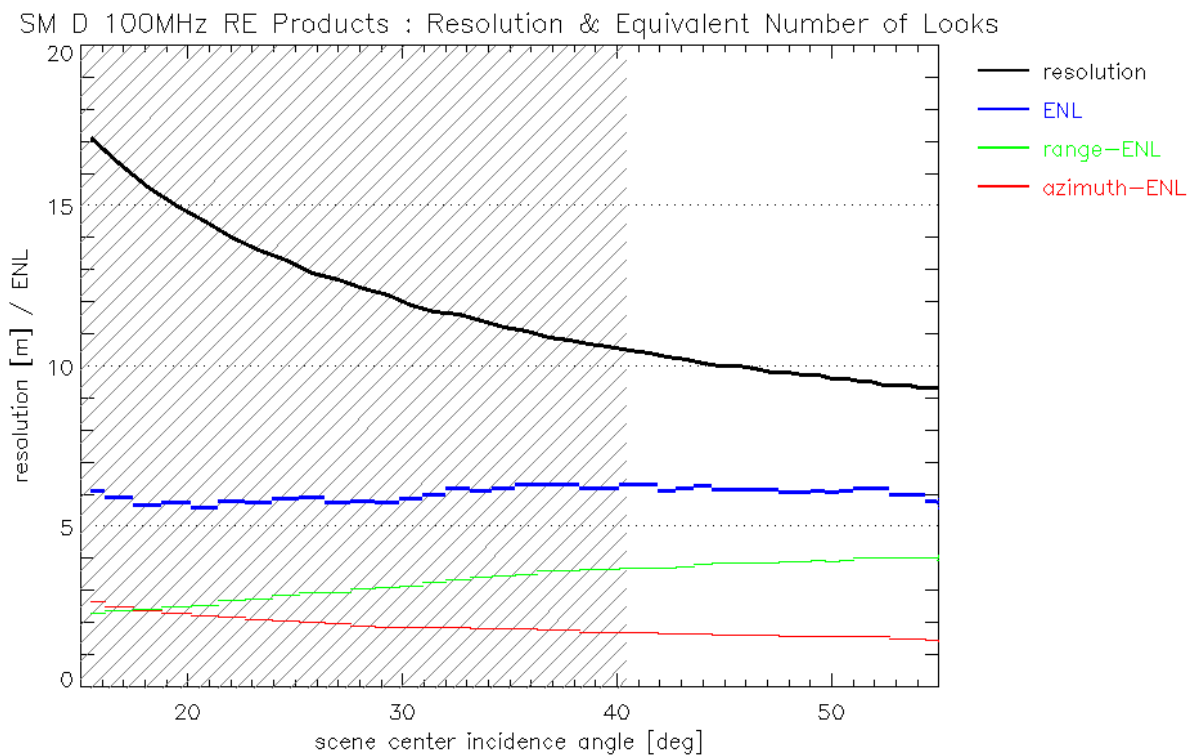

Fig. 5: Stripmap dual polarization RE product variant for 100 MHz range bandwidth.

SM D 100MHz SE Products : Resolution & Equivalent Number of Looks

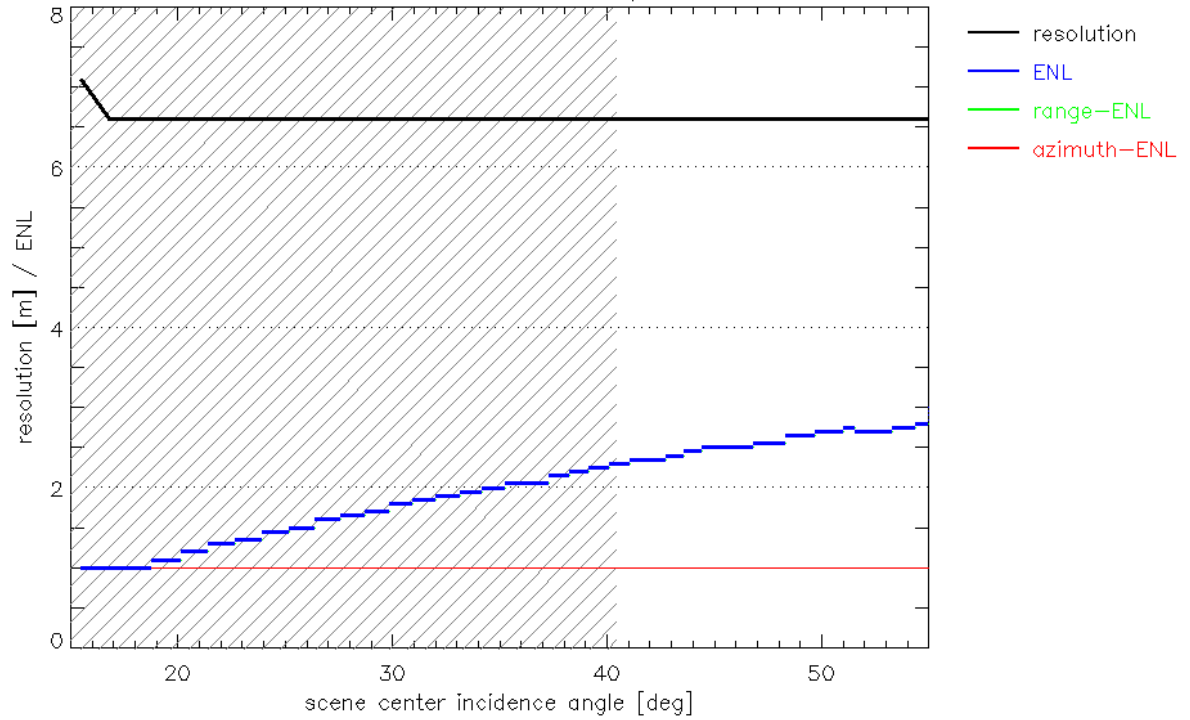

Fig. 6: Stripmap dual polarization SE product variant for 100 MHz range bandwidth.

SM D 150MHz RE Products : Resolution & Equivalent Number of Looks

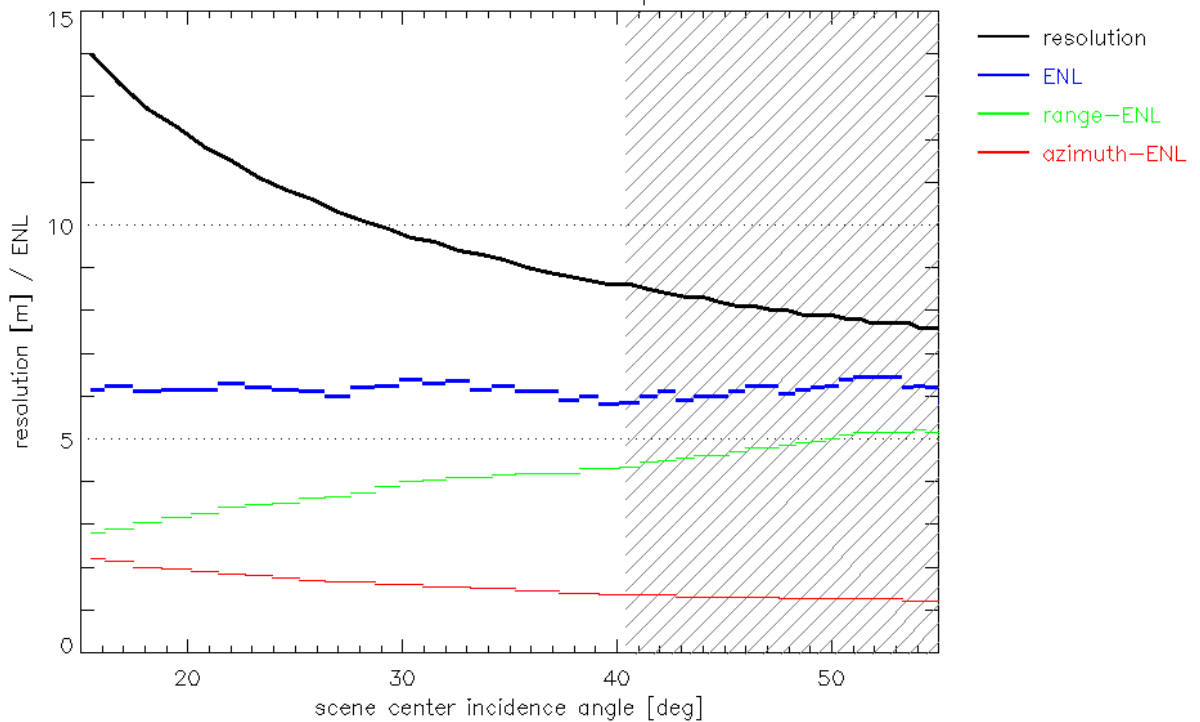

Fig. 7: Stripmap dual polarization RE product variant for 150 MHz range bandwidth.

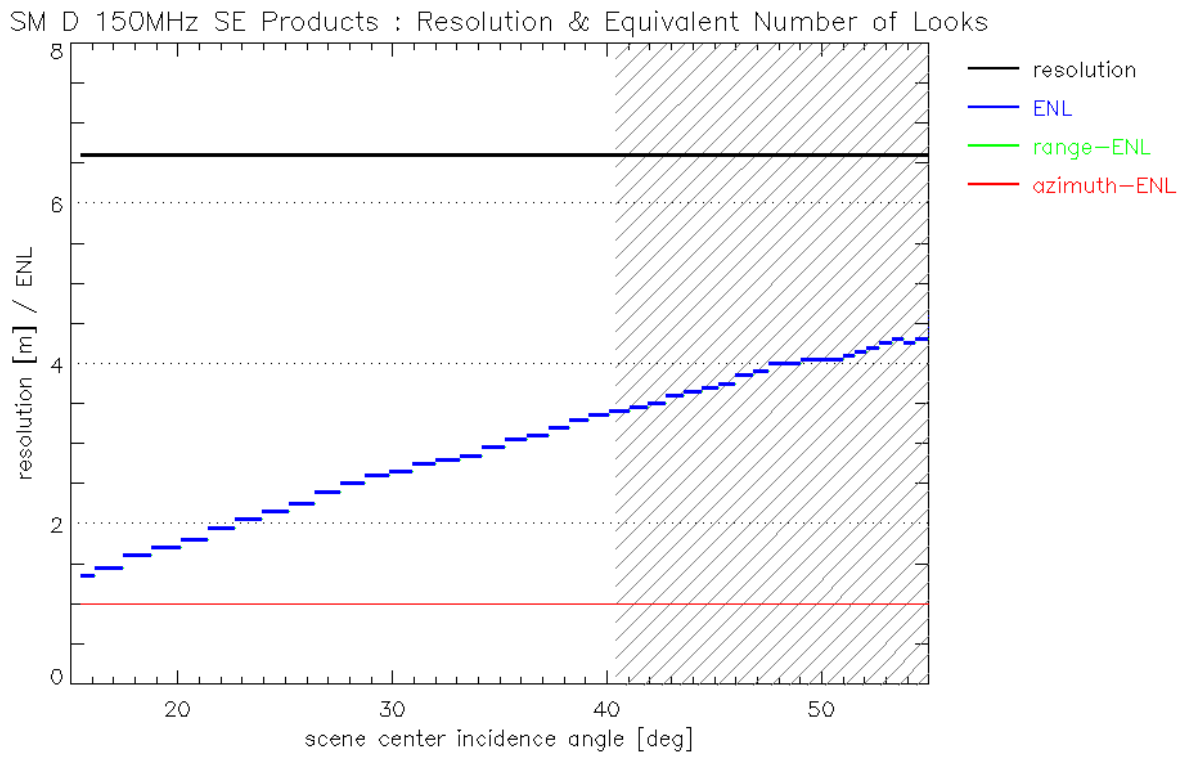

Fig. 8: Stripmap dual polarization SE product variant for 150 MHz range bandwidth.

ScanSAR Products

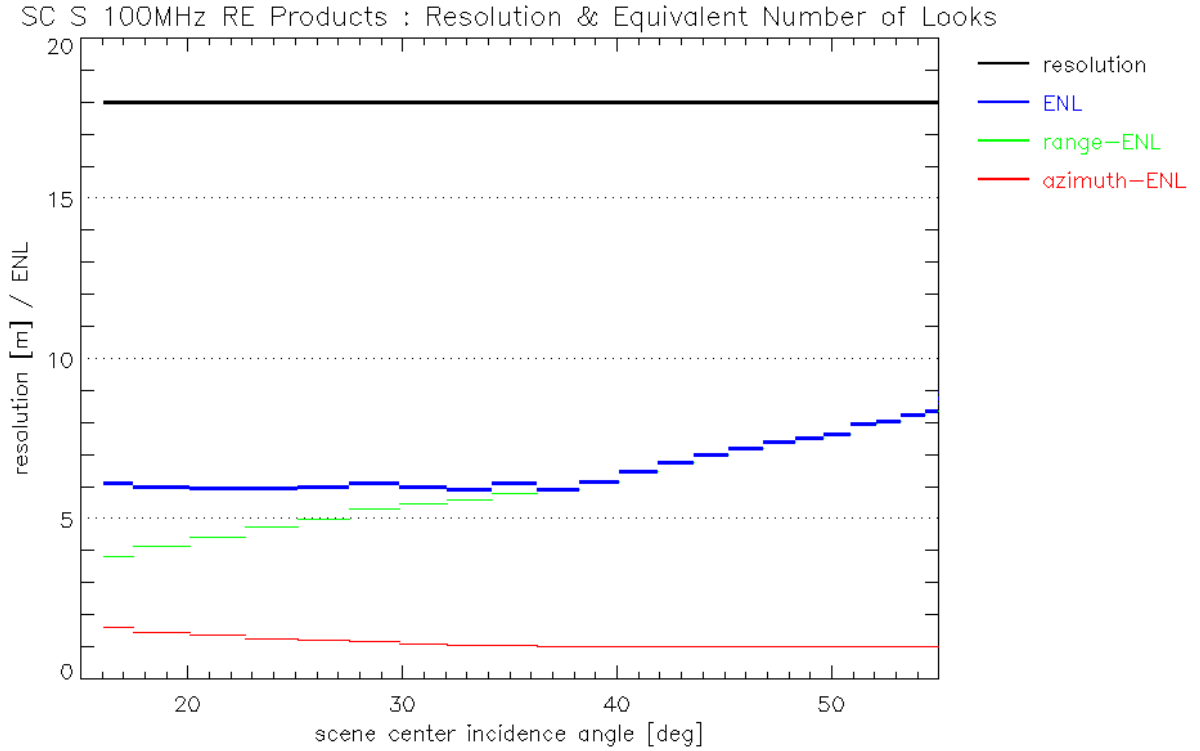

Fig. 9: ScanSAR single polarization RE product variant for 100 MHz range bandwidth.

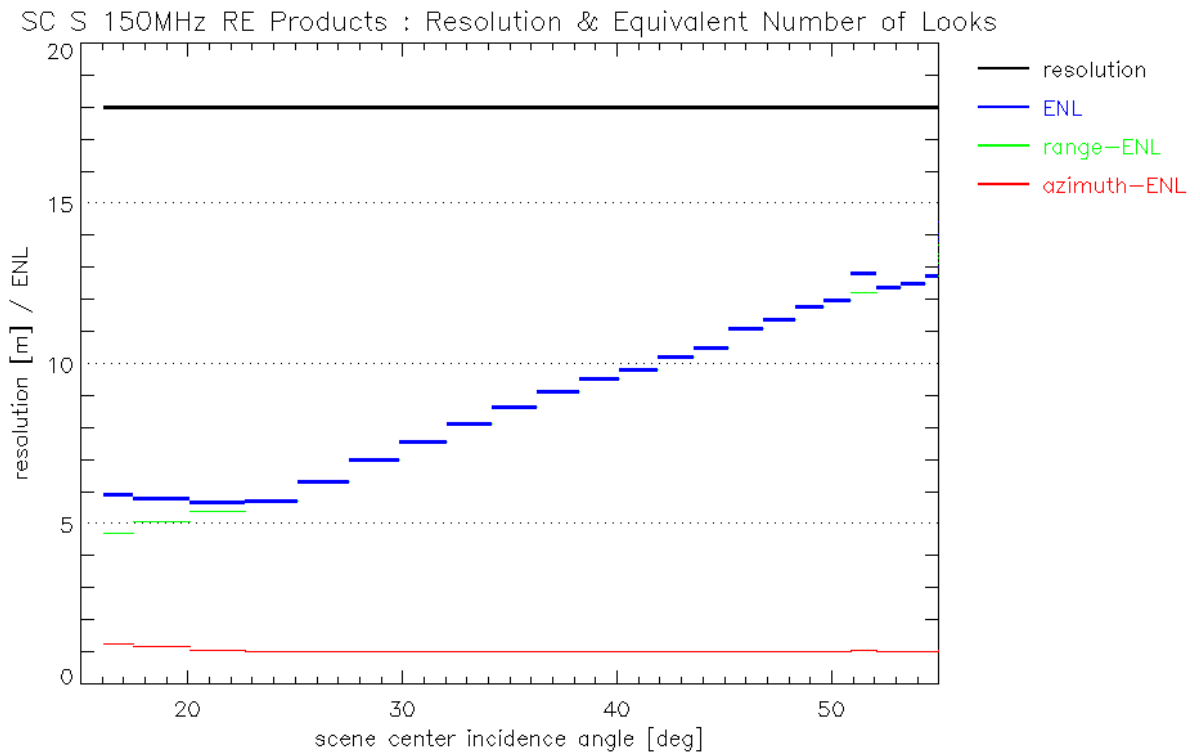

Fig. 10: ScanSAR single polarization RE product variant for 150 MHz range bandwidth.

Spotlight Products

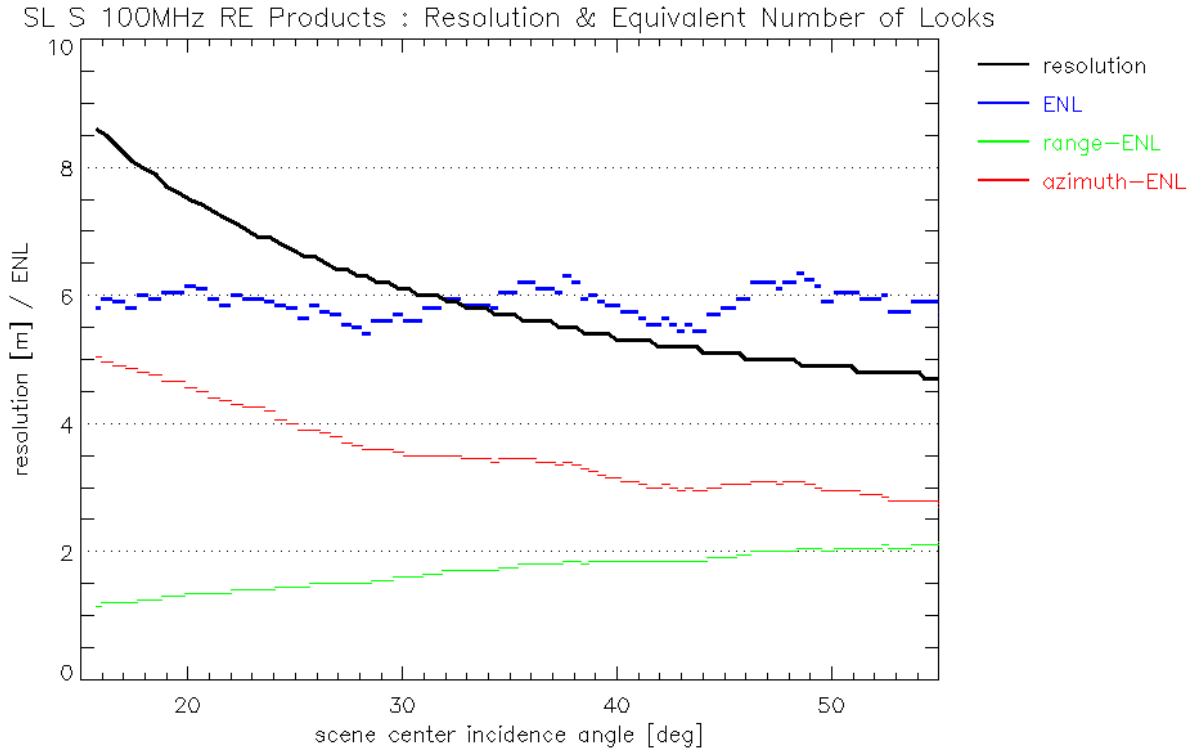

Fig. 11: Spotlight single polarization RE product variant for 100 MHz range bandwidth.

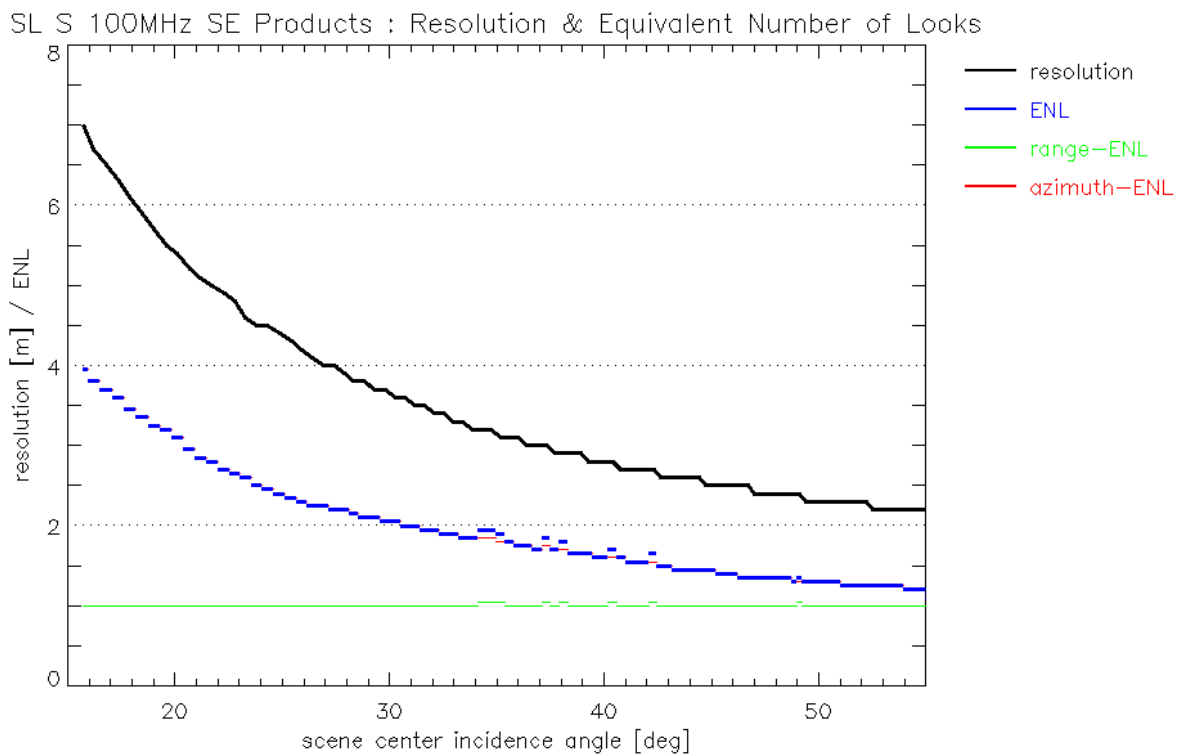

Fig. 12: Spotlight single polarization SE product variant for 100 MHz range bandwidth.

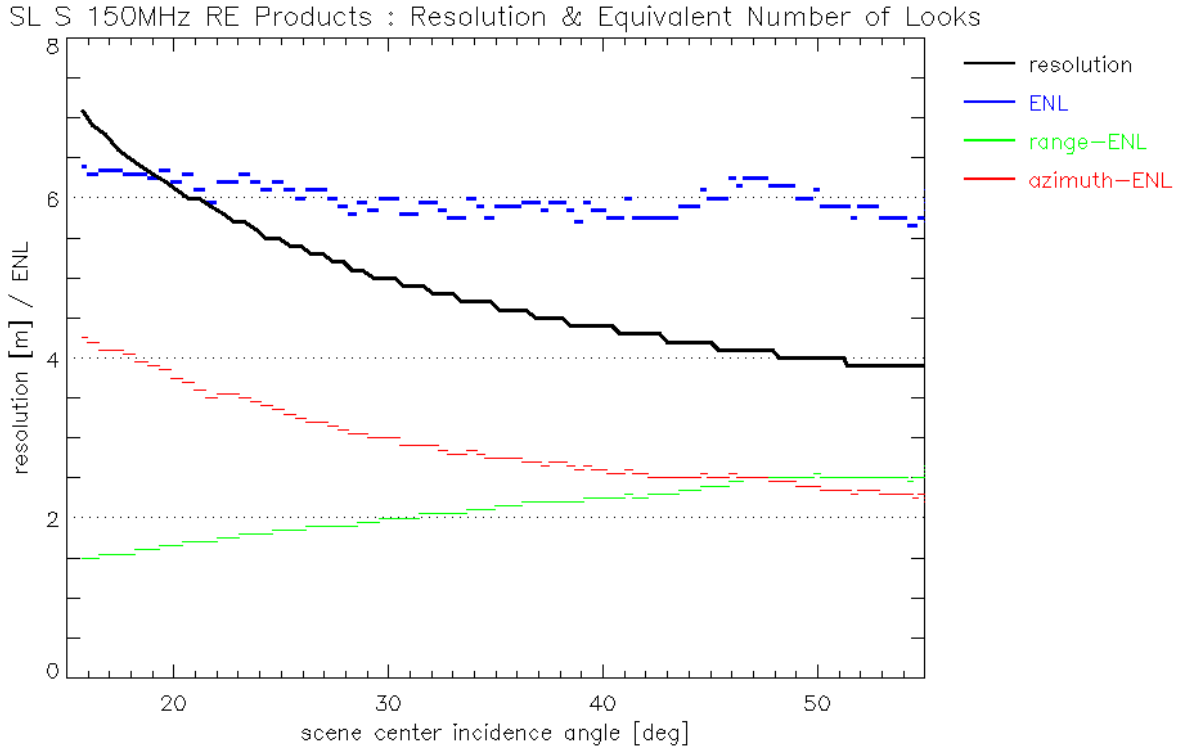

Fig. 13: Spotlight single polarization RE product variant for 150 MHz range bandwidth.

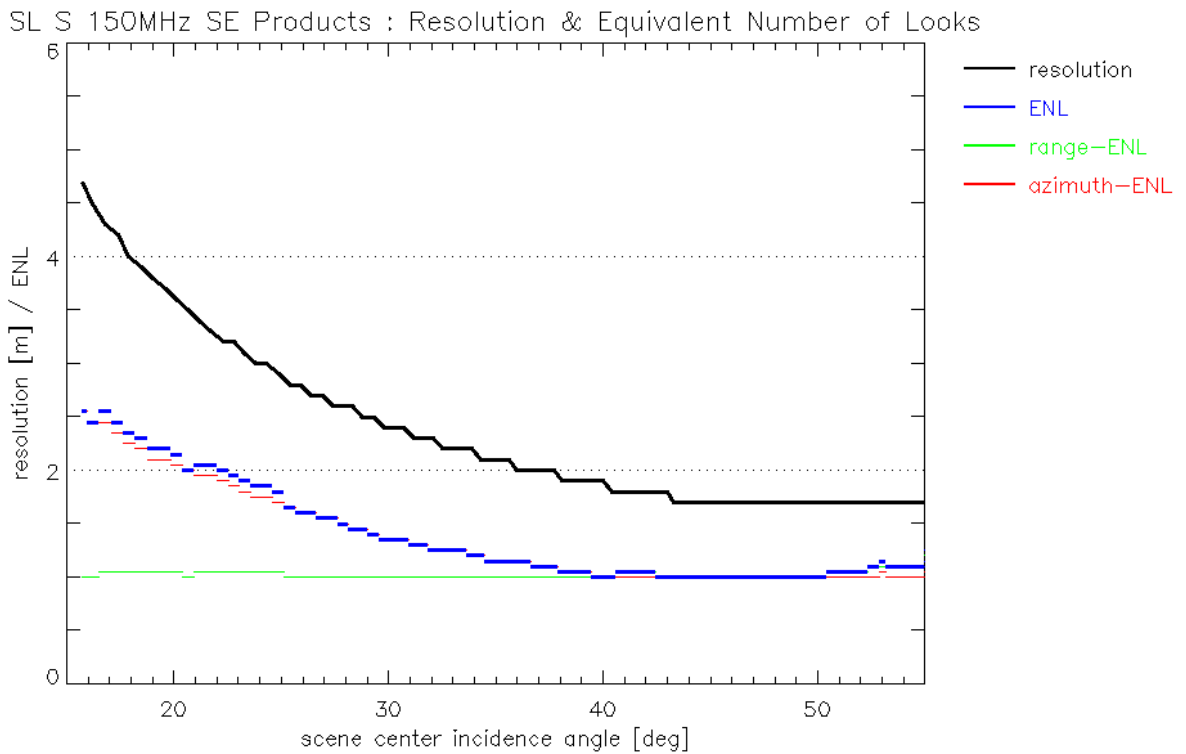

Fig. 14: Spotlight single polarization SE product variant for 150 MHz range bandwidth.

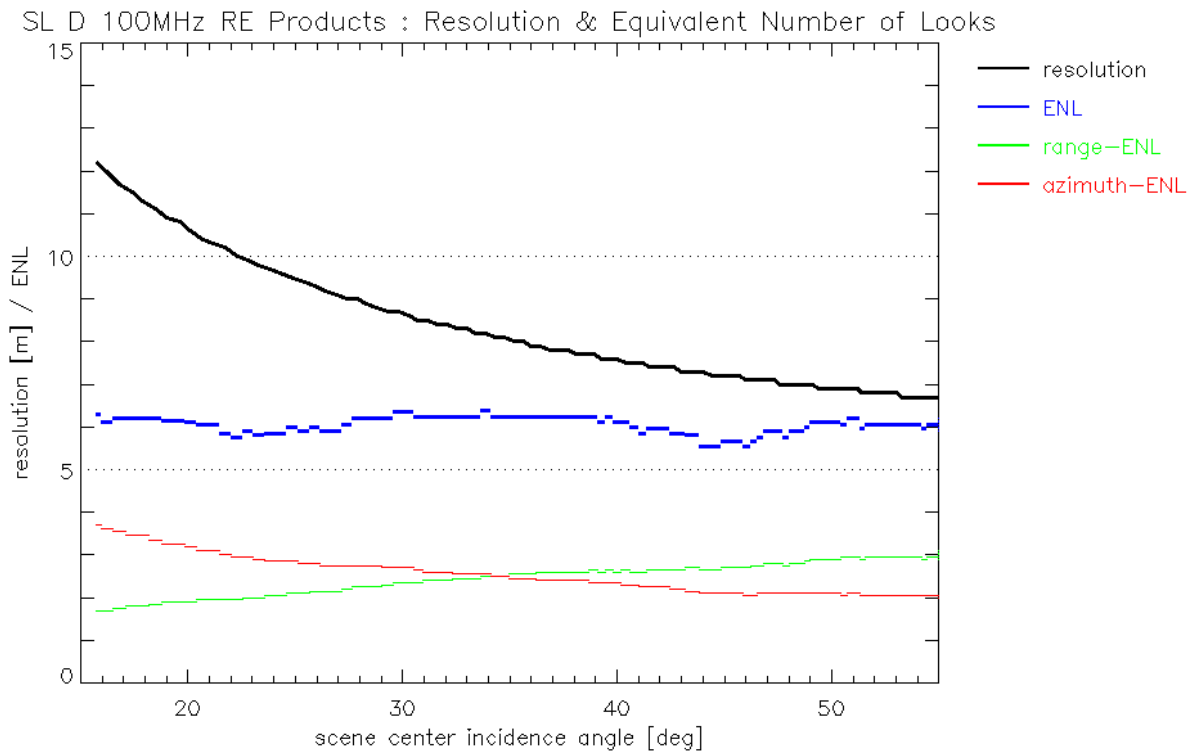

Fig. 15: Spotlight dual polarization RE product variant for 100 MHz range bandwidth.

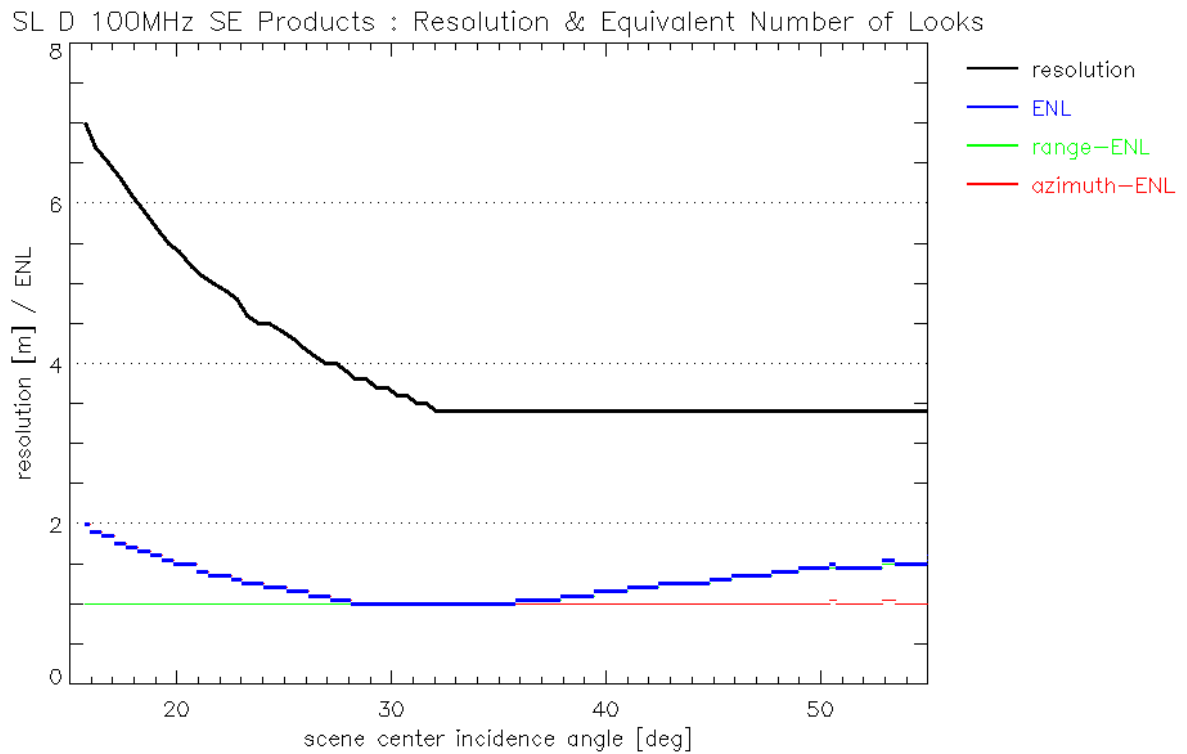

Fig. 16: Spotlight dual polarization SE product variant for 100 MHz range bandwidth.

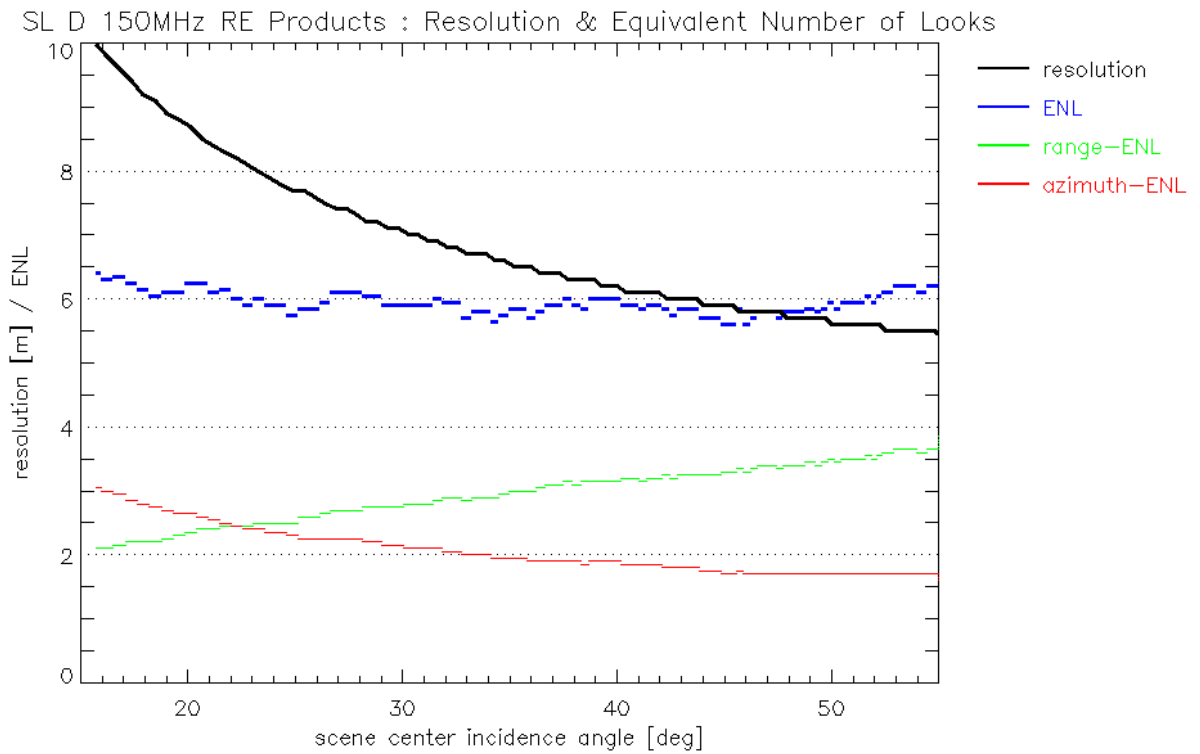

Fig. 17: Spotlight dual polarization RE product variant for 150 MHz range bandwidth.

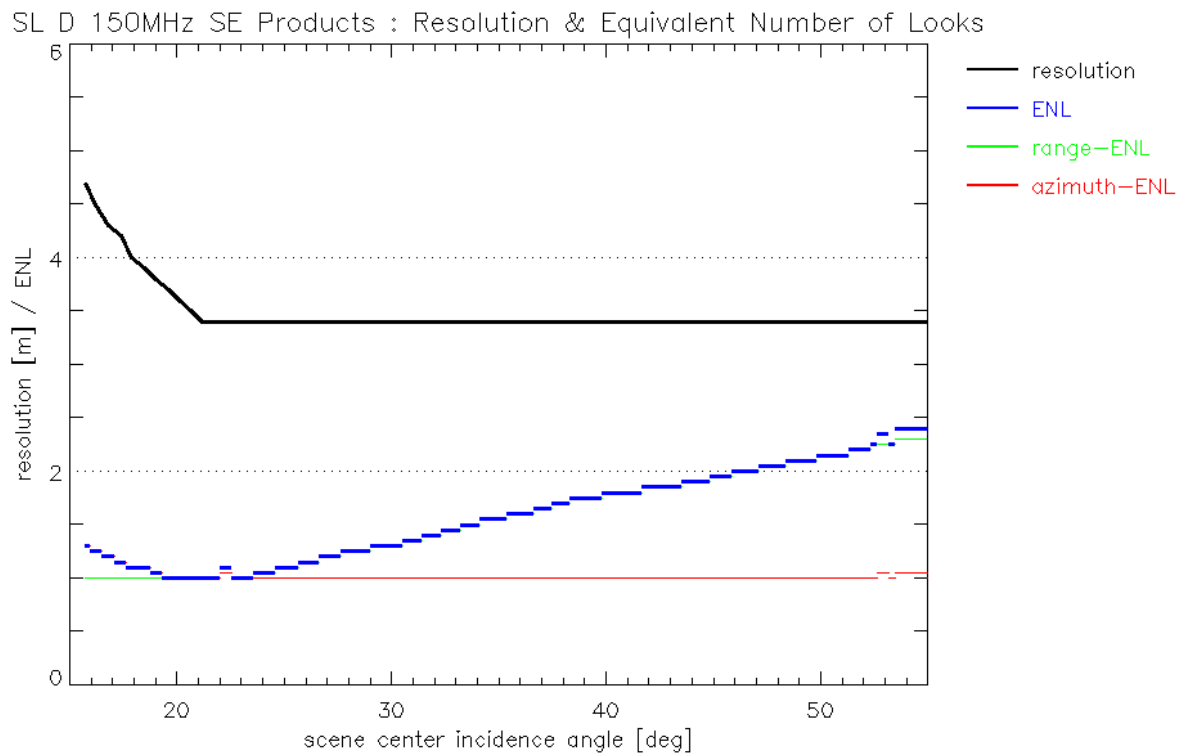

Fig. 18: Spotlight dual polarization SE product variant for 150 MHz range bandwidth.

High-resolution Spotlight Products

HS S 150MHz RE Products : Resolution & Equivalent Number of Looks

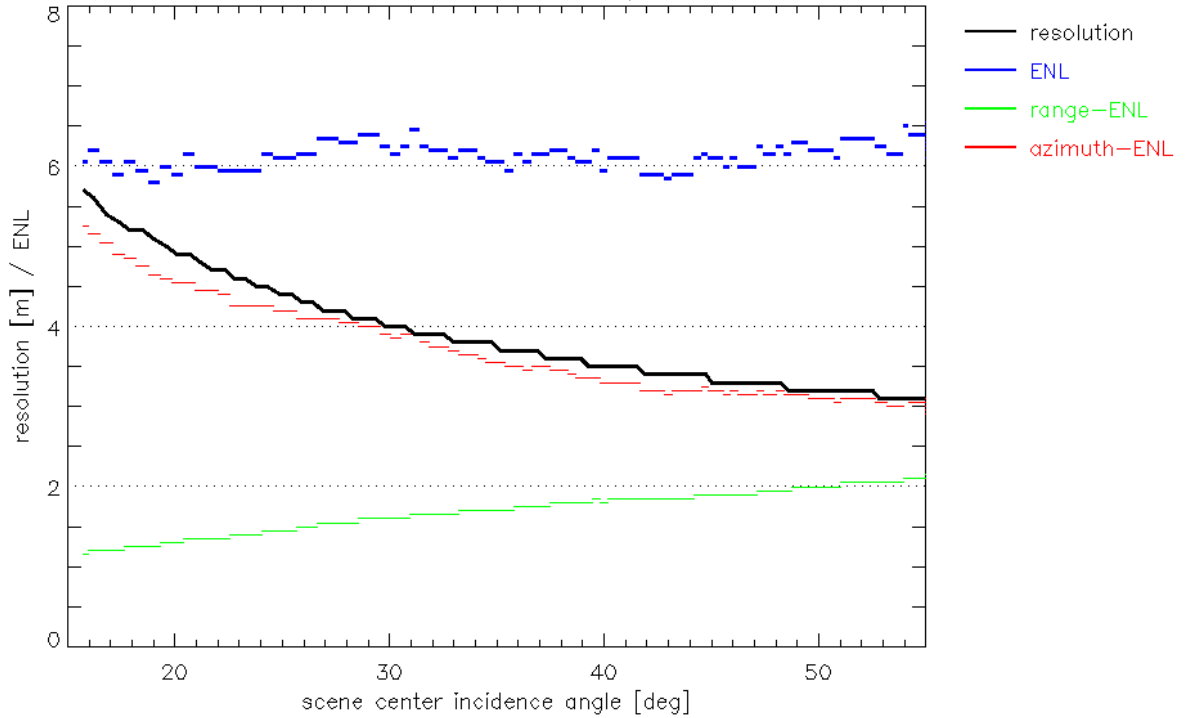

Fig. 19: High-resolution Spotlight single polarization RE product variant for 150 MHz range bandwidth.

HS S 150MHz SE Products : Resolution & Equivalent Number of Looks

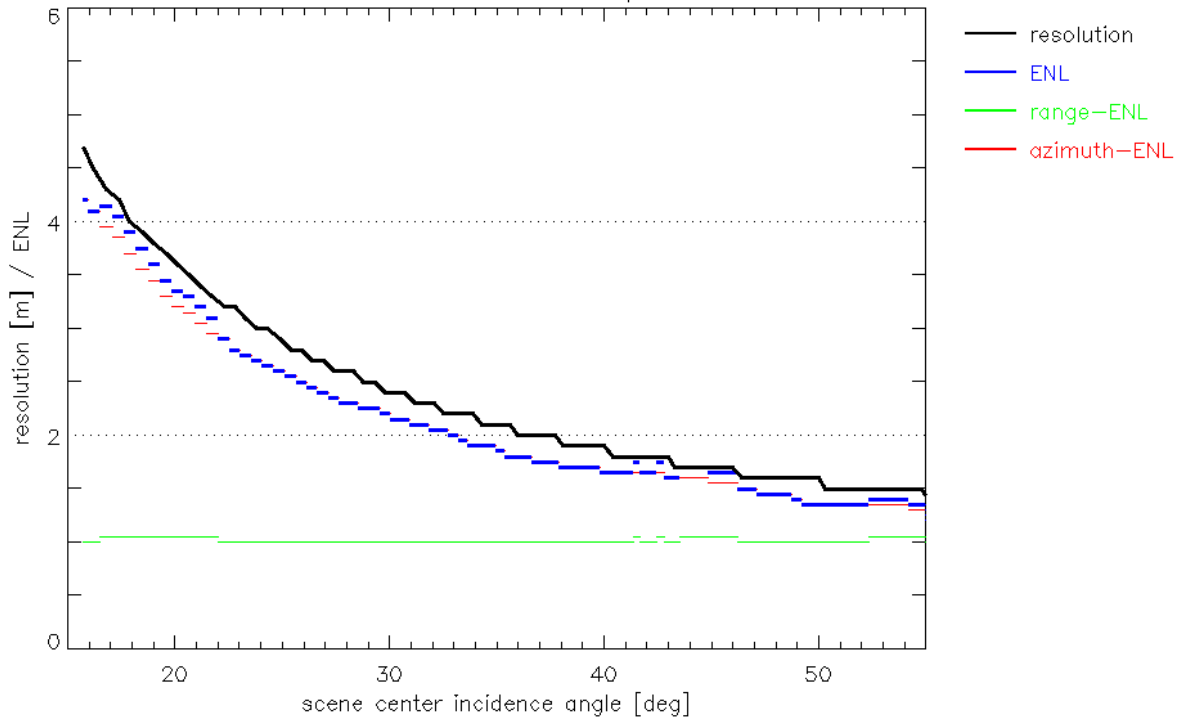

Fig. 20: High-resolution Spotlight single polarization SE product variant for 150 MHz range bandwidth.

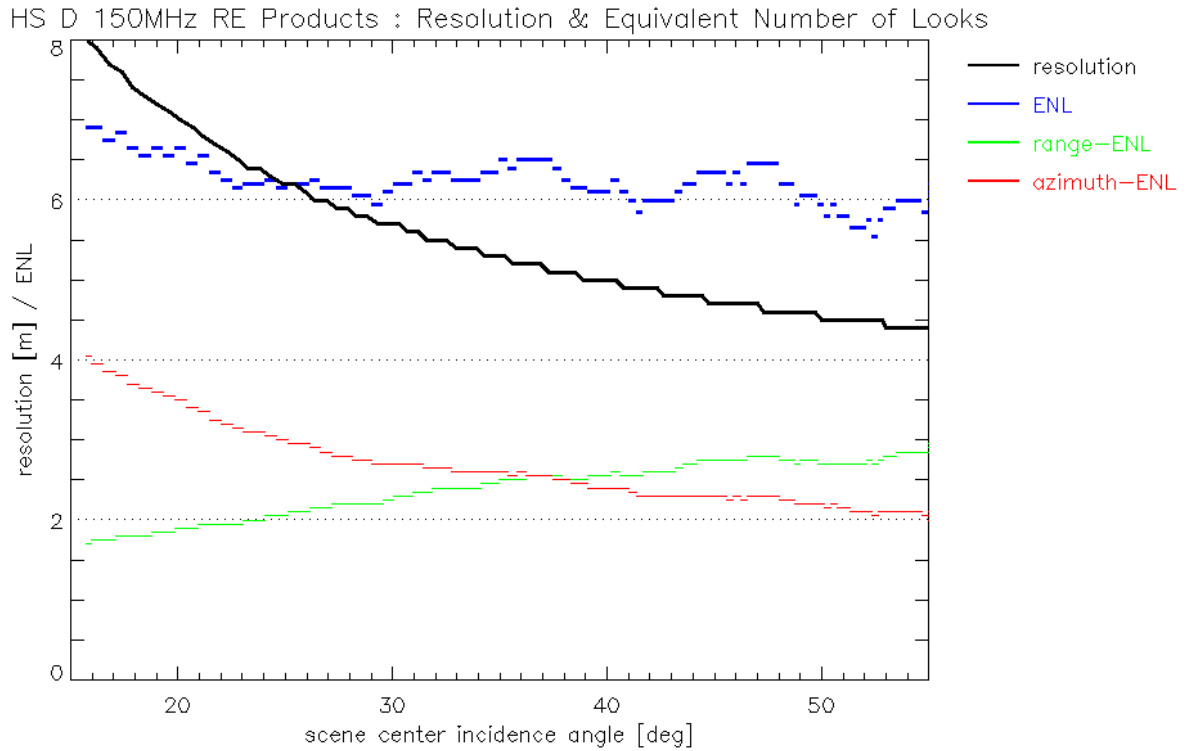

Fig. 21: High-resolution Spotlight dual polarization RE product variant for 150 MHz range bandwidth.

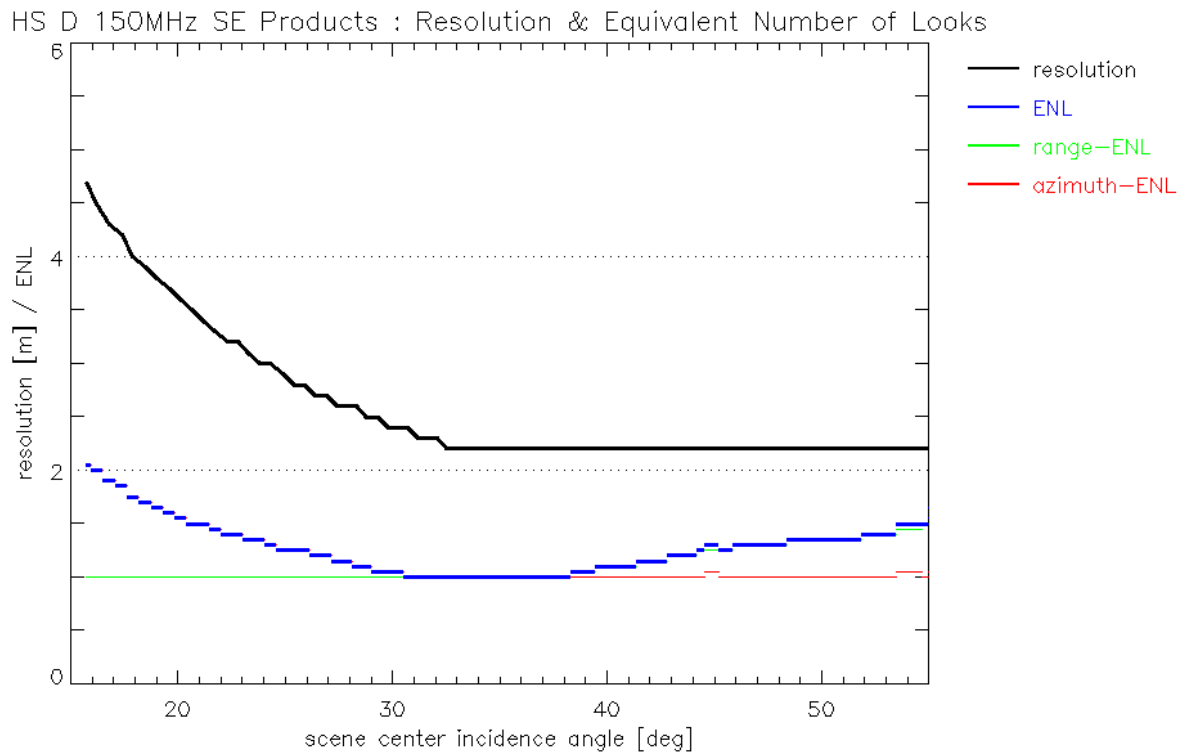

Fig. 22: High-resolution Spotlight dual polarization SE product variant for 150 MHz range bandwidth.

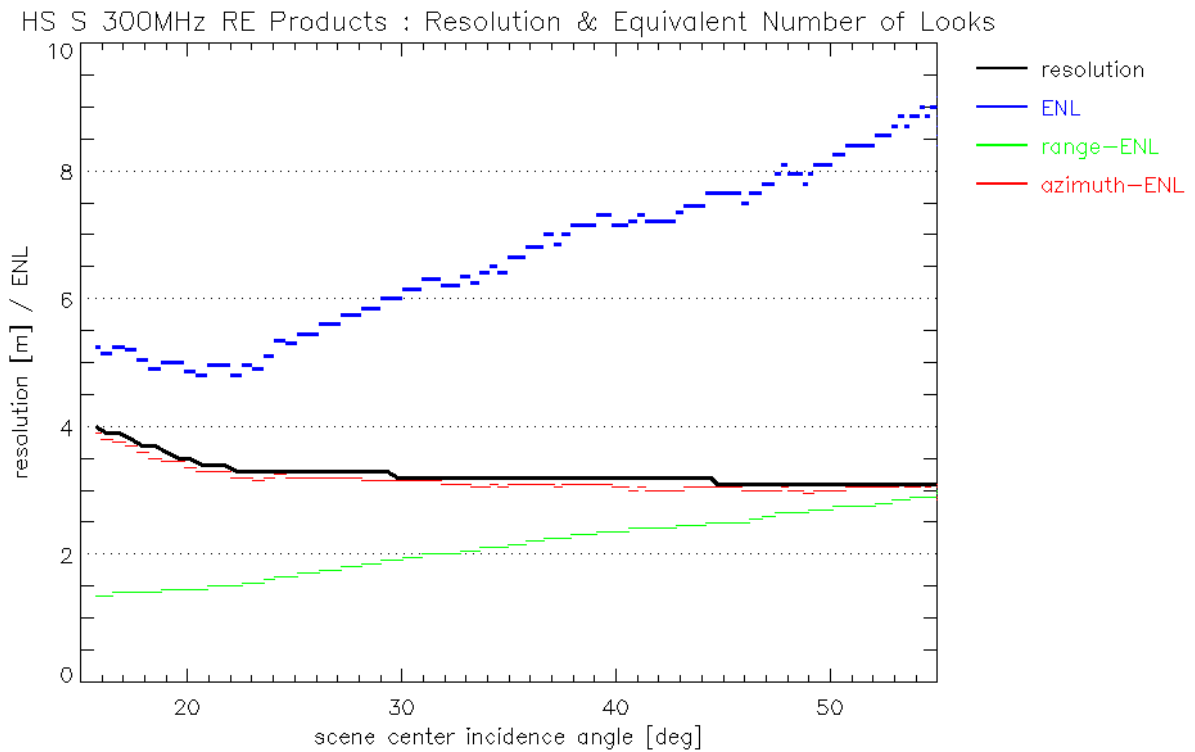

Fig. 23: High-resolution Spotlight single polarization RE product variant for 300 MHz range bandwidth (note that this mode reduces the range extent of the scenes and that the resolution is deliberately limited to 2.6m at best).

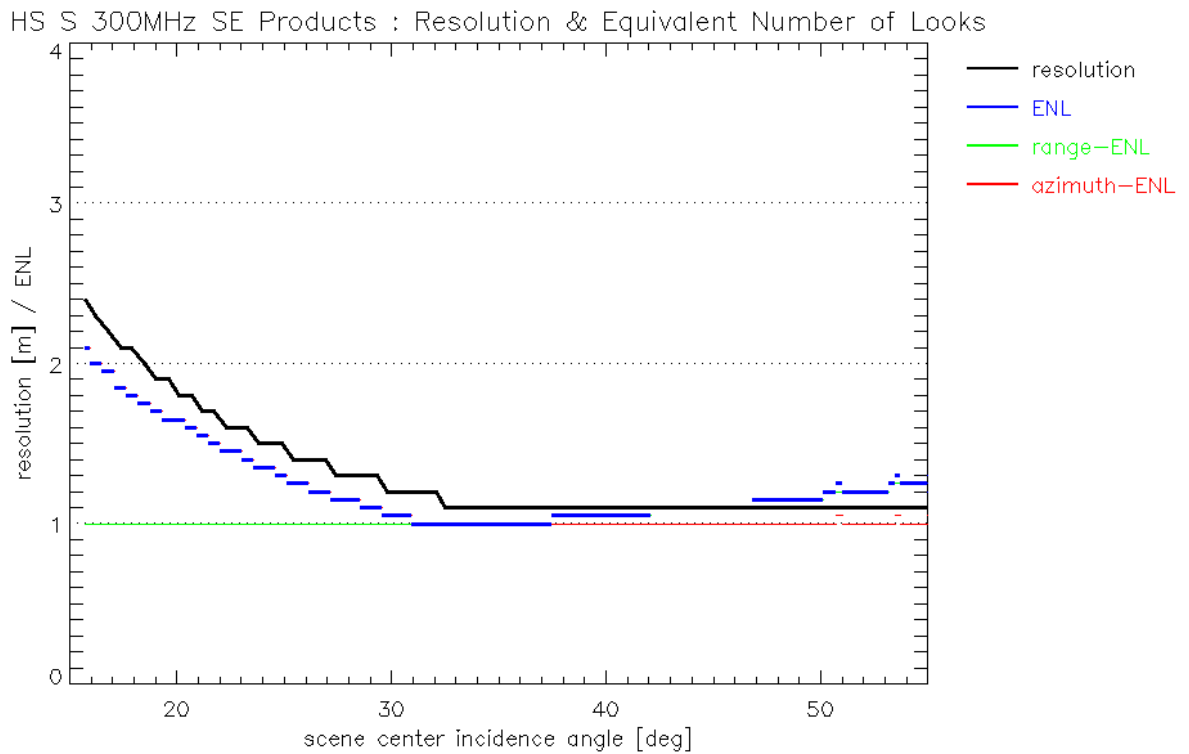

Fig. 24: High-resolution Spotlight single polarization SE product variant for 300 MHz range bandwidth (note that this mode reduces the range extent of the scenes).

ANNEX C) SAR Performance Details and Parameters

In this Annex some explanations and details of the major SAR system performance parameters are provided based on [RD 9] and [RD 10]. These are the basis for most of the product performance parameters. **Note however that the values given here do not directly translate into the specified product characteristics since the latter take also into account the accuracy of auxiliary data (e.g. orbit products) and processing approximations.** Also some background information on the selection of specific instrument modes is given. The data provided here is in general applicable to both instruments in that sense, that minor details may differ but the overall performance is comparable and well within the margins included in the specification. Six beam wide ScanSAR and ST mode parameters are found in Annex D.

Polarization Channel Combinations

There are 12 principal combinations for dual polarization combinations. 6 combinations do not provide new polarization information, e.g. HH-VV and VV-HH. From the remaining 6 combinations 3 provide only small additional information, e.g. HH-HV and HH-VH.

There are 4 basic products with dual polarization, 3 for Stripmap and 1 for Spotlight/HighRes. As the performance for dual polarization far beams is considerably dominated by range ambiguities, the selection of the 3 stripmap dual polarization combination was driven by the range ambiguity performance. The following combinations are basic products:

- HH-VV
- VV-VH
- HH-HV

For Spotlight/HighRes Spotlight only the co-pol combination HH-VV is a basic product.

Improvement of Radiometric Accuracy

The product specification has been updated with improved values for absolute and relative radiometric accuracy of Stripmap products.

ScanSAR radiometry is more complex due to the combination of beams and bursts in this mode but turned out to be of similar accuracy.

The absolute/relative radiometric accuracy is valid for rain rates below 5mm/h and Medium Drop Size.

TX-RX Bandwidth in Stripmap and ScanSAR Modes

Due to the hardware design of the TS-X instrument, 150 MHz Rx-bandwidth is not possible for all Stripmap beams. Depending on the PRF and the incidence angle, the bandwidth is set to 100 MHz for far range beams. The commanding is optimized to always use 150 MHz when possible for optimum radiometric resolution. Since there is no pre-defined fixed beam, the following plot shows the SSC ground range resolution for both frequencies. The overlapping beams are strip_010 to strip_014, i.e. 36° and 45° incidence angle as shown in the figure below. The red line is for 150 MHz and the white line for 100 MHz.

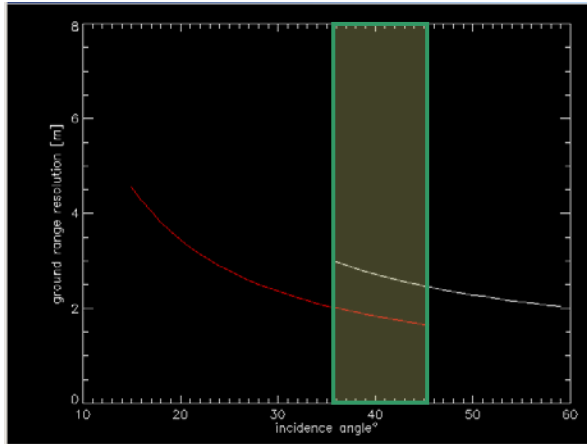

The probability of 100 MHz data taking in full performance beams was estimated based on 2024 basic stripmap DTs acquired until December 2007. The result is shown in the table below.

	#1 00 MHz	# total	% with 100 MHz
strip003	0	296	0.0
strip004	0	81	0.0
strip005	0	65	0.0
strip006	0	287	0.0
strip007	3	132	2.3
strip008	2	59	3.4
strip009	8	136	5.9
strip010	21	304	6.9
strip011	163	163	100.0
strip012	65	65	100.0
strip013	130	147	88.4
strip014	289	289	100.0

2024

total # 100 MHz (strip003-009)	13	1.2%
total # (strip 003-009)	1056	

DTs with 100 MHz acquired in the beams strip003 to strip009 can not fulfill the geometric resolution requirement of SSC 3.3m. From the above it can be derived, that the probability of 100 MHz DTs in beams strip003 to strip009 due to difficult terrain and timing reasons is 1.2%.

Also for the SL/HS modes there is a non-vanishing probability that in extreme conditions the fallback of 100 MHz might be selected to guarantee the swath coverage and adequate timing settings.

For Stripmap dual pol the SSC requirement is 6.6m and thus there is no special reporting on 100 MHz DTs for stripNear of stripFar beams lower than 10. However, analysis of 769 Dual-Pol stripmap DTs carried out that only 1 DT in strip_009 was commanded with 100 MHz.

The change in NESZ to be applied for conversion from 100 MHz to 150 MHz data acquisition is as follows:

$$nesz_{100MHz} = nesz_{150MHz} - 1.76091[dB]$$

The corresponding change in radiometric resolution depends on the SNR and the number of looks and is shown in the next figure:

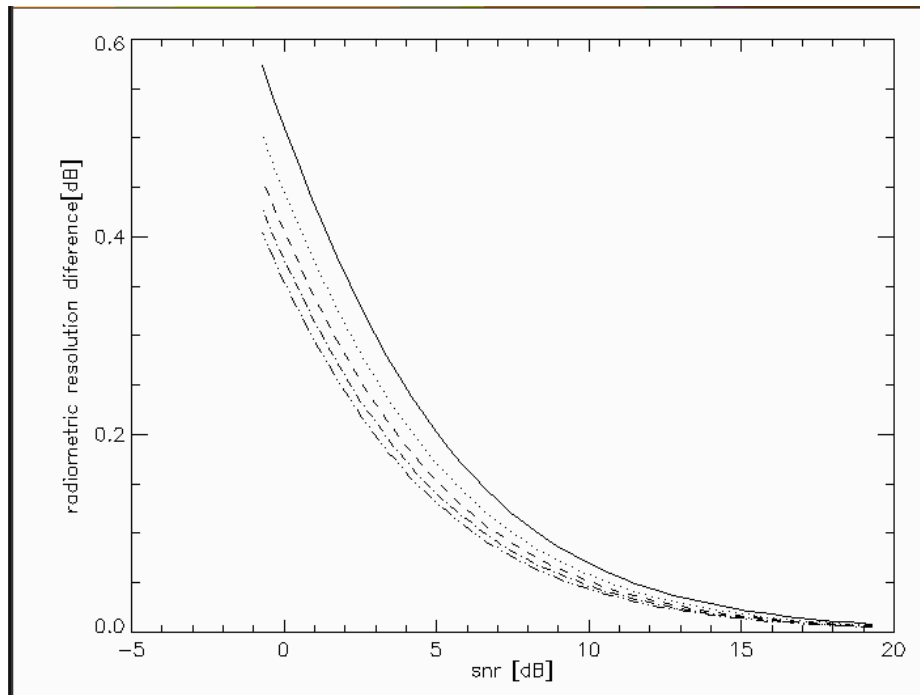

The different lines show the difference in radiometric resolution for SSC for different number of looks, i.e. the continuous line is for 1 look and the lines in direction to the x-axis are for 2,3,4 and 5 looks.

Comment to Radiometric Resolution

There are differences between the theoretical radiometric resolution and the radiometric resolution measured for dedicated scenes. The theoretical value in the product spec is calculated for a certain reference SNR, i.e. reference sigma0 model.

The radiometric resolution depends on the SNR and number of looks N_L according to the following expression:

$$\gamma = 10 \cdot \log \left(1 + \frac{1 + SNR^{-1}}{\sqrt{N_L}} \right)$$

Therefore, the measured values of the radiometric resolution strongly depend on the SNR of the selected area. Curves showing the dependency of the radiometric resolution on the SNR and number of looks are reported in the following figure:

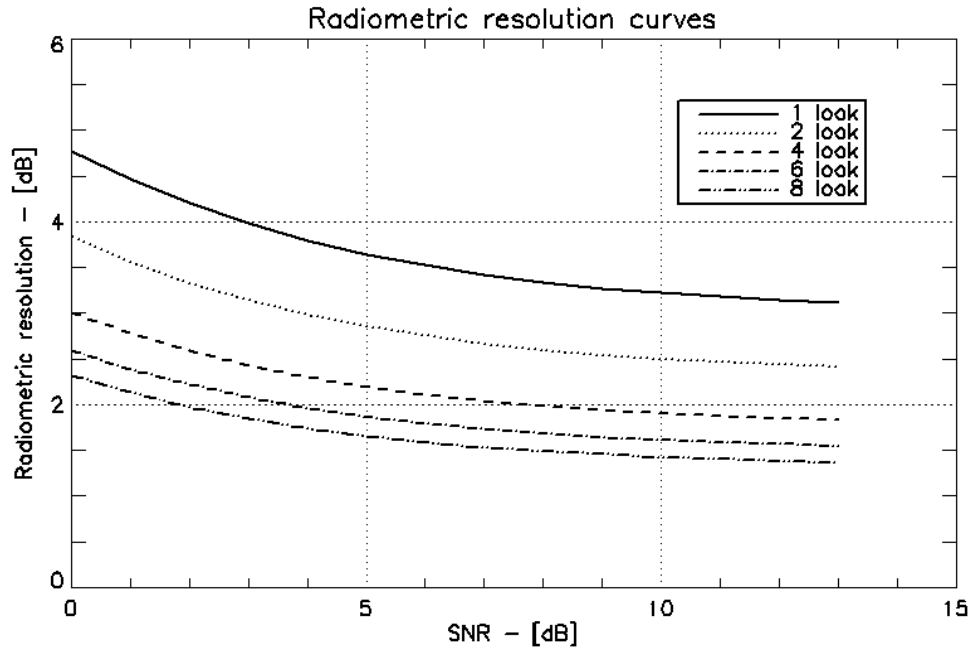

NESZ Calculation and BAQ

The NESZ performance plots in this document are calculated with a raw data compression with a BAQ of 8:8 to allow a fully sigma0 free representation of the NESZ. In any estimation of NESZ degradation due to BAQ there has to be made an assumption in the SNR, i.e. the sigma0 of a scene.

The influence of different BAQ settings on the radiometric resolution is shown in the next figure as a function of SNR. It is less than 0.4 dB for the SSC case which is similar to the specially enhanced products. In radiometrically enhanced products, where the number of looks is high, the variation in radiometric resolution can be neglected.

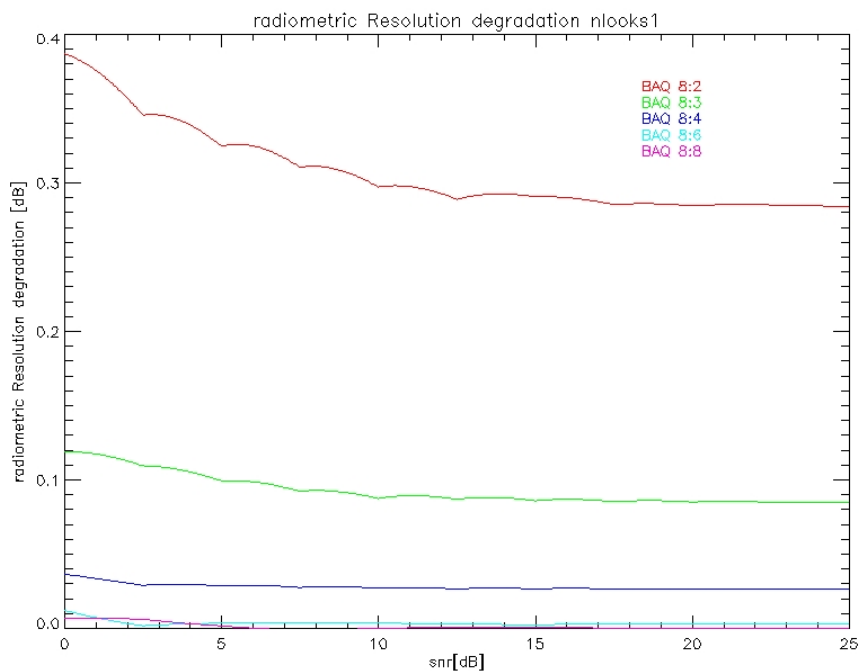



Stripmap and Spotlight Elevation Beam Definition

The following tables show the Stripmap and spotlight elevation beam definition. The Stripmap table also includes the stripmap_near and stripmap_far beams. This pre-launch definition has not been changed during the commissioning phase.



Public

Elevation Beam Identification	Angle Range	Minimum Incidence Angle [°]	Maximum Incidence Angle [°]	Minimum Look Angle [°]	Maximum Look Angle [°]	Ground Swath Width [km]	Ground Swath Overlapp to following swath [km]
strip_001	data collection	14.338	17.906	13.254	16.538	31.589	7.597
stripNear_001	data collection	14.510	16.396	13.413	15.149	16.594	4.598
stripFar_001	data collection	15.876	17.739	14.671	16.385	16.594	4.598
strip_002	data collection	17.058	20.535	15.759	18.952	31.589	7.597
stripNear_002	data collection	17.226	19.065	15.913	17.603	16.594	4.598
stripFar_002	data collection	18.559	20.373	17.139	18.803	16.594	4.598
strip_003	full performance	19.710	23.086	18.196	21.288	31.589	7.597
stripNear_003	full performance	19.874	21.661	18.345	19.984	16.594	4.598
stripFar_003	full performance	21.169	22.929	19.534	21.145	16.594	4.598
strip_004	full performance	22.287	25.556	20.557	23.543	31.589	7.597
stripNear_004	full performance	22.445	24.177	20.702	22.285	16.594	4.598
stripFar_004	full performance	23.701	25.404	21.850	23.404	16.594	4.598
strip_005	full performance	24.783	27.941	22.838	25.711	31.589	7.597
stripNear_005	full performance	24.937	26.610	22.978	24.502	16.594	4.598
stripFar_005	full performance	26.151	27.794	24.084	25.578	16.594	4.598
strip_006	full performance	27.195	30.237	25.034	27.792	31.589	7.597
stripNear_006	full performance	27.343	28.956	25.168	26.633	16.594	4.598
stripFar_006	full performance	28.513	30.096	26.231	27.665	16.594	4.598
strip_007	full performance	29.520	32.445	27.143	29.785	31.588	7.597
stripNear_007	full performance	29.662	31.214	27.272	28.675	16.594	4.598
stripFar_007	full performance	30.788	32.310	28.290	29.663	16.594	4.598
strip_008	full performance	31.756	34.564	29.164	31.688	31.588	7.597
stripNear_008	full performance	31.892	33.383	29.287	30.628	16.594	4.598
stripFar_008	full performance	32.974	34.434	30.261	31.572	16.594	4.598
strip_009	full performance	33.903	36.595	31.095	33.504	31.588	7.597
stripNear_009	full performance	34.034	35.463	31.213	32.493	16.594	4.598
stripFar_009	full performance	35.072	36.471	32.143	33.393	16.594	4.598
strip_010	full performance	35.961	38.540	32.938	35.233	31.588	7.597
stripNear_010	full performance	36.087	37.457	33.051	34.271	16.594	4.598
stripFar_010	full performance	37.081	38.421	33.937	35.128	16.594	4.598
strip_011	full performance	37.933	40.401	34.695	36.878	31.588	7.597
stripNear_011	full performance	38.054	39.364	34.802	35.963	16.594	4.598
stripFar_011	full performance	39.005	40.287	35.645	36.778	16.594	4.598
strip_012	full performance	39.821	42.180	36.366	38.442	31.588	7.597
stripNear_012	full performance	39.936	41.189	36.468	37.572	16.594	4.598
stripFar_012	full performance	40.846	42.071	37.270	38.347	16.594	4.598
strip_013	full performance	41.625	43.881	37.956	39.927	31.588	7.597
stripNear_013	full performance	41.735	42.933	38.052	39.101	16.594	4.598
stripFar_013	full performance	42.605	43.777	38.814	39.836	16.594	4.598
strip_014	full performance	43.350	45.506	39.465	41.337	31.588	6.797
stripNear_014	full performance	43.456	44.601	39.557	40.553	16.594	4.598
stripFar_014	full performance	44.287	45.406	40.280	41.251	16.594	3.799
strip_015	data collection	45.053	47.008	40.945	42.630	29.989	5.998
stripNear_015	data collection	45.153	46.142	41.032	41.886	14.994	2.999
stripFar_015	data collection	45.946	46.913	41.717	42.549	14.994	2.999
strip_016	data collection	46.626	48.494	42.302	43.901	29.989	5.998
stripNear_016	data collection	46.722	47.666	42.385	43.195	14.994	2.999
stripFar_016	data collection	47.480	48.403	43.035	43.824	14.994	2.999
strip_017	data collection	48.129	49.915	43.590	45.106	29.989	5.998
stripNear_017	data collection	48.221	49.123	43.668	44.436	14.994	2.999
stripFar_017	data collection	48.945	49.828	44.285	45.033	14.994	3.149
strip_018	data collection	49.565	51.106	44.811	46.109	26.990	5.398
stripNear_018	data collection	49.644	50.423	44.878	45.535	13.495	2.699
stripFar_018	data collection	50.268	51.031	45.405	46.046	13.495	2.699
strip_019	data collection	50.804	52.285	45.856	47.094	26.990	5.398
stripNear_019	data collection	50.880	51.628	45.919	46.546	13.495	2.699
stripFar_019	data collection	51.480	52.212	46.422	47.033	13.495	2.699
strip_020	data collection	51.994	53.417	46.852	48.032	26.990	5.398
stripNear_020	data collection	52.067	52.786	46.913	47.510	13.495	2.699
stripFar_020	data collection	52.643	53.348	47.392	47.975	13.495	2.699
strip_021	data collection	53.138	54.506	47.802	48.927	26.990	5.398
stripNear_021	data collection	53.208	53.899	47.859	48.429	13.495	2.699
stripFar_021	data collection	53.762	54.439	48.316	48.872	13.495	2.699
strip_022	data collection	54.238	55.553	48.707	49.780	26.990	5.398
stripNear_022	data collection	54.305	54.969	48.762	49.305	13.495	2.699
stripFar_022	data collection	54.837	55.489	49.198	49.728	13.495	2.699



Public

strip_023	data collection	55.295	56.561	49.570	50.594	26.990	5.398
stripNear_023	data collection	55.360	55.999	49.623	50.141	13.495	2.699
stripFar_023	data collection	55.872	56.499	50.038	50.544	13.495	2.699
strip_024	data collection	56.312	57.531	50.394	51.370	26.990	5.398
stripNear_024	data collection	56.375	56.990	50.444	50.938	13.495	2.699
stripFar_024	data collection	56.868	57.472	50.840	51.323	13.495	2.699
strip_025	data collection	57.292	58.466	51.179	52.111	26.990	5.398
stripNear_025	data collection	57.352	57.944	51.227	51.698	13.495	2.699
stripFar_025	data collection	57.827	58.408	51.605	52.065	13.495	2.699
strip_026	data collection	58.235	59.367	51.929	52.818	26.990	5.398
stripNear_026	data collection	58.293	58.864	51.974	52.424	13.495	2.699
stripFar_026	data collection	58.751	59.311	52.335	52.774	13.495	2.699
strip_027	data collection	59.145	60.236	52.644	53.493	26.990	0.000
stripNear_027	data collection	59.200	59.751	52.688	53.117	13.495	2.699
stripFar_027	data collection	59.642	60.182	53.032	53.451	13.495	0.000
number of full performance swaths		12 stripNear Beam					
		12 stripFar Beam					
total number of swaths		27 stripNear Beam					
		27 stripFar Beam					
minimum required ground range	15 km + 1.6 km Margin	15 km without margin for $\theta_{inc} > 45^\circ$,		13.5 km without margin for $\theta_{inc} > 50^\circ$			
swath width	=16.5 km						
minimum required ground swath	3km +1.6 km Margin	3km without margin for $\theta_{inc} > 45^\circ$		2.7 km for $\theta_{inc} > 50^\circ$			
overlap	=4.6 km						
stripNear_001 Beam coverag region start to 15° of incidence angle in ground range:	4.287 km	(required 0.800 km)					
stripNear_003 Beam coverag region start to 20° of incidence angle in ground range:	1.163 km	(required 0.800 km)					
stripFar_014 Beam coverag region end to 45° of incidence angle in ground range:	6.083 km	(required 0.800 km)					
stripFar_027 Beam coverag region end to 60° of incidence angle in ground range:	4.583 km	(required 0.800 km)					

Table 1: Stripmap (and ScanSAR) beam specification.



Public

Elevation Beam Identification	Angle Range	Minimum Incidence Angle [°]	Maximum Incidence Angle [°]	Minimum Look Angle [°]	Maximum Look Angle [°]	Ground Swath Width [km]	Ground Swath Overlapp to next swath [km]
spot_001	data collection	14.677	16.684	13.567	15.414	17.694	12.695
spot_002	data collection	15.247	17.244	14.092	15.930	17.694	12.695
spot_003	data collection	15.815	17.801	14.615	16.442	17.694	12.695
spot_004	data collection	16.380	18.356	15.135	16.952	17.694	12.695
spot_005	data collection	16.942	18.907	15.652	17.458	17.694	12.695
spot_006	data collection	17.501	19.455	16.166	17.961	17.694	12.695
spot_007	data collection	18.057	20.000	16.677	18.461	17.694	12.695
spot_008	data collection	18.610	20.541	17.185	18.958	17.694	12.695
spot_009	data collection	19.159	21.079	17.690	19.451	17.694	12.695
spot_010	full performance	19.706	21.614	18.192	19.941	17.694	12.695
spot_011	full performance	20.249	22.145	18.690	20.427	17.694	12.695
spot_012	full performance	20.789	22.673	19.185	20.910	17.694	12.695
spot_013	full performance	21.326	23.197	19.677	21.390	17.694	12.695
spot_014	full performance	21.859	23.718	20.165	21.865	17.694	12.695
spot_015	full performance	22.389	24.235	20.650	22.338	17.694	12.695
spot_016	full performance	22.915	24.749	21.131	22.806	17.694	12.695
spot_017	full performance	23.437	25.258	21.609	23.271	17.694	12.695
spot_018	full performance	23.956	25.764	22.083	23.732	17.694	12.695
spot_019	full performance	24.472	26.267	22.554	24.190	17.694	12.695
spot_020	full performance	24.984	26.765	23.020	24.643	17.694	12.695
spot_021	full performance	25.492	27.260	23.484	25.093	17.694	12.695
spot_022	full performance	25.996	27.751	23.943	25.539	17.694	12.695
spot_023	full performance	26.497	28.238	24.399	25.982	17.694	12.695
spot_024	full performance	26.993	28.722	24.851	26.420	17.694	12.695
spot_025	full performance	27.487	29.201	25.299	26.855	17.694	12.695
spot_026	full performance	27.976	29.677	25.743	27.286	17.694	12.695
spot_027	full performance	28.461	30.149	26.184	27.713	17.694	12.695
spot_028	full performance	28.943	30.617	26.621	28.136	17.694	12.695
spot_029	full performance	29.421	31.081	27.054	28.555	17.694	12.695
spot_030	full performance	29.895	31.541	27.483	28.970	17.694	12.695
spot_031	full performance	30.365	31.998	27.908	29.382	17.694	12.695
spot_032	full performance	30.831	32.450	28.329	29.790	17.694	12.695
spot_033	full performance	31.293	32.899	28.747	30.193	17.694	12.695
spot_034	full performance	31.752	33.344	29.160	30.593	17.694	12.695
spot_035	full performance	32.207	33.785	29.570	30.990	17.694	12.695
spot_036	full performance	32.657	34.222	29.976	31.382	17.694	12.695
spot_037	full performance	33.104	34.656	30.378	31.770	17.694	12.695
spot_038	full performance	33.547	35.085	30.776	32.155	17.694	12.695
spot_039	full performance	33.987	35.511	31.170	32.536	17.694	12.695
spot_040	full performance	34.422	35.933	31.561	32.913	17.694	12.695
spot_041	full performance	34.854	36.351	31.948	33.286	17.694	12.695
spot_042	full performance	35.282	36.766	32.331	33.656	17.694	12.695
spot_043	full performance	35.706	37.176	32.710	34.021	17.693	12.695
spot_044	full performance	36.126	37.583	33.085	34.384	17.693	12.695
spot_045	full performance	36.542	37.986	33.457	34.742	17.693	12.695
spot_046	full performance	36.955	38.386	33.824	35.097	17.693	12.695
spot_047	full performance	37.364	38.782	34.188	35.448	17.693	12.695
spot_048	full performance	37.769	39.174	34.549	35.795	17.693	12.695
spot_049	full performance	38.171	39.563	34.906	36.139	17.693	12.695
spot_050	full performance	38.569	39.948	35.259	36.479	17.693	12.695
spot_051	full performance	38.963	40.329	35.608	36.815	17.693	12.695
spot_052	full performance	39.353	40.707	35.954	37.149	17.693	12.695
spot_053	full performance	39.740	41.082	36.296	37.478	17.693	12.695
spot_054	full performance	40.124	41.453	36.634	37.804	17.693	12.695
spot_055	full performance	40.504	41.820	36.969	38.127	17.693	12.695
spot_056	full performance	40.880	42.184	37.301	38.446	17.693	12.695
spot_057	full performance	41.253	42.545	37.628	38.762	17.693	12.695
spot_058	full performance	41.622	42.902	37.953	39.074	17.693	12.695
spot_059	full performance	41.988	43.256	38.274	39.383	17.693	12.695
spot_060	full performance	42.351	43.607	38.591	39.689	17.693	12.695
spot_061	full performance	42.710	43.954	38.906	39.991	17.693	12.695
spot_062	full performance	43.065	44.298	39.216	40.290	17.693	12.695
spot_063	full performance	43.418	44.639	39.524	40.586	17.693	12.695
spot_064	full performance	43.767	44.976	39.828	40.878	17.693	12.695
spot_065	full performance	44.113	45.310	40.129	41.168	17.693	12.695
spot_066	full performance	44.455	45.642	40.426	41.454	17.693	12.695



Public

spot_066	full performance	44.455	45.642	40.426	41.454	17.693	12.695
spot_067	full performance	44.794	45.970	40.721	41.737	17.693	12.695
spot_068	full performance	45.130	46.295	41.012	42.017	17.693	12.695
spot_069	full performance	45.463	46.617	41.300	42.294	17.693	12.695
spot_070	full performance	45.793	46.936	41.585	42.568	17.693	12.695
spot_071	full performance	46.120	47.251	41.867	42.839	17.693	12.695
spot_072	full performance	46.443	47.564	42.145	43.107	17.693	12.695
spot_073	full performance	46.764	47.874	42.421	43.372	17.693	12.695
spot_074	full performance	47.081	48.181	42.693	43.635	17.693	12.695
spot_075	full performance	47.396	48.486	42.963	43.894	17.693	12.695
spot_076	full performance	47.707	48.787	43.230	44.150	17.693	12.695
spot_077	full performance	48.016	49.085	43.493	44.404	17.693	12.695
spot_078	full performance	48.322	49.381	43.754	44.655	17.693	12.695
spot_079	full performance	48.625	49.674	44.012	44.903	17.693	12.695
spot_080	full performance	48.925	49.964	44.267	45.148	17.693	12.695
spot_081	full performance	49.222	50.252	44.520	45.391	17.693	12.695
spot_082	full performance	49.516	50.537	44.769	45.631	17.693	12.695
spot_083	full performance	49.808	50.819	45.016	45.868	17.693	12.695
spot_084	full performance	50.097	51.099	45.260	46.103	17.693	12.695
spot_085	full performance	50.383	51.376	45.501	46.335	17.693	12.695
spot_086	full performance	50.667	51.650	45.740	46.564	17.693	12.695
spot_087	full performance	50.948	51.922	45.976	46.791	17.693	12.695
spot_088	full performance	51.226	52.191	46.210	47.016	17.693	12.695
spot_089	full performance	51.502	52.458	46.441	47.238	17.693	12.695
spot_090	full performance	51.776	52.723	46.669	47.458	17.693	12.695
spot_091	full performance	52.046	52.985	46.895	47.675	17.693	12.695
spot_092	full performance	52.315	53.245	47.118	47.890	17.693	12.695
spot_093	full performance	52.580	53.502	47.339	48.102	17.693	12.695
spot_094	full performance	52.844	53.757	47.558	48.312	17.693	12.695
spot_095	full performance	53.105	54.010	47.774	48.520	17.693	12.695
spot_096	full performance	53.364	54.261	47.988	48.726	17.693	12.695
spot_097	full performance	53.620	54.509	48.199	48.929	17.693	12.695
spot_098	full performance	53.874	54.755	48.408	49.130	17.693	12.695
spot_099	full performance	54.126	54.999	48.615	49.329	17.693	12.695
spot_100	full performance	54.375	55.240	48.820	49.526	17.693	12.695
spot_101	data collection	54.622	55.480	49.022	49.720	17.693	12.695
spot_102	data collection	54.867	55.717	49.222	49.913	17.693	12.695
spot_103	data collection	55.110	55.952	49.420	50.103	17.693	12.695
spot_104	data collection	55.351	56.186	49.616	50.292	17.693	12.695
spot_105	data collection	55.589	56.417	49.809	50.478	17.693	12.695
spot_106	data collection	55.826	56.646	50.001	50.662	17.693	12.695
spot_107	data collection	56.060	56.873	50.190	50.844	17.693	12.695
spot_108	data collection	56.292	57.098	50.377	51.024	17.693	12.695
spot_109	data collection	56.522	57.321	50.563	51.203	17.693	12.695
spot_110	data collection	56.751	57.543	50.746	51.379	17.693	12.695
spot_111	data collection	56.977	57.762	50.927	51.554	17.693	12.695
spot_112	data collection	57.201	57.979	51.107	51.726	17.693	12.695
spot_113	data collection	57.423	58.195	51.284	51.897	17.693	12.695
spot_114	data collection	57.644	58.409	51.460	52.066	17.693	12.695
spot_115	data collection	57.862	58.621	51.633	52.233	17.693	12.695
spot_116	data collection	58.079	58.831	51.805	52.398	17.693	12.695
spot_117	data collection	58.294	59.039	51.975	52.562	17.693	12.695
spot_118	data collection	58.507	59.246	52.143	52.723	17.693	12.695
spot_119	data collection	58.718	59.451	52.309	52.883	17.693	12.695
spot_120	data collection	58.927	59.654	52.474	53.042	17.693	12.695
spot_121	data collection	59.135	59.856	52.636	53.198	17.693	12.695
spot_122	data collection	59.341	60.056	52.797	53.353	17.693	0,000

number of full performance swaths	91
total number of swaths	122
Minimum required ground range swath width	17.7 km
Minimum required ground swath overlap	12.7 km
spot_001 coverage region start to 15° of incidence angle in ground range: 2.827 km (required 1.350 km)	
spot_010 coverage region start to 20° of incidence angle in ground range: 2.702 km (required 1.350 km)	
spot_100 coverage region end to 55° of incidence angle in ground range: 4.968 km (required 1.350 km)	
spot_123 coverage region end to 60° of incidence angle in ground range: 1.394 km (required 1.350 km)	

Table 2: High-Resolution and Spotlight beam specification.

Product coverage and swath width degradation (terrain, Height Error Map)

For areas where in the command generation the DEM height error is above 200m, there is the possibility of deviations in the acquired product location from the swath preview as shown in the EOWEB user interface.

From the height error h_{err} for the cases above 200m the displacement of the acquired swath can be calculated for the worst case, i.e. that all other margin like reference orbit deviation or pointing error has been exploited, as follows:

$$\text{displacement} = (h_{err} - 200\text{m}) * \tan(90^\circ - \text{incidence_angle})$$

Note, the displacement does not reduce the delivered swath width but the overlap of the delivered product with the ordered swath based on the user ordered swath. This causes also implicitly a product location mismatch.

The *nominal* height error in the DEM available for command generation is sketched in the following height error map. However, the DEM height error indicates only the uncertainty in each height value but not necessarily a real deviation of entire regions.



80% of the land earth surface have maximum DEM errors smaller than 200m. Larger errors may occur mainly at latitudes $>\pm 60^\circ$.

High-Resolution and Spotlight Scene Extension

Due to the maximization of azimuth resolution only a small margin is applied in the azimuth scene extension, i.e. this can cause small deviations from the specified azimuth scene extent of up to 300m, as observed in the commissioning phase in extreme and rare cases caused by complex terrain and nominal Doppler centroid variations in-between ± 120 Hz.

Performance Plots

The plots are taken from [RD 10]. Note that (except for those of the geometric resolution), they refer to look angles instead of incidence angles.

Note, that the stripmap performance shown in the plots is w.r.t. commanding 150 MHz for the beams strip_001 to strip_0010 and that for higher beams 100 MHz tx bandwidth is commanded.

All dual pol performance is shown for commanded 150 MHz range bandwidth.

A preliminary characterization only of the HS 300 MHz mode for single polarization is given in the performance plots.

In ScanSAR, all beams higher than strip_007 are commanded with 100 MHz, apart from beam strip_009 which is commanded with 150 MHz. Beams strip_006 and lower are commanded with 150 MHz.

Stripmap single

Geometric Resolution

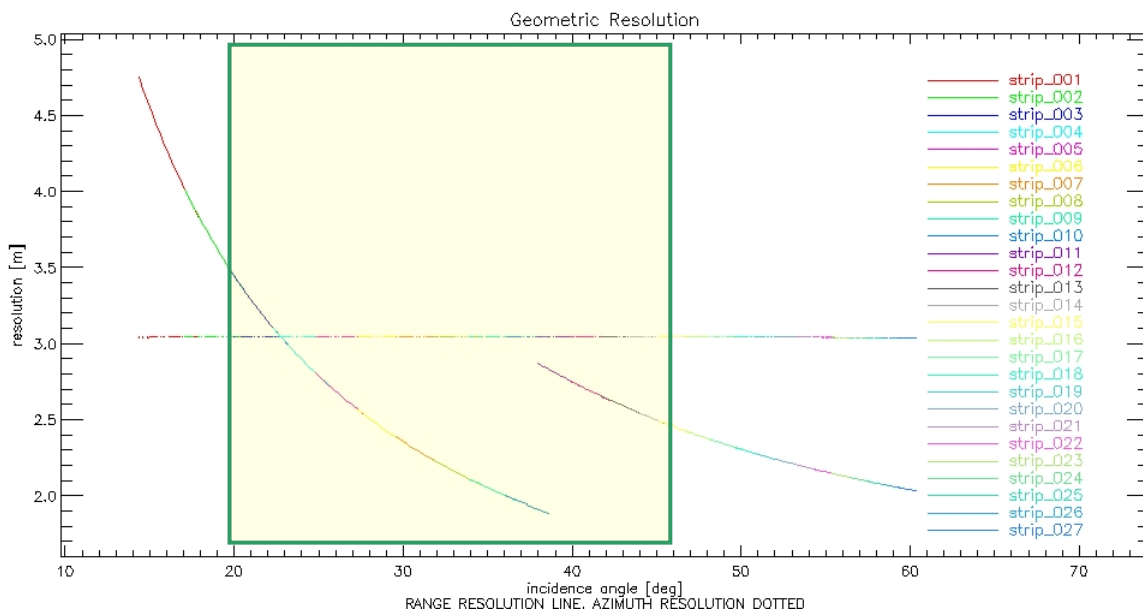

Radiometric Parameters

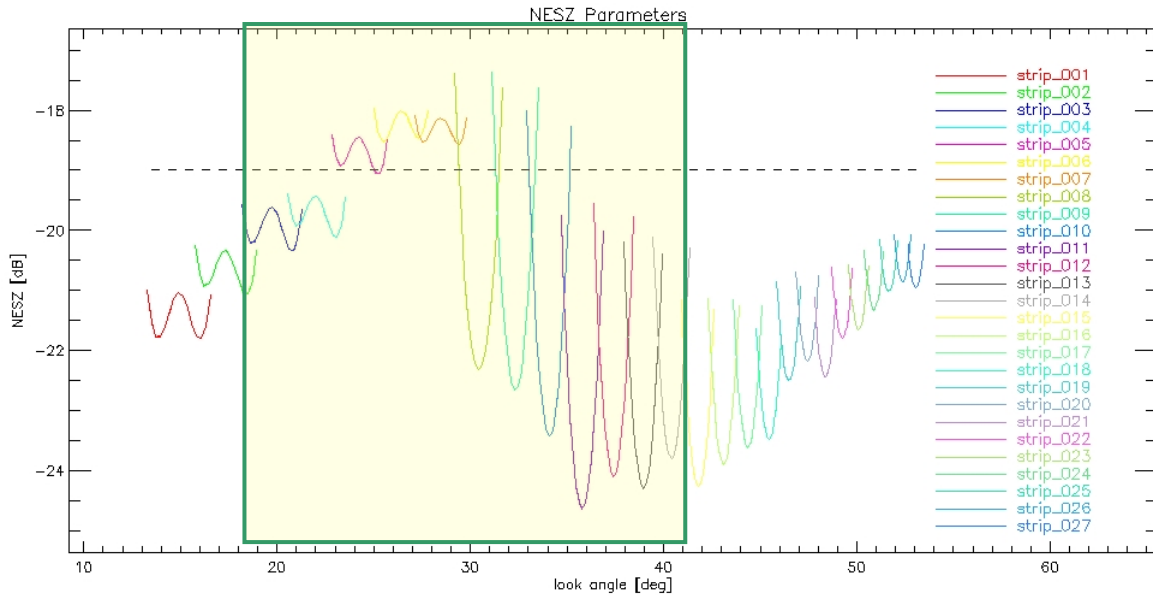

Ambiguity Ratio Parameters

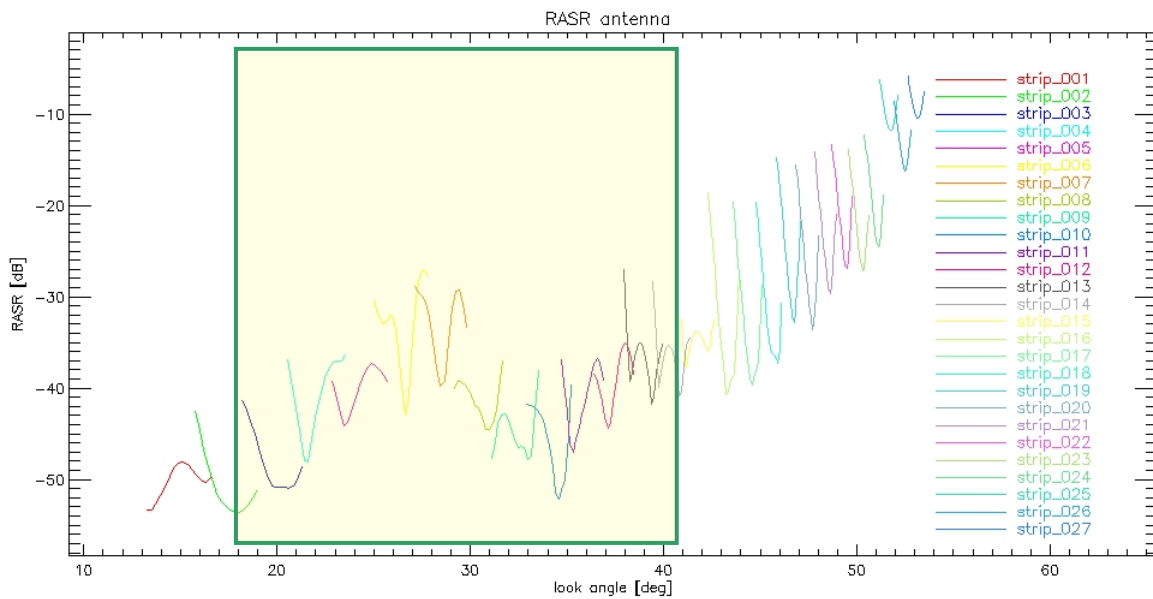

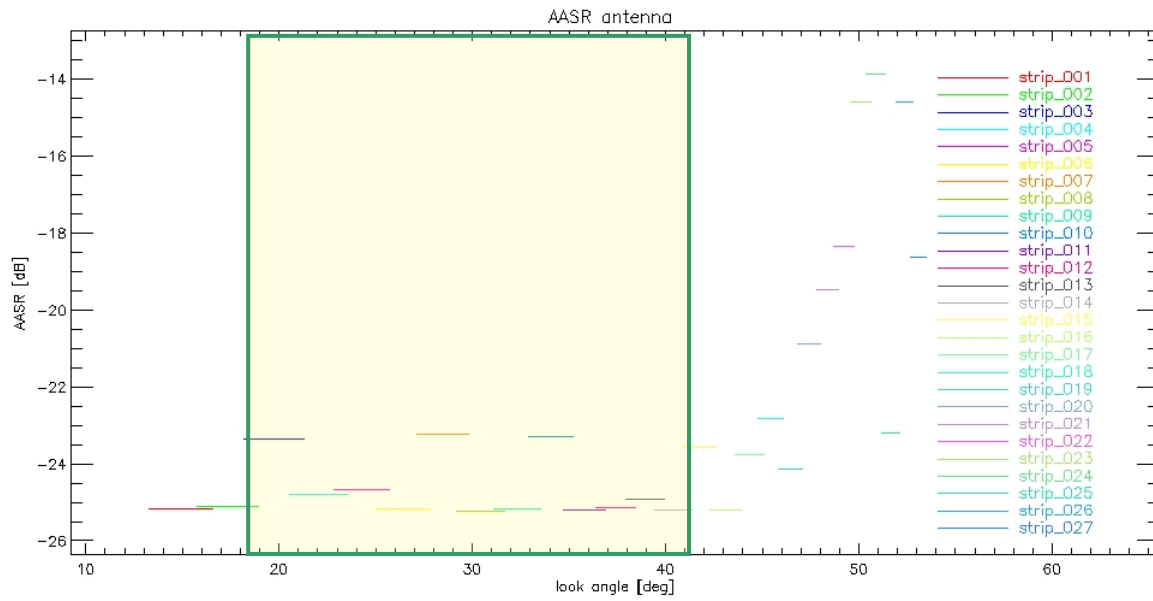

Stripmap dual HHVV

Geometric Resolution

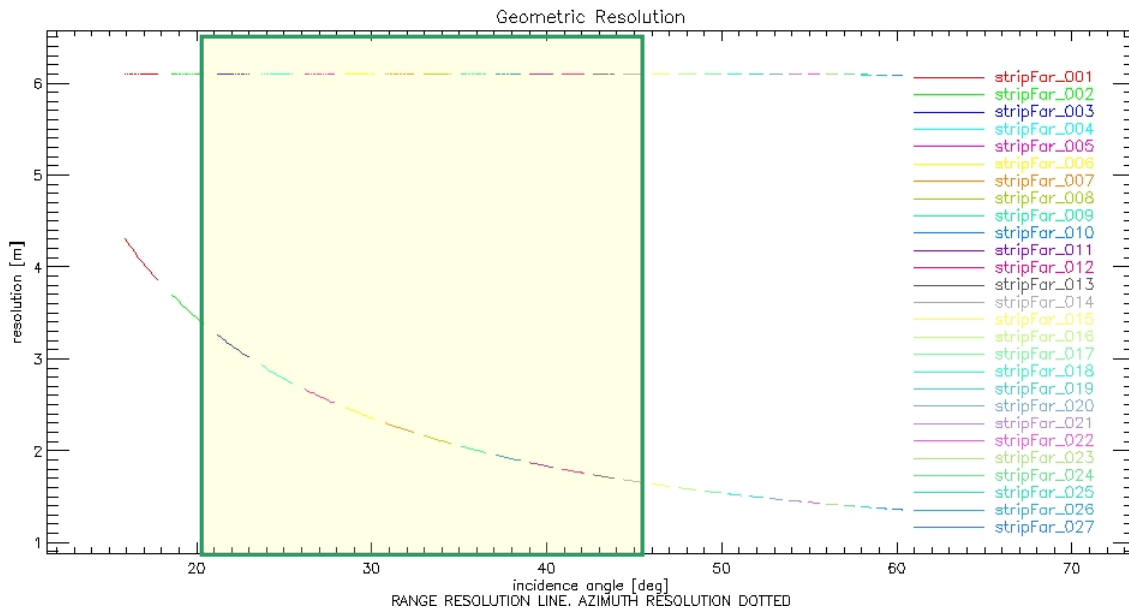

Radiometric Parameters

HH

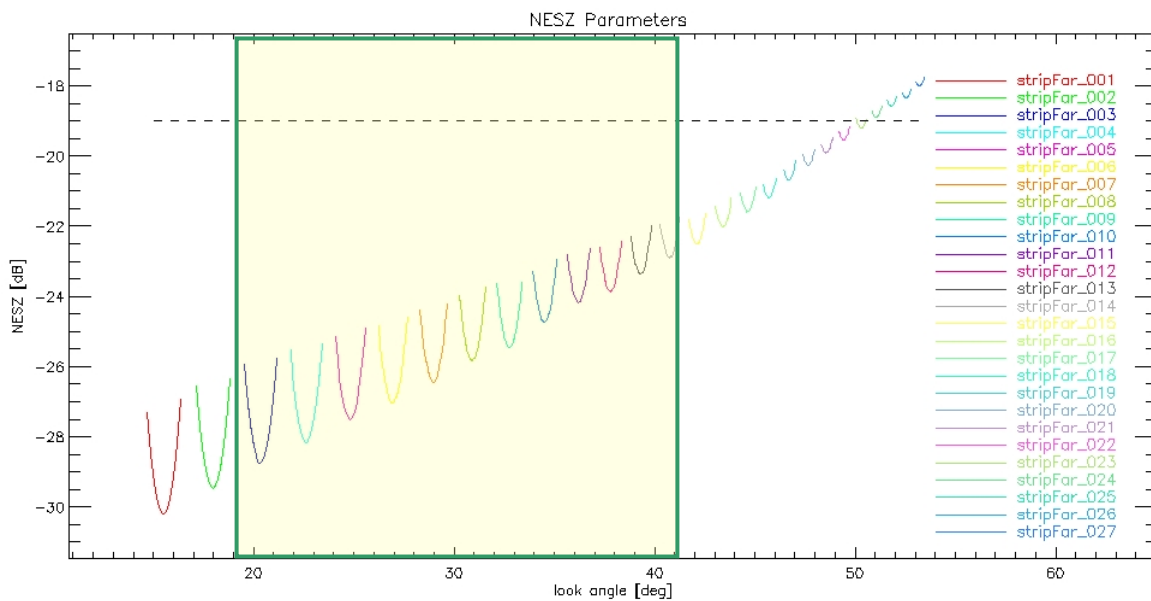

VV

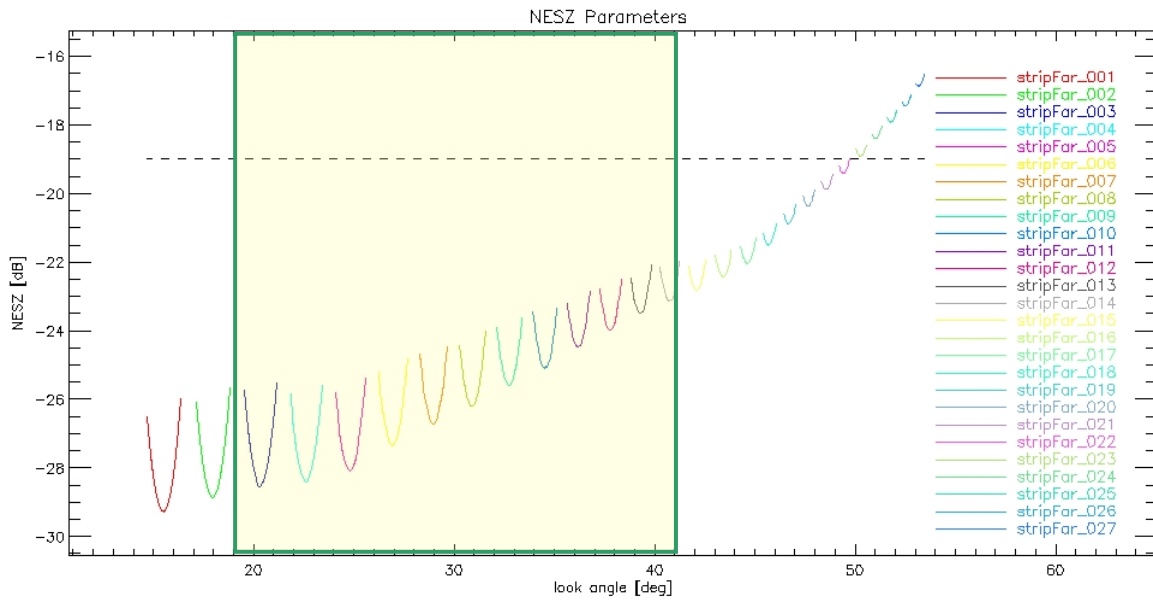

Ambiguity Ratio Parameters

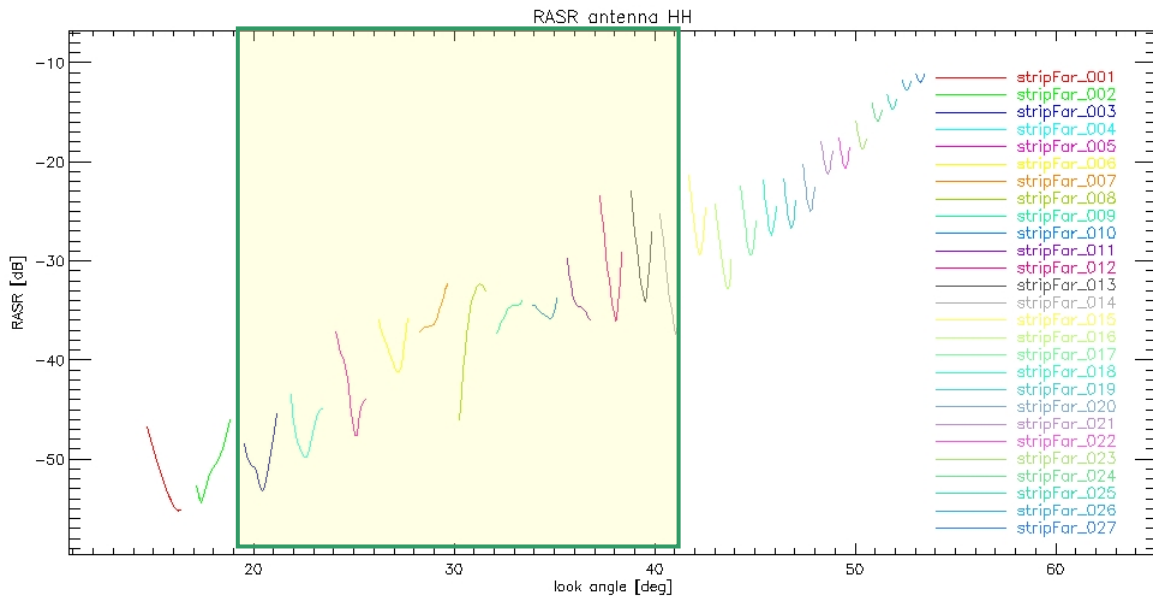

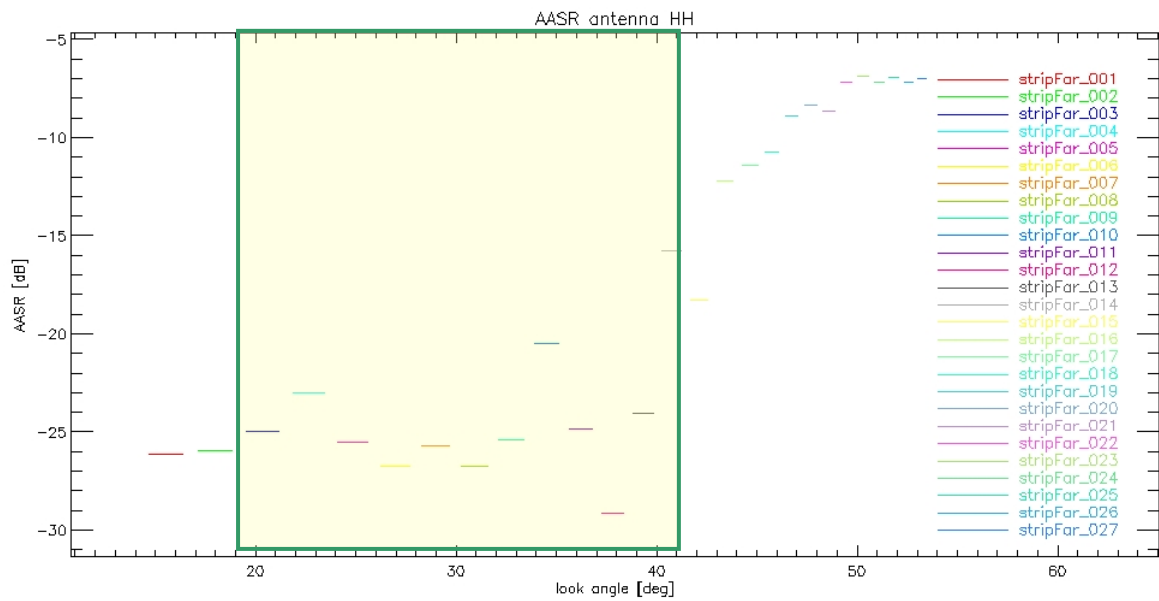
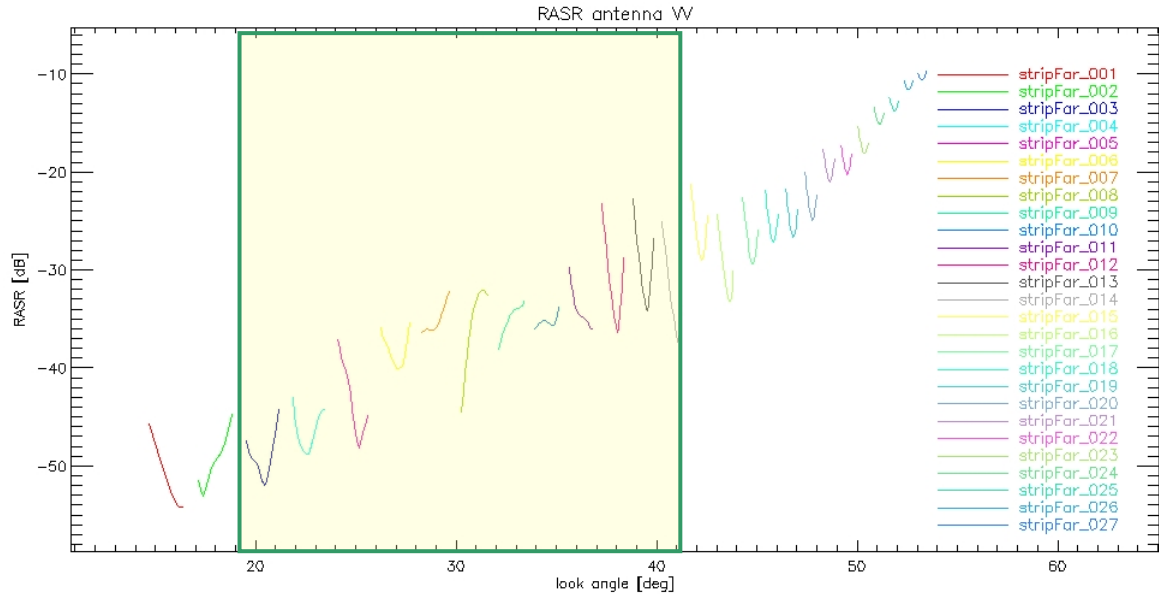

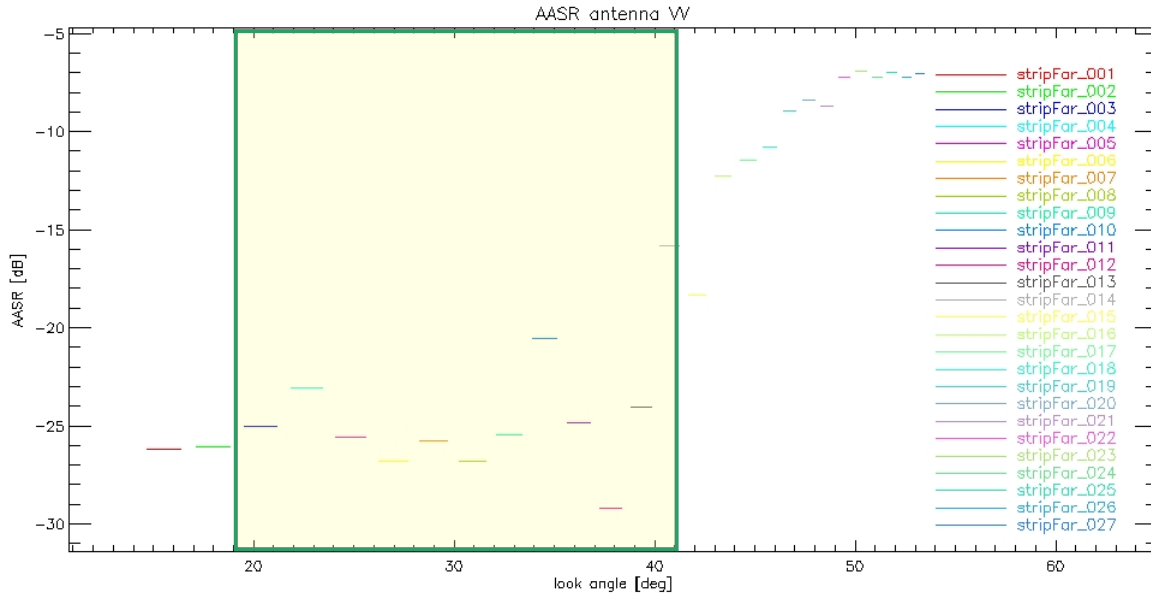

Stripmap dual HHHV (equivalent VVVH)

Geometric Resolution

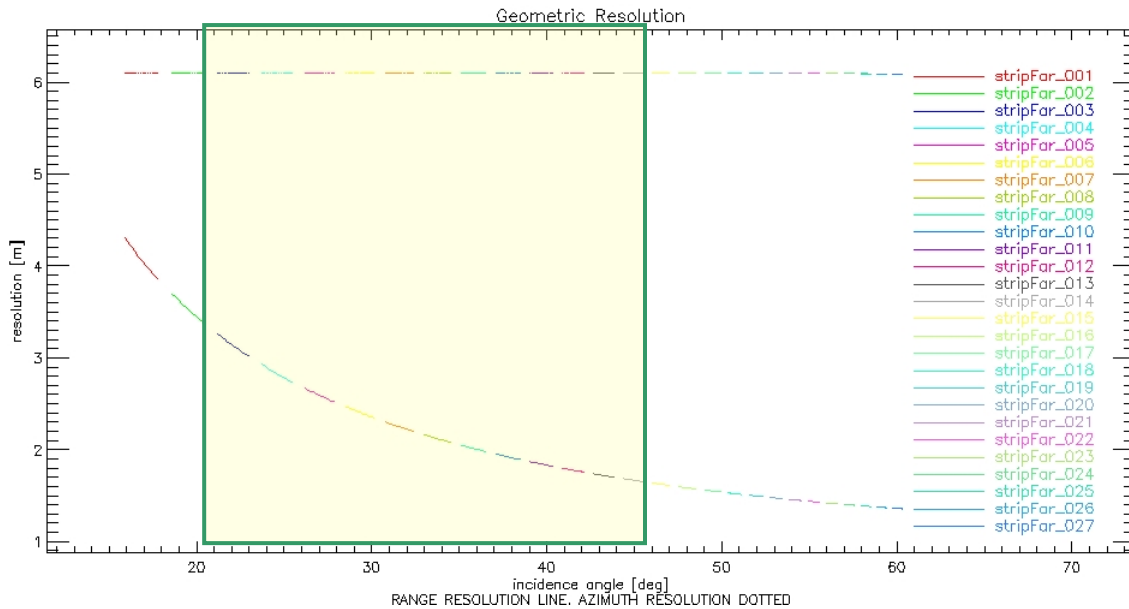

Radiometric Parameters

HH

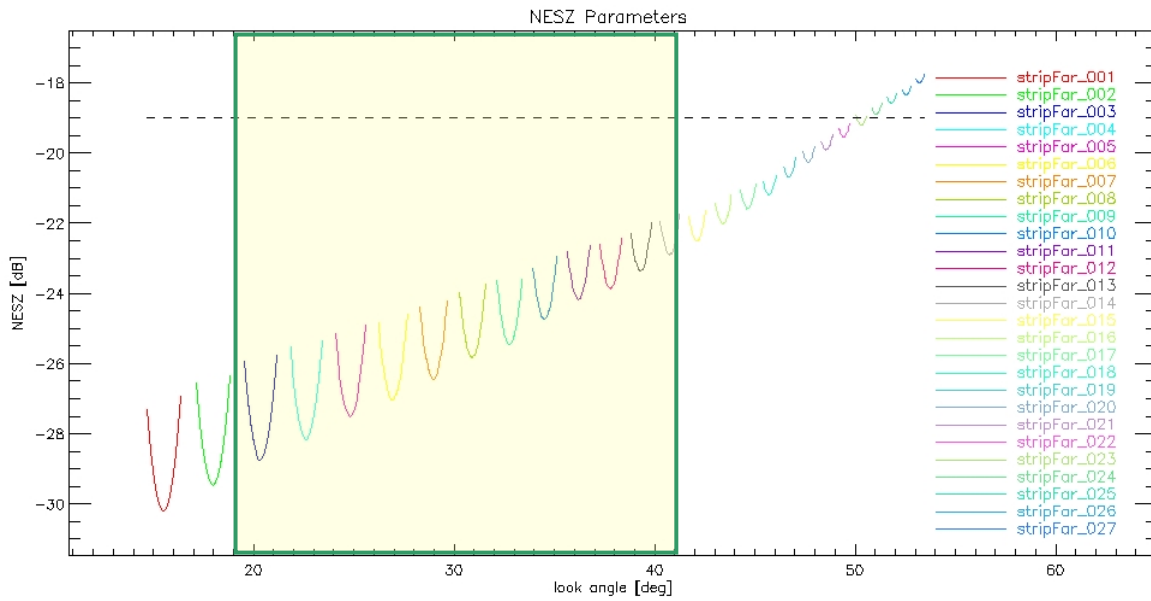

HV

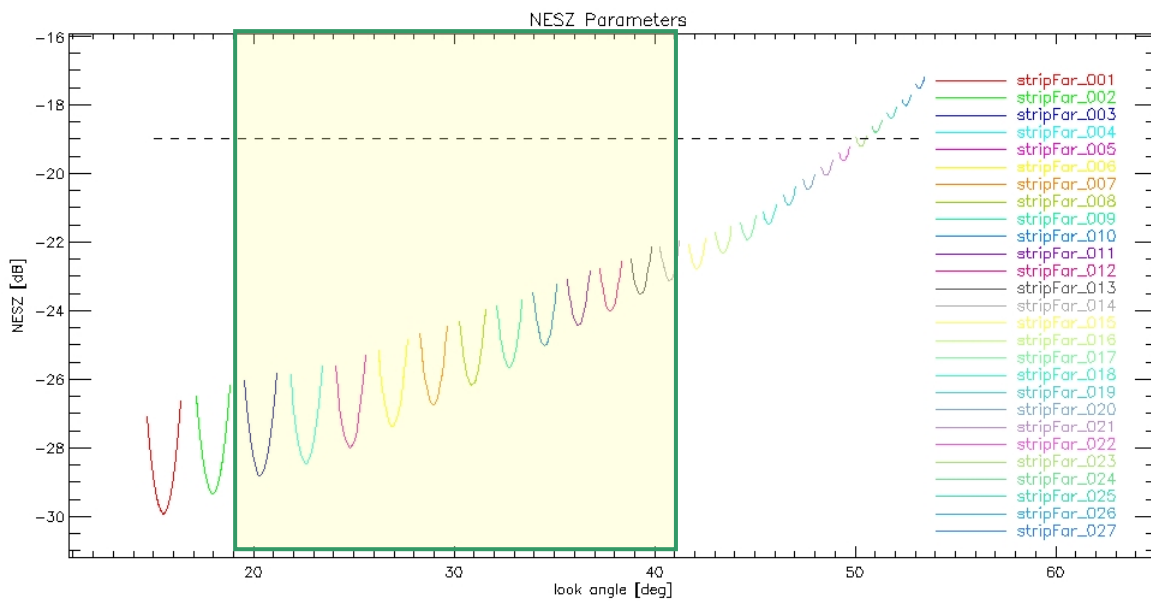

Ambiguity Ratio Parameters

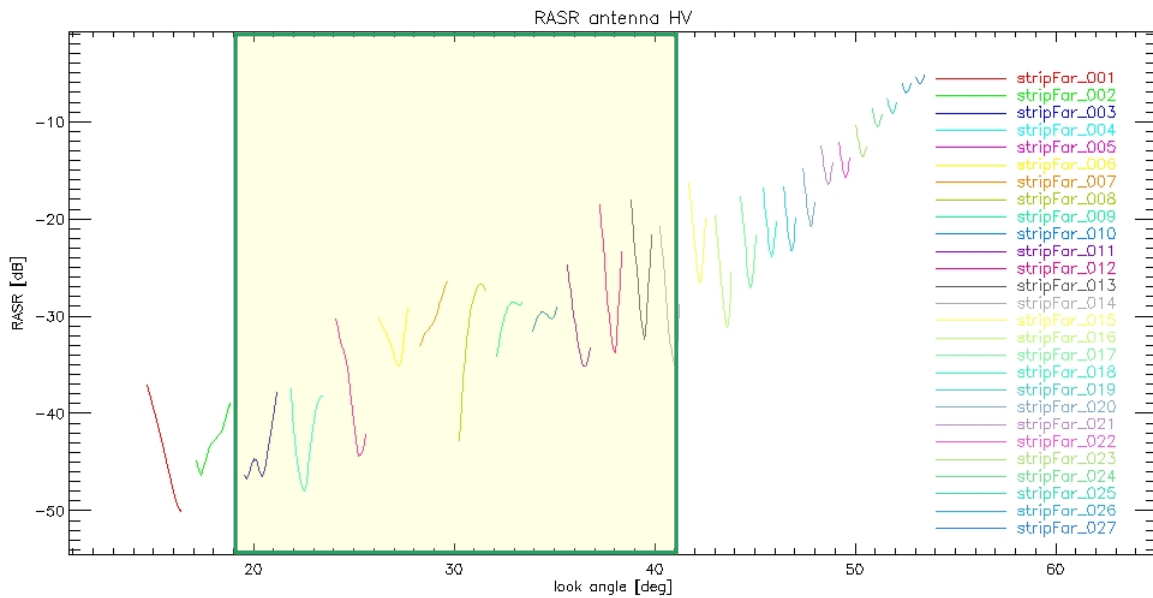
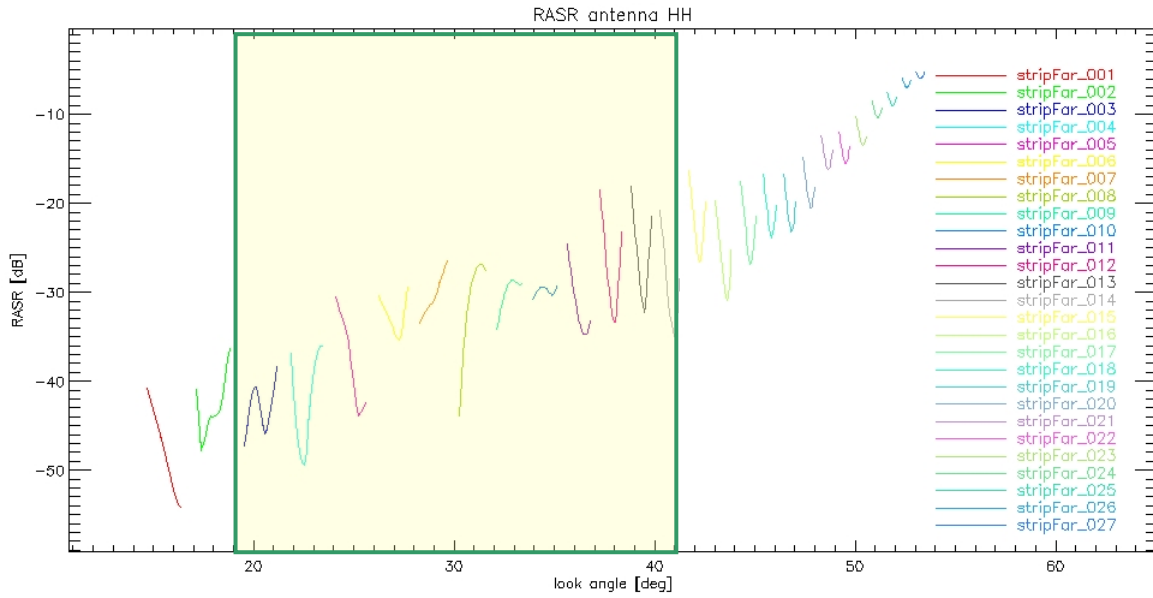

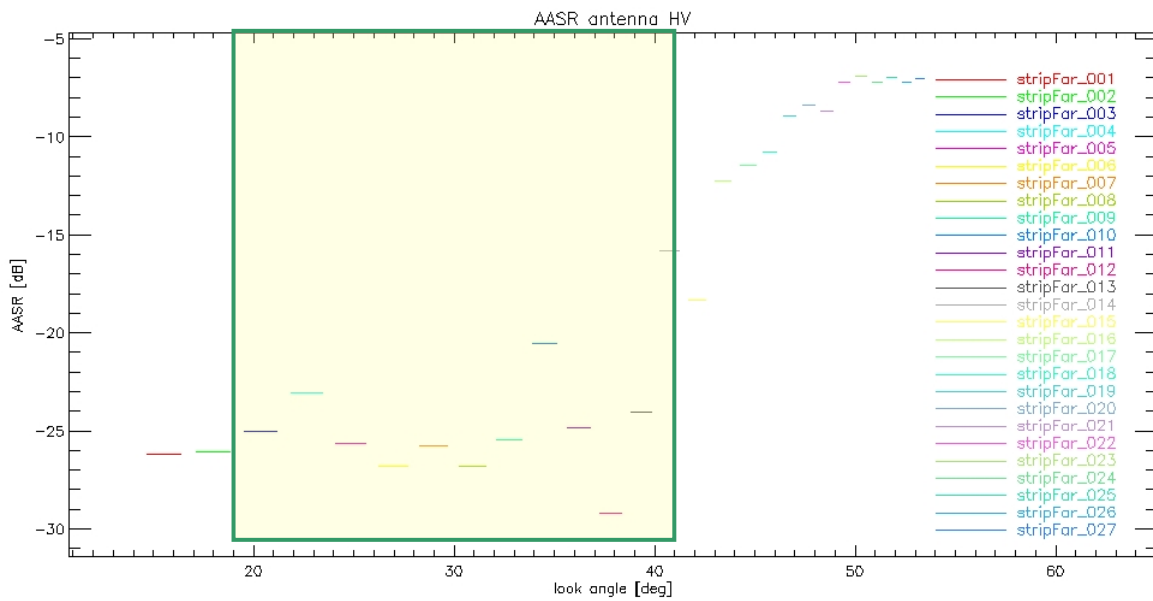
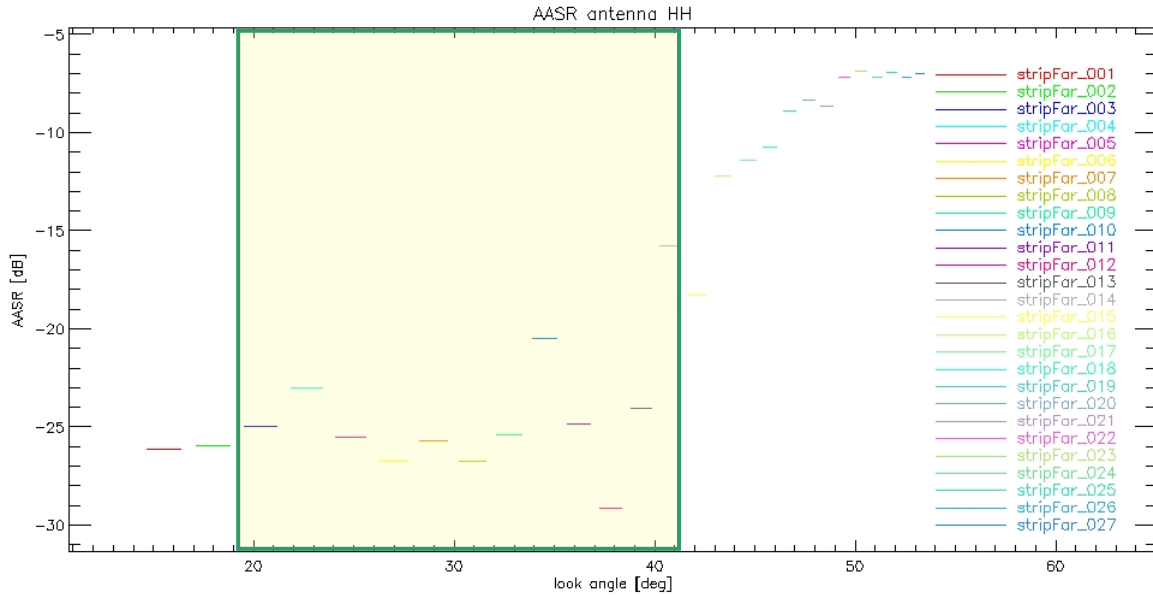

Spotlight single

Geometric Resolution

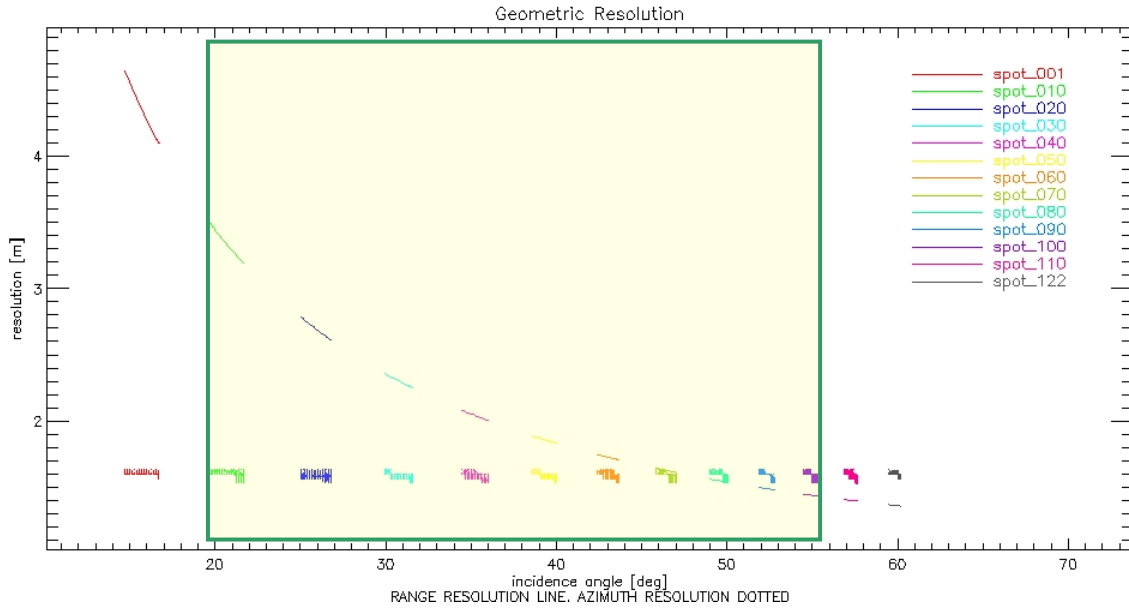

Radiometric Parameters

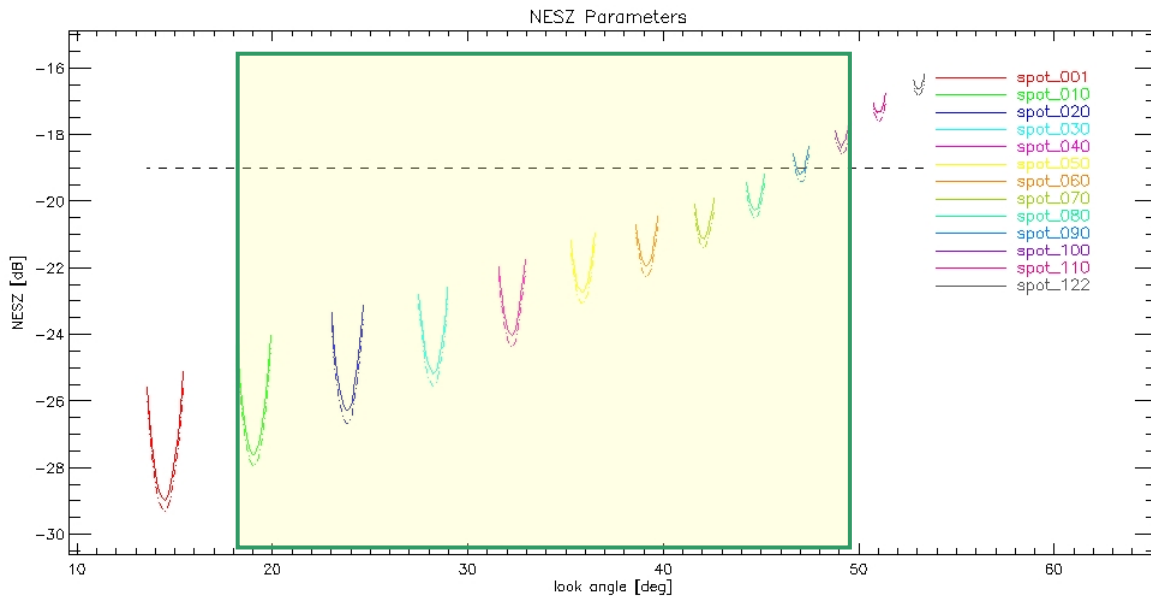

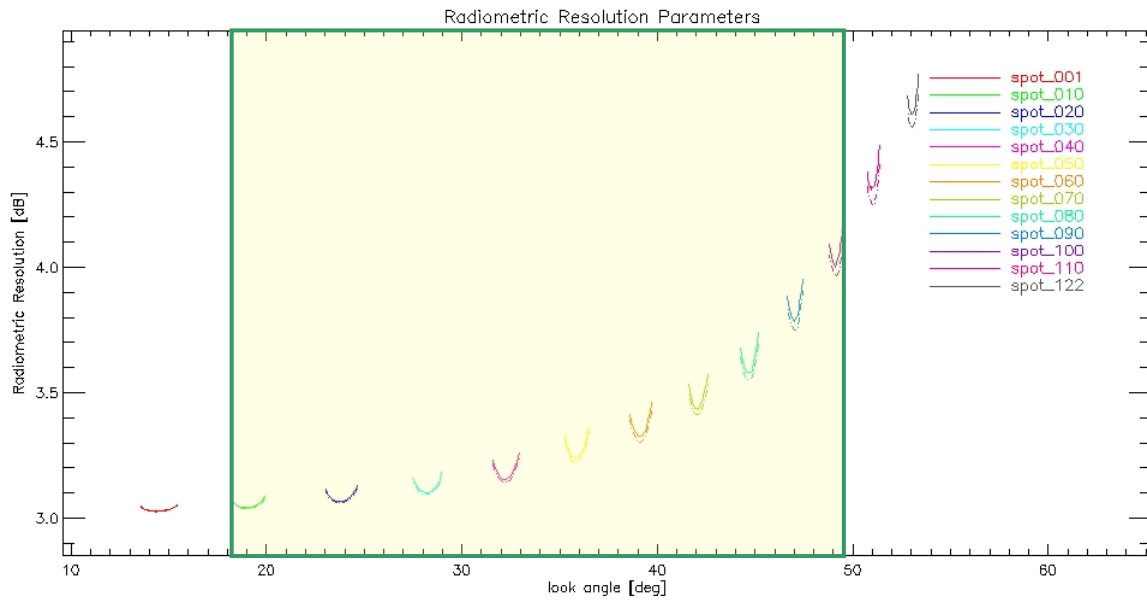

Ambiguity Ratio Parameters

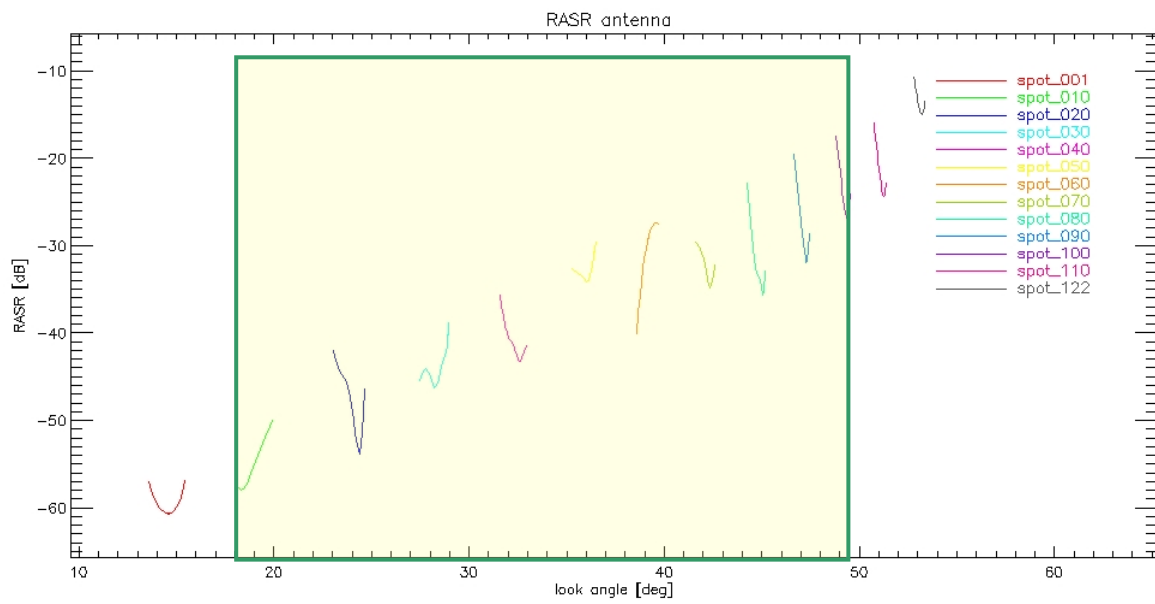

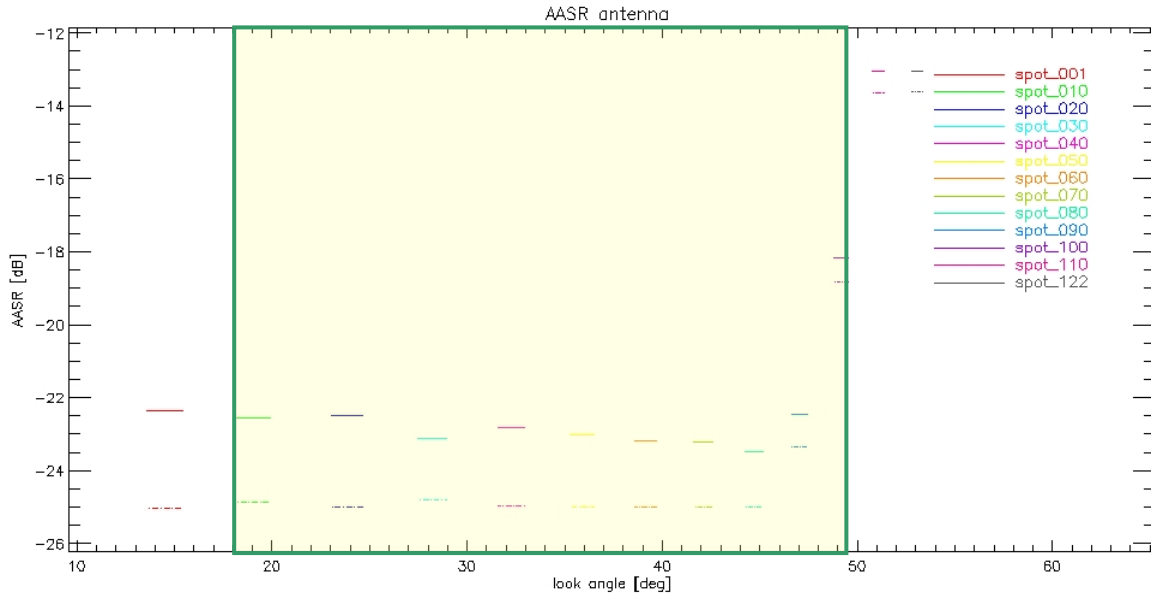

Spotlight dual HH/VV

Geometric Resolution

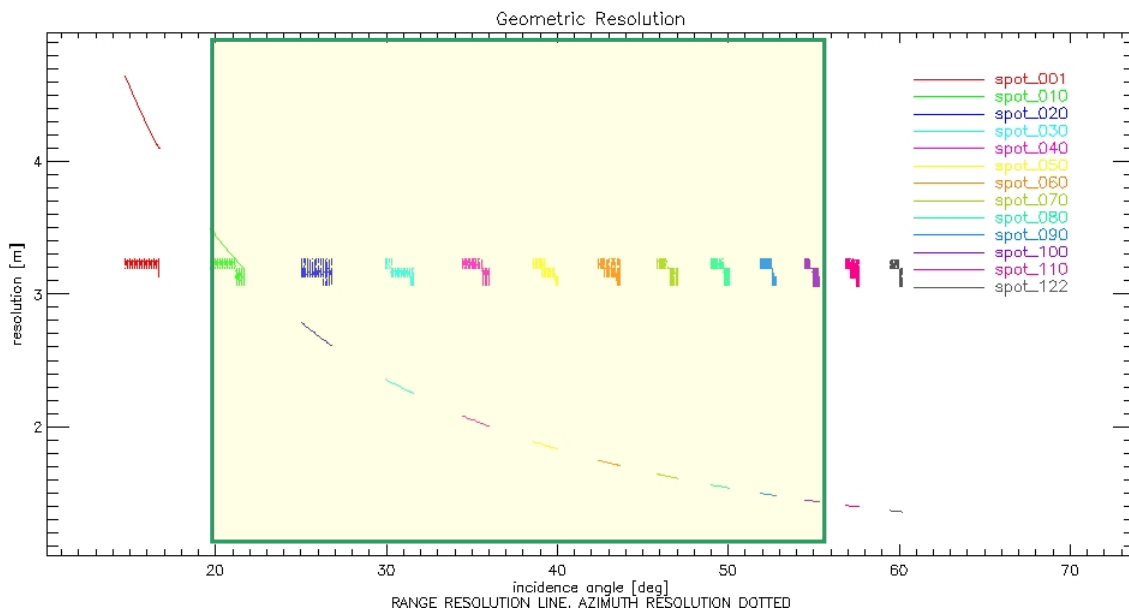

Radiometric Parameters

HH

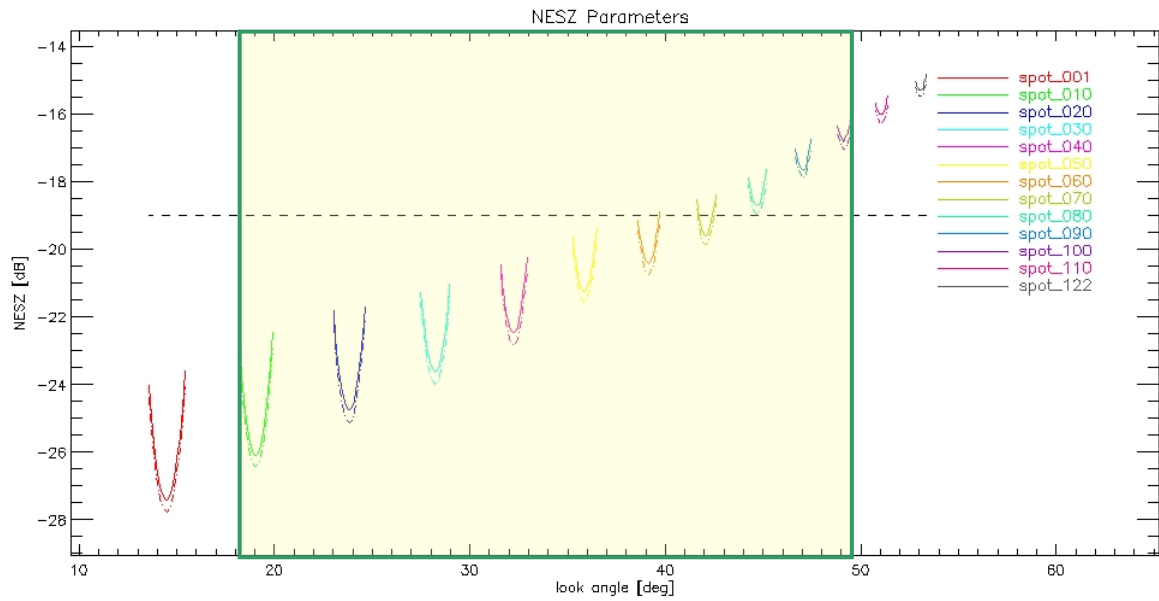

VV

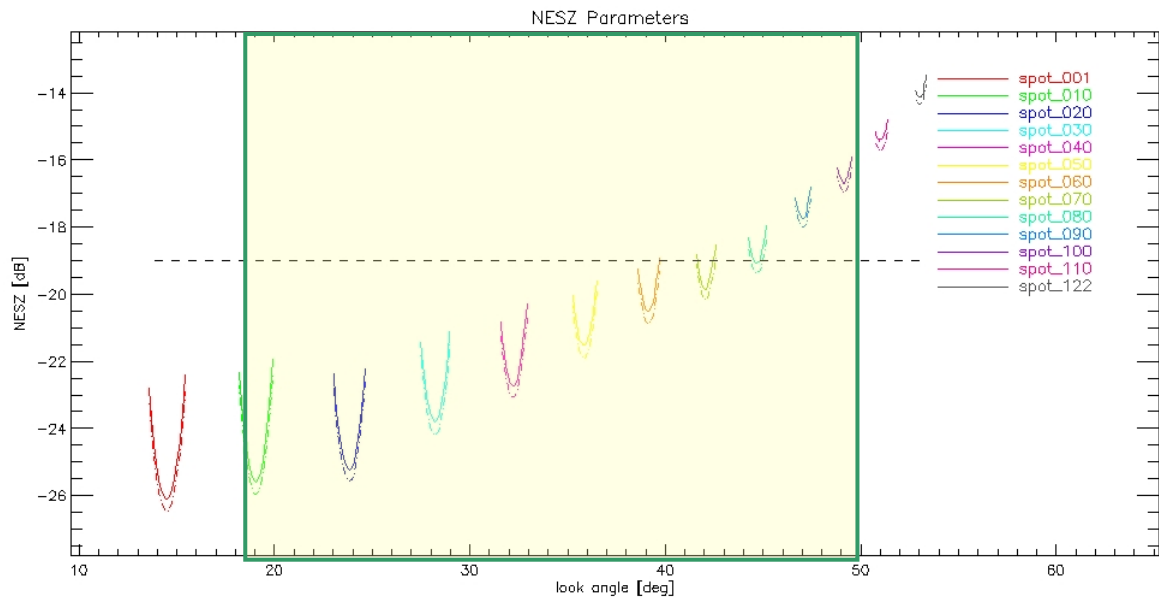

Ambiguity Ratio Parameters

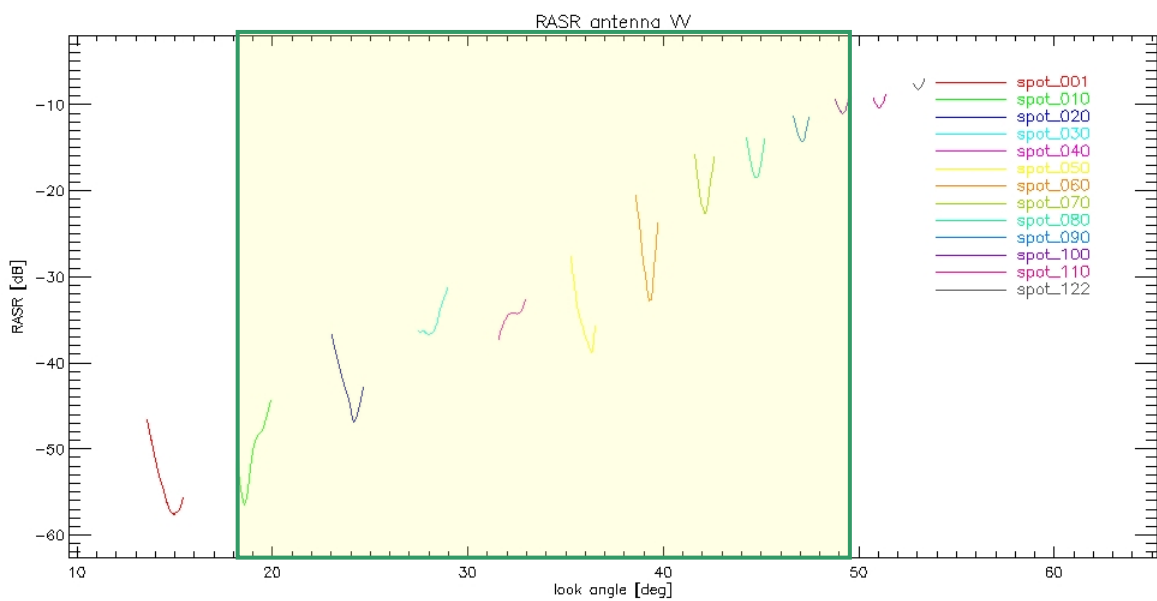
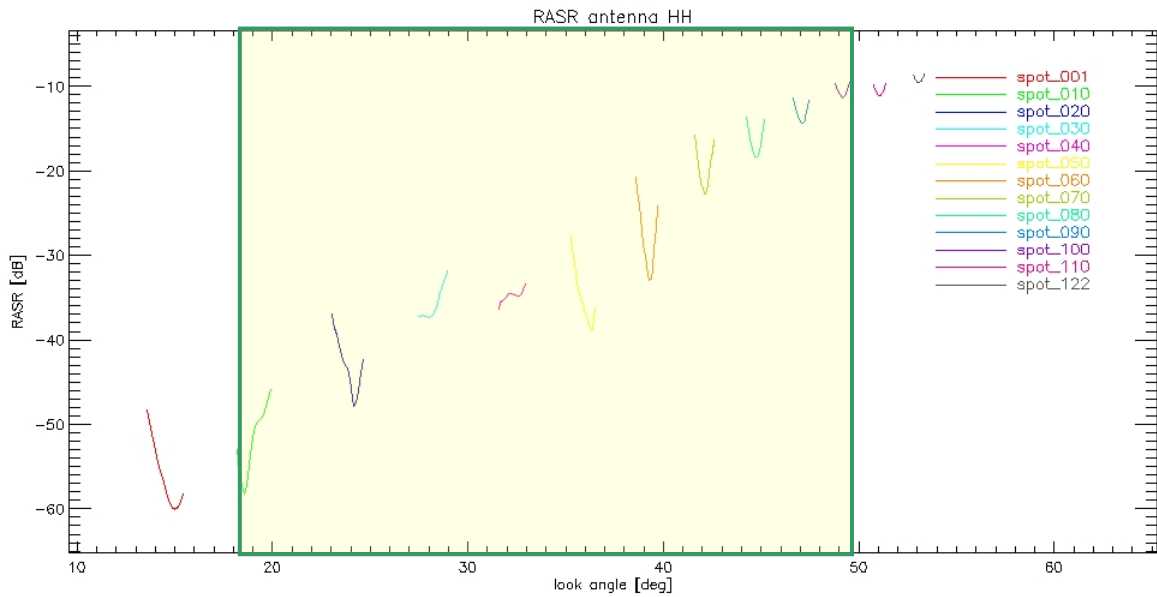

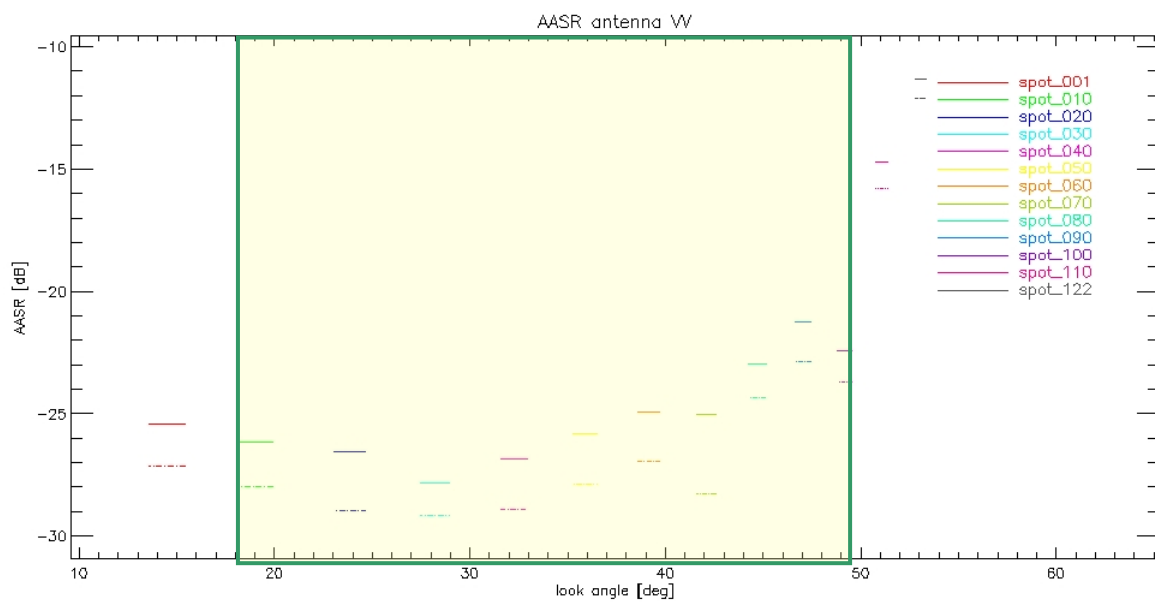
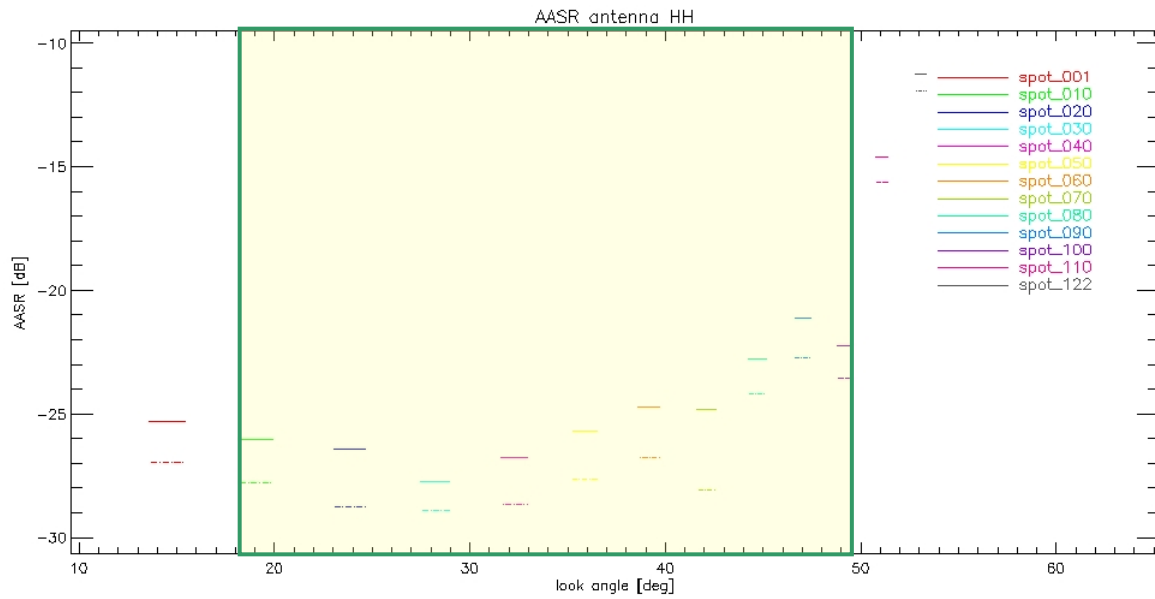

High-Resolution Spotlight single (HS 150MHz)

Geometric Resolution

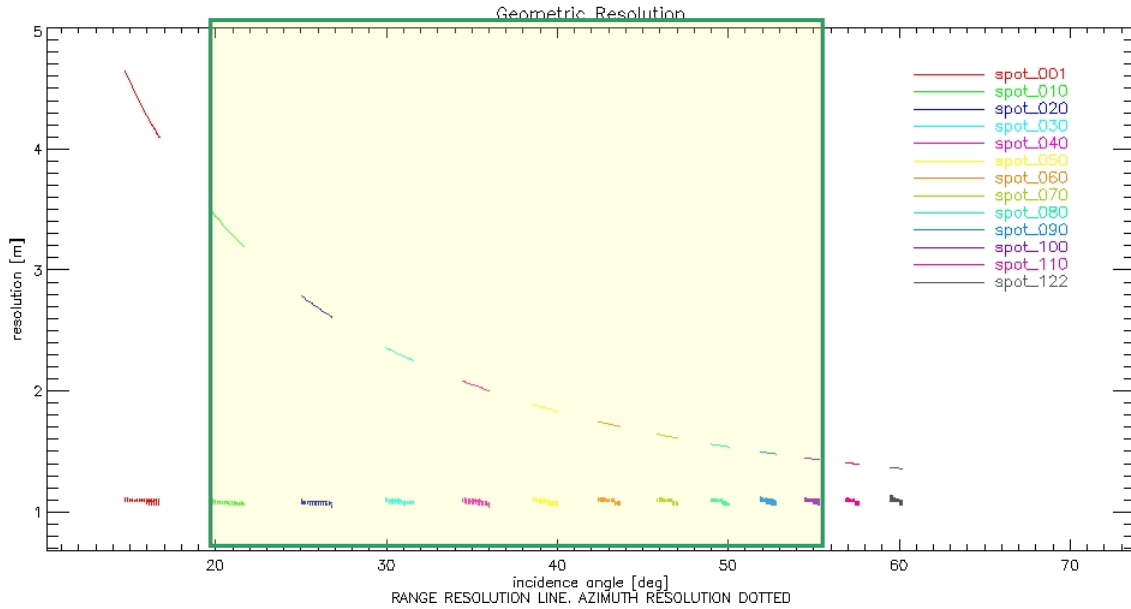

Radiometric Parameters

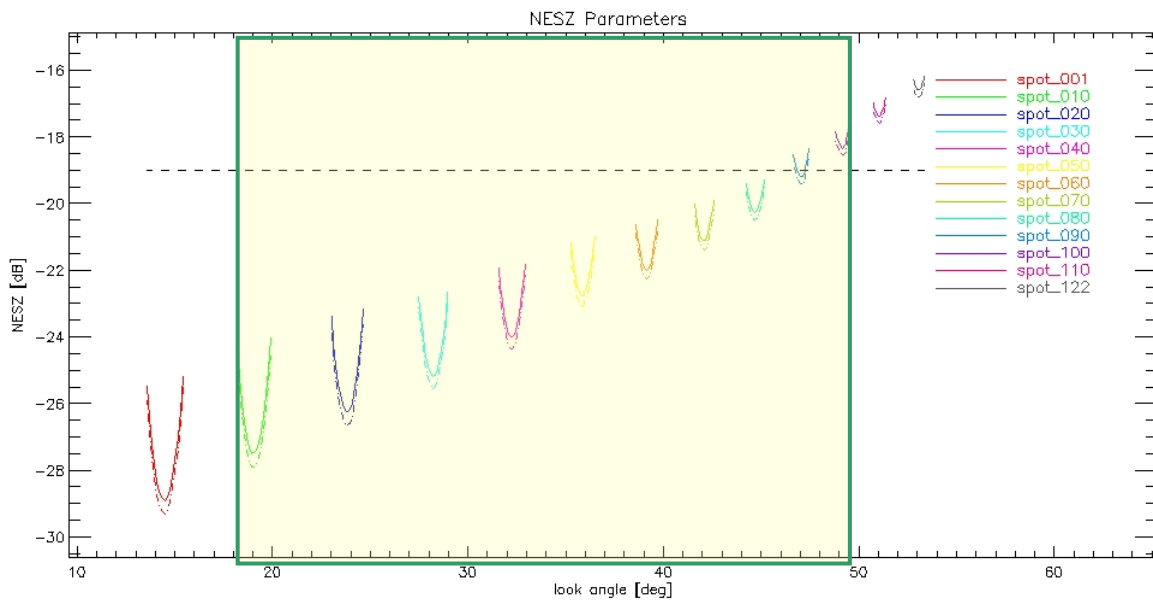

Ambiguity Ratio Parameters

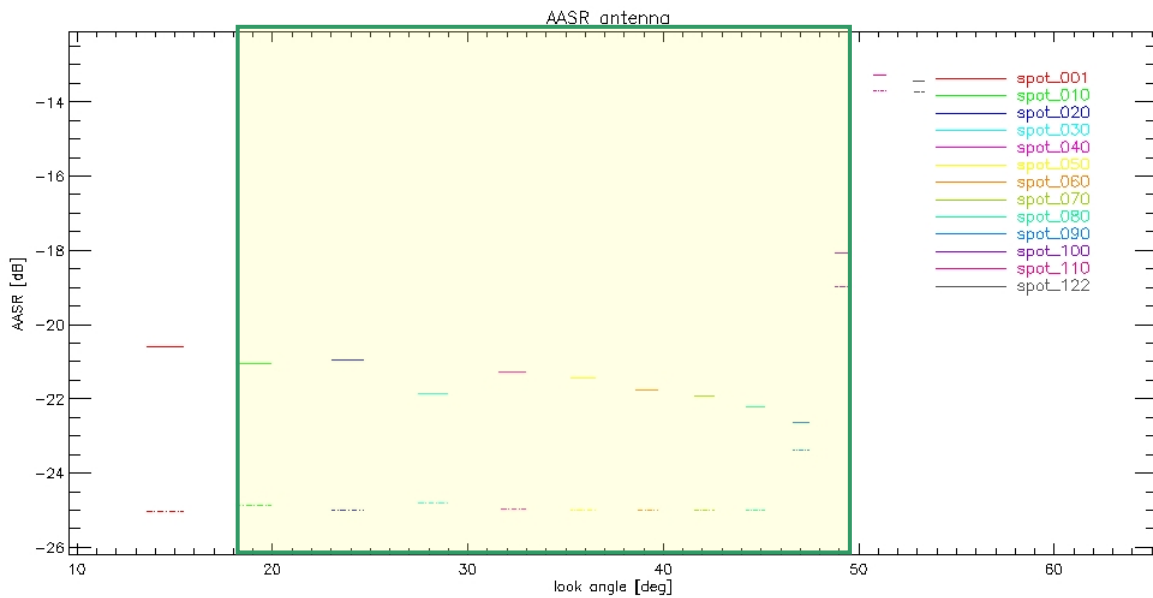
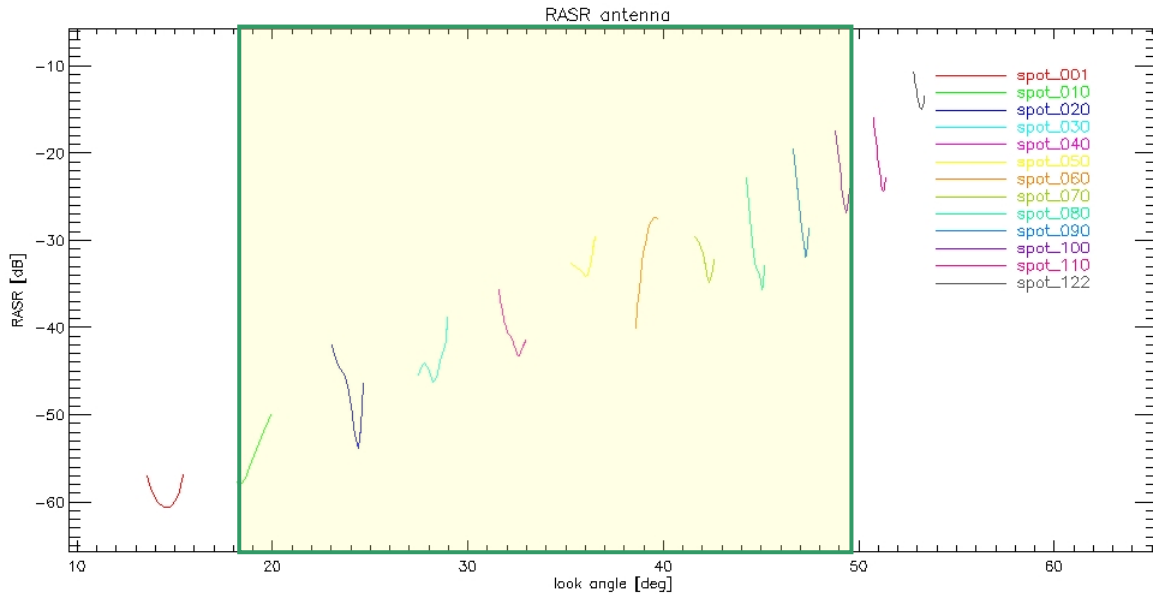

High-Resolution Spotlight 300MHz single (HS 300MHz)

Geometric Resolution

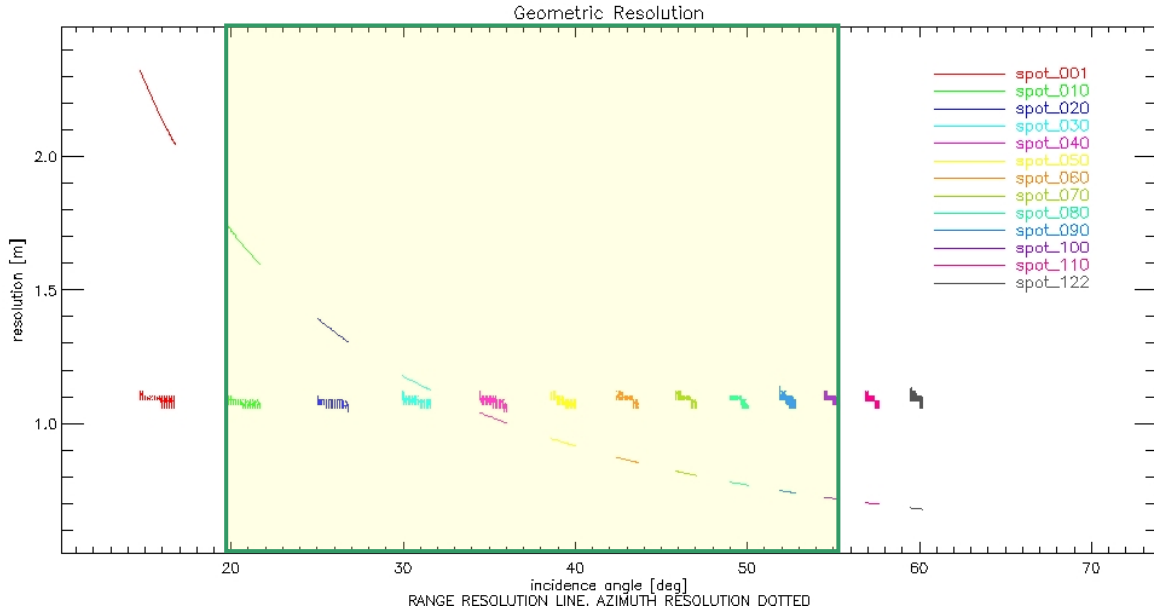

RADIOMETRIC PARAMETERS

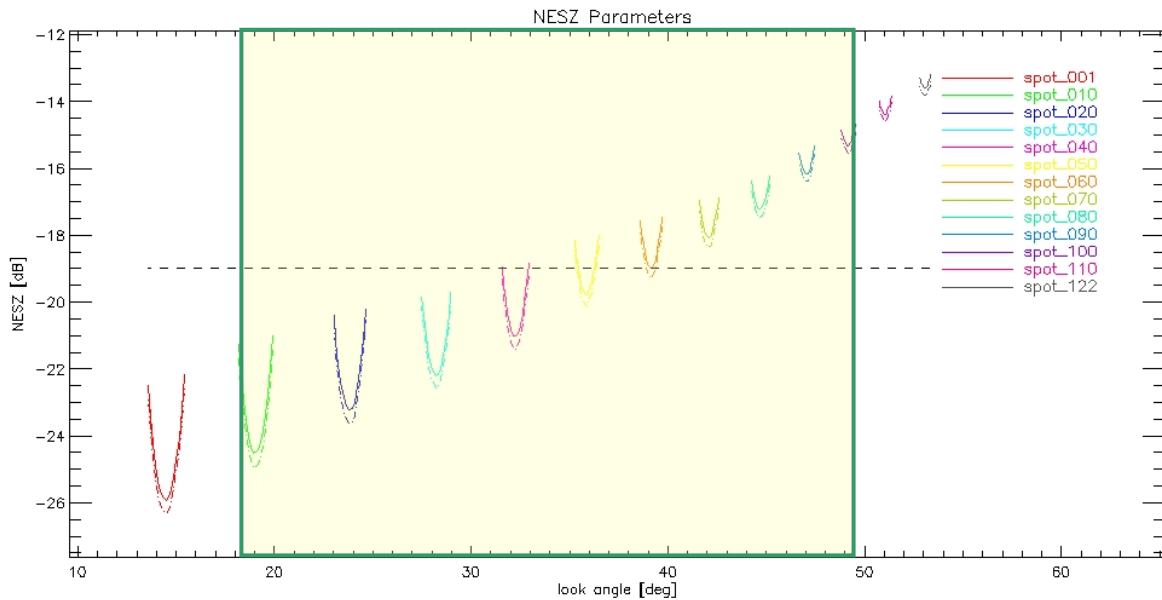

Ambiguities

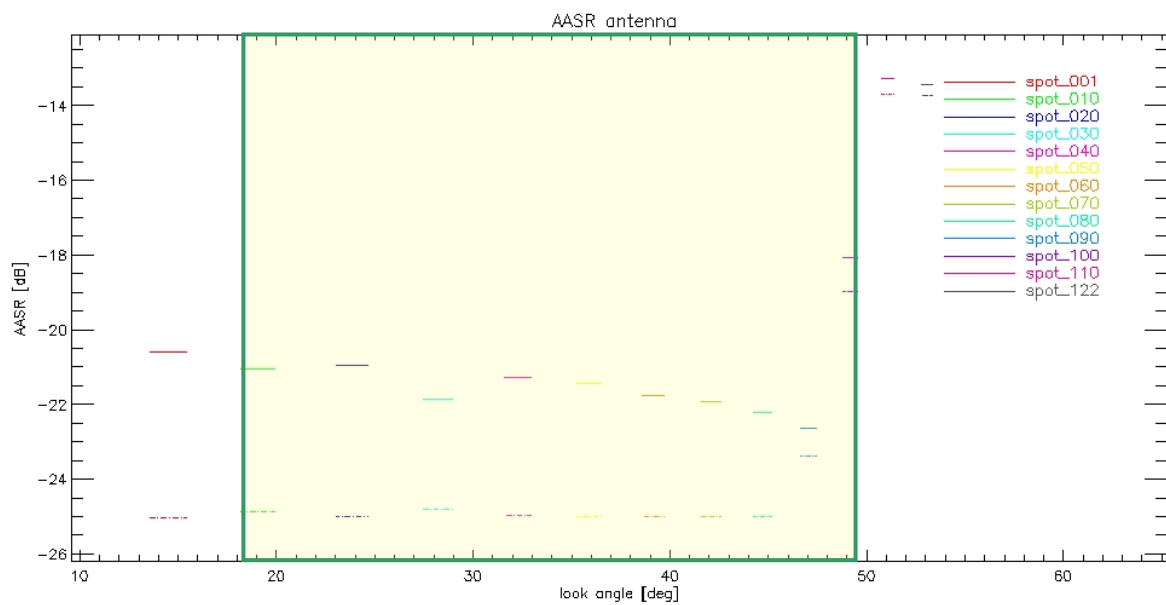
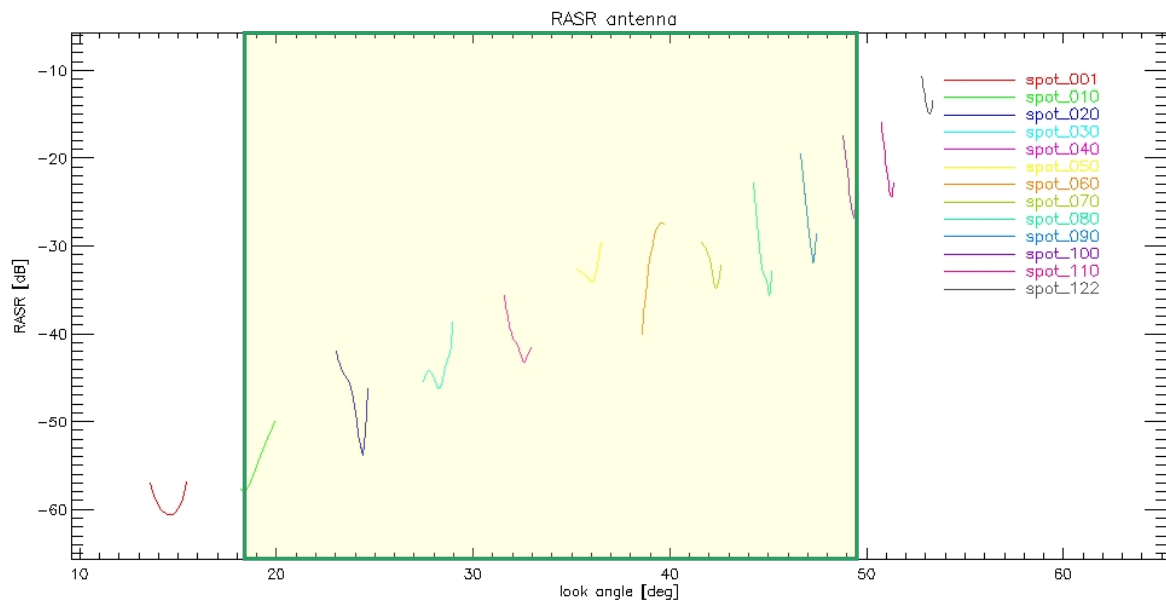

High-Resolution Spotlight dual

Geometric Resolution

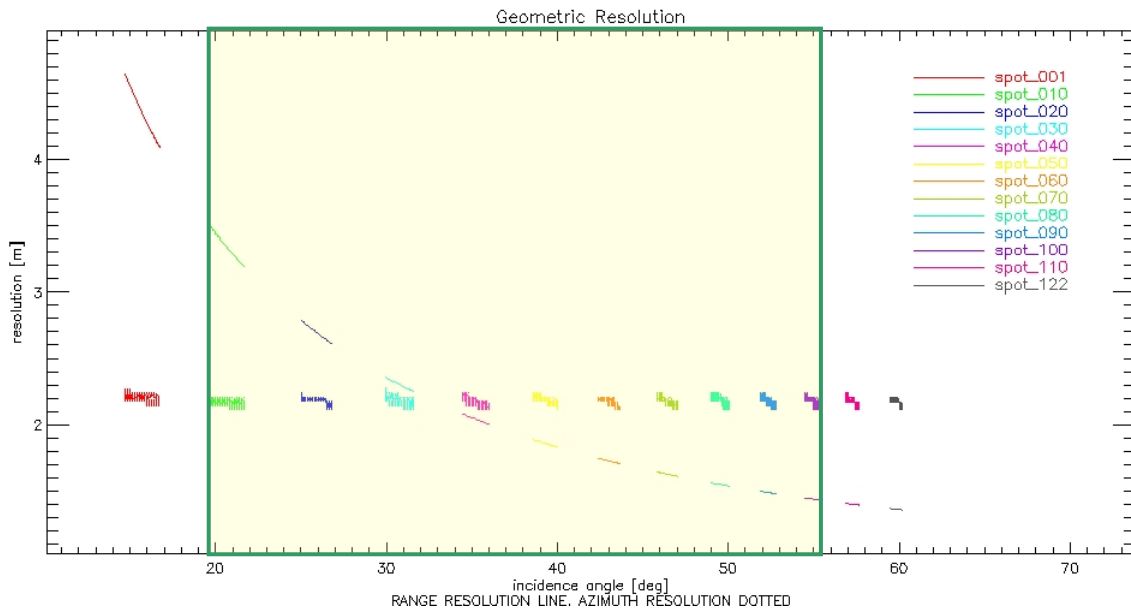

Radiometric Parameters

HH

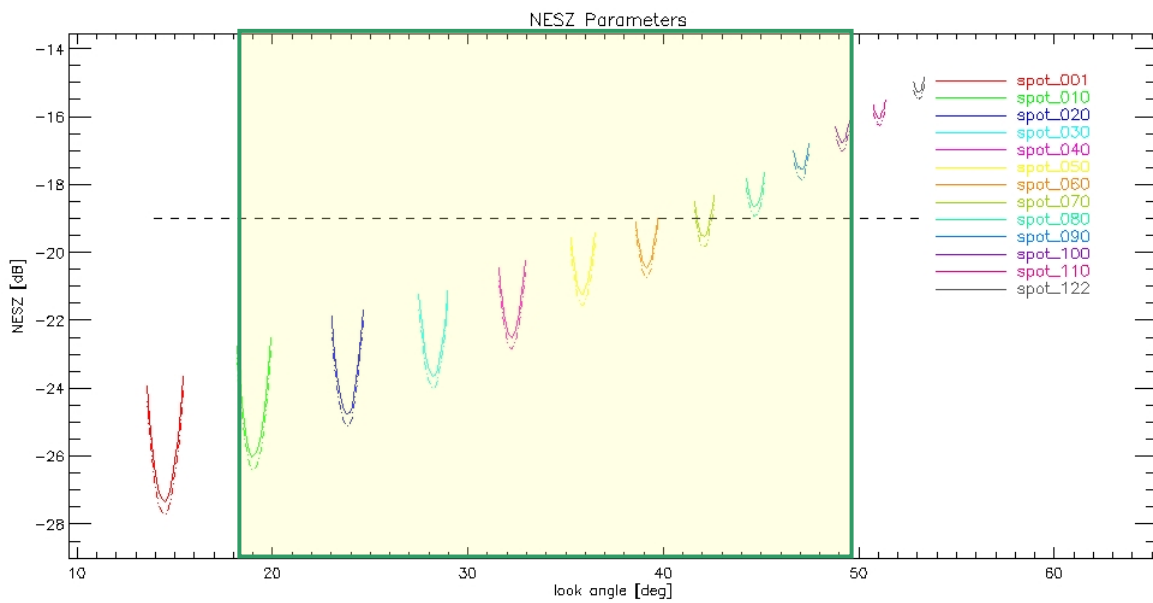

VV

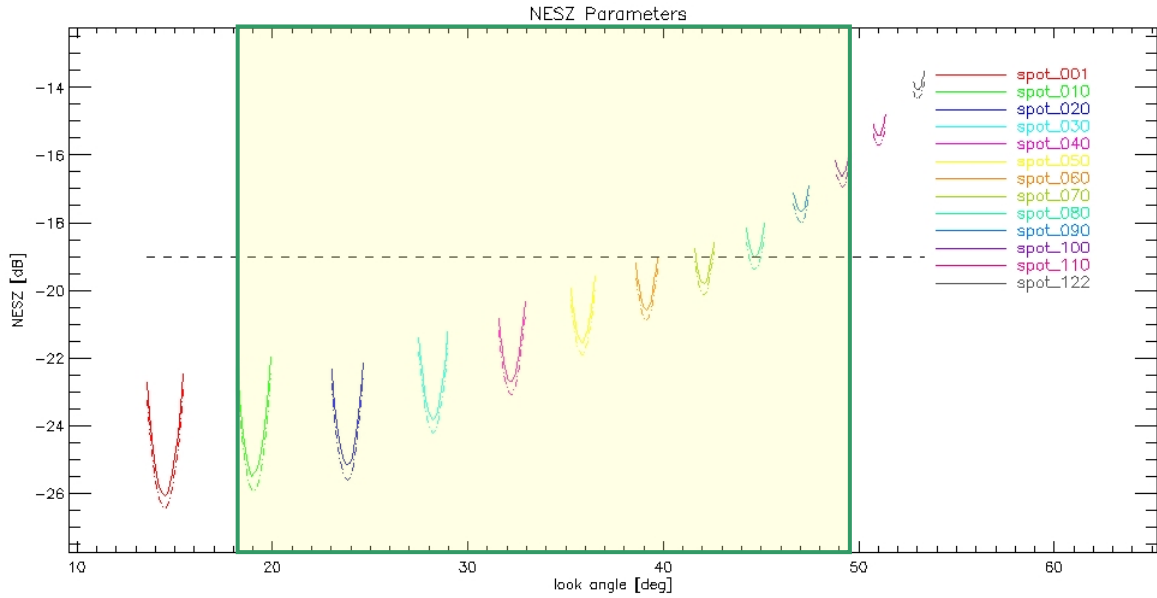

Ambiguity Ratio Parameters

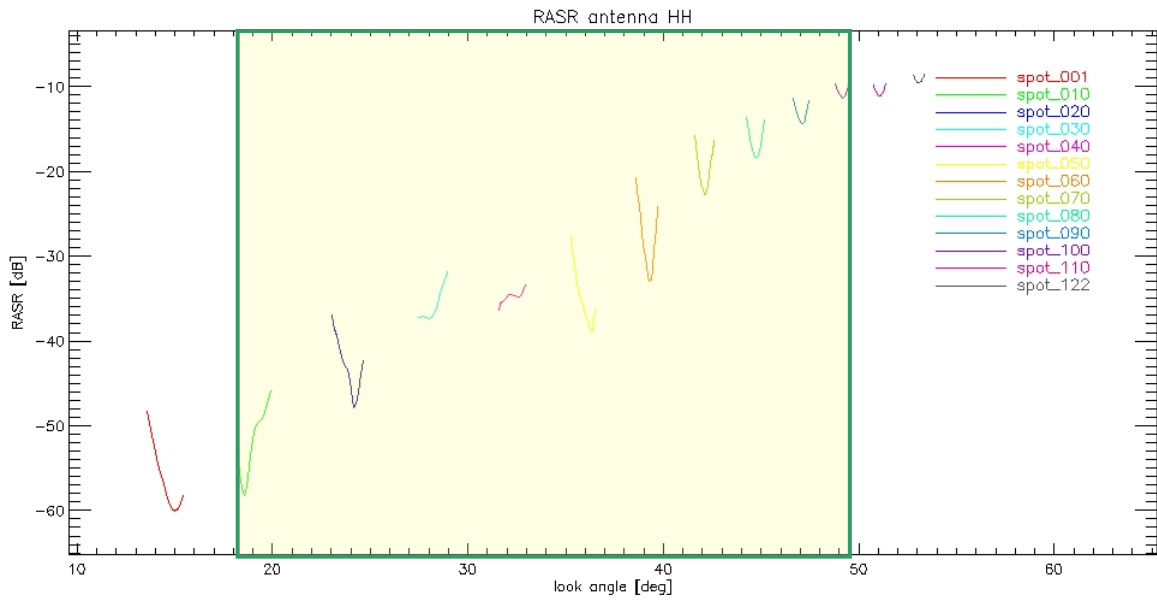

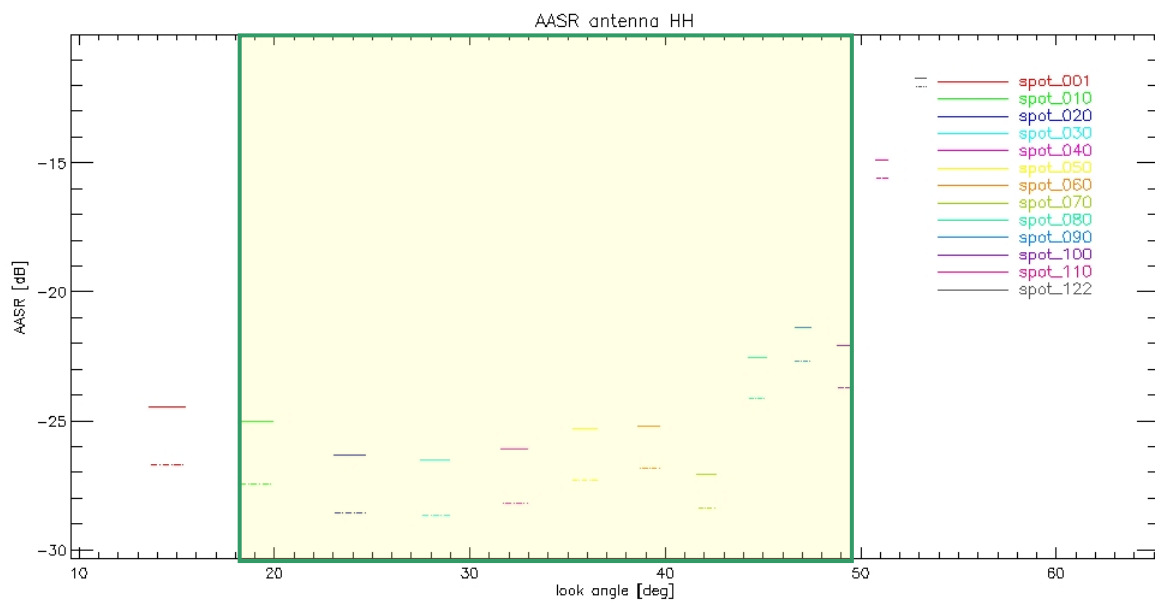
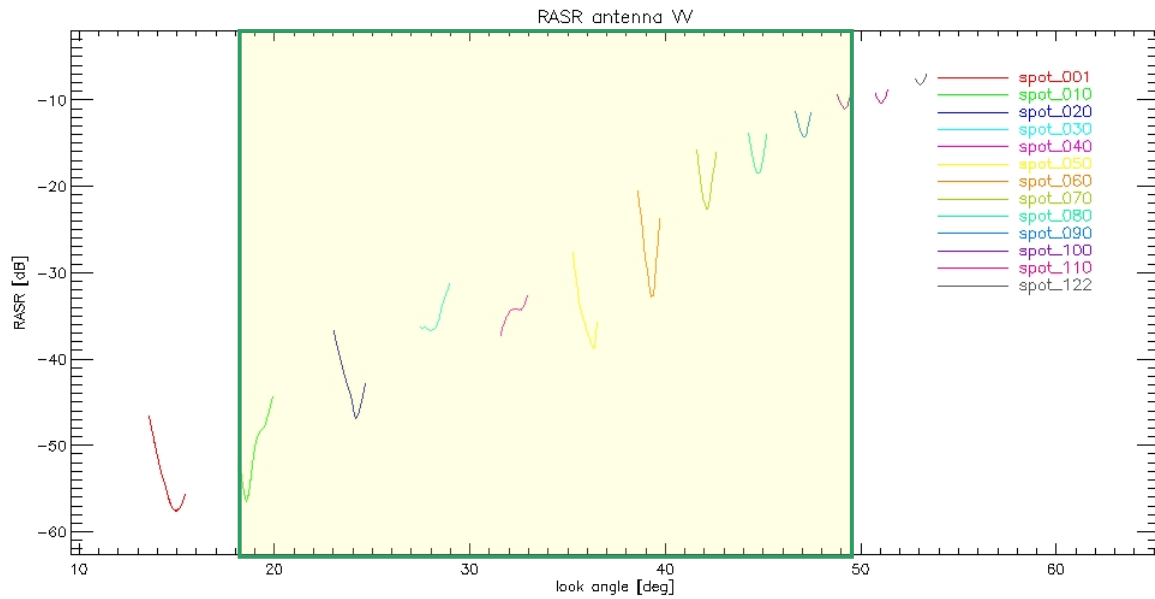

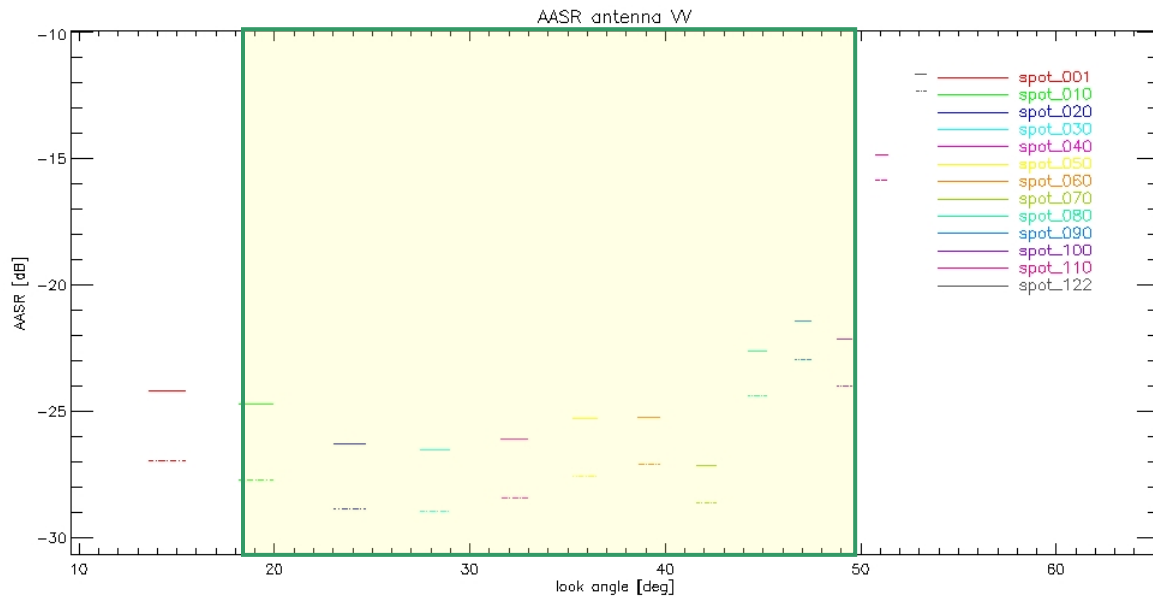

ScanSAR

Note, the completion of the full data collection angle range for ScanSAR can be found in the next section.

Geometric Resolution

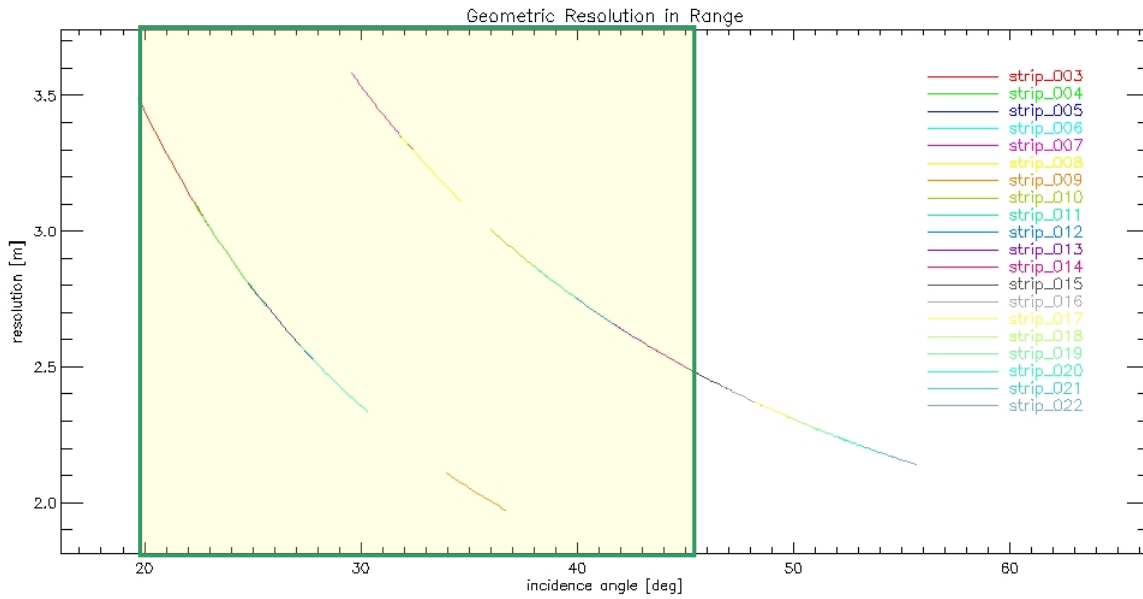

ScanSAR	Beam	Azimuth Resolution [m]
Scan_003-006	strip_003	17.83
	strip_004	17.80
	strip_005	17.81
	strip_006	17.75
Scan_007-010	strip_007	17.93
	strip_008	17.91
	strip_009	17.94
	strip_010	17.91
Scan_011-014	strip_011	18.01
	strip_012	17.98
	strip_013	17.93
	strip_014	17.94
Scan_015-018	strip_015	17.92
	strip_016	17.94
	strip_017	17.91
	strip_018	17.95
Scan_019-022	strip_019	17.81
	strip_020	17.78
	strip_021	17.82
	strip_022	17.79

Radiometric Parameters

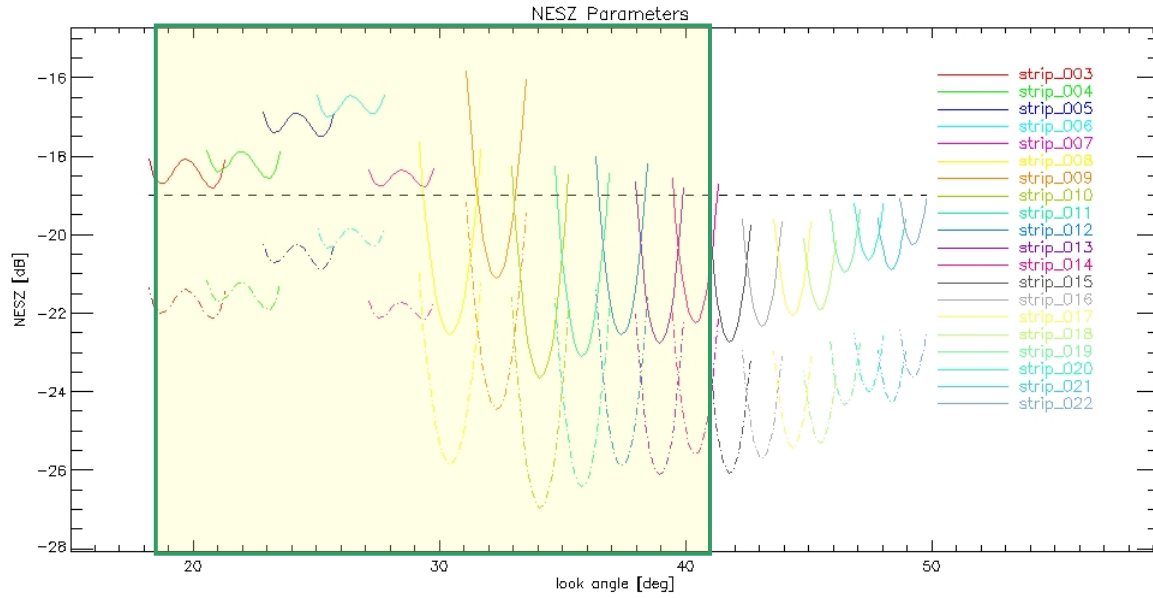

Ambiguity Ratio Parameters

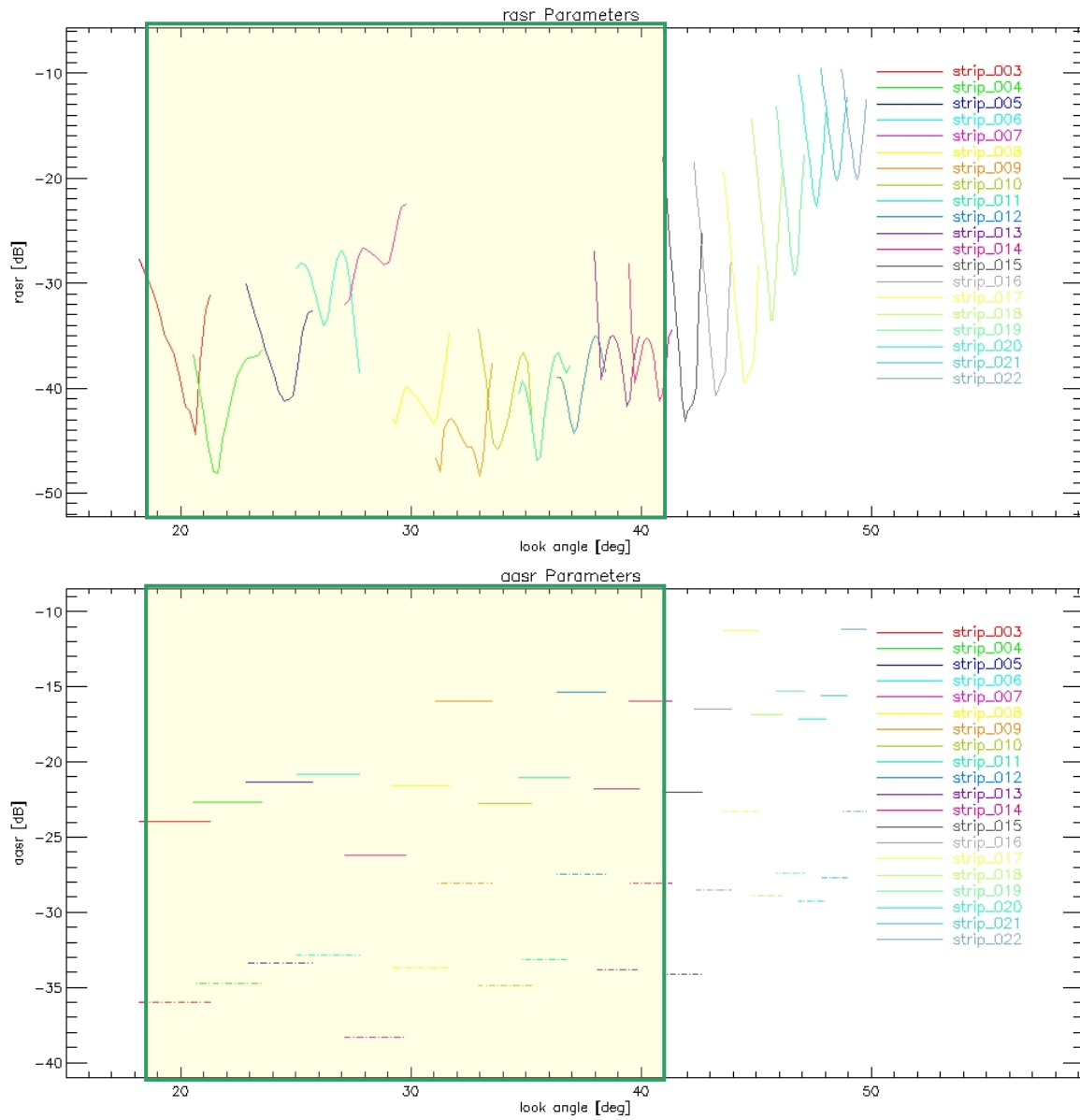

ScanSAR (Completion of Data Collection Angle Range)

Geometric Resolution

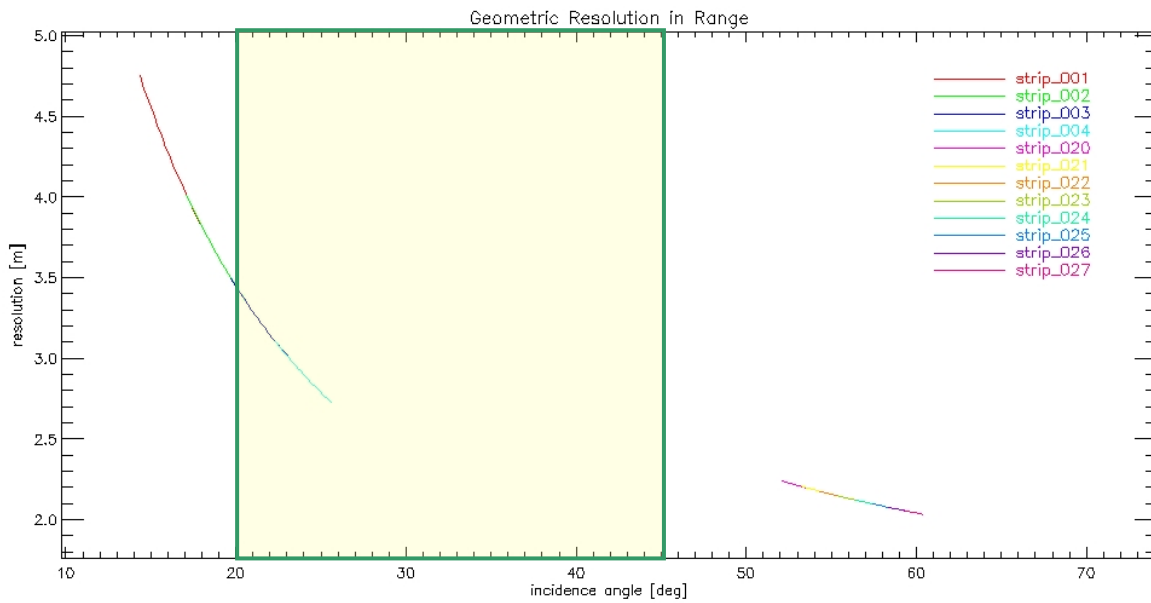

ScanSAR	Beam	Azimuth Resolution [m]
Scan_001-004	strip_001	17.74
	strip_002	17.67
	strip_003	17.70
	strip_004	17.69
Scan_020-023	strip_020	17.78
	strip_021	17.78
	strip_022	17.79
	strip_023	17.79
Scan_024-027	strip_024	17.74
	strip_025	17.73
	strip_026	17.74
	strip_027	17.70

Radiometric Parameters

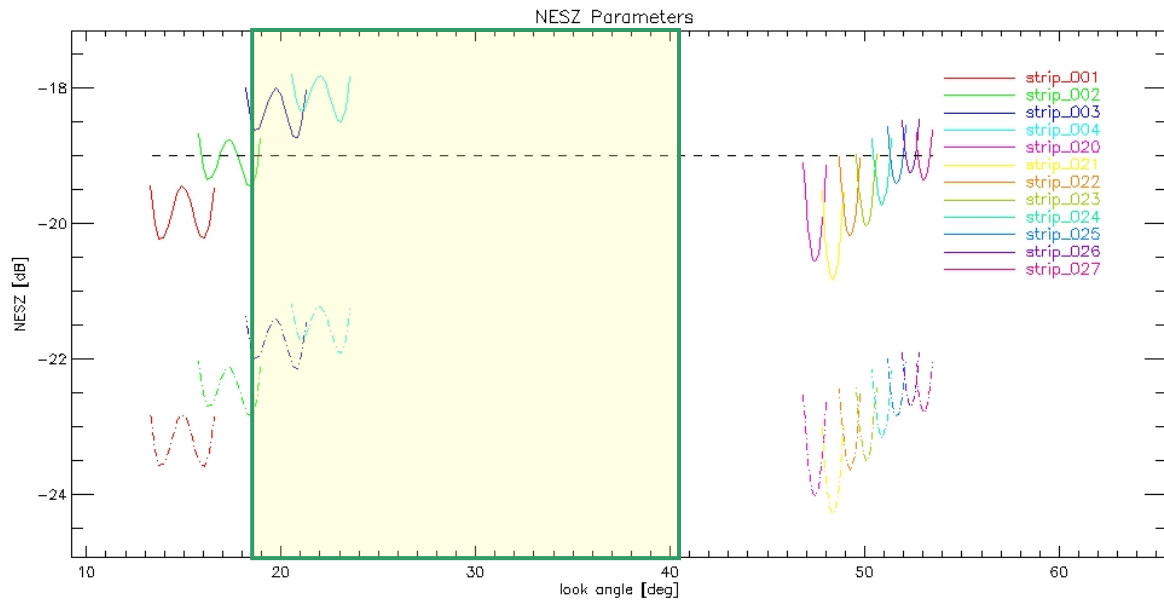

Ambiguity Ratio Parameters

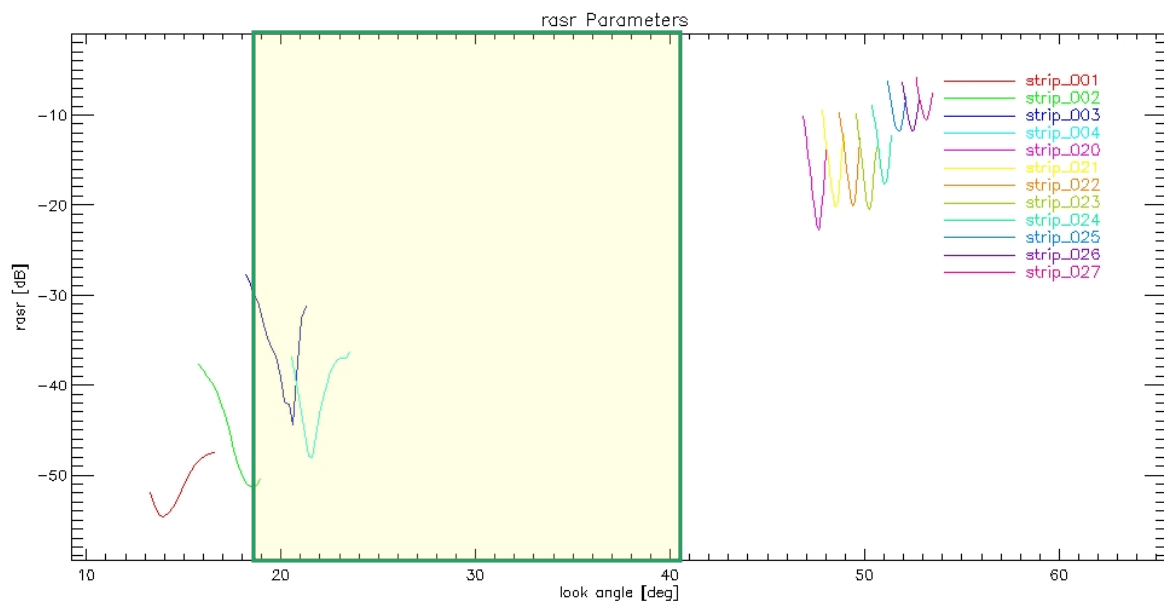

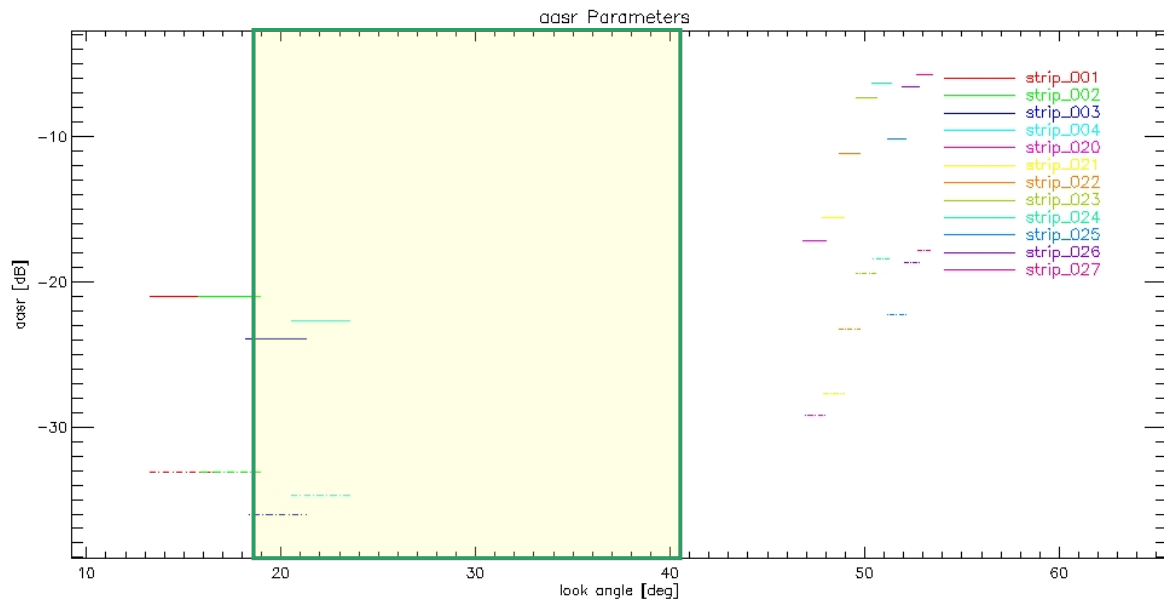

ANNEX D) Six Beam ScanSAR and Staring Spotlight Performance

This Annex contains the product characteristics and performance estimates for the newly implemented six beam ScanSAR and staring spotlight modes based on [RD 11]. **Note however that the values given here do not directly translate into the specified product characteristics since the latter take also into account the accuracy of auxiliary data (e.g. orbit products) and processing approximations.**

ScanSAR (6 Beams)

Wide Beam Definition

Characteristic Parameters of the wide elevation beams designed for and used by wide SC configurations.

Elevation Beam Identification	Performance Range	Minimum Incidence Angle [°]	Maximum Incidence Angle [°]	Minimum Look Angle [°]	Maximum Look Angle [°]	Ground Swath Width [km]	Ground Swath Overlap to next Swath [km]
wideBeam_001	full	15.575	22.789	14.330	20.920	67.688	1.752
wideBeam_002	full	22.625	27.089	20.770	24.820	44.467	1.411
wideBeam_003	full	26.956	31.552	24.700	28.840	49.317	1.404
wideBeam_004	full	31.429	34.966	28.730	31.890	40.587	1.240
wideBeam_005	full	34.865	38.320	31.800	34.860	42.798	0.896
wideBeam_006	full	38.206	40.791	34.760	37.030	32.757	1.276
wideBeam_007	full	40.620	43.204	36.880	39.130	34.984	1.199
wideBeam_008	full	43.054	45.140	39.000	40.800	29.540	1.183
wideBeam_009	full	45.001	47.117	40.680	42.490	32.048	1.171
wideBeam_010	full	46.988	48.960	42.380	44.050	31.396	0.000

Geometric Resolution

The azimuth resolution within each sub-swath of a ScanSAR images is depending on the burst length used per sub-swath. In order to achieve homogeneous azimuth resolution over the whole ScanSAR image the burst length is adapted. Additionally the range chirp bandwidth is adapted per sub-swath. The Figure below shows the azimuth resolution in red and the ground range resolution in blue for the ten beams used by 6 beam SC. The azimuth resolution is better than 40 m and the single look ground range resolution is better than 7 m.

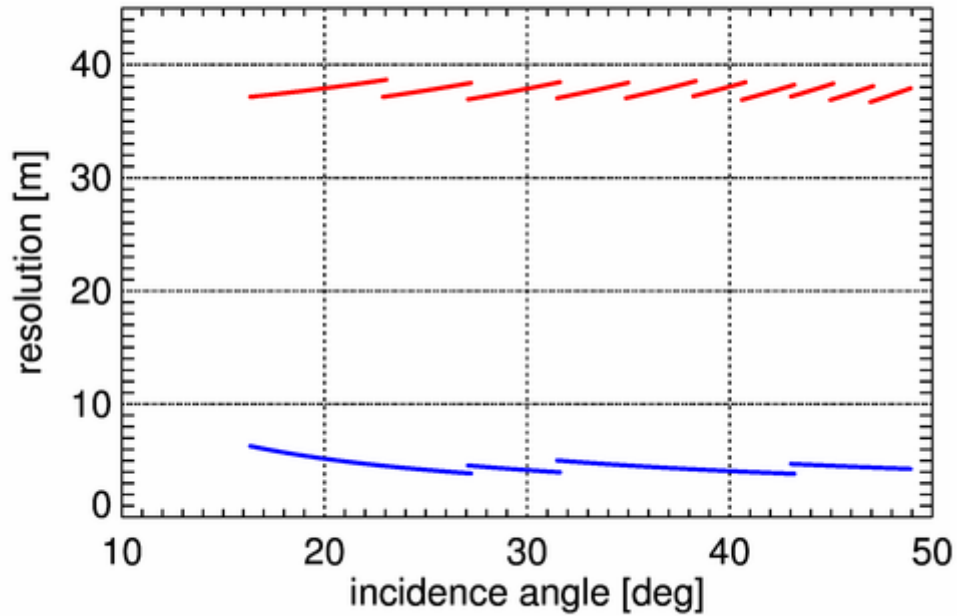

Azimuth resolution (red) and ground range resolution (blue) for wide SC. The ten different beams are clearly visible especially for the azimuth resolution since different burst lengths are used per beam. The ground range resolution is determined by five different range chirp bandwidths.

Range Scene Extent

The nominal range swath width is depicted as the width in kilometers over the supported incidence angle range. The SC swathes are denoted wide_XXX whereas the beams, forming the sub-swathes are denoted wideBeam_XXX (see the Table).

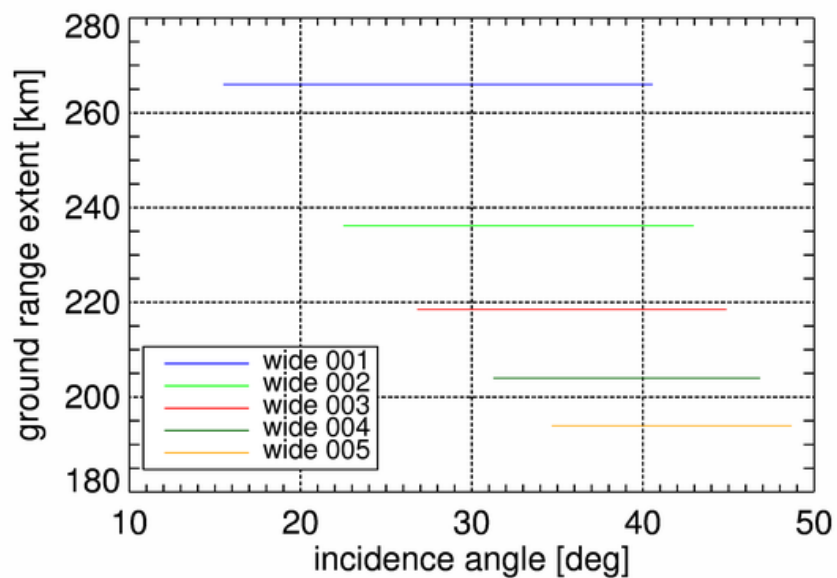

Nominal range swath width of the six beam SC depicted over incidence angle.

Nominal swath widths for the six beam SC:

SC swath name	Nominal Swath Width [km]	Involved Elevation Beams
wide_001	266.0	wideBeam_[1...6]
wide_002	236.1	wideBeam_[2...7]
wide_003	218.5	wideBeam_[3...8]
wide_004	204.0	wideBeam_[4...9]
wide_005	194.0	wideBeam_[5...10]

Global Performance Prediction

Ambiguities

In order to predict the performance of six beam ScanSAR acquisitions a AASR and RASR simulation had been conducted for all possible beam and PRF combinations. The predicted performance of the simulated acquisitions reflects the actually selected PRF, driven by the acquisition geometry (orbit height and topography) and therefore should be very close to a real acquisition.

The Figures show the distributions of the best and the worst AASR values within all scenes, respectively. The simulation results are depicted as the contour lines of a two dimensional histogram, highlighting the dominant regions of the AASR distribution. The best values within a scene are below -24 dB AASR and even the worst values in the scenes are better than -17 dB. The RASR for all elevation beams is shown with the best and worst range target within each simulated scene respectively. A RASR value of better than -19 dB can be achieved for all possible simulation scenarios, even for the worst range target.

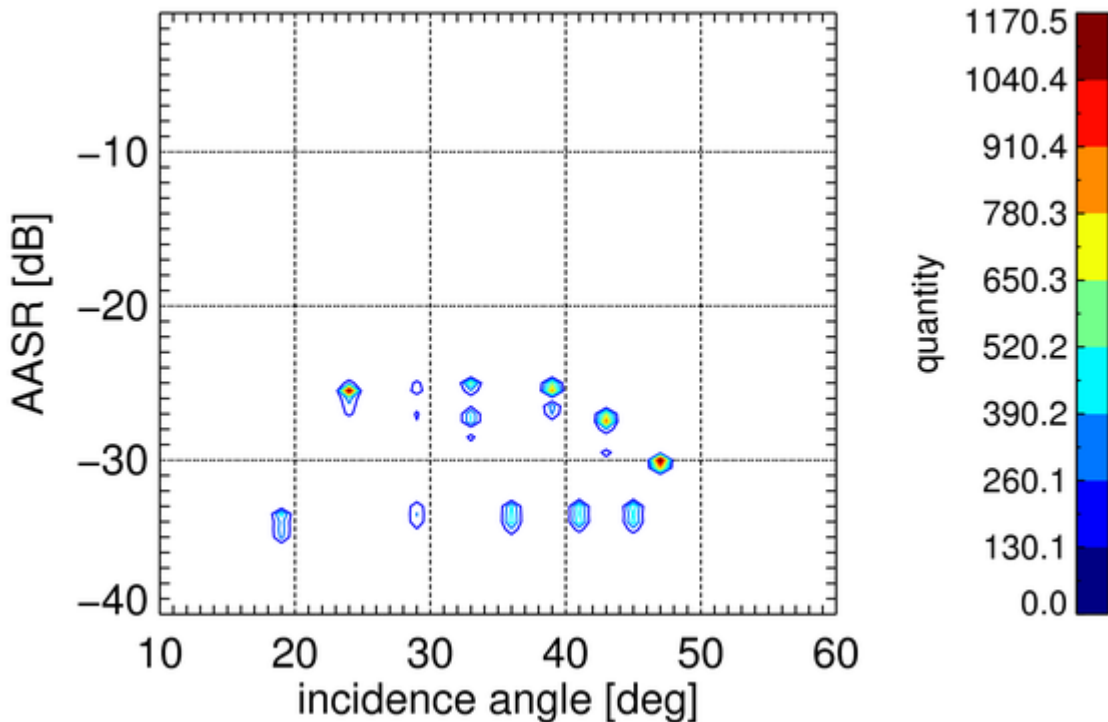

Figure 1 Simulated AASR for the statistical acquisitions. The AASR values of the best point target within each scene are depicted as the contour lines of the two dimensional histogram over incidence angle. The ten elevation beams are clearly distinguishable.

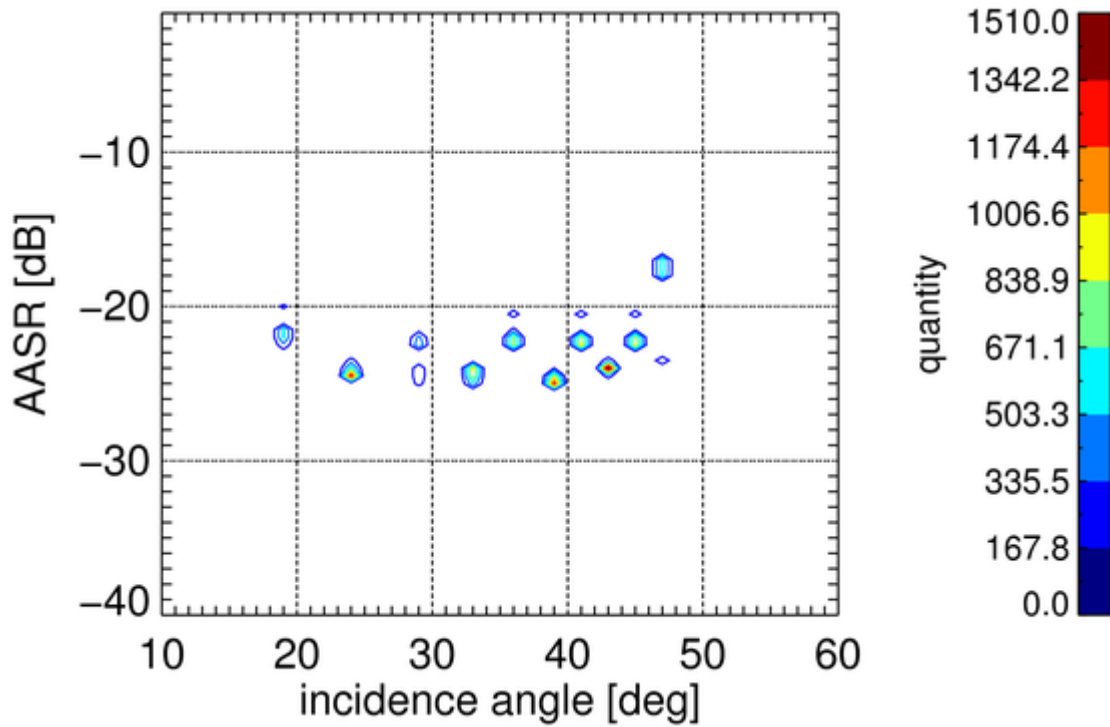

Figure 2 Simulated AASR for the statistical acquisitions. The AASR values of the worst point target within each scene are depicted as the contour lines of the two dimensional histogram over incidence angle.

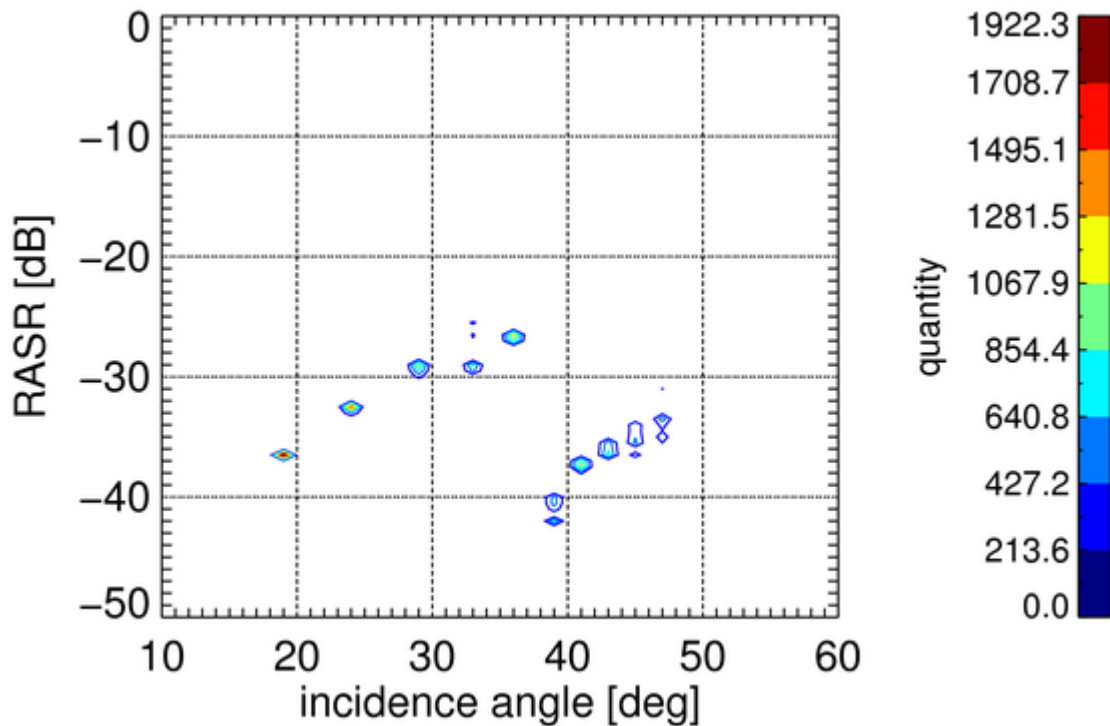

Figure 3 Simulated RASR for the statistical acquisitions. The RASR values of the best point target within each scene are depicted as the contour lines of the two dimensional histogram over incidence angle.

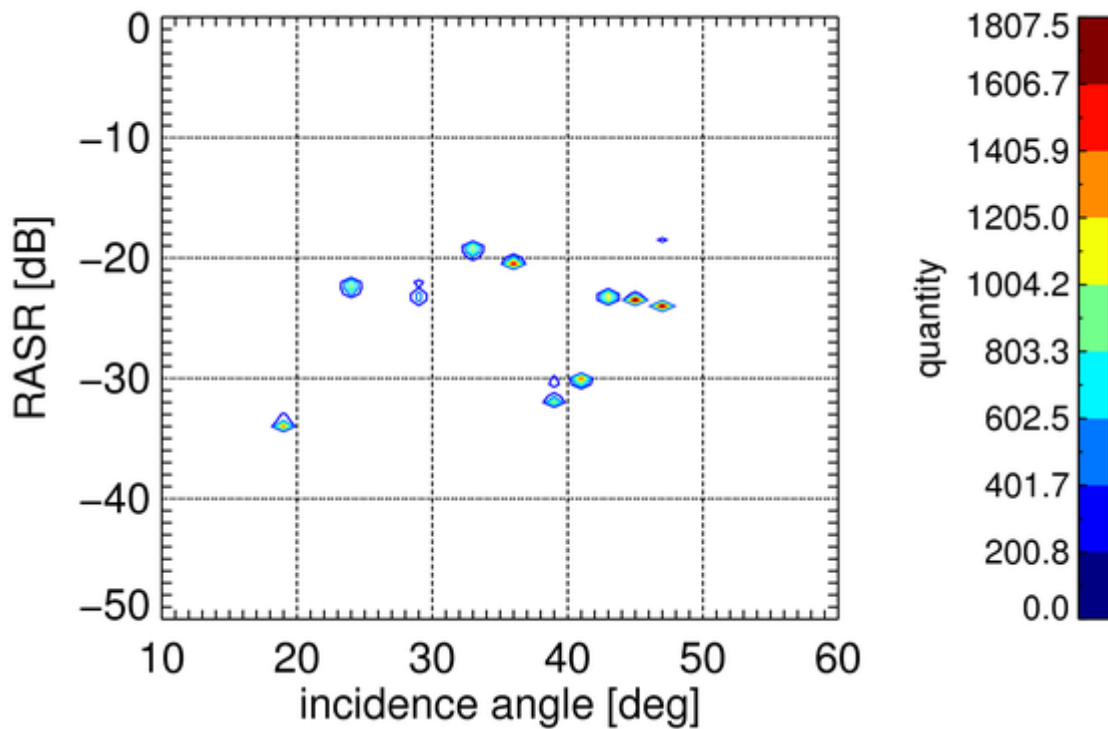

Figure 4 Simulated RASR for the statistical acquisitions. The RASR values of the worst point target within each scene are depicted as the contour lines of the two dimensional histogram over incidence angle.

NESZ

In order to optimize the coverage per beam, special beams have been designed for six beam SC. Besides this the patterns have been shaped in order to achieve a homogeneous gain over the intended coverage region. For 6 beam SC the range chirp bandwidth is also reduced in order to keep the noise equivalent sigma zero (NESZ) almost constant over the whole incidence angle range. Figure 5 depicts the simulated NESZ. Since ScanSAR is an azimuth variant mode also the NESZ is fluctuating in azimuth. The green and red curves refer to the best and the worst NESZ over azimuth, respectively. Blue represents a mean value expected for the image in azimuth direction. The variation between the best and the worst NESZ depends on the processed azimuth bandwidth. The larger the processed azimuth bandwidth the larger is the gain variation introduced by the azimuth antenna pattern. Therefore the NESZ variation increases with increasing processed azimuth bandwidth.

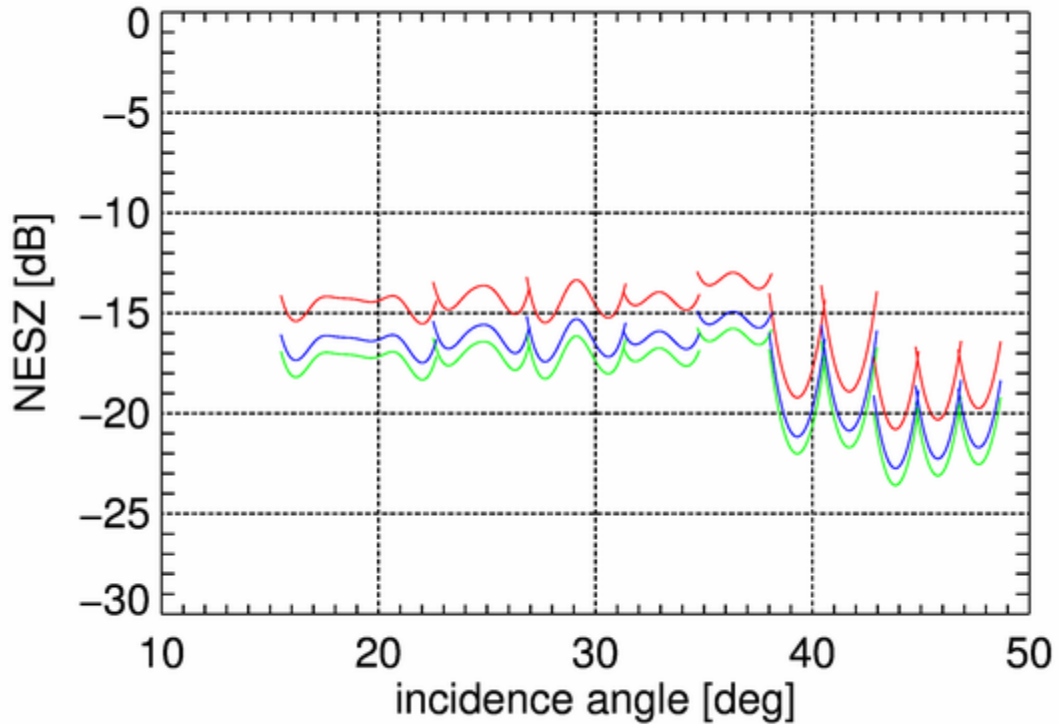

Figure 5 NESZ for the ten wide-beams. For each beam a dedicated range chirp bandwidth and duty cycle combination is used.

Following the simulations the NESZ for six beam SC images is expected to be better than -14 dB for the worst target and in the order of -15 to -17 dB considering a mean NESZ over azimuth. Due to the beam shaping the NESZ variation for the first five beams is very small. The following two beams – only using amplitude taper – show stronger variations. The NESZ variation for the last three un-tapered beams would be the largest, but for these beams only a smaller fraction of the main lobe is used due to the large incidence angle.

Staring Spotlight

Global Performance Prediction

Ambiguity Performance

In order to predict the performance of all simulated acquisitions, an ambiguity simulation has been conducted for all possible beam and PRF combinations. These results could then be used as a lookup table. The predicted performance of the simulated acquisitions reflects the actually selected PRF, driven by the acquisition geometry (orbit height and topography) and therefore should be very close to a real acquisition. Simplifications had been made for the performance prediction, like the assumed backscatter model.

The azimuth ambiguity to signal ratio (AASR) is shown for the center and the azimuth edges of all scenes, respectively. The simulation results are depicted as the contour lines of a two dimensional histogram, highlighting the dominant regions of the AASR distribution. The center of the scene is always below -17 dB and even the edges are better than -16 dB up to an incidence angle of more than 50 degrees. Considering only the full performance part of the scene for steep and medium incidence angles an AASR of better than -17 dB is achieved even for the worst areas of the scene. The range ambiguity to signal ratio (RASR) for all elevation beams is shown with the best and worst range target within each simulated scene respectively. A RASR of better than -20 dB can be achieved for all possible simulation scenarios.

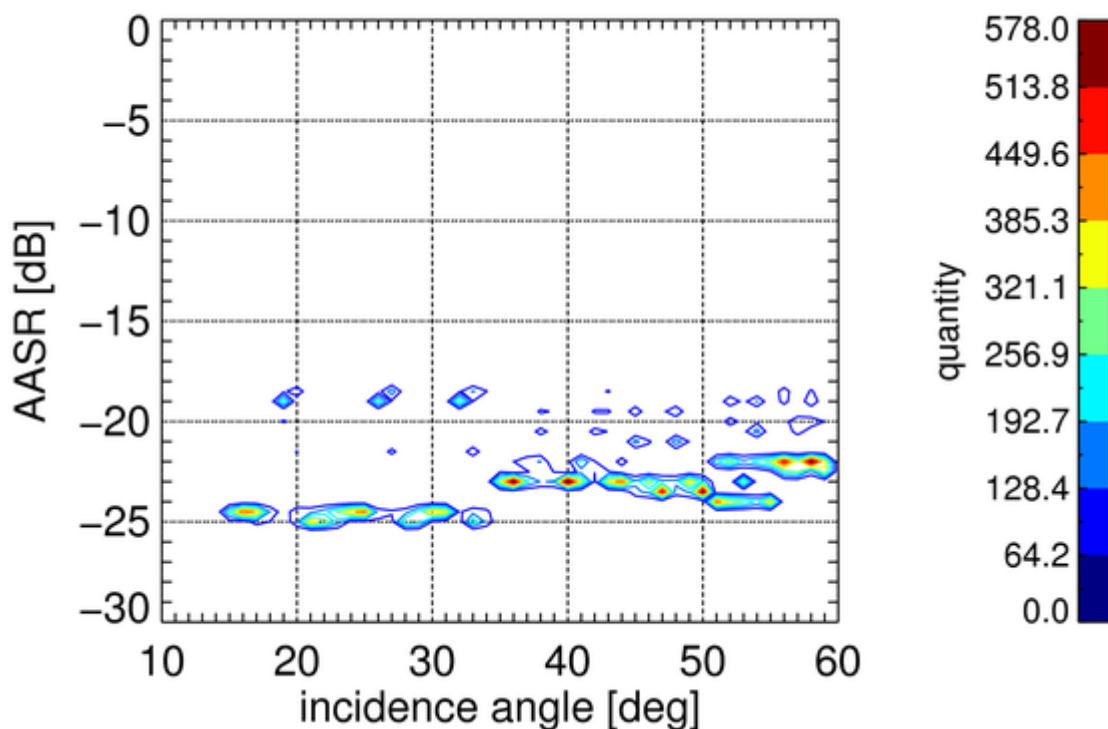

Figure 6 Simulated AASR at scene center for more than 20000 statistical acquisitions. The contour lines of the two dimensional histogram are given, highlighting the dominant regions of predicted AASR.

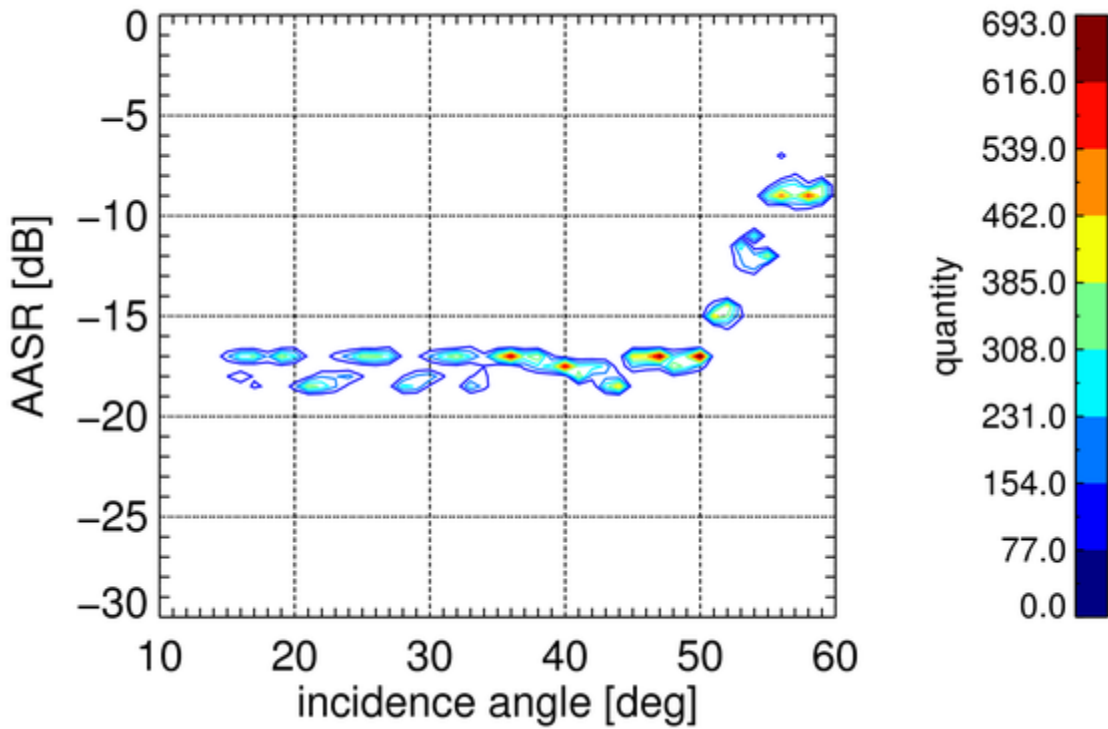

Figure 7 Simulated AASR at the azimuth scene edges of the ST products (as defined by the solid line in the azimuth extent plot) for more than 20000 statistical acquisitions. The contour lines of the two dimensional histogram are given, highlighting the dominant regions of predicted AASR.

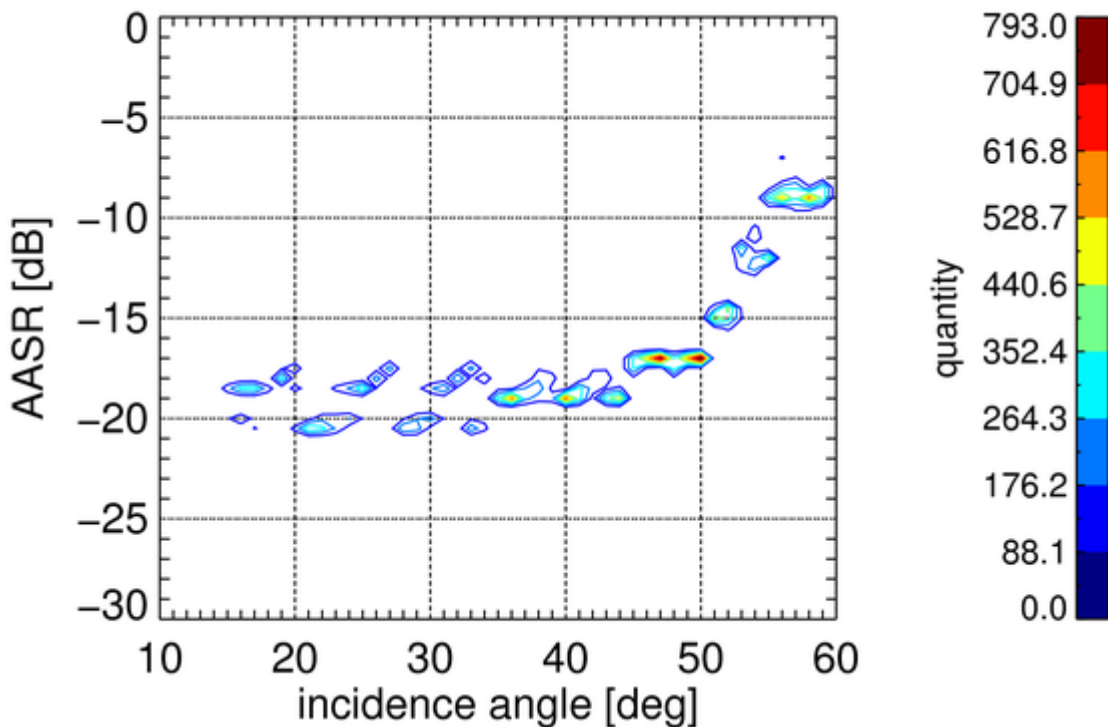

Figure 8 Simulated worst case AASR at the full performance azimuth scene limits of the ST products for more than 20000 statistical acquisitions. The contour lines of the two dimensional histogram are given, highlighting the dominant regions of predicted AASR.

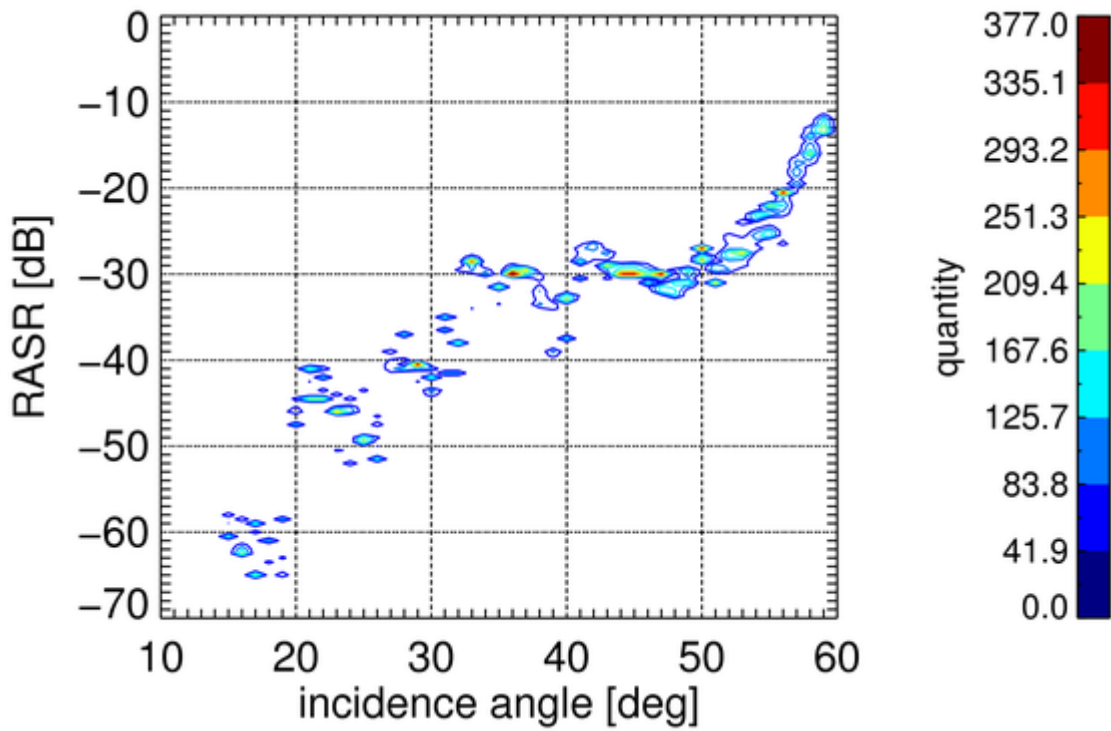

Figure 9 Simulated RASR of the best target over range for more than 20000 statistical acquisitions. The contour lines of the two dimensional histogram are given, highlighting the dominant regions of predicted RASR.

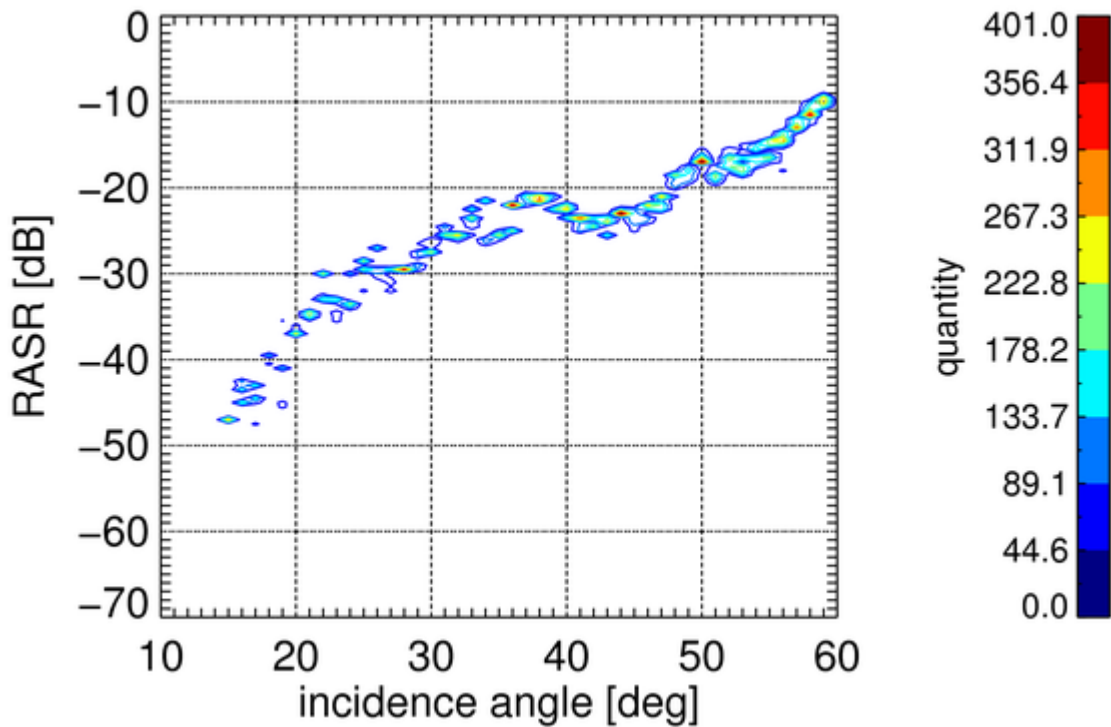

Figure 10 Simulated RASR of the worst target over range for more than 20000 statistical acquisitions. The contour lines of the two dimensional histogram are given, highlighting the dominant regions of predicted RASR.

NESZ

The NESZ of ST scenes is varying over range due to the shape of the elevation antenna pattern like for other SAR imaging modes. Additionally a significant NESZ variation is present in azimuth direction. The azimuth beams are continuously pointing towards the center of the scene. Therefore point targets at the edges of the scene are imaged with reduced antenna gain. The Figure depicts the NESZ degradation over azimuth direction. The NESZ variation over azimuth is expected to be less than 3.3 dB in the full performance azimuth extent. It may be larger in the extended coverage areas of products with steep incidence angles.

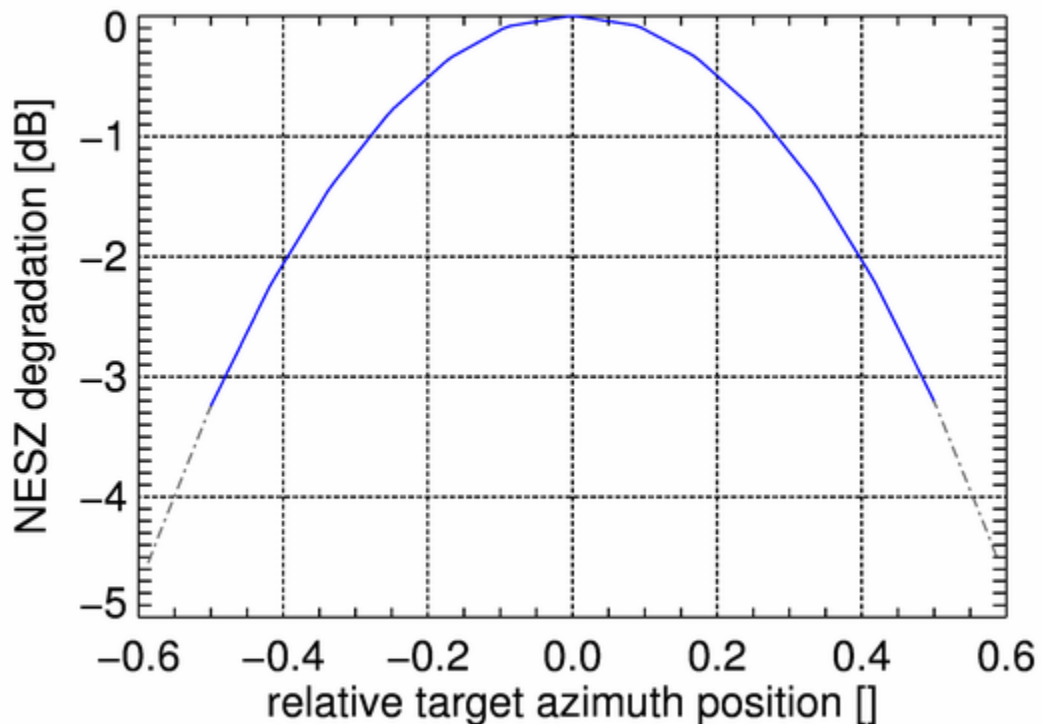

Figure 11 Degradation of the NESZ referenced to the center of the scene (blue curve). The abscissa represents the normalized position of a point target within the whole scene with scene center at zero and +/- 0.5 as the full performance azimuth extent limits. The NESZ degradation for the extended coverage areas in steep incidence angle products is indicated with the dashed-dotted line.

ANNEX E) Acronyms and Abbreviations

AASR	Azimuth Ambiguity to Signal Ratio
ADC	Analog to Digital Converter
D	Dual Polarization
DAC	Direct Access Customer
DEM	Digital Elevation Model
DTAR	Distributed Target Ambiguity Ratio
EEC	Enhanced Ellipsoid Corrected
GEC	Geocoded Ellipsoid Corrected
GTC	Geocoded Terrain Corrected
H	Horizontal Polarization
HS	High Resolution spotlight Mode
ISLR	Integrated Sidelobe Ratio
IRF	Impulse Response Function
MGD	Multi Look Ground Range Detected
NEBZ	Noise Equivalent Beta Zero
NESZ	Noise Equivalent Sigma Zero
PRF	Pulse Repetition Frequency
PSLR	Peak Sidelobe Ratio
PTR	Point Target Response
Q	Quad Polarization
RAW	Raw Data
RASR	Range Ambiguity to Signal Ratio
S	Single Polarization
SAAR	Signal Azimuth Ambiguity Ratio
SC	ScanSAR Mode
SL	spotlight Mode
SM	stripmap Mode
SRTM	Shuttle Radar Topography Mission
SSC	Single Look Slant Range Complex
ST	Staring Spotlight
T	Twin Polarization
TBC	to be confirmed
TBD	to be defined
TMSP	TerraSAR Multi Mode SAR Processor
UPS	Universal Polar Stereographic
UTM	Universal Transverse Mercator
V	Vertical Polarization