

Cattle (*Bos taurus*)

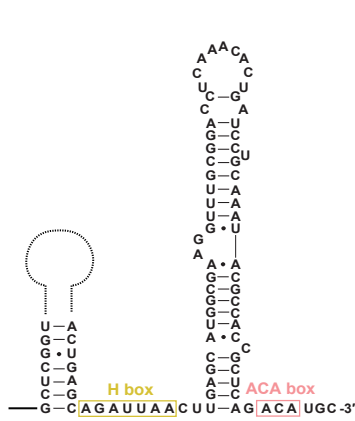

Zebrafish (*Dania rerio*)

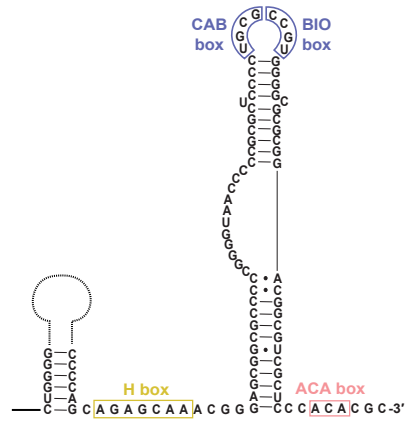

Chicken (*Gallus gallus*)

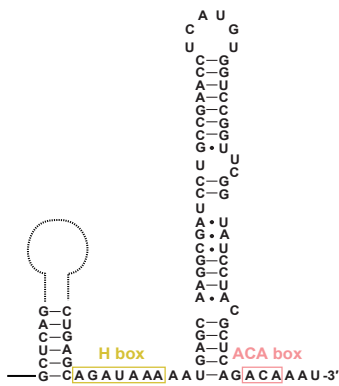

Medaka (*Oryzias latipes*)

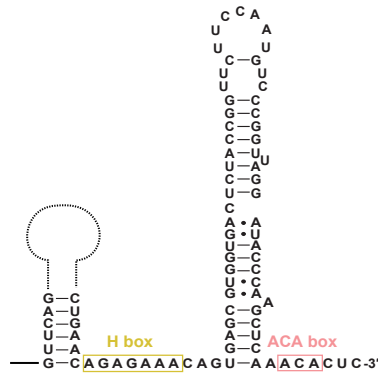

Fugu (*Takifugu rubripes*)

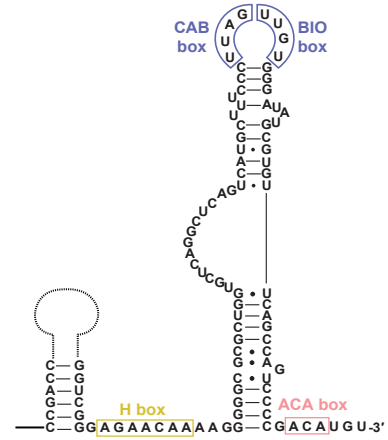

African clawed frog (*Xenopus laevis*)

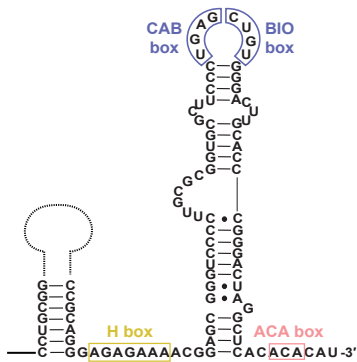

Raccoon (*Procyon lotor*)

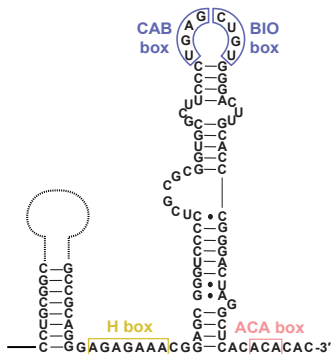

Domestic ferret (*Mustela putorius furo*)

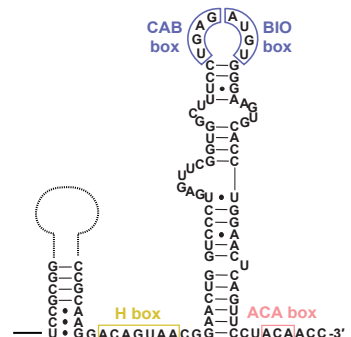

Norway Rat (*Rattus norvegicus*)

Supplementary information, Fig. S7 Schematic diagrams of the RNA secondary structures of the biogenesis domains in vertebrates. The conserved CAB, H and ACA boxes are highlighted in purple, green and blue boxes.