

# Trusted Platform Module Library

## Part 1: Architecture

Family “2.0”

Level 00 Revision 01.38

September 29, 2016

Contact: [admin@trustedcomputinggroup.org](mailto:admin@trustedcomputinggroup.org)

**TCG**

**TCG Published**

Copyright © TCG 2006-2016

## Licenses and Notices

### Copyright Licenses:

- Trusted Computing Group (TCG) grants to the user of the source code in this specification (the "Source Code") a worldwide, irrevocable, nonexclusive, royalty free, copyright license to reproduce, create derivative works, distribute, display and perform the Source Code and derivative works thereof, and to grant others the rights granted herein.
- The TCG grants to the user of the other parts of the specification (other than the Source Code) the rights to reproduce, distribute, display, and perform the specification solely for the purpose of developing products based on such documents.

### Source Code Distribution Conditions:

- Redistributions of Source Code must retain the above copyright licenses, this list of conditions and the following disclaimers.
- Redistributions in binary form must reproduce the above copyright licenses, this list of conditions and the following disclaimers in the documentation and/or other materials provided with the distribution.

### Disclaimers:

- THE COPYRIGHT LICENSES SET FORTH ABOVE DO NOT REPRESENT ANY FORM OF LICENSE OR WAIVER, EXPRESS OR IMPLIED, BY ESTOPPEL OR OTHERWISE, WITH RESPECT TO PATENT RIGHTS HELD BY TCG MEMBERS (OR OTHER THIRD PARTIES) THAT MAY BE NECESSARY TO IMPLEMENT THIS SPECIFICATION OR OTHERWISE. Contact TCG Administration ([admin@trustedcomputinggroup.org](mailto:admin@trustedcomputinggroup.org)) for information on specification licensing rights available through TCG membership agreements.
- THIS SPECIFICATION IS PROVIDED "AS IS" WITH NO EXPRESS OR IMPLIED WARRANTIES WHATSOEVER, INCLUDING ANY WARRANTY OF MERCHANTABILITY OR FITNESS FOR A PARTICULAR PURPOSE, ACCURACY, COMPLETENESS, OR NONINFRINGEMENT OF INTELLECTUAL PROPERTY RIGHTS, OR ANY WARRANTY OTHERWISE ARISING OUT OF ANY PROPOSAL, SPECIFICATION OR SAMPLE.
- Without limitation, TCG and its members and licensors disclaim all liability, including liability for infringement of any proprietary rights, relating to use of information in this specification and to the implementation of this specification, and TCG disclaims all liability for cost of procurement of substitute goods or services, lost profits, loss of use, loss of data or any incidental, consequential, direct, indirect, or special damages, whether under contract, tort, warranty or otherwise, arising in any way out of use or reliance upon this specification or any information herein.

Any marks and brands contained herein are the property of their respective owners.

## Change History

### Revision 98

Added parameter to MemoryMove(), MemoryCopy(), and MemoryConcat() to make sure that the data being moved will fit into the receiving buffer

Change the size of local 2B buffers so that they are sized to the sum of the sizes of the elements rather than any other mathematical construct. This forces the size of the local buffer to track any changes to the sizes of the input components rather than have some assumed relationship.

Made multiple changes to code to eliminate “dead” code (code that could not be reached by any perturbation of the inputs).

Removed the “+” from the handle parameter in TPM2\_HMAC\_Start().

Changed TPM\_RC\_BAD\_TAG to 0x01e so that its value would match TPM\_BADTAG from 1.2

Changed reference implementation so that it would only allow use of default exponent for creation of RSA keys. It will allow other exponents for imported keys.

Changed \_cpri\_GenerateKeyRSA() in CpriRSA.c so that it no longer reads outside the bounds of an array when getting a value to use for encrypting/decrypting with a key, generated from a seed.

Removed TPM\_NV\_INDEX entity name space.

Authorization check includes locality.

### Revision 99

Added phEnableNV to make NV enable independent of the platform hierarchy enable.

Added TPM2\_PolicyNvWritten to permit a policy based on whether or not NV has been written

Added TPM\_PT\_NV\_BUFFER\_MAX, the maximum data size in an NV write.

Added define for HCRTM PCR, platform specific

Return code when an NV hierarchy is disabled is TPM\_RC\_HANDLE.

TPM2\_Shutdown state may be nullified on any subsequent command.

CTR mode increments the entire IV, not just 32 bits.

TPM2\_PolicySecret cannot have a null authHandle.

### Revision 101

Added Definitions for Endorsement Authorization, Owner Authorization, Platform Authorization.

An error may change TPM state under certain conditions.

A restricted signing key cannot have a scheme of TPM\_ALG\_NULL.

Added TPMS\_EMPTY.

TPM2\_Sign: The signing scheme hash algorithm determines the size of the hash to be signed. However, this may be removed in a future revision.

TPM2\_PCR\_Allocate may return an error if the allocation fails.

### **Revision 103**

Added ISO/IEC references and forward.

Handle errors always return TPM\_RC\_HANDLE, not TPM\_RC\_HIERARCHY.

TPM\_PCR\_Allocate does not change allocation for a bank not listed.

For a policy ticket, if expiration is non-negative, a NULL ticket is returned.

### **Revision 105**

Added *lockoutPolicy*.

Added vendor-specific handles.

Added detection of a clock discontinuity to tickets.

Reworked TPM2\_Import description.

### **Revision 107**

Some reworking of H-CRTM, D-RTM.

Some clarification of policy expiration.

Changed references to ISO/IEC standards.

Change PPS, EPS Clear flush resident transient and persistent objects.

### **Revision 109**

Any field upgrade preserves state, not just the standard commands.

Added TPM 2.0 Part 1 description of vendor-specific authorization values.

Refined description of PCR interaction with H-CRTM, TPM2\_Startup, and locality. `_TPM2_Hash_Start` indicates the start of an H-CRTM sequence, not DRTM.

A non-authorization session must have at least one of encrypt, decrypt, or audit set

A policy session timeout can only change to a shorter value.

Added defines for ECC curves and removed some redundant values in the Part B annex.

TPM2\_Sign can use a symmetric key.

TPM2\_NV\_UndefineSpace fails if `TPMA_NV_POLICY_DELETE` is set.

**Revision 111**

TPM2\_ContextSave encrypts just the TPM2B\_CONTEXT\_SENSITIVE structure.

TPM 2.0 Part 2 structures removed algorithms and added notation referring to algorithm registry.

HMAC commands cannot be used with a restricted key.

**Revision 113**

Clarified Auth Role for hierarchies and NV Index.

Added password check to authorization checks.

Indicated that handles returned by the TPM are TPM\_HT\_TRANSIENT (three places).

**Revision 115**

FIPS 186-4 note.

Return codes for tag requires vs. actual mismatch.

**Revision 117**

A trial session cannot use encrypt or decrypt

HMAC is optional when the HMAC key is the Empty Buffer. If present, it must be correct.

CFB uses *sessionValue* in the KDF, not *sessionKey*

FIPS-140 requires NV to be erased when an Index is deleted. NV data must be initialized on a first partial write.

TPM2\_Create for a keyed hash object must have TPM\_ALG\_NULL if *sign* and *decrypt* are both SET or CLEAR.

For an unrestricted HMAC key, if both the key and parameter have a non-NULL scheme, they must match.

**Revision 119**

Defined transient object and made the use of object and sequence object more consistent.

Refined the description of an exclusive audit session, the definition of auditReset, and its relationship to the audit attribute.

Explained that the TPM clock must be accurate even if there is no reliable external clock.

Updated the informative algorithm ID table.

TPM2\_HMAC and TPM2\_HMAC\_Start return code change.

All signing commands, including attestation commands, return TPM\_RC\_KEY for a non-signing key.

TPM2\_SetCommandCodeAuditStatus is not audited when used to change the algorithm.

Trial policy sessions check authorizations.

DA protection does apply to TPM\_RH\_LOCKOUT.

### Revision 121

*continueAuthSession* is ignored for a password session.

Reworked NV attributes to accommodate more NV types. Defined TPM\_NT.

For a hybrid counter Index, the first write always writes through to NV memory.

Added ECC point padding description.

Unmarshaling routines return error code, not bool. Detailed CommandDispatcher parameters. Unmarshal flag set means null is permitted.

The algorithm ID table in this specification is informative.

Context gap must be  $2^n - 1$ .

Handle type 0x03 is for saved sessions, not active session.

Timeout is of length TPM2B\_DIGEST, not UINT64.

nullProof can be used in a ticket.

TPM2\_EncryptDecrypt uses an unrestricted key. The sign attribute is used as an encrypt attribute. A non-null mode cannot be overridden.

A TPM2\_PolicySecret being satisfied by a policy requires a password or auth value. The object must permit password or HMAC authorization.

TPM2\_PolicyNV is an immediate assertion.

### Revision 122

NULL password can have continue set or clear.

Sign attribute becomes encrypt attribute for a symmetric cipher object.

Saved context metadata is normative. Encrypted data is vendor specific.

TPMU\_SYM\_MODE, TPMS\_SCHEME\_XOR selector permits NULL.

If the session requires a policy session, returns TPM\_RC\_AUTH\_TYPE.

TPM2\_NV\_Certify returns TPM\_RC\_NV\_UNINITIALIZED if unwritten even if size is zero.

### Revision 123

Advised that callers should not use NV read public to calculate the Name.

Removed advice that FIPS may require an *authValue* size of half the hash algorithm digest size.

Clarified that *nonceTPM* is only used once in an HMAC calculation when the session is being used for both encrypt and decrypt.

Clarified that *authValue* is an Empty Buffer if a session is not an authorization session.

Clarified that *sessionValue* for authorization sessions that are encrypt or decrypt sessions is *sessionKey* || *authValue* regardless of binding.

Clarified that *nameAlg* is the *authPolicy* hash algorithm.

Structure definition lower limits apply to TPM inputs. Upper limits refer to inputs and outputs.

The year and day of year can indicate an errata date.

TPM\_RC\_NONCE is returned for a nonce value mismatch.

TPMS\_ALGORITHM\_DETAIL\_ECC kdf can be TPM\_ALG\_NULL.

TPMS\_CONTEXT savedHandle indicates the context type.

If a handle in handle area references a session and the session is not present, returns TPM\_RC\_REFERENCE\_H0 + N.

Clarified that the size of an encrypted parameter can be zero.

TPM2\_Startup can result in the PCR update counter non-zero because of PCR resets.

For RSA salt key, the size of an encrypted salt must be the same as the size of the public modulus.

TPM2\_ECDH\_KeyGen requires *restricted* CLEAR and *decrypt* SET.

TPM2\_Commit does not require the *sign* attribute.

TPM\_PolicyOR extends the digest into a Zero Digest PolicyDigest. It does not replace the digest.

TPM2\_PolicyPCR with a trial policy may use the TPM PCR if the caller does provide PCR settings.

TPM2\_PolicyNV, TPM2\_PolicyCounterTimer, TPM2\_NV\_Certify, can return TPM\_RC\_VALUE if the offset is greater than the data size.

Indicated that the reference implementation can do compare operations on a structure using a cast to a byte array, so unmarshaling code must initialize input buffers.

## Revision 124

This revision begins to implement the NV PIN Index type. The information is incomplete and subject to change. It is included as a work in progress rather than create two forks to the specification.

Clarified that TPM2B\_DATA is the size of a TPMT\_HA but is not required to contain an algorithm ID.

Clarified that time can be set to zero at \_TPM2\_Init or TPM2\_Startup.

TPM2\_StartAuthSession rejects a symmetric salt key.

## Revision 125

Continued specifying NV PIN Index. The information is complete but not reviewed and still subject to significant changes.

Session-based encryption should support XOR, but a block cipher is platform specific.

Added TPM\_PT\_MODES for FIPS and other indications. Added TPMA\_MODES.

Clarified the TPMA\_STARTUP\_CLEAR attribute (enable flags) settings on the various startup types.

\_PRIVATE structure - changed from TPMT\_SENSITIVE to TPM2B\_SENSITIVE.

### Revision 126

Reworded the PIN Index and rewrap text.

Added restrictions on *unique* input for TPM2\_Create and TPM2\_CreatePrimary. Removed obsolete TPM\_CC\_PP\_FIRST and TPM\_CC\_PP\_LAST.

### Revision 127

Removed symmetric salt.

### Revision 128

*sensitiveDataOrigin* is set for an asymmetric object.

Clarified that only the template *unique* field may be altered when an object is created.

A PIN index can be used in TPM2\_PolicySecret if read or write locked.

*ehProof* is changed on TPM2\_Clear.

TPM2\_SetPrimaryPolicy requires a policy length consistent with the hash algorithm.

### Revision 130

Augmented section 27.1 “Object Creation / Introduction” by adding the table “Creation Commands” and a description of that table.

Augmented section 27.6.1 “Entropy Creation / Introduction” by adding the table “Deriving Cryptographic Values” and a description of that table.

Added TPM2\_PolicyTemplate(), TPM2\_CreateLoaded(), TPMI\_DH\_PARENT.

### Revision 131

Added TPM2\_PolicyAuthorizeNV(), TPM2\_EncryptDecrypt2().

Noted that TPM2\_Create() may require transient resources.

TPM2\_Clear() increments the *pcrUpdateCounter*, permitting a policy that can be invalidated on TPM2\_Clear().

TPM\_PT\_NV\_BUFFER\_MAX returns the maximum size for NV read and NV certify as well as NV write,



Noted that TPMA\_NV\_POLICY\_DELETE with a policy that cannot be satisfied defines an Index that can never be deleted.

TPM2\_NV\_Read ignores *offset* for bits and counter indexes.

### **Revision 132**

Reworked Part 4 for refactored crypto code merge.

Added application note on audit alternative.

Added command code for PolicyAuthorizeNV and EncryptDecrypt2.

Added getcap for hierarchy policies, and new structure TPMS\_TAGGED\_POLICY.

Offset is ignored when reading counter and bits NV indexes.

ReadClock can have audit session.

### **Revision 133**

Added additional option to ticket expiration, and *timeEpoch*.

TPM2B\_PRIVATE always has authorization value padded.

Clarified GPIO inputs and outputs.

EC Schnorr computation changes.

Salt always uses OAEP.

KDF must reject weak keys.

### **Revision 134**

This was a code merge using revision 133.

### **Revision 135**

Weak symmetric keys will not be generated and cannot be loaded.

OAEP uses the object's scheme. If the object's scheme is ATPM\_ALG\_NULL, uses the objects Name algorithm.

GPIO input and output settings are platform or vendor specific.

### **Revision 135 June 20**

Modified the ECDSA signature calculation

### **Revision 136**

Added PolicyAuthorize definition.

Noted that weak symmetric keys are not permitted.

OAEP uses the key's scheme unless it is NULL

Modifications to the ECDSA sign operation.

Parents use CFB mode, and cannot have a NULL symmetric algorithm

The salt key scheme must be NULL or OAEP.

### **Revision 137**

Updated the interaction between nonceTPM and expiration.

data may be a non - Empty Buffer when a primary key is created.

TPM2\_PolicySecret() referencing a PIN Pass Index returns a NULL ticket.

TPM2\_SelfTest returns TPM\_RC\_FAILURE on failure.

phEnableNV is set on TPM Reset or TPM Restart

TPM2\_Create and TPM2\_CreatePrimary input is actually TPM2\_PUBLIC even though the parameter says TPM2\_TEMPLATE.

TPM2\_PolicySecret for PIN and non-PIN Index clarifications.

TPM2\_PolicyNV, TPM2\_NV\_Read, TPM2\_NV\_Certify may ignore offset parameter.

TPM2\_NV\_GlobalWriteLock, TPM2\_NV\_ReadLock may write NV.

Part 4 added SelfTest.h, Simulator\_fp.h, removed CryptEccData.c,

Part 4 updated TPM2B structure sample.

### **Revision 138**

Added back expiration comment that timeout cannot become smaller.

Explained the result of • TPM\_CAP\_AUTH\_POLICIES.

Removed obsolete CommandDispatcher.h and HandleProcess.h.

## Acknowledgements

The writing of a specification, particularly a security specification, takes many hours for both development and review. This specification is no exception with roughly 100 individuals involved in the process. The TCG would like to acknowledge the contribution of those individuals (listed below) and the companies who allowed them to volunteer their time to the development of this specification.

The TCG would like to acknowledge the special contribution of David Wooten in the development of the TPM 2.0 architecture and documentation of this specification. We also acknowledge the generosity of Microsoft in contributing the code in this specification, written by David Wooten, Jiajing Zhu, and Paul England.

Special thanks are due to David Challener, David Wooten, Julian Hammersley, Graeme Proudler, and Ari Singer who served as Chair of the TPM Working Group at different times during the development of this specification.

The TCG would also like to give special thanks to David Grawrock, David Wooten, and Ken Goldman, who were the editors of this specification.

**Contributors:**

Loic Duflot; ANSSI  
 Frederic Guihery; AMOSSYS  
 Ralf Findeisen; AMD  
 Julian Hammersley; AMD  
 Dean Liberty; AMD  
 Ron Perez; AMD  
 Emily Ratliff; AMD  
 Gary Simpson; AMD  
 Gongyuan Zhuang; AMD  
 John Mersh; ARM Ltd.  
 Kerry Maletsky; Atmel  
 Randy Mummert; Atmel  
 Ronnie Thomas; Atmel  
 Douglas Allen; Broadcom  
 Chares Qi; Broadcom  
 Daniel Nowack; BSI  
 Florian Samson; BSI  
 Bill Lattin; Certicom  
 Matt Harvey; CESA  
 Paul Waller; CESA  
 Bob Bell; Cisco  
 Bill Jacobs; Cisco  
 Rafael Montalvo; Cisco  
 Frank Mosberry; Dell  
 Amy Nelson; Dell  
 Ari Singer; DMI  
 Sigrid Gürgens; Fraunhofer SIT  
 Andreas Fuchs; Fraunhofer SIT  
 Carsten Rudolph; Fraunhofer SIT  
 Carline Covey; Freescale Semiconductor  
 Ira McDonald; High North  
 Vali Ali; Hewlett Packard  
 Liqun Chen; Hewlett Packard  
 Carey Huscroft; Hewlett Packard  
 Wael Ibrahim; Hewlett Packard  
 Graeme Proudler; Hewlett Packard  
 Ken Goldman; IBM  
 Hans Brandl; Infineon  
 Hubert Braunwarth; Infineon  
 Ga-Wai Chin; Infineon  
 Roland Ebrecht; Infineon  
 Markus Gueller; Infineon  
 Ralph Hamm; Infineon  
 Georg Rankl; Infineon  
 Will Arthur; Intel  
 Ernie Brickell; Intel  
 Alex Eydelberg; Intel  
 David Grawrock; Intel  
 Jiangtao Li; Intel  
 David Riss; Intel  
 Ned Smith; Intel  
 Claire Vishik; Intel  
 Monty Wiseman; Intel  
 Joshua Su; ITE  
 David Challener; Johns Hopkins APL  
 Huang Qian; Lenovo  
 Ronald Aigner; Microsoft  
 Jing De Jong-Chen; Microsoft  
 Shon Eizenhoefer; Microsoft  
 Carl Ellison; Microsoft  
 Paul England; Microsoft  
 Leonard Janke; Microsoft  
 Richard Korry; Microsoft  
 Jork Loeser; Microsoft  
 Andrey Marochko; Microsoft  
 Jim Morgan; Microsoft  
 Dennis Mattoon; Microsoft  
 Himanshu Raj; Microsoft  
 David Robinson; Microsoft  
 Rob Spiger; Microsoft  
 Stefan Thom; Microsoft  
 Mark Williams; Microsoft  
 David Wooten; Microsoft  
 Jiajing Zhu; Microsoft  
 Luis Samenta; MIT  
 Ariel Segall; MITRE  
 Nataly Kremer; M-Systems Flash  
 Andrew Regenscheid; NIST  
 Qin Fan; Nationz  
 Jay Liang; Nationz  
 Xin Liu; Nationz  
 Jan-Erik Ekberg; Nokia  
 Michael Cox; NTRU  
 Nick Howgrave-Graham; NTRU  
 William Whyte; NTRU  
 Leooid Asriel; Nuvoton  
 Dan Morav; Nuvoton  
 Erez Naory; Nuvoton  
 Oren Tanami; Nuvoton  
 Dennis Huage; NVIDIA  
 Whllys Ingersoll; Oracle  
 Scott Rotondo; Oracle  
 Timothy Markey; Phoenix  
 Anders Rundgren; PrimeKey Solutions  
 Laszlo Elteto; Safenet  
 Michael Willet; Seagate  
 Olivier Collart; STMicroelectronics  
 Miroslav Dusek; STMicroelectronics  
 Jan Smrcek; STMicroelectronics  
 Mohamed Tabet; STMicroelectronics  
 Paul Sangster; Symantec  
 Jerome Quevremont; Thales  
 Mark Ryan; University of Birmingham  
 Mike Boyle; US Department of Defense  
 Stanley Potter; US Department of Defense  
 Sandi Roddy; US Department of Defense  
 Adrian Stanger; US Department of Defense  
 Kelvin Li; VIA  
 Nick Bone; Vodafone  
 Mihran Dars; Wave Systems  
 Thomas Hardjono; Wave Systems  
 Greg Kazmierczak; Wave Systems  
 Len Veil; Wave Systems

## CONTENTS

1	Scope .....	1
2	Specification Organization.....	2
3	Normative references.....	3
4	Terms and definitions.....	4
5	Symbols and Abbreviated Terms.....	13
5.1	Symbols .....	13
5.2	Abbreviations .....	14
6	Compliance .....	17
7	Conventions .....	18
7.1	Bit and Octet Numbering and Order .....	18
7.2	Sized Buffer References.....	18
7.3	Numbers .....	18
8	Changes from Previous Versions.....	20
9	Trusted Platforms.....	21
9.1	Trust.....	21
9.2	Trust Concepts.....	21
9.2.1	Trusted Building Block.....	21
9.2.2	Trusted Computing Base.....	21
9.2.3	Trust Boundaries .....	21
9.2.4	Transitive Trust.....	22
9.2.5	Trust Authority .....	22
9.3	Trusted Platform Module .....	23
9.4	Roots of Trust .....	23
9.4.1	Root of Trust for Measurement (RTM).....	24
9.4.2	Root of Trust for Storage (RTS).....	24
9.4.3	Root of Trust for Reporting (RTR).....	24
9.5	Basic Trusted Platform Features .....	25
9.5.1	Introduction.....	25
9.5.2	Certification .....	25
9.5.3	Attestation and Authentication .....	26
9.5.4	Protected Location .....	29
9.5.5	Integrity Measurement and Reporting.....	29
10	TPM Protections.....	31
10.1	Introduction .....	31
10.2	Protection of Protected Capabilities.....	31
10.3	Protection of Shielded Locations .....	31
10.4	Exceptions and Clarifications.....	31
11	TPM Architecture.....	33
11.1	Introduction .....	33
11.2	TPM Command Processing Overview.....	33
11.3	I/O Buffer.....	37
11.4	Cryptography Subsystem .....	37

11.4.1	Introduction.....	37
11.4.2	Hash Functions .....	37
11.4.3	HMAC Algorithm.....	38
11.4.4	Asymmetric Operations .....	38
11.4.5	Signature Operations .....	38
11.4.6	Symmetric Encryption .....	41
11.4.7	Extend .....	42
11.4.8	Key Generation .....	43
11.4.9	Key Derivation Function .....	43
11.4.10	Random Number Generator (RNG) Module .....	46
11.4.11	Algorithms .....	48
11.5	Authorization Subsystem .....	49
11.6	Random Access Memory.....	50
11.6.1	Introduction.....	50
11.6.2	Platform Configuration Registers (PCR) .....	50
11.6.3	Object Store .....	51
11.6.4	Session Store .....	51
11.6.5	Size Requirements .....	52
11.7	Non-Volatile (NV) Memory.....	52
11.8	Power Detection Module.....	52
12	TPM Operational States .....	54
12.1	Introduction .....	54
12.2	Basic TPM Operational States.....	54
12.2.1	Power-off State.....	54
12.2.2	Initialization State .....	54
12.2.3	Startup State .....	55
12.2.4	Shutdown State .....	57
12.2.5	Startup Alternatives .....	58
12.3	Self-Test Modes.....	59
12.4	Failure Mode .....	60
12.5	Field Upgrade .....	61
12.5.1	Introduction.....	61
12.5.2	Field Upgrade Mode.....	61
12.5.3	Preserved TPM State .....	64
12.5.4	Field Upgrade Implementation Options.....	65
13	TPM Control Domains .....	66
13.1	Introduction .....	66
13.2	Controls.....	66
13.3	Platform Controls .....	67
13.4	Owner Controls .....	68
13.5	Privacy Administrator Controls .....	68
13.6	Primary Seed Authorizations .....	69
13.7	Lockout Control.....	69
13.8	TPM Ownership .....	70
13.8.1	Taking Ownership .....	70
13.8.2	Releasing Ownership .....	70

14	Primary Seeds.....	72
14.1	Introduction .....	72
14.2	Rationale.....	72
14.3	Primary Seed Properties.....	73
14.3.1	Introduction.....	73
14.3.2	Endorsement Primary Seed (EPS) .....	73
14.3.3	Platform Primary Seed (PPS).....	74
14.3.4	Storage Primary Seed (SPS) .....	74
14.3.5	The Null Seed.....	75
14.4	Hierarchy Proofs .....	75
15	TPM Handles.....	76
15.1	Introduction .....	76
15.2	PCR Handles (MSO=00 <sub>16</sub> ).....	76
15.3	NV Index Handles (MSO=01 <sub>16</sub> ) .....	76
15.4	Session Handles (MSO=02 <sub>16</sub> and 03 <sub>16</sub> ) .....	76
15.5	Permanent Resource Handles (MSO=40 <sub>16</sub> ) .....	77
15.6	Transient Object Handles (MSO=80 <sub>16</sub> ).....	77
15.7	Persistent Object Handles (MSO=81 <sub>16</sub> ).....	78
16	Names .....	79
17	PCR Operations .....	80
17.1	Initializing PCR.....	80
17.2	Extend of a PCR .....	80
17.3	Using Extend with PCR Banks .....	80
17.4	Recording Events .....	81
17.5	Selecting Multiple PCR .....	81
17.6	Reporting on PCR.....	82
17.6.1	Reading PCR .....	82
17.6.2	Attesting to PCR.....	82
17.7	PCR Authorizations .....	83
17.7.1	PCR Not in a Set .....	83
17.7.2	Authorization Set.....	83
17.7.3	Policy Set .....	84
17.7.4	Order of Checking .....	84
17.8	PCR Allocation.....	84
17.9	PCR Change Tracking.....	85
17.10	Other Uses for PCR.....	85
18	TPM Command/Response Structure .....	86
18.1	Introduction .....	86
18.2	Command/Response Header Fields .....	87
18.2.1	tag.....	88
18.2.2	commandSize/responseSize.....	88
18.2.3	commandCode .....	88
18.2.4	responseCode .....	88
18.3	Handles.....	88

18.4	Parameters .....	89
18.5	<i>authorizationSize/parameterSize</i> .....	89
18.6	Authorization Area .....	90
18.6.1	Introduction.....	90
18.6.2	Authorization Structure.....	91
18.6.3	Session Handles .....	92
18.6.4	Session Attributes ( <i>sessionAttributes</i> ) .....	92
18.7	Command Parameter Hash ( <i>cpHash</i> ) .....	94
18.8	Response Parameter Hash ( <i>rpHash</i> ) .....	95
18.9	Command Example .....	95
18.10	Response Example.....	97
19	Authorizations and Acknowledgments .....	98
19.1	Introduction .....	98
19.2	Authorization Roles.....	98
19.3	Physical Presence Authorization .....	99
19.4	Password Authorizations .....	100
19.5	Sessions .....	101
19.6	Session-Based Authorizations.....	101
19.6.1	Introduction.....	101
19.6.2	Authorization Session Formats .....	102
19.6.3	Session Nonces .....	102
19.6.4	Authorization Values .....	104
19.6.5	HMAC Computation .....	104
19.6.6	Note on Use of Nonces in HMAC Computations .....	106
19.6.7	Starting an Authorization Session .....	106
19.6.8	<i>sessionKey</i> Creation .....	107
19.6.9	Unbound and Unsalted Session Key Generation .....	107
19.6.10	Bound Session Key Generation .....	108
19.6.11	Salted Session Key Generation .....	111
19.6.12	Salted and Bound Session Key Generation.....	112
19.6.13	Encryption of <i>salt</i> .....	113
19.6.14	Caution on use of Unsalted Authorization Sessions .....	113
19.6.15	No HMAC Authorization .....	114
19.6.16	Authorization Selection Logic for Objects .....	114
19.6.17	Authorization Session Termination .....	115
19.7	Enhanced Authorization.....	115
19.7.1	Introduction.....	115
19.7.2	Policy Assertion.....	116
19.7.3	Policy AND .....	116
19.7.4	Policy OR.....	118
19.7.5	Order of Evaluation .....	120
19.7.6	Policy Session Creation .....	120
19.7.7	Policy Assertions (Policy Commands) .....	121
19.7.8	Policy Session Context Values .....	124
19.7.9	Policy Example.....	126
19.7.10	Trial Policy.....	126
19.7.11	Modification of Policies.....	126
19.7.12	<i>TPM2_PolicySigned()</i> , <i>TPM2_PolicySecret()</i> , and <i>TPM2_PolicyTicket()</i> .....	128



19.7.13	Use of TPM for authPolicy Computation .....	130
19.7.14	Trial Policy Session .....	130
19.7.15	Use of TPM2_PolicySigned() and TPM2_PolicySecret() without <i>nonceTPM</i> .....	130
19.8	Dictionary Attack Protection.....	131
19.8.1	Introduction.....	131
19.8.2	Lockout Mode Configuration Parameters.....	132
19.8.3	Lockout Mode.....	132
19.8.4	Recovering from Lockout Mode .....	133
19.8.5	Authorization Failures Involving <i>lockoutAuth</i> .....	133
19.8.6	Non-orderly Shutdown.....	133
19.8.7	Justification for Lockout Due to Session Binding .....	134
19.8.8	Sample Configurations for Lockout Parameters .....	134
20	Audit Session .....	136
20.1	Introduction .....	136
20.2	Exclusive Audit Sessions.....	137
20.3	Command Gating Based on Exclusivity .....	137
20.4	Audit Session Reporting .....	137
20.5	Audit Establishment Failures .....	138
20.6	Audit Alternative.....	138
21	Session-based encryption.....	139
21.1	Introduction .....	139
21.2	XOR Parameter Obfuscation .....	140
21.3	CFB Mode Parameter Encryption.....	140
22	Protected Storage .....	142
22.1	Introduction .....	142
22.2	Object Protections .....	142
22.3	Protection Values.....	142
22.4	Symmetric Encryption.....	143
22.5	Integrity .....	143
23	Protected Storage Hierarchy.....	146
23.1	Introduction .....	146
23.2	Hierarchical Relationship between Objects.....	146
23.3	Duplication .....	147
23.3.1	Definition.....	147
23.3.2	Protections .....	148
23.3.3	Rewrap .....	153
23.4	Duplication Group .....	156
23.5	Protection Group.....	157
23.6	Summary of Hierarchy Attributes.....	158
23.7	Primary Seed Hierarchies.....	159
24	Credential Protection.....	160
24.1	Introduction .....	160
24.2	Protocol.....	160
24.3	Protection of Credential .....	160

24.4	Symmetric Encrypt.....	161
24.5	HMAC .....	161
24.6	Summary of Protection Process .....	162
25	Object Attributes.....	163
25.1	Base Attributes.....	163
25.1.1	Introduction.....	163
25.1.2	<i>Restricted</i> Attribute.....	163
25.1.3	<i>Sign</i> Attribute.....	163
25.1.4	<i>Decrypt</i> Attribute.....	163
25.1.5	Uses .....	165
25.2	Other Attributes.....	166
25.2.1	fixedTPM and fixedParent.....	166
25.2.2	stClear .....	166
25.2.3	sensitiveDataOrigin .....	167
25.2.4	userWithAuth.....	167
25.2.5	adminWithPolicy.....	167
25.2.6	noDA.....	168
25.2.7	encryptedDuplication.....	168
26	Object Structure Elements .....	169
26.1	Introduction .....	169
26.2	Public Area.....	169
26.3	Sensitive Area.....	169
26.4	Private Area .....	170
26.5	Qualified Name .....	171
26.6	Sensitive Area Encryption.....	171
26.7	Sensitive Area Integrity.....	171
27	Object Creation .....	173
27.1	Introduction .....	173
27.2	Public Area Template .....	174
27.2.1	Introduction.....	174
27.2.2	type.....	174
27.2.3	nameAlg .....	174
27.2.4	objectAttributes.....	174
27.2.5	authPolicy.....	175
27.2.6	parameters .....	175
27.2.7	unique.....	175
27.3	Sensitive Values .....	175
27.3.1	Overview.....	175
27.3.2	userAuth .....	175
27.3.3	data.....	175
27.4	Creation PCR.....	176
27.5	Public Area Creation.....	176
27.5.1	Introduction.....	176
27.5.2	type, nameAlg, objectAttributes, authPolicy, and parameters .....	176

27.5.3	unique.....	176
27.6	Creation Entropy.....	177
27.6.1	Introduction.....	177
27.6.2	Entropy for Ordinary Objects.....	178
27.6.3	Entropy for Primary Objects.....	178
27.7	Sensitive Area Creation.....	178
27.7.1	Introduction.....	178
27.7.2	type.....	179
27.7.3	authValue.....	179
27.7.4	seedValue.....	179
27.7.5	sensitive.....	180
27.8	Creation Data and Ticket.....	180
27.9	Creation Resources.....	181
28	Object Derivation.....	182
28.1	Introduction.....	182
28.2	Derivation Parameters.....	182
28.3	Public Area Template.....	182
28.4	Entropy for Derived Objects.....	182
28.5	Derivation Process.....	183
29	Object Loading.....	184
29.1	Introduction.....	184
29.2	Load of an Ordinary Object.....	184
29.3	Public-only Load.....	184
29.4	External Object Load.....	185
30	Context Management.....	186
30.1	Introduction.....	186
30.2	Context Data.....	187
30.2.1	Introduction.....	187
30.2.2	Sequence Number.....	187
30.2.3	Handle.....	188
30.2.4	Hierarchy.....	189
30.3	Context Protections.....	189
30.3.1	Context Confidentiality Protection.....	189
30.3.2	Context Integrity Protection.....	190
30.4	Object Context Management.....	191
30.5	Session Context Management.....	191
30.6	Eviction.....	192
30.7	Incidental Use of Object Slots.....	193
31	Attestation.....	194
31.1	Introduction.....	194
31.2	Standard Attestation Structure.....	194
31.3	Privacy.....	195
31.4	Qualifying Data.....	195

31.5	Anonymous Signing.....	195
32	Cryptographic Support Functions.....	196
32.1	Introduction .....	196
32.2	Hash.....	196
32.3	HMAC .....	196
32.4	Hash, HMAC, and Event Sequences .....	196
32.4.1	Introduction.....	196
32.4.2	Hash Sequence.....	197
32.4.3	Event Sequence.....	197
32.4.4	HMAC Sequence.....	197
32.4.5	Sequence Contexts .....	198
32.5	Symmetric Encryption.....	198
32.6	Asymmetric Encryption and Signature Operations.....	198
33	Locality .....	199
34	Hardware Core Root of Trust Measurement (H-CRTM) Event Sequence.....	200
34.1	Introduction .....	200
34.2	Dynamic Root of Trust Measurement.....	200
34.3	H-CRTM before TPM2_Startup() and TPM2_Startup() without H-CRTM .....	201
35	Command Audit.....	202
36	Timing Components .....	204
36.1	Introduction .....	204
36.2	Time .....	205
36.3	Clock.....	205
36.3.1	Introduction.....	205
36.3.2	<i>Clock</i> Implementation.....	206
36.3.3	Orderly Shutdown of <i>Clock</i> .....	206
36.3.4	<i>Clock</i> Initialization at TPM2_Startup().....	207
36.3.5	Setting <i>Clock</i> .....	207
36.3.6	<i>Clock</i> Periodicity.....	208
36.4	resetCount .....	208
36.5	restartCount .....	209
36.6	Note on the Accuracy and Reliability of <i>Clock</i> .....	209
36.7	Privacy Aspects of Clock .....	210
37	NV Memory .....	211
37.1	Introduction .....	211
37.2	NV Indices.....	211
37.2.1	Definition.....	211
37.2.2	NV Index Allocation .....	212
37.2.3	NV Index Deletion .....	213
37.2.4	High-Endurance (Hybrid) Indices .....	213
37.2.5	Reading an NV Index .....	215
37.2.6	Updating an Index .....	215
37.2.7	NV Index in a Policy .....	219
37.2.8	PIN Index Considerations.....	220

37.3	Owner and Platform Evict Objects.....	221
37.4	State Saved by TPM2_Shutdown() .....	222
37.4.1	Background .....	222
37.4.2	NV Orderly Data .....	222
37.4.3	NV Clear Data .....	222
37.4.4	NV Reset Data .....	223
37.5	Persistent NV Data .....	224
37.6	NV Rate Limiting .....	226
37.7	NV Other Considerations .....	227
37.7.1	Power Interruption .....	227
37.7.2	External NV .....	227
37.7.3	PCR in NV .....	228
38	Multi-Tasking .....	229
39	Errors and Response Codes .....	230
39.1	Error Reporting .....	230
39.2	TPM State After an Error .....	230
39.3	Resource Exhaustion Warnings .....	230
39.3.1	Introduction.....	230
39.3.2	Transient Resources .....	230
39.3.3	Temporary Resources.....	231
39.4	Response Code Details .....	231
40	General Purpose I/O .....	233
41	Minimums .....	234
41.1	Introduction .....	234
41.2	Authorization Sessions .....	234
41.3	Transient Objects.....	234
41.4	NV Counters and Bit Fields .....	234
Annex A (informative)	Policy Examples .....	235
A.1	Introduction .....	235
A.2	TPM 1.2 Compatible Authorization.....	235
Annex B (normative/informative)	RSA .....	237
B.1	Introduction .....	237
B.2	RSAEP .....	238
B.3	RSADP.....	238
B.4	RSAES_OAEP.....	238
B.5	RSAES_PKCSV1_5 .....	238
B.6	RSASSA_PKCS1v1_5.....	238
B.7	RSASSA_PSS .....	239
B.8	RSA Key Generation .....	240
B.8.1	Background .....	240
B.8.2	Large Prime Generation .....	240
B.8.3	RSA Key Generation Algorithm.....	241
B.9	RSA Cryptographic Primitives .....	241
B.9.1	Introduction.....	241

B.9.2	TPM2_RSA_Encrypt()	241
B.9.3	TPM2_RSA_Decrypt()	242
B.10	Secret Sharing	242
B.10.1	Overview	242
B.10.2	RSA Encryption of Salt	242
B.10.3	RSA Secret Sharing for Duplication	242
B.10.4	RSA Secret Sharing for Credentials	243
Annex C (normative/informative)	ECC	244
C.1	Introduction	244
C.2	Split Operations	244
C.2.1	Introduction	244
C.2.2	Commit Random Value	244
C.2.3	TPM2_Commit()	245
C.2.4	TPM2_EC_Ephemeral()	246
C.2.5	Recovering the Private Ephemeral Key	247
C.3	ECC-Based Secret Sharing	247
C.4	EC Signing	247
C.4.1	ECDSA	247
C.4.2	ECDA	247
C.4.3	EC Schnorr	249
C.5	ECC Key Generation	251
C.6	Secret Sharing	251
C.6.1	ECDH	251
C.6.2	ECDH Encryption of Salt	252
C.6.3	ECC Secret Sharing for Duplication	252
C.6.4	ECC Secret Sharing for Credentials	252
C.7	ECC Primitive Operations	252
C.7.1	Introduction	252
C.7.2	TPM2_ECDH_KeyGen()	252
C.7.3	TPM2_ECDH_ZGen()	252
C.7.4	Two-phase Key Exchange	253
C.8	ECC Point Padding	254
Annex D (normative/informative)	Support for SMx Family of Algorithms	256
D.1	Introduction	256
D.2	SM2	256
D.2.1	Introduction	256
D.2.2	SM2 Digital Signature Algorithm	257
D.2.3	SM2 Key Exchange	259
D.3	SM3	260
D.4	SM4	260

**Tables**

Table 1 — Block Cipher Parameters .....	41
Table 2 — Hierarchy Control Setting Combinations .....	67
Table 3 — Equations for Computing Entity Names .....	79
Table 4 — Separators .....	87
Table 5 — <i>Tag</i> Values .....	88
Table 6 — Use of Authorization/Session Blocks.....	91
Table 7 — Description of <i>sessionAttributes</i> .....	92
Table 8 — Command Layout for Example Command .....	96
Table 9 — Example Command Showing <i>authorizationSize</i> .....	96
Table 10 — Response Layout for Example Command .....	97
Table 11 — Example Response Showing <i>parameterSize</i> .....	97
Table 12 — Password Authorization of Command.....	100
Table 13 — Password Acknowledgment in Response .....	100
Table 14 — Session-Based Authorization of Command .....	102
Table 15 — Session-Based Acknowledgment in Response.....	102
Table 16 — Schematic of TPM2_StartAuthSession Command .....	106
Table 17 — Handle Parameters for TPM2_StartAuthSession.....	107
Table 18 — Format to Start Unbounded, Unsalted Session.....	108
Table 19 — Format to Start Bound Session .....	110
Table 20 — Format to Start Salted Session .....	111
Table 21 — Format to Start Salted and Bound Session.....	112
Table 22 — Mapping of Hierarchy Attributes .....	158
Table 23 — Allowed Hierarchy Settings .....	159
Table 24 — Mapping of Functional Attributes.....	165
Table 25 — TPM 1.2 Correspondence .....	166
Table 26 — Public Area Parameters .....	169
Table 27 — Sensitive Area Parameters.....	170
Table 28 — Creation Commands .....	173
Table 29 — Deriving Object Entropy .....	178
Table 30 — Standard Attestation Structure .....	194
Table 31 — Contents of the ORDERLY_DATA Structure .....	222
Table 32 — Contents of the STATE_CLEAR_DATA Structure .....	223
Table 33 — Contents of the STATE_RESET_DATA Structure .....	223
Table 34 — Contents of the PERSISTENT_DATA Structure .....	224

## Figures

Figure 1 — Attestation Hierarchy .....	27
Figure 2 — Architectural Overview .....	33
Figure 3 — Command Execution Flow .....	37
Figure 4 — Random Number Generation .....	47
Figure 5 — TPM Startup Sequences .....	57
Figure 6 — On-Demand Self-Test .....	59
Figure 7 — Failure Mode Behavior .....	61
Figure 8 — Resuming Field Upgrade Mode after _TPM_Init.....	63
Figure 9 — Field Upgrade Mode .....	64
Figure 10 — Command Structure .....	87
Figure 11 — Response Structure .....	87
Figure 12 — Command/Response Header Structure .....	87
Figure 13 — Authorization Layout for Command.....	91
Figure 14 — Authorization Layout for Response .....	92
Figure 15 — A 12-input OR Policy .....	120
Figure 16 — Use of TPM2_PolicyAuthorize() to Avoid PCR Brittleness .....	127
Figure 17 — Creating a Private Structure .....	145
Figure 18 — Symmetric Protection of Hierarchy.....	147
Figure 19 — Duplication Process with Inner and Outer Wrapper.....	151
Figure 20 — Duplication Process with Outer Wrapper and No Inner Wrapper .....	152
Figure 21 — Duplication Process with Inner Wrapper and TPM_RH_NULL as NP.....	153
Figure 22 — Duplication Process with no Inner Wrapper and TPM_RH_NULL as NP.....	153
Figure 23 Key Recovery Process .....	154
Figure 24 — Duplication Groups.....	157
Figure 25 — Protection Groups .....	158
Figure 26 — Creating a Identity Structure .....	162
Figure 27 — Response Code Evaluation.....	232



## Trusted Platform Module Library

### Part 1: Architecture

#### 1 Scope

This specification defines the Trusted Platform Module (TPM) a device that enables trust in computing platforms in general. It is broken into parts to make the role of each part clear. All parts are required in order to constitute a complete standard

For a complete definition of all requirements necessary to build a TPM, the designer will need to use the appropriate platform-specific specification to understand all of the requirements for a TPM in a specific application or make appropriate choices as an implementer.

Those wishing to create a TPM need to be aware that this specification does not provide a complete picture of the options and commands necessary to implement a TPM. To implement a TPM the designer needs to refer to the relevant platform-specific specification to understand the options and settings required for a TPM in a specific type of platform or make appropriate choices as an implementer.

**EXAMPLE** The number of platform configuration registers and their attributes are not defined in this specification. Those values would be specified by a platform specific specification or alternatively determined by an implementer.

## 2 Specification Organization

This specification contains four parts, as follows:

### TPM 2.0 Part 1: Architecture

TPM 2.0 Part 1 contains a narrative description of the properties, functions, and methods of a TPM. Unless otherwise noted, this narrative description is *informative*. TPM 2.0 Part 1 contains descriptions of some of the data manipulation routines that are used by this specification. The normative behavior for these routines is in C code in TPM 2.0 Part 3 and TPM 2.0 Part 4. Algorithms and processes described in this TPM 2.0 Part 1 may be made normative by reference from TPM 2.0 Part 2, TPM 2.0 Part 3, or TPM 2.0 Part 4.

### TPM 2.0 Part 2: Structures

TPM 2.0 Part 2 contains a *normative* description of the constants, data types, structures, and unions for the TPM interface. Unless otherwise noted: (1) all tables and C code in TPM 2.0 Part 2 are normative, and (2) normative content in TPM 2.0 Part 2 takes precedence over any other part of this specification.

### TPM 2.0 Part 3: Commands

TPM 2.0 Part 3 contains: (1) a *normative* description of commands, (2) tables describing the command and response formats, and (3) C code that illustrates the actions performed by a TPM. Within TPM 2.0 Part 3, command and response tables have the highest precedence, followed by the C code, followed by the narrative description of the command. TPM 2.0 Part 3 is subordinate to TPM 2.0 Part 2.

A TPM need not be implemented using the C code in TPM 2.0 Part 3. However, any implementation should provide equivalent or, in most cases, identical results as observed at the TPM interface or demonstrated through evaluation.

### TPM 2.0 Part 4: Supporting Routines

TPM 2.0 Part 4 presents C code that describes the algorithms and methods used by the command code in TPM 2.0 Part 3. The code in TPM 2.0 Part 4 augments Parts 2 and 3 to provide a complete description of a TPM, including the supporting framework for the code that performs the command actions.

Any TPM 2.0 Part 4 code may be replaced by code that provides similar results when interfacing to the action code in TPM 2.0 Part 3. The behavior of TPM 2.0 Part 4 code not included in an annex is *normative*, as observed at the interfaces with TPM 2.0 Part 3 code. Code in an annex is provided for completeness, that is, to allow a full implementation of the specification.

NOTE This specification does not provide code for lower-level cryptographic algorithms and use of external libraries is required for a complete implementation.

Extensive modification of the code provided in TPM 2.0 Part 4 annexes is expected for any TPM implementation. Modifications are required in order to interface the TPM code with actual TPM hardware rather than the simulation framework provided. In addition, modifications of the code in TPM 2.0 Part 4 annexes would be necessary in order to meet the needs of applicable evaluation regimes.

### 3 Normative references

The following referenced documents are indispensable for the application of this document. For dated references, only the edition cited applies. For undated references, the latest edition of the referenced document (including any amendments) applies.

IETF RFC 3447, Public-Key Cryptography Standards (PKCS) #1: RSA Cryptography Specifications Version 2.1

[NIST SP800-56A](#), *Recommendation for Pair-Wise Key Establishment Schemes Using Discrete Logarithm Cryptography (Revised)*

[NIST SP800-108](#), *Recommendation for Key Derivation Using Pseudorandom Functions (revised)*

[FIPS PUB 186-3](#), *Digital Signature Standard (DSS)*

ISO/IEC 9797-2, Information technology -- Security techniques -- Message Authentication Codes (MACs) -- Part 2: Mechanisms using a dedicated hash-function

IEEE Std 1363™-2000, *Standard Specifications for Public Key Cryptography*

IEEE Std 1363a™-2004 (Amendment to IEEE Std 1363™-2000), *IEEE Standard Specifications for Public Key Cryptography- Amendment 1: Additional Techniques*

ISO/IEC 10116:2006, *Information technology — Security techniques — Modes of operation for an n-bit block cipher*

GM/T 0003.1-2012: *Public Key Cryptographic Algorithm SM2 Based on Elliptic Curves Part 1: General*

GM/T 0003.2-2012: *Public Key Cryptographic Algorithm SM2 Based on Elliptic Curves Part 2: Digital Signature Algorithm*

GM/T 0003.3-2012: *Public Key Cryptographic Algorithm SM2 Based on Elliptic Curves Part 3: Key Exchange Protocol*

GM/T 0003.5-2012: *Public Key Cryptographic Algorithm SM2 Based on Elliptic Curves Part 5: Parameter definition*

GM/T 0004-2012: *SM3 Cryptographic Hash Algorithm*

GM/T 0002-2012: *SM4 Block Cipher Algorithm*

ISO/IEC 10118-3, Information technology — Security techniques — Hash-functions — Part 3: Dedicated hash functions

ISO/IEC 14888-3, Information technology -- Security techniques -- Digital signature with appendix -- Part 3: Discrete logarithm based mechanisms

ISO/IEC 15946-1, Information technology — Security techniques — Cryptographic techniques based on elliptic curves — Part 1: General

ISO/IEC 18033-3, Information technology — Security techniques — Encryption algorithms — Part 3: Block ciphers

TCG Algorithm Registry

## 4 Terms and definitions

For the purposes of this document, the following terms and definitions apply.

### 4.1

#### “ATH”

sequence of four octets of data containing 41 54 48 00<sub>16</sub> that is used as a label in a KDF

NOTE See 11.4.9.2 for justification for the terminating octet of 00<sub>16</sub>.

### 4.2

#### “CFB”

sequence of four octets containing 43 46 42 00<sub>16</sub> that is used as a label in a KDF

NOTE See 11.4.9.2 for justification for the terminating octet of 00<sub>16</sub>.

### 4.3

#### “DUPLICATE”

sequence of 10 octets containing 44 55 50 4C 49 43 41 54 45 00<sub>16</sub> that is used as a label in a KDF

NOTE See 11.4.9.2 for justification for the terminating octet of 00<sub>16</sub>.

### 4.4

#### “IDENTITY”

sequence of nine octets containing 49 44 45 4E 54 49 54 59 00<sub>16</sub> that is used as a label in a KDF

NOTE See 11.4.9.2 for justification for the terminating octet of 00<sub>16</sub>.

### 4.5

#### “OBFUSCATE”

sequence of 10 octets containing 4F 42 46 55 53 43 41 54 45 00<sub>16</sub> that is used as a label in a KDF

NOTE See 11.4.9.2 for justification for the terminating octet of 00<sub>16</sub>.

### 4.6

#### “SECRET”

sequence of seven octets containing 53 45 43 52 45 54 00<sub>16</sub> that is used as a label in a KDF

NOTE See 11.4.9.2 for justification for the terminating octet of 00<sub>16</sub>.

### 4.7

#### “STORAGE”

sequence of eight octets containing 53 54 4F 52 41 47 45 00<sub>16</sub> that is used as a label in a KDF

NOTE See 11.4.9.2 for justification for the terminating octet of 00<sub>16</sub>.

### 4.8

#### “XOR”

sequence of four octets containing 58 4F 52 00<sub>16</sub> that is used as a label in a KDF

NOTE See 11.4.9.2 for justification for the terminating octet of 00<sub>16</sub>.

**4.9****ancestor**

<object loaded in a TPM> Storage Key that was required to have been loaded prior to loading an object

**4.10****authValue**

octet string containing a value that is used for access authorization. The value is used as a password or to derive a key for an HMAC calculation.

**4.11****authPolicy**

digest value produced by an execution of policy commands and used for access authorization

**4.12****bound**

*authValue* of the Object is not included in the HMAC authorization for the authorization session

**4.13****canonical form**

data structure in the format used for transport to and from the TPM (see 4.36)

**4.14****CLEAR**

bit with a value of zero (0), or the action of causing a bit to have a value of zero (0)

**4.15****command**

discrete TPM function that is exposed externally and recognizable by a TPM's command processor; also the values sent to the TPM to indicate the operation to be performed

**4.16****commandCode**

numeric identifier of the operation to be performed by a TPM

**4.17****context**

collection of data that provides qualifying information about a data object to differentiate it from others of the same type or to differentiate one version of a data object from another

**4.18****cpHash**

hash of the command code, Object names, and parameters of a command

**4.19****Derivation Parent**

loadable key used to derive other keys; a TPM\_ALG\_KEYEDHASH Parent Key

**4.20****descendant**

<Storage Key> Object whose loading is conditional on a specific Storage Key having been previously loaded

**4.21****digest**

result of a hash operation

**4.22****duplicate**

allowing a Protected Object created by a TPM to be used on a different TPM

**4.23****ECDH**

Diffie-Hellman secure secret sharing process using elliptic curve operations

**4.24****entity**

a hierarchy, PCR, object, or NV Index in a TPM shielded location

**4.25****Ephemeral Key**

key created as part of a protocol that is not used again after the protocol is complete

**4.26****EmptyAuth**

Empty Buffer used as an authorization value

**4.27****Empty Buffer**

sized array with no data; indicated by a size field of zero followed by an array containing no elements

**4.28****Empty Digest**

Empty Buffer used as a digest

**4.29****Empty Point**

ECC point with Empty Buffers for both the x and y coordinates

**4.30****Empty Policy**

Empty Buffer used when a policy value is required; as a *policyValue*, an Empty Buffer will satisfy no policy

**NOTE**

No policy can be satisfied by an Empty Policy because an Empty Policy has zero length but a *policyDigest* is the size of a hash digest and a digest is never zero length.

**4.31****Endorsement Authorization**

authorization using either *endorsementAuth* or *endorsementPolicy*

**4.32****Extend****Extended**

operation that replaces the current value of a digest with the hash of a buffer constructed by concatenating new data (normally a digest) to the current value of the digest (see 11.4.7)

**4.33****External Object**

Object that may be loaded into a TPM without being a member of a specific hierarchy

**4.34****Failure mode**

mode in which the TPM returns TPM\_RC\_FAILURE in response to all commands except TPM2\_GetTestResult() or TPM2\_GetCapability()

**4.35****import**

operation that allows a Protected Object not created by a TPM to be incorporated into a hierarchy of the TPM

**4.36****internal form**

data structure using a layout that is specific to an implementation that may or may not be the same as the canonical form

**4.37****Lockout Authorization**

Authorization using either *lockoutAuth* or *lockoutPolicy*

**4.38****non-volatile**

data that is retained even when power is removed

**4.39****NULL**

context-sensitive value that, when applied to a pointer, is a system-defined value indicating that the pointer does not reference data; and, when applied to a structure identified by an algorithm identifier, is the TPM\_ALG\_NULL value indicating that no additional data is present

**4.40****NULL Password****NULL Auth**

authorization where the authorization value is the Empty Buffer, resulting in an authorization that is a sequence of 9 octets containing either 40 00 00 09 00 00 00 00 00<sub>16</sub> or 40 00 00 09 00 00 01 00 00<sub>16</sub>.

**4.41****NULL Signature**

signature with the TPM\_ALG\_NULL signature scheme that contains no data

**4.42****NULL-terminated**

sequence of non-zero values followed by a value containing zero; most often a NULL-terminated string where the values are ASCII-encoded octets

**4.43****NULL Ticket**

ticket structure with *tag* set to a value that is correct for the context, *hierarchy* is TPM\_RH\_NULL, and *digest* is an Empty Buffer

**4.44****NV Index****Index**

user defined non-volatile shielded location

**4.45****Object**

key or data that has a public portion and, optionally, a sensitive portion; and which is a member of a hierarchy

NOTE An NV Index is not an object.

**4.46****octet**

eight bits of data

NOTE On most modern computers, this is the smallest addressable unit of data.

**4.47****orderly shutdown**

when the TPM has completed TPM2\_Shutdown() before power to the TPM is removed or \_TPM\_Init is asserted

**4.48****ordinary key**

key produced with a seed taken from the TPM RNG

cf. Primary Key

**4.49****Owner Authorization**

authorization using either *ownerAuth* or *ownerPolicy*

**4.50****Parent Key**

any object with the *decrypt* and *restricted* attributes SET and the *sign* attribute CLEAR

NOTE There are two types of parent keys: Storage Parent and Derivation Parent.



**4.51****PCR**

one or more platform configuration registers each containing a digest

**4.52****PCR.alg**

hash algorithm associated with a specific PCR

**4.53****PCR bank**

collection of PCR identified by a hash algorithm, with each PCR in the bank containing a digest computed using the bank identifier's hash algorithm

**4.54****PCR.digest**

digest value associated with a specific PCR

**4.55****Permanent Entity**

TPM resource with an architecturally defined handle that does not change

Note                    The value of a Permanent Entity may change

**4.56****Persistent Entity**

TPM resource created by a Protected Capability that persists in TPM memory across power cycles and TPM resets

**4.57****Platform Authorization**

authorization using either *platformAuth* or *platformPolicy*

**4.58****policyDigest**

digest uniquely representing an ordered set of policy commands and operands; used to determine if a policy authorizing an action has been satisfied

**4.59****policySession→cpHash**

policy session context value that, if not the Empty Buffer, is the *cpHash* value that the authorized command is required to have for the authorization to be valid

**4.60****PolicyAuthorize Command**

either TPM2\_PolicyAuthorize() or TPM2\_PolicyAuthorizeNV()

**4.61****platform firmware**

code added to the platform by its manufacturer that is needed for booting and proper platform operation

NOTE                    Commonly, but not exclusively, referred to as BIOS or UEFI or SMM code

**4.62****Primary Key**

key derived from a Primary Seed that is associated with the hierarchy of the Primary Seed

cf. ordinary key

**4.63****Primary Object**

Primary Key or a data blob with a sensitive area that is encrypted using a symmetric key derived from the public area of the object and a Primary Seed

**4.64****private area**

encrypted and integrity protected blob that contains the sensitive area of an object

**4.65****Primary Seed**

large random value contained within a TPM from which Primary Keys and Primary Objects are derived

**4.66****Protected Capability**

operation performed by the TPM on data in a Shielded Location in response to a command sent to the TPM

**4.67****Protected Object**

object with an encrypted sensitive portion, the sensitive portion of which the TPM will only decrypt when it is in a Shielded Location

**4.68****RAM**

memory that may be accessed in any order and which has no endurance limitations

**4.69****reset interval**

period between two successive TPM Resets and the interval during which the *resetCount* is not changed

**4.70****response**

values returned by the TPM when it completes processing of a command

**4.71****Resume PCR**

platform configuration register with a value that is preserved over a TPM Resume sequence

**4.72****Root of Trust**

component that must always behave in the expected manner because its misbehavior cannot be detected

NOTE The complete set of Roots of Trust has at least the minimum set of functions to enable a description of the platform characteristics that affect the trustworthiness of the platform.

#### 4.73

##### **rpHash**

hash of the response code and the parameters of a response

#### 4.74

##### **Sealed Data Object**

encrypted, user-defined, data blob that is associated with a hierarchy and loaded using TPM2\_Load() or TPM2\_CreatePrimary().

#### 4.75

##### **sensitive area**

contain the confidential or secret parts of an object that are required to be encrypted and integrity protected when not in a Shielded Location on a TPM

#### 4.76

##### **sequence object**

transient data structure used to hold hash state that has a handle and may be context swapped

NOTE

See clause 30

#### 4.77

##### **session**

transient TPM structure that maintains the state associated with a sequence of authorizations or an audit digest

#### 4.78

##### **SET**

bit with a value of one (1), or the action of causing a bit to have a value of one (1)

#### 4.79

##### **Shielded Location**

location on a TPM that contains data that is shielded from access by any entity other than the TPM and which may be operated on only by a Protected Capability

#### 4.80

##### **Shutdown(CLEAR)**

abbreviated form of the command TPM2\_Shutdown() with the *startupType* parameter set to TPM\_SU\_CLEAR

#### 4.81

##### **Shutdown(STATE)**

abbreviated form of the command TPM2\_Shutdown() with the *startupType* parameter set to TPM\_SU\_STATE

#### 4.82

##### **sizeof(x)**

operator that returns the number of octets in the operand 'x'

**4.83****Startup(CLEAR)**

abbreviated form of the command TPM2\_Startup() with the *startupType* parameter set to TPM\_SU\_CLEAR

**4.84****Startup(STATE)**

abbreviated form of the command TPM2\_Startup with the *startupType* parameter set to TPM\_SU\_STATE

**4.85****Storage Key**

key used to provide integrity and confidentiality protection for descendant keys that are stored off of the TPM

**4.86****Storage Parent**

Storage Key that is acting as a parent key

**4.87****Temporary Object**

Objects that become unusable after a TPM Reset and that may not be converted into Persistent Objects.

**4.88****temporary resource**

data object created during the execution of a command that does not persist in TPM memory after the command completes

**4.89****TPM\_GENERATED\_VALUE**

32-bit number (FF 54 43 47<sub>16</sub>) that is used to tag structures that are generated by a TPM

**4.90****TPM Reset**

resetting of all TPM internal state to default values due to Startup(CLEAR)

**4.91****TPM Resource Manager****TRM**

software executing on a system with a TPM that ensures that the resources necessary to execute TPM commands are present in the TPM

**4.92****TPM Restart**

Startup(CLEAR) that initializes all PCR but preserves most other TPM state from the previous Shutdown(STATE)

**4.93****TPM Resume**

Startup(STATE) that initializes some PCR but preserves most TPM state from the previous Shutdown(STATE)

**4.94****transient object**

object or sequence object that may be explicitly loaded and unloaded from TPM memory by the TRM; cleared from TPM memory when the TPM is initialized (TPM2\_Startup())

**4.95****transient resource**

object, sequence object, or session that may be explicitly loaded and unloaded from TPM memory by the TRM; cleared from TPM memory when the TPM is initialized (TPM2\_Startup())

**4.96****Trusted Platform Module****TPM**

implementation of this specification

**4.97****user-installable software**

any software that may be installed on a platform other than platform firmware

**4.98****volatile data**

data that is lost when power is removed

**4.99****Zero Digest**

non-zero-length digest with all octets set to zero

**5 Symbols and Abbreviated Terms****5.1 Symbols**

For the purposes of this document, the following symbol definitions apply unless the text is in the Courier font.

$A    B$	concatenation of B to A
$\lceil x \rceil$	the smallest integer not less than x
$\lfloor x \rfloor$	the largest integer not greater than x
$A := B$	assignment of the results of the expression on the right (B) to the parameter on the left
$A = B$	equivalence (A is the same as B)
$\{ A \}$	an optional element
$A \oplus B$	bitwise exclusive OR of elements
$A \& B$	logical AND of elements
$A   B$	the logical OR of elements
$\{ A   B \}$	selection of elements
$\{ A : B \}$	an inclusive range of elements between A and B
$\langle A, B, \dots \rangle$	an ordered list of elements (a tuple)
$0 \dots 0$	a context-sensitive number of octets of zero

<b>F()</b>	denotes a function <b>F</b>
<b>F(<i>p</i> == <i>x</i>)</b>	denotes a function or TPM command <b>F</b> with parameter <i>p</i> set to value <i>x</i>
<b>length(<i>x</i>)</b>	denotes a function that returns the number of significant bits in an integer value <i>x</i>
<b>H()</b>	denotes the hash function
<b>[<i>n</i>]<i>P</i></b>	multiplication of point <i>P</i> by the integer value <i>n</i>
<b>A • B</b>	multiplication of two integer values A and B
<b>A→B</b>	denotes a reference to element B within structure A
<b>A mod B</b>	A modulus B

Text in the **Courier** font indicates code written according to the C language standard.

## 5.2 Abbreviations

For the purposes of this document, the following abbreviations apply.

<b>Abbreviation</b>	<b>Description</b>
<code>_TPM_</code>	Prefix for an indication passed from the system interface of the TPM to a Protected Capability defined in this specification
AK	Attestation Key
BIOS	Basic Input/Output System
CA	Certificate Authority
CFB	Cipher Feedback mode
CPU	Central Processing Unit
CRTM	Core Root of Trust for Measurement
CTR	Counter mode
D-RTM	dynamic RTM
DA	dictionary attack
DoS	Denial of Service
DRBG	Deterministic Random Bit Generator
DSA	Digital Signature Algorithm
EA	Enhanced Authorization
EAL	evaluated assurance level
ECDA	ECC-based Direct Anonymous Attestation
ECDH	Elliptic Curve Diffie-Hellman
EK	Endorsement Key
EPS	Endorsement Primary Seed
FIPS	Federal Information Processing Standard
FUM	Field Upgrade mode
GPIO	General Purpose I/O
HMAC	Hash Message Authentication Code

<b>Abbreviation</b>	<b>Description</b>
I/O	Input/Output
IV	Initialization Vector
KDF	key derivation function
LPC	Low Pin Count
LSb	Least Significant bit
LSO	Least Significant Octet
MSb	Most Significant bit
MSO	Most Significant Octet
NIST	National Institute of Standards and Technology
NP	new parent
NV	non-volatile
NVRAM	Non-Volatile Random Access Memory
OAEP	Optimal Asymmetric Encryption Padding
OEM	Original Equipment Manufacturer
OIAP	Object-Independent Authorization Protocol
OID	Object Identifier in ASN.1 format
OSAP	Object-Specific Authorization Protocol
PCR	platform configuration register(s)
POST	Power on Self-Test
PP	Physical Presence
PPS	Platform Primary Seed
PRF	pseudo-random function
PRNG	pseudo-random number generator
PSS	Probabilistic Signature Scheme
QN	Qualified Name
RNG	random number generator
RSA	Rivest, Shamir and Adleman
RTM	Root of Trust for Measurement
RTR	Root of Trust for Reporting
RTS	Root of Trust for Storage
S-RTM	static RTM
SHA	Secure Hash Algorithm
SMM	System Management mode
SPS	Storage Primary Seed
SRK	Storage Root Key
TBB	trusted building block
TCB	trusted computing base

<b>Abbreviation</b>	<b>Description</b>
TCG	Trusted Computing Group
TPM	Trusted Platform Module
TPM2_	Prefix for a command defined in this specification
TSS	TCG Software Stack
UEFI	Unified Extensible Firmware Interface



## 6 Compliance

Unless the TPM 2.0 Part 3 general description of a command indicates that the command is mandatory, a compliant TPM need not implement the command. However, if implemented, the command is required to have the behavior defined in TPM 2.0 Part 3. A platform-specific specification will indicate the commands from this specification that are required to be implemented in order to be compliant with that platform-specific specification.

The code in this specification is a reference implementation that describes required TPM behavior as observed from the TPM interface. The C-code may be reorganized or rewritten in any desired implementation language and remain compatible with this specification as long as the observable behavior is equivalent.

Even though the code in the reference implementation has undergone extensive testing, it is likely that some errors exist and one or more of those errors could lead to a TPM failure or exploit. Regardless of any other statement about normative behavior, one should not assume that a TPM exploit or failure is an intended behavior. It is not necessary to reproduce such a behavior in order to be compliant with this specification.

**NOTE** Please report bugs in the reference code to the TCG ([admin@trustedcomputinggroup.org](mailto:admin@trustedcomputinggroup.org)) so that the reference code may be brought into compliance with the specification.

The response codes in the specification are normative. An implementation performing a check prescribed by this specification is required to return the indicated error if the check fails. The order in which checks are performed is not normative. This means that a command with multiple errors could return different response codes on different TPMs. However, the response code returned is required to be the normative response code used to indicate the specific failure.

Capacities and algorithms of a TPM implementation may vary from the reference implementation; in this case, the same error would not occur in the same situation (such as, a TPM implementation with more memory may be able to satisfy a request where the reference implementation would have returned an error). However, these differences should not cause a different response code to be returned when the nature of the error is the same as in the reference implementation.

TPM 2.0 Part 4 of the specification contains major subsystems that may change for each instance of a TPM. For example, the NV subsystem of the reference implementation is not representative of the actual implementation of most physical NV implementations but is a crude analog. When the subsystem is rewritten, an equivalent interface should be provided, and the errors returned are required to match those of the reference implementation.

**NOTE** A constraint on the design of the TPM was the process of compliance-testing of different TPM implementations. If a TPM implementation has modularity similar to the reference implementation, then TPM tests that assume a modular design will be able to produce reliable test results on each TPM implementation.

The reference implementation uses static and stack-based allocation of resources and does not do allocations on a heap. However, a TPM implementation may use heap-based memory management in which case some error conditions and codes will differ. These differences are limited, and the allowed response codes and error conditions are defined in 39.3.

## 7 Conventions

### 7.1 Bit and Octet Numbering and Order

An integer value is considered to be an array of one or more octets. The octet at offset zero within the array is the most significant octet (MSO) of the integer. Bit number 0 of that integer is its least significant bit and the is the least significant bit in the last octet in the array.

**EXAMPLE** A 32-bit integer is an array of four octets; the MSO is at offset [0], and the most significant bit is bit number 31. Bit zero of this 32-bit integer is the least significant bit in the octet at offset [3] in the array.

**NOTE 1** Array indexing is zero-based.

**NOTE 2** This definition does not match the “network bit order” used in many IETF documents, such as RFC 4034. In those documents, the most significant bit of a datum has the lowest bit number. It is conventional practice to send that bit first when using a serial network protocol, and the bits are numbered in the order in which they are sent. This specification numbers bits according to the power of two to which they correspond within a datum. This numbering corresponds to the normal convention for bit numbering in hardware registers that hold integer values rather than fixed-point numbers.

The first listed member of a structure is at the lowest offset within the structure and the last listed member is at the highest offset within the structure.

For a character string (letters delimited by “”), the first character of the string contains the MSO.

### 7.2 Sized Buffer References

The specification makes extensive use of a data structure called a *sized buffer*. A sized buffer has a size field followed by an array of octets equal in number to the value in the size field.

The structure will have an identifying name. When the specification references the size field of the structure, the structure name is followed by “.size” (a period followed by the word “size”). When the specification references the octet array of the structure, the structure name is followed by “.buffer” (a period followed by the word “buffer”).

### 7.3 Numbers

Numbers are decimal unless a different radix is indicated.

Unless the number appears in a table intended to be machine readable, the radix is a subscript following the digits of the number. Only radix values of 2 and 16 are used in this specification.

Radix 16 (hexadecimal) numbers have a space separator between groups of two hexadecimal digits.

**EXAMPLE 1** 40 FF 12 34<sub>16</sub>

Radix 2 (binary) numbers use a space separator between groups of four binary digits.

**EXAMPLE 2** 0100 1110 0001<sub>2</sub>

For numbers using a binary radix, the number of digits indicates the number of bits in the representation.

**EXAMPLE 3** 20<sub>16</sub> is a hexadecimal number that contains exactly 8 bits and has a decimal value of 32.

**EXAMPLE 4** 10 0000<sub>2</sub> is a binary number that contains exactly 6 bits and has a decimal value of 32.

EXAMPLE 5       $0\ 20_{16}$  is a hexadecimal number that contains exactly 12 bits and has a decimal value of 32.

A number in a machine-readable table may use the “0x” prefix to denote a base 16 number. In this format, the number of digits is not always indicative of the number of bits in the representation.

EXAMPLE 6      0x20 is a hexadecimal number with a value of 32, and the number of bits is determined by the context.

## 8 Changes from Previous Versions

This version of the TPM specification introduces these additional features to the TPM family:

- Definition of an interface that allows variability of underlying cryptographic algorithms – TPM 1.2 is constrained by its data structures to using RSA and SHA1. The TPM 2.0 structure and interface defines support for a wide range of hash and asymmetric algorithms along with limited support for use of various block, symmetric ciphers. Of particular note is the addition of support for the elliptic curve (ECC) family of asymmetric algorithms.
- Unification of authorization methods – TPM 1.2 has different schemes to authorize the use, delegated use, and migration of objects. This 2.0 specification provides a uniform framework for using authorization capabilities so they may be combined in unique ways to provide more flexibility.
- Expansion of authorization methods – TPM 2.0 allows authorization with clear-text passwords and Hash Message Authentication Code (HMAC). It also allows construction of an arbitrarily complex authorization policy for an object using multiple authorization qualifiers.
- Dedicated BIOS support – TPM 2.0 adds a Storage hierarchy controlled by platform firmware, letting the OEM benefit from the cryptographic capabilities of the TPM regardless of the support provided to the OS.
- Simplified control model – TPM 2.0 needs no special provisioning process to be useful to applications. Although objects on which the TPM operates may have limitations, all commands are available all the time. This lets application developers rely on TPM capabilities being available whenever a TPM is present.

A TPM compatible with this specification need not be compatible with previous TPM specifications.

This specification defines the operations a TPM performs and the structures used for communication between the TPM and the host system. It does not define an electrical interface to the TPM, nor does it specify which subset of TPM 2.0 commands and resources are required for a specific platform. Please refer to platform-specific TPM specifications for this information.

## 9 Trusted Platforms

### 9.1 Trust

In the context of Trusted Computing Group (TCG) specifications, “trust” is meant to convey an expectation of behavior. However, predictable behavior does not necessarily constitute behavior that is worthy of trust. For example, we expect that a bank will behave like a bank, and we expect that a thief will behave like a thief.

In order to determine the expected behavior of a platform, it is necessary to determine its identity as it relates to the platform behavior. Physically different platforms may have identical behavior. If they are constructed of components (hardware and software) that have identical behavior, then their trust properties should be the same.

The TCG defines schemes for establishing trust in a platform that are based on identifying its hardware and software components. The Trusted Platform Module (TPM) provides methods for collecting and reporting these identities. A TPM used in a computer system reports on the hardware and software in a way that allows determination of expected behavior and, from that expectation, establishment of trust.

### 9.2 Trust Concepts

#### 9.2.1 Trusted Building Block

A trusted building block (TBB) is a component or collection of components required to instantiate a Root of Trust. Typically platform-specific, a TBB is part of a Root of Trust that does not have Shielded Locations.

One example of a TBB is the combination of the CRTM, the connection between CRTM storage and a motherboard, the path between CRTM storage and the CPU, the connection between the TPM and a motherboard, and the path between the CPU and the TPM. This combination comprises the Root of Trust for Reporting (RTR).

A TBB is a component that is expected to behave in a way that does not compromise the goals of trusted platforms.

#### 9.2.2 Trusted Computing Base

A trusted computing base (TCB) is the collection of system resources (hardware and software) that is responsible for maintaining the security policy of the system. An important attribute of a TCB is that it be able to prevent itself from being compromised by any hardware or software that is not part of the TCB.

The TPM is not the trusted computing base of a system. Rather, a TPM is a component that allows an independent entity to determine if the TCB has been compromised. In some uses, the TPM can help prevent the system from starting if the TCB cannot be properly instantiated.

#### 9.2.3 Trust Boundaries

The combination of TBB and Roots of Trust form a trust boundary, within which measurement, storage, and reporting may be accomplished for a minimal configuration. In systems that are more complex, it may be necessary for the CRTM to establish trust in other code, by making measurements of that other code and recording the measurement in a PCR. If the CRTM transfers control to that other code regardless of the measurement, then the trust boundary is expanded. If the CRTM will not run that code unless its

measurement is the expected value, the trust boundary remains the same because the measured code is an expected extension of the CRTM.

#### 9.2.4 Transitive Trust

Transitive trust is a process whereby the Roots of Trust establish the trustworthiness of an executable function, and trust in that function is then used to establish the trustworthiness of the next executable function.

Transitive trust may be accomplished either by: (1) knowing that a function enforces a trust policy before it allows a subsequent function to take control of the TCB, or (2) using measurements of subsequent functions so that an independent evaluation may establish the trust. The TPM may support either of these methods.

#### 9.2.5 Trust Authority

When the RTM begins to execute the CRTM, the entity that may vouch for the correctness of the TBB is the entity that created the TBB. For typical systems, this is the platform manufacturer. In other words, the manufacturer is the authority on what constitutes a valid TBB, and its reputation is what allows someone to trust a given TBB.

As the system transitions to code outside the CRTM, the transitive trust chain is maintained by measurement of that code. If execution of that code is conditional on its measurement, then the authority for that code remains unchanged. That is, if the platform manufacturer's CRTM does not run code outside the CRTM unless that code has a specific measured value, then the platform manufacturer remains the trust authority regardless of who provided that code.

In modern architectures, where firmware and software components come from many different suppliers, it is often not feasible for platform manufacturers to know the signers of all code that runs on a platform. Therefore, they may not remain the authority on platform state for very long. The measurements recorded in the RTS then determine the chain of authority for the current system state.

Two different methods allow evaluation of the trust authority for a platform.

- 1) Code is measured (hashed), and its value is recorded in the RTS. If the code is run regardless of its measurement, then the authority for the trust is the digest of the code reported by the RTR. That is, the measurements speak for themselves, and the verifier needs either to have knowledge of the measurements that constitute trustworthy code or knowledge of the measurements that indicates malicious or vulnerable code.
- 2) Code is signed so that the identity of the authority for the code is known. If this identity is recorded in the RTS, the evaluation can be changed. Instead of being based on knowing the digest of the code, it can be based on identities of the signers of the code.

Because trusted sources of code may sometimes produce code with security vulnerabilities, support for revocation is often required. To allow revocation of specific code modules, it is often necessary to use a hybrid solution where both authorities and details are recorded. This simplifies the process of determining whether a module from a specific vendor has been revoked.

**NOTE** If the code is measured (hashed) and not signed, it is harder to know if a specific measurement is valid unless there is a centralized database of all known digests of revoked code. When the identity of the authority is known, one can contact the vendor to determine if it has revoked code with a given hash.

### 9.3 Trusted Platform Module

A TPM is a system component that has state that is separate from the system on which it reports (the host system). The only interaction between the TPM and the host system is through the interface defined in this specification.

TPMs are implemented on physical resources, either directly or indirectly. A TPM may be constructed using physical resources that are permanently and exclusively dedicated to the TPM, and/or using physical resources that are temporarily assigned to the TPM. All of a TPM's physical resources may be located within the same physical boundary, or different physical resources may be within different physical boundaries.

Some TPMs are implemented as single-chip components that are attached to systems (typically, a PC) using a low-performance interface (such as, Low Pin Count, or LPC). The TPM component has a processor, RAM, ROM, and Flash memory. The only interaction with these TPMs is through the LPC bus. The host system cannot directly change the values in TPM memory other than through the I/O buffer that is part of the interface.

Another reasonable implementation of a TPM is to have the code run on the host processor while the processor is in a special execution mode. For these TPMs, parts of system memory are partitioned by hardware so that the memory used by the TPM is not accessible by the host processor unless it is in this special mode. Further, when the host processor switches modes, it always begins execution at specific entry points. This version of a TPM would have many of the same attributes as the stand-alone component in that the only way for the host to cause the TPM to modify its internal state is with well-defined interfaces. There are several different schemes for achieving this mode switching including System Management Mode, Trust Zone™, and processor virtualization.

Definition of the interaction between the host and the TPM is the primary objective of this specification. Prescribed commands instruct the TPM to perform prescribed actions on data held with the TPM. A primary purpose of these commands is to allow determination of the trust state of a platform. The ability of a TPM to accomplish its objective depends on the proper implementation of Roots of Trust.

### 9.4 Roots of Trust

TCG-defined methods rely on Roots of Trust. These are system elements that must be trusted because misbehavior is not detectable. The set of roots required by the TCG provides the minimum functionality necessary to describe characteristics that affect a platform's trustworthiness.

While it is not possible to determine if a Root of Trust is behaving properly, it is possible to know how roots are implemented. Certificates provide assurances that the root has been implemented in a way that renders it trustworthy. For example, a certificate may identify the manufacturer and evaluated assurance level (EAL) of a TPM. This certification provides confidence in the Roots of Trust implemented in the TPM. In addition, a certificate from a platform manufacturer may provide assurance that the TPM was properly installed on a machine that is compliant with TCG specifications so that the Root of Trust provided by the platform may be trusted. See 9.5.2 for more information on certification.

The TCG requires three Roots of Trust in a trusted platform:

- Root of Trust for Measurement (RTM),
- Root of Trust for Storage (RTS), and
- Root of Trust for Reporting (RTR).

Trust in the Roots of Trust can be achieved through a variety of means but is anticipated to include technical evaluation by competent experts.

### 9.4.1 Root of Trust for Measurement (RTM)

The RTM sends integrity-relevant information (measurements) to the RTS. Typically, the RTM is the CPU controlled by the Core Root of Trust for Measurement (CRTM). The CRTM is the first set of instructions executed when a new chain of trust is established. When a system is reset, the CPU begins executing the CRTM. The CRTM then sends values that indicate its identity to the RTS. This establishes the starting point for a chain of trust. See 9.5.5 for a more detailed description of integrity measurement.

### 9.4.2 Root of Trust for Storage (RTS)

The TPM memory is shielded from access by any entity other than the TPM. Because the TPM can be trusted to prevent inappropriate access to its memory, the TPM can act as an RTS.

Some of the information in TPM memory locations is not sensitive and the TPM does not protect it from disclosure. An example of non-sensitive data is the current contents of a platform configuration register (PCR) containing a digest. Other information is sensitive and the TPM does not allow access to the information without proper authority. An example of sensitive data in a Shielded Location is the private part of an asymmetric key.

Sometimes, the TPM uses the contents of one Shielded Location to gate access to another Shielded Location. For example, access to (use of) a private key for signing may be conditioned on PCR having specific values.

### 9.4.3 Root of Trust for Reporting (RTR)

#### 9.4.3.1 Description

The RTR reports on the contents of the RTS. An RTR report is typically a digitally signed digest of the contents of selected values within a TPM.

**NOTE** Not all Shielded Locations are directly accessible. For example, the values of the private part of keys and authorizations are in Shielded Locations on which the TPM will not report.

The values on which the RTR reports typically are

- evidence of a platform configuration in PCR (such as, TPM2\_Quote()),
- audit logs (such as, TPM2\_GetCommandAuditDigest ()), and
- key properties (such as, TPM2\_Certify()).

The interaction between the RTR and RTS is critical. The design and implementation of this interaction should mitigate tampering that would prevent accurate reporting by the RTR. An instantiation of the RTS and RTR will

- be resistant to all forms of software attack and to the forms of physical attack implied by the TPM's Protection Profile, and
- supply an accurate digest of all sequences of presented integrity metrics.

#### 9.4.3.2 Identity of the RTR

The TPM contains cryptographically verifiable identities for the RTR. The identity is in the form of asymmetric aliases (Endorsement Keys or EKs) derived from a common seed. Each seed value and its aliases should be statistically unique to a TPM. That is, the probability of two TPMs having the same EK should be insignificant.



The seed may be used to generate multiple asymmetric keys, all of which would represent the same TPM and RTR.

#### 9.4.3.3 RTR Binding to a Platform

The TPM reports on the state of the platform by quoting the PCR values. For assurance that these PCR values accurately reflect that state, it is necessary to establish the binding between the RTR and the platform. A Platform Certificate can provide proof of this binding. The Platform Certificate is assurance from the certifying authority of the physical binding between the platform (the RTM) and the RTR.

#### 9.4.3.4 Platform Identity and Privacy Considerations

The uniqueness of an EK and its cryptographic verifiability raises the issue of whether direct use of that identity could result in aggregation of activity logs. Analysis of the aggregated activity could reveal personal information that a user of a platform would not otherwise approve for distribution to the aggregators.

To counter undesired aggregation, TCG encourages the use of domain-specific signing keys and restrictions on the use of an EK. The Privacy Administrator controls use of an EK, including the process of binding another key to the EK.

**NOTE** Privacy Administrator's control of the EK differs from Owner control of the RTS providing separation of the security and identity uses of the TPM.

Unless the EK is certified by a trusted entity, its trust and privacy properties are no different from any other asymmetric key that can be generated by pure software methods. Therefore, by itself, the public portion of the EK is not privacy sensitive.

### 9.5 Basic Trusted Platform Features

#### 9.5.1 Introduction

At a minimum, a trusted platform provides the three Roots of Trust described previously. All three roots use certification and attestation to provide evidence of the accuracy of information. A trusted platform will also offer Protected Locations (see 10.3) for the keys and data objects entrusted to it. Finally, a trusted platform may provide integrity measurement to ensure the trustworthiness of a platform by logging changes to platform state; this is done by recording logged entries in PCR for later validation as being correct and unaltered. These basic TPM concepts are now described in detail.

#### 9.5.2 Certification

The nominal method of establishing trust in a key is with a certificate indicating that the processes used for of creating and protecting the key meets necessary security criteria. A certificate may be provided by shipping the TPM with an embedded key (that is, an Endorsement Key) along with a Certificate of Authenticity for the EK. The EK and its certificate may be used to associate credentials (certificates) with other TPM keys; this process is described in 9.5.3.3. When a certified key has attributes that let it sign TPM-created data, it may attest to the TPM-resident record of platform characteristics that affect the integrity (trustworthiness) of a platform.

**NOTE** The EK does not have to be installed when the TPM is shipped. At the factory, an EK may be generated from the Endorsement Seed and a Certificate of Authenticity created for that EK. The EK does not have to be permanently installed in the TPM. When the TPM is in possession of a customer, the customer may, at their discretion, have the TPM use the Endorsement Seed and recreate the EK for which they have a Certificate of Authenticity.

### 9.5.3 Attestation and Authentication

#### 9.5.3.1 Types of Attestation

Trusted platforms employ a hierarchy of attestations:

- 1) An external entity attests to a TPM in order to vouch that the TPM is genuine and complies with this TPM specification. This attestation takes the form of an asymmetric key embedded in a genuine TPM, plus a credential that vouches for the public key of that pair.

NOTE 1 A credential that is used to vouch for the embedded asymmetric key is commonly called an "Endorsement Certificate."

- 2) An external entity attests to a platform in order to vouch that the platform contains a Root-of-Trust-for-Measurement, a genuine TPM, plus a trusted path between the RTM and the TPM. This attestation takes the form of a credential that vouches for information including the public key of the asymmetric key pair in the TPM.

NOTE 2 A credential used to vouch for the platform is commonly called a "Platform Certificate."

- 3) An external entity called an "Attestation CA" attests to an asymmetric key pair in a TPM in order to vouch that a key is protected by an unidentified but genuine TPM, and has particular properties. This attestation takes the form of a credential that vouches for information including the public key of the key pair. An Attestation CA typically relies upon attestations of type 1 and 2 in order to produce attestation of type 3.

NOTE 3 The credential created by the CA is commonly called an "Attestation Key Certificate."

- 4) A trusted platform attests to an asymmetric key pair in order to vouch that a key pair is protected by a genuine but unidentified TPM and has particular properties. This attestation takes the form of a signature signed by the platform's TPM over information that describes the key pair, using an attestation-key protected by the TPM, plus attestation of type 3 that vouches for that attestation-key.

NOTE 4 This type of attestation is done using TPM2\_Certify().

- 5) A trusted platform attests to a measurement in order to vouch that a particular software/firmware state exists in a platform. This attestation takes the form of a signature over a software/firmware measurement in a PCR using an attestation-key protected by the TPM, plus attestation of type 3 or 4 for that attestation-key.

NOTE 5 This is type of attestation is commonly called a "quote" and is done with TPM2\_Quote().

- 6) An external entity attests to a software/firmware measurement in order to vouch for particular software/firmware. This attestation takes the form of a credential that vouches for information including the value of a measurement and the state it represents.

NOTE 6 This is commonly called "third-party certification."

Attestation of types 3 and 4 entail the use of a key to sign the contents of Shielded Locations. An Attestation Key (AK) is a particular type of signing key that has a restriction on its use, in order to prevent forgery (the signing of external data that has the same format as genuine attestation data). The restriction is that an AK may be used only to sign a digest that the TPM has created. If an AK is known to be protected by a TPM (by virtue of attestation of type 3 or 4), it may be relied on to report accurately on Shielded Location content, and not sign externally provided data that appears to be valid and TPM-produced but is not.



**EXAMPLE** If an attacker produced a message block that was identical to a TPM-generated quote, that message block would start with TPM\_GENERATED\_VALUE to indicate that it is a proper TPM quote. When the TPM performs a digest of this block, it notes that the first octets are the same as TPM\_GENERATED\_VALUE. It will not generate the ticket indicating that the message is safe to sign, so an AK may not be used to sign this digest. Similarly, an entity checking an attestation made by an AK must verify that the message signed begins with TPM\_GENERATED\_VALUE in order to verify the message is indeed a TPM-generated quote.

Values signed by an AK may be assured to reflect TPM state, but AKs may also be used for general signing purposes.

An AK does not have much value to a remote challenger if the AK cannot be associated with the platform that it represents. This association is made using the identity certification process.

### 9.5.3.3 Attestation Key Identity Certification

Any TPM user that can create a key on a TPM can create a restricted-use signing key. The key creator may then ask a third party, such as an attestation Certificate Authority (CA), to provide a certificate for it. The attestation CA may request that the caller provide some evidence that the key being certified is a TPM-resident key.

Evidence of TPM residency may be provided using a previously generated certificate for another key on the same TPM. An EK or Platform Certificate may provide this evidence.

**NOTE 1** There is no requirement that certificates come only from an attestation CA. The method described above is an example of a scheme that may be used when privacy is required.

If a certified key may sign, it may be used to certify that some other object is resident on the same TPM. This allows the new AK to be linked to a certified key. A CA may use the certification from the TPM to produce a traditional certificate for the new key.

If the certified key is a decryption key and may not sign, then an alternative method is used to allow the new key or data object to be reliably certified. For this alternative certification, the identity of the Object to be certified and a certificate for the decryption key (such as, an EK) are provided to the CA. From the certificate, the CA determines the public key for the decryption key. The CA then produces a conditional certificate for the Object to be certified.

The certificate is made conditional by performing some operation on the credential (such as, symmetrically encrypting it) with a value that is required to be known before the credential can be used. This process produces a credential qualifier that is given to the TPM containing both the certified decryption key and the key to be certified.

**NOTE 2** A common credential qualifier would be a symmetric key that was used to encrypt the credential. Another option for the credential qualifier would be for it to be all or a portion of the signature of the certificate. Other options are possible.

The credential qualifier is protected using methods that are dependent on the type of the certified decryption key. The general method is described in clause 24. Additional methods appropriate to RSA keys are described in B.10.4 and additional methods appropriate to ECC key are in C.6.4. The protection process produces an encrypted blob, an HMAC over the blob, and a secret value that can only be recovered by the certified decryption key.

TPM2\_ActivateCredential() is used to access the credential qualifier. The TPM recovers the secret value and uses it to generate the keys necessary to decrypt and validate the HMAC and encrypted blob. If the credential qualifier is recovered successfully, and the key being certified by the credential is loaded on the TPM, then the contents of the credential qualifier are returned to the caller. They may then use that value to complete the key certification.

**NOTE 3** The protection process used for credential qualifiers is almost identical to the process used for key import. In order to make sure that there is no misuse of the encrypted structures, an application-specific value is used in the key recovery process. In the case of a credential qualifier, the label "IDENTITY" is used in the KDF that generates the keys (symmetric and HMAC) from the seed value.

TPM2\_ActivateCredential() associates a credential with any object. The choice of attributes for an Object to be certified is at the discretion of the CA. Because a unique identifier for the Object is included in the integrity hash, the TPM enforces the credential's accessibility only if the Object matches the criteria set by the CA as expressed in the object identifier.

#### 9.5.4 Protected Location

When the sensitive portion of an object is not held in a Shielded Location on the TPM, it is encrypted. When encrypted, but not on the TPM, it is not protected from deletion, but it is protected from disclosure of its sensitive portions. Wherever it is stored, it is in a Protected Location.

Objects in long-term protected storage need to be loaded into the TPM for use. The application that created the objects manages their movement from long-term storage to the TPM.

Since a TPM has limited memory, it may be unable to hold all objects required by all applications simultaneously. The TPM supports swapping of object contexts by a TPM Resource Manager (TRM) so that the TPM can service these multiple applications. The object contexts are encrypted before being returned to the TRM by the TPM. If the object is needed later, the TRM can reload the context into the TPM providing a cache-like behavior.

Encryption of Protected Locations uses multiple seeds and keys that never leave the TPM. One of these is the Context Key. It is a symmetric key used to encrypt data when it is temporarily swapped out of the TPM so that a different working set of objects may be loaded. Other sensitive values that never leave the TPM are the Primary Seeds. These seeds are the root of the storage hierarchies that protect objects that are retained by applications. A Primary Seed is a random number used to generate protection keys for other objects; these objects may be Storage Keys that contain protection keys that are then used to protect still more objects.

Primary Seeds may be changed, and when they are changed, the objects they protected will no longer be usable. For example, the Storage Primary Seed (SPS) creates the Storage hierarchy for owner-related data, and that seed changes when the owner changes.

#### 9.5.5 Integrity Measurement and Reporting

The Core Root of Trust for Measurement (CRTM) is the starting point of measurement. This process makes the initial measurements of the platform that are Extended into PCR in the TPM. For measurements to be meaningful, the executing code needs to control the environment in which it is running, so that the values recorded in the TPM are representative of the initial trust state of the platform.

A power-on reset creates an environment in which the platform is in a known initial state, with the main CPU running code from some well-defined initial location. Since that code has exclusive control of the platform at that time, it may make measurements of the platform from firmware. From these initial measurements, a chain of trust may be established. Because this chain of trust is created once when the platform is reset, no change of the initial trust state is possible, so it is called a static RTM (S-RTM).

An alternative method of initializing the platform is available on some processor architectures. It lets the CPU act as the CRTM and apply protections to portions of memory it measures. This process lets a new chain of trust start without rebooting the platform. Because the RTM may be re-established dynamically, this method is called dynamic RTM (D-RTM). Both S-RTM and D-RTM may take a system in an unknown state and return it to a known state. The D-RTM has the advantage of not requiring the system to be rebooted.

An integrity measurement is a value that represents a possible change in the trust state of the platform. The measured object may be anything of meaning but is often

- a data value,
- the hash of code or data, or
- an indication of the signer of some code or data.

The RTM (usually, code running on the CPU) makes these measurements and records them in RTS using Extend. The Extend process (see 17.2) allows the TPM to accumulate an indefinite number of measurements in a relatively small amount of memory.

The digest of an arbitrary set of integrity measurements is statistically unique, and an evaluator might know the values representing particular sequences of measurements. To handle cases where PCR values are not well known, the RTM keeps a log of individual measurements. The PCR values may be used to determine the accuracy of the log, and log entries may be evaluated individually to determine if the change in system state indicated by the event is acceptable.

Implementers play a role in determining how event data is partitioned. TCG's platform-specific specifications provide additional insight into specifying platform configuration and representation as well as anticipated consumers of measurement data.

Integrity reporting is the process of attesting to integrity measurements recorded in a PCR. The philosophy behind integrity measurement, logging, and reporting is that a platform may enter any state possible — including undesirable or insecure states — but is required to accurately report those states. An independent process may evaluate the integrity states and determine an appropriate response.

## 10 TPM Protections

### 10.1 Introduction

This part of the specification describes the protections provided by the Trusted Platform Module. This clause describes the properties of selected capabilities and selected data locations for a TPM that has been evaluated according to a Protection Profile and a TPM that has not been modified by physical means.

TPM protections are based on the concepts of Protected Capabilities and Protected Objects. A Protected Capability is an operation that must be performed correctly for a TPM to be trusted. A Protected Object is data (including keys) that must be protected for a TPM operation to be trusted. Protected Objects in the TPM reside in Shielded Locations; the TPM may manipulate the contents of Shielded Locations only by using Protected Capabilities. Protected Objects outside Shielded Locations have their integrity and confidentiality protected cryptographically.

Since a Protected Object may reside outside of Shielded Location protections, the definition of “access” to a Protected Object denotes disclosure of its contents, not modification. Such objects are not protected against loss or tampering. However, before loading a Shielded Location with an outside object, the TPM will use a secure hash function to validate that the object was properly protected and not altered. If the integrity check fails, the TPM returns an error and does not load the object.

The only operations on Shielded Locations of a TPM are the Protected Capabilities defined in this specification and the vendor-specific operations that meet the requirements of 10.4.

### 10.2 Protection of Protected Capabilities

A Protected Capability may be modified only by other Protected Capabilities in the same TPM. Thus, the process of updating TPM firmware is required to be a Protected Capability.

### 10.3 Protection of Shielded Locations

As noted, access to any data on a TPM requires use of a Protected Capability. Therefore, all information on a TPM is in a Shielded Location. The contents of a Shielded Location are not disclosed unless the disclosure is intended by the definition of the Protected Capability. A TPM is not allowed to export data from a Shielded Location other than by using a Protected Capability.

**NOTE** Data in an I/O buffer that can be modified by the host is not “on” the TPM, even though the I/O buffer may be shielded from access while the TPM is processing a command or generating a response.

### 10.4 Exceptions and Clarifications

Vendor-specific operations may access and modify Shielded Locations on a TPM under the following circumstances.

- A vendor-specific operation may use the standard TPM authorization mechanism.
- A vendor-specific capability may read any TPM-resident structure that is not required to be in a Shielded Location at all times if the usage of that structure is authorized per the structure’s authorization mechanism.

**EXAMPLE** A vendor-specific command may use the public portion of a key. If the key is a user key, no authorization would be required.

NOTE            Among other things, the exception above enables access to a Shielded Location so the structure's access authorization may be checked.

- Vendor-specific operations may use a sequence of Protected Capabilities.
- Vendor-specific operations may use the standard TPM command interface or use a vendor-defined interface.

These clarifications serve to approve specific legitimate interpretations of the requirements.

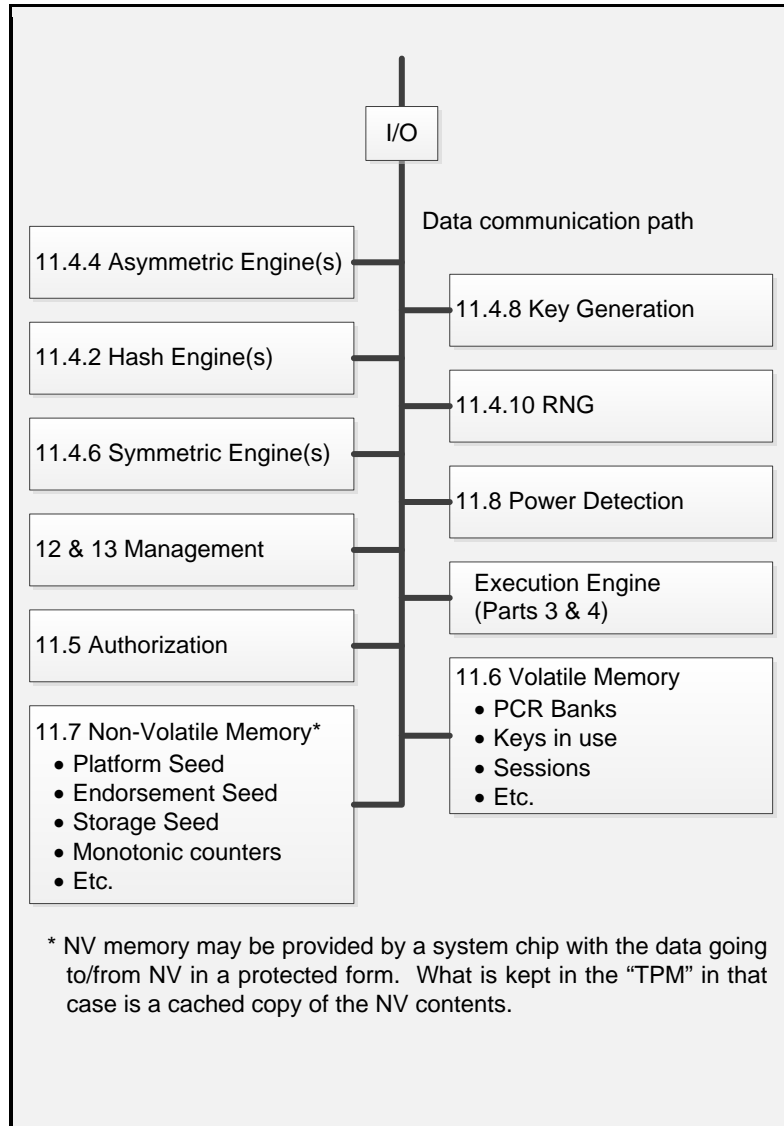
- A vendor-specific operation that takes advantage of exceptions and clarifications to the “protection” requirements should be defined as part of the security target of the TPM. Such a vendor-specific command or capability should be evaluated to determine whether it meets Platform-specific TPM and System Security Targets.
- If a TPM stores vendor-specific cipher-text that is protected against subversion to the same or greater extent as internal TPM-resources stored outside the TPM with TCG-defined methods, then that cipher-text does not require protection from physical attack. If the TPM stores only vendor-specific cipher-text that does not require protection from physical attack, that location may be excluded from analysis when determining whether the TPM complies with the “physical protection” requirements specified by TCG.
- If a TPM uses external memory for non-volatile storage of TPM state (including seeds and proof values), movement of the TPM state to and from the NV memory constitutes a vendor-defined operation that is allowed by this specification. The protection profile of that TPM should include a description of the protections of that data to insure confidentiality and integrity of the data and to mitigate against rollback attacks.



## 11 TPM Architecture

### 11.1 Introduction

This clause describes the overall operation of the TPM and the functional units required for its operation. The major elements of the architecture are shown in Figure 2.



**Figure 2 — Architectural Overview**

### 11.2 TPM Command Processing Overview

Figure 3 is a high-level flow diagram for a TPM command. The figure shows only the normal flow for a command that executes successfully. The tabs on a box indicate the name of the module performing the operation. Additional details for each of the modules shown in Figure 3 are in this clause and in clauses dedicated to those modules.

The partitioning of functions in Figure 3 is illustrative and not normative.

The flow assumes that the command has been placed in an input buffer that is accessible to the Execute Command module (this name is used because of its similarity to the ExecCommand() function in the reference code that performs the functions illustrated here).

**NOTE 1** The mechanism for getting the command into the TPM buffer and providing the command-available indication is specific to each physical interface and is defined in interface-specific documents.

The command structure includes a standard header (see Clause 17.10) that Execute Command validates. It then determines if the command requires access to any Shielded Location that is identified by a handle. If so, it calls the Handle module to verify that the handle references the right type of resource for the command and that the resource is currently loaded on the TPM.

When control returns to Execute Command, it checks the *tag* parameter in the command header to determine if authorization values are provided. If so, Authorizations is called to validate that each of the authorizations is correct. The authorizations are associated with a handle value so the authorization is specific to a particular entity.

After validating the authorizations, Execute Command calls Command Dispatch to unmarshal the remaining command parameters and validate that the required parameters of the required type are present. All parameters are validated to meet the requirements of its data type as defined in TPM 2.0 Part 2 even if the parameter will subsequently be discarded because of optional behavior of a command.

After unmarshaling the parameters, Command Dispatch calls the command-specific library function to execute the specific command. Additional parameter checking may be required in the command-specific actions.

The command processing is structured so that changes to the TPM state do not occur until the TPM can validate that the command parameters are correct and that the resources necessary to complete the command are available. Only then will it make irreversible changes to the TPM state. This structuring ensures that when the TPM returns an error, the TPM will be in the same state as before command actions modified the data in any Shielded Location.

**NOTE 2** Requiring that the TPM retain its state minimizes the interference between applications and helps prevent system instability due to careless use of the TPM by applications.

There are several classes of operations that return an error but may change TPM state.

- An authorization failure may update the dictionary attack mechanism.
- The self test mechanism has state (for example, which algorithms have been tested) that is considered to be different from the command execution state. Changes to this state may occur regardless of the command return code. For example, an implicit self test invoked to test an algorithm required by the command may mark the algorithm as tested.
- If a self test fails, the TPM will go into Failure Mode.

When the command actions are complete, the Command Dispatch marshals response parameters into the output buffer. If the command had authorizations, Acknowledge is called to construct acknowledge session values for the response.

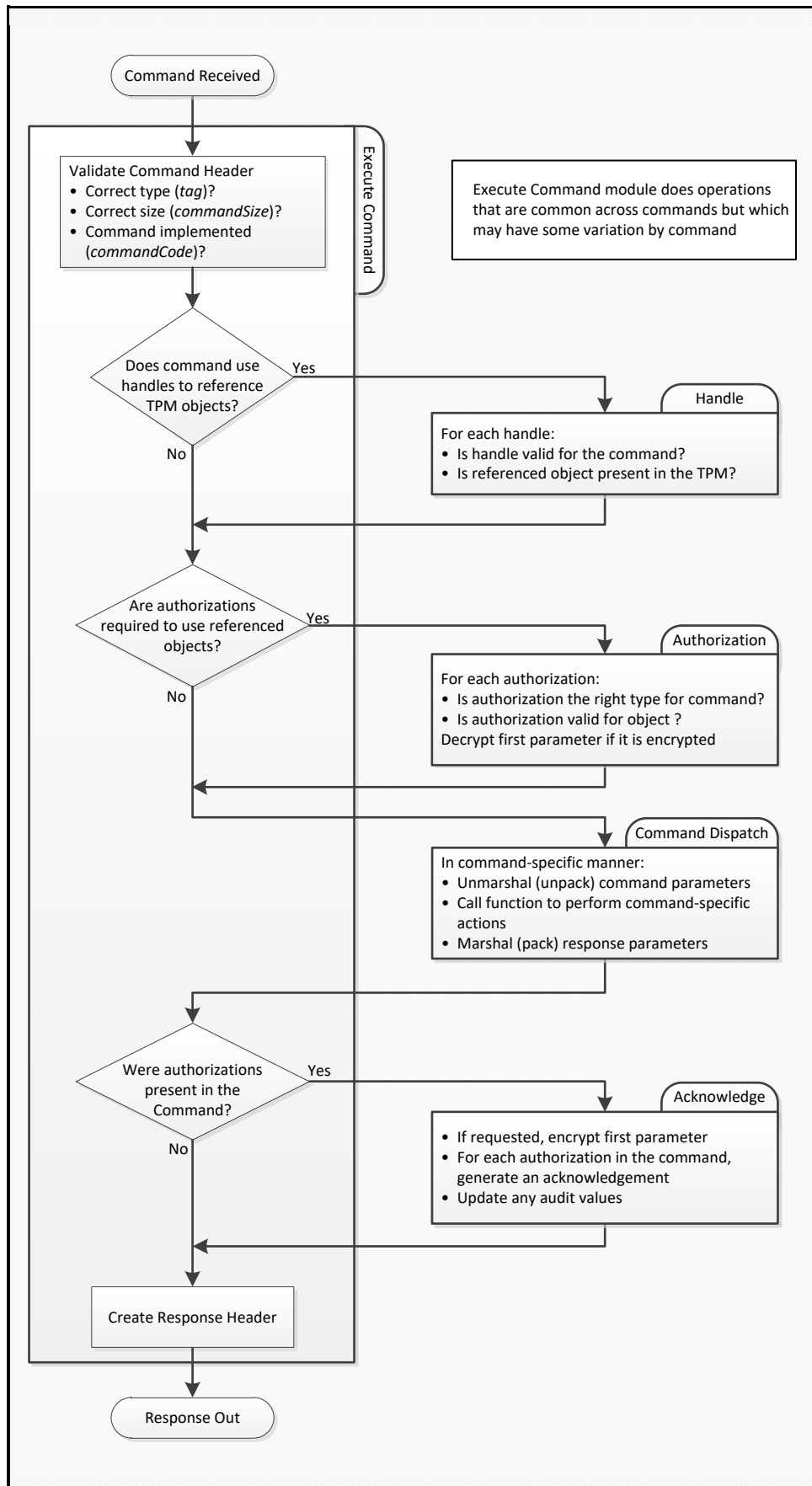
If the command encounters an error, the response packet will contain a code that is characteristic of the error and, when possible, an indication of whether the error was associated with a handle, an authorization session, or a command parameter. No additional qualifying data is present. In most cases, the error code and parameter location value suffice to isolate the problem.

**NOTE 3** In the case of a self-test failure, the TPM response code is not sufficient to diagnose the problem. Therefore, a reporting scheme is provided so that the failure cause can be read. However, error report contents vary by vendor and are not standardized. There is thus no need to standardize self-test response codes because no standard remediation is possible for most self-test failures.

After constructing the response, including acknowledge sessions, the TPM indicates to the interface that the response is ready to be returned.

The TPM command/response structure is described in Clause 17.10. See Clause 19 for a description of the methods for creating the values that authorize use of a TPM Shielded Location and Clause 39 for response code formatting information.

During the processing of these commands, the TPM uses other modules that the following parts of this clause will describe.



### Figure 3 — Command Execution Flow

#### 11.3 I/O Buffer

The I/O buffer is the communications area between a TPM and the host system. The system places command data in the I/O buffer and retrieves response data from the buffer.

A description of the physical processes used to move I/O buffer data to/from the system is beyond the scope of this specification. Platform-specific working groups within the TCG produce the specifications for the physical interfaces to the TPM on their platforms. Those specifications detail the interactions between system software and the TPM I/O buffer.

There is no requirement that the I/O buffer be physically isolated from other parts of the system. It can be a shared memory. However, when processing of a command begins, the implementation must ensure that the TPM is using the correct values. For example, if the TPM performs a hash of the command data as part of the authorization processing, the TPM needs to protect the validated command data from modification. That is, before the data is validated, it is required to be protected from modification. Before the data is modified, it is required to be in a Shielded Location.

#### 11.4 Cryptography Subsystem

##### 11.4.1 Introduction

The Cryptography subsystem implements the TPM's cryptographic functions. It may be called by the Command Parsing module, the Authorization Subsystem, or the Command Execution module. The TPM employs conventional cryptographic operations in conventional ways. These operations include

- hash functions,
- asymmetric encryption and decryption,
- asymmetric signing and signature verification,
- symmetric encryption and decryption,
- symmetric signing (HMAC) and signature verification, and
- key generation.

The remainder of this clause describes some algorithms usually found in a TPM to show how they are handled. These descriptions illustrate, but do not limit, the choice of available algorithms.

##### 11.4.2 Hash Functions

Hash functions may be used directly by external software or as the side effect of many TPM operations. The TPM uses hashing to provide integrity checking and authentication as well as one-way functions, as needed (such as, KDF).

A TPM should implement an approved hash algorithm that has approximately the same security strength as its strongest asymmetric algorithm.

**EXAMPLE** An ECC with a 384-bit key has a security strength of 192 bits. SHA384, with 192 bits of security, would meet the preceding requirement above.

**NOTE** The TCG may create sets of algorithms that do not have the same security strength for the hash and asymmetric algorithms.

A hash function will be denoted by  $H_{algorithm}()$  with the algorithm subscript indicating the hash algorithm or the parameter that contains the hash algorithm identifier. In some cases, the algorithm subscript is missing, in which case the algorithm will be determined by context.

The Command Dispatch module will use the hash function when validating certain types of authorizations. Hash functions are also used in support of other operations in the TPM such as PCR Extend.

### 11.4.3 HMAC Algorithm

The TPM implements the Hash Message Authentication Code (HMAC) algorithm described in ISO/IEC 9797-2.

An HMAC is a form of symmetric signature over some data. It provides assurance that protected data was not modified and that it came from an entity with access to a key value. To have usefulness in protecting data, the key value needs to be a secret or a shared secret.

ISO/IEC 9797-2 defines the HMAC operation as:

$$\mathbf{HMAC}(K, text) = \mathbf{H}((\bar{K} \oplus OPAD) || \mathbf{H}((\bar{K} \oplus IPAD) || text)) \quad (1)$$

(See ISO/IEC 9797-2 for a description of parameters.)

Performing the HMAC computation requires selection of a hash algorithm. This specification modifies the notation from ISO/IEC 9797-2 to be:

$$\mathbf{HMAC}_{hashAlg}(K, text) \quad (2)$$

If the algorithm subscript is not present, the hash algorithm is implied by the context.

The Command Dispatch module may use the HMAC function to validate an authorization. The HMAC function may be used by the Command Execution module in support of its operations.

### 11.4.4 Asymmetric Operations

A TPM uses asymmetric algorithms for attestation, identification, and secret sharing. A TPM may support any asymmetric algorithm to which the TCG has assigned an identifier. An asymmetric algorithm identifier will indicate a family of algorithms and methods that are used with that algorithm.

The methods for using an asymmetric algorithm are found in algorithm-specific annexes to this TPM 2.0 Part 1. Currently, the only supported asymmetric algorithms are RSA (described in Annex B ) and ECC using prime curves (described in Annex B ).

A TPM is required to implement at least one asymmetric algorithm.

### 11.4.5 Signature Operations

#### 11.4.5.1 Signing

The TPM may sign using either an asymmetric or a symmetric algorithm. The method of signing depends on the type of the key. For an asymmetric algorithm, the methods of signing are dependent on the algorithm (RSA or ECC). For symmetric signatures, only the HMAC signing scheme is currently defined. If a key may be used for signing, then it will have the *sign* attribute.

NOTE The signing schemes for RSA are described in B.6 (RSASSA\_PKCS1v1\_5) and B.7 (RSASSA\_PSS). The signing schemes for ECC are described in C.4 (EC Signing).

A key with a sign attribute may also have a restriction on the contents of the message that can be signed with the key. When a key has this restriction, the TPM will not use the key to sign message digests that the TPM did not compute.

Any attestation message produced by a TPM will have a header (TPM\_GENERATED\_VALUE) to identify the data as being produced within a TPM. If a restricted key is used to sign this data, then a relying party can have assurance that the message data came from a TPM.

To allow a restricted key to sign an externally generated message, the TPM is used to produce the message digest. When the TPM computes the digest, it will validate that the message does not begin with TPM\_GENERATED\_VALUE. If it does, then the TPM will not produce the special certification (a ticket) that indicates that the digest was produced by the TPM and is safe to sign with a restricted key.

A key designated as a signing key may be used in any command that uses a signing key. For some commands, the signing scheme may be specified in the command. Not all schemes are valid for all keys, and the TPM generates an error if the scheme is not allowed with the indicated key type.

EXAMPLE 1 The RSASSA-PKCS1-v1\_5 signing scheme is not valid with an ECC key.

EXAMPLE 2 A key that has the "restricted" attribute may only be used with one signing scheme. If it is limited to be used with RSASSA-PSS, it may not be used with RSASSA-PKCS1-v1\_5.

A restricted signing key is required to have a signing scheme specified in the key definition and that is the only signing scheme that is allowed to be used with the key. For an unrestricted key, the key definition may contain a signing scheme selection or the signing scheme may be determined when the key is used. To defer the signing scheme selection, the key would be created with TPM\_ALG\_NULL as the signing scheme selection.

#### 11.4.5.2 Signature Verification

TPM2\_VerifySignature() validates a signature. The command takes a handle of a public key, a digest, and a block that contains the signature over the digest.

The TPM validates that the signature scheme is compatible with the selected key. Any combination of hashes and non-anonymous signature schemes that a TPM supports for signing is also supported for signature verification.

If the signature is valid, the TPM will produce a ticket.

#### 11.4.5.3 Tickets

A ticket is an HMAC signature that uses a proof value as the HMAC key.

NOTE Hierarchy proof values are described in detail in 14.4.

The TPM uses tickets for two purposes:

- re-signing data. After checking an asymmetric signature, the TPM re-signs the digest using a TPM symmetric key. The TPM can later re-verify a signature without having to load the asymmetric key; and

- expanding state memory. When hashing an external message, the TPM has some state that indicates the message did not start with TPM\_GENERATED\_VALUE. This state information cannot be retained indefinitely in the TPM. A ticket allows this state to be stored off of the TPM in a way that is easy for the TPM to validate. When a digest is later presented to the TPM to be signed, the ticket is provided allowing the TPM to validate that the digest to be signed is safe to sign.

The proof value used for a ticket will minimally have a number of bits equal to the size of the digest produced by the hash algorithm.

EXAMPLE        A proof value of 256 bits is required for a SHA256 ticket.

There are five different ticket types:

- 1) TPMT\_TK\_CREATION – this ticket type is produced when an object is created (TPM2\_Create() or TPM2\_CreatePrimary()). The ticket is used in TPM2\_CertifyCreation() so that the TPM can certify that it created a specific object and the environmental parameters (PCR) that were extant when the object was created. This avoids having the digest of the creation data be a permanent part of an object's data structure.
  - 2) TPMT\_TK\_VERIFIED – this ticket type is produced by TPM2\_VerifySignature() and used by TPM2\_PolicyAuthorize(). If a signature is signed by an asymmetric key, the signature verification might be time consuming. If the same authorization is going to be used many times (such as an authorization for TPM2\_PolicyAuthorize()), there is a performance advantage to having the asymmetric authorization converted so that it uses symmetric cryptography which is usually faster. This ticket is the symmetric equivalent authorization.
  - 3) TPMT\_TK\_AUTH – this ticket is produced by TPM2\_PolicySigned() or TPM2\_PolicySecret() and used in TPM2\_PolicyTicket(). A policy authorization can be tied to a specific policy session or allowed to be used in any policy. When it can be used in any policy, it has a time at which it expires (which can be some arbitrary time in the future). The long lived authorization may be given in TPM2\_PolicySigned()/TPM2\_PolicySecret() and a ticket is produced that is used to verify the authorization parameters (what was authorized) and the time in the future when the authorization expires. This ticket is then processed by TPM2\_PolicyTicket() and, until the ticket expires, will have the same effect on the *policyDigest* computation as the original authorization.
- NOTE            If produced by TPM2\_PolicySigned(), the ticket will use the TPM\_ST\_AUTH\_SIGNED structure tag and if produced by TPM2\_PolicySecret(), the ticket will use the TPM\_ST\_AUTH\_SECRET structure tag. TPM2\_PolicyTicket() will use this tag to indicate which command code to use (TPM\_CC\_PolicySigned/TPM\_CC\_PolicySecret) when extending *policyDigest*.
- 4) TPMT\_TK\_HASHCHECK – This ticket is used to indicate that a digest of external data is safe to sign using a restricted signing key. A restricted signing key may only sign a digest that was produced by the TPM. If the digest was produced from externally provided data, there needs to be an indication that the data did not start with the same first octets as are used for data that is generated within the TPM. This prevents “forgeries” of attestation data. This ticket is used to provide the evidence that the data used in the digest was checked by the TPM and is safe to sign. Assuming that the external data is "safe", this type of ticket is produced by TPM2\_Hash() or TPM2\_SequenceComplete() and used by TPM2\_Sign().
  - 5) NULL Ticket – A NULL Ticket is produced when a response has a ticket, but no ticket is produced. An example is TPM2\_PolicySecret() with an expiration time of zero. It does not produce a ticket because, since the expiration time was zero, the authorization expires immediately. In this case, the TPM will return a NULL Ticket. A NULL Ticket may also be used as an input parameter when the command requires a ticket but no ticket data is available.



### 11.4.6 Symmetric Encryption

The TPM uses symmetric encryption to encrypt some command parameters (typically, authentication information) and to encrypt Protected Objects stored outside it. Cipher Feedback mode (CFB) is the only block cipher mode required by this specification.

Any symmetric block cipher supported by a TPM may be used for parameter encryption. However weak keys are not permitted to be used. Additionally, a TPM should support XOR obfuscation, which is a hash-based stream cipher. XOR obfuscation may be used only for confidential parameter passing.

**NOTE** XOR allows an application to have confidential and integrity-protected interactions with only one algorithm in common with the TPM (a hash).

When paired with an asymmetric key — as in an ECC decrypting key — a symmetric key is required to have as many bits of security strength as the asymmetric key with which it is paired.

**EXAMPLE 1** SP800-57 classifies 2048-bit RSA as providing 112 bits of security. AES with 128- or 256-bit keys provides adequate symmetric security for pairing with a 2048-bit RSA key.

**EXAMPLE 2** A prime-modulus ECC key has a security strength that is half the size of the prime modulus. AES with 128- or 256-bit keys is suitable for pairing with a 256-bit ECC key, but AES with 128-bit keys is not recommended for pairing with a 384-bit ECC key.

When a symmetric key is used for data encryption, the encrypted data has an HMAC. This HMAC is checked before the data is decrypted. Verification that the decrypted data is properly associated with the symmetric key is intended to make it more difficult to perform power analysis. To defeat the protections, it would be necessary to defeat two different families of protection rather than one as would exist if the integrity protection were applied to the clear text rather than the cipher text.

#### 11.4.6.1 Block Cipher Modes

The block cipher modes referenced in this specification are defined in ISO/IEC 10116:2006. That specification allows parameterization of most of the modes. In a TPM implementation, the parameters are fixed, as defined in Table 1.

**Table 1 — Block Cipher Parameters**

Mode	Common Name	Parameter	Comments
CTR	Counter	$j = n$	size of the plaintext variable
OFB	Output Feedback	$j = n$	size of the plaintext variable
CBC	Cipher-block Chaining	$m = 1$	interleave factor
CFB	Cipher-feedback	$r = n$	size of feedback buffer
		$k = n$	size of feedback variable
		$j = n$	size of plaintext variable
ECB	Electronic Code Book	none	
<b>NOTE</b> $n$ is the input block size of the cipher.			

#### 11.4.6.2 Cipher Feedback (CFB) Mode

CFB is used when a symmetric block cipher is chosen as the encryption algorithm associated with a session. When used for parameter encryption, the key and Initialization Vector (IV) are derived from a per-session key so that reuse of the same key and IV is statistically unlikely.

**NOTE** ISO/IEC 10116 use the term Start Variable instead of Initialization Vector (IV).

CFB is also used for symmetric encryption of the sensitive area of an object when the object is not stored in a Shielded Location. When used in this way, the key and IV are derived from a secret. In some cases, the IV is set to zero.

### 11.4.6.3 XOR Obfuscation

XOR obfuscation resembles Counter mode (CTR) block encryption, but it uses a KDF as the pseudo-random function instead of a symmetric block cipher.

XOR obfuscation reduces to one (a hash) the number of algorithms that a caller needs in common with the TPM in order to use the TPM with some level of confidentiality and authentication.

This specification's XOR scheme differs from that used in TPM 1.2: it uses a different formulation for input into the hash function.

When this specification calls for use of XOR obfuscation, it uses a function reference. The function prototype is:

$$\mathbf{XOR}(data, hashAlg, key, contextU, contextV) \quad (3)$$

where

<i>data</i>	a variable-sized buffer containing the data to be obfuscated
<i>hashAlg</i>	the hash algorithm to be used in the KDF
<i>key</i>	a variable-sized value containing a secret key
<i>contextU</i>	a variable-sized value used to qualify one of the parties to the operation (often a nonce value)
<i>contextV</i>	a variable-sized value used to qualify one of the parties to the operation (often a nonce value)

The  $\mathbf{XOR}()$  function uses the *hash*, *key*, *contextU*, and *contextV* parameters in a call to  $\mathbf{KDFa}()$  to produce a *mask* value:

$$mask := \mathbf{KDFa}(hashAlg, key, "XOR", contextU, contextV, data.size \cdot 8) \quad (4)$$

NOTE The "XOR" value is defined in 4.8.

The octets of *mask* are then XOR'd with the octets of *data.buffer*.

### 11.4.7 Extend

The Extend operation is used to make incremental updates to a digest value. It is useful for updating PCR, auditing, and constructing policy. Extend uses a hash function to combine new data with an existing digest. Its notation is:

$$digest_{new} := \mathbf{H}_{hashAlg}(digest_{old} || data_{new}) \quad (5)$$

where

<i>digest<sub>new</sub></i>	the value of the digest (such as, a PCR) after the Extend operation
$\mathbf{H}_{hashAlg}$	the hash function using a context-specific algorithm (such as, the hash algorithm associated with a specific bank of PCR)

<i>digest<sub>old</sub></i>	the value of the digest before the Extend operation
<i>data<sub>new</sub></i>	a variable number of octets of data that are to be hashed with the initial value of <i>digest<sub>old</sub></i> to produce Extend results

The Extend operation may also apply to an NV Index that has the TPMA\_NV\_EXTEND attribute.

### 11.4.8 Key Generation

Key generation produces two different types of keys. The first, an ordinary key, is produced using the random number generator (RNG) to seed the computation. The result of the computation is a secret key value kept in a Shielded Location.

The second type, a Primary Key, is derived from a seed value, not the RNG directly. The RNG usually generates the seed that is persistently stored on the TPM. Generation of a Primary Key from a seed is based on use of an approved key derivation function (KDF). The KDF from SP800-108 is widely used in this specification.

This specification places no upper limit on the time allowed to generate a key. Platform-specific specifications may limit the time for generating various key types.

Depending on the application, the TPM may generate a key by

- using bits from the RNG, or
- deriving the key from another secret value.

There are many ways to generate keys; these methods are described in detail in each clause where generation of a key is required.

### 11.4.9 Key Derivation Function

#### 11.4.9.1 Introduction

The TPM uses a hash-based function to generate keys for multiple purposes. This specification uses two different schemes: one for ECDH and one for all other uses of a KDF.

The ECDH KDF is from SP800-56A. The Counter mode KDF, from SP800-108, uses HMAC as the pseudo-random function (PRF). It is referred to in the specification as **KDFa()**.

#### 11.4.9.2 KDFa()

With the exception of ECDH, **KDFa()** is used in all cases where a KDF is required. **KDFa()** uses Counter mode from SP800-108, with HMAC as the PRF.

As defined in SP800-108, the inner loop for building the key stream is:

$$K(i) := \mathbf{HMAC}(K_i, [i]_2 || \mathit{Label} || 00_{16} || \mathit{Context} || [L]_2) \quad (6)$$

where

$K(i)$	the $i^{\text{th}}$ iteration of the KDF inner loop
$\mathbf{HMAC}()$	the HMAC algorithm using an approved hash algorithm

$K_i$	the secret key material
$[i]_2$	a 32-bit counter that starts at 1 and increments on each iteration
<i>Label</i>	a string indicating the use of the key produced by this KDF
<i>Context</i>	a binary string containing information relating to the derived keying material
$[L]_2$	a 32-bit value indicating the number of bits to be returned from the KDF

NOTE 1 Equation (6) is not **KDFa()**. **KDFa()** is the function call defined below.

After each iteration, the HMAC digest data is concatenated to the previously produced value until the size of the concatenated string is at least as large as the requested value. The string is then truncated to the desired size (which causes the loss of some of the most recently added bits), and the value is returned.

When this specification calls for use of this KDF, it uses a function reference to **KDFa()**. The function prototype is:

$$\mathbf{KDFa}(\text{hashAlg}, \text{key}, \text{label}, \text{contextU}, \text{contextV}, \text{bits}) \quad (7)$$

where

<i>hashAlg</i>	a TPM_ALG_ID to be used in the HMAC in the KDF
<i>key</i>	a variable-sized value used as $K_i$
<i>label</i>	a variable-sized, null-terminated string
<i>contextU</i>	a variable-sized value concatenated with <i>contextV</i> to create the <i>Context</i> parameter used in equation (6) above
<i>contextV</i>	a variable-sized value concatenated to <i>contextU</i> to create the <i>Context</i> parameter used in equation (6) above
<i>bits</i>	a 32-bit value used as $[L]_2$ ; and is the number of bits returned by the function

The values of *contextU* and *contextV* are passed as sized buffers and only the buffer data is used to construct the *Context* parameter used in equation (6) above. The size fields of *contextU* and *contextV* are not included in the computation. That is:

$$\text{Context} := \text{contextU.buffer} \parallel \text{contextV.buffer} \quad (8)$$

The 32-bit value of *bits* is in TPM canonical form, with the least significant bits of the value in the highest numbered octet.

Using the parameters from the call to **KDFa()** in equation (6) results in the inner loop being:

$$K(i) := \mathbf{HMAC}(\text{key}, [i]_2 \parallel \text{label} \parallel \text{ContextU.buffer} \parallel \text{ContextV.buffer} \parallel \text{bits}) \quad (9)$$

The implied return from this function is a sequence of octets with a length equal to  $(\text{bits} + 7) / 8$ . If *bits* is not an even multiple of 8, then the returned value occupies the least significant bits of the returned octet array, and the additional, high-order bits in the 0<sup>th</sup> octet are CLEAR. **The unused bits of the most significant octet (MSO) are masked off and not shifted.**

EXAMPLE If **KDFa()** were used to produce a 521-bit ECC private key, the returned value would occupy 66 octets, with the upper 7 bits of the octet at offset zero set to 0.

NOTE 2 As shown in equation (6), there is an octet of zero that separates *Label* from *Context*. In SP800-108, *Label* is a sequence of octets that may or may not have a final octet that is zero. This specification uses a NULL-terminated string for *Label* so that an additional octet of zero is not required.

### 11.4.9.3 KDFe for ECDH

Producing a symmetric encryption key for an ECC-protected object uses “One-Pass Diffie-Hellman, C(1, 1, ECC CDH)” from SP800-56A, 6.2.2.2. The KDF used is the “Concatenation Key Derivation Function (Approved Alternative 1)”. The inner loop of that KDF uses:

$$digest_i := \mathbf{H}(counter \parallel Z \parallel OtherInfo) \quad (10)$$

where

<i>digest<sub>i</sub></i>	the digest generated on the <i>i</i> <sup>th</sup> iteration of the loop ( <i>i</i> starts at 1)
<b>H()</b>	an approved hash function
<i>counter</i>	a 32-bit counter that is initialized to 1 and incremented on each iteration
<i>Z</i>	the X coordinate of the product of a public ECC key and a different private ECC key
<i>OtherInfo</i>	a collection of qualifying data for the KDF defined below

The 32-bit *counter* value is included in TPM canonical form, with the least-significant bit of the counter in the highest numbered octet.

After each iteration, *digest<sub>i</sub>* is concatenated to the previously produced digests (MSO of *digest<sub>i</sub>* follows the LSO of *digest<sub>i-1</sub>*). The number of iterations is determined by the number of bits to be produced and the size of the digest produced by the hash function. In the returned octet string, the MSO of the returned value is the MSO of *digest<sub>1</sub>*.

In SP800-56A, *OtherInfo* is specified as:

$$OtherInfo := AlgorithmID \parallel PartyUInfo \parallel PartyVInfo \{ \parallel SuppPubInfo \} \{ \parallel SuppPrivInfo \} \quad (11)$$

where

<i>AlgorithmID</i>	a bit string that indicates how the derived keying material will be parsed and for which algorithm(s)
<i>PartyUInfo</i>	public information contributed by party U (the initiator)
<i>PartyVInfo</i>	public information contributed by party V (the responder)
<i>SuppPubInfo</i>	public information known to both U and V (optional)
<i>SuppPrivInfo</i>	private (secret) information known to both U and V (optional)

This specification requires that *OtherInfo* be constructed as:

$$OtherInfo := Use \parallel PartyUInfo.buffer \parallel PartyVInfo.buffer \quad (12)$$

where

<i>Use</i>	a null-terminated string indicating the use of the key (e.g., “DUPLICATE”, “IDENTITY”, “SECRET”, etc.). (See clause 4 for the definition of these
------------	---

	values.) This field satisfies the requirements of SP800-56A since the parsing of keying material is determined by the use.
<i>PartyUInfo.buffer</i>	the x-coordinate of the public point of an ephemeral key
<i>PartyVInfo.buffer</i>	the x-coordinate of the public point of a static TPM key

The x-coordinates of the public points are *sized buffers* (that is, integers indicating the size in octets of the buffer that follows). The buffer data is used in the KDF but the size field is not.

When this specification calls for use of this KDF, it uses a function reference to **KDFe()**. The function prototype is:

$$\mathbf{KDFe}(\text{hashAlg}, Z, \text{Use}, \text{PartyUInfo}, \text{PartyVInfo}, \text{bits}) \quad (13)$$

where

<i>hashAlg</i>	the hash algorithm to be used as <b>H()</b> in equation (10) above
<i>Z</i>	the product of a public point and a private x-coordinate
<i>Use</i>	a null-terminated string indicating the use of the key (e.g., "DUPLICATE", "IDENTITY", "SECRET", etc.). (See Clause 4 for the definition of these values.)
<i>PartyUInfo</i>	the x-coordinate of the public point of an ephemeral key
<i>PartyVInfo</i>	the x-coordinate of the public point of a static TPM key
<i>bits</i>	a 32-bit value indicating the number of bits to be returned

The implied return from this function is an octet string containing *bits/8* octets. If *bits* is not an even multiple of 8, the return value is the least-significant bits of the return value, and the additional high-order bits in the 0<sup>th</sup> octet are CLEAR. The unused bits of the MSO are masked off and not shifted.

NOTE The function prototype in (13) is not a C-language prototype but, rather, a prototype to illustrate the parameters of the KDF for specific uses. The C-language prototype will include an extra parameter that will be the buffer to receive the key material generated by the KDF.

#### 11.4.9.4 Rejection of weak keys

Some algorithms have known weak keys. If such a key is generated, it must be discarded, and a new key generated by starting over with another iteration of the KDF. In the case of DES, there are 64 known weak or semi-weak keys. None of them are allowed. In the case of AES, at least one bit in the upper half of the key must be set. Again, if this is not true, the key must be discarded and a new key generated by starting over with another iteration of the KDF.

### 11.4.10 Random Number Generator (RNG) Module

#### 11.4.10.1 Source of Randomness

The RNG is the source of randomness in the TPM. The TPM uses random values for nonces, in key generation, and for randomness in signatures.

The RNG is a Protected Capability with no access control. It nominally consists of

- an entropy source and collector,
- a state register, and

- a mixing function (typically, an approved hash function).

The entropy collector collects entropy from entropy sources and removes bias. The collected entropy is then used to update the state register providing input to the mixing function to produce the random numbers.

The mixing function may be implemented with a pseudo-random number generator (a PRNG). A PRNG may produce numbers that are apparently random from a non-random input (such as, a counter). Combining an approved PRNG with an input that has considerably more entropy than a counter yields an RNG with properties no worse than the underlying PRNG and possibly much better.

The RNG should meet the certification requirements of the intended market.

The TPM should provide sufficient randomness for each use by an internal function. When accessed by an external call, it should be able to provide 32 octets of randomness. Larger requests may fail if insufficient randomness is available.

Each RNG access produces a new value regardless of the data's use. There is no distinction between accesses for internal versus external purposes.

#### 11.4.10.2 Entropy Source and Collector

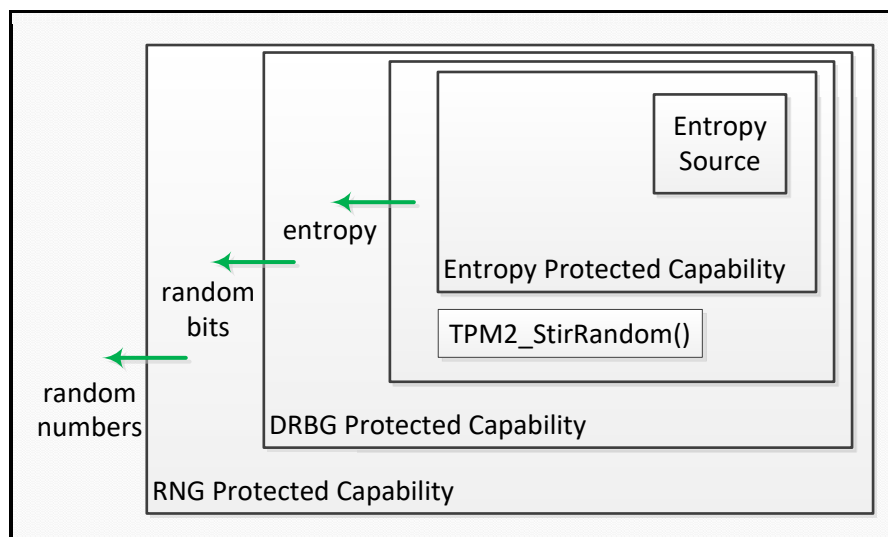
A TPM should have at least one internal source of entropy, and possibly more. These sources could include noise, clock variations, air movement, and other types of events.

As noted, the entropy collector is the process that collects the entropy from various sources and removes bias.

**EXAMPLE** If the entropy source has a bias of creating 60 percent 1s and only 40 percent 0s, then the collector design corrects the bias before sending the information to the state register.

The entropy source and collector should provide entropy to the state register in a manner that is not visible to an outside process or other TPM capability.

The entropy collector should regularly update the state register with additional, unbiased entropy.



**Figure 4 — Random Number Generation**

Any Protected Capability that requires an unpredictable number obtains it from a Random Number Generator (RNG) Protected Capability in the same TPM. The RNG Protected Capability assembles random bits from a Deterministic Random Bit Generator (DRBG) Protected Capability in the same TPM. The DRBG Protected Capability obtains entropy from the entropy Protected Capability in the same TPM and the TPM2\_StirRandom() Protected Capability can be used to add additional information. The entropy Protected Capability obtains entropy from an entropy source in the same TPM.

NOTE 1 The "additional information" added by TPM2\_StirRandom() could be entropy gathered from other sources but the TPM has no way of determining if the value has any entropy or not. As a consequence, it is just deemed to be "additional information."

NOTE 2 The DRBG Protected Capability of a non-FIPS TPM consists of a DRBG mechanism that should comply with NIST Recommendation SP800-90 A, revised March 2012; except it does not comply with its Clause 11.

NOTE 3 The DRBG Protected Capability of a FIPS TPM consists of a DRBG mechanism that complies with NIST Recommendation SP800-90 A, revised March 2012.

The DRBG mechanism security should be at least as strong as the security strength of the strongest cryptographic algorithm implemented in the TPM.

The DRBG Protected Capability should be reseeded using entropy from the entropy Protected Capability when:

- a flag is SET indicating that reseeding is required;
- TPM2\_StirRandom() is executed;
- after the TPM has failed a self-test; or
- before the SPS is replaced.

It may be reseeded at other times, as well.

NOTE 4 Each TPM may be seeded during TPM manufacture, via a manufacturer-specific method, using a personalization string for the DRBG that should be specific to the manufacturer and the type of TPM, plus a manufacturer-provided nonce that is specific to the individual TPM.

### 11.4.10.3 Nonce Creation

The RNG module provides the bits used in any TPM-generated nonce.

## 11.4.11 Algorithms

### 11.4.11.1 Algorithm Identifiers

The structures and commands in this specification are constructed with minimal reliance on algorithm defaults.

In most cases, an algorithm identifier identifies a family of algorithms followed by qualifiers. This differs from the TPM 1.2 version of the specification, which often included the key size in the algorithm identifier (TPM\_ALG\_AES128). This specification only uses the TPM 1.2 form of algorithm identifiers for hash algorithms.

Since this specification depends on being able to discern the hash output size from the algorithm ID, its hash algorithm identifiers imply a digest size.

EXAMPLE 1 Some of the hash algorithm identifiers are TPM\_ALG\_SHA256, TPM\_ALG\_SHA384, and TPM\_ALG\_SM3\_256.



Algorithm identifiers for symmetric and asymmetric encryption identify the family, such as RSA, ECC, AES, etc. For these algorithms, supplementary information is required to define parameters.

EXAMPLE 2 Some family algorithm identifiers are TPM\_ALG\_ECC, TPM\_ALG\_RSA, TPM\_ALG\_SM4, and TPM\_ALG\_AES.

#### 11.4.11.2 Algorithm Support

This specification does not require implementation of any specific set of algorithms. When determining algorithms or algorithm sets supported, implementers should carefully consider factors such as use cases, strength of function, interoperability, backward compatibility, algorithm diversity, etc. TCG recommends using TCG platform-specific specifications that reflect industry best practices.

NOTE 1 It is anticipated that support for TPM 1.2 compatibility will be retained unless support for the 1.2 algorithms (RSA 2048 and SHA1) would prevent that TPM from being sold.

TCG will specify sets of algorithms to be incorporated by various platform-specific specifications. Each set includes a minimum of one hash algorithm, one symmetric encryption algorithm with approved parameters, and one asymmetric encryption/signing algorithm with approved parameters. Without a complete set of algorithms, the TPM would be unable to support all necessary functions.

A TPM may support algorithms in addition to the required sets. These do not need to be part of any set. For example, the TPM may include an additional hash algorithm without including an additional asymmetric or symmetric algorithm.

It is possible, and very likely given the multitude of algorithms supported by the TPM, that key-size support will differ between TPM implementations. In addition, keys created by outside software may greatly increase the number of key sizes that are possible to load.

A TPM will not create or load an object that uses an algorithm that is not supported by the TPM. When creating an object, the TPM checks the template for the object being created and when loading an object the TPM checks the public area of the object. In both cases, the TPM validates that it supports all of the indicated algorithms, parameters, and key sizes.

The strength of at least one algorithm set supported by a TPM should be at least 112 bits. Other algorithms and algorithm sets may be supported in any combination.

NOTE 2 A set's strength is normally determined by the number of bits in a key of the symmetric algorithm. An exception is Suite B, Top Secret, where the strength is considered to be 192 bits even though the symmetric algorithm has 256-bit keys.

If a TPM supports RSA, it should support a key size of 2048 bits or larger. Support for smaller key sizes is allowed but discouraged.

NOTE 3 Support for smaller keys is allowed so that legacy keys may continue to be supported. Use of key-sizes less than 1024 bits is strongly discouraged.

A platform-specific specification may mandate support for algorithms or algorithm sets. It may select only those algorithms for which the TCG has assigned algorithm identifiers.

A TPM may only implement algorithms that have a TCG-assigned algorithm ID.

### 11.5 Authorization Subsystem

The Authorization Subsystem is called by the Command Dispatch module at the beginning and end of command execution. Before the command may be executed, the Authorization Subsystem checks that proper authorization for use of each of the Shielded Locations has been provided.

Some commands access Shielded Locations that require no authorizations; access to some locations may require a single-factor authorization; and access to other Shielded Locations may require use of an authorization policy of arbitrary complexity.

The only cryptographic functions required by the Authorization Subsystem are hash and HMAC. An asymmetric algorithm may be required if TPM2\_PolicySigned() is implemented.

The details of the different methods of authorization are provided in Clause 19.

## 11.6 Random Access Memory

### 11.6.1 Introduction

Random access memory (RAM) holds TPM transient data. Data in TPM RAM is allowed, but not required, to be lost when TPM power is removed. Because the values in TPM RAM may be lost, in this specification they are referred to as being volatile, even if the data loss is implementation-dependent.

When the specification refers to a value that has both volatile and non-volatile copies, they may be kept in a single location as long as that location has the properties of allowing random access and having unlimited endurance.

Not all values in TPM RAM are in Shielded Locations. A portion of TPM RAM contains the I/O buffer with properties that are described in 11.3.

### 11.6.2 Platform Configuration Registers (PCR)

PCR are Shielded Locations used to validate the contents of a log of measurements. The nominal behavior of a trusted platform is to maintain, in a log, a record of the events that affect the security state of the platform, at least through the boot process while it is establishing the TCB. When additions are made to the log, the TPM receives a copy of the log entry or the digest of data described by the log. The data sent to the TPM is included in an accumulative hash in a PCR. The TPM may then provide an attestation of the value in the PCR, which, in turn, verifies the contents of the log.

It is possible for a single PCR to record all log entries. However, this would make it difficult to evaluate the different stages of platform evolution as it boots into the operating system. Normally, multiple PCR are provided in a TPM to allow simplification of the evaluation.

**EXAMPLE 1** A TPM intended for a PC could have a PCR dedicated to recording measurements of the BIOS, a PCR dedicated to the boot ROM on add-in cards, and a PCR dedicated to the OS loader. The platform-specific specifications determine the number of PCR and their attributes in a TPM.

PCR may also be used to gate access to an object. If selected PCR do not have the required values, the TPM will not allow use of the object.

A TPM may maintain multiple banks of PCR. A PCR bank is a collection of PCR that are Extended with the same hash algorithm. PCR banks are identified by the hash algorithm used to Extend the PCR in that bank.

Multiple banks may handle situations where one hash algorithm is required for legacy or compatibility with one set of applications, while a different hash algorithm is required to meet the security needs of another application. Within a bank, all PCR updates use the same hash algorithm. Not all banks need to have the same number of PCR, but the attributes of all PCR with the same Index, other than hash algorithm, are the same in all banks.

**EXAMPLE 2** If PCR[0] has an attribute that allows it to be reset by TPM2\_PCR\_Reset(), then that attribute applies to PCR[0] in all banks.

NOTE 1            Since banks may have different numbers of PCR, a PCR Index value may not be valid for all banks. The allocation of PCR may also be changed by TPM2\_PCR\_Allocate() using Platform Authorization. Changing the PCR allocation does not change the attributes of the PCR.

The contents of a PCR may be modified or reported. The two ways to modify a PCR are to reset it or Extend it. Reporting on a PCR may be accomplished through simple reading, inclusion in an attestation, or inclusion in a policy.

Although listed in this clause, PCR need not be maintained in RAM. They may be kept in non-volatile memory. If kept in non-volatile memory, consideration must be made for the possible impact on TPM performance during the critical boot phase, when many measurements are recorded.

A TPM is required to implement a PCR bank for each supported algorithm. However, a PCR bank may be defined such that it contains no PCR.

NOTE 2            The requirement that a PCR bank be implemented for each hash algorithm allows the unmarshaling to be based on the implemented algorithms rather than the implemented PCR.

The TPM may support Resume PCR that retain their state across a TPM Resume sequence but are set to their default initial value on TPM Reset or TPM Restart.

### 11.6.3 Object Store

TPM RAM holds keys and data that are loaded into the TPM from external memory. In most cases, an object may not be used or modified unless it was first loaded into TPM RAM with one of the object load commands: (TPM2\_Load(), TPM2\_CreatePrimary(), TPM2\_LoadExternal(), or TPM2\_ContextLoad()).

NOTE              TPM2\_Create() does not automatically load the object. After creation, the object needs to be explicitly loaded with TPM2\_Load(), to load both the public and private portions, or with TPM2\_LoadExternal() to load just the public portion.

The structure used for keys may be generalized for use on data objects if the access properties used for keys are suitable for access to these objects.

EXAMPLE          A data blob may be defined so that access requires that some set of PCR has defined values, or an authorization value may be needed for access. Such a data blob, called a Sealed Data Object, is managed in the same way that a key is managed. That is, the Sealed Data Object should be loaded before being accessed, and the loaded blob may be context saved.

The TPM operates on other structures that are passed as parameters in specific commands. These structures are transient and are not stored in the TPM as identifiable entities after the command has completed.

Items loaded in the TPM are given handles to let them be referenced in subsequent commands.

### 11.6.4 Session Store

The TPM uses sessions to control a sequence of operations. A session may audit actions, provide authorizations for actions, or encrypt parameters passed in commands.

A session may be created as needed using one of the session creation commands. The session is assigned a handle at that time.

A TPM may be designed so that the RAM used for sessions is from a memory pool shared with the object store. It may also be designed so that the session store and object store are separated and dedicated.

### 11.6.5 Size Requirements

Random access memory (RAM) should be large enough to handle the transient state, sessions, and objects needed for completion of any implemented command. The minimums for the worst-case command in this specification are:

- two loaded entities (two keys, a key and a Sealed Data Object, or a hash/HMAC sequence and a key);
- three authorization sessions;
- an input buffer able to accommodate the largest command or an output buffer required for the largest possible response;

NOTE The largest command or response depends on the algorithms supported by the implementation.

- any vendor-defined state required for operation; and
- all defined PCR.

### 11.7 Non-Volatile (NV) Memory

The NV memory module stores persistent state associated with the TPM. Some NV memory is available for allocation and use by the platform and entities authorized by the TPM Owner.

TPM NV memory contains Shielded Locations and Shielded Location can only be accessed with Protected Capabilities.

If the specification is not explicit about storage of a parameter, that parameter may be in either RAM or NV, according to vendor preference.

If the NV memory of the TPM is subject to wear, then the TPM should detect whether the data being written to an NV memory location is the same as that currently stored and not perform the NV write if they are the same.

The OS or the platform may define a special NV data structure (an NV Index) in order to store persistent data values. NV memory may also be used persistently to store a loaded object. When a persistent object is referenced in a TPM command, the TPM may move that object into an object slot so it may be accessed more efficiently. The TRM needs to ensure that sufficient object memory RAM is available to allow this movement.

NOTE The movement occurs transparently.

A TPM capability indicates if the TPM is using Transient Object resources when a command references a persistent object. If so, the TRM needs to ensure that a Transient Object slot is available for each persistent object so referenced.

### 11.8 Power Detection Module

This module manages TPM power states in conjunction with platform power states.

All platform-specific TCG specifications that define the binding of the TPM to the platform should include a requirement that the TPM be notified of all power state changes.

The TPM supports only the ON and OFF power states. Any system power transition requiring the RTM to be reset also causes the TPM to be reset (`_TPM_Init`). Any system power transition that causes the TPM to be reset will also cause the RTM to be reset.

**NOTE**            In most cases, the RTM will be a host CPU.

## 12 TPM Operational States

### 12.1 Introduction

This clause describes TPM operational states and state transitions.

### 12.2 Basic TPM Operational States

#### 12.2.1 Power-off State

A hardware TPM is in the Power-off state when reset is being asserted or when no power is applied to the TPM. The TPM may internally generate reset by detecting low power, or reset may be provided by an external source.

It is possible to transition to the Power-off state from any other state because power can be lost at any time.

**NOTE** Uncontrolled transitions to this state are not shown in diagrams/descriptions because they would add unnecessary clutter and provide no additional understanding.

#### 12.2.2 Initialization State

The TPM is placed in its initialization state when it receives the `_TPM_Init` indication. `_TPM_Init` is provided in a platform-specific manner. For a hardware TPM, the `_TPM_Init` is normally signaled by the de-assertion of the TPM's reset signal. It may also be signaled by an interface protocol or setting. For a software implementation, `_TPM_Init` may be a dedicated procedure call.

Regardless of how it is generated, `_TPM_Init` should coincide with a reset of the Roots of Trust for Measurement for which the TPM is the Root of Trust for Reporting. For example, if the TPM is a component on the PC's motherboard, `_TPM_Init` should coincide with a reset of the processor and chipset. After `_TPM_Init` is indicated, the RTM should begin executing the Core Root of Trust for Measurement. It should not be possible to reset the TPM without resetting the RTM. It should not be possible to reset the RTM without resetting the TPM.

While in the Initialization state, the TPM performs basic initialization functions in preparation for accepting commands on the TPM interface. These functions are implementation dependent but, minimally, the TPM should perform validation of the TPM firmware necessary to execute the expected command. If the TPM is in Field Upgrade mode (FUM), the expected command is `TPM2_FieldUpgradeData()`. If the TPM is not in FUM, the expected command is `TPM2_Startup()`.

After completing the initializations, the TPM waits for the next command and, if the command is not the expected first command, the TPM will return an error indicative of the mode. If the TPM returns an error, it will continue to wait for the expected first command.

**NOTE 1** If the TPM is not in FUM, it returns `TPM_RC_INITIALIZE`. If the TPM is in FUM, it returns `TPM_RC_UPGRADE`.

**NOTE 2** If `TPM2_Startup()/TPM2_FieldUpgradeData()` is not the first command to the TPM, it indicates failure of the system to properly enter the CRTM, and the reliability of TPM measurements may not be assured. While it is possible to define a special failure mode that prohibits just PCR-related operations, it is expected to be infrequent enough not to warrant such a mode and, as shown in Figure 5, the TPM does not enter Failure Mode, if the first command is not `TPM2_Startup()`.

When the TPM receives `TPM2_Startup()`, it becomes operational and is able to process other commands.

NOTE 3 For compliance with other standards, such as FIPS 140, it is necessary for the TPM to validate the firmware associated with a command's execution before that command is executed. This includes the code associated with TPM2\_Startup() and TPM2\_FieldUpgradeData(). This validation may require use of a digital signature or message authentication code.

Occasionally, some TPM state may need to be retained over a power transition. This might occur if the platform is entering the Suspend state, where the preponderance of system state is retained. To allow the TPM to reflect this condition, system software may issue TPM2\_Shutdown(TPM\_SU\_STATE) to the TPM.

TPM2\_Shutdown() initiates an orderly shutdown of the TPM. The command's *startupType* parameter indicates the type of startup that is anticipated to follow and the type of data to be saved. For TPM2\_Shutdown(TPM\_SU\_CLEAR), the amount of data saved to NV memory is relatively small, with considerably more information retained when TPM\_SU\_STATE is indicated.

### 12.2.3 Startup State

#### 12.2.3.1 TPM2\_Startup()

TPM2\_Startup() transitions the TPM from the Initialization state to an Operational state. The command includes information from the platform to inform the TPM of the platform's operating state. TPM2\_Startup() has two options: TPM\_SU\_CLEAR and TPM\_SU\_STATE. The operating state of a TPM after TPM2\_Startup() is dependent on how the TPM was shut down and the selected startup option.

#### 12.2.3.2 Startup Types

The following terms are used to refer to the different startup and shutdown operations:

- Startup(CLEAR) means TPM2\_Startup(*startupType* == TPM\_SU\_CLEAR);
- Startup(STATE) means TPM2\_Startup(*startupType* == TPM\_SU\_STATE);
- Shutdown(STATE) means TPM2\_Shutdown(*startupType* == TPM\_SU\_STATE); and
- Shutdown(CLEAR) means TPM2\_Shutdown(*startupType* == TPM\_SU\_CLEAR).

The combinations of Shutdown() and Startup() provide three unique methods of preparing the TPM for operation:

- 1) **TPM Reset** is a Startup(CLEAR) that follows a Shutdown(CLEAR), or a Startup(CLEAR) for which there was no preceding Shutdown() (that is, a disorderly shutdown). A TPM Reset is roughly analogous to a reboot of a platform. As with a reboot, most values are placed in a default initial state, but persistent values are retained. Any value that is not required by this specification to be kept in NV memory is reinitialized. In some cases, this means that values are cleared, in others it means that new random values are selected.
- 2) **TPM Restart** is a Startup(CLEAR) that follows a Shutdown(STATE). This indicates a system that is restoring the OS from non-volatile storage, sometimes called "hibernation". For a TPM Restart, the TPM restores values saved by the preceding Shutdown(STATE) except that all the PCR are set to their default initial state. This allows the TPM to record the boot sequence to ensure that the TCB is properly instantiated while allowing continued function of the restored OS.
- 3) **TPM Resume** is a Startup(STATE) that follows a Shutdown(STATE). This indicates a system that is restarting the OS from RAM memory, sometimes called "sleep." For sleep, the expectation is that the CRTM will perform the minimal actions required to make the system functional and then "return" to the running OS rather than rebooting it. TPM Resume restores all of the state that was saved by Shutdown(STATE), including those PCR that are designated as being preserved by Startup(STATE). PCR not designated as being preserved, are reset to their default initial state.

NOTE 1           The PCR are designated in a platform-specific specification.

If the TPM receives Startup(STATE) that was not preceded by Shutdown(STATE), then there is no state to restore and the TPM will return TPM\_RC\_VALUE. The CRTM is expected to take corrective action to prevent malicious software from manipulating the PCR values such that they would misrepresent the state of the platform. The CRTM would abort the Startup(State) and restart with Startup(CLEAR).

NOTE 2           The startup behavior defined by this specification is different than TPM 1.2 with respect to Startup(STATE). A TPM 1.2 device will enter Failure Mode if no state is available when the TPM receives Startup(STATE). This is not the case in this specification. It is up to the CRTM to take corrective action if it the TPM returns TPM\_RC\_VALUE in response to Startup(STATE).

The TPM is required to validate the integrity of any NV values before those values are used before that state is used. This includes the state saved by TPM2\_Shutdown(STATE)(see 12.2.4). When the TPM determines that some NV value required for proper TPM operation is not valid, the TPM will enter Failure Mode.

It is not specified when the validation of state specific to TPM Resume is to be checked. This gives implementation options that may be specified by a platform-specific specification or determined by the vendor.

The startup sequences are illustrated in Figure 5.



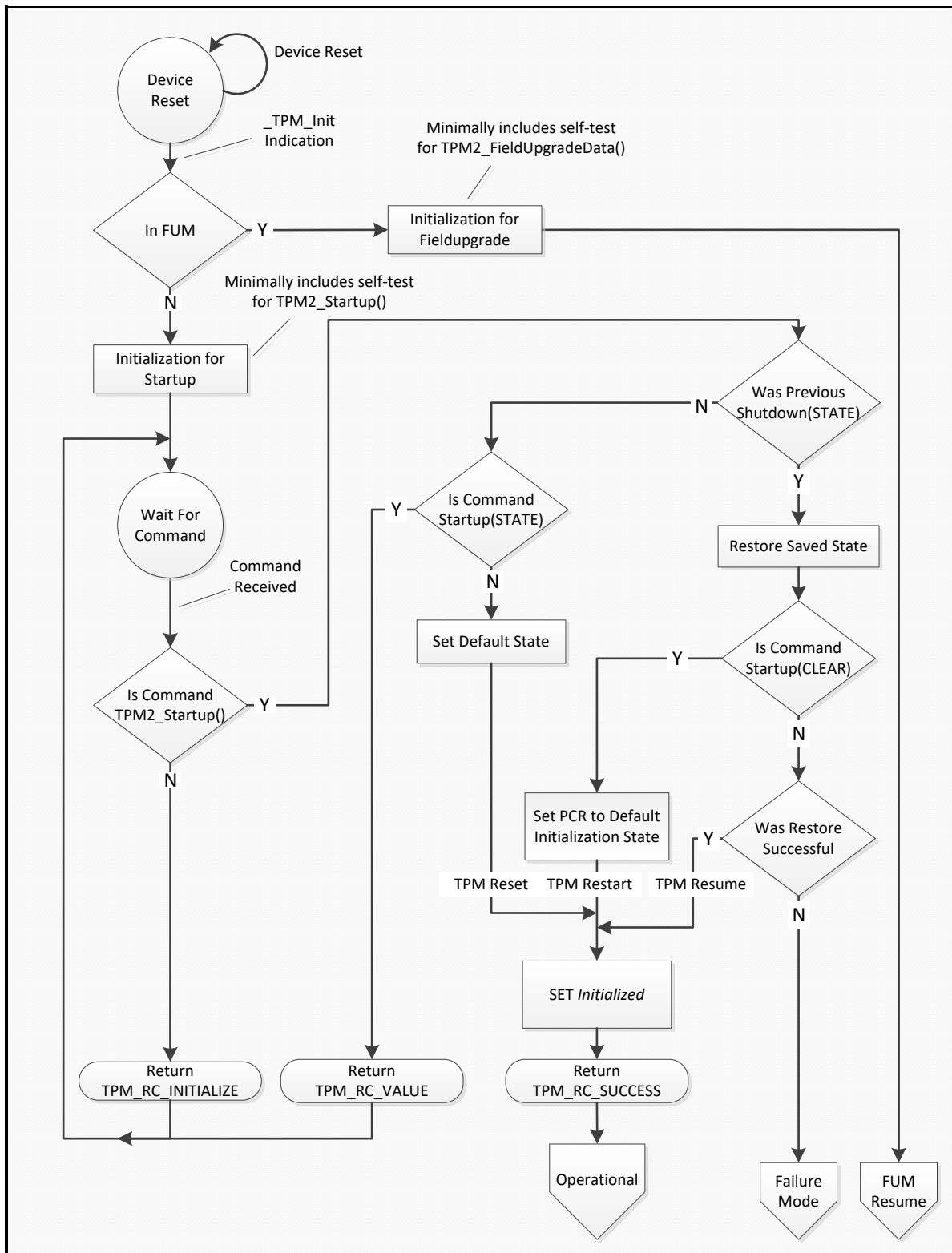


Figure 5 — TPM Startup Sequences

12.2.4 Shutdown State

TPM2\_Shutdown() is used to prepare the TPM for loss of power. As with TPM2\_Startup(), TPM2\_Shutdown() has two options: TPM\_SU\_CLEAR and TPM\_SU\_STATE.

TPM2\_Shutdown(TPM\_SU\_STATE) preserves the majority of the TPM operational state so that it may be restored on a subsequent TPM2\_Startup(). TPM2\_Shutdown(TPM\_SU\_CLEAR) preserves a minimal amount of state, mostly to ensure continuity of the TPM timing functions.

NOTE The timing functions are described in Clause 36.

The TPM preserves state data in NV memory. Data is copied from RAM into NV memory so that it is not lost when power is removed from the TPM. The amount of data copied to NV memory is largely implementation-dependent, but the specification indicates the state data that is required to be preserved. This state data is recovered in a subsequent TPM2\_Startup(). The type of startup determines what parts of the saved state data is restored and what is discarded.

A shutdown is “orderly” if the TPM receives TPM2\_Shutdown() before power is lost and if the state is not subsequently modified by a TPM command before the next \_TPM\_Init.

These commands will invalidate saved TPM state:

NOTE This is not an inclusive list:

- TPM2\_Clear(), TPM2\_ChangeEPS(), TPM2\_ChangePPS() – these commands invalidate saved contexts in the hierarchy. TPM2\_Clear() invalidates preserved contexts in both the storage and endorsement hierarchies.
- TPM2\_ContextSave() – context variables are modified by context save. Saving a session context changes the session context ID and its tracking state (saved or in memory). Saving an object context changes the object context ID.
- TPM2\_ContextLoad() for a session – the context ID and tracking state (in TPM or context saved) for each active session should be retained across a TPM Restart or TPM Resume sequence. Saving or loading a session context changes the context ID or its tracking state. Saving or loading an object context need not invalidate a preserved context.
- Any command that modifies a PCR – regardless of the implementation, any change to a Resume PCR will invalidate the saved state. If the TPM implements TPM2\_PolicyPCR() and uses a PCR generation counter, any PCR modification will change this counter value.

EXAMPLE If a Shutdown(STATE) occurs but, prior to Startup(STATE), a TPM2\_PCR\_Event() is executed selecting a Resume PCR, then the preserved state is no longer valid, and Startup(STATE) is not valid until another Shutdown(STATE) occurs.

- Any command that modifies *Clock* or returns the value of *Clock*.

A TPM implementation may invalidate a preserved context on any command except TPM2\_GetCapability().

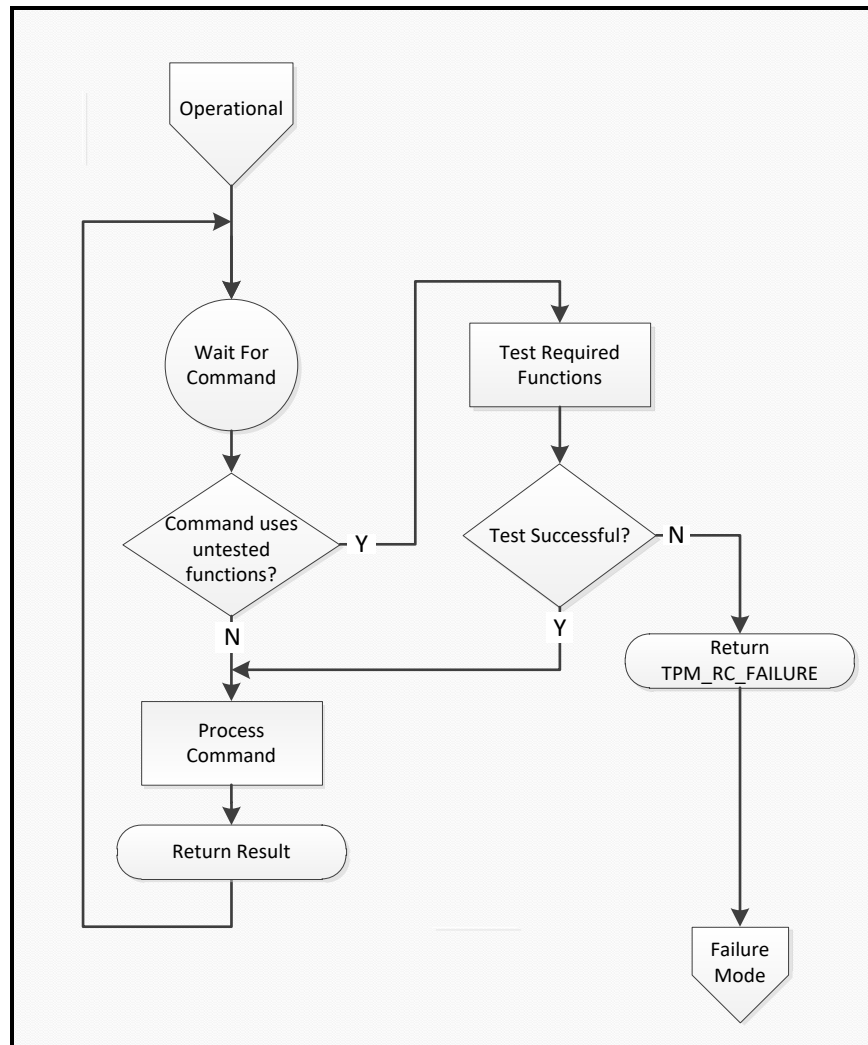
### 12.2.5 Startup Alternatives

The description of the startup process above was given in terms of a command interface. In some systems, the TPM code is run in a special processor mode that provides the required isolation between the TPM state and any other program state. For these implementations, TPM2\_Startup() may not be a command that is actually implemented. That is, the platform initialization may boot, validate the TPM code, and place the TPM in a state that is functionally equivalent to having run TPM2\_Startup() on a discrete TPM component.

### 12.3 Self-Test Modes

If a command requires use of an untested algorithm or functional module, the TPM performs the test and then completes the command actions. When performing a self-test on demand, the TPM should test only those algorithms needed to complete the command. See Figure 6.

NOTE 1 It is preferable for the TPM to perform self-tests on untested algorithms and functional blocks as a background task to increase the likelihood that algorithms are tested before they are needed.



**Figure 6 — On-Demand Self-Test**

After sending `TPM2_Startup()`, the system may use either `TPM2_SelfTest()` or `TPM2_IncrementalSelfTest()` to cause the TPM to perform tests of untested algorithms. `TPM2_SelfTest()` may optionally cause the TPM to perform a full self-test of all algorithms and functional blocks. Once these commands are issued, the TPM returns `TPM_RC_TESTING` for any command that requires use of any testable function until all requested tests are completed.

NOTE 2 FIPS 140-2 requires that all power-on self-tests be complete before the TPM returns any value that depends on the results of a testable function. If compliance with FIPS 140-2 is required, any command that requires use of an untested function causes the TPM to operate as if `TPM2_SelfTest(fullTest = NO)` was received. The TPM returns `TPM_RC_TESTING` and continues to return `TPM_RC_TESTING` until all tests are complete. Alternatively, it may complete all tests and then complete the command. It may also return `TPM_RC_NEEDS_TEST`.

NOTE 3           Authenticated tests may be generated by attaching an audit session to TPM2\_GetTestResult() and then using TPM2\_GetSessionAuditDigest() to obtain the signature.

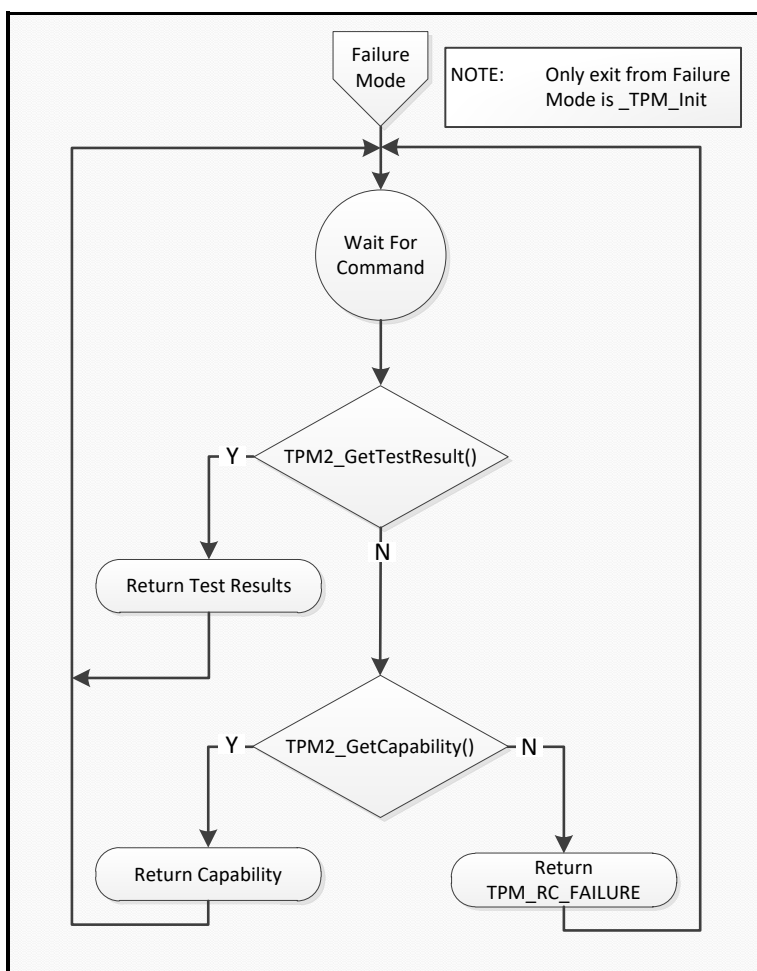
If any self-tests fail, the TPM goes into Failure mode and does not allow execution of any Protected Capabilities except TPM2\_GetTestResult() and TPM2\_GetCapability(). The TPM exits Failure mode when it receives \_TPM\_Init.

## 12.4 Failure Mode

If the TPM fails an internal test, it enters Failure mode. While in Failure mode, the TPM returns TPM\_RC\_FAILURE in response to any command except TPM2\_GetTestResult() or TPM2\_GetCapability() (See Figure 7). While in Failure mode, the TPM is only required to provide a limited number of property values. They are all in the set of TPM properties (TPM\_CAP\_TPM\_PROPERTIES):

- TPM\_PT\_MANUFACTURER
- TPM\_PT\_VENDOR\_STRING\_1
- TPM\_PT\_VENDOR\_STRING\_2
- TPM\_PT\_VENDOR\_STRING\_3
- TPM\_PT\_VENDOR\_STRING\_4
- TPM\_PT\_VENDOR\_TPM\_TYPE
- TPM\_PT\_FIRMWARE\_VERSION\_1
- TPM\_PT\_FIRMWARE\_VERSION\_2

NOTE           An implementation is allowed to return other property values.



**Figure 7 — Failure Mode Behavior**

## 12.5 Field Upgrade

### 12.5.1 Introduction

This specification describes optional Protected Capabilities for upgrading the TPM firmware. The methods described in this specification would allow the upgrade process to be handled in a standard way on TPMs from multiple vendors. The methods described here should not be viewed as limiting the vendor's options for implementation of their own, vendor-specific methods for upgrading the TPM firmware. However, the field upgrade methods chosen by the vendor should not be less robust than the methods described in this specification. In particular, the authorizations for the upgrade should be the same as the field upgrade commands in this specification.

### 12.5.2 Field Upgrade Mode

This specification describes two optional upgrade methods: full and incremental. These terms do not refer to how much of the firmware in the TPM changes, but to how the upgrade is applied.

- For a full upgrade, the TPM stores in Shielded Locations all blocks of the firmware update. It makes no change to the executing firmware unless all the blocks are confirmed to be correct. The upgrade process may be interrupted or abandoned without affecting TPM functionality.

- For an incremental upgrade, firmware updates may be applied as each block is received. The TPM may not be fully functional if the upgrade process is abandoned.

The field upgrade process starts when the TPM receives a properly authorized TPM2\_FieldUpgradeStart(). See Figure 6. That command contains the digest of a first block of the upgrade. If the next command is TPM2\_FieldUpgradeData() and the digest of the data parameter (*fuData*) of the command matches the signed digest in TPM2\_FieldUpgradeStart(), the TPM accepts *fuData* as containing the upgrade data.

The TPM may buffer firmware update blocks and not change the firmware until its buffer is full. When a consequential change to the running firmware is made, the TPM enters Field Upgrade mode (FUM) and does not accept any command but TPM2\_FieldUpgradeData() until the update is complete. See Figure 7. Before the TPM enters FUM

- it may accept other commands, and
- the update sequence may be abandoned by sending a zero-length upgrade data buffer. The TPM acknowledges that it has abandoned the field upgrade by returning TPM\_ALG\_NULL for *nextDigest*.

When the field upgrade process is complete, the TPM may either return to normal operation or enter a mode that requires \_TPM\_Init before normal TPM operations resume. The TPM vendor should determine if a reboot is required after the firmware update and cause the TPM to set the mode appropriately.

If the TPM is reset (\_TPM\_Init) while in FUM and the TPM is not able to revert to normal operation, three possibilities exist for recovery. The choice is determined by the digest of the first upgrade block provided to the TPM after \_TPM\_Init. The TPM may retain up to three digest values that it uses for comparison:

- 1) the digest of the first upgrade block of the current sequence to be used when the intent is to restart the current upgrade sequence from the start (called Digest C in Figure 8);
- 2) the digest of the first block of the firmware that was being replaced (called Digest P in Figure 8) to be used when the intent is to abort the upgrade and restore the previous firmware; and
- 3) the digest of the first upgrade block of the factory installed firmware (called Digest F in Figure 8) to restore the TPM to its factory state.

To enable option 2) above, the TPM may support TPM2\_FirmwareRead() so that the software performing the upgrade can save a copy of the current TPM firmware in case the upgrade fails.

NOTE TPM2\_FirmwareRead() may not be supported on a TPM even if the TPM can perform a field upgrade.

If \_TPM\_Init is received while the TPM is in FUM, then TPM Reset is required after the field upgrade completes, regardless of the nature of the firmware changes. This reset is required because the TPM does not accept TPM2\_Startup() while in FUM, and the TPM will not reflect the state of the platform.

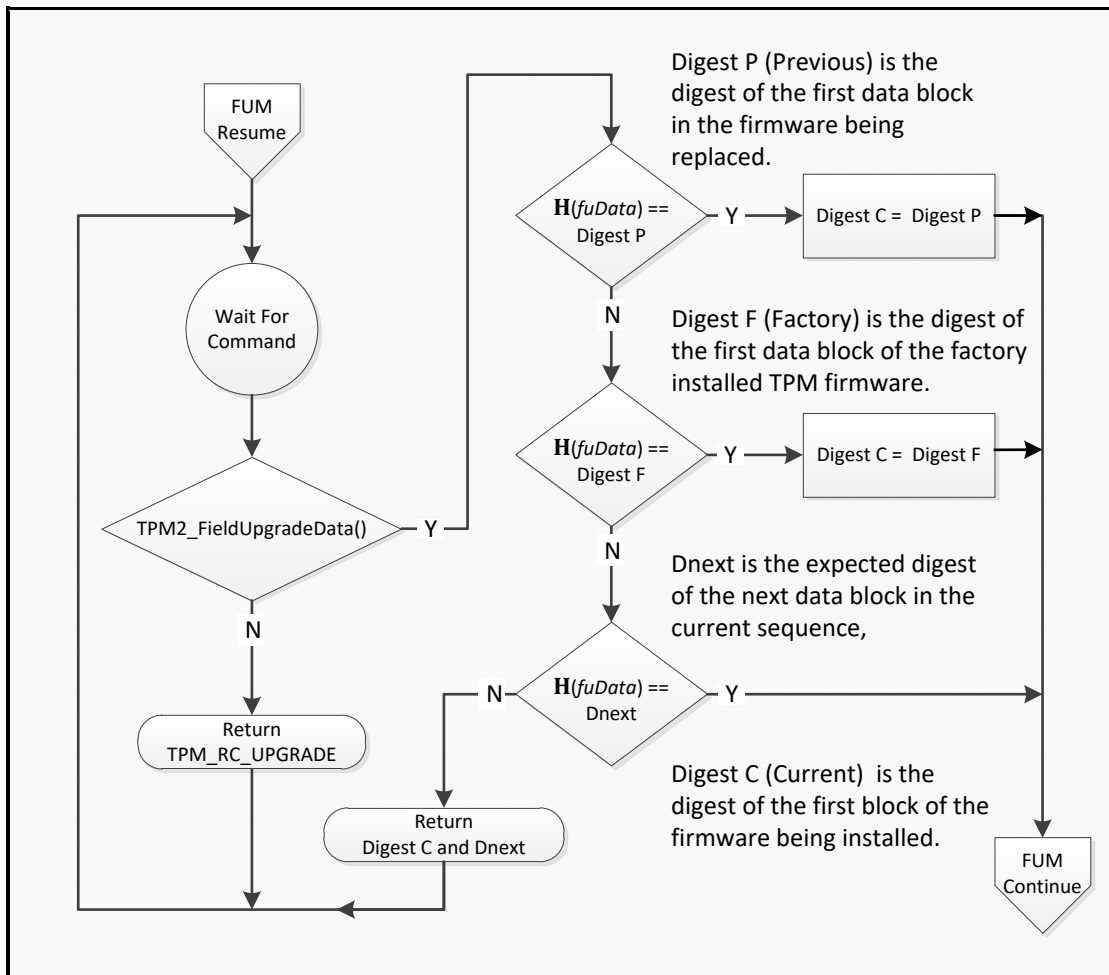


Figure 8 — Resuming Field Upgrade Mode after \_TPM\_Init

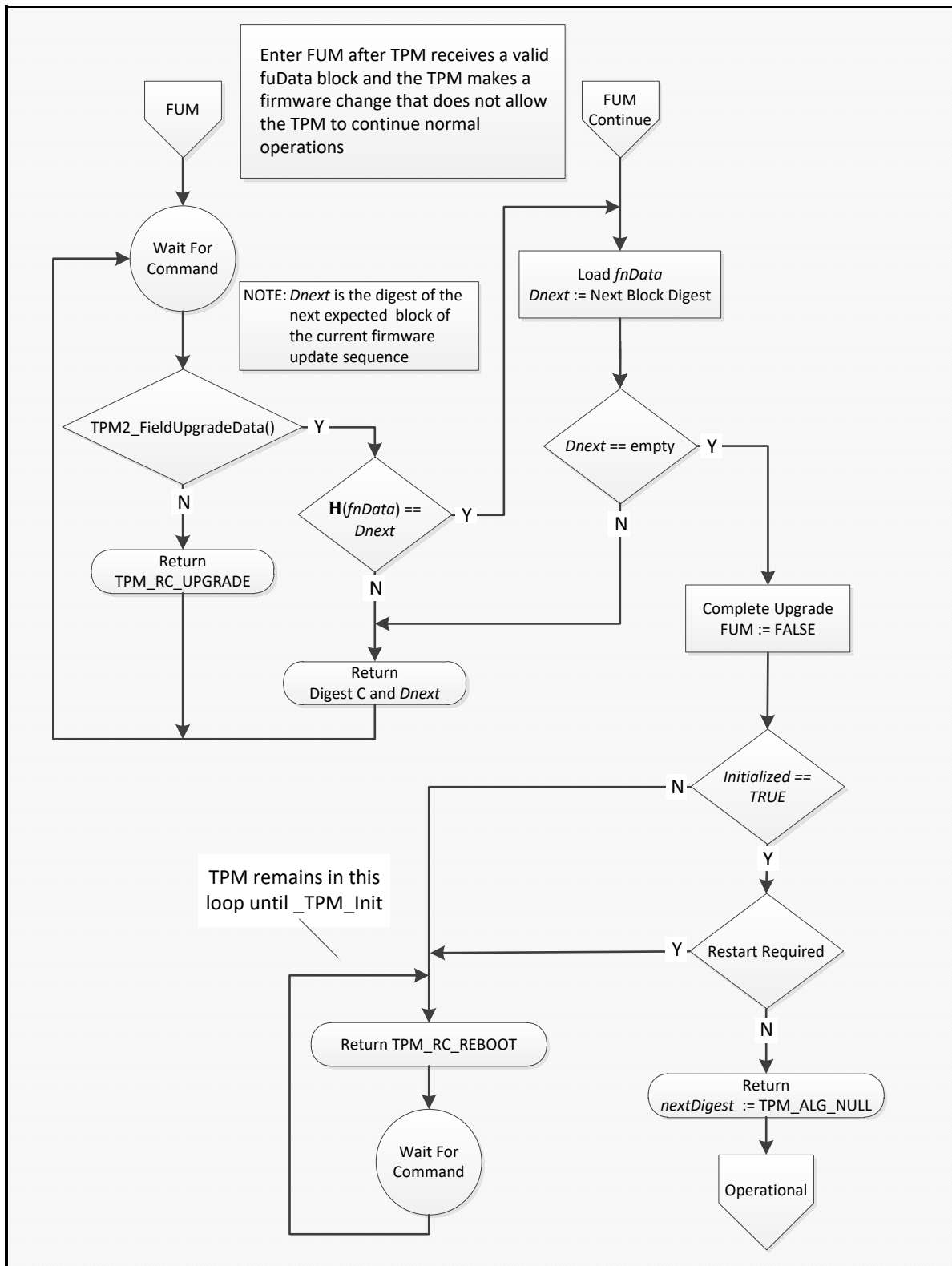


Figure 9 — Field Upgrade Mode

### 12.5.3 Preserved TPM State

A field upgrade may not cause exposure of any data that is specific to a TPM instance. This includes:



- Primary Seeds;
- Hierarchy *authValue*, *authPolicy*, and *proof* values;
- *lockoutAuth* and authorization failure count values;
- PCR *authValue* and *authPolicy* values;
- NV Index allocations and contents;
- Persistent object allocations and contents; and
- Clock.

In particular, if the TPM supports `TPM2_FirmwareRead()`, the returned data is not allowed to contain any data that is unique to the TPM instance.

A field upgrade should not cause the loss of any data that is specific to a TPM instance.

NOTE 1            A platform manufacturer may provide a means to change preserved data to accommodate a case where a field upgrade fixes a flaw that might have compromised TPM secrets.

#### **12.5.4 Field Upgrade Implementation Options**

The method described above for management of a TPM field upgrade is intended for use in a TPM that is implemented as stand-alone component (that is, when the TPM is manufactured and sold as a component that is added to a platform). When the TPM is not a stand-alone component, other methods of field upgrade are possible and are not precluded by this specification.

If other methods are used, the security of that method is the responsibility of the platform manufacturer.

## 13 TPM Control Domains

### 13.1 Introduction

Three entities control the TPM: the platform firmware, the platform Owner, and the Privacy Administrator. The Owner and Privacy Administrator are often the same entity. This control does not give these entities the ability to access user keys or data, but it does give them the ability to control selected TPM resources.

Each of the three entities has its own domain of control. Within that domain are TPM resources reserved to that entity. Each entity exercises its control over its domain by use of domain-specific authorization values.

The NV space defined by the platform firmware has an additional control, *phEnableNV*. When SET, NV space defined by the platform firmware is accessible. When CLEAR, it is inaccessible. This permits independent control of the platform firmware hierarchy and its NV space. For example, the platform hierarchy can be disabled while still permitting access to platform firmware NV space.

### 13.2 Controls

The platform firmware, platform Owner, and Privacy Administrator each have an authorization value and an authorization policy to control some portion of the TPM, including a specific Primary Seed (see clause 14). The authorizations, policies, and Primary Seed for each domain are:

- *platformAuth/platformPolicy/PPS* for platform firmware;
- *ownerAuth/ownerPolicy/SPS* for the Owner; and
- *endorsementAuth/endorsementPolicy/EPS* for the Privacy Administrator.

Associated with each hierarchy is a logical switch (that is, an “enable”) that determines whether the hierarchy is enabled. These enables are *phEnable*, *shEnable*, and *ehEnable*.

When the enable for a hierarchy is SET (1) and the specification indicates that an action may be authorized with an authorization value, the corresponding policy is also allowed. For instance, when *phEnable* is SET and *platformAuth* is allowed, *platformPolicy* may also be used.

When the enable for a hierarchy is CLEAR, neither the corresponding *authValue* nor *authPolicy* may authorize operations.

The interaction of the two authorization types (value and policy) and the associated hierarchy enable are intended to provide a flexible set of controls. Table 2 shows the control combinations.

Table 2 shows the *authValue* as either being "Known" or "Unknown". These correspond to the enabled and disabled states for an *authValue*. When the *authValue* is known, it can be used for authorization but it cannot be used when the *authValue* is unknown. Since a zero-length string (Empty Buffer) is a valid, knowable *authValue*; the way to make the *authValue* unknown, and disable its use, is to set it to a large random number and then discard that number.

Table 2 shows the *authPolicy* as either being "Set" or "Empty". These also correspond to the enabled and disabled states for an *authPolicy*. An *authPolicy* will have to match the value of a digest (*policyDigest*) in order for it to be a valid authorization. Since no digest has a zero length, setting the *authPolicy* to an empty buffer will disable use of the *authPolicy*. It is also possible to disable use of the *authPolicy* by setting it to any value that does not represent a known policy but the conventional way to disable use of *authPolicy* is to set it to an empty buffer (see 19.7 for the description of *policyDigest* generation and use).

**Table 2 — Hierarchy Control Setting Combinations**

<b>hierarchy enable</b>	<b>authValue</b>	<b>authPolicy</b>	<b>Description</b>
SET	Known	Set	The hierarchy is enabled, and objects in it may be loaded. Either authValue or authPolicy may manage resources related to the hierarchy.
SET	Unknown	Set	The authValue may be made unknown by setting it to a random value and then discarding the value. This prevents the authValue from being used. This combination is useful for keeping the hierarchy enabled but using a policy-based delegation scheme for managing hierarchy-related resources. An example is delegating control of creating Primary Objects in a hierarchy to one entity while delegating control of related NV resources to a different entity.
SET	Known	Empty	When the authPolicy is empty, it cannot match any policyDigest value so the use of authPolicy is disabled. This combination is most analogous to the control scheme of TPM 1.2, where an authValue (ownerAuth) is used to manage the resources of the single hierarchy supported by a 1.2 TPM.
CLEAR	N/A	N/A	When an enable is FALSE, the corresponding authValue and authPolicy may not be used to authorize any TPM action.

TPM2\_HierarchyChangeAuth() may change the *authValue* associated with a hierarchy but only if the hierarchy is enabled. Either the *authPolicy* or the *authValue* of a hierarchy may be used to authorize a change to the *authValue*.

### 13.3 Platform Controls

The platform firmware has overall control of the TPM and the availability of the TPM to the platform Owner or Privacy Administrator. The platform firmware is assumed to be provided by the platform manufacturer and performs the management of the hardware in preparation for use by an operating system (the operating system may be provided by a different vendor). In some systems, platform firmware runs after the OS is loaded. Often this firmware is required to ensure the safety of the system.

**EXAMPLE** Some systems have thermal properties that, if not managed properly, could lead to destruction of the system, and could even lead to the system becoming a fire hazard.

If the firmware is crucial to the safety of the system, the platform manufacturer may design in a firmware update process that ensures that only firmware approved by the manufacturer for a specific machine is allowed to be loaded on the system. This firmware may use cryptography to validate the firmware update before it is loaded. The TPM has cryptographic functions that are similar or identical to the functions needed by the platform firmware for its management of the system. Rather than replicate those cryptographic capabilities, the platform firmware is given its own set of TPM resources for its use. Reuse of the TPM cryptographic capabilities by the platform is intended primarily as a cost savings.

The platform manufacturer decides if it is possible to disable use of the TPM by the platform. The method for disabling use of the TPM by the platform is platform-manufacturer specific.

The properties of the TPM required by the platform manufacturer need not match those of the Owner. The platform manufacturer decides what cryptographic algorithms are required to safeguard the platform. These algorithms may differ from the algorithms use by the Owner or the Privacy Administrator.

Platform controls allow the following operations not available to an ordinary TPM user:

- allocation of TPM NV memory;
- PCR configuration;

- control of the availability of any key hierarchies; and
- change of the PPS, SPS, and EPS and reset of associated authorization values and policy.

NOTE 1 This is not a comprehensive list. The uses of the platform controls are documented in TPM 2.0 Part 3. In that document, an authorization of a command that allows the use of the platform handle (TPM\_RH\_PLATFORM) indicates that the command accepts *platformAuth* or *platformPolicy*.

*phEnable* gates use of both *platformAuth/platformPolicy* and the PPS hierarchy, as described in the previous clause. When *phEnable* is CLEAR, a *\_TPM\_Init* is required to SET it.

On any *\_TPM\_Init*, *phEnable* is SET to ensure that the platform may use the TPM during its initialization.

On TPM Reset or TPM Restart, *platformAuth* is set to an EmptyAuth, and *platformPolicy* is set to an Empty Policy.

NOTE 2 Platform controls are reset on TPM Restart because the BIOS goes through a full initialization and has no memory of any previous authorization values.

NOTE 3 *phEnable* must be SET before *TPM2\_Startup* when accommodating the case of an interrupted field upgrade that prevents startup from running. *phEnable* must be SET to permit field upgrade authorization.

A *platformAuth/platformPolicy* may be used in *TPM2\_HierarchyControl()* to SET or CLEAR *shEnable* or *ehEnable*.

### 13.4 Owner Controls

The TPM controls available to the Owner are a subset of those available to the platform. These include

- allocation of TPM NV memory, and
- control of the availability of any storage hierarchies.

The *shEnable* gates use of both *ownerAuth/ownerPolicy* and the SPS hierarchy, as described in 13.2.

The *shEnable* is SET on each TPM Reset, TPM Restart, or when the SPS is changed (*TPM2\_Clear()*). The *shEnable* may be CLEAR (*TPM2\_HierarchyControl()*) using either Lockout Authorization or Platform Authorization. When *shEnable* is CLEAR, it may only be SET (*TPM2\_HierarchyControl()*) if Platform Authorization is provided.

The *ownerAuth* and *ownerPolicy* values are persistent. They are set to standard initialization values when the SPS is changed (*TPM2\_Clear()*): *ownerAuth* is set to an EmptyAuth, and *ownerPolicy* is set to an Empty Policy. They may be explicitly changed by designated commands.

### 13.5 Privacy Administrator Controls

The Privacy administrator has control over the Endorsement Hierarchy and reporting of privacy-sensitive data.

The Privacy Administrator uses *endorsementAuth* and *endorsementPolicy* to exercise its control. The Privacy Administrator has a more limited domain of control than those of the platform firmware and the Owner. The cases when *endorsementAuth* or *endorsementPolicy* are required are:

- when creating Primary Objects in the Endorsement hierarchy, and
- when controlling the availability of the Endorsement hierarchy.

Other actions that may be considered to be privacy-sensitive require use of objects in the Endorsement hierarchy. For example, certification of a TPM object by the TPM produces a data structure that has data that could allow cross-correlation of the objects. This data is obfuscated unless the certifying key is in the Endorsement hierarchy. The privacy administrator of the TPM is expected to manage the creation of objects in the Endorsement hierarchy to ensure that the use of those objects is in accordance with their privacy policy.

The *ehEnable* gates use of *endorsementAuth/endorsementPolicy* and the EPS hierarchy, as described in 13.1. It also gates use of the vendor-specific handles TPM\_RH\_AUTH\_00 to TPM\_RH\_AUTH\_FF. Additionally, when the SPS changes, the objects in the EPS hierarchy are flushed from the TPM, and new EPS objects (that is, Primary Objects) must be created.

NOTE Clearing the hierarchy is necessary to ensure that the new Owner may not abuse objects created by a previous one and so that objects belonging to the previous Owner may not compromise the new one.

The *ehEnable* is SET on each TPM2\_Startup(TPM\_SU\_CLEAR) (that is, TPM Reset or TPM Restart) or when the SPS is changed (TPM2\_Clear()). The *ehEnable* may be CLEAR using either Endorsement Authorization or Platform Authorization. When *ehEnable* is CLEAR, it may be SET using Platform Authorization

NOTE TPM2\_HierarchyControl() will SET or CLEAR *ehEnable* if the proper authorization is provided.

The *endorsementAuth* and *endorsementPolicy* values are persistent. They are set to standard initialization values when the SPS (TPM2\_Clear()) or EPS (TPM2\_ChangeEPS()) are changed: *endorsementAuth* is set to an EmptyAuth, and *endorsementPolicy* is set to an Empty Policy. They may be explicitly changed by designated commands.

### 13.6 Primary Seed Authorizations

Use of a Primary Seed to create a Primary Object requires use of the authorization associated with that Primary Seed: Platform Authorization for the PPS, Owner Authorization for the SPS, and Endorsement Authorization for the EPS.

### 13.7 Lockout Control

A TPM is required to implement a lockout mechanism to protect against so-called “dictionary attacks,” where an attacker tries numerous authorization values until one succeeds. Dictionary attack protection is common for security devices, such as smartcards, that use human input for authorization. A human source of authorization likely has too little entropy to protect against an automated attack, so logic that prevents high-speed guessing of the values is required.

When the dictionary attack lockout is engaged, preventing use of some resources, it is helpful to have a secret value that resets lockout. The TPM stores the secret value as *lockoutAuth*. Alternatively, a policy (*lockoutPolicy*) can be used to reset lockout.

NOTE 1 The primary attack model for the dictionary attack begins when a system falls into the hands of a thief. The thief tries to recover data on the system by guessing the password used to protect a disk’s encryption keys. The dictionary attack logic defeats this attack by preventing the thief from making many guesses before the TPM locks out further attempts. When/if the system is returned to its rightful owner, that owner can enter the *lockoutAuth* value or satisfy *lockoutPolicy*, access the disk encryption keys, and return to normal operation.

NOTE 2 Unfortunately, dictionary attack logic is not forgiving of poor typing or a short memory. If someone types his or her password incorrectly due to clumsiness or poor memory, the dictionary attack logic might not differentiate this from an attack, so it locks the TPM. Lockout Authorization allows recovery from this situation.

The *lockoutAuth* value is reset to EmptyAuth and *lockoutPolicy* to the Empty Buffer when TPM2\_Clear() is executed.

NOTE 3            TPM2\_Clear() changes the SPS rendering all previously-created user objects inaccessible. There are, therefore, no keys for the dictionary attack logic to protect.

The *lockoutAuth* value may be changed (TPM2\_HierarchyChangeAuth()) only when its current value is provided. *LockoutPolicy* may be changed using TPM2\_SetPrimaryPolicy().

Generally, dictionary attack protection is not applied to objects associated with the PPS or to NV Indexes defined using Platform Authorization. The platform firmware is expected to select a high-entropy value when setting the *platformAuth* after a TPM reset. Additionally, since Platform Authorization does not provide access to user data protected by the TPM, disclosure of *platformAuth* does not expose user secrets.

See 19.8 for full details on setting of parameters associated with dictionary attack logic and other aspects of the dictionary attack protection.

## 13.8 TPM Ownership

### 13.8.1 Taking Ownership

Taking ownership of a TPM is the process of inserting authorization values for the *ownerAuth*, *endorsementAuth*, and *lockoutAuth*.

A TPM that has been cleared (TPM2\_Clear()) has its *ownerAuth*, *endorsementAuth*, and *lockoutAuth* values set to EmptyAuth and its *ownerPolicy*, *endorsementPolicy*, and *lockoutPolicy* values set to Empty Buffers. The OS is expected to change these values and manage them on behalf of the platform Owner.

The platform may prevent access to the hierarchies associated with Owner Authorization and Endorsement Authorization and prevent use of the TPM's persistent storage by the operating system and user applications. TPM cryptographic capabilities would still be available, and these could be used as if the TPM were a software cryptographic library.

### 13.8.2 Releasing Ownership

TPM2\_Clear() clears the current Owner from the TPM. A persistent TPM control (TPMA\_PERMANENT.*disableClear*) controls whether TPM2\_Clear() is functional. If *disableClear* is CLEAR, then TPM2\_Clear() may be authorized using either Platform Authorization or Lockout Authorization. If the control is SET, then TPM2\_Clear() is not functional.

NOTE            TPMA\_PERMANENT.*disableClear* may be SET or CLEAR using platformAuth/platformPolicy, giving the platform the ability to enable execution of TPM2\_Clear() when needed.

TPM2\_Clear() instructs the TPM to:

- flush any transient or persistent objects associated with the SPS or EPS hierarchies (PPS objects are not affected);
- release any NV Index locations that do not have their TPMA\_NV\_PLATFORMCREATE attribute SET;
- set *shEnable* and *ehEnable* to TRUE;
- set *ownerAuth*, *endorsementAuth*, and *lockoutAuth* to an EmptyAuth;
- set *ownerPolicy*, *endorsementPolicy*, and *lockoutPolicy* to an Empty Policy;
- replace the existing SPS with a new value from the RNG; and

- recompute *shProof*, and *ehProof*.

## 14 Primary Seeds

### 14.1 Introduction

A Primary Seed is a large, random value that is persistently stored in a TPM; it is never stored off the TPM in any form. Primary Seeds are used in the generation of symmetric keys, asymmetric keys, other seeds, and proof values.

A Primary Seed generates Primary Objects using the methods described in Clause 27.5. In brief, the caller provides the parameters of an object to be created, and the TPM uses these parameters and the Primary Seed in a key derivation function (KDF) to produce an object of the desired type. After the TPM generates a Primary Object, it uses the parameters of that object and the Primary Seed to generate a symmetric key to encrypt the sensitive portion of the object (that is, the private data and authorizations). It then returns the public portion and name of the object to the caller. The Primary Object may then be context saved and loaded like any other object. It may be stored persistently in the TPM's NV memory (TPM2\_EvictControl()).

Primary Seeds generate only Primary Objects. All other objects use the random number generator of the TPM as the source of entropy for generating secrets in the object.

### 14.2 Rationale

The algorithm flexibility provided by this specification makes it possible for the TPM to support many different asymmetric key types. TPM 1.2 supported only the RSA algorithm with a limited number of commonly used parameters. The addition of ECC support significantly increases the number of parameters because curve parameters may vary based on application.

While this flexibility is a major benefit of TPM 2.0, it creates new challenges for managing TPM Endorsement Keys (EKs) and EK certificates. As mentioned in 9.4.3.2, an EK is an identity for the Root of Trust for Reporting (RTR), and algorithm agility creates the possibility of having many identities for the same RTR, with each identity based on a different set of cryptographic algorithms.

One possible approach for handling many EKs and their associated certificates would be for the TPM manufacturer to have the TPM create EKs for many key parameters and store them on the TPM; in this way, a key with the correct parameters would be available in most situations. The TPM vendor could then create one or more certificates for those keys. However, this approach would require a prohibitive amount of NV memory to store all the key pairs and associated parameters. The approach taken in this specification allows certification of a large number of EKs with different parameters without requiring that any of them be stored in persistent TPM memory.

The mechanism of this specification uses a persistent, randomly generated seed value from which EKs are derived. The derivation process lets the TPM generate a different EK for each set of key parameters. As long as the seed value does not change, the same key parameters generate the same EKs.

The typical use of this EK generation approach is as follows: The TPM manufacturer or the platform manufacturer has the TPM create a new Endorsement Primary Seed (EPS) and then generate key pairs based on sets of input parameters and that EPS. The TPM retains the generated keys. Combinations of key parameters should be chosen to ensure that likely TPM users would find a combination to suit their needs. The manufacturer then generates one or more certificates for the generated public keys and then ships the TPM/system with no EK pair stored on it. The system owner decides which key types are needed, and the parameters for those types are entered into the TPM. If the parameters are the same as those used by the manufacturer, the TPM generates the same key pair. The system owner then has an EK with its certificate. A Primary Key does not leave the TPM so the owner has a choice to make. They may either re-create the EK whenever it is needed or tell the TPM to save the EK in persistent memory.



The seed key concept may be applied to two other TPM key hierarchies: one used by platform firmware, and one used for the owner's Storage hierarchy. The Endorsement Keys (EK) are generated from the Endorsement Primary Seed (EPS), platform keys from the Platform Primary Seed (PPS), and Storage Root Keys (SRK) from the Storage Primary Seed (SPS). Each seed value has a different life cycle, but the way it seeds the associated hierarchies is approximately the same.

It is preferred that a TPM manufacturer generate at a certificate for at least one EK before the device ships. This certificate would be based on the EPS that is present in the TPM at that time. While it is possible for the manufacturer to let the TPM populate the EPS and generate an RSA key pair, the unpredictability of the generation time may make injecting an EPS a more attractive option. The time taken to inject an EPS would be deterministic and one or more RSA key pairs could be generated for that EPS outside of the TPM. This could save considerable time during manufacturing.

The external algorithm for generating a key pair from the EPS has to be the same as the algorithm used by the TPM; otherwise, they will generate different keys. The generation times for the external and TPM processes will be proportional so the manufacturer can use the time for external key generation time as an indicator of the time that the TPM will take when the end user attempts to recreate the EK. If the manufacturer does decide to inject an EPS and generate RSA keys outside of the TPM, there is an opportunity to benefit the customer by discarding EPS values that result in long key pair generation times for the certified values.

Another possible option is to inject the EPS and a precomputed pair of RSA primes that are compatible with a specific template (compatible meaning that the primes are the right size and that the prime (p) and p-1 are not evenly divisible by the public exponent). The TPM could access those primes when the associated template is used for an EK. If this method is used, the TPM manufacturer has to make sure it is critical that the precomputed primes are only associated with a single template and that the primes are erased from the TPM when the EPS is changed.

The primary seed approach allows multiple storage hierarchies with differing security properties, as needed by various applications, without requiring that all of the SRKs occupy persistent TPM memory. An SRK may be made persistent in TPM NV memory if required by the application.

This scheme is also used in support of the Platform hierarchy for implementation simplicity.

### 14.3 Primary Seed Properties

#### 14.3.1 Introduction

A Primary Seed is required to have at least twice the number of bits as the security strength of any symmetric or asymmetric algorithm implemented on the TPM.

**EXAMPLE 1** RSA2048 is considered to have a security strength of 112 bits. If it were the strongest algorithm on the TPM, then the required size of an associated Primary Seed would be at least 224 bits.

**EXAMPLE 2** If AES256 were implemented, the Primary Seed would be 512 bits even if: (1) the desired security strength is 196 bits, and (2) AES256 is used only for convenience, as is the case with Suite B.

A different authority controls each Primary Seed. In normal use, Primary Seeds are expected to have different lifetimes.

#### 14.3.2 Endorsement Primary Seed (EPS)

The EPS is used to generate EKs and is the basis of the RTR's identity.

The TPM creates an EPS whenever it is powered on and no EPS is present. `TPM2_ChangeEPS()` may change the EPS (replace it with a new EPS), but this requires authorization by Platform Authorization.

The TPM manufacturer may inject an EPS and, under controlled conditions, compute the asymmetric EKs that the TPM would generate given specific input parameters. Only the TPM vendor may inject an EPS.

When an EPS is replaced, all objects in the Endorsement Hierarchy are invalidated, and certificates associated with the EKs generated from that EPS are no longer useful. This means that certificates for new EPS-based EKs may be needed. The environment in which this process occurs may not provide assurance that the EKs are generated from a genuine TPM. To support recertification in such an environment, the TPM allows cross certification of keys between the Platform hierarchy and the Endorsement hierarchy under control of the platform firmware. Cross certification allows a chain of trust to be maintained as the seeds are changed.

When a platform enters the distribution channel, it is expected to have a certificate for at least one EK for the TPM on that platform.

Either *endorsementAuth* or *endorsementPolicy* is required to use the EPS for creation of a Primary Object in the Endorsement hierarchy.

### 14.3.3 Platform Primary Seed (PPS)

The PPS is used to generate the hierarchy controlled by platform firmware. The hierarchies derived from this seed are for exclusive use by platform firmware and should not be made available to user-installable software (such as, OS and applications).

NOTE 1           The platform firmware may be changed because of actions by a person with possession of the platform, but that is not included in the definition of user-installable software.

The TPM creates a PPS whenever it is powered on and no PPS is present. `TPM2_ChangePPS()` may change the PPS (replace it with a new PPS), but this requires authorization by Platform Authorization.

A PPS may be injected but only by the TPM manufacturer.

Platform Authorization is required to use the PPS to create a Primary Object in the Platform hierarchy.

The authorization for use of objects in the PPS hierarchy should use a policy containing a reference to *platformAuth* and not be based on a key-specific authorization value.

NOTE 2           The TPM does not enforce this imperative.

NOTE 3           A simple way to achieve this control is to create a policy that references *platformAuth* in a `TPM2_PolicySecret()`. If the only component of the policy is `TPM2_PolicySecret()` referencing `TPM_RH_PLATFORM`, the policy may be the same for all objects in the Platform hierarchy and for all platforms that implement the chosen policy hash.

### 14.3.4 Storage Primary Seed (SPS)

The SPS is used to generate hierarchies controlled by the platform owner. This seed generates the keys that serve as Storage Root Keys for normal OS and application use.

The TPM creates the SPS whenever it is powered on and no SPS is present. `TPM2_Clear()` may be used to change the SPS if the TPM owner wants to ensure that no previously generated keys in the Storage hierarchy may be used in the future.

Changing the SPS invalidates all objects in the Storage Hierarchy and they cannot be recreated. Changing the SPS also invalidates all objects in the Endorsement Hierarchy and only the Primary Objects in the Endorsement Hierarchy may be recreated.

#### 14.3.5 The Null Seed

The Null Seed is set to a random value on every TPM reset. The Null Seed can be used to generate hierarchies (primary objects and children of primary keys) that are only usable until the next TPM reset.

Objects in the null-hierarchy cannot be made into persistent objects. However, in other respects objects in this hierarchy behave like objects in the other hierarchy.

### 14.4 Hierarchy Proofs

The TPM uses a proof value to prove that it created or checked an externally provided value. A proof value is associated with a hierarchy and is statistically unique. The proof values are used in tickets. The tickets use the hierarchy-specific proof values. A ticket may not be used when its associated hierarchy is disabled.

**EXAMPLE 1** The TPM may validate asymmetrically signed data. After doing so, it produces a ticket that is an HMAC over the signed data, with the HMAC key being a proof value. This proves to the TPM that it has already checked the asymmetric signature so it does not have to do so again. Subsequently, when the TPM needs to check that the data was properly signed, it may use symmetric cryptography (a hash) rather than asymmetric cryptography to validate the signature.

**EXAMPLE 2** When the TPM performs TPM2\_ContextSave() on an object in the Storage hierarchy, it may include the Storage hierarchy proof (*shProof*) in the object's integrity value. When the SPS is changed, *shProof* will change so that the saved contexts may not be reloaded.

A Platform hierarchy proof (*phProof*), used for objects associated with the Platform hierarchy. *phProof* changes when the PPS changes. An *shProof*, used for the Storage and Endorsement hierarchies, changes when the SPS changes.

**NOTE** It is possible to create objects in the Endorsement Hierarchy that are not Primary Objects. Those Ordinary Objects are considered to belong to a specific TPM Owner. A change of the SPS indicates a change of Owner for the TPM. Inclusion of *ehProof* in the protection of Ordinary Objects in the Endorsement Hierarchy insures that those Objects will be deleted when the Owner changes, because *ehProof* also changes when the Owner changes.

A proof is a value that may be kept in permanent storage on the TPM or it may be regenerated from the PPS or SPS on each boot or as needed. A proof value is never stored off the TPM in any form. Hierarchy proof values are only used as an HMAC key if the result of the computation is stored off the TPM. Examples are saved contexts and tickets. A hierarchy proof value may be used in other computations as long as the result of the computation does not leave the TPM.

The TPM should produce proof values that are the larger of either

- the size of the largest digest produced by any hash algorithm implemented on the TPM, or
- twice the size of the largest symmetric key supported by the TPM.

**EXAMPLE 3** If the TPM implements SHA384 and AES256, the proof value will have a size of 512 bits.

**NOTE** According to SP800-57, the security strength of SHA256 in an HMAC function equals 256 bits. Since security strength is not improved when the key size is larger than the digest size, the recommendation for proof size provides the appropriate strength when the TPM is implementing balanced algorithm sets. A TPM using SHA256, ECC256, and AES128 is balanced, and the proof value is 256 bits.

## 15 TPM Handles

### 15.1 Introduction

TPM resources are referenced by handles that uniquely identify a resource that occupies TPM memory — either RAM or NV. A handle is a 32-bit value. Its most significant octet identifies the type of referenced resource. At any given instant, its low-order 24 bits identify a unique resource of that type. The actual resource identified by the low-order 24 bits may change with time.

A specific handle value may refer to only one TPM-resident resource at a time.

### 15.2 PCR Handles (MSO=00<sub>16</sub>)

To reduce confusion, PCR are assigned handles that have the same values as in previous versions of the specification. A PCR handle is an Index into an array of PCR. A PCR's Index and handle value are the same.

### 15.3 NV Index Handles (MSO=01<sub>16</sub>)

An NV Index is associated with a persistent TPM resource created by TPM2\_NV\_DefineSpace().

### 15.4 Session Handles (MSO=02<sub>16</sub> and 03<sub>16</sub>)

The TPM assigns session handles when an authorization session is started (TPM2\_StartAuthSession()). An HMAC session is assigned a handle with an MSO of 02<sub>16</sub> and a policy session is assigned a handle with an MSO of 03<sub>16</sub>. Each authorization session handle is associated with a unique context that may exist in only one place at a time: either on the TPM in a Shielded Location, or in a saved context as a Protected Object. The handle remains associated with the session as long as the session exists and does not change when the session is context-saved and reloaded.

The low order 3 octets of each session handle are unique. They are assigned interchangeably to HMAC or policy sessions but to only one at a time.

**EXAMPLE 1** If a policy session has a value of 03 00 00 01<sub>16</sub>, then an HMAC session with a value of 02 00 00 01<sub>16</sub> will not be assigned at the same time.

**NOTE 1** The policy and session handles are assigned from a common pool of handle values.

When TPM2\_GetCapability() is used to obtain a list of sessions that are currently loaded on the TPM, the caller would use a handle with an MSO of 02<sub>16</sub>. While this would normally be an HMAC handle reference, the TPM will respond with a list that includes both HMAC and policy sessions. The handles will be returned in ascending order of the low-order three octets.

**EXAMPLE 2** A list of loaded handles returned by the TPM in response to a TPM2\_GetCapability(capability = TPM\_CAP\_HANDLES, property = 02 00 00 00<sub>16</sub>), the TPM might return the list: 02 00 00 02<sub>16</sub>, 03 00 00 04<sub>16</sub>, and 02 00 00 05<sub>16</sub>

When TPM2\_GetCapability() is used to obtain a list of sessions that are active but not on the TPM, the caller would use a handle with an MSO of 03<sub>16</sub> which normally would reference a policy session. The TPM will respond with a list of session handles that are in use, but not on the TPM. Since the TPM does not keep a record of whether the saved session context was an HMAC or policy session, all of the handles in the list will have an MSO of 02<sub>16</sub>.

The TPM is required to maintain a list of all, currently assigned session handles as well as the correct "version number" for any saved session contexts.

NOTE 2 the "version number" is how the TPM prevents replay of an authorization.

When an authorization session is no longer needed, TPM2\_FlushContext() may be used to delete all context associated with the session from TPM memory (see 30.6). The session handle for this command may use an upper octet of either 02<sub>16</sub> or 03<sub>16</sub>.

NOTE 3 Flushing a session context deletes any data in the TPM relating to the context and frees the handle associated with that context and invalidates the version number of any saved context.

NOTE 4 An alternative method of flushing a session context exists that is not available for other entities. On the last use of the session, the caller may indicate (in one of the session attributes) that the session is no longer needed. If the command completes successfully, the TPM will complete the response computations for the session and delete the session context from TPM memory (see 18.6.4).

All session contexts in TPM memory are flushed on any TPM2\_Startup(). The saved session contexts remain valid until a TPM Reset.

### 15.5 Permanent Resource Handles (MSO=40<sub>16</sub>)

Fixed resource handles refer to Shielded Locations that are always associated with the same handle. These resources have handles with an MSO of 40<sub>16</sub>. Examples of these resources are Owner, Platform, and Endorsement hierarchy controls and the Lockout authorization value.

Another type of permanent resource handle is the vendor-specific authorization value. These optional resources may be populated with authorization values that are known only by the TPM manufacturer or some other privileged entity. The update of these authorization values is TPM-manufacturer-dependent.

If present, a vendor-specific authorization value can be used as a bind value within an authorization session or to authorize a policy using the TPM2\_PolicySecret command. In the former case, an entity that knows the authorization value could create an auditable authorization session that only that entity could execute. In the latter case, the entity could create and/or use TPM resources with an authorization policy that only that entity could execute.

Since vendor-specific authorization values might be usable by an entity who knows them to identify the TPM, the use of these authorization values is under the control of the privacy administrator. These authorization values are only usable when the Endorsement Hierarchy is enabled as described in 13.5.

NOTE A use case for the vendor-specific authorization values is to recover in the field from a flaw in the TPM firmware. For example, TPM vendors may provide a mechanism that updates one or more of these authorization values based on the measurement of the TPM firmware. This update mechanism could be used to give the manufacturer confidence that a valid, uncompromised version of the TPM firmware is running. In this scenario, if the manufacturer wished to provide a certificate for an endorsement key generated in the field after a field upgrade to a trusted firmware version occurred, the manufacturer could use an auditable authorization session using the vendor-specific authorization value to verify the properties of the endorsement key and then create a certificate for that new endorsement key.

### 15.6 Transient Object Handles (MSO=80<sub>16</sub>)

The TPM assigns Object handles when an Object is loaded or when the Object's persistence is changed (TPM2\_EvictControl()). Transient Objects in TPM RAM have handles with an MSO of 80<sub>16</sub>; they may have a different value for the three LSOs each time the Object is used. This is because the Object's context may have been swapped out and the TPM assigned a new handle when the object was swapped back in. The TRM ensures that the handle references the correct object.

All Transient Objects are flushed from TPM memory on any TPM2\_Startup(). A loaded Transient Object context may be flushed from TPM memory using TPM2\_FlushContext() and indicating the handle of the loaded context to be flushed.

### 15.7 Persistent Object Handles (MSO=81<sub>16</sub>)

TPM2\_EvictControl() may make a Transient Object into a Persistent Object. A Persistent Object, placed in the TPM's NV memory, is not cleared by a TPM2\_Startup().

Making an Object persistent requires either Platform Authorization or Owner Authorization.

When the TPM changes a Transient Object to a Persistent Object, the caller indicates the handle to be assigned to the Persistent Object. The MSO of the handle is required to be 81<sub>16</sub>. The next most significant bit is required to be CLEAR if the authorization is provided using Owner Authorization and SET if the authorization is provided using Platform Authorization. If the handle is not already in use, and space is available, a persistent copy of the Object is created and assigned the handle provided by the caller. This handle always references the same Persistent Object as long as it remains persistent. The handle assigned to a Persistent Object may be assigned to a new Persistent Object if the first Object is deleted from persistent storage.

## 16 Names

The Name of an entity is its unique identifier. The handle associated with an object may change due to context management (TPM2\_ContextSave() / TPM2\_ContextLoad()), but the Name of an object remains constant. The Name associated with an NV Index will change based on changes to the attributes of the Index.

**EXAMPLE** When an NV Index is initially defined, it will have a Name for an Index with TPMA\_NV\_WRITTEN CLEAR. After the Index is written, the Name will change to reflect that TPMA\_NV\_WRITTEN is SET for the Index.

When an NV Index becomes locked (TPMA\_NV\_WRITELOCKED or TPMA\_NV\_READLOCKED is SET), the Name of the NV Index changes. This has two implications:

The caller should use its copy of the NV public area and calculate the Name before using it in an HMAC authorization calculation. Otherwise, an invalid authorization may trigger the dictionary attack protection depending on TPMA\_NV\_NO\_DA.

The TPM must check access control before checking authorization. For example, it should reject a read to a read locked NV Index before doing an authorization check that might trigger the dictionary attack protection.

The method of computing the Name for an entity varies according to the entity type that is the MSO of the handle. Table 3 shows the method and the handle's MSO for different entity types.

When the computation of a Name uses a hash algorithm, the algorithm identifier is included in the Name structure. If the Name is a handle, the Name is only the handle value.

**Table 3 — Equations for Computing Entity Names**

MSO of Handle	Entity Type	Equation for Computing the Name						
00 <sub>16</sub>	PCR	$Name := handle$ No hash is performed on the handle to produce the name and the name is only the size of the handle.						
02 <sub>16</sub>	HMAC Session							
03 <sub>16</sub>	Policy Session							
40 <sub>16</sub>	Permanent Values							
01 <sub>16</sub>	NV Index	$Name := nameAlg    H_{nameAlg}(handle \rightarrow nvPublicArea)$ where <table style="margin-left: 20px;"> <tr> <td><i>nameAlg</i></td> <td>algorithm used to compute <i>Name</i></td> </tr> <tr> <td><math>H_{nameAlg}</math></td> <td>hash using the <i>nameAlg</i> parameter in the NV Index location associated with <i>handle</i></td> </tr> <tr> <td><i>nvPublicArea</i></td> <td>contents of the TPMS_NV_PUBLIC associated with <i>handle</i></td> </tr> </table>	<i>nameAlg</i>	algorithm used to compute <i>Name</i>	$H_{nameAlg}$	hash using the <i>nameAlg</i> parameter in the NV Index location associated with <i>handle</i>	<i>nvPublicArea</i>	contents of the TPMS_NV_PUBLIC associated with <i>handle</i>
<i>nameAlg</i>	algorithm used to compute <i>Name</i>							
$H_{nameAlg}$	hash using the <i>nameAlg</i> parameter in the NV Index location associated with <i>handle</i>							
<i>nvPublicArea</i>	contents of the TPMS_NV_PUBLIC associated with <i>handle</i>							
80 <sub>16</sub>	Transient Objects <sup>(1)</sup>	$Name := nameAlg    H_{nameAlg}(handle \rightarrow publicArea)$ where <table style="margin-left: 20px;"> <tr> <td><i>nameAlg</i></td> <td>algorithm used to compute <i>Name</i></td> </tr> <tr> <td><math>H_{nameAlg}</math></td> <td>hash using the <i>nameAlg</i> parameter in the object associated with <i>handle</i></td> </tr> <tr> <td><i>publicArea</i></td> <td>contents of the TPMT_PUBLIC associated with <i>handle</i></td> </tr> </table>	<i>nameAlg</i>	algorithm used to compute <i>Name</i>	$H_{nameAlg}$	hash using the <i>nameAlg</i> parameter in the object associated with <i>handle</i>	<i>publicArea</i>	contents of the TPMT_PUBLIC associated with <i>handle</i>
<i>nameAlg</i>	algorithm used to compute <i>Name</i>							
$H_{nameAlg}$	hash using the <i>nameAlg</i> parameter in the object associated with <i>handle</i>							
<i>publicArea</i>	contents of the TPMT_PUBLIC associated with <i>handle</i>							
81 <sub>16</sub>	Persistent Objects							

NOTE 1) The Name of a sequence object is an Empty Buffer (see 32.4.5).

When an object is created, a "template" for the public area is used to define the properties for the new object. That template has the structure of an object's public area. The Name of a public area template is computed in the same way as the Name of a Transient Object.

## 17 PCR Operations

### 17.1 Initializing PCR

All platform configuration registers (PCR) are reset to their default initial condition on TPM Reset and TPM Restart. Some PCR may be designated as being preserved by TPM Resume. Those that are preserved are restored to the state that they had at the last TPM2\_Shutdown(STATE) operation. When TPM2\_Startup() completes successfully, PCR that are not designated as being preserved by TPM Resume will be in their default initial condition.

If allowed by its attributes, a PCR may also be reset by TPM2\_PCR\_Reset() or by a Dynamic Root of Trust (D-RTM) sequence (see 34.2). PCR attributes are defined in a platform-specific specification. They determine the reset value of a PCR as well as the localities required to perform the reset.

The default initial condition for any PCR, other than PCR[0], is either all bits CLEAR or all bits SET. For PCR[0], the default initial condition may all bits CLEAR, all bits SET, the locality at which TPM2\_Startup() was received, or an indicator that the first measurement came from an H-CRTM. Other platform types may use other means of identifying the locality of the access.

A platform-specific specification may choose from the options list above.

**EXAMPLE 1** A platform-specific specification may designate that the default initial condition for PCR[0-16] is all zeros, and for PCR[17-20], it is all ones.

**EXAMPLE 2** A platform-specific specification may designate that the default initial condition for PCR[0] is the locality indicator and that PCR[1-16] have an initial condition of all zeros.

**NOTE** The locality indicator is an integer value between 0 and the maximum locality implemented on a TPM. Currently, the maximum hardware locality is 4. In a TPMA\_LOCALITY, a locality of four would be represented by the octet 0001 0000<sub>2</sub>. When encoded for a PCR initial value, locality 4 would be represented by the octet 0000 0100<sub>2</sub>.

**EXAMPLE 3** A virtual TPM may use a unique identifier for each of the software entities that might access it. If specific software is associated with a specific PCR, then the reset value of that PCR may be the unique identifier of the software that is allowed to change it.

TPM2\_PCR\_Reset() requires that the proper authorization be provided for the operation (see 17.7).

### 17.2 Extend of a PCR

Other than reset, described above, the only way to change a PCR value is to Extend it. The Extend operation on a PCR is defined as

$$PCR_{new} := H_{alg}(PCR_{old} || digest) \quad (14)$$

After each Extend, the PCR value is unique for the specific order and combination of digest values that were Extended.

Except for D-RTM, authorization is required to extend a PCR (see 17.7).

### 17.3 Using Extend with PCR Banks

TPM2\_PCR\_Extend() has a handle to indicate the PCR to Extend and the data to be Extended. Extended data is a structure that contains one or more digests along with the algorithm identifier for the digest(s). Each digest is Extended to the PCR bank that has the same algorithm. If no digest data is provided for one of the PCR banks, no change is made to the PCR in that bank.



The TPM should perform the following operation for each algorithm in which *pcrNum* is defined:

$$PCR.digest[pcrNum][alg]_{new} := H_{alg}(PCR.digest[pcrNum][alg]_{old} || digest) \quad (15)$$

where

$H_{alg}$	hash function using the algorithm associated with the PCR instance
<i>PCR.digest</i>	digest value in a PCR
<i>pcrNum</i>	PCR numeric selector
<i>alg</i>	PCR algorithmic selector
<i>digest</i>	digest part of the list entry that has the same algorithm identifier as the PCR bank

**EXAMPLE** If a TPM supports three PCR banks (such as, SHA-1, SHA256, and SHA512), then an Extend to PCR[2] with a SHA-1 digest and SHA256 digest would be Extended to PCR[2] in the SHA-1 bank, and the SHA256 digest would be Extended to PCR[2] in the SHA256 bank. There would be no change to any PCR in the SHA512 bank.

## 17.4 Recording Events

An alternative way to record log entries is to input the full log entry to the TPM rather than performing the digests outside the TPM. This performs a hash on the log entry for each of the hash algorithms supported by the TPM. Events no larger than 1024 octets may use TPM2\_PCR\_Event(). Events exceeding 1024 octets may use the sequence commands: TPM2\_HashSequenceStart(), TPM2\_SequenceUpdate(), and TPM2\_EventSequenceComplete().

TPM2\_PCR\_Event() and TPM2\_EventSequenceComplete() return a list of tagged digests. The digests are the digests of the event data using the hash algorithm of each bank.

**EXAMPLE** For a TPM implementing two banks (such as, SHA256 and SM3), the event commands return a list of two tagged digests.

TPM2\_EventSequenceComplete() requires that proper authorization be provided (see 17.7).

Recording of an event may also occur as the result of a `_TPM_Hash_Start/_TPM_Hash_Data/_TPM_Hash_End` sequence (an *H-CRTM Event Sequence*). The indications for the H-CRTM sequence come from the TPM interface and not through the command buffer. On receipt of `_TPM_Hash_Start`, the TPM will create an Event Sequence context. If no object context space is available when the TPM receives `_TPM_Hash_Start`, the TPM will flush a context (vendor's choice) in order to create the Event Sequence context. `_TPM_Hash_Data` is used to update the H-CRTM Event Sequence context and `_TPM_Hash_End` completes the sequence. The digest or digests computed during the H-CRTM Event Sequence will be extended into the PCR designated by the relevant platform-specific specification. A platform-specific specification may allow an H-CRTM Event Sequence before or after TPM2\_Startup(). An H-CRTM Event prior to TPM2\_Startup() affects PCR[0]. After TPM2\_Startup(), an H-CRTM Event affects PCR[17].

## 17.5 Selecting Multiple PCR

TPM2\_PCR\_Event() implicitly selects all PCR with the same Index. Some commands allow the selection of multiple PCR in different banks. Examples are TPM2\_PCR\_Read(), TPM2\_Quote(), and TPM2\_PolicyPCR() that allow the caller to make arbitrary selections of PCR in multiple banks.

When a command allows multiple PCR to be selected, a list of selectors is used. Each entry in the list consists of an algorithm ID followed by a bit array. Each bit in the bit array corresponds to one PCR. If a bit is SET, then the indicated PCR in the bank corresponding to the algorithm ID is selected.

The bit correspondence to PCR is that the bit corresponding to PCR[ $n$ ] is the ( $n \bmod 8$ ) bit in the  $\lfloor n/8 \rfloor$  octet of the array.

**EXAMPLE** An array to select PCR[0] and PCR[13] in a TPM with 16 PCR would be 01 20<sub>16</sub>. The bit for PCR[0] is the  $0 \bmod 8 = 0^{\text{th}}$  bit in the  $\lfloor 0/8 \rfloor = 0^{\text{th}}$  octet (the octet with the 01<sub>16</sub> value) and the bit for PCR[13] is the  $13 \bmod 8 = 5^{\text{th}}$  bit in the  $\lfloor 13/8 \rfloor = 1^{\text{st}}$  octet (the octet with the 20<sub>16</sub> value).

The list of selectors is processed in order. The selected PCR are concatenated, with the lowest numbered PCR in the first selector being the first in the list and the highest numbered PCR in the last selector being the last.

TPM2\_PCR\_Read() returns a list of PCR values that correspond to the PCR selected in the selector list. TPM2\_Quote() and TPM2\_PolicyPCR() digest the concatenation of PCR.

It is not an error for the PCR selection to indicate a PCR that is not implemented in a bank. No value is included in the concatenation of PCR for an unimplemented PCR. It is an error if the algorithm ID selects a hash algorithm that is not implemented.

## 17.6 Reporting on PCR

### 17.6.1 Reading PCR

TPM2\_PCR\_Read() reads the current values of a selection of PCR. For this command, the caller indicates a list of PCR to be read using a PCR selection structure. This structure is an array of lists. Each array entry has a hash identifier and a bit field. The hash identifier indicates the bank of PCR, and the bit field indicates the PCR being selected in the bank.

In the response, the TPM provides a PCR selection structure and a list of PCR values. The PCR selection structure indicates the PCR that are present in the return structure. The size of the requested return data structure may not fit in the available TPM output buffer. In that case, the list of PCR values is truncated, and the response PCR selection structure indicates the PCR that were returned. If the returned structure does not contain all of the PCR, the caller may modify the selection structure and make another read request to get additional PCR values.

Since the PCR may change between the calls to collect the full set of PCR of interest, the TPM returns a counter that increments on most invocations of TPM2\_PCR\_Extend(), TPM2\_PCR\_Event(), TPM2\_EventSequenceComplete(), or TPM2\_PCR\_Reset() (see 17.9 for exemptions). If this counter value changes between calls, the sequence may need to be repeated until the desired PCR are all returned with no change to the counter value.

### 17.6.2 Attesting to PCR

In some cases, it is necessary for selected PCR to be in a specific state. When indicating that state, it is not desirable to have to list the contents of each PCR. Instead, a digest of a concatenation of PCR (a composite PCR digest) will indicate the current contents of all of the PCR of interest.

The PCR to be included in the composite digest are selected by the same type of structure used for TPM2\_PCR\_Read(). The selection structure is first filtered so that unimplemented PCR are not in the selection structure. Then, a composite digest of all of the selected PCR is created. Finally, the filtered selection structure and the composite digest are hashed to create the final digest value. That digest may be compared to a required digest (TPM2\_PolicyPCR()) or returned in an attestation (TPM2\_Quote()).

To validate an attestation quote, a remote caller will typically use the PCR to recalculate the digest value. The TPM 1.2 quote command returns the PCR values along with the digest. In TPM 2.0, because of hash agility, the PCR set could have exceeded the response buffer size. Therefore, TPM2\_Quote() returns only the digest, and the PCR values must be retrieved separately.

This can lead to a race condition. The PCR values can change between the time of the quote and the time they are read. There are several solutions. The PCR can be read before and after the quote to ensure that they did not change. Alternatively, the quote digest can be validated locally against the PCR before returning results to a remote caller, and the quote can be rerun until the validation succeeds.

## 17.7 PCR Authorizations

TPM2\_PCR\_Reset(), TPM2\_PCR\_Extend(), TPM2\_PCR\_Event(), and TPM2\_EventSequenceComplete() require authorization for the PCR being modified. The type of the authorization may differ based on the PCR being modified. A PCR may be defined as having a fixed, EmptyAuth; a variable *authValue*; or a variable *authPolicy*.

The authorization (*authValue* or *authPolicy*) for a PCR may apply to a set of PCR. That is, several PCR may be designated as using the same authorization value so that changing the authorization value (*authValue* or *authPolicy*) of any PCR in the set will change the value for all PCR in the set. A set of PCR that are authorized by an *authValue* are in an *authorization set*. A set of PCR that are authorized by an *authPolicy* are in a *policy set*.

The type of authorization associated with each PCR is fixed by a platform-specific specification. For each set, the platform-specific specification defines the PCRs that are in the set. A PCR should not be in more than one policy set or one authorization set.

A PCR may be in both a policy set and an authorization set. If it is in both, the only way to use the *authValue* of the authorization set is with a policy that contains TPM2\_PolicyAuthValue() or TPM2\_PolicyPassword().

An indication of the PCR in an authorization set may be read using TPM2\_GetCapability(*capability* == TPM\_CAP\_PCR\_PROPERTIES, *property* == TPM\_PT\_PCR\_AUTH) and the PCR in a policy set may be read using TPM2\_GetCapability(*capability* == TPM\_CAP\_PCR\_PROPERTIES, *property* == TPM\_PT\_PCR\_POLICY).

NOTE 1 The reference implementation only provides support for one set of each type. If additional sets are needed, the property types for TPM\_CAP\_PCR\_PROPERTIES may be extended.

NOTE 2 If a PCR is in multiple policy or authorization sets, the TPM will use the policy or authorization of the lowest numbered set. That is, the set with the lowest TPM\_PT\_PCR\_POLICY or TPM\_PT\_PCR\_AUTH property.

To authorize a PCR, the correct authorization type is required, which will depend on the authorization set of a PCR. In all cases, The EmptyAuth value may be provided in either an HMAC session using a zero-length *authValue* in the HMAC calculation or as a zero length password.

### 17.7.1 PCR Not in a Set

If the PCR is in no set, then the authorization may only be with an EmptyAuth value.

### 17.7.2 Authorization Set

If the PCR is in an *authorization set*, then the *authValue* of the PCR is provided either with an HMAC session or in a password. When a PCR has a fixed, EmptyAuth value, an authorization session is still required.

When a PCR has a variable *authValue*, that *authValue* is reset to an EmptyAuth on each STARTUP(CLEAR). It is preserved across STARTUP(STATE). A variable *authValue* may be changed using TPM2\_PCR\_SetAuthValue() by an entity with knowledge of the *authValue*.

### 17.7.3 Policy Set

An *authPolicy* for a policy set has both a hash algorithm and a digest value.

If the hash algorithm for the *authPolicy* is TPM\_ALG\_NULL, the policy has not been set. This *uninitialized policy set* will use an EmptyAuth.

If the digest algorithm for the policy is not TPM\_ALG\_NULL, then the policy set is an *initialized policy set*. If the PCR is in an initialized policy set, then the authorization may only be given with a policy session.

The hash algorithm for all policy sets is set to TPM\_ALG\_NULL by TPM2\_ChangePPS(). The algorithm and *authPolicy* associated with a PCR may only be changed using TPM2\_SetAuthPolicy() by an entity with knowledge of the Platform Authorization.

If an HMAC session or a password is used for a PCR in an initialized policy set, then the TPM will return an error (TPM\_RC\_AUTH\_TYPE). If a policy session is used for a PCR that is not in an initialized policy set, then the TPM will return an error (TPM\_RC\_POLICY\_FAIL). Neither of these two failures would cause an update of the dictionary attack protection.

### 17.7.4 Order of Checking

When determining the correct type of authorization for a PCR, the TPM will use the authorization type. If the authorization is a password or HMAC session, The TPM will check to see if the PCR is in an authorization set.

## 17.8 PCR Allocation

A TPM may support reallocation of the PCR by the platform. To change the allocation of PCR, the platform would use TPM2\_PCR\_Allocate(). The allocation structure has a PCR selection for each implemented hash algorithm. To allocate a PCR in a bank, the corresponding bit would be SET in the selection for that bank.

The TPM2\_PCR\_Allocate() changes to PCR allocation take effect upon the next TPM2\_Startup(TPM\_SU\_CLEAR) and persist until the next TPM2\_PCR\_Allocate().

NOTE 1 Because of RAM limitations, an implementation may not allow arbitrary allocation of PCR within a bank. This does not create a deployment issue as the platform is expected to be able to manage the TPMs that would be attached to that platform.

An allocation may not be made for PCR if the attributes for the PCR are not defined by the platform-specific specification of that TPM.

NOTE 2 The attributes for a PCR include the Startup() initialization value, the locality for reset, and the locality for extend.

There is a requirement that a bank exists for each hash algorithm but there is no requirement that the bank have any PCR (that is, all selection PCR selection bits for the bank may be CLEAR).

It is a valid implementation for the TPM to ship with a specific PCR allocation that is not changeable. If the TPM does not allow the changing of the allocation, it would not implement TPM2\_PCR\_Allocate().

## 17.9 PCR Change Tracking

To support the use of PCR in policy the TPM maintains a *pcrUpdateCounter*. In general, this counter is incremented each time a PCR is modified (either extended or reset). This counter is used when a policy requires that PCR have a specific value (see 19.7.7.6).

A platform-specific specification may designate that updates of selected PCR will not cause a change to *pcrUpdateCounter*.

A bitmap of the PCR that can be updated without changing *pcrUpdateCounter* can be read with `TPM2_GetCapability(capability == TPM_CAP_PCR_PROPERTY, property == TPM_PT_PCR_NO_INCREMENT)`.

## 17.10 Other Uses for PCR

The PCR-related commands defined in this library cover common use cases: for example logging of components during boot or a runtime-switch in the TCB. Platform-specific specifications define PCR attributes that control this behavior and describe how PCR should be used by external software.

However, PCR are designed for more generalized representation of platform state, and platform-specific specifications may define additional PCR behaviors that capture this. Generally, a platform specification may define a PCR to represent any value that is authoritatively known by the TPM or has been securely communicated to the TPM. For instance, a TPM for a “trusted lock” might define a PCR that has value of zero to indicate that a door is closed, and one to indicate that a door is open or a virtual-TPM specification might define a PCR that has a value that represents some characteristic of the virtual machine that is issuing the TPM command. This specification demands no particular behavior or value-semantics for such PCR.

NOTE            A PCR can “represent” a value either by having the PCR set to that value or by having the PCR extended with the value. In the case of the “trusted lock,” it is more likely that the PCR would contain either a zero or one to represent the state of the lock than that each change to the lock be extended to a PCR.

This does not mean that the platform-specific working groups are allowed to define new commands to operate on PCR.

## 18 TPM Command/Response Structure

### 18.1 Introduction

A command is a TPM Protected Capability that indicates an operation to be performed by the TPM. It contains from one to five components, in the following order:

- 1) a command header that indicates the overall size of the command, the command code, and a tag indicating whether the Authorization Area is present;
- 2) a command-dependent number (zero to three) of handles identifying the Shielded Locations with/on which the command (Protected Capability) operates;
- 3) a 32-bit value indicating the size of the Authorization Area;
- 4) an Authorization Area containing one to three session structures; and

NOTE Components 3 and 4 always occur together. The authorization size parameter is not present if there are no sessions in the Authorization Area.

- 5) a command-dependent parameter area containing qualifying information for the command.

A response contains

- 1) a response header that indicates the overall size of the response, the response code, and a tag indicating whether the Authorization Area is present;
- 2) a command-dependent number (zero or one) of handles identifying the Shielded Locations with/on which the command (Protected Capability) operates;
- 3) a 32-bit value indicating the size of the parameter area;
- 4) a command-dependent parameter area containing the values produced by the TPM; and
- 5) an Authorization Area containing one to three session structures.

NOTE Components 3 and 5 always occur together. That is, if the Authorization Area is empty, the 32-bit value for the parameter size will not be present.

As with the command, the formats for the remaining areas of the response are dependent on the value of the associated command code. The session and parameter area order are reversed in a response.

The ordering of authorization structures and command-dependent parameters is intended to minimize TPM complexity. In a command, the authorization structures are first in order that the TPM can generate its authorization digests from the command-dependent parameters as they arrive. In a response, command-dependent parameters are first in order that the TPM can use the output buffer to assemble the command-dependent parameters prior to generating its authorization digests.

NOTE: In traditional implementations, all of the octets of a command are available at the same time so skipping around in the data structure was not an issue. In some anticipated implementations, this will not be the case and the processing of a command or response will need to be more linear.

For tables in this specification, the separators indicating the demarcations between the header, handle, authorization, and parameter components are shown in Table 4.

**Table 4 — Separators**





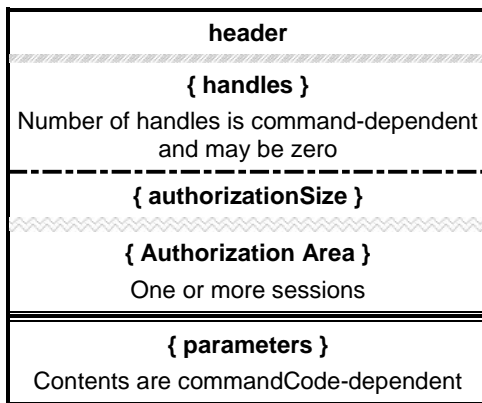
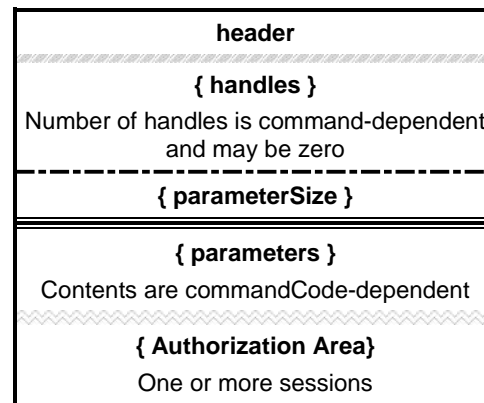
Separator	Meaning
	This type of separator is followed by one or more handles.
	In a command, this type of separator is followed by a 32-bit value indicating the number of octets in the <i>Authorization Area</i> . In a response, it is followed by a 32-bit value indicating the number of <i>parameter</i> octets (present only if tag for command/response is TPM_ST_SESSIONS).
	This type of separator is followed by one or more session structures (present only if tag for command/response is TPM_ST_SESSIONS).
	This type of separator is followed by one or more parameters

Figure 10 and Figure 11 show the basic layout of a TPM command and response (see 18.9 for a detailed example command and 18.10 for a detailed example response).



**Figure 10 — Command Structure**

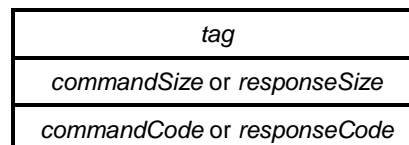


**Figure 11 — Response Structure**

NOTE Not all sessions in the Authorization Area are required to be used for authorization. Sessions may also be used for audit or parameter encryption.

**18.2 Command/Response Header Fields**

A command or response header always contains three values, displayed in Figure 12.



**Figure 12 — Command/Response Header Structure**

### 18.2.1 tag

A *tag* is present in all commands sent to the TPM and in responses received from the TPM. The *tag* indicates whether a command is formatted according to TPM 1.2 or this 2.0 specification. If the latter, the *tag* indicates if any session data is present.

Table 5 lists the *tag* values used for commands and response defined in this specification.

NOTE The tags for commands defined in this specification indicate only whether the command uses one or more sessions, and do not indicate the number of sessions present in the Authorization Area. Each session structure that uses a variable session handle follows the same format, which may be parsed to find the start of the next session.

**Table 5 — Tag Values**

Value	Description
TPM_ST_NO_SESSIONS	This value indicates that the command or response is formatted according to this specification and that the Authorization Area is empty. It is used in a response if the command used this tag or if the command did not complete successfully.
TPM_ST_SESSIONS	This value indicates that the command or response is formatted according to this specification and that the Authorization Area contains one or more authorizations. It indicates that the <i>authorizationSize</i> value is present; in a response, it indicates that the <i>parameterSize</i> value is present.

### 18.2.2 commandSize/responseSize

The *commandSize/responseSize* value indicates the total number of octets of this command/response, starting with the first octet of *tag*.

### 18.2.3 commandCode

The *commandCode* appears only in the command to the TPM. It indicates the operation that the TPM should perform and the formats of the handle and parameter areas for the command and response. The *commandCode* parameter is included in the command parameter hash (*cpHash*) and the response parameter hash (*rpHash*).

### 18.2.4 responseCode

The *responseCode* appears only in the response from the TPM. A *responseCode* of TPM\_RC\_SUCCESS (zero) indicates that the TPM has successfully completed the command and, depending on the command format, that the handle, parameter, and authorization components are present.

A non-zero *responseCode* indicates an error or fault. In this case, *tag* will be TPM\_ST\_NO\_SESSIONS, and *responseSize* is 10, indicating that no octets follow the *responseCode*. No handle, parameter, or session response components are present.

## 18.3 Handles

Handles are TPM-assigned values that let the caller indicate the TPM-resident structure that a command is to manipulate. That is, the handle identifies the Shielded Location with/on which a Protected Capability is to operate. Some TPM commands (such as, TPM2\_Startup()) require no handles.



The number of handles in the command and in the response is implied by the *commandCode*. It also indicates the command handles that have an associated authorization session. Handles that require authorization in an associated authorization session are listed ahead of handles that do not have an associated authorization session.

EXAMPLE TPM2\_ObjectChangeAuth() has two handles, one (*objectHandle*) that uses an authorization session, and one (*parentHandle*) that does not. The standard command syntax requires that *objectHandle* occur first.

A response may have handles only if the *responseCode* is TPM\_RC\_SUCCESS.

The architectural limit for the number of handles in the handle area is seven. This limit is determined by the error-reporting scheme.

NOTE No currently defined command uses more than three handles.

## 18.4 Parameters

The *commandCode* indicates the structure of the optional handle and parameter areas. The contents of these parameter areas differ for commands and responses. Some TPM commands (such as, TPM2\_Clear()) require no parameters.

All parameter values and the *commandCode* are included in the *cpHash* or *rpHash*. *authorizationSize* is not included in the *cpHash*, and *parameterSize* is not included in the *rpHash*.

NOTE 1 If a parameter is encrypted, it is included in the *cpHash/rpHash* after encryption.

A response may have parameters only if the *responseCode* is TPM\_RC\_SUCCESS.

The architectural limit for the number of parameters in the handle area is 15. This limit is determined by the error-reporting scheme.

NOTE 2 This is the limit of parameters in the parameter list, not the number of values that may be in the parameter area. If a command needs more than 15 parameters, a new structure may be defined that encapsulates two or more of those parameters into a single structure, which may then be unmarshaled as a unit. The only loss is that error reporting may not provide as much detail when a compound parameter has an error.

As described in clause 21, for a command or response parameter to be encrypted, it must be the first parameter and it must be a TPM2B type.

NOTE 3 In order to encrypt more than one parameter, they must be encapsulated in a TPM2B making them a single parameter.

EXAMPLE The TPM2B\_SENSITIVE\_CREATE is the first parameter to TPM2\_CreatePrimary(). The data member, TPMS\_SENSITIVE\_CREATE, has two members, a TPM2B\_AUTH and a TPM2B\_SENSITIVE\_DATA. The encapsulation of them in the TPM2B\_SENSITIVE\_CREATE permits both to be encrypted.

## 18.5 *authorizationSize/parameterSize*

These values are only present if the tag of the command/response is TPM\_ST\_SESSIONS.

In a command, the *authorizationSize* indicates the number of octets in all of the authorization structures in the Authorization Area of the command. *authorizationSize* does not include the four octets of the *authorizationSize* value. The minimum value for *authorizationSize* is 9.

NOTE 1 The maximum value depends on the size of the largest digest produced by any hash implemented on the TPM.

NOTE 2 The driver and the TPM use the *authorizationSize* field to determine the number of authorizations. After *authorizationSize* bytes have been processed, there are no more authorizations.

In a response, *parameterSize* indicates the number of octets in the parameter area of the response and does not include the four octets of the *parameterSize* value. *parameterSize* may have a value of zero.

*authorizationSize* is not included in *cpHash*, and *parameterSize* is not included in the *rpHash*.

## 18.6 Authorization Area

### 18.6.1 Introduction

The Authorization Area is present in a command only if *tag* for the command is TPM\_ST\_SESSIONS. If present, the Authorization Area will contain:

- zero, one, or two authorizations (session or password);
- an optional session used for decrypting data sent to the TPM;
- an optional session used for encrypting data sent by the TPM; or
- an optional session used for auditing.

If *tag* is TPM\_ST\_SESSIONS, then the Authorization Area will have at least one but no more than three authorization/session blocks. If *tag* is TPM\_ST\_NO\_SESSIONS, then there is no Authorization Area.

The number of authorization sessions that a command will have is indicated in the command schematic in TPM 2.0 Part 3. If a handle in the handle area has the "@" decoration, then an authorization session is required be present (an authorization session being either a password, a policy session, or an HMAC session).

The authorization sessions occur in the order of the associated entity handles. That is, the first handle with an "@" decoration will be associated with the first session in the Authorization Area.

Other sessions may be added to the Authorization Area. Those sessions may be designated as being for encryption, decryption, or audit; in any combination, in any order. However, in a single command, only one session is allowed to have the *encrypt* attribute, one session is allowed to have the *decrypt* attribute and one session is allowed to have the *audit* attribute.

A single session may be used for authorization, encryption, decryption, and audit at the same time. That is, if a session has one handle with the "@" decoration, the associated authorization session may have the *encrypt*, *decrypt*, and *audit* attributes all set. A password authorization may not be used for anything but authorization and the TPM will return an error (TPM\_RC\_ATTRIBUTES) if *encrypt*, *decrypt*, or *audit* is SET in a password authorization.

NOTE 1 If an authorization session has *encrypt*, *decrypt*, and *audit* all SET, then the command can only have one authorization session.

The combinations of attributes allowed for each session are summarized in Table 6.

**Table 6 — Use of Authorization/Session Blocks**

Position	password authorization <sup>(1)(6)</sup>	authorization session <sup>(2)(6)</sup>	encryption session <sup>(3)</sup>	decryption session <sup>(4)</sup>	audit session <sup>(5)</sup>
1	✓	✓	✓	✓	✓
2	✓	✓	✓	✓	✓
3			✓	✓	✓

NOTES:

- 1) a password authorization may not be used for encryption, decryption, or audit.
- 2) an HMAC authorization session may also be used for encryption, decryption, and audit and a policy authorization session may also be used for encryption and decryption
- 3) only one session may be designated as being used for encryption
- 4) only one session may be designated as being used for decryption
- 5) password authorization sessions and policy sessions may not be used for audit
- 6) authorization sessions come before sessions used only for encryption, decryption, or audit

In TPM 2.0 Part 3, the schematic for each command will indicate if it has handles and if use of those handles requires authorizations. If there is an *at* symbol ("@" ) character in front of the handle name, then use of the TPM resource associated with the handle requires authorization and an authorization (session or password) will be present. An authorization will be present for each TPM resource that requires authorization (each handle with an "@"). An additional indication that a handle requires authorization is that, in the "Description" column of the command schematic, each handle has an "Auth Index:" entry. If that entry says "None", then no authorization is required. If that entry is followed by a number, then the number indicates the order of the associated authorization in the list of authorizations.

NOTE 2 Currently, no command requires more than two authorizations.

If a command requires authorizations, then those authorizations will be first in the list of authorizations/sessions. They may then be followed by other sessions used for encryption, decryption, or audit.

If the *responseCode* is TPM\_RC\_SUCCESS, the response has the same number of sessions in the same order as the request. Otherwise, no authorization or audit sessions are present.

## 18.6.2 Authorization Structure

### 18.6.2.1 Command

In a command, each authorization structure has the format shown in Figure 13.

session handle	A four-octet value indicating the session handle associated with this data block (will be TPM_RS_PW for a password authorization)
size field	A two-octet value indicating the number of octets in <i>nonce</i>
nonce	If present, an octet array that contains a number chosen by the caller
session attributes	A single octet with bit fields that indicate session usage
size field	A two-octet value indicating the number of octets in <i>authorization</i>
authorization	If present, an octet array that contains either an HMAC or a password, depending on the session type

**Figure 13 — Authorization Layout for Command**

### 18.6.2.2 Response

In a response, each session structure has the format shown in Figure 14.

size field	A two-octet value indicating the number of octets in <i>nonce</i> (will be zero for a password authorization)
nonce	If present, an octet array that contains a number chosen by the TPM
session attributes	A single octet with bit fields that indicate session usage
size field	A two-octet value indicating the number of octets in <i>acknowledgment</i>
acknowledgment	If present, an octet array that contains an HMAC

**Figure 14 — Authorization Layout for Response**

Clause 19.6.7 describes the methods for creating an authorization session.

### 18.6.3 Session Handles

Session handles are described in 15.4. They identify the session being referenced by a specific session structure.

For a given command, the handle associated with a specific HMAC or policy session may occur only once in the Authorization Area. The handle representing a password authorization (TPM\_RS\_PW) can occur multiple times.

### 18.6.4 Session Attributes (*sessionAttributes*)

Each session has a *sessionAttributes* octet to indicate how the session is to be applied. Table 7 explains the meaning of the fields in this octet.

If a session is not being used for authorization, at least one of decrypt, encrypt, or audit must be SET.

**Table 7 — Description of *sessionAttributes***

Attribute	Meaning
continueSession	<p>This attribute is used to indicate to the TPM if the session is to remain 'active' when the command completes. If this attribute is CLEAR in the command and the command completes successfully (TPM_RC_SUCCESS), then the session will be flushed from TPM memory and the associated session handle will be available to be assigned to new sessions.</p> <p>When the TPM responds, it will echo this attribute to indicate that the session remains open. (See the exception for password authorization below).</p> <p>NOTE In this context, "echo" means that the value of a session attribute will be the same in the response as it was in the command.</p> <p>The primary purpose of this attribute is to eliminate having to do explicit flushes (TPM2_FlushContext()) of a session when it is no longer used. Having this bit CLEAR on the last use of the session will end it and reclaim the TPM resources assigned to this session.</p> <p>For a password authorization, this attribute has no effect, as there are no TPM resources associated with a password authorization. This attribute will always be SET in a response associated with a password authorization.</p> <p>If the audit attribute is SET, then this attribute should also be SET since the audit data will be lost if the session is flushed.</p>

Attribute	Meaning
decrypt	<p>This attribute is used to indicate to the TPM that the secrets associated with the session are to be used to decrypt the first parameter of the command (the session-based encryption scheme is defined in clause 21). The parameter will be decrypted after the HMAC computations are successfully completed.</p> <p>This attribute may only be SET in a command that has a sized buffer as its first parameter.</p> <p>This attribute is required to be CLEAR in a password session. If SET in a password session, then the TPM will return an error because there is no session key for the decrypt operation</p> <p>This attribute is echoed by the TPM in the corresponding session in the response</p> <p>This attribute may only be SET in one session per command. A session with this attribute does not need to be associated with an entity identified in the handle area. That is, the session may be added just for using the session's secret for parameter decryption.</p> <p>This attribute can be SET in combination with any other session attribute.</p>
encrypt	<p>This attribute is used to indicate to the TPM that the secrets associated with the session are to be used to encrypt the first parameter of the response (the session-based encryption scheme is defined in clause 21). The parameter will be encrypted before the TPM performs the HMAC computations for any of the sessions.</p> <p>This attribute may only be SET in a response that has a sized buffer as its first parameter.</p> <p>This attribute is required to be CLEAR in a password session. If SET in a password session, then the TPM will return an error because there is no session key for the encrypt operation.</p> <p>This attribute is echoed by the TPM in the corresponding session in the response.</p> <p>This attribute may only be SET in one session per command. A session with this attribute does not need to be associated with an entity identified in the handle area. That is, the session may be added just for using the session's secret for parameter decryption.</p> <p>This attribute can be SET in combination with any other session attribute.</p>
audit	<p>This attribute indicates that the session is being used for audit. A digest is maintained in the session context and is updated each time the session is used with a command and <i>audit</i> is SET.</p> <p>This attribute does not need to be SET in every use of the session but the TPM will only update the audit data when the session is used with this attribute SET.</p> <p>This attribute has no meaning for a password authorization and is required to be CLEAR.</p> <p>This attribute is not allowed to be SET in a policy or trial policy session. This is because the context of the policy session would have to increase in order to hold the additional audit digest. This is significant overhead and, rather than require the additional memory in policy sessions, use of audit is restricted to HMAC sessions.</p> <p>After an HMAC session is started (TPM2_StartAuthSession(<i>sessionType</i> = TPM_SE_HMAC), this attribute may be set in any subsequent use of the session. On the first use of the session with this attribute set, the TPM will initialize the audit digest to 0...0 and then extend the cpHash for the command and then extend the rpHash for the command.</p> <p>This attribute will be echoed by the TPM in the response.</p> <p>This attribute may be used in combination with any other session attributes but only one session in each command may have this attribute SET.</p>

Attribute	Meaning
auditExclusive	<p>This attribute is use to restrict use of an audit session. When this attribute is SET, the TPM will validate that the session has been used for all auditable commands since the audit sequence was started.</p> <p>NOTE      An audit sequence is started when the audit digest is reset to 0...0. The audit digest is set to 0...0 when the session is first used as an audit session and when the audit digest is reset (see the description of the <i>auditReset</i> attribute below).</p> <p>If the session was used for all auditable commands, then it is said to be "exclusive"(see 20.2 for explanation of exclusive audit sessions).</p> <p>If this attribute is SET and the session is exclusive, then the command will execute. Otherwise, the TPM will fail this command to indicate to the caller that some TPM actions were not included in the audit sequence.</p> <p>Evaluation of the exclusive status is done at the start of the command. A session does not obtain the exclusive status until the end of the command (this prevents a session from becoming exclusive if the command fails). The implication of this processing is that, if this attribute is SET in the command that starts the audit sequence, the command will fail because the session has not yet become exclusive.</p> <p>In a response, this attribute will be SET if the session has exclusive status. When a session is first used as an audit session this attribute will be SET in the response as no command has executed without this session since the start of the sequence.</p> <p>This attribute may only be SET when the <i>audit</i> attribute is SET which excludes this attribute from being SET on a password authorization or a policy session.</p>
auditReset	<p>This attribute allows the caller to restart an audit sequence with a session that has previously been used for audit. If the associated command completes successfully, the TPM will initialize the session audit hash with 0...0 before Extending the cpHash and the rpHash. The response will have the exclusive attribute SET.</p> <p>This attribute may only be SET if audit is SET.</p> <p>The TPM will echo this attribute in the response.</p>

### 18.7 Command Parameter Hash (*cpHash*)

The command parameter hash (*cpHash*) is used in the computation of a command authorization HMAC and is included in the digests of session and command audits (depending on the policy, the *cpHash* may also be used in the authorization). The *cpHash* is computed from the parameters of the command as follows:

$$cpHash := H_{sessionAlg}(commandCode \{ || Name1 \{ || Name2 \{ || Name3 \} \} \{ || parameters \} \}) \quad (16)$$

where

$H_{sessionAlg}$	hash function using the algorithm selected for the session when it was initialized
<i>commandCode</i>	command code for the command
<i>Name1</i>	unique identity of the entity associated with the first handle
<i>Name2</i>	unique identity of the entity associated with the second handle
<i>Name3</i>	unique identity of the entity associated with the third handle

*parameters* remaining command parameters

### 18.8 Response Parameter Hash (*rpHash*)

The response parameter hash is used in the computation of a response acknowledgment HMAC and is included in the digest of session and command audits. The *rpHash* is computed from the parameters of the response as follows:

$$rpHash := H_{sessionAlg}(responseCode || commandCode \{ || parameters \}) \quad (17)$$

where

$H_{sessionAlg}$	hash function using the algorithm selected for the session when it was initialized
<i>responseCode</i>	command result code
<i>commandCode</i>	the <i>commandCode</i> from the command
<i>parameters</i>	response parameters

The contents of the *handles* area of the response are not included in the *rpHash*.

NOTE An *rpHash* needs to be computed only when the *responseCode* is TPM\_SUCCESS, which means that it is redundant to include the response code. It is retained for legacy reasons.

### 18.9 Command Example

Table 8 shows an example of a command schematic used in this specification. The command has two object handles (*handleA* and *handleB*). The "@" on the *handleA* name indicates that use of the entity associated with the handle requires authorization. The command has at least one session to authorize use of *handleA*. It will not have a session for use of *handleB*. The Authorization Area may have an additional audit session and a session used only for parameter encryption. Since one session is required, *tag* is TPM\_ST\_SESSIONS, and the *authorizationSize* field is present.

Although they are not shown in the command schematic, the *authorizationSize* value and the Authorization Area would be present in the command buffer, and be located between *handleB* and *dataSize*.

NOTE: The Authorization Area is not shown with the command schematic because no single representation is possible.

The command and response tables have three columns.

- 1) **Type** – This column indicates the data type of the parameter passed to the TPM in a command or received from the TPM in a response.
- 2) **Name** – This column indicates the name of the parameter. This name is referenced in the description of the command that precedes the command table and in the detailed actions of the command that follows the response table.

- 3) **Description** – This column provides a limited description of the parameter and indicates the possible options for the command.

## EXAMPLE 1

Table 8 — Command Layout for Example Command

Type	Name	Description
TPMI_ST_COMMAND_TAG	tag	TPM_ST_SESSIONS
UINT32	commandSize	
TPM_CC	commandCode	TPM_CC_Example
TPM_HANDLE	@handleA	handle to use for one object of the command Auth Index: 1 Auth Role: USER
TPM_HANDLE	handleB	handle to use for the second object Auth Index: None
UINT32	dataSize	example data size
OCTET	data[dataSize]	example data

Table 9 illustrates all command octets for the command in Table 8. In this example, the nonce size is 20 octets and the authorization HMAC is computed using SHA256. The values in shaded cells are not shown in the TPM 2.0 Part 3 schematic of the command but are included in the command data sent to the TPM.

## EXAMPLE 2

Table 9 — Example Command Showing *authorizationSize*

Offset	Size	Parameter	Value
0	2	tag	TPM_ST_SESSIONS
2	4	commandSize	<b>209</b> < size in octets of the command >
6	4	commandCode	TPM_CC_Example
10	4	handleA	< a valid TPM resource handle >
14	4	handleB	< a valid TPM resource handle >
18	4	authorizationSize	<b>61</b> < size of the authorization session >
22	4	authHandle	< a valid TPMI_SH_AUTH_SESSION >
26	2	nonceCallerSize	<b>20</b> < size of <i>nonce</i> >
28	20	nonceCaller	< a 20-octet random value >
48	1	sessionAttributes	(continueSession=1)
49	2	hmacSize	<b>32</b> <size of <i>HMAC</i> >
51	32	HMAC	< a 32-octet HMAC value based on SHA256 >
83	2	dataSize	<b>32</b> < size of the buffer >
85	124	data[dataSize]	< 124 octet buffer >
209			



## 18.10 Response Example

Table 10 shows an example schematic as it would appear in TPM 2.0 Part 3. The example is for a response sent from the TPM after successful completion of the example command in Table 8. The response has the same number of sessions in the same order as did the command.

EXAMPLE 1

**Table 10 — Response Layout for Example Command**

Type	Name	Description
TPM_ST	tag	TPM_ST_SESSIONS
UINT32	responseSize	
TPM_RC	responseCode	response code of the operation
TPM_HANDLE	handle	not included in the rpHash
UINT32	dataSize	size in octets of the following data
OCTET	data[dataSize]	a returned block of information

Table 11 illustrates the full response for the command in Table 8. As in the command, the nonce size is 20 octets and the acknowledgment HMAC is computed using SHA256. The values in shaded cells are not shown in the TPM 2.0 Part 3 schematic of the response but are present in the response data from the TPM.

EXAMPLE 2

**Table 11 — Example Response Showing *parameterSize***

Offset	Size	Parameter	Value
0	2	tag	TPM_ST_SESSIONS
2	4	responseSize	<b>203</b> < size in octets of the response >
6	4	responseCode	<b>0</b> < success >
10	4	handle	< a valid TPM_HANDLE >
14	4	parameterSize	<b>128</b>
18	4	dataSize	<b>124</b>
22	124	data[dataSize]	< 124 octet buffer >
146	2	nonceTpmSize	<b>20</b>
148	20	nonceTPM	< a 20-octet random value >
168	1	sessionAttributes	(continueSession=1)
169	2	hmacSize	<b>32</b>
171	32	HMAC	< a 32-octet HMAC value based on SHA256 >
203			

## 19 Authorizations and Acknowledgments

### 19.1 Introduction

Many commands to the TPM reference TPM-resident structures, and use of these structures may require authorization. This authorization is provided in structured data that follows the command data. When an authorization is provided to a TPM, the TPM will provide an acknowledgment.

To provide flexibility in how the authorizations are given to the TPM, this specification defines three authorization types:

- 1) password;
- 2) HMAC; and
- 3) policy.

Depending on the command, zero, one, or two authorizations may be required. In a command, the authorizations follow the handles and in a response, the authorization replies follow the response parameters. The command definition indicates how many authorizations are required.

### 19.2 Authorization Roles

For each object and NV Index, there is a set of operations that can be performed on or with that object or NV Index. The operations are divided into groups, based on the impact of the operation on the object. To perform an operation with or on an object in a group, the authorization specific to that group must be provided. When performing an operation in one of the groups, the caller is acting in a specific role with respect to that object.

The TPM supports three different authorization roles. The role and attributes determine whether a password or HMAC can be used for authorization. A policy (if not the Empty Policy) can always be used.

- 1) **USER** – this authorization role is used for the normal uses of a key (e.g., signing with a signing key, or loading the child of a Storage Key). Methods are defined to allow USER role authorization to be provided either with an authorization value (*authValue*) or a policy. If *userWithAuth* is SET then USER role authorization may be provided with a password authorization or an HMAC session. If *userWithAuth* is CLEAR, then a password and HMAC authorizations may not be used to provide USER role authorizations. A policy session that satisfies the *authPolicy* of the entity may be used regardless of the setting of *userWithAuth*.

NOTE 1 For USER role, an *authPolicy* is satisfied when the *policyDigest* of a policy session matches the value of the *authPolicy* value of the object.

NOTE 2 If use of an object is to be gated based on PCR values, a policy session is required (see 19.7). If the intent is that different Users have access to the object but only if the PCR are correct, then it is likely that authorization with the *authValue* will be disabled; otherwise, the caller could circumvent PCR protections simply by providing the *authValue*.

- 2) **ADMIN** – the object Administrator controls the certification of an object (TPM2\_Certify() and TPM2\_ActivateCredential()) and controls changing of the *authValue* of an object (TPM2\_ObjectChangeAuth()). When an action requires ADMIN role authorization, that authorization may be provided using the *authValue* of the object if the *adminWithPolicy* attribute of the object is CLEAR. As with USER role authorization, ADMIN role may always be provided with a policy session as long as the policy session satisfies the *authPolicy* of the object.

NOTE 3 For ADMIN role, an *authPolicy* is satisfied when *policySession→policyDigest* matches the value of the *authPolicy* value of the object and *policySession→commandCode* matches *commandCode* for the authorized command.

EXAMPLE If the *adminWithPolicy* attribute of an object is SET, and if no branch in the object's policy equation contains `TPM2_PolicyCommandCode(TPM_CC_Certify)`, then certification of that key may not occur.

3) **DUP** – this authorization role is only used for `TPM2_Duplicate()`. If duplication is allowed, authorization must always be provided by a policy session and the *authPolicy* equation of the object must contain a command that sets the policy command code to `TPM_CC_Duplicate`.

### 19.3 Physical Presence Authorization

Authorization for some commands requires that it be provided with Platform Authorization. Authorization for some other commands allows use of either Platform Authorization or Owner Authorization (Most of these commands cause persistent state change of the TPM). For these commands, it is possible to require that authorization be augmented with an out-of-band method.

For commands that require Platform Authorization and commands that require a hierarchy authorization, it is possible to require an out-of-band authorization. This may take any number of forms, such as a dedicated pin in the TPM, a special signaling method through the TPM interface, or any desired alternative. Whatever the form, the out-of-band authorization is referred to in this specification as Physical Presence (PP). This does not mean that the signaling requires a human to be physically present in order for the indication to be provided. The term is used in this specification because it was used in previous TPM specifications to refer to a similar concept.

The TPM maintains a table of the commands that require that PP be asserted to authorize command execution. Only certain commands may be included in this table. If, in TPM 2.0 Part 3, the schematic for a command has `TPM_RH_PLATFORM` in the "Description" column for one of the handles, then that command can be added to the list of commands that require PP. Otherwise, it may not.

NOTE 1 In the "Description" column, `TPM_RH_PLATFORM` will be followed by `+PP` if assertion of Physical Presence is required or `+{PP}` to indicate that assertion of Physical Presence may be required if indicated by the table.

NOTE 2 A platform-specific specification may require that the table be initialized in a specific way. It could even require that the table have certain commands defined to require PP confirmation even though a PP interface is not provided on the TPM. This would serve to disable the use of that command by the platform.

When the authorization handle is `TPM_RH_PLATFORM`, the TPM checks the table to see if the command requires confirmation with PP. If so, PP is checked before the TPM performs any other authorization checks.

`TPM2_PP_Commands()` is used to change the contents of the table of commands that require confirmation with PP authorization. Authorization of the command `TPM2_PP_Commands()` requires that PP be asserted and `TPM2_PP_Commands()` may not be removed from the list of commands that require PP.

NOTE 3 This constraint on `TPM2_PP_Commands()` prevents setting or modification of the table if no PP interface exists on the TPM.

The contents of the table may be read using `TPM2_GetCapability(capability == TPM_CAP_PP_COMMANDS)`.

## 19.4 Password Authorizations

A plaintext password value may be used to authorize an action when use of an *authValue* is allowed. A plaintext password may be appropriate for cases in which the path between the caller and the TPM is trusted or when the authorization value is well known. For these instances, encryption of parameters or the hiding of authorization values in an HMAC is not required.

NOTE 1 While it may seem relatively easy for a caller to perform an HMAC, there are situations where the caller is resource-constrained and unable to do so. This is especially true when the calling software does not support the hash algorithms implemented in the TPM. Additionally, authentication using a cryptographic protocol makes it difficult to provide operating system abstractions.

A reserved authorization handle (TPM\_RS\_PW) indicates that the authorization is a password.

TPM\_RS\_PW is always available, and a separate action to create an authorization session is not required. A password authorization does not use nonces. *sessionAttributes*→*continueSession* is ignored.

A password authorization lets the caller send more or fewer octets than are present in the object's authorization field. The TPM truncates any octets of zero on either of the two values before they are compared.

If present, a password authorization is always associated with a command handle that requires authorization as there is no session context associated with a password that would allow it to be used for encryption or command audit.

Unlike other handles for other session types, the TPM\_RS\_PW session handle may be used for more than one authorization.

Password authorization data sent to the TPM has the format shown in Table 12.

**Table 12 — Password Authorization of Command**

Type	Name	Description
TPMI_SH_AUTH_SESSION	authHandle	required to be the reserved authorization session handle TPM_RS_PW
TPM2B_NONCE	nonceCaller	required to be an Empty Buffer
TPMA_SESSION	sessionAttributes	only <i>continueSession</i> may be SET
TPM2B_AUTH	password	authorization compared to the <i>authValue</i> of the TPM entity

Table 13 illustrates the format of a password authorization in a response. This structure is provided to ensure a one-to-one correspondence between the sessions in the command and in the response.

**Table 13 — Password Acknowledgment in Response**

Type	Name	Description
TPM2B_NONCE	nonceTPM	zero-length for a password authorization
TPMA_SESSION	sessionAttributes	copy of the flags from the password authorization in the command, <i>continueSession</i> will be SET
TPM2B_AUTH	hmac	zero-length buffer for a password authorization

NOTE 2 This structure is used to provide symmetry between password and other response sessions.

## 19.5 Sessions

A session is a collection of TPM state that changes after each use of that session. When an object context is loaded into the TPM, multiple copies of the object context may exist both on the TPM and in saved contexts (see clause 30). When a session context is created, only one copy of that context may exist, either on the TPM or as a saved context. The context of a session changes on each use.

A session has a handle that is assigned by the TPM when the session is created. That handle will always refer to the same session until the session is closed. If a handle is re-assigned to a subsequently created session, the session context data will contain a TPM-generated nonce that makes the new instance of the session unique, even though the handle may have been used previously. This nonce will change each time the session is used so that previous instances of the same session can be distinguished from each other (i.e., the nonce prevents reuse of stale session contexts).

There are three uses of a session:

- 1) **authorization** – A session associated with a handle is used to authorize use of an object associated with a handle. If it is not a password authorization, it may also be used to provide keys for encryption of command or response parameters. A policy session used to authorize may not also be used as an audit session. An HMAC session used to authorize may be used as an audit session.
- 2) **audit** – An audit session collects a digest of command/response parameters to provide proof that a certain sequence of events occurred. An audit session may also be used to provide secrets for encryption of command or response parameters and may be used for authorization of an HMAC session.
- 3) **encryption** – A session that is not used for authorization or audit may be present for the purpose of encrypting command or response parameters. If an encryption-only session exists, it will follow the authorization sessions and may come before or after a session used only for audit.

A command may have as many as three authorization blocks. Password blocks may only be used for authorization so the maximum number of password blocks is equal to the number of authorizations required by the command.

## 19.6 Session-Based Authorizations

### 19.6.1 Introduction

Session-based authorizations are used both for protocols that require confidentiality for the authorization value and for audit sessions that require tracking of a sequence of commands sent to the TPM. An authorization session also provides a means of linking the uses of the session.

There are two types of session-based authorization: HMAC and policy. Both types of session are initiated using `TPM2_StartAuthSession()`. That command establishes the parameters that will be used for the authorizations. The *sessionType* parameter determines if the session will be an HMAC or policy session. When the session is started, the hash algorithm and TPM nonce size used in the session are specified by the caller. The command may include an initial caller nonce and a *salt* value to generate the session key. The parameters of each session are independent from the parameters of any other session and are limited only by the capabilities of the TPM. When `TPM2_StartAuthSession()` completes successfully, the TPM returns a handle for the session as well as the initial *nonceTPM* value.

Once an authorization session is established, it may be used to authorize actions in multiple commands. The session is not ended until explicitly closed or flushed.

The secret values of a session are determined by the handles used when the session is started. The command for starting a session allows selection of up to two object handles. One handle indicates a TPM

object that is used to encrypt a salt value that is sent when the session is started. A second handle indicates an object containing a shared secret. The salt value and the shared secret are combined with a nonce provided by the caller to create the session secrets.

### 19.6.2 Authorization Session Formats

For a session-based authorization session, the authorization structure for a command is as shown in Table 14.

**Table 14 — Session-Based Authorization of Command**

Type	Name	Description
TPMI_SH_AUTH_SESSION	authHandle	the handle for the authorization session
TPM2B_NONCE	nonceCaller	the caller-provided session nonce; size may be zero
TPMA_SESSION	sessionAttributes	the flags associated with the session
TPM2B_AUTH	hmac	the session HMAC digest value

In a response, the format for the acknowledgement is as shown in Table 15.

**Table 15 — Session-Based Acknowledgment in Response**

Type	Name	Description
TPM2B_NONCE	nonceTPM	the TPM-provided session nonce. Size is as specified when the session was started.
TPMA_SESSION	sessionAttributes	the flags associated with the session. This attribute should be the same as the values in the command except <i>continueSession</i> may be CLEAR.
TPM2B_AUTH	hmac	the session HMAC digest value

### 19.6.3 Session Nonces

#### 19.6.3.1 Overview

The primary use of a nonce in a session is to prevent an authorization from being reused. When the session is started by `TPM2_StartAuthSession()`, the caller indicates, among other things, the size of the nonces to be used in the authorization HMAC and an initial nonce value (*nonceCaller*). After establishing the session, the TPM returns a handle to identify the session and a TPM-generated random nonce (*nonceTPM*). The TPM stores this *nonceTPM* in the context of the session.

Each time the session is used for authorization, the caller performs an HMAC using, along with other parameters, the last *nonceTPM* for the session and a new *nonceCaller* for the session. The TPM then uses the received *nonceCaller* and the saved *nonceTPM* to validate the HMAC. For a response, the TPM uses the last *nonceCaller* and a newly generated *nonceTPM* in the HMAC. The caller then uses the received *nonceTPM* and the saved *nonceCaller* to validate the HMAC in the response.

A nonce has a size field indicating the number of octets in the nonce followed by the nonce data. The nonce size is not included in the HMAC computation.

### 19.6.3.2 Session Nonce Size

When an authorization session is created, the caller provides an initial nonce (*nonceCaller*). The size field of *nonceCaller* is retained by the TPM and used to determine the size of all nonces generated by the TPM (*nonceTPM*) in the subsequent uses of the session. The minimum size for *nonceCaller* in TPM2\_StartAuthSession() is 16 octets.

After the initial session setup, the caller may use any size for a *nonceCaller* in each use of the session. The *nonceCaller* size may vary from zero (0) up to the size of *nonceTPM* (the initial *nonceCaller* size).

NOTE A TPM implementation may allow larger nonce sizes but the caller should not expect a TPM to accept a nonce size larger than the initial *nonceCaller* size.

The maximum size that may be requested for *nonceTPM* is the size of the digest produced by the authorization session hash.

EXAMPLE For SHA-1 the maximum size for *nonceTPM* is 20 octets and for SHA256 it is 32 octets.

When a session nonce is used in the authorization session HMAC, the *size* field of the nonce is not included in the authorization computation. If the nonce *size* field is zero (0), then the nonce does not affect the authorization HMAC value.

### 19.6.3.3 Guidance on Nonce Size Selection

The size of the nonce should be chosen to provide a reasonable guarantee that a TPM-generated nonce value will not be used twice with the same *sessionKey*. The choice of nonce size is not related to the number of uses of a specific authorization session but is related to the number of uses of the *sessionKey*.

An HMAC *sessionKey* is derived from the *authValue* kept in an object and that *authValue* may have a long lifetime. To prevent replay attacks on a long-lived *authValue*, use of large nonces is recommended.

NOTE 1 The combined *nonceCaller* plus *nonceTPM* are what determine the anti-replay protection provided by the nonces. Making the combined size larger than the block size of the session hash is not particularly useful. If the caller does not have a good source of entropy for an RNG, then making the *nonceTPM* the size of the digest of the session hash is recommended, so that a *nonceCaller* size of zero would be satisfactory.

NOTE 2 When using a session for encryption, if a parameter is encrypted in a response to one command and a parameter is encrypted in the request of the next command, and they both use the same session for encryption, then the caller should provide a *nonceCaller* in order to prevent the use of the same encryption key on the input and output. A nonce of length 1 with a value of zero would suffice.

### 19.6.3.4 Nonce Binding

A command may have sessions other than those required for authorization. One use of an extra session is to encrypt a command or response parameter. If an extra encrypting session were removed by an attacker, the TPM would not properly encrypt/decrypt the data and could, as a result, fail to encrypt a response parameter. To prevent removal of extra encrypting sessions, the *nonceTPM* of each of these sessions is included in the HMAC computation of the first authorization session of a command. If an extra session is removed by an attacker, the first authorization will fail and the command will not be executed.

To simplify the logic in the TPM, the *nonceTPM* of any session used for encryption of command or response data is included in the HMAC computation for the first session even if the encrypt or decrypt session is also an authorization session.

NOTE If the first session is a password authorization, then the path to the TPM is trusted and there is no need to guard against the extra session being removed, also there is probably no need for parameter encryption when a trusted path is present.

## 19.6.4 Authorization Values

### 19.6.4.1 Overview

An object may have a value used to authorize various actions on the object. An authorization session is the mechanism through which a caller proves knowledge of the authorization value (*authValue*) needed to allow an action.

An *authValue* may be sent as a password that does not provide confidentiality (see 19.4), or in an HMAC-based authorization session that can provide confidentiality of the *authValue*.

### 19.6.4.2 authValue Size

An *authValue* may be as small as zero octets but not larger than the digest size of the algorithm used to compute the Name of the object.

EXAMPLE If the Name algorithm for an object is SHA256, then the largest *authValue* for the object would be 32 octets.

### 19.6.4.3 Authorization Size Convention

When an *authValue* is based on a password or passphrase, then the *authValue* should be the password/phrase as long as the password/phrase is no larger than the digest produced by the *nameAlg* of the object.

EXAMPLE If the passphrase is “This is a sample passphrase”, and *nameAlg* is TPM\_ALG\_SHA256, then the *authValue* is 27 octets long containing the value “This is a sample passphrase”.

Trailing octets of zero are to be removed from any string before it is used as an *authValue*.

If the password/phrase, with trailing zeros removed, is longer than the digest produced by the *nameAlg* of the object, then the password/phrase – with trailing octets of zero removed – is hashed using *nameAlg* and the resulting hash given to the TPM as the *authValue* for the object.

## 19.6.5 HMAC Computation

The HMAC computation for all session types is the same. A *sessionKey* value is concatenated to an *authValue* to create the key that is used in the computation of the HMAC in a command or response. If *sessionkey* and *authvalue* are both the Empty Buffer, see 19.6.15.

$$\begin{aligned}
 \mathit{authHMAC} := & \mathbf{HMAC}_{\mathit{sessionAlg}} ((\mathit{sessionKey} || \mathit{authValue}), \\
 & (\mathit{pHash} || \mathit{nonceNewer} || \mathit{nonceOlder} \\
 & \{ || \mathit{nonceTPM}_{\mathit{decrypt}} \} \{ || \mathit{nonceTPM}_{\mathit{encrypt}} \} \\
 & || \mathit{sessionAttributes}))
 \end{aligned}
 \tag{18}$$

where

$\mathbf{HMAC}_{\mathit{sessionAlg}}$	the HMAC function using the hash algorithm specified when the session was started
$\mathit{sessionKey}$	a value that is computed in a protocol-dependent way, using <b>KDFa()</b> . When used in an HMAC or KDF, the size field for this value is not included.
$\mathit{authValue}$	a value that is found in the sensitive area of an entity. This value is an EmptyAuth if the HMAC is being computed to authorize an action on the



object to which the session is bound. The size field for this value is not included in any KDF or hash function.

NOTE 1 For policy sessions, the *authValue* is not included in the HMAC calculation unless the policy session included TPM2\_PolicyAuthValue() and it was not superseded by TPM2\_PolicyPassword().

NOTE 2 Trailing zeros are always removed from an *authValue* before it is used in an authorization computation.

*pHash* digest of the command (cpHash) or response parameters (rpHash) using the session hash algorithm.

*nonceNewer* a value that is generated by the entity using the session. A new nonce is generated on each use of the session. For a command, this will be nonceCaller and for a response, nonceTPM. The nonce size field is not included in the HMAC.

*nonceOlder* a value that was received the previous time the session was used. For a command, this will be nonceTPM and for a response, nonceCaller. The nonce size field is not included in the HMAC.

*nonceTPM<sub>decrypt</sub>* in the HMAC computation for the first authorization session of a command, if a different session is being used for parameter decryption, then the nonceTPM for that session is included in the HMAC of the first authorization session; but only in the command (see 19.6.3.4). The nonce size field is not included in the HMAC.

NOTE 3 The *decrypt* session is used by the TPM to decrypt a parameter in the command.

NOTE 4 The nonce of the *decrypt* session is included even if that session is also used for authorization.

*nonceTPM<sub>encrypt</sub>* in the HMAC computation for the first authorization session of a command, if a different session is being used for parameter encryption, then the nonceTPM for that session is included in the HMAC of the first authorization session; but only in the command (see 19.6.3.4). The nonce size field is not included in the HMAC.

NOTE 5 The *encrypt* session is used by the TPM to encrypt a parameter in the response.

NOTE 6 The nonce of the *encrypt* session is included even if that session is also used for authorization.

NOTE 7 If the same session (not the first session) is used for decrypt and encrypt, its *nonceTPM* is only used once. If different sessions are used for decrypt and encrypt, both *nonceTPMs* are included.

*sessionAttributes* an octet indicating the attributes associated with a particular use of the session

With the exception of *sessionAttributes*, all the values are large numbers, typically with sizes of 20 octets or more.

In the HMAC computation equations shown below, the possibility that the HMAC computation may include *nonceTPM<sub>decrypt</sub>* or *nonceTPM<sub>encrypt</sub>* is indicated by "*nonceOlder\**" (asterisk added).

### 19.6.6 Note on Use of Nonces in HMAC Computations

In equation (18), and the HMAC computation equations that follow, all of the nonce values are in TPM2B\_NONCE data structures. In the HMAC computations, the nonce entries should all be read as if they had the *.buffer* suffix indicating that only the data portion of a nonce is ever used in an HMAC computation.

### 19.6.7 Starting an Authorization Session

TPM2\_StartAuthSession() is used to start an authorization session. The parameters of this command may be chosen to produce sessions with different properties.

**Table 16 — Schematic of TPM2\_StartAuthSession Command**

Type	Name	Description
TPM_ST	tag	
UINT32	commandSize	
TPM_CC	commandCode	TPM_CC_StartAuthSession
TPMI_DH_OBJECT+	tpmKey	handle of a loaded key used to encrypt <i>salt</i> may be TPM_RH_NULL Auth Index: None
TPMI_DH_ENTITY+	bind	entity providing the <i>authValue</i> may be TPM_RH_NULL Auth Index: None
TPM2B_NONCE	nonceCaller	initial <i>nonceCaller</i> , sets nonce size for the session
TPM_SE	sessionType	indicates the type of session (HMAC or policy)
TPM2B_ENCRYPTED_SECRET	encryptedSalt	<i>tpmKey</i> algorithm-dependent secret if <i>tpmKey</i> is TPM_RH_NULL, this shall be an Empty Buffer
TPMT_SYM_DEF+	symmetric	the algorithm and key size for parameter encryption may select TPM_ALG_NULL
TPMI_ALG_HASH	authHash	hash algorithm to use for the session; and shall be a hash algorithm implemented on the TPM and not TPM_ALG_NULL

The two values that determine the session protection values are *tpmKey* and *bind*. Both of these handles can reference TPM\_RH\_NULL or a TPM entity. The *tpmKey* parameter references the key that is used to encrypt a salt value that is used in the computation of the *sessionKey*. The *bind* parameter references a TPM entity that may provide an *authValue* to the computation for the *sessionKey*. The four variations for *tpmKey* and *bind* give sessions with different properties.

**Table 17 — Handle Parameters for TPM2\_StartAuthSession**

<b>tpmKey</b>	<b>bind</b>	<b>session properties</b>
TPM_RH_NULL	TPM_RH_NULL	Unbound session
TPM_RH_NULL	TPM entity	Bound session
TPM key	TPM_RH_NULL	Salted session
TPM key	TPM entity	Salted and bound session

### 19.6.8 sessionKey Creation

A *sessionKey* value is used in the HMAC computation as shown in equation (18). If both *tpmKey* and *bind* are TPM\_RH\_NULL, then *sessionKey* is set to an Empty Buffer. Otherwise, the *sessionKey* is created as follows:

$$sessionKey := KDFa(sessionAlg, (authValue || salt), "ATH", nonceTPM, nonceCaller, bits) \quad (19)$$

where

<i>sessionAlg</i>	a TPM_ALG_ID for a hash that was chosen by the caller when the session was started
<i>authValue</i>	if <i>bind</i> is not TPM_RH_NULL, a TPM2B_AUTH.buffer that is found in the sensitive area of a TPM entity; otherwise, an Empty Buffer
<i>salt</i>	if <i>tpmKey</i> is not TPM_RH_NULL, then the salt value recovered from <i>encryptedSalt</i> ; otherwise, an Empty Buffer
"ATH"	a four-octet label value (see 4.1)
<i>nonceTPM</i>	a TPM2B_NONCE that is generated by the TPM when the session was started
<i>nonceCaller</i>	a TPM2B_NONCE that is provided by the caller when the session was started.
<i>bits</i>	the number of bits returned is the size of the digest produced by <i>sessionAlg</i>

NOTE When an authorization failure occurs, the TPM will check to see if the use of the object is exempt from dictionary attack protection. If it is exempt, the response code is changed from TPM\_RC\_AUTH\_FAIL to TPM\_RC\_BAD\_AUTH and no increment of the failed authorization counter occurs (see 19.8).

### 19.6.9 Unbound and Unsalted Session Key Generation

In this session key generation method used by TPM2\_StartAuthSession(), *tpmKey* and *bind* are both TPM\_RH\_NULL. This results in the session having no *sessionKey* (it is an Empty Buffer). The session is not bound to any object.

NOTE This session type is similar to the OIAP session of TPM 1.2.

A session started using this format can be used for parameter encryption while executing TPM commands. However, during these commands, the key used to encrypt the parameter will only use the *authValue* of the object being accessed by the commands in the key generation, so the strength of the encryption will be no better than the entropy in the *authValue* of the object.

When computing the HMAC, the *authValue* of the referenced entity is used:

$$\text{authHMAC} := \text{HMAC}_{\text{sessionAlg}}(\text{authValue}_{\text{entity}}.\text{buffer}, (\text{pHash} || \text{nonceNewer}.\text{buffer} || \text{nonceOlder}.*.\text{buffer} || \text{sessionAttributes})) \quad (20)$$

If the size of *authValue* is zero, then the caller may omit the HMAC from the authorization (see No HMAC Authorization 19.6.15).

**Table 18 — Format to Start Unbounded, Unsalted Session**

Type	Name	Description
TPM_ST	tag	
UINT32	commandSize	
TPM_CC	commandCode	TPM_CC_StartAuthSession
TPMI_DH_OBJECT+	tpmKey	TPM_RH_NULL
TPMI_DH_ENTITY+	bind	TPM_RH_NULL
TPM2B_NONCE	nonceCaller	initial <i>nonceCaller</i> , sets <i>nonceTPM</i> size for the session
TPM2B_ENCRYPTED_SECRET	encryptedSalt	00 00 <sub>16</sub>
TPM_SE	sessionType	indicates the type of the session (HMAC, policy, or trial)
TPMT_SYM_DEF+	symmetric	will normally be TPM_ALG_NULL for an unbound and unsalted session
TPMI_ALG_HASH	authHash	hash algorithm to use for the session; required to be a hash algorithm implemented on the TPM and not TPM_ALG_NULL

NOTE When *sessionType* is TPM\_SE\_TRIAL, there is no benefit in using any other version of TPM2\_StartAuthSession() as a trial session is not allowed to be used for authorization. This means that the *sessionKey* of the session will never be used so there is no point in having the TPM generate it.

### 19.6.10 Bound Session Key Generation

In this session key generation method used by TPM2\_StartAuthSession(), *tpmKey* is TPM\_RH\_NULL indicating that no *salt* value is present but *bind* references some TPM entity with an *authValue*.

NOTE 1 This session type has properties that are similar to an OSAP session in TPM 1.2.

The *sessionKey* is computed using the *authValue* from *bind* and an Empty Buffer in place of the *salt* value.

$$\text{sessionKey} := \text{KDFa}(\text{sessionAlg}, \text{authValue}_{\text{bind}}, \text{"ATH"}, \text{nonceTPM}, \text{nonceCaller}, \text{bits}) \quad (21)$$

NOTE 2 If handle references a TPM resource that has an EmptyAuth, the *sessionKey* is still computed.

When performing an HMAC for authorization, the HMAC key is normally the concatenation of the entity's *authValue* to the sessions *sessionKey* (created at `TPM2_StartAuthSession()`). See (22). However, if the authorization is for the entity to which the session is bound, the *authValue* is not included in the HMAC key. See (23). When a policy requires that an HMAC be computed, it is always done according to (22).

$$\text{authHMAC} := \text{HMAC}_{\text{sessionAlg}}(\text{sessionKey} || \text{authValue}_{\text{entity}}, \\ (\text{pHash} || \text{nonceNewer} || \text{nonceOlder}^* || \text{sessionAttributes})) \quad (22)$$

$$\text{authHMAC} := \text{HMAC}_{\text{sessionAlg}}(\text{sessionKey}, \\ (\text{pHash} || \text{nonceNewer} || \text{nonceOlder}^* || \text{sessionAttributes})) \quad (23)$$

NOTE 3 Binding to an entity different from the one being authorized is a way of adding entropy to the session key. It is useful in cases where the entity being authorized has a low entropy authorization value.

The TPM is required to keep track of the entity to which the session is bound. This is nominally accomplished when the session is started by recording, in the session context, the Name of the *bind* entity. For an NV Index or persistent handle, the TPM is required to also record the authorization value associated with the entity.

NOTE 4 In the Part 4 reference implementation, the authorization value is combined with the Name and stored in the `SESSION→boundEntity` member.

NOTE 5 Recording of the NV Index authorization is required to prevent an attacker from "squatting" on an Index. This would be accomplished by creating an NV Index that has properties that are identical to an NV Index that is expected to be created, but with an authorization value known to the attacker. The attacker would then start an authorization session bound to the NV Index and delete the NV Index. When the NV Index to be attacked is created, the attacker would have an authorization session bound to an Index with the same Name and could access to the NV Index even though the actual authorization value is unknown.

On a command, the TPM will check to see if the authorization is being used for the entity to which it was bound. If so, then the *authValue* of the bound entity is not used in the HMAC computation. The TPM will record the fact that the *authValue* was not used in the HMAC computation of the authorization and not include it in the HMAC computation on the response.

NOTE 6 This allows the session to remain bound to an NV Index for the duration of the first command that writes to the Index even though the Name of the Index changes during the command processing. The session will not be bound to the Index when the command completes. The session can continue to be used, but it, in effect, is no longer bound because there is no longer a TPM entity with the correct Name.

For a persistent object, the authorization value is included so that authorization can be revoked. If the administrator for a persistent object changes the authorization, sessions bound to the old authorization should no longer be valid.

NOTE 7 To change the authorization of a persistent object, `TPM2_ObjectChangeAuth()` would be called. It would return a new sensitive area. The current persistent object would be deleted (`TPM2_EvictControl()`) and the object with the new authorization loaded (`TPM2_Load()`). Finally, the loaded object would be made persistent (`TPM2_EvictControl()`). It is only required that the old object be deleted if the new object is to have the same handle or if it is desired to revoke the old authorization.

The *noDA* attribute of the bind object is recorded in the session context. For a description of the rationale, see clause 19.8.7.

**Table 19 — Format to Start Bound Session**

Type	Name	Description
TPM_ST	tag	
UINT32	commandSize	
TPM_CC	commandCode	TPM_CC_StartAuthSession
TPMI_DH_OBJECT+	tpmKey	TPM_RH_NULL
TPMI_DH_ENTITY	bind	entity providing the <i>authValue</i> to which the session is bound and not TPM_RH_NULL
TPM2B_NONCE	nonceCaller	initial <i>nonceCaller</i> , sets <i>nonceTPM</i> size for the session
TPM2B_ENCRYPTED_SECRET	encryptedSalt	00 00 <sub>16</sub>
TPM_SE	sessionType	indicates the type of the session (HMAC, policy, or trial)
TPMT_SYM_DEF+	symmetric	if the session is to be used for parameter encryption, set this to an algorithm and key size
TPMI_ALG_HASH	authHash	hash algorithm to use for the session; required to be a hash algorithm implemented on the TPM and not TPM_ALG_NULL

### 19.6.11 Salted Session Key Generation

In this session key generation method used by `TPM2_StartAuthSession()`, `bind` is `TPM_RH_NULL`, indicating that no entity is referenced to provide an `authValue`, but `tpmKey` is present and indicates a key used to encrypt the `salt` value. The `sessionKey` is computed with an Empty Buffer in place of the `authValue`.

$$sessionKey := \mathbf{KDFa} (sessionAlg, salt, \text{"ATH"}, nonceTPM, nonceCaller, bits) \quad (24)$$

Because `bind` is `TPM_RH_NULL`, the session is not bound to any entity. When the session is used to access any entity, the HMAC will use the `sessionKey` and the `authValue` of that entity.

$$authHMAC := \mathbf{HMAC}_{sessionAlg} ((sessionKey || authValue_{entity}), \\ (pHash || nonceNewer || nonceOlder^* \\ || sessionAttributes)) \quad (25)$$

**Table 20 — Format to Start Salted Session**

Type	Name	Description
TPM_ST	tag	
UINT32	commandSize	
TPM_CC	commandCode	TPM_CC_StartAuthSession
TPMI_DH_OBJECT	tpmKey	handle of a loaded key used to encrypt <i>salt</i>
TPMI_DH_ENTITY+	bind	TPM_RH_NULL
TPM2B_NONCE	nonceCaller	initial <i>nonceCaller</i> , sets <i>nonceTPM</i> size for the session
TPM2B_ENCRYPTED_SECRET	encryptedSalt	conveys a secret value used to generate the <i>sessionKey</i> – method of conveying this value is dependent on the type of <i>tpmKey</i>
TPM_SE	sessionType	indicates the type of the session (HMAC, policy, or trial)
TPMT_SYM_DEF+	symmetric	if the session is to be used for parameter encryption, set this to an algorithm and key size
TPMI_ALG_HASH	authHash	hash algorithm to use for the session; required to be a hash algorithm implemented on the TPM and not TPM_ALG_NULL

### 19.6.12 Salted and Bound Session Key Generation

This version of `TPM2_StartAuthSession()` creates a session that has properties that are similar to the OSAP session type of TPM 1.2 but also allows salting. For this version of the command, `bind` is used to provide an `authValue`, `tpmKey` encrypts the `salt` value and the `sessionKey` is computed using both.

$$\text{sessionKey} := \text{KDFa}(\text{sessionAlg}, (\text{authValue} \text{bind} || \text{salt}), \text{"ATH"}, \text{nonceTPM}, \text{nonceCaller}, \text{bits}) \quad (26)$$

If the session is an HMAC session:

- Because `bind` is present, the session is bound to that entity. That is, when the session is used to authorize use of the bound entity, the HMAC will use `sessionKey` but not the `authValue`.

$$\text{authHMAC} := \text{HMAC}_{\text{sessionAlg}}(\text{sessionKey}, (\text{pHash} || \text{nonceNewer} || \text{nonceOlder}^* || \text{sessionAttributes})) \quad (27)$$

If the session is a policy session:

- The session is not bound to that entity. That is, when the session is used to authorize use of any entity, the HMAC (if required) will use the `sessionKey` and the `authValue`.

$$\text{authHMAC} := \text{HMAC}_{\text{sessionAlg}}((\text{sessionKey} || \text{authValue}_{\text{entity}}), (\text{pHash} || \text{nonceNewer} || \text{nonceOlder}^* || \text{sessionAttributes})) \quad (28)$$

- The `noDA` attribute of the `bind` object is recorded in the session context. For a description of the rationale, see clause 19.8.7.

**Table 21 — Format to Start Salted and Bound Session**

Type	Name	Description
TPM_ST	tag	
UINT32	commandSize	
TPM_CC	commandCode	TPM_CC_StartAuthSession
TPMI_DH_OBJECT+	tpmKey	handle of a loaded key used to encrypt <code>salt</code>
TPMI_DH_ENTITY	bind	entity providing the <code>authValue</code> and to which the session is bound
TPM2B_NONCE	nonceCaller	initial <code>nonceCaller</code> , sets <code>nonceTPM</code> size for the session
TPM2B_ENCRYPTED_SECRET	encryptedSalt	contains a secret value used to generate the <code>sessionKey</code> – method of encrypting this value is dependent on the type of <code>tpmKey</code>
TPM_SE	sessionType	indicates the type of the session (HMAC, policy, or trial)
TPMT_SYM_DEF+	symmetric	if the session is to be used for parameter encryption, set this to an algorithm and key size
TPMI_ALG_HASH	authHash	hash algorithm to use for the session; required to be a hash algorithm implemented on the TPM and not TPM_ALG_NULL



### 19.6.13 Encryption of *salt*

#### 19.6.13.1 Overview

The *salt* parameter for TPM2\_StartAuthSession() may be symmetrically or asymmetrically encrypted using the methods described in this clause.

The value produced by the secret exchange process using *salt* should be the size of the digest produced by the *authHash* of the session. For ECC, the size of the *seed* is limited because it is an ECC point; but for RSA, XOR, and AES, the size of *salt* may vary.

When the value of *salt* is determined, it is used in the computation of *sessionKey* as shown in equation (19).

#### 19.6.13.2 Asymmetric Encryption of Salt

The methods of encrypting the salt and producing the session secret differ for each asymmetric algorithm. The methods are described in the algorithm-specific annexes to this specification.

### 19.6.14 Caution on use of Unsalted Authorization Sessions

If an *authValue* has low entropy, confidentiality of the value may not be preserved if the *authValue* is used in an unsalted authorization session. For an unbound, unsalted session, the HMAC computation for the response from the TPM is:

$$\text{authHMAC} := \text{HMAC}_{\text{sessionAlg}}(\text{authValue}, (\text{rpHash} || \text{nonceTPM} || \text{nonceCaller} || \text{sessionAttributes})) \quad (29)$$

If an attacker can read the response from the TPM, then the only values unknown to the attacker are *authValue* and *nonceCaller*. An attacker may be able to determine *nonceCaller* by reading the command as it is sent to the TPM. If the attacker has all the variables but *authValue*, they could perform an "off-line" attack on the *authValue* using trial versions of *authValue* until one is found that produces a matching *authHMAC*.

NOTE 1 In this context, an "off-line" attack means that the attacker can perform computations that do not involve the TPM meaning that the protections that the TPM provides against *authValue* attacks has no effect.

It is important to note that this vulnerability only occurs if an attacker has access to both the command and response of a successful command using the *authValue*. If a user has a password protecting a key and the system is lost or stolen, the key is protected because the attacker will not be able to observe the legitimate owner of the key perform a successful operation with the key.

For a bound session without salt, the attack is a bit more complicated. The HMAC computation for the response is:

$$\text{authHMAC} := \text{HMAC}_{\text{sessionAlg}}((\text{sessionKey} || \text{authValue}_{\text{entity}}), (\text{pHash} || \text{nonceNewer} || \text{nonceOlder} || \text{sessionAttributes})) \quad (30)$$

If the attacker observes a TPM2\_StartAuthSession() command and response and the *authValue* for the bind entity has low entropy, then they would have all of the components of *sessionKey* except for the *authValue* of the *bind* entity. Then, by observing another successful transaction, an attacker could know everything but the two *authValues* and they could again perform an offline attack.

NOTE 2 If the successful operation is on the *bind* entity, then only one *authValue* is unknown.

As with the unbound and unsalted session, the vulnerability for a bound session only occurs if the attacker is able to observe successful command response sequences.

Salting provides a mechanism to allow use of low entropy *authValues* and still maintain confidentiality for the *authValue*. It is also possible to use a high entropy *authValue* to protect the confidentiality of a low-entropy value. For instance, if the *bind* entity *authValue* has high-entropy, then there would be greater computational complexity in guessing *sessionKey* || *authValue<sub>entity</sub>*. Depending on the *authValue* and *salt* sizes, a bound session could have a *sessionKey* that is as difficult to guess as does a salted session.

### 19.6.15 No HMAC Authorization

For a session-based authorization, both HMAC and policy, an *authHMAC* value is computed as shown in equation (18) and that value is used as *hmac* in an authorization or acknowledgement as shown in Table 14 and Table 15 respectively. If an authorization session is started with *bind* and *tpmKey* both set to TPM\_RH\_NULL, then *sessionKey* in equation (18) will be an Empty Buffer. If the *authValue* in equation (18) is also an Empty Buffer, then the HMAC key will be an Empty Buffer. When this situation exists, the caller has the option of either providing the results of the *authHMAC* computation, or not.

If *authHMAC* is provided, it will be computed as shown in equation (18) with an Empty Buffer as the HMAC key and the TPM will validate that the value in *hmac* matches the internally calculated value.

If *authHMAC* is not provided, the size of *hmac* (see Table 14) will be zero and the TPM will accept this value of *hmac* as providing valid authorization for the object.

For an HMAC session, *authValue* in equation (18) will only be an Empty Buffer if the *authValue* of the authorized object is an EmptyAuth, the session is a bind session and the authorization is for the entity to which the session is bound, or if the session is not an authorization session.

For a policy session, two situations will result in *authValue* being an Empty Buffer:

- 1) the *authValue* of the authorized object is an EmptyAuth, or
- 2) the policy does not use the *authValue* of the object (that is, the evaluated policy does not contain TPM2\_PolicyAuthValue())(see 19.7.7.6).

For these two cases, if *sessionKey* is an Empty Buffer, *hmac* is allowed to be either a valid *authHMAC* or an Empty Buffer. For a bound or salted policy session, *sessionKey* is not an Empty Buffer, and *hmac* must be valid.

NOTE A policy session that does not use TPM2\_PolicyAuthValue() would use a bound or salted session if that session is also used for encryption.

For a policy session that contains TPM2\_PolicyPassword(), the password takes precedence and must be present in *hmac*.

The TPM will use the same formulation in the response as was in the command. This is, if *hmac* was non-zero in the command, the TPM will compute *authHMAC* as shown in equation (18) and use the result as *hmac*. If *hmac* was an Empty Buffer in the command, it will be an Empty Buffer in the response.

### 19.6.16 Authorization Selection Logic for Objects

Each object has two attributes in its public structure to indicate how use of the object is authorized.

- 1) ***userWithAuth*** – If this attribute is SET, then USER role authorization for an object may be provided with an HMAC session or a password. If this attribute is CLEAR, then the *authValue* may not be used for USER role authorization, meaning that authorization may not be done using an HMAC session or a password. USER role authorizations with a policy are always allowed regardless of the setting of this attribute.
- 2) ***adminWithPolicy*** – If this attribute is SET, then ADMIN role authorization for an object may only be provided with a policy session. If this attribute is CLEAR, then authorization may be provided with a policy session, with an HMAC session, or with a password.

When authorization is with a policy session and ADMIN role authorization is being provided, the command code value of the policy session must match the command code for the command being authorized.

For TPM\_RH\_OWNER, TPM\_RH\_ENDORSEMENT, and TPM\_RH\_PLATFORM); *userWithAuth* and *adminWithPolicy* are always SET.

For an NV Index, NV Index attributes (TPMA\_NV) determine authorization selection.

NOTE For TPM\_RH\_OWNER, TPM\_RH\_ENDORSEMENT, and TPM\_RH\_PLATFORM); *userWithAuth* and *adminWithPolicy* do not have to be implemented as separate attributes. The code may simply assume that the attributes are SET and act accordingly.

### 19.6.17 Authorization Session Termination

The TPM will terminate a session (authorization or audit) and clear all associated context under the following circumstances:

- when TPM2\_FlushContext() selects the session;
- if *sessionAttributes.continueSession* is CLEAR in the command, the TPM will CLEAR the *continueSession* flag in the response and perform TPM2\_FlushContext() actions;

NOTE When *sessionAttributes.continueSession* is CLEAR in the command but the command does not return success, then the session is not terminated.

- on TPM Reset, all authorization sessions are terminated; and
- on TPM Resume or TPM Restart, authorization sessions in TPM memory will be terminated but sessions context saved off the TPM will remain active.

## 19.7 Enhanced Authorization

### 19.7.1 Introduction

Enhanced authorization is a TPM capability that allows entity-creators or administrators to require specific tests or actions to be performed before an action can be completed. The specific policy is encapsulated in a value called an *authPolicy* that is associated with an entity

When an HMAC session is used for authorization, the *authValue* of the entity is used to determine if the authorization is valid. When a policy session is used for authorization, the *authPolicy* of the entity is used.

Many TPM entities have or may have an associated *authPolicy*. A policy defines the conditions for use of an entity. For example,

- a policy may limit the use of a key unless selected PCR have specific values;
- a policy may not allow use of a key after a specific time;
- a policy may require that authorization to change an NV Index be provided by two different entities; or
- a policy may limit a particular signing key to attest to PCR values but not to certify another TPM key.

A policy may be arbitrarily complex. However, the policy is expressed as one (statistically unique) digest called the *authPolicy*.

The digest representing a particular policy may be included in an Object or NV Index when the Object or NV Index is created (the digest representing a policy is created using the methods described in subsequent parts of this clause). In order to use the Object or Index, a policy session is created and then the TPM is given a sequence of policy commands that modify the digest in the policy session. After executing all of the commands of the policy, the TPM will have computed a digest value that is characteristic of the policy. The policy session is then used as an authorization session. If the digest accumulated in the policy session matches the *policyDigest* of the entity (and certain other optional conditions are true) then the command is authorized.

After a policy session is used for authorization, *policySession*→*nonceTPM* is changed to a new, random value; *policySession*→*startTime* is set to the current time; and the other values of the policy session context are initialized to the state they had when the session was first created by TPM2\_StartAuthSession() (see 19.7.8).

The mechanisms of policy creation and evaluation are explained in the remainder of this clause

### 19.7.2 Policy Assertion

An assertion is a statement that something is true. In an authorization policy, an assertion is a statement of something that must be true before the policy is satisfied. For example, an assertion may be that a set of PCR must have specific values to allow an object to be authorized for use in a specific command. The list of all policy assertions defined by this specification is in 19.7.7.6.

A combination of one or more assertions is used to construct an authorization policy.

### 19.7.3 Policy AND

A policy may be expressed in an equation as a set of assertions that must all be satisfied before the policy is valid. For example, a policy that requires that 4 assertions be true could be written as:

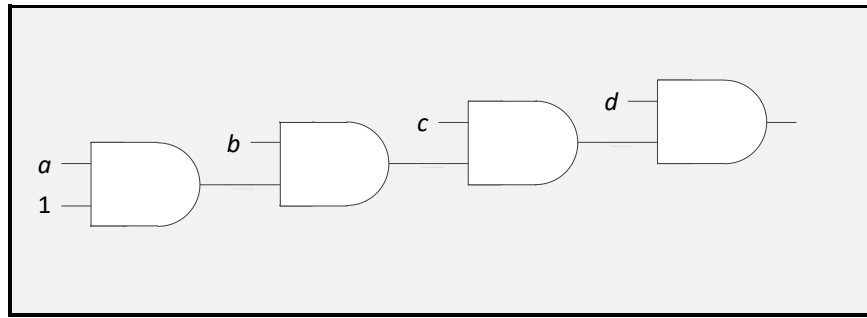
$$a \& b \& c \& d$$

A possible implementation of the policy logic would be to have all the assertions evaluated at the same time to determine if the policy is satisfied. This approach would require that the TPM resources scale with the number of assertions that would need to be evaluated for the policy.

The alternative use in the TPM is to evaluate the expression one assertion at a time with each assertion ANDed with the results of the previous evaluation.

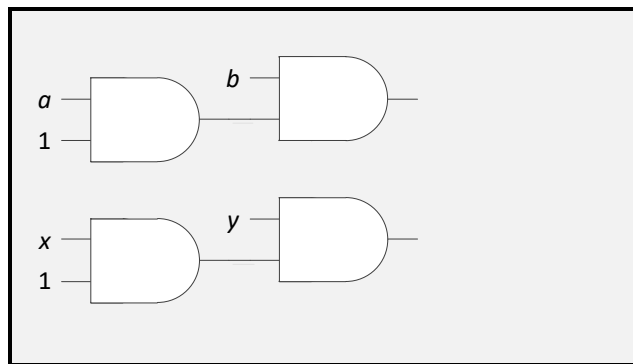
$$(((1 \& a) \& b) \& c) \& d$$

The (1 & a) term means that assertion *a* is ANDed with an initial TRUE. This allows each assertion to be just the AND of a new assertion with the results of the previous assertion evaluation. A pictorial representation of the policy evaluation is:



Any number of assertions can be combined in this way using a fixed set of TPM resources.

The logic of a TPM policy cannot actually be expressed as a simple 1 or 0. For the policy to be valid, not only does it need to evaluate to "TRUE" but it also has to be the correct policy. For example, these two policies may both evaluate to the same logic value (TRUE), but they do not represent the same policies.



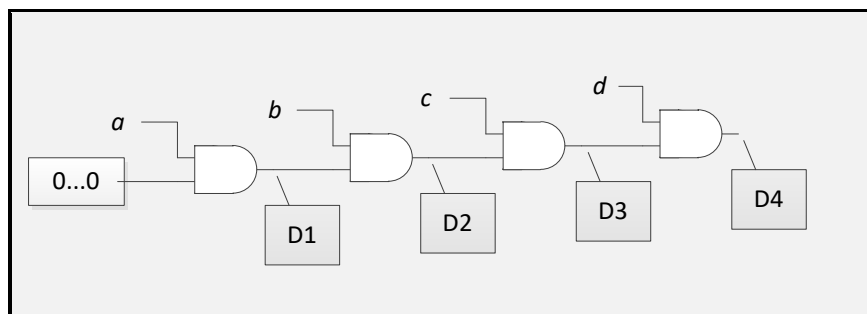
So that it can differentiate  $(a \& b)$  from  $(x \& y)$ , the TPM will update a running digest value for each assertion that is added to the policy. The final digest value indicates the policy that was evaluated.

The running digest value is called the *policyDigest*. The *policyDigest* is initialized to a Zero Digest (0...0) when the policy session is started (TPM2\_StartAuthSession()). Then, as each policy assertion is evaluated, the *policyDigest* is updated.

$$policyDigest_{new} := H(policyDigest_{old} || PolicyAssertion)$$

NOTE 1 This should be recognizable as the Extend operation.

The *policyDigest* will only be updated if a policy assertion is valid (TRUE) (see 19.7.10 for exception relating to trial policies). This gives an alternative possibility for interpreting the output of one of the policy AND gates. Instead of simply being a 1 (TRUE) or 0 (FALSE), the output of the gate is current value of the *policyDigest*. Using this perspective, the four-term policy becomes:



where

0...0	the initial value of the policy digest
D1	$\mathbf{H}(0\dots0 \parallel a)$
D2	$\mathbf{H}(D1 \parallel b)$
D3	$\mathbf{H}(D2 \parallel c)$
D4	$\mathbf{H}(D3 \parallel d)$

NOTE 2 In these illustrations, the parameters for the Extend operations are simple parameters ("a", "b", etc.). The actual parameters for the Extend are more complex but including the details in the illustrations would add complexity without adding clarity.

#### 19.7.4 Policy OR

If the only type of policy assertion was an AND, then the policies that could be evaluated by the TPM would be of limited value. To make the policies more flexible, an OR policy assertion is defined. As with a logic OR gate, the OR policy assertion will be valid if any of the inputs is valid.

A simple policy using an OR might be written as:

$$(a \& b) | (x \& y)$$

or as:

$$(((0\dots0) \& a) \& b) | (((0\dots0) \& x) \& y)$$

Evaluating the AND branches individually, the left side evaluates to:

$$D_{\text{left}} := \mathbf{H}(\mathbf{H}(0\dots0 \parallel a) \parallel b)$$

and the right side to:

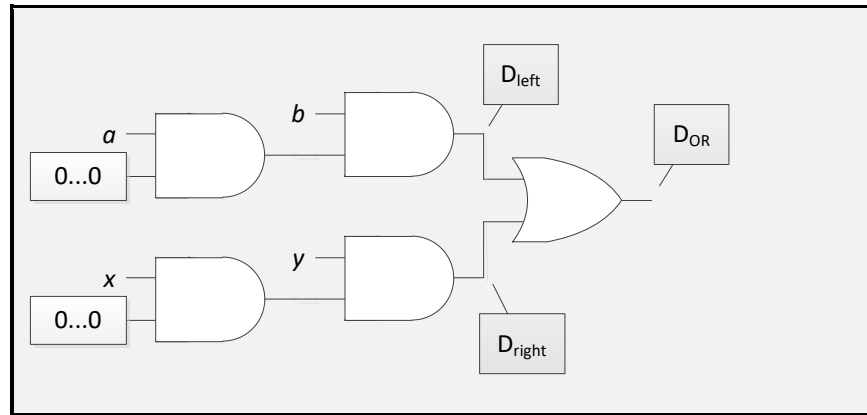
$$D_{\text{right}} := \mathbf{H}(\mathbf{H}(0\dots0 \parallel x) \parallel y)$$

Then, the output from a 2-input policy OR operation will be defined to be

$$policyDigest_{\text{new}} := \mathbf{H}(D_{\text{left}} \parallel D_{\text{right}})$$

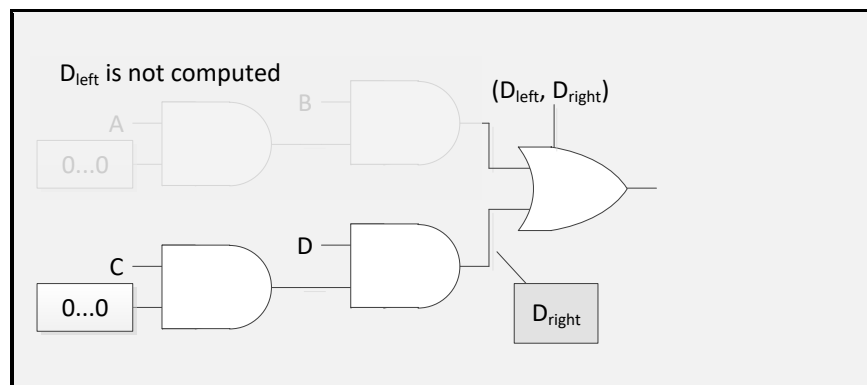
Notice that the OR operation replaces the *policyDigest* with a new value instead of Extending it as is done in an AND operation.

Pictorially, a policy with an OR is:

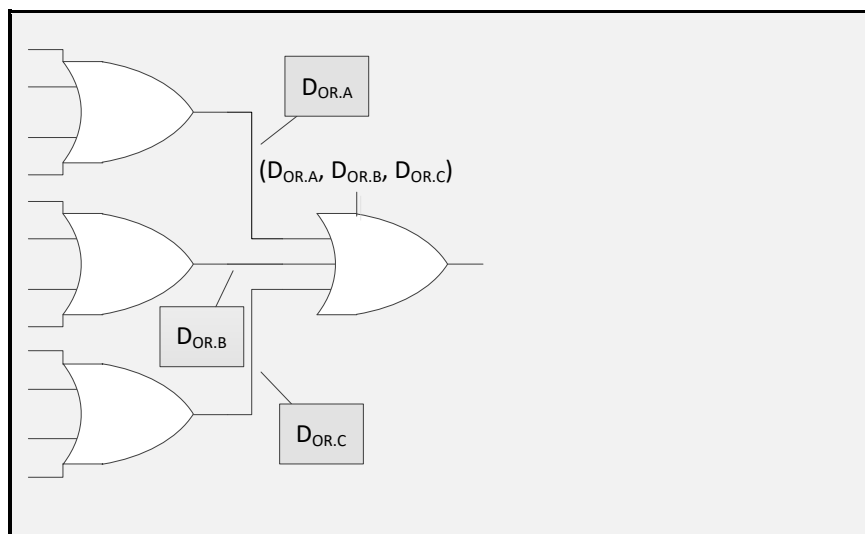


The TPM processes the OR by comparing the current value of *policyDigest* with a list of digest values provided by the caller. If *policyDigest* is on the list, then the TPM will digest the concatenation of all of the digests in the list. For example, to perform the OR operation above, assume that the TPM has processed (*a* & *b*) producing  $D_{left}$ . Then the TPM would be given a list of digests ( $D_{left}$ ,  $D_{right}$ ). Because the *policyDigest* is on the list, the TPM computes  $D_{OR} := H(D_{left} | D_{right})$  and replaces *policyDigest*. Note that if the TPM had processed (*c* & *d*) to compute  $D_{right}$ , and was then given the same list of digests ( $D_{left}$ ,  $D_{right}$ ), the resulting *policyDigest* would be the same.

When processing a policy that has an OR, only one branch of the policy needs to be evaluated. For example, if C and D assertions were valid, then only the *right* branch would need to be evaluated.



The list given to the TPM for a `TPM2_PolicyOR()` is limited to 8 digests. However, the effective size of the list can be expanded indefinitely by using cascading OR. Figure 15 illustrates one of the many ways to construct a 12 input OR.



**Figure 15 — A 12-input OR Policy**

When the OR list can contain 8 digests, 64 different branches can be ORed in just two levels.

The result of an OR operation may be an input to an AND assertion allowing construction of arbitrarily complex policies.

### 19.7.5 Order of Evaluation

Because the TPM uses digests, the order of evaluations is important. For policy evaluation, (A & B) is not the same as (B & A). In addition, when performing an OR operation, the same list of digests (same number in the same order) must be given to the TPM each time. The list ( $D_{left}$ ,  $D_{right}$ ) will not give the same result as ( $D_{right}$ ,  $D_{left}$ ) or ( $D_{left}$ ,  $D_{right}$ ,  $D_{other}$ ).

### 19.7.6 Policy Session Creation

`TPM2_StartAuthSession(sessionType = TPM_SE_POLICY)` is used to start an authorization session. The authorization session may use any of the four options for *tpmKey* and *bind*.

**NOTE 1** A policy session does not maintain a binding with a specific object. The *bind* parameter is used only for session key creation. This allows the context space of the session that is used for the binding value to be dedicated to other policy parameters.

The most typical use of a policy session will be with *tpmKey* and *bind* both set to `TPM_RH_NULL`. When this option is selected, an HMAC computation might not be performed when the policy session is used and the session *nonce* and *auth* values may be Empty Buffers. See TPM 2.0 Part 3, `TPM2_PolicyAuthValue`.

**NOTE 2** When the session is created, *nonceCaller* still needs to be provided and its size is required to meet the minimum requirements of the command.

When the authorization session is to be used to authorize a command that has an encrypted command or response parameter, then either *tpmKey* or *bind* should be used in the `TPM2_StartAuthSession()` that starts the session so that a secure *sessionKey* is created.



## 19.7.7 Policy Assertions (Policy Commands)

### 19.7.7.1 Introduction

In TPM 2.0 Part 3 of the specification the set of policy assertions are the commands with names of the form TPM2\_Policyxxx() where "xxx" is an indicator of the type of policy assertion. For example, TPM2\_PolicySigned() is a policy assertion that an authorization was signed by a specific entity; and TPM2\_PolicyPCR() is an assertion that a selected set of PCR have a specific value.

Normally, each policy command will cause the *policyDigest* to be changed in a different way which is why they are different commands. In some cases, the policy command will also cause other changes to the policy session context. For example, TPM2\_PolicyLocality() modifies the policy state that indicates the locality that is allowed when the policy session is used for authorization. TPM2\_PolicyCommandCode() changes the policy state so that the policy may only be used to authorize a specific command.

The details of the *policyDigest* computation performed by each policy command are provided in the General Description section of each command found in TPM 2.0 Part 3. The description also indicates the policy state that is modified.

The assertions fall into three different groups: immediate, deferred, and combined.

### 19.7.7.2 Immediate Assertions

For an immediate assertion, the input values are validated and the TPM will return a failure and not update the *policyDigest* if the assertion is not valid. An example of an immediate assertion is TPM2\_PolicyNV(). For this assertion, the TPM validates the logical or arithmetic relationship between an input value and an NV Index. If the specified relationship is not valid, the TPM returns an error and the *policyDigest* is not modified. If the relationship is valid, then the *policyDigest* is updated with the Index Name and the relationship that was validated.

### 19.7.7.3 Deferred Assertions

For a deferred assertion, the TPM will update the *policyDigest* based on the input values and record some parameters in the policy session's context. These parameters are checked when the policy is used for authorization. An example of a deferred assertion is TPM2\_PolicyCommandCode(). For this assertion, the input is a TPM command code. The *policyDigest* will be updated to record the fact that the TPM2\_PolicyCommandCode() was executed and the *commandCode* value that was specified. The TPM also directly records the *commandCode* parameter in the policy session context. When the policy is used for authorization, the TPM will verify that the command being authorized is the same as the command in the policy and the authorization (and command) will fail if they are not the same.

### 19.7.7.4 Combined Assertions

For a combined assertion, the TPM will validate some condition of the input and record or modify some parameters in the policy session's context. An example of a combined assertion is TPM2\_PolicySigned(). For this assertion type, the TPM validates that the parameters of the command have been signed by the indicated key. If so, it will update the policy session context based on the input parameters. One of the context values that may be updated is the *cpHash* of the session. If the *cpHash* of the authorized command is not the same as the authorized *cpHash* then the command will not be authorized.

### 19.7.7.5 Repetition of Assertions

In general, any policy assertion may occur multiple times within a policy as long as the assertion is compatible with previous assertions. An example of an incompatible set of assertions is two occurrences of `TPM2_PolicyCommandCode()` that specify different command codes.

The TPM will return an error if an assertion is incompatible with a previous assertion. It is possible that the failed assertion is incompatible with an assertion of a different type. For example, a `TPM2_PolicyCpHash()` may be incompatible with a `TPM2_PolicySigned()`. If they specify different values of *policySession*→*cpHash*, then the TPM will return an error.

NOTE When referring to an *element* of the policy context, the notation *policySession*→*element* is used to denote a particular member of the policy context.

### 19.7.7.6 List of Assertions

The assertions listed in this clause will all update the *policyDigest* of the policy session being operated on if the assertion condition is met. They may also cause a change to other policy session, context values (the list of policy session context values is in 19.7.8) as indicated in the brief description for each assertion.

- **TPM2\_PolicyAuthorize()** – valid if *policySession*→*policyDigest* has the value authorized by the selected key. This is an immediate assertion and is described in more detail in 19.7.11.
- **TPM2\_PolicyAuthorizeNV()** – valid if the specified NV Index contains a hash algorithm identifier and a digest value that match the hash algorithm and *policySession*→*policyDigest*. This immediate assertion changes *policySession*→*policyDigest* and is described in more detail in 19.7.11.
- **TPM2\_PolicyAuthValue()** – valid if *authValue* of the authorized entity is provided when the policy session is used for authorization. This deferred assertion will SET *policySession*→*isAuthValueNeeded*. When the policy is used for authorization, the TPM will check *policySession*→*isAuthValueNeeded*. If it is SET, then the TPM performs an HMAC check on the session as if it were an HMAC session. This HMAC validation will only succeed if the caller is able to prove knowledge of the entity's *authValue* by computing the correct HMAC.
- **TPM2\_PolicyCommandCode()** – valid when the authorized command has the specified command code. This deferred assertion sets *policySession*→*commandCode*.
- **TPM2\_PolicyCounterTimer()** – valid when a portion of the TPM's TPMS\_TIME\_INFO structure has the desired numerical relationship with another value. This is an immediate assertion. If the selected subset of the TPM's TPMS\_TIME\_INFO structure does not have the specified relationship with the input data, then the TPM will return an error and not change the *policyDigest*. See 36.1 for use cases.
- **TPM2\_PolicyCpHash()** – valid if the cpHash of the authorized command has a specific value. This deferred assertion *modifies* *policySession*→*cpHash*.
- **TPM2\_PolicyDuplicationSelect()** – valid if the handles of the authorized command reference specific objects and the command code is TPM2\_Duplicate(). This deferred assertion modifies *policySession*→*cpHash* and *policySession*→*commandCode*.
- **TPM2\_PolicyLocality()** – valid if the command being authorized is being executed at one of the allowed localities. This is a deferred assertion that modifies *policySession*→*locality*. For localities 0-4, the input locality parameter is a bit field that indicates the allowed localities. If an execution of this assertion would result in no locality being allowed, then the TPM will return an error. For extended localities, *policySession*→*locality* is set to the *locality* parameter of the command if the *policySession*→*locality* was not previously set. Otherwise, the *locality* parameter is required to be the same as the current value of *policySession*→*locality*.
- **TPM2\_PolicyNameHash()** – valid if the handles of the authorized command reference specific objects. This deferred assertion modifies *policySession*→*cpHash*.
- **TPM2\_PolicyNV()** – valid if the contents of NV have the desired relationship with another value. This is an immediate assertion. If the selected portion of the NV Index does not have the specified relationship with the input data, then the TPM will return an error and not change the *policyDigest*.
- **TPM2\_PolicyNvWritten()** – valid when the TPMA\_NV\_WRITTEN attribute of the specified NV Index has the desired value. This deferred assertion sets *policySession*→*checkNvWritten* and the state of *policySession*→*nvWrittenState*.
- **TPM2\_PolicyOR()** – valid if *policySession*→*policyDigest* is on a list of digests. This is an immediate assertion. If *policySession*→*policyDigest* is not on the list of digests, then TPM returns an error. Otherwise, *policySession*→*policyDigest* is replaced with the digest of the list.
- **TPM2\_PolicyPassword()** – valid if the *authValue* of the authorized entity is provided when the session is used for authorization. This deferred assertion will SET *policySession*→*isPasswordNeeded*. When the policy is used for authorization, the TPM will check *policySession*→*isPasswordNeeded*. If it is SET, then the TPM performs a password check on the session as if it were a password session. . This password validation will only succeed if the caller is able to prove knowledge of the entity's *authValue* by providing the correct value as the password.

NOTE 1 A session may use TPM2\_PolicyAuthValue() and TPM2\_PolicyPassword() interchangeably. If TPM2\_PolicyAuthValue() and TPM2\_Policy Password() are both used, then TPM will perform the check according to the last one used in the policy.

- **TPM2\_PolicyPCR()** – valid if the selected PCR have the desired value. This assertion may be either an combined or a deferred assertion. If the caller provides a digest, the TPM validates that the current values of the PCR match the input value and return an error (TPM\_RC\_VALUE) if not. If this command completes successfully, the *policyDigest* will have been updated with the digest of the selected PCR. The TPM will also record that the PCR have been checked. If the PCR are changed after they are checked but before the policy is used for authorization, then the policy will fail.

NOTE 2            The reference implementation provides this assurance by maintaining a PCR update counter that increments each time the PCR are modified. The update counter is saved in the policy session context. If the update counter does not change between the check of the PCR and the use of the policy session for authorization, then the PCR are the same.

- **TPM2\_PolicyPhysicalPresence()** – valid if the physical presence is asserted when the authorized command is executed. This deferred assertion sets *policySession→isPPRequired*.
- **TPM2\_PolicySecret()** – valid if the knowledge of a secret value is provided. This assertion is an immediate and possibly also a deferred assertion. Based on the input parameters, this command may modify *policySession→cpHash* and *policySession→timeout*.

NOTE 3            The secret value will be the *authValue* of some TPM entity.

- **TPM2\_PolicySigned()** – valid if the parameters are properly signed. This assertion is an immediate and possibly also a deferred assertion. Based on the input parameters, this command may modify *policySession→cpHash* and *policySession→timeout*.
- **TPM2\_PolicyTemplate()** – valid if the hash of the *inPublic* parameter of TPM2\_Create(), TPM2\_CreatePrimary(), or TPM2\_CreateLoaded() matches the *templateHash* in this command. This deferred assertion sets *policySession→cpHash*.
- **TPM2\_PolicyTicket()** – valid if the ticket is valid. This assertion is an immediate and possibly also a deferred assertion. Based on the input parameters, this command may modify *policySession→cpHash* and *policySession→timeout*.

### 19.7.8 Policy Session Context Values

A policy session context contains the state and tracking information for evaluation of a policy. The context values are set to their default values when the session is created and again each time the session is successfully used to authorize a command.

The values may be changed by a policy assertion. The policy assertions are listed in 19.7.7.6 with an indication of the policy session context values that they modify. The policy session context values are described further here.

- ***policyDigest*** – digest that is updated by each assertion. The default value for *policyDigest* is a Zero Digest (a buffer with a length equal to the digest size of the hash algorithm with all octets having a value of zero).
- ***nonceTPM*** – set from the RNG and is sized according to the size of *nonceCaller* in TPM2\_StartAuthSession(). This value does not change during the policy evaluation. However, it does change when the policy session is used for authorization.
- ***cpHash*** – set by an assertion that limits the authorization to a specific set of command parameters. If an assertion would set *policySession→cpHash* and a previous assertion has set *policySession→cpHash* to a different value, then the assertion will fail. The default for *policySession→cpHash* is an Empty Buffer.
- ***nameHash*** – set by TPM2\_PolicyNameHash() and indicates the combination of Name values for a command. This context parameter occupies the same location as *policySession→cpHash*. If an assertion would set *policySession→cpHash* and a previous assertion has set *cpHash* to a different value, then the assertion will fail. The default for *policySession→nameHash* is an Empty Buffer.

- **startTime** – set to `TPMS_TIME_INFO.clockInfo.clock` when `policySession→nonceTPM` changes. No assertion changes this value. It is updated to the current value of `clock` by `TPM2_StartAuthSession()` and when the session is used for authorization.
- **timeout** – the time when the policy session expires. Its default setting is an implementation-specific value corresponding to “never expires.” This value is updated if an assertion has a non-zero expiration time that is sooner than the current setting of `policySession→timeOut`. An assertion may only decrease the value of `policySession→timeout`.
- **commandCode** – set by an assertion that limits the policy to a specific command but does not limit the command parameters (`TPM2_PolicyCpHash()` limits the command and its parameters). If an assertion sets `policySession→commandCode` and a previous assertion has set `policySession→commandCode` to a different value, then the TPM will return an error. The default for `policySession→commandCode` is an implementation-specific value that indicates that it has not been set.
- **pcrUpdateCounter** – set by `TPM2_PolicyPCR()`. The TPM maintains a `pcrUpdateCounter` that is incremented each time a PCR changes (with a few exceptions as described in 17.9). When it executes `TPM2_PolicyPCR()`, the TPM will copy `pcrUpdateCounter` to `policySession→pcrUpdateCounter`. When the policy session is used for authorization, the TPM will verify that `policySession→pcrUpdateCounter` matches `pcrUpdateCounter`. A match provides assurance that the PCR values still match the values evaluated by `TPM2_PolicyPCR()`.
- **commandLocality** – indicates the locality required for the command being authorized by the policy. The default for `policySession→commandLocality` is any locality. Each locality that is not enabled in `TPM2_PolicyLocality(locality)` is disabled in `policySession→commandLocality`. If the result of this operation would result in there being no locality at which the policy would be valid, the TPM will return an error and not change `policySession→commandLocality`. If `commandLocality` is set to an extended locality (greater than 31), then the locality cannot be change by subsequent `TPM2_PolicyLocality()`.
- **isPPRequired** – SET by `TPM2_PolicyPhysicalPresence()` to indicate that presence is required to be asserted when authorized command is executed. The default value is CLEAR.
- **isAuthValueNeeded** – SET by `TPM2_PolicyAuthValue()` to indicate that the `authValue` of the authorized entity will need to be provided when the policy session is used for authorization. The `authValue` is required to be included in an HMAC. The default value is CLEAR. It will also be CLEAR by `TPM2_PolicyPassword()`
- **isPasswordNeeded** – SET by `TPM2_PolicyPassword()` to indicate that the `authValue` of the authorized entity will need to be provided when the policy session is used for authorization. The `authValue` is required to be provided as a password. The default value is CLEAR. It will also be CLEAR by `TPM2_PolicyAuthValue()`.
- **isTrialPolicy** – SET to indicate that `policySession→policyDigest` is to be updated even if the assertion is not valid. The session may not be used for authorization.
- **checkNvWritten** – SET to indicate that the `TPMA_NV_WRITTEN` attribute of the authorized NV Index must be compared with `nvWrittenState`.
- **nvWrittenState** – SET when `TPMA_NV_WRITTEN` is required to be SET in the NV Index being authorized. This attribute has no meaning when **checkNvWritten** is not SET.

### 19.7.9 Policy Example

In TPM 1.2, the basic policy for use of a key was limited to a combination of an authorization value and PCR state. This policy was built in to each key. In TPM 2.0 there is no built-in policy. A TPM 2.0 policy that is the same as the TPM 1.2 policy is:

```
TPM2_PolicyPCR() & TPM2_PolicyAuthValue()
```

Note This policy could also be written as

```
TPM2_PolicyAuthValue() & TPM2_PolicyPCR()
```

This policy would have a different *policyDigest* because the order of evaluation affects the digest.

To associate this policy with a key, evaluate the policy to determine the *policyDigest* that it would generate. Then create the key with this digest as the *authPolicy* and CLEAR the *userWithAuth* attribute. When *userWithAuth* is CLEAR, USER mode actions for the key will require use of the key's *authPolicy*.

### 19.7.10 Trial Policy

The policy evaluation to determine the value for the *authPolicy* may be done in software that does the same *policyDigest* computation as the TPM. Alternatively, a trial policy session may be used. A trial policy session is created and used in a sequence of policy commands just like a normal policy session. The difference is, in a trial policy, a policy assertion is always assumed to be TRUE and the *policyDigest* updated accordingly. The *policyDigest* value computed in the trial policy can be read from the TPM and used as an object's *authPolicy*. Since the assertions in the trial policy do not need to be valid, the trial session may not be used for authorization.

### 19.7.11 Modification of Policies

Some policies, such as those associated with the hierarchies, may be altered directly by changing the *authPolicy* value. Policies associated with Objects and NV Indices may not be directly altered. The reason that these policies may not be altered is that the policy can affect the trust that someone places in the use of that entity. For example, a key may only be trusted if it may only be used when the PCR have a specific set of values. If the policy could be changed, then the PCR check could be removed and the key would no longer be trusted. There would be no way for the trusting entity to know if a version of the key exists where the PCR are not checked.

Even though there is no way to directly change a policy, it can be indirectly changed. The command that allows this is TPM2\_PolicyAuthorize(). When this command is included in a policy, it allows a designated entity (an "authority") to authorize a *policyDigest* to be included in the policy. This is best described with an example.

It is common to seal a data value to PCR values so that the data value can only be recovered if the platform has booted in a known way. A problem with this is that if there is a BIOS update, the PCR will change and the sealed data value can no longer be retrieved and some kind of recovery process is necessary. The inability of a policy to accommodate changes to PCR values is called "brittleness". That term suggests that the policy is easy to break (make unusable). This brittleness could be a problem with TPM 2.0 if the policy was completely fixed.

Figure 16 illustrates the use of TPM2\_PolicyAuthorize() to implement a flexible policy. This assertion evaluation checks to see if the current *policyDigest* is authorized by a signing key – that is, did an authorizing entity sign a digest indicating that a specific value of *policyDigest* represents a known set of PCR values. If the *policyDigest* value was signed, then *policyDigest* is replaced by a digest of the Name of the key that was used for authorization and *policyRef* (see 19.7.12).

NOTE 1 Other information is included with the Name of the key when the new *policyDigest* is computed in order to indicate that the Name was included as the result of a TPM2\_PolicyAuthorize() operation.

NOTE 2 This example purposefully avoids using terms that would indicate that the signing entity does anything other than indicate that the PCR values are the expected values. In particular, the signing entity does not have to certify that the PCR values are safe. The signing entity may provide other assurances but, in the case of PCR, it is not necessary to warrant anything other than that the PCR values are expected.

An example of how of this assertion type may be used to avoid PCR brittleness is shown in Figure 16. This shows the example policy in 19.7.9 but with the ability to satisfy the policy with different PCR values.

NOTE 3 The actual *authPolicy* in the authorized entity would contain (PolicyAuthorize & PolicyAuthValue).

As shown, a PolicyPCR assertion is followed by PolicyAuthorize(). If there is an authorization signed by KEY for the current *policyDigest* (in this case,  $D_{PCR.A}$ ), then the result of the PolicyAuthorize() will be  $D_{KEY}$ . This is the same output that would be produced if the input to the PolicyAuthorize() were  $D_{PCR.B}$  and there was an authorization signed by KEY for  $D_{PCR.B}$ . That is, in TPM2\_PolicyAuthorize(), if the key authorized the current *policyDigest*, *policyDigest* reset to a Zero Digest and then extended with the Name of the key. The *policyDigest* value  $D_{final}$  no longer reflects the previous value ( $D_{PCR.A}$  or  $D_{PCR.B}$ ).

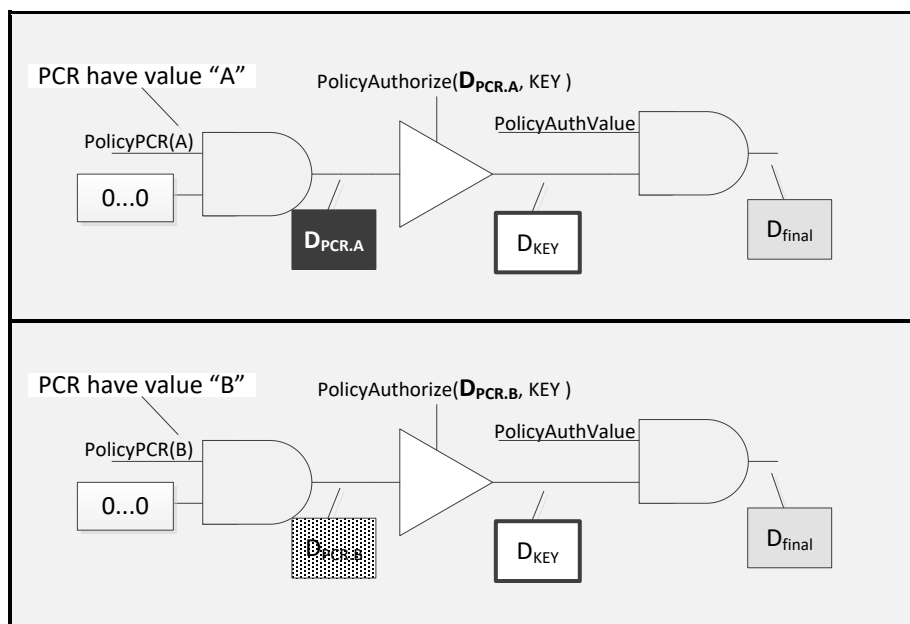


Figure 16 — Use of TPM2\_PolicyAuthorize() to Avoid PCR Brittleness

In the case of a BIOS update that changes PCR, the platform OEM could provide a signature for the PCR values created by the new BIOS. Now, if the policy of the sealed data includes a TPM2\_PolicyAuthorize() from the OEM, then the BIOS can be updated and no recovery process would be needed to deal with the new PCR values. That is, with either authorized set of PCR,  $D_{KEY}$  and  $D_{final}$  will be the same, even though  $D_{PCR.A}$  and  $D_{PCR.B}$  are different.

An additional way to indirectly modify a policy uses TPM2\_PolicyAuthorizeNV(). This command specifies an NV Index location of a policy that will be effective for an entity, the effective policy being policy digest stored in the data at that NV index. When a policy is formed using TPM2\_PolicyAuthorizeNV(), the NV Index Name is specified. When the entity is to be authorized, the policy stored in the data of the named index is satisfied, and then TPM2\_PolicyAuthorizeNV() is executed. If the policy stored in that index matches the *policySession->policyDigest*, then the *policySession->policyDigest* is replaced with results of first setting the *policySession->policyDigest* to the Zero Digest, and then extending it with the command code concatenated with the name of the NV index, which will contain the modified policy. The main

difference between this command and TPM2\_PolicyAuthorize() is that multiple policies can be used to satisfy TPM2\_PolicyAuthorize(), as long as they are all signed with the appropriate key. Only the policy that is currently stored in the NV index can satisfy TPM2\_PolicyAuthorizeNV().

### 19.7.12 TPM2\_PolicySigned(), TPM2\_PolicySecret(), and TPM2\_PolicyTicket()

The set of assertions discussed in this clause have properties that enable a number of authorization scenarios. Among these are:

- the ability to grant an authorization that can persist for a specific amount of time (because in many protocols, access to a resource (such as, a network) is granted for some time interval); and
- the ability to associate an authorization with a policy of the authorizing entity (because in many instances, the authorizing entity may use the same key or secret for different purposes).

TPM2\_PolicySigned() and TPM2\_PolicySecret() convey an authorization by signing a set of parameters that indicate the nature of the authorization. With TPM2\_PolicySigned() the signature is with a key value (symmetric or asymmetric) and with TPM2\_PolicySecret() the signature is with an HMAC using an *authValue* in the HMAC key.

The policy assertions of TPM2\_PolicySigned() and TPM2\_PolicySecret() can be time limited. When a policy's authorization is time limited, it expires (is no longer valid) when TPM *Time* is greater than the indicated value for the authorization. An expiration time can be expressed in two ways. A *timeout* is an absolute value of *Time*. An *expiration* value is a relative value in seconds from the start *Time* of the policy session to which the authorization applies.

Both TPM2\_PolicySigned() and TPM2\_PolicySecret() can produce tickets that enable authorizations to be used and reused over a period of time and in different policy sessions. These tickets are used in TPM2\_PolicyTicket().

These three commands have several input parameters in common:

- **nonceTPM** – the value returned by TPM2\_StartAuthSession() or when a session is used for an authorization. It is used to limit the use of a policy assertion to a specific policy session. If a policy command includes a *nonceTPM*, then the TPM will return an error if it does not match *policySession*→*nonceTPM*.
- **cpHashA** – if the caller chooses to limit the authorization to a specific command and command parameters, they would include this value in the signed data structure. Use of this parameter allows the caller to provide an authorization that is similar to the HMAC authorization. That type of authorization is only valid for a specific command and set of command parameters. If this parameter is not part of the signed authorization, then this parameter should be set to the Empty Buffer.
- **policyRef** – in some circumstances, it is desirable to have an authorization convey some information relating to the authorizing entity. For example, a fingerprint reader may have a signing key that it uses to verify when it has recognized a fingerprint regardless of whose fingerprint it might be. This type of authorization would be difficult to use if it were not possible to indicate whose fingerprint was scanned. The *policyRef* parameter would allow the fingerprint reader to provide this indication. The TPM includes this value in the *policyDigest*. In the example of the fingerprint reader, this would mean that the *policyDigest* would only have the correct value if the fingerprint reader scanned a finger from the correct person. If this parameter is not part of the signed authorization, then this parameter should be an Empty Buffer.
- **expiration** this parameter is used to place a time limit on an authorization. It is either the number of seconds from the last time that the *nonceTPM* of a policy session was changed, or the value of *Time* after which a policy assertion is no longer valid.
- **timeout** – this indicates the value of *Time* after which a policy assertion is no longer valid.



If a TPM2\_PolicySigned() or TPM2\_PolicySecret() has a non-zero *expiration* parameter:

- If *nonceTPM* is not included, *expiration* is a *timeout*.
- If *expiration* is a negative number, a ticket will be produced

NOTE For TPM2\_PolicySecret(), if *authHandle* references a PIN Pass Index, then no ticket will be produced even if *expiration* is negative. This prevents use of a ticket to bypass the limit count on an PIN Pass Index.

When a policy session is started, a *nonceTPM* is generated and the current value of *Time* is copied to *policySession*→*startTime*. When a policy assertion includes a non-zero *expiration* and a *nonceTPM*, then *policySession*→*startTime* is added to the absolute value of *expiration* to determine the *timeout* for the policy assertion. If a policy assertion includes a non-zero value in its *expiration* parameter but no *nonceTPM*, then the *expiration* parameter is used directly as a *timeout*

When an assertion produces a *timeout*, the *timeout* value is placed in *policySession*→*timeout*. If *policySession*→*timeout* has previously been set, then it will be updated with the lesser of *timeout* and *policySession*→*timeout*.

When *Time* has a greater value than *policySession*→*timeout*, the policy session expires and cannot be used for authorization. If the authorization used a *timeout* (no *nonceTPM*), then the authorization will also expire on the next TPM Reset.

NOTE 1 A policy assertion includes an *expiration* when the *expiration* parameter is non-zero. A policy assertion includes a *nonceTPM* when its *nonceTPM* parameter is not the Empty Buffer.

NOTE 2 *expiration* may need to be converted to milliseconds before being added to *policySession*→*startTime*.

NOTE 3 When an *expiration* parameter is used directly as a *timeout*, *expiration* is the value of *Time* in seconds when the assertion expires. When an assertion contains a *timeout* parameter (only in TPM2\_PolicyTicket()), *timeout* is an implementation-dependent value.

A ticket contains a digest of the command parameters of the assertion along with a ticket *timeout*. As long as a ticket has not expired, its effect on a *policySession*→*policyDigest* and *policySession*→*timeout* will be the same as the TPM2\_PolicySigned() or TPM2\_PolicySecret() command that generated the ticket. For example, one may use a TPM2\_PolicySigned() command with an expiration of -3600 (the negative of the number of seconds in an hour) to return a ticket. For the next hour, that ticket can be used with TPM2\_PolicyTicket() to grant whatever other permissions were approved by the TPM2\_PolicySigned() command.

When the TPM is not able to report the passage of time (*Time* does not advance), accurate timing of assertions is not possible. To prevent having a timed assertion persist past the intended timeout, a TPM is required to invalidate any time based assertion that was created before a discontinuity in the TPM's measurement of time. Such a discontinuity can occur when *Time* does not advance or when *Time* is reset. This requirement is met by having a number (a counter or a nonce) that changes each time that there is a time discontinuity (an epoch) and by including *timeEpoch* in the computation of time-based assertions. This implies that each policy session will need to:

- record *timeEpoch* when the session is created (in *policySession*→*timeEpoch*);
- validate that the *timeEpoch* associated with a time-limited assertion is the same as *policySession*→*timeEpoch* before the assertion is accepted; and
- when a time-limited policy is used for authorization, verify that the current TPM *timeEpoch* matches *policySession*→*timeEpoch*.

If a counter is used for *timeEpoch*, it needs to be saved in NV memory whenever it changes. If the number used for *timeEpoch* is a nonce, it can be kept in RAM and changed on each time discontinuity.

NOTE 4 A *timeEpoch* nonce needs to be large enough that a replay is infeasible. That is, a ticket issued with a given nonce should not be useable after a future power cycle because the nonce values happens to match. In the context of a specific ticket, a nonce collision is not a “birthday problem” as the nonce has to match exactly rather than being one of a group of values that are equivalent.

### 19.7.13 Use of TPM for authPolicy Computation

To use a policy for authorization for an object or NV Index, the creator of an object or NV Index is required to know, at the time of creation of the Object or NV Index, the digest of the policy. The computation of this policy requires duplication of the steps that would be performed by the TPM when it evaluates the policy and updates the accumulated *policyDigest* of the session.

This computation can be done by software but would require that the policy update process for each command be replicated by software. As an alternative, the TPM can be used to perform the computation.

To use the TPM, a policy session is created and various policy commands are sent to the TPM as if the policy were being evaluated in order to authorize an action. TPM2\_PolicyGetDigest() may then be used to read the final *policyDigest* from the TPM. That *policyDigest* value may then be used as the *authPolicy* parameter in a new Object/NV Index.

NOTE There is no requirement that the *authPolicy* for each Object or NV Index be unique.

If the policy is complex and uses TPM2\_PolicyOR(), it will be necessary to compute multiple *policyDigest* values. The same policy session can be used for all of the computations by using TPM2\_PolicyRestart() after the *policyDigest* for a branch is computed. When the last branch is computed, it may be used in a TPM2\_PolicyOR that is constructed from the previously computed values.

TPM2\_PolicyGetDigest() could also be used to help validate the software that is implementing the digest computation. The value computed by the TPM can be compared to the value computed by the software library to insure that they are the same. If desired, TPM2\_PolicyGetDigest() can be called after each policy command.

### 19.7.14 Trial Policy Session

If a policy requires a signed (symmetric or asymmetric) authorization for an action, that authorization may not be available at the time that the Object/NV Index is created and, in fact, the authorizing entity might not be willing or able to provide the necessary authorization at the time of creation.

EXAMPLE 1 If the Object is to have a duplication authorization, the duplication authority may not provide the authorization for the duplication when the Object is created. If they did, then the migration policy could be computed; the *policyDigest* of the session read and placed in a new Object, and immediately used for duplication of the Object. The duplication authority may not want to allow the duplication at that time.

The TPM provides a special type of policy session to be used for the purpose of computing the policy without enabling the use of the policy. When a session is created by TPM2\_StartAuthSession(*policyType* = TPM\_SE\_TRIAL), a policy session is created that cannot be used for authorization. Since it cannot be used for authorization, authorizations are not needed in the computation of the policy.

EXAMPLE 2 If TPM2\_PolicySigned() is called to update the digest of a trial policy session, the signature is not validated but the *policyDigest* is updated as if a correct signature was provided.

### 19.7.15 Use of TPM2\_PolicySigned() and TPM2\_PolicySecret() without *nonceTPM*

The primary purpose of including *nonceTPM* in TPM2\_PolicySigned() and TPM2\_PolicySecret() is to restrict the use of the policy assertion to a specific policy session so that the assertion may only be used once. *nonceTPM* serves a different purpose when the assertion is structured so

that a ticket is produced. In that case, the intent is that the assertion can apply to more than one policy session, so *nonceTPM* serves a different purpose – to associate the assertion with a specific TPM.

Each *nonceTPM* is expected to be statistically unique and not appear on any other TPM (this is just expected to be true and not required to be true). Therefore, when an assertion includes *nonceTPM*, the assertion will only be usable on one policy session on a specific TPM.

NOTE When a ticket is produced, that ticket is always restricted to use on a specific TPM because of the use of TPM- and hierarchy-specific proof values in the ticket computation.

When the policy assertion does not include *nonceTPM*, then is it possible to use the assertion with any policy session. For TPM2\_PolicySecret() the assertion may still be associated with a specific TPM if the authorization for the *authObject* uses an HMAC or policy session. This is because that authorization session will be TPM specific. For TPM2\_PolicySigned(), when there is no *nonceTPM* in the assertion, then the assertion may be used on any policy session on any TPM where the public part of *authObject* may be loaded (that is, any TPM that is compatible with this specification). This may be suitable when an assertion is limited to performing specific actions (through *cpHash*) or specific policies (though *policyRef*), but this capability should be used with caution.

## 19.8 Dictionary Attack Protection

### 19.8.1 Introduction

The TPM incorporates mechanisms that provide protection against guessing or exhaustive searches of authorization values stored within the TPM.

The dictionary attack (DA) protection logic is triggered when the rate of authorization failures is too high. If this occurs, the TPM enters Lockout mode in which the TPM will return TPM\_RC\_LOCKOUT for an operation that requires use of a DA protected *authValue*. Depending on the settings of the configurable parameters described below, the TPM can “self-heal” after a specified amount of time or be programmatically reset using proof of knowledge of an authorization value or satisfaction of a policy

The *authValue* for an object receives DA protection unless the object's *noDA* attribute is SET. The *authValue* for an NV Index receives DA protection unless the TPMA\_NV\_NO\_DA attribute of the Index is SET. The *authValue* associated with a permanent entity, other than TPM\_RH\_LOCKOUT, does not receive DA protection. Sequence objects created by TPM2\_HMAC\_Start() and TPM2\_HashSequenceStart() do not receive DA protection.

NOTE 1 Authorization values associated with permanent entities, other than TPM\_RH\_LOCKOUT, are expected to be high-entropy values that are managed by a computer or will be well-known values. In either case, they will not need DA protection. While it is safer when *lockoutAuth* is a high-entropy value, it is possible that *lockoutAuth* will be a value chosen to be remembered by a human which will likely have less entropy than other permanent entities. As a consequence, *lockoutAuth* is DA protected even though it is a permanent entity.

The reason for being able to exclude entities from DA protection is that lockout of all TPM use could make the system unstable. The OS may have uses for the TPM that should not be blocked due to authorization problems with keys associated with user-mode applications. The OS is expected to use a well-known or high-entropy *authValue* for any entities that it manages and an *authValue* of neither type needs DA-protection.

An *authValue* may be used for authorization in three ways:

- 1) a password;

- 2) the *authValue* parameter in the HMAC computation of equation (18); or
- 3) the *authValue* parameter in the computation of *sessionKey* for a bound session as shown in equation (19).

All uses of a DA protected *authValue* receive DA protection.

NOTE 2 A TPM PIN Index provides a type of DA protection for an individual TPM entity. This is described in 37.2.8.

### 19.8.2 Lockout Mode Configuration Parameters

The TPM uses four, 32-bit, non-volatile state variables to control the initiation and recovery from the DA-lockout mode.

NOTE The "NV" notation indicates that these values are required to be held in persistent memory and be updated in NV when they change

a) ***failedTries*** (NV) – This counter is incremented when the TPM returns TPM\_RC\_AUTH\_FAIL. TPM2\_Clear() will reset this counter to zero. This counter is also set to zero on a successful invocation of TPM2\_DictionaryAttackLockReset(). This counter is decremented by one after *recoveryTime* seconds if:

- 1) the TPM does not record an authorization failure of a DA-protected entity,
- 2) there is no power interruption, and
- 3) *failedTries* is not zero.

NOTE If the TPM has a trusted source of time that runs when TPM power is lost, then *failedTries* may be reduced when power is restored. The amount that *failedTries* is decremented would be dependent on the duration of the power loss and the value of *recoveryTime*.

b) ***maxTries*** (NV) – The TPM is in Lockout mode as long as *failedTries* equals this value. When a new owner is installed, *maxTries* is set to its default value as specified in the relevant platform-specific specification.

c) ***recoveryTime*** (NV) – This value indicates, in seconds, the rate at which *failedTries* is decremented. This can be set to a large value ( $2^{32} - 1$ ) which essentially inhibits automatic exit from Lockout mode. When a new owner is installed, this value is set to its default value as specified in the relevant platform-specific specification.

d) ***lockoutRecovery*** (NV) – This value indicates the delay in seconds between attempts to use *lockoutAuth*. The time delay only applies after an authorization failure using *lockoutAuth*. A value of zero indicates that a system reboot (TPM2\_Startup(TPM\_SU\_CLEAR)) is required between lockout attempts.

The parameters *maxTries*, *recoveryTime*, and *lockoutRecovery* are set with TPM2\_DictionaryAttackParameters(). This command requires Lockout Authorization.

### 19.8.3 Lockout Mode

The TPM is in Lockout mode while *failedTries* is equal to *maxTries*. While in Lockout mode, any use of a DA-protected *authValue* will return TPM\_RC\_LOCKOUT.

NOTE 1 An exception is that TPM2\_DictionaryAttackLockReset() is allowed to execute even though *lockoutAuth* is DA protected.

NOTE 2 If there is an authorization failure that does not increment *failedTries*, the TPM returns TPM\_RC\_BAD\_AUTH

An authorization failure may occur with a password or an HMAC. For a policy authorization, the policy is validated before the HMAC is computed. If the policy fails, the TPM returns TPM\_RC\_POLICY to indicate that dictionary attack protection was not involved.

NOTE 3 A policy authorization does not always have an associated HMAC.

#### 19.8.4 Recovering from Lockout Mode

The TPM can recover from Lockout mode in three ways.

- 1) TPM2\_DictionaryAttackLockReset() sets *failedTries* to zero. This command requires Lockout Authorization. The TPM does not have to be in Lockout mode in order to use this command.
- 2) The TPM decrements *failedTries* by one if no TPM resets are recorded during *recoveryTime*.

NOTE 1 If the TPM is in Lockout mode, then the TPM will always leave Lockout mode when *failedTries* decrements because *failedTries* will no longer be equal to *maxTries*.

NOTE 2 The failure count is not decremented below zero.

- 3) *failedTries* is set to zero if the owner changes.

Configuration and programmatic recovery of the dictionary attack logic requires proof of knowledge of Lockout Authorization. When the TPM owner is changed by changing the SPS, *lockoutAuth* is set to the EmptyAuth and *lockoutPolicy* is set to the Empty Buffer

TPM2\_DictionaryAttackLockReset() allows external software to reset the dictionary attack protection logic by providing Lockout Authorization. This command can be used when the TPM is in Lockout mode.

#### 19.8.5 Authorization Failures Involving *lockoutAuth*

When *lockoutAuth* is used in an authorization and that authorization fails, the TPM enters a lockout state intended to provide special protection for the *lockoutAuth* value. An authorization failure associated with *lockoutAuth* causes the TPM to enter this special lockout state regardless of the setting of *failedTries* and *maxTries*.

When in this special lockout state, the TPM will not allow use of *lockoutAuth*. The TPM will exit this state when TPM2\_DictionaryAttackLockReset() is used with a successful *lockoutPolicy* or after the TPM is powered for a configurable time period (*lockoutRecovery*). If *lockoutRecovery* is set to zero, then the TPM will not exit this state until the next TPM2\_Startup() or until *lockoutPolicy* is used.

NOTE The design depends upon the trusted computing base to filter commands to the TPM such as TPM2\_DictionaryAttackLockReset(). This prevents a rogue application from completing a denial of service attack on the TPM by intentionally sending the command with a bad *lockoutAuth*.

#### 19.8.6 Non-orderly Shutdown

A TPM may be implemented such that the command execution unit does not always have access to NV memory (see 37.7.2). For such an implementation, it may not be possible to increment the NV copy of *failedTries* when the authorization failure occurs. When the failure occurs, the TPM will return TPM\_RC\_AUTH\_FAIL and, until the NV version of *failedTries* is updated, the TPM will be in lockout.

It is possible that the TPM will be reset when a write to the NV version of *failedTries* is pending. If the TPM did not handle this special case, then an attacker could try an authorization for a DA protected object when NV writes are not possible. When the TPM restarted, the failed attempt would not be recorded and the attacker could try again.

To prevent this type of attack, at `TPM2_Startup()`, the TPM checks if it is starting after an orderly shutdown. If not, and *failedTries* is not already equal to *maxTries*, then the TPM will increment *failedTries* by one.

NOTE This check and increment of *failedTries* may not necessary if it is impractical for an attacker to prevent update of the NV version of *failedTries*.

### 19.8.7 Justification for Lockout Due to Session Binding

When a bound session is created, the caller does not have to prove knowledge of the *authValue* of the bind object. The *authValue* is used in the creation of the *sessionKey* and if the caller does not know the *authValue*, they will not be able to compute the correct *sessionKey* and use the authorization session.

A bound authorization session may be used to authorize actions on another object. If that object does not have DA protection, then an attacker could use binding to circumvent DA protection on the bind object.

The attack is as follows:

- a) An attacker creates an object (D) that has no DA protection and *authValue* known to the attacker.
- b) An attacker guesses a possible *authValue* for a DA protected object (object A).
- c) The attacker uses object A as the *bind* object in `TPM2_StartAuthSession()` to create a session (S).
- d) The attacker uses session S to authorize an action on object D.
- e) If the authorization fails, the attacker goes to step b) and tries a new value.

By retaining the DA state of object A in the session state, the attack is prevented. When the session is used for authorization, the authorization failure counter (*failedTries*) is incremented if either the entity being authorized is subject to DA protection or if the session is bound to an entity that has DA protection.

NOTE If a session is bound to a permanent entity other than `TPM_RH_LOCKOUT`, then the session is not bound to an entity that has DA protection.

### 19.8.8 Sample Configurations for Lockout Parameters

#### 19.8.8.1 Introduction

Two common configurations are anticipated: one for enterprise-managed TPMs, and one for home users.

NOTE It is anticipated that the operating system will layer additional anti-hammering protection atop that provided by the TPM so that it is unlikely that one OS user will be able to interfere with the actions of another user or the trusted computing base (TCB).

#### 19.8.8.2 Enterprise Use

In this use, it is expected that the TPM owner will set the *lockoutAuth* to a high-entropy value that is held in a database and set the *lockoutRecovery* to a small, non-zero value, such as one. The enterprise will use this value to recover the TPM when suitable non-automated validation procedures have been performed.

The enterprise would likely set *maxTries* to a relatively low value (such as, 10).

For a server or data center, the *recoveryTime* would be set to a large value (such as,  $2^{32} - 1$ ) implying manual recovery. For laptops, a setting of a few hours would provide adequate protection for PINs.

### 19.8.8.3 Home or Unmanaged Use

In this application, the *lockoutAuth* may be set to a random, high-entropy value that is then erased so that programmatic lockout recovery is not possible. *maxTries* and *recoveryTime* can be set to balance security and convenience.

NOTE            If this configuration is used, the only way to execute `TPM2_Clear()` to change the owner is to use Platform Authorization.

## 20 Audit Session

### 20.1 Introduction

An audit session allows for the auditing of a selected sequence of commands so that evidence may be provided that the commands were executed.

Any HMAC authorization session may be designated for auditing but only one session may be used for audit in each command. A session is designated for auditing by setting the *audit* attribute in the session.

When a session is first used as an audit session, the TPM will initialize the audit hash for the audit session. The initialization value is a Zero Digest with the number of octets determined by the hash algorithm of the session.

If the session was bound when created (see 19.6.10 and 19.6.12), the bind value is lost and any further use of the session for authorization will require that the *authValue* be used in the HMAC.

Since the first use of an audit session may cause the size of the session context to change, the command may fail due to insufficient memory. TPM-management software may save other session contexts and retry the command.

NOTE 1            The TPM is required to have sufficient memory to allow three sessions to be simultaneously loaded, one of which may be an audit session.

For all commands using a session tagged as audit (including the initial use), if the command completes successfully, the *cpHash* and the *rpHash* are Extended to the audit session digest. When a command fails, the audit session digest is not changed and, as is normal in the case of a command failure, the sessions are not included in the response and session nonces are not updated.

The equation for updating the audit session digest is:

$$auditDigest_{new} := H_{auditAlg}(auditDigest_{old} || cpHash || rpHash) \quad (31)$$

The hash algorithm is the algorithm designated in TPM2\_StartAuthSession().

Unless a command description indicates that no sessions are allowed, an audit session may be used with any command. A command may have only one audit session.

An audit session uses the same session format as other HMAC-based sessions. The method of computing the HMAC differs in that, if the audit session is not associated with any object handle, no *authValue* is available for use in the authorization HMAC. All HMAC computations for an audit session will set *authValue* to an Empty Buffer.

NOTE 2            If the *sessionKey* is also an Empty Buffer, then no HMAC computation is performed and the *hmac* parameter of the session structure will be an Empty Buffer.

If an unbound and unsalted session is used as the basis for the audit session, then there is no assurance from the audit session that the commands being audited are actually associated with a TPM. On the other hand, a bound session allows association with a known *authValue* in a TPM, which can provide assurance that the commands being audited are actually associated with a specific TPM. However, if others know the *authValue*, then the unsalted audit session may have the same association issue as the unbound session. A salted session can be associated with a key that is known to be TPM-resident so the audit based on a salted session can be reliably associated with a specific TPM.



## 20.2 Exclusive Audit Sessions

An exclusive audit session permits the TPM to prove that a series of commands were executed with no intervening commands that were not audited by the exclusive audit session.

In a response, the *auditExclusive* attribute of an audit session will indicate if the TPM has executed any commands that were not audited by the session. If there was another user of the TPM, the *auditExclusive* attribute will be CLEAR. If not, the audit session is exclusive and the *auditExclusive* attribute will be SET.

The TPM keeps track of the current exclusive session. At most, one active session may have the *auditExclusive* status. A session becomes the current exclusive audit session when it is first used as an audit session, regardless of the setting of *auditReset*. It may also become the current exclusive audit session if the *auditReset* attribute of the session is SET in the command. In the response, the *auditExclusive* attribute of the session will be SET and the session is exclusive. The session is no longer the current exclusive audit session if it is flushed (TPM2\_FlushContext()) or if an auditable command is executed that does not use the current exclusive audit session.

NOTE 1 *auditReset* may only be SET if *audit* is also SET.

A command that is not allowed to have any sessions will not change the current exclusive audit session. Those commands include the context management commands (TPM2\_ContextSave(), TPM2\_ContextLoad(), and TPM2\_Flush()), TPM2\_Startup(), and TPM2\_ReadClock().

NOTE 2 It is the responsibility of the TCG Software Stack (TSS) or other controlling software to preserve the integrity of the exclusive audit session. As the purpose of the exclusive audit session is to show that no other commands were executed during the session, the expectation is that the controlling software would limit access to the TPM to prevent any other uses of the TPM.

## 20.3 Command Gating Based on Exclusivity

If the *auditExclusive* attribute of an audit session is SET in the command, then the TPM will return TPM\_RC\_EXCLUSIVE if the audit session is not the current exclusive audit session.

NOTE 1 As with other error returns, no change is made to the state of the session and it remains active.

NOTE 2 *auditExclusive* in a command only determines whether the command is executed. It does not affect the exclusive status of the session.

NOTE 3 *auditExclusive* may only be SET if *audit* is also SET.

## 20.4 Audit Session Reporting

The audit status of an audit session can be determined with TPM2\_GetSessionAuditDigest(). This command returns a signed data structure that includes the audit session digest.

Because the audit digest is signed before the audit digest is updated, the *cpHash* and *rpHash* for a TPM2\_GetSessionAuditDigest() is not included in the audit digest of the signed data structure. Possession of the audit digest is proof that the command executed. However, the *cpHash* and *rpHash* of TPM2\_GetSessionAuditDigest() will be included in subsequent audits if the audit session remains active.

TPM2\_GetSessionAuditDigest() requires that the indicated session be an audit session and will return TPM\_RC\_TYPE if it is not. The TPM does not change internal state unless the command actions complete successfully. This means that a session cannot become an audit session unless the command in which it is designated as an audit session completes successfully. From this we can conclude that a session cannot be designated as being an audit session in a TPM2\_GetSessionAuditDigest() in which the same session is the audited session.

## 20.5 Audit Establishment Failures

If a command is the first use of a session as an audit session, and the command fails, then the state of a session as an audit sessions will not change. This means that, if a session was not an audit session before the command was executed, it will not be an audit session after the command fails. If a session was an audit session before the command was executed, it will be an audit session after the command fails.

If a command fails, then the exclusive status of sessions does not change. A session that was exclusive before the command failure is exclusive after the command failure.

## 20.6 Audit Alternative

Both `TPM2_GetSessionAuditDigest()` and `TPM2_GetCommandAuditDigest()` require Endorsement Authorization. If an application does not have Endorsement Authorization, it can still obtain proof that a command was run on a particular TPM. The application must have a *fixedTPM* asymmetric encryption key that is trusted to be on the TPM. This key would have similar trust properties to the signing key that would be used with the `TPM2_Get...AuditDigest()` commands. The application uses an audit session that is a salted session with the trusted key specified as *tpmKey*. The salt forces an HMAC session. The HMAC verification is proof that the command was run on that TPM.

## 21 Session-based encryption

### 21.1 Introduction

Several commands have parameters that may need to be encrypted going to or from the TPM. An example is the authorization data that is passed to the TPM when an object is created or when the authorization value is changed. Session-based encryption may be used to ensure confidentiality of these parameters.

Not all commands support parameter encryption. If session-based encryption is allowed, only the first parameter in the parameter area of a request or response may be encrypted. That parameter must have an explicit size field. Only the data portion of the parameter is encrypted. The TPM should support session-based encryption using XOR obfuscation. Support for a block cipher using CFB mode is platform specific. These two encryption methods (XOR and CFB) do not require that the data be padded for encryption so the encrypted data size and the plain-text data size is the same.

If the symmetric algorithm is TPM\_ALG\_NULL and encryption or decryption is specified, the TPM returns TPM\_RC\_SYMMETRIC.

Any first parameter may be encrypted as long as the parameter has a size field.

Session-based encryption uses the algorithm parameters established when the session is started and values that are derived from the session-specific *sessionKey*. The encryption values are created in a way that is dependent on both the session type and the session encryption parameters.

If a session is also being used for authorization, *sessionValue* (see 21.2 and 21.3) is *sessionKey* || *authValue*. The binding of the session is ignored. If the session is not being used for authorization, *sessionValue* is *sessionKey*.

If *sessionAttributes.decrypt* is SET in a session in a command, and the first parameter of the command is a sized buffer, then that parameter is encrypted using the encryption parameters of the session. If *sessionAttributes.encrypt* is SET in a session of a command, and the first parameter of the response is a sized buffer, then the TPM will encrypt that parameter using the encryption parameters of the session. The *encrypt* attribute may only be SET in one session that is used in a command and the *decrypt* attribute may only be SET in one session per command. The attributes may be SET in different sessions or in the same session.

Parameters in commands are encrypted before any *cpHash* is computed. Parameters in responses are encrypted before any *rpHash* is computed.

The parameter data buffer is protected with either XOR obfuscation or CFB mode encryption. The size field of the parameter is not protected.

When a command/response with an encrypted parameter is received, the *cpHash/rpHash* is computed as required for the sessions before the parameter is decrypted.

NOTE           The caller may obfuscate the true size of an authorization value by adding octets of zero to the end. The extra octets of zero will have no impact on the authorization computations and may be discarded by the TPM.

The two methods of session-based encryption used in this specification are, by themselves, malleable. That is, an attacker can make a controlled change (bit reversal) in the encrypted data that will result in an identical change in the decrypted data. This kind of attack is mitigated by the HMAC authorization session verification.

## 21.2 XOR Parameter Obfuscation

For session-based obfuscation using **XOR()**, the operation is:

$$\mathbf{XOR}(\textit{parameter}, \textit{hashAlg}, \textit{sessionValue}, \textit{nonceNewer}, \textit{nonceOlder}) \quad (32)$$

where

<i>parameter</i>	a variable sized buffer containing the parameter to be obfuscated
<i>hashAlg</i>	the hash algorithm associated with the session
<i>sessionValue</i>	see 21.1
<i>nonceNewer</i>	for commands, this will be <i>nonceCaller</i> and for responses it will be <i>nonceTPM</i>
<i>nonceOlder</i>	for commands, this will be <i>nonceTPM</i> and for responses it will be <i>nonceCaller</i>

NOTE 1 The **XOR()** function is defined in 11.4.6.3.

NOTE 2 The obfuscated size of parameter is the same as the size of the underlying parameter. That is, if a TPM2B\_CREATE is obfuscated, the size of the obfuscated data is the same as the size of the data.

## 21.3 CFB Mode Parameter Encryption

When session-based encryption uses a symmetric block cipher, an encryption key and IV will be generated from:

$$\mathbf{KDFa}(\textit{hashAlg}, \textit{sessionValue}, \text{“CFB”}, \textit{nonceNewer}, \textit{nonceOlder}, \textit{bits}) \quad (33)$$

where

<i>hashAlg</i>	the hash algorithm associated with the session
<i>sessionValue</i>	see 21.1
“CFB”	label to differentiate use of <b>KDFa()</b> (see 4.2)
<i>nonceNewer</i>	<i>nonceCaller</i> for a command and <i>nonceTPM</i> for a response
<i>nonceOlder</i>	<i>nonceTPM</i> for a command and <i>nonceCaller</i> for a response
<i>bits</i>	the number of bits required for the symmetric key plus an IV

NOTE 1 The IV size is equal to the block size of the cipher.

The most significant octets of the returned value are used as the encryption key and the remaining octets are used as the IV. The number of octets used for the encryption key and for the IV is dependent on the algorithm parameters of the session.

EXAMPLE For AES, the block size is 16 octets regardless of the key size. If the key size were 256 bits (32 octets), then, in the call to **KDFa()**, *bits* would be set to 48\*8. The most significant 32 octets of the returned value would be used as the key for the encryption and the next 16 octets would be used for the IV.

NOTE 2 If the key size is not an even multiple of 8 bits, the first N octets of the returned value will contain the key and the remaining octets the IV. N is the smallest integer such that (N \* 8) ≥ the key size.

The data portion of the parameter is then encrypted using the symmetric key and the symmetric block cipher algorithm associated with the session.

## 22 Protected Storage

### 22.1 Introduction

When a Protected Object is in the TPM, it is in a Shielded Location because the only access to the context of the object is with a Protected Capability (a TPM command). The size of TPM memory may be limited and if the only storage for Protected Objects were the TPM Shielded Locations, the TPM's usefulness would be reduced. The effective memory of the TPM is expanded by using cryptographic methods for Protected Objects when they are not in Shielded Locations.

### 22.2 Object Protections

The cryptographic protections for a Protected Object include encryption to prevent disclosure of the confidential contents, and an integrity check to allow detection of modifications to the externally stored Protected Object. The integrity check detects modifications to either the confidential or the non-confidential portions of the Protected Object.

The integrity value is computed over the encrypted data. If the integrity check fails, then symmetric decryption will not occur. Since the integrity value contains the digest of the associated public area (its Name), the confidential contents of the Protected Object will not be decrypted if they are not properly paired with a public area.

### 22.3 Protection Values

The protection of a sensitive area uses two keys. These values are created from a secret value associated with an object's Storage Parent. One of the keys is used as an HMAC key and the second is a symmetric encryption key.

A seed value is used in the generation of the symmetric encryption key and the HMAC key. The source of the seed is dependent on the situation. If the protections are for an object in a hierarchy, the seed is the *seedValue* in the Storage Parent's sensitive area. If the protections are for a duplication blob, the seed is derived from a shared secret that is protected using asymmetric methods of the new parent. The algorithm-specific annexes contain the formulations for deriving the seed when asymmetric protections are used.

To produce the symmetric key, the seed value and object Name are used in **KDFa()** as shown in equation (34). This method is used when a symmetric key is generated for the protection of sensitive areas attached to a hierarchy or sensitive data in a duplication blob (see 23.3).

NOTE 1 This method is also used to generate the symmetric key used for the protection of credential values (see clause 24.4).

To produce the HMAC key, the seed is used in **KDFa()** as shown in equation (36). This method is used when an HMAC is used to protect the integrity of a sensitive area attached to a hierarchy or for sensitive data in a duplication blob.

NOTE 2 This method is also used to generate the HMAC key for credential values (see clause 24.4).

When performing symmetric encryption, an IV of zero is used unless the same symmetric key is used multiple times. The same symmetric key is used each time that the sensitive area of a child changes due to TPM2\_ObjectChangeAuth(). For encryption of a child, a random IV is generated by the TPM each time it performs the encryption.

## 22.4 Symmetric Encryption

A symmetric key is used to encrypt the sensitive area of an object that was created by TPM2\_Create() or imported by TPM2\_Import(). It is also used when re-encrypting a sensitive area when the authorization value is changed (TPM2\_ObjectChangeAuth()). The symmetric key is derived from a seed value contained in the Storage Parent's sensitive area and the Name of the protected object.

The block cipher used for encrypting the object's sensitive area is the symmetric cipher of the Storage Parent.

The symmetric key for the encryption is computed by:

$$symKey := \mathbf{KDFa}(pNameAlg, seedValue, \text{"STORAGE"}, name, \text{NULL}, bits) \quad (34)$$

where

<i>pNameAlg</i>	<i>nameAlg</i> of the object's Storage Parent
<i>seedValue</i>	symmetric seed value in the sensitive area of the object's Storage Parent (see 27.7.4)
"STORAGE"	a value used to differentiate the uses of the KDF
<i>name</i>	Name of the object being encrypted / decrypted
<i>bits</i>	number of bits required for the symmetric key

When a *symKey* is being used to protect the sensitive area of a child object, the TPM will create a random IV value (*symIv*) that is the size of an encryption block of the symmetric algorithm. This *symIV* is included in the private area and in the HMAC computation of the sensitive area. A *symIV* of zero is used when encrypting the sensitive area for duplication or a credential to be used in TPM2\_ActivateCredential().

The *symKey* and *symIv* are used to encrypt the sensitive data.

$$encSensitive := \mathbf{CFB}_{pSymAlg}(symKey, symIv, sensitive) \quad (35)$$

where

$\mathbf{CFB}_{pSymAlg}$	symmetric encryption in CFB mode using the symmetric algorithm of the Storage Parent
<i>symKey</i>	symmetric key from (34)
<i>symIv</i>	IV from RNG or 0
<i>sensitive</i>	a TPM2B_SENSITIVE containing the sensitive area structure being protected

NOTE The *size* and *buffer* fields of *sensitive* are encrypted.

After the data is encrypted, the TPM2B\_IV containing the random *symIv* is placed in front of the encrypted data in preparation for the integrity computation. If the *symIV* was zero, then no value is added to the encrypted data.

## 22.5 Integrity

The HMAC key (*HMACkey*) for the integrity is computed by:

$$HMACkey := \mathbf{KDFa}(pNameAlg, seedValue, \text{"INTEGRITY"}, \text{NULL}, \text{NULL}, bits) \quad (36)$$

where

- pNameAlg* the *nameAlg* of the object's Storage Parent
- seedValue* the symmetric seed value in the sensitive area of the object's Storage Parent (see 27.7.4)
- "INTEGRITY" a value used to differentiate the uses of the KDF
- bits* the number of bits in the digest produced by *pNameAlg*

*HMACkey* is then used in the integrity computation.

An HMAC is performed over the *symIV* and the *encSensitive* produced in (35).

NOTE 1 This is called an *outerHMAC* because it is the same HMAC process that is used when an object is duplicated. The duplication can produce an inner and an outer HMAC.

$$outerHMAC := \mathbf{HMAC}_{pNameAlg}(HMACkey, symIV || encSensitive || name.buffer) \quad (37)$$

where

- $\mathbf{HMAC}_{pNameAlg}$  the HMAC function using *nameAlg* of the object's Storage Parent
- HMACkey* a value derived from the Storage Parent's symmetric protection value (*seedValue*) according to equation (36)
- symIV* a marshaled TPM2B\_IV containing the symmetric IV value used in (35). Both the size and buffer fields are included in the HMAC
- encSensitive* encrypted TPM2B\_SENSITIVE produced in (35); after encryption, the size and buffer fields are not separable
- name.buffer* the Name of the object being protected (does not include a size field)

The integrity value is placed before the symmetric IV.

NOTE 2 Placement of the integrity value at the beginning of the sensitive area in preparation simplifies the process of finding the integrity value when the protected data contains variable-sized elements.

NOTE 3 Inclusion of the Name ensures that the sensitive area is associated with the correct public area.

<p>Marshal the sensitive area into a TPM2B_SENSITIVE</p>	<table border="1" style="margin-left: auto; margin-right: auto; border-collapse: collapse;"> <tr><td style="padding: 2px;">size</td></tr> <tr><td style="padding: 2px;">sensitiveType</td></tr> <tr><td style="padding: 2px;">authValue</td></tr> <tr><td style="padding: 2px;">seedValue</td></tr> <tr><td style="padding: 2px;">[sensitiveType]sensitive</td></tr> </table>	size	sensitiveType	authValue	seedValue	[sensitiveType]sensitive
size						
sensitiveType						
authValue						
seedValue						
[sensitiveType]sensitive						
<p>Create a symmetric key and IV for encryption:</p> $symKey := \mathbf{KDFa}(pNameAlg, seed, \text{"STORAGE"}, name, \text{NULL}, bits)$ <p><i>symIV</i> := bits from the RNG</p>						



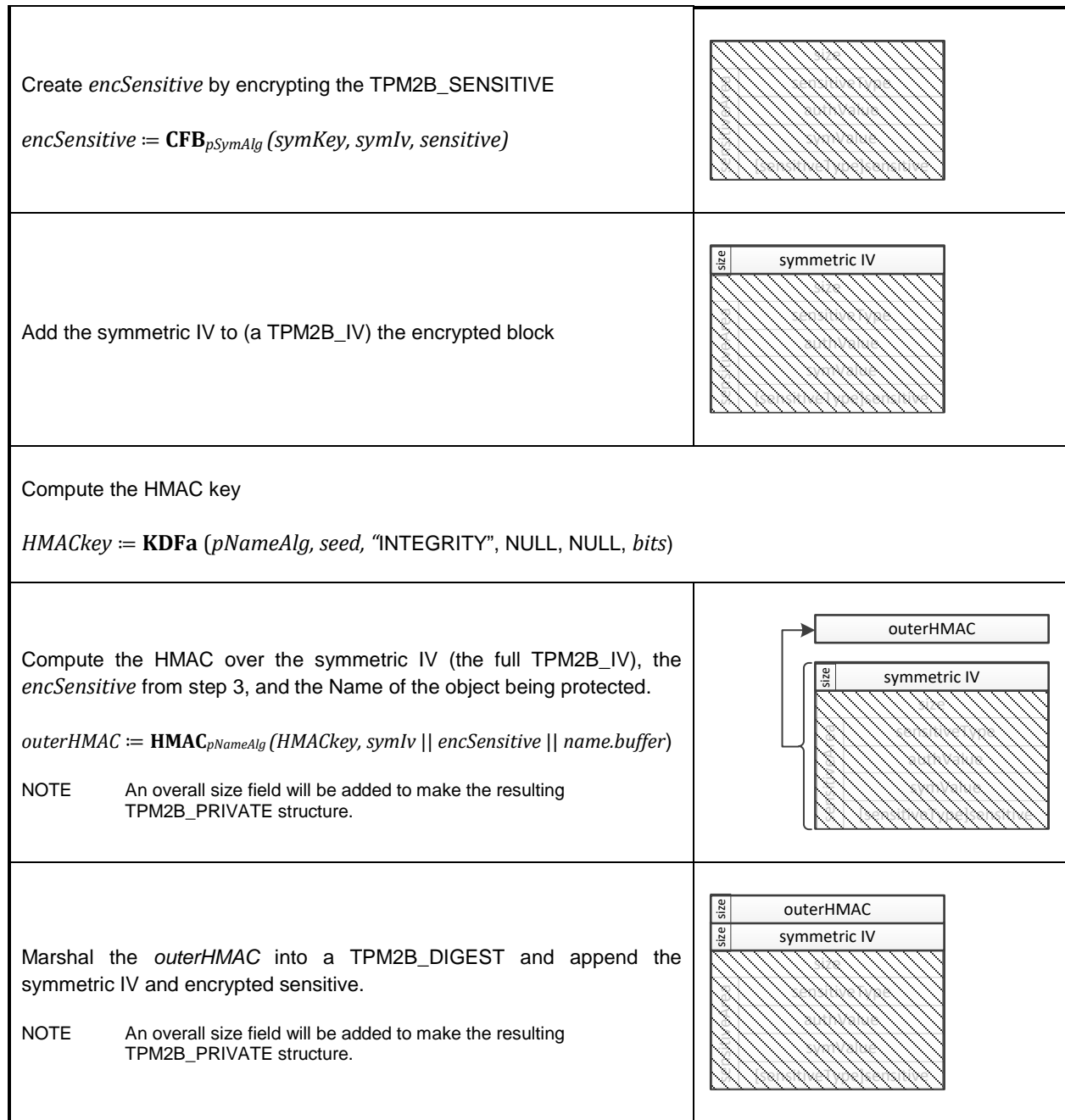


Figure 17 — Creating a Private Structure

## 23 Protected Storage Hierarchy

### 23.1 Introduction

The TPM supports the creation of hierarchies of Protected Locations. A hierarchy is constructed with Storage Keys as the connectors to which other types of objects (keys, data, and other connectors) may be attached.

The hierarchical relationship of objects allows segregation of objects based on the system-operating environment (established by PCR or authorizations) as well as simplifying the management of groups of related objects.

### 23.2 Hierarchical Relationship between Objects

A hierarchy is rooted in a secret seed key, kept in the TPM. To create a hierarchy of keys, the seed key (Primary Seed) is used to generate a key that uses a specific set of algorithms. If this key is a restricted decryption key, then it is a Parent Key. If it is not a Derivation Parent, then it is a Storage Parent under which other objects may be created or attached.

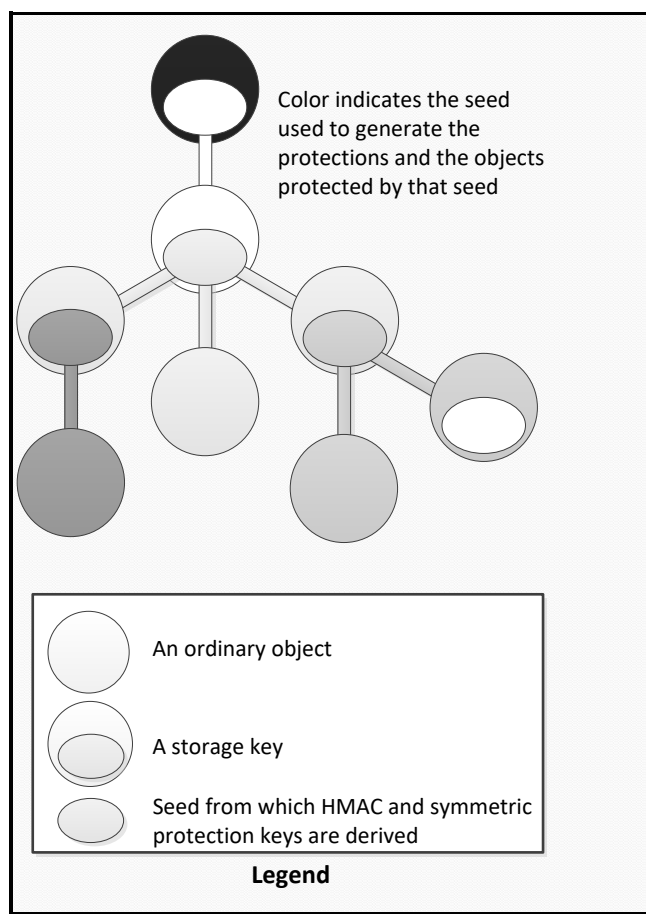
A Storage Parent provides protection for the sensitive area in another object (a child) when that object is stored outside of the TPM. Protection is provided by symmetric encryption and HMAC-based integrity protection of the sensitive area. There are two different cases for sensitive area encryption: storage and duplication.

When an Ordinary Object is created (TPM2\_Create() or TPM2\_CreateLoaded()) the keys used for protection of the Object's sensitive area are derived from a seed value (*seedValue*) in the sensitive area of the Storage Key. When an Object is prepared for duplication, its sensitive area is protected by a random key and a form of Diffie-Hellman is used to convey the key to the duplication target.

The objects in a hierarchy have a parent-child relationship. A Storage Key that is protecting other objects is a Storage Parent and the objects that it is protecting are its children. The ancestors of an object are the parent keys that connect the object to a TPM Primary Seed. Descendants of a key are all the objects that have that Parent as an ancestor. Unless it is intended to be used as a parent, a child object may be of any type.

A Derived Object is a child of its Derivation Parent. Both Primary Objects and Derived Objects are derived from seed values. For a Primary Object, the seed value is a Primary Seed and for a Derivation Object the seed value is the secret seed value in the Derivation Parent.

The sensitive part of an object created from a seed is not stored off of the TPM except in a context blobs (see section 30). This means that the seed used to create the Object is not also used to generate protection keys for the Object. When an Object is duplicated, its sensitive area is protected by a random key so the creation seed is not put at risk by the duplication process (see 23.3).



**Figure 18 — Symmetric Protection of Hierarchy**

There are two classes of Storage Keys: asymmetric and symmetric. All Storage Keys contain a symmetric protection key. An asymmetric Storage Key has a public identity that can be used as the target of an identity-based or secret-based duplication operation. An object that is a symmetric block cipher Object may also be a Storage Key, but may only be the target of secret-based duplication

## 23.3 Duplication

### 23.3.1 Definition

Duplication is the process of allowing an object to be a child of additional Storage Parent keys. The new parent (NP) may be in a hierarchy of the same TPM or of a different TPM.

The creator of an object controls the duplication process by selecting the duplication policy for the object.

Authorization for duplication requires a policy session. The policy sequence is required to have a command that causes the *commandCode* value of the policy context to be set to TPM\_CC\_Duplicate. This enables the DUP role of the policy, which is a requirement for duplication.

Duplication occurs on a loaded object and produces a new, sensitive structure that is encrypted using the methods of the NP. This new sensitive structure may not be used until TPM2\_Import() has been executed to convert the object from "external" to "internal" protections.

NOTE 1 External protections use both asymmetric and symmetric cryptography, whereas the internal protections only use symmetric cryptography.

When an Object is duplicated, its sensitive area may be protected with an outer wrapper, an inner wrapper, or both. The outer wrapper uses Diffie-Hellman based on asymmetric keys and provides identity-based duplication. The inner wrapper uses a symmetric key that is under control of the duplication authority for the Object. Duplication using an inner wrapper is secret-based duplication.

NOTE 2 The duplication authority is the entity that controls the conditions under which an Object may be duplicated.

### 23.3.2 Protections

#### 23.3.2.1 Introduction

In TPM2\_Duplicate(), the caller may specify that the object should be protected with an inner, symmetric encryption. That is, the sensitive area is symmetrically encrypted before it is asymmetrically encrypted using the methods of the NP. If a symmetric inner wrapper is desired, the caller may provide a key or allow the TPM to generate the key.

If the *encryptedDuplication* attribute is SET in the object being duplicated, then it is required that the object have an inner wrapper and that the new parent not be TPM\_RH\_NULL. For such an object, the TPM will return an error (TPM\_RC\_SYMMETRIC) if the *symmetricAlg* parameter in TPM2\_Duplicate() is TPM\_ALG\_NULL and TPM\_RC\_HIERARARCHY if the *newParentHandle* parameter is TPM\_RH\_NULL.

Creation of a duplicate object uses two encryption phases. The first is used to apply an inner wrapper and the second is to encrypt using the algorithms of the NP.

The *encryptedDuplication* attribute of all objects in a duplication group are required to have the same setting. When an object is created with the *fixedParent* attribute CLEAR, then the *encryptedDuplication* attribute may be SET or CLEAR if the *fixedTPM* attribute is SET in the Storage Parent. If the *fixedTPM* attribute of a Storage Parent is not SET, then the *encryptedDuplication* attribute is required to be the same in all descendant objects of that Storage Parent.

#### 23.3.2.2 Inner Duplication Wrapper

For the first phase, the TPM computes an integrity hash over the sensitive data. This hash includes the Name of the public area associated with this object.

$$innerIntegrity := H_{nameAlg}(sensitive || name) \quad (38)$$

where

$H_{nameAlg}$	hash function using the <i>nameAlg</i> of the object
<i>sensitive</i>	a TPM2B_SENSITIVE
<i>name</i>	the Name of the object being protected

A TPM2B\_DIGEST containing the integrity digest value is prepended to the sensitive area and the buffer (integrity plus sensitive) is encrypted using CFB.

$$encSensitive := CFB_{pSymAlg}(symKey, 0, innerIntegrity || sensitive) \quad (39)$$

where

$CFB_{pSymAlg}$	symmetric encryption in CFB mode using the algorithm specified in the command
-----------------	---

<i>symKey</i>	<i>encryptionKeyIn</i> parameter in TPM2_Duplicate() or a value from the RNG if no key is provided
<i>innerIntegrity</i>	value from (38)
<i>sensitive</i>	the sensitive value used in (38)

If no inner wrapper is specified, no integrity value is computed and no encryption occurs in this first phase and

$$encSensitive := sensitive \quad (40)$$

### 23.3.2.3 Outer Duplication Wrapper

In the second phase, the *encSensitive* produced by phase 1 is encrypted and integrity checked using processes similar to those defined in clause 22. However, the seed from which the protection keys are derived is protected by the asymmetric algorithm of the NP. The method of generating *seed* is determined by the asymmetric algorithm of the NP. The different methods are described in annexes to this TPM 2.0 Part 1, for example, B.10.3 or C.6.3. The seed is selected prior to integrity generation for *encSensitive* or encryption of *encSensitive*.

NOTE For an RSA new parent, *seed* is not allowed to be larger than the size of the digest produced by the *nameAlg* of the object. When the TPM creates *seed*, it will be exactly the size of the *nameAlg* of the new parent.

Given a value for *seed*, a symmetric encryption key (*symKey*) is created by:

$$symKey := \mathbf{KDFa}(npNameAlg, seed, \text{"STORAGE"}, Name, \text{NULL}, bits) \quad (41)$$

where

<i>npNameAlg</i>	the <i>nameAlg</i> of the new parent
<i>seed</i>	the symmetric seed value
"STORAGE"	a value used to differentiate the uses of the KDF
<i>Name</i>	the Name of the object being encrypted or decrypted
<i>bits</i>	the number of bits required for the symmetric key

The *symKey* is used to encrypt the *encSensitive*.

$$dupSensitive := \mathbf{CFB}_{npSymAlg}(symKey, 0, encSensitive) \quad (42)$$

where

$\mathbf{CFB}_{npSymAlg}$	symmetric encryption in CFB mode using the algorithm of the new parent
<i>symKey</i>	symmetric key from (41)
<i>encSensitive</i>	value from either (39) or (40)

Next, an HMAC key is generated from seed:

$$HMACkey := \mathbf{KDFa}(npNameAlg, seed, \text{"INTEGRITY"}, \text{NULL}, \text{NULL}, bits) \tag{43}$$

where

- npNameAlg* the *nameAlg* of the object's new parent
- seed* the symmetric seed value used in (41)
- "INTEGRITY" a value used to differentiate the uses of the KDF.
- bits* the number of bits in the digest produced by *npNameAlg*

An HMAC is then generated over the *dupSensitive* data. The Name of the associated public area is included in the HMAC computation to ensure that the sensitive area will only be decrypted when the proper public and private areas are used in TPM2\_Import().

$$outerHMAC := \mathbf{HMAC}_{npNameAlg}(HMACkey, dupSensitive || Name) \tag{44}$$

where

- $\mathbf{HMAC}_{npNameAlg}$  the HMAC function using nameAlg of the new parent
- HMACkey* a value derived from the new parent symmetric protection value according to equation (43)
- dupSensitive* symmetrically encrypted sensitive area produced in (42)
- Name* the Name of the object being duplicated

To complete the duplication process, the TPM2B\_PUBLIC and TPM2B\_ENCRYPTED\_SECRET produced by TPM2\_Duplicate() are used in TPM2\_Import() at the TPM containing the public and private portions of the NP. If the private area is doubly encrypted, then the symmetric key used for the inner wrapper is also given to the TPM.

TPM2\_Import() will recover the symmetric key according to the algorithm of the NP. The TPM2B\_PRIVATE is decrypted. If an inner wrapper is present, the TPM2B\_PRIVATE is decrypted using the supplied symmetric key. After symmetric decryption, the integrity value is checked.

<p>Marshal the <i>sensitive</i> area into a TPM2B_SENSITIVE</p> <p>NOTE If no inner or outer wrapper is applied to the object, this structure is returned as the <i>duplicate</i> parameter in the response for TPM2_Duplicate().</p>	<table border="1" style="width: 100%;"> <tr><td colspan="2" style="text-align: center;">size</td></tr> <tr><td rowspan="4" style="writing-mode: vertical-rl; transform: rotate(180deg);">sensitiveArea</td><td style="text-align: center;">sensitiveType</td></tr> <tr><td style="text-align: center;">authValue</td></tr> <tr><td style="text-align: center;">seedValue</td></tr> <tr><td style="text-align: center;">[sensitiveType]sensitive</td></tr> </table>	size		sensitiveArea	sensitiveType	authValue	seedValue	[sensitiveType]sensitive				
size												
sensitiveArea	sensitiveType											
	authValue											
	seedValue											
	[sensitiveType]sensitive											
<p>Compute an <i>innerIntegrity</i> value</p> $innerIntegrity := \mathbf{H}_{nameAlg}(sensitive    name)$	<table border="1" style="width: 100%;"> <tr><td colspan="2" style="text-align: center;">size</td></tr> <tr><td colspan="2" style="text-align: center;">innerIntegrity digest</td></tr> <tr><td colspan="2" style="text-align: center;">size</td></tr> <tr><td rowspan="4" style="writing-mode: vertical-rl; transform: rotate(180deg);">sensitiveArea</td><td style="text-align: center;">sensitiveType</td></tr> <tr><td style="text-align: center;">authValue</td></tr> <tr><td style="text-align: center;">seedValue</td></tr> <tr><td style="text-align: center;">[sensitiveType]sensitive</td></tr> </table>	size		innerIntegrity digest		size		sensitiveArea	sensitiveType	authValue	seedValue	[sensitiveType]sensitive
size												
innerIntegrity digest												
size												
sensitiveArea	sensitiveType											
	authValue											
	seedValue											
	[sensitiveType]sensitive											

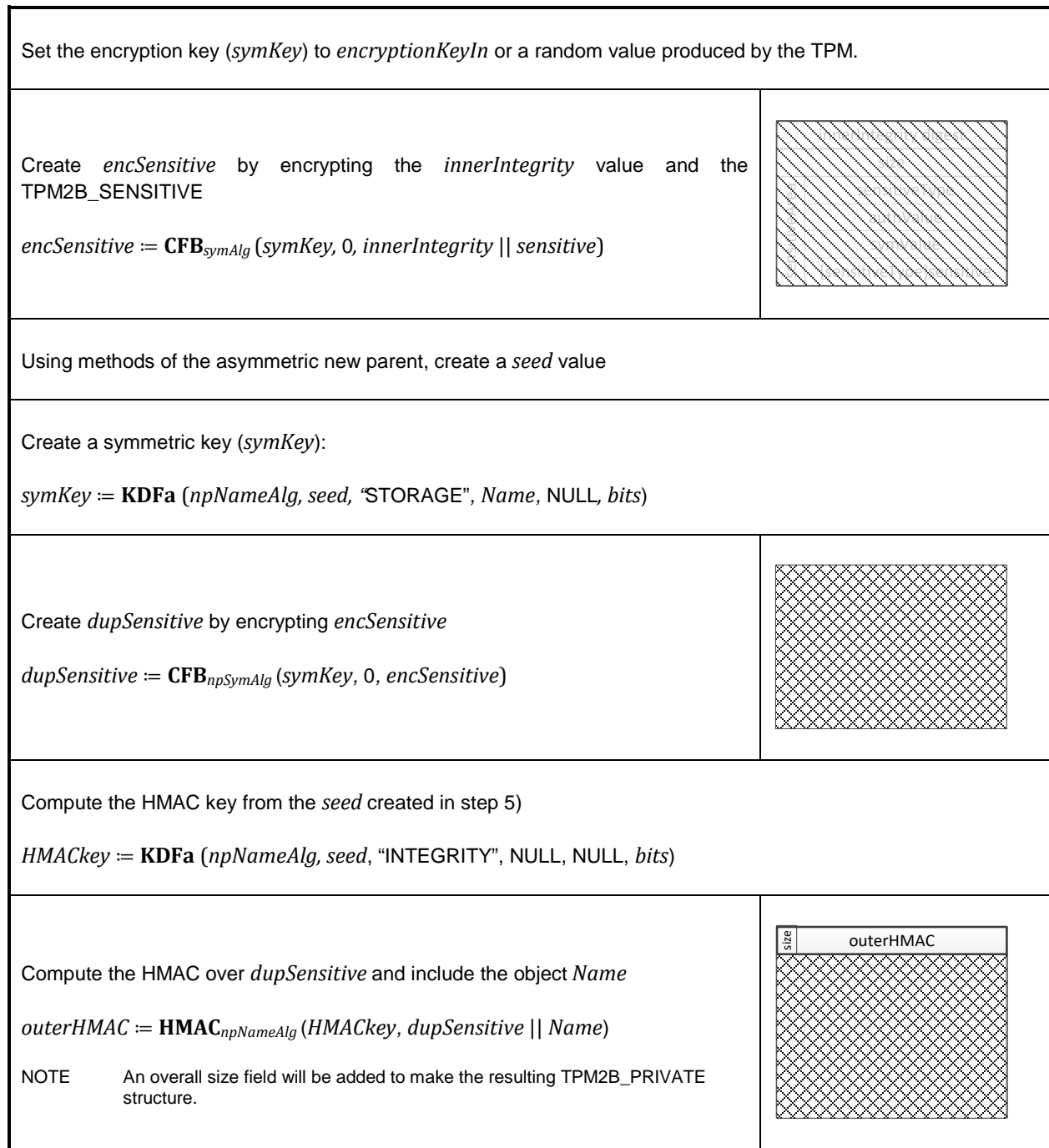


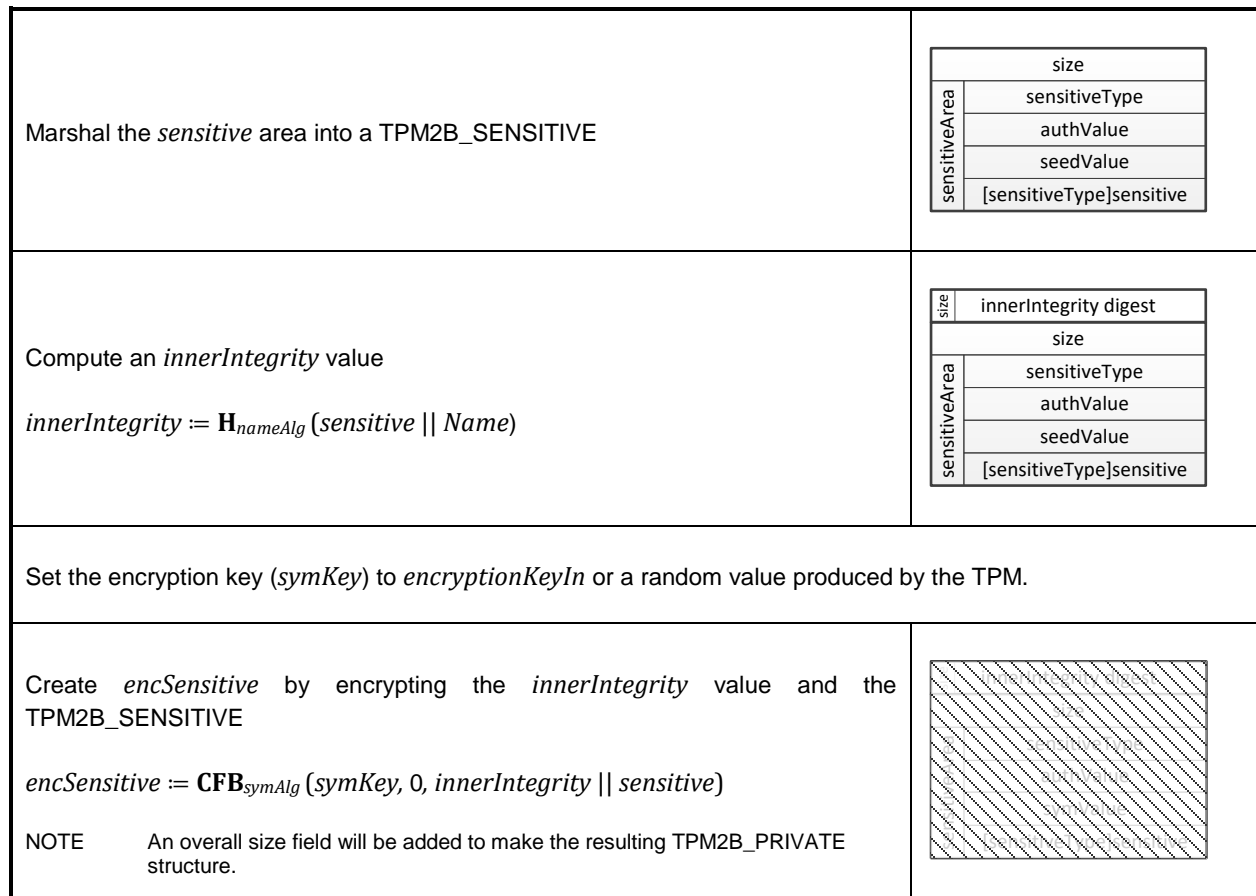
Figure 19 — Duplication Process with Inner and Outer Wrapper

Figure 20 illustrates the processing of a duplication blob when no inner wrapper is used in the sensitive area.

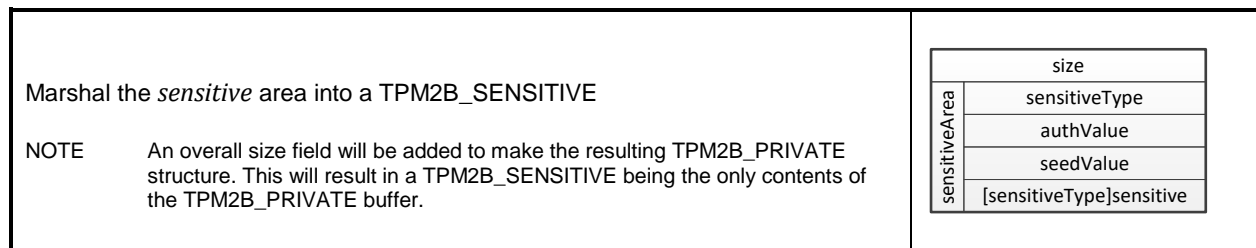


**Figure 20 — Duplication Process with Outer Wrapper and No Inner Wrapper**





**Figure 21 — Duplication Process with Inner Wrapper and TPM\_RH\_NULL as NP**



**Figure 22 — Duplication Process with no Inner Wrapper and TPM\_RH\_NULL as NP**

### 23.3.3 Rewrap

#### 23.3.3.1 Introduction

TPM2\_Rewrap() is a primitive of an exemplar key recovery service that performs all its security-sensitive processes on TPMs.

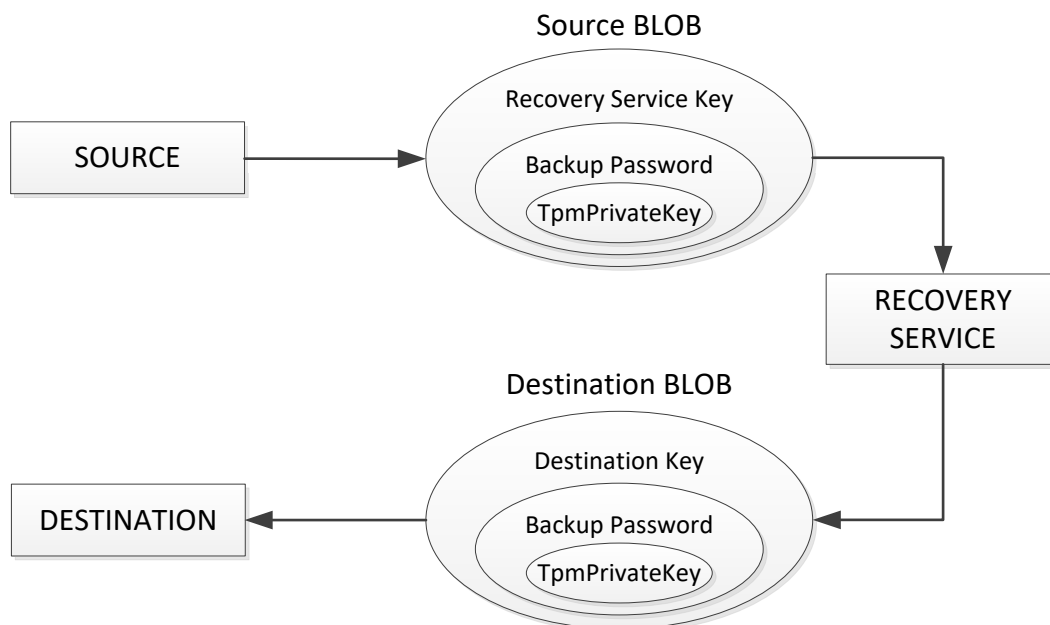
The effect of the recovery service is indistinguishable from duplication of a source key directly from a source platform to a destination platform.

The advantage of the recovery service is that

- registration of a source key with the recovery service relies upon an operational source platform, but not upon an operational destination platform, and
- delivery of the source key by the recovery service relies upon an operational destination platform, but not upon an operational source platform.

The recovery service keeps a source key from a source platform, irrespective of whether the destination platform is known. The source key is protected from the recovery service by virtue of a backup password that must be kept hidden from the recovery service but revealed to a destination platform. When the destination platform is revealed to the recovery service, the recovery service facilitates the installation of the source key in the destination platform.

- While the source platform is operational, the source platform uses `TPM2_Duplicate()` to create a doubly wrapped duplication BLOB using a source key *TpmPrivateKey*, a backup password, and the recovery service's public key. (Duplication BLOBs are described earlier in this subclause. Note that the "Outer Duplication Wrapper" subclause explains that the outer wrapping is symmetric encryption that depends on a seed generated from a public key.)
- While the source platform is operational, the source platform sends the duplication BLOB (Source BLOB in Figure 23) to the recovery service, which stores the BLOB.
- When a destination platform is revealed to the recovery service, the recovery service uses `TPM2_Rewrap()` to derive another doubly wrapped duplication BLOB using the original doubly wrapped duplication BLOB, the recovery service's key, and the destination platform's public key.
- When the destination platform is operational, the recovery service sends the derived duplication BLOB (Recovery BLOB in Figure 23) to the destination platform.
- While the destination platform is operational, the destination platform uses `TPM2_Import()` to create a normal key BLOB from the derived duplication BLOB, the destination platform's key, and the backup password.



**Figure 23 Key Recovery Process**

### 23.3.3.2 Creating a backed-up key

- At the source platform, a key to be backed up,  $sourceKey = [sourcePubKey, sourceSensitiveKey]$ , and the recovery service's public key  $recoveryServicePubKey$  are loaded in the source TPM.

- b) At the source TPM, TPM2\_Duplicate() is used to create the doubly wrapped duplication BLOB, which is *sourceSensitiveKey*, wrapped by *encryptionKeyIn*, wrapped by *recoveryServicePubKey*. The parameters to TPM2\_Duplicate() are:
- 1) *objectHandle* - references the key *sourceKey* to be sent to the recovery service
  - 2) *newParentHandle* - references the recovery service's public key *recoveryServicePubKey*
  - 3) *encryptionKeyIn* - is the backup password (this is an optional parameter and if the caller does not provide a value, the TPM will generate one)
  - 4) *symmetricAlg* – the encryption algorithm for the inner wrapper
- c) The TPM returns:
- 1) *encryptionKeyOut* – returned only if the TPM generated the key used for the inner wrapper
  - 2) *duplicate* – the wrapped sensitive area of *objectHandle*; the Source BLOB.
  - 3) *outSymSeed* - a protected version of the seed used to make the symmetric key used for outer wrapping encryption
- d) The duplication BLOB *duplicate* is sent to the recovery service

### 23.3.3.3 Recovering a backed-up key

- a) At the recovery service's platform, the recovery service's key *recoveryServiceKey* = [*recoveryServicePubKey* , *recoveryServiceSensitiveKey*], and the destination platform's public key *destinationPubKey* are loaded into the recovery service's TPM.
- b) At the recovery service's TPM, TPM2\_Rewrap() is used to replace the outer wrapper of the Source BLOB with an outer wrapper tied to the Destination Key *destinationPubKey*. The parameters for TPM2\_Rewrap() are:
- 1) *oldParent* - references the recovery service's key *recoveryServiceKey*
  - 2) *newParent* – references the destination platform's public key *destinationPubKey*
  - 3) *induplicate* – the Source BLOB
  - 4) *inSymSeed* - this is *outSymSeed* from the source platform. It is needed to derive the symmetric key used by the source platform for outer wrapping encryption
- c) At the recovery service, the TPM will return
- 1) *outDuplicate* – the rewrapped Destination BLOB
  - 2) *outSymSeed* - a protected version of the seed used to make the symmetric key used by the recovery service for outer wrapping encryption
- d) At the destination platform, the destination platform's key *destinationKey* = [*destinationPubKey* , *destinationSensitiveKey*] is loaded into the TPM.
- e) At the destination platform, TPM2\_Import() is used to create *outPrivate* , which is a normal key BLOB that may be loaded into the TPM on the platform. The parameters to TPM2\_Import() are:
- 1) *parentHandle* – a reference to the destination platform's key (this will become the Storage Parent for the imported object)
  - 2) *encryptionKey* – the backup password (*encryptionKeyIn* or *encryptionKeyOut*)
  - 3) *objectPublic* – the public area of the key being imported
  - 4) *duplicate* – the Destination BLOB *outDuplicate* from the recovery service
  - 5) *inSymSeed* is *outSymSeed* from the recovery service. It is needed to derive the symmetric key used by the recovery service for outer wrapping encryption

- f) At the destination platform, the TPM returns
- 1) *outPrivate* – the sensitive area of the imported object

### 23.4 Duplication Group

The duplication process allows an object or segment of a hierarchy to be duplicated for use in another hierarchy. This ability facilitates key distribution and backup. A duplication group is a group of objects in a hierarchy under a duplication root. The entire duplication group may be moved to another hierarchy by duplicating the duplication root.

When an object is created, its duplication attribute (*fixedParent*) is selected. If *fixedParent* is CLEAR, then the object may be operated on by TPM2\_Duplicate(). This command allows the sensitive area of an object to be encrypted under a new parent so that it may be used in a different TPM hierarchy. The act of duplicating a Storage Key has the side effect of duplicating all of its descendants regardless of the setting of their *fixedParent* attribute. That is, if a Storage Parent is usable in a different hierarchy, then all the descendants of the Storage Parent are also usable in the different hierarchy as well.

NOTE 1           No modification of the encryption of a child object is required to make it usable on another hierarchy. This is because the Storage Key that is duplicated contains the information used to protect its children. Duplication of the protection information has the effect of duplicating the objects protected by that information.

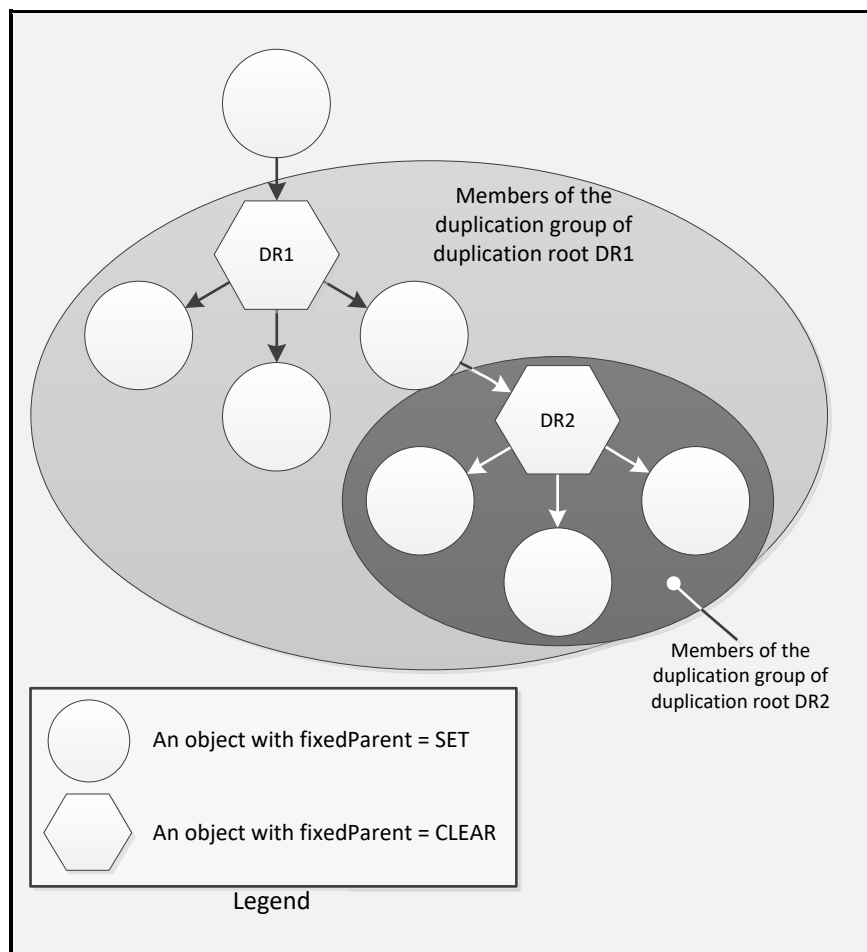
NOTE 2           If a particular Storage Parent is usable in multiple hierarchies, then descendants of that Storage Parent are usable in the same hierarchies regardless of when they are created. That is, if they are created after the duplication of the Storage Parent, they are still usable in multiple hierarchies.

If an object has *fixedParent* CLEAR, it is the root of a duplication group. If the object is not a Storage Key, then the group will have a single member. For a Storage Key, the duplication group consists of all objects that are duplicated as a direct consequence of duplicating the group root.

Objects that have *fixedParent* SET cannot be directly duplicated (that is, they may not be the referenced *objectHandle* in TPM2\_Duplicate()). However, they can be implicitly duplicated if an ancestor has *fixedParent* CLEAR and that ancestor is duplicated.

Objects that have *fixedParent* SET and have no ancestors with *fixedParent* CLEAR are the only objects that are not part of a duplication group. These objects are identified by having their *fixedTPM* attribute SET. All objects that are in a duplication group have their *fixedTPM* attribute CLEAR.

An object may be a member of more than one duplication group. This would occur if more than one of its ancestor Storage Keys has *fixedParent* CLEAR or if an object and one of its ancestors has *fixedParent* CLEAR.



**Figure 24 — Duplication Groups**

### 23.5 Protection Group

The algorithms (asymmetric, symmetric, and hash) and key sizes used to protect child keys are consistent within a protection group. The protection group is all of the descendants of a duplication root not including other duplication roots or their descendants.

By requiring all of the non-duplicable Storage Keys to use the same algorithm, it is easier to determine the security properties of a hierarchy. If an object's `fixedTPM` attribute is SET, then all of the ancestor keys of that object use the same set of algorithms. If an object's `fixedTPM` is not SET, then the protections are determined by the duplication authority for each of the duplication roots in the object's hierarchy.

The reason that the protections are determined by the duplication authority and not by the algorithms of the key is that a duplication authority can attach a duplication root to a software-generated new parent. Inspecting the hierarchy in which an object exists does not guarantee the protections of the object unless the object's `fixedTPM` is SET.

Change of the algorithm set at a duplication root is illustrated in Figure 25.

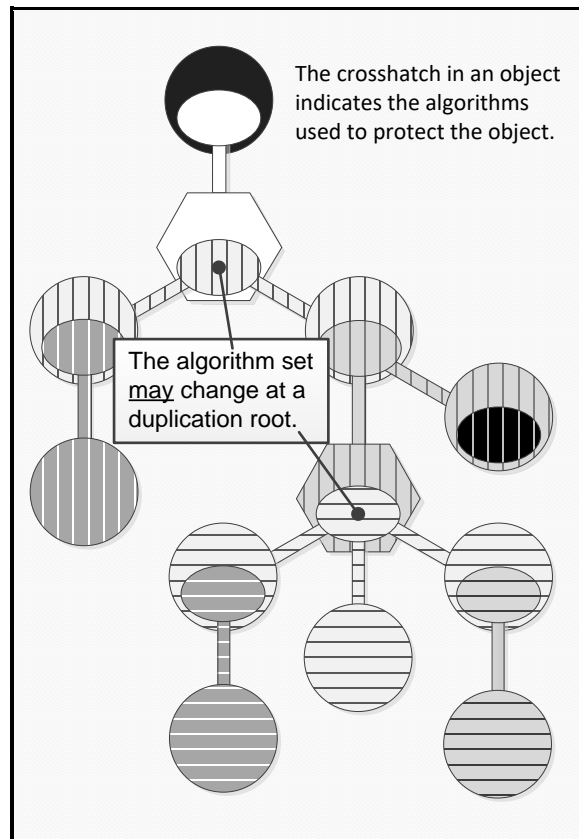


Figure 25 — Protection Groups

### 23.6 Summary of Hierarchy Attributes

The hierarchy attributes of an object indicate how the object is connected to the hierarchy. They indicate if the object could be extant in other hierarchies and if the object may be duplicated directly by TPM2\_Duplicate().

Table 22 lists the possible combinations of an object’s hierarchy attributes and the interpretation of each combination.

Table 22 — Mapping of Hierarchy Attributes

<i>fixedParent</i>	<i>fixedTPM</i>	Description
0	0	This combination represents a duplication root.
0	1	This combination is not allowed.
1	0	This combination indicates an object that is permanently in the protection group of its Storage Parent. It cannot be the <i>objectHandle</i> reference in TPM2_Duplicate().
1	1	This combination indicates an object that was created on a specific TPM and no duplicate of the object is possible.

### 23.7 Primary Seed Hierarchies

A Primary Object is an object that is derived from a Primary Seed value. The sensitive area of a Primary Object is not stored off of the TPM. The Primary Object will need to be regenerated each time it is needed or it can be made persistent in NV memory on the TPM (TPM2\_EvictControl()).

NOTE 1 A Primary Object may be duplicated in which case its sensitive area will be stored off of the TPM.

NOTE 2 The reason for not allowing a Primary Object to be stored off of the TPM is to prevent certain types of power analysis attacks on the primary seed values.

Once created, a Primary Object may be context-saved/restored.

A Primary Object may have *fixedParent* SET or CLEAR. If a Primary Object has *fixedParent* SET, then *fixedTPM* is required to be SET.

#### Hierarchy Attributes Settings Matrix

Table 23 shows the combinations of hierarchy settings allowed for an object. In the table, the check marks ("✓") indicate that the combination is allowed.

**Table 23 — Allowed Hierarchy Settings**

<i>fixedTPM</i> setting in		Object's <i>fixedParent</i>		Comments
parent	object	CLEAR	SET	
CLEAR	CLEAR	✓	✓	if the parent's <i>fixedTPM</i> attribute is CLEAR, the child's <i>fixedTPM</i> is required to be CLEAR
CLEAR	SET			
SET	SET		✓	if the parent of an object has <i>fixedTPM</i> SET, then <i>fixedParent</i> and <i>fixedTPM</i> must have the same setting in the child(1)(2)
SET	CLEAR	✓		
NOTE				
1) For purposes of this table, the parent of a Primary Object is considered to have a <i>fixedTPM</i> attribute that is always SET.				
2) If the parent has <i>fixedTPM</i> SET, then a child may be duplicable ( <i>fixedParent</i> == CLEAR) or not ( <i>fixedParent</i> == SET). If the child is not duplicable, then it is required to have the same setting of <i>fixedTPM</i> as its parent.				

The consistency of the hierarchy settings is checked in object templates (TPM2\_Create()) and TPM2\_CreatePrimary()) and in public areas for loaded objects (TPM2\_Load()) or duplicated objects (TPM2\_Import()).

## 24 Credential Protection

### 24.1 Introduction

The TPM supports a privacy preserving protocol for distributing credentials for keys on a TPM. The process allows a credential provider to assign a credential to a TPM object, such that the credential provider cannot prove that the object is resident on a particular TPM but the credential is not available unless the object is resident on a device that the credential provider believes is an authentic TPM.

### 24.2 Protocol

The initiator of the credential process will provide, to a credential provider, the public area of a TPM object for which a credential is desired along with the credentials for a TPM key (usually an EK). The credential provider will inspect the credentials of the “EK” and the properties indicated in the public area to determine if the object should receive a credential. If so, the credential provider will issue a credential for the public area.

The credential provider may require that the credential only be useable if the public area is a valid object on the same TPM as the “EK.” To ensure this, the credential provider encrypts the credential and then “wraps” the credential encryption key with the public key of the “EK.”

**NOTE** “EK” is used to indicate that an EK is typically used for this process but any storage key may be used. It is up to the credential provider to decide what is acceptable for an “EK.”

The encrypted credential and the wrapped encryption key are then delivered to the initiator. The initiator can decrypt the credential by loading the “EK” and the object onto the TPM and asking the TPM to return the credential encryption key. The TPM will decrypt the credential encryption key using the private “EK” and validate that the credentialed object (public and private) is loaded on the TPM. If so, the TPM has validated that the properties of the object match the properties required by the credential provider and the TPM will return the credential encryption key.

This process preserves privacy by allowing TPM objects to have credentials from the credential provider that are not tied to a specific TPM. If the object is a signing key, that key may be used to sign attestations, and the credential can assert that the signing key is on a valid TPM without disclosing the exact TPM.

A second property of this protocol is that it prevents the credential provider from proving anything about the object for which it provided the credential. The credential provider could have produced the credential with no information from the TPM as the TPM did not need to provide a proof-of-possession of any private key in order for the credential provider to create the credential. The credential provider can know that the credential for the object could not be in use unless the object was on the same TPM as the “EK” but the credential provider cannot prove it.

### 24.3 Protection of Credential

The credential blob (which typically contains the information used to decrypt the actual credential) from the credential provider contains a value that is returned by the TPM if the TPM2\_ActivateCredential() is successful. The value may be anything that the credential provider wants to place in the credential blob but is expected to be values that are used to decrypt a blob containing the actual credentials of an object.

The credential provider protects the credential value (CV) with an integrity HMAC and encryption in much the same way as a credential blob. The difference is, when *seed* is generated, the label is “IDENTITY” instead of “DUPLICATE”.



## 24.4 Symmetric Encrypt

A seed is derived from values that are protected by the asymmetric algorithm of the “EK”. The methods of generating the seed are determined by the asymmetric algorithm of the “EK” and are described in an annex to this TPM 2.0 Part 1. In the process of creating *seed*, the label is required to be “INTEGRITY.”

NOTE If a duplication blob is given to the TPM, its HMAC key will be wrong and the HMAC check will fail.

Given a value for *seed*, a key is created by:

$$\mathit{symKey} := \mathbf{KDFa}(\mathit{ekNameAlg}, \mathit{seed}, \text{“STORAGE”}, \mathit{name}, \text{NULL}, \mathit{bits}) \quad (45)$$

where

<i>ekNameAlg</i>	the <i>nameAlg</i> of the key serving as the “EK”
<i>seed</i>	the symmetric seed value produced using methods specific to the type of asymmetric algorithms of the “EK”
“STORAGE”	a value used to differentiate the uses of the KDF
<i>name</i>	the Name of the object associated with the credential
<i>bits</i>	the number of bits required for the symmetric key

The *symKey* is used to encrypt the CV. The IV is set to 0.

$$\mathit{enclIdentity} := \mathbf{CFB}_{\mathit{ekSymAlg}}(\mathit{symKey}, 0, \mathit{CV}) \quad (46)$$

where

$\mathbf{CFB}_{\mathit{ekSymAlg}}$	symmetric encryption in CFB mode using the symmetric algorithm of the key serving as “EK”
<i>symKey</i>	symmetric key from (45)
<i>CV</i>	the credential value (a TPM2B_DIGEST)

## 24.5 HMAC

A final HMAC operation is applied to the *enclIdentity* value. This is to ensure that the TPM can properly associate the credential with a loaded object and to prevent misuse of or tampering with the CV.

The HMAC key (*HMACkey*) for the integrity is computed by:

$$\mathit{HMACkey} := \mathbf{KDFa}(\mathit{ekNameAlg}, \mathit{seed}, \text{“INTEGRITY”}, \text{NULL}, \text{NULL}, \mathit{bits}) \quad (47)$$

where

<i>ekNameAlg</i>	the <i>nameAlg</i> of the target “EK”
<i>seed</i>	the symmetric seed value used in (45); produced using methods specific to the type of asymmetric algorithms of the “EK”
“INTEGRITY”	a value used to differentiate the uses of the KDF

*bits* the number of bits in the digest produced by *ekNameAlg*

NOTE Even though the same value for label is used for each integrity HMAC, *seed* is created in a manner that is unique to the application. Since *seed* is unique to the application, the HMAC is unique to the application.

*HMACkey* is then used in the integrity computation.

$$identityHMAC := HMAC_{ekNameAlg}(HMACkey, encIdentity || Name) \tag{48}$$

where

- HMAC<sub>ekNameAlg</sub>** the HMAC function using *nameAlg* of the “EK”
- HMACkey* a value derived from the “EK” symmetric protection value according to equation (47).
- encIdentity* symmetrically encrypted sensitive area produced in (46)
- Name* the Name of the object being protected

The integrity structure is constructed by placing the *identityHMAC* (size and hash) in the buffer ahead of the *encIdentity*.

### 24.6 Summary of Protection Process



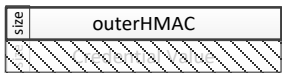
Marshal the CV into a TPM2B_DIGEST	
Using methods of the asymmetric “EK”, create a <i>seed</i> value	
Create a symmetric key for encryption: $symKey := KDFa(ekNameAlg, seed, \text{“STORAGE”}, Name, NULL, bits)$	
Create <i>encIdentity</i> by encrypting the CV $encIdentity := CFB_{ekSymAlg}(symKey, 0, CV)$	
Compute the HMAC key $HMACkey := KDFa(ekNameAlg, seed, \text{“INTEGRITY”}, NULL, NULL, bits)$	
Compute the HMAC over the <i>encIdentity</i> from step 4 $outerHMAC := HMAC_{ekNameAlg}(HMACkey, encIdentity    Name)$	

Figure 26 — Creating a Identity Structure

## 25 Object Attributes

### 25.1 Base Attributes

#### 25.1.1 Introduction

Three attributes are used to determine how the TPM may use an object. These attributes are designated as *restricted*, *sign*, and *decrypt*. The Boolean combinations of these attributes are used to express the full range of behaviors for objects.

#### 25.1.2 *Restricted* Attribute

When the *restricted* attribute of a key is SET, the key may only operate on other objects that follow strict, but simple, format rules. A restricted key is not usable in all commands that use a key of that type. The restrictions on each type of key are explained in the clauses describing the *sign* and *decrypt* attributes.

The *restricted* attribute has no meaning when applied to an object that has both *sign* and *decrypt* CLEAR and *restricted* is required to be CLEAR for those objects.

#### 25.1.3 *Sign* Attribute

This attribute may apply either to symmetric or asymmetric keys. A signing key uses its sensitive area key to sign data. The signature is returned by the TPM.

An asymmetric signing key may perform signing according to the key family (such as, RSA or ECC) and the signing method selected. An external entity may use the public portion of an asymmetric key to validate that the information was signed by someone with knowledge of the private portion of the key.

For a symmetric cipher object, this attribute determines whether the key can encrypt.

A symmetric key that can sign is used for performing an HMAC computation. This signature can be checked by another entity that knows the HMAC secret key in order to validate the source of the information.

NOTE No signing algorithm for a symmetric block cipher is currently defined by the TCG. If one is defined, then the limitation of this paragraph would change.

A restricted signing key may only sign a digest that has been produced by the TPM. The digest may be over externally supplied data or an internally generated structure. An internally generated structure that is to be signed will have the characteristic TPM\_GENERATED\_VALUE as the first octets in the structure to be hashed and signed. When the TPM generates a digest over externally provided data, the TPM validates that the first octets of the data are not equal to the TPM\_GENERATED\_VALUE. When a digest is signed by a restricted signing key, there is no ambiguity about whether or not the signed data was generated by the TPM.

A restricted signing key is occasionally referred to in this specification as an Attesting or Attestation Key.

#### 25.1.4 *Decrypt* Attribute

An asymmetric decryption key uses the private asymmetric key in its sensitive area to decrypt data blobs that have been encrypted using the public portion of the key. A symmetric decryption key uses the key in its sensitive area to decrypt data that has been encrypted by that key.

A key that has both *decrypt* and *restricted* attributes SET only accepts data that has a specific structure. The encrypted data block must have as its first element an integrity value for the remainder of the structure. This integrity value is an HMAC of the encrypted data. This format allows the TPM to prevent misuse of the restricted decryption keys that are the basis of the protected storage hierarchy.

If the sensitive data is part of a child object, the symmetric and HMAC keys are derived from the symmetric seed value (*seedValue*) in the sensitive area of the Storage Parent. If the sensitive data is a duplication or certification blob, the symmetric and HMAC keys are derived from a single use seed. That seed is then protected using the asymmetric public key of the intended recipient of the protected blob.

When loading a protected blob, the TPM validates the integrity value before decrypting the data. The only way that the integrity value can be correct is if it were created by some entity with access to the unencrypted sensitive data.

**NOTE** The specific threat scenario that is addressed by this scheme is that an attacker will use a protected blob in a command that is not appropriate for that blob. For example, an attacker may load the sensitive portion of an asymmetric key and attempt to access the sensitive area using TPM2\_Unseal(). The TPM will unseal data, but not a key. The attacker may attempt to modify the public area of the key in order to trick the TPM into thinking that the protected blob contains a sealed data rather than a private key. The integrity value prevents these deceptions.

A restricted decryption key is often referred to in this specification as a Storage Key.

### 25.1.5 Uses

Table 24 shows the combinations of an object's functional attributes and describes the resulting properties.

**Table 24 — Mapping of Functional Attributes**

<i>sign</i>	<i>decrypt</i>	<i>restricted</i>	Description
0	0	0	A data blob. Can be accessed using TPM2_Unseal().  NOTE: This attribute set may only be used for a keyedHash object.
0	0	1	Not allowed. The TPM will not load or create an object with this setting.
0	1	0	A key that can be used in any operation that requires a decryption key, except that the key may not be a storage key.
0	1	1	Indicates that only the default schemes and modes of the key may be used In this specification, key with these properties is referred to as a Parent Key. Asymmetric keys and symmetric keys with these attributes are Storage Parents, and hash objects with these attributes are Derivation Parents. The TPM only allows keys with these attributes to be used on objects that have a specific structure. For Storage Parents, use includes create, load, unseal, and activate credential.
1	0	0	Indicates a key that may be used with any signing operation including quote, certify, and sign. The recipient of signatures generated by this key should be aware that quotes and certifications can be forged so the trust would not be in the key but in the entity that knows the key authorization value. If use with object type TPM_ALG_KEYEDHASH, then the key may be used for HMAC operations.
1	0	1	This combination indicates a key that can sign any digest that the TPM has created. The TPM only signs a digest over externally provided data that did not have as its first octets TPM_GENERATED_VALUE. This key can be used reliably for quoting, certifying, and signing. No signing command is prohibited for this type of key. Only the default schemes and modes of the object may be used.
1	1	0	A general-purpose key that can be used with any command that requires a key as long as the command is compatible with the key algorithm. However, this key may not be a Storage Key (the parent of other keys).
1	1	1	This type of key is currently not supported because use of a signing key as a storage node could prevent an application from being able to use the TPM in a way that is compliant with FIPS.

Table 25 shows the correspondence between the TPM 1.2 method of identifying key properties and the method in this specification.

**Table 25 — TPM 1.2 Correspondence**

TPM 1.2 Name	<i>sign</i>	<i>decrypt</i>	<i>restricted</i>	Comments
TPM_KEY_SIGNING	1	0	0	In TPM 1.2, keys had restricted schemes. In this specification, the scheme is defined in the command.
TPM_KEY_STORAGE	0	1	1	The functional properties are nearly the same as TPM 1.2. This key could only be used to protect and unprotect items in a Protection hierarchy.
TPM_KEY_IDENTITY	1	0	1	In TPM 1.2, an Identity key was highly constrained and could not, for example, sign a structure that was not produced by the TPM. In this specification, the restricted signing key can sign (within the limits defined in clause 25.1.3) a digest produced by the TPM. This allows, for example, an Attestation Key to sign a PKCS#10 certificate request.
TPM_KEY_AUTHCHANGE	-	-	-	This is not used in this specification and its use was deprecated in TPM 1.2. The functionality is provided by session encryption.
TPM_KEY_BIND	0	1	0	Functionality is roughly equivalent between the TPM 1.2 type and the unrestricted decryption key. The specification would use TPM2_RSA_Decrypt() in place of the TPM 1.2 TPM_Unbind().
TPM_KEY_LEGACY	1	1	0	Use of these keys is only constrained by the key family properties. For example, an ECC key will not perform TPM2_RSA_Decrypt().
TPM_KEY_MIGRATE	0	1	1	A Storage Key may be the object of a re-wrap if the new parent is allowed within the policy for the object. The policy for duplication of the object is always visible in the public area.
Sealed Data				A blob containing user defined data

## 25.2 Other Attributes

### 25.2.1 fixedTPM and fixedParent

These attributes are described in detail in clause 23.

### 25.2.2 stClear

This attribute indicates an object that will need to be reloaded after any Startup(CLEAR). Objects may be loaded into the TPM and their context saved by the TPM resource manager. Normally, these saved contexts may be reloaded at any time before the next TPM Reset. However, if this attribute is SET, then the saved context associated with the object will be invalidated on each TPM Restart as well as on TPM Reset.

An object that has this attribute SET may not be made persistent.

### 25.2.3 sensitiveDataOrigin

The meaning and allowed settings for this attribute are different for Created and Derived Objects. For a Derived Object, this attribute is required always to be CLEAR. For a Created Object, this attribute is SET if the sensitive data of the object is to be generated by the TPM.

NOTE 1 The reason that *sensitiveDataOrigin* is to be CLEAR for a derived object is that it is impractical to use it to indicate anything about the provenance of the seed value used in deriving an object. The only case in which the *sensitiveDataOrigin* of the Derivation Parent might reasonably be reflected in the derived key is when *sensitiveDataOrigin* and *fixedTPM* are both SET in the parent. For all other cases, there is no way for the TPM to provide any assurance about the setting of *sensitiveDataOrigin*. However, for a derived key with *fixedTPM* SET, it is a relatively simple matter to check the setting of this attribute in the Derivation Parent. Rather than add to the TPM the complexity of validating that a Derivation Parent has the correct combination of attributes to allow this attribute to be SET, it was decided to require that this attribute be CLEAR rather than ignored. This is because this attribute does not change the way that Object derivation takes place as it does with Object creation.

When a symmetric object (TPM\_ALG\_KEYEDHASH or TPM\_ALG\_SYM) is created, the caller may provide the secret data or have the TPM generate it. If the TPM is to be the source of the data, then the caller will SET this attribute. Otherwise, this attribute will be CLEAR and the caller-provided data will be used.

When an asymmetric object is created, this attribute must be SET. The public part of an asymmetric object is determined by its private key. If the caller has control over both the public and sensitive areas, then the TPM cannot ensure that the key is statistically unique. This is not an issue unless the object also has *fixedTPM* SET. One of the assumptions of a *fixedTPM* object is that it is statistically unique. This would not be the case for an asymmetric key if the caller provided the data. To avoid the possibility of creating a *fixedTPM* object on multiple TPMs, an asymmetric key is required to have its private key generated by the TPM or the object may be imported. If it is imported, *fixedTPM* will not be SET.

NOTE 2 The requirement that *sensitiveDataOrigin* be SET for asymmetric objects is enforced indirectly. When an asymmetric key is created, the caller is not allowed to provide the sensitive data of the key. Because the caller does not provide the sensitive data, *sensitiveDataOrigin* is required to be SET. Since this relationship is only checked when the object is created, *sensitiveDataOrigin* is allowed to have any setting when an object is loaded or imported.

### 25.2.4 userWithAuth

This attribute indicates that the object's *authValue* may be used to provide the USER role authorizations for the object. If this attribute is CLEAR then USER role authorizations may only be provided by satisfying the object's *authPolicy* in a policy session. A policy session may be used for USER mode authorizations when this attribute is SET or CLEAR.

### 25.2.5 adminWithPolicy

This attribute indicates that authorization for an action requiring the ADMIN role requires that the *authPolicy* of the object be satisfied. If this attribute is CLEAR, then the *authValue* may be used in an HMAC session to perform operations that require ADMIN role.

As with USER role authorizations, any ADMIN role action may be authorized with a policy session that satisfies the *authPolicy*.

The primary reason for having a set of operations that require ADMIN role is to allow each of the actions to be individually controlled. When a policy is used for an ADMIN role action, the policy must contain a command that sets the *commandCode* for the policy to the specific command. This allows each ADMIN role action to be individually enabled and controlled without having to group them.

### 25.2.6 noDA

If this attribute is SET in an object, then authorization failures of the object will not invoke dictionary attack protections. In addition, actions on an object with this attribute SET are not subject to lockout. This attribute is used to ensure that access to objects used by the OS is not blocked due to actions by users. An OS would be expected either to use objects with well-known values or to use high-entropy authorization values. In neither case is dictionary attack protection required.

### 25.2.7 encryptedDuplication

If this attribute is CLEAR, then an object may be duplicated with *newParentHandle* set to TPM\_RH\_NULL, which means that there is no outer wrapper for the object. If the caller does not specify an inner wrapper, then the object may be exported with this sensitive area in the clear.

While the entity that controls duplication is expected to be trusted to maintain the confidentiality of the sensitive area of a key during duplication, conformance to some standards requires that the sensitive area be encrypted when it leaves the TPM and reliance on the caller is not adequate for those standards. This attribute provides a method of producing objects that conform to those standards.

NOTE It is understood that the duplication authority can still arrange to have access to the sensitive area of the key by creating a software key and having the TPM duplicate to that key.



## 26 Object Structure Elements

### 26.1 Introduction

The TPM is intended to provide a means of creating a Storage hierarchy to protect data and keys (keys generated by the TPM or some other entity). Each of these objects (keys and data) has two components. The first is a public area that contains the attributes of the object and a public identity. The second is the sensitive area that contains the elements of the object that require TPM protections. These elements include an authorization value, one or more secret key values, and, in some cases, sealed data values.

The structure definitions for both the public and sensitive areas of an object define how the information is to be arranged when it crosses the TPM interface. The organization of these structures as they exist within the TPM is at the discretion of the TPM vendor. However, the actions of commands in this specification are defined in terms of these presumptive structures and any implementation will need to produce equivalent results.

### 26.2 Public Area

The public area contains the information for identification of an object and its properties. The fields of the public are listed and described in Table 26.

**Table 26 — Public Area Parameters**

Parameter	Description
type	This identifies the type of the object. An algorithm ID is used as the type identifier because the structures contain parameters that are specific to the types of operations that can be performed on or with the object. For example, an RSA type would contain an RSA key pair that could be used for operations defined for RSA. An AES type would be used for symmetric encryption or decryption.
nameAlg	This is a second algorithm ID that identifies the hash algorithm used for computing the Name of the object.
objectAttributes	This contains the set of attributes of the object. These attributes are in five classes: 1) usage ( <i>sign, encrypt, restricted</i> ); 2) authorization ( <i>userWithAuth, adminWithPolicy, noDA</i> ); 3) duplication ( <i>fixedParent, fixedTPM, encryptedDuplication</i> ); 4) creation ( <i>sensitiveDataOrigin</i> ); and 5) persistence ( <i>stClear</i> ).
authPolicy	This will contain the authorization policy for the object if one is defined. <i>nameAlg</i> is used as the <i>authPolicy</i> hash algorithm,  NOTE An object that is intended to be duplicated must have an <i>authPolicy</i> enabling the duplication.
[type]parameters	The parameters of an object are dependent on the object <i>type</i> . For symmetric key object, the parameters would indicate the size of the key and the default encryption mode. For an asymmetric object (RSA or ECC), the parameters would indicate the key size, signing scheme, and symmetric encryption methods associated with the key.
[type]unique	The unique value of an object is also dependent on the object <i>type</i> . For an asymmetric object, this will be the public key. For a symmetric object, this will be a value computed by hashing values in the sensitive area.

### 26.3 Sensitive Area

The sensitive area is related to the public area and contains the data that are required to be encrypted when not in a Shielded Location on the TPM. It contains the authorization value and the item-specific

information such as the private or secret portion of a key. If an object is a Storage Key, it contains the symmetric key that is used to encrypt its child object.

The structure of the sensitive area is shown in Table 27.

**Table 27 — Sensitive Area Parameters**

Parameter	Description
sensitiveType	This identifies the type of the object for this sensitive area. This value and the type parameter of the public area are the same.
authValue	This is the authorization value for the object. It is a octet array of zero or more octets. The authorization value for an object may not have more octets than the digest produced by the object's <i>nameAlg</i> .
seedValue	This value is required for Storage Keys and is the seed used to generate the protection values for the child objects of the Key. This is optional for asymmetric keys that are not Storage Keys and is not used if present. For all other object types, this is an obfuscation value. It is hashed with the <i>sensitive</i> field to produce the <i>unique</i> value in the public area. Including this value in the computation obfuscates <i>unique</i> so that the <i>sensitive</i> value cannot be determined from the <i>unique</i> field.
[sensitiveType]sensitive	The contents of this parameter are dependent on <i>sensitiveType</i> . For an asymmetric key, this will contain the private key. For a symmetric key, this will be the key. For an HMAC key this is the HMAC key value. For a data object, this will be the sensitive data.

Each sensitive area created by the TPM contains some TPM-created data that makes each sensitive area statistically unique. This will be either an asymmetric key or a large random number. The unique values in the sensitive area are cryptographically linked to values in the public area in a way that makes each public area statistically unique. The fact that a sensitive area is statistically unique and cryptographically linked to a public area ensures that a TPM can detect any attempt to substitute the sensitive area associated with a public area.

**NOTE** Such a substitution would allow subversion of secrets-based policy authorization. If an attacker could use an arbitrary sensitive area with a public area with a known Name, the attacker could perform TPM2\_PolicySecret() and cause the *policyDigest* to be updated with the chosen Name even though the attacker does not know the authorization value of the correct sensitive area. Cryptographic linking of the sensitive area to the public area ensures that this type of attack is not practical.

## 26.4 Private Area

When a sensitive area is not in a Shielded Location on a TPM, it is integrity-protected and symmetrically encrypted. There is more than one format for a protected sensitive area but the loadable (TPM2\_Load()) form of the protected sensitive area is called a “private” area.

**NOTE 1** Another format is a saved context.

The process of converting a sensitive area to a private area requires that the sensitive area be marshaled to its canonical form. This marshaled structure is then encrypted using a key derived from the Storage Parent's symmetric seed (*seedValue*). An HMAC is performed over the data with the Name of the associated sensitive area include in the HMAC. The combination of the HMAC and the encrypted sensitive area is a key's private area.

**NOTE 2** Similar protections are used when an object is context saved or duplicated.

## 26.5 Qualified Name

The Qualified Name (QN) of an object is the digest of all of the Names of all of the ancestor keys back to the Primary Seed at the root of the hierarchy. The QN of an object includes the Name of the object. The QN uses the Name hash of the current object to compute the QN for the object.

EXAMPLE 1 Assuming that key *A* is the Storage Parent of object *B*, then the Qualified Name of *B* ( $QN_B$ ) is:

$$QN_B := \mathbf{H}_B (QN_A || NAME_B)$$

The QN is not a digest of all of the entities loaded into the TPM. It is a digest of all of the entities in a chain.

EXAMPLE 2 Assume two entities with public areas of *A* and *B* and different Name hash algorithms ( $H_A$  and  $H_B$ ). Also assume that they share the same parent *P* with a QN of  $QN_P$ . The QN for *A* is  $QN_A := H_A(QN_P || H_A(A))$  and the QN for *B* is  $QN_B := H_B(QN_P || H_B(B))$ .

The primary purpose of the Qualified Name is to supplement the environmental information relating to object creation and object use. The environment of an object includes its hierarchy. The hierarchy starts at a Primary Seed and includes all ancestor keys for the object. The Qualified Name of an object is included in its creation data. The Qualified Name permits validation that a list of ancestor Names is correct. It is then possible to determine if, for example, all ancestor keys use sufficient cryptographic strength. The Qualified Name of an object is included in its certification to indicate that the key is being used in a different environment (ancestry) than the one in which it was created.

Both the Name and Qualified Name for a Primary Seed are the handle of the Primary Seed. If the parent handle is TPM\_RH\_NULL, Name and QN are also TPM\_RH\_NULL. This makes the QN of a Primary Object or Temporary Object equal to:

$$QN := \mathbf{H}_{nameAlg} (A \text{ hierarchy handle} || \text{Primary Object Name}) \quad (49)$$

NOTE The creation data for an object includes both the Name and QN of the Storage Parent of that object.

## 26.6 Sensitive Area Encryption

When a sensitive area is in a loadable format (a private area), the symmetric encryption key is derived from the secret seed (*seedValue*) of the parent.

When a sensitive area has been encrypted for duplication, the sensitive area is symmetrically encrypted with a key that is protected using asymmetric methods associated with the new parent. Before a duplicated object may be loaded, it must be “imported” (TPM2\_Import()) and encrypted using the symmetric key derived from the secret seed of the new parent.

NOTE Clause 30.3 describes the protections that are applied to a sensitive area when it is part of a saved context.

All symmetric encryption of the sensitive area uses Cipher Feedback (CFB) mode.

The method of generating the encryption key and IV for the encryption is described in clause 22.

## 26.7 Sensitive Area Integrity

When an object is not in a Shielded Location, it is susceptible to modification through means other than through a Protected Capability. An HMAC-based integrity scheme allows these modifications to be detected. The integrity HMAC includes the sensitive data and some representation of the public area. Inclusion of the public area preserves the binding between the two elements of the object.

The HMAC key is generated from the same seed that is used for generating the symmetric encryption key and IV. The HMAC of the protected structure is required to be checked before the sensitive area is decrypted.

## 27 Object Creation

### 27.1 Introduction

TPM2\_Create(), TPM2\_CreatePrimary() and TPM2\_CreateLoaded() are used to create the objects (keys and data) that are part of a TPM's Storage hierarchy. TPM2\_CreatePrimary() is used to create Primary Objects that are derived from a Primary Seed. TPM2\_Create() is used to create Ordinary Objects that are generated with values from the TPM RNG. TPM2\_CreateLoaded() can be used to create a Primary or Ordinary Object.

NOTE 1 TPM2\_CreateLoaded() may also be used for Derived Objects. This is covered in more detail in clause 28.

**Table 28 — Creation Commands**

Creation command	TPM2_CreatePrimary()	TPM2_Create()	TPM2_CreateLoaded()		
			Primary Seed	Storage Parent	Derivation Parent
Parent Handle Type	Primary Seed	Storage Parent	Primary Seed	Storage Parent	Derivation Parent
Created Object Type	Primary	Ordinary	Primary	Ordinary	Derived
Public Area Returned	yes	yes	yes	yes	yes
Sensitive Area Returned	no	yes	no	yes	no
<i>creationData</i> Returned	yes	yes	no	no	no

Table 28 compares and contrasts the creation of objects by TPM2\_CreatePrimary(), TPM2\_Create(), and TPM2\_CreateLoaded(). In particular, when creating keys:

- TPM2\_CreatePrimary() – creates and loads Primary Objects for immediate use, and provides *creationData*.
- TPM2\_Create() – creates Ordinary Objects for later use (via TPM2\_Load()). TPM2\_Create() returns a BLOB containing the sensitive area of an Ordinary Object and provides *creationData*.
- TPM2\_CreateLoaded()– depending on the type of the parent, generates and loads a Primary Object, an Ordinary Object; or Derived Object.

Authorization to use the Parent is required in order to generate a child. Authorization to use a Primary Seed is required in order to create a Primary Object.

All of the objects created by these commands are similar in most respects. For TPM2\_Create() and TPM2\_CreatePrimary(), the parameters required to create an object are the same for both commands. They are:

- a public area template,
- the sensitive values,
- optional user-provided identification data, and
- the optional creation PCR selection.

For TPM2\_CreateLoaded(), the only parameters are the public area template and the sensitive values.

NOTE 2 The user-data and PCR parameters are not used for TPM2\_CreateLoaded() as it does not return the *creationData* used for creation certification. For objects where the creation certification is necessary, the TPM2\_Create() or TPM2\_CreatePrimary() functions are available.

Any type of object that can be created with TPM2\_Create() can be created with TPM2\_CreatePrimary() or TPM2\_CreateLoaded().

NOTE 3 TPM2\_CreateLoaded() can be used for creation of asymmetric keys but it may not be used for derivation of certain types of asymmetric keys. This limitation is because of the variability in algorithms for some asymmetric key types (such as RSA).

The sensitive area of an Object created from a seed does not leave the TPM except in a saved context or by duplication. If a Primary Object is not made persistent in the TPM (TPM2\_EvictControl()) it will need to be recreated after each TPM Reset. If it is not context saved, it will need to be recreated after the next TPM2\_Startup().

## 27.2 Public Area Template

### 27.2.1 Introduction

A public area template describes the desired attributes of the object to be created. The TPM uses this template to guide the creation of the new object.

The format of the template has to match the desired format of the object to be created, in all details. The item-specific information (the *unique* field) will be replaced by the TPM in the creation process, but all other fields in the created object will be identical to those in the template.

In general, the fields in the public area are checked as if the object were being loaded under the Storage Parent indicated in the creation command.

### 27.2.2 type

This parameter indicates the basic type of the object and determines the format of the *parameters* and *unique* fields. The type may indicate a symmetric key, an asymmetric key, or a data value.

The allowed values for *type* are: TPM\_ALG\_SYMCIPHER, TPM\_ALG\_KEYEDHASH, TPM\_ALG\_RSA, or TPM\_ALG\_ECC.

NOTE The list of types may change. If an algorithm ID is allowed for use as a public area type, it is denoted by an "O" in the "Type" column of the TPM\_ALG\_ID constants table published by the TCG.

### 27.2.3 nameAlg

The *nameAlg* parameter in the template is set according to the object type. If the object is a restricted-decryption key, then the object is required to have the same *nameAlg* as the Storage Parent. For all other cases, the *nameAlg* may be any supported hash algorithm.

In the case of TPM2\_LoadExternal(), *nameAlg* is allowed to be TPM\_ALG\_NULL. When this value is selected, the TPM does not validate the cryptographic linkage between the public and sensitive portions of the object. Since the *nameAlg* is TPM\_ALG\_NULL, the object has no Name.

NOTE Certification of the key with no Name has no meaning as the certification will have no Name for the certified object.

### 27.2.4 objectAttributes

These flags must be set according to the rules appropriate for loading the object. The required settings are found in TPM 2.0 Part 2, in the definition of TPMA\_OBJECT.

### 27.2.5 authPolicy

If use of an object is to be gated by a policy (including PCR), the template will contain the policy hash. Otherwise, this entry will be set to the Empty Policy.

### 27.2.6 parameters

This field contains parameters that describe the details of the object indicated in *type*.

For a Storage Key that has *fixedParent* SET in its *objectAttributes*, these parameters will be identical to the parameters of the Storage Parent. For other objects, these parameters may vary according to the *type* and application.

### 27.2.7 unique

The *unique* field of the template is the only field in the public area that is replaced by the TPM during the object creation process. The caller may place any value in this field as long as the structure of the value is consistent with the *type* field. That is, this field should be structured in the same way as the data that will be placed in this field by the TPM. The caller may also set the size of this field to zero and the TPM will replace it with a correctly sized structure.

## 27.3 Sensitive Values

### 27.3.1 Overview

The sensitive values that are provided when the object is created allow initial setting of the *authValue* for the object and may provide some other object-sensitive value. The sensitive value may be an encryption key or sealed data.

The sensitive values provided to the TPM in *TPM2\_Create()* and *TPM2\_CreatePrimary()* (the *inSensitive* parameter) may optionally be encrypted using standard session-based encryption techniques. Since session-based encryption allows use of a different session for authorization and encryption, the session used for encrypting the authorization and other sensitive data does not have to be the same as the authorization session for the Storage Parent of the newly created object. This ensures that the entity that controls the Storage Parent does not automatically gain access to the secret values of a child.

### 27.3.2 userAuth

The *userAuth* value is the initial *authValue* for the created object. This value may be no larger than the digest produced by the *nameAlg* of the object.

NOTE This limitation ensures that any valid *authValue* will be usable on any TPM that can load the key. If this limitation were not imposed, then some TPM might not be able to load a duplicated object because the *authValue* was too large for the implementation.

### 27.3.3 data

This contains information that the caller wants to be incorporated in the sensitive part of the created object. This may be either a symmetric key or user data. If *data* is an Empty Buffer, then the *sensitiveDataOrigin* attribute of the template is required to be SET. If *data* is not empty, then *sensitiveDataOrigin* is required to be CLEAR.

If the object type is TPM\_ALG\_KEYEDHASH and both *sign* and *encrypt* are CLEAR, then the created object is a Sealed Data Object and the TPM will return an error (TPM\_RC\_SIZE) if *data* is an Empty Buffer.

If the created object is an asymmetric key and not a primary key, then *data* is required to be an Empty Buffer and *sensitiveDataOrigin* in the template is required to be SET. For a primary key, *data* permits personalization of the key with private data, data that can be provided as an encrypted parameter.

NOTE If the caller were allowed to specify the private key, then for some types of asymmetric algorithms (such as, ECC) the actions of the TPM would not determine the Name of the object. Since the TPM has no effect on the creation of such an object, the preferred means of having such a key become part of a hierarchy is to import it with TPM2\_Import().

## 27.4 Creation PCR

The PCR selection that is present in TPM2\_Create() or TPM2\_CreatePrimary() parameters is used to select the PCR values that will best represent the environment in which the object was created. The selection and the PCR are hashed according to the creation data algorithm and included in the creation data (a TPM2B\_CREATION\_DATA) that is returned in the command response.

NOTE When an Object is created, the TPM produces a ticket that it (the TPM) can use to verify that it created the Object. This allows the TPM to certify that it created the Object (TPM2\_CertifyCreation()).

## 27.5 Public Area Creation

### 27.5.1 Introduction

This clause describes how the TPM uses the parameters of TPM2\_Create() and TPM2\_CreatePrimary() to set the values in the public area of the created object.

This clause does not describe the error conditions if the parameters are bad. That information is provided in the description of TPM2\_Create() and TPM2\_CreatePrimary() in TPM 2.0 Part 3.

### 27.5.2 type, nameAlg, objectAttributes, authPolicy, and parameters

The TPM will validate that these parameters are consistent in the template and then copy them from template into the created structure without modification.

### 27.5.3 unique

#### 27.5.3.1 Introduction

This parameter will contain a *type*-specific structure. It is used to ensure that each object has a statistically unique identity. The methods used to create *unique* ensure that it is cryptographically bound to the contents of the sensitive area. Creation of *unique* from the sensitive data uses non-invertible processes (such as, a hash) so that the *unique* value does not compromise the confidentiality of the sensitive area.

The computation of *unique* uses one or more values in the sensitive area of the object. At least one of the sensitive area values will be provided by the TPM to ensure that *unique* is, in fact, unique. For asymmetric keys, uniqueness is provided by the public key and the public key is mathematically linked to the private key in the sensitive area.



For symmetric objects (symmetric keys, HMAC keys, and data blobs), the key (or data) is hashed with a TPM-generated obfuscation value and the resulting digest is used as the *unique* value.

There are two reasons for generating the *unique* parameter for symmetric objects in this way. The first is that it protects the contents of the user-provided data. If the secret data has low entropy, then making the *unique* parameter a simple digest of that data would allow an offline attack to determine what the secret data might be. The large, random, obfuscation value generated by the TPM is not known to an attacker, which mitigates this threat.

The second reason for this method is that it prevents an attacker from stealing an object's identity. If the identity were not based on the contents of the sensitive area, then an attacker could create a sensitive structure and associate it with the public area of any symmetric object. Having the sensitive area contain information that can cryptographically link the sensitive area to the public area prevents this kind of substitution.

The methods for producing *unique* for each of the object types are described in the remainder of 27.5.3.

### 27.5.3.2 TPM\_ALG\_KEYEDHASH

This type is used for an HMAC key or data block. The computation for *unique* for a KeyedHash object is:

$$unique := H_{nameAlg}(obfuscate || key) \quad (50)$$

where

$H_{nameAlg}$	hash using <i>nameAlg</i> from the object template
<i>obfuscate</i>	the contents of <i>seedValue.buffer</i> in the object's sensitive area
<i>key</i>	the contents of <i>sensitive.bits.buffer</i> in the object's sensitive area; this will be either an HMAC key, a data blob, or a symmetric key.

### 27.5.3.3 TPM\_ALG\_SYMCIPHER

This type is used for a symmetric block cipher key. The *unique* value is computed as shown in (50).

### 27.5.3.4 TPM\_ALG\_RSA

For an RSA key, *unique* is the public modulus of the key. It is computed as described in B.8.

### 27.5.3.5 TPM\_ALG\_ECC

For an ECC key, *unique* is the public point computed as described in C.5.

## 27.6 Creation Entropy

### 27.6.1 Introduction

The reference code uses common algorithms for generating keys of a specific type. That is, there is one algorithm for generating RSA keys, one for ECC keys, one for HMAC keys and one for symmetric keys.

NOTE RSA and ECC are "if implemented."

When calling these functions, the caller is allowed to indicate where the function should get entropy for use in the algorithm. This allows these functions to be used for Primary, Derived, and Ordinary Objects simply by changing the source of “entropy.”

**Table 29 — Deriving Object Entropy**

<b>Object Type</b>	<b>Source of Object Entropy</b>	<b>Described in Clause</b>
Primary	DRBG initialized using a hierarchy seed and the hash of the input template	27.6.3
Ordinary	TPM's default DRBG	27.6.2
Derived	KDF	28.4

Table 29 compares and contrasts the methods used to create the cryptographic values of primary, ordinary and derived keys.

- A Primary Object is intended to be created multiple times, in the absence of any other key, with the minimum amount of persistent storage. As a result, the cryptographic values of primary keys are created by instantiating a DRBG.
- An Ordinary Object is intended to be created exactly once and persistently stored. As a result, the cryptographic values of ordinary objects are created by the DRBG that is used by default when a TPM requires random data. This DRBG is seeded with entropy when the TPM was created and topped-up with additional entropy added at intervals.
- A derived key is intended to be derived multiple times from a parent key, and not persistently stored. As a result, the cryptographic values of derived keys are created by applying a KDF and hash algorithm specified in the Derivation Parent to the Derivation Parent's symmetric key, using label and context values provided by the caller.

### 27.6.2 Entropy for Ordinary Objects

For an Ordinary Object, the caller would pass a NULL pointer. When the key generation function needs a random number it would pass that NULL pointer to the random number generator. Because the pointer is NULL, the random number generator will use the default random number generator of the TPM which produces numbers that are as random as the TPM is able to produce.

### 27.6.3 Entropy for Primary Objects

For a Primary Object, the caller would instantiate a deterministic random number generator (DRBG) and seed the DRBG with a primary seed, a template hash, and a use string. The key generation function would pass this pointer to the random number generator which would use this state instead of the TPM's default state. This produces a sequence of bits that have as much entropy as the primary seed and which have a property that is required for generating a Primary Object – the DRBG state can be reinstated each time the same Primary Object is created.

Choice of the entropy generation for Primary Objects is a vendor option.

NOTE The reference implementation uses a DRBG based on SP800-90A in order to minimize compliance issues.

## 27.7 Sensitive Area Creation

### 27.7.1 Introduction

This clause indicates how the TPM creates the sensitive portion of an object (a TPMT\_SENSITIVE).

The process for computing the contents of a sensitive area is determined by the type of the object, indicated in the *type* field of *template*.

Some of the sensitive area fields may contain data that is provided by the caller. Some of the fields are always provided by the TPM. When a TPM-provided field is in a Primary Object, the TPM-provided data is always derived, in some way, from the associated Primary Seed such that the same Primary Object can be reproduced as long as the associated Primary Seed remains unchanged. For Ordinary Objects, an implementation may either get the TPM-provided data from the RNG, or compute the fields of the object as if it were a Primary Object, but with a random number used in place of a Primary Seed.

The performance difference between the two methods of producing asymmetric objects is negligible as the majority of the work is in validating the choices rather than in generating them. For symmetric objects, the difference might be worth having different methods for Primary and Ordinary Objects but there is an added cost in development and testing that could offset the benefit of any slight performance advantage.

For Ordinary Objects, the method used for generating *sensitive* should be used for generating *seedValue*. That is, if *sensitive* is generated by taking values from the RNG, then *seedValue* should be generated by taking values from the RNG. If *sensitive* is generated by creating a random seed and using the methods used for Primary Keys, then that same seed should be used for generating *seedValue*.

### 27.7.2 *type*

The *type* parameter of the object's sensitive area is a copy of the type parameter from the object's public-area template.

### 27.7.3 *authValue*

The *authValue* of the object is copied from the *userAuth* field of the *inSensitive* parameter of commands such as TPM2\_Create(), TPM2\_CreateLoaded, or TPM2\_CreatePrimary(), or from *newAuth* in commands such as TPM2\_ObjectChangeAuth.

When the TPM returns a TPM2B\_PRIVATE structure, the TPM pads the TPM2B\_AUTH to its maximum size.

NOTE This prevents the TPM from leaking the size of the authorization value in cases where trailing zeros are stripped.

### 27.7.4 *seedValue*

For a symmetric object, *seedValue* field is used as an *obfuscation* value. It is also used to hold the symmetric seed value for Storage Keys.

For an asymmetric key that is not a Parent, *seedValue* is not needed and the TPM will ignore the value if it is present.

For a Storage Parent *seedValue* is used as a seed for generating the integrity and confidentiality values for protecting child objects of the key.

For all object types, when *seedValue* is present, it is at least half the size of the digest produced by the *nameAlg* of the object.

NOTE 1 Presuming that the protection algorithms of a Storage Key are reasonably balanced (a requirement), then this size of seed will provided adequate entropy required for protection of the child Object.

NOTE 2 The reference code always produces a *seedValue* that is the size of the digest of the nameAlg.

*seedValue* is generated using the “entropy” source used for the object type (see 27.6).

When creating a Primary Object in the Endorsement Hierarchy, it is required that the entropy source be updated to reflect the current SPS. This allows the *sensitiveValue* to remain the same after a change of the SPS but prevents any previously-generated Child Objects in the Endorsement Hierarchy from being loaded after the SPS changes.

NOTE 3 In the reference implementation, this is accomplished by reseeding the DRBG state with the proof value of the storage hierarchy.

## 27.7.5 sensitive

### 27.7.5.1 Symmetric Objects

Symmetric objects have a *type* of TPM\_ALG\_SYMCIPHER or TPM\_ALG\_KEYEDHASH. For a symmetric object, the sensitive object data may be provided by the caller or generated by the TPM.

If *sensitiveDataOrigin* attribute in the object template is CLEAR, then the sensitive data is provided by the caller. If provided by the caller, the sensitive data will be in the *data* field of the *inSensitive* parameter of TPM2\_Create() or TPM2\_CreatePrimary(). For TPM2\_CreateLoaded(), if the Parent is a Derivation Parent, then *sensitiveDataOrigin* is required to be CLEAR in the template.

If *sensitiveDataOrigin* is SET, it indicates that the TPM is the source of the sensitive data and the *data* field of the *inSensitive* parameter is required to be an Empty Buffer.

A user provided symmetric key is required to be the size indicated by *parameters.symDetail.keyBits.sym* in the template. It is the number of octets required to hold the number of bits indicated.

NOTE 1 If the key has fewer significant digits than necessary, pad octets of zero are required. The pad octets are added to the high-order end of the key.

A user provided HMAC key is not allowed to be larger than the smaller of the block size of the hash algorithm or 128 octets. Limiting the size to 128 octets is for compatibility of structures between TPM.

NOTE 2 The HMAC algorithm requires that keys larger than the hash block size be hashed before use. This may result in fewer bits of entropy in the HMAC key than expected by the caller. The TPM will not allow the caller to specify an overly large value for the HMAC key. If the caller desires to use a larger value, they should perform the digest externally and pass the resulting digest to the TPM for use as the HMAC key.

If not provided by the caller, *sensitive* is generated by the TPM. For a TPM\_ALG\_KEYEDHASH object, the size is the digest size of the nameAlg of the object. For a TPM\_ALG\_SYMCIPHER object, the size is equal to  $(parameters.symDetail.keyBits.sym + 7) / 8$ .

### 27.7.5.2 Asymmetric Objects

The *sensitive* field in an asymmetric key object is the private key. The key is generated in a way that is specific to the algorithm and is described in an algorithm-specific annex of this TPM 2.0 Part 1.

EXAMPLE RSA key generation is described in B.8 and ECC key generation is described in C.5.

## 27.8 Creation Data and Ticket

When it creates an object, the TPM also creates a data structure that describes the environment in which the object was created. This data includes:

- a digest of selected PCR at the time of object creation and a bit-map indicating the PCR that were included in the list. The PCR selection is those PCR indicated in the call to TPM2\_Create() and TPM2\_CreatePrimary().
- the locality at which the object was created
- the *nameAlg* of the Storage Parent. If the parent is a Primary Seed, then the algorithm will be TPM\_ALG\_NULL.
- the Name of the Storage Parent. If the parent is a Primary Seed, then the Name will be the handle of the seed.
- the Qualified Name of the Storage Parent. If the parent is a Primary Seed, then the Qualified Name will be the handle of the seed.
- some additional data provided by the caller that is to be associated with the new object

In addition to these values, the TPM will create a ticket that will allow the TPM to validate that the creation data was generated by the TPM.

The creation data will act as a form of certification of the object that is most useful when *fixedTPM* is CLEAR in the created object. Without this information, it would not be possible to determine how the object came to be in the hierarchy where it is found. When the object is moved, it would be up to the duplication authority to provide some certification of the duplication process. If there is no creation data indicating that the object was created in the place where it was found, and there is no certificate from the duplication authority for the object, then it may be difficult to establish the trustworthiness of the object.

NOTE                    In this case, the trustworthiness of the object refers to determining that the sensitive area of the object has only ever been accessible by trusted entities such as other TPMs.

## 27.9 Creation Resources

When a Primary Object is created, it is also loaded in a TPM object slot and the handle is returned. If no free object slot is available, the TPM will return TPM\_RC\_OBJECT\_MEMORY.

When creating an ordinary object, the TPM may use an object slot as scratch memory in which it builds the object. If the implementation does use this scheme and no object slot is available, then the TPM will return TPM\_RC\_OBJECT\_MEMORY.

## 28 Object Derivation

### 28.1 Introduction

This section describes the differences between Object creation and Object derivation. If no difference is stated, then there is none.

The TPM2\_CreateLoaded() command is used for derivation. This command can be used to create or derive any type of object with the type of Object determined by the type of the entity referenced by the *parentHandle* parameter. If *parentHandle* references a Primary Seed, then a Primary Object is created; if *parentHandle* references a Storage Parent, then an Ordinary Object is created; and if *parentHandle* references a Derivation Parent, then a Derived Object is generated.

NOTE For a given template (*inPublic*), the same Primary Object is created by both TPM2\_CreatePrimary() and TPM2\_CreateLoaded().

### 28.2 Derivation Parameters

For object derivation the TPM uses the *sensitive* value in a Derivation Parent as a key in a key derivation function (KDF). The KDF that is to be used in Object derivation is a property of the Derivation Parent and may include the hash algorithm to use in the derivation process.

NOTE **KDFa** (TPM\_ALG\_KDF1\_SP800\_108) is the only KDF that is currently supported by the reference code,

Most KDFs require additional parameters in order to have different types of keys derived for different applications. The TPM allows two additional parameters (*label* and *context*) to be provided in TPM2\_CreateLoaded(). These additional parameters can be provided in two ways: in the *unique* field of the *inPublic* value, or in the *data* field of the *inPrivate* parameter. If provided in the *unique* field, the corresponding value in the *inPrivate.data* field is required to be an empty buffer.

### 28.3 Public Area Template

For TPM2\_CreateLoaded(), a TPM2B\_TPMPATE is used for the *inPublic* parameter instead of a TPM2B\_PUBLIC. The difference in parameters is to allow overloading of the *unique* field in the *inPublic* parameter. For a TPM2B\_PUBLIC, the *unique* field is unmarshaled based on the *type* of *inPublic*. For a TPM2B\_TEMPLATE, the *inPublic* is unmarshaled as a byte array and passed to the TPM2\_CreateLoaded() action code where it is unmarshaled based on the type of parent and *type* of *inPublic*.

When using TPM2\_CreateLoaded() to create a Primary or Ordinary Object, the caller should use the same format for the unique field that would be used when creating the Object with TPM2\_CreatePrimary() or TPM2\_Create(). The derivation-specific format is required when *parentHandle* references a Derivation Parent.

For object creation, *sensitiveDataOrigin* indicates to the TPM whether the caller is providing the sensitive data or if the TPM is to generate it. For Object Derivation, the caller provides values that influence the derivation process but the caller does not explicitly set the sensitive value. For this reason, *sensitiveDataOrigin* is required to be CLEAR in the template for a Derived Object.

### 28.4 Entropy for Derived Objects

For a Derived Object, the caller creates a structure that contains the parameters needed for the KDF. For KDFa, this would include:

- a hash algorithm (*hashAlg*);
- a pointer to the *sensitive* value in the Derivation Parent;
- a pointer to a *label* value (could be NULL);
- a pointer to a *context* value (could be NULL); and
- a *counter* initialized to one (1).

When used to get a value (*Value*) with *numBits* bits, the call to KDFa would be:

$$Value := \mathbf{KDFa} (hashAlg, sensitive, label, context, counter, bits) \quad (51)$$

The value of counter is updated on each call and contains the total number of digests that were produced since the structure was created.

### 28.5 Derivation Process

The derivation process is required to be the same for all TPMs. That is, with the same inputs, all TPMs will generate the same Derived Objects.

When generating a Derived Object, the TPM will create the entropy structure for a KDF and pass a pointer to the structure to the function that creates Objects. The algorithm for generating an Object is as described in clause 27.7.

NOTE            The method of generating RSA keys is highly variable and is normally chosen according to the constraints of the application. In some cases compliance is the overriding factor and in others, performance may be the determining factor. Since no single algorithm seems to be optimum for all the constraints and it would not be acceptable to require that TPMs implement one RSA key generation for compliance and one for interoperability, the TCG has chosen not to support derivation for RSA keys.

## 29 Object Loading

### 29.1 Introduction

An object is either a key or data that can be loaded into the TPM for use. An object must be loaded before the TPM can use or modify the object. Loading may require that the USER role authorization for the Storage Parent be provided

### 29.2 Load of an Ordinary Object

It is possible to load just the public portion of an object into the TPM (TPM2\_LoadExternal()) or to load both the public and private portions (TPM2\_Load()). If the sensitive area is to be manipulated or used, then both portions are required to be loaded.

When loading an object, multiple consistency checks are performed. Among these checks:

- a) Is the HMAC of the encrypted private area correct – this ensures that the sensitive area was not modified, that the sensitive area and the provided public area are matched, and that the object is a descendant of the Storage Parent.
- b) Is the unique parameter of the public area cryptographically bound to the sensitive data – this is required to prevent improper association of a public area with a sensitive area. If this check were not done, an attacker could use a public area that had a Name that is the same as a different object and associate a different sensitive area with the public area. If the object were used in TPM2\_PolicySecret(), the attacker could get the TPM to create a *policyDigest* with any desired hash value.

**EXAMPLE** A legitimate policy uses signature validation of a key with Name1. An attacker could create an object with Name1 (copy the data from the legitimate key) and then create a sensitive area that had an *authValue* known to the attacker, instead of using TPM2\_PolicySigned() to create the policy.

- c) Are the attributes consistent – these values need to be checked even if the integrity check indicates that the values were not modified. This is because the object may have been created by software using inconsistent values. The integrity may be good but the values may be wrong.

- 1) If *fixedTPM* is SET, *fixedTPM* must also be SET in the Storage Parent.

**NOTE** If *fixedTPM* is properly SET, then the other checks need not be made because the object is verified to have been created on the TPM that loaded the object, so the other attributes are known to be correct.

- 2) If *fixedParent* is CLEAR, then *fixedTPM* must also be CLEAR.

- 3) If *restricted* is SET, only one of *sign* or *decrypt* may be SET.

### 29.3 Public-only Load

There are several cases, such as duplication or signature verification, when only the public portion of an asymmetric key can be loaded. The public-only load of an object requires that the caller associate the object with one of the hierarchies. This association is needed when the key is used for signature verification so that the TPM can determine which proof value to use in the ticket.

A public-only load occurs when the *inPrivate* parameter to TPM2\_LoadExternal() has a size of zero.



## 29.4 External Object Load

External Objects allow the cryptographic processes of the TPM to be used on keys that are not part of a TPM hierarchy. The public portion of an asymmetric key may be loaded so that the TPM can be used to validate a signature. A symmetric key may be loaded so that the symmetric engines of the TPM may be used to encrypt or decrypt data.

TPM2\_LoadExternal() is used to load an External Object. When only the public portion is loaded, the attributes of the object are arbitrary but the structures are required to be consistent with the type. That is, if an RSA signing key is loaded, the signing scheme must be a valid scheme for an RSA key.

When the sensitive portion of the object is loaded (such as, a symmetric key), the sensitive area is not encrypted by a Storage Parent but may be encrypted using parameter encryption. The *fixedParent* and *fixedTPM* attributes are required to be CLEAR when both parts are loaded. This check allows the object to be used in any command that is valid for the type including certification.

**NOTE** If an entity has access to both the public and sensitive portions of a key, then the entity could import the key and then certify it.

An external object can be associated with a hierarchy when it is loaded. This allows creation of tickets that are specific to a hierarchy in commands such as TPM2\_VerifySignature().

If the hierarchy with which an External object is associated is disabled, the object will be flushed. If the associated hierarchy is disabled when TPM2\_LoadExternal() is called, the object will not load.

## 30 Context Management

### 30.1 Introduction

To allow the TPM to be shared among many applications, the TPM supports context management. The objects, sequence objects, and sessions used by an application may be loaded into the TPM when needed and saved when a different application is using the TPM. The TPM Resource Manager (TRM) is responsible for swapping the contexts so that the necessary resources are present in the TPM when needed.

There are two types of contexts: those associated with Transient Objects, and those associated with authorization sessions.

The four commands used to manage the contexts are

- 1) **TPM2\_ContextSave()** – the TPM integrity protects, encrypts, and returns the context associated with a handle,
- 2) **TPM2\_ContextLoad()** – allows a previously saved context to be loaded to TPM RAM and have a handle assigned,
- 3) **TPM2\_FlushContext()** – the context information associated with the specified handle is erased from TPM RAM, and
- 4) **TPM2\_EvictControl()** – allows the owner or the platform firmware to designate objects that are to remain TPM-resident over TPM2\_Startup() events. This command will return a new handle.

A saved context is cryptographically bound to a specific TPM so that it may not be loaded on a different TPM. This binding is provided by using a statistically unique proof value in the generation of the protection values for a context (see 30.3 and 30.3.2). When the proof value of a hierarchy changes, saved object contexts belonging to that context can no longer be loaded into the TPM. The proof value for a context will change when its Primary Seed changes. Additionally, *ehProof* will change when either the SPS or EPS changes.

NOTE 1 In the reference implementation, *ehProof* is a non-volatile value from the RNG. It is allowed that the *ehProof* be generated by a KDF using both the EPS and SPS as inputs. If generated with a KDF, the *ehProof* can be generated on an as-needed basis or made a non-volatile value.

Saved contexts for all objects and sessions are invalidated on a TPM Reset. In the reference implementation, the encryption keys for contexts are changed by TPM Reset so previously saved contexts may no longer be loaded. Saved session contexts remain valid until the session is closed, or TPM Reset. If the *stClear* attribute of an object is SET, then saved contexts for the object are invalidated on either TPM Reset or TPM Restart (that is, any time the TPM does a Startup(CLEAR)). If the *stClear* attribute of an object is CLEAR, then the saved contexts for that object are valid and may be loaded into the TPM until the next TPM Reset.

NOTE 2 In the reference design, when an object context is saved, the current value of *clearCount* is placed in the context. When the context is loaded, if the object is a *stClear* object, the value in the object is compared to the current value of *clearCount*. If they are not the same, then the context load fails.

Objects and sessions are not retained in TPM memory after a TPM2\_Startup() and it is necessary for the TRM to save the contexts for any session or object that is to be useable after TPM Restart or TPM Resume.

NOTE 3 The TPM might lose power between a TPM2\_Shutdown(TPM\_SU\_STATE) and the subsequent TPM2\_Startup(). With respect to context preservation, the TPM behavior is defined to be the same whether the TPM loses power or not.

The structure of a saved context TPM2B\_CONTEXT\_DATA may be defined by the vendor but a saved context is required to have its integrity and confidentiality protected by cryptographic means. Parts 3 and 4 of this specification implement the normative requirements for providing confidentiality and integrity protection for saved contexts. These protections are described in more detail in subsequent parts of this clause 30.

NOTE 4 The algorithms chosen for integrity and confidentiality protection of a saved context are vendor specific. However, the cryptographic strengths of the algorithms used are required to be the highest of any algorithm of the same type implemented on the TPM.

## 30.2 Context Data

### 30.2.1 Introduction

The data structure TPMS\_CONTEXT returned by TPM2\_ContextSave contains context metadata as well as the actual context TPM2B\_CONTEXT\_DATA. The context metadata contains:

- a sequence number,
- a handle, *savedHandle*, and

NOTE For Transient Objects, this *savedHandle* in a saved context data structure is not the same as the handle used by the TPM to reference loaded objects and by TPM commands to describe the object being operated on.

- a hierarchy selector.

The actual context contains:

- an integrity HMAC, and
- an encrypted data blob.

The structure of the metadata is normative. The internal structure TPMS\_CONTEXT\_DATA of the actual context is vendor specific. The encrypted data blob contains the data necessary to reconstruct the full object or session context in the TPM. The other fields are defined in the remainder of this clause 30.2.

The structure of the context contains both confidential and non-confidential data. This specification requires encryption of the confidential data. The TPMS\_CONTEXT structure is normative. The structure of the enclosed TPMS\_CONTEXT\_DATA is vendor-specific, and its confidential data must be encrypted.

### 30.2.2 Sequence Number

New protection values are generated each time a context is saved. The protection values are an HMAC key, a symmetric key, and an initial value. The values are made unique by including a counter value in the generation process (see 30.3 and 30.3.2). The counter value used for the context is stored in the sequence number field of the context structure. Two counters are used for generating the sequence numbers. One counter is used for transient and sequence object contexts. A second counter is used for session contexts.

There are two counters used to provide sequence numbers. The counter (*objectContextID*) provides sequence numbers for Transient Objects. This counter is incremented each time an object context is saved. The counter (*contextCounter*) is used to provide sequence numbers for sessions and increments when a session context is created or loaded (its behavior is described in more detail in 30.5). When creating the context structure, the TPM sets the *sequence* parameter to the value of the counter used in the generation of the protection values for the context.

When a context is loaded, (TPM2\_ContextLoad()), the TPM checks that the *sequence* parameter is in a viable range before starting the operation. For an object, the viable range is any number that is less than the current value of the object sequence counter. For a session, the sequence number must also be less than the session sequence number but it must also be greater than the sequence number minus the allowable range for session sequence number.

In the reference implementation, *objectContextID* is a 64-bit counter that is initialized to zero at startup and is expected to never overflow. The size is platform-specific.

**EXAMPLE** For purposes of this example, assume that the sequence counter value is only 16 bits and that the session counter indicates the last assigned session context had a value of  $10_{16}$ . It would then be an error if the *sequence* parameter in a loaded session context is greater than  $10_{16}$ . Assume further that the TPM only allows a range of 256 between session values (explanation in 30.5). Then it would be an error if the sequence parameter of the session in TPM2\_ContextLoad() is less than  $10_{16} - 01_{16} = 0F_{16}$ , and the TPM will not load the context.

### 30.2.3 Handle

The *savedHandle* number for a context indicates the type of the context (object or authorization session). The type of the context is used to determine how to reconstruct the protection values for validation of the context. If the *savedHandle* value in the context is changed by software, the context will not load.

For a session, the same handle is assigned to the context whether the context is loaded in the TPM or in a saved context. That is, *savedHandle* is the same as the handle the TPM uses to refer to the session. A session handle will have an MSO of TPM\_HT\_HMAC\_SESSION ( $02_{16}$ ) or TPM\_HT\_POLICY\_SESSION ( $03_{16}$ ). The range of values in the handle index (the low-order three octets of the handle) is TPM dependent. In the reference implementation, the low order bits of the session context handles fall within a range from 0 to MAX\_ACTIVE\_SESSIONS – 1 and the TPM will generate an error and do no further processing of the context if the handle is outside of this range.

A *savedHandle* MSO of TPM\_HT\_TRANSIENT ( $80_{16}$ ), indicates that the context is an Object or sequence object. For an object, the *savedHandle* parameter of the context structure does not indicate the handle value used by the TPM to reference the object (when a Transient Object context is not on the TPM, the TPM retains no information about that context). Therefore, the *savedHandle* value is not used for Transient Object contexts in the same way that it is used for session contexts. Instead, the *savedHandle* is used to indicate the type of the Transient Object context.

Three *savedHandle* values are defined for Transient Object contexts:

- 1)  $00\ 00\ 00_{16}$  – indicates a Transient Object that does not have the *stateClear* property;

**NOTE** An Object has the *stateClear* property when *stClear* is SET in the Object or in any of its ancestor keys.

- 2)  $00\ 00\ 01_{16}$  – indicates a sequence Object (see 32.4.5); and
- 3)  $00\ 00\ 02_{16}$  – indicates a Transient Object that has the *stateClear* property.

**EXAMPLE** A sequence Object will have a 32-bit handle value of  $80\ 00\ 00\ 01_{16}$ .

If the *savedHandle* type is TPM\_HT\_TRANSIENT, the TPM will not generate or load a context with any other value besides the three values described above for the handle's index.

Objects that have the *stateClear* property are invalidated by Startup(CLEAR). To enforce this, the TPM will include *clearCount* in the integrity value of the Object.

TPM processing of contexts with *savedHandle* values of  $80\ 00\ 00\ 00_{16}$  or  $80\ 00\ 00\ 01_{16}$  is the same. The reason for differentiating sequence Objects is to identify the context for the convenience of the TPM

resource manager (TRM). The TRM needs to manage sequence objects differently from other Transient Objects. Because the context of a sequence object changes each time the sequence is updated, the context needs to be saved each time the context is used. The context of a Transient Object does not change on use. Therefore, the TRM can optimize by saving the Transient Object context only once.

### 30.2.4 Hierarchy

The hierarchy parameter of the context indicates which of the hierarchy proof values are used in the creation of the protection values for the context. For objects, this value is determined by the hierarchy of the object and may be TPM\_RH\_NULL for a Temporary Object. Sequence objects and sessions are in the Null hierarchy.

## 30.3 Context Protections

### 30.3.1 Context Confidentiality Protection

A symmetric block cipher is used to protect the confidentiality of a saved context. The algorithm is selected by the TPM vendor but is required to have the highest security strength of any symmetric block cipher implemented on the TPM.

When the context is created by TPM2\_ContextSave(), the value of *sequence* is stored in the TPM2B\_CONTEXT\_SENSITIVE context before it is encrypted. When the context is loaded, the value of *sequence* is compared to the value in the loaded TPM2B\_CONTEXT\_SENSITIVE context after it is decrypted. If the values are not the same, then the TPM will enter failure mode as this is symptomatic of a specific type of power analysis attack.

The symmetric key and IV are regenerated when a context is loaded. It is required that the symmetric key and IV not be generated until the context integrity has been validated.

NOTE 1 This restriction prevents simultaneous power-analysis attacks on the integrity and encryption values of a context. Since the integrity is checked first, no attempt is made to create the symmetric key if the integrity check fails.

**KDFa()** is used to generate the symmetric encryption key and IV for context encryption. The parameters of the call are:

$$(symKey, symIv) := \mathbf{KDFa}(hashAlg, hProof, vendorString, sequence, handle, bits) \quad (52)$$

where

<i>hashAlg</i>	a hash algorithm chosen by the vendor
<i>hProof</i>	the proof value associated with the hierarchy associated with the context
<i>vendorString</i>	a value used to differentiate the uses of the KDF
<i>sequence</i>	the sequence parameter of the TPMS_CONTEXT
<i>handle</i>	the handle parameter of the TPMS_CONTEXT
<i>bits</i>	the number of bits needed for a symmetric key and IV for the context encryption

NOTE 2 The value of *vendorString* is required to be different from any other label string used in a **KDFa()** call. The reference implementation uses "CONTEXT\_ENCRYPT"

NOTE 3 The *nullProof* is used as the hProof value for a context in the Null hierarchy so that the encryption keys do not repeat and so that they change on each TPM Reset.

The key and IV produced in (52) are used to encrypt the object or session context

$$encContext := \mathbf{CFB}_{symAlg}(symKey, symIv, context) \quad (53)$$

where

$\mathbf{CFB}_{symAlg}$	symmetric encryption in CFB mode using a symmetric algorithm chosen by the TPM vendor
$symKey$	symmetric key from (52)
$symIv$	IV from (52)
$context$	the context being protected (a TPM2B_CONTEXT_DATA)

NOTE 4 The *size* field and the *buffer* field of *context* are encrypted.

### 30.3.2 Context Integrity Protection

The integrity of a saved context is protected by an HMAC using a hash algorithm selected by the TPM vendor. The hash algorithm chosen is required to have the highest security strength of any hash algorithm implemented on the TPM. See TPM 2.0 Part 2 TPM\_PT\_CONTEXT\_HASH.

The HMAC is constructed using the proof value associated with the hierarchy to which the object belongs. Since the proof value changes when the associated Primary Seed changes, HMAC validation for a previously saved context will fail when the associated Primary Seed changes; and that context may no longer be loaded. Other values in the HMAC computation serve to invalidate other context subsets without necessarily invalidating them all.

EXAMPLE The *clearCount* value is included in the HMAC of a context for an object with the *stClear* attribute so that the context will be invalidated on each TPM Restart as well as each TPM Reset.

The only TPM state change that invalidates all saved contexts is TPM Reset.

Sessions, Sequences, and Temporary Objects are in the “null” hierarchy.

The HMAC integrity computation for a saved context is:

$$contextHMAC := \mathbf{HMAC}_{vendorAlg}(hProof, resetValue \{ || clearCount \} || sequence || handle || encContext) \quad (54)$$

where

$\mathbf{HMAC}_{vendorAlg}$	HMAC using a vendor-defined hash algorithm
$hProof$	the hierarchy proof as selected by the hierarchy parameter of the TPMS_CONTEXT
$resetValue$	either a counter value that increments on each TPM Reset and is not reset over the lifetime of the TPM; or a random value that changes on each TPM Reset and has the size of the digest produced by vendorAlg
$clearCount$	a counter value that is incremented on each TPM Resume and may be incremented or set to zero on TPM Reset. This value is only included if the handle value is 80 00 00 02 <sub>16</sub> .

NOTE the handle value is 80 00 00 02<sub>16</sub> when the *stClear* attribute of the object is SET or when the *stClear* attribute is set in one of the object's ancestor keys.

sequence the sequence parameter of the TPMS\_CONTEXT

handle	the handle parameter of the TPMS_CONTEXT
<i>encContext</i>	the encrypted context blob

### 30.4 Object Context Management

When an object's context is saved, a copy of the object context is integrity protected, encrypted, and returned to the caller. The original context remains in the TPM and the TPM retains its handle. A saved object context may be reloaded into the TPM with TPM2\_ContextLoad(). If the TPM has sufficient memory available, it will load the object and assign a handle. If other copies of the same object are in TPM memory, they are unaffected. An object context is only removed from TPM memory with TPM2\_FlushContext(), deletion of the associated hierarchy seed, or TPM2\_Startup().

The handle assigned to an object when it is loaded may not be assigned to any other TPM resource, object, or session. When the object is flushed from TPM memory, its handle may be assigned to another TPM resource when it is loaded or created.

Software may create as many copies of an object context as desired. When an object is not in TPM memory, it has no associated handle. If an object context is saved and subsequently reloaded, it is likely that a different handle will be assigned to the object.

When the Primary Seed is changed for the hierarchy associated with an object, all objects associated with that hierarchy are flushed from TPM memory. The TPM will no longer load saved contexts associated with the previous Primary Seed.

When an attempt is made to load an object or an object context (TPM2\_Load(), TPM2\_CreatePrimary(), TPM2\_LoadExternal() or TPM2\_ContextLoad()) and the TPM does not have sufficient RAM to hold the object, the TPM will return TPM\_RC\_OBJECT\_MEMORY or TPM\_RC\_MEMORY. This warning code is normally handled by the TRM. It indicates that an object or a session needs to be unloaded from TPM memory before the command can complete. If the TPM returns TPM\_RC\_OBJECT\_MEMORY, it indicates that an object must be flushed from TPM memory. If the TPM returns TPM\_RC\_MEMORY, then it is possible that removal from TPM RAM of either an object or a session would allow the command to complete.

When a command references a persistent object, the TPM may move the object from NV into an object slot. If no slot is available, the TPM will return TPM\_RC\_OBJECT\_MEMORY.

An implementation is allowed to use an object slot for temporary memory in execution of TPM2\_Import() and return TPM\_RC\_OBJECT\_MEMORY if a slot is not available.

If the TPM uses an object slot for temporary memory, the slot will be freed at the end of the command in which the slot was allocated.

If a TPM receives Shutdown(STATE) before the \_TPM\_Init, then the saved object contexts will continue to be usable after a TPM Restart or TPM Resume. An exception is that an object may be created with the *stClear* attribute. If this attribute is SET in an object or an ancestor of an object, then the saved context will be invalidated on TPM Restart. All saved object contexts are invalidated by TPM Reset.

### 30.5 Session Context Management

A session context is created by TPM2\_StartAuthSession(). The context associated with a session is unique. That is, the data describing the session's state may be either on the TPM or saved off the TPM, but not both. Further, a saved session context may only be loaded once. These limitations on the session context are intended to prevent possible attacks based on replay of authorizations.

The handle associated with a session does not change as long as the session is active. The session is active until closed by the *continueSession* flag being FALSE or until the session context is flushed from the TPM by TPM2\_FlushContext().

The nominal implementation uses a volatile counter (*contextCounter*) that increments each time a session is created or context loaded. This count value is assigned to the created or loaded session context and serves as a version number for the session context. If the session context is saved and reloaded, it is assigned a new version number. *contextCounter* is saved by Shutdown(STATE) and reset on TPM Reset.

The TPM maintains a database of concurrent sessions so that it can validate that a reloaded session context is the most recent version. It is required that the TPM be able to ensure that the restored context is the correct context regardless of the number of contexts created.

The size of *contextCounter* affects the size of the memory required for tracking each of the contexts. It is therefore desirable that the counter only be large enough for the majority of applications, meaning that it will not be large enough for all applications. In those applications, a method is required to handle counter rollover.

One scheme for handling rollover is to maintain an even/odd interval. If, for example, a nonce were being used for each interval, then the TPM could maintain two nonces, one to be used when the MSb of the volatile counter is 0 and the other when the MSb is 1. When the counts of all the sessions have the same MSb, then a new nonce can be created for use when the MSb changes. This scheme works unless a session has a long lifetime. That is, if the session is created when the MSb is 0, and the session is still active when the counter reaches its maximum value with all bits equal 1, then the context with an MSb of 0 will need to be discarded.

Rather than have the old session be automatically flushed, the TPM provides an indication that it is reaching its limit and that one or more saved session contexts need to have their *sequence* number updated to the current interval in preparation for the context counter rollover.

The indication that the context counter is approaching its limit is provided when an authorization session is created or loaded. If the creation or loading of a session would make it impossible for the TPM to bring all contexts into the current interval, then it would return an error (TPM\_RC\_CONTEXT\_GAP) and not create or load the new session. On receiving this error, the management software either would explicitly flush old session contexts or would load the old session contexts to update their associated counter values.

When the TPM returns TPM\_RC\_CONTEXT\_GAP, it will not allow an authorization session to be created and it will only allow the oldest authorization session to be loaded. When the oldest session is loaded, its *sequence* number is updated. It may be used or saved with its new *sequence* number.

**NOTE** The TPM must provide the indication of the session-tracking limit being reached before the maximum count is reached. If there are three sessions in the 'odd' interval and the end of the 'even' interval is being reached, then the TPM must indicate the limit while there are still three available session sequence numbers in the 'even' interval. This allows the sessions in the 'odd' interval to be loaded and saved with an 'even' interval session sequence number and with no session in the 'odd' interval so that a new 'odd' interval identifier can be created.

Session contexts in TPM RAM are flushed on any TPM2\_Startup(). Saved session contexts are not invalidated and may be reloaded after a TPM Restart or TPM Resume. Saved session contexts are invalidated on a TPM Reset.

### 30.6 Eviction

Eviction is the process of removing the context associated with an object or session from TPM RAM to allow for other sessions or objects to be loaded or created. Saving a session context removes the majority of the session context from TPM RAM. Saving an object context does not remove it from TPM



memory. When applied to an object, `TPM2_FlushContext()` will remove it from the TPM RAM but not invalidate the saved contexts of that object. When applied to a session, `TPM2_FlushContext()` will invalidate the session whether its context is in TPM RAM or saved.

An object may be copied to persistent TPM NV memory with `TPM2_EvictControl()`. When made persistent, `TPM2_FlushContext()` and `TPM2_Startup(TPM_SU_CLEAR)` have no effect on the persistent copy of the object.

A session may not be made persistent.

Use of `TPM2_EvictControl()` requires either Owner Authorization or Platform Authorization. An object made persistent using *ownerAuth* may be evicted from persistent memory using either Owner Authorization or Platform Authorization. An object made persistent using Platform Authorization may only be evicted from persistent memory using Platform Authorization.

### 30.7 Incidental Use of Object Slots

In most cases, the TRM will explicitly load and unload (flush) objects from the TPM's object memory. In three cases, the TPM will make use of object slots as a side effect and the TRM needs to deal with potential resource issues that may arise. The three cases are: `TPM2_Import()`, use of persistent objects, and `_TPM_Hash_Start`.

`TPM2_Import()` allows an implementation to use an object slot for its "scratch" memory while operating on the import blob. When the command completes the slot will be available. An implementation that uses this option may return `TPM_RC_OBJECT_MEMORY` if a needed slot is not available. This return code is in the group of response codes that are expected to be handled by the resource manager.

When a handle references a persistent object, a TPM implementation is allowed to return `TPM_RC_OBJECT_MEMORY` if an object slot is not available. This allows the TPM to keep the persistent image of the object in a compressed form and decompress it into an object slot for efficient processing. The version of the persistent object held in an object slot will be removed when the command completes.

When the TPM receives `_TPM_Hash_Start`, it will unconditionally create an Event Sequence context. If an object slot is available, the TPM will use the available slot. If an object slot is not available, the TPM will flush an arbitrary object context and use that slot. At the end of the event sequence (`_TPM_Hash_End`), the slot used for the Event Sequence will be vacant. The TRM should be aware that the `_TPM_Hash_Start` sequence may cause loss of a loaded object.

## 31 Attestation

### 31.1 Introduction

Attestation is the action of having the TPM sign some internal TPM data. Confidence in the attestation is related to the confidence in the key that is used to sign. The highest confidence is provided by a *fixedTPM*, restricted signing key that is created on a TPM with a certificate from the TPM manufacturer.

The TPM may be used to attest to several different types of data:

- PCR data – TPM2\_Quote()
- *Clock* and *Time* data – TPM2\_GetTime()
- Audit digests – TPM2\_GetCommandAuditDigest() and TPM2\_GetSessionAuditDigest()
- Other TPM Objects – TPM2\_Certify()

For all of these commands, the TPM produces a standard attestation structure and appends the command-specific data. The resulting data block is then hashed and signed by the selected signing key. The selected key may be any key that has the *sign* attribute SET. If the signing key is unrestricted, then the caller may indicate the signing scheme to be used. If the signing key is restricted, the TPM will return an error (TPM\_RC\_SCHEME) unless the scheme selector in the attestation command is TPM\_ALG\_NULL.

### 31.2 Standard Attestation Structure

The contents of the standard attestation structure are described in Table 30.

**Table 30 — Standard Attestation Structure**

Parameter	Type	Description
magic	TPM_GENERATED	This unique value (TPM_GENERATED_VALUE) occurs as the first octets in any TPM-generated attestation structure. This field is used to prevent use of a restricted signing key to sign a forgery of an attestation. A TPM will not allow a restricted signing key to sign any external data if that data starts with this unique value. The way that the TPM enforces this restriction is that a TPM will not use a restricted key to sign a digest that the TPM did not produce. Since the TPM produced the digest, it can ensure that any external data did not start with this value.
type	TPMI_ST_ATTEST	This identifies the type of the attestation structure and indicates the contents of the <i>attested</i> parameter.
qualifiedSigner	TPM2B_NAME	This is the Qualified Name of the key used to sign the attestation data. A key that can be duplicated may be signing in different locations and this Qualified Name allows the Verifier to determine the environment in which the signature was produced.
extraData	TPM2B_DATA	external info supplied by caller (often in <i>qualifyingData</i> parameter) NOTE A TPM2B_DATA structure provides room for a digest and a method indicator to indicate the components of the digest. The definition of this method indicator is outside the scope of this specification.
clockInfo	TPMS_CLOCK_INFO	The values of <i>Clock</i> , <i>resetCount</i> , <i>restartCount</i> , and <i>Safe</i>
firmwareVersion	UINT64	This TPM-vendor-defined value changes when the firmware on the TPM changes, if that change is meaningful to the security of the TPM.
[type]attested	TPMU_ATTEST	the type-specific attestation information

### 31.3 Privacy

The attestation block contains information that could allow cross correlation of attestation values. The combination of a *firmwareVersion* and *clockInfo* could be used to identify that two attestations were signed by keys on the same TPM. This correlation is possible because the combination of *resetCount*, *restartCount*, and *firmwareVersion* could be unique. Even if the combination is not unique for all TPM, an imperfect correlation may be adequate for certain types of activity tracking.

The TPM prevents such tracking by adding obfuscation values to the reported values of *resetCount*, *restartCount*, and *firmwareVersion*. This obfuscation value is different for each key and TPM (see 36.7). Although the values are obfuscated, they do not lose any of their usefulness for indicating changes to the values. While the absolute values are not visible in the attestation, it is still possible to look at attestations signed by the same key and determine how many times the TPM was reset or restarted between the attestations and to see the delta in the firmware version number (if any).

It is sometimes necessary to have the non-obfuscated values of the *clockInfo* and *firmwareVersion* included in an attestation. Support for this is provided by allowing signing keys in the Endorsement hierarchy. When a key in the Endorsement hierarchy signs an attestation, no obfuscation is applied. The underlying presumption is that the TPM's Privacy Administrator controls the Endorsement hierarchy and it is possible, through policy, to limit the use of keys in that hierarchy so that authorization from the Privacy Administrator is always required.

### 31.4 Qualifying Data

Each of the attestation commands has a parameter called *qualifyingData*. This parameter is not interpreted by the TPM and may contain any data chosen by the caller. The most common use of this parameter is expected to be as a nonce to ensure "freshness" of an attestation.

### 31.5 Anonymous Signing

If an anonymous scheme (TPM\_ALG\_ECDSA) is used for signing in any attestation command, the *qualifiedSigner* parameter will be an Empty Buffer.

NOTE 1            If the *qualifiedSigner* field was properly populated (not the Empty Buffer), then the unique identity of the signing key would be disclosed.

For TPM2\_Certify() using an anonymous signing scheme, both the *qualifiedSigner* and *qualifiedName* of the certified key are set to an Empty Buffer.

NOTE 2            If the *qualifiedName* field was not cleared, then it would be possible to establish a hierarchical relationship between the certified objects. This is not desirable for an anonymous scheme.

## 32 Cryptographic Support Functions

### 32.1 Introduction

In TPM 1.2, the cryptographic primitives were not exposed for general purpose use. For example, the RSA engine could not be used for exponentiation. This specification provides commands that allow access to the primitive cryptographic processes of the TPM.

One assumption in TPM 1.2 was that the host processor usually had much greater performance than the processor used for the TPM so there was no point in having the TPM do something that the host could do much faster. In addition, TPM 1.2 was a passive device with limited bandwidth. While it is true that the host processor will usually have more capability than the TPM, this will not be true in all cases. In fact, on some systems, the main processor will be able to switch execution environments and perform the TPM operations. In others, the TPM may be built around a cryptographic coprocessor that has significantly greater processing capability for cryptographic operations than the host. These higher performance implementations will not be performance-limited by being attached to the system with a low-bandwidth interface. These performance differences mean that exposure of the cryptographic primitives of TPM 2.0 makes more sense than it did in TPM 1.2.

Another reason to make the cryptographic primitives available is that not all software will implement all the algorithms that may be in the TPM. For example, a BIOS may not implement the RSA algorithm but would want to check the RSA signature of some code.

This clause describes the commands and methods that may be provided by a TPM compliant to this specification.

### 32.2 Hash

TPM2\_Hash() will create a digest of a block of data using the indicated hash algorithm. If the amount of data to be hashed exceeds that input buffer size of the TPM, then a hash sequence is used (see 32.4).

If the data used to create the digest does not have TPM\_GENERATED\_VALUE as its first octets, then the response to TPM2\_Hash() will contain a ticket indicating that the digest may be signed with a restricted signing key.

**NOTE** The creation of the ticket may be suppressed by using TPM\_RH\_NONE as the hierarchy parameter in TPM2\_Hash().

### 32.3 HMAC

TPM2\_HMAC() will compute an HMAC over a block of data using a TPM-resident value for the HMAC key. In this command, the handle parameter is required to reference an object with a *type* of TPM\_ALG\_KEYEDHASH with the *sign* attribute SET.

### 32.4 Hash, HMAC, and Event Sequences

#### 32.4.1 Introduction

When the amount of data to be included in a digest cannot or will not be sent to the TPM in one of the atomic hash/HMAC commands (TPM2\_Hash(), or TPM2\_HMAC()) then a sequence of commands may be used to provide incremental updates to the digest.

A sequence is started with either TPM2\_HashSequenceStart() or TPM2\_HMAC\_Start(); increments of data are added to the sequence digest(s) using TPM2\_SequenceUpdate(); and

TPM2\_SequenceComplete() or TPM2\_EventSequenceComplete() is used to complete a sequence. TPM2\_SequenceComplete() and TPM2\_EventSequenceComplete() may also provide the last data to be included in the sequence digest(s).

Three types of sequences are defined:

- 1) hash
- 2) Event
- 3) HMAC

### 32.4.2 Hash Sequence

In a hash sequence, the TPM will perform a hash over all the data in the sequence using the selected algorithm.

TPM2\_SequenceComplete() completes the hash sequence and returns a digest of the data. Additionally, if the data used to create the digest did not start with TPM\_GENERATED\_VALUE, then a ticket is produced indicating that the digest may be signed with a restricted key.

A hash sequence is:

- a) TPM2\_HashSequenceStart() (*hashAlg* is a supported hash algorithm), followed by
- b) TPM2\_SequenceUpdate() (zero or more), followed by
- c) TPM2\_SequenceComplete()

### 32.4.3 Event Sequence

For an Event Sequence, the TPM will potentially create multiple digests over the data (a digest for each PCR bank). TPM2\_EventSequenceComplete() is used to complete the sequence and return a list of digests; and, if a PCR handle is provided, each digest is extended into the corresponding PCR bank.

EXAMPLE If a TPM implements both a SHA1 and a SHA256 bank, then the list will contain two digests.

An Event Sequence is:

- a) TPM2\_HashSequenceStart() (*hashAlg* is TPM\_ALG\_NULL), followed by
- b) TPM2\_SequenceUpdate() (zero or more) followed by
- c) TPM2\_EventSequenceComplete() (will do an Extend if *pcrHandle* is a PCR and not TPM\_RH\_NULL)

### 32.4.4 HMAC Sequence

For an HMAC sequence, the TPM will use the indicated key as the HMAC key and perform an HMAC computation over the data of the sequence using the specified hash algorithm.

TPM2\_SequenceComplete() completes the HMAC sequence and returns the HMAC value.

NOTE The response for TPM2\_SequenceComplete() also has a *validation* parameter. This parameter is used for a hash sequence to indicate if the digest is safe to sign with a restricted key. This parameter is not used for an HMAC sequence so the TPM will set the *validation* parameter to a NUL Ticket

An HMAC sequence is:

- a) TPM2\_HMAC\_Start() (*hashAlg* is a supported hash algorithm), followed by
- b) TPM2\_SequenceUpdate() (zero or more) followed by
- c) TPM2\_SequenceComplete()

#### 32.4.5 Sequence Contexts

Sequences involve hashing of data and the intermediate hash state must be retained by the TPM in a protected location. This intermediate state is kept in a vendor-specific structure that may occupy an object slot on the TPM.

A sequence context is assigned a handle so that it may be saved and restored like any Transient Object. Its properties are not identical to other Objects because the sequence context is updated on each use. In addition, unlike other Objects, the public portion of a sequence is not readable with TPM2\_ReadPublic(). A sequence context can be replayed if one has the authorization for the sequence.

If an authorization or audit for a sequence object requires computation of a *cpHash* and an *rpHash*, the Name associated with *sequenceHandle* will be the Empty Buffer.

When TPM2\_EventSequenceComplete() or TPM2\_SequenceComplete() completes successfully, the sequence context is flushed from the TPM.

A sequence is exempt from dictionary attack protection and authorization failures will not cause the TPM to enter lockout.

#### 32.5 Symmetric Encryption

TPM2\_EncryptDecrypt() is defined for symmetric encryption and decryption of blocks of data. Support for this command in a TPM may cause the TPM to be subject to different jurisdictions' legal import/export controls than would apply to a TPM without these commands.

The command supports chaining of encryption so that the encryption/decryption may be done incrementally as the data arrives or to handle the cases where the block of data is larger than will fit into a single TPM buffer.

#### 32.6 Asymmetric Encryption and Signature Operations

The annexes to this TPM 2.0 Part 1 contain descriptions of the cryptographic encryption/decryption and signature primitives that are defined for each of the asymmetric algorithms supported by the specification.

### 33 Locality

In some systems, accesses to the TPM are segregated by privilege level. The interface to the TPM may be able to discriminate the different privilege levels and provide an indication to the TPM when the access is at a privilege level other than the default level.

The indication of privilege level can be used in access control policy to ensure that the operation on an object is occurring at the right level. The privilege level of a command is called its Locality.

The method by which the TPM interface determines the Locality of an access is system-dependent. The TPM interface provides a Locality indication to the TPM each time the TPM is accessed. The contents of the command or response buffer are not changed by the Locality indication.

The definition of the modifier is platform-specific. Depending on the platform, the modifier could be a special bus cycle or additional input pins on the TPM. One example would be special cycles on the Low Pin Count (LPC) bus that inform the TPM it is under the control of a process on the PC platform. The assumption is that spoofing the modifier to the TPM requires more than just a simple hardware attack, and would require expertise and possibly special hardware.

The locality value is represented as a byte and locality values have two separate representations. Localities 0 through 4 are represented as bits in the byte with 0000 0001<sub>2</sub> representing locality 0 and 0001 0000<sub>2</sub> representing locality 4. This representation allows multiple localities to be represented in a single byte as long as the localities are in the range of 0-4. This representation of locality is compatible with previous versions of this specification.

A second representation is for localities above 4. These are called *extended localities*. For extended localities, the locality byte is an integer value representing the locality. Because of the format for localities 0-4, the first extended locality is 32. The range of extended localities is 32-255. The locality value may indicate only one extended locality at a time.

NOTE                   Locality 5 through 31 cannot be selected.

## 34 Hardware Core Root of Trust Measurement (H-CRTM) Event Sequence

### 34.1 Introduction

A process that puts the system in a known state running known code creates the starting point for a chain of trust. A computer system reset puts the processor and chipset into a known state, and the processor (the root of trust for measurement) begins executing code provided by the platform manufacturer. This initial code is the core root of trust for measurement (CRTM). It is code that must be trusted as there is no way to tell what that code is other than to rely on the manufacturer. Usually, one of the actions of the CRTM is to extend a PCR with a value that represents the identity of the CRTM. This boot process starts the chain of trust with two different roots that are usually from different sources: the RTM from a CPU vendor and a CRTM from a platform manufacture.

Some system implementations support an alternative method of starting a chain of trust that makes the CPU the CRTM. For this method, the CPU is placed in a known state and measures the code that it will run. Before being measured, this code is protected so that it cannot be tampered with and there is assurance that the code that is measured is the code that is executed. Since the CPU is both executing the measured code and measuring it, it is both the RTM and the CRTM. This is called a hardware-based core root of trust for measurement or H-CRTM.

The TPM supports an H-CRTM by providing special interface indications that allow the TPM to determine when it is receiving data from the RTM acting as CRTM. These indications are:

- **\_TPM\_Hash\_Start** – sent by the RTM to indicate the start of a H-CRTM Event Sequence. The TPM will initialize an H-CRTM Event Sequence context. The H-CRTM Event Sequence context contains hash state for each bank of PCR. This indication is only allowed from the RTM when it has been put into a known "good" state as defined by the RTM manufacturer. There is only one **\_TPM\_Hash\_Start** per H-CRTM Event Sequence.
- **\_TPM\_Hash\_Data** – sent by the RTM to update the digests in the H-CRTM Event Sequence contexts with H-CRTM data. An H-CRTM Event Sequence may have zero or more **\_TPM\_Hash\_Data** indications.
- **\_TPM\_Hash\_End** – sent by the RTM to indicate the end of the H-CRTM Event Sequence. On receipt of this indication, the TPM will take actions that are dependent on whether the H-CRTM occurred before or after **TPM2\_Startup()**. The actions taken as the result of this indication will always include initialization of at least one PCR followed by a PCR being extended with the H-CRTM data.

During an H-CRTM sequence, if any indication other the **\_TPM\_Hash\_Data** occurs between the **\_TPM\_Hash\_Start** and **\_TPM\_Hash\_End** indications (including receipt of a command), then the H-CRTM Event Sequence is abandoned, the H-CRTM Event Sequence context is flushed, and no change to any PCR occurs.

NOTE The interface may be designed such that it is not possible to interrupt this sequence.

### 34.2 Dynamic Root of Trust Measurement

When an H-CRTM occurs after **TPM2\_Startup()** it is called the dynamic root of trust for measurement (D-RTM).

NOTE There is no special designation for when the H-CRTM occurs before **TPM2\_Startup()**

NOTE The D-RTM sequence may be repeated one or more times after **TPM2\_Startup()**. On each invocation of the D-RTM sequence, the RTM must be in the same known state.

For D-RTM, the TPM will initialize one or more PCR to zero and then extend PCR[17] in each bank with the H-CRTM data accumulated in the H-CRTM Event Sequence.



$$\text{PCR}[17][\text{hashAlg}] := \mathbf{H}_{\text{hashAlg}}(0\dots0 \parallel \mathbf{H}_{\text{hashAlg}}(\text{hash\_data})) \quad (55)$$

Where

*hash\_data* all the octets of data received in `_TPM_Hash_Data` indications

The PCR that are initialized and extended as a result of a D-RTM event are specified in a platform-specific TPM specification.

### 34.3 H-CRTM before TPM2\_Startup() and TPM2\_Startup() without H-CRTM

If the H-CRTM sequence occurs before `TPM2_Startup()`, then only `PCR[0]` will be affected. When `_TPM_Hash_End` is received, the TPM will complete the Event Sequence digests. It will then initialize `PCR[0]` to 4 and Extend the H-CRTM Event Sequence data. The value `0...4` represents evidence that the initial measurement was from an H-CRTM.

$$\text{PCR}[0][\text{hashAlg}] := \mathbf{H}_{\text{hashAlg}}(0\dots04 \parallel \mathbf{H}_{\text{hashAlg}}(\text{hash\_data})) \quad (56)$$

where

`0...04` denotes a numeric value of 4 with high-order bits of 0 to make the value the size of a digest computed with *hashAlg*

*hash\_data* all the octets of data received in `_TPM_Hash_Data` indications

If `PCR[0]` is initialized by an H-CRTM event before `TPM2_Startup()`, then `TPM2_Startup(CLEAR)` will not change the value of `PCR[0]`. Otherwise, `TPM2_Startup(CLEAR)` will set `PCR[0]` to the locality of the `TPM2_Startup()` command.

If there is an H-CRTM event before a `TPM2_Startup(CLEAR)`, there must be an H-CRTM event before a subsequent `TPM2_Startup(STATE)`. The locality of the `TPM2_Startup(STATE)` is not checked against the locality of the previous `TPM2_Startup(CLEAR)`

If there is no H-CRTM event before `TPM2_Startup(CLEAR)`, there must be no H-CRTM event before a subsequent `TPM2_Startup(STATE)` and the `TPM2_Startup(STATE)` must have the same locality as the previous `TPM2_Startup(CLEAR)`.

## 35 Command Audit

The command audit mechanism allows the TPM owner to create a verifiable log of each execution of selected commands.

TPM2\_SetCommandCodeAuditStatus() is used either to change the list of commands being audited or to change the audit hash algorithm (it cannot change both in the same command). This command requires either Platform Authorization or Owner Authorization. The selection may change at any time.

NOTE 1 It is anticipated that a small number of commands will be selected for audit, most likely those commands that provide identities and control of the TPM. However, there are few restrictions on which commands may be audited.

The audit log, the list of executed TPM commands and responses, is maintained outside the TPM by an untrusted party. Enabling the audit function of a TPM does not guarantee that the log will be properly maintained. The TPM audit function simply provides a means to determine if the log was properly maintained.

It is not necessary to continuously maintain the audit log in order to use the audit capability. When an audit log is started, the current contents of the audit digest register can be read to establish the starting value for the log. At the end of the audit interval, the audit digest register can be read again and the contents of the audit log over the audit interval can be verified.

An audit can be used to track use of keys and, therefore, is potentially privacy sensitive. For this reason, the privacy administrator of the TPM must authorize access to the audit digest register. Authorization from the privacy administrator is expressed using Endorsement Authorization.

The update of the audit digest register occurs when the command completes successfully and the response has been created. The command audit update is:

$$audit_{new} := H_{auditAlg}(audit_{old} || cpHash || rpHash) \quad (57)$$

where

$H_{auditAlg}$	hash function using the currently selected audit hash algorithm
$audit_{old}$	the previously computed audit digest
$cpHash$	the command parameter hash using the audit hash
$rpHash$	the response parameter hash using the audit hash

NOTE 2 Clause 18.7 describes the process for computing  $cpHash$  and clause 0 describes the process for computing the  $rpHash$ .

The audit mechanism uses two components: an audit digest register and an audit counter. The audit counter is a non-volatile register that counts the number of audit logs that are created. If the audit digest register contains all octets of zero when an audit event is recorded, then a new audit log is being created and the audit counter is incremented.

An audit log ends and the audit digest is cleared when the command TPM2\_GetCommandAuditDigest() returns a signature.

NOTE 3 The audit counter is incremented when the new log starts so that a missing log cannot be dismissed as being irrelevant. Because a new audit log is started only when an auditable event occurs, any missing log is suspect.

The audit counter is non-volatile and is reset to zero by TPM2\_Clear(). The audit digest register is reset when an unanticipated power event occurs (that is, loss of TPM power without an orderly shutdown). The audit digest is preserved over any orderly shutdown.

The audit digest register is reset by a TPM2\_SetCommandCodeAuditStatus() that changes the audit digest algorithm *auditAlg*.

An audit report structure contains the current value of the audit digest register and the value of the audit counter.

NOTE 4            The signed audit structure is a TPM2B\_ATTEST structure that contains other qualifying information about the signing environment.

Because the audit mechanism utilizes NV memory, endurance may be a factor. The endurance requirements of the audit mechanism are platform-specific.

NOTE 5            The command audit session counter is incremented on the first auditable command in a session. This should be infrequent so the endurance of the counter is not likely to be a major issue.

When the TPM is in Failure mode, command audit is not functional and command audit of TPM2\_GetTestResult() and TPM2\_GetCapability() will not occur.

TPM2\_SetCommandAuditStatus() is audited when it changes the list of audited commands. It is not possible to disable audit of this command. If TPM2\_SetCommandAuditStatus() is used to change the audit hash algorithm, then the command is not audited and evidence of this operation is provided by the change in the hash algorithm reported when the command audit value is read.

## 36 Timing Components

### 36.1 Introduction

The TPM has timing components for use in time-stamping of attestations and for gating policy

*Time* is a free-running hardware value that is not under software control. *Time* advances when the *Time* circuit is powered and is reset to zero when power to the *Time* hardware is lost.

NOTE 1 Typically, the *Time* hardware will be powered down when the rest of the TPM is powered down.

*Clock* is a value that is derived from *Time* and advances as *Time* advances. *Clock* may be advanced in order to bring it into alignment with real time. However, *Clock* may not be set back except by installing a new owner.

The *resetCount* and *restartCount* values allow detection of power loss that could cause discontinuities in the time recorded by *Clock*. The *Safe* flag indicates whether *Clock* might have been wound backwards, in which case the current *Clock* value would be unsafe. The timing components are exposed through commands that:

- read the value of *Clock*, *Time*, *resetCount*, and *restartCount* (TPM2\_GetTime());
- time-stamp externally provided data using a signature key and *Clock*, *resetCount*, and *restartCount* (TPM2\_GetTime(), TPM2\_Quote(), TPM2\_Certify(), and other restricted signing operations);

NOTE 2 TPM2\_ReadClock() returns uncertified (not signed) values. TPM2\_GetTime() returns a structure and an optional signature over the data. TPM2\_ReadClock() is used by the OS to manage the timing resources of the TPM and TPM2\_GetTime() is for attestation of time and is under control of the privacy administrator.

- allow *Clock* to be adjusted forward (TPM2\_SetClock());
- allow the rate of advance of *Clock* to be adjusted (TPM2\_ClockRateAdjust()); and
- allow objects to be lifetime-limited using authorization policy expressions that reference *Safe*, *Clock*, *Time*, *resetCount*, and *restartCount* (TPM2\_PolicyCounterTimer()).

Potential use cases for the TPM timing components include:

- lifetime limits for keys when certificate revocation is impossible or undesirable;
- time-limited delegation of rights (such as, the right to use or duplicate a key for 1 hour);
- time-stamping of security event logs to ensure that events cannot be forged in the past;
- boot-counter stamping of event logs to ensure that a log associated with a particular reboot cannot be deleted without leaving a trace;
- boot-counter/PCR-counter stamping of keys to indicate they were created during OS installation;
- time-stamping of attestation values as an alternative to the use of a nonce in online protocols; and
- indication of whether a TPM/platform has rebooted since last checked.

*Clock* is *not* designed to be a replacement for other online or local time sources and is not appropriate for all uses. Later clauses describe the behavior of timing resources and their specific security properties. Implementers and relying parties should understand the limitations before using these features.

## 36.2 Time

*Time* is a 64-bit value that contains the time in milliseconds that the circuit providing *Time* has been powered.

NOTE Depending on the frequency of the TPM oscillator and the setting of the frequency divisor (TPM2\_ClockRateAdjust()), the rate at which *Time* advances may be in error by as much as 32.5%.

*Time* is unaffected by TPM2\_ClockSet().

The circuit providing *Time* may be powered independently from the rest of the TPM. The *Time* hardware needs to provide a reliable indication that it has lost power or has been reset. *Time* should not be reset unless the TPM will receive a \_TPM\_Init indication before resuming operation.

*Time* need not advance continuously when powered. The *Time* hardware is required to provide a reliable indication if *Time* has stopped advancing.

## 36.3 Clock

### 36.3.1 Introduction

*Clock* is a time value that can be advanced but never rolled back. It may increment in volatile memory. If so, it is periodically written to NV memory.

A non-orderly shutdown may cause a write to NV memory to be missed. Other values that are written to NV on an orderly shutdown will be advanced to a known safe value on the next startup. However, *Clock* is not advanced because power outages would cause the clock to be advanced to a time in the future and it could not be adjusted back to an accurate value. To indicate that a value reported in *Clock* may be a repeat of a previously reported value, a flag (*safe*) is CLEAR after a non-orderly shutdown. After the next NV update of *Clock*, *safe* is SET to indicate that *Clock* is not a repeat.

*Clock* is a volatile value that advances at the rate that *Time* advances. A non-volatile value (*NV Clock*) is updated periodically from *Clock*. *NV Clock* will always move forward as *Clock* advances. However, because of unexpected power loss, it is possible that the same value of *Clock* will be reported more than once. The mitigations for this are described in subsequent parts of this clause (36.3).

The accuracy of *Clock* is approximate. The causes of inaccuracy are

- the TPM's time reference may not be accurate, and
- the TPM must rely on external software to provide initial or periodic adjustments to *Clock* settings.

The interpretation of the time-origin (t=0) is out of the scope of this specification, although Coordinated Universal Time (UTC) is expected to be a common convention.

The value of *Clock* may be set forward by external software (TPM2\_ClockSet()) to compensate for power interruptions or clock slew, but, except for changes in ownership (TPM2\_Clear()), the TPM will not allow external software to set *Clock* backward.

The value of *Clock* may be advanced by TPM2\_ClockSet() using either platform or owner authorization.

NOTE The value of *Clock* may not be advanced beyond FF FF 00 00 00 00 00 00<sub>16</sub>. This restriction prevents any possibility of *Clock* rolling over during its lifetime and simplifies use of *Clock* in policies.

The TPM may be driven by an imprecise internal or external frequency source. To compensate, the TPM allows external software with a more reliable time source to make limited (+/-15%) adjustments to the rate of advancement of *Clock*.

### 36.3.2 *Clock* Implementation

The technology used for non-volatile storage may make the update rate for *NV Clock* an endurance issue. To mitigate this, the interval between updates of *NV Clock* from *Clock* are allowed to be as long as once per  $2^{22}$  milliseconds.

NOTE If *NV Clock* is implemented in a technology that allows millisecond updates and has no endurance issues, then *Clock* and *NV Clock* may be the same.

Since *NV Clock* may be updated at a low rate, a power event may cause the value in *Clock* to appear to go backward. For example, assume that the update interval for *NV Clock* is the maximum allowed value ( $2^{22}$  milliseconds or approximately 70 minutes). Power may be removed from the TPM and *Time* just before an update of *NV Clock*. Then, when power is restored, *Clock* will be restored from *NV Clock* and *Clock* may have a value that is more than an hour older than the last reported value of *Clock*. This illustrates that the values of *Clock* reported by the TPM for the first hour of operation may have a lower value than values returned before the power outage.

The *Safe* flag in the TPMS\_TIME\_INFO structure is used to indicate if the reported value of *Clock* is guaranteed not to be a repeat of a previously reported value. The *Safe* flag is described in more detail in the following clause.

### 36.3.3 Orderly Shutdown of *Clock*

In order to reduce the amount of time that must pass before *Safe* is SET, the TPM supports an orderly shutdown. TPM2\_Shutdown() is used to indicate to the TPM that software anticipates the loss of TPM power and that the appropriate state should be preserved. When the TPM receives TPM2\_Shutdown(), it will copy all of the bits of *Clock* to *NV Clock*. After an orderly shutdown, the TPM will SET a non-volatile flag to indicate that an orderly shutdown has occurred.

NOTE 1 To allow the *NV Clock* to only have to record the upper bits of *Clock*, an alternate implementation is to keep *Clock* in memory that has a copy saved on an orderly shutdown and to restore *Clock* from that memory on the next power up.

After an orderly shutdown, *Clock* continues to count and *NV Clock* will be updated at the normal rate.

Any time a command is executed that uses the value of *Clock*, the flag indicating orderly shutdown will be CLEAR even if this command occurs subsequent to TPM2\_Shutdown(). This flag may be SET when *NV Clock* is updated from *Clock*.

NOTE 2 It is possible for the TPM to perform multiple shutdowns before TPM power is actually lost.

If *Safe* is not SET when TPM2\_Shutdown() is received, then *NV Clock* must not be set from *Clock* and *Safe* must not be SET on the subsequent startup.

It is permitted for the low-order 10 bits of *Clock* to come from *Time* and for *NV Clock* not to implement those bits. That is, *NV Clock* does not maintain resolution to better than  $2^{10}$  milliseconds. If an implementation uses this option, then *Safe* will be CLEAR at least for the first  $2^{10}$  milliseconds of TPM operation.

*Clock* remains safe as long as *Time* is powered. That is, if there is a non-Orderly shutdown and the TPM is powered down but *Time* is powered, then *Clock* will be updated the next time the TPM starts. Since time is not lost, *Clock* will not appear to go backwards and *Safe* can be SET. During the time that the

TPM is powered down it is not necessary for *Time* to advance, it simply needs not to be set to a lower time value.

### 36.3.4 *Clock* Initialization at TPM2\_Startup()

On any TPM2\_Startup() or \_TPM\_Init (vendor's choice), *Clock* is loaded from *NV Clock* and *Clock* begins incrementing at a one millisecond rate. *NV Clock* is then updated, no less frequently than the update interval. It is anticipated that the first update of *NV Clock* will occur when some number of low-order bits of the volatile *Clock* become zero, indicating the passage of the update interval. For example, assuming that the *NV Clock* update interval is  $2^{12}$  (approximately every 4 seconds), the TPM may perform an update of *NV Clock* whenever the low-order 12 bits of volatile *Clock* are zero.

NOTE 1 If the TPM had an orderly shutdown, the low-order bits of the *NV Clock* will likely not be zero, so the first update of *NV Clock* after the \_TPM\_Init will occur in less than the normal update interval.

NOTE 2 If the TPM received TPM2\_Shutdown() and a subsequent command that used *Clock*, then the *NV* value of *Clock* will likely be non-zero, but *Safe* will be CLEAR.

### 36.3.5 Setting *Clock*

The value in the volatile *Clock* may be set forward using TPM2\_ClockSet(). The *newTime* parameter of TPM2\_ClockSet() is required to have a greater value than the volatile *Clock*. So that policies that rely on *Clock* do not have to contend with the possibility of the value of *Clock* wrapping, *newTime* may not be greater than FF FF 00 00 00 00 00 00<sub>16</sub>.

If TPM2\_ClockSet() causes the volatile and non-volatile versions of *Clock* to differ by more than the implementation-dependent update interval, then *NV Clock* will be updated before TPM2\_ClockSet() returns.

NOTE 1 It is not necessary that all the bits of *NV Clock* be updated. Only the bits of *NV Clock* that are updated in the normal update process need to be changed.

EXAMPLE Assume the update of *NV Clock* occurs every  $2^{12}$  milliseconds (00 00 10 00<sub>16</sub>), that the low-order 32 bits of *NV Clock* are 00 00 00 00<sub>16</sub> and *Clock* are 00 00 0F 00<sub>16</sub>, and that a *newTime* advances *Clock* to 00 00 11 00<sub>16</sub>. Since this makes the difference between *Clock* and *NV Clock* more than the update interval ( $2^{12}$ ), *NV Clock* is updated to 00 00 11 00<sub>16</sub>.

The expected management for *Clock* is for a coarse (large) update to be made after TPM2\_Startup() in order to recover the time lost when the TPM was not powered. After that single large change, *Clock* is expected to be updated with relatively small values to keep it synchronized with real time. If software manages *Clock* in this manner, TPM2\_ClockSet() will not have to be throttled in order to avoid *NV* wear-out.

NOTE 2 System software may purposely cause the rate of *Clock* advance to be slower than real time and just make minor adjustments when an attestation of some sort is required. If managed in this way, TPM2\_ClockSet() may be executed many times between update intervals. Because update of the *NV* portion of *Clock* is not allowed unless the difference between the two versions is at least as large as the update interval, TPM2\_ClockSet() will not need throttling to avoid wear-out.

NOTE 3 The specification could have been written so that TPM2\_ClockSet() would never invoke *NV* throttling. That is, the value for *newTime* could have been set such that the rate of *NV Clock* update would be at an acceptable rate or TPM2\_ClockSet() would fail. This logic is complex, and under normal circumstances, redundant. As a consequence, the specification does not place restrictions on the values of *newTime* other than those listed above. The fact that TPM2\_ClockSet() requires Owner Authorization or Platform Authorization should provide some level of protection against an attacker using TPM2\_ClockSet() for a wear-out attack on the TPM. TPMs may implement wear-protection if extraordinary rates of update are observed.

### 36.3.6 Clock Periodicity

The TPM clock may be driven by an internal or external frequency source or be derived from a time source supplied by its operating environment. TPM profiles shall specify the time source to be used and the required accuracy.

External software may make limited adjustments to the rate of advance of *Clock* to provide a better approximation to real time.

This specification requires that the nominal rate of advance of *Clock* when powered is within 15% of the rate of UTC. If the external clock is not reliable, the TPM must provide its own clock with the necessary accuracy. External software may indicate that *Clock* is not advancing at the rate of UTC and that the rate needs to be increased or decreased. The command to adjust the clock rate is `TPM2_ClockRateAdjust()`. The *newRate* parameter of this command allows fine or coarse upward or downward adjustments to the current counting rate. This specification does not define coarse or fine adjustment percentages, and software that manages the TPM must infer this from observed behavior.

The range of adjustment of the rate is dependent on the design of the TPM. It is required that the variation in the rate be large enough that it will allow software to adjust the rate of *Clock* advance to be the same as UTC. The TPM should not allow rate adjustments that are larger than the design tolerance of the TPM.

**EXAMPLE 1** A TPM is designed to have a nominal internal oscillator frequency of 10 MHz with a tolerance of +/- 15% and a presettable counter that is used to count the oscillator clocks and generate an output every second that is used to advance *Clock*. To cover the tolerance of the oscillator, the preset for the counter would have to be between 8,500,000 and 11,500,000.

**EXAMPLE 2** A TPM is designed as above but with the additional ability to accept an outside frequency reference as long as that reference is at least +/-15%. If the external source is more accurate than +/-15%, then the TPM may still allow an adjustment over the 8,500,000 to 11,500,000 range.

**NOTE 1** In the worst case, an attacker who knows either the Platform Authorization or Owner Authorization value may be able to make the TPM run 32.5% ( $1.15^2$ ) fast or slow. However, an attacker who knows the Platform Authorization or Owner Authorization could also set *Clock* arbitrarily far into the future.

An error is returned if external software tries to adjust the clock rate outside specified bounds.

The TPM may store adjustments to the nominal clock rate in volatile memory. If it does, then adjustment should only be stored on an orderly shutdown and not during the actions of `TPM2_ClockRateAdjust()`. That is, the adjustment value should be in volatile memory and only saved to nonvolatile memory on an orderly shutdown.

**NOTE 2** This constraint on `TPM2_ClockRateAdjust()` is so that software may make changes to the rate at arbitrarily high rates without causing an NV event that might require throttling.

### 36.4 resetCount

The *resetCount* is a non-volatile, 32-bit counter that is incremented on a successful TPM Reset. It may be read using `TPM2_ReadClock()` and be used in an authorization policy (`TPM2_PolicyCounterTimer()`). Additionally, the contents of the *resetCount* are included in the attestation data for any of the attestation commands.

**NOTE 1** Depending on the hierarchy of the signing key, the value of *resetCount* may be obfuscated so that a verifier can tell that the counter has changed, but cannot know the absolute value of the counter.

The purposes of *resetCount* are to indicate when the static trust state of the platform may have changed and to indicate a possible discontinuity in *Clock*.



NOTE 2            Since the volatile *Clock* is reloaded from the *NV Clock* on each `_TPM_Init`, the volatile *Clock* will lose some time in nearly all circumstances.

*resetCount* is incremented whenever the TPM starts up and all previous state is lost (i.e., on a TPM Reset). *resetCount* is set to zero in `TPM2_Clear()`.

### 36.5 restartCount

In addition to TPM Reset, other events may cause a discontinuity in TPM-recorded time or in the Root of Trust for Reporting (RTR). A suspend-resume cycle will cause a time discontinuity. `_TPM_Hash_Start` can cause an RTR discontinuity in the dynamic Root of Trust for Measurement (D-RTM) PCR. The *restartCount* is used to provide an indication of these discontinuities.

The *restartCount* is a non-volatile, 32-bit counter that increments when the TPM executes TPM Resume, TPM Restart, or `_TPM_Hash_Start`. Since *resetCount* increments on each TPM Reset, the combination of *resetCount* and *restartCount* accounts for the cases when a discontinuity may occur, allowing TPM *Time* to fall behind real time.

NOTE            When software sets *Clock* forward, that is a positive time discontinuity under control of software. The negative discontinuities of *Clock* are due to hardware actions that may be outside of the control of software.

The combination of *resetCount* and *restartCount* also accounts for the discontinuities of the RTR. A change in *resetCount* indicates a discontinuity in the static RTR, and a change in *restartCount* indicates a change in the dynamic RTR.

*restartCount* is reset to 0 on TPM Reset – when *resetCount* is incremented. This does not cause a loss of information about the dynamic RTR because a change to *resetCount* also implies a change to the dynamic RTR.

### 36.6 Note on the Accuracy and Reliability of *Clock*

*Clock* is designed to allow a managed environment, such as enterprise, to maintain a small deviation between *Clock* and real time. If the platform is not managed, if the platform falls into the hands of an adversary, or if the platform is controlled by malware, then accuracy of *Clock* is diminished. This note addresses considerations that influence the applicability of *Clock* for time-stamping and for time-limited objects.

This analysis assumes that the TPM is not physically attacked, but that adversaries may manipulate external software and local clocks like the CMOS clock on PC platforms.

It is assumed that, under normal operation, external software adjusts *Clock* at platform startup and subsequently makes occasional additional rate and forwarding adjustments to ensure that *Clock* remains within acceptable tolerances. Enterprise management servers or web services may occasionally request time-stamped nonces to check that *Clock* meets network policy.

If *Clock* is used to time-stamp event log entries, then server software should ensure that *Clock* is accurate (as described above), and client software may occasionally record TPM *Time* values counter-signed by external authoritative time-stamping services to provide fiduciary time markers. These services may include the *Clock* and *Time* values as well as the initialization counters (*resetCount* and *restartCount*). The minimal security guarantees provided by the TPM in this case are

- proper ordering of events logged at times greater than 1 millisecond apart (apart from when associated with discontinuities in the *resetCount* and *restartCount*), and

- that time stamps can never be forged to indicate a time in the past. If the value of *Clock* could be “stale,” *Safe* will indicate as much. If *Clock* has occasionally been reported to other authorities or has been counter-signed, then the accuracy of the other time stamps can be interpolated more accurately.

If *Clock* is used to lifetime-limit objects, then when the platform is properly managed, objects will become inaccessible with temporal accuracy related to the precision of clock management and the update interval of *NV Clock*. If the lifetime has the granularity of *NV Clock* update, then once it becomes inaccessible, it cannot be recovered because, at that granularity, *Clock* will not move backward. If the granularity of the lifetime needs to be shorter than the update interval of *Clock*, then the *Safe* flag can be checked to see if the value of *Clock* may be “stale” or not.

If the platform falls into adversarial hands, the attacker will never be able to recover already revoked objects. However, for objects with lifetimes in the future, an adversary may effectively stop the passage of time so that objects never expire.

**EXAMPLE** To make TPM *Time* “stop,” the platform should only be turned on briefly to access the time-limited object and then turned off in a way that prevents an orderly shutdown of the TPM. If the TPM is left on for less than the update interval and the platform does not have an orderly shutdown, *Clock* will continue to repeat values within the range of an update interval. In a managed environment, a platform with a *Clock* that has a value that is substantially different from real time will likely be denied further network services. For a system in an unmanaged environment, a more complex policy using *resetCount* and *Time* may be used to limit access to objects even if time does not advance (for example, the policy may allow access for 20 minutes or 2 reboots).

When the owner of the platform changes (new SPS generated) *Clock* is reset to zero. Using *Clock* to do time stamping with a non-duplicable key does not constitute a vulnerability because the signing key also becomes inaccessible when the owner changes, so no new events can be created. If the time-stamping key is duplicable, then a more detailed security analysis is needed — for instance, examination of the Qualified Name in the signing structure.

If *Clock* is used in other policy settings, similar considerations apply. If an object is destroyed when the owner is changed, then *Clock* reset is benign. However, if an object survives an owner change (such as, an NV Index created by the platform), then use of *Clock* in its access policy may not be appropriate.

### 36.7 Privacy Aspects of Clock

The attestation structures return several values that, when taken together, may be sufficiently unique to identity a specific platform. For example, the difference between *Clock* and *Time* is, during the interval of a boot, likely to be somewhat unique for a platform. When combined with *resetCount* and *restartCount*, the values can become very indicative of a specific platform. If these values allow signatures from two keys to be correlated, then those keys remain correlated as long as they are in use. The TPM uses authorizations and obfuscation values to prevent this type of unwanted correlation.

All attestations contain a TPMS\_CLOCK\_INFO structure. That structure contains *Clock*, *resetCount*, *restartCount*, and *Safe*. The attestation structure also contains a 64-bit value that is indicative of the firmware version number. When these values are going to be signed by a key that is not in the Platform or Endorsement hierarchy, *resetCount*, *restartCount*, and firmware version number have a key-specific value added to them before they are put into the attestation structure. The addition allows the determination of change in values but prevents disclosure of the exact value.

Each Attestation Key has a different 128-bit obfuscation value that is constant for the lifetime of the key. It is computed by:

$$\text{obfuscation} := \text{KDFa}(\text{signHandle} \rightarrow \text{nameAlg}, \text{shProof}, \text{“OBFUSCATE”}, \text{signHandle} \rightarrow \text{QN}, 0, 128)$$

(58)

## 37 NV Memory

### 37.1 Introduction

Each TPM is required to have some non-volatile memory. This memory is used to retain values across power events. The NV memory is used to hold:

- NV Index values,
- objects made persistent by TPM2\_EvictControl,
- state saved by TPM2\_Shutdown(), and
- Persistent NV data.

### 37.2 NV Indices

#### 37.2.1 Definition

An NV Index is space that is defined by a user of the TPM. The Index is identified by a unique handle value. An NV Index handle has an MSO of TPM\_HT\_NV\_INDEX.

The NV Index structure has:

- An identifying handle – this handle is assigned by the caller when the Index is defined and is used to reference the Index. The handle associated with an Index has an MSO of TPM\_HT\_NV\_INDEX.
- A *nameAlg* – this parameter indicates the hash algorithm used in the computation of the Name of the Index (see clause 16).
- An authorization policy – this parameter is optional and is the digest of the policy for the NV Index. For the policy to apply to an operation, the corresponding TPMA\_NV\_POLICY\_READ, TPMA\_NV\_POLICY\_WRITE, or TPMA\_NV\_POLICY\_DELETE attribute needs to be SET. Different policies for read, write, and delete can be achieved using policy OR terms and TPM2\_PolicyCommandCode().
- A set of NV Index attributes – this parameter determines the nature of the Index and who may manipulate or read the Index.
- An authorization value that is no larger than the size of the digest produced by the *nameAlg* of the NV Index.
- A value indicating the size of the Index data – this parameter indicates the number of octets that are required to hold the NV data. For some Index types, the size is fixed.
- The NV Index data that may be modified according to the type of the NV Index.

All the parts of the NV Index structure, except for the *authValue* and Index data, constitute the public portion of the Index. They are hashed using the *nameAlg* to produce the Name of the Index.

The public area of the Index may be read using TPM2\_NV\_ReadPublic().

NOTE TPM2\_NV\_ReadPublic() also returns the Name of the NV Index.

An NV Index can be designated as a hybrid Index. A hybrid Index is intended for applications where frequent updates are expected. High frequency updates is generally not compatible with the technology currently used for nonvolatile storage on a TPM. A hybrid Index maintains a volatile (RAM) and a non-volatile copy of its Index data. A write to an ordinary Index is immediately written to NV memory but a

write to a hybrid Index may only update the copy of the Index data in RAM. The non-volatile copy of a hybrid NV Index is updated on TPM2\_Shutdown().

If an NV Index has TPMA\_NV\_ORDERLY SET, then it is a hybrid Index.

**NOTE 1** The user of a hybrid NV Index must understand that data may be lost if the TPM does not shut down in an orderly fashion so that the volatile data can be written to NV memory.

Whether or not NV Index is an hybrid, when an NV Index is defined (TPM2\_NV\_DefineSpace()), the persistent values of the NV Index are written to NV if the command completes successfully.

Any NV Index type can be defined as a hybrid. The conditions under which the write to NV memory occur vary, and are described below.

**NOTE 2** An implementation is not required to support an arbitrary number of hybrid indices and is not required to support any ordinary hybrid Index with a size of more than eight octets.

### 37.2.2 NV Index Allocation

An NV Index is allocated with TPM2\_NV\_DefineSpace(). Either Platform Authorization or Owner Authorization is required in order to allocate an Index. The caller indicates the NV Index to assign to the NV location, the access controls for the Index, and the type and or size of the data buffer that should be reserved for writing. While the allocation process does write the meta-data for the Index to NV, it does not write to the data area of the Index data and a read of the NV location before it is written will return an error (TPM\_RC\_NV\_UNINITIALIZED).

When an NV Index is defined (TPM2\_NV\_DefineSpace), its TPMA\_NV\_WRITTEN attribute will be CLEAR. Until the Index is written by a party that can satisfy the write policy, the Index is defined but has no data, and TPM2\_PolicyNV() and TPM2\_NV\_Read() will fail.

TPMA\_NV\_WRITTEN is SET when an authorized party first writes the Index. This permits a relying party to know that the value in the Index was written by an authorized party. It is not simply a default value that was present when the Index was defined (or deleted and redefined to attempt a roll back.)

A replying party can read the Index attributes and policy, which are public, to determine the authorized party.

**NOTE** The meta-data of an NV Index is the data relating to the NV Index description (Index number, policy, attributes, data size, and *authValue*) along with any additional information that the TPM needs to manage the NV Index memory.

Different types of NV Index may be supported.

- **Ordinary** – an Index with an NV Index type of TPM\_NT\_ORDINARY contains data that is opaque to the TPM that is modified using TPM2\_NV\_Write().
- **Counter** – an Index with an NV Index type of TPM\_NT\_COUNTER contains a 64-bit counter that is modified using TPM2\_NV\_Increment().
- **Bit field** – an Index with an NV Index type of TPM\_NT\_BITS contains 64 bits that are initialized to 0 and are modified using TPM2\_NV\_SetBits().
- **Extend** – an Index with an NV Index type of TPM\_NT\_EXTEND contains a value that has behaviour similar to a PCR and is modified using TPM2\_NV\_Extend().
- **PIN Fail** - an Index with an NV Index type of TPM\_NT\_PIN\_FAIL that contains a TPMS\_NV\_PIN\_COUNTER\_PARAMETERS structure that is modified using TPM2\_NV\_Write() or by using the *authValue* of the Index. *pinCount* is reset when an authorization attempt using *authValue* succeeds. *pinCount* is incremented after an authorization attempt using *authValue* fails. *pinCount*

cannot increment beyond *pinLimit* because *authValue* authorization is locked out if *pinCount*  $\geq$  *pinLimit*. A Pin Fail Index can be modified with TPM2\_NV\_Write.

- **PIN Pass** - an Index with an NV Index type of TPM\_NT\_PIN\_PASS that contains a TPMS\_NV\_PIN\_COUNTER\_PARAMETERS structure that is modified using TPM2\_NV\_Write() or by using the *authValue* of the Index. *pinCount* is incremented after an authorization attempt using *authValue* succeeds. *pinCount* cannot increment beyond *pinLimit* because *authValue* authorization is locked out if *pinCount*  $\geq$  *pinLimit*. A Pin Pass Index can be modified with TPM2\_NV\_Write.

TPM2\_NV\_DefineSpace() can fail if an Index with the requested handle already exists or if there is insufficient NV memory for the allocation. Creation of a hybrid Index will fail if there is insufficient RAM available for the allocation. The command will fail if an Index type is not supported.

EXAMPLE If the TPM does not implement TPM2\_NV\_Extend(), then the TPM will not allow creation of an NV Index that has the TPMA\_NV\_EXTEND attribute.

If the Index to be created has its TPMA\_NV\_POLICY\_DELETE attribute SET, then platform authorization is required for allocation. This attribute is only allowed to be selected if TPM2\_NV\_UndefineSpaceSpecial() is implemented on the TPM.

NOTE This attribute indicates that a policy is required to delete the Index. It permits creation of an Index that can never be deleted, for example, by specifying an Empty Policy. Requiring platform authorization protects against the current TPM owner creating such an Index.

### 37.2.3 NV Index Deletion

An NV Index can be removed using either TPM2\_NV\_UndefineSpace() or TPM2\_NV\_UndefineSpaceSpecial().

If the TPMA\_NV\_POLICY\_DELETE attribute is SET, then the Index can only be deleted if ADMIN role authorization is provided. ADMIN role authorization is provided by a policy session with the *commandCode* of the policy set to TPM2\_NV\_UndefineSpaceSpecial().

TPM2\_NV\_UndefineSpace is used to delete other Indices from the NV. The authorization given for deleting the Index is required to be the same as the authorization given to allocate the Index.

TPM2\_Clear() will remove any NV Index that used Owner Authorization to define the Index. TPM2\_Clear() uses either TPM\_RH\_LOCKOUT or TPM\_RH\_PLATFORM.

TPM2\_ChangePPS() does not cause any NV Index to be removed.

NOTE To comply with FIPS-140, the data contents and authorization value must be erased when the NV Index is deleted.

### 37.2.4 High-Endurance (Hybrid) Indices

#### 37.2.4.1 Description

Some applications need the ability to make frequent updates to non-volatile values such as monotonic counters. A high update rate is generally not compatible with the technology currently used for non-volatile storage on a TPM. To allow the TPM to support high-update rates while protecting the endurance of the NV memory, a hybrid Index type is defined.

When an NV Index is defined with the TPMA\_NV\_ORDERLY attribute SET, the TPM will allocate the required NV memory as well as space in TPM RAM for the data value. During normal operation, updates to the Index will modify the RAM copy of the Index data with updates to the NV on Shutdown() or

whenever the RAM copy of a counter is divisible by a set modulus. In some cases, the data write may never occur.

**NOTE** The value of the modulus is implementation specific and can be accessed using `TPM2_GetCapability(capability == TPM_CAP_TPM_PROPERTY, property == TPM_PT_ORDERLY_COUNT)`. The returned value is the modulus - 1. This value is referred to as `MAX_ORDERLY_COUNT`.

If the `TPMA_NV_ORDERLY` attribute of an Index is SET, the TPM will perform special processing on the Index at `TPM2_Startup()`. The processing is dependent on the type of the Index.

### 37.2.4.2 Hybrid Indices Other than Counter Indices

For hybrid Indices that are not Counters, the NV Index data in volatile memory is copied to non-volatile memory on a Shutdown(STATE). The data need not be copied to non-volatile memory on Shutdown(CLEAR).

- On TPM Resume, the non-volatile copy of the Index data is copied into the volatile version of the NV Index data.
- On TPM Reset, the `TPMA_NV_WRITTEN` attribute will be initialized to CLEAR. On a subsequent update of the Index, it will be initialized before it is updated.
- On TPM Restart, if `TPMA_NV_CLEAR_STCLEAR` is SET, the NV Index is initialized as in b) above. If `TPMA_NV_CLEAR_STCLEAR` is CLEAR, then the NV Index is initialized as in a) above.

**NOTE** `TPMA_NV_CLEAR_STCLEAR` may not be SET if the NV Index type is `TPMA_NV_COUNTER`. Counters are either restored (on an orderly startup) or set to a higher value (on a non-orderly startup).

### 37.2.4.3 Counter Hybrid Indices

The hybrid counter Index is designed so that it will be monotonically increasing and not miss an increment command regardless of the type of shutdown or startup.

For a Counter NV Index with the `TPMA_NV_ORDERLY` attribute, Index data in non-volatile memory is written to NV on any Shutdown().

**NOTE 1** For a Counter (or any other Index) that has `TPMA_NV_ORDERLY CLEAR`, non-volatile memory is written on any update of the NV Index.

On any orderly startup of the TPM (`TPM2_Startup()` following an orderly shutdown), the NV value of a hybrid counter Index will be copied to the RAM version. The count will be able to continue without any discontinuity.

On a non-orderly startup, the value of the counter in NV is adjusted before it is copied to RAM. A counter is adjusted by logical OR of the value of `MAX_ORDERLY_COUNT` to the NV value. This sets the RAM version of the counter to the maximum value it could have had before being updated due to the modulus test. This ensures that the RAM counter value is no less than any previously used counter value.

**EXAMPLE** Assume that `MAX_ORDERLY_COUNT` contains 0F FF<sub>16</sub> and that the TPM lost power without an orderly shutdown. On a startup, if an orderly counter is found to have a value of 00 00 00 00 00 01 73 A1<sub>16</sub>, then the RAM version is updated to 00 00 00 00 00 01 7F FF<sub>16</sub>.

**NOTE 2** When the RAM version of the counter is set this way, it is not necessary to immediately update the counter to NV. If the counter is incremented, then it will be automatically saved to NV when the low bits become zero.

NOTE 3 If the RAM counter were initialized so that the low bits were zero and a subsequent un-orderly shutdown occurred, the counter would have to be advanced again, whether it had been incremented or not. By setting the counter to the maximum value before NV update, there is no need to advance the count on a subsequent unorderly shutdown unless the counter was used.

### 37.2.5 Reading an NV Index

Read access to an NV Index is provided with TPM2\_NV\_Read(), TPM2\_NV\_Certify(), and TPM2\_PolicyNV(). For all of these commands, read authorization is required. The attributes of the Index determine what authorizations are allowed. TPMA\_NV\_PPREAD allows the Index to be read using Platform Authorization; TPMA\_NV\_OWNERREAD allows the Index to be read using Owner Authorization; TPMA\_NV\_AUTHREAD allows the Index to be read using the *authValue* of the Index; and TPMA\_NV\_POLICYREAD allows the Index to be read if the *authPolicy* of the Index is satisfied.

At least one of TPMA\_NV\_PPREAD, TPMA\_NV\_OWNERREAD, TPMA\_NV\_AUTHREAD or TPMA\_NV\_POLICYREAD needs to be SET or the TPM will not allocate the Index.

An access control (TPMA\_NV\_READ\_STCLEAR) allows reading of the Index to be temporarily blocked. When this attribute is SET, TPM2\_NV\_ReadLock() may be used to temporarily disable read access to the Index. When the Index has been locked for read, the TPMA\_NV\_READLOCKED attribute of the Index will be SET. TPMA\_NV\_READLOCKED will be CLEAR on the next TPM Reset or TPM Restart. If the TPMA\_NV\_READLOCKED attribute is SET when the Index is read, the TPM returns TPM\_RC\_NV\_LOCKED.

The *authPolicy* of the NV Index may be constructed such that it only applies for reading or for writing. It may be constructed to allow general reading and limited writing or general writing and limited reading. If reading or writing of the Index is to be restricted based on PCR values, then read authorization needs to use *authPolicy*.

### 37.2.6 Updating an Index

#### 37.2.6.1 Introduction

The command used to update an Index is determined by the NV Index type. TPM2\_NV\_Write() is used to modify an Ordinary Index or a PIN Index, TPM2\_NV\_Increment() is used to modify a Counter Index, TPM2\_NV\_SetBits() is used to modify a Bit Field Index, and TPM2\_NV\_Extend() is used to modify an Extend Index. For all of these commands, write authorization is required.

The attributes of the Index determine what authorizations are allowed. TPMA\_NV\_PPWRITE allows the Index to be modified using Platform Authorization; TPMA\_NV\_OWNERWRITE allows the Index to be modified using Owner Authorization; TPMA\_NV\_AUTHWRITE allows the Index to be modified using the *authValue* of the Index; and TPMA\_NV\_POLICYWRITE allows the Index to be modified if the *authPolicy* of the Index is satisfied.

At least one of TPMA\_NV\_PPWRITE, TPMA\_NV\_OWNERWRITE, TPMA\_NV\_AUTHWRITE or TPMA\_NV\_POLICYWRITE needs to be SET or the TPM will not allocate the Index. For a PIN Index, TPMA\_NV\_AUTHWRITE may not be SET and at least one of the other three write methods is required to be selected.

NOTE 1 A method other than TPMA\_NV\_AUTHWRITE is required for a PIN Index because the *authValue* of a PIN Index is not accessible until the Index is written.

An access control (TPMA\_NV\_WRITE\_STCLEAR) allows modification of the Index to be temporarily blocked. When this attribute is SET, TPM2\_NV\_WriteLock() or TPM2\_NV\_GlobalWriteLock() may be used to temporarily disable modify access to the Index. When the Index has been locked for modify, the

TPMA\_NV\_WRITELOCKED attribute of the Index will be SET. TPMA\_NV\_WRITELOCKED attribute will be CLEAR on the next TPM Reset or TPM Restart.

An Index can be created such that modifications are not possible after the Index is first locked for writing. If the TPMA\_NV\_WRITEDEFINE attribute is SET, TPM2\_WriteLock() or TPM2\_NV\_GlobalWriteLock() will SET TPMA\_NV\_WRITELOCKED for the Index. This attribute will remain SET until the Index is deleted (TPM2\_NV\_UndefineSpace()).

**NOTE** If TPMA\_NV\_WRITELOCKED is SET, but TPMA\_NV\_WRITTEN is CLEAR, then TPMA\_NV\_WRITELOCKED is CLEAR by TPM Reset or TPM Restart. This is true even if the TPMA\_NV\_WRITEDEFINE attribute is set. It prevents an NV Index from being defined that can never be written, and permits a use case where an Index is defined, but the user wants to prohibit writes until after a reboot.

If the TPMA\_NV\_WRITELOCKED attribute is SET when an attempt is made to modify the Index, the TPM returns TPM\_RC\_NV\_LOCKED.

For a PIN Fail Index, the TPM will return TPM\_RC\_NC\_ATTRIBUTES if TPMA\_NV\_NO\_DA is CLEAR.

### 37.2.6.2 NV Ordinary Index Update

TPM2\_NV\_Write() is used to modify the contents of an ordinary Index. The modification may be to the entire Index or, if the Index attributes allow (TPMA\_NV\_WRITE\_ALL CLEAR), the size of the data to write can be as small as zero octets.

When a partial write is allowed, the *offset* parameter of TPM2\_NV\_Write() may be non-zero or the *size* of the data parameter may be less than the *size* of the Index. The TPM checks the TPMA\_NV\_WRITTEN attribute. If it is CLEAR, then the TPM will initialize the remainder of the Index to either all zero or all one. Alternatively, the TPM can initialize the entire Index at the time the Index is defined.

If the sum of the size of the *data* parameter and the *offset* parameter in TPM2\_NV\_Write() is greater than the size of the Index, then the TPM will not perform the write and will return an error.

On any TPM2\_NV\_Write() (including a size of zero), if the modification is successful, then the TPMA\_NV\_WRITTEN attribute of the Index will be SET. Any octets not initialized by the first write will have a value of all zero or all one.

**EXAMPLE** If the Index is defined to contain 2 octets, and the first write of the Index is a single octet of 55<sub>16</sub>, to offset 0, then the next read of the full Index will return 55 00<sub>16</sub>.

If the Ordinary Index has the TPMA\_NV\_ORDERLY attribute, then only the RAM version of the Index is written. Any update will be lost if there is an un-orderly shutdown. Otherwise, the data is preserved.

### 37.2.6.3 NV Counter Index

When an Index has the TPMA\_NV\_COUNTER attribute, it behaves as a monotonic counter and may only be modified using TPM2\_NV\_Increment().

When an NV counter is created, it has no value and the TPMA\_NV\_WRITTEN attribute will be CLEAR.

On each TPM2\_NV\_Increment() the TPM checks the TPMA\_NV\_WRITTEN attribute of the Index. If it is CLEAR, then the TPM will initialize the 8-octet counter value with the TPM's largest NV Counter Index value. This value is required to be the largest count held by any NV Counter over the lifetime of the TPM. The TPMA\_NV\_WRITTEN attribute will be SET.

After checking TPMA\_NV\_WRITTEN and performing any required initialization operations, the TPM will increment the Counter.



**NOTE 1** The TPM will need to maintain a largest-count value. It is not necessary to update this value except when a NV Index is deleted. If the NV Index being deleted has the largest value held by an NV Index, then this value would be copied to the largest-count value. The value of an NV Counter Index after the first increment is larger than the largest-count value.

**NOTE 2** Since no counter can ever repeat a previous value ever contained in any NV Counter Index, a counter with a particular Name cannot be rolled back by deleting it and redefining it.

If the TPMA\_NV\_ORDERLY attribute is CLEAR, the increment will occur on the NV version of the counter (no RAM version exists). If the TPMA\_NV\_ORDERLY attribute is SET, the increment will occur on the RAM version of the counter, and if this causes a rollover, the NV version of the counter is updated. However, if TPMA\_NV\_WRITTEN is CLEAR, the NV version of the counter is also written. Once SET, TPMA\_NV\_WRITTEN of a counter is never CLEAR.

An Index may be defined with the TPMA\_NV\_ORDERLY attribute to indicate that the Index is expected to be modified at a high frequency and that the data is only required to persist when the TPM goes through an orderly shutdown process. For a counter, it also means that it will be written to NV when the counter has reached some threshold value. The threshold value for counters (MAX\_ORDERLY\_COUNT) is implementation dependent and can be read using TPM2\_GetCapability(capability = TPM\_CAP\_PT, property = TPM\_PT\_ORDERLY\_COUNT). This property has one of 32 values that can be expressed as  $(2^N-1)$  where N is between 1 and 32.

**EXAMPLE** If MAX\_ORDERLY\_COUNT is 00 00 0F FF<sub>16</sub>, then whenever the RAM version of a counter is incrementing, causing the low-order 12 bits to be zero, the NV version of the counter is updated.

The meaning of this threshold value is that when the counter is incremented such that the counter value ANDed with MAX\_ORDERLY\_COUNT is zero, then the NV version of the counter will be updated.

**NOTE** Another way to express this is to simply say that the NV version of the counter will be updated when the low order bits of the counter “roll-over”.

The TPM is required to ensure that, when an NV Counter is read, its value is not less than a previously reported value of the counter. That is, it may not go backward. If the shutdown was orderly, then, regardless of the type of the NV Counter, the NV value of a counter will not be less than the last reported value. If the shutdown was not orderly and the NV Counter has the TPMA\_NV\_ORDERLY attribute, then a value of the Counter may have been read from the RAM version of the counter but the NV version may not have been updated. To handle this case, if the TPMA\_NV\_ORDERLY attribute of an NV Counter is SET, and the TPM shutdown was not orderly, then, at TPM2\_Startup() the TPM will OR the value of MAX\_ORDERLY\_COUNT to the contents of the non-volatile counter and set that as the current count in the RAM version of the counter.

**NOTE** The TPM must prevent a rollback attack caused by a counter being deleted and then being recreated with a lower value. To do this, the TPM may keep track of the value of the highest count of a deleted counter using a phantom counter. When a counter is deleted, the current value of the counter is compared to the current phantom counter and other counters. If the value is larger than the phantom counter and other counters, the phantom counter is updated. When a new NV counter is created, it starts with the highest value of all the counters, including the phantom counter.

For an NV Index defined as a counter, the NV copy of the data will be updated whenever a specified number of low order bits of the RAM copy become all zeros. That number of low order bits is TPM implementation-dependent. The setting for a TPM may be found using TPM2\_GetCapability(TPM\_CAP\_TPM\_PROPERTIES, TPM\_PT\_ORDERLY\_COUNT). That capability is MAX\_ORDERLY\_COUNT.

For an NV Index defined as an ordinary, bit field or extend type, no periodic update interval is defined. They are only persisted to NV if the TPM receives an orderly shutdown. The TPMA\_NV\_CLEAR\_STCLEAR attribute has no effect on an NV Counter Index and it may be SET or CLEAR in the template.

#### 37.2.6.4 NV Bit Field Index

When an Index has the TPMA\_NV\_BITS attribute it may only be modified by TPM2\_NV\_SetBits().

When an NV Bit Field Index is created, it has no value and the TPMA\_NV\_WRITTEN attribute will be CLEAR.

On each TPM2\_NV\_SetBits(), the TPM will check the TPMA\_NV\_WRITTEN attribute of the Index. If it is CLEAR, the TPM will set the 64 bits of the Index to zero. The TPM will then SET the TPMA\_NV\_WRITTEN attribute for the Index.

After checking TPMA\_NV\_WRITTEN and doing any necessary initialization, the TPM will OR the *bits* parameter to the Index.

If the TPMA\_NV\_ORDERLY attribute is not SET, the NV value of the Index is written with the modified value. If no bits were SET in the *bits*, the NV Index data will only be updated if TPMA\_NV\_WRITTEN was CLEAR when the command execution was started.

If TPMA\_NV\_ORDERLY is SET, the RAM version of the Bit Field data is updated but it is not written to NV. The data is only preserved on a Shutdown(STATE).

#### 37.2.6.5 NV Extend Index

When an Index has the TPMA\_NV\_EXTEND attribute, it may only be modified by TPM2\_NV\_Extend().

When an NV Extend Index is created, it has no value and the TPMA\_NV\_WRITTEN attribute will be CLEAR.

On each TPM2\_NV\_Extend(), the TPM will check the TPMA\_NV\_WRITTEN attribute of the Index. If it is CLEAR, the TPM will initialize the Index to a Zero Digest that is the size of the digest produced by the *nameAlg* of the Index. The TPM will then SET the TPMA\_NV\_WRITTEN attribute for the Index.

After checking TPMA\_NV\_WRITTEN and doing any necessary initialization, the TPM will extend the Index using:

$$nvIndex \rightarrow data_{new} := H_{nameAlg}(nvIndex \rightarrow data_{old} || data.buffer) \quad (59)$$

where

$H_{nameAlg}$	the hash algorithm indicated in $nvIndex \rightarrow nameAlg$
$nvIndex \rightarrow data$	the value of the data field in the Index
$data.buffer$	the data buffer of the command parameter

If the TPMA\_NV\_ORDERLY attribute is not SET, the NV value of the Index is written with the modified value.

If TPMA\_NV\_ORDERLY is SET, the RAM version of the Index is updated but it is not written to NV. The data is only preserved on a Shutdown(CLEAR).

#### 37.2.6.6 NV PIN Index

TPM2\_NV\_Write() is used to modify the contents of a PIN Index. The modification may be to the entire Index or, if the Index attributes allow (TPMA\_NV\_WRITE\_ALL CLEAR), the size of the data to write can be as small as zero octets.

When a partial write is allowed, the *offset* parameter of TPM2\_NV\_Write() may be non-zero or the *size* of the *data* parameter may be less than the *size* of the Index. The TPM checks the TPMA\_NV\_WRITTEN attribute. If it is CLEAR, then the TPM will initialize the remainder of the Index to either all zero or all one. Alternatively, the TPM can initialize the entire Index at the time the Index is defined.

If the sum of the size of the *data* parameter and the *offset* parameter in TPM2\_NV\_Write() is greater than the size of the Index, then the TPM will not perform the write and will return an error.

On any TPM2\_NV\_Write() (including a size of zero), if the modification is successful, then the TPMA\_NV\_WRITTEN attribute of the Index will be SET. Any octets not initialized by the first write will have a value of zero.

**EXAMPLE** If the Index is defined to contain 2 octets, and the first write of the Index is a single octet of 55<sub>16</sub>, to offset 0, then the next read of the full Index will return 55 00<sub>16</sub>.

If the Index has the TPMA\_NV\_ORDERLY attribute SET, then only the RAM version of the Index is written. Any update will be lost if there is an un-orderly shutdown. Otherwise, the data is preserved.

If the *authValue* of a PIN Index is used for authorization, then the authorization will fail if the *pinCount* field of the Index is not less than the *pinLimit* field or if the TPMA\_NV\_WRITTEN attribute of the Index is CLEAR.

When the *authValue* of a PIN Index is used for authorization and the authorization succeeds, the *pinCount* field is set to zero if the Index is PIN Fail and incremented if the Index is PIN Pass. If the authorization fails, *pinCount* is incremented for a PIN Fail Index and left unchanged for a PIN Pass Index.

### 37.2.7 NV Index in a Policy

TPM2\_PolicyNV() may be used to include the contents of an NV Index in a policy command. TPM2\_PolicyNV() allows various comparisons of the value of the NV data with a reference value.

TPM2\_PolicyNV() is an immediate assertion (see 19.7.7.2). If the comparison succeeds, the TPM will update the *policyDigest* with the comparison values and the access controls on the referenced Index, including the *authPolicy*. Inclusion of the update policy of the Index provides a means of identifying the update properties of the Index. To make effective use of this command, writing of the Index should be dependent on *authPolicy*. If the policy must be met in order to write the Index, then it is possible to ensure that only the correct entity may recreate the Index. If other write authorizations are allowed, then it is not possible to know if the Index was written by a known entity.

If an NV Index is used in TPM2\_PolicyNV() after it is defined but before it is first written, then the TPM will return an error.

The nominal use of a PIN Index is to reference the Index in an entity's policy in TPM2\_PolicySecret(). The TPM2\_PolicySecret() will succeed if *pinCount* is less than *pinLimit* and the caller is able to provide the *authValue* of the Index in the authorization. If the rest of the policy is satisfied, access to the PIN-protected entity will be allowed.

**NOTE 1** A PIN Fail Index provides a form of individual Dictionary Attack defense that is not affected by the TPM's global Dictionary Attack mechanism. In particular, it can be used to allow the TPM to emulate the behaviour of a smart card.

**NOTE 2** A PIN Pass Index allows count-limited use of a TPM object. An example use would be to only allow access to a decryption key for protected content.

## 37.2.8 PIN Index Considerations

### 37.2.8.1 Restricting the number of uses of an object with PIN Pass

It is possible to limit the number of *authValue* (PIN) authorizations of a particular key or entity.

A key or object has a limited number of authorizations when its policy has a TPM2\_PolicySecret assertion pointing to an PIN Pass NV Index.

A PIN Pass's *pinLimit* is the number of correct authorization attempts that are permitted before authorization via *authValue* is locked out. If *pinCount* is less than its *pinLimit*, *pinCount* is incremented immediately by the TPM after *authValue* authorization succeeds. There is no automatic reset or decrement method for *pinCount*. Once *pinCount* equals *pinLimit*, an administrator must reduce *pinCount* and/or increase *pinLimit* using TPM2\_NV\_Write, or delete the Index.

### 37.2.8.2 Localized Dictionary Attack protection with PIN Fail

It is possible to authorize a particular key or object via an *authValue* (PIN) that has its own individual Dictionary Attack defense and does not use (and is not affected by) the TPM's global Dictionary Attack defense mechanism. This may be useful when a TPM is used to emulate a smartcard, for example.

A key or object has localized Dictionary Attack protection if its policy has a TPM2\_PolicySecret assertion pointing to an PIN Fail NV Index.

A PIN Fail's *pinLimit* is the number of incorrect authorization attempts that are permitted before authorization via *authValue* is locked out. If *pinCount* is less than its *pinLimit*, *pinCount* is incremented immediately by the TPM after *authValue* authorization fails. *pinCount* is reset to zero by the TPM whenever *authValue* authorization succeeds.

### 37.2.8.3 PIN Index Attributes

A PIN Index may be read or write locked. If read or write locked, the Index may still be referenced by TPM2\_PolicySecret(). An Index disabled using *phEnableNV* (if platform created) or *shEnable* (if owner created) cannot be used in a policy. If a policy points to an unwritten PIN Pass or PIN Fail Index, the Index's authorization check must fail because *pinLimit* is not written.

NOTE 1           Allowing a PIN Index to be used when write locked allows it to be used as a PIN but prevents writing of the *pinLimit*.

TPMA\_NV\_ORDERLY may be SET or CLEAR, however, if SET the Index will revert to unwritten on TPM Reset and possibly on TPM Restart (depending on TPMA\_NV\_CLEAR\_STCLEAR). This will cause the Index to not be usable for PIN authorization until it is reinitialized.

TPM2\_PolicyAuthValue() and TPM2\_PolicyPassword() cannot be used in the policy that does the initial write to a PIN Index. This is because these policy commands require that the *authValue* of the PIN Index to be used and the *authValue* of a PIN Index cannot be used until it is first written. Therefore, it may be desirable that TPMA\_NV\_POLICYWRITE is SET so that the PIN Index value may be initialized.

If TPMA\_NV\_POLICYREAD, TPMA\_NV\_PPREAD, or TPMA\_NV\_OWNERREAD is SET then the Index may read using TPM2\_NV\_Read (with those authorizations) without affecting the contents of the Index. If TPMA\_NV\_AUTHREAD is the only method of reading the Index, then the act of reading the Index could change its *pinCount*.

NOTE 2           Using the NV Index authorization value for the read would consume a PIN Pass Index authorization or reset the PIN Fail *pinCount*. In addition, *authValue* can't be used for authorization once *pinCount*  $\geq$  *pinLimit*.

NOTE 3 In a PIN Fail Index, it may be desirable that TPMA\_NV\_AUTHREAD is SET, so *pinCount* can be reset by reading the NV Index with valid *authValue* authorization.

TPMA\_NV\_AUTHREAD is SET, so *pinCount* can be reset by reading the NV Index with valid *authValue* authorization.

It is recommended that the Index have a policy that includes a PolicySigned assertion, to unambiguously identify the Index and the entity authorized to initialize the Index.

NOTE 4 This prevents covert attacks where an Index is secretly deleted and replaced.

If the *authObject* parameter of TPM2\_PolicySecret() references a PIN Pass Index, then the command may succeed, but a NULL ticket will be returned. The reason is that the ticket could allow more accesses to a count limited object than allowed by the PIN Pass Index.

NOTE 5 Without this restriction, a caller could get a ticket for a count limited object and use the ticket instead of using the PIN Pass Index. This could, potentially, allow unlimited access to a PIN Pass entity.

If a PIN Pass or PIN Fail Index is referenced as a bind object, the TPM must return TPM\_RC\_HANDLE. Otherwise, the sequence in which the TPM processes authorizations would enable a hammering attack on the Index.

Restrictions on PIN Pass and PIN Fail Indexes are specified in Part 3 TPM2\_NV\_DefineSpace.

### 37.3 Owner and Platform Evict Objects

In some applications, it is desirable for an object to be made persistent in the TPM so that it is always available. An example of when this would be useful is for a Primary Key. Having the Primary Key be always available avoids the time penalty of re-computing the Primary Key after each TPM Reset.

TPM2\_EvictControl() is used to make a loaded object persistent by saving it to the TPM's NV memory. This command is also used to remove a persistent object.

To be made persistent, an object needs to have both public and private portions loaded; the object cannot be in the NULL hierarchy, the object cannot have the *stClear* attribute SET, and the object cannot be a descendant of a key with the *stClear* attribute SET.

The type of the *objectHandle* parameter of TPM2\_EvictControl() determines if the Object is to be made persistent or to be removed from persistent memory. If *objectHandle* is a Transient Object, it is made persistent and, if *objectHandle* is a persistent object, it is deleted. The Transient Object is not affected.

When making a Transient Object persistent, the *persistentHandle* parameter of TPM2\_EvictControl() indicates which handle is to be assigned to the persistent version of the object. The TPM will not allow assignment of a persistent handle if that handle is already assigned to a persistent object.

If *objectHandle* is a Transient Object in the Platform Hierarchy, Platform Authorization must be provided. If *objectHandle* is in the Endorsement or Storage Hierarchy, Owner Authorization is required.

The persistent handle space is divided evenly between the Platform and the Owner. The persistent handles that may be assigned when Owner Authorization is provided are in the range 81 00 00 00<sub>16</sub> to 81 7F FF FF<sub>16</sub>. Handles in the range 81 80 00 00<sub>16</sub> to 81 FF FF FF<sub>16</sub> may be assigned when Platform Authorization is provided. When removing a persistent object, the authorization used to persist the object is required to remove it.

## 37.4 State Saved by TPM2\_Shutdown()

### 37.4.1 Background

TPM2\_Shutdown() is used for an orderly shutdown of the TPM. When doing an orderly shutdown, the TPM will save some state to NV memory. In the reference implementation, the state saved is separated into three groups:

- 1) NV Orderly Data – data that is saved on any Shutdown and is not reset,
- 2) NV Clear Data – data that is saved on Shutdown(STATE) and is reset on TPM Restart or TPM Reset (such as, PCR), and
- 3) NV Reset Data – data that is saved on Shutdown(STATE) and is reset on TPM Reset (such as session context tracking information).

### 37.4.2 NV Orderly Data

The data in this structure is saved to NV on any Shutdown type and restored on any Startup. It may have special initialization performed if the Startup is not orderly. In the reference implementation, this data is collected into a special data structure (ORDERLY\_DATA) the contents of which are illustrated in Table 31.

**Table 31 — Contents of the ORDERLY\_DATA Structure**

Parameter	Description	Changed By:
clock	This is the version of <i>Clock</i> that is updated on any Shutdown and on any rollover of the RAM version of <i>Clock</i> .	TPM2_Clear(), TPM2_Startup(), passage of time
clockSafe	used to determine the <i>Safe</i> value reported in the TPMS_CLOCK_INFO structure. This value is CLEAR when a Startup is not orderly and once CLEAR, is not SET until the RAM value of <i>Clock</i> rolls over.	TPM2_Clear(), TPM2_Startup(), passage of time

### 37.4.3 NV Clear Data

Data in this structure is saved to NV on any Shutdown(STATE) but is set to its default initialization value if the subsequent Startup is either TPM Reset or TPM Restart. In the reference implementation, data of this type is collected into a single data structure (STATE\_CLEAR\_DATA) as illustrated in Table 32.

NOTE The default reset value is applied on either TPM Reset or TPM Restart. These change conditions are not listed in the “Changed By” column.

**Table 32 — Contents of the STATE\_CLEAR\_DATA Structure**

Parameter	Description	Changed By
shEnable	the enable for the storage hierarchy. The default initialization value is SET.	TPM2_HierarchyControl()
ehEnable	the enable for the endorsement hierarchy. The default initialization value is SET.	TPM2_HierarchyControl()
platformAlg	the hash algorithm used for <i>platformPolicy</i> . The default initialization value is TPM_ALG_NULL	TPM2_SetPrimaryPolicy()
platformPolicy	the policy used if the authorization session is a policy session and the authorized handle is TPM_RH_PLATFORM. The default initialization value is an Empty Buffer.	TPM2_SetPrimaryPolicy()
platformAuth	the authorization value used if the authorization handle is TPM_RH_PLATFORM and the authorization is provided by password or an HMAC session. . The default initialization value is an Empty Buffer.	TPM2_HierarchyChangeAuth()
pcrSave	a data structure that holds the PCR that are preserved across Startup(STATE). The PCR in this structure are determined by a platform-specific TPM specification. . The default initialization value for each PCR is determined by the relevant platform-specific specification but is normally a Zero Digest for each PCR in the structure.	TPM2_PCR_Extend(), TPM2_PCR_Event()

#### 37.4.4 NV Reset Data

Data in this structure is saved to NV on any Shutdown(STATE) and restored by a subsequent Startup of any type. In the case of a TPM Reset, the values are set to their specified initialization value. In the reference implementation, data of this type is collected into a single data structure (STATE\_RESET\_DATA) as illustrated in Table 33.

**Table 33 — Contents of the STATE\_RESET\_DATA Structure**

Parameter	Description	Changed By <sup>(1)</sup>
nullProof	proof value used with entities associated with the TPM_RH_NULL hierarchy (including all session contexts, sequences, and Temporary Objects); initialization value is from the RNG	
nullSeed	seed value used for creating Temporary Objects with TPM_RH_NULL as a parent; initialization value is from the RNG	
clearCount	a value that is incremented each time the TPM performs a TPM Resume; used to tag contexts for <i>stClear</i> objects so that they may not be reloaded after a TPM Resume; initialization value is zero	TPM2_Startup(CLEAR)
objectContextID	counter that is incremented each time an object is context saved; used to ensure that the encryption key and IV for each saved object is unique; initialization value is zero	TPM2_ContextSave()
contextArray	an array for keeping the version numbers of the associated saved session contexts; used to prevent replay of authorization sessions; each element is initialized to zero indicating that it is not assigned	TPM2_ContextLoad(), ContextSave(), StartAuthSession()

Parameter	Description	Changed By <sup>(1)</sup>
contextCount	the value used to set the version number for each saved context; initialization value is 0.	TPM2_ContextSave(), TPM2_StartAuthSession()
commandAuditDigest	the current command code audit digest; initialization value is an Empty Digest.	Any audited command, TPM2_GetCommandAuditDigest()
restartCount	counts the number of TPM Resume, TPM Restart, or D-RTM events. Initialization value is zero.	TPM2_Startup(), _TPM_Hash_End
pcrUpdateCounter	counts the number of changes to PCR; because this value is used in policy sessions, it is not reset until the context protections for saved session contexts are changed. Initialization value is zero	TPM2_PCR_Extend(), TPM2_PCR_Event(), TPM2_PCR_Reset()
commitCounter	the number of times TPM2_Commit() is executed; initialization value is zero.	TPM2_Commit()
commitNonce	value used to create the pseudo-random values used in two-phase signing operations; initialization value is from the random number generator.	
commitArray	bit vector used to indicate that only one first phase of a two phase signing operation has occurred; initialization value is all bits CLEAR.	sign-phase of two-phase sign, TPM2_Commit()
NOTE (1) The default reset value is applied on each TPM Reset. This change condition is not listed in the "Changed By" column.		

### 37.5 Persistent NV Data

The data in this category is data that is always present in the TPM. This does not mean that the data cannot be changed, but that there is always a value associated with the location. The data can be changed by a Protected Capability.

In the reference implementation, the persistent NV data is in the PERSISTENT\_DATA structure. Its contents are listed in Table 34. While this table shows the context of the structure in the reference implementation, it is only illustrative. An implementation may change the contents in order to satisfy the requirements of the implementation.

**Table 34 — Contents of the PERSISTENT\_DATA Structure**

Parameter	Description	Changed By
disableClear	This value is CLEAR if TPM_RH_OWNER is allowed for authorization of TPM2_Clear().	TPM2_ClearControl(), TPM2_Clear()
ownerAlg	the hash algorithm used for the <i>ownerPolicy</i>	TPM2_SetPrimaryPolicy(), TPM2_Clear()
ownerPolicy	the policy used if the authorization session is a policy session and the authorized handle is TPM_RH_OWNER	TPM2_SetPrimaryPolicy(), TPM2_Clear()
endorsementAlg	the hash algorithm used for the <i>endorsementPolicy</i>	TPM2_SetPrimaryPolicy(), TPM2_Clear()
endorsementPolicy	the policy used if the authorization session is a policy session and the authorized handle is TPM_RH_ENDORSEMENT	TPM2_SetPrimaryPolicy(), TPM2_Clear()
ownerAuth	the authorization value used if the authorization handle is TPM_RH_OWNER and the authorization is provided by password or an HMAC session	TPM2_HierarchyChangeAuth(), TPM2_Clear()



Parameter	Description	Changed By
endorsementAuth	the authorization value used if the authorization handle is TPM_RH_ENDORSEMENT and the authorization is provided by password or an HMAC session	TPM2_HierarchyChangeAuth(), TPM2_Clear()
lockoutAuth	the authorization value used if the authorization handle is TPM_RH_LOCKOUT and the authorization is provided by password or an HMAC session	TPM2_HierarchyChangeAuth(), TPM2_Clear()
lockoutAlg	the hash algorithm used for the <i>lockoutPolicy</i>	TPM2_SetPrimaryPolicy(), TPM2_Clear()
lockoutPolicy	the policy used if the authorization session is a policy session and the authorized handle is TPM_RH_LOCKOUT	TPM2_SetPrimaryPolicy(), TPM2_Clear()
epSeed	the seed value for the Endorsement Hierarchy	TPM2_ChangeEPS()
ehProof	the proof value for the Endorsement Hierarchy. It is used to tag tickets and saved object contexts for objects in the Endorsement Hierarchy.	TPM2_ChangeEPS() TPM2_Clear()
spSeed	the seed value for the Storage Hierarchy	TPM2_Clear()
shProof	the proof value for the Storage Hierarchy. It is used to tag tickets and saved object contexts for objects in the Storage Hierarchy.	TPM2_Clear()
ppSeed	the seed value for the Platform Hierarchy	TPM2_ChangePPS()
phProof	the proof value for the Platform Hierarchy. It is used to tag tickets and saved object contexts for objects in the Platform Hierarchy.	TPM2_ChangePPS()
resetCount	a counter that increments on each TPM Reset	TPM Reset, TPM2_Clear()
totalResetCount	a value that increments on each TPM Reset. This value is used as <i>resetValue</i> in equation (54) to tag saved contexts.	TPM Reset
pcrPolicies	This structure is used when a platform-specific specification requires that update of certain PCR requires policy authorization.	TPM2_PCR_SetAuthPolicy()
pcrAuthValues	This structure is used when a platform-specific specification requires that update of certain PCR requires HMAC or password authorization	TPM2_PCR_SetAuthValue()
pcrAllocated	This structure is used when an platform-specific specification requires support for TPM2_PCR_Allocate() to change the algorithms used for PCR and the population of the PCR in each bank.	TPM2_PCR_Allocate()
ppList	In the reference implementation, this is an array of bits that is used to indicate the commands that require assertion of Physical Presence when TPM_RH_PLATFORM is used for authorization.	TPM2_PP_Commands()
failedTries	count of the number of authorization failures for objects that are subject to Dictionary Attack protection. This value can count down if no authorization failures occur for <i>lockoutRecovery</i> time.	TPM2_DictionaryAttackLockReset(), authorization failures, passage of time ( <i>recoveryTime</i> )

Parameter	Description	Changed By
maxTries	the maximum value for <i>failedTries</i> before the TPM enters lockout	TPM2_DictionaryAttackParameters()
recoveryTime	the time that must pass before <i>failedTries</i> is decremented	TPM2_DictionaryAttackParameters()
lockoutRecovery	the time that must pass after an authorization failure using TPM_RH_LOCKOUT	TPM2_DictionaryAttackParameters()
lockoutAuthEnabled	when CLEAR, TPM_RH_LOCKOUT may not be used for authorization	TPM_RH_LOCKOUT auth failure, passage of time (lockoutRecovery)
orderlyState	between a TPM2_Shutdown() and _TPM_Init, no TPM command caused a change to the TPM's state to make the state in NV inconsistent with the state in TPM RAM	many
auditCommands	in the reference implementation, a bit array indicating which commands are audited	TPM2_SetCommandCodeAuditStatus()
auditHashAlg	the hash algorithm used for the command audit	TPM2_SetCommandCodeAuditStatus()
auditCounter	a counter that increments on the first audited command following a reset of the command audit digest. The count is only incremented if the command completes with TPM_RC_SUCCESS.	audited command
algorithmSet	this is a vendor-specific value that indicates the algorithm set that is in use on the TPM. This value may be used selectively to disable algorithms implemented in the TPM.	TPM2_SetAlgorithmSet()
firmwareV1	the more significant 32-bits of the vendor-assigned, firmware revision	TPM2_FieldUpgradeStart(), TPM2_FieldUpgradeData()
firmwareV2	the less significant 32-bits of the vendor-assigned, firmware revision	TPM2_FieldUpgradeStart(), TPM2_FieldUpgradeData()

### 37.6 NV Rate Limiting

The TPM is allowed to limit the rate at which updates are made to NV memory. An update occurs when an NV Index is defined or undefined, when an NV Index is modified, and when the persistence of an object is changed with TPM2\_EvictControl(). An NV modification is allowed for other commands in an implementation dependent way. The rate for limiting the updates is TPM dependent.

When the TPM will prevent execution of a command because it is rate-limiting NV updates, the TPM will return TPM\_RC\_NV\_RATE. This code is in the group of warning return codes meaning that the command might succeed if retried later.

NOTE 1           Checking to see if the NV is being rate limited may occur at any part of the command execution. This means that the TPM may return TPM\_RC\_NV\_RATE before it has validated all of the parameters of the command. As a consequence, when the command is retried when the TPM is not rate limiting, it may fail due to incorrect parameters.

TPM2\_GetCapability() with *capability* = TPM\_CAP\_PROPERTIES and *property* = TPM\_PT\_NV\_WRITE\_RECOVERY will provide an estimate of the number of milliseconds before the TPM will be able to accept a command that will modify the TPM NV.

NOTE 2           After TPM2\_Shutdown(), any command is allowed to cause a change of the TPM's orderly shutdown state and the TPM may return TPM\_RC\_NV\_RATE in response to commands that are not normally allowed to make modifications to the TPM NV state.

## 37.7 NV Other Considerations

### 37.7.1 Power Interruption

A TPM is not required to maintain the integrity of the data in an NV Index if a power loss interrupts the write. After the interruption, the TPM should indicate that the Index no longer exists. The interruption of a write to one Index is not allowed to affect the integrity of other Indices.

### 37.7.2 External NV

#### 37.7.2.1 Introduction

An implementation is allowed to use an external device for storing non-volatile TPM data. This may include all application defined NV (NV Indices and persistent objects) as well as all TPM state data. When stored in an external device, the data is required to be encrypted, integrity checked, and rollback protected using algorithms that have the highest security strength of any algorithm implemented on the TPM.

The encryption keys used to encrypt the data in the NV shall be protected in a manner which is defined by the TPM profile which is being implemented. The level and manner of protection for these keys shall also be specified and shall be at least as strong as the keys themselves. For a chip-based implementation, the encryption keys used to encrypt the data stored in NV are not allowed to be exposed outside of the TPM, even if encrypted.

The protection keys used to protect external NV data will be contained in or derived from a persistent value that does not leave the physical TPM. That persistent value must not be a global secret.

NOTE In many implementations, it is expected that the persistent values will be stored in fuses.

#### 37.7.2.2 Access Interruptions

When an external device is used for non-volatile storage, that device may not always be accessible to the TPM command execution engine. When the memory is not accessible, operations that require update of NV will return TPM\_RC\_NV\_UNAVAILABLE.

NOTE When updates to NV are being rate limited (but the NV is accessible), the TPM will return TPM\_RC\_NV\_RATE.

During the time when NV is not available for update, *Clock* should not advance and *Safe* should be NO when accessed.

When NV is not available, the implementation may or may not advance *Clock*. If *Clock* is not being advanced, the TPM will return TPM\_RC\_NV\_UNAVAILABLE for commands that do comparisons to *Clock* or adjustments of *Clock*. These commands are:

- TPM2\_PolicySigned() or TPM2\_PolicySecret() with a non-zero *expiration*;
- TPM2\_PolicyTicket(); and
- TPM2\_PolicyCounterTimer() if any part of TPMS\_TIME\_INFO.*clockInfo.clock* is used in the operation.

When NV is not available, the implementation may or may not advance *Time*. If *Time* is not being advanced, then TPM2\_PolicyCounterTimer() will return TPM\_RC\_NV\_UNAVAILABLE if any part of TPMS\_TIME\_INFO.*time* is used in the operation.

### **37.7.3 PCR in NV**

If a TPM implementation places PCR in NV space, it should also use a caching scheme to prevent NV wearout.

## 38 Multi-Tasking

An implementation of the TPM may use cycles of a host processor for execution. The operating system on the host processor may not be able to operate properly if the TPM uses large blocks of time to complete execution of a command. In such systems, the TPM may be designed to yield after completion of a portion of the command so that the command may be resumed later.

When the TPM yields before completion of a command, it may return `TPM_RC_YIELDED`. This code indicates that the exact command that the TPM was executing may be resubmitted later. If the next command to the TPM is not the yielded command, the TPM may lose any state associated with the command that yielded so that when the yielded command is restarted, it may restart from the beginning.

## 39 Errors and Response Codes

### 39.1 Error Reporting

When a command fails, the TPM will return a 10-octet response that indicates the response code. No auxiliary information is provided by an error other than what may be inferred from the context of the error.

### 39.2 TPM State After an Error

When the TPM returns an error that is related to command execution, the TPM is required to preserve the TPM state. Except for the possible effect on the dictionary attack logic, it should be as though the command had not been received.

In some cases, an otherwise asynchronous operation may cause the TPM to create an error. For example, if the TPM is doing self-test of functions on an as-needed basis, the TPM may return an error due to failure of the self-test. The TPM should preserve the fact that it has failed the self-test but it should not preserve any command-specific results.

When a command modifies NV RAM, the action of writing the NV may fail and it may not be recoverable. If the TPM cannot recover from the NV write failure, then it should disable the NV so that the affected NV locations cannot be accessed.

### 39.3 Resource Exhaustion Warnings

#### 39.3.1 Introduction

The executable specification has been optimized for comprehension and correctness. In particular, the reference implementation has been designed to minimize the locations in the code where resource exhaustion can occur, so that recovery from these situations is simplified. This is known not to achieve an efficient use of limited RAM resources, and other implementations may choose methods that are more aggressive in their use of memory. These implementations will invariably have error conditions that are not covered in the normative clauses of the reference implementation. This clause describes the methods that are recommended for reporting of these errors.

Allocated resources are classified by their persistence relative to a command's execution. A transient resource is one that can be moved to or from TPM memory using a context management command (TPM2\_ContextLoad(), TPM2\_ContextSave()). These resources may continue to occupy TPM memory after completion of a command. A temporary resource is used in the processing of a command, but is disposed of before the command completes. The following two clauses describe the expected behavior of the TPM when it is unable to create either of these resource types.

#### 39.3.2 Transient Resources

The TPM reference implementation allocates space for a configuration-defined number of transient resources of the maximum size supported by the configuration parameters. This allocation occurs during the compilation process of the reference implementation. The maximum size of the objects is determined by the structure definitions in TPM 2.0 Part 2. The reference implementation presumes that, if a resource slot is available, then any object that might be stored in that slot will fit.

A practical consequence of this approach is that the only resource allocation failure for a transient resource occurs when all the dedicated slots of the appropriate type (object, sequence object, or session) are full. For objects, the number of available slots determines when the resources are all used. For sessions, there are two slot resources: handles and session contexts.

When the TPM is out of object slots, it returns `TPM_RC_OBJECT_MEMORY`. When out of session context slots, it returns `TPM_RC_SESSION_MEMORY`. When the TPM is out of handle slots for sessions, the response code is `TPM_RC_SESSION_HANDLES`.

For a system using dynamic allocation of memory for transient resources, the TPM should return an error response code that indicates the type of resource that needs to be removed from the TPM for the command to complete. If removal of either an object or a session from TPM memory would free memory for the command, then the TPM may return `TPM_RC_MEMORY`. If removal of a specific resource is required, the TPM should return a code that indicates the specific resource (`TPM_RC_OBJECT_MEMORY` or `TPM_RC_SESSION_MEMORY`).

### 39.3.3 Temporary Resources

The TPM reference implementation is designed so that temporary resources are allocated on the execution stack. Static analysis of the code allows the maximum size of the stack to be determined so that resource exhaustion for a temporary resource cannot occur.

This construction vastly simplifies the control flow of the normative command actions, since no additional memory management code is required. However, other memory management schemes for temporary resources are allowed. Error handling for these implementations is complex and beyond the scope of this specification. However, the TPM is required to follow the standard error reporting rules.

- If the TPM returns an error, the state of the TPM is required to be restored to the state that existed before the command execution began.

NOTE 1 One exception is state that would change even if a command were not executed, such as *Clock*, *Time*, dictionary attack lockout recovery, and related state. Another exception is state deliberately changed as a result of the error, such as the count of authorization failures and NV PIN Fail index values.

- The TPM will return `TPM_RC_MEMORY` if removal of one or more transient resources will allow the command to complete.

NOTE 2 If the TPM requires the removal of a specific type of resource, then it should return the specific response code (`TPM_RC_SESSION_MEMORY` or `TPM_RC_OBJECT_MEMORY`) rather than the non-specific `TPM_RC_MEMORY` response.

- If a session must be flushed before a new session can be created, the TPM will return `TPM_RC_SESSION_HANDLES`.

The consequence of these requirements is that the TPM is required to be able to return the memory allocation to the same state that existed before the command execution began. It is also required that no change to NV memory be made before all temporary resources required for completion of the command have been allocated.

### 39.4 Response Code Details

The response code from the TPM is a 32-bit value but the TPM only uses the low-order 12 bits to communicate its warnings or errors, leaving the remaining 20 bits for use by software.

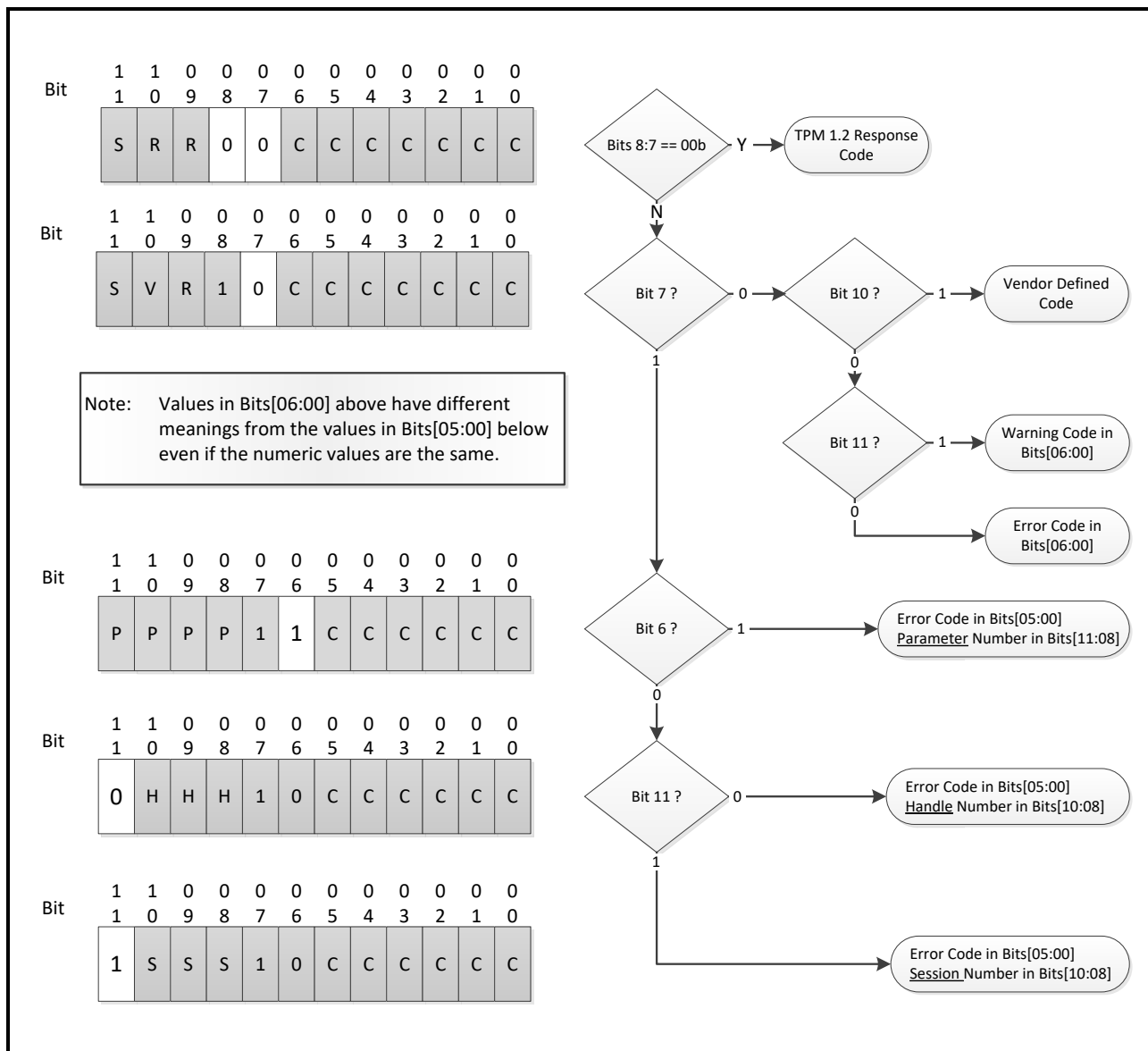
The response codes are encoded so that certain errors can be associated with the component in which the error occurred, and the specific element of the component. In cases where the error cannot be associated with a specific parameter of the command, the response code will be sufficiently differentiated to allow determination of the cause of the error.

EXAMPLE 1 If the second handle in the handle area was the wrong type for the command, the TPM would return `TPM_RC_VALUE + TPM_RC_H + TPM_RC_2`.

**EXAMPLE 2** If the TPM can determine that the error was in the handle area but not the handle in error, the TPM would return TPM\_RC\_VALUE + TPM\_RC\_H.

The design of the response codes was constrained so that the response codes returned for commands defined in this specification would be different from the response codes defined by the previous version of the specification, TPM 1.2. This constraint leads to a layout that satisfies the requirements, but is not intuitive.

An algorithm for evaluating the response code to determine the nature of the error and the command handle, session, or parameter value in error is shown in the Figure 27 flow chart.



**Figure 27 — Response Code Evaluation**



## 40 General Purpose I/O

A TPM may have one or more I/O pins that inputs or outputs a logic state. TPM2\_NV\_Read and TPM2\_NV\_Write may be used to access the value of GPIO using normal access controls.

A platform-specific specification defines the mapping of NV Indices to individual General Purpose I/O (GPIO). Whether the TPM reserves any NV storage for the indicated GPIO is platform specific.

This specification does not require the NV Indices associated with GPIO pins to be pre-allocated. When one of the Indices reserved for GPIO pins is defined, it is automatically associated with the corresponding GPIO pin.

NOTE 1            The owner and platform space is segregated and it is expected that the GPIO pins will be assigned to Index values in the Index space reserved for the platform.

NOTE 2            The TCG maintains a registry of reserved NV Index values.

The controls that let the GPIO pin be used either as an input or an output are vendor or platform specific.

For outputs, if the Index has the TPMA\_NV\_ORDERLY attribute SET, the output state is volatile, and becomes non-volatile on an orderly shutdown. If the TPMA\_NV\_ORDERLY attribute is CLEAR, the output state is non-volatile.

For inputs, a read of the Index returns TPMI\_YES\_NO, where YES indicates a logic 1 and NO indicates a logic 0 on the input pin.

## 41 Minimums

### 41.1 Introduction

This clause lists the minimums for specific functional blocks where a minimum is needed to ensure proper TPM operation.

Platform-specific TPM specifications may impose other minimums but those minimums are not allowed to be less than the minimums in this specification.

### 41.2 Authorization Sessions

An active authorization session is a session that is currently loaded into TPM memory and can be addressed with a session handle in a command. A concurrent session is an authorization session that either is loaded on the TPM or has its context saved.

A command may require no more than three sessions divided according to the needs of the command. The TPM is required to be able to support execution of a command with three authorization sessions.

The management of sessions is different from the management of objects. Management software can keep the contexts for an indefinite number of objects and load them as required. The number of concurrent sessions, however, is limited by the resources that the TPM can devote to tracking those sessions.

The TPM should support a minimum of 64 concurrent sessions. Fewer sessions would impair the ability of the TPM to conduct concurrent operations with multiple users.

### 41.3 Transient Objects

In order to be able to execute all commands, the TPM needs to have two active, loaded objects of any type. A Transient Object is an object that occupies TPM memory and may be referenced by handle. The number of Transient Objects that the TPM supports does not include those objects that have been placed in persistent TPM memory.

NOTE A TPM implementation may copy an object from persistent storage into a Transient Object slot in order to speed up access to the object data.

### 41.4 NV Counters and Bit Fields

All TPM implementations should allow at least one NV Index to be allocated for use as a monotonic counter (TPMA\_NV\_COUNTER) or bit field (TPMA\_NV\_BITS). The number of these Index types determines how many different policies may include revocation as part of their logic. When the number of these Index types is too small, the software complexity of handling revocation becomes too complex to manage.

NOTE 1 This minimum (1) may be adequate for a TPM in a simple embedded system but is too low for a TPM in a complex system such as a PC. Platform-specific specifications for more complex systems should mandate support for at least sixteen (16) counter or bit field Indices.

NOTE 2 The requirement that a TPM support the TPMA\_NV\_COUNTER or TPMA\_NV\_BITS attribute implies that the TPM is required to implement either TPM2\_NV\_Increment() or TPM2\_NV\_SetBits().

## Annex A (informative) Policy Examples

### A.1 Introduction

This clause compares authorization between TPM 1.2 and this specification.

### A.2 TPM 1.2 Compatible Authorization

A TPM 1.2 key may have its use gated by PCR and *authValue*. To select this authorization, the key would be created with a *pcrSelection* with at least one bit SET and the *digestAtRelease* set to indicate the digest of the selected PCR. Additionally, the key's TPM\_AUTH\_DATA\_USAGE would be set to TPM\_AUTH\_ALWAYS. To perform the authorization, an authorization session is created and used to prove knowledge of the *authValue* in the authorization HMAC. If the HMAC check is successful and the digest of the selected PCR matches the *digestAtRelease*, the action is approved.

For a TPM compatible with this specification, use of PCR for access control requires a policy. The policy should be created at the time of object creation so that the policy requires selected PCR to have a specific value. This is similar to determining the *digestAtRelease* in TPM 1.2. The policy will use two factors: PCR and an *authValue*. The first policy command will be TPM2\_PolicyPCR() and it will modify the *policyDigest* by:

$$policyDigest_1 := H_{contextAlg}(policyDigest_0 || TPM\_CC\_Policy\_PCR || PCR\ Selection || PCR\ digest) \quad (60)$$

where

$H_{contextAlg}$	hash function using the context hash algorithm
<i>policyDigest<sub>0</sub></i>	an array of octets of zero equal in length to the size of the policy digest
TPM_CC_Policy_PCR	a constant indicating the command modifying the <i>policyDigest</i>
<i>PCR Selection</i>	a TPML_PCR_SELECTION that indicates the PCR that will be included in the PCR digest
<i>PCR digest</i>	the expected digest of the PCR selected by the PCR Selection; the PCR are hashed using the hash algorithm of the policy session

To cause the TPM to compute an HMAC using the *authValue* of the object, a TPM2\_PolicyAuthValue() would be included in the policy. It would modify the *policyDigest* as:

$$policyDigest_2 := H_{contextAlg}(policyDigest_1 || TPM\_CC\_PolicyAuthValue) \quad (61)$$

where

$H_{contextAlg}$	hash function using the context hash algorithm
<i>policyDigest<sub>1</sub></i>	the result of performing the operation in equation (60) above
TPM_CC_PolicyAuthValue	the command code for TPM2_PolicyAuthValue()

The value of *policyDigest<sub>2</sub>* would be included in the template of the object in the *authPolicy* parameter.

To use the object, a policy authorization session would be started using TPM2\_StartAuthSession(). Then a TPM2\_PolicyPCR() and TPM2\_PolicyAuthSession() would be executed using the handle of the authorization session. If the PCR were the same as those used when performing the operation of

equation (60), then the *policyDigest* of the policy session will match the *authPolicy* of the object. Because the policy sequence contained `TPM2_PolicyAuthValue()`, the TPM will check that the HMAC in the authorization indicates that the caller knows the *authValue* of the object (same computation as performed on an HMAC session). If both checks succeed, the object is properly authorized.

## Annex B (normative/informative) RSA

### B.1 Introduction

The RSA asymmetric algorithm is used for digital signatures, secret sharing, and encryption.

A TPM that supports RSA should support a public modulus size of at least 2,048 bits. Support for other key sizes is permitted.

NOTE 1           The reference implementation supports key sizes of 1024, 2048, and 3072.

When the size ( $k$ ) of the public modulus ( $n$ ) of an RSA key is given, then  $\lfloor \log_2 n \rfloor = (k - 1)$ . Additionally, for a two-prime system, the primes ( $p$  and  $q$ ) satisfy  $\lfloor \log_2(p^2) \rfloor = (k - 1)$  and  $\lfloor \log_2(q^2) \rfloor = (k - 1)$ .

The RSA algorithm requires the methods of encryption and signing defined in IETF RFC 3447. This includes support for RSAES-OAEP, RSAES-PKCS1-v1.5, RSASSA-PKCS1-v1.5, and RSASSA-PSS.

The RSA structures in this specification support only public keys that are the product of two primes. Support for other numbers of primes is allowed, but it is performed in a vendor-specific manner and thus beyond the scope of this specification.

A TPM is required only to support a public exponent ( $e$ ) of  $2^{16}+1$ . Support for other exponents is allowed but discouraged.

NOTE 2           The reference implementation does not support an exponent size smaller than 7 nor does it allow keys to be created on the TPM with a public exponent less than  $2^{16} + 1$ .

When loading an RSA key, the TPM validates that its public and private portions are properly paired by dividing the public modulus by the single private prime and requiring that the remainder be zero. The TPM does not validate whether input values are primes.

NOTE 3           Validating the pairing of the public and private key portions need not be performed when the key is being loaded. However, this check is performed before the authorization value of the key or the private portion of the asymmetric key may be used.

The TPM will also validate that the provided and computed prime factors are in an acceptable range. To be acceptable, the square of the prime is required to have the same number of significant bits as the public modulus.

## B.2 RSAEP

This is the RSA public key primitive defined in IETF RFC 3447, clause 5.1.1. It is a modular exponentiation of a message ( $m$ ) with the public exponent ( $e$ ), modulo the public modulus ( $n$ ) to produce the cipher text ( $c$ ). This is expressed as:

$$c := m^e \pmod{n} \quad (62)$$

where

$c$	the encrypted message
$m$	a value $0 < m < n$ to be encrypted
$e$	the public exponent (default is $2^{16} + 1$ )
$n$	the public modulus

## B.3 RSADP

This is the RSA private key primitive defined in PSCS#1v2.1, clause 5.1.2. This clause describes the private key in two forms: as a pair and as a quintuple. The reference implementation uses the pair form with a private exponent ( $d$ ). Using this form, the RSADP operation recovers a message from a cipher text by:

$$m := c^d \pmod{n} \quad (63)$$

NOTE The reference implementation also supports use of the CRT form of the private exponent.

## B.4 RSAES\_OAEP

This encryption scheme is defined in IETF RFC 3447. It is the only scheme used with an RSA-restricted decryption key. The algorithm identifier for this scheme is TPM\_ALG\_OAEP.

For RSA keys protecting a secret value (such as, an encryption key or a session secret), the  $L$  parameter is a null-terminated string indicating the intended use of the encrypted value. A command that accepts or creates an RSA-encrypted secret indicates the value of the string to use for  $L$ . The RSA key's *scheme* hash algorithm (or, if it is TPM\_ALG\_NULL, the RSA key's Name algorithm) is used to compute  $lhash := \mathbf{H}(L)$ , and the null termination octet is included in the digest.

MGF1 (as defined in IEEE Std 1363<sup>TM</sup>-2000) computes  $dbMask$  and  $seedMask$ . The mask-generation function uses the Name algorithm of the RSA key as the hash algorithm.

## B.5 RSAES\_PKCSV1\_5

This encryption scheme is defined in IETF RFC 3447. It has no parameters. The algorithm identifier for this scheme is TPM\_ALG\_RSAES.

## B.6 RSASSA\_PKCS1v1\_5

This signing scheme is defined in IETF RFC 3447. The algorithm identifier for this scheme is TPM\_ALG\_RSASSA.

An RSA-restricted signing key may use either this algorithm or RSASSA\_PSS, but not both. An unrestricted signing key may select as its default either this algorithm or RSASSA\_PSS. If TPM\_ALG\_NULL is selected, the caller will specify the scheme in the signing command.

This signature scheme prepends an OID to a digest before signing with the private key. It may be used in any command that allows an asymmetric signing operation.

For signing commands that use restricted signing keys, the TPM provides the OID that corresponds to the digest algorithm, and the OID provided by the caller is discarded.

For commands that use unrestricted signing keys, the TPM uses the caller-provided OID.

**NOTE 1** If the command does not provide a parameter for the OID, then the TPM provides the OID even if the key is not restricted.

For hash algorithms where the TCG defines a TPM\_ALG\_ID, the TCG provides the OID to use with restricted signing keys. Currently, the defined values are:

- SHA1

30 21 30 09 06 05 2B 0E 03 02 1A 05 00 04 14<sub>16</sub>

- SHA256

30 31 30 0d 06 09 60 86 48 01 65 03 04 02 01 05 00 04 20<sub>16</sub>

- SHA384

30 41 30 0d 06 09 60 86 48 01 65 03 04 02 02 05 00 04 30<sub>16</sub>

- SHA512

30 51 30 0d 06 09 60 86 48 01 65 03 04 02 03 05 00 04 40<sub>16</sub>

**NOTE 2** These values are from IETF RFC 3447.

**NOTE 3** The listing above is not normative. TCG maintains the normative list.

## B.7 RSASSA\_PSS

This signing scheme is defined in IETF RFC 3447. The algorithm identifier for this scheme is TPM\_ALG\_RSAPSS.

A restricted signing key may use either this algorithm or RSASSA\_PKCS1v15, but not both. An unrestricted signing key may use either this algorithm, RSASSA\_PKCS1v15, or TPM\_ALG\_NULL. If TPM\_ALG\_NULL is selected, the caller can specify the signing scheme in the signing command.

When used with a restricted signing key, the hash algorithms for messages (M) and M' are the same.

When used with an unrestricted signing key, the hash algorithm for M and M' can differ.

For both restricted and unrestricted signing keys, the random salt length will be the largest size allowed by the key size and message digest size.

**NOTE** If the TPM implementation is required to be compliant with FIPS 186-4, then the random salt length will be the largest size allowed by that specification.

## B.8 RSA Key Generation

### B.8.1 Background

The implementation of the RSA key-generation function should meet the requirements of the intended market. The methods in FIPS 186-3 are recommended.

In the reference implementation, the primes used for the key are generated using the methods of FIPS 186-3, B.3.3 "Generation of Random Primes that are Probably Prime."

NOTE FIPS 186-3 only allows this method to be used for primes of 1024 bits or larger. For smaller primes, the methods described in B.3.5 "Generation of Probable Primes with Conditions Based on Auxiliary Provable Primes" or B.3.6 "Generation of Probable Primes with Conditions Based on Auxiliary Probable Primes" can be used if FIPS compliance is required.

### B.8.2 Large Prime Generation

For generating a prime the reference implementation has two different implementations: one using testing of candidates and the other using a number sieve. The process for testing of candidates is described in this clause.

The inputs are:

- *primeSize* – this is the number of bits in the prime to be generated. It should be half the number of bits in the public modulus to be generated
- *e* – the public exponent

NOTE 1 In the reference implementation, the exponent is required to be a prime number  $> 2^{16}$

- a random number generation function according to the type of key being generated (see 27.6.2 and 27.6.3)

NOTE 2 Derivation of RSA keys is not supported.

The prime generation process is:

- a) set prime candidate *p* to the next *primeSize* number of bits from the provided random number generation function
- b) adjust *p* so that the high-order two bits and the low order bit are one

NOTE 3 In the reference implementation, when a prime is generated, the upper two octets for prime candidates are verified to be  $B5\ 05_{16}$  or greater. This forces the prime to be greater than  $0.7071075439453125 * 2^{(n/2)}$  where *n* is the number of bits in the public modulus. This is slightly larger than the required value of  $\sqrt{2}/2 * 2^{(n/2)}$ . This value ensures that the MSb of the product of these to prime will be SET. Setting of the two most significant bits would also ensure that the magnitude of the product is large enough but reduced the range of allowed primes by small factor (about 4.3%).

- c) test *p* to determine if it is probably prime
  - 1) Using a greatest common divisor (**GCD()**) function, see if *p* shares any common factors with a composite number that is the product of the first 1024 primes and if so, go to a).
  - 2) do *N* rounds of Miller-Rabin where *N* is determined by the size of the prime and if the test fails on any round, go to a)

NOTE 4 The value for *N* may be found in FIPS 186-3, Table C.2.



NOTE 5 The witness values used by Miller-Rabin are from the same random number function used to generate the prime candidate.

d) return  $p$

### B.8.3 RSA Key Generation Algorithm

The key generation process is:

- a) initialize the values of the algorithm
  - 1) Set *securityStrength* according to the size of the public modulus of the key to be generated as specified in SP800-57 part 1.
  - 2)  $primeSize := 1/2$  the size of the RSA modulus (*inPublic.parameters.keyBits* of the template)
- b) find a first prime ( $p$ ) using the method in B.8.2
- c) find a second prime ( $q$ ) using the method in B.8.2:
- d) If  $|p - q| < 2^{100}$ , go to b)
- e) compute the public modulus  $n := p \cdot q$

NOTE 1 Depending on the starting values the algorithm could take many iterations to find two suitable primes.

f) compute the private exponent  $d := e^{-1} \pmod{(p-1)(q-1)}$

NOTE 2 The reference implementation also provides an option to use the CRT form of the private exponent  $d$ .

g) if  $d < 2^{nLen/2}$  where  $nLen$  is the number of bits in the public modulus ( $n$ ), then go to step b)

NOTE 3 If required, a random value is encrypted with the public exponent and decrypted with the private exponent to validate that the key can be used for signing and signature verification.

h) return  $n$ ,  $p$  and  $d$

## B.9 RSA Cryptographic Primitives

### B.9.1 Introduction

When RSA is implemented on a TPM, it may provide these additional commands to support cryptographic operations. The command description in TPM 2.0 Part 3 indicates the restrictions on the types of keys that may be used with each of the commands.

### B.9.2 TPM2\_RSA\_Encrypt()

TPM2\_RSA\_Encrypt() may be used to perform encryption according to the methods described in IETF RFC 3447. If the scheme of the key is TPM\_ALG\_NULL, then the encryption scheme may be specified in the command. Otherwise, the scheme specified in the key will be used. The scheme options are:

- TPM\_ALG\_NULL – selects RSAES as described in B.2
- TPM\_ALG\_OAEP – selects RSAES\_OAEP as described in B.4
- TPM\_ALG\_RSAES – selects RSAES\_PKCSV1\_5 as described in B.5

### B.9.3 TPM2\_RSA\_Decrypt()

TPM2\_RSA\_Decrypt() performs the decryption operations defined in IETF RFC 3447, clause 7.1.2. The handle used in this command is required to have the *decrypt* attribute SET. If the scheme of the key is TPM\_ALG\_NULL, then the encryption scheme may be specified in the command. Otherwise, the scheme specified in the key will be used. The scheme options are:

- **TPM\_ALG\_NULL** – selects RSADP as described in B.3
- **TPM\_ALG\_OAEP** – selects RSAES\_OAEP as described in B.4
- **TPM\_ALG\_RSAES** – selects RSAES\_PKCSV1\_5 as described in B.5

## B.10 Secret Sharing

### B.10.1 Overview

When data is to be delivered securely to the TPM a secret sharing mechanism is required. There are three cases when RSA is used for secret sharing:

- 1) injecting a salt value for an authorization session,
- 2) exchanging protection values for object duplication, and
- 3) exchanging protection values for identity credentials.

For each of these uses, a secret value is OAEP encrypted as described in B.4.

The size of the secret value is limited to the size of the digest produced by the *scheme* hash algorithm (or *nameAlg* if the scheme hash algorithm is TPM\_ALG\_NULL) of the object that is associated with the public key used for OAEP encryption.

### B.10.2 RSA Encryption of Salt

In TPM2\_StartAuthSession(), when *tpmKey* is an RSA key, the secret value (*salt*) is encrypted using OAEP as described in B.4. The string “SECRET” (see 4.5) is used as the *L*. The data value in OAEP-encrypted blob (*salt*) is used to compute *sessionKey*.

### B.10.3 RSA Secret Sharing for Duplication

When the new parent for a duplicated object is an RSA key, a random seed value is created and used in the KDF operations to generate a symmetric encryption key and IV according to equation (34) and an HMAC key according to equation (36). The seed value will be OAEP encrypted to the public key of the new parent as described in B.4 using “DUPLICATE” as the *L* parameter. The seed size will be the size of a digest produced by the OAEP hash algorithm of the new parent.

On TPM2\_Import() the private key of the new parent is used to decrypt the key protector containing the seed value. If the label value in the OAEP encrypted blob is not “DUPLICATE”, then the decryption routine should generate an error. The error should cause the seed value to be set to an invalid value so that the error will not be reported until the integrity HMAC is validated.

NOTE This is to ensure consistency in behavior with ECC and to minimize the information available to an attacker.

**B.10.4 RSA Secret Sharing for Credentials**

When a credential is protected (such as `TPM2_MakeCredential()` and `TPM2_ActivateCredential()`), a random seed value is created and used as described in B.10.3. The only difference is that the label value used for the KDF will be "IDENTITY" instead of "DUPLICATE"

## Annex C (normative/informative) ECC

### C.1 Introduction

The ECC algorithm is used for digital signatures and for secret sharing.

NOTE 1 As implemented in a TPM, ECC is not used directly for encryption of data. Rather, ECDH secret sharing is used to establish a symmetric key, and then a symmetric algorithm is used for the actual data encryption.

A TPM should support prime modulus ECC.

If the ECC algorithm is supported, the TPM is required to support ECDSA and ECDH (SP800-56A, Clause 6.2.2.2 “One-Pass Diffie-Hellman, C(1, 1, ECC CDH)”).

The TPM should support ECC key sizes of at least 256 bits. Support for other key sizes is allowed.

NOTE 2 It is anticipated that the recommended ECC key size will increase over time in revisions to this specification.

The TPM does not check the security of ECC curve parameters. It does check that the public and private keys are properly paired.

NOTE 3 Validating the pairing of the key's public and private portions need not be performed when the key is being loaded. However, this check is required to be performed before the authorization value of the key or the private portion of the asymmetric key may be used.

### C.2 Split Operations

#### C.2.1 Introduction

Several of the EC schemes use two-phase protocols in which the TPM generates an ephemeral key pair in the first phase and uses that ephemeral key in the second phase. These protocols require that the ephemeral key only be used once. Ordinary TPM keys have context that may be saved and restored by TPM context management. This clause describes the methods used to implement the required single use ephemeral keys.

#### C.2.2 Commit Random Value

A split operation requires two TPM commands the first of which is TPM2\_Commit(). It uses a TPM-generated, random value in the commit computation. A second command (such as, any of the signing commands) completes the split signing operation and uses the same commit value. The random commit value is required to:

- have the number of bits equal to the security strength of the signing key;
- not be known outside of the TPM; and
- only be used once.

Because the random value is not allowed to be known outside of the TPM, the TPM is required to store the random value between the two commands in split sequence. To allow more than one split sequence to be in process at a time, the TPM may have an array of values and return a count value as one of the

response parameters of the TPM2\_Commit() indicating the array entry being used for the sequence. This count value is an input to the TPM in the command that completes the split sequence.

NOTE The number of split sequences supported by the TPM may be found using TPM2\_GetCapability(*capability* = TPM\_CAP\_TPM\_PROPERTIES, *property* = TPM\_PT\_SPLIT\_MAX).

To minimize the size of the array used for storing these values, a TPM may generate pseudo-random values instead.

If using pseudo-random values, the TPM creates the value using **KDFa()**, a counter (*commitCount*), and a random value (*commitRandom*). On each TPM Reset, the TPM will select a new random value for *commitRandom* and reset *commitCount* to zero. On TPM2\_Commit(), the TPM would use the current value of the *commitCounter* to generate the pseudo-random value (*r*) by

$$r := \mathbf{KDFa}(\textit{nameAlg}, \textit{commitRandom}, \text{"ECDAA Commit"}, \textit{name}, \textit{commitCount}, \textit{bits}) \quad (64)$$

where

<i>nameAlg</i>	the <i>nameAlg</i> of the signing key ( <i>signHandle</i> )
<i>commitRandom</i>	the current value of <i>commitRandom</i>
"ECDAA Commit"	value used to differentiate uses of <b>KDFa()</b>
<i>name</i>	the Name of <i>signHandle</i>
<i>commitCount</i>	the current value of <i>commitCount</i>
<i>bits</i>	the number of bits in a digest using <i>nameAlg</i>

To track the usage of the *commitCount*, the TPM maintains a bit array (*A*[]) that has a power of 2 number of bits (*N*) (that is, the bits indexes of *A*[] are from 0 to  $2^N-1$ ). After computing the value of *r*, the low-order *N* bits of *commitCount* are used to index *A*[] and the corresponding bit is SET. The low-order 16 bits of *commitCount* are returned as the *counter* parameter.

### C.2.3 TPM2\_Commit()

TPM2\_Commit() performs the first part of a split operation. The TPM will perform the point multiplications on the provided points and return intermediate signing values. Alternatively, the TPM will simply return a public ephemeral key based on a commit private value. The *signHandle* parameter refers to an ECC key. TPM2\_Commit() has the following parameters, all of which are optional.

<i>P1</i>	point on the curve used by <i>signHandle</i> (a TPM2B_ECC_POINT)
<i>s2</i>	octet array used to derive x-coordinate of a base point (a TPM2B_ECC_PARAMETER)
<i>y2</i>	y-coordinate of the point associated with <i>s2</i> (a TPM2B_ECC_PARAMETER)

NOTE 1 *P1* is a TPM2B\_ECC\_POINT, a sized buffer containing a TPMS\_ECC\_POINT. It is not a sized buffer containing an array of bytes. A size of zero for the TPM2B\_ECC\_POINT will create an unmarshaling error because the minimum size for *P1* is 4 (two ECC parameters, both of which are Empty Buffers). If *P1* is an Empty Buffer, the TPM returns TPM\_RC\_INSUFFICIENT regardless of *s2* and *y2*. If *P1* is an Empty Point and *s2* and *y2* are Empty Buffers, then the TPM will set  $E := [r]G$  where *r* is the commit random value and *G* is the generator point for the curve.

In the algorithm below, the following additional values are used in addition to the command parameters:

$H_{nameAlg}$	hash function using the <i>nameAlg</i> of the key associated with <i>signHandle</i>
$p$	field modulus of the curve associated with <i>signHandle</i>
$n$	order of the curve associated with <i>signHandle</i>
$d_s$	private key associated with <i>signHandle</i>
$G$	generator of the curve associated with <i>signHandle</i>
$c$	counter that increments each time TPM2_Commit() is executed
$A[i]$	array of bits used to indicate when a value of $c$ has been used in a signing operation; the values of $i$ are 0 to $2N-1$ .
$N$	$\log_2$ of the number of values in $A$
$k$	nonce that is set to a random value each on each TPM Reset; the nonce size is twice the security strength of any ECDA key supported by the TPM

The commit algorithm is:

- a) Validate that  $s_2$  and  $y_2$  are either both Empty Buffers or both not Empty Buffers (TPM\_RC\_SIZE)
- b) If  $s_2$  is an Empty Buffer, skip to step e)
- c) compute  $x_2 := H_{nameAlg}(s_2) \bmod p$
- d) if  $(x_2, y_2)$  is not a point on the curve of *signHandle*, return TPM\_RC\_ECC\_POINT
- e) if  $p_1$  is not an Empty Point and  $p_1$  is not a point on the curve of *signHandle*, return TPM\_RC\_ECC\_POINT
- f) set  $K$ ,  $L$ , and  $E$  to be Empty Buffers
- g) generate or derive  $r$  (see C.2.2)
- h) set  $r := r \bmod n$
- i) if  $s_2$  is not an Empty Buffer, set  $K := [d_s](x_2, y_2)$  and  $L := [r](x_2, y_2)$
- j) if  $p_1$  is not an Empty Point, set  $E := [r](p_1)$
- k) if  $p_1$  is an Empty Point and  $s_2$  is an Empty Buffer, set  $E := [r]G$
- l) if  $K$ ,  $L$ , or  $E$  is the point at infinity, return TPM\_RC\_NO\_RESULT
- m) set  $counter := commitCount$
- n) set  $commitCount := commitCount + 1$

NOTE 2 Depending on the method of generating  $r$ , it may be necessary to update the tracking array here.

- o) output  $K$ ,  $L$ ,  $E$  and  $counter$

NOTE 3 Depending on the input parameters,  $K$  and  $L$  or  $E$  may be Empty Points

#### C.2.4 TPM2\_EC\_Ephemeral()

TPM2\_EC\_Ephemeral() is similar to TPM2\_Commit() in that it uses the commit random value to generate an ephemeral key for use in a two-phase operation. However, TPM2\_EC\_Ephemeral() only used the

random value  $r$  to generate a corresponding public key  $Q := [r]G$  where  $G$  is the generator point for a specified curve.

As with `TPM2_Commit()`, a counter value is returned. This value needs to be used in a subsequent command in order to complete the two-phase operation.

### C.2.5 Recovering the Private Ephemeral Key

To complete a split or two-phase operation, the TPM uses the same random or pseudo-random value generated in `TPM2_Commit()`. The random or pseudo-random value is determined by the *counter* field provided as an input parameter for the command that is the second phase of the split operation.

If the values are stored in an array, *counter* is used to index the array and, after the value is used in the signing operation, the value is erased. If using the pseudo-random method, the following algorithm is used to reconstruct the random value.

- a) set  $t :=$  low-order 16 bits of *commitCount*
- b) verify that  $t - 2^N < \textit{counter} < t$ ; else return `TPM_RC_RANGE`
- c) set  $i :=$  low-order  $N$  bits of *counter*
- d) if  $A[i]$  is CLEAR, return `TPM_RC_VALUE`
- e) set  $c := \textit{commitCount} - t$
- f) if  $\textit{counter} \geq t$ ;  $c := c - 2^{16}$
- g)  $c := c + \textit{counter}$
- h) compute  $r$  as in equation (64) using  $c$  in place of *commitCount*
- i) if the command completes successfully set  $A[i] := 0$

## C.3 ECC-Based Secret Sharing

An ECC key protects a secret in two cases: object duplication and seeding of a session. In both cases, the method for generating the required key uses `KDFe()`, as described in 11.4.9.3.

## C.4 EC Signing

### C.4.1 ECDSA

For a TPM compliant with this specification, the default ECC signing scheme (DSA) is as defined ISO/IEC 14888-3.

### C.4.2 ECDA

#### C.4.2.1 Introduction

If a TPM supports ECC, it is recommended that it also support the ECDA scheme described in this clause C.4.2.

Direct Anonymous Attestation based on ECC (ECDA) is a TPM signature scheme that provides anonymous signatures (meaning that different signatures from the same signer cannot be correlated), or pseudonymous signatures (meaning that different signatures from the same signer can be correlated but

the identity of the signer is still unknown). Multiple ECDAAs schemes are supported in this TPM implementation.

The TPM signs data with an ECDAAs key in an unconventional way. A Verifier verifies signature values using data equivalent to a public key, and verifies the public key using data equivalent to a certificate (which is also called a credential) supplied by an Issuer. However, the public key and the credential are randomized by the TPM and the TPM's Host platform before they are sent to the Verifier. This prevents both the Verifier and the Issuer from identifying the TPM that created the signature value.

It is anticipated that the most common use of ECDAAs will be to certify (TPM2\_Certify()) a TPM object (usually a key). A credential issuer will provide a certificate for an ECDAAs key. This certificate will validate that the ECDAAs key belongs to a valid TPM without disclosing the ECDAAs key. That ECDAAs key may then be used to certify other TPM objects. These certificates prove that the certified object belongs to a valid TPM without disclosing the identity of that TPM. If the certified key is a signing key, it may then be used to attest to various TPM states, without disclosing the identity of the TPM to which it belongs.

This scheme is substantially different from the AIK scheme in 1.2 in that the ECDAAs key may be used to provide the anonymity for keys rather than having to send each new attestation key to a privacy certificate authority (PCA) in order to have an anonymizing certificate produced. After a certificate has been obtained for an ECDAAs key, it may be used to produce anonymized certificates for many TPM keys without requiring additional interaction with a privacy CA.

An ECDAAs key may be used in any command that produces a signature. The TPM may not be used to verify an ECDAAs signature.

#### **C.4.2.2 ECDAAs Key Generation on the TPM**

While any signing key may be an ECDAAs key, it is most useful as a Primary Key in the Endorsement hierarchy. This ensures that a TPM will normally produce the same ECDAAs keys and receive the same credentials from a given Issuer, no matter how many times the credentialing process is performed, and no matter how many owners the TPM has had. This property is desirable because an Issuer should only give credentials to a platform after verifying that the platform has the architecture of a trusted platform. The Issuer would give replacement (different) credentials only when it is necessary to retire the old credentials. Replacement credentials erase the previous DAA history of the platform, at least as far as the credentials from that issuer are concerned. Replacement might be desirable, as when a platform changes hands, for example, in order to eliminate any association via DAA between the seller and the buyer. On the other hand, replacement might be undesirable, since it enables a rogue to rejoin a community from which it has been barred. Replacement is done by submitting a different TPMT\_PUBLIC.unique field value to the TPM when the key is created (TPM2\_Create() or TPM2\_CreatePrimary()). Software may use any value of TPMT\_PUBLIC.unique field at any time, in any order, but the Issuer can detect when a request uses a different value from the previous request, and could reject the request.

The cryptographic parameters of the curve are indicated by the template in the command (TPM2\_Create() or TPM2\_CreatePrimary()) that creates the curve. The curve ID depends on the Issuer who is expected to provide a credential for the DAA key (different Issuers may require different curves). The TPM generates a private key ( $d_s$ ) and a public key ( $Q_s$ ). The non-cryptographic parameters in the template (that is, object attributes and signing scheme) are chosen by the entity that calls the command to create the DAA key. Inappropriate choice of the non-cryptographic parameters will cause the Issuer to reject an application for a DAA credential.

The security strength of an ECDAAs key is the same as an ECC key of the same size. The key size is determined by the order of the curve ( $n$ ) and the cofactor ( $h$ ).

If the Endorsement Primary Seed is used as the DAA seed, then, like other EK, an ECDAAs key will change whenever the EPS is changed.



The process for generating an ECDA key is identical to the process used for any ECC key.

For the TCG defined ECDA protocol, the curve described by  $p$ ,  $n$ , and  $b$  is a Barreto-Naehrig (BN) elliptic curve. BN curves are of the form  $y^2=x^3+b$  as defined in [ISO/IEC 15946-5 : 2008 Clause 7.3 “BN curve”], which is equivalent to [IEEE P1363.3 (Draft 2) Clause A.11.5 BN Curves].

NOTE The linear term ( $a$ ) of generic ECC curves (curves with the form  $y^2=x^3+ax+b$ ) is zero in BN curves. All BN curves are suitable but some are less efficient than others. The BN curves recommended in this version of DAA were chosen by the DAA designers.

The cryptographic value of the public key in the resultant TPM key structure is  $Q_s$ , which is used by the Issuer when computing the membership credential on the DAA private key  $d_s$ .  $Q_s$  is not used to verify the DAA signatures produced by the TPM and corresponding host platform.

### C.4.2.3 ECDA Sign Operation

The ECDA scheme may be used in any command that uses a signing key. These are, the attestation group and TPM2\_Sign().

For an attestation command using the ECDA scheme, both the *qualifiedSigner* and *extraData* fields in the attestation block (a TPMS\_ATTEST) are set to be the Empty Buffer before the data is hashed. The attestation data is then marshaled and hashed. The resulting hash data is then concatenated to the first hash to produce the value to sign ( $P$ ).

$$P := \mathbf{H}_{\text{schemeHash}}(\text{qualifyingData} || \mathbf{H}_{\text{schemeHash}}(\text{TPMS\_ATTEST})) \quad (65)$$

For TPM2\_Sign(), the value to sign is the input *digest* and

$$P := \text{digest} \quad (66)$$

To complete the ECDA sign operation, the TPM uses the same random or pseudo-random value ( $r$ ) used in TPM2\_Commit(). The value is determined by the *counter* field in the scheme parameter of the signing command. This parameter is used in the process defined in C.2.5.

The signature is created using a modified Schnorr signature using the  $P$  and  $r$  values described above:

- a) set  $k$  to a random value such that  $0 < k < n$
- b) compute  $T := \mathbf{H}(k || P)(\text{mod } n)$
- c) compute integer  $s := (r + Td_s)(\text{mod } n)$
- d) if  $s = 0$ , output failure (negligible probability)

The signature is the tuple  $(k, s)$ .

NOTE The  $k$  value is returned in the  $R$  parameter of the TPMT\_SIGNATURE structure.

## C.4.3 EC Schnorr

### C.4.3.1 Introduction

If a TPM supports ECC, it should support the TPM\_ALG\_EC Schnorr scheme.

The scheme description uses the following values:

$G$	generator point for the curve of the signing key
$d_S$	private value of the signing key
$Q_S$	public point of the signing key ( $Q_S := [d_S]G$ )
$n$	order of $G$
$H_{schemeHash}$	hash algorithm specified in the signing scheme

### C.4.3.2 EC Schnorr Sign

An EC Schnorr signature is generated when the signing scheme for a key is TPM\_ALG\_ECSCNORR. The scheme may be used in any signing operation

To sign a digest  $P$

- set  $k$  to a random value such that  $0 < k < n$
- compute  $E := (x_E, y_E) := [k]G$
- if  $E$  is the point at infinity, go to a)
- compute  $r := \text{TRUNC}(H_{schemeHash}(\text{FE2BS}(x_E) || P), n)$

NOTE 1  $x_E$  is a field element with the same number of bits as the curve order  $n$

NOTE 2 **TRUNC()** is a function that reduces the number of octets in the first argument until it has no more octets than the second argument. Truncation occurs from the less significant end of the number. If the digest produced by  $H_{schemeHash}$  has the same number of octets as the curve order  $n$ , then no truncation occurs.

NOTE 3 **FE2BS()** is a function that converts the number  $x_E$  (a field element) into a canonical value (octet or byte string) with the same number of octets as the field order  $n$ . This may result in a value with leading octets of zero. As  $x_E$  is computed (mod  $p$ ) the value may be greater than  $n$

- compute integer  $s := (k + rd_S) \pmod{n}$

NOTE 4 This is the same computation as step c) in C.4.2.3.

- if  $s = 0$  or  $s = k$  go to a)

NOTE 5 The  $s = k$  check is to eliminate the possibility that  $0 = r \pmod{n}$ . Optionally, an implementation could check after d) that  $0 \neq r \pmod{n}$ .

The signature is the tuple  $(r, s)$ .

### C.4.3.3 EC Schnorr Signature Validate

To validate a Schnorr signature  $(r, s)$  over digest  $P$

- verify that  $0 < s < n$
- compute  $(x_E, y_E) := [s]G + [-r]Q_S$
- compute  $r' := \text{TRUNC}(H_{schemeHash}(\text{FE2BS}(x_E) || P), n)$
- the signature is valid if  $r' = r$

NOTE The comparison of  $r'$  and  $r$  is done assuming that both values are numeric and not octet strings. This reduces the chance of interoperability problems due to padding performed on  $r$ .

## C.5 ECC Key Generation

For an ECC key, the method of FIPS 186-3, Annex B.4.2 *Key Pair Generation By Testing Candidates* is used. The caller provides a random number generation function according to the type of key being generated (see 27.6.2, 27.6.3, and 28.4) and that function is called when random bits are required by the generation process. The key generation process is:

- a) obtain a random value  $d$  of **length**( $n$ ) where  $n$  is the order of the curve
- b) set  $d := d + 1$
- c) unless  $0 < d < n$  go to a)

NOTE The time required for generating a key pair is theoretically unbounded when using this method. However, it is statistically unlikely that this will take more than one or two iterations.

- d) compute  $G := (x_G, y_G) := [d]G$
- e) return  $d$  and  $G$

## C.6 Secret Sharing

### C.6.1 ECDH

For secret sharing with an ECC key, the One-Pass Diffie-Hellman, C(1, 1, ECC CDH) method from SP800-56A is used.

Using the notation of SP800-56A, the initiator generates an ephemeral key pair  $(d_{e,U}, Q_{e,U})$  from the curve parameters. The public point of the ephemeral key  $(Q_{e,U})$  is used by the recipient to recover the shared secret.

The initiator uses the private portion of the ephemeral key  $(d_{e,U})$  and the public portion  $(Q_{s,V})$  of an ECC key of the recipient and computes the point  $P := h [d_{e,U}]Q_{s,V}$ . Then it will set  $Z := x_P$  where  $x_P$  is the x-coordinate of  $P$ .

The recipient may compute  $P := h [d_{s,V}]Q_{e,U}$  and  $Z := x_P$ .

The  $Z$  value is used in **KDFe** to generate a value for *seed* that is appropriate for the use of the seed. The seed will be the size of the digest produced by the *hashAlg* used in the KDF. Seed is computed by:

$$seed := \mathbf{KDFe}(hashAlg, Z, label, PartyUInfo, PartyVInfo, bits) \quad (67)$$

where

<i>hashAlg</i>	the nameAlg of the recipient key
<i>Z</i>	the x coordinate ( $x_P$ ) of the product ( $P$ ) of a public point and a private key ( $P := h [d] Q$ )
<i>label</i>	an application-dependent value
<i>PartyUInfo</i>	the x-coordinate of the secret exchange value ( $Q_{e,U}$ )
<i>PartyVInfo</i>	the x-coordinate of a public key ( $Q_{s,V}$ )

*bits* the number of bits in the digest of hashAlg

### C.6.2 ECDH Encryption of Salt

In TPM2\_StartAuthSession(), when *tpmKey* is an ECC key, a seed value is produced as described in C.6.1 with the *label* parameter set to “SECRET”. This seed value is then used as the session secret.

### C.6.3 ECC Secret Sharing for Duplication

When the new parent for a duplicated object is an ECC key, an ephemeral key is created and used to generate a seed value as described in C.6.1. When creating the seed, the label parameter is set to “DUPLICATE”. The seed value is then used to generate the encryption and integrity values for the duplication blob as described in clause 22.

### C.6.4 ECC Secret Sharing for Credentials

When the decryption key for an identity blob is an ECC key, an ephemeral key is created and used to generate a seed value as described in C.6.1. When creating the seed, the label parameter is set to “IDENTITY”. The seed value is then used to generate the encryption and integrity values for the identity blob as described in clause 22.

## C.7 ECC Primitive Operations

### C.7.1 Introduction

When ECC is implemented on a TPM, it may provide these additional commands to support cryptographic operations with unrestricted ECC keys.

### C.7.2 TPM2\_ECDH\_KeyGen()

TPM2\_ECDH\_KeyGen produces an ephemeral key pair. It multiplies the private ephemeral key with the public point of a loaded TPM key to produce the Diffie-Hellman shared secret.

This function can be performed by software as the public key and parameters are known. The function would be provided by the TPM as a service.

Since the operation can be performed by software, no authorization is required to use the public portion of the key and the key attributes are not checked.

### C.7.3 TPM2\_ECDH\_ZGen()

TPM2\_ECDH\_ZGen performs the ECDH primitive function with one static and one ephemeral key as defined in SP800-56A, clause 6.2.2. The input point ( $Q_e$ ) is multiplied by the private coordinate ( $d_s$ ) to produce the point  $Z = (x_Z, y_Z) := hd_s Q_e$ .

Since this operation used the private portion of an ECC key, authorization is required. To prevent inadvertent compromise of a signing key, *sign* and *restricted* are required to be CLEAR in the referenced key.

## C.7.4 Two-phase Key Exchange

### C.7.4.1 Introduction

Various key exchange protocols use an ephemeral key from each party. For these protocols, each party generates an ephemeral key and that key is sent to the other party along with other information. The other party then uses the key material from the other party along with its own ephemeral key to generate the key-exchange values.

These protocols require two phases. In the first phase, the TPM generates an ephemeral key to be sent to the other party. In the second phase, the TPM combines data from the other party with the ephemeral key generated in the first phase. The protocols require that the ephemeral key generated by the TPM only be used once and be discarded after the key exchange is complete. This property of this key is the same as required for ECDA.

TPM2\_EC\_Ephemeral() uses the commit mechanism to generate a random value ( $r$ ) and a public key  $P := [r]G$ . The value of  $P$  is returned to the caller along with the counter value associated with  $r$ .

TPM2\_ZGen\_2Phase() is used to complete the second phase of the key exchange. The counter value returned by TPM2\_EC\_Ephemeral() is provided from which the TPM recreates  $r$  and regenerates the associated public key. When TPM2\_ZGen\_2Phase() completes successfully, the TPM will "retire" the  $r$  value so that it may not be used again.

One of the parameters of TPM2\_ZGen\_2Phase() is a scheme selector (*inScheme*). This indicates to the TPM which of the supported schemes is to be used. This annex describes two of the allowed schemes. They are the two EC schemes from SP800-56A that require two ephemeral and two static keys. The schemes are described in SP800-56A in 6.1.1.2 *Full Unified Model, C(2, 2, ECC CDH)* and 6.1.1.4 *Full MQV, C(2, 2, ECC MQV)*. These schemes use the following terms:

$d_{s,A}$	the private part of a TPM-resident ECC key referenced by the <i>keyA</i> parameter
$Q_{s,A}$	the public point of the key referenced by <i>keyA</i> equal to $[d_{s,A}]G$ with coordinates $(x_{s,A}, y_{s,A})$
$d_{e,A}$	a private ephemeral key generated by the TPM (the value of $r$ associated with <i>counter</i> parameter)
$Q_{e,A}$	the public ephemeral key associated with <i>counter</i> equal to $[d_{e,A}]G$ or $[r]G$ with coordinates $(x_{e,A}, y_{e,A})$
$Q_{s,B}$	the <i>inQsB</i> parameter – a point on the curve of <i>keyA</i> assumed to be a static public key associated with the other party in the key exchange with coordinates $(x_{s,B}, y_{s,B})$
$Q_{e,B}$	the <i>inQeB</i> parameter – a point on the curve of <i>keyA</i> assumed to be an ephemeral public key associated with the other party in the key exchange with coordinates $(x_{e,B}, y_{e,B})$

### C.7.4.2 Full Unified Model

When this scheme is selected for TPM2\_ZGen\_2Phase(), the TPM will:

- a) set  $outZ1 := [d_{s,A}]Q_{s,B}$
- b) set  $outZ2 := [d_{e,A}]Q_{e,B}$

NOTE If outZ1 or outZ2 is the point at infinity, then both coordinate values of the point will be Empty Buffers.

### C.7.4.3 Full MQV

This scheme uses an associated value function (**avf**()) that is defines as:

Inputs:

$Q = (x, y)$  a public key  
 $n$  the modulus of the curve containing  $Q$

Process:

#### Process:

- a) Set  $f := \lceil (\lceil \log_2(n) \rceil / 2) \rceil$
- b) Set  $x' = 2^f + (x \bmod 2^f)$
- c) return  $x'$

The MQV computation is:

- d) validate that  $Q_{s,B}$  and  $Q_{e,B}$  are on the curve associated with  $d_{s,A}$
- e) using *counter*, recover  $d_{e,A} = r$  as described in C.2.5
- f) set  $Q_{e,A} := [d_{e,A}]G$  where  $G$  is the generator point for the curve of  $d_{s,A}$
- g) set  $t_A := (d_{e,A} + d_{s,A} \cdot \mathbf{avf}(Q_{e,A})) \pmod{n}$
- h) set  $outZ1 := [h \cdot t_A] (Q_{e,B} + [\mathbf{avf}(Q_{e,B})](Q_{s,B}))$

NOTE 1 if *outZ1* is the point at infinity both the coordinate values of outZ1 will be Empty Buffers

NOTE 2 This protocol may be susceptible to unknown key-share (UKS) attacks.

## C.8 ECC Point Padding

To provide consistent behaviour across all TPM implementations this clause specifies the padding requirements for ECC parameters.

When ECC parameters are returned by the TPM as output parameters in a response, they must be padded with zeros to the length of the respective curve (e.g., 32 bytes for NIST P-256). The padding is placed at the beginning. When the ECC parameters are returned by the command TPM2\_ECC\_Parameters(), they have to match the exact format as specified in the TCG Algorithm registry.

When ECC parameters are input parameters to the TPM, the padding is optional. An exception is the command TPM2\_Import(), where the public and private ECC input parameters (*objectPublic*, *duplicate*) must be padded with zeros. This allows consistent processing - the TPM verifies the cryptographic binding between public and sensitive area when the key is loaded. Therefore, it recalculates the ECC parameters and compares them to the input. All other commands must process the ECC parameters as they were input to the TPM without removing or adding zero padding.

When an ECC parameter is the result of an ECC point multiplication, the ECC point is required to be padded. This is to ensure that when the result of the point multiplication is used as input to the KDFe() function, the calculated ECDH secret is always the same across all TPM implementations. External software that recalculates the KDFe() function outside of the TPM has to consider this.

## Annex D (normative/informative) Support for SMx Family of Algorithms

### D.1 Introduction

This section provides additional information for implementation of the SM2, SM3, and SM4 algorithms published by State Encryption Management Bureau, China.

### D.2 SM2

#### D.2.1 Introduction

SM2 is contains information relating to ECC cryptography and is in five parts.

- Part 1: General – "provides necessary basics of mathematics and related cryptographic techniques used in public key cryptographic algorithm SM2 based on elliptic curves." The methods of this part are compatible with the EC methods in other standards and no special considerations are necessary to accommodate this standard

[GM/T 0003.1-2012 *Public Key Cryptographic Algorithm SM2 Based on Elliptic Curves, part1: General Protocol*, published by State Encryption Management Bureau, China]

- Part 2: *Digital Signature Algorithm* – defines the process for generation and verification of a digital signature using the methods described in Part 1. The signing method in this part of the standard require addition of a new signing scheme and methods. These are described in this annex. .

[GM/T 0003.2-2012 *Public Key Cryptographic Algorithm SM2 Based on Elliptic Curves, part2: Digital Signature Algorithm*, published by State Encryption Management Bureau, China]

- Part 3: *Key Exchange Protocol* – defines a two phase key exchange protocol using the methods of Part 1. The method in this part of the SM2 standard is supported by addition of a key exchange command (TPM2\_ZGen\_2Phase()). The algorithm is fully described in TPM 2.0 Part 3 of this TPM specification.

[GM/T 0003.3-2012 *Public Key Cryptographic Algorithm SM2 Based on Elliptic Curves, part3: Key Exchange Protocol*, published by State Encryption Management Bureau, China]

- Part 4: *Public Key Encryption Algorithm* – defines an encryption method using single pass EC Diffie-Hellman to exchange a key that is then used to generate a stream cipher. The TPM does not use this method.

[GM/T 0003.4-2012 *Public Key Cryptographic Algorithm SM2 Based on Elliptic Curves, part4: Public Key Encryption Algorithm*, published by State Encryption Management Bureau, China.]

- Part5: *Parameter definition* – defines the parameters for a 256-bit ECC curve.

[GM/T 0003.5-2012 *Public Key Cryptographic Algorithm SM2 Based on Elliptic Curves, part5: Parameter definition*, published by State Encryption Management Bureau, China]



## D.2.2 SM2 Digital Signature Algorithm

### D.2.2.1 SM2 Sign

The SM2 signing scheme has an algorithm ID of TPM\_ALG\_SM2. If the TPM implements this algorithm, then any structure that allows a ECC-based signing scheme may use this algorithm ID.

The TPM only implements a portion of the full SM2 signing scheme. That portion is the part that uses the private key to sign a digest.

The inputs to the algorithm are:

$e$	a digest to sign
$d_s$	a private ECC key
$n$	the modulus of the curve for $d_s$

The computation implemented in the TPM is:

- set  $k$  to a random value such that  $1 \leq k \leq n-1$
- compute  $P_1 := (x_1, y_1) := [k]G$
- compute  $r := e + x_1 \pmod{n}$
- if  $r$  equals 0 or  $(r + k)$  equals  $n$ , go to 0
- compute  $s := ((1 + d_s)^{-1} \cdot (k - r \cdot d_s)) \pmod{n}$
- if  $s$  equals 0, go to 0
- the signature is the tuple  $(r, s)$

### D.2.2.2 SM2 Signature Verification

For verification (TPM2\_VerifySignature() and TPM2\_PolicySigned()), the inputs are:

$e$	the digest that was signed
$(r, s)$	the signature tuple
$P$	a public ECC key
$G$	the generator point for the curve of $P$
$n$	the modulus of the curve for $d_s$

- The verification computation performed by the TPM is:
- verify that  $r$  and  $s$  are in the inclusive interval 1 to  $(n - 1)$
- compute  $t := (r + s) \pmod{n}$
- verify that  $0 < t$
- compute  $(x, y) := [s]G + [t]P$
- compute  $r' := (e + x) \pmod{n}$
- verify that  $r' = r$

If any of the verification steps fails, then the signature is not valid.

### D.2.2.3 Implementation Issues

In the SM2 standard, the message to sign is combined with key-specific data to produce an  $e$  value that is signed using the algorithm shown above. The computation for  $e$  uses a value  $Z_A$  that, according to the SM2 standard, is computed by:

$$Z_A := \mathbf{H}(ENTL_A || ID_A || a || b || x_G || y_G || x_A || y_A) \quad (68)$$

where

$ENTL_A$	two octets containing the length of $ID_A$ in octets
$ID_A$	octet string containing information that can identify an entity's identity unambiguously (see ISO/IEC 15946-3 3.9)
$a$	coefficient for the linear term of the equation for the curve of the signing key
$b$	coefficient for the constant term of the equation for the curve of the signing key
$x_G$	the x coordinate of the generator point for the curve of the signing key
$y_G$	the y coordinate of the generator point for the curve of the signing key
$x_A$	the x coordinate of the public key of the signing key
$y_A$	the y coordinate of the public key of the signing key

Using  $Z_A$  and a message ( $M$ ) the digest to sign ( $e$ ) is computed by:

$$e := \mathbf{H}(Z_A || M) \quad (69)$$

Since the TPM does not do the operation in equation (69), the caller may need to modify the input message before using the TPM to sign the digest. If the application requires it, the caller would need to do the computation of  $e$  before giving the value to the TPM to sign.

One consequence of this is that attestation operations will not create a signature that is in all details, compliant with SM2 Part 2. Instead, the attestation signatures will be TPM specific. The reason that attestations do not sign using the full scheme are:

- There is no infrastructure for the distribution of  $ID_A$  values
- Requiring the use of an  $ID_A$  value in a signature could allow correlation of a user and void the privacy assurances of the attestation
- Ensuring that an external digest does not match a valid attestation becomes intractable.

The reason that the attestation problem becomes intractable is that, using  $Z_A$  with an attestation means that the first bytes that were used to form the digest of the signed value ( $e$ ) would vary with each key used to sign. An attacker could perform a hash using the key specific values followed by message data that has all the characteristics of an attestation. The TPM will not be able to discern the transition from  $Z_A$  data to the false attestation data.

To prevent this kind of attack without adding excessive complexity to the TPM, the attestation is done without including  $Z_A$ . Since the use of  $Z_A$  does not improve the security of the SM2 signature, leaving it out does not compromise the value of the SM2 signing process for attestations. Also, since an attestation only has meaning in the context of a TPM, having TPM-specific verification of a signature over an attestation block should not create an issue.

TPM2\_Sign() may be used with the TPM\_ALG\_SM2 scheme identifier to create a full SM2-compatible signature. To do an SM2 signature, the application would compute  $Z_A$ , and then use the resulting digest as the first data in one of the TPM hash commands (which could be a TPM2\_HashSequenceStart()); with the  $Z_A$  value followed by the message data ( $M$ ). The digest of  $\mathbf{H}(Z_A || M)$  would then be used as the *digest* parameter for TPM2\_Sign().

NOTE Since  $Z_A$  is a constant value for a key, an application might choose to keep  $Z_A$  as part of the meta-data for the key so that it would not need to be recomputed each time the key is used for an SM2 signature.

### D.2.3 SM2 Key Exchange

#### D.2.3.1 Introduction

The key exchange algorithm in GM/T 0003.3-2012 is a two-phase algorithm. It is similar to the scheme described in C.7.4.3.

NOTE This protocol may be susceptible to unknown key-share (UKS) attacks.

This SM2 key exchange computations use an associated value function (**avfSM2()**) that is similar to the function defined in SP800-56A with the only differencing being that the result is one bit less than the value defined in SP800-56A. The **avfSM2()** function is:

Inputs:

$Q = (x, y)$	a public key
$n$	the modulus of the curve containing $Q$

Process:

- set  $f := \lceil (\lceil \log_2(n) \rceil / 2) \rceil - 1$
- set  $x' := 2^f + (x \pmod{2^f})$
- return  $x'$

NOTE This function is similar to the function in SP800-56A except that, in the formulation in GM/T 0002-2012 as shown in a) above, the value of  $f$  is one less than the equivalent in SP800-56A.

#### D.2.3.2 SM2 Key Exchange Protocol

The key exchange protocol is between two entities, A and B. The TPM performs computations as party A. Since the protocol is symmetric, both party A and party B may be TPMs and they will both perform the same operations, using the values from the other TPM as party B values.

The caller must use TPM2\_EC\_Ephemeral() to have the TPM generate a single-use ephemeral key. The ephemeral public key is sent to the other party as  $Q_{e,B}$ .

The inputs to the key exchange computation are:

<i>counter</i>	the counter parameter from TPM2_Commit()
$Q_{s,B}$	a public EC key from party B; usually, the public part of a static key
$Q_{e,B}$	a public EC key; usually, the public part of an ephemeral key
$d_{s,A}$	a private EC key (an unrestricted decryption key)

The protocol:

- a) validate that  $Q_{s,B}$  and  $Q_{e,B}$  are on the curve associated with  $d_{s,A}$
- b) using *counter*, recover  $r$  as described in C.2.5
- c) set  $Q_{e,A} := [r]G$  where  $G$  is the generator point for the curve of  $d_{s,A}$
- d) set  $t_A := (d_{s,A} + d_{e,A} \cdot \mathbf{avfSM2}(Q_{e,A})) \pmod{n}$
- e) set  $Z := [h \cdot t_A] (Q_{s,B} + [\mathbf{avfSM2}(Q_{e,B})](Q_{e,B}))$
- f) if  $Z$  is the point at infinity, return failure

### D.3 SM3

[GM/T 0004-2012 *Cryptographic Hash Algorithm SM3*, published by State Encryption Management Bureau, China]

SM3 is a hash algorithm that uses a 512-bit block and produces a digest of 256 bits.

If the TPM implements this algorithm, then the algorithm ID for SM3 (TPM\_ALG\_SM3\_256) may be used in any structure that allows a hash algorithm.

### D.4 SM4

[GM/T 0002-2012 *Block Cipher Algorithm SM4*, published by State Encryption Management Bureau, China]

SM4 is a symmetric block cipher with a key and block size of 128 bits.

If the TPM implements this algorithm, then the algorithm ID for SM4 (TPM\_ALG\_SM4) may be used in any structure that allows a symmetric block cipher.