



Aalborg Universitet

AALBORG UNIVERSITY
DENMARK

Cooperative Energy Management for a Cluster of Households Prosumers

Hernández, Adriana Carolina Luna; Aldana, Nelson Leonardo Diaz; Graells, Moises; Quintero, Juan Carlos Vasquez; Guerrero, Josep M.

Published in:

I E E E Transactions on Consumer Electronics

DOI (link to publication from Publisher):

[10.1109/TCE.2016.7613189](https://doi.org/10.1109/TCE.2016.7613189)

Publication date:

2016

Document Version

Submitted manuscript

[Link to publication from Aalborg University](#)

Citation for published version (APA):

Hernández, A. C. L., Aldana, N. L. D., Graells, M., Quintero, J. C. V., & Guerrero, J. M. (2016). Cooperative Energy Management for a Cluster of Households Prosumers. I E E E Transactions on Consumer Electronics, 62(3), 235 - 242. DOI: 10.1109/TCE.2016.7613189

General rights

Copyright and moral rights for the publications made accessible in the public portal are retained by the authors and/or other copyright owners and it is a condition of accessing publications that users recognise and abide by the legal requirements associated with these rights.

- ? Users may download and print one copy of any publication from the public portal for the purpose of private study or research.
- ? You may not further distribute the material or use it for any profit-making activity or commercial gain
- ? You may freely distribute the URL identifying the publication in the public portal ?

Take down policy

If you believe that this document breaches copyright please contact us at vbn@aub.aau.dk providing details, and we will remove access to the work immediately and investigate your claim.

Cooperative Energy Management for a Cluster of Households Prosumers

Adriana C. Luna, *Student Member*, IEEE, Nelson L. Díaz, *Student Member*, IEEE, Moisès Graells, Juan C. Vázquez, *Senior Member* and Josep M. Guerrero, *Fellow Member*, IEEE

Abstract — *The increment of electrical and electronic appliances for improving the lifestyle of residential consumers has led to a larger demand of energy. In order to supply their energy requirements, the consumers have changed the paradigm by integrating renewable energy sources to their power grid. Therefore, consumers become prosumers in which they internally generate and consume energy looking for an autonomous operation. This paper proposes an energy management system for coordinating the operation of distributed household prosumers. It was found that better performance is achieved when cooperative operation with other prosumers in a neighborhood environment is achieved. Simulation and experimental results validate the proposed strategy by comparing the performance of islanded prosumers with the operation in cooperative mode¹.*

Index Terms — **Cluster of Prosumers, Cooperative Management, Energy Manage System, Household Prosumer.**

I. INTRODUCTION

The modern living style involves increments in the acquisition of electrical and electronics appliances to make our daily life easier and more comfortable. The appliances vary from white goods, such as refrigerators, washing machines or kitchen stoves, to small entertainment and information appliances such as video game consoles, tablets, phones, TV sets, etc. This is a generalized phenomenon in home areas that implies increments in global energy consumption [1]. It is forecasted that by 2030 the world energy demand will be doubled and similarly the carbon dioxide emission due to conventional power generation systems will increase by 75% [2]. In that case, the capability and reliability of the conventional energy generation and transmission system as well as its environmental impact will be seriously compromised [3]. In light of the growing concern about ensuring the energy supply, without increasing the greenhouse gas emission, the integration of renewable energy sources (RES) has been recently promoted for household consumers as



Fig. 1. Household Prosumer

can be seen in Fig. 1. [2]

This new trend in the integration of RESs means a change in the paradigm for energy consumers, which is motivated not only by personal environmental commitment but also for economic reasons. From the point of view of the Distribution System Operator, the increasing penetration of RES, implies additional technical challenges in regulation, support and control of the traditional power grid [4], [5]. The cost associated to the new technological requirements, is mainly passed to the end-consumers by means of surcharges in the electricity [5]. This fact, together with less attractive tariffs for selling the renewable energy generation to the main grid, and also taking into account more efficient energy consumption of new appliances, have changed the preferences of the household energy consumers. Household consumers want to be as much independent as possible from the main grid and promoting self-energy consumption, which in turn is reflected in reductions on the energy bill [6]. Even considering the initial investment associated with the installation of RES, household consumers are still willing to deploy RESs even under low internal rate of return [7].

Within this new scenario, there is a change in the paradigm of typical household consumers in which they have become household prosumers, since they not only consume but also produce their own energy based on local resources and requirements. Due to the unpredictable nature of the RESs and for increasing the local consumption rate of RESs, generation prosumers have to integrate Energy Storage Systems (ESS) within their small-scale power systems [8]. ESSs based on batteries are the most commonly used for household applications, because batteries offer a good commitment

¹ A.C. Luna, is with the Department of Energy Technology, Aalborg University, 9220, Denmark (e-mail: acl@et.aau.dk).

N. L. Díaz is with the Department of Energy Technology, Aalborg University, 9220, Denmark and also with Universidad Distrital F. J. C., Bogota, Colombia (e-mail: nda@et.aau.dk, nldiaza@udistrital.edu.co).

M. Graells is with Chemical Engineering Department, Universitat Politècnica de Catalunya (e-mail: moises.graells@upc.edu).

J. C. Vasquez is with the Department of Energy Technology, Aalborg University, 9220, Denmark (e-mail: juq@et.aau.dk).

J. M. Guerrero is with the Department of Energy Technology, Aalborg University, 9220, Denmark (e-mail: joz@et.aau.dk).

between energy density, life cycling and cost [4], [9]. In that case, a household prosumer can be seen as a small-scale microgrid where the operation of distributed units (RESs, ESSs and appliances) can be coordinated for ensuring a reliable operation of the local power grid [10].

For an optimal operation of each prosumer, it is required an energy management system (EMS) which ensures the power balance of the local power system and optimizes the power consumption and generation at home [11]. To be more clear, the EMS schedules the operation of the distributed energy resources (DERs) by considering load requirements, while ensuring proper ESSs performance, and maximizing the use of renewable energy resources [12].

To achieve an independent operation of the main grid, the prosumer can operate in islanded mode. However, due to the uncertain generation of the RESs, sometimes it is not possible to meet the required demand relying only on local DERs, or store the surplus of energy when the ESSs are fully charged [13]. Because of that, prosumers sometimes have to disconnect their load, or waste some available energy from the RESs in order to avoid excessive discharge and overcharge of the ESSs. Nevertheless, a better performance can be achieved when an external power system can help with some energy support the prosumer. At this sense, a prosumer can cooperate with others neighbor prosumers, in order to reach a better global performance and increase the reliability of the cooperative cluster of residential microgrids [14]. A cluster of household prosumers can be seen as a neighborhood as is shown in Fig. 2

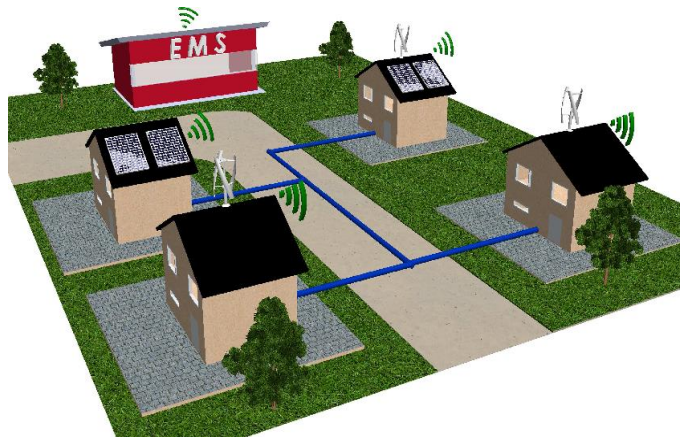

Fig. 2. Neighborhood of household prosumers.

Cooperative approaches have been considered previously for allowing energy trading between prosumers, in the case when a prosumer has a surplus of energy at the time when other prosumer requires more energy [15]. Because of that, some authors have pointed more on focused on discussing mechanisms for trading energy between neighbors [16]. Other approaches have explored the advantages and mutual benefits derived from constant cooperative operation without predefined trade rules, in terms of the overall reduction in battery usage and fair distribution of energy surpluses among prosumers [17].

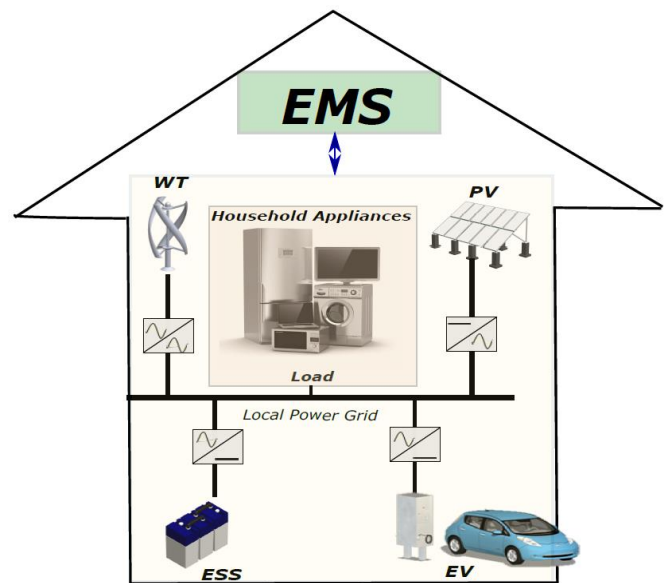

Fig. 3. Electrical Scheme of a Household Prosumer.

In this paper, a central EMS is proposed for ensuring an optimal operation of a cluster of islanded residential prosumers operating in islanded mode. The proposed strategy, considers cooperative operations between prosumers such as power sharing and storage energy balance. Nevertheless, the optimization problems consider restrictions for fair disconnection of the loads, by taking into account unequal generation and consumption profiles of each prosumer. The performance of islanded prosumers is compared with the performance of the cooperative cluster of prosumers. Experimental results are used in order to evaluate the proposed strategy. This paper is an extended version of the conference paper [18], which includes a detailed description of the optimization problem and extends the evaluation of the performance of clusters of household prosumers under different scenarios.

II. HOUSEHOLD PROSUMERS

A. Islanded prosumers

The paradigm for private owners is to achieve autonomous power supply and consumption based on their own installed energy resources, and become independent from the utility grid [6]. Islanded operation requires maximizing the generation from RESs while ensuring safe operational conditions for the stored energy in ESSs, which in turn will be reflected in longer lifespan for their installation. In light of the above, an EMS can schedule optimally the operation of the distributed resources within a small-scale microgrid by forecasting the resource availability and scheduling the power generation [3], [19], [20].

A typical configuration of a household prosumer based on renewable energy can be seen in Fig. 1. The residential power grid is composed by renewable energy generation units, energy storage systems and household appliances which can be seen as an aggregated load. A simplified electrical scheme can be seen in Fig. 3. The renewable sources can be photovoltaic (PV) generators, small wind turbine (WT)

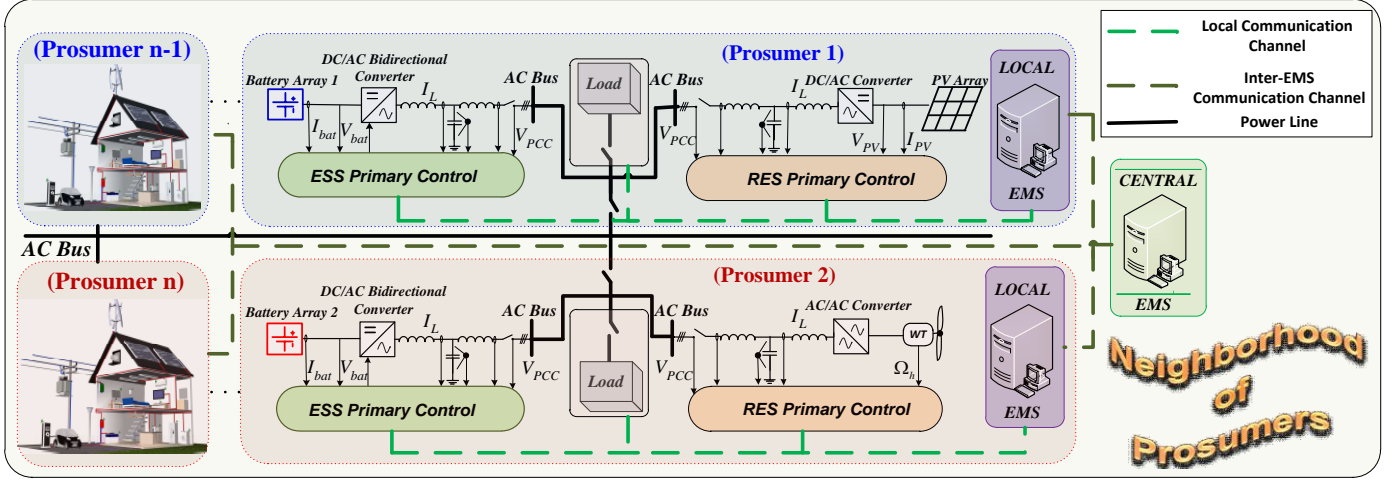

Fig. 4. Scheme of a cluster of household prosumers.

generators or combinations of both. Also, ESS are required for smooth the variability of RESs, they are commonly based on batteries arrays and also battery based electric vehicles have been recently used [8], [21].

Commonly, ESSs are the responsible of ensuring the power balance in the islanded power grid by regulating the voltage and frequency in the common bus. Because of that, ESS will operate in voltage control mode (VCM) [22], [23]. Meanwhile, RESs will operates as power sources and their power reference P^* will be determined by the minimum value between the scheduled power P_g from the EMS and the power defined by an algorithm of maximum power point tracking (MPPT), P_{MPPT} [19].

The cycle life of batteries decreases with deep discharge, and overcharge may cause high degradation of batteries. Because of that, it is important to constrain the state of charge (SoC) of a battery within a safe window (normally 20 to 90%) [4]. From the point of view of the residential owner, this is an important issue to take into account, since the installation cost and replacement cost of batteries represent a big percentage of the total cost of the installed local energy system [24]. Therefore, for ensuring the power balance of the local power system and properly constrains the SoC of the batteries, sometimes it is necessary to shift the load or limit the RESs generation during periods of low and high generation, respectively. Consequently, the main objective of the power scheduling performed by the EMS is to ensure a reliable supply of the load as long as safe SoC window is warranted.

B. Neighborhood of Household Prosumers

Geographical aggregation of household prosumers can be considered as a neighborhood. As members of a community, independent household prosumers may cooperate between them in order to enhance the performance of their own installed power systems. Fig. 4 shows a scheme of a neighborhood of n household prosumers. Each prosumer is able to operate independently from their neighbors with its

own local EMS. On top of that, a central EMS can coordinate the operation of the distributed prosumers in order to improve the behavior of the local power systems. This improvement can be reflected in more usage of the renewable resources and less disconnection of the loads. On top of that, additional collaborative behaviors such as shared regulation of the common bus and stored energy balance between distributed ESSs can be easily addressed by the central EMS. Each prosumer uses a full-duplex communication channel between their DERs with the local EMS. Also, another communication channel can be considered between local EMSs and the central EMS. In local area power system, wireless communication has been easily deployed with good performance for home and neighborhood area networks [25]–[27].

III. INDEPENDENT PROSUMER OPTIMIZATION MODEL

The problem for optimal coordination of DERs has been defined as a mixed integer linear programming (MILP) model that is composed by real variables, x , and binary variables, z , and can be written in general as,

$$\begin{aligned}
 \min_{x,z} \quad & f(x,z) = a^T x + b^T z \\
 \text{subject to.} \quad & G(x,z) = c \\
 & H(x,z) \leq d \\
 & x \in \mathbb{R}, z \in [0,1]
 \end{aligned} \tag{1}$$

where, $f(x,z)$ is the objective function, c and d are scalar vectors, and $G(x,z)$, $H(x,z)$ are linear combinations of the variables that define equalities and inequalities constraints. Along this section, the mathematical formulation of the optimization problem will be presented in detail.

The variables used in the model are presented in Table I, one binary variable ($z = z_{load}(t)$) and real variables (x which are the others shown variables). Note that the variables are denoted in lower-case. The parameters used in the model are summarized in Table II.

TABLE I
VARIABLES OF THE LOCAL MODEL

Variable	Description
$p_g(t)$	Power references for RES
$p_{bat}(t)$	Power of the battery
$SoC(t)$	SoC of the battery
$z_{load}(t)$	Connection of load
cost	Whole cost computed as objective function

TABLE II
PARAMETERS OF THE LOCAL MODEL

Parameter	Description
T	Time of scheduling
Δt	Duration of interval
$P_{load}(t)$	Average load consumption
$P_{max}(t)$	Power max for RES
$C_{load}(t)$	Penalty cost for load disconnection
$C_g(t)$	Penalty cost for curtailed generation
SoC_{max}	Maximum state of charge
SoC_{min}	Minimum state of charge
φ_{bat}	Coefficient of the ESS

The parameters SoC_{max} , SoC_{min} and φ_{bat} are related to the battery bank. SoC_{max} is selected to allow the battery to be fully charged without overcharging and SoC_{min} is chosen to limit the depth of discharge (DoD) accordingly with the recommendation of the IEEE1561-2007 standard [28]. φ_{bat} is a proportionality constant which relates the stored energy in kWh with the SOC of the battery in percentage. φ_{bat} depends on the main parameters of the battery bank which are the nominal voltage, $V_{batt_{nom}}$, the capacity C_{bat} (in Ah) and the charging/discharging efficiency η_c as,

$$\varphi_{bat} = \eta_c / (C_{bat} * V_{batt_{nom}}). \quad (2)$$

Additionally, the model uses the index $t = \{1, 2, \dots, T\}$ for the discrete time intervals of Δt , with T as time horizon for the optimization.

A. Objective Function

The objective function aims to minimize load disconnection of each household and maximize the use of available generation, and can be written as,

$$\min_{x,z} f(x,z) = \text{cost} = \sum_{t=1}^T P_{load}(t)\Delta t * (1 - z_{load}(t)) * C_{load}(t) + \sum_{t=1}^T [P_{max}(t)\Delta t - p_g(t)\Delta t] * C_g(t). \quad (3)$$

The first term in (3) corresponds to the cost associated to disconnect the load, which is equal to 0 if the load is connected ($z_{load} = 1$).

The second term is a penalization for not using the available power in the RESs, computed as the difference between the predicted available profile of energy and the power reference multiplied by the penalty cost of curtailment.

B. Constraints

1) *Balance equation*: The demand must be supplied by the sources and the storage system.

$$p_g(t)\Delta t + p_{bat}(t)\Delta t = P_{load}(t)\Delta t * z_{load}(t), \quad \forall t. \quad (4)$$

2) *Power Sources*: The power reference for the power source at each t , $p_g(t)$, must be less than or equal to the maximum power that can be provided for them $P_{max}(t)$, at these t ,

$$0 \leq p_g(t) \leq P_{max}(t), \quad \forall t. \quad (5)$$

3) *Energy Storage System*: The SoC of a battery can be defined in terms of the power as,

$$SoC(t) = SoC(t-1) - \varphi_{bat} * [p_{bat}(t)\Delta t], \quad \forall t. \quad (6)$$

Note that, when $p_{bat}(t)$ is positive, the battery provides energy to the load (it is being discharged) and when is negative, it absorbs energy from the sources (it is being charged). This variable must be limited,

$$P_{bat_{min}} \leq p_{bat}(t) \leq P_{bat_{max}}, \quad \forall i, t. \quad (7)$$

Additionally, the SOC at each t is bounded in the range,

$$SoC_{min} \leq SoC(t) \leq SoC_{max}, \quad \forall t. \quad (8)$$

IV. OPTIMIZATION MODEL FOR CLUSTER OF PROSUMERS

For the cluster of prosumers, the MILP model presented in the previous section is adapted. In this case, the index $i = \{1, 2, \dots, n\}$ is added to represent the i -th prosumer of a cluster of n household prosumers. Nevertheless, due to the variability of the primary energy resources under certain environmental conditions it is not possible to ensure a continuous supply of the load. Because of that, it is necessary to disconnect the load totally or partially. For partial disconnection of the load, the optimization problem penalizes more the prosumer with low ratio between local generation and consumption.

A. Objective Function

Here, the objective function minimizes disconnection of the load, for the households interconnected in the cluster, and maximizes the available generation as,

$$\sum_{t=1}^T \sum_{i=1}^n P_{load}^{(i)}(t) \Delta t * (1 - z_{load}^{(i)}(t)) * C_{load}^{(i)}(t) * \xi^{(i)} + \sum_{t=1}^T \sum_{i=1}^n [P_{max}^{(i)}(t) \Delta t - p_g^{(i)}(t) \Delta t] * C_g^{(i)}(t) \quad (9)$$

where the parameter $\xi^{(i)}$ has been included in order to penalize the load disconnection, and it is defined as,

$$\xi^{(i)} = \sum_{t=1}^T P_{max}^{(i)}(t) / \left(\sum_{t=1}^T P_L^{(i)}(t) \right), \forall i. \quad (10)$$

The value of $\xi^{(i)}$ will bigger for the prosumer with larger ratio between generation and consumption and the disconnection of its load will be highly penalized in the optimization model. On the contrary, for small values of $\xi^{(i)}$, the load of that prosumer will be more likely to be disconnected when required. In this way, a fair criterion for load disconnection is provided within the optimization model.

B. Constraints

1) *Balance equation*: The energy balance should be fulfilled in the cluster of prosumers, and it can be written as,

$$\sum_{i=1}^n p_g^{(i)}(t) \Delta t + \sum_{i=1}^n p_{bat}^{(i)}(t) \Delta t = \sum_{i=1}^n P_{load}^{(i)}(t) \Delta t * z_{load}^{(i)}(t), \forall t. \quad (11)$$

2) *Power Sources*: The scheduled generation reference can be generalized for the cluster of prosumers as,

$$0 \leq p_g^{(i)}(t) \leq P_{max}^{(i)}(t), \forall i, t. \quad (12)$$

3) *Battery*: The SoC can be rewritten as,

$$SoC^{(i)}(t) = SoC^{(i)}(t-1) - \varphi_{bat} * [p_{bat}^{(i)}(t) \Delta t] \quad \forall i, t. \quad (13)$$

In the same way, the boundaries of the related variables can be written as,

$$SoC_{min} \leq SoC^{(i)}(t) \leq SoC_{max}, \forall i, t \quad (14)$$

$$Pbat_{min} \leq p_{bat}^{(i)}(t) \leq Pbat_{max}, \forall i, t.$$

Additionally, in order to enhance the performance of distributed ESSs, which are cooperating within the cluster of household prosumers, the operation of the cooperative power grid is complemented with energy storage balance between distributed ESSs [29]. The equalization of the SoC between ESSs brings additional advantages to the overall performance of them, such as reduction in the DoD and faster charge of all the distributed ESSs [30]. For considering the effect of SoC equalization between distributed ESSs within the optimization model, an additional condition is defined as,

$$SoC^{(i)}(t) = SoC^{(j)}(t), \forall i \neq j, t \geq 1. \quad (15)$$

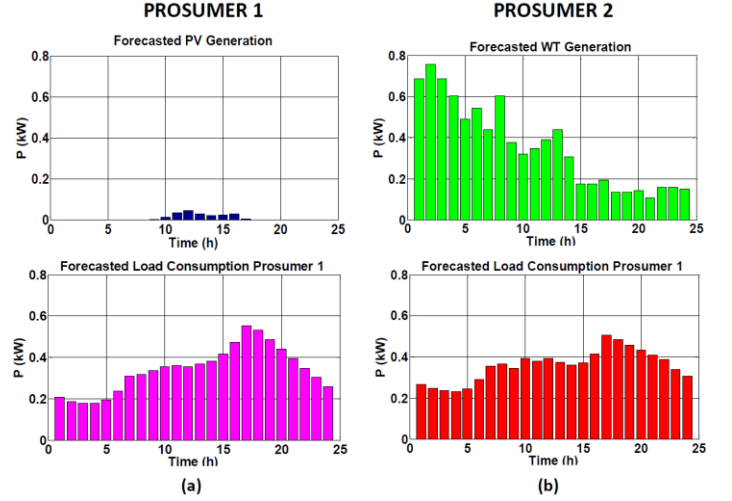

Fig. 5. Forecasted generation and consumption for (a) prosumer 1 and (b) prosumer 2

In this way, the optimization problem equalizes the SoC of the ESS in the household after the first time slot.

V. SIMULATION RESULTS

The EMS determines the load connection and power references for the local RES units based on a 24-h ahead optimal scheduling. The optimization problem is solved by using a commercial algebraic modeling language. The model is tested by using forecasted data of generation and consumption of for a day, with time slots of one hour ($\Delta t = 1$ h), as is shown in Fig. 5 for a typical winter day. To simplify the analysis, as case study is considered a neighborhood composed by $n = 2$ household prosumers one with PV generation (prosumer 1) and the other with WT generation (prosumer 2). Table III summarizes the values of the parameters used for case study.

TABLE III
PARAMETERS OF THE MODEL

Parameter	Value
n	2
T	24 [h]
Δt	1 [h]
$P_{load}(t)$	345 [kW]
$P_{max}^{(i)}(t)$	0-1.2 [kW]
C_{load}, C_g	1 [€]
SoC_{max}	90 [%]
SoC_{min}	20 [%]
$SoC(0)$	[70, 80] [%]
φ_{bat}	7.55 [%/kWh]
$\xi^{(i)}$	0 - 2

Fig. 5 shows the forecasted generation and load profiles for prosumer 1 (Fig. 5a) and prosumer 2 (Fig. 5b) respectively. Those data are used for the optimization program to schedule

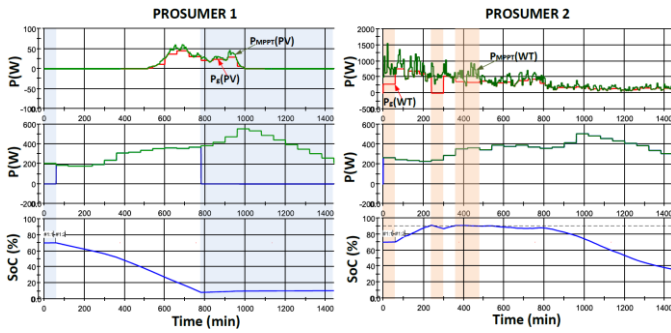

Fig. 6. Generation, consumption and SoC profiles for (a) prosumer 1 and (b) prosumer 2

the power generation and load connection in a daily basis.

Real time simulation is performed into a real time platform. The model downloaded to this platform is previously established as a simulation model which includes the RESs generation profiles for 24h, the local controllers of the power converters as well as a detailed model of valve-regulated lead-acid (VRLA) batteries [31]. On top of that, the references scheduled by the EMS are downloaded in a table and are read by the simulation model every time slot of the scheduling. Furthermore, to perform the real simulation of one day, the data were time-scaled i.e. one hour corresponds to one minute of simulation, so that the whole simulation spends 1440 s. instead of 1440 min [32].

Fig. 6 shows the generation profiles, load consumption profiles and the SoC for prosumer 1 (Fig. 6a) and 2 (Fig. 6b) respectively. In this figure, it is possible to see that for the prosumer 1 the load has to be shedding for 12 hours one at the beginning of the day and 11 hours more after 14 hours. Meanwhile, in the case of the prosumer 2 the power generation at the WT is curtailed for 4 hours in order to limit the SoC to 90 %.

On the other hand, Fig. 7 shows the PV (prosumer 1) and WT (prosumer 2) generation profiles, the load profiles for both prosumers and the SoC when prosumers are cooperating between them. In this case, the SoC is equalized between prosumer 1 and 2. In addition, it is possible to see that WT generation is not curtailed and the load of prosumer 1 is only disconnected during two hours. The load of prosumer 1 is penalized with more disconnection since this prosumer has small ration between generation and consumption (ξ in equation (10)). Nevertheless, the overall operation of both prosumers is improved and the use of RESs generation is maximized thanks to the cooperative operation between them.

VI. EXPERIMENTAL RESULTS

The proposed strategy has been tested experimentally in the in the Microgrid Research Laboratory of Aalborg University. The experimental setup is integrated by fourth inverters fed by a stiff dc source as is shown in Fig. 8. Each of the inverters is connected to a LCL filter which, in turn, is connected to the common bus of each local power grid. In this case constant loads are considered for both prosumers each one with a nominal value of 345W.

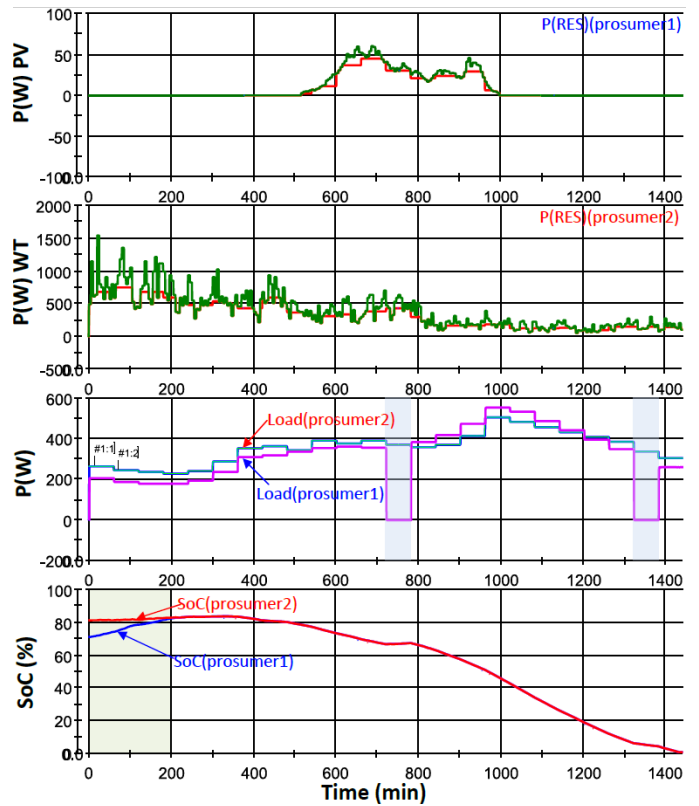

Fig. 7. Operation profiles for the cooperative cluster of household prosumers

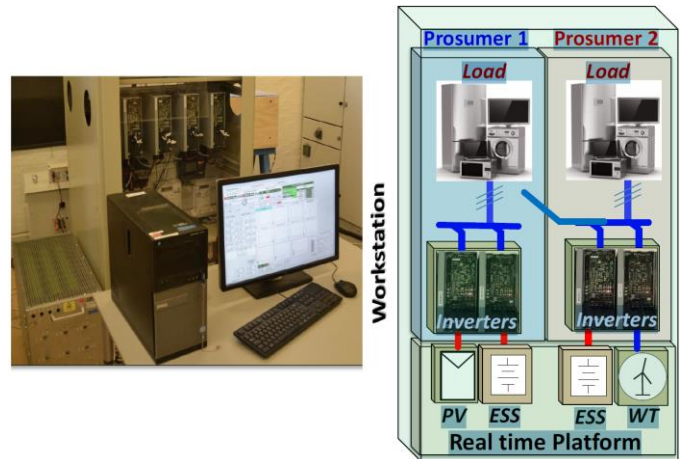

Fig. 8. Experimental setup

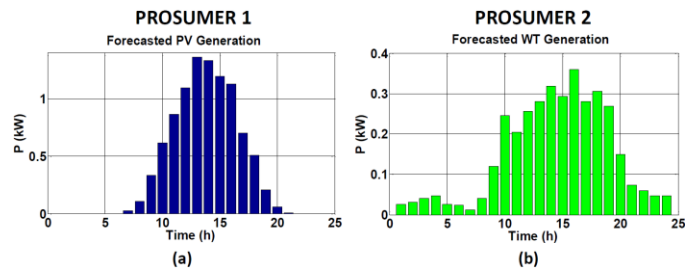

Fig. 9. Forecasted generation for (a) prosumer 1 and (b) prosumer 2

Fig. 9 shows the foretasted generation profiles for prosumer 1 and 2 (Fig. 5a) and (Fig. 5b) respectively for a spring day.

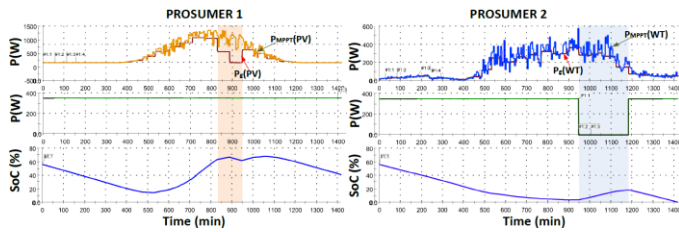

Fig. 10. Experimental generation, consumption and SoC profiles for (a) prosumer 1 and (b) prosumer 2

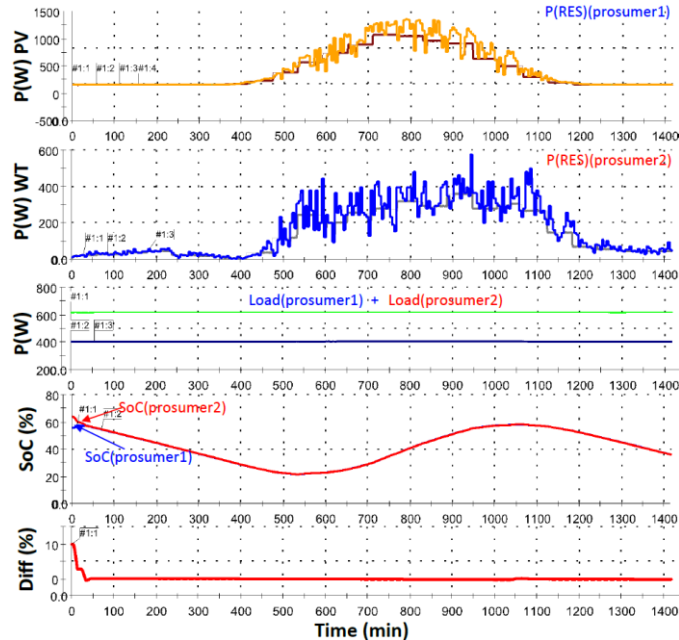

Fig. 11. Experimental results with central scheduling

Fig. 10 shows the experimental results obtained for independent operation of prosumer 1 and 2 respectively. Here, it is possible to see that the generation for prosumer 1 is curtailed for 2 hours in order to avoid overcharge of the ESS. Meanwhile, the load of prosumer 2 is disconnected for 4 hour. On the contrary, Fig. 11 shows the performance of the household prosumers operating in a cooperative way and controlled by the central EMS. In this case the generation from RESs is maximized and the disconnection of the loads is completely avoided. Additionally, SoC equalization between ESSs and proper operation levels for the SoC is achieved.

VII. CONCLUSION

The proposed central EMS enhances the performance of the cluster of household prosumers compared to independent operation of them. This improvement can be reflected in better loads profile connections and mayor usage of the renewable resources. On top of that, collaborative behaviors such a power sharing and stored energy balance between distributed ESSs can be easily addressed by the central EMS. This strategy ensures the global balance of the system, while maximizing the use of distributed generators. Cooperative operation between household prosumers is a feasible option in

order to achieve independence from the main grid while increasing the reliability and usage of the local power system.

REFERENCES

- [1] J. Han, C. s. Choi, W. k. Park, I. Lee, and S. h. Kim, "Smart home energy management system including renewable energy based on zigbee and plc," *IEEE Trans. on Consumer Electron.*, vol. 60, pp. 198–202, May 2014.
- [2] A. Keyhani, *Design of Smart Power Grid Renewable Energy Systems*. Wiley, 2011.
- [3] J. Catalão, *Electric Power Systems: Advanced Forecasting Techniques and Optimal Generation Scheduling*. Taylor & Francis, 2012.
- [4] F. Marra and G. Yang, "Chapter 10 - decentralized energy storage in residential feeders with photovoltaics," in *Energy Storage for Smart Grids* (P. D. Lu, ed.), pp. 277 – 294, Boston: Academic Press, 2015.
- [5] J. P. Chaves-Avila, K. Wurzburg, T. Gomez, and P. Linares, "The green impact: How renewable sources are changing eu electricity prices," *IEEE Power and Energy Magazine*, vol. 13, pp. 29–40, July 2015.
- [6] M. Castillo-Cagigal, E. Caamano-Martin, E. Matallanas, D. Masa-Bote, A. Gutierrez, F. Monasterio-Huelin, and J. Jimenez-Leube, "PV self-consumption optimization with storage and active fDSMg for the residential sector," *Solar Energy*, vol. 85, no. 9, pp. 2338 – 2348, 2011.
- [7] A. Olson et al., "Halfway There: Can California Achieve a 50% Renewable Grid?," in *IEEE Power and Energy Magazine*, vol. 13, no. 4, pp. 41-52, July-Aug. 2015.
- [8] Y. M. Wi, J. U. Lee, and S. K. Joo, "Electric vehicle charging method for smart homes/buildings with a photovoltaic system," *IEEE Trans. Consumer Electron.*, vol. 59, pp. 323–328, May 2013.
- [9] M. Beaudin, H. Zareipour, A. Schellenberg, and W. Rosehart, "Chapter 1 - energy storage for mitigating the variability of renewable electricity sources," in *Energy Storage for Smart Grids* (P. D. Lu, ed.), pp. 1 – 33, Boston: Academic Press, 2015.
- [10] J. C. Vasquez, J. M. Guerrero, J. Miret, M. Castilla, and L. G. de Vicuna, "Hierarchical control of intelligent microgrids," *IEEE Industrial Electronics Magazine*, vol. 4, pp. 23–29, Dec 2010.
- [11] Y. s. Son, T. Pulkkinen, K. d. Moon, and C. Kim, "Home energy management system based on power line communication," *IEEE Trans. on Consumer Electronics*, vol. 56, pp. 1380–1386, Aug 2010.
- [12] M. Elsieid, A. Oukaour, H. Gualous, and R. Hassan, "Energy management and optimization in microgrid system based on green energy," *Energy*, vol. 84, pp. 139 – 151, 2015.
- [13] N. L. Daz, D. Wu, T. Dragicevic, J. C. Vsquez, and J. M. Guerrero, "Fuzzy droop control loops adjustment for stored energy balance in distributed energy storage system," in *9th International Conference on Power Electronics and ECCE Asia (ICPE-ECCE Asia)*, 2015.
- [14] Q. Shafiee, T. Dragicevic, J. Vasquez, and J. Guerrero, "Hierarchical control for multiple dc-microgrids clusters," *IEEE Transactions on Energy Conversion*, vol. 29, pp. 922–933, Dec 2014.
- [15] Y. Luo, S. Itaya, S. Nakamura, and P. Davis, "Autonomous cooperative energy trading between prosumers for microgrid systems," in *2014 IEEE 39th Conference on Local Computer Networks Workshops (LCN Workshops)*, pp. 693–696, Sept 2014.
- [16] D. Ilic, P. G. D. Silva, S. Karmouskos, and M. Griesemer, "An energy market for trading electricity in smart grid neighbourhoods," in *2012 6th IEEE International Conference on Digital Ecosystems Technologies (DEST)*, pp. 1–6, June 2012.
- [17] M. Alam, S. D. Ramchurn, and A. Rogers, "Cooperative energy exchange for the efficient use of energy and resources in remote communities," in *Proc. 2013 International Conference on Autonomous Agents and Multi-agent Systems, AAMAS '13*, (Richland, SC), pp. 731–738, International Foundation for Autonomous Agents and Multiagent Systems, 2013.
- [18] A. C. Luna, N. L. Diaz, M. Graells, J. M. Guerrero, and J. C. Vasquez, "Cooperative management for a cluster of residential prosumers," in *2016 IEEE International Conference on Consumer Electronics (ICCE)*, pp. 593–594, Jan 2016.
- [19] A. Luna, N. Diaz, F. Andrade, M. Graells, J. Guerrero, and J. Vasquez, "Economic power dispatch of distributed generators in a grid-connected microgrid," in *9th International Conference on Power Electronics and ECCE Asia (ICPE-ECCE Asia)*, 2015, pp. 1161–1168, June 2015.

- [20] R. Palma-Behnke, C. Benavides, F. Lanas, B. Severino, L. Reyes, J. Llanos, and D. Saez, "A microgrid energy management system based on the rolling horizon strategy," *IEEE Transactions on Smart Grid*, vol. 4, pp. 996–1006, June 2013.
- [21] W. Kempton and S. E. Letendre, "Electric vehicles as a new power source for electric utilities," *Transportation Research Part D: Transport and Environment*, vol. 2, no. 3, pp. 157–175, 1997.
- [22] J. Pecos Lopes, C. Moreira, and A. Madureira, "Defining control strategies for microgrids islanded operation," *IEEE Transactions on Power Systems*, vol. 21, pp. 916–924, May 2006.
- [23] D. Wu, F. Tang, T. Dragicovic, J. Vasquez, and J. Guerrero, "Autonomous active power control for islanded ac microgrids with photovoltaic generation and energy storage system," *IEEE Transactions on Power Conversion*, vol. 29, pp. 882–892, Dec 2014.
- [24] B. Mozafari and S. Mohammadi, "Optimal sizing of energy storage system for microgrids," *Sadhana*, vol. 39, no. 4, pp. 819–841, 2014.
- [25] L. Siow, P. So, H. Gooi, F. Luo, C. Gajanayake, and Q. Vo, "Wi-fi based server in microgrid energy management system," in *IEEE Region 10 Conference TENCON 2009*, pp. 1–5, Jan 2009.
- [26] A. Llaría, O. Curea, J. Jimenez, J. Martin, and A. Zuloaga, "Wireless communication system for microgrids management in islanding," in *Proc. 2011-14th European Conference on Power Electronics and Applications (EPE 2011)*, pp. 1–10, Aug 2011.
- [27] D. m. Han and J. h. Lim, "Smart home energy management system using ieee 802.15.4 and zigbee," *IEEE Transactions on Consumer Electronics*, vol. 56, pp. 1403–1410, Aug 2010.
- [28] I. S. C. C. 21, "Guide for optimizing the performance and life of lead acid batteries in remote hybrid power systems," *IEEE Std 1561-2007*, pp. C1–25, 2008.
- [29] N. L. Daz, A. C. Luna, J. C. Vsquez, and J. M. Guerrero, "Equalization algorithm for distributed energy storage systems in islanded ac microgrids," in *41st Annual Conference of the IEEE Industrial Electronics Society, IECON 2015*, pp. 004661–004666, Nov 2015.
- [30] N. L. Diaz, D. Wu, T. Dragicovic, J. C. Vasquez, and J. M. Guerrero, "Stored energy balance for distributed pv-based active generators in an ac microgrid," in *2015 IEEE Power Energy Society General Meeting*, pp. 1–5, July 2015.
- [31] T. Kim and W. Qiao, "A hybrid battery model capable of capturing dynamic circuit characteristics and nonlinear capacity effects," *IEEE Transactions on Energy Conversion*, vol. 26, pp. 1172–1180, Dec 2011.
- [32] A. Ruiz-Alvarez, A. Colet-Subirachs, F. A.-C. Figuerola, O. Gomis-Bellmunt, and A. Sudria-Andreu, "Operation of a utility connected microgrid using an iec 61850-based multi-level management system," *IEEE Transactions on Smart Grid*, vol. 3, pp. 858–865, June 2012.

BIOGRAPHIES



A. C. Luna (S'06) received the B.S. degree in electronic engineering in 2006 and M.S. degree in Industrial Automation in 2011, both from Universidad Nacional de Colombia. She is currently working toward the Ph.D. degree in the Department of Energy Technology at Aalborg University, Aalborg, Denmark.

Her research work focuses on energy management systems of microgrids, and specifically on architectures and algorithms for scheduling and optimization for operation level in microgrids.



N. L. Diaz (S'09) received the B.S. degree in Electronic Engineering from the Universidad Distrital F.J.C in 2008, and the M.S. degree in Industrial Automation from the Universidad Nacional de Colombia in 2011, Bogota, Colombia. He is currently pursuing the Ph.D. degree from the Department of Energy Technology, Aalborg University, Aalborg, Denmark. He is member of the Research Laboratory of Alternative Energy Sources, Universidad Distrital F.J.C. and Microgrid Research Group, Aalborg University.

His current research interests include microgrids and power converters control.



M. Graells (Moisés Graells is Associate Professor of Chemical Engineering at Universitat Politècnica de Catalunya (UPC). He holds a degree in Chemical Science from Universitat Autònoma de Barcelona (UAB, 1989) and he obtained his Ph.D. in 1996 at UPC.

His research interests have focused on the modeling, integration and optimization of chemical processes, especially batch processes. Regarding methodological aspects, his interests are the modeling and optimization techniques, computer aided tools for decision making, information management and standardization.

Recently, his investigation also includes the modeling of complex chemical systems and the study of renewable energy systems



J. C. Vásquez (M'12-SM'14) received the B.S. degree in electronics engineering from the Autonomous University of Manizales, Manizales, Colombia, and the Ph.D. degree in automatic control, robotics, and computer vision from the Technical University of Catalonia, Barcelona, Spain, in 2004 and 2009, respectively. He was with the Autonomous University of Manizales working as a teaching assistant and the Technical University of Catalonia as a Post-Doctoral Assistant in 2005 and 2008 respectively. In 2011, he was Assistant Professor and from 2014 he is working as an Associate Professor at the Department of Energy Technology, Aalborg University, Denmark where he is the Vice Programme Leader of the Microgrids Research Program. From Feb. 2015 to April. 2015 he was a Visiting Scholar at the Center of Power Electronics Systems (CPES) at Virginia Tech. His current research interests include operation, advanced hierarchical and cooperative control, optimization and energy management applied to distributed generation in AC and DC microgrids. He has authored and co-authored more than 100 technical papers only in Microgrids in international IEEE conferences and journals.

Dr. Vasquez is currently a member of the IEC System Evaluation Group SEG4 on LVDC Distribution and Safety for use in Developed and Developing Economies, the Renewable Energy Systems Technical Committee TC-RES in IEEE Industrial Electronics, PELS, IAS, and PES Societies.



J. M. Guerrero (S'01-M'04-SM'08-FM'15) received the B.S. degree in telecommunications engineering, the M.S. degree in electronics engineering, and the Ph.D. degree in power electronics from the Technical University of Catalonia, Barcelona, in 1997, 2000 and 2003, respectively. Since 2011, he has been a Full Professor with the Department of Energy Technology, Aalborg University, Denmark, where he is responsible for the Microgrid Research Program. From 2012 he is a guest Professor at the Chinese Academy of Science and the Nanjing University of Aeronautics and Astronautics; from 2014 he is chair Professor in Shandong University; from 2015 he is a distinguished guest Professor in Hunan University; and from 2016 he is a visiting professor fellow at Aston University, UK.

His research interests is oriented to different microgrid aspects, including power electronics, distributed energy-storage systems, hierarchical and cooperative control, energy management systems, smart metering and the internet of things for AC/DC microgrid clusters and islanded minigrids; recently specially focused on maritime microgrids for electrical ships, vessels, ferries and seaports. Prof. Guerrero is an Associate Editor for the IEEE TRANSACTIONS ON POWER ELECTRONICS, the IEEE TRANSACTIONS ON INDUSTRIAL ELECTRONICS, and the IEEE Industrial Electronics Magazine, and an Editor for the IEEE TRANSACTIONS ON SMART GRID and IEEE TRANSACTIONS ON ENERGY CONVERSION. He has been Guest Editor of the IEEE TRANSACTIONS ON POWER ELECTRONICS Special Issues: Power Electronics for Wind Energy Conversion and Power Electronics for Microgrids; the IEEE TRANSACTIONS ON INDUSTRIAL ELECTRONICS Special Sections: Uninterruptible Power Supplies systems, Renewable Energy Systems, Distributed Generation and Microgrids, and Industrial Applications and Implementation Issues of the Kalman Filter; the IEEE TRANSACTIONS ON SMART GRID Special Issues: Smart DC Distribution Systems and Power Quality in Smart Grids; the IEEE TRANSACTIONS ON ENERGY CONVERSION Special Issue on Energy Conversion in Next-generation Electric Ships. He was the chair of the Renewable Energy Systems Technical Committee of the IEEE Industrial Electronics Society. He received the best

paper award of the IEEE Transactions on Energy Conversion for the period 2014-2015. In 2014 and 2015 he was awarded by Thomson Reuters as Highly Cited Researcher, and in 2015 he was elevated as IEEE Fellow for his contributions on "distributed power systems and microgrids."