

# Schwinger Sources: Visualization and Explanation

Frank Dodd (Tony) Smith, Jr. - 2018

## Abstract

In E8-Cl(16) Physics, elementary particles are not point particles in or with smooth manifold structures but are finite Schwinger Source regions with size scale from Planck  $10^{(-33)}$  cm to Source Region Boundaries at scale  $10^{(-24)}$  cm.

At scales larger than  $10^{(-24)}$  cm spacetime and other relevant structures can be usefully and accurately considered to be smooth manifolds, thus permitting use of Armand Wyler's methods of calculating force strengths, particle masses, etc.

At Schwinger Source scales Planck  $10^{(-33)}$  cm to scale  $10^{(-24)}$  cm the internal structure of Schwinger Sources is QuasiCrystal Lattice derived from E8 Lattices, permitting Indra's Net BlockChain Physics of Schwinger Source Indra Jewels.

## Table of Contents

### Part I - Visualization ... pages 2-23

### Part II - Explanation:

Quantum Kernel Functions and Schwinger Source Green's Functions ... page 24

Clifford - Lagrangian and Microtubules ... pages 26

Harmonic Analysis and Wyler Calculations ... pages 27-29

Schwinger Source size and number of virtual particle-antiparticle pairs ... pages 30-32

E8 and H4 M4 and H4 CP2 Root Vectors and Lagrangian ... pages 33-37

Full Lattice Schwinger Source QuasiCrystal Internal Structure ... pages 38-42

Indra's Net of Schwinger Sources and BlockChain Physics ... pages 43-47

Results of E8-Cl(16) Schwinger Source Physics ... pages 48-49

## Visualization of Schwinger Sources with Root Vectors and Weyl Chambers

( Explanation of this Visualization is given in Part II of this paper )

### E8 Root Vectors represent Valence Fermions of the Schwinger Source Cloud.

E8 is two 600-cells, each with 120 vertices:

H4 M4 representing Conformal Gravity and the M4 part of M4 x CP2 Kaluza-Klein  
where M4 = 4D Minkowski Physical Spacetime  
and

H4 CP2 representing the Standard Model and the CP2 part of M4 x CP2  
where CP2 = SU(3) / SU(2) x U(1) Internal Symmetry Space

The H4 M4 600-cell is larger than the H4 CP2 600-cell by the Golden Ratio

**E8 240 Root Vectors =**

**= H4M4 120**

+

**H4CP2 120**

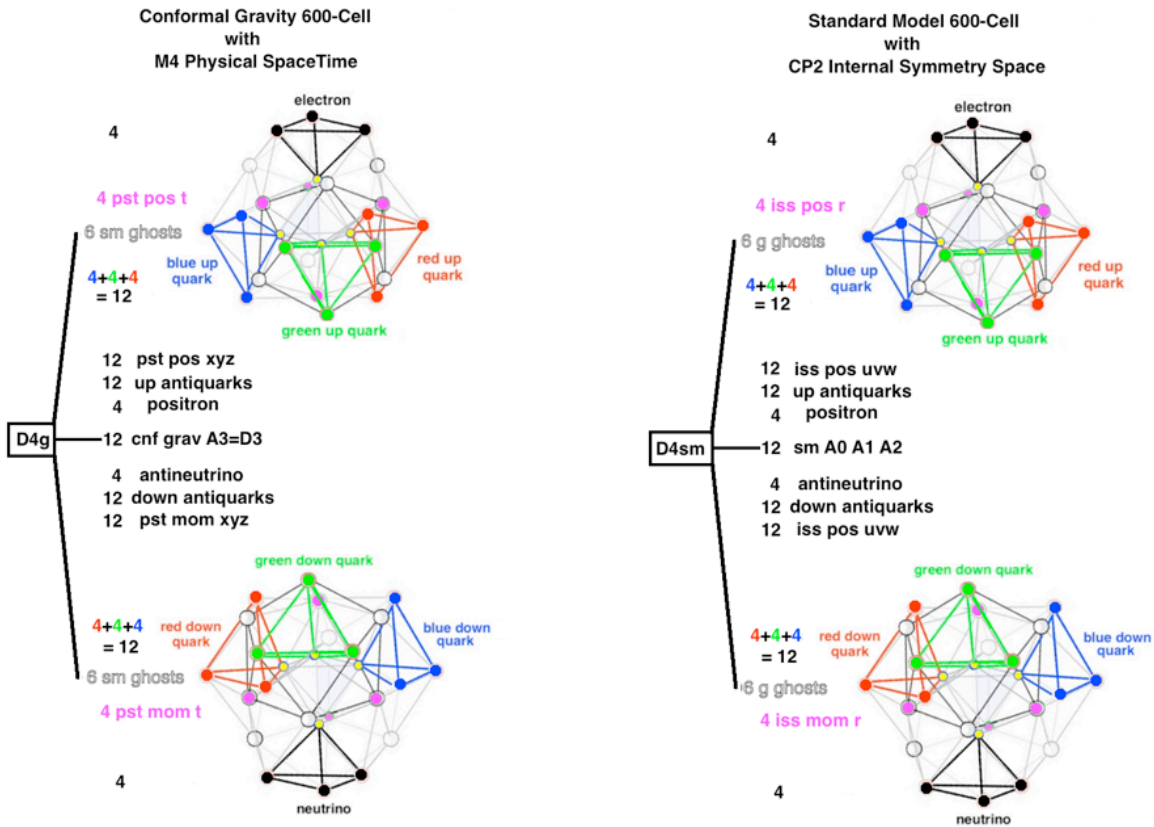

Each First-Generation Fermion is represented by a 4-vertex Tetrahedron  
in the H4 M4 600-cell and in the H4 CP2 600-cell.

**The Valence Fermion is represented as  
the corresponding two Tetrahedra being activated.**

**Weyl Chambers are formed by  
Reflection Hyperplanes perpendicular to Root Vectors**

**240 E8 Root Vector Hyperplanes intersect to form  
 $128 \times 8! \times 27 \times 5 = 696,729,600$  Weyl Chambers  
that are 8-dim bounded by 7-dim faces**

**120 H4 Root Vector Hyperplanes intersect to form  
 $8 \times 4! \times 3 \times 25 = 14,400$  Weyl Chambers  
that are 4-dim bounded by 3-dim faces**

**Use D3 as simple example  
to understand Root Vectors and Weyl Chambers:**

**12 D3 Root Vector Hyperplanes intersect to form  
 $4 \times 3! = 24$  Weyl Chambers  
that are 3-dim bounded by 2-dim faces**

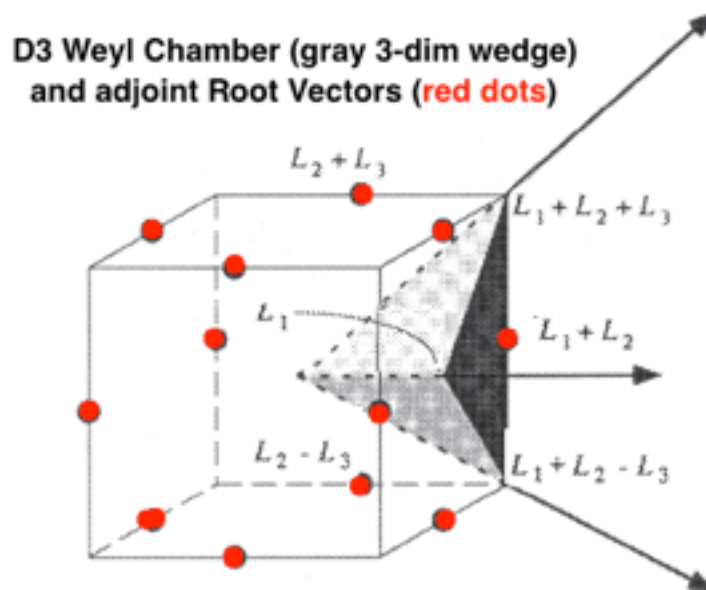

**D3 Lie Algebra comes from  
Reflections of Root Vectors through  
Hyperplanes of Surfaces of Weyl Chambers**

**At each Lattice Vertex**

**D3 has 12 Root Vectors and 24 Weyl Chambers**

**Each Root Vector is in 2 Weyl Chambers**

**Each Weyl Chamber includes a Root Vector  
from which it inherits Fibonacci Chain Structure**

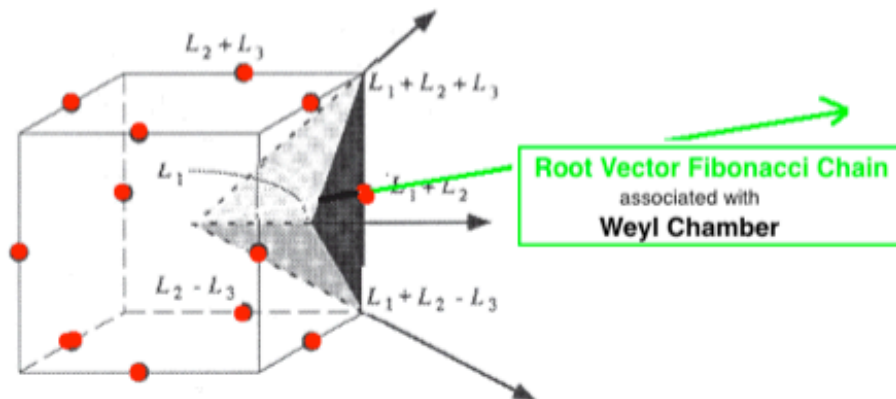

**If the Root Vector is a seed of a Schwinger Source  
then the Schwinger Source fills the Weyl Chamber  
up to  $10^{(-24)}$  cm with virtual particles/antiparticles  
in QuasiCrystal Structure of the Fibonacci Chain**

**For an E8 Lattice, at each Vertex is 240 Root Vectors  
(240 half-lines from vertex, 120 full lines through vertex)  
and  $696,729,600 = 2^7 \times 8! \times 27 \times 5$  Weyl Chambers**

**For an H4 Lattice, at each Vertex is 120 Root Vectors  
(120 half-lines from vertex, 60 full lines through vertex)  
and  $14,400 = 2^3 \times 4! \times 3 \times 25$  Weyl Chambers**

**For H4 and E8 each Weyl Chamber does not include a Root Vector  
but it does include Vectors closely related to Root Vectors  
so that each Weyl Chamber does inherit Fibonacci Chain Structure**

Our Universe has 8-dim Octonionic E8 Spacetime  
 only through the Inflation Era  
 After Inflation it has M4 x CP2 Kaluza-Klein Quaternionic Spacetime

Octonionic E8 breaks down into two copies of Quaternionic H4  
 one for Gravity and M4 Spacetime part of Kaluza-Klein  
 the other for Standard Model and CP2 part of Kaluza-Klein

For the H4 of M4 Spacetime with 600-cell symmetry,  
 at each Vertex is 120 Root Vectors  
 (120-half-lines from Vertex, 60 full lines through Vertex)  
 and  $14,400 = 2^3 \times 4! \times 3 \times 5^2 = 24 \times 600$  Weyl Chambers

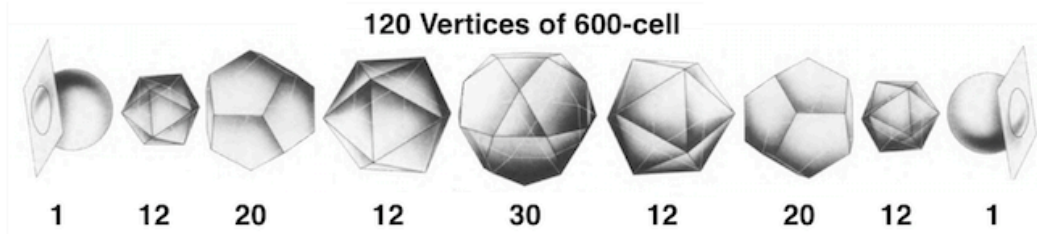

Each of the 600 Tetrahedra of the H4 600-cell  
 forms a cone Chamber over the center of the 600-cell  
 with 4 Fibonacci Chain edges from center to a Root Vector

Each of the 600 Tetrahedra can be decomposed into  
 4 Tetrahedra plus 1 Octahedron which in turn  
 can be decomposed into  
 $4 \times 4$  Tetrahedra plus  $1 \times 8$  Tetrahedra = 24 Tetrahedra

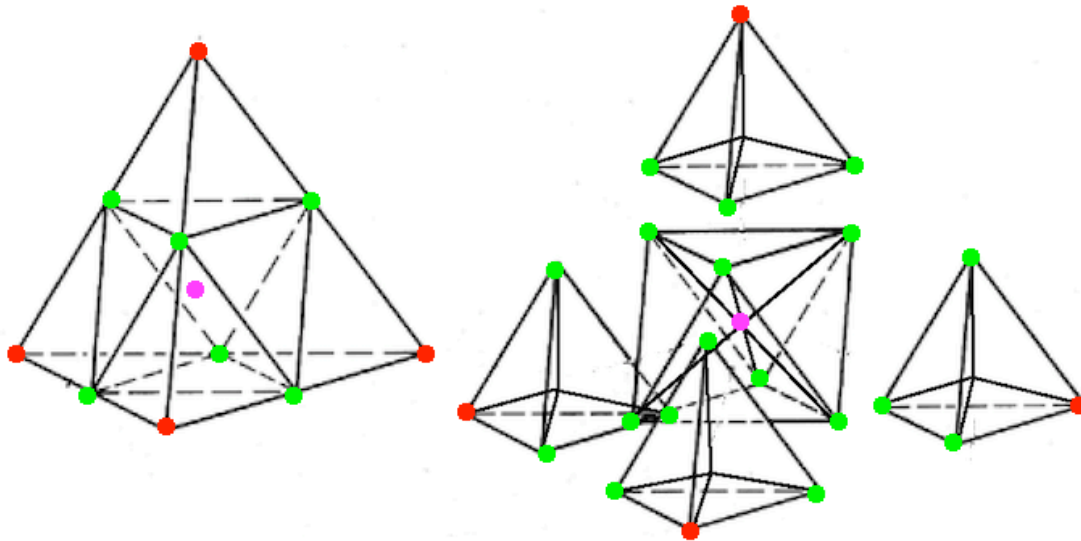

Red Dots = Root Vectors with Fibonacci Chains  
 Green Dots = MidPoints of Root Vector Pairs - inherited Fibonacci  
 Magenta Dot - Center of 600-cell Tetrahedron and of Octahedron

For each of the 600 Tetrahedra  
each of the 4 decomposition Tetrahedra

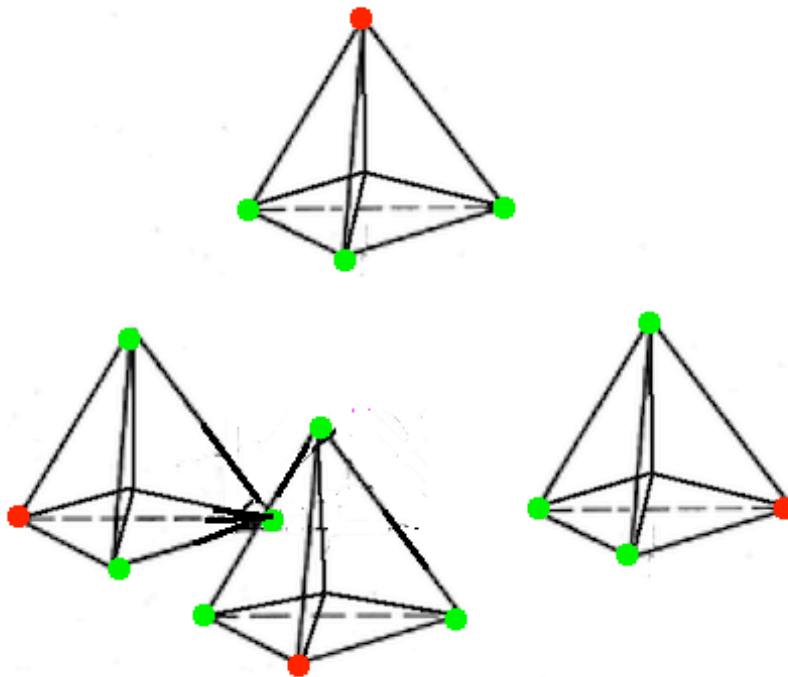

decomposes into 4 Weyl Chamber Tetrahedra

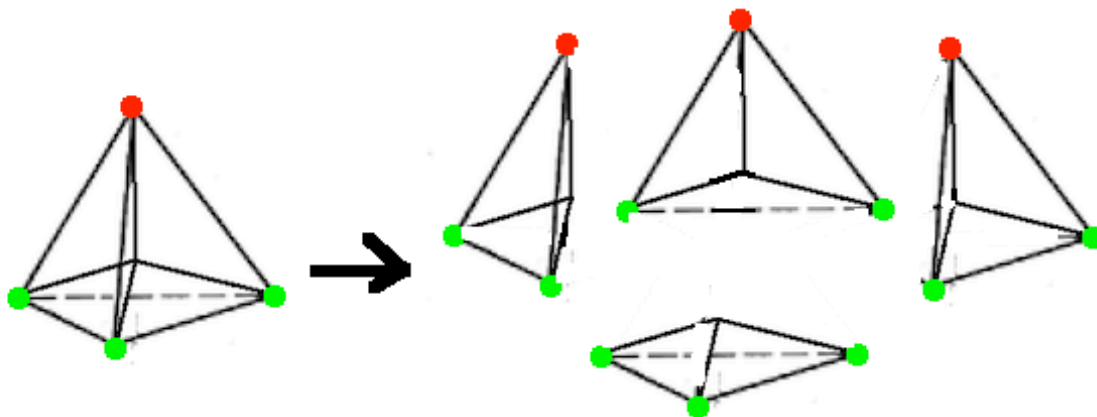

with 3 of the 4 containing 1 Root Vector Fibonacci Chain  
for QuasiCrystal Schwinger Sources  
and 2 MidPoints of Root Vector Pairs  
therefore inheriting Fibonacci structure for QuasiCrystal Schwinger Sources

and 1 of the 4 containing 3 MidPoints of Root Vector pairs  
therefore inheriting Fibonacci structure for QuasiCrystal Schwinger Sources

and

the decomposition Octahedron

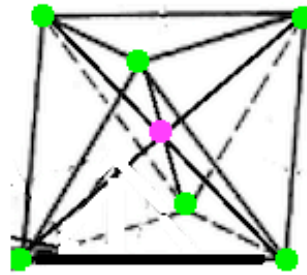

decomposes into 8 Weyl Chamber Tetrahedra  
each of which contains 3 MidPoints of Root Vector Pairs  
and so inheriting Fibonacci structure for QuasiCrystal Schwinger Sources

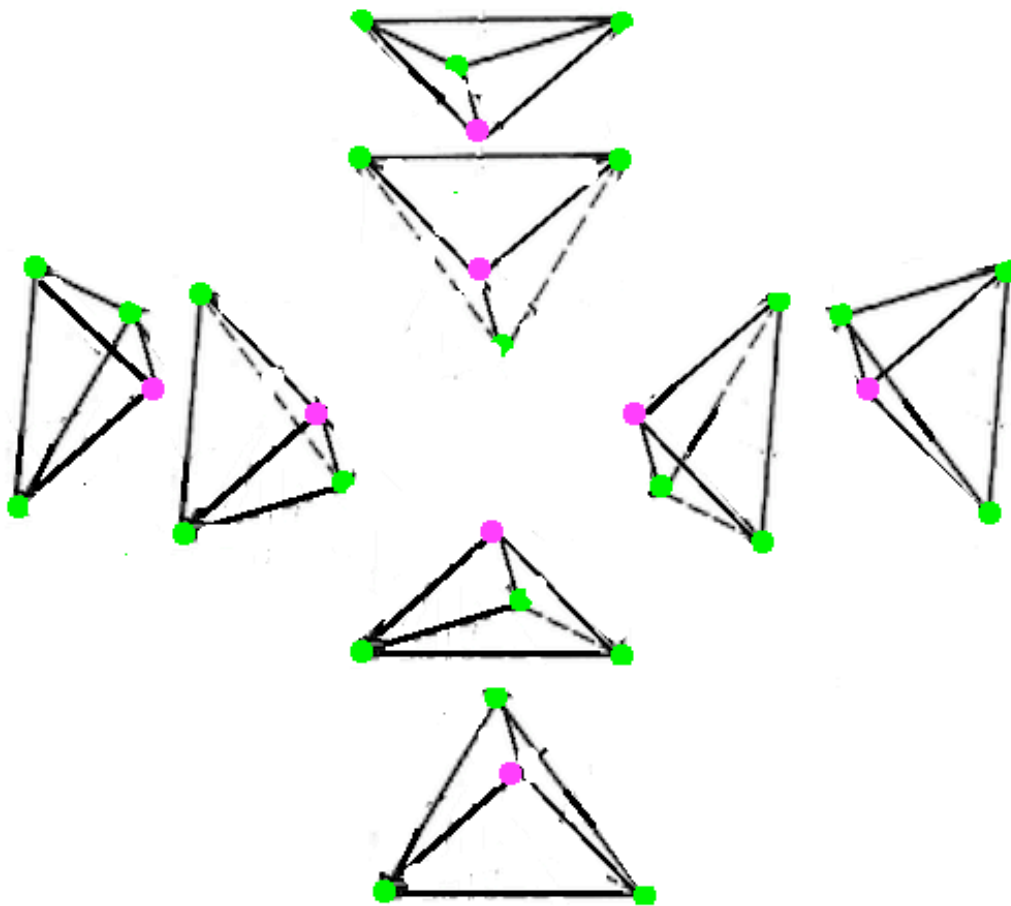

Therefore H4 has 600 Tetrahedral Cells  
each of which has  $4 \times 4 + 8 = 24$  Weyl Chambers  
for a total of  $600 \times 24 = 14,400$  Weyl Chambers  
with each Weyl Chamber having  
Fibonacci structure for QuasiCrystal Schwinger Sources

**Filling of the Weyl Chamber has been discussed for the D3 Lie Group in the context of Quantum Computing by Watts, Vala, Mueller, Calarco, Whaley, Reich, Goerz, and Koch in arXiv 1412.7347**

where they say:

"... The **geometric theory of ...[ A3 Lie Group SU(4) = D3 Lie Group Spin(6) ]...**

provides a very useful classification of two-qubit operations ...

Perfect entanglers (PEs) are non-local two-qubit operations that are capable of creating a maximally-entangled state out of some initial product state. ...

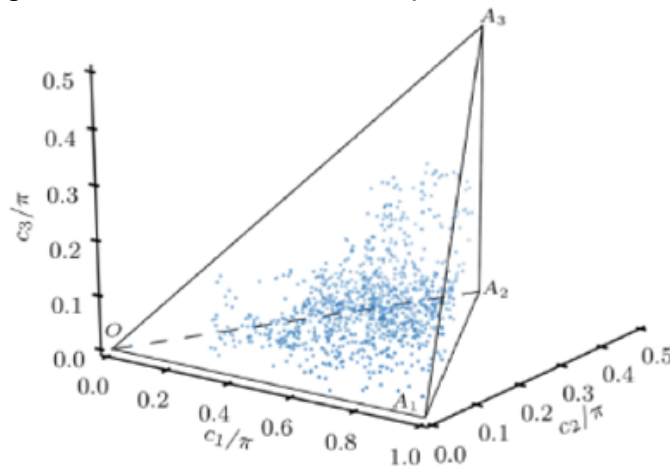

Sampling of reachable points in the Weyl chamber ... for ... full set of 15 generators in the [ A3 = D3 ] Lie algebra ... **every point in the Weyl chamber can be reached ...**".

**The Quantum Computing Point of View is useful in working with**

**the Schwinger Source BlockChain Indra's Net**

**The Fibonacci Structure is useful in working with**

**Schwinger Source QuasiCrystal Structure**

and with

**the Finite Sized Schwinger Source Weyl Chamber Cloud**

**being the Empire of the Valence Fermion**



Now, look only at the H4 M4 600-cell to see how the Valence Fermion looks in M4 Minkowski Physical Spacetime:

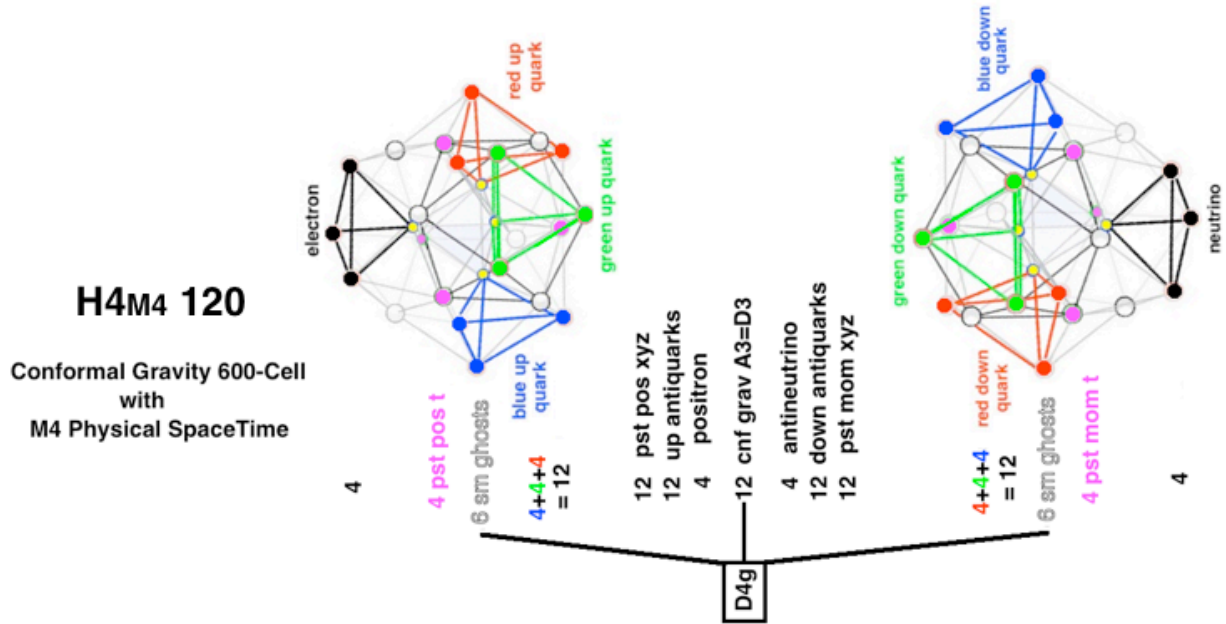

and look at the Fibonacci Shell Structure of the M4 part of the Schwinger Source Cloud

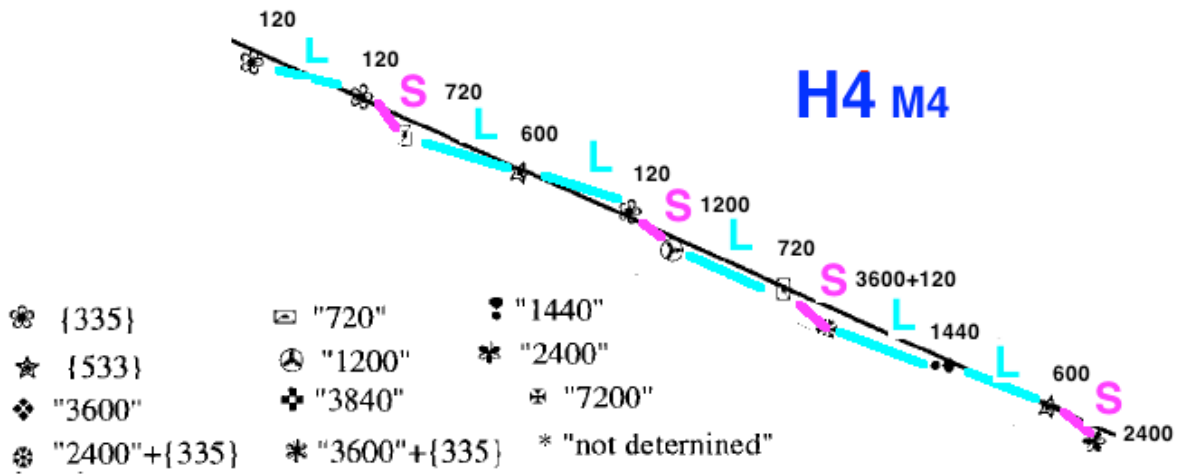

Then look only at the H4 CP2 600-cell to see how the Valence Fermion looks in CP2 Internal Symmetry Space:

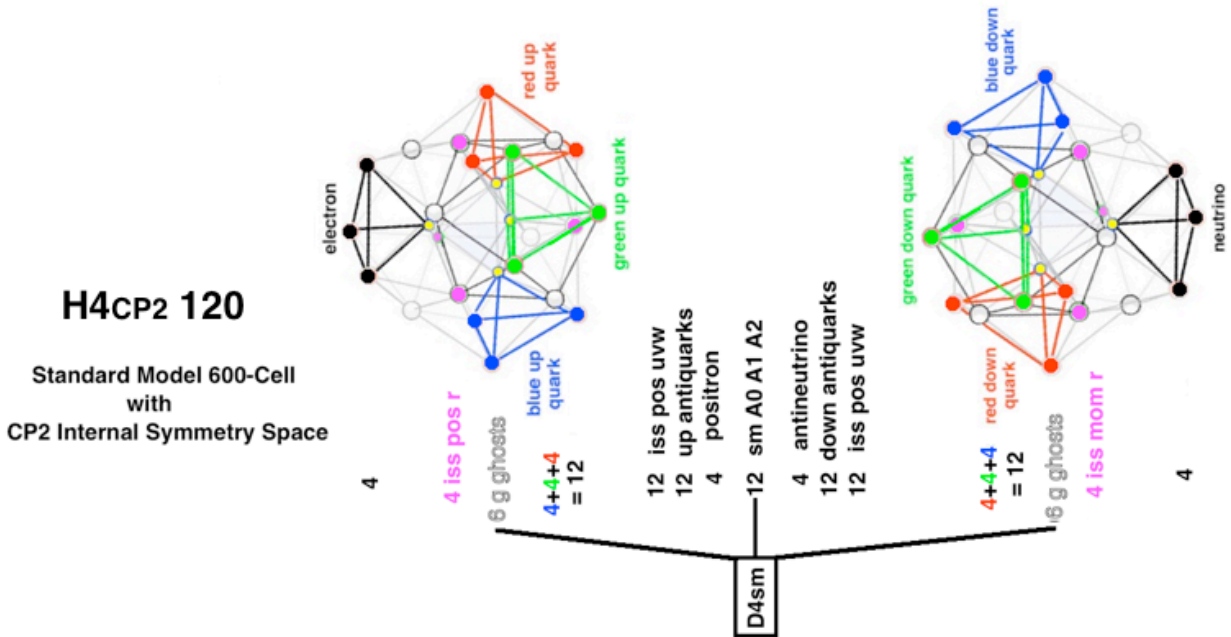

and look at the Fibonacci Shell Structure of the CP2 part of the Schwinger Source Cloud

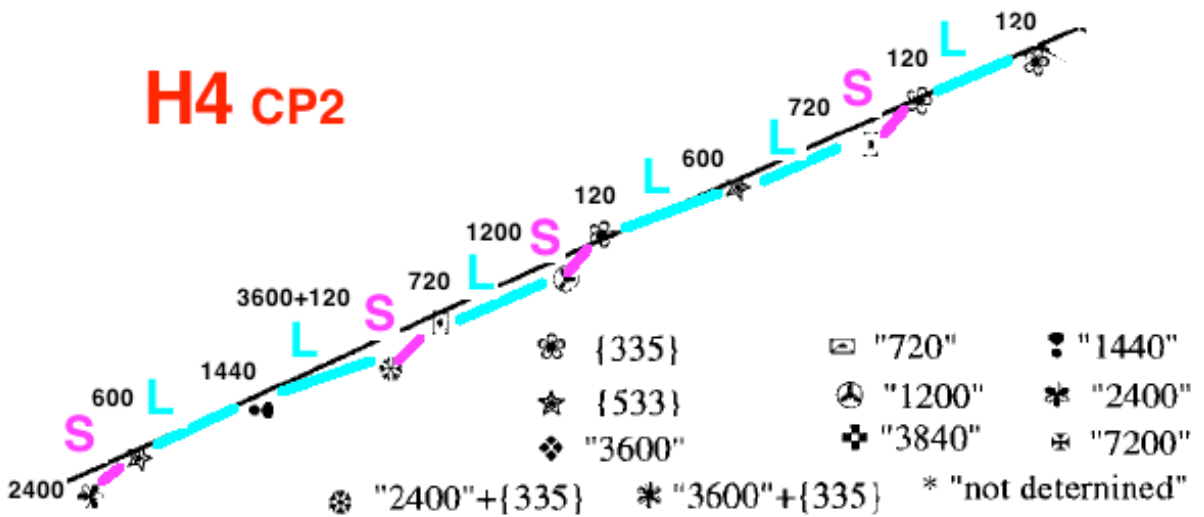

Then look at the combined Shell Structures of H4 M4 and H4 CP2:

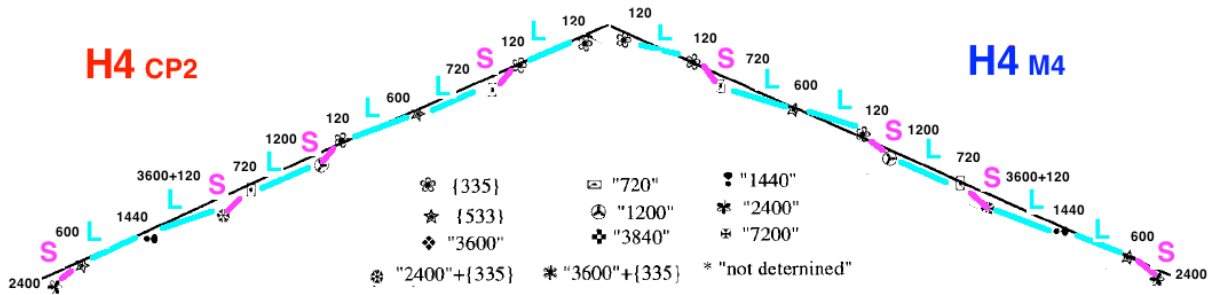

At this stage, you see the M4 and CP2 parts of the Schwinger Source Cloud but

you have not yet seen the full E8 Schwinger Source Cloud.

For that, you need to go to the 7th Step:

Finally,

combine the H4 M4 and H4 CP2 parts to form the full E8 Schwinger Source:

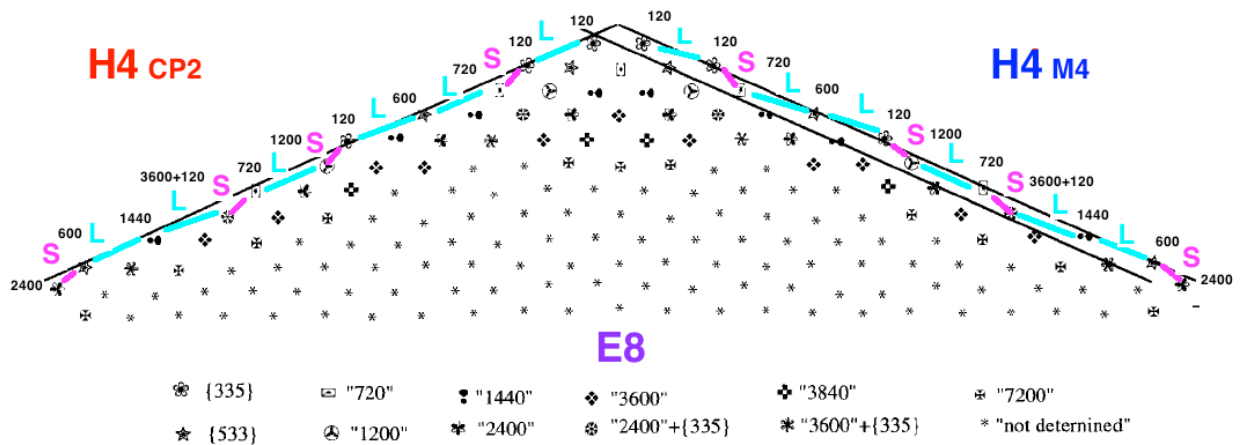

## How does the Schwinger Source look on larger scales ?

In the 4D M4 Minkowski Physical Spacetime part of M4 x CP2 Kaluza-Klein it looks like a Gravitational Black Hole.

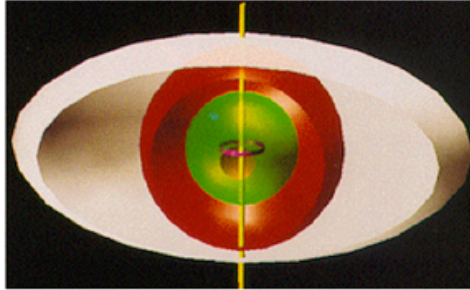

Ergosphere (white), Outer Event Horizon (red), Inner Event Horizon (green), and Ring Singularity (purple) from Black Holes - A Traveller's Guide, by Clifford Pickover (Wiley 1996).

**David Finkelstein invented the one-way membrane of the Black Hole.  
David's Black Hole can be generalized to deal with Spin  
and the. ( -1 +1 ) Charge of the U(2) ElectroWeak Force**

The generalization is called a Kerr-Newman Black Hole,

The Zeldovich-Hawking Process,  
in which a Virtual Particle-AntiParticle Pair near the Event Horizon can be separated  
with one of the Virtual Pair going into the Black Hole  
and  
the other going into External Spacetime,

can be applied to Quark-AntiQuark Virtual Pairs showing that

**a Black Hole can carry Color Charge of the SU(3) Color Force.**

## What is the Geometrical Symmetry Structure of each type of Schwinger Source?

### Neutrino:

Volume in 4D Minkowski M4 is Complex Bounded Domain type IV4  
with Symmetric Space Spin(6) / Spin(4)xU(1) Lie Ball  
and Shilov Boundary RP1 x S3 Lie Sphere

Volume in 8D is Complex Bounded Domain type IV8  
with Symmetric Space Spin(10) / Spin(8)xU(1) Lie Ball  
and Shilov Boundary RP1 x S7 Lie Sphere

By Triality the 8D M4 Spacetime Shilov Boundary Lie Sphere  
is isomorphic to the 8D CP2 Fermion Particle Symmetry Space  
Lie Sphere RP1 x S7 Shilov Boundary  
with basis  $\{1, i, j, k, E, I, J, K\} = \{Nu, rDQ, gDQ, bDq, E, rUQ, gUQ, bUQ\}$   
and  
to the corresponding  
8D CP2 Fermion AntiParticle Symmetry Space

Conformal Gravity has 15 generators.  
1 is the Dilaton corresponding to the Higgs  
4 are Special Conformal corresponding to Dark Energy  
10 are anti-deSitter for Einstein-Hilbert Gravity  
2 of the 10 are Cartan Subalgebra  
8 of the 10 can carry Charges  
6 of the 8 carry SU(3) Color Charge ( R G B )  
2 of the 8 can carry U(2) ElectroWeak Charge ( -1 +1 )  
1 of the 2 carries Charge 0 of the Neutrino  
which gives the Neutrino mass formula a Graviton factor of 0  
so that the tree-level Neutrino mass is Zero.

The Neutrino is only related to the RP1 of  $S^7 \times RP^1$   
because the Neutrino carries only no Charge  
so  
the Neutrino should have at tree level  
a spinor manifold volume factor  $V(Q_{\text{neutrino}})$  of unit volume of Zero.

## Electron:

Volume in 4D Minkowski M4 is Complex Bounded Domain type IV4  
with Symmetric Space Spin(6) / Spin(4)xU(1) Lie Ball  
and Shilov Boundary RP1 x S3 Lie Sphere

Volume in 8D is Complex Bounded Domain type IV8  
with Symmetric Space Spin(10) / Spin(8)xU(1) Lie Ball  
and Shilov Boundary RP1 x S7 Lie Sphere

By Triality the 8D M4 Spacetime Shilov Boundary Lie Sphere  
is isomorphic to the 8D CP2 Fermion Particle Symmetry Space  
Lie Sphere RP1 x S7 Shilov Boundary  
with basis  $\{1, i, j, k, E, I, J, K\} = \{N_u, rDQ, gDQ, bDq, E, rUQ, gUQ, bUQ\}$   
and  
to the corresponding  
8D CP2 Fermion AntiParticle Symmetry Space

Conformal Gravity has 15 generators.  
1 is the Dilaton corresponding to the Higgs  
4 are Special Conformal corresponding to Dark Energy  
10 are anti-deSitter for Einstein-Hilbert Gravity  
2 of the 10 are Cartan Subalgebra  
8 of the 10 can carry Charges  
6 of the 8 carry SU(3) Color Charge ( R G B )  
2 of the 8 can carry U(2) ElectroWeak Charge ( -1 +1 )  
1 of the 2 carries Charge +1 of the Electron  
which gives the Electron mass formula a Graviton factor of 1.

The Electron is only related to the equatorial S1 = U(1) of the S7 of S<sup>7</sup> x RP<sup>1</sup>  
because the Electron carries only U(1) ElectroWeak Charge  
so  
the Electron should have  
a spinor manifold volume factor V(Qelectron) of unit volume of S1 = U(1).

### **Down Quark (either Red, Green, or Blue):**

Volume in 4D Minkowski M4 is Complex Bounded Domain type IV4  
with Symmetric Space Spin(6) / Spin(4)xU(1) Lie Ball  
and Shilov Boundary RP1 x S3 Lie Sphere

Volume in 8D is Complex Bounded Domain type IV8  
with Symmetric Space Spin(10) / Spin(8)xU(1) Lie Ball  
and Shilov Boundary RP1 x S7 Lie Sphere

By Triality the 8D M4 Spacetime Shilov Boundary Lie Sphere  
is isomorphic to the 8D CP2 Fermion Particle Symmetry Space  
Lie Sphere RP1 x S7 Shilov Boundary  
with basis  $\{1, i, j, k, E, I, J, K\} = \{N_u, rDQ, gDQ, bDq, E, rUQ, gUQ, bUQ\}$   
and

to the corresponding  
8D CP2 Fermion AntiParticle Symmetry Space

Conformal Gravity has 15 generators.  
1 is the Dilaton corresponding to the Higgs  
4 are Special Conformal corresponding to Dark Energy  
10 are anti-deSitter for Einstein-Hilbert Gravity  
2 of the 10 are Cartan Subalgebra  
8 of the 10 can carry Charges  
6 of the 8 carry SU(3) Color Charge ( R G B )  
which gives the Down Quark mass formula a Graviton factor of 6.

The Down Quarks correspond to Octonions i, j, k  
which, by gluon interactions, can be taken into each other.

By also using weak boson interactions,  
they can also be taken into I, J, and K, the red, blue, and green Up Quarks.  
Given the Up and Down quarks, Pions can be formed from quark-antiquark pairs,  
and the Pions can decay to produce electrons and neutrinos.

Therefore the Down Quarks are related to all parts of  $S^7 \times RP^1$ ,  
the compact manifold corresponding to  $\{ 1, i, j, k, E, I, J, K \}$   
and therefore a Down Quark should have

a spinor manifold volume factor  $V(Q_{\text{down quark}})$  of the volume of  $S^7 \times RP^1$ .

The ratio of the Down Quark spinor manifold volume factor  
to the Electron spinor manifold volume factor is

$$V(Q_{\text{down quark}}) / V(Q_{\text{electron}}) = V(S^7 \times RP^1) / 1 = \pi^5 / 3.$$

Since the first generation graviton factor is 6 for Down Quarks and 1 for Electron  
 $m_d / m_e = 6 V(S^7 \times RP^1) = 2 \pi^5 = 612.03937$

### Up Quark (either Red, Green, or Blue):

Volume in 4D Minkowski M4 is Complex Bounded Domain type IV4  
with Symmetric Space Spin(6) / Spin(4)xU(1) Lie Ball  
and Shilov Boundary RP1 x S3 Lie Sphere

Volume in 8D is Complex Bounded Domain type IV8  
with Symmetric Space Spin(10) / Spin(8)xU(1) Lie Ball  
and Shilov Boundary RP1 x S7 Lie Sphere

By Triality the 8D M4 Spacetime Shilov Boundary Lie Sphere  
is isomorphic to the 8D CP2 Fermion Particle Symmetry Space  
Lie Sphere RP1 x S7 Shilov Boundary  
with basis  $\{1, i, j, k, E, I, J, K\} = \{N_u, rDQ, gDQ, bDq, E, rUQ, gUQ, bUQ\}$   
and  
to the corresponding  
8D CP2 Fermion AntiParticle Symmetry Space

Conformal Gravity has 15 generators.  
1 is the Dilaton corresponding to the Higgs  
4 are Special Conformal corresponding to Dark Energy  
10 are anti-deSitter for Einstein-Hilbert Gravity  
2 of the 10 are Cartan Subalgebra  
8 of the 10 can carry Charges  
6 of the 8 carry SU(3) Color Charge ( R G B )  
which gives the Up Quark mass formula a Graviton factor of 6.

As the up quarks correspond to I, J, and K,  
which are the octonion transforms under E of i, j, and k of the down quarks,  
the up quarks and down quarks have the same constituent mass  
 $\mu_u = \mu_d$ .

Antiparticles have the same mass as the corresponding particles.

Since the model only gives ratios of masses,  
the mass scale is fixed so that the electron mass  $m_e = 0.5110$  MeV.  
Then, the constituent mass of the down quark is  $m_d = 312.75$  MeV,  
and the constituent mass for the up quark is  $m_u = 312.75$  MeV.  
These results when added up give a total mass of first generation fermion particles:  
 $\Sigma m_{f1} = 1.877$  GeV

The proton mass is taken to be  
the sum of the constituent masses of its constituent quarks  
so  
 $m_{\text{proton}} = m_u + m_u + m_d = 938.25$  MeV  
which is close to the experimental value of 938.27 MeV.



## Second and Third Generation Fermions:

First Generation Fermions are represented by Octonions with 8 basis elements { 1, i, j, k, E, I, J, K }

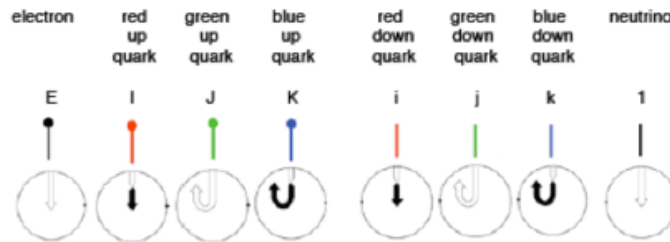

1 = 1 = Neutrino

1 = E = electron

3 = i, j, k = Down Quarks (r,g,b = 3)

3 = I, J, K = Up Quarks (r,g,b = 3)

**Second Generation Fermions** are represented by Pairs of Octonions with  $8 \times 8 = 64$  basis elements

1 = {11} = Mu Neutrino

3 = 2+1 = {1E, E1, EE} = Muon

9 = 3x3 = {1r, r1, rr or 1g, g1, gg or 1b, b1, bb} = Strange Quarks (r,g,b = 3)

51 = 17x3 = Charm Quarks (r,g,b = 3)

Example: Blue Charm Quark

Rules: a Pair belongs to the Blue Charm Quark if:

1 - There is at least one Blue element and the other element is Blue or Colorless (black) and at least one element is NonAssociative (that is, is either E or I or J or K)

2 - There is one Red element and one Green element (Red x Green = Blue).

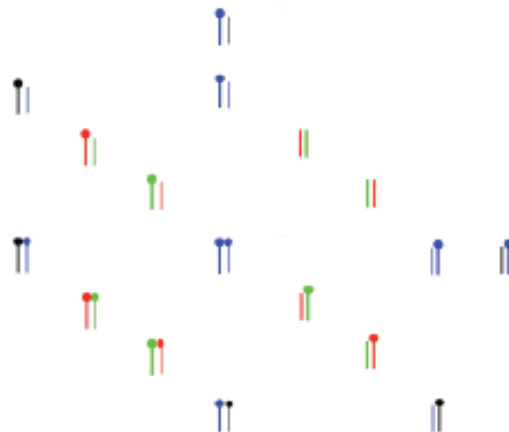

**Third Generation Fermions** are represented by Triples of Octonions  
with  $8 \times 8 \times 8 = 512$  basis elements

$$\begin{aligned}
 1 &= \{111\} = \text{Tau Neutrino} \\
 7 &= 3+3+1 = \{11E, 1E1, E11, EE1, E1E, 1EE, EEE\} = \text{Tauon} \\
 21 &= 7 \times 3 = \text{Beauty Quarks (r,g,b = 3)} \\
 483 &= 161 \times 3 = 23 \times 7 \times 3 = \text{Truth Quarks (r,g,b = 3)}
 \end{aligned}$$

Example: Blue Truth Quark

Rules: a Triple belongs to the Blue Truth Quark if:

- 1 - There is at least one Blue element and all other elements are Blue or Colorless (black) and at least one element is NonAssociative (that is, is either E or I or J or K)
- 2 - There is one Red element and one Green element and the other element is Colorless (Red x Green = Blue)
- 3 - The Triple has one element each that is Red, Green, or Blue, in which case the color of the Third element (for Third Generation) is determinative and must be Blue.

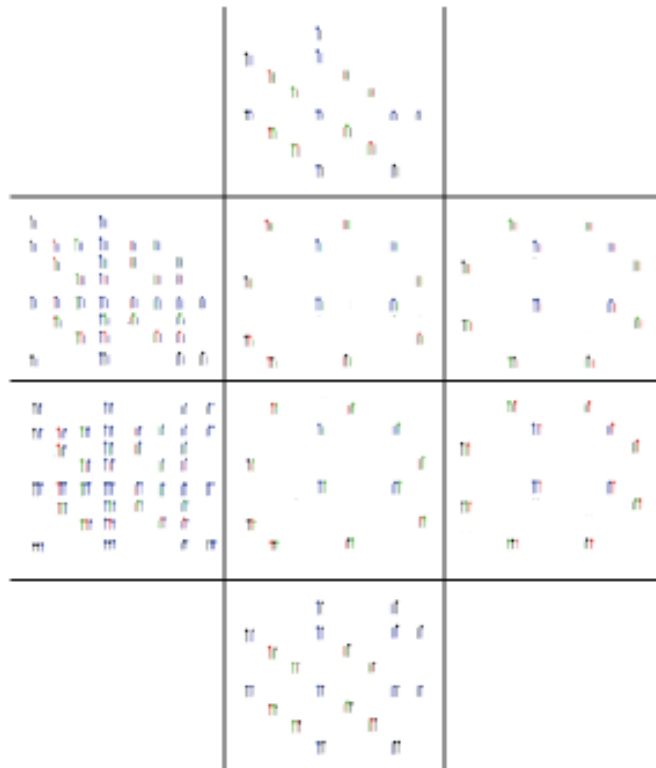

## Photon

The Standard Model U(1) Electromagnetic Force bosons (photons) live in a U(1) subalgebra of the U(2) local group of  $CP^2 = SU(3) / U(2)$   
They "see" M4 Physical spacetime as four 1-sphere circles  $S^1 \times S^1 \times S^1 \times S^1 = T^4$   
( $T^4 = 4$ -torus) each of whose dimension is 1 and has volume  $2\pi$

Their part of the Physical Lagrangian is

$\int_{T^4} (\text{U(1) Electromagnetism Gauge Boson Term})$   
an integral over SpaceTime  $T^4$ .

Schwinger Source for U(1) photons that carry no charge,  
so the Complex Bounded Domains and Shilov Boundaries can be set equal to 1  
and the Electromagnetic Force Strength is given by  
the SpaceTime  $T^4$  volume.

One fourth of the Electromagnetic Force Strength is give by  $2\pi$ .

The total Electromagnetic Force Strength  
relative to the geometric strength of Einstein-Hilbert Gravity is  $1/137.03608$

The force strength is given at the characteristic energy level  
of the generalized Bohr radius which for U(1) Electromagnetism is about 4KeV.

## Weak Boson

The Standard Model SU(2) Weak Force bosons live in a SU(2) subalgebra of the U(2) local group of CP2 = SU(3) / U(2). They "see" M4 Physical spacetime as two 2-spheres S2 x S2 each of whose dimension is 2 and each of whose volume is 4 pi.

Their part of the Physical Lagrangian is

$\int$  SU(2) Weak Force Gauge Boson Term  
S2xS2 .  
an integral over SpaceTime S2 x S2.

Schwinger Source for SU(2) Weak Force bosons is the Complex Bounded Domain is two copies of IV3 Lie Ball each with Symmetric Space Lie Sphere Spin(5) / Spin(3)xU(1) and volume pi^3 / 24 and Shilov Boundary RP1 x S2 with volume 4 pi^2

Due to the action of the Higgs mechanism, for the Weak Force, the effective force strength that we see in our experiments is suppressed by the Weak Boson masses squared ( 1 / ( MW+^2 + MW-^2 + MWO^2 ) ). The unsuppressed Weak Force strength is the Geometric Part of the force strength.

One half of the Geometric Weak Force Strength is given by ( 4 pi ) ( 4 pi^2 ) / ( pi^3 / 24 )^( 1 / 2 )

( pi^3 / 24 )^( 1 / 2 ) = ( Vol(IV3) )^( 1 / 2 ) is a dimensional normalization factor to reconcile the dimensionality of the Internal Symmetry Space Bounded Domain with the dimensionality of Spacetime Lagrangian Base Manifold.

The geometric force strength, relative to the geometric strength of Einstein-Hilbert Gravity, of the Weak Force is 0.2535

The total force strength of the SU(2) Weak Force, including the suppression factor of the Weak Boson masses squared, is given by  
 $G_w \times M_{\text{proton}}^2 = \text{about } 1.05 \times 10^{(-5)}$

Note that MWO is the mass of the SU(2) WO Weak boson that combines with the U(1) boson by the Higgs mechanism to form the Zo Weak boson and the Photon. MWO is about 98 GeV, MW+ = MW- is about 80 GeV, MZo is about 92 GeV, and the Photon is massless.

## Gluon

The Standard Model SU(3) Color Force bosons ( gluons ) live in a SU(3) subalgebra of the SU(4) subalgebra of D4 = Spin(8). They "see" M4 Physical spacetime as the complex projective plane CP2 whose dimension is 4 and whose volume is  $8 \pi^2 / 3$

Their part of the Physical Lagrangian is

$\int_{CP2}$  SU(3) Color Force Gauge Boson Term  
an integral over SpaceTime CP2.

Schwinger Source for SU(3) Color Force bosons ( gluons ) is the Complex Bounded Domain B6 (ball) with Symmetric Space SU(4) / SU(3)xU(1) and volume  $\pi^3 / 6$  and Shilov Boundary S5 with volume  $4 \pi^3$

The Color Force Strength is given by  
( Vol(CP2) ) ( Vol(S5) / Vol(B6)^( 1 / 4 ) )

Vol(B6)^( 1 / 4 ) is a dimensional normalization factor to reconcile the dimensionality of the Internal Symmetry Space Bounded Domain with the dimensionality of Spacetime Lagrangian Base Manifold.

The force strength, relative to the geometric strength of Einstein-Hilbert Gravity, of the SU(3) Color Force is 0.6286 at the characteristic energy level of the Color Force (about 245 MeV).

The color force strength was calculated using a simple perturbative QCD renormalization group equation at various energies, with the following results:  
Energy Level Color Force Strength

245 MeV	0.6286
5.3 GeV	0.166
34 GeV	0.121
91 GeV	0.106

Taking other effects, such as Nonperturbative QCD, into account, should give a Color Force Strength of about 0.125 at about 91 GeV

Note ( thanks to Carlos Castro for noticing these ) that the volume listed for S5 is for a squashed S5, a Shilov boundary of the complex domain corresponding to the symmetric space SU(4) / SU(3) x U(1) and also that the volume listed for CP2 is unconventional, but physically justified by noting that S4 and CP2 can be seen as having the same physical volume, with the only difference being structure at infinity.

## Conformal Graviton

The Gravity Gauge Bosons (Schwinger-Euclidean versions) live in a Spin(5) subalgebra of the Spin(6) Conformal subalgebra of  $D4 = Spin(8)$ . They "see" M4 Physical spacetime as the 4-sphere  $S^4$  whose dimension is 4 and whose volume is  $8 \pi^2 / 3$

Their part of the Physical Lagrangian is

$\int_{S^4}$  Gravity Gauge Boson Term  
an integral over SpaceTime  $S^4$ .

Schwinger Source for Spin(5) MacDowell-Mansouri Gravity bosons is the Complex Bounded Domain IV5 Lie Ball with Symmetric Space Lie Sphere Spin(7) / Spin(5)xU(1) and volume  $\pi^5 / 2^4 5!$  and Shilov Boundary  $RP^1 \times S^4$  with volume  $8 \pi^3 / 3$

Due to Stabilization of Condensate SpaceTime by virtual Planck Mass Gravitational Black Holes, the effective force strength of Gravity that we see in our experiments is suppressed by the square of the Planck Mass ( $1 / M_{\text{Planck}}^2$ ). The unsuppressed Gravity force strength is the Geometric Part of the force strength.

The Geometric Einstein-Hilbert Gravity Strength is given by  $(\text{Vol}(S^4)) (\text{Vol}(IV5) / \text{Vol}(RP^1 \times S^4))^{1/4}$

$\text{Vol}(RP^1 \times S^4)^{1/4}$  is a dimensional normalization factor to reconcile the dimensionality of the Internal Symmetry Space Bounded Domain with the dimensionality of Spacetime Lagrangian Base Manifold.

The geometric force strength, relative to the geometric strength of Einstein-Hilbert Gravity, of Spin(5) MacDowell-Mansouri Gravity is obviously 1.

The total force strength  $G_{\text{grav}}$  of Spin(5) MacDowell-Mansouri Gravity, including the Planck Mass squared suppression factor, is given by  $G_{\text{grav}} \times M_{\text{proton}}^2 = \text{about } 5 \times 10^{(-39)}$

## **Higgs**

Higgs = Fermion Particle-AntiParticle Condensate,  
especially Truth Quark - Truth AntiQuark

## **Quantum Bohmion**

Quantum Bohmion = spin-2 traceless of 26D World-Line-String Theory

## Quantum Kernel Functions and Schwinger Source Green's Functions

Fock "Fundamental of Quantum Mechanics" (1931) showed that it requires Linear Operators "... represented by a definite integral [of a]... kernel ... function ...".

Hua "Harmonic Analysis of Functions of Several Complex Variables in the Classical Domains" (1958) showed Kernel Functions for Complex Classical Domains.

Schwinger (1951 - see Schweber, PNAS 102, 7783-7788) "... introduced a description in terms of Green's functions, what Feynman had called propagators ... The Green's functions are vacuum expectation values of time-ordered Heisenberg operators, and the field theory can be defined non-perturbatively in terms of these functions ...[which]... gave deep structural insights into QFTs; in particular ... the structure of the Green's functions when their variables are analytically continued to complex values ...".

Wolf (J. Math. Mech 14 (1965) 1033-1047) showed that the Classical Domains (complete simply connected Riemannian symmetric spaces) representing 4-dim Spacetime with Quaternionic Structure are:

$$\begin{aligned} S^1 \times S^1 \times S^1 \times S^1 &= 4 \text{ copies of } U(1) \\ S^2 \times S^2 &= 2 \text{ copies of } SU(2) \\ CP^2 &= SU(3) / SU(2) \times U(1) \\ S^4 &= Spin(5) / Spin(4) = \text{Euclidean version of } Spin(2,3) / Spin(1,3) \end{aligned}$$

**Armand Wyler** (1971 - C. R. Acad. Sc. Paris, t. 271, 186-188) showed how to use **Green's Functions = Kernel Functions** of Classical Domain structures characterizing **Sources = Leptons, Quarks, and Gauge Bosons,** to calculate **Particle Masses and Force Strengths**

Schwinger (1969 - see physics/0610054) said: "... operator field theory ... replace[s] the particle with ... properties ... distributed throughout ... small volumes of three-dimensional space ... particles ... must be created ... even though we vary a number of experimental parameters ... The properties of the particle ... remain the same ... We introduce a quantitative description of the particle source in terms of a source function ... we do not have to claim that we can make the source arbitrarily small ... the experimenter... must detect the particles ...[by]... collision that annihilates the particle ... the source ... can be ... an abstraction of an annihilation collision, with the source acting negatively, as a sink ... The basic things are ... the source functions ... describing the intermediate propagation of the particle ...".

**Creation and Annihilation operators** indicate a Clifford Algebra, and 8-Periodicity shows that the basic Clifford Algebra is formed by tensor products of 256-dim  $Cl(8)$  such as  $Cl(8) \times Cl(8) = Cl(16)$  containing 248-dim  $E_8 = 120\text{-dim } D_8 + 128\text{-dim } D_8$  half-spinor whose maximal contraction is a realistic generalized Heisenberg Algebra

$$h_{92} \times A_7 = 5\text{-graded } 28 + 64 + ((SL(8, R) + 1) + 64 + 28$$



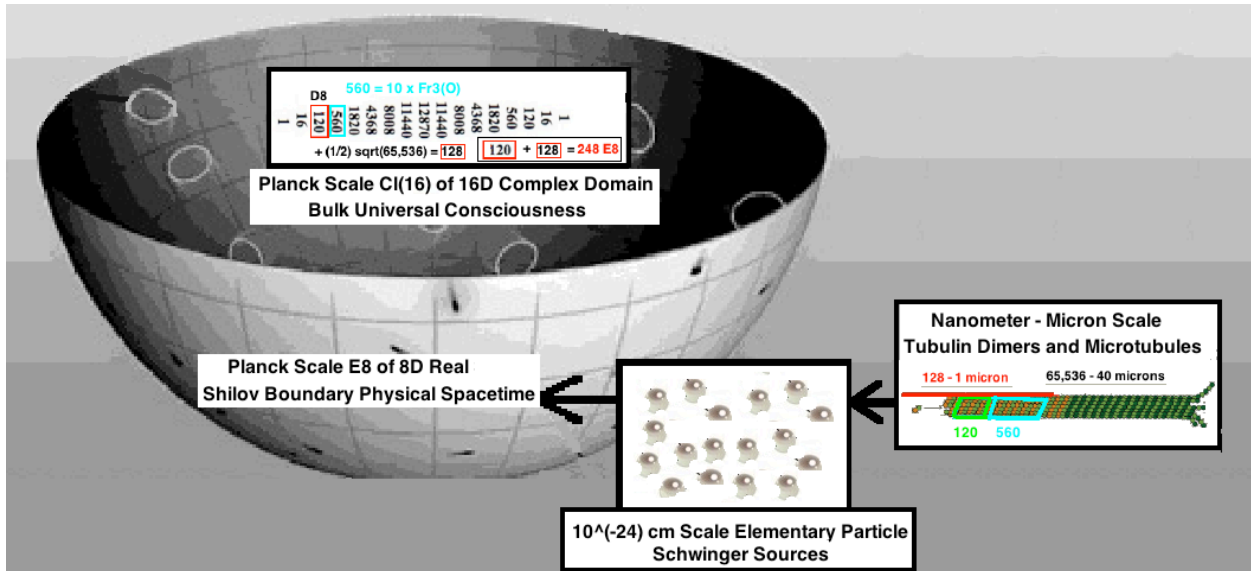

In E8-Cl(16) Physics **Spacetime is the 8-dimensional Shilov Boundary RP1 x S7** of the **Type IV8 Bounded Complex Domain Bulk Space** of the Symmetric Space Spin(10) / Spin(8)xU(1) which **Bulk Space** has 16 Real dimensions and is the Vector Space of the Real Clifford Algebra Cl(16).

By 8-Periodicity,

Cl(16) = tensor product Cl(8) x Cl(8) = Real 256x256 Matrix Algebra M(R,256) and so has 256x256 = 65,536 elements.

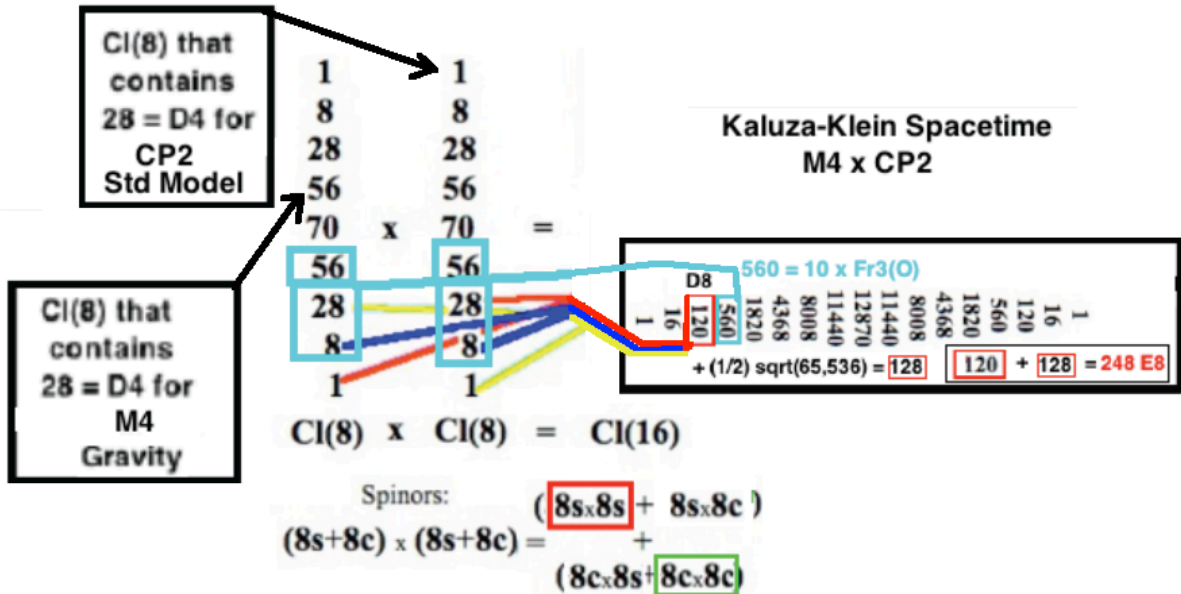

Cl(8) has 8 Vectors, 28 BiVectors, and 16 Spinors with 8+28+16 = 52 = F4 Lie Algebra and has 56 TriVectors for the Fr3(O) Freudenthal Algebra of World-Line String Theory.

Cl(16) has 120 BiVectors, and 128 Half-Spinors with 120+128 = 248 = E8 Lie Algebra, and has 560 TriVectors for 10 copies of Fr3(O).

The 248 E8 elements of Cl(16) define a Lagrangian for the Standard Model and for Gravity - Dark Energy so that  $65,536 - 248 - 560 = 64,728$  elements of Cl(16) can carry Bits of Information.

The Complex Bulk Space Cl(16) contains the Maximal Contraction of E8 which is  $H_{92} + A_7$  a generalized Heisenberg Algebra of Quantum Creation-Annihilation Operators with graded structure

$$28 + 64 + ((SL(8,R)+1) + 64 + 28$$

We live in the Physical Minkowski M4 part of Kaluza-Klein M4 x CP2 structure of  $RP^1 \times S^7$  **Boundary**.

(where  $CP^2 = SU(3) / SU(2) \times U(1)$  is Internal Symmetry Space of Standard Model gauge groups)

Our Consciousness is based on Binary States of Tubulin Dimers (each 4x4x8 nm size) in Microtubules.

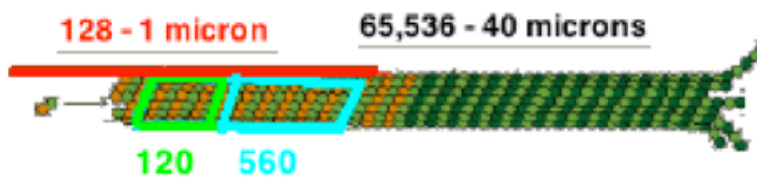

Microtubules are cylinders of sets of 13 Dimers with maximal length about 40,000 nm so that each Microtubule can contain about  $13 \times 40,000 / 8 = 65,000$  Bits of Information. The Physical Boundary in which we live is a Real Shilov Boundary in which E8 is manifested as Lagrangian Structure of Real Forms of E8 with Lagrangian Symmetric Space structure:

E8 / D8 = (OxO)P2 for 8 First-Generation Fermion Particles and 8 First-Generation Fermion AntiParticles (8 components of each)  
D8 / D4 x D4 for 8-dim spacetime paths, one for each of 8 Fermion Types  
D4 for Standard Model Gauge Bosons and Gravity - Dark Energy Ghosts  
D4 for Gravity - Dark Energy Gauge Bosons, Propagator Phase, and Standard Model Ghosts

Microtubule Information in the Physical Shilov Boundary has Resonant Connection to Cl(16) Information in Bulk Complex Domain Spacenby the spin-2 Bohm Quantum Potential with Sarfatti Back-Reaction of 26D String Theory of World-Lines consistent with Poisson Kernel as derivative of Green's function.

The Bulk Space Complex Domain Type IV8 corresponds to the Symmetric Space  $Spin(10) / Spin(8) \times U(1)$  and is a Lie Ball whose Shilov Boundary  $RP^1 \times S^7$  is a Lie Sphere 8-dim Spacetime. It is related to the Stiefel Manifold  $V(10,2) = Spin(10) / Spin(8)$  of dimension  $20-3 = 17$  by the fibration

$$Spin(10) / Spin(8) \times U(1) \rightarrow V(10,2) \rightarrow U(1)$$

It can also be seen as a tube  $z = x + iy$  whose imaginary part is physically inverse momentum so that its points give both position and momentum (see R. **Coquereaux** Nuc. Phys. B. 18B (1990) 48-52 "Lie Balls and Relativistic Quantum Fields").

In "Harmonic Analysis of Functions of Several Complex Variables in the Classical Domains" L. K. **Hua** said: "... Editor's Foreword ... M. I. Graev ...

Poisson kernel can be defined in group-theoretic terms. Let  $\mathfrak{R}$  be one of the domains considered in the book, and  $\mathfrak{C}$  its characteristic manifold. Let  $z$  be a point in  $\mathfrak{R}$  and  $C_z$  the group of those analytic automorphisms of  $\mathfrak{R}$  which leave  $z$  invariant. It can be shown that the group  $C_z$  is transitive on  $\mathfrak{C}$ , i.e., transforms any point of  $\mathfrak{C}$  into any other point. The measure on  $\mathfrak{C}$  which is invariant under the transformations in  $C_z$  is then simply equal to the Poisson kernel.

...[ Characteristic Manifold = Shilov Boundary ]...

In 1935, E. Cartan [1] proved that there exist only six types of irreducible homogeneous bounded symmetric domains. Beside the four types, RI, RII, RIII, RIV there exist only two; their dimensions are 16 and 27.  
 [ 16-Complex-Dimensional  $E_6 / Spin(10) \times U(1) = (C \times O)P_2$   
 27-Complex-Dimensional  $E_7 / E_6 \times U(1) = J(3, (C \times O))$  ]

The domain  $\mathfrak{R}_{IV}$  of  $n$ -dimensional ( $n > 2$ ) vectors

$$z = (z_1, z_2, \dots, z_n)$$

( $z_k$  are complex numbers) satisfying the conditions:

$$|zz'|^2 + 1 - 2zz' > 0, \quad |zz'| < 1.$$

The complex dimension of the four domains is  $mn, n(n+1)/2, n(n-1)/2, n$ .

The author has shown (cf. L. K. Hua [3]) that  $\mathfrak{R}_{IV}$  can also be regarded as a homogeneous space of  $2 \times n$  real matrices. Therefore, the study of all these domains can be reduced to a study of the geometry of matrices.

The manifolds  $\mathfrak{C}_I, \mathfrak{C}_{II}, \mathfrak{C}_{III}$  and  $\mathfrak{C}_{IV}$  have real dimension  $m(2n-m), n(n+1)/2, n(n-1)/2 + (1+(-1)^n)(n-1)/2$  and  $n$ , respectively.

The characteristic manifold of the domain  $\mathfrak{R}_{IV}$  consists of vectors of the form  $e^{i\theta}x$ , where  $0 \leq \theta \leq \pi$ , and  $x = (x_1, \dots, x_n)$  is a real vector which satisfies the condition  $xx' = 1$ .

$$H(z, \theta, x) = \frac{1}{V(\mathfrak{C}_{IV}) [(x - e^{-i\theta}z)(x - e^{-i\theta}z)']^{n/2}},$$

the magnitude of the volume  $V(\mathfrak{C}_{IV})$ : 
$$V(\mathfrak{C}_{IV}) = \frac{2\pi^{\frac{n}{2}+1}}{\Gamma\left(\frac{n}{2}\right)}.$$

The Bergman kernel of the domain  $\mathfrak{R}_{IV}$  is

$$\frac{1}{V(\mathfrak{R}_{IV})} (1 + |zz'|^2 - 2\bar{z}z')^{-n},$$

where,  $V(\mathfrak{R}_{IV}) = \frac{\pi^n}{2^{n-1} \cdot n!}.$

THE POISSON KERNEL FOR  $\mathfrak{R}_{IV}$

$$P(z, \xi) = \frac{1}{V(\mathfrak{R}_{IV})} \cdot \frac{(1 + |zz'|^2 - 2\bar{z}z')^{\frac{n}{2}}}{|(z - \xi)(z - \xi)'|^n},$$

where  $\xi \in \mathfrak{E}_{IV}.$

HARMONIC ANALYSIS ON LIE SPHERES

$$\int_{\mathfrak{R}_{IV}} |zz'|^{2l} \Phi_{f-2l}(z, \bar{z}) \bar{z}$$

$$= (N_{f-2l} - N_{f-2l-2}) \frac{l \Gamma(n) \Gamma\left(\frac{n}{2} + 1\right) \Gamma\left(f + \frac{n}{2} - l\right)}{2\pi^{\frac{n}{2}} \Gamma\left(l + \frac{n}{2} + 1\right) \Gamma(f + n - l)} V(\mathfrak{R}_{IV}).$$

...

In Annals of Mathematics 55 (1952) 19-33 P. R. **Garabedian** said “...

we turn here to a more direct development of the theory of boundary value problems associated with the Cauchy-Riemann equations for analytic functions of several complex variables.

This boundary value problem is solved by means of a Dirichlet principle, and we introduce a Green's function in terms of which the solution can be expressed as a boundary integral. A formula giving the Bergman kernel function for several variables [1] in terms of this Green's function is obtained, and we thus generalize known theorems from the theory of functions of one complex variable

for analytic functions of several complex variables.

Bergman [1] defines a kernel function  $k(z, t)$ , analytic in  $z$  and  $\bar{t}$  for  $z, t \in D$

**THEOREM 3.** *The analytic kernel function  $k(z, t)$  with*

$$g(t) = \int_D g(z) \overline{k(z, t)} d\tau$$

*for each analytic function  $g$  in  $D$  has the representation*

*$k(z, t) = \Delta_z \theta(z, t)$  in terms of the Green's function  $\theta(z, t)$ .*

...”

E8 Physics constructs the **Lagrangian** integral such that the **mass m emerges as the integral over the Schwinger Source spacetime region** of its Kerr-Newman cloud of virtual particle/antiparticle pairs plus the Valence Fermion so that the volume of the Schwinger Source fermion defines its mass, which, being dressed with the particle/antiparticle pair cloud, gives **quark mass as constituent mass**.

**Armand Wyler used Harmonic Geometry to calculate:**

**Fermion masses** as a product of four factors:

$$V(\text{Qfermion}) \times N(\text{Graviton}) \times N(\text{octonion}) \times \text{Sym}$$

$V(\text{Qfermion})$  is the volume of the part of the half-spinor fermion particle manifold  $S^7 \times \mathbb{R}P^1$  related to the fermion particle by photon, weak boson, or gluon interactions.

$N(\text{Graviton})$  is the number of types of  $\text{Spin}(0,5)$  graviton related to the fermion.

$N(\text{octonion})$  is an octonion number factor relating up-type quark masses to down-type quark masses in each generation.

$\text{Sym}$  is an internal symmetry factor, relating 2nd and 3rd generation massive leptons to first generation fermions. It is not used in first-generation calculations.

**Force Strengths** are made up of two parts:

the relevant spacetime manifold of gauge group global action

the  $U(1)$  photon sees 4-dim spacetime as  $T^4 = S^1 \times S^1 \times S^1 \times S^1$

the  $SU(2)$  weak boson sees 4-dim spacetime as  $S^2 \times S^2$

the  $SU(3)$  weak boson sees 4-dim spacetime as  $CP^2$

the  $\text{Spin}(5)$  of gravity sees 4-dim spacetime as  $S^4$

and

the volume of the Shilov boundary corresponding to the symmetric space with local symmetry of the gauge boson. The nontrivial Shilov boundaries are:

for  $SU(2)$  Shilov =  $\mathbb{R}P^1 \times S^2$

for  $SU(3)$  Shilov =  $S^5$

for  $\text{Spin}(5)$  Shilov =  $\mathbb{R}P^1 \times S^4$

Schwinger Sources as described above are continuous manifold structures of Bounded Complex Domains and their Shilov Boundaries but the E8-Cl(16) model at the Planck Scale has spacetime condensing out of Clifford structures forming a Lorentz Leech lattice underlying 26-dim String Theory of World-Lines with  $8 + 8 + 8 = 24$ -dim of fermion particles and antiparticles and of spacetime. **The automorphism group of a single 26-dim String Theory cell modulo the Leech lattice is the Monster Group of order about  $8 \times 10^{53}$ .**

The Monster Group is of order  
 8080 , 17424, 79451, 28758, 86459, 90496, 17107, 57005, 75436, 80000, 00000  
 =  
 $2^{46} \cdot 3^{20} \cdot 5^9 \cdot 7^6 \cdot 11^2 \cdot 13^3 \cdot 17 \cdot 19 \cdot 23 \cdot 29 \cdot 31 \cdot 41 \cdot 47 \cdot 59 \cdot 71$   
 or about  $8 \times 10^{53}$

This chart (from Wikipedia) shows the Monster M and other Sporadic Finite Groups

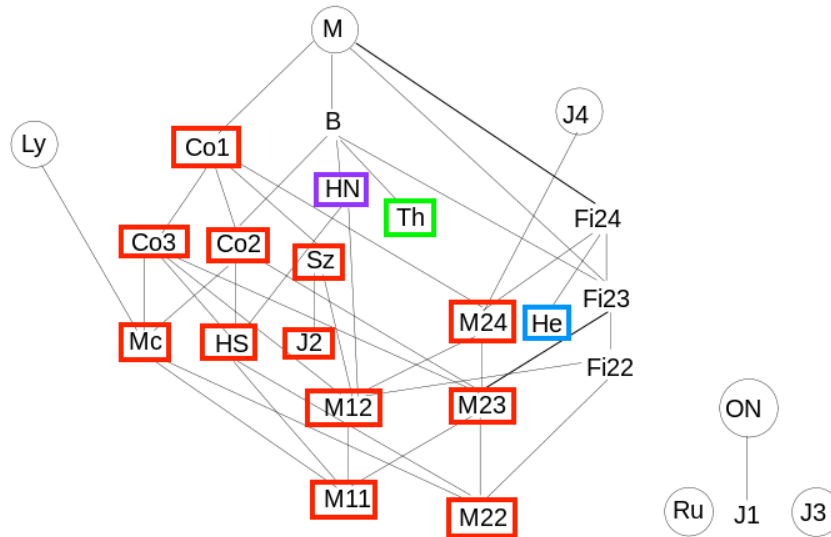

The order of Co1 is  $2^{21} \cdot 3^9 \cdot 5^4 \cdot 7^2 \cdot 11 \cdot 13 \cdot 23$  or about  $4 \times 10^{18}$ .

Aut(Leech Lattice) = double cover of Co1.

The order of the double cover  $2 \cdot \text{Co1}$  is  $2^{22} \cdot 3^9 \cdot 5^4 \cdot 7^2 \cdot 11 \cdot 13 \cdot 23$  or about  $0.8 \times 10^{19}$ .

Taking into account the non-sporadic part of the Leech Lattice symmetry

according to the ATLAS at [brauer.maths.qmul.ac.uk/Atlas/v3/spor/M/](http://brauer.maths.qmul.ac.uk/Atlas/v3/spor/M/)

the Schwinger Source Kerr-Newman Cloud Symmetry  $s 2^{(1+24)} \cdot \text{Co1}$

of order  $139511839126336328171520000 = 1.4 \times 10^{26}$

Co1 and its subgroups account for 12 of the 19 subgroups of the Monster M.

Of the remaining 7 subgroups, Th and He are independent of the Co1 related

subgroups and HN has substantial independent structure.

Th = Thompson Group. Wikipedia says "... Th ... was ... constructed ... as the automorphism group of a certain lattice in the 248-dimensional Lie algebra of E8.

It does not preserve the Lie bracket of this lattice, but

does preserve the Lie bracket mod 3, so is a subgroup of the Chevalley group E8(3).

The subgroup preserving the Lie bracket (over the integers) is a maximal

subgroup of the Thompson group called the Dempwolff group (which unlike the

Thompson group is a subgroup of the compact Lie group E8) ...

the Thompson group acts on a vertex operator algebra over the field with 3 elements.

This vertex operator algebra contains the E8 Lie algebra over  $\mathbf{F}_3$ ,

giving the embedding of Th into E8(3) ...

The Schur multiplier and the outer automorphism group of ... Th ... are both trivial.

Th is a sporadic simple group of order  $215 \cdot 310 \cdot 53 \cdot 72 \cdot 13 \cdot 19 \cdot 31$

$= 90745943887872000 \approx 9 \times 10^{16}$  ...".

He = Held Group. Wikipedia says "... The smallest faithful complex representation has dimension 51; there are two such representations that are duals of each other.

It centralizes an element of order 7 in the Monster group. ...

the prime 7 plays a special role in the theory of the group ...

the smallest representation of the Held group over any field is

the 50 dimensional representation over the field with 7 elements ...

He ... acts naturally on a vertex operator algebra over the field with 7 elements ...

The outer automorphism group has order 2 and the Schur multiplier is trivial. ...

He is a sporadic simple group of order  $210 \cdot 33 \cdot 52 \cdot 73 \cdot 17$

$= 4030387200 \approx 4 \times 10^9$  ...".

HN = Harada-Norton Group. Wikipedia says "... The prime 5 plays a special role ...

it centralizes an element of order 5 in ... the Monster group ...and as a result acts

naturally on a vertex operator algebra over the field with 5 elements ... it acts on

a 133 dimensional algebra over  $\mathbf{F}_5$  with a commutative but nonassociative product ...

Its Schur multiplier is trivial and its outer automorphism group has order 2 ...

HN is a sporadic simple group of order  $2^{14} \cdot 3^6 \cdot 5^6 \cdot 7 \cdot 11 \cdot 19$

$= 273030912000000 \approx 3 \times 10^{14}$  ...

HN has an involution whose centralizer is of the form  $2.HS.2$ , where HS is the Higman-Sims group ... of order  $2^9 \cdot 3^2 \cdot 5^3 \cdot 7 \cdot 11 = 44352000 \approx 4 \times 10^7$  ... [whose] Schur multiplier has order 2 ... [and whose] outer automorphism group has order 2 ... HS is ... a subgroup of ... the Conway groups  $Co_0$ ,  $Co_2$  and  $Co_3$  ...".

$Co_1 \times Th \times He \times HN / HS$  together have order about  $4 \times 9 \times 4 \times 10^{(18+16+9+7)}$   
= about  $10^{52}$  which is close to the order of  $M =$  about  $10^{54}$ .

The components of the Monster Group describe the composition of Schwinger Sources:

$Co_1$  gives the number of particles in the Schwinger Source Kerr-Newman Cloud emanating from a Valence particle in a Planck-scale cell of E8 Physics SpaceTime.

$Th$  gives the 3-fold E8 Triality structure relating 8-dim SpaceTime to First-Generation Fermion Particles and AntiParticles.

$He$  gives the 7-fold algebraically independent Octonion Imaginary E8 Integral Domains that make up 7 of the 8 components of Octonion Superposition E8 SpaceTime.

$HN / HS$  gives the 5-fold symmetry of 120-element Binary Icosahedral E8 McKay Group beyond the 24-element Binary Tetrahedral E6 McKay Group at which level the Shilov Boundaries of Bounded Complex Domains emerge to describe SpaceTime and Force Strengths and Particle Masses.

**When a fermion particle/antiparticle appears in E8 spacetime** it does not remain a single Planck-scale entity because **Tachyons create a cloud of particles/antiparticles**. The cloud is one Planck-scale Fundamental Fermion Valence Particle plus an effectively neutral cloud of particle/antiparticle pairs forming a Kerr-Newman black hole. That cloud constitutes the **Schwinger Source**. Its **structure comes from the 24-dim Leech lattice part of the Monster Group which is**

**$2^{(1+24)}$  times the double cover of  $Co_1$ , for a total order of about  $10^{26}$ .**

Since a Leech lattice is based on copies of an E8 lattice and since there are 7 distinct E8 integral domain lattices there are 7 (or 8 if you include a non-integral domain E8 lattice) distinct Leech lattices. The physical Leech lattice is a superposition of them, effectively adding a factor of 8 to the order.

The volume of the Kerr-Newman Cloud is on the order of  $10^{27}$  x Planck scale, so the Kerr-Newman Cloud **Source should contain about  $10^{27}$  particle/antiparticle pairs and its size should be about  $10^{(27/3)} \times 1.6 \times 10^{(-33)}$  cm = roughly  $10^{(-24)}$  cm.**



## Schwinger Source QuasiCrystal Internal Structure

Above the scale of Schwinger Sources (  $10^{-24}$  cm ) E8-CI(16) Physics structures such as Spacetime, Symmetric Spaces, and Bounded Complex Domains and their Shilov Boundaries, are well approximated by smooth manifolds so that the geometric techniques of Amand Wyler give good results for force strengths, particle masses, etc.

Below the scale of Schwinger Sources (  $10^{-24}$  cm down to Planck  $10^{-33}$  cm ) the fundamental structures are E8 lattices and QuasiCrystals derived therefrom. Planck Scale is about  $10^{-33}$  cm. Schwinger Souce Scale is about  $10^{-24}$  cm, a scale about  $10^9$  larger than the Planck Scale.

The 240 E8 Root Vector Vertices of each cell of 8D E8-CI(16) Physics Spacetime can be represented in 2D as done by Ray Aschheim

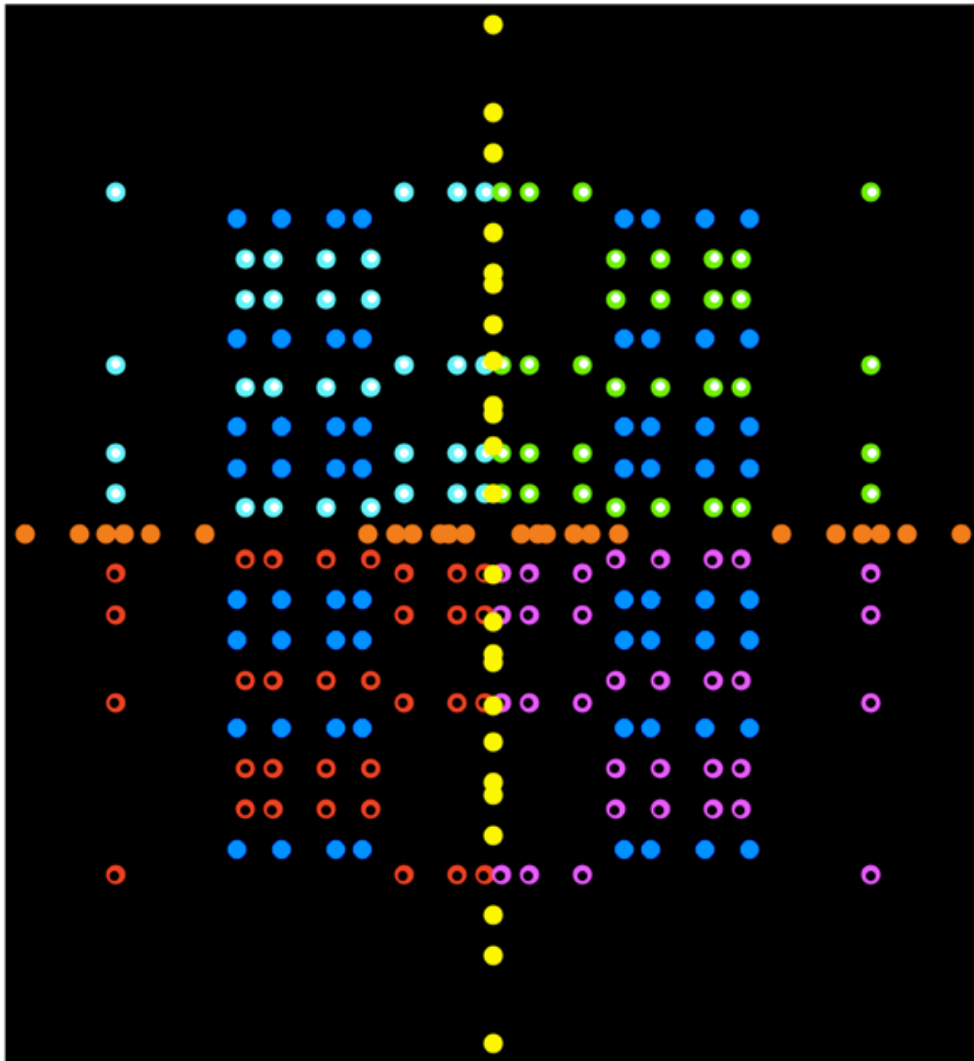

The E8-CI(16) Physical interpretation of the 240 E8 Root Vectors is

## E8 / D8 for 8-dim Spacetime components of 8+8 First-Generation Fermions

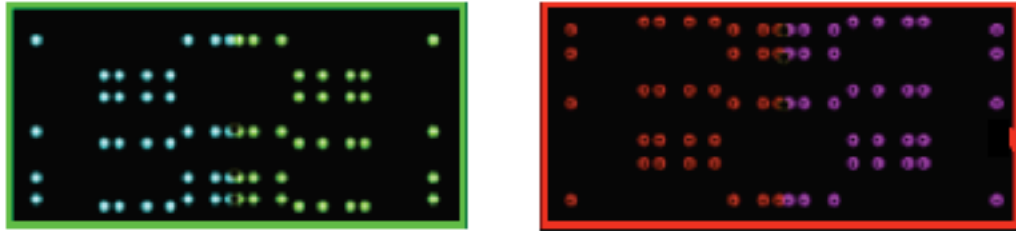

Green and Cyan dots with white centers (32+32 = 8x8 dots)  
for Fermion Particles

and

Red and Magenta dots with black centers (32+32 = 8x8 dots)  
for Fermion AntiParticles

## D8 / D4 x D4 for Spacetime Superposition of 8 types of E8 Lattice

The 64 generators (8x8 = 64 blue dots) correspond to an 8-dim base manifold of an E8 Lagrangian in which Spacetime 8V of 26D String Theory is represented by 8-branes whose Planck-Scale Lattice Structure is that of a superposition of 8 types of E8 Lattice: 7 E8 Integral Domains corresponding to the 7 Imaginary Octonion Basis Elements and 1 E8 Lattice (not an Integral Domain - Kirmse's Mistake) corresponding to the Octonion Real Axis. The 64 Blue Root Vectors of the space D8 / D4 x D4 also represent the  $A_{7+1} = SL(8, R) + 1$  in the Maximal Contraction Heisenberg Algebra of E8 with structure  $28 + 64 + (A_{7+1}) = 64 + 28$  where  $A_7$  is Unimodular  $SL(8, R)$  Gravity.

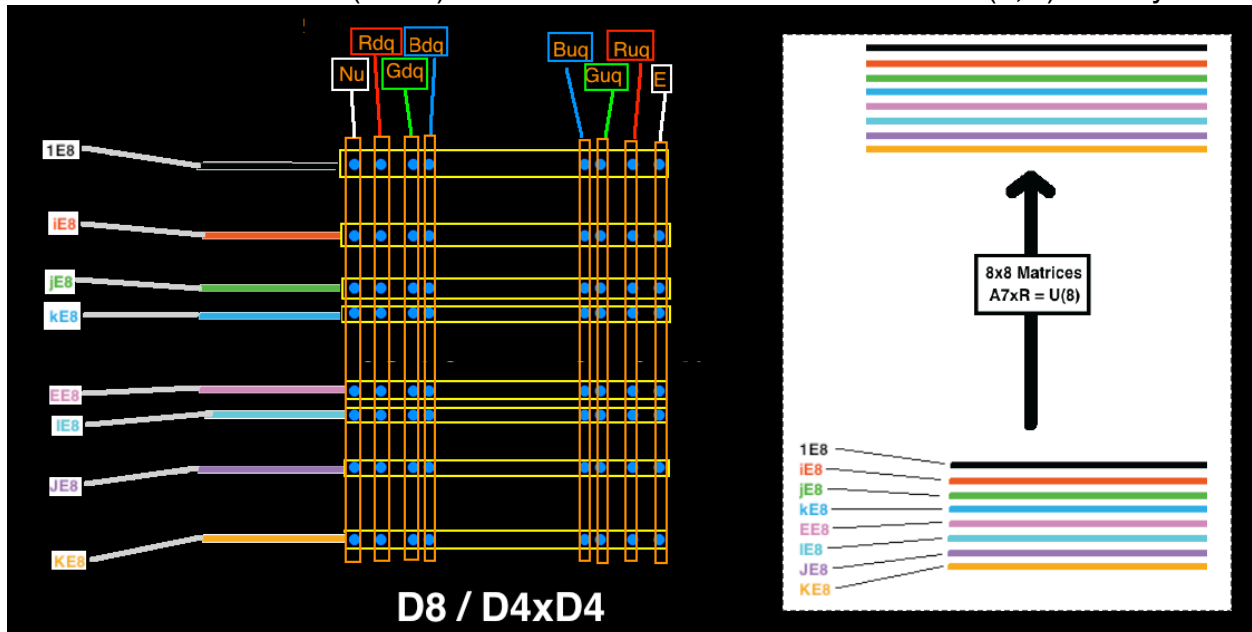

The map from one 8-brane superposition to the next is by 8x8 Matrices representing the central grade-0 part  $A_{7+1}$  of the Heisenberg Maximal Contraction Algebra of E8,

## D4 for Gravity - Dark Energy Gauge Bosons and Standard Model Ghosts

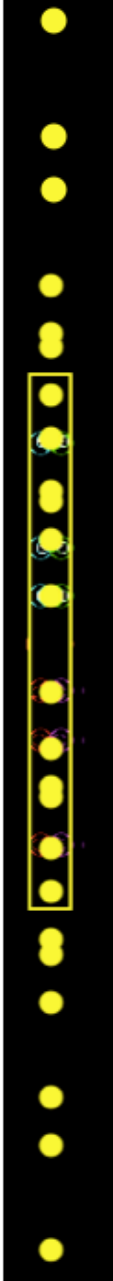

The 24 Yellow Root Vectors of the D4 of E8 Gravity + Standard Model Ghosts are on the Vertical Y-axis.

12 of them in the Yellow Box represent the 12 Root Vectors of the Conformal Gauge Group  $SU(2,2) = Spin(2,4)$  of Conformal Gravity + Dark Energy.

The 4 Cartan Subalgebra elements of  $SU(2,2) \times U(1) = U(2,2)$  correspond to the 4 Cartan Subalgebra elements of D4 of E8 Gravity + Standard Model Ghosts and to the other half of the 8 Cartan Subalgebra elements of E8.

The other  $24 - 12 = 12$  Yellow Root Vectors represent Ghosts of 12D Standard Model whose Gauge Groups are  $SU(3) SU(2) U(1)$ .

Gravity and Dark Energy come from its Conformal Subgroup  $SU(2,2) = Spin(2,4)$   
(see Appendix - Details of Conformal Gravity and ratio DE : DM : OM)

$SU(2,2) = Spin(2,4)$  has 15 generators:

1 Dilation representing Higgs Ordinary Matter

4 Translations representing Primordial Black Hole Dark Matter

10 = 4 Special Conformal + 6 Lorentz representing Dark Energy  
(see Irving Ezra Segal, "Mathematical Cosmology and Extragalactic Astronomy" (Academic 1976))

The basic ratio Dark Energy : Dark Matter : Ordinary Matter =  $10:4:1 = 0.67 : 0.27 : 0.06$   
When the dynamics of our expanding universe are taken into account, the ratio is calculated to be **0.75 : 0.21 : 0.04**

The  $U(1)$  of  $SU(2,2) \times U(1) = U(2,2)$  represents the Propagator Phase Internal Clock

## D4 for Standard Model Gauge Bosons and Gravity - Dark Energy Ghosts

The 24 Orange Root Vectors of the D4 of E8 Standard Model + Gravity Ghosts are on the Horizontal X-axis.



8 of them in the Orange Box represent the 8 Root Vectors of the Standard Model Gauge Groups SU(3) SU(2) U(1).

Their 4 Cartan Subalgebra elements correspond to the 4 Cartan Subalgebra elements of D4 of E8 Standard Model + Gravity Ghosts and to half of the 8 Cartan Subalgebra elements of E8.

The other 24-8 = 16 Orange Root Vectors represent Ghosts of 16D U(2,2) which contains the Conformal Group SU(2,2) = Spin(2,4) that produces Gravity + Dark Energy by the MacDowell-Mansouri mechanism.

Standard Model Gauge groups come from CP2 = SU(3) / SU(2) x U(1)

(as described by Batakis in Class. Quantum Grav. 3 (1986) L99-L105)

Electroweak SU(2) x U(1) is gauge group as isotropy group of CP2.

SU(3) is global symmetry group of CP2 but due to Kaluza-Klein M4 x CP2 structure of compact CP2 at every M4 spacetime point, it acts as Color gauge group with respect to M4.

Here is how the 240 E8 Root Vectors define an 8D Lagrangian:

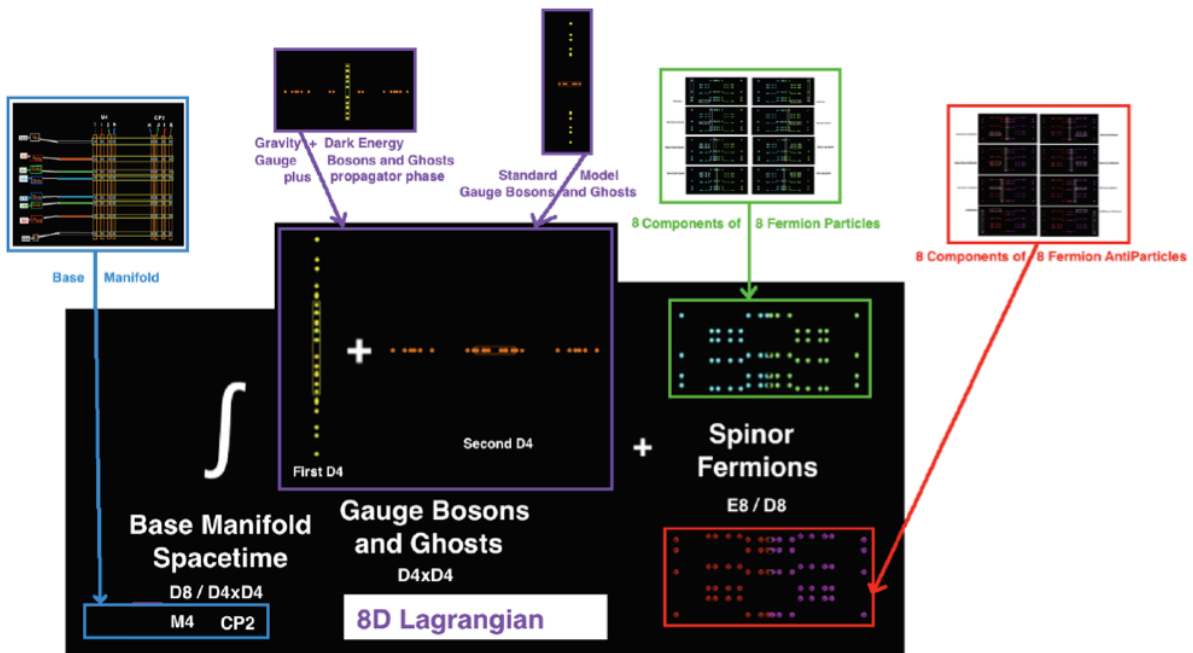

Here is how the 8D Lagrangian goes to 4D Lagrangian of M4 x CP2 Kaluza-Klein so that the Higgs and Fermion Generations 2 and 3 emerge:

# Lagrangian

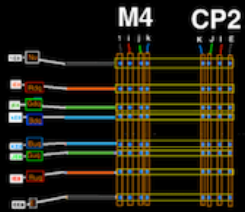

A7+1  
D8 / D4xD4

**Mayer Mechanism**

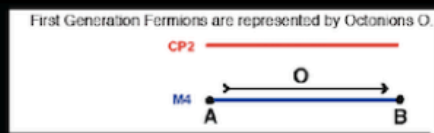

3 Kaluza-Klein  
Fermion Generations

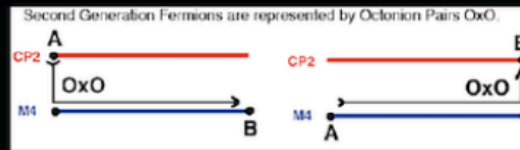

**HIGGS**

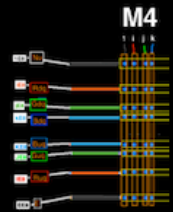
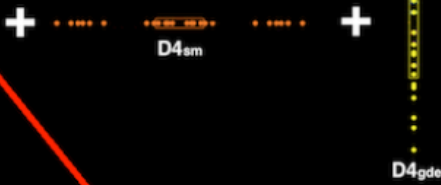

**NJL**  
Higgs as  
Condensate of  $T \bar{T}$

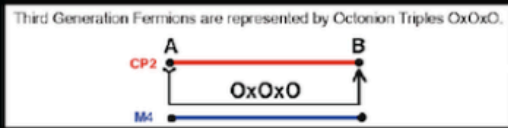

RGB Truth Quarks

RGB Truth AntiQuarks

This mapping of the shell structure of a full E8 Lattice is adapted from the book "Geometrical Frustration" by Sadoc and Mosseri

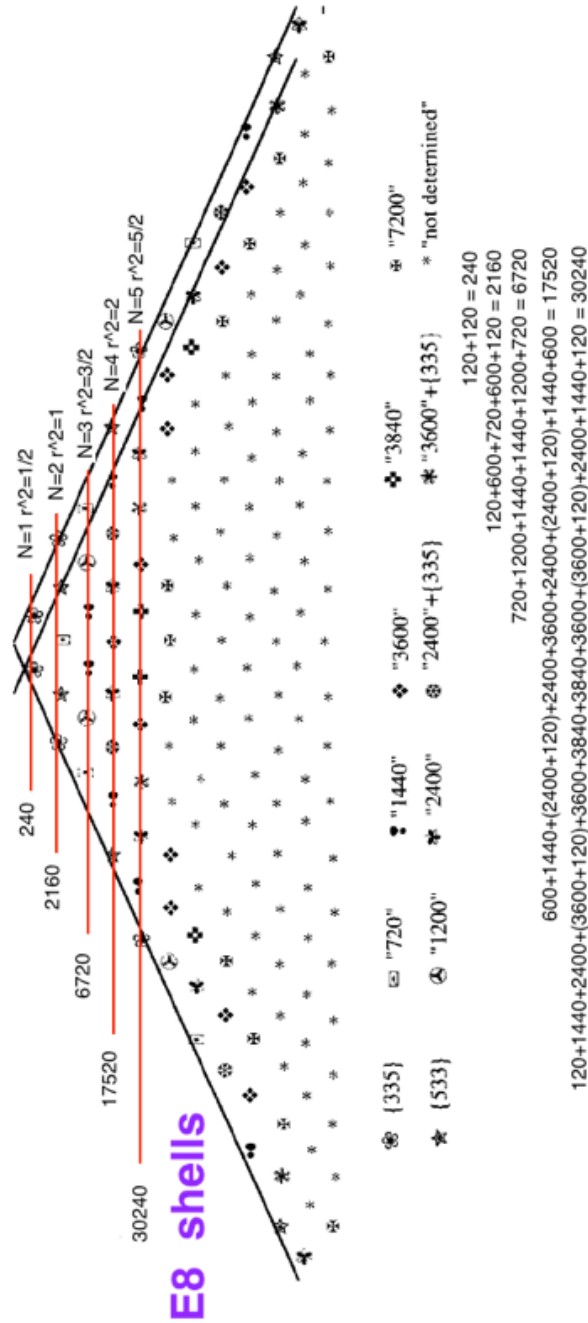

**If you consider only the Root Vectors neighboring the Origin of the Lattices,**  
 that is, only the first Lattice shell, then you see that  
 the 240 Root Vectors of E8 are made up of two copies of the 120 Root Vectors of H4

One H4 describes the Standard Model and is related to CP2 of M4 x CP2 Kaluza-Klein.

The other describes Conformal Gravity + Dark Energy and U(1) Propagator Phase  
 and is related to M4 of M4 x CP2 Kaluza-Klein.

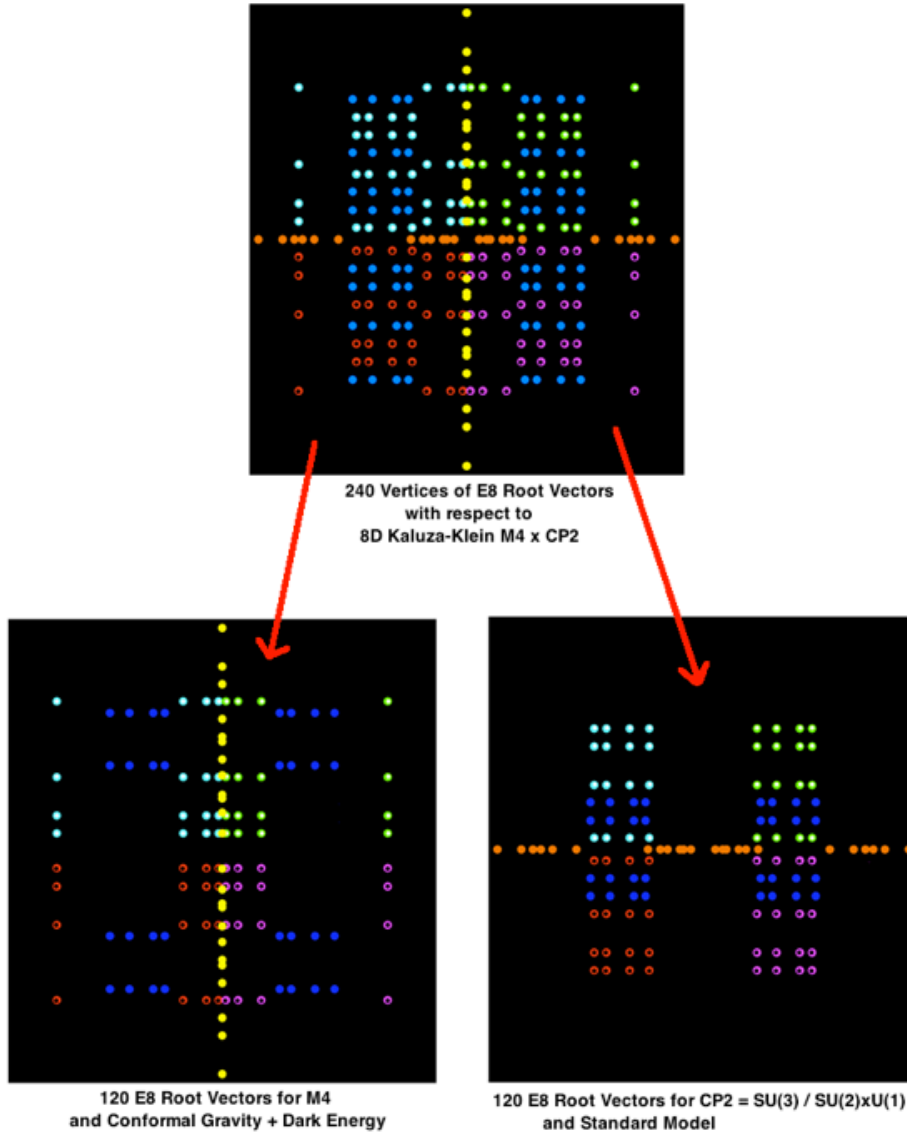

The 120 Root Vectors for H4 tiling of M4 Minkowski Physical Spacetime (H4 M4)  
 and  
 the 120 Root Vectors for H4 tiling of CP2 Internal Symmetry Space (H4 CP2)  
 form two 600-cells, one with Golden Ratio edge length (define it to be for M4)  
 and the other with Unit edge length (define it to be for CP2)

To see the internal structure of a Schwinger Source look at the M4 part of M4 x CP2 Kaluza-Klein Spacetime and choose a Fermion Type whose Schwinger Source structure you want to see (for example, Electron).

First, chose only those E8 Lattice vertices with CP2 coordinates = zero so that you have only M4 coordinates being non-zero. Here is a schematic diagram of how E8 Lattice breaks down into H4 CP2 Lattice and H4 M4 Lattice

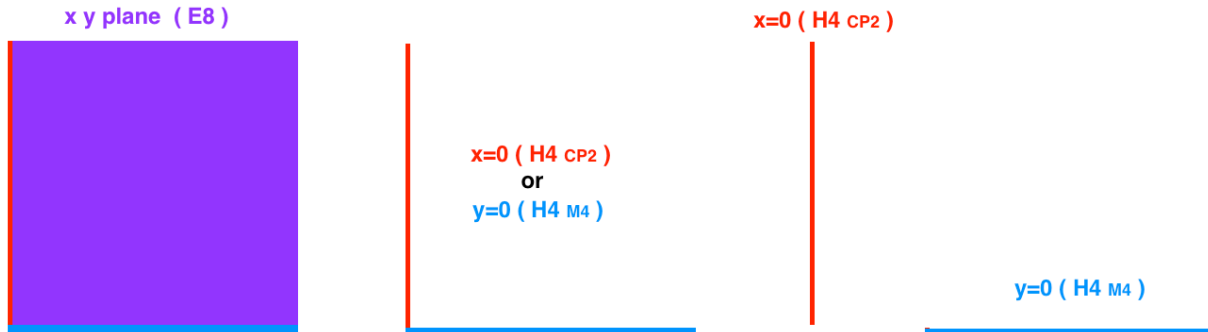

Then project from 8D E8 Lattice space to 4D H4 Lattice space for M4 in which each 4D H4 Lattice vertex is surrounded by 120 vertices at Golden Ratio distance from the origin point.

Then select the Fermion (Electron in this example) that is located at the M4 coordinates of the origin point.

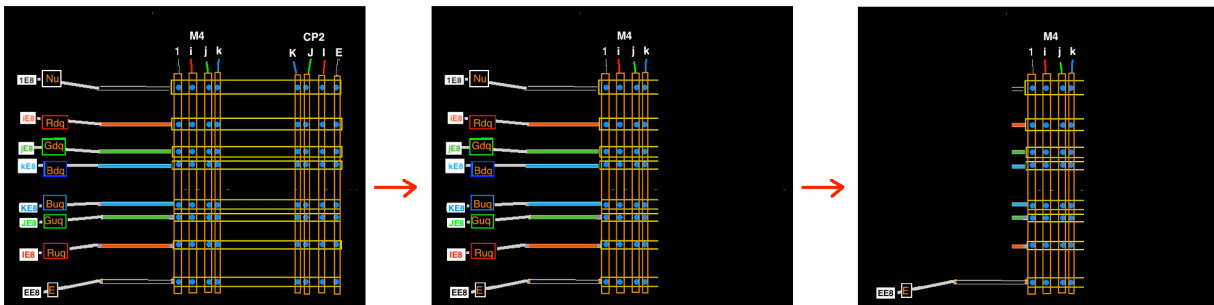

The image on the far right is the representation of

**a Valence Electron at the M4 coordinates of the origin point**

which is surrounded by its 120 nearest-neighbor vertices which are all at Golden Ratio distance and which form a 600-cell



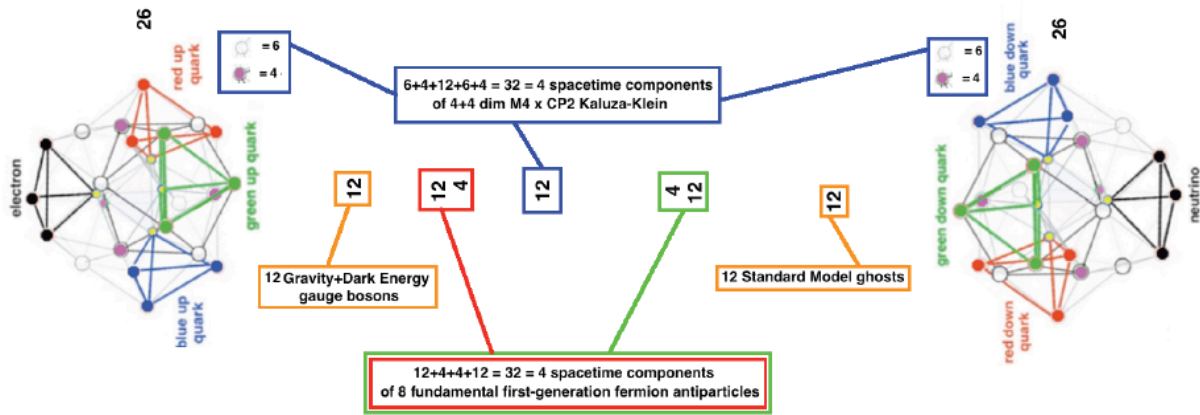

in which the Electron and its M4 coordinates are represented by the Tetrahedron of 4 vertices at the top (far left) of the 600-cell.

A more detailed view how full E8 Lattice breaks down into full H4 CP2 Qiasicrystal Lattice and full H4 M4 Quasicrystal Lattice is shown on the following page, where you can see some interesting phenomena, such as:

The E8 lattice (interior of the diagram) is periodic, a property inherited from its 8-dimensional structure.

Both the H4 M4 and H4 CP2 Lattices are Fibonacci-type Quasicrystals with chain structure L S L L S L S L L S ... inherited from the fact that some E8 lattice lines are longer than the preceding line by 2 and others are longer by 4.

All the things in the H4 M4 Fibonacci Chain are Golden Ratio larger than the corresponding things in the H4 CP2 Fibonacci Chain.

The H4 CP2 Quasicrystal determines the Standard Model Internal Symmetry of its Schwinger Source through  $CP2 = SU(3) / SU(2) \times U(1)$ .

The H4 M4 Quasicrystal determines the Spacetime Properties, including filling the volume, of the Schwinger Source through the Conformal  $U(2,2)$  symmetry.

The size and volume of the Schwinger Source ( $10^{-24}$  cm and  $10^{27}$  particle-antiparticle pairs) is imposed on the H4 M4 Quasicrystal by the Monster symmetry of Lattice Spacetime at the Planck scale, and then imposed on the H4 CP2 Quasicrystal by symmetry with H4 M4.

The Indra Net mirroring ability of each of the  $10^{27}$  virtual elements of a Schwinger Source is of the order of the Monster Group of the Spacetime Lattice Cell of the Valence H4 M4 600-cell which is on the order of  $10^{53}$ , so that the total mirroring capacity of a single Schwinger Source is  $10^{27} \times 10^{53} = 10^{80}$  which is enough mirroring capacity to maintain an Indra's Net Blockchain System of all the particles in Our Universe.

H4 CP2

H4 M4

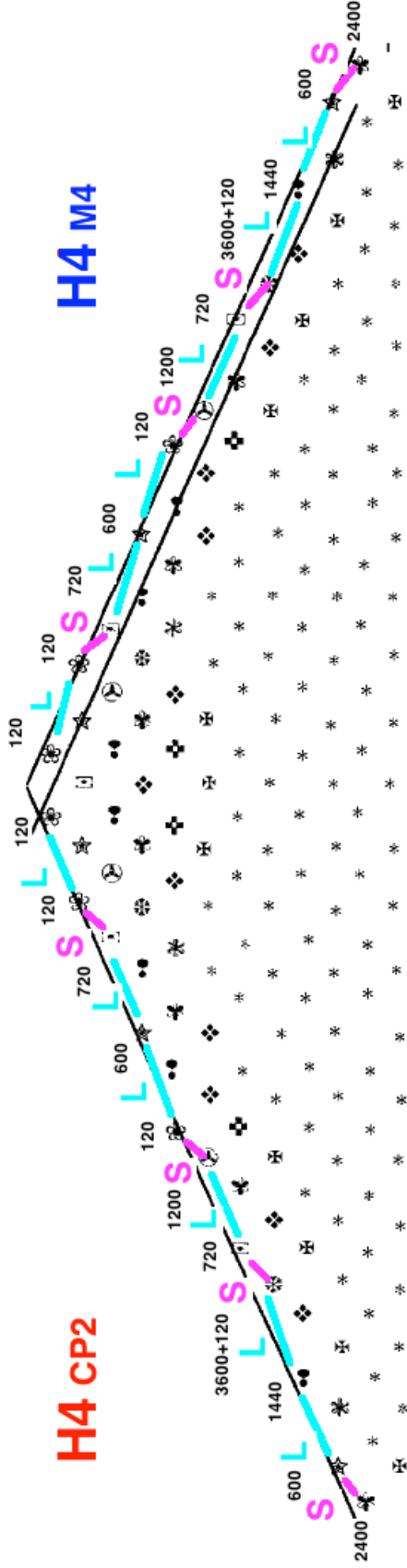

E8

- ☉ {335}    ☐ "720"    ⚙ "1440"    ⚙ "3600"    ⚙ "7200"
- ★ {533}    ⚙ "1200"    ⚙ "2400"    ⚙ "2400"+{335}    ⚙ "3840"    ⚙ "3600"+{335}    ⚙ "not determined"

## Indra's Net of Schwinger Sources

Each Schwinger Source particle-antiparticle pair should see (with Bohm Potential) the rest of our Universe in the perspective of  $8 \times 10^{53}$  Monster Symmetry so a **Schwinger Source acting as a Jewel of Indra's Net** of Schwinger Source Bohm Quantum Blockchain Physics (viXra 1801.0086 )  
**can see / reflect  $10^{27} \times 8 \times 10^{53} = 8 \times 10^{80}$  Other Schwinger Source Jewels of Indra's Net.**

### How many Schwinger Sources are in the Indra's Net of Our Universe ?

Based on gr-qc/0007006 by Paola Zizzi, the Inflation Era of Our Universe ended with Quantum Decoherence when its number of qubits reached  $2^{64}$  for  $Cl(64) = Cl(8)^8$  self-reflexivity whereby each  $Cl(8)$  8-Periodicity component corresponded to each basis element of the  $Cl(8)$  Vector Space.

At the End of Inflation, each of the  $2^{64}$  qubits transforms into  $2^{64}$  elementary first-generation fermion particle-antiparticle pairs. The resulting  $2^{64} \times 2^{64}$  pairs constitute a Zizzi Quantum Register of order  $2^{64} \times 2^{64} = 2^{128}$ .

At Reheating time  $T_n = (n+1) T_{Planck}$  the Register has  $(n+1)^2$  qubits so at Reheating Our Universe has  $(2^{128})^2 = 2^{256} = 10^{77}$  qubits and since each qubit corresponds to fermion particle-antiparticle pairs that average about 0.66 GeV so

**the number of particles in our Universe at Reheating is about  $10^{77}$  nucleons which, being less than  $10^{80}$ , can be reflected by Schwinger Source Indra Jewels.**

The Reheating process raises the energy/temperature at Reheating to  $E_{reh} = 10^{14}$  GeV, the geometric mean of the  $E_{Planck} = 10^{19}$  GeV and  $E_{decoh} = 10^{10}$  GeV.

After Reheating, our Universe enters the Radiation-Dominated Era, and, since there is no continuous creation, particle production stops, so the  **$10^{77}$  nucleon Baryonic Mass of our Universe has been mostly constant since Reheating**

## Indra's Net

"... "Indra's net" is the net of the Vedic deva Indra, whose net hangs over his palace on Mount Meru, the axis mundi of Buddhist and Hindu cosmology. In this metaphor, Indra's net has a multifaceted jewel at each vertex, and each jewel is reflected in all of the other jewels ... the image of "Indra's net" is used to describe the interconnectedness of the universe ... Francis H Cook describes Indra's net thus:  
"Far away in the heavenly abode of the great god Indra, there is a wonderful net ... a single glittering jewel in each "eye" of the net ... in ... each of the jewels ... its polished surface ... reflect[s] all the other jewels in the net ... Not only that, but each of the jewels reflected in this one jewel is also reflecting all the other jewels ..."

Image from <https://brightwayzen.org/meetings-placeholder/indras-net-honoring-interdependence-scales/> :

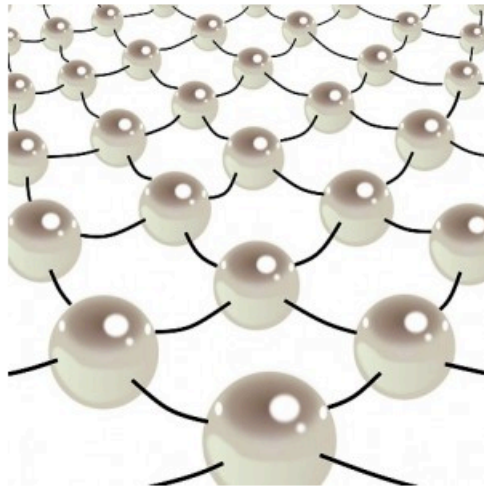

In E8-Cl(16) Physics each Indra Jewel is a Schwinger Source.

### 26D Freudenthal Fr3(O) String Theory - Bohm Quantum Potential

To understand **Schwinger Sources of E8 Physics start with 26D String Theory:**  
interpret **Strings as World-Lines** of Particles and  
**spin-2 String Theory 24x24 symmetric matrices**  
**as carriers of Bohm Quantum Potential** (not gravitons).

Luis E. Ibanez and Angel M. Uranga in “String Theory and Particle Physics” said:  
“... String theory proposes ... small one-dimensional extended objects, strings,  
of typical size  $L_s = 1/M_s$ , with  $M_s$  known as the string scale ...  
As a string evolves in time, it sweeps out a two-dimensional surface in spacetime,  
known as the worldsheet, which is the analog of the ... worldline of a point particle ...  
for the bosonic string theory ... the classical string action is the total area spanned by  
the worldsheet ... This is the ... Nambu– Goto action ...”.

Consider the Gray Fine-Grained History ( [quant-ph/9712037v2](https://arxiv.org/abs/quant-ph/9712037v2) ) to be a World-Line  
String with Interference Factors at each time step.



**The Gray Fine-Grained History Quantum Theory is  
equivalent to the Nambu-Goto action of 26D String Theory.  
Nambu-Goto 24x24 traceless spin-2 particle is  
Quantum Bohmion carrier of Bohm Quantum Potential**

Further, Ibanez and Uranga also said:

“... The string ground state corresponds to a 26d spacetime tachyonic scalar field  $T(x)$ . This tachyon ... is ... unstable

...

The massless two-index tensor splits into irreducible representations of  $SO(24)$  ... Its trace corresponds to a scalar field, the dilaton  $\phi$ , whose vev fixes the string interaction coupling constant  $g_s$

...

the antisymmetric part is the 26d 2-form field  $BMN$

...

**The symmetric traceless part is the 26d graviton  $GMN$  ...”.**

**My interpretation of the symmetric traceless part**  
differs from that of Ibanez and Uranga in that it  
**is the carrier of the Bohm Quantum Potential.**

Closed string tachyons localized at orbifolds of fermions produce virtual clouds of particles / antiparticles that dress fermions.

Dilatons are Goldstone bosons of spontaneously broken scale invariance that (analogous to Higgs) go from mediating a long-range scalar gravity-type force to the nonlocality of the Bohm-Sarfatti Quantum Potential.

The antisymmetric  $SO(24)$  little group is related to the Monster automorphism group that is the symmetry of each cell of Planck-scale local lattice structure.

Joe Polchinski in “String Theory, Volume 1, An Introduction to the Bosonic String” said: “... we find at  $m^2 = -4/\alpha'$  the tachyon, and at  $m^2 = 0$  the  $24 \times 24$  states of the graviton, dilaton, and antisymmetric tensor ...”.

**My interpretation of what Polchinski describes as the graviton**  
differs from that of Polchinski in that it  
**is the carrier of the Bohm Quantum Potential.**

The  $24 \times 24$  Real Symmetric Matrices form the Jordan Algebra  $J(24, \mathbb{R})$ .  
 $24$ -Real-dim space has a natural Octonionic structure of  $3$ -Octonionic-dim space.  
The corresponding Jordan Algebra is  $J(3, \mathbb{O}) = 3 \times 3$  Hermitian Octonion matrices.  
**Their 26-dim traceless part  $J(3, \mathbb{O})_0$  describes the 26-dim Bosonic String Theory and the algebra of its Quantum States**, so that  
**the  $24 \times 24$  traceless symmetric spin-2 particle is the Quantum Bohmion that carries the Bohm Quantum Potential for interactions among Strings = World-Line Histories of Schwinger Sources.**

### **Blockchain Structure of Bohm Quantum Potential**

Andrew Gray in arXiv quant-ph/9712037 said:

“... probabilities are ... assigned to entire fine-grained histories ...  
base[d] ... on the Feynman path integral formulation ...”

so in E8 Physics the Indra's Net of Schwinger Source Jewels

would not have Bohm Quantum Potential interactions between two Jewels,  
rather the interactions would be between the two entire World-Line History Strings



( image adapted from <http://www.blockchaintechnologies.com/> )

According to <https://hbr.org/2017/01/the-truth-about-blockchain> “... **How Blockchain Works ...**

#### **1. Distributed Database**

Each party on a blockchain has access to the entire database and its complete history. No single party controls the data or the information. Every party can verify the records of its transaction partners directly, without an intermediary.

#### **2. Peer-to-Peer Transmission**

Communication occurs directly between peers instead of through a central node. Each node stores and forwards information to all other nodes.

#### **3. Transparency with Pseudonymity**

Every transaction and its associated value are visible to anyone with access to the system. Each node, or user, on a blockchain has a unique 30-plus-character alphanumeric address that identifies it. Users can choose to remain anonymous or provide proof of their identity to others. Transactions occur between blockchain addresses.

#### **4. Irreversibility of Records**

Once a transaction is entered in the database and the accounts are updated, the records cannot be altered, because they're linked to every transaction record that came before them (hence the term “chain”). Various computational algorithms and approaches are deployed to ensure that the recording on the database is permanent, chronologically ordered, and available to all others on the network.

## 5. Computational Logic

The digital nature of the ledger means that blockchain transactions can be tied to computational logic and in essence programmed. So users can set up algorithms and rules that automatically trigger transactions between nodes. ...”.

With respect to Bohm Quantum Potential of E8 Physics Schwinger Sources there is no Human directly controlling any Event / Interaction / Transaction, as they are all completely controlled by the Laws of Physics which define “algorithms and rules that automatically trigger transactions between nodes” .

**Each Node is a Schwinger Source that is connected by Bohm Quantum Potential to all other Schwinger Source Nodes in our Universe and governed by the “algorithms and rules” of the E8 Physics Lagrangian and the Algebraic Quantum Field Theory arising from the completion of the union of all tensor products of copies of  $Cl(16)$  each copy of  $Cl(16)$  containing E8 and the E8 Lagrangian.**

According to <http://www.blockchaintechnologies.com/> “... A blockchain is a type of distributed ledger, comprised of unchangable, digitally recorded data in packages called *blocks*. These digitally recorded "blocks" of data is stored in a linear *chain* ...



... A distributed ledger is a consensus of replicated, shared, and synchronized digital data geographically spread across multiple sites, countries, and/or institutions ...”

**or, in the case of the E8 Physics Indra’s Net of Schwinger Source Jewels, spread across the entirety of our Universe.**

The idea of Schwinger Sources as more than mere points is in David Finkelstein’s Space-Time Code 1968 in which David said “... “... What is too simple about general relativity is the space-time point ... each point of space-time is some kind of assembly of some kind of thing ... Each point, as Feynman once put it, has to remember with precision the values of indefinitely many fields describing many elementary particles; has to have data inputs and outputs connected to neighboring points; has to have a little arithmetic element to satisfy the field equations; and all in all might just as well be a complete computer ...”.

## Results of E8 Physics Calculations:

Here is a summary of E8 Physics model calculation results. Since ratios are calculated, values for one particle mass and one force strength are assumed. Quark masses are constituent masses. Most of the calculations are tree-level, so more detailed calculations might be even closer to observations.

Fermions as Schwinger Sources have geometry of Complex Bounded Domains with Kerr-Newman Black Hole structure size about  $10^{(-24)}$  cm.

( for calculation details see viXra 1804.0121 )

**Dark Energy : Dark Matter : Ordinary Matter = 0.75 : 0.21 : 0.04**

Particle/Force	Tree-Level	Higher-Order
e-neutrino	0	0 for nu <sub>1</sub>
mu-neutrino	0	$9 \times 10^{(-3)}$ eV for nu <sub>2</sub>
tau-neutrino	0	$5.4 \times 10^{(-2)}$ eV for nu <sub>3</sub>
electron	0.5110 MeV	
down quark	312.8 MeV	charged pion = 139 MeV
up quark	312.8 MeV	proton = 938.25 MeV
		neutron - proton = 1.1 MeV
muon	104.8 MeV	106.2 MeV
strange quark	625 MeV	
charm quark	2090 MeV	
tauon	1.88 GeV	
beauty quark	5.63 GeV	
truth quark (low state)	130 GeV	(middle state) 174 GeV (high state) 218 GeV
W+	80.326 GeV	
W-	80.326 GeV	
W0	98.379 GeV	Z0 = 91.862 GeV
Mplanck	$1.217 \times 10^{19}$ GeV	
Higgs VEV (assumed)	252.5 GeV	
Higgs (low state)	126 GeV	(middle state) 182 GeV (high state) 239 GeV
Gravity Gg (assumed)	1	
(Gg)(Mproton <sup>2</sup> / Mplanck <sup>2</sup> )		$5 \times 10^{(-39)}$
EM fine structure	1/137.03608	
Weak Gw	0.2535	
Gw(Mproton <sup>2</sup> / (Mw+ <sup>2</sup> + Mw- <sup>2</sup> + Mz0 <sup>2</sup> ))		$1.05 \times 10^{(-5)}$
Color Force at 0.245 GeV	0.6286	0.106 at 91 GeV

**Kobayashi-Maskawa parameters for W+ and W- processes are:**

	d	s	b
u	0.975	0.222	0.00249 -0.00388i
c	-0.222 -0.000161i	0.974 -0.0000365i	0.0423
t	0.00698 -0.00378i	-0.0418 -0.00086i	0.999

The phase angle d13 is taken to be 1 radian.



## E8 Physics:

Higgs and Truth Quark = 3-Mass-State Nambu-Jona-Lasinio System:

Higgs at 125 GeV and Truth Quark at 130 GeV

Higgs at 200 GeV and Truth Quark at 174 GeV

Higgs at 250 GeV and Truth Quark at 220 GeV

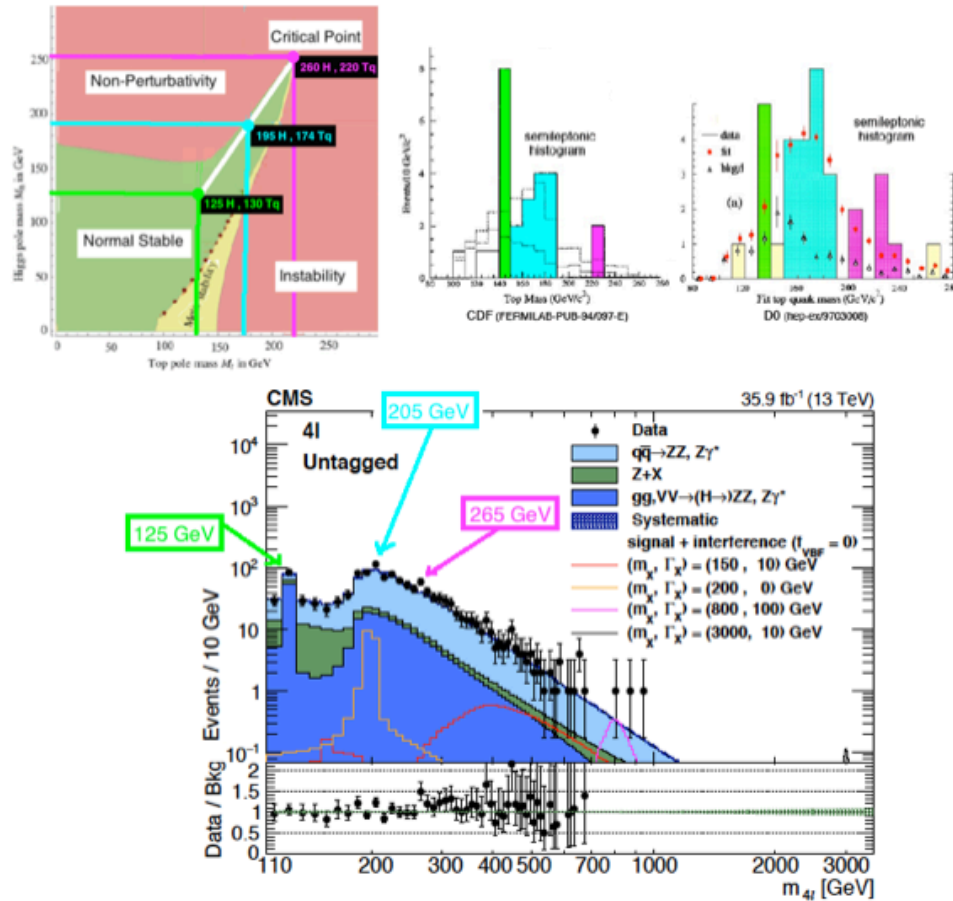

Upper Left = Higgs-Truth Quark mass state phase diagram

Upper Center = CDF semileptonic histogram of 3 Truth Quark Mass States

FERMILAB-PUB-94/097E

Upper Right = D0 semileptonic histogram of 3 Truth Quark Mass States

hep-ex/9703008

Lower = CMS  $H \rightarrow ZZ^* \rightarrow 4l$  histogram of 3 Higgs Mass States

arXiv 1804.01939