

Practical Matter-Wave Antiballistic Defense Shield Technologies

RICHARD L AMOROSO

Noetic Advanced Studies Institute
amoroso@noeticadvancedstudies.us

Utilizing a new concept of a static (albeit relativistic) de Broglie matter-wave resonance hierarchy to coherently putatively control a highly symmetric M-Theory model of SUSY structural-phenomenology of the ‘total’ regime of spacetime, practical matter-wave antiballistic defense shield technologies appear feasible in the near term. The model although obvious to us is not based on ‘politically correct’ theory and has therefore been missed by the scientific community’s rigid adherence to myopic views of quantum theory and cosmology. In simple terms the vacuum (Dirac type), not just the superficial surface equated with the zero-point field and quantum stochasticity, but the complete HD structural regime of spacetime itself. This requires a completed form of quantum theory able to manipulate causality (surmount uncertainty through an ontological form of scale invariant conformal invariance) and utilize unitary field parameters (topological) to control constructive interference of the matter-wave resonant hierarchy. Another key element is to discard the belief that nucleons have been created at a primordial Big Bang era. Operation of the shield technologies relies on the central premise of de Broglie-Bohm modeling of quantum theory (albeit radically extended in several ways) that matter is continuously created, annihilated and recreated as physically real stationary waves imbedded in the local fabric of spacetime. We anticipate matter-wave antiballistic defense shield technologies to appear in three stages or generations: 1) Simple coherently controlled constructive interference that might strengthen aluminum to the density of depleted uranium. 2) Full incorporation of the HD SUSY properties of spacetime. 3) Mature manipulation of spacetime, nanoscale programmable matter, probable antimatter phase configurations, energy efficiency and incursive nonlinear control of the nonlocal ‘coherence-length’. From our vantage point we envision no physical reason why the 3rd generation device cannot withstand nuclear ordinance as soon as the principles outlined here are incorporated in the design of shield technologies. In this respect this chapter is a review of the various principles required for implementing matter-wave defense shield technologies rather than a complete engineering manual.

12.1 Introduction – Current Status of Shield Technology

Until this writing the concept of ‘shields’ only existed as a construct of science fiction media dating from about 1920. Such shields usually take the form of a force field designed to protect

against a variety of weapons by deflecting or absorbing their impact. The field is projected along the surface or directed into the space around a spaceship, planet, moon, space station or building. Some are small enough to shield a soldier in combat, or from radiation or biological contaminants. These shields are often invisible or appear as translucent surfaces that glow when struck.

A variety of shield technologies are already under development by organizations such as NASA's Institute for Advanced Concepts which is currently exploring several types of active electrostatic defensive energy force-field radiation shield technologies [1-3]. These efforts are for the design of deflector shields for protecting spacecraft traveling beyond the safety of the earth's magnetic field from high energy charged particles like solar protons and electrons and galactic center cosmic ray particles from striking or penetrating a ship [4,5]. These 'active shields' deflect charged particles through the Lorentz force on a point charge

$$F_L = qE + qv \times B \quad (12.1)$$

where q is the charge of a single radiation particle, v the particle velocity, E is the electric field of the shield, and B the magnetic field component of the shield. The type of shield is determined by the field type:

- Electrostatic shield – only the electric field (time-independent)
- Magnetic shield – only the magnetic field (time-independent)
- Plasma shield – both electric and magnetic fields.

One popular design being considered by NASA utilizes an array inflatable spheres about five meters in diameter placed atop forty-meter poles. For repelling protons smaller negatively charged spheres are placed around the periphery with somewhat larger positively charged spheres are placed in the center. The spheres are charged with about 100 megavolts. A mesh underneath the array acts as a ground plane. Other designs consider magnetic fields and plasma arrays [1-3]. See Fig. 12.1. These are not the type of defense shield to be considered here, although the antiballistic shields we have in mind would readily repel radiation.

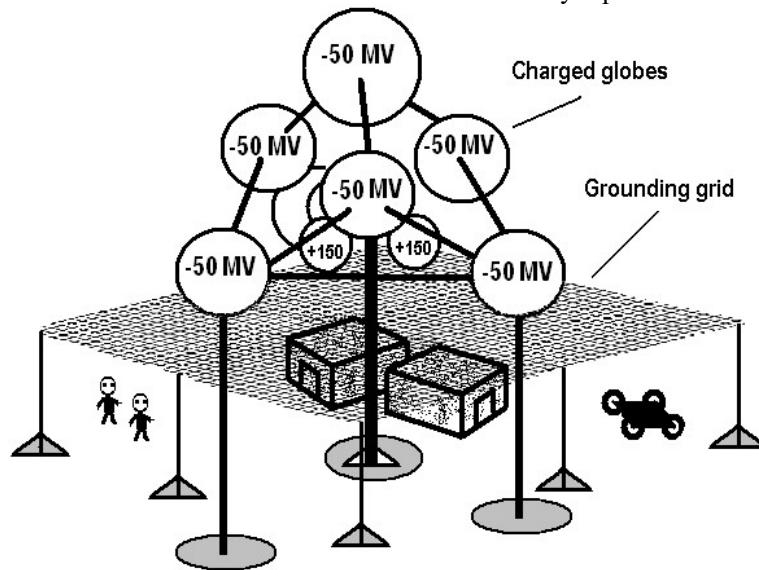

Figure 12.1 Schematic of a popular NASA radiation shield design. Figure redrawn from [1].

12.2 Overview of New Theoretical and Physical Requirements

Trying to address the vacuum has been like confronting an irresistible force and immovable object. The vacuum is thought to contain infinite energy but none of it is considered accessible beyond virtual quanta for a duration of the Planck time. It seems if this were not so the fabric of the cosmos and our perception of reality would unravel; so that we may not really ‘dip a ladle in’ and draw any soup out. How then may we utilize or engineer it for various purposes? The ‘vacuum’ is everything and nothing, everywhere and nowhere; it is infinite potentia. In the midst of this our virtual holographic regime of spacetime. Relative to us as observers the surface topology of spacetime is a stochastic quantum foam of virtual quanta called the zero-point field believed to be governed by the Copenhagen uncertainty principle. To get at the vacuum we must reach beyond or through this surface barrier. We cannot ‘tug’ on it as conceptualized in the Chinese finger puzzle in Fig. 12.2 below.

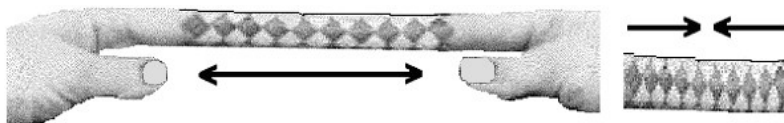

Figure 12.2 Chinese finger cuff – a) The harder one pulls the tighter one gets stuck. b) When kept relaxed the fingers slide out easily. Perhaps this is like the operation of string tension and coupling.

This loosening and tightening illustrated by the Chinese finger cuff in Fig. 12.2 is reminiscent of the ‘leapfrog’ cycle of coordinate fixing and unfixing (Chap. 6) inherent in the continuous-state standing-wave that is programmable in HAM cosmology. This is the putative element that makes or breaks the whole shield technology gambit. Our approach is opposite to the high energy bombardment currently used in pair production [6,7]; it is a ‘gentle’ approach combining the phenomenology of the standard model of quantum theory with a new ontological energyless approach that surmounts the uncertainty principle (see Chaps. 9 & 11) by application of a coherently controlled covariant resonance hierarchy. For this we need a special definition of the vacuum, which for the most part exists, but has been ignored in the literature as unpopular because it introduces photon mass, m_γ which is erroneously assumed to violate Gauge principles. We have addressed this vacuum to varying degrees in Chaps. 7 & 9. The features of the covariant Dirac vacuum of interest here is that it is polarizable because for extended EM theory (Proca equation) Maxwell’s equations do not cut off at the vacuum but are continuous into or through it. This is key for resonant manipulation; not the usual 4D context of the required Causal Stochastic Interpretation of quantum theory, but its extended-completed HD version as inherent in HAM cosmology. Once we are conceptually over that critical hurdle (difficult for those adhering to the status quo) it is a straight forward matter to utilize the protocols of Chaps. 9 & 11 to ballistically program the vacuum in terms of the additional features introduced and extended here for amorphous Ising model lattice-gas cellular automata following the seminal work of Toffoli and from other parameters found in the literature such as non-Newtonian fluid mechanics and various nanotechnology techniques [8-14].

We see the main inertia to developing defense shield technologies is adamant adherence to the Copenhagen interpretation of quantum theory and associated limits inherent in the parameters of a Big Bang cosmology. Some GUT theories postulate proton decay with a half-life of 10^{36} years [15,16] according to $p \rightarrow e^+ + \pi^0$; $\pi^0 \rightarrow 2\gamma$. The conundrum is that this lends some support to the Copenhagen/Big Bang scenario of nucleosynthesis occurring near the time of the original singularity. The lifetime of a proton is not the concern; it is its true

quantum nature in terms of relativistic quantum field theory. However what we need to do is extend the de Broglie-Bohm point of view that suggests matter is a form of HD complex standing-wave that is continuously annihilated and recreated with the quantum wave function piloted by a unitary anthropic action principle tantamount to a ‘super-quantum potential.

Einstein postulated that Planck’s quantization rule applied to an atom oscillating about its equilibrium point in a solid [17]. For shield technology we must extend this principle to spherical ‘standing de Broglie matter-waves’ in spacetime the internal motion of which obeys the Lorentz transformation. Simultaneous points produced by the wave are wavelet centers according to Huygens’ principle [18] that reinforce their common envelope (of the main wave) because if the waves are parallel they summate. Another important consideration in this regard that all of the energy of the particle is focused at one point for all observers [19]. This is aligned with M-theory where all elementary particles are not discrete points but comprised of fundamental resonance modes of vibrating strings of a fixed tension [20].

If we remind ourselves of the $360^\circ - 720^\circ$ Dirac spherical rotation of the electron spinor suggesting HD topological components for the fundamental structure of matter the idea is not as difficult to explore. The intuitive reader will realize this additional topology is almost a proof, as shown by the representation of physical quantum states in abstract mathematical spaces like Hilbert space, phase space or configuration space, of the incompleteness of quantum theory which when complete will entail a physically real space (Chaps. 9,11) for the manipulation of observable properties of operators. The probability amplitude is not considered real, but in Cramer’s transactional interpretation [21] an event is considered to be a physically real standing wave with all off diagonal elements also real so that an extended or completed form of quantum theory would be manifest in a physically real conformal space. The great import of this situation is that the phase elements of quantum mechanics are physically real which has far reaching consequences and is required for our development of shield technology.

In Chaps. 9 & 11 we have confined our discussion for the most part to atomic or molecular quantum systems. Here it is essential to program spacetime itself [22], so as Copenhagen has ignored the physicality of this HD topology; we must in a sense take the perspective of an HD observer and ignore the ‘particle-in-a-box’ and deal with the HD topological structural-phenomenology, which I suppose is a roundabout way of saying we must move well beyond non-relativistic quantum mechanics to an extended or dualistic form of relativistic quantum field theory. By dualistic we mean taking our fundamental basis not from the resultant particulate matter as a stage for sequencing the locus of the evolution of quantum states for present events but from the mirror symmetric standing-wave elements from which the resultant particle arises which can be thought of as two Calabi-Yau 3-forms (Fig. 12.x). This is an HD extension of Cramer’s transactional interpretation [21], a standing-wave model requiring a pair of Dirac equations, one for R1 and one for R2 – the future-past advanced-retarded components of the virtual discretized present instant forming our perceived virtual reality.

Until now physicists have generally accepted the existence of de Broglie matter waves, $\lambda = h / \rho$ for accelerated particles; but with little utility other than to demonstrate their existence through a variety of diffraction experiments applied to elementary particles, atoms and molecules in order to confirm the wave-particle duality of all matter [23-31]. De Broglie waves are physically real matter-waves associated with any moving particle traveling in a surrounding material medium [32,33].

$$h\nu_0 = m_0c^2. \quad (12.2)$$

This limited view of matter-waves has little bearing on the development of matter-wave defense shields. The development of matter-wave shield technologies depends on a new view of cosmology, quantum theory and its associated new view of the nature of matter and a reconsideration of the nature of relativistic de Broglie wave mechanics.

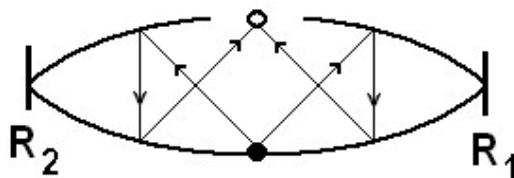

Figure 12.3 2D rendition of an HD holographic process. An object (black circle) placed inside two parabolic mirrors produces a virtual image (white circle). It is suggested that our virtual holographic reality is produced in a similar fashion by Cramer future-past standing-wave parameters of spacetime.

Initially we were very timid in considering that a design for defense shields could be presented that could withstand atomic bombs. But with continued contemplation and research especially in reading De Broglie's original paper where he mentions that "...the quantum principle suggests associating this internal energy with a simple periodic phenomenon of frequency, ν_0 such that, $h\nu_0 = m_0c^2$ " [30]. This is the same amount of energy that occurs in an atomic bomb, so ideally once the model is sufficiently mature there is more than adequate energy hanging around to offset an incident amount tantamount to a nuclear explosion when non-linear conditions are setup properly. This however would only be the stage two shield technology indicative in the cry of Star Trek's Capt. Kirk "More power to the shields Scotty" which only utilizes intermediate vacuum engineering. But it wasn't so much the reminder of the inherent energy, it was the manner we were struck by de Broglie's statements about the periodicity of the internal energy, a notion left out of most textbooks and is a key element of the Vigier causal interpretation of quantum theory [34,35] that we felt could be applied to cellular automata. Toffoli gives the metaphor of a band leader conducting the various instrument players in a band; this is the usual Turing machine programming. Then he relates that the programming of cellular automata is internal for each unit allowing nonlinear ballistic computation [8,9].

Simplistically if one tears out a tiny segment of a holographic film the whole image may still be reproduced only much less bright and with much less resolution. Continuing the metaphor, then if one considers the tiny piece the usual energy associated with a coordinate point in the vacuum zero-point field, one must now utilize or set up a back-reaction potential that asymptotically approaches infinity as the mean-free-path ballistic coherence length increases [36,37]. In reverse (the zero-point becomes the infinity point), by a coherent control cumulative interaction process, the wave structure of matter may undergo a power-factored constructive interference when set up in a Mirror symmetry-T-duality spacetime resonance hierarchy. The tricky part at the limit of our current comprehension is a manipulation of the arrow of time essential to creating a focused array.

To achieve this result a new basis for the standard model of particle theory is required, one cast in an F-Theory Holographic Anthropic Multiverse (HAM) with a commensurate form of Relativistic Quantum Field Theory utilizing Dirac spherical rotation parameters and de Broglie matter-waves. The effectiveness of a shield is directly proportional to the amount of vacuum energy available to it. This vacuum energy is not utilized directly. The vacuum efficiently conserves itself at an apparent level of give and take one would expect if an immovable object met an irresistible force. The substance of the matter is that one does not wish to present the

coherence length for the conservation parameters of a virtual photon if one is confronted with the explosive capacity of a 20 megaton nuclear device. It would not be practical to try to develop a shield technology where one would apply the amount of energy tantamount to what would be required for a shield even if a zepto (10^{-21}) or yocto (10^{-24}) second switch could turn on the power at the instant of impact. What is needed instead is to move from the current Copenhagen phenomenological viewpoint to the extended (completed) de Broglie-Bohm ‘ontological’ point of view as the basis for programming the vacuum. What we have failed to realize from the Copenhagen view is that we are the vacuum and to operate our devices from the perspective that it also is the vacuum rather than from the local perspective where so-called collapse of the wave-function and the uncertainty principle rule the day. What we are trying to delineate is that nothing new needs to be created or built; it already exists. We need merely to uncouple the perspective of operation and recouple it to the required resonant phase modality in the continuous-state hierarchy. See Chaps 9& 11.

As stated we are required to utilize a concept of static de Broglie matter-waves rather than the customary point of view of an associated wave with projectiles. The associated material medium for our ‘static’ de Broglie matter-waves [38] is the vacuum of spacetime itself which we will look at as a programmable tessellation of Ising model lattice gas cellular automata arising from the continuous-state parameters of the close-packed cosmological least-units inherent to HAM cosmology which tile the spacetime backcloth. Conformally correlated with this vacuum regime we couple resonantly and program a Nanoscale kinematic matrix substrate of amorphous programmable matter to facilitate an ontological phase cascade. The basis for developing a de Broglie ballistic defense shield arises from the Einstein-de Broglie stability conditions [30].

$$\begin{aligned} \int_0^{T_r} (p_x dx + p_y dy + p_z dz) &= \\ \int_0^{T_r} \frac{m_0}{\sqrt{1-\beta^2}} (p_x dx + p_y dy + p_z dz) dt &= \quad (12.3) \\ \frac{m_0 \beta^2 c^2}{\sqrt{1-\beta^2}} T_r &= nh. \end{aligned}$$

12.3 Critical Philosophical Considerations on the Limits of Potentia

The sub-quantum domain has been called a stochastic foam, a regime within which time asymmetry is considered more fundamental than quantum theory; and that time emerges from a more fundamental unitary domain organizing the structure of and guiding the evolution of events in local reality [39,40]. We consider this a regime of infinite potentia the utility of which is essential to the defense shield technology. This usage is beyond the usual meaning applied to Heisenberg potentia because it only refers to the body of probabilistic states of the wave function before a measurement is taken. We do wish to align with those who claim nothing exists before a measurement, but to an even greater degree in that reality itself does not exist either other than for the basis of the observer. This is a multilevel process; first the boundary conditions forming the foundation of reality are created, then the quantum stochasticity of matter as its upper bound. Observed reality evanesces from a central hysteresis loop of this action. We don’t think anyone has suggested this before, that reality is like an intermediate continuous-state collapse, a ‘Dirac twist’ collapse as a stage for all the rest of what is considered

the microscopic evolution of the quantum wave function to rest on. We see this pretty much as if the film in an analog movie projector is a 2D or 3D hologram strip and the bulb in the projector an anthropic laser producing the perceived 3D images on the screen perceived by the observer seated in the theatre (Figs. 5.2,5.3) This is not a popular view because it represents a dualist-interactionist model of awareness [41] and gives an inherent importance to the nature and role of the observer. We believe this correct and have presented empirical models to support it [42,43]; the protocols delineated in Chaps. 9 & 11 are related. Could all this mumbo-jumbo be skipped for the purposes here? Would the reader be satisfied if we merely postulated a deeper Dirac sea rather than the usual thinner Planck surface of the stochasticity of the zero-point field? We look at the zero-point field as the ‘fog over the ocean’; whereas we require the utility of the full depth of the ocean. We wish to stick with something that suggests a domain that is truly like a hologram in an HD sense because it seems the most efficient manner to operate an anthropic multiverse.

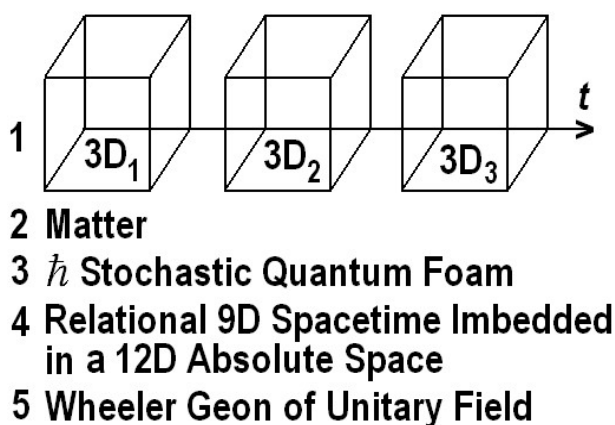

Figure 12.4 Reductionist hierarchic levels of HAM reality from the local standing-wave future-past eternal present to the atemporal geon of unitarity.

We insist up front that this shield technology is impossible to any degree of power without Gödelizing outside the limiting domain of Copenhagen quantum theory into this 5th regime of Fig. 12.4 beyond spacetime to a degree where even the de Broglie-Bohm version is also unsatisfactory and needs further extension to the point of full ontological completion. One must get ‘under’ or ‘beyond’ spacetime in order to engineer or program the required full Ising lattice rotations that are able to utilize the ‘infinite’ power inherent in the vacuum by ‘ontologically becoming the vacuum’. The other reason this Gödelization [44] is so important is the requirement not just to summation the phase of stationary de Broglie matter-waves (they are only level 2-3 on Fig, 12.4), but to also coherently control the phases of the topological hierarchy so the mean-free-path will ballistically compute [45,46] in a sufficiently HD regime. The full Gödelization process controls the symmetry of the arrow of time. The ontological foray into level 5 achieved by pro-gramming the geometric information of spacetime is before time at the level of the unitary field. This is key to controlling the mean-free-path because it is this manipulation that allows the complete control of the Ising model hypersphere spin flips in a manner able to ‘reflect the infinity’ of the vacuum and be able to withstand nuclear ordinance.

12.4 The Shield Vacuum

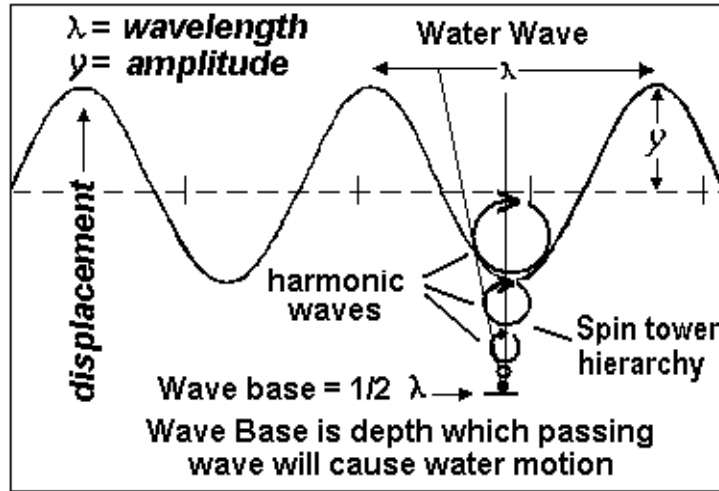

Figure 12.5 Dynamics of water-waves. Water remains stationary as waves pass through. Ocean surface waves are a combination of transverse and longitudinal waves; thus surface points follow orbital paths as in the HAM spacetime model.

The essential shield vacuum is considered to be a form of the well-known covariant polarized Dirac vacuum extended to include a deep structure of close-packed HD least cosmological units introduced by the HAM cosmological paradigm in this volume. This regime of deep structure includes an infinite domain of programmable holographic potential. For purposes of delineating our shield technology, we model the least-unit topology of the ‘Dirac sea’ with properties characteristic of water waves. When the ‘ocean depth’ becomes shallow near the shore the waves summate. We use this effect later to model standing-wave boundary conditions of the resonant summation hierarchy in conjunction with conditions mechanically called ‘perfect rolling motion’ (Fig. 12.6).

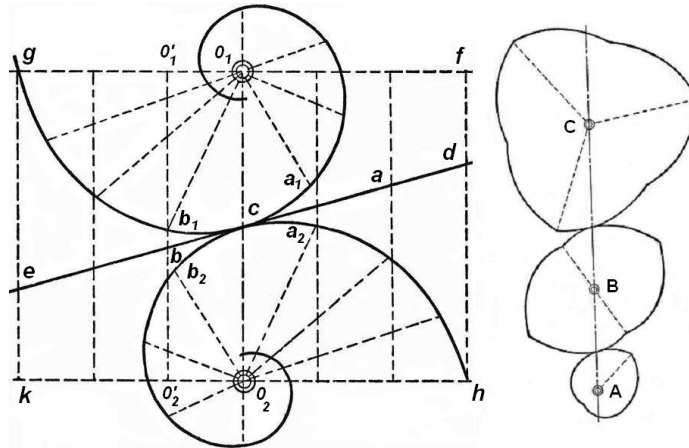

Figure 12.6 Perfect rolling motion allows a resonance hierarchy to be set up at the points of contact that are in phase. Here logarithmic spirals are used to conceptually illustrate the hierarchical coupling concept.

Another way for illustrating resonant hierarchy properties more akin to spacetime topology is the genus-1 helicoid parking-garage structure in Fig. 12.7 which also symbolizes the Calabi-

Yau duality/mirror symmetry; or the Kaluza-Klein spin tower which model the Cramer-like standing-wave structure of virtual 3(4)D reality. Maybe we overdo these horrendous explanatory concatenations in our wish to convey how to align and couple spin-spin modes coherently in the HD hierarchy. The approach is to consider the vacuum as a cellular automata topology and program it with coherent control methods.

Genus-1 Helicoid 'Parking-Garage'

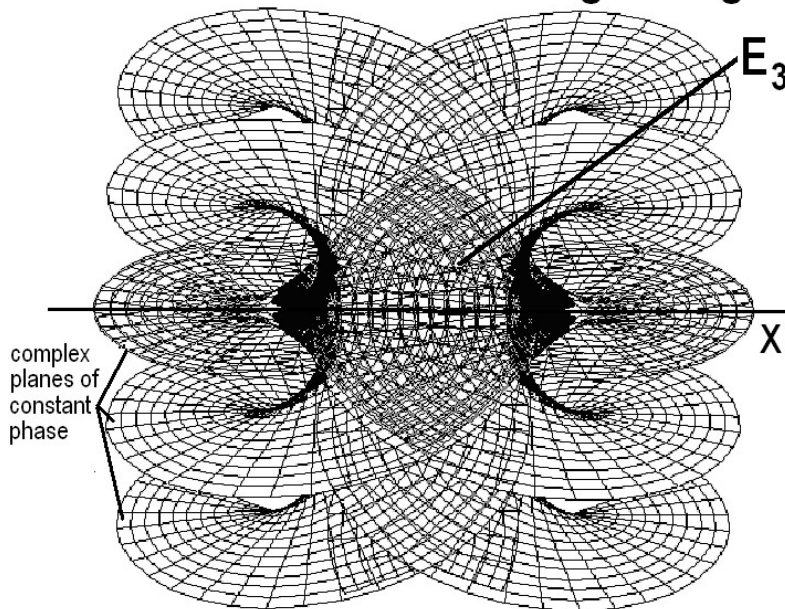

Figure 12.7 Genus-1 helicoid ‘parking garage’ hierarchy representing the advanced-retarded future-past symmetry of a mirror symmetric Calabi-Yau dual 3-form K-K spin tower inherent in the continuous-state fabric of spacetime.

12.5 What are the Required Vacuum Parameters?

Surprisingly, not just the dynamics of the zero-point field, such as the Van der Waal forces, the Casimir effect, *Zitterbewegung*, Zeeman-Stark effects and such, are open to manipulation by the application of EM fields for example, but the whole structure of the fabric of spacetime itself should be considered amenable to vacuum engineering [22,23,49-51]. It is fully utilizing this degree of accessibility that is required to develop practical matter-wave antiballistic defense shield technologies. This is not evident from within the domain described by the Copenhagen interpretation of quantum theory, or a Big Bang oriented string theory. The plausibility arises only under the auspices of a radical new cosmological perspective which we here call HAM cosmology. The current view of the de Broglie-Bohm [35] and Cramer interpretations [21] go halfway; and string theory (M-theory is perhaps 80% there in available parameters but heretofore not organized in a helpful manner. De Broglie-Bohm-Vigier and Cramer need extension to the HD regime of a 12D F-Theory [20]; and string theory needs to step away from the Big Bang’s limiting insight into the symmetry conditions to align SUSY symmetry breaking with the unique vacuum afforded by the anthropic unitary principles driving the hierarchical structure of cosmology as a complex self-organized system.

The details of these radical new symmetry conditions are somewhat daunting at first bite especially since they are ‘not politically correct’; and we hardly claim to muster a complete understanding at this writing ourselves leaving little gap to be filled by the inspiration of those that follow. Before presenting the substantive details of shield technology it is of passing interest to note for example:

- A .357 Magnum Handgun firing a 150 gram slug at 400 meters per second would have an impact of ~ 500 Joules.
- A chunk of space debris in low Earth orbit (LEO) with a velocity of ~ 16 km/s would be a projectile with an impact of ~ 130 Mega Joules per kilogram.
- A mature matter-wave antiballistic defense shield technology able to deter, for example, a 20 kiloton nuclear explosion would require the ability to repel an energy of ~ 80 Tera Joules.

A primitive prototype ‘test of concept’ shield could be constructed by using just a focused constructive interference of de Broglie matter-waves which might be like increasing the strength an aluminum sheet to the tensile strength of depleted uranium. This initial ‘foray’ would arise from a more primitive or superficial utilization of the extended form of quantum theory. Engineers could conceivably get stuck at this level even with a full blown completion of quantum theory if an insufficient understanding of the vacuum structural-phenomenology remained.

Recent work called ‘sparking the vacuum’ at SLAC has with high energy photon beams produced e^- , e^+ pairs [47,48]. This ‘head on’ approach requires a lot of energy because it attacks the vacuum surface head on which remains sealed. Although in reverse, this is like the Chinese finger puzzle (Fig. 12.2) - the harder one pulls the more stuck the finger becomes, if relaxed the fingers slip out easily. Our process is like that, it manipulates the periodic coupling moments of string tension leaving the vacuum lattice open. If the usual Copenhagen collapse model is like the view of an orchard/vineyard where from some periodic positions one sees into infinity and from others the trees or particulate positions block the view. The HD model is like the view from a helicopter where the whole programmable array is open to view.

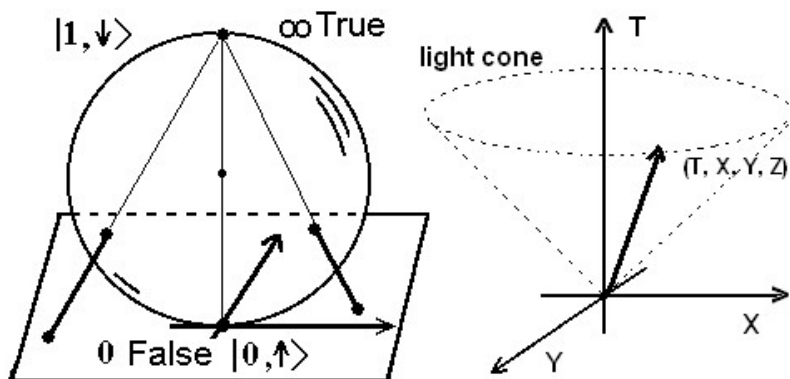

Figure 12.8 a) Block sphere rendition of a qubit. b) Relativistic qubit or r-qubit with more degrees of freedom.

If the close-packed cosmological least-units tiling the spacetime backcloth are considered to have properties like an Ising model lattice-gas Bloch sphere cellular automata array then space becomes programmable as has been suggested [22,49]. A Bloch sphere is a form of Riemann sphere here purported to fill the spacetime raster as Calabi-Yau dual 3-forms where

relativistic, r-qubits become physically real rotatable transformable Ising lattice-gas Riemann spheres to which when perfect rolling motion resonance techniques are applied cascade transformations for ballistic computing can be set up..

Construction materials of the bunker, vehicle or personnel shield must have a special layer specifically for shield material or be completely constructed out of shield materials that contain alloys with amorphous nanoscale programmable matter [8,9,14,51] as the site where the cellular automata Ising model lattice gas programming occurs. Following Smolin [52,53] for ideas he developed for loop quantum gravity further consider these programmable Bloch spheres as a raster of complex spacetime s[in networks.

QUENCHABLE COMPLEX SPACETIME SPIN NETWORK

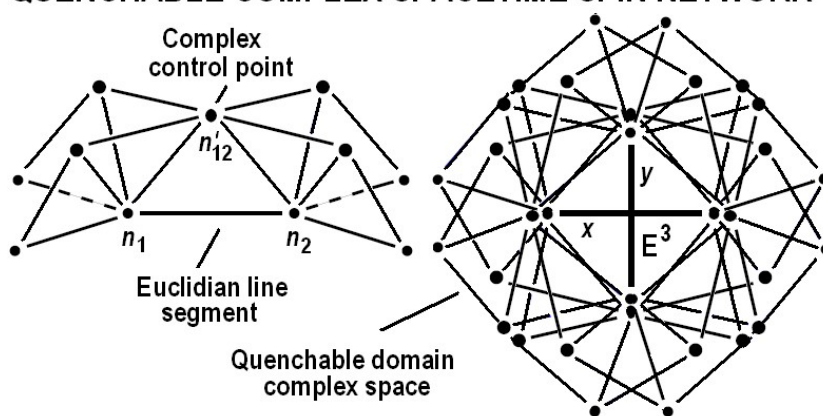

Figure 12.9 Spin networks of the programmable matter array with periodic control points for setting up the nanotech programmable matter substructure able to implement energy cascades in conjunction with ballistic programming.

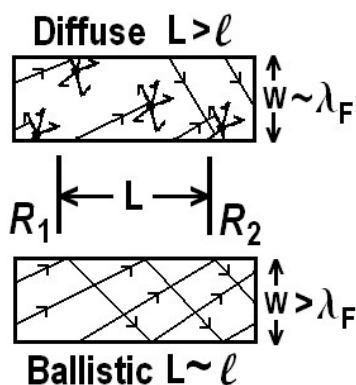

Figure 12.10 By resonant phase coherence the basis for a ballistic transport avalanche may be programmed into the spacetime topology using amorphous nanotech materials that simulate or map to the structural-phenomenology of spacetime. L is the coherence length of the resonator, and l the mean free path.

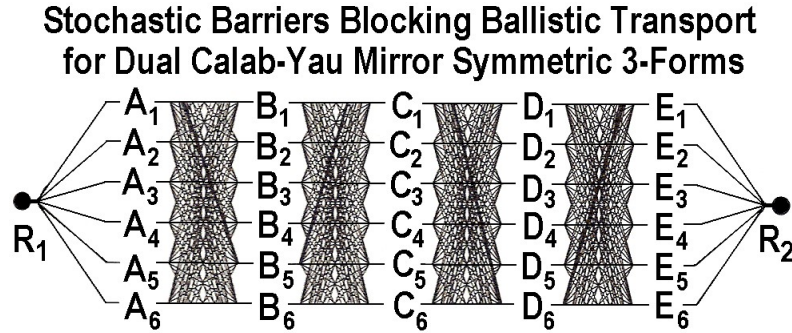

Figure 12.11 A Quantum Calabi-Yau spacetime brane array with 6^5 possible locked paths acting as a barrier to ballistic transport by stochastically disrupting the mean-free-path. The array must be programmed as a harmonic oscillator resonance hierarchy to order the topology coherently.

In Fig. 12.12 application of the proper resonant field at nodes R1-R2 will prepare the mean-free-path for a ballistic transport ‘avalanche’ for quenchable shield parameters in the 1st order and unquenchable or infinite recursion in the asymptotic stepwise infinite limit as in Fig. 12.9.

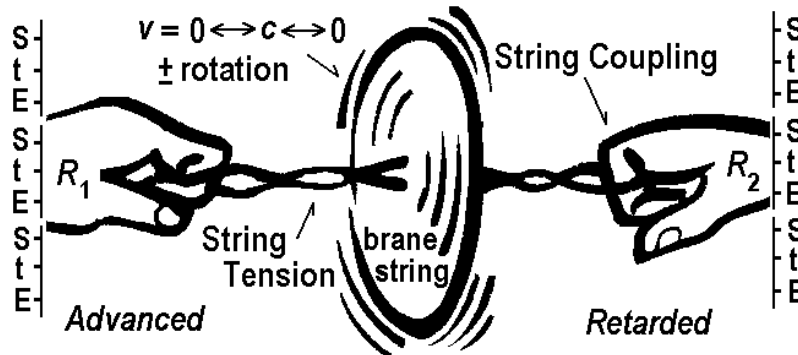

Figure 12.12 Conceptualization of the spin tension-coupling dynamics of a 2-brane spacetime element representing one of the 6^5 paths of Fig. 12.11.

In the HAM cosmology as stated the spacetime raster is self-organized and thus has all the properties of complex self-organized systems such as incursion and evolution controlled by an external action principle [41,54]. With a strike on a grid, 2D x,y for simplicity, the points parameters are updated. If the force is below threshold, i.e. quenchable, the neighboring elements of the array help to maintain equilibrium; but for a $z(x,y) \rightarrow z(x,y) + 1 > \text{threshold}$ an avalanche occurs [55-57]. This has an associated asymptotic power law that fractally (Figure 12.13) propagates with a domino effect of varied stepwise levels and thresholds of quenchable and infinite ballistic transport parameters mediated by the ability of the algorithm to program the amorphous nanoscale material for coherently control of the spacetime hierarchy.

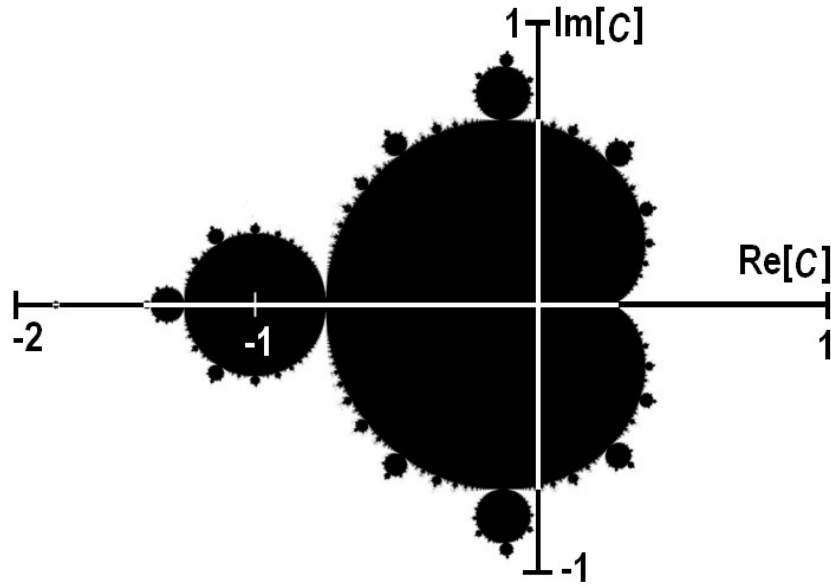

Figure 12.13 Map of the Mandelbrot fractal set from Eq. 12.4. We use it to illustrate the continuous fractal-like incursion through the HD hierarchy that occurs when ballistic computing of the spacetime topology is achieved.

The Mandelbrot fractal set can be mathematically produced by the Feigenbaum fractal generator, $F_C(x) = x^2 + C$ which produces an iteration fulcrum with a period-doubling bifurcation cascade by repeated iteration of, F_C which is a family of complex polynomials from the critical point, x_0

$$\begin{aligned}
 x_0 &= x \\
 x_1 &= F_C(x) = x^2 + C \\
 x_2 &= F_C(F_C(x)) = (x^2 + C)^2 + C \\
 x_3 &= F_C^3(x) \\
 &\vdots \\
 x_n &= F_C^n(x)
 \end{aligned} \tag{12.4}$$

where C is a complex number and for $C = i$ the sequence is $0, i, (-1+i), -i, (-1+i), -1, \dots$. The map may escape to infinity or stay within the Mandelbrot set of a disk with infinite radii [58]. In contrast the Mandelbrot fractal set generator, $F_C(Z) = Z^2 + C$ where $Z = x - iy$ and $c = c_1 + ic_2$ maps a subset of the complex plane (Fig. 12.13) for values of c whose orbits don't escape to infinity by

$$Z^2 + C = (x + iy)^2 + (c_1 + ic_2) = x^2 + y^2 + c_1 + (2xy + c_2) \tag{12.5}$$

12.6 Domain Wall Boundary Conditions and Emission Absorption Loci for Advanced-Retarded Waves

We shall consider a static thick domain wall constructed by a scalar field with self-interaction in the Schwarzschild black hole spacetime [59,60].

$$g = -\left(1 - \frac{2M}{R}\right) dt^2 + \left(1 - \frac{2M}{R}\right)^{-1} dR^2 + R^2 (d\vartheta^2 + \sin^2 \vartheta d\varphi^2) \quad (11.6)$$

The metric of the background Schwarzschild black hole is written in terms of the isotropic coordinates, t, r, ϑ, φ , where the new radial coordinate, r is defined by

$$R = r \left(1 + \frac{M}{2r}\right)^2. \quad (11.7)$$

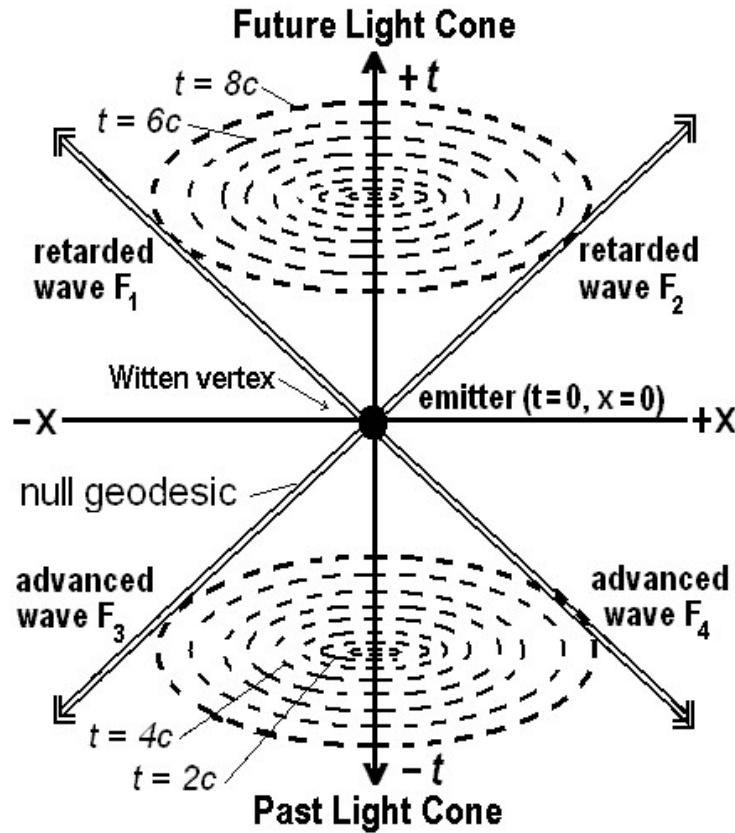

Figure 12.14 Cramer transaction emission locus at $x, t = 0, 0$. We are concerned with the boundary conditions in the region outside the event horizon, where $r \geq M/2$ which are of interest even though here applied to a black hole because it might reflect scale invariant principles.

The scalar equation in spherical coordinates of wave motion in spacetime which has

spherical symmetry [61,62]

$$\nabla^2 \Phi - \frac{1}{c^2} \frac{\partial^2 \Phi}{\partial t^2} = 0 \tag{12.8}$$

where Φ is the wave amplitude. The equation has two solutions

$$\begin{aligned} \Phi_{out} &= \frac{1}{r} \Phi_{max} \exp(i\omega t - ikr) \\ \Phi_{in} &= \frac{1}{r} \Phi_{max} \exp(i\omega t + ikr) \end{aligned} \tag{12.9}$$

which for the programming of spacetime can be applied to the propagation of Cramer's advanced retarded waves from an emission locus at $x, t = 0, 0$ by Eqs. 12.9 & 12.10 and Fig. 12.14.

$$\begin{aligned} F_{1-Ret} &= F_0 e^{-ikx} e^{-2\pi i f t}, & F_{2-Ret} &= F_0 e^{ikx} e^{-2\pi i f t} \\ F_{3-Adv} &= F_0 e^{-ikx} e^{2\pi i f t}, & F_{4-Adv} &= F_0 e^{ikx} e^{2\pi i f t} \end{aligned} \tag{12.10}$$

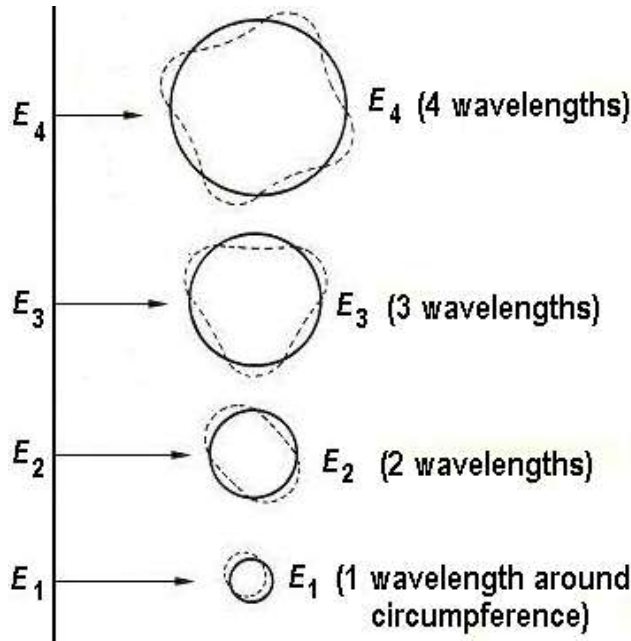

Figure 12.15. A Ring may vibrate with n standing wavelengths depending on the relationship of the circumference to the multiple number of whole wavelengths. Simplified here, it is suggested that the topology of spacetime and matter vibrate on and as hyperspherical surfaces.

Traditionally electron standing-waves oscillate about the atomic nucleus. Here we attempt to expand the wave nature of matter itself as static waves centered on the locus of least

spacetime units as it is annihilated and recreated in the arrow of time relative to the observer. This requires a conversion of the de Broglie wave equation, $mvr = n(h/2\pi)$ to a static form amenable to the parameters of continuous-state cosmology [19,38]. For Hyperspherical Representation the magnitudes of the radial coordinates of a two-state wavefunction, $\psi(\vec{r}_1, \vec{r}_2)$ in hyperspherical representation are replaced by the hyper-spherical radius, R and the hyperspherical angle, α such that

$$R \equiv (r_1^2 + r_2^2)^{1/2} \quad \text{and} \quad \alpha \equiv \arctan \frac{r_2}{r_1} \quad (12.11)$$

in order that the symmetries may be more clearly shown. The hyperspherical radius, R represents the size of the two-state system and the hyperspherical angle, α is a measure of the radial correlation of the two-state system [63]. It is critical to note that when $\alpha = \pi/4$, $r_1 = r_2$; and when $\alpha = 0$ or $\pi/2$ one of the states is at a greater distance from the least-unit vertex than the other.

12.7 Energy Increase from Ising Model Lattice-Gas Properties

In terms of the SUSY spacetime lattice represented by close-packed least units functioning as a Riemann 3-sphere Ising model spin lattice, where total energy, $E_T \{s_i\}$ is a function of the spin hysteresis loop

$$E_T \{s_i\} = \sum_i e_i(s_i) = E_0 - \sum_i h_i s_i \quad (12.12)$$

where $e_i(s_i)$ is the energy of an isolated individual least unit, E_0 the ground state and h_i the energy from spin orientation from the external field that allows coherent control of the Ising spin lattice [64]. The external field is the unitary action driving the evolution of the spacetime lattice structure as a putative self-organized complex system.

A surface of constant phase, $k \cdot r - \omega t = k_x x + k_y y + k_z z - \omega t = \text{constant}$ is a wavefront [17]. For a surface of constant phase if any wave equation has a time harmonic (sinusoidal) solution of the form $Ae^{i\phi}$ where A is the amplitude and the phase, ϕ a function of position with (x, y, z) constant and phase difference 2π separated by wavelength, $\lambda = 2\pi/k$. The direction cosines of the planes of constant phase are proportional to k and move in the direction of k equal to the phase velocity where

$$\mu = \frac{\omega}{k} = \frac{\omega}{\sqrt{k_x^2 + k_y^2 + k_z^2}}. \quad (12.13)$$

Where $\lambda = 2\pi/k = 2\pi\hbar/p = h/p$ is equivalent to the de Broglie matter wave relations, $E = \hbar\omega$, $\mathbf{p} = \hbar\mathbf{k}$ [65].

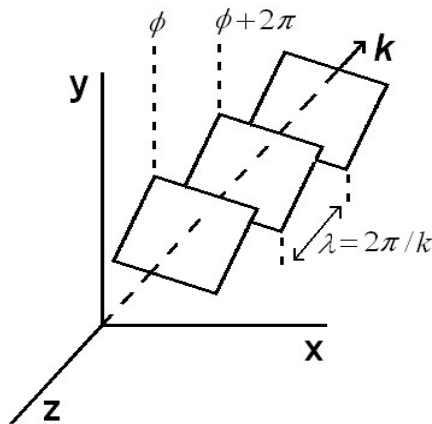

Figure 12.16 Surface of constant phase, in this case to represent orthogonal standing reality waves.

12.8 Programming Matter Through Cellular Automata

Programmable matter is defined as a material that locally adjusts its response to external inputs through programmed control. Amorphous Ising model lattice-gas cellular automata can be used for programming spacetime if designed to mirror the spacetime structure utilized. Each independent computational element in the amorphous or stochastic (accepting all) medium is identically programmed on a topological surface which in this case conforms to the least-unit tori of spacetime. There are too many units to program individually so programming is achieved by neighbor connectedness. Toffoli formed a metaphor to describe this neighbor model [8,9]. Usually a marching band has a leader, this will not work for cellular automata where local self-assembly is internalized for each individual unit which acts as its own agent. This is a fundamental requirement for a massive ballistic response. The nanostructure of the defense shield materials must contain a computing substrate that is composed of fine-grained computing nodes distributed throughout space which communicate using only this nearest neighbor type of interactions [8,9,12,13,66]. According to Drexler [66] the closely packed computational units may be constructed to simulate a fractal system that for us would mean has the required incursive properties.

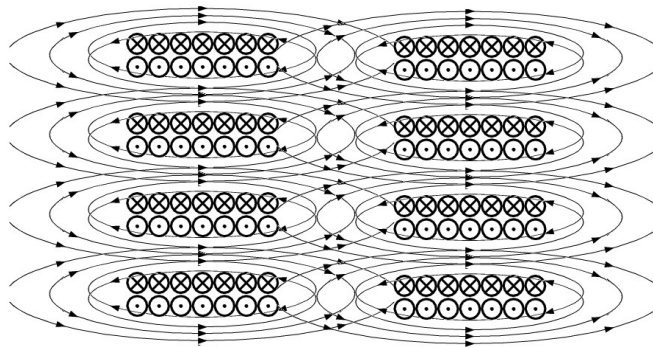

Figure 12.17 Nanoscale programmable matter substrate acting as receptors of modulated cascades to be built into the construction materials to act as a transducer of static de Broglie matter-waves resonating from the cellular automata into the hierarchical structure of spacetime.

12.9 Introduction to de Broglie Matter-Waves

De Broglie by considering a material moving object of restmass, m_0 for a stationary observer suggested that a phase wave, or 'pilot' wave, accompanies a particle because the principle of inertia said it should possess an internal energy equal to m_0c^2 [30]. This phase wave arises as an inevitable consequence of de Broglie's assumption of the internal periodic phenomenon of the particle and the Lorentz transformation laws of the special theory of relativity

$$hv_0 = m_0c^2, \quad (12.14)$$

with $v = \beta c$, ($\beta < 1$) for total energy $v = m_0c^2 / h\sqrt{1-\beta^2}$. De Broglie's result arose from a combination of the principle of Einstein's special relativity and the quantum relationship for the observer which he initially applied to a photon of nonzero restmass, m_γ ($< 10^{-50}$ g) which because of its associated internal motion he associated with a piloting phase wave of frequency, ν at each point in space.

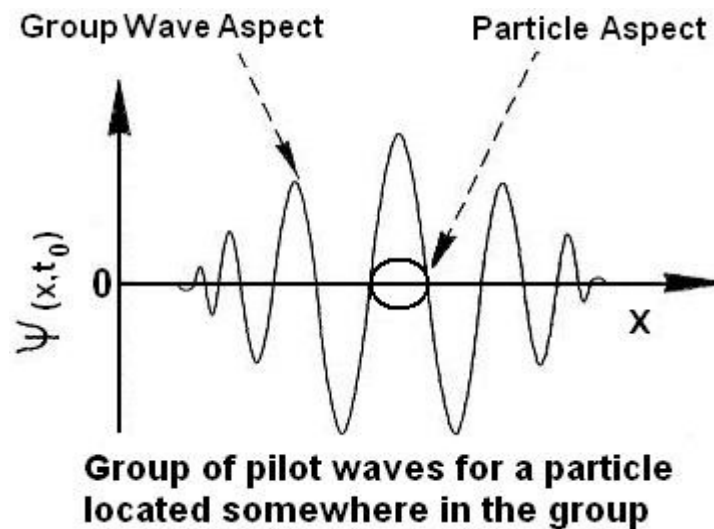

Figure 12.18 The group velocity of de Broglie waves is associated with the velocity of a particle.

MacKinnon [19,38,67] described the de Broglie wave packet for stationary states and nondispersive wave packets of a free particle. He states that the nondispersive wave packet, ψ is a solution of

$$\square\psi = 0 \quad (12.15)$$

where

$$\square = \nabla^2 - \frac{1}{c^2} \frac{\partial^2}{\partial t^2}. \quad (12.16)$$

From this MacKinnon shows that the nondispersive wave packet for a particle relative to the observer has the form

$$\psi = \sin(kr / \hbar) \exp[i(\omega t - k_0 x)] \quad (12.17)$$

where

$$k = m_0 c / \hbar, \quad r = \left\{ \frac{(x - vt^2)}{1 - (v^2 / c^2)} + y^2 + z^2 \right\}^{1/2}, \quad (12.18)$$

$$\omega = mc^2 / \hbar \quad k_0 = mv / \hbar.$$

Equation 12.17 is a spherically symmetric solution to Eq. 12.15 after being subjected to the Lorentz transform as initially obtained by de Broglie.

Of critical interest to us is MacKinnon's work to set up a de Broglie wave packet for a stationary state. Although we are interested in relativistic waves it is not for de Broglie waves for the usual particles in coordinate motion but for de Broglie waves for stationary matter with internal 'continuous-state relativistic effects.

Consider two identical particles moving in opposite directions relative to an observer at x^* and t^*

$$\psi_1^* = A \cos(\omega t^* - kx^*), \quad \psi_2^* = A \cos(\omega t^* + kx^*) \quad (12.19)$$

which represent standing waves when solved by the Schrödinger equation for a particle in a box and cannot depend on the reference frame [38]. MacKinnon concludes that these stationary states are static and for which Bohm postulated a quantum potential to account for it. MacKinnon carries this point further [19] to suggest that:

The motion of a particle in spacetime does not depend on the motion relative to it of any observer or any frame of reference [and] if the particle has an internal vibration of the type hypothesized by de Broglie, the phase of that vibration at any point in spacetime must appear to be the same for all observers...Each observer or reference frame will have its own de Broglie wave for the particle. The phase of the particle's vibration must, by definition, be the same as that for all possible de Broglie waves at the point where the particle is. By superimposing all these possible de Broglie waves, a [nondispersive] wave packet is formed centered in space on the particle.

In his original work de Broglie was not able to properly form a wave packet that could localize the particle; MacKinnon was able to construct a wave packet from de Broglie's original wave phenomena that is also nondispersive [19].

12.10 Coherent Control of Standing Matter-Waves

If it were possible to conceptually summarize everything required to develop a de Broglie matter-wave antiballistic defense shield it is illustrated in Fig. 12.20 above which is an exploded conformal scale-invariant view of the continuous-state wave-particle seesaw leapfrog dynamics inherent in the topology of spacetime shown as a template within a brane topology hierarchy amenable to application of resonance.

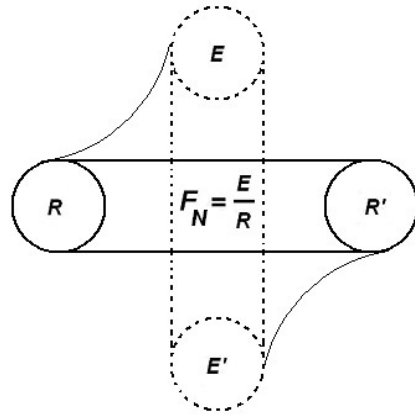

Figure 12.19 Ultimately the control mechanism for controlling standing de Broglie waves depends on applying the noetic field equation to the other programming parameters for the ballistic programming of cellular automata.

DEFENSE SHIELD SPACETIME TEMPLATE

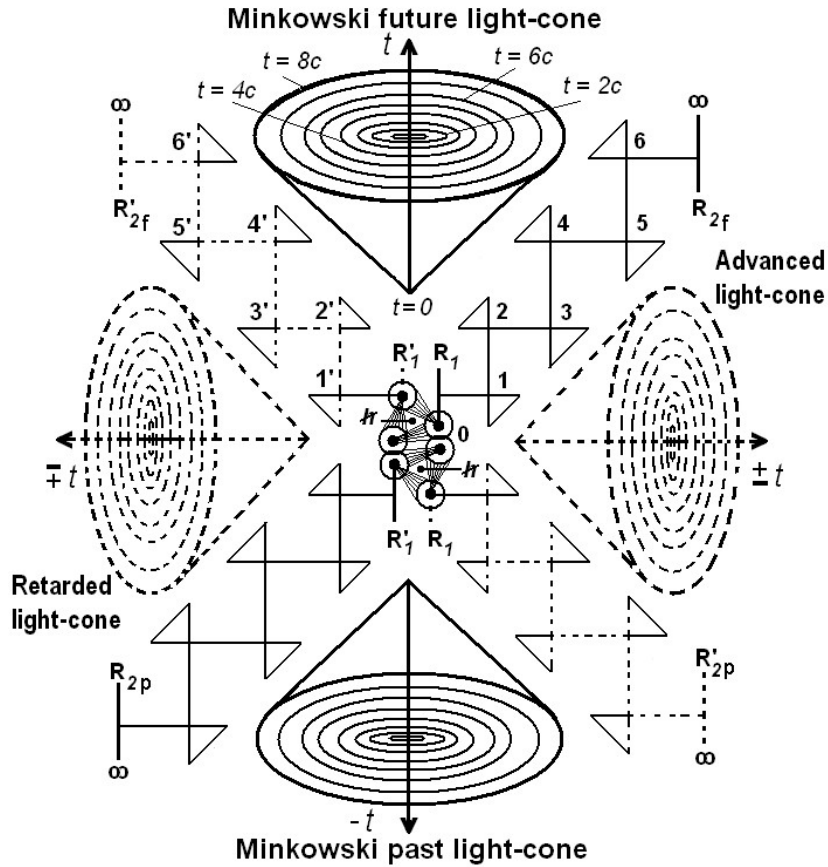

Figure 12.20 Conceptualized schema of the underlying spacetime structure utilized as a template for modulating the matter-wave resonance hierarchy mimicked in the programmable matter of the shield construction materials.

12.11 Afterward

When gazing out the window of ones mind it is hard to imagine that tangible objects like moons, mountains or cannon balls from a certain perspective can be as gossamer as the essence of love. The solid surfaces we walk on are made of relativistic holographic oscillations of tiny electron waves that quantum mechanically are everywhere and nowhere at the same time. If the nucleus of an atom were the size of the Earth the electron orbitals would be further away than the moon. That's a lot of empty space. We are made out of and imbedded in these materials and unaware of just how virtual reality is. It's the planes of constant quantum phase that make it so for us. A very complex self-organized dynamic holographic image process just for the observers benefit. By $E = mc^2$ there is a lot of energy in a pinhead; a baseball size clump of plutonium can level a city. Remembering a cartoon seen some decades ago depicting a couple of astronauts just as they were rounding the far side of the moon and the surprised looks they had when they saw that the moon was just a painted billboard; it's quite a challenge to accept a reality of that form. But this is the form that the principles here are based on.

We have provided a preliminary introduction for constructing matter-wave antiballistic defense shield technologies. The 1st prototype or test of the concept may be no more than constructive interference of stationary de Broglie waves that could in practice give aluminum the strength of depleted uranium for example. This would have some immediate utility in various applications. However what we predict is that a true shield, perhaps the 3rd generation technology, would utilize all of the deep structure of spacetime and be able to withstand a nuclear blast. Internal power consumption is required to operate the programmable matter substrate, in line with the mundane Star Trek cry by Captain Kirk: 'more power to the shields Scotty!'. The mature antiballistic defense shield technology would have these same subelements, i.e. coherently controlled constructive interference of matter-waves, nanoscale program-able matter substrate, but also the leading edge or wave envelope would not merely be a Huygens wave front but be programmed with an antimatter spin structure which would asymptotically increase the shields effectiveness. Also with sufficiently versatile programming this 'surface' would not create a percussive back-reaction but annihilate or damp the phases of the incoming matter and shock waves to attenuation by destructive rather than constructive interference techniques.

12.12 Summary of the Defense Shield Design Parameters

We have given a model for antiballistic matter-wave defense shield technology. It is not an engineering blueprint; the first prototype will requires a little more effort. We take a moment to summarize the salient features and requirements:

- Observed reality is like a virtual HD standing-wave of future-past advanced-retarded parameters.
- All current thinking confined to the limits of any/all standard models, i.e. particle physics, cosmology or quantum theory is insufficient and we therefore can safely emphasize that a de Broglie matter-wave defense shield cannot be built from within these confines.
- Most particularly matter in the extended de Broglie-Bohm-Vigier causal stochastic interpretation of quantum theory, the wave function is physically real as are both 'wave and particle' which may exist simultaneously. The properties of the Dirac equation is extended from the original concept of matter to include both spacetime and domain walls of the reality of the observer, all of which are created-annihilated and recreated in a covariant continuous-state scale-invariant process.

- The Dirac Polarized vacuum is a programmable ‘ocean’ of potentia, part of which we treat as a backcloth of ‘close-packed’ least cosmological units with Ising model properties like a cellular automata.
- In this general context the key to a de Broglie matter-wave antiballistic defense shield is simply to ballistically program the mean-free-path of this HD spacetime array, not in the usually considered linear path but for all coordinates simultaneously in a minimum of 6 spatial dimensions. Six-D may not turn out to be adequate; the three temporal and three unitary (for quantum potential or piloting) may also need to be addressed. We ‘guess’ three may drop out and just a 9D matrix will be required.
- We see three generations of shield technology:
 1. Limited HD programming – constructive interference of matter-waves giving aluminum the strength of depleted uranium.
 2. Full shield that could withstand nuclear ordinance but would require energy input for operation ala Star Trek ‘more power to the shields, Scotty’.
 3. Mature 3rd generation shield technology with all refinements. Antimatter topological configurations of cellular automata programming. Utilizes the infinite energy of the vacuum or even energy taken from the projectile with no energy input required.
- Some form of Noetic Transformation (Chap. 5) is probably required in the programming. Possibly the unique identifier term for a person to receive a transcendent insight can be omitted; but perhaps with a many-body addition to handle the ‘ubiquity factor’ whereas the individual the requirement is more like a singularity which wouldn’t require ballistic transport conditions.

FORMS OF THE NOETIC TRANSFORMATION

1. Observer receives transcendent information form HD, \Downarrow
2. Subject S_1 and S_2 have open channel \Leftrightarrow between them.
3. Ballistic spacetime programming for HD, $\Uparrow \swarrow \searrow \nearrow \Leftrightarrow$
4. Combination of 2. & 3. plus imbedding information
 - a. Structural-phenomenological for spacetime info.
 - b. Data content – like imbedding actual qualia in quantum computer music

Acknowledgement

In the spirit of the recent tercentenary of one of our heroes, early American printer, journalist, publisher, author, philanthropist, abolitionist, public servant, scientist, librarian, diplomat, statesman and inventor Benjamin Franklin, who put all of his myriad patents, such as the Franklin stove, bifocals, the medical catheter, lightning rod, swim fins, and the odometer in the public domain; in this same spirit we would like to offer our insights into defense shield technology as a gift toward world peace. Franklin believed:

As we benefit from the inventions of others, we should be glad to share our own...freely and gladly.

We are Americans who consider ourselves highly patriotic, but also good world citizens. Many American are ashamed at how poorly our country has been run recently. If we wish to continue to ‘police the planet’ and present diplomatic, scientific and democratic leadership; we

need to do a lot better. Case in point regarding the content of this chapter; the US Department of Defense (DOD) created DARPA, the Defense Advanced Research Projects Agency in 1958 by order of then US President Dwight D. Eisenhower in response to the surprise Russian launch of Sputnik. Eisenhower's guidance was clear: 'find and quickly develop advanced technology for the Armed Forces so the United States would never again suffer a technological surprise by another nation'.

In direct contact with DARPA management, we were told DARPA was not interested in our shield technology proposals, 'that they knew of no experiment....'; we said we knew this, we wanted to present the experiment, if they wouldn't fund that at least let us write a 'white paper' describing it. We were politely told to 'come back in twenty years'. We also tried the DARPA BAA research programs; but our institute wasn't considered large enough to pass the type of 'Dunn & Bradstreet' screening the BAA system required. Finally we attempted to get a NATO advanced projects grant but could not find a willing NATO Mediterranean or Eastern European partner which was part of the application requirements. So there you have it...Of course we commit no treason here as theory of any kind apparently is not considered a threat to national security. But just in case we gave no blueprint.

What are the remaining enlightened person's priorities – God, country, world, family, self? American prophet Brigham Young said, 'all scientific discovery comes as revelation from God'. So we give this technology back to God! Let the arms race, no, let the peace race begin...

References

- [1] Levy, R.H. & Fren, F.W. (1967) The plasma radiation shield: concept, and applications to space vehicles, Prepared under NASA Contract No. NAS 8-20310 NASA CR-61176.
- [2] Buhler, C.R. & Wichmann, L. (2005) Analysis of a Lunar Base Electrostatic Radiation Shield Concept, Phase I Final Report, Kennedy Space Center, Florida: ASRC Aerospace Corporation.
- [3] US Army Corps of Engineers (1946) Fundamentals of Protective Design.
- [4] Davisson, C.J. & Germer, L.H. (1928) Reflection of electrons by a crystal of nickel, PNAS, v 14, pp 317-323.
- [5] Thomson, G.P. (1927) The diffraction of cathode rays by thin films of platinum, Nature 120, p. 802.
- [6] Hubbell, J.H. (2006) Electron positron pair production by photons: A historical overview, Radiation Physics and Chemistry 75:6; 614–623.
- [7] Agger, C.K. (1996) The Theory of Photon-Impact Bound-Free Pair Production and Applications to Relativistic Heavy-Ion Collisions, www.modspil.dk/agger/speciale.pdf.
- [8] Toffoli, T. Programmable Matter: An introduction, Cambridge: MIT Univ. Press (in preparation).
- [9] Toffoli, T. & Margolus, N. (1987) Cellular Automata Machines; A New Environment for Modeling, Cambridge: MIT Univ. Press; Russian translation (1991) *Mashiny Kletochnykh Avtomatov, Izdatelstvo 'Mir'*.
- [10] Ionicioiu, R., Amaratunga, G. & Udrea, F. (2000) Quantum computation with ballistic electrons, arXiv:quant-ph/0011051v1.
- [11] Viswanathan, G.M. & Viswanathan, T.M. (2008) Spontaneous symmetry breaking and finite time singularities in D-dimensional incompressible flow with fractional dissipation, arXiv:0807.1563v1 [physics.flu-dyn].

- [12] Kodama, T. & Koide, T. (2008) Memory effects and transport coefficients for non-Newtonian fluids, arXiv:0812.4138v1 [hep-ph].
- [13] Abelson, H. et al. (2000) Amorphous computing, *Communications of the ACM*, 43:74-82.
- [14] Wolfram, S. (1994) *Cellular Automata and Complexity*, Reading: Addison-Wesley.
- [15] Sreekantan, B.V. (1984) Searches for proton decay and superheavy magnetic monopoles, *J Astrophysics & Astronomy*, vol. 5, p. 251–271.
- [16] Hagiwara, K. et al. (2002) Particle Data Group current best estimates of proton lifetime, *Phys. Rev. D* 66, 010001.
- [17] Peebles, P.J.E. (1992) *Quantum Mechanics*, Princeton: Princeton Univ. Press.
- [18] Huygens, C. (1690) *Traite de la Lumiere*, (Treatise on Light).
- [19] McKinnon, L. (1978) A nondispersive de Broglie wave packet, *Foundations of Physics*, 8:3-4; 157-176.
- [20] Kaku, M. (1998) *Introduction to Superstrings & M-Theory*, 2nd ed., New York: Springer.
- [21] Cramer, J.G. (1986) The Transactional Interpretation of Quantum Mechanics, *Rev. Mod. Phys* 58, 647-687.
- [22] Zizzi, P. (2005) Spacetime at the Planck scale: The quantum computer view, in R.L Amoroso, B. Lehnert & J-P Vigier (eds.), *Beyond the Standard Model: Searching for Unity in Physics*, Oakland: Noetic Press.
- [23] Kulhánek, J. (1965) Propagation of de Broglie waves in space-time, *Il Nuovo Cimento*, 38:3; 1955-1965.
- [24] Croca, J.R., Garuccio, A., Lepore, V.L. & Moreira, R.N. (1990) Quantum-optical predictions for an experiment on the de Broglie waves detection, *Foundations Physics Letters*, 3:6; 557-564.
- [25] Feoli, A. & Scarpetta, G. (1998) De Broglie Matter Waves from the Linearized Einstein Field Equations, *Foundations Phys L*, 11:4; 395-403.
- [26] Lepore, V.L. (1992) Homodyne detection of de Broglie waves, *Foundations of Physics Letters*, 5:5; 469-478
- [27] Croca, J.R., Ferrero, M., Garuccio, A. & Lepore, V.L. (1997) An experiment to test the reality of de Broglie waves, *Foundations of Physics Letters*, 10:5; 441-447.
- [28] Barut, A.O. (1990) Quantum theory of single events: Localized de Broglie wavelets, Schrödinger waves, and classical trajectories, *Foundations of Physics*, 20: 10.
- [29] Rauch, H. (2008) Test of quantum mechanics by neutron interferometry, *European Physical J - Special Topics*, V.159, No.1.
- [30] de Broglie, L. (1923) Radiation, waves and quanta, *Comptes Rendus*, Vol. 177, pp. 507-510.
- [31] Davisson, C.J. & Germer, L.H. (1929) A test for polarization of electron waves by reflection, *Phys Rev* 33: 5; 760-772.
- [32] Dewdney, C., Kyprianidis, A., Vigier, J-P., Garuccio, A. & Gueret, Ph. (1984) Time-dependent neutron interferometry: Evidence in favour of de Broglie waves, *Lettere Al Nuovo Cimento*, 40:16; 1971-1985.
- [33] Croca, R. (1987) Neutron interferometry can prove (or refute) the existence of de Broglie's waves, *Foundations Phys*, Vol. 17, No. 10.
- [34] Rybakov, Y.P. (1974) On the causal interpretation of quantum mechanics, *Foundations of Physics*, Vol. 4, No. 2.
- [35] Vigier, J-P (2000) selected papers, in S. Jeffers, B. Lehnert, N. Abramson, & L. Chebotarev (eds.) *Jean-Pierre Vigier and the Stochastic Interpretation of Quantum Mechanics*, Montreal: Aperion.
- [36] Yang, S., Hammack, A.T., Fogler, M.M. & Butov, L.V. (2006) Coherence length of cold

- exciton gases in coupled quantum wells, arXiv:cond-mat/0606683v1.
- [37] Kleinert, H. (2005) Vortex origin of tricritical point in Ginzburg-Landau theory, arXiv:cond-mat/0509430v1.
- [38] McKinnon, L. (1979) The de Broglie wave packet for a simple stationary state, *Foundations of Physics*, 9:9-10; 787-791.
- [39] Barbour, J. (1999) *Then end of time - The next revolution in physics*, Oxford Press, Oxford, U.K.
- [40] Leibniz, G.W. (1768) *Opera Omnia*. 6 volumes, Louis Dutens, ed. Geneva
- [41] Amoroso, R.L. & Pribram, K.H. (eds.) *The Complementarity of Mind and Body: Realizing the Dream of Descartes, Einstein and Eccles*, Cambridge: MIT University Press.
- [42]] Chu, M-Y.J. & Amoroso, R.L. (2008) Empirical mediation of the primary mechanism initiating protein conformation in prion propagation, in D. Dubois (ed.) *Partial Proceedings of CASYS07, IJCAS, Vol. 22, Univ. Liege Belgium*.
- [43] Amoroso, R.L. (1996) The production of Fröhlich and Bose-Einstein coherent states in in vitro paracrystalline oligomers using phase control laser interferometry, *Bioelectrochemistry & Bioenergetics*, 41:1, pp.39-42.
- [44] Smullyan, R.M. (1992) *Gödel's Incompleteness Theorems*, Oxford: Oxford University Press.
- [45] Heiblum, M., Nathan, M.I., Thomas, D.C. & Knoedler, C.M. (1985) Observation of Ballistic Transport in GaAs, *Phys Rev L*, 55:20; 2200-03.
- [46] Javey, A., Guo, J., Paulsson, M., Wang, Q., Mann, D., Lundstrom, M. & Dai, H. (2003) High-field, quasi-ballistic transport in short carbon nanotubes, arXiv: 0309/0309242.
- [47] Hubbell, J. H. (2006) Electron positron pair production by photons: A historical overview, *Radiation Phys.& Chem.* 75:6; 614-623.
- [48] Schwinger, J. (1950) Physical consequences of vacuum polarization, *Phys. Rev.* 78:135; 105.
- [49] Lloyd, S. (2006) *Programming the Universe*, New York: Knoph.
- [50] Marshall, T. (2002) Engineering the vacuum, in R.L. Amoroso, G. Hunter, M. Kafatos & J-P Vigier (eds.) *Gravitation and Cosmology: From the Hubble Radius to the Planck Scale*, Dordrecht: Kluwer.
- [51] McCarthy, W. (2003) *Hacking Matter*, New York: Basic Books.
- [52] Smolin, L.(1997) The future of spin networks, arXiv:gr-qc/9702030v1.
- [53] Smolin, L. (2002) Quantum gravity with a positive cosmological constant, arXiv:hep-th/0209079v1.
- [54] Amoroso, R.L & Amoroso, P.J. (2004) The fundamental limit and origin of complexity in biological systems: A new model for the origin of life, in D. Dubois, (ed.) *Computing Anticipatory Systems, Proceedings of CASYS04, 6th Int. Conf., Liege, Belgium, 11-16 Aug, 2003, AIP Proceedings Vol. 718, pp. 144-159.*
- [55] Jensen, H.J. (1998) *Self-Organized Criticality - Emergent Complex Behavior in Physical and Biological Systems*, Cambridge Univ. Press.
- [56] Krink, T. & Tomsen, R. (2001) Self-organized criticality and mass extinction in evolutionary algorithms, *Proc. IEEE int. Conf. on Evolutionary Computing*, pp. 1155-1161.
- [57] Bak, P., Tang, C. & Wiesenfeld, T.(1987) Self-organized criticality: an explanation of 1/f noise, *Phys Review Letters*. Vol. 59, No. 4.
- [58] Feigenbaum, M.J. (1980) Universal behavior in nonlinear systems, *Los Alamos Science* v1, p4-27.
- [59] Morisawa, Y., Ida, D., Ishibashi, A.& Ken-ichi Nakao, K-I (2002) Thick domain walls around a black hole, arXiv:gr-qc/0209070v2.
- [60] Morisawa, Y., Yamazaki, R., Ida, D., Ishibashi, A. & Nakao, K-I

- (2000) Thick domain walls intersecting a black hole, arXiv:gr-qc/0005022v1.
- [61] Wolff, M. (2002) Cosmology, the quantum universe and electron spin, in R.L. Amoroso, G. Hunter, M. Kafatos & J-P Vigier (eds.) *Gravitation and Cosmology: From the Hubble Radius to the Planck Scale*, pp. 517-524, Dordrecht: Kluwer.
- [62] Wolff, M. (2008) *Schrödinger's Universe and the Origin of the Natural Laws*, Parker: Outskirts Press.
- [63] Starace, A.F. (1988) Hyperspherical description of two-electron systems, in Briggs, J.S., Kleinpoppen, H. & Lutz, H.O. (eds.) *Fundamental Processes of Atomic Dynamics*, pp. 235-258, NY: Plenum.
- [64] Harding, S.L., Miller, J.F. & Rietman, E.A. (2006) Evolution in materio: Exploiting the physics of materials for computation, arXiv:cond-mat/0611462v1.
- [65] L. De Broglie, *Théorie générale des Particules à Spin (Méthode de Fusion)*, p. 93-116. Paris, Gauthier-Villars, 1943.
- [66] Drexler, K.E. (1992) *Nanosystems : Molecular Machinery, Manufacturing and Computation*, New York : Wiley & Sons.
- [67] MacKinnon, L. (1981) A fundamental equation in quantum mechanics? *Let Al Nuovo Cimento*, 32:10; 311-316.