



## CRAHNs: Cognitive radio ad hoc networks

Ian F. Akyildiz\*, Won-Yeol Lee, Kaushik R. Chowdhury

Broadband Wireless Networking Laboratory, School of Electrical and Computer Engineering, Georgia Institute of Technology, Atlanta, GA 30332, United States

### ARTICLE INFO

#### Article history:

Available online 14 January 2009

#### Keywords:

Cognitive radio  
Ad hoc networks  
Spectrum sensing  
Spectrum sharing  
Spectrum decision  
Spectrum mobility  
Medium access control protocol  
Common control channel  
Routing protocol  
Transport protocol  
Commons model

### ABSTRACT

Cognitive radio (CR) technology is envisaged to solve the problems in wireless networks resulting from the limited available spectrum and the inefficiency in the spectrum usage by exploiting the existing wireless spectrum opportunistically. CR networks, equipped with the intrinsic capabilities of the cognitive radio, will provide an ultimate *spectrum-aware* communication paradigm in wireless communications. CR networks, however, impose unique challenges due to the high fluctuation in the available spectrum as well as diverse quality-of-service (QoS) requirements. Specifically, in cognitive radio ad hoc networks (CRAHNs), the distributed multi-hop architecture, the dynamic network topology, and the time and location varying spectrum availability are some of the key distinguishing factors. In this paper, intrinsic properties and current research challenges of the CRAHNs are presented. First, novel spectrum management functionalities such as spectrum sensing, spectrum sharing, and spectrum decision, and spectrum mobility are introduced from the viewpoint of a network requiring distributed coordination. A particular emphasis is given to distributed coordination between CR users through the establishment of a common control channel. Moreover, the influence of these functions on the performance of the upper layer protocols, such as the network layer, and transport layer protocols are investigated and open research issues in these areas are also outlined. Finally, a new direction called the commons model is explained, where CRAHN users may independently regulate their own operation based on pre-decided spectrum etiquette.

© 2009 Elsevier B.V. All rights reserved.

### 1. Introduction

Recent technological advances have resulted in the development of wireless ad hoc networks composed of devices that are self-organizing and can be deployed without infrastructure support. These devices generally have small form factors, and have embedded storage, processing and communication ability. While ad hoc networks may support different wireless standards, the current state-of-the-art has been mostly limited to their operations in the 900 MHz and the 2.4 GHz industrial, scientific and medical (ISM) bands. With the growing proliferation of wireless devices, these bands are increasingly getting congested. At the same time, there are several frequency bands licensed

to operators, such as in the 400–700 MHz range, that are used sporadically or under-utilized for transmission [23].

The licensing of the wireless spectrum is currently undertaken on a long-term basis over vast geographical regions. In order to address the critical problem of spectrum scarcity, the FCC has recently approved the use of unlicensed devices in licensed bands. Consequently, dynamic spectrum access (DSA) techniques are proposed to solve these current spectrum inefficiency problems. This new area of research foresees the development of cognitive radio (CR) networks to further improve spectrum efficiency. The basic idea of CR networks is that the unlicensed devices (also called cognitive radio users or secondary users) need to vacate the band once the licensed device (also known as a primary user) is detected. CR networks, however, impose unique challenges due to the high fluctuation in the available spectrum as well as diverse quality-of-service (QoS) requirements [3]. Specifically, in CR ad

\* Corresponding author. Tel.: +1 404 894 5141; fax: +1 404 894 7883.  
E-mail addresses: [ian@ece.gatech.edu](mailto:ian@ece.gatech.edu) (I.F. Akyildiz), [wylee@ece.gatech.edu](mailto:wylee@ece.gatech.edu) (W.-Y. Lee), [kaushikc@ece.gatech.edu](mailto:kaushikc@ece.gatech.edu) (K.R. Chowdhury).

hoc networks (CRAHNs), the distributed multi-hop architecture, the dynamic network topology, and the time and location varying spectrum availability are some of the key distinguishing factors. These challenges necessitate novel design techniques that simultaneously address a wide range of communication problems spanning several layers of the protocol stack.

Cognitive radio technology is the key technology that enables a CRAHN to use spectrum in a dynamic manner. The term, cognitive radio, can formally be defined as follows [22]:

A “Cognitive Radio” is a radio that can change its transmitter parameters based on interaction with the environment in which it operates.

From this definition, two main characteristics of the cognitive radio can be defined as follows [32,82]:

- *Cognitive capability*: Cognitive capability refers to the ability of the radio technology to capture or sense the information from its radio environment. This capability cannot simply be realized by monitoring the power in some frequency bands of interest but more sophisticated techniques, such as autonomous learning and action decision are required in order to capture the temporal and spatial variations in the radio environment and avoid interference to other users. Through this capability, the portions of the spectrum that are unused at a specific time or location can be identified. Consequently, the best spectrum and appropriate operating parameters can be selected.
- *Reconfigurability*: The cognitive capability provides spectrum awareness whereas reconfigurability enables the radio to be dynamically programmed according to the radio environment. More specifically, the cognitive radio can be programmed to transmit and receive on a variety of frequencies and to use different transmission access technologies supported by its hardware design [41].

The ultimate objective of the cognitive radio is to obtain the best available spectrum through cognitive capability and reconfigurability as described before. Since most of the spectrum is already assigned, the most important challenge is to share the licensed spectrum without interfering with the transmission of other licensed users as illustrated in Fig. 1. The cognitive radio enables the usage of temporarily unused spectrum, which is referred to as *spectrum hole* or *white space* [32]. If this band is further utilized by a licensed user, the cognitive radio moves to another spectrum hole or stays in the same band, altering its transmission power level or modulation scheme to avoid interference as shown in Fig. 1.

According to the network architecture, cognitive radio (CR) networks can be classified as the infrastructure-based CR network and the CRAHNs [3]. The infrastructure-based CR network has a central network entity such as a base-station in cellular networks or an access point in wireless local area networks (LANs). On the other hand, the CRAHN does not have any infrastructure backbone. Thus, a CR user can communicate with other CR users through ad hoc connection on both licensed and unlicensed spectrum bands.

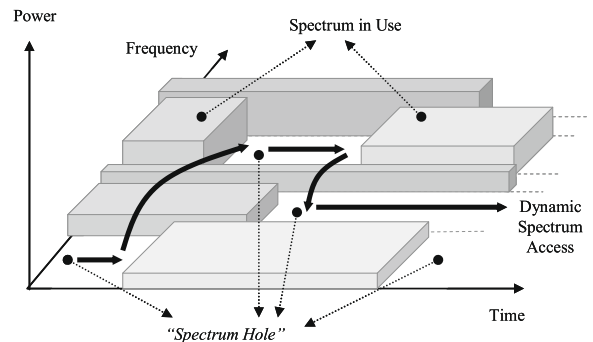

Fig. 1. Spectrum hole concept.

In the infrastructure-based CR networks, the observations and analysis performed by each CR user feeds the central CR base-station, so that it can make decisions on how to avoid interfering with primary networks. According to this decision, each CR user reconfigures its communication parameters, as shown in Fig. 2a. On the contrary, in CRAHNs, each user needs to have all CR capabilities and is responsible for determining its actions based on the local observation, as shown in Fig. 2b. Since the CR user cannot predict the influence of its actions on the entire network with its local observation, cooperation schemes are essential, where the observed information can be exchanged among devices to broaden the knowledge on the network.

This paper presents functional descriptions and current research challenges of CRAHNs. We first give the differences between CRAHNs and classical ad hoc networks in Section 2. In Section 3, we provide a brief overview of the spectrum management framework for cognitive radio ad hoc networks. In Sections 4–7, we explain the existing work and challenges in spectrum sensing, spectrum decision, spectrum sharing, spectrum mobility, respectively. These functions need a reliable control channel for message exchanges, whose design approaches are described in Section 8. Next, we investigate how CR features influence the performance of the upper layer protocols, and explain the research challenges on routing and transport protocols in Sections 9 and 10, respectively. The efforts underway in realizing coexistence among the CR users in absence of the licensed users are presented in Section 11. Finally, we conclude the paper in Section 12.

## 2. Classical ad hoc networks vs. cognitive radio ad hoc networks

The changing spectrum environment and the importance of protecting the transmission of the licensed users of the spectrum mainly differentiate classical ad hoc networks from CRAHNs. We describe these unique features of CRAHNs compared to classical ad hoc networks as follows:

- *Choice of transmission spectrum*: In CRAHNs, the available spectrum bands are distributed over a wide frequency range, which vary over time and space. Thus, each user shows different spectrum availability according to the

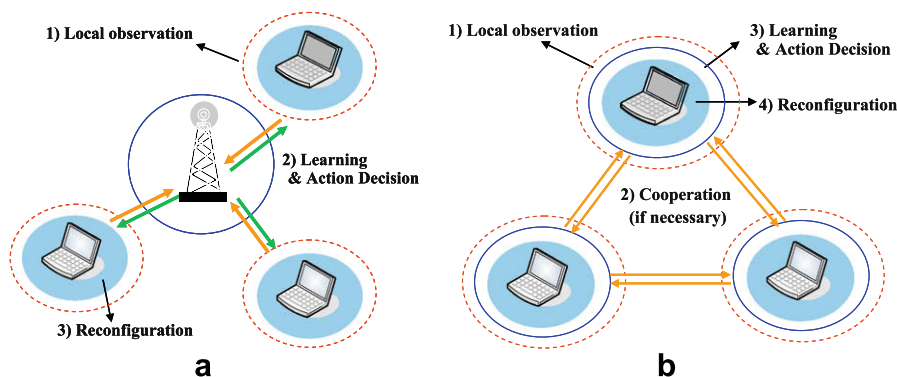

Fig. 2. Comparison between CR capabilities for: (a) infrastructure-based CR networks, and (b) CRAHNs.

primary user (PU) activity. As opposed to this, classical ad hoc networks generally operate on a pre-decided channel that remains unchanged with time. For the ad hoc networks with multi-channel support, *all* the channels are continuously available for transmission, though nodes may select few of the latter from this set based on self-interference constraints. A key distinguishing factor is the primary consideration of protecting the PU transmission, which is entirely missing in classical ad hoc networks.

- **Topology control:** Ad hoc networks lack centralized support, and hence must rely on local coordination to gather topology information. In classical ad hoc networks, this is easily accomplished by periodic beacon messages on the channel. However, in CRAHNs, as the licensed spectrum opportunity exists over large range of frequencies, sending beacons over all the possible channels is not feasible. Thus, CRAHNs are highly probable to have incomplete topology information, which leads in an increase in collisions among CR users as well as interference to the PUs.
- **Multi-hop/multi-spectrum transmission:** The end-to-end route in the CRAHN consists of multiple hops having different channels according to the spectrum availability. Thus, CRAHNs require collaboration between routing and spectrum allocation in establishing these routes. Moreover, the spectrum switches on the links are frequent based on PU arrivals. As opposed to classical ad hoc networks, maintaining end-to-end QoS involves not only the traffic load, but also how many different channels and possibly spectrum bands are used in the path, the number of PU induced spectrum change events, consideration of periodic spectrum sensing functions, among others.
- **Distinguishing mobility from PU activity:** In classical ad hoc networks, routes formed over multiple hops may periodically experience disconnections caused by node mobility. These cases may be detected when the next hop node in the path does not reply to messages and the retry limit is exceeded at the link layer. However, in CRAHNs, a node may not be able to transmit immediately if it detects the presence of a PU on the spectrum, even in the absence of mobility. Thus, correctly inferring mobility conditions and initiating the appropriate

recovery mechanism in CRAHNs necessitate a different approach from the classical ad hoc networks.

We now describe the spectrum management function framework for CRAHNs in the next section that enables the spectrum-aware operation.

### 3. Spectrum management framework for cognitive radio ad hoc networks

The components of the cognitive radio ad hoc network (CRAHN) architecture, as shown in Fig. 3a, can be classified in two groups as the *primary network* and the *CR network* components. The *primary network* is referred to as an existing network, where the *primary users (PUs)* have a license to operate in a certain spectrum band. If primary networks have an infrastructure support, the operations of the PUs are controlled through *primary base stations*. Due to their priority in spectrum access, the PUs should not be affected by unlicensed users. The *CR network* (or secondary network) does not have a license to operate in a desired band. Hence, additional functionality is required for CR users (or secondary user)<sup>1</sup> to share the licensed spectrum band. Also, CR users are mobile and can communicate with each other in a multi-hop manner on both licensed and unlicensed spectrum bands. Usually, CR networks are assumed to function as stand-alone networks, which do not have direct communication channels with the primary networks. Thus, every action in CR networks depends on their local observations.

In order to adapt to dynamic spectrum environment, the CRAHN necessitates the spectrum-aware operations, which form a *cognitive cycle* [3,32,61]. As shown in Fig. 3b, the steps of the cognitive cycle consist of four spectrum management functions: spectrum sensing, spectrum decision, spectrum sharing, and spectrum mobility. To implement CRAHNs, each function needs to be incorporated into the classical layering protocols, as shown in Fig. 4. The following are the main features of spectrum management functions [3]:

<sup>1</sup> In this paper, the terms “user” and “node” are interchangeably used.

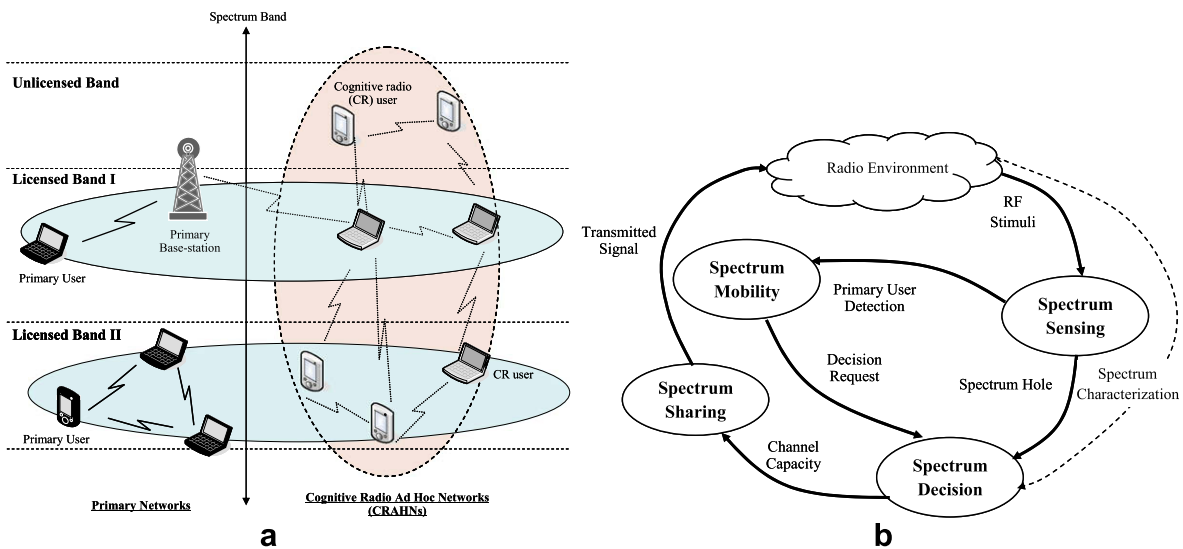

Fig. 3. The CRAHN architecture and the cognitive radio cycle are shown in (a) and (b), respectively.

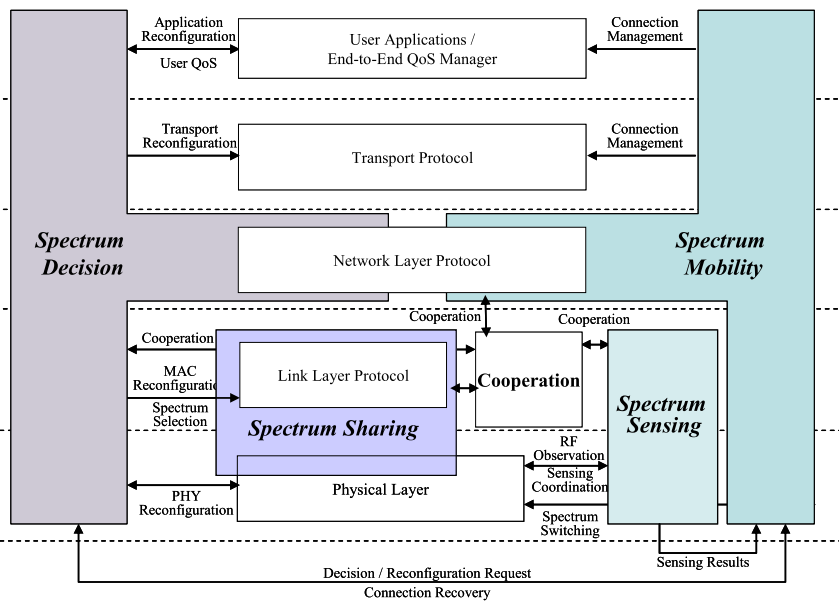

Fig. 4. Spectrum management framework for CRAHNs.

- **Spectrum sensing:** A CR user can be allocated to only an unused portion of the spectrum. Therefore, a CR user should monitor the available spectrum bands, and then detect spectrum holes. Spectrum sensing is a basic functionality in CR networks, and hence it is closely related to other spectrum management functions as well as layering protocols to provide information on spectrum availability.
- **Spectrum decision:** Once the available spectrums are identified, it is essential that the CR users select the most appropriate band according to their QoS requirements. It is important to characterize the spectrum band in terms of both radio environment and the statistical behaviors

of the PUs. In order to design a decision algorithm that incorporates dynamic spectrum characteristics, we need to obtain *a priori* information regarding the PU activity. Furthermore, in CRAHNs, spectrum decision involves jointly undertaking spectrum selection and route formation.

- **Spectrum sharing:** Since there may be multiple CR users trying to access the spectrum, their transmissions should be coordinated to prevent collisions in overlapping portions of the spectrum. Spectrum sharing provides the capability to share the spectrum resource opportunistically with multiple CR users which includes *resource allocation* to avoid interference caused to the

primary network. For this, *game theoretical approaches* have also been used to analyze the behavior of selfish CR users. Furthermore, this function necessitates a *CR medium access control (MAC) protocol*, which facilitates the *sensing control* to distribute the sensing task among the coordinating nodes as well as *spectrum access* to determine the timing for transmission.

- **Spectrum mobility:** If a PU is detected in the specific portion of the spectrum in use, CR users should vacate the spectrum immediately and continue their communications in another vacant portion of the spectrum. For this, either a new spectrum must be chosen or the affected links may be circumvented entirely. Thus, spectrum mobility necessitates a *spectrum handoff* scheme to detect the link failure and to switch the current transmission to a new route or a new spectrum band with minimum quality degradation. This requires collaborating with spectrum sensing, neighbor discovery in a link layer, and routing protocols. Furthermore, this functionality needs a *connection management* scheme to sustain the performance of upper layer protocols by mitigating the influence of spectrum switching.

To overcome the drawback caused by the limited knowledge of the network, all of spectrum management functions are based on cooperative operations where CR users determine their actions based on the observed information exchanged with their neighbors.

In the following sections, we introduce the spectrum management functions for CRAHNs. Then, we investigate how these spectrum management functions are integrated into the existing layering functionalities in ad hoc networks and address the challenges of them.

#### 4. Spectrum sensing for cognitive radio ad hoc networks

A cognitive radio is designed to be aware of and sensitive to the changes in its surrounding, which makes spectrum sensing an important requirement for the realization of CR networks. Spectrum sensing enables CR users to exploit the unused spectrum portion adaptively to the radio environment. This capability is required in the following cases: (1) CR users find available spectrum holes over a wide frequency range for their transmission (*out-of-band sensing*), and (2) CR users monitor the spectrum band during the transmission and detect the presence of primary networks so as to avoid interference (*in-band sensing*).

As shown in Fig. 5, the CRAHN necessitates the following functionalities for spectrum sensing:

- **PU detection:** The CR user observes and analyzes its local radio environment. Based on these location observations of itself and its neighbors, CR users determine the presence of PU transmissions, and accordingly identify the current spectrum availability.
- **Cooperation:** The observed information in each CR user is exchanged with its neighbors so as to improve sensing accuracy.

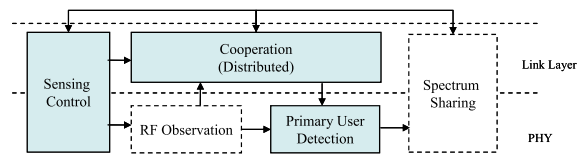

Fig. 5. Spectrum sensing structure for ad hoc CR networks.

- **Sensing control:** This function enables each CR user to perform its sensing operations adaptively to the dynamic radio environment. In addition, it coordinates the sensing operations of the CR users and its neighbors in a distributed manner, which prevents false alarms in cooperative sensing.

In order to achieve high spectrum utilization while avoiding interference, spectrum sensing needs to provide high detection accuracy. However, due to the lack of a central network entity, CR ad hoc users perform sensing operations independently of each other, leading to an adverse influence on sensing performance. In the following subsection, we investigate these basic functionalities required for spectrum sensing to address this challenge in CRAHNs.

##### 4.1. Primary user detection

Since CR users are generally assumed not to have any real-time interaction with the PU transmitters and receivers, they do not know the exact information of the ongoing transmissions within the primary networks. Thus, PU detection depends on the only local radio observations of CR users. Generally, PU detection techniques for CRAHNs can be classified into three groups [3]: *primary transmitter detection*, *primary receiver detection*, and *interference temperature management* (see Fig. 6). As shown in Fig. 7a, *transmitter detection* is based on the detection of the weak signal from a primary transmitter through the local observations of CR users. The *primary receiver detection* aims at finding the PUs that are receiving data within the communication range of a CR user [86]. As depicted in Fig. 7b, the local oscillator (LO) leakage power emitted by the radio frequency (RF) front-end of the primary receiver is usually exploited, which is typically weak. Thus, although it provides the most effective way to find spectrum holes, currently this method is only feasible in the detection of the

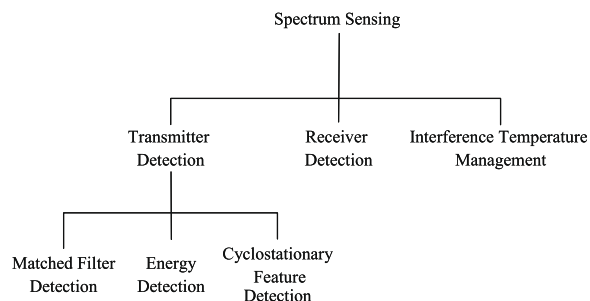

Fig. 6. Classification of spectrum sensing.

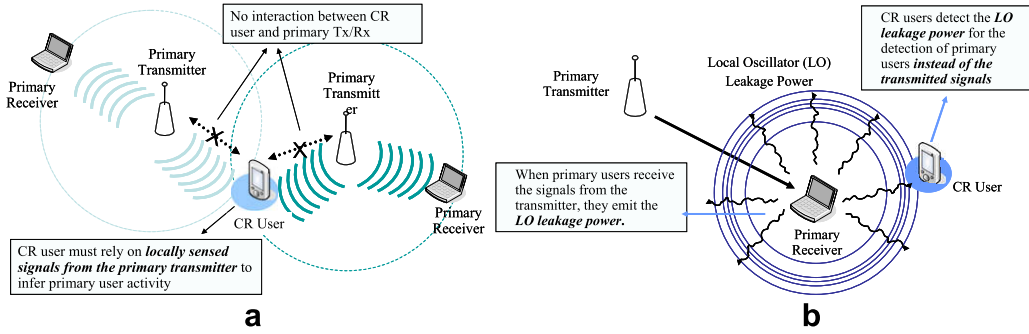

Fig. 7. Spectrum sensing techniques: (a) transmitter detection, and (b) receiver detection.

TV receivers. *Interference temperature management* accounts for the cumulative RF energy from multiple transmissions, and sets a maximum cap on their aggregate level that the primary receiver could tolerate, called an *interference temperature limit* [24]. As long as CR users do not exceed this limit by their transmissions, they can use this spectrum band. However, the difficulty of this model lies in accurately measuring the interference temperature since CR users cannot distinguish between actual signals from the PU and noise/interference. For these reasons, most of current research on spectrum sensing in CRAHNS has mainly focused on primary transmitter detection.

In transmitter detection, in order to distinguish between used and unused spectrum bands, CR users should have the capability to detect their own signal from a PU transmitter. The local RF observation used in PU detection sensing is based on the following hypothesis model:

$$r(t) = \begin{cases} n(t) & H_0, \\ hs(t) + n(t) & H_1, \end{cases} \quad (1)$$

where  $r(t)$  is the signal received by the CR user,  $s(t)$  is the transmitted signal of the PU,  $n(t)$  is a zero-mean additive white Gaussian noise (AWGN) and  $h$  is the amplitude gain of the channel.  $H_0$  is a null hypothesis, which states that there is no licensed user signal in a certain spectrum band. On the other hand,  $H_1$  is an alternative hypothesis, which indicates that there exists some PU signal.

Three schemes can be used for the transmitter detection in spectrum sensing: *matched filter detection*, *energy detection*, and *feature detection* [6].

#### 4.1.1. Matched filter detection

The *matched filter* is the linear optimal filter used for coherent signal detection to maximize the signal-to-noise ratio (SNR) in the presence of additive stochastic noise. As shown in Fig. 8, it is obtained by correlating a known original PU signal  $s(t)$  with a received signal  $r(t)$  where  $T$  is the symbol duration of PU signals. Then the output of the matched filter is sampled at the synchronized timing. If the sampled value  $Y$  is greater than the threshold  $\lambda$ , the spectrum is determined to be occupied by the PU transmission. This detection method is known as an optimal detector in stationary Gaussian noise. It shows a fast sensing time, which requires  $O(1/SNR)$  samples to achieve a given target detection probability [6,73]. However, the matched filter necessitates not only a priori knowledge of the char-

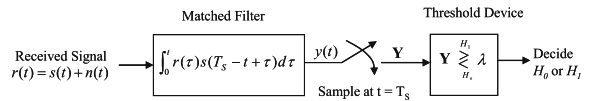

Fig. 8. Block diagram of matched filter detection.

acteristics of the PU signal but also the synchronization between the PU transmitter and the CR user. If this information is not accurate, then the matched filter performs poorly. Furthermore, CR users need to have different multiple matched filters dedicated to each type of the PU signal, which increases the implementation cost and complexity. For more practical implementation, a pilot signal of PU systems is used for the matched filter detection in [7]. In this method, PU transmitters send the pilot signal simultaneously with data, and CR users have its perfect knowledge, which may not still be feasible in CRAHNS. For this reason, energy detection and feature detection are the most commonly used for spectrum sensing in CRAHNS.

#### 4.1.2. Energy detection

The *energy detector* is optimal to detect the unknown signal if the noise power is known. In the energy detection, CR users sense the presence/absence of the PUs based on the energy of the received signals. As shown in Fig. 9, the measured signal  $r(t)$  is squared and integrated over the observation interval  $T$ . Finally, the output of the integrator is compared with a threshold  $\lambda$  to decide if a PU is present [20].

While the energy detector is easy to implement, it has several shortcomings. The energy detector requires  $O(1/SNR^2)$  samples for a given detection probability [6,73]. Thus, if CR users need to detect weak PU signals (SNR:  $-10$  dB to  $-40$  dB), the energy detection suffers from longer detection time compared to the matched filter detection. Furthermore, since the energy detection depends only on the SNR of the received signal, its performance is susceptible to uncertainty in noise power. If the noise

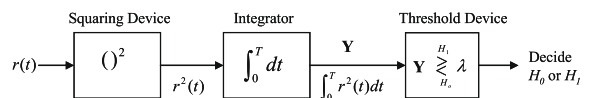

Fig. 9. Block diagram of energy detection.

power is uncertain, the energy detector will not be able to detect the signal reliably as the SNR is less than a certain threshold, called an *SNR wall* [81]. In addition, while the energy detector can only determine the presence of the signal but cannot differentiate signal types. Thus, the energy detector often results in false detection triggered by the unintended CR signals. For these reasons, in order to use energy detection, CRAHNs need to provide the synchronization over the sensing operations of all neighbors, i.e., each CR user should be synchronized with the same sensing and transmission schedules. Otherwise, CR users cannot distinguish the received signals from primary and CR users, and hence the sensing operations of the CR user will be interfered by the transmissions of its neighbors.

4.1.3. Feature detection

Feature detection determines the presence of PU signals by extracting their specific features such as pilot signals, cyclic prefixes, symbol rate, spreading codes, or modulation types from its local observation. These features introduce built-in periodicity in the modulated signals, which can be detected by analyzing a spectral correlation function as shown in Fig. 10. The feature detection leveraging this periodicity is also called *cyclostationary detection*. Here, the spectrum correlation of the received signal  $r(t)$  is averaged over the interval  $T$ , and compared with the test statistic to determine the presence of PU signals, similar to energy detection [6].

The main advantage of the feature detection is its robustness to the uncertainty in noise power. Furthermore, it can distinguish the signals from different networks. This method allows the CR user to perform sensing operations independently of those of its neighbors without synchronization. Although feature detection is most effective for the nature of CRAHNs, it is computationally complex and requires significantly long sensing time [36].

In [25], the enhanced feature detection scheme combining cyclic spectral analysis with pattern recognition based on neural networks is proposed. The distinct features of the received signal are extracted using cyclic spectral analysis and represented by both spectral coherent function and spectral correlation density function. The neural network, then, classifies signals into different modulation types. In [64], it is shown that the feature detection enables the detection of the presence of the Gaussian minimum shift keying (GMSK) modulated GSM signal (PU signal) in the channel under severe interference from the orthogonal frequency division multiplexing (OFDM) based wireless LAN signal (CR signal) by exploiting different cyclic signatures of both signals. A covariance-based detection scheme based on the statistical covariance or auto-correlations of the received signal is proposed in [92]. The statistical covariance matrices or autocorrelations of signal and noise are generally different. The statistical covariance matrix of

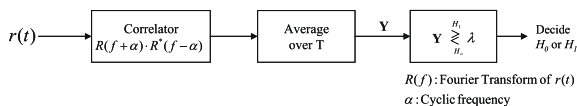

Fig. 10. Block diagram of feature detection [6].

noise is determined by the receiving filter. Based on this characteristic, it differentiates the presence of PU users and noise. The method can be used for various signal detection applications without knowledge of the signal, the channel and noise power.

4.2. Sensing control

The main objective of spectrum sensing is to find more spectrum access opportunities without interfering with primary networks. To this end, the sensing operations of CR users are controlled and coordinated by a sensing controller, which considers two main issues on: (1) how long and frequently CR users should sense the spectrum to achieve sufficient sensing accuracy in in-band sensing, and (2) how quickly CR user can find the available spectrum band in out-of-band sensing, which are summarized in Fig. 11.

4.2.1. In-band sensing control

The first issue is related to the maximum spectrum opportunity as well as interference avoidance. The in-band sensing generally adopts the periodic sensing structure where CR users are allowed to access the spectrum only during the transmission period followed by sensing (observation) period. In the periodic sensing, longer sensing time leads to higher sensing accuracy, and hence to less interference. But as the sensing time becomes longer, the transmission time of CR users will be decreased. Conversely, while longer transmission time increases the access opportunities, it causes higher interference due to the lack of sensing information. Thus, how to select the proper sensing and transmission times is an important issue in spectrum sensing.

Sensing time optimization is investigated in [28] and [84]. In [84], the sensing time is determined to maximize the channel efficiency while maintaining the required detection probability, which does not consider the influence of a false alarm probability. In [28], the sensing time is optimized for a multiple spectrum environment so as to maximize the throughput of CR users.

The focus in [42] and [68] is on determining optimal transmission time. In [68], for a given sensing time, the transmission time is determined to maximize the throughput of the CR network while the packet collision probabil-

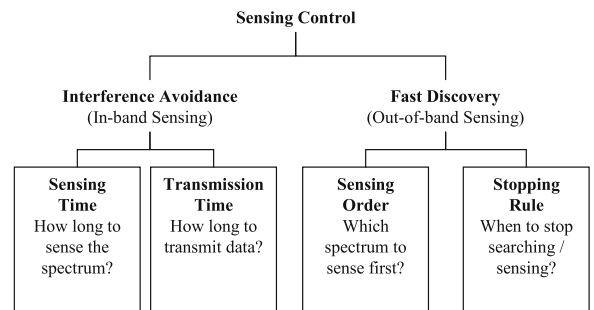

Fig. 11. Configuration parameters coordinated by sensing control.

ity for the primary network is under a certain threshold. However, similar to [84], this method does not consider a false alarm probability for estimating collision probability and throughput. In [42], a maximum transmission time is determined to protect multiple heterogeneous PUs based on the perfect sensing where no detection error is considered. All efforts stated above, mainly focus on determining either optimal sensing time or optimal transmission time. On the other hand, in [49], a theoretical framework is developed to optimize both sensing and transmission times simultaneously in such a way as to maximize the transmission efficiency subject to interference avoidance constraints where both parameters are determined adaptively depending on the time-varying cooperative gain.

#### 4.2.2. Out-of-band sensing control

When a CR user needs to find new available spectrum band (out-of-band sensing), a *spectrum discovery time* is another crucial factor to determine the performance of CRAHNS. Thus, this spectrum sensing should have a coordination scheme not only to discover as many spectrum opportunities as possible but also to minimize the delay in finding them. This is also an important issue in spectrum mobility to reduce the switching time, which will be explained in Section 7.

First, the proper selection of spectrum sensing order can help to reduce the spectrum discovery time in out-of-band sensing. In [53], an  $n$ -step serial search scheme is proposed mainly focusing on correlated occupancy channel models, where the spectrum availability of current spectrum is assumed to be dependent on that of its adjacent spectrum bands. In [44] and [45], both transmission time and spectrum searching sequence are optimized by minimizing searching delay as well as maximizing spectrum opportunities.

Moreover, if the CR user senses more spectrum bands, it is highly probable to detect a better spectrum band while resulting in longer spectrum searching time. To exploit this tradeoff efficiently, a well-defined stopping rule of spectrum searching is essential in out-of-band sensing. In [40], an optimal stopping time is determined to maximize the expected capacity of CR users subject to the maximum number of spectrum bands a CR user can use simultaneously.

#### 4.3. Cooperation

In CRAHNS, each CR user needs to determine spectrum availability by itself depending only on its local observations. However the observation range of the CR user is small and typically less than its transmission range. Thus, even though CR users find the unused spectrum portion, their transmission may cause interference at the primary receivers inside their transmission range, the so-called *receiver uncertainty problem* [3]. Furthermore, if the CR user receives a weak signal with a low signal-to-noise ratio (SNR) due to multi-path fading, or it is located in a shadowing area, it cannot detect the signal of the PUs. Thus, in CRAHNS, spectrum sensing necessitates an efficient cooperation scheme in order to prevent interference to PUs outside the observation range of each CR user [3,26]. A

common cooperative scheme is forming clusters to share the sensing information locally. Such a scheme for wireless mesh networks is proposed in [16], where the mesh router and the mesh clients supported by it form a cluster. Here, the mesh clients send their individual sensing results to the mesh router, which are then combined to get the final sensing result. Since CRAHNS do not have the central network entity, this cooperation should be implemented in a distributed manner.

For cooperation, when a CR user detects the PU activities, it should notify its observations promptly to its neighbors to evacuate the busy spectrum. To this end, a reliable control channel is needed for discovering neighbors of a CR user as well as exchanging sensing information. The concerns related to the selection and operation of the control channel are described in detail in Section 8. In addition to this, asynchronous sensing and transmission schedules make it difficult to exchange sensing information between neighbors. Thus, robust neighbor discovery and reliable information exchange are critical issues in implementing cooperative sensing in CRAHNS. This cooperation issue will be also leveraged by other spectrum management functions: spectrum decision, spectrum sharing, and spectrum mobility.

In [52], a notification protocol based on in-band signaling is proposed to disseminate the evacuation information among all CR users and thus evacuate the licensed spectrum reliably. This protocol uses the spreading code for its transmission, leading to tolerance in interference from both primary and other CR transmissions. Furthermore, due to its flooding-based routing scheme, it requires little prior information on the network topology and density. In [72], an optimal cooperative sensing strategy is proposed, where the final decision is based on a linear combination of the local test statistics from individual CR users. The combining weight for each user's signal indicates its contribution to the cooperative decision making. For example, if a CR user receives a higher-SNR signal and frequently makes its local decision consistent with the real hypothesis, then its test statistic has a larger weighting coefficient. In case of CR users in a deep fading channel, smaller weights are used to reduce their negative influence on the final decision.

Cooperative detection is theoretically more accurate since the uncertainty in a single user's detection can be minimized through collaboration [60]. Moreover, multi-path fading and shadowing effects can be mitigated so that the detection probability is improved in a heavily shadowed environment. However, cooperative approaches cause adverse effects on resource-constrained networks due to the overhead traffic.

#### 4.4. Research challenges

- *Support of asynchronous sensing:* Since each user has independent and asynchronous sensing and transmission schedules in CRAHNS, it can detect the transmissions of other CR users as well as PUs during its sensing period. However, with the energy detection, which is most commonly used for spectrum sensing, CR user cannot distinguish the transmission of CR and



PUs, and can detect only the presence of a transmission. As a result, the transmission of CR users detected during sensing operations causes false alarm in spectrum sensing, which leads to an increase in spectrum opportunities. Thus, how to coordinate the sensing cooperation of each CR user to reduce these false alarms is the most important issue in spectrum sensing.

- *Optimization of cooperative sensing:* Cooperative sensing introduces another crucial issue. By requesting the sensing information from several CR users, the user that initiates the cooperative sensing, improves the accuracy but also increases the network traffic. However, this also results in higher latency in collecting this information due to channel contention and packet re-transmissions. Thus, CRAHNs are required to consider these factors which must be optimized for correct and efficient sensing.

## 5. Spectrum decision for cognitive radio ad hoc networks

CRAHNs require capabilities to decide on the best spectrum band among the available bands according to the QoS requirements of the applications. This notion is called *spectrum decision* and constitutes a rather important but yet unexplored topic. Spectrum decision is closely related to the channel characteristics and the operations of PUs. Spectrum decision usually consists of two steps: First, each spectrum band is characterized based on not only local observations of CR users but also statistical information of primary networks. Then, based on this characterization, the most appropriate spectrum band can be chosen.

Generally, CRAHNs have unique characteristics in spectrum decision due to the nature of multi-hop communication. Spectrum decision needs to consider the end-to-end route consisting of multiple hops. Furthermore, available spectrum bands in CR networks differ from one hop to the other. As a result, the connectivity is spectrum-dependent, which makes it challenging to determine the best combination of the routing path and spectrum. Thus, spectrum decision in ad hoc networks should interact with routing protocols, which will be explained in the Section 9. The following are main functionalities required for spectrum decision:

- *Spectrum characterization:* Based on the observation, the CR users determine not only the characteristics of each available spectrum but also its PU activity model.
- *Spectrum selection:* The CR user finds the best spectrum band for each hop on the determined end-to-end route so as to satisfy end-to-end QoS requirements.
- *Reconfiguration:* The CR users reconfigure communication protocol as well as communication hardware and RF front-end according to the radio environment and user QoS requirements.

CR ad hoc users require spectrum decision in the beginning of the transmission. As depicted in Fig. 12, through *RF observation*, CR users characterize the available spectrum bands by considering the received signal strength, interfer-

ence, and the number of users currently residing in the spectrum, which are also used for resource allocation in classical ad hoc networks. However, unlike classical ad hoc networks, each CR user observes heterogeneous spectrum availability which is varying over time and space due to the PU activities. This changing nature of the spectrum usage is considered in the spectrum characterization. Based on this characterization, CR users determine the best available spectrum band to satisfy its QoS requirements. Furthermore, quality degradation of the current transmission can also initiate spectrum decision to maintain the quality of a current session.

### 5.1. Spectrum characterization

#### 5.1.1. Radio environment

Since the available spectrum holes show different characteristics, which vary over time, each spectrum hole should be characterized by considering both the time-varying radio environment and the spectrum parameters such as operating frequency and bandwidth. Hence, it is essential to define parameters that can represent a particular spectrum band as follows:

- *Interference:* From the amount of the interference at the primary receiver, the permissible power of a CR user can be derived, which is used for the estimation of the channel capacity.
- *Path loss:* The path loss is closely related to the distance and frequency. As the operating frequency increases, the path loss increases, which results in a decrease in the transmission range. If transmission power is increased to compensate for the increased path loss, interference at other users may increase.
- *Wireless link errors:* Depending on the modulation scheme and the interference level of the spectrum band, the error rate of the channel changes.
- *Link layer delay:* To address different path loss, wireless link error, and interference, different types of link layer protocols are required at different spectrum bands. This results in different link layer delays.

It is desirable to identify the spectrum bands combining all the characterization parameters described above for accurate spectrum decision. However, a complete analysis and modeling of spectrum in CR networks is yet to be developed.

#### 5.1.2. Primary user activity

In order to describe the dynamic nature of CR networks, we need a new metric to capture the statistical behavior of primary networks, called *primary user (PU) activity*. Since there is no guarantee that a spectrum band will be available during the entire communication of a CR user, the estimation of PU activity is a very crucial issue in spectrum decision.

Most of CR research assumes that PU activity is modeled by exponentially distributed inter-arrivals [4,15,44,45,49,93]. In this model, the PU traffic can be modeled as a two state birth–death process with death rate  $\alpha$  and birth rate  $\beta$ . An ON (Busy) state represents the period used by

PUs and an OFF (Idle) state represents the unused period [77]. Since each user arrival is independent, each transition follows the Poisson arrival process. Thus, the length of ON and OFF periods are exponentially distributed.

There are some efforts to model the PU activity in specific spectrum bands based on field experiments. In [87], the characteristics of primary usage in cellular networks are presented based on the call records collected by network systems, instead of real measurement. This analysis shows that an exponential call arrival model is adequate to capture the PU activity while the duration of wireless voice calls does not follow an exponential distribution. Furthermore, it is shown that a simpler random walk can be used to describe the PU activity under high traffic load conditions. In [27], a statistical traffic model of Wireless LANs based on a semi-Markov model is proposed to describe the temporal behavior of wireless LANs. Through empirical studies, it is shown that a hyper-Erlang distribution of the busy duration provides the best fitness to both stationary UDP traffic and non-stationary HTTP traffic in Wireless LANs. However, the complexity of this distribution hinders its practical implementation in CR functions.

The above approaches are *fixed* models based on offline measurements. Hence, they do not adequately capture the time varying nature of the PU activity. In addition, similar to the classical Poisson model, these approaches fail to capture the bursty and spiky characteristics of the monitored data [67,38]. However, as mentioned in [87], accounting for the short term fluctuations is also important so that CR users can accurately detect more transmission opportunities. In order to accurately track the changing PU activity a novel real-time based PU activity model for CR networks is developed in [8]. Here, the PU signal samples are first collected over a pre-determined duration. Then, the observed PU signals are clustered together, if they are greater than a threshold. Based on this clustering, the current PU arrival-departure rates can be estimated. The duration of collecting the signal samples, as well as the threshold for classifying the observed value as a legitimate PU signal are calculated in this work. However, this approach needs several PU signal samples collected at one centralized location. Thus, this needs to be extended for CRAHNS, so that each CR user may form individual clusters of the PU signals, based on their local observation, which can then be combined to give the complete PU activity model. Moreover, the additive white Gaussian noise (AWGN) channel model used in the proposed approach does not incorporate the effects of fading and shadowing, which can lower the accuracy of the PU activity prediction.

## 5.2. Spectrum selection

Once the available spectrum bands are characterized, the most appropriate spectrum band should be selected. Based on user QoS requirements and the spectrum characteristics, the data rate, acceptable error rate, delay bound, the transmission mode, and the bandwidth of the transmission can be determined. Then, according to a spectrum selection rule, the set of appropriate spectrum bands can be chosen. However, as stated previously, since the entire communication session consists of multiple hops with het-

erogeneous spectrum availability, the spectrum selection rule is closely coupled with routing protocols in CRAHNS. Since there exist numerous combinations of route and spectrum between the source and destination, it is infeasible to consider all possible links for spectrum decision. In order to determine the best route and spectrum more efficiently, spectrum decision necessitates the dynamic decision framework to adapt to the QoS requirements of the user and channel conditions. Furthermore, in recent research, the route selection is performed independent of the spectrum decision. Although this method is quite simple, it cannot provide an optimal route because spectrum availability on each hop is not considered during route establishment. Thus, joint spectrum and routing decision method is essential for CRAHNS, as described later in Section 5.4.

Furthermore, because of the operation of primary networks, CR users cannot obtain a reliable communication channel for long durations. Moreover, CR users may not detect any single spectrum band to meet the user's requirements. Therefore, CR users can adopt the multi-radio transmissions where each transceiver (radio interface) tunes to different non-contiguous spectrum bands for different users and transmits data simultaneously. This method can create a signal that is not only capable of high data throughput, but is also immune to the interference and the PU activity. Even if a PU appears in one of the current spectrum bands, or one of the next hop neighbor disappears, the rest of the connections continue their transmissions unaffected [5,50]. In addition, transmission in multiple spectrum bands allows lower power to be used in each spectrum band. As a result, less interference with PUs is achieved, compared to the transmission on single spectrum band. As a result, less interference with PUs is achieved, compared to the transmission on single spectrum band. For these reasons, spectrum decision should support multiple spectrum selection capabilities. For example, how to determine the number of spectrum bands and how to select the set of appropriate bands are still open research issues in CR networks.

## 5.3. Reconfiguration

Besides spectrum and route selection, spectrum decision involves reconfiguration in CRAHNS. The protocols for different layers of the network stack must adapt to the channel parameters of the operating frequency. Once the spectrum is decided, CR users need to select the proper communication modules such as physical layer technology and upper layer protocols adaptively dependent on application requirements as well as spectrum characteristics, and then reconfigure their communication system accordingly. In [70], the adaptive protocols are developed to determine the transmission power as well as the best combination of modulation and error correction code for a new spectrum band by considering changes in the propagation loss.

## 5.4. Research challenges

- *PU activity modeling*: Most of the current research on spectrum sensing are based on a simple ON–OFF model

for PU activities, which cannot capture the diverse characteristics of all existing primary networks. This inaccurate model for primary networks leads to an adverse influence on spectrum sensing resulting in either lower spectrum access opportunities or higher interference to the primary networks. Some of the empirical models on PU activities, described in Section 5.1, are not computationally feasible in practical situations. Thus, we need to develop more practical PU activity models by considering the characteristics of access technologies as well as traffic types.

- **Joint spectrum decision and reconfiguration framework:** Once the available spectrum bands are characterized, the most appropriate spectrum band should be selected by considering the QoS requirements (sustainable rate, delay, jitter, average session time, acceptable loss rate, etc) and the spectrum characteristics. However, according to the reconfigurable transmission parameters such as modulation type, error control scheme, and communication protocol, these spectrum characteristics change significantly. Sometimes, with only reconfiguration, CR users can maintain the quality of the current session. For example, even if SNR is changed, bit rate and bit error rate (BER) can be maintained by exploiting an adaptive modulation, instead of changing spectrum and route. Hence, there is a need for a joint spectrum decision and reconfiguration framework so as to find the optimal combination of the spectrum band and parameter configuration according to applications with diverse QoS requirements.

### 6. Spectrum sharing for cognitive radio ad hoc networks

The shared nature of the wireless channel necessitates coordination of transmission attempts between CR users. In this respect, spectrum sharing provides the capability to maintain the QoS of CR users without causing interference to the PUs by coordinating the multiple access of CR users as well as allocating communication resources adaptively to the changes of radio environment. Thus, spectrum sharing is performed in the middle of a communication session and within the spectrum band, and includes many

functionalities of a medium access control (MAC) protocol and resource allocation in classical ad hoc networks. However, the unique characteristics of cognitive radios such as the coexistence of CR users with PUs and the wide range of available spectrum incur substantially different challenges for spectrum sharing in CRAHNS.

Spectrum sharing techniques are generally focused on two types of solutions, i.e., spectrum sharing inside a CR network (intra-network spectrum sharing), and among multiple coexisting CR networks (inter-network spectrum sharing) [3]. However, since the CRAHNS do not have any infrastructure to coordinate inter-network operations, they are required to consider the only intra-network spectrum sharing functionality. Furthermore, similar to spectrum sensing, the CR users need to have all CR sharing capabilities due to the lack of a central entity. Thus, all decisions on spectrum sharing need to be made by CR users in a distributed manner. Fig. 13 depicts the functional blocks for spectrum sharing in CRAHNS. As explained in Section 4, spectrum sharing shares some functionalities with spectrum sensing in CRAHNS as follows:

- **Resource allocation:** Based on the QoS monitoring results, CR users select the proper channels (channel allocation) and adjust their transmission power (power control) so as to achieve QoS requirements as well as resource fairness. Especially, in power control, sensing results need to be considered so as not to violate the interference constraints.
- **Spectrum access:** It enables multiple CR users to share the spectrum resource by determining who will access the channel or when a user may access the channel. This is (most probably) a random access method due to the difficulty in synchronization.

Once a proper spectrum band is selected in spectrum decision, communication channels in that spectrum need to be assigned to a CR user while determining its transmission power to avoid the interference to the primary network (*resource allocation*). Then the CR user decides when the spectrum should be accessed to avoid collisions with other CR users (*spectrum access*). In the following subsections, we describe unique features in spectrum sharing,

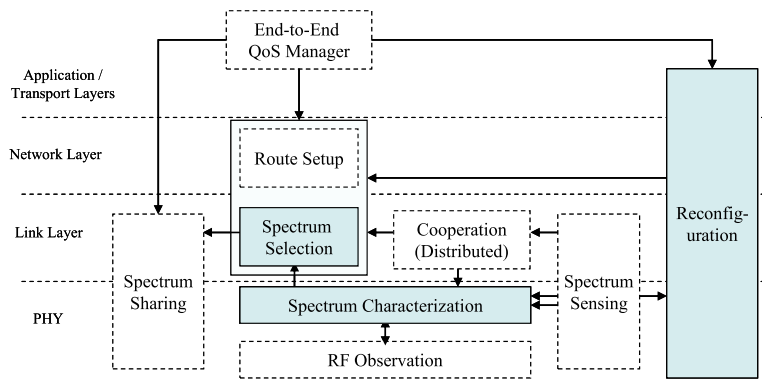

Fig. 12. Spectrum decision structure for ad hoc CR networks.

especially focusing on resource allocation and spectrum access in CRAHNs.

### 6.1. Resource allocation

Based on the local observation on the determined spectrum band, CR users need to determine their communication resources intelligently. In general, game theoretic approaches have been exploited to determine the communication resources of each user in CRAHNs [21,39,63]. Each CR user has a common interest to use the spectrum resources as much as possible. However, CR users have competing interests to maximize their own share of the spectrum resources. i.e., the activity of one CR user can impact the activities of the others. Furthermore, the rational decisions of a CR user must be undertaken while anticipating the responses of its rivals. Game theory provides an efficient distributed spectrum sharing scheme by describing the conflict and cooperation among CR users, and hence allowing each CR user to rationally decide on its best action.

In game theory, the output (*outcomes*) of the process (*game*) is the function of the inputs (*actions*) from several different decision makers (*players*) who may have potentially conflicting objectives (*preferences*) with regards to the outcome of the process. In CRAHNs, each game component: players, preferences, actions, and outcomes are interpreted as follows: (1) *players* will be either CR users or PUs, (2) the *preferences* can be considered as the communication metrics that must be optimized, such as throughput or delay, and are expressed in the form of a utility function, (3) *actions* represent the choice of the communication resources (channel, transmission power) made by a player, and (4) *outcomes* is the observed performance of the network (SNR, bandwidth allocation) as a result of the individual actions. Depending on the relationship between these components, game theoretic approaches can exploit diverse game models. Among them, the following game models are mainly considered for spectrum sharing in CRAHNs [62].

- *Normal (or strategic) form game*: This is a simple and basic model in game theory. In this model, all players make their decisions simultaneously and this process occurs only once for each player. Furthermore, they are assumed to be aware of not only their own utility functions but also the utility functions for all the other players in the game.
- *Repeated game*: This model is defined as a sequence of stages, where each stage is the a normal form game. Based on the past actions, current observations, and future expectations, players determine their actions at each stage. The actions of each player are assumed to be synchronized. In this model, the action strategies can be updated in each stage adapting to the actions and outcomes observed previously. Based on the outcome of each stage of the game, the players can incorporate punishment and reward strategies, which are well-suited for wireless networks. If a player deviates from the previously negotiated strategy, the other players choose their actions so as to reduce the outcome of the offending player.

- *Asynchronous myopic repeated game*: A *myopic repeated game* is a repeated game where the strategy update of a player is based on only its observation of the game at the most recent stage. Since players in a myopic repeated game are not able to consider future outcomes in determining the current actions, they employ simpler myopic strategies, instead of complex multi-stage strategies used in general repeated games. Here, all decisions at each stage are made simultaneously, similar to the classical repeated games. However, the myopic repeated games model may not be feasible for distributed wireless networks, such as CRAHNs. This is because CRAHNs may require random or asynchronous decisions due to the absence of a central network entity. In this case, an *asynchronous myopic repeated game* provides a better model for spectrum sharing, in which decisions do not have to be made synchronously. In this model, the actions of each player adapt to the most recent state of networks under a variety of different decision timings.
- *Mixed (or probabilistic) strategy game*: Some of normal form games may not have a steady-state solution, called *Nash equilibrium* where no selfish CR user has incentive to unilaterally change its action. To overcome this limitation, game theoretic approaches introduce a mixed strategy game, where players employ their strategies based on the probabilities of each action. This approach achieves the Nash equilibrium even though it does not exist in pure strategies.

Although the game theoretic approaches can achieve the Nash equilibrium, they cannot guarantee the Pareto optimum, leading to lower network capacity. Besides game theory, other solutions such as graph theory, can be also used for resource allocation in CRAHNs. In the following subsections, we explain two main issues in resource allocation: channel allocation and power allocation.

#### 6.1.1. Channel allocation

If a CR user uses a frequency division multiple access where a single spectrum consists of multiple channels or orthogonal frequency division multiplexing (OFDM), it needs to determine channels or sub-carriers so as to satisfy their QoS requirements. For channel allocation, a graph coloring based collaborative spectrum allocation scheme is proposed in [69], where a topology-optimized allocation algorithm is used for the fixed topology. In mobile networks, however, the network topology changes due to the node mobility. Using this global optimization approach, the network needs to completely recompute spectrum assignments for all users after each change, resulting in high computational and communication overhead. Furthermore it may require a central network entity to control channel allocation.

Thus, a distributed spectrum allocation based on local bargaining is proposed in [9], where CR users negotiate spectrum assignment within local self-organized groups according to a poverty line that ensures a minimum channel allocation to each user and hence focuses on fairness of users. For the resource-constrained networks such as sensor and ad hoc networks, a rule-based device centric spectrum management is proposed in [10]. In this method,

instead of collaborating with other users, CR users access the spectrum independently according to both local observation and predetermined rules, leading to minimizing the communication overhead. In [63], game theory is exploited to analyze the behavior of the CR user for distributed adaptive channel allocation. It is assumed that CR users exploit code division multiple access (CDMA) and determine the operating channel and the coding rate by keeping transmission power constant. It is shown that the cooperative case can be modeled as an exact potential game, which converges to a pure strategy Nash equilibrium solution. However, this framework has been shown not to be applicable for non-cooperative spectrum sharing. Thus a learning algorithm has been proposed for a non-cooperative case. The evaluations reveal that Nash equilibrium point for cooperative users is reached quickly and results in a certain degree of fairness as well as improved throughput. On the other hand, the learning algorithm for non-cooperative users converge to a mixed strategy allocation. Moreover, the fairness is degraded when non-cooperative approach is used. While this approach results in slightly worse performance, the information exchange required by selfish users is significantly low.

6.1.2. Power allocation

In the power allocation, the CR user needs to adjust its transmission power by considering co-channel (or inter-user) interference. In addition, power allocation should be based on the PU activities in its transmission not to violate the interference constraints. Cooperation among neighbors helps to enhance the performance of spectrum sharing, especially in power allocation which should be aware of the PU activities in the transmission range.

In [21], spectrum sharing for unlicensed band is proposed based on the one-shot normal form game and repeated game. Furthermore, it is shown that orthogonal power allocation, i.e., assigning the channel to only one transmission to avoid co-channel interference with other neighbors, is optimal for maximizing the entire network capacity. In [35], both single channel and multi-channel asynchronous distributed pricing (SC/MC-ADP) schemes are proposed, where each CR user announces its interference price to other nodes. Using this information from its neighbors, the CR user can first allocate a channel and in case there exist users in that channel, then, determine its transmit power. While there exist users using distinct channels, multiple users can share the same channel by adjusting their transmit power. Furthermore, the SC-ADP algorithm provides higher rates to users when compared to selfish algorithms where users select the best channel without any knowledge about their neighbors' interference levels. While this method considers the channel and power allocation at the same time, it does not address the heterogeneous spectrum availability over time and space which is a unique characteristic in CRAHNS.

6.2. Spectrum access – CR MAC

Spectrum sharing includes a MAC functionality as well. However, unlike classical MAC protocols in ad hoc networks, CR MAC protocols are closely coupled with spec-

trum sensing, especially in sensing control described in Section 4.2. In CRAHNS, the sensing schedules are determined and controlled by each user and not being controlled and synchronized by the central network entity. Thus, instead of this periodic sensing, CR ad hoc users may adopt the aperiodic or on-demand sensing triggered by only spectrum sharing operations can trigger the spectrum sensing, i.e., when CR users want to transmit or are requested their spectrum availability by neighbor users. Furthermore, sensing and transmission intervals, determined by the sensing control in spectrum sensing, influence the performance of spectrum access.

We classify the existing literature on MAC protocols based on the nature of channel access, i.e., random access, time slotted, and a hybrid protocol that is a combination of the two, as shown in Fig. 14. Moreover, the number of radio transceivers needed also influences the protocol design. We describe this classification as follows:

6.2.1. Random access – CR MAC protocols

The MAC protocols in this class do not need time synchronization, and are generally based on the CSMA/CA principle. The spectrum sensing considerations are closely coupled with the MAC layer packet transmission in the hardware constrained MAC (HC-MAC) protocol proposed in [40]. Typically, the radio can only sense a finite portion of the spectrum at a given time, and for single transceiver devices, sensing results in decreasing the data transmission rate. HC-MAC derives the optimal duration for sensing based on the reward obtained for correct results, as against the need aggressively scanning the spectrum at the cost of transmission time. A key difference of this protocol as against the previous work is that the sensing at either ends

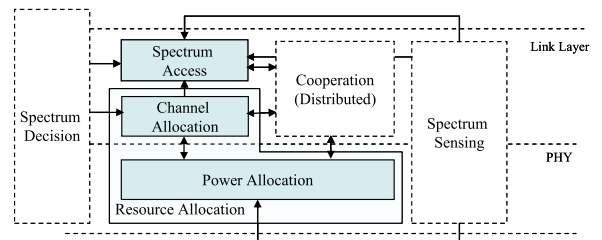

Fig. 13. Spectrum sharing structure for ad hoc CR networks.

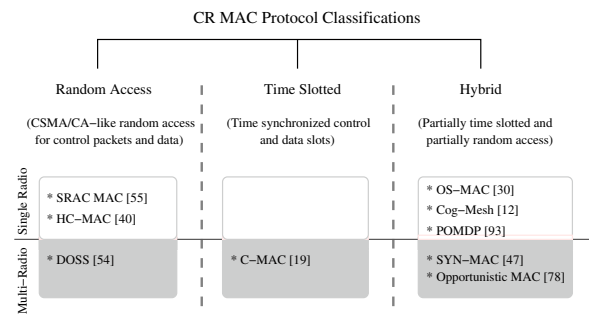

Fig. 14. Classification of CR ad hoc MAC protocols.

of the link is initiated *after* the channel contention on the dedicated CCC. The feasible channels at the two CR users on the link are then determined. However, the control messages used for channel negotiation may not be received by the neighboring nodes, and their transmission may influence the sensing results of the CR users that win the contention. The presence of interferers that may cause jamming in the CR user frequencies are considered in the single-radio adaptive channel (SRAC) MAC protocol [55]. However, this work does not completely address the means to detect the presence of a jammer, and how the ongoing data transmission is switched immediately to one of the possible backup channels when the user is suddenly interrupted.

For multi-radio protocols, the dynamic open spectrum sharing (DOSS) MAC protocol provides an innovative solution to prevent the hidden node and exposed node problem [54]. Three radios are assigned distinctly to the control, data and busy-tone band, respectively. The channels used for data transfer are mapped to the frequencies in the busy tone band. Thus, whenever a node transmits or receives data on a given channel, it also emits a busy signal in the corresponding busy tone band. While this scheme can solve the problem of missing the control packets by the neighboring CR users, we believe that this solution can also be applied to coordinate the MAC layer sensing. A node may sense on the channel which does not have a corresponding busy tone, thereby ensuring that the transmission of the other CR users are not mistaken for the PU activity. The main drawbacks of the DOSS protocol is the inefficient spectrum use by the tri-band (CCC, busy tone, and data) design. Moreover, the presence of separate transceivers for each of these bands adds to the hardware complexity and cost.

### 6.2.2. Time slotted MAC protocols

These MAC protocols need network-wide synchronization, where the time is divided into slots for both the control channel and the data transmission. In the cognitive MAC (C-MAC) protocol [19], closely based on the IEEE 802.22 standard, has distinct slots in the beaconing period for each CR user. The protocol identifies the current best channel based on the node and traffic information contained in the beacon, called the rendezvous channel (RC), and also a list of backup channels (BCs) that may be used in its place. The RC is used as a control channel and the data transmission may occur over different entirely different channels. C-MAC defines super-frames for each channel, composed of a data transfer period (DTP), beacon period (BP) and quiet period (QP). The BP and QP do not overlap with the similar durations on the other bands. This allows the other CR users to disseminate their local information through beacons (in the BP) as well as allow accurate sensing in the QPs. The CR users periodically visit the RC to obtain the neighborhood information, synchronize themselves and also to broadcast any change in the spectrum used for data.

The authors assume that the RC may be different initially for the different group of nodes, but will converge to a network wide constant over time. This may not be feasible in a distributed setting. Moreover, the RC is used as an

out-of-band control channel and the period synchronizing by the CR user on the RC reduces the data transmission time, as well as results in spectrum inefficiency. Moreover, it is not clear how the QPs and the BPs are ensured to be non-overlapping in time when the super-frame structure is decided locally at the node.

### 6.2.3. Hybrid protocols

These protocols use a partially slotted transmission, in which the control signaling generally occurs over synchronized time slots. However, the following data transmission may have random channel access schemes, without time synchronization. In a different approach, the durations for control and data transfer may have predefined durations constituting a super-frame that is common to all the users in the network. Within each control or data duration, the access to the channel may be completely random. Cog-Mesh considers a clustered architecture, in which the time frame is divided into intervals dedicated for intra- and inter-cluster operations [12]. The intra-cluster signaling is initiated by the cluster-head, and includes beacon exchange, maintaining an updated neighborhood information, and data transmission. The inter-cluster operations include reserved time durations for new CR users to join the clusters, and for routing between the cluster-heads of the adjacent clusters. A similar approach is proposed in the opportunistic spectrum MAC (OS-MAC) protocol [30], which has fixed durations for forming these groups of CR users, determining their continued usage of a channel, and exchanging the channel traffic load. Such cluster or group based architectures have an overhead of forming and maintaining the node associations in presence of user mobility, similar to the CCC problem described in Section 8. A MAC protocol based on partially observable Markov decision process (POMDP) is proposed in [93], where the CR user completes both the sensing and the data transmission within a time slot. Classical CSMA/CA with RTS-CTS enabled is used for the data transfer. This protocol differs from the others as it has a *learning* function that characterizes the availability of the channel based on the past decisions. Each time a successful data transfer is completed, the choice of the channel is rewarded. In addition, the time for sensing and transmission within a slot are optimized for high CR network throughput. However, this protocol relies on the assumption that the PU transmission pattern does not change over long intervals of time. Moreover, the network performance during the initial stages is low, and the time over which an acceptable accuracy in the channel selection is reached needs to be determined for different PU activity patterns.

For the case of multi-radio protocols, each of the available channels are assigned non-overlapping time slots in SYNchronized MAC (SYN-MAC) [47]. The CR users know the channel schedules and may only transmit in the slotted durations reserved for the channels. While this may ensure accurate spectrum sensing by forcing silent periods in the channels, it also leads to a significant wastage of the spectrum resource. Moreover, the throughput is also severely degraded as CR users must now wait for the assigned time in the current cycle to transmit to other nodes in the neighborhood that have the common free channels. A simple

protocol with two dedicated radios for slotted control signaling and based data transfer, is discussed in [78]. CR users randomly select the channels to sense, and a probabilistic estimate of the number of primary channels sensed as a function of the number of the CR users, is derived. This considerably simplifies the computational overhead from [93], that shares the same sensing optimization goal.

### 6.3. Research challenges

Since spectrum sharing and sensing share some of functionalities, most of the issues are similar to those of spectrum sensing, which are explained as follows:

- **Distributed power allocation:** The CRAHN user determines the transmission power in a distributed manner without support of the central entity, which may cause interference due to the limitation of sensing area even if it does not detect any transmission in its observation range. Thus, spectrum sharing necessitates sophisticated power control methods for adapting to the time-varying radio environment so as to maximize capacity with the protection of the transmissions of PUs.
- **Topology discovery:** The use of non-uniform channels by different CR users makes topology discovery difficult. From Fig. 15a, we see that the CR users A and B experience different PU activity in their respective coverage areas and thus may only be allowed to transmit on mutually exclusive channels. The allowed channels for CR A (1,2) being different from those used by CR B (3) makes it difficult to send out periodic beacons informing the nodes within transmission range of their own ID and other location coordinates needed for networking.
- **Spectrum access and coordination:** In classical ad hoc networks, the request to send (RTS) and clear to send (CTS) mechanism is used to signal control of the channel and reduce simultaneous transmissions to an extent. In CR networks, however, the available spectrum is dynamic and users may switch the channel after a given communicating pair of nodes have exchanged the channel access signal. Thus, a fresh set of RTS-CTS exchange may need to be undertaken in the new channel to enforce a silence zone among the neighboring CR users in the new spectrum. Moreover, the CR users monitoring the earlier channel are oblivious to the spectrum change on the link. They continue to maintain their timers and wait for the duration needed to complete the entire data

transfer before initiating their own transmission. This leads to inefficient spectrum use, and new coordination mechanisms among the CR users is necessary whenever the spectrum access conditions change. In Fig. 15b, the CR user C observes that the spectrum is currently being used by the CR users A and B. During the ongoing transfer, CR user A may detect a PU arrival, causing the spectrum on the link A-B to be changed. As this spectrum change occurs after the RTS-CTS control message exchange, user C continues to remain silent for the duration of the transfer specified earlier. This leads to lost spectrum opportunity as the PU detected by user A does not affect transmission by CR user C.

- **Evolution and learning:** The occupancy history of the spectrum bands by the PUs may vary with the time of the day and location. It is desired that the MAC protocol learns the characteristic PU activity and accordingly alters its spectrum selection and data transmission strategy. Although the POMDP MAC protocol proposed in [93], takes the initial steps in this direction, more detailed and elaborate learning models are needed. How long should the learning duration be, and its effect during the network operation are issues that need to be investigated. Moreover, the problem of constructing detailed channel occupancy needs further research, so that the different times of the day and different locations traversed by the mobile CR user can be incorporated. The probabilistic spectrum selection algorithm that uses this history may be designed to guarantee performance bounds during long-term operation. For this, open challenges include how the theoretical research and network operation are combined, so that the gains arising from the choice of the spectrum at the link layer are appropriately weighted in each decision round, and the computational time for considering the past history is minimized.

## 7. Spectrum mobility for cognitive radio ad hoc networks

CR users are generally regarded as ‘visitors’ to the spectrum. Hence, if the specific portion of the spectrum in use is required by a PU, the communication needs to be continued in another vacant portion of the spectrum. This notion is called *spectrum mobility*. Spectrum mobility gives rise to a new type of handoff in CR networks, the so-called *spectrum handoff*, in which, the users transfer their connections to an unused spectrum band. In CRAHNs, spectrum handoff occurs: (1) when PU is detected, (2) the CR user loses its connection due to the mobility of users involved in an on-going communication, or (3) with a current spectrum band cannot provide the QoS requirements.

In spectrum handoff, temporary communication break is inevitable due to the process for discovering a new available spectrum band. Since available spectrums are discontinuous and distributed over a wide frequency range, CR users may require the reconfiguration of operation frequency in its RF front-end, which leads to significantly longer switching time. The purpose of the spectrum mobility management in CRAHNs is to ensure smooth and fast

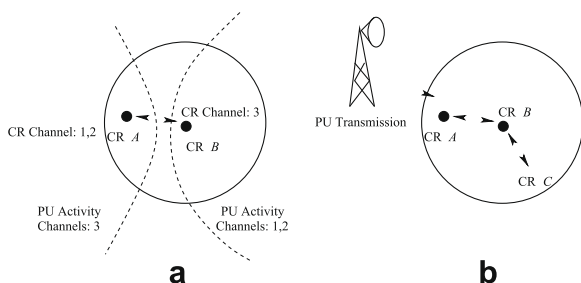

Fig. 15. Spectrum sharing challenges in CRAHNs.

transition leading to minimum performance degradation during a spectrum handoff. Furthermore, in spectrum mobility, the protocols for different layers of the network stack should be transparent to the spectrum handoff and the associated latency, and adapt to the channel parameters of the operating frequency. We describe this adaptation in the routing and transport protocols, covered in Sections 9 and 10, respectively.

Another intrinsic characteristic of spectrum mobility in CR networks is the interdependency with the routing protocols. Similar to the spectrum decision, the spectrum mobility needs to involve the recovery of link failure on the end-to-end route. Thus, it needs to interact with routing protocols to detect the link failure due to either user mobility or PU appearance, which is explained in Section 9.

In the following, the main functionalities required for spectrum mobility in the CRAHN are described:

- *Spectrum Handoff*: The CR user switches the spectrum band physically and reconfigures the communication parameters for an RF front-end (e.g. operating frequency, modulation type).
- *Connection management*: The CR user sustains the QoS or minimizes quality degradation during the spectrum switching by interacting with each layering protocols.

As stated previously, the spectrum mobility events can be detected as a link failure caused by user mobility as well as PU detection. Furthermore, the quality degradation of the current transmission also initiates spectrum mobility. When these spectrum mobility events are detected through spectrum sensing, neighbor discovery, and routing protocol, they trigger the spectrum mobility procedures. Fig. 16 illustrates the functional blocks for spectrum mobility in CRAHNs. By collaborating with spectrum decision, a CR user determines a new spectrum band on the determined route, and switch its current session to the new spectrum (*spectrum handoff*). During the spectrum handoff, the CR user need to maintain current transmission not to be interfered by the switching latency. In the following subsection, we investigate the two main functionalities in spectrum mobility: spectrum handoff and connection management.

### 7.1. Spectrum handoff

Spectrum handoff can be implemented based on two different strategies. In *reactive spectrum handoff*, CR users perform spectrum switching after detecting link failure due to spectrum mobility. This method requires immediate spectrum switching without any preparation time, resulting in significant quality degradation in on-going transmissions. On the other hand, in *proactive spectrum handoff* CR users predict future activity in the current link and determine a new spectrum while maintaining the current transmission, and then perform spectrum switching before the link failure happens. Since proactive spectrum handoff can maintain current transmissions while searching a new spectrum band, the spectrum switching is faster but requires more complex algorithms for these concurrent operations. Depending on the events that triggers the spectrum mobility, different handoff strategies are needed.

While reactive spectrum handoff is generally used in the event of a PU appearance, proactive spectrum handoff is suitable for the events of user mobility or spectrum quality degradation. These events do not require immediate spectrum switching, and can be easily predicted. Even in the PU appearance event, the proactive spectrum handoff may be used instead of the reactive scheme, but requires an accurate model for PU activity to avoid an adverse influence on communication performance [88].

In addition, for seamless communication in dynamic radio environments, this spectrum handoff should support intelligent connection releasing and re-establishing procedures during spectrum switching. When a CR user is moving, it needs to determine whether it should stay connected to its next hop forwarder through power control or immediately switching to a new neighbor. This has to be undertaken ensuring the network stays connected throughout the handoff procedure.

Spectrum handoff delay is the most crucial factor in determining the performance of spectrum mobility. This delay is dependent on the following operations in CR networks: First, the different layers of the protocol stack must adapt to the channel parameters of the operating frequency. Thus, each time a CR user changes its frequency, the network protocols may require modifications on the operation parameters, which may cause protocol reconfiguration delay. Also we need to consider the spectrum and route recovery time and the actual switching time determined by the RF front-end reconfiguration. Furthermore, to find the new spectrum and route, CR users need to perform out-of-band sensing and neighbor discovery. Recent research has explored the minimization of the delay in out-of-band sensing through the search-sequence optimization, which is explained in Section 4.2. Furthermore, for more efficient spectrum discovery in out-of-band sensing, IEEE 802.22 adopts the backup channel lists which are selected and maintained so as to provide the highest probability of finding an available spectrum band within the shortest time [37]. In [45] an algorithm for updating the backup channel lists is proposed to support fast and reliable opportunity discovery with the cooperation of neighbor users.

To mitigate the delay effect on the on-going transmission, connection management needs to coordinate the spectrum switching by collaborating with upper-layer protocols, which will be explained in the following subsection.

### 7.2. Connection management

When the current operational frequency becomes busy in the middle of a communication by a CR user, then applications running in this node have to be transferred to another available frequency band. However, the selection of new operational frequency may take time. An important requirement of connection management protocols is the information about the duration of a spectrum handoff. Once the latency information is available, the CR user can predict the influence of the temporary disconnection on each protocol layer, and accordingly preserve the ongoing communications with only minimum performance degradation through the reconfiguration of each protocol layer and an error control scheme. Consequently, multi-layer



mobility management protocols are required to accomplish the spectrum mobility functionalities. These protocols support mobility management adaptive to different types of applications. For example, a transmission control protocol (TCP) connection can be put to a wait state until the spectrum handoff is over. Moreover, since the TCP parameters will change after a spectrum handoff, it is essential to learn the new parameters and ensure that the transition from the old parameters to new parameters are carried out rapidly.

### 7.3. Research challenges

To the best of our knowledge, there exists no research effort to address the problems of spectrum mobility in CRAHNS to date. Although the routing mechanisms that have been investigated in the classical ad hoc networks may lay the groundwork in this area, there still exist many open research topics:

- **Switching delay management:** The spectrum switching delay is closely related to not only hardware, such as an RF front-end, but also to algorithm development for spectrums sensing, spectrum decision, link layer, and routing. Thus, it is desirable to design spectrum mobility in a cross-layer approach to reduce the operational overhead among each functionalities and to achieve a faster switching time. Furthermore, the estimation of accurate latency in spectrum handoff is essential for reliable connection management.
- **Flexible spectrum handoff framework:** As stated previously, there are two different spectrum handoff strategies: reactive and proactive spectrum handoffs, which show different influence on the communication performance. Furthermore, according to the mobility event, a spectrum switching time will change. For example, since a PU activity region is typically larger than the transmission range of CR users, multiple hops may be influenced by spectrum mobility events at the same time, which makes the recovery time much longer. Furthermore, spectrum handoff should be performed while adapting to the type of applications and network environment. In case of a delay-sensitive application, CR users can use a proactive switching, instead of a reactive switching. In this method, through the prediction of PU activities, CR users switch the spectrum before PUs appear, which helps to reduce the spectrum switching time significantly. On the other hand, energy constrained devices such as sensors need reactive spectrum switching. Thus, we need to develop a flexible spectrum handoff framework to exploit different switching strategies.

The different CR functionalities of spectrum sensing, decision, sharing, and mobility need to be implemented within the protocol stack of a wireless device. Specifically, in the subsequent sections, we discuss the key challenges faced at the network and transport layers as well as a control channel in the link layer unique to CR networks and the considerations that play a pivotal role in protocol design.

## 8. Common control channel

The common control channel (CCC) is used for supporting the transmission coordination and spectrum related information exchange between the CR users. It facilitates neighbor discovery, helps in spectrum sensing coordination, control signaling and exchange of local measurements between the CR users. The operation of the CCC is different from the data transmission over the licensed band in the following aspects:

- CR users may optimize their channel use over a number of constraints, such as channel quality, access time, observed PU activity, network load, among others during CR data transmission. However, these parameters are not known to the CR users in advance at the start of the network operation, and thus, it is a challenge to choose the CCC with the minimum or no exchange of network information.
- Spectrum bands that are currently used for data transfer may suddenly become unavailable when a PU appears. While the data communication is interrupted, the affected CR users need to coordinate a new spectrum that does not interfere with the PUs on either end of the link. This control information used in the new spectrum selection must be sent reliably and thus, an *always on* CCC is needed.

Fig. 17 shows the different design approaches that may be followed for establishing and using the CCC. The two main approaches are *in-band* and *out-of-band* CCC,

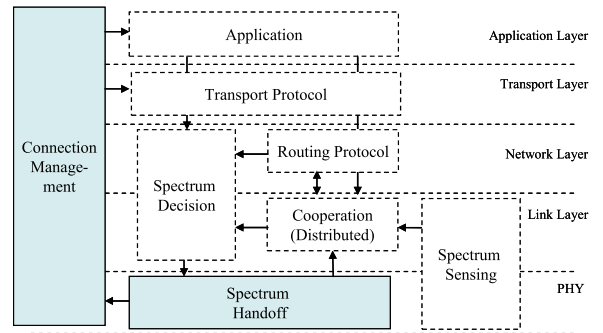

Fig. 16. Spectrum mobility structure for ad hoc CR networks.

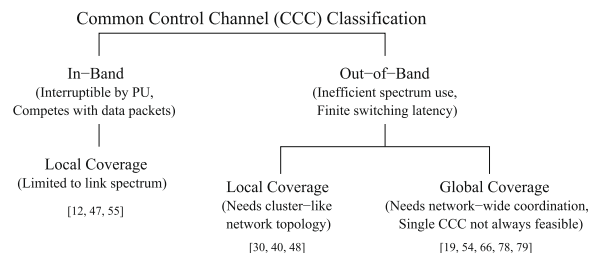

Fig. 17. Common control channel design classification.

depending on whether the control channel shares the data channel or uses a dedicated spectrum, respectively. For in-band operation, the range of the CCC is limited to *local coverage*. As opposed to this, out-of-band CCC may have dedicated spectrum assigned as a constant through the network, i.e. *global coverage*, or may use different region-specific bands, i.e. *local coverage*.

### 8.1. In-band CCC

The licensed spectrum used for ongoing data transmission band may be used to transmit the control messages for the case of *in-band* signaling [12,47,55]. In this case, the CCC operation is only for a specific purpose and for a temporary duration. Moreover, each node pair may use a different channel for communication. As the CCC is the same as the channel used for data, the extent of coverage of the CCC is local, i.e. unique to the corresponding node pair. The advantage of this approach is that a separate dedicated transceiver is not needed for the CCC. Moreover, there is no added spectrum switching cost in single transceiver systems, as they do not need to frequently change the spectrum for control and data messages.

While the in-band CCC simplifies the coordination protocol between the CR users, there are several drawbacks to using this approach. Firstly, the CCC is affected whenever a PU reclaims the operational spectrum. At this time, the new spectrum acceptable to both ends of an active link needs to be identified and this exchange of information is difficult without an available CCC. Secondly, the control messages may affect the data transmission and reduce the end-to-end throughput. Moreover, as the channel used for CCC changes frequently, and hence new CR users that join the network may have a considerable initial setup time to find the channel for sending their respective *join* requests.

### 8.2. Out-of-band CCC

Out-of-band signaling (through a licensed channel reserved for CCC use or by using the unlicensed band) minimizes the CCC disruptions caused by PU activity. In this case, the spectrum reservation for the CCC may either be made for a short duration, or there may be a permanent assignment. As an example, the spectrum sensing function may necessitate quiet periods in the neighborhood of the sensing node or integrating measured values from several different sources, so that the transmitted power of the PUs may be accurately detected. At such times, the CCC may be set up for coordinating these quiet periods with the other CR users, and communicating the sensed information back to the initiating node. After the sensing procedure is complete, the CCC is no longer active and the spectrum can be reclaimed for data transmission.

As the data and the control signaling are separate, more than one transceiver may be needed for dedicated CCC monitoring. For single radio devices, the cost of switching between the data band and the CCC, and the associated deaf period when the CCC is not sensed, must be accounted for in the protocol design. The different types of out-of-band CCC design approaches are mentioned below:

#### 8.2.1. Local coverage

CR users may be grouped into clusters and a common CCC may be used for all the nodes in the same cluster. This grouping of nodes may be based on their physical proximity, spectrum usage conditions, and other common environmental factors [30,40,48]. In the ideal case, the set of nodes using the CCC should be varied (and hence, the number of active CCCs in the network) to reflect the changing spectrum conditions, with the best case being a network-wide common CCC.

#### 8.2.2. Global coverage

For the CCCs that have global coverage [19,54,66,79,78], the channel for communication must be carefully chosen so that they are not interrupted over long periods of time. While this considerably simplifies the CCC operation, there are some drawbacks of this method. The PU activity varies from one geographical region to another, and hence, it is difficult to identify a CCC that is global, or uniformly acceptable throughout the entire network. In addition, collecting and disseminating this information to all the CR users in a distributed manner involves repeated network-wide flooding.

### 8.3. Research challenges

The design of a CCC has the following challenges:

- *Choice of spectrum for CCC:* Most of the current CR MAC protocols assume an out-of-band CCC that adds to the spectrum usage. For this, learning based techniques need to be devised so that the best spectrum that guarantees continued use even in the presence of PU activity can be determined. In addition, for single-transceiver systems, this may involve frequent switching of the radio transceiver from the CCC to the operational channel, that adds a finite cost in the form of switching time. This time must be accounted for in the CCC design. Novel techniques like ultra-wideband may also be used to realize an 'always on' CCC.
- *Determining the CCC coverage:* The area of coverage of the CCC depends upon the extent of the region that displays correlated PU behavior. For the approaches that use a cluster-like architecture with a common CCC shared among its members, the coverage of the CCC is the same as the footprint of the cluster region, which restricts the design flexibility. A key challenge here is the collection of the network information with minimum coordination and mapping these observed factors to a physical region where a common CCC may be used.
- *Overhead of CCC establishment:* A demand-based CCC design is best suited for highly dynamic spectrum and mobility conditions. However, the overhead of repeatedly setting up the CCC is justified when the spectrum sensing is performed intermittently, or the control messaging in each round of the sensing coordination is significant. Such on-demand CCCs need further overhead analysis and tradeoff consideration.

## 9. Network layer for cognitive radio ad hoc networks

At the network layer, the selection of the transmission bands and the routing path must be undertaken jointly, as described earlier in Section 7. This is a key challenge as nodes only have limited local information. The sudden appearance of a PU may render certain channels unusable in the vicinity of CR nodes, necessitating a local change in the existing routes. In such situations, the routing layer is presented with two options. The first of these involves circumventing the affected region, thereby increasing the path length and consequently, the end-to-end delay. As an alternative, the channel may be changed in the region of PU activity keeping the routing path constant, thus incurring a one-time channel switching delay. Unlike infrastructure-based networks, node mobility may cause frequent route outages and the repeating the entire route setup process is costly in terms of resource usage. Nodes may also move into regions of PU activity thus necessitating immediate route management procedures.

### 9.1. Basic framework

A general routing framework is presented in Fig. 18. Classical ad hoc routing tables keep only the next hop information (limited information). For CR networks, the routing table must first be expanded to include the channel, transmission rate, modulation and such other parameters that are unique to each link (full information). Channel switching involves a finite delay, which affects the final end-to-end performance [14]. By expanding the route tables to cover the full channel usage along the entire path from the current node to the destination, the choice of channels may be so chosen to minimize the number of channel switches along the path. The need for increased spectrum information along the path involves higher storage space and the database access times must be expedited for sifting through the comparatively larger volume of path information.

The decision to alter an existing route or switch a channel cannot be taken in isolation. The *decision block* responsible for this takes in sensing inputs, path information and the existing QoS performance to help in a judicious choice.

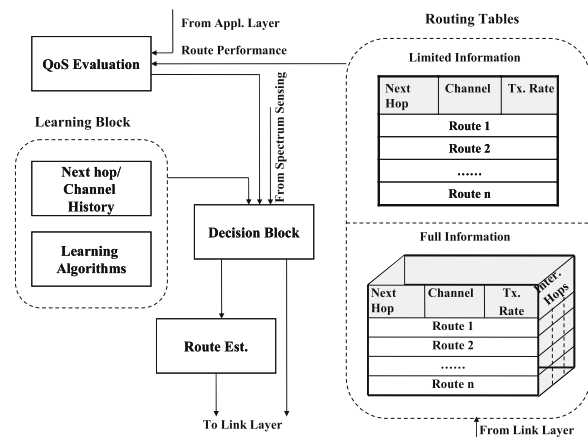

Fig. 18. Routing framework for ad hoc CR networks.

The *QoS evaluation* block influences the *decision block* by measuring how close the current performance of the routing algorithm fares with the requirements specified by the application layer. It may signal the need for a new route establishment, through the *route establishment* block, or continue on the existing path without changes. A framework that uses the traffic information, such as the inter-arrival time for packets, the length and count of the number of the packets among others to decide the spectrum allocation along the current route is given in [57].

As networks evolve towards the self-learning and environment aware paradigm, the routing framework must also incorporate a *learning block*. This block may take as inputs the channel and path decisions made for a given routing cycle and weight the available options based on feedback from the destination. It tunes the working of the routing layer over time and helps the decision block to make progressively better channel and path switching decisions.

### 9.2. Classification of CR routing algorithms

Classical ad hoc network routing algorithms can be classified on the basis of their: (i) support for maintaining multiple routes between a given source-destination pair [1], (ii) ability to guarantee specific QoS requirements [31], (iii) knowledge of the geographical location [59], (iv) scalability with respect to network size [34], and (v) consideration of energy conservation [2]. However, for CRAHNS, the integration of spectrum management functions in the establishment of end-to-end routes is of critical importance, which is not addressed in these works.

We classify the existing works in CR routing protocols based on their support for: (i) spectrum decision, i.e., joint selection of the spectrum with the choice of the next hop forwarder node, (ii) joint spectrum decision with PU awareness, where the CR users have the ability to identify the locations where PUs are present and allow the routes to avoid them, and (iii) joint spectrum decision and re-configurability, where the route can be adapted with local spectrum changes or by selecting a different set of forwarding nodes altogether. This classification is summarized in Fig. 19 for protocols using a dedicated CCC and in-band transmission for forwarding the control messages used in the route formation.

- **Routing with spectrum decision:** The routing protocol at the network layer chooses the next hop node among the possible candidate forwarders while accounting for the spectrum that may be used on the chosen link. Thus, the spectrum and path selection occur jointly, which ensures that the route remains connected during the network operation as each link has a set of feasible spectrum bands.

The CR users forming the route should be able to assign the link spectrum so that the delay in changing the spectrum at a node is minimized over the path. However, if the same spectrum is used at consecutive links, the spectrum access time is shared by the nodes on the link that are within range of each other. As only one node on the link can active send or receive packets, it adversely impacts the throughput. The multi-hop single-trans-

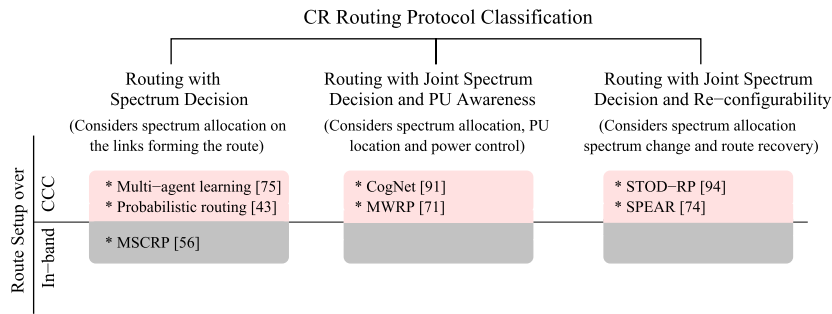

Fig. 19. Routing classification in CRAHNS.

ceiver CR routing protocol (MSCRP) is proposed to balance these two conflicting approaches [56]. First, analogous to the classical AODV protocol, the route request (RREQ) is forwarded over all the possible channels to the destination. The latter then decides on the spectrum selection for the shortest path based on analytical estimates of the time for spectrum switching, channel contention, and data transmission.

A multi-agent learning approach named *adaptive fictitious play*, is described in [75]. The CR users exchange their channel selection information periodically, that also provides information of the extent to which the different classes of traffic (delay sensitive or otherwise) on a given channel is affected. The *fictitious play* algorithm learns the channel decision strategies of the neighboring CR users over time to identify the channels that are likely to be used by them. This estimation is leveraged by the CR user to construct its own set of favorable channels, each of which may have a different bandwidth, interference level and link delay. A similar approach is presented in [43], wherein the link weights are first calculated probabilistically based on interference from the PUs, the received signal strength, and the PU occupancy rate on all the channels at the given link. The CR users calculate an expected delay from themselves to the possible destinations, and run a classical distance-vector algorithm, such as Bellman Ford or Dijkstra, to decide on the optimal path at each hop.

- **Routing with joint spectrum decision and PU awareness:** The routes in a CR network must explicitly provide a measure of protection to the ongoing communication of the PUs. For this, the route may avoid the regions known to have high PU activity entirely or jointly allocate transmission power to incur greater number of hops and minimize the probability of interfering with the primary receivers.

A path-centric spectrum assignment framework (CogNet) is proposed in [91] that constructs a multi-layered graph of the network at each node. Each layer corresponds to one channel and a given CR user is reflected in all the layers as a *sub-node* or a vertex point. Vertical edges between the sub-nodes associated with the same CR user represent the capability of data forwarding between the different channels on the node. Similarly, other users that are reachable from a given node using a channel are connected by horizontal edges on the layer corresponding to that spectrum. The vertical edges may

be assigned weights corresponding to the spectrum switching time, while the horizontal edge is given a weight as a function of the spectrum access delay. Moreover, the primary network transmission may be protected by assigning higher horizontal edge costs associated with links in regions of the PU activity. The minimum weight path to the destination can now be derived if each node in the network has the complete layer graph. However, this work assumes that a link-state algorithm is in place to disseminate the node information throughout the network, which is difficult to achieve in large, mobile ad hoc networks. Moreover, the spectrum decision is not communicated to the other network nodes explicitly, leading to possible conflicts in the choice of the spectrum.

A novel resource allocation method for choosing the spectrum bandwidth on a link, while considering traffic and power allocation at a node during route formation, is presented in [90]. First, the total available spectrum is divided into sub-bands in a distributed manner such that a conflict free channel assignment can be made for any given transmitter–receiver pair. Thus, the number of sub-bands formed depends upon the number of active neighbors of a node, with smaller capacity available per flow in bottleneck nodes. Each node has a maximum allowed transmission power, that may be used for restricting its coverage range to prevent interference with the PUs in its vicinity. The routing algorithm chooses the next hop based on the spectrum bandwidth available for the link, and also the traffic generation rate at each candidate forwarding node that is within its coverage range. However, the distributed algorithm converges to an optimal selection over time, and further investigation is needed on the limiting duration for this convergence. Moreover, the work in [90] presents a theoretical framework and a protocol implementation is needed.

The minimum weight routing protocol (MWRP) looks at architectures where each CR user may be equipped with transceivers for different wireless technologies, such as cellular (TDMA/FDMA/CSMA) and also 802.11 b/g cards [71]. Each transmission technology has an associated weight that increases with the distance of coverage. The routing protocol aims to find the node and the transmission system on it that gives the minimum cumulative weight to the destination. Though the choice of the communication technology could depend upon

the allowed coverage range for the CR user (if there is a presence of a PU in its vicinity), the algorithm neither performs channel selection nor considers the intra-CRAHN interference caused by the transceiver selection.

- **Routing with joint spectrum decision and re-configurability:** This class of routing protocols has the key ability to recover from changes in the spectrum caused by PU arrival. The main choice during the route re-configuration is whether locally choosing a new spectrum on the affected link will allow the route to remain connected, or if the path needs to be reconstructed entirely.

The spectrum-aware routing protocol (SPEAR) identifies multiple feasible routes during the route-setup stage [74]. It ensures that a single spectrum is used throughout the route and incorporates measures that limit the number of route-setup messages propagated in the network. The destination selects the final operational route, and the channels on each link are reserved at this stage for a pre-determined time. Each node, however, may locally change the spectrum during route operation as long as the end-to-end routing metrics, such as throughput and delay are maintained. If this local adaptation fails, then SPEAR invokes a fresh route formation from the source.

Spectrum considerations are included in the routing protocol proposed for mesh networks in [94]. Here, a lookup tree is constructed using the mesh routers as the nodes, for each channel of the spectrum band such that the trees have a common root node. The root of the tree serves to maintain a directory of the CR users that can be reached on a given channel. By first querying the root node, a CR user may identify the current channel of the destination node, which can then be reached independently of the tree structure.

### 9.3. Research challenges

The routing challenges at the network layer in the ad hoc CR networks are summarized below:

- **Joint path-channel optimization:** The arrival time of the RREQ on the common control channel (CCC) is not indicative of the channel quality of the links that form the path. In the routing protocol proposed in [56], the RREQ is sent on all the possible channels to solve this problem. As shown in Fig. 20, it may arrive at the destination gateway through path  $P_2$ , earlier than path  $P_1$ , as it uses comparatively fewer hops. Path  $P_2$  is chosen over path  $P_1$  though the latter may have lesser packet latency when the actual channels for data transfer come into play. This problem arises as not all channels are available for use along the path, depending upon the PU activity. In addition, in a general CR network, channels may be of different bandwidth, have varying propagation characteristics and may be available for unequal time durations. Simple distance minimization techniques or sequential approaches of path assignment followed by channel selection may not yield optimal results. Both sequential and joint path-channel selection algorithms that minimize the hop count and yet maintain conflict-

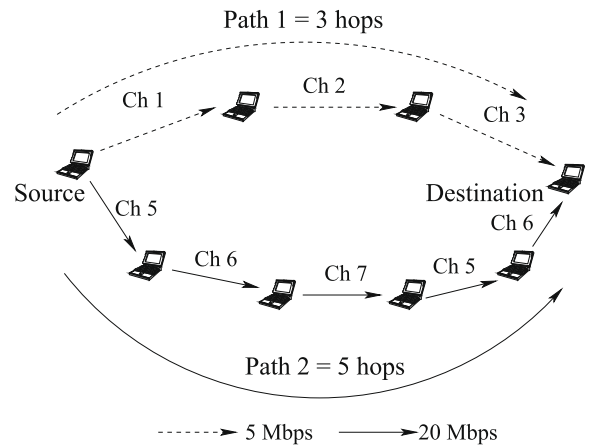

Fig. 20. Mobility of the source and destination and the change in routes.

free channels are proposed in [83]. However, this approach needs a link-state protocol that can assimilate the network information at each CR user, before the optimal path is derived.

- **Spectrum awareness:** In a dynamic CR network, the PUs may use the channels for intermittent durations causing the need to change the routing paths. At such times, the routing protocol is faced with two options, i.e., change the physical regions through which the existing path passes or switch the channel altogether [18]. At this time, the routing protocol may: (i) switch channels within the same spectrum band, (ii) switch spectrum bands altogether, (iii) circumvent the affected region on the same channel, or (iv) continue along the shortest path in the same channel by adapting its transmission, if this path intersects regions of PU activity. Thus, there is a need to design new routing protocols that considers the spectrum sensing function, spectrum decision, MAC layer spectrum access technology and end-to-end performance requirements.

## 10. Transport layer for cognitive radio ad hoc networks

As the transport protocol usually runs at the end nodes (source and destination), it has limited knowledge of the conditions of the intermediate nodes. Typically, routes in an ad hoc network may involve multiple hops, and hence the end-to-end reliability becomes important. By regulating the transmission rate of the source, the transport layer adapts to the congestion in the route and maintains a buffer of unacknowledged packets for error recovery. The main problem in classical ad hoc networks is incorrectly attributing packet losses to network congestion, when they are actually caused by mobility of the nodes or bad channel conditions. Several modifications to the de-facto standard transmission control protocol (TCP) have been proposed to address these issues in the last decade. However, for CRAHNs, these approaches cannot be directly applied owing the following reasons:

- **Route disruptions due to spectrum sensing:** In CRAHNs, when an intermediate node on the route is engaged in spectrum sensing it is unable to forward packets. For classical ad hoc networks, route disruptions are handled by freezing the TCP state [13,29], while a new path is identified. However, in CRAHNs, the route disconnection during sensing is *virtual*, i.e., the same route will be resumed once the sensing is completed. Thus, the sending rate at the source should be reduced to an optimal value in CRAHNs that prevents buffer overflow in the intermediate nodes, instead of a complete stop as seen in classical ad hoc networks.
- **Large bandwidth variations:** The primary spectrum availability may change rapidly. Moreover, as the opportunity for using large bandwidth ranges is possible, sudden availability (or, conversely a sudden loss of the spectrum) is a common feature in CR networks. However, the congestion window in classical TCP relies on incoming ACKs to increase its size, and does not immediately reflect the new bandwidth conditions. A similar conclusion is drawn in [76], where TCP cannot effectively adapt to brief reductions in capacity, if the end-to-end delay is large. Bandwidth estimation techniques have been proposed in [11,58] for classical ad hoc networks but they do not respond immediately to the available spectrum. Thus, there is a need for a new bandwidth estimation and congestion window scaling algorithm for TCP to make the efficient use of the available spectrum.
- **Throughput vs. sensing tradeoffs:** The duration of the periodic spectrum sensing decides, in part, the end-to-end performance – a shorter sensing time may result in higher throughput but may affect the transport layer severely if a PU is mis-detected. Thus, the sensing scheme needs to be integrated in the design of the transport protocol. However, TCP solutions for classical ad hoc networks only focus on end-to-end TCP throughput, and the sensing optimization is entirely absent.
- **Node mobility:** In classical ad-hoc networks, TCP-EFLN [33] and ATCP [51] react to the route disruption *after* it happens by an explicit notification in the form of the internet control message protocol (ICMP) message at the IP layer. For CRAHNs, intermediate nodes may continue their periodic sensing if a route failure is detected at a further downstream node. In such cases, the route failure message is delayed at each hop that undertakes sensing and the source is informed much later. This results in an increased number of packet losses in the now discarded path. A scheme for classical ad hoc networks for reducing the packet losses by routing layer feedback is proposed in [89]. However, this method uses cached routes and does not involve new route discovery. For CRAHNs, the changing spectrum environment may not guarantee that the feasibility of the cached route, and hence a *predictive* mobility model needs to be incorporated in the TCP rate control mechanism.

Two broad approaches may be adopted in the design of transport layer protocols: (i) The standard TCP and UDP protocols may be adapted by making them channel aware and sensitive to PU activity, and (ii) scenario and

application specific protocols may be devised that tradeoff the generality in implementation for optimum performance under known channel conditions. In the following, we describe the working of a new TCP-based protocol for CRAHNs, called TP-CRAHN [17]. To the best of our knowledge, this is the first work to address the transport layer challenges in CRAHNs,

### 10.1. TP-CRAHN: A transport protocol for CR ad hoc networks

TP-CRAHN comprises of the following six states, as shown by the state diagram in Fig. 21. They are (i) *connection establishment*, (ii) *normal*, (iii) *spectrum sensing*, (iv) *spectrum change*, (v) *mobility predicted*, and (vi) *route failure*. Each of these states addresses a particular CR network condition as follows:

- **Connection establishment state:** In this state, a three-way handshake is used to setup the TCP connection. The spectrum sensing durations and start times of the intermediate nodes are also made known to the source. On successful handshake, the protocol enters into the Normal state.
- **Normal state:** This state comes into play when there is no periodic sensing, spectrum switching or anticipated node mobility. The congestion window operates similar to the classical TCP newReno. The source collects the residual buffer capacity, link latency and the calculated link bandwidth at each node by piggybacking this information over the incoming ACK.
- **Spectrum sensing state:** As the source knows the exact start and stop times for sensing, it limits the congestion window so that the previous hop node along the path does not incur a buffer overflow for the duration of the sensing. Moreover, it decides on the optimal sensing time for each link by maintaining a history of the PU activity in the vicinity i.e., it reduces the sensing time for undisturbed links thereby increasing end-to-end throughput.

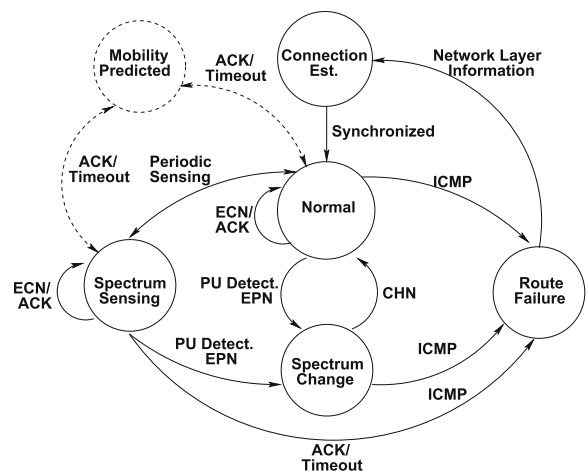

Fig. 21. Finite state machine model of our transport protocol.

- *Spectrum switching state*: When a PU appears, the time taken to identify a new channel is not known in advance. At this time, the TCP state at the source is frozen. After the new spectrum is chosen, the bandwidth is estimated by link layer interaction and communicated to the source. This immediately changes the congestion window appropriately if the change in the bandwidth affects the earlier bottleneck bandwidth of the path.
- *Mobility predicted state*: Based on Kalman filtering, each node makes a prediction if the next hop node will be out of range in the next calculation epoch. If this is true, the source is signaled to limit the congestion window below the TCP threshold, thereby preventing large packet losses if the route failure actually occurs.
- *Route failure state*: This state can be inferred if there is no expected sensing, no detected PU but possibility of node mobility, as predicted by the above state. In this case, the source stops the transmission and awaits further notification from the network layer for new route establishment.

Some of the state transitions, such as from the *normal* state to the *spectrum sensing* state and vice versa, occur at periodic intervals. The *mobility predicted* state is a transient state, in which, the congestion window is set to a limit and control is passed back to the normal state immediately. All the other transitions are event driven and in response to specific network conditions, such as congestion, PU appearance, and route outage.

By a smooth and continuous interaction between these six states, the CR user can adequately accommodate the spectrum management functions at the transport layer. While the work proposed in [17] attempts to address most of the challenges in transport protocol design for CR networks, there are few challenges that must be addressed.

## 10.2. Research challenges

- *Control message reliability*: The control messages that inform the source of the changing spectrum conditions in the intermediate nodes must be reliably delivered. Especially, for single-transceiver systems, these control messages may be dropped at the link layer, if the next hop node is engaged in communication over a different link for long time durations. To ensure these messages reach the source, priority queues, multiple transceivers, or a change in the link layer retry limit may be explored.
- *Non-TCP solutions*: While TCP is used widely, there are other non-TCP based protocols that may be used [80]. Instead of window based TCP schemes, equation based rate control may also be explored. Another interesting approach is the use of multiple flavors of transmission control, with preference of one over the other based on the network conditions. As an example, equation based schemes may respond faster to large changes in bandwidth, while classical TCP recovers from the transient congestion quickly.

Thus, it remains an open research area to develop robust transport layer protocols that can adapt their

parameters independent of the underlying design of the network.

## 11. CR ad hoc networks based on commons model

Spectrum can be shared among multiple users under pre-decided regulatory models. There are two general models for assigning spectrum usage rights in CR networks as follows [23]:

- *Exclusive use model*: In this model, the spectrum is licensed to users within a given geographical region with well established rules for their protection from external interference. This is the classical view of the CR network, where devices may opportunistically transmit in these licensed frequencies, such that the licensed users are not affected. For this, the CR users determine their choice of spectrum, transmit power, modulation and other communication parameters with the dual aims of maximizing network performance, as well as, preventing any disruption to the licensed users.
- *Commons model*: This model does not provide protection from interference to a given user of the spectrum from the other CR users that also seek opportunistic transmission. Thus, the users are largely self-regulated and must adhere to *etiquettes* to mitigate possible disruption to the others. This approach can be visualized as a flat spectrum usage plane, without any presence of licensed users with priority access.

We next describe the commons model in detail based on: (i) spectrum etiquette and standardization efforts, and (ii) mutual sharing of the spectrum through cooperation and selfish competition.

### 11.1. Spectrum etiquette and standardization

Spectrum etiquette involves devising protocols that ensure CR devices having different hardware capabilities, carrying traffic with varying QoS requirements, and forming dissimilar connected topologies coexist with fairness in transmission opportunity and end-to-end performance. The problem of identifying a common set of rules becomes more involved in case of CR ad hoc networks belonging to different independent operators that may be present in spatially overlapped regions. There are several forums and committees created both in the user domain and also through government efforts. As an example of the non-profit user domain working group, the IEEE SCC41 P1900.5 group aims to define a policy language along with the consideration of the possible architectures for specifying interoperable, vendor-independent control of networks that are enabled with dynamic spectrum access ability [65]. Similarly, in absence of an appropriate industry organization, the US DARPA wireless networking after next (WNaN) program considers the problem of policy regulation from the viewpoint of software development for the CR radios. However, both these efforts are at a nascent stage and formulation of a set of universally applicable etiquette seems a difficult challenge.

### 11.2. Mutual spectrum sharing through cooperation and selfish competition

In the absence of standard spectrum etiquette, competition based approaches may allow sharing of the spectrum among the CRAHN users, and both cooperative and selfish approaches are discussed in [63]. Cooperation may involve choosing an optimal transmission power, channel bandwidth, transmission rate, among others parameters such that the user's own performance is maximized, along with that of the overall network. In competitive approaches, each user may progressively increase its own usage of the spectrum resource and other communication parameters selfishly till its performance is affected by similar operation of the neighboring users. In this case, the user does not seek to maximize the collective gain, but simply tries to protect its own transmission, thereby settling on a choice of optimal parameters over time [85]. While cooperative strategies are more suited for users belonging to a single operator, the competition based approaches are viable for inter-operator CRAHN coexistence.

We next describe the main research challenges in realizing the spectrum commons model for CRAHNs.

### 11.3. Research challenges

- **Determination of channel structure:** Under the commons model, the spectrum is made available as a contiguous frequency block, that must be separated into channels for use by the CR users. The number of channels should be such that the CR users have sufficient choice is choosing distinct and non-overlapping channels whenever possible, and at the same time be able to sustain a minimum desired channel throughput. In the absence of a central entity, balancing this tradeoff by creating an optimal number of channel divisions is a challenge.
- **Detection of selfish behavior:** As the spectrum is shared by the CR users, they may choose the channel structure independently of the others. Moreover, users belonging to different CR operators may have different channel specifications, such as the amount of allowed spectral leakage in the neighboring channels, transmission masks, channel bandwidth, among others. In such cases, it is important to detect the CR users that exhibit selfish behavior by using the spectrum that exceeds the regulations laid down by the specifications [46]. This may allow some of the CR users to unfairly improve their performance at the cost of the others, making it necessary to devise strategies to detect this selfish behavior.
- **Penalizing and regulatory policing:** As CR ad hoc networks do not have a centralized admission control scheme, penalizing the CR users for selfish or malicious behavior is difficult. Moreover, regulatory policing rules must be established for each free spectrum pool, so that CR users can collectively decide on their inclination to forward traffic originating from the node engaging in selfish behavior.

## 12. Conclusions

CR networks are envisaged to solve the problem of spectrum scarcity by making efficient and opportunistic use of frequencies reserved for the use of licensed users of the bands. To realize the goals of truly ubiquitous spectrum-aware communication, the CR devices need to incorporate the spectrum sensing, spectrum decision, spectrum sharing, and spectrum mobility functionalities. The main challenge in CRAHNs is to integrate these functions in the layers of the protocol stack, so that the CR users can communicate reliably in a distributed manner, over a multi-hop/multi-spectrum environment, without any infrastructure support.

The discussions provided in this survey strongly advocate cooperative spectrum-aware communication protocols that consider the spectrum management functionalities. This cross-layer design requirement necessitates a rethinking of the existing solutions developed for classical wireless networks. Many researchers are currently engaged in developing the communication technologies and protocols required for CRAHNs. However, to ensure efficient spectrum-aware communication, more research is needed along the lines introduced in this survey.

## References

- [1] S. Adibi, S. Erfani, A multipath routing survey for mobile ad hoc networks, in: Proceedings of the IEEE Consumer Communications and Networking Conference (CCNC), vol. 2, January 2006, pp. 984–988.
- [2] K. Akkaya, M. Younis, A survey on routing protocols for wireless sensor networks, *Ad Hoc Networks* (Elsevier) 3 (3) (2005) 325–349.
- [3] I.F. Akyildiz, W.-Y. Lee, M.C. Vuran, M. Shantidev, NeXt generation/dynamic spectrum access/cognitive radio wireless networks: a survey, *Computer Networks Journal* (Elsevier) 50 (2006) 2127–2159.
- [4] A. Al Daoud, M. Alanyali, D. Starobinski, Secondary pricing of spectrum in cellular CDMA networks, in: Proceedings of the IEEE DySPAN 2007, Dublin, Ireland, April 2007, pp. 535–542.
- [5] R.W. Brodersen, A. Wolisz, D. Cabric, S.M. Mishra, D. Willkomm, Corvus: a cognitive radio approach for usage of virtual unlicensed spectrum, Berkeley Wireless Research Center (BWRC) White paper, 2004.
- [6] D. Cabric, S.M. Mishra, R.W. Brodersen, Implementation issues in spectrum sensing for cognitive radios, in: Proceedings of the IEEE Asilomar Conference on Signals, Systems and Computers 2004, November 2004, pp. 772–776.
- [7] D. Cabric, A. Tkachenko, R.W. Brodersen, Spectrum sensing measurements of pilot, energy, and collaborative detection, in: Proceedings of the IEEE Military Communications Conference (MILCOM), October 2006.
- [8] B. Canberk, I.F. Akyildiz, S. Oktug, Primary user activity modeling using first-difference filter clustering and correlation in cognitive radio networks, December 2008, submitted for publication.
- [9] L. Cao, H. Zheng, Distributed spectrum allocation via local bargaining, in: Proceedings of the IEEE Sensor and Ad Hoc Communications and Networks (SECON), September 2005, pp. 475–486.
- [10] L. Cao, H. Zheng, Distributed rule-regulated spectrum sharing, *IEEE Journal on Selected Areas in Communications* 26 (1) (2008) 130–145.
- [11] A. Capone, L. Fratta, F. Martignon, Bandwidth estimation schemes for TCP over wireless networks, *IEEE Transactions on Mobile Computing* 3 (2) (2004) 129–143.
- [12] T. Chen, H. Zhang, G.M. Maggio, I. Chlamtac, CogMesh: a cluster-based cognitive radio network, in: Proceedings of the IEEE DySPAN, April 2007, pp. 168–178.
- [13] K. Chandran, S. Raghunathan, S. Venkatesan, R. Prakash, A feedback-based scheme for improving TCP performance in ad hoc wireless



- networks, *IEEE Personal Communications Magazine* 8 (1) (2001) 34–39.
- [14] G. Cheng, W. Liu, Y. Li, W. Cheng, Joint on-demand routing and spectrum assignment in cognitive radio networks, in: *Proceedings of the IEEE ICC*, June 2007, pp. 6499–6503.
- [15] C. Chou, S. Shankar, H. Kim, K.G. Shin, What and how much to gain by spectrum agility?, *IEEE Journal on Selected Areas in Communications* 25 (3) (2007) 576–588.
- [16] K.R. Chowdhury, I.F. Akyildiz, Cognitive wireless mesh networks with dynamic spectrum access, *IEEE Journal of Selected Areas in Communications* 26 (1) (2008) 168–181.
- [17] K.R. Chowdhury, M.D. Felice, I.F. Akyildiz, TP-CRAHN: A transport protocol for cognitive radio ad-hoc networks, in: *Proceedings of the IEEE Infocom 2009*, Rio de Janeiro, Brazil, April 2009.
- [18] K.R. Chowdhury, M.D. Felice, SEARCH: a routing protocol for mobile cognitive radio ad-hoc networks, December 2008, submitted for publication.
- [19] C. Cordeiro, K. Challapali, C-MAC: a cognitive MAC protocol for multi-channel wireless networks, in: *Proceedings of the IEEE DySPAN*, April 2007, pp. 147–157.
- [20] F. Digham, M. Alouini, M. Simon, On the energy detection of unknown signals over fading channels, in: *Proceedings of the IEEE ICC 2005*, vol. 5, May 2003, pp. 3575–3579.
- [21] R. Etkin, A. Parekh, D. Tse, Spectrum sharing for unlicensed bands, *IEEE Journal of Selected Areas in Communications* 25 (3) (2007) 517–528.
- [22] FCC, Notice of proposed rule making and order, ET Docket No. 03-222, December 2003.
- [23] FCC, Spectrum policy task force report, ET Docket No. 02-135, November 2002.
- [24] FCC, Notice of inquiry and notice of proposed rulemaking, ET Docket No. 03-237, November 2003.
- [25] A. Fehske, J.D. Gaeddert, J.H. Reed, A new approach to signal classification using spectral correlation and neural networks, in: *Proceedings of the IEEE DySPAN 2005*, November 2005, pp. 144–150.
- [26] M. Gandetto, C. Regazzoni, Spectrum sensing: a distributed approach for cognitive terminals, *IEEE Journal on Selected Areas in Communications* 25 (3) (2007) 546–557.
- [27] S. Geirhofer, L. Tong, B.M. Sadler, Dynamic spectrum access in the time domain: modeling and exploiting white space, *IEEE Communications Magazine* 45 (5) (2007) 66–72.
- [28] A. Ghasemi, E.S. Sousa, Optimization of spectrum sensing for opportunistic spectrum access in cognitive radio networks, in: *Proceedings of the IEEE Consumer Communications and Networking Conference (CCNC) 2007*, Las Vegas, NV, USA, Jan, 2007, pp. 1022–1026.
- [29] T. Goff, J. Moronski, D.S. Phatak, V. Gupta, Freeze-TCP: a true end-to-end TCP enhancement mechanism for mobile environments, in: *Proceedings of the IEEE INFOCOM*, Tel-Aviv, Israel, March 2000, pp. 1537–1545.
- [30] B. Hamdaoui, K.G. Shin, OS-MAC: an efficient MAC protocol for spectrum-agile wireless networks, *IEEE Transactions on Mobile Computing* 7 (8) (2008) 915–930.
- [31] L. Hanzo (II), R. Tafazolli, A survey of QoS routing solutions for mobile ad hoc networks, in: *IEEE Communications Surveys and Tutorials*, vol. 9 (2), 2nd Quarter 2007, pp. 50–70.
- [32] S. Haykin, Cognitive radio: brain-empowered wireless communications, *IEEE Journal on Selected Areas in Communications* 23 (2) (2005) 201–220.
- [33] G. Holland, N.H. Vaidya, Analysis of TCP performance over mobile ad hoc networks, in: *Proceedings of the ACM MOBICOM*, Seattle, WA, USA, August 1999, pp. 219–230.
- [34] X. Hong, K. Xu, M. Gerla, Scalable routing protocols for mobile ad hoc networks, *IEEE Network Magazine* 16 (4) (2002) 11–21.
- [35] J. Huang, R.A. Berry, M.L. Honig, Spectrum sharing with distributed interference compensation, in: *Proceedings of the IEEE DySPAN 2005*, November 2005, pp. 88–93.
- [36] Y. Hur, J. Park, W. Woo, J.S. Lee, K. Lim, C.-H. Lee, H.S. Kim, J. Laskar, A cognitive radio (CR) system employing a dual-stage spectrum sensing technique: a multi-resolution spectrum sensing (MRSS) and a temporal signature detection (TSD) technique, in: *Proceedings of the IEEE Globecom 2006*, November 2006.
- [37] IEEE 802.22 WG, Draft standard for wireless regional area networks Part 22: Cognitive wireless RAN medium access control (MAC) and physical layer (PHY) specifications: policies and procedures for operation in the TV bands, in: *IEEE P802.22/D0.3.8.1*, September 2007.
- [38] R. Jain, S. Member, Shawn, A. Routhier, Packet trains: measurements and a new model for computer network traffic, *IEEE Journal on Selected Areas in Communications* 4 (1986) 986–995.
- [39] Z. Ji, K.J.R. Liu, Dynamic spectrum sharing: a dynamic spectrum sharing: a game theoretical overview, *IEEE Communications Magazine* 4 (5) (2007) 88–94.
- [40] J. Jia, Q. Zhang, X. Shen, HC-MAC: a hardware-constrained cognitive MAC for efficient spectrum management, *IEEE Journal on Selected Areas in Communications* 26 (1) (2008) 106–117.
- [41] F.K. Jondral, Software-defined radio: basic and evolution to cognitive radio, *EURASIP Journal on Wireless Communication and Networking* (2005).
- [42] E. Jung, X. Liu, Opportunistic spectrum access in heterogeneous user environments, in: *Proceedings of the IEEE DySPAN 2008*, Chicago, IL, USA, October 2008.
- [43] H. Khalife, S.S. Ahuja, N. Malouch, M. Krunz, Probabilistic path selection in opportunistic cognitive radio networks, in: *Proceedings of the IEEE Globecom*, November 2008.
- [44] H. Kim, K.G. Shin, Efficient discovery of spectrum opportunities with MAC-layer sensing in cognitive radio networks, *IEEE Transactions on Mobile Computing* 7 (5) (2008) 533–545.
- [45] H. Kim, K.G. Shin, Fast discovery of spectrum opportunities in cognitive radio networks, in: *Proceedings of the IEEE DySPAN 2008*, Chicago, IL, USA, October 2008.
- [46] H. Kim, J. M. Peha, Detecting selfish behavior in a cooperative commons, in: *Proceedings of the IEEE DySPAN 2008*, Chicago, IL, USA, October 2008.
- [47] Y.R. Kondareddy, P. Agrawal, Synchronized MAC Protocol for multi-hop cognitive radio networks, in: *Proceedings of the IEEE International Conference on Communication (ICC)*, May 2008, pp. 3198–3202.
- [48] L. Le, E. Hossain, OSA-MAC: a MAC protocol for opportunistic spectrum access in cognitive radio networks, in: *Proceedings of the IEEE Wireless Communications and Networking Conference (WCNC)*, May 2008, pp. 1426–1430.
- [49] W.-Y. Lee, I.F. Akyildiz, Optimal spectrum sensing framework for cognitive radio networks, *IEEE Transactions on Wireless Communications* 7 (10) (2008) 3845–3857.
- [50] W.-Y. Lee, I. F. Akyildiz, A spectrum decision framework for cognitive radio networks, July 2008, submitted for publication.
- [51] J. Liu, S. Singh, ATCP: TCP for mobile ad hoc networks, *IEEE Journal on Selected Areas of Communication* 19 (7) (2001) 1300–1315.
- [52] X. Liu, Z. Ding, ESCAPE: a channel evacuation protocol for spectrum-agile networks, in: *Proceedings of the IEEE DySPAN 2007*, Dublin, Ireland, April 2007.
- [53] L. Luo, S. Roy, Analysis of search schemes in cognitive radio, in: *Proceedings of the IEEE SECON 2007*, San Diego, CA, USA, June 2007, pp. 647–654.
- [54] L. Ma, X. Han, C.-C. Shen, Dynamic open spectrum sharing for wireless ad hoc networks, in: *Proceedings of the IEEE DySPAN*, November 2005, pp. 203–213.
- [55] L. Ma, C.-C. Shen, B. Ryu, Single-radio adaptive channel algorithm for spectrum agile wireless ad hoc networks, in: *Proceedings of the IEEE DySPAN*, April 2007, pp. 547–558.
- [56] H. Ma, L. Zheng, X. Ma, Y. Luo, Spectrum-aware routing for multi-hop cognitive radio networks with a single transceiver, in: *Proceedings of the Cognitive Radio Oriented Wireless Networks and Communications (CrownCom)*, 15–17 May 2008, pp. 1–6.
- [57] B. S. Manoj, R.R. Rao, M. Zorzi, On the use of higher layer information, in: *Proceedings of the IEEE Globecom*, November 2007.
- [58] S. Mascolo, C. Casetti, M. Gerla, M.Y. Sanadidi, R. Wang, TCP westwood: bandwidth estimation for enhanced transport over wireless links, in: *Proceedings of the ACM MOBICOM*, Rome, Italy, 2001, pp. 287–297.
- [59] M. Mauve, A. Widmer, H. Hartenstein, A survey on position-based routing in mobile ad hoc networks, *IEEE Network Magazine* 15 (6) (2001) 30–39.
- [60] S.M. Mishra, A. Sahai, R.W. Brodersen, Cooperative sensing among cognitive radios, in: *Proceedings of the IEEE ICC 2006*, vol. 4, June 2006, pp. 1658–1663.
- [61] J. Mitola III, Cognitive radio for flexible mobile multimedia communication, in: *Proceedings of the IEEE International Workshop on Mobile Multimedia Communications (MoMuC) 1999*, November 1999, pp. 3–10.
- [62] J. Neel, Analysis and design of cognitive radio networks and distributed radio resource management algorithms, Ph.D. Dissertation, Virginia Polytechnic Institute and State University, September 2006.
- [63] N. Nie, C. Comaniciu, Adaptive channel allocation spectrum etiquette for cognitive radio networks, in: *Proceedings of the IEEE DySPAN 2005*, November 2005, pp. 269–278.

- [64] M. Oner, F. Jondral, On the extraction of the channel allocation information in spectrum pooling systems, *IEEE Journal on Selected Areas in Communications* 25 (3) (2007) 558–565.
- [65] IEEE P1900.5 Policy Language and Policy Architectures for Managing Cognitive Radio for Dynamic Spectrum Access Applications. <<https://ict-e3.eu/project/standardization/IEEE-SCC41.html>>.
- [66] P. Pawelczak, R. Venkatesha Prasad, L. Xia, I.G.M.M. Niemegeers, Cognitive radio emergency networks – requirements and design, in: *Proceedings of the IEEE DySPAN*, November 2005, pp. 601–606.
- [67] V. Paxson, S. Floyd, Wide-area traffic: the failure of Poisson modeling, *IEEE/ACM Transactions on Networking* 3 (1995) 226–244.
- [68] Y. Pei, A.T. Hoang, Y.-C. Liang, Sensing throughput tradeoff in cognitive radio networks: how frequently should spectrum sensing be carried out? in: *Proceedings of the IEEE International Symposium on Personal, Indoor and Mobile Radio Communications (PIMRC) 2007*, Athens, Greece, July 2007.
- [69] C. Peng, H. Zheng, B.Y. Zhao, Utilization and fairness in spectrum assignment for opportunistic spectrum access, *ACM Mobile Networks and Applications (MONET)* 11 (4) (2006) 555–576.
- [70] M.B. Pursley, T.C. Royster IV, Low-complexity adaptive transmission for cognitive radios in dynamic spectrum access networks, *IEEE Journal on Selected Areas in Communications* 26 (1) (2008) 83–94.
- [71] C.W. Pyo, M. Hasegawa, Minimum weight routing based on a common link control radio for cognitive wireless ad hoc networks, in: *Proceedings of the International Conference on Wireless Communications and Mobile Computing (IWCMC)*, August 2007, pp. 399–404.
- [72] Z. Quan, S. Cui, A.H. Sayed, Optimal linear cooperation for spectrum sensing in cognitive radio networks, *IEEE Journal of Selected in Signal Processing* 2 (1) (2008) 28–40.
- [73] A. Sahai, N. Hoven, R. Tandra, Some fundamental limits on cognitive radio, in: *Proceedings of the Allerton Conference on Communication, Control, and Computing*, 2003.
- [74] A. Sampath, L. Yang, L. Cao, H. Zheng, B.Y. Zhao, High throughput spectrum-aware routing for cognitive radio based ad hoc networks, in: *Proceedings of the International Conference on Cognitive Radio Oriented Wireless Networks and Communications (CROWNCOM)*, May 2008.
- [75] H.-P. Shiang, M. van der Schaar, Delay-sensitive resource management in multi-hop cognitive radio networks, in: *Proceedings of the IEEE DySPAN*, October 2008.
- [76] A.M.R. Slingerland, P. Pawelczak, R.V. Prasad, A. Lo, R. Helmat, Performance of transport control protocol over dynamic spectrum access links, in: *Proceedings of the IEEE DySPAN 2007*, April 2007, pp. 486–495.
- [77] K. Sriram, W. Whitt, Characterizing superposition arrival processes in packet multiplexers for voice and data, *IEEE Journal of Selected Areas in Communications SAC-4* (6) (1986) 833–846.
- [78] H. Su, X. Zhang, Opportunistic MAC protocols for cognitive radio based wireless networks, in: *Proceedings of the Annual Conference on Information Sciences and Systems (CISS)*, March 2007, pp. 363–368.
- [79] H. Su, X. Zhang, CREAM-MAC: an efficient cognitive radio-enabled multi-channel mac protocol for wireless networks, in: *Proceedings of the IEEE International Symposium on World of Wireless, Mobile and Multimedia Networks*, June 2008, pp. 1–8.
- [80] K. Sundaresan, V. Anantharaman, H.-Y. Hsieh, R. Sivakumar, ATP: a reliable transport protocol for ad hoc networks, *IEEE Transactions on Mobile Computing* 4 (6) (2005) 588–603.
- [81] R. Tandra, A. Sahai, SNR walls for signal detectors, *IEEE Journal of Selected in Signal Processing* 2 (1) (2008) 4–17.
- [82] R.W. Thomas, L.A. DaSilva, A.B. MacKenzie, Cognitive networks, in: *Proceedings of the IEEE DySPAN 2005*, November 2005, pp. 352–360.
- [83] Q. Wang, H. Zheng, Route and spectrum selection in dynamic spectrum networks, in: *Proceedings of the IEEE Consumer Communication and Networking Conference (CCNC)*, January 2006.
- [84] P. Wang, L. Xiao, S. Zhou, J. Wang, Optimization of detection time for channel efficiency in cognitive radio systems, in: *Proceedings of the IEEE Wireless Communications and Networking Conference (WCNC) 2007*, Hong Kong, China, March 2007, pp. 111–115.
- [85] X. Wang, Q. Zhu, Power control for cognitive radio based on game theory, in: *Proceedings of the IEEE Wireless Communications, Networking and Mobile Computing (WiCom) 2007*, September 2007, pp. 1256–1259.
- [86] B. Wild, K. Ramchandran, Detecting primary receivers for cognitive radio applications, in: *Proceedings of the IEEE DySPAN 2005*, November 2005, pp. 124–130.
- [87] D. Willkomm, S. Machiraju, J. Bolot, A. Wolisz, Primary users in cellular networks: a large-scale measurement study, in: *Proceedings of the IEEE DySPAN 2008*, Chicago, IL, USA, October 2008.
- [88] L. Yang, L. Cao, H. Zheng, Proactive channel access in dynamic spectrum network, in: *Proceedings of the Cognitive Radio Oriented Wireless Networks and Communications (CROWNCOM) 2007*, Orlando, FL, USA, August 2007, pp. 482–486.
- [89] X. Yu, Improving TCP performance over mobile ad hoc networks by exploiting cross-layer information awareness, in: *Proceedings of the ACM MOBICOM*, Philadelphia, PA, USA, September 2004, pp. 231–244.
- [90] Y. Xi, E.M. Yeh, Distributed algorithms for spectrum allocation, power control, routing, and congestion control in wireless networks, in: *Proceedings of the ACM MobiHoc*, September 2007, pp. 180–189.
- [91] C. Xin, L. Ma, C.-C. Shen, A path-centric channel assignment framework for cognitive radio wireless networks, *Mobile Networks Applications (Kluwer)* 13 (5) (2008) 463–476.
- [92] Y. Zeng, Y.-C. Liang, Covariance based signal detections for cognitive radio, in: *Proceedings of the IEEE DySPAN 2007*, Dublin, Ireland, April 2007, pp. 202–207.
- [93] Q. Zhao, L. Tong, A. Swami, Y. Chen, Decentralized cognitive MAC opportunistic spectrum access in ad hoc networks: A POMDP Framework, *IEEE Journal on Selected Areas in Communications* 25 (3) (2007) 589–600.
- [94] G. Zhu, M.D. Felice, I.F. Akyildiz, STOD-RP: a spectrum-tree based on-demand routing protocol for multi-hop cognitive radio networks, in: *Proceedings of the IEEE Globecom*, November 2008.



**Ian F. Akyildiz** received the B.S., M.S., and Ph.D. degrees in Computer Engineering from the University of Erlangen-Nuernberg, Germany, in 1978, 1981 and 1984, respectively. Currently, he is the Ken Byers Distinguished Chair Professor with the School of Electrical and Computer Engineering, Georgia Institute of Technology, Atlanta, and Director of Broadband Wireless Networking Laboratory. Since June 2008, he is an Honorary Professor with the School of Electrical Engineering at the Universitat Politecnica de Catalunya, Barcelona, Spain. He is the Editor-in-Chief of *Computer Networks (COMNET Journal (Elsevier))* as well as the founding Editor-in-Chief of the *AD HOC NETWORK JOURNAL (Elsevier)* and *PHYSICAL COMMUNICATION (PHYCOM) JOURNAL (Elsevier)*. His current research interests are in cognitive radio networks, wireless sensor networks, wireless mesh networks, and nano-communications. He received the “Don Federico Santa Maria Medal” for his services to the Universidad de Federico Santa Maria, in 1986. From 1989 to 1998, he served as a National Lecturer for ACM and received the ACM Outstanding Distinguished Lecturer Award in 1994. He received the 1997 IEEE Leonard G. Abraham Prize Award (IEEE Communications Society) for his paper entitled “Multimedia Group Synchronization Protocols for Integrated Services Architectures” published in the *IEEE JOURNAL OF SELECTED AREAS IN COMMUNICATIONS (JSAC)* in January 1996. He received the 2002 IEEE Harry M. Goode Memorial Award (IEEE Computer Society) with the citation “for significant and pioneering contributions to advanced architectures and protocols for wireless and satellite networking.” He received the 2003 IEEE Best Tutorial Award (IEEE Communication Society) for his paper entitled “A Survey on Sensor Networks,” published in *IEEE COMMUNICATIONSMAGAZINE*, in August 2002. He also received the 2003 ACM Sigmoble Outstanding Contribution Award with the citation “for pioneering contributions in the area of mobility and resource management for wireless communication networks”. He received the 2004 Georgia Tech Faculty Research Author Award for his “outstanding record of publications of papers between 1999 and 2003”. He also received the 2005 Distinguished Faculty Achievement Award from School of ECE, Georgia Tech. He has been a Fellow of the Association for Computing Machinery (ACM) since 1996.



**Won-Yeol Lee** received his B.S. and M.S. degrees from Department of Electronic Engineering, Yonsei University, Seoul, Korea in 1997 and 1999, respectively. From 1999 to 2004, he was a research engineer of Network R&D Center and Wireless Multimedia Service Division at LG Telecom, Seoul, Korea. Currently he is a graduate research assistant and Ph.D. candidate in the Broadband Wireless Networking Laboratory School of Electrical and Computer Engineering, Georgia Institute of Technology, Atlanta, GA., under the guid-

ance of Prof. Ian F. Akyildiz. His current research interests include cognitive radio networks, next generation wireless communications, and wireless sensor networks.



**Kaushik R. Chowdhury** received his B.E. degree in Electronics Engineering with distinction from VJTI, Mumbai University, India, in 2003. He received his M.S. degree in Computer Science from the University of Cincinnati, OH, in 2006, graduating with the outstanding thesis award. He is currently a research assistant and Ph.D. candidate in the Broadband Wireless Networking Laboratory at the School of Electrical and Computer Engineering, Georgia Institute of Technology, Atlanta, GA. His current research interests

include cognitive radio architectures, and resource allocation in wireless multimedia sensor networks. He is a student member of the IEEE.