

---

# **Durability and Corrosion of Aluminium and Its Alloys: Overview, Property Space, Techniques and Developments**

---

N. L. Sukiman, X. Zhou, N. Birbilis, A.E. Hughes,  
J. M. C. Mol, S. J. Garcia, X. Zhou and G. E. Thompson

Additional information is available at the end of the chapter

<http://dx.doi.org/10.5772/53752>

---

## **1. Introduction**

Aluminium (Al) is an important structural engineering material, its usage ranking only behind ferrous alloys (Birbilis, Muster et al. 2011). The growth in usage and production of Al continues to increase (Davis 1999). The extensive use of Al lies in its strength:density ratio, toughness, and to some degree, its corrosion resistance. From a corrosion perspective, which is most relevant to this chapter, Al has been a successful metal used in a number of applications from commodity roles, to structural components of aircraft. A number of Al alloys can be satisfactorily deployed in environmental/atmospheric conditions in their conventional form, leaving the corrosion protection industry to focus on market needs in more demanding applications (such as those which require coating systems, for example, the aerospace industry).

Relatively pure aluminium presents good corrosion resistance due to the formation of a barrier oxide film that is bonded strongly to its surface (passive layer) and, that if damaged, reforms immediately in most environments; i.e. re-passivation (Davis 1999). This protective oxide layer is especially stable in near-neutral solutions of most non-halide salts leading to excellent pitting resistance. Nevertheless, in open air solutions containing halide ions, with Cl<sup>-</sup> being the most common, aluminium is susceptible to pitting corrosion. This process occurs, because in the presence of oxygen, the metal is readily polarised to its pitting potential,

and because chlorides contribute to the formation of soluble chlorinated aluminium (hydr)oxide which interferes with the formation of a stable oxide on the aluminium surface.

Aluminium and its alloys readily oxidises, including when Al is present in either in solid solution or in intermetallic (IM) particles. Industrial alloy surfaces however, tend to be as heterogeneous as their underlying microstructures. The surface of a wrought or cast alloy is likely to contain not only aluminium oxide alone, but may for example contain a fragment of a mixed Al-Mg oxide for alloys rich in Mg (Harvey, Hughes et al. 2008)). This is primarily because of the heat of segregation of Mg is high and it has a favorable free energy for oxide formation. If however an Al surface is mechanically undisturbed - then the surface oxide is relatively protective. Though, most real surfaces have some sort of mechanical finishing which results in the formation of a near surface deformed layer (NSDL) and shingling. Shingling occurs where the alloy matrix is spread across the surface including IM particles in abrasion and milling (Scholes, Furman et al. 2006; Muster, Hughes et al. 2009). This is because the IM particles are harder than the surrounding matrix and less susceptible to deformation (Zhou, Liu et al. 2011). Even on polished surfaces, the matrix and the IM particles rapidly form different oxide structures (Juffs, Hughes et al. 2001; Juffs, Hughes et al. 2002). This is almost certainly due to different chemical environments and different electrochemical reactions over the IM particles compared to the matrix. Furthermore, the morphology and the oxide are not continuous from the IM particles to the matrix and this represents a potential defect site in the context of corrosion. For the purposes of descriptions herein, IM particles can be classified into three main types; i) precipitates, ii) constituent particles and iii) dispersoids. Precipitates are typically in the shape of needles, laths, plates or spherical with the size ranging from Angstroms to fractions of a micrometer. They are formed by nucleation and growth from a supersaturated solid solution during low temperature aging and may be concentrated along the grain boundaries. Constituent particles however, are relatively large with irregular shape and the size can be up to 10 micrometers. This type of particle forms during solidification of the alloy and is not fully dissolved by subsequent thermomechanical processing (including solution heat treatments). They can be found in colonies of several IM crystals or different compound types. On the contrary, dispersoids are small particles with size ranging from 0.05 to 0.5 micrometers. They are thermally stable intermetallics of a fine size that are functional for controlling grain size and recrystallisation behavior. Dispersoids form by low level additions of highly insoluble elements such as Cr, Mn or Zr.

This chapter will aim to cover some of the important aspects related to the corrosion of Al-alloys, bearing in mind the role of alloy chemistry. In addition, some of the topical aspects related to techniques and ongoing developments in the general field of Al-alloy corrosion are presented. An attempt has been made to give the reader an overview of the key technical aspects, but unfortunately for comprehensive insight into the topic overall, the size of this chapter alone cannot be a replacement to dedicated monographs on the specific topics at hand; nor the ever-evolving journal literature that represents the state of the art. To aid in the transfer of information, this chapter has been divided into a number of sections to treat the widely varying topics independently.

## 1.1. The general performance of the Al-alloy classes

The corrosion potential of an aluminium alloy in a given environment is primarily determined by the composition of the aluminium rich solid solution, which constitutes the predominant volume fraction and area fraction of the alloy microstructure (Davis 1999). While the potential is not affected significantly by second phase IM particles of microscopic size, these particles frequently have corrosion potentials (when measured in isolation) differing from that of the solid solution matrix resulting in local (micro-) galvanic cells, when IMs are polarised to the corrosion potential of the alloy. The result is that local currents on the alloy surface differ, establishing anodes and cathodes. Since most of the commercial aluminium alloys contain additions of more than one type of alloying element, the effects of multiple elements on solution potential are approximately additive. The amounts retained in solid solution, particularly for more highly alloyed compositions, depend on production and thermal processing so that the heat treatment and other processing variables influence the final electrode potential of the product.

By measuring the potentials of grain boundaries and grain bodies separately, the difference in potential responsible for local types of corrosion such as intergranular corrosion, exfoliation, and stress corrosion cracking (SCC) can be quantified (Guillaumin and Mankowski 1998; Zhang and Frankel 2003). By measuring the corrosion potential of IMs (Buchheit 1995), and indeed by measurement of the polarisation response of IMs, even more significant insights into localised corrosion can be gained (Birbilis and Buchheit 2005). Such specialist topics are not dealt with in their entirety herein, however an abridged written summary of the performance of the key Al-alloy classes (as outlined by the Aluminium Association (Hatch 1984)) is provided below.

### 1.1.1. 1xxx series alloys

Corrosion resistance of aluminium increases with increasing metal purity, however the use of the >99.8% grades is usually confined to those applications where very high corrosion resistance or ductility is required. In regards to such specialist applications however, the actual number of applications are very few. Consequently 1xxx series alloys are not commonly used or sold (but do serve as important feedstock to secondary alloy producers or production). In the instance where general-purpose alloys for lightly stressed applications are required, such alloys are approximately 99% pure aluminium and offer adequate corrosion resistance in near neutral environments. 1xxx is also sometimes used in cladding for example AA1230 is used as clad on AA2024 (Hatch 1984)

### 1.1.2. 2xxx series alloys

Copper is one of the most common alloying additions - since it has appreciable solubility and can impart significant strengthening by promotion of age hardening (in fact, the Al-Cu system was the classical/original age hardening system (Hatch 1984)). These alloys were the foundation of the modern aerospace construction industry and, for example AA2024 (Al-4.4Cu-1.5Mg-0.8Mn), which is still used in many applications to this day, can achieve strengths in excess of 500MPa depending on temper (Polmear 2006).

### 1.1.3. 3xxx series alloys

The 3xxx series alloys are a commodity product that is nominally available in the form of thin sheet (for beverage can usage). The key alloying element, Manganese, has a relatively low solubility in aluminium but can improve corrosion resistance when remaining in solid solution. Additions of manganese of up to about 1% form the basis of the non-heat treatable wrought alloys with good corrosion resistance, moderate strength (i.e. AA3003 tensile strength ~110MPa) and exceptionally high formability (Polmear 2006).

### 1.1.4. 5xxx series alloys

Magnesium has significant solubility in aluminium and imparts substantial solid solution strengthening (which can also contribute to enhanced work hardening characteristics) (Davis 1999; Polmear 2006). The 5xxx series alloys (containing <~6% Mg) do not age harden. Whilst it is possible for  $\beta$ -phase ( $Mg_2Al_3$ ) to precipitate in systems with above ~3%Mg, the  $\beta$ -phase is not a strengthening precipitate and actually weakens the alloy (by depleting the solute of Mg). Nominally, the corrosion resistance of 5xxx series alloys is good and their mechanical properties make them ideally suited for structural use in aggressive conditions (such as marine vessels). Fully work-hardened AA5456 (Al-4.7Mg-0.7Mn-0.12Cr) has a tensile strength of >380MPa. One corrosion issue with fully work-hardened 5xxx series alloys is that the heavy dislocation density (and supersaturation of the solid solution with Mg) can permit the sensitization of the microstructure by precipitation of deleterious  $\beta$ -phase ( $Mg_2Al_3$ ) during sustained high temperature exposure (i.e. in service) (Baer, Windisch et al. 2000; Searles, Gouma et al. 2002; Davenport, Yuan et al. 2006; Goswami, Spanos et al. 2010).

### 1.1.5. 6xxx series alloys

Silicon additions alone can lower the melting point of aluminium whilst simultaneously increasing fluidity (which is why the vast majority of cast Al products contain various amounts of Si). These alloys are increasing in importance in automotive applications for engine and drive train components – however are yet to realise the majority of market share. Heat-treatable Al-Mg-Si are predominantly structural materials (strengths >300MPa are possible), all of which have an appreciable resistance to corrosion, immunity to SCC and are weldable. To date, 6xxx series alloys are mainly used in extruded form, although increasing amounts of sheet are being produced (Birbilis, Muster et al. 2011). Magnesium and silicon additions are made in balanced amounts to form quasi-binary Al-Mg<sub>2</sub>Si alloys, or excess silicon additions are made beyond the level required to form Mg<sub>2</sub>Si. Alloys containing magnesium and silicon in excess of 1.4% develop higher strength upon aging.

### 1.1.6. 7xxx series alloys

The Al-Zn-Mg alloy system provides a range of commercial compositions, primarily where strength is the key requirement (and this can be achieved without relatively high cost or complex alloying). Al-Zn-Mg-Cu alloys have traditionally offered the greatest potential for age hardening and as early as 1917 a tensile strength of 580MPa was achieved, however,

such alloys were not suitable for commercial use until their high susceptibility to stress corrosion cracking could be moderated (Song, Dietzel et al. 2004; Birbilis, Cavanaugh et al. 2006; Lin, Liao et al. 2006; Lynch, Knight et al. 2009). Aerospace needs led to the introduction of a range of high strength aerospace alloys of which AA7075 (Al-5.6Zn-2.5Mg-1.6Cu-0.4Si-0.5Fe-0.3Mn-0.2Cr-0.2Ti) is perhaps the most well-known, and which is now essentially wholly superseded by AA7150 (or the 7x50 family). The high strength 7xxx series alloys derive their strength from the precipitation of  $\eta$ -phase ( $MgZn_2$ ) and its precursor forms. The heat treatment of the 7xxx series alloys is complex, involving a range of heat treatments that have been developed to balance strength and stress corrosion cracking performance - including secondary (or more) heat treatments that can include retrogression and re-aging (Fleck, Calleros et al. 2000; Ferrer, Koul et al. 2003; Zieliński, Chrzanowski et al. 2004; Marlaud, Deschamps et al. 2010).

#### 1.1.7. 8xxx series alloys

Nominally reserved for the sundry alloys, 8xxx series alloys include a number of Lithium (Li) containing alloys. Li is soluble in aluminium to ~ 4 wt% (corresponding to ~ 16 at%). As these alloys of high specific strength and stiffness readily respond to heat treatment, research and development has intensified due to their potential for widespread usage in aerospace applications (Lavernia and Grant 1987; Dorward and Pritchett 1988; Giummarra, Thomas et al. 2007). Based on the impressive lightweight of such alloys, present day aircraft are comprised of some portion of Al-Li based alloys (modern generations of which actually include low Li levels and hence are nowadays designated as 2xxx alloys (Ambat and Dwarakadasa 1992; Garrard 1994; Semenov 2001; Giummarra, Thomas et al. 2007). First generation Li-containing alloys displayed some of the highest corrosion rates of all aluminium alloys, where susceptibility to intergranular corrosion was challenging. Modern Al-Cu-Li seem to have overcome this challenge; however it is also important to recognise that production requires specialised melting and casting, not presently available in most commercial facilities.

## 2. Corrosion of aluminium and its alloys in aqueous environment

### 2.1. Environmental corrosion of aluminium

Corrosion in aluminium alloys is generally of a local nature, because of the separation of anodic and cathodic reactions and solution resistance limiting the galvanic cell size. The basic anodic reaction is metal dissolution:



While the cathodic reactions are oxygen reduction:

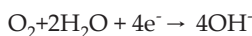

or hydrogen reduction in acidified solution such as in a pit environment as a result of aluminium ion hydrolysis:

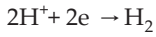

It is the interaction between local cathodes and anodes and the alloy matrix that leads to nearly all forms of corrosion in aluminium alloys. These include pitting corrosion, selective dissolution, trenching, intermetallic particle etchout, intergranular attack and exfoliation corrosion. Surface and subsurface grain etchout is also influenced by grain energy which is derived from grain defect density. Grain etchout, has a significant role in exfoliation corrosion since the volume of hydrated aluminium oxide generated during dissolution is larger than the original volume of the grain.

The general consensus for Al and its alloys is that they are resistant towards corrosion in mildly aggressive aqueous environments. The protective oxide layer represents the thermodynamic stability of Al alloys in corrosive environment - acting as a physical barrier as well as capable to repair itself in oxidizing environments if damaged. While the passive layer breakdown mechanism by chloride ions is still in debate (Sato 1990; McCafferty 2010) due to the complexity of the process (Szkłarska-Smialowska 2002), the general consensus is that localized attack starts by adsorption of aggressive anions and formation of soluble transitional complexes with the cations at the oxide surface. Thermodynamic principles to explain and predict the passivity phenomenon that controls the corrosion behavior of Al are summarised by Pourbaix-type analysis. This results in a plot of potential vs. pH based on the electrochemical reaction of the species involved, the representation known as a Pourbaix diagram (Pourbaix 1974) as shown in Figure 1.

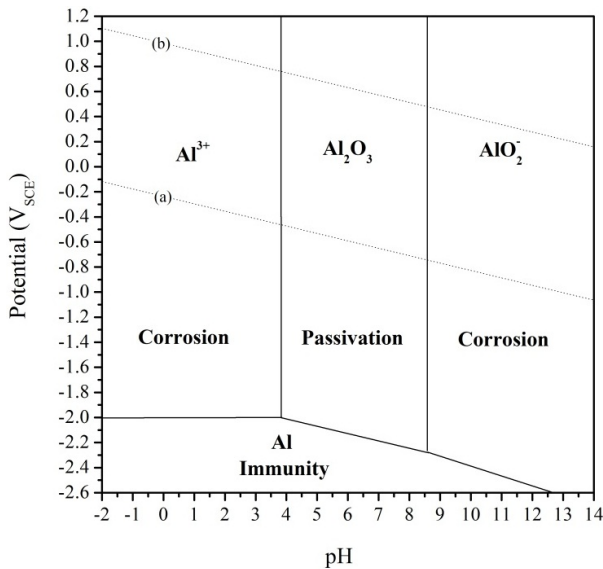

**Figure 1.** E-pH diagram for pure Al at 25°C in aqueous solution (adapted from Pourbaix 1974). The lines (a) and (b) correspond to water stability and its decomposed product.

It is seen that Al is nominally passive in the pH range of ~4 to 9 due to the presence of an  $\text{Al}_2\text{O}_3$  film. In environments that deviate from the near neutral range, the continuity of this film can be disrupted in which the film becomes soluble, facilitating the relatively rapid of dissolution the alloy. In the acidic range, Al is oxidised by forming  $\text{Al}^{3+}$ , whilst  $\text{AlO}_2^-$  occurs in alkaline range.

The E-pH diagram gives an impression that corrosion prediction is a straightforward process, however in actual engineering applications, there are several variables that weren't considered by Pourbaix. These include (i) the presence of alloying elements in most engineering metals (ii) the presence of substances in the electrolyte such as chloride (albeit that this has been addressed in more modern computations), (iii) the operating temperature of the alloy, (iv) the mode of corrosion, and (v) the rate of reaction. Taking these factors into account is nominally done on a case by case (i.e. alloy by alloy) basis, and a revised version of an E-pH diagram for 5xxx series alloys in 0.5M sodium chloride is given in Figure 2.

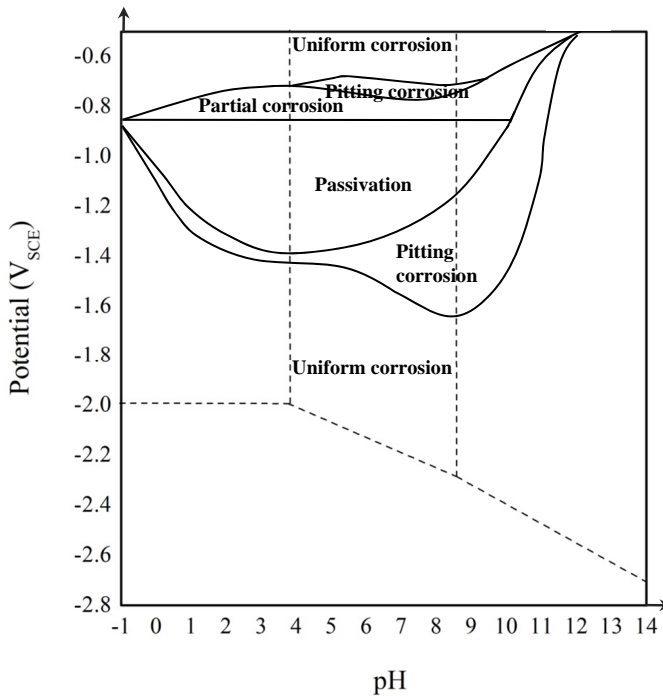

**Figure 2.** Mode of corrosion based on experimental data for AA5086 in the presence of 0.5M sodium chloride (adapted from Gimenez, Rameau et al. 1981)

Figure 2 indicates windows where localized attack is highly possible in the supposed passive region (Gimenez, Rameau et al. 1981). It is also seen that localised attack is possible across the whole range of pH depending on the specific potential. One should therefore not rely solely on

the Pourbaix diagram as a direct index to actual corrosion rates, with rates needing to be independently measured for a given alloy-electrolyte combination (Ambat and Dwarakadasa 1992). Finally, whilst not to be discussed in detail here, it is prudent to indicate that effectively all Al-alloys do not attain practical/empirical immunity as evidence in Figure 1. Cathodic polarisation tends to contribute to alloy deterioration by two modes. Firstly, the accumulation of hydroxyl ions at the Al-surface will cause chemical dissolution of the Al. Secondly, Al is a very strong hydride former, and hydrogen from the cathodic reaction at such negative potentials will serve combine with Al to form hydrides (Perrault 1979).

## 2.2. Kinetic stability of aluminium alloys

Kinetics represents the rate of reaction during corrosion. When exposed to an aqueous environment, metals stabilise to a value of electrochemical potential that is characteristic of the material and its composition for a given electrolyte. This potential is the potential at which anodic and cathodic reactions upon the metal surface are equal, and the value of this potential is thus significantly influenced by factors that can alter the relative rates of anodic or cathodic reaction efficiency upon the metal surface (i.e. alloying, precipitate state, etc.).

Most typically, the potentiodynamic polarisation test is used to characterise the corrosion performance of an alloy (as far as determination of mechanistic aspects from an instantaneous test). This method gives vital kinetic information such as current density over a range of potentials, pitting potential (if it exists), corrosion potential, the passive current density and potentially more information in reverse scans, etc. Thus factors affecting corrosion as discussed in the previous sections can be evaluated with much higher confidence. For example, Figure 3 shows a polarisation curve of Pure Al compare to AA2024-T3 (Al-4.3Cu-1.5Mg-0.6Mn) in 0.1M NaCl.

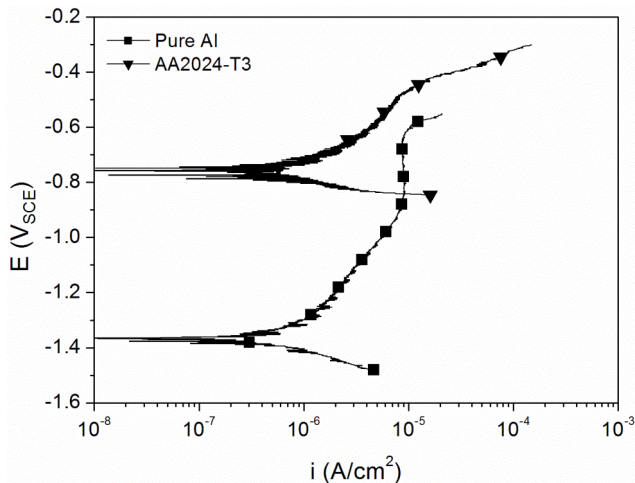
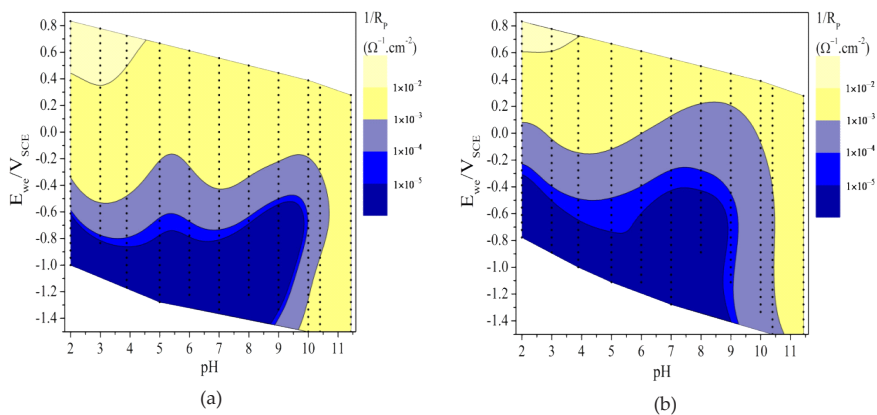

**Figure 3.** Polarisation curve of pure Al and AA2024-T3 exposed to 0.1M NaCl for 7 days collected at 1mV/s<sup>-1</sup> (adapted from (Sukiman, Birbilis et al. 2010))



Comparison of alloy behavior and dominant reactions can be made in a quantitative manner. The anodic branch of the polarisation curve gives information related to the anodic/dissolution reaction while the cathodic branch represents the reduction reaction (nominally oxygen reduction, but at lower potentials or in strong acids, water reduction). The addition of more noble alloying elements typically increases the corrosion potential to more noble values (Davis 1999) and this is dramatically observed in Figure 3. This ennoblement however does not correlate to the rate of corrosion (as judged by Figure 3), whereby we see the pure Al versus AA2024-T3 has a difference in potential of  $\sim 0.5V$ . In addition, the main practical threat for Al alloys is localised attack such as pitting, so in that vein, a more noble value of pitting potential does not necessarily signify a better corrosion resistance (Frankel 1998; Birbilis and Buchheit 2005). Rather generally, the electrochemical reactions upon Al-alloys are heavily influenced by the chemistry and microstructure of the alloy – which we attempt to discuss in the following section.

Moving beyond potentiodynamic polarisation towards a true measure of kinetic stability in the E-pH domain (similar in concept to Pourbaix diagrams however which give ‘speed’ and not just thermodynamic likelihood) there are tests which can be done in this regard. In order to develop an improved understanding of overall kinetic stability of a metal over the potential-pH space, methods including the staircase potentiometric-electrochemical impedance spectroscopy (SPEIS) can be used to establish so-called kinetic stability diagrams, as previously demonstrated for pure Al (Zhou, Birbilis et al. 2010) and depicted in Figure 4. The specifics of SPEIS will be introduced in section 5.3.



**Figure 4.** Contour plots of  $1/R_p$  for the E-pH space and their data for (a) A portion of a 99.9999% Al ingot single crystal and (b) a polycrystalline specimen from the identical ingot in (a) (adapted from (Zhou, Birbilis et al. 2010)

In Figure 4, presentation of the reciprocal of polarisation resistance ( $1/R_p$ ) is the metric of reaction ‘speed’, as it is proportional to the reaction rate at a given condition. The influence of potential and pH is presented not only for pure Al in the sample which was single crystal,

but also for a polycrystalline sample. As a result, one is also able to assess the effect of grain structure from Figure 4. Most importantly however, Figure 4 reveals that the rate of reaction stays in a low range in areas that extend beyond that of the Pourbaix diagram in terms of certain E-pH combinations – indicating that although Al may be in a thermodynamically unstable region, the reaction rate can be maintained to be low enough to make it still be useful in an engineering context. Similarly, there are regions of high potential where pure aluminium may be in a thermodynamically stable region, but unusable – owing to transpassive dissolution. Finally, in terms of microstructure effects, it is seen that the exact same material can have a different kinetic response based on structural factors alone. Such differences are not detectable or predicted from thermodynamic analysis in any way, and this highlights the importance of approaches which provide kinetic information to meet demands of engineering applications.

### 2.3. The property space and corrosion property profile of aluminium alloys

As technologies continue to advance with more challenging applications and environments, a general understanding of durability limits across the class of Al-alloys is essential. Durability needed in a broad sense is the ability to withstand an environment while maintaining mechanical integrity. This indicates a requirement to understand the property space for Al and its alloys. Figure 5 shows a trend that is in line with the notion that increases in hardness (used here as a proxy to yield strength) show increases in corrosion rate.

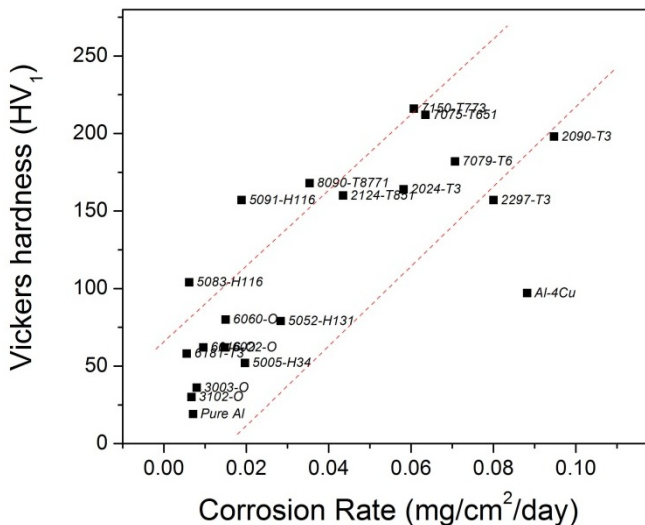

**Figure 5.** Corrosion rate as determined from weight loss data for commercial Al alloys collected after 14 days exposure in quiescent 0.1M NaCl presented against alloy hardness.

From Figure 5, it can be argued that the data is divided into two main groups, one at each end of the corrosion rate spectrum. High hardness/strength aluminium alloys were found to populate the high corrosion rate space. This is in contrast to the medium to low hardness/strength alloys that revealed considerably lower corrosion rates. The alloys that show the highest corrosion rates are the 'precipitation hardenable' family. Besides the high number density of precipitate particles in such alloys, they also contain an appreciable population of constituent type particles (Chen, Gao et al. 1996; Wei 2001; Andreatta, Terryn et al. 2004; Ilevbare, Schneider et al. 2004; Birbilis, Cavanaugh et al. 2006; Boag, Hughes et al. 2009; Hughes, MacRae et al. 2010; Xu, Birbilis et al. 2011). These particles are industrially necessary, since the complex chemistry of precipitation hardenable alloys (that can contain up to 10 alloying elements) have significant alloying additions added via alloy rich master alloys. It is also observed that the alloys that show the highest corrosion rates also contain appreciable amount of copper.

The plot in Figure 5 allows one to identify a region of property space (at the top left corner) that has potential for future alloys, with ongoing efforts aiming to reach such space (in addition to controlling ductility). Efforts that regard in are underway, focusing on corrosion rate (Carroll, Gouma et al. 2000; Norova, Ganiev et al. 2003; Rosalbino, Angelini et al. 2003; Cavanaugh, Birbilis et al. 2007; Lucente and Scully 2007; Fang, Chen et al. 2009; Graver, Pedersen et al. 2009; Ralston, Birbilis et al. 2010; Tan and Allen 2010; Xu, Birbilis et al. 2011; Brunner, Birbilis et al. 2012) and strength (Poole, Seter et al. 2000; Pedersen and Arnberg 2001; Fuller, Krause et al. 2002; Raviprasad, Hutchinson et al. 2003; Lee, Shin et al. 2004; Oliveira Jr, de Barros et al. 2004; Zhao, Liao et al. 2004; Kim, Kim et al. 2005; Teixeira, Bourgeois et al. 2007; McKenzie and Lapovok 2010; Wang, Zhang et al. 2010; Puga, Costa et al. 2011; Zhong, Feng et al. 2011; Westermann, Hopperstad et al. 2012). However, such studies are done independently of both properties thus the symbiotic effect can't be readily evaluated to date.

### 3. Corrosion of aluminium and its alloys in aqueous environment

#### 3.1. The role of chemistry on corrosion

Alloying elements are added to aluminium for various reasons, with improving mechanical properties the principal reason. These elements introduce heterogeneity into the microstructure, which is the main cause of localised corrosion that initiates in the form of pitting. Each alloying element has a different effect on the corrosion of Al, and in this section we *briefly* discuss the role of alloying elements on corrosion of Al.

##### 3.1.1. Influence of magnesium

Mg is one of the major elements added to Al to improve mechanical properties by solid solution strengthening – and can be found in 5xxx alloys, as well as 2xxx, 3xxx, 6xxx and 7xxx commercial alloys. Mg can stabilize GP zones, has a high solubility in Al and decreases the alloy density. Muller and Galvele showed that Mg when present in solid solution does not

have a significant effect on the pitting corrosion of Al which can be understood on the basis of standard potentials of Al and Mg (Muller and Galvele 1977). Moreover, Mg decreases the rate of the cathodic reaction when present in solid solution, increasing corrosion resistance, which may appear counterintuitive, but is rather obvious (as Mg has a very low exchange current density and hence retards the cathodic reaction). In contrast, excess amounts of Mg in the alloy or a long term exposure to elevated temperature will cause the precipitation of either  $\text{Al}_8\text{Mg}_2$  or  $\text{Al}_3\text{Mg}_2$  (Searles, Gouma et al. 2002; Davenport, Yuan et al. 2006; Oguocha, Adigun et al. 2008; Jain, Lim et al. 2012). These phases form typically along grain boundaries (Baer, Windisch et al. 2000; Goswami, Spanos et al. 2010) and are known to be anodic with respect to Al matrix therefore prone to localized corrosion (Vetrano, Williford et al. 1997; Aballe, Bethencourt et al. 2001; Jones, Baer et al. 2001; Brunner, May et al. 2010). Mg in 2xxx, 6xxx and 7xxx alloys however, forms precipitates with other alloying elements to strengthen the alloy where role of Mg mainly depends upon the other alloying additions (Ringer, Hono et al. 1996; Buchheit, Grant et al. 1997; Campestrini, van Westing et al. 2000; Guillaumin and Mankowski 2000; Eckermann, Suter et al. 2008).

### 3.1.2. Influence of silicon

The addition of Si in conjunction with Mg, which is typical in 6xxx series Al alloys, allows  $\text{Mg}_2\text{Si}$  particles to precipitate. There is vast literature on the chemical composition of the Mg-Si phase and its role on mechanical properties (Hirth, Marshall et al. 2001; Usta, Glicksman et al. 2004; Stelling, Irretier et al. 2006; Eckermann, Suter et al. 2008; Zeng, Wei et al. 2011). This particle is beneficial in terms of increasing strength but renders the alloy prone to localised corrosion (Eckermann, Suter et al. 2008). The electrochemical behavior of  $\text{Mg}_2\text{Si}$  was investigated recently and it was shown that  $\text{Mg}_2\text{Si}$  remains more 'anodic' (i.e.. less noble) than the matrix in Al-alloys. As a consequence of this,  $\text{Mg}_2\text{Si}$  remains anodic and undergoes selective dissolution in the Al-matrix. Some 6xxx series alloys contain excess Si. Excess amount of Si however increases the cathodic reaction rate (Eckermann, Suter et al. 2008) and are unfavorable since Si tends to be present along the grain boundary and this may lead to intergranular corrosion and stress corrosion cracking (Guillaumin and Mankowski 2000; Larsen, Walmsley et al. 2008; Zeng, Wei et al. 2011).

### 3.1.3. Influence of copper

The presence of Cu is viewed as detrimental to corrosion due to the formation of cathodic particles capable of sustaining the cathodic reaction locally and efficiently, such as  $\text{Al}_2\text{Cu}$  and  $\text{AlCu}_2\text{Mg}$ . In some cases where low Cu content is used, the impact of Cu is minimal, however given that corrosion is not the principal alloy design criteria in most instance, Cu is common in many (most) Al-alloys. The 2xxx series alloys are Cu rich, however Cu is added to other alloy classes such as the 6xxx series where it can increase strength when present in trace amounts, and also enhance precipitation hardening. The same is true in 7xxx alloys, with most modern aerospace alloys having appreciable amounts of Cu that can increase strength by modifying precipitation and minimising SCC via incorporation into precipitates (such as  $\text{Mg}(\text{Zn},\text{Cu})_2$ ).

In general however, there is still some debate on the precise role of Cu, which also depends on the temper condition. Muller and Buchheit found that Cu in the form of solid solution decreases pitting susceptibility through the ennoblement of pitting potential. While Muller and Galvele reported an increase in pitting potential for solid solution content of Cu up to 5 wt%. In the case of Al-Cu-Mg alloys which contain S phase ( $\text{Al}_2\text{CuMg}$ ), large differences in solution potential between Cu (highly noble) and Mg exist, with significant focus on corrosion of S phase (Buchheit, Grant et al. 1997; Guillaumin and Mankowski 1998; Buchheit, Montes et al. 1999; Ilevbare, Schneider et al. 2004; Boag, Hughes et al. 2011) revealing dealloying and selective dissolution that leads to preferential dissolution of Mg and Al with Cu remnant being redistributed at or near the site of the  $\text{Al}_2\text{CuMg}$ . A range of other particles associated with Cu have been reported such as  $\text{Al}_7\text{Cu}_2\text{Fe}$ . However recent microprobe studies of a number of batches of AA2024-T351 indicate five common compositions across modern alloys which do not have the same composition as older alloy stock indicating that this is still an active area of research (Hughes, Glenn et al. 2012). In general, Cu, or Cu containing particles are capable of supporting high oxygen reductions rates and hence undesirable from corrosion perspective (Mazurkiewicz and Piotrowski 1983; Scully, Knight et al. 1993; Buchheit 2000; Birbilis, Cavanaugh et al. 2006).

#### 3.1.4. Influence of zinc

In high strength commercial aluminium alloys such 7xxx series alloys, Zn is added to stimulate precipitation hardening. Alloys containing high levels of Zn such as the modern aerospace alloys 7050 and 7150 are amongst the highest strengths of Al-alloys owing to the high number density of precipitates such as  $\text{MgZn}_2$  which is evenly distributed throughout the Al matrix (Ringer, Hono et al. 1996; Andreatta, Terryn et al. 2004; Sha and Cerezo 2004; Birbilis and Buchheit 2005; Polmear 2006) in 5xxx alloys. The addition of Zn to Al-Mg alloys was reported to improve resistance against SCC (Unocic, Kobe et al. 2006) where a small amount of Zn added into AA5083 alloy was found to reduce the corrosion - reporting that Zn can promote the formation of Al-Mg-Zn ( $\tau$  phase) instead of  $\text{Al}_3\text{Mg}_2$  ( $\beta$  phase) the latter of which is responsible for stress corrosion cracking (Carroll, Gouma et al. 2000; Carroll, Gouma et al. 2001).

#### 3.1.5. Influence of iron

Iron is typically present as an impurity in all commercial Al alloys due to the production process of Al alloys. Unless specifically required for specialist applications, it is simply too expensive to remove all iron (even in aluminium destined for aerospace applications). Despite having a small fraction of the composition, iron is detrimental to corrosion due to its low solubility and hence ability to form constituent particles which are cathodic to the Al-matrix such as  $\text{Al}_3\text{Fe}$  (Nisancioglu 1990). Additionally, iron is capable of sustaining cathodic reactions more efficiently than Al (Galvele 1976; Szklarska-Smialowska 1999). In more complex alloys, Fe can also combine with other alloying elements such as Mn or Cu (in the latter case forming  $\text{Al}_7\text{Cu}_2\text{Fe}$ ), which are also a major issue for corrosion (Birbilis, Cavanaugh et al. 2006) since the combination of Fe and Cu provides even greater cathodic efficiency for such particles. Corrosion associated with such noble cathodic constituents/intermetallics leads to

an increase in local pH of the solution further enhancing anodic dissolution of the Al matrix adjacent to say,  $\text{Al}_3\text{Fe}$  (Seri 1994; Park, Paik et al. 1999; Birbilis and Buchheit 2005; Ambat, Davenport et al. 2006).

### 3.1.6. Influence of manganese

The addition of Mn is effective in reducing the pitting susceptibility of Al alloys particularly in the context of modifying Fe containing intermetallic particles (Nisancioglu 1990) (where Mn can substitute for Fe, rendering the resulting constituent particle somewhat less noble) The presence of Mn has been noted as reducing the concentration of Fe and reducing the degree of resultant corrosion (Koroleva, Thompson et al. 1999); owing to the formation of  $\text{Al}_6\text{MnFe}$  has a similar electrochemical potential with that of the Al matrix. However, it has also been noted that an excess of Mn can lead to an increase in the cathodic activity when beyond the solubility limit (solubility of Mn in Al is 1.25 wt%) – with constituents such as  $\text{Al}_6\text{Mn}$  readily forming (Liu and Cheng 2010). Generally however, the presence of Mn constituent particles are not as detrimental as particles rich in Fe or Cu (Birbilis and Buchheit 2005; Cavanaugh, Birbilis et al. 2007), which is evidenced by the reliable corrosion performance of 3xxx commercial Al alloy (Zamin 1981; Seri and Tagashira 1986; Tahani, Chaieb et al. 2003; Liu and Cheng 2011).

### 3.1.7. Influence of lithium

The addition of Li in Al alloys is efficient at significantly reducing alloy density whilst increasing strength – making it an obvious contender in the range of transport, namely aero, applications. Al-Li alloys are a rather specialised field that spans the past five decades, with descriptions originally in the 8xxx series compositional space (with principally Li rich compositions). Such so-called 1<sup>st</sup> generation Al-Li alloys were only used in specialised applications owing to their susceptibility to cracking. The cracking issue was later managed via new alloy compositions and thermomechanical processing (2<sup>nd</sup> generation Al-Li alloys), however until relatively recently Al-Li alloys were not so popular owing to relatively high corrosion rates and localised forms of corrosion propagation. Most recently, the 3<sup>rd</sup> generation of Al-Li alloys has gained significant attention and growing usage in commodity aerospace applications. These 3<sup>rd</sup> generation alloys are actually 2xxx series alloys, with less Li than Cu. These new 2xxx series alloys will be a significant alloy of the future, whilst still further research is required (from a corrosion perspective) to fully understand the performance, particularly as a function of thermomechanical treatment. Some abridged information regarding the role of Li upon corrosion is included here. In Li rich alloys, the formation of strengthening phase,  $\text{Al}_3\text{Li}$  which is dispersed homogeneously throughout the matrix, is responsible for the increase in strength (Lavernia and Grant 1987). It is however detrimental to corrosion as  $\text{Al}_3\text{Li}$  initially form along the grain boundaries. As Li is an active (i.e. less noble) element, this will localise dissolution to Li rich regions and therefore susceptibility to attack such as intergranular corrosion is high (Martin 1988). When Cu is also added in conjunction with Li (in alloys such as AA2090) the precipitation of phases such as  $T_1$  ( $\text{Al}_2\text{CuLi}$ ) occurs. There are two modes of attack associated with  $T_1$ , one of which  $T_1$  at the precipitate free

zone is dissolved forming small pits, while the other is when  $T_1$  undergo selective dissolution along with dissolution of the adjacent Al matrix leaving larger pits (Buis and Schijve 1992; Buchheit, Wall et al. 1995).

### 3.1.8. Influence of activating elements (i.e. Pb, Sn)

Lead (Pb) and tin (Sn) are usually present in low levels as trace elements (Gundersen, Aytac et al. 2004; Premendra, Terryn et al. 2009). When present in trace amounts, their influence is minimal or negligible. When (by say, recycling or contamination) the levels rise above the solubility limits, the presence of Pb leads to segregation that results in Pb-rich film at the metal - oxide interface when the alloy is heat treated at elevated temperature (Sævik, Yu et al. 2005) causing the Al oxide film to destabilise particularly in the presence of chloride. The disruption of Al oxide film leads to an increase in anodic reaction rate which not only increases the pitting susceptibility, but can activate the entire surface. This process is called anodic activation, and has been well documented for a number of years by studies from the group of Nisancioglu (Keuon, Nordlien et al. 2003; Gundersen, Aytac et al. 2004; Yu, Sævik et al. 2004; Yu, Sævik et al. 2005; Walmsley, Sævik et al. 2007; Jia, Graver et al. 2008; Graver, Pedersen et al. 2009; Anawati, Graver et al. 2010; Graver, van Helvoort et al. 2010; Anawati, Diplas et al. 2011). There have been some efforts to reduce the activation effect of Pb by addition of more noble alloying elements such as Cu in the hope that the addition of Cu may alter the surface potential - hence reducing the activation (Anawati, Diplas et al. 2011). A similar result was observed for the addition of Mg (Jia, Graver et al. 2008), however, such methods are not viable on the basis that the Pb interfering with the oxide is an effect in addition to any changes in the alloy potential. The presence of Sn along with Pb however reduces the dissolution rate when annealed at the maximum temperature of 600°C for an hour at which Sn is found to dissolve in the aluminium solid solution diluting the Sn concentration on the surface (Graver, Pedersen et al. 2009).

### 3.1.9. Influence of other element, including Zr, Cr, Sc, Ti, W and Sr

These elements are typically added independently in small amounts (i.e. <0.2 wt%) for the purpose of grain refinement, to reduce recrystallisation as well as minimising the effect of intermetallic compounds (Vetrano, Henager Jr et al. 1998). Elements such as Zr and Ti are able to form intermetallics at high temperatures in the Al melt, and persist as finely dispersed particles of  $Al_3Zr$  and  $Al_3Ti$  within the solidified matrix, which, based on their fine size (i.e.  $\ll 1 \mu m$ ), have a minimal impact on corrosion (Scully, Knight et al. 1993). Similarly with scandium (Sc) additions above the solubility limit the formation of  $Al_3Sc$  will occur, contributing to the strength and significantly reducing recrystallisation during thermomechanical processing (Cavanaugh, Birbilis et al. 2007). In general, and neglecting  $Al_3Fe$ , such dispersoids are based on the  $Al_3X$  system where X is Zr, Ti, Sc, Er, etc, and taking the form of fine insoluble dispersoids which are functional in grain inoculation and refinement. As such, there are specific alloying additions of Ti and Zr to high strength alloys such as AA7075 (Senkov, Bhat et al. 2005; Zou, Pan et al. 2007; He, Zhang et al. 2010).

Whilst not studied in detail, it has been posited that the ability to suppress recrystallisation leads to lower corrosion rates by avoiding the formation of high angle grain boundaries (Fang, Chen et al. 2009). Furthermore, there are also complex second and third order interactions between sparingly soluble elements that extend beyond the predictions of simple phase diagrams. An example is that the addition of Sr will impact intermetallics such as  $Al_5FeSi$ , making them smaller in both their size and volume fraction (Ashtari, Tezuka et al. 2003; Eidhed 2008). Such an effect has a role in corrosion by minimising the number of intermetallic sites. The purpose however of this section, is not to describe the metallurgy, as that has been done classically as far back as Mondolfo (Mondolfo 1971; Mondolfo and Barlock 1975), but to emphasise the microstructures direct impact on corrosion.

In common alloys prepared by conventional casting technologies, transition metals (TMs) such as W, Mo and Cr are not employed owing to their very low solubility limits. However it is important to note that when prepared in sputtered or thin film forms, such Al-TM alloys display the lowest corrosion rates of all the Al-alloys. Shaw successfully produced the alloys by sputter deposition and found that these elements increased the pitting potential and passivity of the alloys as well as inability to form second phase upon heat treatment (Shaw, Fritz et al. 1990; Shaw, Davis et al. 1991). The work of Frankel also showed promising results (Frankel, Russak et al. 1989; Frankel, Davenport et al. 1992; Tailleart, Gauthier et al. 2009).

### 3.2. The role of microstructure on corrosion

In order to understand the corrosion performance of Al alloys, and following on from the previous section, an appreciation of the microstructure is vital. Alloying elements and thermomechanical processing play an important role in dictating the type of microstructure produced. For homogeneous alloys, such as pure Al or 5xxx series alloys, corrosion susceptibility is low due to lack of pre-existing microstructural attack sites. The main concern however is regarding heterogeneous alloys, particularly the higher strength Al alloys such as the 2xxx, 7xxx and heat-treatable 6xxx series, where microstructural heterogeneity is a necessity. The most common features of a microstructure are the intermetallic particles which are classified into precipitates (forming from nucleation and growth, nominally 1nm to 300nm in diameter), constituent particles (from insoluble or impurity elements, unable to redissolve, nominally a few microns, to a few tens of microns, in size) and dispersoids (nominally  $\ll$  1 micron in size) (Polmear 2006). Each of these features consists of different electrochemical characteristics (including their native electrochemical potential and the currents they can sustain at a given potential characteristic of the alloy which they populate) and act as the sites which dictate the severity of corrosion attack. Work on categorising such intermetallics in relation to corrosion is plentiful and now has been going on for several decades (Mazurkiewicz and Piotrowski 1983; Scully, Knight et al. 1993; Buchheit, Grant et al. 1997; Birbilis and Buchheit 2005; Eckermann, Suter et al. 2008; Goswami, Spanos et al. 2010; Boag, Hughes et al. 2011; Hughes, Boag et al. 2011). We make the distinction in this chapter that whilst such intermetallics are responsible for corrosion initiation steps, including pitting, we will not cover corrosion propagation in detail (i.e. stress corrosion, or intergranular corrosion) since they would require a dedicated chapter.



The knowledge of intermetallic chemistry and the electrochemistry allows a prediction of the mode of corrosion and the propensity of the attack (Cavanaugh, Buchheit et al. 2009). Theoretically, a more active particle (i.e. less noble) will become a local anode and consequently corrode while the more noble particles become cathodes (Szklarska-Smialowska 1999). This is not always a true reflection of kinetics however, as reported by Birbilis where the capability of the element to sustain the cathodic reduction process can not be deduced by relative nobility as well (Birbilis and Buchheit 2005). As corrosion occurs upon Al alloys, particularly pitting and early damage accumulation, two types of corrosion mode are identified. In one mode of attack where the intermetallic is classified as a cathode, the surrounding matrix tends to corrode leaving a ring shape around the particle or also called trenching. There is still some uncertainty on whether or not the trench itself is a result of microgalvanic coupling alone, or if the major contributor is local pH elevation, however a good treatise of this topic was given in a multi-part series of papers by the group at Virginia (Ilevbare, Schneider et al. 2004; Schneider, Ilevbare et al. 2004; Schneider, Ilevbare et al. 2007). In some cases damage may propagate to the base of the particle and eventually lead to particle fall out (Buchheit, Grant et al. 1997). The other mode of attack is when the intermetallic acts as anode and matrix as cathode; whereby the intermetallic will corrode leaving a cavity on the surface. Finally, in some microstructurally complex systems with ternary and above alloying additions, another type of attack found to not follow the traditional way of determining anode and cathode is incongruent dissolution commonly found in 2xxx and 7xxx due to the presence of S phase (Al<sub>2</sub>CuMg) (Buchheit, Grant et al. 1997; Guillaumin and Mankowski 1998). This intermetallic contains Cu and Mg, whereby (Blanc, Lavelle et al. 1997; Buchheit, Martinez et al. 2000), S phase experiences selective dissolution of the highly active Mg hence leaving Cu remnants at the bottom of the pit (Buchheit, Grant et al. 1997; Büchler, Watari et al. 2000) or redistributed near the particle site. Although the more detailed study of Boag et al. indicated that Al might be preferentially removed in the initial stages of attack on S-phase (first 2.5 minutes) as both Cu and Mg were observed to be present after Al dissolution at 5 minutes. This may have been due to a combination of the types of aluminium hydroxyl-chloro complexes that form and the partial switching of the areas of S-phase to Cu remnants where cathodic reactions lead to the formation of insoluble Mg(OH)<sub>2</sub> (Boag, Hughes et al. 2011). After 15 minutes the Mg is removed as well and no chloride was detected on these particles. The attack then continues with the dissolution of Al matrix (Buchheit, Grant et al. 1997; Guillaumin and Mankowski 1998). Localized attack of the intermetallic also influenced by the chloride content and pH of the electrolyte. Higher chloride content is widely reported to have higher pitting occurrence due to passive layer disruption of chloride ions (Seri 1994; Blanc, Lavelle et al. 1997; Ilevbare, Schneider et al. 2004) but this does not necessarily mean the pit will propagate deeper (Cavanaugh, Buchheit et al. 2010). There exists a dedicated monograph on this topic (Muster, Hughes et al. 2009). It has also been noted that the intermetallic Mg<sub>2</sub>Si can undergo similar incongruent dissolution, whereby Si enrichment occurs at the expense of dissolving Mg (Birbilis and Buchheit 2005; Jain, 2006; Eckermann, Suter et al. 2008; Gupta, Sukiman et al. 2012).

The revelation of a large number of microstructure vs. corrosion micrographs will not be done herein, however if the readers are interested, a nice expose of such images exists in

Cavanaugh (Cavanaugh 2009). Instead, a demonstration is given here. Figure 6 shows the micron scale microstructure for 2024-T3 and 5083-H116 before and after corrosion exposure in 0.1M NaCl for 14 days. These relatively low magnification images do not reveal the precipitate structure in AA2024-T3, instead showing the coarse intermetallics that exist in the alloys. What is observed is that a higher intermetallic density gives more possible sites for localised attack. In the relatively widely studied 2024-T3 (Guillaumin and Mankowski 1998; Schmutz and Frankel 1998; Campestrini, van Westing et al. 2000; Leblanc and Frankel 2002; Boag, Hughes et al. 2009; Hughes, MacRae et al. 2010; Ralston, Birbilis et al. 2010; Boag, Hughes et al. 2011; Hughes, Boag et al. 2011; Zhou, Luo et al. 2012). pitting attack is associated with the Cu containing intermetallic such as *S* phase (coarse and precipitated) and the intermetallic density in AA2024-T3 is high, owing to the very large number of alloying elements which can leave the possibility of forming constituent particles based on Fe, or Si, or Cu, or Mn, etc. In contrast to AA2024, the alloy 5083-H116 with a smaller number of alloying elements, and Cu free, has a lower constituent number density. In addition to the Mg remaining in solid solution and reduces the susceptibility to localised attack (Vetrano, Williford et al. 1997; Aballe, Bethencourt et al. 2001; Yasakau, Zheludkevich et al. 2007).

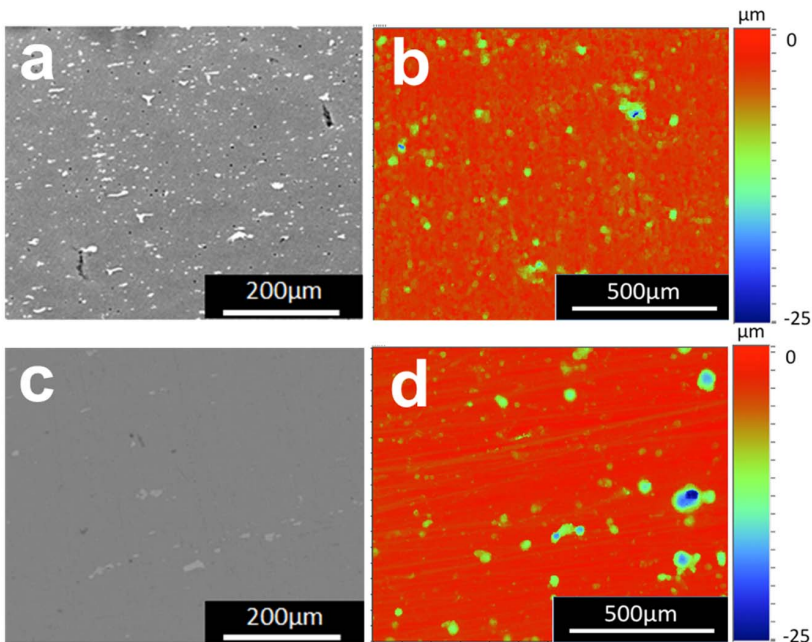

**Figure 6.** SEM images for AA2024-T3 and AA5083-H116 before exposure in (a) and (c) and after exposure in 0.1M NaCl for 14 days in (b) and (d). These are comparative images to show the extent of damage following immersion.

## 4. Corrosion protection

This section covers general approaches to protection of aluminium alloys in view of recent advances in the understanding of alloy microstructure. It includes an overview of pretreatment processes such as anodising, conversion coating and organic coatings (barrier and inhibitor combinations). It will examine recent advances in inhibitor design such as building in multifunctionality and touch upon self-healing coating systems. Approaches using multifunctionality can target anodic and cathodic reactions more effectively than using individual monofunctional inhibitors.

Standard metal finishing processes, which have been used for many years, are likely to continue to be used into the future unless they contain chemicals that are targeted for replacement such as chromium. The function of these coatings is primarily to provide better adhesion properties for paint coatings and a secondary role is to provide corrosion protection. The general approach for applying these coatings relies on metal finishing treatments (treatment prior to painting involving immersion in acidic and alkaline baths) with the objective of reducing the heterogeneous nature of the metal surface such as removing the NSDL and second phase particles (Muster 2009). This is achieved in multistep treatment processes for metal protection (Twite and Bierwagen 1998; Buchheit 2003; Muster 2009) as for instance:

- selective deoxidation (IM particle removal and surface etching);
- deposition or growth of a manufactured oxide via electrochemical (anodising) or chemical (conversion coating) means;
- use of an organic coating for specific applications, normally including a primer and a top-coat.

On aluminium, most anodised coating processes produce an outer oxide with a cellular structure on top of a thin barrier layer that provides some protection against corrosion. Inhibitors can be incorporated into the outer porous layer of the anodized layer during formation or as a seal after formation to offer some extra protection upon damage. Chromic acid anodizing is one of a number of processes that are available for electrochemical growth of surface protective oxides. More environmentally friendly alternatives to chromic acid anodizing such as sulfuric, sulfuric-boric, sulphuric-tartaric and phosphoric based processes have been available for a long time. There have been a number of recent advances in reducing the energy consumption of anodizing processes as well as improving coating properties. These advances are based on an improved understanding of the alloy microstructure described above and involve selective removal of second phase particles as part of the anodising process.

An alternative approach to anodizing is to precipitate a coating on a surface through chemical means called conversion coatings. For high strength Al-alloys such as 2xxx and 7xxx series chromate conversion coating (CrCC) is still the preferred process. Replacements for the toxic chromate-based conversion coatings include a range of treatments based on self-assembled monolayers, sol-gel chemistries, Ti/Z oxyfluorides, rare earth, cobalt, vanadates,

molybdates and permanganate processes (Twite and Bierwagen 1998; Buchheit 2003; Kendig and Buchheit 2003). These processes are widely developed for chemically pretreated surfaces that have nearly all the IM particles removed (by chemical pretreatment) and are not specifically designed to address electrochemical and compositional variations found for a heterogeneous surface such as when the IM phases are present. Work like that in (Buchheit and Birbilis 2010) depicting the reaction rate variation across the surface, however, opens an avenue to start designing inhibitors where the initial reaction rate distribution across a surface can be significantly reduced to limit the overall activity of the surface. In this context reaction of inhibitive phases with manufactured IM compounds as well as IM particles within the alloy have been studied for a number of systems (Juffs, Hughes et al. 2001; Juffs 2002; Juffs, Hughes et al. 2002; Birbilis, Buchheit et al. 2005; Scholes, Hughes et al. 2009).

Once the anodised or conversion coating is applied, the surface is ready to receive the organic coating. There are many different types of organic coatings, however because of the focus on 2xxx and 7xxx alloy used in the aerospace industry this section will only deal with that application area. The organic coating system usually consists of a primer and a topcoat. The primer is the main protective layer including corrosion inhibitors that can be released when corrosive species or water reach the metal. From the perspective of providing protection for the underlying aluminium alloy, the inhibitor needs to be available during a corrosion event at a concentration higher than the minimum concentration at which the inhibitor stops corrosion (critical concentration). While this sounds obvious, the critical inhibitor concentration needs to be maintained over many years for structures such as airframes, where maintenance may not be possible in parts of the aircraft because of poor access. The chromate systems itself provide continuous protection and repair to the surface for as long as the dose of chromate remains above the critical concentration. This mechanism of inhibitor release and metal protection is recognized as a self-healing mechanism, since the release of the active species recovers the protective layer on top of the metal.

The search for green inhibitors as replacements for chromate has been driven by legislative imperatives for a number of years. Needless to say, replacement inhibitors do not have the same intrinsic inhibitive power at low solubility as chromate. Thus solubility, inhibitive power and transport within the primer system (which consists of a number of inorganic phases as well as the epoxy) ultimately mean that finding a replacement for chromate is difficult. This means that alternatives must be present at higher concentration leading to the use of more soluble compounds and consequently encapsulation as a method of regulating the response to external or internal triggers emerges as a prospective way to achieve this objective.

Many current inhibitors are water soluble salts and thus ionic. Consequently, they exist as either anions or cation in solution and perform the single function of anodic or cathodic inhibition. So the simplest improvement to inhibitor design is to increase the functionality by finding compounds which play both a cationic and anionic inhibitive role. A large range of cations including Zn, Ca, and rare earths (Bohm, McMurray et al. 2001; Du, Damron et al. 2001; Kendig and Buchheit 2003; Taylor and Chambers 2008; Muster, Hughes et al. 2009) have been combined with either organic (Osborne, Blohowiak et al. 2001; Sinko 2001; Voevo-

din, Balbyshev et al. 2003; Khramov, Voevodin et al. 2004; Blin, Koutsoukos et al. 2007; Taylor and Chambers 2008; Muster, Hughes et al. 2009) or inorganic (oxyanions, carbonates, phosphates, phosphites, nitrates, nitrites, silicate (Bohm, McMurray et al. 2001; Sinko 2001; Blin, Koutsoukos et al. 2007; Taylor and Chambers 2008) compounds.

Anions with dual functionality, such as some of the transition metal oxyanions which are both oxidants and anions, have been investigated extensively. The oxidizing oxyanions or some organophosphates have some degree of bio-inhibition required for some applications. Substitution of different organophosphates into rare earth-based inhibitors provide versatility in designing inhibitors for specific applications (Birbilis, Buchheit et al. 2005; Hinton, Dubrulle et al. 2006; Ho, Brack et al. 2006; Blin, Koutsoukos et al. 2007; Markley, Forsyth et al. 2007; Markley, Hughes et al. 2007; Forsyth, Markley et al. 2008; Deacon, Forsyth et al. 2009; Scholes, Hughes et al. 2009). Thus Ce(di-butyl phosphate)<sub>3</sub> is a good inhibitor and relatively “green” whereas Ce(di-phenyl phosphate)<sub>3</sub> is also a good inhibitor, but the diphenyl phosphate also has strong bio-inhibition characteristics (García 2011). However, good bio-inhibition usually means that there are increased environmental and health risks. Obviously the number of cathodic and anodic inhibitors means that there are an enormous number of possible combinations, particularly if ternary and quaternary combinations are considered. Hence high-throughput techniques are being used to assess new inhibitor.

As pointed out above, the kinetics of inhibitor release are of the utmost importance since the inhibitor should be available at levels above the critical inhibitor concentration. Optimization of the release kinetics by novel delivery systems becomes integral to incorporation of new inhibitors.

There are a number of different mechanisms investigated for release of healing agents or corrosion inhibitors which can be incorporated into organic coatings. Both mechanical damage and water are triggers for inhibitor release. In the former case mechanical damage breaks capsules containing water soluble inhibitors. In the latter case water dissolves inhibitor directly incorporated in the primer. Droplet formation within defects such as scratches means that the inhibitor is only released when required i.e., when the defect is moist (Furman, Scholes et al. 2006). There is some evidence to suggest that initial high release of inhibitors may be facilitated through atmospheric exposure of the intact paint where penetration of water into the film “prepares” the inhibitor, probably via surface hydrolysis reactions, within the paint, for diffusion and release into the defect (Joshua Du, Damron et al. 2001; Furman, Scholes et al. 2006; Scholes, Furman et al. 2006; Souto, González-García et al. 2010). The presence of water in the film allows soluble inhibitor species to be released into the paint system and diffuse to the metal/coating interface to provide in-situ corrosion prevention or repair called pre-emptive healing (Zin, Howard et al. 1998; Osborne, Blohowiak et al. 2001; Mardel, Garcia et al. 2011). Thus it has been demonstrated that water can trigger cerium dibutylphosphate (Ce(dbp)<sub>3</sub>) release into an epoxy matrix resulting in improved adhesion and resistance to filiform corrosion attack through interfacial modification (Mardel, Garcia et al. 2011)

In terms of delivery systems, hard capsules, which have been used in polymer healing (Dry 1996; White, Sottos et al. 2001; Mookhoek, Mayo et al. 2010) need to be smaller for paint systems particularly in the aerospace industry where coatings are typically 20  $\mu\text{m}$  or less (Yin, Rong et al. 2007; Fischer 2010; Hughes, Coles et al. 2010; Mookhoek, Mayo et al. 2010). In polymer applications, capsules up to a few hundred microns can be accommodated (Yin, Rong et al. 2007; Wu, Meure et al. 2008; Tedim, Poznyak et al. 2010). The concept of encapsulation has already been successfully applied to protective organic coatings under different concepts: i) liquids filling completely the void created by the damage by adopting a bi-component systems where one component is encapsulated and the other distributed in the matrix (Cho, White et al. 2009), or single based components with water reactive oils like linseed and tung oils (Suryanarayana, Rao et al. 2008; Samadzadeh, Boura et al. 2010) and ii) liquids (i.e. silyl esters) forming a hydrophobic and highly adhesive layer covering the metallic surface by reaction with the underlying metal and the humidity in air (García, Fischer et al. 2011). One adaption for capsules is to increase the volume of self-healing material by manufacturing rods instead of spheres. Rods with the same cross-sections as spheres can deliver larger volumes of material (Bon, Mookhoek et al. 2007; Mookhoek, Fischer et al. 2009). For inhibitors, their role is to prevent a surface reaction (corrosion) and therefore, the volume of material required is much smaller than that required to actually fill the defect. Consequently, there has been considerable effort looking at “nano-containers” (Voevodin, Balbyshev et al. 2003; Raps, Hack et al. 2009; Tedim, Poznyak et al. 2010).

Water is the most obvious trigger since it can permeate most polymers. pH variations are more specific and respond to the pH excursions that occur in corrosion reactions and by an understanding reactions that occur at different sites in the alloy microstructure. The presence of chloride ions (and other anions) within the coating can be used as specific triggers for the release of corrosion inhibitors and uptake of corrosives using anion exchange materials, such as layered double hydroxides (e.g. hydrotalcites) (Tedim, Poznyak et al. 2010) (Bohm, McMurray et al. 2001; Buchheit, Guan et al. 2003; Williams and McMurray 2003; Zheludkevich, Salvado et al. 2005; Mahajanarn and Buchheit 2008). In this context hydrotalcites have been loaded with vanadate, chromate, nitrate and carbonate which exchange for chloride ions and prevent interfacial damage (Bohm, McMurray et al. 2001; Williams and McMurray 2003; Mahajanarn and Buchheit 2008). The incorporation of Mg particles into paint act as sacrificial anodes to protect Al alloys and steels (Battocchi, Simoes et al. 2006).

## 5. Recent advances in aspects related to corrosion of aluminium alloys

The search for new multifunctional inhibitors has led to the development of high throughput and combinatorial assessment of new combination of inhibitors. These include multielectrode techniques, and high throughput versions of standard corrosion tests. A range of new electrochemical techniques including AC/DC/AC, SVET, LEIS, SECM and SIET will also be described.

Since corrosion of aluminium alloys tends to be dominated by electrochemical processes, most of the techniques employed for the evaluation of corrosion and protection are based on electrochemical approaches. Furthermore, combining electrochemical techniques with other microscopic, analytical and spectroscopic techniques enables the identification of corrosion products in solution (such as inductive coupled plasma (ICP) and UV-Vis). This combination provides an even broader mechanistic understanding of the level of corrosion and/or corrosion protection.

The increasing number of corrosion inhibitor alternatives to chromates has boosted interest in developing high-throughput techniques and combinatorial assessment of new corrosion inhibitors in aqueous solution. At the same time, the traditional techniques (accelerated or not) employed in the evaluation of the performance of organic coatings require long evaluation periods and are relatively expensive to run, and only offer qualitative or semi-quantitative information at best (e.g. salt fog spray tests). For these reasons, new accelerated techniques for the evaluation of coating performance that offer quantitative results are needed.

Figure 7 shows a simplified flowchart for the formulation of anticorrosive (organic) coatings. The chart includes some of the most common techniques employed in corrosion inhibitor and coating performance evaluation. In the figure, the parallel and complex line of the development of the polymeric matrix (i.e. organic coating) is not included, but awareness of its existence is important, since factors such as the corrosion inhibitor/coating matrix compatibility should be taken into account. For the development of anticorrosive organic coatings, several steps are proposed:

**a.** Formulation of inhibitors:

The number of corrosion inhibitor candidates is virtually unlimited, and is motivated by the urgent need to replace chromate based inhibitors by environmentally friendly and non-toxic ones, as well as the development of new concepts such as self-healing and synergies between anodic and cathodic inhibitors which open up the broad range of possibilities of organic chemistry. One example of the complexity of the introduction of organic compounds as corrosion inhibitors is the effect that the position of certain groups in a cyclic organic compound can have in the corrosion protection efficiency (Harvey, Hardin et al. 2011).

**b.** Evaluation in aqueous solution:

Once the inhibitors have been formulated, they can be tested by means of traditional aqueous solution tests such as electrochemical impedance spectroscopy (EIS), potentiodynamic polarisation (PP), immersion tests and weight loss/gain. Also local electrochemical techniques (see point 4-evaluation of organic coatings) give very important information of the mechanisms of corrosion protection offered by the different species in solution. Since traditional techniques require long periods of time and a large number of samples, the introduction of high-throughput techniques as a preceding step is important in order to reduce the number of inhibitors that enter further evaluation processes using traditional aqueous solution tests. It is necessary to highlight that high-throughput techniques are not aimed at re-

placing traditional tests but at complementing them in order to reduce cost and time in the corrosion inhibitor selection process. Some examples are: single metal, multielectrode array (Chambers, Taylor et al. 2005; Chambers and Taylor 2007), microchannels (White, Hughes et al. 2009) and multi metal multielectrode (Muster, Hughes et al. 2009; García, Muster et al. 2010; Kallip, Bastos et al. 2010).

c. Introduction into an organic matrix:

The introduction of pigments into organic coatings adds some extra difficulties to the whole process, leading to a lot of extra research to avoid undesirable reactions between the polymer matrix and the inhibitors. Some of the parameters to take into account are the ratio between the pigment volume concentration (PVC) and the critical pigment volume concentration (CPVC), the possible side reactions between the polymer and the pigment, with consequences in parameters like the barrier properties, gloss, active corrosion protection, and adhesion amongst others. At the same time, parameters such as contaminant reduction and parameters related to the polymeric matrix itself (such as adhesion and the glass transition temperature (T<sub>g</sub>)) should be considered. In any case, once the pigments have been introduced into the organic coating, the coating's performance has to be tested for protection efficiency and if results are promising, then start the optimization process.

d. Evaluation of the performance of organic coatings:

As in the case of aqueous solution tests for evaluation of corrosion inhibitors, the introduction of accelerated tests to evaluate coatings performance is necessary to reduce the amount of time and number of samples that move into traditional assessment. Several techniques have been proposed in this direction, such as the technique AC/DC/AC (Hollaender 1997; Bethencourt, Botana et al. 2004; Rodriguez, Gracenea et al. 2004; Garcia and Suay 2006; Garcia and Suay 2006) (García, Rodríguez et al. 2007; Garcia and Suay 2007) (Garcia and Suay 2007; García and Suay 2007; García and Suay 2009), (Poelman, Olivier et al. 2005; Allahar, Bierwagen et al. 2010; Allahar, Wang et al. 2010), and thermal cycling (Bierwagen, He et al. 2000). Also new concepts like the use of flow induced degradation (Wang 2009) are interesting for developing accelerated testing techniques.

e. Optimisation:

Before entering the pre-commercialization phase, the final step of anticorrosive coatings formulation is the optimization, which is the improvement of the system by modifying pigments concentration, type, and delivery systems to improve and extend the service lifetime protection and compatibility with the matrix. This step is iterative as shown in Figure 7. The whole process from conception to commercialization of the system can take several years.

Due to the impossibility to cover the broad amount of existing (new) high-throughput techniques for selection of corrosion inhibitors for aluminium alloys and accelerated tests for evaluation of protective organic coatings on aluminium alloys, we focus on two electrochemical techniques that have attracted a broad interest most recently due to their high potential and relatively well understood evaluation procedure.



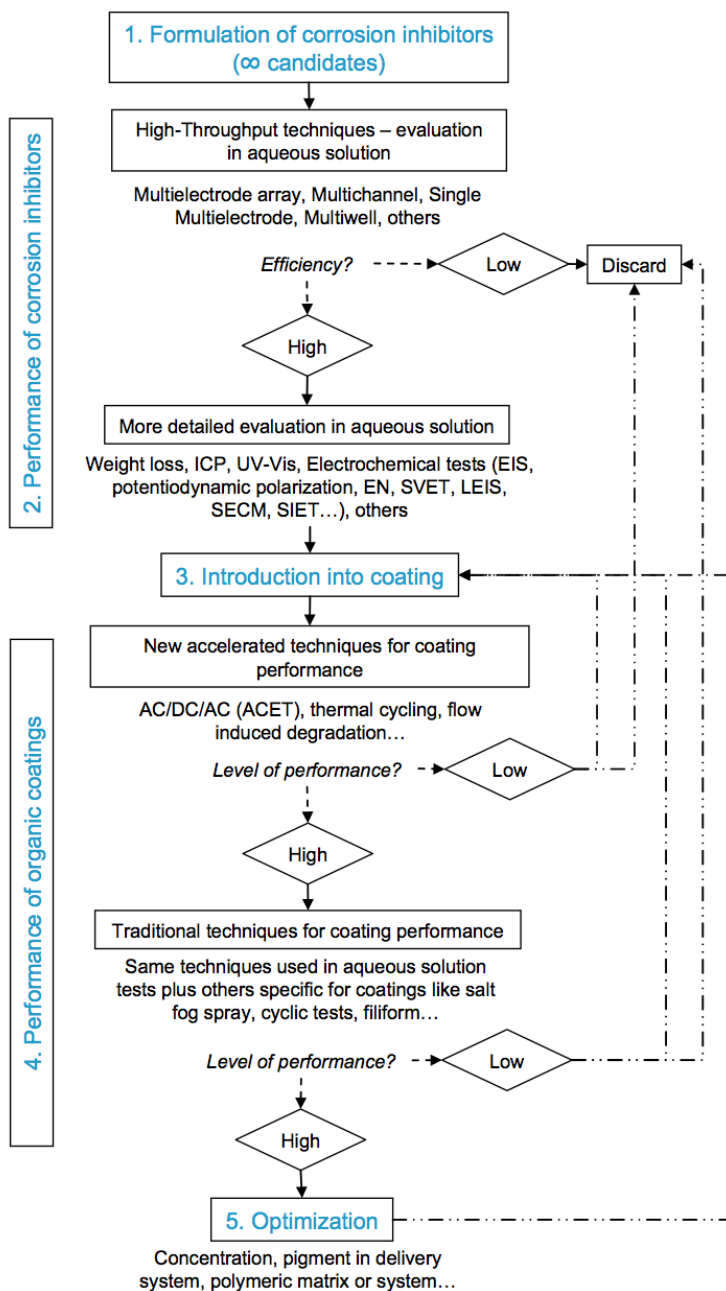

**Figure 7.** Simplified flowchart for anticorrosive coatings development departing from the inhibitor design or formulation.

### 5.1. High throughput assessment

In terms of high-throughput techniques, those based on electrochemical approaches are of most interest, since their measurement principles are closely related to familiar research techniques such as Electrochemical Impedance Spectroscopy (EIS) and potentiodynamic polarisation (PP), while at the same time offer quantitative information about the corrosion and corrosion protection mechanisms.

Chambers and Taylor (Chambers, Taylor et al. 2005; Chambers and Taylor 2007) first presented the use of multi-electrode arrays for rapid screening of corrosion inhibitors in different concentrations and pHs, putting identical pairs of AA2024-T3 wires into a large number of separate reaction cells containing different inhibitive solutions and applying a 100mV potential between the two wires in each cell (Figure 8(a)). The current between both electrodes was used to determine the polarisation resistance. With this set-up they were able to evaluate for one metal many different combinations of inhibitors and their synergistic behavior, while at the same time showing its possible application for evaluating the influence of the pH on inhibitors' efficiency.

Based on the work of Taylor and Chambers, Muster et al. (Muster, Hughes et al. 2009) proposed a variation of the method using a combination of different pairs of metals assembled together (Figure 8(b)) to form what was presented as a multielectrode (ME). The basic idea of this ME was to test a combination of nine pairs (or as many as are interesting) of different metals in the same electrode configuration connected by means of a multiplexer to a potentiostat/galvanostat. Measurements consist of applying 100mV between a selected pair of the same metals within the ME and measure the current flow between them, repeating afterwards the same procedure for the other metal pairs. This set up was employed to rapidly evaluate, without removing the ME from the solution, the concentration range at which a particular inhibitor or combination of inhibitors were offering corrosion protection. Hence, the setup allowed the determination of optimal metal-inhibitor combinations, while significantly reducing the evaluation time with respect to conventional PP tests, without the need of a reference electrode, which simplifies the experimental setup.

In a second paper (Garcia, Muster et al. 2010), the authors studied the effect of the pH and inhibitor type on the correlation between the ME and PP for AA2024-T3. The findings were promising due to the high level of correlation between the ME and traditional techniques, although some discrepancies were found for corrosion inhibitors that can speciate or precipitate at certain pHs. Nevertheless, the non-correlation was assumed to be dependent on the type of corrosion inhibitors and not due to conceptual or experimental mismatching between techniques.

A second concern with the ME was the possibility of cross-contamination due to the presence of several metals in one solution. Garcia et al. (Garcia, Muster et al. 2010) also addressed this problem studying the effect of cross-contamination for the AA2024-T3 wires within the ME. This study showed that if there was cross-contamination then it was not significant enough to influence the results. Despite these results, some more studies should be performed with the ME to check cross-contaminations for other metals such as AA7075-T6

which could be more susceptible to copper plating coming from other metals such as AA2024-T3.

The results obtained so far with multielectrodes (multielectrode array and ME) are very promising and relatively extended information can be found in literature. Nevertheless, more studies and data treatment simplification need to be performed to completely validate these techniques and lead them to an industrial application level.

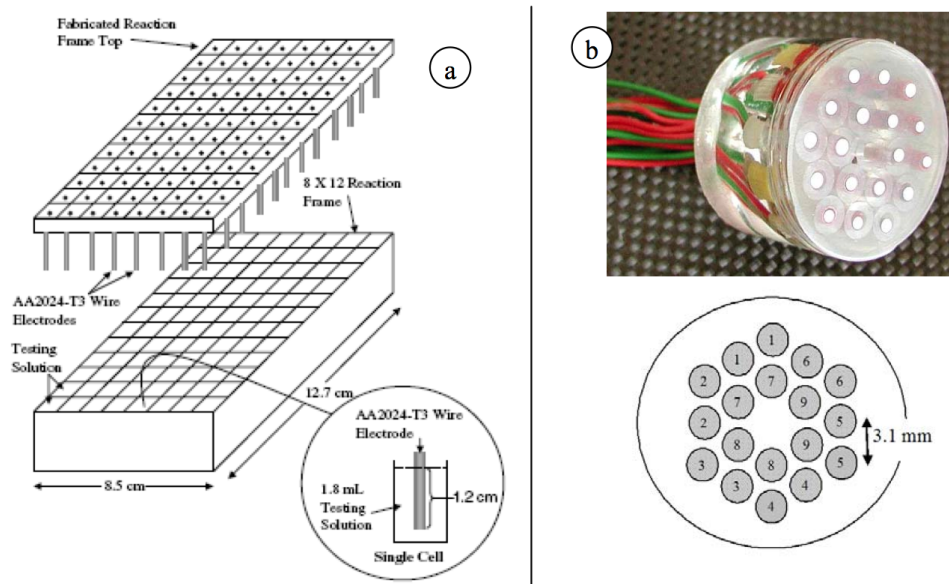

**Figure 8.** a) single metal multiarray (Chambers and Taylor 2007); b) multimetal multielectrode (Muster, Hughes et al. 2009)

## 5.2. AC/DC/AC accelerated technique for coating evaluation

This technique has already reached its maturity and is actually employed at an industrial level under the name of accelerated electrochemical technique (ACET) (Medco). Although the industrial application differs from the research technique (AC/DC/AC), the evaluation and testing are conceptually similar. The early version of the AC/DC/AC technique was performed for the packaging industry (Hollaender 1997). The accelerated technique developed by Hollaender (named AC/DC/AC) was based on the use of temporary stresses to accelerate degradation, and consisted of a first EIS test (AC) to evaluate the initial state of the coating, followed by a cathodic polarisation (DC) and a new EIS (AC) to detect the degradation of the lacquer.

The work initiated by Hollaender was further developed by Suay, Garcia and Rodriguez who successfully applied a modified version of the AC/DC/AC technique to evaluate the performance of organic coatings for carbon steel protection and compared the obtained re-

sults with EIS, salt-fog spray, and cyclic tests. The technique was then tested for liquid paints (Bethencourt, Botana et al. 2004; Rodríguez, Gracenea et al. 2004), powder coatings (García and Suay 2006; García and Suay 2006; García and Suay 2007; García and Suay 2007) and cataphoretic paints to optimize parameters such as cataphoretic potential and curing time (Poelman, Olivier et al. 2005; García, Rodríguez et al. 2007; García and Suay 2007; García and Suay 2009). The new version of the technique included a crucial step: the relaxation of potentials (open circuit potential relaxation) after the application of each cathodic polarisation. Furthermore, the potentials applied during the cathodic polarisation depended on the type of coating that was studied, although  $-4\text{V}$  for 20 minutes was preferred. Figure 9(a) shows a schematic of the AC/DC/AC technique procedure, including the relaxation step proposed by Garcia and Suay. The AC/DC/AC cycle is repeated 6 times (6 cycles) leading to a testing time per sample of around 24 hours, which is a significant improvement when compared to traditional EIS and salt-fog tests which require weeks or months. Nevertheless, depending on the quality of the coatings the number of cycles could be increased and the relaxation time reduced or extended.

The cathodic polarisation aims to degrade the coating and coating-metal interface (e.g. pore formation and delamination) due to hydrogen and  $\text{OH}^-$  production. If the coating is good then it has a higher number of cycles to degrade and the effects in the impedance and potentials relaxation are less pronounced, while a lower quality coating will display a faster degradation. An example of these effects compared to traditional EIS and salt-fog spray is presented by Garcia et al. (García and Suay 2009)

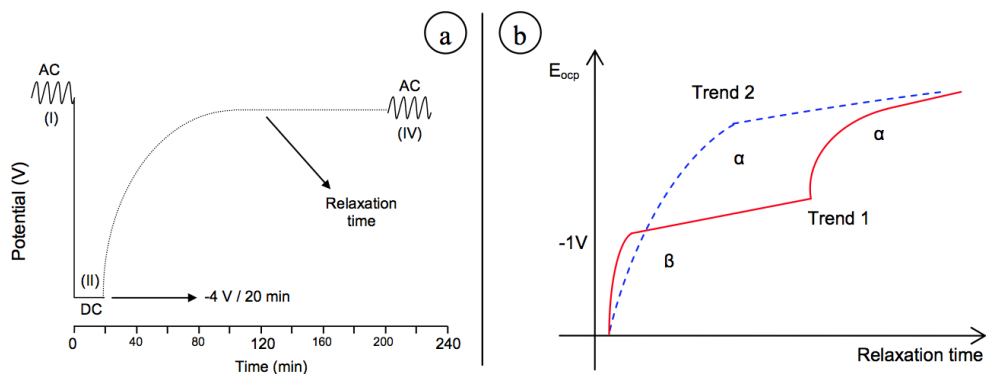

**Figure 9.** a) AC/DC/AC testing scheme (García and Suay 2009); b) Trends in relaxation of potentials.

Apart from the EIS spectral evolution with cycles, for which a higher drop of impedance is related to higher degradation, the evolution of the open circuit potential after polarisation (relaxation of potentials with time) provides extra crucial information about the degradation of the systems under study (García and Suay 2006). When the cathodic polarisation finishes, the potential of the system relaxes leading to two types of trends depending on the quality of the film (Figure 9(b)):

- a. Strongly degraded systems (Trend 1, Figure 9(b)), show two time relaxations of the potential, namely  $\alpha$  and  $\beta$ . The first relaxation in time ( $\beta$ ) is related to the end of the cathodic reactions that took place at the metallic surface. This relaxation is observed as a quick relaxation around  $-1V$  (with small variations depending on the system). The second relaxation ( $\alpha$ ), which occurs later in time, corresponds to ions and electrolyte leaving the coating. The relaxation ( $\beta$ ) could not be detected in all cases due to extremely long relaxation times, although if enough time was allowed this relaxation was then detected, supporting the idea of the two relaxation processes (García and Suay 2009)
- b. Less degraded systems (Trend 2, Figure 9(b)), only show relaxation  $\alpha$  which is detected at relatively short times of relaxation. This relaxation will take place at longer times as ions and electrolyte penetrate deeper into the film. More recently, Allahar et al. (Allahar, Wang et al. 2009; Allahar, Upadhyay et al. 2010; Wang, Battocchi et al. 2010) have performed an extensive study on the understanding of the AC/DC/AC technique and its principles, leading to a broader understanding of the relaxation of potentials and supporting previous theories, while at the same time further validating the technique.

In this section we have highlighted the complexity of the selection of corrosion inhibitors and anticorrosive coatings formulation leading to the design and validation of high-throughput and accelerated techniques, which at a certain stage can become commercial techniques. The interest in developing new techniques and understanding those already existing is indeed growing in recent years due to the need of developing environmentally friendly and non-toxic systems.

### 5.3. Staircase impedance

Staircase potenti-electrochemical impedance spectroscopy (SPEIS) is based on EIS, nowadays common for investigating electrochemical and corrosion system. The basis of EIS is by measuring impedance over a range of frequency and the data obtained is expressed graphically in Bode or Nyquist plot format. As for SPEIS, it is designed for impedance measurements over a range of frequency as well as over a range of voltages (similar to the signal sequence used for Mott-Schottky analysis (Barsoukov and Macdonald 2005; Orazem and Tribollet 2008)). The potential range is divided into several potential steps and each step contains a DC relaxation period for a given rest time ( $T_R$ ) to allow the current to stabilize; subsequently followed by an EIS test (Zhou, Birbilis et al. 2010). During the DC potential signal, the current at each potential is also recorded. Figure 10 demonstrates this process.

This method is used to assess the kinetic stability of electrochemical reactions over a range of potentials and pH, which gives a rather detailed insight into the corrosion behavior. In SPEIS however, by setting a range of voltage allows more details observation of how the system response at a particular voltage or 'step', even though it is not sufficient to explain the kinetic processes occurring. As reported by Zhou, SPEIS is able to illustrate the effect of pH and potential on the corrosion kinetics with clarity and able to obtain more information beyond the Pourbaix diagram (Zhou, Birbilis et al. 2010), including structural effects such as alloying, etc.

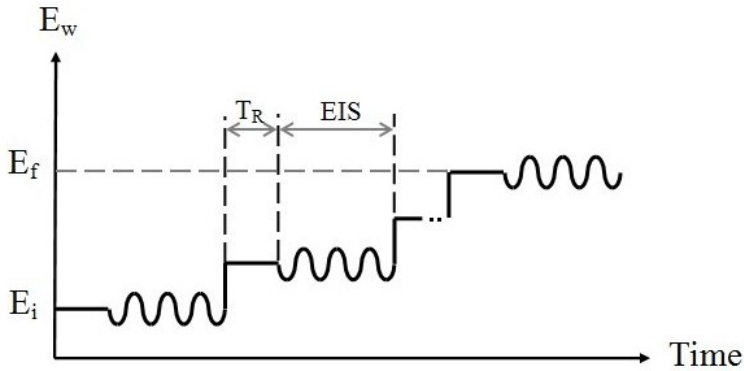

**Figure 10.** Illustration of polarizing signal during SPEIS

#### 5.4. Potentiostatic transients for determination of metastable and stable pitting

Since pitting is the most common type of corrosion in Al alloys, researchers commonly default to the investigation of pitting potential,  $E_{pit}$  as a means for evaluating the corrosion performance. A more noble  $E_{pit}$  is often accepted as better resistance to pitting. However, there are some significant limitations in such simple assessments (Gupta, Sukiman et al. 2012). For example, the pitting potential yields no information regarding how many pits form or how large pits may be. Additionally, the environment plays a key role in the severity of pitting damage (i.e. pit depth, pit size) (Cavanaugh 2009).

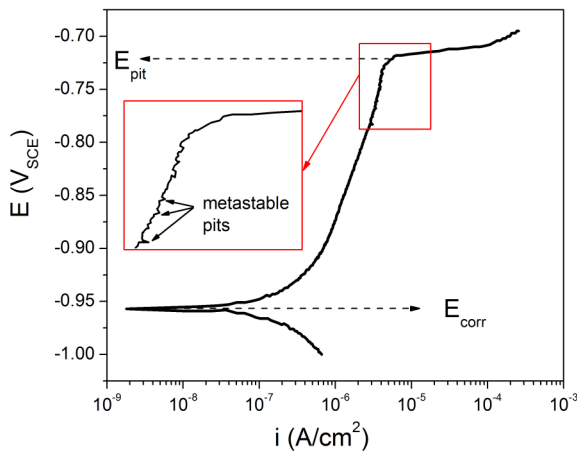

**Figure 11.** Polarisation curve indicating the corrosion potential  $E_{corr}$  and  $E_{pit}$  with metastable pits region prior to  $E_{pit}$  highlighted in the inset (adapted from (Cavanaugh 2009))

Pits that form at pitting potential are known as stable pits. However, at potentials slightly below pits stabilization (at  $E_{\text{pit}}$ ), pitting like events occur that are known as metastable pit (small surges of current that repassivate). Wu suggested that individual metastable pitting events influence subsequent events (Wu, Scully et al. 1997), and such events are readily observed in Al-alloys. Figure 11 indicates the metastable pitting region in a typical potentiodynamic polarisation curve, where  $E_{\text{pit}}$  is also depicted.

In order to measure metastable pitting, a potentiostatic value is selected at a potential just below  $E_{\text{pit}}$  where the metastable pitting events are the most frequent (while still in the passive region) (Cavanaugh 2009). Metastable pitting events are measured by counting the current fluctuations when an alloy is held potentiostatically for a period of time. The transient currents as shown in Figure 12 depend on the nucleation, growth and repassivation of the metastable pits.

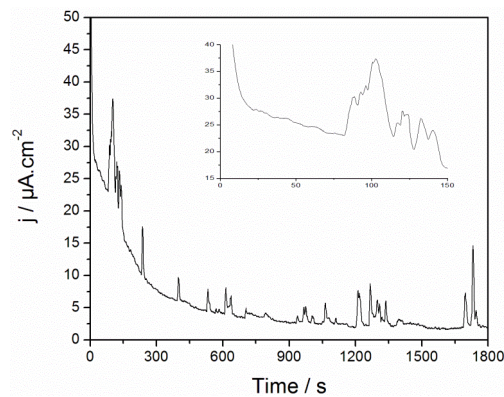

**Figure 12.** Current transient for AA5083-H116 obtained at 25mV below  $E_{\text{pit}}$ . Inset shows a zoom of a region of interest that represents the typical transient features (adapted from(Gupta, Sukiman et al. 2012))

The number of metastable pitting is expected to be proportional to the amount of pits formed (Williams, Stewart et al. 1994; Cavanaugh, Birbilis et al. 2012). This is confirmed by (Gupta, Sukiman et al. 2012), where the numbers of metastable pitting from potentiostatic test for various commercial Al alloys correlate with stable pitting tested in a long term immersion test. Ilevbare and Burstein however, stated that multiple metastable events may correspond to only one pit site (Burstein, Liu et al. 2004; Ilevbare, Schneider et al. 2004; Sasaki and Isaacs 2004; Trueman 2005; Speckert and Burstein 2011), however most of such analyses were not performed on Al-alloys. Since there are few studies on metastable pitting of Al alloy, the associated theory and principles will evolve in the coming decade. It is however obvious that metastable pitting analysis can be used to compare the pitting susceptibility between different environments [Cavanaugh 2009] and alloy systems [Gupta, Sukiman et al. 2012] more effectively than an examination of ( $E_{\text{pit}}$ ) alone.

Aside from the methods described above, the use of modern tests does not exclude the use of other traditional tests that require longer testing times and samples such as salt fog spray tests, weight determination, outdoor exposure, or cyclic salt fog-climatic chamber tests, but they aim at providing unique insights that are relevant to specific problems at hand such as pitting germination and inhibitor selection.

It is also worth mentioning here, the great interest that local electrochemical techniques have recently attracted to evaluate the corrosion protection offered when the coatings are damaged (i.e. self-healing). These techniques have been successfully applied to several conceptually different self-healing systems like scanning vibrating electrode technique (SVET) for encapsulated agents (Hughes, Cole et al. 2010; García, Fischer et al. 2011), scanning electrochemical microscope (SECM) for shape memory polymers, selective ion electrode technique (SIET) to evaluate activity of metals (Lamaka, Karavai et al. 2008), and local electrochemical impedance spectroscopy (LEIS) for evaluation of corrosion protection by inhibitor release from coatings (Jorcin, Aragon et al. 2006)

## 6. Summary and challenges

This chapter has given an abridged and focused treatment of the corrosion behavior of Al alloys on the basis of chemistry, microstructure and environment. Understanding these parameters is crucial in deployment of Al-alloys, but also in the development of more durable Al-alloys. It is obvious that alloying (i.e. chemistry) and microstructure dictates not only mechanical strength – but also corrosion performance. In this chapter we stopped short of discussing corrosion propagation such as intergranular corrosion, exfoliation corrosion and stress corrosion cracking – given space constraints, however such topics (along with hydrogen embrittlement) remain critical for structural alloy deployment.

In regards to corrosion protection, we have attempted to cover some modern developments and present some new techniques to assess the corrosion behavior designed to meet the more complicated and challenging requirements of inhibitor selection / chromate replacement. The information gathered from these techniques is beneficial for future protection and alloy development.

Looking to the future, the current strategy to increase strength by precipitation hardening of a crystalline matrix may no longer be feasible if an alloy with strength higher than 1000MPa is required. Methods to meet this threshold include (the un-upscalable) severe plastic deformation method such as High Pressure Torsion (Liddicoat, Liao et al. 2010) – however the thermal stability of these structures is low. Alternatively the strength of Al based metals could be significantly enhanced (up to 1500MPa) when rapidly quenched to form amorphous alloys (Masumoto 1994; Inoue and Takeuchi 2004; Li, Li et al. 2009; Yang, Yao et al. 2009). Such alloys typically use transition metals such as Zr, Ti, Nb, La, etc (Inoue, Gook et al. 1995; Zawrah and Shaw 2003; Rizzi and Battezzati 2004; Samanta, Manna et al. 2007; Huang, Li et al. 2008; Li, Li et al. 2009), however, again – the stability of such structures is unknown, and the ability form large components is also a challenge. From a corrosion point



of view, amorphous Al-alloys appear promising (Manna, Chattopadhyay et al. 2004; Lucente and Scully 2007; Lucente and Scully 2008; Tailleart, Huang et al. 2012) with the corrosion behavior of such alloys is not widely explored therefore leaves a lot of opportunities for new discoveries.

## Author details

N. L. Sukiman<sup>1,6</sup>, X. Zhou<sup>1</sup>, N. Birbilis<sup>1</sup>, A.E. Hughes<sup>2</sup>, J. M. C. Mol<sup>3</sup>, S. J. Garcia<sup>4</sup>, X. Zhou<sup>5</sup> and G. E. Thompson<sup>5</sup>

1 Department of Materials Engineering, Monash University, Clayton, Australia

2 CSIRO Materials Science and Technology, Melbourne, Australia

3 TU Delft, Materials Department, Delft, Netherlands

4 TU Delft, Aerospace Engineering, Delft, Netherlands

5 School of Materials, The University of Manchester, Manchester, United Kingdom

6 Department of Mechanical Engineering, University of Malaya, Kuala Lumpur, Malaysia

## References

- [1] Aballe, A., M. Bethencourt, et al. (2001). "Localized alkaline corrosion of alloy AA5083 in neutral 3.5% NaCl solution." *Corrosion Science* 43(9): 1657-1674.
- [2] Allahar, K. N., V. Upadhyay, et al. (2010). "Characterizing the relaxation of the open-circuit potential during an AC-DC-AC accelerated test." *Corrosion* 66(9): 0950011-09500111.
- [3] Allahar, K. N., D. Wang, et al. (2009). Real time monitoring of an air force topcoat/mg-rich primer system in b117 exposure by -embedded electrodes.
- [4] Ambat, R., A. J. Davenport, et al. (2006). "Effect of iron-containing intermetallic particles on the corrosion behaviour of aluminium." *Corrosion Science* 48(11): 3455-3471.
- [5] Ambat, R. and E. S. Dwarakadasa (1992). "The Influence of PH on the Corrosion of Medium Strength Aerospace Alloy-8090, Alloy-2091 And Alloy-2014." *Corrosion Science* 33(5): 681-690.
- [6] Anawati, S. Diplas, et al. (2011). "Effect of copper on anodic activity of aluminum-lead model alloy in chloride solution." *Journal of The Electrochemical Society* 158(5): C158-C163.

- [7] Anawati, S. Diplas, et al. (2011). "Surface Characterization of Heat Treated AlPbCu Model Alloys." *Journal of The Electrochemical Society* 158(6): C178-C184.
- [8] Anawati, B. Graver, et al. (2010). "Multilayer corrosion of aluminum activated by lead." *Journal of The Electrochemical Society* 157(10): C313-C320.
- [9] Andreatta, F., H. Terryn, et al. (2004). "Corrosion behaviour of different tempers of AA7075 aluminium alloy." *Electrochimica Acta* 49(17-18): 2851-2862.
- [10] Ashtari, P., H. Tezuka, et al. (2003). "Influence of Sr and Mn additions on intermetallic compound morphologies in Al-Si-Cu-Fe cast alloys." *Materials Transactions* 44(12): 2611-2616.
- [11] Baer, D. R., C. F. Windisch, et al. (2000). "Influence of Mg on the corrosion of Al." *Journal of Vacuum Science & Technology a-Vacuum Surfaces and Films* 18(1): 131-136.
- [12] Barsoukov, E. and J. R. Macdonald (2005). *Solid State Devices, in Impedance spectroscopy: theory, experiment, and applications*, Wiley-Interscience, Inc.
- [13] Battocchi, D., A. M. Simoes, et al. (2006). "Comparison of testing solutions on the protection of Al-alloys using a Mg-rich primer." *Corrosion Science* 48(8): 2226-2240.
- [14] Bethencourt, M., F. J. Botana, et al. (2004). "Lifetime prediction of waterborne acrylic paints with the AC-DC-AC method." *Progress in Organic Coatings* 49(3): 275-281.
- [15] Birbilis, N. and R. G. Buchheit (2005). "Electrochemical Characteristics of Intermetallic Phases in Aluminum Alloys." *Journal of The Electrochemical Society* 152(4): B140.
- [16] Birbilis, N., R. G. Buchheit, et al. (2005). "Inhibition of AA2024-T3 on a phase-by-phase basis using an environmentally benign inhibitor, cerium dibutyl phosphate." *Electrochemical and Solid State Letters* 8(11): C180-C183.
- [17] Birbilis, N., M. K. Cavanaugh, et al. (2006). "Electrochemical behavior and localized corrosion associated with Al<sub>7</sub>Cu<sub>2</sub>Fe particles in aluminum alloy 7075-T651." *Corrosion Science* 48(12): 4202-4215.
- [18] Birbilis, N., T. Muster, et al. (2011). *Corrosion of Aluminum Alloys. Corrosion Mechanisms in Theory and Practice, Third Edition*, CRC Press: 705-736.
- [19] Blanc, C., B. Lavelle, et al. (1997). "The role of precipitates enriched with copper on the susceptibility to pitting corrosion of the 2024 aluminium alloy." *Corrosion Science* 39(3): 495-510.
- [20] Blin, F., P. Koutsoukos, et al. (2007). "The corrosion inhibition mechanism of new rare earth cinnamate compounds - Electrochemical studies." *Electrochimica Acta* 52(21): 6212-6220.
- [21] Boag, A., A. E. Hughes, et al. (2011). "Corrosion of AA2024-T3 Part I: Localised corrosion of isolated IM particles." *Corrosion Science* 53(1): 17-26.

- [22] Boag, A., A. E. Hughes, et al. (2009). "How complex is the microstructure of AA2024-T3?" *Corrosion Science* 51(8): 1565-1568.
- [23] Bohm, S., H. N. McMurray, et al. (2001). "Novel environment friendly corrosion inhibitor pigments based on naturally occurring clay minerals." *Materials and Corrosion-Werkstoffe Und Korrosion* 52(12): 896-903.
- [24] Bon, S. A. F., S. D. Mookhoek, et al. (2007). "Route to stable non-spherical emulsion droplets." *European Polymer Journal* 43(11): 4839-4842.
- [25] Brunner, J. G., J. May, et al. (2010). "Localized corrosion of ultrafine-grained Al-Mg model alloys." *Electrochimica Acta* 55(6): 1966-1970.
- [26] Buchheit, R. G. (1995). "A Compilation of Corrosion Potentials Reported for Intermetallic Phases in Aluminum-Alloys." *Journal of The Electrochemical Society* 142(11): 3994-3996.
- [27] Buchheit, R. G. (2000). "Electrochemistry of  $\theta$  (Al<sub>2</sub>Cu), S (Al<sub>2</sub>CuMg) and T1 (Al<sub>2</sub>Cu-Li) and localized corrosion and environment assisted cracking in high strength Al alloys." *Materials Science Forum* 331: II/.
- [28] Buchheit, R. G. and N. Birbilis (2010). "Electrochemical microscopy: An approach for understanding localized corrosion in microstructurally complex metallic alloys." *Electrochimica Acta* 55(27): 7853-7859.
- [29] Buchheit, R. G., R. P. Grant, et al. (1997). "Local Dissolution Phenomena Associated with S Phase (Al<sub>2</sub>CuMg) Particles in Aluminum Alloy 2024-T3." *Journal of The Electrochemical Society* 144(8): 2621-2628.
- [30] Buchheit, R. G., H. Guan, et al. (2003). "Active corrosion protection and corrosion sensing in chromate-free organic coatings." *Progress in Organic Coatings* 47(3-4): 174-182.
- [31] Buchheit, R. G., Hughes, A.E. (2003). *Chromate and Chromate-Free Coatings. Corrosion: Fundamentals, Testing and Protection*. C. Moosbrugger. Mterials Park, Oh, USA, ASM International. 13A: 720 -735.
- [32] Buchheit, R. G., M. A. Martinez, et al. (2000). "Evidence for Cu Ion Formation by Dissolution and Dealloying the Al<sub>2</sub>CuMg Intermetallic Compound in Rotating Ring-Disk Collection Experiments." *Journal of The Electrochemical Society* 147(1): 119-124.
- [33] Buchheit, R. G., L. P. Montes, et al. (1999). "The Electrochemical Characteristics of Bulk-Synthesized Al<sub>2</sub>CuMg." *Journal of The Electrochemical Society* 146(12): 4424-4428.
- [34] Buchheit, R. G., F. D. Wall, et al. (1995). "Anodic Dissolution-Based Mechanism for the Rapid Cracking, Preexposure Phenomenon Demonstrated by Aluminum-Lithium-Copper Alloys." *Corrosion* 51(6): 417-428.

- [35] Büchler, M., T. Watari, et al. (2000). "Investigation of the initiation of localized corrosion on aluminum alloys by using fluorescence microscopy." *Corrosion Science* 42(9): 1661-1668.
- [36] Buis, A. and J. Schijve (1992). "Stress-Corrosion Cracking Behavior of Al Li-2090-T83 In Artificial Seawater." *Corrosion* 48(11): 898-909.
- [37] Burstein, G. T., C. Liu, et al. (2004). "Origins of pitting corrosion." *Corrosion Engineering Science and Technology* 39(1): 25-30.
- [38] Campestrini, P., E. P. M. van Westing, et al. (2000). "Relation between microstructural aspects of AA2024 and its corrosion behaviour investigated using AFM scanning potential technique." *Corrosion Science* 42(11): 1853-1861.
- [39] Carroll, M. C., P. I. Gouma, et al. (2001). "Effects of minor Cu additions on a Zn-modified Al-5083 alloy." *Materials Science and Engineering: A* 319-321(0): 425-428.
- [40] Carroll, M. C., P. I. Gouma, et al. (2000). "Effects of Zn additions on the grain boundary precipitation and corrosion of Al-5083." *Scripta Materialia* 42(4): 335-340.
- [41] Cavanaugh, M., N. Birbilis, et al. (2007). "Investigating localized corrosion susceptibility arising from Sc containing intermetallic Al<sub>3</sub>Sc in high strength Al-alloys." *Scripta Materialia* 56(11): 995-998.
- [42] Cavanaugh, M. K. (2009). Modelling the environmental dependence of localized corrosion evolution in AA7075-T651, Ohio State University.
- [43] Cavanaugh, M., N. Birbilis, et al. (2007). "Investigating localized corrosion susceptibility arising from Sc containing intermetallic Al<sub>3</sub>Sc in high strength Al-alloys." *Scripta Materialia* 56(11): 995-998.
- [44] Cavanaugh, M. K., N. Birbilis, et al. (2009). "A Quantitative Study on the Effects of Environment and Microstructure on Pit Initiation in Al-alloys." *ECS Transactions* 16(52): 1-11.
- [45] Cavanaugh, M. K., N. Birbilis, et al. (2012). "Modeling pit initiation rate as a function of environment for Aluminum alloy 7075-T651." *Electrochimica Acta* 59: 336-345.
- [46] Cavanaugh, M. K., R. G. Buchheit, et al. (2009). "Evaluation of a simple microstructural-electrochemical model for corrosion damage accumulation in microstructurally complex aluminum alloys." *Engineering Fracture Mechanics* 76(5): 641-650.
- [47] Cavanaugh, M. K., R. G. Buchheit, et al. (2010). "Modeling the environmental dependence of pit growth using neural network approaches." *Corrosion Science* 52(9): 3070-3077.
- [48] Chambers, B. D. and S. R. Taylor (2007). "High-Throughput Assessment of Inhibitor Synergies on Aluminum Alloy 2024-T3 Through Measurement of Surface Copper Enrichment." *Corrosion* 63(3): 268-276.

- [49] Chambers, B. D., S. R. Taylor, et al. (2005). "Rapid Discovery of Corrosion Inhibitors and Synergistic Combinations Using High-Throughput Screening Methods." *Corrosion* 61(5): 480-489.
- [50] Chen, G. S., M. Gao, et al. (1996). "Microconstituent-Induced Pitting Corrosion in Aluminum Alloy 2024-T3." *Corrosion (Houston)* 52(1): 8-15.
- [51] Cho, S. H., S. R. White, et al. (2009). "Self-Healing Polymer Coatings." *Advanced Materials* 21(6): 645-+.
- [52] Davenport, A. J., Y. Yuan, et al. (2006). "Intergranular Corrosion and Stress Corrosion Cracking of Sensitised AA5182." *Materials Science Forum* 519-521: 641-646.
- [53] Davis, J. R. (1999). *Corrosion of aluminum and aluminum alloys*, Materials Park, OH : ASM International.
- [54] Deacon, G. B., M. Forsyth, et al. (2009). "Synthesis and Characterisation of Rare Earth Complexes Supported by para-Substituted Cinnamate Ligands." *Zeitschrift Fur Anorganische Und Allgemeine Chemie* 635(6-7): 833-839.
- [55] Dorward, R. C. and T. R. Pritchett (1988). "Advanced aluminium alloys for aircraft and aerospace applications." *Materials & Design* 9(2): 63-69.
- [56] Dry, C. (1996). "Procedures developed for self-repair of polymer matrix composite materials." *Composite Structures* 35(3): 263-269.
- [57] Du, Y. J., M. Damron, et al. (2001). "Inorganic/organic hybrid coatings for aircraft aluminum alloy substrates." *Progress in Organic Coatings* 41(4): 226-232.
- [58] Eckermann, F., T. Suter, et al. (2008). "The influence of MgSi particle reactivity and dissolution processes on corrosion in Al-Mg-Si alloys." *Electrochimica Acta* 54(2): 844-855.
- [59] Eidhed, W. (2008). "Effects of solution treatment time and Sr-modification on microstructure and mechanical property of Al-Si piston alloy." *Journal of Materials Science and Technology* 24(1): 29-32.
- [60] Fang, H. C., K. H. Chen, et al. (2009). "Effect of Cr, Yb and Zr additions on localized corrosion of Al-Zn-Mg-Cu alloy." *Corrosion Science* 51(12): 2872-2877.
- [61] Ferrer, C. P., M. G. Koul, et al. (2003). "Improvements in strength and stress corrosion cracking properties in aluminum alloy 7075 via low-temperature retrogression and re-aging heat treatments." *Corrosion* 59(6): 520-528.
- [62] Fischer, H. R. (2010). *natural Science* 2: 873-901.
- [63] Fleck, P., D. Calleros, et al. (2000). "Retrogression and reaging of 7075 T6 aluminum alloy." *Materials Science Forum* 331: 1/.
- [64] Forsyth, M., T. Markley, et al. (2008). "Inhibition of corrosion on AA2024-T3 by new environmentally friendly rare earth organophosphate compounds." *Corrosion* 64(3): 191-197.

- [65] Frankel, G. S. (1998). "Pitting Corrosion of Metals." *Journal of The Electrochemical Society* 145(6): 2186-2198.
- [66] Frankel, G. S., A. J. Davenport, et al. (1992). "X-ray absorption study of electrochemically grown oxide films on Al-Cr sputtered alloys." *Journal of The Electrochemical Society* 139(7): 1812-1820.
- [67] Frankel, G. S., M. A. Russak, et al. (1989). "Pitting of Sputtered Aluminum Alloy Thin Films." *Journal of The Electrochemical Society* 136(4): 1243-1244.
- [68] Fuller, C. B., A. R. Krause, et al. (2002). "Microstructure and mechanical properties of a 5754 aluminum alloy modified by Sc and Zr additions." *Materials Science and Engineering A* 338(1-2): 8-16.
- [69] Furman, S. A., F. H. Scholes, et al. (2006). "Corrosion in artificial defects. II. Chromate reactions." *Corrosion Science* 48(7): 1827-1847.
- [70] Galvele, J. R. (1976). "Transport Processes and the Mechanism of Pitting of Metals." *Journal of The Electrochemical Society* 123(4): 464-474.
- [71] García, S. J., H. R. Fischer, et al. (2011). "Self-healing anticorrosive organic coating based on an encapsulated water reactive silyl ester: Synthesis and proof of concept." *Progress in Organic Coatings* 70(2-3): 142-149.
- [72] García, S. J., Mol, J.M.C., Muster, T.H., Hughes, A.E., Mardel, J., Miller, T., Markely, T., Terry, H., de Wit, J.H.W. (2011). Advances in the Selection and use of Rare-Earth-Based Inhibitors for Self Healing Organic Coatings, Accepted for publication in *Self-Healing Properties of New Surface Treatments. Green Inhibitors*. L. Fedrizzi, EFC-Maney Publishing. 58.
- [73] García, S. J., T. H. Muster, et al. (2010). "The influence of pH on corrosion inhibitor selection for 2024-T3 aluminium alloy assessed by high-throughput multielectrode and potentiodynamic testing." *Electrochimica Acta* 55(7): 2457-2465.
- [74] García, S. J., M. T. Rodríguez, et al. (2007). "Evaluation of cure temperature effects in cathoretic automotive primers by electrochemical techniques." *Progress in Organic Coatings* 60(4): 303-311.
- [75] García, S. J. and J. Suay (2006). "Anticorrosive properties of an epoxy-Meldrum acid cured system catalyzed by erbium III trifluoromethanesulfonate." *Progress in Organic Coatings* 57(4): 319-331.
- [76] García, S. J. and J. Suay (2006). "Application of electrochemical techniques to study the effect on the anticorrosive properties of the addition of ytterbium and erbium triflates as catalysts on a powder epoxy network." *Progress in Organic Coatings* 57(3): 273-281.
- [77] García, S. J. and J. Suay (2007). "A comparative study between the results of different electrochemical techniques (EIS and AC/DC/AC). Application to the optimisation of

- the cathophoretic and curing parameters of a primer for the automotive industry." *Progress in Organic Coatings* 59(3): 251-258.
- [78] García, S. J. and J. Suay (2007). "Influence on the anticorrosive properties of the use of erbium (III) trifluoromethanesulfonate as initiator in an epoxy powder clearcoat." *Corrosion Science* 49(8): 3256-3275.
- [79] García, S. J. and J. Suay (2009). "Optimization of deposition voltage of cathophoretic automotive primers assessed by EIS and AC/DC/AC." *Progress in Organic Coatings* 66(3): 306-313.
- [80] Garrard, W. N. (1994). "Corrosion Behavior of Aluminum-Lithium Alloys." *Corrosion* 50(3): 215-225.
- [81] Gimenez, P., J. J. Rameau, et al. (1981). "Experimental pH potential diagram of aluminium for seawater." *Corrosion* 37: 673-682.
- [82] Giummarra, C., B. Thomas, et al. (2007). "New Al-Li Alloys for Aerospace Applications." *Proceedings of the Light Metals Technology Conference*.
- [83] Goswami, R., G. Spanos, et al. (2010). "Precipitation behavior of the  $\beta$  phase in Al-5083." *Materials Science and Engineering: A* 527(4-5): 1089-1095.
- [84] Graver, B., A. M. Pedersen, et al. (2009). "Anodic Activation of Aluminum by Trace Element Tin." *ECS Transactions* 16(52): 55-69.
- [85] Graver, B., A. T. J. van Helvoort, et al. (2010). "Effect of heat treatment on anodic activation of aluminium by trace element indium." *Corrosion Science* 52(11): 3774-3781.
- [86] Guillaumin, V. and G. Mankowski (1998). "Localized corrosion of 2024 T351 aluminium alloy in chloride media." *Corrosion Science* 41(3): 421-438.
- [87] Guillaumin, V. and G. Mankowski (2000). "Localized corrosion of 6056 T6 aluminium alloy in chloride media." *Corrosion Science* 42(1): 105-125.
- [88] Gundersen, J. T. B., A. Aytac, et al. (2004). "Effect of heat treatment on electrochemical behaviour of binary aluminium model alloys." *Corrosion Science* 46(3): 697-714.
- [89] Gupta, R. K., N. L. Sukiman, et al. (2012). "Metastable pitting characteristics of aluminium alloys measured using current transients during potentiostatic polarisation." *Electrochimica Acta* 66: 245-254.
- [90] Gupta, R. K., N. L. Sukiman, et al. (2012). "Electrochemical Behavior and Localized Corrosion Associated with Mg<sub>2</sub>Si Particles in Al and Mg Alloys." *ECS Electrochemistry Letters* 1(1): B1-B3.
- [91] Harvey, T. G., S. G. Hardin, et al. (2011). "The effect of inhibitor structure on the corrosion of AA2024 and AA7075." *Corrosion Science* 53(6): 2184-2190.
- [92] Harvey, T. G., A. E. Hughes, et al. (2008). "Non-chromate deoxidation of AA2024-T3: Sodium bromate-nitric acid (20-60)." *Applied Surface Science* 254(11): 3562-3575.

- [93] Hatch, J. E. (1984). Aluminum: properties and physical metallurgy, Metals Park, Ohio : American Society for Metals.
- [94] He, Y., X. Zhang, et al. (2010). "Effect of minor Cr, Mn, Zr, Ti and B on grain refinement of as-cast Al-Zn-Mg-Cu alloys." *Xiyou Jinshu Cailiao Yu Gongcheng/Rare Metal Materials and Engineering* 39(7): 1135-1140.
- [95] Hinton, B. R. W., N. Dubrulle, et al. (2006). Raman, EDS and SEM studies of the interaction of corrosion inhibitor Ce(dbp)<sub>3</sub> with AA2024-T3. 4th International Symposium on Aluminium Surface Science and Technology. Beaune, France.
- [96] Hirth, S. M., G. J. Marshall, et al. (2001). "Effects of Si on the aging behaviour and formability of aluminium alloys based on AA6016." *Materials Science and Engineering A* 319-321: 452-456.
- [97] Ho, D., N. Brack, et al. (2006). "Cerium dibutylphosphate as a corrosion inhibitor for AA2024-T3 aluminum alloys." *Journal of the Electrochemical Society* 153(9): B392-B401.
- [98] Hollaender, J. (1997). "Rapid assessment of food/package interactions by electrochemical impedance spectroscopy (EIS)." *Food Additives and Contaminants* 14(6-7): 617-626.
- [99] Huang, Z. H., J. F. Li, et al. (2008). "Primary crystallization of Al-Ni-RE amorphous alloys with different type and content of RE." *Materials Science and Engineering: A* 489(1-2): 380-388.
- [100] Hughes, A. E., A. Boag, et al. (2011). "Corrosion of AA2024-T3 Part II: Co-operative corrosion." *Corrosion Science* 53(1): 27-39.
- [101] Hughes, A. E., A. M. Glenn, et al. (2012). A Consistent Description of Intermetallic Particle Composition: An analysis of 10 Batches of AA2024-T3. Aluminium Surface Science & Technology, Sorrento, Italy.
- [102] Hughes, A. E., C. MacRae, et al. (2010). "Sheet AA2024-T3: A new investigation of microstructure and composition." *Surface and Interface Analysis* 42(4): 334-338.
- [103] Hughes, A. E., I. S. Cole, et al. (2010). "Designing green, self-healing coatings for metal protection." *NPG Asia Materials* 2(4): 143-151.
- [104] Hughes, A. E., I. S. Coles, et al. (2010). "Combining Green and Self Healing for a new Generation of Coatings for Metal Protection." *Nature Asia Materials* 2(4): 143-151.
- [105] Ilevbare, G. O., O. Schneider, et al. (2004). "In Situ Confocal Laser Scanning Microscopy of AA 2024-T3 Corrosion Metrology." *Journal of The Electrochemical Society* 151(8): B453.
- [106] Inoue, A., J. S. Gook, et al. (1995). "New amorphous alloys in Al-Mg-Ln (Ln = La, Ce or Nd) systems prepared by rapid solidification (rapid publication)." *Materials Transactions, JIM* 36(7): 794-796.



- [107] Inoue, A. and A. Takeuchi (2004). "Recent progress in bulk glassy, nanoquasicrystalline and nanocrystalline alloys." *Materials Science and Engineering: A* 375–377(0): 16-30.
- [108] Jain, S. (2006). Corrosion and protection of heterogeneous cast Al-Si (356) and Al-Si-Fe-Cu (380) alloys by chromate and cerium inhibitors, Ohio State University.
- [109] Jain, S., M. L. C. Lim, et al. (2012). "Spreading of intergranular corrosion on the surface of sensitized Al-4.4Mg alloys: A general finding." *Corrosion Science* 59: 136-147.
- [110] Jia, Z., B. Graver, et al. (2008). "Effect of magnesium on segregation of trace element lead and anodic activation in aluminum Alloys." *Journal of The Electrochemical Society* 155(1): C1-C7.
- [111] Jones, R. H., D. R. Baer, et al. (2001). "Role of Mg in the stress corrosion cracking of an Al-Mg alloy." *Metallurgical and Materials Transactions A: Physical Metallurgy and Materials Science* 32(7): 1699-1711.
- [112] Jorcin, J. B., E. Aragon, et al. (2006). "Delaminated areas beneath organic coating: A local electrochemical impedance approach." *Corrosion Science* 48(7): 1779-1790.
- [113] Joshua Du, Y., M. Damron, et al. (2001). "Inorganic/organic hybrid coatings for aircraft aluminum alloy substrates." *Progress in Organic Coatings* 41(4): 226-232.
- [114] Juffs, L. (2002). Investigation of Corrosion Coating Deposition on Microscopic and Macroscopic Intermetallic Phases of Aluminium Alloys. Master of Science, RMIT.
- [115] Juffs, L., A. E. Hughes, et al. (2002). "The use of macroscopic modelling of intermetallic phases in aluminium alloys in the study of ferricyanide accelerated chromate conversion coatings." *Corrosion Science* 44(8): 1755-1781.
- [116] Juffs, L., A. E. Hughes, et al. (2001). "The use of macroscopic modelling of intermetallic phases in aluminium alloys in the study of ferricyanide accelerated chromate conversion coatings." *Micron* 32(8): 777-787.
- [117] Kallip, S., A. C. Bastos, et al. (2010). "A multi-electrode cell for high-throughput SVET screening of corrosion inhibitors." *Corrosion Science* 52(9): 3146-3149.
- [118] Kannan, M. B. and V. S. Raja (2010). Enhancing the localized corrosion resistance of high strength 7010 Al-alloy. 138: 1-6.
- [119] Kendig, M. W. and R. G. Buchheit (2003). "Corrosion Inhibition of Aluminum and Aluminum Alloys by Soluble Chromates, Chromate Coatings, and Chromate-Free Coatings." *Corrosion* 59(5): 379-400.
- [120] Keuon, Y. W., J. H. Nordlien, et al. (2003). "Electrochemical activation of aluminum by trace element lead." *Journal of The Electrochemical Society* 150(11): B547-B551.
- [121] Khramov, A. N., N. N. Voevodin, et al. (2004). "Hybrid organo-ceramic corrosion protection coatings with encapsulated organic corrosion inhibitors." *Thin Solid Films* 447–448(0): 549-557.

- [122] Kim, K. T., J. M. Kim, et al. (2005). Effect of alloying elements on the strength and casting characteristics of high strength Al-Zn-Mg-Cu alloys. 475-479: 2539-2542.
- [123] Kim, W. J., C. S. Chung, et al. (2003). "Optimization of strength and ductility of 2024 Al by equal channel angular pressing (ECAP) and post-ECAP aging." *Scripta Materialia* 49(4): 333-338.
- [124] Koroleva, E. v., G. e. Thompson, et al. (1999). "Surface morphological changes of aluminium alloys in alkaline solution:: effect of second phase material." *Corrosion Science* 41(8): 1475-1495.
- [125] Lamaka, S. V., O. V. Karavai, et al. (2008). "Monitoring local spatial distribution of Mg<sup>2+</sup>, pH and ionic currents." *Electrochemistry Communications* 10(2): 259-262.
- [126] Larsen, M. H., J. C. Walmsley, et al. (2008). "Intergranular corrosion of copper-containing AA6xxx AlMgSi aluminum alloys." *Journal of The Electrochemical Society* 155(11): C550-C556.
- [127] Lavernia, E. J. and N. J. Grant (1987). "Aluminum Lithium Alloys." *Journal of Materials Science* 22(5): 1521-1529.
- [128] Leblanc, P. and G. S. Frankel (2002). "A study of corrosion and pitting initiation of AA2024-T3 using atomic force microscopy." *Journal of The Electrochemical Society* 149(6): B239-B247.
- [129] Lee, Y. B., D. H. Shin, et al. (2004). "Effect of annealing temperature on microstructures and mechanical properties of a 5083 Al alloy deformed at cryogenic temperature." *Scripta Materialia* 51(4): 355-359.
- [130] Li, C., D. Y. Li, et al. (2009). "Microstructure and mechanical properties of multicomponent aluminum alloy by rapid solidification." *Journal of Materials Engineering and Performance* 18(1): 79-82.
- [131] Li, J. F., Z. Q. Zheng, et al. (2007). "Exfoliation corrosion and electrochemical impedance spectroscopy of an Al-Li alloy in EXCO solution." *Materials and Corrosion* 58(4): 273-279.
- [132] Liddicoat, P. V., X.-z. Liao, et al. (2010). "Nanostructural hierarchy increases the strength of aluminium alloys." *Nature Communications* 1(6): 63-63.
- [133] Lin, J. C., H. L. Liao, et al. (2006). "Effect of heat treatments on the tensile strength and SCC-resistance of AA7050 in an alkaline saline solution." *Corrosion Science* 48(10): 3139-3156.
- [134] Liu, Y. and Y. F. Cheng (2010). "Role of second phase particles in pitting corrosion of 3003 Al alloy in NaCl solution." *Materials and Corrosion* 61(3): 211-217.
- [135] Liu, Y. and Y. F. Cheng (2011). "Characterization of passivity and pitting corrosion of 3003 aluminum alloy in ethylene glycol-water solutions." *Journal of Applied Electrochemistry* 41(2): 151-159.

- [136] Lucente, A. M. and J. R. Scully (2007). "Pitting of Al-based amorphous-nanocrystalline alloys with solute-lean nanocrystals." *Electrochemical and Solid-State Letters* 10(5): 39-43.
- [137] Lucente, A. M. and J. R. Scully (2008). "Localized corrosion of Al-based amorphous-nanocrystalline alloys with solute-lean nanocrystals: Pit stabilization." *Journal of The Electrochemical Society* 155(5): C234-C243.
- [138] Lynch, S. P., S. P. Knight, et al. (2009). Stress-corrosion cracking of Al-Zn-Mg-Cu alloys effects of composition and heat-treatment.
- [139] Mahajanarn, S. P. V. and R. G. Buchheit (2008). "Characterization of inhibitor release from Zn-Al- V10O28 (6-) hydrotalcite pigments and corrosion protection from hydro-talcite-pigmented epoxy coatings." *Corrosion* 64(3): 230-240.
- [140] Manna, I., P. P. Chattopadhyay, et al. (2004). "Development of amorphous and nano-crystalline Al<sub>65</sub>Cu<sub>35-x</sub>Zr<sub>x</sub> alloys by mechanical alloying." *Materials Science and Engineering: A* 379(1-2): 360-365.
- [141] Mardel, J., S. J. Garcia, et al. (2011). "The characterisation and performance of Ce(dbp)<sub>3</sub>-inhibited epoxy coatings." *Progress in Organic Coatings* 70(2-3): 91-101.
- [142] Markley, T. A., M. Forsyth, et al. (2007). "Corrosion protection of AA2024-T3 using rare earth diphenyl phosphates." *Electrochimica Acta* 52(12): 4024-4031.
- [143] Markley, T. A., A. E. Hughes, et al. (2007). "Influence of praseodymium - Synergistic corrosion inhibition in mixed rare-earth diphenyl phosphate systems." *Electrochemical and Solid State Letters* 10(12): C72-C75.
- [144] Marlaud, T., A. Deschamps, et al. (2010). "Evolution of precipitate microstructures during the retrogression and re-ageing heat treatment of an Al-Zn-Mg-Cu alloy." *Acta Materialia* 58(14): 4814-4826.
- [145] Martin, J. W. (1988). "Aluminum-Lithium Alloys." *Annual Review of Materials Science* 18: 101-119.
- [146] Masumoto, T. (1994). "Recent progress in amorphous metallic materials in Japan." *Materials Science and Engineering: A* 179-180, Part 1(0): 8-16.
- [147] Mazurkiewicz, B. and A. Piotrowski (1983). "The electrochemical behaviour of the Al<sub>2</sub>Cu intermetallic compound." *Corrosion Science* 23(7): 697-707.
- [148] McCafferty, E. (2010). *Passivity*
- [149] *Introduction to Corrosion Science*, Springer New York: 209-262.
- [150] McKenzie, P. W. J. and R. Lapovok (2010). "ECAP with back pressure for optimum strength and ductility in aluminium alloy 6016. Part 2: Mechanical properties and texture." *Acta Materialia* 58(9): 3212-3222.
- [151] Medco.

- [152] Mondolfo, L. F. (1971). "Discussion of "grain-size refining of primary crystals in hypereutectic Al-Si and Al-Ge alloys"." *Metallurgical Transactions* 2(4): 1254.
- [153] Mondolfo, L. F. and J. G. Barlock (1975). "Effect of superheating on structure of some aluminum alloys." *Metallurgical Transactions B* 6(4): 565-572.
- [154] Mookhoek, S. D., H. R. Fischer, et al. (2009). "A numerical study into the effects of elongated capsules on the healing efficiency of liquid-based systems." *Computational Materials Science* 47(2): 506-511.
- [155] Mookhoek, S. D., S. C. Mayo, et al. (2010). "Applying SEM-Based X-ray Microtomography to Observe Self-Healing in Solvent Encapsulated Thermoplastic Materials." *Advanced Engineering Materials* 12(3): 228-234.
- [156] Muller, I. L. and J. R. Galvele (1977). "Pitting potential of high purity binary aluminium alloys—II. AlMg and AlZn alloys." *Corrosion Science* 17(12): 995-1007.
- [157] Muster, T. H., A. E. Hughes, et al. (2009). "A rapid screening multi-electrode method for the evaluation of corrosion inhibitors." *Electrochimica Acta* 54(12): 3402-3411.
- [158] Muster, T. H., A. E. Hughes, et al. (2009). *Cu Distributions in Aluminium Alloys*, New York, Nova Science Publishers.
- [159] Muster, T. H., Hughes, A.E., Thompson. G.E. (2009). *Cu Distributions in Aluminium Alloys*. New York, Nova Science Publishers.
- [160] Nisancioglu, K. (1990). "Electrochemical Behavior of Aluminum-Base Intermetallics Containing Iron." *Journal of The Electrochemical Society* 137(1): 69-77.
- [161] Nisancioglu, K. and H. Holtan (1978). "Measurement of the critical pitting potential of aluminium." *Corrosion Science* 18(9): 835-849.
- [162] Norova, M. T., I. N. Ganiev, et al. (2003). "Enhancement of the corrosion resistance of aluminum-lithium alloys by microalloying with calcium." *Russian Journal of Applied Chemistry* 76(4): 547-549.
- [163] Oguocha, I., O. Adigun, et al. (2008). "Effect of sensitization heat treatment on properties of Al-Mg alloy AA5083-H116." *Journal of Materials Science* 43(12): 4208-4214.
- [164] Oliveira Jr, A. F., M. C. de Barros, et al. (2004). "The effect of RRA on the strength and SCC resistance on AA7050 and AA7150 aluminium alloys." *Materials Science and Engineering A* 379(1-2): 321-326.
- [165] Orazem, M. E. and B. Tribollet (2008). *Semiconducting Systems, in Electrochemical Impedance Spectroscopy*, John Wiley & Sons.
- [166] Osborne, J. H., K. Y. Blohowiak, et al. (2001). "Testing and evaluation of nonchromated coating systems for aerospace applications." *Progress in Organic Coatings* 41(4): 217-225.

- [167] Park, J. O., C. H. Paik, et al. (1999). "Influence of Fe-Rich Intermetallic Inclusions on Pit Initiation on Aluminum Alloys in Aerated NaCl." *Journal of The Electrochemical Society* 146(2): 517-523.
- [168] Pedersen, L. and L. Arnberg (2001). "The effect of solution heat treatment and quenching rates on mechanical properties and microstructures in AlSiMg foundry alloys." *Metallurgical and Materials Transactions A: Physical Metallurgy and Materials Science* 32(3): 525-532.
- [169] Perrault, G. G. (1979). "Role of Hydrides in the Equilibrium of Aluminum in Aqueous Solutions." *J Electrochem Soc* 126(2): 199-204.
- [170] Poelman, M., M. G. Olivier, et al. (2005). "Electrochemical study of different ageing tests for the evaluation of a cathaphoretic epoxy primer on aluminium." *Progress in Organic Coatings* 54(1): 55-62.
- [171] Polmear, I. J. (2006). *Light alloys : from traditional alloys to nanocrystals*, Oxford ; Burlington, MA : Elsevier/Butterworth-Heinemann.
- [172] Poole, W. J., J. A. Seter, et al. (2000). "A model for predicting the effect of deformation after solution treatment on the subsequent artificial aging behavior of AA7030 and AA7108 alloys." *Metallurgical and Materials Transactions A: Physical Metallurgy and Materials Science* 31(9): 2327-2338.
- [173] Pourbaix, M. (1974). *Atlas of Electrochemical Equilibria in Aqueous Solutions*. National Association of Corrosion Engineers, Houston, TX, USA.
- [174] Premendra, P., H. Terryn, et al. (2009). "A comparative electrochemical study of commercial and model aluminium alloy (AA5050)." *Materials and Corrosion* 60(6): 399-406.
- [175] Puga, H., S. Costa, et al. (2011). "Influence of ultrasonic melt treatment on microstructure and mechanical properties of AlSi9Cu3 alloy." *Journal of Materials Processing Technology* 211(11): 1729-1735.
- [176] Ralston, K. D., N. Birbilis, et al. (2010). "Role of nanostructure in pitting of Al-Cu-Mg alloys." *Electrochimica Acta* 55(27): 7834-7842.
- [177] Ralston, K. D., N. Birbilis, et al. (2010). "Revealing the relationship between grain size and corrosion rate of metals." *Scripta Materialia* 63(12): 1201-1204.
- [178] Raps, D., T. Hack, et al. (2009). "Electrochemical study of inhibitor-containing organic-inorganic hybrid coatings on AA2024." *Corrosion Science* 51(5): 1012-1021.
- [179] Raviprasad, K., C. R. Hutchinson, et al. (2003). "Precipitation processes in an Al-2.5Cu-1.5Mg (wt. %) alloy microalloyed with Ag and Si." *Acta Materialia* 51(17): 5037-5050.
- [180] Ringer, S. P., K. Hono, et al. (1996). "Nucleation of precipitates in aged AlCuMg(Ag) alloys with high Cu:Mg ratios." *Acta Materialia* 44(5): 1883-1898.

- [181] Rizzi, P. and L. Battezzati (2004). "Mechanical properties of Al based amorphous and devitrified alloys containing different rare earth elements." *Journal of Non-Crystalline Solids* 344(1-2): 94-100.
- [182] Rodríguez, M. T., J. J. Gracenea, et al. (2004). "Testing the influence of the plasticizers addition on the anticorrosive properties of an epoxy primer by means of electrochemical techniques." *Progress in Organic Coatings* 50(2): 123-131.
- [183] Rosalbino, F., E. Angelini, et al. (2003). "Influence of the rare earth content on the electrochemical behaviour of Al-Mg-Er alloys." *Intermetallics* 11(5): 435-441.
- [184] Sævik, Ø., Y. Yu, et al. (2005). "Characterization of lead enrichment on electrochemically active AlPb model alloy." *Journal of The Electrochemical Society* 152(9): B334-B341.
- [185] Samadzadeh, M., S. H. Boura, et al. (2010). "A review on self-healing coatings based on micro/nanocapsules." *Progress in Organic Coatings* 68(3): 159-164.
- [186] Samanta, A., I. Manna, et al. (2007). "Phase evolution in Al-Ni-(Ti, Nb, Zr) powder blends by mechanical alloying." *Materials Science and Engineering A* 464(1-2): 306-314.
- [187] Sasaki, K. and H. S. Isaacs (2004). "Origins of Electrochemical Noise during Pitting Corrosion of Aluminum." *Journal of The Electrochemical Society* 151(3): B124-B133.
- [188] Sato, N. (1990). "An overview on the passivity of metals." *Corrosion Science* 31(0): 1-19.
- [189] Schmutz, P. and G. S. Frankel (1998). "Characterization of AA2024-T3 by scanning Kelvin probe force microscopy." *Journal of The Electrochemical Society* 145(7): 2285-2295.
- [190] Schneider, O., G. O. Ilevbare, et al. (2007). "In situ confocal laser scanning microscopy of AA2024-T3 corrosion metrology: III. Underfilm corrosion of epoxy-coated AA2024-T3." *Journal of The Electrochemical Society* 154(8): C397-C410.
- [191] Schneider, O., G. O. Ilevbare, et al. (2004). "In situ confocal laser scanning microscopy of AA 2024-T3 corrosion metrology II. Trench formation around particles." *Journal of The Electrochemical Society* 151(8): B465-B472.
- [192] Scholes, F. H., S. A. Furman, et al. (2006). "Chromate leaching from inhibited primers: Part I. Characterisation of leaching." *Progress in Organic Coatings* 56(1): 23-32.
- [193] Scholes, F. H., S. A. Furman, et al. (2006). "Corrosion in artificial defects. I: Development of corrosion." *Corrosion Science* 48(7): 1812-1826.
- [194] Scholes, F. H., A. E. Hughes, et al. (2009). "Interaction of Ce(dbp)(3) with surface of aluminium alloy 2024-T3 using macroscopic models of intermetallic phases." *Corrosion Engineering Science and Technology* 44(6): 416-424.

- [195] Scully, J. R., T. O. Knight, et al. (1993). "Electrochemical characteristics of the Al<sub>2</sub>Cu, Al<sub>3</sub>Ta and Al<sub>3</sub>Zr intermetallic phases and their relevancy to the localized corrosion of Al alloys." *Corrosion Science* 35(1-4): 185-195.
- [196] Searles, J. L., P. I. Gouma, et al. (2002). "Stress Corrosion Cracking of Sensitized AA5083 (Al-4.5Mg-1.0Mn)." *Materials Science Forum* 396-402: 1437-1442.
- [197] Semenov, A. M. (2001). "Effect of Mg additions and thermal treatment on corrosion properties of Al-Li-Cu-base alloys." *Protection of Metals* 37(2): 126-131.
- [198] Senkov, O., R. Bhat, et al. (2005). "Microstructure and properties of cast ingots of Al-Zn-Mg-Cu alloys modified with Sc and Zr." *Metallurgical and Materials Transactions A* 36(8): 2115-2126.
- [199] Seri, O. (1994). "The effect of NaCl concentration on the corrosion behavior of aluminum containing iron." *Corrosion Science* 36(10): 1789-1803.
- [200] Seri, O. and K. Tagashira (1986). "Effect of Manganese Content on Corrosion Characteristics of Al-Mn Alloys." *Keikinzoku/Journal of Japan Institute of Light Metals* 36(12): 806-812.
- [201] Sha, G. and A. Cerezo (2004). "Characterization of precipitates in an aged 7xxx series Al alloy." *Surface and Interface Analysis* 36(5-6): 564-568.
- [202] Shaw, B. A., G. D. Davis, et al. (1991). "The Influence of Tungsten Alloying Additions on the Passivity of Aluminum." *Journal of The Electrochemical Society* 138(11): 3288-3295.
- [203] Shaw, B. A., T. L. Fritz, et al. (1990). "The Influence of Tungsten on the Pitting of Aluminum Films." *Journal of The Electrochemical Society* 137(4): 1317-1318.
- [204] Sinko, J. (2001). "Challenges of chromate inhibitor pigments replacement in organic coatings." *Progress in Organic Coatings* 42(3-4): 267-282.
- [205] Song, R. G., W. Dietzel, et al. (2004). "Stress corrosion cracking and hydrogen embrittlement of an Al-Zn-Mg-Cu alloy." *Acta Materialia* 52(16): 4727-4743.
- [206] Souto, R. M., Y. González-García, et al. (2010). "Examination of organic coatings on metallic substrates by scanning electrochemical microscopy in feedback mode: Revealing the early stages of coating breakdown in corrosive environments." *Corrosion Science* 52(3): 748-753.
- [207] Speckert, L. and G. T. Burstein (2011). "Combined anodic/cathodic transient currents within nucleating pits on Al-Fe alloy surfaces." *Corrosion Science* 53(2): 534-539.
- [208] Stelling, O., A. Irretier, et al. (2006). New light-weight aluminum alloys with high Mg<sub>2</sub>Si-content by spray forming. 519-521: 1245-1250.
- [209] Sukiman, N. L., N. Birbilis, et al. (2010). Corrosion Maps For Aluminium Alloys. Proc. Conf. Corrosion And Prevention '10. Adelaide, Australia, Australasian Corrosion Association (ACA).

- [210] Suryanarayana, C., K. C. Rao, et al. (2008). "Preparation and characterization of microcapsules containing linseed oil and its use in self-healing coatings." *Progress in Organic Coatings* 63(1): 72-78.
- [211] Szklarska-Smialowska, Z. (1999). "Pitting corrosion of aluminum." *Corrosion Science* 41(9): 1743-1767.
- [212] Szklarska-Smialowska, Z. (2002). "Mechanism of pit nucleation by electrical breakdown of the passive film." *Corrosion Science* 44(5): 1143-1149.
- [213] Tahani, A., E. Chaieb, et al. (2003). "Electrochemical study of the influence of rolling on the resistance. The corrosion of alloy of aluminium 3003 in milieu 3% NaCl." *Transactions of the SAEST (Society for Advancement of Electrochemical Science and Technology)* 38(1): 43-46.
- [214] Tailleart, N., B. Gauthier, et al. (2009). Metallurgical and physical factors in improving the corrosion resistance of thermally sprayed semi-amorphous Al-Co-Ce coatings.
- [215] Tan, L. and T. R. Allen (2010). "Effect of thermomechanical treatment on the corrosion of AA5083." *Corrosion Science* 52(2): 548-554.
- [216] Taylor, S. R. and B. D. Chambers (2008). "Identification and Characterization of Non-chromate Corrosion Inhibitor Synergies Using High-Throughput Methods." *Corrosion* 64(3): 255-270.
- [217] Tedim, J., S. K. Poznyak, et al. (2010). "Enhancement of Active Corrosion Protection via Combination of Inhibitor-Loaded Nanocontainers." *Acs Applied Materials & Interfaces* 2(5): 1528-1535.
- [218] Teixeira, J. D. C., L. Bourgeois, et al. (2007). A study of the microstructural evolution and strengthening effects of non-spherical precipitates in an al-cu-based alloy. 561-565: 2317-2320.
- [219] Trueman, A. R. (2005). "Determining the probability of stable pit initiation on aluminium alloys using potentiostatic electrochemical measurements." *Corrosion Science* 47(9): 2240-2256.
- [220] Twite, R. L. and G. P. Bierwagen (1998). "Review of Alternatives to Chromate for Corrosion Protection of Aluminum Aerospace Alloys." *Progress in Organic Coatings* 33(2): 91-100.
- [221] Unocic, K. A., P. Kobe, et al. (2006). "Grain Boundary Precipitate Modification for Improved Intergranular Corrosion Resistance." *Materials Science Forum* 519-521: 327-332.
- [222] Usta, M., M. E. Glicksman, et al. (2004). "The effect of heat treatment on Mg<sub>2</sub>Si coarsening in aluminum 6105 alloy." *Metallurgical and Materials Transactions A: Physical Metallurgy and Materials Science* 35 A(2): 435-438.



- [223] Vetrano, J. S., C. H. Henager Jr, et al. (1998). Use of Sc, Zr and Mn for grain size control in Al-Mg alloys.
- [224] Vetrano, J. S., R. E. Williford, et al. (1997). Influence of microstructure and thermal history on the corrosion susceptibility of AA5083. TMS Annual Meeting, Orlando, FL, USA.
- [225] Voevodin, N. N., V. N. Balbyshev, et al. (2003). "Nanostructured coatings approach for corrosion protection." *Progress in Organic Coatings* 47(3-4): 416-423.
- [226] Walmsley, J. C., Ø. Sævik, et al. (2007). "Nature of segregated lead on electrochemically active AlPb model alloy." *Journal of The Electrochemical Society* 154(1): C28-C35.
- [227] Wang, D., D. Battocchi, et al. (2010). "In situ monitoring of a Mg-rich primer beneath a topcoat exposed to Prohesion conditions." *Corrosion Science* 52(2): 441-448.
- [228] Wang, W. t., X. m. Zhang, et al. (2010). "Influences of Ce addition on the microstructures and mechanical properties of 2519A aluminum alloy plate." *Journal of Alloys and Compounds* 491(1-2): 366-371.
- [229] Wei, R. P. (2001). "A model for particle-induced pit growth in aluminum alloys." *Scripta Materialia* 44(11): 2647-2652.
- [230] Westermann, I., O. S. Hopperstad, et al. (2012). "Effect of alloying elements on stage-III work-hardening behaviour of Al -Zn-Mg(-Cu) alloys." *International Journal of Materials Research* 103(5): 603-608.
- [231] White, P. A., A. E. Hughes, et al. (2009). "High-throughput channel arrays for inhibitor testing: Proof of concept for AA2024-T3." *Corrosion Science* 51(10): 2279-2290.
- [232] White, S. R., N. R. Sottos, et al. (2001). "Autonomic healing of polymer composites." *Nature* 409(6822): 794-797.
- [233] Williams, D. E., J. Stewart, et al. (1994). "The nucleation, growth and stability of micropits in stainless steel." *Corrosion Science* 36(7): 1213-1235.
- [234] Williams, G. and H. N. McMurray (2003). "Anion-exchange inhibition of filiform corrosion on organic coated AA2024-T3 aluminum alloy by hydrotalcite-like pigments." *Electrochemical and Solid State Letters* 6(3): B9-B11.
- [235] Wu, B., J. R. Scully, et al. (1997). "Cooperative stochastic behavior in localized corrosion: I. Model." *Journal of The Electrochemical Society* 144(5): 1614-1620.
- [236] Wu, D. Y., S. Meure, et al. (2008). "Self-healing polymeric materials: A review of recent developments." *Progress in Polymer Science* 33(5): 479-522.
- [237] Xu, D. K., N. Birbilis, et al. (2011). "Effect of solution treatment on the corrosion behaviour of aluminium alloy AA7150: Optimisation for corrosion resistance." *Corrosion Science* 53(1): 217-225.

- [238] Yang, B. J., J. H. Yao, et al. (2009). "Al-rich bulk metallic glasses with plasticity and ultrahigh specific strength." *Scripta Materialia* 61(4): 423-426.
- [239] Yasakau, K. A., M. L. Zheludkevich, et al. (2007). "Role of intermetallic phases in localized corrosion of AA5083." *Electrochimica Acta* 52(27 SPEC. ISS.): 7651-7659.
- [240] Yin, T., M. Z. Rong, et al. (2007). "Self-healing epoxy composites - Preparation and effect of the healant consisting of microencapsulated epoxy and latent curing agent." *Composites Science and Technology* 67(2): 201-212.
- [241] Yu, Y., Ø. Sævik, et al. (2005). "Effect of annealing temperature on anodic activation of rolled AA8006 aluminum alloy by trace element lead." *Journal of The Electrochemical Society* 152(9): B327-B333.
- [242] Yu, Y., Ø. Saevlk, et al. (2004). "Characterization of lead enrichment on electrochemically activated binary Al-Pb model alloy." *Materials Forum* 28: 270-276.
- [243] Zamin, M. (1981). "ROLE OF Mn In the Corrosion Behavior of Al-Mn Alloys." *Corrosion* 37(11): 627-632.
- [244] Zawrah, M. and L. Shaw (2003). "Microstructure and hardness of nanostructured Al-Fe-Cr-Ti alloys through mechanical alloying." *Materials Science and Engineering: A* 355(1-2): 37-49.
- [245] Zeng, F.-l., Z.-l. Wei, et al. (2011). "Corrosion mechanism associated with Mg<sub>2</sub>Si and Si particles in Al-Mg-Si alloys." *Transactions of Nonferrous Metals Society of China* 21(12): 2559-2567.
- [246] Zhang, W. and G. S. Frankel (2003). "Transitions between pitting and intergranular corrosion in AA2024." *Electrochimica Acta* 48(9): 1193-1210.
- [247] Zhao, Y. H., X. Z. Liao, et al. (2004). "Microstructures and mechanical properties of ultrafine grained 7075 Al alloy processed by ECAP and their evolutions during annealing." *Acta Materialia* 52(15): 4589-4599.
- [248] Zheludkevich, M. L., I. M. Salvado, et al. (2005). "Sol-gel coatings for corrosion protection of metals." *Journal of Materials Chemistry* 15(48): 5099-5111.
- [249] Zhong, J., K. Feng, et al. (2011). Effect of RE on the mechanical properties of 7075 Al alloy. 150-151: 1286-1289.
- [250] Zhou, X., N. Birbilis, et al. (2010). "Kinetic Stability of Aluminium." *Corrosion & Prevention Corrosion*, Adelaide, Australia.
- [251] Zhou, X., Y. Liu, et al. (2011). "Near-Surface Deformed Layers on Rolled Aluminum Alloys." *Metallurgical and Materials Transactions A* 42(5): 1373-1385.
- [252] Zhou, X., C. Luo, et al. (2012). "Study of localized corrosion in AA2024 aluminium alloy using electron tomography." *Corrosion Science* 58: 299-306.

- [253] Zieliński, A., J. Chrzanowski, et al. (2004). "Influence of retrogression and reaging on microstructure, mechanical properties and susceptibility to stress corrosion cracking of an Al-Zn-Mg alloy." *Materials and Corrosion* 55(2): 77-87.
- [254] Zin, I. M., R. L. Howard, et al. (1998). "The mode of action of chromate inhibitor in epoxy primer on galvanized steel." *Progress in Organic Coatings* 33(3-4): 203-210.
- [255] Zou, L., Q.-l. Pan, et al. (2007). "Effect of minor Sc and Zr addition on microstructures and mechanical properties of Al-Zn-Mg-Cu alloys." *Transactions of Nonferrous Metals Society of China* 17(2): 340-345.

