

Process Control Optimization for Hydroelectric Power Based on Neural Network Algorithm

*Haoming Xu, **Deyi Wang, ***Jiajun Liu

*Xi'an University of Technology, Xi'an 710048, China; Yangling Vocational & Technical College, Yangling 712100, China (xuhaoming1982@163.com)

**Xi'an University of Technology, Xi'an 710048, China

***Xi'an University of Technology, Xi'an 710048, China

Abstract

It is crucial for a hydropower station to operate smoothly in a safety and steady way. In this paper, we explore the current development trend and intelligent control theory of hydropower control system. The mathematical expressions are set up here for the system hardware and software, respectively. An integrated model was also developed for servo system of each mathematical model linear combination, which lays a theoretical foundation for model identification of hydropower units; this paper introduces the neural network and the fuzzy control theories and analyzes the BP and RBF network structures and identification simulation. The experimental results show that the RBF network can improve the iterative efficiency, speed up the analysis and identification, and avoid sluggish condition of global approximation convergence. The fuzzy control rule for PID controller is optimized as a result the Fuzzy PID control may speed up the adjustment, and increase the speed at which the system tends to be stable, provided that the system stability is ensured. It, therefore, contributes the most to the safety of the power grid.

Keywords

Hydropower unit, Fuzzy control, Neural network, Parameter optimization.

1. Introduction

In recent years, hydropower, as a kind of green energy resource, has become increasingly popular in China. There is an unprecedentedly vast market. The hydropower station is generally located in a remote area, which has posed a great challenge in terms of automation and intelligence; Due to the complexity and diversification of hydropower unit, the traditional control strategy always plays a poor effect [1], e.g. the water head at the guide vane opening is prone to rise up, the mechanical inertia of generator is high, the perturbation is hardly stabilized, and the operating conditions are complex and changeable, it is urgent to face the challenges of intelligent operation of hydropower units [2].

With the rocketing development of computer-based intelligent control theory, some progress has been made in the application of hydropower unit. [3] Salhi et al. studied the mode control of speed governing system for water turbine. [5] Nagode et al. made a study on adaptive control of hydropower unit. [6] Guo et al. explored the stability of hydropower unit by using feedback linearization. The above results show that, based on the intelligent control theory, the linear and nonlinear model system control can make instant response to current information and have good control effect.

Therefore, this paper studies the hydropower unit from the perspective of the model in question, and using the neural network and fuzzy control in the field of intelligence control, to improve the control performance of hydropower units.

2. Parametric Control Theory of Hydropower Unit

The parameter control of hydropower unit implies two conditions. The first is to identify the prototype of hydropower unit designed currently. The second is that appropriate controller is designed for the prototype of hydropower unit designed currently. The parametric control of hydropower unit, as a kind of system control, includes relevant system identification control theories, i.e. fuzzy control, neural network and intelligent algorithm [7], which are characterized by the following:

(1) Fuzzy control theory. When it is used in the hydropower unit, other theories or algorithms are generally integrated (PI theory, TSK theory, co-evolution algorithm, double immunity control algorithm) to avoid the natural defects of the fuzzy controller and improve the control precision.

(2) Neural network theory. The information is processed by the neural network in a distributed way. With a variety of inputs, it combines with computer technology, circuit technology to achieve the information processing capabilities of neural network. This theory can also address the complex

modeling. If used with other theories, such as, prediction control algorithm, PMDL, ANFIS, single-gain neuron PSD, etc. [8], it can present a good control for giant perturbation system, thus realizing the modeling and control of hydropower unit prototype.

(3) Intelligent algorithm theory. As an algorithm of optimized controller, the intelligent algorithm can optimize the fuzzy control theory and the neural network theory. The common optimization algorithms include SGA, GA and improved GA, which improve the control precision [9].

3. Mathematical Modelling and Model Identification of Hydropower Unit Based on Neural Network Theory

3.1 Mathematical Modelling

The software and hardware of the hydropower system include water turbine, generator, conduit system and control system. The fluid inertia of water turbine and the mechanical inertia of the generator are adverse factors that affect the control performance of unit system. The mathematical model of each part comes here as follows:

For the model of the electro-hydraulic servo system [10], it is expressed as below:

$$\frac{Y(s)}{U(s)} = \frac{1}{T_{y1}T_y s^2 + T_y s + 1} \quad (1)$$

If $T_{y1} \ll T_y$, it is simplified as:

$$\frac{Y(s)}{U(s)} = \frac{1}{T_y s + 1} \quad (2)$$

For the conduit system, if the perturbation is lesser, the pipe is short (<600m),

$$G_h(s) = \frac{h(s)}{q(s)} = -T_w s \quad (3)$$

For the turbine system, the torque and flow are expressed using Taylor series expansion:

$$\Delta \mathbf{m}_i = \frac{\partial \mathbf{m}_i}{\partial \mathbf{y}} \Delta \mathbf{y} + \frac{\partial \mathbf{m}_i}{\partial \mathbf{x}} \Delta \mathbf{x} + \frac{\partial \mathbf{m}_i}{\partial \mathbf{h}} \Delta \mathbf{h} = \mathbf{e}_y \Delta \mathbf{y} + \mathbf{e}_x \Delta \mathbf{x} + \mathbf{e}_h \Delta \mathbf{h}; \quad (4)$$

$$\Delta \mathbf{q}_i = \frac{\partial \mathbf{q}_i}{\partial \mathbf{y}} \Delta \mathbf{y} + \frac{\partial \mathbf{q}_i}{\partial \mathbf{x}} \Delta \mathbf{x} + \frac{\partial \mathbf{q}_i}{\partial \mathbf{h}} \Delta \mathbf{h} = \mathbf{e}_{qy} \Delta \mathbf{y} + \mathbf{e}_{qx} \Delta \mathbf{x} + \mathbf{e}_{qh} \Delta \mathbf{h} \quad (5)$$

For the generator system, it converts mechanical energy into electrical energy, considering the load variable, the system's first-order model is:

$$\Delta m_i - \Delta m_g - e_g \Delta x = T_a' \frac{d\Delta x}{dt} = (T_a + T_b) \frac{d\Delta x}{dt} \quad (6)$$

T_a -- Mechanical inertia time of generator unit

T_b -- Inertia coefficient of the load converted to the unit side

Then the conduit system is expressed as: $\mathbf{G}_s(\mathbf{s}) = \frac{1}{T_a' s + e_n}$

For the overall system of hydropower units, the function transfer form as above is shown in Figure 1.

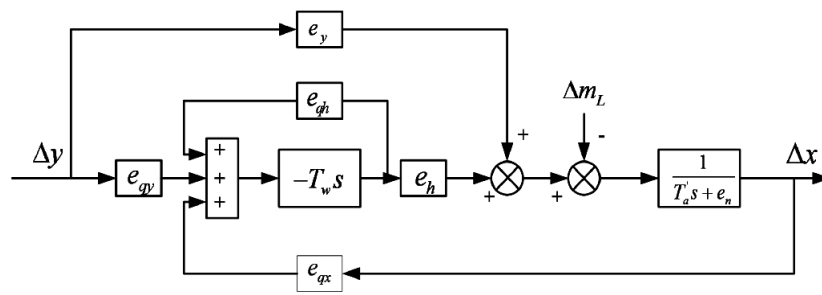

Fig.1. Water turbine transfer function

The Mason formula simplifies the transfer function as:

$$\text{Forward channel: } \mathbf{p}_1 = \frac{e_{qy} e_h T_w s}{T_a' s + e_n}, \quad \mathbf{p}_2 = \frac{e_y}{T_a' s + e_n}$$

$$\text{Loop: } \mathbf{l}_1 = -e_{qy} T_w s, \quad \mathbf{l}_2 = -\frac{e_{qy} e_h T_w}{T_a' s + e_n}$$

$$\text{Jepson - type: } \Delta = 1 - (\mathbf{l}_1 + \mathbf{l}_2);$$

$$\text{Cofactor: } \Delta_1 = 1 \quad \Delta_2 = 1 - \mathbf{l}_1;$$

Transfer function:

$$\mathbf{G}(s) = \frac{\mathbf{p}_1 \Delta_1 + \mathbf{p}_2 \Delta_2}{\Delta} = \frac{\frac{e_{qy} e_h T_w s}{T_a' s + e_n} + \frac{e_y}{T_a' s + e_n} (1 + e_{qy} T_w s)}{1 + e_{qy} T_w s + \frac{e_{qy} e_h T_w s}{T_a' s + e_n}} = \frac{(e_y e_{qh} - e_{qy} e_h) T_w s + e_y}{e_{qh} - T_a' T_w s^2 + [(e_n e_{qh} - e_{qx} e_h) T_w + T_a'] s + e_n} \quad (7)$$

As can be seen from the above formulae, the hydropower model is rather complex. In fact, when the hydropower unit operates, it is not always stable with intense fluctuations, etc. Therefore, it is difficult to build accurate mathematical model using the traditional modeling method. On this basis, the neural network can be used to identify the hydropower units

3.2 Mathematical model identification

Based on the analysis in 3.1, we know that the hydropower unit must be identified by combination with the neural network. The neural network methods are divided into two classes, i.e. BP and RBF [11], whose principles are shown in Figures 2 and 6, respectively.

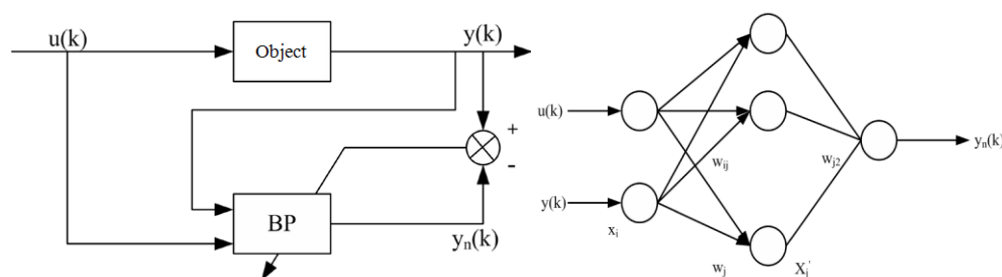

(a)BP Network identification (b)Used for identification of BP network

Fig.2. BP network identification of structure

Where, k is the time value, $u(k)$ denotes the signal; $\mathbf{y}(\mathbf{k})$ denotes the actual output signal; $\mathbf{y}_n(\mathbf{k})$ represents output signal identified based on the BP network; \mathbf{w}_{ij} represents the weight of the interlayer. BP algorithm generally includes forward propagation and reverse propagation, the latter mainly adjusts the weight between the interlayers, as shown in Figure 3 below.

To verify the performance of BP network identification, select a hydropower unit, the parameters are shown in Table 1 below. Under different working conditions, the dynamic process for 10% perturbation is identified. The target error results are shown in Figure 4, the identification results are shown in Figure 5.

Tab.1. Parameter selection

Parameter	Values
Turbine model	HL 220
Rated head	68m
Rated speed	300 r / min
Rated flow	33 m ³ /s
Nominal output	17.5WM

The unit of inertial time constant	8.72s
The relay inertial time constant	0.1s
Number of hidden nodes	15 and 25
The number of iterations	400

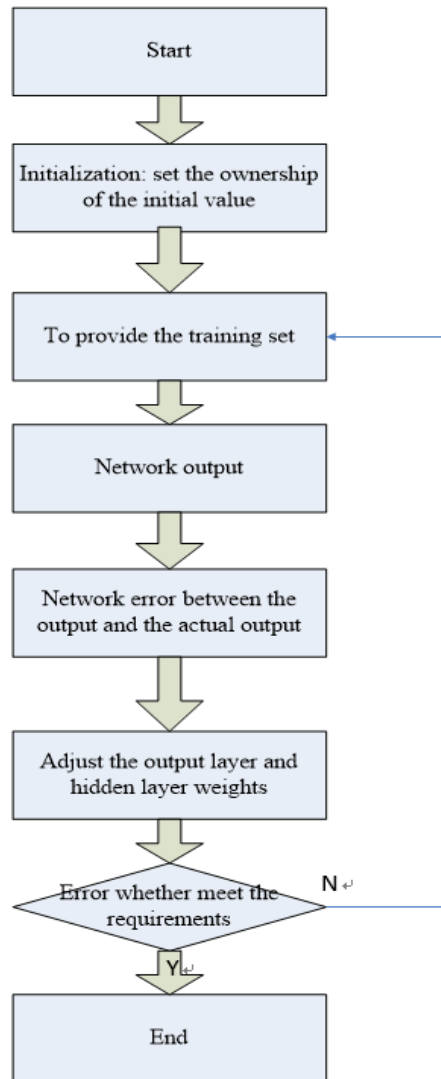

Fig.3. BP network learning steps

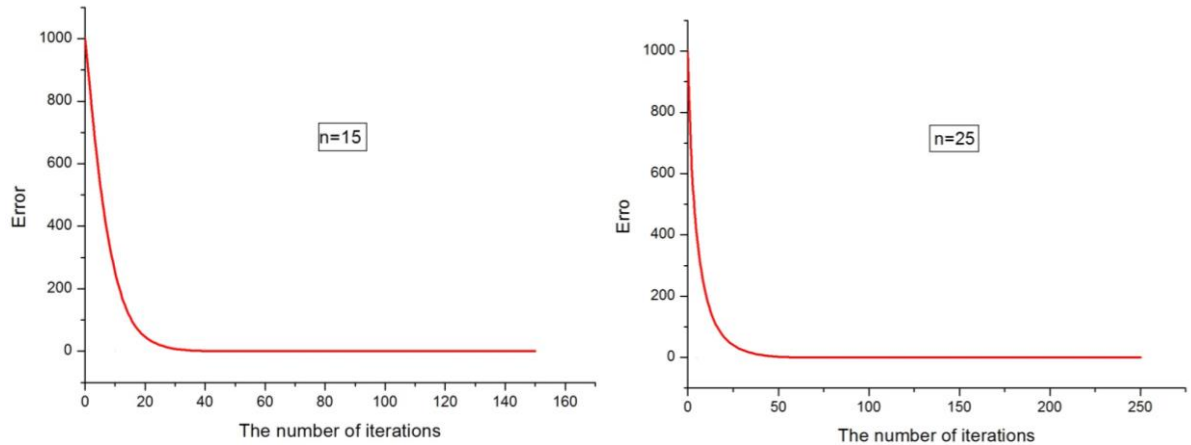

Fig.4. BP network training error changes

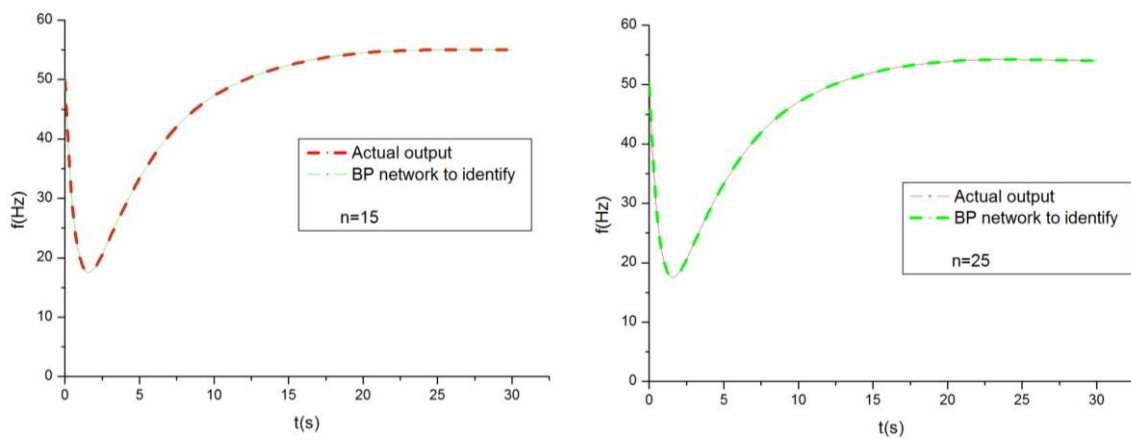
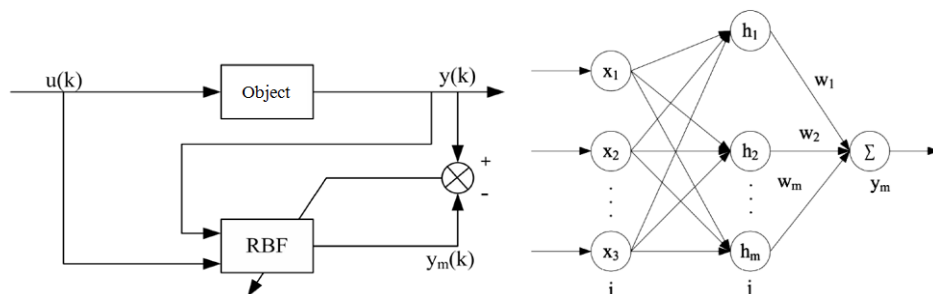

Fig.5. Frequency interference 10% changes in BP network to identify the results

It can be seen from the above two figures, the number of hidden nodes is lesser, the convergence time and the number of iterations of the BP network get much less ($n = 15$, the number of iterations is 150 times; $n = 25$, the number of iterations is 250 times), however the error is relatively large during the identification.



(a) RBF Network identification (b) Used for identification of RBF network

Fig.6. RBF network identification of structure

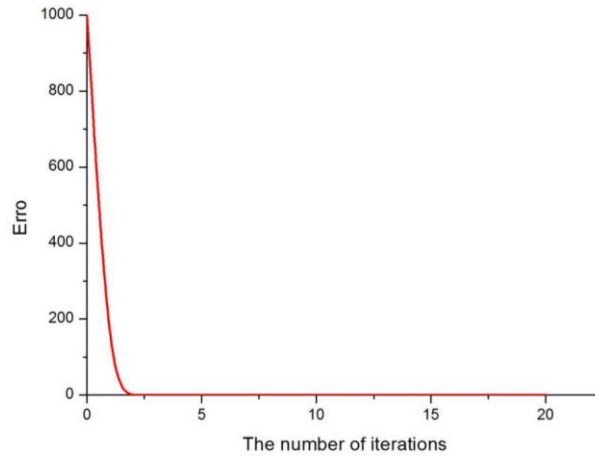

Fig.7. RBF network training error changes

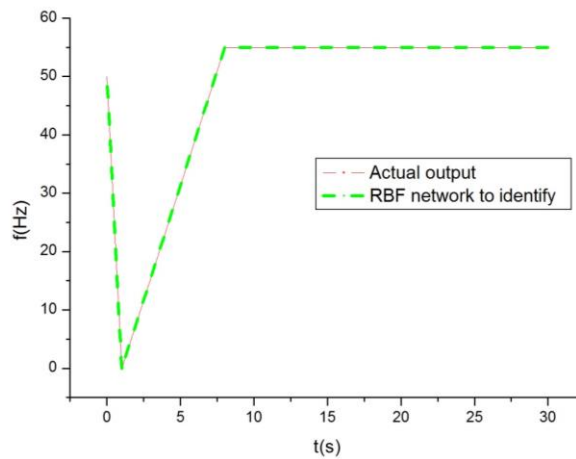

Fig.8. Frequency interference 10% changes in RBF network to identify the results

RBF network design process differs from the BP. On the RBF network, A center coordinate vector and the width of Gauss function must be set in order to determine link weight between the hidden layer and output layer [11]. As compared with Fig. 7, Fig. 8 and Fig. 5 and Fig. 6, it can be found that RBF network identification is made more accurate. As a local approximation neural network, RBF network identification can greatly improve iterative efficiency for hydropower units and avoid sluggish phenomenon of global approximation convergence.

4. Probe into Intelligent Control

4.1 Neural Network Optimization Parameters

Now the traditional PID control technique is widely used in small and medium-sized hydropower units, which hardly adapts to diversified conditions with low control precision and

poor covariant. In the paper, a neural network algorithm is integrated into the controller RBF-PID in control structure as shown in Fig. 9. RBF-PID can dynamically change the traditional PID parameters based on the information timely provided by the RBF network to accomplish optimization of the controller [12].

When the frequency interference of given generator system is 8%, the simulation experiment compares to the control effects of RBF-PID and PID. The parameters in simulation experiment are shown in Table 2. The control effect is shown in Fig. 10. As can be seen from the Fig., RBF-PID controller can restore smooth and steady operation within a shorter time.

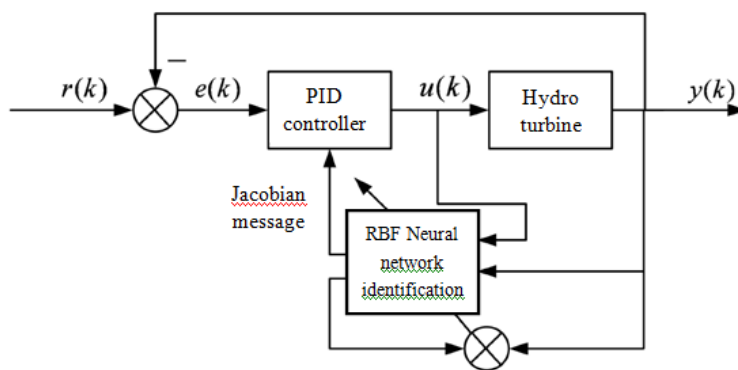

Fig.9. RBF - PID controller design

Tab.2. The simulation experiment parameters

Parameter	Value
PID initial value	[3,0.005,1]
Learning factors of initial value	[0.6,0.5,0.1]
Neurons in hidden layer nodes	5

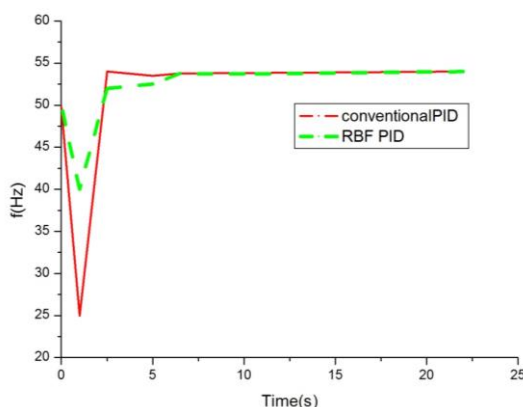

Fig.10. RBF - PID compared with PID control effect

4.2 Probe into intelligent control of hydropower unit

Fuzzy control does not need dependence on the precise mathematical model of system and accurate system information. At this time, when the control system is hardly expressed using mathematical model, the fuzzy control is superior to the others. Fuzzy control captures the signal from the fuzzy to clear based on fuzzy control rule and control mechanism, the relevant control rule is shown in Table 3 below.

The operating modes may be switched repeatedly during the operation of generator system. The working conditions are subjected to change [13]. Now Fuzzy control is introduced to improve the fuzzy control rules of parameters $\Delta K_p, \Delta K_i, \Delta K_d$. The following results are deduced from the errors occurred when the generator system operates, its gradient and PID parameters:

- (1) When the error gets higher, the initial PID parameter K_p may increase. This coincides with normal demand for system adjustment;
- (2) When the error shows moderate, the initial PID parameter K_p diminishes accordingly, whereas K_i, K_d may increase. This coincides with normal demand for system adjustment;
- (3) When the error is lower, the initial PID parameters K_p, K_i go up accordingly, whereas K_d may down. This coincides with normal demand for system adjustment;

Tab.3. The basic fuzzy control rules

	NB	NS	ZE	PS	PB
NB	NB	NB	NS	NS	ZE
NS	NB	NS	NS	ZE	PS
ZE	NS	NS	ZE	PS	PS
PS	NS	ZE	PS	PS	PB
PB	ZE	PS	PS	PB	PB

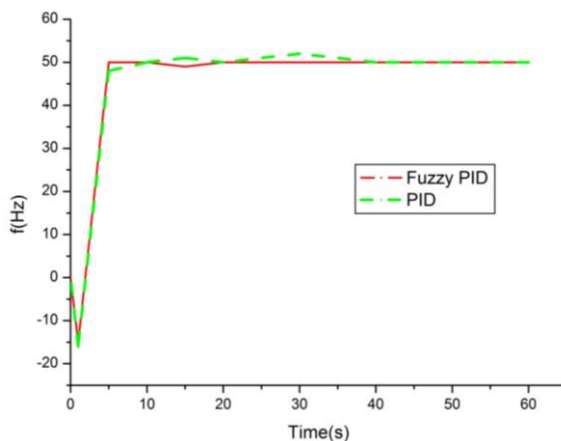

Fig.11. Conventional PID and Fuzzy PID

Simulation results are shown in Fig. 11. As can be seen from the Fig, Fuzzy PID control can adapt to control adjustment under multiple conditions and in variable states by modifying the rules for fuzzy control parameters. Then the adjustment speed also increased in the case that the stability is ensured. We think that the PID controller added in fuzzy inference features a high adjustment rate and good stability, whose control effect is superior to that of conventional PID control when the control object is subjected to intense perturbation.

Conclusion

This paper explores the application of the intelligent control theory based on the fuzzy control theory and the neural network theory in terms of identification and optimization of control parameters on the hydropower unit, from which the results and related conclusions are derived as below:

(1) The mathematical model of hydropower unit is analyzed, and the mathematical expressions are created for every hardware and software respectively. The overall model of servo system is obtained for linear combination of each mathematical model, which lays a theoretical foundation for model identification of hydropower unit.

(2) The BPF and RBF networks are adopted to have a contrastive analysis from the design network structure to identification simulations, respectively. It is considered that the analysis processes of both are roughly consistent. The RBF network, as a local approximation neural network, can improve the iterative efficiency, speed up the analysis and identification, and avoid sluggish phenomenon of the global approximation convergence.

(3) On the basis of RBF network, PID controller is optimized for fuzzy control rules. The optimization and simulation results show that fuzzy PID control is adaptable to multiple conditions, variable states with fast adjustment, which not only ensures the stability of the system, but also improves the speed at which it tends to be stable.

References

1. N. Kishor, Zero-order TS fuzzy model to predict hydro turbine speed in closed loop operation, 2008, *Applied Soft Computing*, vol. 8, no. 2, pp. 1074-1084.
2. M. Lown, E. Swidenbank, B.W. Hogg, Adaptive fuzzy logic control of a turbine generator system, 2002, *Transactions on Energy Conversion*, vol. 12, no. 4, pp. 394-399.

3. I. Salhi, S. Doubabi, N. Essounbouli, A. Hamzaoui, Application of multi-model control with fuzzy switching to a micro hydro-electrical power plant, 2010, *Renewable Energy*, vol. 35, no. 9, pp. 2071-2079.
4. M.B. Djukanovic, M.S. Calovic, B.V. Vesovic, D.J. Sobajic, Neuro-fuzzy controller of low head hydropower plants using adaptive-network based fuzzy inference system, 1997, *IEEE Transactions on Energy Conversion*, vol. 12, no. 4, pp. 375-381.
5. K. Nagode, I. Škrjanc, Modelling and internal fuzzy model power control of a Francis water turbine, 2014, *Energies*, vol. 7, no. 2, pp. 874-889.
6. W. Guo, J. Yang, W. Yang, J. Chen, Y. Teng, Regulation quality for frequency response of turbine regulating system of isolated hydroelectric power plant with surge tank, 2015, *International Journal of Electrical Power & Energy Systems*, vol. 73, pp. 528-538.
7. M.B. Djukanovic, D.M. Dobrijevic, M.S. Calovic, M. Novicevic, D.J. Sobajic, Coordinated stabilizing control for the exciter and governor loops using fuzzy set theory and neural nets, 1997, *International Journal of Electrical Power and Energy Systems*, vol. 19, no. 8, pp. 489-499.
8. H. Mohamad, H. Mokhlis, A.H.A. Bakar, H.W. Ping, A review on islanding operation and control for distribution network connected with small hydro power plant, 2011, *Renewable & Sustainable Energy Reviews*, vol. 15, no. 8, pp. 3952-3962.
9. Z. Chen, Y. Yuan, X. Yuan, Y. Huang, X. Li, W. Li, Application of multi-objective controller to optimal tuning of PID gains for a hydraulic turbine regulating system using adaptive grid particle swarm optimization, 2015, *Isa Transactions*, vol. 56, pp. 173-187.
10. A.J. Chipperfield, B. Bica, P.J. Fleming, Fuzzy scheduling control of a gas turbine aero-engine: a multiobjective approach, 2002, *Transactions on Industrial Electronics*, vol. 49, no. 3, pp. 536-548.
11. C. Deters, H.K. Lam, E.L. Secco, H.A. Würdemann, L.D. Seneviratne, K. Althoefer, Accurate bolt tightening using model-free fuzzy control for wind turbine hub bearing assembly, 2015, *Transactions on Control Systems Technology*, vol. 23, no. 1, pp. 1-12.
12. A. Demiroren, E. Yesil, Automatic generation control with fuzzy logic controllers in the power system including smes units, 2004, *International Journal of Electrical Power & Energy Systems*, vol. 26, no. 4, pp. 291-305.
13. B. Han, L. Zhou, F. Yang, Z. Xiang, Individual pitch controller based on fuzzy logic control for wind turbine load mitigation, 2016, *IET Renewable Power Generation*, vol. 10, no. 5, pp. 687-693.