



An Architectural Design for Brokered Collaborative Content Delivery System*

Mikael Fernandus Simalango¹, Sangyoon Oh^{†2}

(^{1,2}WISE Research Lab, Ajou University, Suwon, South Korea)

(²School of Information and Communication Engineering, Ajou University, Suwon, South Korea)

[†]E-mail: syoh@ajou.ac.kr

Received xxxxx, 2010; Revision accepted xxxxx, 2010; Crosschecked xxxxx, 2010

Abstract: Advances in web technologies have driven massive content uploads and requests that can be identified by the increased usage of multimedia web and social web services. This situation enforces the content providers to scale their infrastructure in order to cope with the extra provisioning of network traffic, storage and other resources. Since the complexity and cost factors in scaling the infrastructure exist, we propose a novel solution for providing and delivering contents to clients by introducing a brokered collaborative content delivery system. The architectural design of this system leverages content redundancy and content distribution mechanisms in other content providers to deliver contents to the clients. With the recent emergence of cloud computing, we show that this system can also be adopted to run on the cloud. In this paper, we focus on a brokering scheme to mediate user requests to the most appropriate content provider based on a ranking system. The architecture provides a novel Global Rank Value (GRV) concept in estimating content provider capability and transforming the QoS requirement of a content request. A fairness model that will bring this design to be attractive to the current content delivery regime is also introduced. Through simulation, we show that using fair provider selection, contents can be provisioned by a better pool of qualified providers thus leveraging the collaboration and preventing potential QoS violation that may occur when the size of pool is smaller.

Keywords: Heterogeneous networks, content delivery, QoS provisioning, ranking system, fairness

doi: xxxxxxxxxxxx

Document code: A

CLC number: TPxxx

1 Introduction

These recent years, the web has been transformed to become more social as represented by the growth of social networking web applications and platforms like Facebook and Twitter. In such application platforms, users post and share contents, links and resources with other users. Contents are stored on provider's infrastructure and then become accessible to the provider's users.

We categorize accessible contents into two types: cold content and hot content. A hot content is a content that is more frequently accessed while cold content is accessed less frequently. How the content is categorized as a hot or cold content depends on the workload distribution of content requests across the server, which normally follows Zipf distribution (Qiu *et al.*, 2001; Adamics and Huberman, 2002). Based on the workload pattern, a certain percentage of content with higher number of requests can be considered hot and some percentage of content with lower number of requests can be considered cold. Hot and cold contents are also handled in different ways. Hot contents are often cached or replicated at

* This research was supported by the MKE(The Ministry of Knowledge Economy), Korea, under the ITRC(Information Technology Research Center) support program supervised by the NIPA(National IT Industry Promotion Agency (NIPA-2010-(C1090-1021-0011))

* This paper was completed with Ajou university research fellowship of 2010(S-2010-G0001-00054)

some other servers (Davison, 2001; Sivasubramanian *et al.*, 2004) so that when there is a spike of requests, such contents can still be retrieved from the cache in order to reduce the performance penalty caused by the long queue. Caching and replication are of less benefit to be applied on cold contents. However, they will not be deleted immediately in order to fulfill future requests. Consequently, they just fill up the disks without being accessed frequently.

1.1 Harnessing Redundancy at the Content Provider

One of the issues in the heavily user-centric social web are storing the abundant contents and loading them upon requests. Let us take an example from the Facebook case again. According to data published by the company (Facebook, 2009), there are approximately 10 million videos uploaded each month. By assuming each video has a size of 5 mega bytes, roughly 50 additional terabytes of storage is required each month, indicating the necessity of a well-planned architectural design of the storage system.

Considering the magnitude of monthly uploads, it is not an absurd idea to consider that there can be replications of contents in the storage system. Combined with other content or multimedia services offered by the platform, user created content (UCC) will enlarge the size of the storage. When there is another platform or some coexisting social platforms, we will have more possibilities in spotting similarities or even exactness of contents stored. This situation is rephrased as content redundancy.

In a content distribution network (CDN), replication of contents is intended, mainly targeted to improve the content delivery time besides improving the overall quality of con-

tent delivery. Similarly, a collaborative content delivery system is developed to benefit from the network infrastructure and the algorithms implemented by partner content providers in delivering contents to their clients. However, one prominent issue in establishing a collaborative content delivery system is to show that such scheme also provides benefit to the participating providers in the collaboration besides the benefit reaped from the users subscribed to each provider's services.

We argue that a multi-party agreement between a content provider and external partner content providers can be enacted in order to regulate the per-transaction content provisioning cost that is a crucial issue in establishing a multi-party collaboration. With the availability of such agreement, a collaborative content delivery system will be realized as a system that enables users to automatically retrieve contents from a list of content provider networks. By creating a proper provider selection mechanism, the federated content delivery system can also be expected to satisfy SLA required by users.

1.2 A Perspective of Cross-Network Load Balancing in the Cloud

Many efforts have been made to maintain the quality of contents served to the users by deploying the load balancing mechanism. They are aimed to preserve the Quality of Service (QoS) experienced by the users during the content delivery besides prolonging the health of the network providing the content. Load balancing addresses this problem by distributing the load to spare nodes or peers thus enabling requests to be handled more evenly.

The scope of load balancing is normally internal, spanning over the same network where the infrastructure belongs to the same entity. This situation enables flexibility in ar-

chitecting the overall load balancing and traffic distribution scheme. With the introduction of grid computing paradigm a decade ago (Foster *et al.*, 2001) and the recent emergence of cloud computing (Foster *et al.*, 2008), however, load balancing has been expanded into a way of distributing workload over heterogeneous networks that are distributed regionally and also globally.

In cloud computing specifically, the question about load balancing is expanded to devising a mechanism to balance the loads over the networks of various cloud providers. Emergence of cloud computing has also induced the establishment of several infrastructural cloud providers such as Amazon Web Services¹, Joyent², Rackspace³ and GoGrid⁴. Nevertheless, it has been reported (Dejun *et al.*, 2009; Hill and Humphrey, 2009; Akioka and Muraoka, 2010; Wang and Ng, 2010) that the performance of services provided by a single IaaS (Infrastructure as a Service)-cloud provider was not always stable and showed variability of performance. One characteristics of cloud computing is utility computing whereas cloud user and provider can establish a loose contract for cloud service provisioning. It is then possible to establish contract with several providers at a same time. Since having more alternatives of providers is potential to improve the performance of overall content delivery, it is reasonable that a collaborative content delivery system can also be viewed as an effort to distribute the workload in terms of delivery of content requests across the pool of infrastructural cloud service providers.

Hence, it will be very interesting if we can also address cross-network load balancing both from traditional content delivery network

perspective and IaaS-cloud perspective in order to 1) ensure the provisioning of contents at the expected SLA to users accessing a broker or content portal that acts as the gateway to various content providers, and to 2) provide methods of evaluating the performance of multiple providers and choosing an appropriate service on per-transaction basis based on performance matrix and other consideration.

1.3 Contributions and the Organization of This Paper

Our main contribution is the proposal itself, which is an architectural design for collaborative content delivery system. In this architecture, contents can be fed by several providers located in different networks. The networks are associated with different jurisdiction or authority, and thus the total control and comprehensive information about the networks can not be gained. As a result, we consider that total reliance on a certain provider to serve all the contents to the clients is undesirable. We leverage the role of a broker that manage the federation of several partner content providers that are capable of serving contents to the client. The broker orchestrates provider assessment with minimum intervention by conducting a periodic evaluation of the performance of the providers. Such mechanism is proposed to reduce the possibility of QoS violation in content delivery and also to better reflect the current capability of providers.

In this work, we present a brokering scheme to manage content provider selection based on the QoS parameters-supplied ranking system. We present how to rank a content provider and how a provider is chosen for a content delivery request. We also present the idea of fairness in the collaborative content delivery system. Fairness is our approach to bearing with the economic aspect of imple-

¹ aws.amazon.com

² www.joyent.com

³ www.rackspace.com

⁴ www.gogrid.com

menting this architecture and also to exhibit cross network load balancing.

The rest of this paper is organized as follows. In Section 2, we present the previous work that motivates the development of our architectural design. In Section 3, we describe the architecture of the brokered collaborative content delivery system that enables the delegation of content delivery to partner content providers. Section 4 presents the implementation of this architecture in a simulated environment and how the testbed for real-world implementations can be built. In Section 5, we present the analysis of our proposed architecture. We provide the numerical evaluation and microbenchmark test results of our model. Section 6 shows our vision of the current architecture and our future research direction. Finally, we conclude this paper in Section 7.

2 Related Works

A collaborative content delivery system is built on a foundation of several concepts, which primarily include, content delivery networks, load balancing, service overlay networks and infrastructural cloud services; we will briefly review each of these in this section.

2.1 Content Delivery Networks

There are three eminent content delivery systems on the internet (Saroju *et al.*, 2002): client/server web, content delivery networks (CDNs), and peer-to-peer file sharing systems. In client/server web, users through web clients (e.g.: browsers) request contents from web servers using the HTTP protocol. The requested contents will be provided by the servers after completing some processing or simply retrieved from cache. In a P2P system, content requests are satisfied by peers in a collaborated distributed system. Content delivery networks

(sometimes also called content distribution networks) (Khrishnamurthy *et al.*, 2001) are dedicated collections of servers located on the internet. These servers attempt to offload work from origin servers by delivering content on their behalf.

The servers in a CDN may be located at the same site as the origin server or at different locations on the internet. Some algorithms have been proposed to assign content delivery to certain contact point of a CDN, mainly leveraging the idea of network coordinates (Ball and Pietzuch, 2008; Ng and Zhang, 2002; Almeida *et al.*, 2004). CDN infrastructure can be owned by another entity outside the content provider. This is possible through the contract enactment between the content provider and the CDN owner in order to utilize the infrastructure.

Currently there exist various implementations of CDN ranging from commercial ones such as Akamai⁵ to free, academic-inclined CDNs particularly CoralCDN⁶ and CoDeeN⁷. We will briefly discuss about the last two in the following section.

2.1.1 CoralCDN

CoralCDN (Freedman *et al.*, 2004) is a peer-to-peer content distribution network that leverages DNS redirection through the mechanism of URL modification in delegating content delivery from a portal, which in CoralCDN term is referred to as publisher, to the CDN. A modified or “coralized” URL is prefixed by the portal identifier taken from its domain name and followed by the domain name of CoralCDN provider.

A client request containing a coralized URL will be resolved by one or some DNS

⁵ www.akamai.com

⁶ www.coralcdn.org

⁷ codeen.cs.princeton.edu

servers registered under the CoralCDN domain name. If a record of the publisher domain exists in a DNS server, it will try to find the closest HTTP proxy to the client and then redirect client to that proxy. If the proxy is caching the content locally, it will return the content directly to the client. Otherwise, it will look up its index to find other cooperative proxies storing the content.

The indexing layer is built by using DSHT (Distributed Sloppy Hash Table) abstraction. This abstraction serves several purposes that include finding Coral DNS servers close to client's networks, finding HTTP proxies caching particular object and locating nearby Coral nodes. A record in DSHT is a key-value pair whereas unlike traditional DHT with single key-value pairs, one key in DSHT may have multiple values.

A node ID in CoralCDN is given the same address space with the key. A routing table exists for every DSHT. This table enables the traversal to find nodes closer to a certain key k . The nearby nodes caches key/value pairs to the key being referenced thus reducing hot-spot congestion when requests to a key increase dramatically.

To improve routing and data placement, CoralCDN uses several levels of DSHTs called clusters. The implementation applies three levels of clusters namely level-0 or global, level-1 or regional, and level-2 or local. For each level, nodes assigned in the same cluster will have the same cluster ID. Whenever possible, CoralCDN will try to find a local (level-2) node(s) that can satisfy a request to key k in order to reduce content delivery time to client.

Even though it was originally designed to handle flash crowds, a term to describe the phenomenon of temporary load spikes in an underprovisioned content server, five-year

usage analysis of CoralCDN shows that it is also used to serve long-term popular content and unpopular content (Freedman, 2010).

2.1.2 CoDeeN

CoDeeN (Wang *et al.*, 2004) is an academic testbed for CDN built on top of PlanetLab⁸ global research network. The CoDeeN CDN is principally a chain of proxies distributed geographically according to the distribution of PlanetLab nodes. These proxies run in either forward-mode (forward proxies) or reverse-mode (reverse proxies). A proxy is said to be working on forward mode when it intercepts direct client-server communication by handling the requests on behalf of clients to the destination servers. On the other hand, a reverse proxy works by providing responses on behalf of the provisioning servers to the clients.

To use CoDeeN, a user should manually configure its browser to delegate requests to a proxy of choice. The choice is naturally made upon the closeness of estimated network distance between user and the proxy. When a user invokes a request through the browser as the client, the proxy will try to satisfy this request locally. However, when cache miss occurs, which means that the requested content is not locally available, the redirector component in the forward proxy will redirect the request into another proxy, which acts as a reverse proxy for the origin servers. For most requests, the redirector considers request locality, system load, reliability, and proximity when selecting another CoDeeN proxy node.

CoDeeN nodes leverage CoDNS (Park *et al.*, 2004) for name lookups. CoDNS is a method and tool for resolving name lookup queries through the incorporation of cooperative nodes or peer nodes. Normally, a node will query name lookup to its local name servers.

⁸ www.planet-lab.org

However, when the performance of local name servers degrades, it can forward the query to peer nodes. The peer nodes resolve name lookups to different name servers with that of the querying node. Some criteria are determined as the basis of peer-node selection, which include proximity, locality and availability.

2.2 Load Balancing Schemes

A load balancing scheme mainly aims to maintain the performance of a system under a heavy load condition by distributing the load to several processing nodes. The nodes can take forms as memory, CPUs, servers, network links and other resources. Referring to the 7-layer OSI model, load balancing is usually conducted in the network layer (layer 3) and application layer (layer 7).

Load balancing in the network layer mainly focuses on routing the packets over the network so that a traffic unbalance at a certain edge of the network is mitigated. Various techniques and several algorithms have been proposed and implemented (Bahi *et al.*, 2005; Martin *et al.*, 2007; Kleinberg *et al.*, 2001). These efforts mainly emphasize on balancing the traffic according to the dynamics of the network.

In the application layer, load balancing is achieved through the involvement of middleware or load manager that distributes the load to the processing nodes. Based on their creation, load balancing mechanisms are categorized into autonomous, semi autonomous and manual. In the first category, the scheme generally aims at automatically planning and executing load distribution strategies through the incorporation of a middleware. An example of this scheme is Cygnus (Balasubramanian *et al.*, 2004), a middleware framework capable of making load balancing decisions based on ap-

plication-defined metrics and dynamically configuring load balancing strategies at run time. For the second category, various approaches exist but they generally involves configurable admission control (Sharifian *et al.*, 2008; Huang and Fang, 2004; Xu *et al.*, 2004; Zhang and Fan, 2008).

In the third category, the load balancing scheme is conducted manually by a network administrator. This scheme usually involves manual configuration of DNS server redirection for handling upcoming requests. Compared to the other two, the latter scheme is more primitive, not resilient to the sudden changes of network traffic, making it inappropriate to be deployed in a dynamic network.

2.3 Service Overlay Networks

Service Overlay Network or SON (Duan *et al.*, 2003; Tran, 2005) is a new concept in ensuring end-to-end QoS assurance. SON is an application-layer network built on top of the traditional IP-layer networks. The concept of SON is illustrated in Fig. 1. In the figure, an access network where a service can be requested or provisioned is connected to another access network at another end via multiple routes. These routes represent an overlay of the several networks that operate under different authorities.

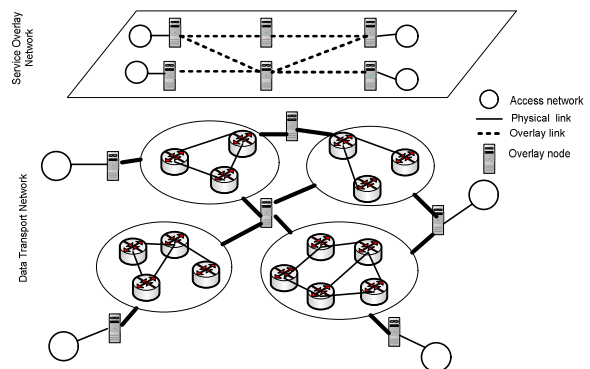

Fig. 1. The concept of SON

The entity that operates the SON, hence a SON operator, buys bandwidth from underlying network domains with certain QoS guarantees from each of the network domains. A bilateral service level agreement (SLA) is formally enacted to state the SON operator request and commitment to provisioning from a network owner. The underlying networks will ensure that the SON operator is able to provide end-to-end value-added QoS sensitive services such as VoIP and Video-on-Demand to its users.

To create an efficient route over the underlying networks, the SON operator puts gateways or overlay nodes between two underlying networks that act as a manager to requests' routing from one access network to another. The authors in (Duan *et al.*, 2003) also describe a mechanism for static bandwidth provisioning for overlay networks and a penalty system if the SON operator overutilizes the bandwidth.

Another view of SON (Peterson, 2003) suggests that an overlay node be placed in the underlying network instead of being separately provisioned by the SON operator as a gateway to the network. An overlay node should also be capable of provisioning a service and possess capabilities to multiplex multiple services by properly allocating and scheduling slices of the node's processor, network and storage resources. Each service will have its own overlay management running on its own slices. However, a shared management over all overlay nodes is also suggested to ease the topology probing of the overlay networks.

2.4 Infrastructural Cloud Services

Cloud computing is an emerging computing paradigm that attracts growing interest from researchers (Rimal *et al.*, 2009; Birman *et al.*, 2009; Foster *et al.*, 2008). This paradigm

enables computation on demand by utilizing compute resources that are provided as services. In cloud computing, users may not need to have knowledge or expertise in, or control over the technology stack in the cloud. This is since they can rent the cloud services offered by the providers and pay on usage basis. With such feature, cloud users are more flexible in planning their budget for initial deployment and further scaling.

Services in cloud computing follows layered architecture of the cloud. Generally, a cloud is built upon three layers; Infrastructure as a Service (IaaS) layer that is stacked at the lowest level, Platform as a Service (PaaS) that comes at the intermediary level, and Software as a Service (SaaS) that overlays all the underlying cloud services. Each layer also corresponds to varying degree of control over resources and management effort from its user. An IaaS user affords more control over resources but requires more management effort. Correspondingly, an SaaS user spends less management effort but have less control over the resources. Given a cloud service provider, it may provide all or one type of cloud services to the users.

IaaS is a service for utilizing compute cycles, CPUs, I/Os, storage, and network that are assembled on top of virtualization of the physical resources. This set of virtualized resources is executed as a virtual machine (VM). A VM provides the environment for one or several applications to run, including an operating system.

In the legacy server, physical hardware and OS with applications are tightly coupled. In contrast, resources in a virtualized system are already abstracted thus reducing the coupling between hardware and OS with applications. As a result, a VM can be instantiated, suspended, terminated, cloned, migrated, and

deleted. If a VM management service is operated by an infrastructural cloud service provider, it can provide dynamic VM instantiation and execution. Reflecting this into content delivery realm, a proxy that is representable as a VM can be dynamically activated or deactivated depending on the workload content requests.

3 QoS-aware Collaborative Content Delivery System

To achieve and maintain high performance regardless of the workload dynamics, the workloads should be properly distributed by routing clients to nodes that can satisfy the client requirements. In a CDN, there can be several candidate nodes that can satisfy a unique request. However, network oscillation, stricter QoS requirements, content unavailability and other factors can also prevent any node from satisfying a request. This incites the idea of building a collaborative content delivery system that involves several CDNs or content provider networks (CPNs) that are managed by different authorities. A CPN is a superset of a CDN. It can be a pure CDN provider catering to multiple subscribers or a content service having its own dedicated network. Questions following this idea include the architecture of such system, level of collaboration or federation and the feasibility and benefit of its implementation in real world scenario.

We are interested in exploiting end users' QoS requirements in building the architecture. We define QoS as service quality that is characterized by several attributes or parameters with each having either ordinal or interval value. We then define measurable QoS as quantifiable service quality whose attributes or parameters are of interval values and can be measured through certain mechanism or tool

and obtained either instantly or after certain period of time. The architecture should leverage QoS levels supported by each provider network when deciding how client requests will be satisfied. Each client pertains to a minimum QoS requirement that can be met by one or several providers.

To embrace the economic aspect, which is content revenue sharing, and implement cross network load balancing to anticipate SLA violation, a fairness model is also proposed in order to route clients to one of the qualified providers instead of always to the highest rank provider.

3.1 Brokering in a Collaborative Content Delivery System

The existence of various CDNs and CPNs with each having its own architecture may bring the question about the feasibility and complexity of integrating the systems to form a collaborative content delivery system. While we believe that a deeper integration of incumbent CDNs and CPNs by creating a perfect overlay is possible, such integration will not proceed in an easy path. Besides the technological challenge, deep integration is susceptible to conflicts of interests among collaborators, which may make such collaborative system unconvincing. We are then inclined to incorporate a brokering system in the design of a collaborative content delivery system.

A broker is a mediator between users represented by clients and an array of content providers. At the same time, the broker can also be the provider of some contents. The broker accepts a client request and determines if the request can be satisfied locally or should be forwarded to its partner content providers. A content indexing layer is maintained by the broker so that it can decide how to satisfy a content request. When it determines that con-

tent can only be provisioned by partner content providers, it runs its algorithm of content provider selection and reroutes the client to the gateway of selected content provider. More detailed discussion about the broker architecture, network topology and content provider selection mechanism is elaborated in the subsequent parts of this section.

Taking current content delivery realm to reflect the proposed system, a broker can be represented as a portal. The portal has its user base that uses various services including content download or streaming offered by the portal. Establishing a collaborative content delivery system is beneficial for the portal especially when 1) it runs a subscription model where some classes of users are defined based on their subscription type, 2) its infrastructure is underprovisioned for occasional bursty traffic but scaling horizontally by adding new nodes may not be an efficient solution, or 3) the cost of utilizing third party content delivery service is comparable with the cost of self-fulfilling the content request.

As implied, a broker in this work is an entity run by an authority that is independent of those of the content providers and capable of mediating the heterogeneous services. We then refer to this type of brokering as a hard brokering. This is different with soft brokering that integrates services under various providers through a common communication bus and equips itself with autonomic self-managing capability. We choose a hard brokering design since we project this type of brokering to involve less modification at the partner content providers' side thus making the design more viable to be implemented in a real deployment.

3.2 The Network Topology of a Brokered Collaborative Content Delivery System

The network of a brokered collaborative content delivery system consists of the broker network combined with several content provider networks. A content provider network (CPN) can be a network of a pure CDN provider catering to multiple subscribers or a content service having its own dedicated network. We explain each part of the networks and describe how to create an overlay network from these heterogeneous networks.

A CDN provides users with better convenience upon accepting content, either by downloading or streaming, from the content servers managed by the CDN. The key concept to improve the user experience is by establishing distributed replica catalogs. These catalogs store caches or replicated contents locally. They are connected to each other through high speed networks that enable quick replication from central servers. The geographical view of a content provider network can be seen in Fig. 2.

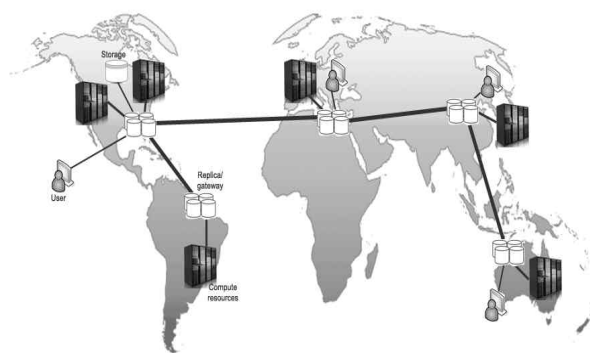

Fig. 2. Geographical view of a content provider network

When a user located near a replica catalog invokes a content request, the gateway or managerial node in the replica will handle content provisioning to the users by trying to find the content locally whenever possible. Hence, content retrieval can be made possible without grabbing from the central replica catalog. Techniques in retrieving contents from the content servers can be based on distributed hash table (Balakrishnan *et al.*, 2003), multi-

cast tree, Data Grid (Venugopal *et al.*, 2006), or other variants.

A CDN provider caters to a number of CDN users that we refer to as subscribers. The users can be individuals or entities. However, in this article, we specifically use the term “subscriber” to refer to the entity subscriber. In the case of the use of a commercial CDN provider, a contract is traditionally established between a subscriber and a provider. This contract expresses Service Level Agreement (SLA) that can be supported by the provider in exchange of compensation provided by the subscriber. Upon the establishment of the contract, the subscriber is granted access to utilize the infrastructure owned by the CDN provider by providing a means and method to host contents owned by the subscriber. The subscriber lets the provider manage the distribution of the contents in the replica catalog and delivery of the contents to the users of the subscriber.

Nevertheless, in the proposed collaborative content delivery system, we use the term content provider network (CPN) instead of CDN to reflect the network of a partner content provider. This is since we do not restrict to specific types of networks that can build such system. In the following discussion, we show how our proposed system can also be constructed by leveraging emerging cloud computing paradigm.

With the advent of cloud computing, big enterprises that host infrastructure worldwide can also offer the utilization of their infrastructure (Simalango and Oh, 2009b) as a service. This translates into the possibility of on demand utilization of infrastructure. The concept of collaborative content providers can then be applied to a number of Infrastructure-as-a-Service (IaaS) providers that also provide management platforms for virtual

machine instances. Such type of IaaS providers represent the array of content providers as previously shown in Fig. 2. By having the management platform, each IaaS provider is capable of managing where and how content is stored and retrieved on the network.

Different with a traditional CDN provider that guarantees SLA to its subscribers, QoS assurance is a challenge in a cloud-based collaborative content delivery system. Besides the opaque view of the IaaS provider’s network from its tenant perspective, virtualization issues (Akioka and Muraoka, 2010; Hill and Humphrey, 2009; Wang and Ng, 2010) and multitenancy of the IaaS provider’s infrastructure also contribute to the performance oscillation of requests provisioned by the network. Total reliance to a single IaaS provider’s network is reasonable to be avoided. In doing so, the portal may utilize several IaaS providers at once. This option is feasible since cost is incurred on utilization basis so that redundancy of content networks is not costly compared to traditional infrastructural-cost basis.

3.2.1 Overlay Content Network

We introduce the concept of overlay content network (OCN) to represent the network topology of the brokered collaborative content delivery system. This concept is visualized in Fig. 3 and is inspired from the SON concept. This concept also has some similarities with that of in Grido (Das *et al.*, 2005), especially in terms of using virtual coordinate to map the overlay node.

In the figure, there are several content providers at the lateral collaborative network. Each of the content provider networks is connected to the broker or portal through a facet or gateway. This gateway will manage how a content request is provisioned in its network.

The portal or broker maintains the list of contents retrievable from the partner provider networks and contents that it can satisfy locally. When a client asks a broker for content, the broker will search its content index. If it finds that the content request should be satisfied by a partner content provider, it will select a provider and contact the gateway of the provider network. The broker provides information about the client invoking the request that includes IP address of the client and the latency between client and broker. The gateway should determine which node in its network delivers the content to the client.

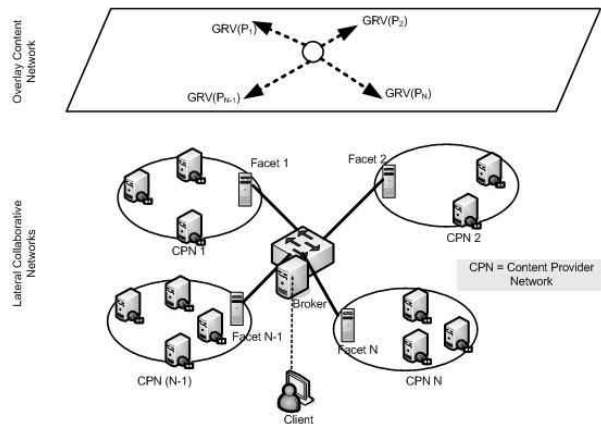

Fig. 3. The concept of Overlay Content Network

Lateral collaborative networks are transformed into the overlay content network plane as follows. The broker is located at the center of the plane and arrows with various lengths are connected to the center point as their pivot. The length of each arrow corresponds to the GRV (Global Rank Value) of respective provider. A provider GRV is calculated by the broker from series of QoS measures collected during a certain time interval. It shows generic capability of a provider in satisfying request requirement and implies the tendency of a content provider to be selected in a content request. The longer the arrow is, the bigger GRV a content provider will be, indicating higher tendency to be selected in a content delivery transaction.

A content request from a client can be mapped to a GRV value and hence another arrow in the overlay content network plane. For all arrows in the plane, we use their lengths as the radii and then form a circle. This is illustrated in Fig. 3. In the figure, we can notice that GRV arrow for the client request, which is $GRV(U_1)$, forms a bigger circle than the one formed by provider 2 arrow [$GRV(P_2)$]. This circle, however, is smaller than those formed by GRV arrows of provider 1 [$GRV(P_1)$], provider N-1 [$GRV(P_{N-1})$] and provider N [$GRV(P_N)$].

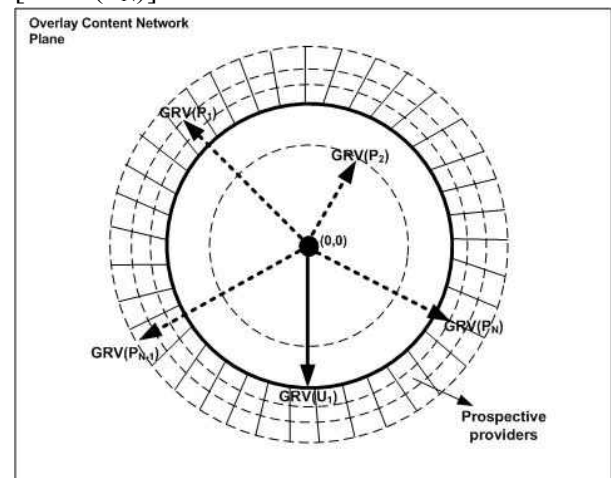

Fig. 4. A bird's-eye view of an OCN Plane

As GRV implies the tendency of a provider to be selected as the provider of a content request, we consider the circular area outside the client request circle as promising area where the request can be satisfied according to SLA requirement. Providers located in this area are then labeled as prospective providers.

Elaborate background of GRV and mechanism for deriving the value is explained in Section 3.5.

3.3 Content Distribution and Delivery Scenarios

Figure 3 illustrates how contents are distributed over the networks; broker and partner content providers. As mentioned previously and shown in Fig. 4, content delivery can be

satisfied by either the broker or partner providers. The broker hosts some portion of contents denoted as content a, b and c, which is usually small in terms of quantity or request volume. The emphasis on small quantity or request volume of the contents is made to bolster the idea of underprovisioned broker that can benefit from collaboration. The remaining portion of contents is hosted by the partner content providers.

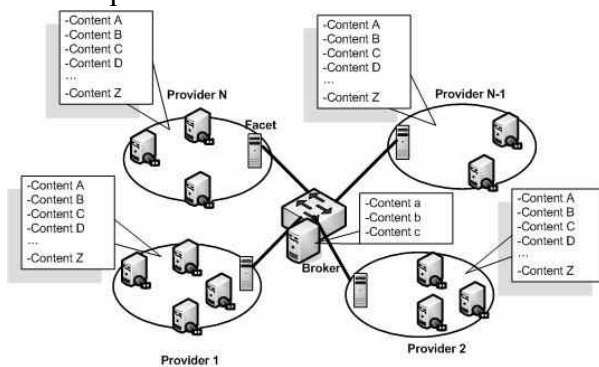

Fig. 5. Content distribution scenario

The broker maintains the list of external contents namely content A,B,...,Z retrievable from the partner content provider networks in its content indexing layer. By analyzing content request pattern, the broker decides if certain content is better served by content provider. As an example, a broker may decide to host popular contents at content provider networks due to the limitation of its capability. For such case, it notifies all the gateways the metadata of the content, which contains information about content origin and checksum, and let the gateways manage the replication of the content in their networks.

The indexing layer contains a hash table with records of content keys and their corresponding values. A key is obtained by hashing a content name using a hash algorithm such as SHA. A key has multiple values that include internal content flag and optional excluded provider index(es). An internal content flag is set to true if the content can be served by the

broker itself. By default this flag is set to false. In a real-world scenario, it is difficult to achieve a perfect content replication as depicted in Fig. 5. Therefore, excluded provider index field can be optionally added to enlist the index of providers in which the content is not available.

Assuming N number of partner content providers in Fig. 5, a content c_i may only be available at k providers, where $k < N$. An algorithm §1 that processes provider selection should filter providers that have content for such request before selecting the provider of the content delivery transaction. In an IaaS-based brokered collaborative content delivery system, however, the scenario of perfect content replication can be achieved. Since we consider IaaS providers as partner content providers of the broker, it can push contents to all instances it runs on the IaaS provider networks and exert total replication over all of them.

3.3.1 QoS Measures to Estimate Provider Capability

We now discuss about how the broker distributes content request to its partner content providers. Since we assume minimal knowledge about the network dynamicity of the partner content providers, distributing content requests requires a non trivial strategy to ensure content delivery meets desired QoS requirements. We propose a mechanism of estimating recent state of the provider by measuring several values of their QoS attributes, processing the values and calculating GRVs of the providers. Having the GRVs, we can then invoke an algorithm to match a content request with one of the prospective providers.

Table 1 summarizes the QoS measurement methods. The methods are grouped based on entity that conducts the QoS measurement,

which we refer to as the QoS referee. Since there are three types of entities in the system, which are client, broker, and partner content provider, there can also be three distinct types of QoS referee.

	QoS referee		
	Client	Broker	Provider
Client type	Thick client	Thick or thin client	Thick or thin client
Measurement methods	Periodic measure during content delivery	Heartbeat message for QoS measurement prior to content delivery, small content request to selected provider, periodic measures to all providers	Self QoS measure based on agreed technique
Advantages	Reflects global provider reliability better	-Requires less modification to network protocol and client side -Easy to implement	-Language agnostic implementation at provider side -Easy to implement
Disadvantages	-Unfair values for congested client networks -Requires add-on at the client side -Incomplete measures for bad providers	QoS measures do not directly map client's perceived values	QoS measures can be biased

Table 1. QoS measurement methods for different types of QoS referees

In the first measurement method, the client is assigned as the QoS referee. During the content delivery transaction, it measures the

parameterized QoS values and sends the aggregate or average values to the broker after the completion of the delivery in order to be subsequently processed. Since clients are distributed geographically, this method reaps the benefit in constructing a better map of provider capability over wider geographical span. However, this method requires the client to be a thick client. This is since the client should pre-process the QoS measures before sending it back to the broker. Another disadvantage is it can not get the QoS measure of a provider that is never selected within a certain time interval. This missing information results in the broker incapable of updating the capability of some providers.

The second measurement method sets the broker as the QoS referee. The broker may exert several approaches to measuring QoS attributes of the providers. Based on the regularity, the approaches can be categorized into periodic measures and ad-hoc measures. The periodic measure approach is conducted by measuring parameterized QoS values from all the providers periodically. Conversely, ad-hoc measure approach tries to obtain the QoS measures from a selected provider for every content delivery transaction or to a random provider whenever necessary. The advantage of ad hoc approach is it can quickly detect service degradation at certain provider. However, similar with client-refereed measurement, the broker-refereed ad hoc approach may suffer from QoS measure imbalance. On the other side, the periodic approach presents balanced QoS measures across all providers. Since the measurement is conducted by the broker, the client can be a thin client. Nevertheless, the notion that the broker is a single entity leads to less accurate mapping of global provider capability. In order to cope with this problem, the broker can provide some thick clients or agents

that are distributed geographically and let the agents conduct the QoS measurement periodically and forward the measures to the broker.

The last scenario, provider-refereed QoS measurement, delegates the QoS measurement to the providers. Each provider may measure the parameterized QoS values while provisioning the content to the client, measure periodically, or using other agreed mechanism. QoS measures from each provider will be then reported to the broker to be processed. The main disadvantage of this method is potential subjectivity to QoS measures by the provider.

Having discussed the possible QoS measurement methods, we decided to use broker-refereed periodic QoS measures in the rest of our design.

3.4 QoS Attributes for Content Delivery

So far we have discussed about the QoS measurement but have not mentioned about QoS attributes or parameters that can be considered in a content delivery. Contents are categorized into static and dynamic contents. Each category pertains to different characteristics, and thus QoS assessment also diverges. It is important to choose QoS parameters that are measurable and appropriate to each category. Some primary parameters that are often used in measuring the content delivery are throughput, latency and bit rate. Other secondary parameters can also be used, depending on the purpose of the content delivery. If QoS parameters are multidimensional, then chosen QoS parameters may have relationships with other parameters. As for example, there can be relationship between throughput and cost of service with waiting time with waiting time. Higher throughput may lead to less waiting time. Correspondingly, more expensive cost of

service may lead to less waiting time (Guo *et al.*, 2008).

In content delivery, performance is a critical issue and is subject to network condition and the states of client and server. Performance can be classified into two different categories: network performance and user-perceived performance (Fielding, 2000). Network performance describes some attributes of communication like throughput, bandwidth and usable bandwidth. User-perceived performance, on the other hand, describes the impact of information flow on the network to the user. Latency and completion time are two sample measures in this category.

Our approach primarily combines the network performance with user-perceived performance. This is since the broker is capable of sensing several network performance metrics and also user-perceived performance metrics. Measuring a user-perceived performance metric can be exemplified by the broker requesting certain content from a provider and then measure the completion time for such request. If the broker acts as the only entity that conducts QoS measures, however, the calculation of global user-perceived performance of a certain provider can be much biased. Using distributed agents to help conduct the measurements may help the broker reduce the disparity between its estimation of such QoS attribute and the mean value of the attribute as sensed by global users.

3.5 Transforming QoSes into Global Ranking

Quantifiable ordinal and measurable interval QoS values are used to determine the Global Rank Values (GRV) of a content provider and successively its global rank among other providers. Given N content providers in the brokered collaborative content delivery

system, rank 1 implies the most reliable content provider, and thus becoming the most preferred one, and rank N refers to the least reliable content provider hence the least preferred one.

GRV of a content provider is a number that reflects the aggregate capability of the content provider to satisfy desired QoS levels required by a user in a content delivery transaction, regardless of users' geographical location. This number is synthesized by a GRV formulation process for provider. On the contrary, GRV of a content request is a number that reflects the QoS level required by user for that request. This number is synthesized by a GRV formulation process for content request. The formulation of GRV for provider and GRV for a content request is also explained in this section.

3.5.1 Formulating GRV of a Content Provider

Let us assume that there are $m > 0$ measurable QoS parameters as seen in Eq. (1).

$$Q = \{q_1, q_2, \dots, q_j, \dots, q_m\} \quad (1)$$

Given a provider P_i , $1 \leq i \leq N$, QoS measures of this provider at time t , where t indicates the QoS measurement starting time, is denoted as

$$Q(P_i) = \{q_1^{P_i}, q_2^{P_i}, \dots, q_j^{P_i}, \dots, q_m^{P_i}\}_t \quad (2)$$

We stated that the broker should measure the QoS of all providers periodically. For every QoS measurement, the provider will obtain N QoS measure sets or $N * m$ values of QoS attributes. Now let us define a time interval ΔT_1 , during which the broker can conduct C_{B-P} -times QoS measurements, which B-P symbolizes Broker-Provider, and obtain $N * C_{B-P}$ QoS measure sets or $N * m * C_{B-P}$ values of QoS attributes. This also means that within the interval, we conduct the measures

for every $T_{measure} = \frac{\Delta T_1}{C_{B-P}}$. As another implication, one-time QoS measure sets of all providers should be collected in a time less than $T_{measure}$.

To calculate the provider GRVs and build their ranks, we can either use one-time measure sets or all QoS measure sets in ΔT_1 . In order to reduce processing overhead at the broker side, we use the aggregate QoS measure sets for the GRV calculation. The term ΔT_1 is therefore referring to the time for updating the GRVs and reranking all providers, hence we can denote the term as $T_{rerank} = \Delta T_1$. Following this expression, we can rewrite $T_{measure}$ as :

$$T_{measure} = \frac{T_{rerank}}{C_{B-P}} \quad (3)$$

QoS attributes in Eq. (1) comprise of values measured in different dimensions. To evaluate these values and use them as the basis of GRV calculation requires the transformation of all the values into a common dimension. This is achievable through normalization. Various methods of data normalization and multicriteria evaluation can be seen in (Ginevicius, 2008). We are interested in adopting data normalization in VIKOR method and modify SAW (Simple Additive Weighting), a multicriteria evaluation technique, to build the GRV. Data normalization in VIKOR is expressed by Eq. (4).

$$\tilde{r}_{xy} = \frac{\max_y r_{xy} - r_{xy}}{\max_y r_{xy} - \min_y r_{xy}}, (0 \leq \tilde{r}_{xy} \leq 1) \quad (4)$$

In Eq. (4), x is a criterion, y is an alternative, r_{xy} denotes the criterion x -th value of y -th alternative and \tilde{r}_{xy} denotes the normalized value of the x -th criterion for the y -th alternative.

Indexes and variables of the base normalization equation Eq. (4) can be explained in the GRV formulation as follows. The criterion x corresponds to QoS attribute index. The alternative y corresponds to the provider index. Variable r_{xy} refers to the provider i -th value of the j -th QoS attribute. Finally, variable \tilde{r}_{xy} refers to the provider i -th normalized value of the j -th QoS attribute. For each QoS attribute q_j , we define the minimum value of the attribute or lower bound L_j and the maximum value or upper bound U_j . We then rewrite Eq. (4) as follows:

$$\tilde{q}_j^{P_i} = \frac{U_j - q_j^{P_i}}{U_j - L_j}, (0 \leq \tilde{q}_j^{P_i} \leq 1) \quad (5)$$

By observing the characteristic of the QoS attributes, we can group them into two based on the interpretation of the value. The first group is “small positive” attributes. Small values of the attribute imply positive or preferred QoS level. Latency, response time, completion time and jitter are examples of QoS attributes under this category. Intuitively, there exists the group of “big positive” attributes. QoS attributes in this group are preferable to have bigger values. Throughput, availability and reliability exemplify the attributes in the group. Referring to Eq. (5), we can notice that it considers all QoS attributes being “big positive”. Since $0 \leq \tilde{q}_j^{P_i} \leq 1$, it is obvious that the normalized value of “small positive” attributes will be $1 - \{\tilde{q}_j^{P_i}\}_{big_positive}$. Adding scaling factor ω into Eq. (5), we can then write the equation as follows:

$$\tilde{q}_j^{P_i} = \begin{cases} \frac{(U_j - q_j^{P_i})\omega}{U_j - L_j}, big_positive(q_j) \\ (1 - \frac{U_j - q_j^{P_i}}{U_j - L_j})\omega, small_positive(q_j) \end{cases} \quad (6)$$

Having the formula for normalizing the parameterized QoS values, the next step involves the transformation of the normalized values into a GRV. Simple additive weighting (SAW) is a multicriteria evaluation method that is expressed as:

$$S_y = \sum_{x=1}^m \omega_x \tilde{r}_{xy} \quad (7)$$

where S_y is the value obtained in multicriteria evaluation of the y -th alternative; ω_x is the x -th criterion weight; \tilde{r}_{xy} is the normalized value of the x -th criterion for the y -th alternative.

We construct the GRV as using average additive double weighting approach. In this approach we use the first weighting for the QoS attributes. The second weighting is applied to each set of the averaged value of normalized weighted QoS measures in T_{rerank} . Let us rewrite Eq. (7) as:

$$\|Q^*\|(P_i) = \sum_{j=1}^m \alpha_j \tilde{q}_j^{P_i} \quad (8)$$

where $\|Q^*\|(P_i)$ denotes the addition of normalized values QoS of QoS attributes of provider P_i . We can also write Eq. (8) as a dot product of two matrixes; A that is constructed from the QoS attribute weights and $(\tilde{Q}^{P_i})^T$, as shown in Eq. (9).

$$\|Q^*\|(P_i) = A.(\tilde{Q}^{P_i})^T$$

$$\|Q^*\|(P_i) = [\alpha_1 \quad \alpha_2 \quad \dots \quad \alpha_m] \begin{bmatrix} \tilde{q}_1^{P_i} \\ \tilde{q}_2^{P_i} \\ \vdots \\ \tilde{q}_m^{P_i} \end{bmatrix} \quad (9)$$

The average of $\|Q^*\|(P_i)$ is denoted as $av(\|Q^*\|(P_i))$ and formulated as:

$$av(\|Q^*\|(P_i)) = \frac{\|Q^*\|(P_i)}{m} = \frac{1}{m} \sum_{j=1}^m \alpha_j \tilde{q}_j^{P_i} \quad (10)$$

$$= \frac{1}{m} [\alpha_1 \quad \alpha_2 \quad \dots \quad \alpha_m] \begin{bmatrix} \tilde{q}_1^{P_i} \\ \tilde{q}_2^{P_i} \\ \vdots \\ \tilde{q}_m^{P_i} \end{bmatrix} \quad (11)$$

subject to

$$\alpha_1 + \alpha_2 + \dots + \alpha_m = m \quad (12)$$

Using the value of $av(\|Q^*\|(P_i))$, we can calculate the GRV by adding C_{B-P} -times of $av(\|Q^*\|(P_i))$ obtained in T_{rerank} and calculate the average value. As the performance of a provider may change from time to time in T_{rerank} , we care more about the most recent measurement to better reflect the current state of the provider. In other words, we should add weighting to each measure set by assigning more weight to more recent QoS measures and less weight to older QoS measures in T_{rerank} . We can express this as:

$$GRV(P_i) = \frac{\sum_{k=1}^{C_{B-P}} Func(k) * [av(\|Q^*\|(P_i))]_k}{C_{B-P}} \quad (13)$$

where $Func(k)$ is the weighting function with input k -th QoS measurement in T_{rerank} . We determine that the condition of $Func(k)$ should satisfy:

$$Func(k) = \frac{1}{1 + \delta(k)} \quad (14)$$

subject to

$$0 \leq \delta(k) \leq 1 \quad (15)$$

The notation $\delta(k)$ in Eq. (14) refers to desired perturbation for the weighting function. It is obvious that Eq. (14) limits the discount of

weight to 50% of the calculated $av(\|Q^*\|(P_i))$. The percentage is chosen to emphasize that all measures in T_{rerank} are at least 50% relevant to the current state of the provider.

We can choose some functions that can fit the purpose of increasing the value of $Func(k)$, hence adding more weight with small perturbation, as k gets bigger. However, we will describe the reasoning of the selection from statistical analysis perspective.

The first consideration is the notion of successive measures in T_{rerank} . Central limit theorem states that when an infinite number of successive random samples are taken from a population, the distribution of sample means for each sample will become approximately normally distributed irrespective of the population distribution. Given that we take large enough QoS measures in T_{rerank} , $av(\|Q^*\|(P_i))$ sets in T_{rerank} will tend to be distributed normally.

As for the second consideration, we address the possibility of some QoS attributes being statistically dependent. Statistical dependence can be detected from the linear or non-linear correlation between the attributes. The model assumes m QoS attributes but let users select the attributes that are statistically independent. For detecting linear correlation and reducing the number of evaluated QoS attributes, Principal Component Analysis (PCA) (Shlens, 2009; Smith, 2002) can be a used a method for the evaluation. Another method is by using Independent Component Analysis (Comon, 1994) to extract the attributes that are statistically independent. Extending the model to automatically check statistical dependence between the attributes is beyond the scope of current work. This model however, accommodates the possibility of the existence of statistical dependence by design-

ing the weighting factor to have an element of Gaussian noise represented in a Gaussian distribution.

Referring to Eq. (14), we now construct the perturbation factor $\delta(k)$ from the Gaussian distribution. A Gaussian distribution is expressed as:

$$f(x) = \frac{e^{(-x^2/2)}}{\sqrt{2\pi}} \quad (15)$$

Generalizing the magnitude of this function, we rewrite it as:

$$g(x) = ce^{(-x^2/2)} \quad (16)$$

To construct the perturbation factor, we can manipulate the slope of the plotted curve expressed in Eq. (16) on a Cartesian coordinate. The curve is illustrated in Fig. 6. We use the right slope to conveniently yield positive perturbation. The perturbation is created by calculating the difference between two points on $g(x)$.

Since we want specific behavior of perturbation, which is smaller in value for bigger k , we rephrase the term perturbation factor as “irrelevance factor”. Small irrelevance corresponds to higher relevancy, and thus more weight of QoS measures. Conversely, bigger irrelevance corresponds to less weight of QoS measures. By analyzing the slope of the Gaussian curve, we can construct the irrelevance factor as follows. Let $x_0 = 0$ denote the start of sampling region and x_{\max} denote the end of the sampling region in the positive region of the curve. Within the interval $[x_0, x_{\max}]$, there exists C_{B-P} -times of QoS measurements. By dividing the interval with C_{B-P} , we will obtain $\Delta = \frac{x_{\max}}{C_{B-P}}$. We define the irrelevance factor $M(k) = M_k$ as:

$$M_k = g(x_k) - g(x_{\max})$$

$$= ce^{(-(k\Delta)^2/2)} - ce^{(-x_{\max}^2/2)} \quad (17)$$

$$M_k = c \left(e^{(-k^2 x_{\max}^2 / 2 C_{B-P}^2)} - e^{(-x_{\max}^2 / 2)} \right) \quad (17)$$

subject to

$$0 \leq M_k \leq 1 \quad (18)$$

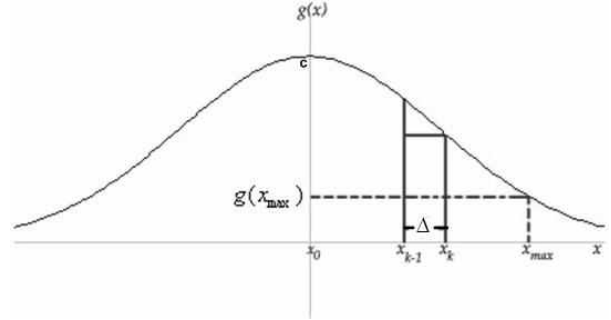

Fig. 6. A Gaussian function for constructing irrelevance factor

From Eq. (17), we should prove that M_k will be maximized for smallest k and minimized for the largest possible k . By differentiating M_k on k , we obtain:

$$\frac{\partial}{\partial k} M_k = -\frac{cx_{\max}^2}{C_{B-P}^2} ke^{(-x_{\max}^2 k^2 / 2 C_{B-P}^2)} \quad (19)$$

From Eq. (19), it is concluded that $k = 0$ will return the minimum or maximum value. Substituting $k = 0$ into M_k returns the biggest value of M_k , hence the highest irrelevance. Following this observation, we need to verify if the biggest $k = C_{B-P}$ will return the minimum M_k . Substituting $k = C_{B-P}$ into M_k yields $M_k = 0$, which satisfies our requirement.

Having formulated the weighting function for GRV, we can now formulate the final GRV formula as follows:

$$GRV(P_i) = \frac{\sum_{k=1}^{C_{B-P}} Func(k) * [av(\|Q^*\|(P_i))]_k}{C_{B-P}}$$

$$= \frac{\sum_{k=1}^{C_{B-P}} \frac{1}{1 + M_k} * \left[\frac{\|Q^*\|(P_i)}{m} \right]_k}{C_{B-P}}$$

$$GRV(P_i) = \frac{1}{mC_{B-P}} \sum_{k=1}^{C_{B-P}} \frac{1}{1+M_k} [\|Q^*\|(P_i)]_k \quad (20)$$

where

$$M_k = c \left(e^{(-k^2 x_{\max}^2 / 2C_{B-P}^2)} - e^{(-x_{\max}^2 / 2)} \right)$$

From Eq. (20), we are interested in knowing the minimum and maximum value of the GRV that can be obtained by a provider. The minimum GRV can be obtained as follows:

$$\begin{aligned} \min(GRV(P_i)) &= \frac{1}{mC_{B-P}} \sum_{k=1}^{C_{B-P}} \frac{1}{1+M_k} * 0 \\ \min(GRV(P_i)) &= 0 \end{aligned} \quad (21)$$

For the maximum GRV, we proceed with the calculation as follows:

$$\begin{aligned} \max(GRV(P_i)) &= \frac{1}{mC_{B-P}} \sum_{k=1}^{C_{B-P}} \frac{1}{1+M_k} [m\omega]_k \\ &= \frac{m\omega}{mC_{B-P}} \sum_{k=1}^{C_{B-P}} \frac{1}{1+M_k} \\ \max(GRV(P_i)) &= \frac{\omega}{C_{B-P}} \sum_{k=1}^{C_{B-P}} \frac{1}{1+M_k} \end{aligned} \quad (22)$$

We can then conclude that the interval of the GRV is given by:

$$0 \leq GRV(P_i) \leq \frac{\omega}{C_{B-P}} \sum_{k=1}^{C_{B-P}} \frac{1}{1+M_k} < \omega \quad (23)$$

3.5.2 Formulating GRV of a Content Request

In the discussion about OCN plane in Subsection 3.2.1, we mentioned about “prospective providers” to refer to providers that are considered to be capable of delivering content to the client while complying with the QoS-level requirements. Finding capable providers are done by comparing the GRV of the providers with the projected GRV for the request.

To compute the GRV for the content request, we need to acquire the QoS requirements of the request. This is possible with two ways. The first way is by embedding the QoS information in the request header and let the

broker read the information and calculate the GRV for the request. The other way is by attaching the ID of the user who requests the content in the request query and let broker check the user class for the ID. Each user class should be associated with QoS requirements for all attributes that are used in building the GRV. After obtaining QoS information, the broker can build the GRV for the request.

The process of calculating GRV for a content request is similar with calculating GRV of a provider with a difference that we assume $\|Q^*\|(P_i)$ to be constant for all k . We then modify the base GRV formula from Eq. (20) as follows:

$$\begin{aligned} GRV(P_i) &= \frac{1}{mC_{B-P}} \sum_{k=1}^{C_{B-P}} \frac{1}{1+M_k} [\|Q^*\|(P_i)]_k \\ GRV(R_i) &= \frac{1}{mC_{B-P}} \sum_{k=1}^{C_{B-P}} \frac{1}{1+M_k} [\|Q^*\|(R_i)]_k \\ [\|Q^*\|(R_i)]_1 &= \dots = [\|Q^*\|(R_i)]_{C_{B-P}} \end{aligned} \quad (24)$$

$$GRV(R_i) = \frac{\|Q^*\|(R_i)}{mC_{B-P}} \sum_{k=1}^{C_{B-P}} \frac{1}{1+M_k} \quad (25)$$

3.6 Initializing Global Ranking of Content Providers

Let N be the number of initial partner content providers $P = \{P_1, P_2, \dots, P_N\}$. Contents $c = \{c_A, c_B, \dots, c_Z\}$ exist at each of the providers and are ready to be provisioned upon request as previously shown in Fig. 5. The broker will bootstrap the system by calculating the initial GRVs and rank of the providers. A seed generator is deployed to take d random samples of c whose size does not exceed threshold $size_{th}$ and ask for their deliveries from each provider to the broker. Every time, the content delivery transaction is accomplished, a set of QoS values $\{q_1, q_2, \dots, q_m\}$ will have been measured. By applying Eq. (20), the broker will obtain the GRV for all providers, followed

with their respective ranks. This process is depicted in Fig. 7.

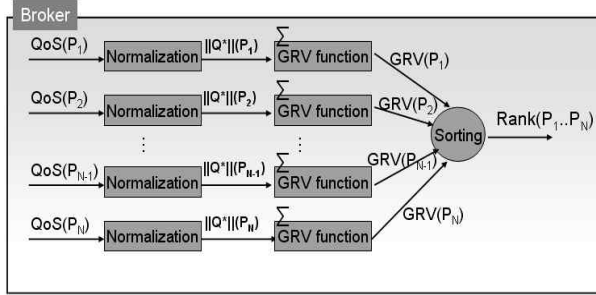

Fig. 7. Block diagram of global ranking initialization

Algorithm 1 shows how the broker determines the initial ranking of each provider in more detail. On line 3-5, the broker defines some contents it wants to request from all partner providers. The number of the sample contents d can be less than C_{B-P} . Line 7-13 show the loop for retrieving the series of contents from partner providers and measuring the QoS for the deliveries. In the implementation, the broker can spawn a thread for each provider, given that N is not big and let the thread monitor the QoS measure collection for each provider. Having obtained all the QoS sets, the broker compute the GRV for all providers, sort the GRVs and then assign the initial rank of the providers.

Algorithm 1: InitializeProviderRank

- 1 Define the initial content provider set P with N number of providers $P = \{P_1, P_2, \dots, P_N\}$
- 2 Define d measures for each provider in P
- 3 Define chosen content set $c_{sel} = \text{null}$ from content set c
- 4 **for all** i such that $1 \leq i \leq d$ **do**
- 5 $c_{sel}(i) = \text{Distinct Select}(c)$ with $\text{size} < \text{size}_{th}$
- 6 **end for**
- 7 **for all** i such that $1 \leq i \leq N$ **do**
- 8 **for each** index in c_{sel} as j **do**

- 9 Request Content c_j
- 10 **while** content is being delivered **do**
- 11 Measure QoS parameters Q
- 12 **end while**
- 13 **end for**
- 14 Compute $GRV(P_i)$
- 15 **end for**
- 16 $\text{sort}(GRV(P_i))$
- 17 $\text{rank}(P_i) := \text{position}(GRV(P_i))$

The initial rank will be used as the basis of the provider selection mechanism explained later in this section. As the system begins to operate, more contents are delivered and more requests should be served. This necessitates the update of providers' ranks to better reflect their recent states. To do so, subsequent reranking processes are conducted for every T_{rerank} . The algorithm constructed for provider reranking, which uses the broker-refereed periodic approach, is shown in Algorithm 2.

Algorithm 2: ProviderRerankingPeriodic

- 1 Define N number of content providers and provider set P
- 2 Get last reranking time $t_{rerank-1}$
- 3 Define C_{B-P} value
- 4 Calculate QoS measurement time $T_{measure}$
- 5 **while** true **do**
- 6 **if** $\text{now} - t_{rerank-1} \geq T_{rerank}$ **then** //start reranking process
- 7 Take $N * C_{B-P}$ number of measured QoS values sets in T_{rerank}
- 8 Order QoS values sets according to provider index and measure time
- 9 $Q_{or-dered} = \{ \{ Q(P_1)_1, Q(P_1)_2, \dots, Q(P_1)_{C_{B-P}} \}, \dots, \{ Q(P_N)_1, Q(P_N)_2, \dots, Q(P_N)_{C_{B-P}} \} \}$
- 10 **for each** i such that $1 \leq i \leq N$ **do**
- 11 Compute $GRV(P_i)$

```

12  end for
13  sort(GRV(Pi))
14  rank(Pi) := position(GRV(Pi))
15  else //collect QoS values periodically or
      select provider if there is request
16  if Content Request is true then
17  if Local content is true then
18  Deliver content
19  else
20  if QoS requirements exist then
21   $Q(R_u) = \{q_1, q_2, \dots, q_m\}$ 
22  else
23  Get user ID
24  Get user class from ID
25   $Q(R_u) = Q_{class} \{q_1, q_2, \dots, q_m\}$ 
26  end if
27  Compute GRV of content request
28  Select Provider y in P
29  Ask for Content Delivery from Py
30  end if
31  else //measure QoS every  $T_{measure}$ 
32  Define z=1
33  for every  $T_{measure}$  do
34  for all i such that  $1 \leq i \leq N$  do
35  Send Heartbeat Message M to Pi
36  Get Response R
37  Measure  $Q_{P_i|z} = \{q_1, q_2, \dots, q_m\}$ 
38  end for
39  next z
40  end for
41  end if
42  end if
43 end while

```

Algorithm 2 is divided into two main parts. The first part contains reranking process that calculates GRV every T_{rerank} . This part is shown on line 6-14 in the algorithm. On line 7-9, the broker identifies all the QoS measure sets taken in T_{rerank} and segregates the sets according to the corresponding provider indexes and measurement time. GRV for each

provider will then be calculated using formula in Eq. (20). Sorting the GRV values of all providers as shown on line 13 will allow to rebuild the rank of all providers as expressed on line 14.

The other part of Algorithm 2 manages the process of collecting QoS measure sets from the providers every $T_{measure}$ and at the same time delivers content to client if there is any request. This part can be found on line 15-42 in the algorithm. Line 16-30 shows how the broker handles content request. If the content is available locally and its delivery is satisfiable by the broker, it will directly deliver the content to the client without incorporating partner content provider as can be seen on line 17-18. Otherwise, the broker will check the information of desired QoS level for the content request as shown on line 20-21, or when such information is not available, the user class invoking this request (line 23-25). The computed GRV of the request will then be used as the basis of selecting provider that delivers the content to the client.

Line 31-41 of Algorithm 2 shows the mechanism of collecting QoS measure sets from partner content providers. Every $T_{measure}$, a heartbeat message requesting a small content that can be located anywhere in the content provider network is sent to the gateway of each provider. The message sender can be the broker itself or when applicable, distributed agents. Parameterized QoS attribute values can be measured while accepting the response or after the response is complete, depending on QoS attributes selected. In case of distributed agents, QoS measure sets should be immediately reported back to the broker. However, reporting is not necessary if the broker self-conduct the measurements. The sets are then stored by the broker to be evaluated at the reranking time.

Even though we assume that there are N providers in the collaboration, there is also a possibility for a new provider to join or leave the ecosystem. Assume that T_{rerank} is big enough, join/leave event should be processed immediately to let the broker have more updated view of partner content providers. For the join case, the provider should calculate the GRV of new provider using mechanism demonstrated on line 8-13 in Algorithm 1. As for the leave case, the broker should pop out the leaving provider from the provider list and update provider ranks accordingly using steps shown on line 16-17 in Algorithm 1.

3.7 Provider Selection for Content Delivery

In a portal system, it is a common practice to segregate users into classes. Some users are more privileged and prioritized while some others are considered to be pertaining to modest or less significance. The same also applies to our proposed architecture. We assume that there are K classes of users the broker. Each class is associated with a certain interval of desired QoS values.

There are two alternatives in satisfying the QoS requirements of the content provisioning. The first one is generous provisioning. This kind of provisioning considers all providers that can satisfy above the floor value of QoS requirement as prospective, including those who can satisfy above the ceiling value of the requirement. The second alternative is called tight provisioning. As its name suggests, the broker filters out overqualified providers and only considers providers whose capabilities of meeting the QoS requirement fit in the interval.

In this article, we address generous provisioning and let tight provisioning to be a subject of future discussion due to the need of

extensive elaboration. Generous provisioning can be conveniently implemented if there is small disparity of contract values established between the broker and the partner content providers. Another constraint is that the contract terms are fixed for longer period instead of dynamically changing per transaction like discussed in (Comuzzi and Pernici, 2009). Generous provisioning tends to present better user-perceived performance since the content request may be satisfied by a provider with higher estimated capability thus more highly-assured compliance to QoS requirement.

Provider selection under generous provisioning scheme is formulated as follows. Let $GU_{\min} = \{GRV_{\min}^1, GRV_{\min}^2, \dots, GRV_{\min}^K\}$ denote the set of minimum QoS requirements for all K classes that are represented by their corresponding GRVs. In the set, GRV_{\min}^K refers to the highest requirement or the privileged user class. A content request may have specific QoS requirement or retreats to the user class invoking the request in general cases. A naïve provider selection is introduced to apply the principle of serving the content from the best provider whenever possible and described in Algorithm 3.

Algorithm 3: NaïveProviderSelection

- 1 Define provider set P with N numbers of provider
- 2 Define T_{res} as resilience time
- 3 Define t_{last} as time of last content request
- 4 Define J as index of last provider in candidates
- 5 **if** $GRV(Req)$ exists **then**
- 6 $GRV_{\min}^X = GRV(Req)$
- 7 **else**
- 8 Obtain X as user class
- 9 Compute GRV_{\min}^X from $Q_{\min}(X)$

```

10 end if
11 if Excluded provider(Req) exists then
12   excluded_provider[] = List.toArray()
13 end if
14 for all i such that  $1 \leq i \leq N$  do
15   if  $GRV(P_i) \geq GRV_{min}^X$  then
16     if  $P_i$  not in excluded_provider then
17       Array Candidates[] = Pi
18     end if
19   end if
20 end for
21 if Candidates is empty then
22   Notify client
23   Choose current rank 1 provider
24 else
25   sort_desc(Candidates)
26   if  $(now - t_{last}) > T_{res}$  then
27     choose Candidates[0]
28   else
29     J = next J
30     if  $GRV(Candidates[j]) \geq GRV_{min}^X$  then
31       current_provider = Candidates[J]
32     else
33       current_provider = Candidates[0]
34     end if
35     Select current_provider
36   end if
37 end if

```

Line 14-20 in Algorithm 3 compares the GRV requirement of the content request with current GRVs of providers. Providers having GRVs above the requirement are then marked as candidates. Line 27 shows how a provider with highest GRV is chosen to provision the content to client. However, doing so iteratively may lead to service degradation due to congestion at the provider network caused by the stream of successive requests. Since the reranking process is periodic, this degradation may not be detected until the next reranking.

To avoid such circumstance, T_{res} is defined as the resilience time, which is the time to resort to the best provider for a content delivery request. Given a time $t < T_{res}$, the system will instead try to select the next candidate provider in order to distribute the load to other providers. Line 29-35 shows how the content provider is shifted from the first rank provider to the second rank and so forth before finally set back to the best provider again when there is no lower rank provider that can meet the QoS requirement.

3.8 The Fairness Issue and Cross Network Load Balancing

It can be noticed that naïve provider selection algorithm primarily tries to choose the expectedly best candidate before it implements an ordered round-robin selecting process during a high spike of requests. Provider shifting in the algorithm can be viewed as a method of load balancing the workloads across content provider networks in order to circumvent the degradation of the quality of service. However, it can be observed that in normal traffic where requests come in a time bigger than T_{res} within T_{rerank} , they will always be served by the same provider even though several qualified candidates exist. We consider this acceptable by design but can be impractical in real-world implementation. There are at least two concerns on avoiding content delivery monopoly by a single provider. The first concern is monopoly diminishes the principle of collaboration with multiple providers, which is the essence of this proposal. The latter is single content sourcing is prone to SLA violation especially in the case of flash crowd. The fairness concept is then introduced to simultaneously address monopoly and SLA violation issues.

Several concepts of fairness pertaining to the networks have been proposed (Kleinberg *et al.*, 2001; Ngubiri and Vliet, 2009) including the popular Jain index (Jain *et al.*, 1984). In this architecture, we use the Jain index as the basis of fairness measurement. Jain index is expressed by the following formula:

$$f(z) = \frac{\left[\sum_{i=1}^n z_i \right]^2}{\sum_{i=1}^n z_i^2}, z_i \geq 0 \quad (26)$$

where $f(z)$ indicates the fairness index, n symbolizes the number of contending users and z_i denotes the resource allocation for the i -th user.

Referring to Eq. (26), we need to determine the allocation that can increase the fairness index. Let $\Pr(P_i | \text{Re } q)$ denote the probability of P_i serving the content request $\text{Re } q$. According to Bayes theorem, we can calculate the probability as:

$$\Pr(P_i | \text{Re } q) = \frac{\Pr(\text{Re } q | P_i) \Pr(P_i)}{\Pr(\text{Re } q)} \quad (27)$$

where $\Pr(\text{Re } q)$ denotes the probability of the content request to be satisfied, $\Pr(P_i)$ denotes the probability of the i -th provider to be selected as the provider in a content delivery transaction, $\Pr(\text{Re } q | P_i)$ denotes the probability of the request is satisfied given the provider is the i -th provider.

Given that the request can be satisfied if $GRV(P_i) \geq GRV(\text{Re } q)$ while P_i can provision content to at most K classes of users, Eq. (27) can be rewritten into:

$$\Pr(P_i | \text{Re } q) = \frac{\sum_{P_i \in \phi_j} \left(\frac{1}{\sum \phi_j} \right) \cdot \frac{1}{N}}{\sum (GRV(P_i) \geq GRV(\text{Re } q))} N$$

$$\Pr(P_i | \text{Re } q) = \frac{\sum_{P_i \in \phi_j} \left(\frac{1}{\sum \phi_j} \right)}{\sum (GRV(P_i) \geq GRV(\text{Re } q))} \quad (28)$$

where ϕ_j denotes the set of providers that can deliver contents to users of the j -th class, $1 \leq j \leq K$. The allocation of content provisioning for each provider is thus defined as:

$$z_{P_i} = \Pr(P_i | \text{Re } q) * \frac{\Pr \text{ov}(P_i)}{\sum_{j=1}^N \Pr \text{ov}(P_j)} \quad (29)$$

where $\Pr \text{ov}(P_i)$ denotes the number of contents provisioned by the i -th provider within T_{rerank} .

The algorithm of fair provider selection is then composed as follows:

Algorithm 4: FairProviderSelection

- 1 Define provider set P with N numbers of providers
- 2 Get number of contents served by providers in this epoch $\sum_{j=1}^N \Pr \text{ov}(P_j)$
- 3 **if** $GRV(\text{Re } q)$ does not exist **then**
- 4 Obtain X as user class
- 5 **else**
- 6 Compute GRV_{\min}^X from Q_{\min}^*
- 7 Determine class J so that $GRV_{\min}^J > GRV_{\min}^X$
- 8 **end if**
- 9 **if** Excluded provider(Req) exists **then**
- 10 excluded_provider = List.toArray()
- 11 **end if**
- 12 **for all** i such that $1 \leq i \leq N$ **do**
- 13 **if** P_i not in excluded_provider **then**
- 14 **for all** j such that $J \leq j \leq K$
- 15 **if** $GRV(P_i) \geq GRV_{\min}^j$ **then**
- 16 Array Candidates[j][i] = $\{P_i, \Pr \text{ov}(P_i)\}$

```

17   end if
18   end for
19   end if
20 end for
21 for all i such that  $1 \leq i \leq \sum Candidates$  do
22   Array Allocation[  $P_i$  ] =  $z_{P_i}$ 
23 end for
24 sort(Allocation)
25 Choose provider in Allocation[0]
   //provider with smallest allocation
26 Update fairness index

```

To proceed with fair provider selection, the user class that is associated with the request should be obtained. This is shown on line 3-8 in Algorithm 4. Subsequently, we then determine the provider candidates for each class that has GRV bigger than the GRV of the request. Building this candidacy list is expressed by line 9-20. We then calculate the allocation for each provider in the list and select the provider with the lowest allocation to improve the fairness.

4. Implementation and Testbed Description

Implementing the architectural design in real-world scenario will be challenging, given the constraint in establishing the desired collaboration with partner content providers. However, we devise a real world scenario deployment along with the microbenchmark evaluation and numerical simulation.

For the real world deployment, a provider can be a data center or a chain of coordinated data centers with each hosting several content-storage nodes. The provider provides a node with dedicated DNS name that acts as the gateway or contact point with the broker. Every time the provider is assigned to provision content, it will incorporate its own method in assigning a node that serves the content to

the client. It is, however, natural that providers are heterogeneous in terms of infrastructure and enabling technologies. Given this situation, communication among broker, client and provider should follow a certain standard or protocol in order to bridge the heterogeneity.

In our previous work (Simalango and Oh, 2009a), we proposed a model for enabling content delivery across heterogeneous providers using the SOA approach. The model basically uses a client-refereed approach in which the client should return its assessed QoS values after content provisioning ends. In an ideal content delivery scenario in which network and client constraints are diminished, this approach is expected to work well in mapping and predicting provider capability. However, as we described in earlier section, tasking more computation on the client also means transforming the client from a thin client to a thick client. This is sometimes of less user's interest since the demand of new plug-in or client installation on user's machine may pop up a security warning from the security software which could deter the user from using the service.

Despite the shortcoming of our previous proposal, we want to reflect some ideas in the design that relate to the establishment of the collaboration protocol. In the model, every content delivery is identified by a unique session id. For every new request, a session id is generated by the broker and then distributed to the client and selected provider. The initial purpose of distributing the session id is to enable both user and provider to send a "feedback" message to the broker regarding the corresponding content delivery transaction. The feedback message may contain the termination of content provisioning, acknowledgment of service provisioning, or even an error message. Besides monitoring purpose,

this feedback can also be used by the broker to evolve the GRV model to better estimate the match between QoS compliance and QoS claim of the partner content providers. Details of the protocol are beyond the scope of this article.

In the evaluation section, we will present the simulation and testing of the ranking system and provider selection algorithm. The simulation aims to check the intrinsic properties of the GRV concept and how feasible it is for real deployment. Based on the numerical results, the behavior of the brokering system during runtime will be predicted. The simulation provides a comparison between the proposed provider selection algorithms and traditional load balancing algorithms so that the type of algorithm better fitted for the architecture can be justified. The environment and testbed for the simulation are described in Table 2.

Item	Numerical simulations	Algorithm simulations	
		Server	Client
RAM	2GB	8GB	4GB
Processor	2.8 GHz single core	2 quad core @1.6GHz	quad core@1.6 GHz
OS	Windows XP SP3	RHEL 4 64-bit	Fedora 10 64-bit
LAN	100 Mbps	1Gbps	1 Gbps
Communication	-	TCP	TCP

Table 2. Simulation and testbed environment

In Table 2, we can see the setup for numerical simulations and algorithm simulations. Numerical simulations were conducted on a single host. The simulation tries to check the properties of GRV and its dynamics for various conditions of irrelevance factors, measurement

time and number of QoS attributes. Algorithm simulations were run on two nodes. One node, the server, acted as the broker that received requests from the client. The server run several provider threads and executed provider selection based on the dynamicity of the provider threads.

5. Evaluation and Analysis

This section evaluates the GRV calculation and the effectiveness of algorithms proposed for selecting providers in numerous content delivery transactions. A discussion complementing the analysis is also provided. We divide the analyses into two parts. The first part mainly discusses about the GRV formulation and its behavior. The latter part contains an evaluation of the algorithms for provider ranking initialization, provider selection and the implication to the quality of content delivery service. To conduct the evaluations, we built a simulator named CollabCDS WiseSim (CollabCDS, 2010) that is capable of conducting numerical simulations for GRV and provider selection algorithms of the proposed architecture. The simulator consists of a set of tools built using Java and command-line PHP technologies.

5.1 Impact of Different Parameter Setups to GRV Calculation

GRV is a novel concept proposed in this paper. It is used extensively to estimate the capability of providers and matching a content request with a set of prospective providers. To recall the formulas, we rewrite the GRV equation as follows:

- GRV of a provider

$$GRV(P_i) = \frac{1}{mC_{B-P}} \sum_{k=1}^{C_{B-P}} \frac{1}{1+M_k} [\| Q^* \| (P_i)]_k$$

- GRV of a content request

$$GRV(R_i) = \frac{\|Q^*\|(R_i)}{mC_{B-P}} \sum_{k=1}^{C_{B-P}} \frac{1}{1+M_k}$$

As shown in the equations, GRV consists of configurable elements; m , C_{B-P} , and c and x_{max} in M_k . We want to analyze the impact of variations of these configurable elements into the final value of the GRV.

First simulation was conducted to observe the behavior of irrelevance factor M_k under different setups of its configurable elements. Recall that the equation for M_k is

$$M_k = c \left(e^{(-k^2 x_{max}^2 / 2 C_{B-P}^2)} - e^{(-x_{max}^2 / 2)} \right)$$

subject to

$$\begin{aligned} 0 &\leq M_k \leq 1 \\ M_{C_{B-P}} &= \min(M_k) \\ M_1 &= \max(M_k) \end{aligned}$$

Observing the terms after c , it is obvious that the conditions can be satisfied for any $\{k, x_{max}, C_{B-P}\} > 0$ if

$$0 < c \leq 1 \tag{30}$$

To proceed with the simulation, we set up 16 cases with different values of x_{max} , C_{B-P} and c that complies with constraint in Eq. 30. The simulation sets for the configurable parameters are $x_{max}^{sim} = \{1,2,3,4\}$, $C_{B-P}^{sim} = \{2,5,10,20\}$ and $c^{sim} = \{0.1,0.2,\dots,1\}$ respectively.

Figure 8 illustrates the behavior of irrelevance factor for different frequencies of QoS measures in T_{rerank} , that is C_{B-P} . We can observe that if we do more measurements, we will have higher value of irrelevance at $k = 1$. In Fig. 8a, the maximum value of irrelevance factor is 0.79 that is achieved when $c=1$ and $k=1$. In Fig. 8b, the maximum value is 0.84 for $c=1$ and $k=1$. In Fig. 8c, this value increases into 0.86 for the same c and k .

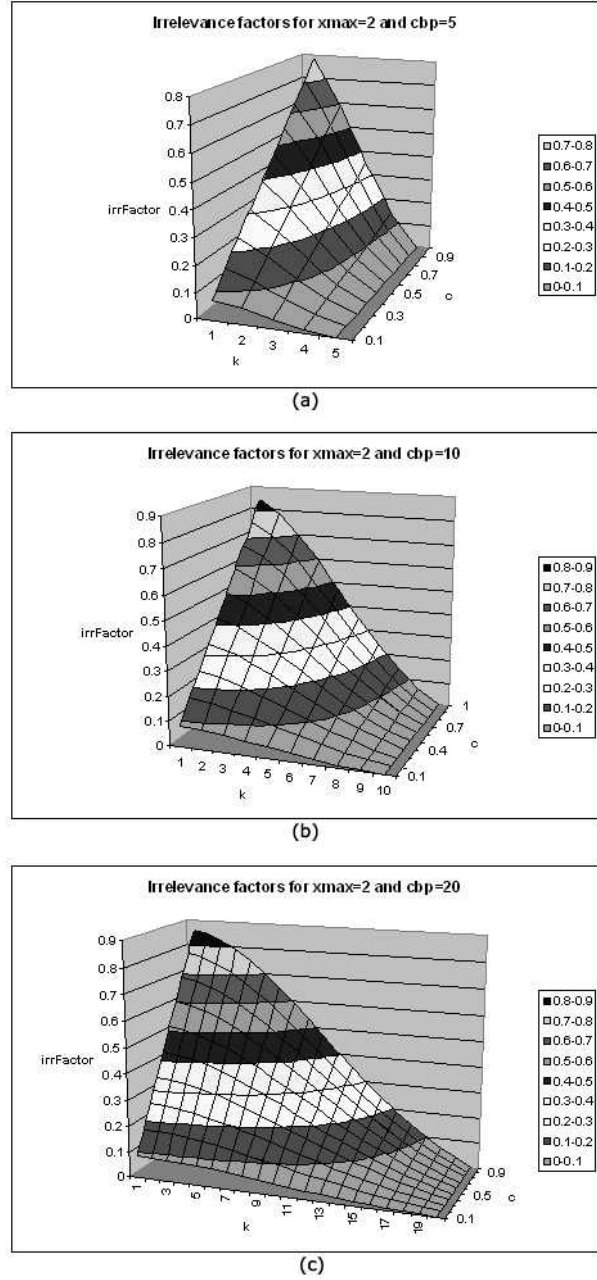

Fig. 8. Irrelevance factor planes for different C_{B-P} and identical x_{max}

We can also notice that the irrelevance factor plane has less steep slope as C_{B-P} increases. At smaller c , the line drawn on the slope will have smaller declination angle. As c gets bigger, we can observe that the declination angle will also get bigger.

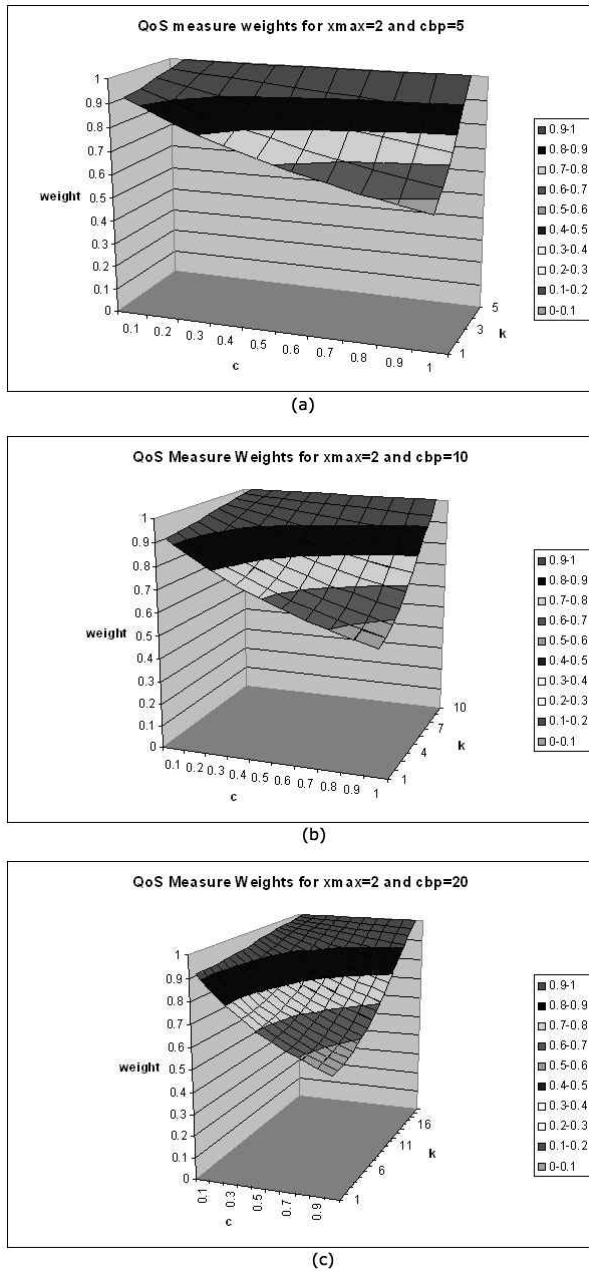

Fig. 9. QoS measure weights for irrelevance factor planes in Fig. 8

As demonstrated in Eq. (14), the k -th irrelevance factor will contribute to the value of QoS measure weight $Func(k)$. Based on the irrelevance factor planes depicted in Fig. 8, we show the corresponding QoS measure weight planes in Fig. 9. In Fig. 9a, 9b and 9c, we can see that the weight is always equal to 1 when $k = C_{B-P}$. For smaller k , it is obvious that the

weight is less than 1. This observation fits our purpose of putting the highest importance to the most recent QoS measurement.

In Fig. 9, we can observe the impact of different values of c to the QoS measure weights. As shown in the picture, when c is small, the weights of the k -th and $k+1$ -th measures do not differ much. However, as c gets closer to 1, the difference becomes larger. As for example, in Fig. 9a, the minimum weight for $c = 0.1$ is 0.93, which is close enough to the maximum value of 1. However, when $c = 1$, the minimum weight is 0.56, which indicates bigger weight difference for two successive QoS measurements.

Figure 9 also shows that if we do more measurements when all other parameters are unchanged, the weight difference between the first and the last measure becomes bigger but the average difference between k -th and $k+1$ -th becomes smaller. Table 3 exhibits this statement. It contains the comparison between QoS measure weights in Fig. 9a, 9b, and 9c when $c = 1$.

k	$Func(k)$		
	$C_{B-P}=5$	$C_{B-P}=10$	$C_{B-P}=20$
1	0.559353	0.542046	0.537728
2	0.628609	0.559353	0.542046
3	0.739964	0.588258	0.549251
4	0.875119	0.628609	0.559353
5	1	0.679719	0.572357
6	-	0.739964	0.588258
7	-	0.806467	0.607028
8	-	0.875119	0.628609
9	-	0.94112	0.652894
10	-	1	0.679719
11	-	-	0.708848
12	-	-	0.739964
13	-	-	0.772665
14	-	-	0.806467
15	-	-	0.840819

16	-	-	0.875119
17	-	-	0.908752
18	-	-	0.94112
19	-	-	0.971686
20	-	-	1
Min	0.559353	0.542046	0.537728
Max	1	1	1
Av. Diff.	0.0881	0.046	0.023

Table 3. Impact of different frequencies of measurements to weight difference

Analyzing Table 3, we can conclude that if the frequency of measurement is too big, the impact of weighting will be less effective. Thus, we need to set the the frequency to a value that can bring the model to be more accurate in estimating the current state of a provider.

We also need to observe the effect of different values of x_{max} into the weights. For the observation, we will compare $Func(k)$ planes drawn for $x_{max}^{sim} = \{1,2,4\}$ and $C_{B-p} = 5$. This is shown in Fig. 10. In the figure, we can observe the weight differentiation for different values of x_{max} . In Fig. 10, we can notice that as x_{max} gets bigger, the plane changes in outer shape from convex to concave. As a consequence, when the plane is concave, the weight of the oldest QoS measure will be lower than its counterpart in the convex plane. Translating this into into the GRV value, the convex plane will yield smaller GRV value when all other parameters including the normalized values of the QoS attributes are identical.

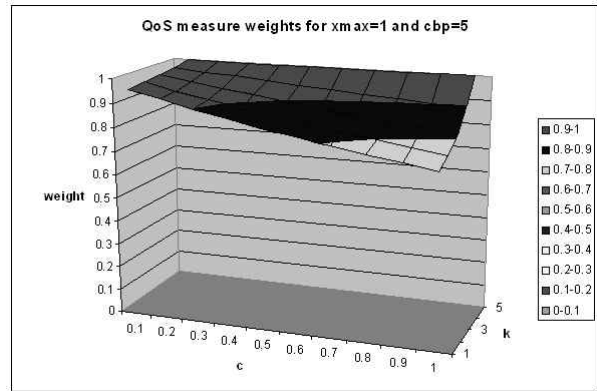

(a)

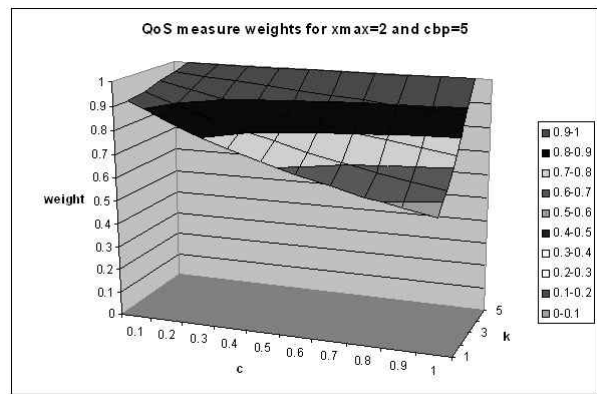

(b)

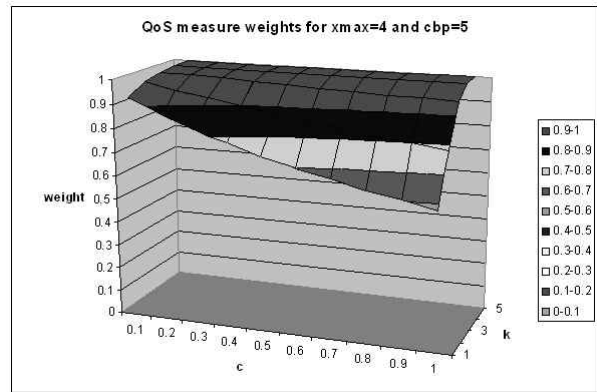

(c)

Fig. 10. Impacts of different values of x_{max} to QoS measure weights

To conclude the discussion about parameter configurations, we have seen that different parameter setups can contribute to the calculated value of the GRV. Since we directly compare the GRV of a request with the GRV of a provider, we can analyze if a certain setup can properly satisfy the QoS requirement of the content request. Hence, the system can be

equipped with self-learning capability to self-tune the parameters so that less SLA violations may occur.

5.2 Ranking System and Provider Selection Algorithm Evaluation and Analysis

To evaluate the ranking system in a more realistic setup, we use QWS dataset (Al-Masri and Mahmoud, 2007). This dataset contains QoS measures for several Web Services. We argue that invoking web services can be used as an alternative way to get QoS measures from providers. QWS dataset contains aggregate QoS measures from several service providers. We consider this value as an input to initialize the ranks of the providers.

We used QWS dataset version 2 that contains 9 usable types of QoS attributes and later conducted an experiment to check the processing time of the initial GRV by using the information from the dataset. The usable QoS attributes in the datasets are response time, availability, throughput, successability, reliability, compliance, best practices, latency, and documentation. We filtered the dataset based on a keyword to get records that expectedly fall into the same category. We used the words “content”, “news” and “web” and obtained 6,25 and 100 records respectively. The number of the records translates as the number of initial content providers in the system. For each set of provides, we ran the rank initialization algorithm and collected the processing time for increasing the number of QoS attribute. As can be seen in Fig. 9, when the number of providers increases, the processing time becomes longer. Also, as we consider more QoS attributes, the processing time also increases. This is expected since the initialization algorithm should process as much information as inputted without the existence of cache or preliminary

knowledge that can optimize the processing time.

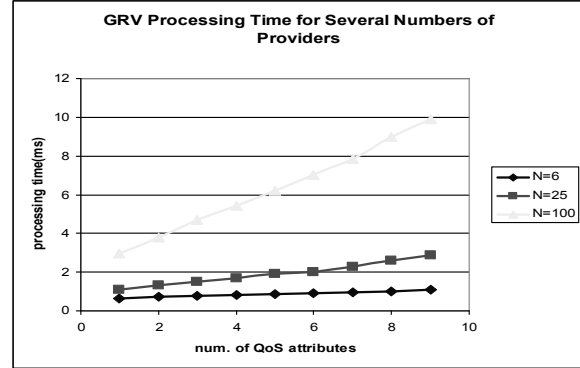

Fig. 11. GRV processing time for increasing the number of QoS attributes

From the figure, it can be seen that the time complexity is $O(m)$ with respect to the number of QoS attributes. However, the time complexity becomes worse with regard to the number of providers. As we take a look at the steps in Algorithm 1, the time complexity is determined by GRV computation and GRV sorting process. By revisiting the GRV formula, it is expected that the rank initialization has a lower bound $O(mn \log n)$.

In Fig. 12, the manifestations of the selected providers, which are reflected as expected GRVs using several provider selection algorithms, can be observed. Each algorithm handles client requests in a different way, and thus resulting in different selected provider for the requests. Since each provider pertains to a certain GRV value, the provider index can be represented as the expected GRV values shown in the figure.

The simulation assumed a total of 1000 clients from the same user class requesting contents from the broker with random arrival time from 10ms to 1s after the previous client. For each client, four provider selection algorithms were implemented simultaneously, which are naive, fair, round-robin and random. The first two are proposed algorithms in this

work, while the rest are common load balancing algorithms found in the references. Based on the decision of each algorithm, the data generated curve for the corresponding data was plotted and adjoined with results from other algorithms.

For the experiment, the value of N is $N=100$ from the previous ranking initialization simulation. Using this value, the minimum and maximum GRV values obtained are $GRV=39.81$ and $GRV=74.04$, respectively. The experiment also sets a condition that computed user $GRV=50$; thus, not all providers are qualified to provision content to the client. The simulation was started by running provider selection using the Naive algorithm. In this simulation, the value of T_{res} was set to 0.5 sec. Following this, simulations were conducted for the remaining algorithms, and the results were interpolated with the graphical plot from the Naive algorithm simulation. Table 4 summarizes the configuration for the experiment.

Referring to Fig.12, we can see that in comparison with the other algorithms, Naive algorithm in Fig. 12a yields a higher expected provider GRV due to its nature of always choosing the best provider in terms of expected GRV whenever possible.

This paper refers to the expected provider GRV instead of real time provider GRV since such GRV reflects provider's condition in the last T_{rerank} instead of at the time of content request. Any requests in the picture were initiated after $T_{rerank}+t_{arr}(k)$. When k is small, we can expect a provider performance to approach its performance at T_{rerank} . However, when k becomes bigger, a provider performance can be degraded and its real time GRV can be lower than the expected GRV. This is mainly caused by the fixed bandwidth and resources that the provider has. As it handles more re-

quests, it adds more stacks in its request queues so that a request may not be immediately provisioned, and thus resulting in degraded performance, especially if the queuing system does not provide good concurrency support (Welsh, 2002). This is why we need to anticipate by implementing cross-network load balancing through all the potential providers by selecting from a bigger array of providers to provision the contents.

Parameter	Symbol	Value
Total clients served	U	1000
Arrival time	t_{arr}	$t_{arr-1} + [0.01, 1]s$
Number of provider	N	100
Minimum GRV	$\min(GRV(P_i))$	39.81
Maximum GRV	$\max(GRV(P_i))$	74.04
Computed user GRV	GRV_u	50
Resilient time	$T_{resilient}$	0.5 sec.

Table 4. Simulation configurations for provider selection algorithms

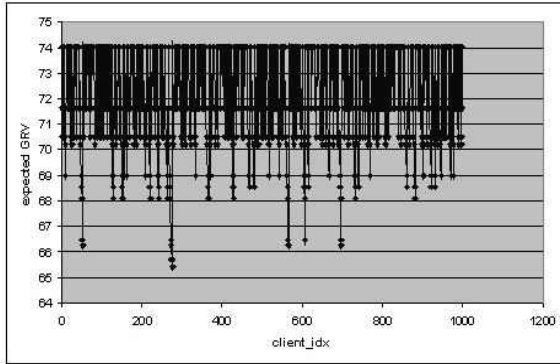

a) Expected GRV for Naive Algorithm

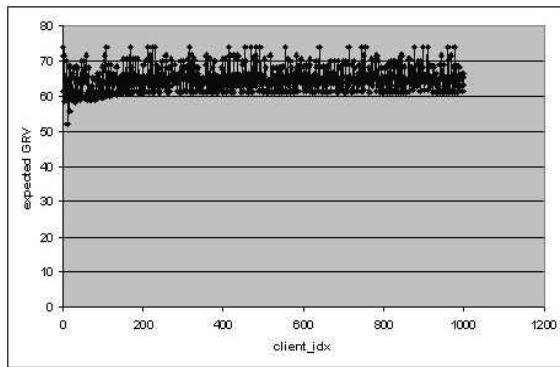

b) Expected GRV for Fair Algorithm

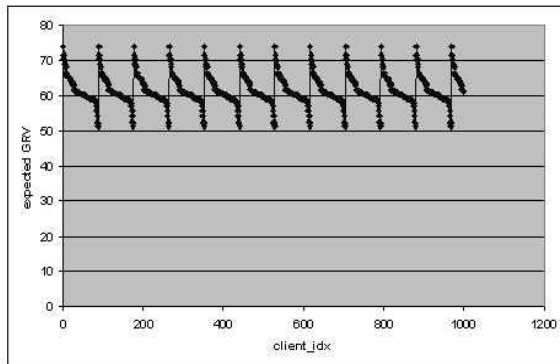

c) Expected GRV for Round Robin Algorithm

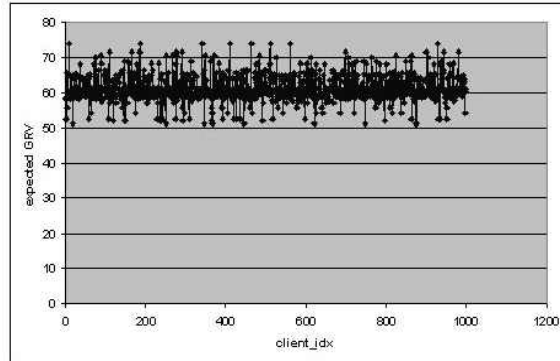

d) Expected GRV for Random Algorithm

Fig. 12. Expected GRV plots from several provider selection algorithms

The round robin algorithm in Fig. 12c shows a good distribution of selected providers. However, as we see in the diagram, there are repetitive periods when this algorithm will select providers near threshold GRV. While this is acceptable by design, it can be risky during the implementation as a near-threshold provider can also experience performance degradation within T_{rerank} . Let us consider a case where the real time GRV of a provider is lower than the computed user GRV. This will result in a failure to meet the required QoS level during the content delivery transaction. This issue also applies to the random algorithm shown in Fig. 12d that is unable to provide guarantee of well-distributed high rank providers for the selection process. We can see that the expected GRV in the random algorithm is also unpredictable. Sometimes it goes close to the threshold GRV that is less desirable and should be avoided in the implementation.

The argument is supplemented with the statistical comparison of the aforementioned provider selection algorithms. In Table 5, the data of mean, standard deviation and estimated reliability of each algorithm are provided.

Estimated reliability is defined in Eq. (31) and refers to the estimated capability of a provider to ensure that it can meet the QoS level required by the user. As we deal with distributed systems with minimum control over the participating systems, we can not obtain real time network data of each system. A better option to get through this limitation is by implementing the load balancing technique, a proven technique in providing better user experience. Thus, the estimated reliability equation devised also implicitly reflects the ability of the provider selection algorithm to do load

balancing among high profile candidate providers.

$$\rho_{est} = \frac{(\overline{GRV}(P_{selected}) - GRV_u) * \sigma(GRV(P_{selected}))}{GRV_u} * 100\% \quad (31)$$

Algorithm	Mean	Standard deviation	Estimated reliability
Naïve	72.289	1.918	85.48%
Fair	64.686	3.251	95.49%
Round robin	61.558	3.933	90.91%
Random	61.258	3.806	85.7%

Table 5. Statistical comparison of the provider selection algorithms

It can be seen in Table 5 that the fair provider selection algorithm outperforms others by achieving the highest estimated reliability. Comes at the second place is the round robin algorithm. By using the basic load balancing principle and assuming the queue buffer is emptied immediately, it is obvious that round-robin will balance the load quickly and evenly to all available providers. However, given the constraint that the system prefers higher profile providers to modest profile providers, the Fair Algorithm shows its effectiveness in dealing with the situation.

6 Conclusion

We have proposed an architectural design for collaborative content delivery system as a solution to leverage content redundancy in a content provider network and a system to elastically scale underprovisioned portal. This architecture relies on a hard brokering system in which a broker is situated to route user requests to an appropriate provider.

Our proposed architecture relies on QoS measures of the partner content providers. The measures are conducted periodically by the broker and will be used to map the expected

performance of a provider prior to provisioning contents to clients. We developed a novel GRV concept to rank providers based on the historical values of QoS measures and have shown that the projected capability reflected in the GRV value can be used as a method for assessing provider capability in ensuring an SLA-compliant content delivery to users. We have also shown that our fair provider selection algorithm achieved 95.5% estimated reliability. With such high percentage of reliability, we can expect to mitigate failure in meeting QoS requirement due to lagging of the reranking process by actively switching among qualified content providers.

The architecture proposed in this paper can be a suitable option for existing independent content delivery systems to collaborate and achieve budget efficiency by sharing contents over various providers. It has been shown that the provider selection algorithm can exhibit good load balancing strategies that can be translated as proper revenue sharing among partner content providers that supply contents to a broker or portal. Moreover, this proposal can be adapted to be implemented in the future IaaS-based portal system that manages content storage over distributed storage networks owned by various IaaS providers.

7 Future Work

It is clear that more complexity lies on adjusting the proposed architecture to be appropriate for today's content delivery. Some assumptions made in this proposal may not be applicable in real-world scenarios, and thus modification should be done to the pertinent implementation. In the real implementation of a fully-fledged collaborative content delivery system, several other tasks are actually also involved and should also be taken care. Future

work will consist of developing a working protocol for achieving a collaborative content delivery system, and to implement better tracking, accounting, and auditing management for content delivery.

Another subject of interest will be achieving scalability. It will be very beneficial to be able to scale the brokering system despite complex provider selection and content delivery protocols. Along with the interest is the work on aligning the architecture with the future IaaS-based storage system.

References

- Adamic, L. A., Huberman, B. A., 2002. Zipf's Law and the Internet. *Glottometrics* 3:143-150.
- Akioka, S., Muraoka, Y., 2010. HPC Benchmarks on EC2. Proc. of 24th IEEE Conference on Advanced Information Networking and Applications Workshop (WAINA), p. 1029-1034. [doi: 10.1109/WAINA.2010.166]
- Al-Masri, E., Mahmoud, Q. H., 2007. QoS-based Discovery and Ranking of Web Services. Proc. 16th IEEE ICCCN, p. 529-534. [doi: 10.1109/ICCCN.2007.4317873]
- Almeida, J. M., Eager, D. L., Vernon, M. K., Wright, S. J., 2004. Minimizing Delivery Cost in Scalable Content Distribution Systems. *IEEE Transactions on Multimedia*, 6(2):356-365. [doi: 10.1109/TMM.2003.822796]
- Bahi, J., Couturier, R., Vernier, F., 2005. Synchronous Load Balancing on Dynamic Networks. *Journal of Distributed Computing*, 65(11):1397-1405. [doi: 10.1016/j.jpdc.2005.05.007]
- Balakrishnan, H., Kaashoek, M. F., Karger, D., Morris, R., Stoica, I., 2003. Looking up Data in P2P Systems. *Communication of the ACM*, 46(2):43-48.
- Balasubramanian, J., Schmidt, D. C., Dowdy, L., Othman, O., 2004. Evaluating the Performance of Middleware Load Balancing Strategies. Proc. 8th IEEE EDOC, p. 135-146. [doi: 10.1109/EDOC.2004.11]
- Ball, N., Pietzuch, P., 2008. Distributed Content Delivery Using Load-Aware Network Coordinates. Proc. of 2008 ACM CoNEXT, article 77. [doi: 10.1145/1544012.1544089]
- Birman, K., Chockler, G., and Renesse, R. v., 2009. Toward a Cloud Computing Research Agenda. *ACM SIGACT News*, 40(2):68-80. [doi: 10.1145/1556154.1556172]
- CollabCDS WiseSim, <http://wise.ajou.ac.kr/mikael/collabeds>, last visited Feb 2010.
- Comon, P., 1994. Independent Component Analysis, a New Concept? *Signal Processing* 36(1994): 287-314.
- Comuzzi, M., Pernici, B., 2009. A Framework for QoS-based Web Service Contracting. *ACM Transactions on the Web*, 3(3), article 10. [doi: 10.1145/1541822.1541825]
- Das, S., Nandan, A., Parker, M. G., Pau, G., Gerla, M., 2005. Grido – An Architecture for A Grid-based Overlay Network. Proc. 2nd QSHINE, p. 27. [doi: 10.1109/QSHINE.2005.27]
- Davison, B. D., 2001. A Web Caching Primer. *IEEE Internet Computing*, 5(4):38-45. [doi: 10.1109/4236.939449]
- Dejun, J., Pierre, G., and Chi, C.-H. 2009. EC2 Performance Analysis for Resource Provisioning of Service-Oriented Applications. Proc. 3rd Workshop on Non-Functional Properties and SLA Management in Service-Oriented Computing (NFPSLAM-SOC'09).
- Duan, Z., Zhang, Z.-Li, Hou, Y. T., 2003. Service Overlay Networks: SLAs, QoS, and Bandwidth Provisioning. *IEEE/ACM Transactions on Networking*, 11(6): 870-883. [doi: 10.1109/TNET.2003.820436]
- Facebook Statistics, <http://www.facebook.com/press/info.php?statistics>, last visited August 2009.
- Fielding, R. T., 2000. Architectural Styles and the Design of Network-based Software Architectures. Ph. D. dissertation, University of California Irvine, USA.
- Foster, I., Kesselman, C., Tuecke, S., 2001. The Anatomy of the Grid: Enabling Scalable Virtual Organization. *The Intl. Journal of High Performance Computing Applications*, 15(3):200-222. [doi: 10.1177/109434200101500302]
- Foster, I., Zhao, Y., Raicu, I., and Lu, S., 2008. Cloud Computing and Grid Computing 360-Degree Compared. *Grid Computing Environment Workshop*, p. 1-10. [doi: 10.1109/GCE.2008.4738445]
- Freedman, M. J., Freudenthal, E., Mazieres, D., 2004. Democratizing Content Publication with Coral. Proc. of 1st USENIX/ACM Symposium on Networked Systems Design and Implementation.
- Freedman, M. J., 2010. Experiences with CoralCDN: A Five-Year Operational View. Proc. of 7th USENIX/ACM Symposium on Networked Systems Design and Implementation.
- Ginevicius, R., 2008. Normalization of Quantities of Various Dimensions, *Journal of Business Economics and Management*, 9(1): 79-86.
- Guo, L.-Y., Chen, H.-P., Yang, G., Fei, R.-Y., 2008. A QoS Evaluation Algorithm for Web Service Ranking Based on Artificial Neural Network. Proc. of CSSE, p. 381-384. [doi: 10.1109/CSSE.2008.1108]
- Hill, Z., Humphrey, M., 2009. A Quantitative Analysis of High Performance Computing with Amazon's EC2 Infrastructure: The Death of Local Cluster? Proc. of 10th IEEE/ACM Conference on Grid Computing, p. 26-33. [doi: 10.1109/GRID.2009.5353067]
- Huang, Y.-F., Fang, C.-C., 2004. Load Balancing for Clusters of VOD Servers. *Information Sciences*, 164: 113-138. [doi: 10.1016/j.ins.2003.10.005]
- Jain, R., Chiu, D.-M. W., Hawe, W. R., 1984. A Quantitative Measure of Fairness and Discrimination for Resource

- Allocation in Shared Computer System. Technical Report TR-301, DEC Research.
- Krishnamurthy, B., Wills, C., Zhang, Y., 2001. On the Use and Performance of Content Distribution Networks. Proc. 1st ACM SIGCOMM Workshop on Internet Measurement, p. 169-182. [doi: 10.1145/505202.505224]
- Kleinberg, J., Rabani, Y., Tardos, E., 2001. Fairness in Routing and Load Balancing. *Journal of Computer and System Sciences*, 63(1): 2-20. [doi: 10.1006/jcss.2001.1752]
- Martin, R., Menth, M., Hemmkepler, M., 2007. Accuracy and Dynamics of Multi-Stage Load Balancing for Multipath Internet Routing. IEEE International Conference on Communications, p. 6311-6318. [doi: 10.1109/ICC.2007.1045]
- Ng, T. S. E., Zhang, H., 2002. Predicting Internet Network Distance with Coordinates-Based Approaches. In 21st IEEE INFOCOM, . [doi: 10.1109/INFCOM.2002.1019258]
- Ngubiri, J., Vliet, M. V., 2009. A Metric of Fairness for Parallel Job Schedulers. *Concurrency and Comput.: Pract. Exper.*, 21(12): 1525-1546. [doi: 10.1002/cpe.v21:12]
- Park, K., Pai, V. S., Peterson, L., Wang, Z., 2004. CoDNS: Improving DNS Performance and Reliability via Cooperative Lookups. Proc. of 6th Conf. on Symposium on Operating Systems Design and Implementation.
- Peterson, L., Anderson, T., Culler, D., Roscoe, T., 2003. A Blueprint for Introducing Disruptive Technology into the Internet. ACM SIGCOMM Computer Communication Review, 33(1): 59-64.
- Qiu, L., Padmanabhan, V. N., Voelker, G. M., 2001. On the Placement of Web Server Replicas. Proc 20th IEEE INFOCOM, pp. 1587-1596. [doi: 10.1109/INFCOM.2001.916655]
- Rimal, B. P., Choi, E., and Lumb, I., 2009. A Taxonomy and Survey of Cloud Computing System. Proc 5th International Joint Conference on INC, IMS, and IDC, p. 44-51. [doi: 10.1109/NCM.2009.218]
- Saroiu, S., Gummadi, K. P., Dunn, R. J., Gribble, S. D., Levy, H. M., 2002. An Analysis of Internet Content Delivery Systems. *ACM SIGOPS Operating Systems Review*, 36(SI): 315-327. [doi: 10.1145/844128.844158]
- Sharifian, S., Motamedi, S. A., Akbari, M. K., 2008. A Content-Based Load Balancing Algorithm with Admission Control for Cluster Web Servers. *Future Generation Computer Systems*, 24(8): 775-787. [doi: 10.1016/j.future.2008.03.005]
- Shlens, J., 2009. A Tutorial on Principal Component Analysis; Center for Neural Science, New York University, USA.
- Simalango, M. F., Oh, S., 2009. A Model for QoS-Aware Service Oriented Architecture in the Realm of Content Delivery. Proc. of 2009 ICIME, p. 262-266. [doi: 10.1109/ICIME.2009.88]
- Simalango, M. F., Oh, S., 2009. On Feasibility of Enterprise Cloud for Scientific Computing. Proc. of 2009 Korea Computer Congress, p. 372-377.
- Sivasubramanian, S., Szymaniak, M., Pierre, G., Steen, M. V., 2004. Replication for Web Hosting Systems. *ACM Computing Surveys*, 36(3): 291-334. [doi: 10.1145/1035570.1035573]
- Smith, L. I., 2002. A Tutorial on Principal Component Analysis; Cornell University, USA.
- Tran, H. T., 2005. On the Service Overlay Network Concept for End-to-End QoS Assurances. Research Report FTW-TR-2005-024.
- Venugopal, S., Buyya, R., Ramamohanarao, K., 2006. A Taxonomy of Data Grids for Distributed Data Sharing, Management and Processing. *ACM Computing Surveys*, 38(1): article 3. [doi: 10.1145/1132952.1132955]
- Wang, G., Ng, T. S. E., 2010. The Impact of Virtualization on Network Performance of Amazon EC2 Data Center. Proc. of 29th Conference on Information Communications (INFOCOM), p. 1163-1171. [doi: 10.1109/INFCOM.2010.5461931]
- Wang, L., Park, K., Pang, R., Pai, V., Peterson, L., 2004. Reliability and Security in the CoDeeN Content Distribution Network. Proc. of USENIX Annual Technical Conference, p. 14.
- Welsh, M. D., 2002. An Architecture for Highly Concurrent, Well-Conditioned Internet Services. Ph. D. dissertation, University of California, Berkeley, USA.
- Xu, Z., Huang, R., Bhuyan, L. N., 2004. Load Balancing of DNS-Based Distributed Web Server Systems with Page Caching. Proc. of 2004 ICPADS, p. 587. [doi: 10.1109/ICPADS.2004.51]
- Zhang, Z., Fan, W., 2008. Web Server Load Balancing: A Queueing Analysis. *European Journal of Operational Research*, 186(2): 681-693. [doi: 10.1016/j.ejor.2007.02.011]