



Power Control and Connectivity Solutions

Appleton and O-Z/Gedney

A complete selection of controls, plugs, receptacles and hazardous location fittings.



EMERSON POWERS, CONTROLS AND CONNECTS EQUIPMENT THROUGHOUT YOUR FACILITY.

Appleton and O-Z/Gedney products offer flexible control designs that adapt to the needs of almost any material handling application, including motor driven conveyors, cranes, unloaders, bulk handling systems and other machinery used in hazardous areas where ignitable vapors, gases or combustible dusts are present. Secure electrical connections to equipment used to build, repair, operate or maintain manufacturing plants, marine terminals, cell towers or exploration equipment power is required to keep facilities operational. Achieving this safely requires connectivity solutions you can install quickly and rely on to provide quick access to power across a job site. We offer dozens of designs for electrical connections in commercial, industrial, harsh and hazardous environments. Running cable and conduit through hazardous locations demands products that you can rely on to protect people, property and productivity. Where there is risk for explosion or fire due to ignitable gases, vapors or dusts, choosing the right electrical fitting is critical. We offer cable glands, connectors and fittings that help you run power to where it's needed.

From time tested designs to new innovations, with devices and options available to meet virtually any requirement, Emerson has solutions available to suit your needs for durability and corrosion resistance. Whether you are designing a new facility, adding production capacity to an existing plant, or reconfiguring current equipment needs, we have the controls, plugs, connectors and fittings that help you control power and run it where you it.

Notes

Power, Control and Connectivity Solutions

Table of Contents

Description	Page
Table of Contents	iii
Product Safety Statement	iv
Alphanumeric Index	v
Controls	1
Plugs and Receptacles	379
Hazardous Location Fittings	591

Product Safety Statement

The information contained in this catalog is based on our experience to date and is believed to be reliable. All weights and dimensions are approximate. This catalog supersedes and voids all previous literature.

Information in this catalog is subject to change without notice. At times, it may be necessary to modify the materials, finishes, or other components of the product. These modifications will meet or exceed the performance or functional requirements of the product.

Appleton Group designs and manufactures a range of electrical products that meet the electrical codes of different geographic markets. Many of these products are evaluated by internationally recognized third-party product safety testing and certification agencies.

As a safety precaution, users of these products must verify the product is appropriate for their application by consulting the electrical code and safety standards for their area.

Appleton Group products should be installed in accordance with the installation instructions provided with the product and all applicable electrical codes. Additional safety requirements are indicated by appropriate Danger, Warning and Caution statements which follow the suggested format of the American National Standards Institute (ANSI).

These statements are intended to inform not only knowledgeable, sophisticated installers and users, but also those who will have casual contact with the product. Failure to follow this information could result in serious personal injury. Where appropriate these statements may appear on:

1. The product carton
2. The label attached to the product carton
3. The instruction sheet
4. The product itself in a conspicuous manner where physical space allows

Any questions with regard these statements or safety should be addressed to:

Product Safety Officer
Appleton Group
9377 W. Higgins Road
Rosemont, IL 60018
1-800-621-1506
www.emerson.com

Alphanumeric Index

Catalog Number	Page	Catalog Number	Page	Catalog Number	Page	Catalog Number	Page
050NPTET5	644	100A2FRC5005	623	115TE1FU5004	615	2016PX2K0505	608
050NPTETS	646	100C2KX4005	598	125NPTET5	644	2016PX2K0755	608
050NPTLN5	644	100C2KX5	598	125NPTETS	646	2016PX2K5	608
050NPTSW4	645	100C2KX5005	598	125NPTLN5	644	2016PX2KREX5	610
075NPTET5	644	100E1FU4005	625	125NPTSW4	645	2016PX2KRX505	610
075NPTETS	646	100E1FU5	625	130A25	596	2016PX2KRX755	610
075NPTLN5	644	100E1FU5005	625	130A25005	596	2016PX2KX0505	626
075NPTSW4	645	100E1FW4005	618	130A26005	596	2016PX2KX0755	626
093958	265	100E1FW5	618	130A2F5	613	2016PX2KX5	626
093959	266	100E1FW5005	618	130A2F5005	613	2016PX2KXREX5X	628
095485	642	100E1FX4005	621	130A2F6005	613	2016PX2KXRX505X	628
095486	642	100E1FX5	621	130A2FRC5	623	2016PX2KXRX755X	628
095487	642	100E1FX5005	621	130A2FRC5005	623	2016SPXREX5X	606
095488	642	100ET5	644	130A2FRC6005	623	2016T30505	603
095605	139	100ETS2	646	130E1FU5	625	2016T30755	603
095605	155	100LN5	644	130E1FU5005	625	2016T35	603
095605	171	100LSW	647	130E1FU6005	625	2016TE1FU0504	615
095605	181	100NPTET5	644	130E1FW5	618	2016TE1FU0754	615
095605	617	100NPTETS	646	130E1FW5005	618	2016TE1FU4	615
095606	617	100NPTLN5	644	130E1FW6005	618	20A20505	596
095714	642	100NPTSW4	645	130E1FX5	621	20A20755	596
095715	642	100PX2K4005	608	130E1FX5005	621	20A25	596
095756	617	100PX2K5	608	130E1FX6005	621	20A2F0505	613
095757	617	100PX2K5005	608	130T35	603	20A2F0755	613
095758	617	100PX2KX4005	626	130T35005	603	20A2F5	613
095759	617	100PX2KX5	626	130T36005	603	20A2FRC0505	623
095800	617	100PX2KX5005	626	130TE1FU4	615	20A2FRC0755	623
095801	617	100PX4005	604	130TE1FU5004	615	20A2FRC5	623
095802	617	100PX5	604	130TE1FU6004	615	20C2KX0505	598
095803	617	100PX5005	604	150NPTET5	644	20C2KX0755	598
095804	617	100SW4	645	150NPTETS	646	20C2KX5	598
095805	617	100T34005	603	150NPTLN5	644	20E1FU0505	625
096496	550	100T35	603	150SPTNW4	645	20E1FU0755	625
097494	550	100T35005	603	16ET5	644	20E1FU5	625
097499	552	100TE1FU4	615	16ETS2	646	20E1FW0505	618
098656	179	100TE1FU4004	615	16LN5	644	20E1FW0755	618
098657	139	100TE1FU5004	615	16SW4	645	20E1FW5	139
098657	155	115A24005	596	200NPTET5	644	20E1FW5	155
098657	171	115A25	596	200NPTETS	646	20E1FW5	171
098657	181	115A25005	596	200NPTLN5	644	20E1FW5	181
098657	232	115A2F4005	613	200NPTSW4	645	20E1FW5	618
098661	179	115A2F5	613	2016A20505	596	20E1FX0505	621
OEC-50	709	115A2F5005	613	2016A20755	596	20E1FX0755	621
OEC-75	709	115A2FRC4005	623	2016A25	596	20E1FX5	139
OELB-50	709	115A2FRC5	623	2016A2F0505	613	20E1FX5	155
OELB-75	709	115A2FRC5005	623	2016A2F0755	613	20E1FX5	171
OELL-50	709	115E1FU4005	625	2016A2F5	613	20E1FX5	181
OELL-75	709	115E1FU5	625	2016A2FRC0505	623	20E1FX5	621
OELR-50	709	115E1FU5005	625	2016A2FRC0755	623	20ETS	644
OELR-75	709	115E1FW4005	618	2016A2FRC5	623	20ETS2	139
OET-50	709	115E1FW5	618	2016C2KX0505	598	20ETS2	155
OET-75	709	115E1FW5005	618	2016C2KX0755	598	20ETS2	171
100A24005	596	115E1FX4005	621	2016C2KX5	598	20ETS2	181
100A25	596	115E1FX5	621	2016E1FW0505	618	20ETS2	646
100A25005	596	115E1FX5005	621	2016E1FW0755	618	20LN5	644
100A2F4005	613	115T34005	603	2016E1FW5	618	20LPX0505	604
100A2F5	613	115T35	603	2016E1FX0505	621	20LPX0755	604
100A2F5005	613	115T35005	603	2016E1FX0755	621	20LPX5	604
100A2FRC4005	623	115TE1FU4	615	2016E1FX5	621	20LPXREX0505X	606
100A2FRC5	623	115TE1FU4004	615	2016LSW	647	20LPXREX0755X	606

Alphanumeric Index

Catalog Number	Page	Catalog Number	Page	Catalog Number	Page	Catalog Number	Page
20LPXREX5X	606	20SPX2KX5	626	25PX2KX5	626	32A2FRC1005	623
20LSW	647	20SPX2KXREX5X	628	25PX2KXREX0755X	628	32A2FRC1255	623
20PX0505	604	20SPX2KXRX0505X	628	25PX2KXREX1005X	628	32A2FRC5	623
20PX0755	604	20SPX2KXRX0755X	628	25PX2KXREX5X	628	32C2KX1005	598
20PX2K0505	608	20SPX5	604	25PX5	604	32C2KX1255	598
20PX2K0755	608	20SPXREX0505X	606	25PXREX0755X	606	32C2KX5	598
20PX2K5	608	20SPXREX0755X	606	25PXREX1005X	606	32E1FU1005	625
20PX2KREX0505	610	20SPXREX5X	606	25PXREX5X	606	32E1FU1255	625
20PX2KREX0755	610	20ST30505	603	25SE1FU0755	625	32E1FU5	625
20PX2KREX5	610	20ST30755	603	25SE1FU1005	625	32E1FW1005	618
20PX2KX0505	626	20ST35	603	25SE1FU5	625	32E1FW1255	618
20PX2KX0755	626	20STE1FU0504	615	25SE1FW0755	618	32E1FW5	618
20PX2KX5	626	20STE1FU0754	615	25SE1FW1005	618	32E1FX1005	621
20PX2KXREX0505X	628	20STE1FU4	615	25SE1FW5	618	32E1FX1255	621
20PX2KXREX0755X	628	20SW4	645	25SE1FX0755	621	32E1FX5	621
20PX2KXREX5X	628	20T30505	603	25SE1FX1005	621	32ET5	644
20PX5	604	20T30755	603	25SE1FX5	621	32ETS2	646
20PXREX0505X	606	20T35	603	25SPX2K0755	608	32LN5	644
20PXREX0755X	606	20TE1FU0504	615	25SPX2K1005	608	32LPX1005	604
20PXREX5X	606	20TE1FU0754	615	25SPX2K5	608	32LPX1255	604
20S16E1FU0505	625	20TE1FU4	615	25SPX2KREX5	610	32LPX5	604
20S16E1FU0755	625	25ONPTET5	644	25SPX2KRX0755	610	32LPXREX1005X	606
20S16E1FU5	625	25ONPTETS	646	25SPX2KRX1005	610	32LPXREX1255X	606
20S16PX0505	604	25ONPTLN5	644	25SPX2KX0755	626	32LPXREX5X	606
20S16PX0755	604	25ONPTSW4	645	25SPX2KX1005	626	32LSW	647
20S16PX5	604	25A20755	596	25SPX2KX5	626	32PX1005	604
20S16PXREX0505X	606	25A21005	596	25SPX2KXREX5X	628	32PX1255	604
20S16PXREX0755X	606	25A25	596	25SPX2KXRX0755X	628	32PX2K1005	608
20SA20505	596	25A2F0755	613	25SPX2KXRX1005X	628	32PX2K1255	608
20SA20755	596	25A2F1005	613	25ST30755	603	32PX2K5	608
20SA25	596	25A2F5	613	25ST31005	603	32PX2KREX1005	610
20SA2F0505	613	25A2FRC0755	623	25ST35	603	32PX2KREX1255	610
20SA2F0755	613	25A2FRC1005	623	25STE1FU0754	615	32PX2KREX5	610
20SA2F5	613	25A2FRC5	623	25STE1FU1004	615	32PX2KX1005	626
20SA2FRC0505	623	25C2KX0755	598	25STE1FU4	615	32PX2KX1255	626
20SA2FRC0755	623	25C2KX1005	598	25SW4	645	32PX2KX5	626
20SA2FRC5	623	25C2KX5	598	25T30755	603	32PX2KXREX1005X	628
20SC2KX0505	598	25E1FU0755	625	25T31005	603	32PX2KXREX1255X	628
20SC2KX0755	598	25E1FU1005	625	25T35	603	32PX2KXREX5X	628
20SC2KX5	598	25E1FU5	625	25TE1FU0754	615	32PX5	604
20SE1FU0505	625	25E1FW0755	618	25TE1FU1004	615	32PXREX1005X	606
20SE1FU0755	625	25E1FW1005	618	25TE1FU4	615	32PXREX1255X	606
20SE1FU5	625	25E1FW5	618	2RAPIDEX80	606	32PXREX5X	606
20SE1FW0505	618	25E1FX0755	621	2RAPIDEX80	610	32SW4	645
20SE1FW0755	618	25E1FX1005	621	2RAPIDEX80	628	32T31005	603
20SE1FW5	618	25E1FX5	621	2RAPIDEX80	631	32T31255	603
20SE1FX0505	621	25ET5	644	30ONPTET5	644	32T35	603
20SE1FX0755	621	25ETS2	646	30ONPTETS	646	32TE1FU1004	615
20SE1FX5	621	25LN5	644	30ONPTLN5	644	32TE1FU1254	615
20SLSW	647	25LSW	647	30ONPTSW4	645	32TE1FU4	615
20SPX0505	604	25PX0755	604	30CRING	429	35ONPTET5	644
20SPX0755	604	25PX1005	604	30CRING	469	35ONPTETS	646
20SPX2K0505	608	25PX2K0755	608	30SCAP	429	35ONPTLN5	644
20SPX2K0755	608	25PX2K1005	608	30SCAP	469	35ONPTSW4	645
20SPX2K5	608	25PX2K5	608	32A21005	596	3RAPIDEX80	606
20SPX2KREX5	610	25PX2KREX0755	610	32A21255	596	3RAPIDEX80	610
20SPX2KRX0505	610	25PX2KREX1005	610	32A25	596	3RAPIDEX80	628
20SPX2KRX0755	610	25PX2KREX5	610	32A2F1005	613	3RAPIDEX80	631
20SPX2KX0505	626	25PX2KX0755	626	32A2F1255	613	40A21255	596
20SPX2KX0755	626	25PX2KX1005	626	32A2F5	613	40A21505	596

Alphanumeric Index

Catalog Number	Page	Catalog Number	Page	Catalog Number	Page	Catalog Number	Page
40A25	596	500055	672	50A2F2505	613	50SPX1505	604
40A2F1255	613	500056	672	50A2F5	613	50SPX2005	604
40A2F1505	613	500057	672	50A2FRC2005	623	50SPX2K1505	608
40A2F5	613	500058	672	50A2FRC2505	623	50SPX2K2005	608
40A2FRC1255	623	500059	672	50A2FRC5	623	50SPX2K5	608
40A2FRC1505	623	500060	673	50C2KX2005	598	50SPX2KREX5	610
40A2FRC5	623	500061	673	50C2KX2505	598	50SPX2KRX1505	610
40C2KX1255	598	500062	673	50C2KX5	598	50SPX2KRX2005	610
40C2KX1505	598	500063	673	50E1FU2005	625	50SPX2KX1505	626
40C2KX5	598	500064	673	50E1FU2505	625	50SPX2KX2005	626
40E1FU1255	625	500065	673	50E1FU5	625	50SPX2KX5	626
40E1FU1505	625	500066	673	50E1FW2005	618	50SPX2KXREX5X	628
40E1FU5	625	500067	673	50E1FW2505	618	50SPX2KXRX1505X	628
40E1FW1255	618	500068	673	50E1FW5	618	50SPX2KXRX2005X	628
40E1FW1505	618	500069	673	50E1FX2005	621	50SPX5	604
40E1FW5	618	500070	673	50E1FX2505	621	50SPXREX1505X	606
40E1FX1255	621	500071	673	50E1FX5	621	50SPXREX2005X	606
40E1FX1505	621	500072	673	50ET5	644	50SPXREX5X	606
40E1FX5	621	500073	673	50ETS2	646	50ST31505	603
40ET5	644	500074	673	50LN5	644	50ST32005	603
40ETS2	646	500075	673	50LSW	647	50ST35	603
40LN5	644	500076	673	50PX2005	604	50STE1FU1504	615
40LSW	647	500077	673	50PX2505	604	50STE1FU2004	615
40PX1255	604	500078	673	50PX2K2005	608	50STE1FU4	615
40PX1505	604	500079	673	50PX2K2505	608	50SW4	645
40PX2K1255	608	500080	673	50PX2K5	608	50T32005	603
40PX2K1505	608	500081	673	50PX2KREX2005	610	50T32505	603
40PX2K5	608	500082	673	50PX2KREX2505	610	50T35	603
40PX2KREX1255	610	500083	673	50PX2KREX5	610	50TE1FU2004	615
40PX2KREX1505	610	500084	673	50PX2KX2005	626	50TE1FU2504	615
40PX2KREX5	610	500085	673	50PX2KX2505	626	50TE1FU4	615
40PX2KX1255	626	500086	673	50PX2KX5	626	63A22505	596
40PX2KX1505	626	500087	673	50PX2KXREX2005X	628	63A23005	596
40PX2KX5	626	500088	673	50PX2KXREX5X	628	63A25	596
40PX2KXREX1255X	628	500089	673	50PX5	604	63A2F2505	613
40PX2KXREX1505X	628	500090	673	50PXREX2005X	606	63A2F3005	613
40PX2KXREX5X	628	500091	673	50PXREX2505X	606	63A2F5	613
40PX5	604	500092	673	50PXREX5X	606	63A2FRC2505	623
40PXREX1255X	606	500093	673	50SA21505	596	63A2FRC3005	623
40PXREX1505X	606	500094	673	50SA22005	596	63A2FRC5	623
40PXREX5X	606	500095	673	50SA25	596	63C2KX2505	598
40SW4	645	500096	673	50SA2F1505	613	63C2KX3005	598
40T31255	603	500097	673	50SA2F2005	613	63C2KX5	598
40T31505	603	500098	673	50SA2F5	613	63E1FU2505	625
40T35	603	500106	673	50SA2FRC1505	623	63E1FU3005	625
40TE1FU1254	615	500146	699	50SA2FRC2005	623	63E1FU5	625
40TE1FU1504	615	500147	699	50SA2FRC5	623	63E1FW2505	618
40TE1FU4	615	500148	699	50SC2KX1505	598	63E1FW3005	618
4RAPIDEX80	631	500149	699	50SC2KX2005	598	63E1FW5	618
500044	671	500150	699	50SC2KX5	598	63E1FX2505	621
500045	671	500151	699	50SE1FU1505	625	63E1FX3005	621
500046	671	500152	699	50SE1FU2005	625	63E1FX5	621
500047	671	500153	699	50SE1FU5	625	63ET5	644
500048	671	500154	699	50SE1FW1505	618	63ETS2	646
500049	671	500155	699	50SE1FW2005	618	63LN5	644
500050	671	500158	671	50SE1FW5	618	63LSW	647
500051	671	50A22005	596	50SE1FX1505	621	63PX2505	604
500052	671	50A22505	596	50SE1FX2005	621	63PX2K 3005	608
500053	671	50A25	596	50SE1FX5	621	63PX2K2505	608
500054	672	50A2F2005	613	50SLSW	647	63PX2K5	608

Alphanumeric Index

Catalog Number	Page	Catalog Number	Page	Catalog Number	Page	Catalog Number	Page
63PX2KREX2505	610	63SW4	645	737DT3M45	638	757DT95	641
63PX2KREX3005	610	63T32505	603	737DT3T15	638	75A23005	596
63PX2KREX5	610	63T33005	603	737DT3T25	638	75A23505	596
63PX2KX2505	626	63T35	603	737DT4M45	638	75A25	596
63PX2KX3005	626	63TE1FU2504	615	737DT4M55	638	75A2F3005	613
63PX2KX5	626	63TE1FU3004	615	737DT4T25	638	75A2F3505	613
63PX2KXREX2505X	628	63TE1FU4	615	737DT4T35	638	75A2F5	613
63PX2KXREX3005X	628	737DM1M25	638	737DT5M55	638	75A2FRC3005	623
63PX2KXREX5X	628	737DM1T15	638	737DT5M65	638	75A2FRC3505	623
63PX3005	604	737DM2M15	638	737DT5T35	638	75A2FRC5	623
63PX5	604	737DM2M35	638	737DT5T45	638	75C2KX3005	598
63PXREX2005X	606	737DM2T15	139	737DT6M65	638	75C2KX3505	598
63PXREX2505X	606	737DM2T15	155	737DT6M75	638	75C2KX5	598
63PXREX5X	606	737DM2T15	171	737DT6T45	638	75E1FU3005	625
63SA22005	596	737DM2T15	181	737DT6T55	638	75E1FU3505	625
63SA22505	596	737DM2T15	638	737DT7M75	638	75E1FU5	625
63SA25	596	737DM2T25	139	737DT7M85	638	75E1FW3005	618
63SA2F2005	613	737DM2T25	155	737DT7T55	638	75E1FW3505	618
63SA2F2505	613	737DM2T25	171	737DT7T65	638	75E1FW5	618
63SA2F5	613	737DM2T25	181	737DT8M85	638	75E1FX3005	621
63SA2FRC2005	623	737DM2T25	638	737DT8T65	638	75E1FX3505	621
63SA2FRC2505	623	737DM3M15	638	737DT8T75	638	75E1FX5	621
63SA2FRC5	623	737DM3M25	638	737DT9T75	638	75ET5	644
63SC2KX2005	598	737DM3M45	638	737DT9T85	638	75ETS2	646
63SC2KX2505	598	737DM3T25	638	747DAM15	639	75LN5	644
63SC2KX5	598	737DM3T35	638	747DAM25	639	75LSW	647
63SE1FU2005	625	737DM4M25	638	747DAM35	639	75PX2K3005	608
63SE1FU2505	625	737DM4M35	638	747DAM45	639	75PX2K3505	608
63SE1FU5	625	737DM4M55	638	747DAM55	639	75PX2K5	608
63SE1FW2005	618	737DM4T35	638	747DAM65	639	75PX2KREX3005	610
63SE1FW2505	618	737DM4T45	638	747DAM75	639	75PX2KREX3505	610
63SE1FW5	618	737DM5M35	638	747DAM85	639	75PX2KREX5	610
63SE1FX2005	621	737DM5M45	638	747DAM95	639	75PX2KX3005	626
63SE1FX2505	621	737DM5M65	638	747DAT15	639	75PX2KX3505	626
63SE1FX5	621	737DM5T45	638	747DAT25	639	75PX2KX5	626
63SLSW	647	737DM5T55	638	747DAT35	639	75PX2KXREX3005X	628
63SPX2005	604	737DM6M45	638	747DAT45	639	75PX2KXREX3505X	628
63SPX2505	604	737DM6M55	638	747DAT55	639	75PX2KXREX5X	628
63SPX2K2005	608	737DM6M75	638	747DAT65	639	75PX3005	604
63SPX2K2505	608	737DM6T55	638	747DAT75	639	75PX3505	604
63SPX2K5	608	737DM6T65	638	747DAT85	639	75PX5	604
63SPX2KREX5	610	737DM7M55	638	757DM105	641	75PXREX3005X	606
63SPX2KRX2005	610	737DM7M65	638	757DM15	641	75PXREX3505X	606
63SPX2KRX2505	610	737DM7M85	638	757DM25	641	75PXREX5X	606
63SPX2KX2005	626	737DM7T65	638	757DM35	641	75SA22505	596
63SPX2KX2505	626	737DM7T75	638	757DM45	641	75SA23005	596
63SPX2KX5	626	737DM8M65	638	757DM55	641	75SA25	596
63SPX2KXREX5X	628	737DM8M75	638	757DM65	641	75SA2F2505	613
63SPX2KXRX2005X	628	737DM8M95	638	757DM75	641	75SA2F3005	613
63SPX2KXRX2505X	628	737DM8T75	638	757DM85	641	75SA2F5	613
63SPX5	604	737DM8T85	638	757DM95	641	75SA2FRC2505	623
63SPXREX2005X	606	737DM9M105	638	757DT105	641	75SA2FRC3005	623
63SPXREX2505X	606	737DT10T85	638	757DT15	641	75SA2FRC5	623
63SPXREX5X	606	737DT10T95	638	757DT25	641	75SC2KX2505	598
63ST32005	603	737DT11M25	638	757DT35	641	75SC2KX3005	598
63ST32505	603	737DT11T25	638	757DT45	641	75SC2KX5	598
63ST35	603	737DT12M25	638	757DT55	641	75SE1FU2505	625
63STE1FU2004	615	737DT2M35	638	757DT65	641	75SE1FU3005	625
63STE1FU2504	615	737DT2T15	638	757DT75	641	75SE1FU5	625
63STE1FU4	615	737DT3M35	638	757DT85	641	75SE1FW2505	618

Alphanumeric Index

Catalog Number	Page	Catalog Number	Page	Catalog Number	Page	Catalog Number	Page
75SE1FW3005	618	90A2F5	613	ACP1022CD	464	ACP3034BC	461
75SE1FW5	618	90A2FRC3005	623	ACP1022CD	465	ACP3034BC	466
75SE1FX2505	621	90A2FRC3505	623	ACP1023CD	435	ACP3034BC	485
75SE1FX3005	621	90A2FRC5	623	ACP1023CD	441	ACP3034BC	488
75SE1FX5	621	90A2X3505	596	ACP1023CD	446	ACP3034BC	491
75SLSW	647	90C2KX3505	598	ACP1023CD	449	ACP3034BC	495
75SPX2505	604	90C2KX4005	598	ACP1023CD	452	ACP3044BC	460
75SPX2K2505	608	90C2KX5	598	ACP1023CD	464	ACP3044BC	461
75SPX2KX3005	608	90E1FU3505	625	ACP1023CD	465	ACP3044BC	466
75SPX2K5	608	90E1FU4005	625	ACP1033CD	464	ACP6022BC	462
75SPX2KREX5	610	90E1FU5	625	ACP1033CD	465	ACP6022BC	463
75SPX2KRX2505	610	90E1FW3005	618	ACP1034CD	426	ACP6023BC	430
75SPX2KRX3005	610	90E1FW3505	618	ACP1034CD	435	ACP6023BC	435
75SPX2KX3005	626	90E1FW5	618	ACP1034CD	441	ACP6023BC	441
75SPX2KX5	626	90E1FX3005	621	ACP1034CD	446	ACP6023BC	446
75SPX2KXREX5X	628	90E1FX3505	621	ACP1034CD	449	ACP6023BC	449
75SPX2KXRX2505X	628	90E1FX5	621	ACP1034CD	452	ACP6023BC	452
75SPX2KXRX3005X	628	90ET5	644	ACP1034CD	464	ACP6023BC	462
75SPX3005	604	90ETS2	646	ACP1034CD	465	ACP6023BC	463
75SPX5	604	90LN5	644	ACP1034CD	466	ACP6033BC	462
75SPXREX2505X	606	90LSW	647	ACP1034CD	488	ACP6033BC	463
75SPXREX3005X	606	90PX2K3005	608	ACP1034CD	491	ACP6034BC	426
75SPXREX5X	606	90PX2K3505	608	ACP1034CD	495	ACP6034BC	430
75ST32505	603	90PX2K5	608	ACP1044CD	464	ACP6034BC	435
75ST33005	603	90PX2KREX3505	610	ACP1044CD	465	ACP6034BC	441
75ST35	603	90PX2KREX4005	610	ACP1044CD	466	ACP6034BC	446
75STE1FU2504	615	90PX2KREX5	610	ACP15034CD	435	ACP6034BC	449
75STE1FU3004	615	90PX2KX3505	626	ACP15034CD	441	ACP6034BC	452
75STE1FU4	615	90PX2KX4005	626	ACP15034CD	446	ACP6034BC	462
75SW4	645	90PX2KX5	626	ACP15034CD	464	ACP6034BC	463
75T33005	603	90PX2KXREX3005X	628	ACP15034CD	465	ACP6034BC	466
75T33505	603	90PX2KXREX4005X	628	ACP15034CD	466	ACP6034BC	485
75T35	603	90PX2KXREX5X	628	ACP15034DE	435	ACP6034BC	488
75TE1FU3004	615	90PX3505	604	ACP15034DE	441	ACP6034BC	491
75TE1FU3504	615	90PX4005	604	ACP15034DE	446	ACP6034BC	495
75TE1FU4	615	90PX5	604	ACP15034DE	464	ACP6044BC	462
767DM15	643	90PXREX3505X	606	ACP15034DE	465	ACP6044BC	463
767DM25	643	90PXREX4005X	606	ACP15034DE	466	ACP6044BC	466
767DM35	643	90PXREX5X	606	ACP3022BC	460	ACPCAP1004	466
767DM45	643	90SW4	645	ACP3022BC	461	ACPCAP3034	466
767DM55	643	90T33005	603	ACP3023BC	430	ACPCAP6004	466
767DM65	643	90T33505	603	ACP3023BC	435	ACSE040805SQ02D	279
767DM75	643	90T35	603	ACP3023BC	441	ACSE040805SQ12D	279
767DM85	643	90TE1FU3504	615	ACP3023BC	446	ACSE040805SQD02	279
767DM95	643	90TE1FU4	615	ACP3023BC	449	ACSE040805SQD03	279
767DT15	643	90TE1FU4004	615	ACP3023BC	452	ACSE040805SQD12	279
767DT25	643	A3463D94G18	298	ACP3023BC	460	ACSE040805SQD13	279
767DT35	643	A3463D94G18	298	ACP3023BC	461	ACSEW050903	234
767DT45	643	A3463D94G18	314	ACP3023BC	466	ACSEW050903	236
767DT55	643	A3463D94G18	314	ACP3033BC	460	ACSEW060804	234
767DT65	643	A999SX8	298	ACP3033BC	461	ACSEW060804	236
767DT75	643	A999SX8	314	ACP3033BC	466	ACSEW061004	234
767DT85	643	A999SX8	298	ACP3034BC	426	ACSEW061004	236
8-100	651	A999SX8	314	ACP3034BC	430	ACSEW061204	234
8-50	651	AC1-A	689	ACP3034BC	435	ACSEW061204	236
8-75	651	AC1F01-A	689	ACP3034BC	441	ACSEW061604	234
90A23005	596	AC1F01-A0Z	697	ACP3034BC	446	ACSEW061604	236
90A25	596	AC5-A	689	ACP3034BC	449	ACSEW071106	234
90A2F3005	613	ACK12F-A	689	ACP3034BC	452	ACSEW071106	236
90A2F3505	613	ACK6F-A	689	ACP3034BC	460	ACSEW080806	234

Alphanumeric Index

Catalog Number	Page	Catalog Number	Page	Catalog Number	Page	Catalog Number	Page
ACSEW080806	236	ACSEW182410	234	ADR1023	464	AE1047	499
ACSEW081006	234	ACSEW182410	236	ADR1033	464	AE1048	499
ACSEW081006	236	ACSEW183008	234	ADR1034	464	AE1BA	283
ACSEW081307	234	ACSEW183008	236	ADR1044	464	AE1BA4W1	287
ACSEW081307	236	ACSEW183608	234	ADR15034	464	AE1BA6W1	287
ACSEW091105	234	ACSEW183608	236	ADR20023	474	AE1BB	285
ACSEW091105	236	ACSEW183610	234	ADR20033	474	AE1BB4W1C3	290
ACSEW091504	234	ACSEW183610	236	ADR20034	474	AE1BB4W1C4	290
ACSEW091504	236	ACSEW184207	234	ADR20044	474	AE1BB4W1CD	293
ACSEW101006	234	ACSEW184207	236	ADR3022	460	AE1BB4W1CE	293
ACSEW101006	236	ACSEW206008	234	ADR3023	460	AE1BB6W1C3	290
ACSEW101406	234	ACSEW206008	236	ADR3033	460	AE1BB6W1C4	290
ACSEW101406	236	ACSEW242408	234	ADR3034	460	AE1BB6W1CB	293
ACSEW101408	234	ACSEW242408	236	ADR3044	460	AE1BB6W1CD	293
ACSEW101408	236	ACSEW242410	234	ADR6022	462	AE1BM1S112	296
ACSEW112005	234	ACSEW242410	236	ADR6023	462	AE1BM1S13	296
ACSEW112005	236	ACSEW243008	234	ADR6033	462	AE1BM1S16	296
ACSEW112406	234	ACSEW243008	236	ADR6034	462	AE1BM1S19	296
ACSEW112406	236	ACSEW243608	234	ADR6044	462	AE1BN1S1F12	297
ACSEW113006	234	ACSEW243608	236	ADRE3022-50	460	AE1BN1S1F3	297
ACSEW113006	236	ACSEW243610	234	ADRE3022-75	460	AE1BN1S1F6	297
ACSEW121206	234	ACSEW243610	236	ADRE3023-100	460	AE1BN1S1F9	297
ACSEW121206	236	ACSEW303808	234	ADRE3023-75	460	AE2BA	283
ACSEW121208	234	ACSEW303808	236	ADRE3033-100	460	AE2BA4W1	287
ACSEW121208	236	ACSEW303816	234	ADRE3033-75	460	AE2BA6W1	287
ACSEW121806	234	ACSEW303816	236	ADRE3034-100	460	AE2BB	285
ACSEW121806	236	ADJA1022-125	464	ADRE3034-75	460	AE2BB4W1C4	290
ACSEW121808	234	ADJA1022-150	464	ADRE3044-100	460	AE2BB4W1C5	290
ACSEW121808	236	ADJA1023-125	464	ADRE3044-75	460	AE2BB4W1CG	293
ACSEW122408	234	ADJA1023-150	464	ADRE6022-100	462	AE2BB4W1CJ	293
ACSEW122408	236	ADJA1033-125	464	ADRE6022-125	462	AE2BB6W1C4	290
ACSEW123608	236	ADJA1033-150	464	ADRE6023-100	462	AE2BB6W1C5	290
ACSEW133806	234	ADJA1034-150	464	ADRE6023-125	462	AE2BB6W1CF	293
ACSEW133806	236	ADJA1034-200	464	ADRE6033-100	462	AE2BB6W1CG	293
ACSEW141406	234	ADJA1044-150	464	ADRE6033-125	462	AE321	497
ACSEW141406	236	ADJA1044-200	464	ADRE6034-125	462	AE327	497
ACSEW141408	234	ADJA15034-150	464	ADRE6034-150	462	AE331	497
ACSEW141408	236	ADJA15034-200	464	ADRE6044-125	462	AE332	497
ACSEW142408	234	ADJA20023-150	474	ADRE6044-150	462	AE337	497
ACSEW142408	236	ADJA20023-200	474	AE0BA	283	AE338	497
ACSEW153707	234	ADJA20023-250	474	AE0BA4W1	287	AE341	497
ACSEW153707	236	ADJA20033-150	474	AE0BA6W1	287	AE342	497
ACSEW161606	234	ADJA20033-200	474	AE0BB	285	AE347	497
ACSEW161606	236	ADJA20033-250	474	AE0BB4W1C1	290	AE348	497
ACSEW161608	234	ADJA20034-150	474	AE0BB4W1C2	290	AE3BA	283
ACSEW161608	236	ADJA20034-200	474	AE0BB4W1C3	290	AE3BA4W1	287
ACSEW161812	234	ADJA20034-250	474	AE0BB4W1CA	293	AE3BA6W1	287
ACSEW161812	236	ADJA20044-200	474	AE0BB4W1CB	293	AE3BB	285
ACSEW162206	234	ADJA20044-250	474	AE0BB6W1C1	290	AE3BB4W1C5	290
ACSEW162206	236	ADJA6022-100	462	AE0BB6W1C2	290	AE3BB4W1C7	290
ACSEW162408	234	ADJA6022-125	462	AE0BB6W1C3	290	AE3BB4W1CN	293
ACSEW162408	236	ADJA6023-100	462	AE0BB6W1CA	293	AE3BB4W1CP	293
ACSEW162806	234	ADJA6023-125	462	AE1021	499	AE3BB6W1C5	290
ACSEW162806	236	ADJA6033-100	462	AE1027	499	AE3BB6W1C7	290
ACSEW181806	234	ADJA6033-125	462	AE1031	499	AE3BB6W1CJ	293
ACSEW181806	236	ADJA6034-125	462	AE1032	499	AE3BB6W1CN	293
ACSEW181808	234	ADJA6034-150	462	AE1037	499	AE4BA	283
ACSEW181808	236	ADJA6044-125	462	AE1038	499	AE4BA4W1	287
ACSEW182408	234	ADJA6044-150	462	AE1041	499	AE4BA6W1	287
ACSEW182408	236	ADR1022	464	AE1042	499	AE4BB	285

Alphanumeric Index

Catalog Number	Page	Catalog Number	Page	Catalog Number	Page	Catalog Number	Page
AE4BB4W1C8	290	AELABA4W11	305	AEPGA	298	AERC56	498
AE4BB4W1CQ	293	AELABA4W12	305	AEPGA	314	AERH13	467
AE4BB4W1CS	293	AELABM1S112	312	AEPGI	348	AERH13	497
AE4BB6W1C7	290	AELABM1S13	312	AEPL-50	348	AERH23	467
AE4BB6W1C8	290	AELABM1S16	312	AEPI-1021	499	AERH23	497
AE4BB6W1CP	293	AELABM1S19	312	AEPI-1031	499	AERH33	467
AE4BB6W1CQ	293	AELBBA	301	AEPI-1032	499	AERH33	497
AE5BA	283	AELBBA4W13	305	AEPI-1041	499	AERH36	467
AE5BA4W1	287	AELBBB	303	AEPI-1042	499	AERH36	498
AE5BA6W1	287	AELBBB4W1C10	308	AEPI-321	497	AERH46	467
AE5BB	285	AELBBB4W1C20	308	AEPI-331	497	AERH46	498
AE5BB4W1C0	290	AELBBB4W1C30	308	AEPI-332	497	AERH56	467
AE5BB4W1CU	293	AELBBB4W1C31	308	AEPI-341	497	AERH56	498
AE5BB4W1CV	293	AELBBB4W1C41	308	AEPI-342	497	AESS22ML	298
AE5BB4W1CX	293	AELBBB4W1C42	308	AEPI-621	498	AESS22ML	314
AE5BB6W1C0	290	AELBBB4W1C52	308	AEPI-631	498	AESS31MN	298
AE5BB6W1CU	293	AELBBB4W1CA0	310	AEPI-632	498	AESS31MN	314
AE5BB6W1CV	293	AELBBB4W1CB0	310	AEPI-641	498	AEXMS-A	315
AE621	498	AELBBB4W1CD1	310	AEPI-642	498	AEXMS-B	315
AE627	498	AELBBB4W1CE1	310	AEPL1G	298	AEXMS-C	315
AE631	498	AELBBB4W1CG2	310	AEPL1G	314	AEXMS-D	315
AE632	498	AELBBB4W1CJ2	310	AEPL1R	298	AEXMS-E	315
AE637	498	AELBBN1S1F12	313	AEPL1R	314	AEXMS-F	315
AE638	498	AELBBN1S1F3	313	AEPL2G	298	AEXMS-G	315
AE641	498	AELBBN1S1F6	313	AEPL2G	314	AEXMS-H	315
AE642	498	AELBBN1S1F9	313	AEPL2R	298	AEXMS-J	315
AE647	498	AELFBA	301	AEPL2R	314	AEXMS-K	315
AE648	498	AELFBA4W14	305	AEPL4G	298	AFA1	352
AEE13	467	AELFBB	303	AEPL4G	314	AFA10	352
AEE13	497	AELFBB4W1C53	308	AEPL4R	298	AFA2	352
AEE23	467	AELFBB4W1C73	308	AEPL4R	314	AFA20	352
AEE23	497	AELFBB4W1C84	308	AEPRC	298	AFA4327X11	298
AEE33	467	AELFBB4W1CN3	310	AEPRC	314	AFA4327X11	314
AEE33	497	AELFBB4W1CP3	310	AEPTGE	298	AFA4327X12	298
AEE36	467	AELFBB4W1CQ4	310	AEPTGE	314	AFA4327X12	314
AEE36	498	AELFBB4W1CS4	310	AEPTRE	298	AFA4327X13	298
AEE36	499	AELLBA	301	AEPTRE	314	AFA4327X13	314
AEE46	467	AELLBA4W15	305	AERA13	467	AFABMB	352
AEE46	498	AELLBB	303	AERA13	497	AFABMBS	352
AEE46	499	AELLBB4W1C05	308	AERA23	467	AFABMBSX	352
AEE56	467	AELLBB4W1CU5	310	AERA23	497	AFAX1	352
AEE56	498	AELLBB4W1CV5	310	AERA33	467	AFAX10	352
AEE56	499	AELLBB4W1CX5	310	AERA33	497	AFAX2	352
AEI-1021	499	AEP10253	499	AERA36	467	AFAX20	352
AEI-1031	499	AEP10353	499	AERA36	498	AFCPT050	298
AEI-1032	499	AEP10363	499	AERA46	467	AFCPT050	314
AEI-1041	499	AEP10453	499	AERA46	498	AFCPT050R	298
AEI-1042	499	AEP10463	499	AERA56	467	AFCPT050R	314
AEI-321	497	AEP3251	497	AERA56	498	AFCPT100	298
AEI-331	497	AEP3351	497	AERC13	467	AFCPT100	314
AEI-332	497	AEP3361	497	AERC13	497	AFCPT150	298
AEI-341	497	AEP3451	497	AERC23	467	AFCPT150	314
AEI-342	497	AEP3461	497	AERC23	497	AFCPT200	298
AEI-621	498	AEP6252	498	AERC33	467	AFCPT200	314
AEI-631	498	AEP6352	498	AERC33	497	AFCPT250	298
AEI-632	498	AEP6362	498	AERC36	467	AFCPT250	314
AEI-641	498	AEP6452	498	AERC36	498	AFCPT300	298
AEI-642	498	AEP6462	498	AERC46	467	AFCPT300	314
AELABA	301	AEPDGRE	298	AERC46	498	AFCPT500	298
AELABA4W10	305	AEPDGRE	314	AERC56	467	AFCPT500	314

Alphanumeric Index

Catalog Number	Page	Catalog Number	Page	Catalog Number	Page	Catalog Number	Page
AFCP750	298	AJA100	499	AMH8	285	API-3023	468
AFCP750	314	AJA200	478	AMH8	287	API-3033	468
AFSC1	355	AJA20023-150	475	AMH8	290	API-3034	468
AFSS1	355	AJA20023-200	475	AMH8	293	API-3044	468
AFSX300	355	AJA20023-250	475	AMH8	301	API40023	478
AFU0333-01	358	AJA20033-150	475	AMH8	303	API40033	478
AFU0333-02	358	AJA20033-200	475	AMH8	305	API40034	478
AFU0333-03	358	AJA20033-250	475	AMH8	308	API40044	478
AFU0333-04	358	AJA20034-150	475	AMH8	310	API40123	478
AFU0333-05	358	AJA20034-200	475	AP20023CD	474	API40133	478
AFU0333-06	358	AJA20034-250	475	AP20023CD	475	API40134	478
AFU0333-07	358	AJA20044-200	475	AP20023E	474	API40144	478
AFU0333-08	358	AJA20044-250	475	AP20023E	475	API-6022	468
AFU0333-10	358	AJA310	467	AP20033CD	474	API-6023	468
AFU0333-11	358	AJA310	498	AP20033CD	475	API-6033	468
AFU0333-20	358	AJA310	499	AP20033E	474	API-6034	468
AFU0333-22	358	AJA40023-400	476	AP20033E	475	API-6044	468
AFU0333-30	358	AJA40033-400	476	AP20034CD	474	API-6044	468
AFU0333-33	358	AJA40034-400	476	AP20034CD	475	APR10253	499
AFU0333-40	358	AJA40034-400N4	476	AP20034E	474	APR10353	499
AFU0333-44	358	AJA40044-400	476	AP20034E	475	APR10363	499
AFU0333-50	358	AJA40044-400N4	476	AP20034E	475	APR10453	499
AFU0333-55	358	AJA40123-400	476	AP20044CD	474	APR10463	499
AFU0333-60	358	AJA40133-400	476	AP20044CD	475	APR3251	497
AFU0333-66	358	AJA40134-400	476	AP20044E	474	APR3351	497
AFU0333-70	358	AJA40134-400N4	476	AP20044E	475	APR3361	497
AFU0333-77	358	AJA40144-400	476	AP40023E	476	APR3451	497
AFU0333-80	358	AJA40144-400N4	476	AP40023E	477	APR3461	497
AFU0333-88	358	AJA410	467	AP40033E	476	APR6252	498
AFUMB	359	AJA410	498	AP40033E	477	APR6352	498
AFUTSL	359	AJA410	499	AP40034E	476	APR6362	498
AFUTSR	359	AJA410	499	AP40034E	477	APR6452	498
AFUX0333-01	358	AJA510	467	AP40044E	476	APR6462	498
AFUX0333-02	358	AJA510	498	AP40044E	477	AR20023	475
AFUX0333-03	358	AJA510	499	AP40123F	476	AR20033	475
AFUX0333-04	358	AJA520	478	AP40123F	477	AR20034	475
AFUX0333-05	358	AJA610	467	AP40123G	476	AR20044	475
AFUX0333-06	358	AJA610	498	AP40123G	477	AR40023	476
AFUX0333-07	358	AJA610	499	AP40133F	476	AR40033	476
AFUX0333-08	358	AJA620	478	AP40133F	477	AR40034	476
AFUX0333-08	358	AJA720	478	AP40133G	477	AR40034N4	476
AFUX0333-10	358	AJAC720	478	AP40133G	476	AR40044	476
AFUX0333-11	358	AJB238	478	AP40134F	477	AR40044N4	476
AFUX0333-20	358	AJB620	478	AP40134F	476	AR40123	476
AFUX0333-22	358	ALE250	698	AP40134G	477	AR40133	476
AFUX0333-30	358	ALENOZZLE	698	AP40134G	476	AR40134	476
AFUX0333-33	358	AMH7	283	AP40144F	477	AR40134N4	476
AFUX0333-40	358	AMH7	285	AP40144F	476	AR40144	476
AFUX0333-44	358	AMH7	287	AP40144G	477	AR40144N4	476
AFUX0333-50	358	AMH7	290	AP40144G	476	ARC1022CD	465
AFUX0333-55	358	AMH7	293	API-1022	468	ARC1023CD	465
AFUX0333-60	358	AMH7	296	API-1023	468	ARC1033CD	465
AFUX0333-66	358	AMH7	297	API-1033	468	ARC1034CD	465
AFUX0333-70	358	AMH7	301	API-1034	468	ARC1044CD	465
AFUX0333-77	358	AMH7	303	API-1044	468	ARC15034CD	465
AFUX0333-80	358	AMH7	305	API-15034	468	ARC15034DE	465
AFUX0333-88	358	AMH7	308	API20023	478	ARC20023CD	475
AJ-11	298	AMH7	310	API20033	478	ARC20023E	475
AJ-11	314	AMH7	312	API20034	478	ARC20033CD	475
AJA100	467	AMH7	313	API20044	478	ARC20033E	475
AJA100	498	AMH8	283	API-3022	468	ARC20034CD	475

Alphanumeric Index

Catalog Number	Page	Catalog Number	Page	Catalog Number	Page	Catalog Number	Page
ARC20034E	475	ASR60FDAUX-C	485	BR200-150A	660	CN-06-316PN	519
ARC20044CD	475	ASR60FDAUX-0	485	BR200-75	660	CN-06-316PN	577
ARC20044E	475	AZ-10104/6	239	BR200-75A	660	CN-06-316SN	519
ARC3022BC	461	AZ-10146/8	239	BR250-150	660	CN-06-316SN	577
ARC3023BC	461	AZ-11205	239	BR250-150A	660	CN-06-322PN	519
ARC3033BC	461	AZ-11246	239	BR300-200	660	CN-06-322PN	578
ARC3034BC	461	AZ-11306	239	BR300-200A	660	CN-06-322SN	519
ARC3044BC	461	AZ-12126/8	239	BR350-250	660	CN-06-322SN	578
ARC40023E	477	AZ-12186/8	239	BR350-250A	660	CN-06-324PN	519
ARC40033E	477	AZ-12248	239	BR400-300	660	CN-06-324PN	578
ARC40034E	477	AZ-12368	239	BR400-300A	660	CN-06-324SN	519
ARC40044E	477	AZ-13386	239	BR500-400	660	CN-06-324SN	578
ARC40123F	477	AZ-14146/8	239	BR500-400A	660	CN-06-327PN	519
ARC40123G	477	AZ-14248	239	BR75-50	660	CN-06-327PN	577
ARC40133F	477	AZ-15377	239	BR75-50A	660	CN-06-327SN	519
ARC40133G	477	AZ-16166/8	239	BRTB4X	298	CN-06-327SN	577
ARC40134F	477	AZ-161812	239	BRTB4X	314	CN-06-333PN	519
ARC40134G	477	AZ-16226	239	BRTB4X	429	CN-06-333PN	578
ARC40144F	477	AZ-16248	239	BRTB4X	675	CN-06-333SN	519
ARC40144G	477	AZ-16286	239	Bulletin 600	318	CN-06-333SN	578
ARC6022BC	463	AZ-18186/8	239	Bulletin 600	325	CN-06-334PN	521
ARC6023BC	463	AZ-18248/10	239	Bulletin 600	330	CN-06-334PN	580
ARC6033BC	463	AZ-18308	239	CEPI-3023B	423	CN-06-334SN	521
ARC6034BC	463	AZ-18368/10	239	CEPI-3034B	423	CN-06-334SN	580
ARC6044BC	463	AZ-18427	239	CEPI-6023BC	423	CN-06-348PN	520
ARI-1022	468	AZ-20608	239	CEPI-6034BC	423	CN-06-348PN	579
ARI-1023	468	AZ-24248/10	239	CERI-3023	423	CN-06-348SN	520
ARI-1033	468	AZ-24308	239	CERI-3034	423	CN-06-348SN	579
ARI-1034	468	AZ-24368/10	239	CERI-6023	423	CN-06-349PN	577
ARI-1044	468	AZ-30388	239	CERI-6034	423	CN-06-349SN	577
ARI-15034	468	AZ-593	239	CES-3023	423	CN-06-353PN	520
ARI20023	478	AZ-6104	239	CES-3034	423	CN-06-353PN	578
ARI20033	478	AZ-6124	239	CES-30B	423	CN-06-353SN	520
ARI20034	478	AZ-6164	239	CES-6023	423	CN-06-353SN	578
ARI20044	478	AZ-684	239	CES-6034	423	CN-06-354PN	520
ARI-3022	468	AZ-7116	239	CES-60B	423	CN-06-354PN	579
ARI-3023	468	AZ-8106	239	CESD-3023	423	CN-06-354SN	520
ARI-3033	468	AZ-8137	239	CESD-3034	423	CN-06-354SN	579
ARI-3034	468	AZ-886	239	CESD-30B	423	CN-06-355PN	521
ARI-3044	468	AZ-9115	239	CESD-6023	423	CN-06-355PN	580
ARI40023	478	AZ-9154	239	CESD-6034	423	CN-06-355SN	521
ARI40033	478	BR100-50	660	CESD-60B	423	CN-06-355SN	580
ARI40034	478	BR100-50A	660	CESD-60B	423	CN-08-312PN	522
ARI40044	478	BR100-75	660	CESR-3023	423	CN-08-312PN	581
ARI40123	478	BR100-75A	660	CESR-3034	423	CN-08-312SN	522
ARI40133	478	BR125-100	660	CESR-6023	423	CN-08-312SN	581
ARI40134	478	BR125-100A	660	CESR-6034	423	CN-08-316PN	520
ARI40144	478	BR125-75	660	CLMPR23P100	469	CN-08-316PN	578
ARI-6022	468	BR125-75A	660	CLMPR23P60	469	CN-08-316SN	520
ARI-6023	468	BR150-100	660	CLMPR30	469	CN-08-316SN	578
ARI-6033	468	BR150-100A	660	CLMPR4P100	469	CN-08-321PN	523
ARI-6034	468	BR150-125	660	CLMPR4P60	469	CN-08-321PN	582
ARI-6044	468	BR150-125A	660	CN-06-310PN	520	CN-08-321SN	523
ASR3034	485	BR150-75	660	CN-06-310PN	579	CN-08-321SN	582
ASR3034F	485	BR150-75A	660	CN-06-310SN	520	CN-08-325PN	522
ASR30AUX	485	BR200-100	660	CN-06-310SN	579	CN-08-325PN	581
ASR30FDAUX	485	BR200-100A	660	CN-06-314PN	519	CN-08-325SN	522
ASR6034	485	BR200-125	660	CN-06-314PN	577	CN-08-325SN	581
ASR6034F	485	BR200-125A	660	CN-06-314SN	519	CN-08-328PN	519
ASR60AUX	485	BR200-150	660	CN-06-314SN	577	CN-08-328PN	578

Alphanumeric Index

Catalog Number	Page	Catalog Number	Page	Catalog Number	Page	Catalog Number	Page
CN-08-328SN	519	CN-10-387PN	523	CN-5006-6E	525	CN-6306-02C	585
CN-08-328SN	578	CN-10-387PN	582	CN-5006-6E	585	CN-6306-04C	525
CN-08-335PN	523	CN-10-387SN	523	CN-5006-8E	525	CN-6306-04C	585
CN-08-335PN	582	CN-10-387SN	582	CN-5006-8E	585	CN-6306-06C	525
CN-08-335SN	523	CN-10-388PN	522	CN-5008-10E	525	CN-6306-06C	585
CN-08-335SN	582	CN-10-388PN	581	CN-5008-10E	585	CN-6306-08C	525
CN-08-355PN	522	CN-10-388SN	522	CN-5008-12E	525	CN-6306-08C	585
CN-08-355PN	581	CN-10-388SN	581	CN-5008-12E	585	CN-6306-10C	525
CN-08-355SN	522	CN-12-352PN	524	CN-5008-14E	525	CN-6306-10C	585
CN-08-355SN	581	CN-12-352PN	583	CN-5008-14E	585	CN-6306-12C	525
CN-08-375PN	520	CN-12-352SN	524	CN-5008-16E	525	CN-6306-12C	585
CN-08-375PN	578	CN-12-352SN	583	CN-5008-16E	585	CN-6306-14C	525
CN-08-375SN	520	CN-12-355PN	521	CN-5008-18E	525	CN-6306-14C	585
CN-08-375SN	578	CN-12-355PN	579	CN-5008-18E	585	CN-6306-15C	525
CN-08-376PN	521	CN-12-355SN	521	CN-5008-20E	525	CN-6306-15C	585
CN-08-376PN	580	CN-12-355SN	579	CN-5008-20E	585	CN-6308-06C	525
CN-08-376SN	521	CN-12-371PN	524	CN-5008-22E	525	CN-6308-06C	585
CN-08-376SN	580	CN-12-371PN	582	CN-5008-22E	585	CN-6308-08C	525
CN-08-377PN	522	CN-12-371SN	524	CN-5008-23E	525	CN-6308-08C	585
CN-08-377PN	581	CN-12-371SN	582	CN-5008-23E	585	CN-6308-10C	525
CN-08-377SN	522	CN-12-384PN	524	CN-5008-6E	525	CN-6308-10C	585
CN-08-377SN	581	CN-12-384PN	583	CN-5008-6E	585	CN-6308-12C	525
CN-08-381PN	521	CN-12-384SN	524	CN-5008-8E	525	CN-6308-12C	585
CN-08-381PN	580	CN-12-384SN	583	CN-5008-8E	585	CN-6308-14C	525
CN-08-381SN	521	CN-14-339PN	524	CN-5010-10E	525	CN-6308-14C	585
CN-08-381SN	580	CN-14-339PN	583	CN-5010-10E	585	CN-6308-16C	525
CN-10-313PN	524	CN-14-339SN	524	CN-5010-14E	525	CN-6308-16C	585
CN-10-313PN	583	CN-14-339SN	583	CN-5010-14E	585	CN-6308-18C	525
CN-10-313SN	524	CN400420L	526	CN-5010-18E	525	CN-6308-18C	585
CN-10-313SN	583	CN400420L	584	CN-5010-18E	585	CN-6308-20C	525
CN-10-332PN	523	CN400820L	526	CN-5010-20E	525	CN-6308-20C	585
CN-10-332PN	581	CN400820L	584	CN-5010-20E	585	CN-6308-22C	525
CN-10-332SN	523	CN401020L	526	CN-5010-24E	525	CN-6308-22C	585
CN-10-332SN	581	CN401020L	584	CN-5010-24E	585	CN-6308-23C	525
CN-10-350PN	523	CN401220L	526	CN-5010-28E	525	CN-6308-23C	585
CN-10-350PN	582	CN401220L	584	CN-5010-28E	585	CN-6310-10C	525
CN-10-350SN	523	CN401221L	526	CN-5010-31E	525	CN-6310-10C	585
CN-10-350SN	582	CN401221L	584	CN-5010-31E	585	CN-6310-12C	525
CN-10-359PN	520	CN401620L	526	CN-5012-16E	525	CN-6310-12C	585
CN-10-359PN	579	CN401620L	584	CN-5012-16E	585	CN-6310-14C	525
CN-10-359SN	520	CN410420L	526	CN-5012-20E	525	CN-6310-14C	585
CN-10-359SN	579	CN410420L	584	CN-5012-20E	585	CN-6310-16C	525
CN-10-374PN	523	CN410820L	526	CN-5012-24E	525	CN-6310-16C	585
CN-10-374PN	582	CN410820L	584	CN-5012-24E	585	CN-6310-18C	525
CN-10-374SN	523	CN411020L	526	CN-5012-28E	525	CN-6310-18C	585
CN-10-374SN	582	CN411020L	584	CN-5012-28E	585	CN-6310-20C	525
CN-10-375PN	522	CN411220L	526	CN-5012-32E	525	CN-6310-20C	585
CN-10-375PN	580	CN411220L	584	CN-5012-32E	585	CN-6310-22C	525
CN-10-375SN	522	CN411620L	526	CN-5012-36E	525	CN-6310-22C	585
CN-10-375SN	580	CN411620L	584	CN-5012-36E	585	CN-6310-24C	525
CN-10-376PN	522	CN-5006-10E	525	CN-5012-39E	525	CN-6310-24C	585
CN-10-376PN	581	CN-5006-10E	585	CN-5012-39E	585	CN-6310-26C	525
CN-10-376SN	522	CN-5006-12E	525	CN-5014-24E	525	CN-6310-26C	585
CN-10-376SN	581	CN-5006-12E	585	CN-5014-28E	525	CN-6310-28C	525
CN-10-380PN	580	CN-5006-14E	525	CN-5014-32E	525	CN-6310-28C	585
CN-10-380SN	580	CN-5006-14E	585	CN-5014-36E	525	CN-6310-30C	525
CN-10-386PN	523	CN-5006-15E	525	CN-5014-40E	525	CN-6310-30C	585
CN-10-386PN	582	CN-5006-15E	585	CN-5014-44E	525	CN-6310-31C	525
CN-10-386SN	523	CN-5006-4E	525	CN-5014-46E	525	CN-6310-31C	585
CN-10-386SN	582	CN-5006-4E	585	CN-6306-02C	525	CN-6312-16C	525

Alphanumeric Index

Catalog Number	Page	Catalog Number	Page	Catalog Number	Page	Catalog Number	Page
CN-6312-16C	585	CN-W-5310N	526	CPS152R	417	DA1550	268
CN-6312-18C	525	CN-W-5310N	586	CPS233RXXKIT	412	DA1550	275
CN-6312-18C	585	CN-W-5312N	526	CPSA-2350	412	DA1560	268
CN-6312-20C	525	CN-W-5312N	586	CPSA-2375	412	DA1560	275
CN-6312-20C	585	CN-W-5314N	526	CPSCA	412	DA1575	268
CN-6312-22C	525	CN-W-5314N	586	CPSCA	417	DA1575	275
CN-6312-22C	585	CPC1-23100	412	CPSR23	412	DA1610	268
CN-6312-24C	525	CPC1-2350	412	CRN38	675	DA1610	275
CN-6312-24C	585	CPC1-2375	412	CRN50	675	DA16100	268
CN-6312-26C	525	CPC2-23100	412	CRN75	675	DA16100	275
CN-6312-26C	585	CPC2-2350	412	DA1310	268	DA16125	268
CN-6312-28C	525	CPC2-2375	412	DA1310	275	DA16125	275
CN-6312-28C	585	CPE1-23100	412	DA13100	268	DA1615	268
CN-6312-30C	525	CPE1-2350	412	DA13100	275	DA1615	275
CN-6312-30C	585	CPE1-2375	412	DA13125	268	DA16150	268
CN-6312-32C	525	CPE2-23100	412	DA13125	275	DA16150	275
CN-6312-32C	585	CPE2-2350	412	DA1315	268	DA1620	268
CN-6312-34C	525	CPE2-2375	412	DA1315	275	DA1620	275
CN-6312-34C	585	CPH3023BC	423	DA13150	268	DA16200	268
CN-6312-36C	525	CPH3023BC	430	DA13150	275	DA16200	275
CN-6312-36C	585	CPH3023BC	435	DA1320	268	DA16250	268
CN-6312-38C	525	CPH3023BC	441	DA1320	275	DA16250	275
CN-6312-38C	585	CPH3023BC	449	DA13200	268	DA1630	268
CN-6312-39C	525	CPH3034BC	423	DA13200	275	DA1630	275
CN-6312-39C	585	CPH3034BC	430	DA13250	268	DA1640	268
CN-6314-24C	525	CPH3034BC	435	DA13250	275	DA1640	275
CN-6314-26C	525	CPH3034BC	441	DA1330	268	DA165	268
CN-6314-28C	525	CPH3034BC	449	DA1330	275	DA165	275
CN-6314-30C	525	CPH6023BC	430	DA1340	268	DA1650	268
CN-6314-32C	525	CPH6023BC	435	DA1340	275	DA1650	275
CN-6314-34C	525	CPH6023BC	441	DA135	268	DA1660	268
CN-6314-36C	525	CPH6023BC	449	DA135	275	DA1660	275
CN-6314-38C	525	CPH-6023BC	423	DA1350	268	DA1675	268
CN-6314-40C	525	CPH6034BC	423	DA1350	275	DA1675	275
CN-6314-42C	525	CPH6034BC	430	DA1360	268	DA1W1E101	262
CN-6314-44C	525	CPH6034BC	435	DA1360	275	DA1W1E201	262
CN-6314-46C	525	CPH6034BC	441	DA1375	268	DA1W1L001	259
CN-8006-15E	525	CPH6034BC	449	DA1375	275	DA1W1T101	258
CN-8006-15E	585	CPP2023	412	DA1510	268	DA1W1T102	258
CN-8008-23E	525	CPP516	417	DA1510	275	DA1W1T103	258
CN-8008-23E	585	CPR23	412	DA15100	268	DA1W1T104	258
CN-8010-31E	525	CPRCA	412	DA15100	275	DA1W1T201	258
CN-8010-31E	585	CPS152-101	416	DA15125	268	DA1W3E101	262
CN-8012-39E	525	CPS152-102	416	DA15125	275	DA1W3E201	262
CN-8012-39E	585	CPS152-102GFI	416	DA1515	268	DA1W3L001	259
CN-8014-46E	525	CPS152-111	416	DA1515	275	DA1W3T101	258
CN-C10-379PN	577	CPS152-112	416	DA15150	268	DA1W3T102	258
CN-C10-379SN	577	CPS152-112GFI	416	DA15150	275	DA1W3T103	258
CN-C12-353PN	521	CPS152-201	416	DA1520	268	DA1W3T104	258
CN-C12-353PN	579	CPS152-202	416	DA1520	275	DA1W3T201	258
CN-C12-353SN	521	CPS152-202GFI	416	DA15200	268	DA2W2E101	262
CN-C12-353SN	579	CPS152-211	416	DA15200	275	DA2W2T201	258
CN-C12-375PN	521	CPS152-212	416	DA15250	268	DA2W2T202	258
CN-C12-375PN	580	CPS152-212GFI	416	DA15250	275	DA3W2E601	262
CN-C12-375SN	521	CPS152-301	416	DA1530	268	DA4W2E202	262
CN-C12-375SN	580	CPS152-302	416	DA1530	275	DA5310	268
CN-W-5306N	526	CPS152-302GFI	416	DA1540	268	DA5310	275
CN-W-5306N	586	CPS152-311	416	DA1540	275	DA53100	268
CN-W-5308N	526	CPS152-312	416	DA155	268	DA53100	275
CN-W-5308N	586	CPS152-312GFI	416	DA155	275	DA53125	268

Alphanumeric Index

Catalog Number	Page	Catalog Number	Page	Catalog Number	Page	Catalog Number	Page
DA53125	275	DA56150	275	DBR1023HFB70	439	DBR6034EH60	439
DA5315	268	DA5620	268	DBR1023HFB90	439	DBR6034EH70	439
DA5315	275	DA5620	275	DBR1034DS	439	DBR6034EH90	439
DA53150	268	DA56200	268	DBR1034EH100	439	DBR6034FB100	439
DA53150	275	DA56200	275	DBR1034EH50	439	DBR6034FB50	439
DA5320	268	DA56250	268	DBR1034EH70	439	DBR6034FB60	439
DA5320	275	DA56250	275	DBR1034EH90	439	DBR6034FB70	439
DA53200	268	DA5630	268	DBR1034FB100	439	DBR6034FB90	439
DA53200	275	DA5630	275	DBR1034FB50	439	DBR6034HFB100	439
DA53250	268	DA5640	268	DBR1034FB70	439	DBR6034HFB50	439
DA53250	275	DA5640	275	DBR1034FB90	439	DBR6034HFB60	439
DA5330	268	DA565	268	DBR1034HFB100	439	DBR6034HFB70	439
DA5330	275	DA565	275	DBR1034HFB50	439	DBR6034HFB90	439
DA5340	268	DA5650	268	DBR1034HFB70	439	DC9P	266
DA5340	275	DA5650	275	DBR1034HFB90	439	DC9R	265
DA535	268	DA5660	268	DBR3023DS	439	DCB5P	266
DA535	275	DA5660	275	DBR3023EH20	439	DCB5R	265
DA5350	268	DA5675	268	DBR3023EH30	439	DCB9P	266
DA5350	275	DA5675	275	DBR3023EH40	439	DCB9R	265
DA5360	268	DA5GP	266	DBR3023EH50	439	DC-Q	18
DA5360	275	DA5GR	265	DBR3023FB20	439	DD9P	266
DA5375	268	DA5W2E301	262	DBR3023FB30	439	DD9R	265
DA5375	275	DA5W2E302	262	DBR3023FB40	439	DEJS100A	429
DA5510	268	DA5W2E401	262	DBR3023FB50	439	DEJS100A	436
DA5510	275	DA5W2E601	262	DBR3023HFB20	439	DEJS100A	442
DA55100	268	DA5W2T301	259	DBR3023HFB30	439	DEJS100B	429
DA55100	275	DA5W2T302	259	DBR3023HFB40	439	DEJS100B	436
DA55125	268	DA9RP	266	DBR3023HFB50	439	DEJS100B	442
DA55125	275	DA9RR	265	DBR3034DS	439	DEJS30	429
DA5515	268	DB-38	676	DBR3034EH20	439	DEJS30	436
DA5515	275	DB-50	676	DBR3034EH30	439	DEJS30	442
DA55150	268	DBB-50SS	676	DBR3034EH40	439	DEJS60A	429
DA55150	275	DBD20NB	677	DBR3034EH50	439	DEJS60A	436
DA5520	268	DBE20B	139	DBR3034FB20	439	DEJS60A	442
DA5520	275	DBE20B	155	DBR3034FB30	439	DEJS60B	429
DA55200	268	DBE20B	171	DBR3034FB40	439	DEJS60B	436
DA55200	275	DBE20B	181	DBR3034FB50	439	DEJS60B	442
DA55250	268	DBE20B	677	DBR3034HFB20	439	DG5P	266
DA55250	275	DBE20P	139	DBR3034HFB30	439	DG5R	265
DA5530	268	DBE20P	155	DBR3034HFB40	439	DGD1A	267
DA5530	275	DBE20P	171	DBR3034HFB50	439	DH5P	266
DA5540	268	DBE20P	181	DBR6023DS	439	DH5R	265
DA5540	275	DBE20P	677	DBR6023EH100	439	DLP00	267
DA555	268	DBE20S	139	DBR6023EH50	439	DLP01	267
DA555	275	DBE20S	155	DBR6023EH60	439	DM200-04	698
DA5550	268	DBE20S	171	DBR6023EH70	439	DM48A	268
DA5550	275	DBE20S	181	DBR6023EH90	439	DMA1348P	268
DA5560	268	DBE20S	677	DBR6023FB100	439	DMA1348R	268
DA5560	275	DBPM22	267	DBR6023FB50	439	DMA1548P	268
DA5575	268	DBR1023DS	439	DBR6023FB60	439	DMA1548R	268
DA5575	275	DBR1023EH100	439	DBR6023FB70	439	DMA1648P	268
DA5610	268	DBR1023EH50	439	DBR6023FB90	439	DMA1648R	268
DA5610	275	DBR1023EH70	439	DBR6023HFB100	439	DMA5348P	268
DA56100	268	DBR1023EH90	439	DBR6023HFB50	439	DMA5348R	268
DA56100	275	DBR1023FB100	439	DBR6023HFB60	439	DMA5548P	268
DA56125	268	DBR1023FB50	439	DBR6023HFB70	439	DMA5548R	268
DA56125	275	DBR1023FB70	439	DBR6023HFB90	439	DMA5648P	268
DA5615	268	DBR1023FB90	439	DBR6034DS	439	DMA5648R	268
DA5615	275	DBR1023HFB100	439	DBR6034EH100	439	DPB12P	266
DA56150	268	DBR1023HFB50	439	DBR6034EH50	439	DPB12R	265

Alphanumeric Index

Catalog Number	Page	Catalog Number	Page	Catalog Number	Page	Catalog Number	Page
DPB48P	266	DSS	267	EBR15034FD125	433	EBR6023EH100	433
DPB48R	265	DU-NP-Q	18	EBR15034FD125W	446	EBR6023EH50	433
DPB85P	266	EBR1023EH100	433	EBR15034FD150	433	EBR6023EH60	433
DPB85R	265	EBR1023EH50	433	EBR15034FD150W	446	EBR6023EH70	433
DPBLENS	267	EBR1023EH70	433	EBR3023EH20	433	EBR6023EH90	433
DPG12P	266	EBR1023EH90	433	EBR3023EH30	433	EBR6023EHD100W	446
DPG12R	265	EBR1023EHD100W	446	EBR3023EH40	433	EBR6023EHD50W	446
DPG48P	266	EBR1023EHD50W	446	EBR3023EH50	433	EBR6023EHD60W	446
DPG48R	265	EBR1023EHD70W	446	EBR3023EHD20W	446	EBR6023EHD70W	446
DPG85P	266	EBR1023EHD90W	446	EBR3023EHD30W	446	EBR6023EHD90W	446
DPG85R	265	EBR1023FB100	433	EBR3023EHD40W	446	EBR6023FB100	433
DPGLENS	267	EBR1023FB50	433	EBR3023EHD50W	446	EBR6023FB50	433
DPLD1S	267	EBR1023FB70	433	EBR3023FB20	433	EBR6023FB60	433
DPLD2S	267	EBR1023FB90	433	EBR3023FB30	433	EBR6023FB70	433
DPR12P	266	EBR1023FD100W	446	EBR3023FB40	433	EBR6023FB90	433
DPR12R	265	EBR1023FD50W	446	EBR3023FB50	433	EBR6023FD100W	446
DPR48P	266	EBR1023FD70W	446	EBR3023FD20W	446	EBR6023FD50W	446
DPR48R	265	EBR1023FD90W	446	EBR3023FD30W	446	EBR6023FD60W	446
DPR85P	266	EBR1023FDB100W	446	EBR3023FD40W	446	EBR6023FD70W	446
DPR85R	265	EBR1023FDB50W	446	EBR3023FD50W	446	EBR6023FD90W	446
DPRENS	267	EBR1023FDB70W	446	EBR3023FDB20W	446	EBR6023FDB100W	446
DPW12P	266	EBR1023FDB90W	446	EBR3023FDB30W	446	EBR6023FDB50W	446
DPW12R	265	EBR1023HFB100	433	EBR3023FDB40W	446	EBR6023FDB60W	446
DPW48P	266	EBR1023HFB50	433	EBR3023FDB50W	446	EBR6023FDB70W	446
DPW48R	265	EBR1023HFB70	433	EBR3023HFB20	433	EBR6023FDB90W	446
DPW85P	266	EBR1023HFB90	433	EBR3023HFB30	433	EBR6023HFB100	433
DPW85R	265	EBR1023HFD100W	446	EBR3023HFB40	433	EBR6023HFB50	433
DPWLENS	267	EBR1023HFD50W	446	EBR3023HFB50	433	EBR6023HFB60	433
DPY12P	266	EBR1023HFD70W	446	EBR3023HFD20W	446	EBR6023HFB70	433
DPY12R	265	EBR1023HFD90W	446	EBR3023HFD30W	446	EBR6023HFB90	433
DPY48P	266	EBR1034EH100	433	EBR3023HFD40W	446	EBR6023HFD100W	446
DPY48R	265	EBR1034EH50	433	EBR3023HFD50W	446	EBR6023HFD50W	446
DPY85P	266	EBR1034EH70	433	EBR3034EH20	433	EBR6023HFD60W	446
DPY85R	265	EBR1034EH90	433	EBR3034EH30	433	EBR6023HFD70W	446
DPYLENS	267	EBR1034EHD100W	446	EBR3034EH40	433	EBR6023HFD90W	446
DR9P	266	EBR1034EHD50W	446	EBR3034EH50	433	EBR6034EH100	433
DR9R	265	EBR1034EHD70W	446	EBR3034EHD20W	446	EBR6034EH50	433
DRNB4X	298	EBR1034EHD90W	446	EBR3034EHD30W	446	EBR6034EH60	433
DRNB4X	314	EBR1034FB100	433	EBR3034EHD40W	446	EBR6034EH70	433
DS116P	266	EBR1034FB50	433	EBR3034EHD50W	446	EBR6034EH90	433
DS116R	265	EBR1034FB70	433	EBR3034FB20	433	EBR6034EHD100W	446
DS21601P	266	EBR1034FB90	433	EBR3034FB30	433	EBR6034EHD50W	446
DS21601R	265	EBR1034FD100W	446	EBR3034FB40	433	EBR6034EHD60W	446
DS21602P	266	EBR1034FD50W	446	EBR3034FB50	433	EBR6034EHD70W	446
DS21602R	265	EBR1034FD70W	446	EBR3034FD20W	446	EBR6034EHD90W	446
DS216P	266	EBR1034FD90W	446	EBR3034FD30W	446	EBR6034FB100	433
DS216R	265	EBR1034FDB100W	446	EBR3034FD40W	446	EBR6034FB50	433
DS316P	266	EBR1034FDB50W	446	EBR3034FD50W	446	EBR6034FB60	433
DS316R	265	EBR1034FDB70W	446	EBR3034FDB20W	446	EBR6034FB70	433
DS41601P	266	EBR1034FDB90W	446	EBR3034FDB30W	446	EBR6034FB90	433
DS41602P	266	EBR1034HFB100	433	EBR3034FDB40W	446	EBR6034FD100W	446
DS416P	266	EBR1034HFB50	433	EBR3034FDB50W	446	EBR6034FD50W	446
DS416R	265	EBR1034HFB70	433	EBR3034HFB20	433	EBR6034FD60W	446
DSA	267	EBR1034HFB90	433	EBR3034HFB30	433	EBR6034FD70W	446
DSB	267	EBR1034HFD100W	446	EBR3034HFB40	433	EBR6034FD90W	446
DSG	267	EBR1034HFD50W	446	EBR3034HFB50	433	EBR6034FDB100W	446
DSN	267	EBR1034HFD70W	446	EBR3034HFD20W	446	EBR6034FDB50W	446
DSNPH	267	EBR1034HFD90W	446	EBR3034HFD30W	446	EBR6034FDB60W	446
DSPH	267	EBR15034FD100	433	EBR3034HFD40W	446	EBR6034FDB70W	446
DSR	267	EBR15034FD100W	446	EBR3034HFD50W	446	EBR6034FDB90W	446

Alphanumeric Index

Catalog Number	Page	Catalog Number	Page	Catalog Number	Page	Catalog Number	Page
EBR6034HFB100	433	ECGJH-100-15	656	ECGJH-400-30	656	ECLK-125-12	656
EBR6034HFB50	433	ECGJH-100-18	656	ECGJH-400-33	656	ECLK-125-15	656
EBR6034HFB60	433	ECGJH-100-21	656	ECGJH-400-36	656	ECLK-125-18	656
EBR6034HFB70	433	ECGJH-100-24	656	ECGJH-40-18	656	ECLK-125-21	656
EBR6034HFB90	433	ECGJH-100-27	656	ECGJH-50-10	656	ECLK-125-24	656
EBR6034HFD100W	446	ECGJH-100-30	656	ECGJH-50-12	656	ECLK-125-27	656
EBR6034HFD50W	446	ECGJH-100-33	656	ECGJH-50-15	656	ECLK-125-30	656
EBR6034HFD60W	446	ECGJH-100-36	656	ECGJH-50-18	656	ECLK-125-33	656
EBR6034HFD70W	446	ECGJH-100-6	656	ECGJH-50-21	656	ECLK-125-36	656
EBR6034HFD90W	446	ECGJH-100-8	656	ECGJH-50-24	656	ECLK-150-12	656
EBRH1023DS	433	ECGJH-125-12	656	ECGJH-50-27	656	ECLK-150-15	656
EBRH1034DS	433	ECGJH-125-15	656	ECGJH-50-30	656	ECLK-150-18	656
EBRH3023DS	433	ECGJH-125-18	656	ECGJH-50-33	656	ECLK-150-21	656
EBRH3034DS	433	ECGJH-125-21	656	ECGJH-50-36	656	ECLK-150-24	656
EBRH6023DS	433	ECGJH-125-24	656	ECGJH-50-4	656	ECLK-150-27	656
EBRH6034DS	433	ECGJH-125-27	656	ECGJH-50-6	656	ECLK-150-30	656
EBRI1023	429	ECGJH-125-30	656	ECGJH-50-8	656	ECLK-150-33	656
EBRI1023	436	ECGJH-125-33	656	ECGJH-75-10	656	ECLK-150-36	656
EBRI1023	442	ECGJH-125-36	656	ECGJH-75-12	656	ECLK-200-12	656
EBRI1034	429	ECGJH-150-12	656	ECGJH-75-15	656	ECLK-200-15	656
EBRI1034	436	ECGJH-150-15	656	ECGJH-75-18	656	ECLK-200-18	656
EBRI1034	442	ECGJH-150-18	656	ECGJH-75-21	656	ECLK-200-21	656
EBRI15034	429	ECGJH-150-21	656	ECGJH-75-24	656	ECLK-200-24	656
EBRI15034	436	ECGJH-150-24	656	ECGJH-75-27	656	ECLK-200-27	656
EBRI15034	442	ECGJH-150-27	656	ECGJH-75-30	656	ECLK-200-30	656
EBRI3023	429	ECGJH-150-30	656	ECGJH-75-33	656	ECLK-200-33	656
EBRI3023	436	ECGJH-150-33	656	ECGJH-75-36	656	ECLK-200-36	656
EBRI3023	442	ECGJH-150-36	656	ECGJH-75-4	656	ECLK-50-10	656
EBRI3034	429	ECGJH-200-12	656	ECGJH-75-6	656	ECLK-50-12	656
EBRI3034	436	ECGJH-200-15	656	ECGJH-75-8	656	ECLK-50-15	656
EBRI3034	442	ECGJH-200-18	656	ECH2023	409	ECLK-50-18	656
EBRI6023	429	ECGJH-200-21	656	ECH20232	409	ECLK-50-21	656
EBRI6023	436	ECGJH-200-24	656	ECHF-50-10	658	ECLK-50-24	656
EBRI6023	442	ECGJH-200-27	656	ECHF-50-12	658	ECLK-50-27	656
EBRI6034	429	ECGJH-200-30	656	ECHF-50-15	658	ECLK-50-30	656
EBRI6034	436	ECGJH-200-33	656	ECHF-50-18	658	ECLK-50-33	656
EBRI6034	442	ECGJH-200-36	656	ECHF-50-4	658	ECLK-50-36	656
ECC2023	410	ECGJH-250-12	656	ECHF-50-6	658	ECLK-50-4	656
ECC20232	410	ECGJH-250-15	656	ECHF-50-8	658	ECLK-50-6	656
ECC503RH	454	ECGJH-250-18	656	ECHF-75-10	658	ECLK-50-8	656
ECC503RH-C	454	ECGJH-250-21	656	ECHF-75-12	658	ECLK-75-10	656
ECC505RH	454	ECGJH-250-24	656	ECHF-75-15	658	ECLK-75-12	656
ECC505RH-C	454	ECGJH-250-27	656	ECHF-75-18	658	ECLK-75-15	656
ECC506RH	454	ECGJH-250-30	656	ECHF-75-4	658	ECLK-75-18	656
ECC506RH-C	454	ECGJH-250-33	656	ECHF-75-6	658	ECLK-75-21	656
ECC753RH	454	ECGJH-250-36	656	ECHF-75-8	658	ECLK-75-24	656
ECC753RH-C	454	ECGJH-300-12	656	ECHT2023	409	ECLK-75-27	656
ECC755RH	454	ECGJH-300-15	656	ECHT20232	409	ECLK-75-30	656
ECC755RH-C	454	ECGJH-300-18	656	ECLK-100-10	656	ECLK-75-33	656
ECC756RH	454	ECGJH-300-21	656	ECLK-100-12	656	ECLK-75-36	656
ECC756RH-C	454	ECGJH-300-24	656	ECLK-100-15	656	ECLK-75-4	656
ECCL2023	410	ECGJH-300-27	656	ECLK-100-18	656	ECLK-75-6	656
ECD50B4X	429	ECGJH-300-30	656	ECLK-100-21	656	ECLK-75-8	656
ECD50B4X	675	ECGJH-300-33	656	ECLK-100-24	656	ECP-1523	387
ECDB38	675	ECGJH-300-36	656	ECLK-100-27	656	ECP-1523	396
ECDB38B	675	ECGJH-400-12	656	ECLK-100-30	656	ECP-2023	387
ECDB50B	675	ECGJH-400-15	656	ECLK-100-33	656	ECP-2023	396
ECDB50HP	675	ECGJH-400-21	656	ECLK-100-36	656	ECP-2023	402
ECGJH-100-10	656	ECGJH-400-24	656	ECLK-100-6	656	ECP-2023	407
ECGJH-100-12	656	ECGJH-400-27	656	ECLK-1008	656	ECP-20232	387

Alphanumeric Index

Catalog Number	Page	Catalog Number	Page	Catalog Number	Page	Catalog Number	Page
ECP-20232	396	ECS3MU1	92	ECS7K3W	95	ECSKPC120	102
ECP-20232	402	ECS3U1	92	ECS7K4W	95	ECSKPC347	102
ECP-20232	407	ECS3U2	92	ECS7U2	92	ECSKPOT10K	102
ECS1	104	ECS3UM1	92	ECS7U4	92	ECSKPOT25K	102
ECS10	104	ECS4	104	ECS8	104	ECSKPOT5K	102
ECS11	104	ECS4F13	95	ECS9	104	ECSKSA82U	101
ECS110	103	ECS4F17	95	ECS9F1	95	ECSKSA86U	101
ECS110	395	ECS4F23	95	ECS9F2	95	ECSKU1	100
ECS12	104	ECS4F27	95	ECS9F3W	95	ECSKU2	100
ECS13	104	ECS4F33	95	ECS9F4W	95	ECSKUM1	100
ECS14	104	ECS4F3W3	95	ECS9JRU2	93	ED2KB102	50
ECS15	104	ECS4F3W7	95	ECS9K1	95	ED2KB12	50
ECS16	104	ECS4F4W7	95	ECS9K2	95	ED2KB345	50
ECS175	103	ECS4K13	95	ECS9K3W	95	ED2KB35	50
ECS175	395	ECS4K17	95	ECS9K4W	95	ED2KBJ1	50
ECS2	104	ECS4K23	95	ECS9U2	92	ED2KBJ1U1	50
ECS210	103	ECS4K27	95	ECS9U2JRJG	93	ED2KBJ2	50
ECS210	395	ECS4K33	95	ECS9U4	92	ED2KBU1	50
ECS275	103	ECS4K3W3	95	ECSK102	101	ED2KBU2	50
ECS275	395	ECS4K3W7	95	ECSK12	101	ED2S110102	49
ECS2F13	95	ECS4K4W7	95	ECSK1B	103	ED2S11012	49
ECS2F17	95	ECS4PC120	96	ECSK-2023	395	ED2S110345	49
ECS2F23	95	ECS4PC347	96	ECSK-2023	398	ED2S11035	49
ECS2F27	95	ECS4POT10K	96	ECSK-20232	395	ED2S110J1	48
ECS2F33	95	ECS4POT25K	96	ECSK2B	103	ED2S110J1U1	48
ECS2F3W3	95	ECS4POT5K	96	ECSK2JR	100	ED2S110J2	48
ECS2F3W7	95	ECS4SA82U	94	ECSK2P	103	ED2S110U1	48
ECS2F4W7	95	ECS4SA86U	94	ECSK345	101	ED2S110U2	48
ECS2K13	95	ECS5	104	ECSK35	101	ED2S150102	49
ECS2K17	95	ECS5102	94	ECSK3P	103	ED2S15012	49
ECS2K23	95	ECS512	94	ECSKB	103	ED2S150345	49
ECS2K27	95	ECS52JR	93	ECSKF1	101	ED2S15035	49
ECS2K33	95	ECS5345	94	ECSKF13	101	ED2S150J1	48
ECS2K3W3	95	ECS535	94	ECSKF17	101	ED2S150J1U1	48
ECS2K3W7	95	ECS5F1	95	ECSKF2	101	ED2S150J2	48
ECS2K4W7	95	ECS5F2	95	ECSKF23	101	ED2S150U1	48
ECS2PC120	96	ECS5F3W	95	ECSKF27	101	ED2S150U2	48
ECS2PC347	96	ECS5F4W	95	ECSKF33	101	ED2S175102	49
ECS2POT10K	96	ECS5JGU1	93	ECSKF3W	101	ED2S17512	49
ECS2POT25K	96	ECS5JR	93	ECSKF3W3	101	ED2S175345	49
ECS2POT5K	96	ECS5JRU2	93	ECSKF3W7	101	ED2S17535	49
ECS2SA82U	94	ECS5K1	95	ECSKF4W	101	ED2S175J1	48
ECS2SA86U	94	ECS5K2	95	ECSKF4W7	101	ED2S175J1U1	48
ECS3	104	ECS5K3W	95	ECSK-GFI	398	ED2S175J2	48
ECS3102	94	ECS5K4W	95	ECSKJGU1	100	ED2S175U1	48
ECS312	94	ECS5MU1	92	ECSKJGU2	100	ED2S175U2	48
ECS32JR	93	ECS5U1	92	ECSKJR	100	ED2S210J1U2	49
ECS3345	94	ECS5U2	92	ECSKK1	101	ED2S210J2U2	49
ECS335	94	ECS5UM1	92	ECSKK13	101	ED2S250J1U2	49
ECS3F1	95	ECS6	104	ECSKK17	101	ED2S250J2U2	49
ECS3F2	95	ECS6TIM60AC	106	ECSKK2	101	ED2S275J1U2	49
ECS3F3W	95	ECS7	104	ECSKK23	101	ED2S275J2U2	49
ECS3F4W	95	ECS7F1	95	ECSKK27	101	ED2SC110102	49
ECS3JGU1	93	ECS7F2	95	ECSKK33	101	ED2SC11012	49
ECS3JR	93	ECS7F3W	95	ECSKK3W	101	ED2SC110345	49
ECS3JRU2	93	ECS7F4W	95	ECSKK3W3	101	ED2SC11035	49
ECS3K1	95	ECS7JGJRU2	93	ECSKK3W7	101	ED2SC110J1	48
ECS3K2	95	ECS7JRU2	93	ECSKK4W	101	ED2SC110J1U1	48
ECS3K3W	95	ECS7K1	95	ECSKK4W7	101	ED2SC110J2	48
ECS3K4W	95	ECS7K2	95	ECSKMU1	100	ED2SC110U1	48

Alphanumeric Index

Catalog Number	Page	Catalog Number	Page	Catalog Number	Page	Catalog Number	Page
ED2SC110U2	48	EDKF22-Q	73	EDS1230	87	EDS175-R23	72
ED2SC150102	49	EDKF23W-AQ	73	EDS1240	87	EDS175-R3W	72
ED2SC15012	49	EDKF23W-Q	73	EDS128	87	EDS175-R3W3	72
ED2SC150345	49	EDKF24W-AQ	73	EDS1284	32	EDS175-R4W	72
ED2SC15035	49	EDKF24W-Q	73	EDS1290	32	EDS175-RU1	11
ED2SC150J1	48	EDKF31-AQ	73	EDS147	404	EDS175-RU2	11
ED2SC150J1U1	48	EDKF31-Q	73	EDS147	418	EDS177	327
ED2SC150J2	48	EDKF32-AQ	73	EDS147	42	EDS177	42
ED2SC150U1	48	EDKF32-Q	73	EDS147-SA	404	EDS177	56
ED2SC150U2	48	EDKF33W-AQ	73	EDS147-SA	418	EDS177	89
ED2SC175102	49	EDKF33W-Q	73	EDS147-SA	42	EDS177-SA	327
ED2SC17512	49	EDKL-J1U2	37	EDS150-1MS	318	EDS177-SA	42
ED2SC175345	49	EDKL-J2U1	37	EDS150-2MS	318	EDS177-SA	56
ED2SC17535	49	EDKL-J3	37	EDS150-F1	71	EDS177-SA	89
ED2SC175J1	48	EDKL-U3	37	EDS150-F2	71	EDS210-1MS	318
ED2SC175J1U1	48	EDK-R21-Q	73	EDS150-F3W	71	EDS210-2MS	318
ED2SC175J2	48	EDK-R22-Q	73	EDS150-F4W	71	EDS210-F1	71
ED2SC175U1	48	EDK-R23W-Q	73	EDS150-R1	72	EDS210-F2	71
ED2SC175U2	48	EDK-R24W-Q	73	EDS150-R2	72	EDS210-F3W	71
ED2SC210J1U2	49	EDK-R31-Q	73	EDS150-R3W	72	EDS210-F4W	71
ED2SC210J2U2	49	EDK-R32-Q	73	EDS150-R4W	72	EDS210-R1	72
ED2SC250J1U2	49	EDK-R33W-Q	73	EDS150-RU1	11	EDS210-R2	72
ED2SC250J2U2	49	EDS110-1MS	318	EDS1596	36	EDS210-R3W	72
ED2SC275J1U2	49	EDS110-2MS	318	EDS171	327	EDS210-R4W	72
ED2SC275J2U2	49	EDS110-F1	71	EDS171	404	EDS210-RU1	11
ED2SK1	54	EDS110-F13	71	EDS171	418	EDS210-RU2	11
ED2SK2	54	EDS110-F2	71	EDS171	42	EDS21100	325
ED2SKB	54	EDS110-F23	71	EDS171	56	EDS21101	324
EDK1MSAB	318	EDS110-F3W	71	EDS171	89	EDS21102	324
EDK1MSW	318	EDS110-F3W3	71	EDS1714	32	EDS21271	34
EDK2MSAB	318	EDS110-F4W	71	EDS171-SA	327	EDS21272	34
EDK2MSW	318	EDS110-R1	72	EDS171-SA	404	EDS21273	34
EDKB-102	34	EDS110-R13	72	EDS171-SA	418	EDS21274	34
EDKB-102-S634	34	EDS110-R2	72	EDS171-SA	42	EDS2129	87
EDKB-102-S635	34	EDS110-R23	72	EDS171-SA	56	EDS2130	87
EDKB-12	34	EDS110-R3W	72	EDS171-SA	89	EDS2140	87
EDKB-345	34	EDS110-R3W3	72	EDS172	327	EDS218	87
EDKB-345-S634	34	EDS110-R4W	72	EDS172	404	EDS2184	32
EDKB-345-S635	34	EDS110-RU1	11	EDS172	418	EDS2190	32
EDKB-345-S636	34	EDS110-RU2	11	EDS172	42	EDS2192	36
EDKB-35	34	EDS11100	325	EDS172	56	EDS2192UM1	36
EDKB-DPB	36	EDS11101	324	EDS172	89	EDS2194	36
EDKB-DPBM	36	EDS11102	324	EDS172-SA	327	EDS2199	325
EDKB-J1	37	EDS11271	34	EDS172-SA	404	EDS21MC2	324
EDKB-J1DU1	37	EDS11272	34	EDS172-SA	418	EDS21MC3	324
EDKB-J1U1	37	EDS11273	34	EDS172-SA	42	EDS22100	325
EDKB-J1U2	37	EDS11274	34	EDS172-SA	56	EDS22101	324
EDKB-J2	37	EDS1129	87	EDS172-SA	89	EDS22102	324
EDKB-RU1	36	EDS1130	87	EDS175-1MS	318	EDS2229	87
EDKB-RU2	36	EDS1140	87	EDS175-2MS	318	EDS2230	87
EDKB-U1	37	EDS118	87	EDS175-F1	71	EDS2240	87
EDKB-U1L	36	EDS1184	32	EDS175-F13	71	EDS228	87
EDKB-U2	37	EDS1190	32	EDS175-F2	71	EDS2284	32
EDKB-U2L	36	EDS1192	36	EDS175-F23	71	EDS2290	32
EDKB-UM1	37	EDS1192UM1	36	EDS175-F3W	71	EDS2294	36
EDKB-UM1L	36	EDS1194	36	EDS175-F3W3	71	EDS2299	325
EDKB-UM2	37	EDS1199	325	EDS175-F4W	71	EDS22MC2	324
EDKF21-AQ	73	EDS11MC2	324	EDS175-R1	72	EDS22MC3	324
EDKF21-Q	73	EDS11MC3	324	EDS175-R13	72	EDS247	404
EDKF22-AQ	73	EDS1229	87	EDS175-R2	72	EDS247	418

Alphanumeric Index

Catalog Number	Page	Catalog Number	Page	Catalog Number	Page	Catalog Number	Page
EDS247	42	EDS3140	87	EDS377	42	EDSC150-F2	71
EDS247-SA	404	EDS318	87	EDS377	56	EDSC150-F3W	71
EDS247-SA	418	EDS3184	32	EDS377	89	EDSC150-F4W	71
EDS247-SA	42	EDS3190	32	EDS377-SA	327	EDSC150-R1	72
EDS250-1MS	318	EDS3192	36	EDS377-SA	42	EDSC150-R2	72
EDS250-2MS	318	EDS3192UM1	36	EDS377-SA	56	EDSC150-R3W	72
EDS250-F1	71	EDS3194	36	EDS377-SA	89	EDSC150-R4W	72
EDS250-R1	72	EDS3199	325	EDSC110-1MS	318	EDSC150-RU1	11
EDS2596	36	EDS31MC2	324	EDSC110-2MS	318	EDSC150-RU2	11
EDS2696	36	EDS31MC3	324	EDSC110-F1	71	EDSC1596	36
EDS271	327	EDS32100	325	EDSC110-F13	71	EDSC1696	36
EDS271	404	EDS32101	324	EDSC110-F2	71	EDSC171	327
EDS271	418	EDS32102	324	EDSC110-F23	71	EDSC171	404
EDS271	42	EDS3229	87	EDSC110-F3W	71	EDSC171	418
EDS271	56	EDS3230	87	EDSC110-F3W3	71	EDSC171	42
EDS271	89	EDS3240	87	EDSC110-F4W	71	EDSC171	56
EDS2714	32	EDS328	87	EDSC110-R1	72	EDSC171	89
EDS271-SA	327	EDS3284	32	EDSC110-R13	72	EDSC1714	32
EDS271-SA	404	EDS3290	32	EDSC110-R2	72	EDSC171-SA	327
EDS271-SA	418	EDS3294	36	EDSC110-R23	72	EDSC171-SA	404
EDS271-SA	42	EDS3299	325	EDSC110-R3W	72	EDSC171-SA	418
EDS271-SA	56	EDS32MC2	324	EDSC110-R3W3	72	EDSC171-SA	42
EDS271-SA	89	EDS32MC3	324	EDSC110-R4W	72	EDSC171-SA	56
EDS272	327	EDS347	404	EDSC110-RU1	11	EDSC171-SA	89
EDS272	404	EDS347	418	EDSC110-RU2	11	EDSC172	327
EDS272	418	EDS347	42	EDSC1100	325	EDSC172	404
EDS272	42	EDS347-SA	404	EDSC11101	324	EDSC172	418
EDS272	56	EDS347-SA	418	EDSC11102	324	EDSC172	42
EDS272	89	EDS347-SA	42	EDSC11271	34	EDSC172	56
EDS272-SA	327	EDS3591	87	EDSC11272	34	EDSC172	89
EDS272-SA	404	EDS3593	87	EDSC11273	34	EDSC172-SA	327
EDS272-SA	418	EDS3594	87	EDSC11274	34	EDSC172-SA	404
EDS272-SA	42	EDS3596	36	EDSC1129	87	EDSC172-SA	418
EDS272-SA	56	EDS3696	36	EDSC1130	87	EDSC172-SA	42
EDS272-SA	89	EDS371	327	EDSC1140	87	EDSC172-SA	56
EDS275-1MS	318	EDS371	404	EDSC118	87	EDSC172-SA	89
EDS275-2MS	318	EDS371	418	EDSC1184	32	EDSC175-1MS	318
EDS275-F1	71	EDS371	42	EDSC1190	32	EDSC175-2MS	318
EDS275-F3W	71	EDS371	56	EDSC1192	36	EDSC175-F1	71
EDS275-R1	72	EDS371	89	EDSC1192UM1	36	EDSC175-F13	71
EDS275-R3W	72	EDS3714	32	EDSC1194	36	EDSC175-F2	71
EDS275-RU1	11	EDS371-SA	327	EDSC1199	325	EDSC175-F23	71
EDS275-RU2	11	EDS371-SA	404	EDSC11MC2	324	EDSC175F3W	71
EDS277	327	EDS371-SA	418	EDSC11MC3	324	EDSC175-F3W3	71
EDS277	42	EDS371-SA	42	EDSC1229	87	EDSC175F4W	71
EDS277	56	EDS371-SA	56	EDSC1230	87	EDSC175-R1	72
EDS277	89	EDS371-SA	89	EDSC1240	87	EDSC175-R13	72
EDS277-SA	327	EDS372	327	EDSC128	87	EDSC175-R2	72
EDS277-SA	42	EDS372	404	EDSC1284	32	EDSC175-R23	72
EDS277-SA	56	EDS372	418	EDSC1290	32	EDSC175-R3W	72
EDS277-SA	89	EDS372	42	EDSC1294	36	EDSC175-R3W3	72
EDS31100	325	EDS372	56	EDSC147	404	EDSC175-R4W	72
EDS31101	324	EDS372	89	EDSC147	418	EDSC175-RU1	11
EDS31102	324	EDS372-SA	327	EDSC147	42	EDSC175-RU2	11
EDS31271	34	EDS372-SA	404	EDSC147-SA	404	EDSC177	327
EDS31272	34	EDS372-SA	418	EDSC147-SA	418	EDSC177	42
EDS31273	34	EDS372-SA	42	EDSC147-SA	42	EDSC177	56
EDS31274	34	EDS372-SA	56	EDSC150-1MS	318	EDSC177	89
EDS3129	87	EDS372-SA	89	EDSC150-2MS	318	EDSC177-SA	327
EDS3130	87	EDS377	327	EDSC150-F1	71	EDSC177-SA	42

Alphanumeric Index

Catalog Number	Page	Catalog Number	Page	Catalog Number	Page	Catalog Number	Page
EDSC177-SA	56	EDSC250-R3W	72	EDSC3140	87	EDSC377	42
EDSC177-SA	89	EDSC250-R4W	72	EDSC318	87	EDSC377	56
EDSC210-1MS	318	EDSC250-RU1	11	EDSC3184	32	EDSC377	89
EDSC210-2MS	318	EDSC250-RU2	11	EDSC3190	32	EDSC377-SA	327
EDSC210-F1	71	EDSC2596	36	EDSC3192	36	EDSC377-SA	42
EDSC210-F2	71	EDSC2696	36	EDSC3192UM1	36	EDSC377-SA	56
EDSC210-F3W	71	EDSC271	327	EDSC3194	36	EDSC377-SA	89
EDSC210-F4W	71	EDSC271	404	EDSC3199	325	EDSF12	88
EDSC210-R1	72	EDSC271	418	EDSC31MC2	324	EDSF21Q	88
EDSC210-R2	72	EDSC271	42	EDSC31MC3	324	EDSF22Q	88
EDSC210-R3W	72	EDSC271	56	EDSC32100	325	EDSF23WQ	88
EDSC210-R4W	72	EDSC271	89	EDSC32101	324	EDSF24WQ	88
EDSC210-RU1	11	EDSC2714	32	EDSC32102	324	EDSF31Q	88
EDSC210-RU2	11	EDSC271-SA	327	EDSC3229	87	EDSF32Q	88
EDSC21100	325	EDSC271-SA	404	EDSC3230	87	EDSF33WQ	88
EDSC21101	324	EDSC271-SA	418	EDSC3240	87	EDSF34W	88
EDSC21102	324	EDSC271-SA	42	EDSC328	87	EDSK-1J	38
EDSC21271	34	EDSC271-SA	56	EDSC3284	32	EDSK-1JSS	38
EDSC21272	34	EDSC271-SA	89	EDSC3290	32	EDSK-1MSAB	325
EDSC21273	34	EDSC272	327	EDSC3294	36	EDSK-1MSW	324
EDSC21274	34	EDSC272	404	EDSC3299	325	EDSK-2J	38
EDSC2129	87	EDSC272	418	EDSC32MC2	324	EDSK-2MSAB	325
EDSC2130	87	EDSC272	42	EDSC32MC3	324	EDSK-2MSW	324
EDSC2140	87	EDSC272	56	EDSC347	404	EDSK-2SP	38
EDSC218	87	EDSC272	89	EDSC347	418	EDSK-B	38
EDSC2184	32	EDSC272-SA	327	EDSC347	42	EDSK-3PB	38
EDSC2190	32	EDSC272-SA	404	EDSC347-SA	404	EDSK-MC2	324
EDSC2192	36	EDSC272-SA	418	EDSC347-SA	418	EDSK-MC3	324
EDSC2192UM1	36	EDSC272-SA	42	EDSC347-SA	42	EFD110-2MS	318
EDSC2194	36	EDSC272-SA	56	EDSC3591	87	EFD110-3MS	318
EDSC2199	325	EDSC272-SA	89	EDSC3593	87	EFD110ANLQ	22
EDSC21MC2	324	EDSC275-1MS	318	EDSC3594	87	EFD110ANLQ	320
EDSC21MC3	324	EDSC275-2MS	318	EDSC3596	36	EFD110ANLQ	391
EDSC22100	325	EDSC275-F1	71	EDSC3696	36	EFD110ANLQ	413
EDSC22101	324	EDSC275-F2	71	EDSC371	327	EFD110ANLQ	74
EDSC22102	324	EDSC275-F3W	71	EDSC371	404	EFD110ANLQ	82
EDSC2229	87	EDSC275-F4W	71	EDSC371	418	EFD110NLQ	22
EDSC2230	87	EDSC275-R1	72	EDSC371	42	EFD110NLQ	320
EDSC2240	87	EDSC275-R2	72	EDSC371	56	EFD110NLQ	391
EDSC228	87	EDSC275-R3W	72	EDSC371	89	EFD110NLQ	413
EDSC2284	32	EDSC275-R4W	72	EDSC3714	32	EFD110NLQ	74
EDSC2290	32	EDSC275-RU1	11	EDSC371-SA	327	EFD110NLQ	82
EDSC2294	36	EDSC275-RU2	11	EDSC371-SA	404	EFD1234	33
EDSC2299	325	EDSC277	327	EDSC371-SA	418	EFD1471	33
EDSC22MC2	324	EDSC277	42	EDSC371-SA	42	EFD1473	33
EDSC22MC3	324	EDSC277	56	EDSC371-SA	56	EFD150-2MS	318
EDSC247	404	EDSC277	89	EDSC371-SA	89	EFD150-3MS	318
EDSC247	418	EDSC277-SA	327	EDSC372	327	EFD150ANLQ	22
EDSC247	42	EDSC277-SA	42	EDSC372	404	EFD150ANLQ	320
EDSC247-SA	404	EDSC277-SA	56	EDSC372	418	EFD150ANLQ	391
EDSC247-SA	418	EDSC277-SA	89	EDSC372	42	EFD150ANLQ	413
EDSC247-SA	42	EDSC31100	325	EDSC372	56	EFD150ANLQ	74
EDSC250-1MS	318	EDSC31101	324	EDSC372	89	EFD150ANLQ	82
EDSC250-2MS	318	EDSC31102	324	EDSC372-SA	327	EFD150NLQ	22
EDSC250-F1	71	EDSC31271	34	EDSC372-SA	404	EFD150NLQ	320
EDSC250-F2	71	EDSC31272	34	EDSC372-SA	418	EFD150NLQ	391
EDSC250-F3W	71	EDSC31273	34	EDSC372-SA	42	EFD150NLQ	413
EDSC250-F4W	71	EDSC31274	34	EDSC372-SA	56	EFD150NLQ	74
EDSC250-R1	72	EDSC3129	87	EDSC372-SA	89	EFD150NLQ	82
EDSC250-R2	72	EDSC3130	87	EDSC377	327	EFD175-2MS	318

Alphanumeric Index

Catalog Number	Page	Catalog Number	Page	Catalog Number	Page	Catalog Number	Page
EFD175-3MS	318	EFD275ANLQ	391	EFDB150-J1U2	10	EFDC175NLQ	413
EFD175ANLQ	22	EFD275ANLQ	413	EFDB150-J2	13	EFDC175NLQ	74
EFD175ANLQ	320	EFD275ANLQ	74	EFDB150-U1	9	EFDC175NLQ	82
EFD175ANLQ	391	EFD275ANLQ	82	EFDB150-U2	9	EFDC1868	33
EFD175ANLQ	413	EFD275-J1	13	EFDB150-UM1	9	EFDC210ANLQ	22
EFD175ANLQ	74	EFD275-J1U2	10	EFDB175-102	14	EFDC210ANLQ	320
EFD175ANLQ	82	EFD275-J2	13	EFDB175-12	14	EFDC210ANLQ	391
EFD175NLQ	22	EFD275-J2U2	10	EFDB175-345	14	EFDC210ANLQ	413
EFD175NLQ	320	EFD275NLQ	22	EFDB175-35	14	EFDC210ANLQ	74
EFD175NLQ	391	EFD275NLQ	320	EFDB175-DU1	12	EFDC210ANLQ	82
EFD175NLQ	413	EFD275NLQ	391	EFDB175-DU2	12	EFDC210-J1	13
EFD175NLQ	74	EFD275NLQ	413	EFDB175-J1	13	EFDC210-J1U2	10
EFD175NLQ	82	EFD275NLQ	74	EFDB175-J1U1	10	EFDC210-J2	13
EFD1868	33	EFD275NLQ	82	EFDB175-J1U2	10	EFDC210-J2U2	10
EFD1NL	22	EFD275-U1	9	EFDB175-J2	13	EFDC210NLQ	22
EFD1NL	320	EFD275-U2	9	EFDB175-U1	9	EFDC210NLQ	320
EFD1NL	391	EFD2868	33	EFDB175-U2	9	EFDC210NLQ	391
EFD1NL	74	EFD2NL	22	EFDB175-UM1	9	EFDC210NLQ	413
EFD1NL	82	EFD2NL	320	EFDC110-2MS	318	EFDC210NLQ	74
EFDC210ANLQ	22	EFD2NL	391	EFDC110-3MS	318	EFDC210NLQ	82
EFDC210ANLQ	320	EFD2NL	74	EFDC110ANLQ	22	EFDC210-U1	9
EFDC210ANLQ	391	EFD2NL	82	EFDC110ANLQ	320	EFDC210-U2	9
EFDC210ANLQ	413	EFD3234	33	EFDC110ANLQ	391	EFDC2234	33
EFDC210ANLQ	74	EFDC3471	33	EFDC110ANLQ	413	EFDC2471	33
EFDC210ANLQ	82	EFDC3473	33	EFDC110ANLQ	74	EFDC2473	33
EFDC210-J1	13	EFDC3868	33	EFDC110ANLQ	82	EFDC250ANLQ	22
EFDC210-J1U2	10	EFDC3NL	22	EFDC110NLQ	22	EFDC250ANLQ	320
EFDC210-J2	13	EFDC3NL	320	EFDC110NLQ	320	EFDC250ANLQ	391
EFDC210-J2U2	10	EFDC3NL	391	EFDC110NLQ	391	EFDC250ANLQ	413
EFDC210NLQ	22	EFDC3NL	74	EFDC110NLQ	413	EFDC250ANLQ	74
EFDC210NLQ	320	EFDC3NL	82	EFDC110NLQ	74	EFDC250ANLQ	82
EFDC210NLQ	391	EFDC4NL	22	EFDC110NLQ	82	EFDC250-J1	13
EFDC210NLQ	413	EFDC4NL	320	EFDC1234	33	EFDC250-J1U2	10
EFDC210NLQ	74	EFDC4NL	391	EFDC1471	33	EFDC250-J2	13
EFDC210NLQ	82	EFDC4NL	74	EFDC1473	33	EFDC250-J2U2	10
EFDC210-U1	9	EFDC4NL	82	EFDC150-2MS	318	EFDC250NLQ	22
EFDC210-U2	9	EFDC5NL	22	EFDC150-3MS	318	EFDC250NLQ	320
EFDC2234	33	EFDC5NL	320	EFDC150ANLQ	22	EFDC250NLQ	391
EFDC2471	33	EFDC5NL	391	EFDC150ANLQ	320	EFDC250NLQ	413
EFDC2473	33	EFDC5NL	74	EFDC150ANLQ	391	EFDC250NLQ	74
EFDC250ANLQ	22	EFDC5NL	82	EFDC150ANLQ	413	EFDC250NLQ	82
EFDC250ANLQ	320	EFDB110-102	14	EFDC150ANLQ	74	EFDC250-U1	9
EFDC250ANLQ	391	EFDB110-12	14	EFDC150ANLQ	82	EFDC250-U2	9
EFDC250ANLQ	413	EFDB110-345	14	EFDC150NLQ	22	EFDC275ANLQ	22
EFDC250ANLQ	74	EFDB110-35	14	EFDC150NLQ	320	EFDC275ANLQ	320
EFDC250ANLQ	82	EFDB110-DU1	12	EFDC150NLQ	391	EFDC275ANLQ	391
EFDC250-J1	13	EFDB110-DU2	12	EFDC150NLQ	413	EFDC275ANLQ	413
EFDC250-J1U2	10	EFDB110-J1	13	EFDC150NLQ	74	EFDC275ANLQ	74
EFDC250-J2	13	EFDB110-J1U1	10	EFDC150NLQ	82	EFDC275ANLQ	82
EFDC250-J2U2	10	EFDB110-J1U2	10	EFDC175-2MS	318	EFDC275-J1	13
EFDC250NLQ	22	EFDB110-J2	13	EFDC175-3MS	318	EFDC275-J1U2	10
EFDC250NLQ	320	EFDB110-U1	9	EFDC175ANLQ	22	EFDC275-J2	13
EFDC250NLQ	391	EFDB110-U2	9	EFDC175ANLQ	320	EFDC275-J2U2	10
EFDC250NLQ	413	EFDB110-UM1	9	EFDC175ANLQ	391	EFDC275NLQ	22
EFDC250NLQ	74	EFDB150-102	14	EFDC175ANLQ	413	EFDC275NLQ	320
EFDC250NLQ	82	EFDB150-12	14	EFDC175ANLQ	74	EFDC275NLQ	391
EFDC250-U1	9	EFDB150-345	14	EFDC175ANLQ	82	EFDC275NLQ	413
EFDC250-U2	9	EFDB150-35	14	EFDC175NLQ	22	EFDC275NLQ	74
EFDC275ANLQ	22	EFDB150-J1	13	EFDC175NLQ	320	EFDC275NLQ	82
EFDC275ANLQ	320	EFDB150-J1U1	10	EFDC175NLQ	391	EFDC275-U1	9

Alphanumeric Index

Catalog Number	Page	Catalog Number	Page	Catalog Number	Page	Catalog Number	Page
EFDC275-U2	9	EFDC10-J1	13	EFDT50-J2U2	10	EF5150-2023M	384
EFDC2868	33	EFDC10-J1U2	10	EFDT50NLQ	22	EF5150A-GFI	389
EFDC3234	33	EFDC10-J2	13	EFDT50NLQ	320	EF5150-F1	79
EFDC3471	33	EFDC10-J2U2	10	EFDT50NLQ	391	EF5150-F3W	79
EFDC3473	33	EFDC10NLQ	22	EFDT50NLQ	413	EF5150-F4W	79
EFDC3868	33	EFDC10NLQ	320	EFDT50NLQ	74	EF5150-GFI	389
EFDCB110-102	14	EFDC10NLQ	391	EFDT50NLQ	82	EF5150-R1	80
EFDCB110-12	14	EFDC10NLQ	413	EFDT75-J1	13	EF5150-R3W	80
EFDCB110-345	14	EFDC10NLQ	74	EFDT75-J1U2	10	EF5150-R4W	80
EFDCB110-35	14	EFDC10NLQ	82	EFDT75-J2	13	EF51524	33
EFDCB110-DU1	12	EFDC10NLQ	13	EFDT75-J2U2	10	EF51561	33
EFDCB110-DU2	12	EFDC10NLQ	10	EFDT75NLQ	22	EF51624	33
EFDCB110-J1	13	EFDC10NLQ	13	EFDT75NLQ	320	EF5175-2023	383
EFDCB110-J1U1	10	EFDC10NLQ	10	EFDT75NLQ	391	EF5175-20232	383
EFDCB110-J1U2	10	EFDC10NLQ	22	EFDT75NLQ	413	EF5175-20232M	384
EFDCB110-J2	13	EFDC10NLQ	320	EFDT75NLQ	74	EF5175-2023M	384
EFDCB110-U1	9	EFDC10NLQ	391	EFDT75NLQ	82	EF5175A-GFI	389
EFDCB110-U2	9	EFDC10NLQ	413	EFKB-102	15	EF5175-F1	79
EFDCB110-UM1	9	EFDC10NLQ	74	EFKB-102-SLC	15	EF5175-F13	79
EFDCB150-102	14	EFDC10NLQ	82	EFKB-102-SRC	15	EF5175-F2	79
EFDCB150-12	14	EFDC10NLQ	13	EFKB-12	15	EF5175-F23	79
EFDCB150-345	14	EFDC10NLQ	10	EFKB-345	15	EF5175-F3W	79
EFDCB150-35	14	EFDC10NLQ	13	EFKB-345-SLC	15	EF5175-F4W	79
EFDCB150-J1	13	EFDC10NLQ	10	EFKB-345-SRC	15	EF5175-GFI	389
EFDCB150-J1U1	10	EFDC10NLQ	22	EFKB-35	15	EF5175-R1	80
EFDCB150-J1U2	10	EFDC10NLQ	320	EFKB-637-SRC	15	EF5175-R2	80
EFDCB150-J2	13	EFDC10NLQ	391	EFKB-DU1	18	EF5175-R3W	80
EFDCB150-U1	9	EFDC10NLQ	413	EFKB-DU2	18	EF5175-R4W	80
EFDCB150-U2	9	EFDC10NLQ	74	EFKB-J1	16	EF5210-2023	383
EFDCB150-UM1	9	EFDC10NLQ	82	EFKB-J1DU1	16	EF5210-20232	383
EFDCB175-102	14	EFDL10-J1DU2	12	EFKB-J1U1	16	EF5210-20232M	385
EFDCB175-12	14	EFDL10-J1U2	10	EFKB-J1U2	16	EF5210-2023GFI	389
EFDCB175-345	14	EFDL10-J2U1	10	EFKB-J2	16	EF5210-2023M	385
EFDCB175-35	14	EFDL10-J3	13	EFKB-PC120	16	EF5210A-2023GFI	389
EFDCB175-DU1	12	EFDL10Q	22	EFKB-PC277	16	EF5210-F2	79
EFDCB175-DU2	12	EFDL10-U3	9	EFKB-U1	16	EF5210-F23	79
EFDCB175-J1	13	EFDL50-J1U2	10	EFKB-U2	16	EF5210-F3W	79
EFDCB175-J1U1	10	EFDL50-J2U1	10	EFKB-UM1	16	EF5210-F4W	79
EFDCB175-J1U2	10	EFDL50-J3	13	EKFK12AQ	81	EF5210-R2	80
EFDCB175-J2	13	EFDL50Q	22	EKFK12Q	81	EF5210-R3W	80
EFDCB175-U1	9	EFDL50-U3	9	EKFK12AQ	81	EF5210-R4W	80
EFDCB175-U2	9	EFDL75-J1DU2	12	EKFK34WAQ	81	EF5250-2023	383
EFDCB175-UM1	9	EFDL75-J1U2	10	EKFK34WQ	81	EF5250-20232	383
EFDC10-J1DU2	12	EFDL75-J2U1	10	EKFK34WQA	81	EF5250-20232M	385
EFDC10-J1U2	10	EFDL75-J3	13	EKFL-3HQ	17	EF5250-2023GFI	389
EFDC10-J2U1	10	EFDL75Q	22	EKFL-J1DU2	18	EF5250-2023M	385
EFDC10-J3	13	EFDL75-U3	9	EKMSQ	318	EF5250A-2023GFI	389
EFDC10Q	22	EFDT10-J1	13	EKFR12Q	81	EF5250-F1	79
EFDC10-U3	9	EFDT10-J1U2	10	EKFR34WQ	81	EF5250-R1	80
EFDC150-J1U2	10	EFDT10-J2	13	EK-RU1-Q	11	EF52524	33
EFDC150-J2U1	10	EFDT10-J2U2	10	EK-RU2-Q	11	EF52561	33
EFDC150-J3	13	EFDT10NLQ	22	EF5110-2023	383	EF52624	33
EFDC150Q	22	EFDT10NLQ	320	EF5110-20232	383	EF52661	33
EFDC150-U3	9	EFDT10NLQ	391	EF5110-20232M	384	EF5275-2023	383
EFDC175-J1DU2	12	EFDT10NLQ	413	EF5110-2023M	384	EF5275-20232	383
EFDC175-J1U2	10	EFDT10NLQ	74	EF5110A-GFI	389	EF5275-20232M	385
EFDC175-J2U1	10	EFDT10NLQ	82	EF5110-GFI	389	EF5275-2023GFI	389
EFDC175-J3	13	EFDT50-J1	13	EF5150-2023	383	EF5275-2023M	385
EFDC175Q	22	EFDT50-J1U2	10	EF5150-20232	383	EF5275A-2023GFI	389
EFDC175-U3	9	EFDT50-J2	13	EF5150-20232M	384	EF5275-F1	79

Alphanumeric Index

Catalog Number	Page	Catalog Number	Page	Catalog Number	Page	Catalog Number	Page
EFS275-F13	79	EFSC210-F3W	79	EFSFR3WQ	81	ELF90-100	650
EFS275-R1	80	EFSC210-F4W	79	EFSFR3WQ	123	ELF90-100-A	650
EFS2MSQ	318	EFSC210-R2	80	EFSFR4WQ	88	ELF90-125	650
EFS3524	33	EFSC210-R3W	80	EFSFR4WQ	81	ELF90-125-A	650
EFS3561	33	EFSC210-R4W	80	EFSFR4WQ	123	ELF90-50	650
EFS3624	33	EFSC250-2023	383	EFSR-2023	383	ELF90-50-A	650
EFS3661	33	EFSC250-20232	383	EFSR-20232	383	ELF90-75	650
EFS3MSQ	318	EFSC250-20232M	385	EFSR-20232K	383	ELF90-75-A	650
EFSB150-20232M	384	EFSC250-2023GFI	389	EFSR-20232M	385	ELFF-450	651
EFSB150-2023M	384	EFSC250-2023M	385	EFSR-2023K	383	ELM90-100	650
EFSB175-20232M	384	EFSC250A-2023GFI	389	EFSR-2023M	385	ELM90-50	650
EFSB175-2023M	384	EFSC250-F1	79	EFSR-GFI	389	ELM90-50-A	650
EFSC110-2023	383	EFSC250-F2	79	EFSR-U1Q	11	ELM90-75	650
EFSC110-20232	383	EFSC250-F3W	79	EFSR-U2Q	11	ELM90-75-A	650
EFSC110-20232M	384	EFSC250-F4W	79	EGC210	350	ELMF90-100	650
EFSC110-2023M	384	EFSC250-R1	80	EGCK1P	350	ELMF90-100-A	650
EFSC110A-GFI	389	EFSC250-R2	80	EGCKECC	350	ELMF90-125	650
EFSC110-GFI	389	EFSC250-R3W	80	EL-9100	651	ELMF90-50	650
EFSC150-2023	383	EFSC250-R4W	80	EL-9125	651	ELMF90-50-A	650
EFSC150-20232	383	EFSC2524	33	EL-9150	651	ELMF90-75	650
EFSC150-20232M	384	EFSC2561	33	EL-9200	651	ELMF90-75-A	650
EFSC150-2023M	384	EFSC2624	33	EL-950	651	ELMFL90-100	650
EFSC150A-GFI	389	EFSC2661	33	EL-975	651	ELMFL90-100-A	650
EFSC150-F1	79	EFSC275-2023	383	ELBD-100	703	ELMFL90-125	650
EFSC150-F2	79	EFSC275-20232	383	ELBD-100A	702	ELMFL90-150	650
EFSC150-F3W	79	EFSC275-20232M	385	ELBD-125	703	ELMFL90-200	650
EFSC150-F4W	79	EFSC275-2023GFI	389	ELBD-125A	702	ELMFL90-50	650
EFSC150-GFI	389	EFSC275-2023M	385	ELBD-150	703	ELMFL90-50-A	650
EFSC150-R1	80	EFSC275A-2023GFI	389	ELBD-150A	702	ELMFL90-75	650
EFSC150-R2	80	EFSC275-F1	79	ELBD-200	703	ELMFL90-75-A	650
EFSC150-R3W	80	EFSC275-F13	79	ELBD-200A	702	ENR11201	401
EFSC150-R4W	80	EFSC275-F2	79	ELBD-250	703	ENR11202	401
EFSC1524	33	EFSC275-F23	79	ELBD-250A	702	ENR12201	401
EFSC1561	33	EFSC275-F3W	79	ELBD-300	703	ENR12202	401
EFSC1624	33	EFSC275-F4W	79	ELBD-300A	702	ENR21201	401
EFSC1661	33	EFSC275-R1	80	ELBD-350	703	ENR21202	401
EFSC175-2023	383	EFSC275-R2	80	ELBD-350A	702	ENR22201	401
EFSC175-20232	383	EFSC275-R3W	80	ELBD-400	703	ENR22202	401
EFSC175-20232M	384	EFSC275-R4W	80	ELBD-400A	702	ENR31201	401
EFSC175-2023M	384	EFSC3524	33	ELBD-50	703	ENR31202	401
EFSC175A-GFI	389	EFSC3561	33	ELBD-50A	702	ENR32201	401
EFSC175-F1	79	EFSC3624	33	ELBD-75	703	ENR32202	401
EFSC175-F13	79	EFSC3661	33	ELBD-75A	702	ENR5201	401
EFSC175-F2	79	EFSCB150-20232M	384	ELBY-100	700	ENR6202	401
EFSC175-F23	79	EFSCB150-2023M	384	ELBY-100A	700	ENRC11201	401
EFSC175-F3W	79	EFSCB175-20232M	384	ELBY-125	700	ENRC11202	401
EFSC175-F4W	79	EFSCB175-2023M	384	ELBY-125A	700	ENRC12201	401
EFSC175-GFI	389	EFSFR13Q	81	ELBY-50	700	ENRC12202	401
EFSC175-R1	80	EFSFR13Q	123	ELBY-50A	700	ENRC21201	401
EFSC175-R2	80	EFSFR1Q	88	ELBY-75	700	ENRC21202	401
EFSC175-R3W	80	EFSFR1Q	81	ELBY-75A	700	ENRC22201	401
EFSC175-R4W	80	EFSFR1Q	123	ELF45-100	650	ENRC22202	401
EFSC210-2023	383	EFSFR23Q	81	ELF45-125	650	ENRC31201	401
EFSC210-20232	383	EFSFR23Q	123	ELF45-150	650	ENRC31202	401
EFSC210-20232M	385	EFSFR2Q	88	ELF45-150-A	650	ENRC32201	401
EFSC210-2023GFI	389	EFSFR2Q	81	ELF45-200	650	ENRC32202	401
EFSC210-2023M	385	EFSFR2Q	123	ELF45-50	650	EPL-B6W	120
EFSC210A-2023GFI	389	EFSFR3W3Q	81	ELF45-50-A	650	EPL-B6W	20
EFSC210-F2	79	EFSFR3W3Q	123	ELF45-75	650	EPL-B6W	40
EFSC210-F23	79	EFSFR3WQ	88	ELF45-75-A	650	EPL-B6W	99

Alphanumeric Index

Catalog Number	Page	Catalog Number	Page	Catalog Number	Page	Catalog Number	Page
EPILLED A	120	ES5W5	336	EXGJH-412	653	EXLK-215	653
EPILLED A	20	ES600500	687	EXGJH-415	653	EXLK-218	653
EPILLED A	40	ESKB-1PBQ	17	EXGJH-418	653	EXLK-221	653
EPILLED A	99	ESKB-2PBQ	17	EXGJH-421	653	EXLK-224	653
EPILLED G	120	ESKB-2SPQ	17	EXGJH-424	653	EXLK-227	653
EPILLED G	20	ESKB-3JPBQ	17	EXGJH-427	653	EXLK-230	653
EPILLED G	40	ESKB-BQ	17	EXGJH-430	653	EXLK-233	653
EPILLED G	99	ESUF-100	682	EXGJH-433	653	EXLK-236	653
EPILLED R	120	ESUF-50	682	EXGJH-436	653	EXLK-24	653
EPILLED R	20	ESUF-75	682	EXGJH-512	653	EXLK-26	653
EPILLED R	40	ESUM-100	682	EXGJH-515	653	EXLK-28	653
EPILLED R	99	ESUM-50	682	EXGJH-518	653	EXLK-310	653
EPX4A30Z	587	ESUM-75	682	EXGJH-521	653	EXLK-312	653
EPX4B70Z	587	EXGJH-1012	653	EXGJH-524	653	EXLK-315	653
ERC50	707	EXGJH-1015	653	EXGJH-527	653	EXLK-318	653
ERC75	707	EXGJH-1018	653	EXGJH-530	653	EXLK-321	653
ERLB50	707	EXGJH-1021	653	EXGJH-533	653	EXLK-324	653
ERLB75	707	EXGJH-1024	653	EXGJH-536	653	EXLK-327	653
ERLL50	707	EXGJH-1027	653	EXGJH-612	653	EXLK-330	653
ERLL75	707	EXGJH-1030	653	EXGJH-615	653	EXLK-333	653
ERLR50	707	EXGJH-1033	653	EXGJH-618	653	EXLK-336	653
ERLR75	707	EXGJH-1036	653	EXGJH-621	653	EXLK-36	653
ERS2	337	EXGJH-110	653	EXGJH-624	653	EXLK-38	653
ERS3	337	EXGJH-112	653	EXGJH-627	653	EXLK-412	653
ERT50	707	EXGJH-115	653	EXGJH-630	653	EXLK-415	653
ERT75	707	EXGJH-118	653	EXGJH-633	653	EXLK-418	653
ERTB50	707	EXGJH-121	653	EXGJH-636	653	EXLK-421	653
ERTB75	707	EXGJH-124	653	EXGJH-712	653	EXLK-424	653
ES0W1	336	EXGJH-127	653	EXGJH-715	653	EXLK-427	653
ES0W2	336	EXGJH-130	653	EXGJH-718	653	EXLK-430	653
ES0W4	336	EXGJH-133	653	EXGJH-721	653	EXLK-433	653
ES0W5	336	EXGJH-136	653	EXGJH-724	653	EXLK-436	653
ES10050	687	EXGJH-14	653	EXGJH-727	653	EXLK-512	653
ES10075	687	EXGJH-16	653	EXGJH-730	653	EXLK-515	653
ES150100	687	EXGJH-18	653	EXGJH-733	653	EXLK-518	653
ES1W1	336	EXGJH-210	653	EXGJH-736	653	EXLK-521	653
ES1W2	336	EXGJH-212	653	EXGJH-812	653	EXLK-524	653
ES1W4	336	EXGJH-215	653	EXGJH-815	653	EXLK-527	653
ES1W5	336	EXGJH-218	653	EXGJH-818	653	EXLK-530	653
ES2	336	EXGJH-221	653	EXGJH-821	653	EXLK-533	653
ES200125	687	EXGJH-224	653	EXGJH-824	653	EXLK-536	653
ES200150	687	EXGJH-227	653	EXGJH-827	653	EXLK-612	653
ES250200	687	EXGJH-230	653	EXGJH-830	653	EXLK-615	653
ES2W1	336	EXGJH-233	653	EXGJH-833	653	EXLK-618	653
ES2W2	336	EXGJH-236	653	EXGJH-836	653	EXLK-621	653
ES2W4	336	EXGJH-24	653	EXLK-110	653	EXLK-624	653
ES2W5	336	EXGJH-26	653	EXLK-112	653	EXLK-627	653
ES3	336	EXGJH-28	653	EXLK-115	653	EXLK-630	653
ES3W1	336	EXGJH-310	653	EXLK-118	653	EXLK-633	653
ES3W2	336	EXGJH-312	653	EXLK-121	653	EXLK-636	653
ES3W4	336	EXGJH-315	653	EXLK-124	653	EY-100	695
ES3W5	336	EXGJH-318	653	EXLK-127	653	EY-125	695
ES4	336	EXGJH-321	653	EXLK-130	653	EY-150	695
ES400300	687	EXGJH-324	653	EXLK-133	653	EY-200	695
ES4W2	336	EXGJH-327	653	EXLK-136	653	EY-50	695
ES4W4	336	EXGJH-330	653	EXLK-14	653	EY-75	695
ES4W5	336	EXGJH-333	653	EXLK-16	653	EYA-100	691
ES5	336	EXGJH-336	653	EXLK-18	653	EYA-100A	691
ES500400	687	EXGJH-36	653	EXLK-210	653	EYA-125	691
ES5W4	336	EXGJH-38	653	EXLK-212	653	EYA-125A	691

Alphanumeric Index

Catalog Number	Page	Catalog Number	Page	Catalog Number	Page	Catalog Number	Page
EYA-150	691	EYD-200	693	EYDM-350	693	EYM-300AL	683
EYA-150A	691	EYD-250	693	EYDM-350	686	EYM-350	683
EYA-200	691	EYD-26	685	EYDM-350AL	686	EYM-350AL	683
EYA-200A	691	EYD-3	685	EYDM-400	693	EYM-400	683
EYA-250	691	EYD-300	693	EYDM-400	686	EYM-400AL	683
EYA-250A	691	EYD-350	693	EYDM-400AL	686	EYM-50	695
EYA-300	691	EYD-36	685	EYDM-50	693	EYM-50	683
EYA-300A	691	EYD-4	685	EYDM-50	686	EYM-500	683
EYA-350	691	EYD-400	693	EYDM-50AL	686	EYM-50AL	683
EYA-350A	691	EYD-46	685	EYDM-75	693	EYM-600	683
EYA-400	691	EYD-5	685	EYDM-75	686	EYM-75	695
EYA-400A	691	EYD-50	693	EYDM-75AL	686	EYM-75	683
EYA-50	691	EYD-56	685	EYDX-100	694	EYM-75AL	683
EYA-500	691	EYD-6	685	EYDX-125	694	EYS-012	680
EYA-50A	691	EYD-66	685	EYDX-150	694	EYS-0126	680
EYA-600	691	EYD-7	685	EYDX-200	694	EYS-014	680
EYA-75	691	EYD-75	693	EYDX-250	694	EYS-0146	680
EYA-75A	691	EYD-76	685	EYDX-300	694	EYS-1	681
EYAM-100	691	EYD-8	685	EYDX-50	694	EYS-10	680
EYAM-100A	691	EYD-86	685	EYDX-75	694	EYS-106	680
EYAM-125	691	EYD-9	685	EYF-100	683	EYS-11	680
EYAM-125A	691	EYD-96	685	EYF-100AL	683	EYS-116	680
EYAM-150	691	EYDEF100	684	EYF-125	683	EYS-16	681
EYAM-150A	691	EYDEF100AL	684	EYF-125AL	683	EYS-2	681
EYAM-200	691	EYDEF125	684	EYF-150	683	EYS-21	680
EYAM-200A	691	EYDEF125AL	684	EYF-150AL	683	EYS-216	680
EYAM-250	691	EYDEF150	684	EYF-200	683	EYS-26	681
EYAM-250A	691	EYDEF150AL	684	EYF-200AL	683	EYS-3	681
EYAM-300	691	EYDEF200	684	EYF-250	683	EYS-31	680
EYAM-300A	691	EYDEF200AL	684	EYF-250AL	683	EYS-316	680
EYAM-350	691	EYDEF250	684	EYF-300	683	EYS-36	681
EYAM-350A	691	EYDEF250AL	684	EYF-300AL	683	EYS-4	680
EYAM-400	691	EYDEF300	684	EYF-350	683	EYS-46	680
EYAM-400A	691	EYDEF300AL	684	EYF-350AL	683	EYS-5	680
EYAM-50	691	EYDEF350	684	EYF-400	683	EYS-56	680
EYAM-500	691	EYDEF350AL	684	EYF-400AL	683	EYS-6	680
EYAM-50A	691	EYDEF400	684	EYF-50	683	EYS-66	680
EYAM-600	691	EYDEF400AL	684	EYF-500	683	EYS-7	680
EYAM-75	691	EYDEF50	684	EYF-50AL	683	EYS-76	680
EYAM-75A	691	EYDEF50AL	684	EYF-600	683	EYS-8	680
EYAX-100	692	EYDEF75	684	EYF-75	683	EYS-86	680
EYAX-125	692	EYDEF75AL	684	EYF-75AL	683	EYS-9	680
EYAX-150	692	EYDM-100	693	EYFK16	697	EYS-96	680
EYAX-200	692	EYDM-100	686	EYFK4	697	EYSEF100	684
EYAX-250	692	EYDM-100AL	686	EYFK8	697	EYSEF100AL	684
EYAX-300	692	EYDM-125	693	EYM-100	695	EYSEF125	684
EYAX-350	692	EYDM-125	686	EYM-100	683	EYSEF125AL	684
EYAX-400	692	EYDM-125AL	686	EYM-100AL	683	EYSEF150	684
EYAX-50	692	EYDM-150	693	EYM-125	695	EYSEF150AL	684
EYAX-75	692	EYDM-150	686	EYM-125	683	EYSEF200	684
EYCK160Z	697	EYDM-150AL	686	EYM-125AL	683	EYSEF200AL	684
EYCK5LB	697	EYDM-200	693	EYM-150	695	EYSEF250	684
EYD-1	685	EYDM-200	686	EYM-150	683	EYSEF250AL	684
EYD-10	685	EYDM-200AL	686	EYM-150AL	683	EYSEF300	684
EYD-100	693	EYDM-250	693	EYM-200	695	EYSEF300AL	684
EYD-106	685	EYDM-250	686	EYM-200	683	EYSEF350	684
EYD-125	693	EYDM-250AL	686	EYM-200AL	683	EYSEF350AL	684
EYD-150	693	EYDM-300	693	EYM-250	683	EYSEF400	684
EYD-16	685	EYDM-300	686	EYM-250AL	683	EYSEF400AL	684
EYD-2	685	EYDM-300AL	686	EYM-300	683	EYSEF50	684

Alphanumeric Index

Catalog Number	Page	Catalog Number	Page	Catalog Number	Page	Catalog Number	Page
EYSEF50AL	684	ID2SR6034	452	LBH-1012A	704	LNPREVQ	41
EYSEF75	684	ID2SR6034F	452	LBH-1012AN4	704	LNPRUNQ	120
EYSEF75AL	684	IDSR1034	495	LBH-1520	705	LNPRUNQ	21
EYSF-100	679	IDSR1034-NF	495	LBH-1520A	704	LNPRUNQ	41
EYSF-100AL	679	IDSR1034-NF-W	495	LBH-1520AN4	704	LNPSLOWQ	120
EYSF-125	679	IDSR1034-W	495	LBH-2530	705	LNPSLOWQ	21
EYSF-150	679	IDSR3034	495	LBH-2530A	704	LNPSLOWQ	41
EYSF-200	679	IDSR3034-NF	495	LBH-2530AN4	704	LNPSPQ	120
EYSF-250	679	IDSR3034-NF-W	495	LBH-400	705	LNPSPQ	21
EYSF-300	679	IDSR3034-W	495	LBH-400A	704	LNPSPQ	41
EYSF-400	679	IDSR6034	495	LBH-400AN4	704	LNPSTQ	120
EYSF-50	679	IDSR6034-NF	495	LBY-10	701	LNPSTQ	21
EYSF-50AL	679	IDSR6034-NF-W	495	LBY-125	701	LNPSTQ	41
EYSF-75	679	IDSR6034-W	495	LBY-150	701	LNPTSTQ	120
EYSF-75AL	679	JBR3023-150	429	LBY-50	701	LNPTSTQ	21
EYSM-100	679	JBR3034-150	429	LBY-75	701	LNPTSTQ	41
EYSM-100AL	679	JBR6023-150	429	LNPBQ	120	LNPUPQ	120
EYSM-50	679	JBR6034-150	429	LNPBQ	21	LNPUPQ	21
EYSM-50AL	679	JGBNA	120	LNPBQ	41	LNPUPQ	41
EYSM-75	679	JGBNA	20	LNPBQ	120	LSF32	613
EYSM-75AL	679	JGBNA	40	LNPBQ	21	LSF33	603
F01	689	JGBNA	99	LNPBQ	41	LSF33	604
F01	698	JGBNB	120	LNPBQ	120	LSF33	608
F02	689	JGBNB	20	LNPBQ	21	LSF33	615
F02	698	JGBNB	40	LNPBQ	41	LSF33	618
F038	689	JGBNB	99	LNPBQ	120	LSF33	621
F038	698	JGBNC	120	LNPBQ	21	LSF33	625
F04	689	JGBNC	20	LNPBQ	41	LSF33	626
F04	698	JGBNC	40	LNPBQ	120	LSF33	633
F075	689	JGBNC	99	LNPBQ	21	LSF34	603
F075	698	JGBNG	120	LNPBQ	41	LSF34	613
F08	689	JGBNG	20	LNPBQ	120	LSF34	615
F08	698	JGBNG	40	LNPBQ	21	LSF34	618
F1	689	JGBNG	99	LNPBQ	41	LSF34	621
F1	698	JGBNO	120	LNPBQ	120	LSF34	625
FASDA	362	JGBNO	20	LNPBQ	21	LSF34	633
FASEA	362	JGBNO	40	LNPBQ	41	LSF35	603
FASEM	362	JGBNO	99	LNPBQ	120	LSF35	613
FP-3023	421	JGBNR	120	LNPBQ	21	LSF35	615
FP-3034	421	JGBNR	20	LNPBQ	41	LSF35	618
FSQC3430	426	JGBNR	40	LNPBQ	120	LSF35	621
FSQC5640	426	JGBNR	99	LNPBQ	21	LSF35	625
FSQC61040	426	KL02A	378	LNPBQ	41	MAT-6050A	587
FSQX3023-100	421	KL02D	378	LNPBQ	120	MAT-6050B	587
FSQX3034-100	421	KL04A	378	LNPBQ	21	MAT-6050C	587
FU40	273	KL04D	378	LNPBQ	41	MAT-6051A	587
GFS1	403	KL11A	378	LNPBQ	120	MAT-6051B	587
GFS1	417	KL23A	378	LNPBQ	21	MAT-6051C	587
GUSC75-2	125	LAB1	53	LNPBQ	41	MD2SR1023F	449
GUSC75-3	125	LAB1	66	LNPBQ	120	MD2SR1023U	449
ID2SR1023	452	LAB21	73	LNPBQ	21	MD2SR1034F	449
ID2SR1023F	452	LAB21	88	LNPBQ	41	MD2SR1034U	449
ID2SR1034	452	LAB22	73	LNPBQ	120	MD2SR3023F	449
ID2SR1034F	452	LAB22	88	LNPBQ	21	MD2SR3023U	449
ID2SR3023	452	LAB23W	73	LNPBQ	41	MD2SR3034F	449
ID2SR3023F	452	LAB23W	88	LNPBQ	120	MD2SR3034U	449
ID2SR3034	452	LBH-0507	705	LNPBQ	21	MD2SR6023F	449
ID2SR3034F	452	LBH-0507A	704	LNPBQ	41	MD2SR6023U	449
ID2SR6023	452	LBH-0507AN4	704	LNPBQ	120	MD2SR6034F	449
ID2SR6023F	452	LBH-1012	705	LNPBQ	21	MD2SR6034U	449

Alphanumeric Index

Catalog Number	Page	Catalog Number	Page	Catalog Number	Page	Catalog Number	Page
ME-323S	668	MNPEMLXX06-*	510	MNREP-00-10-332PN	506	MSB550D42F	342
ME-324S	668	MNPEMLXX08-*	510	MNREP-00-10-332SN	506	MSB750D42	342
ME-325S	668	MNPEMLXX10-*	510	MNREP-00-10-386SN	506	MSB750D42F	342
MEP13-3-B206-333SN	573	MNPEMLXX12-*	510	MNREP0012-*	516	MST01	318
MEP13-3-B206-334SN	573	MNPEMLXX14-*	510	MNREP-00-12-371PN	506	MST01	324
MEP13-3-B206-355PN	573	MNPEMLXXC10-*	510	MNREP-00-12-371SN	506	MST01	330
MEP13-3-C208-321PN	573	MNPEMLXXC12-*	510	MNREP0014-*	516	MST02	318
MEP13-3-C208-321SN	573	MNPEMLXXC14-*	510	MNREP00C10-*	516	MST02	324
MEP13-3-C208-355SN	573	MNPEMLXXC14-*	510	MNREP00C12-*	516	MST02	330
MEP13-3-D210-376PN	573	MNPEMLXXC14-*	510	MNREP00C14-*	516	N1D75-102	115
MEP13-3-D210-386SN	573	MNPEMLXXC14-*	510	MOG-C12-535PN	577	N1D75-12	115
MEP13-4-1006-355SN	573	MNPEMLXXC14-*	510	MOG-C12-535SN	577	N1D75-1MSAB	330
MEP15-3-B206-355SN	573	MNPEMLXXC14-*	510	MOG-C12-777PN	577	N1D75-1MSW	330
MEP15-3-C208-321PN	573	MNPEMLXXC14-*	510	MOG-C12-777SN	577	N1D75-2023	406
MEP15-3-D210-376SN	573	MNPEMLXXC14-*	510	MREP1316PT3K	551	N1D75-20232	406
MEP15-4-1006-355PN	573	MNPEMLXXC14-*	510	MREP2F	549	N1D75-2MS	330
MEP17-3-B206-333PN	573	MNPEMLXXC14-*	510	MREP4316B	550	N1D75-2MSAB	330
MEP17-3-B206-334PN	573	MNPEMLXXC14-*	510	MREP4316P	550	N1D75-2MSW	330
MEP17-3-C208-355PN	573	MNPEMLXXC14-*	510	MREP4316PT4K	551	N1D75-345	115
MNPBQ	119	MNPEMLXXC14-*	510	MREP4F	550	N1D75-35	115
MNPBQ	19	MNPEMLXXC14-*	510	MREP4G	550	N1D75-3MS	330
MNPBQ	40	MNPEMLXXC14-*	510	MRES4316PT3KH	552	N1D75-F1	123
MNPEDLJXX06-*	512	MNPEMLXXC14-*	510	MRES4316PT4KH	552	N1D75-F13	123
MNPEDLJXX08-*	512	MNPEMLXXC14-*	510	MSB003D42	342	N1D75-F2	123
MNPEDLJXX10-*	512	MNPEMLXXC14-*	510	MSB003D42F	342	N1D75-F23	123
MNPEDLJXX12-*	512	MNPEMLXXC14-*	510	MSB005D42	342	N1D75-F3W	123
MNPEDLJXX14-*	512	MNPEMLXXC14-*	510	MSB005D42F	342	N1D75-F3W3	123
MNPEDLJXXC10-*	512	MNPEMLXXC14-*	510	MSB007D42	342	N1D75-F4W	123
MNPEDLJXXC12-*	512	MNPEMLXXC14-*	510	MSB007D42F	342	N1D75FA-U1	115
MNPEDLJXXC14-*	512	MNPEMLXXC14-*	510	MSB011D42	342	N1D75-J1	114
MNPEDLXX06-*	512	MNPEMLXXC14-*	510	MSB011D42F	342	N1D75-J1102	115
MNPEDLXX08-*	512	MNPEMLXXC14-*	510	MSB015D42	342	N1D75-J112	115
MNPEDLXX10-*	512	MNPEMLXXC14-*	510	MSB015D42F	342	N1D75-J1345	115
MNPEDLXX12-*	512	MNPEMLXXC14-*	510	MSB022D42	342	N1D75-J135	115
MNPEDLXX14-*	512	MNPEMLXXC14-*	510	MSB022D42F	342	N1D75-J1U1	114
MNPEDLXXC10-*	512	MNPEMLXXC14-*	510	MSB030D42	342	N1D75-J1U2	114
MNPEDLXXC12-*	512	MNPEMLXXC14-*	510	MSB030D42F	342	N1D75-J2	114
MNPEDLXXC14-*	512	MNPEMLXXC14-*	510	MSB040D42	342	N1D75Q	117
MNPEKL-06-06-327PN	506	MNPEMLXXC14-*	510	MSB040D42F	342	N1D75Q	123
MNPEKL-10-06-354PN	506	MNPEMLXXC14-*	510	MSB055D42	342	N1D75-U1	114
MNPEKL-10-06-355PN	506	MNPEMLXXC14-*	510	MSB055D42F	342	N1D75-U2	114
MNPEKL-12-08-325PN	506	MNPEMLXXC14-*	510	MSB075D42	342	N1D75-U3	114
MNPEKLJ-18-10-386PN	506	MNPEMLXXC14-*	510	MSB075D42F	342	N1D75-UM1	114
MNPEKLJ-22-12-371PN	506	MNPEMLXXC14-*	510	MSB090D42	342	N1DC75-102	115
MNPEKLJXX06-*	511	MNPEMLXXC14-*	510	MSB090D42F	342	N1DC75-12	115
MNPEKLJXX08-*	511	MNPEMLXXC14-*	510	MSB110D42	342	N1DC75-1MSAB	330
MNPEKLJXX10-*	511	MNPEMLXXC14-*	510	MSB110D42F	342	N1DC75-1MSW	330
MNPEKLJXX12-*	511	MNPEMLXXC14-*	510	MSB150D42	342	N1DC75-2023	406
MNPEKLJXX14-*	511	MNPEMLXXC14-*	510	MSB150D42F	342	N1DC75-20232	406
MNPEKLJXXC10-*	511	MNPEMLXXC14-*	510	MSB185D42	342	N1DC75-2MS	330
MNPEKLJXXC12-*	511	MNPEMLXXC14-*	510	MSB185D42F	342	N1DC75-2MSAB	330
MNPEKLJXXC14-*	511	MNPEMLXXC14-*	510	MSB220D42	342	N1DC75-2MSW	330
MNPEKLXX06-*	511	MNPEMLXXC14-*	510	MSB220D42F	342	N1DC75-345	115
MNPEKLXX08-*	511	MNPEMLXXC14-*	510	MSB300D42	342	N1DC75-35	115
MNPEKLXX10-*	511	MNPEMLXXC14-*	510	MSB300D42F	342	N1DC75-3MS	330
MNPEKLXX12-*	511	MNPEMLXXC14-*	510	MSB370D42	342	N1DC75-F1	123
MNPEKLXX14-*	511	MNPEMLXXC14-*	510	MSB370D42F	342	N1DC75-F13	123
MNPEKLXXC10-*	511	MNPEMLXXC14-*	510	MSB450D42	342	N1DC75-F2	123
MNPEKLXXC12-*	511	MNPEMLXXC14-*	510	MSB450D42F	342	N1DC75-F23	123
MNPEKLXXC14-*	511	MNPEMLXXC14-*	510	MSB550D42	342	N1DC75-F3W	123

Alphanumeric Index

Catalog Number	Page	Catalog Number	Page	Catalog Number	Page	Catalog Number	Page
N1DC75-F3W3	123	N2DC75-J1U1	114	NMACP6034BC	485	PLG-250A	660
N1DC75-F4W	123	N2DC75-J1U2	114	NMRB-BL	119	PLG-250C	661
N1DC75FA-U1	115	N2DC75-J2	114	NMRB-BL	19	PLG-250CA	661
N1DC75-J1	114	N2DC75Q	117	NMRB-BL	39	PLG-250S	660
N1DC75-J1102	115	N2DC75-U1	114	NMRB-BL	97	PLG-300	660
N1DC75-J112	115	N2DC75-U2	114	NMRB-GR	119	PLG-300A	660
N1DC75-J1345	115	N2DC75-U3	114	NMRB-GR	19	PLG-300C	661
N1DC75-J135	115	N2DC75-UM1	114	NMRB-GR	39	PLG-300CA	661
N1DC75-J1U1	114	N2K-102	116	NMRB-GR	97	PLG-300S	660
N1DC75-J1U2	114	N2K-102SLC	116	NMRBM-RE	119	PLG-350C	661
N1DC75-J2	114	N2K-102SRC	116	NMRBM-RE	19	PLG-350CA	661
N1DC75Q	117	N2K-12	116	NMRBM-RE	40	PLG-350S	660
N1DC75Q	123	N2K-1PL	117	NMRBM-RE	97	PLG-400	660
N1DC75-U1	114	N2K-2PL	117	NMRB-RE	119	PLG-400A	660
N1DC75-U2	114	N2K-2SP	117	NMRB-RE	19	PLG-400C	661
N1DC75-U3	114	N2K-345	116	NMRB-RE	39	PLG-400CA	661
N1DC75-UM1	114	N2K-345SLC	116	NMRB-RE	97	PLG-400S	660
N1K-102	116	N2K-345SRC	116	NPB-LG1	118	PLG-500C	661
N1K-102SLC	116	N2K-35	116	NPB-LG1	19	PLG-50R	660
N1K-102SRC	116	N2K-3JPB	117	NPB-LG1	39	PLG-50R	661
N1K-12	116	N2K-637SRC	116	NPB-LG1	97	PLG-50RA	660
N1K-1PL	117	N767ERM12	643	NPB-LG1-LL	118	PLG-50RA	661
N1K-2PL	117	N767ERM22	643	NPB-LG1-LL	19	PLG-50S	660
N1K-2SP	117	N767ERM32	643	NPB-LG1-LL	39	PLG-600C	661
N1K-345	116	N767ERM42	643	NPB-LG2	118	PLG-75R	660
N1K-345SLC	116	N767ERM52	643	NPB-LG2	19	PLG-75R	661
N1K-345SRC	116	N767ERM62	643	NPB-LG2	39	PLG-75RA	660
N1K-35	116	N767ERM72	643	NPB-LG2	97	PLG-75RA	661
N1K-3JPB	117	N767ERM82	643	NPB-LG2-LL	118	PLG-75S	660
N1K-637SRC	116	N767ERM92	643	NPB-LG2-LL	19	PRD316FBB	558
N1K-F12	123	N767ERT12	643	NPB-LG2-LL	39	PRD316FBC	558
N1K-F34W	123	N767ERT22	643	NPBRKT-CONT	17	PRD316FPB	558
N2D75-102	115	N767ERT32	643	NPBRKT-CONT	38	PRD316FPC	558
N2D75-12	115	N767ERT42	643	NPBRKT-CONT	88	PRD316FVB	558
N2D75-345	115	N767ERT52	643	NPBRKT-EFDB	17	PRD316FYC	558
N2D75-35	115	N767ERT62	643	NPBRKT-EFDB	73	PRD316PB	557
N2D75FA-U1	115	N767ERT72	643	NPBRKT-N1N2	117	PRD316PP	557
N2D75-J1	114	N767ERT82	643	NPBRKT-N1N2	124	PRD316PY	557
N2D75-J1102	115	NBL-SR	119	PLG-100R	660	PRD316RB	557
N2D75-J112	115	NBL-SR	19	PLG-100R	661	PRD316RP	557
N2D75-J1345	115	NBL-SR	39	PLG-100RA	660	PRD316RY	557
N2D75-J135	115	NBL-SR	97	PLG-100RA	661	PRD412PR	557
N2D75-J1U1	114	NBN-WB	118	PLG100-S	359	PRD412RR	557
N2D75-J1U2	114	NBN-WB	18	PLG-100S	660	PRD416FRB	558
N2D75-J2	114	NBN-WB	39	PLG-125	660	PRD416FRC	558
N2D75Q	117	NBN-WB	97	PLG-125A	660	PRD416PR	557
N2D75-U1	114	NCP-1523	387	PLG-125R	661	PRD416RR	557
N2D75-U2	114	NCP-1523	396	PLG-125RA	661	PRD432FRB	558
N2D75-U3	114	NCP-2023	387	PLG-125S	660	PRD432FRC	558
N2D75-UM1	114	NCP-2023	396	PLG-150	660	PRD432PR	557
N2DC75-102	115	NCP-2023	402	PLG-150A	660	PRD432RR	557
N2DC75-12	115	NCP-2023	407	PLG-150R	661	PRD480PR	557
N2DC75-345	115	NCP-20232	387	PLG-150RA	661	PRD480RR	557
N2DC75-35	115	NCP-20232	396	PLG-150S	660	PRD516FRB	558
N2DC75FA-U1	115	NCP-20232	402	PLG-200	660	PRD516FRC	558
N2DC75-J1	114	NCP-20232	407	PLG-200A	660	PRD516PR	557
N2DC75-J1102	115	NFA-G	115	PLG-200R	661	PRD516RR	557
N2DC75-J112	115	NMACP3034BC	460	PLG-200RA	661	PRE216FP	530
N2DC75-J1345	115	NMACP3034BC	485	PLG-200S	660	PRE216FW	530
N2DC75-J135	115	NMACP6034BC	462	PLG-250	660	PRE216FW1	530

Alphanumeric Index

Catalog Number	Page	Catalog Number	Page	Catalog Number	Page	Catalog Number	Page
PRE216MP	530	PRE432RR	535	PREESTM20	155	PVC06	611
PRE216MW	530	PRE463PB	540	PREESTM20	171	PVC06	615
PRE216MW1	530	PRE463PN	540	PREESTM20	181	PVC06	618
PRE216PP	530	PRE463PN1	540	PREESTM20	531	PVC06	621
PRE216PW	530	PRE463PR	540	PREESTM25	536	PVC06	625
PRE216PW1	530	PRE463PR1	540	PTBC200A	479	PVC06	629
PRE216RP	530	PRE463RBU5	540	PTBC200B	479	PVC06	633
PRE216RW	530	PRE463RN1U5	540	PTBC400A	479	PVC06	626
PRE216RW1	530	PRE463RNU5	540	PTBC400B	479	PVC09	598
PRE316FB	530	PRE463RR1U5	540	PTGB200E	479	PVC09	603
PRE316FP	530	PRE463RRU5	540	PTGB30	469	PVC09	604
PRE316FY	530	PRE463RRU5T	541	PTGB400E	479	PVC09	607
PRE316MB	530	PRE512PN	545	PTGB400F	479	PVC09	608
PRE316MP	530	PRE512PN1	545	PTGB400G	479	PVC09	611
PRE316MY	530	PRE512PR	545	PTGB60	469	PVC09	613
PRE316PB	530	PRE512PR1	545	PTGBCD	469	PVC09	615
PRE316PP	530	PRE512RN1U6	545	PTGBCE	479	PVC09	618
PRE316PY	530	PRE512RNU6	545	PTGBDE	469	PVC09	621
PRE316RB	530	PRE512RR1U6	545	PTGBUBC	469	PVC09	623
PRE316RP	530	PRE512RRU6	545	PTK200WA3	479	PVC09	625
PRE316RY	530	PRE516FB	531	PTK200WA4	479	PVC09	629
PRE332FB	535	PRE516FG	531	PTK750-3P	479	PVC09	633
PRE332FY	535	PRE516FR	531	PTK750-4P	479	PVC09	634
PRE332MB	535	PRE516MB	531	PTK84-3P	479	PVC09	626
PRE332MY	535	PRE516MG	531	PTK84-4P	479	PVC10	604
PRE332PB	535	PRE516MR	531	PTLC200A	479	PVC10	607
PRE332PY	535	PRE516PB	531	PTLC200B	479	PVC10	613
PRE332RB	535	PRE516PG	531	PTLOCK2004	479	PVC10	623
PRE332RY	535	PRE516PR	531	PTLOCK4004	479	PVC10	634
PRE412PN	545	PRE516RB	531	PTRGL100	469	PVC11	598
PRE412PN1	545	PRE516RG	531	PTRGL30	469	PVC11	603
PRE412PR	545	PRE516RR	531	PTRGL60	469	PVC11	608
PRE412PR1	545	PRE532FB	535	PTSC100A	469	PVC11	611
PRE412RN1U6	545	PRE532FR	535	PTSC100B	469	PVC11	615
PRE412RNU6	545	PRE532MB	535	PTSC30	469	PVC11	618
PRE412RR1U6	545	PRE532MR	535	PTSC60A	469	PVC11	621
PRE412RRU6	545	PRE532PB	535	PTSC60B	469	PVC11	625
PRE416FB	531	PRE532PR	535	PTTC100A	469	PVC11	629
PRE416FN	531	PRE532RB	535	PTTC100B	469	PVC11	633
PRE416FR	531	PRE532RR	535	PTTC30	469	PVC11	626
PRE416MB	531	PRE563PN	540	PTTC30	485	PVC13	604
PRE416MN	531	PRE563PN1	540	PTTC60A	469	PVC13	607
PRE416MR	531	PRE563PR	540	PTTC60B	469	PVC13	613
PRE416PB	531	PRE563PR1	540	PTTC60B	485	PVC13	623
PRE416PN	531	PRE563RN1U5	540	PVC04	604	PVC13	634
PRE416PR	531	PRE563RNU5	540	PVC04	607	PVC14	613
PRE416RB	531	PRE563RR1U5	540	PVC04	613	PVC15	598
PRE416RN	531	PRE563RRU5	540	PVC04	615	PVC15	603
PRE416RR	531	PRE563RRU5T	541	PVC04	618	PVC15	604
PRE432FB	535	PRE616FP	530	PVC04	621	PVC15	607
PRE432FN	535	PRE616FW	530	PVC04	623	PVC15	608
PRE432FR	535	PRE616MP	530	PVC04	625	PVC15	611
PRE432MB	535	PRE616MW	530	PVC04	626	PVC15	615
PRE432MN	535	PRE616PP	530	PVC05	604	PVC15	618
PRE432MR	535	PRE616PW	530	PVC05	607	PVC15	621
PRE432PB	535	PRE616RP	530	PVC05	613	PVC15	623
PRE432PN	535	PRE616RW	530	PVC05	623	PVC15	625
PRE432PR	535	PREECAM20	531	PVC06	598	PVC15	629
PRE432RB	535	PREECAM25	536	PVC06	603	PVC15	633
PRE432RN	535	PREESTM20	139	PVC06	608	PVC15	626

Alphanumeric Index

Catalog Number	Page	Catalog Number	Page	Catalog Number	Page	Catalog Number	Page
PVC16	634	PVC25	629	RB125-100A	669	RB-330A	670
PVC17	613	PVC25	634	RB125-50	669	RB-330S	670
PVC18	598	PVC25	626	RB125-50A	669	RB-331	670
PVC18	603	PVC26	604	RB125-75	669	RB-331A	670
PVC18	604	PVC26	607	RB125-75A	669	RB-332	670
PVC18	607	PVC26	613	RB150-100	669	RB-332A	670
PVC18	608	PVC26	623	RB150-100A	669	RB-333	670
PVC18	611	PVC27	634	RB150-125	669	RB-333A	670
PVC18	615	PVC28	598	RB150-125A	669	RB-334	670
PVC18	618	PVC28	603	RB150-50	669	RB-334A	670
PVC18	621	PVC28	608	RB150-50A	669	RB-335	670
PVC18	623	PVC28	611	RB150-75	669	RB-335A	670
PVC18	625	PVC28	615	RB150-75A	669	RB-336	670
PVC18	629	PVC28	618	RB200-100	669	RB-336A	670
PVC18	633	PVC28	621	RB200-100A	669	RB-337	670
PVC18	634	PVC28	625	RB200-125	669	RB-337A	670
PVC18	626	PVC28	629	RB200-125A	669	RB-339	670
PVC20	613	PVC28	633	RB200-150	669	RB-339A	670
PVC21	598	PVC28	626	RB200-150A	669	RB-340	670
PVC21	603	PVC30	598	RB200-50	669	RB-340A	670
PVC21	604	PVC30	603	RB200-50A	669	RB-341	670
PVC21	607	PVC30	608	RB200-75	669	RB-341A	670
PVC21	608	PVC30	611	RB200-75A	669	RB-342	670
PVC21	611	PVC30	615	RB250-100	669	RB-342A	670
PVC21	615	PVC30	618	RB250-100A	669	RB-349	670
PVC21	618	PVC30	621	RB250-125	669	RB-349A	670
PVC21	621	PVC30	625	RB250-125A	669	RB-350	670
PVC21	623	PVC30	629	RB250-150	669	RB350-200	669
PVC21	625	PVC30	626	RB250-150A	669	RB350-200A	669
PVC21	629	PVC31	604	RB250-200	669	RB350-250	669
PVC21	633	PVC31	607	RB250-200A	669	RB350-250A	669
PVC21	634	PVC31	613	RB300-100	669	RB350-300	669
PVC21	626	PVC31	623	RB300-100A	669	RB350-300A	669
PVC22	613	PVC32	598	RB300-125	669	RB-350A	670
PVC23	598	PVC32	603	RB300-125A	669	RB-351	670
PVC23	603	PVC32	608	RB300-150	669	RB-351A	670
PVC23	604	PVC32	611	RB300-150A	669	RB-355	670
PVC23	607	PVC32	615	RB300-200	669	RB-355A	670
PVC23	608	PVC32	618	RB300-200A	669	RB-356	670
PVC23	611	PVC32	621	RB300-250	669	RB-356A	670
PVC23	615	PVC32	625	RB300-250A	669	RB-357	670
PVC23	618	PVC32	629	RB-320S	670	RB-357A	670
PVC23	621	PVC32	633	RB-321A	670	RB400-200	669
PVC23	623	PVC32	634	RB-321S	670	RB400-200A	669
PVC23	625	PVC32	626	RB-322A	670	RB400-250	669
PVC23	629	PVC36	603	RB-322S	670	RB400-250A	669
PVC23	633	PVC37	633	RB-323A	670	RB400-300	669
PVC23	626	RAPIDEX30	606	RB-323S	670	RB400-300A	669
PVC24	604	RAPIDEX30	610	RB-324A	670	RB400-350	669
PVC24	607	RAPIDEX30	628	RB-324S	670	RB400-350A	669
PVC24	613	RAPIDEX30	631	RB-325A	670	RB500-350	669
PVC24	634	RAPIDEX80	606	RB-325S	670	RB500-350A	669
PVC25	598	RAPIDEX80	610	RB-326A	670	RB500-400	669
PVC25	603	RAPIDEX80	628	RB-326S	670	RB500-400A	669
PVC25	608	RAPIDEX80	631	RB-327A	670	RB50-13	669
PVC25	611	RB100-50	669	RB-327S	670	RB50-13A	669
PVC25	615	RB100-50A	669	RB-328A	670	RB50-25	669
PVC25	618	RB100-75	669	RB-328S	670	RB50-25A	669
PVC25	621	RB100-75A	669	RB-329A	670	RB50-38	669
PVC25	625	RB125-100	669	RB-329S	670	RB50-38A	669

Alphanumeric Index

Catalog Number	Page	Catalog Number	Page	Catalog Number	Page	Catalog Number	Page
RB600-400	669	SLNP-AOHQ	116	SLNP-ROJQ	35	SNP-OFF-Q	118
RB600-400A	669	SLNP-AOHQ	14	SLNP-ROJQ	116	SNP-OFF-Q	19
RB600-500	669	SLNP-AOHQ	98	SLNP-ROJQ	14	SNP-OFF-Q	39
RB600-500A	669	SLNP-B3	35	SLNP-ROJQ	98	SNP-OFF-Q	97
RB75-50	669	SLNP-B3	116	SLNP-SRSQ	116	SNP-ON-Q	118
RB75-50A	669	SLNP-B3	14	SLNP-SRSQ	14	SNP-ON-Q	19
REC-0705S	662	SLNP-B3	98	SLNP-SRSQ	35	SNP-ON-Q	39
REC-1005S	662	SLNP-BQ	35	SLNP-SRSQ	98	SNP-ON-Q	97
REC-1007S	662	SLNP-BQ	116	SLNP-SS	35	SNP-OPEN-Q	118
REC-1207	662	SLNP-BQ	14	SLNP-SS	116	SNP-OPEN-Q	19
REC-1210	662	SLNP-BQ	98	SLNP-SS	14	SNP-OPEN-Q	39
REC-1507	662	SLNP-FORQ	35	SLNP-SS	98	SNP-OPEN-Q	97
REC-1510	662	SLNP-FORQ	116	SLNP-UDQ	35	SNP-RAISE-Q	118
REC-2007	662	SLNP-FORQ	14	SLNP-UDQ	116	SNP-RAISE-Q	19
REC-2010	662	SLNP-FORQ	98	SLNP-UDQ	14	SNP-RAISE-Q	39
REC-2012	662	SLNP-FRQ	35	SLNP-UDQ	98	SNP-RAISE-Q	97
REC-2015	662	SLNP-FRQ	116	SMPB-LG	118	SNP-RESET-Q	118
REC-2515	662	SLNP-FRQ	14	SMPB-LG	19	SNP-RESET-Q	19
REC-3020	662	SLNP-FRQ	98	SMPB-LG	39	SNP-RESET-Q	39
REC-4030	662	SLNP-HAQ	35	SMPB-LG	97	SNP-RESET-Q	97
REC-5040	662	SLNP-HAQ	116	SMPB-U1-Q	118	SNP-REV-Q	118
RSI104D	272	SLNP-HAQ	14	SMPB-U1-Q	18	SNP-REV-Q	19
RSI114A	272	SLNP-HAQ	98	SMPB-U1-Q	39	SNP-REV-Q	39
RSI124A	272	SLNP-HO AQ	35	SMPB-U1-Q	97	SNP-REV-Q	97
RSI204D	272	SLNP-HO AQ	116	SNP-B-Q	118	SNP-RUN-Q	118
RSI214A	272	SLNP-HO AQ	14	SNP-B-Q	19	SNP-RUN-Q	19
RSI224A	272	SLNP-HO AQ	98	SNP-B-Q	39	SNP-RUN-Q	39
SBL-3-Q	116	SLNP-HORQ	35	SNP-B-Q	97	SNP-RUN-Q	97
SBL-3-Q	14	SLNP-HORQ	116	SNP-CLOSE-Q	118	SNP-SLOW-Q	118
SBL-3-Q	35	SLNP-HORQ	14	SNP-CLOSE-Q	19	SNP-SLOW-Q	19
SBL-3-Q	98	SLNP-HORQ	98	SNP-CLOSE-Q	39	SNP-SLOW-Q	39
SD100A	346	SLNP-JORQ	35	SNP-CLOSE-Q	97	SNP-SLOW-Q	97
SD100AN	346	SLNP-JORQ	116	SNP-DOWN-Q	118	SNP-SP-Q	118
SD100AY	346	SLNP-JORQ	14	SNP-DOWN-Q	19	SNP-SP-Q	19
SD11	346	SLNP-JORQ	98	SNP-DOWN-Q	39	SNP-SP-Q	39
SD11N	346	SLNP-LORQ	116	SNP-DOWN-Q	97	SNP-SP-Q	97
SD11N25C	350	SLNP-LORQ	14	SNP-FAST-Q	118	SNP-ST-Q	118
SD11Y	346	SLNP-LORQ	35	SNP-FAST-Q	19	SNP-ST-Q	19
SD50A	346	SLNP-LORQ	98	SNP-FAST-Q	39	SNP-ST-Q	39
SD50AN	346	SLNP-LRQ	35	SNP-FAST-Q	97	SNP-ST-Q	97
SD50AR	346	SLNP-LRQ	14	SNP-FWD-Q	118	SNP-TEST-Q	118
SD75AY	346	SLNP-LRQ	98	SNP-FWD-Q	19	SNP-TEST-Q	19
SDG	346	SLNP-OFON	14	SNP-FWD-Q	39	SNP-TEST-Q	39
SDP	346	SLNP-OFON	35	SNP-FWD-Q	97	SNP-TEST-Q	97
SK4A185	138	SLNP-OO	35	SNP-HIGH-Q	118	SNP-UP-Q	118
SK4A185	154	SLNP-OO	116	SNP-HIGH-Q	19	SNP-UP-Q	19
SK4A185	170	SLNP-OO	14	SNP-HIGH-Q	39	SNP-UP-Q	39
SK4A185	180	SLNP-OO	98	SNP-HIGH-Q	97	SNP-UP-Q	97
SK4A185	209	SLNP-ORQ	35	SNP-JOG-Q	118	SPBB-DU1-Q	18
SK4A185	211	SLNP-ORQ	116	SNP-JOG-Q	19	SPBB-U1-Q	118
SK4A185	231	SLNP-ORQ	14	SNP-JOG-Q	39	SPBB-U1-Q	18
SLNP-102Q	35	SLNP-ORQ	98	SNP-JOG-Q	97	SPBB-U1-Q	39
SLNP-102Q	14	SLNP-RJQ	35	SNP-LOWER-Q	118	SPBB-U1-Q	97
SLNP-102Q	98	SLNP-RJQ	116	SNP-LOWER-Q	19	SPBB-U2DBL	118
SLNP-102Q	116	SLNP-RJQ	14	SNP-LOWER-Q	39	SPBB-U2DBL	18
SLNP-AHQ	35	SLNP-RJQ	98	SNP-LOWER-Q	97	SPBB-U2DBL	39
SLNP-AHQ	116	SLNP-ROFQ	35	SNP-LOW-Q	118	SPBB-U2DBL	97
SLNP-AHQ	14	SLNP-ROFQ	116	SNP-LOW-Q	19	SPLNSAMB	119
SLNP-AHQ	98	SLNP-ROFQ	14	SNP-LOW-Q	39	SPLNSAMB	20
SLNP-AOHQ	35	SLNP-ROFQ	98	SNP-LOW-Q	97	SPLNSAMB	40

Alphanumeric Index

Catalog Number	Page	Catalog Number	Page	Catalog Number	Page	Catalog Number	Page
SPLNSAMB	99	SSBAS-2-3	98	TC075028	600	TC350315	600
SPLNSGRB	119	SSBASL-1-3	34	TC075028NB	600	TC350315NB	600
SPLNSGRB	20	SSBASL-1-3	116	TC075028SS	600	TC350315SS	600
SPLNSGRB	40	SSBASL-1-3	15	TC075055	600	TC400315	600
SPLNSGRB	99	SSBASL-1-3	98	TC075055NB	600	TC400315NB	600
SPLNSREB	119	SSBASL-2-3	34	TC075055SS	600	TC400315SS	600
SPLNSREB	20	SSBASL-2-3	116	TC075079	600	TC400354	600
SPLNSREB	40	SSBASL-2-3	15	TC075079NB	600	TC400354NB	600
SPLNSREB	99	SSBASL-2-3	98	TC075079SS	600	TC400354SS	600
SPLSAMB	119	SSBASRA-2-3	34	TC100079	600	TC-CN-10-20L	527
SPLSAMB	20	SSBASRA-2-3	116	TC100079NB	600	TC-CN-10-20L	586
SPLSAMB	40	SSBASRA-2-3	15	TC100079SS	600	TC-CN-12-20L	527
SPLSAMB	99	SSMTG	66	TC100104	600	TC-CN-12-20L	586
SPLSBLB	119	SWD016C100A	364	TC100104NB	600	TC-CN-16-20L	527
SPLSBLB	20	SWD016C100C	364	TC100104SS	600	TC-CN-16-20L	586
SPLSBLB	40	SWD016S200A	364	TC125104	600	TC-CN-M309	527
SPLSBLB	99	SWD016S200C	364	TC125104NB	600	TC-CN-M309	586
SPLSCLB	119	SWD016S300A	364	TC125104SS	600	TEP-LGH	527
SPLSCLB	20	SWD016S300C	364	TC125127	600	TEP-LGH	586
SPLSCLB	40	SWD016S400A	364	TC125127NB	600	TEP-SMH	527
SPLSCLB	99	SWD016S400C	364	TC125127SS	600	TEP-SMH	586
SPLSGRB	119	SWD020S300B	367	TC150127	600	TES-10H	527
SPLSGRB	20	SWD020S400B	367	TC150127NB	600	TES-10H	586
SPLSGRB	40	SWD032S200A	364	TC150127SS	600	TES-12H	527
SPLSGRB	99	SWD032S200C	364	TC150150	600	TES-12H	586
SPLSOPB	119	SWD032S300A	364	TC150150NB	600	TES-16H	527
SPLSOPB	20	SWD032S300C	364	TC150150SS	600	TES-16H	586
SPLSOPB	40	SWD032S300D	367	TC200150	600	TI-10H	527
SPLSOPB	99	SWD032S400A	364	TC200150NB	600	TI-10H	586
SPLSREB	119	SWD032S400C	364	TC200150SS	600	TI-12H	527
SPLSREB	20	SWD032S400D	367	TC200174	600	TI-12H	586
SPLSREB	40	SWD063S300E	367	TC200174NB	600	TI-16H	527
SPLSREB	99	SWD063S400E	367	TC200174SS	600	TI-16H	586
SPLSSCB	119	SWD100S300F	367	TC200197	600	TMC2-050075A	632
SPLSSCB	20	SWD100S400F	367	TC200197NB	600	TMC2-050075NB	632
SPLSSCB	40	SWD125S300G	367	TC200197SS	600	TMC2-050075SS	632
SPLSSCB	99	SWD125S400G	367	TC250174	600	TMC2-050099A	632
SSBA1-2Q	34	SWD160S300G	367	TC250174NB	600	TMC2-050099NB	632
SSBA1-2Q	116	SWD160S400G	367	TC250174SS	600	TMC2-050099SS	632
SSBA1-2Q	15	SWD250S300H	367	TC250197	600	TMC2-075075A	632
SSBA1-2Q	98	SWD250S400H	367	TC250197NB	600	TMC2-075075NB	632
SSBA1-3Q	34	SWE016C100A	371	TC250197SS	600	TMC2-075075SS	632
SSBA1-3Q	116	SWE016C101AG	371	TC250220	600	TMC2-075099A	632
SSBA1-3Q	15	SWE016S200A	371	TC250220NB	600	TMC2-075099NB	632
SSBA1-3Q	98	SWE016S201AG	371	TC250220SS	600	TMC2-075099SS	632
SSBA2-2Q	34	SWE020C100AG	371	TC250244	600	TMC2-075118A	632
SSBA2-2Q	116	SWE020S202AG	371	TC250244NB	600	TMC2-075118NB	632
SSBA2-2Q	15	SWE020S301AG	371	TC250244SS	600	TMC2-075118SS	632
SSBA2-2Q	98	SWE020S401AG	371	TC300220	600	TMC2-100118A	632
SSBA2-3Q	34	SWE063S302EG	374	TC300220NB	600	TMC2-100118NB	632
SSBA2-3Q	116	SWE063S402EG	374	TC300220SS	600	TMC2-100118SS	632
SSBA2-3Q	15	SWE160S302JG	374	TC300244	600	TMC2-100137A	632
SSBA2-3Q	98	SWE160S402JG	374	TC300244NB	600	TMC2-100137NB	632
SSBAS-1-3	34	SWE160S402JS	374	TC300244SS	600	TMC2-100137SS	632
SSBAS-1-3	116	TC050028	600	TC300268	600	TMC2-125137A	632
SSBAS-1-3	15	TC050028NB	600	TC300268NB	600	TMC2-125137NB	632
SSBAS-1-3	98	TC050028SS	600	TC300268SS	600	TMC2-125137SS	632
SSBAS-2-3	34	TC050055	600	TC350268	600	TMC2-125162A	632
SSBAS-2-3	116	TC050055NB	600	TC350268NB	600	TMC2-125162NB	632
SSBAS-2-3	15	TC050055SS	600	TC350268SS	600	TMC2-125162SS	632

Alphanumeric Index

Catalog Number	Page	Catalog Number	Page	Catalog Number	Page	Catalog Number	Page
TMC2-125190A	632	TMC2X-100137AX	631	TMCX125NB	634	U21W4B3	145
TMC2-125190NB	632	TMC2X-100137NBX	631	TMCX150A	634	U21W4D9A5	144
TMC2-125190SS	632	TMC2X-100137SSX	631	TMCX150NB	634	U21W4E3	145
TMC2-150162A	632	TMC2X-125137AX	631	TMCX200A	634	U21W4E5	145
TMC2-150162NB	632	TMC2X-125137NBX	631	TMCX200NB	634	U21W4E9	145
TMC2-150162SS	632	TMC2X-125137SSX	631	TMCX200SA	634	U21W4H3	148
TMC2-150190A	632	TMC2X-125162AX	631	TMCX200SNB	634	U21W4J1	148
TMC2-150190NB	632	TMC2X-125162NBX	631	TMCX250A	634	U21W4LG5	147
TMC2-150190SS	632	TMC2X-125162SSX	631	TMCX250NB	634	U21W4LG5LR9	147
TMC2-150200A	632	TMC2X-125190AX	631	TMCX250SA	634	U21W4LR9	147
TMC2-150200NB	632	TMC2X-125190NBX	631	TMCX250SNB	634	U21W4M3	148
TMC2-150200SS	632	TMC2X-125190SSX	631	TMCX300A	634	U21W4N3	148
TMC2-150233A	632	TMC2X-150162AX	631	TMCX300NB	634	U21W4PB	146
TMC2-150233NB	632	TMC2X-150162NBX	631	TMCX350A	634	U21W4PG	146
TMC2-150233SS	632	TMC2X-150162SSX	631	TMCX350NB	634	U21W4PGPR	147
TMC2-200200A	632	TMC2X-150190AX	631	TRE100A2	277	U21W4PR	146
TMC2-200200NB	632	TMC2X-150190NBX	631	TRE100A3	277	U21W4PW	146
TMC2-200200SS	632	TMC2X-150190SSX	631	TRE100B2	277	U21W4PY	146
TMC2-200233A	632	TMC2X-150200AX	631	TRE160A2	277	U21W4R9	145
TMC2-200233NB	632	TMC2X-150200NBX	631	TRE160A3	277	U21X301	198
TMC2-200233SS	632	TMC2X-150200SSX	631	TRE160B2	277	U21X302	198
TMC2-200272A	632	TMC2X-200200AX	631	TRE250A2	277	U21X3B3	145
TMC2-200272NB	632	TMC2X-200200NBX	631	TRE250A3	277	U21X3D9A5	144
TMC2-200272SS	632	TMC2X-200200SSX	631	TRE250B2	277	U21X3E3	145
TMC2-250272A	632	TMC2X-200233AX	631	TRE400A2	277	U21X3E5	145
TMC2-250272NB	632	TMC2X-200233NBX	631	TRE400A3	277	U21X3E9	145
TMC2-250272SS	632	TMC2X-200233SSX	631	TRE400B2	277	U21X3H3	148
TMC2-300325A	632	TMC2X-250233AX	631	U2023PGFID1G3	390	U21X3J1	148
TMC2-300325NB	632	TMC2X-250233NBX	631	U2023PGFID1R3	390	U21X3LG5	147
TMC2-300325SS	632	TMC2X-250233SSX	631	U21U101	198	U21X3LG5LR9	147
TMC2-350325A	632	TMC2X-250272AX	631	U21U102	198	U21X3LR9	147
TMC2-350325NB	632	TMC2X-250272NBX	631	U21U301	198	U21X3M3	148
TMC2-350325SS	632	TMC2X-250272SSX	631	U21U302	198	U21X3N3	148
TMC2-350376A	632	TMC2X-300272AX	631	U21W101	198	U21X3PB	146
TMC2-350376NB	632	TMC2X-300272NBX	631	U21W102	198	U21X3PG	146
TMC2-350376SS	632	TMC2X-300272SSX	631	U21W201	198	U21X3PGPR	147
TMC2-400376A	632	TMC2X-300325AX	631	U21W202	198	U21X3PR	146
TMC2-400376NB	632	TMC2X-300325NBX	631	U21W2B3	145	U21X3PW	146
TMC2-400376SS	632	TMC2X-300325SSX	631	U21W2D9A5	144	U21X3PY	146
TMC2-400425A	632	TMC2X-350325AX	631	U21W2E3	145	U21X3R9	145
TMC2-400425NB	632	TMC2X-350325NBX	631	U21W2E5	145	U21Z301	198
TMC2-400425SS	632	TMC2X-350325SSX	631	U21W2E9	145	U21Z302	198
TMC2X-050075AX	631	TMC2X-350376AX	631	U21W2H3	148	U21Z303	145
TMC2X-050075NBX	631	TMC2X-350376NBX	631	U21W2J1	148	U21Z3D9A5	144
TMC2X-050075SSX	631	TMC2X-350376SSX	631	U21W2LG5	147	U21Z3E3	145
TMC2X-050099AX	631	TMC2X-400376AX	631	U21W2LG5LR9	147	U21Z3E5	145
TMC2X-050099NBX	631	TMC2X-400376NBX	631	U21W2LR9	147	U21Z3E9	145
TMC2X-050099SSX	631	TMC2X-400376SSX	631	U21W2M3	148	U21Z3H3	148
TMC2X-075075AX	631	TMC2X-400425AX	631	U21W2N3	148	U21Z3J1	148
TMC2X-075075NBX	631	TMC2X-400425NBX	631	U21W2PB	146	U21Z3LG5	147
TMC2X-075075SSX	631	TMC2X-400425SSX	631	U21W2PG	146	U21Z3LG5LR9	147
TMC2X-075099AX	631	TMCX050A	634	U21W2PGPR	147	U21Z3LR9	147
TMC2X-075099NBX	631	TMCX050NB	634	U21W2PR	146	U21Z3M3	148
TMC2X-075099SSX	631	TMCX050SA	634	U21W2PW	146	U21Z3N3	148
TMC2X-075118AX	631	TMCX050SNB	634	U21W2PY	146	U21Z3PB	146
TMC2X-075118NBX	631	TMCX075A	634	U21W2R9	145	U21Z3PG	146
TMC2X-075118SSX	631	TMCX075NB	634	U21W301	198	U21Z3PGPR	147
TMC2X-100118AX	631	TMCX100A	634	U21W302	198	U21Z3PR	146
TMC2X-100118NBX	631	TMCX100NB	634	U21W401	198	U21Z3PW	146
TMC2X-100118SSX	631	TMCX125A	634	U21W402	198	U21Z3PY	146

Alphanumeric Index

Catalog Number	Page	Catalog Number	Page	Catalog Number	Page	Catalog Number	Page
U21Z3R9	145	U22X3PGA3	150	U23W2LG5LB3LR9	153	U23Z3PGA3A3	152
U21Z401	198	U22X3PGA5	150	U23W2PGA3A3	152	U23Z3PGA5A9	152
U21Z402	198	U22X3PGA5A9	151	U23W2PGA5A9	152	U23Z3PGA5A9D9	153
U22U104	198	U22X3PGPRA5A9	151	U23W2PGA5A9D9	153	U23Z3PGPRD9A5	153
U22U106	198	U22X3PRA3	150	U23W2PGPRD9A5	153	U23Z3PRA3A3	152
U22U108	198	U22X3PRA9	150	U23W2PRA3A3	152	U23Z3PRA5A9	152
U22U126	198	U22X3VA13M3	151	U23W2PRA5A9	152	U23Z3VA13A5A9	153
U22U304	198	U22Z304	198	U23W2VA13A5A9	153	U23Z411	199
U22U306	198	U22Z306	198	U23W311	199	U23Z414	199
U22U308	198	U22Z308	198	U23W314	199	U23Z416	199
U22U326	198	U22Z326	198	U23W316	199	U23Z417	199
U22W104	198	U22Z3A3A3	149	U23W317	199	U23Z418	199
U22W106	198	U22Z3A3D3	149	U23W318	199	U23Z420	199
U22W108	198	U22Z3A5A9	149	U23W320	199	U23Z423	199
U22W126	198	U22Z3A5A9D9	150	U23W323	199	U23Z424	199
U22W204	198	U22Z3A5D9	149	U23W324	199	U41W201	197
U22W206	198	U22Z3PGA3	150	U23W411	199	U41W2A3	175
U22W208	198	U22Z3PGA5	150	U23W414	199	U41W2A5	175
U22W226	198	U22Z3PGA5A9	151	U23W416	199	U41W2A9	175
U22W2A3A3	149	U22Z3PGPRA5A9	151	U23W417	199	U41W2B3	175
U22W2A3D3	149	U22Z3PRA3	150	U23W418	199	U41W2C3	175
U22W2A5A9	149	U22Z3PRA9	150	U23W420	199	U41W2C9	175
U22W2A5A9D9	150	U22Z3VA13M3	151	U23W423	199	U41W2D3	175
U22W2A5D9	149	U22Z404	198	U23W424	199	U41W2D9	175
U22W2PGA3	150	U22Z406	198	U23W4A5A9D3	151	U41W2E3	175
U22W2PGA5	150	U22Z408	198	U23W4LG5LB3LR9	153	U41W2H3	176
U22W2PGA5A9	151	U22Z426	198	U23W4PGA3A3	152	U41W2J1	176
U22W2PGPRA5A9	151	U23U111	199	U23W4PGA5A9	152	U41W2M3	176
U22W2PRA3	150	U23U114	199	U23W4PGA5A9D9	153	U41W2N3	176
U22W2PRA9	150	U23U116	199	U23W4PGPRD9A5	153	U41W2PB	176
U22W2VA13M3	151	U23U117	199	U23W4PRA3A3	152	U41W2PG	176
U22W304	198	U23U118	199	U23W4PRA5A9	152	U41W2PR	176
U22W306	198	U23U120	199	U23W4VA13A5A9	153	U41W2PW	176
U22W308	198	U23U123	199	U23X311	199	U41W2PY	176
U22W326	198	U23U124	199	U23X314	199	U41W2R9	175
U22W404	198	U23U311	199	U23X316	199	U42W204	197
U22W406	198	U23U314	199	U23X317	199	U42W234	197
U22W408	198	U23U316	199	U23X318	199	U42W2A3A3	176
U22W426	198	U23U317	199	U23X320	199	U42W2A3D3	177
U22W4A3A3	149	U23U318	199	U23X323	199	U42W2A5A9	176
U22W4A3D3	149	U23U320	199	U23X324	199	U42W2A5D9	177
U22W4A5A9	149	U23U323	199	U23X3A5A9D3	151	U42W2PGA3	177
U22W4A5A9D9	150	U23U324	199	U23X3LG5LB3LR9	153	U42W2PGA5	177
U22W4A5D9	149	U23W111	199	U23X3PGA3A3	152	U42W2PRA3	177
U22W4PGA3	150	U23W114	199	U23X3PGA5A9	152	U42W2PRA9	177
U22W4PGA5	150	U23W116	199	U23X3PGA5A9D9	153	U42W2VA13	177
U22W4PGA5A9	151	U23W117	199	U23X3PGPRD9A5	153	U43W211	197
U22W4PGPRA5A9	151	U23W118	199	U23X3PRA3A3	152	U43W221	197
U22W4PRA3	150	U23W120	199	U23X3PRA5A9	152	U43W223	197
U22W4PRA9	150	U23W123	199	U23X3VA13A5A9	153	U43W225	197
U22W4VA13M3	151	U23W124	199	U23Z311	199	U43W2A3A3D3	178
U22X304	198	U23W211	199	U23Z314	199	U43W2A5A9D3	178
U22X306	198	U23W214	199	U23Z316	199	U43W2PGA3A3	178
U22X308	198	U23W216	199	U23Z317	199	U43W2PGA5A9	178
U22X326	198	U23W217	199	U23Z318	199	U43W2PRA3A3	178
U22X3A3A3	149	U23W218	199	U23Z320	199	U43W2PRA5A9	178
U22X3A3D3	149	U23W220	199	U23Z323	199	U43W2VA13A5A9	179
U22X3A5A9	149	U23W223	199	U23Z324	199	U43W2VA13M3	179
U22X3A5A9D9	150	U23W224	199	U23Z3A5A9D3	151	U61U101	200
U22X3A5D9	149	U23W2A5A9D3	151	U23Z3LG5LB3LR9	153	U61U127	200

Alphanumeric Index

Catalog Number	Page	Catalog Number	Page	Catalog Number	Page	Catalog Number	Page
U61U301	200	U61X3M3	133	U62W429	200	U63W332	200
U61U327	200	U61X3N3	133	U62W4A3A3	134	U63W333	200
U61W101	200	U61X3PB	131	U62W4A3D3	134	U63W430	200
U61W127	200	U61X3PG	131	U62W4A5A9	134	U63W432	200
U61W201	200	U61X3PGPR	132	U62W4A5A9D9	136	U63W433	200
U61W227	200	U61X3PR	131	U62W4A5D9	134	U63W4A5A9D3	136
U61W2B3	130	U61X3PW	131	U62W4PGA5	135	U63W4PGA5A9D9	137
U61W2D9A5	129	U61X3PY	131	U62W4PGA5	135	U63W4PGPRD9A5	137
U61W2E3	130	U61X3R9	130	U62W4PGA5A9	136	U63W4VA13A5A9	137
U61W2E5	130	U61Z301	200	U62W4PRA3	135	U63X330	200
U61W2E9	130	U61Z327	200	U62W4PRA9	135	U63X332	200
U61W2H3	133	U61Z3B3	130	U62W4VA13M3	136	U63X333	200
U61W2J1	133	U61Z3D9A5	129	U62X304	200	U63X3A5A9D3	136
U61W2LG5	132	U61Z3E3	130	U62X326	200	U63X3PGA5A9D9	137
U61W2LG5LR9	132	U61Z3E5	130	U62X329	200	U63X3PGPRD9A5	137
U61W2LR9	132	U61Z3E9	130	U62X3A3A3	134	U63X3VA13A5A9	137
U61W2M3	133	U61Z3H3	133	U62X3A3D3	134	U63Z330	200
U61W2N3	133	U61Z3J1	133	U62X3A5A9	134	U63Z332	200
U61W2PB	131	U61Z3LG5	132	U62X3A5A9D9	136	U63Z333	200
U61W2PG	131	U61Z3LG5LR9	132	U62X3A5D9	134	U63Z3A5A9D3	136
U61W2PGPR	132	U61Z3LR9	132	U62X3PGA5	135	U63Z3PGA5A9D9	137
U61W2PR	131	U61Z3M3	133	U62X3PGA5	135	U63Z3PGPRD9A5	137
U61W2PW	131	U61Z3N3	133	U62X3PGA5A9	136	U63Z3VA13A5A9	137
U61W2PY	131	U61Z3PB	131	U62X3PRA3	135	U63Z430	200
U61W2R9	130	U61Z3PG	131	U62X3PRA9	135	U63Z432	200
U61W301	200	U61Z3PGPR	132	U62X3VA13M3	136	U63Z433	200
U61W327	200	U61Z3PR	131	U62Z304	200	U81U101	201
U61W401	200	U61Z3PW	131	U62Z326	200	U81U102	201
U61W427	200	U61Z3PY	131	U62Z329	200	U81W101	201
U61W4B3	130	U61Z3R9	130	U62Z3A3A3	134	U81W102	201
U61W4D9A5	129	U61Z401	200	U62Z3A3D3	134	U81W201	201
U61W4E3	130	U61Z427	200	U62Z3A5A9	134	U81W202	201
U61W4E5	130	U62U104	200	U62Z3A5A9D9	136	U81W2B3	161
U61W4E9	130	U62U126	200	U62Z3A5D9	134	U81W2D9A5	160
U61W4H3	133	U62U129	200	U62Z3PGA3	135	U81W2E3	161
U61W4J1	133	U62U304	200	U62Z3PGA5	135	U81W2E5	161
U61W4LG5	132	U62U326	200	U62Z3PGA5A9	136	U81W2E9	161
U61W4LG5LR9	132	U62U329	200	U62Z3PRA3	135	U81W2H3	164
U61W4LR9	132	U62W104	200	U62Z3PRA9	135	U81W2J1	164
U61W4M3	133	U62W126	200	U62Z3VA13M3	136	U81W2LG5	163
U61W4N3	133	U62W129	200	U62Z404	200	U81W2LG5LR9	163
U61W4PB	131	U62W204	200	U62Z426	200	U81W2LR9	163
U61W4PG	131	U62W226	200	U62Z429	200	U81W2M3	164
U61W4PGPR	132	U62W229	200	U63U130	200	U81W2N3	164
U61W4PR	131	U62W2A3A3	134	U63U132	200	U81W2PB	162
U61W4PW	131	U62W2A3D3	134	U63U133	200	U81W2PG	162
U61W4PY	131	U62W2A5A9	134	U63U330	200	U81W2PGPR	163
U61W4R9	130	U62W2A5A9D9	136	U63U332	200	U81W2PR	162
U61X301	200	U62W2A5D9	134	U63U333	200	U81W2PW	162
U61X327	200	U62W2PGA3	135	U63W130	200	U81W2PY	162
U61X3B3	130	U62W2PGA5	135	U63W132	200	U81W2R9	161
U61X3D9A5	129	U62W2PGA5A9	136	U63W133	200	U81W4B3	161
U61X3E3	130	U62W2PRA3	135	U63W230	200	U81W4D9A5	160
U61X3E5	130	U62W2PRA9	135	U63W232	200	U81W4E3	161
U61X3E9	130	U62W2VA13M3	136	U63W233	200	U81W4E5	161
U61X3H3	133	U62W304	200	U63W2A5A9D3	136	U81W4E9	161
U61X3J1	133	U62W326	200	U63W2PGA5A9D9	137	U81W4H3	164
U61X3LG5	132	U62W329	200	U63W2PGPRD9A5	137	U81W4J1	164
U61X3LG5LR9	132	U62W404	200	U63W2VA13A5A9	137	U81W4LG5	163
U61X3LR9	132	U62W426	200	U63W330	200	U81W4LG5LR9	163

Alphanumeric Index

Catalog Number	Page	Catalog Number	Page	Catalog Number	Page	Catalog Number	Page
U81W4LR9	163	U82W108	201	U82Z3PRA9	166	U83W4PGA5A9	168
U81W4M3	164	U82W126	201	U82Z3VA13M3	167	U83W4PGA5A9D9	169
U81W4N3	164	U82W204	201	U82Z404	201	U83W4PGPRD9A5	169
U81W4PB	162	U82W207	201	U82Z407	201	U83W4PRA3A3	168
U81W4PG	162	U82W208	201	U82Z408	201	U83W4PRA5A9	168
U81W4PGPR	163	U82W226	201	U82Z426	201	U83W4VA13A5A9	169
U81W4PR	162	U82W2A3A3	165	U83U111	202	U83X311	202
U81W4PW	162	U82W2A3D3	165	U83U116	202	U83X316	202
U81W4PY	162	U82W2A5A9	165	U83U117	202	U83X317	202
U81W4R9	161	U82W2A5A9D9	166	U83U118	202	U83X318	202
U81X301	201	U82W2A5D9	165	U83U120	202	U83X320	202
U81X302	201	U82W2PGA3	166	U83U123	202	U83X323	202
U81X3B3	161	U82W2PGA5	166	U83U124	202	U83X324	202
U81X3D9A5	160	U82W2PGA5A9	167	U83U311	202	U83X3A5A9D3	168
U81X3E3	161	U82W2PGPRA5A9	167	U83U316	202	U83X3LG5LB3LR9	169
U81X3E5	161	U82W2PRA3	166	U83U317	202	U83X3PGA3A3	168
U81X3E9	161	U82W2PRA9	166	U83U318	202	U83X3PGA5A9	168
U81X3H3	164	U82W2VA13M3	167	U83U320	202	U83X3PGA5A9D9	169
U81X3J1	164	U82W4A3A3	165	U83U323	202	U83X3PGPRD9A5	169
U81X3LG5	163	U82W4A3D3	165	U83U324	202	U83X3PRA3A3	168
U81X3LG5LR9	163	U82W4A5A9	165	U83W111	202	U83X3PRA5A9	168
U81X3LR9	163	U82W4A5A9D9	166	U83W116	202	U83X3VA13A5A9	169
U81X3M3	164	U82W4A5D9	165	U83W117	202	U83Z311	202
U81X3N3	164	U82W4PGA3	166	U83W118	202	U83Z316	202
U81X3PB	162	U82W4PGA5	166	U83W120	202	U83Z317	202
U81X3PG	162	U82W4PGA5A9	167	U83W123	202	U83Z318	202
U81X3PGPR	163	U82W4PGPRA5A9	167	U83W124	202	U83Z320	202
U81X3PR	162	U82W4PRA3	166	U83W211	202	U83Z323	202
U81X3PW	162	U82W4PRA9	166	U83W216	202	U83Z324	202
U81X3PY	162	U82W4VA13M3	167	U83W217	202	U83Z3A5A9D3	168
U81X3R9	161	U82X304	201	U83W218	202	U83Z3LG5LB3LR9	169
U81Z301	201	U82X307	201	U83W220	202	U83Z3PGA3A3	168
U81Z302	201	U82X308	201	U83W223	202	U83Z3PGA5A9	168
U81Z3B3	161	U82x326	201	U83W224	202	U83Z3PGA5A9D9	169
U81Z3D9A5	160	U82X3A3A3	165	U83W2A5A9D3	168	U83Z3PGPRD9A5	169
U81Z3E3	161	U82X3A3D3	165	U83W2LG5LB3LR9	169	U83Z3PRA3A3	168
U81Z3E5	161	U82X3A5A9	165	U83W2PGA3A3	168	U83Z3PRA5A9	168
U81Z3E9	161	U82X3A5A9D9	166	U83W2PGA5A9	168	U83Z3VA13A5A9	169
U81Z3H3	164	U82X3A5D9	165	U83W2PGA5A9D9	169	U83Z411	202
U81Z3J1	164	U82X3PGA3	166	U83W2PGPRD9A5	169	U83Z416	202
U81Z3LG5	163	U82X3PGA5	166	U83W2PRA3A3	168	U83Z417	202
U81Z3LG5LR9	163	U82X3PGA5A9	167	U83W2PRA5A9	168	U83Z418	202
U81Z3LR9	163	U82X3PGPRA5A9	167	U83W2VA13A5A9	169	U83Z420	202
U81Z3M3	164	U82X3PRA3	166	U83W311	202	U83Z423	202
U81Z3N3	164	U82X3PRA9	166	U83W316	202	U83Z424	202
U81Z3PB	162	U82X3VA13M3	167	U83W317	202	UA0BP	205
U81Z3PG	162	U82Z304	201	U83W318	202	UA0BR	205
U81Z3PGPR	163	U82Z307	201	U83W320	202	UA0GP	205
U81Z3PR	162	U82Z308	201	U83W323	202	UA0GR	205
U81Z3PW	162	U82Z326	201	U83W324	202	UA0RGP	205
U81Z3PY	162	U82Z3A3A3	165	U83W411	202	UA0RGR	205
U81Z3R9	161	U82Z3A3D3	165	U83W416	202	UA0RP	205
U81Z401	201	U82Z3A5A9	165	U83W417	202	UA0RR	205
U81Z402	201	U82Z3A5A9D9	166	U83W418	202	UA0WP	205
U82U104	201	U82Z3A5D9	165	U83W420	202	UA0WR	205
U82U107	201	U82Z3PGA3	166	U83W423	202	UA0YP	205
U82U108	201	U82Z3PGA5	166	U83W424	202	UA0YR	205
U82U126	201	U82Z3PGA5A9	167	U83W4A5A9D3	168	UB0P	207
U82W104	201	U82Z3PGPRA5A9	167	U83W4LG5LB3LR9	169	UB0R	207
U82W107	201	U82Z3PRA3	166	U83W4PGA3A3	168	UBP	232

Alphanumeric Index

Catalog Number	Page	Catalog Number	Page	Catalog Number	Page	Catalog Number	Page
UBP	550	UCBBC250U	63	UCLP-JOG	67	UCMHBL	65
UC0P	209	UCBBC275	63	UCLP-JOR	55	UCMHGR	52
UC0R	209	UCBBC275U	63	UCLP-JOR	67	UCMHGR	65
UCB5P	205	UCBBC310	63	UCLP-LOR	55	UCMHMBL	52
UCB5P	207	UCBBC310U	63	UCLP-LOR	67	UCMHMBL	65
UCB5P	209	UCBBC350	63	UCLP-LOW	55	UCMHMGR	52
UCB5P	211	UCBBC350U	63	UCLP-LOW	67	UCMHMGR	65
UCB5P	213	UCBBC375	63	UCLP-LOWER	55	UCMHMRE	52
UCB5P	215	UCBBC375U	63	UCLP-LOWER	67	UCMHMRE	65
UCB5P	219	UCBBC410	63	UCLP-LR	55	UCMHRE	52
UCB5R	139	UCBBC410U	63	UCLP-LR	67	UCMHRE	65
UCB5R	155	UCBBC450	63	UCLP-OFF	55	UCMPBLG	54
UCB5R	171	UCBBC450U	63	UCLP-OFF	67	UCMPBLG	66
UCB5R	181	UCBBC475	63	UCLP-ON	55	UCPB1BL	52
UCB5R	205	UCBBC475U	63	UCLP-ON	67	UCPB1BL	65
UCB5R	207	UCC1	63	UCLP-OO	55	UCPB1BU	52
UCB5R	209	UCC2	63	UCLP-OO	67	UCPB1BU	65
UCB5R	211	UCC3	63	UCLP-OOO	55	UCPB1GR	52
UCB5R	213	UCC4	63	UCLP-OOO	67	UCPB1GR	65
UCB5R	215	UCHUB10	63	UCLP-OPEN	55	UCPB1RE	52
UCB5R	219	UCHUB10U	63	UCLP-OPEN	67	UCPB1RE	65
UCB9P	205	UCHUB50	63	UCLP-OR	55	UCPB1YL	52
UCB9P	207	UCHUB50U	63	UCLP-OR	67	UCPB1YL	65
UCB9P	209	UCHUB75	63	UCLP-ORS	55	UCPB2BL	52
UCB9P	211	UCHUB75U	63	UCLP-ORS	67	UCPB2BL	65
UCB9P	213	UCLG1	54	UCLP-RAISE	55	UCPB2BU	52
UCB9P	215	UCLG1	66	UCLP-RAISE	67	UCPB2BU	65
UCB9P	219	UCLP-102	55	UCLP-RESET	55	UCPB2GR	52
UCB9R	139	UCLP-102	67	UCLP-RESET	67	UCPB2GR	65
UCB9R	155	UCLP-AH	55	UCLP-REV	55	UCPB2RE	52
UCB9R	171	UCLP-AH	67	UCLP-REV	67	UCPB2RE	65
UCB9R	181	UCLP-AO	55	UCLP-RG	55	UCPB2YL	52
UCB9R	205	UCLP-AO	67	UCLP-RG	67	UCPB2YL	65
UCB9R	207	UCLP-AOH	55	UCLP-ROF	55	UCPBBL	53
UCB9R	209	UCLP-AOH	67	UCLP-ROF	67	UCPBBL	66
UCB9R	211	UCLP-AOM	55	UCLP-ROJ	55	UCPBBL	53
UCB9R	213	UCLP-AOM	67	UCLP-ROJ	67	UCPBBL	66
UCB9R	215	UCLP-B	55	UCLP-ROL	55	UCPBAPBL	52
UCB9R	219	UCLP-B	67	UCLP-ROL	67	UCPBAPBL	65
UCBB210	63	UCLP-CLOSE	55	UCLP-RUN	55	UCPBAPBU	52
UCBB210U	63	UCLP-CLOSE	67	UCLP-RUN	67	UCPBAPBU	65
UCBB250	63	UCLP-DOWN	55	UCLP-SLOW	55	UCPBAPGR	52
UCBB250U	63	UCLP-DOWN	67	UCLP-SLOW	67	UCPBAPGR	65
UCBB275	63	UCLP-FAST	55	UCLP-SP	55	UCPBAPRE	52
UCBB275U	63	UCLP-FAST	67	UCLP-SP	67	UCPBAPRE	65
UCBB310	63	UCLP-FOR	55	UCLP-SRS	55	UCPBAPYL	52
UCBB310U	63	UCLP-FOR	67	UCLP-SRS	67	UCPBAPYL	65
UCBB350	63	UCLP-FR	55	UCLP-SS	55	UCPBGR	53
UCBB350U	63	UCLP-FR	67	UCLP-SS	67	UCPBGR	66
UCBB375	63	UCLP-FWD	55	UCLP-ST	55	UCPB1BL	52
UCBB375U	63	UCLP-FWD	67	UCLP-ST	67	UCPB1BL	65
UCBB410	63	UCLP-HA	55	UCLP-TEST	55	UCPB1GR	52
UCBB410U	63	UCLP-HA	67	UCLP-TEST	67	UCPB1GR	65
UCBB450	63	UCLP-HIGH	55	UCLP-TOO	55	UCPB1RE	52
UCBB450U	63	UCLP-HIGH	67	UCLP-TOO	67	UCPB1RE	65
UCBB475	63	UCLP-HOA	55	UCLP-UD	55	UCPB2BL	52
UCBB475U	63	UCLP-HOA	67	UCLP-UD	67	UCPB2BL	65
UCBBC210	63	UCLP-HOR	55	UCLP-UP	55	UCPB2GR	52
UCBBC210U	63	UCLP-HOR	67	UCLP-UP	67	UCPB2GR	65
UCBBC250	63	UCLP-JOG	55	UCMHBL	52	UCPB2RE	52

Alphanumeric Index

Catalog Number	Page	Catalog Number	Page	Catalog Number	Page	Catalog Number	Page
UCPBM2RE	65	UCS17512	62	UCSC17512	62	UCSS23SRC	64
UCPBMBL	53	UCS175345	62	UCSC175345	62	UCSS3	53
UCPBMBL	66	UCS175345ALT	62	UCSC175345ALT	62	UCSS3	66
UCPBMGR	53	UCS17535	62	UCSC17535	62	UCSS3SLC	53
UCPBMGR	66	UCS175J1	61	UCSC175J1	61	UCSS3SLC	66
UCPBMRE	53	UCS175U1	61	UCSC175U1	61	UCSS3SRC	53
UCPBMRE	66	UCS175UM1	61	UCSC175UM1	61	UCSS3SRC	66
UCPBMRYBL	53	UCS210J1U1	62	UCSC210J1U1	62	UCSSA23	51
UCPBMRYBL	66	UCS210J2	61	UCSC210J2	61	UCSSA23	64
UCPBMRYGR	53	UCS210U2	61	UCSC210U2	61	UCSSA23SLC	51
UCPBMRYGR	66	UCS250J1U1	62	UCSC250J1U1	62	UCSSA23SLC	64
UCPBMRYRE	53	UCS250J2	61	UCSC250J2	61	UCSSA23SRC	51
UCPBMRYRE	66	UCS250U2	61	UCSC250U2	61	UCSSA23SRC	64
UCPBRE	53	UCS275J1U1	62	UCSC275J1U1	62	UCSSA23SRL	51
UCPBRE	66	UCS275J2	61	UCSC275J2	61	UCSSA23SRL	64
UCPBYL	53	UCS275U2	61	UCSC275U2	61	UCSSA3	53
UCPBYL	66	UCS310J1U1102	62	UCSC310J1U1102	62	UCSSA3	66
UCPLA	52	UCS310J1U112	62	UCSC310J1U112	62	UCSSA3SLC	53
UCPLA	65	UCS310J1U2	62	UCSC310J1U2	62	UCSSA3SLC	66
UCPLADC	52	UCS310J2U1	62	UCSC310J2U1	62	UCSSA3SRC	53
UCPLADC	65	UCS310J3	61	UCSC310J3	61	UCSSA3SRC	66
UCPLB	52	UCS310U3	61	UCSC310U3	61	UCSSA3SRL	53
UCPLB	65	UCS350J1U1102	62	UCSC350J1U1102	62	UCSSA3SRL	66
UCPLBDC	52	UCS350J1U112	62	UCSC350J1U112	62	UDOP	207
UCPLBDC	65	UCS350J1U2	62	UCSC350J1U2	62	UDOR	207
UCPLG	52	UCS350J2U1	62	UCSC350J2U1	62	UEOP	211
UCPLG	65	UCS350J3	61	UCSC350J3	61	UEOR	211
UCPLGDC	52	UCS350U3	61	UCSC350U3	61	UFOP	211
UCPLGDC	65	UCS375J1U1102	62	UCSC375J1U1102	62	UFOR	211
UCPLP-B	55	UCS375J1U112	62	UCSC375J1U112	62	UGOP	211
UCPLP-B	67	UCS375J1U2	62	UCSC375J1U2	62	UGOR	211
UCPLP-OFF	55	UCS375J2U1	62	UCSC375J2U1	62	UHOP	213
UCPLP-OFF	67	UCS375J3	61	UCSC375J3	61	UHOR	213
UCPLP-ON	55	UCS375U3	61	UCSC375U3	61	UIA01	170
UCPLP-ON	67	UCS410J2U2	62	UCSC410J2U2	62	UIA01	138
UCPLP-RUN	55	UCS410J4	61	UCSC410J4	61	UIA01	154
UCPLP-RUN	67	UCS410U4	61	UCSC410U4	61	UIA01	180
UCPLR	52	UCS450J2U2	62	UCSC450J2U2	62	UIA01	205
UCPLR	65	UCS450J4	61	UCSC450J4	61	UIA01	215
UCPLRDC	52	UCS450U4	61	UCSC450U4	61	UIA01	231
UCPLRDC	65	UCS475J2U2	62	UCSC475J2U2	62	UIA02	154
UCPLUG	54	UCS475J4	61	UCSC475J4	61	UIA02	170
UCPLUG	66	UCS475U4	61	UCSC475U4	61	UIA02	138
UCS110102	62	UCSC110102	62	UCSS12	51	UIA02	180
UCS11012	62	UCSC11012	62	UCSS12	64	UIA02	205
UCS110345	62	UCSC110345	62	UCSS13	51	UIA02	215
UCS110345ALT	62	UCSC110345ALT	62	UCSS13	64	UIA02	231
UCS11035	62	UCSC11035	62	UCSS13SLC	51	UIA03	154
UCS110J1	61	UCSC110J1	61	UCSS13SLC	64	UIA03	170
UCS110U1	61	UCSC110U1	61	UCSS13SRC	51	UIA03	138
UCS110UM1	61	UCSC110UM1	61	UCSS13SRC	64	UIA03	180
UCS150102	62	UCSC150102	62	UCSS2	53	UIA03	205
UCS15012	62	UCSC15012	62	UCSS2	66	UIA03	215
UCS150345	62	UCSC150345	62	UCSS22	51	UIA03	231
UCS150345ALT	62	UCSC150345ALT	62	UCSS22	64	UIA04	154
UCS15035	62	UCSC15035	62	UCSS23	51	UIA04	170
UCS150J1	61	UCSC150J1	61	UCSS23	64	UIA04	138
UCS150U1	61	UCSC150U1	61	UCSS23SLC	51	UIA04	180
UCS150UM1	61	UCSC150UM1	61	UCSS23SLC	64	UIA04	205
UCS175102	62	UCSC175102	62	UCSS23SRC	51	UIA04	215

Alphanumeric Index

Catalog Number	Page	Catalog Number	Page	Catalog Number	Page	Catalog Number	Page
UIA04	231	UIAW	180	UILG	231	ULPLA06	180
UIA05	154	UIAW	205	UILR	138	ULPLA06	231
UIA05	170	UIAW	215	UILR	154	ULPLA07	154
UIA05	138	UIAW	231	UILR	170	ULPLA07	170
UIA05	180	UIAY	154	UILR	180	ULPLA07	138
UIA05	205	UIAY	170	UILR	231	ULPLA07	180
UIA05	215	UIAY	138	UILW	138	ULPLA07	231
UIA05	231	UIAY	180	UILW	154	ULPLA08	154
UIA06	154	UIAY	205	UILW	170	ULPLA08	170
UIA06	170	UIAY	215	UILW	180	ULPLA08	138
UIA06	138	UIAY	231	UILW	231	ULPLA08	180
UIA06	180	UIL01	138	UILW	138	ULPLA08	231
UIA06	205	UIL01	154	UILY	154	ULPLA09	154
UIA06	215	UIL01	170	UILY	170	ULPLA09	170
UIA06	231	UIL01	180	UILY	180	ULPLA09	138
UIA07	170	UIL01	231	UILY	231	ULPLA09	180
UIA07	138	UIL02	138	UJOP	213	ULPLA09	231
UIA07	154	UIL02	154	UJOR	213	ULPLA10	154
UIA07	180	UIL02	170	UKOP	213	ULPLA10	170
UIA07	205	UIL02	180	UKOR	213	ULPLA10	138
UIA07	215	UIL02	231	ULB0P	215	ULPLA10	180
UIA07	231	UIL03	138	ULB0R	215	ULPLA10	231
UIA08	170	UIL03	154	ULG0P	215	ULPLA11	170
UIA08	138	UIL03	170	ULG0R	215	ULPLA11	138
UIA08	154	UIL03	180	ULINEREC4XKIT	383	ULPLA11	154
UIA08	180	UIL03	231	ULINEREC4XKIT	401	ULPLA11	180
UIA08	205	UIL04	138	ULINEREC4XKIT	410	ULPLA11	231
UIA08	215	UIL04	154	ULPL	138	ULPLA12	170
UIA08	231	UIL04	170	ULPL	154	ULPLA12	138
UIAB	170	UIL04	180	ULPL	170	ULPLA12	154
UIAB	138	UIL04	231	ULPL	180	ULPLA12	180
UIAB	154	UIL05	138	ULPL	231	ULPLA12	231
UIAB	180	UIL05	154	ULPLA01	170	ULPLA13	170
UIAB	205	UIL05	170	ULPLA01	138	ULPLA13	138
UIAB	215	UIL05	180	ULPLA01	154	ULPLA13	154
UIAB	231	UIL05	231	ULPLA01	180	ULPLA13	180
UIAG	138	UIL06	138	ULPLA01	231	ULPLA13	231
UIAG	154	UIL06	154	ULPLA02	170	ULPLA14	170
UIAG	170	UIL06	170	ULPLA02	138	ULPLA14	138
UIAG	180	UIL06	180	ULPLA02	154	ULPLA14	154
UIAG	205	UIL06	231	ULPLA02	180	ULPLA14	180
UIAG	215	UIL07	138	ULPLA02	231	ULPLA14	231
UIAG	231	UIL07	154	ULPLA03	170	ULPLA15	138
UIAN	170	UIL07	170	ULPLA03	138	ULPLA15	154
UIAN	138	UIL07	180	ULPLA03	154	ULPLA15	170
UIAN	154	UIL07	231	ULPLA03	180	ULPLA15	180
UIAN	180	UIL08	138	ULPLA03	231	ULPLA15	231
UIAN	205	UIL08	154	ULPLA04	170	ULPLA16	138
UIAN	215	UIL08	170	ULPLA04	138	ULPLA16	154
UIAN	231	UIL08	180	ULPLA04	154	ULPLA16	170
UIAR	138	UIL08	231	ULPLA04	180	ULPLA16	180
UIAR	154	UILB	138	ULPLA04	231	ULPLA16	231
UIAR	170	UILB	154	ULPLA05	170	ULPLA17	138
UIAR	180	UILB	170	ULPLA05	138	ULPLA17	154
UIAR	205	UILB	180	ULPLA05	154	ULPLA17	170
UIAR	215	UILB	231	ULPLA05	180	ULPLA17	180
UIAR	231	UILG	138	ULPLA05	231	ULPLA17	231
UIAW	170	UILG	154	ULPLA06	170	ULPLA18	138
UIAW	138	UILG	170	ULPLA06	138	ULPLA18	154
UIAW	154	UILG	180	ULPLA06	154	ULPLA18	170

Alphanumeric Index

Catalog Number	Page	Catalog Number	Page	Catalog Number	Page	Catalog Number	Page
ULPLA18	180	ULPLH04	180	ULPLJ07	180	ULPSA09	180
ULPLA18	231	ULPLH04	231	ULPLJ07	231	ULPSA09	231
ULPLA19	138	ULPLH05	138	ULPLJ08	138	ULPSA10	154
ULPLA19	154	ULPLH05	154	ULPLJ08	154	ULPSA10	170
ULPLA19	170	ULPLH05	170	ULPLJ08	170	ULPSA10	138
ULPLA19	180	ULPLH05	180	ULPLJ08	180	ULPSA10	180
ULPLA19	231	ULPLH05	231	ULPLJ08	231	ULPSA10	231
ULPLA20	138	ULPLH06	138	ULPLJ09	138	ULPSA11	170
ULPLA20	154	ULPLH06	154	ULPLJ09	154	ULPSA11	138
ULPLA20	170	ULPLH06	170	ULPLJ09	170	ULPSA11	154
ULPLA20	180	ULPLH06	180	ULPLJ09	180	ULPSA11	180
ULPLA20	231	ULPLH06	231	ULPLJ09	231	ULPSA11	231
ULPLA21	138	ULPLH07	138	ULPS	138	ULPSA12	170
ULPLA21	154	ULPLH07	154	ULPS	154	ULPSA12	138
ULPLA21	170	ULPLH07	170	ULPS	170	ULPSA12	154
ULPLA21	180	ULPLH07	180	ULPS	180	ULPSA12	180
ULPLA21	231	ULPLH07	231	ULPS	231	ULPSA12	231
ULPLA22	138	ULPLH08	138	ULPSA01	170	ULPSA13	170
ULPLA22	154	ULPLH08	154	ULPSA01	138	ULPSA13	138
ULPLA22	170	ULPLH08	170	ULPSA01	154	ULPSA13	154
ULPLA22	180	ULPLH08	180	ULPSA01	180	ULPSA13	180
ULPLA22	231	ULPLH08	231	ULPSA01	231	ULPSA13	231
ULPLA23	138	ULPLH09	138	ULPSA02	170	ULPSA14	170
ULPLA23	154	ULPLH09	154	ULPSA02	138	ULPSA14	138
ULPLA23	170	ULPLH09	170	ULPSA02	154	ULPSA14	154
ULPLA23	180	ULPLH09	180	ULPSA02	180	ULPSA14	180
ULPLA23	231	ULPLH09	231	ULPSA02	231	ULPSA14	231
ULPLA24	138	ULPLJ01	138	ULPSA03	170	ULPSA15	170
ULPLA24	154	ULPLJ01	154	ULPSA03	138	ULPSA15	138
ULPLA24	170	ULPLJ01	170	ULPSA03	154	ULPSA15	154
ULPLA24	180	ULPLJ01	180	ULPSA03	180	ULPSA15	180
ULPLA24	231	ULPLJ01	231	ULPSA03	231	ULPSA15	231
ULPLA25	138	ULPLJ02	138	ULPSA04	170	ULPSA16	138
ULPLA25	154	ULPLJ02	154	ULPSA04	138	ULPSA16	154
ULPLA25	170	ULPLJ02	170	ULPSA04	154	ULPSA16	170
ULPLA25	180	ULPLJ02	180	ULPSA04	180	ULPSA16	180
ULPLA25	231	ULPLJ02	231	ULPSA04	231	ULPSA16	231
ULPLA26	138	ULPLJ03	138	ULPSA05	170	ULPSA17	138
ULPLA26	154	ULPLJ03	154	ULPSA05	138	ULPSA17	154
ULPLA26	170	ULPLJ03	170	ULPSA05	154	ULPSA17	170
ULPLA26	180	ULPLJ03	180	ULPSA05	180	ULPSA17	180
ULPLA26	231	ULPLJ03	231	ULPSA05	231	ULPSA17	231
ULPLH01	138	ULPLJ04	138	ULPSA06	170	ULPSA18	138
ULPLH01	154	ULPLJ04	154	ULPSA06	138	ULPSA18	154
ULPLH01	170	ULPLJ04	170	ULPSA06	154	ULPSA18	170
ULPLH01	180	ULPLJ04	180	ULPSA06	180	ULPSA18	180
ULPLH01	231	ULPLJ04	231	ULPSA06	231	ULPSA18	231
ULPLH02	138	ULPLJ05	138	ULPSA07	154	ULPSA19	138
ULPLH02	154	ULPLJ05	154	ULPSA07	170	ULPSA19	154
ULPLH02	170	ULPLJ05	170	ULPSA07	138	ULPSA19	170
ULPLH02	180	ULPLJ05	180	ULPSA07	180	ULPSA19	180
ULPLH02	231	ULPLJ05	231	ULPSA07	231	ULPSA19	231
ULPLH03	138	ULPLJ06	138	ULPSA08	154	ULPSA20	138
ULPLH03	154	ULPLJ06	154	ULPSA08	170	ULPSA20	154
ULPLH03	170	ULPLJ06	170	ULPSA08	138	ULPSA20	170
ULPLH03	180	ULPLJ06	180	ULPSA08	180	ULPSA20	180
ULPLH03	231	ULPLJ06	231	ULPSA08	231	ULPSA20	231
ULPLH04	138	ULPLJ07	138	ULPSA09	154	ULPSA21	138
ULPLH04	154	ULPLJ07	154	ULPSA09	170	ULPSA21	154
ULPLH04	170	ULPLJ07	170	ULPSA09	138	ULPSA21	170

Alphanumeric Index

Catalog Number	Page	Catalog Number	Page	Catalog Number	Page	Catalog Number	Page
ULPSA21	180	ULPSH07	180	ULSCA	401	UNF600A	667
ULPSA21	231	ULPSH07	231	ULSCM	385	UNF600R	664
ULPSA22	138	ULPSH08	138	ULWOP	215	UNF600R	667
ULPSA22	154	ULPSH08	154	ULWOR	215	UNF75	665
ULPSA22	170	ULPSH08	170	ULYOP	215	UNF7550A	667
ULPSA22	180	ULPSH08	180	ULYOR	215	UNF75-50NR	664
ULPSA22	231	ULPSH08	231	UMOP	213	UNF75-50NR-A	664
ULPSA23	138	ULPSH09	138	UMOR	213	UNF7550S	667
ULPSA23	154	ULPSH09	154	UNOP	213	UNF75A	667
ULPSA23	170	ULPSH09	170	UNOR	213	UNF75NR	664
ULPSA23	180	ULPSH09	180	UNA100	649	UNF75NR-A	664
ULPSA23	231	ULPSH09	231	UNA50	649	UNF75S	667
ULPSA24	138	ULPSJ01	138	UNA75	649	UNFL100	665
ULPSA24	154	ULPSJ01	154	UNAF100	648	UNFL50	665
ULPSA24	170	ULPSJ01	170	UNAF50	648	UNFL75	665
ULPSA24	180	ULPSJ01	180	UNAF75	648	UNL50-75N	664
ULPSA24	231	ULPSJ01	231	UNAM100	649	UNL50N	664
ULPSA25	138	ULPSJ02	138	UNAM50	649	UNL75-50N	664
ULPSA25	154	ULPSJ02	154	UNAM75	649	UNL75N	664
ULPSA25	170	ULPSJ02	170	UNF100	665	UNPB	138
ULPSA25	180	ULPSJ02	180	UNF100A	667	UNPB	154
ULPSA25	231	ULPSJ02	231	UNF100NR	664	UNPB	170
ULPSA26	138	ULPSJ03	138	UNF100NR-A	664	UNPB	180
ULPSA26	154	ULPSJ03	154	UNF100S	667	UNPB	231
ULPSA26	170	ULPSJ03	170	UNF125A	667	UNPG	138
ULPSA26	180	ULPSJ03	180	UNF125NR	664	UNPG	154
ULPSA26	231	ULPSJ03	231	UNF125NR	667	UNPG	170
ULPSH01	138	ULPSJ04	138	UNF125NR-A	664	UNPG	180
ULPSH01	154	ULPSJ04	154	UNF150A	667	UNPG	231
ULPSH01	170	ULPSJ04	170	UNF150NR	664	UNPN	138
ULPSH01	180	ULPSJ04	180	UNF150NR	667	UNPN	154
ULPSH01	231	ULPSJ04	231	UNF150NR-A	664	UNPN	170
ULPSH02	138	ULPSJ05	138	UNF200A	667	UNPN	180
ULPSH02	154	ULPSJ05	154	UNF200NR	664	UNPN	231
ULPSH02	170	ULPSJ05	170	UNF200NR	667	UNPR	138
ULPSH02	180	ULPSJ05	180	UNF200NR-A	664	UNPR	154
ULPSH02	231	ULPSJ05	231	UNF250A	667	UNPR	170
ULPSH03	138	ULPSJ06	138	UNF250R	664	UNPR	180
ULPSH03	154	ULPSJ06	154	UNF250R	667	UNPR	231
ULPSH03	170	ULPSJ06	170	UNF250R-A	664	UNPW	138
ULPSH03	180	ULPSJ06	180	UNF300A	667	UNPW	154
ULPSH03	231	ULPSJ06	231	UNF300R	664	UNPW	170
ULPSH04	138	ULPSJ07	138	UNF300R	667	UNPW	180
ULPSH04	154	ULPSJ07	154	UNF300R-A	664	UNPW	231
ULPSH04	170	ULPSJ07	170	UNF350A	667	UNPY	138
ULPSH04	180	ULPSJ07	180	UNF350R	664	UNPY	154
ULPSH04	231	ULPSJ07	231	UNF350R	667	UNPY	170
ULPSH05	138	ULPSJ08	138	UNF350R-A	664	UNPY	180
ULPSH05	154	ULPSJ08	154	UNF400A	667	UNPY	231
ULPSH05	170	ULPSJ08	170	UNF400R	664	UNY100	665
ULPSH05	180	ULPSJ08	180	UNF400R	667	UNY100A	667
ULPSH05	231	ULPSJ08	231	UNF400R-A	664	UNY100NR	664
ULPSH06	138	ULPSJ09	138	UNF50	665	UNY100NR-A	664
ULPSH06	154	ULPSJ09	154	UNF500A	667	UNY100S	667
ULPSH06	170	ULPSJ09	170	UNF500R	664	UNY125	667
ULPSH06	180	ULPSJ09	180	UNF500R	667	UNY125NA	667
ULPSH06	231	ULPSJ09	231	UNF50A	667	UNY125NR	664
ULPSH07	138	ULR0P	215	UNF50NR	664	UNY125NR-A	664
ULPSH07	154	ULR0R	215	UNF50NR-A	664	UNY150	667
ULPSH07	170	ULSCA	383	UNF50S	667	UNY150NA	667

Alphanumeric Index

Catalog Number	Page	Catalog Number	Page	Catalog Number	Page	Catalog Number	Page
UNY150NR	664	UPLD2S	232	US1612-0061P	223	US1623-0027P	221
UNY150NR-A	664	UPMA	205	US1612-0061R	223	US1623-0027R	221
UNY200	667	UPMA	207	US1622-0002P	221	US1623-0028P	223
UNY200NA	667	UPMA	209	US1622-0002R	221	US1623-0028R	223
UNY200NR	664	UPMA	211	US1622-0003P	223	US1623-0029P	224
UNY200NR-A	664	UPMA	213	US1622-0003R	223	US1623-0029R	224
UNY250	667	UPMA	215	US1622-0004P	223	US1623-0030P	224
UNY250A	667	UPMA	217	US1622-0004R	223	US1623-0030R	224
UNY250R	664	UPMA	232	US1622-0005P	223	US1623-0031P	224
UNY250R-A	664	UPROP	217	US1622-0005R	223	US1623-0031R	224
UNY300	667	UPROR	217	US1622-0007P	223	US1623-0032P	224
UNY300A	667	UPR316PB6	563	US1622-0007R	223	US1623-0032R	224
UNY300R	664	UPR316PY4	563	US1622-0008P	223	US1623-0038P	221
UNY300R-A	664	UPR316RB6	563	US1622-0008R	223	US1623-0038R	221
UNY350	667	UPR316RY4	563	US1622-0009P	223	US1623-0039P	224
UNY350A	667	UPR332PB6	568	US1622-0009R	223	US1623-0039R	224
UNY350R	664	UPR332PY4	568	US1622-0010P	223	US1623-0040P	224
UNY350R-A	664	UPR332RB6	568	US1622-0010R	223	US1623-0040R	224
UNY400	667	UPR332RY4	568	US1622-0011P	223	US1623-0041P	224
UNY400A	667	UPR416PB9	563	US1622-0011R	223	US1623-0041R	224
UNY400R	664	UPR416PN5	564	US1622-0012P	223	US1623-0042P	224
UNY400R-A	664	UPR416PN7	563	US1622-0012R	223	US1623-0042R	224
UNY50	665	UPR416PR6	563	US1622-0013P	223	US1623-0046P	224
UNY500	667	UPR416RB9	563	US1622-0013R	223	US1623-0046R	224
UNY500A	667	UPR416RN5	564	US1622-0014P	223	US1623-0047P	224
UNY500R	664	UPR416RN7	563	US1622-0014R	223	US1623-0047R	224
UNY50A	667	UPR416RR6	563	US1622-0015P	223	US1623-0048P	221
UNY50NR	664	UPR432PB9	568	US1622-0015R	223	US1623-0048R	221
UNY50NR-A	664	UPR432PN5	568	US1622-0016P	221	US1623-0049P	224
UNY50S	667	UPR432PN7	568	US1622-0016R	221	US1623-0049R	224
UNY600	667	UPR432PR6	568	US1622-0017P	223	US1623-0050P	224
UNY600A	667	UPR432RB9	568	US1622-0017R	223	US1623-0050R	224
UNY600R	664	UPR432RN5	568	US1622-0018P	223	US1623-0051P	224
UNY75	665	UPR432RN7	568	US1622-0018R	223	US1623-0051R	224
UNY7550A	667	UPR432RR6	568	US1622-0019P	223	US1623-0052P	224
UNY75-50NR	664	UPR516PB9	563	US1622-0019R	223	US1623-0052R	224
UNY75-50NR-A	664	UPR516PN5	564	US1622-0020P	223	US1623-0054P	224
UNY7550S	667	UPR516PN7	563	US1622-0020R	223	US1623-0054R	224
UNY75A	667	UPR516PR6	563	US1622-0021P	223	US1623-0055P	224
UNY75NR	664	UPR516RB9	563	US1622-0021R	223	US1623-0055R	224
UNY75NR-A	664	UPR516RN5	564	US1622-0043P	223	US1623-0059P	224
UNY75S	667	UPR516RN7	563	US1622-0043R	223	US1623-0059R	224
UNYL100	665	UPR516RR6	563	US1622-0045P	223	US1623-0068P	224
UNYL50	665	UPR532PB9	568	US1622-0045R	223	US1623-0068R	224
UNYL75	665	UPR532PN7	568	US1622-0053P	223	US1623-0070P	224
UPB0P	217	UPR532PR6	568	US1622-0053R	223	US1623-0070R	224
UPB0R	217	UPR532RB9	568	US1622-0073P	223	US1623-0071P	224
UPBL	217	UPR532RN7	568	US1622-0073R	223	US1623-0071R	224
UPGOP	217	UPR532RR6	568	US1622-0074P	223	US1623-0072P	224
UPGOR	217	UPRL	217	US1622-0074R	223	US1623-0072R	224
UPGL	217	UPWOP	217	US1623-0022P	223	US1623-0075P	224
UPLD1S	139	UPWOR	217	US1623-0022R	223	US1623-0075R	224
UPLD1S	155	UPWL	217	US1623-0023P	223	US1623-0076P	224
UPLD1S	171	UPYOP	217	US1623-0023R	223	US1623-0076R	224
UPLD1S	181	UPYOR	217	US1623-0024P	223	US1623-0087P	224
UPLD1S	232	UPYL	217	US1623-0024R	223	US1623-0087R	224
UPLD2S	139	UR0P	207	US1623-0025P	223	US1623-9002P	224
UPLD2S	155	UR0R	207	US1623-0025R	223	US1623-9002R	224
UPLD2S	171	US1612-0056P	223	US1623-0026P	223	US1624-0044P	225
UPLD2S	181	US1612-0056R	223	US1623-0026R	223	US1624-0044R	225

Alphanumeric Index

Catalog Number	Page	Catalog Number	Page	Catalog Number	Page	Catalog Number	Page
US1624-0057P	225	US1634-0183P	226	US1643-0127P	227	US1643-1165P	228
US1624-0057R	225	US1634-0183R	226	US1643-0127R	227	US1643-1165R	228
US1624-0058P	225	US1634-1119P	226	US1643-0129P	227	US1643-1166P	228
US1624-0058R	225	US1634-1119R	226	US1643-0129R	227	US1643-1166R	228
US1624-0062P	225	US1634-1145P	226	US1643-0131P	227	US1643-1167P	228
US1624-0062R	225	US1634-1145R	226	US1643-0131R	227	US1643-1167R	228
US1624-0065P	225	US1634-1151P	226	US1643-0132P	227	US1643-1172P	228
US1624-0065R	225	US1634-1151R	226	US1643-0132R	227	US1643-1172R	228
US1624-0084P	225	US1642-0102P	221	US1643-0133P	227	US1643-1173P	228
US1624-0084R	225	US1642-0102R	221	US1643-0133R	227	US1643-1173R	228
US1628-0036P	225	US1642-0103P	226	US1643-0139P	227	US1643-1174P	228
US1628-0036R	225	US1642-0103R	226	US1643-0139R	227	US1643-1174R	228
US1632-0122P	225	US1642-0104P	226	US1643-0140P	227	US1643-1176P	228
US1632-0122R	225	US1642-0104R	226	US1643-0140R	227	US1643-1176R	228
US1632-1153P	225	US1642-0105P	226	US1643-0153P	227	US1643-1178P	228
US1632-1153R	225	US1642-0105R	226	US1643-0153R	227	US1643-1178R	228
US1633-0136P	225	US1642-0106P	221	US1643-0157P	227	US1643-1179P	228
US1633-0136R	225	US1642-0106R	221	US1643-0157R	227	US1643-1179R	228
US1633-0138P	221	US1642-0107P	226	US1643-0158P	227	US1643-1201P	228
US1633-0138R	221	US1642-0107R	226	US1643-0158R	227	US1643-1201R	228
US1633-0144P	225	US1642-0116P	226	US1643-0159P	227	US1643-1203P	228
US1633-0144R	225	US1642-0116R	226	US1643-0159R	227	US1643-1203R	228
US1633-0145P	225	US1642-0134P	226	US1643-0160P	227	US1643-1206P	228
US1633-0145R	225	US1642-0134R	226	US1643-0160R	227	US1643-1206R	228
US1633-0161P	225	US1642-0135P	226	US1643-0162P	227	US1643-1208P	228
US1633-0161R	225	US1642-0135R	226	US1643-0162R	227	US1643-1208R	228
US1633-0167P	225	US1642-0137P	226	US1643-0169P	227	US1643-1213P	228
US1633-0167R	225	US1642-0137R	226	US1643-0169R	227	US1643-1213R	228
US1633-0197P	221	US1642-0152P	226	US1643-0170P	227	US1643-1215P	228
US1633-0197R	221	US1642-0152R	226	US1643-0170R	227	US1643-1215R	228
US1633-0199P	225	US1642-0154P	226	US1643-0175P	227	US1643-1217P	228
US1633-0199R	225	US1642-0154R	226	US1643-0175R	227	US1643-1217R	228
US1633-1109P	225	US1642-0173P	226	US1643-0176P	227	US1643-1220P	228
US1633-1109R	225	US1642-0173R	226	US1643-0176R	227	US1643-1220R	228
US1633-1112P	225	US1642-1105P	226	US1643-0180P	227	US1643-1222P	228
US1633-1112R	225	US1642-1105R	226	US1643-0180R	227	US1643-1222R	228
US1633-1120P	225	US1642-1122P	226	US1643-1103P	227	US1643-1225P	228
US1633-1120R	225	US1642-1122R	226	US1643-1103R	227	US1643-1225R	228
US1633-1142P	225	US1642-1147P	226	US1643-1104P	227	US1643-1226P	228
US1633-1142R	225	US1642-1147R	226	US1643-1104R	227	US1643-1226R	228
US1633-1155P	225	US1642-1162P	226	US1643-1106P	227	US1643-1232P	228
US1633-1155R	225	US1642-1162R	226	US1643-1106R	227	US1643-1232R	228
US1633-1171P	225	US1642-1234P	226	US1643-1108P	227	US1643-9001P	228
US1633-1171R	225	US1642-1234R	226	US1643-1108R	227	US1643-9001R	228
US1633-1202P	225	US1643-0111P	226	US1643-1111P	227	US1644-0110P	228
US1633-1202R	225	US1643-0111R	226	US1643-1111R	227	US1644-0110R	228
US1633-1209P	225	US1643-0112P	226	US1643-1113P	227	US1644-0123P	228
US1633-1209R	225	US1643-0112R	226	US1643-1113R	227	US1644-0123R	228
US1633-1210P	225	US1643-0113P	226	US1643-1116P	227	US1644-0130P	228
US1633-1210R	225	US1643-0113R	226	US1643-1116R	227	US1644-0130R	228
US1633-1230P	226	US1643-0114P	226	US1643-1125P	227	US1644-0143P	228
US1633-1230R	226	US1643-0114R	226	US1643-1125R	227	US1644-0143R	228
US1634-0146P	226	US1643-0118P	227	US1643-1129P	227	US1644-0147P	228
US1634-0146R	226	US1643-0118R	227	US1643-1129R	227	US1644-0147R	228
US1634-0168P	226	US1643-0119P	221	US1643-1134P	227	US1644-0148P	228
US1634-0168R	226	US1643-0119R	221	US1643-1134R	227	US1644-0148R	228
US1634-0178P	226	US1643-0120P	227	US1643-1138P	227	US1644-0150P	228
US1634-0178R	226	US1643-0120R	227	US1643-1138R	227	US1644-0150R	228
US1634-0181P	226	US1643-0121P	227	US1643-1159P	227	US1644-0151P	228
US1634-0181R	226	US1643-0121R	227	US1643-1159R	227	US1644-0151R	228

Alphanumeric Index

Catalog Number	Page
US1644-0155P	229
US1644-0155R	229
US1644-0156P	229
US1644-0156R	229
US1644-0164P	229
US1644-0164R	229
US1644-0171P	229
US1644-0171R	229
US1644-0198P	229
US1644-0198R	229
US1644-0608P	229
US1644-0608R	229
US1644-0611P	229
US1644-0611R	229
US1644-0614P	229
US1644-0614R	229
US1644-1102P	229
US1644-1102R	229
US1644-1114P	229
US1644-1114R	229
US1644-1115P	229
US1644-1115R	229
US1644-1124P	229
US1644-1124R	229
US1644-1127P	229
US1644-1127R	229
US1644-1128P	229
US1644-1128R	229
US1644-1132P	229
US1644-1132R	229
US1644-1133P	229
US1644-1133R	229
US1644-1136P	229
US1644-1136R	229
US1644-1139P	229
US1644-1139R	229
US1644-1143P	229
US1644-1143R	229
US1644-1144P	229
US1644-1144R	229
US1644-1146P	229
US1644-1146R	229
US1644-1154P	229
US1644-1154R	229
US1644-1156P	229
US1644-1156R	229
US1644-1163P	229
US1644-1163R	229
US1644-1164P	229
US1644-1164R	229
US1644-1168P	229
US1644-1168R	229
US1644-1169P	230
US1644-1169R	230
US1644-1180P	230
US1644-1180R	230
US1644-1204P	230
US1644-1204R	230
US1644-1205P	230
US1644-1205R	230

Catalog Number	Page
US1644-1207P	230
US1644-1207R	230
US1644-1211P	230
US1644-1211R	230
US1644-1212P	230
US1644-1212R	230
US1644-1219P	230
US1644-1219R	230
US1644-1224P	230
US1644-1224R	230
US1644-1229P	230
US1644-1229R	230
US1645-1110P	230
US1645-1110R	230
US1645-1235P	230
US1645-1235R	230
USH	221
VA1348P	274
VA1348R	274
VA1548P	274
VA1548R	274
VA1648P	274
VA1648R	274
VA5348P	274
VA5348R	274
VA5548P	274
VA5548R	274
VA5648P	274
VA5648R	274
VAW48	274
WS100AUX1	495
WS100AUX2	495
WS30AUX1	495
WS30AUX2	495
WS60AUX1	495
WS60AUX2	495
WSAUX1	488
WSAUX1	491
WSAUX2	488
WSAUX2	491
WSR10352	488
WSR103542	488
WSR3352	488
WSR33542	488
WSR6352	488
WSR63542	488
WSRD10352N4SD	491
WSRD10352N4WSD	491
WSRD10352SQ	491
WSRD10352WSQ	491
WSRD103542N4SD	491
WSRD103542N4WSD	491
WSRD103542SQ	491
WSRD103542WSQ	491
WSRD3352N4SD	491
WSRD3352N4WSD	491
WSRD3352SQ	491
WSRD3352WSQ	491
WSRD33542N4SD	491
WSRD33542N4WSD	491

Catalog Number	Page
WSRD33542SQ	491
WSRD33542WSQ	491
WSRD6352	491
WSRD6352N4SD	491
WSRD6352N4WSD	491
WSRD6352SQ	491
WSRD6352WSQ	491
WSRD63542	491
WSRD63542N4SD	491
WSRD63542N4WSD	491
WSRD63542SQ	491
WSRD63542WSQ	491
WSRDAUX1	491
WSRDAUX2	491
XSS-82U	99
XSS-86U	99

Controls

Description	Page	NEC	CEC	ATEX/IEC
NEC/CEC Explosionproof Control Stations and Switches				
EFD/EFDB and EDS Control Stations and Pilot Lights	4	X		
Contender™ Series Factory Sealed Control Stations and Pilot Lights	27	X	X	
Division 2 Contender™ Series Control Stations and Pilot Lights	45	X	X	
UniCode™ Series Factory Sealed Control Stations and Pilot Lights	58	X	X	
EDS Factory Sealed Tumbler Switches	69	X		
EFS Non-Sealed Tumbler Switches	78	X		
Contender™ Series Factory Sealed Front Operated Tumbler Switches	86	X	X	
ECS Selector Switch Control Stations	91		X	
ECS Configurable Control Stations	104	X	X	
ECS Series Timer Control Station	106		X	
Intraground™ N1 and N2 Series Control Stations	107	X		
Intraground™ N1 Series Nonmetallic Tumbler Switches	122	X		
GUSC Heavy Duty Tumbler Switches	125	X	X	
NEC/CEC, ATEX/IEC Ex Increased Safety Control Stations				
Unicode™ 2 Series Stainless Steel Control Stations and Switches	126	X	X	X
Unicode™ 2 Series Polyester Control Stations and Switches	141	X	X	X
Unicode™ 2 Series Aluminum Control Stations and Switches	157			X
Unicode™ 2 Series Polyamide Control Stations	173			X
Unicode™ 2 Series Customized Control Stations	183	X	X	X
Unicode™ 2 Series Pre-Drilled Control Stations	195	X	X	X
Unicode™ 2 Series Push Buttons	204	X	X	X
Unicode™ 2 Series Mushroom Push Buttons	206	X	X	X
Unicode™ 2 Series Key Release Mushroom Push Buttons	208	X	X	X
Unicode™ 2 Series Key Momentary Push Buttons	210	X	X	X
Unicode™ 2 Series Rotary Actuators	212	X	X	X
Unicode™ 2 Series Illuminated Push Buttons	214	X	X	X
Unicode™ 2 Series Pilot Lights	216	X	X	X
Unicode™ 2 Series 1-Pole Contact Block	218	X	X	X
Unicode™ 2 Series 16 Amp Switches	220	X	X	X
Unicode™ 2 Series Accessories	231	X	X	X
NEC/CEC, ATEX/IEC Ex Explosionproof/Flameproof Control Stations and Switches				
ACSEW Cast Control Centers	233	X	X	X
• ACSEW Control Operators	255	X	X	



EFD/EFDB Push Button and Pilot Light



Contender™ Control Stations



Division 2 Contender™



Unicode™



EDS Tumbler Switches



EFS Non-Sealed Tumbler Switches



Contender™ Tumbler Switches



ECS Selector Switch Control Stations



ECS Configurable Control Stations



ECS Timer and Control Stations



Intraground™ N1/N2 Control Stations



Intraground™ N1 Tumbler Switches



GUSC Tumbler Switches



Stainless Steel Unicode™ 2 Stock, Customized, Pre-Drilled



Polyester Unicode™ 2 Stock, Customized, Pre-Drilled



Aluminum Unicode™ 2 Stock, Customized, Pre-Drilled



Polyamide Unicode™ 2 Stock, Customized, Pre-Drilled



ACSEW Cast Control Centers

Controls

Description	Page	NEC	CEC	ATEX/IEC
ATEX/IECEx Flameproof Control Stations and Relays				
ATX™ D Series Aluminum Control Stations	257			X
ATX™ D Series Pre-Drilled Control Stations	261			X
ATX™ D Series Control Station Actuators, Pilot Lights, Contact Blocks, Switches and Accessories	264			X
ATX™ RSI Intrinsic Safety Relay	271			X
ATEX/IECEx Increased Safety Control Stations				
ATX™ FU40 Fuse Carrier	273			X
ATX™ V Series AC Ammeter	274			X
ATX™ TRE Series Ex e Transformers	276			X
NEC/CEC Explosionproof Motor Starters				
ACSE Series Manual Motor Starters	279	X	X	
AEB Series Bolted Combination and Non-Combination Full Voltage Motor Starters	281	X		
AELB Series Bolted Combination and Non-Combination Full Voltage Motor Starters	299	X		
AEXMS Series Manual Motor Starters	315	X		
EDS Series Factory Sealed Manual Motor Starters and Contactors	317	X	X	
Contender™ Series Factory Sealed Manual Motor Starters and Contactors	323	X	X	
Intraground™ N1 Series Nonmetallic Manual Motor Starters and Enclosures	329	X		
EBC Bolt-On Series Combination Line Starters with Breakers	333		X	
ES Bolt-On Series Line Starter Enclosures	335		X	



D Series Aluminum Control Stations



D Series Pre-Drilled Control Stations



D Series Accessories



RSI Series Relays



FU40 Fuse Carrier



V Series Ammeter



TRE Control Transformers



ACSE Motor Starters



AEB/AELB Motor Starters



AEXMS Motor Starters



EDS Motor Starters



Contender™ Motor Starters and Contactors



Intraground™ N1 Motor Starters



EBC Line Starters



ES Line Starter

Controls

Description	Page	NEC	CEC	ATEX/ IEC
ATEX/IECEx Flameproof Motor Starters				
ATX™ DM Series Motor Starters	339			X
ATX™ MS Series Motor Starters	340			X
NEC/CEC Hazardous Indicators and Grounding Devices				
SD Series Static Discharge Grounding Reelites™	345	X	X	
NEC/CEC Explosionproof Indicators and Grounding Devices				
AEPGI Series Ground Indicator	348	X		
EGC Static Ground Indicator	349		X	
NEC/CEC Explosionproof Conveyor Switches				
AFA and AFAX Conveyor Belt Alignment Switches	351	X	X	
AFSX Speed Responsive Switch	354	X	X	
AFU and AFUX Conveyor Control Switches	357	X		
ATEX/IECEx Increased Safety Call Points Stations and Audio Signaling Devices				
ATX™ FAS Series "Break Glass" Call Points	361			X
ATX™ SWD Series 16 and 32 Amp Switches, Circuit Breakers and "Break Glass" Call Points	363			X
ATX™ SWD Series 20, 32, 63, 100, 125, 160 and 250 A Isolator Switches, Circuit Breakers and "Break Glass" Call Points	366			X
ATX™ SWE Series 16 and 20 Amp Switches, Circuit Breakers, and "Break Glass" Call Points	370			X
ATX™ SWE Series 40, 63 and 160 Amp Switches, Circuit Breakers, and "Break Glass" Call Points	373			X
ATX™ KL Series Audio Signaling Devices	377			X



DM Motor Starters



MS Motor Starters



SD Series



AEPGI Ground Indicator



EGC Ground Indicator



AFA and AFAX Alignment Switches



AFSX Switches



AFU and AFUX Control Switches



FAS Call Points



SWD Call Points



SWE Call Points



KL Series Signaling Devices

EFD/EFDB and EDS Series Factory Sealed Control Stations

Explosionproof, Dust-Ignitionproof

NEC:

Class I, Division 1 and 2, Groups B+, C, D
Class II, Division 1 and 2, Groups E, F, G
Class III
NEMA 3, 7CD, 9EFG

Applications

- Push buttons and selector switches are used in conjunction with contactors or magnetic starters for remote control of motors. They provide circuit control and/or selection.
- Pilot lights provide visual assurance that an electrical function is being performed at a remote or local location.
- EFD/EFDB and EDS factory sealed control stations confine arcing of device within the enclosure, preventing ignition of ignitable atmospheres during control operation of motors and other equipment.
- Used in classified areas where flammable vapors, gases or highly combustible dusts are present.
- For installation in chemical and petrochemical plants, refineries, and other process industries.

Features

- EFD/EFDB Push Buttons and Selector Switches
 - Eliminate need for adding sealing fittings and compound at each conduit entrance.
 - Heavy-duty push buttons, 10 Amp, 600 Vac rated.
 - Dozens of possible combinations of push buttons, pilot lights and selector switches.
 - Smooth, rounded integral bushing in each EFD/EFDB hub protects conductor insulation.
 - Accurately tapped, tapered hubs for tight, rigid joints and ground continuity.
 - Stainless steel push button shaft operates within stainless steel bushing assuring long, maintenance free operation.
 - Push button and selector switch contacts are silver cadmium oxide which are "sealed" in lower phenolic chamber isolated from corrosive elements. Assures positive contact and long, trouble-free operation.
 - Enclosed stainless steel helper spring prevents accidental operation of push button in severe vibration installations.
 - Push button models also available with dust cap for use in areas where excessive dust, moisture or corrosive conditions are encountered.
 - Corrosion resistant captive stainless steel hex head cap screws hold EFDB covers to body.
 - All EFD/EFDB momentary push buttons are supplied with lockout type guards as standard. Hole in guard will accept locks with up to 1/4" hasp. Permits locking of push button to prevent unauthorized operation.
 - Clearly marked terminals with brass screws assure quick, easy wiring.
- EFD/EFDB Pilot Lights
 - Factory sealed pilot lights supplied with red jewel/guard assembly and 120 Vac/Vdc, 50/60 Hz, 6 Watt, Type 6S6 lamp.
 - Models also available in combination with factory sealed push buttons and selector switches.
- EFD/EFDB Selector Switches
 - Factory sealed selector switches furnished with nylon cam-operated, heavy-duty push buttons for either 2-position or 3-position maintained contact operation.
 - High thermal and arc resistance, high dielectric strength.
- EDS Push Buttons
 - Factory sealed — eliminates need for adding sealing fittings and compound at each conduit entrance.
 - Heavy duty, 10 Amp, 600 Vac.
 - Switch is enclosed in separate sealing chamber.



EFDB Push Button



EFDB Photocontrol



EDS Rocker Arm Push Button



EFDB Push Button with Dust Cap



EFD Combination Pilot Light and Push Buttons



EFD Pilot Light



EFDB Selector Switch



EFDB Maintained Push Button

- Sealing chamber has smooth, double flanges that mate both to cover and mounting enclosure to provide flame-tight joints.
- Pigtail leads from push buttons are factory sealed in sealing well.
- Stainless steel hex head screws attach sealing chamber to cover and mounting enclosure.
- Side rocker arm push button has lockout holes.
- EFD/EFDB backbox supplied with internal ground screw.

Standard Materials

- EFDB control stations: malleable iron body with copperfree (4/10 of 1% max.) aluminum cover
- SPBB push button: copperfree (4/10 of 1% max.) aluminum upper barrel and phenolic lower barrel with nylon plastic button (dust cap models have neoprene buttons)
- SPLN/SPLS pilot light: copperfree (4/10 of 1% max.) aluminum guard and body assembly; steel clamping ring; and tempered glass jewel
- SSBA selector switch: copperfree (4/10 of 1% max.) aluminum operator mechanism, nylon cam, and sealed phenolic contact block
- EDS control stations: malleable iron body and cover; copperfree (4/10 of 1% max.) aluminum sealing chamber; and nylon operating handle

Standard Finishes

♦ Select items suitable for Class I, Division 1 and 2, Groups B, C and D; Class II, Groups E, F and G and Class III. See product selection pages for suitable items.

EFD/EFDB and EDS Series Factory Sealed Control Stations

Explosionproof, Dust-Ignitionproof

NEC:

Class I, Division 1 and 2, Groups B⁺, C, D
 Class II, Division 1 and 2, Groups E, F, G
 Class III
 NEMA 3, 7CD, 9EFG

- EFD/EFDB control stations: body, triple-coat—(1) zinc electroplate, (2) chromate, and (3) epoxy powder coat
- SPBB push button, SPLN/SPLS pilot light and SSBA selector switch: natural finish
- EDS control stations: body and cover: triple-coat—(1) zinc electroplate, (2) chromate, and (3) epoxy powder coat sealing chamber, natural finish

Options

- 1- or 2-gang copperfree (4/10 of 1% max.) aluminum bodies and covers available. Add suffix — **A**.
- Three position selector switches with modified operation.
 - Momentary contact right position, spring return to center, maintained contact left position. Add suffix — **SRC**.
 - Momentary contact left position, spring return to center, maintained contact right position. Add suffix — **SLC**.
 - Alternate contacts add suffix — **ALT**.
- EFD/EFDB selector switch lockout locks two or three position handle in any position. Add suffix — **LD**.
- Push button front operated mushroom head (momentary contact): Order by suffixes for desired color as follows:
 - Red — **NMRBRE**
 - Green — **NMRBGR**
 - Black — **NMRBBL**
- EFD/EFDB pilot light jewel/guard assembly. Order by suffixes if color desired is other than red, as follows:
 - Amber — **JGBA**
 - Blue — **JGBB**
 - Clear — **JGBC**
 - Green — **JGBG**;
 - Opal — **JGBO**
- For colored LED jewel/guard assembly, order by suffixes:
 - Red — **LEDR**
 - Green — **LEDG**
 - Amber — **LEDA**
- EFD/EFDB pilot light transformers for single pilot light per gang. Order by suffix:

Primary Voltage	Lamp Voltage	Suffix
220	120	-TR-2
277	120	-TR-3
440	120	-TR-4
550	120	-TR-5

- EFD and EDS units may be supplied with brazed hubs as 3-, 4-, and 5-gang in a variety of hub configurations. See Ordering Information page for how to order these and other "custom" units by adding suffixes to mounting body catalog numbers.
- Securing Rod for EFD/EFDB Push Button Lockout Guard. Add suffix — **SR**.
- NPBRKT** Nameplate Mounting Bracket to make circuit description/identification easy.
 - Pre-drilled holes in bottom of bracket allow direct mounting to control stations with existing cover bolts.
 - Pre-drilled holes in middle of bracket allow mounting of customer's circuit identification nameplate; epoxy glue may also be used for mounting (phenolic nameplate not included).
 - Bracket eliminates costly field installation of drilling and tapping to accommodate circuit identification nameplate.
 - Brackets fit side-by-side on 2-, 3- and 4-gang boxes and 3-devices.

NEC Certifications and Compliances

- UL Standards: UL 508, UL 698, UL 1203
- UL Listed: E10449, E81751

Related Products

- For Hazardous Location Photocontrols, see *Lighting Section*.

Illustrated Features



EDS factory sealed rocker arm push button control station — shows separate sealing chamber and device construction. Rocker arm has holes for lock.



Securing Rod for EFD/EFDB Push Button Lockout Guard — available as an optional item as catalog number NBL-SR (single guard only) or add Suffix — SR to push button catalog number. Lockout Guard, furnished as standard with the EFD/EFDB push button, may also be padlocked.



SPBB factory sealed push button used in EFD/EFDB Series — standard type and unit with dust cap.

SPBB Design Features

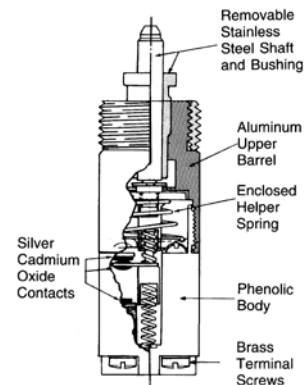

◆ Select items suitable for Class I, Division 1 and 2, Groups B, C and D; Class II, Groups E, F and G and Class III. See product selection pages for suitable items.

EFD/EFDB and EDS Series Factory Sealed Control Stations

Explosionproof, Dust-Ignitionproof

NEC:

Class I, Division 1 and 2, Groups B+, C, D
 Class II, Division 1 and 2, Groups E, F, G
 Class III
 NEMA 3, 7CD, 9EFG

Catalog Numbering Guide

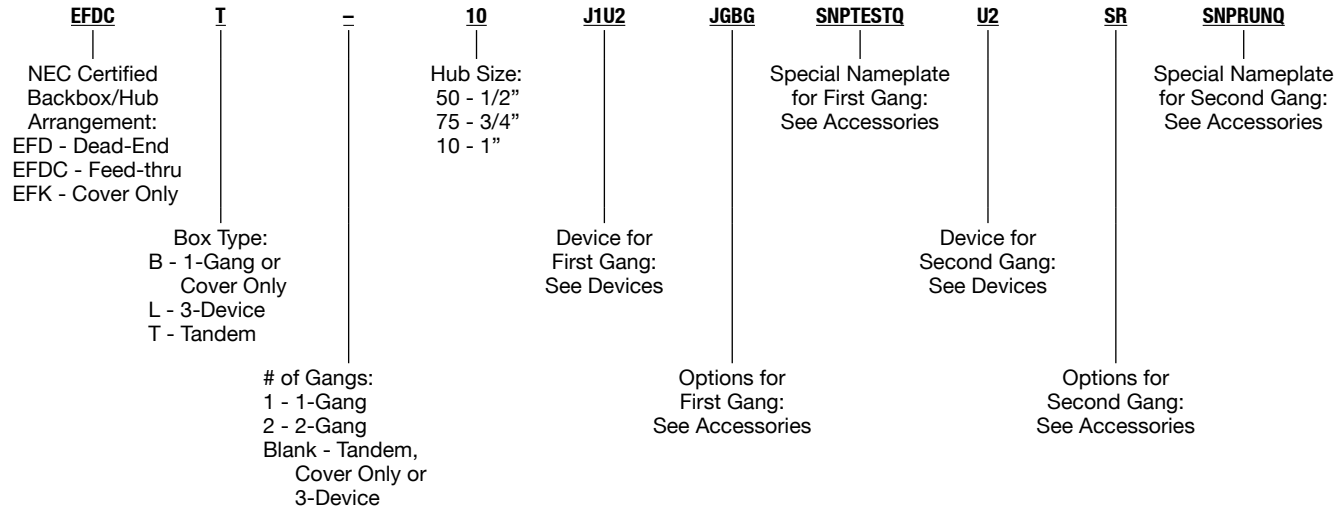

Full Catalog # EFDCT10-J1U2-JGBG-SNPTESTQ-U2-SNPTESTQ-SNPRUNQ

Feed-Thru Tandem Box with 1" Hubs.
 In Gang #1: 2 Momentary Push Buttons and a Green Pilot Light.
 In Gang #2: 2 Momentary Push Buttons with One Securing Rod.
 With Special "Test" and "Run" Push Button Nameplates.

Options

Options Description	Suffix
Momentary Push Button Securing Rod	SR
Selector Switch Lockout	LD
Spring Return From Right Selector Switch (3 Positions Only)	SRC
Spring Return From Left Selector Switch (3 Positions Only)	SLC
Alternate Contacts Selector Switch	ALT
Change One Red Lens to Green Lens	JGBG
Change One Red Lens to Opal Lens	JGBO
Change One Red Lens to Amber Lens	JGBA
Change One Red Lens to Blue Lens	JGBB
Change One Red Lens to Clear Lens	JGBC
Add 220/120 Vac Transformer (J1 Device Only)	TR2
Add 277/120 Vac Transformer (J1 Device Only)	TR3
Add 440/120 Vac Transformer (J1 Device Only)	TR4
Add 550/120 Vac Transformer (J1 Device Only)	TR5
Change One Red Pilot to Red LED	LEDR
Change One Red Lens to Green LED	LEDG
Change One Red Lens to Amber LED	LEDA
Add Red Mushroom Head to Momentary Push Button	NMRBRE
Add Black Mushroom Head to Momentary Push Button	NMRBBL
Add Green Mushroom Head to Momentary Push Button	NMRBGR
Locking Guard for Maintained Push Button	SMPBLG

♦ Select items suitable for Class I, Division 1 and 2, Groups B, C and D; Class II, Groups E, F and G and Class III. See product selection pages for suitable items.

EFD/EFDB and EDS Series Factory Sealed Control Stations

Explosionproof, Dust-Ignitionproof

NEC:

Class I, Division 1 and 2, Groups B⁺, C, D
 Class II, Division 1 and 2, Groups E, F, G
 Class III
 NEMA 3, 7CD, 9EFG

Devices	Available in 1-G, 2-G, Tandem	Available in 3-Device	Suffix
One Pilot Light (Red Standard)	Y		J1
Two Pilot Lights	Y		J2
One Pilot Light and One Momentary Push Button	Y		J1U1
One Pilot Light and Two Momentary Push Buttons	Y	Y	J1U2
One Pilot Light and One Maintained Push Button	Y		J1UM1
One Pilot Light and One Dust Cap Push Button	Y		J1DU1
One Pilot Light and One 12 Selector Switch (2 Position, 2 Circuit)	Y		J112
One Pilot Light and One 35 Selector Switch (2 Position, 4 Circuit)	Y		J135
One Pilot Light and One 102 Selector Switch (3 Position, 2 Circuit)	Y		J1102
One Pilot Light and One 345 Selector Switch (3 Position, 4 Circuit)	Y		J1345
One Monetary Push Button	Y		U1
Two Monetary Push Buttons	Y		U2
Two Side-By-Side Momentary Push Buttons	Y		U2DBL
Three Monetary Push Buttons	Y	Y	U3
One Momentary Push Button and One Maintained Push Button	Y		U1UM1
One Momentary Push Button and One Dust Cap Push Button	Y		U1DU1
One Momentary Push Button and One 12 Selector Switch (2 Position, 2 Circuit)	Y		U112
One Momentary Push Button and One 35 Selector Switch (2 Position, 4 Circuit)	Y		U135
One Momentary Push Button and One 102 Selector Switch (3 Position, 2 Circuit)	Y		U1102
One Momentary Push Button and One 345 Selector Switch (3 Position, 4 Circuit)	Y		U1345
One Maintained Push Button (Mushroom Head - Red)	Y		UM1
Two Maintained Push Button	Y		UM2
One Maintained and One Dust Cap Push Button	Y		UM1DU1
One Maintained Push Button and One 12 Selector Switch (2 Position, 2 Circuit)	Y		UM112
One Maintained Push Button and One 35 Selector Switch (2 Position, 4 Circuit)	Y		UM135
One Maintained Push Button and One 102 Selector Switch (3 Position, 2 Circuit)	Y		UM1102
One Maintained Push Button and One 345 Selector Switch (3 Position, 4 Circuit)	Y		UM1345
One Dust Cap Push Button	Y		DU1
Two Dust Cap Push Buttons	Y		DU2
One Dust Cap and One 12 Selector Switch (2 Position, 2 Circuit)	Y		DU112
One Dust Cap and One 35 Selector Switch (2 Position, 4 Circuit)	Y		DU135
One Dust Cap and One 102 Selector Switch (3 Position, 2 Circuit)	Y		DU1102
One Dust Cap and One 345 Selector Switch (3 Position, 4 Circuit)	Y		DU1345
One 12 Selector Switch (2 Position, 2 Circuit)	Y		12
One 35 Selector Switch (2 Position, 4 Circuit)	Y		35
One 102 Selector Switch (3 Position, 2 Circuit)	Y		102
One 345 Selector Switch (3 Position, 4 Circuit)	Y		345
120 Vac Photocell	Y		PC120
277 Vac Photocell	Y		PC277
Three Dust Cap Push Buttons		Y	DU3
One Momentary and Two Maintained Push Buttons		Y	U1UM2
Two Momentary and One Maintained Push Buttons	Y	Y	U2UM1
Three Maintained Push Buttons		Y	UM3
Three Pilot Lights		Y	J3
Two Pilot Lights and One Momentary Push Button		Y	J2U1
One Pilot Light and Two Dust Cap Push Buttons		Y	J1DU2
Two Pilot Lights and One Dust Cap Push Button		Y	J2DU1
One Pilot Light and Two Maintained Push Buttons		Y	J1UM2
Two Pilot Lights and One Maintained Push Button		Y	J2UM1

◆ Select items suitable for Class I, Division 1 and 2, Groups B, C and D; Class II, Groups E, F and G and Class III. See product selection pages for suitable items.

EFD/EFDB Series Factory Sealed Control Stations

Explosionproof, Dust-Ignitionproof

NEC:

Class I, Division 1 and 2, Groups B+, C, D
 Class II, Division 1 and 2, Groups E, F, G
 Class III
 NEMA 3, 7CD, 9EFG

Nameplates ①

Description	Suffix
Mushroom Head Push Buttons (Maintained and Momentary)	
Start	MNPSTQ
Stop	MNPSPQ
Emergency Stop	MNPESTPQ
Blank	MNPBQ
Pilot Light Nameplates	
Blank	LNPBQ
Forward	LNPFWDQ
Jog	LNPJOGQ
Run	LNPRUNQ
Stop	LNPSPQ
Start	LNPSTQ
Down	LNPDOWNQ
Fast	LNPFASTQ
Slow	LNPSLOWQ
Raise	LNPRAISEQ
Lower	LNPLOWERQ
Reset	LNPRESETQ
Off	LNPOFFQ
On	LNPONQ
Reverse	LNPREVQ
Close	LNPCLOSEQ
Open	LNPOPENQ
Up	LNPUPQ
Test	LNPTTESTQ
Low	LNPLOWQ
High	LNPHIGHQ
Two Position Selection Switch Nameplates	
Forward—Reverse	SLNPFRQ
Hand—Auto ②	SLNPHAQ
On—Off	SLNPOO
Start—Stop	SLNPSS
Blank	SLNPBQ
Up—Down	SLNPUDQ
Run—Jog	SLNPRJQ
Auto—Hand	SLNPAHQ
Off—Remote	SLNPORQ

Description	Suffix
Three Position Selection Switch Nameplates	
Forward—Off—Reverse	SLNPFORQ
Hand—Off—Auto ②	SLNPHOAQ
Run—Off—Jog	SLNPROJQ
Blank	SLNPB3
Reverse—Off—Forward	SLNPROFQ
Auto—Off—Hand	SLNPAOHQ
Hand—Off—Remote	SLNPHORQ
1—Off—2	SLNP102Q
Jog—Off—Run	SLNPJORQ
Stop—Run—Start	SLNPSRSQ
Local—Off—Remote	SLNPLOQ
Momentary Push Buttons	
<i>For Rectangular Weatherboot Style Only (Not for round weatherboot style)</i>	
Blank ②	SNPBQ
Forward	SNPFWDQ
Jog	SNPJOGQ
Run	SNPRUNQ
Stop ②	SNPSPQ
Start ②	SNPSTQ
Down	SNPDOWNQ
Fast	SNPFASTQ
Slow	SNPSLOWQ
Raise	SNPRAISEQ
Lower	SNPLOWERQ
Reset	SNPRESETQ
Off	SNPOFFQ
On	SNPONQ
Reverse	SNPREVQ
Close	SNPCLOSEQ
Open	SNPOPENQ
Up	SNPUPQ
Test	SNPTTESTQ
Low	SNPLOWQ
High	SNPHIGHQ

① Custom nameplates are not available.

② Included as standard (no need to use suffix).

◆ Select items suitable for Class I, Division 1 and 2, Groups B, C and D; Class II, Groups E, F and G and Class III. See product selection pages for suitable items.













EFD/EFDB Series Factory Sealed Control Stations

Explosionproof, Dust-Ignitionproof

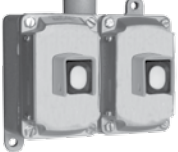
10 Amp, 600 Vac Max. for Heavy Duty Use. Furnished with Internal Ground Screw.

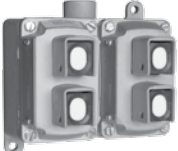
NEC:

Class I, Division 1, Groups B, C, D
 Class I, Division 2, Groups B, C, D
 Class II, Division 1 and 2, Groups E, F, G
 Class III
 NEMA 3, 7CD, 9EFG

	Hub Size (Inches)	Description	Nameplate Marking	Catalog Number		
				Dead-End	Feed-Thru	
1-Gang ♦ ① — Momentary Contact						
	1/2	1 Circuit Universal		Start/Stop	EFDB150-U1	EFDCB150-U1
	3/4				EFDB175-U1	EFDCB175-U1
	1				EFDB110-U1	EFDCB110-U1
	1/2	2 Circuits Universal		Start/Stop	EFDB150-U2	EFDCB150-U2
	3/4				EFDB175-U2	EFDCB175-U2
	1				EFDB110-U2	EFDCB110-U2
1-Gang ♦ ① — Red Mushroom Head — Maintained Contact — Emergency Stop Nameplate						
	1/2	1 Circuit Universal		Emergency Stop	EFDB150-UM1	EFDCB150-UM1
	3/4				EFDB175-UM1	EFDCB175-UM1
	1				EFDB110-UM1	EFDCB110-UM1
2-Gang ① — Momentary Contact						
	1/2	2 Circuits Universal		Start/Stop	EFD250-U1	EFDC250-U1
	3/4				EFD275-U1	EFDC275-U1
	1				EFD210-U1	EFDC210-U1
	1/2	4 Circuits Universal		Start/Stop	EFD250-U2	EFDC250-U2
	3/4				EFD275-U2	EFDC275-U2
	1				EFD210-U2	EFDC210-U2
3-Device ② — Momentary Contact						
	1/2	3 Circuits Universal		Start/Stop	EFDL50-U3	EFDCL50-U3
	3/4				EFDL75-U3	EFDCL75-U3
	1				EFDL10-U3	EFDCL10-U3

① Malleable iron body and aluminum cover. For aluminum body, add suffix —A.

② Aluminum body not available.

♦ Shaded area indicates items suitable for Class I, Division 1 and 2, Groups B, C and D; Class II, Groups E, F and G and Class III. For Class I, Division 1, Group B, external seals must be installed at each conduit entrance.







EFD/EFDB Series Factory Sealed Control Stations

Combination Push Button and Pilot Light. Explosionproof, Dust-Ignitionproof

10 Amp, 600 Vac Max. for Heavy Duty Use. Momentary Contact. Furnished with Internal Ground Screw.

NEC:

- Class I, Division 1, Groups B*, C, D
- Class I, Division 2, Groups B, C, D
- Class II, Division 1 and 2, Groups E, F, G
- Class III
- NEMA 3, 7CD, 9EFG

		Hub Size (Inches)	Description	Nameplate Marking	Catalog Number	
					Dead-End	Feed-Thru
1-Gang ♦ ①						
 	1 Circuit, 1 Pilot Light	1/2	1 Circuit	Start/Stop	EFDB150-J1U1	EFDCB150-J1U1
		3/4	Universal and 1 Pilot Light		EFDB175-J1U1	EFDCB175-J1U1
		1			EFDB110-J1U1	EFDCB110-J1U1
	2 Circuit, 1 Pilot Light	1/2	2 Circuit	Start/Stop	EFDB150-J1U2	EFDCB150-J1U2
		3/4	Universal and 1 Pilot Light		EFDB175-J1U2	EFDCB175-J1U2
		1			EFDB110-J1U2	EFDCB110-J1U2
2-Gang						
 	2 Circuit, 1 Pilot Light	1/2	2 Circuit	Start/Stop	efd250-J1U2	efdc250-J1U2
		3/4	Universal and 1 Pilot Light		efd275-J1U2	efdc275-J1U2
		1			efd210-J1U2	efdc210-J1U2
	2 Circuit, 2 Pilot Light	1/2	2 Circuit	Start/Stop	efd250-J2U2	efdc250-J2U2
		3/4	Universal and 2 Pilot Lights		efd275-J2U2	efdc275-J2U2
		1			efd210-J2U2	efdc210-J2U2
3-Device ②						
 	2 Circuit, 1 Pilot Light	1/2	2 Circuit	Start/Stop	efdl50-J1U2	efdcl50-J1U2
		3/4	Universal and 1 Pilot Light		efdl75-J1U2	efdcl75-J1U2
		1			efdl10-J1U2	efdcl10-J1U2
	1 Circuit, 2 Pilot Lights	1/2	1 Circuit	Start/Stop	efdl50-J2U1	efdcl50-J2U1
		3/4	Universal and 2 Pilot Lights		efdl75-J2U1	efdcl75-J2U1
		1			efdl10-J2U1	efdcl10-J2U1
2-Gang Tandem ②						
 	2 Circuit, 2 Pilot Lights	1/2	2 Circuit	Start/Stop	efdt50-J1U2	efdct50-J1U2
		3/4	Universal and 1 Pilot Light		efdt75-J1U2	efdct75-J1U2
		1			efdt10-J1U2	efdct10-J1U2
	2 Circuit, 1 Pilot Light	1/2	2 Circuit	Start/Stop	efdt50-J2U2	efdct50-J2U2
		3/4	Universal and 2 Pilot Lights		efdt75-J2U2	efdct75-J2U2
		1			efdt10-J2U2	efdct10-J2U2

For tandem bodies, external seals must be installed within 1.5 meters (5 feet) of each conduit entrance for Class I, Groups C and D. Pilot Lights furnished with 6 Watt, 120 Vac 6S6 lamp and red jewel—Other colored jewels and LED's listed under accessories and parts.

- ① Malleable iron body and aluminum cover. For aluminum body, add suffix —A.
- ② Aluminum body not available.

♦ Shaded area indicates items suitable for Class I, Division 1 and 2, Groups B, C and D; Class II, Groups E, F and G and Class III. For Class I, Division 1, Group B, external seals must be installed at each conduit entrance.

EDS Series Factory Sealed Control Stations

Push Button. With Rocker Arm Handle. Explosionproof, Dust-Ignitionproof

10 Amp, 600 Vac Max. for Heavy Duty Use. Furnished with Internal Ground Screw.



NEC:



Class I, Division 1 and 2, Groups B♦, C, D



Class II, Division 1 and 2, Groups E, F, G

Class III

NEMA 3, 7CD, 9EFG

		Hub Size (Inches)	Description	Nameplate Marking	Catalog Number		
					Dead-End	Feed-Thru	
1-Gang ♦ – Malleable Iron Body and Cover ① – Momentary Contact							
		1/2	1 Circuit Universal		Specify	EDS150-RU1	EDSC150-RU1
		3/4				EDS175-RU1	EDSC175-RU1
		1				EDS110-RU1	EDSC110-RU1
		1/2	2 Circuits Universal		Specify	—	EDSC150-RU2
		3/4				EDS175-RU2	EDSC175-RU2
		1				EDS110-RU2	EDSC110-RU2
1 Circuit	2 Circuit						

2-Gang – Malleable Iron Body and Cover ① – Momentary Contact							
		1/2	2 Circuits Universal		Specify	—	EDSC250-RU1
		3/4				EDS275-RU1	EDSC275-RU1
		1				EDS210-RU1	EDSC210-RU1
		1/2	4 Circuits Universal		Specify	—	EDSC250-RU2
		3/4				EDS275-RU2	EDSC275-RU2
		1				EDS210-RU2	EDSC210-RU2
2 Circuit	4 Circuit						

		Description	Nameplate Marking	Catalog Number		
				Cover Assembly	Switch Only	
Cover and Chamber with Device – Momentary Contact						
	When installed on a 1/2" or 3/4" single gang box the cover assembly is suitable for use in Group B environments but will not be marked Group B.					
		1 Circuit Universal		Specify	EFK-RU1-Q	EFSR-U1Q
		2 Circuits Universal		Specify	EFK-RU2-Q	EFSR-U2Q

① For aluminum body add suffix —A (Not suitable for Class I, Group B).





♦ Shaded area indicates items suitable for Class I, Group B, in addition to Class I, Groups C and D; Class II, Groups E, F, and G; and Class III.

EFD/EFDB Series Factory Sealed Control Stations

Dust Cap Push Button. Explosionproof, Dust-Ignitionproof

10 Amp, 600 Vac Max. for Heavy Duty Use. Momentary Contact. Furnished with Internal Ground Screw.

NEC:
 Class I, Division 1, Groups B⁺, C, D
 Class I, Division 2, Groups B, C, D
 Class II, Division 1 and 2, Groups E, F, G
 Class III
 NEMA 3, 7CD, 9EFG

	Hub Size (Inches)	Description	Nameplate Marking	Catalog Number		
				Dead-End	Feed-Thru	
1-Gang ①						
	3/4	1 Circuit Universal		Start/Stop	EFDB175-DU1	EFDCB175-DU1
	1				EFDB110-DU1	EFDCB110-DU1
	3/4	2 Circuits Universal		Start/Stop	EFDB175-DU2	EFDCB175-DU2
	1				EFDB110-DU2	EFDCB110-DU2
3-Device ②						
	3/4	2 Circuits Universal and 1 Pilot Light		Start/Stop	EFDL75-J1DU2	EFDCL75-J1DU2
	1				EFDL10-J1DU2	EFDCL10-J1DU2

① Malleable iron body and aluminum cover. For aluminum body, add suffix —A.

② Aluminum body not available.

♦ Shaded area indicates items suitable for Class I, Groups B, C and D; Class II, Groups E, F, and G; and Class III. For Class I, Group B external seals must be installed at each conduit entrance.













EFD/EFDB Series Factory Sealed Control Stations

Pilot Lights. Explosionproof, Dust-Ignitionproof

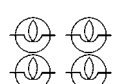
Pilot Light Furnished with 6 Watt, 120 Vac 6S6 Lamp and Red Jewel.†Furnished with Internal Ground Screw.

NEC:

Class I, Division 1, Groups B♦, C, D
 Class I, Division 2, Groups B, C, D
 Class II, Division 1 and 2, Groups E, F, G
 Class III
 NEMA 3, 7CD, 9EFG

	Hub Size (Inches)	Description	Catalog Number		
			Dead-End	Feed-Thru	
1-Gang ♦ ③					
	1/2	One Pilot Light		EFDB150-J1	EFDCB150-J1
	3/4			EFDB175-J1	EFDCB175-J1
	1			EFDB110-J1	EFDCB110-J1
	1/2	Two Pilot Lights		EFDB150-J2	EFDCB150-J2
	3/4			EFDB175-J2	EFDCB175-J2
	1			EFDB110-J2	EFDCB110-J2
2-Gang ①					
	1/2	Two Pilot Lights		EFD250-J1	EFDC250-J1
	3/4			EFD275-J1	EFDC275-J1
	1			EFD210-J1	EFDC210-J1
	1/2	Four Pilot Lights		EFD250-J2	EFDC250-J2
	3/4			EFD275-J2	EFDC275-J2
	1			EFD210-J2	EFDC210-J2
3-Device ②					
	1/2	Three Pilot Lights		EFDL50-J3	EFDCL50-J3
	3/4			EFDL75-J3	EFDCL75-J3
	1			EFDL10-J3	EFDCL10-J3
2-Gang Tandem ②					
	1/2	Two Pilot Lights		EFDT50-J1	EFDCT50-J1
	3/4			EFDT75-J1	EFDCT75-J1
	1			EFDT10-J1	EFDCT10-J1
	1/2	Four Pilot Lights		EFDT50-J2	EFDCT50-J2
	3/4			EFDT75-J2	EFDCT75-J2
	1			EFDT10-J2	EFDCT10-J2

① Malleable iron body and aluminum cover. For aluminum body, add suffix -A.

② Aluminum body not available. For tandem bodies, external seals must be installed within 1.5 meters (5 feet) of each conduit entrance for Class I, Groups C and D.

③ Other colored jewels, pilot lights and LED's listed under accessories and parts.

♦ Shaded area indicates items suitable for Class I, Groups B, C and D; Class II, Groups E, F, and G; and Class III. For Class I, Division 1, Group B, external seals must be installed at each conduit entrance.

EFDB Series Factory Sealed Control Stations

Selector Switches and Photocontrols. Explosionproof, Dust-Ignitionproof

10 Amp, 600 Vac Max. for Heavy Duty Use. Furnished with Internal Ground Screw.

NEC:
 Class I, Division 1 and 2, Groups B♦, C, D
 Class II, Division 1 and 2, Groups E, F, G
 Class III
 NEMA 3, 7CD, 9EFG

	Hub Size (Inches)	Description	Diagram			Catalog Number	
			Left	Center	Right	Dead-End	Feed-Thru
2 Position Selector Switches — 1-Gang ♦ ① — Maintained Contact							
	1/2					EFDB150-12	EFDCB150-12
	3/4	2 Position, 2 Circuit		None		EFDB175-12	EFDCB175-12
	1					EFDB110-12	EFDCB110-12
	1/2					EFDB150-35	EFDCB150-35
	3/4	2 Position, 4 Circuits		None		EFDB175-35	EFDCB175-35
	1					EFDB110-35	EFDCB110-35

Nameplate: Hand—Auto

	Hub Size (Inches)	Description	Diagram			Catalog Number	
			Left	Center	Right	Dead-End	Feed-Thru
3 Position Selector Switches — 1-Gang ♦ ① — Maintained Contact							
<i>Three position units can be supplied for momentary contact right position, spring return to center, maintained contact left position. Add suffix —SRC.</i>							
	1/2					EFDB150-102	EFDCB150-102
	3/4	3 Position, 2 Circuit				EFDB175-102	EFDCB175-102
	1					EFDB110-102	EFDCB110-102
	1/2					EFDB150-345	EFDCB150-345
	3/4	3 Position, 4 Circuits				EFDB175-345	EFDCB175-345
	1					EFDB110-345	EFDCB110-345

Nameplate: Hand—Off—Auto

Selector Switches Nameplates ②



Two Position



Three Position

Two Position Nameplates		Three Position Nameplates	
Forward—Reverse	SLNP-FRQ	Forward—Off—Reverse	SLNP-FORQ
Hand—Auto	SLNP-HAQ	Hand—Off—Auto	SLNP-HOAQ
On—Off	SLNP-OO	Run—Off—Jog	SLNP-ROJQ
Start—Stop	SLNP-SS	Blank	SLNP-B3
Blank	SLNP-BQ	Reverse—Off—Forward	SLNP-ROFQ
Up—Down	SLNP-UDQ	Auto—Off—Hand	SLNP-AOHQ
Run—Job	SLNP-RJQ	Hand—Off—Remote	SLNP-HORQ
Auto—Hand	SLNP-AHQ	1—Off—2	SLNP-102Q
Off—Remote	SLNP-ORQ	Jog—Off—Run	SLNP-JORQ
Local Remote	SLNP-LRQ	Stop—Run—Start	SLNP-SRSQ
Off—On	SLNP-OFON	Local—Off—Remote	SLNP-LORQ

Selector Switch Locking Devices — Permit locking in any position



Description	Catalog Number
Two or Three Positions	SBL-3-Q

① Malleable iron body and aluminum cover. For aluminum body add suffix —A (Suitable for Class I, Division 1 and 2, Group B—single gang only).

② Custom nameplates are not available.

♦ Shaded area indicates items suitable for Class I, Division 1 and 2, Groups B, C and D; Class II, Groups E, F and G and Class III. For Class I, Division 1, Group B, external seals must be installed at each conduit entrance.

EFDB Series Factory Sealed Control Stations

Selector Switch Cover Assemblies. Explosionproof, Dust-Ignitionproof

10 Amp, 600 Vac Max. for Heavy Duty Use.

NEC:

Class I, Division 1 and 2, Groups B⁺, C, D
 Class II, Division 1 and 2, Groups E, F, G
 Class III
 NEMA 3, 7CD, 9EFG

EFDB Selector Switch Operator/Switch Assembly — Maintained Contact ①

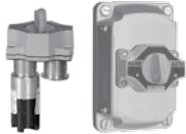
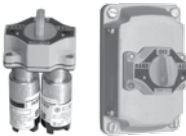
	Thread Size (In., NPSM)	Description	Diagram			Catalog Number	
			Left	Center	Right	Switch Assembly Only	Switch Assembly with Cover
2 Position							
 <p>Nameplate: Hand—Auto</p>	1/2	2 Position, 2 Circuit		None		SSBA1-2Q	EFKB-12
	1/2	2 Position, 4 Circuits		None		SSBA2-2Q	EFKB-35
3 Position							
 <p>Nameplate: Hand—Off—Auto</p>	1/2	3 Position, 2 Circuit				SSBA1-3Q	EFKB-102
	1/2	3 Position, 4 Circuit				SSBA2-3Q	EFKB-345

EFDB Selector Switch Operator/Switch Assembly — Modified Operations ①

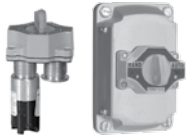
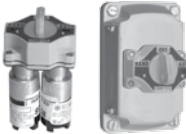
	Thread Size (In., NPSM)	Description	Diagram			Catalog Number	
			Left	Center	Right	Switch Assembly Only	Switch Assembly with Cover
3 Position							
Momentary contact right position. Spring return to center. Maintained contact left position.							
<i>Note: Standard legend plate reads Hand/Off/Auto</i>							
 <p>2 Circuit</p>	1/2	3 Position, 2 Circuit				SSBAS-1-3	EFKB-102-SRC
	1/2	3 Position, 4 Circuits				SSBAS-2-3	EFKB-345-SRC
Momentary contact left position. Spring return to center. Maintained contact right position.							
<i>Note: Standard legend plate reads Auto/Off/Hand</i>							
 <p>4 Circuit</p>	1/2	3 Position, 2 Circuit				SSBASL-1-3	EFKB-102-SLC
	1/2	3 Position, 4 Circuits				SSBASL-2-3	EFKB-345-SLC
Momentary contact right position. Spring return to center. Maintained contact left position.							
<i>Note: Standard legend plate reads Stop/Run/Start</i>							
	1/2	3 Position, 4 Circuits				SSBASRA-2-3	EFKB-637-SRC











① When installed on a single gang box the cover assembly is suitable for use in Group B environments but will not be marked Group B.

◆ Select items suitable for Class I, Division 1 and 2, Groups B, C and D; Class II, Groups E, F and G and Class III. See product selection pages for suitable items.

EFD/EFDB and EDS Series Factory Sealed Control Stations

EFKB Covers With Pilot Lights and/or Push Buttons. For EFD Bodies

NEC:
 Class I, Division 1 and 2, Groups C, D
 Class II, Division 1 and 2, Groups E, F, G
 Class III

Description		Nameplate Marking	Catalog Number
Cover complete with Push Button — Factory Sealed — Momentary Contact ①②			
<i>For use on standard EFD bodies</i>			
		1 Circuit Universal	Start/Stop
		2 Circuit Universal	Start/Stop
EFKB-U1	EFKB-U2		EFKB-U1
			EFKB-U2
Cover complete with Red Mushroom Head Push Button — Factory Sealed — Maintained Contact ①②			
<i>For use on standard EFD bodies – Emergency Stop Nameplate</i>			
		1 Circuit Universal (Red)	Emergency Stop
			EFKB-UM1
Cover complete with Pilot Lights — Factory Sealed — Momentary Contact ①②			
<i>6 Watt, 120 Vac, Type 6S6 Lamp. For use on standard EFD bodies</i>			
		One pilot light (red jewel ③) and two universal push buttons	Start/Stop
J1U2	J1U1	One pilot light (red jewel ③) and one universal push button	Start/Stop
		One pilot light (red jewel ③) and one universal push button—dust cap	Start/Stop
J1	J2	One pilot light (red jewel ③)	Start/Stop
		Two pilot lights (red jewels ③)	Start/Stop
		Photocontrol relay cover (120 Vac)	EFKB-PC120
		Photocontrol relay cover (208-277 Vac)	EFKB-PC277
PC			

① All covers are copperfree aluminum. Supplied with four captive stainless steel bolts.
 ② When installed on a single gang box the cover assembly is suitable for use in Group B environments but will not be marked Group B.
 ③ Colored jewels, pilot lights and LED's listed under accessories and parts







EFD/EFDB and EDS Series Factory Sealed Control Stations

ESK/EFK Covers For Pilot Lights, Push Buttons, or Selector Switches.

NEC:
 Class I, Division 1 and 2, Groups C, D
 Class II, Division 1 and 2, Groups E, F, G
 Class III

Covers Only — for use on standard EFD bodies

Supplied with 4 cover bolts and blank cover nameplate.

		Description	Catalog Number
Push Button or Pilot Light Covers — 3/4" Tapped Openings ①			
		One opening: one push button or one pilot light	ESKB-1PBQ
ESKB-1PBQ	ESKB-2PBQ	Two openings: two push buttons, two pilot lights, or one of each	ESKB-2PBQ
		Three openings: three device (EFDL) three push buttons or three pilot lights, or combination of push button(s) and pilot light(s)	EFKL-3HQ ②
EFKL-3HQ			
Push Button or Selector Switch Cover — 1/2" Tapped Openings ①			
		Two openings: selector switch or two push buttons	ESKB-2SPQ
Push Button, Pilot Light or Selector Switch Covers — 3/4" top and 1/2" Bottom Tapped Openings ①			
		One top and two bottom openings: one pilot light, two push buttons; one pilot light, one selector switch.	ESKB-3JPBQ
ESKB-3JPBQ	ESKB-BQ	Blank	ESKB-BQ
Nameplate Mounting Bracket			
		Bracket with blank silver/black nameplate for EFDB series	NPBRKT-EFDB
		Bracket with blank silver/black nameplate for 3-device EFD series	NPBRKT-CONT
		To order bracket with control station, add suffix -NPBRKT to end of catalog number.	
		To order engraved nameplates, add desired markings after catalog number. Maximum of 2 lines with 12 characters (including spaces) per line.	
		<i>Note: Mount bracket between cover screws and cover. Do not mount bracket between ground joint flame path between cover and backbox.</i>	

① All covers are copperfree aluminum. Supplied with four captive stainless steel bolts.

② Catalog number EFKL-3HQ supplied with 6 stainless steel non-captive bolts.

EFD/EFDB and EDS Series Factory Sealed Control Stations

EFD/EFDB Push Button Accessories and Parts

NEC:
 Class I, Division 1 and 2, Groups B, C, D
 Class II, Division 1 and 2, Groups E, F, G
 Class III

Description		Catalog Number
-------------	--	----------------

Push Button, Factory Sealed – Momentary Contact



SPBB-U1-Q

10 Amp 600 Vac Heavy Duty 1/2" thread size (NPSM). Furnished with 1/2" to 3/4" enlarger, Weather Boot, Guard, Start, Stop and Blank Nameplates.

Single Push Button Universal **SPBB-U1-Q**



SPBB-U2DBL

Double Push Button Universal **SPBB-U2DBL**

Push Button, Red, Factory Sealed – Maintained Contact



10 Amp 600 Vac Heavy Duty 1/2" thread size (NPSM). Furnished with 1/2" to 3/4" enlarger and Emergency Stop Nameplate (guard not furnished).

Single Push Button Universal **SMPB-U1-Q**

Rectangular Button with Weather Boot



Furnished with Start, Stop and Blank Nameplates

NBN-WB

Description	Nameplate Marking	Catalog Number
-------------	-------------------	----------------

Push Button and Replacement Cap

Has 1/2 - 14 thread size (NPSM). Supplied with 1/2" to 3/4" enlarger.



SPBB-DU1-Q



DC-Q

Dust Cap - Push Button STOP-START-BLANK **SPBB-DU1-Q**

Replacement Dust Cap Only STOP-START-BLANK **DC-Q**



STOP-START-BLANK

Nameplate STOP-START-BLANK **DU-NP-Q**

Covers Complete with Pilot Lights, Push Buttons – Factory Sealed

When installed on a single gang box the cover assembly is suitable for use in Group B environments but will not be marked Group B.



EFKB-DU1



EFKB-DU2

1 Circuit Universal Specify **EFKB-DU1**

2 Circuits Universal Specify **EFKB-DU2**



2 Circuits Universal and 1 Pilot Light Specify **EFKL-J1DU2** ①









① For use with three device mounting bodies.

EFD/EFDB and EDS Series Factory Sealed Control Stations

EFD/EFDB Push Button Accessories and Parts

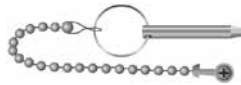
NEC:

Class I, Division 1 and 2, Groups B, C, D
 Class II, Division 1 and 2, Groups E, F, G
 Class III

		Description		Catalog Number	
Nameplates for Rectangular Push Buttons					
 SNP-OFF-Q		Blank	SNP-B-Q	Off	SNP-OFF-Q
		Forward	SNP-FWD-Q	On	SNP-ON-Q
		Jog	SNP-JOG-Q	Reverse	SNP-REV-Q
		Run	SNP-RUN-Q	Open	SNP-OPEN-Q
		Stop	SNP-SP-Q	Close	SNP-CLOSE-Q
 SNP-ON-Q		Start	SNP-ST-Q	Up	SNP-UP-Q
		Down	SNP-DOWN-Q	Test	SNP-TEST-Q
		Fast	SNP-FAST-Q	Low	SNP-LOW-Q
		Slow	SNP-SLOW-Q	High	SNP-HIGH-Q
		Raise	SNP-RAISE-Q		
		Lower	SNP-LOWER-Q		
		Reset	SNP-RESET-Q		
Push Button Replacement Locking Guards — Glass Reinforced Polypropylene — Gasketed					
 Maintained Switch Guard  Single Guard  Double Guard		<i>Has hole for 1/4" hasp.</i>			
		Single Guard (Maintained Switch)		SMPB-LG	
		Single Guard		NPB-LG1	
		Double Guard		NPB-LG2	
		Single Guard (No Lockout Holes)		NPB-LG1-LL	
	Double Guard (No Lockout Holes)		NPB-LG2-LL		
Push Button Securing Rod with Chain — Stainless Steel					
		For use with Single Guard Only		NBL-SR	
Mushroom Button with Weather Boot for Use with Momentary Contact — Gasketed					
		Black		NMRB-BL	
		Green		NMRB-GR	
		Red		NMRB-RE	
Mushroom Button					
		For Use with Maintained Contact — Solid-Colored Nonmetallic Button			
		Red		NMRBM-RE	
Nameplates For Momentary and Maintained Mushroom Head Push Button					
 MNPESTPQ		Start		MNPSTQ	
		Stop		MNPSPQ	
		Emergency Stop		MNPESTPQ	
		Blank		MNPBQ	

EFD/EFDB and EDS Series Factory Sealed Control Stations

EFD/EFDB Push Button Accessories

NEC:
 Class I, Division 1 and 2, Groups B♦, C, D
 Class II, Division 1 and 2, Groups E, F, G
 Class III

Description	Catalog Number
-------------	----------------

Pilot Light, Factory Sealed



Pilot Light

Chamber Only

Incandescent

Furnished with 6S6 120 Vac incandescent lamp, jewel and guard. Has 457 mm (18") long, type SFF-2 pigtail leads; +150 °C (+302 °F). Body has 3/4" straight thread (NPSM).

With Red Jewel	SPLSREB
With Green Jewel	SPLSGRB
With Amber Jewel	SPLSAMB
With Blue Jewel	SPLSBLB
With Clear Jewel	SPLSCLB
With Opal Jewel	SPLSOPB

LED

Furnished with candelabra base 120 Vac LED, jewel and guard. Has 457 mm (18") long, type SFF-2 pigtail leads; +150 °C (+302 °F). Body has 3/4" straight thread (NPSM).

With Red LED, Clear Jewel	SPLNSREB
With Green LED, Clear Jewel	SPLNSGRB
With Amber LED, Clear Jewel	SPLNSAMB

Chamber Only (Same as above, less jewel, guard and lamp)

SPLSSCB

Pilot Light Jewel/Guard Assembly

The below catalog numbers indicate an assembly of the Pilot Light Jewels and Guards. Jewels and Guards are not available as separate items.



Amber Jewel/Guard	JGBNA
Blue Jewel/Guard	JGBNB
Clear Jewel/Guard	JGBNC
Green Jewel/Guard	JGBNG
Opal Jewel/Guard	JGBNO
Red Jewel/Guard	JGBNR

Replacement Bulbs



EPL-B6W

EPLLEDR

Clear Bulbs

Furnished with candelabra base. 6 Watt, 120 Vac, Type 6S6

EPL-B6W

LED Replacements

Furnished with candelabra base. 120 Vac, 10 mA.

Red LED	EPLLEDR
Green LED	EPLLEDG
Amber LED	EPLLEDA

Transformer

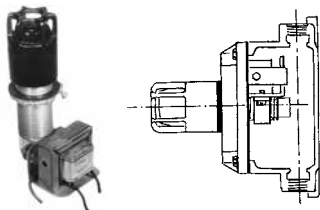

Add Suffix as listed below. Transformer clamps directly to pilot light barrel. **Only one pilot light transformer assembly per one gang body.**

Primary Vac	Lamp Vac	Suffix
220	120	TR2
277	120	TR3
440	120	TR4
550	120	TR5

♦ Suitable for Class I, Group B when installed in an enclosure rated for Class I, Group B.

EFD/EFDB and EDS Series Factory Sealed Control Stations

EFD/EFDB Push Button Accessories

NEC:

Class I, Division 1 and 2, Groups B, C, D
 Class II, Division 1 and 2, Groups E, F, G
 Class III

	Description	Catalog Number
Nameplates for Pilot Light		
 <p>LNPRUNQ</p>	Blank	LNPBQ
	Forward	LNPFWDQ
	Jog	LNPJOGQ
	Run	LNPRUNQ
	Stop	LNPSPQ
	Start	LNPSTQ
	Down	LNPDOWNQ
	Fast	LNPFASTQ
	Slow	LNPSLOWQ
	Raise	LNPRAISEQ
	Lower	LNPLOWERQ
	Reset	LNPRESETQ
	Off	LNPOFFQ
	On	LNPONQ
	Reverse	LNPREVQ
	Close	LNPCLOSEQ
	Open	LNPOPENQ
Up	LNPUPQ	
Test	LNPTTESTQ	
Low	LNPLLOWQ	
High	LNPHIGHQ	







CONTROLS: NEC/CEC EXPLOSIONPROOF CONTROL STATIONS AND SWITCHES

EFD/EFDB and EDS Series Factory Sealed Control Stations

Mounting Bodies

Furnished with Internal Ground Screw.

NEC:
 Class I, Division 1 and 2, Groups C, D
 Class II, Division 1 and 2, Groups E, F, G
 Class III
 NEMA 7CD, 9EFG

	Type	Hub Size (Inches)	Catalog Number	
			Malleable Iron	Aluminum
1-Gang				
	Dead-End	1/2	EFD150NLQ	EFD150ANLQ
		3/4	EFD175NLQ	EFD175ANLQ
		1	EFD110NLQ	EFD110ANLQ
	Feed-Thru	1/2	EFDC150NLQ	EFDC150ANLQ
		3/4	EFDC175NLQ	EFDC175ANLQ
		1	EFDC110NLQ	EFDC110ANLQ
2-Gang				
	Dead-End	1/2	EFD250NLQ	EFD250ANLQ
		3/4	EFD275NLQ	EFD275ANLQ
		1	EFD210NLQ	EFD210ANLQ
	Feed-Thru	1/2	EFDC250NLQ	EFDC250ANLQ
		3/4	EFDC275NLQ	EFDC275ANLQ
		1	EFDC210NLQ	EFDC210ANLQ
Tandem ①				
	Dead-End	1/2	EFDT50NLQ	—
		3/4	EFDT75NLQ	—
		1	EFDT10NLQ	—
	Feed-Thru	1/2	EFDC250NLQ	—
		3/4	EFDC275NLQ	—
		1	EFDC210NLQ	—
3-Device				
	Dead-End	1/2	EFDL50Q	—
		3/4	EFDL75Q	—
		1	EFDL10Q	—
	Feed-Thru	1/2	EFDCL50Q	—
		3/4	EFDCL75Q	—
		1	EFDCL10Q	—
Blank Bodies for Brazed Hubs				
	1-Gang		EFD1NL	—
	2-Gang		EFD2NL	—
	3-Gang		EFD3NL	—
	4-Gang		EFD4NL	—
	5-Gang		EFD5NL	—

Construct complete catalog numbers per EFD Cast Device Boxes Ordering Information on following page. Hubs will be located in center of walls and evenly spaced unless otherwise specified. Where spacings are critical, submit sketch showing exact spacing requirements.

① For tandem bodies, external seals must be installed within 1.5 meters (5 feet) of each conduit entrance for Class I, Groups C and D.

EFD/EFDB and EDS Series Factory Sealed Control Stations

EFD Cast Device Box Ordering Information. Blank Bodies for Brazed Threaded Hubs

1-, 2-, 3-, 4- and 5-Gang Boxes. Brazed Threaded Hubs for Rigid Conduit, 1/2" thru 1"; Brazed Union Hubs, 1/2" thru 1".

NEC:

- Class I, Division 1 and 2, Groups C, D
- Class II, Division 1 and 2, Groups E, F, G
- Class III
- NEMA 7CD, 9EFG

Determine catalog number as follows:

- (1) Select EFD device box catalog number;
- (2) Select "Standard Hub Arrangement Diagram" number; and
- (3) Select symbols that represent hub sizes from "Symbol Table." (Use "0" where no hub is required, and separate the various divisions of the complete catalog number by dashes.)

Example

The blank body device box selected is EFD3NL and the hub arrangement is diagram #8. Hub "a" is to be 3/4" brazed threaded; hub "b", 1" brazed threaded; hub "c", 3/4" brazed threaded; hub "d", no hub is required; and hub "e", 1" brazed union.

The complete catalog number will be: **EFD-3NL-8-23203E**

If a "Standard Hub Arrangement" is not suitable for the application, or when hubs are to be more accurately spaced, submit sketch locating hubs (1) from centerlines of walls and (2) from outside back of box (or from mounting lug surface if lugs are supplied).

All hubs will be located in centerlines of walls and evenly spaced unless otherwise specified.

Symbol Table

Hub Size (Inches)	Brazed Threaded Hub Symbol	Brazed Union Hub Symbol
Blank	0	0
1/2	1	1E
3/4	2	2E
1	3	3E

Standard Hub Arrangement Diagrams

Hub "a" is always TOP of box

2-, 3-, 4- and 5-Gang (Front View)

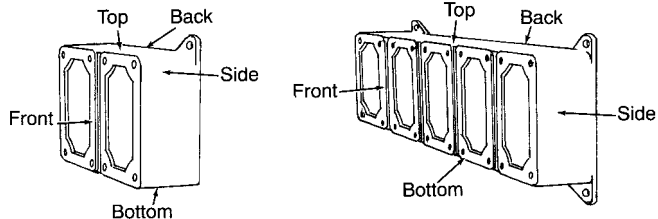
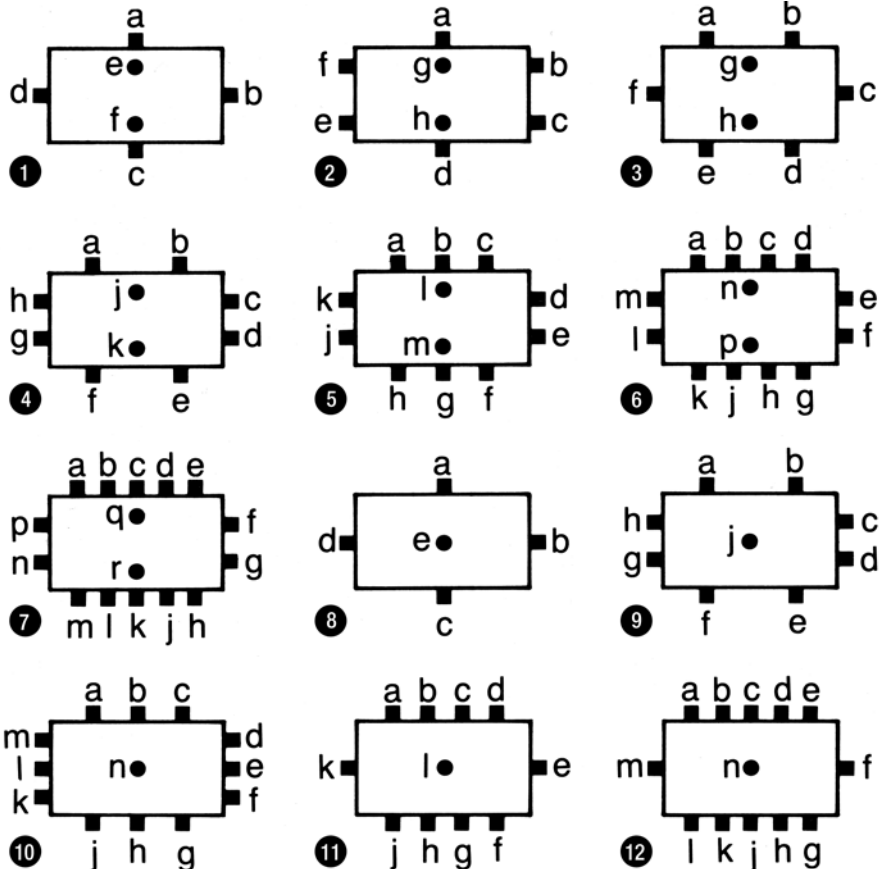

1-Gang (Front View)

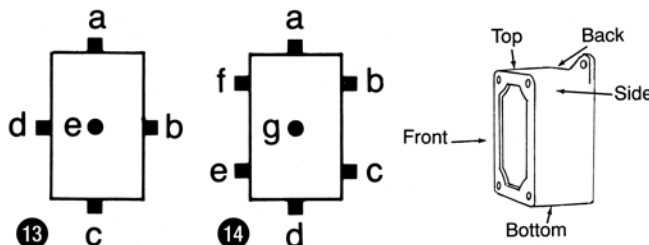

EFD/EFDB and EDS Series Factory Sealed Control Stations

EFD/EFDB 1- and 2-Gang

NEC:
 Class I, Division 1 and 2, Groups C, D
 Class II, Division 1 and 2, Groups E, F, G
 Class III
 NEMA 7CD, 9EFG

Dimensions in Millimeters (Inches)

EFD/EFDB — 1- and 2-Gang Combination Pilot Light and Push Buttons

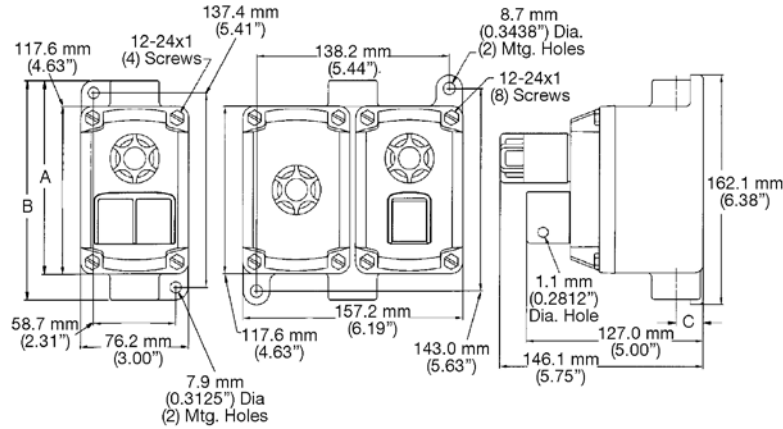

EFD/EFDB — 1-Gang Dust Cap Push Button and 1-Gang Maintained Contact Push Button

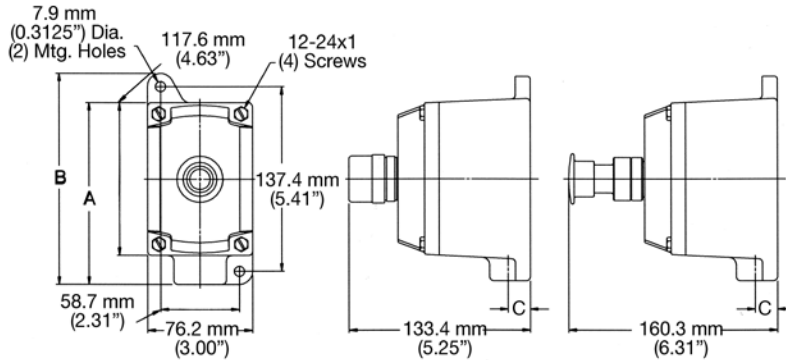

EDS — 1- and 2-Gang Rocker Arm Push Button

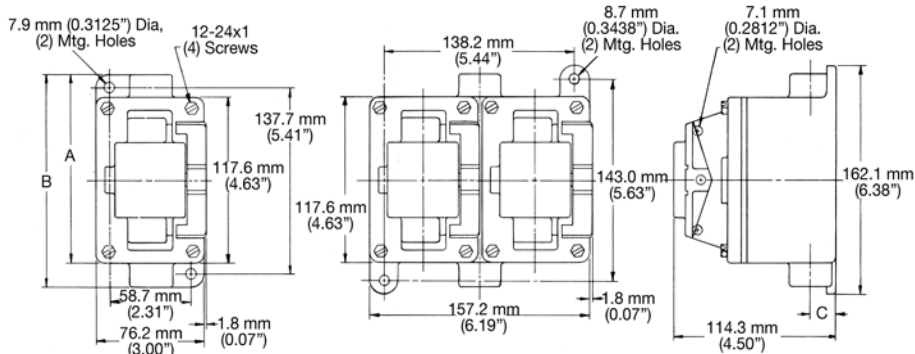

Hub Size (Inches)	Dimensions in Millimeters (Inches)		
	A	B	C
1/2 and 3/4	136.7 (5.38)	155.7 (6.13)	19.8 (0.78)
1	139.7 (5.50)	160.3 (6.31)	23.9 (0.94)

EFD/EFDB and EDS Series Factory Sealed Control Stations

EFD 3-Device and 2-Gang Tandem

NEC:

Class I, Division 1 and 2, Groups C, D
 Class II, Division 1 and 2, Groups E, F, G
 Class III
 NEMA 7CD, 9EFG

Dimensions in Millimeters (Inches)

EFD — 3-Device Pilot Light and Push Buttons

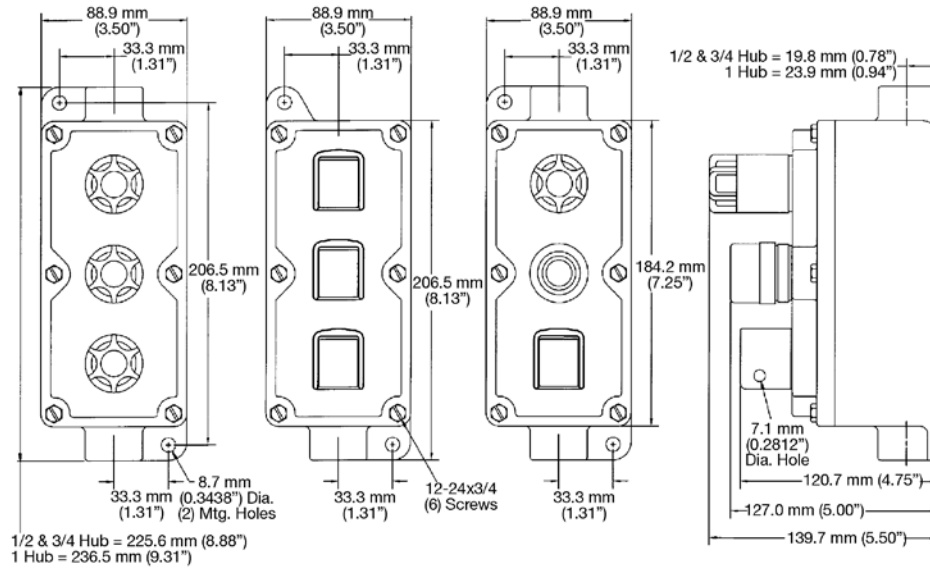

EFD — 2-Gang Tandem Pilot Light and Push Buttons

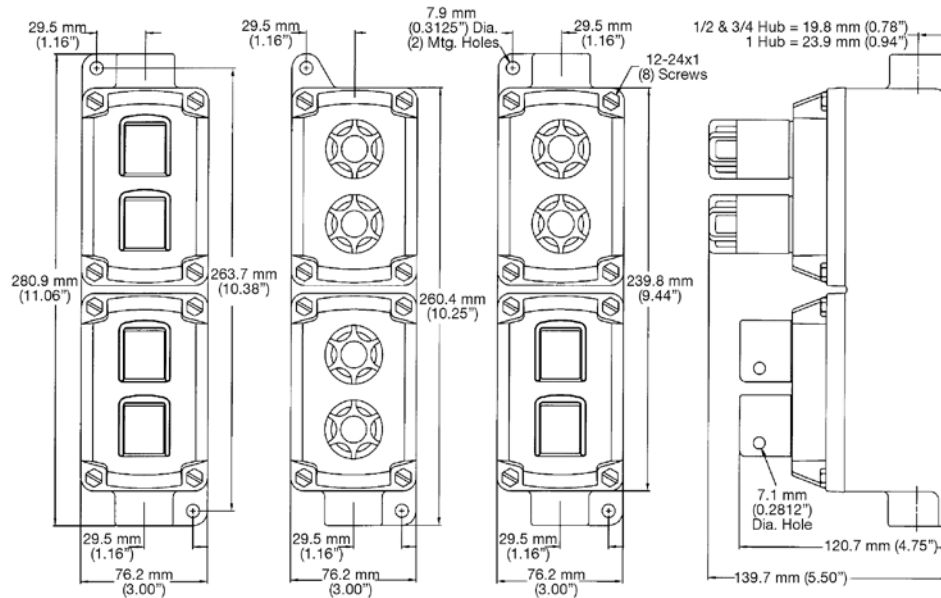

EFD/EFDB and EDS Series Factory Sealed Control Stations

Mounting Bracket

NEC:
Class I, Division 1 and 2, Groups C, D
Class II, Division 1 and 2, Groups E, F, G
Class III
NEMA 7CD, 9EFG

Dimensions in Millimeters (Inches)

NPBRKT Nameplate Mounting Bracket

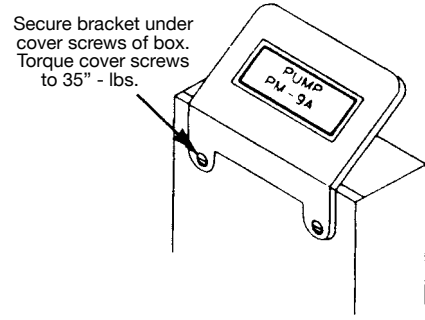
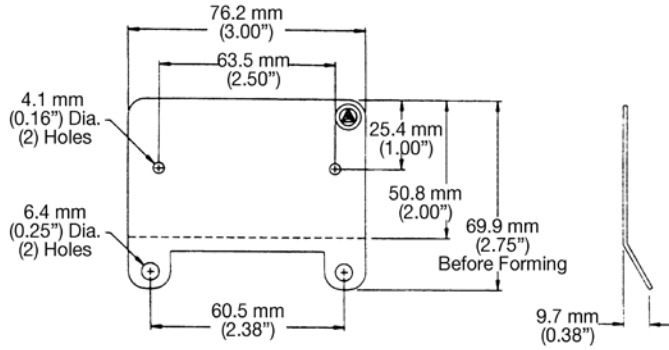

Contender™ Series Factory Sealed Control Stations and Pilot Lights

Explosionproof, Dust-Ignitionproof

Furnished with Internal Ground Screw.

NEC/CEC:

Class I, Division 1, Groups C, D
Class I, Division 2, Groups B, C, D
Class II, Division 1 and 2, Groups E, F, G
Class III
NEMA 3, 7CD, 9EFG

Applications

- Push buttons and selector switches are used in conjunction with contactors or magnetic starters for remote control of motors. They provide circuit control and/or selection.
- Pilot lights provide visual assurance that an electrical function is being performed at a remote or local location.
- Confine arcing of device within the enclosure, preventing ignition of ignitable atmospheres during control operation of motors and other equipment.
- Used in classified areas where flammable vapors, gasses or highly combustible dusts are present.
- For installation in:
 - Chemical plants
 - Petrochemical plants
 - Refineries
 - Other process industries
 - Where corrosive elements are present

Features

- Covers are UL Listed when used on Contender bodies.
- Finish is epoxy powder coat for enhanced corrosion resistance.
- Large backbox for ample wiring room.
- Ground screw installed in bodies for ground continuity.
- Corrosion resistant stainless steel hex head captive screws hold covers to body.
- Factory sealed enclosure eliminates need for adding sealing fittings and compound at each conduit entrance.
- Heavy duty, 10 Amp, 600 Vac.
- Factory sealed pilot lights supplied with jewel/guard assembly and 120 Vac/Vdc, 50/60 Hz, 6 Watt lamp (LED provided as option).
- Dozens of possible combinations of push buttons, pilot lights and selector switches.
- Accurately tapped, tapered hubs for tight rigid joints and ground continuity.
- Stainless steel push button shaft operates within stainless steel bushing assuring long, maintenance free operation.
- Smooth, rounded integral bushing in each hub protects conductor insulation.
- Push button and selector switch contacts are silver cadmium oxide which are "sealed" in lower phenolic chamber isolated from corrosive elements. Assures positive contact and long, trouble free operation.
- Enclosed stainless steel helper spring prevents accidental operation of push button in severe vibration installations.
- All momentary push buttons are supplied with lockout type guards as standard. Hole in guard will accept locks with up to 1/4" hasp. Permits locking of push button to prevent unauthorized operation.
- Clearly marked terminals with brass screws and spade terminals assure quick, easy wiring.

Standard Materials

- Control station body and cover: malleable iron
- SPBB push button: copperfree (4/10 of 1% max.) aluminum upper barrel and phenolic lower barrel with nylon plastic button
- SPBB dust cap push button: neoprene buttons
- SPLS pilot light: copperfree (4/10 of 1% max.) aluminum guard and body assembly; steel clamping ring; and tempered glass jewel



Push Button



Combination Push Button and Pilot Light



Rocker Arm Push Button



Maintained Push Button



Pilot Light



Selector Switch

- SSBA selector switch: copperfree (4/10 of 1% max.) aluminum operator mechanism, nylon cam, and sealed phenolic contact block

Standard Finishes

- Control station body: triple coat—(1) zinc electroplate, (2) chromate, and (3) epoxy powder coat
- SPBB push button, SPLS pilot light and SSBA selector switch: natural finish

Classified by UL for use in specific combinations with Cooper Crouse-Hinds EDS covers and bodies.

Contender™ Series Factory Sealed Control Stations and Pilot Lights

Explosionproof, Dust-Ignitionproof

UNILETS™ for use with Threaded Metal Conduit. Furnished with Internal Ground Screw.

NEC/CEC:

Class I, Division 1, Groups C, D
Class I, Division 2, Groups B, C, D
Class II, Division 1 and 2, Groups E, F, G
Class III
NEMA 3, 7CD, 9EFG

Options

- 1- or 2-gang boxes:
 - For aluminum cover only, add suffix - **A**.
 - For aluminum body and cover, add suffix - **SA**.
- Three position selector switches with modified operation:
 - Momentary contact right position, spring return to center; maintained contact left position. Add suffix - **S634**.
 - Momentary contact left position, spring return to center; maintained contact right position. Add suffix - **S635**.
 - Momentary contact right position, spring return to center; maintained contact left position; alternate contacts. Add suffix - **S636**.
- Selector switch lockout locks two or three position handle in any position. Add suffix - **S349**.
- Momentary push button securing rod, add suffix - **S153**.
- Pilot light jewel/guard assembly. Order by suffixes if color desired is other than red:
 - Amber- **J6**
 - Opal- **J8**
 - Clear - **J10**
 - Blue- **J11**
 - Green- **J3**
- Bodies and covers (1- or 2-gang) in copperfree (4/10 of 1% max.) aluminum. Add suffix - **SA**.
- Securing rod for push button lockout guard, add suffix- **S153**.
- LED pilot lights are available in lieu of incandescent pilot lights. Order by suffixes for desired color as follows:
 - Red- **LED1**
 - Green- **LED3**
 - Amber- **LED6**

NEC/CEC Certifications and Compliances

- UL Standards: UL 508, UL 698, UL 1203
- CSA Standards: C22.2 No. 14
- cULus Listed: E10449

Related Products

- For Division 1, Group B applications, refer to *EFDB Series*.

Illustrated Features



Securing Rod for Push Button Lockout Guard – available as optional item. Lockout Guard furnished as standard with the Push Button, may also be padlocked. Suffix- **S153**.

SPBB factory sealed push button — standard type and unit with dust cap.



SPBB Design Features

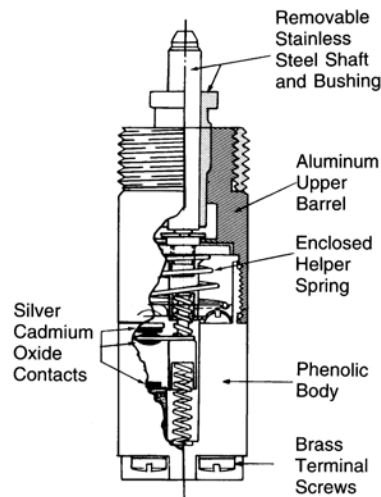

Contender™ Series Factory Sealed Control Stations and Pilot Lights

Explosionproof, Dust-Ignitionproof

UNILETS™ for use with Threaded Metal Conduit. Furnished with Internal Ground Screw.

NEC/CEC:

Class I, Division 1, Groups C, D
 Class I, Division 2, Groups B, C, D
 Class II, Division 1 and 2, Groups E, F, G
 Class III
 NEMA 3, 7CD, 9EFG

Catalog Numbering Guide

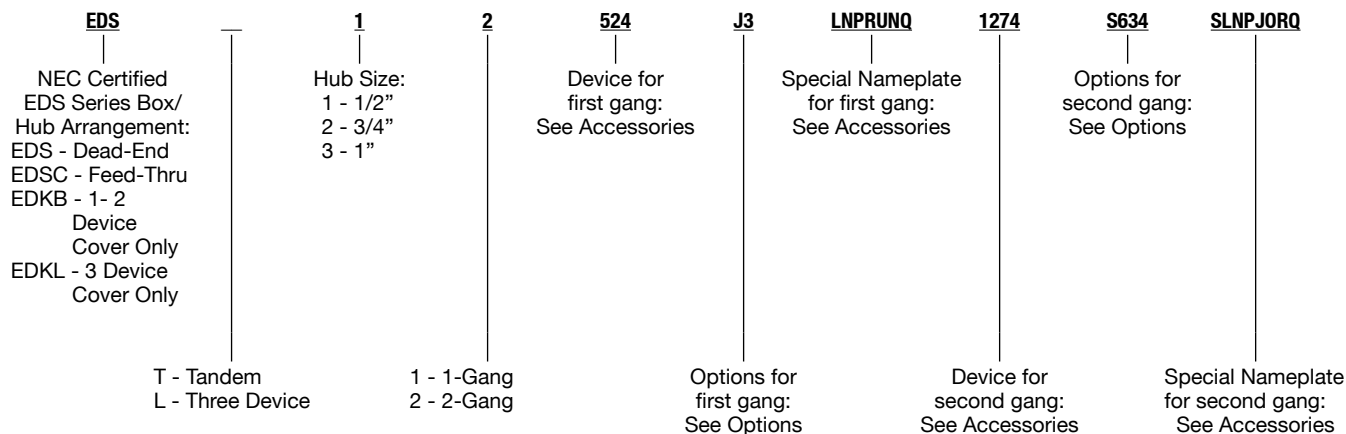

Full Catalog Number: EDSC12-524-J3-LNPUPQ-1274-S634-SLNPJORQ

Feed-Thru 2-Gang Box with 1/2" Hub:

In Gang #1: One Pilot Light with UP Nameplate

In Gang #2: One 3-Position, 4-Circuit Spring Return from the right Selector Switch with JOG-OFF-RUN Nameplate.

Options

Description	Suffix
Momentary Push Button Securing Rod	S153
Selector Switch Lockout	S349
Spring Return From Right Selector Switch (3 Positions Only)	S634
Spring Return From Left Selector Switch (3 Positions Only)	S635
Alternate Contacts Selector Switch	S636
Change One Red Lens to Green Lens	J3
Change One Red Lens to Opal Lens	J8
Change One Red Lens to Amber Lens	J6
Change One Red Lens to Blue Lens	J11
Change One Red Lens to Clear Lens	J10
Add 220/120 Vac Transformer (J1 Device Only)	S801
Add 277/120 Vac Transformer (J1 Device Only)	S802
Add 440/120 Vac Transformer (J1 Device Only)	S803
Add 550/120 Vac Transformer (J1 Device Only)	S804
Change One Red Pilot to Red LED	LED1
Change One Red Lens to Green LED	LED3
Change One Red Lens to Amber LED	LED6
Add Red Mushroom Head to Momentary Push Button	S805
Add Black Mushroom Head to Momentary Push Button	S806
Add Green Mushroom Head to Momentary Push Button	S807
Locking Guard for Maintained Push Button	S808

Contender™ Series Factory Sealed Control Stations and Pilot Lights

Explosionproof, Dust-Ignitionproof

UNILETS™ for use with Threaded Metal Conduit. Furnished with Internal Ground Screw.

NEC/CEC:

Class I, Division 1, Groups C, D
 Class I, Division 2, Groups B, C, D
 Class II, Division 1 and 2, Groups E, F, G
 Class III
 NEMA 3, 7CD, 9EFG

Devices

Device Description	Available in 1-G, 2-G Tandem	Available in Three Device	Suffix
One Pilot Light (Red Standard)	Y		524
Two Pilot Lights	Y		561
One Pilot Light and One Momentary Push Button	Y		473
One Pilot Light and Two Momentary Push Buttons	Y	Y	234
One Pilot Light and One Maintained Push Button	Y		701
One Pilot Light and One Dust-Cap Push Button	Y		702
One Pilot Light and One 12 Selector Switch (2 Position, 2 Circuit)	Y		703
One Pilot Light and One 35 Selector Switch (2 Position, 4 Circuit)	Y		704
One Pilot Light and One 102 Selector Switch (3 Position, 2 Circuit)	Y		705
One Pilot Light and One 345 Selector Switch (3 Position, 4 Circuit)	Y		706
One Monetary Push Button	Y		84
Two Monetary Push Buttons	Y		90
Two Side-By-Side Momentary Push Buttons	Y		95
Three Monetary Push Buttons	Y	Y	707
One Momentary Push Button and One Maintained Push Button	Y		708
One Momentary Push Button and One Dust Cap Push Button	Y		709
One Momentary Push Button and One 12 Selector Switch (2 Position, 2 Circuit)	Y		710
One Momentary Push Button and One 35 Selector Switch (2 Position, 4 Circuit)	Y		711
One Momentary Push Button and One 102 Selector Switch (3 Position, 2 Circuit)	Y		712
One Momentary Push Button and One 345 Selector Switch (3 Position, 4 Circuit)	Y		713
One Maintained Push Button (Mushroom Head - Red)	Y		714
Two Maintained Push Button	Y		715
One Maintained and One Dust Cap Push Button	Y		716
One Maintained Push Button and One 12 Selector Switch (2 Position, 2 Circuit)	Y		717
One Maintained Push Button and One 35 Selector Switch (2 Position, 4 Circuit)	Y		718
One Maintained Push Button and One 102 Selector Switch (3 Position, 2 Circuit)	Y		719
One Maintained Push Button and One 345 Selector Switch (3 Position, 4 Circuit)	Y		720
One Dust Cap Push Button	Y		721
Two Dust Cap Push Buttons	Y		722
One Dust Cap and One 12 Selector Switch (2 Position, 2 Circuit)	Y		723
One Dust Cap and One 35 Selector Switch (2 Position, 4 Circuit)	Y		724
One Dust Cap and One 102 Selector Switch (3 Position, 2 Circuit)	Y		725
One Dust Cap and One 345 Selector Switch	Y		726
One 12 Selector Switch (2 Position, 2 Circuit)	Y		271
One 35 Selector Switch (2 Position, 4 Circuit)	Y		272
One 102 Selector Switch (3 Position, 2 Circuit)	Y		273
One 345 Selector Switch (3 Position, 4 Circuit)	Y		274
120 Vac Photocell	Y		727
277 Vac Photocell	Y		728
Three Dust Cap Push Buttons		Y	729
One Momentary and Two Maintained Push Buttons		Y	730
Two Momentary and One Maintained Push Buttons	Y	Y	731
Three Maintained Push Buttons		Y	732
Three Pilot Lights		Y	476
Two Pilot Lights and One Momentary Push Button		Y	733
One Pilot Light and Two Dust Cap Push Buttons		Y	734
Two Pilot Lights and One Dust Cap Push Button		Y	735
One Pilot Light and Two Maintained Push Buttons		Y	736
Two Pilot Lights and One Maintained Push Button		Y	737

Contender™ Series Factory Sealed Control Stations and Pilot Lights

Explosionproof, Dust-Ignitionproof

UNILETS™ for use with Threaded Metal Conduit. Furnished with Internal Ground Screw.

NEC/CEC:

Class I, Division 1, Groups C, D
 Class I, Division 2, Groups B, C, D
 Class II, Division 1 and 2, Groups E, F, G
 Class III
 NEMA 3, 7CD, 9EFG

Nameplates ①

Description	Suffix
Mushroom Head Push Buttons (Maintained and Momentary)	
Start	MNPSTQ
Stop	MNPSPQ
Emergency Stop	MNPESTPQ
Blank	MNPBQ
Pilot Light Nameplates	
Blank	LNPBQ
Forward	LNPFWDQ
Jog	LNPJOGQ
Run	LNPRUNQ
Stop	LNPSQ
Start	LNPSTQ
Down	LNPDOWNQ
Fast	LNPFASTQ
Slow	LNPSLOWQ
Raise	LNPRAISEQ
Lower	LNPLOWERQ
Reset	LNPRESETQ
Off	LNPOFFQ
On	LNPONQ
Reverse	LNPREVQ
Close	LNPCLOSEQ
Open	LNPOPENQ
Up	LNPUPQ
Test	LNPTTESTQ
Low	LNPLWQ
High	LNPHIGHQ
Two Position Selection Switch Nameplates	
Forward-Reverse	SLNPFRQ
Hand—Auto ②	SLNPHAQ
On—Off	SLNPOO
Start—Stop	SLNPSS
Blank	SLNPBQ
Up—Down	SLNPUDQ
Run—Jog	SLNPRJQ
Auto—Hand	SLNPAHQ
Off—Remote	SLNPORQ
Off—On	SLNPOFON

① Custom nameplates are not available.

② Included as standard (no need to use suffix).

Description	Suffix
Three Position Selection Switch Nameplates	
Forward—Off—Reverse	SLNPFORQ
Hand—Off—Auto	SLNPHOAQ
Run—Off—Jog	SLNPROJQ
Blank	SLNPB3
Reverse—Off—Forward	SLNPROFQ
Auto—Off—Hand	SLNPAOHQ
Hand—Off—Remote	SLNPHORQ
1—Off—2	SLNP102Q
Jog—Off—Run	SLNPJORQ
Stop—Run—Start	SLNPSRSQ
Local—Off—Remote	SLNPLORQ
Momentary Push Buttons	
<i>For Rectangular Weatherboot Style Only (not for round weatherboot style)</i>	
Blank ②	SNPBQ
Forward	SNPFWDQ
Jog	SNPJOGQ
Run	SNPRUNQ
Stop ②	SNPSPQ
Start ②	SNPSTQ
Down	SNPDOWNQ
Fast	SNPFASTQ
Slow	SNPSLOWQ
Raise	SNPRAISEQ
Lower	SNPLOWERQ
Reset	SNPRESETQ
Off	SNPOFFQ
On	SNPONQ
Reverse	SNPREVQ
Close	SNPCLOSEQ
Open	SNPOPENQ
Up	SNPUPQ
Test	SNPTTESTQ
Low	SNPLWQ
High	SNPHIGHQ











Contender™ Series Factory Sealed Control Stations and Pilot Lights

Push Button Stations. Explosionproof, Dust-Ignitionproof

10 Amp, 600 Vac Max. for Heavy Duty Use Momentary Contact. Furnished with Internal Ground Screw.

NEC/CEC:

Class I, Division 1, Groups C, D
 Class I, Division 2, Groups B, C, D
 Class II, Division 1 and 2, Groups E, F, G
 Class III
 NEMA 3, 7CD, 9EFG

	Hub Size (Inches)	Description	Nameplate Marking	Catalog Number		
				Dead-End	Feed-Thru	
1-Gang ①						
	1/2	1 Circuit Universal		Start/Stop	EDS1184	EDSC1184
	3/4				EDS2184	EDSC2184
	1				EDS3184	EDSC3184
	1/2	2 Circuits Universal		Start/Stop	EDS1190	EDSC1190
	3/4				EDS2190	EDSC2190
	1				EDS3190	EDSC3190
Red Mushroom Head — Maintained Contact — Emergency Stop Nameplate						
	1/2	1 Circuit Universal		Emergency Stop	EDS1714	EDSC1714
	3/4				EDS2714	EDSC2714
	1				EDS3714	EDSC3714
2-Gang ①						
	1/2	2 Circuit Universal		Start/Stop	EDS1284	EDSC1284
	3/4				EDS2284	EDSC2284
	1				EDS3284	EDSC3284
	1/2	4 Circuits Universal		Start/Stop	EDS1290	EDSC1290
	3/4				EDS2290	EDSC2290
	1				EDS3290	EDSC3290

① Malleable Iron Body and Cover. For Aluminum Body and Cover, add suffix - SA.

















Contender™ Series Factory Sealed Control Stations and Pilot Lights

Combination Push Button and Pilot Light Stations. Explosionproof, Dust-Ignitionproof

10 Amp, 600 Vac Max. for Heavy Duty Use Momentary Contact. Furnished with Internal Ground Screw.

NEC/CEC:

Class I, Division 1, Groups C, D
 Class I, Division 2, Groups B, C, D
 Class II, Division 1 and 2, Groups E, F, G
 Class III
 NEMA 3, 7CD, 9EFG

	Hub Size (Inches)	Description ②	Nameplate Marking	Catalog Number Dead-End Feed-Thru	
1-Gang ①					
	1/2	One Pilot Light		EFS1524 EFSC1524	
	3/4			EFS2524 EFSC2524	
	1			EFS3524 EFSC3524	
	1/2	Two Pilot Lights		EFS1561 EFSC1561	
	3/4			EFS2561 EFSC2561	
	1			EFS3561 EFSC3561	
2-Gang ①					
	1/2	Two Pilot Lights		EFS1624 EFSC1624	
	3/4			EFS2624 EFSC2624	
	1			EFS3624 EFSC3624	
	1/2	Four Pilot Lights		— EFSC1661	
	3/4			EFS2661 EFSC2661	
	1			EFS3661 EFSC3661	
1-Gang ①					
	1/2	1 Circuit Universal and 1 Pilot Light		Specify	EFD1473 EFDC1473
	3/4				EFD2473 EFDC2473
	1				EFD3473 EFDC3473
	1/2	2 Circuits Universal and 1 Pilot Light		Specify	EFD1234 EFDC1234
	3/4				EFD2234 EFDC2234
	1				EFD3234 EFDC3234
2-Gang ①					
	1/2	2 Circuits Universal and 1 Pilot Light		Specify	EFD1471 EFDC1471
	3/4				EFD2471 EFDC2471
	1				EFD3471 EFDC3471
	1/2	2 Circuits Universal and 2 Pilot Lights		Specify	EFD1868 EFDC1868
	3/4				EFD2868 EFDC2868
	1				EFD3868 EFDC3868

① Malleable Iron Body and Cover. For Aluminum Body and Cover, add suffix - SA.

② Pilot Lights furnished with 6 Watt, 120 Vac 6S6 lamp and Red Jewel - for other colors, add color suffix for each pilot light: Amber - J6, Blue - J11, Clear - J10, Green - J3, Opal - J8.

Contender™ Series Factory Sealed Control Stations and Pilot Lights

Selector Switches. Explosionproof, Dust-Ignitionproof

10 Amp, 600 Vac Max. for Heavy Duty Use Momentary Contact. Furnished with Internal Ground Screw.

NEC/CEC:

Class I, Division 1, Groups C, D
 Class I, Division 2, Groups B, C, D
 Class II, Division 1 and 2, Groups E, F, G
 Class III
 NEMA 3, 7CD, 9EFG

Selector Switches	Hub Size (Inches)	Description	Left	Diagram Center	Right	Catalog Number	
						Dead-End	Feed-Thru
2 Position Selector Switches — 1-Gang ① ③ — Maintained Contact							
	1/2	2 Position, 2 Circuit		None		EDS11271	EDSC11271
	3/4					EDS21271	EDSC21271
	1					EDS31271	EDSC31271
	1/2	2 Position, 4 Circuits		None		EDS11272	EDSC11272
	3/4					EDS21272	EDSC21272
	1					EDS31272	EDSC31272

Nameplate: Hand—Auto

3 Position Selector Switches — 1-Gang ① ③ — Maintained Contact							
	1/2	3 Position, 2 Circuit				EDS11273	EDSC11273
	3/4					EDS21273	EDSC21273
	1					EDS31273	EDSC31273
	1/2	3 Position, 4 Circuits				EDS11274	EDSC11274
	3/4					EDS21274	EDSC21274
	1					EDS31274	EDSC31274

Nameplate: Hand—Off—Auto

Thread Size (In., NPSM)	Description	Left	Diagram Center	Right	Switch Catalog Number	
					Assembly Only	Assembly w/Cover

EDKB Selector Switch Operator/Switch Assembly ② ③ — Maintained Contact

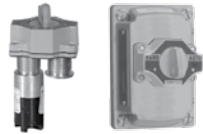

Nameplate: Hand—Auto



Nameplate: Hand—Off—Auto

2 Position							
1/2	2 Position, 2 Circuit		None		SSBA1-2Q	EDKB-12	
1/2	2 Position, 4 Circuits		None		SSBA2-2Q	EDKB-35	
3 Position							
1/2	3 Position, 2 Circuit				SSBA1-3Q	EDKB-102	
1/2	3 Position, 4 Circuit				SSBA2-3Q	EDKB-345	

EDKB Selector Switch Operator/Switch Assembly ② — Modified Operations — 3 Position

Momentary contact right position. Spring return to center. Maintained contact left position.

Note: Standard legend plate reads Hand/Off/Auto

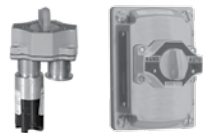

2 Circuit

1/2	3 Position, 2 Circuit				SSBAS-1-3	EDKB-102-S634
1/2	3 Position, 4 Circuits				SSBAS-2-3	EDKB-345-S634

Momentary contact left position. Spring return to center. Maintained contact right position.

Note: Standard legend plate reads Auto/Off/Hand



4 Circuit

1/2	3 Position, 2 Circuit				SSBASL-1-3	EDKB-102-S635
1/2	3 Position, 4 Circuits				SSBASL-2-3	EDKB-345-S635

Momentary contact right position. Spring return to center. Maintained contact left position.

Note: Standard legend plate reads Stop/Run/Start

1/2	3 Position, 4 Circuits				SSBASRA-2-3	EDKB-345-S636
-----	------------------------	--	--	--	-------------	---------------

① Malleable Iron Body and Cover. For Aluminum Body and Cover, add suffix - SA.

② For Aluminum Cover only, add suffix - A.

③ Supplied as standard with maintained contact selector switches. Specify catalog number from nameplate listings if other than standard nameplate is desired.

Contender™ Series Factory Sealed Control Stations and Pilot Lights



Explosionproof, Dust-Ignitionproof

10 Amp, 600 Vac Max. for Heavy Duty Use Momentary Contact. Furnished with Internal Ground Screw.

NEC/CEC:

Class I, Division 1, Groups C, D
 Class I, Division 2, Groups B, C, D
 Class II, Division 1 and 2, Groups E, F, G
 Class III
 NEMA 3, 7CD, 9EFG

Selector Switches Nameplates ①

		Two Position Nameplates		Three Position Nameplates	
 <p>Two Position</p>	Forward—Reverse	SLNP-FRQ	Forward—Off—Reverse	SLNP-FORQ	
	Hand—Auto	SLNP-HAQ	Hand—Off—Auto	SLNP-HOAQ	
	On—Off	SLNP-OO	Run—Off—Jog	SLNP-ROJQ	
	Start—Stop	SLNP-SS	Blank	SLNP-B3	
	Blank	SLNP-BQ	Reverse—Off—Forward	SLNP-ROFQ	
 <p>Three Position</p>	Up—Down	SLNP-UDQ	Auto—Off—Hand	SLNP-AOHQ	
	Run—Job	SLNP-RJQ	Hand—Off—Remote	SLNP-HORQ	
	Auto—Hand	SLNP-AHQ	1—Off—2	SLNP-102Q	
	Off—Remote	SLNP-ORQ	Jog—Off—Run	SLNP-JORQ	
	Local Remote	SLNP-LRQ	Stop—Run—Start	SLNP-SRSQ	
	Off—On	SLNP-OFON	Local—Off—Remote	SLNP-LORQ	

Selector Switch Locking Devices — Permit Locking In Any Position

Description	Catalog Number
 <p>Two or Three Positions</p>	SBL-3-Q

① Custom nameplates are not available.

Contender™ Series Factory Sealed Control Stations and Pilot Lights







Push Button. With Rocker Arm Handle. Explosionproof, Dust-Ignitionproof

10 Amp, 600 Vac Max. for Heavy Duty Use Momentary Contact. Furnished with Internal Ground Screw.





NEC/CEC:

Class I, Division 1, Groups C, D
 Class I, Division 2, Groups B, C, D
 Class II, Division 1 and 2, Groups E, F, G
 Class III
 NEMA 3, 7CD, 9EFG









Rocker Arm Handle

		Hub Size (Inches)	Description	Contact Arrangement	Nameplate Marking	Catalog Number ①	
						Dead-End	Feed-Thru
1-Gang — Malleable Iron Body and Cover ②							
		1/2				EDS1596	EDSC1596
		3/4	1 Circuit Universal		Specify	EDS2596	EDSC2596
		1				EDS3596	EDSC3596
2-Gang — Malleable Iron Body and Cover ②							
		1/2				—	EDSC1696
		3/4	2 Circuits Universal		Specify	EDS2696	EDSC2696
		1				EDS3696	EDSC3696
		1/2				—	EDSC1294
		3/4	4 Circuits Universal		Specify	EDS2294	EDSC2294
		1				EDS3294	EDSC3294

Single Push Button

		Hub Size (Inches)	Description	Contact Arrangement	Catalog Number ①	
					Dead-End	Feed-Thru
1-Gang						
		1/2	2 Circuits Universal		EDS1192	EDSC1192
		3/4	Momentary		EDS2192	EDSC2192
		1			EDS3192	EDSC3192
Nameplate: Start/Stop Momentary	Nameplate: Emergency Stop Maintained Mushroom Head	1/2	2 Circuits Universal Red Maintained		EDS1192UM1	EDSC1192UM1
		3/4			EDS2192UM1	EDSC2192UM1
		1			EDS3192UM1	EDSC3192UM1

Cover Assemblies ②

		Description	Contact Arrangement	Nameplate Marking	Catalog Number Cover With Device
	EDKB-RU2 EDKB-U2L EDKB-DPB	1 Circuit Universal		Specify	EDKB-RU1
		2 Circuits Universal		Specify	EDKB-RU2
		1 Circuit Universal		Specify	EDKB-U1L
		1 Circuit Universal		Specify	EDKB-UM1L
		2 Circuits Universal		Specify	EDKB-U2L
		2 Circuit Universal		Specify	EDKB-DPB
		2 Circuits Universal (Maintained)		Specify	EDKB-DPBM

① Malleable Iron Body and Cover. For Aluminum Body and Cover, add suffix - SA.

② For Aluminum Cover only, add suffix - A.











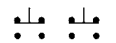

Contender™ Series Factory Sealed Control Stations and Pilot Lights

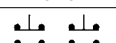
For Contender™ Bodies

NEC/CEC:

Class I, Division 1, Groups C, D
 Class I, Division 2, Groups B, C, D
 Class II, Division 1 and 2, Groups E, F, G
 Class III

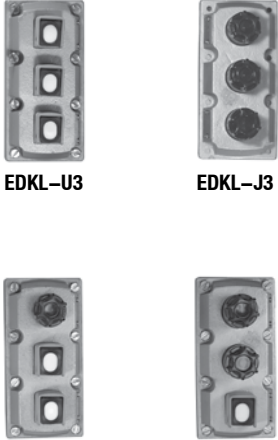
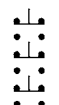
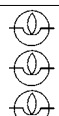
Covers

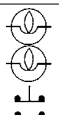
		Description	Contact Arrangement	Nameplate Marking	Catalog Number ①
		Complete with Push Button – Factory Sealed – Momentary Contact <i>For use on standard EDS bodies (furnished with 4 stainless steel captive bolts)</i>			
EDKB-U1	EDKB-U2	1 Circuit Universal		Start/Stop	EDKB-U1
		2 Circuit Universal		Start/Stop	EDKB-U2
		Complete with Mushroom Head Push Button – Factory Sealed – Maintained Contact <i>For use on standard EDS bodies</i>			
EDKB-UM1	EDKB-UM2	1 Circuit Universal (Red)		Emergency Stop	EDKB-UM1
		2 Circuit Universal (Red)		Specify	EDKB-UM2
		Complete with Pilot Lights – Factory Sealed – Momentary Contact <i>6 Watt 120 Vac, Type 6S6 Lamp. For use on standard EDS bodies (furnished with 4 stainless steel captive bolts)</i>			
EDKB-J1U2	EDKB-J1U1	One pilot light (red jewel ②) and two universal push buttons		Specify	EDKB-J1U2
		One pilot light (red jewel ②) and one universal push button		Specify	EDKB-J1U1
EDKB-J1	EDKB_J2	One pilot light (red jewel ②) and one universal push button–dust cap		Specify	EDKB-J1DU1
		One pilot light (red jewel ②)		Specify	EDKB-J1
		Two pilot lights (red jewel ②)		Specify	EDKB-J2
		Complete with Pilot Lights and Push Buttons – Factory Sealed <i>For use on standard EDS bodies (furnished with 8 stainless steel captive bolts)</i>			
EDKL-U3	EDKL-J3	3 Circuits Universal		Start/Stop	EDKL-U3
		Three Pilot Lights (red jewels ②)			EDKL-J3
EDKL-J1U2	EDKL-J2U1	One Pilot Light (red jewel ②) and two universal circuits		Specify	EDKL-J1U2
		Two Pilot Lights (red jewels ②) and one universal circuit		Specify	EDKL-J2U1

① For Aluminum Cover only, add suffix - A.

② For other colors, add color suffix for each pilot light: Amber—JGBA, Blue—JGBB, Clear—JGBC, Green—JGBG, Opal—JGBO.

Contender™ Series Factory Sealed Control Stations and Pilot Lights







For Contender™ Bodies Only

NEC/CEC:

Class I, Division 1, Groups C, D
 Class I, Division 2, Groups B, C, D
 Class II, Division 1 and 2, Groups E, F, G
 Class III

Covers ② Only — for use on standard Contender bodies

Supplied with 4 stainless steel captive bolts ③.

		Description	Catalog Number ①
 EDSK-1J	 EDSK-2J	Push Button and Pilot Light Covers — 3/4" Tapped Openings	
		One opening: one push button or one pilot light	EDSK-1J
	 EDSKL-3PB		Two openings: two push buttons, two pilot lights, or one of each
		Three openings: three device, three push buttons or three pilot lights, or combination of push button(s) and pilot light(s)	EDSKL-3PB ③
		Push Button or Selector Switch Cover — 1/2" Tapped Openings	
		Two openings: selector switch or two push buttons (side by side)	EDSK-2SP
 EDSK-1JSS	 EDSK-B	Push Button, Pilot Light or Selector Switch Covers — 3/4" top and 1/2" Bottom Tapped Openings	
		One top and two bottom openings: one pilot light, two push buttons (side by side); one pilot light, one selector switch.	EDSK-1JSS
		Blank	EDSK-B
		Nameplate Mounting Bracket Mount bracket between cover screws and cover. Do not mount bracket between ground joint flame path between cover and backbox.	
		Bracket with blank silver/black nameplate	NPBRKT-CONT
		To order bracket with control station, add suffix -NPBRKT to end of catalog number.	
		To order engraved nameplates, add desired markings after catalog number. Maximum of 2 lines with 12 characters (including spaces) per line.	

① For Aluminum Cover only, add suffix - A.















② Must be used with Contender Series backboxes.

③ Catalog number EDSKL-3PB supplied with 8 stainless steel non-captive bolts.

Contender™ Series Factory Sealed Control Stations and Pilot Lights

Replacement Parts and Accessories

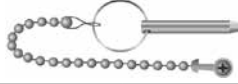
NEC/CEC:
 Class I, Division 1, Groups C, D
 Class I, Division 2, Groups B, C, D
 Class II, Division 1 and 2, Groups E, F, G
 Class III

	Description	Contact Arrangement	Catalog Number	
Push Button — Factory Sealed — Momentary Contact				
 SPBB-U1-Q	10 Amp 600 Vac Heavy Duty 1/2" thread size (NPSM). Furnished with 1/2" to 3/4" enlarger, Weather Boot, Guard, Start, Stop and Blank Nameplates. Single Push Button	Universal	 SPBB-U1-Q	
	 SPBB-U2DBL	Double Push Button	Universal	 SPBB-U2DBL
Push Button — Red Mushroom Head — Factory Sealed — Maintained Contact				
	10 Amp 600 Vac Heavy Duty 1/2" thread size (NPSM). Furnished with 1/2" to 3/4" enlarger and Emergency Stop Nameplate (guard not furnished). Single Push Button	Universal	 SMPB-U1-Q	
	Rectangular Button with Weather Boot 	Furnished with Start, Stop and Blank Nameplates.		NBN-WB
Nameplates for Rectangular Push Buttons				
 SNP-OFF-Q  SNP-ON-Q	Blank	SNP-B-Q	Off	SNP-OFF-Q
	Forward	SNP-FWD-Q	On	SNP-ON-Q
	Jog	SNP-JOG-Q	Reverse	SNP-REV-Q
	Run	SNP-RUN-Q	Open	SNP-OPEN-Q
	Stop	SNP-SP-Q	Close	SNP-CLOSE-Q
	Start	SNP-ST-Q	Up	SNP-UP-Q
	Down	SNP-DOWN-Q	Test	SNP-TEST-Q
	Fast	SNP-FAST-Q	Low	SNP-LOW-Q
	Slow	SNP-SLOW-Q	High	SNP-HIGH-Q
	Raise	SNP-RAISE-Q		
	Lower	SNP-LOWER-Q		
	Reset	SNP-RESET-Q		
	Push Button Replacement Locking Guards — Glass Reinforced Polypropylene — Gasketed			
	 Maintained Mushroom Head Switch Guard  Single Guard  Double Guard	Has hole for 1/4" hasp. Single Guard (Maintained Mushroom Head Switch)		SMPB-LG
Single Guard			NPB-LG1	
Double Guard			NPB-LG2	
Single Guard (No Lockout Holes)			NPB-LG1-LL	
Double Guard (No Lockout Holes)			NPB-LG2-LL	
Push Button Securing Rod with Chain — Stainless Steel				
	For use with Single Guard Only		NBL-SR	
Mushroom Head Button with Weather Boot for Use with Momentary Contact — Gasketed				
	Black		NMRB-BL	
	Green		NMRB-GR	
	Red		NMRB-RE	

Contender™ Series Factory Sealed Control Stations and Pilot Lights

Replacement Parts and Accessories

NEC/CEC:
 Class I, Division 1, Groups C, D
 Class I, Division 2, Groups B, C, D
 Class II, Division 1 and 2, Groups E, F, G
 Class III

Description	Catalog Number
-------------	----------------

Mushroom Head Push Button



For Use with Mushroom Head Button — Maintained Contact — Solid-Colored Nonmetallic Red

NMRBM-RE



MNPESTPQ

Nameplates For Mushroom Head Push Button For Momentary and Maintained

Start	MNPSTQ
Stop	MNPSQ
Emergency Stop	MNPESTPQ
Blank	MNPBQ

Pilot Light — Factory Sealed



Pilot Light



Chamber Only

Incandescent

Furnished with 6S6 120 Vac incandescent lamp, jewel and guard. Has 457 mm (18") long, type SFF-2 pigtail leads; +150 °C (+302 °F). Body has 3/4" straight thread (NPSM)

With Red Jewel	SPLSREB
With Green Jewel	SPLSGRB
With Amber Jewel	SPLSAMB
With Blue Jewel	SPLSBLB
With Clear Jewel	SPLSCLB
With Opal Jewel	SPLSOPB

LED

Furnished with candelabra base 120 Vac LED, jewel and guard. Has 457 mm (18") long, type SFF-2 pigtail leads; +150 °C (+302 °F). Body has 3/4" straight thread (NPSM).

With Red LED, Clear Jewel	SPLNSREB
With Green LED, Clear Jewel	SPLNSGRB
With Amber LED, Clear Jewel	SPLNSAMB

Chamber Only (Same as above, less jewel, guard and lamp) **SPLSSCB**

Pilot Light Jewel/Guard Assembly



The below catalog numbers indicate an assembly of the Pilot Light Jewels and Guards. Jewels and Guards are not available as separate items.

Amber Jewel/Guard	JGBNA
Blue Jewel/Guard	JGBNB
Clear Jewel/Guard	JGBNC
Green Jewel/Guard	JGBNG
Opal Jewel/Guard	JGBNO
Red Jewel/Guard	JGBNR

Replacement Bulbs

Clear Bulbs

Furnished with candelabra base. 6 Watt, 120 Vac Type 6S6 **EPL-B6W**

LED Replacements

Furnished with candelabra base. 120 Vac, 10 mA

Red LED	EPLLEDR
Green LED	EPLLEDG
Amber LED	EPLLEDA



EPL-B6W





EPLLEDR

Contender™ Series Factory Sealed Control Stations and Pilot Lights

Replacement Parts and Accessories

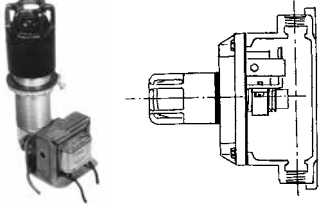
NEC/CEC:
 Class I, Division 1, Groups C, D
 Class I, Division 2, Groups B, C, D
 Class II, Division 1 and 2, Groups E, F, G
 Class III

	Primary Vac	Lamp Vac	Suffix
Transformer			
	Add Suffix as listed below. Transformer clamps directly to pilot light barrel. Only one pilot light transformer assembly per one gang body.		
	220	120	TR2
	277	120	TR3
	440	120	TR4
	550	120	TR5





	Description	Catalog Number
Nameplates for Pilot Light		
	Blank	LNPBQ
	Forward	LNPFWDQ
	Jog	LNPJOGQ
	Run	LNPRUNQ
	Stop	LNPSPQ
	Start	LNPSTQ
	Down	LNPDOWNQ
	Fast	LNPFASTQ
	Slow	LNPSLOWQ
	Raise	LNPRAISEQ
	Lower	LNPLOWERQ
	Reset	LNPRESETQ
	Off	LNPOFFQ
	On	LNPONQ
	Reverse	LNPREVQ
	Close	LNPCLOSEQ
	Open	LNPOPENQ
Up	LNPUPQ	
Test	LNPTTESTQ	
Low	LNPLLOWQ	
High	LNPHIGHQ	



CONTROLS: NEC/CEC EXPLOSIONPROOF CONTROL STATIONS AND SWITCHES

Contender™ Series Factory Sealed Control Stations and Pilot Lights Mounting Bodies. Explosionproof, Dust-Ignitionproof

NEC/CEC:
 Class I, Division 1, Groups C, D
 Class I, Division 2, Groups B, C, D
 Class II, Division 1 and 2, Groups E, F, G
 Class III

	Type	Hub Size (Inches)	Catalog Number	
			Malleable Iron	Aluminum
1-Gang				
	Dead-End	1/2	EDS171	EDS171-SA
		3/4	EDS271	EDS271-SA
		1	EDS371	EDS371-SA
	Feed-Thru	1/2	EDSC171	EDSC171-SA
		3/4	EDSC271	EDSC271-SA
		1	EDSC371	EDSC371-SA
2-Gang				
	Dead-End	1/2	EDS172	EDS172-SA
		3/4	EDS272	EDS272-SA
		1	EDS372	EDS372-SA
	Feed-Thru	1/2	EDSC172	EDSC172-SA
		3/4	EDSC272	EDSC272-SA
		1	EDSC372	EDSC372-SA
3-Device				
	Dead-End	1/2	EDS147	EDS147-SA
		3/4	EDS247	EDS247-SA
		1	EDS347	EDS347-SA
	Feed-Thru	1/2	EDSC147	EDSC147-SA
		3/4	EDSC247	EDSC247-SA
		1	EDSC347	EDSC347-SA
Tandem ①				
	Dead-End	1/2	EDS177	EDS177-SA
		3/4	EDS277	EDS277-SA
		1	EDS377	EDS377-SA
	Feed-Thru	1/2	EDSC177	EDSC177-SA
		3/4	EDSC277	EDSC277-SA
		1	EDSC377	EDSC377-SA

① For tandem bodies, external seals must be installed within 1.5 meters (5 feet) of each conduit entrance for Class I, Groups C and D.

Contender™ Series Factory Sealed Control Stations and Pilot Lights

NEC/CEC:
 Class I, Division 1, Groups C, D
 Class I, Division 2, Groups B, C, D
 Class II, Division 1 and 2, Groups E, F, G
 Class III

Mounting Body Dimensions in Millimeters (Inches)

1-Gang

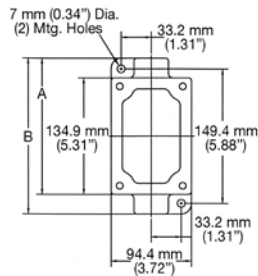

2-Gang

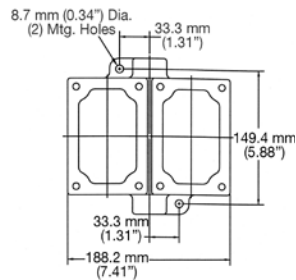

1- and 2-Gang Side View

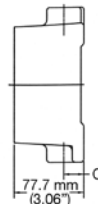

3-Device

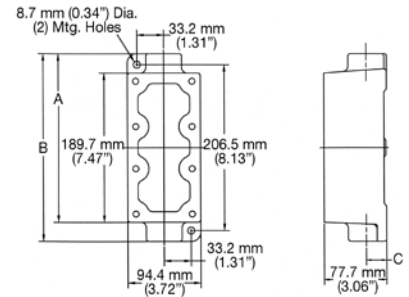

Tandem

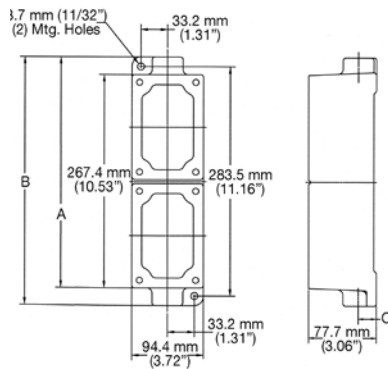

NPBRKT Nameplate Mounting Bracket

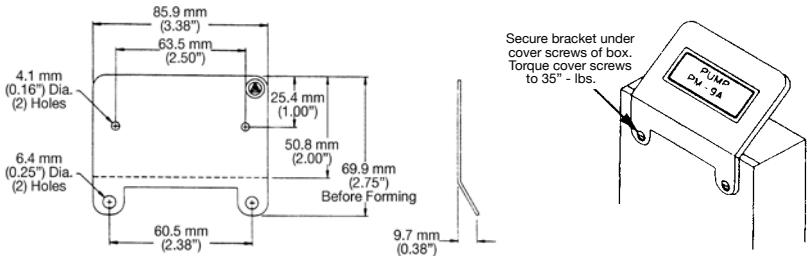

Inlet Type	Hub Size (Inches)	Dimensions in Millimeters (Inches)		
		A	B	C
1-Gang	1/2	153.9 (6.06)	173.0 (6.81)	19.1 (0.75)
	3/4	153.9 (6.06)	173.0 (6.81)	22.4 (0.88)
	1	156.7 (6.17)	179.6 (7.03)	25.4 (1.00)
2-Gang	1/2	153.9 (6.06)	173.0 (6.81)	22.4 (0.88)
	3/4	153.9 (6.06)	173.0 (6.81)	22.4 (0.88)
	1	156.7 (6.17)	179.6 (7.03)	25.4 (1.00)
3-Device	1/2	211.8 (8.34)	233.4 (9.19)	25.4 (1.00)
	3/4	211.8 (8.34)	233.4 (9.19)	25.4 (1.00)
	1	211.8 (8.34)	233.4 (9.19)	25.4 (1.00)
Tandem	1/2	287.3 (11.31)	309.1 (12.09)	22.4 (0.88)
	3/4	287.3 (11.31)	309.1 (12.09)	22.4 (0.88)
	1	290.6 (11.44)	312.7 (12.31)	25.4 (1.00)

Contender™ Series Factory Sealed Control Stations and Pilot Lights

NEC/CEC:
 Class I, Division 1, Groups C, D
 Class I, Division 2, Groups B, C, D
 Class II, Division 1 and 2, Groups E, F, G
 Class III

Dimensions in Millimeters (Inches)

1- and 2-Gang Combination Pilot Light and Push Button

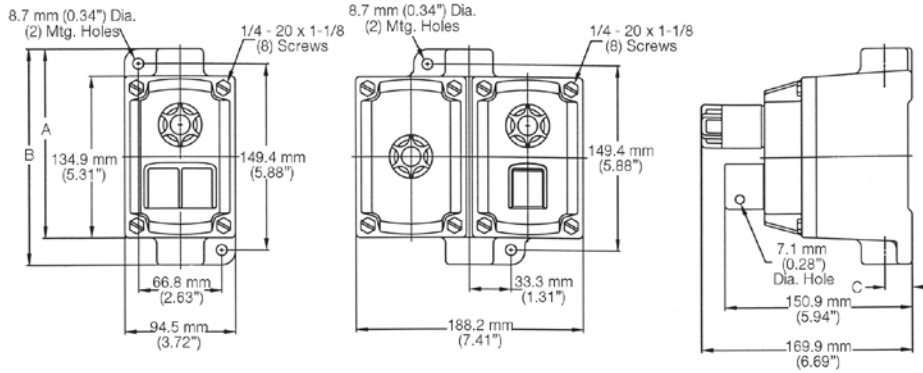

1-Gang Dust Cap Push Button and Maintained Push Button

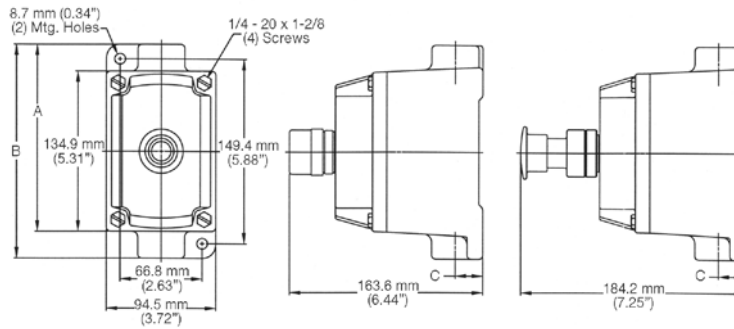

1- and 2-Gang Rocker Arm Push Button

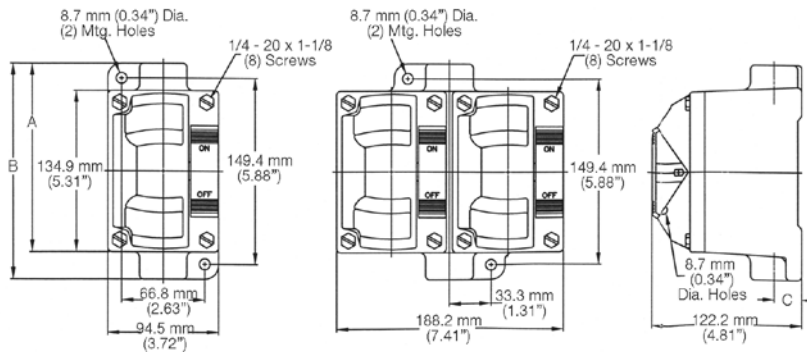

Inlet Type	Hub Size (Inches)	Dimensions in Millimeters (Inches)		
		A	B	C
1-Gang	1/2	153.9 (6.06)	173.0 (6.81)	19.1 (0.75)
	3/4	153.9 (6.06)	165.4 (6.51)	22.4 (0.88)
	1	156.7 (6.17)	179.6 (7.03)	25.4 (1.00)
2-Gang	1/2 and 3/4	153.9 (6.06)	165.4 (6.51)	22.4 (0.88)
	1	156.7 (6.17)	179.6 (7.03)	25.4 (1.00)

Appleton®

CONTROLS: NEC/CEC EXPLOSIONPROOF CONTROL STATIONS AND SWITCHES

Division 2 Contender™ Series Factory Sealed Control Stations

NEC/CEC:
 Class I, Division 2, Groups B, C, D
 Zone 2
 Class II, Division 1 and 2, Groups E, F, G
 Class III

NEC/CEC:
 NEMA 3, 3R, 4*, 4X*, 12
 IP66 ^

Applications

- For use in washdown areas and other damp, wet and highly corrosive areas.
- Push buttons and selector switches are used in conjunction with contactors or magnetic starters for remote control of motors in hazardous locations. They provide circuit control and/or selection.
- Pilot lights provide visual assurance that an electrical function is being performed at a remote or local hazardous location.

Features

- Corrosion resistant captive stainless steel screws holds cover to body.
- Silicone gasket ensures high degree of water ingress protection.
- The Labyrinth switch used in push buttons and selector switches, is rated A600 heavy pilot duty and P150.
- Temperature rating: -25 °C to +40 °C (-13 °F to -104 °F).
- Wide variety of devices and options results in a control station tailor-made to the application.
- Pilot light employs LED cluster with lifetime of 100,000 hours that can be used at either 120 Vac or 240 Vac. Optional pilot light has 12/24 Vdc ratings.
- Bodies furnished with internal ground screw and external ground lug.
- Factory sealed, no external seals required.

Standard Materials

- Backbox: malleable iron or copperfree (4/10 of 1% max.) aluminum
- Cover: die-cast aluminum
- Screws: stainless steel
- Gasket: silicone

Standard Finishes

- Malleable iron backbox: triple coat—(1) zinc electroplate, (2) chromate, and (3) epoxy powder coat
- Aluminum backbox and cover: epoxy powder coat

Options

- For aluminum mounting body, add suffix **-A**.
- UCPL pilot light. Order by suffixes if color desired is other than red, as follows:
 - Green **-JGBG**
 - Amber **-JGBA**
 - Blue **-JGBB**
- For Vdc pilot light, add suffix **-DC**. (Push buttons and selector switches have Vac and Vdc ratings as standard.)
- Standard momentary push button colors are listed next to catalog numbers for assembled control stations. Order by suffixes for desired color as follows:
 - Red **-PBRE**
 - Green **-PBGR**
 - Black **-PBBL**
 - Yellow **-PBYL**
 - Blue **-PBBU**
- Push button front operated mushroom head (maintained contact). Order by suffixes if color desired is other than red, as follows:
 - Green **-NMRBMGR**
 - Black **-NMRBMBL**

▼ Product with iron backbox is NEMA 4 rated. With aluminum backbox (add suffix **-A**), product is NEMA 4X rated.

▲ When a pilot light is selected, assembly is rated IP56.

Classified by UL for use in specific combinations with Cooper Crouse-Hinds EDS covers and bodies.



1-Gang Push Button and Pilot Light



1-Gang Selector Switch



2-Gang Push Buttons and Pilot Lights



- Push button front operated mushroom head (momentary contact). Order by suffixes if color desired is other than black, as follows:
 - Red **-NMRBRE**
 - Green **-NMRBGR**
 - Black **-NMRBBL**
- Three position selector switches with modified operation:
 - Momentary contact right position, spring return to center, maintained contact left position add suffix **-SRC**.
 - Momentary contact left position, spring return to center, maintained contact right position add suffix **-SLC**.
 - Momentary contact left and right positions, spring return to center add suffix **-SRL** (only available on -345 with ALT option).
 - Alternate contacts add suffix **-ALT**.

NEC/CEC Certifications and Compliances

- UL Standards: UL 508, UL 698, UL 1203, UL 1604, ISA 12.12.01
- CSA Standards: C22.2 No. 14-M, C22.2 No. 213-M, C22.2 No. 25, C22.2 No. 30
- cULus Listed: E10449, E81751

Appleton

CONTROLS: NEC/CEC EXPLOSIONPROOF CONTROL STATIONS AND SWITCHES

Division 2 Contender™ Series Factory Sealed Control Stations

NEC/CEC:
 Class I, Division 2, Groups B, C, D
 Zone 2
 Class II, Division 1 and 2, Groups E, F, G
 Class III

NEC/CEC:
 NEMA 3, 3R, 4*, 4X*, 12
 IP66 ^

Catalog Numbering Guide

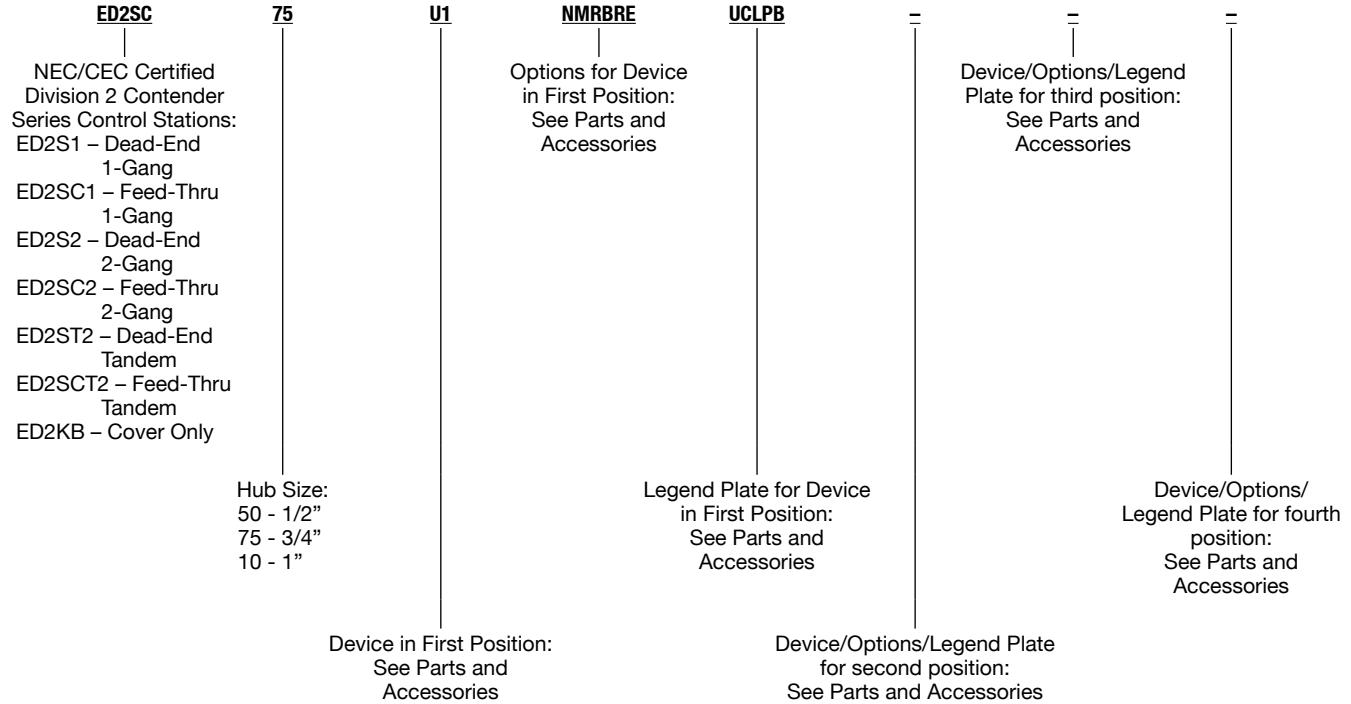

CONTROLS: NEC/CEC EXPLOSIONPROOF CONTROL STATIONS AND SWITCHES

▼ Product with iron backbox is NEMA 4 rated. With aluminum backbox (add suffix -A), product is NEMA 4X rated.
 ▲ When a pilot light is selected, assembly is rated IP56.

Division 2 Contender™ Series Factory Sealed Control Stations

NEC/CEC:
 Class I, Division 2, Groups B, C, D
 Zone 2
 Class II, Division 1 and 2, Groups E, F, G
 Class III

NEC/CEC:
 NEMA 3, 3R, 4*, 4X*, 12
 IP66 ^

Devices		Nameplate Options ①	
Device Descriptions	Suffix	Device Descriptions	Suffix
Momentary Push Button - 1NO/NC	U1	Two Position Selection Switch Nameplates	
Momentary Push Button - 2NO/NC	UD1	Forward—Reverse	UCLP-FR
Maintained Push Button - 1 NO/NC	UM1	Hand—Auto	UCLP-HA
Maintained Push Button - 2 NO/NC	UDM1	On—Off	UCLP-OO
Pilot Light	J1	Start—Stop	UCLP-SS
2-POS 2-CKT Selector Switch	12	Blank	UCLP-B
3-POS 2-CKT Selector Switch	102	Three Position Selection Switch Nameplates	
2-POS 4-CKT Selector Switch	35	Forward—Off—Reverse	UCLP-FOR
3-POS 4-CKT Selector Switch (Labyrinth Switch Only)	345	Hand—Off—Auto	UCLP-HOA
Close-up Plug	PLG	Run—Off—Jog	UCLP-ROJ
Blank Cover	B	Blank	UCLP-B
Options		Pilot Lights	
Options Descriptions	Suffix	Blank	UCPLP-B
Amber Pilot Light	JGBA	Run	UCPLP-RUN
Green Pilot Light	JGBG	On	UCPLP-ON
Blue Pilot Light	JGBB	Off	UCPLP-OFF
DC Rating for Pilot Light	DC	Close	UCPLP-CLOSE
Red Mushroom Head - Momentary Push Button	NMRBRE	Push Buttons	
Green Mushroom Head - Momentary Push Button	NMRBGR	<i>(Standard, Mushroom Head and Mushroom Head Maintained)</i>	
Black Mushroom Head - Momentary Push Button	NMRBBL	Blank	UCLP-B
Black Mushroom Head - Maintained Push Button	NMRBMBL	Off	UCLP-OFF
Green Mushroom Head - Maintained Push Button	NMRBMGR	On	UCLP-ON
Spring Return from Right - Selector Switch (3 Position Only)	SRC	Forward	UCLP-FWD
Spring Return from Left - Selector Switch (3 Position Only)	SLC	Reverse	UCLP-REV
Spring Return from Right and Left - Selector Switch (3 Pos, 4 Ckt and Alt Contacts Only)	SRL	Jog	UCLP-JOG
Alternate Contacts - Selector Switch	ALT	Run	UCLP-RUN
Red Momentary Push Button	PBRE	Start	UCLP-ST
Green Momentary Push Button	PBGR	Stop	UCLP-SP
Accessories		Up	UCLP-UP
Accessories Descriptions	Suffix	Down	UCLP-DOWN
Mushroom Head Push Button Locking Guard	UCMPBLG	Fast	UCLP-FAST
		Slow	UCLP-SLOW
		Raise	UCLP-RAISE
		Lower	UCLP-LOWER
		Open	UCLP-OPEN
		Close	UCLP-CLOSE
		Low	UCLP-LOW
		High	UCLP-HIGH
		Test	UCLP-TEST
		Rest	UCLP-RESET
		Emergency Stop	UCLP-ESTP

① Custom nameplates are available. Contact your local sales representative for details.

▼ Product with iron backbox is NEMA 4 rated. With aluminum backbox (add suffix -A), product is NEMA 4X rated.











▲ When a pilot light is selected, assembly is rated IP56.

Division 2 Contender™ Series Factory Sealed Control Stations

NEC/CEC:
Class I, Division 2, Groups B, C, D
Zone 2
Class II, Division 1 and 2, Groups E, F, G
Class III

NEC/CEC:
NEMA 3, 3R, 4*, 4X*, 12
IP66 ^

1-Gang Push Button and Pilot Lights – Momentary

	Hub Size (Inches)	Description	Diagram	Standard Legend Plate Marking and Device Color	Catalog Number	
					Dead-End	Feed-Thru
	1/2	1 Circuit Universal		Start/Green	ED2S150U1	ED2SC150U1
	3/4				ED2S175U1	ED2SC175U1
	1				ED2S110U1	ED2SC110U1
	1/2	2 Circuits Universal		Start/Green Stop/Red	ED2S150U2	ED2SC150U2
	3/4				ED2S175U2	ED2SC175U2
	1				ED2S110U2	ED2SC110U2
	1/2	1 Circuits Universal 1 Pilot Light		Start/Green Blank/Red	ED2S150J1U1	ED2SC150J1U1
	3/4				ED2S175J1U1	ED2SC175J1U1
	1				ED2S110J1U1	ED2SC110J1U1
	1/2	1 Pilot Light		Blank/Red	ED2S150J1	ED2SC150J1
	3/4				ED2S175J1	ED2SC175J1
	1				ED2S110J1	ED2SC110J1
	1/2	2 Pilot Lights		Blank/Red	ED2S150J2	ED2SC150J2
	3/4				ED2S175J2	ED2SC175J2
	1				ED2S110J2	ED2SC110J2

▼ Product with iron backbox is NEMA 4 rated. With aluminum backbox (add suffix -A), product is NEMA 4X rated.





▲ When a pilot light is selected, assembly is rated IP56.

Division 2 Contender™ Series Factory Sealed Control Stations





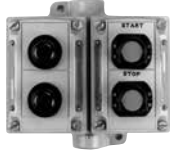









NEC/CEC:
 Class I, Division 2, Groups B, C, D
 Zone 2
 Class II, Division 1 and 2, Groups E, F, G
 Class III

NEC/CEC:
 NEMA 3, 3R, 4*, 4X*, 12
 IP66 ^

2-Gang Push Buttons and Pilot Lights – Momentary

	Hub Size (Inches)	Description	Diagram	Standard Legend Plate Marking and Device Color	Catalog Number	
					Dead-End	Feed-Thru
	1/2	2 Circuits Universal and 1 Pilot Light		Push Buttons: Start/Green Stop/Red Pilot Light: Blank/Red	ED2S250J1U2	ED2SC250J1U2
	3/4				ED2S275J1U2	ED2SC275J1U2
	1				ED2S210J1U2	ED2SC210J1U2
	1/2	2 Circuits Universal and 2 Pilot Lights		Push Buttons: Start/Green Stop/Red Pilot Light: Blank/Red	ED2S250J2U2	ED2SC250J2U2
	3/4				ED2S275J2U2	ED2SC275J2U2
	1				ED2S210J2U2	ED2SC210J2U2

1-Gang Selector Switches











	Hub Size (Inches)	Description	Diagram			Standard Legend Plate Marking and Device Color	Catalog Number	
			Left	Center	Right		Dead-End	Feed-Thru
	1/2	2 Position 2 Circuit		None		On/Off	ED2S15012	ED2SC15012
	3/4		ED2S17512	ED2SC17512				
	1		ED2S11012	ED2SC11012				
	1/2	2 Position 4 Circuit		None		On/Off	ED2S15035	ED2SC15035
	3/4		ED2S17535	ED2SC17535				
	1		ED2S11035	ED2SC11035				
	1/2	3 Position 2 Circuit				Hand/Off/Auto	ED2S150102	ED2SC150102
	3/4		ED2S175102	ED2SC175102				
	1		ED2S110102	ED2SC110102				
	1/2	3 Position 4 Circuit				Hand/Off/Auto	ED2S150345	ED2SC150345
	3/4		ED2S175345	ED2SC175345				
	1		ED2S110345	ED2SC110345				















▼ Product with iron backbox is NEMA 4 rated. With aluminum backbox (add suffix -A), product is NEMA 4X rated.
 ▲ When a pilot light is selected, assembly is rated IP56.

Division 2 Contender™ Series Factory Sealed Control Stations

NEC/CEC:
 Class I, Division 2, Groups B, C, D
 Zone 2
 Class II, Division 1 and 2, Groups E, F, G
 Class III

Cover Assemblies

	Description	Diagram	Standard Legend Plate Marking and Device Color	Catalog Number
	1 Circuit Universal		Start/Green	ED2KBU1
	2 Circuit Universal		Start/Green Stop/Red	ED2KBU2
	1 Pilot Light		Blank/Red	ED2KBJ1
	2 Pilot Light		Blank/Red	ED2KBJ2
	1 Pilot Light and 1 Circuit Universal		Push button: Start/Green Pilot Light: Blank/Red	ED2KBJ1U1

	Description	Left	Diagram Center	Right	Standard Legend Plate Marking and Device Color	Catalog Number
	2 Positions 2 Circuits		None		On/Off Selector Switch	ED2KB12
	2 Positions 4 Circuits		None		On/Off Selector Switch	ED2KB35
	3 Positions 2 Circuits				Hand/Off/Auto Selector Switch	ED2KB102
	3 Positions 4 Circuits				Hand/Off/Auto Selector Switch	ED2KB345





Appleton

CONTROLS: NEC/CEC EXPLOSIONPROOF CONTROL STATIONS AND SWITCHES

Division 2 Contender™ Series Factory Sealed Control Stations

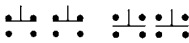
NEC/CEC:
 Class I, Division 2, Groups B, C, D
 Zone 2
 Class II, Division 1 and 2, Groups E, F, G
 Class III

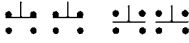
Selector Switch

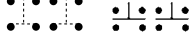
	Description	Diagram	Catalog Number
 2 Position, 2 Circuit	2 Position, 2 Circuit, Maintain Contact Left Position, Maintain Contact Right Position On/Off nameplate		UCSS12
	2 Position, 4 Circuit, Maintain Contact Left Position, Maintain Contact Right Position On/Off nameplate		UCSS22
 2 Position, 4 Circuit	3 Position, 2 Circuit, Maintain Contact Left Position, Maintain Contact Right Position Hand-Off-Auto nameplate		UCSS13
	3 Position, 2 Circuit, Momentary Contact Right Position, Spring Return to Center, Maintain Contact Left Position		UCSS13SRC
 2 Position, 4 Circuit	3 Position, 2 Circuit, Momentary Contact Left Position, Spring Return to Center, Maintain Contact Right Position		UCSS13SLC
	3 Position, 4 Circuit Maintain Contact Left Position Maintain Contact Right Position		UCSS23
 2 Position, 4 Circuit	3 Position, 4 Circuit, Alternate Contacts Maintain Contact Left Position Maintain Contact Right Position		UCSSA23
	3 Position, 4 Circuit Momentary Contact Right Position Spring Return to Center Maintain Contact Left Position		UCSS23SRC
 3 Position, 2 Circuit	3 Position, 4 Circuit, Alternate Contacts, Momentary Contact Right Position, Spring Return to Center, Maintain Contact Left Position		UCSSA23SRC
	3 Position, 4 Circuit, Momentary Contact Left Position, Spring Return to Center, Maintain Contact Right Position		UCSS23SLC
 3 Position, 4 Circuit	3 Position, 4 Circuit, Alternate Contacts, Momentary Contact Left Position; Spring Return to Center, Maintain Contact Right Position		UCSSA23SLC
	3 Position, 4 Circuit, Alternate Contacts, Momentary Contact Left Position, Spring Return to Center, Momentary Contact Right Position		UCSSA23SRL

Appleton

CONTROLS: NEC/CEC EXPLOSIONPROOF CONTROL STATIONS AND SWITCHES

Division 2 Contender™ Series Factory Sealed Control Stations

NEC/CEC:
 Class I, Division 2, Groups B, C, D
 Zone 2
 Class II, Division 1 and 2, Groups E, F, G
 Class III





	Description	Catalog Number
Assembled Push Buttons – Supplied with blank nameplates		
	Momentary Black - One Labyrinth Switch	UCPB1BL
	Momentary Black - Two Labyrinth Switches	UCPB2BL
	Momentary Red - One Labyrinth Switch	UCPB1RE
	Momentary Red - Two Labyrinth Switches	UCPB2RE
	Momentary Green - One Labyrinth Switch	UCPB1GR
	Momentary Green - Two Labyrinth Switches	UCPB2GR
	Momentary Yellow - One Labyrinth Switch	UCPB1YL
	Momentary Yellow - Two Labyrinth Switches	UCPB2YL
	Momentary Blue - One Labyrinth Switch	UCPB1BU
	Momentary Blue - Two Labyrinth Switches	UCPB2BU
	Maintained Black - One Labyrinth Switch	UCPBM1BL
	Maintained Black - Two Labyrinth Switches	UCPBM2BL
	Maintained Red - One Labyrinth Switch	UCPBM1RE
	Maintained Red - Two Labyrinth Switches	UCPBM2RE
	Maintained Green - One Labyrinth Switch	UCPBM1GR
	Maintained Green - Two Labyrinth Switches	UCPBM2GR
Pilot Lights – Supplied with blank nameplates		
	Red LED Pilot Light (120/240 Vac)	UCPLR
	Green LED Pilot Light (120/240 Vac)	UCPLG
	Amber LED Pilot Light (120/240 Vac)	UCPLA
	Blue LED Pilot light (120/240 Vac)	UCPLB
	Red LED Pilot Light (12/24 Vdc)	UCPLRDC
	Green LED Pilot Light (12/24 Vdc)	UCPLGDC
	Amber LED Pilot Light (12/24 Vdc)	UCPLADC
	Blue LED Pilot Light (12/24 Vdc)	UCPLBDC
Sub Components For Push Buttons		
	Green Momentary Mushroom Head	UCMHGR
	Red Momentary Mushroom Head	UCMHRE
	Black Momentary Mushroom Head	UCMHBL
	Green Maintained Mushroom Head	UCMHMGR
	Red Maintained Mushroom Head	UCMHMRE
	Black Maintained Mushroom Head	UCMHMBL
	Green Cap for Momentary Push Button	UCPBCAPGR
	Red Cap for Momentary Push Button	UCPBCAPRE
	Black Cap for Momentary Push Button	UCPBCAPBL
	Yellow Cap for Momentary Push Button	UCPBCAPYL
	Blue Cap for Momentary Push Button	UCPBCAPBU

Appleton®

CONTROLS: NEC/CEC EXPLOSIONPROOF CONTROL STATIONS AND SWITCHES

Division 2 Contender™ Series Factory Sealed Control Stations

NEC/CEC:
 Class I, Division 2, Groups B, C, D
 Zone 2
 Class II, Division 1 and 2, Groups E, F, G
 Class III

	Description	Catalog Number
Actuators Without Contact Blocks for Selector Switches — Supplied with blank nameplates		
	2 Position Selector Switch	UCSS2
	3 Position Selector Switch	UCSS3
	3 Position Selector Switch - Spring Return From Right	UCSS3SRC
	3 Position Selector Switch - Spring Return From Left	UCSS3SLC
	3 Position Selector Switch - Alternate Contacts	UCSSA3
	3 Position Selector Switch - Alternate Contacts Spring - Return From Right	UCSSA3SRC
	3 Position Selector Switch - Alternate Contacts Spring - Return From Left	UCSSA3SLC
	3 Position Selector Switch - Alternate Contacts Spring - Return From Right and Left	UCSSA3SRL
Actuators Without Contact Blocks For Push Buttons — Supplied with blank nameplates		
	Momentary Actuator Push Button - Black	UCPBBL
	Momentary Actuator Push Button - Red	UCPBRE
	Momentary Actuator Push Button - Green	UCPBGR
	Momentary Actuator Push Button - Blue	UCPBBLU
	Momentary Actuator Push Button - Yellow	UCPBYL
	Maintained Mushroom Head for Push Button - Black	UCPMBBL
	Maintained Mushroom Head for Push Button - Red	UCPBMRE
	Maintained Mushroom Head for Push Button - Green	UCPBMGR
	Momentary Mushroom Head for Push Button - Black	UCPBMYBL
	Momentary Mushroom Head for Push Button - Red	UCPBMYRE
	Momentary Mushroom Head for Push Button - Green	UCPBMYGR
	Contact Block	
	Labyrinth Switch	LAB1
	The standard labyrinth switch is available with universal contacts (1 NO/1 NC). The switch is a UL recognized component and is rated for A600 heavy pilot duty (AC) and P150 (DC) as defined by UL 508. Hazardous location ratings include Class I, Division 2, Groups B, C, D.	



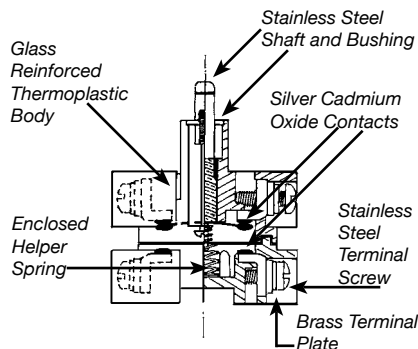



Rating Designation



	A600	P150
	10 Amp Continuous @ 600 Vac	5 Amp Continuous @ 125 Vdc
	7200VA (Make) 720VA (Break)	138VA @ 300 Vdc 1.1 Amp @ 125 Vdc
	Make Amp	Break Amp
120 Vac	60	6
240 Vac	30	3
480 Vac	15	1.5
600 Vac	12	2

Division 2 Contender™ Series Factory Sealed Control Stations

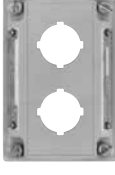
NEC/CEC:
 Class I, Division 2, Groups B, C, D
 Zone 2
 Class II, Division 1 and 2, Groups E, F, G
 Class III

	Description	Catalog Number
Accessories		
	Close-Up Plug	UCPLUG
	Momentary Push Button Locking Guard (included as standard with push button)	UCLG1 ①
	Maintained Mushroom Head Push Button Locking Guard (Locks Button in Down Position)	UCMPBLG ①
Covers		
	Single Device	ED2SK1
	Two Device	ED2SK2
	Blank Cover	ED2SKB ①

① Requires a padlock with 6 mm (0.25") hasp.

Division 2 Contender™ Series Factory Sealed Control Stations

NEC/CEC:
 Class I, Division 2, Groups B, C, D
 Zone 2
 Class II, Division 1 and 2, Groups E, F, G
 Class III

Legend Plates

Gray With Black Letters	Green With White Letters	Red With White Letters
For Push button and Selector Switches	For Push button and Selector Switches	For Push button and Selector Switches
UCLP - ____ (Add Desired Marking) ①	UCLPG - ____ (Add Desired Marking) ①	UCPLR - ____ (Add Desired Marking) ①
For Pilot Lights	For Pilot Lights	For Pilot Lights
UCPLP - ____ (Add Desired Marking) ①	UCPLPG - ____ (Add Desired Marking) ①	UCPLPR - ____ (Add Desired Marking) ①

Standard Legend Plates



Description	Catalog Number	Description	Catalog Number
Two Position Selector Switch			
Forward—Reverse	UCLP-FR	Run—Jog	UCLP-RG
Hand—Auto	UCLP-HA	Off—Remote	UCLP-OR
On—Off	UCLP-OO	Auto—Hand	UCLP-AH
Start—Stop	UCLP-SS	Auto—Off	UCLP-AO
Local—Remote	UCLP-LR	Blank	UCLP-B
Up—Down	UCLP-UD		
Three Position Selector Switch			
Reverse—Off—Forward	UCLP-ROF	Hand—Off—Remote	UCLP-HOR
Forward—Off—Reverse	UCLP-FOR	Local—Off—Remote	UCLP-LOR
Hand—Off—Auto	UCLP-HOA	Remote—Off—Local	UCLP-ROL
Auto—Off—Hand	UCLP-AOH	Auto—Off—Manual	UCLP-AOM
Jog—Off—Run	UCLP-JOR	Open—Off—Close	UCLP-OOC
Run—Off—Jog	UCLP-ROJ	Test—Off—On	UCLP-TOO
Off—Run—Start	UCLP-ORS	1—Off—2	UCLP-1O2
Stop—Run—Start	UCLP-SRS	Blank	UCLP-B
Push Buttons (Standard, Momentary and Maintained Mushroom Heads)			
Blank	UCLP-B	Fast	UCLP-FAST
Off	UCLP-OFF	Slow	UCLP-SLOW
On	UCLP-ON	Raise	UCLP-RAISE
Forward	UCLP-FWD	Lower	UCLP-LOWER
Reverse	UCLP-REV	Open	UCLP-OPEN
Jog	UCLP-JOG	Close	UCLP-CLOSE
Run	UCLP-RUN	Low	UCLP-LOW
Start	UCLP-ST	High	UCLP-HIGH
Stop	UCLP-SP	Test	UCLP-TEST
Up	UCLP-UP	Reset	UCLP-RESET
Down	UCLP-DOWN		
Pilot Lights			
Blank	UCPLP-B	On	UCPLP-ON
Run	UCPLP-RUN	Off	UCPLP-OFF

① Standard legend plate markings listed above.

Division 2 Contender™ Series Factory Sealed Control Stations

Bodies Furnished with Internal Ground Screw.

NEC:
 Class I, Division 1, Groups C, D
 Class I, Division 2, Group B, C, D
 Class II, Division 1 and 2, Groups E, F, G
 Class III

	Type	Hub Size (Inches)	Catalog Number	
			Malleable Iron	Aluminum
1-Gang				
	Dead-End	1/2	EDS171	EDS171-SA
		3/4	EDS271	EDS271-SA
		1	EDS371	EDS371-SA
	Feed-Thru	1/2	EDSC171	EDSC171-SA
		3/4	EDSC271	EDSC271-SA
		1	EDSC371	EDSC371-SA
2-Gang				
	Dead-End	1/2	EDS172	EDS172-SA
		3/4	EDS272	EDS272-SA
		1	EDS372	EDS372-SA
	Feed-Thru	1/2	EDSC172	EDSC172-SA
		3/4	EDSC272	EDSC272-SA
		1	EDSC372	EDSC372-SA
Tandem ①				
	Dead-End	1/2	EDS177	EDS177-SA
		3/4	EDS277	EDS277-SA
		1	EDS377	EDS377-SA
	Feed-Thru	1/2	EDSC177	EDSC177-SA
		3/4	EDSC277	EDSC277-SA
		1	EDSC377	EDSC377-SA

① For tandem bodies, external seals must be installed within 1.5 meters (5 feet) of each conduit entrance for Class I, Groups C and D.
 ▼ Product with iron backbox is NEMA 4 rated. With aluminum backbox (add suffix -A), product is NEMA 4X rated.
 ▲ When a pilot light is selected, assembly is rated IP56.

Division 2 Contender™ Series Factory Sealed Control Stations

NEC/CEC:
Class I, Division 2, Groups B, C, D
Zone 2
Class II, Division 1 and 2, Groups E, F, G
Class III

Dimensions in Millimeters (Inches)

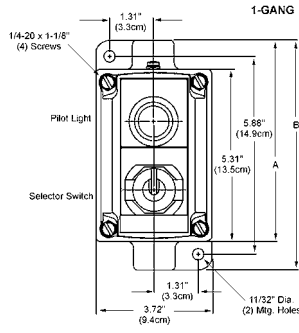

1-Gang Front View

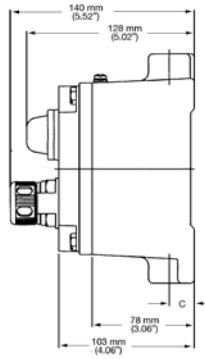

1- and 2-Gang Side View

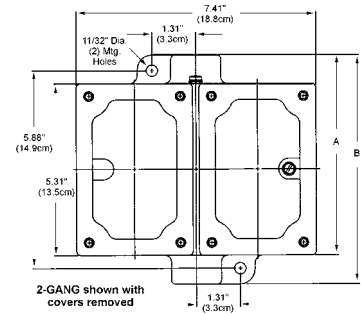

2-Gang Front View

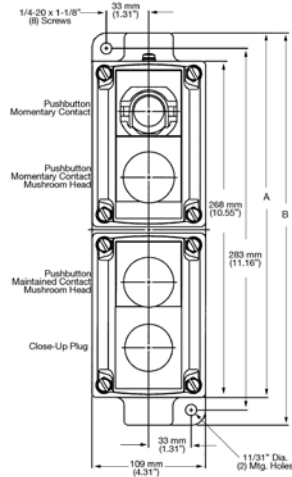

Tandem Front View

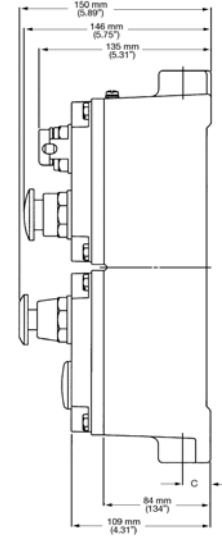

Tandem Side View

Inlet Type	Hub Size (Inches)	Dimensions in Millimeters (Inches)		
		A	B	C
1-Gang	1/2	153.9 (6.06)	173.0 (6.81)	19.1 (0.75)
	3/4	153.9 (6.06)	173.0 (6.81)	22.4 (0.88)
	1	156.7 (6.17)	179.6 (7.03)	25.4 (1.00)
2-Gang	1/2 and 3/4	153.9 (6.06)	173.0 (6.81)	22.4 (0.88)
	1	156.7 (6.17)	179.6 (7.03)	25.4 (1.00)
Tandem	1/2 and 3/4	287.3 (11.31)	309.1 (12.09)	22.4 (0.88)
	1	290.6 (11.44)	312.7 (12.31)	25.4 (1.00)

UniCode™ Series Factory Sealed Control Stations and Pilot Lights

NEC/CEC:
Class I, Division 2, Groups B, C, D
Class I, Zone 2, Group IIC
Class II, Groups E, F, G
Class III

NEC/CEC:
Type 3, 3R, 4, 4X
IP66

Applications

- For use in hazardous areas as defined by the National Electrical Code (NEC), and Canadian Electrical Code (CEC).
- For use in washdown areas and other damp, wet and highly corrosive areas.
- Push buttons and selector switches are used in conjunction with contactors or magnetic starters for remote control of motors in hazardous locations. They provide circuit control and/or selection.
- Pilot lights provide visual assurance that an electrical function is being performed at a remote or local hazardous location.
- For installation in:
 - Chemical and petrochemical plants
 - Refineries
 - Pulp and paper processing plants
 - Other industrial applications

Features

- Corrosion resistant captive stainless steel screws hold covers to body.
- Available with two types of explosion proof protection. The Labyrinth switch is rated A600 heavy pilot duty and P150.
- Durable materials and construction exceeds UL environmental requirements including impact.
- Enclosures constructed of specially formulated fiberglass reinforced thermoset polyester with low surface resistivity that will not hold a static charge.
- Wide variety of devices and options results in a control station tailor made to the application.
- Pilot light employs LED cluster with lifetime of 100,000 hours that can be used at either 120 Vac or 240 Vac.
- Optional pilot light has 12 Vac/24 Vdc ratings.
- Both the standard hub and union hub provide ground path continuity in feed-thru applications.
- Factory sealed — no external seals required.
- Optional union hub allows temporary rotation of hub for ease of installation.

Standard Materials

- Body and cover: fiberglass reinforced thermoset polyester
- Standard hub, union hub and ground plate: stainless steel and Noryl®
- UCPB push button and UCSS selector switch operators: polyester, Valox™, and stainless steel
- Screws: stainless steel
- Pilot light: glass jewel

Options

- UCPL Pilot Light is red as standard; if green is desired, add suffix **-JGBG**; if amber is desired, add suffix **-JGBA**; if blue is desired, add suffix **-JGBB**.
- Stainless steel mounting feet available, add suffix **-SSMTG**.
- For Vdc pilot light, add suffix **-DC** to catalog number (push buttons and selector switches have Vac and Vdc ratings as standard).
- Push button front operated mushroom head (maintained contact): standard color is red. Also available in green, add suffix **-NMRBMGR**; and black, add suffix **-NMRBMBL**.
- Push button front operated mushroom head (momentary contact): standard color is black. Also available in red, add suffix **-NMRBRE**; in green, add suffix **-NMRBGR**; or black, add suffix **-NMRBBL**.

► Noryl is a registered trademark of General Electric Corp.



1 Device

2 Device



3 Device

4 Device

- Standard momentary push button colors are listed next to catalog numbers for assembled control stations. To change color to red, add suffix **-PBRE**; to change color to green, add suffix **-PBGR**; to change color to black, add suffix **-PBBL**; to change color to yellow, add suffix to **-PBYL**; to change color to blue, add suffix **-PBBU**.
- Three position selector switches with modified operation: Momentary contact right position, spring return to center, maintained contact left position add suffix **-SRC**; Momentary contact left position, spring return to center, maintained contact right position add suffix **-SLC**; Momentary contact left and right positions, spring return to center add suffix **-SRL** (only available on **-345** with **ALT** option); Alternate contacts add suffix **-ALT**.
- For complete list of options, see Options and Accessories.

NEC/CEC Certifications and Compliances

- UL Standards: UL 508, UL 698, UL 1604, ISA 12.12.01
- CSA Standards: C22.2 No. 25, C22.2 No. 213-M, C22.2 No. 14-M
- cULus Listed: E10449

UniCode™ Series Factory Sealed Control Stations and Pilot Lights

NEC/CEC:
Class I, Division 2, Groups B, C, D
Class I, Zone 2, Group IIC
Class II, Groups E, F, G
Class III

NEC/CEC:
Type 3, 3R, 4, 4X
IP66

Illustrated Features

Labyrinth Switch Details

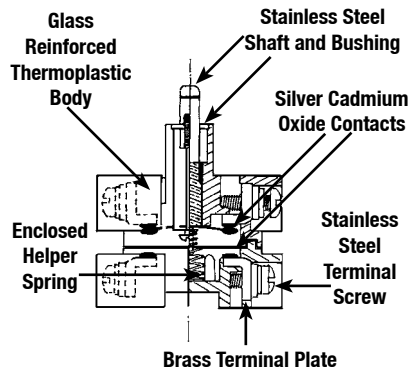

The standard Labyrinth switch is available with universal contacts (1 NO/1 NC). The switch is a UL recognized component and is rated for A600 heavy pilot duty (AC) and P150 (DC) as defined by UL 508. Hazardous Location ratings include Class I, Division 2, Groups B, C, D.

A600 Rating Designation

10 Amp Continuous @ 600 Vac – 7200VA (Make) 720VA (Break)

	Make Amp	Break Amp
120 Vac	60	6
240 Vac	30	3
480 Vac	15	1.5
600 Vac	12	2

P150 Rating Designation

5 Amp Continuous @ 125 Vdc

138VA @ 300 Vdc

1.1 Amp @ 125 Vdc

Hub Details

Two different hubs are available on the UniCode line. Both Versions exceed the UL conduit torque requirements. However, different features are offered by each:

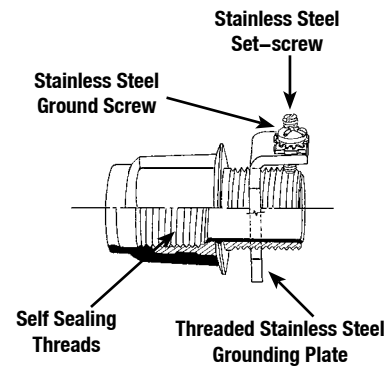

Standard hubs are of stainless steel and Noryl® construction. Stainless steel ground plate is threaded and includes stainless steel set-screw and ground screw.

Stainless Steel/Noryl® Hub

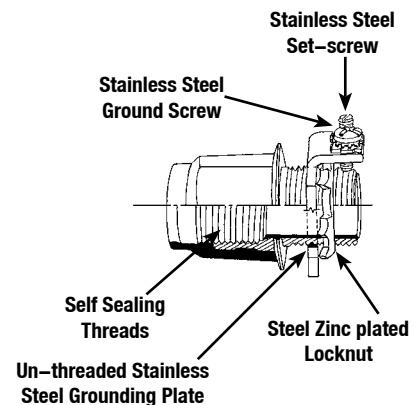

Optional union hubs are of stainless steel and Noryl® construction. Ground plate is stainless steel and not threaded. Hub spins freely for ease of installation; then steel locknut is tightened to secure hub.

► Noryl is a registered trademark of General Electric Corp.

UniCode™ Series Factory Sealed Control Stations and Pilot Lights

NEC/CEC:
 Class I, Division 2, Groups B, C, D
 Class I, Zone 2, Group IIC
 Class II, Groups E, F, G
 Class III

NEC/CEC:
 Type 3, 3R, 4, 4X
 IP66

Catalog Numbering Guide

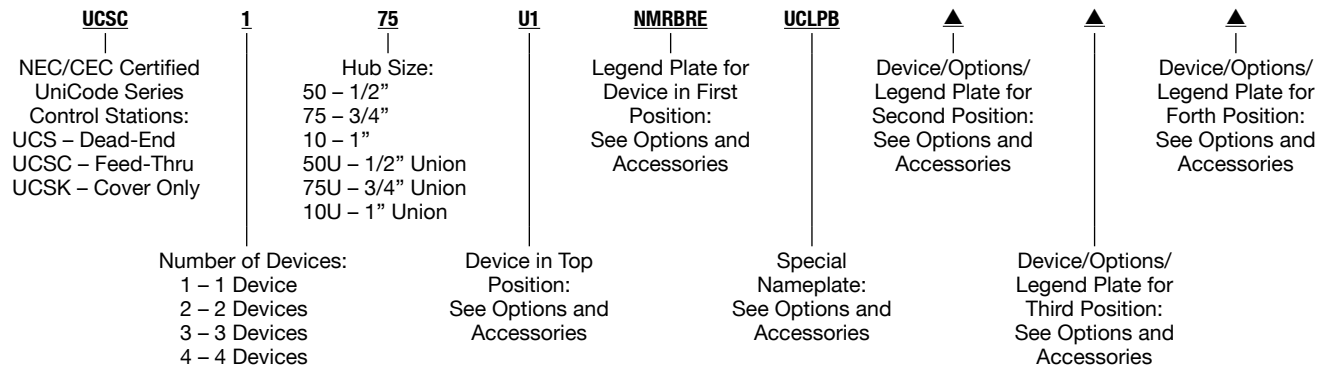

Device Descriptions	Device Code
Momentary Push Button - 1NO/NC	U1 ①
Momentary Push Button - 2NO/NC	UD1
Maintained Push Button - 1NO/NC	UM1
Maintained Push Button - 2NO/NC	UDM1
Pilot Light	J1 ②
2-POS 2-CKT Selector Switch	12
3-POS 2-CKT Selector Switch	102
2-POS 4-CKT Selector Switch	35
3-POS 4-CKT Selector Switch (Labyrinth Switch Only)	345
Close-up Plug	PLG
Options Descriptions	Device Code
Amber Pilot Light	JGBA
Green Pilot Light	JGBG
Blue Pilot Light	JGBB
DC Rating for Pilot Light	DC
Red Mushroom Head - Momentary Push Button	NMRBRE
Green Mushroom Head - Momentary Push Button	NMRBGR
Black Mushroom Head - Momentary Push Button	NMRBBL
Black Mushroom Head - Maintained Push Button	NMRBMBL
Green Mushroom Head - Maintained Push Button	NMRBMGR
Spring Return from Right - Selector Switch (3 Position Only)	SRC
Spring Return from Left - Selector Switch (3 Position Only)	SLC
Spring Return from Right and Left - Selector Switch (3 Pos, 4 Ckt and Alt Contacts Only)	SRL
Alternate Contacts - Selector Switch	ALT
Red Momentary Push Button	PBRE
Green Momentary Push Button	PBGR
Accessories Descriptions	Accessory Code
Stainless Steel Mounting Feet	SSMTG
Mushroom Head Push Button Locking Guard	UCMPBLG

① Momentary push buttons are black. Add —**PBRE** for red or —**PBGR** for green.
 ② Pilot lights are red. Add —**JGBA** for amber, —**JGBG** for green or —**JGBB** for blue.

UniCode™ Series Factory Sealed Control Stations and Pilot Lights

NEC/CEC:
Class I, Division 2, Groups B, C, D
Class I, Zone 2, Group IIC
Class II, Groups E, F, G
Class III

NEC/CEC:
Type 3, 3R, 4, 4X
IP66

Hub Size (Inches)	Description	Diagram	Standard Legend Plate Marking and Device Color	Catalog Number	
				Dead-End	Feed-Thru

Push Buttons



Momentary Contact

1/2				UCS150U1	UCSC150U1
3/4	1 Circuit Universal		Start/Green	UCS175U1	UCSC175U1
1				UCS110U1	UCSC110U1
1/2				UCS250U2	UCSC250U2
3/4	2 Circuits Universal		Start/Green Stop/Red	UCS275U2	UCSC275U2
1				UCS210U2	UCSC210U2
1/2				UCS350U3	UCSC350U3
3/4	3 Circuits Universal		Blank/Black	UCS375U3	UCSC375U3
1				UCS310U3	UCSC310U3
1/2				UCS450U4	UCSC450U4
3/4	4 Circuits Universal		Blank/Black	UCS475U4	UCSC475U4
1				UCS410U4	UCSC410U4

Maintained Contact

1/2				UCS150UM1	UCSC150UM1
3/4	1 Circuit Universal		Emergency Stop/Red	UCS175UM1	UCSC175UM1
1				UCS110UM1	UCSC110UM1

Pilot Lights



Pilot Light has terminals for 120 or 240 Vac — Uses 8 cluster LED

1/2				UCS150J1	UCSC150J1
3/4	1 Pilot Light		Blank/Red	UCS175J1	UCSC175J1
1				UCS110J1	UCSC110J1
1/2				UCS250J2	UCSC250J2
3/4	2 Pilot Lights		Blank/Red	UCS275J2	UCSC275J2
1				UCS210J2	UCSC210J2
1/2				UCS350J3	UCSC350J3
3/4	3 Pilot Lights		Blank/Red	UCS375J3	UCSC375J3
1				UCS310J3	UCSC310J3
1/2				UCS450J4	UCSC450J4
3/4	4 Pilot Lights		Blank/Red	UCS475J4	UCSC475J4
1				UCS410J4	UCSC410J4

UniCode™ Series Factory Sealed Control Stations and Pilot Lights

NEC/CEC:
Class I, Division 2, Groups B, C, D
Class I, Zone 2, Group IIC
Class II, Groups E, F, G
Class III

NEC/CEC:
Type 3, 3R, 4, 4X
IP66

Hub Size (Inches)	Description	Diagram			Standard Legend Plate Marking and Device Color	Catalog Number	
		Left	Center	Right		Dead-End	Feed-Thru
Selector Switches							
1/2	2 Positions, 2 Circuits		None		On/Off	UCS15012	UCSC15012
3/4						UCS17512	UCSC17512
1						UCS11012	UCSC11012
1/2	2 Positions, 4 Circuits		None		On/Off	UCS15035	UCSC15035
3/4						UCS17535	UCSC17535
1						UCS11035	UCSC11035
1/2	3 Positions, 2 Circuits				Hand/Off/Auto	UCS150102	UCSC150102
3/4						UCS175102	UCSC175102
1						UCS110102	UCSC110102
1/2	3 Positions, 4 Circuits				Hand/Off/Auto	UCS150345	UCSC150345
3/4						UCS175345	UCSC175345
1						UCS110345	UCSC110345
1/2	3 Positions, 4 Circuits, Alternate Contacts				Hand/Off/Auto	UCS150345ALT	UCSC150345ALT
3/4						UCS175345ALT	UCSC175345ALT
1						UCS110345ALT	UCSC110345ALT
Pilot Lights and Push Buttons							
1/2	1 Circuit Universal and 1 Pilot Light				Pilots: Blank/Red; Push Button: Start/Green	UCS250J1U1	UCSC250J1U1
3/4						UCS275J1U1	UCSC275J1U1
1						UCS210J1U1	UCSC210J1U1
1/2	1 Circuit Universal and 2 Pilot Lights				Pilots: Blank/Red; Push Button: Start/Green	UCS350J2U1	UCSC350J2U1
3/4						UCS375J2U1	UCSC375J2U1
1						UCS310J2U1	UCSC310J2U1
1/2	2 Circuits Universal and 1 Pilot Light				Pilot: Blank/Red; Push Button: Start/Green, Stop/Red	UCS350J1U2	UCSC350J1U2
3/4						UCS375J1U2	UCSC375J1U2
1						UCS310J1U2	UCSC310J1U2
1/2	2 Circuits Universal and 2 Pilot Lights				Pilot: Blank/Red; Push Button: Start/Green, Stop/Red	UCS450J2U2	UCSC450J2U2
3/4						UCS475J2U2	UCSC475J2U2
1						UCS410J2U2	UCSC410J2U2
Pilot Lights, Push Buttons and Selector Switches							
1/2	1 Circuit Universal, 1 Pilot Light and 1 Selector Switch			None	Pilot: Blank/Red; Push Button: Blank/Black; Sel. Switch: On/Off	UCS350J1U112	UCSC350J1U112
3/4						UCS375J1U112	UCSC375J1U112
1						UCS310J1U112	UCSC310J1U112
1/2	1 Circuit Universal, 1 Pilot Light and 1 Selector Switch				Pilot: Blank/Red; Push Button: Blank/Black; Sel. Switch: Hand/On/Off	UCS350J1U1102	UCSC350J1U1102
3/4						UCS375J1U1102	UCSC375J1U1102
1						UCS310J1U1102	UCSC310J1U1102

Appleton

CONTROLS: NEC/CEC EXPLOSIONPROOF CONTROL STATIONS AND SWITCHES

UniCode™ Series Factory Sealed Control Stations and Pilot Lights

Mounting Bodies Covers and Replacement Hubs

NEC/CEC:
Class I, Division 2, Groups B, C, D
Class I, Zone 2, Group IIC
Class II, Groups E, F, G
Class III

NEC/CEC:
Type 3, 3R, 4, 4X
IP66

Covers Only

Covers sold separately are marked Class I, Division 2, Groups B, C, D; Class I, Zone 2, Group IIC; NEMA 3, 3R, 4, 4X only.

	Description	Catalog Number
	1 Device	UCC1
	2 Device	UCC2
	3 Device	UCC3
	4 Device	UCC4

Replacement Hubs — For use with Threaded Metal Conduit

	Hub Size (Inches)	Catalog Number	
		Standard Hub	Union Hub
	1/2	UCHUB50	UCHUB50U
	3/4	UCHUB75	UCHUB75U
	1	UCHUB10	UCHUB10U

Mounting Bodies

	Description	Hub Size (Inches)	Standard Hub		Union Hub	
			Dead-End	Feed-Thru	Dead-End	Feed-Thru
	1 Device or 2 Device	1/2	UCBB250	UCBBC250	UCBB250U	UCBBC250U
		3/4	UCBB275	UCBBC275	UCBB275U	UCBBC275U
	1	UCBB210	UCBBC210	UCBB210U	UCBBC210U	
3 Device	1/2	UCBB350	UCBBC350	UCBB350U	UCBBC350U	
	3/4	UCBB375	UCBBC375	UCBB375U	UCBBC375U	
	1	UCBB310	UCBBC310	UCBB310U	UCBBC310U	
4 Device	1/2	UCBB450	UCBBC450	UCBB450U	UCBBC450U	
	3/4	UCBB475	UCBBC475	UCBB475U	UCBBC475U	
	1	UCBB410	UCBBC410	UCBB410U	UCBBC410U	

Appleton







CONTROLS: NEC/CEC EXPLOSIONPROOF CONTROL STATIONS AND SWITCHES

UniCode™ Series Factory Sealed Control Stations and Pilot Lights

Selector Switches. Component Parts

NEC/CEC:
 Class I, Division 2, Groups B, C, D
 Class I, Zone 2, Group IIC
 Class II, Groups E, F, G
 Class III

Selector Switch

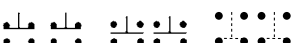
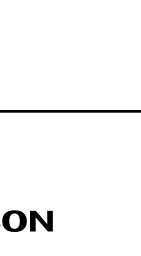
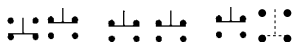
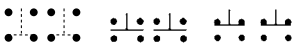
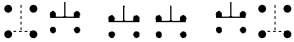
	Description	Diagram	Catalog Number
 2 Position, 2 Circuit	2 Position, 2 Circuit, Maintain Contact Left Position, Maintain Contact Right Position On/Off nameplate		UCSS12
	2 Position, 4 Circuit, Maintain Contact Left Position, Maintain Contact Right Position On/Off nameplate		UCSS22
 2 Position, 4 Circuit	3 Position, 2 Circuit, Maintain Contact Left Position, Maintain Contact Right Position Hand-Off-Auto nameplate		UCSS13
	3 Position, 2 Circuit, Momentary Contact Right Position, Spring Return to Center, Maintain Contact Left Position		UCSS13SRC
 3 Position, 2 Circuit	3 Position, 2 Circuit, Momentary Contact Left Position, Spring Return to Center, Maintain Contact Right Position		UCSS13SLC
	3 Position, 4 Circuit Maintain Contact Left Position Maintain Contact Right Position		UCSS23
 3 Position, 2 Circuit	3 Position, 4 Circuit, Alternate Contacts Maintain Contact Left Position Maintain Contact Right Position		UCSSA23
	3 Position, 4 Circuit Momentary Contact Right Position Spring Return to Center Maintain Contact Left Position		UCSS23SRC
 3 Position, 4 Circuit	3 Position, 4 Circuit, Alternate Contacts, Momentary Contact Right Position, Spring Return to Center, Maintain Contact Left Position		UCSSA23SRC
	3 Position, 4 Circuit, Momentary Contact Left Position, Spring Return to Center, Maintain Contact Right Position		UCSS23SLC
	3 Position, 4 Circuit, Alternate Contacts, Momentary Contact Left Position; Spring Return to Center, Maintain Contact Right Position		UCSSA23SLC
	3 Position, 4 Circuit, Alternate Contacts, Momentary Contact Left Position, Spring Return to Center, Momentary Contact Right Position		UCSSA23SRL

Appleton

CONTROLS: NEC/CEC EXPLOSIONPROOF CONTROL STATIONS AND SWITCHES

UniCode™ Series Factory Sealed Control Stations and Pilot Lights

Component Parts

NEC/CEC:
 Class I, Division 2, Groups B, C, D
 Class I, Zone 2, Group IIC
 Class II, Groups E, F, G
 Class III

	Description	Catalog Number
Assembled Push Buttons		
	Momentary Black - One Labyrinth Switch	UCPB1BL
	Momentary Black - Two Labyrinth Switches	UCPB2BL
	Momentary Red - One Labyrinth Switch	UCPB1RE
	Momentary Red - Two Labyrinth Switches	UCPB2RE
	Momentary Green - One Labyrinth Switch	UCPB1GR
	Momentary Green - Two Labyrinth Switches	UCPB2GR
	Momentary Yellow - One Labyrinth Switch	UCPB1YL
	Momentary Yellow - Two Labyrinth Switches	UCPB2YL
	Momentary Blue - One Labyrinth Switch	UCPB1BU
	Momentary Blue - Two Labyrinth Switches	UCPB2BU
	Maintained Black - One Labyrinth Switch	UCPBM1BL
	Maintained Black - Two Labyrinth Switches	UCPBM2BL
	Maintained Red - One Labyrinth Switch	UCPBM1RE
	Maintained Red - Two Labyrinth Switches	UCPBM2RE
	Maintained Green - One Labyrinth Switch	UCPBM1GR
	Maintained Green - Two Labyrinth Switches	UCPBM2GR
Sub Components For Push Buttons		
	Green Momentary Mushroom Head	UCMHGR
	Red Momentary Mushroom Head	UCMHRE
	Black Momentary Mushroom Head	UCMHBL
	Green Maintained Mushroom Head	UCMHMGR
	Red Maintained Mushroom Head	UCMHMRE
	Black Maintained Mushroom Head	UCMHMBL
	Green Cap for Momentary Push button	UCPBCAPGR
	Red Cap for Momentary Push button	UCPBCAPRE
	Black Cap for Momentary Push button	UCPBCAPBL
	Yellow Cap for Momentary Push button	UCPBCAPYL
	Blue Cap for Momentary Push button	UCPBCAPBU
	Pilot Lights	
	Red LED Pilot Light (120/240 Vac)	UCPLR
	Green LED Pilot Light (120/240 Vac)	UCPLG
	Amber LED Pilot Light (120/240 Vac)	UCPLA
	Blue LED Pilot Light (120/240 Vac)	UCPLB
	Red LED Pilot Light (12/24 Vdc)	UCPLRDC
	Green LED Pilot Light (12/24 Vdc)	UCPLGDC
	Amber LED Pilot Light (12/24 Vdc)	UCPLADC
	Blue LED Pilot Light (12/24 Vdc)	UCPLBDC

UniCode™ Series Factory Sealed Control Stations and Pilot Lights

Component Parts

NEC/CEC:
 Class I, Division 2, Groups B, C, D
 Class I, Zone 2, Group IIC
 Class II, Groups E, F, G
 Class III

Actuators Without Contact Blocks



Selector Switch



Momentary Push Button



Maintained Mushroom Head Push Button

Description	Catalog Number For LAB1
2 Position Selector Switch	UCSS2
3 Position Selector Switch	UCSS3
3 Position Selector Switch - Spring Return From Right	UCSS3SRC
3 Position Selector Switch - Spring Return From Left	UCSS3SLC
3 Position Selector Switch - Alternate Contacts	UCSSA3
3 Position Selector Switch - Alternate Contacts Spring, Return From Right	UCSSA3SRC
3 Position Selector Switch - Alternate Contacts Spring, Return From Left	UCSSA3SLC
3 Position Selector Switch - Alternate Contacts Spring, Return From Right and Left	UCSSA3SRL
For LAB1 Switch	Catalog Number
Momentary Push button - Black	UCPBBL
Momentary Push button - Red	UCPBRE
Momentary Push button - Green	UCPBGR
Momentary Push button - Blue	UCPBBU
Momentary Push button - Yellow	UCPBYL
Maintained Mushroom Head - Black	UCPBMBL
Maintained Mushroom Head - Red	UCPBMR
Maintained Mushroom Head - Green	UCPBMRG
Momentary Mushroom Head - Black	UCPBMYBL
Momentary Mushroom Head - Red	UCPBMYRE
Momentary Mushroom Head - Green	UCPBMYGR

Contact Block

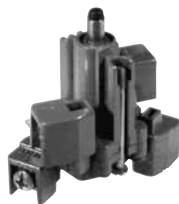

Labyrinth Switch

Labyrinth Switch — Universal (1 NO, 1 NC)

LAB1

The Standard labyrinth switch is available with universal contacts (1 NO/1 NC). The switch is a UL recognized component and is rated for A600 heavy pilot duty (Vac) and P150 (Vdc) as defined by UL 508. Hazardous location ratings include Class I, Division 2, Groups B, C, D.

A600 Rating Designation	Vac	Make Amp	Break Amp	P150 Rating Designation
10 Amp Continuous @ 600 Vac	120	60	6	5 Amp Continuous @125 Vdc
7200VA (Make) 720VA (Break)	240	30	3	138VA @ 300 Vdc
	480	15	1.5	1.1 Amp @ 125 Vdc
	600	12	2	

Accessories



Description	Catalog Number
Close-Up Plug	UCPLUG
Momentary Push Button Locking Guard (Included as standard with push button)	UCLG1
Maintained Mushroom Head Push Button Locking Guard ① (Locks Button in Down Position)	UCMPBLG
2 Stainless Steel Mounting Feet	SSMTG

① Requires a padlock with 6 mm (0.25") hasp.

UniCode™ Series Factory Sealed Control Stations and Pilot Lights

Component Parts

NEC/CEC:
 Class I, Division 2, Groups B, C, D
 Class I, Zone 2, Group IIC
 Class II, Groups E, F, G
 Class III

Legend Plates

Gray With Black Letters	Green With White Letters	Red With White Letters
For Push button and Selector Switches	For Push button and Selector Switches	For Push button and Selector Switches
UCLP - _____ (Add Desired Marking) ①	UCLPG - _____ (Add Desired Marking) ①	UCPLR - _____ (Add Desired Marking) ①
For Pilot Lights	For Pilot Lights	For Pilot Lights
UCPLP - _____ (Add Desired Marking) ①	UCPLPG - _____ (Add Desired Marking) ①	UCPLPR - _____ (Add Desired Marking) ①

Standard Legend Plates

Description	Catalog Number	Description	Catalog Number
Two Position Selector Switch			
Forward—Reverse	UCLP-FR	Run—Jog	UCLP-RG
Hand—Auto	UCLP-HA	Off—Remote	UCLP-OR
On—Off	UCLP-OO	Auto—Hand	UCLP-AH
Start—Stop	UCLP-SS	Auto—Off	UCLP-AO
Local—Remote	UCLP-LR	Blank	UCLP-B
Up—Down	UCLP-UD		
Three Position Selector Switch			
Reverse—Off—Forward	UCLP-ROF	Hand—Off—Remote	UCLP-HOR
Forward—Off—Reverse	UCLP-FOR	Local—Off—Remote	UCLP-LOR
Hand—Off—Auto	UCLP-HOA	Remote—Off—Local	UCLP-ROL
Auto—Off—Hand	UCLP-AOH	Auto—Off—Manual	UCLP-AOM
Job—Off—Run	UCLP-JOR	Open—Off—Close	UCLP-OOC
Run—Off—Jog	UCLP-ROJ	Test—Off—On	UCLP-TOO
Off—Run—Start	UCLP-ORS	1—Off—2	UCLP-1O2
Stop—Run—Start	UCLP-SRS	Blank	UCLP-B
Push Buttons (Standard, Momentary and Maintained Mushroom Heads)			
Blank	UCLP-B	Fast	UCLP-FAST
Off	UCLP-OFF	Slow	UCLP-SLOW
On	UCLP-ON	Raise	UCLP-RAISE
Forward	UCLP-FWD	Lower	UCLP-LOWER
Reverse	UCLP-REV	Open	UCLP-OPEN
Jog	UCLP-JOG	Close	UCLP-CLOSE
Run	UCLP-RUN	Low	UCLP-LOW
Start	UCLP-ST	High	UCLP-HIGH
Stop	UCLP-SP	Test	UCLP-TEST
Up	UCLP-UP	Reset	UCLP-RESET
Down	UCLP-DOWN		
Pilot Lights			
Blank	UCPLP-B	On	UCPLP-ON
Run	UCPLP-RUN	Off	UCPLP-OFF

① Standard legend plate markings listed above.

UniCode™ Series Factory Sealed Control Stations and Pilot Lights

NEC/CEC:
 Class I, Division 2, Groups B, C, D
 Class I, Zone 2, Group IIC
 Class II, Groups E, F, G
 Class III

NEC/CEC:
 Type 3, 3R, 4, 4X
 IP66

Dimensions in Millimeters (Inches)

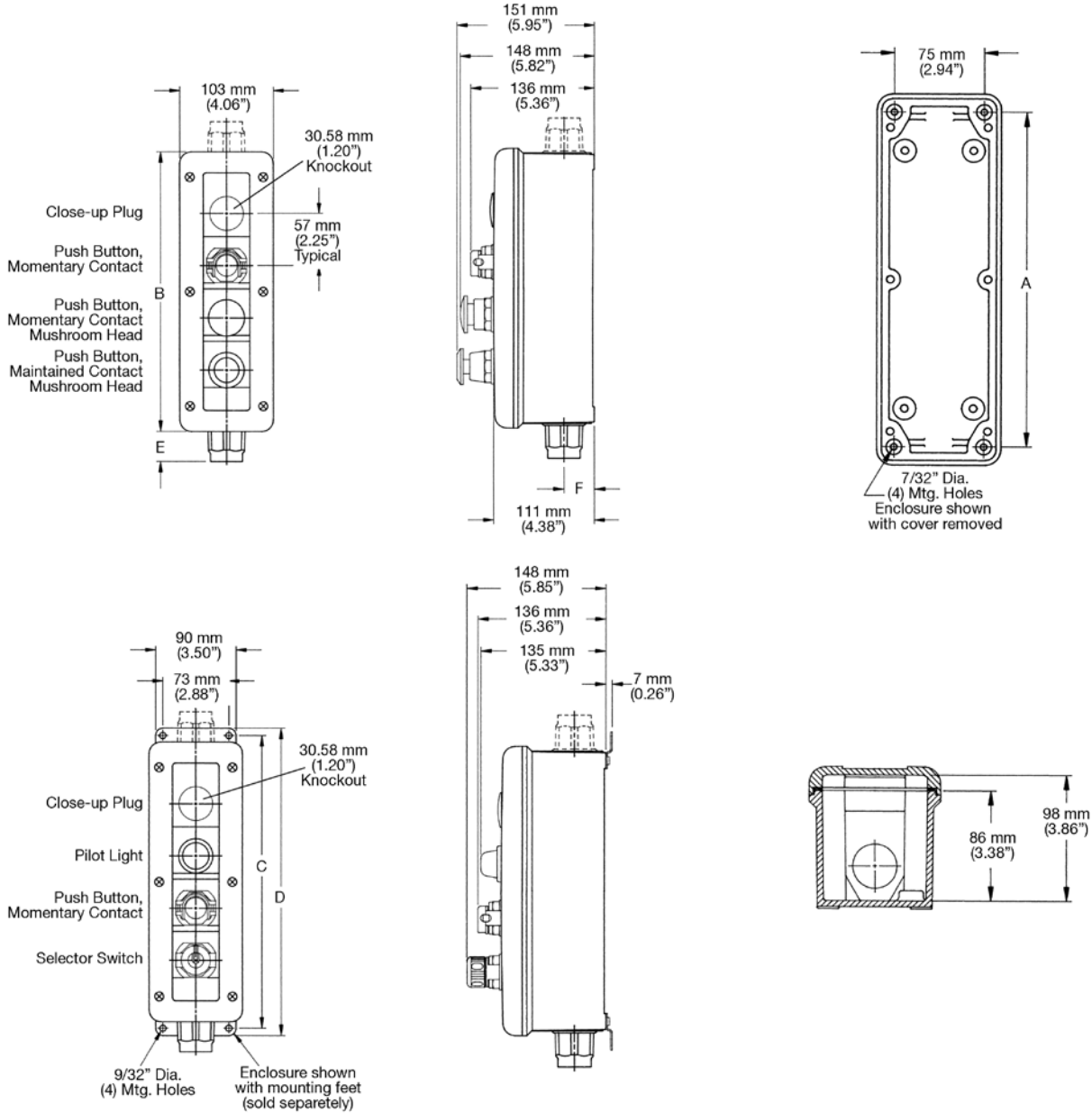

Enclosures	Hub Size (Inches)	Dimensions in Millimeters (Inches)					
		A	B	C	D	E	F
1 or 2 Device	1/2	162.1 (6.38)	192.0 (7.56)	206.5 (8.13)	222.8 (8.77)	31.2 (1.23)	26.9 (1.06)
3-Device	3/4	219.2 (8.63)	249.2 (9.81)	263.7 (10.38)	279.9 (11.02)	31.8 (1.25)	26.9 (1.06)
4 Device	1	276.4 (10.88)	306.3 (12.06)	320.8 (12.63)	337.1 (13.27)	32.5 (1.28)	33.3 (1.31)

EDS Factory Sealed Tumbler Switches

Explosionproof, Dust-Ignitionproof

UNILETS™ for Use with Threaded Metal Conduit.

NEC:

Class I, Division 1 and 2, Groups B♦, C, D

Class II, Division 1 and 2, Groups E, F, G

Class III

NEMA 3, 7 B♦CD, 9EFG

Applications

- Designed to prevent arcing of enclosed switches in ignitable atmospheres during connect and disconnect operation of lighting and light power loads.
- For use in classified areas where ignitable vapors, gases or highly combustible dusts are present.
- For installation in:
 - Chemical plants
 - Petrochemical plants
 - Refineries
 - Other process industries

Features

- Enclosures have external mounting lugs for ease of mounting.
- Smooth, rounded integral bushing in each hub protects conductor insulation.
- Enclosures furnished with internal ground screw.
- 20 Amp and 30 Amp units available for use with 120-277 Vac.
- Factory sealed switches are designed to a UL Standard so that any arcing devices are contained within an explosionproof labyrinth switch (standard switch and sealing chamber on select models). Tumbler switch devices are approved for installation without additional external sealing fittings.
- 1/2" and 3/4" 1-gang units suitable for Class I, Group B, in addition to Class I, Groups C and D; Class II, Groups E, F and G; and Class III.
- 20 Amp 4-way and all 30 Amp models utilize a switch enclosed in separate sealing chamber. Smooth double-face, accurately ground surfaces on sealing chamber flange mate with cover and body to provide positive flame-tight construction.
- Sealing chamber has prewired factory sealed pigtail leads to switch.
- Corrosion resistant, strong stainless steel hex head cap screws attach cover/body/sealing chamber assembly for approved flame-tight construction.
- Threaded stainless steel operating handle provides positive Corrosion resistant operation.
- Choice of front-operating or side rocker arm handle—each may be locked in ON or OFF position.

Standard Materials

- Body and cover: malleable iron
- Sealing chamber (on select models): copperfree (4/10 of 1% max.) aluminum
- Handle: nylon 6/6
- Optional nameplate mounting bracket: corrosion resistant stainless steel

Standard Finishes

- Tumbler switches: triple-coat—(1) zinc electroplate, (2) chromate, and (3) epoxy powder coat



Front Operated



Rocker Arm Operated

Illustrated Features



Handles may be locked in ON or OFF position

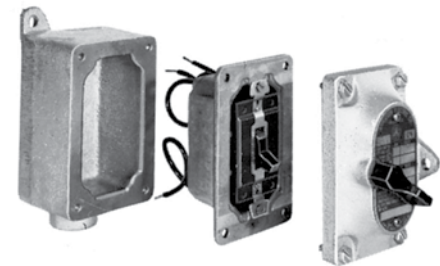

Separate sealing chamber and switch construction. Used on 20 Amp 4-way and all 30 Amp models.



Explosionproof Labyrinth Switch
Used on all 20 Amp models excluding 4-way.

♦ Indicates items which are suitable for Class I, Group B, as well as Class I, Groups C and D; Class II, Groups E, F, G; and Class III. See product selection pages for suitable items.

EDS Factory Sealed Tumbler Switches

Explosionproof, Dust-Ignitionproof

UNILETS™ for Use with Threaded Metal Conduit.

NEC:

Class I, Division 1 and 2, Groups B♦, C, D

Class II, Division 1 and 2, Groups E, F, G

Class III

NEMA 3, 7 B♦CD, 9EFG

Options

- 1- or 2-gang copperfree (4/10 of 1% max.) aluminum bodies and covers ① available. Add suffix – A.
- **NPBRKT** nameplate mounting bracket to make circuit description/identification easy.
 - Pre-drilled holes in bottom of bracket allow direct mounting to control stations with existing cover bolts.
 - Pre-drilled holes in middle of bracket allow mounting of customer's circuit identification nameplate; epoxy glue may also be used for mounting (phenolic nameplate not included).
 - Bracket eliminates costly field installation of drilling and tapping to accommodate circuit identification nameplate.
 - Brackets fit side-by-side on 2-, 3- and 4-gang boxes and 3-devices.

Standard Materials

- Body and cover: malleable iron

NEC Certifications and Compliances

- UL Standards: UL 894, UL 1203
- UL Listed: E10523, E81751

Ordering Information for "Custom" Units

- Devices, covers and bodies may be ordered separately so that a *different* EDS chamber/switch assembly may be used in *each* gang.
- Order components separately as follows:
 - (1) select mounting body catalog number,
 - (2) select cover catalog number with desired switch operation (1-pole, 2-pole, 3-way or 4-way).

How to Order Hub Arrangements

- Simply send sketch indicating sizes and locations for brazed hubs on body or bodies selected from catalog listings. Orient sketch so that cover opening faces front and mounting lugs face upward and downward (box wall opposite cover should be referred to as the *back* of box).

Bodies and Hubs Available

- Tumbler switches may be ordered in single thru five gang deep malleable iron blank bodies with brazed hubs as specified at any location.
- Tumbler switches may be ordered with tandem malleable iron boxes with additional brazed hubs as specified.
- Standard malleable iron single and 2-gang tumbler switches may be ordered with additional brazed hubs as specified.
- Single and 2-gang tumbler switches may be ordered with aluminum boxes with additional brazed hubs as specified.

Related Products

- For classified-location push button, pilot light and selector switch control stations, see *EFD/EFDB and EDS Control Stations and Pilot Lights*.

♦ Indicates items which are suitable for Class I, Group B, as well as Class I, Groups C and D; Class II, Groups E, F, G; and Class III. See product selection pages for suitable items.

① Aluminum rocker arm cover is not available.





EDS Factory Sealed Tumbler Switches

Explosionproof, Dust-Ignitionproof

Malleable Iron Body and Cover. Furnished with Internal Ground Screw.

NEC:

Class I, Division 1, Groups B+, C, D
 Class I, Division 2, Groups B, C, D
 Class II, Division 1 and 2, Groups E, F, G
 Class III
 NEMA 3, 7CD, 9EFG

	Hub Size (Inches)	Switch	Dead-End	Catalog Number ①	Feed-Thru
1-Gang — Front Operated					
20 Amp — 120-277 Vac ②					
	1/2	1-Pole	EDS150-F1	EDSC150-F1	
	1/2	2-Pole	EDS150-F2	EDSC150-F2	
	1/2	3-Way	EDS150-F3W	EDSC150-F3W	
	1/2	4-Way	EDS150-F4W ④	EDSC150-F4W ④	
Dead-End	3/4	1-Pole	EDS175-F1	EDSC175-F1	
	3/4	2-Pole	EDS175-F2	EDSC175-F2	
	3/4	3-Way	EDS175-F3W	EDSC175F3W	
	3/4	4-Way	EDS175-F4W ④	EDSC175F4W ④	
	1	1-Pole	EDS110-F1	EDSC110-F1	
	1	2-Pole	EDS110-F2	EDSC110-F2	
	1	3-Way	EDS110-F3W	EDSC110-F3W	
	1	4-Way	EDS110-F4W ④	EDSC110-F4W ④	
30 Amp — 120-277 Vac ③					
Feed-Thru	3/4	1-Pole	EDS175-F13 ④	EDSC175-F13 ④	
	3/4	2-Pole	EDS175-F23 ④	EDSC175-F23 ④	
	3/4	3-Way	EDS175-F3W3 ④	EDSC175-F3W3 ④	
	1	1-Pole	EDS110-F13 ④	EDSC110-F13 ④	
	1	2-Pole	EDS110-F23 ④	EDSC110-F23 ④	
	1	3-Way	EDS110-F3W3 ④	EDSC110-F3W3 ④	
2-Gang — Front Operated					
20 Amp — 120-277 Vac ②					
	1/2	1-Pole	EDS250-F1	EDSC250-F1	
	1/2	2-Pole	—	EDSC250-F2	
	1/2	3-Way	—	EDSC250-F3W	
	1/2	4-Way	—	EDSC250-F4W ④	
Dead-End	3/4	1-Pole	EDS275-F1	EDSC275-F1	
	3/4	2-Pole	—	EDSC275-F2	
	3/4	3-Way	EDS275-F3W	EDSC275-F3W	
	3/4	4-Way	—	EDSC275-F4W ④	
	1	1-Pole	EDS210-F1	EDSC210-F1	
	1	2-Pole	EDS210-F2	EDSC210-F2	
	1	3-Way	EDS210-F3W	EDSC210-F3W	
	1	4-Way	EDS210-F4W ④	EDSC210-F4W ④	
Feed-Thru					

① For aluminum backbox and cover, add suffix -A.

② 20 Amp — 1 HP at 120 Vac and 2 HP at 240 Vac.

③ 30 Amp — 2 HP at 120 Vac or 240 Vac.

④ Contains standard switch and sealing chamber.





◆ Shaded area indicates items suitable for Class I, Group B, as well as Class I, Groups C and D; Class II, Groups E, F, G; and Class III.

EDS Factory Sealed Tumbler Switches

Explosionproof, Dust-Ignitionproof

Malleable Iron Body and Cover. Furnished with Internal Ground Screw.

NEC:
 Class I, Division 1, Groups B+, C, D
 Class I, Division 2, Groups B, C, D
 Class II, Division 1 and 2, Groups E, F, G
 Class III
 NEMA 3, 7 B+CD, 9EFG

		Hub Size (Inches)	Switch	Catalog Number ①	
				Dead-End	Feed-Thru
1-Gang — Rocker Arm Operated					
20 Amp — 120-277 Vac ②					
	Dead-End	1/2	1-Pole	EDS150-R1	EDSC150-R1
		1/2	2-Pole	EDS150-R2	EDSC150-R2
		1/2	3-Way	EDS150-R3W	EDSC150-R3W
		1/2	4-Way	EDS150-R4W ④	EDSC150-R4W ④
	Feed-Thru	3/4	1-Pole	EDS175-R1	EDSC175-R1
		3/4	2-Pole	EDS175-R2	EDSC175-R2
		3/4	3-Way	EDS175-R3W	EDSC175-R3W
		3/4	4-Way	EDS175-R4W ④	EDSC175-R4W ④
30 Amp — 120-277 Vac ③					
		3/4	1-Pole	EDS175-R13 ④	EDSC175-R13 ④
		3/4	2-Pole	EDS175-R23 ④	EDSC175-R23 ④
		3/4	3-Way	EDS175-R3W3 ④	EDSC175-R3W3 ④
		1	1-Pole	EDS110-R13 ④	EDSC110-R13 ④
		1	2-Pole	EDS110-R23 ④	EDSC110-R23 ④
		1	3-Way	EDS110-R3W3 ④	EDSC110-R3W3 ④
2-Gang — Rocker Arm Operated					
20 Amp — 120-277 Vac ②					
	Dead-End	1/2	1-Pole	EDS250-R1	EDSC250-R1
		1/2	2-Pole	—	EDSC250-R2
		1/2	3-Way	—	EDSC250-R3W
		1/2	4-Way	—	EDSC250-R4W ④
	Feed-Thru	3/4	1-Pole	EDS275-R1	EDSC275-R1
		3/4	2-Pole	—	EDSC275-R2
		3/4	3-Way	EDS275-R3W	EDSC275-R3W
		3/4	4-Way	—	EDSC275-R4W ④
		1	1-Pole	EDS210-R1	EDSC210-R1
		1	2-Pole	EDS210-R2	EDSC210-R2
		1	3-Way	EDS210-R3W	EDSC210-R3W
		1	4-Way	EDS210-R4W ④	EDSC210-R4W ④

① For aluminum backbox, add suffix -A.

② 20 Amp — 1 HP at 120 Vac and 2 HP at 240 Vac.

③ 30 Amp — 2 HP at 120 Vac or 240 Vac.

④ Contains standard switch and sealing chamber.

◆ Shaded area indicates items suitable for Class I, Group B, as well as Class I, Groups C and D; Class II, Groups E, F, G; and Class III.

EDS Factory Sealed Tumbler Switches



Explosionproof, Dust-Ignitionproof

Malleable Iron Body and Cover. Furnished with Internal Ground Screw.

NEC:

Class I, Division 1 and 2, Groups C, D
 Class II, Division 1 and 2, Groups E, F, G
 Class III
 NEMA 3, 7CD, 9EFG

Factory Assembled Switch Assembly

	Switch Type	Catalog Number			
		20 Amp, 120–277 Vac ①		30 Amp, 120–277 Vac ②	
		Malleable Iron	Aluminum	Malleable Iron	Aluminum
 <p>Front Cover</p>	1-Pole	EDKF21-Q ③	EDKF21-AQ ③	EDKF31-Q ④	EDKF31-AQ ④
	2-Pole	EDKF22-Q ③	EDKF22-AQ ③	EDKF32-Q ④	EDKF32-AQ ④
	3-Way	EDKF23W-Q ③	EDKF23W-AQ ③	EDKF33W-Q ④	EDKF33W-AQ ④
	4-Way	EDKF24W-Q ④	EDKF24W-AQ ④	—	—
 <p>Rocker Cover/Chamber</p>	1-Pole	EDK-R21-Q ③		EDK-R31-Q ④	
	2-Pole	EDK-R22-Q ③		EDK-R32-Q ④	
	3-Way	EDK-R23W-Q ③		EDK-R33W-Q ④	
	4-Way	EDK-R24W-Q ④		—	
 <p>Factory Sealed Switch Only</p>	1-Pole	LAB21		—	
	2-Pole	LAB22		—	
	3-Way	LAB23W		—	

Nameplate Mounting Bracket

Description	Catalog Number
 <p>Bracket with blank silver/black nameplate for EFDB series</p> <p>To order bracket with control station, add suffix -NPBRKT to end of catalog number.</p> <p>To order engraved nameplates, add desired markings after catalog number. Maximum of 2 lines with 12 characters (including spaces) per line.</p> <p><i>Note: Mount bracket between cover screws and cover. Do not mount bracket between ground joint flame path between cover and backbox.</i></p>	NPBRKT-EFDB

① 20 Amp Switches 1 HP at 120 Vac and 2 HP at 240 Vac.
 ② 30 Amp Switches 2 HP at 120 Vac or 240 Vac.
 ③ Contains Factory Sealed Switch; no sealing chamber.
 ④ With sealing chamber.

EFD Factory Sealed Tumbler Switches

Furnished with Internal Ground Screw.

NEC:
 Class I, Division 1 and 2, Groups C, D
 Class II, Division 1 and 2, Groups E, F, G
 Class III
 NEMA 7CD, 9EFG

Mounting Bodies

	Type	Hub Size (Inches)	Catalog Number	
			Malleable Iron	Aluminum
1-Gang				
	Dead-End	1/2	EFD150NLQ	EFD150ANLQ
		3/4	EFD175NLQ	EFD175ANLQ
		1	EFD110NLQ	EFD110ANLQ
	Feed-Thru	1/2	EFDC150NLQ	EFDC150ANLQ
		3/4	EFDC175NLQ	EFDC175ANLQ
		1	EFDC110NLQ	EFDC110ANLQ
2-Gang				
	Dead-End	1/2	EFD250NLQ	EFD250ANLQ
		3/4	EFD275NLQ	EFD275ANLQ
		1	EFD210NLQ	EFD210ANLQ
	Feed-Thru	1/2	EFDC250NLQ	EFDC250ANLQ
		3/4	EFDC275NLQ	EFDC275ANLQ
		1	EFDC210NLQ	EFDC210ANLQ
Tandem ①				
	Dead-End	1/2	EFDT50NLQ	—
		3/4	EFDT75NLQ	—
		1	EFDT10NLQ	—
	Feed-Thru	1/2	EFDC250NLQ	—
		3/4	EFDC275NLQ	—
		1	EFDC210NLQ	—

Blank Bodies for Brazed Hubs

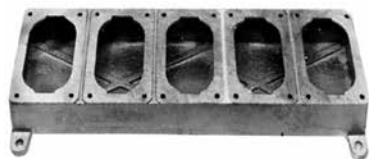

Construct complete catalog numbers per EFD Cast Device Boxes Ordering Information on following page. Hubs will be located in center of walls and evenly spaced unless otherwise specified. Where spacings are critical, submit sketch showing exact spacing requirements.

1-Gang	EFD1NL
2-Gang	EFD2NL
3-Gang	EFD3NL
4-Gang	EFD4NL
5-Gang	EFD5NL

① For tandem bodies, external seals must be installed within 1.5 meters (5 feet) of each conduit entrance for Class I, Groups C and D.

EDS Factory Sealed Tumbler Switches

Blank Bodies for Brazed Threaded Hubs

Single, Two, Three, Four and Five Gang Boxes. Brazed Threaded Hubs for Rigid Conduit, 1/2" thru 1"; Brazed Union Hubs, 1/2" thru 1".

NEC:

Class I, Division 1 and 2, Groups C, D
 Class II, Division 1 and 2, Groups E, F, G
 Class III
 NEMA 7CD, 9EFG

Cast Device Box Ordering Information

- Determine catalog number as follows:**
- (1) Select EFD device box catalog number;
 - (2) Select "Standard Hub Arrangement Diagram" number; and
 - (3) Select symbols that represent hub sizes from "Symbol Table." (Use "0" where no hub is required, and separate the various divisions of the complete catalog number by dashes.)

Example

The blank body device box selected is EFD3NL and the hub arrangement is diagram #8. Hub "a" is to be 3/4" brazed threaded; hub "b", 1" brazed threaded; hub "c", 3/4" brazed threaded; hub "d", no hub is required; and hub "e", 1" brazed union.
 The complete catalog number will be: **EFD-3NL-8-23203E**

If a "Standard Hub Arrangement" is not suitable for the application, or when hubs are to be more accurately spaced, submit sketch locating hubs (1) from centerlines of walls and (2) from outside back of box (or from mounting lug surface if lugs are supplied).

All hubs will be located in centerlines of walls and evenly spaced unless otherwise specified.

Symbol Table

Hub Size (Inches)	Brazed Threaded Hub Symbol	Brazed Union Hub Symbol
Blank	0	0
1/2	1	1E
3/4	2	2E
1	3	3E

Standard Hub Arrangement Diagrams

Hub "a" is always TOP of box

2-, 3-, 4- and 5-Gang (Front View)

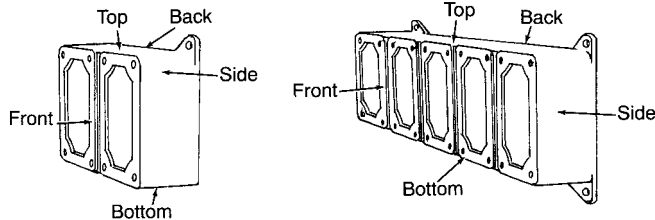
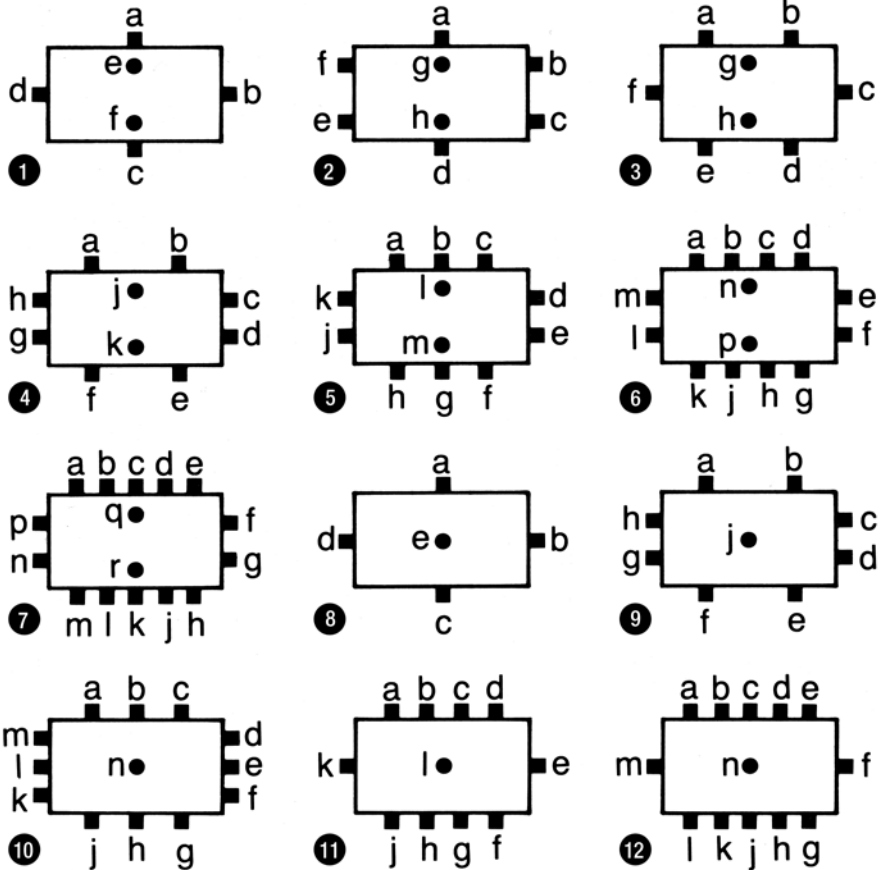

1-Gang (Front View)

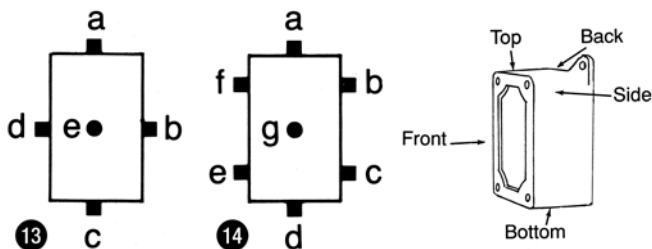

Appleton

CONTROLS: NEC/CEC EXPLOSIONPROOF CONTROL STATIONS AND SWITCHES

EDS Factory Sealed Tumbler Switches

NEC:
 Class I, Division 1, Groups B♦, C, D
 Class I, Division 2, Groups B, C, D
 Class II, Division 1 and 2, Groups E, F, G
 Class III
 NEMA 3, 7 B♦CD, 9EFG

Dimensions in Millimeters (Inches)

Front Operated Tumbler Switches

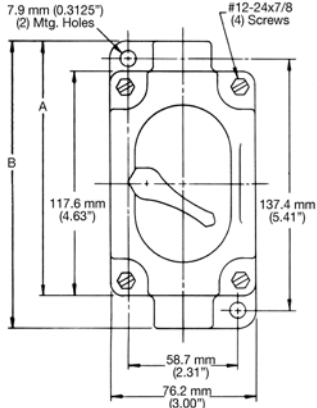

Front — 1-Gang

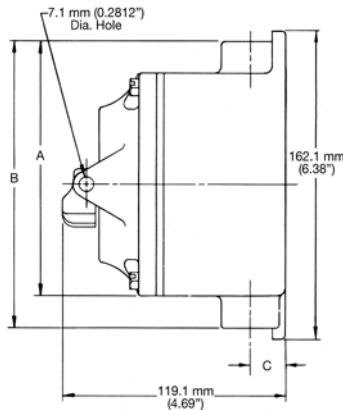

Side

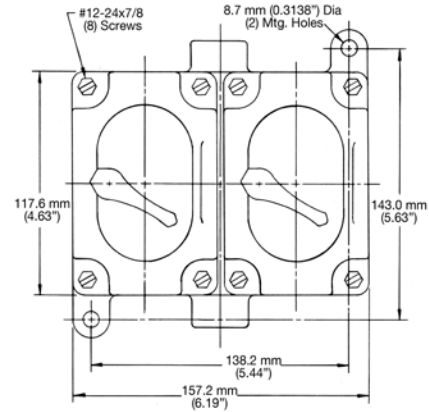

Front — 2-Gang

Hub Size (Inches)	Dimensions in Millimeters (Inches)		
	A	B	C
1/2 and 3/4	136.7 (5.38)	155.7 (6.13)	19.8 (0.78)
1	139.7 (5.50)	160.3 (6.31)	23.9 (0.94)

Rocker Arm Operated Tumbler Switches

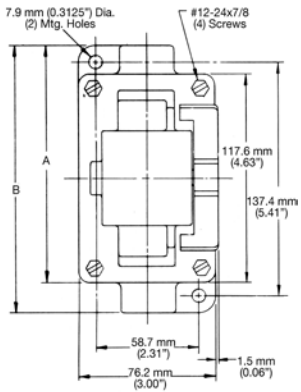

Front — 1-Gang

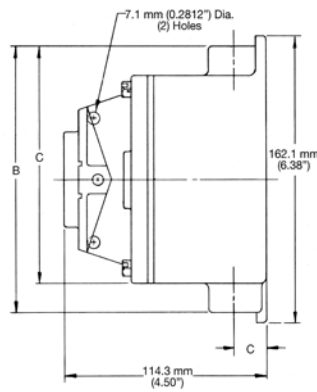

Side

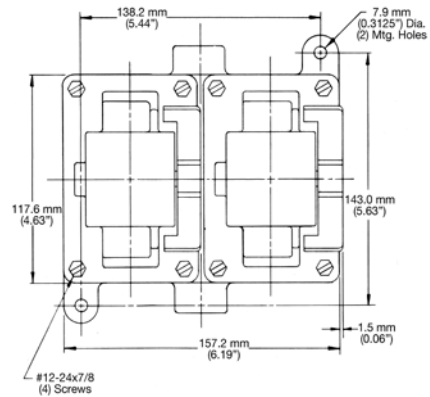

Front — 2-Gang

Hub Size (Inches)	Dimensions in Millimeters (Inches)		
	A	B	C
1/2 and 3/4	136.7 (5.38)	155.7 (6.13)	19.8 (0.78)
1	139.7 (5.50)	160.3 (6.31)	23.9 (0.94)

♦ Indicates items which are suitable for Class I, Group B, as well as Class I, Groups C and D; Class II, Groups E, F, G; and Class III. See product selection pages for suitable items.

EDS Factory Sealed Tumbler Switches

NEC:

- Class I, Division 1, Groups B*, C, D
- Class I, Division 2, Groups B, C, D
- Class II, Division 1 and 2, Groups E, F, G
- Class III
- NEMA 3, 7 B*CD, 9EFG

Dimensions in Millimeters (Inches)

Tandem

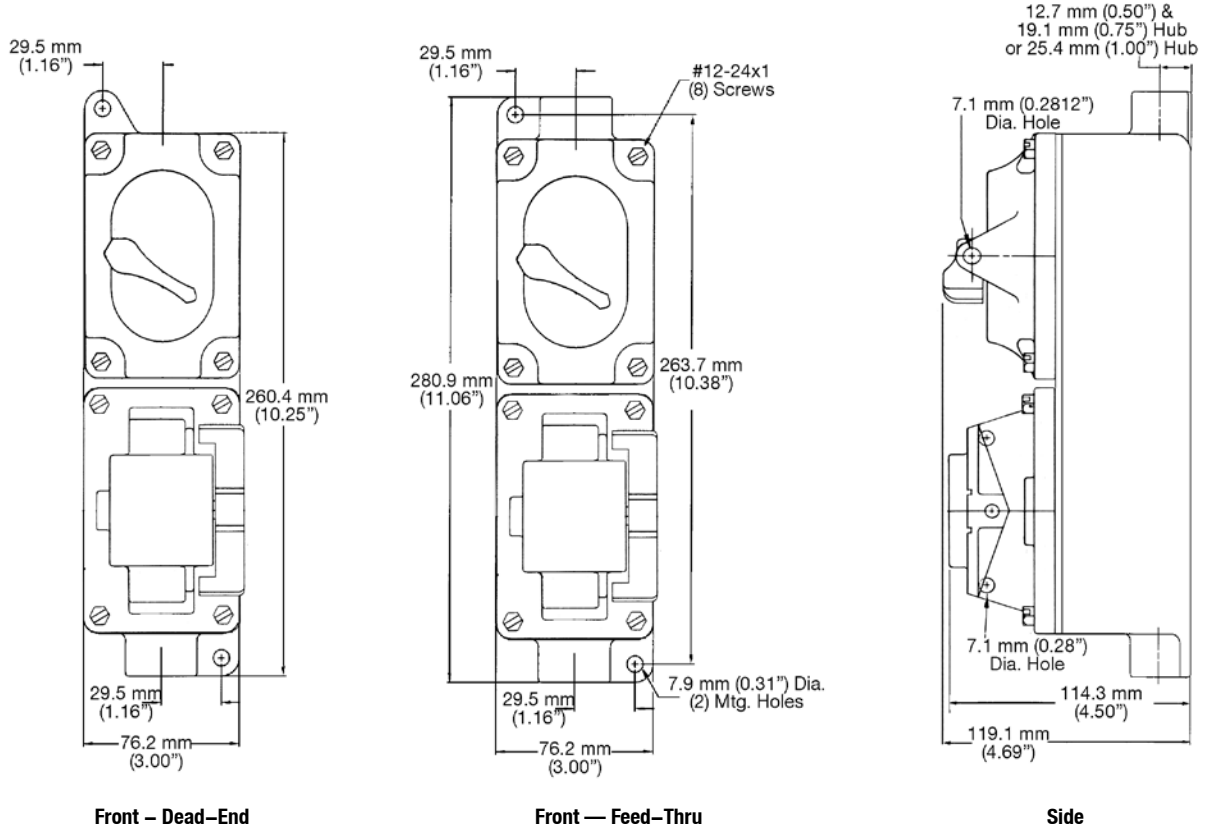

NPBRKT Nameplate Mounting Bracket

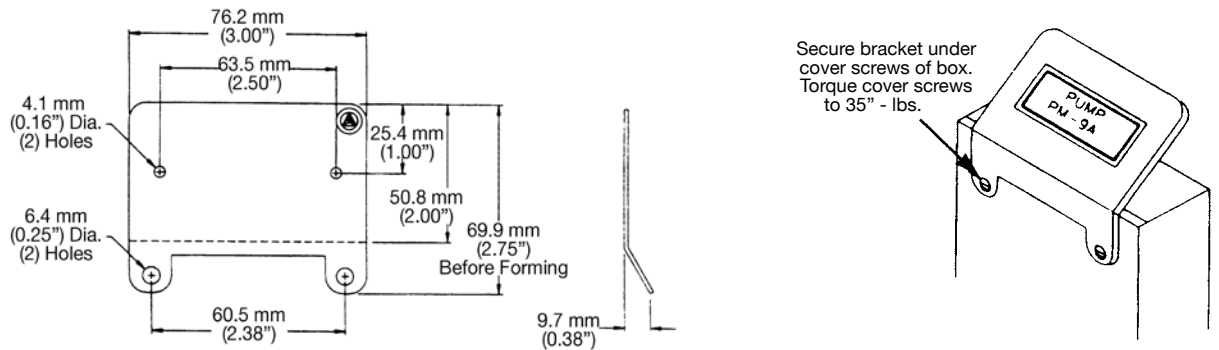

◆ Indicates items which are suitable for Class I, Group B, as well as Class I, Groups C and D; Class II, Groups E, F, G; and Class III. See product selection pages for suitable items.

EFS Non-Sealed Tumbler Switches

Explosionproof, Dust-Ignitionproof

Malleable Iron Body and Cover. Furnished with Internal Ground Screw.

NEC:

Class I, Division 1 and 2, Groups C, D
Class II, Division 1 and 2, Groups E, F, G
Class III
NEMA 7CD, 9EFG

Applications

- Designed to prevent arcing of enclosed switches in ignitable atmospheres during connect and disconnect operation of lighting and light power loads.
- For use in classified areas where ignitable vapors, gases or highly combustible dusts are present.
- For installation in:
 - Chemical and petrochemical plants
 - Refineries
 - Other process industries

Features

- Enclosures have external mounting lugs for ease of mounting.
- Smooth, rounded integral bushing in each hub protects conductor insulation.
- Enclosures furnished with internal ground screw.
- 20 Amp and 30 Amp units available for use with 120-277 Vac.
- Smooth ground mating surfaces assure flame-tight joint between cover and mounting enclosure.
- Stainless steel hex head cap screws for attaching cover to mounting enclosure.
- Choice of front-operating or side rocker arm handle—each may be locked in ON or OFF position.
- Each handle has close-tolerance threaded stainless steel shaft to meet explosionproof requirements.
- Enclosures furnished with internal ground screw.

Options

- 1- or 2-gang copperfree (4/10 of 1% max.) aluminum bodies and covers available. Add suffix – **A**.
- **NPBRKT** nameplate mounting bracket to make circuit description/identification easy.
 - Pre-drilled holes in bottom of bracket allow direct mounting to control stations with existing cover bolts.
 - Pre-drilled holes in middle of bracket allow mounting of customer's circuit identification nameplate; epoxy glue may also be used for mounting (phenolic nameplate not included).
 - Bracket eliminates costly field installation of drilling and tapping to accommodate circuit identification nameplate.
 - Brackets fit side-by-side on 2-, 3- and 4-gang boxes and 3-devices.

Standard Materials

- Body and cover: malleable iron
- Handle: nylon 6/6
- Optional nameplate mounting bracket: corrosion resistant stainless steel

Standard Finishes

- Tumbler switch body: triple-coat—(1) zinc electroplate, (2) chromate, and (3) epoxy powder coat

NEC Certifications and Compliances

- UL Standards: UL 894, UL 1203
- UL Listed: E10523, E81751

Ordering Information for "Custom" Units

- Devices, covers and bodies may be ordered separately so that a different EFS switch may be used in each gang.
- Order components separately as follows:
 - (1) select body catalog number,
 - (2) select cover catalog number, and



Front Operated



Rocker Arm Operated

Illustrated Features



Handles may be locked in ON or OFF position

- (3) select switch or switch assembly catalog number (1-pole, 2-pole, 3-way or 4-way available in listings).

How to Order Hub Arrangements

- Simply send sketch indicating sizes and locations for brazed hubs on body or bodies selected from catalog listings. Orient sketch so that cover opening faces front and mounting lugs face upward and downward (box wall opposite cover should be referred to as the *back* of box).

Bodies and Hubs Available

- Tumbler switches may be ordered in single thru five gang deep malleable iron blank bodies with brazed hubs as specified at any location.
- Tumbler switches may be ordered with tandem malleable iron boxes with additional brazed hubs as specified.
- Standard malleable iron single and 2-gang tumbler switches may be ordered with additional brazed hubs as specified.
- Single and 2-gang tumbler switches may be ordered with aluminum boxes with additional brazed hubs as specified.

Related Products

- For classified-location push button, pilot light and selector switch control stations, see *EFD/EFDB and EDS Control Stations and Pilot Lights*.





EFS Non-Sealed Tumbler Switches

Front Operated. Explosionproof, Dust-Ignitionproof

Malleable Iron Body and Cover. Furnished with Internal Ground Screw.

NEC:

Class I, Division 1 and 2, Groups C, D
 Class II, Division 1 and 2, Groups E, F, G
 Class III
 NEMA 7CD, 9EFG

	Hub Size (Inches)	Switch	Dead-End	Feed-Thru	Catalog Number ①
1-Gang					
 <p>Dead-End</p>	20 Amp — 120-277 Vac ②				
	1/2	1-Pole	EFS150-F1	EFSC150-F1	
	1/2	2-Pole	—	EFSC150-F2	
	1/2	3-Way	EFS150-F3W	EFSC150-F3W	
	1/2	4-Way	EFS150-F4W	EFSC150-F4W	
	3/4	1-Pole	EFS175-F1	EFSC175-F1	
	3/4	2-Pole	EFS175-F2	EFSC175-F2	
	3/4	3-Way	EFS175-F3W	EFSC175-F3W	
 <p>Feed-Thru</p>	3/4	4-Way	EFS175-F4W	EFSC175-F4W	
	30 Amp — 120-277 Vac ③				
	3/4	1-Pole	EFS175-F13	EFSC175-F13	
	3/4	2-Pole	EFS175-F23	EFSC175-F23	
2-Gang					
 <p>Dead-End</p>	20 Amp — 120-277 Vac ②				
	1/2	1-Pole	EFS250-F1	EFSC250-F1	
	1/2	2-Pole	—	EFSC250-F2	
	1/2	3-Way	—	EFSC250-F3W	
	1/2	4-Way	—	EFSC250-F4W	
	3/4	1-Pole	EFS275-F1	EFSC275-F1	
	3/4	2-Pole	—	EFSC275-F2	
	3/4	3-Way	—	EFSC275-F3W	
 <p>Feed-Thru</p>	3/4	4-Way	—	EFSC275-F4W	
	1	2-Pole	EFS210-F2	EFSC210-F2	
	1	3-Way	EFS210-F3W	EFSC210-F3W	
	1	4-Way	EFS210-F4W	EFSC210-F4W	
	30 Amp — 120-277 Vac ③				
	3/4	2-Pole	EFS275-F13	EFSC275-F13	
3/4	2-Pole	—	EFSC275-F23		
1	2-Pole	EFS210-F23	EFSC210-F23		



① For aluminum backbox and cover, add suffix -A.
 ② 20 Amp — 1 HP at 120 Vac and 2 HP at 240 Vac.
 ③ 30 Amp — 2 HP at 120 Vac or 240 Vac.

EFS Non-Sealed Rocker Tumbler Switches

Arm Operated. Explosionproof, Dust-Ignitionproof

Furnished with Internal Ground Screw.

NEC:
 Class I, Division 1 and 2, Groups C, D
 Class II, Division 1 and 2, Groups E, F, G
 Class III
 NEMA 7CD, 9EFG

	Hub Size (Inches)	Switch	Dead-End	Catalog Number	Feed-Thru
1-Gang					
 Dead-End	20 Amp — 120-277 Vac ①				
	1/2	1-Pole	EFS150-R1	EFSC150-R1	
	1/2	2-Pole	—	EFSC150-R2	
	1/2	3-Way	EFS150-R3W	EFSC150-R3W	
	1/2	4-Way	EFS150-R4W	EFSC150-R4W	
	3/4	1-Pole	EFS175-R1	EFSC175-R1	
	3/4	2-Pole	EFS175-R2	EFSC175-R2	
	3/4	3-Way	EFS175-R3W	EFSC175-R3W	
	3/4	4-Way	EFS175-R4W	EFSC175-R4W	
	 Feed-Thru	20 Amp — 120-277 Vac ①			
1/2		1-Pole	EFS250-R1	EFSC250-R1	
1/2		2-Pole	—	EFSC250-R2	
1/2		3-Way	—	EFSC250-R3W	
1/2		4-Way	—	EFSC250-R4W	
3/4		1-Pole	EFS275-R1	EFSC275-R1	
3/4		2-Pole	—	EFSC275-R2	
3/4		3-Way	—	EFSC275-R3W	
3/4		4-Way	—	EFSC275-R4W	
1		2-Pole	EFS210-R2	EFSC210-R2	
1	3-Way	EFS210-R3W	EFSC210-R3W		
1	4-Way	EFS210-R4W	EFSC210-R4W		

① 20 Amp — 1 HP at 120 Vac and 2 HP at 240 Vac.



EFS Non-Sealed Tumbler Switches

Switch Covers and Switches. Explosionproof, Dust-Ignitionproof

Furnished with Internal Ground Screw.

NEC:

Class I, Division 1 and 2, Groups C, D
 Class II, Division 1 and 2, Groups E, F, G
 Class III
 NEMA 7CD, 9EFG

	Switch Type	Catalog Number			
		20 Amp, 120–277 Vac ①		30 Amp, 120–277 Vac ②	
		Malleable Iron	Aluminum	Malleable Iron	Aluminum
 Front Cover	1-Pole	EFKF12Q	EFKF12AQ	EFKF12Q	EFKF12QA
	2-Pole	EFKF12Q	EFKF12AQ	EFKF12Q	EFKF12QA
	3-Way	EFKF34WQ	EFKF34WAQ	EFKF34WQ	EFKF34WQA
	4-Way	EFKF34WQ	EFKF34WAQ	—	—
 Rocker Cover	1-Pole	EFKR12Q	—	EFKR12Q	—
	2-Pole	EFKR12Q	—	EFKR12Q	—
	3-Way	EFKR34WQ	—	EFKR34WQ	—
	4-Way	EFKR34WQ	—	—	—
 Non-Factory Sealed Switch	1-Pole	EFSFR1Q	—	EFSFR13Q	—
	2-Pole	EFSFR2Q	—	EFSFR23Q	—
	3-Way	EFSFR3WQ	—	EFSFR3W3Q	—
	4-Way	EFSFR4WQ	—	—	—

① 20 Amp Switches 1 HP at 120 Vac and 2 HP at 240 Vac.



② 30 Amp Switches 2 HP at 120 Vac or 240 Vac.

EFS Non-Sealed Tumbler Switches

EFD Mounting Bodies

Furnished with Internal Ground Screw.

NEC:
 Class I, Division 1 and 2, Groups C, D
 Class II, Division 1 and 2, Groups E, F, G
 Class III
 NEMA 7CD, 9EFG

	Type	Hub Size (Inches)	Catalog Number	
			Malleable Iron	Aluminum
1-Gang				
	Dead-End	1/2	EFD150NLQ	EFD150ANLQ
		3/4	EFD175NLQ	EFD175ANLQ
		1	EFD110NLQ	EFD110ANLQ
	Feed-Thru	1/2	EFDC150NLQ	EFDC150ANLQ
		3/4	EFDC175NLQ	EFDC175ANLQ
		1	EFDC110NLQ	EFDC110ANLQ
2-Gang				
	Dead-End	1/2	EFD250NLQ	EFD250ANLQ
		3/4	EFD275NLQ	EFD275ANLQ
		1	EFD210NLQ	EFD210ANLQ
	Feed-Thru	1/2	EFDC250NLQ	EFDC250ANLQ
		3/4	EFDC275NLQ	EFDC275ANLQ
		1	EFDC210NLQ	EFDC210ANLQ
Tandem ①				
	Dead-End	1/2	EFDT50NLQ	—
		3/4	EFDT75NLQ	—
		1	EFDT10NLQ	—
	Feed-Thru	1/2	EFDC250NLQ	—
		3/4	EFDC275NLQ	—
		1	EFDC210NLQ	—

Blank Bodies for Brazed Hubs

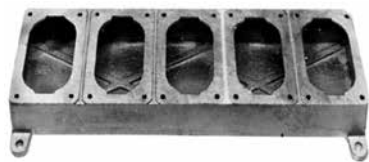

Construct complete catalog numbers per EFD Cast Device Boxes Ordering Information on following page. Hubs will be located in center of walls and evenly spaced unless otherwise specified. Where spacings are critical, submit sketch showing exact spacing requirements.

1-Gang	EFD1NL	—
2-Gang	EFD2NL	—
3-Gang	EFD3NL	—
4-Gang	EFD4NL	—
5-Gang	EFD5NL	—

① For tandem bodies, external seals must be installed within 1.5 meters (5 feet) of each conduit entrance for Class I, Groups C and D.

EFS Non-Sealed Tumbler Switches

Cast Device Box Ordering Information. Blank Bodies for Brazed Threaded Hubs

Single, Two, Three, Four and Five Gang Boxes. Brazed Threaded Hubs for Rigid Conduit, 1/2" thru 1"; Brazed Union Hubs, 1/2" thru 1".

NEC:

Class I, Division 1 and 2, Groups C, D
 Class II, Division 1 and 2, Groups E, F, G
 Class III
 NEMA 7CD, 9EFG

Determine catalog number as follows:

- (1) Select EFD device box catalog number;
- (2) Select "Standard Hub Arrangement Diagram" number; and
- (3) Select symbols that represent hub sizes from "Symbol Table." (Use "0" where no hub is required, and separate the various divisions of the complete catalog number by dashes.)

Example

The blank body device box selected is EFD3NL and the hub arrangement is diagram #8. Hub "a" is to be 3/4" brazed threaded; hub "b", 1" brazed threaded; hub "c", 3/4" brazed threaded; hub "d", no hub is required; and hub "e", 1" brazed union.

The complete catalog number will be:
EFD-3NL-8-23203E

If a "Standard Hub Arrangement" is not suitable for the application, or when hubs are to be more accurately spaced, submit sketch locating hubs (1) from centerlines of walls and (2) from outside back of box (or from mounting lug surface if lugs are supplied).

All hubs will be located in centerlines of walls and evenly spaced unless otherwise specified.

Symbol Table

Hub Size (Inches)	Brazed Threaded Hub Symbol	Brazed Union Hub Symbol
Blank	0	0
1/2	1	1E
3/4	2	2E
1	3	3E

Standard Hub Arrangement Diagrams

Hub "a" is always TOP of box

2-, 3-, 4- and 5-Gang (Front View)

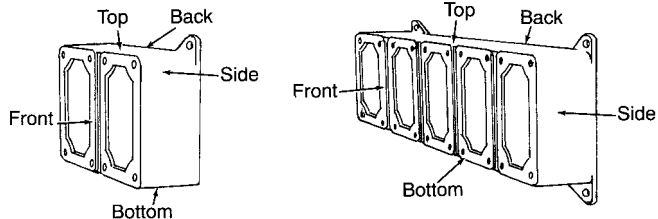
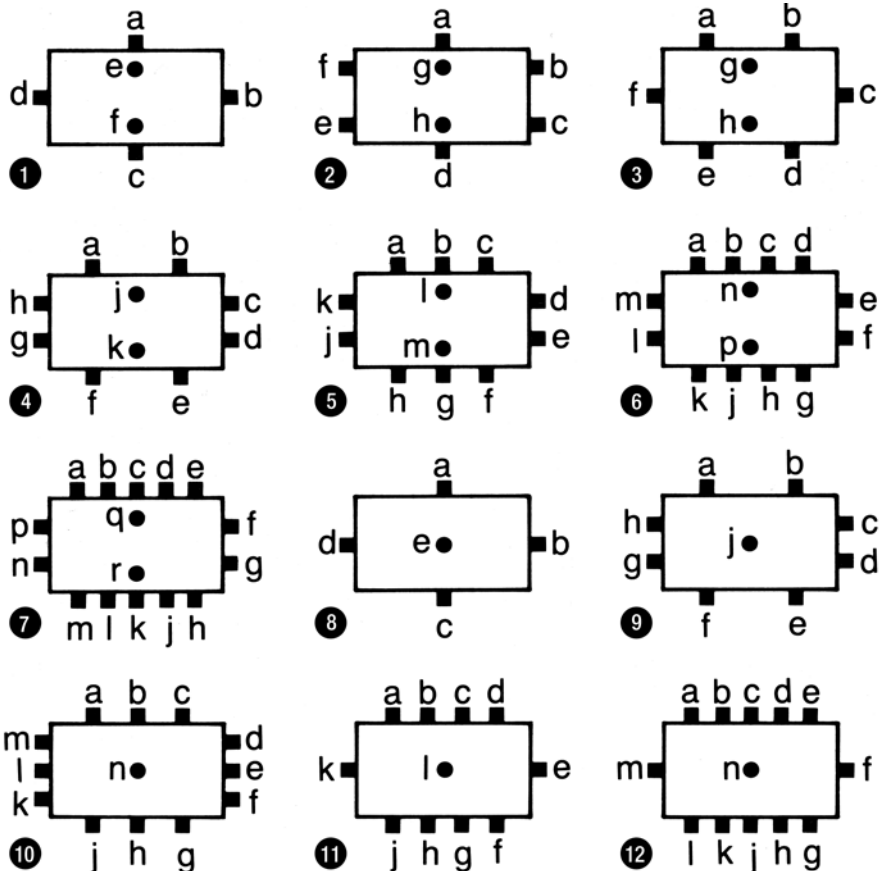

1-Gang (Front View)

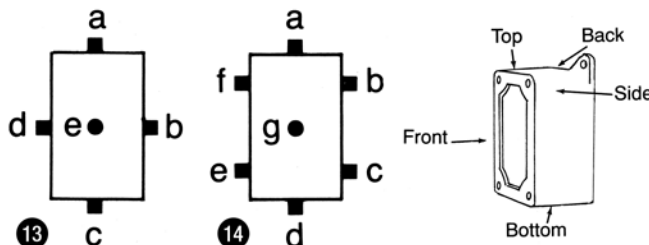

EFS Non-Sealed Tumbler Switches

NEC:
 Class I, Division 1 and 2, Groups C, D
 Class II, Division 1 and 2, Groups E, F, G
 Class III
 NEMA 7CD, 9EFG

Dimensions in Millimeters (Inches)

Front Operated Tumbler Switches

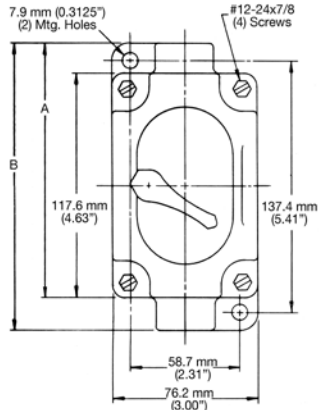

Front — 1-Gang

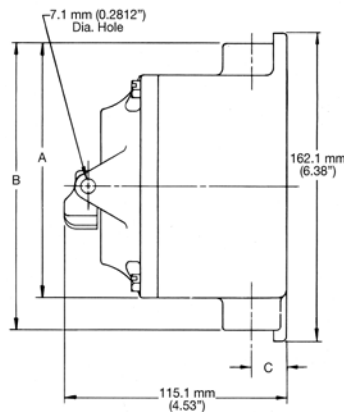

Side

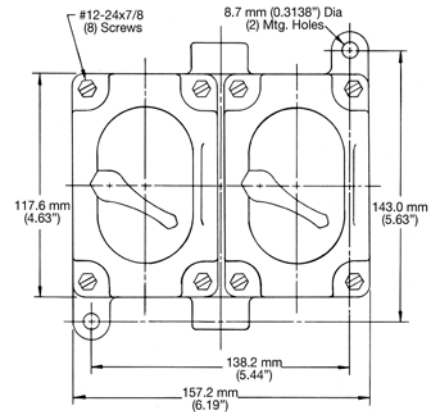

Front — 2-Gang

Hub Size (Inches)	Dimensions in Millimeters (Inches)		
	A	B	C
1/2 and 3/4	136.7 (5.38)	155.7 (6.13)	19.8 (0.78)
1	139.7 (5.50)	160.3 (6.31)	23.9 (0.94)

Rocker Arm Operated Tumbler Switches

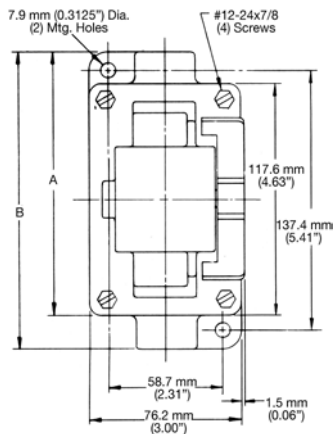

Front — 1-Gang

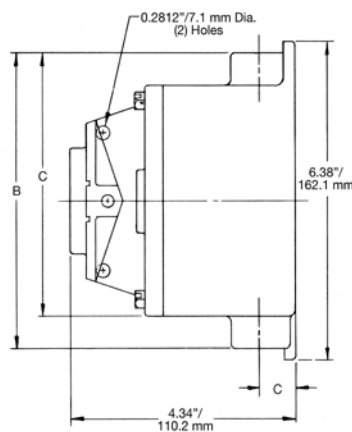

Side

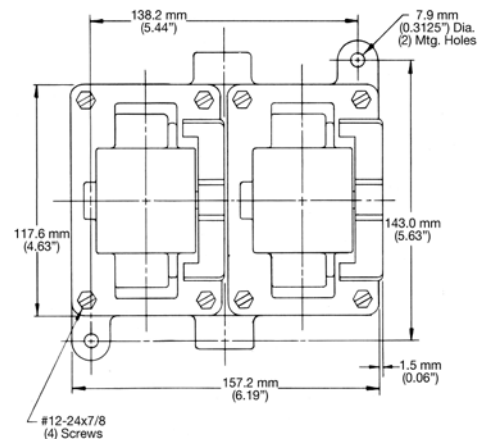

Front — 2-Gang

Hub Size (Inches)	Dimensions in Millimeters (Inches)		
	A	B	C
1/2 and 3/4	136.7 (5.38)	155.7 (6.13)	19.8 (0.78)
1	139.7 (5.50)	160.3 (6.31)	23.9 (0.94)

Appleton

CONTROLS: NEC/CEC EXPLOSIONPROOF CONTROL STATIONS AND SWITCHES

EFS Non-Sealed Tumbler Switches

NEC:
 Class I, Division 1 and 2, Groups C, D
 Class II, Division 1 and 2, Groups E, F, G
 Class III
 NEMA 7CD, 9EFG

Dimensions in Millimeters (Inches)

Tandem

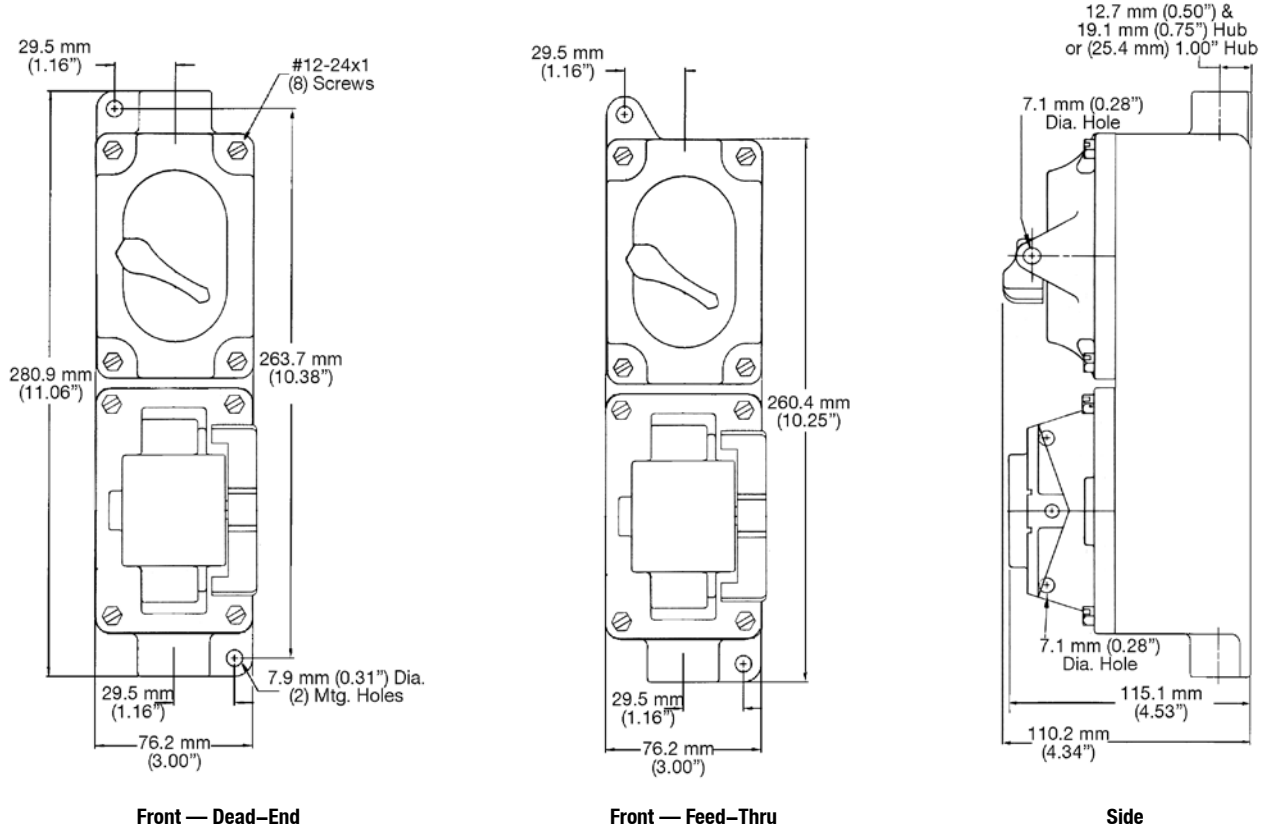

CONTROLS: NEC/CEC EXPLOSIONPROOF CONTROL STATIONS AND SWITCHES

Contender™ Series Factory Sealed Front Operated Tumbler Switches

Explosionproof, Dust-Ignitionproof

Malleable Iron Body and Cover. Furnished with Internal Ground.

NEC/CEC:

Class I, Division 1, Groups C, D
Class I, Division 2, Group B*, C, D
Class II, Division 1 and 2, Groups E, F, G
Class III
NEMA 3, 7CD, 9EFG

Applications

- Designed to prevent arcing of enclosed switches in ignitable atmospheres during connect and disconnect operation of lighting and light power loads.
- For use in classified areas where ignitable vapors, gases or highly combustible dusts are present.
- For installation in:
 - Chemical plants
 - Petrochemical plants
 - Refineries
 - Other process industries

Features

- Enclosures have external mounting lugs for ease of mounting.
- Smooth, rounded integral bushing in each hub protects conductor insulation.
- Enclosures furnished with internal ground screw.
- 20 Amp and 30 Amp units available for use with 120-277 Vac.
- Smooth ground mating surfaces assure flame-tight joint between cover and mounting enclosure.
- Stainless steel hex head cap screws for attaching cover to mounting enclosure.
- Choice of front-operating or side rocker arm handle—each may be locked in ON or OFF position.
- Each handle has close-tolerance threaded stainless steel shaft to meet Explosionproof requirements.
- Enclosures furnished with internal ground screw.

Options

- 1- or 2-gang copperfree (4/10 of 1% max.) aluminum bodies and covers available. Add suffix – SA.
- NPBRKT nameplate mounting bracket to make circuit description/identification easy.
 - Pre-drilled holes in bottom of bracket allow direct mounting to control stations with existing cover bolts.
 - Pre-drilled holes in middle of bracket allow mounting of customer's circuit identification nameplate; epoxy glue may also be used for mounting (phenolic nameplate not included).
 - Bracket eliminates costly field installation of drilling and tapping to accommodate circuit identification nameplate.
 - Brackets fit side-by-side on 2-, 3- and 4-gang boxes and 3-devices.

Standard Materials

- Body and cover: malleable iron
- Handle: nylon 6/6
- Optional nameplate mounting bracket: corrosion resistant stainless steel

Standard Finishes

- Tumbler switches: triple-coat—(1) zinc electroplate, (2) chromate, and (3) epoxy powder coat

NEC/CEC Certifications and Compliances

- UL Standards: UL 894, UL 1203
- CSA Standards: C22.2 No. 14
- cULus Listed: E10449



Illustrated Features

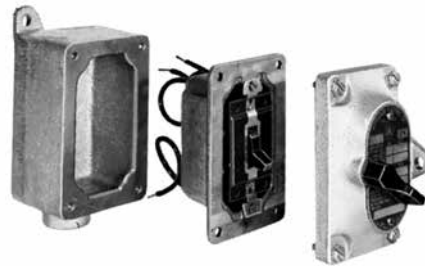

Separate sealing chamber and switch construction.
Used on 20 Amp 4-way and all 30 Amp models.



Explosionproof Labyrinth Switch
Used on all 20 Amp models excluding 4-way.

♦ Indicates items which are suitable for Class I, Division 2, Group B. See product selection pages for suitable items.





Contender™ Series Factory Sealed Front Operated Tumbler Switches

Explosionproof, Dust-Ignitionproof

Malleable Iron Body and Cover. Furnished with Internal Ground.

NEC/CEC:

Class I, Division 1, Groups C, D
 Class I, Division 2, Group B*, C, D
 Class II, Division 1 and 2, Groups E, F, G
 Class III
 NEMA 3, 7CD, 9EFG

	Hub Size (Inches)	Switch	Dead-End	Feed-Thru	Catalog Number ①
1-Gang					
20 Amp — 120-277 Vac ②					
	1/2	1-Pole	EDS1129 ♦	EDSC1129 ♦	
	1/2	2-Pole	EDS118 ♦	EDSC118 ♦	
	1/2	3-Way	EDS1130 ♦	EDSC1130 ♦	
	1/2	4-Way	EDS1140	EDSC1140	
Dead-End	3/4	1-Pole	EDS2129 ♦	EDSC2129 ♦	
	3/4	2-Pole	EDS218 ♦	EDSC218 ♦	
	3/4	3-Way	EDS2130 ♦	EDSC2130 ♦	
	3/4	4-Way	EDS2140	EDSC2140	
	1	1-Pole	EDS3129 ♦	EDSC3129 ♦	
	1	2-Pole	EDS318 ♦	EDSC318 ♦	
	1	3-Way	EDS3130 ♦	EDSC3130 ♦	
	1	4-Way	EDS3140	EDSC3140	
30 Amp — 120-277 Vac ③					
Feed-Thru	1	1-Pole	EDS3591	EDSC3591	
	1	2-Pole	EDS3593	EDSC3593	
	1	3-Way	EDS3594	EDSC3594	
2-Gang					
20 Amp — 120-277 Vac ②					
	1/2	1-Pole	EDS1229 ♦	EDSC1229 ♦	
	1/2	2-Pole	EDS128 ♦	EDSC128 ♦	
	1/2	3-Way	EDS1230 ♦	EDSC1230 ♦	
	1/2	4-Way	EDS1240	EDSC1240	
Dead-End	3/4	1-Pole	EDS2229 ♦	EDSC2229 ♦	
	3/4	2-Pole	EDS228 ♦	EDSC228 ♦	
	3/4	3-Way	EDS2230 ♦	EDSC2230 ♦	
	3/4	4-Way	EDS2240	EDSC2240	
	1	1-Pole	EDS3229 ♦	EDSC3229 ♦	
	1	2-Pole	EDS328 ♦	EDSC328 ♦	
	1	3-Way	EDS3230 ♦	EDSC3230 ♦	
	1	4-Way	EDS3240	EDSC3240	
Feed-Thru					

① For Aluminum body and cover, add suffix —SA.

② 20 Amp Switches 1 HP at 120 Vac and 2 HP at 240 Vac.

③ 30 Amp Switches 2 HP at 120 Vac or 240 Vac.

♦ Contains Factory Sealed Switch; no sealing chamber. Suitable for Class I, Division 2, Group B.

Contender™ Series Factory Sealed Front Operated Tumbler Switches

Switch Covers and Sealing Chamber/Switch Assemblies. Explosionproof, Dust-Ignitionproof

Malleable Iron Body and Cover. Furnished with Internal Ground Screw.

NE/CEC:

Class I, Division 1, Groups C, D
 Class I, Division 2, Group B*, C, D
 Class II, Division 1 and 2, Groups E, F, G
 Class III
 NEMA 3, 7CD, 9EFG

Factory Sealed Front Cover/Chamber/Switch Assembly

Switch Type	Catalog Number ①		
	20 Amp 120–277 Vac ②	30 Amp 120–277 Vac ③	
	1-Pole	EDSF21Q ♦	EDSF31Q
	2-Pole	EDSF22Q ♦	EDSF32Q
	3-Way	EDSF23WQ ♦	EDSF33WQ
	4-Way	EDSF24WQ	—

Cover/Switch Assembly

Switch Type	Front Cover Only	Catalog Number EFSFR Switch ④	Factory Sealed LAB Switch	
	1-Pole	EDSF12	EFSFR1Q	LAB21
	2-Pole	EDSF12	EFSFR2Q	LAB22
	3-Way	EDSF34W	EFSFR3WQ	LAB23W
	4-Way	EDSF34W	EFSFR4WQ	—

Front Cover Only



EFSFR Switch



Factory Sealed Switch Only

Nameplate Mounting Bracket

Mount bracket between cover screws and cover. Do not mount bracket between ground joint flame path between cover and backbox.

Description	Catalog Number
 <p>Bracket with blank silver/black nameplate for Contender series</p> <p>To order bracket with control station, add suffix -NPBRKT to end of catalog number.</p> <p>To order engraved nameplates, add desired markings after catalog number. Maximum of 2 lines with 12 characters (including spaces) per line.</p>	NPBRKT-CONT

① With sealing chamber.

② 20 Amp Switches 1 HP at 120 Vac and 2 HP at 240 Vac.

③ 30 Amp Switches 2 HP at 120 Vac or 240 Vac.

④ Requires the use of Code recognized sealing method as part of installation.

♦ Contains Factory Sealed Switch; no sealing chamber. Suitable for Class I, Division 2, Group B.

Contender™ Series Factory Sealed Front Operated Tumbler Switches

EDS Mounting Bodies

Furnished with Internal Ground Screw.

NEC/CEC:

Class I, Division 1, Groups C, D
 Class I, Division 2, Group B, C, D
 Class II, Division 1 and 2, Groups E, F, G
 Class III

	Type	Hub Size (Inches)	Catalog Number	
			Malleable Iron	Aluminum
1-Gang				
	Dead-End	1/2	EDS171	EDS171-SA
		3/4	EDS271	EDS271-SA
		1	EDS371	EDS371-SA
	Feed-Thru	1/2	EDSC171	EDSC171-SA
		3/4	EDSC271	EDSC271-SA
		1	EDSC371	EDSC371-SA
2-Gang				
	Dead-End	1/2	EDS172	EDS172-SA
		3/4	EDS272	EDS272-SA
		1	EDS372	EDS372-SA
	Feed-Thru	1/2	EDSC172	EDSC172-SA
		3/4	EDSC272	EDSC272-SA
		1	EDSC372	EDSC372-SA
Tandem ①				
	Dead-End	1/2	EDS177	EDS177-SA
		3/4	EDS277	EDS277-SA
		1	EDS377	EDS377-SA
	Feed-Thru	1/2	EDSC177	EDSC177-SA
		3/4	EDSC277	EDSC277-SA
		1	EDSC377	EDSC377-SA

① For tandem bodies, external seals must be installed within 1.5 meters (5 feet) of each conduit entrance for Class I, Groups C and D.

Contender™ Series Factory Sealed Front Operated Tumbler Switches

NEC/CEC:
 Class I, Division 1, Groups C, D
 Class I, Division 2, Group B*, C, D
 Class II, Division 1 and 2, Groups E, F, G
 Class III
 NEMA 3, 7CD, 9EFG

Dimensions in Millimeters (Inches)

Front Operated Tumbler Switches

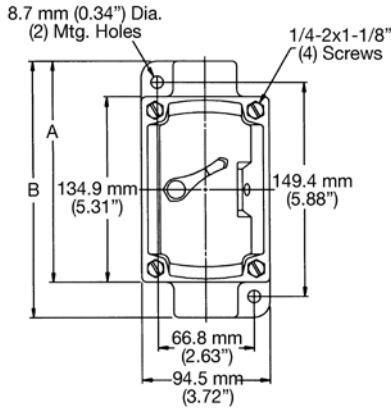

Front — 1-Gang

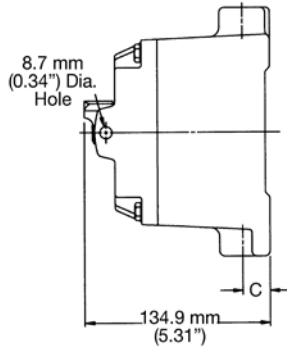

Side

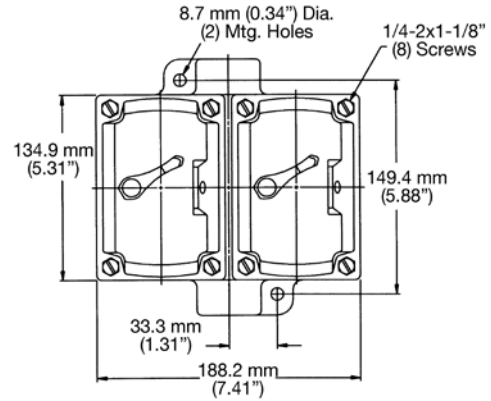

Front — 2-Gang

Dimensions in Millimeters (Inches)

Hub Size (Inches)	A	B	C
1/2 and 3/4	153.9 (6.06)	173.0 (6.81)	19.1 (0.75)
1	156.7 (6.17)	178.6 (7.03)	25.4 (1.00)

Dimensions in Millimeters (Inches)

NPBRKT Nameplate Mounting Bracket

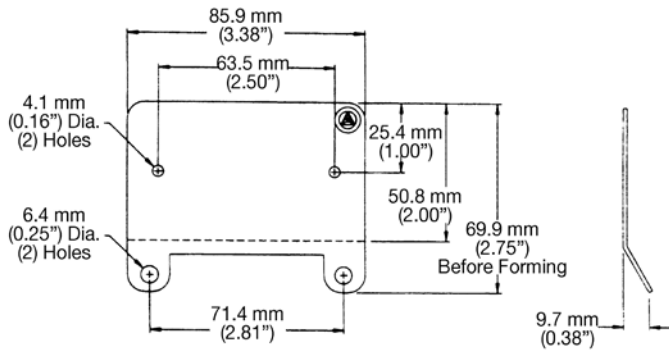

Secure bracket under cover screws of box. Torque cover screws to 35" - lbs.

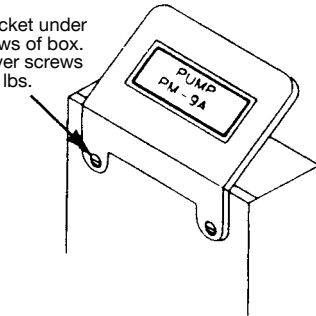

* Indicates items which are suitable for Class I, Division 2, Group B. See product selection pages for suitable items.

ECS Selector Switch Control Stations

Explosionproof, Dust-Ignitionproof, Factory Sealed and Non-Factory Sealed

CEC:

Class I, Division 1 and 2, Groups B, C, D

Class II, Division 1 and 2, Groups E, F, G

Class III

CSA Type 3R, 7BCD, 9EFG

Applications

- Push buttons and selector switches are used in conjunction with contactors and magnetic starters for remote control of motors. They provide circuit control and selection.
- Pilot lights provide visual indication that an electrical circuit is engaged either at a remote or local location.
- Toggle switches are used to connect or disconnect electrical operating lighting or other low power loads.

Features

- Corrosion resistant captive stainless steel hex head bolts hold cover to body.
- Dozens of possible combinations of push buttons, selector switches and pilot lights. Contact your local sales representative for combinations not found in the catalog.
- Push buttons supplied standard with neoprene weather boot.
- Clearly marked terminals with brass screws assure quick, easy wiring.
- Push buttons and selector switches employ heavy duty, 10 Amp 600 Vac rated contact blocks.
- Push button and selector switch contacts are silver cadmium oxide assuring long trouble free operation.
- Pilot Lights are supplied with jewel guard and 120 Vac lamp.
- Factory sealed push buttons are supplied with lockout type guards. Hole in guard locks with up to 1/4" hasp. Permits locking of push button to prevent unauthorized operation.
- Factory sealed control stations confine the arcing to the devices within the enclosure. Eliminates the need for adding external sealing fittings at each conduit entry. (Non-factory sealed devices available, contact your local sales representative.)
- Smooth rounded integral bushing in hub protects conductor insulation.
- Accurately tapped, tapered hubs for tight, rigid joints and ground continuity.
- Temperature rating: T6

Standard Materials

- Cover: aluminum alloy
- Body: cast copperfree (4/10 of 1% max.) aluminum
- Push buttons: aluminum upper barrel and phelonic lower barrel
- Dust cap models: neoprene buttons
- Pilot light guard and body assembly: aluminum and tempered glass jewel
- Clamping ring: steel
- Selector switch: aluminum operator mechanism and nylon cam

Standard Finishes

- Body and cover: baked epoxy paint
- Operators: natural finish

Options

- LED pilot light available. Substitute **J** in catalog number with **L**.
- Three position selector switches with modified operation.
 - Momentary contact right position, spring return to center, maintained contact left position. Add suffix —**S634**.
 - Momentary contact left position, spring return to center, maintained contact right position. Add suffix —**S635**.
- Selector switch lockout for factory sealed units locks two or three position handle in any position. Add suffix —**S349**.



1-Gang — Start and Stop



2-Gang — GFCI and Receptacle

- Pilot light jewel/guard assembly, order by suffixes:
 - Red —**JR**
 - Amber —**JA**
 - Blue —**JB**
 - Clear —**JC**
 - Green —**JG**
 - Opal —**JO**
- For colored LED jewel/guard assembly, order by suffixes:
 - Red —**LR**
 - Amber —**LA**
 - Blue —**LB**
 - Clear —**LC**
 - Green —**LG**
 - Opal —**LO**
- Securing rod for push button factory sealed units. Add suffix —**S153**.
- CSA Type 4X enclosure and cover. Add suffix —**4X**.

CEC Certifications and Compliances









- CSA Standards: CSA C22.2 No. 25, CSA C22.2 No. 30, CSA C22.2 No. 14-M
- CSA Certified: 038339

ECS Selector Switch Control Stations

Explosionproof, Dust-Ignitionproof, Factory Sealed and Non-Factory Sealed

CEC:
 Class I, Division 1 and 2, Groups B, C, D
 Class II, Division 1 and 2, Groups E, F, G
 Class III
 CSA Type 3R, 7BCD, 9EFG

ECS Series Push Button Stations — Factory Sealed Devices

	Hub Size (Inches)	Description	Contact Arrangement	Legend Plate	Catalog Number
1-Gang					
	3/4	1 Circuit		Start	ECS3U1
	1	Universal		Start	ECS5U1
	3/4	2 Circuit		Start/Stop	ECS3U2
	1	Universal		Start/Stop	ECS5U2
Emergency Stop — Maintained Contact					
	3/4	1 Circuit		Stop	ECS3UM1
	1	Universal		Stop	ECS5UM1
Emergency Stop — Momentary Contact					
	3/4	1 Circuit		Stop	ECS3MU1
	1	Universal		Stop	ECS5MU1
2-Gang					
	3/4	2 Circuit		Start/Stop	ECS7U2
	1	Universal		Start/Stop	ECS9U2
	3/4	4 Circuit		Start/Stop	ECS7U4
	1	Universal		Start/Stop	ECS9U4















ECS Selector Switch Control Stations

Explosionproof, Dust-Ignitionproof, Factory Sealed and Non-Factory Sealed

CEC:

Class I, Division 1 and 2, Groups B, C, D
 Class II, Division 1 and 2, Groups E, F, G
 Class III
 CSA Type 3R, 7BCD, 9EFG

































ECS Pilot Lights and Push Buttons — Factory Sealed Devices

	Hub Size (Inches)	Description	Contact Arrangement	Legend Plate	Catalog Number
1-Gang					
	3/4	One Red		None	ECS3JR
	1	Pilot Light		None	ECS5JR
	3/4	Two Red		None	ECS32JR
	1	Pilot Lights		None	ECS52JR
1-Gang					
	3/4	1 Circuit Universal and 1 Green Pilot Light		Start	ECS3JGU1
	1	1 Circuit Pilot Light and 1 Green Pilot Light		Start	ECS5JGU1
	3/4	2 Circuit Universal and 1 Red Pilot Light		Start Stop	ECS3JRU2
	1	2 Circuit Universal and 1 Red Pilot Light		Start Stop	ECS5JRU2
2-Gang					
	3/4	2 Circuit Universal and 1 Red Pilot Light		Start Stop	ECS7JRU2
	1	2 Circuit Universal and 1 Red Pilot Light		Start Stop	ECS9JRU2
	3/4	2 Circuit Universal and 1 Red and 1 Green Pilot Light		Start Stop	ECS7JGJRU2
	1	2 Circuit and Universal 1 Red and 1 Green Pilot Light		Start Stop	ECS9U2JRJG

ECS Selector Switch Control Stations

Explosionproof, Dust-Ignitionproof, Factory Sealed and Non-Factory Sealed

CEC:
 Class I, Division 1 and 2, Groups B, C, D
 Class II, Division 1 and 2, Groups E, F, G
 Class III
 CSA Type 3R, 7BCD, 9EFG





	Thread Size (Inches)	Description	Left	Diagram Centre	Right	Legend Plate	Catalog Number
Selector Switches — Factory Sealed Devices							
	3/4	2 Position		None		Start/Stop	ECS312
	1	2 Circuit		None		Start/Stop	ECS512
	3/4	2 Position		None		Start/Stop	ECS335
	1	4 Circuit		None		Start/Stop	ECS535
	3/4	3 Position				Hand/Off/Auto	ECS3102
	1	2 Circuit				Hand/Off/Auto	ECS5102
	3/4	3 Position				Hand/Off/Auto	ECS3345
	1	4 Circuit				Hand/Off/Auto	ECS5345
Key Operated Selector Switches — Non-Factory Sealed Devices							
<i>Key removable in one position.</i>							
	3/4	2 Position		None		Start/Stop	ECS2SA82U
	1	2 Circuit		None		Start/Stop	ECS4SA82U
	3/4	3 Position				Hand/Off/Auto	ECS2SA86U
	1	2 Circuit				Hand/Off/Auto	ECS4SA86U

ECS Toggle Switch Control Stations

Explosionproof, Dust-Ignitionproof, Factory Sealed and Non-Factory Sealed

CEC:
Class I, Division 1 and 2, Groups B, C, D
Class II, Division 1 and 2, Groups E, F, G
Class III
CSA Type 3R, 7BCD, 9EFG

Toggle Switches ① — No Motor Ratings

		Hub Size (Inches)	Type	Catalog Number			
				Front Operated	Key Operated		
1-Gang — 20 Amp, 120 to 277 Vac							
		Factory Sealed Devices					
		1/2 – 3/4	1-Pole	ECS3F1	ECS3K1		
		1	1-Pole	ECS5F1	ECS5K1		
		1/2 – 3/4	2-Pole	ECS3F2	ECS3K2		
		1	2-Pole	ECS5F2	ECS5K2		
		1/2 – 3/4	3 Way	ECS3F3W	ECS3K3W		
		1	3 Way	ECS5F3W	ECS5K3W		
		Non-Factory Sealed Devices					
		1/2 – 3/4	4 Way	ECS3F4W	ECS3K4W		
		1	4 Way	ECS5F4W	ECS5K4W		
2-Gang — 20 Amp, 120 to 277 Vac							
		Factory Sealed Devices					
		1/2 – 3/4	1-Pole	ECS7F1	ECS7K1		
		1	1-Pole	ECS9F1	ECS9K1		
		1/2 – 3/4	2-Pole	ECS7F2	ECS7K2		
		1	2-Pole	ECS9F2	ECS9K2		
		1/2 – 3/4	3 Way	ECS7F3W	ECS7K3W		
		1	3 Way	ECS9F3W	ECS9K3W		
		Non-Factory Sealed Devices					
		1/2 – 3/4	4 Way	ECS7F4W	ECS7K4W		
		1	4 Way	ECS9F4W	ECS9K4W		
1-Gang — 20 Amp, 347 Vac — Non-Factory Sealed Devices							
		1/2 – 3/4	1-Pole	ECS2F17	ECS2K17		
		1	1-Pole	ECS4F17	ECS4K17		
		1/2 – 3/4	2-Pole	ECS2F27	ECS2K27		
		1	2-Pole	ECS4F27	ECS4K27		
		1/2 – 3/4	3 Way	ECS2F3W7	ECS2K3W7		
		1	3 Way	ECS4F3W7	ECS4K3W7		
		1/2 – 3/4	4 Way	ECS2F4W7	ECS2K4W7		
		1	4 Way	ECS4F4W7	ECS4K4W7		
		1-Gang — 30 Amp, 120 to 277 Vac — Non-Factory Sealed Devices					
				1/2 – 3/4	1-Pole	ECS2F13	ECS2K13
1	1-Pole			ECS4F13	ECS4K13		
1/2 – 3/4	2-Pole			ECS2F23	ECS2K23		
1	2-Pole			ECS4F23	ECS4K23		
1/2 – 3/4	3 Way			ECS2F3W3	ECS2K3W3		
1	3 Way			ECS4F3W3	ECS4K3W3		
1/2 – 3/4	3-Pole			ECS2F33	ECS2K33		
1	3-Pole			ECS4F33	ECS4K33		

① Optional flush mounted single LED indicator light - add suffix **-LED**.

ECS Selector Switch Control Stations

Explosionproof, Dust-Ignitionproof, Factory Sealed and Non-Factory Sealed

CEC:
 Class I, Division 1 and 2, Groups B, C, D
 Class II, Division 1 and 2, Groups E, F, G
 Class III
 CSA Type 3R, 7BCD, 9EFG

Potentiometer — 1-Gang — Non-Factory Sealed Devices

Other potentiometer resistances available, contact your local sales representative.



Hub Size (Inches)	Resistance	Catalog Number
1/2 – 3/4	2500 Ohms	ECS2POT25K
1	2500 Ohms	ECS4POT25K
1/2 – 3/4	5000 Ohms	ECS2POT5K
1	5000 Ohms	ECS4POT5K
1/2 – 3/4	10000 Ohms	ECS2POT10K
1	10000 Ohms	ECS4POT10K

Photocontrol — 1-Gang — Non-Factory Sealed and Non Group B Devices



















Hub Size (Inches)	Electrical Rating	Catalog Number
1/2 – 3/4	120 Vac, 1000 VA	ECS2PC120
1	120 Vac, 1000 VA	ECS4PC120
1/2 – 3/4	347 Vac, 1000 VA	ECS2PC347
1	347 Vac, 1000 VA	ECS4PC347

ECS Selector Switch Control Stations

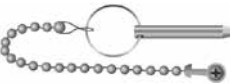
Explosionproof, Dust-Ignitionproof, Factory Sealed and Non-Factory Sealed

CEC:
 Class I, Division 1 and 2, Groups B, C, D
 Class II, Division 1 and 2, Groups E, F, G
 Class III
 CSA Type 3R, 7BCD, 9EFG

Description		Catalog Number
Push Button, Factory Sealed — Momentary Contact		
 SPBB-U1-Q  SPBB-U2DBL	10 Amp 600 Vac Heavy Duty 1/2" thread size (NPSM). Furnished with 1/2" to 3/4" enlarger, Weather Boot, Guard, Start, Stop and Blank Nameplates. Single Push Button Universal 	SPBB-U1-Q
	Double Push Button Universal 	SPBB-U2DBL
Push Button, Red, Factory Sealed — Maintained Contact		
	10 Amp 600 Vac Heavy Duty 1/2" thread size (NPSM). Furnished with 1/2" to 3/4" enlarger and Emergency Stop Nameplate (guard not furnished). Single Push Button Universal 	SMPB-U1-Q
Rectangular Button with Weather Boot		
	Furnished with Start, Stop and Blank Nameplates	NBN-WB
Nameplates for Rectangular Push Buttons		
 SNP-OFF-Q  SNP-ON-Q	Blank SNP-B-Q Off SNP-OFF-Q Forward SNP-FWD-Q On SNP-ON-Q Jog SNP-JOG-Q Reverse SNP-REV-Q Run SNP-RUN-Q Open SNP-OPEN-Q Stop SNP-SP-Q Close SNP-CLOSE-Q Start SNP-ST-Q Up SNP-UP-Q Down SNP-DOWN-Q Test SNP-TEST-Q Fast SNP-FAST-Q Low SNP-LOW-Q Slow SNP-SLOW-Q High SNP-HIGH-Q Raise SNP-RAISE-Q Lower SNP-LOWER-Q Reset SNP-RESET-Q	
Push Button Replacement Locking Guards — Glass Reinforced Polypropylene — Gasketed		
 Maintained Switch Guard  Single Guard  Double Guard	Has hole for 1/4" hasp. Single Guard (Maintained Switch) Single Guard Double Guard	SMPB-LG NPB-LG1 NPB-LG2
Push Button Securing Rod with Stainless Steel Chain		
	For use with Single Guard Only	NBL-SR
Mushroom Button with Weather Boot for Use with Momentary Contact — Gasketed		
 Black  Green  Red		NMRB-BL NMRB-GR NMRB-RE
Mushroom Button for Use with Maintained Contact — Solid-Colored Nonmetallic Button		
	Red	NMRBM-RE

Appleton

CONTROLS: NEC/CEC EXPLOSIONPROOF CONTROL STATIONS AND SWITCHES

ECS Selector Switch Control Stations

Explosionproof, Dust-Ignitionproof, Factory Sealed and Non-Factory Sealed

CEC:
 Class I, Division 1 and 2, Groups B, C, D
 Class II, Division 1 and 2, Groups E, F, G
 Class III
 CSA Type 3R, 7BCD, 9EFG

Thread Size (In., NPSM)	Description	Left	Diagram Center	Right	Catalog Number
-------------------------	-------------	------	----------------	-------	----------------

Selector Switch Assembly — Maintained Contact

When installed on a single gang box the cover assembly is suitable for use in Group B environments but will not be marked Group B.

2 Position Note: Standard legend plate reads HAND AUTO



1 Position



2 Position

1/2	2 Position, 2 Circuit		None		SSBA1-2Q
1/2	2 Position, 4 Circuits		None		SSBA2-2Q
1/2	3 Position, 2 Circuit				SSBA1-3Q
1/2	3 Position, 4 Circuit				SSBA2-3Q

Selector Switch Assembly — Modified Operations

When installed on a single gang box the cover assembly is suitable for use in Group B environments but will not be marked Group B.

3 Position Note: Standard legend plate reads Hand/Off/Auto

Momentary contact right position. Spring return to center. Maintained contact left position.



2 Circuit



4 Circuit

1/2	3 Position, 2 Circuit				SSBAS-1-3
1/2	3 Position, 4 Circuits				SSBAS-2-3
1/2	3 Position, 2 Circuit				SSBASL-1-3
1/2	3 Position, 4 Circuits				SSBASL-2-3

Momentary contact left position. Spring return to center. Maintained contact right position.

Selector Switches Nameplates



Two Position



Three Position

Two Position Nameplates		Three Position Nameplates	
Forward—Reverse	SLNP-FRQ	Forward—Off—Reverse	SLNP-FORQ
Hand—Auto	SLNP-HAQ	Hand—Off—Auto	SLNP-HOAQ
On—Off	SLNP-OO	Run—Off—Jog	SLNP-ROJQ
Start—Stop	SLNP-SS	Blank	SLNP-B3
Blank	SLNP-BQ	Reverse—Off—Forward	SLNP-ROFQ
Up—Down	SLNP-UDQ	Auto—Off—Hand	SLNP-AOHQ
Run—Job	SLNP-RJQ	Hand—Off—Remote	SLNP-HORQ
Auto—Hand	SLNP-AHQ	1—Off—2	SLNP-102Q
Off—Remote	SLNP-ORQ	Jog—Off—Run	SLNP-JORQ
Local Remote	SLNP-LRQ	Stop—Run—Start	SLNP-SRSQ
		Local—Off—Remote	SLNP-LORQ

Selector Switch Locking Devices — Permit locking in any position.



Description	Catalog Number
Two or Three Positions	SBL-3-Q

ECS Selector Switch Control Stations

Explosionproof, Dust-Ignitionproof, Factory Sealed and Non-Factory Sealed

CEC:
 Class I, Division 1 and 2, Groups B, C, D
 Class II, Division 1 and 2, Groups E, F, G
 Class III
 CSA Type 3R, 7BCD, 9EFG

	Description	Catalog Number
	Key Operated Selector Switch Replacement Parts	
	Two Position key operated 1 N/C - 1 N/O contact	XSS-82U
	Three Position key operated 1 N/C - 1 N/O contact	XSS-86U

Pilot Light – Factory Sealed



Pilot Light

Chamber Only

Incandescent

Furnished with 6S6 120 Vac incandescent lamp, jewel and guard.
 Has 457 mm (18") long, type SFF-2 pigtail leads; +150 °C (+302 °F). Body has 3/4" straight thread (NPSM).

With Red Jewel	SPLSREB
With Green Jewel	SPLSGRB
With Amber Jewel	SPLSAMB
With Blue Jewel	SPLSBLB
With Clear Jewel	SPLSCLB
With Opal Jewel	SPLSOPB

LED

Furnished with candelabra base 120 Vac LED, jewel and guard.
 Has 457 mm (18") long, type SFF-2 pigtail leads; +150 °C (+302 °F). Body has 3/4" straight thread (NPSM).

With Red LED, Clear Jewel	SPLNSREB
With Green LED, Clear Jewel	SPLNSGRB
With Amber LED, Clear Jewel	SPLNSAMB

Chamber Only (Same as above, less jewel, guard and lamp)

SPLSSCB

Pilot Light Jewel/Guard Assembly

The below catalog numbers indicate an assembly of the Pilot Light Jewels and Guards.
 Jewels and Guards are not available as separate items.



Amber Jewel/Guard	JGBNA
Blue Jewel/Guard	JGBNB
Clear Jewel/Guard	JGBNC
Green Jewel/Guard	JGBNG
Opal Jewel/Guard	JGBNO
Red Jewel/Guard	JGBNR

Replacement Bulbs



EPL-B6W

EPLLEDR

Clear Bulbs

Furnished with candelabra base. 6 Watt, 120 Vac, Type 6S6

EPL-B6W

LED Replacements

Furnished with candelabra base. 120 Vac, 10 mA.

Red LED	EPLLEDR
Green LED	EPLLEDG
Amber LED	EPLLEDA

Transformer

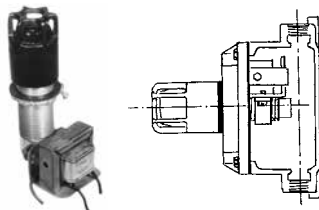





















Add Suffix as listed below. Transformer clamps directly to pilot light barrel.
Only one pilot light transformer assembly per one gang body.

Primary Vac	Lamp Vac	Suffix
220	120	TR2
277	120	TR3
440	120	TR4
550	120	TR5

ECS Selector Switch Control Stations

Explosionproof, Dust-Ignitionproof, Factory Sealed and Non-Factory Sealed

CEC:
 Class I, Division 1 and 2, Groups B, C, D
 Class II, Division 1 and 2, Groups E, F, G
 Class III
 CSA Type 3R, 7BCD, 9EFG

		Description	Contact Arrangement	Legend Plate	Catalog Number
Push Buttons/Pilot Lights – Factory Sealed – Cover Assembly Only					
 		1 Circuit Universal		Start	ECSKU1
		2 Circuit Universal	 	Start/Stop	ECSKU2
ECSKU1	ECSKU2				
		Emergency Stop (Maintained) 1 Circuit Universal		Stop	ECSKUM1
		Emergency Stop (Momentary) 1 Circuit Universal		Stop	ECSKMU1
ECSKUM1, ECSKMU1					
 		1 Red Pilot Light		—	ECSKJR
		2 Red Pilot Lights	 	—	ECSK2JR
ECSKJR	ECSK2JR				
		1 Green Pilot Light and 1 Universal Push Button	 	Start	ECSKJGU1
ECSKJGU1					
		1 Green Pilot Light and 2 Universal Push Buttons	  	Start	ECSKJGU2
ECSKJRU2					

Appleton

CONTROLS: NEC/CEC EXPLOSIONPROOF CONTROL STATIONS AND SWITCHES

ECS Selector Switch Control Stations

Explosionproof, Dust-Ignitionproof, Factory Sealed and Non-Factory Sealed









CEC:

Class I, Division 1 and 2, Groups B, C, D

Class II, Division 1 and 2, Groups E, F, G

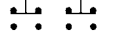
Class III



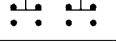
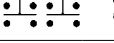
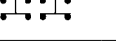

CSA Type 3R, 7BCD, 9EFG





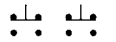
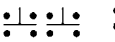

		Description	Diagram Left	Centre	Diagram Right	Legend Plate	Catalog Number
Selector Switches ② – Factory Sealed – Cover Assembly Only							
 2 Position	 3 Position	2 Position 2 Circuit		None		Start/Stop	ECSK12
		2 Position 4 Circuit		None		Start/Stop	ECSK35
		3 Position 2 Circuit				Hand/Off/Auto	ECSK102
		3 Position 4 Circuit				Hand/Off/Auto	ECSK345

Key-Operated Selector Switches – Non-Factory Sealed – Cover Assembly Only

Key removable in one position.

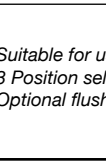
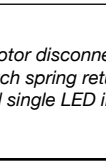

2 Position 2 Circuit		None		Start/Stop	ECSKSA82U
3 Position 4 Circuit				Hand/Off/Auto	ECSKSA86U

		Type	Catalog Number	
			Front Operated	Key Operated
Toggle Switches ① ③ – Cover Assembly Only – No Motor Ratings				
		20 Amp 120/277 Vac, Factory Sealed		
 ECSKF1	 ECSKK1	1-Pole	ECSKF1	ECSKK1
		2-Pole	ECSKF2	ECSKK2
		3 Way	ECSKF3W	ECSKK3W
		20 Amp 120/277 Vac, Non-Factory Sealed		
 ECSKF17	 ECSKK17	4 Way	ECSKF4W	ECSKK4W
		20 Amp 347 Vac, Non-Factory Sealed		
		1-Pole	ECSKF17	ECSKK17
		2-Pole	ECSKF27	ECSKK27
 ECSKF13	 ECSKK13	3 Way	ECSKF3W7	ECSKK3W7
		4 Way	ECSKF4W7	ECSKK4W7
		30 Amp 120/277 Vac – Non-Factory Sealed		
 ECSKF13	 ECSKK13	1-Pole	ECSKF13	ECSKK13
		2-Pole	ECSKF23	ECSKK23
		3 Way	ECSKF3W3	ECSKK3W3
		3-Pole	ECSKF33	ECSKK33

① Suitable for use as a motor disconnect.



② 3 Position selector switch spring return from right: add suffix **-S634**. 3 Position selector switch spring return from left: add suffix **-S635**.

③ Optional flush mounted single LED indicator light - add suffix **-LED**.

ECS Selector Switch Control Stations

Explosionproof, Dust-Ignitionproof, Factory Sealed and Non-Factory Sealed

CEC:
 Class I, Division 1 and 2, Groups B, C, D
 Class II, Division 1 and 2, Groups E, F, G
 Class III
 CSA Type 3R, 7BCD, 9EFG

	Rating	Catalog Number ①
Photocontrol — Non-Factory Sealed and Non Group B Devices		
	120 Vac, 1000 VA	ECSKPC120
	347 Vac, 1000 VA	ECSKPC347
	Resistance	Catalog Number
Potentiometer — Non-Factory Sealed Devices		
	2500 Ohms	ECSKPOT25K
	5000 Ohms	ECSKPOT5K
	10000 Ohms	ECSKPOT10K

① Optional flush mounted single LED indicator light - add suffix **-LED**.

ECS Selector Switch Control Stations

Explosionproof, Dust-Ignitionproof, Factory Sealed and Non-Factory Sealed

CEC:

Class I, Division 1 and 2, Groups B, C, D
 Class II, Division 1 and 2, Groups E, F, G
 Class III
 CSA Type 3R, 7BCD, 9EFG

Hub Size (Inches)	Description	Catalog Number
-------------------	-------------	----------------

ECS Series Mounting Boxes

CSA Certified when complete with ECKSK cover assembly. Boxes and covers sold separately. Boxes are complete with feed-thru hubs, mounting feet, ground screw and close-up plug for dead-end use. For 1/2" entry on ECS-172 and ECS-275 reducer required.



3/4	1-Gang	ECS175
1	1-Gang	ECS110
3/4	2-Gang	ECS275
1	2-Gang	ECS210

Description	Catalog Number
-------------	----------------

ECS Replacement Covers

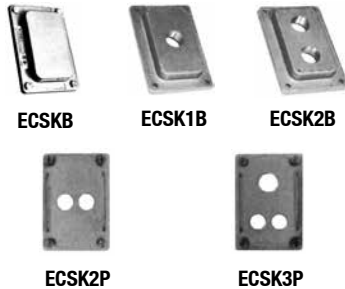

Blank Cover	ECKSKB
1 Device Cover	ECKSK1B
2 Device Cover	ECKSK2B
Dual Push button/Selector Switch Cover	ECKSK2P
Pilot Light and Dual Push button/Selector Switch Cover	ECKSK3P

Dimensions in Millimeters (Inches)

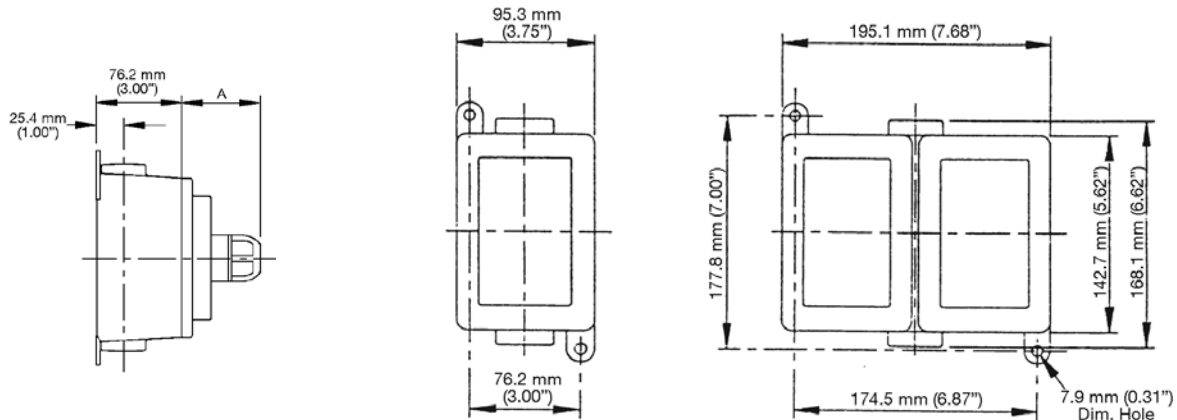

Device	A — Dimensions in Millimeters (Inches)
Push Button Switch	45.0 (1.81)
Selector Switch	57.2 (2.25)
Pilot Light	69.9 (2.75)
Mushroom Head Switch	56.4 (2.18)
Snap Switch	39.6 (1.56)
GFI	41.1 (1.62)
Photocontrol	53.8 (2.12)

ECS Configurable Control Stations

Explosionproof

NEC/CEC:

Class I, Division 1 and 2 Groups C, D
 Class II, Division 1 and 2 Groups E, F, G
 Class III
 Type 3R, 7, 9

Applications

- Control stations are used in classified areas.
- These enclosures are designed to accommodate up to 16 push buttons, selector switches and pilot lights when specified.

Features

- Precision ground flame path between box and cover.
- 3/4" conduit opening top and bottom standard, maximum 1-1/2" available.
- Operators are spaced on 2-1/8" centers.
- Ground lug package and installation instructions included.
- Cast-on slotted mounting feet.

Standard Materials and Finishes

- Enclosure: copperfree (4/10 of 1% max.) aluminum
- Shot blast

NEC/CEC Certifications and Compliances

- UL Standards: UL 508, UL 698, UL 1203
- UL Listed: E87975
- CSA Standards: C22.2 No. 14M, C22.2 No. 25, C22.2 No. 30
- CSA Certified: 038339

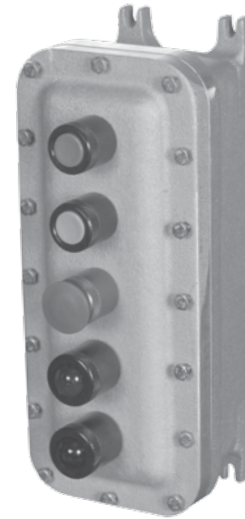

Appleton

CONTROLS: NEC/CEC EXPLOSIONPROOF CONTROL STATIONS AND SWITCHES

Number of Operators	Inside Dimensions in Millimeters (Inches)			Mounting Dimensions in Millimeters (Inches)		Shipping Wt. kgs (lbs)	Catalog Number
	W	H	D	A	B		
1	88.9 (3.50)	76.2 (3.00)	76.2 (3.00)	82.6 (3.25)	139.7 (5.50)	2.7 (6)	ECS1
2	88.9 (3.50)	177.8 (7.00)	76.2 (3.00)	82.6 (3.25)	228.6 (9.00)	4.1 (9)	ECS2
3	88.9 (3.50)	177.8 (7.00)	76.2 (3.00)	82.6 (3.25)	228.6 (9.00)	4.1 (9)	ECS3
4	88.9 (3.50)	279.4 (11.00)	76.2 (3.00)	82.6 (3.25)	330.2 (13.00)	5.0 (11)	ECS4
5	88.9 (3.50)	279.4 (11.00)	76.2 (3.00)	82.6 (3.25)	330.2 (13.00)	5.0 (11)	ECS5
6	88.9 (3.50)	381.0 (15.00)	76.2 (3.00)	82.6 (3.25)	731.8 (17.00)	6.8 (15)	ECS6
7	88.9 (3.50)	457.2 (18.00)	76.2 (3.00)	82.6 (3.25)	508.0 (20.00)	7.7 (17)	ECS7
8	88.9 (3.50)	457.2 (18.00)	76.2 (3.00)	82.6 (3.25)	508.0 (20.00)	7.7 (17)	ECS8
9	88.9 (3.50)	609.6 (24.00)	76.2 (3.00)	82.6 (3.25)	660.4 (26.00)	10.0 (22)	ECS9
10	88.9 (3.50)	609.6 (24.00)	76.2 (3.00)	82.6 (3.25)	660.4 (26.00)	10.0 (22)	ECS10
11	88.9 (3.50)	609.6 (24.00)	76.2 (3.00)	82.6 (3.25)	660.4 (26.00)	10.0 (22)	ECS11
12	88.9 (3.50)	762.0 (30.00)	76.2 (3.00)	82.6 (3.25)	812.8 (32.00)	77.8 (26)	ECS12
13	88.9 (3.50)	762.0 (30.00)	76.2 (3.00)	82.6 (3.25)	812.8 (32.00)	77.8 (26)	ECS13
14	88.9 (3.50)	762.0 (30.00)	76.2 (3.00)	82.6 (3.25)	812.8 (32.00)	77.8 (26)	ECS14
15	88.9 (3.50)	914.4 (36.00)	76.2 (3.00)	82.6 (3.25)	965.2 (38.00)	15.9 (35)	ECS15
16	88.9 (3.50)	914.4 (36.00)	76.2 (3.00)	82.6 (3.25)	965.2 (38.00)	15.9 (35)	ECS16

ECS Configurable Control Stations

Explosionproof

NEC/CEC:
 Class I, Division 1 and 2 Groups C, D
 Class II, Division 1 and 2 Groups E, F, G
 Class III
 Type 3R, 7, 9

Option Suffix	Description
A2X	2-position Selector Switch (Specify Legend Plate)
A3X	3-position Selector Switch (Specify Legend Plate)
A31X	Spring Return From Left To Center
A32X	Spring Return From Right To Center To Center
A34X	Key Operated 3-position Selector Switch
POL	Potentiometer (Specify Number Of Turns, Watts and Ohms)
BD	Breather/Drain (1 Each) (Includes Outlets and Installation)
G1	Gray Coated Outside Only
G2	Gray Coated Inside/Outside
L ① +	Voltage Code - Specify: 1 - 120 Vac Pigtail 2 - 240/120 Vac Transformer 3 - 120/6 Vac Transformer 4 - 480/120 Vac Transformer 5 - 600/120 Vac Transformer 6 - 6 Vac Pigtail 7 - 12 Vac Pigtail 8 - 24 Vac Pigtail 9 - 48 Vac Pigtail Pilot Light Lens Color - Specify: A - Amber B - Blue C - Clear G - Green R - Red
LED	LED Pilot Lights

Option Suffix	Description
M	Stainless Steel Mounting Hardware
MH1	0.25" - 20 x 1.25" Bolts 0.25" - 20 Hex Nuts 0.25" Washers
MH2	0.375" - 16 x 1.25" Bolts 0.375" - 16 Hex Nuts 0.375" Washers
NP	Phenolic Nameplate (Specify Legend)
RS	Reset (Mechanical)
S1X	Start Push button
S2X	Stop Push button
S3X	Start-Stop Split Push button
S4X	Emergency Stop (Momentary)
S5X	Emergency Stop (Maintained)
S6X	Black Push button (NO)
S7X	Black Push button (NC)
S8X	Black Push button (NO/NC)
U	Close Up Plug (0.75 - 14 NPSM)
KA1	Contact Block (NO/NC)
KA2	Contact Block (NO)
KA3	Contact Block (NC)

Appleton®

CONTROLS: NEC/CEC EXPLOSIONPROOF CONTROL STATIONS AND SWITCHES

See AEP Series short barrel operators (ACSEW Cast Control Operators pages) for more details.
 ① Voltage Code plus Pilot Light Lens Color.

ECS Series Timer Control Station

Explosionproof, Dust-Ignitionproof

CEC:
 Class I, Division 1 and 2, Groups B, C, D
 Class II, Division 1 and 2, Groups E, F, G
 Class III
 CSA Type 3R, 7BCD, 9EFG

Applications

- Provides timed operation of electrical circuits for lighting, small pumps, heat tracing, etc.

Features

- Corrosion resistant, captive stainless steel hex head bolts fix the cover to the body.
- Lockable push buttons are supplied standard with neoprene weatherprotected boot.
- Yellow LED indicator light for easy confirmation of activation.
- Corrosion resistant, gray polyester finished body.
- Quality CMOS type electronic timer allows for timing range of 0.1 seconds to 600 hours.
- Rated operational voltage of 100-240 Vac 50/60 Hz with a published tolerance of 85-264 Vac at 10 Amps (resistive).
- Suitable for operation in -20 °C to +65 °C (-4 °F to +149 °F) ambients.
- Timer tested for shock and vibration resistance.

Standard Materials

- Cast enclosures: copperfree (max. 4/10 of 1%) aluminum
- Indicator light: polyester finished aluminum guard and body assembly. Steel clamping ring with tempered glass jewel
- Body: supplied with an O-ring seal

Standard Finishes

- Housing and cover: electrostatically applied gray polyester epoxy powder coating



Options

- CSA Type 4X enclosure add suffix **-4X**.

CEC Certifications and Compliances

- CSA Standards: CSA C22.2 No. 25, CSA C22.2 No. 30, CSA C22.2 No. 14-M
- CSA Certified: 038339
- Optional 4X Rating

Appleton

CONTROLS: NEC/CEC EXPLOSIONPROOF CONTROL STATIONS AND SWITCHES

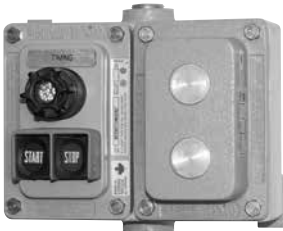
	Max. Amps	Conduit Entries	Entry Size (Inches)	Catalog Number
	10	2	3/4	ECS6TIM60AC

While built to rigorous quality standards, user is responsible to provide a backup or fail-safe provision to the timer in applications when heavy damage or personal safety may be caused in case of timer failure.

Dimensions in Millimeters (Inches)

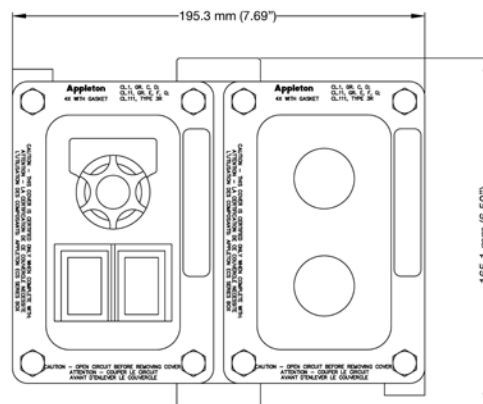
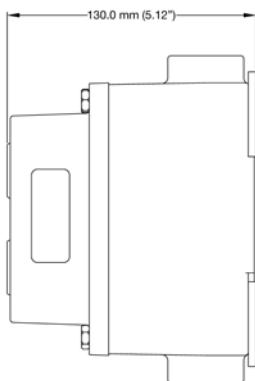

Intraground™ N1 Series Control Stations

Nonmetallic

10 Amp, 600 Vac Max. for Heavy Duty Use.

NEC — N1 Series (Non-Factory Sealed): Ⓞ
Class I, Division 1 and 2, Groups C, D
NEMA 3R, 4X, 7CD, 12

Applications

- Listed for use in Class I, Division 1 and 2, Group C and D atmospheres such as:
 - Diethyl ether
 - Methyl ethyl ketone
 - Acetone
 - Toluene
 - No. 3 fuel oil
 - Ammonium hydroxide (20%)
 - Benzene
 - Regular unleaded gas
 - Ethyl acetate
 - Hexane
 - Methanol
- Not suitable for:
 - Ethylene dichloride
 - Partially halogenated hydrocarbons
- Sealing fittings must be field installed adjacent to enclosure on all conduit runs.
- Explosionproof, with sealing fittings installed at each conduit entrance, the N1 Series enclosures withstood a hydrostatic test of four times the maximum internal explosion pressure that could be developed from a gas or vapor explosion.
- Push buttons and selector switches are used in conjunction with contactors or magnetic starters for remote control of motors in hazardous locations. They provide circuit control and/or selection.
- Pilot lights provide visual assurance that an electrical function is being performed at a remote or local hazardous location.

Features

- Nonmetallic construction with metal imbedded grounding grid. No need to install special wires and parts for grounding. Feed-thru or dead-end grounded 1/2" or 3/4" conduit openings for threaded conduit.
- Special grounding wire furnished with each box provides safe grounding when cover is removed.
- Ideal for use in corrosive environments. Nonmetallic enclosures with corrosion resistant parts coated with epoxy, Teflon® Ⓞ or Mylar® Ⓞ, these control stations offer unsurpassed resistance to chemicals.
- Unique labyrinth-path construction assures flame-tight joint between body and cover.
- Silicone gasket, specially designed for the labyrinth-path joint, prevents entrance of moisture without interfering with the venting of cooled hazardous gases and vapors.
- Typical mechanical properties of 24,500 psi tensile strength, 3% elongation at break, 33,000 psi flexural strength, and 1,200,000 psi flexural modulus.
- Electrical properties of sample specimens: dielectric strength (in air) of 769 at 1/16".
- High strength thermoplastic polyetherimide, together with thick walls (5/16") and sound structural design (rounded corners) provides superior resistance to impact and crushing.
- Excellent resistance to ultraviolet light and water.
- Excellent conduit connection strength.
- Excellent resistance to attack by fungi and mold.
- Superior flammability resistance.



Push Button



Pilot Light



Selector Switch



Combination Push Button and Pilot Light



Combination Selector Switch and Pilot Light

Related Products

- Sealing fitting must be installed at each conduit entrance of the N1 enclosure to be explosionproof. See *Hazardous Location Fittings Section*.

Ⓞ For Class I, Division 1 applications, sealing fittings must be field installed adjacent to enclosure on all conduit runs.

Ⓞ Teflon and Mylar are registered trademarks of E. I. du Pont de Nemours and Company.

Intraground™ N2 Series Control Stations

Nonmetallic

10 Ampere, 600 Vac Max. for Heavy Duty Use.

NEC — N2 Series (Factory Sealed):
Class I, Division 2, Groups B, C, D
Class II, Division 1 and 2, Groups E, F, G
Class III
NEMA 3R, 4X, 9EFG, 12

Applications

- Listed for use in Class I, Division 2, Group B, C and D atmospheres such as:
 - Diethyl ether
 - Methyl ethyl ketone
 - Acetone
 - Toluene
 - No. 3 fuel oil
 - Ammonium hydroxide (20%)
 - Benzene
 - Regular unleaded gas
 - Ethyl acetate
 - Hexane
 - Methanol.
- Listed for use in Class II, Division 1 and 2, Groups E, F and G.
- Dust-tight construction. After 32 hour UL test, no magnesium dust entered the enclosure.
- Push buttons and selector switches are used in conjunction with contactors or magnetic starters for remote control of motors in hazardous locations. They provide circuit control and/or selection.
- Pilot lights provide visual assurance that an electrical function is being performed at a remote or local hazardous location.

Features

- Factory sealed — no external seals required.
- Nonmetallic construction with metal imbedded grounding grid. No need to install special wires and parts for grounding. Feed-thru or dead-end grounded 1/2" or 3/4" conduit openings for threaded conduit.
- Special grounding wire furnished with each box provides safe grounding when cover is removed.
- Ideal for use in corrosive environments. Nonmetallic enclosures with corrosion resistant parts coated with epoxy, Teflon® ① or Mylar® ②, these control stations offer unsurpassed resistance to chemicals.
- Silicone gasket, specially designed for the labyrinth-path point between cover and body, prevents entrance of moisture and dust.
- Molded of high-tensile 30% glass reinforced thermoplastic polyetherimide. Enclosure walls are 5/16" thick.
- Typical mechanical properties of 17,000 psi tensile strength, 3% elongation at break, 27,000 psi flexural strength, and 1,100,000 psi flexural modulus (UL tests showed 18,918 psi tensile strength and 30,675 psi flexural strength).
- Electrical properties of sample specimens: dielectric strength of 490 at 1/8" and a comparative track index of 185V/0.058".
- Superior impact resistance.
- Extremely low water absorption. This important quality assures dimensional stability.
- Excellent resistance to ultraviolet light and water.
- UL Temperature Index (continuous use temperature): +130 °C (+266 °F) electrical properties, +130 °C (+266 °F) mechanical properties with impact, and +140 °C (+284 °F) mechanical properties without impact.
- Superior flammability resistance.
- Excellent pull-out resistance.



Push Button



Pilot Light



Selector Switch



Combination Push Button and Pilot Light



Combination Selector Switch and Pilot Light

① Teflon and Mylar are registered trademarks of E. I. du Pont de Nemours and Company.

Intraground™ N1 and N2 Series Control Stations

Nonmetallic

10 Ampere, 600 Vac Max. for Heavy Duty Use.

NEC — N1 Series (Non-Factory Sealed): ☉
Class I, Division 1 and 2, Groups C, D
NEMA 3R, 4X, 7CD, 12

NEC — N2 Series (Factory Sealed):
Class I, Division 2, Groups B, C, D
Class II, Division 1 and 2, Groups E, F, G
Class III
NEMA 3R, 4X, 9EFG, 12

Features

- Heavy duty push button, 10 Amp 600 Vac rated.
- Dozens of possible combinations of push buttons, pilot lights and selector switches.
- Smooth, rounded integral bushing in each conduit opening protects conduct or insulation.
- Accurately tapped, tapered conduit openings for tight, rigid joints and ground continuity.
- Push Buttons, Selector Switches, and Pilot Lights
 - Stainless steel push button shaft operates within stainless steel bushing, assuring long, maintenance-free operation.
 - Push button and selector switch contacts are silver cadmium oxide which are "sealed" in lower phenolic chamber isolated from corrosive elements. Assures positive contact and long, trouble-free operation.
 - Enclosed stainless steel helper spring prevents accidental operation of push button in severe vibration installations.
 - Corrosion resistant stainless steel Teflon® ① coated hex head cap screws hold covers to body.
 - Push buttons are supplied with lockout type guards as standard. Hole in guard will accept locks with up to 1/4" hasp. Permits locking of push button to prevent unauthorized operation.
 - Clearly marked terminals with brass screws assure quick, easy wiring.
 - Pilot light supplied with jewel/guard assembly and 120 Vac, 6 Watt type 6S6 lamp, 120 Vac/Vdc, 50/60 Hz, 6 Watt.

Standard Materials

- Body and cover: 30% glass-reinforced thermoplastic polyetherimide
- SPBB push button: aluminum upper barrel and phenolic lower barrel with nylon plastic button. Glass reinforced polypropylene guard. Silicone weather boot. Aluminum nameplate
- SPLS pilot light: aluminum guard and body assembly; steel clamping ring; and tempered glass jewel
- SSBA selector switch: aluminum housing, nylon knobs and cams, and sealed phenolic contact block
- NBN rectangular button with weather boot: Nylon plastic button with neoprene weather boot. Aluminum nameplate
- NMRB mushroom button with weather boot: anodized aluminum buttons with neoprene weather boot
- Selector switch locking devices and push button securing rods: stainless steel
- Cover bolts: stainless steel
- Nameplates: copperfree (4/10 of 1% max.) aluminum
- Receptacles: copperfree (4/10 of 1% max.) aluminum

Standard Finishes

- Cover bolts: Teflon® ①
- Nameplates: Mylar® ①
- Pilot light guard and clamping ring: epoxy

Options

- Three position selector switches with modified operation. For description and switch diagram, refer to switch operators.
 - Momentary contact right position, spring return to center, maintained contact left position. Add suffix **–SRC**.
 - Momentary contact left position, spring return to center, maintained contact right position. Add suffix **–SLC**.
- Alternate contacts add suffix **–ALT**.
- Selector switch Lockout: locks 2- or 3-position handle in any position. Suffix **–LD**.
- Push button front operated mushroom head (momentary contact):
 - Red **–NMRBRE**
 - Green **–NMRBGR**
 - Black, add suffix **–NMRBBL**.
- Pilot light jewel/guard assembly. Order by suffixes if color desired is other than red, as follows:
 - Amber **–JGBA**
 - Blue **–JGBB**
 - Clear **–JGBC**
 - Green **–JGBG**
 - Opal **–JGBO**
- For colored LED jewel/guard assembly, order by suffixes:
 - Red **–LEDR**
 - Green **–LEDG**
 - Amber **–LEDA**
- Pilot light transformers for single pilot light per gang. Order by suffix:

Primary Voltage	Lamp Voltage	Suffix
220	120	TR-2
277	120	TR-3
440	120	TR-4
550	120	TR-5

- Securing rod for push button lockout guard. Add suffix **–SR**.
- **NPBRKT** nameplate mounting bracket to make circuit description/identification easy.
 - Pre-drilled holes in bottom of bracket allow direct mounting to control stations with existing cover bolts.
 - Pre-drilled holes in middle of bracket allow mounting of customer's circuit identification nameplate; epoxy glue may also be used for mounting (phenolic nameplate not included).
 - Bracket eliminates costly field installation of drilling and tapping to accommodate circuit identification nameplate.
 - Brackets fit side-by-side on 2-, 3- and 4-gang boxes and 3-devices.

NEC Certifications and Compliances

- UL Standards: UL 508, UL 698, UL 1203
- UL Listed: E10449, E81751

☉ For Class I, Division 1 applications, sealing fittings must be field installed adjacent to enclosure on all conduit runs.

① Teflon and Mylar are registered trademarks of E. I. du Pont de Nemours and Company.

Intraground™ N1 and N2 Series Control Stations

Nonmetallic

10 Ampere, 600 Vac Max. for Heavy Duty Use.

NEC — N1 Series (Non-Factory Sealed): ☉
Class I, Division 1 and 2, Groups C, D
NEMA 3R, 4X, 7CD, 12

NEC — N2 Series (Factory Sealed):
Class I, Division 2, Groups B, C, D
Class II, Division 1 and 2, Groups E, F, G
Class III
NEMA 3R, 4X, 9EFG, 12

Illustrated Features



Aluminum grounding grid, imbedded into the nonmetallic enclosure during molding, provides complete grounding system. No field work. No extra grounding wires or parts required.

SPBB Design Features

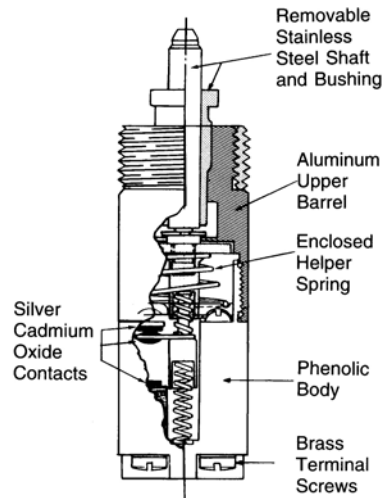

☉ For Class I, Division 1 applications, sealing fittings must be field installed adjacent to enclosure on all conduit runs.

Intraground™ N1 and N2 Series Control Stations

Nonmetallic

10 Ampere, 600 Vac Max. for Heavy Duty Use.

NEC — N1 Series (Non-Factory Sealed): ☉
Class I, Division 1 and 2, Groups C, D
NEMA 3R, 4X, 7CD, 12

NEC — N2 Series (Factory Sealed):
Class I, Division 2, Groups B, C, D
Class II, Division 1 and 2, Groups E, F, G
Class III
NEMA 3R, 4X, 9EFG, 12

Catalog Numbering Guide

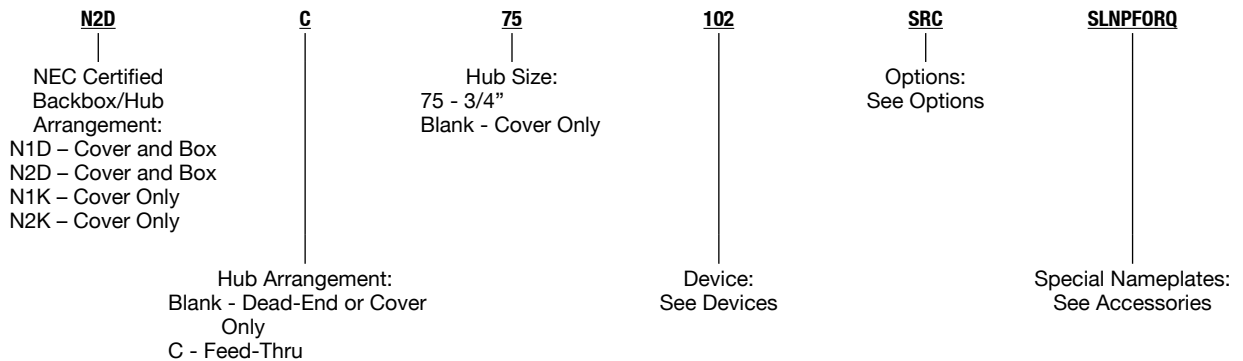

Full Catalog # N2DC75-102-SRC-SLNPFORQ

Feed-Thru N2D Box with 3/4" Hubs:
With A 2-Circuit, 3 Position
Spring Return from the Right
Selector Switch and "Forward-Off-Reverse" Nameplate

Options

Options Description	Suffix
Momentary Push Button Securing Rod	SR
Selector Switch Lockout	LD
Spring Return From Right Selector Switch (3 Positions Only)	SRC
Spring Return From Left Selector Switch (3 Positions Only)	SLC
Alternate Contacts Selector Switch	ALT
Change One Red Lens to Green Lens	JGBG
Change One Red Lens to Opal Lens	JGBO
Change One Red Lens to Amber Lens	JGBA
Change One Red Lens to Blue Lens	JGBB
Change One Red Lens to Clear Lens	JGBC
Add 220/120 Vac Transformer (J1 Device Only)	TR2
Add 277/120 Vac Transformer (J1 Device Only)	TR3
Add 440/120 Vac Transformer (J1 Device Only)	TR4
Add 550/120 Vac Transformer (J1 Device Only)	TR5
Change One Red Pilot to Red LED	LEDR
Change One Red Lens to Green LED	LEDG
Change One Red Lens to Amber LED	LEDA
Add Red Mushroom Head to Momentary Push Button	NMRBRE
Add Black Mushroom Head to Momentary Push Button	NMRBBL
Add Green Mushroom Head to Momentary Push Button	NMRBGR
Locking Guard for Maintained Push Button	SMPBLG

☉ For Class I, Division 1 applications, sealing fittings must be field installed adjacent to enclosure on all conduit runs.

Intraground™ N1 and N2 Series Control Stations Devices

Nonmetallic

NEC – N1 Series (Non-Factory Sealed): ☉
 Class I, Division 1 and 2, Groups C, D
 NEMA 3R, 4X, 7CD, 12

NEC – N2 Series (Factory Sealed):
 Class I, Division 2, Groups B, C, D
 Class II, Division 1 and 2, Groups E, F, G
 Class III
 NEMA 3R, 4X, 9EFG, 12

Devices

Device Description	Suffix
One Pilot Light (Red Standard)	J1
Two Pilot Lights	J2
One Pilot Light and One Momentary Push Button	J1U1
One Pilot Light and Two Momentary Push Buttons	J1U2
One Pilot Light and One Maintained Push Button	J1UM1
One Pilot Light and One Dust-Cap Push Button	J1DU1
One Pilot Light and One 12 Selector Switch (2 Position, 2 Circuit)	J112
One Pilot Light and One 35 Selector Switch (2 Position, 4 Circuit)	J135
One Pilot Light and One 102 Selector Switch (3 Position, 2 Circuit)	J1102
One Pilot Light and One 345 Selector Switch (3 Position, 4 Circuit)	J1345
One Monetary Push Button	U1
Two Monetary Push Buttons	U2
Two Side-By-Side Momentary Push Buttons	U2DBL
Three Monetary Push Buttons	U3
One Momentary Push Button and One Maintained Push Button	U1UM1
One Momentary Push Button and One Dust-Cap Push Button	U1DU1
One Momentary Push Button and One 12 Selector Switch (2 Position, 2 Circuit)	U112
One Momentary Push Button and One 35 Selector Switch (2 Position, 4 Circuit)	U135
One Momentary Push Button and One 102 Selector Switch (3 Position, 2 Circuit)	U1102
One Momentary Push Button and One 345 Selector Switch (3 Position, 4 Circuit)	U1345
One Maintained Push Button (Mushroom Head - Red)	UM1
Two Maintained Push Button	UM2
One Maintained and One Dust-Cap Push Button	UM1DU1
One Maintained Push Button and One 12 Selector Switch (2 Position, 2 Circuit)	UM112
One Maintained Push Button and One 35 Selector Switch (2 Position, 4 Circuit)	UM135
One Maintained Push Button and One 102 Selector Switch (3 Position, 2 Circuit)	UM1102
One Maintained Push Button and One 345 Selector Switch (3 Position, 4 Circuit)	UM1345
One Dust Cap Push Button	DU1
Two Dust Cap Push Buttons	DU2
One Dust Cap and One 12 Selector Switch (2 Position, 2 Circuit)	DU112
One Dust Cap and One 35 Selector Switch (2 Position, 4 Circuit)	DU135
One Dust Cap and One 102 Selector Switch (3 Position, 2 Circuit)	DU1102
One Dust Cap and One 345 Selector Switch (3 Position, 4 Circuit)	DU1345
One 12 Selector Switch (2 Position, 2 Circuit)	12
One 35 Selector Switch (2 Position, 4 Circuit)	35
One 102 Selector Switch (3 Position, 2 Circuit)	102
One 345 Selector Switch (3 Position, 4 Circuit)	345

☉ For Class I, Division 1 applications, sealing fittings must be field installed adjacent to enclosure on all conduit runs.

Intraground™ N1 and N2 Series Control Stations

Nonmetallic

10 Ampere, 600 Vac Max. for Heavy Duty Use. N1 Series – Neutral Color; N2 Series – Blue Color.

NEC — N1 Series (Non-Factory Sealed) : ☉
Class I, Division 1 and 2, Groups C, D
NEMA 3R, 4X, 7CD, 12

NEC — N2 Series (Factory Sealed):
Class I, Division 2, Groups B, C, D
Class II, Division 1 and 2, Groups E, F, G
Class III
NEMA 3R, 4X, 9EFG, 12

Nameplates ①

Description	Suffix
Mushroom Head Push Buttons (Maintained and Momentary)	
Start	MNPSTQ
Stop	MNPSPQ
Emergency Stop	MNPESTPQ
Blank	MNPBQ
Pilot Light Nameplates	
Blank	LNPBQ
Forward	LNPFWQ
Jog	LNPJOGQ
Run	LNPRUNQ
Stop	LNPSPQ
Start	LNPSTQ
Down	LNPDOWNQ
Fast	LNPFASTQ
Slow	LNPLOWQ
Raise	LNPRAISEQ
Lower	LNPLOWERQ
Reset	LNPRESETQ
Off	LNP OFFQ
On	LNPONQ
Reverse	LNPREVQ
Close	LNPCLOSEQ
Open	LNPOPENQ
Up	LNPUPQ
Test	LNPTESTQ
Low	LNPLOWQ
High	LNP HIGHQ
Two Position Selection Switch Nameplates	
Forward—Reverse	SLNPFRQ
Hand—Auto ②	SLNPHAQ
On—Off	SLNPOO
Start—Stop	SLNPSS
Blank	SLNPBQ
Up—Down	SLNPUDQ
Run—Jog	SLNPRJQ
Auto—Hand	SLNPAHQ
Off—Remote	SLNPORQ

Description	Suffix
Three Position Selection Switch Nameplates	
Forward—Off—Reverse	SLNPFORQ
Hand—Off—Auto ②	SLNPHOAQ
Run—Off—Jog	SLNPROJQ
Blank	SLNPB3
Reverse—Off—Forward	SLNPROFQ
Auto—Off—Hand	SLNPAOHQ
Hand—Off—Remote	SLNPHORQ
1—Off—2	SLNP102Q
Jog—Off—Run	SLNPJORQ
Stop—Run—Start	SLNPSRSQ
Local—Off—Remote	SLNP LORQ
Momentary Push Buttons	
<i>For Rectangular Weatherboot Style Only (Not for round weatherboot style)</i>	
Blank ②	SNPBQ
Forward	SNPFWDQ
Jog	SNPJOGQ
Run	SNPRUNQ
Stop ②	SNPSPQ
Start ②	SNPSTQ
Down	SNPDOWNQ
Fast	SNPFASTQ
Slow	SNPSLOWQ
Raise	SNPRAISEQ
Lower	SNPLOWERQ
Reset	SNPRESETQ
Off	SNPOFFQ
On	SNPONQ
Reverse	SNPREVQ
Close	SNPCLOSEQ
Open	SNPOPENQ
Up	SNPUPQ
Test	SNPTESTQ
Low	SNPLOWQ
High	SNPHIGHQ

① Custom nameplates are not available.

② Included as standard (no need to use suffix).

☉ For Class I, Division 1 applications, sealing fittings must be field installed adjacent to enclosure on all conduit runs.

Intraground™ N1 and N2 Series Control Stations

Push Button and Push Button/Pilot Light. Nonmetallic

10 Ampere, 600 Vac Max. for Heavy Duty Use. N1 Series – Neutral Color; N2 Series – Blue Color.

NEC – N1 Series (Non-Factory Sealed): ☉
Class I, Division 1 and 2, Groups C, D
NEMA 3R, 4X, 7CD, 12

NEC – N2 Series (Factory Sealed):
Class I, Division 2, Groups B, C, D
Class II, Division 1 and 2, Groups E, F, G
Class III
NEMA 3R, 4X, 9EFG, 12

		Hub Size (Inches) ①	Description	Diagram	Nameplate Marking	Catalog Number	
						N1 Series ☉	N2 Series
1-Gang Push Buttons – Momentary Contact							
		Dead-End					
		1/2 or 3/4	1 Circuit Universal		Start/Stop	N1D75-U1	N2D75-U1
		1/2 or 3/4	2 Circuits Universal		Start/Stop	N1D75-U2	N2D75-U2
		Feed-Thru					
		1/2 or 3/4	1 Circuit Universal		Start/Stop	N1DC75-U1	N2DC75-U1
		1/2 or 3/4	2 Circuits Universal		Start/Stop	N1DC75-U2	N2DC75-U2
1 Circuit	2 Circuit						
1-Gang Push Buttons – Maintained Contact Red Mushroom Head – Emergency Stop Nameplate							
		Dead-End					
		1/2 or 3/4	1 Circuit Universal		Emergency Stop	N1D75-UM1	N2D75-UM1
		Feed-Thru					
		1/2 or 3/4	1 Circuit Universal		Emergency Stop	N1DC75-UM1	N2DC75-UM1
3-Device Push Buttons – Momentary Contact							
		Dead-End					
		1/2 or 3/4	3 Circuits Universal		Start/Stop	N1D75-U3	N2D75-U3
		Feed-Thru					
		1/2 or 3/4	3 Circuit Universal		Start/Stop	N1DC75-U3	N2DC75-U3
1-Gang Push Button/Pilot Light – Momentary Contact							
		Dead-End					
		1/2 or 3/4	1 Circuit Universal and 1 Pilot Light		Specify	N1D75-J1U1	N2D75-J1U1
		1/2 or 3/4	2 Circuits Universal and 1 Pilot Light		Specify	N1D75-J1U2	N2D75-J1U2
		Feed-Thru					
		1/2 or 3/4	1 Circuit Universal and 1 Pilot Light		Specify	N1DC75-J1U1	N2DC75-J1U1
		1/2 or 3/4	2 Circuits Universal and 1 Pilot Light		Specify	N1DC75-J1U2	N2DC75-J1U2
1 Circuit 1 Pilot Light	2 Circuit 1 Pilot Lights						
1-Gang Pilot Lights							
		Dead-End					
		1/2 or 3/4	1 Pilot Light		Specify	N1D75-J1	N2D75-J1
		1/2 or 3/4	2 Pilot Lights		Specify	N1D75-J2	N2D75-J2
		Feed-Thru					
		1/2 or 3/4	1 Pilot Light		Specify	N1DC75-J1	N2DC75-J1
		1/2 or 3/4	2 Pilot Lights		Specify	N1DC75-J2	N2DC75-J2
1 Pilot Light	2 Pilot Lights						

① Furnished with 3/4" to 1/2" NPT reducer.

☉ For Class I, Division 1 applications, sealing fittings must be field installed adjacent to enclosure on all conduit runs.

































Intraground™ N1 and N2 Series Control Stations

Selector Switch Control Stations and Fire Alarm Station. Nonmetallic

10 Ampere, 600 Vac Max. for Heavy Duty Use. N1 Series – Neutral Color; N2 Series – Blue Color.



NEC – N1 Series (Non-Factory Sealed): ☉
Class I, Division 1 and 2, Groups C, D
NEMA 3R, 4X, 7CD, 12

NEC – N2 Series (Factory Sealed):
Class I, Division 2, Groups B, C, D
Class II, Division 1 and 2, Groups E, F, G
Class III
NEMA 3R, 4X, 9EFG, 12

	Hub Size (Inches) ①	Pilot Light Diagram	Switch Diagram			Catalog Number	
			Left	Center	Right	With Pilot Light	With Out Pilot Light
Dead-End							
	1/2 or 3/4 — Pilot Light and 2-Pos., 2-Cir. Selector Switch			None		N1D75-J112	N1D75-12
						N2D75-J112	N2D75-12
	1/2 or 3/4 — Pilot Light and 2-Pos., 4-Cir. Selector Switch			None		N1D75-J135	N1D75-35
						N2D75-J135	N2D75-35
<i>Note: Standard legend plate reads Hand/Auto</i>							
	1/2 or 3/4 — Pilot Light and 3-Pos., 2-Cir. Selector Switch					N1D75-J1102	N1D75-102
						N2D75-J1102	N2D75-102
	1/2 or 3/4 — Pilot Light and 3-Pos., 4-Cir. Selector Switch					N1D75-J1345	N1D75-345
						N2D75-J1345	N2D75-345
<i>Note: Standard legend plate reads Hand/Off/Auto</i>							
Feed-Thru							
	1/2 or 3/4 — Pilot Light and 2-Pos., 2-Cir. Selector Switch			None		N1DC75-J112	N1DC75-12
						N2DC75-J112	N2DC75-12
	1/2 or 3/4 — Pilot Light and 2-Pos., 4-Cir. Selector Switch			None		N1DC75-J135	N1DC75-35
						N2DC75-J135	N2DC75-35
<i>Note: Standard legend plate reads Hand/Auto</i>							
	1/2 or 3/4 — Pilot Light and 3Pos., 2-Cir. Selector Switch					N1DC75-J1102	N1DC75-102
						N2DC75-J1102	N2DC75-102
	1/2 or 3/4 — Pilot Light and 3-Pos., 4-Cir. Selector Switch					N1DC75-J1345	N1DC75-345
						N2DC75-J1345	N2DC75-345
<i>Note: Standard legend plate reads Hand/Off/Auto</i>							

Fire Alarm Station, Factory Sealed – Universal Contacts, with hammer on chain



Hub Size (Inches) ①	Description	Catalog Number	
		N1 Series ☉ (Neutral Color)	N2 Series (Red Color)
Dead-End			
1/2 or 3/4	Universal 2 Position, 1 Circuit		N1D75FA-U1 N2D75FA-U1
Feed-Thru			
1/2 or 3/4	Universal 2 Position, 1 Circuit		N1DC75FA-U1 N2DC75FA-U1
Replacement Glass (For N1 or N2)			
			NFA-G

① Furnished with a 3/4" to 1/2" NPT reducer.

☉ For Class I, Division 1 applications, sealing fittings must be field installed adjacent to enclosure on all conduit runs. Do not use in atmospheres containing electrically conductive dusts (most coal dusts are not electrically conductive).

Intraground™ N1 and N2 Series Control Stations

Selector Switch Operators and Cover Assemblies. Nonmetallic

For use with N1 and N2 Series Bodies Only. 10 Ampere, 600 Vac Max. for Heavy Duty Use. N1 Series – Neutral Color; N2 Series – Blue Color.

NEC – N1 Series (Non-Factory Sealed): ☉
Class I, Division 1 and 2, Groups C, D
NEMA 3R, 4X, 7CD, 12

NEC – N2 Series (Factory Sealed):
Class I, Division 2, Groups B, C, D
Class II, Division 1 and 2, Groups E, F, G
Class III
NEMA 3R, 4X, 9EFG, 12

Thread Size (Inches, NPSM)	Description	Left	Diagram Center	Right	N1/N2 Switch Assembly Only	Assembly with Cover N1 Switch	Assembly with Cover N2 Switch
Maintained Contact							
1/2	2 Position, 2 Circuit				SSBA1-2Q	N1K-12	N2K-12
1/2	2 Position, 4 Circuit				SSBA2-2Q	N1K-35	N2K-35
<i>Note: Standard legend plate reads Hand/Auto</i>							
1/2	3 Position, 2 Circuit				SSBA1-3Q	N1K-102	N2K-102
1/2	3 Position, 4 Circuit				SSBA2-3Q	N1K-345	N2K-345
<i>Note: Standard legend plate reads Hand/Off/Auto</i>							
Modified Operations							
Momentary contact right position. Spring return to center. Maintained contact left position.							
1/2	3 Position, 2 Circuit				SSBAS-1-3	N1K-102SRC	N2K-102SRC
1/2	3 Position, 4 Circuit				SSBAS-2-3	N1K-345SRC	N2K-345SRC
<i>Note: Standard legend plate reads Hand/Off/Auto</i>							
Momentary contact left position. Spring return to center. Maintained contact right position.							
1/2	3 Position, 2 Circuit				SSBASL-1-3	N1K-102SLC	N2K-102SLC
1/2	3 Position, 4 Circuit				SSBASL-2-3	N1K-345SLC	N2K-345SLC
<i>Note: Standard legend plate reads Auto/Off/Hand</i>							
Momentary contact right position. Spring return to center. Maintained contact left position.							
1/2	3 Position, 4 Circuit				SSBASRA-2-3	N1K-637SRC	N2K-637SRC
<i>Note: Standard legend plate reads Stop/Run/Start</i>							



2 Circuit (2 or 3 Position)



4 Circuit (2 or 3 Position)

Nameplates



Two Position



Three Position

	Two Position Nameplates	Three Position Nameplates
Forward—Reverse	SLNP-FRQ	Forward—Off—Reverse SLNP-FORQ
Hand—Auto ☉	SLNP-HAQ	Hand—Off—Auto ☉ SLNP-HOAQ
On—Off	SLNP-OO	Run—Off—Jog SLNP-ROJQ
Start—Stop	SLNP-SS	Blank SLNP-B3
Blank	SLNP-BQ	Reverse—Off—Forward SLNP-ROFQ
Up—Down	SLNP-UDQ	Auto—Off—Hand SLNP-AOHQ
Run—Jog	SLNP-RJQ	Hand—Off—Remote SLNP-HORQ
Auto—Hand	SLNP-AHQ	1—Off—2 SLNP-1O2Q
Off—Remote	SLNP-ORQ	Jog—Off—Start SLNP-JORQ
		Stop—Run—Start SLNP-SRSQ
		Local—Off—Remote SLNP-LORQ

Selector Switch Locking Devices



Two or Three Positions — Permit locking in any position.

SBL-3-Q

☉ Supplied as standard with Maintained Contact Selector Switches.

☉ For Class I, Division 1 applications, sealing fittings must be field installed adjacent to enclosure on all conduit runs.

Intragrind™ N1 and N2 Series Control Stations



Nonmetallic.

For use with N1 and N2 Series Bodies Only. All Covers Supplied with Four Bolts and Blank Nameplate. N1 Series– Neutral Color; N2 Series– Blue Color.

NEC – N1 Series (Non-Factory Sealed): ①
Class I, Division 1 and 2, Groups C, D
NEMA 3R, 4X, 7CD, 12

NEC – N2 Series (Factory Sealed):
Class I, Division 2, Groups B, C, D
Class II, Division 1 and 2, Groups E, F, G
Class III
NEMA 3R, 4X, 9EFG, 12

Covers Only – for Use with Nonmetallic Mounting Bodies Below

	Description	Catalog Number	
		N1 Series	N2 Series
	Pilot Light or Push Button Covers 3/4" tapped openings One opening: one pilot light or one push button ①	N1K-1PL	N2K-1PL
	Two openings: two pilot lights; two push buttons – one pilot light and one push button ①	N1K-2PL	N2K-2PL
	Push Button or Selector Switch Covers 1/2" tapped openings Two openings: selector switch or two push buttons	N1K-2SP	N2K-2SP
	Push Button, Pilot light or Selector Switch Covers One 3/4" top and two 1/2" bottom tapped openings One top and two bottom openings – one pilot light, two push buttons; one pilot light, one selector switch; or three push buttons ①	N1K-3JPB	N2K-3JPB

1-Gang Nonmetallic Mounting Bodies – for use with Covers Above

	Description	Hub Size (Inches) ②	Catalog Number	
			N1 Series	N2 Series
	Dead-End	1/2 or 3/4	N1D75Q	N2D75Q
	Feed-Thru	1/2 or 3/4	N1DC75Q	N2DC75Q

Nameplate Mounting Bracket

Description	Catalog Number
 <p>Bracket for N1, N2 Series</p> <p>To order bracket with control station, add suffix -NPBRKT to end of catalog number.</p> <p><i>Note: Secure mount bracket using cover nameplate screws.</i></p>	NPBRKT-N1N2

① Furnished with 3/4" to 1/2" NPSM reducer.

② Furnished with a 3/4" to 1/2" NPT reducer.

③ For Class I, Division 1 applications, sealing fittings must be field installed adjacent to enclosure on all conduit runs.

Intraground™ N1 and N2 Series Control Stations

Nonmetallic

10 Ampere, 600 Vac Max. for Heavy Duty Use. N1 Series – Neutral Color; N2 Series – Blue Color.

NEC:
 Class I, Division 1 and 2, Groups B*, C, D
 Class II, Division 1 and 2, Groups E, F, G
 Class III

Description	Diagram	Catalog Number
-------------	---------	----------------

Push Button – Factory Sealed – Momentary Contact



SPBB-U1-Q

10 Amp 600 Vac Heavy Duty 1/2" thread size (NPSM). Furnished with 1/2" to 3/4" enlarger, Weather Boot, Guard, Start, Stop and Blank Nameplates.

Single Push Button

Universal



SPBB-U1-Q



SPBB-U2DBL

Double Push Button

Universal



SPBB-U2DBL

Push Button – Red Mushroom Head – Factory Sealed – Maintained Contact



10 Amp 600 Vac Heavy Duty 1/2" thread size (NPSM). Furnished with 1/2" to 3/4" enlarger and Emergency Stop Nameplate (guard not furnished).

Single Push Button

Universal



SMPB-U1-Q

Rectangular Button with Weather Boot



Furnished with Start, Stop and Blank Nameplates

NBN-WB

Nameplates for Rectangular Push Buttons



SNP-OFF-Q



SNP-ON-Q

Blank

Forward

Jog

Run

Stop

Start

Down

Fast

Slow

Raise

Lower

Reset

SNP-B-Q

SNP-FWD-Q

SNP-JOG-Q

SNP-RUN-Q

SNP-SP-Q

SNP-ST-Q

SNP-DOWN-Q

SNP-FAST-Q

SNP-SLOW-Q

SNP-RAISE-Q

SNP-LOWER-Q

SNP-RESET-Q

Off

On

Reverse

Open

Close

Up

Test

Low

High

SNP-OFF-Q

SNP-ON-Q

SNP-REV-Q

SNP-OPEN-Q

SNP-CLOSE-Q

SNP-UP-Q

SNP-TEST-Q

SNP-LOW-Q

SNP-HIGH-Q

Push Button Replacement Locking Guards – Glass Reinforced Polypropylene – Gasketed



Maintained
Mushroom Head
Switch Guard

Has hole for 1/4" hasp.

Single Guard (Maintained Switch)

SMPB-LG



Single Guard

Single Guard

NPB-LG1



Double Guard

NPB-LG2



Single Guard (No Lockout Holes)

NPB-LG1-LL

Double Guard

Double Guard (No Lockout Holes)

NPB-LG2-LL

♦ Suitable for Class I, Group B when installed in an enclosure rated for Class I, Group B.

Intraground™ N1 and N2 Series Control Station







Nonmetallic

10 Ampere, 600 Vac Max. for Heavy Duty Use. N1 Series – Neutral Color; N2 Series – Blue Color.

NEC:

Class I, Division 1 and 2, Groups B*, C, D
 Class II, Division 1 and 2, Groups E, F, G
 Class III

Push Button Accessories and Parts

	Description	Catalog Number
	Push Button Securing Rod with Chain – Stainless Steel For use with Single Guard Only	NBL-SR
	Mushroom Head Button with Weather Boot for Use with Momentary Contact – Gasketed Black Green Red	NMRB-BL NMRB-GR NMRB-RE
	Mushroom Head Push Button For Use with Mushroom Head Push Button – Maintained Contact – Solid-Colored Nonmetallic Red	MNPRM-RE
	Nameplates – Mushroom Head Push Button For Momentary and Maintained Start Stop Emergency Stop Blank	MNPSTQ MNPSPQ MNPESTPQ MNPBQ
	Pilot Light	
	Chamber Only	
	Incandescent Furnished with 6S6 120 Vac incandescent lamp, jewel and guard. Has 457 mm (18") long, type SFF-2 pigtail leads; +150 °C (+302 °F). Body has 3/4" straight thread (NPSM). With Red Jewel With Green Jewel With Amber Jewel With Blue Jewel With Clear Jewel With Opal Jewel	SPLSREB SPLSGRB SPLSAMB SPLSBLB SPLSCLB SPLSOPB
	LED Furnished with candelabra base 120 Vac LED, jewel and guard. Has 457 mm (18") long, type SFF-2 pigtail leads; +150 °C (+302 °F). Body has 3/4" straight thread (NPSM). With Red LED, Clear Jewel With Green LED, Clear Jewel With Amber LED, Clear Jewel	SPLNSREB SPLNSGRB SPLNSAMB
	Chamber Only (Same as above, less jewel, guard and lamp)	SPLSSCB

♦ Suitable for Class I, Group B when installed in an enclosure rated for Class I, Group B.

Intraground™ N1 and N2 Series Control Stations

Nonmetallic



10 Ampere, 600 Vac Max. for Heavy Duty Use. N1 Series – Neutral Color; N2 Series – Blue Color.

NEC:
 Class I, Division 1 and 2, Groups B*, C, D
 Class II, Division 1 and 2, Groups E, F, G
 Class III

Push Button Accessories and Parts

Description	Catalog Number
Pilot Light Jewel/Guard Assembly	
<i>The below catalog numbers indicate an assembly of the Pilot Light Jewels and Guards. Jewels and Guards are not available as separate items.</i>	
 Amber Jewel/Guard	JGBNA
Blue Jewel/Guard	JGBNB
Clear Jewel/Guard	JGBNC
Green Jewel/Guard	JGBNG
Opal Jewel/Guard	JGBNO
Red Jewel/Guard	JGBNR

Replacement Bulbs

	Clear Bulbs Furnished with candelabra base. 6 Watt, 120 Vac, Type 6S6	EPL-B6W
	LED Replacements Furnished with candelabra base. 120 Vac, 10 mA.	
	Red LED	EPLLEDR
	Green LED	EPLLEDG
	Amber LED	EPLLEDA

Transformer

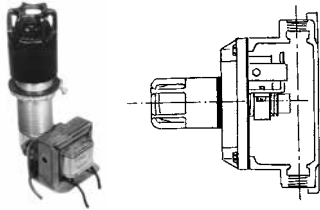

Add Suffix as listed below. Transformer clamps directly to pilot light barrel.
Only one pilot light transformer assembly per one gang body.

Primary Vac	Lamp Vac	Suffix
220	120	TR2
277	120	TR3
440	120	TR4
550	120	TR5

Nameplates for Pilot Light



LNPRUNQ

Description	Catalog Number	Description	Catalog Number
Blank	LNPBQ	Reset	LNPRESETQ
Forward	LNPFDQ	Off	LNPOFFQ
Jog	LNPJOGQ	On	LNPONQ
Run	LNPRUNQ	Reverse	LNPREVQ
Stop	LNPSPQ	Close	LNPCLOSEQ
Start	LNPSTQ	Open	LNPOPENQ
Down	LNPDOWNQ	Up	LNPUPQ
Fast	LNPFASTQ	Test	LNPTSTQ
Slow	LNPLOWQ	Low	LNPLOWQ
Raise	LNPRASEQ	High	LNPHIGHQ
Lower	LNPLOWERQ		

♦ Suitable for Class I, Group B when installed in an enclosure rated for Class I, Group B.

Intraground™ N1 and N2 Series Control Stations

NEC — N1 Series (Non-Factory Sealed): ☉
 Class I, Division 1 and 2, Groups C, D
 NEMA 3R, 4X, 7CD, 12

NEC — N2 Series (Factory Sealed):
 Class I, Division 2, Groups B, C, D
 Class II, Division 1 and 2, Groups E, F, G
 Class III
 NEMA 3R, 4X, 9EFG, 12

Dimensions in Millimeters (Inches)

Push Button/Pilot Light

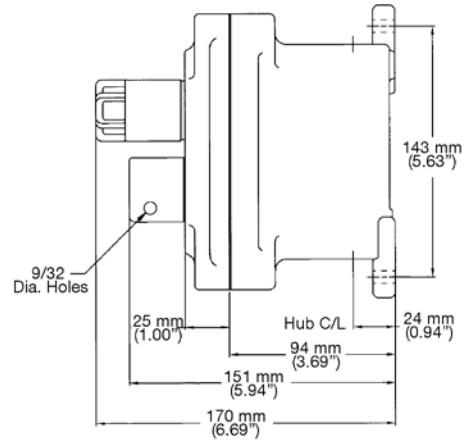
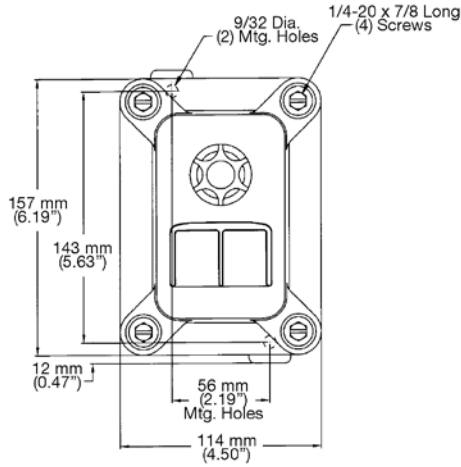

Selector Switch

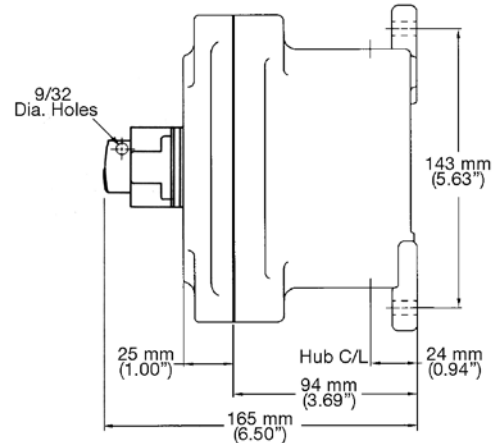
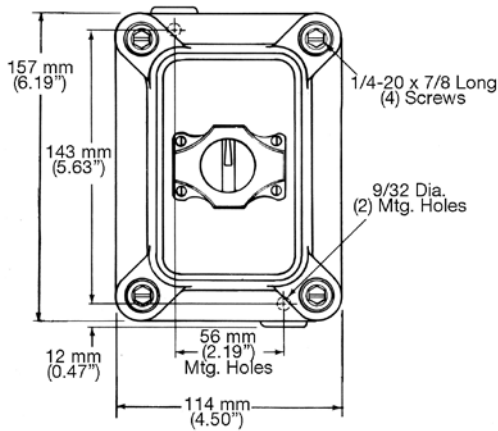

NPBRKT Nameplate Mounting Bracket

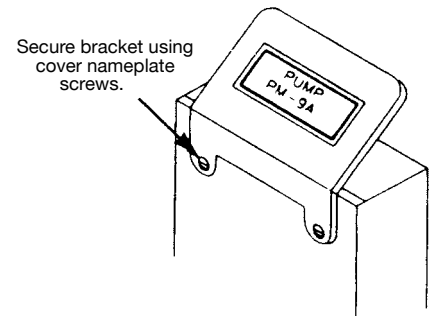
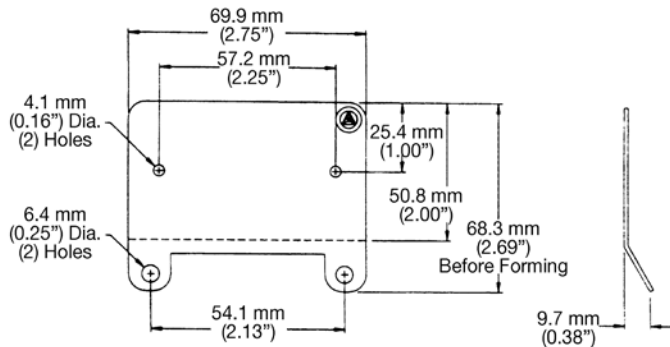

☉ For Class I, Division 1 applications, sealing fittings must be field installed adjacent to enclosure on all conduit runs.

Intraground™ N1 Series Nonmetallic Tumbler Switches

Explosionproof

Enclosures and Covers Have Neutral Color. Non-Factory Sealed. ①

NEC:

Class I, Division 1 and 2, Groups C, D
NEMA 3, 4X, 7CD, 12

Applications

- Listed for use in Class I, Group C and D, Division 1 and 2 atmospheres such as:
 - Diethyl ether
 - Methyl ethyl ketone
 - Acetone
 - Toluene
 - No. 3 fuel oil
 - Ammonium hydroxide (20%)
 - Benzene
 - Regular unleaded gas
 - Ethyl acetate
 - Hexane and methanol
- Not suitable for:
 - Ethylene dichloride
 - Partially halogenated hydrocarbons.
- Sealing fittings must be field installed adjacent to enclosure on all conduit runs. ①
- Explosionproof. With sealing fittings installed at each conduit entrance, the N1 Series enclosures withstood a hydrostatic test of four times the maximum internal explosion pressure that could be developed from a gas or vapor explosion in actual use.

Features

- Nonmetallic construction with metal imbedded grounding grid. No need to install special wires and parts for grounding. Feed-thru or dead-end grounded 1/2" or 3/4" conduit openings for threaded conduit.
- Special grounding wire furnished with each box provides safe grounding when cover is removed.
- Ideal for use in corrosive environments. Nonmetallic enclosures with corrosion resistant parts coated with epoxy, Teflon® ② or Mylar® ②, these switches offer unsurpassed resistance to a wide variety of corrosive chemicals.
- Unique labyrinth-path construction assures flame-tight joint between body and cover.
- Silicone gasket, specially designed for the labyrinth-path joint, prevents entrance of moisture without interfering with the venting of cooled hazardous gases and vapors.
- Typical mechanical properties of 24,500 psi tensile strength, 3% elongation at break, 33,000 psi flexural strength, and 1,200,000 psi flexural modulus.
- Electrical properties of sample specimens: dielectric strength (in air) of 769 at 1/16".
- High strength thermoplastic polyetherimide, together with thick walls (5/16") and sound structural design (rounded corners) provides superior resistance to impact and crushing.
- Excellent resistance to ultraviolet light and water.
- Excellent conduit connection strength.
- Excellent resistance to attack by fungi and mold.
- Excellent heat deflection temperature: sample specimens rated at +210 °C (+410 °F).
- UL Temperature Index (continuous use temperature): +170 °C (+338 °F) electrical properties, +170 °C (+338 °F) mechanical properties with impact.
- Superior flammability resistance.



- Enclosures have external mounting lugs for ease of mounting.
- Smooth, rounded integral bushing in each hub protects conductor insulation.
- 20 Amp and 30 Amp units available for use with 120-277 Vac.
- Corrosion resistant, strong stainless steel Teflon® ② coated hex head cap screws attach cover and body for approved flame-tight construction.
- Operating handle has close-tolerance threaded stainless steel shaft to meet explosionproof requirements. Provides positive corrosion resistant operation.
- Handle may be locked in ON or OFF position.

Standard Materials

- Body and cover: 30% glass-reinforced thermoplastic polyetherimide — neutral color
- Handle: nylon 6/6
- Cover bolts: stainless steel
- Nameplates: aluminum

Standard Finishes

- Cover bolts: Teflon® ②
- Nameplates: Mylar® ②

NEC Certifications and Compliances

- UL Standards: UL 894, UL 1203
- UL Listed: E10523

Related Products

- For classified-location push button, pilot light and selector switch control stations, see *Non-Hazardous Control Stations Section*.
- For sealing fittings, See *Hazardous Location Fittings Section*.

① Sealing fittings not furnished. Sealing fittings must be field-installed adjacent to enclosure on all conduit runs. See *Hazardous Location Fittings Section*.

② Teflon and Mylar are registered trademarks of E. I. du Pont de Nemours and Company.

Intraground™ N1 Series Nonmetallic Tumbler Switches

Explosionproof



Enclosures and Covers Have Neutral Color. Non-Factory Sealed. ①

NEC:
Class I, Division 1 and 2, Groups C, D
NEMA 3, 4X, 7CD, 12



Aluminum grounding grid, imbedded into the nonmetallic enclosure during molding, provides complete grounding system. No field work. No extra grounding wires or parts required.

Switch	Hub Size (Inches)	Catalog Number ②				
		20 Ampere – 120–277 Vac ③		30 Ampere – 120–277 Vac ④		
		Dead-End	Feed-Thru	Dead-End	Feed-Thru	
1-Gang Tumbler Switches						
	1-Pole	1/2 or 3/4	N1D75-F1	N1DC75-F1	N1D75-F13	N1DC75-F13
	2-Pole	1/2 or 3/4	N1D75-F2	N1DC75-F2	N1D75-F23	N1DC75-F23
	3-Way	1/2 or 3/4	N1D75-F3W	N1DC75-F3W	N1D75-F3W3	N1DC75-F3W3
	4-Way	1/2 or 3/4	N1D75-F4W	N1DC75-F4W	-	-

Switch	Hub Size (Inches)	Catalog Number ②				
		20 Ampere – 120–277 Vac ③		30 Ampere – 120–277 Vac ④		
		Cover	Switch	Cover	Switch	
1-Gang Covers and Switches						
<i>All covers furnished with four bolts and blank nameplate.</i>						
		1-Pole	N1K-F12	EFSFR1Q	N1K-F12	EFSFR13Q
		2-Pole	N1K-F12	EFSFR2Q	N1K-F12	EFSFR23Q
		3-Way	N1K-F34W	EFSFR3WQ	N1K-F34W	EFSFR3W3Q
		4-Way	N1K-F34W	EFSFR4WQ		

Hub Size (Inches)	Catalog Number ②	
	Dead-End	Feed-Thru
1-Gang Nonmetallic Mounting Bodies		
<i>For use with covers above.</i>		
	1/2 or 3/4	N1D75Q N1DC75Q

① Sealing fittings must be field-installed adjacent to enclosure on all conduit runs.

② Furnished with a 3/4" to 1/2" NPT reducer.

③ 20 Amp – 1 HP at 120 Vac and 2 HP at 240 Vac.

④ 30 Amp – 2 HP at 120 Vac or 240 Vac.

Intraground™ N1 Series Nonmetallic Tumbler Switches

Explosionproof

Enclosures and Covers Have Neutral Color. Non-Factory Sealed. ①

NEC:
Class I, Division 1 and 2, Groups C, D
NEMA 3, 4X, 7CD, 12

Nameplate Mounting Bracket

Description	Catalog Number
-------------	----------------



Bracket for N1 Series

NPBRKT-N1N2

To order bracket with control station, add suffix **-NPBRKT** to end of catalog number.

Note: Mount bracket between cover screws and cover. Do not mount bracket between ground joint flame path between cover and backbox.

Dimensions in Millimeters (Inches)

Front Operated Tumbler Switches

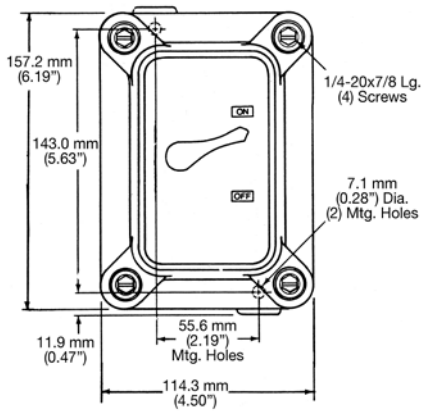

Front

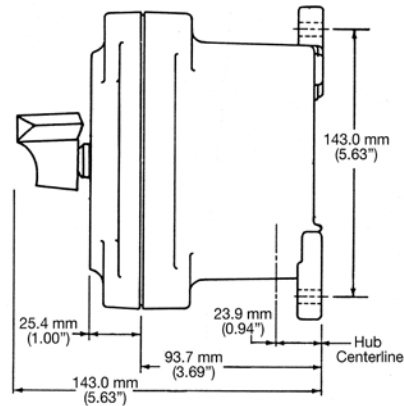

Side

NPBRKT Nameplate Mounting Bracket

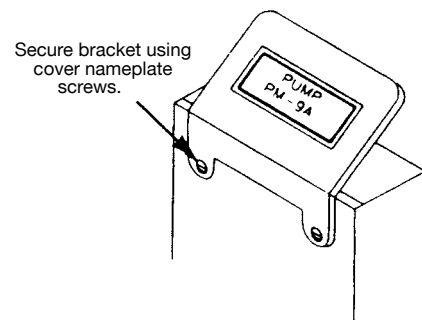
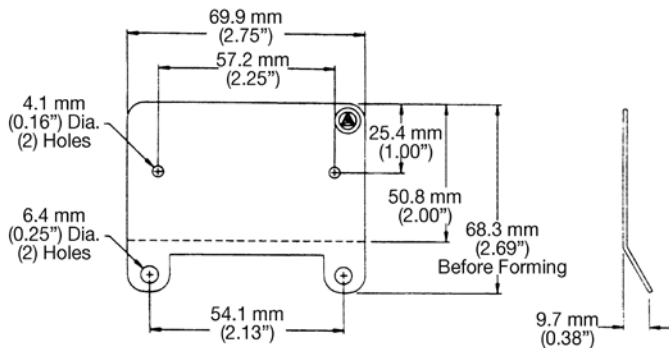

① Sealing fittings not furnished. Sealing fittings must be field-installed adjacent to enclosure on all conduit runs. See Hazardous Location Fittings Section.

GUSC Heavy Duty Tumbler Switches

Explosionproof, Dust-Ignitionproof

30 Amp, 600 Vac UNILETS™ for Use with Rigid Metal Conduit and IMC.

NEC/CEC:

Class I, Division 1 and 2, Group D
 Class II, Division 1 and 2, Groups E, F, G
 Class III
 NEMA 7D, 9EFG

Applications

- For heavy-duty usage. Units available for disconnect use up to 20 HP at 600 Vac.
- For controlling motors and other apparatus.
- Confines arcing of switch, if any, to enclosure interior.
- For use in such classified locations as:
 - Paint and varnish plants
 - Grain elevators
 - Coal or grain processing
 - Gasoline bulk loading terminals
 - Metal finishing areas

Features

- Heavy-duty disconnect use up to 600 Vac.
- Compact design permits use in cramped quarters as on machinery.
- Threaded cover provides easy access for wiring and maintenance.
- Provided with mounting lugs.
- Smooth, rounded integral bushing in each hub protects conductor insulation.

- Accurately tapped, tapered hubs for tight, rigid joints and ground continuity.
- Threaded stainless steel shaft for operating handle.
- Lockable operating handle.

Standard Materials

- Body: malleable iron
- Cover: copperfree (4/10 of 1% max.) aluminum

Standard Finishes

- Body: triple-coat (1) zinc electroplate, (2) chromate, and (3) epoxy powder coat
- Cover: natural finish

NEC/CEC Certifications and Compliances

- UL Standard: UL 894

Hub Size (Inches)	Switch	Switch Rating	Catalog Number
3/4	2-Pole	30 Amp, 600 Vac 3 HP, 240 Vac 7-1/2 HP, 480 Vac 10 HP, 600 Vac	GUSC75-2
	3-Pole	30 Amp, 600 Vac 7-1/2 HP, 240 Vac 15 HP, 480 Vac 20 HP, 600 Vac	GUSC75-3



Dimensions in Millimeters (Inches)

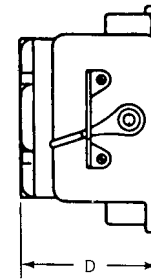
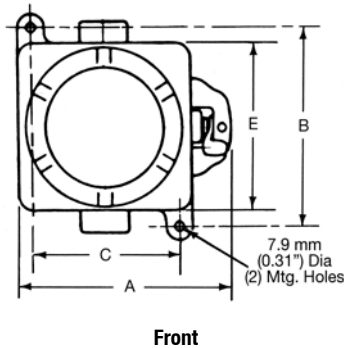

Switch	Dimensions in Millimeters (Inches)				
	A	B	C	D	E
2- and 3-pole	153.9 (6.06)	143 (5.63)	106.4 (4.19)	100.1 (3.94)	117.6 (4.63)

Unicode™ 2 Series Stainless Steel Control Stations and Switches

Increased Safety

NEC:
Class I, Division 2, Groups A, B, C, D
Class II, Groups E, F, G
Class III
Ex de IIC/DIP A21
IP66, Type 4X①

CEC:
Class I, Division 2, Groups A, B, C, D
Class II, Groups F, G
Class III; Type 4X①
Class I, Zone 1, AEx de IIC/ AEx tD 21
IP66

ATEX/IECEx:
Zone 1 and 2 – 21 and 22
Ⓢ II 2 GD
Ex de IIC/Ex demb IIC/ Ex tD A21
IP66 – IK10

Applications

- Local control stations and motor control stations for use in hazardous areas covering the broadest possible range of applications.
- Control of equipment at:
 - Power plants
 - Chemical and petrochemical plants
 - Petroleum refineries
 - Reverse osmosis plants
 - Pulp and paper processing plants
 - Various industrial applications
- Push buttons and selector switches are used in conjunction with contactors or magnetic starters for remote control of motors in hazardous locations. They provide circuit control and/or selection.
- Pilot lights provide visual assurance that an electrical function is being performed at a remote or hazardous location.
- For use in washdown areas.

Features

- Employs Ex de method of protection which eliminates the need for external seals.
- Operators include push buttons, illuminated push buttons, selector switches, control and load break switches and LED pilot lights.
- Pilot light employs high intensity single LED with lifetime of 100,000 hours that can be used at:
 - 12 Vac to 254 Vac 50/60 Hz
 - 12 Vdc to 60 Vdc
- Up to 3 contact blocks per actuator can be used.
- Contact block technical data:
 - IEC rated operating voltage (Ue): 500 Vac – 110 Vdc
 - IEC switching capacity:
 - AC12: 16 Amp/400 Vac
 - AC14: 10 Amp/400 Vac
 - AC15: 6 Amp/500 Vac
 - DC13: 2 Amp/24 Vdc and 1 Amp/110 Vdc
 - NEMA switching capacity: A600: 10 Amp/600 Vac
- Selector switch technical data:
 - IEC rated operating voltage: 690 Vac
 - IEC rated operating current: maximum 16 Amp
 - IEC switching capacity:
 - AC1: 16 Amp/690 Vac
 - AC15: 16 Amp/415 Vac
 - AC3: 8 Amp/500 Vac
 - AC3: 4 Amp/690 Vac
 - AC3: 16 Amp/690 Vac
 - DC1: 10 Amp/24 Vdc
 - DC1: 6 Amp/60 Vdc
 - DC1: 6 Amp/110 Vdc (2 contacts wired in series)
 - DC1: 6 Amp/220 Vdc (3 contacts in series)
 - NEMA switching capacity: A600: 10 Amp/600 Vac
- Enclosures are rated for IP66 with firmly secured gasket.
- Operators and contact blocks are spaced for easy wiring.
- Wide selection of termination methods available.
- Choice of DIN rail mounted high performance contact block suitable for low intensity (less than 5 mA).
- TS35 rail mounted components are held securely in place during operation and easily removed for service.



U62W2PRA5A9

- Brass Inserts are provided for TS35 DIN rails or mounting plates to be installed inside the enclosure.
- Captive, corrosion resistant stainless steel cover screws.

Standard Materials

- Body and cover: 316L stainless steel with natural finish
- Cover screws: 304 stainless steel

Accessories

- Key for changing actuator blocks.
- Guard for mushroom head actuator.
- Padlockable guard.
- M5 and M6 earth stud.
- Combination drain and breather available in brass, polyamide and stainless steel.

Options

- Nameplates: Stainless Steel or Lamacoid with different color combinations.
- Padlocking facility at left, center, right or any position on selector switches.
- Padlocking facility for momentary and maintained push buttons.
- Special contact arrangements available, see *Unicode™ 2 Series Customized Control Stations*.

① Overall hazardous location and ingress protection rating depends on the rating of the optional certified components used.

Unicode™ 2 Series Stainless Steel Control Stations and Switches

Increased Safety

NEC:

Class I, Division 2, Groups A, B, C, D
Class II, Groups E, F, G
Class III
Ex de IIC/DIP A21
IP66, Type 4X^①

CEC:

Class I, Division 2, Groups A, B, C, D
Class II, Groups F, G
Class III; Type 4X^①
Class I, Zone 1, AEx de IIC/ AEx tD 21
IP66

ATEX/IECEx:

Zone 1 and 2 – 21 and 22
⊕ II 2 GD
Ex de IIC/Ex demb IIC/ Ex tD A21
IP66 – IK10

NEC/CEC Certifications and Compliances

- Certification Type JBe
 - Temperature Class: T6 (at +40°C) or T5 (at +55°C)
 - Surface Temperature: T80 °C (at +40°C) to T95 °C (at +55°C) (T176 °F to T203 °F)
 - Ambient Temperature: -40 °C to +55 °C (-40 °F to +131°F)
 - CAN/CSA Standard: C22.2 No. O-M91, No. 25-M66, No. 213-M1987, No. 60079-0:07, No. 60529-2005, E60079-7-2003
 - UL Standard: 60079-0, 60079-7
 - Other Standards: ANSI/IEC60529-2004, ANSI/ISA 12.12.01-2011
 - cCSAus Certificate: 2356734

ATEX/IECEx Certification and Compliances

- Certification Type JBe
 - Gas: Zone 1 and 2
 - Conforming to ATEX 94/9/CE: ⊕ II 2 G
 - Type of Protection: Ex de IIC/Ex demb IIC
 - Temperature Class: T5 to T6
 - Dust: Zone 21 and 22
 - Conforming to ATEX 94/9/CE: ⊕ II 2 D
 - Type of Protection: Ex tD A21
 - Surface Temperature: T80 °C to T95 °C (T176 °F to T203 °F)
 - Ambient Temperature: -50 °C to +70 °C (-58 °F to +158 °F) (empty enclosure, temperature to be determined according to actuator)
 - CE Declaration of Conformity: 50232
 - ATEX Certificate: LCIE 02 ATEX 6118X
 - IECEx Certificate: LCI 11.0008X
 - Index of Protection according EN/IEC 60529: IP66
 - Impact Resistance (shock): IK10

EURASEC Certification

- Certification Type JBe
 - EURASEC RU C-FR Г505.B.00911

Other Certification ^②

- Certification Type JBe
 - INMETRO Certificate: BVC 11.0418-X

^① Overall hazardous location and ingress protection rating depends on the rating of the optional certified components used.

^② INMETRO certification available on special request only. Contact your local sales representative for more information.

Unicode™ 2 Series Stainless Steel Control Stations and Switches

Increased Safety

NEC:
 Class I, Division 2, Groups A, B, C, D
 Class II, Groups E, F, G
 Class III
 Ex de IIC/DIP A21
 IP66, Type 4X①

CEC:
 Class I, Division 2, Groups A, B, C, D
 Class II, Groups F, G
 Class III; Type 4X①
 Class I, Zone 1, AEx de IIC/ AEx tD 21
 IP66

ATEX/IECEx:
 Zone 1 and 2 – 21 and 22
 ② II 2 GD
 Ex de IIC/Ex demb IIC/ Ex tD A21
 IP66 – IK10

CONTROLS: NEC/CEC, ATEX/IECEx INCREASED SAFETY CONTROL STATIONS

Size 1 Stainless Steel Control Station

Included: 1 white self-adhesive laminated plastic nameplate, 1 brass earth continuity plate ②, 1 blanking plug ③, 1 cable gland ③.

Description/Function	Diagram	Entry Location	Entry Size	Weight kg (lb)	Volume dm ³ (in ³)	Catalog Number
Momentary Push Buttons						
Green insert 'I' + red insert 'O' with 1NO + 1NC momentary contact		Bottom	2 x M20	1.2 (2.65)	4.3 (262.40)	U61W2A3
		Feed-Thru	2 x M25	1.2 (2.65)	4.3 (262.40)	U61W4A3
			1 x 3/4"	1.2 (2.65)	4.3 (262.40)	U61Z3A3
		2 x 3/4"	2 x 3/4"	1.2 (2.65)	4.3 (262.40)	U61X3A3
		Bottom	2 x M20	1.2 (2.65)	4.3 (262.40)	U61W2A5
		Feed-Thru	2 x M25	1.2 (2.65)	4.3 (262.40)	U61W4A5
			1 x 3/4"	1.2 (2.65)	4.0 (244.1)	U61Z3A5
		2 x 3/4"	2 x 3/4"	1.2 (2.65)	4.3 (262.40)	U61X3A5
1x red push button 'O' with 1NC momentary contact		Bottom	2 x M20	1.2 (2.65)	4.3 (262.40)	U61W2A9
		Feed-Thru	2 x M25	1.2 (2.65)	4.3 (262.40)	U61W4A9
			1 x 3/4"	1.2 (2.65)	4.3 (262.40)	U61Z3A9
		2 x 3/4"	2 x 3/4"	1.2 (2.65)	4.3 (262.40)	U61X3A9
Twin Momentary Push Buttons ④						
1x green push button 'I' with 1NO contact 1x red push button 'O' with 1NC contact momentary contacts		Bottom	2 x M20	1.3 (2.87)	4.3 (262.40)	U61W2A5A9
		Feed-Thru	2 x M25	1.3 (2.87)	4.3 (262.40)	U61W4A5A9
			1 x 3/4"	1.3 (2.87)	4.3 (262.40)	U61Z3A5A9
		2 x 3/4"	2 x 3/4"	1.3 (2.87)	4.3 (262.40)	U61X3A5A9
		Bottom	2 x M20	1.3 (2.87)	4.3 (262.40)	U61W2A3A3
		Feed-Thru	2 x M25	1.3 (2.87)	4.3 (262.40)	U61W4A3A3
			1 x 3/4"	1.3 (2.87)	4.3 (262.40)	U61Z3A3A3
		2 x 3/4"	2 x 3/4"	1.3 (2.87)	4.3 (262.40)	U61X3A3A3

Additional combinations available, please refer to Unicode 2 Series - Customized Control Stations section.

① Overall hazardous location and ingress protection rating depends on the rating of the optional certified components used.

② Not required for stainless steel.

③ Not included if NPT hubs are selected.

④ Vertically mounted devices in stainless steel models.

Unicode™ 2 Series Stainless Steel Control Stations and Switches

Increased Safety

NEC:
 Class I, Division 2, Groups A, B, C, D
 Class II, Groups E, F, G
 Class III
 Ex de IIC/DIP A21
 IP66, Type 4X①

CEC:
 Class I, Division 2, Groups A, B, C, D
 Class II, Groups F, G
 Class III; Type 4X①
 Class I, Zone 1, AEx de IIC/ AEx tD 21
 IP66

ATEX/IECEx:
 Zone 1 and 2 – 21 and 22
 ② II 2 GD
 Ex de IIC/Ex demb IIC/ Ex tD A21
 IP66 – IK10

Size 1 Stainless Control Station

Included: 1 white self-adhesive laminated plastic nameplate, 1 brass earth continuity plate ②, 1 blanking plug ③, 1 cable gland ③.

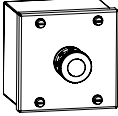
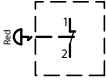
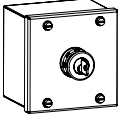
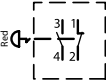
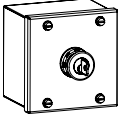
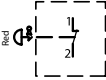
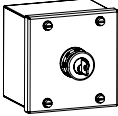
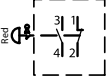
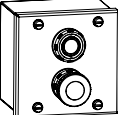
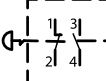
Description/Function	Diagram	Entry Location	Entry Size	Weight kg (lb)	Volume dm³ (in³)	Catalog Number	
Emergency Stop							
 Red mushroom head push-pull 1NC maintained contact		Bottom	2 x M20	1.2 (2.65)	4.3 (262.40)	U61W2D9	
		Bottom	2 x M25	1.2 (2.65)	4.3 (262.40)	U61W4D9	
		Feed-Thru	2 x 3/4"	1.2 (2.65)	4.3 (262.40)	U61Z3D9	
	 Red mushroom head push-pull 1NO + 1NC maintained contact		Bottom	2 x M20	1.2 (2.65)	4.3 (262.40)	U61W2D3
			Bottom	2 x M25	1.2 (2.65)	4.3 (262.40)	U61W4D3
			Feed-Thru	2 x 3/4"	1.2 (2.65)	4.3 (262.40)	U61X3D3
 Red mushroom head key release 1NC maintained contact		Bottom	2 x M20	1.2 (2.65)	4.3 (262.40)	U61W2C9	
		Bottom	2 x M25	1.2 (2.65)	4.3 (262.40)	U61W4C9	
		Feed-Thru	2 x 3/4"	1.2 (2.65)	4.3 (262.40)	U61Z3C9	
	 Red mushroom head key release 1NO + 1NC maintained contact		Bottom	2 x M20	1.2 (2.65)	4.3 (262.40)	U61W2C3
			Bottom	2 x M25	1.2 (2.65)	4.3 (262.40)	U61W4C3
			Feed-Thru	2 x 3/4"	1.2 (2.65)	4.3 (262.40)	U61Z3C3
Push Pull Emergency Stop + Push Button ④							
 1x red mushroom head push-pull with 1NC maintained contact 1x green push button 'I' with 1NO momentary contact		Bottom	2 x M20	1.3 (2.87)	4.3 (262.40)	U61W2D9A5	
		Bottom	2 x M25	1.3 (2.87)	4.3 (262.40)	U61W4D9A5	
		Feed-Thru	2 x 3/4"	1.3 (2.87)	4.3 (262.40)	U61Z3D9A5	
		Feed-Thru	2 x 3/4"	1.3 (2.87)	4.3 (262.40)	U61X3D9A5	

Additional combinations available, please refer to Unicode 2 Series - Customized Control Stations section.

- ① Overall hazardous location and ingress protection rating depends on the rating of the optional certified components used.
- ② Not required for stainless steel.
- ③ Not included if NPT hubs are selected.
- ④ Vertically mounted devices in stainless steel models.

Unicode™ 2 Series Stainless Steel Control Stations and Switches

Increased Safety

NEC:
Class I, Division 2, Groups A, B, C, D
Class II, Groups E, F, G
Class III
Ex de IIC/DIP A21
IP66, Type 4X①







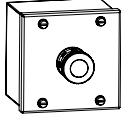
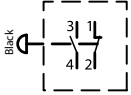

CEC:
Class I, Division 2, Groups A, B, C, D
Class II, Groups F, G
Class III; Type 4X①
Class I, Zone 1, AEx de IIC/ AEx tD 21
IP66

ATEX/IECEX:
Zone 1 and 2 – 21 and 22
Ex II 2 GD
Ex de IIC/Ex demb IIC/ Ex tD A21
IP66 – IK10

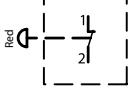
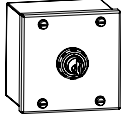
CONTROLS: NEC/CEC, ATEX/IECEX INCREASED SAFETY CONTROL STATIONS

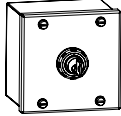
Size 1 Stainless Steel Control Station

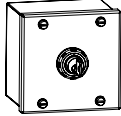
Included: 1 white self-adhesive laminated plastic nameplate ②, 1 brass earth continuity plate ②, 1 blanking plug ③, 1 cable gland ③.

Description/Function	Diagram	Entry Location	Entry Size	Weight kg (lb)	Volume dm³ (in³)	Catalog Number	
Mushroom Head Push Button ④							
 Black mushroom head push button 1NO + 1NC momentary contact		Bottom	2 x M20	1.2 (2.65)	4.3 (262.40)	U61W2B3	
		Bottom	2 x M25	1.2 (2.65)	4.3 (262.40)	U61W4B3	
		1 x 3/4"	1.2 (2.65)	4.3 (262.40)	U61Z3B3		
	Feed-Thru	2 x 3/4"	1.2 (2.65)	4.3 (262.40)	U61X3B3		
	 Red mushroom head push button 1NC momentary contact		Bottom	2 x M20	1.2 (2.65)	4.3 (262.40)	U61W2R9
			Bottom	2 x M25	1.2 (2.65)	4.3 (262.40)	U61W4R9
1 x 3/4"		1.2 (2.65)	4.3 (262.40)	U61Z3R9			
Feed-Thru		2 x 3/4"	1.2 (2.65)	4.3 (262.40)	U61X3R9		
Key Push Button ④							
 With key removable in both positions 1NO + 1NC maintained contact		Bottom	2 x M20	1.2 (2.65)	4.3 (262.40)	U61W2E3	
		Bottom	2 x M25	1.2 (2.65)	4.3 (262.40)	U61W4E3	
		1 x 3/4"	1.2 (2.65)	4.3 (262.40)	U61Z3E3		
	Feed-Thru	2 x 3/4"	1.2 (2.65)	4.3 (262.40)	U61X3E3		
	 With key removable in both positions 1NO maintained contact		Bottom	2 x M20	1.2 (2.65)	4.3 (262.40)	U61W2E5
			Bottom	2 x M25	1.2 (2.65)	4.3 (262.40)	U61W4E5
1 x 3/4"			1.2 (2.65)	4.3 (262.40)	U61Z3E5		
Feed-Thru	2 x 3/4"	1.2 (2.65)	4.3 (262.40)	U61X3E5			
 With key removable in both positions 1NC maintained contact		Bottom	2 x M20	1.2 (2.65)	4.3 (262.40)	U61W2E9	
		Bottom	2 x M25	1.2 (2.65)	4.3 (262.40)	U61W4E9	
		1 x 3/4"	1.2 (2.65)	4.3 (262.40)	U61Z3E9		
Feed-Thru	2 x 3/4"	1.2 (2.65)	4.3 (262.40)	U61X3E9			

Additional combinations available, please refer to Unicode 2 Series - Customized Control Stations section.

① Overall hazardous location and ingress protection rating depends on the rating of the optional certified components used.

② Not required for stainless steel.

③ Not included if NPT hubs are selected.

④ Vertically mounted devices in stainless steel models.

Unicode™ 2 Series Stainless Steel Control Stations and Switches

Increased Safety





NEC:
 Class I, Division 2, Groups A, B, C, D
 Class II, Groups E, F, G
 Class III
 Ex de IIC/DIP A21
 IP66, Type 4X①

CEC:
 Class I, Division 2, Groups A, B, C, D
 Class II, Groups F, G
 Class III; Type 4X①
 Class I, Zone 1, AEx de IIC/ AEx tD 21
 IP66

ATEX/IECEX:
 Zone 1 and 2 – 21 and 22
 ② II 2 GD
 Ex de IIC/Ex demb IIC/ Ex tD A21
 IP66 – IK10

Size 1 Stainless Steel Control Station

Included: 1 white self-adhesive laminated plastic nameplate, 1 brass earth continuity plate ②, 1 blanking plug ③, 1 cable gland ③.

Description/Function	Diagram	Entry Location	Entry Size	Weight kg (lb)	Volume dm ³ (in ³)	Catalog Number
Pilot Light						
1x red pilot light ④		Bottom	2 x M20	1.2 (2.65)	4.3 (262.40)	U61W2PR
			2 x M25	1.2 (2.65)	4.3 (262.40)	U61W4PR
			1 x 3/4"	1.2 (2.65)	4.3 (262.40)	U61Z3PR
		Feed-Thru	2 x 3/4"	1.2 (2.65)	4.3 (262.40)	U61X3PR
1x green pilot light ④		Bottom	2 x M20	1.2 (2.65)	4.3 (262.40)	U61W2PG
			2 x M25	1.2 (2.65)	4.3 (262.40)	U61W4PG
			1 x 3/4"	1.2 (2.65)	4.3 (262.40)	U61Z3PG
		Feed-Thru	2 x 3/4"	1.2 (2.65)	4.3 (262.40)	U61X3PG
1x blue pilot light ④		Bottom	2 x M20	1.2 (2.65)	4.3 (262.40)	U61W2PB
			2 x M25	1.2 (2.65)	4.3 (262.40)	U61W4PB
			1 x 3/4"	1.2 (2.65)	4.3 (262.40)	U61Z3PB
		Feed-Thru	2 x 3/4"	1.2 (2.65)	4.3 (262.40)	U61X3PB
1x yellow pilot light ④		Bottom	2 x M20	1.2 (2.65)	4.3 (262.40)	U61W2PY
			2 x M25	1.2 (2.65)	4.3 (262.40)	U61W4PY
			1 x 3/4"	1.2 (2.65)	4.3 (262.40)	U61Z3PY
		Feed-Thru	2 x 3/4"	1.2 (2.65)	4.3 (262.40)	U61X3PY
1x white pilot light ④		Bottom	2 x M20	1.2 (2.65)	4.3 (262.40)	U61W2PW
			2 x M25	1.2 (2.65)	4.3 (262.40)	U61W4PW
			1 x 3/4"	1.2 (2.65)	4.3 (262.40)	U61Z3PW
		Feed-Thru	2 x 3/4"	1.2 (2.65)	4.3 (262.40)	U61X3PW

Additional combinations available, please refer to Unicode 2 Series - Customized Control Stations section.

① Overall hazardous location and ingress protection rating depends on the rating of the optional certified components used.

② Not required for stainless steel.

③ Not included if NPT hubs are selected.

④ 12 Vac to 254 Vac 50/60 Hz - 12 Vdc to 60 Vdc.

Unicode™ 2 Series Stainless Steel Control Stations and Switches

Increased Safety

NEC:
 Class I, Division 2, Groups A, B, C, D
 Class II, Groups E, F, G
 Class III
 Ex de IIC/DIP A21
 IP66, Type 4X①

CEC:
 Class I, Division 2, Groups A, B, C, D
 Class II, Groups F, G
 Class III; Type 4X①
 Class I, Zone 1, AEx de IIC/ AEx tD 21
 IP66

ATEX/IECEX:
 Zone 1 and 2 – 21 and 22
 ② II 2 GD
 Ex de IIC/Ex demb IIC/ Ex tD A21
 IP66 – IK10

Size 1 Stainless Steel Control Station

Included: 1 white self-adhesive laminated plastic nameplate, 1 brass earth continuity plate ②, 1 blanking plug ③, 1 cable gland ③.

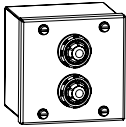
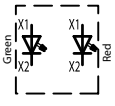
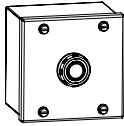
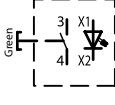
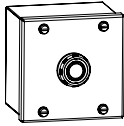
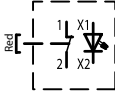
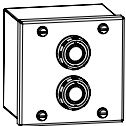
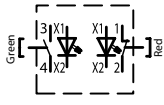
Description/Function	Diagram	Entry Location	Entry Size	Weight kg (lb)	Volume dm ³ (in ³)	Catalog Number
Twin Pilot Light ④						
 1x green pilot light ⑤ 1x red pilot light ⑤		Bottom	2 x M20	1.3 (2.87)	4.3 (262.40)	U61W2PGPR
		Bottom	2 x M25	1.3 (2.87)	4.3 (262.40)	U61W4PGPR
		Feed-Thru	1 x 3/4"	1.3 (2.87)	4.3 (262.40)	U61Z3PGPR
		Feed-Thru	2 x 3/4"	1.3 (2.87)	4.3 (262.40)	U61X3PGPR
Illuminated Push Button						
 1x green illuminated push button with 1NO contact momentary contacts		Bottom	2 x M20	1.2 (2.65)	4.3 (262.40)	U61W2LG5
		Bottom	2 x M25	1.2 (2.65)	4.3 (262.40)	U61W4LG5
		Feed-Thru	1 x 3/4"	1.2 (2.65)	4.3 (262.40)	U61Z3LG5
		Feed-Thru	2 x 3/4"	1.2 (2.65)	4.3 (262.40)	U61X3LG5
 1x red illuminated push button with 1NC contact momentary contacts		Bottom	2 x M20	1.2 (2.65)	4.3 (262.40)	U61W2LR9
		Bottom	2 x M25	1.2 (2.65)	4.3 (262.40)	U61W4LR9
		Feed-Thru	1 x 3/4"	1.2 (2.65)	4.3 (262.40)	U61Z3LR9
		Feed-Thru	2 x 3/4"	1.2 (2.65)	4.3 (262.40)	U61X3LR9
Twin Illuminated Push Button ④						
 1x green illuminated push button with 1NO contact 1x red illuminated push button with 1NC contact momentary contacts		Bottom	2 x M20	1.3 (2.87)	4.3 (262.40)	U61W2LG5LR9
		Bottom	2 x M25	1.3 (2.87)	4.3 (262.40)	U61W4LG5LR9
		Feed-Thru	1 x 3/4"	1.3 (2.87)	4.3 (262.40)	U61Z3LG5LR9
		Feed-Thru	2 x 3/4"	1.3 (2.87)	4.3 (262.40)	U61X3LG5LR9

Additional combinations available, please refer to Unicode 2 Series - Customized Control Stations section.

- ① Overall hazardous location and ingress protection rating depends on the rating of the optional certified components used.
- ② Not required for stainless steel.
- ③ Not included if NPT hubs are selected.
- ④ Vertically mounted devices in stainless steel models.
- ⑤ 12 Vac to 254 Vac 50/60 Hz - 12 Vdc to 60 Vdc.

Unicode™ 2 Series Stainless Steel Control Stations and Switches

Increased Safety





NEC:
 Class I, Division 2, Groups A, B, C, D
 Class II, Groups E, F, G
 Class III
 Ex de IIC/DIP A21
 IP66, Type 4X①

CEC:
 Class I, Division 2, Groups A, B, C, D
 Class II, Groups F, G
 Class III; Type 4X①
 Class I, Zone 1, AEx de IIC/ AEx tD 21
 IP66

ATEX/IECEx:
 Zone 1 and 2 – 21 and 22
 ② II 2 GD
 Ex de IIC/Ex demb IIC/ Ex tD A21
 IP66 – IK10

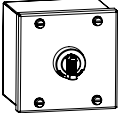
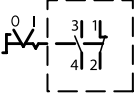
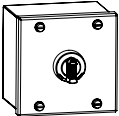
Size 1 Stainless Steel Control Station

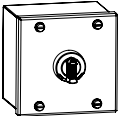
Included: 1 white self-adhesive laminated plastic nameplate, 1 brass earth continuity plate ②, 1 blanking plug ③, 1 cable gland ③.

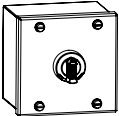
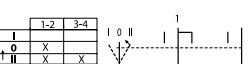
Description/Function	Diagram	Entry Location	Entry Size	Weight kg (lb)	Volume dm ³ (in ³)	Catalog Number
2-Position Selector Switch						
 <p>2 fixed positions '0 - I' 1NO + 1NC contact</p>		Bottom	2 x M20	1.2 (2.65)	4.3 (262.40)	U61W2H3
		Bottom	2 x M25	1.2 (2.65)	4.3 (262.40)	U61W4H3
		Bottom	1 x 3/4"	1.2 (2.65)	4.3 (262.40)	U61Z3H3
		Feed-Thru	2 x 3/4"	1.2 (2.65)	4.3 (262.40)	U61X3H3
3-Position Selector Switch						
 <p>3 fixed positions 'I - 0 - II' 2NO contact</p>		Bottom	2 x M20	1.2 (2.65)	4.3 (262.40)	U61W2J1
		Bottom	2 x M25	1.2 (2.65)	4.3 (262.40)	U61W4J1
		Bottom	1 x 3/4"	1.2 (2.65)	4.3 (262.40)	U61Z3J1
		Feed-Thru	2 x 3/4"	1.2 (2.65)	4.3 (262.40)	U61X3J1
 <p>3 positions 'I - 0 - II' with spring return from I to 0 1NO + 1NC contact</p>		Bottom	2 x M20	1.2 (2.65)	4.3 (262.40)	U61W2N3
		Bottom	2 x M25	1.2 (2.65)	4.3 (262.40)	U61W4N3
		Bottom	1 x 3/4"	1.2 (2.65)	4.3 (262.40)	U61Z3N3
		Feed-Thru	2 x 3/4"	1.2 (2.65)	4.3 (262.40)	U61X3N3
 <p>3 positions 'I - 0 - II' with spring return from II to 0 1NO + 1NC contact</p>		Bottom	2 x M20	1.2 (2.65)	4.3 (262.40)	U61W2M3
		Bottom	2 x M25	1.2 (2.65)	4.3 (262.40)	U61W4M3
		Bottom	1 x 3/4"	1.2 (2.65)	4.3 (262.40)	U61Z3M3
		Feed-Thru	2 x 3/4"	1.2 (2.65)	4.3 (262.40)	U61X3M3

Additional combinations available, please refer to Unicode 2 Series - Customized Control Stations section.

- ① Overall hazardous location and ingress protection rating depends on the rating of the optional certified components used.
- ② Not required for stainless steel.
- ③ Not included if NPT hubs are selected.

Unicode™ 2 Series Stainless Steel Control Stations and Switches

Increased Safety

NEC:
 Class I, Division 2, Groups A, B, C, D
 Class II, Groups E, F, G
 Class III
 Ex de IIC/DIP A21
 IP66, Type 4X①



CEC:
 Class I, Division 2, Groups A, B, C, D
 Class II, Groups F, G
 Class III; Type 4X①
 Class I, Zone 1, AEx de IIC/ AEx tD 21
 IP66

ATEX/IECEX:
 Zone 1 and 2 – 21 and 22
 II 2 GD
 Ex de IIC/Ex demb IIC/ Ex tD A21
 IP66 – IK10

CONTROLS: NEC/CEC, ATEX/IECEX INCREASED SAFETY CONTROL STATIONS

Size 2 Stainless Steel Control Station

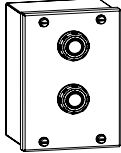
Included: 1 white self-adhesive laminated plastic nameplate, 1 brass earth continuity plate ②, 1 blanking plug ③, 1 cable gland ③.

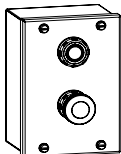
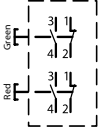
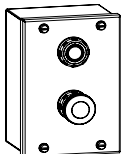
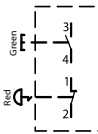
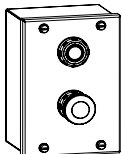
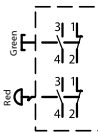
Description/Function	Diagram	Entry Location	Entry Size	Weight kg (lb)	Volume dm³ (in³)	Catalog Number	
Twin Push Button							
 <p>1x green push button 'I' with 1NO contact 1x red push button 'O' with 1NC contact momentary contacts</p>		Bottom	2 x M20	1.8 (3.97)	4.3 (262.40)	U62W2A5A9	
		Bottom	2 x M25	1.8 (3.97)	4.3 (262.40)	U62W4A5A9	
		1 x 3/4"	1.8 (3.97)	4.3 (262.40)	U62Z3A5A9		
	Feed-Thru	2 x 3/4"	1.8 (3.97)	4.3 (262.40)	U62X3A5A9		
	 <p>1x green push button 'I' with 1NO + 1NC contact 1x red push button 'O' with 1NO + 1NC contact momentary contacts</p>		Bottom	2 x M20	1.8 (3.97)	4.3 (262.40)	U62W2A3A3
			Bottom	2 x M25	1.8 (3.97)	4.3 (262.40)	U62W4A3A3
1 x 3/4"		1.8 (3.97)	4.3 (262.40)	U62Z3A3A3			
Feed-Thru		2 x 3/4"	1.8 (3.97)	4.3 (262.40)	U62X3A3A3		
Push Button + Push-Pull Emergency Stop							
 <p>1x green push button 'I' with 1NO momentary contact 1x red mushroom head push-pull with 1NC maintained contact</p>		Bottom	2 x M20	1.8 (3.97)	4.3 (262.40)	U62W2A5D9	
		Bottom	2 x M25	1.8 (3.97)	4.3 (262.40)	U62W4A5D9	
		1 x 3/4"	1.8 (3.97)	4.3 (262.40)	U62Z3A5D9		
	Feed-Thru	2 x 3/4"	1.8 (3.97)	4.3 (262.40)	U62X3A5D9		
	 <p>1x green push button 'I' with 1NO + 1NC momentary contact 1x red mushroom head push-pull with 1NO + 1NC maintained contact</p>		Bottom	2 x M20	1.8 (3.97)	4.3 (262.40)	U62W2A3D3
			Bottom	2 x M25	1.8 (3.97)	4.3 (262.40)	U62W4A3D3
1 x 3/4"		1.8 (3.97)	4.3 (262.40)	U62Z3A3D3			
Feed-Thru	2 x 3/4"	1.8 (3.97)	4.3 (262.40)	U62X3A3D3			

Additional combinations available, please refer to Unicode 2 Series - Customized Control Stations section.

- ① Overall hazardous location and ingress protection rating depends on the rating of the optional certified components used.
- ② Not required for stainless steel.
- ③ Not included if NPT hubs are selected.

Unicode™ 2 Series Stainless Steel Control Stations and Switches

Increased Safety





NEC:
 Class I, Division 2, Groups A, B, C, D
 Class II, Groups E, F, G
 Class III
 Ex de IIC/DIP A21
 IP66, Type 4X①

CEC:
 Class I, Division 2, Groups A, B, C, D
 Class II, Groups F, G
 Class III; Type 4X①
 Class I, Zone 1, AEx de IIC/ AEx tD 21
 IP66

ATEX/IECEx:
 Zone 1 and 2 – 21 and 22
 ② II 2 GD
 Ex de IIC/Ex demb IIC/ Ex tD A21
 IP66 – IK10

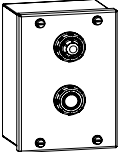
Size 2 Stainless Steel Control Station

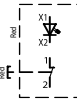
Included: 1 white self-adhesive laminated plastic nameplate, 1 brass earth continuity plate ②, 1 blanking plug ③, 1 cable gland ③.

Description/Function	Diagram	Entry Location	Entry Size	Weight kg (lb)	Volume dm³ (in³)	Catalog Number
Pilot Light + Push Button						
 1x green light ④ 1x green push button 'I' with 1NO momentary contact		Bottom	2 x M20	1.8 (3.97)	4.3 (262.40)	U62W2PGA5
		Bottom	2 x M25	1.8 (3.97)	4.3 (262.40)	U62W4PGA5
		Feed-Thru	1 x 3/4"	1.8 (3.97)	4.3 (262.40)	U62Z3PGA5
		Feed-Thru	2 x 3/4"	1.8 (3.97)	4.3 (262.40)	U62X3PGA5
1x green light ④ 1x green push button 'I' with 1NO + 1NC momentary contacts		Bottom	2 x M20	1.8 (3.97)	4.3 (262.40)	U62W2PGA3
		Bottom	2 x M25	1.8 (3.97)	4.3 (262.40)	U62W4PGA3
		Feed-Thru	1 x 3/4"	1.8 (3.97)	4.3 (262.40)	U62Z3PGA3
		Feed-Thru	2 x 3/4"	1.8 (3.97)	4.3 (262.40)	U62X3PGA3
1x red light ④ 1x red push button 'O' with 1NC momentary contact		Bottom	2 x M20	1.8 (3.97)	4.3 (262.40)	U62W2PRA9
		Bottom	2 x M25	1.8 (3.97)	4.3 (262.40)	U62W4PRA9
		Feed-Thru	1 x 3/4"	1.8 (3.97)	4.3 (262.40)	U62Z3PRA9
		Feed-Thru	2 x 3/4"	1.8 (3.97)	4.3 (262.40)	U62X3PRA9
1x red light ④ 1x red push button 'O' with 1NO + 1NC momentary contact		Bottom	2 x M20	1.8 (3.97)	4.3 (262.40)	U62W2PRA3
		Bottom	2 x M25	1.8 (3.97)	4.3 (262.40)	U62W4PRA3
		Feed-Thru	1 x 3/4"	1.8 (3.97)	4.3 (262.40)	U62Z3PRA3
		Feed-Thru	2 x 3/4"	1.8 (3.97)	4.3 (262.40)	U62X3PRA3

Additional combinations available, please refer to Unicode 2 Series - Customized Control Stations section.

- ① Overall hazardous location and ingress protection rating depends on the rating of the optional certified components used.
- ② Not required for stainless steel.
- ③ Not included if NPT hubs are selected.
- ④ 12 Vac to 254 Vac 50/60 Hz - 12 Vdc to 60 Vdc.

Unicode™ 2 Series Stainless Steel Control Stations and Switches

Increased Safety

NEC:
 Class I, Division 2, Groups A, B, C, D
 Class II, Groups E, F, G
 Class III
 Ex de IIC/DIP A21
 IP66, Type 4X①

CEC:
 Class I, Division 2, Groups A, B, C, D
 Class II, Groups F, G
 Class III; Type 4X①
 Class I, Zone 1, AEx de IIC/ AEx tD 21
 IP66

ATEX/IECEx:
 Zone 1 and 2 – 21 and 22
 II 2 GD
 Ex de IIC/Ex demb IIC/ Ex tD A21
 IP66 – IK10

CONTROLS: NEC/CEC, ATEX/IECEx INCREASED SAFETY CONTROL STATIONS

Size 2 Stainless Steel Control Station

Included: 1 white self-adhesive laminated plastic nameplate, 1 brass earth continuity plate ②, 1 blanking plug ③, 1 cable gland ③.

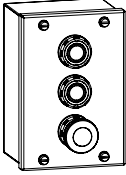
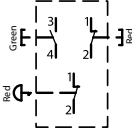
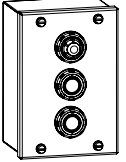
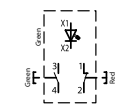
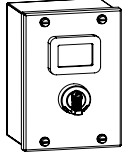
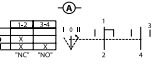
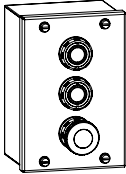
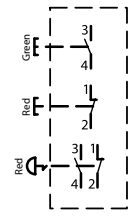
Description/Function	Diagram	Entry Location	Entry Size	Weight kg (lb)	Volume dm ³ (in ³)	Catalog Number
Twin Push Buttons + Push-Pull Emergency Stop						
 <p>1x green push button 'I' with 1NO contacts 1x red push button 'O' with 1NC contacts momentary contacts 1x red mushroom head push-pull with 1x NC maintained contact</p>		Bottom	2 x M20	1.9 (4.19)	4.5 (274.6)	U62W2A5A9D9
		Bottom	2 x M25	1.9 (4.19)	4.5 (274.6)	U62W4A5A9D9
		Feed-Thru	1 x 3/4"	1.9 (4.19)	4.5 (274.6)	U62Z3A5A9D9
		Feed-Thru	2 x 3/4"	1.9 (4.19)	4.5 (274.6)	U62X3A5A9D9
Pilot Light + Twin Push Buttons ④						
 <p>1x green light ④ 1x green push button 'I' with 1NO 1x red push button 'O' with 1NC momentary contacts</p>		Bottom	2 x M20	1.9 (4.19)	4.5 (274.60)	U62W2PGA5A9
		Bottom	2 x M25	1.9 (4.19)	4.5 (274.60)	U62W4PGA5A9
		Feed-Thru	1 x 3/4"	1.9 (4.19)	4.5 (274.60)	U62Z3PGA5A9
		Feed-Thru	2 x 3/4"	1.9 (4.19)	4.5 (274.60)	U62X3PGA5A9
Ammeter + 3-Position Selector Switch ⑤						
 <p>1x ammeter 48 x 48 mm, 1A C.T., 3 F.L.C., with 0 - 1 - 3 scale 1x switch 3 positions 'I - 0 - II' with spring return from II to 0 1NO + 1NC contact</p>		Bottom	2 x M20	1.8 (3.97)	4.3 (262.4)	U62W2VA13M3
		Bottom	2 x M25	1.8 (3.97)	4.3 (262.4)	U62W4VA13M3
		Feed-Thru	1 x 3/4"	1.8 (3.97)	4.3 (262.4)	U62Z3VA13M3
		Feed-Thru	2 x 3/4"	1.8 (3.97)	4.3 (262.4)	U62X3VA13M3
Twin Push Buttons + Push-Pull Emergency Stop ④						
 <p>1x green push button 'I' with 1NO contact 1x red push button 'O' with 1NC contact momentary contacts 1x red mushroom head push-pull emergency button with 1NO + 1NC maintained contacts</p>		Bottom	2 x M20	1.9 (4.19)	4.5 (274.60)	U63W2A5A9D3
		Bottom	2 x M25	1.9 (4.19)	4.5 (274.60)	U63W4A5A9D3
		Feed-Thru	1 x 3/4"	1.9 (4.19)	4.5 (274.60)	U63Z3A5A9D3
		Feed-Thru	2 x 3/4"	1.9 (4.19)	4.5 (274.60)	U63X3A5A9D3

Additional combinations available, please refer to Unicode 2 Series - Customized Control Stations section.

- ① Overall hazardous location and ingress protection rating depends on the rating of the optional certified components used.
- ② Not required for stainless steel.
- ③ Not included if NPT hubs are selected.
- ④ 12 Vac to 254 Vac 50/60 Hz - 12 Vdc to 60 Vdc.
- ⑤ Certified for ATEX/IECEx only.

Unicode™ 2 Series Stainless Steel Control Stations and Switches

Increased Safety

NEC:
 Class I, Division 2, Groups A, B, C, D
 Class II, Groups E, F, G
 Class III
 Ex de IIC/DIP A21
 IP66, Type 4X①

CEC:
 Class I, Division 2, Groups A, B, C, D
 Class II, Groups F, G
 Class III; Type 4X①
 Class I, Zone 1, AEx de IIC/ AEx tD 21
 IP66

ATEX/IECEX:
 Zone 1 and 2 – 21 and 22
 ② II 2 GD
 Ex de IIC/Ex demb IIC/ Ex tD A21
 IP66 – IK10

Size 3 Stainless Steel Control Station

Included: 1 white self-adhesive laminated plastic nameplate, 1 brass earth continuity plate ②, 1 blanking plug ③, 1 cable gland ③.

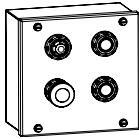
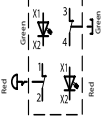
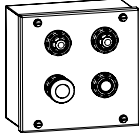
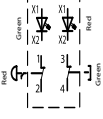
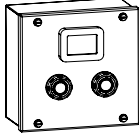
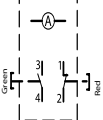
Description/Function	Diagram	Entry Location	Entry Size	Weight kg (lb)	Volume dm ³ (in ³)	Catalog Number
Pilot Light + Twin Push Buttons + Push-Pull Emergency Stop						
 <p>1x green light 1x green push button 'I' with 1NO contact 1x red push button 'O' with 1NC contact momentary contacts 1x red mushroom head push-pull with 1x NC maintained contact</p>		Bottom	2 x M20	2.1 (4.63)	10.5 (640.70)	U63W2PGA5A9D9
		Bottom	2 x M25	2.1 (4.63)	10.5 (640.70)	U63W4PGA5A9D9
			1 x 3/4"	2.1 (4.63)	10.5 (640.70)	U63Z3PGA5A9D9
		Feed-Thru	2 x 3/4"	2.1 (4.63)	10.5 (640.70)	U63X3PGA5A9D9
Twin Pilot Lights + Push-Pull Emergency Stop + Push Button ③						
 <p>1x green light + 1x red light ③ 1x red mushroom head push-pull with 1x NC maintained contact 1x green push button 'I' with 1NO momentary contact</p>		Bottom	2 x M20	2.1 (4.63)	10.5 (640.70)	U63W2PGPRD9A5
		Bottom	2 x M25	2.1 (4.63)	10.5 (640.70)	U63W4PGPRD9A5
			1 x 3/4"	2.1 (4.63)	10.5 (640.70)	U63Z3PGPRD9A5
		Feed-Thru	2 x 3/4"	2.1 (4.63)	10.5 (640.70)	U63X3PGPRD9A5
Ammeter + Twin Push Buttons ⑤						
 <p>1x ammeter 48 x 48 mm, 1A C.T., 3 F.L.C., with 0 - 1 - 3 scale 1x green push button 'I' with 1NO contact 1x red push button 'O' with 1NC contact momentary contacts</p>		Bottom	2 x M20	2.1 (4.63)	10.5 (640.70)	U63W2VA13A5A9
		Bottom	2 x M25	2.1 (4.63)	10.5 (640.70)	U63W4VA13A5A9
			1 x 3/4"	2.1 (4.63)	10.5 (640.70)	U63Z3VA13A5A9
		Feed-Thru	2 x 3/4"	2.1 (4.63)	10.5 (640.70)	U63X3VA13A5A9

Additional combinations available, please refer to Unicode 2 Series - Customized Control Stations section.

- ① Overall hazardous location and ingress protection rating depends on the rating of the optional certified components used.
- ② Not required for stainless steel.
- ③ Not included if NPT hubs are selected.
- ④ 12 Vac to 254 Vac 50/60 Hz - 12 Vdc to 60 Vdc.
- ⑤ Certified for ATEX/IECEX only.

Unicode™ 2 Series Stainless Steel Control Stations and Switches

Increased Safety

NEC:
 Class I, Division 2, Groups A, B, C, D
 Class II, Groups E, F, G
 Class III
 Ex de IIC/DIP A21
 IP66, Type 4X①

CEC:
 Class I, Division 2, Groups A, B, C, D
 Class II, Groups F, G
 Class III; Type 4X①
 Class I, Zone 1, AEx de IIC/ AEx tD 21
 IP66

ATEX/IECEX:
 Zone 1 and 2 – 21 and 22
 II 2 GD
 Ex de IIC/Ex demb IIC/ Ex tD A21
 IP66 – IK10

CONTROLS: NEC/CEC, ATEX/IECEX INCREASED SAFETY CONTROL STATIONS

Nameplates – Set of 10

Blank self-adhesive, laminated plastic 58 mm x 18 mm (2.29" x 0.71").

Color	Catalog Number
White (black letters)	UNPW
Yellow (black letters)	UNPY
Red (white letters)	UNPR
Blue (white letters)	UNPB
Black (white letters)	UNPN
Green (white letters)	UNPG

Standard Legend Plates

Two sizes available. Self-adhesive yellow laminated plastic (black lettering).

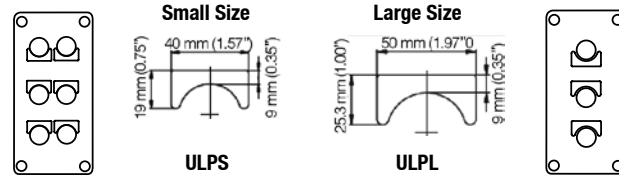

Inserts for Push Button – Set of 5

Marking	Color	Catalog Number
(unmarked)	Green	UIAG
(unmarked)	Red	UIAR
(unmarked)	Yellow	UIAY
(unmarked)	White	UIAW
(unmarked)	Blue	UIAB
(unmarked)	Black	UIAN
ON	Green	UIA01
OFF	Red	UIA02
START	Green	UIA03
STOP	Red	UIA04
MARCHE	Green	UIA05
ARRET	Red	UIA06
I	Green	UIA07
O	Red	UIA08

Inserts for Illuminated Push Button – Set of 5

Marking	Color	Catalog Number
(unmarked)	Green	UILG
(unmarked)	Red	UILR
(unmarked)	Yellow	UILY
(unmarked)	White	UILW
(unmarked)	Blue	UILB
ON	Green	UIL01
OFF	Red	UIL02
START	Green	UIL03
STOP	Red	UIL04
MARCHE	Green	UIL05
ARRET	Red	UIL06
I	Green	UIL07
O	Red	UIL08

Spare Key

For all key-operated buttons.

Description	Catalog Number
Spare key type 4 A 185	SK4A185

Text	Catalog Number	
	Small	Large
Blank (set of 10)	ULPS	ULPL
ON	ULPSA01	ULPLA01
OFF	ULPSA02	ULPLA02
FORWARD	ULPSA03	ULPLA03
REVERSE	ULPSA04	ULPLA04
JOG	ULPSA05	ULPLA05
RUN	ULPSA06	ULPLA06
START	ULPSA07	ULPLA07
STOP	ULPSA08	ULPLA08
UP	ULPSA09	ULPLA09
DOWN	ULPSA10	ULPLA10
FAST	ULPSA11	ULPLA11
SLOW	ULPSA12	ULPLA12
RAISE	ULPSA13	ULPLA13
LOWER	ULPSA14	ULPLA14
OPEN	ULPSA15	ULPLA15
CLOSE	ULPSA16	ULPLA16
LOW	ULPSA17	ULPLA17
HIGH	ULPSA18	ULPLA18
TEST	ULPSA19	ULPLA19
RESET	ULPSA20	ULPLA20
EMERGENCY STOP	ULPSA21	ULPLA21
MARCHE	ULPSA22	ULPLA22
ARRET	ULPSA23	ULPLA23
ARRET D'URGENCE	ULPSA24	ULPLA24
HAUT	ULPSA25	ULPLA25
BAS	ULPSA26	ULPLA26
O—I	ULPSH01	ULPLH01
ON—OFF	ULPSH02	ULPLH02
START—STOP	ULPSH03	ULPLH03
STOP—START	ULPSH04	ULPLH04
HAND—AUTO	ULPSH05	ULPLH05
MANU—AUTO	ULPSH06	ULPLH06
FORWARD—REVERSE	ULPSH07	ULPLH07
REMOTE—LOCAL	ULPSH08	ULPLH08
MARCHE—ARRET	ULPSH09	ULPLH09
I—O—II	ULPSJ01	ULPLJ01
OFF—O—ON	ULPSJ02	ULPLJ02
START—NORMAL—STOP	ULPSJ03	ULPLJ03
HAND—OFF—AUTO	ULPSJ04	ULPLJ04
MANU—O—AUTO	ULPSJ05	ULPLJ05
FORWARD—OFF—REVERSE	ULPSJ06	ULPLJ06
LOCAL—REMOTE—AUTO	ULPSJ07	ULPLJ07
LOCAL—O—REMOTE	ULPSJ08	ULPLJ08
MARCHE—NORMAL—ARRET	ULPSJ09	ULPLJ09

① Overall hazardous location and ingress protection rating depends on the rating of the optional certified components used.

Unicode™ 2 Series Stainless Steel Control Stations and Switches

Increased Safety

NEC:
 Class I, Division 2, Groups A, B, C, D
 Class II, Groups E, F, G
 Class III
 Ex de IIC/DIP A21
 IP66, Type 4X^①

CEC:
 Class I, Division 2, Groups A, B, C, D
 Class II, Groups F, G
 Class III; Type 4X^①
 Class I, Zone 1, AEx de IIC/ AEx tD 21
 IP66

ATEX/IECEX:
 Zone 1 and 2 – 21 and 22
 II 2 GD
 Ex de IIC/Ex demb IIC/ Ex tD A21
 IP66 – IK10

	Description	Catalog Number
	Additional Contacts Each actuator is capable of activating 3 contacts. Exception: Illuminated push button and all actuators with key: 2 contacts maximum 1NO contact 1NC contact	UCB5R UCB9R
	Yellow Guard Mushroom head protection for emergency stop	098657
	Padlockable Guard Stainless steel and plastic cover, capacity: 3 padlocks diameter 6 mm (0.24") maximum (not supplied) For push button and rotary actuator For mushroom head actuator	UPLD1S UPLD2S
	Cable Gland Exe For unarmored cable Exe - IP66 - in polyamide entry thread seal M20 (capacity 6.5-14.5 mm)	095605
	For armored cable Exe/Exd - IP66 - in nickel plated brass (without entry thread seal) Braid and Tape type: M20 (inner: 6.4-14.0/outer: 12.5-20.9 mm) Single Wired Armor (SWA): M20 (inner: 6.4-14.0/outer: 12.5-20.9 mm)	20E1FX5 20E1FW5
	Adaptors Exd/Exe - IP66 in nickel plated brass (without entry thread seal) Male M20 - Female 1/2" NPT Male M20 - Female 3/4" NPT	737DM2T15 737DM2T25
	Entry Thread Seal M20 (in white nylon)	20ETS2
	Combination Drain and Breather Exe - IP66 - supplied with entry thread seal and locknut M20 male thread in Polyamide M20 male thread in Brass M20 male thread in Stainless Steel	DBE20P DBE20B DBE20S
	Feed-Thru Earth Stud Terminal Exe - IP66 - supplied with weatherproof seal and green/yellow earth conductor - 300 mm (11.81") length M20 with M5 earth and 2.5 mm ² (0.004 in ²) conductor	PREESTM20

^① Overall hazardous location and ingress protection rating depends on the rating of the optional certified components used.

Unicode™ 2 Series Stainless Steel Control Stations and Switches

Increased Safety

NEC:
 Class I, Division 2, Groups A, B, C, D
 Class II, Groups E, F, G
 Class III
 Ex de IIC/DIP A21
 IP66, Type 4X^①

CEC:
 Class I, Division 2, Groups A, B, C, D
 Class II, Groups F, G
 Class III; Type 4X^①
 Class I, Zone 1, AEx de IIC/ AEx tD 21
 IP66

ATEX/IECEX:
 Zone 1 and 2 – 21 and 22
 Ex II 2 GD
 Ex de IIC/Ex demb IIC/ Ex tD A21
 IP66 – IK10

CONTROLS: NEC/CEC, ATEX/IECEX INCREASED SAFETY CONTROL STATIONS

Dimensions in Millimeters (Inches)

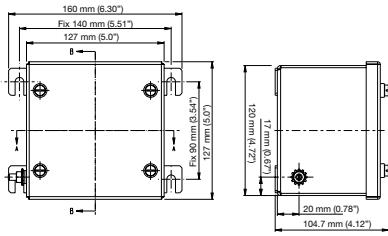

Size 1 Box

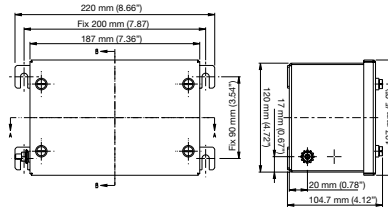

Size 2 Box

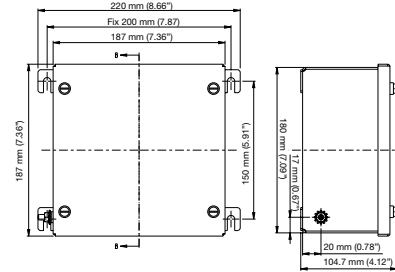

Size 3 Box

^① Overall hazardous location and ingress protection rating depends on the rating of the optional certified components used.

Unicode™ 2 Series Fiberglass Reinforced Polyester Control Stations and Switches

Increased Safety

NEC:
Class I, Division 2, Groups A, B, C, D
Class II, Groups E, F, G
Class III
Ex de IIC/DIP A21
IP66, Type 4X^①

CEC:
Class I, Division 2, Groups A, B, C, D
Class II, Groups F, G
Class III; Type 4X^①
Class I, Zone 1, AEx de IIC/ AEx tD 21
IP66

ATEX/IECEx:
Zone 1 and 2 – 21 and 22
Ex II 2 GD
Ex de IIC/Ex demb IIC/ Ex tD A21
IP66 – IK10

Applications

- Local control stations and motor control stations for use in hazardous areas covering the broadest possible range of applications.
- Control of equipment at:
 - Power plants
 - Chemical and petrochemical plants
 - Petroleum refineries
 - Reverse osmosis plants
 - Pulp and paper processing plants
 - Various industrial applications
- Push buttons and selector switches are used in conjunction with contactors or magnetic starters for remote control of motors in hazardous locations. They provide circuit control and/or selection.
- Pilot lights provide visual assurance that an electrical function is being performed at a remote or hazardous location.
- For use in washdown areas.

Features

- Employs Ex de method of protection which eliminates the need for external seals.
- Operators include push buttons, illuminated push buttons, selector switches, control and load break switches and LED pilot lights.
- Pilot light employs high intensity single LED with lifetime of 100,000 hours that can be used at:
 - 12 Vac to 254 Vac 50/60 Hz
 - 12 Vdc to 60 Vdc
- Up to 3 contact blocks per actuator can be used.
- Contact block technical data:
 - IEC rated operating voltage (Ue): 500 Vac – 110 Vdc
 - IEC switching capacity:
 - AC12: 16 Amp/400 Vac
 - AC14: 10 Amp/400 Vac
 - AC15: 6 Amp/500 Vac
 - DC13: 2 Amp/24 Vdc and 1 Amp/110 Vdc
 - NEMA switching capacity: A600: 10 Amp/600 Vac
- Selector switch technical data:
 - IEC rated operating voltage: 690 Vac
 - IEC rated operating current: maximum 16 Amp
 - IEC switching capacity:
 - AC1: 16 Amp/690 Vac
 - AC15: 16 Amp/415 Vac
 - AC3: 8 Amp/500 Vac
 - AC3: 4 Amp/690 Vac
 - AC3: 16 Amp/690 Vac
 - DC1: 10 Amp/24 Vdc
 - DC1: 6 Amp/60 Vdc
 - DC1: 6 Amp/110 Vdc (2 contacts wired in series)
 - DC1: 6 Amp/220 Vdc (3 contacts in series)
 - NEMA switching capacity: A600: 10 Amp/600 Vac
- Enclosures are rated for IP66 with firmly secured gasket.
- Operators and contact blocks are spaced for easy wiring.
- Wide selection of termination methods available.
- Choice of DIN rail mounted high performance contact block suitable for low intensity (less than 5 mA).
- TS35 rail mounted components are held securely in place during operation and easily removed for service.



U22W2PGA5

- Brass Inserts are provided for TS35 DIN rails or mounting plates to be installed inside the enclosure.
- Captive, corrosion resistant stainless steel cover screws.

Standard Materials

- Body and cover: fiberglass reinforced polyester (FRP) with black finish
- Cover screws: 316 stainless steel

Accessories

- Key for changing actuator blocks.
- Guard for mushroom head actuator.
- Padlockable guard.
- M5 and M6 earth stud.
- Combination drain and breather available in brass, polyamide and stainless steel.

Options

- Nameplates: Stainless Steel or Lamacoid with different color combinations.
- Padlocking facility at left, center, right or any position on selector switches.
- Padlocking facility for momentary and maintained push buttons.
- Special contact arrangements available, see *Unicode™ 2 Series Customized Control Stations*.

NEC/CEC Certifications and Compliances

- Certification Type CSPe
 - Temperature Class: T5 or T6
 - Ambient Temperature: -55°C to +60°C (-67°F to +140°F)
 - CAN/CSA Standards: C22.2 No. 0-M91, No. 25-M66, No. 213-M1987, No. 94-M91, No. 60079-0:07, No. 60529-2005, E60079-7-2003
 - UL Standards: 60079-0, 60079-7, 50
 - Other Standards: ANSI/IEC 60529-2004, ANSI/ISA 12.12.01-2011
 - cCSAus Certificate: 2356952

^① Overall hazardous location and ingress protection rating depends on the rating of the optional certified components used.

Unicode™ 2 Series Fiberglass Reinforced Polyester Control Stations and Switches

Increased Safety

NEC:
Class I, Division 2, Groups A, B, C, D
Class II, Groups E, F, G
Class III
Ex de IIC/DIP A21
IP66, Type 4X^①

CEC:
Class I, Division 2, Groups A, B, C, D
Class II, Groups F, G
Class III; Type 4X^①
Class I, Zone 1, AEx de IIC/ AEx tD 21
IP66

ATEX/IECEx:
Zone 1 and 2 – 21 and 22
Ⓢ II 2 GD
Ex de IIC/Ex demb IIC/ Ex tD A21
IP66 – IK10

CONTROLS: NEC/CEC, ATEX/IECEx INCREASED SAFETY CONTROL STATIONS

ATEX/IECEx Certification and Compliances

- Certification Type CSPe
 - Gas: Zone 1 and 2
 - Conforming to ATEX 94/9/CE: Ⓢ II 2 G
 - Type of Protection: Ex de IIC/Ex demb IIC
 - Temperature Class: T6
 - Dust: Zone 21 and 22
 - Conforming to ATEX 94/9/CE: Ⓢ II 2 D
 - Type of Protection: Ex tD A21
 - Surface Temperature: T75 °C (T167 °F)
 - Ambient Temperature: -55 °C to +60 °C (-67°F to +140°F)
(empty enclosure, temperature to be determine according actuator)
 - CE Declaration of Conformity: 52084
 - ATEX Certificate: LCIE 00 ATEX 3032X
 - IECEx Certificate: IECEx LCI 09.0016X

EURASEC Certification

- Certification Type CSPe
 - EURASEC RU C-FR ГБ05.В.00911

Other Certification ^②

- Certification Type CSPe
 - INMETRO Certificate: BVC 11.0637-X

^① Overall hazardous location and ingress protection rating depends on the rating of the optional certified components used.

^② INMETRO certification available on special request only. Contact your local sales representative for more information.

Unicode™ 2 Series Fiberglass Reinforced Polyester Control Stations and Switches

Increased Safety

NEC:
 Class I, Division 2, Groups A, B, C, D
 Class II, Groups E, F, G
 Class III
 Ex de IIC/DIP A21
 IP66, Type 4X①

CEC:
 Class I, Division 2, Groups A, B, C, D
 Class II, Groups F, G
 Class III; Type 4X①
 Class I, Zone 1, AEx de IIC/ AEx tD 21
 IP66

ATEX/IECEx:
 Zone 1 and 2 – 21 and 22
 Ⓢ II 2 GD
 Ex de IIC/Ex demb IIC/ Ex tD A21
 IP66 – IK10

Size 1 Polyester Control Station

Included: 1 white self-adhesive laminated plastic nameplate, 1 brass earth continuity plate, 1 blanking plug ②, 1 cable gland ②.

Description/Function	Diagram	Entry Location	Entry Size	Weight kg (lb)	Volume dm ³ (in ³)	Catalog Number
Momentary Push Buttons						
Green insert 'I' + red insert 'O' with 1NO + 1NC momentary contact		Bottom	2 x M20	1.0 (2.20)	4.0 (244.10)	U21W2A3
			2 x M25	1.0 (2.20)	4.0 (244.10)	U21W4A3
			1 x 3/4"	1.0 (2.20)	4.0 (244.10)	U21Z3A3
		Feed-Thru	2 x 3/4"	1.0 (2.20)	4.0 (244.10)	U21X3A3
			2 x M20	1.0 (2.20)	4.0 (244.10)	U21W2A5
			2 x M25	1.0 (2.20)	4.0 (244.10)	U21W4A5
1x green push button 'I' with 1NO momentary contact		Bottom	2 x M20	1.0 (2.20)	4.0 (244.10)	U21W2A5
			2 x M25	1.0 (2.20)	4.0 (244.10)	U21W4A5
			1 x 3/4"	1.0 (2.20)	4.0 (244.10)	U21Z3A5
		Feed-Thru	2 x 3/4"	1.0 (2.20)	4.0 (244.10)	U21X3A5
			2 x M20	1.0 (2.20)	4.0 (244.10)	U21W2A9
			2 x M25	1.0 (2.20)	4.0 (244.10)	U21W4A9
1x red push button 'O' with 1NC momentary contact		Bottom	2 x M20	1.0 (2.20)	4.0 (244.10)	U21W2A9
			2 x M25	1.0 (2.20)	4.0 (244.10)	U21W4A9
			1 x 3/4"	1.0 (2.20)	4.0 (244.10)	U21Z3A9
		Feed-Thru	2 x 3/4"	1.0 (2.20)	4.0 (244.10)	U21X3A9
			2 x M20	1.1 (2.43)	4.0 (244.10)	U21W2A5A9
			2 x M25	1.1 (2.43)	4.0 (244.10)	U21W4A5A9
1x green push button 'I' with 1NO contact 1x red push button 'O' with 1NC contact momentary contacts		Bottom	2 x M20	1.1 (2.43)	4.0 (244.10)	U21W2A5A9
			2 x M25	1.1 (2.43)	4.0 (244.10)	U21W4A5A9
			1 x 3/4"	1.1 (2.43)	4.0 (244.10)	U21Z3A5A9
		Feed-Thru	2 x 3/4"	1.1 (2.43)	4.0 (244.10)	U21X3A5A9
			2 x M20	1.1 (2.43)	4.0 (244.10)	U21W2A3A3
			2 x M25	1.1 (2.43)	4.0 (244.10)	U21W4A3A3
1x green push button 'I' with 1NO + 1NC contact 1x red push button 'O' with 1NO + 1NC contact momentary contacts		Bottom	2 x M20	1.1 (2.43)	4.0 (244.10)	U21W2A3A3
			2 x M25	1.1 (2.43)	4.0 (244.10)	U21W4A3A3
			1 x 3/4"	1.1 (2.43)	4.0 (244.10)	U21Z3A3A3
		Feed-Thru	2 x 3/4"	1.1 (2.43)	4.0 (244.10)	U21X3A3A3

Additional configurations available, please refer to Unicode 2 Series - Customized Control Stations section.

① Overall hazardous location and ingress protection rating depends on the rating of the optional certified components used.

② Not included if NPT hubs are selected.

Unicode™ 2 Series Fiberglass Reinforced Polyester Control Stations and Switches

Increased Safety

NEC:
 Class I, Division 2, Groups A, B, C, D
 Class II, Groups E, F, G
 Class III
 Ex de IIC/DIP A21
 IP66, Type 4X①

CEC:
 Class I, Division 2, Groups A, B, C, D
 Class II, Groups F, G
 Class III; Type 4X①
 Class I, Zone 1, AEx de IIC/ AEx tD 21
 IP66

ATEX/IECEx:
 Zone 1 and 2 – 21 and 22
 ② II 2 GD
 Ex de IIC/Ex demb IIC/ Ex tD A21
 IP66 – IK10

CONTROLS: NEC/CEC, ATEX/IECEx INCREASED SAFETY CONTROL STATIONS

Size 1 Polyester Control Station

Included: 1 white self-adhesive laminated plastic nameplate, 1 brass earth continuity plate, 1 blanking plug ②, 1 cable gland ②.

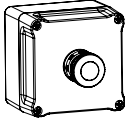
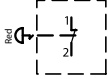
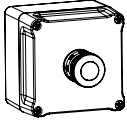
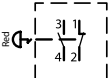
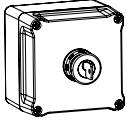
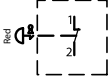
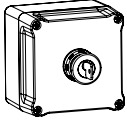
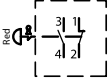
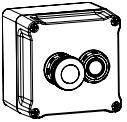
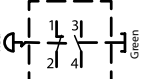
Description/Function	Diagram	Entry Location	Entry Size	Weight kg (lb)	Volume dm³ (in³)	Catalog Number	
Emergency Stop							
		Bottom	2 x M20	1.0 (2.20)	4.0 (244.10)	U21W2D9	
		Bottom	2 x M25	1.0 (2.20)	4.0 (244.10)	U21W4D9	
		Feed-Thru	2 x 3/4"	1.0 (2.20)	4.0 (244.10)	U21Z3D9	
			Bottom	2 x M20	1.0 (2.20)	4.0 (244.10)	U21W2D3
			Bottom	2 x M25	1.0 (2.20)	4.0 (244.10)	U21W4D3
			Feed-Thru	2 x 3/4"	1.0 (2.20)	4.0 (244.10)	U21X3D3
		Bottom	2 x M20	1.0 (2.20)	4.0 (244.10)	U21W2C9	
		Bottom	2 x M25	1.0 (2.20)	4.0 (244.10)	U21W4C9	
		Feed-Thru	2 x 3/4"	1.0 (2.20)	4.0 (244.10)	U21X3C9	
			Bottom	2 x M20	1.0 (2.20)	4.0 (244.10)	U21W2C3
			Bottom	2 x M25	1.0 (2.20)	4.0 (244.10)	U21W4C3
			Feed-Thru	2 x 3/4"	1.0 (2.20)	4.0 (244.10)	U21X3C3
Push Pull Emergency Stop + Push Button							
		Bottom	2 x M20	1.1 (2.43)	4.0 (244.10)	U21W2D9A5	
		Bottom	2 x M25	1.1 (2.43)	4.0 (244.10)	U21W4D9A5	
		Feed-Thru	2 x 3/4"	1.1 (2.43)	4.0 (244.10)	U21Z3D9A5	
		Feed-Thru	2 x 3/4"	1.1 (2.43)	4.0 (244.10)	U21X3D9A5	

Additional combinations available, please refer to Unicode 2 Series - Customized Control Stations section.

① Overall hazardous location and ingress protection rating depends on the rating of the optional certified components used.

② Not included if NPT hubs are selected.

Unicode™ 2 Series Fiberglass Reinforced Polyester Control Stations and Switches

Increased Safety



NEC:
 Class I, Division 2, Groups A, B, C, D
 Class II, Groups E, F, G
 Class III
 Ex de IIC/DIP A21
 IP66, Type 4X^①

CEC:
 Class I, Division 2, Groups A, B, C, D
 Class II, Groups F, G
 Class III; Type 4X^①
 Class I, Zone 1, AEx de IIC/ AEx tD 21
 IP66

ATEX/IECEx:
 Zone 1 and 2 – 21 and 22
 Ⓢ II 2 GD
 Ex de IIC/Ex demb IIC/ Ex tD A21
 IP66 – IK10

Size 1 Polyester Control Station

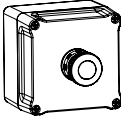
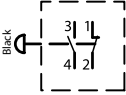
Included: 1 white self-adhesive laminated plastic nameplate, 1 brass earth continuity plate, 1 blanking plug ^②, 1 cable gland ^②.

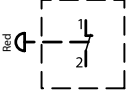
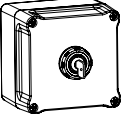
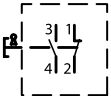
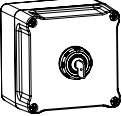
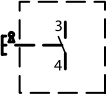
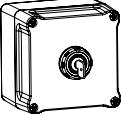
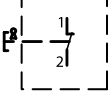
Description/Function	Diagram	Entry Location	Entry Size	Weight kg (lb)	Volume dm ³ (in ³)	Catalog Number	
Mushroom Head Push Button							
 Black mushroom head push button 1NO + 1NC momentary contact		Bottom	2 x M20	1.0 (2.20)	4.0 (244.10)	U21W2B3	
		Bottom	2 x M25	1.0 (2.20)	4.0 (244.10)	U21W4B3	
		Feed-Thru	2 x 3/4"	1.0 (2.20)	4.0 (244.10)	U21Z3B3	
	 Red mushroom head push button 1NC momentary contact		Bottom	2 x M20	1.0 (2.20)	4.0 (244.10)	U21W2R9
			Bottom	2 x M25	1.0 (2.20)	4.0 (244.10)	U21W4R9
			Feed-Thru	2 x 3/4"	1.0 (2.20)	4.0 (244.10)	U21X3R9
Key Push Button							
 With key removable in both positions 1NO + 1NC maintained contact		Bottom	2 x M20	1.0 (2.20)	4.0 (244.10)	U21W2E3	
		Bottom	2 x M25	1.0 (2.20)	4.0 (244.10)	U21W4E3	
		Feed-Thru	2 x 3/4"	1.0 (2.20)	4.0 (244.10)	U21Z3E3	
	 With key removable in both positions 1NO maintained contact		Bottom	2 x M20	1.0 (2.20)	4.0 (244.10)	U21W2E5
			Bottom	2 x M25	1.0 (2.20)	4.0 (244.10)	U21W4E5
			Feed-Thru	2 x 3/4"	1.0 (2.20)	4.0 (244.10)	U21X3E5
 With key removable in both positions 1NC maintained contact		Bottom	2 x M20	1.0 (2.20)	4.0 (244.10)	U21W2E9	
		Bottom	2 x M25	1.0 (2.20)	4.0 (244.10)	U21W4E9	
		Feed-Thru	2 x 3/4"	1.0 (2.20)	4.0 (244.10)	U21X3E9	

Additional combinations available, please refer to Unicode 2 Series - Customized Control Stations section.

^① Overall hazardous location and ingress protection rating depends on the rating of the optional certified components used.

^② Not included if NPT hubs are selected.

Unicode™ 2 Series Fiberglass Reinforced Polyester Control Stations and Switches

Increased Safety





NEC:
 Class I, Division 2, Groups A, B, C, D
 Class II, Groups E, F, G
 Class III
 Ex de IIC/DIP A21
 IP66, Type 4X①

CEC:
 Class I, Division 2, Groups A, B, C, D
 Class II, Groups F, G
 Class III; Type 4X①
 Class I, Zone 1, AEx de IIC/ AEx tD 21
 IP66

ATEX/IECEX:
 Zone 1 and 2 – 21 and 22
 Ex II 2 GD
 Ex de IIC/Ex demb IIC/ Ex tD A21
 IP66 – IK10

Size 1 Polyester Control Station

Included: 1 white self-adhesive laminated plastic nameplate, 1 brass earth continuity plate, 1 blanking plug ②, 1 cable gland ②.

Description/Function	Diagram	Entry Location	Entry Size	Weight kg (lb)	Volume dm³ (in³)	Catalog Number
Pilot Light						
1x red pilot light ③		Bottom	2 x M20	1.0 (2.20)	4.0 (244.10)	U21W2PR
			2 x M25	1.0 (2.20)	4.0 (244.10)	U21W4PR
			1 x 3/4"	1.0 (2.20)	4.0 (244.10)	U21Z3PR
		Feed-Thru	2 x 3/4"	1.0 (2.20)	4.0 (244.10)	U21X3PR
1x green pilot light ③		Bottom	2 x M20	1.0 (2.20)	4.0 (244.10)	U21W2PG
			2 x M25	1.0 (2.20)	4.0 (244.10)	U21W4PG
			1 x 3/4"	1.0 (2.20)	4.0 (244.10)	U21Z3PG
		Feed-Thru	2 x 3/4"	1.0 (2.20)	4.0 (244.10)	U21X3PG
1x blue pilot light ③		Bottom	2 x M20	1.0 (2.20)	4.0 (244.10)	U21W2PB
			2 x M25	1.0 (2.20)	4.0 (244.10)	U21W4PB
			1 x 3/4"	1.0 (2.20)	4.0 (244.10)	U21Z3PB
		Feed-Thru	2 x 3/4"	1.0 (2.20)	4.0 (244.10)	U21X3PB
1x yellow pilot light ③		Bottom	2 x M20	1.0 (2.20)	4.0 (244.10)	U21W2PY
			2 x M25	1.0 (2.20)	4.0 (244.10)	U21W4PY
			1 x 3/4"	1.0 (2.20)	4.0 (244.10)	U21Z3PY
		Feed-Thru	2 x 3/4"	1.0 (2.20)	4.0 (244.10)	U21X3PY
1x white pilot light ③		Bottom	2 x M20	1.0 (2.20)	4.0 (244.10)	U21W2PW
			2 x M25	1.0 (2.20)	4.0 (244.10)	U21W4PW
			1 x 3/4"	1.0 (2.20)	4.0 (244.10)	U21Z3PW
		Feed-Thru	2 x 3/4"	1.0 (2.20)	4.0 (244.10)	U21X3PW

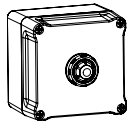

Additional combinations available, please refer to Unicode 2 Series - Customized Control Stations section.

① Overall hazardous location and ingress protection rating depends on the rating of the optional certified components used.

② Not included if NPT hubs are selected.

③ 12 Vac to 254 Vac 50/60 Hz - 12 Vdc to 60 Vdc.

Unicode™ 2 Series Fiberglass Reinforced Polyester Control Stations and Switches

Increased Safety

NEC:
 Class I, Division 2, Groups A, B, C, D
 Class II, Groups E, F, G
 Class III
 Ex de IIC/DIP A21
 IP66, Type 4X^①

CEC:
 Class I, Division 2, Groups A, B, C, D
 Class II, Groups F, G
 Class III; Type 4X^①
 Class I, Zone 1, AEx de IIC/ AEx tD 21
 IP66

ATEX/IECEX:
 Zone 1 and 2 – 21 and 22
 Ex de IIC/Ex demb IIC/ Ex tD A21
 IP66 – IK10

Size 1 Polyester Control Station

Included: 1 white self-adhesive laminated plastic nameplate, 1 brass earth continuity plate, 1 blanking plug ^②, 1 cable gland ^②.

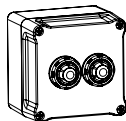
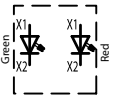
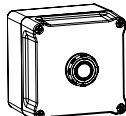
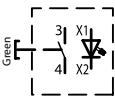
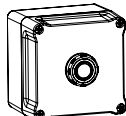
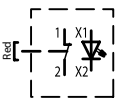
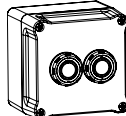
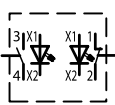
Description/Function	Diagram	Entry Location	Entry Size	Weight kg (lb)	Volume dm ³ (in ³)	Catalog Number
Twin Pilot Light						
 1x green pilot light ^③ 1x red pilot light ^③		Bottom	2 x M20	1.1 (2.43)	4.0 (244.10)	U21W2PGPR
		Bottom	2 x M25	1.1 (2.43)	4.0 (244.10)	U21W4PGPR
		Feed-Thru	1 x 3/4"	1.1 (2.43)	4.0 (244.10)	U21Z3PGPR
		Feed-Thru	2 x 3/4"	1.1 (2.43)	4.0 (244.10)	U21X3PGPR
Illuminated Push Button						
 1x green illuminated push button with 1NO contact momentary contacts		Bottom	2 x M20	1.0 (2.20)	4.0 (244.10)	U21W2LG5
		Bottom	2 x M25	1.0 (2.20)	4.0 (244.10)	U21W4LG5
		Feed-Thru	1 x 3/4"	1.0 (2.20)	4.0 (244.10)	U21Z3LG5
		Feed-Thru	2 x 3/4"	1.0 (2.20)	4.0 (244.10)	U21X3LG5
 1x red illuminated push button with 1NC contact momentary contacts		Bottom	2 x M20	1.0 (2.20)	4.0 (244.10)	U21W2LR9
		Bottom	2 x M25	1.0 (2.20)	4.0 (244.10)	U21W4LR9
		Feed-Thru	1 x 3/4"	1.0 (2.20)	4.0 (244.10)	U21Z3LR9
		Feed-Thru	2 x 3/4"	1.0 (2.20)	4.0 (244.10)	U21X3LR9
Twin Illuminated Push Button						
 1x green illuminated push button with 1NO contact momentary contacts 1x red illuminated push button with 1NC contact momentary contacts		Bottom	2 x M20	1.0 (2.20)	4.0 (244.10)	U21W2LG5LR9
		Bottom	2 x M25	1.0 (2.20)	4.0 (244.10)	U21W4LG5LR9
		Feed-Thru	1 x 3/4"	1.0 (2.20)	4.0 (244.10)	U21Z3LG5LR9
		Feed-Thru	2 x 3/4"	1.0 (2.20)	4.0 (244.10)	U21X3LG5LR9

Additional combinations available, please refer to Unicode 2 Series - Customized Control Stations section.

^① Overall hazardous location and ingress protection rating depends on the rating of the optional certified components used.

^② Not included if NPT hubs are selected.

^③ 12 Vac to 254 Vac 50/60 Hz - 12 Vdc to 60 Vdc.

Unicode™ 2 Series Fiberglass Reinforced Polyester Control Stations and Switches

Increased Safety

NEC:
 Class I, Division 2, Groups A, B, C, D
 Class II, Groups E, F, G
 Class III
 Ex de IIC/DIP A21
 IP66, Type 4X①

CEC:
 Class I, Division 2, Groups A, B, C, D
 Class II, Groups F, G
 Class III; Type 4X①
 Class I, Zone 1, AEx de IIC/ AEx tD 21
 IP66

ATEX/IECEx:
 Zone 1 and 2 – 21 and 22
 II 2 GD
 Ex de IIC/Ex demb IIC/ Ex tD A21
 IP66 – IK10

CONTROLS: NEC/CEC, ATEX/IECEx INCREASED SAFETY CONTROL STATIONS

Size 1 Polyester Control Station

Included: 1 white self-adhesive laminated plastic nameplate, 1 brass earth continuity plate, 1 blanking plug ②, 1 cable gland ②.

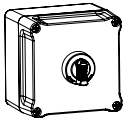
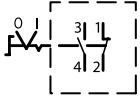
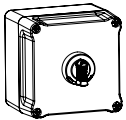
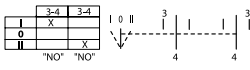
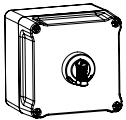
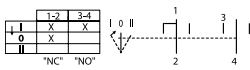
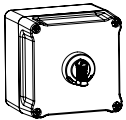
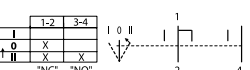
Description/Function	Diagram	Entry Location	Entry Size	Weight kg (lb)	Volume dm ³ (in ³)	Catalog Number
2-Position Selector Switch						
 <p>2 fixed positions '0 - I' 1NO + 1NC contact</p>		Bottom	2 x M20	1.0 (2.20)	4.0 (244.10)	U21W2H3
			2 x M25	1.0 (2.20)	4.0 (244.10)	U21W4H3
			1 x 3/4"	1.0 (2.20)	4.0 (244.10)	U21Z3H3
		Feed-Thru	2 x 3/4"	1.0 (2.20)	4.0 (244.10)	U21X3H3
3-Position Selector Switch						
 <p>3 fixed positions 'I - 0 - II' 2NO contact</p>		Bottom	2 x M20	1.0 (2.20)	4.0 (244.10)	U21W2J1
			2 x M25	1.0 (2.20)	4.0 (244.10)	U21W4J1
			1 x 3/4"	1.0 (2.20)	4.0 (244.10)	U21Z3J1
		Feed-Thru	2 x 3/4"	1.0 (2.20)	4.0 (244.10)	U21X3J1
 <p>3 positions 'I - 0 - II' with spring return from I to 0 1NO + 1NC contact</p>		Bottom	2 x M20	1.0 (2.20)	4.0 (244.10)	U21W2N3
			2 x M25	1.0 (2.20)	4.0 (244.10)	U21W4N3
			1 x 3/4"	1.0 (2.20)	4.0 (244.10)	U21Z3N3
		Feed-Thru	2 x 3/4"	1.0 (2.20)	4.0 (244.10)	U21X3N3
 <p>3 positions 'I - 0 - II' with spring return from II to 0 1NO + 1NC contact</p>		Bottom	2 x M20	1.0 (2.20)	4.0 (244.10)	U21W2M3
			2 x M25	1.0 (2.20)	4.0 (244.10)	U21W4M3
			1 x 3/4"	1.0 (2.20)	4.0 (244.10)	U21Z3M3
		Feed-Thru	2 x 3/4"	1.0 (2.20)	4.0 (244.10)	U21X3M3

Additional combinations available, please refer to Unicode 2 Series - Customized Control Stations section.

① Overall hazardous location and ingress protection rating depends on the rating of the optional certified components used.

② Not included if NPT hubs are selected.

Unicode™ 2 Series Fiberglass Reinforced Polyester Control Stations and Switches

Increased Safety



NEC:
 Class I, Division 2, Groups A, B, C, D
 Class II, Groups E, F, G
 Class III
 Ex de IIC/DIP A21
 IP66, Type 4X^①

GEC:
 Class I, Division 2, Groups A, B, C, D
 Class II, Groups F, G
 Class III; Type 4X^①
 Class I, Zone 1, AEx de IIC/ AEx tD 21
 IP66

ATEX/IECEx:
 Zone 1 and 2 – 21 and 22
 ② II 2 GD
 Ex de IIC/Ex demb IIC/ Ex tD A21
 IP66 – IK10

Size 2 Polyester Control Station

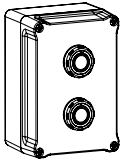
Included: 1 white self-adhesive laminated plastic nameplate, 1 brass earth continuity plate, 1 blanking plug ^②, 1 cable gland ^②.

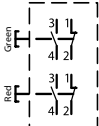
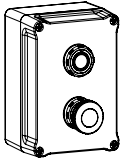
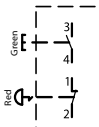
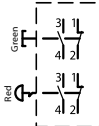
Description/Function	Diagram	Entry Location	Entry Size	Weight kg (lb)	Volume dm ³ (in ³)	Catalog Number	
Twin Push Button							
 <p>1x green push button 'I' with 1NO contact 1x red push button 'O' with 1NC contact momentary contacts</p>		Bottom	2 x M20	1.2 (2.65)	4.0 (244.10)	U22W2A5A9	
		Bottom	2 x M25	1.2 (2.65)	4.0 (244.10)	U22W4A5A9	
	Feed-Thru	1 x 3/4"	1.2 (2.65)	4.0 (244.10)	U22Z3A5A9		
	Feed-Thru	2 x 3/4"	1.2 (2.65)	4.0 (244.10)	U22X3A5A9		
	<p>1x green push button 'I' with 1NO + 1NC contact 1x red push button 'O' with 1NO + 1NC contact momentary contacts</p>		Bottom	2 x M20	1.2 (2.65)	4.0 (244.10)	U22W2A3A3
			Bottom	2 x M25	1.2 (2.65)	4.0 (244.10)	U22W4A3A3
Feed-Thru		1 x 3/4"	1.2 (2.65)	4.0 (244.10)	U22Z3A3A3		
Feed-Thru		2 x 3/4"	1.2 (2.65)	4.0 (244.10)	U22X3A3A3		
Push Button + Push-Pull Emergency Stop							
 <p>1x green push button 'I' with 1NO momentary contact 1x red mushroom head push-pull with 1NC maintained contact</p>		Bottom	2 x M20	1.2 (2.65)	4.0 (244.10)	U22W2A5D9	
		Bottom	2 x M25	1.2 (2.65)	4.0 (244.10)	U22W4A5D9	
	Feed-Thru	1 x 3/4"	1.2 (2.65)	4.0 (244.10)	U22Z3A5D9		
	Feed-Thru	2 x 3/4"	1.2 (2.65)	4.0 (244.10)	U22X3A5D9		
	<p>1x green push button 'I' with 1NO + 1NC momentary contact 1x red mushroom head push-pull with 1NO + 1NC maintained contact</p>		Bottom	2 x M20	1.2 (2.65)	4.0 (244.10)	U22W2A3D3
			Bottom	2 x M25	1.2 (2.65)	4.0 (244.10)	U22W4A3D3
Feed-Thru		1 x 3/4"	1.2 (2.65)	4.0 (244.10)	U22Z3A3D3		
Feed-Thru		2 x 3/4"	1.2 (2.65)	4.0 (244.10)	U22X3A3D3		

Additional combinations available, please refer to Unicode 2 Series - Customized Control Stations section.

^① Overall hazardous location and ingress protection rating depends on the rating of the optional certified components used.

^② Not included if NPT hubs are selected.

Unicode™ 2 Series Fiberglass Reinforced Polyester Control Stations and Switches

Increased Safety

CONTROLS: NEC/CEC, ATEX/IECex INCREASED SAFETY CONTROL STATIONS







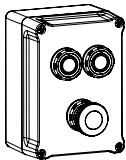
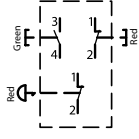
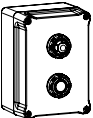

NEC:
 Class I, Division 2, Groups A, B, C, D
 Class II, Groups E, F, G
 Class III
 Ex de IIC/DIP A21
 IP66, Type 4X①

CEC:
 Class I, Division 2, Groups A, B, C, D
 Class II, Groups F, G
 Class III; Type 4X①
 Class I, Zone 1, AEx de IIC/ AEx tD 21
 IP66

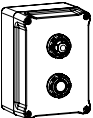
ATEX/IECEx:
 Zone 1 and 2 – 21 and 22
 Ⓢ II 2 GD
 Ex de IIC/Ex demb IIC/ Ex tD A21
 IP66 – IK10

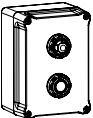
Size 2 Polyester Control Station

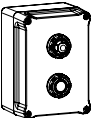
Included: 1 white self-adhesive laminated plastic nameplate, 1 brass earth continuity plate, 1 blanking plug ②, 1 cable gland ②.

Description/Function	Diagram	Entry Location	Entry Size	Weight kg (lb)	Volume dm ³ (in ³)	Catalog Number
Twin Push Buttons + Push-Pull Emergency Stop						
 <p>1x green push button 'I' with 1NO contacts 1x red push button 'O' with 1NC contacts momentary contacts 1x red mushroom head push-pull with 1x NC maintained contact</p>		Bottom	2 x M20	1.3 (2.87)	4.0 (244.10)	U22W2A5A9D9
		Bottom	2 x M25	1.3 (2.87)	4.0 (244.10)	U22W4A5A9D9
		Feed-Thru	1 x 3/4"	1.3 (2.87)	4.0 (244.10)	U22Z3A5A9D9
		Feed-Thru	2 x 3/4"	1.3 (2.87)	4.0 (244.10)	U22X3A5A9D9
Pilot Light + Push Button						
 <p>1x green light ③ 1x green push button 'I' with 1NO momentary contact</p>		Bottom	2 x M20	1.2 (2.65)	4.0 (244.10)	U22W2PGA5
		Bottom	2 x M25	1.2 (2.65)	4.0 (244.10)	U22W4PGA5
		Feed-Thru	1 x 3/4"	1.2 (2.65)	4.0 (244.10)	U22Z3PGA5
		Feed-Thru	2 x 3/4"	1.2 (2.65)	4.0 (244.10)	U22X3PGA5
 <p>1x green light ③ 1x green push button 'I' with 1NO + 1NC momentary contacts</p>		Bottom	2 x M20	1.2 (2.65)	4.0 (244.10)	U22W2PGA3
		Bottom	2 x M25	1.2 (2.65)	4.0 (244.10)	U22W4PGA3
		Feed-Thru	1 x 3/4"	1.2 (2.65)	4.0 (244.10)	U22Z3PGA3
		Feed-Thru	2 x 3/4"	1.2 (2.65)	4.0 (244.10)	U22X3PGA3
 <p>1x red light ③ 1x red push button 'O' with 1NC momentary contact</p>		Bottom	2 x M20	1.2 (2.65)	4.0 (244.10)	U22W2PRA9
		Bottom	2 x M25	1.2 (2.65)	4.0 (244.10)	U22W4PRA9
		Feed-Thru	1 x 3/4"	1.2 (2.65)	4.0 (244.10)	U22Z3PRA9
		Feed-Thru	2 x 3/4"	1.2 (2.65)	4.0 (244.10)	U22X3PRA9
 <p>1x red light 1x red push button 'O' with 1NO + 1NC momentary contact</p>		Bottom	2 x M20	1.2 (2.65)	4.0 (244.10)	U22W2PRA3
		Bottom	2 x M25	1.2 (2.65)	4.0 (244.10)	U22W4PRA3
		Feed-Thru	1 x 3/4"	1.2 (2.65)	4.0 (244.10)	U22Z3PRA3
		Feed-Thru	2 x 3/4"	1.2 (2.65)	4.0 (244.10)	U22X3PRA3

Additional combinations available, please refer to Unicode 2 Series - Customized Control Stations section.

① Overall hazardous location and ingress protection rating depends on the rating of the optional certified components used.

② Not included if NPT hubs are selected.

③ 12 Vac to 254 Vac 50/60 Hz - 12 Vdc to 60 Vdc.

Unicode™ 2 Series Fiberglass Reinforced Polyester Control Stations and Switches

Increased Safety



NEC:
 Class I, Division 2, Groups A, B, C, D
 Class II, Groups E, F, G
 Class III
 Ex de IIC/DIP A21
 IP66, Type 4X①

CEC:
 Class I, Division 2, Groups A, B, C, D
 Class II, Groups F, G
 Class III; Type 4X①
 Class I, Zone 1, AEx de IIC/ AEx tD 21
 IP66

ATEX/IECEx:
 Zone 1 and 2 - 21 and 22
 ② II 2 GD
 Ex de IIC/Ex demb IIC/ Ex tD A21
 IP66 - IK10

Size 2 Polyester Control Station

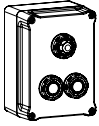
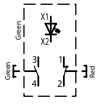
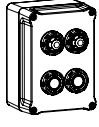
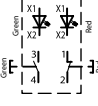
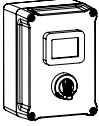
Included: 1 white self-adhesive laminated plastic nameplate, 1 brass earth continuity plate, 1 blanking plug ②, 1 cable gland ②.

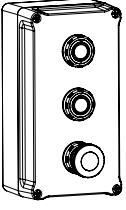
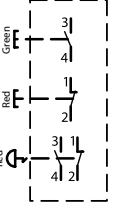
Description/Function	Diagram	Entry Location	Entry Size	Weight kg (lb)	Volume dm ³ (in ³)	Catalog Number
Pilot Light + Twin Push Buttons ③						
 <p>1x green light ③ 1x green push button 'I' with 1NO 1x red push button 'O' with 1NC momentary contacts</p>		Bottom	2 x M20	1.3 (2.87)	4.0 (244.10)	U22W2PGA5A9
		Bottom	2 x M25	1.3 (2.87)	4.0 (244.10)	U22W4PGA5A9
		Feed-Thru	1 x 3/4"	1.3 (2.87)	4.0 (244.10)	U22Z3PGA5A9
		Feed-Thru	2 x 3/4"	1.3 (2.87)	4.0 (244.10)	U22X3PGA5A9
Twin Pilot Lights + Twin Push Buttons						
 <p>1x green light + 1x red light ③ 1x green push button 'I' with 1NO 1x red push button 'O' with 1NC momentary contacts</p>		Bottom	2 x M20	1.3 (2.87)	4.0 (244.10)	U22W2PGPRA5A9
		Bottom	2 x M25	1.3 (2.87)	4.0 (244.10)	U22W4PGPRA5A9
		Feed-Thru	1 x 3/4"	1.3 (2.87)	4.0 (244.10)	U22Z3PGPRA5A9
		Feed-Thru	2 x 3/4"	1.3 (2.87)	4.0 (244.10)	U22X3PGPRA5A9
Ammeter + 3-Position Selector Switch ④						
 <p>1x ammeter 48 x 48 mm, 1A C.T., 3 F.L.C., with 0 - 1 - 3 scale 1x switch 3 positions 'I - 0 - II' with spring return from II to 0 1NO + 1NC contact</p>		Bottom	2 x M20	1.2 (2.65)	4.0 (244.10)	U22W2VA13M3
		Bottom	2 x M25	1.2 (2.65)	4.0 (244.10)	U22W4VA13M3
		Feed-Thru	1 x 3/4"	1.2 (2.65)	4.0 (244.10)	U22Z3VA13M3
		Feed-Thru	2 x 3/4"	1.2 (2.65)	4.0 (244.10)	U22X3VA13M3
Twin Push Buttons + Push-Pull Emergency Stop ③						
 <p>1x green push button 'I' with 1NO contact 1x red push button 'O' with 1NC contact momentary contacts 1x red mushroom head push-pull emergency button with 1NO + 1NC maintained contacts</p>		Bottom	2 x M20	1.4 (3.09)	6.0 (366.14)	U23W2A5A9D3
		Bottom	2 x M25	1.4 (3.09)	6.0 (366.14)	U23W4A5A9D3
		Feed-Thru	1 x 3/4"	1.4 (3.09)	6.0 (366.14)	U23Z3A5A9D3
		Feed-Thru	2 x 3/4"	1.4 (3.09)	6.0 (366.14)	U23X3A5A9D3

Additional combinations available, please refer to Unicode 2 Series - Customized Control Stations section.

- ① Overall hazardous location and ingress protection rating depends on the rating of the optional certified components used.
- ② Not included if NPT hubs are selected.
- ③ 12 Vac to 254 Vac 50/60 Hz - 12 Vdc to 60 Vdc.
- ④ Certified for ATEX/IECEx only.

Unicode™ 2 Series Fiberglass Reinforced Polyester Control Stations and Switches

Increased Safety

NEC:
 Class I, Division 2, Groups A, B, C, D
 Class II, Groups E, F, G
 Class III
 Ex de IIC/DIP A21
 IP66, Type 4X①

CEC:
 Class I, Division 2, Groups A, B, C, D
 Class II, Groups F, G
 Class III; Type 4X①
 Class I, Zone 1, AEx de IIC/ AEx tD 21
 IP66

ATEX/IECEx:
 Zone 1 and 2 – 21 and 22
 Ⓢ II 2 GD
 Ex de IIC/Ex demb IIC/ Ex tD A21
 IP66 – IK10

CONTROLS: NEC/CEC, ATEX/IECEx INCREASED SAFETY CONTROL STATIONS

Size 3 Polyester Control Station

Included: 1 white self-adhesive laminated plastic nameplate, 1 brass earth continuity plate, 1 blanking plug ②, 1 cable gland ②.

Description/Function	Diagram	Entry Location	Entry Size	Weight kg (lb)	Volume dm³ (in³)	Catalog Number
Pilot Light + Twin Push Buttons						
1x green light ③ 1x green push button 'I' with 1NO contact 1x red push button 'O' with 1NC contact momentary contacts		Bottom	2 x M20	1.4 (3.09)	6.0 (366.14)	U23W2PGA5A9
		Bottom	2 x M25	1.4 (3.09)	6.0 (366.14)	U23W4PGA5A9
		Feed-Thru	2 x 3/4"	1.4 (3.09)	6.0 (366.14)	U23Z3PGA5A9
		Feed-Thru	2 x 3/4"	1.4 (3.09)	6.0 (366.14)	U23X3PGA5A9
		Bottom	2 x M20	1.4 (3.09)	6.0 (366.14)	U23W2PRA5A9
		Bottom	2 x M25	1.4 (3.09)	6.0 (366.14)	U23W4PRA5A9
1x red light ③ 1x green push button 'I' with 1NO contact 1x red push button 'O' with 1NC contact momentary contacts		Bottom	2 x M20	1.4 (3.09)	6.0 (366.14)	U23W2PGA3A3
		Bottom	2 x M25	1.4 (3.09)	6.0 (366.14)	U23W4PGA3A3
		Feed-Thru	2 x 3/4"	1.4 (3.09)	6.0 (366.14)	U23Z3PGA3A3
		Feed-Thru	2 x 3/4"	1.4 (3.09)	6.0 (366.14)	U23X3PGA3A3
		Bottom	2 x M20	1.4 (3.09)	6.0 (366.14)	U23W2PRA3A3
		Bottom	2 x M25	1.4 (3.09)	6.0 (366.14)	U23W4PRA3A3
1x red light ③ 1x green push button 'I' with 1NO + 1NC contact 1x red push button 'O' with 1NO + 1NC contact momentary contacts		Bottom	2 x M20	1.4 (3.09)	6.0 (366.14)	U23W2PGA3A3
		Bottom	2 x M25	1.4 (3.09)	6.0 (366.14)	U23W4PGA3A3
		Feed-Thru	2 x 3/4"	1.4 (3.09)	6.0 (366.14)	U23Z3PGA3A3
		Feed-Thru	2 x 3/4"	1.4 (3.09)	6.0 (366.14)	U23X3PGA3A3
		Bottom	2 x M20	1.4 (3.09)	6.0 (366.14)	U23W2PRA3A3
		Bottom	2 x M25	1.4 (3.09)	6.0 (366.14)	U23W4PRA3A3
1x red light ③ 1x green push button 'I' with 1NO + 1NC contact 1x red push button 'O' with 1NO + 1NC contact momentary contacts		Bottom	2 x M20	1.4 (3.09)	6.0 (366.14)	U23W2PGA3A3
		Bottom	2 x M25	1.4 (3.09)	6.0 (366.14)	U23W4PGA3A3
		Feed-Thru	2 x 3/4"	1.4 (3.09)	6.0 (366.14)	U23Z3PGA3A3
		Feed-Thru	2 x 3/4"	1.4 (3.09)	6.0 (366.14)	U23X3PGA3A3
		Bottom	2 x M20	1.4 (3.09)	6.0 (366.14)	U23W2PRA3A3
		Bottom	2 x M25	1.4 (3.09)	6.0 (366.14)	U23W4PRA3A3

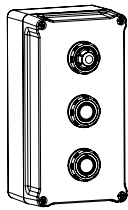

Additional combinations available, please refer to Unicode 2 Series - Customized Control Stations section.

① Overall hazardous location and ingress protection rating depends on the rating of the optional certified components used.

② Not included if NPT hubs are selected.

③ 12 Vac to 254 Vac 50/60 Hz - 12 Vdc to 60 Vdc.

Unicode™ 2 Series Fiberglass Reinforced Polyester Control Stations and Switches

Increased Safety

NEC:
 Class I, Division 2, Groups A, B, C, D
 Class II, Groups E, F, G
 Class III
 Ex de IIC/DIP A21
 IP66, Type 4X①

GEC:
 Class I, Division 2, Groups A, B, C, D
 Class II, Groups F, G
 Class III; Type 4X①
 Class I, Zone 1, AEx de IIC/ AEx tD 21
 IP66

ATEX/IECEx:
 Zone 1 and 2 – 21 and 22
 ② II 2 GD
 Ex de IIC/Ex demb IIC/ Ex tD A21
 IP66 – IK10

Size 3 Polyester Control Station

Included: 1 white self-adhesive laminated plastic nameplate, 1 brass earth continuity plate, 1 blanking plug ②, 1 cable gland ②.

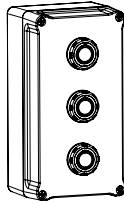
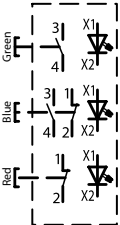
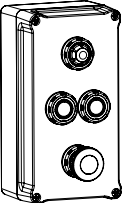
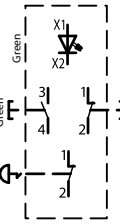
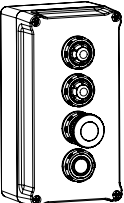
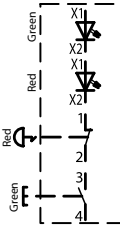
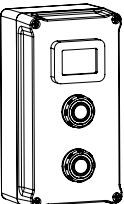
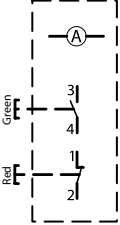
Description/Function	Diagram	Entry Location	Entry Size	Weight kg (lb)	Volume dm³ (in³)	Catalog Number
Triple Illuminated Push Buttons ③						
 <p>1x green illuminated push button with 1NO contact 1x blue illuminated push button with 1NO + 1NC contact 1x red illuminated push button with NC contact momentary contacts</p>		Bottom	2 x M20	1.4 (3.09)	6.0 (366.14)	U23W2LG5LB3LR9
			2 x M25	1.4 (3.09)	6.0 (366.14)	U23W4LG5LB3LR9
			1 x 3/4"	1.4 (3.09)	6.0 (366.14)	U23Z3LG5LB3LR9
		Feed-Thru	2 x 3/4"	1.4 (3.09)	6.0 (366.14)	U23X3LG5LB3LR9
Pilot Light + Twin Push Buttons + Push-Pull Emergency Stop						
 <p>1x green light 1x green push button 'I' with 1NO contact 1x red push button 'O' with 1NC contact momentary contacts 1x red mushroom head push-pull with 1x NC maintained contact</p>		Bottom	2 x M20	1.4 (3.09)	6.0 (366.14)	U23W2PGA5A9D9
			2 x M25	1.4 (3.09)	6.0 (366.14)	U23W4PGA5A9D9
			1 x 3/4"	1.4 (3.09)	6.0 (366.14)	U23Z3PGA5A9D9
		Feed-Thru	2 x 3/4"	1.4 (3.09)	6.0 (366.14)	U23X3PGA5A9D9
Twin Pilot Lights + Push-Pull Emergency Stop + Push Button ②						
 <p>1x green light + 1x red light ③ 1x red mushroom head push-pull with 1x NC maintained contact 1x green push button 'I' with 1NO momentary contact</p>		Bottom	2 x M20	1.4 (3.09)	6.0 (366.14)	U23W2PGPRD9A5
			2 x M25	1.4 (3.09)	6.0 (366.14)	U23W4PGPRD9A5
			1 x 3/4"	1.4 (3.09)	6.0 (366.14)	U23Z3PGPRD9A5
		Feed-Thru	2 x 3/4"	1.4 (3.09)	6.0 (366.14)	U23X3PGPRD9A5
Ammeter + Twin Push Buttons ④						
 <p>1x ammeter 48 x 48 mm, 1A C.T., 3 F.L.C., with 0 - 1 - 3 scale 1x green push button 'I' with 1NO contact 1x red push button 'O' with 1NC contact momentary contacts</p>		Bottom	2 x M20	1.4 (3.09)	6.0 (366.14)	U23W2VA13A5A9
			2 x M25	1.4 (3.09)	6.0 (366.14)	U23W4VA13A5A9
			1 x 3/4"	1.4 (3.09)	6.0 (366.14)	U23Z3VA13A5A9
		Feed-Thru	2 x 3/4"	1.4 (3.09)	6.0 (366.14)	U23X3VA13A5A9

Additional combinations available, please refer to Unicode 2 Series - Customized Control Stations section.

① Overall hazardous location and ingress protection rating depends on the rating of the optional certified components used.

② Not included if NPT hubs are selected.

③ 12 Vac to 254 Vac 50/60 Hz - 12 Vdc to 60 Vdc.

④ Certified for ATEX/IECEx only.

Unicode™ 2 Series Fiberglass Reinforced Polyester Control Stations and Switches

Increased Safety

CONTROLS: NEC/CEC, ATEX/IECEx INCREASED SAFETY CONTROL STATIONS

NEC:
 Class I, Division 2, Groups A, B, C, D
 Class II, Groups E, F, G
 Class III
 Ex de IIC/DIP A21
 IP66, Type 4X^①

CEC:
 Class I, Division 2, Groups A, B, C, D
 Class II, Groups F, G
 Class III; Type 4X^①
 Class I, Zone 1, AEx de IIC/ AEx tD 21
 IP66

ATEX/IECEx:
 Zone 1 and 2 – 21 and 22
 II 2 GD
 Ex de IIC/Ex demb IIC/ Ex tD A21
 IP66 – IK10

Nameplates – Set of 10

Blank self-adhesive, laminated plastic 58 mm x 18 mm (2.29" x 0.71").

Color	Catalog Number
White (black letters)	UNPW
Yellow (black letters)	UNPY
Red (white letters)	UNPR
Blue (white letters)	UNPB
Black (white letters)	UNPN
Green (white letters)	UNPG

Standard Legend Plates

Two sizes available. Self-adhesive yellow laminated plastic (black lettering).

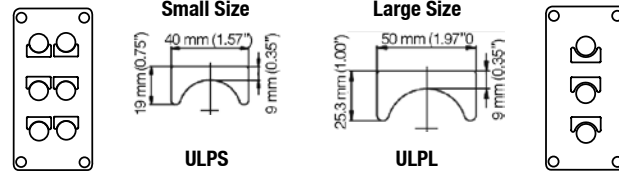

Inserts for Push Button – Set of 5

Marking	Color	Catalog Number
(unmarked)	Green	UIAG
(unmarked)	Red	UIAR
(unmarked)	Yellow	UIAY
(unmarked)	White	UIAW
(unmarked)	Blue	UIAB
(unmarked)	Black	UIAN
ON	Green	UIA01
OFF	Red	UIA02
START	Green	UIA03
STOP	Red	UIA04
MARCHE	Green	UIA05
ARRET	Red	UIA06
I	Green	UIA07
O	Red	UIA08

Inserts for Illuminated Push Button – Set of 5

Marking	Color	Catalog Number
(unmarked)	Green	UILG
(unmarked)	Red	UILR
(unmarked)	Yellow	UILY
(unmarked)	White	UILW
(unmarked)	Blue	UILB
ON	Green	UIL01
OFF	Red	UIL02
START	Green	UIL03
STOP	Red	UIL04
MARCHE	Green	UIL05
ARRET	Red	UIL06
I	Green	UIL07
O	Red	UIL08

Spare Key

For all key-operated buttons.

Description	Catalog Number
Spare key type 4 A 185	SK4A185

Text	Catalog Number	
	Small	Large
Blank (set of 10)	ULPS	ULPL
ON	ULPSA01	ULPLA01
OFF	ULPSA02	ULPLA02
FORWARD	ULPSA03	ULPLA03
REVERSE	ULPSA04	ULPLA04
JOG	ULPSA05	ULPLA05
RUN	ULPSA06	ULPLA06
START	ULPSA07	ULPLA07
STOP	ULPSA08	ULPLA08
UP	ULPSA09	ULPLA09
DOWN	ULPSA10	ULPLA10
FAST	ULPSA11	ULPLA11
SLOW	ULPSA12	ULPLA12
RAISE	ULPSA13	ULPLA13
LOWER	ULPSA14	ULPLA14
OPEN	ULPSA15	ULPLA15
CLOSE	ULPSA16	ULPLA16
LOW	ULPSA17	ULPLA17
HIGH	ULPSA18	ULPLA18
TEST	ULPSA19	ULPLA19
RESET	ULPSA20	ULPLA20
EMERGENCY STOP	ULPSA21	ULPLA21
MARCHE	ULPSA22	ULPLA22
ARRET	ULPSA23	ULPLA23
ARRET D'URGENCE	ULPSA24	ULPLA24
HAUT	ULPSA25	ULPLA25
BAS	ULPSA26	ULPLA26
O—I	ULPSH01	ULPLH01
ON—OFF	ULPSH02	ULPLH02
START—STOP	ULPSH03	ULPLH03
STOP—START	ULPSH04	ULPLH04
HAND—AUTO	ULPSH05	ULPLH05
MANU—AUTO	ULPSH06	ULPLH06
FORWARD—REVERSE	ULPSH07	ULPLH07
REMOTE—LOCAL	ULPSH08	ULPLH08
MARCHE—ARRET	ULPSH09	ULPLH09
I—O—II	ULPSJ01	ULPLJ01
OFF—O—ON	ULPSJ02	ULPLJ02
START—NORMAL—STOP	ULPSJ03	ULPLJ03
HAND—OFF—AUTO	ULPSJ04	ULPLJ04
MANU—O—AUTO	ULPSJ05	ULPLJ05
FORWARD—OFF—REVERSE	ULPSJ06	ULPLJ06
LOCAL—REMOTE—AUTO	ULPSJ07	ULPLJ07
LOCAL—O—REMOTE	ULPSJ08	ULPLJ08
MARCHE—NORMAL—ARRET	ULPSJ09	ULPLJ09

^① Overall hazardous location and ingress protection rating depends on the rating of the optional certified components used.

Unicode™ 2 Series Fiberglass Reinforced Polyester Control Stations and Switches

Increased Safety

NEC:
 Class I, Division 2, Groups A, B, C, D
 Class II, Groups E, F, G
 Class III
 Ex de IIC/DIP A21
 IP66, Type 4X^①

CEC:
 Class I, Division 2, Groups A, B, C, D
 Class II, Groups F, G
 Class III; Type 4X^①
 Class I, Zone 1, AEx de IIC/ AEx tD 21
 IP66

ATEX/IECEx:
 Zone 1 and 2 – 21 and 22
 II 2 GD
 Ex de IIC/Ex demb IIC/ Ex tD A21
 IP66 – IK10

	Description	Catalog Number
	Additional Contacts Each actuator is capable of activating 3 contacts. Exception: Illuminated push button and all actuators with key: 2 contacts maximum 1NO contact 1NC contact	UCB5R UCB9R
	Yellow Guard Mushroom head protection for emergency stop	098657
	Padlockable Guard Stainless steel and plastic cover, capacity: 3 padlocks diameter 6 mm (0.24") maximum (not supplied) For push button and rotary actuator For mushroom head actuator	UPLD1S UPLD2S
	Cable Gland Exe For unarmored cable Exe - IP66 - in polyamide entry thread seal M20 (capacity 6.5-14.5 mm)	095605
	For armored cable Exe/Exd - IP66 - in nickel plated brass (without entry thread seal) Braid and Tape type: M20 (inner: 6.4-14.0/outer: 12.5-20.9 mm)	20E1FX5
	Single Wired Armor (SWA): M20 (inner: 6.4-14.0/outer: 12.5-20.9 mm)	20E1FW5
	Adaptors Exd/Exe - IP66 in nickel plated brass (without entry thread seal) Male M20 - Female 1/2" NPT Male M20 - Female 3/4" NPT	737DM2T15 737DM2T25
	Entry Thread Seal M20 (in white nylon)	20ETS2
	Combination Drain and Breather Exe - IP66 - supplied with entry thread seal and locknut M20 male thread in Polyamide M20 male thread in Brass M20 male thread in Stainless Steel	DBE20P DBE20B DBE20S
	Feed-Thru Earth Stud Terminal Exe - IP66 - supplied with weatherproof seal and green/yellow earth conductor - 300 mm (11.81") length M20 with M5 earth and 2.5 mm ² (0.004 in ²) conductor	PREESTM20

^① Overall hazardous location and ingress protection rating depends on the rating of the optional certified components used.

Unicode™ 2 Series Fiberglass Reinforced Polyester Control Stations and Switches

Increased Safety

NEC:
 Class I, Division 2, Groups A, B, C, D
 Class II, Groups E, F, G
 Class III
 Ex de IIC/DIP A21
 IP66, Type 4XⓈ

CEC:
 Class I, Division 2, Groups A, B, C, D
 Class II, Groups F, G
 Class III; Type 4XⓈ
 Class I, Zone 1, AEx de IIC/ AEx tD 21
 IP66

ATEX/IECEx:
 Zone 1 and 2 – 21 and 22
 Ⓢ II 2 GD
 Ex de IIC/Ex demb IIC/ Ex tD A21
 IP66 – IK10

CONTROLS: NEC/CEC, ATEX/IECEx INCREASED SAFETY CONTROL STATIONS

Dimensions in Millimeters (Inches)

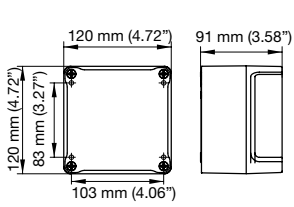

Size 1 Box

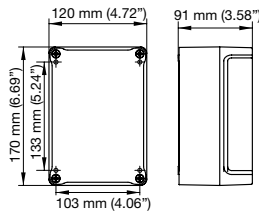

Size 2 Box

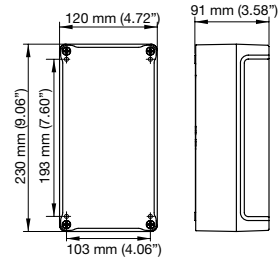

Size 3 Box

Mounting/Fixing Details for Above Boxes: Four Holes Ø 5 mm (0.20")

Unicode™ 2 Series Aluminum Control Stations and Switches

Increased Safety

ATEX/IECEX:
Zone 1 and 2 – 21 and 22
II 2 GD
Ex de IIC/Ex demb IIC/ Ex tD A21
IP66 – IK10

Applications

- Local control stations and motor control stations for use in hazardous areas covering the broadest possible range of applications.
- Control of equipment at:
 - Power plants
 - Chemical and petrochemical plants
 - Petroleum refineries
 - Reverse osmosis plants
 - Pulp and paper processing plants
 - Various industrial applications
- Push buttons and selector switches are used in conjunction with contactors or magnetic starters for remote control of motors in hazardous locations. They provide circuit control and/or selection.
- Pilot lights provide visual assurance that an electrical function is being performed at a remote or hazardous location.
- For use in washdown areas.

Features

- Employs Ex de method of protection which eliminates the need for external seals.
- Operators include push buttons, illuminated push buttons, selector switches, control and load break switches and LED pilot lights.
- Pilot light employs high intensity single LED with lifetime of 100,000 hours that can be used at:
 - 12 Vac to 254 Vac 50/60 Hz
 - 12 Vdc to 60 Vdc
- Up to 3 contact blocks per actuator can be used.
- Contact block technical data:
 - IEC rated operating voltage (Ue): 500 Vac – 110 Vdc
 - IEC switching capacity:
 - AC12: 16 Amp/400 Vac
 - AC14: 10 Amp/400 Vac
 - AC15: 6 Amp/500 Vac
 - DC13: 2 Amp/24 Vdc and 1 Amp/110 Vdc
 - NEMA switching capacity: A600: 10 Amp/600 Vac
- Selector switch technical data:
 - IEC rated operating voltage: 690 Vac
 - IEC rated operating current: maximum 16 Amp
 - IEC switching capacity:
 - AC1: 16 Amp/690 Vac
 - AC15: 16 Amp/415 Vac
 - AC3: 8 Amp/500 Vac
 - AC3: 4 Amp/690 Vac
 - AC3: 16 Amp/690 Vac
 - DC1: 10 Amp/24 Vdc
 - DC1: 6 Amp/60 Vdc
 - DC1: 6 Amp/110 Vdc (2 contacts wired in series)
 - DC1: 6 Amp/220 Vdc (3 contacts in series)
 - NEMA switching capacity: A600: 10 Amp/600 Vac
- Enclosures are rated for IP66 with firmly secured gasket.
- Operators and contact blocks are spaced for easy wiring.
- Wide selection of termination methods available.
- Choice of DIN rail mounted high performance contact block suitable for low intensity (less than 5 mA).
- TS35 rail mounted components are held securely in place during operation and easily removed for service.



U83W2 PRA5A9

- Brass Inserts are provided for TS35 DIN rails or mounting plates to be installed inside the enclosure.
- Captive, corrosion resistant stainless steel cover screws.

Standard Materials

- Body and cover: aluminum with gray epoxy powder coating
- Cover screws: 304 stainless steel

Accessories

- Key for changing actuator blocks.
- Guard for mushroom head actuator.
- Padlockable guard.
- M5 and M6 earth stud.
- Combination drain and breather available in brass, polyamide and stainless steel.

Options

- Nameplates: Stainless Steel or Lamacoid with different color combinations.
- Padlocking facility at left, center, right or any position on selector switches.
- Padlocking facility for momentary and maintained push buttons.
- Special contact arrangements available, see *Unicode™ 2 Series Customized Control Stations*.

Unicode™ 2 Series Aluminum Control Stations and Switches

Increased Safety

ATEX/IECEX:
Zone 1 and 2 – 21 and 22
Ⓜ II 2 GD
Ex de IIC/Ex demb IIC/ Ex tD A21
IP66 – IK10

CONTROLS: NEC/CEC, ATEX/IECEX INCREASED SAFETY CONTROL STATIONS

ATEX/IECEX Certification and Compliances

- Fiberglass Reinforced Polyester (FRP)
 - Certification Type CSPe
 - Gas: Zone 1 and 2
 - Conforming to ATEX 94/9/CE: Ⓜ II 2 G
- Certification Type PCe
 - Gas: Zone 1 and 2
 - Conforming to ATEX 94/9/CE: Ⓜ II 2 G
 - Type of Protection: Ex de IIC/Ex demb IIC
 - Temperature Class: T6
 - Dust: Zone 21 and 22
 - Conforming to ATEX 94/9/CE: Ⓜ II 2 D
 - Type of Protection: Ex tD A21
 - Surface Temperature: T75 °C (T167 °F)
 - Ambient Temperature: -55 °C to +60 °C (-67 °F to +140 °F)
(empty enclosure, temperature to be determine according actuator)
 - CE Declaration of Conformity: 50221
 - ATEX Certificate: LCIE 02 ATEX 6047
 - Index of Protection according EN/IEC 60529: IP66
 - Impact Resistance (shock): IK10

EURASEC Certification

- Certification Type PCe
 - EURASEC RU C-FR Г505.B.00911

Unicode™ 2 Series Aluminum Control Stations and Switches

Increased Safety

ATEX/IECEX:
 Zone 1 and 2 – 21 and 22
 II 2 GD
 Ex de IIC/Ex demb IIC/ Ex tD A21
 IP66 – IK10

Size 1 Aluminum Control Station

Included: 1 white self-adhesive laminated plastic nameplate, 1 brass earth continuity plate ①, 1 blanking plug ②, 1 cable gland ②.

Description/Function	Diagram	Entry Location	Entry Size	Weight kg (lb)	Volume dm ³ (in ³)	Catalog Number		
Momentary Push Buttons								
Green insert 'I' + red insert 'O' with 1NO + 1NC momentary contact		Bottom	2 x M20	1.0 (2.20)	2.7 (164.80)	U81W2A3		
		Feed-Thru	2 x M25	1.0 (2.20)	2.7 (164.80)	U81W4A3		
			1 x 3/4"	1.0 (2.20)	2.7 (164.80)	U81Z3A3		
			2 x 3/4"	1.0 (2.20)	2.7 (164.80)	U81X3A3		
				Bottom	2 x M20	1.0 (2.20)	2.7 (164.80)	U81W2A5
				Feed-Thru	2 x M25	1.0 (2.20)	2.7 (164.80)	U81W4A5
1 x 3/4"	1.0 (2.20)				2.7 (164.80)	U81Z3A5		
2 x 3/4"	1.0 (2.20)				2.7 (164.80)	U81X3A5		
1x red push button 'O' with 1NC momentary contact				Bottom	2 x M20	1.0 (2.20)	2.7 (164.80)	U81W2A9
				Feed-Thru	2 x M25	1.0 (2.20)	2.7 (164.80)	U81W4A9
		1 x 3/4"	1.0 (2.20)		2.7 (164.80)	U81Z3A9		
		2 x 3/4"	1.0 (2.20)		2.7 (164.80)	U81X3A9		
		Twin Momentary Push Buttons						
				Bottom	2 x M20	1.1 (2.43)	2.7 (164.80)	U81W2A5A9
Feed-Thru	2 x M25			1.1 (2.43)	2.7 (164.80)	U81W4A5A9		
	1 x 3/4"			1.1 (2.43)	2.7 (164.80)	U81Z3A5A9		
	2 x 3/4"			1.1 (2.43)	2.7 (164.80)	U81X3A5A9		
1x green push button 'I' with 1NO + 1NC contact 1x red push button 'O' with 1NO + 1NC contact momentary contacts				Bottom	2 x M20	1.1 (2.43)	2.7 (164.80)	U81W2A3A3
				Feed-Thru	2 x M25	1.1 (2.43)	2.7 (164.80)	U81W4A3A3
		1 x 3/4"	1.1 (2.43)		2.7 (164.80)	U81Z3A3A3		
		2 x 3/4"	1.1 (2.43)		2.7 (164.80)	U81X3A3A3		

Additional configurations available, please refer to Unicode 2 Series - Customized Control Stations section.

① Not required for aluminum.

② Not included if NPT hubs are selected.

Unicode™ 2 Series Aluminum Control Stations and Switches





Increased Safety

ATEX/IECEX:
 Zone 1 and 2 – 21 and 22
 II 2 GD
 Ex de IIC/Ex demb IIC/ Ex tD A21
 IP66 – IK10

CONTROLS: NEC/CEC, ATEX/IECEX INCREASED SAFETY CONTROL STATIONS

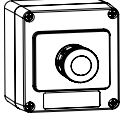
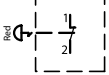
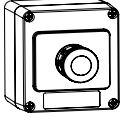
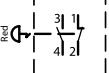
Size 1 Aluminum Control Station

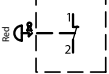
Included: 1 white self-adhesive laminated plastic nameplate, 1 brass earth continuity plate ①, 1 blanking plug ②, 1 cable gland ②.

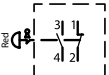
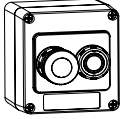
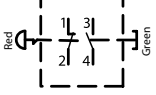
Description/Function	Diagram	Entry Location	Entry Size	Weight kg (lb)	Volume dm³ (in³)	Catalog Number	
Emergency Stop							
 Red mushroom head push-pull 1NC maintained contact		Bottom	2 x M20	1.0 (2.20)	2.7 (164.80)	U81W2D9	
		Bottom	2 x M25	1.0 (2.20)	2.7 (164.80)	U81W4D9	
		1 x 3/4"	1.0 (2.20)	2.7 (164.80)	U81Z3D9		
	Feed-Thru	2 x 3/4"	1.0 (2.20)	2.7 (164.80)	U81X3D9		
	 Red mushroom head push-pull 1NO + 1NC maintained contact		Bottom	2 x M20	1.0 (2.20)	2.7 (164.80)	U81W2D3
			Bottom	2 x M25	1.0 (2.20)	2.7 (164.80)	U81W4D3
1 x 3/4"			1.0 (2.20)	2.7 (164.80)	U81Z3D3		
Feed-Thru	2 x 3/4"	1.0 (2.20)	2.7 (164.80)	U81X3D3			
 Red mushroom head key release 1NC maintained contact		Bottom	2 x M20	1.0 (2.20)	2.7 (164.80)	U81W2C9	
		Bottom	2 x M25	1.0 (2.20)	2.7 (164.80)	U81W4C9	
		1 x 3/4"	1.0 (2.20)	2.7 (164.80)	U81Z3C9		
	Feed-Thru	2 x 3/4"	1.0 (2.20)	2.7 (164.80)	U81X3C9		
	 Red mushroom head key release 1NO + 1NC maintained contact		Bottom	2 x M20	1.0 (2.20)	2.7 (164.80)	U81W2C3
			Bottom	2 x M25	1.0 (2.20)	2.7 (164.80)	U81W4C3
1 x 3/4"			1.0 (2.20)	2.7 (164.80)	U81Z3C3		
Feed-Thru	2 x 3/4"	1.0 (2.20)	2.7 (164.80)	U81X3C3			
Push Pull Emergency Stop + Push Button							
 1x red mushroom head push-pull with 1NC maintained contact 1x green push button 'I' with 1NO momentary contact		Bottom	2 x M20	1.1 (2.43)	2.7 (164.80)	U81W2D9A5	
		Bottom	2 x M25	1.1 (2.43)	2.7 (164.80)	U81W4D9A5	
		1 x 3/4"	1.1 (2.43)	2.7 (164.80)	U81Z3D9A5		
		Feed-Thru	2 x 3/4"	1.1 (2.43)	2.7 (164.80)	U81X3D9A5	

Additional combinations available, please refer to Unicode 2 Series - Customized Control Stations section.

① Not required for aluminum.

② Not included if NPT hubs are selected.



Unicode™ 2 Series Aluminum Control Stations and Switches

Increased Safety

ATEX/IECEX:
 Zone 1 and 2 – 21 and 22
 II 2 GD
 Ex de IIC/Ex demb IIC/ Ex tD A21
 IP66 – IK10

Size 1 Aluminum Control Station

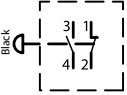
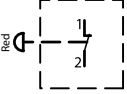
Included: 1 white self-adhesive laminated plastic nameplate, 1 brass earth continuity plate ①, 1 blanking plug ②, 1 cable gland ③.

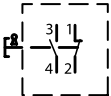
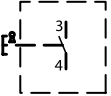
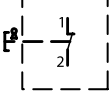
Description/Function	Diagram	Entry Location	Entry Size	Weight kg (lb)	Volume dm ³ (in ³)	Catalog Number
Mushroom Head Push Button						
 Black mushroom head push button 1NO + 1NC momentary contact		Bottom	2 x M20	1.0 (2.20)	2.7 (164.80)	U81W2B3
		Bottom	2 x M25	1.0 (2.20)	2.7 (164.80)	U81W4B3
		1 x 3/4"	1.0 (2.20)	2.7 (164.80)	U81Z3B3	
	Feed-Thru	2 x 3/4"	1.0 (2.20)	2.7 (164.80)	U81X3B3	
		Bottom	2 x M20	1.0 (2.20)	2.7 (164.80)	U81W2R9
		Bottom	2 x M25	1.0 (2.20)	2.7 (164.80)	U81W4R9
1 x 3/4"		1.0 (2.20)	2.7 (164.80)	U81Z3R9		
Feed-Thru	2 x 3/4"	1.0 (2.20)	2.7 (164.80)	U81X3R9		
Key Push Button						
 With key removable in both positions 1NO + 1NC maintained contact		Bottom	2 x M20	1.0 (2.20)	2.7 (164.80)	U81W2E3
		Bottom	2 x M25	1.0 (2.20)	2.7 (164.80)	U81W4E3
		1 x 3/4"	1.0 (2.20)	2.7 (164.80)	U81Z3E3	
	Feed-Thru	2 x 3/4"	1.0 (2.20)	2.7 (164.80)	U81X3E3	
		Bottom	2 x M20	1.0 (2.20)	2.7 (164.80)	U81W2E5
		Bottom	2 x M25	1.0 (2.20)	2.7 (164.80)	U81W4E5
1 x 3/4"		1.0 (2.20)	2.7 (164.80)	U81Z3E5		
Feed-Thru	2 x 3/4"	1.0 (2.20)	2.7 (164.80)	U81X3E5		
	Bottom	2 x M20	1.0 (2.20)	2.7 (164.80)	U81W2E9	
	Bottom	2 x M25	1.0 (2.20)	2.7 (164.80)	U81W4E9	
	1 x 3/4"	1.0 (2.20)	2.7 (164.80)	U81Z3E9		
Feed-Thru	2 x 3/4"	1.0 (2.20)	2.7 (164.80)	U81X3E9		

Additional combinations available, please refer to Unicode 2 Series - Customized Control Stations section.

① Not required for aluminum.

② Not included if NPT hubs are selected.

Unicode™ 2 Series Aluminum Control Stations and Switches





Increased Safety

ATEX/IECEX:
 Zone 1 and 2 – 21 and 22
 II 2 GD
 Ex de IIC/Ex demb IIC/ Ex tD A21
 IP66 – IK10

CONTROLS: NEC/CEC, ATEX/IECEX INCREASED SAFETY CONTROL STATIONS

Size 1 Aluminum Control Station

Included: 1 white self-adhesive laminated plastic nameplate, 1 brass earth continuity plate ①, 1 blanking plug ②, 1 cable gland ③.

Description/Function	Diagram	Entry Location	Entry Size	Weight kg (lb)	Volume dm³ (in³)	Catalog Number
Pilot Light						
1x red pilot light ③		Bottom	2 x M20	1.0 (2.20)	2.7 (164.80)	U81W2PR
			2 x M25	1.0 (2.20)	2.7 (164.80)	U81W4PR
		Feed-Thru	1 x 3/4"	1.0 (2.20)	2.7 (164.80)	U81Z3PR
			2 x 3/4"	1.0 (2.20)	2.7 (164.80)	U81X3PR
1x green pilot light ③		Bottom	2 x M20	1.0 (2.20)	2.7 (164.80)	U81W2PG
			2 x M25	1.0 (2.20)	2.7 (164.80)	U81W4PG
		Feed-Thru	1 x 3/4"	1.0 (2.20)	2.7 (164.80)	U81Z3PG
			2 x 3/4"	1.0 (2.20)	2.7 (164.80)	U81X3PG
1x blue pilot light ③		Bottom	2 x M20	1.0 (2.20)	2.7 (164.80)	U81W2PB
			2 x M25	1.0 (2.20)	2.7 (164.80)	U81W4PB
		Feed-Thru	1 x 3/4"	1.0 (2.20)	2.7 (164.80)	U81Z3PB
			2 x 3/4"	1.0 (2.20)	2.7 (164.80)	U81X3PB
1x yellow pilot light ③		Bottom	2 x M20	1.0 (2.20)	2.7 (164.80)	U81W2PY
			2 x M25	1.0 (2.20)	2.7 (164.80)	U81W4PY
		Feed-Thru	1 x 3/4"	1.0 (2.20)	2.7 (164.80)	U81Z3PY
			2 x 3/4"	1.0 (2.20)	2.7 (164.80)	U81X3PY
1x white pilot light ③		Bottom	2 x M20	1.0 (2.20)	2.7 (164.80)	U81W2PW
			2 x M25	1.0 (2.20)	2.7 (164.80)	U81W4PW
		Feed-Thru	1 x 3/4"	1.0 (2.20)	2.7 (164.80)	U81Z3PW
			2 x 3/4"	1.0 (2.20)	2.7 (164.80)	U81X3PW



Additional combinations available, please refer to Unicode 2 Series - Customized Control Stations section.

- ① Not required for aluminum.
- ② Not included if NPT hubs are selected.
- ③ 12 Vac to 254 Vac 50/60 Hz - 12 Vdc to 60 Vdc.

Unicode™ 2 Series Aluminum Control Stations and Switches

Increased Safety

ATEX/IECEX:
 Zone 1 and 2 – 21 and 22
 II 2 GD
 Ex de IIC/Ex demb IIC/ Ex tD A21
 IP66 – IK10

Size 1 Aluminum Control Station

Included: 1 white self-adhesive laminated plastic nameplate, 1 brass earth continuity plate ①, 1 blanking plug ②, 1 cable gland ②.

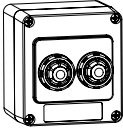
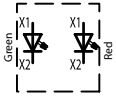
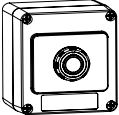
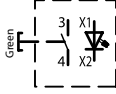
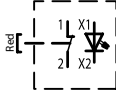
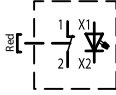
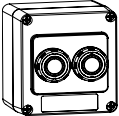
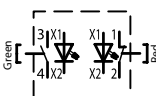
Description/Function	Diagram	Entry Location	Entry Size	Weight kg (lb)	Volume dm ³ (in ³)	Catalog Number
Twin Pilot Light						
 1x green pilot light ③ 1x red pilot light ③		Bottom	2 x M20	1.1 (2.43)	2.7 (164.80)	U81W2PGPR
		Bottom	2 x M25	1.1 (2.43)	2.7 (164.80)	U81W4PGPR
		Bottom	1 x 3/4"	1.1 (2.43)	2.7 (164.80)	U81Z3PGPR
		Feed-Thru	2 x 3/4"	1.1 (2.43)	2.7 (164.80)	U81X3PGPR
Illuminated Push Button						
 1x green illuminated push button with 1NO contact momentary contacts		Bottom	2 x M20	1.0 (2.20)	2.7 (164.80)	U81W2LG5
		Bottom	2 x M25	1.0 (2.20)	2.7 (164.80)	U81W4LG5
		Bottom	1 x 3/4"	1.0 (2.20)	2.7 (164.80)	U81Z3LG5
		Feed-Thru	2 x 3/4"	1.0 (2.20)	2.7 (164.80)	U81X3LG5
 1x red illuminated push button with 1NC contact momentary contacts		Bottom	2 x M20	1.0 (2.20)	2.7 (164.80)	U81W2LR9
		Bottom	2 x M25	1.0 (2.20)	2.7 (164.80)	U81W4LR9
		Bottom	1 x 3/4"	1.0 (2.20)	2.7 (164.80)	U81Z3LR9
		Feed-Thru	2 x 3/4"	1.0 (2.20)	2.7 (164.80)	U81X3LR9
Twin Illuminated Push Button						
 1x green illuminated push button with 1NO contact momentary contacts 1x red illuminated push button with 1NC contact momentary contacts		Bottom	2 x M20	1.1 (2.43)	2.7 (164.80)	U81W2LG5LR9
		Bottom	2 x M25	1.1 (2.43)	2.7 (164.80)	U81W4LG5LR9
		Bottom	1 x 3/4"	1.1 (2.43)	2.7 (164.80)	U81Z3LG5LR9
		Feed-Thru	2 x 3/4"	1.1 (2.43)	2.7 (164.80)	U81X3LG5LR9

Additional combinations available, please refer to Unicode 2 Series - Customized Control Stations section.

- ① Not required for aluminum.
- ② Not included if NPT hubs are selected.
- ③ 12 Vac to 254 Vac 50/60 Hz - 12 Vdc to 60 Vdc.

Unicode™ 2 Series Aluminum Control Stations and Switches







Increased Safety

ATEX/IECEX:
 Zone 1 and 2 – 21 and 22
 II 2 GD
 Ex de IIC/Ex demb IIC/ Ex tD A21
 IP66 – IK10

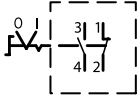
CONTROLS: NEC/CEC, ATEX/IECEX INCREASED SAFETY CONTROL STATIONS

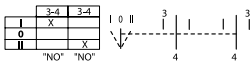
Size 1 Aluminum Control Station

Included: 1 white self-adhesive laminated plastic nameplate, 1 brass earth continuity plate ①, 1 blanking plug ②, 1 cable gland ②.

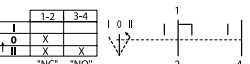
Description/Function	Diagram	Entry Location	Entry Size	Weight kg (lb)	Volume dm ³ (in ³)	Catalog Number
2-Position Selector Switch						
 <p>2 fixed positions '0 - I' 1NO + 1NC contact</p>		Bottom	2 x M20	1.0 (2.20)	2.7 (164.80)	U81W2H3
		Bottom	2 x M25	1.0 (2.20)	2.7 (164.80)	U81W4H3
		Feed-Thru	1 x 3/4"	1.0 (2.20)	2.7 (164.80)	U81Z3H3
		Feed-Thru	2 x 3/4"	1.0 (2.20)	2.7 (164.80)	U81X3H3
3-Position Selector Switch						
 <p>3 fixed positions 'I - 0 - II' 2NO contact</p>		Bottom	2 x M20	1.0 (2.20)	2.7 (164.80)	U81W2J1
		Bottom	2 x M25	1.0 (2.20)	2.7 (164.80)	U81W4J1
		Feed-Thru	1 x 3/4"	1.0 (2.20)	2.7 (164.80)	U81Z3J1
		Feed-Thru	2 x 3/4"	1.0 (2.20)	2.7 (164.80)	U81X3J1
 <p>3 positions 'I - 0 - II' with spring return from I to 0 1NO + 1NC contact</p>		Bottom	2 x M20	1.0 (2.20)	2.7 (164.80)	U81W2N3
		Bottom	2 x M25	1.0 (2.20)	2.7 (164.80)	U81W4N3
		Feed-Thru	1 x 3/4"	1.0 (2.20)	2.7 (164.80)	U81Z3N3
		Feed-Thru	2 x 3/4"	1.0 (2.20)	2.7 (164.80)	U81X3N3
 <p>3 positions 'I - 0 - II' with spring return from II to 0 1NO + 1NC contact</p>		Bottom	2 x M20	1.0 (2.20)	2.7 (164.80)	U81W2M3
		Bottom	2 x M25	1.0 (2.20)	2.7 (164.80)	U81W4M3
		Feed-Thru	1 x 3/4"	1.0 (2.20)	2.7 (164.80)	U81Z3M3
		Feed-Thru	2 x 3/4"	1.0 (2.20)	2.7 (164.80)	U81X3M3

Additional combinations available, please refer to Unicode 2 Series - Customized Control Stations section.

① Not required for aluminum.

② Not included if NPT hubs are selected.



Unicode™ 2 Series Aluminum Control Stations and Switches

Increased Safety

ATEX/IECEX:
 Zone 1 and 2 – 21 and 22
 II 2 GD
 Ex de IIC/Ex demb IIC/ Ex tD A21
 IP66 – IK10

Size 2 Aluminum Control Station

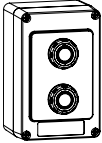
Included: 1 white self-adhesive laminated plastic nameplate, 1 brass earth continuity plate ①, 1 blanking plug ②, 1 cable gland ②.

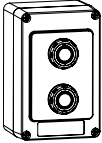
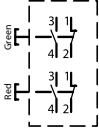
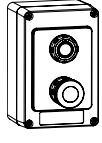
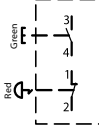
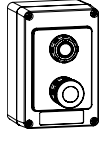
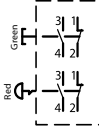
Description/Function	Diagram	Entry Location	Entry Size	Weight kg (lb)	Volume dm ³ (in ³)	Catalog Number	
Twin Push Button							
 <p>1x green push button 'I' with 1NO contact 1x red push button 'O' with 1NC contact momentary contacts</p>		Bottom	2 x M20	1.3 (2.87)	2.7 (164.80)	U82W2A5A9	
		Bottom	2 x M25	1.3 (2.87)	2.7 (164.80)	U82W4A5A9	
		1 x 3/4"	1.3 (2.87)	2.7 (164.80)	U82Z3A5A9		
	Feed-Thru	2 x 3/4"	1.3 (2.87)	2.7 (164.80)	U82X3A5A9		
	 <p>1x green push button 'I' with 1NO + 1NC contact 1x red push button 'O' with 1NO + 1NC contact momentary contacts</p>		Bottom	2 x M20	1.3 (2.87)	2.7 (164.80)	U82W2A3A3
			Bottom	2 x M25	1.3 (2.87)	2.7 (164.80)	U82W4A3A3
1 x 3/4"		1.3 (2.87)	2.7 (164.80)	U82Z3A3A3			
Feed-Thru		2 x 3/4"	1.3 (2.87)	2.7 (164.80)	U82X3A3A3		
Push Button + Push-Pull Emergency Stop							
 <p>1x green push button 'I' with 1NO momentary contact 1x red mushroom head push-pull with 1NC maintained contact</p>		Bottom	2 x M20	1.3 (2.87)	2.7 (164.80)	U82W2A5D9	
		Bottom	2 x M25	1.3 (2.87)	2.7 (164.80)	U82W4A5D9	
		1 x 3/4"	1.3 (2.87)	2.7 (164.80)	U82Z3A5D9		
	Feed-Thru	2 x 3/4"	1.3 (2.87)	2.7 (164.80)	U82X3A5D9		
	 <p>1x green push button 'I' with 1NO + 1NC momentary contact 1x red mushroom head push-pull with 1NO + 1NC maintained contact</p>		Bottom	2 x M20	1.3 (2.87)	2.7 (164.80)	U82W2A3D3
			Bottom	2 x M25	1.3 (2.87)	2.7 (164.80)	U82W4A3D3
1 x 3/4"		1.3 (2.87)	2.7 (164.80)	U82Z3A3D3			
Feed-Thru		2 x 3/4"	1.3 (2.87)	2.7 (164.80)	U82X3A3D3		

Additional combinations available, please refer to Unicode 2 Series - Customized Control Stations section.

① Not required for aluminum.

② Not included if NPT hubs are selected.

Unicode™ 2 Series Aluminum Control Stations and Switches





Increased Safety

ATEX/IECEX:
 Zone 1 and 2 – 21 and 22
 II 2 GD
 Ex de IIC/Ex demb IIC/ Ex tD A21
 IP66 – IK10

CONTROLS: NEC/CEC, ATEX/IECEX INCREASED SAFETY CONTROL STATIONS

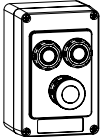
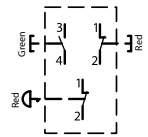
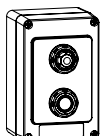
Size 2 Aluminum Control Station

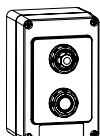
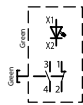
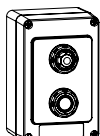
Included: 1 white self-adhesive laminated plastic nameplate, 1 brass earth continuity plate ①, 1 blanking plug ②, 1 cable gland ②.

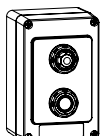
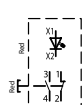
Description/Function	Diagram	Entry Location	Entry Size	Weight kg (lb)	Volume dm ³ (in ³)	Catalog Number
Twin Push Buttons + Push-Pull Emergency Stop						
 <p>1x green push button 'I' with 1NO contacts 1x red push button 'O' with 1NC contacts momentary contacts 1x red mushroom head push-pull with 1x NC maintained contact</p>		Bottom	2 x M20	1.3 (2.87)	2.7 (164.80)	U82W2A5A9D9
		Bottom	2 x M25	1.3 (2.87)	2.7 (164.80)	U82W4A5A9D9
		Feed-Thru	1 x 3/4"	1.3 (2.87)	2.7 (164.80)	U82Z3A5A9D9
		Feed-Thru	2 x 3/4"	1.3 (2.87)	2.7 (164.80)	U82X3A5A9D9
Pilot Light + Push Button						
 <p>1x green light ③ 1x green push button 'I' with 1NO momentary contact</p>		Bottom	2 x M20	1.2 (2.65)	2.7 (164.80)	U82W2PGA5
		Bottom	2 x M25	1.2 (2.65)	2.7 (164.80)	U82W4PGA5
		Feed-Thru	1 x 3/4"	1.2 (2.65)	2.7 (164.80)	U82Z3PGA5
		Feed-Thru	2 x 3/4"	1.2 (2.65)	2.7 (164.80)	U82X3PGA5
 <p>1x green light ③ 1x green push button 'I' with 1NO + 1NC momentary contacts</p>		Bottom	2 x M20	1.2 (2.65)	2.7 (164.80)	U82W2PGA3
		Bottom	2 x M25	1.2 (2.65)	2.7 (164.80)	U82W4PGA3
		Feed-Thru	1 x 3/4"	1.2 (2.65)	2.7 (164.80)	U82Z3PGA3
		Feed-Thru	2 x 3/4"	1.2 (2.65)	2.7 (164.80)	U82X3PGA3
 <p>1x red light ③ 1x red push button 'O' with 1NC momentary contact</p>		Bottom	2 x M20	1.2 (2.65)	2.7 (164.80)	U82W2PRA9
		Bottom	2 x M25	1.2 (2.65)	2.7 (164.80)	U82W4PRA9
		Feed-Thru	1 x 3/4"	1.2 (2.65)	2.7 (164.80)	U82Z3PRA9
		Feed-Thru	2 x 3/4"	1.2 (2.65)	2.7 (164.80)	U82X3PRA9
 <p>1x red light 1x red push button 'O' with 1NO + 1NC momentary contact</p>		Bottom	2 x M20	1.2 (2.65)	2.7 (164.80)	U82W2PRA3
		Bottom	2 x M25	1.2 (2.65)	2.7 (164.80)	U82W4PRA3
		Feed-Thru	1 x 3/4"	1.2 (2.65)	2.7 (164.80)	U82Z3PRA3
		Feed-Thru	2 x 3/4"	1.2 (2.65)	2.7 (164.80)	U82X3PRA3

Additional combinations available, please refer to Unicode 2 Series - Customized Control Stations section.

① Not required for aluminum.

② Not included if NPT hubs are selected.

③ 12 Vac to 254 Vac 50/60 Hz - 12 Vdc to 60 Vdc.



Unicode™ 2 Series Aluminum Control Stations and Switches

Increased Safety

ATEX/IECEX:
 Zone 1 and 2 – 21 and 22
 II 2 GD
 Ex de IIC/Ex demb IIC/ Ex tD A21
 IP66 – IK10

Size 2 Aluminum Control Station

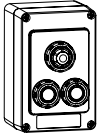
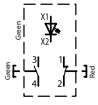
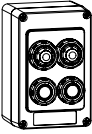
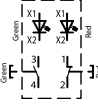
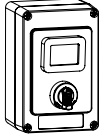
Included: 1 white self-adhesive laminated plastic nameplate, 1 brass earth continuity plate ①, 1 blanking plug ②, 1 cable gland ②.

Description/Function	Diagram	Entry Location	Entry Size	Weight kg (lb)	Volume dm ³ (in ³)	Catalog Number
Pilot Light + Twin Push Buttons ③						
 <p>1x green light ③ 1x green push button 'I' with 1NO 1x red push button 'O' with 1NC momentary contacts</p>		Bottom	2 x M20	1.3 (2.87)	2.7 (164.80)	U82W2PGA5A9
		Bottom	2 x M25	1.3 (2.87)	2.7 (164.80)	U82W4PGA5A9
		Bottom	1 x 3/4"	1.3 (2.87)	2.7 (164.80)	U82Z3PGA5A9
		Feed-Thru	2 x 3/4"	1.3 (2.87)	2.7 (164.80)	U82X3PGA5A9
Twin Pilot Lights + Twin Push Buttons						
 <p>1x green light + 1x red light ② 1x green push button 'I' with 1NO 1x red push button 'O' with 1NC momentary contacts</p>		Bottom	2 x M20	1.3 (2.87)	2.7 (164.80)	U82W2PGPRA5A9
		Bottom	2 x M25	1.3 (2.87)	2.7 (164.80)	U82W4PGPRA5A9
		Bottom	1 x 3/4"	1.3 (2.87)	2.7 (164.80)	U82Z3PGPRA5A9
		Feed-Thru	2 x 3/4"	1.3 (2.87)	2.7 (164.80)	U82X3PGPRA5A9
Ammeter + 3-Position Selector Switch						
 <p>1x ammeter 48 x 48 mm, 1A C.T., 3 F.L.C., with 0 - 1 - 3 scale 1x switch 3 positions 'I - 0 - II' with spring return from II to 0 1NO + 1NC contact</p>		Bottom	2 x M20	1.2 (2.65)	2.7 (164.80)	U82W2VA13M3
		Bottom	2 x M25	1.2 (2.65)	2.7 (164.80)	U82W4VA13M3
		Bottom	1 x 3/4"	1.2 (2.65)	2.7 (164.80)	U82Z3VA13M3
		Feed-Thru	2 x 3/4"	1.2 (2.65)	2.7 (164.80)	U82X3VA13M3

Additional combinations available, please refer to Unicode 2 Series - Customized Control Stations section.

- ① Not required for aluminum.
- ② Not included if NPT hubs are selected.
- ③ 12 Vac to 254 Vac 50/60 Hz - 12 Vdc to 60 Vdc.

Unicode™ 2 Series Aluminum Control Stations and Switches



Increased Safety

ATEX/IECEX:
 Zone 1 and 2 – 21 and 22
 II 2 GD
 Ex de IIC/Ex demb IIC/ Ex tD A21
 IP66 – IK10

CONTROLS: NEC/CEC, ATEX/IECEX INCREASED SAFETY CONTROL STATIONS

Size 3 Aluminum Control Station

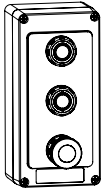
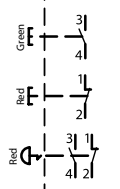
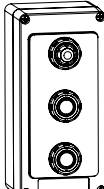
Included: 1 white self-adhesive laminated plastic nameplate, 1 brass earth continuity plate ①, 1 blanking plug ②, 1 cable gland ②.

Description/Function	Diagram	Entry Location	Entry Size	Weight kg (lb)	Volume dm ³ (in ³)	Catalog Number
Twin Push Buttons + Push-Pull Emergency Stop ③						
 <p>1x green push button 'I' with 1NO contact 1x red push button 'O' with 1NC contact momentary contacts 1x red mushroom head push-pull emergency button with 1NO + 1NC maintained contacts</p>		Bottom	2 x M20	1.6 (3.53)	4.2 (256.30)	U83W2A5A9D3
		Bottom	2 x M25	1.6 (3.53)	4.2 (256.30)	U83W4A5A9D3
			1 x 3/4"	1.6 (3.53)	4.2 (256.30)	U83Z3A5A9D3
		Feed-Thru	2 x 3/4"	1.6 (3.53)	4.2 (256.30)	U83X3A5A9D3
Pilot Light + Twin Push Buttons						
 <p>1x green light ③ 1x green push button 'I' with 1NO contact 1x red push button 'O' with 1NC contact momentary contacts</p> <p>1x red light ③ 1x green push button 'I' with 1NO contact 1x red push button 'O' with 1NC contact momentary contacts</p> <p>1x green light ③ 1x green push button 'I' with 1NO + 1NC contact 1x red push button 'O' with 1NO + 1NC contact momentary contacts</p> <p>1x red light ③ 1x green push button 'I' with 1NO + 1NC contact 1x red push button 'O' with 1NO + 1NC contact momentary contacts</p>			2 x M20	1.6 (3.53)	4.2 (256.30)	U83W2PGA5A9
		Bottom	2 x M25	1.6 (3.53)	4.2 (256.30)	U83W4PGA5A9
			1 x 3/4"	1.6 (3.53)	4.2 (256.30)	U83Z3PGA5A9
		Feed-Thru	2 x 3/4"	1.6 (3.53)	4.2 (256.30)	U83X3PGA5A9
			2 x M20	1.6 (3.53)	4.2 (256.30)	U83W2PRA5A9
		Bottom	2 x M25	1.6 (3.53)	4.2 (256.30)	U83W4PRA5A9
			1 x 3/4"	1.6 (3.53)	4.2 (256.30)	U83Z3PRA5A9
		Feed-Thru	2 x 3/4"	1.6 (3.53)	4.2 (256.30)	U83X3PRA5A9
			2 x M20	1.6 (3.53)	4.2 (256.30)	U83W2PGA3A3
		Bottom	2 x M25	1.6 (3.53)	4.2 (256.30)	U83W4PGA3A3
			1 x 3/4"	1.6 (3.53)	4.2 (256.30)	U83Z3PGA3A3
		Feed-Thru	2 x 3/4"	1.6 (3.53)	4.2 (256.30)	U83X3PGA3A3
	2 x M20	1.6 (3.53)	4.2 (256.30)	U83W2PRA3A3		
Bottom	2 x M25	1.6 (3.53)	4.2 (256.30)	U83W4PRA3A3		
	1 x 3/4"	1.6 (3.53)	4.2 (256.30)	U83Z3PRA3A3		
Feed-Thru	2 x 3/4"	1.6 (3.53)	4.2 (256.30)	U83X3PRA3A3		

Additional combinations available, please refer to Unicode 2 Series - Customized Control Stations section.

① Not required for aluminum.

② Not included if NPT hubs are selected.

③ 12 Vac to 254 Vac 50/60 Hz - 12 Vdc to 60 Vdc.



Unicode™ 2 Series Aluminum Control Stations and Switches

Increased Safety

ATEX/IECEX:
 Zone 1 and 2 – 21 and 22
 II 2 GD
 Ex de IIC/Ex demb IIC/ Ex tD A21
 IP66 – IK10

Size 3 Aluminum Control Station

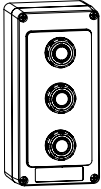
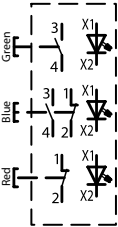
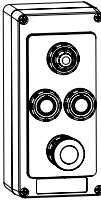
Included: 1 white self-adhesive laminated plastic nameplate ①, 1 brass earth continuity plate ②, 1 blanking plug ②, 1 cable gland ②.

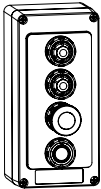
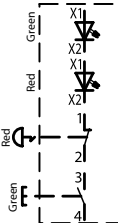
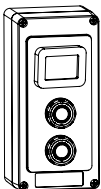
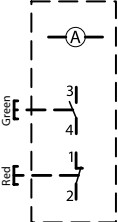
Description/Function	Diagram	Entry Location	Entry Size	Weight kg (lb)	Volume dm³ (in³)	Catalog Number
Triple Illuminated Push Buttons ③						
 <p>1x green illuminated push button with 1NO contact 1x blue illuminated push button with 1NO + 1NC contact 1x red illuminated push button with NC contact momentary contacts</p>		Bottom	2 x M20	1.6 (3.53)	4.2 (256.30)	U83W2LG5LB3LR9
		Bottom	2 x M25	1.6 (3.53)	4.2 (256.30)	U83W4LG5LB3LR9
		Feed-Thru	1 x 3/4"	1.6 (3.53)	4.2 (256.30)	U83Z3LG5LB3LR9
		Feed-Thru	2 x 3/4"	1.6 (3.53)	4.2 (256.30)	U83X3LG5LB3LR9
Pilot Light + Twin Push Buttons + Push-Pull Emergency Stop						
 <p>1x green light 1x green push button 'I' with 1NO contact 1x red push button 'O' with 1NC contact momentary contacts 1x red mushroom head push-pull with 1x NC maintained contact</p>		Bottom	2 x M20	1.6 (3.53)	4.2 (256.30)	U83W2PGA5A9D9
		Bottom	2 x M25	1.6 (3.53)	4.2 (256.30)	U83W4PGA5A9D9
		Feed-Thru	1 x 3/4"	1.6 (3.53)	4.2 (256.30)	U83Z3PGA5A9D9
		Feed-Thru	2 x 3/4"	1.6 (3.53)	4.2 (256.30)	U83X3PGA5A9D9
Twin Pilot Lights + Push-Pull Emergency Stop + Push Button ②						
 <p>1x green light + 1x red light ③ 1x red mushroom head push-pull with 1x NC maintained contact 1x green push button 'I' with 1NO momentary contact</p>		Bottom	2 x M20	1.6 (3.53)	4.2 (256.30)	U83W2PGPRD9A5
		Bottom	2 x M25	1.6 (3.53)	4.2 (256.30)	U83W4PGPRD9A5
		Feed-Thru	1 x 3/4"	1.6 (3.53)	4.2 (256.30)	U83Z3PGPRD9A5
		Feed-Thru	2 x 3/4"	1.6 (3.53)	4.2 (256.30)	U83X3PGPRD9A5
Ammeter + Twin Push Buttons						
 <p>1x ammeter 48 x 48 mm, 1A C.T., 3 F.L.C., with 0 - 1 - 3 scale 1x green push button 'I' with 1NO contact 1x red push button 'O' with 1NC contact momentary contacts</p>		Bottom	2 x M20	1.6 (3.53)	4.2 (256.30)	U83W2VA13A5A9
		Bottom	2 x M25	1.6 (3.53)	4.2 (256.30)	U83W4VA13A5A9
		Feed-Thru	1 x 3/4"	1.6 (3.53)	4.2 (256.30)	U83Z3VA13A5A9
		Feed-Thru	2 x 3/4"	1.6 (3.53)	4.2 (256.30)	U83X3VA13A5A9

Additional combinations available, please refer to Unicode 2 Series - Customized Control Stations section.

① Not required for aluminum.

② Not included if NPT hubs are selected.

③ 12 Vac to 254 Vac 50/60 Hz - 12 Vdc to 60 Vdc.

Unicode™ 2 Series Aluminum Control Stations and Switches

Increased Safety

ATEX/IECEX:
Zone 1 and 2 – 21 and 22
II 2 GD
Ex de IIC/Ex demb IIC/ Ex tD A21
IP66 – IK10

CONTROLS: NEC/CEC, ATEX/IECEX INCREASED SAFETY CONTROL STATIONS

Nameplates – Set of 10

Blank self-adhesive, laminated plastic 58 mm x 18 mm (2.29" x 0.71").

Color	Catalog Number
White (black letters)	UNPW
Yellow (black letters)	UNPY
Red (white letters)	UNPR
Blue (white letters)	UNPB
Black (white letters)	UNPN
Green (white letters)	UNPG

Inserts for Push Button – Set of 5

Marking	Color	Catalog Number
(unmarked)	Green	UIAG
(unmarked)	Red	UIAR
(unmarked)	Yellow	UIAY
(unmarked)	White	UIAW
(unmarked)	Blue	UIAB
(unmarked)	Black	UIAN
ON	Green	UIA01
OFF	Red	UIA02
START	Green	UIA03
STOP	Red	UIA04
MARCHE	Green	UIA05
ARRET	Red	UIA06
I	Green	UIA07
O	Red	UIA08

Inserts for Illuminated Push Button – Set of 5

Marking	Color	Catalog Number
(unmarked)	Green	UILG
(unmarked)	Red	UILR
(unmarked)	Yellow	UILY
(unmarked)	White	UILW
(unmarked)	Blue	UILB
ON	Green	UIL01
OFF	Red	UIL02
START	Green	UIL03
STOP	Red	UIL04
MARCHE	Green	UIL05
ARRET	Red	UIL06
I	Green	UIL07
O	Red	UIL08

Spare Key

For all key-operated buttons.

Description	Catalog Number
Spare key type 4 A 185	SK4A185

Standard Legend Plates

Two sizes available. Self-adhesive yellow laminated plastic (black lettering).

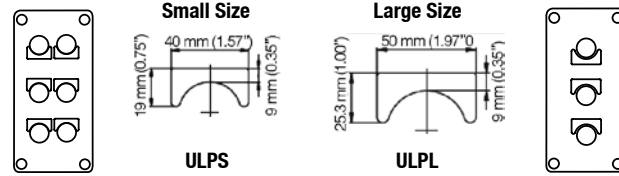

Text	Catalog Number	
	Small	Large
Blank (set of 10)	ULPS	ULPL
ON	ULPSA01	ULPLA01
OFF	ULPSA02	ULPLA02
FORWARD	ULPSA03	ULPLA03
REVERSE	ULPSA04	ULPLA04
JOG	ULPSA05	ULPLA05
RUN	ULPSA06	ULPLA06
START	ULPSA07	ULPLA07
STOP	ULPSA08	ULPLA08
UP	ULPSA09	ULPLA09
DOWN	ULPSA10	ULPLA10
FAST	ULPSA11	ULPLA11
SLOW	ULPSA12	ULPLA12
RAISE	ULPSA13	ULPLA13
LOWER	ULPSA14	ULPLA14
OPEN	ULPSA15	ULPLA15
CLOSE	ULPSA16	ULPLA16
LOW	ULPSA17	ULPLA17
HIGH	ULPSA18	ULPLA18
TEST	ULPSA19	ULPLA19
RESET	ULPSA20	ULPLA20
EMERGENCY STOP	ULPSA21	ULPLA21
MARCHE	ULPSA22	ULPLA22
ARRET	ULPSA23	ULPLA23
ARRET D'URGENCE	ULPSA24	ULPLA24
HAUT	ULPSA25	ULPLA25
BAS	ULPSA26	ULPLA26
O—I	ULPSH01	ULPLH01
ON—OFF	ULPSH02	ULPLH02
START—STOP	ULPSH03	ULPLH03
STOP—START	ULPSH04	ULPLH04
HAND—AUTO	ULPSH05	ULPLH05
MANU—AUTO	ULPSH06	ULPLH06
FORWARD—REVERSE	ULPSH07	ULPLH07
REMOTE—LOCAL	ULPSH08	ULPLH08
MARCHE—ARRET	ULPSH09	ULPLH09
I—O—II	ULPSJ01	ULPLJ01
OFF—O—ON	ULPSJ02	ULPLJ02
START—NORMAL—STOP	ULPSJ03	ULPLJ03
HAND—OFF—AUTO	ULPSJ04	ULPLJ04
MANU—O—AUTO	ULPSJ05	ULPLJ05
FORWARD—OFF—REVERSE	ULPSJ06	ULPLJ06
LOCAL—REMOTE—AUTO	ULPSJ07	ULPLJ07
LOCAL—O—REMOTE	ULPSJ08	ULPLJ08
MARCHE—NORMAL—ARRET	ULPSJ09	ULPLJ09

Unicode™ 2 Series Aluminum Control Stations and Switches

Increased Safety

ATEX/IECEX:
 Zone 1 and 2 – 21 and 22
 II 2 GD
 Ex de IIC/Ex demb IIC/ Ex tD A21
 IP66 – IK10

	Description	Catalog Number
	Additional Contacts Each actuator is capable of activating 3 contacts. Exception: Illuminated push button and all actuators with key: 2 contacts maximum 1NO contact 1NC contact	UCB5R UCB9R
	Yellow Guard Mushroom head protection for emergency stop	098657
	Padlockable Guard Stainless steel and plastic cover, capacity: 3 padlocks diameter 6 mm (0.24") maximum (not supplied) For push button and rotary actuator For mushroom head actuator	UPLD1S UPLD2S
	Cable Gland Exe For unarmored cable Exe - IP66 - in polyamide entry thread seal M20 (capacity 6.5-14.5 mm)	095605
	For armored cable Exe/Exd - IP66 - in nickel plated brass (without entry thread seal) Braid and Tape type: M20 (inner: 6.4-14.0/outer: 12.5-20.9 mm) Single Wired Armor (SWA): M20 (inner: 6.4-14.0/outer: 12.5-20.9 mm)	20E1FX5 20E1FW5
	Adaptors Exd/Exe - IP66 in nickel plated brass (without entry thread seal) Male M20 - Female 1/2" NPT Male M20 - Female 3/4" NPT	737DM2T15 737DM2T25
	Entry Thread Seal M20 (in white nylon)	20ETS2
	Combination Drain and Breather Exe - IP66 - supplied with entry thread seal and locknut M20 male thread in Polyamide M20 male thread in Brass M20 male thread in Stainless Steel	DBE20P DBE20B DBE20S
	Feed-Thru Earth Stud Terminal Exe - IP66 - supplied with weatherproof seal and green/yellow earth conductor - 300 mm (11.81") length M20 with M5 earth and 2.5 mm ² (0.004 in ²) conductor	PREESTM20

CONTROL STATIONS: NEC/CEC, ATEX/IECEX INCREASED SAFETY CONTROL STATIONS

Appleton

Unicode™ 2 Series Aluminum Control Stations and Switches

Increased Safety

ATEX/IECEX:
 Zone 1 and 2 – 21 and 22
 II 2 GD
 Ex de IIC/Ex demb IIC/ Ex tD A21
 IP66 – IK10

CONTROLS: NEC/CEC, ATEX/IECEX INCREASED SAFETY CONTROL STATIONS

Dimensions in Millimeters (Inches)

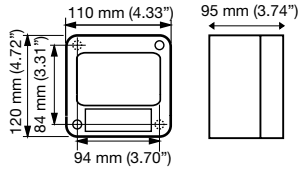

Size 1 Box

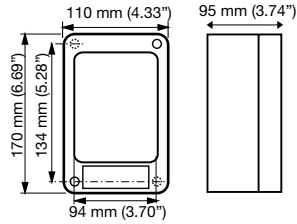

Size 2 Box

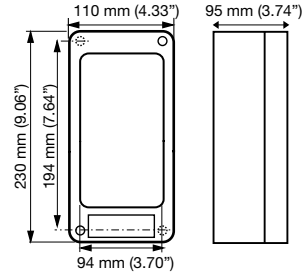

Size 3 Box

Mounting/Fixing Details for above Boxes: Two Holes \varnothing 5 mm (0.20")

Unicode™ 2 Series Polyamide Control Stations

Increased Safety

For use in IEC governed hazardous areas. Polyamide is not recognized for use in any NEC/CEC governed hazardous areas.

ATEX:

Zone 1 and 2 – 21 and 22

II 2 GD

Ex de IIC/Ex demb IIC/Ex tD A21

IP66 – IK09

Applications

- For use in IEC governed hazardous areas. Polyamide is not recognized for use in any NEC/CEC governed hazardous areas.
- Local control stations and motor control stations for use in hazardous areas covering the broadest possible range of applications.
- Control of equipment at:
 - Power plants
 - Chemical and petrochemical plants
 - Petroleum refineries
 - Reverse osmosis plants
 - Pulp and paper processing plants
 - Various industrial applications
- Push buttons and selector switches are used in conjunction with contactors or magnetic starters for remote control of motors in hazardous locations. They provide circuit control and/or selection.
- Pilot lights provide visual assurance that an electrical function is being performed at a remote or hazardous location.
- For use in washdown areas.

Features

- Employs Ex de method of protection which eliminates the need for external seals.
- Operators include push buttons, illuminated push buttons, selector switches, control and load break switches and LED pilot lights.
- Pilot light employs high intensity single LED with lifetime of 100,000 hours that can be used at:
 - 12 Vac to 254 Vac 50/60 Hz
 - 12 Vdc to 60 Vdc
- Up to 3 contact blocks per actuator can be used.
- Contact block technical data:
 - IEC rated operating voltage (Ue): 500 Vac – 110 Vdc
 - IEC switching capacity:
 - AC12: 16 Amp/400 Vac
 - AC14: 10 Amp/400 Vac
 - AC15: 6 Amp/500 Vac
 - DC13: 2 Amp/24 Vdc and 1 Amp/110 Vdc
 - NEMA switching capacity: A600: 10 Amp/600 Vac
- Selector switch technical data:
 - IEC rated operating voltage: 690 Vac
 - IEC rated operating current: maximum 16 Amp
 - IEC switching capacity:
 - AC1: 16 Amp/690 Vac
 - AC15: 16 Amp/415 Vac
 - AC3: 8 Amp/500 Vac
 - AC3: 4 Amp/690 Vac
 - AC3: 16 Amp/690 Vac
 - DC1: 10 Amp/24 Vdc
 - DC1: 6 Amp/60 Vdc
 - DC1: 6 Amp/110 Vdc (2 contacts wired in series)
 - DC1: 6 Amp/220 Vdc (3 contacts in series)
 - NEMA switching capacity: A600: 10 Amp/600 Vac
- Enclosures are rated for IP66 with firmly secured gasket.
- Operators and contact blocks are spaced for easy wiring.
- Wide selection of termination methods available.
- Choice of DIN rail mounted high performance contact block suitable for low intensity (less than 5 mA).



U43W2 VA13A5A9



U42W2 A5A9

- TS35 rail mounted components held securely in place during operation and easily removed for service.
- Brass Inserts are provided for TS35 DIN rails or mounting plate to be installed inside the enclosure.
- Captive, corrosion resistant stainless steel cover screws.

Standard Materials

- Body, cover, cable gland and blanking plug: polyamide, black finish
- Cover screws: stainless steel
- Optional nameplates: stainless steel

Accessories

- Key for changing actuator blocks.
- Guard for mushroom head actuator.
- Padlockable guard.
- M5 earth stud.
- Combination drain and breather available in brass, polyamide and stainless steel.

Options

- Nameplates: Lamacoid with different color combinations.
- Padlocking ability at left, center, right or any position on selector switches.
- Padlocking ability for momentary and maintained push buttons.
- Special contact arrangements available, see *Unicode 2 Series Customized Control Stations*.

Unicode™ 2 Series Polyamide Control Stations

Increased Safety

For use in IEC governed hazardous areas. Polyamide is not recognized for use in any NEC/CEC governed hazardous areas.

ATEX:

Zone 1 and 2 – 21 and 22

⊕ II 2 GD

Ex de IIC/Ex demb IIC/Ex tD A21

IP66 – IK09

ATEX Certifications and Compliances

- Certification Type PCe
 - Gas: Zone 1 and 2
 - Conforming to ATEX 94/9/CE: ⊕ II 2 G
 - Type of Protection: Ex de IIC/Ex demb IIC (depending of the actuator)
 - Temperature Class: T6
 - Dust: Zone 21 and 22
 - Conforming to ATEX 94/9/CE: ⊕ II 2 D
 - Type of Protection: Ex tD A21
 - Surface Temperature: T75 °C (T167 °F)
 - Ambient Temperature: -20 °C to +55 °C (-4 °F to +131 °F)
 - CE Declaration of Conformity: 50221
 - ATEX Certificate: LCIE 00 ATEX 6047
 - Index of Protection according EN/IEC 60529: IP66
 - Impact Resistance (shock): IK09

EURASEC Certification

- EURASEC RU C-FR Г505.B.00911

Other Certification ①

- INMETRO Certificate: BVC 11.0640-X

① INMETRO certification available on special request only. Contact your local sales representative for more information.

Unicode™ 2 Series Polyamide Control Stations

Increased Safety

For use in IEC governed hazardous areas. Polyamide is not recognized for use in any NEC/CEC governed hazardous areas.

ATEX:

Zone 1 and 2 – 21 and 22

II 2 GD















Ex de IIC/Ex demb IIC/Ex tD A21

IP66 – IK09

Size 1 Polyamide Control Station:

Included: 1 white self-adhesive laminated plastic nameplate, 2 x M20 bottom clearance entries, 1 blanking plug, 1 cable gland in polyamide [Ø 6.5 mm to 14.5 mm (0.26" to 0.57")], 2 locknuts.



Description/Function	Diagram	Bottom Entries	Weight kg (lb)	Volume dm ³ (in ³)	Catalog Number	
Momentary Push Button						
	Green insert "I" + red insert "O" with 1NO + 1NC momentary contacts		2 x M20	0.48 (1.06)	2.5 (152.56)	U41W2A3
	1x green push button "I" with 1NO momentary contact		2 x M20	0.48 (1.06)	2.5 (152.56)	U41W2A5
	1x red push button "O" with 1NC momentary contact		2 x M20	0.48 (1.06)	2.5 (152.56)	U41W2A9
Emergency Stop						
	Red mushroom head push-pull 1NC maintained contact		2 x M20	0.48 (1.06)	2.5 (152.56)	U41W2D9
	Red mushroom head push-pull 1NO + 1NC maintained contacts		2 x M20	0.48 (1.06)	2.5 (152.56)	U41W2D3
	Red mushroom head key release 1NC maintained contact		2 x M20	0.48 (1.06)	2.5 (152.56)	U41W2C9
	Red mushroom head key release 1NO + 1NC maintained contacts		2 x M20	0.48 (1.06)	2.5 (152.56)	U41W2C3
Mushroom Head Push Button						
	Black mushroom head push button 1NO + 1NC momentary contacts		2 x M20	0.48 (1.06)	2.5 (152.56)	U41W2B3
	Red mushroom head push button 1NC momentary contact		2 x M20	0.48 (1.06)	2.5 (152.56)	U41W2R9
Key Push Button						
	With key removable in both positions 1NO + 1NC maintained contacts		2 x M20	0.48 (1.06)	2.5 (152.56)	U41W2E3

Unicode™ 2 Series Polyamide Control Stations

Increased Safety

For use in IEC governed hazardous areas. Polyamide is not recognized for use in any NEC/CEC governed hazardous areas.

ATEX:
 Zone 1 and 2 – 21 and 22
 II 2 GD
 Ex de IIC/Ex demb IIC/Ex tD A21
 IP66 – IK09

CONTROLS: NEC/CEC, ATEX/IECex INCREASED SAFETY CONTROL STATIONS

Size 1 Polyamide Control Station:

Included: 1 white self-adhesive laminated plastic nameplate, 2 x M20 bottom clearance entries, 1 blanking plug, 1 cable gland in polyamide [Ø 6.5 mm to 14.5 mm (0.26" to 0.57")], 2 locknuts.



Description/Function	Diagram	Bottom Entries	Weight kg (lb)	Volume dm³ (in³)	Catalog Number
Pilot Light					
1x red pilot light ①		2 x M20	0.48 (1.06)	2.5 (152.56)	U41W2PR
1x green pilot light ①		2 x M20	0.48 (1.06)	2.5 (152.56)	U41W2PG
1x blue pilot light ①		2 x M20	0.48 (1.06)	2.5 (152.56)	U41W2PB
1x yellow pilot light ①		2 x M20	0.48 (1.06)	2.5 (152.56)	U41W2PY
1x white pilot light ①		2 x M20	0.48 (1.06)	2.5 (152.56)	U41W2PW

2-Position Selector Switch



2 fixed positions '0 - I'
 1NO + 1NC contacts

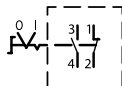

2 x M20 0.48 (1.06) 2.5 (152.56) U41W2H3

3-Position Selector Switch



3 fixed positions 'I - 0 - II'
 2NO contact

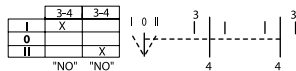

2 x M20 0.48 (1.06) 2.5 (152.56) U41W2J1

3 positions 'I - 0 - II'
 With spring return from I to 0
 1NO + 1NC contacts

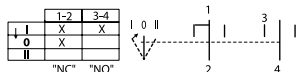

2 x M20 0.48 (1.06) 2.5 (152.56) U41W2N3

3 positions 'I - 0 - II'
 With spring return from II to 0
 1NO + 1NC contacts

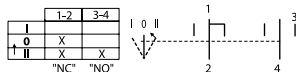

2 x M20 0.48 (1.06) 2.5 (152.56) U41W2M3

Size 2 Polyamide Control Station:

Included: 1 white self-adhesive laminated plastic nameplate, 2 x M20 bottom clearance entries, 1 blanking plug, 1 cable gland in polyamide [Ø 6.5 mm to 14.5 mm (0.26" to 0.57")], 2 locknuts.



Description/Function	Diagram	Bottom Entries	Weight kg (lb)	Volume dm³ (in³)	Catalog Number
Twin Push Button					
1x green push button 'I' with 1NO contact 1x red push button 'O' with 1NC contact Momentary contacts		2 x M20	0.62 (1.37)	2.5 (152.56)	U42W2A5A9
1x green push button 'I' with 1NO + 1NC contacts 1x red push button 'O' with 1NO + 1NC contacts Momentary contacts		2 x M20	0.62 (1.37)	2.5 (152.56)	U42W2A3A3

① 12 Vac to 254 Vac 50/60 Hz - 12 Vdc to 60 Vdc.

Unicode™ 2 Series Polyamide Control Stations

Increased Safety

For use in IEC governed hazardous areas. Polyamide is not recognized for use in any NEC/CEC governed hazardous areas.

ATEX:

Zone 1 and 2 – 21 and 22

II 2 GD



Ex de IIC/Ex demb IIC/Ex tD A21

IP66 – IK09

Size 2 Polyamide Control Station:

Included: 1 white self-adhesive laminated plastic nameplate, 2 x M20 bottom clearance entries, 1 blanking plug, 1 cable gland in polyamide [Ø 6.5 mm to 14.5 mm (0.26" to 0.57")], 2 locknuts.

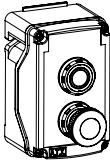
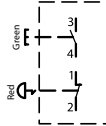
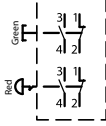
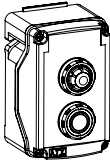

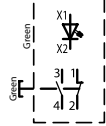
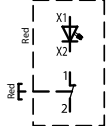
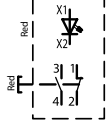
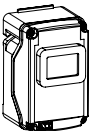
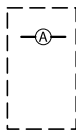
Description/Function	Diagram	Bottom Entries	Weight kg (lb)	Volume dm³ (in³)	Catalog Number
Push Button + Push-Pull Emergency Stop					
 <p>1x green push button 'I' with 1NO momentary contact 1x red mushroom head push-pull with 1NC maintained contact</p>		2 x M20	0.62 (1.37)	2.5 (152.56)	U42W2A5D9
		2 x M20	0.62 (1.37)	2.5 (152.56)	U42W2A3D3
Push Button + Push-Pull Emergency Stop					
 <p>1x green light ① 1x green push button 'I' with 1NO Momentary contact</p> <p>1x green light ① 1x green push button 'I' with 1NO + 1NC Momentary contacts</p> <p>1x red light ① 1x red push button 'O' with 1NC Momentary contact</p> <p>1x red light ① 1x red push button 'O' with 1NO + 1NC Momentary contacts</p>		2 x M20	0.62 (1.37)	2.5 (152.56)	U42W2PGA5
		2 x M20	0.62 (1.37)	2.5 (152.56)	U42W2PGA3
		2 x M20	0.62 (1.37)	2.5 (152.56)	U42W2PRA9
		2 x M20	0.62 (1.37)	2.5 (152.56)	U42W2PRA3
Ammeter					
 <p>1x ammeter 48 x 48 mm, (1.89" x 1.89") 1A C.T., 3 F.L.C., with 0 - 1 - 3 scale</p>		2 x M20	0.56 (1.23)	2.5 (152.56)	U42W2VA13

① 12 Vac to 254 Vac 50/60 Hz - 12 Vdc to 60 Vdc.

Unicode™ 2 Series Polyamide Control Stations

Increased Safety

For use in IEC governed hazardous areas. Polyamide is not recognized for use in any NEC/CEC governed hazardous areas.



ATEX:
 Zone 1 and 2 – 21 and 22
 II 2 GD
 Ex de IIC/Ex demb IIC/Ex tD A21
 IP66 – IK09

CONTROLS: NEC/CEC, ATEX/IECEx INCREASED SAFETY CONTROL STATIONS

Size 3 Polyamide Control Station:

Included: 1 white self-adhesive laminated plastic nameplate, 2 x M20 bottom clearance entries, 1 blanking plug, 1 cable gland in polyamide [Ø 6.5 mm to 14.5 mm (0.26" to 0.57")], 2 locknuts.

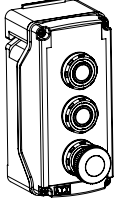
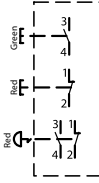
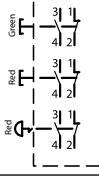
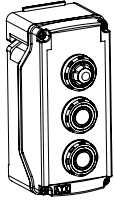
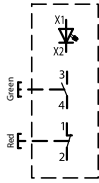
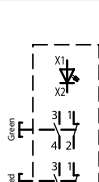
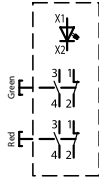

Description/Function	Diagram	Bottom Entries	Weight kg (lb)	Volume dm³ (in³)	Catalog Number
Twin Push Buttons + Push-Pull Emergency Stop					
 <p>1x green push button 'I' with 1NO contacts 1x red push button 'O' with 1NC contact Momentary contacts 1x red mushroom head push-pull emergency button with 1NO + 1NC maintained contacts</p>		2 x M20	0.78 (1.72)	2.5 (152.56)	U43W2A5A9D3
<p>1x green push button 'I' with 1NO + 1NC contacts 1x red push button 'O' with 1NO + 1NC contacts Momentary contacts 1x red mushroom head push-pull emergency button with 1NO + 1NC maintained contacts</p>		2 x M20	0.78 (1.72)	2.5 (152.56)	U43W2A3A3D3
Pilot Light + Twin Push Buttons					
 <p>1x green light ① 1x green push button 'I' with 1NO contact 1x red push button 'O' with 1NC contact Momentary contacts</p>		2 x M20	0.78 (1.72)	2.5 (152.56)	U43W2PGA5A9
<p>1x red light ① 1x green push button 'I' with 1NO contact 1x red push button 'O' with 1NO contact Momentary contacts</p>		2 x M20	0.78 (1.72)	2.5 (152.56)	U43W2PRA5A9
<p>1x green light ① 1x green push button 'I' with 1NO + 1NC contacts 1x red push button 'O' with 1NO + 1NC contacts Momentary contacts</p>		2 x M20	0.78 (1.72)	2.5 (152.56)	U43W2PGA3A3
<p>1x red light ① 1x green push button 'I' with 1NO + 1NC contacts 1x red push button 'O' with 1NO + 1NC contacts Momentary contacts</p>		2 x M20	0.78 (1.72)	2.5 (152.56)	U43W2PRA3A3

① 12 Vac to 254 Vac 50/60 Hz - 12 Vdc to 60 Vdc.

Unicode™ 2 Series Polyamide Control Stations

Increased Safety

For use in IEC governed hazardous areas. Polyamide is not recognized for use in any NEC/CEC governed hazardous areas.



ATEX:

Zone 1 and 2 – 21 and 22
 II 2 GD
 Ex de IIC/Ex demb IIC/Ex tD A21
 IP66 – IK09

Size 3 Polyamide Control Station:

Included: 1 white self-adhesive laminated plastic nameplate, 2 x M20 bottom clearance entries, 1 blanking plug, 1 cable gland in polyamide [Ø 6.5 mm to 14.5 mm (0.26" to 0.57")], 2 locknuts.

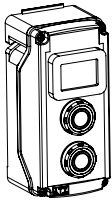
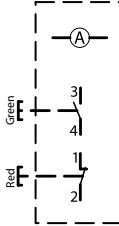
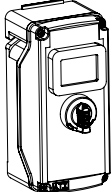
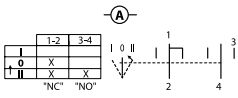

Description/Function	Diagram	Bottom Entries	Weight kg (lb)	Volume dm ³ (in ³)	Catalog Number
Ammeter + Twin Push Button					
 <p>1x ammeter 1.89 x 1.89 in/48 x 48 mm, 1A C.T., 3 F.L.C., with 0 - 1 - 3 scale 1x green push button 'I' with 1NO contact 1x red push button 'O' with 1NC contact Momentary contacts</p>		2 x M20	0.80 (1.76)	2.5 (152.56)	U43W2VA13A5A9
Ammeter + 3-Position Selector Switch					
 <p>1x ammeter 1.89 x 1.89 in/48 x 48 mm, 1A C.T., 3 F.L.C., with 0 - 1 - 3 scale 1x 3-position selector switch 'I - 0 - II' with spring return from II to 0 1NO + 1NC contacts</p>		2 x M20	0.80 (1.76)	2.5 (152.56)	U43W2VA13M3
Special Accessories for Polyamide Enclosure					
 <p>Brass Earthing Plate for 2 x M20 Equipped with 2 earth connections</p>					098661
 <p>Tube or Frame Fixing FOR SIZE 1 ONLY For all tube diameter ≥ 80 mm (3.15") Using a metal strip (not supplied) maximum width 22 mm (0.87")</p>					098656

CONTROL STATION: NEC/CEC, ATEX/IECEX INCREASED SAFETY CONTROL STATIONS



Unicode™ 2 Series Polyamide Control Station Accessories

Increased Safety

For use in IEC governed hazardous areas. Polyamide is not recognized for use in any NEC/CEC governed hazardous areas.

ATEX:
 Zone 1 and 2 – 21 and 22
 II 2 GD
 Ex de IIC/Ex demb IIC/Ex tD A21
 IP66 – IK09

CONTROLS: NEC/CEC, ATEX/IECEx INCREASED SAFETY CONTROL STATIONS

Nameplates – Set of 10

Blank self-adhesive, laminated plastic 58 mm x 18 mm (2.29" x 0.71").

Color	Catalog Number	Pack
White (black letters)	UNPW	1
Yellow (black letters)	UNPY	1
Red (white letters)	UNPR	1
Blue (white letters)	UNPB	1
Black (white letters)	UNPN	1
Green (white letters)	UNPG	1

Inserts for Push Button – Set of 5

Marking	Color	Catalog Number	Pack
(unmarked)	Green	UIAG	1
(unmarked)	Red	UIAR	1
(unmarked)	Yellow	UIAY	1
(unmarked)	White	UIAW	1
(unmarked)	Blue	UIAB	1
(unmarked)	Black	UIAN	1
ON	Green	UIA01	1
OFF	Red	UIA02	1
START	Green	UIA03	1
STOP	Red	UIA04	1
MARCHE	Green	UIA05	1
ARRET	Red	UIA06	1
I	Green	UIA07	1
O	Red	UIA08	1

Inserts for Illuminated Push Button – Set of 5

Marking	Color	Catalog Number	Pack
(unmarked)	Green	UILG	1
(unmarked)	Red	UILR	1
(unmarked)	Yellow	UILY	1
(unmarked)	White	UILW	1
(unmarked)	Blue	UILB	1
ON	Green	UIL01	1
OFF	Red	UIL02	1
START	Green	UIL03	1
STOP	Red	UIL04	1
MARCHE	Green	UIL05	1
ARRET	Red	UIL06	1
I	Green	UIL07	1
O	Red	UIL08	1

Spare Key

For all key-operated buttons.

Description	Catalog Number	Pack
Spare key type 4 A 185	SK4A185	1

Standard Legend Plates

Two sizes available. Self-adhesive yellow laminated plastic (black lettering).

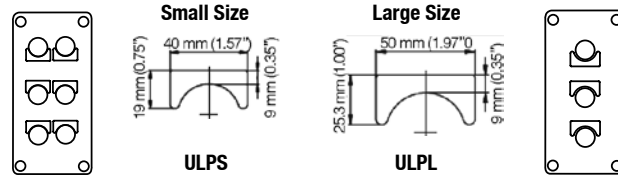

Text	Catalog Number		Pack
	Small	Large	
Blank (set of 10)	ULPS	ULPL	1
ON	ULPSA01	ULPLA01	1
OFF	ULPSA02	ULPLA02	1
FORWARD	ULPSA03	ULPLA03	1
REVERSE	ULPSA04	ULPLA04	1
JOG	ULPSA05	ULPLA05	1
RUN	ULPSA06	ULPLA06	1
START	ULPSA07	ULPLA07	1
STOP	ULPSA08	ULPLA08	1
UP	ULPSA09	ULPLA09	1
DOWN	ULPSA10	ULPLA10	1
FAST	ULPSA11	ULPLA11	1
SLOW	ULPSA12	ULPLA12	1
RAISE	ULPSA13	ULPLA13	1
LOWER	ULPSA14	ULPLA14	1
OPEN	ULPSA15	ULPLA15	1
CLOSE	ULPSA16	ULPLA16	1
LOW	ULPSA17	ULPLA17	1
HIGH	ULPSA18	ULPLA18	1
TEST	ULPSA19	ULPLA19	1
RESET	ULPSA20	ULPLA20	1
EMERGENCY STOP	ULPSA21	ULPLA21	1
MARCHE	ULPSA22	ULPLA22	1
ARRET	ULPSA23	ULPLA23	1
ARRET D'URGENCE	ULPSA24	ULPLA24	1
HAUT	ULPSA25	ULPLA25	1
BAS	ULPSA26	ULPLA26	1
O - I	ULPSH01	ULPLH01	1
ON - OFF	ULPSH02	ULPLH02	1
START - STOP	ULPSH03	ULPLH03	1
STOP - START	ULPSH04	ULPLH04	1
HAND - AUTO	ULPSH05	ULPLH05	1
MANU - AUTO	ULPSH06	ULPLH06	1
FORWARD - REVERSE	ULPSH07	ULPLH07	1
REMOTE - LOCAL	ULPSH08	ULPLH08	1
MARCHE - ARRET	ULPSH09	ULPLH09	1
I - O - II	ULPSJ01	ULPLJ01	1
OFF - O - ON	ULPSJ02	ULPLJ02	1
START - NORMAL - STOP	ULPSJ03	ULPLJ03	1
HAND - OFF - AUTO	ULPSJ04	ULPLJ04	1
MANU - O - AUTO	ULPSJ05	ULPLJ05	1
FORWARD - OFF - REVERSE	ULPSJ06	ULPLJ06	1
LOCAL - REMOTE - AUTO	ULPSJ07	ULPLJ07	1
LOCAL - O - REMOTE	ULPSJ08	ULPLJ08	1
MARCHE - NORMAL - ARRET	ULPSJ09	ULPLJ09	1

Unicode™ 2 Series Polyamide Control Station Accessories

Increased Safety

For use in IEC governed hazardous areas. Polyamide is not recognized for use in any NEC/CEC governed hazardous areas.

ATEX:

Zone 1 and 2 – 21 and 22

II 2 GD

Ex de IIC/Ex demb IIC/Ex tD A21

IP66 – IK09

	Description	Catalog Number
	Additional Contacts Each actuator is capable of activating 3 contacts. Exception: Illuminated push button and all actuators with key: 2 contacts maximum 1NO contact 1NC contact	UCB5R UCB9R
	Yellow Guard Mushroom head protection for emergency stop	098657
	Padlockable Guard Stainless steel and plastic cover, capacity: 3 padlocks diameter 6 mm (0.24") maximum (not supplied)	
	For push button and rotary actuator	UPLD1S
	For mushroom head actuator	UPLD2S
	Cable Gland Exe For unarmored cable Exe - IP66 - in polyamide entry thread seal M20 (capacity 6.5-14.5 mm)	095605
	For armored cable Exe/Exd - IP66 - in nickel plated brass (without entry thread seal)	
	Braid and Tape type: M20 (inner: 6.4-14.0/outer: 12.5-20.9 mm)	20E1FX5
	Single Wired Armor (SWA): M20 (inner: 6.4-14.0/outer: 12.5-20.9 mm)	20E1FW5
	Adaptors Exd/Exe - IP66 in nickel plated brass (without entry thread seal)	
	Male M20 - Female 1/2" NPT	737DM2T15
	Male M20 - Female 3/4" NPT	737DM2T25
	Entry Thread Seal M20 (in white nylon)	20ETS2
	Combination Drain and Breather Exe - IP66 - supplied with entry thread seal and locknut	
	M20 male thread in Polyamide	DBE20P
	M20 male thread in Brass	DBE20B
	M20 male thread in Stainless Steel	DBE20S
	Feed-Thru Earth Stud Terminal Exe - IP66 – supplied with weatherproof seal and green/yellow earth conductor – 300 mm (11.81") length M20 with M5 earth and 2.5 mm ² (0.004 in ²) conductor	PREESTM20

CONTROL STATION: NEC/CEC, ATEX/IECEX INCREASED SAFETY CONTROL STATIONS

Appleton

Unicode™ 2 Series Polyamide Control Stations

Increased Safety

For use in IEC governed hazardous areas. Polyamide is not recognized for use in any NEC/CEC governed hazardous areas.

ATEX:
 Zone 1 and 2 – 21 and 22
 II 2 GD
 Ex de IIC/Ex demb IIC/Ex tD A21
 IP66 – IK09

CONTROLS: NEC/CEC, ATEX/IECex INCREASED SAFETY CONTROL STATIONS

Dimensions in Millimeters (Inches)

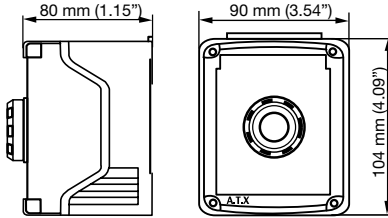

Size 1 Enclosure

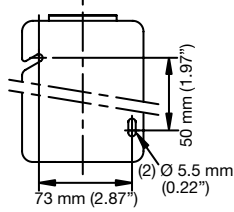

Size 1 Mounting/Fixing Details

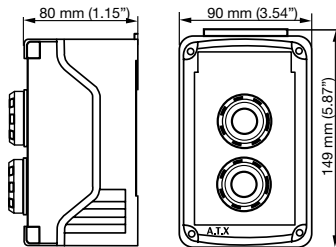

Size 2 Enclosure

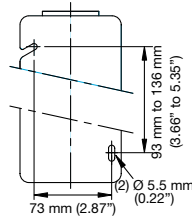

Size 2 and 3 Mounting/Fixing Details

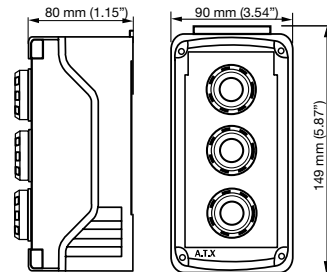

Size 3 Enclosure

Unicode™ 2 Series Customized Control Stations

Increased Safety

Polyamide, Fiberglass Reinforced Polyester, 316L Stainless Steel, Aluminum

NEC:

Class I, Division 2, Groups A, B, C, D
Class II, Groups E, F, G
Class III
Ex de IIC/DIP A21
IP66, Type 4X^①

CEC:

Class I, Division 2, Groups A, B, C, D
Class II, Groups F, G
Class III; Type 4X^①
Class I, Zone 1, AEx de IIC/ AEx tD 21
IP66

ATEX/IECEX:

Zone 1 and 2 – 21 and 22
Ⓢ II 2 GD
Ex de IIC/Ex demb IIC/ Ex tD A21
IP66 – IK10

Applications

- Local control stations and motor control stations for use in hazardous areas covering the broadest possible range of applications.
- Control of equipment at:
 - Power plants
 - Chemical and petrochemical plants
 - Petroleum refineries
 - Reverse osmosis plants
 - Pulp and paper processing plants
 - Various industrial applications
- Push buttons and selector switches are used in conjunction with contactors or magnetic starters for remote control of motors in hazardous locations. They provide circuit control and/or selection.
- Pilot lights provide visual assurance that an electrical function is being performed at a remote or hazardous location.
- For use in washdown areas.

Features

- Employs Ex de method of protection which eliminates the need for external seals.
- Operators include push buttons, illuminated push buttons, selector switches, control and load break switches and LED pilot lights.
- Pilot light employs high intensity single LED with lifetime of 100,000 hours that can be used at:
 - 12 Vac to 254 Vac 50/60 Hz
 - 12 Vdc to 60 Vdc
- Up to 3 contact blocks per actuator can be used.
- Contact block technical data:
 - IEC rated operating voltage (Ue): 500 Vac – 110 Vdc
 - IEC switching capacity:
 - AC 12: 16 Amps/400 Vac
 - AC 14: 10 Amps/400 Vac
 - AC 15: 6 Amps/500 Vac
 - DC 13: 2 Amps/24 Vdc and 1 Amp/110 Vdc
 - NEMA switching capacity: A600: 10 Amp/600 Vac
- Selector switch technical data:
 - IEC rated operating voltage: 690 Vac
 - IEC rated operating current: maximum 16 Amps
 - IEC switching capacity:
 - AC1: 16 Amps/690 Vac
 - AC15: 16 Amps/415 Vac
 - AC3: 8 Amps/500 Vac
 - AC3: 4 Amps/690 Vac
 - AC3: 16 Amps/690 Vac
 - DC1: 10 Amps/24 Vdc
 - DC1: 6 Amps/60 Vdc
 - DC1: 6 Amp/110 Vdc (2 contacts wired in series)
 - DC1: 6 Amp/220 Vdc (3 contacts in series)
 - NEMA switching capacity: A600: 10 Amps/600 Vac
- Enclosures are rated for IP66 with firmly secured gasket.
- Operators and contact blocks are spaced for easy wiring.
- Wide selection of termination methods available.
- Choice of DIN rail mounted high performance contact block suitable for low intensity (less than 5 mA).
- TS35 rail mounted components held securely in place during operation and easily removed for service.
- Brass Inserts are provided for TS35 DIN rails or mounting plate to be installed inside the enclosure.



Polyester



Polyamide



Stainless Steel



Aluminum

- Captive, corrosion resistant stainless steel cover screws.

Standard Materials

- Polyamide
 - Body, cover, cable gland and blanking plug: polyamide, black finish
- Fiberglass Reinforced Polyester (FRP)
 - Body and cover: fiberglass reinforced polyester, black finish
- Stainless Steel
 - Body, cover and cover screws: 316L stainless steel, natural finish
- Aluminum
 - Body and cover: aluminum with gray epoxy powder coating.
- Cable gland and blanking plug: polyamide
- Cover screws for 316L stainless steel or aluminum body: 304 stainless steel
- Cover screws for fiberglass reinforced polyester body: 316 stainless steel
- Optional nameplates: stainless steel

Accessories

- Key for changing actuator blocks.
- Guard for mushroom head actuator.
- Padlockable guard.
- M5 and M6 earth stud.
- Combination drain and breather available in brass, polyamide and stainless steel.

^① Overall hazardous location and ingress protection rating depends on the rating of the optional certified components used.

Unicode™ 2 Series Customized Control Stations

Increased Safety

Polyamide, Fiberglass Reinforced Polyester, 316L Stainless Steel, Aluminum

NEC:
Class I, Division 2, Groups A, B, C, D
Class II, Groups E, F, G
Class III
Ex de IIC/DIP A21
IP66, Type 4X^①

CEC:
Class I, Division 2, Groups A, B, C, D
Class II, Groups F, G
Class III; Type 4X^①
Class I, Zone 1, AEx de IIC/ AEx tD 21
IP66

ATEX/IECEx:
Zone 1 and 2 – 21 and 22
Ex de IIC/Ex demb IIC/ Ex tD A21
IP66 – IK10

Options

- Nameplates: Lamacoid with different color combinations.
- Padlocking facility at left, center, right or any position on selector switches.
- Padlocking facility for momentary and maintained push buttons.

NEC/CEC Certifications and Compliances

- Fiberglass Reinforced Polyester (FRP)
 - Certification Type CSPe
 - Temperature Class: T5 or T6
 - Ambient Temperature: -55 °C to +60 °C (-67 °F to +140 °F)
 - CAN/CSA Standards: C22.2 No. 0-M91, No. 25-M66, No. 213-M1987, No. 94-M91, No. 60079-0:07, No. 60529-2005, E60079-7-2003
 - UL Standards: 60079-0, 60079-7, 50
 - Other Standards: ANSI/IEC 60529-2004, ANSI/ISA 12.12.01-2011
 - cCSAus Certificate: 2356952
- Stainless Steel
 - Certification Type JBe
 - Temperature Class: T6 (at +40 °C) or T5 (at +55 °C)
 - Surface Temperature: T80 °C (at +40 °C) to T95 °C (at +55 °C) (T176 °F to T203 °F)
 - Ambient Temperature: -40 °C to +55 °C (-40 °F to +131 °F)
 - CAN/CSA Standard: C22.2 No. 0-M91, No. 25-M66, No. 213-M1987, No. 60079-0:07, No. 60529-2005, E60079-7-2003
 - UL Standard: 60079-0, 60079-7
 - Other Standards: ANSI/IEC60529-2004, ANSI/ISA 12.12.01-2011
 - cCSAus Certificate: 2356734

ATEX/IECEx Certification and Compliances

- Polyamide
 - Certification Type PCe
 - Gas: Zone 1 and 2
 - Conforming to ATEX 94/9/CE: Ex II 2 G
 - Type of Protection: Ex de IIC/Ex demb IIC
 - Temperature Class: T6
 - Dust: Zone 21 and 22
 - Conforming to ATEX 94/9/CE: Ex II2 D
 - Type of Protection: Ex tD A21
 - Surface Temperature: T75 °C (T167 °F)
 - Ambient Temperature: -20 °C to +55 °C (-4 °F to +131 °F)
 - CE Declaration of Conformity: 50221
 - ATEX Certificate: LCIE 00 ATEX 6047
 - Index of Protection according EN/IEC 60529: IP66
 - Impact Resistance (shock): IK09
- Fiberglass Reinforced Polyester (FRP)
 - Certification Type CSPe
 - Gas: Zone 1 and 2
 - Conforming to ATEX 94/9/CE: Ex II 2 G
 - Type of Protection: Ex de IIC/Ex demb IIC
 - Temperature Class: T6
 - Dust: Zone 21 and 22
 - Conforming to ATEX 94/9/CE: Ex II2 D
 - Type of Protection: Ex tD A21
 - Surface Temperature: T75 °C (T167 °F)
 - Ambient Temperature: -55 °C to +60 °C (-67 °F to +140 °F) (empty enclosure, temperature to be determine according actuator)

- CE Declaration of Conformity: 52084
- ATEX Certificate: LCIE 00 ATEX 3032X
- IECEx Certificate: IECEx LCI 09.0016X
- Stainless Steel
 - Certification Type JBe
 - Gas: Zone 1 and 2
 - Conforming to ATEX 94/9/CE: Ex II 2 G
 - Type of Protection: Ex de IIC/Ex demb IIC
 - Temperature Class: T5 to T6
 - Dust: Zone 21 and 22
 - Conforming to ATEX 94/9/CE: Ex II2 D
 - Type of Protection: Ex tD A21
 - Surface Temperature: T80 °C to T95 °C (T176 °F to T203 °F)
 - Ambient Temperature: -50 °C to +70 °C (-58 °F to +158 °F) (empty enclosure, temperature to be determine according actuator)
 - CE Declaration of Conformity: 50232
 - ATEX Certificate: LCIE 02 ATEX 6118X
 - IECEx Certificate: LCI 11.0008X
 - Index of Protection according EN/IEC 60529: IP66
 - Impact Resistance (shock): IK10
- Aluminum
 - Certification Type PCe
 - Gas: Zone 1 and 2
 - Conforming to ATEX 94/9/CE: Ex II 2 G
 - Type of Protection: Ex de IIC/Ex demb IIC
 - Temperature Class: T6
 - Dust: Zone 21 and 22
 - Conforming to ATEX 94/9/CE: Ex II2 D
 - Type of Protection: Ex tD A21
 - Surface Temperature: T75 °C (T167 °F)
 - Ambient Temperature: -55 °C to +60 °C (-67 °F to +140 °F) (empty enclosure, temperature to be determine according actuator)
 - CE Declaration of Conformity: 50221
 - ATEX Certificate: LCIE 02 ATEX 6047
 - Index of Protection according EN/IEC 60529: IP66
 - Impact Resistance (shock): IK10

EURASEC Certification

- Certification Type PCe (Polyamide)
 - EURASEC RU C-FR 6505.B.00911
- Certification Type CSPe (Fiberglass Reinforced Polyester)
 - EURASEC RU C-FR 6505.B.00911
- Certification Type JBe (Stainless Steel)
 - EURASEC RU C-FR 6505.B.00911
- Certification Type PCe (Aluminum)
 - EURASEC RU C-FR 6505.B.00911

Other Certification ^②

- Certification Type PCe (Polyamide)
 - INMETRO Certificate: BVC 11.0640-X
- Certification Type CSPe (Fiberglass Reinforced Polyester)
 - INMETRO Certificate: BVC 11.0637-X
- Certification Type JBe (Stainless Steel)
 - INMETRO Certificate: BVC 11.0418-X

^① Overall hazardous location and ingress protection rating depends on the rating of the optional certified components used.

^② INMETRO certification available on special request only. Contact your local sales representative for more information.

Unicode™ 2 Series Customized Control Stations

Increased Safety

Polyamide, Fiberglass Reinforced Polyester, 316L Stainless Steel, Aluminum

NEC:

Class I, Division 2, Groups A, B, C, D
 Class II, Groups E, F, G
 Class III
 Ex de IIC/DIP A21
 IP66, Type 4X^①

CEC:

Class I, Division 2, Groups A, B, C, D
 Class II, Groups F, G
 Class III; Type 4X^①
 Class I, Zone 1, AEx de IIC/ AEx tD 21
 IP66

ATEX/IECEX:

Zone 1 and 2 – 21 and 22
 Ex II 2 GD
 Ex de IIC/Ex demb IIC/ Ex tD A21
 IP66 – IK10

Catalog Numbering Guide - Unicode 2 Enclosures

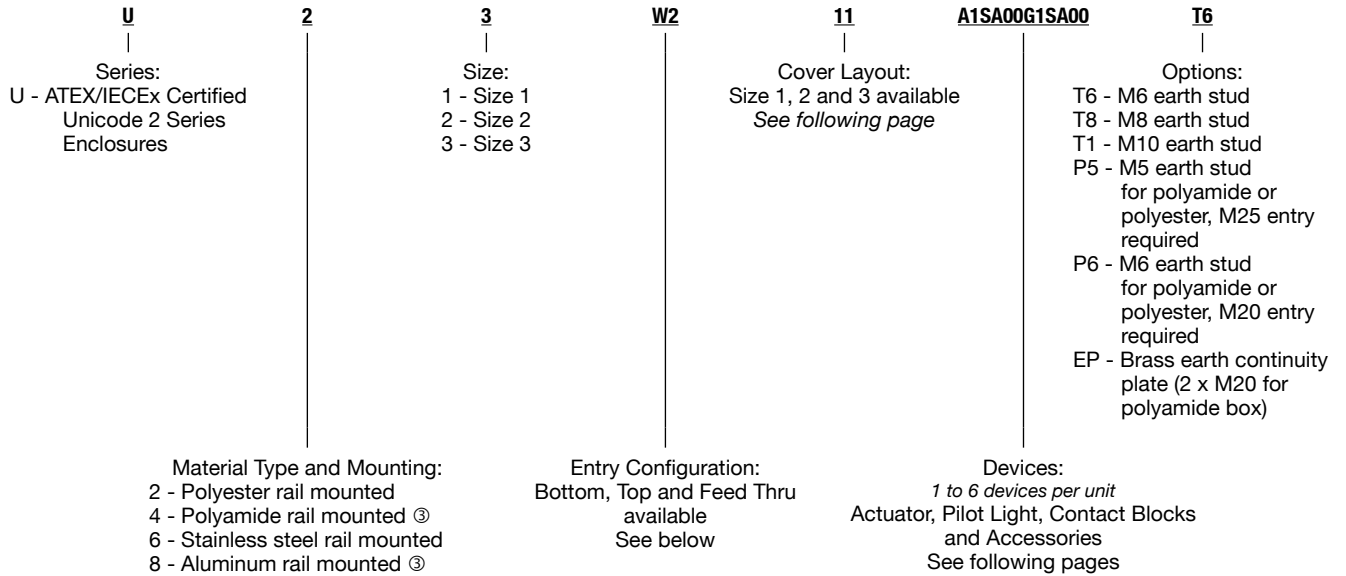

Entry Configuration

	NPT					Metric			
	1/2"	2 x 1/2"	3/4"	2 x 3/4"	1"	M20	2 x M20 ^②	M25	2 x M25
Bottom	Z1	Z2	Z3	Z4	Z5	W1	W2	W3	W4
Top	Y1	Y2	Y3	Y4	Y5	V1	V2	V3	V4
Feed Thru	X1	X2	X3	X4	X5	U1	U2	U3	U4

^① Overall hazardous location and ingress protection rating depends on the rating of the optional certified components used.

^② Polyamide versions: Only 2 x M20 available at bottom.

^③ Not recognized for use in any NEC/CEC governed hazardous areas.

Unicode™ 2 Series Customized Control Stations

Increased Safety

Polyamide, Fiberglass Reinforced Polyester, 316L Stainless Steel, Aluminum

NEC:
 Class I, Division 2, Groups A, B, C, D
 Class II, Groups E, F, G
 Class III
 Ex de IIC/DIP A21
 IP66, Type 4X^①

CEC:
 Class I, Division 2, Groups A, B, C, D
 Class II, Groups F, G
 Class III; Type 4X^①
 Class I, Zone 1, AEx de IIC/ AEx tD 21
 IP66

ATEX/IECEX:
 Zone 1 and 2 – 21 and 22
 Ex II 2 GD
 Ex de IIC/Ex demb IIC/ Ex tD A21
 IP66 – IK10

CONTROLS: NEC/CEC, ATEX/IECEX INCREASED SAFETY CONTROL STATIONS

Drilled Cover Layout

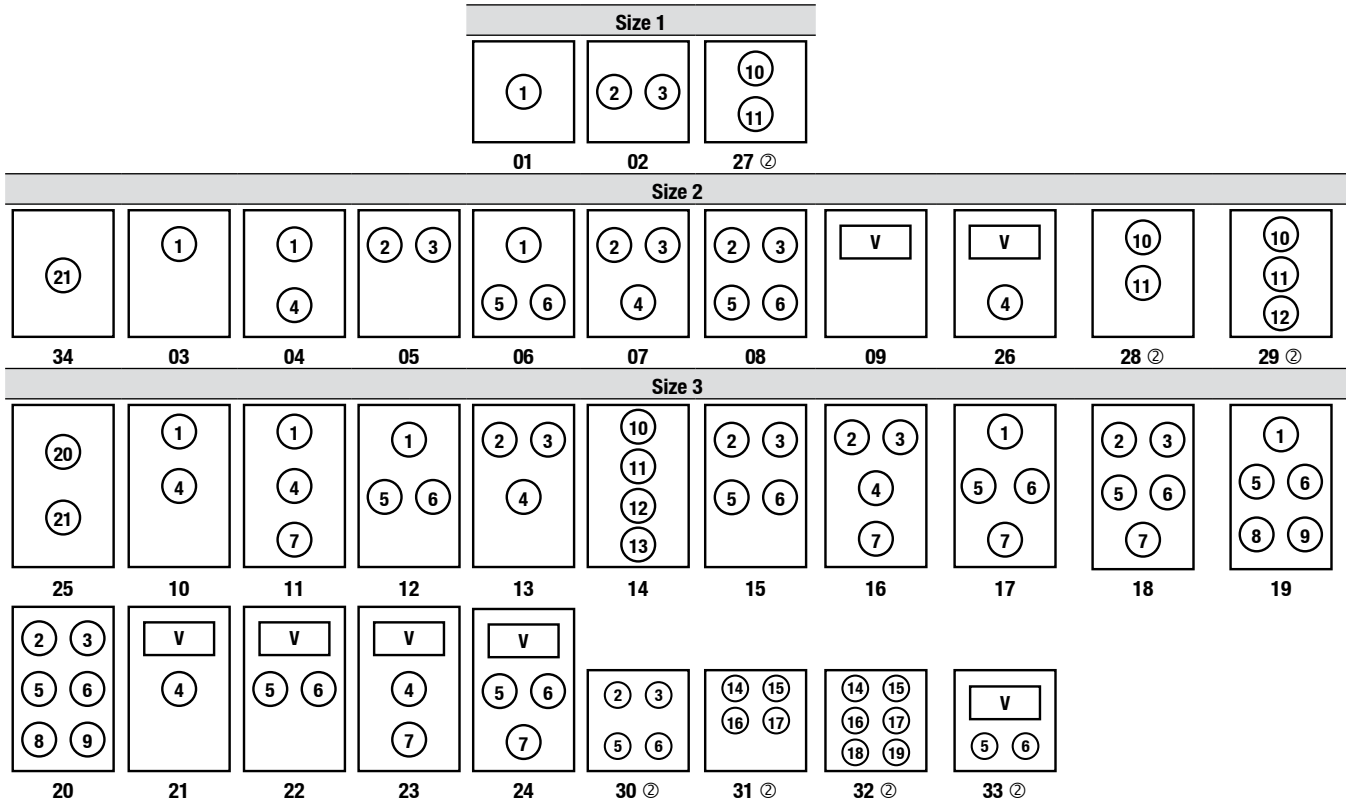

Device Examples with Options

Description	
Push button with 1 NO contact and green (unmarked) insert	A5G
Push button with 1 NC contact, padlocking device and red (unmarked) insert	A92R
Push button with 2 NO contacts and START green insert	A103
Push button with 2 NO contacts, padlocking device and START green insert	A1203
Push button with 2 NO contacts, padlocking device, START green insert and DOWN small legend plate	A1203SA10
Red push-pull emergency stop mushroom head with 2 NC contacts and padlocking device	D23
Red push-pull emergency stop mushroom head with 1 NO + 1 NC contacts and protective guard	D31
Red push-pull emergency stop mushroom head with 1 NO + 1 NC contacts and padlocking device	D33
Green illuminated push button with 1 NO contact	LG5
Green illuminated push button with 2 NO contacts, padlocking device and START green insert	LG1203

Description	
Green pilot light	PG
Red pilot light with STOP large legend plate	PRLA08
2-position rotary actuator with 2 NO contacts and padlocking device	H12
2-position rotary actuator with 2 NO contacts and HAND—AUTO small legend plate	H1SH05
3-position I—O—II rotary actuator (I + II maintained) with 2 NO contacts	J1
3-position I—O—II rotary actuator (I + II maintained) with 2 NO contacts and FORWARD—OFF—REVERSE large legend plate	J1LJ06
2-position 2-pole switch	US32
2-position 2-pole switch with 0—I large legend plate	US32 LH01
2-position 4-pole switch	US35
2-position 4-pole switch with 0—I large legend plate	US35LH01
2 position 2-pole selector switch with STOP—START large legend plate	US30LH04
3 position 2-pole selector switch with OFF—0—ON large legend plate	US31LJ02

^① Overall hazardous location and ingress protection rating depends on the rating of the optional certified components used.
^② Stainless steel version only.

Unicode™ 2 Series Customized Control Station Functions

Increased Safety

Polyamide, Fiberglass Reinforced Polyester, 316L Stainless Steel, Aluminum

NEC:

Class I, Division 2, Groups A, B, C, D
Class II, Groups E, F, G
Class III
Ex de IIC/DIP A21
IP66, Type 4X^①

CEC:

Class I, Division 2, Groups A, B, C, D
Class II, Groups F, G
Class III; Type 4X^①
Class I, Zone 1, AEx de IIC/ AEx tD 21
IP66

ATEX/IECEx:

Zone 1 and 2 – 21 and 22
II 2 GD
Ex de IIC/Ex demb IIC/ Ex tD A21
IP66 – IK10

Devices	
Push Buttons, Momentary Contacts (3 maximum)	
With 2 NO momentary contacts	A1
With 2 NC momentary contacts	A2
With 1 NO + 1 NC momentary contacts	A3
With 2 NO + 1 NC momentary contacts	A4
With 1 NO momentary contact	A5
With 1 NO + 2 NC momentary contacts	A6
With 3 NO momentary contacts	A7
With 3 NC momentary contacts	A8
With 1 NC momentary contact	A9
Guard and Padlocking Devices	
Guard for mushroom head push button	1
Padlocking device for push button and rotary actuator	2
Padlocking device for mushroom head push button	3
Inserts for Push Buttons and Illuminated Push Buttons	
Green (unmarked)	G
Red (unmarked)	R
Yellow (unmarked)	Y
White (unmarked)	W
Blue (unmarked)	B
Black (unmarked)	N
ON (green)	01
OFF (red)	02
START (green)	03
STOP (red)	04
MARCHE (green)	05
ARRET (red)	06
I (green)	07
O (red)	08

Legend Plates		
Legend Plates for Push Buttons and Pilot Lights <i>(Located Above Device)</i>		
Text	Small	Large
Blank	SA00	LA00
ON	SA01	LA01
OFF	SA02	LA02
FORWARD	SA03	LA03
REVERSE	SA04	LA04
JOG	SA05	LA05
RUN	SA06	LA06
START	SA07	LA07
STOP	SA08	LA08
UP	SA09	LA09
DOWN	SA10	LA10
FAST	SA11	LA11
SLOW	SA12	LA12
RAISE	SA13	LA13
LOWER	SA14	LA14
OPEN	SA15	LA15
CLOSE	SA16	LA16
LOW	SA17	LA17
HIGH	SA18	LA18
TEST	SA19	LA19
RESET	SA20	LA20

Legend Plates (Continued)		
Legend Plates for Push Buttons and Pilot Lights <i>(Located Above Device)</i>		
EMERGENCY STOP	SA21	LA21
MARCHE	SA22	LA22
ARRET	SA23	LA23
ARRET D'URGENCE	SA24	LA24
HAUT	SA25	LA25
BAS	SA26	LA26

Devices	
Illuminated Push Buttons, Momentary Contacts (2 maximum)	
Green with 2 NO momentary contacts	LG1
Green with 2 NC momentary contacts	LG2
Green with 1 NO + 1 NC momentary contacts	LG3
Green with 1 NO momentary contacts	LG5
Green with 1 NC momentary contacts	LG9
Red with 2 NO momentary contacts	LR1
Red with 2 NC momentary contacts	LR2
Red with 1 NO + 1 NC momentary contacts	LR3
Red with 1 NO momentary contacts	LR5
Red with 1 NC momentary contacts	LR9
<i>For other colors replace 2nd letter to B for Blue, W for White and Y for Yellow. Example: Blue – LB1</i>	

Device Options	
Push buttons complete with key removable in both positions (2 contacts maximum)	
With 2 NO contacts	E1
With 2 NC contacts	E2
With 1 NO + 1 NC contacts	E3
With 1 NO contact	E5
With 1 NC contact	E9
Push buttons complete with key removable in ON position (2 contacts maximum)	
With 2 NO contacts	F1
With 2 NC contacts	F2
With 1 NO + 1 NC contacts	F3
With 1 NO contact	F5
With 1 NC contact	F9
Push buttons complete with key removable in OFF position (2 contacts maximum)	
With 2 NO contacts	G1
With 2 NC contacts	G2
With 1 NO + 1 NC contacts	G3
With 1 NO contact	G5
With 1 NC contact	G9

^① Overall hazardous location and ingress protection rating depends on the rating of the optional certified components used.

Unicode™ 2 Series Customized Control Station Functions

Increased Safety

Polyamide, Fiberglass Reinforced Polyester, 316L Stainless Steel, Aluminum

NEC:
Class I, Division 2, Groups A, B, C, D
Class II, Groups E, F, G
Class III
Ex de IIC/DIP A21
IP66, Type 4X①

CEC:
Class I, Division 2, Groups A, B, C, D
Class II, Groups F, G
Class III; Type 4X①
Class I, Zone 1, AEx de IIC/ AEx tD 21
IP66

ATEX/IECEx:
Zone 1 and 2 – 21 and 22
II 2 GD
Ex de IIC/Ex demb IIC/ Ex tD A21
IP66 – IK10

CONTROLS: NEC/CEC, ATEX/IECEx INCREASED SAFETY CONTROL STATIONS

Appleton

Device Options	
Black Mushroom Head Push Buttons, Momentary Contacts (3 maximum)	
With 2 NO momentary contacts	B1
With 2 NC momentary contacts	B2
With 1 NO + 1 NC momentary contacts	B3
With 2 NO + 1 NC momentary contacts	B4
With 1 NO momentary contact	B5
With 1 NO + 2 NC momentary contacts	B6
With 3 NO momentary contacts	B7
With 3 NC momentary contacts	B8
With 1 NC momentary contact	B9

Devices	
Red Mushroom Head Push Buttons, Momentary Contacts (3 maximum)	
With 2 NO momentary contacts	R1
With 2 NC momentary contacts	R2
With 1 NO + 1 NC momentary contacts	R3
With 2 NO + 1 NC momentary contacts	R4
With 1 NO momentary contact	R5
With 1 NO + 2 NC momentary contacts	R6
With 3 NO momentary contacts	R7
With 3 NC momentary contacts	R8
With 1 NC momentary contact	R9

Red Mushroom Head Emergency Stop Buttons, Maintained (3 contacts maximum)	
Push-pull version with 2 NO maintained contacts	D1
Push-pull version with 2 NC maintained contacts	D2
Push-pull version with 1 NO + 1 NC maintained contacts	D3
Push-pull version with 2 NO + 1 NC maintained contacts	D4
Push-pull version with 1 NO maintained contact	D5
Push-pull version with 1 NO + 2 NC maintained contacts	D6
Push-pull version with 3 NO maintained contacts	D7
Push-pull version with 3 NC maintained contacts	D8
Push-pull version with 1 NC maintained contact	D9

Red Mushroom Head Emergency Stop Buttons, Maintained Contacts (2 maximum)	
Key to release with 2 NO maintained contacts	C1
Key to release with 2 NC maintained contacts	C2
Key to release with 1 NO + 1 NC maintained contacts	C3
Key to release with 1 NO maintained contact	C5
Key to release with 1 NC maintained contact	C9

LED Pilot Lights	
Blue color	PB
Green color	PG
Red color	PR
White color	PW
Yellow color	PY

Devices	
2 Positions O-I Rotary Actuator (O and I Maintained)	
With 2 NO maintained contacts	H1
With 2 NC maintained contacts	H2
With 1 NO + 1 NC maintained contacts	H3
With 2 NO + 1 NC maintained contacts	H4
With 1 NO maintained contact	H5
With 1 NO + 2 NC maintained contacts	H6
With 3 NO maintained contacts	H7
With 3 NC maintained contacts	H8
With 1 NC maintained contact	H9

Legend Plates for 2-Position Selector Switches (Located Above Device)			
Text	Small	Large	
O-I	SH01	LH01	
ON-OFF	SH02	LH02	
START-STOP	SH03	LH03	
STOP-START	SH04	LH04	
HAND-AUTO	SH05	LH05	
MANU-AUTO	SH06	LH06	
FORWARD-REVERSE	SH07	LH07	
REMOTE-LOCAL	SH08	LH08	
MARCHE-ARRET	SH09	LH09	

3 Positions I-O-II Rotary Actuator (I and II maintained)	
With 2 NO maintained contacts	J1
With 2 NC maintained contacts	J2
With 1 NO + 1 NC maintained contacts	J3
With 2 NO + 1 NC maintained contacts	J4
With 1 NO + 2 NC maintained contacts	J6
With 3 NO maintained contacts	J7
With 3 NC maintained contacts	J8

3 Positions I-O-II Rotary Actuator (I and II spring-return to O)	
With 2 NO contacts	K1
With 2 NC contacts	K2
With 1 NO + 1 NC contacts	K3
With 2 NO + 1 NC contacts	K4
With 1 NO + 2 NC contacts	K6
With 3 NO contacts	K7
With 3 NC contacts	K8

3 Positions I-O-II Rotary Actuator (I Maintained and II Spring-Return to O)	
With 2 NO contacts	M1
With 2 NC contacts	M2
With 1 NO + 1 NC contacts	M3
With 2 NO + 1 NC contacts	M4
With 1 NO + 2 NC contacts	M6
With 3 NO contacts	M7
With 3 NC contacts	M8

3 Positions I-O-II Rotary Actuator (I Spring-Return to O + II Maintained)	
With 2 NO contacts	N1
With 2 NC contacts	N2
With 1 NO + 1 NC contacts	N3
With 2 NO + 1 NC contacts	N4
With 1 NO + 2 NC contacts	N6
With 3 NO contacts	N7
With 3 NC contacts	N8

① Overall hazardous location and ingress protection rating depends on the rating of the optional certified components used.

Unicode™ 2 Series Customized Control Station Functions

Increased Safety

Polyamide, Fiberglass Reinforced Polyester, 316L Stainless Steel, Aluminum

NEC:

Class I, Division 2, Groups A, B, C, D
Class II, Groups E, F, G
Class III
Ex de IIC/DIP A21
IP66, Type 4X①

CEC:

Class I, Division 2, Groups A, B, C, D
Class II, Groups F, G
Class III; Type 4X①
Class I, Zone 1, AEx de IIC/ AEx tD 21
IP66

ATEX/IECEx:

Zone 1 and 2 – 21 and 22
② II 2 GD
Ex de IIC/Ex demb IIC/ Ex tD A21
IP66 – IK10

Devices	
16A Selector Switches ② Other contact arrangements are available, contact your local sales representative.	
2 position 2-pole Selector switch	US30
3 position 2-pole Selector switch	US31
2 position 2-pole switch	US32
3 position 2-pole Selector switch with spring return from 135° to 90°	US33
3 position 2-pole Selector switch with spring return from 45° to 90°	US34
2 position 4-pole switch	US35
3 position 4-pole Selector switch	US36
2 position 4-pole Selector switch	US37
3 position 3-pole Selector switch with spring return from 45° to 90°	US38
3 position 3-pole Selector switch with spring return from 135° to 90°	US39

Legend Plates for 3-Position Selector Switches

(Located Above Device)

Text	Small	Large
I—O—II	SJ01	LJ01
OFF—O—ON	SJ02	LJ02
START—NORMAL—STOP	SJ03	LJ03
HAND—OFF—AUTO	SJ04	LJ04
MANUAL—O—AUTO	SJ05	LJ05
FORWARD—OFF—REVERSE	SJ06	LJ06
LOCAL—REMOTE—AUTO	SJ07	LJ07
LOCAL—O—REMOTE	SJ08	LJ08
MARCHE—NORMAL—ARRET	SJ09	LJ09

Devices	
Ammeters 48 x 48 mm ③	
1A C.T. and 3 F.L.C. with 0-1-3 scale	VA13
1A C.T. and 5 F.L.C. with 0-1-5 scale	VA15
1A C.T. and 6 F.L.C. with 0-1-6 scale	VA16
5A C.T. and 3 F.L.C. with 0-1-3 scale	VA53
5A C.T. and 5 F.L.C. with 0-1-5 scale	VA55
5A C.T. and 6 F.L.C. with 0-1-6 scale	VA56
Box Options	
Earth Stud	
M6 earth stud	T6
M8 earth stud	T8
M10 earth stud	T1
M5 earth stud for polyamide or polyester, M20 entry required	P5
M6 earth stud for polyamide or polyester, M25 entry required	P6
Earth Continuity Plate	
Brass	EP
Plug	
Cover blanking plug	BP

① Overall hazardous location and ingress protection rating depends on the rating of the optional certified components used.

② Additional configurations available. See Unicode 2 Series 16 Amp Switches in the Component and Accessories section. Choose the contact arrangement, then add the last four digits of the switch part number in the custom configured control station catalog number.

③ Ammeters are not NEC/CEC Certified.

Unicode™ 2 Series Customized Control Stations Ordering Example

Increased Safety

Polyamide, Fiberglass Reinforced Polyester, 316L Stainless Steel, Aluminum

NEC:
 Class I, Division 2, Groups A, B, C, D
 Class II, Groups E, F, G
 Class III
 Ex de IIC/DIP A21
 IP66, Type 4X[Ⓛ]

CEC:
 Class I, Division 2, Groups A, B, C, D
 Class II, Groups F, G
 Class III; Type 4X[Ⓛ]
 Class I, Zone 1, AEx de IIC/ AEx tD 21
 IP66

ATEX/IECEx:
 Zone 1 and 2 – 21 and 22
 II 2 GD
 Ex de IIC/Ex demb IIC/ Ex tD A21
 IP66 – IK10

CONTROLS: NEC/CEC, ATEX/IECEx INCREASED SAFETY CONTROL STATIONS

Ordering Example:



Polyester Customized Control Station Specifications – Type U2

Polyester Customized Control Station Specifications – Type: U4																																																																						
Company Name: _____	Address: _____																																																																					
Contact: _____	Project: _____																																																																					
Phone/Fax: _____																																																																						
Email: _____																																																																						
Box Definition																																																																						
<table border="1"> <tr> <th>Size 1</th> <th colspan="2">Size 2</th> </tr> <tr> <td> <table border="1"> <tr> <td>1</td> <td>2 3</td> </tr> <tr> <td>01 <input type="checkbox"/></td> <td>02 <input type="checkbox"/></td> </tr> </table> </td> <td colspan="2"> <table border="1"> <tr> <td>1</td> <td>2 3</td> <td>2 3</td> <td>1</td> <td>2 3</td> <td>2 3</td> <td>2 3</td> <td>V</td> <td>V</td> </tr> <tr> <td>03 <input type="checkbox"/></td> <td>04 <input type="checkbox"/></td> <td>05 <input type="checkbox"/></td> <td>06 <input type="checkbox"/></td> <td>07 <input type="checkbox"/></td> <td>08 <input type="checkbox"/></td> <td>09 <input type="checkbox"/></td> <td>20 <input type="checkbox"/></td> <td>26 <input type="checkbox"/></td> </tr> </table> </td> </tr> <tr> <th colspan="3">Size 3</th> </tr> <tr> <td> <table border="1"> <tr> <td>20</td> <td>1</td> <td>1</td> <td>1</td> <td>2 3</td> <td>2 3</td> <td>2 3</td> <td>2 3</td> <td>1</td> <td>2 3</td> <td>2 3</td> <td>2 3</td> <td>2 3</td> <td>V</td> <td>V</td> <td>V</td> <td>V</td> </tr> <tr> <td>28 <input type="checkbox"/></td> <td>10 <input type="checkbox"/></td> <td>11 <input checked="" type="checkbox"/></td> <td>12 <input type="checkbox"/></td> <td>13 <input type="checkbox"/></td> <td>14 <input type="checkbox"/></td> <td>15 <input type="checkbox"/></td> <td>16 <input type="checkbox"/></td> <td>17 <input type="checkbox"/></td> <td>18 <input type="checkbox"/></td> <td>19 <input type="checkbox"/></td> <td>20 <input type="checkbox"/></td> <td>21 <input type="checkbox"/></td> <td>22 <input type="checkbox"/></td> <td>23 <input type="checkbox"/></td> <td>24 <input type="checkbox"/></td> <td>27 <input type="checkbox"/></td> </tr> </table> </td> <td colspan="2"></td> </tr> </table>			Size 1	Size 2		<table border="1"> <tr> <td>1</td> <td>2 3</td> </tr> <tr> <td>01 <input type="checkbox"/></td> <td>02 <input type="checkbox"/></td> </tr> </table>	1	2 3	01 <input type="checkbox"/>	02 <input type="checkbox"/>	<table border="1"> <tr> <td>1</td> <td>2 3</td> <td>2 3</td> <td>1</td> <td>2 3</td> <td>2 3</td> <td>2 3</td> <td>V</td> <td>V</td> </tr> <tr> <td>03 <input type="checkbox"/></td> <td>04 <input type="checkbox"/></td> <td>05 <input type="checkbox"/></td> <td>06 <input type="checkbox"/></td> <td>07 <input type="checkbox"/></td> <td>08 <input type="checkbox"/></td> <td>09 <input type="checkbox"/></td> <td>20 <input type="checkbox"/></td> <td>26 <input type="checkbox"/></td> </tr> </table>		1	2 3	2 3	1	2 3	2 3	2 3	V	V	03 <input type="checkbox"/>	04 <input type="checkbox"/>	05 <input type="checkbox"/>	06 <input type="checkbox"/>	07 <input type="checkbox"/>	08 <input type="checkbox"/>	09 <input type="checkbox"/>	20 <input type="checkbox"/>	26 <input type="checkbox"/>	Size 3			<table border="1"> <tr> <td>20</td> <td>1</td> <td>1</td> <td>1</td> <td>2 3</td> <td>2 3</td> <td>2 3</td> <td>2 3</td> <td>1</td> <td>2 3</td> <td>2 3</td> <td>2 3</td> <td>2 3</td> <td>V</td> <td>V</td> <td>V</td> <td>V</td> </tr> <tr> <td>28 <input type="checkbox"/></td> <td>10 <input type="checkbox"/></td> <td>11 <input checked="" type="checkbox"/></td> <td>12 <input type="checkbox"/></td> <td>13 <input type="checkbox"/></td> <td>14 <input type="checkbox"/></td> <td>15 <input type="checkbox"/></td> <td>16 <input type="checkbox"/></td> <td>17 <input type="checkbox"/></td> <td>18 <input type="checkbox"/></td> <td>19 <input type="checkbox"/></td> <td>20 <input type="checkbox"/></td> <td>21 <input type="checkbox"/></td> <td>22 <input type="checkbox"/></td> <td>23 <input type="checkbox"/></td> <td>24 <input type="checkbox"/></td> <td>27 <input type="checkbox"/></td> </tr> </table>	20	1	1	1	2 3	2 3	2 3	2 3	1	2 3	2 3	2 3	2 3	V	V	V	V	28 <input type="checkbox"/>	10 <input type="checkbox"/>	11 <input checked="" type="checkbox"/>	12 <input type="checkbox"/>	13 <input type="checkbox"/>	14 <input type="checkbox"/>	15 <input type="checkbox"/>	16 <input type="checkbox"/>	17 <input type="checkbox"/>	18 <input type="checkbox"/>	19 <input type="checkbox"/>	20 <input type="checkbox"/>	21 <input type="checkbox"/>	22 <input type="checkbox"/>	23 <input type="checkbox"/>	24 <input type="checkbox"/>	27 <input type="checkbox"/>		
Size 1	Size 2																																																																					
<table border="1"> <tr> <td>1</td> <td>2 3</td> </tr> <tr> <td>01 <input type="checkbox"/></td> <td>02 <input type="checkbox"/></td> </tr> </table>	1	2 3	01 <input type="checkbox"/>	02 <input type="checkbox"/>	<table border="1"> <tr> <td>1</td> <td>2 3</td> <td>2 3</td> <td>1</td> <td>2 3</td> <td>2 3</td> <td>2 3</td> <td>V</td> <td>V</td> </tr> <tr> <td>03 <input type="checkbox"/></td> <td>04 <input type="checkbox"/></td> <td>05 <input type="checkbox"/></td> <td>06 <input type="checkbox"/></td> <td>07 <input type="checkbox"/></td> <td>08 <input type="checkbox"/></td> <td>09 <input type="checkbox"/></td> <td>20 <input type="checkbox"/></td> <td>26 <input type="checkbox"/></td> </tr> </table>		1	2 3	2 3	1	2 3	2 3	2 3	V	V	03 <input type="checkbox"/>	04 <input type="checkbox"/>	05 <input type="checkbox"/>	06 <input type="checkbox"/>	07 <input type="checkbox"/>	08 <input type="checkbox"/>	09 <input type="checkbox"/>	20 <input type="checkbox"/>	26 <input type="checkbox"/>																																														
1	2 3																																																																					
01 <input type="checkbox"/>	02 <input type="checkbox"/>																																																																					
1	2 3	2 3	1	2 3	2 3	2 3	V	V																																																														
03 <input type="checkbox"/>	04 <input type="checkbox"/>	05 <input type="checkbox"/>	06 <input type="checkbox"/>	07 <input type="checkbox"/>	08 <input type="checkbox"/>	09 <input type="checkbox"/>	20 <input type="checkbox"/>	26 <input type="checkbox"/>																																																														
Size 3																																																																						
<table border="1"> <tr> <td>20</td> <td>1</td> <td>1</td> <td>1</td> <td>2 3</td> <td>2 3</td> <td>2 3</td> <td>2 3</td> <td>1</td> <td>2 3</td> <td>2 3</td> <td>2 3</td> <td>2 3</td> <td>V</td> <td>V</td> <td>V</td> <td>V</td> </tr> <tr> <td>28 <input type="checkbox"/></td> <td>10 <input type="checkbox"/></td> <td>11 <input checked="" type="checkbox"/></td> <td>12 <input type="checkbox"/></td> <td>13 <input type="checkbox"/></td> <td>14 <input type="checkbox"/></td> <td>15 <input type="checkbox"/></td> <td>16 <input type="checkbox"/></td> <td>17 <input type="checkbox"/></td> <td>18 <input type="checkbox"/></td> <td>19 <input type="checkbox"/></td> <td>20 <input type="checkbox"/></td> <td>21 <input type="checkbox"/></td> <td>22 <input type="checkbox"/></td> <td>23 <input type="checkbox"/></td> <td>24 <input type="checkbox"/></td> <td>27 <input type="checkbox"/></td> </tr> </table>	20	1	1	1	2 3	2 3	2 3	2 3	1	2 3	2 3	2 3	2 3	V	V	V	V	28 <input type="checkbox"/>	10 <input type="checkbox"/>	11 <input checked="" type="checkbox"/>	12 <input type="checkbox"/>	13 <input type="checkbox"/>	14 <input type="checkbox"/>	15 <input type="checkbox"/>	16 <input type="checkbox"/>	17 <input type="checkbox"/>	18 <input type="checkbox"/>	19 <input type="checkbox"/>	20 <input type="checkbox"/>	21 <input type="checkbox"/>	22 <input type="checkbox"/>	23 <input type="checkbox"/>	24 <input type="checkbox"/>	27 <input type="checkbox"/>																																				
20	1	1	1	2 3	2 3	2 3	2 3	1	2 3	2 3	2 3	2 3	V	V	V	V																																																						
28 <input type="checkbox"/>	10 <input type="checkbox"/>	11 <input checked="" type="checkbox"/>	12 <input type="checkbox"/>	13 <input type="checkbox"/>	14 <input type="checkbox"/>	15 <input type="checkbox"/>	16 <input type="checkbox"/>	17 <input type="checkbox"/>	18 <input type="checkbox"/>	19 <input type="checkbox"/>	20 <input type="checkbox"/>	21 <input type="checkbox"/>	22 <input type="checkbox"/>	23 <input type="checkbox"/>	24 <input type="checkbox"/>	27 <input type="checkbox"/>																																																						
* Terminal block available as option. (maximum: 10 x terminals 2.5mm ²)																																																																						
Entry Position 	Entries (clearance hole) <input checked="" type="checkbox"/> M20 <input type="checkbox"/> M25 <input type="checkbox"/> 3/4" NPT (via hub)	Earth Stud (At Bottom) <input checked="" type="checkbox"/> Without <input type="checkbox"/> T6 Stainless Steel Earth Stud <input type="checkbox"/> T8 Stainless Steel Earth Stud																																																																				
	Earth Continuity Plate Brass Earth Plate as Standard <input type="checkbox"/> Stainless Steel Earth Plate	Location <input type="checkbox"/> A <input type="checkbox"/> B <input type="checkbox"/> C <input type="checkbox"/> D <input type="checkbox"/> A, B, C, D																																																																				
Cable Glands <input checked="" type="checkbox"/> Without <input type="checkbox"/> Type: _____ Quantity: _____		Plugs <input checked="" type="checkbox"/> Without <input type="checkbox"/> Type: _____ Quantity: _____																																																																				
Nameplate <table border="1"> <thead> <tr> <th>Option</th> <th>Type</th> <th>Color</th> </tr> </thead> <tbody> <tr> <td><input type="checkbox"/> Without</td> <td><input checked="" type="checkbox"/> 58 x 18 Self-Adhesive Laminated Plastic</td> <td><input checked="" type="checkbox"/> White (black letters) <input type="checkbox"/> Blue (white letters)</td> </tr> <tr> <td><input type="checkbox"/> With (complete Type and color)</td> <td><input type="checkbox"/> 65 x 18 Screw On Laminated Plastic <input type="checkbox"/> 65 x 18 Screw On in Stainless steel (available with black lettering only) Text (1 line): _____</td> <td><input type="checkbox"/> Yellow (black letters) <input type="checkbox"/> Black (white letters) <input type="checkbox"/> Red (white letters) <input type="checkbox"/> Green (white letters)</td> </tr> </tbody> </table>	Option	Type	Color	<input type="checkbox"/> Without	<input checked="" type="checkbox"/> 58 x 18 Self-Adhesive Laminated Plastic	<input checked="" type="checkbox"/> White (black letters) <input type="checkbox"/> Blue (white letters)	<input type="checkbox"/> With (complete Type and color)	<input type="checkbox"/> 65 x 18 Screw On Laminated Plastic <input type="checkbox"/> 65 x 18 Screw On in Stainless steel (available with black lettering only) Text (1 line): _____	<input type="checkbox"/> Yellow (black letters) <input type="checkbox"/> Black (white letters) <input type="checkbox"/> Red (white letters) <input type="checkbox"/> Green (white letters)																																																													
Option	Type	Color																																																																				
<input type="checkbox"/> Without	<input checked="" type="checkbox"/> 58 x 18 Self-Adhesive Laminated Plastic	<input checked="" type="checkbox"/> White (black letters) <input type="checkbox"/> Blue (white letters)																																																																				
<input type="checkbox"/> With (complete Type and color)	<input type="checkbox"/> 65 x 18 Screw On Laminated Plastic <input type="checkbox"/> 65 x 18 Screw On in Stainless steel (available with black lettering only) Text (1 line): _____	<input type="checkbox"/> Yellow (black letters) <input type="checkbox"/> Black (white letters) <input type="checkbox"/> Red (white letters) <input type="checkbox"/> Green (white letters)																																																																				
Functions <table border="1"> <thead> <tr> <th>Position</th> <th>Actuator</th> <th>Contacts</th> <th>Insert</th> <th>Legend Plate</th> <th>Guard</th> </tr> </thead> <tbody> <tr><td> </td><td> </td><td> </td><td> </td><td> </td><td> </td></tr> <tr><td> </td><td> </td><td> </td><td> </td><td> </td><td> </td></tr> <tr><td> </td><td> </td><td> </td><td> </td><td> </td><td> </td></tr> <tr><td> </td><td> </td><td> </td><td> </td><td> </td><td> </td></tr> <tr><td> </td><td> </td><td> </td><td> </td><td> </td><td> </td></tr> <tr><td> </td><td> </td><td> </td><td> </td><td> </td><td> </td></tr> <tr><td> </td><td> </td><td> </td><td> </td><td> </td><td> </td></tr> <tr><td> </td><td> </td><td> </td><td> </td><td> </td><td> </td></tr> </tbody> </table>			Position	Actuator	Contacts	Insert	Legend Plate	Guard																																																														
Position	Actuator	Contacts	Insert	Legend Plate	Guard																																																																	
* Terminal Blocks (optional) Option for Box No. 03-05-09-10-12-13-15-21-22 only		Type 2.5 mm ²	Quantity (10 maximum)																																																																			
Additional Instructions: _____																																																																						

Polyester Control Station

- Size 3 with 3 vertical actuators.
- 2 x M20 entries at bottom with brass earth continuity plate.
- Without earth stud.
- Without cable glands and plugs.
- White self-adhesive nameplate with black lettering.
- Text: MOTOR 4
- Position 1: Green pilot light without legend plate.
- Position 2: Green start push button with 2 x NO contacts.
- Green start insert without legend plate and guard.
- Position 7: Emergency stop push-pull mushroom head with 2 x NC contacts without legend plate and guard.

Part No.: U23W211 PG A103 D2

The following inquiry forms should be filled out and sent to your local Appleton/ATX Representative.

[Ⓛ] Overall hazardous location and ingress protection rating depends on the rating of the optional certified components used.

Unicode™ 2 Series Customized Control Stations — Stainless Steel

Increased Safety

NEC:
 Class I, Division 2, Groups A, B, C, D
 Class II, Groups E, F, G
 Class III
 Ex de IIC/DIP A21
 IP66, Type 4X^①

CEC:
 Class I, Division 2, Groups A, B, C, D
 Class II, Groups F, G
 Class III; Type 4X^①
 Class I, Zone 1, AEx de IIC/ AEx tD 21
 IP66

ATEX/IECEx:
 Zone 1 and 2 – 21 and 22
 Ex de IIC/Ex demb IIC/ Ex tD A21
 IP66 – IK10

Stainless Steel Customized Control Station Specifications — Type: U6

Company Name: _____ Address: _____
 Contact: _____
 Phone/Fax: _____
 Email: _____ Project: _____

Box Definition

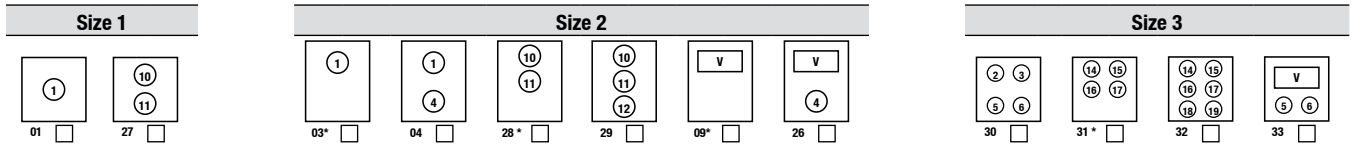

* Terminal block available as option. (maximum: 10 x terminals 2.5 mm²)

Entry Position

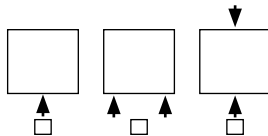

Entries — Clearance Hole

- M20
- M25
- 3/4" NPT (via hub)

Earth Stud — At Bottom

- T6 Stainless Steel Earth Stud as Standard
- T8 Stainless Steel Earth Stud

Location

- A B C D A, B, C, D

Cable Glands

- Without
- Type:

Quantity:

Plugs

- Without
- Type:

Quantity:

Nameplate

Option	Type	Color	
<input type="checkbox"/> Without	<input type="checkbox"/> 58 x 18 mm (2.28 x 0.71") Self-Adhesive Laminated Plastic	<input type="checkbox"/> White (black letters)	<input type="checkbox"/> Blue (white letters)
<input type="checkbox"/> With (complete Type and color)	<input type="checkbox"/> 65 x 18 mm (2.56 x 0.71") Screw On Laminated Plastic	<input type="checkbox"/> Yellow (black letters)	<input type="checkbox"/> Black (white letters)
	<input type="checkbox"/> 65 x 18 mm (2.56 x 0.71") Screw On Stainless Steel (available with black lettering only)	<input type="checkbox"/> Red (white letters)	<input type="checkbox"/> Green (white letters)
	Text (1 line): _____		

Functions

Position	Actuator	Contacts	Insert	Legend Plate	Guard

* Terminal Blocks (optional)

Option for Box No. 03-09-28-31 only

Type

2.5 mm²

Quantity (10 maximum)

Additional Instructions:

^① Overall hazardous location and ingress protection rating depends on the rating of the optional certified components used. Please ensure to check with your sales representative for hazardous location and ingress protection rating accuracy.

Unicode™ 2 Series Customized Control Stations — Polyester

Increased Safety

NEC:
 Class I, Division 2, Groups A, B, C, D
 Class II, Groups E, F, G
 Class III
 Ex de IIC/DIP A21
 IP66, Type 4X^①

CEC:
 Class I, Division 2, Groups A, B, C, D
 Class II, Groups F, G
 Class III; Type 4X^①
 Class I, Zone 1, AEx de IIC/ AEx tD 21
 IP66

ATEX/IECEx:
 Zone 1 and 2 – 21 and 22
 II 2 GD
 Ex de IIC/Ex demb IIC/ Ex tD A21
 IP66 – IK10

CONTROLS: NEC/CEC, ATEX/IECEx INCREASED SAFETY CONTROL STATIONS

Polyester Customized Control Station Specifications — Type: U4

Company Name: _____
 Contact: _____
 Phone/Fax: _____
 Email: _____

Address: _____

 Project: _____

Box Definition

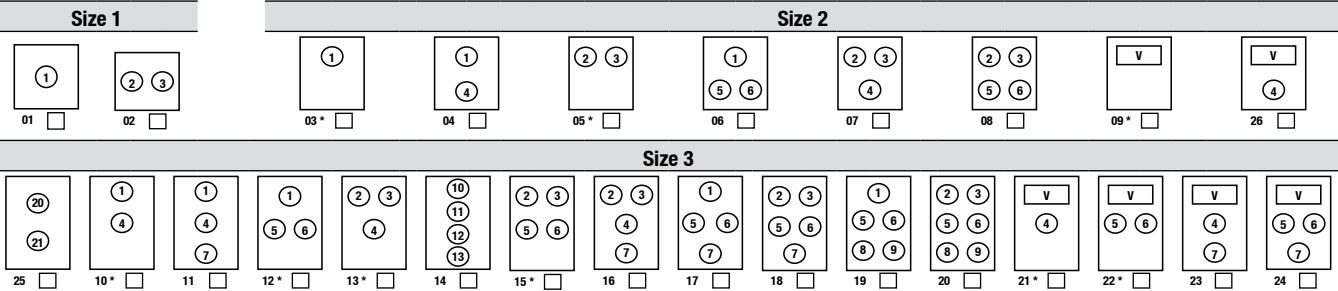

* Terminal block available as option. (maximum: 10 x terminals 2.5 mm²)

Entry Position

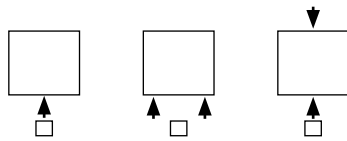

Entries — Clearance Hole

- M20
- M25
- 3/4" NPT (via hub)

Earth Continuity Plate

- Brass Earth Plate as Standard
- Stainless Steel Earth Plate

Earth Stud — At Bottom

- Without
- T6 Stainless Steel Earth Stud
- T8 Stainless Steel Earth Stud

Location

- A B C D A, B, C, D

Cable Glands

- Without
 - Type: _____
- Quantity: _____

Plugs

- Without
 - Type: _____
- Quantity: _____

Nameplate

Option	Type	Color
<input type="checkbox"/> Without	<input type="checkbox"/> 58 x 18 mm (2.28 x 0.71") Self-Adhesive Laminated Plastic	<input type="checkbox"/> White (black letters) <input type="checkbox"/> Blue (white letters)
<input type="checkbox"/> With (complete Type and color)	<input type="checkbox"/> 65 x 18 mm (2.56 x 0.71") Screw On Laminated Plastic	<input type="checkbox"/> Yellow (black letters) <input type="checkbox"/> Black (white letters)
	<input type="checkbox"/> 65 x 18 mm (2.56 x 0.71") Screw On in Stainless steel (available with black lettering only)	<input type="checkbox"/> Red (white letters) <input type="checkbox"/> Green (white letters)

Text (1 line): _____

Functions

Position	Actuator	Contacts	Insert	Legend Plate	Guard

* Terminal Blocks (optional)

Option for Box No. 03-05-09-10-12-13-15-21-22 only

Type

2.5 mm²

Quantity (10 maximum)

Additional Instructions:

^① Overall hazardous location and ingress protection rating depends on the rating of the optional certified components used. Please ensure to check with your sales representative for hazardous location and ingress protection rating accuracy.

Unicode™ 2 Series Customized Control Stations — Aluminum

Increased Safety

ATEX/IECEX:
 Zone 1 and 2 – 21 and 22
 II 2 GD
 Ex de IIC/Ex demb IIC/ Ex tD A21
 IP66 – IK10

Aluminum Customized Control Station Specifications — Type: U8

Company Name: _____
 Contact: _____
 Phone/Fax: _____
 Email: _____

Address: _____

 Project: _____

Box Definition

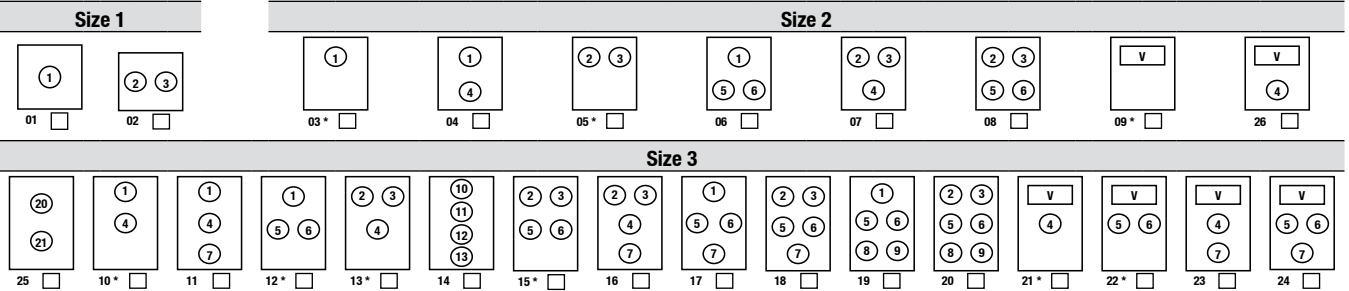

* Terminal block available as option. (maximum: 10 x terminals 2.5 mm²)

Entry Position

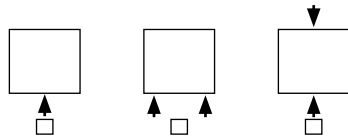

Entries — Clearance Hole

- M20
- M25
- 3/4" NPT (via hub)

Earth Stud — At Bottom

- T5 External Earth Stud as Standard
- T6 Stainless Steel Earth Stud
- T8 Stainless Steel Earth Stud

Location

- A B C D A, B, C, D

Cable Glands

- Without
- Type: _____ Quantity: _____

Plugs

- Without
- Type: _____ Quantity: _____

Nameplate

Option	Type	Color	
<input type="checkbox"/> Without	<input type="checkbox"/> 58 x 18 mm (2.28 x 0.71") Self-Adhesive Laminated Plastic	<input type="checkbox"/> White (black letters)	<input type="checkbox"/> Blue (white letters)
<input type="checkbox"/> With (complete Type and color)	<input type="checkbox"/> 65 x 18 mm (2.56 x 0.71") Screw On Laminated Plastic	<input type="checkbox"/> Yellow (black letters)	<input type="checkbox"/> Black (white letters)
	<input type="checkbox"/> 65 x 18 mm (2.56 x 0.71") Screw On in Stainless steel (available with black lettering only)	<input type="checkbox"/> Red (white letters)	<input type="checkbox"/> Green (white letters)
	Text (1 line): _____		

Functions

Position	Actuator	Contacts	Insert	Legend Plate	Guard

* Terminal Blocks (optional) Type Quantity (10 maximum)
 Option for Box No. 03-05-09-10-12-13-15-21-22 only 2.5 mm²

Additional Instructions:

① Overall hazardous location and ingress protection rating depends on the rating of the optional certified components used. Please ensure to check with your sales representative for hazardous location and ingress protection rating accuracy.

Unicode™ 2 Series Customized Control Stations — Polyamide

Increased Safety

ATEX/IECEX:
 Zone 1 and 2 – 21 and 22
 II 2 GD
 Ex de IIC/Ex demb IIC/Ex tD A21
 IP66 – IK09

CONTROLS: NEC/CEC, ATEX/IECEX INCREASED SAFETY CONTROL STATIONS









Polyamide Customized Control Station Specifications — Type: U4

Company Name: _____
 Contact: _____
 Phone/Fax: _____
 Email: _____

Address: _____

 Project: _____

Box Definition

Size 1	Size 2			Size 3			
							
01 <input type="checkbox"/>	34 <input type="checkbox"/>	04 <input type="checkbox"/>	09 <input type="checkbox"/>	25 <input type="checkbox"/>	11 <input type="checkbox"/>	21 <input type="checkbox"/>	23 <input type="checkbox"/>

Entry Position

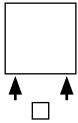

Entries — Clearance Hole

M20

Earth Continuity Plate

- Brass Earth Plate
 Stainless Steel Earth Plate

Earth Stud — At Bottom

- Without
 T6 Stainless Steel Earth Stud (via M20 entry)

Cable Glands

- Without
 Type: _____ Quantity: _____

Plugs

- Without
 Type: _____ Quantity: _____

Nameplate

Option	Type
<input type="checkbox"/> Without	<input type="checkbox"/> 58 x 18 mm (2.28 x 0.71") Self-Adhesive Laminated Plastic
<input type="checkbox"/> With (complete Type and color)	Text (1 line): _____

Color	
<input type="checkbox"/> White (black letters)	<input type="checkbox"/> Blue (white letters)
<input type="checkbox"/> Yellow (black letters)	<input type="checkbox"/> Black (white letters)
<input type="checkbox"/> Red (white letters)	<input type="checkbox"/> Green (white letters)

Functions

Position	Actuator	Contacts	Insert	Legend Plate	Guard

Additional Instructions: _____

Unicode™ 2 Series Pre-Drilled Control Stations

Increased Safety

Polyamide, Fiberglass Reinforced Polyester, 316L Stainless Steel, Aluminum

NEC:

Class I, Division 2, Groups A, B, C, D
Class II, Groups E, F, G
Class III
Ex de IIC/DIP A21
IP66, Type 4X^①

CEC:

Class I, Division 2, Groups A, B, C, D
Class II, Groups F, G
Class III; Type 4X^①
Class I, Zone 1, AEx de IIC/ AEx tD 21
IP66

ATEX/IECEx:

Zone 1 and 2 – 21 and 22
⊕ II 2 GD
Ex de IIC/Ex demb IIC/ Ex tD A21
IP66 – IK10

Applications

- Local control stations and motor control stations for use in hazardous areas covering the broadest possible range of applications.
- Control of equipment at:
 - Power plants
 - Chemical and petrochemical plants
 - Petroleum refineries
 - Reverse osmosis plants
 - Pulp and paper processing plants
 - Various industrial applications
- For use in washdown areas.

Features

- Enclosures are rated for IP66 with firmly secured gasket.
- Captive, corrosion resistant stainless steel cover screws.

Standard Materials

- Polyamide
 - Body, cover, cable gland and blanking plug: polyamide, black finish
- Polyester
 - Body and cover: fiberglass reinforced polyester, black finish.
- Stainless Steel
 - Body, cover and cover screws: 316L stainless steel, natural finish
- Aluminum
 - Body and cover: aluminum with gray epoxy powder coating.
- Cable gland and blanking plug: polyamide
- Cover screws for 316L stainless steel or aluminum body: 304 stainless steel
- Cover screws for fiberglass reinforced polyester body: 316 stainless steel
- Nameplate: white self-adhesive laminated plastic

NEC/CEC Certifications and Compliances

- Fiberglass Reinforced Polyester (FRP)
 - Certification Type CSPe
 - Temperature Class: T5 or T6
 - Ambient Temperature: -55°C to +60°C (-67°F to +140°F)
 - CAN/CSA Standards: C22.2 No. 0-M91, No. 25-M66, No. 213-M1987, No. 94-M91, No. 60079-0:07, No. 60529-2005, E60079-7-2003
 - UL Standards: 60079-0, 60079-7, 50
 - Other Standards: ANSI/IEC 60529-2004, ANSI/ISA 12.12.01-2011
 - cCSAus Certificate: 2356952
- Stainless Steel
 - Certification Type JBe
 - Temperature Class: T6 (at +40°C) or T5 (at +55°C)
 - Surface Temperature: T80 °C (at +40°C) to T95 °C (at +55°C) (T176 °F to T203 °F)
 - Ambient Temperature: -40 °C to +55 °C (-40 °F to +131 °F)
 - CAN/CSA Standard: C22.2 No. 0-M91, No. 25-M66, No. 213-M1987, No. 60079-0:07, No. 60529-2005, E60079-7-2003
 - UL Standard: 60079-0, 60079-7
 - Other Standards: ANSI/IEC60529-2004, ANSI/ISA 12.12.01-2011
 - cCSAus Certificate: 2356734



Polyamide U43W211



Polyester U23W211



Stainless Steel U62W229



Aluminum U83W211

ATEX/IECEx Certifications and Compliances

- Polyamide
 - Certification Type PCe
 - Gas: Zone 1 and 2
 - Conforming to ATEX 94/9/CE: ⊕ II 2 G
 - Type of Protection: Ex de IIC or Ex demb IIC
 - Temperature Class: T6
 - Dust: Zone 21 and 22
 - Conforming to ATEX 94/9/CE: ⊕ II 2 D
 - Type of Protection: Ex tD A21
 - Surface Temperature: T167 °C to T75 °C (T333 °F to T167 °F)
 - Ambient Temperature: -20 °C to +55 °C (-4 °F to +131 °F)
 - CE Declaration of Conformity: 50221
 - ATEX Certificate: LCIE 00 ATEX 6047
 - IEC Certificate: LCIE Ex 00.017
 - Index of Protection according EN/IEC 60529: IP66
 - Impact Resistance (shock): IK10

^① Overall hazardous location and ingress protection rating depends on the rating of the optional certified components used.

Unicode™ 2 Series Pre-Drilled Control Stations

Increased Safety

Polyamide, Fiberglass Reinforced Polyester, 316L Stainless Steel, Aluminum

NEC:
Class I, Division 2, Groups A, B, C, D
Class II, Groups E, F, G
Class III
Ex de IIC/DIP A21
IP66, Type 4X①

CEC:
Class I, Division 2, Groups A, B, C, D
Class II, Groups F, G
Class III; Type 4X①
Class I, Zone 1, AEx de IIC/ AEx tD 21
IP66

ATEX/IECEx:
Zone 1 and 2 – 21 and 22
Ⓢ II 2 GD
Ex de IIC/Ex demb IIC/ Ex tD A21
IP66 – IK10

CONTROLS: NEC/CEC, ATEX/IECEx INCREASED SAFETY CONTROL STATIONS

- Fiberglass Reinforced Polyester (FRP)
 - Certification Type CSPe
 - Gas: Zone 1 and 2
 - Conforming to ATEX 94/9/CE: Ⓢ II 2 G
 - Type of Protection: Ex de IIC or Ex demb IIC
 - Temperature Class: T6
 - Dust: Zone 21 and 22
 - Conforming to ATEX 94/9/CE: Ⓢ II 2 D
 - Type of Protection: Ex tD A21
 - Surface Temperature: T75 °C (T167 °F)
 - Ambient Temperature: -55 °C to +70 °C (-67 °F to +158 °F)
 - CE Declaration of Conformity: 52084
 - ATEX Certificate: LCIE 00 ATEX 3032X
 - IECEx Certificate: IECEx LCI 09.0016X
 - Index of Protection according EN/IEC 60529: IP66
 - Impact Resistance (shock): IK10
- Stainless Steel
 - Certification Type JBe
 - Gas: Zone 1 and 2
 - Conforming to ATEX 94/9/CE: Ⓢ II 2 G
 - Type of Protection: Ex de IIC or Ex demb IIC
 - Temperature Class: T5 to T6
 - Dust: Zone 21 and 22
 - Conforming to ATEX 94/9/CE: Ⓢ II 2 D
 - Type of Protection: Ex tD A21
 - Surface Temperature: T80 °C to T95 °C (T176 °F to T203 °F)
 - Ambient Temperature: -50 °C to +70 °C (-58 °F to +158 °F)
 - CE Declaration of Conformity: 50232
 - ATEX Certificate: LCIE 02 ATEX 6118X
 - IECEx Certificate: LCI 11.0008X
 - Index of Protection according EN/IEC 60529: IP66
 - Impact Resistance (shock): IK10
- Aluminum
 - Certification Type PCe
 - Gas: Zone 1 and 2
 - Conforming to ATEX 94/9/CE: Ⓢ II 2 G
 - Type of Protection: Ex de IIC or Ex demb IIC
 - Temperature Class: T6
 - Dust: Zone 21 and 22
 - Conforming to ATEX 94/9/CE: Ⓢ II 2 D
 - Type of Protection: Ex tD A21
 - Surface Temperature: T75 °C (T167 °F)
 - CE Declaration of Conformity: 50221
 - ATEX Certificate: LCIE 02 ATEX 6047
 - Index of Protection according EN/IEC 60529: IP66
 - Impact Resistance (shock): IK10

Other Certification ②

- Certification Type PCe (Polyamide)
 - INMETRO Certificate: BVC 11.0640-X
- Certification Type CSPe (Polyester)
 - INMETRO Certificate: BVC 11.0637-X
- Certification Type JBe (Stainless Steel)
 - INMETRO Certificate: BVC 11.0418-X

EURASEC Certification

- Certification Type PCe (Polyamide)
 - EURASEC RU C-FR Г505.B.00911
- Certification Type CSPe (Polyester)
 - EURASEC RU C-FR Г505.B.00911
- Certification Type JBe (Stainless Steel)
 - EURASEC RU C-FR Г505.B.00911

① Overall hazardous location and ingress protection rating depends on the rating of the optional certified components used.

② INMETRO certification available on special request only. Contact your local sales representative for more information.

Unicode™ 2 Series Pre-Drilled Polyamide Control Stations

Increased Safety

ATEX/IECEX:
 Zone 1 and 2 – 21 and 22
 II 2 GD
 Ex de IIC/Ex demb IIC/Ex tD A21
 IP66 – IK09

Polyamide Pre-drilled Boxes for Control Stations

Included: 1 white self-adhesive laminated plastic nameplate (black lettering),
 2 clearance entries at bottom.

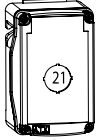
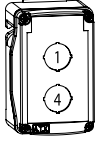
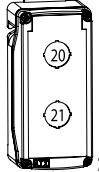
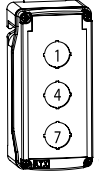
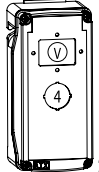
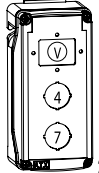

	Description/ Function	Entries	Weight kg (lb)	Volume dm ³ (in ³)	Catalog Number 2 Bottom
Size 1 Pre-Drilled Enclosures					
 01	For 1 actuator 1 vertical rail	M20	0.7 (1.54)	2.5 (152.56)	U41W201
Size 2 Pre-Drilled Enclosures					
 34	For 1 actuator 1 vertical rail	M20	0.9 (1.98)	2.5 (152.56)	U42W234
 04	For 2 actuators 1 vertical rail	M20	0.9 (1.98)	2.5 (152.56)	U42W204
Size 3 Pre-Drilled Enclosures					
 25	For 2 actuators 1 vertical rail	M20	1.0 (2.20)	2.5 (152.56)	U43W225
 11	For 3 actuators 1 vertical rail	M20	1.0 (2.20)	2.5 (152.56)	U43W211
 21	For 1 ammeter 48 x 48 + 1 actuator 1 vertical rail	M20	1.0 (2.20)	2.5 (152.56)	U43W221
 23	For 1 ammeter 48 x 48 + 2 actuators 1 vertical rail	M20	1.0 (2.20)	2.5 (152.56)	U43W223

CONTROL STATIONS: NEC/CEC, ATEX/IECEX INCREASED SAFETY CONTROL STATIONS



Unicode™ 2 Series Pre-Drilled Polyester Control Stations

Increased Safety

NEC:
Class I, Division 2, Groups A, B, C, D
Class II, Groups E, F, G
Class III
Ex de IIC/DIP A21
IP66, Type 4X①



CEC:
Class I, Division 2, Groups A, B, C, D
Class II, Groups F, G
Class III; Type 4X①
Class I, Zone 1, AEx de IIC/ AEx tD 21
IP66

ATEX/IECEX:
Zone 1 and 2 – 21 and 22
II 2 GD
Ex de IIC/Ex demb IIC/ Ex tD A21
IP66 – IK10

Polyester Pre-Drilled Boxes for Control Stations

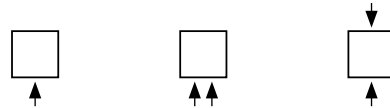
Included: 1 white self-adhesive laminated plastic nameplate (black lettering), 1 earth continuity brass plate, threaded entries.

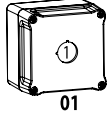

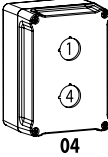
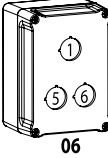
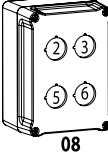
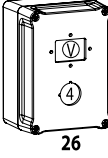
Description/ Function	Entries	Weight kg (lb)	Volume dm ³ (in ³)	Catalog Number		
				1 Bottom	2 Bottom	Feed-Thru
Size 1 Pre-Drilled Enclosures						
 01 For 1 actuator 1 horizontal rail	M20	0.8 (1.76)	2.7 (164.76)	U21W101	U21W201	U21U101
	M25			U21W301	U21W401	U21U301
	3/4"			U21Z301	U21Z401	U21X301
 02 For 2 actuators 1 horizontal rail	M20	0.8 (1.76)	2.7 (164.76)	U21W102	U21W202	U21U102
	M25			U21W302	U21W402	U21U302
	3/4"			U21Z302	U21Z402	U21X302
Size 2 Pre-Drilled Enclosures						
 04 For 2 actuators 1 vertical rail	M20	1.0 (2.20)	4.2 (256.30)	U22W104	U22W204	U22U104
	M25			U22W304	U22W404	U22U304
	3/4"			U22Z304	U22Z404	U22X304
 06 For 3 actuators 2 horizontal rails	M20	1.0 (2.20)	4.2 (256.30)	U22W106	U22W206	U22U106
	M25			U22W306	U22W406	U22U306
	3/4"			U22Z306	U22Z406	U22X306
 08 For 4 actuators 2 horizontal rails	M20	1.0 (2.20)	4.2 (256.30)	U22W108	U22W208	U22U108
	M25			U22W308	U22W408	U22U308
	3/4"			U22Z308	U22Z408	U22X308
 26 For 1 ammeter 48x48 +1 actuator 1 vertical rail	M20	1.0 (2.20)	4.2 (256.30)	U22W126	U22W226	U22U126
	M25			U22W326	U22W426	U22U326
	3/4"			U22Z326	U22Z426	U22X326

① Overall hazardous location and ingress protection rating depends on the rating of the optional certified components used.

Unicode™ 2 Series Pre-Drilled Polyester Control Stations

Increased Safety

NEC:
 Class I, Division 2, Groups A, B, C, D
 Class II, Groups E, F, G
 Class III
 Ex de IIC/DIP A21
 IP66, Type 4X^①

CEC:
 Class I, Division 2, Groups A, B, C, D
 Class II, Groups F, G
 Class III; Type 4X^①
 Class I, Zone 1, AEx de IIC/ AEx tD 21
 IP66

ATEX/IECEX:
 Zone 1 and 2 – 21 and 22
 Ⓢ II 2 GD
 Ex de IIC/Ex demb IIC/ Ex tD A21
 IP66 – IK10

Polyester Pre-Drilled Boxes for Control Stations

Included: 1 white self-adhesive laminated plastic nameplate (black lettering), 1 earth continuity brass plate, threaded entries.

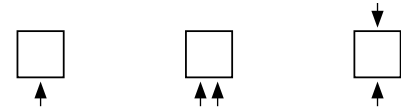

Description/ Function	Entries	Weight kg (lb)	Volume dm ³ (in ³)	Catalog Number		
				1 Bottom	2 Bottom	Feed-Thru
Size 3 Pre-Drilled Enclosures – 230 mm x 120 mm x 91 mm (9.06" x 4.72" x 3.58")						
	M20			U23W111	U23W211	U23U111
	M25	1.1 (2.43)	4.2 (256.30)	U23W311	U23W411	U23U311
	3/4"			U23Z311	U23Z411	U23X311
	M20			U23W114	U23W214	U23U114
	M25	1.1 (2.43)	4.2 (256.30)	U23W314	U23W414	U23U314
	3/4"			U23Z314	U23Z414	U23X314
	M20			U23W116	U23W216	U23U116
	M25	1.1 (2.43)	4.2 (256.30)	U23W316	U23W416	U23U316
	3/4"			U23Z316	U23Z416	U23X316
	M20			U23W117	U23W217	U23U117
	M25	1.1 (2.43)	4.2 (256.30)	U23W317	U23W417	U23U317
	3/4"			U23Z317	U23Z417	U23X317
	M20			U23W118	U23W218	U23U118
	M25	1.1 (2.43)	4.2 (256.30)	U23W318	U23W418	U23U318
	3/4"			U23Z318	U23Z418	U23X318
	M20			U23W120	U23W220	U23U120
	M25	1.1 (2.43)	4.2 (256.30)	U23W320	U23W420	U23U320
	3/4"			U23Z320	U23Z420	U23X320
	M20			U23W123	U23W223	U23U123
	M25	1.1 (2.43)	4.2 (256.30)	U23W323	U23W423	U23U323
	3/4"			U23Z323	U23Z423	U23X323
	M20			U23W124	U23W224	U23U124
	M25	11.1 (2.43)	4.2 (256.30)	U23W324	U23W424	U23U324
	3/4"			U23Z324	U23Z424	U23X324

^① Overall hazardous location and ingress protection rating depends on the rating of the optional certified components used.

Unicode™ 2 Series Pre-Drilled Stainless Steel Control Stations

Increased Safety

NEC:
Class I, Division 2, Groups A, B, C, D
Class II, Groups E, F, G
Class III
Ex de IIC/DIP A21
IP66, Type 4X^①

CEC:
Class I, Division 2, Groups A, B, C, D
Class II, Groups F, G
Class III; Type 4X^①
Class I, Zone 1, AEx de IIC/ AEx tD 21
IP66

ATEX/IECEX:
Zone 1 and 2 – 21 and 22
Ex de IIC/Ex demb IIC/ Ex tD A21
IP66 – IK10

Stainless Steel Pre-drilled Boxes for Control Stations

Included: 1 white self-adhesive laminated plastic nameplate (black lettering), clearance entries.

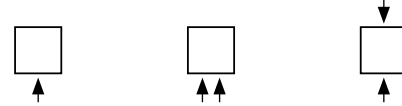

Description/ Function	Entries	Weight kg (lb)	Volume dm ³ (in ³)	1 Bottom	Catalog Number 2 Bottom	Feed-Thru
Size 1 Pre-Drilled Enclosures						
<p>01</p>	M20	1.0 (2.20)	2.7 (164.76)	U61W101	U61W201	U61U101
	M25			U61W301	U61W401	U61U301
	3/4"			U61Z301	U61Z401	U61X301
<p>27</p>	M20	1.0 (2.20)	2.7 (164.76)	U61W127	U61W227	U61U127
	M25			U61W327	U61W427	U61U327
	3/4"			U61Z327	U61Z427	U61X327
Size 2 Pre-Drilled Enclosures						
<p>04</p>	M20	1.5 (3.31)	3.6 (219.69)	U62W104	U62W204	U62U104
	M25			U62W304	U62W404	U62U304
	3/4"			U62Z304	U62Z404	U62X304
<p>29</p>	M20	1.5 (3.31)	3.6 (219.69)	U62W129	U62W229	U62U129
	M25			U62W329	U62W429	U62U329
	3/4"			U62Z329	U62Z429	U62X329
<p>26</p>	M20	1.5 (3.31)	3.6 (219.69)	U62W126	U62W226	U62U126
	M25			U62W326	U62W426	U62U326
	3/4"			U62Z326	U62Z426	U62X326
Size 3 Pre-Drilled Enclosures						
<p>30</p>	M20	1.8 (3.97)	5.3 (323.43)	U63W130	U63W230	U63U130
	M25			U63W330	U63W430	U63U330
	3/4"			U63Z330	U63Z430	U63X330
<p>32</p>	M20	1.8 (3.97)	5.3 (323.43)	U63W132	U63W232	U63U132
	M25			U63W332	U63W432	U63U332
	3/4"			U63Z332	U63Z432	U63X332
<p>33</p>	M20	1.8 (3.97)	5.3 (323.43)	U63W133	U63W233	U63U133
	M25			U63W333	U63W433	U63U333
	3/4"			U63Z333	U63Z433	U63X333

^① Overall hazardous location and ingress protection rating depends on the rating of the optional certified components used.

Unicode™ 2 Series Pre-Drilled Aluminum Control Stations

Increased Safety

ATEX/IECEX:
 Zone 1 and 2 – 21 and 22
 II 2 GD
 Ex de IIC/Ex demb IIC/ Ex tD A21
 IP66 – IK10

Aluminum Pre-drilled boxes for Control Stations
 Included: 1 white self-adhesive laminated plastic nameplate
 (black lettering), clearance entries.

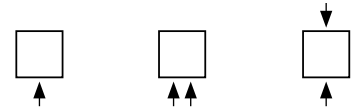

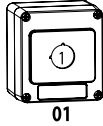
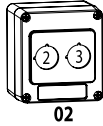
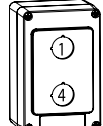
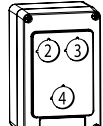
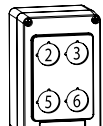
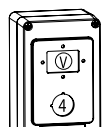
Description/Function	Entries	Weight kg (lb)	Volume dm ³ (in ³)	Catalog Number		
				1 Bottom	2 Bottom	Feed-Thru
Size 1 Pre-Drilled Enclosures						
 01 For 1 actuator 1 horizontal rail	M20	1.0 (2.20)	2.7 (164.76)	U81W101	U81W201	U81U101
	3/4"			U81Z301	U81Z401	U81X301
 02 For 2 actuators 1 horizontal rail	M20	1.0 (2.20)	2.7 (164.76)	U81W102	U81W202	U81U102
	3/4"			U81Z302	U81Z402	U81X302
Size 2 Pre-Drilled Enclosures						
 04 For 2 actuators 1 vertical rail	M20	1.5 (3.31)	2.7 (164.76)	U82W104	U82W204	U82U104
	3/4"			U82Z304	U82Z404	U82X304
 07 For 3 actuators 2 horizontal rails	M20	1.5 (3.31)	2.7 (164.76)	U82W107	U82W207	U82U107
	3/4"			U82Z307	U82Z407	U82X307
 08 For 4 actuators 2 horizontal rails	M20	1.5 (3.31)	2.7 (164.76)	U82W108	U82W208	U82U108
	3/4"			U82Z308	U82Z408	U82X308
 26 For 1 Ammeter 48x48 + 1 actuator 1 vertical rail	M20	1.5 (3.31)	2.7 (164.76)	U82W126	U82W226	U82U126
	3/4"			U82Z326	U82Z426	U82x326

① Overall hazardous location and ingress protection rating depends on the rating of the optional certified components used.

Unicode™ 2 Series Pre-Drilled Aluminum Control Stations

Increased Safety

ATEX/IECEX:
 Zone 1 and 2 – 21 and 22
 II 2 GD
 Ex de IIC/Ex demb IIC/ Ex tD A21
 IP66 – IK10

CONTROLS: NEC/CEC, ATEX/IECEX INCREASED SAFETY CONTROL STATIONS

Aluminum Pre-drilled boxes for Control Stations

Included: 1 white self-adhesive laminated plastic nameplate (black lettering), clearance entries.

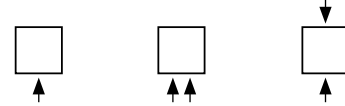

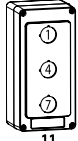
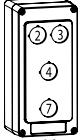
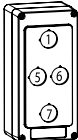
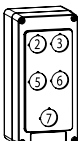
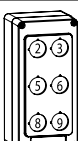
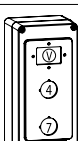
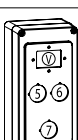
Description/Function		Entries	Weight kg (lb)	Volume dm ³ (in ³)	1 Bottom	Catalog Number 2 Bottom	Feed-Thru
Size 3 Pre-Drilled Enclosures – 230 mm x 110 mm x 95 mm (9.06" x 4.33" x 3.74")							
		M20			U83W111	U83W211	U83U111
	For 3 actuators 1 vertical rail	M25	1.8 (3.97)	4.2 (256.30)	U83W311	U83W411	U83U311
		3/4"			U83Z311	U83Z411	U83X311
		M20			U83W116	U83W216	U83U116
	For 4 actuators 3 horizontal rails	M25	1.8 (3.97)	4.2 (256.30)	U83W316	U83W416	U83U316
		3/4"			U83Z316	U83Z416	U83X316
		M20			U83W117	U83W217	U83U117
	For 4 actuators 3 horizontal rails	M25	1.8 (3.97)	4.2 (256.30)	U83W317	U83W417	U83U317
		3/4"			U83Z317	U83Z417	U83X317
		M20			U83W118	U83W218	U83U118
	For 5 actuators 3 horizontal rails	M25	1.8 (3.97)	4.2 (256.30)	U83W318	U83W418	U83U318
		3/4"			U83Z318	U83Z418	U83X318
		M20			U83W120	U83W220	U83U120
	For 6 actuators 3 horizontal rails	M25	1.8 (3.97)	4.2 (256.30)	U83W320	U83W420	U83U320
		3/4"			U83Z320	U83Z420	U83X320
		M20			U83W123	U83W223	U83U123
	For 1 ammeter 48x48 + 2 actuators 1 vertical rail	M25	1.8 (3.97)	4.2 (256.30)	U83W323	U83W423	U83U323
		3/4"			U83Z323	U83Z423	U83X323
		M20			U83W124	U83W224	U83U124
	For 1 ammeter 48x48 + 3 actuators 1 vertical rail (V) 2 horizontal rails (5-6-7)	M25	1.8 (3.97)	4.2 (256.30)	U83W324	U83W424	U83U324
		3/4"			U83Z324	U83Z424	U83X324

① Overall hazardous location and ingress protection rating depends on the rating of the optional certified components used.

Unicode™ 2 Series Pre-Drilled Control Stations

Increased Safety

Polyamide, Fiberglass Reinforced Polyester, 316L Stainless Steel, Aluminum ①

NEC:

Class I, Division 2, Groups A, B, C, D
 Class II, Groups E, F, G
 Class III
 Ex de IIC/DIP A21
 IP66, Type 4X①

CEC:

Class I, Division 2, Groups A, B, C, D
 Class II, Groups F, G
 Class III; Type 4X①
 Class I, Zone 1, AEx de IIC/ AEx tD 21
 IP66

ATEX/IECEX:

Zone 1 and 2 – 21 and 22
 Ex II 2 GD
 Ex de IIC/Ex demb IIC/ Ex tD A21
 IP66 – IK10

Dimensions in Millimeters (Inches)

Polyamide

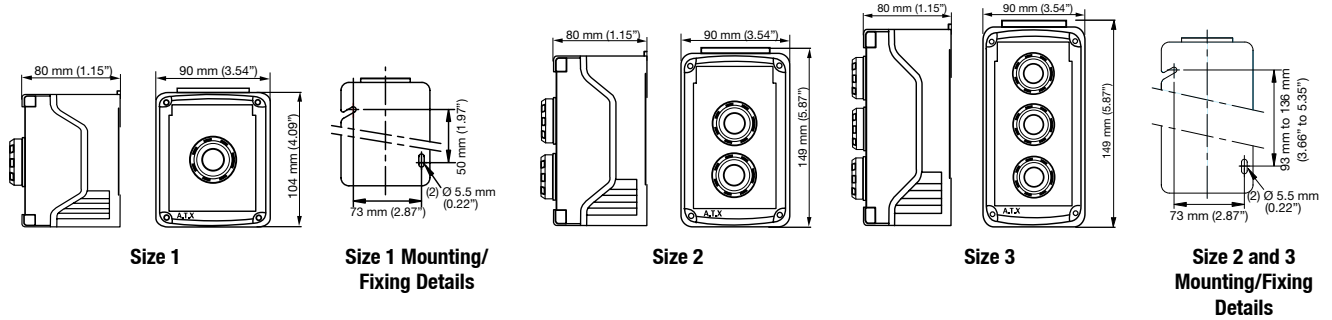

Fiberglass Reinforced Polyester

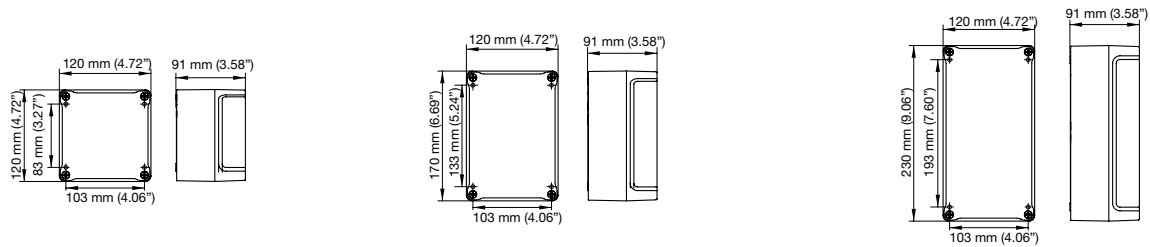

Mounting/Fixing Details for Above Boxes: Four Holes Ø 5 mm (0.20")

316L Stainless Steel

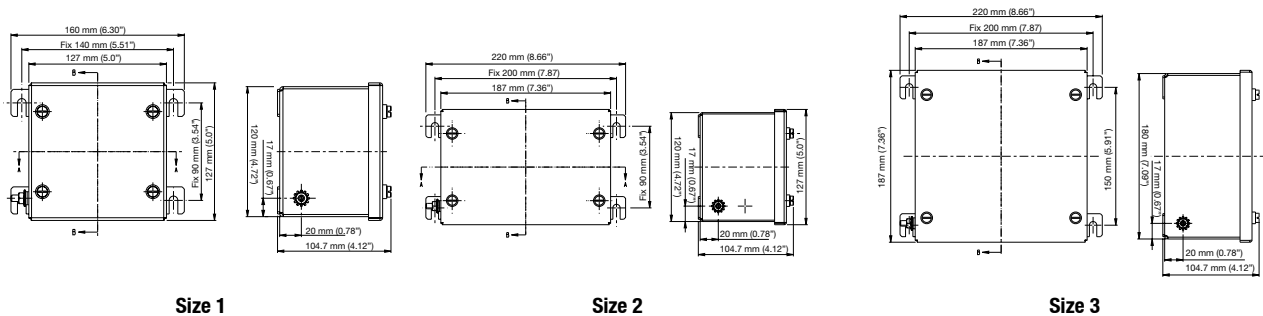

Aluminum

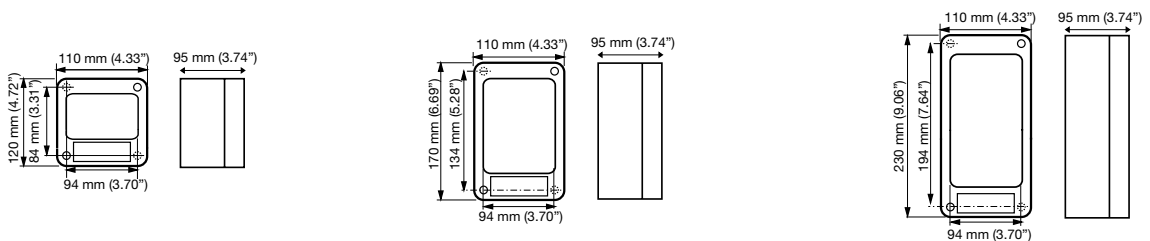

Mounting/Fixing Details for above Boxes: Two Holes Ø 5 mm (0.20")

Unicode™ 2 Series Push Buttons

Components for Increased Safety Enclosures

NEC/CEC:
 Class I, Division 2, Groups A, B, C, D
 Class I, Zone 1, AEx de IIC
 Class I, Zone1, AEx e IIC

NEC/CEC:
 Class II, Division 2, Groups F, G
 Class III
 Type 4X/IP66 ①

ATEX/IECEx:
 Zone 1 and 2 – 21 and 22
 Ⓢ II 2 GD
 IP66 – IK10

Features

- Can be equipped with up to three Unicode 2 Series Contact Blocks (UCB) Series contact blocks.
- Globally certified.
- Available in TS35 rail mounted or panel mounted.

Standard Materials

- Body: polyamide
- Seal: ethylene propylene diene Monomer (M-class) rubber (EPDM)

NEC/CEC Certifications and Compliances

- Certification Type TCe
 - Operating Temperature: -40 °C to +60 °C (-40 °F to +140 °F)
 - Ingress Protection (solid and liquid): IP66 and Type 4X ①
 - CAN/CSA Standards: C22.2 No. 0-M91, No. 14-05, No. 94-M91, No. 213-M1987, No. 60079-0:07, No. 60079-1:07, No. 60529:05, E60079-7-03, E61241-1-1:02
 - UL Standards: UL 508, UL 50E, UL 60079-0, UL 60079-1, UL 60079-7
 - Other Standards: ANSI/ISA 12.12.01-2011, ANSI/ISA 61241-0 (12.10.02)-2006, ANSI/ISA 61241-1(12.10.03)-2006
 - CSA Certificate: 2358701

ATEX/IECEx Certifications and Compliances

- Certification Type TCe
 - Gas: Zone 1 and 2
 - Conforming to ATEX 94/9/CE: Ⓢ II 2 G
 - Type of Protection: Ex e IIC Gb
 - Dust: Zone 21 and 22
 - Conforming to ATEX 94/9/CE: Ⓢ II 2 D
 - Type of Protection: Ex tb IIIC Db
- Surface Temperature: -40 °C to +60 °C (-40 °F to +140 °F)
- CE Declaration of Conformity: 5C242
- ATEX Certificate: LCIE 09 ATEX 3010U
- IECEx Certificate: IECEx LCI 09.0011U
- Index of Protection according EN/IEC 60529: IP66
- Impact Resistance (shock): IK10

EURASEC Certification

- EURASEC RU C-FR. Г505.В00909

Other Certification ②

- INMETRO Certificate: BVC 10.0044-U



Dimensions in Millimeters (Inches)

Rail Mounted Contacts

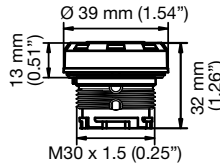

Panel Mounted Contacts

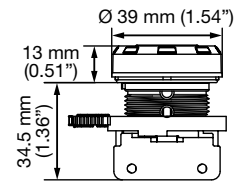

CONTROLS: NEC/CEC, ATEX/IECEx INCREASED SAFETY CONTROL STATIONS

Appleton

① Overall hazardous location and ingress protection rating depends on the rating of the optional certified components used.

② INMETRO certification available on special request only. Contact your local sales representative for more information.

Unicode™ 2 Series Push Buttons

Components for Increased Safety Enclosures

NEC/CEC:
Class I, Division 2, Groups A, B, C, D
Class I, Zone 1, AEx de IIC
Class I, Zone 1, AEx e IIC

NEC/CEC:
Class II, Division 2, Groups F, G
Class III
Type 4X/IP66 ①

ATEX/IECEX:
Zone 1 and 2 – 21 and 22
Ⓢ II 2 GD
IP66 – IK10

	Weight in Kilograms (Pounds)		Volume dm ³ (in ³)		Pack	Catalog Number	
	Rail Mounted	Panel Mounted	Rail Mounted	Panel Mounted		Rail Mounted	Panel Mounted
Spring Return - Push Button (contact block to be ordered separately) For legend plates, guards and blanking plugs see accessories pages.							
Red + Green	0.03 (0.06)	0.05 (0.11)	0.06 (3.66)	0.17 (10.37)	1	UA0RGR	UA0RGP
Green	0.03 (0.06)	0.05 (0.11)	0.06 (3.66)	0.17 (10.37)	1	UA0GR	UA0GP
Red	0.03 (0.06)	0.05 (0.11)	0.06 (3.66)	0.17 (10.37)	1	UA0RR	UA0RP
White	0.03 (0.06)	0.05 (0.11)	0.06 (3.66)	0.17 (10.37)	1	UA0WR	UA0WP
Blue	0.03 (0.06)	0.05 (0.11)	0.06 (3.66)	0.17 (10.37)	1	UA0BR	UA0BP
Yellow	0.03 (0.06)	0.05 (0.11)	0.06 (3.66)	0.17 (10.37)	1	UA0YR	UA0YP
1-Pole Contact Blocks							
1 x NO						UCB5R	UCB5P
1 x NC	0.032 (0.071)		0.06 (3.66)		1	UCB9R	UCB9P
Spare Parts							
Rail to panel mounted conversion adaptor	0.02 (0.04)		0.08 (4.88)		1		UPMA

Marking	Color	Weight kg (lb)	Volume dm ³ (in ³)	Pack	Catalog Number
Set of Five Spare Inserts					
(unmarked)	Green	0.01 (0.02)	0.01 (0.61)	1	UIAG
(unmarked)	Red	0.01 (0.02)	0.01 (0.61)	1	UIAR
(unmarked)	Yellow	0.01 (0.02)	0.01 (0.61)	1	UIAY
(unmarked)	White	0.01 (0.02)	0.01 (0.61)	1	UIAW
(unmarked)	Blue	0.01 (0.02)	0.01 (0.61)	1	UIAB
(unmarked)	Black	0.01 (0.02)	0.01 (0.61)	1	UIAN
ON	Green	0.01 (0.02)	0.01 (0.61)	1	UIA01
OFF	Red	0.01 (0.02)	0.01 (0.61)	1	UIA02
START	Green	0.01 (0.02)	0.01 (0.61)	1	UIA03
STOP	Red	0.01 (0.02)	0.01 (0.61)	1	UIA04
MARCHE	Green	0.01 (0.02)	0.01 (0.61)	1	UIA05
ARRET	Red	0.01 (0.02)	0.01 (0.61)	1	UIA06
I	Green	0.01 (0.02)	0.01 (0.61)	1	UIA07
O	Red	0.01 (0.02)	0.01 (0.61)	1	UIA08

① Overall hazardous location and ingress protection rating depends on the rating of the optional certified components used.

Unicode™ 2 Series Mushroom Push Buttons

Components for Increased Safety Enclosures

NEC/CEC:
 Class I, Division 2, Groups A, B, C, D
 Class I, Zone 1, AEx de IIC
 Class I, Zone1, AEx e IIC

NEC/CEC:
 Class II, Division 2, Groups F, G
 Class III
 Type 4X/IP66 ①

ATEX/IECEX:
 Zone 1 and 2 – 21 and 22
 II 2 GD
 IP66 – IK10

Features

- Can be equipped with up to three Unicode 2 Series Contact Blocks (UCB) contact blocks.
- Globally certified.
- Available in TS35 rail mounted or panel mounted.

Standard Materials

- Body: polyamide
- Seal: ethylene propylene diene Monomer (M-class) rubber (EPDM)

NEC/CEC Certifications and Compliances

- Certification Type TCe
 - Operating Temperature: -40 °C to +60 °C (-40 °F to +140 °F)
 - Ingress Protection (solid and liquid): IP66 and Type 4X ①
 - CAN/CSA Standards: C22.2 No. 0-M91, No. 14-05, No. 94-M91, No. 213-M1987, No. 60079-0:07, No. 60079-1:07, No. 60529:05, E60079-7-03, E61241-1-1:02
 - UL Standards: UL 508, UL 50E, UL 60079-0, UL 60079-1, UL 60079-7
 - Other Standards: ANSI/ISA 12.12.01-2011, ANSI/ISA 61241-0 (12.10.02)-2006, ANSI/ISA 61241-1(12.10.03)-2006
 - CSA Certificate: 2358701

ATEX/IECEX Certifications and Compliances

- Certification Type TCe
 - Gas: Zone 1 and 2
 - Conforming to ATEX 94/9/CE: II 2 G
 - Type of Protection: Ex e IIC Gb
 - Dust: Zone 21 and 22
 - Conforming to ATEX 94/9/CE: II 2 D
 - Type of Protection: Ex tb IIIC Db
- Surface Temperature: -40 °C to +60 °C (-40 °F to +140 °F)
- CE Declaration of Conformity: 5C242
- ATEX Certificate: LCIE 09 ATEX 3010U
- IECEX Certificate: IECEX LCI 09.0011U
- Index of Protection according EN/IEC 60529: IP66
- Impact Resistance (shock): IK10

EURASEC Certification

- EURASEC RU C-FR. F505.B00909

Other Certification ②

- INMETRO Certificate: BVC 10.0044-U

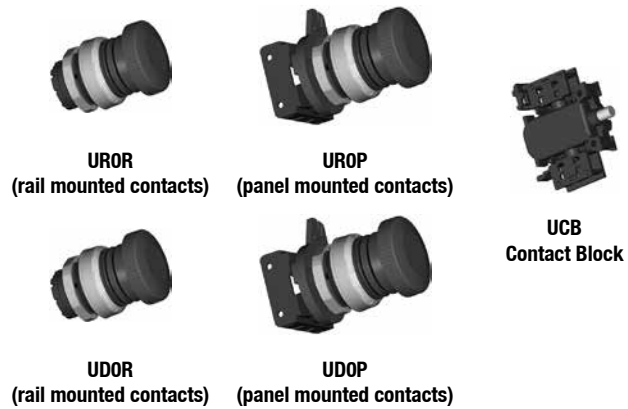

Dimensions in Millimeters (Inches)

Rail Mounted Contacts

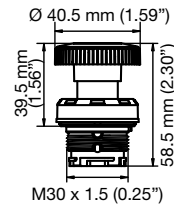

Panel Mounted Contacts

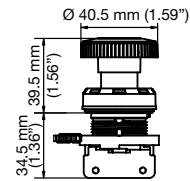

Unicode™ 2 Series Mushroom Push Buttons

Components for Increased Safety Enclosures

NEC/CEC:
 Class I, Division 2, Groups A, B, C, D
 Class I, Zone 1, AEx de IIC
 Class I, Zone1, AEx e IIC

NEC/CEC:
 Class II, Division 2, Groups F, G
 Class III
 Type 4X/IP66 ①

ATEX/IECEX:
 Zone 1 and 2 – 21 and 22
 II 2 GD
 IP66 – IK10

	Weight kg (lb)		Volume dm ³ (in ³)		Pack	Catalog Number	
	Rail Mounted	Panel Mounted	Rail Mounted	Panel Mounted		Rail Mounted	Panel Mounted
Spring Return Mushroom Head Push Button (contact block to be ordered separately)							
<i>Legend plates, guards, blanking plugs (see Accessories page).</i>							
Red	0.045 (0.099)	0.06 (0.13)	0.26 (15.87)	0.12 (7.32)	1	UR0R	UR0P
Black	0.045 (0.099)	0.06 (0.13)	0.26 (15.87)	0.12 (7.32)	1	UB0R	UB0P
Push-Pull Mushroom Head Push Button (contact block to be ordered separately)							
<i>Legend plates, guards, blanking plugs (see Accessories page).</i>							
Red Emergency Stop	0.045 (0.099)	0.06 (0.13)	0.12 (7.32)	0.26 (15.87)	1	UD0R	UD0P
1-Pole Contact Blocks							
1 x NO	0.032 (0.071)		0.06 (3.66)		1	UCB5R	UCB5P
1 x NC						UCB9R	UCB9P
Accessories							
Rail to panel mounted conversion adaptor	0.02 (0.04)		0.08 (4.88)		1		UPMA

CONTROL S: NEC/CEC, ATEX/IECEX INCREASED SAFETY CONTROL STATIONS

Appleton®

① Overall hazardous location and ingress protection rating depends on the rating of the optional certified components used.

Unicode™ 2 Series Key Release Mushroom Push Buttons

Components for Increased Safety Enclosures

NEC/CEC:

Class I, Division 2 Groups A, B, C, D
 Class I, Zone 1, Ex e d IIC Gb
 Class I, Zone 1, AEx e d IIC Gb
 Class II, Division 1, Groups E, F, G

NEC/CEC:

Class II, Zone 21, Ex tb IIIC Db
 Class II, Zone 21, AEx t IIIC Db
 Class III, Division 1
 IP6X

ATEX/IECEX:

Zone 1 and 2 – 21 and 22
 Ⓜ II 2 GD
 IP66 - IK10

Features

- Can be equipped with up to three Unicode 2 Series Contact Blocks (UCB) contact blocks.
- Globally certified.
- Available in TS35 rail mounted or panel mounted.

Standard Materials

- Body: thermosetting plastic
- Seal: ethylene propylene diene Monomer (M-class) rubber (EPDM)

NEC/CEC Certifications and Compliances

- Certification Type AUX
 - Rated Ambient Temperature: -55 °C to +70 °C (-67 °F to +158 °F)
- UL Standards: UL No. 61010-1 (2nd Edition), UL 60079-0 (5th Edition 2009), UL 60079-1 (6th Edition 2009), UL 60079-7 (Ed 4th 2008), UL 60079-31:2009
- UL Certificate: E184198
- CAN/CSA Standards: C22.2 No. 0-10, C22.2 No. 61010-1-04, C22.2 No 213 (2nd Edition), C22.2 No. 60079-0:07, C22.2 No. 60079-1:07, No. 60079-7:03, No. 60079-31:12, E61241-1-1:02, C22.2 No. 60529:05 (R 2010)
- CSA Certificate: 2661552
- Other Standards: ANSI/ISA-12.12.01 (2013), ANSI/ISA-61241-0 (12.10.02)-2006 (R2011), ANSI/ISA-61241-1 (12.10.03)-2006 (R2011), ANSI/IEC 60529-2004

ATEX Certifications and Compliances

- Certification Type AUX
 - Gas: Zone 1 and 2
 - Conforming to ATEX 94/9/CE: Ⓜ II 2 G
 - Type of Protection: Ex e II
 - Dust: Zone 21 and 22
 - Conforming to ATEX 94/9/CE: Ⓜ II 2 D
 - Type of Protection: Ex tD A21
- Surface Temperature: -20 °C to +70 °C (-4 °F to +158 °F)
- CE Declaration of Conformity: 5C206
- ATEX Certificate: LCIE 00 ATEX 0002U
- Index of Protection according EN/IEC 60529: IP66
- Impact Resistance (shock): 7 Joules

EURASEC Certification

- EURASEC RU C-FR. Г505.В00909

Other Certification ①

- INMETRO Certificate: BVC 11.0644-U



UCOR (rail mounted contacts) UCOP (panel mounted contacts) UCB Contact Block

Dimensions in Millimeters (Inches)

Rail Mounted Contacts

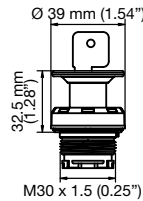

Panel Mounted Contacts

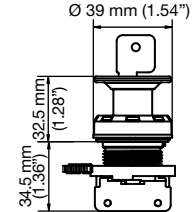

① INMETRO certification available on special request only. Contact your local sales representative for more information.

Unicode™ 2 Series Key Release Mushroom Push Buttons

Components for Increased Safety Enclosures

NEC/CEC:

Class I, Division 2 Groups A, B, C, D
 Class I, Zone 1, Ex e d IIC Gb
 Class I, Zone 1, AEx e d IIC Gb
 Class II, Division 1, Groups E, F, G

NEC/CEC:

Class II, Zone 21, Ex tb IIIC Db
 Class II, Zone 21, AEx t IIIC Db
 Class III, Division 1
 IP6X

ATEX/IECEX:

Zone 1 and 2 – 21 and 22
 II 2 GD
 IP66 - IK10

	Weight kg (lb)		Volume dm ³ (in ³)		Pack	Catalog Number	
	Rail Mounted	Panel Mounted	Rail Mounted	Panel Mounted		Rail Mounted	Panel Mounted
Key Release Mushroom Head Push Button (contact block to be ordered separately)							
<i>For legend plates, guards and blanking plugs see accessories page.</i>							
Red	0.085 (0.183)	0.096 (0.212)	0.09 (5.49)	0.25 (15.26)	1	UC0R	UC0P
1-Pole Contact Blocks							
1 x NO						UCB5R	UCB5P
1 x NC	0.032 (0.071)		0.06 (3.66)		1	UCB9R	UCB9P
Spare Parts							
Spare key (type 4A 185)		—		—		SK4A185	SK4A185
Rail to panel mounted conversion adaptor	0.02 (0.04)		0.08 (4.88)		1	—	UPMA

CONTROL S: NEC/CEC, ATEX/IECEX INCREASED SAFETY CONTROL STATIONS



Unicode™ 2 Series Key Momentary Push Buttons

Components for Increased Safety Enclosures

NEC/CEC:

Class I, Division 2 Groups A, B, C, D
 Class I, Zone 1, Ex e d IIC Gb
 Class I, Zone 1, AEx e d IIC Gb
 Class II, Division 1, Groups E, F, G

NEC/CEC:

Class II, Zone 21, Ex tb IIIC Db
 Class II, Zone 21, AEx t IIIC Db
 Class III, Division 1
 IP6X

ATEX/IECEX:

Zone 1 and 2 – 21 and 22
 Ⓢ II 2 GD
 IP66 - IK10

Features

- Can be equipped with up to three Unicode 2 Series Contact Blocks (UCB) contact blocks.
- Globally certified.
- Available in TS35 rail mounted or panel mounted.

Standard Materials

- Body: thermosetting plastic
- Seal: ethylene propylene diene Monomer (M-class) rubber (EPDM)

NEC/CEC Certifications and Compliances

- Certification Type AUX
 - Rated Ambient Temperature: -55 °C to +70 °C (-67 °F to +158 °F)
- UL Standards: UL No. 61010-1 (2nd Edition), UL 60079-0 (5th Edition 2009), UL 60079-1 (6th Edition 2009), UL 60079-2 (Ed 4th 2008), UL 60079-31:2009
- UL Certificate: E184198
- CAN/CSA Standards: C22.2 No. 0-10, C22.2 No. 61010-1-04, C22.2 No 213 (2nd Edition), C22.2 No. 60079-0:07, C22.2 No. 60079-1:07, No. 60079-7:03, No. 60079-31:12, E61241-1-1:02, C22.2 No. 60529:05 (R 2010)
- CSA Certificate: 2661552
- Other Standards: ANSI/ISA-12.12.01 (2013), ANSI/ISA-61241-0 (12.10.02)-2006 (R2011), ANSI/ISA-61241-1 (12.10.03)-2006 (R2011), ANSI/IEC 60529-2004

ATEX Certifications and Compliances

- Certification Type AUX
 - Gas: Zone 1 and 2
 - Conforming to ATEX 94/9/CE: Ⓢ II 2 G
 - Type of Protection: Ex e II
 - Dust: Zone 21 and 22
 - Conforming to ATEX 94/9/CE: Ⓢ II 2 D
 - Type of Protection: Ex tD A21
- Surface Temperature: -20 °C to +70 °C (-4 °F to +158 °F)
- CE Declaration of Conformity: 5C206
- ATEX Certificate: LCIE 00 ATEX 0002U
- Index of Protection according EN/IEC 60529: IP66
- Impact Resistance (shock): 7 Joules

EURASEC Certification

- EURASEC RU C-FR. Г505.В00909

Other Certification ①

- INMETRO Certificate: BVC 11.0644-U



Dimensions in Millimeters (Inches)

Rail Mounted Contacts

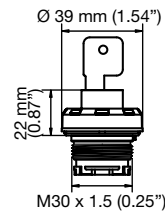

Panel Mounted Contacts

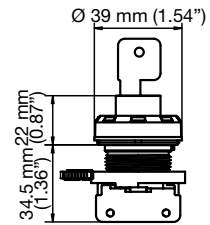

① INMETRO certification available on special request only. Contact your local sales representative for more information.

Unicode™ 2 Series Key Momentary Push Buttons

Components for Increased Safety Enclosures

NEC/CEC:

Class I, Division 2 Groups A, B, C, D
 Class I, Zone 1, Ex e d IIC Gb
 Class I, Zone 1, AEx e d IIC Gb
 Class II, Division 1, Groups E, F, G

NEC/CEC:

Class II, Zone 21, Ex tb IIIC Db
 Class II, Zone 21, AEx t IIIC Db
 Class III, Division 1
 IP6X

ATEX/IECEX:

Zone 1 and 2 – 21 and 22
 Ⓢ II 2 GD
 IP66 - IK10

	Weight kg (lb)		Volume dm ³ (in ³)		Pack	Catalog Number	
	Rail Mounted	Panel Mounted	Rail Mounted	Panel Mounted		Rail Mounted	Panel Mounted
Key Momentary Push Button (contact block to be ordered separately)							
<i>For legend plates, guards and blanking plugs see accessories page.</i>							
Key removable in both positions	0.080 (0.176)	0.093 (0.205)	0.08 (4.88)	0.20 (12.20)	1	UE0R	UE0P
Key removable in ON positions	0.080 (0.176)	0.093 (0.205)	0.08 (4.88)	0.20 (12.20)	1	UF0R	UF0P
Key removable in OFF positions	0.080 (0.176)	0.093 (0.205)	0.08 (4.88)	0.20 (12.20)	1	UG0R	UG0P
1-Pole Contact Blocks							
1 x NO	0.032 (0.071)		0.06 (3.66)		1	UCB5R	UCB5P
1 x NC						UCB9R	UCB9P
Spare Parts							
Spare key (type 4A 185)	—		—			SK4A185	SK4A185
Rail to panel mounted conversion adaptor	0.02 (0.04)		0.08 (4.88)		1	—	UPMA

CONTROL S: NEC/CEC, ATEX/IECEX INCREASED SAFETY CONTROL STATIONS



Unicode™ 2 Series Rotary Actuators

Components for Increased Safety Enclosures

NEC/CEC:
 Class I, Division 2, Groups A, B, C, D
 Class I, Zone 1, AEx de IIC
 Class I, Zone1, AEx e IIC

NEC/CEC:
 Class II, Division 2, Groups F, G
 Class III
 Type 4X/IP66 ①

ATEX/IECEX:
 Zone 1 and 2 – 21 and 22
 Ⓢ II 2 GD
 IP66 – IK10

CONTROLS: NEC/CEC, ATEX/IECEX INCREASED SAFETY CONTROL STATIONS

Features

- Can be equipped with up to three Unicode 2 Series Contact Blocks (UCB) contact blocks.
- Globally certified.
- Available in TS35 rail mounted or panel mounted.

Standard Materials

- Body: thermosetting plastic
- Seal: ethylene propylene diene Monomer (M-class) rubber (EPDM)

NEC/CEC Certifications and Compliances

- Certification Type TCe
 - Operating Temperature: -40 °C to +60 °C (-40 °F to +140 °F)
 - Ingress Protection (solid and liquid): IP66 and Type 4X ①
 - CAN/CSA Standards: C22.2 No. 0-M91, No. 14-05, No. 94-M91, No. 213-M1987, No. 60079-0:07, No. 60079-1:07, No. 60529:05, E60079-7-03, E61241-1-1:02
 - UL Standards: UL 508, UL 50E, UL 60079-0, UL 60079-1, UL 60079-7
 - Other Standards: ANSI/ISA 12.12.01-2011, ANSI/ISA 61241-0 (12.10.02)-2006, ANSI/ISA 61241-1(12.10.03)-2006
 - CSA Certificate: 2358701

ATEX/IECEX Certifications and Compliances

- Certification Type TCe
 - Gas: Zone 1 and 2
 - Conforming to ATEX 94/9/CE: Ⓢ II 2 G
 - Type of Protection: Ex e IIC Gb
 - Dust: Zone 21 and 22
 - Conforming to ATEX 94/9/CE: Ⓢ II 2 D
 - Type of Protection: Ex tb IIIC Db
- Surface Temperature: -40 °C to +60 °C (-40 °F to +140 °F)
- CE Declaration of Conformity: 5C242
- ATEX Certificate: LCIE 09 ATEX 3010U
- IECEx Certificate: IECEx LCI 09.0011U
- Index of Protection according EN/IEC 60529: IP66
- Impact Resistance (shock): IK10

EURASEC Certification

- EURASEC RU C-FR. F505.B00909

Other Certification ②

- INMETRO Certificate: BVC 11.0644-U

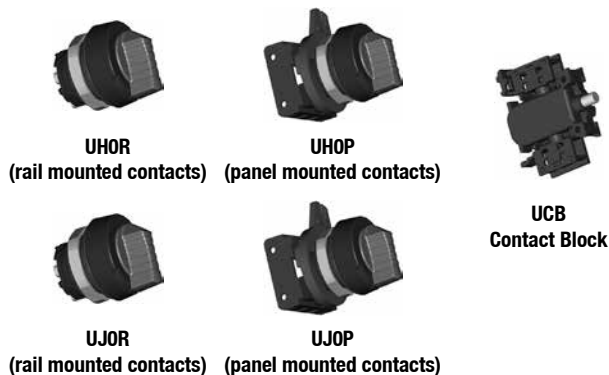

Dimensions in Millimeters (Inches)

Rail Mounted Contacts

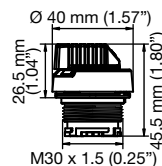

Panel Mounted Contacts

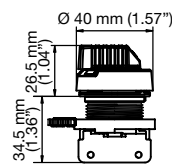

① Overall hazardous location and ingress protection rating depends on the rating of the optional certified components used.

② INMETRO certification available on special request only. Contact your local sales representative for more information.

Unicode™ 2 Series Rotary Actuators

Components for Increased Safety Enclosures

NEC/CEC:
 Class I, Division 2, Groups A, B, C, D
 Class I, Zone 1, AEx de IIC
 Class I, Zone1, AEx e IIC

NEC/CEC:
 Class II, Division 2, Groups F, G
 Class III
 Type 4X/IP66 ①

ATEX/IECEX:
 Zone 1 and 2 – 21 and 22
 II 2 GD
 IP66 – IK10

	Weight kg (lb)		Volume dm ³ (in ³)		Pack	Catalog Number		
	Rail Mounted	Panel Mounted	Rail Mounted	Panel Mounted		Rail Mounted	Panel Mounted	
2-Position Rotary Actuator (contact block to be ordered separately)								
<i>For legend plates, guards and blanking plugs see accessories page.</i>								
2-Positions Selector Switch (O-I), 2 maintained positions	0.038 (0.084)	0.051 (0.112)	0.09 (5.49)	0.22 (13.43)	1	UH0R	UH0P	
3-Position Rotary Actuator (contact block to be ordered separately)								
<i>Legend plates, guards, blanking plugs (see Accessories page).</i>								
3-Position Selector Switch, I and II position maintained (I-O-II)	0.038 (0.084)	0.051 (0.112)	0.09 (5.49)	0.22 (13.43)	1	UJ0R	UJ0P	
3-Position Selector Switch, I and II spring return to O (I->O<-II)	0.038 (0.084)	0.051 (0.112)	0.09 (5.49)	0.22 (13.43)	1	UK0R	UK0P	
3-Position Selector Switch, I maintained, II spring return to O (I-O<-II)	0.038 (0.084)	0.051 (0.112)	0.09 (5.49)	0.22 (13.43)	1	UM0R	UM0P	
3-Position Selector Switch, I spring return to O, II maintained (I->O-II)	0.038 (0.084)	0.051 (0.112)	0.09 (5.49)	0.22 (13.43)	1	UN0R	UN0P	
1-Pole Contact Blocks								
1 x NO	0.032 (0.071)		0.06 (3.66)		1	UCB5R	UCB5P	
1 x NC						UCB9R	UCB9P	
Spare Parts								
Rail to panel mounted conversion adaptor	0.02 (0.04)		0.08 (4.88)		1	—	UPMA	

Wiring Diagrams

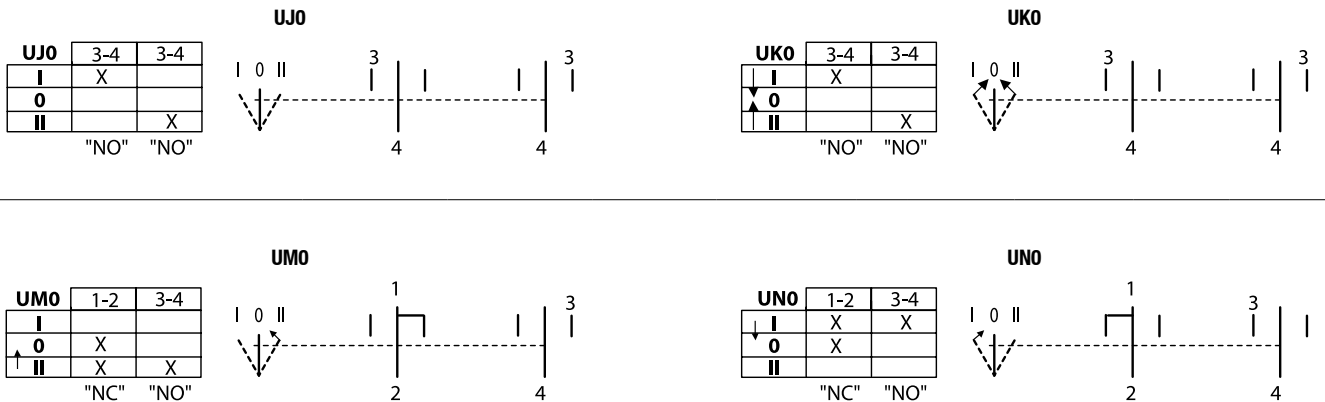

① Overall hazardous location and ingress protection rating depends on the rating of the optional certified components used.

Unicode™ 2 Series Illuminated Push Buttons

Components for Increased Safety Enclosures

NEC/CEC:
Class I, Division 2, Groups A, B, C, D
Class I, Zone 1, AEx de IIC
Class I, Zone 1, AEx e IIC

NEC/CEC:
Class II, Division 2, Groups F, G
Class III
Type 4X/IP66 ①

ATEX/IECEX:
Zone 1 and 2 – 21 and 22
Ⓜ II 2 GD
IP66 – IK10

Features

- Can be equipped with up to two Unicode 2 Series Contact Blocks (UCB) contact blocks.
- Globally certified.
- Available in TS35 rail mounted or panel mounted.
- Long lifetime, high intensity single LED light.
- Rated operating voltage (Ue): 12 Vac to 254 Vac, 50/60 Hz and 12 Vdc to 60 Vdc.
- Terminal connection: 2.5 mm² (0.004 in²)
- Operational life: 100,000 hours.

Standard Materials

- Body: polyamide
- Lens: polycarbonate
- Seal: ethylene propylene diene Monomer (M-class) rubber (EPDM)

NEC/CEC Certifications and Compliances

- Certification Type TCe
 - Operating Temperature: -40 °C to +60 °C (-40 °F to +140 °F)
 - Ingress Protection (solid and liquid): IP66 and Type 4X ①
 - CAN/CSA Standards: C22.2 No. 0-M91, No. 14-05, No. 94-M91, No. 213-M1987, No. 60079-0:07, No. 60079-1:07, No. 60529:05, E60079-7-03, E61241-1-1:02
 - UL Standards: UL 508, UL 50E, UL 60079-0, UL 60079-1, UL 60079-7
 - Other Standards: ANSI/ISA 12.12.01-2011, ANSI/ISA 61241-0 (12.10.02)-2006, ANSI/ISA 61241-1(12.10.03)-2006
 - CSA Certificate: 2358701

ATEX/IECEX Certifications and Compliances

- Certification Type TCe (Actuator and Lens).
 - Gas: Zone 1 and 2
 - Conforming to ATEX 94/9/CE: Ⓜ II 2 G
 - Type of Protection: Ex e IIC Gb
 - Dust: Zone 21 and 22
 - Conforming to ATEX 94/9/CE: Ⓜ II 2 D
 - Type of Protection: Ex tb IIIC Db
 - Surface Temperature: -40 °C to +60 °C (-40 °F to +140 °F)
 - CE Declaration of Conformity: 5C242
 - ATEX Certificate: LCIE 09 ATEX 3010U
 - IECEx Certificate: IECEx LCI 09.0011U
 - Index of Protection according EN/IEC 60529: IP66
 - Impact Resistance (shock): IK10
- Certification Type CVe (Contact Block and Pilot Light)
 - Gas: Zone 1 and 2
 - Conforming to ATEX 94/9/CE: Ⓜ II 2 G
 - Type of Protection: Ex e IIC
 - Dust: Zone 21 and 22
 - Conforming to ATEX 94/9/CE: Ⓜ II 2 D
 - Type of Protection: Ex tD A21
 - Surface Temperature: -40 °C to +75 °C (-40 °F to +167 °F)
 - CE Declaration of Conformity: 5C243
 - ATEX Certificate: LCIE 09 ATEX 3001U
 - IECEx Certificate: IECEx LCI 09.0002U



ULGOH
(rail mounted contacts)



ULGOP
(panel mounted contacts)



UCB
Contact Block



UIL08

EURASEC Certification

- Certification Type TCe (Actuator and Lens)
 - EURASEC RU C-FR. Г505.В00909
- Certification Type CVe (Contact Block and Pilot Light)
 - EURASEC RU C-FR. Г505.В00909

Other Certification ②

- Certification Type TCe (Actuator and Lens)
 - INMETRO Certificate: BVC 10.0044-U
- Certification Type CVe (Contact Block and Pilot Light)
 - INMETRO Certificate: BVC 10.0047-U

① Overall hazardous location and ingress protection rating depends on the rating of the optional certified components used.

② INMETRO certification available on special request only. Contact your local sales representative for more information.

Unicode™ 2 Series Illuminated Push Buttons

Components for Increased Safety Enclosures

NEC/CEC:
Class I, Division 2, Groups A, B, C, D
Class I, Zone 1, AEx de IIC
Class I, Zone1, AEx e IIC

NEC/CEC:
Class II, Division 2, Groups F, G
Class III
Type 4X/IP66 ①

ATEX/IECEX:
Zone 1 and 2 – 21 and 22
II 2 GD
IP66 – IK10

	Weight kg (lb)		Volume dm ³ (in ³)		Pack	Catalog Number	
	Rail Mounted	Panel Mounted	Rail Mounted	Panel Mounted		Rail Mounted	Panel Mounted
Spring Return Illuminated Push Button (contact block to be ordered separately) For legend plates, guards and blanking plugs see accessories page.							
Green	0.062 (0.137)	0.075 (0.165)	0.26 (15.87)	0.28 (17.09)	1	ULG0R	ULG0P
Red	0.062 (0.137)	0.075 (0.165)	0.26 (15.87)	0.28 (17.09)	1	ULR0R	ULR0P
White	0.062 (0.137)	0.075 (0.165)	0.26 (15.87)	0.28 (17.09)	1	ULW0R	ULW0P
Blue	0.062 (0.137)	0.075 (0.165)	0.26 (15.87)	0.28 (17.09)	1	ULB0R	ULB0P
Yellow	0.062 (0.137)	0.075 (0.165)	0.26 (15.87)	0.28 (17.09)	1	ULY0R	ULY0P

1-Pole Contact Blocks

1 x NO						UCB5R	UCB5P
1 x NC	0.032 (0.071)		0.06 (3.66)		1	UCB9R	UCB9P

Spare Parts

Rail to panel mounted conversion adaptor	0.02 (0.04)		0.08 (4.88)		1	—	UPMA
--	-------------	--	-------------	--	---	---	------

Marking	Color	Weight kg (lb)	Volume dm ³ (in ³)	Pack	Catalog Number
Set of Five Spare Inserts					
(unmarked)	Green	0.01 (0.02)	0.01 (0.61)	1	UIAG
(unmarked)	Red	0.01 (0.02)	0.01 (0.61)	1	UIAR
(unmarked)	Yellow	0.01 (0.02)	0.01 (0.61)	1	UIAY
(unmarked)	White	0.01 (0.02)	0.01 (0.61)	1	UIAW
(unmarked)	Blue	0.01 (0.02)	0.01 (0.61)	1	UIAB
(unmarked)	Black	0.01 (0.02)	0.01 (0.61)	1	UIAN
ON	Green	0.01 (0.02)	0.01 (0.61)	1	UIA01
OFF	Red	0.01 (0.02)	0.01 (0.61)	1	UIA02
START	Green	0.01 (0.02)	0.01 (0.61)	1	UIA03
STOP	Red	0.01 (0.02)	0.01 (0.61)	1	UIA04
MARCHE	Green	0.01 (0.02)	0.01 (0.61)	1	UIA05
ARRET	Red	0.01 (0.02)	0.01 (0.61)	1	UIA06
I	Green	0.01 (0.02)	0.01 (0.61)	1	UIA07
O	Red	0.01 (0.02)	0.01 (0.61)	1	UIA08

Dimensions in Millimeters (Inches)

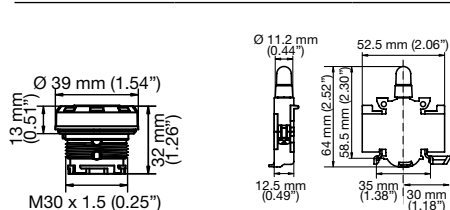

Rail Mounted Contacts

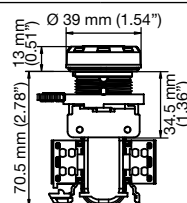

Panel Mounted Contacts

Wiring Diagram



① Overall hazardous location and ingress protection rating depends on the rating of the optional certified components used.

Unicode™ 2 Series Pilot Lights

Components for Increased Safety Enclosures

NEC/CEC:
 Class I, Division 2, Groups A, B, C, D
 Class I, Zone 1, AEx de IIC
 Class I, Zone1, AEx e IIC

NEC/CEC:
 Class II, Division 2, Groups F, G
 Class III
 Type 4X/IP66 ①

ATEX/IECEX:
 Zone 1 and 2 – 21 and 22
 Ⓢ II 2 GD
 IP66 – IK10

CONTROLS: NEC/CEC, ATEX/IECEX INCREASED SAFETY CONTROL STATIONS

Features

- Globally certified.
- Available in TS35 rail mounted or panel mounted.
- Long lifetime, high intensity single LED light.
- Rated operating voltage (Ue): 12 Vac to 254 Vac, 50/60 Hz and 12 Vdc to 60 Vdc.
- Terminal connection: 2.5 mm² (0.004 in²)
- Operational life: 100,000 hours.

Standard Materials

- Body: polyamide
- Lens: polycarbonate
- Seal: ethylene propylene diene Monomer (M-class) rubber (EPDM)

NEC/CEC Certifications and Compliances

- Actuator and Lens: Certification Type TCe
 - Operating Temperature: -40 °C to +60 °C (-40 °F to +140 °F)
 - Ingress Protection (solid and liquid): IP66 and Type 4X ①
 - CAN/CSA Standards: C22.2 No. 0-M91, No. 14-05, No. 94-M91, No. 213-M1987, No. 60079-0:07, No. 60079-1:07, No. 60529:05, E60079-7-03, E61241-1-1:02
 - UL Standards: UL 508, UL 50E, UL 60079-0, UL 60079-1, UL 60079-7
 - Other Standards: ANSI/ISA 12.12.01-2011, ANSI/ISA 61241-0 (12.10.02)-2006, ANSI/ISA 61241-1(12.10.03)-2006
 - CSA Certificate: 2358701

ATEX/IECEX Certifications and Compliances

- Certification Type TCe (Actuator and Lens)
 - Gas: Zone 1 and 2
 - Conforming to ATEX 94/9/CE: Ⓢ II 2 G
 - Type of Protection: Ex e IIC Gb
 - Dust: Zone 21 and 22
 - Conforming to ATEX 94/9/CE: Ⓢ II 2 D
 - Type of Protection: Ex tb IIIC Db
 - Surface Temperature: -40 °C to +60 °C (-40 °F to +140 °F)
 - CE Declaration of Conformity: 5C242
 - ATEX Certificate: LCIE 09 ATEX 3010U
 - IECEX Certificate: IECEX LCI 09.0011U
 - Index of Protection according EN/IEC 60529: IP66
 - Impact Resistance (shock): IK10
- Certification Type CVe (Contact Block and Pilot Light)
 - Gas: Zone 1 and 2
 - Conforming to ATEX 94/9/CE: Ⓢ II 2 G
 - Type of Protection: Ex e IIC
 - Dust: Zone 21 and 22
 - Conforming to ATEX 94/9/CE: Ⓢ II 2 D
 - Type of Protection: Ex tD A21
 - Surface Temperature: -40 °C to +75 °C (-40 °F to +167 °F)
 - CE Declaration of Conformity: 5C243
 - ATEX Certificate: LCIE 09 ATEX 3001U
 - IECEX Certificate: IECEX LCI 09.0002U



UPGOR
(rail mounted contacts)



UPGOP
(panel mounted contacts)

EURASEC Certification

- Certification Type TCe (Actuator and Lens)
 - EURASEC RU C-FR. Г505.В00909
- Certification Type CVe (Contact Block and Pilot Light)
 - EURASEC RU C-FR. Г505.В00909

Other Certification ②

- Certification Type TCe (Actuator and Lens)
 - INMETRO Certificate: BVC 10.0044-U
- Certification Type CVe (Contact Block and Pilot Light)
 - INMETRO Certificate: BVC 10.0047-U

① Overall hazardous location and ingress protection rating depends on the rating of the optional certified components used.

② INMETRO certification available on special request only. Contact your local sales representative for more information.

Unicode™ 2 Series Pilot Lights

Components for Increased Safety Enclosures

NEC/CEC:
 Class I, Division 2, Groups A, B, C, D
 Class I, Zone 1, AEx de IIC
 Class I, Zone1, AEx e IIC

NEC/CEC:
 Class II, Division 2, Groups F, G
 Class III
 Type 4X/IP66 ①

ATEX/IECEX:
 Zone 1 and 2 – 21 and 22
 Ⓢ II 2 GD
 IP66 – IK10

	Weight kg (lb)		Volume dm ³ (in ³)		Pack	Catalog Number	
	Rail Mounted	Panel Mounted	Rail Mounted	Panel Mounted		Rail Mounted	Panel Mounted
Pilot Light: 12 Vac to 254, Vac 50/60 Hz, 12 Vdc to 60 Vdc. For legend plates, guards and blanking plugs see accessories page.							
Green	0.056 (0.123)	0.069 (0.152)	0.29 (17.70)	0.31 (18.92)	1	UPGOR	UPG0P
Red	0.056 (0.123)	0.069 (0.152)	0.29 (17.70)	0.31 (18.92)	1	UPROR	UPR0P
White	0.056 (0.123)	0.069 (0.152)	0.29 (17.70)	0.31 (18.92)	1	UPWOR	UPW0P
Blue	0.056 (0.123)	0.069 (0.152)	0.29 (17.70)	0.31 (18.92)	1	UPBOR	UPB0P
Yellow	0.056 (0.123)	0.069 (0.152)	0.29 (17.70)	0.31 (18.92)	1	UPYOR	UPY0P
Spare Parts							
Rail to panel mounted conversion adaptor	0.02 (0.04)		0.08 (4.88)		1		UPMA
Spare Lenses							
Green	0.03 (0.06)		0.06 (3.66)		1	UPGL	UPGL
Red	0.03 (0.06)		0.06 (3.66)		1	UPRL	UPRL
White	0.03 (0.06)		0.06 (3.66)		1	UPWL	UPWL
Blue	0.03 (0.06)		0.06 (3.66)		1	UPBL	UPBL
Yellow	0.03 (0.06)		0.06 (3.66)		1	UPYL	UPYL

Dimensions in Millimeters (Inches)

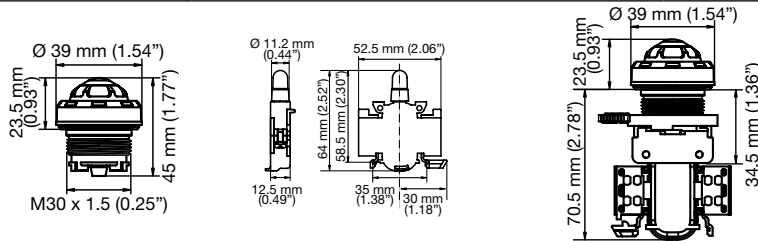

Rail Mounted Contacts

Panel Mounted Contacts

Wiring Diagram

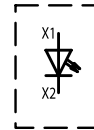

① Overall hazardous location and ingress protection rating depends on the rating of the optional certified components used.

Unicode™ 2 Series 1–Pole Contact Block

Components for Increased Safety Enclosures

NEC/CEC:
 Class I, Division 2, Groups A, B, C, D
 Class I, Zone 1, AEx de IIC
 Class I, Zone1, AEx e IIC

NEC/CEC:
 Class II, Division 2, Groups F, G
 Class III
 Type 4X/IP66 ①

ATEX/IECEx:
 Zone 1 and 2 – 21 and 22
 Ⓢ II 2 GD
 IP66 – IK10

CONTROLS: NEC/CEC, ATEX/IECEx INCREASED SAFETY CONTROL STATIONS

Features

- Globally certified.
- Available in TS35 rail mounted or panel mounted.
- High performance contact block suitable for low intensity (less than 5mA).
- Rated operating voltage (Ue): 500 Vac – 110 Vdc.
- Switching capacity:
 - AC12: 16 Amp/400 Vac
 - AC14: 10 Amp/400 Vac
 - AC15: 6 Amp/500 Vac
 - DC13: 2 Amp/24 Vdc and 1 Amp/110 Vdc
- Terminal connection: 2.5 mm² (0.004 in²)
- Operational life: 100,000 hours.

Standard Materials

- Body: polyamide
- Contact: silver alloy

NEC/CEC Certifications and Compliances

- Certification Type Cve
 - Operating Temperature: -40 °C to +75 °C (-40 °F to +167 °F)
 - Ingress Protection (solid and liquid): IP66 and Type 4X ①
 - CAN/CSA Standards: C22.2 No. 0-M91, No. 14-05, No. 94-M91, No. 213-M1987, No. 60079-0:07, No. 60079-1:07, No. 60529:05, E60079-7-03, E61241-1-1:02
 - UL Standards: UL 508, UL 50E, UL 60079-0, UL 60079-1, UL 60079-7
 - Other Standards: ANSI/ISA 12.12.01-2011, ANSI/ISA 61241-0 (12.10.02)-2006, ANSI/ISA 61241-1(12.10.03)-2006
 - CSA Certificate: 2358701

ATEX/IECEx Certifications and Compliances

- Certification Type Cve
 - Gas: Zone 1 and 2
 - Conforming to ATEX 94/9/CE: Ⓢ II 2 G
 - Type of Protection: Ex e IIC
 - Dust: Zone 21 and 22
 - Conforming to ATEX 94/9/CE: Ⓢ II 2 D
 - Type of Protection: Ex tD A21
- Surface Temperature: -40 °C to +75 °C (-40 °F to +167 °F)
- CE Declaration of Conformity: 5C243
- ATEX Certificate: LCIE 09 ATEX 3001U
- IECEx Certificate: IECEx LCI 09.0002U

EURASEC Certification

- EURASEC RU C-FR.1605.B00909

Other Certification ②

- INMETRO Certificate: BVC 10.0047-U



UCB5R
 Rail Mounted Contacts
 Top Access



UCB5P
 Panel Mounted Contacts
 Bottom Access

① Overall hazardous location and ingress protection rating depends on the rating of the optional certified components used.

② INMETRO certification available on special request only. Contact your local sales representative for more information.

Unicode™ 2 Series 1–Pole Contact Block

Components for Increased Safety Enclosures

NEC/CEC:
Class I, Division 2, Groups A, B, C, D
Class I, Zone 1, AEx de IIC
Class I, Zone1, AEx e IIC

NEC/CEC:
Class II, Division 2, Groups F, G
Class III
Type 4X/IP66 ①

ATEX/IECEX:
Zone 1 and 2 – 21 and 22
Ⓢ II 2 GD
IP66 – IK10

	Weight kg (lb)		Volume dm ³ (in ³)		Pack	Catalog Number	
	Rail Mounted	Panel Mounted	Rail Mounted	Panel Mounted		Rail Mounted	Panel Mounted
1-Pole Contact Blocks							
1 x NO		0.032 (0.071)		0.06 (3.66)	1	UCB5R	UCB5P
1 x NC						UCB9R	UCB9P

Dimensions in Millimeters (Inches)

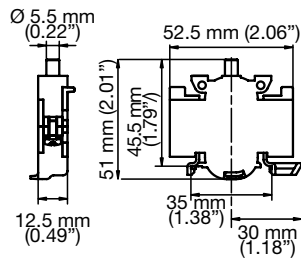

Wiring Diagram



① Overall hazardous location and ingress protection rating depends on the rating of the optional certified components used.

Unicode™ 2 Series 16 Amp Switches

Components for Increased Safety Enclosures

NEC:
Class I, Division 2, Groups A, B, C, D
Class I, Zone 1, AEx de IIC

CEC:
Class I, Division 2, Groups A, B, C, D
Ex de IIC

ATEX/IECEX:
Zone 1 and 2 – 21 and 22
Ⓜ II 2 GD

CONTROLS: NEC/CEC, ATEX/IECEX INCREASED SAFETY CONTROL STATIONS

Features

- 2, 3, 4, 6 or 8-pole switches:
 - Available in TS35 rail mounted or panel mounted.
 - Padlockable
 - Can be equipped with switch and changeover switch contact blocks
- Switching capacity:
 - AC 1, 16 Amp, 690 Vac
 - AC 3, 8 Amp, 500 Vac
 - AC 3, 4 Amp, 690 Vac
 - AC 15, 16 Amp, 415 Vac
 - DC 1, 10 Amp, 24 Vdc
 - DC 1, 6 Amp, 60 Vdc
 - DC 1: 6 Amp/110 Vdc (2 contacts wired in series)
 - DC 1: 6 Amp/220 Vdc (3 contacts in series)
- Terminal connection: 1.5 mm² - 2.5 mm² (0.002 in² - 0.004 in²) (stranded), 1.5 mm² - 4 mm² (0.002 in² - 0.006 in²) (solid)
- Operational life: 10,000 cycles.



US30R
(rail mounted switch)



US30P
(panel mounted switch)



USH Ⓜ
(switch handle)

Standard Materials

- Body: polyamide
- Contact: silver

NEC/CEC Certifications and Compliances

- Switches: Certification Type SW16
 - Ambient Temperature: -55 °C to +80 °C (-67 °F to +176 °F)
 - CAN/CSA Standards: C22.2 No. 0-12, No. 14-10, No. 213-M1987, No. 60079-0, No. 60079-1, No. E60079-7,
 - UL Standards: UL 508, UL 60079-0, UL 60079-1, UL 60079-7
 - Other Standards: ANSI/ISA 12.12.01
 - CSA Certificate: 2644203

ATEX/IECEX Certifications and Compliances ①

- Certification Type SW16 (Switches)
 - Gas: Zone 1 and 2
 - Conforming to ATEX 94/9/CE: Ⓜ II 2 G
 - Type of Protection: Ex db eb IIC
 - Dust: Zone 21 and 22
 - Must be used in an approved dustproof enclosure
 - Operating Temperature: -55 °C to +80 °C (-67 °F to +176 °F)
 - CE Declaration of Conformity: 5C249
 - ATEX Certificate: LCIE 12 ATEX 3068U
 - IECEX Certificate: IECEX LCIE 12.0021U
- Certification Type AUXe (Handles) Ⓜ
 - Gas: Zone 1 and 2
 - Conforming to ATEX 94/9/CE: Ⓜ II 2 G
 - Type of Protection: Ex e II
 - Dust: Zone 21 and 22
 - Conforming to ATEX 94/9/CE: Ⓜ II 2 D
 - Type of Protection: Ex tD A21
 - Ambient Temperature: -20 °C to +55 °C (-4 °F to +131 °F)
 - CE Declaration of Conformity: 5C221
 - ATEX Certificate: LCIE 03 ATEX 0012U
- Index of Protection according EN/IEC 60529: IP66
- Impact Resistance (shock): IK10

EURASEC Certification

- Certification Type SW16 (Switches)
 - EURASEC RU C-FR.Г505.В00909

① These products are certified only when used as components in factory assembled panels.

② USH handle is ATEX certified it is not for use in IECEX explosive atmospheres.

Unicode™ 2 Series 16 Amp Switches Standard Configurations

Components for Increased Safety Enclosures

NEC:
Class I, Division 2, Groups A, B, C, D
Class I, Zone 1, AEx de IIC

CEC:
Class I, Division 2, Groups A, B, C, D
Ex de IIC

ATEX/IECEx:
Zone 1 and 2 – 21 and 22
Ex II 2 GD

	Diagram Number	Wiring Diagram	Catalog Number	
			Rail Mounted	Panel Mounted
Two Pole Selector Switches (handle to be ordered separately)				
2 position 2-pole selector switch	002		US1622-0002R	US1622-0002P
2 position 2-pole selector switch	016		US1622-0016R	US1622-0016P
3 position 2-pole selector switch	027		US1623-0027R	US1623-0027P
3 position 2-pole selector switch with spring return from 135° to 90°	038		US1623-0038R	US1623-0038P
3 position 2-pole selector switch with spring return from 45° to 90°	048		US1623-0048R	US1623-0048P
Three or Four Pole Selector Switches (handle to be ordered separately)				
2 position 4-pole selector switch	102		US1642-0102R	US1642-0102P
3 position 4-pole selector switch	119		US1643-0119R	US1643-0119P
2 position 4-pole selector switch	106		US1642-0106R	US1642-0106P
3 position 3-pole — Late break, early make selector switch with spring return from 45° to 90°	138		US1633-0138R	US1633-0138P
3 position 3-pole — Late break, early make selector switch with spring return from 135° to 90°	197		US1633-0197R	US1633-0197P
Padlockable lever handle for all selector switches				USH ①

① USH handle is ATEX certified. it is not for use in IECEx explosive atmospheres.

Unicode™ 2 Series 16 Amp Switches

Components for Increased Safety Enclosures

NEC:
Class I, Division 2, Groups A, B, C, D
Class I, Zone 1, AEx de IIC

CEC:
Class I, Division 2, Groups A, B, C, D
Ex de IIC

ATEX/IECEx:
Zone 1 and 2 – 21 and 22
II 2 GD

CONTROLS: NEC/CEC, ATEX/IECEx INCREASED SAFETY CONTROL STATIONS

Appleton

Dimensions in Millimeters (Inches)

16 Amp Switches

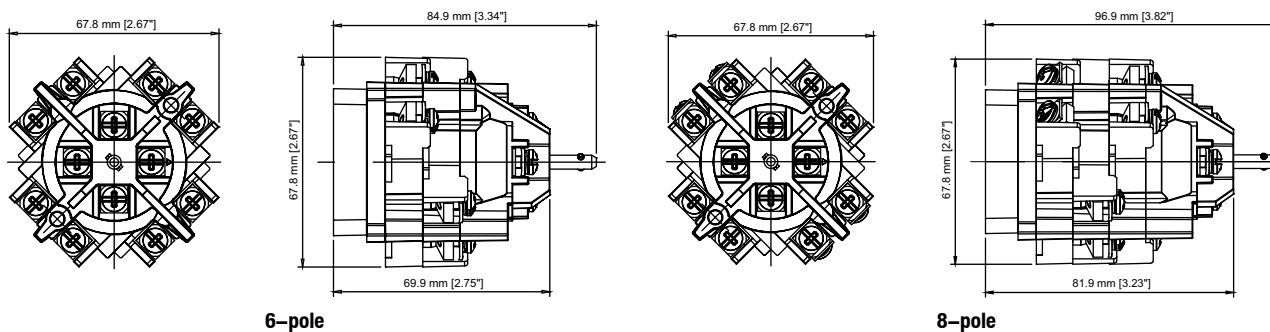
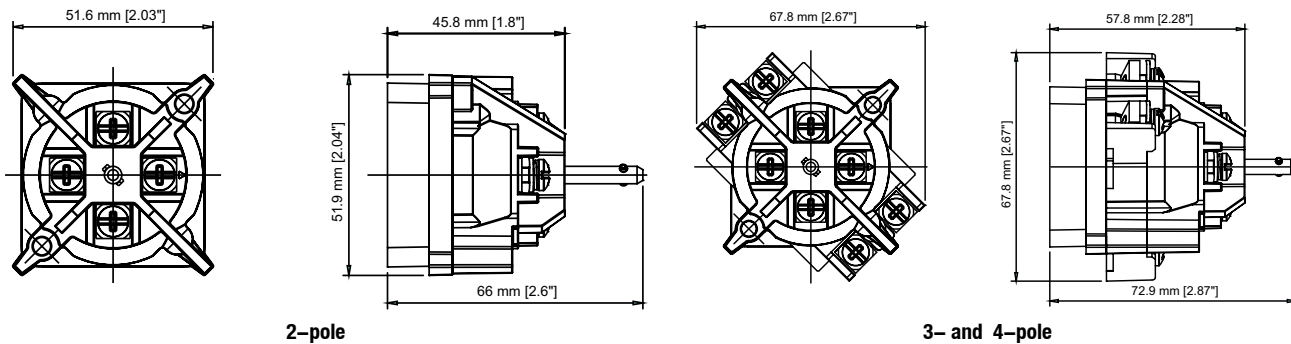

USH Handle ①

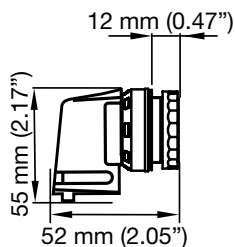

① USH handle is ATEX certified. It is not for use in IECEx explosive atmospheres.

Unicode™ 2 Series 16 Amp Switches Custom Configurations

Components for Increased Safety Enclosures

NEC:
Class I, Division 2, Groups A, B, C, D
Class I, Zone 1, AEx de IIC

CEC:
Class I, Division 2, Groups A, B, C, D
Ex de IIC

ATEX/IECEX:
Zone 1 and 2 – 21 and 22
II 2 GD

Wiring Diagram	Catalog Number		Wiring Diagram	Catalog Number	
	Rail Mounted	Panel Mounted		Rail Mounted	Panel Mounted
1-pole 2 position					
	US1612-0056R	US1612-0056P		US1612-0061R	US1612-0061P
2-pole 2 position					
	US1622-0003R	US1622-0003P		US1622-0015R	US1622-0015P
	US1622-0004R	US1622-0004P		US1622-0017R	US1622-0017P
	US1622-0005R	US1622-0005P		US1622-0018R	US1622-0018P
	US1622-0007R	US1622-0007P		US1622-0019R	US1622-0019P
	US1622-0008R	US1622-0008P		US1622-0020R	US1622-0020P
	US1622-0009R	US1622-0009P		US1622-0021R	US1622-0021P
	US1622-0010R	US1622-0010P		US1622-0043R	US1622-0043P
	US1622-0011R	US1622-0011P		US1622-0045R	US1622-0045P
	US1622-0012R	US1622-0012P		US1622-0053R	US1622-0053P
	US1622-0013R	US1622-0013P		US1622-0073R	US1622-0073P
	US1622-0014R	US1622-0014P		US1622-0074R	US1622-0074P
2-pole 3 position					
	US1623-0022R	US1623-0022P		US1623-0025R	US1623-0025P
	US1623-0023R	US1623-0023P		US1623-0026R	US1623-0026P
	US1623-0024R	US1623-0024P		US1623-0028R	US1623-0028P

CONTROL S: NEC/CEC, ATEX/IECEX INCREASED SAFETY CONTROL STATIONS



Unicode™ 2 Series 16 Amp Switches Custom Configurations

Components for Increased Safety Enclosures

NEC:
Class I, Division 2, Groups A, B, C, D
Class I, Zone 1, AEx de IIC

CEC:
Class I, Division 2, Groups A, B, C, D
Ex de IIC

ATEX/IECEx:
Zone 1 and 2 – 21 and 22
Ex II 2 GD

CONTROLS: NEC/CEC, ATEX/IECEx INCREASED SAFETY CONTROL STATIONS

Appleton®

Wiring Diagram	Catalog Number		Wiring Diagram	Catalog Number	
	Rail Mounted	Panel Mounted		Rail Mounted	Panel Mounted
2-pole 3 position					
	US1623-0029R	US1623-0029P		US1623-0052R	US1623-0052P
	US1623-0030R	US1623-0030P		US1623-0054R	US1623-0054P
	US1623-0031R	US1623-0031P		US1623-0055R	US1623-0055P
	US1623-0032R	US1623-0032P		US1623-0059R	US1623-0059P
	US1623-0039R	US1623-0039P		US1623-0068R	US1623-0068P
	US1623-0040R	US1623-0040P		US1623-0070R	US1623-0070P
	US1623-0041R	US1623-0041P		US1623-0071R	US1623-0071P
	US1623-0042R	US1623-0042P		US1623-0072R	US1623-0072P
	US1623-0046R	US1623-0046P		US1623-0075R	US1623-0075P
	US1623-0047R	US1623-0047P		US1623-0076R	US1623-0076P
	US1623-0049R	US1623-0049P		US1623-0087R	US1623-0087P
	US1623-0050R	US1623-0050P		US1623-9002R	US1623-9002P
	US1623-0051R	US1623-0051P			

Unicode™ 2 Series 16 Amp Switches Custom Configurations

Components for Increased Safety Enclosures

NEC:
Class I, Division 2, Groups A, B, C, D
Class I, Zone 1, AEx de IIC

CEC:
Class I, Division 2, Groups A, B, C, D
Ex de IIC

ATEX/IECEX:
Zone 1 and 2 – 21 and 22
Ex II 2 GD

Wiring Diagram	Catalog Number		Wiring Diagram	Catalog Number	
	Rail Mounted	Panel Mounted		Rail Mounted	Panel Mounted
2-pole 4 position					
	US1624-0044R	US1624-0044P		US1624-0062R	US1624-0062P
	US1624-0057R	US1624-0057P		US1624-0065R	US1624-0065P
	US1624-0058R	US1624-0058P		US1624-0084R	US1624-0084P
2-pole 8 position					
	US1628-0036R	US1628-0036P	—	—	—
3-pole 2 position					
	US1632-0122R	US1632-0122P		US1632-1153R	US1632-1153P
3-pole 3 position					
	US1633-0136R	US1633-0136P		US1633-1120R	US1633-1120P
	US1633-0144R	US1633-0144P		US1633-1142R	US1633-1142P
	US1633-0145R	US1633-0145P		US1633-1155R	US1633-1155P
	US1633-0161R	US1633-0161P		US1633-1171R	US1633-1171P
	US1633-0167R	US1633-0167P		US1633-1202R	US1633-1202P
	US1633-0199R	US1633-0199P		US1633-1209R	US1633-1209P
	US1633-1109R	US1633-1109P		US1633-1210R	US1633-1210P
	US1633-1112R	US1633-1112P		—	—

CONTROL S: NEC/CEC, ATEX/IECEX INCREASED SAFETY CONTROL STATIONS



Unicode™ 2 Series 16 Amp Switches Custom Configurations

Components for Increased Safety Enclosures

NEC:
Class I, Division 2, Groups A, B, C, D
Class I, Zone 1, AEx de IIC

CEC:
Class I, Division 2, Groups A, B, C, D
Ex de IIC

ATEX/IECEx:
Zone 1 and 2 – 21 and 22
II 2 GD

CONTROLS: NEC/CEC, ATEX/IECEx INCREASED SAFETY CONTROL STATIONS



Wiring Diagram	Catalog Number		Wiring Diagram	Catalog Number	
	Rail Mounted	Panel Mounted		Rail Mounted	Panel Mounted
3-pole 3 position					
		US1633-1230R US1633-1230P	—	—	—
3-pole 4 position					
		US1634-0146R US1634-0146P			US1634-0183R US1634-0183P
		US1634-0168R US1634-0168P			US1634-1119R US1634-1119P
		US1634-0178R US1634-0178P			US1634-1145R US1634-1145P
		US1634-0181R US1634-0181P			US1634-1151R US1634-1151P
4-pole 2 position					
		US1642-0103R US1642-0103P			US1642-0152R US1642-0152P
		US1642-0104R US1642-0104P			US1642-0154R US1642-0154P
		US1642-0105R US1642-0105P			US1642-0173R US1642-0173P
		US1642-0107R US1642-0107P			US1642-1105R US1642-1105P
		US1642-0116R US1642-0116P			US1642-1122R US1642-1122P
		US1642-0134R US1642-0134P			US1642-1147R US1642-1147P
		US1642-0135R US1642-0135P			US1642-1162R US1642-1162P
		US1642-0137R US1642-0137P			US1642-1234R US1642-1234P
4-pole 3 position					
		US1643-0111R US1643-0111P			US1643-0113R US1643-0113P
		US1643-0112R US1643-0112P			US1643-0114R US1643-0114P

Unicode™ 2 Series 16 Amp Switches Custom Configurations

Components for Increased Safety Enclosures

NEC:
Class I, Division 2, Groups A, B, C, D
Class I, Zone 1, AEx of IIC

CEC:
Class I, Division 2, Groups A, B, C, D
Ex de IIC

ATEX/IECEX:
Zone 1 and 2 – 21 and 22
Ex II 2 GD

Wiring Diagram	Catalog Number		Wiring Diagram	Catalog Number	
	Rail Mounted	Panel Mounted		Rail Mounted	Panel Mounted
	US1643-0118R	US1643-0118P		US1643-0170R	US1643-0170P
	US1643-0120R	US1643-0120P		US1643-0175R	US1643-0175P
	US1643-0121R	US1643-0121P		US1643-0176R	US1643-0176P
	US1643-0127R	US1643-0127P		US1643-0180R	US1643-0180P
	US1643-0129R	US1643-0129P		US1643-1103R	US1643-1103P
	US1643-0131R	US1643-0131P		US1643-1104R	US1643-1104P
	US1643-0132R	US1643-0132P		US1643-1106R	US1643-1106P
	US1643-0133R	US1643-0133P		US1643-1108R	US1643-1108P
	US1643-0139R	US1643-0139P		US1643-1111R	US1643-1111P
	US1643-0140R	US1643-0140P		US1643-1113R	US1643-1113P
	US1643-0153R	US1643-0153P		US1643-1116R	US1643-1116P
	US1643-0157R	US1643-0157P		US1643-1125R	US1643-1125P
	US1643-0158R	US1643-0158P		US1643-1129R	US1643-1129P
	US1643-0159R	US1643-0159P		US1643-1134R	US1643-1134P
	US1643-0160R	US1643-0160P		US1643-1138R	US1643-1138P
	US1643-0162R	US1643-0162P		US1643-1159R	US1643-1159P
	US1643-0169R	US1643-0169P			

CONTROL S: NEC/CEC, ATEX/IECEX INCREASED SAFETY CONTROL STATIONS



Unicode™ 2 Series 16 Amp Switches Custom Configurations

Components for Increased Safety Enclosures

NEC:
Class I, Division 2, Groups A, B, C, D
Class I, Zone 1, AEx de IIC

CEC:
Class I, Division 2, Groups A, B, C, D
Ex de IIC

ATEX/IECEx:
Zone 1 and 2 – 21 and 22
II 2 GD

CONTROLS: NEC/CEC, ATEX/IECEx INCREASED SAFETY CONTROL STATIONS



Wiring Diagram	Catalog Number		Wiring Diagram	Catalog Number	
	Rail Mounted	Panel Mounted		Rail Mounted	Panel Mounted
4-pole 3 position					
	US1643-1165R	US1643-1165P		US1643-1206R	US1643-1206P
	US1643-1166R	US1643-1166P		US1643-1208R	US1643-1208P
	US1643-1167R	US1643-1167P		US1643-1213P	US1643-1213P
	US1643-1172R	US1643-1172P		US1643-1215P	US1643-1215P
	US1643-1173R	US1643-1173P		US1643-1217P	US1643-1217P
	US1643-1174R	US1643-1174P		US1643-1220P	US1643-1220P
	US1643-1176R	US1643-1176P		US1643-1222R	US1643-1222P
	US1643-1178R	US1643-1178P		US1643-1225R	US1643-1225P
	US1643-1179R	US1643-1179P		US1643-1226R	US1643-1226P
	US1643-1201R	US1643-1201P		US1643-1232R	US1643-1232P
	US1643-1203R	US1643-1203P		US1643-9001R	US1643-9001P
4-pole 4 position					
	US1644-0110R	US1644-0110P		US1644-0147R	US1644-0147P
	US1644-0123R	US1644-0123P		US1644-0148R	US1644-0148P
	US1644-0130R	US1644-0130P		US1644-0150R	US1644-0150P
	US1644-0143R	US1644-0143P		US1644-0151R	US1644-0151P

Unicode™ 2 Series 16 Amp Switches Custom Configurations

Components for Increased Safety Enclosures

NEC:
Class I, Division 2, Groups A, B, C, D
Class I, Zone 1, AEx de IIC

CEC:
Class I, Division 2, Groups A, B, C, D
Ex de IIC

ATEX/IECEX:
Zone 1 and 2 – 21 and 22
II 2 GD

Wiring Diagram	Catalog Number		Wiring Diagram	Catalog Number	
	Rail Mounted	Panel Mounted		Rail Mounted	Panel Mounted
4-pole 4 position					
	US1644-0155R	US1644-0155P		US1644-1128R	US1644-1128P
	US1644-0156R	US1644-0156P		US1644-1132R	US1644-1132P
	US1644-0164R	US1644-0164P		US1644-1133R	US1644-1133P
	US1644-0171R	US1644-0171P		US1644-1136R	US1644-1136P
	US1644-0198R	US1644-0198P		US1644-1139R	US1644-1139P
	US1644-0608R	US1644-0608P		US1644-1143R	US1644-1143P
	US1644-0611R	US1644-0611P		US1644-1144R	US1644-1144P
	US1644-0614R	US1644-0614P		US1644-1146R	US1644-1146P
	US1644-1102R	US1644-1102P		US1644-1154R	US1644-1154P
	US1644-1114R	US1644-1114P		US1644-1156R	US1644-1156P
	US1644-1115R	US1644-1115P		US1644-1163R	US1644-1163P
	US1644-1124R	US1644-1124P		US1644-1164R	US1644-1164P
	US1644-1127R	US1644-1127P		US1644-1168R	US1644-1168P

CONTROL S: NEC/CEC, ATEX/IECEX INCREASED SAFETY CONTROL STATIONS



Unicode™ 2 Series 16 Amp Switches Custom Configurations

Components for Increased Safety Enclosures

NEC:
Class I, Division 2, Groups A, B, C, D
Class I, Zone 1, AEx de IIC

CEC:
Class I, Division 2, Groups A, B, C, D
Ex de IIC

ATEX/IECEx:
Zone 1 and 2 – 21 and 22
II 2 GD

CONTROLS: NEC/CEC, ATEX/IECEx INCREASED SAFETY CONTROL STATIONS

Wiring Diagram	Catalog Number		Wiring Diagram	Catalog Number	
	Rail Mounted	Panel Mounted		Rail Mounted	Panel Mounted
4-pole 4 position					
	US1644-1169R	US1644-1169P		US1644-1211R	US1644-1211P
	US1644-1180R	US1644-1180P		US1644-1212R	US1644-1212P
	US1644-1204R	US1644-1204P		US1644-1219R	US1644-1219P
	US1644-1205R	US1644-1205P		US1644-1224R	US1644-1224P
	US1644-1207R	US1644-1207P		US1644-1229R	US1644-1229P
4-pole 5 position					
	US1645-1110R	US1645-1110P		US1645-1235R	US1645-1235P

Appleton

Unicode™ 2 Series Accessories

Components for Increased Safety Enclosures

NEC:
Class I, Division 2, Groups A, B, C, D
Class I, Zone 1, AEx de IIC

CEC:
Class I, Division 2, Groups A, B, C, D
Ex de IIC

ATEX/IECEX:
Zone 1 and 2 – 21 and 22
II 2 GD

Nameplates – Set of 10

Blank self-adhesive, laminated plastic 58 mm x 18 mm (2.28" x 0.71").

Color	Catalog Number
White (black letters)	UNPW
Yellow (black letters)	UNPY
Red (white letters)	UNPR
Blue (white letters)	UNPB
Black (white letters)	UNPN
Green (white letters)	UNPG

Inserts for Push Button – Set of 5

Marking	Color	Catalog Number
(unmarked)	Green	UIAG
(unmarked)	Red	UIAR
(unmarked)	Yellow	UIAY
(unmarked)	White	UIAW
(unmarked)	Blue	UIAB
(unmarked)	Black	UIAN
ON	Green	UIA01
OFF	Red	UIA02
START	Green	UIA03
STOP	Red	UIA04
MARCHE	Green	UIA05
ARRET	Red	UIA06
I	Green	UIA07
O	Red	UIA08

Inserts for Illuminated Push Button – Set of 5

Marking	Color	Catalog Number
(unmarked)	Green	UILG
(unmarked)	Red	UILR
(unmarked)	Yellow	UILY
(unmarked)	White	UILW
(unmarked)	Blue	UILB
ON	Green	UIL01
OFF	Red	UIL02
START	Green	UIL03
STOP	Red	UIL04
MARCHE	Green	UIL05
ARRET	Red	UIL06
I	Green	UIL07
O	Red	UIL08

Spare Key

For all key-operated buttons.

Description	Catalog Number
Spare key type 4 A 185	SK4A185

Standard Legend Plates

Two sizes available. Self-adhesive yellow laminated plastic (black lettering).

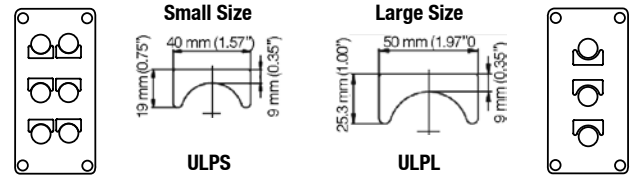

Text	Catalog Number	
	Small	Large
Blank (set of 10)	ULPS	ULPL
ON	ULPSA01	ULPLA01
OFF	ULPSA02	ULPLA02
FORWARD	ULPSA03	ULPLA03
REVERSE	ULPSA04	ULPLA04
JOG	ULPSA05	ULPLA05
RUN	ULPSA06	ULPLA06
START	ULPSA07	ULPLA07
STOP	ULPSA08	ULPLA08
UP	ULPSA09	ULPLA09
DOWN	ULPSA10	ULPLA10
FAST	ULPSA11	ULPLA11
SLOW	ULPSA12	ULPLA12
RAISE	ULPSA13	ULPLA13
LOWER	ULPSA14	ULPLA14
OPEN	ULPSA15	ULPLA15
CLOSE	ULPSA16	ULPLA16
LOW	ULPSA17	ULPLA17
HIGH	ULPSA18	ULPLA18
TEST	ULPSA19	ULPLA19
RESET	ULPSA20	ULPLA20
EMERGENCY STOP	ULPSA21	ULPLA21
MARCHE	ULPSA22	ULPLA22
ARRET	ULPSA23	ULPLA23
ARRET D'URGENCE	ULPSA24	ULPLA24
HAUT	ULPSA25	ULPLA25
BAS	ULPSA26	ULPLA26
O—I	ULPSH01	ULPLH01
ON—OFF	ULPSH02	ULPLH02
START—STOP	ULPSH03	ULPLH03
STOP—START	ULPSH04	ULPLH04
HAND—AUTO	ULPSH05	ULPLH05
MANU—AUTO	ULPSH06	ULPLH06
FORWARD—REVERSE	ULPSH07	ULPLH07
REMOTE—LOCAL	ULPSH08	ULPLH08
MARCHE—ARRET	ULPSH09	ULPLH09
I—O—II	ULPSJ01	ULPLJ01
OFF—O—ON	ULPSJ02	ULPLJ02
START—NORMAL—STOP	ULPSJ03	ULPLJ03
HAND—OFF—AUTO	ULPSJ04	ULPLJ04
MANU—O—AUTO	ULPSJ05	ULPLJ05
FORWARD—OFF—REVERSE	ULPSJ06	ULPLJ06
LOCAL—REMOTE—AUTO	ULPSJ07	ULPLJ07
LOCAL—O—REMOTE	ULPSJ08	ULPLJ08
MARCHE—NORMAL—ARRET	ULPSJ09	ULPLJ09

Unicode™ 2 Series Accessories



Components for Increased Safety Enclosures

NEC:
Class I, Division 2, Groups A, B, C, D
Class I, Zone 1, AEx de IIC

CEC:
Class I, Division 2, Groups A, B, C, D
Ex de IIC

ATEX/IECEX:
Zone 1 and 2 – 21 and 22
II 2 GD

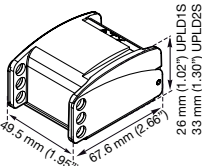
CONTROLS: NEC/CEC, ATEX/IECEX INCREASED SAFETY CONTROL STATIONS

	Description	Catalog Number
	Yellow Guard Mushroom head protection for emergency stop	098657
	Padlockable Guard Stainless steel and plastic cover, capacity: 3 padlocks, 6 mm (0.24") maximum diameter (not supplied) For push button and rotary actuator	UPLD1S
	For mushroom head actuator	UPLD2S
	Cover Blanking Plug For cover drilling — 30.5 mm (1.2") diameter	UBP
	Device Adaptor Rail to panel mounted conversion adaptor	UPMA

ACSEW Cast Control Centers

Explosionproof, Dust-Ignitionproof

NEC/CEC:

Class I, Division 1 and 2, Groups B, C, D
Class II, Division 1 and 2, Groups E, F, G
Class III
NEMA 4, 7BCD, 9EFG

ATEX/IECEx:

Zone 1 and 2 – 21 and 22
⊕ II 2 GD
IP66 – IK10

Application

- Explosionproof control centers are used where hazardous materials are handled or stored.
- Grouping push buttons, switches, pilot devices and glass lenses in one enclosure will satisfy a wide range of control applications. This is most beneficial when having areas with minimum space or needing to centralize all controls in one area.

Features

- Precision machined flame path between body and cover.
- Bolt on stainless steel slotted mounting feet.
- Flexible hinge mounting on either side, (hinges standard on catalog numbers ACSEW121206 and above).
- External flange maximizes internal space.
- Wall thickness suitable for minimum of five full threads.
- Factory assembled and wired to specifications.
- Operators are spaced on 2-1/2" centers.
- All push buttons and selector switches have stainless steel shafts.
- Push button and selector switches are rated 10 Amp 600 Vac.
- Pilot lights are rated 6 Vac up to 600 Vac with transformer.
- Round windows available in a wide range of sizes.
- Provision for mounting pan.
- Ground lug package and installation instructions for termination of ground wires enclosed.
- O-ring gasket insures watertight integrity.

Standard Materials

- Bodies and covers: sand cast copperfree (4/10 of 1% max.) aluminum
- Cover bolts and mounting feet: stainless steel
- O-ring: neoprene

Standard Finish

- Bodies and covers: shot blast finish

Options

- Custom drilling and tapping.
- Gray epoxy powder coat available to provide NEMA 4X rating. Add suffix **-G2**.
- Standard product has UL and CSA certification. For cULus certification only, add suffix **-CUL**.
- ATEX complete product certification add suffix **-X**.
- ATEX U Component certification add suffix **-XU**.
- For window installed option, contact your local representative for maximum number of operators.

NEC/CEC Certifications and Compliances

- UL Standards: UL 1203
- UL Classified: E84577
- UL Listed: Control Operators E87975
- CSA Standards: C22.2 No. 14-M, C22.2 No. 24, C22.2 No. 30
- CSA Certified: 042130

ATEX/IECEx Certifications and Compliances

- Certification Type JBEW U2
 - Gas, Zones 1 and 2
 - Conforming to ATEX 94/9/CE: CE 0081 ⊕ II 2 G
 - ATEX/IEC Protection: Ex d IIB + H₂
 - Dust, Zones 21 and 22
 - Conforming to ATEX 94/9/CE: CE 0081 ⊕ II 2 D
 - ATEX/IEC Protection: Ex tD A21
 - Ambient Temperature: -40 °C to +55 °C (-40 °F to +131 °F)



- CE Declaration of Conformity: 5C239
- ATEX Certificate: LCIE 06 ATEX 0010U
- IECEx Certificate: IECEx LCI 08.001X
- Internal Volume: > 2 dm³ (122 in³) - 2 liters
- Certification Type JBEW
 - Gas, Zones 1 and 2
 - Conforming to ATEX 94/9/CE: CE 0081 ⊕ II 2 G
 - ATEX/IEC Protection: Ex d IIB + H₂
 - Temperature Class: T6 to T4
 - Dust, Zones 21 and 22
 - Conforming to ATEX 94/9/CE: CE 0081 ⊕ II 2 D
 - ATEX/IEC Protection: Ex tD A21
 - Surface Temperature: T80 °C to T130 °C (T176 °F to T266 °F)
 - Ambient Temperature: -40 °C to +55 °C (-40 °F to +131 °F)
- CE Declaration of Conformity: 50279
- ATEX Certificate: LCIE 07 ATEX 6069X
- Internal Volume: > 2 dm³ (122 in³) - 2 liters
- Ingress Protection (solid and liquid): IP66
- Impact Resistance (shock): IK10
- Ex Standards: EN/IEC 60079-0; 60079-1; 61241-0; 61241-1
- Other Standards: EN/IEC 60529 (IP), 62262 (IK)

ACSEW Cast Control Centers

Explosionproof, Dust-Ignitionproof

NEC/CEC:

Class I, Division 1 and 2, Groups B, C, D
 Class II, Division 1 and 2, Groups E, F, G
 Class III
 NEMA 4, 7BCD, 9EFG

ATEX/IECEX:

Zone 1 and 2 – 21 and 22
 II 2 GD
 IP66 – IK10

Dimensions in Millimeters (Inches)					
Flat Machinable Space		Conduit Area			
Q	P	L	N	M	K
231.9 (9.13)	117.6 (4.63)	228.6 (9.00)	115.8 (4.56)	65.0 (2.56)	50.8 (2.00)
158.8 (6.25)	108.0 (4.25)	171.5 (6.75)	120.7 (4.75)	57.2 (2.25)	63.5 (2.50)
263.7 (10.38)	146.1 (5.75)	252.5 (9.94)	136.7 (5.38)	55.6 (2.19)	50.8 (2.00)
257.3 (10.13)	104.9 (4.13)	279.4 (11.00)	127.0 (5.00)	58.7 (2.31)	57.2 (2.25)
331.7 (13.06)	139.7 (5.50)	384.3 (15.13)	143.0 (5.63)	57.2 (2.25)	58.7 (2.31)
277.9 (10.94)	189.0 (7.44)	247.7 (9.75)	158.8 (6.25)	104.9 (4.13)	85.9 (3.38)
158.8 (6.25)	158.8 (6.25)	146.1 (5.75)	146.1 (5.75)	95.3 (3.75)	82.6 (3.25)
209.6 (8.25)	158.8 (6.25)	216.2 (8.51)	158.8 (6.25)	101.6 (4.00)	88.9 (3.50)
360.4 (14.19)	228.6 (9.00)	285.8 (11.25)	160.3 (6.31)	44.5 (1.75)	69.9 (2.75)
282.7 (11.13)	238.3 (9.38)	238.3 (9.38)	193.8 (7.63)	82.6 (3.25)	82.6 (3.25)
314.5 (12.38)	158.8 (6.25)	362.7 (14.28)	200.2 (7.88)	88.9 (3.50)	76.2 (3.00)
182.6 (7.19)	182.6 (7.19)	179.3 (7.06)	179.3 (7.06)	76.2 (3.00)	85.9 (3.38)
323.9 (12.75)	222.3 (8.75)	311.2 (12.25)	209.6 (8.25)	84.1 (3.31)	79.5 (3.13)
323.9 (12.75)	222.3 (8.75)	311.2 (12.25)	209.6 (8.25)	157.2 (6.19)	112.8 (4.44)
433.3 (17.06)	212.9 (8.38)	452.4 (17.81)	238.3 (9.38)	63.5 (2.50)	88.9 (3.50)
543.1 (21.38)	196.9 (7.75)	574.8 (22.63)	231.9 (9.13)	106.4 (4.19)	101.6 (4.00)
666.8 (26.25)	193.8 (7.63)	701.8 (27.63)	230.1 (9.06)	103.1 (4.06)	106.4 (4.19)
235.0 (9.25)	235.0 (9.25)	266.7 (10.50)	266.7 (10.50)	95.3 (3.75)	95.3 (3.75)
235.0 (9.25)	235.0 (9.25)	266.7 (10.50)	266.7 (10.50)	153.9 (6.06)	120.7 (4.75)
387.4 (15.25)	235.0 (9.25)	382.5 (15.06)	230.1 (9.06)	76.2 (3.00)	88.9 (3.50)
387.4 (15.25)	235.0 (9.25)	382.5 (15.06)	230.1 (9.06)	127.0 (5.00)	108.0 (4.25)
558.8 (22.00)	254.0 (10.00)	557.3 (21.94)	247.7 (9.75)	139.7 (5.50)	108.0 (4.25)
844.6 (33.25)	241.3 (9.50)	873.3 (34.38)	238.3 (9.38)	139.7 (5.50)	115.8 (4.56)
892.3 (35.13)	270.0 (10.63)	908.1 (35.75)	292.1 (11.50)	98.6 (3.88)	109.5 (4.31)
279.4 (11.00)	279.4 (11.00)	317.5 (12.50)	317.5 (12.50)	88.9 (3.50)	98.6 (3.88)
279.4 (11.00)	279.4 (11.00)	317.5 (12.50)	317.5 (12.50)	139.7 (5.50)	101.6 (4.00)
539.8 (21.25)	301.8 (11.88)	558.8 (22.00)	320.8 (12.63)	155.7 (6.13)	101.6 (4.00)
863.6 (34.00)	390.7 (15.38)	890.5 (35.06)	339.9 (13.38)	125.5 (4.94)	133.4 (5.25)
336.6 (13.25)	336.6 (13.25)	355.6 (14.00)	355.6 (14.00)	88.9 (3.50)	98.6 (3.88)
336.6 (13.25)	336.6 (13.25)	355.6 (14.00)	355.6 (14.00)	155.7 (6.13)	124.0 (4.88)
425.5 (16.75)	374.7 (14.75)	409.7 (16.13)	355.6 (14.00)	252.5 (9.94)	177.8 (7.00)
482.6 (19.00)	330.2 (13.00)	496.8 (19.56)	344.4 (13.56)	57.2 (2.25)	84.1 (3.31)
539.8 (21.25)	336.6 (13.25)	558.8 (22.00)	355.6 (14.00)	152.4 (6.00)	134.9 (5.31)
641.4 (25.25)	336.6 (13.25)	636.5 (25.06)	331.7 (13.06)	44.5 (1.75)	79.5 (3.13)
387.4 (15.25)	387.4 (15.25)	406.4 (16.00)	406.4 (16.00)	88.9 (3.50)	104.9 (4.13)
387.4 (15.25)	387.4 (15.25)	406.4 (16.00)	406.4 (16.00)	139.7 (5.50)	114.3 (4.50)
539.8 (21.25)	387.4 (15.25)	552.5 (21.75)	400.1 (15.75)	139.7 (5.50)	128.5 (5.06)
539.8 (21.25)	387.4 (15.25)	552.5 (21.75)	400.1 (15.75)	190.5 (7.50)	146.1 (5.75)
692.2 (27.25)	387.4 (15.25)	711.2 (28.00)	406.4 (16.00)	139.7 (5.50)	120.7 (4.75)
850.9 (33.50)	368.3 (14.50)	866.9 (34.13)	401.6 (15.81)	139.7 (5.50)	120.7 (4.75)
850.9 (33.50)	368.3 (14.50)	866.9 (34.13)	401.6 (15.81)	190.5 (7.50)	139.7 (5.50)
997.0 (39.25)	397.0 (15.63)	1038.4 (40.88)	435.1 (17.13)	127.0 (5.00)	127.0 (5.00)
1432.1 (56.3)	416.1 (16.38)	1460.5 (57.50)	444.5 (17.50)	127.0 (5.00)	120.7 (4.75)
539.8 (21.25)	539.8 (21.25)	562.1 (22.13)	562.1 (22.13)	139.7 (5.50)	127.0 (5.00)
539.8 (21.25)	539.8 (21.25)	562.1 (22.13)	562.1 (22.13)	190.5 (7.50)	155.7 (6.13)
657.4 (25.88)	505.0 (19.88)	695.5 (27.38)	543.1 (21.38)	150.9 (5.94)	133.4 (5.25)
844.6 (33.25)	533.4 (21.00)	863.6 (34.00)	533.4 (21.00)	149.4 (5.88)	130.3 (5.13)
844.6 (33.25)	533.4 (21.00)	863.6 (34.00)	533.4 (21.00)	190.5 (7.50)	152.4 (6.00)
1013.0 (39.8)	809.8 (31.88)	879.6 (34.63)	676.4 (26.63)	120.7 (4.75)	155.7 (6.13)
1013.0 (39.8)	809.8 (31.88)	879.6 (34.63)	676.4 (26.63)	120.7 (4.75)	155.7 (6.13)

Dimensions in Millimeters (Inches)

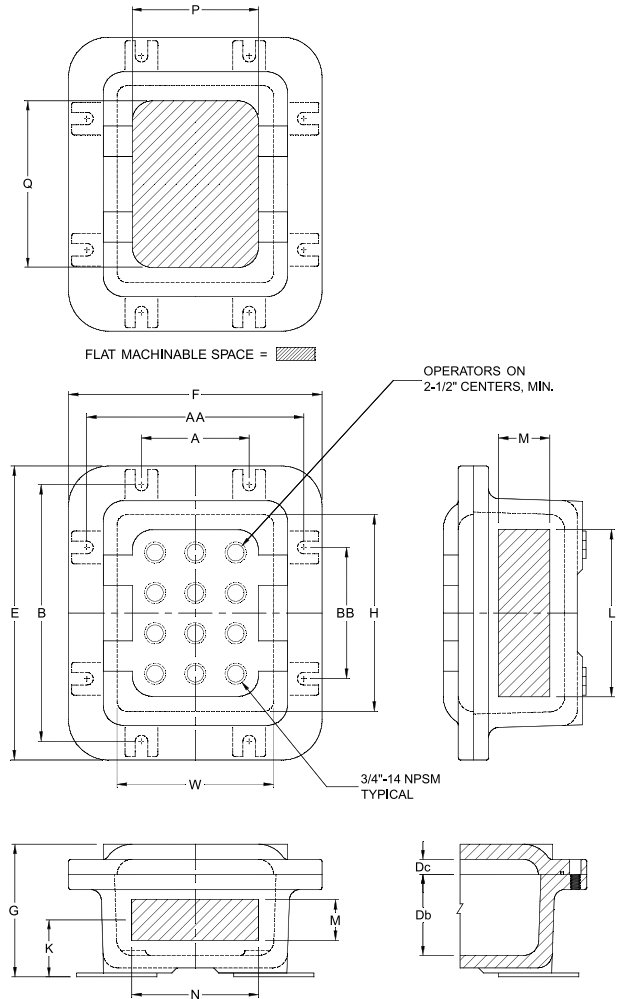

CONTROLS: NEC/CEC, ATEX/IECEX EXPLOSIONPROOF/FLAMEPROOF CONTROL STATIONS AND SWITCHES



ACSEW Cast Control Centers

Explosionproof, Dust-Ignitionproof

NEC/CEC:
 Class I, Division 1 and 2, Groups B, C, D
 Class II, Division 1 and 2, Groups E, F, G
 Class III
 NEMA 4, 7BCD, 9EFG

IECEX:
 Zone 1 and 2 – 21 and 22
 II 2 GD
 ATEX/IEC
 IP66 – IK10

CONTROLS: NEC/CEC, ATEX/IECEX EXPLOSIONPROOF/FLAMEPROOF CONTROL STATIONS AND SWITCHES

Catalog Number ①	Maximum Window Size Group B, C, D in Millimeters (Inches)	Maximum Number of Operators ②	Number of Rows (Tall) (Wide)		Cover Thickness Millimeters (Inches)	Maximum Conduit Size (NPT)	Approximate Weight Kgs (Lbs)	Mounting Hardware Catalog Number
ACSEW050903	N/A	8	4	2	12.7 (0.50)	1.50	9.5 (21)	AMH2
ACSEW060804	N/A	6	3	2	19.1 (0.75)	2.00	9.1 (20)	AMH2
ACSEW061004	N/A	8	4	2	16.0 (0.63)	1.50	12.2 (27)	AMH2
ACSEW061204	N/A	8	4	2	16.0 (0.63)	2.00	15.9 (25)	AMH2
ACSEW061604	N/A	10	5	2	16.0 (0.63)	1.50	14.5 (32)	AMH2
ACSEW071106	76.2 (3.00)	12	6	2	19.1 (0.75)	2.00	15.9 (35)	AMH2
ACSEW080806	76.2 (3.00)	9	3	3	19.1 (0.75)	2.00	13.6 (30)	AMH2
ACSEW081006	76.2 (3.00)	9	3	3	19.1 (0.75)	2.00	16.4 (36)	AMH4
ACSEW081307	76.2 (3.00)	15	5	3	19.1 (0.75)	2.00	13.6 (30)	AMH2
ACSEW091105	101.6 (4.00)	16	4	4	17.5 (0.69)	2.00	10.0 (22)	AMH2
ACSEW091504	76.2 (3.00)	15	5	3	19.1 (0.75)	2.00	15.0 (33)	AMH2
ACSEW101006	101.6 (4.00)	9	3	3	19.1 (0.75)	2.00	20.0 (44)	AMH2
ACSEW101406	101.6 (4.00)	20	5	4	19.1 (0.75)	2.00	25.0 (55)	AMH4
ACSEW101408	101.6 (4.00)	20	5	4	19.1 (0.75)	4.00	27.2 (60)	AMH2
ACSEW112005	101.6 (4.00)	21	7	3	22.4 (0.88)	3.00	38.6 (85)	AMH8
ACSEW112406	101.6 (4.00)	27	9	3	22.4 (0.88)	3.00	32.7 (72)	AMH8
ACSEW113006	2 @ 101.6 (4.00)	33	11	3	22.4 (0.88)	3.00	51.3 (113)	AMH8
ACSEW121206	101.6 (4.00)	16	4	4	19.1 (0.75)	3.00	29.5 (65)	AMH8
ACSEW121208	101.6 (4.00)	16	4	4	19.1 (0.75)	3.50	31.8 (70)	AMH8
ACSEW121806	101.6 (4.00)	24	6	4	19.1 (0.75)	4.00	40.9 (90)	AMH5
ACSEW121808	101.6 (4.00)	24	6	4	19.1 (0.75)	4.00	45.8 (101)	AMH5
ACSEW122408	101.6 (4.00)	36	9	4	25.4 (1.00)	4.00	62.6 (138)	AMH4
ACSEW123608 ③	3 @ 127.0 (5.00)	39	13	3	28.7 (1.13)	4.00	98.9 (218)	AMH5
ACSEW133806	3 @ 127.0 (5.00)	56	14	4	25.4 (1.00)	3.50	86.2 (190)	AMH8
ACSEW141406	127.0 (5.00)	16	4	4	19.1 (0.75)	3.50	44.5 (98)	AMH8
ACSEW141408	127.0 (5.00)	16	4	4	19.1 (0.75)	3.00	47.6 (105)	AMH8
ACSEW142408	177.8 (7.00)	40	8	5	25.4 (1.00)	4.00	59.4 (131)	AMH6
ACSEW153707	2 @ 228.6 (9.00)	65	13	5	28.7 (1.13)	4.00	113.4 (250)	AMH8
ACSEW161606	228.6 (9.00)	25	5	5	25.4 (1.00)	3.50	59.9 (132)	AMH8
ACSEW161608	228.6 (9.00)	25	5	5	25.4 (1.00)	4.00	63.5 (140)	AMH8
ACSEW161812	228.6 (9.00)	42	7	6	31.8 (1.25)	4.00	68.0 (150)	AMH8
ACSEW162206 ③	228.6 (9.00)	35	7	5	31.8 (1.25)	3.00	59.0 (130)	AMH8
ACSEW162408	228.6 (9.00)	40	8	5	26.9 (1.06)	4.00	81.6 (180)	AMH6
ACSEW162806 ③	2 @ 228.6 (9.00)	50	10	5	25.4 (1.00)	3.00	68.0 (150)	AMH8
ACSEW181806	228.6 (9.00)	36	6	6	23.9 (0.94)	3.50	85.3 (188)	AMH8
ACSEW181808	228.6 (9.00)	36	6	6	23.9 (0.94)	4.00	89.8 (198)	AMH8
ACSEW182408	228.6 (9.00)	48	8	6	33.3 (1.31)	4.00	101.6 (224)	AMH8
ACSEW182410	228.6 (9.00)	48	8	6	33.3 (1.31)	4.00	106.6 (235)	AMH8
ACSEW183008	2 @ 228.6 (9.00)	66	11	6	31.8 (1.25)	4.00	120.2 (265)	AMH5
ACSEW183608	2 @ 228.6 (9.00)	78	13	6	28.7 (1.13)	4.00	113.4 (250)	AMH8
ACSEW183610	2 @ 228.6 (9.00)	78	13	6	28.7 (1.13)	4.00	122.5 (270)	AMH8
ACSEW184207	2 @ 228.6 (9.00)	90	15	6	31.8 (1.25)	4.00	140.6 (310)	AMH8
ACSEW206008 ③	3 @ 228.6 (9.00)	132	22	6	25.4 (1.00)	4.00	236.3 (521)	AMH6
ACSEW242408	228.6 (9.00)	64	8	8	28.7 (1.13)	4.00	102.1 (225)	AMH8
ACSEW242410 ③	228.6 (9.00)	64	8	8	28.7 (1.13)	4.00	108.9 (240)	AMH8
ACSEW243008	2 @ 177.8 (7.00)	80	10	8	28.7 (1.13)	4.00	190.5 (420)	AMH8
ACSEW243608	2 @ 228.6 (9.00)	104	13	8	38.1 (1.50)	4.00	190.5 (420)	AMH5
ACSEW243610	2 @ 228.6 (9.00)	104	13	8	38.1 (1.50)	4.00	204.1 (450)	AMH5
ACSEW303808	4 @ 228.6 (9.00)	130	13	10	44.5 (1.75)	4.00	272.1 (600)	AMH6
ACSEW303816 ③	4 @ 228.6 (9.00)	130	13	10	44.5 (1.75)	4.00	362.9 (800)	AMH6

Due to the nature of the sand cast process, external dimensions are subject to vary +/- 3.2 mm (0.125").
 ① ATEX complete product certification will bear an X suffix. ATEX U Component certification will bear an XU suffix.
 ② With window installed contact your local representative for maximum number of operators.
 ③ These Cast Control Centers does not have ATEX certifications.



ACSEW Cast Control Center Options and Accessories

Explosionproof, Dust-Ignitionproof

NEC/CEC:

Class I, Division 1 and 2, Groups B, C, D
Class II, Division 1 and 2, Groups E, F, G
Class III
NEMA 4, 7BCD, 9EFG

ATEX/IECEX:

Zone 1 and 2 – 21 and 22
II 2 GD
IP66 – IK10

Round Windows

Catalog Number	Description
AW5	3" Viewing Area, Round Group B
AW6	4" Viewing Area, Round Group B
AW7	5" Viewing Area, Round Group B
AW10	7" Viewing Area, Round Group B
AW12	9" Viewing Area, Round Group B

Square Windows

Contact your local representative

Circuit Breaker Operators

Catalog Number	Description
AV1W	150AF Circuit Breaker Mechanism
AV2W	250AF Circuit Breaker Mechanism

Options

Factory Installed Suffix	Field Installed Catalog Number	Description
AB	N/A	Set of 4 standoffs 1/2" high
BR	BRTB4X	Breather, NEMA 4X (includes outlet and installation)
DN	DRNB4X	Drain, NEMA 4X (includes outlet and installation)
EGS	N/A	External grounding stud 3/8"-16
G1	N/A	Gray Powder Coat Epoxy (outside)
G2	N/A	Gray Powder Coat Epoxy (inside and outside)
H		Hinges stainless steel
	AHOF12SS	Hinge Kit, 2 light duty SS hinges
	AHOF22SS	Hinge Kit, 2 heavy duty SS hinges
	AHOF23SS	Hinge Kit, 3 heavy duty SS hinges
K ①	N/A	Terminal blocks 600 Vac, 30 Amp (example: 5 points = 5K)
NP	N/A	Plastic nameplate, 2" x 4", 1/8" black letters on white surface, 3 lines max., specify legend.
NPSM75	N/A	3/4" NPSM Drill and Tap
Z	See Options and Accessories	Mounting pan

Mounting Hardware

Field Installed Catalog Number	Description
AMH1	1/4" - 20 x 1-1/4" Bolt, 1/4" - 20 Hex Nut, 1/4" Washers
AMH2	3/8" - 16 x 1-1/4" Bolt, 3/8" - 16 Hex Nut, 3/8" Washers
AMH3	7/16" - 14 x 1-3/4" Bolt, 7/16" - 14 Hex Nut, 7/16" Washers
AMH4	1/2" - 13 x 1-3/4" Bolt, 1/2" - 13 Hex Nut, 1/2" Washers
AMH5	1/2" - 13 x 2" Bolt, 1/2" - 13 Hex Nut, 1/2" Washers
AMH6	5/8" - 11 x 2" Bolt, 5/8" - 11 Hex Nut, 5/8" Washers
AMH7	1/2" - 13 x 1-1/4" Bolt, 1/2" - 13 Hex Nut, 1/2" Washers
AMH8	5/8" - 11 x 1-1/4" Bolt, 5/8" - 11 Hex Nut, 5/8" Washers

Drill and Tap Options

Symbol	Conduit Size (Inches – NPT)
A	1/2
B	3/4
C	1
D	1-1/4
E	1-1/2
F	2
G	2-1/2
H	3
J	3-1/2
K	4

Blind Tapped Holes

Suffix	Screw Size
BT1	#6 - 1/4"
BT2	5/16" - 1/2"

① Indicate number of points.

ACSEW Cast Control Center Options and Accessories

Explosionproof, Dust-Ignitionproof

NEC/CEC:

Class I, Division 1 and 2, Groups B, C, D
 Class II, Division 1 and 2, Groups E, F, G
 Class III
 NEMA 4, 7BCD, 9EFG

ATEX/IECEX:

Zone 1 and 2 – 21 and 22
 II 2 GD
 IP66 – IK10

Operators/Pilot Devices

Factory Installed Suffix	Description
A2X	2-Pos Selector Switch
A3X	3-Pos Selector Switch
A31X	Spring Return From Left to Center
A32X	Spring Return From Right to Center
A33X	Spring Return From Left and Right to Center
A34X	3-Pos Selector Switch - Key Operated
L1	Amber Pilot Light, 120 Vac
L12	Amber Pilot Light, 240 Vac
L14	Amber Pilot Light, 480 Vac
L12G	Amber Pilot Light, 240 Vac, Guarded
L14G	Amber Pilot Light, 480 Vac, Guarded
L1G	Amber Pilot Light, 120 Vac, Guarded
L2	Blue Pilot Light, 120 Vac
L22	Blue Pilot Light, 240 Vac
L24	Blue Pilot Light, 480 Vac
L22G	Blue Pilot Light, 240 Vac, Guarded
L24G	Blue Pilot Light, 480 Vac, Guarded
L2G	Blue Pilot Light, 120 Vac, Guarded
L3	Clear Pilot Light, 120 Vac
L32	Clear Pilot Light, 240 Vac
L34	Clear Pilot Light, 480 Vac
L32G	Clear Pilot Light, 240 Vac, Guarded
L34G	Clear Pilot Light, 480 Vac, Guarded
L3G	Clear Pilot Light, 120 Vac, Guarded
L4	Green Pilot Light, 120 Vac
L42	Green Pilot Light, 240 Vac
L44	Green Pilot Light, 480 Vac
L42G	Green Pilot Light, 240 Vac, Guarded
L4G	Green Pilot Light, 120 Vac, Guarded
L5	Red Pilot Light, 120 Vac

Factory Installed Suffix	Description
L52	Red Pilot Light, 240 Vac
L54	Red Pilot Light, 480 Vac
L52G	Red Pilot Light, 240 Vac, Guarded
L5G	Red Pilot Light, 120 Vac, Guarded
LP1X	Amber Lighted Push Button, 120 Vac
LP12X	Amber Lighted Push Button, 240 Vac
LP14X	Amber Lighted Push Button, 480 Vac
LP2X	Blue Lighted Push Button, 120 Vac
LP22X	Blue Lighted Push Button, 240 Vac
LP24X	Blue Lighted Push Button, 480 Vac
LP3X	Clear Lighted Push Button, 120 Vac
LP32X	Clear Lighted Push Button, 240 Vac
LP34X	Clear Lighted Push Button, 480 Vac
LP4X	Green Lighted Push Button, 120 Vac
LP42X	Green Lighted Push Button, 240 Vac
LP44X	Green Lighted Push Button, 480 Vac
LP4X	Green Lighted Push Button, 120 Vac
LP52X	Red Lighted Push Button, 240 Vac
LP54X	Red Lighted Push Button, 480 Vac
PO1	Potentiometer Operator, Short Barrel
PO2	Potentiometer Operator, Long Barrel
RS	Reset Button
S1X	Start Button
S2X	Stop Button
S3X	Start/Stop Button
S4X	Emergency Stop
S5X	Emergency Stop, Maintained
S6X	Black Push Button, NO
S7X	Black Push Button, NC
S8X	Black Push Button, NO/NC

CONTROLS: NEC/CEC, ATEX/IECEX EXPLOSIONPROOF/FLAMEPROOF CONTROL STATIONS AND SWITCHES



ACSEW Cast Control Center Options and Accessories

Explosionproof, Dust-Ignitionproof

NEC/CEC:
 Class I, Division 1 and 2, Groups B, C, D
 Class II, Division 1 and 2, Groups E, F, G
 Class III
 NEMA 4, 7BCD, 9EFG

ATEX/IECEX:
 Zone 1 and 2 – 21 and 22
 II 2 GD
 IP66 – IK10

Mounting Pans

Mounting Pan Catalog Number	Junction Box Catalog Number	Overall Dimensions in Millimeters (Inches)	
		W	H
AZ-593	ACSEW050903	88.9 (3.50)	215.9 (8.50)
AZ-684	ACSEW060804	114.3 (4.50)	165.1 (6.50)
AZ-6104	ACSEW061004	127.0 (5.00)	254.0 (10.00)
AZ-6124	ACSEW061204	139.7 (5.50)	279.4 (11.00)
AZ-6164	ACSEW061604	13.4 (5.25)	381.0 (15.00)
AZ-7116	ACSEW071106	165.1 (6.50)	254.0 (10.00)
AZ-886	ACSEW080806	165.1 (6.50)	165.1 (6.50)
AZ-8106	ACSEW081006	165.1 (6.50)	215.9 (8.50)
AZ-8137	ACSEW081307	152.4 (6.00)	279.4 (11.00)
AZ-9115	ACSEW091105	209.6 (8.25)	254.0 (10.00)
AZ-9154	ACSEW091504	206.5 (8.13)	374.65 (14.75)
AZ-10104/6	ACSEW101006	190.5 (7.50)	190.5 (7.50)
AZ-10146/8	ACSEW101406	228.6 (9.00)	330.2 (13.00)
AZ-10146/8	ACSEW101408	228.6 (9.00)	330.2 (13.00)
AZ-11205	ACSEW112005	266.7 (10.50)	482.6 (19.00)
AZ-11246	ACSEW112406	251.0 (9.88)	590.6 (23.25)
AZ-11306	ACSEW113006	251.0 (9.88)	723.9 (28.50)
AZ-12126/8	ACSEW121206	266.7 (10.50)	266.7 (10.50)
AZ-12126/8	ACSEW121208	266.7 (10.50)	266.7 (10.50)
AZ-12186/8	ACSEW121806	266.7 (10.50)	419.1 (16.50)
AZ-12186/8	ACSEW121808	266.7 (10.50)	419.1 (16.50)
AZ-12248	ACSEW122408	273.1 (10.75)	574.8 (22.63)
AZ-12368	ACSEW123608	254.0 (10.00)	863.6 (34.00)
AZ-13386	ACSEW133806	292.1 (11.50)	924.1 (36.38)
AZ-14146/8	ACSEW141406	311.2 (12.25)	311.2 (12.25)

Mounting Pan Catalog Number	Junction Box Catalog Number	Overall Dimensions in Millimeters (Inches)	
		W	H
AZ-14146/8	ACSEW141408	311.2 (12.25)	311.2 (12.25)
AZ-14248	ACSEW142408	355.6 (14.00)	568.5 (22.38)
AZ-15377	ACSEW153707	368.3 (14.50)	901.7 (35.50)
AZ-16166/8	ACSEW161606	381.0 (15.00)	381.0 (15.00)
AZ-16166/8	ACSEW161608	381.0 (15.00)	381.0 (15.00)
AZ-161812	ACSEW161812	381.0 (15.00)	406.4 (16.00)
AZ-16226	ACSEW162206	355.6 (14.00)	508.0 (20.00)
AZ-16248	ACSEW162408	374.7 (14.75)	577.9 (22.75)
AZ-16286	ACSEW162806	355.6 (14.00)	660.4 (26.00)
AZ-18186/8	ACSEW181806	406.4 (16.00)	406.4 (16.00)
AZ-18186/8	ACSEW181808	406.4 (16.00)	406.4 (16.00)
AZ-18248/10	ACSEW182408	406.4 (16.00)	558.8 (22.00)
AZ-18248/10	ACSEW182410	406.4 (16.00)	558.8 (22.00)
AZ-18308	ACSEW183008	406.4 (16.00)	711.2 (28.00)
AZ-18368/10	ACSEW183608	431.8 (17.00)	882.7 (34.75)
AZ-18368/10	ACSEW183610	431.8 (17.00)	882.7 (34.75)
AZ-18427	ACSEW184207	431.8 (17.00)	1016.0 (40.00)
AZ-20608	ACSEW206008	457.2 (18.00)	1460.5 (57.50)
AZ-24248/10	ACSEW242408	558.8 (22.00)	558.8 (22.00)
AZ-24248/10	ACSEW242410	558.8 (22.00)	558.8 (22.00)
AZ-24308	ACSEW243008	571.5 (22.50)	711.2 (28.00)
AZ-24368/10	ACSEW243608	558.8 (22.00)	863.6 (34.00)
AZ-24368/10	ACSEW243610	558.8 (22.00)	863.6 (34.00)
AZ-30388	ACSEW303808	711.2 (28.00)	914.1 (36.00)
AZ-30388	ACSEW303816	711.2 (28.00)	914.1 (36.00)

CONTROL S, NEC/CEC, ATEX/IECEX EXPLOSIONPROOF/FLAMEPROOF CONTROL STATIONS AND SWITCHES



ACSEW Control Operators: Push Button Components

Momentary Contact. Explosionproof

NEC/CEC:
 Class I, Division 1 and 2, Groups B, C, D
 Class II, Division 1 and 2, Groups E, F, G
 Class III
 NEMA 4, 7BCD, 9EFG

ATEX/IECEX:
 Zone 1 and 2 – 21 and 22
 II 2 GD
 IP66 – IK10

Catalog Numbering Guide

AE
 Appleton Explosionproof

P
 Push Button

D
 Dual Push Button:
 Omit for Single Push Button

B
 Color:
 B - Black
 R - Red
 G - Green

A
 Contact Arrangement:
 A - 1 NO
 B - 2 NO
 C - 1 NC
 D - 2 NC
 E - 1 NO and 1 NC
 F - 2 NO and 2 NC

L
 Long Barrel:
 Omit for Short Barrel



AEPBA



AEPDGRA

Single Push Buttons

Contacts ①	Button Color	Catalog Number	
		Short Barrel	Long Barrel
1 NO	Black	AEPBA	AEPBA-L
1 NO	Red	AEPRA	AEPRA-L
1 NO	Green	AEPGA	AEPGA-L
2 NO	Black	AEPBB	AEPBB-L
2 NO	Red	AEPRB	AEPRB-L
2 NO	Green	AEPGB	AEPGB-L
1 NC	Black	AEPBC	AEPBC-L
1 NC	Red	AEPRC	AEPRC-L
1 NC	Green	AEPGC	AEPGC-L
2 NC	Black	AEPBD	AEPBD-L
2 NC	Red	AEPRD	AEPRD-L
2 NC	Green	AEPGD	AEPGD-L
1 NO and 1 NC	Black	AEPBE	AEPBE-L
1 NO and 1 NC	Red	AEPRE	AEPRE-L
1 NO and 1 NC	Green	AEPGE	AEPGE-L
2 NO and 2 NC	Black	AEPBF	AEPBF-L
2 NO and 2 NC	Red	AEPRF	AEPRF-L
2 NO and 2 NC	Green	AEPGF	AEPGF-L

Dual Push Buttons

Contacts ①	Button Color	Catalog Number	
		Short Barrel	Long Barrel
2 NO	Green/Red	AEPDGRB	AEPDGRB-L
2 NO	Black/Black	AEPDBBB	AEPDBBB-L
2 NC	Green/Red	AEPDGRD	AEPDGRD-L
2 NC	Black/Black	AEPDBBD	AEPDBBD-L
1 NO and 1 NC	Green/Red	AEPDGRE	AEPDGRE-L
1 NO and 1 NC	Black/Black	AEPDBBE	AEPDBBE-L
2 NO and 2 NC	Green/Red	AEPDGRF	AEPDGRF-L
2 NO and 2 NC	Black/Black	AEPDBBF	AEPDBBF-L

① NO = Normally Open; NC = Normally Closed.

NOTE: Use long barrel devices on enclosure applications with cover thickness exceeding 22.225 mm (0.875").
 For legend plates, see Options, Accessories and Nameplates. All Operators are 3/4" NPSM.

CONTROLS: NEC/CEC, ATEX/IECEX EXPLOSIONPROOF/FLAMEPROOF CONTROL STATIONS AND SWITCHES



ACSEW Control Operators: Pilot Light Components

Explosionproof

NEC/CEC:
 Class I, Division 1 and 2, Groups B, C, D
 Class II, Division 1 and 2, Groups E, F, G
 Class III
 NEMA 4, 7BCD, 9EFG

ATEX/IECEX:
 Zone 1 and 2 – 21 and 22
 II 2 GD
 IP66 – IK10

Catalog Numbering Guide

AE
 NEC/CEC Certified
 Appleton Explosionproof

PL
 Pilot Light

G
 Guard:
 Omit for Standard Version
 (no guard)

1
 Voltage:
 1 - 120 Vac Pigtail
 2 - 240/120 Vac Transformer
 3 - 120/6 Vac Transformer
 4 - 480/120 Vac Transformer
 5 - 600/120 Vac Transformer
 6 - 6 Vac Pigtail
 7 - 12 Vac Pigtail
 8 - 24 Vac Pigtail
 9 - 48 Vac Pigtail

A
 Color:
 A - Amber
 B - Blue
 C - Clear
 R - Red
 G - Green

L
 Long Barrel:
 Omit for Short Barrel



Standard



Guarded

Voltage	Lens Color	Pilot Light Catalog Number		Guarded Pilot Light Catalog Number	
		Short Barrel	Long Barrel	Short Barrel	Long Barrel
120 Vac/Vdc Pigtail	Amber	AEPL1A ①	AEPL1A-L ①	AEPLG1A ①	AEPLG1A-L ①
	Red	AEPL1R ①	AEPL1R-L ①	AEPLG1R ①	AEPLG1R-L ①
	Green	AEPL1G ①	AEPL1G-L ①	AEPLG1G ①	AEPLG1G-L ①
	Clear	AEPL1C ①	AEPL1C-L ①	AEPLG1C ①	AEPLG1C-L ①
	Blue	AEPL1B ①	AEPL1B-L ①	AEPLG1B ①	AEPLG1B-L ①
240 Vac Transformer w/120 Vac Lamp	Amber	AEPL2A ②	AEPL2A-L ②	AEPLG2A ②	AEPLG2A-L ②
	Red	AEPL2R ②	AEPL2R-L ②	AEPLG2R ②	AEPLG2R-L ②
	Green	AEPL2G ②	AEPL2G-L ②	AEPLG2G ②	AEPLG2G-L ②
	Clear	AEPL2C ②	AEPL2C-L ②	AEPLG2C ②	AEPLG2C-L ②
	Blue	AEPL2B ②	AEPL2B-L ②	AEPLG2B ②	AEPLG2B-L ②
120 Vac Transformer w/6 Vac Lamp	Amber	AEPL3A ②	AEPL3A-L ②	AEPLG3A ②	AEPLG3A-L ②
	Red	AEPL3R ②	AEPL3R-L ②	AEPLG3R ②	AEPLG3R-L ②
	Green	AEPL3G ②	AEPL3G-L ②	AEPLG3G ②	AEPLG3G-L ②
	Clear	AEPL3C ②	AEPL3C-L ②	AEPLG3C ②	AEPLG3C-L ②
	Blue	AEPL3B ②	AEPL3B-L ②	AEPLG3B ②	AEPLG3B-L ②

① For pilot light with ATEX Certification place an X suffix at the end of the catalog number; example: AEPL1AX.

② Not available with ATEX Certification.

NOTE: Use long barrel devices on enclosure applications with cover thickness exceeding 22.225 mm (0.875"). For legend plates, see Options, Accessories and Nameplates. All Operators are 3/4" NPSM.

Visit our website at www.emerson.com or contact us at (800) 621-1506.
 © November 2016

CONTROL S: NEC/CEC, ATEX/IECEX EXPLOSIONPROOF/FLAMEPROOF CONTROL STATIONS AND SWITCHES



ACSEW Control Operators: Pilot Light Components

Explosionproof

NEC/CEC:
Class I, Division 1 and 2, Groups B, C, D
Class II, Division 1 and 2, Groups E, F, G
Class III
NEMA 4, 7BCD, 9EFG

ATEX/IECEX:
Zone 1 and 2 – 21 and 22
II 2 GD
IP66 – IK10

CONTROLS: NEC/CEC, ATEX/IECEX EXPLOSIONPROOF/FLAMEPROOF CONTROL STATIONS AND SWITCHES

Voltage	Lens Color	Pilot Light Catalog Number		Guarded Pilot Light Catalog Number	
		Short Barrel	Long Barrel	Short Barrel	Long Barrel
480 Vac Transformer w/120 Vac Lamp	Amber	AEPL4A ②	AEPL4A-L ②	AEPLG4A ②	AEPLG4A-L ②
	Red	AEPL4R ②	AEPL4R-L ②	AEPLG4R ②	AEPLG4R-L ②
	Green	AEPL4G ②	AEPL4G-L ②	AEPLG4G ②	AEPLG4G-L ②
	Clear	AEPL4C ②	AEPL4C-L ②	AEPLG4C ②	AEPLG4C-L ②
	Blue	AEPL4B ②	AEPL4B-L ②	AEPLG4B ②	AEPLG4B-L ②
600 Vac Transformer w/120 Vac Lamp	Amber	AEPL5A ②	AEPL5A-L ②	AEPLG5A ②	AEPLG5A-L ②
	Red	AEPL5R ②	AEPL5R-L ②	AEPLG5R ②	AEPLG5R-L ②
	Green	AEPL5G ②	AEPL5G-L ②	AEPLG5G ②	AEPLG5G-L ②
	Clear	AEPL5C ②	AEPL5C-L ②	AEPLG5C ②	AEPLG5C-L ②
	Blue	AEPL5B ②	AEPL5B-L ②	AEPLG5B ②	AEPLG5B-L ②
6 Vac/Vdc Pigtail	Amber	AEPL6A ①	AEPL6A-L ①	AEPLG6A ①	AEPLG6A-L ①
	Red	AEPL6R ①	AEPL6R-L ①	AEPLG6R ①	AEPLG6R-L ①
	Green	AEPL6G ①	AEPL6G-L ①	AEPLG6G ①	AEPLG6G-L ①
	Clear	AEPL6C ①	AEPL6C-L ①	AEPLG6C ①	AEPLG6C-L ①
	Blue	AEPL6B ①	AEPL6B-L ①	AEPLG6B ①	AEPLG6B-L ①
12 Vac/Vdc Pigtail	Amber	AEPL7A ①	AEPL7A-L ①	AEPLG7A ①	AEPLG7A-L ①
	Red	AEPL7R ①	AEPL7R-L ①	AEPLG7R ①	AEPLG7R-L ①
	Green	AEPL7G ①	AEPL7G-L ①	AEPLG7G ①	AEPLG7G-L ①
	Clear	AEPL7C ①	AEPL7C-L ①	AEPLG7C ①	AEPLG7C-L ①
	Blue	AEPL7B ①	AEPL7B-L ①	AEPLG7B ①	AEPLG7B-L ①
24 Vac/Vdc Pigtail	Amber	AEPL8A ①	AEPL8A-L ①	AEPLG8A ①	AEPLG8A-L ①
	Red	AEPL8R ①	AEPL8R-L ①	AEPLG8R ①	AEPLG8R-L ①
	Green	AEPL8G ①	AEPL8G-L ①	AEPLG8G ①	AEPLG8G-L ①
	Clear	AEPL8C ①	AEPL8C-L ①	AEPLG8C ①	AEPLG8C-L ①
	Blue	AEPL8B ①	AEPL8B-L ①	AEPLG8B ①	AEPLG8B-L ①
48 Vac/Vdc Pigtail	Amber	AEPL9A ①	AEPL9A-L ①	AEPLG9A ①	AEPLG9A-L ①
	Red	AEPL9R ①	AEPL9R-L ①	AEPLG9R ①	AEPLG9R-L ①
	Green	AEPL9G ①	AEPL9G-L ①	AEPLG9G ①	AEPLG9G-L ①
	Clear	AEPL9C ①	AEPL9C-L ①	AEPLG9C ①	AEPLG9C-L ①
	Blue	AEPL9B ①	AEPL9B-L ①	AEPLG9B ①	AEPLG9B-L ①

① For pilot light with ATEX Certification place an X suffix at the end of the catalog number; example: AEPL1AX.

② Not available with ATEX Certification.

NOTE: Use long barrel devices on enclosure applications with cover thickness exceeding 22.225 mm (0.875").
For legend plates, see Options, Accessories and Nameplates. All Operators are 3/4" NPSM.

ACSEW Control Operators: Lighted Push Button Components

Momentary Contact. Explosionproof

NEC/CEC:
 Class I, Division 1 and 2, Groups B, C, D
 Class II, Division 1 and 2, Groups E, F, G
 Class III
 NEMA 4, 7BCD, 9EFG

ATEX/IECEX:
 Zone 1 and 2 - 21 and 22
 II 2 GD
 IP66 - IK10

Catalog Numbering Guide

AE
 Appleton Explosionproof

PT
 Push Button, Lighted

—
 Voltage:
 Blank - 120 Vac
 8 - 24 Vac

A
 Color:
 A - Amber
 B - Blue
 C - Clear
 R - Red
 G - Green

A
 Contact
 Arrangement:
 A - 1 NO
 B - 2 NO
 C - 1 NC
 D - 2 NC
 E - 1 NO and 1 NC
 F - 2 NO and 2 NC

L
 Long Barrel:
 Omit for Short
 Barrel



Contacts ①	Lens Color	Catalog Number	
		Short Barrel	Long Barrel
1 NO	Amber	AEPTAA	AEPTAA-L
1 NO	Red	AEPTRA	AEPTRA-L
1 NO	Green	AEPTGA	AEPTGA-L
1 NO	Clear	AEPTCA	AEPTCA-L
1 NO	Blue	AEPTBA	AEPTBA-L
2 NO	Amber	AEPTAB	AEPTAB-L
2 NO	Red	AEPTRB	AEPTRB-L
2 NO	Green	AEPTGB	AEPTGB-L
2 NO	Clear	AEPTCB	AEPTCB-L
2 NO	Blue	AEPTBB	AEPTBB-L
1 NC	Amber	AEPTAC	AEPTAC-L
1 NC	Red	AEPTRC	AEPTRC-L
1 NC	Green	AEPTGC	AEPTGC-L
1 NC	Clear	AEPTCC	AEPTCC-L
1 NC	Blue	AEPTBC	AEPTBC-L

Contacts ①	Lens Color	Catalog Number	
		Short Barrel	Long Barrel
2 NC	Amber	AEPTAD	AEPTAD-L
2 NC	Red	AEPTRD	AEPTRD-L
2 NC	Green	AEPTGD	AEPTGD-L
2 NC	Clear	AEPTCD	AEPTCD-L
2 NC	Blue	AEPTBD	AEPTBD-L
1 NO and 1 NC	Amber	AEPTAE	AEPTAE-L
1 NO and 1 NC	Red	AEPTRE	AEPTRE-L
1 NO and 1 NC	Green	AEPTGE	AEPTGE-L
1 NO and 1 NC	Clear	AEPTCE	AEPTCE-L
1 NO and 1 NC	Blue	AEPTBE	AEPTBE-L
2 NO and 2 NC	Amber	AEPTAF	AEPTAF-L
2 NO and 2 NC	Red	AEPTRF	AEPTRF-L
2 NO and 2 NC	Green	AEPTGF	AEPTGF-L
2 NO and 2 NC	Clear	AEPTCF	AEPTCF-L
2 NO and 2 NC	Blue	AEPTBF	AEPTBF-L

① NO = Normally Open; NC = Normally Closed.

NOTE: Use long barrel devices on enclosure applications with cover thickness exceeding 22.225 mm (0.875"). For legend plates, see Options, Accessories and Nameplates. All Operators are 3/4" NPSM.

CONTROL S: NEC/CEC, ATEX/IECEX EXPLOSIONPROOF/FLAMEPROOF CONTROL STATIONS AND SWITCHES



ACSEW Control Operators: Mushroom Head Push Button Components

Momentary Contact. Explosionproof

NEC/CEC:
 Class I, Division 1 and 2, Groups B, C, D
 Class II, Division 1 and 2, Groups E, F, G
 Class III
 NEMA 4, 7BCD, 9EFG

ATEX/IECEX:
 Zone 1 and 2 – 21 and 22
 II 2 GD
 IP66 – IK10

Catalog Numbering Guide

AE
 NEC/CEC Certified
 Appleton Explosionproof

P
 Push Button

M
 Mushroom Head, Momentary

B
 Color:
 B - Black
 R - Red
 G - Green

A
 Contact Arrangement:
 A - 1 NO
 B - 2 NO
 C - 1 NC
 D - 2 NC
 E - 1 NO and 1 NC
 F - 2 NO and 2 NC

L
 Long Barrel:
 Omit for Short Barrel



Contacts ①	Lens Color	Catalog Number	
		Short Barrel	Long Barrel
1 NO	Black	AEPMBA	AEPMBA-L
1 NO	Red	AEPMRA	AEPMRA-L
1 NO	Green	AEPMGA	AEPMGA-L
2 NO	Black	AEPMBB	AEPMBB-L
2 NO	Red	AEPMRB	AEPMRB-L
2 NO	Green	AEPMGB	AEPMGB-L
1 NC	Black	AEPMBC	AEPMBC-L
1 NC	Red	AEPMRC	AEPMRC-L
1 NC	Green	AEPMGC	AEPMGC-L

Contacts ①	Lens Color	Catalog Number	
		Short Barrel	Long Barrel
2 NC	Black	AEPMBD	AEPMBD-L
2 NC	Red	AEPMRD	AEPMRD-L
2 NC	Green	AEPMGD	AEPMGD-L
1 NO and 1 NC	Black	AEPMBE	AEPMBE-L
1 NO and 1 NC	Red	AEPMRE	AEPMRE-L
1 NO and 1 NC	Green	AEPMGE	AEPMGE-L
2 NO and 2 NC	Black	AEPMBF	AEPMBF-L
2 NO and 2 NC	Red	AEPMRF	AEPMRF-L
2 NO and 2 NC	Green	AEPMGF	AEPMGF-L

① NO = Normally Open; NC = Normally Closed.

NOTE: Use long barrel devices on enclosure applications with cover thickness exceeding 22.225 mm (0.875").
 For legend plates, see Options, Accessories and Nameplates. All Operators are 3/4" NPSM.

ACSEW Control Operators: Mushroom Head Push Button Components

Maintained Contact. Explosionproof

NEC/CEC:
 Class I, Division 1 and 2, Groups B, C, D
 Class II, Division 1 and 2, Groups E, F, G
 Class III
 NEMA 4, 7BCD, 9EFG

ATEX/IECEX:
 Zone 1 and 2 – 21 and 22
 II 2 GD
 IP66 – IK10

Catalog Numbering Guide

AE
 NEC/CEC Certified
 Appleton Explosionproof

P
 Push Button

MC
 Mushroom Head, Maintained

B
 Color:
 B - Black
 R - Red
 G - Green

A
 Contact Arrangement:
 A - 1 NO
 B - 2 NO
 C - 1 NC
 D - 2 NC
 E - 1 NO and 1 NC
 F - 2 NO and 2 NC

L
 Long Barrel:
 Omit for Short Barrel



Contacts ①	Lens Color	Catalog Number	
		Short Barrel	Long Barrel
1 NO	Black	AEPMCBA	AEPMCBA-L
1 NO	Red	AEPMCRA	AEPMCRA-L
1 NO	Green	AEPMCGA	AEPMCGA-L
2 NO	Black	AEPMCBB	AEPMCBB-L
2 NO	Red	AEPMCRB	AEPMCRB-L
2 NO	Green	AEPMCGB	AEPMCGB-L
1 NC	Black	AEPMCBC	AEPMCBC-L
1 NC	Red	AEPMCRC	AEPMCRC-L
1 NC	Green	AEPMCGC	AEPMCGC-L

Contacts ①	Lens Color	Catalog Number	
		Short Barrel	Long Barrel
2 NC	Black	AEPMCBD	AEPMCBD-L
2 NC	Red	AEPMCRD	AEPMCRD-L
2 NC	Green	AEPMCGD	AEPMCGD-L
1 NO and 1 NC	Black	AEPMCBE	AEPMCBE-L
1 NO and 1 NC	Red	AEPMCRE	AEPMCRE-L
1 NO and 1 NC	Green	AEPMCGE	AEPMCGE-L
2 NO and 2 NC	Black	AEPMCBF	AEPMCBF-L
2 NO and 2 NC	Red	AEPMCRF	AEPMCRF-L
2 NO and 2 NC	Green	AEPMCGF	AEPMCGF-L

① NO = Normally Open; NC = Normally Closed.

NOTE: Use long barrel devices on enclosure applications with cover thickness exceeding 22.225 mm (0.875"). For legend plates, see Options, Accessories and Nameplates. All Operators are 3/4" NPSM.

ACSEW Miniature Control Operators

Explosionproof

NEC/CEC:

Class I, Division 1 and 2, Groups B, C, D
Class II, Division 1 and 2, Groups E, F, G
Class III
NEMA 4, 7BCD, 9EFG

Features

- Installation centers reduced to 1" centers.
- Allows selection of smaller enclosures.
- 3/8 - 16 thread.
- Stainless steel actuator shaft.
- Solid silver contacts rated 6 Amps at 125 Vac, 3 Amps at 250 Vac.



Contact Configuration	Catalog Number
DPDT Maintained	AEPMOB-3
DPDT Momentary	AEPMOB-4

CONTROLS: NEC/CEC, ATEX/IECEx EXPLOSIONPROOF/FLAMEPROOF CONTROL STATIONS AND SWITCHES



NOTE: Use long barrel devices on enclosure applications with cover thickness exceeding 22.225 mm (0.875").
For legend plates, see Options, Accessories and Nameplates. Miniature operators are NOT 3/4" NPSM.

ACSEW Control Operators: Selector Switch Components

Explosionproof

NEC/CEC:
 Class I, Division 1 and 2, Groups B, C, D
 Class II, Division 1 and 2, Groups E, F, G
 Class III
 NEMA 4, 7BCD, 9EFG

ATEX/IECEX:
 Zone 1 and 2 – 21 and 22
 II 2 GD
 IP66 – IK10

Catalog Numbering Guide

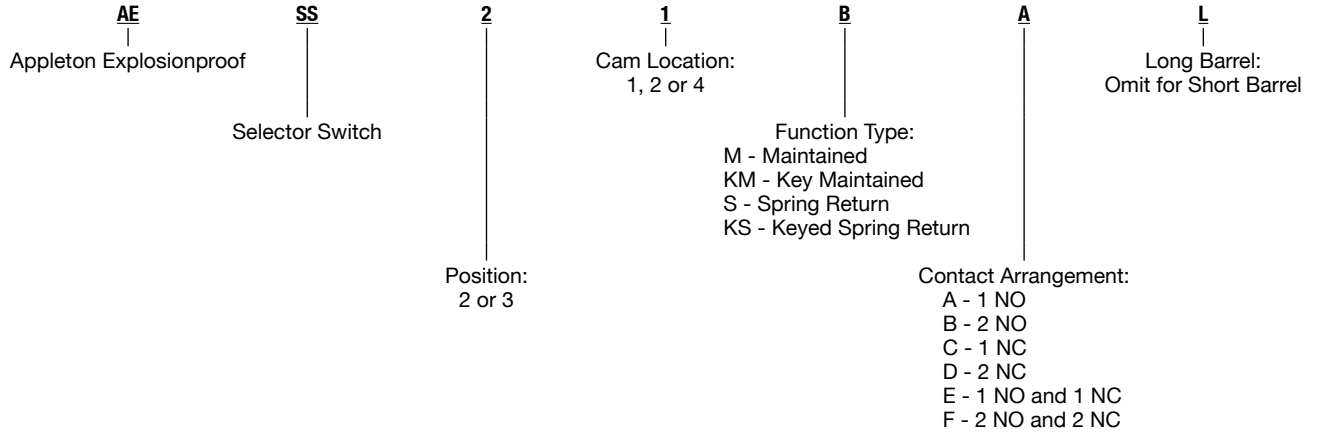

Two Position – Maintained Contact

Contact	Lever Position X=Closed, O=Open		Catalog Number		Contact Block Position		Cam Location
	Left	Right	Standard Bushing	Long Bushing	L	R	
1	O	X	AESS22MG	AESS22MG-L	NO	-	2
1	X	O	AESS22MH	AESS22MH-L	-	NO	2
1	O	X	AESS22ML	AESS22ML-L	NO	NO	2
2	X	O					
1	O	X	AESS22MM	AESS22MM-L	NO	NC	2
2	O	X					
1	X	O					
2	O	X	AESS22MR	AESS22MR-L	2NC	2NC	2
3	X	O					
4	O	X					

NOTE: Use long barrel devices on enclosure applications with cover thickness exceeding 22.225 mm (0.875"). For legend plates, see Options, Accessories and Nameplates. All Operators are 3/4" NPSM.

ACSEW Control Operators: Selector Switch Components

Explosionproof

NEC/CEC:
 Class I, Division 1 and 2, Groups B, C, D
 Class II, Division 1 and 2, Groups E, F, G
 Class III
 NEMA 4, 7BCD, 9EFG

ATEX/IECEx:
 Zone 1 and 2 – 21 and 22
 II 2 GD
 IP66 – IK10

Two Position – Spring Return Right to Center

Contact	Lever Position X=Closed, O=Open		Catalog Number		Contact Block Position		Cam Location
	Left	Right	Standard Bushing	Long Bushing	L	R	
1	O	X	AESS22SG	AESS22SG-L	NO	-	2
1	X	O	AESS22SH	AESS22SH-L	-	NO	2
1	O	X	AESS22SL	AESS22SL-L	NO	NO	2
2	X	O			NO	NO	
1	O	X	AESS22SM	AESS22SM-L	NO	NC	2
2	O	X			NO	NC	
1	X	O	AESS22SR	AESS22SR-L	2NC	2NC	2
2	O	X					
3	X	O					
4	O	X					

Three Position – Maintained Contact

Contact	Lever Position X=Closed, O=Open			Catalog Number		Contact Block Position		Cam Location
	Left	Center	Right	Standard Bushing	Long Bushing	L	R	
1	O	O	X	AESS31MN	AESS31MN-L	NC	NC	1
2	X	O	O					
1	X	O	O	AESS31MQ	AESS31MQ-L	-	NOC	1
2	O	X	X					
1	O	O	X	AESS34MN	AESS34MN-L	NC	NC	4
2	O	X	O					
1	X	O	O	AESS32MN	AESS32MN-L	NC	NC	2
2	O	X	O					
1	O	O	X	AESS31MS	AESS31MS-L	2NC	2NC	1
2	X	O	O					
3	O	O	X					
4	X	O	O					
1	O	O	X	AESS34MS	AESS34MS-L	2NC	2NC	4
2	O	X	O					
3	O	O	X					
4	O	X	O					
1	X	O	O	AESS32MS	AESS32MS-L	2NC	2NC	2
2	O	X	O					
3	X	O	O					
4	O	X	O					

NOTE: Use long barrel devices on enclosure applications with cover thickness exceeding 22.225 mm (0.875"). See options page for legend plates. All Operators are 3/4" NPSM.

CONTROLS: NEC/CEC, ATEX/IECEx EXPLOSIONPROOF/FLAMEPROOF CONTROL STATIONS AND SWITCHES



ACSEW Control Operators: Selector Switch Components

Explosionproof

NEC/CEC:
 Class I, Division 1 and 2, Groups B, C, D
 Class II, Division 1 and 2, Groups E, F, G
 Class III
 NEMA 4, 7BCD, 9EFG

ATEX/IECEx:
 Zone 1 and 2 – 21 and 22
 II 2 GD
 IP66 – IK10

Three Position – Spring Return – Maintained Contact

Contact	Lever Position X=Closed, O=Open			Catalog Number		Contact Block Position		Cam Location
	Left	Center	Right	Standard Bushing	Long Bushing	L	R	
1	O	O	X	AESS31SN	AESS31SN-L	NC	NC	1
2	X	O	O					
1	X	O	O	AESS31SQ	AESS31SQ-L	-	NOC	1
2	O	X	X					
1	O	O	X	AESS34SN	AESS34SN-L	NC	NC	4
2	O	X	O					
1	X	O	O	AESS32SN	AESS32SN-L	NC	NC	2
2	O	X	O					
1	O	O	X	AESS31SS	AESS31SS-L	2NC	2NC	1
2	X	O	O					
3	O	O	X					
4	X	O	O					
1	O	O	X	AESS34SS	AESS34SS-L	2NC	2NC	4
2	O	X	O					
3	O	O	X					
4	O	X	O					
1	X	O	O	AESS32SS	AESS32SS-L	2NC	2NC	2
2	O	X	O					
3	X	O	O					
4	O	X	O					

CONTROL S: NEC/CEC, ATEX/IECEx EXPLOSIONPROOF/FLAMEPROOF CONTROL STATIONS AND SWITCHES

NOTE: Use long barrel devices on enclosure applications with cover thickness exceeding 22.225 mm (0.875").
 For legend plates, see Options, Accessories and Nameplates. All Operators are 3/4" NPSM.

ACSEW Control Operators: Selector Switch Components

Explosionproof

NEC/CEC:
Class I, Division 1 and 2, Groups B, C, D
Class II, Division 1 and 2, Groups E, F, G
Class III
NEMA 4, 7BCD, 9EFG

ATEX/IECEx:
Zone 1 and 2 – 21 and 22
II 2 GD
IP66 – IK10

Two Position – Key Operated ①② – Maintained Contact

Contact	Lever Position X=Closed, O=Open		Catalog Number		Contact Block Position		Cam Location
	Left	Right	Standard Bushing	Long Bushing	L	R	
1	O	X	AESS22KMG	AESS22KMG-L	NO	—	2
1	X	O	AESS22KMH	AESS22KMH-L	—	NO	2
1	O	X	AESS22KML	AESS22KML-L	NO	NO	2
2	X	O			NO	NO	
1	O	X	AESS22KMM	AESS22KMM-L	NO	NC	2
2	O	X			NO	NC	
1	X	O	AESS22KMR	AESS22KMR-L	2NC	2NC	2
2	O	X					
3	X	O					
4	O	X					

Two Position – Key Operated ①② – Spring Return Right to Center

Contact	Lever Position X=Closed, O=Open		Catalog Number		Contact Block Position		Cam Location
	Left	Right	Standard Bushing	Long Bushing	L	R	
1	O	X	AESS22KSG	AESS22KSG-L	NO	—	2
1	X	O	AESS22KSH	AESS22KSH-L	—	NO	2
1	O	X	AESS22KSL	AESS22KSL-L	NO	NO	2
2	X	O			NO	NO	
1	O	X	AESS22KSM	AESS22KSM-L	NO	NC	2
2	O	X			NO	NC	
1	X	O	AESS22KSR	AESS22KSR-L	2NC	2NC	2
2	O	X					
3	X	O					
4	O	X					

① Locks are normally provided keyed differently. If keyed-alike locks are required, specify suffix **-KA1** and a standard type of identical locks will be provided. If a unique set of keyed-alike locks is required, specify and contact your local representative for delivery.

② Key removable from one field selectable position only. Contact your local representative for key removable in two positions.

NOTE: Use long barrel devices on enclosure applications with cover thickness exceeding 22.225 mm (0.875").
For legend plates, see Options, Accessories and Nameplates. All Operators are 3/4" NPSM.

CONTROLS: NEC/CEC, ATEX/IECEx EXPLOSIONPROOF/FLAMEPROOF CONTROL STATIONS AND SWITCHES



ACSEW Control Operators: Selector Switch Components

Explosionproof

NEC/CEC:
 Class I, Division 1 and 2, Groups B, C, D
 Class II, Division 1 and 2, Groups E, F, G
 Class III
 NEMA 4, 7BCD, 9EFG

ATEX/IECEX:
 Zone 1 and 2 – 21 and 22
 II 2 GD
 IP66 – IK10

Three Position — Key Operated ①② — Maintained Contact

Contact	Lever Position X=Closed, O=Open			Catalog Number		Contact Block Position		Cam Location																																																																																																			
	Left	Center	Right	Standard Bushing	Long Bushing	L	R																																																																																																				
1	O	O	X	AESS31KMN	AESS31KMN-L	NC	NC	1																																																																																																			
2	X	O	O						1	X	O	O	AESS31KMQ	AESS31KMQ-L	—	NOC	1	2	O	X	X	1	O	O	X	AESS34KMN	AESS34KMN-L	NC	NC	4	2	O	X	O	1	X	O	O	AESS32KMN	AESS32KMN-L	NC	NC	2	2	O	X	O	1	O	O	X	AESS31KMS	AESS31KMS-L	2NC	2NC	1	2	X	O	O	3	O	O	X	4	X	O	O	1	O	O	X	AESS34KMS	AESS34KMS-L	2NC	2NC	4	2	O	X	O	3	O	O	X	4	O	X	O	1	X	O	O	AESS32KMS	AESS32KMS-L	2NC	2NC	2	2	O	X	O	3	X	O	O	4
1	X	O	O	AESS31KMQ	AESS31KMQ-L	—	NOC	1																																																																																																			
2	O	X	X						1	O	O	X	AESS34KMN	AESS34KMN-L	NC	NC	4	2	O	X	O	1	X	O	O	AESS32KMN	AESS32KMN-L	NC	NC	2	2	O	X	O	1	O	O	X	AESS31KMS	AESS31KMS-L	2NC	2NC	1	2	X	O	O	3	O	O	X						4	X	O	O	1	O	O	X	AESS34KMS	AESS34KMS-L	2NC	2NC	4	2	O	X						O	3	O	O	X	4	O	X	O	1	X	O	O	AESS32KMS	AESS32KMS-L	2NC						2NC	2	2	O	X	O	3	X	O
1	O	O	X	AESS34KMN	AESS34KMN-L	NC	NC	4																																																																																																			
2	O	X	O						1	X	O	O	AESS32KMN	AESS32KMN-L	NC	NC	2	2	O	X	O	1	O	O	X	AESS31KMS	AESS31KMS-L	2NC	2NC	1	2	X	O	O	3	O	O	X						4	X	O	O	1	O	O	X	AESS34KMS	AESS34KMS-L	2NC	2NC	4	2	O	X	O	3	O	O	X						4	O	X	O	1	X	O	O	AESS32KMS	AESS32KMS-L	2NC	2NC	2	2	O	X	O	3	X	O	O				4	O	X	O										
1	X	O	O	AESS32KMN	AESS32KMN-L	NC	NC	2																																																																																																			
2	O	X	O						1	O	O	X	AESS31KMS	AESS31KMS-L	2NC	2NC	1	2	X	O	O	3	O	O	X						4	X	O	O	1	O	O	X	AESS34KMS	AESS34KMS-L	2NC	2NC	4	2	O	X	O	3	O	O	X						4	O	X	O	1	X	O	O	AESS32KMS	AESS32KMS-L	2NC	2NC	2	2	O	X	O	3	X	O	O						4	O	X	O																					
1	O	O	X	AESS31KMS	AESS31KMS-L	2NC	2NC	1																																																																																																			
2	X	O	O																																																																																																								
3	O	O	X																																																																																																								
4	X	O	O						1	O	O	X	AESS34KMS	AESS34KMS-L	2NC	2NC	4	2	O	X	O	3	O	O	X	4	O	X	O	1	X	O	O	AESS32KMS	AESS32KMS-L	2NC	2NC	2	2	O	X	O	3	X	O	O	4	O	X	O																																																									
1	O	O	X	AESS34KMS	AESS34KMS-L	2NC	2NC	4																																																																																																			
2	O	X	O																																																																																																								
3	O	O	X																																																																																																								
4	O	X	O						1	X	O	O	AESS32KMS	AESS32KMS-L	2NC	2NC	2	2	O	X	O	3	X	O	O	4	O	X	O																																																																														
1	X	O	O	AESS32KMS	AESS32KMS-L	2NC	2NC	2																																																																																																			
2	O	X	O																																																																																																								
3	X	O	O																																																																																																								
4	O	X	O																																																																																																								

CONTROL S: NEC/CEC, ATEX/IECEX EXPLOSIONPROOF/FLAMEPROOF CONTROL STATIONS AND SWITCHES

- ① Locks are normally provided keyed differently. If keyed-alike locks are required, specify suffix **-KA1** and a standard type of identical locks will be provided. If a unique set of keyed-alike locks is required, specify and contact your local representative for delivery.
- ② Key removable from one field selectable position only. Contact your local representative for key removable in two positions.

NOTE: Use long barrel devices on enclosure applications with cover thickness exceeding 22.225 mm (0.875"). For legend plates, see Options, Accessories and Nameplates. All Operators are 3/4" NPSM.

ACSEW Control Operators: Selector Switch Components

Explosionproof

NEC/CEC:
 Class I, Division 1 and 2, Groups B, C, D
 Class II, Division 1 and 2, Groups E, F, G
 Class III
 NEMA 4, 7BCD, 9EFG

ATEX/IECEX:
 Zone 1 and 2 – 21 and 22
 II 2 GD
 IP66 – IK10

Three Position – Key Operated ①② – Spring Return

Contact	Lever Position X=Closed, O=Open			Catalog Number		Contact Block Position		Cam Location
	Left	Center	Right	Standard Bushing	Long Bushing	L	R	
1	O	O	X	AESS31KSN	AESS31KSN-L	NC	NC	1
2	X	O	O					
1	X	O	O	AESS31KSQ	AESS31KSQ-L	—	NOC	1
2	O	X	X					
1	O	O	X	AESS34KSN	AESS34KSN-L	NC	NC	4
2	O	X	O					
1	X	O	O	AESS32KSN	AESS32KSN-L	NC	NC	2
2	O	X	O					
1	O	O	X	AESS31KSS	AESS31KSS-L	2NC	2NC	1
2	X	O	O					
3	O	O	X					
4	X	O	O					
1	O	O	X	AESS34KSS	AESS34KSS-L	2NC	2NC	4
2	O	X	O					
3	O	O	X					
4	O	X	O					
1	X	O	O	AESS32KSS	AESS32KSS-L	2NC	2NC	2
2	O	X	O					
3	X	O	O					
4	O	X	O					

CONTROLS: NEC/CEC, ATEX/IECEX EXPLOSIONPROOF/FLAMEPROOF CONTROL STATIONS AND SWITCHES



① Locks are normally provided keyed differently. If keyed-alike locks are required, specify suffix **-KA1** and a standard type of identical locks will be provided. If a unique set of keyed-alike locks is required, specify and contact your local representative for delivery.

② Key removable from one field selectable position only. Contact your local representative for key removable in two positions.

NOTE: Use long barrel devices on enclosure applications with cover thickness exceeding 22.225 mm (0.875"). For legend plates, see Options, Accessories and Nameplates. All Operators are 3/4" NPSM.

ACSEW Control Operator Accessories

Explosionproof

NEC/CEC:

Class I, Division 1 and 2, Groups B, C, D
 Class II, Division 1 and 2, Groups E, F, G
 Class III
 NEMA 4, 7BCD, 9EFG

ATEX/IECEX:

Zone 1 and 2 – 21 and 22
 II 2 GD
 IP66 – IK10

	Item	Description	Catalog Number
	<p>360° Rotating Shaft</p>	<p>Manual operated shaft used for devices requiring external adjustment. The shaft is 6.35 mm (0.25") diameter and is provided with a coupling to compensate for misalignment.</p>	<p>ARO250C</p>
	<p>Standard Reset Button</p>	<p>Six-inch length can be field modified for specific length. Suitable for use in Class I, Groups B, C and D applications.</p> <p>For long barrel</p>	<p>AEPRS AEPRSL</p>
	<p>Miniature Reset Button</p>	<p>Six-inch length can be field modified for specific length. Suitable for use in Class I, Groups B, C and D applications. 3/8 - 16 Threads.</p>	<p>AEPRM ①</p>
	<p>Weather Cap For Push Button Devices</p>	<p>Field attachable weather cap snaps on easily without the use of adhesives.</p> <p>Black</p> <p>Green</p> <p>Red</p>	<p>PBCAPB PBCAPG PBCAPR</p>
	<p>Plug</p>	<p>3/4" NPSM to plug unused openings.</p>	<p>AA-9400</p>
 <p data-bbox="261 1654 313 1675">AP02</p> <p data-bbox="513 1717 565 1738">AP01</p>	<p>Potentiometer Operator</p>	<p>Operator for use with potentiometers having a 6.35 mm (0.25") diameter by 22.225 mm (0.875") long shaft. The operator is furnished with a control knob and dial plate marked 0 to 100.</p> <p>Long bushing for applications where enclosure cover thickness is greater than 22.225 mm (0.875").</p>	<p>AP01 AP02</p>

① Not available with ATEX Certification.

NOTE: Use long barrel devices on enclosure applications with cover thickness exceeding 22.225 mm (0.875"). For legend plates, see Options, Accessories and Nameplates. All Operators are 3/4" NPSM.

ACSEW Control Operator Options, Accessories and Nameplates

Explosionproof

NEC/CEC:
Class I, Division 1 and 2, Groups B, C, D
Class II, Division 1 and 2, Groups E, F, G
Class III
NEMA 4, 7BCD, 9EFG

ATEX/IECEx:
Zone 1 and 2 – 21 and 22
II 2 GD
IP66 – IK10

Optional Features

Item Description	Suffix
Keyed Alike (Selector Switches)	KA1
Additional Keys (Keyed Selector Switches)	441-KEYS

NOTE: Additional keys may only be purchased when ordering devices.
Keys may not be purchased for devices installed in the field.

Nameplates

Legend Plate	Catalog Number
Start	A441-01
Stop	A441-02
High	A441-03
Low	A441-04
On	A441-05
Off	A441-06
Forward	A441-07
Reverse	A441-08
Open	A441-09
Close	A441-10
Up	A441-11
Down	A441-12
Reset	A441-13
Run	A441-14
Trip	A441-15
Blank	A441-16
Emergency Stop (Red)	A441-17
Custom Engraved Legend Plates (Specify Lettering)	A441-16SP
Off—On	A441-20
Open—Close	A441-21
For—Rev	A441-22
High—Low	A441-23
Start—Stop	A441-24
Up—Down	A441-25
Local—Remote	A441-26
Hand—Off—Auto	A441-30
For—Off—Rev	A441-31
Open—Off—Close	A441-32
Off—Low—High	A441-33
Push to Start—Push to Stop	A441-40

Accessories

Lamp Description	Catalog Number
6 Vac Lamp	A6S6-6V
12 Vac Lamp	A6S6-12V
24 Vac Lamp	A6S6-24V
48 Vac Lamp	A6S6-48V
120 Vac Lamp	A6S6-120V
135 Vac Lamp	A6S6-135V
240 Vac Lamp	A6S6-240V

Pilot Light Replacement Kit — Pilot Lights (120 V)

Catalog Number	Lens Color
Amber	AEPRLAA
Blue	AEPRLAB
Clear	AEPRLAC
Green	AEPRLAG
Red	AEPRLAR

Guarded Pilot Lights (120 V)

Catalog Number	Lens Color
Amber	AEPRLAA-G
Blue	AEPRLAB-G
Clear	AEPRLAC-G
Green	AEPRLAG-G
Red	AEPRLAR-G

Push-to-Test Pilot Lights (120 V)

Catalog Number	Lens Color
Amber	AEPTRLA-A
Blue	AEPTRLA-B
Clear	AEPTRLA-C
Green	AEPTRLA-G
Red	AEPTRLA-R

Contact Block	Catalog Number
1 NO/1 NC	A9001 KA1
1 NO	A9001 KA2
1 NC	A9001 KA3

CONTROLS: NEC/CEC, ATEX/IECEx EXPLOSIONPROOF/FLAMEPROOF CONTROL STATIONS AND SWITCHES



ACSEW Control Operators

Add 1" to length for Contact Block. Thread Size — 3/4" NPSM.

NEC/CEC:

Class I, Division 1 and 2, Groups B, C, D
 Class II, Division 1 and 2, Groups E, F, G
 Class III
 NEMA 4, 7BCD, 9EFG

ATEX/IECEX:

Zone 1 and 2 – 21 and 22
 II 2 GD
 IP66 – IK10

Dimensions in Millimeters (Inches)

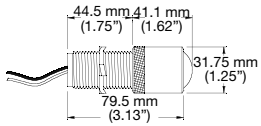
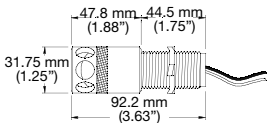
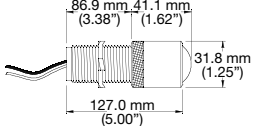
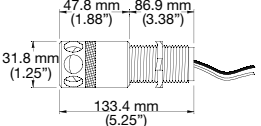
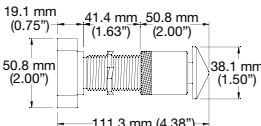
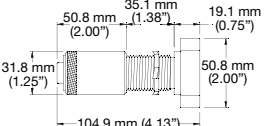
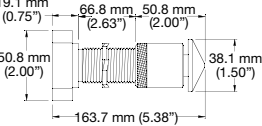
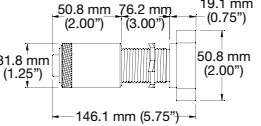
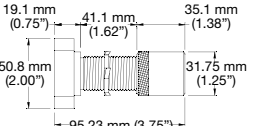
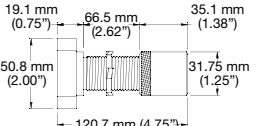
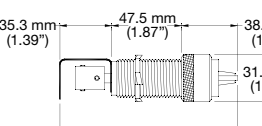
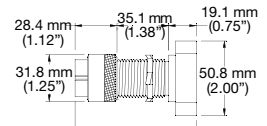
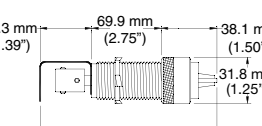
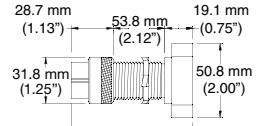
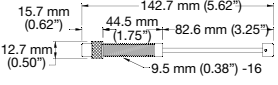
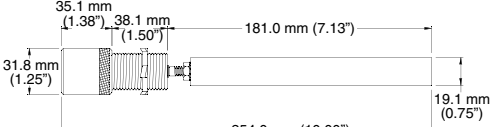
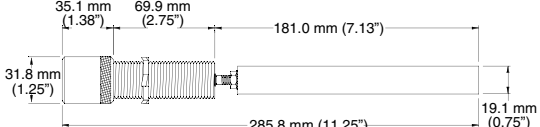
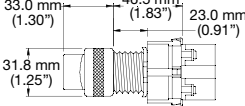
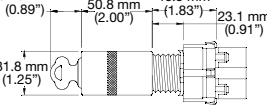
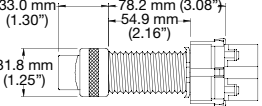
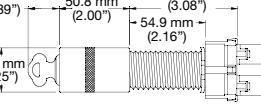
Short Barrel		Long Barrel	
 <p>Standard Pilot Light</p>	 <p>Guarded Pilot Light</p>	 <p>Standard Pilot Light</p>	 <p>Guarded Pilot Light</p>
 <p>Mushroom Head Push Button</p>	 <p>Push-To-Test Pilot Light</p>	 <p>Mushroom Head Push Button</p>	 <p>Push-To-Test Pilot Light</p>
 <p>Push Button</p>		 <p>Push Button</p>	
 <p>Potentiometer Operator</p>	 <p>Dual Push Button</p>	 <p>Potentiometer Operator</p>	 <p>Dual Push Button</p>
 <p>Miniature Reset Button</p>			
 <p>Standard Reset Button</p>		 <p>Standard Reset Button</p>	
 <p>Selector Switch</p>	 <p>Keyed Selector Switch</p>	 <p>Selector Switch</p>	 <p>Keyed Selector Switch</p>

CONTROL-S, NEC/CEC, ATEX/IECEX EXPLOSIONPROOF/FLAMEPROOF CONTROL STATIONS AND SWITCHES



ACSEW Series Drill and Tap Schedule

Customer's original purchase order must accompany completed form

NEC/CEC:
 Class I, Division 1 and 2, Groups B, C, D
 Class II, Division 1 and 2, Groups E, F, G
 Class III
 NEMA 4, 7BCD, 9EFG

ATEX/IECEX:
 Zone 1 and 2 - 21 and 22
 II 2 GD
 IP66 - IK10

Company Name _____
 Shipping Address _____
 Account Number _____ Purchase Order Number _____
 Part Number _____ Purchase Order Date _____
 Quantity _____ Internal Order Number _____

Position	Conduit Size	Dimension "X"	Dimension "K"
1			
2			
3 CL			
4			
5			
6			
7			
8 CL			
9			
10			
11			
12			
13 CL			
14			
15			
16			
17			
18 CL			
19			
20			

	Yes	No
Entries Required:	<input type="checkbox"/>	<input type="checkbox"/>
Standard Hinges Required:	<input type="checkbox"/>	<input type="checkbox"/>
Alternate Hinges Required:	<input type="checkbox"/>	<input type="checkbox"/>
Back Pan Required:	<input type="checkbox"/>	<input type="checkbox"/>
Factory to locate X and K *	<input type="checkbox"/>	<input type="checkbox"/>

* If No is checked, the X and K dimensions must be supplied in Schedule above.

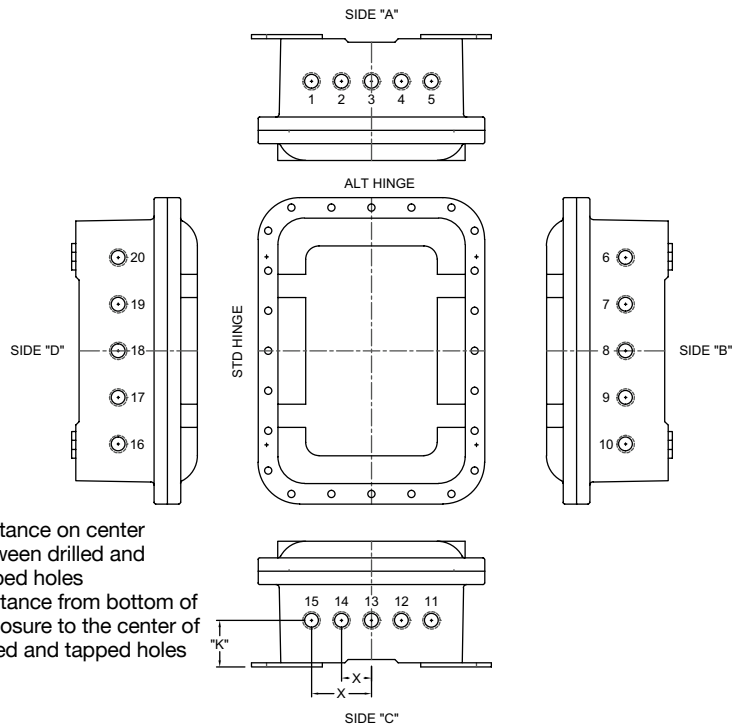

X = distance on center between drilled and tapped holes
 K = distance from bottom of enclosure to the center of drilled and tapped holes

Drilling and Tapping Guidelines

Conduit Size (NPT)	Minimum Spacing For Conduit Centers Millimeters (Inches)										
	1/2	3/4	1	1-1/4	1-1/2	2	2-1/2	3	3-1/2	4	
1/2	54.1 (2.13)	54.1 (2.13)	57.2 (2.25)	66.8 (2.63)	71.4 (2.81)	79.5 (3.13)	92.2 (3.63)	101.6 (4.00)	114.3 (4.50)	114.3 (4.50)	
3/4	54.1 (2.13)	54.1 (2.13)	57.2 (2.25)	66.8 (2.63)	71.4 (2.81)	79.5 (3.13)	92.2 (3.63)	101.6 (4.00)	114.3 (4.50)	114.3 (4.50)	
1	57.2 (2.25)	57.2 (2.25)	60.5 (2.38)	71.4 (2.81)	76.2 (3.00)	82.8 (3.25)	95.3 (3.75)	104.9 (4.13)	114.3 (4.50)	117.6 (4.63)	
1-1/4	66.8 (2.63)	66.8 (2.63)	71.4 (2.81)	79.5 (3.13)	84.1 (3.31)	92.2 (3.63)	104.9 (4.13)	114.3 (4.50)	120.7 (4.75)	127.0 (5.00)	
1-1/2	71.4 (2.81)	71.4 (2.81)	76.2 (3.00)	84.1 (3.31)	88.9 (3.50)	96.8 (3.81)	109.5 (4.31)	117.6 (4.63)	125.5 (4.94)	133.4 (5.25)	
2	79.5 (3.13)	79.5 (3.13)	82.8 (3.25)	92.2 (3.63)	96.8 (3.81)	104.9 (4.13)	117.6 (4.63)	127.0 (5.00)	148.1 (5.83)	146.1 (5.75)	
2-1/2	92.2 (3.63)	92.2 (3.63)	95.3 (3.75)	104.9 (4.13)	109.5 (4.31)	117.6 (4.63)	130.3 (5.13)	84.1 (3.31)	146.1 (5.75)	155.7 (6.13)	
3	101.6 (4.00)	101.6 (4.00)	104.9 (4.13)	114.3 (4.50)	117.6 (4.63)	127.0 (5.00)	84.1 (3.31)	146.1 (5.75)	152.4 (6.00)	158.8 (6.25)	
3-1/2	114.3 (4.50)	114.3 (4.50)	114.3 (4.50)	120.7 (4.75)	125.5 (4.94)	136.7 (5.38)	146.1 (5.75)	152.4 (6.00)	158.8 (6.25)	165.1 (6.50)	
4	114.3 (4.50)	114.3 (4.50)	117.6 (4.63)	127.0 (5.00)	133.4 (5.25)	146.1 (5.75)	155.7 (6.13)	158.8 (6.25)	165.1 (6.50)	171.5 (6.75)	

ATX™ D Series Aluminum Control Stations

Flameproof

ATEX:
Zone 1 and 2 – 21 and 22
 Ⓜ II 2 GD
 IP66 – IK10

Applications

- Local control stations for use in hazardous areas.
- Control of electrical equipment at power plants, chemical and petrochemical plants, petroleum refineries, pulp and paper processing plants and various industrial applications.

Features

- 1 and 2 Function Ex d IIC:
 - Supplied with actuators, contact blocks and pilot lights.
 - TS35 rail mounted contact blocks.
 - Threaded flameproof joint.
 - Connection: 2 x 2.5 mm² (0.004 in²) maximum.
 - Internal earth: 2 x 4 mm² (0.006 in²).
 - External ground: M5
 - 1 x M20 or M25 threaded entry at bottom.
 - Cable glands and plugs to be ordered separately.
- 2 and 3 Function Exd IIB:
 - Supplied with actuators and rail mounting pilot lights and contact blocks.
 - Flanged flameproof joint.
 - Yellow laminated plastic legend plate with black lettering.
 - Connection : 2 x 2.5 mm² (0.004 in²) maximum.
 - Internal earth: 2 x 4 mm² (0.006 in²).
 - External earth: M6 screw.
 - 2 x M20 threaded entries at the bottom.
 - Cable glands and plugs to be ordered separately.

Standard Materials

- Box: gray painted marine grade aluminum alloy

Options

- For other configurations, see pre-drilled control stations or consult factory.

ATEX Certifications and Compliances

- Certification Type BR1d
 - Gas, Zones 1 and 2
 - Conforming to ATEX 94/9/CE: Ⓜ II 2 G
 - Type of Protection: Ex d IIC
 - Temperature Class: T6 for Ta = +40 °C (+104 °F), T5 for Ta = +55 °C (+131 °F)
 - Dust, Zones 21 and 22
 - Conforming to ATEX 94/9/CE: Ⓜ II 2 D
 - Type of Protection: Ex tD A21
 - Surface Temperature: T95 °C (T203 °F)
 - Ambient Temperature: -40 °C to +55 °C (-40 °F to +131 °F)
 - CE Declaration of Conformity: 20530
 - ATEX Certificate: LCIE 02 ATEX 6056
- Certification Type CF2D
 - Gas, Zones 1 and 2
 - Conforming to ATEX 94/9/CE: Ⓜ II 2 G
 - Type of Protection: Ex d IIB
 - Temperature Class: T6 for Ta ≤ +40 °C (+104 °F), T5 for +40 °C (+104 °F) < Ta ≤ +55 °C (+131 °F)
 - Dust, Zones 21 and 22
 - Conforming to ATEX 94/9/CE: Ⓜ II 2 D
 - Type of Protection: Ex tD A21
 - Surface Temperature: T95 °C (T203 °F)
 - Ambient Temperature: -40 °C to +55 °C (-40 °F to +131 °F)
 - CE Declaration of Conformity: 50254
 - ATEX Certificate: LCIE 03 ATEX 6061X

- Index of Protection according EN/IEC 60529: IP66
- Impact Resistance (shock): IK10
- Internal Volume: ≤ 2 dm³ (122 in³) - 2 liters

EURASEC Certification

- EURASEC RU C-FR. Г505.B.00911

Other Certification ①

- INMETRO Certificate: BVC 11.0482

1 Function



2 Function



2 Function



3 Function



① INMETRO certification available on special request only. Contact your local sales representative for more information.





ATX™ D Series Aluminum Control Stations

Flameproof

ATEX:
Zone 1 and 2 – 21 and 22
II 2 GD
IP66 – IK10

Appleton



CONTROLS: ATEX/IECEx FLAMEPROOF CONTROL STATIONS AND RELAYS

Type	Description/Function	Bottom Entries	Weight kg (lb)	Volume dm ³ (in ³)	Catalog Number
1 Function Ex d IIC Control Stations					
Spring Return Push Button					
	BR1d 1x black spring return push button with 1NO + 1NC momentary contacts	1 x M20	1.0 (2.20)	3.75 (24.41)	DA1W1T101
	BR1d 1x black spring return push button with 1NO + 1NC momentary contacts	1 x M25	1.0 (2.20)	3.75 (24.41)	DA1W3T101
Mushroom Head Push Button					
	BR1d 1x red mushroom head push-pull with 1NO + 1NC maintained contacts Padlockable in both positions	1 x M20	1.2 (2.65)	3.75 (24.41)	DA1W1T102
	BR1d 1x red mushroom head push-pull with 1NO + 1NC maintained contacts Padlockable in both positions	1 x M25	1.2 (2.65)	3.75 (24.41)	DA1W3T102
	BR1d Red mushroom head key release with 1NO + 1NC maintained contact Unlocked with key (MS1)	1 x M20	1.2 (2.65)	3.75 (24.41)	DA1W1T104
	BR1d Red mushroom head key release with 1NO + 1NC maintained contact Unlocked with key (MS1)	1 x M25	1.2 (2.65)	3.75 (24.41)	DA1W3T104
Time Delayed Push Button 230 V 50/60 Hz					
	BR1d 1x time delayed black impulse push button adjustable from 25s to 15mn For 1000 W incandescent or 400 W fluorescent max.	1 x M20	1.2 (2.65)	3.75 (24.41)	DA1W1T103
	BR1d 1x time delayed black impulse push button adjustable from 25 s to 15 mn For 1000 W incandescent or 400 W fluorescent max.	1 x M25	1.2 (2.65)	3.75 (24.41)	DA1W3T103
Twin Push Buttons					
	BR1d 1x green spring return 'I' push button with 1NO momentary contact 1x red spring return 'O' push button with 1NC momentary contact	1 x M20	1.2 (2.65)	3.75 (24.41)	DA1W1T201
	BR1d 1x green spring return 'I' push button with 1NO momentary contact 1x red spring return 'O' push button with 1NC momentary contact	1 x M25	1.2 (2.65)	3.75 (24.41)	DA1W3T201
2 Function Ex d IIB Control Stations					
Twin Push Buttons					
	CF2D 1x green spring return 'I' push button with 1NO momentary contact 1x red spring return 'O' push button with 1NC momentary contact	2 x M20	2.5 (5.51)	7.00 (427.17)	DA2W2T201
	CF2D 1x green spring return 'I' push button with 1NO momentary contact 1x red mushroom head push-pull with 1NO+1NC maintained contacts	2 x M20	2.5 (5.51)	7.00 (427.17)	DA2W2T202

ATX™ D Series Aluminum Control Stations

Flameproof

ATEX:
Zone 1 and 2 – 21 and 22
II 2 GD
IP66 – IK10

Type	Description/Function	Bottom Entries	Weight kg (lb)	Volume dm ³ (in ³)	Catalog Number
3 Function Ex d IIB Control Stations					
Pilot Light and Twin Push Buttons					
	CF2D 1x red/green LED light 85 to 264 Vac 1x green spring return 'I' push button with 1NO momentary contact 1x red spring return 'O' push button with 1NC momentary contact	2 x M20	3.3 (7.28)	9.00 (549.21)	DA5W2T301
Ammeter and Twin Push Buttons					
	CF2D 1x ammeter 48 x 48 CT1A 3 x FLC 0-1-3A 1x green spring return 'I' push button with 1NO momentary contact 1x red spring return 'O' push button with 1NC momentary contact	2 x M20	3.3 (7.28)	9.00 (549.21)	DA5W2T302
Ex d IIC Limit Switch ①					
Limit Switch Stainless steel roller control perpendicular for surface fixing. 1/4 turn fixing (may be modified by end user).					
	BR1d 1x roller plunger - travel 7 mm max. - Force 22 newtons with 1NO+1NC momentary contacts	1 x M20	1.0 (2.20)	4.60 (280.71)	DA1W1L001
	BR1d 1x roller plunger - travel 7 mm max. - Force 22 newtons with 1NO+1NC momentary contacts	1 x M25	1.0 (2.20)	4.60 (280.71)	DA1W3L001

Technical Data	
Contact Block	LED Pilot Light
Insulation Voltage (Ui) 500 V	Rated Voltage 85 Vac to 264 Vac, 50/60 Hz
Switching Capacity	Rating 5-15 mA
AC 15 4 A/115 V, 4 A/230 V, 2 A/500 V	Max. Power 0.33 W
DC 13 3 A/24 V, 1.7 A/42 V, 1.2 A/60 V, 0.8 A/110 V, 0.3 A/220 V	Operation life Average 100,000 Hours at +25 °C (+77 °F)
Terminal connections 0.75 to 2.5 mm ² (0.001 to 0.004 in ²)	
Operation life >5,000,000 Operations	
Light Switch	
Insulation Voltage (Ui) 500 V	
Switching Capacity	
AC 15 450 W/48 V, 900 W/110 V, 1900 W/230 V	
DC 13 100 W/48 V, 100 W/110 V, 95 W/230 V	
Terminal connections 0.75 to 2.5 mm ² (0.001 to 0.004 in ²)	
Operation life > 1,000,000 Operations	

ATX™ D Series Aluminum Control Stations

Flameproof

ATEX:
 Zone 1 and 2 – 21 and 22
 II 2 GD
 IP66 – IK10

Appleton

CONTROLS: ATEX/IECEx FLAMEPROOF CONTROL STATIONS AND RELAYS

Electrical Diagrams

NO Contact Block



NC Contact Block



LED Pilot Light



Time Delayed Push Button

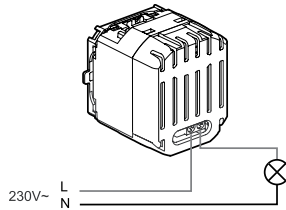

Dimensions in Millimeters (Inches)

1 Function

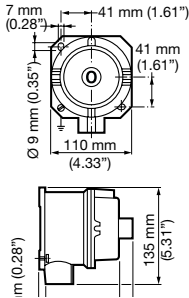

1 Function Emergency Stop

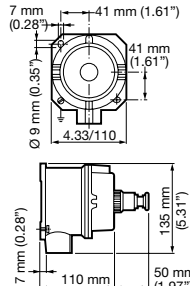

2 Functions

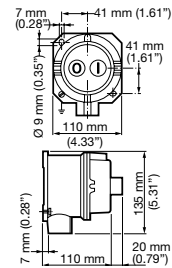

Limit Switch

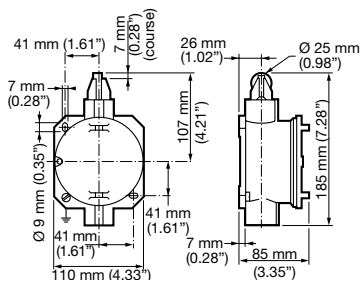

2 Functions

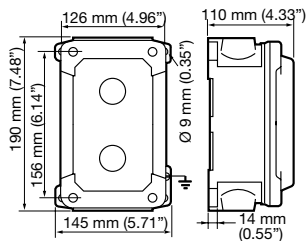

3 Functions

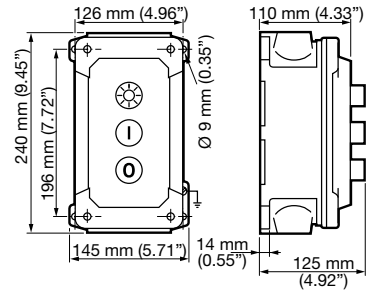

ATX™ D Series Pre-Drilled Control Stations

Flameproof

ATEX:

Zone 1 and 2 – 21 and 22

⊕ II 2 GD

IP66 – IK09/IK10

Applications

- Local control stations for use in hazardous areas.
- Control of equipment at power plants, chemical and petrochemical plants, petroleum refineries, pulp and paper processing plants and various industrial applications.

Features

- 1 and 2 Function Ex d IIC:
 - For TS35 rail mounted contact block.
 - Actuators and contact blocks to be ordered separately.
 - Up to 3 contacts per function.
 - Threaded flameproof joint.
 - Internal earth terminal 2 x 4 mm² (0.006 in²).
 - External ground terminal: M5.
 - 1 x M20 or M25 threaded entry at bottom.
 - Cable glands and plugs to be ordered separately.
- 2 to 6 Function Ex d IIB:
 - For TS35 rail mounted contact block.
 - Actuators and contact blocks to be ordered separately.
 - Up to 3 contacts per function.
 - Flanged flameproof joint.
 - Yellow laminated plastic legend plate with black lettering.
 - Internal earth terminal: 2 x 4 mm² (0.006 in²).
 - External earth terminal: M6 screw and M8 earth stud (CF2B type).
 - 2 x M20 threaded entries at the bottom.
 - Cable glands and plugs to be ordered separately.

Standard Materials

- Box: gray painted marine grade aluminum alloy
- CF2B box: gray painted cast iron for CF2B

ATEX Certifications and Compliances

- Certification Type BR1d
 - Gas, Zones 1 and 2
 - Conforming to ATEX 94/9/CE: ⊕ II 2 G
 - Type of Protection: Ex d IIC
 - Temperature Class: T6 for Ta = +40 °C (+104 °F), T5 for Ta = +55 °C (+131 °F)
 - Dust, Zones 21 and 22
 - Conforming to ATEX 94/9/CE: ⊕ II 2 D
 - Type of Protection: Ex tD A21
 - Surface Temperature: T95 °C (T203 °F)
 - Ambient Temperature: -40 °C to +55 °C (-40 °F to +131 °F)
 - Impact Resistance (shock): IK10
 - CE Declaration of Conformity: 20530
 - ATEX Certificate: LCIE 02 ATEX 6056
 - Index of Protection according EN/IEC 60529: IP66
- Certification Type CF2D
 - Gas, Zones 1 and 2
 - Conforming to ATEX 94/9/CE: ⊕ II 2 G
 - Type of Protection: Ex d IIB
 - Temperature Class: T6 for Ta = +40 °C (+104 °F), T5 for Ta = +55 °C (+131 °F)
 - Dust, Zones 21 and 22
 - Conforming to ATEX 94/9/CE: ⊕ II 2 D
 - Type of Protection: Ex tD A21
 - Surface Temperature: T95 °C (T203 °F)
 - Ambient Temperature: -40 °C to +55 °C (-40 °F to +131 °F)
 - Impact Resistance (shock): IK10
 - CE Declaration of Conformity: 50254
 - ATEX Certificate: LCIE 03 ATEX 6061X
 - Index of Protection according EN/IEC 60529: IP66

① INMETRO certification available on special request only. Contact your local sales representative for more information.

1 Function



2 Function



2 Function



3 Function



6 Function



- Certification Type BR2d
 - Gas, Zones 1 and 2
 - Conforming to ATEX 94/9/CE: ⊕ II 2 G
 - Type of Protection: Ex d IIC
 - Temperature Class: T6
 - Dust, Zones 21 and 22
 - Conforming to ATEX 94/9/CE: ⊕ II 2 D
 - Type of Protection: Ex tD A21
 - Surface Temperature: T80 °C (T176 °F)
 - Ambient Temperature: -40 °C to +55 °C (-40 °F to +131 °F)
 - Impact Resistance (shock): IK09
 - CE Declaration of Conformity: 50256
 - ATEX Certificate: LCIE 03 ATEX 6062
 - Index of Protection according EN/IEC 60529: IP66
- Certification Type CF2B
 - Gas, Zones 1 and 2
 - Conforming to ATEX 94/9/CE: ⊕ II 2 G
 - Type of Protection: Ex d IIC
 - Temperature Class: T6 for Ta ≤ +40 °C (+104 °F), T5 for +40 (+104 °F) °C < Ta ≤ +55 °C (+131 °F)
 - Dust, Zones 21 and 22
 - Conforming to ATEX 94/9/CE: ⊕ II 2 D
 - Type of Protection: Ex tD A21
 - Surface Temperature: T95 °C (T203 °F)
 - Ambient Temperature: -40 °C to +55 °C (-40 °F to +131 °F)
 - Impact Resistance (shock): IK10
 - CE Declaration of Conformity: 50254
 - ATEX Certificate: LCIE 03 ATEX 6061X
 - Index of Protection according EN/IEC 60529: IP66
 - Internal Volume: ≤ 2 dm³ (122 in³) - 2 liters

EURASEC Certification

- EURASEC RU G-FR. Г505.В.00911

Other Certification ①









- INMETRO: BR 230482-Be1D

ATX™ D Series Pre-Drilled Control Stations

Flameproof

ATEX:
Zone 1 and 2 – 21 and 22
II 2 GD
IP66 – IK09/IK10

For TS35 Rail Mounted Actuators

Type	Description/Function	Bottom Entries	Weight kg (lb)	Volume dm ³ (in ³)	Catalog Number	
1 Function Ex d IIC Control Stations:						
	BR1d	For push button, pilot light or selector switch	1 x M20	0.9 (1.98)	2 (122)	DA1W1E101
	BR1d	For push button, pilot light or selector switch	1 x M25	0.9 (1.98)	2 (122)	DA1W3E101
2 Function Ex d IIC Pre-drilled Box:						
	BR1d	For push button (non-mushroom type) 2 contacts maximum for each function	1 x M20	0.9 (1.98)	2 (122)	DA1W1E201
	BR1d	For push button (non-mushroom type) 2 contacts maximum for each function	1 x M25	0.9 (1.98)	2 (122)	DA1W3E201
2 Function Ex d IIB Pre-drilled Box:						
	CF2D	For push button, pilot light or selector switch	2 x M20	2.3 (5.07)	7 (427)	DA4W2E202
3 Function Ex d IIB Pre-drilled Box:						
	CF2D	For push button, pilot light or selector switch (2 switches maximum)	2 x M20	3 (6.61)	7 (427)	DA5W2E301
	CF2D	For push button, pilot light and ammeter 48 x 48 mm (1.73 x 1.73") (ammeter with round barrel)	2 x M20	3 (6.61)	7 (427)	DA5W2E302
4 Function Ex d IIB Pre-drilled Box:						
	CF2D	For push button, pilot light and ammeter 48 x 48 mm (1.73 x 1.73") (ammeter with round barrel)	2 x M20	3 (6.61)	7 (427)	DA5W2E401
6 Function Ex d IIB Pre-drilled Box:						
	CF2D	For push button and pilot light 2 Contacts maximum for each function	2 x M20	3 (6.61)	7 (427)	DA5W2E601
	CF2B	For push button, pilot light or selector switch (3 switches maximum)	2 x M20	13 (28.66)	13 (793)	DA3W2E601
1 Meter Ex d IIC Pre-drilled Box:						
	BR2d	For indicator 72 x 72 mm (2.83 x 2.83") or 96 x 96 mm (3.78 x 3.78") with round barrel Mounting plate for indicator diameter. 67 mm (2.64")	2 x M20	4 (8.82)	11 (671)	DA2W2E102

ATX™ D Series Pre-Drilled Control Stations

Flameproof

ATEX:
 Zone 1 and 2 – 21 and 22
 II 2 GD
 IP66 – IK09/IK10

Dimensions in Millimeters (Inches) for TS35 Rail Mounted Operators

BR1d (1 Function)

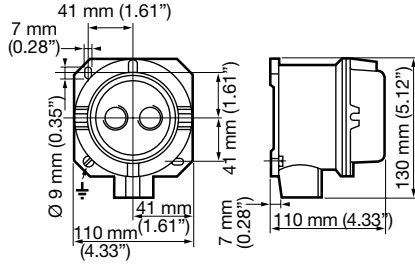

BR1d (2 Functions)

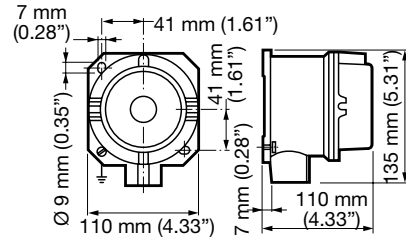

CF2D (2 Functions)

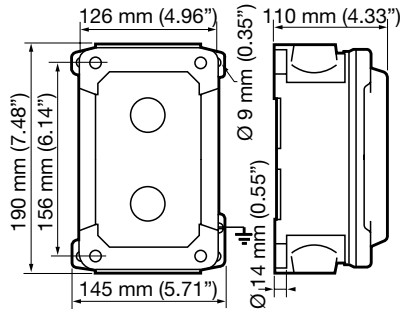

CF2D (3–4–6 Functions)

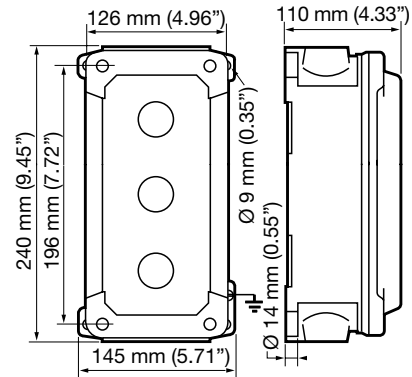

CF2B (6 Functions)

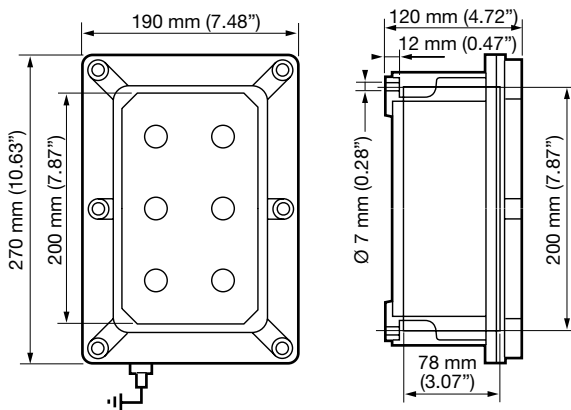

BR2d

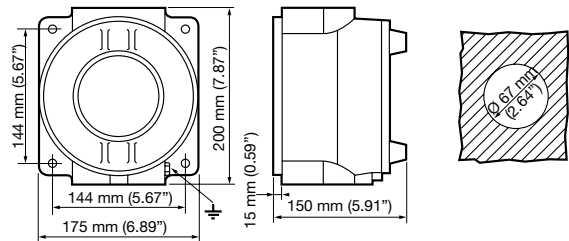

ATX™ D Series Actuators, Pilot Lights, Contact Blocks, Switches and Accessories

Flameproof

ATEX/IECEX:
Zone 1 and 2 – 21 and 22
II 2 GD
IP66 – IK10

Applications

- Suitable for use with certified flameproof Ex d enclosures for control equipment.

Features

- DIN rail mounted (TS35) and panel mounted versions.
- Large range of M22 x 1.5 mm (0.059") screwed actuator operators including, push buttons, rotary actuators, pilot lights, ammeters and selector switches.
- Fully supplied with actuator, shaft, contact block and yellow laminated plastic legend plate with black lettering 60 x 50 mm (2.36" x 1.97").

Standard Materials

- Box: gray painted marine grade aluminum alloy
- CF2B box: gray painted cast iron for CF2B

ATEX/IECEX Certifications and Compliances

- Certification Type TCD
 - Gas, Zones 1 and 2
 - Conforming to ATEX 94/9/CE: II 2 G
 - ATEX/IEC Protection: Ex d IIC
 - Dust, Zones 21 and 22
 - Conforming to ATEX 94/9/CE: II 2 D
 - ATEX/IEC Protection: Ex tD A21
 - Surface Temperature: -40 °C to +60 °C (-40 °F to +140 °F)
 - CE Declaration of Conformity: 5C213
 - ATEX Certificate: LCIE 02 ATEX 0036 U
 - IECEX Certificate: IECEX LCI 10.0022U
- Index of Protection according EN/IEC 60529: IP66
- Impact Resistance (shock): IK10

EURASEC Certification

- EURASEC RU C-FR. Г505.В.00909

Rail Mounted Version

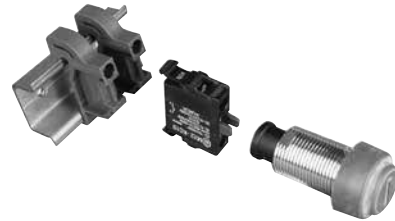



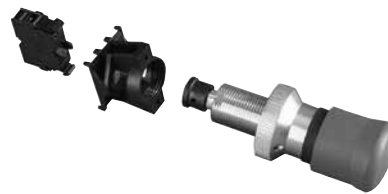



Panel Mounted Version



ATX™ D Series TS35 Rail Mounted Actuators and Contact Blocks

Flameproof

ATEX/IECEX:
 Zone 1 and 2 – 21 and 22
 II 2 GD
 IP66 – IK10

Description/Function		Weight kg (lb)	Volume dm ³ (in ³)	Catalog Number ①	
	Spring Return Push Button				
	Green spring return 'I' push button with 1NO momentary contact	0.2 (0.44)	0.4 (24.4)	DA5GR	
	Red spring return 'O' push button with 1NC momentary contact	0.2 (0.44)	0.4 (24.4)	DA9RR	
	Mushroom Head Push Button				
	Red mushroom head spring return with 1NC momentary contact Padlockable in both positions	0.2 (0.44)	0.4 (24.4)	DR9R	
	Red mushroom head push pull with 1NC maintained contact Padlockable in both positions	0.2 (0.44)	0.4 (24.4)	DD9R	
	Red mushroom head key release with 1NC maintained contact Unlocked with key (MS1)	0.2 (0.44)	0.4 (24.4)	DC9R	
	Rotary Actuator				
	2 maintained positions with 1NO maintained contact	0.2 (0.44)	0.4 (24.4)	DH5R	
	2 maintained positions key operated with 1NO maintained contact key removable in both positions (MS1)	0.2 (0.44)	0.4 (24.4)	DG5R	
	Additional Contacts				
	1 x NO contact	0.1 (0.22)	0.2 (12.20)	DCB5R	
	1 x NC contact	0.1 (0.22)	0.2 (12.20)	DCB9R	
	LED Pilot Lights				
	Red 12 to 30 Vac/Vdc	0.1 (0.22)	0.4 (24.4)	DPR12R	
	Green 12 to 30 Vac/Vdc	0.1 (0.22)	0.4 (24.4)	DPG12R	
	White 12 to 30 Vac/Vdc	0.1 (0.22)	0.4 (24.4)	DPW12R	
	Blue 12 to 30 Vac/Vdc	0.1 (0.22)	0.4 (24.4)	DPB12R	
	Yellow 12 to 30 Vac/Vdc	0.1 (0.22)	0.4 (24.4)	DPY12R	
	Red 48 to 60 Vac/Vdc	0.1 (0.22)	0.4 (24.4)	DPR48R	
	Green 48 to 60 Vac/Vdc	0.1 (0.22)	0.4 (24.4)	DPG48R	
	White 48 to 60 Vac/Vdc	0.1 (0.22)	0.4 (24.4)	DPW48R	
	Blue 48 to 60 Vac/Vdc	0.1 (0.22)	0.4 (24.4)	DPB48R	
	Yellow 48 to 60 Vac/Vdc	0.1 (0.22)	0.4 (24.4)	DPY48R	
	Red 85 to 264 Vac	0.1 (0.22)	0.4 (24.4)	DPR85R	
	Green 85 to 264 Vac	0.1 (0.22)	0.4 (24.4)	DPG85R	
	White 85 to 264 Vac	0.1 (0.22)	0.4 (24.4)	DPW85R	
	Blue 85 to 264 Vac	0.1 (0.22)	0.4 (24.4)	DPB85R	
	Yellow 85 to 264 Vac	0.1 (0.22)	0.4 (24.4)	DPY85R	
		Transfer Kit			
		To be used when replacing old catalog number range of contacts 094057 and 094058 and old catalog number range of indicators 093990-093991 and 094090-094091	0.2 (0.44)	0.4 (24.4)	093958
	16 A Switches				
	1-pole switch with non-padlockable handle "0-1"	0.3 (0.66)	0.5 (30.51)	DS116R	
	2-pole switch with non-padlockable handle "0-1"	0.3 (0.66)	0.5 (30.51)	DS216R	
	3-pole switch with non-padlockable handle "0-1"	0.3 (0.66)	0.5 (30.51)	DS316R	
	4-pole switch with non-padlockable handle "0-1"	0.3 (0.66)	0.5 (30.51)	DS416R	
	2 way 1-pole selector switch with non-padlockable handle "1-2"	0.3 (0.66)	0.5 (30.51)	DS21601R	
	3 way 1-pole selector switch with non-padlockable handle "1-0-2"	0.3 (0.66)	0.5 (30.51)	DS21602R	

① Legend plate supplied.







ATX™ D Series Panel Mounted Actuators and Contact Blocks

Flameproof

ATEX/IECEX:
Zone 1 and 2 – 21 and 22
II 2 GD
IP66 – IK10

Appleton

CONTROLS: ATEX/IECEX FLAMEPROOF CONTROL STATIONS AND RELAYS





Description/Function		Weight kg (lb)	Volume dm ³ (in ³)	Catalog Number ①
	Spring Return Push Button			
	Green spring return 'I' push button with 1NO momentary contact	0.2 (0.44)	0.4 (24.4)	DA5GP
	Red spring return 'O' push button with 1NC momentary contact	0.2 (0.44)	0.4 (24.4)	DA9RP
	Mushroom Head Push Button			
	Red mushroom head spring return with 1NC momentary contact Padlockable in both positions	0.2 (0.44)	0.4 (24.4)	DR9P
	Red mushroom head push pull with 1NC maintained contact Padlockable in both positions	0.2 (0.44)	0.4 (24.4)	DD9P
	Red mushroom head key release with 1NC maintained contact Unlocked with key (MS1)	0.2 (0.44)	0.4 (24.4)	DC9P
	Rotary Actuator			
	2 maintained positions with 1NO maintained contact	0.2 (0.44)	0.4 (24.4)	DH5P
	2 maintained positions key operated with 1NO maintained contact key removable in both positions (MS1)	0.2 (0.44)	0.4 (24.4)	DG5P
	Additional Contacts			
	1 x NO contact	0.1 (0.22)	0.2 (12.20)	DCB5P
	1 x NC contact	0.1 (0.22)	0.2 (12.20)	DCB9P
	LED Pilot Lights			
	Red 12 to 30 Vac/Vdc	0.1 (0.22)	0.4 (24.4)	DPR12P
	Green 12 to 30 Vac/Vdc	0.1 (0.22)	0.4 (24.4)	DPG12P
	White 12 to 30 Vac/Vdc	0.1 (0.22)	0.4 (24.4)	DPW12P
	Blue 12 to 30 Vac/Vdc	0.1 (0.22)	0.4 (24.4)	DPB12P
	Yellow 12 to 30 Vac/Vdc	0.1 (0.22)	0.4 (24.4)	DPY12P
	Red 48 to 60 Vac/Vdc	0.1 (0.22)	0.4 (24.4)	DPR48P
	Green 48 to 60 Vac/Vdc	0.1 (0.22)	0.4 (24.4)	DPG48P
	White 48 to 60 Vac/Vdc	0.1 (0.22)	0.4 (24.4)	DPW48P
	Blue 48 to 60 Vac/Vdc	0.1 (0.22)	0.4 (24.4)	DPB48P
	Yellow 48 to 60 Vac/Vdc	0.1 (0.22)	0.4 (24.4)	DPY48P
	Red 85 to 264 Vac	0.1 (0.22)	0.4 (24.4)	DPR85P
	Green 85 to 264 Vac	0.1 (0.22)	0.4 (24.4)	DPG85P
	White 85 to 264 Vac	0.1 (0.22)	0.4 (24.4)	DPW85P
	Blue 85 to 264 Vac	0.1 (0.22)	0.4 (24.4)	DPB85P
Yellow 85 to 264 Vac	0.1 (0.22)	0.4 (24.4)	DPY85P	
	Transfer Kit			
	To be used when replacing old catalog number range of contacts 094055 and 094056 and old catalog number range of indicators 093992-093993 and 094092-094093	0.2 (0.44)	0.4 (24.4)	093959
	16 A Switches			
	1-pole switch with non-padlockable handle "0-1"	0.3 (0.66)	0.5 (30.51)	DS116P
	2-pole switch with non-padlockable handle "0-1"	0.3 (0.66)	0.5 (30.51)	DS216P
	3-pole switch with non-padlockable handle "0-1"	0.3 (0.66)	0.5 (30.51)	DS316P
	4-pole switch with non-padlockable handle "0-1"	0.3 (0.66)	0.5 (30.51)	DS416P
	2 way 1-pole selector switch with non-padlockable handle "1-2"	0.3 (0.66)	0.5 (30.51)	DS21601P
	3 way 1-pole selector switch with non-padlockable handle "1-0-2"	0.3 (0.66)	0.5 (30.51)	DS21602P
	2 way 2-pole selector switch with non-padlockable handle "1-2"	0.3 (0.66)	0.5 (30.51)	DS41601P
	3 way 2-pole selector switch with non-padlockable handle "1-0-2"	0.3 (0.66)	0.5 (30.51)	DS41602P

① Legend plate supplied.

ATX™ D Series Accessories

Flameproof

ATEX/IECEX:
 Zone 1 and 2 – 21 and 22
 II 2 GD
 IP66 – IK10

	Description/Function	Weight kg (lb)	Volume dm ³ (in ³)	Catalog Number
	Spare Shrouds for Spring Return Push Buttons			
	Green shroud marked "1"	0.1 (0.22)	0.2 (12.20)	DSG
	Red shroud marked "0"	0.1 (0.22)	0.2 (12.20)	DSR
	Green shroud marked "start"	0.1 (0.22)	0.2 (12.20)	DSS
	Red shroud marked "A Réarmement"	0.1 (0.22)	0.2 (12.20)	DSA
	Black shroud (unmarked)	0.1 (0.22)	0.2 (12.20)	DSN
	Blue shroud (unmarked)	0.1 (0.22)	0.2 (12.20)	DSB
	Aluminum Guard Painted Red			
	Mushroom head actuator protection			DGD1A
	Stainless Steel Padlocking Devices			
	For spring return push button			DPLD1S
	For rotary actuator, red mushroom head spring return or push-pull			DPLD2S
	Spare Lenses for Pilot Lights			
	Red	0.1 (0.22)	0.2 (12.20)	DPRENS
	Green	0.1 (0.22)	0.2 (12.20)	DPGLENS
	White	0.1 (0.22)	0.2 (12.20)	DPWLENS
	Blue	0.1 (0.22)	0.2 (12.20)	DPBLENS
	Yellow	0.1 (0.22)	0.2 (12.20)	DPYLENS
	Spare Handle for Switches			
	Non-padlockable handle	0.2 (0.44)	0.2 (12.20)	DSNPH
	 Padlockable handle — 48 mm x 48 mm (1.89" x 1.89")	0.06 (0.13)	0.3 (18.31)	DSPH
	Laminated Plastic Legend Plate with Black Lettering			
	Large size — 60 mm x 50 mm (2.36 in x 1.97")			DLP00
	Small size — 45 mm x 31.2 mm (1.77" x 1.24")			DLP01
	Blanking Plug			
	Used to close up unused openings on cover M22 x 1.5 mm (0.059")	0.2 (0.44)	0.2 (12.20)	DBPM22

ATX™ D Series AC Ammeter

Flameproof

ATEX/IECEX:
 Zone 1 and 2 – 21 and 22
 II 2 GD
 IP66 – IK10

48 mm x 48 mm (1.89" x 1.89") — Connection on Current Transformer — Deflection 90° — Class 1.5 — Round Barrel

Description/Function	Weight kg (lb)	Volume dm ³ (in ³)	Catalog Number
Rail Mounted			
1A C.T. 3 x F.L.C. with 0-1-3 Scale	0.1 (0.22)	0.4 (24.4)	DMA1348R
1A C.T. 5 x F.L.C. with 0-1-5 Scale	0.1 (0.22)	0.4 (24.4)	DMA1548R
1A C.T. 6 x F.L.C. with 0-1-6 Scale	0.1 (0.22)	0.4 (24.4)	DMA1648R
5A C.T. 3 x F.L.C. with 0-1-3 Scale	0.1 (0.22)	0.4 (24.4)	DMA5348R
5A C.T. 5 x F.L.C. with 0-1-5 Scale	0.1 (0.22)	0.4 (24.4)	DMA5548R
5A C.T. 6 x F.L.C. with 0-1-6 Scale	0.1 (0.22)	0.4 (24.4)	DMA5648R
Panel Mounted			
1A C.T. 3 x F.L.C. with 0-1-3 Scale	0.1 (0.22)	0.4 (24.4)	DMA1348P
1A C.T. 5 x F.L.C. with 0-1-5 Scale	0.1 (0.22)	0.4 (24.4)	DMA1548P
1A C.T. 6 x F.L.C. with 0-1-6 Scale	0.1 (0.22)	0.4 (24.4)	DMA1648P
5A C.T. 3 x F.L.C. with 0-1-3 Scale	0.1 (0.22)	0.4 (24.4)	DMA5348P
5A C.T. 5 x F.L.C. with 0-1-5 Scale	0.1 (0.22)	0.4 (24.4)	DMA5548P
5A C.T. 6 x F.L.C. with 0-1-6 Scale	0.1 (0.22)	0.4 (24.4)	DMA5648P
AC Ammeter Accessory			
Red Adjustable Index			DM48A



Interchangeable Dials for Above Ammeter

Scale	Number	Catalog Number	Scale	Number	Catalog Number	Scale	Number	Catalog Number
For 1 A Current Transformer 3 x F.L.C.			For 1 A Current Transformer 6 x F.L.C.			For 5 A Current Transformer 5 x F.L.C.		
0 - 5 - 15	A	DA135	0 - 5 - 30	A	DA165	0 - 5 - 25	A	DA555
0 - 10 - 30	A	DA1310	0 - 10 - 60	A	DA1610	0 - 10 - 50	A	DA5510
0 - 15 - 45	A	DA1315	0 - 15 - 90	A	DA1615	0 - 15 - 75	A	DA5515
0 - 20 - 60	A	DA1320	0 - 20 - 120	A	DA1620	0 - 20 - 100	A	DA5520
0 - 30 - 90	A	DA1330	0 - 30 - 180	A	DA1630	0 - 30 - 150	A	DA5530
0 - 40 - 120	A	DA1340	0 - 40 - 240	A	DA1640	0 - 40 - 200	A	DA5540
0 - 50 - 150	A	DA1350	0 - 50 - 300	A	DA1650	0 - 50 - 250	A	DA5550
0 - 60 - 180	A	DA1360	0 - 60 - 360	A	DA1660	0 - 60 - 300	A	DA5560
0 - 75 - 225	A	DA1375	0 - 75 - 450	A	DA1675	0 - 75 - 375	A	DA5575
0 - 100 - 300	A	DA13100	0 - 100 - 600	A	DA16100	0 - 100 - 500	A	DA55100
0 - 125 - 375	A	DA13125	0 - 125 - 750	A	DA16125	0 - 125 - 625	A	DA55125
0 - 150 - 450	A	DA13150	0 - 150 - 900	A	DA16150	0 - 150 - 750	A	DA55150
0 - 200 - 600	A	DA13200	0 - 200 - 1200	A	DA16200	0 - 200 - 1000	A	DA55200
0 - 250 - 750	A	DA13250	0 - 250 - 1500	A	DA16250	0 - 250 - 1250	A	DA55250
For 1 A Current Transformer 5 x F.L.C.			For 5 A Current Transformer 3 x F.L.C.			For 5 A Current Transformer 6 x F.L.C.		
0 - 5 - 25	A	DA155	0 - 5 - 15	A	DA535	0 - 5 - 30	A	DA565
0 - 10 - 50	A	DA1510	0 - 10 - 30	A	DA5310	0 - 10 - 60	A	DA5610
0 - 15 - 75	A	DA1515	0 - 15 - 45	A	DA5315	0 - 15 - 90	A	DA5615
0 - 20 - 100	A	DA1520	0 - 20 - 60	A	DA5320	0 - 20 - 120	A	DA5620
0 - 30 - 150	A	DA1530	0 - 30 - 90	A	DA5330	0 - 30 - 180	A	DA5630
0 - 40 - 200	A	DA1540	0 - 40 - 120	A	DA5340	0 - 40 - 240	A	DA5640
0 - 50 - 250	A	DA1550	0 - 50 - 150	A	DA5350	0 - 50 - 300	A	DA5650
0 - 60 - 300	A	DA1560	0 - 60 - 180	A	DA5360	0 - 60 - 360	A	DA5660
0 - 75 - 375	A	DA1575	0 - 75 - 225	A	DA5375	0 - 75 - 450	A	DA5675
0 - 100 - 500	A	DA15100	0 - 100 - 300	A	DA53100	0 - 100 - 600	A	DA56100
0 - 125 - 625	A	DA15125	0 - 125 - 375	A	DA53125	0 - 125 - 750	A	DA56125
0 - 150 - 750	A	DA15150	0 - 150 - 450	A	DA53150	0 - 150 - 900	A	DA56150
0 - 200 - 1000	A	DA15200	0 - 200 - 600	A	DA53200	0 - 200 - 1200	A	DA56200
0 - 250 - 1250	A	DA15250	0 - 250 - 750	A	DA53250	0 - 250 - 1500	A	DA56250

ATX™ D Series Actuators, Pilot Lights, Contact Blocks, Switches and Accessories

Flameproof

ATEX/IECEX:
 Zone 1 and 2 – 21 and 22
 II 2 GD
 IP66 – IK10

Technical Data

Contact Block

NO Contact Block	NC Contact Block
Insulation Voltage (Ui)	500 V
Switching Capacity	
AC 15	4 A/115 V, 4 A/230 V, 2 A/500 V
DC 13	3 A/24 V, 1.7 A/42 V, 1.2 A/60 V, 0.3 A/220 V
Terminal connections	0.75 mm ² to 2.5 mm ² (0.0012 in ² to 0.004 in ²)
Operation life	>5,000,000 Operations

LED Pilot Light

Rated Voltage	85-264 Vac, 50/60 Hz
Rating	5-15mA
Max. Power	0.33 W
Operation life	Average 100,000 Hours at +25 °C (+77 °F)

16 A Selector Switch

Rated insulation voltage	690 V	
Thermal rating	20 A	
AC 21	16 A	
AC 15	6 A	
AC 23	3 x 230 V	4 KW
	3 x 400 V	7.5 KW
	3 x 500 V	5.5 KW
	3 x 690 V	4 KW
AC 3	3 x 230 V	3 KW
	3 x 400 V	4 KW
	3 x 500 V	5.5 KW
	3 x 690 V	3 KW
Flexible Terminal connections	2.5 mm ² (0.004 in ²)	
Solid Terminal connections	4 mm ² (0.006 in ²)	

16 A Selector Switch Positions — X = Contact Closed

DS116

Positions	Contacts
	1-2
0	
1	X

DS216

Positions	Contacts	
	1-2	3-4
0		
1	X	X

DS316

Positions	Contacts		
	1-2	3-4	5-6
0			
1	X	X	X

DS416

Positions	Contacts			
	1-2	3-4	5-6	7-8
0				
1	X	X	X	X

DS21601

Positions	Contacts	
	1-2	3-4
1	X	
2		X

DS21602

Positions	Contacts	
	1-2	3-4
1	X	
0		
2		X

DS41601

Positions	Contacts			
	1-2	3-4	5-6	7-8
1	X		X	
2		X		X

DS41602

Positions	Contacts			
	1-2	3-4	5-6	7-8
1	X		X	
0				
2		X		X

ATX™ D Series Actuators, Pilot Lights, Contact Blocks, Switches and Accessories

Flameproof

ATEX/IECEX:
 Zone 1 and 2 – 21 and 22
 II 2 GD
 IP66 – IK10

Dimensions in Millimeters (Inches)

Rail Mounted

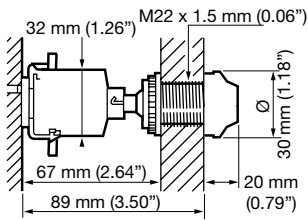
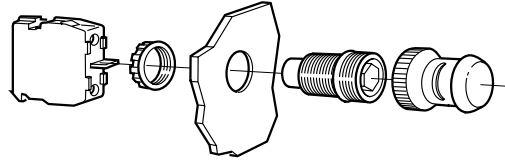

Rail Mounted Push Button

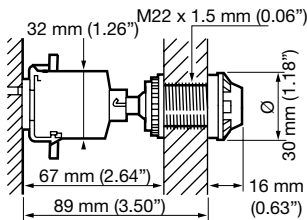

Rail Mounted Pilot Light

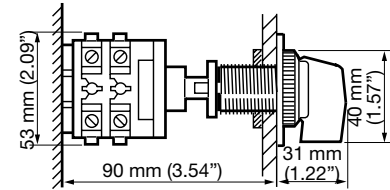

Back Mounted Switch

Panel Mounted

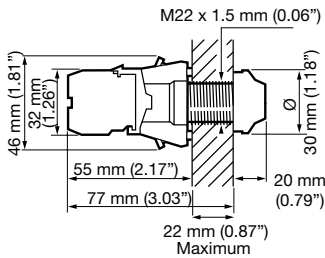
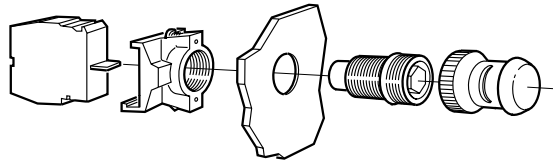

Panel Mounted Push Button

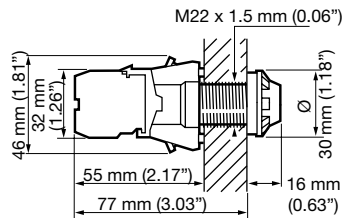

Panel Mounted Pilot Light

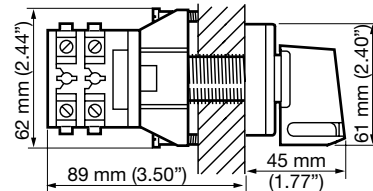

Panel Mounted Switch

Accessories

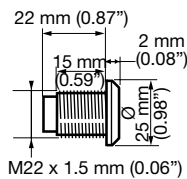

Blanking Plug

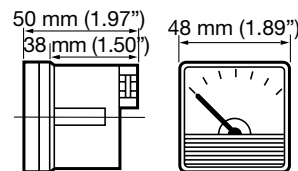

Ammeter

ATX™ RSI Series Intrinsic Safety Relays for Safe Areas For Flameproof Enclosures

ATEX:
Zone 1 and 2 – 21 and 22
II 2 GD
IP66 – IK10

Applications

- Single Channel Relay:
 - For installation in a safe area (NIS area) or Exd box.
- 2-Channel Relay:
 - For installation in a safe area (NIS area).

Features

- Single and 2-Channel Relay:
 - Provides galvanic isolation of the circuits between the IS area and the NIS area.
 - Mounting on EN 50 022 rail.
 - Input signal (from hazardous area) selected by jumpers:
 - 2-wire NAMUR proximity switch.
 - Volt-free contact (switched current 8.2 V, 8 mA).
 - Direct or reverse repeater selected by jumper.
 - Connection: 2-conductor cable, dielectric strength 500 V, cross-section 2.5 mm² (0.004 in²), distance between cables: 8 mm (0.315").
 - Connection: 2.5 mm² (0.004 in²) maximum
- Single Channel Relay:
 - Transmits to the safe (NIS) area one signal received from the hazardous (IS) area.
 - Relay can be supplied with 24 – 28 Vdc, 110 – 140 Vac, 200 – 240 V.
 - Output signal (safe area) - electromagnetic relay, 1 changeover switch:
 - 6 Amp maximum (at 24 V)
 - Maximum: 5 Amp, 250 V, 10 Hz (switching frequency)
- 2-Channel Relay:
 - Transmits to the safe (NIS) area two signals received from the hazardous (IS) area.
 - Relay can be supplied with 24 – 48 Vdc, 110 – 140 V, 200 – 240 V.
 - Output signal (safe area) – electromagnetic relay, 2 changeover switches:
 - 6 A maximum (at 24 V)
 - Maximum: 5 Amp, 250 V, 10 Hz (switching frequency)

ATEX Certifications and Compliances

- Certification Type RDN
 - Gas, Zones 1 and 2
 - Conforming to ATEX 94/9/CE: II 1 G
 - Dust, Zones 21 and 22
 - Conforming to ATEX 94/9/CE: II 1 D
 - Type of Protection: Ex ia IIC
 - Surface Temperature: -10 °C to +60 °C (-14 °F to +140 °C)
 - CE Declaration of Conformity: 50270

Other Certification

- SIL 2

1-Channel Relay



2-Channel Relay



ATX™ RSI Series Intrinsic Safety Relays for Safe Areas For Flameproof Enclosures

ATEX:
Zone 1 and 2 - 21 and 22
II 2 GD
IP66 - IK10

Appleton

CONTROLS: ATEX/IECEx FLAMEPROOF CONTROL STATIONS AND RELAYS

Catalog Numbering Guide

U
|
Series:
ATEX Certified

3
|
Channel Number:
1 - Single channel
2 - Two channel

11
|
Voltage:
04D - 24 - 48 Vdc
14A - 110 - 140 Vac 50/60 Hz
24A - 200 - 240 Vac 50/60 Hz

Relays

Description	Catalog Number
Single Channel Relay	
200 - 240 V - 50/60 Hz	RSI124A
110 - 140 V - 50/60 Hz	RSI114A
24 - 48 V - 50/60 Hz	RSI104D
2-Channel Relay	
200 - 240 V - 50/60 Hz	RSI224A
110 - 140 V - 50/60 Hz	RSI214A
24 - 48 V - 50/60 Hz	RSI204D

Dimensions in Millimeters (Inches)

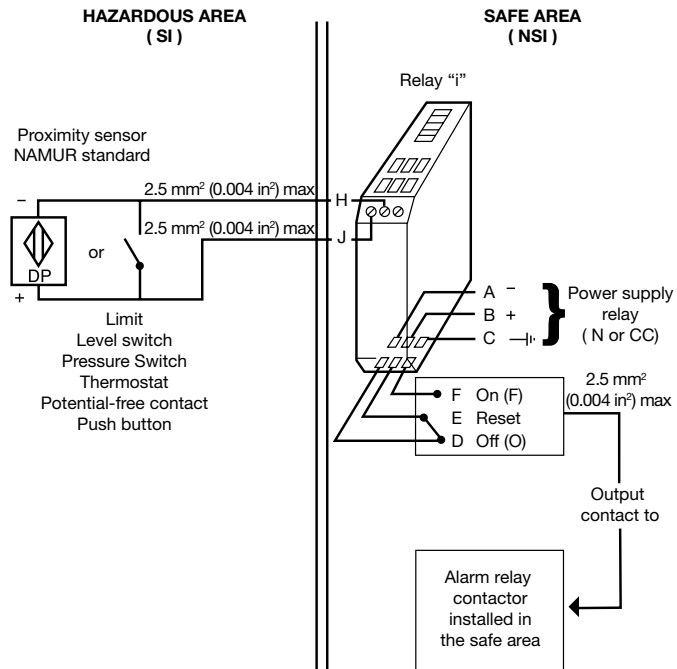
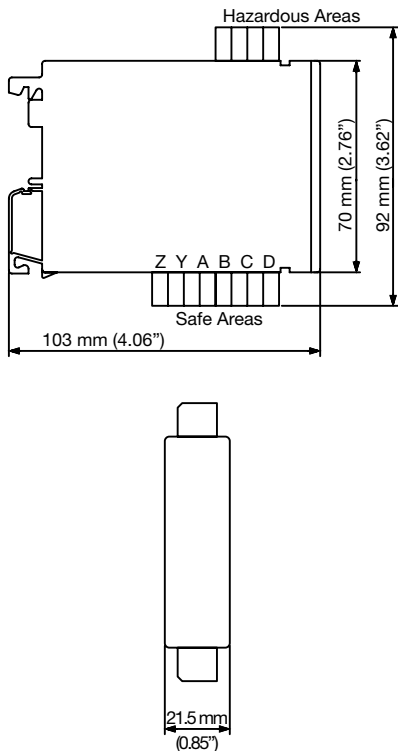

ATX™ FU40 Series Fuse Carrier

Components for Increased Safety Enclosures

ATEX/IECEX:
Zone 1 and 2
⊕ II 2 G

Applications

- Useful as back-up fuse protection or as main fuse protection for hazardous locations.
- Can be fitted inside increased safety Ex e enclosures.

Features

- For 14 mm x 51 mm (0.55" x 2.01") cylindrical cartridge fuse 16A gG Max. and 40 A aM Max.
- Adaptor which clips onto EN 50 022 and EN 50 035 rail.
- Connection via 2 mm² x 10 mm² (0.0031 in² x 0.0155 in²) terminals.

Standard Material

- Polyamide

ATEX/IECEX Certifications and Compliances

- Certification Type FU40
 - Gas, Zones 1 and 2
 - Conforming to ATEX 94/9/CE: ⊕ II 2 G
 - Type of Protection: Ex db eb IIC or Ex d e IIC Gb
- Service Temperature: -40 °C to +80 °C (-40 °F to +176 °F)
- CE Declaration of Conformity: 5C258
- ATEX Certificate: LCIE 15 ATEX 3014U
- IECEX Certificate: IECEX LCIE 15.0007U

Other Certification ①

- Certification Type FU40
 - INMETRO Certificate: BVC 11.0593-U



Weight kg (lb)	Volume dm ³ (in ³)	Fuse Size mm (in)	Catalog Number
0.1 (0.22)	0.4 (24.4)	14 x 51 (0.55 x 2.01)	FU40

Dimensions in Millimeters (Inches)

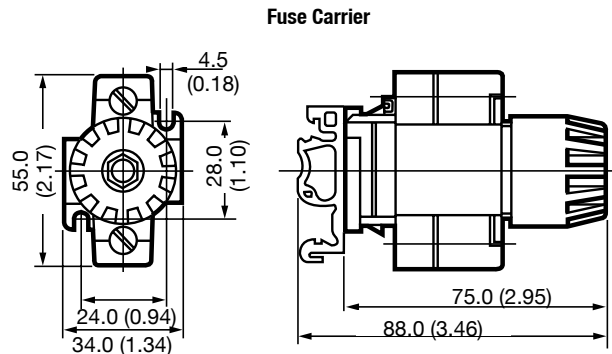

① INMETRO certification available on special request only. Contact your local sales representative for more information.

ATX™ V Series AC Ammeters

Components for Increased Safety Enclosures

ATEX:
Zone 1 and 2
II 2 G

Applications

- Suitable for use with certified Ex e enclosures for control equipment in industrial processes.

Features

- DIN rail mounted (TS35) and panel mounted versions.

Technical Data

- Rated Voltage: 500 V
- Frequency: 25 to 100 Hz
- Consumption: 0.7 VA
- Permanent overload: 1.2 In
- Instantaneous overload: 10 In/5s
- Terminal connections: M5 Terminals for lugs

ATEX Certifications and Compliances

- Certification Type C48D
 - Gas: Zone 1 and 2
 - Conforming to ATEX 94/9/CE: II 2 G
 - Type of Protection: Ex em II
- Dust: Zone 21 and 22
 - Conforming to ATEX 94/9/CE: II 2 G
 - Type of Protection: Authorized to be used with an approved dustproof enclosure
- Service Temperature: -25 °C to +55 °C (-13 °F to +131 °F)
- Declaration of Conformity: 5C215
- ATEX Certificate: LCIE 02 ATEX 0006U

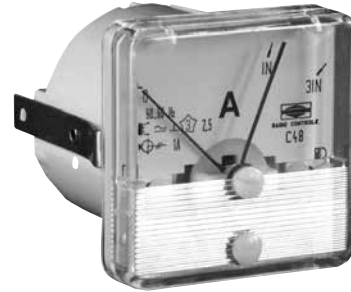

AC Ammeter

AC Ammeter — 48 mm x 48 mm (1.89" x 1.89")

Connection on current transformer — Deflection 90° — Red adjustable index — Accuracy class 1.5 — Round barrel

Description	Weight kg (lb)	Volume dm ³ (in ³)	Catalog Number
Rail Mounted			
1A C.T. 3 x F.L.C. with 0-1-3 Scale	0.1 (0.22)	0.4 (24.4)	VA1348R
1A C.T. 5 x F.L.C. with 0-1-5 Scale	0.1 (0.22)	0.4 (24.4)	VA1548R
1A C.T. 6 x F.L.C. with 0-1-6 Scale	0.1 (0.22)	0.4 (24.4)	VA1648R
5A C.T. 3 x F.L.C. with 0-1-3 Scale	0.1 (0.22)	0.4 (24.4)	VA5348R
5A C.T. 5 x F.L.C. with 0-1-5 Scale	0.1 (0.22)	0.4 (24.4)	VA5548R
5A C.T. 6 x F.L.C. with 0-1-6 Scale	0.1 (0.22)	0.4 (24.4)	VA5648R
Panel Mounted			
1A C.T. 3 x F.L.C. with 0-1-3 Scale	0.1 (0.22)	0.4 (24.4)	VA1348P
1A C.T. 5 x F.L.C. with 0-1-5 Scale	0.1 (0.22)	0.4 (24.4)	VA1548P
1A C.T. 6 x F.L.C. with 0-1-6 Scale	0.1 (0.22)	0.4 (24.4)	VA1648P
5A C.T. 3 x F.L.C. with 0-1-3 Scale	0.1 (0.22)	0.4 (24.4)	VA5348P
5A C.T. 5 x F.L.C. with 0-1-5 Scale	0.1 (0.22)	0.4 (24.4)	VA5548P
5A C.T. 6 x F.L.C. with 0-1-6 Scale	0.1 (0.22)	0.4 (24.4)	VA5648P
Window for Ammeter 48 mm x 48 mm (1.89" x 1.89")			
	0.1 (0.22)	0.4 (24.4)	VAW48

ATX™ V Series AC Ammeters

Components for Increased Safety Enclosures

ATEX:
Zone 1 and 2
II 2 G

Interchangeable Dials for V Series AC Ammeter

Scale		Catalog Number	
1 A Current Transformer 3 x F.L.C.			
0	- 5	15	A DA135
0	- 10	30	A DA1310
0	- 15	45	A DA1315
0	- 20	60	A DA1320
0	- 30	90	A DA1330
0	- 40	120	A DA1340
0	- 50	150	A DA1350
0	- 60	180	A DA1360
0	- 75	225	A DA1375
0	- 100	300	A DA13100
0	- 125	375	A DA13125
0	- 150	450	A DA13150
0	- 200	600	A DA13200
0	- 250	750	A DA13250
1 A Current Transformer 5 x F.L.C.			
0	- 5	25	A DA155
0	- 10	50	A DA1510
0	- 15	75	A DA1515
0	- 20	100	A DA1520
0	- 30	150	A DA1530
0	- 40	200	A DA1540
0	- 50	250	A DA1550
0	- 60	300	A DA1560
0	- 75	375	A DA1575
0	- 100	500	A DA15100
0	- 125	625	A DA15125
0	- 150	750	A DA15150
0	- 200	1000	A DA15200
0	- 250	1250	A DA15250
1 A Current Transformer 6 x F.L.C.			
0	- 5	30	A DA165
0	- 10	60	A DA1610
0	- 15	90	A DA1615
0	- 20	120	A DA1620
0	- 30	180	A DA1630
0	- 40	240	A DA1640
0	- 50	300	A DA1650
0	- 60	360	A DA1660
0	- 75	450	A DA1675
0	- 100	600	A DA16100
0	- 125	750	A DA16125
0	- 150	900	A DA16150
0	- 200	1200	A DA16200
0	- 250	1500	A DA16250

Scale		Catalog Number	
5 A Current Transformer 3 x F.L.C.			
0	- 5	15	A DA535
0	- 10	30	A DA5310
0	- 15	45	A DA5315
0	- 20	60	A DA5320
0	- 30	90	A DA5330
0	- 40	120	A DA5340
0	- 50	150	A DA5350
0	- 60	180	A DA5360
0	- 75	225	A DA5375
0	- 100	300	A DA53100
0	- 125	375	A DA53125
0	- 150	450	A DA53150
0	- 200	600	A DA53200
0	- 250	750	A DA53250
5 A Current Transformer 5 x F.L.C.			
0	- 5	25	A DA555
0	- 10	50	A DA5510
0	- 15	75	A DA5515
0	- 20	100	A DA5520
0	- 30	150	A DA5530
0	- 40	200	A DA5540
0	- 50	250	A DA5550
0	- 60	300	A DA5560
0	- 75	375	A DA5575
0	- 100	500	A DA55100
0	- 125	625	A DA55125
0	- 150	750	A DA55150
0	- 200	1000	A DA55200
0	- 250	1250	A DA55250
5 A Current Transformer 6 x F.L.C.			
0	- 5	30	A DA565
0	- 10	60	A DA5610
0	- 15	90	A DA5615
0	- 20	120	A DA5620
0	- 30	180	A DA5630
0	- 40	240	A DA5640
0	- 50	300	A DA5650
0	- 60	360	A DA5660
0	- 75	450	A DA5675
0	- 100	600	A DA56100
0	- 125	750	A DA56125
0	- 150	900	A DA56150
0	- 200	1200	A DA56200
0	- 250	1500	A DA56250

Dimensions in Millimeters (Inches) and Drilling Information

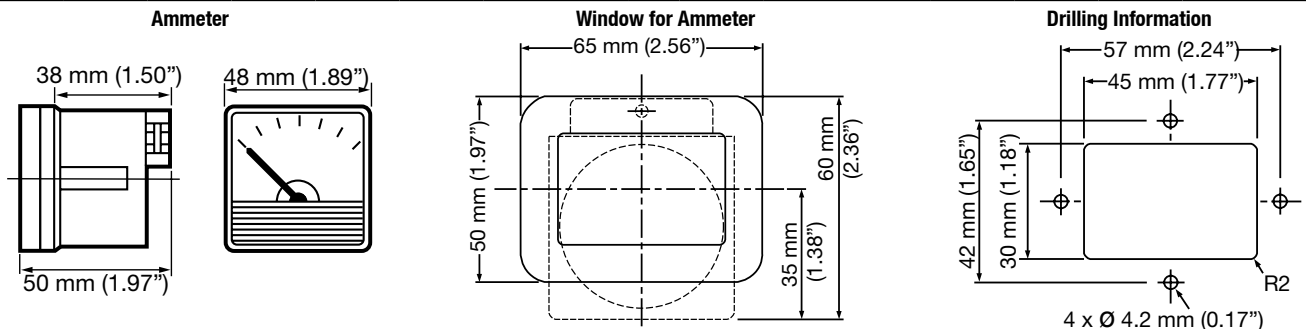

ATX™ TRE Series Ex e Transformers

Increased Safety

ATEX/IECEX:
Zone 1 and 2
Ⓜ II 2 G

Applications

- Equipment transformers are useful where the available voltage must be changed to accommodate the voltage required by the load and safety voltage.
- Suitable for use in certified increased safety enclosures and OEM increased safety applications.
- Requires primary and secondary protection by fuses or Branch Circuit Breaker.

Features

- Single phase 50/60 Hz.
- Class I.
- Circuit insulation voltage between:
 - 4500 V between windings.
 - 2300 V between primary winding and earth.
 - 1800 V between secondary winding and earth.
- Ex e Terminals capacity 4 mm² (0.006 in²).

Standard Materials

- Copper windings
- Insulation Class F

ATEX/IECEX Certifications and Compliances

- Certification Type TRE
 - Gas, Zones 1 and 2
 - Conforming to ATEX 94/9/CE: Ⓜ II 2 G
 - Type of Protection: Ex eb IIC
 - Service Temperature: -20 °C to +90 °C (-20 °C to +90 °C)
 - CE Declaration of Conformity: 5C259
 - ATEX Certificate: LCIE 15 ATEX 3042U
 - IECEX Certificate : IECEX LCIE 15.0034U

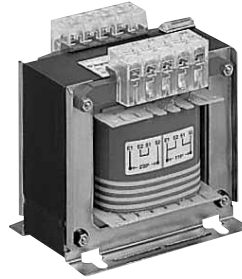

400 VA

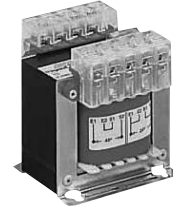

100 VA

ATX™ TRE Series Ex e Transformers

Increased Safety

ATEX/IECEX:
Zone 1 and 2
II 2 G

Catalog Numbering Guide

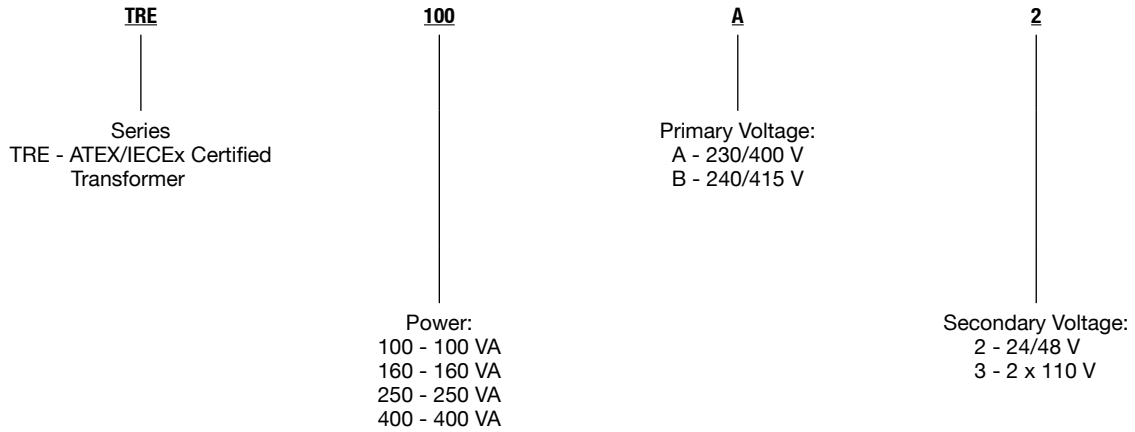

Primary	Secondary	Power	Weight kg (lb)	Volume dm ³ (in ³)	Certified Type	Catalog Number
230/400 V	24/48 V	100 VA	2.7 (5.95)	4 (244)	TSN	TRE100A2
		160 VA	4.9 (10.80)	4 (244)	TSN	TRE160A2
		250 VA	5.4 (11.90)	7 (427)	TSN	TRE250A2
		400 VA	6.9 (153.21)	7 (427)	TSN	TRE400A2
	2x110 V	100 VA	2.7 (5.95)	4 (244)	TSCN	TRE100A3
		160 VA	4.9 (10.80)	4 (244)	TSCN	TRE160A3
		250 VA	5.4 (11.90)	7 (427)	TSCN	TRE250A3
		400 VA	6.9 (153.21)	7 (427)	TSCN	TRE400A3
240/415 V	24/48 V	100 VA	2.7 (5.95)	4 (244)	TSN	TRE100B2
		160 VA	4.9 (10.80)	4 (244)	TSN	TRE160B2
		250 VA	5.4 (11.90)	7 (427)	TSN	TRE250B2
		400 VA	6.9 (153.21)	7 (427)	TSN	TRE400B2



CONTROLS: ATEX/IECEX INCREASED SAFETY CONTROL STATIONS

ATX™ TRE Series Ex e Transformers

Increased Safety

ATEX/IECEX:
Zone 1 and 2
II 2 G

Dimensions in Millimeters (Inches)

	Power	A	B	C	F	Fixing G	Ø	Weight kg (lb)
	100 VA	94 (3.70)	91 (3.58)	91 (3.58)	64 (2.52)	66 (2.60)	4.8 (0.19)	1.8 (3.97)
	160 VA	96 (3.78)	102 (4.02)	96 (3.78)	84 (3.31)	78 (3.07)	5.8 (0.23)	3.2 (7.05)
	150 VA	108 (4.25)	110 (4.33)	100 (3.94)	84 (3.31)	82 (3.23)	5.8 (0.23)	4.4 (9.70)
	400 VA	126 (4.96)	126 (4.96)	115 (4.53)	90 (3.54)	99 (3.90)	6.5 (0.26)	6.0 (13.23)

Overcurrent Protection

Power	Power Loss	Primary Overcurrent Protection						Secondary Overcurrent Protection					
		Fuses		MCB Curve C	MCB Curve D	MCB Curve C	MCB Curve D	Fuses			MCB Curve C		
		230/240 V	400/415 V	230/240 V	400/415 V	24 V	48 V	110 V	24 V	48 V	110 V		
100 VA	6 W	1A aM	1A aM	3 A	1 A	2 A	1 A	4 A gG	2 A gG	1 A gG	4 A	2 A	1 A
160 VA	10 W	2A aM	1A aM	6 A	2 A	2 A	1 A	8 A gG	4 A gG	1 A gG	6 A	4 A	2 A
250 VA	15 W	2A aM	2A aM	6 A	3 A	3 A	2 A	10 A gG	6 A gG	2 A gG	10 A	6 A	2 A
400 VA	25 W	4A aM	2A aM	10 A	6 A	6 A	2 A	16 A gG	8 A gG	4 A gG	16 A	4 A	4 A

Appleton

CONTROLS: ATEX/IECEX INCREASED SAFETY CONTROL STATIONS

ACSE Series Manual Motor Starters

Explosionproof, Dust-Ignitionproof, Waterproof

NEC/CEC:
 Class I, Division 1 and 2, Groups C and D
 Class II, Division 1 and 2, Groups E, F, G
 Class III
 NEMA 3, 3R, 7CD

Application

- Explosionproof across the line manual motor starters for starting single and polyphase Vac or Vdc motors.

Features

- Rugged, compact enclosures supplied with Square D, Allen Bradley or GE manual motor starters using three overloads.
- Mating surfaces are precision milled to exceed explosionproof specifications. Covers secure with stainless steel (300 Series) hex head bolts.
- Bolt on mounting feet.
- Push buttons are positive operating and can be locked in the stop position.

Standard Materials

- Enclosure: cast aluminum
- Shaft, bushing and cover bolts: stainless steel (300 Series)
- Mounting feet: aluminum

Standard Finishes

- Housing: natural

NEC/CEC Certifications and Compliances

- UL Standard: UL 1203
- UL Classified: E84577
- CSA Standards: C22.2 No. 14, C22.2 No. 25, C22.2 No. 30
- CSA Certified: 042130

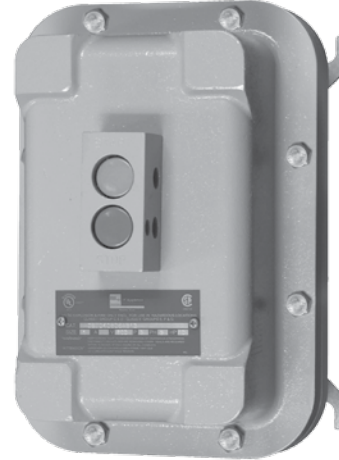

CONTROLS: NEC/CEC EXPLOSIONPROOF MOTOR STARTERS

NEMA Size	No. of Poles	Motor Voltage	Maximum Horsepower		Catalog Number ① ②
			Single Phase	Poly Phase	
0	2	115	1	—	ACSE040805SQD02
		230	2	—	
1	2	115	2	—	ACSE040805SQD12
		230	3	—	
0	3	115	—	—	ACSE040805SQD03
		200 - 230	—	3	
1	3	380 - 575	—	5	ACSE040805SQD13
		115	—	—	
0	2	200 - 230	—	7-1/2	ACSE040805SQ02D
		380 - 575	—	10	
1	2	115	—	1 - DC	ACSE040805SQ12D
		230	—	1-1/2 - DC	
0	3	115	—	1-1/2 - DC	ACSE040805SQ12D
		230	—	2 - DC	

① Square D starter provided as standard. For Allen Bradley starter, change **SQD** to **AB**. For GE starter, change **SQD** to **GE**.

② Add suffix for heater. Contact your local representative for details.

► Square D is a registered trademark of Schneider Electric. Allen-Bradley is a registered trademark of Rockwell Automation. GE is a registered trademark of General Electric Company.

ACSE Series Manual Motor Starters

Explosionproof, Dust-Ignitionproof, Waterproof

NEC/CEC:
 Class I, Division 1 and 2, Groups C and D
 Class II, Division 1 and 2, Groups E, F, G
 Class III
 NEMA 3, 3R, 7CD

Select heater elements based on motor nameplate listed Full Load Amps (FLA). Trip rating of elements is 125% of motor minimum FLA listed for the elements. Three heaters required per starter.

Heater Table

Square D [■]		Cutler-Hammer ⁺	
Motor Full Load Amps at +40 °C (+104 °F)	Add Suffix	Motor Full Load Amps at +40 °C (+104 °F)	Add Suffix
0.28 - 0.29	-B44	0.25 - 0.26	-FH03
0.30 - 0.33	-B51	0.27 - 0.29	-FH04
0.34 - 0.36	-B57	0.30 - 0.32	-FH05
0.37 - 0.44	-B63	0.33 - 0.35	-FH06
0.45 - 0.52	-B71	0.36 - 0.39	-FH07
0.53 - 0.59	-B81	0.40 - 0.44	-FH08
0.60 - 0.64	-B92	0.45 - 0.49	-FH09
0.65 - 0.71	-B103	0.50 - 0.55	-FH10
0.72 - 0.80	-B116	0.56 - 0.61	-FH11
0.81 - 0.90	-B130	0.62 - 0.68	-FH12
0.91 - 1.03	-B145	0.69 - 0.75	-FH13
1.04 - 1.14	-B167	0.76 - 0.83	-FH14
1.15 - 1.27	-B188	0.84 - 0.91	-FH15
1.28 - 1.44	-B210	0.92 - 1.00	-FH16
1.45 - 1.63	-B240	1.01 - 1.10	-FH17
1.64 - 1.79	-B265	1.11 - 1.22	-FH18
1.80 - 2.01	-B300	1.23 - 1.35	-FH19
2.02 - 2.19	-B330	1.36 - 1.50	-FH20
2.20 - 2.52	-B370	1.51 - 1.66	-FH21
2.53 - 2.95	-B415	1.67 - 1.84	-FH22
2.96 - 3.17	-B485	1.85 - 2.03	-FH23
3.18 - 3.50	-B550	2.04 - 2.23	-FH24
3.51 - 3.73	-B625	2.24 - 2.45	-FH25
3.74 - 4.22	-B690	2.46 - 2.69	-FH26
4.23 - 4.68	-B770	2.70 - 2.95	-FH27
4.69 - 4.98	-B820	2.96 - 3.23	-FH28
4.99 - 5.59	-B910	3.24 - 3.53	-FH29
5.60 - 6.43	-B102	3.54 - 3.85	-FH30
6.44 - 7.41	-B115	3.87 - 4.22	-FH31
7.42 - 8.02	-B128	4.23 - 4.61	-FH32
8.03 - 8.59	-B140	4.62 - 5.03	-FH33
8.60 - 9.52	-B155	5.04 - 5.49	-FH34
9.53 - 10.5	-B175	5.50 - 5.99	-FH35
10.6 - 11.2	-B195	6.00 - 6.53	-FH36
11.3 - 12.7	-B220	6.54 - 7.11	-FH37
12.8 - 14.3	-B250	7.12 - 7.73	-FH38
14.4 - 16.1	-B280	7.74 - 8.40	-FH39
16.2 - 17.8	-B320	8.41 - 9.12	-FH40
17.9 - 20.1	-B360	9.13 - 9.89	-FH41
20.2 - 22.6	-B400	9.90 - 1.70	-FH42
22.7 - 25.5	-B450	10.8 - 11.8	-FH43
25.6 - 26.0	-B500	11.9 - 13.0	-FH44
		13.1 - 14.0	-FH45
		14.1 - 15.0	-FH46
		15.1 - 16.1	-FH47
		16.2 - 17.3	-FH48
		17.4 - 18.6	-FH49
		18.7 - 20.0	-FH50
		20.1 - 21.5	-FH51
		21.6 - 23.2	-FH52
		23.3 - 25.0	-FH53
		25.1 - 26.8	-FH54

■ Square D is a registered trademark of Schneider Electric.
 + Cutler-Hammer is a registered trademark of Eaton Corporation.

Dimensions in Millimeters (Inches)

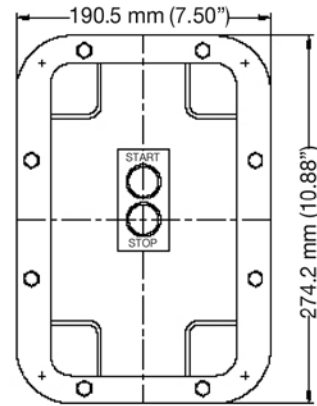

Cover View

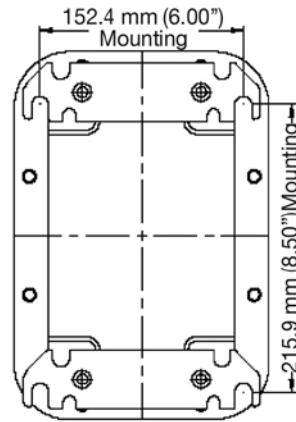

Back View

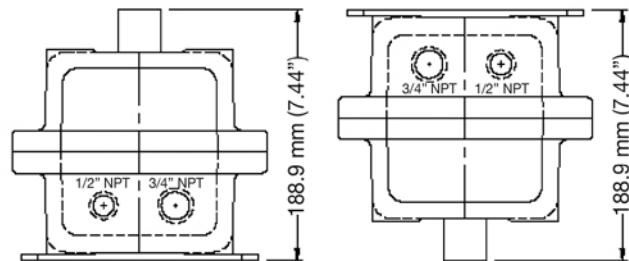

Top and Bottom View

AEB Series Bolted Motor Starters and Contactors

Explosionproof, Dust-Ignitionproof, Watertight

Full Voltage. Combination and Non-Combination.

NEC/CEC:

Class I, Division 1 and 2, Groups B, C, D
Class I, Zone 1 and 2, Groups IIB + H₂
Class II, Division 1 and 2, Groups E, F, G
Class III

NEC/CEC:

NEMA 4, 4X, 7BCD, 9EFG
CSA Type 4, 4X

Application

- Combination and non-combination motor starters are used in areas where hazardous materials are handled or stored.
- These units provide disconnecting means, undervoltage protection, circuit protection, and motor running protection.

Features

- Copperfree cast aluminum.
- Precision machined flame path between box and cover.
- Bolt on slotted mounting feet.
- Stainless steel, captive Quad-Lead® cover bolts (disengage in 1-1/2 turns).
- External stainless steel breaker operating handle.
- Ground lug package and installation instructions for termination of ground wire enclosed.
- Four point control terminal block, NEMA 1B with wire markers.
- Breaker operators can be locked in the ON or OFF position (combination starters only).
- Four plugged 3/4" NPSM outlets drilled and tapped for control devices.
- Standard outlets top and bottom.
- Plugged 1/2" outlets top and bottom for optional breather/drain.
- Components are mounted on a galvanized steel removable pan.
- Enclosures are designed to accept Cutler-Hammer †, or Square D ■ motor starters/circuit breakers. For other manufacturers, contact your local representative.
- O-ring gasket insures watertight integrity.

Standard Materials

- Bodies and covers: copperfree (4/10 of 1%) aluminum
- Block hinges, cover bolts, handle, breaker and operator shafts: stainless steel
- O-ring: neoprene

Standard Finish

- Corrosion resistant gray powder coat epoxy inside and out

Options

- See modifications page.

NEC Certifications and Compliances

- ANSI/UL Standards: UL 508, UL 50, UL 1203
- CSA Standards: C22.2 No. 0-10, C22.2 No. 14-10, C22.2 No. 25-1996, C22.2 No. 30-M1986 and C22.2 No. 94-M91
- cCSAus Certified: 2561837

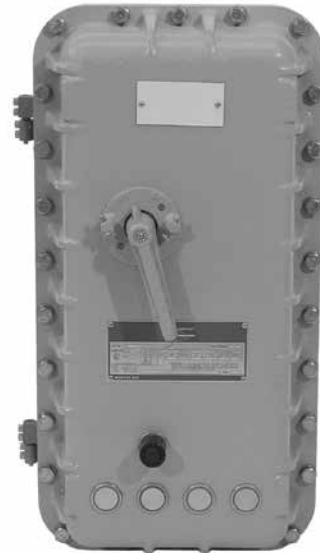

CONTROLS: NEC/CEC EXPLOSIONPROOF MOTOR STARTERS

Appleton®

† Cutler-Hammer is a registered trademark of Eaton Corporation.

■ Square D is a registered trademark of Schneider Electric.

AEB Series Bolted Motor Starters and Contactors

Explosionproof, Dust-Ignitionproof, Watertight

Full Voltage. Combination and Non-Combination.

NEC/CEC:

Class I, Division 1 and 2, Groups B, C, D
 Class I, Zone 1 and 2, Groups IIB + H₂
 Class II, Division 1 and 2, Groups E, F, G
 Class III

NEC/CEC:

NEMA 4, 4X, 7BCD, 9EFG
 CSA Type 4, 4X

Catalog Numbering Guide

Example: The part number below depicts an Appleton, Class I, Division I, Groups B, C and D, NEMA Size 1, Bolted type, Combination Full Voltage Nonreversing Motor Starter operating at 480 Vac, Cutler-Hammer + starter w/120 Vac control voltage, and a Cutler-Hammer 7A MCP. If a breaker is not required, omit last two characters.

CONTROLS: NEC/CEC EXPLOSIONPROOF MOTOR STARTERS

Appleton®

<p>AE</p> <p>NEC/CEC Certified AE Series</p>	<p>1</p> <p>NEMA Size:</p> <p>0 1 2 3 4 5</p>	<p>B B</p> <p>Starter Function: A - FVNR (ATL) B - Combination FVNR M - Lighting Contactor (3- thru 12-pole) ① N - Combination Lighting Contactor (3- thru 12-pole) ①</p> <p>Optional Starter Function ②: C - FVR D - Combination FVR E - 2S1W F - Comb. 2S1W G - 2S2W H - Combination 2S2W J - Contactor (3 pole) K - Combination Contactor (3-pole)</p>	<p>4</p> <p>Operating Voltage:</p> <p>1 - 120 Vac 2 - 240 Vac 3 - 380 Vac 4 - 480 Vac 6 - 600 Vac 9 - 208 Vac</p>	<p>W</p> <p>Starter Manufacturer: ③</p> <p>W - Standard; Eaton/Cutler-Hammer (A200) C - Freedom (AN16) Bi Metal; Eaton/Cutler-Hammer and A - Freedom (AN19) Electronic; Eaton/Cutler-Hammer S - Square D</p>	<p>1</p> <p>Control Voltage (120 V coil standard):</p> <p>1 - 120 Vac 2 - 240 Vac 3 - 380 Vac 4 - 480 Vac 6 - 600 Vac 8 - 480 V Coil/120 V Control 9 - 208 Vac 0 - 277 Vac</p>	<p>C</p> <p>Breaker Manufacturer: ③</p> <p>C - Cutler-Hammer S - Square D</p>	<p>2</p> <p>MCP or Breaker Trip:</p> <p>MCP 1 - 3 Amp 2 - 7 Amp 3 - 15 Amp 4 - 30 Amp 5 - 50 Amp 6 - 70 Amp 7 - 100 Amp 8 - 150 Amp 9 - 250 Amp 0 - 400 Amp</p>	<p>▲</p> <p>Suffix for Other Options/Features: See Modifications</p> <p>Breaker Trip (Thermal Mag): A - 15 Amp B - 20 Amp C - 25 Amp D - 30 Amp E - 35 Amp F - 40 Amp G - 50 Amp H - 60 Amp J - 70 Amp K - 80 Amp M - 90 Amp N - 100 Amp P - 125 Amp Q - 150 Amp R - 175 Amp S - 200 Amp T - 225 Amp U - 250 Amp V - 300 Amp W - 350 Amp X - 400 Amp</p>
---	--	--	---	--	--	---	--	--

① Standard starter is manufactured by Square D; electrically operated, electrically held. Optional starter manufacture is ASCO; electrically operated, mechanically held. Contact your local sales representative for details.
 ② Contact your local sales representative for details.
 ③ Contact your local sales representative for additional UL Classified starters (Allen Bradley 509 and Vacuum, Sprecher and Schuh, Siemens, GE, and Cutler Hammer ITT Softstart and V200 Vacuum).

AEB Series Bolted Motor Starters and Contactors

Explosionproof, Dust-Ignitionproof, Watertight

Full Voltage. Combination and Non-Combination.

NEC/CEC:

Class I, Division 1 and 2, Groups B, C, D
 Class I, Zone 1 and 2, Groups IIB + H₂
 Class II, Division 1 and 2, Groups E, F, G
 Class III

NEC/CEC:

NEMA 4, 4X, 7BCD, 9EFG
 CSA Type 4, 4X

Empty Enclosure

NEMA Size	Catalog Number [▲]	Approximate Weight kg (lb)	Standard Conduit (Inches)	Mounting Hardware Set Catalog Number
Full Voltage Nonreversing Enclosure Only				
0	AE0BA	36 (80)		
1	AE1BA	36 (80)	1-1/2	
2	AE2BA	39 (85)		AMH7
3	AE3BA	64 (140)	2	
4	AE4BA	64 (140)	2-1/2	
5	AE5BA	227 (500)	4	AMH8

Dimensions in Millimeters (Inches) – Starter Only

Enclosure Layout for Size 0, 1 and 2 – Starter Only

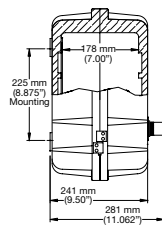

Left Side View

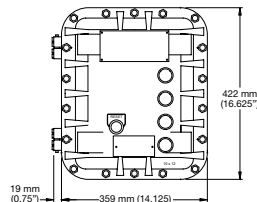

Front View

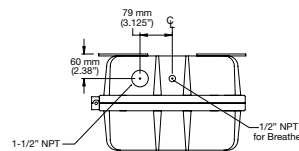

Top View

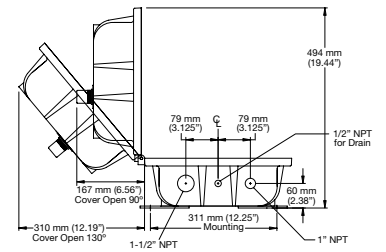

Bottom View

Enclosure Layout for Size 3 – Starter Only

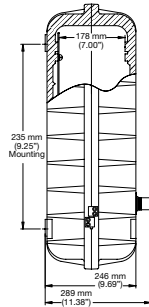

Left Side View

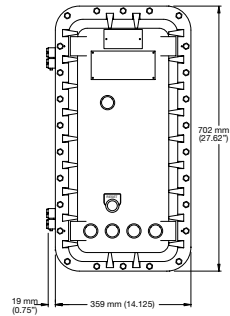

Front View

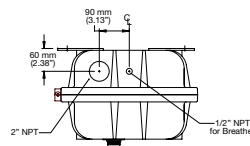

Top View

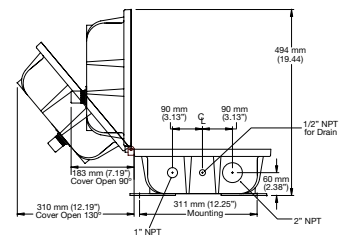

Bottom View

▲ To complete the catalog number please add the appropriate suffix for other options/features. Suffixes, see AEB Series Motor Starters Modifications.

AEB Series Bolted Motor Starters and Contactors

Explosionproof, Dust-Ignitionproof, Watertight

Full Voltage. Combination and Non-Combination.

NEC/CEC:

Class I, Division 1 and 2, Groups B, C, D
 Class I, Zone 1 and 2, Groups IIB + H₂
 Class II, Division 1 and 2, Groups E, F, G
 Class III

NEC/CEC:

NEMA 4, 4X, 7BCD, 9EFG
 CSA Type 4, 4X

CONTROLS: NEC/CEC EXPLOSIONPROOF MOTOR STARTERS

Dimensions in Millimeters (Inches) – Starter Only

Enclosure Layout for Size 4 – Starter Only

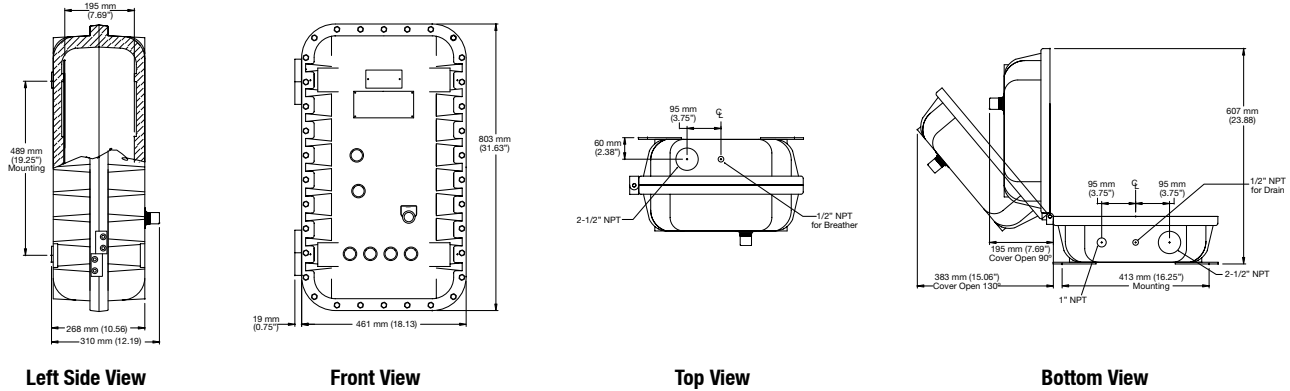

Enclosure Layout for Size 5 – Starter Only

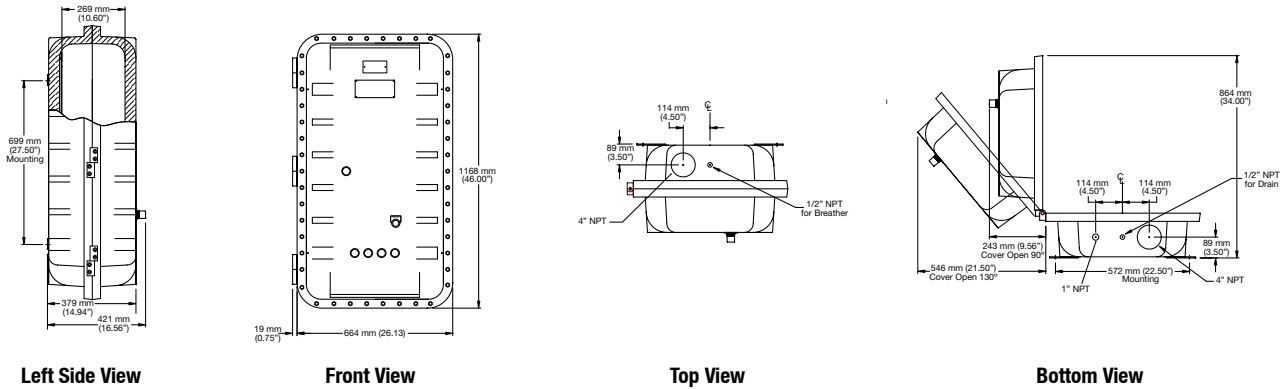

Appleton®

AEB Series Bolted Motor Starters and Contactors

Explosionproof, Dust-Ignitionproof, Watertight

Full Voltage. Combination and Non-Combination.

NEC/CEC:

Class I, Division 1 and 2, Groups B, C, D
 Class I, Zone 1 and 2, Groups IIB + H₂
 Class II, Division 1 and 2, Groups E, F, G
 Class III

NEC/CEC:

NEMA 4, 4X, 7BCD, 9EFG
 CSA Type 4, 4X

Empty Enclosure

NEMA Size	Catalog Number [▲]	Approximate Weight kg (lb)	Standard Conduit (Inches)	Mounting Hardware Set Catalog Number
Combination Full Voltage Nonreversing Enclosure Only				
0	AE0BB	36 (80)	1-1/2	AMH7
1	AE1BB	36 (80)		
2	AE2BB	39 (85)		
3	AE3BB	64 (140)	2-1/2	AMH8
4	AE4BB	64 (140)		
5	AE5BB	227 (500)		

Dimensions in Millimeters (Inches) – Combination

Enclosure Layout for Size 0, 1 and 2 – Combination

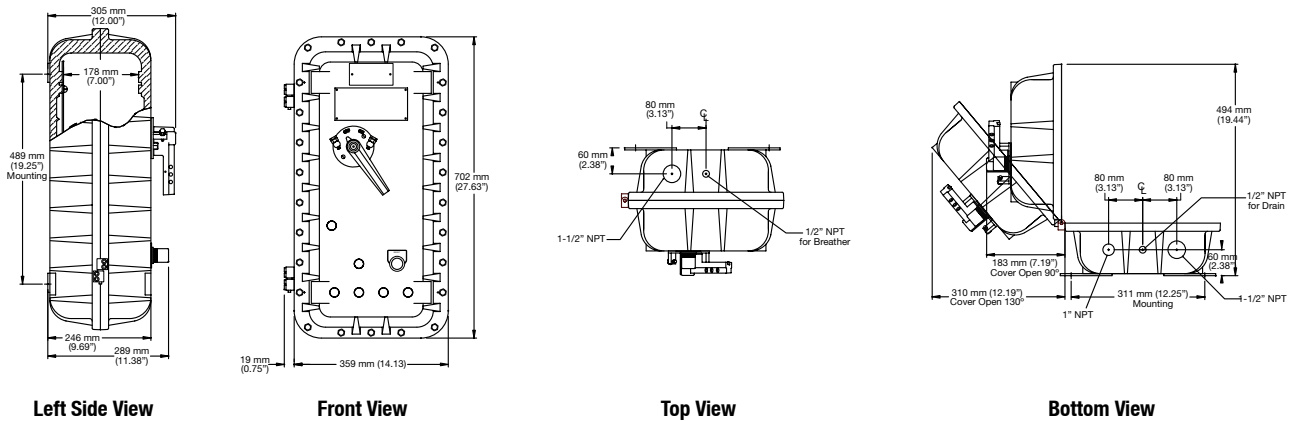

Enclosure Layout for Size 3 and 4 – Combination

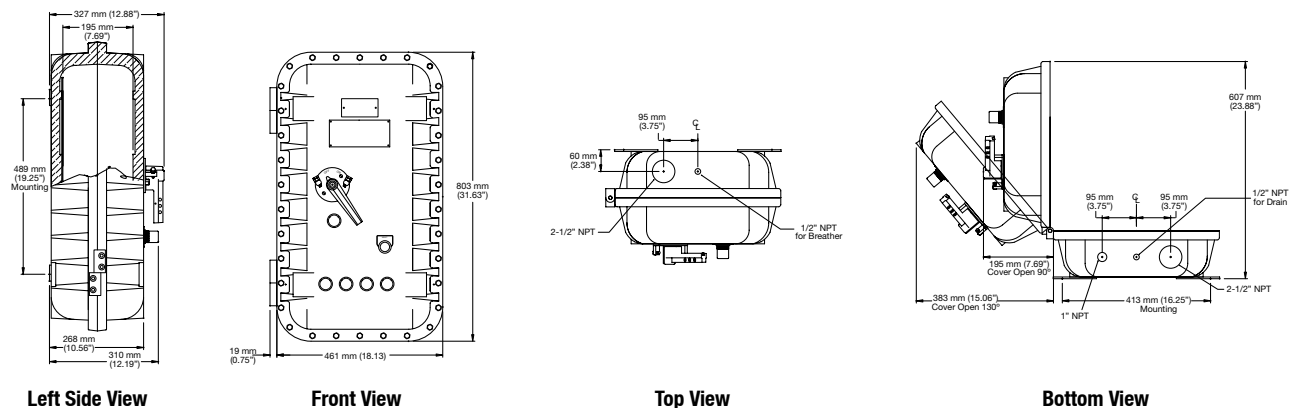

[▲] To complete the catalog number please add the appropriate suffix for other options/features. Suffixes, see AEB Series Motor Starters Modifications.

AEB Series Bolted Motor Starters and Contactors

Explosionproof, Dust-Ignitionproof, Watertight

Full Voltage. Combination and Non-Combination.

NEC/CEC:

Class I, Division 1 and 2, Groups B, C, D
 Class I, Zone 1 and 2, Groups IIB + H₂
 Class II, Division 1 and 2, Groups E, F, G
 Class III

NEC/CEC:

NEMA 4, 4X, 7BCD, 9EFG
 CSA Type 4, 4X

Dimensions in Millimeters (Inches) – Combination

Enclosure Layout for Size 5 – Combination

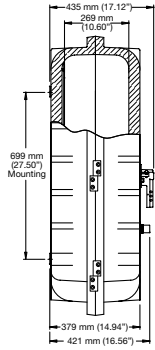

Left Side View

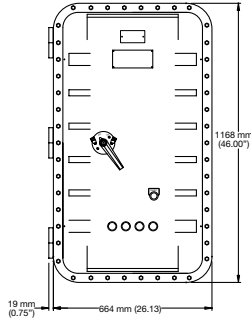

Front View

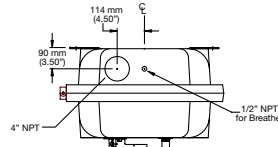

Top View

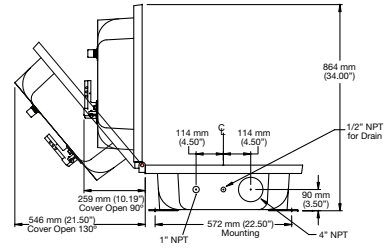

Bottom View

CONTROLS: NEC/CEC EXPLOSIONPROOF MOTOR STARTERS

Appleton®

AEB Series Bolted Motor Starters and Contactors

Explosionproof, Dust-Ignitionproof, Watertight

Full Voltage. Combination and Non-Combination.

NEC/CEC:

Class I, Division 1 and 2, Groups B, C, D
 Class I, Zone 1 and 2, Groups IIB + H₂
 Class II, Division 1 and 2, Groups E, F, G
 Class III

NEC/CEC:

NEMA 4, 4X, 7BCD, 9EFG
 CSA Type 4, 4X

Full Voltage Motor Starter — Nonreversing — 3-Phase, 60 Hertz, 120 V Coil

Line Voltage	NEMA Size	Maximum Horsepower	Amp Trip	Catalog Number [▲]	Approximate Weight kg (lb)	Conduit Size (Inches)	Mounting Hardware Set Catalog Number
480	0	5	NA	AE0BA4W1	36 (80)	1-1/2	AMH7
	1	10	NA	AE1BA4W1	36 (80)		
	2	25	NA	AE2BA4W1	39 (85)	2	
	3	50	NA	AE3BA4W1	64 (140)		
	4	100	NA	AE4BA4W1	64 (140)	2-1/2	
600	5	200	NA	AE5BA4W1	227 (500)	4	AMH8
	0	5	NA	AE0BA6W1	57 (125)	1-1/2	AMH7
	1	10	NA	AE1BA6W1	57 (125)		
	2	25	NA	AE2BA6W1	59 (130)	2	
	3	50	NA	AE3BA6W1	88 (195)		
4	100	NA	AE4BA6W1	88 (195)	2-1/2		
	5	200	NA	AE5BA6W1	227 (500)	4	AMH8

Wiring Diagrams

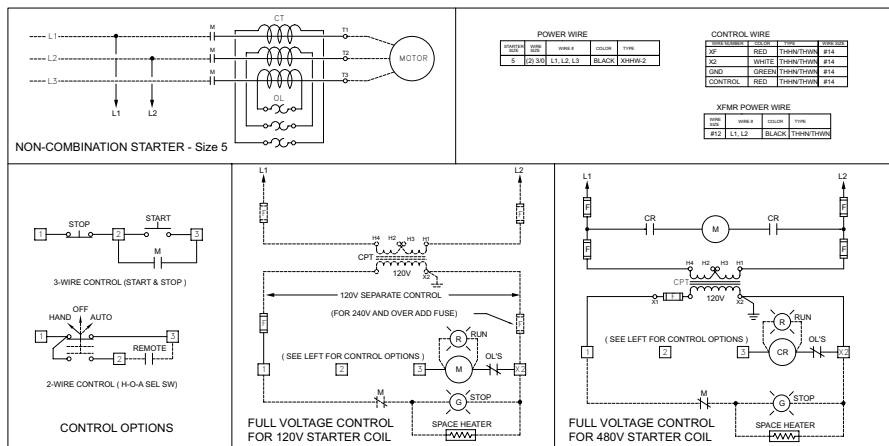
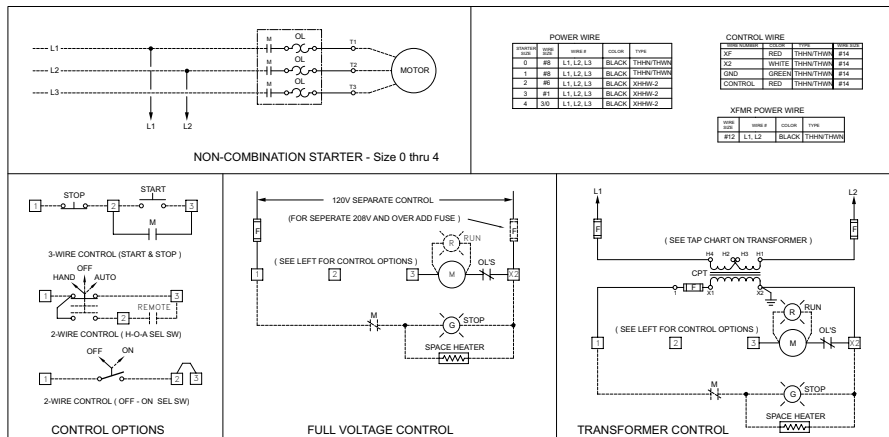

▲ To complete the catalog number please add the appropriate suffix for other options/features. Suffixes, see AEB Series Motor Starters Modifications.

AEB Series Bolted Motor Starters and Contactors

Explosionproof, Dust-Ignitionproof, Watertight

Full Voltage. Combination and Non-Combination.

NEC/CEC:

Class I, Division 1 and 2, Groups B, C, D
 Class I, Zone 1 and 2, Groups IIB + H₂
 Class II, Division 1 and 2, Groups E, F, G
 Class III

NEC/CEC:

NEMA 4, 4X, 7BCD, 9EFG
 CSA Type 4, 4X

Dimensions in Millimeters (Inches) – Starter Only

Enclosure Layout for Size 0, 1 and 2 – Starter Only

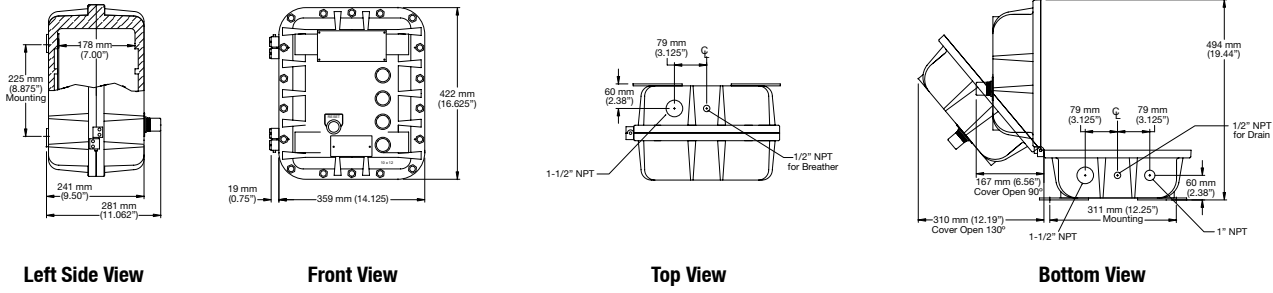

Enclosure Layout for Size 3 – Starter Only

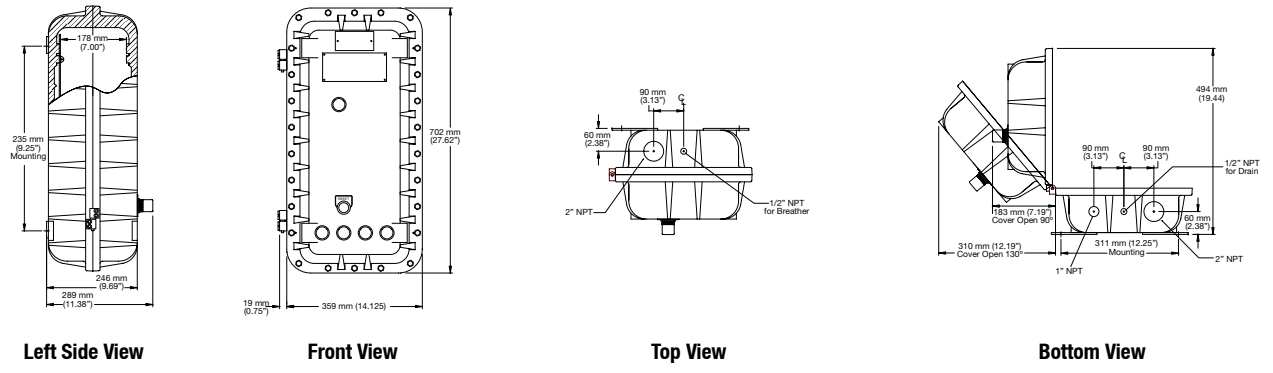

CONTROLS: NEC/CEC EXPLOSIONPROOF MOTOR STARTERS

Appleton

AEB Series Bolted Motor Starters and Contactors

Explosionproof, Dust-Ignitionproof, Watertight

Full Voltage. Combination and Non-Combination.

NEC/CEC:

Class I, Division 1 and 2, Groups B, C, D
 Class I, Zone 1 and 2, Groups IIB + H₂
 Class II, Division 1 and 2, Groups E, F, G
 Class III

NEC/CEC:

NEMA 4, 4X, 7BCD, 9EFG
 CSA Type 4, 4X

Dimensions in Millimeters (Inches) – Starter Only

Enclosure Layout for Size 4 – Starter Only

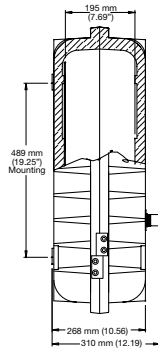

Left Side View

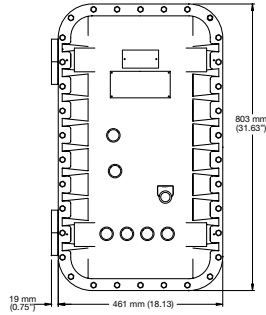

Front View

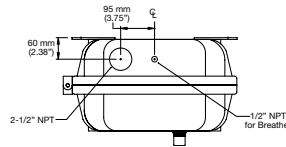

Top View

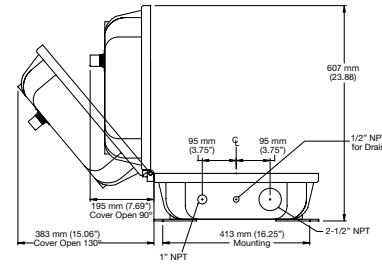

Bottom View

Enclosure Layout for Size 5 – Starter Only

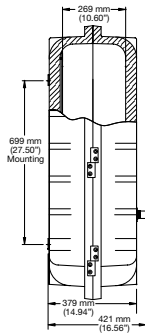

Left Side View

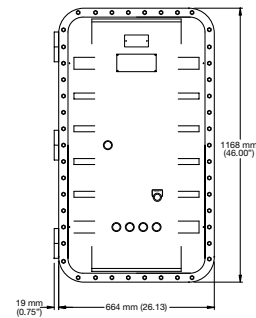

Front View

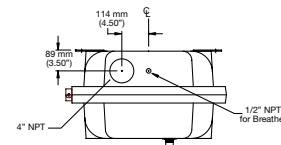

Top View

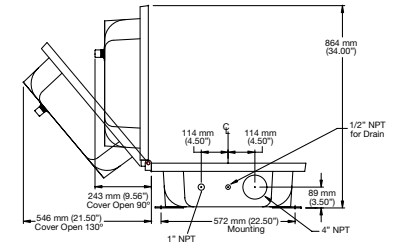

Bottom View

CONTROLS: NEC/CEC EXPLOSIONPROOF MOTOR STARTERS



AEB Series Bolted Motor Starters and Contactors

Explosionproof, Dust-Ignitionproof, Watertight

Full Voltage. Combination and Non-Combination.

NEC/CEC:
 Class I, Division 1 and 2, Groups B, C, D
 Class I, Zone 1 and 2, Groups IIB + H₂
 Class II, Division 1 and 2, Groups E, F, G
 Class III

NEC/CEC:
 NEMA 4, 4X, 7BCD, 9EFG
 CSA Type 4, 4X

Combination Full Voltage Motor Starters With Motor Circuit Protector (MCP) – Nonreversing – 3-Phase, 60 Hertz, 120 V Coil

Line Voltage	NEMA Size	Maximum Horsepower	Amp Trip	Catalog Number [▲]	Approximate Weight kg (lb)	Conduit Size (Inches)	Mounting Hardware Set Catalog Number	
480	0	1	3	AE0BB4W1C1	57 (125)	1-1/2	AMH7	
		3	7	AE0BB4W1C2	57 (125)			
		5	15	AE0BB4W1C3	57 (125)			
	1	7	15	AE1BB4W1C3	57 (125)			
		10	30	AE1BB4W1C4	59 (130)			
	2	12	30	AE2BB4W1C4	59 (130)			
		25	50	AE2BB4W1C5	59 (130)			
	3	30	50	AE3BB4W1C5	88 (195)			2-1/2
		50	100	AE3BB4W1C7	88 (195)			
	4	100	150	AE4BB4W1C8	88 (195)			4
5	200	400	AE5BB4W1C0	227 (500)				
600	0	1	3	AE0BB6W1C1	57 (125)	1-1/2	AMH7	
		3	7	AE0BB6W1C2	57 (125)			
		5	15	AE0BB6W1C3	57 (125)			
	1	7	15	AE1BB6W1C3	57 (125)			
		10	30	AE1BB6W1C4	57 (125)			
	2	20	30	AE2BB6W1C4	59 (130)			2-1/2
		25	50	AE2BB6W1C5	59 (130)			
	3	40	50	AE3BB6W1C5	88 (195)			2-1/2
		50	100	AE3BB6W1C7	88 (195)			
	4	60	100	AE4BB6W1C7	88 (195)			4
100		150	AE4BB6W1C8	88 (195)				
5	200	400	AE5BB6W1C0	227 (500)	4	AMH8		

▲ To complete the catalog number please add the appropriate suffix for other options/features. Suffixes, see AEB Series Motor Starters Modifications.

AEB Series Bolted Motor Starters and Contactors

Explosionproof, Dust-Ignitionproof, Watertight

Full Voltage. Combination and Non-Combination.

NEC/CEC:

Class I, Division 1 and 2, Groups B, C, D
 Class I, Zone 1 and 2, Groups IIB + H₂
 Class II, Division 1 and 2, Groups E, F, G
 Class III

NEC/CEC:

NEMA 4, 4X, 7BCD, 9EFG
 CSA Type 4, 4X

Combination Full Voltage Motor Starters With Motor Circuit Protector (MCP) – Nonreversing – 3-Phase, 60 Hertz, 120 V Coil

Wiring Diagram

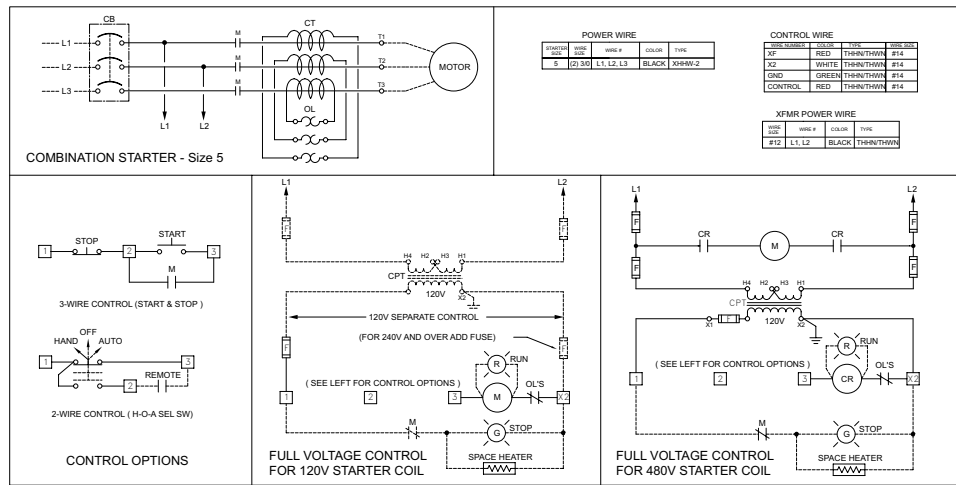
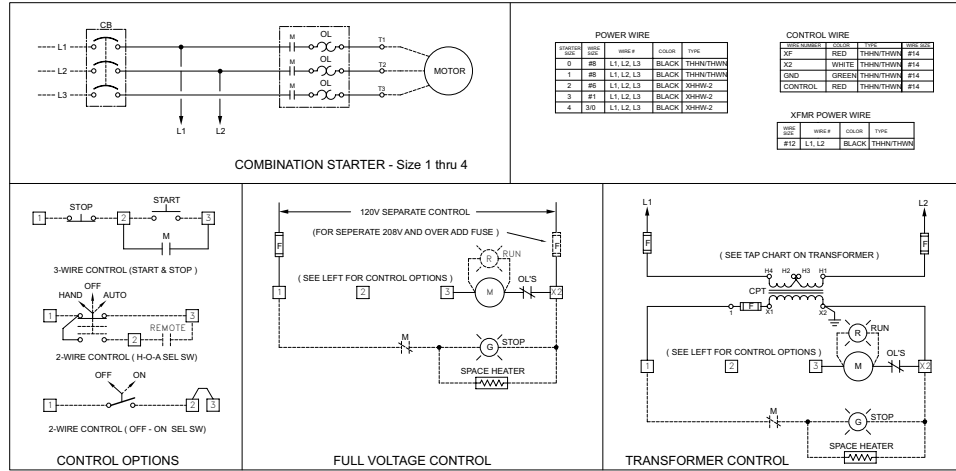

CONTROLS: NEC/CEC EXPLOSIONPROOF MOTOR STARTERS



AEB Series Bolted Motor Starters and Contactors

Explosionproof, Dust-Ignitionproof, Watertight

Full Voltage. Combination and Non-Combination.

NEC/CEC:

Class I, Division 1 and 2, Groups B, C, D
 Class I, Zone 1 and 2, Groups IIB + H₂
 Class II, Division 1 and 2, Groups E, F, G
 Class III

NEC/CEC:

NEMA 4, 4X, 7BCD, 9EFG
 CSA Type 4, 4X

CONTROLS: NEC/CEC EXPLOSIONPROOF MOTOR STARTERS

Dimensions in Millimeters (Inches) – Combination
Enclosure Layout for Size 0, 1 and 2 – Combination

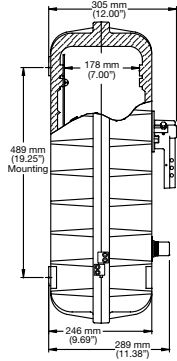

Left Side View

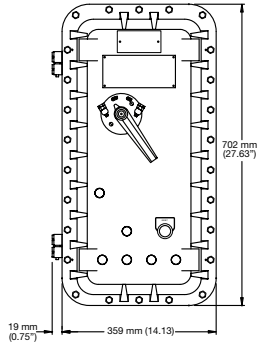

Front View

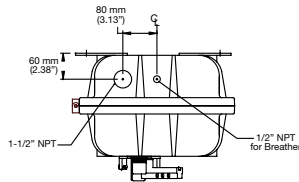

Top View

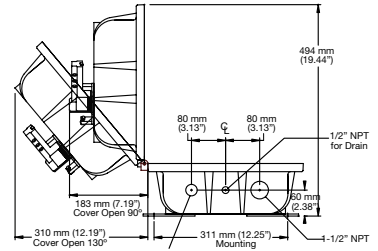

Bottom View

Enclosure Layout for Size 3 and 4 – Combination

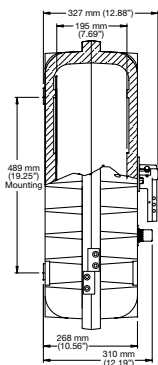

Left Side View

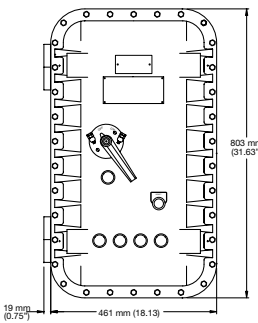

Front View

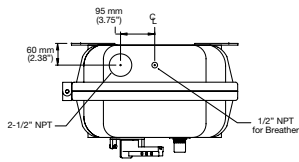

Top View

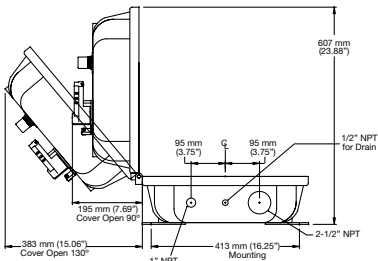

Bottom View

Enclosure Layout for Size 5 – Combination

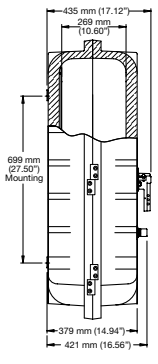

Left Side View

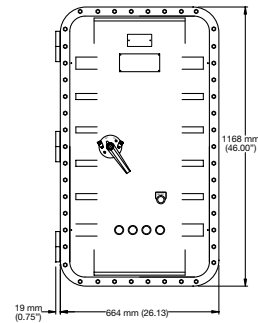

Front View

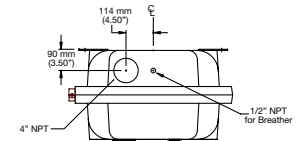

Top View

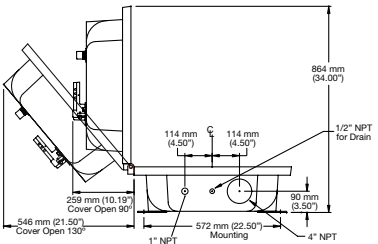

Bottom View

AEB Series Bolted Motor Starters and Contactors

Explosionproof, Dust-Ignitionproof, Watertight

Full Voltage. Combination and Non-Combination.

NEC/CEC:

Class I, Division 1 and 2, Groups B, C, D
 Class I, Zone 1 and 2, Groups IIB + H₂
 Class II, Division 1 and 2, Groups E, F, G
 Class III

NEC/CEC:

NEMA 4, 4X, 7BCD, 9EFG
 CSA Type 4, 4X

Combination Full Voltage Motor Starters with Thermal Magnetic Circuit Breaker – Nonreversing – 3-Phase, 60 Hertz, 120 V Coil

Line Voltage	NEMA Size	Maximum Horsepower	Amp Trip	Catalog Number [▲]	Approximate Weight kg (lb)	Conduit Size (Inches)	Mounting Hardware Set Catalog Number	
480	0	3	15	AE0BB4W1CA	57 (125)	1-1/2	AMH7	
		5	20	AE0BB4W1CB	57 (125)			
	1	7-1/2	30	AE1BB4W1CD	57 (125)			
		10	35	AE1BB4W1CE	57 (125)			
	2	20	50	AE2BB4W1CG	59 (130)			2-1/2
		25	70	AE2BB4W1CJ	59 (130)			
	3	50	100	AE3BB4W1CN	88 (195)	4	AMH8	
			125	125	AE3BB4W1CP			88 (195)
		4	75	150	AE4BB4W1CQ			88 (195)
			100	200	AE4BB4W1CS			88 (195)
		5	125	250	AE5BB4W1CU			227 (500)
			150	300	AE5BB4W1CV			227 (500)
600	0	5	15	AE0BB6W1CA	57 (125)	1-1/2	AMH7	
		7-1/2	20	AE1BB6W1CB	57 (125)			
	1	10	30	AE1BB6W1CD	57 (125)			
		15	40	AE2BB6W1CF	59 (130)			
	2	25	50	AE2BB6W1CG	59 (130)			2-1/2
		30	70	AE3BB6W1CJ	88 (195)			
	3	50	100	AE3BB6W1CN	88 (195)			
		75	125	AE4BB6W1CP	88 (195)			
	4	100	150	AE4BB6W1CQ	88 (195)	4	AMH8	
		150	250	AE5BB6W1CU	227 (500)			
	5	200	300	AE5BB6W1CV	227 (500)			

CONTROLS: NEC/CEC EXPLOSIONPROOF MOTOR STARTERS



▲ To complete the catalog number please add the appropriate suffix for other options/features. Suffixes, see AEB Series Motor Starters Modifications.

AEB Series Bolted Motor Starters and Contactors

Explosionproof, Dust-Ignitionproof, Watertight

Full Voltage. Combination and Non-Reversing – 3-Phase, 60 Hertz, 120 V Coil

NEC/CEC:
 Class I, Division 1 and 2, Groups B, C, D
 Class I, Zone 1 and 2, Groups IIB + H₂
 Class II, Division 1 and 2, Groups E, F, G
 Class III

NEC/CEC:
 NEMA 4, 4X, 7BCD, 9EFG
 CSA Type 4, 4X

Combination Full Voltage Motor Starters with Thermal Magnetic Circuit Breaker – Nonreversing – 3-Phase, 60 Hertz, 120 V Coil

Wiring Diagram

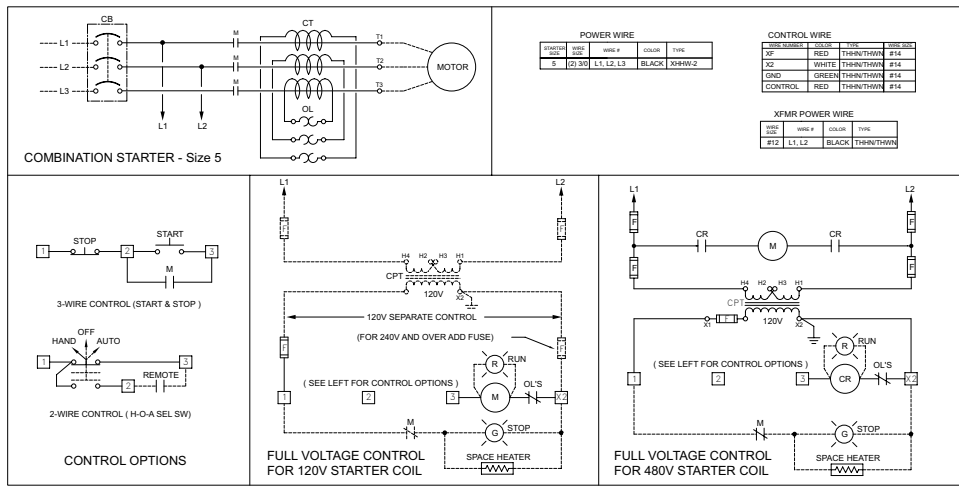
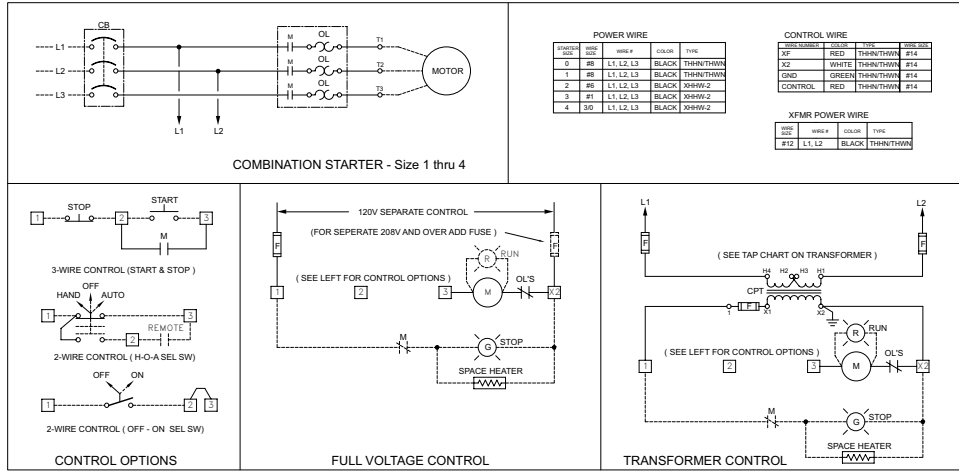

CONTROLS: NEC/CEC EXPLOSIONPROOF MOTOR STARTERS

Appleton

AEB Series Bolted Motor Starters and Contactors

Explosionproof, Dust-Ignitionproof, Watertight

Full Voltage. Combination and Non-Combination.

NEC/CEC:

Class I, Division 1 and 2, Groups B, C, D
 Class I, Zone 1 and 2, Groups IIB + H₂
 Class II, Division 1 and 2, Groups E, F, G
 Class III

NEC/CEC:

NEMA 4, 4X, 7BCD, 9EFG
 CSA Type 4, 4X

Dimensions in Millimeters (Inches) – Combination

Enclosure Layout for Size 0, 1 and 2 – Combination

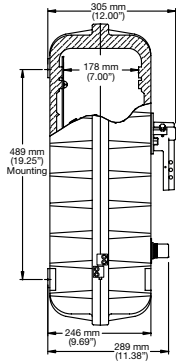

Left Side View

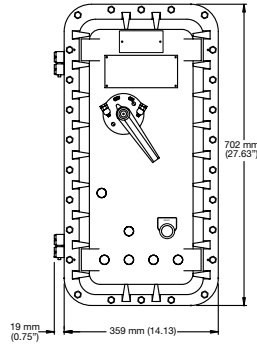

Front View

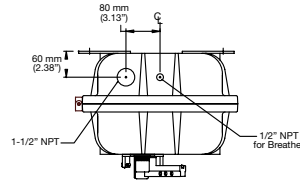

Top View

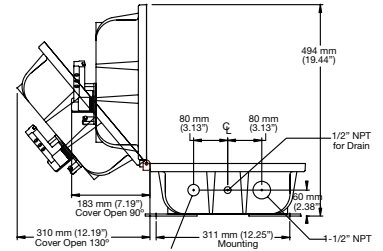

Bottom View

Enclosure Layout for Size 3 and 4 – Combination

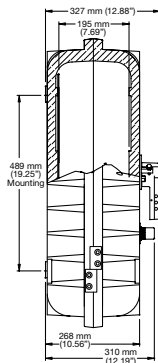

Left Side View

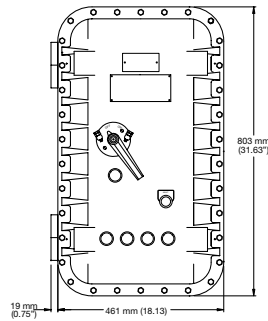

Front View

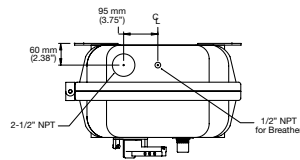

Top View

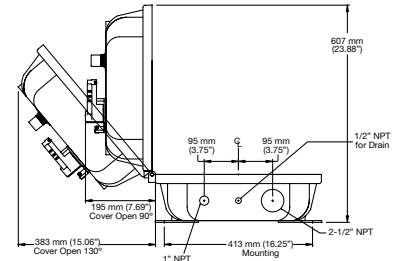

Bottom View

Enclosure Layout for Size 5 – Combination

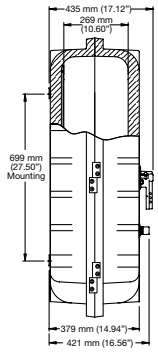

Left Side View

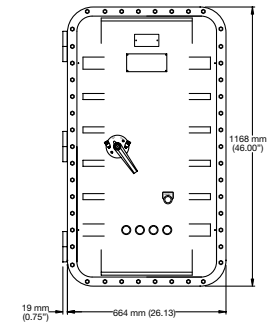

Front View

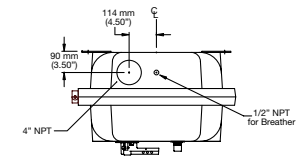

Top View

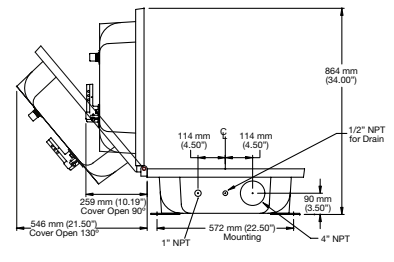

Bottom View

CONTROLS: NEC/CEC EXPLOSIONPROOF MOTOR STARTERS



AEB Series Bolted Motor Starters and Contactors

Explosionproof, Dust-Ignitionproof, Watertight

Full Voltage. Combination and Non-Combination.

NEC/CEC:

Class I, Division 1 and 2, Groups B, C, D
 Class I, Zone 1 and 2, Groups IIB + H₂
 Class II, Division 1 and 2, Groups E, F, G
 Class III

NEC/CEC:

NEMA 4, 4X, 7BCD, 9EFG
 CSA Type 4, 4X

CONTROLS: NEC/CEC EXPLOSIONPROOF MOTOR STARTERS

Appleton®

Lighting Contactor — 3-Pole — 60 Hertz, 120 V Coil

Line Voltage	Enclosure Size	Contactor Amps	Number of Poles	Catalog Number [▲]	Approximate Weight kg (lb)	Conduit Size (Inches)	Mounting Hardware Set Catalog Number
120	1	30	3	AE1BM1S13	57 (125)	1-1/2	AMH7
			6	AE1BM1S16			
			9	AE1BM1S19			
			12	AE1BM1S112			

Wiring Diagram

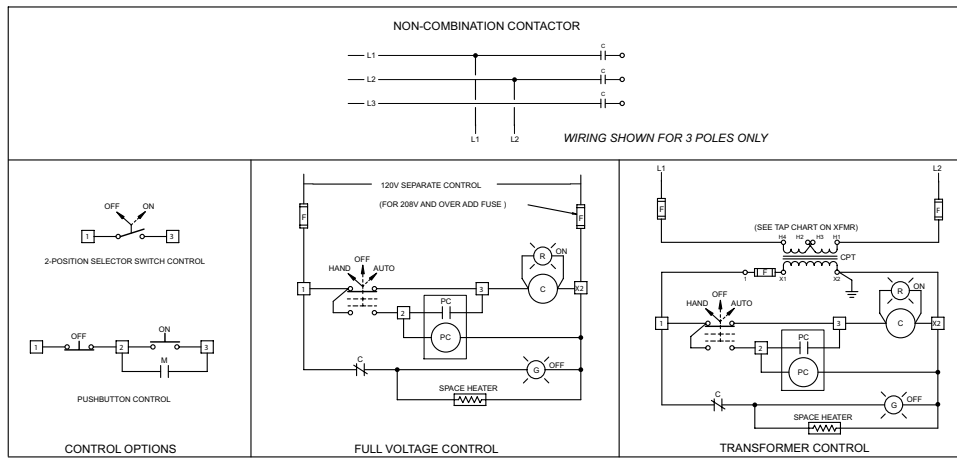

Dimensions in Millimeters (Inches) — Lighting Contactor

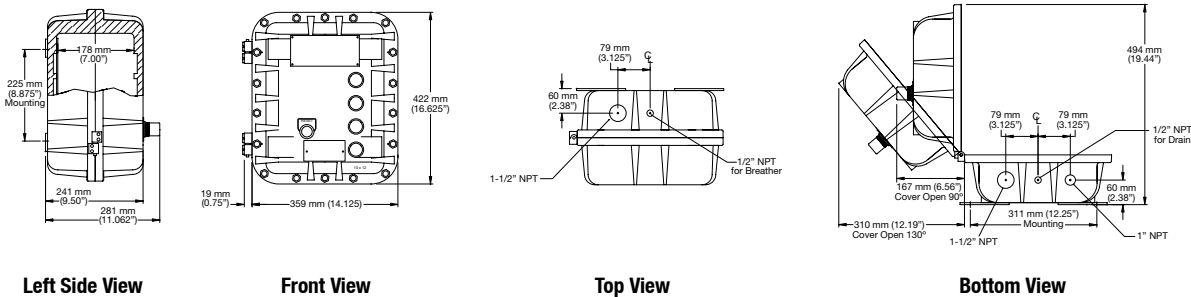

▲ To complete the catalog number please add the appropriate suffix for other options/features. Suffixes, see AEB Series Motor Starters Modifications.

AEB Series Bolted Motor Starters and Contactors

Explosionproof, Dust-Ignitionproof, Watertight

Full Voltage. Combination and Non-Combination.

NEC/CEC:

Class I, Division 1 and 2, Groups B, C, D
 Class I, Zone 1 and 2, Groups IIB + H₂
 Class II, Division 1 and 2, Groups E, F, G
 Class III

NEC/CEC:

NEMA 4, 4X, 7BCD, 9EFG
 CSA Type 4, 4X

Combination Lighting Contactor — 3-Pole — 60 Hertz, 120 V Coil

Line Voltage	Enclosure Size	Contactor Amps	Contactor Amps	Number of Poles	Catalog Number [▲]	Approximate Weight kg (lb)	Conduit Size (Inches)	Mounting Hardware Set Catalog Number
120	1	30	40	3	AE1BN1S1F3	57 (125)	1-1/2	AMH7
				6	AE1BN1S1F6			
				9	AE1BN1S1F9			
				12	AE1BN1S1F12			

Wiring Diagram

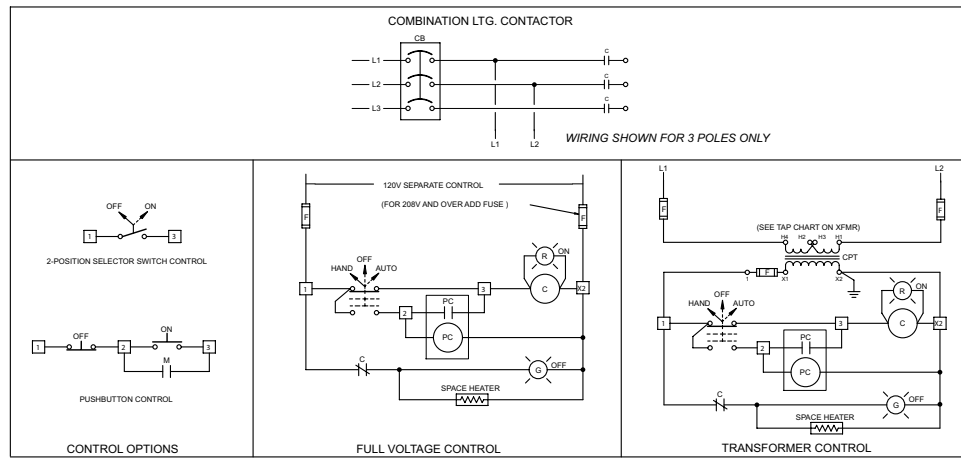

Dimensions in Millimeters (Inches) — Combination Lighting Contactor

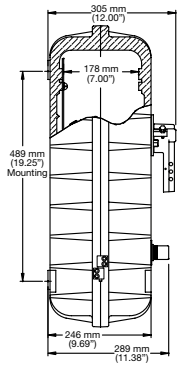

Left Side View

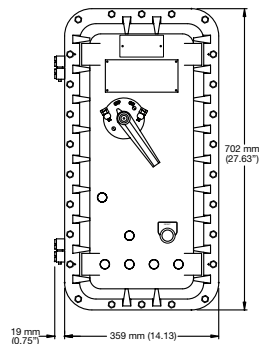

Front View

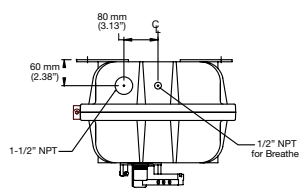

Top View

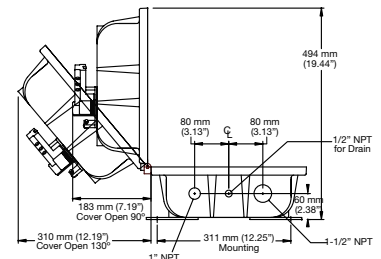

Bottom View

[▲] To complete the catalog number please add the appropriate suffix for other options/features. Suffixes, see AEB Series Motor Starters Modifications.

AEB Series Bolted Motor Starters and Contactors

Explosionproof, Dust-Ignitionproof, Watertight

Full Voltage. Combination and Non-Combination.

NEC/CEC:
Class I, Division 1 and 2, Groups B, C, D
Class I, Zone 1 and 2, Groups IIB + H₂
Class II, Division 1 and 2, Groups E, F, G
Class III

NEC/CEC:
NEMA 4, 4X, 7BCD, 9EFG
CSA Type 4, 4X

Modifications

Description	Suffix Factory Installed	Catalog Number Field Installed
Operators ①		
Start/Stop dual push button	S3X	AEPDGRE
Stop push button	S2X	AEPRC
Start push button	S1X	AEPGA
Stop, lighted PB, red 120 Vac	LP5X	AEPTRE
Start, lighted PB, green 120 Vac	LP4X	AEPTGE
3 position selector switch specify legend	A3X	AESS31MN
2 position selector switch specify legend	A2X	AESS22ML
Red pilot light, 120 Vac	L5	AEPL1R
Green pilot light, 120 Vac	L4	AEPL1G
Red pilot light, 240 Vac	L52	AEPL2R
Green pilot light, 240 Vac	L42	AEPL2G
Red pilot light, 480 Vac	L54	AEPL4R
Green pilot light, 480 Vac	L44	AEPL4G
NEMA 4X Breather/Drain Fittings		
Drain fitting	DN	DRNB4X
Breather fitting (Drilled and tapped installation included.)	BR	BRTB4X
Control Power Options ②③		
Fused CPT, 50 Va	T1	AFCPT050
Fused CPT, 100 Va	T2	AFCPT100
Fused CPT, 200 Va	T3	AFCPT200
Fused CPT, 250 Va	T4	AFCPT250
Fused CPT, 50 Va w/interposing relay	T5	AFCPT050R
Fused CPT, 150 Va	T6	AFCPT150
Fused CPT, 300 Va	T7	AFCPT300
Fused CPT, 500 Va	T8	AFCPT500
Fused CPT, 750 Va	T9	AFCPT750
Separate control fused circuit	S-120V	n/a
Specify starter coil voltage	S-240V	n/a
	S-480V	n/a

Description	Suffix Factory Installed	Catalog Number Field Installed
Nameplates		
Engraved nameplate — black letters on white surface, 50.8 x 101.6 mm (2" x 4"), 3.18 mm (0.125") letters, 3 lines max. specify legend	NP	n/a
Space Heater		
	120 Vac	O-120V AFA4327X11
40 Watt enclosure space heaters	240 Vac	O-240V AFA4327X12
	480 Vac	O-480V AFA4327X13
Control Terminal Blocks (Above 12 points contact your local representative)		
20 Amp, 600 Vac	8 point	8K n/a
NEMA 1B w/wire markers	12 point	12K n/a
Cutler-Hammer + Starter Auxiliary Contacts		
Size 0-4 ④	1NO/1NC	X11C AJ-11
	2NO/2NC	X22C AJ-11 (2 ea.)
Size 5 ⑤	1NO/1NC	X511C A3463D94G18
	2NO/2NC	X522C A3463D94G18 (2 ea.)
Square D ■ Starter Auxiliary Contacts		
Size 0-5 ⑥	1NO/1NC	X11S A999SX8
	2NO/2NC	X22S A999SX8 (2 ea.)
Number of Poles on Lighting Contactors		
30 Amp, 120 Vac	3 Poles	3
30 Amp, 120 Vac	6 Poles	6
30 Amp, 120 Vac	9 Poles	9
30 Amp, 120 Vac	12 Poles	12

NOTE: **CPT** includes primary and secondary fuses.

① Add **-L** to part no. for Size 5 starters.

② Size 1 and 2 150 Vac Max. Size 3 and 4 300 Vac Max.

③ Contact your local representative for other voltages.

④ 8 Aux. Contacts Max. includes one seal-in and seven added.

⑤ 4 Aux. Contacts Max. includes one seal-in and three added.

⑥ Size 0-1 includes one seal-in and four added. Size 2-5 includes one seal-in and three added.

+ Cutler-Hammer is a registered trademark of Eaton Corporation.

■ Square D is a registered trademark of Schneider Electric.

AE LB Series 65 kAIC Bolted Motor Starters and Contactors

Explosionproof, Dust-Ignitionproof, Watertight

Full Voltage. Combination and Non-Combination.

NEC:

Class I, Division 1 and 2, Groups C, D
Class I, Zone 1 and 2, Groups IIB
Class II, Division 1 and 2, Groups E, F, G
Class III
NEMA 4, 4X, 7BCD, 9EFG

Application

- Combination and non-combination motor starters are used in areas where hazardous materials are handled or stored.
- These units provide disconnecting means, undervoltage protection, circuit protection, and motor running protection.

Features

- 65,000 AIC. Highest interrupt rated enclosure in the industry.
- Copperfree cast aluminum.
- Precision machined flame path between box and cover.
- Bolt on slotted mounting feet.
- Stainless steel, captive Quad-Lead® cover bolts (disengage in 1-1/2 turns).
- External stainless steel breaker operating handle.
- Ground lug package and installation instructions for termination of ground wire enclosed.
- Four point control terminal block, NEMA 1B with wire markers.
- Breaker operators can be locked in the ON or OFF position (combination starters only).
- Four plugged 3/4" NPSM outlets drilled and tapped for control devices.
- Standard outlets top and bottom.
- Plugged 1/2" outlets top and bottom for optional breather/drain.
- Components are mounted on a galvanized steel removable pan.
- Enclosures are designed to accept Cutler-Hammer †, or Square D ■ motor starters/circuit breakers. For other manufacturers, contact your local representative.
- O-ring gasket insures watertight integrity.

Standard Materials

- Bodies and covers: copperfree (4/10 of 1%) aluminum
- Block hinges, cover bolts, handle, breaker and operator shafts: stainless steel
- O-ring: neoprene

Standard Finish

- Corrosion resistant gray powder coat epoxy inside and out

Options

- See options table.

NEC Certifications and Compliances

- UL Standards: UL 50, UL 1203
- UL Classified: E84577

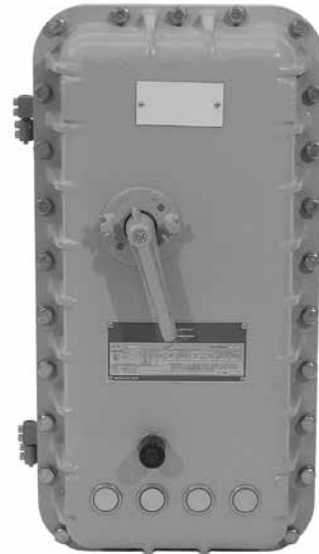

CONTROLS: NEC/CEC EXPLOSIONPROOF MOTOR STARTERS

Appleton®

† Cutler-Hammer is a registered trademark of Eaton Corporation.
■ Square D is a registered trademark of Schneider Electric.

AELB Series 65 kAIC Bolted Motor Starters and Contactors

Explosionproof, Dust-Ignitionproof, Watertight

Full Voltage. Combination and Non-Combination.

NEC:

Class I, Division 1 and 2, Groups C, D
 Class I, Zone 1 and 2, Groups IIB
 Class II, Division 1 and 2, Groups E, F, G
 Class III
 NEMA 4, 4X, 7BCD, 9EFG

Catalog Numbering Guide

Example: The part number below depicts an Appleton, Class I, Division I, Groups C and D, NEMA Size 1, Bolted type, Combination Full Voltage Nonreversing Motor Starter operating at 480 Vac, Cutler-Hammer + starter w/120 Vac control voltage, and a Cutler-Hammer 7A MCP.

If a breaker is not required, omit last two characters.

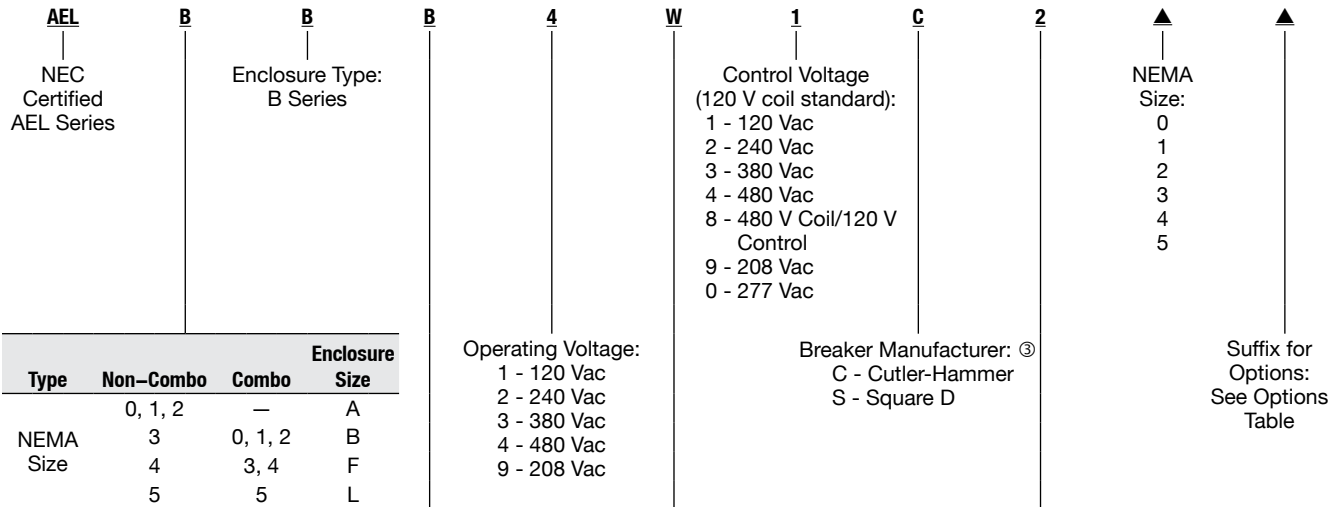

	Enclosure		
Type	Non-Combo	Combo	Size
NEMA	0, 1, 2	—	A
Size	3	0, 1, 2	B
	4	3, 4	F
	5	5	L

Starter Function:
 A - FVNR (ATL)
 B - Combination FVNR
 M - Lighting Contactor
 (3- thru 12-pole) ①
 N - Combination
 Lighting Contactor
 (3- thru 12-pole) ①

Optional Starter Function ②:
 C - FVR
 D - Combination FVR
 E - 2S1W
 F - Comb. 2S1W
 G - 2S2W
 H - Combination 2S2W
 J - Contactor (3 pole)
 K - Combination
 Contactor (3-pole)

Starter Manufacturer: ③
 W - Standard; Eaton/
 Cutler-Hammer
 (A200)
 C - Freedom (AN16)
 Bi Metal; Eaton/
 Cutler-Hammer
 A - Freedom (AN19)
 Electronic; Eaton/
 Cutler-Hammer
 S - Square D

MCP or Breaker Trip:

<p>MCP: 1 - 3 Amp 2 - 7 Amp 3 - 15 Amp 4 - 30 Amp 5 - 50 Amp 6 - 70 Amp 7 - 100 Amp 8 - 150 Amp 9 - 250 Amp 0 - 400 Amp</p>	<p>Breaker Trip (Thermal Mag): A - 15 Amp B - 20 Amp C - 25 Amp D - 30 Amp E - 35 Amp F - 40 Amp G - 50 Amp H - 60 Amp J - 70 Amp K - 80 Amp M - 90 Amp N - 100 Amp P - 125 Amp Q - 150 Amp R - 175 Amp S - 200 Amp T - 225 Amp U - 250 Amp V - 300 Amp W - 350 Amp X - 400 Amp</p>
--	---

① Standard starter is manufactured by Square D; electrically operated, electrically held. Optional starter manufacture is ASCO; electrically operated, mechanically held. Contact your local sales representative for details.

② Contact your local sales representative for details.

③ Contact your local sales representative for manufactures (Allen Bradley, Sprecher and Schuh, Siemens, GE).

AELB Series 65 kAIC Bolted Motor Starters and Contactors

Explosionproof, Dust-Ignitionproof, Watertight

Full Voltage. Combination and Non-Combination.

NEC:

- Class I, Division 1 and 2, Groups C, D
- Class I, Zone 1 and 2, Groups IIB
- Class II, Division 1 and 2, Groups E, F, G
- Class III
- NEMA 4, 4X, 7BCD, 9EFG

Empty Enclosure

NEMA Size	Catalog Number [▲]	Approximate Weight kg (lb)	Standard Conduit (Inches)	Mounting Hardware Set Catalog Number
Full Voltage Nonreversing Enclosure Only				
0	AELABA	36 (80)		
1	AELABA	36 (80)	1-1/2	
2	AELABA	39 (85)		AMH7
3	AELBBA	64 (140)	2	
4	AELFBA	64 (140)	2-1/2	
5	AELLBA	227 (500)	4	AMH8

Dimensions in Millimeters (Inches) – Starter Only

Enclosure Layout for Size 0, 1 and 2 – Starter Only

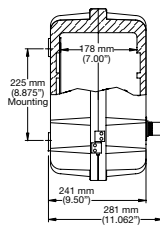

Left Side View

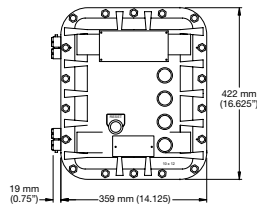

Front View

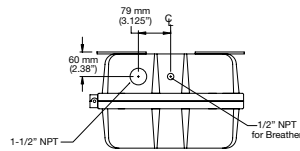

Top View

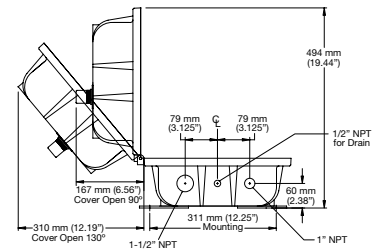

Bottom View

Enclosure Layout for Size 3 – Starter Only

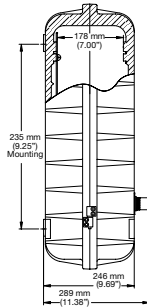

Left Side View

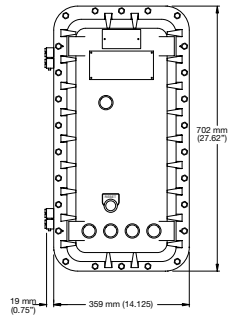

Front View

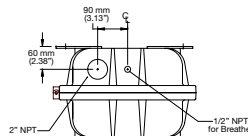

Top View

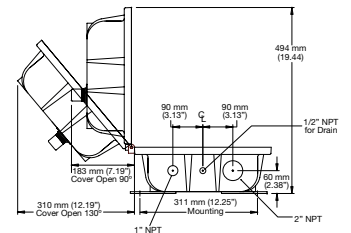

Bottom View

▲ To complete the catalog number please add the appropriate suffix for other options/features. Suffixes, see AEB Series Motor Starters Modifications.

AE LB Series 65 kAIC Bolted Motor Starters and Contactors

Explosionproof, Dust-Ignitionproof, Watertight

Full Voltage. Combination and Non-Combination.

NEC:

- Class I, Division 1 and 2, Groups C, D
- Class I, Zone 1 and 2, Groups IIB
- Class II, Division 1 and 2, Groups E, F, G
- Class III
- NEMA 4, 4X, 7BCD, 9EFG

Dimensions in Millimeters (Inches) – Starter Only

Enclosure Layout for Size 4 – Starter Only

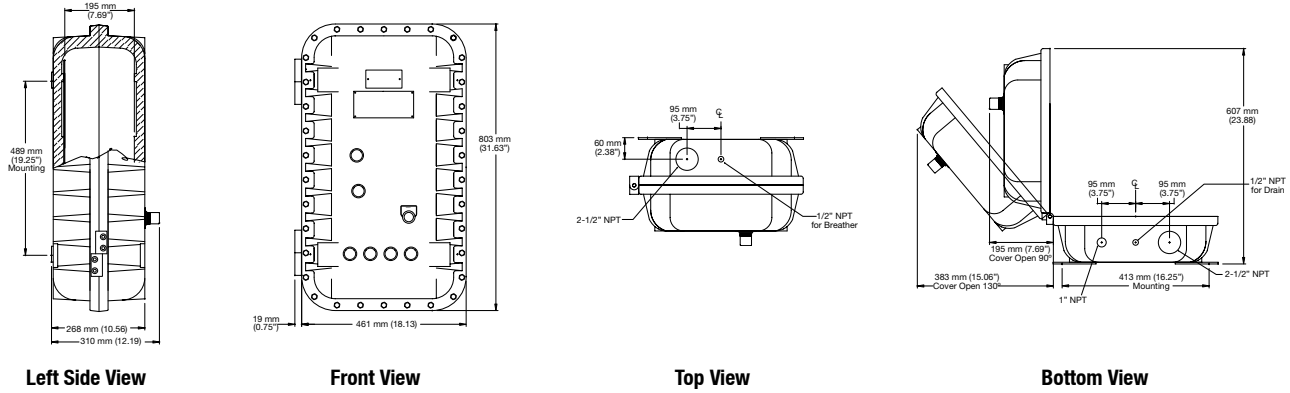

Enclosure Layout for Size 5 – Starter Only

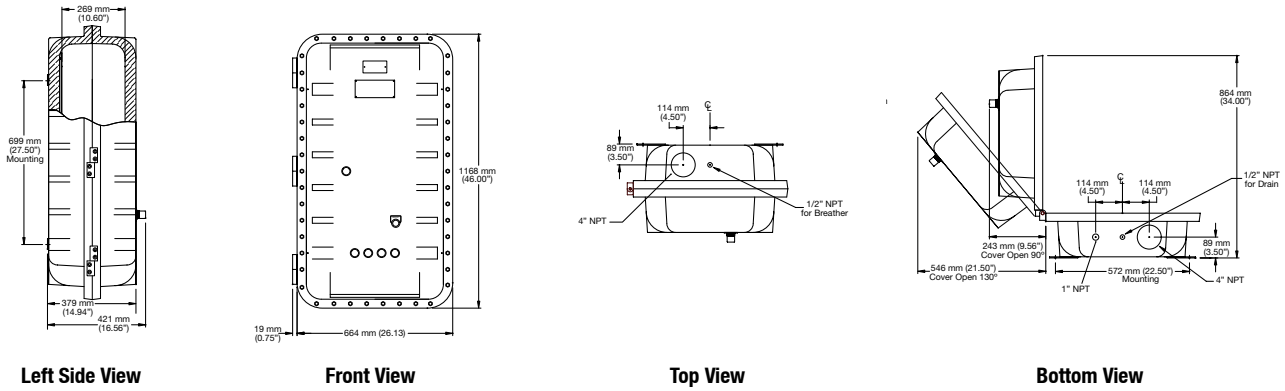

CONTROLS: NEC/CEC EXPLOSIONPROOF MOTOR STARTERS

Appleton

AELB Series 65 kAIC Bolted Motor Starters and Contactors

Explosionproof, Dust-Ignitionproof, Watertight

Full Voltage. Combination and Non-Combination.

NEC:

- Class I, Division 1 and 2, Groups C, D
- Class I, Zone 1 and 2, Groups IIB
- Class II, Division 1 and 2, Groups E, F, G
- Class III
- NEMA 4, 4X, 7BCD, 9EFG

Empty Enclosure

NEMA Size	Catalog Number [▲]	Approximate Weight kg (lb)	Standard Conduit (Inches)	Mounting Hardware Set Catalog Number
Combination Full Voltage Nonreversing Enclosure Only				
0	AELBBB	36 (80)		
1	AELBBB	36 (80)	1-1/2	
2	AELBBB	39 (85)		AMH7
3	AELFBB	64 (140)		
4	AELFBB	64 (140)	2-1/2	
5	AELLBB	227 (500)	4	AMH8

Dimensions in Millimeters (Inches) – Combination

Enclosure Layout for Size 0, 1 and 2 – Combination

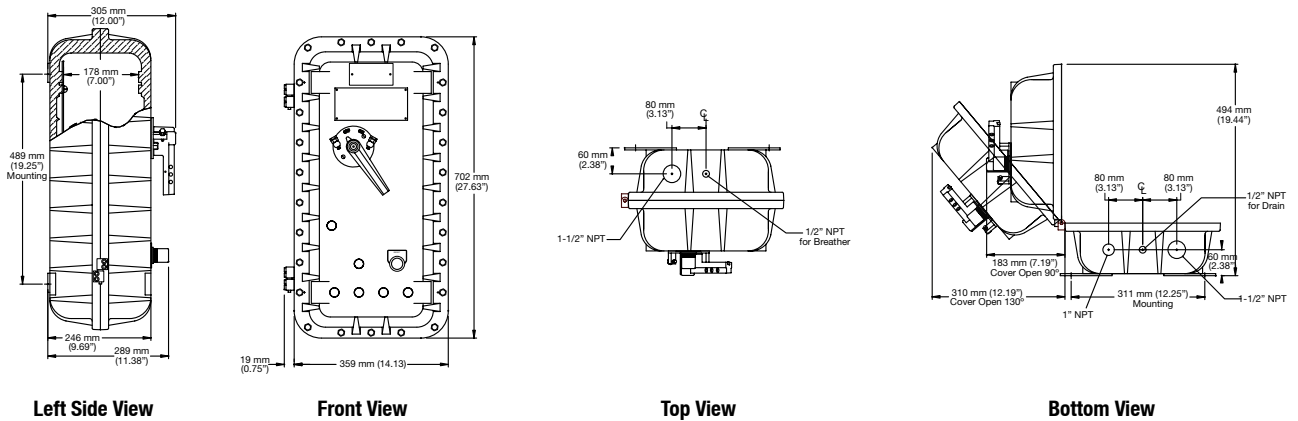

Enclosure Layout for Size 3 and 4 – Combination

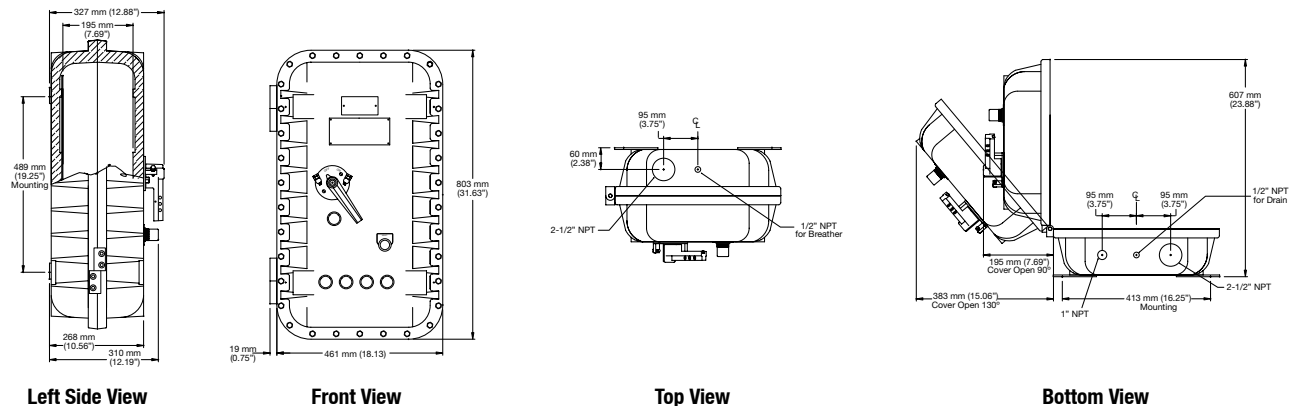

▲ To complete the catalog number please add the appropriate suffix for other options/features. Suffixes, see AEB Series Motor Starters Modifications.

AELB Series 65 kAIC Bolted Motor Starters and Contactors

Explosionproof, Dust-Ignitionproof, Watertight

Full Voltage. Combination and Non-Combination.

NEC/CEC:

Class I, Division 1 and 2, Groups B, C, D
 Class I, Zone 1 and 2, Groups IIB + H₂
 Class II, Division 1 and 2, Groups E, F, G NEC:
 Class I, Division 1 and 2, Groups C, D
 Class I, Zone 1 and 2, Groups IIB

Class II, Division 1 and 2, Groups E, F, G

Class III
 NEMA 4, 4X, 7BCD, 9EFG
 Class III

NEC/CEC:

NEMA 4, 4X, 7BCD, 9EFG
 CSA Type 4, 4X

Dimensions in Millimeters (Inches) – Combination

Enclosure Layout for Size 5 – Combination

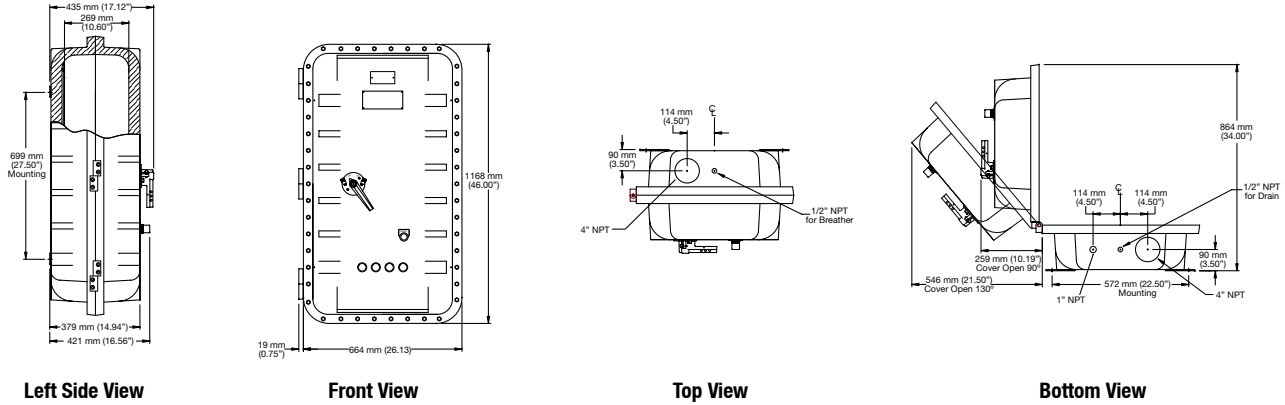

CONTROLS: NEC/CEC EXPLOSIONPROOF MOTOR STARTERS



AELB Series 65 kAIC Bolted Motor Starters and Contactors

Explosionproof, Dust-Ignitionproof, Watertight

Full Voltage. Combination and Non-Combination.

NEC:

- Class I, Division 1 and 2, Groups C, D
- Class I, Zone 1 and 2, Groups IIB
- Class II, Division 1 and 2, Groups E, F, G
- Class III
- NEMA 4, 4X, 7BCD, 9EFG

Full Voltage Motor Starter — Nonreversing — 3-Phase, 60 Hertz, 120 V Coil

Line Voltage	NEMA Size	Maximum Horsepower	Amp Trip	Catalog Number [▲]	Approximate Weight kg (lb)	Conduit Size (Inches)	Mounting Hardware Set Catalog Number
480	0	5	NA	AELABA4W10	36 (80)	1-1/2	AMH7
	1	10	NA	AELABA4W11	36 (80)		
	2	25	NA	AELABA4W12	39 (85)	2	
	3	50	NA	AELBBA4W13	64 (140)		
	4	100	NA	AELFBA4W14	64 (140)	2-1/2	
5	200	NA	AELLBA4W15	227 (500)	4	AMH8	

Wiring Diagrams

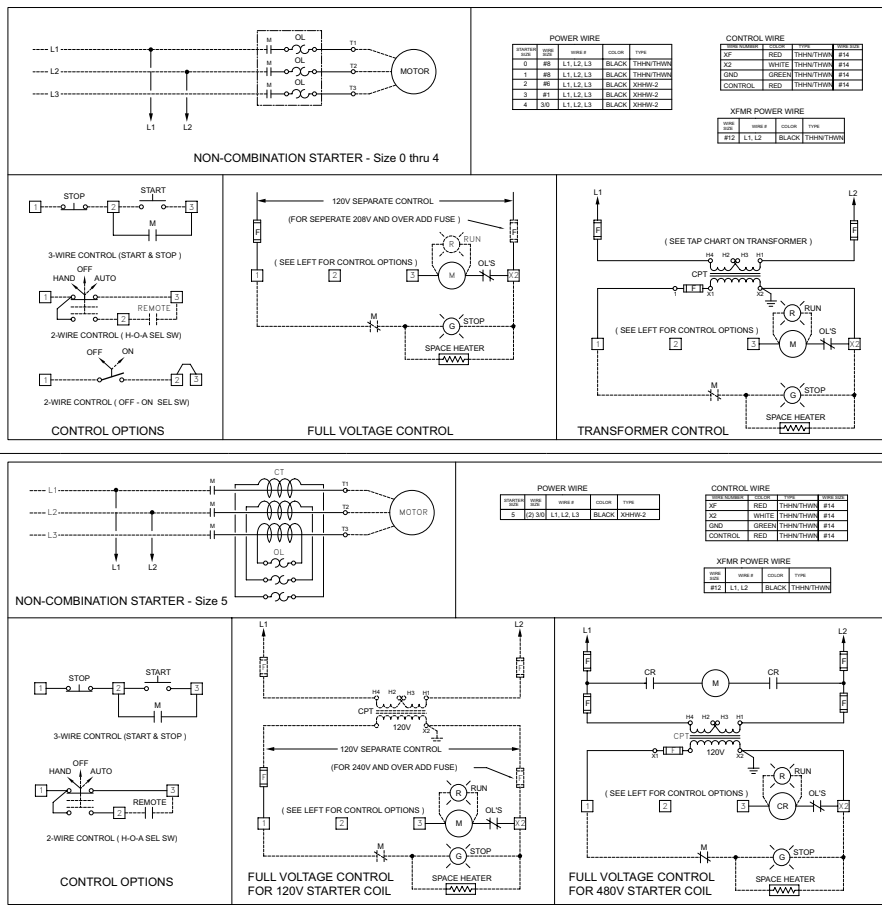

▲ To complete the catalog number please add the appropriate suffix for other options/features. Suffixes, see AEB Series Motor Starters Modifications.

AELB Series 65 kAIC Bolted Motor Starters and Contactors

Explosionproof, Dust-Ignitionproof, Watertight

Full Voltage. Combination and Non-Combination.

NEC:

- Class I, Division 1 and 2, Groups C, D
- Class I, Zone 1 and 2, Groups IIB
- Class II, Division 1 and 2, Groups E, F, G
- Class III
- NEMA 4, 4X, 7BCD, 9EFG

Dimensions in Millimeters (Inches) – Starter Only

Enclosure Layout for Size 0, 1 and 2 – Starter Only

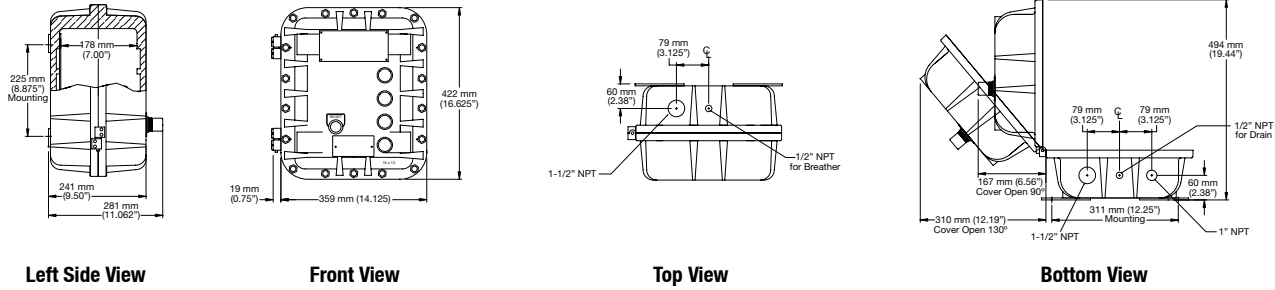

Enclosure Layout for Size 3 – Starter Only

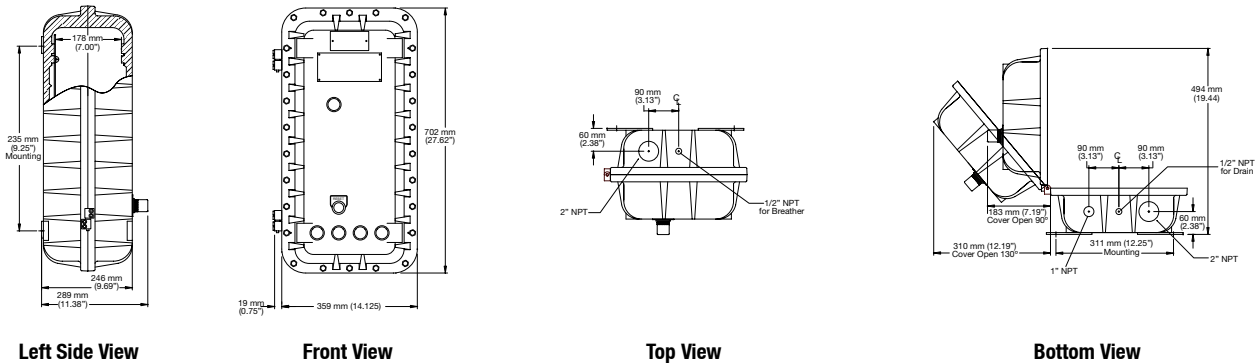

CONTROLS: NEC/CEC EXPLOSIONPROOF MOTOR STARTERS

Appleton

AE LB Series 65 kAIC Bolted Motor Starters and Contactors

Explosionproof, Dust-Ignitionproof, Watertight

Full Voltage. Combination and Non-Combination.

NEC:

- Class I, Division 1 and 2, Groups C, D
- Class I, Zone 1 and 2, Groups IIB
- Class II, Division 1 and 2, Groups E, F, G
- Class III
- NEMA 4, 4X, 7BCD, 9EFG

Dimensions in Millimeters (Inches) – Starter Only

Enclosure Layout for Size 4 – Starter Only

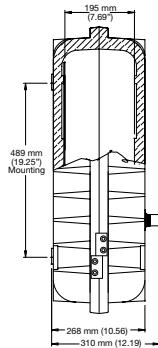

Left Side View

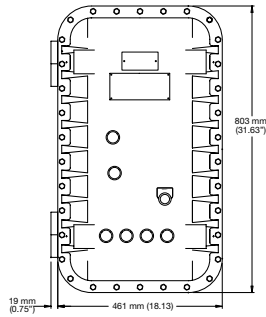

Front View

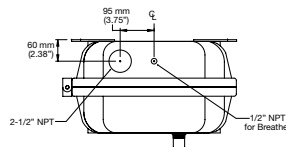

Top View

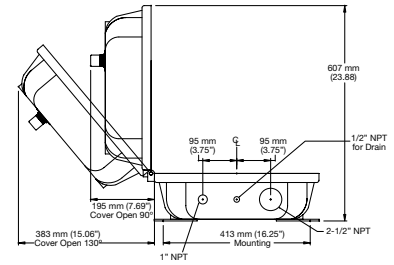

Bottom View

Enclosure Layout for Size 5 – Starter Only

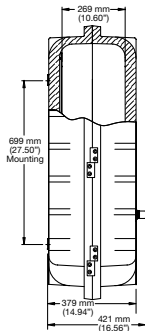

Left Side View

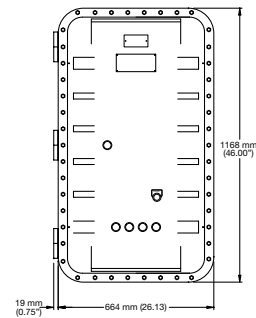

Front View

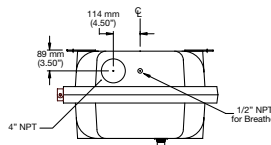

Top View

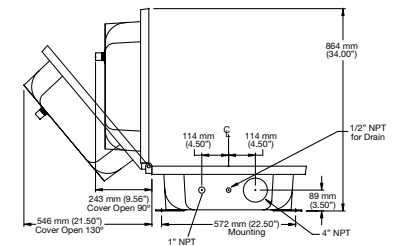

Bottom View

CONTROLS: NEC/CEC EXPLOSIONPROOF MOTOR STARTERS



AELB Series 65 kAIC Bolted Motor Starters and Contactors

Explosionproof, Dust-Ignitionproof, Watertight

Full Voltage. Combination and Non-Combination.

NEC:

- Class I, Division 1 and 2, Groups C, D
- Class I, Zone 1 and 2, Groups IIB
- Class II, Division 1 and 2, Groups E, F, G
- Class III
- NEMA 4, 4X, 7BCD, 9EFG

Combination Full Voltage Motor Starters With Motor Circuit Protector (MCP) – Nonreversing – 3-Phase, 60 Hertz, 120 V Coil

Line Voltage	NEMA Size	Maximum Horsepower	Amp Trip	Catalog Number [▲]	Approximate Weight kg (lb)	Conduit Size (Inches)	Mounting Hardware Set Catalog Number	
480	0	1	3	AELBBB4W1C10	57 (125)	1-1/2	AMH7	
		3	7	AELBBB4W1C20	57 (125)			
		5	15	AELBBB4W1C30	57 (125)			
	1	7	15	AELBBB4W1C31	57 (125)			
		10	30	AELBBB4W1C41	59 (130)			
	2	12	30	AELBBB4W1C42	59 (130)			
		25	50	AELBBB4W1C52	59 (130)			
	3	30	50	AELFBB4W1C53	88 (195)			2-1/2
		50	100	AELFBB4W1C73	88 (195)			
	4	100	150	AELFBB4W1C84	88 (195)			4
5	200	400	AELBBB4W1C05	227 (500)				

Wiring Diagram

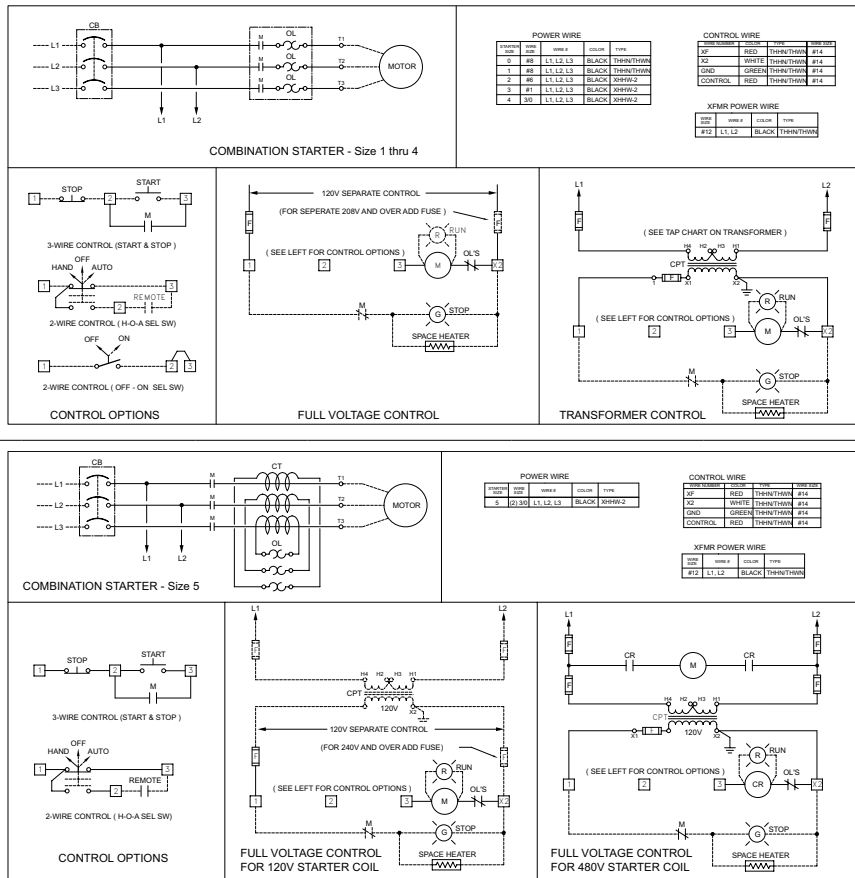

▲ To complete the catalog number please add the appropriate suffix for other options/features. Suffixes, see AEB Series Motor Starters Modifications.

AE LB Series 65 kAIC Bolted Motor Starters and Contactors

Explosionproof, Dust-Ignitionproof, Watertight

Full Voltage. Combination and Non-Combination.

NEC:

- Class I, Division 1 and 2, Groups C, D
- Class I, Zone 1 and 2, Groups IIB
- Class II, Division 1 and 2, Groups E, F, G
- Class III
- NEMA 4, 4X, 7BCD, 9EFG

Dimensions in Millimeters (Inches) – Combination
Enclosure Layout for Size 0, 1 and 2 – Combination

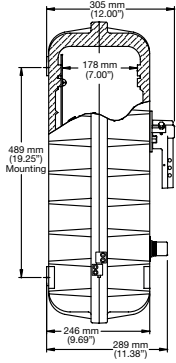

Left Side View

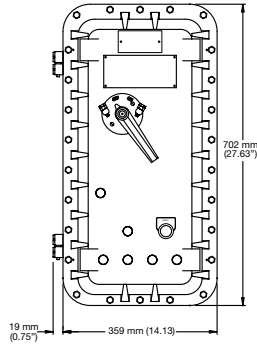

Front View

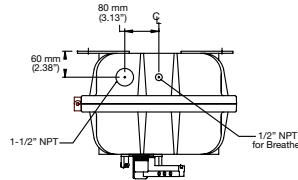

Top View

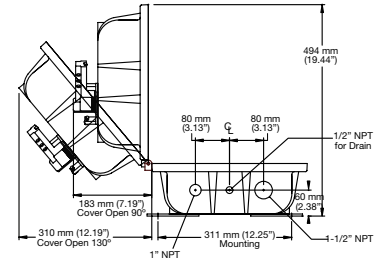

Bottom View

Enclosure Layout for Size 3 and 4 – Combination

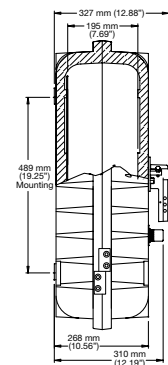

Left Side View

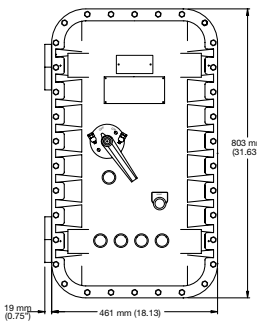

Front View

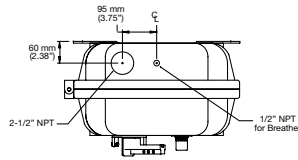

Top View

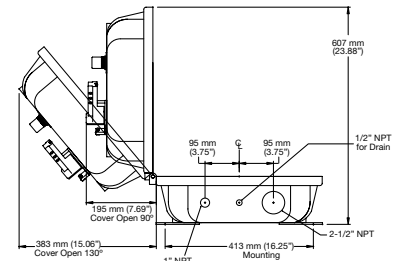

Bottom View

Enclosure Layout for Size 5 – Combination

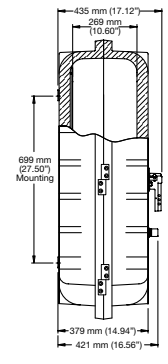

Left Side View

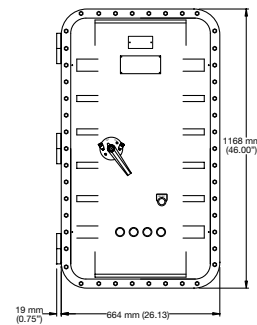

Front View

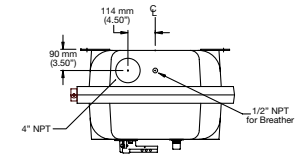

Top View

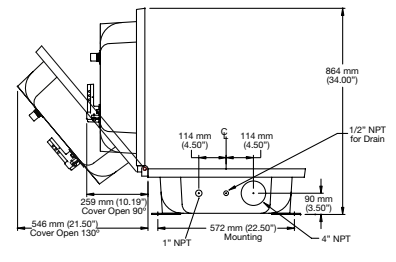

Bottom View

CONTROLS: NEC/CEC EXPLOSIONPROOF MOTOR STARTERS



AELB Series 65 kAIC Bolted Motor Starters and Contactors

Explosionproof, Dust-Ignitionproof, Watertight

Full Voltage. Combination and Non-Combination.

NEC:
 Class I, Division 1 and 2, Groups C, D
 Class I, Zone 1 and 2, Groups IIB
 Class II, Division 1 and 2, Groups E, F, G
 Class III
 NEMA 4, 4X, 7BCD, 9EFG

Combination Full Voltage Motor Starters with Thermal Magnetic Circuit Breaker – Nonreversing – 3-Phase, 60 Hertz, 120 V Coil

Line Voltage	NEMA Size	Maximum Horsepower	Amp Trip	Catalog Number [▲]	Approximate Weight kg (lb)	Conduit Size (Inches)	Mounting Hardware Set Catalog Number		
480	0	3	15	AELBBB4W1CA0	57 (125)	1-1/2	AMH7		
		5	20	AELBBB4W1CB0	57 (125)				
	1	7-1/2	30	AELBBB4W1CD1	57 (125)				
		10	35	AELBBB4W1CE1	57 (125)				
	2	20	50	AELBBB4W1CG2	59 (130)			2-1/2	AMH7
		25	70	AELBBB4W1CJ2	59 (130)				
	3	50	100	AELFBB4W1CN3	88 (195)				
		60	125	AELFBB4W1CP3	88 (195)				
	4	75	150	AELFBB4W1CQ4	88 (195)				
		100	200	AELFBB4W1CS4	88 (195)				
	5	125	250	AELLBB4W1CU5	227 (500)	4	AMH8		
		150	300	AELLBB4W1CV5	227 (500)				
		200	400	AELLBB4W1CX5	227 (500)				

Wiring Diagram

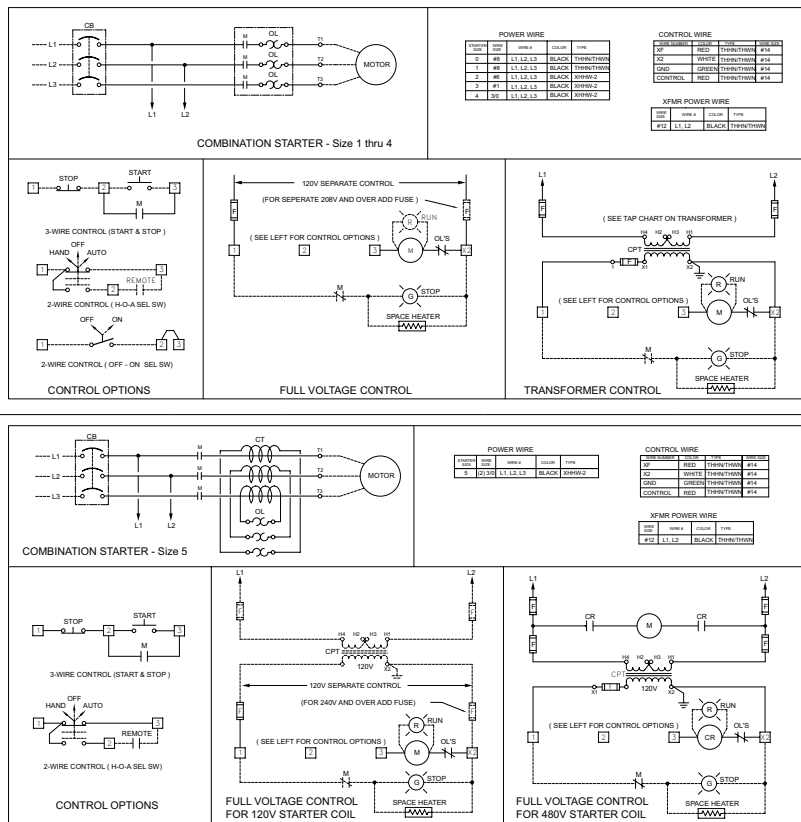

▲ To complete the catalog number please add the appropriate suffix for other options/features. Suffixes, see AEB Series Motor Starters Modifications.

AE LB Series 65 kAIC Bolted Motor Starters and Contactors

Explosionproof, Dust-Ignitionproof, Watertight

Full Voltage. Combination and Non-Combination.

NEC:

- Class I, Division 1 and 2, Groups C, D
- Class I, Zone 1 and 2, Groups IIB
- Class II, Division 1 and 2, Groups E, F, G
- Class III
- NEMA 4, 4X, 7BCD, 9EFG

Dimensions in Millimeters (Inches) – Combination

Enclosure Layout for Size 0, 1 and 2 – Combination

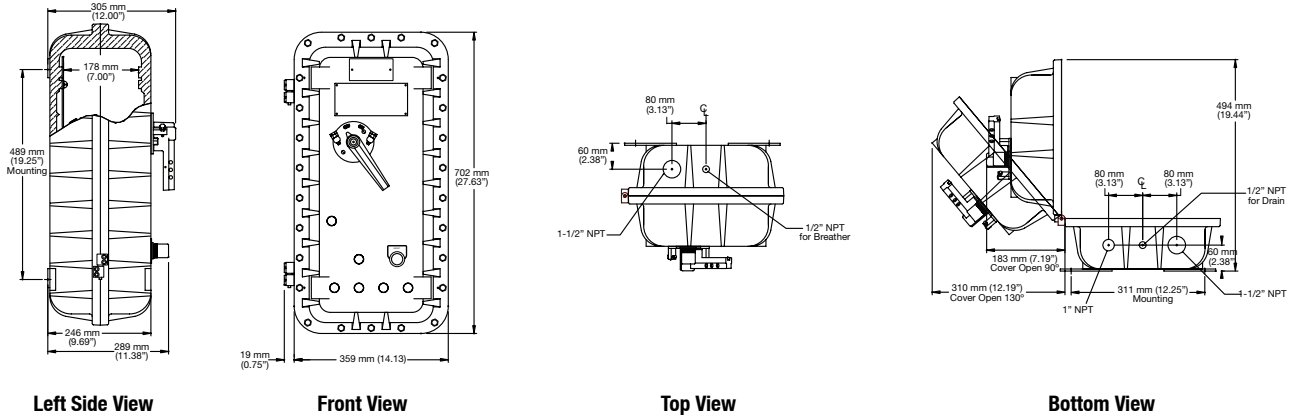

Enclosure Layout for Size 3 and 4 – Combination

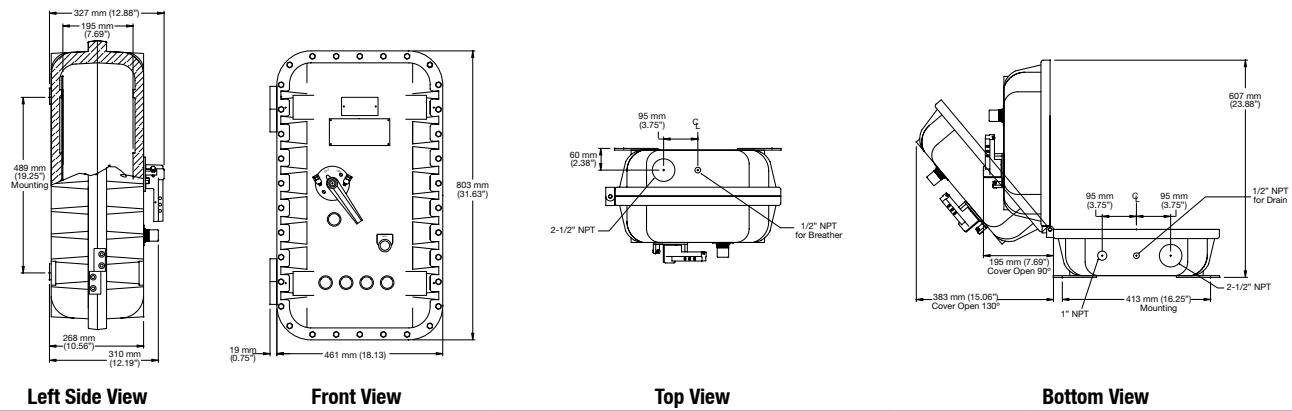

Enclosure Layout for Size 5 – Combination

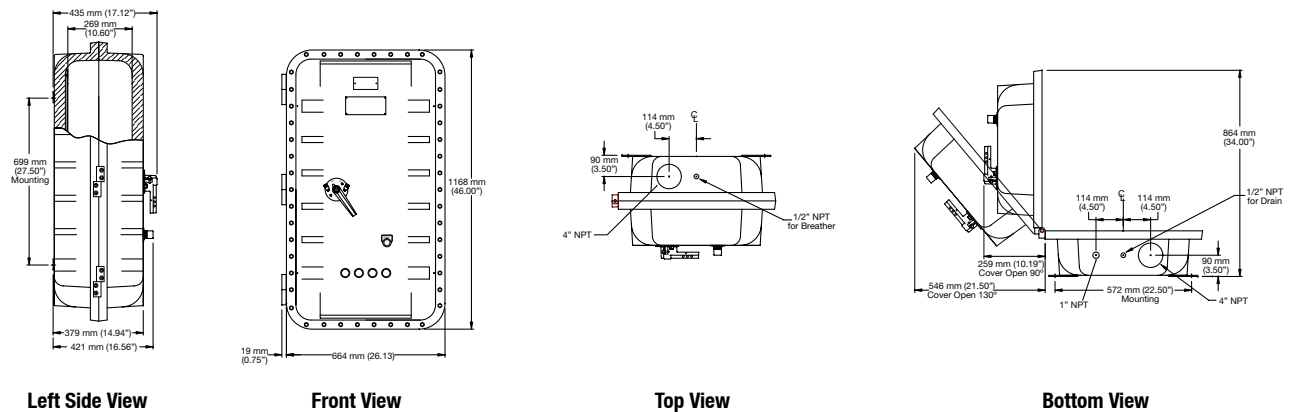

AELB Series 65 kAIC Bolted Motor Starters and Contactors

Explosionproof, Dust-Ignitionproof, Watertight

Full Voltage. Combination and Non-Combination.

NEC:

- Class I, Division 1 and 2, Groups C, D
- Class I, Zone 1 and 2, Groups IIB
- Class II, Division 1 and 2, Groups E, F, G
- Class III
- NEMA 4, 4X, 7BCD, 9EFG

Lighting Contactor — 3-Pole — 60 Hertz, 120 V Coil

Line Voltage	Enclosure Size	Contactors Amps	Number of Poles	Catalog Number [▲]	Approximate Weight kg (lb)	Conduit Size (Inches)	Mounting Hardware Set Catalog Number
120	1	30	3	AELABM1S13	57 (125)	1-1/2	AMH7
			6	AELABM1S16			
			9	AELABM1S19			
			12	AELABM1S112			

Wiring Diagram

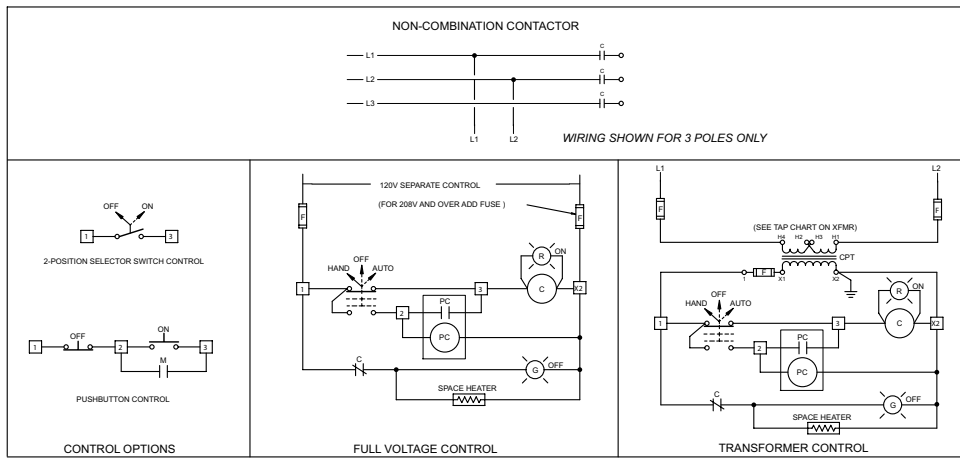

Dimensions in Millimeters (Inches) — Lighting Contactor

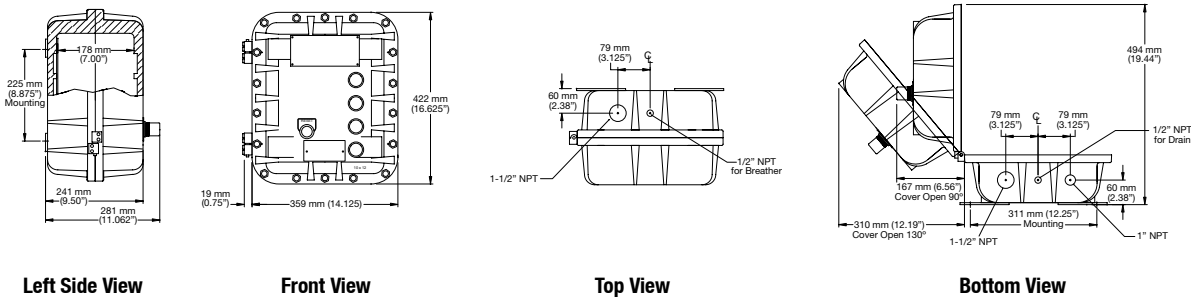

Left Side View

Front View

Top View

Bottom View

▲ To complete the catalog number please add the appropriate suffix for other options/features. Suffixes, see AEB Series Motor Starters Modifications.

AELB Series 65 kAIC Bolted Motor Starters and Contactors

Explosionproof, Dust-Ignitionproof, Watertight

Full Voltage. Combination and Non-Combination.

NEC:

- Class I, Division 1 and 2, Groups C, D
- Class I, Zone 1 and 2, Groups IIB
- Class II, Division 1 and 2, Groups E, F, G
- Class III
- NEMA 4, 4X, 7BCD, 9EFG

Combination Lighting Contactor — 3-Pole — 60 Hertz, 120 V Coil

Line Voltage	Enclosure Size	Contactor Amps	Contactor Amps	Number of Poles	Catalog Number [▲]	Approximate Weight kg (lb)	Conduit Size (Inches)	Mounting Hardware Set Catalog Number
120	1	30	40	3	AELBBN1S1F3	57 (125)	1-1/2	AMH7
				6	AELBBN1S1F6			
				9	AELBBN1S1F9			
				12	AELBBN1S1F12			

Wiring Diagram

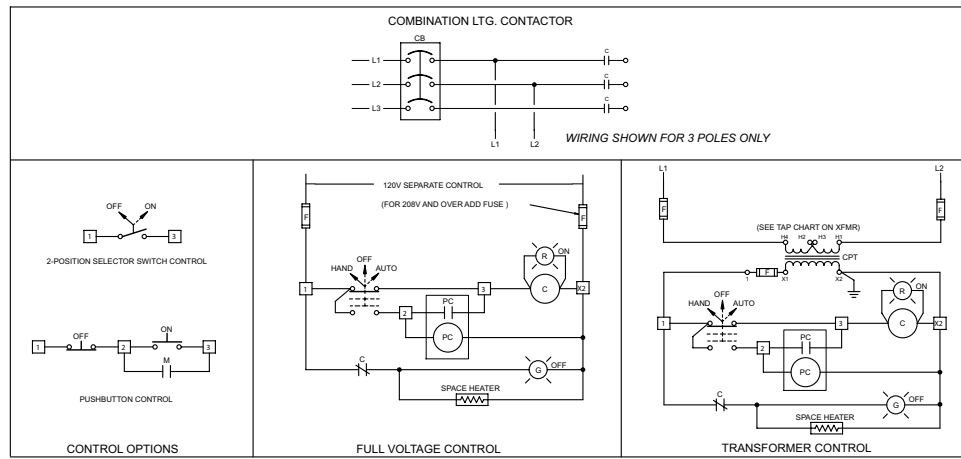

Dimensions in Millimeters (Inches) — Combination Lighting Contactor

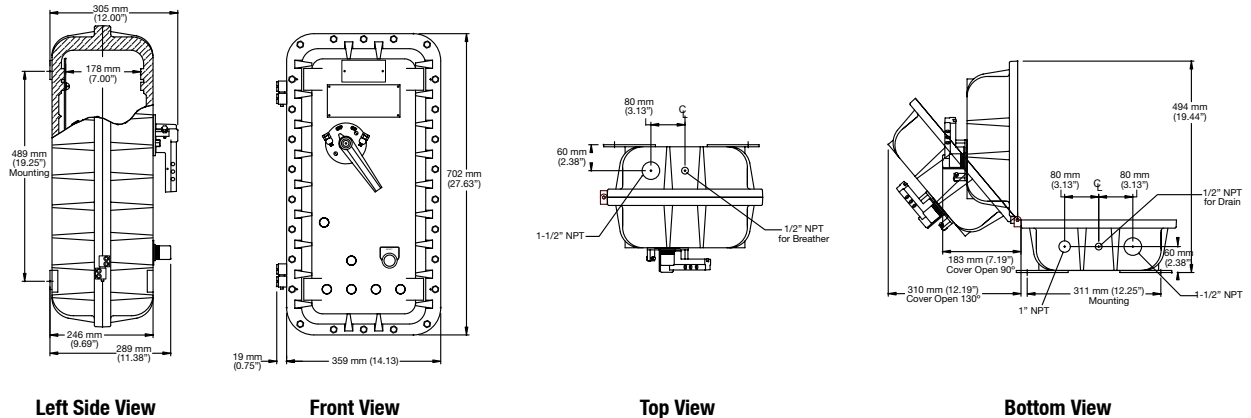

[▲] To complete the catalog number please add the appropriate suffix for other options/features. Suffixes, see AEB Series Motor Starters Modifications.

AE LB Series 65 kAIC Bolted Motor Starters and Contactors

Explosionproof, Dust-Ignitionproof, Watertight

Full Voltage. Combination and Non-Combination.

NEC:

Class I, Division 1 and 2, Groups C, D
 Class I, Zone 1 and 2, Groups IIB
 Class II, Division 1 and 2, Groups E, F, G
 Class III
 NEMA 4, 4X, 7BCD, 9EFG

Modifications

Description	Suffix Factory Installed	Catalog Number Field Installed
Operators ①		
Start/Stop dual push button	S3X	AEPDGRE
Stop push button	S2X	AEPRC
Start push button	S1X	AEPGA
Stop, lighted PB, red 120 Vac	LP5X	AEPTRE
Start, lighted PB, green 120 Vac	LP4X	AEPTGE
3 position selector switch specify legend	A3X	AESS31MN
2 position selector switch specify legend	A2X	AESS22ML
Red pilot light, 120 Vac	L5	AEPL1R
Green pilot light, 120 Vac	L4	AEPL1G
Red pilot light, 240 Vac	L52	AEPL2R
Green pilot light, 240 Vac	L42	AEPL2G
Red pilot light, 480 Vac	L54	AEPL4R
Green pilot light, 480 Vac	L44	AEPL4G
NEMA 4X Breather/Drain Fittings		
Drain fitting	DN	DRNB4X
Breather fitting (Drilled and tapped installation included.)	BR	BRTB4X
Control Power Options ②③		
Fused CPT, 50 Va	T1	AFCPT050
Fused CPT, 100 Va	T2	AFCPT100
Fused CPT, 200 Va	T3	AFCPT200
Fused CPT, 250 Va	T4	AFCPT250
Fused CPT, 50 Va w/interposing relay	T5	AFCPT050R
Fused CPT, 150 Va	T6	AFCPT150
Fused CPT, 300 Va	T7	AFCPT300
Fused CPT, 500 Va	T8	AFCPT500
Fused CPT, 750 Va	T9	AFCPT750
Separate control fused circuit	S-120V	n/a
Specify starter coil voltage	S-240V	n/a
	S-480V	n/a

Description	Suffix Factory Installed	Catalog Number Field Installed
Nameplates		
Engraved nameplate — black letters on white surface, 50.8 x 101.6 mm (2" x 4"), 3.18 mm (0.125") letters, 3 lines max. specify legend	NP	—
Space Heater		
	120 Vac	O-120V AFA4327X11
40 Watt enclosure space heaters	240 Vac	O-240V AFA4327X12
	480 Vac	O-480V AFA4327X13
Control Terminal Blocks (Above 12 points contact your local representative)		
20 Amp, 600 Vac	8 point	8K —
NEMA 1B w/wire markers	12 point	12K —
Cutler-Hammer + Starter Auxiliary Contacts		
Size 0-4 ④	1NO/1NC	X11C AJ-11
	2NO/2NC	X22C AJ-11 (2 ea.)
Size 5 ⑤	1NO/1NC	X511C A3463D94G18
	2NO/2NC	X522C A3463D94G18 (2 ea.)
Square D ■ Starter Auxiliary Contacts		
Size 0-5 ⑥	1NO/1NC	X11S A999SX8
	2NO/2NC	X22S A999SX8 (2 ea.)
Number of Poles on Lighting Contactors		
30 Amp, 120 Vac	3 Poles	3
30 Amp, 120 Vac	6 Poles	6
30 Amp, 120 Vac	9 Poles	9
30 Amp, 120 Vac	12 Poles	12

NOTE: CPT includes primary and secondary fuses.

① Add —L to part no. for Size 5 starters.

② Size 1 and 2 150 Vac Max. Size 3 and 4 300 Vac Max.

③ Contact your local representative for other voltages.

④ 8 Aux. Contacts Max. includes one seal-in and seven added.

⑤ 4 Aux. Contacts Max. includes one seal-in and three added.

⑥ Size 0-1 includes one seal-in and four added. Size 2-5 includes one seal-in and three added.

+ Cutler-Hammer is a registered trademark of Eaton Corporation.

■ Square D is a registered trademark of Schneider Electric.

AEXMS Series Manual Motor Starters

Explosionproof, Dust-Ignitionproof, Watertight

NEC:

Class I, Division 1 and 2, Groups C, D
 Class II, Division 1 and 2, Groups E, F, G
 Class III
 NEMA 3, 3R, 4, 4X, 7CD, 9EFG

Applications

- Explosionproof across the line manual motor starters for starting polyphase Vac motors.

Features

- Rugged, compact enclosures supplied with Square D [■] or Cutler-Hammer [‡] manual motor starters using three overloads.
- Mating surfaces are precision milled to exceed explosionproof specifications. Covers secure with stainless steel (300 Series) hex head bolts.
- O-ring gasket provides NEMA Type 4 rating.
- Four cast on mounting feet allow easy rack or individual mounting.
- Enclosures have standard conduit openings at top and bottom.
- Operating levers are positive operating and can be locked in the ON or OFF position.

Standard Materials

- Enclosure and handle: cast copperfree (4/10 of 1%) aluminum
- Shaft, bushing and cover bolts: stainless steel (300 Series)
- Mounting hardware: stainless steel

Standard Finishes

- Housing: two coat epoxy powder coat

NEC Certifications and Compliances

- UL Standards: UL 508, UL 698, UL 1203
- UL Listed: E76550



CONTROLS: NEC/CEC EXPLOSIONPROOF MOTOR STARTERS

Appleton

Catalog Number [▲]	NEMA Size	Number of Poles	Motor Starter Series	Motor Starter Model Number
AEXMS-A	0	2	Square D 2510	TB01
AEXMS-F	0	2	Cutler-Hammer B100	M0B
AEXMS-D	0	3	Square D 2510	TB02
AEXMS-J	0	3	Cutler-Hammer B100	M0C
AEXMS-B	1	2	Square D 2510	TC01
AEXMS-G	1	2	Cutler-Hammer B100	M1B
AEXMS-E	1	3	Square D 2510	TC03
AEXMS-K	1	3	Cutler-Hammer B100	M1C
AEXMS-C	1-1/2	2	Square D 2510	TC02
AEXMS-H	1-1/2	2	Cutler-Hammer B100	MDB

Horsepower Ratings

Starter Size	Poles	Phase	120	Max. Horsepower Ratings			
				Volts AC 208/240	480/600	120	Volts DC 230
0	3	3	2	3	5	—	—
1	3	3	3	7-1/2	10	—	—
1-1/2	2	1	3	5	—	—	—
0	2	1	1	2	—	1	1-1/2
1	2	1	2	3	—	1-1/2	2

[▲] Add suffix for heater. See table on next page.

[■] Square D is a registered trademark of Schneider Electric.

[‡] Cutler-Hammer is a registered trademark of Eaton Corporation.

AEXMS Series AC Manual Motor Starter Heater

Explosionproof, Dust-Ignitionproof, Watertight

NEC:
 Class I, Division 1 and 2, Groups C, D
 Class II, Division 1 and 2, Groups E, F, G
 Class III
 NEMA 3, 3R, 4, 4X, 7CD, 9EFG

Select heater elements based on motor nameplate listed Full Load Amps (FLA). Trip rating of elements is 125% of motor minimum FLA listed for the elements. Three heaters required per starter.

Dimensions in Millimeters (Inches)

Heater Table

Square D [®]		Cutler-Hammer ⁺	
Motor Full Load Amps at +40 °C (+104 °F)	Add Suffix	Motor Full Load Amps at +40 °C (+104 °F)	Add Suffix
0.28 - 0.29	-B44	0.25 - 0.26	-FH03
0.30 - 0.33	-B51	0.27 - 0.29	-FH04
0.34 - 0.36	-B57	0.30 - 0.32	-FH05
0.37 - 0.44	-B63	0.33 - 0.35	-FH06
0.45 - 0.52	-B71	0.36 - 0.39	-FH07
0.53 - 0.59	-B81	0.40 - 0.44	-FH08
0.60 - 0.64	-B92	0.45 - 0.49	-FH09
0.65 - 0.71	-B103	0.50 - 0.55	-FH10
0.72 - 0.80	-B116	0.56 - 0.61	-FH11
0.81 - 0.90	-B130	0.62 - 0.68	-FH12
0.91 - 1.03	-B145	0.69 - 0.75	-FH13
1.04 - 1.14	-B167	0.76 - 0.83	-FH14
1.15 - 1.27	-B188	0.84 - 0.91	-FH15
1.28 - 1.44	-B210	0.92 - 1.00	-FH16
1.45 - 1.63	-B240	1.01 - 1.10	-FH17
1.64 - 1.79	-B265	1.11 - 1.22	-FH18
1.80 - 2.01	-B300	1.23 - 1.35	-FH19
2.02 - 2.19	-B330	1.36 - 1.50	-FH20
2.20 - 2.52	-B370	1.51 - 1.66	-FH21
2.53 - 2.95	-B415	1.67 - 1.84	-FH22
2.96 - 3.17	-B485	1.85 - 2.03	-FH23
3.18 - 3.50	-B550	2.04 - 2.23	-FH24
3.51 - 3.73	-B625	2.24 - 2.45	-FH25
3.74 - 4.22	-B690	2.46 - 2.69	-FH26
4.23 - 4.68	-B770	2.70 - 2.95	-FH27
4.69 - 4.98	-B820	2.96 - 3.23	-FH28
4.99 - 5.59	-B910	3.24 - 3.53	-FH29
5.60 - 6.43	-B102	3.54 - 3.85	-FH30
6.44 - 7.41	-B115	3.87 - 4.22	-FH31
7.42 - 8.02	-B128	4.23 - 4.61	-FH32
8.03 - 8.59	-B140	4.62 - 5.03	-FH33
8.60 - 9.52	-B155	5.04 - 5.49	-FH34
9.53 - 10.5	-B175	5.50 - 5.99	-FH35
10.6 - 11.2	-B195	6.00 - 6.53	-FH36
11.3 - 12.7	-B220	6.54 - 7.11	-FH37
12.8 - 14.3	-B250	7.12 - 7.73	-FH38
14.4 - 16.1	-B280	7.74 - 8.40	-FH39
16.2 - 17.8	-B320	8.41 - 9.12	-FH40
17.9 - 20.1	-B360	9.13 - 9.89	-FH41
20.2 - 22.6	-B400	9.90 - 1.70	-FH42
22.7 - 25.5	-B450	10.8 - 11.8	-FH43
25.6 - 26.0	-B500	11.9 - 13.0	-FH44
		13.1 - 14.0	-FH45
		14.1 - 15.0	-FH46
		15.1 - 16.1	-FH47
		16.2 - 17.3	-FH48
		17.4 - 18.6	-FH49
		18.7 - 20.0	-FH50
		20.1 - 21.5	-FH51
		21.6 - 23.2	-FH52
		23.3 - 25.0	-FH53
		25.1 - 26.8	-FH54

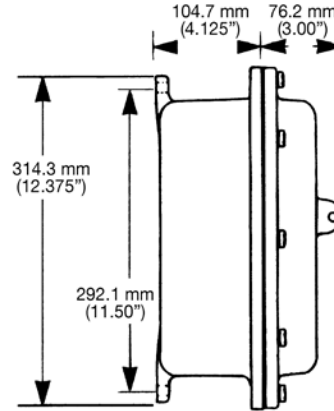

Side View

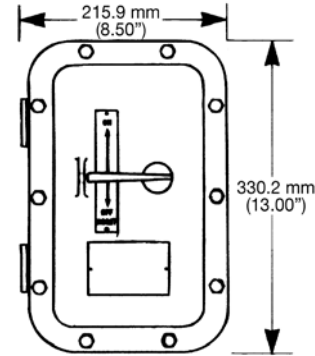

Cover View

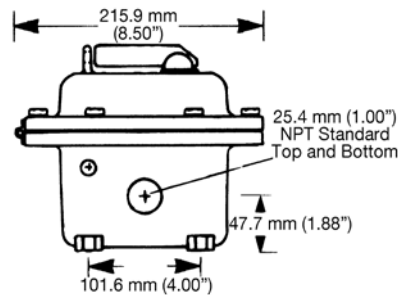

Bottom View

■ Square D is a registered trademark of Schneider Electric.
 † Cutler-Hammer is a registered trademark of Eaton Corporation.

EDS Series Factory Sealed Manual Motor Starters and Contactors

Explosionproof, Dust-Ignitionproof

NEC/CEC:

Class I, Division 1 and 2, Groups C, D
Class II, Division 1 and 2, Groups E, F, G
Class III
NEMA 3, 3R, 7CD, 9EFG

Applications

- Manual motor starters are available to meet any plant installation requirement.
- They may be used to install a variety of electrical wiring devices and comes complete with covers and dead-end or feed-thru hub arrangements. Available with or without heater.
- Complete units are ideal for manual starting of small Vac or Vdc motors in locations made hazardous by the presence of flammable vapors, gases or combustible dust.

Features

- Easily readable operator handle with provisions for padlocking in the ON or OFF position.
- Cast in hubs.
- Interchangeable heater units.

Standard Materials

- Body and cover: malleable iron
- Sealing chamber: copperfree (4/10 of 1% max.) aluminum
- Operating handle: nylon

Standard Finishes

- Body and cover: gray epoxy powder coat

Options

- For Aluminum Backbox and Cover add suffix **-A**.
- Starters are furnished with one interchangeable heater. Select heater number from heater selection table and add appropriate suffix to catalog number. For example, a complete catalog number with Allen-Bradley ◀ motor starter and Allen-Bradley ◀ 0-17 amp heater: EDS150-1MSAB-AB1.

NEC/CEC Certifications and Compliances

- UL Standards: UL 508, UL 698, UL 1203
- CSA Standards: C22.2 No 14-M, C22.2 No. 25, C22.2 No. 30
- cULus Listed: E76550, E81751



1-Gang
Dead-End



2-Gang
Feed-Thru

CONTROLS: NEC/CEC EXPLOSIONPROOF MOTOR STARTERS

Appleton

◀ Allen-Bradley is a registered trademark of Rockwell Automation.

EDS Series Factory Sealed Manual Motor Starters and Contactors

Explosionproof, Dust-Ignitionproof

NEC/CEC:
 Class I, Division 1 and 2, Groups C, D
 Class II, Division 1 and 2, Groups E, F, G
 Class III
 NEMA 3, 3R, 7CD, 9EFG



Factory Sealed Manual Motor Starters

Poles	Hub Size (Inches)	Catalog Number Cover/Chamber/Device		1-Gang Catalog Number ②		2-Gang Catalog Number ②	
		Allen Bradley ◀ ①	Cutler-Hammer + ①	Dead-End	Feed-Thru	Dead-End	Feed-Thru
1	1/2			EDS150-1MS	EDSC150-1MS	EDS250-1MS	EDSC250-1MS
	3/4	EDK1MSAB	EDK1MSW	EDS175-1MS	EDSC175-1MS	EDS275-1MS	EDSC275-1MS
	1			EDS110-1MS	EDSC110-1MS	EDS210-1MS	EDSC210-1MS
2	1/2			EDS150-2MS	EDSC150-2MS	EDS250-2MS	EDSC250-2MS
	3/4	EDK2MSAB	EDK2MSW	EDS175-2MS	EDSC175-2MS	EDS275-2MS	EDSC275-2MS
	1			EDS110-2MS	EDSC110-2MS	EDS210-2MS	EDSC210-2MS

Manual Motor Starter Horsepower Ratings

Poles	120-240 Vac	32 Vdc	120 Vdc	240 Vdc	Allen-Bradley ◀ Catalog Number	Cutler-Hammer + Catalog Number
1	1 HP	—	—	—	Bulletin 600	—
2	1 HP	—	3/4 HP	3/4 HP	Bulletin 600	—
1	1 HP	1/4 HP	—	1/4 HP	—	MST01
2	1 HP	1/4 HP	1 HP	1 HP	—	MST02

EFD Non-Factory Sealed Manual Contactors — No Heater Options

Poles	Hub Size (Inches)	Catalog Numbers		Description	Switch Ratings
		Dead-End	Feed-Thru		
2	1/2	EFD150-2MS	EFDC150-2MS	SQUARE D Class 2510, Type KO-1	30 Amp, 250 Vac/Vdc; 20 Amp, 600 Vac; 1 HP, 115 Vac; 2 HP, 230 Vac; 3 HP, 460-575 Vac
	3/4	EFD175-2MS	EFDC175-2MS		
	1	EFD110-2MS	EFDC110-2MS		
3	1/2	EFD150-3MS	EFDC150-3MS	ARROW-HART AH7810-UD	30 Amp, 600 Vac; 3 HP, 120 Vac; 7-1/2 HP, 240 Vac; 15 HP, 480 Vac; 15 HP 600 Vac
	3/4	EFD175-3MS	EFDC175-3MS		
	1	EFD110-3MS	EFDC110-3MS		

Non-Factory Sealed Components

Poles	Description	Catalog Number
—	Cover only	EFKMSQ
2	Device only	EFS2MSQ
3	Device only	EFS3MSQ

+ Cutler-Hammer is a registered trademark of Eaton Corporation.

◀ Allen-Bradley is a registered trademark of Rockwell Automation.

① For heaters, see following page.

② **Ordering Instructions:** Add suffix **-AB** to catalog number for Allen-Bradley motor starter; add suffix **-W** for Cutler-Hammer motor starter. Starters are furnished with one interchangeable heater. Select heater number from heater selection table and add appropriate suffix to catalog number. For example, a complete catalog number with Allen-Bradley motor starter and Allen-Bradley heater: **EDS150-1MSAB-AB1**. For Aluminum Backbox and Cover add suffix **-A**.

EDS Series Factory Sealed Manual Motor Starter and Contactor Heaters

Allen-Bradley and Cutler-Hammer heaters and starters are not interchangeable with each other.

NEC/CEC:

Class I, Division 1, Groups C, D
 Class I, Division 2, Groups B, C, D
 Class II, Division 1 and 2, Groups E, F, G
 Class III
 NEMA 3, 3R, 7CD, 9EFG

The "Full Load Motor Current" listed in the tables below are ratings which determine the proper heat element that should be used with the EDS Series starters. Refer to motor nameplate for its full load motor current. It is our recommendation that for normal conditions the heater element selected should have a capacity of 20 to 25% greater than the full load current of the motor. This applies to standard +40 °C (+104 °F) temperature rise motors. For +50 °C (+122 °F) rise motors, a heater not greater than 115% full load current should be selected.

However, due to the difference between full load motor currents of various motor manufacturers of the same size motors, the above information is approximate.

If selection of heater element is uncertain as might be in the case of a motor subject to frequent starting and intermittent load, it is advisable to contact the starter manufacturer or his local representative giving full particulars, such as motor horsepower, voltage, phase cycles, name or manufacturer or pertinent data that may aid in the selection of the proper heater element.

Allen-Bradley ◀

Full Load Motor Current (Amp)	Add Suffix EDS
0.17	-AB1
0.21	-AB2
0.25	-AB3
0.32	-AB4
0.39	-AB5
0.46	-AB6
0.57	-AB7
0.71	-AB8
0.79	-AB9
0.87	-AB10
0.98	-AB11
1.08	-AB12
1.19	-AB13
1.30	-AB14
1.43	-AB15
1.58	-AB16
1.75	-AB17
1.88	-AB18
2.13	-AB19
2.40	-AB20
2.58	-AB21
2.92	-AB22
3.09	-AB23
3.32	-AB24
3.77	-AB25
4.16	-AB26
4.51	-AB27
4.93	-AB28
5.43	-AB29
6.03	-AB30
6.83	-AB31
7.72	-AB32
8.24	-AB33
8.90	-AB34
9.60	-AB35
10.80	-AB36
12.00	-AB37
13.50	-AB38
15.20	-AB39

Cutler-Hammer †

Full Load Motor Current (Amp)	Heater Rating (Amp)	Add Suffix EDS
0.40-0.43	0.50	-WH1
0.44-0.48	0.55	-WH2
0.49-0.53	0.61	-WH3
0.54-0.58	0.67	-WH4
0.59-0.64	0.74	-WH5
0.65-0.71	0.81	-WH6
0.72-0.78	0.89	-WH7
0.79-0.87	0.98	-WH8
0.88-0.95	1.10	-WH9
0.96-1.03	1.20	-WH10
1.04-1.15	1.30	-WH11
1.16-1.27	1.45	-WH12
1.28-1.35	1.60	-WH13
1.36-1.51	1.70	-WH14
1.52-1.67	1.90	-WH15
1.68-1.83	2.10	-WH16
1.84-1.99	2.30	-WH17
2.00-2.23	2.50	-WH18
2.24-2.47	2.80	-WH19
2.48-2.71	3.10	-WH20
2.72-2.95	3.40	-WH21
2.96-3.27	3.70	-WH22
3.28-3.59	4.10	-WH23
3.60-3.99	4.50	-WH24
4.00-4.39	5.00	-WH25
4.40-4.79	5.50	-WH26
4.80-5.26	6.00	-WH27
5.27-5.83	6.60	-WH28
5.84-6.39	7.30	-WH29
6.40-7.03	8.00	-WH30
7.07-7.74	8.80	-WH31
7.75-8.46	9.70	-WH32
8.47-9.35	10.60	-WH33
9.36-10.30	11.70	-WH34
10.31-11.35	12.90	-WH35
11.36-12.47	14.20	-WH36
12.48-13.67	15.60	-WH37
13.68-15.12	17.10	-WH38
15.13-16.00	18.60	-WH39

† Cutler-Hammer is a registered trademark of Eaton Corporation.

◀ Allen-Bradley is a registered trademark of Rockwell Automation.

CONTROLS: NEC/CEC EXPLOSIONPROOF MOTOR STARTERS

Appleton®

EFD Mounting Bodies for EDS Series Factory Sealed Motor Starters

Explosionproof, Dust-Ignitionproof





Furnished with Internal Ground Screw.

NEC/CEC:

Class I, Division 1, Groups C, D
 Class I, Division 2, Groups B, C, D
 Class II, Division 1 and 2, Groups E, F, G
 Class III
 NEMA 3, 3R, 7CD, 9EFG

CONTROLS: NEC/CEC EXPLOSIONPROOF MOTOR STARTERS

Appleton

	Type	Hub Size (Inches)	Catalog Number	
			Malleable Iron	Aluminum
1-Gang				
	Dead-End	1/2	EFD150NLQ	EFD150ANLQ
		3/4	EFD175NLQ	EFD175ANLQ
		1	EFD110NLQ	EFD110ANLQ
	Feed-Thru	1/2	EFDC150NLQ	EFDC150ANLQ
		3/4	EFDC175NLQ	EFDC175ANLQ
		1	EFDC110NLQ	EFDC110ANLQ
2-Gang				
	Dead-End	1/2	EFD250NLQ	EFD250ANLQ
		3/4	EFD275NLQ	EFD275ANLQ
		1	EFD210NLQ	EFD210ANLQ
	Feed-Thru	1/2	EFDC250NLQ	EFDC250ANLQ
		3/4	EFDC275NLQ	EFDC275ANLQ
		1	EFDC210NLQ	EFDC210ANLQ
Tandem ①				
	Dead-End	1/2	EFDT50NLQ	—
		3/4	EFDT75NLQ	—
		1	EFDT10NLQ	—
	Feed-Thru	1/2	EFDC75NLQ	—
		3/4	EFDC75NLQ	—
		1	EFDC75NLQ	—
Blank Bodies for Brazed Hubs				
	1-Gang		EFD1NL	
	2-Gang		EFD2NL	
	3-Gang		EFD3NL	
	4-Gang		EFD4NL	
	5-Gang		EFD5NL	

① For tandem bodies, external seals must be installed within 1.5 meters (5 feet) of each conduit entrance for Class I, Groups C and D.

EFD Cast Device Boxes; Blank Bodies for Brazed Threaded Hubs

Ordering Information

1-, 2-, 3-, 4- and 5-Gang Boxes. Brazed Threaded Hubs for Rigid Conduit, 1/2" thru 1"; Brazed Union Hubs, 1/2" thru 1".

NEC/CEC:

Class I, Division 1, Groups C, D
 Class I, Division 2, Groups B, C, D
 Class II, Division 1 and 2, Groups E, F, G
 Class III
 NEMA 3, 3R, 7CD, 9EFG

Determine catalog number as follows:

- (1) Select EFD device box catalog number;
- (2) Select "Standard Hub Arrangement Diagram" number; and
- (3) Select symbols that represent hub sizes from "Symbol Table." (Use "0" where no hub is required, and separate the various divisions of the complete catalog number by dashes.)

Example

The blank body device box selected is EFD3NL and the hub arrangement is diagram #8. Hub "a" is to be 3/4" brazed threaded; hub "b", 1" brazed threaded; hub "c", 3/4" brazed threaded; hub "d", no hub is required; and hub "e", 1" brazed union.

The complete catalog number will be:
EFD-3NL-8-23203E

If a "Standard Hub Arrangement" is not suitable for the application, or when hubs are to be more accurately spaced, submit sketch locating hubs (1) from centerlines of walls and (2) from outside back of box (or from mounting lug surface if lugs are supplied).

All hubs will be located in centerlines of walls and evenly spaced unless otherwise specified.

Symbol Table

Hub Size (Inches)	Brazed Threaded Hub Symbol	Brazed Union Hub Symbol
Blank	0	0
1/2	1	1E
3/4	2	2E
1	3	3E

Standard Hub Arrangement Diagrams

Hub "a" is always TOP of box

2-, 3-, 4- and 5-Gang (Front View)

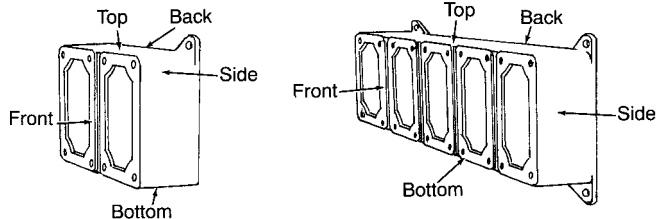
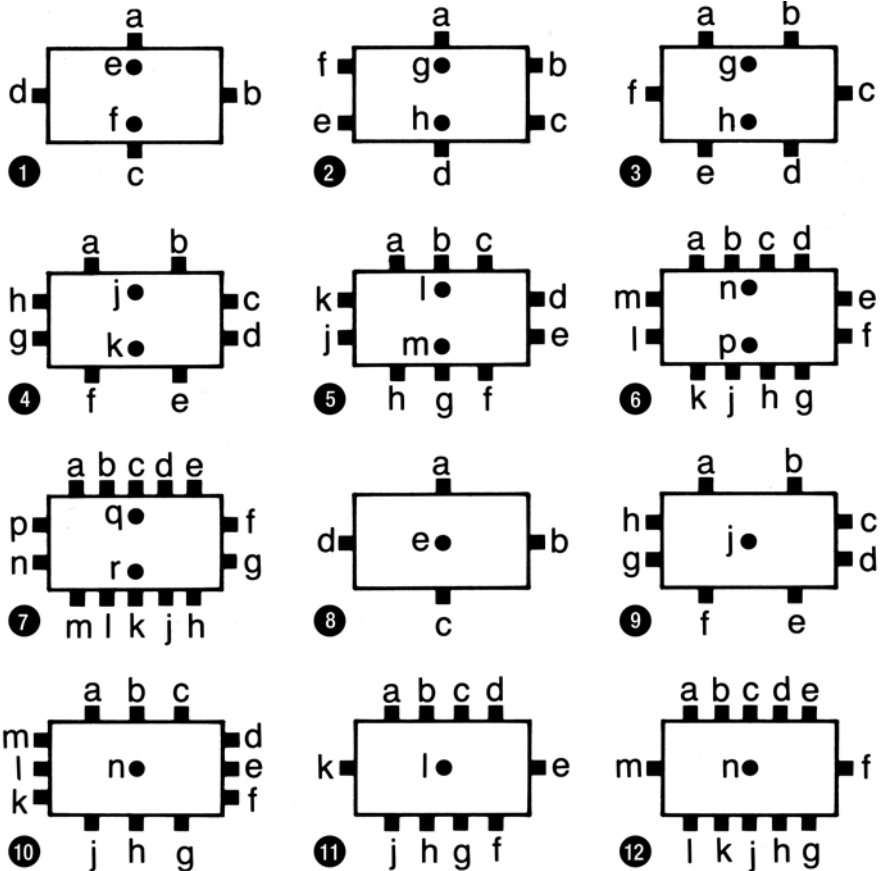

1-Gang (Front View)

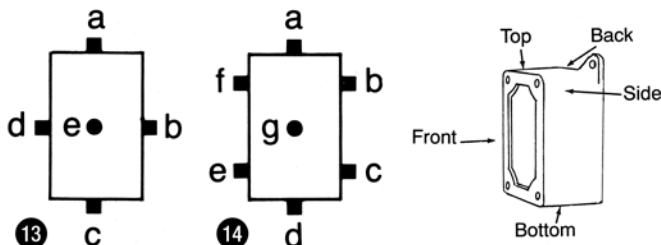

CONTROLS: NEC/CEC EXPLOSIONPROOF MOTOR STARTERS

Appleton

EDS Series Factory Sealed Manual Motor Starters and Contactors

Explosionproof, Dust-Ignitionproof

NEC/CEC:

Class I, Division 1, Groups C, D
 Class I, Division 2, Groups B, C, D
 Class II, Division 1 and 2, Groups E, F, G
 Class III
 NEMA 3, 3R, 7CD, 9EFG

Dimensions in Millimeters (Inches)

1-Gang and 2-Gang

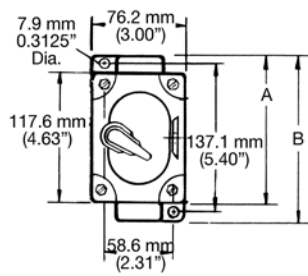

1-Gang Front

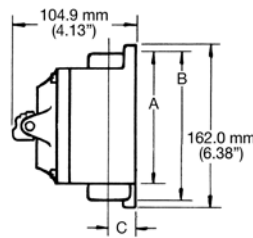

1- and 2-Gang Side

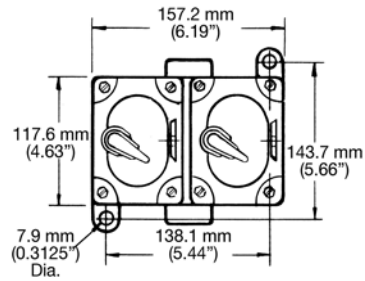

2-Gang Front

CONTROLS: NEC/CEC EXPLOSIONPROOF MOTOR STARTERS

Hub Size (Inches)	Dimensions in Millimeters (Inches)		
	A	B	C
1/2	153.9 (6.06)	172.9 (6.81)	19.0 (0.75)
3/4	153.9 (6.06)	172.9 (6.81)	22.3 (0.88)
1	156.7 (6.17)	178.5 (7.03)	25.4 (1.00)

Contender™ Series Factory Sealed Manual Motor Starters and Contactors

Explosionproof, Dust-Ignitionproof

NEC/CEC:

Class I, Division 1 and 2, Groups C, D
Class II, Division 1 and 2, Groups E, F, G
Class III
NEMA 3, 7CD, 9EFG

Applications

- Manual motor starters are available to meet any plant installation requirement.
- They may be used to install a variety of electrical wiring devices and comes complete with covers and dead-end or feed-thru hub arrangements. Available with or without the heater.
- Complete units are ideal for manual starting of small Vac or Vdc motors in locations made hazardous by the presence of flammable vapors, gases or combustible dust.

Features

- Easily readable operator handle with provisions for padlocking in the ON or OFF position.
- Cast in hubs.
- Interchangeable heater units.

Standard Materials

- Body and cover: malleable iron
- Sealing chamber: copperfree (4/10 of 1% max.) aluminum
- Operating handle: nylon

Standard Finishes

- Body and cover: gray epoxy powder coat

Options

- For Aluminum Backbox and Cover add suffix **-SA**.
- Starters are furnished with one interchangeable heater. Select heater number from heater selection table and add appropriate suffix to catalog number. For example, a complete catalog number with Allen-Bradley ◀ motor starter and Allen-Bradley ◀ 0-17 amp heater: EPS2199-P1.

NEC/CEC Certifications and Compliances

- UL Standards: UL 508, UL 698, UL 1203,
- CSA Standards: CSA C22.2 No. 14-M, C22.2 No. 25, C22.2 No. 30
- cULus Listed: E81751, E76550



1-Gang
Dead-End



2-Gang
Feed-Thru

CONTROLS: NEC/CEC EXPLOSIONPROOF MOTOR STARTERS

Appleton

◀ Allen-Bradley is a registered trademark of Rockwell Automation.

Contender™ Series Factory Sealed Manual Motor Starters and Contactors

Explosionproof, Dust-Ignitionproof

NEC/CEC:
 Class I, Division 1 and 2, Groups C, D
 Class II, Division 1 and 2, Groups E, F, G
 Class III
 NEMA 3, 7CD, 9EFG



Factory Sealed Manual Motor Starters with Cutler-Hammer + Devices

Poles	Hub Size (Inches)	Catalog Number Cover/Chamber/Device	1-Gang Catalog Number ①		2-Gang Catalog Number ①	
			Dead-End	Feed-Thru	Dead-End	Feed-Thru
1	1/2	EDSK-1MSW	EDS11101	EDSC11101	—	—
	3/4		EDS21101	EDSC21101	EDS22101	EDSC22101
	1		EDS31101	EDSC31101	EDS32101	EDSC32101
2	1/2	EDSK-2MSW	EDS11102	EDSC11102	—	—
	3/4		EDS21102	EDSC21102	EDS22102	EDSC22102
	1		EDS31102	EDSC31102	EDS32102	EDSC32102

Manual Motor Starter Horsepower Ratings

Poles	120–240 Vac	32 Vdc	120 Vdc	240 Vdc	Cutler-Hammer + Catalog Number
1	1 HP	1/4 HP	—	1/4 HP	MST01
2	1 HP	1/4 HP	1 HP	1 HP	MST02



Factory Sealed Motor Rated Switches — No Heater Options

Poles	Hub Size (Inches)	Catalog Number Cover/Chamber/Device	1-Gang Catalog Number		2-Gang Catalog Number	
			Dead-End	Feed-Thru	Dead-End	Feed-Thru
2	1/2	EDSK-MC2	EDS11MC2	EDSC11MC2	—	—
	3/4		EDS21MC2	EDSC21MC2	EDS22MC2	EDSC22MC2
	1		EDS31MC2	EDSC31MC2	EDS32MC2	EDSC32MC2
3	1/2	EDSK-MC3	EDS11MC3	EDSC11MC3	—	—
	3/4		EDS21MC3	EDSC21MC3	EDS22MC3	EDSC22MC3
	1		EDS31MC3	EDSC31MC3	EDS32MC3	EDSC32MC3

Manual Contactor Switch Ratings

Poles	Description	Rating
2	Square D – Class 2510, Type KO-1	30 Amp, 250 Vac/Vdc; 20 Amp, 600 Vac; 1 HP, 115 Vac; 2 HP, 230 Vac; 3 HP, 460-575 Vac
3	Arrow-Hart – AH7810-UD	30 Amp, 600 Vac; 3 HP, 120 Vac; 7-1/2 HP, 240 Vac; 15 HP, 480 Vac; 15 HP 600 Vac

+ Cutler-Hammer is a registered trademark of Eaton Corporation.

① **Ordering Instructions:** Starters and starter cover assemblies are furnished with one interchangeable heater. Select heater number from heater selection table and add appropriate suffix to catalog number. For example, a complete catalog number with Cutler-Hammer motor starter and Cutler-Hammer heater: EDS11101-W1. Available in aluminum — add suffix -SA.

CONTROLS: NEC/CEC EXPLOSIONPROOF MOTOR STARTERS

Appleton®

Contender™ Series Factory Sealed Manual Motor Starters

Explosionproof, Dust-Ignitionproof

NEC/CEC:
 Class I, Division 1 and 2, Groups C, D
 Class II, Division 1 and 2, Groups E, F, G
 Class III
 NEMA 3, 7CD, 9EFG



Factory Sealed Manual Motor Starters with Allen-Bradley ◀ 600 Devices

Poles	Hub Size (Inches)	Catalog Number Cover/Chamber/Device	1-Gang Catalog Number ①		2-Gang Catalog Number ①	
			Dead-End	Feed-Thru	Dead-End	Feed-Thru
1	1/2	EDSK-1MSAB ①	EDS1199	EDSC1199	—	—
	3/4		EDS2199	EDSC2199	EDS2299	EDSC2299
	1		EDS3199	EDSC3199	EDS3299	EDSC3299
2	1/2	EDSK-2MSAB ①	EDS11100	EDSC11100	—	—
	3/4		EDS21100	EDSC21100	EDS22100	EDSC22100
	1		EDS31100	EDSC31100	EDS32100	EDSC32100

Manual Motor Starter Horsepower Ratings

Poles	120–240 Vac	32 Vdc	120 Vdc	240 Vdc	Allen-Bradley ◀ Catalog Number
1	1 HP	—	—	—	Bulletin 600
2	1 HP	—	3/4 HP	3/4 HP	Bulletin 600

CONTROLS: NEC/CEC EXPLOSIONPROOF MOTOR STARTERS

Appleton®

◀ Allen-Bradley is a registered trademark of Rockwell Automation.

① **Ordering Instructions:** Starters are furnished with one interchangeable heater. Select heater number from heater selection table and add appropriate suffix to catalog number. For example, a complete catalog number with an Allen-Bradley motor starter and an Allen-Bradley heater: **EDS1199-P5**. Available in aluminum; add suffix **-SA**.

Contender™ Series Factory Sealed Manual Motor Starter and Contactor Heaters

Allen-Bradley ◀ and Cutler-Hammer † heaters and starters are not interchangeable with each other.

NEC/CEC:

Class I, Division 1 and 2, Groups C, D
 Class II, Division 1 and 2, Groups E, F, G
 Class III
 NEMA 3, 7CD, 9EFG

The "Full Load Motor Current" listed in the tables below are ratings which determine the proper heat element that should be used with the EDS Series starters. Refer to motor nameplate for its full load motor current. It is our recommendation that for normal conditions the heater element selected should have a capacity of 20 to 25% greater than the full load current of the motor. This applies to standard +40 °C (+104 °F) temperature rise motors. For +50 °C (+122 °F) rise motors, a heater not greater than 115% full load current should be selected.

However, due to the difference between full load motor currents of various motor manufacturers of the same size motors, the above information is approximate.

If selection of heater element is uncertain as might be in the case of a motor subject to frequent starting and intermittent load, it is advisable to contact the starter manufacturer or his local representative giving full particulars, such as motor horsepower, voltage, phase cycles, name or manufacturer or pertinent data that may aid in the selection of the proper heater element.

CONTROLS: NEC/CEC EXPLOSIONPROOF MOTOR STARTERS

Appleton®

Allen-Bradley ◀

Full Load Motor Current (Amp)	Add Suffix Contender/EDS
0.17	P1
0.21	P2
0.25	P3
0.32	P4
0.39	P5
0.46	P6
0.57	P7
0.71	P8
0.79	P9
0.87	P10
0.98	P11
1.08	P12
1.19	P13
1.30	P14
1.43	P15
1.58	P16
1.75	P17
1.88	P18
2.13	P19
2.40	P20
2.58	P21
2.92	P22
3.09	P23
3.32	P24
3.77	P25
4.16	P26
4.51	P27
4.93	P28
5.43	P29
6.03	P30
6.83	P31
7.72	P32
8.24	P33
8.90	P34
9.60	P35
10.80	P36
12.00	P37
13.50	P38
15.20	P39

Cutler-Hammer †



Full Load Motor Current (Amp)	Heater Rating (Amp)	Add Suffix Contender
0.40-0.43	0.50	W1
0.44-0.48	0.55	W2
0.49-0.53	0.61	W3
0.54-0.58	0.67	W4
0.59-0.64	0.74	W5
0.65-0.71	0.81	W6
0.72-0.78	0.89	W7
0.79-0.87	0.98	W8
0.88-0.95	1.10	W9
0.96-1.03	1.20	W10
1.04-1.15	1.30	W11
1.16-1.27	1.45	W12
1.28-1.35	1.60	W13
1.36-1.51	1.70	W14
1.52-1.67	1.90	W15
1.68-1.83	2.10	W16
1.84-1.99	2.30	W17
2.00-2.23	2.50	W18
2.24-2.47	2.80	W19
2.48-2.71	3.10	W20
2.72-2.95	3.40	W21
2.96-3.27	3.70	W22
3.28-3.59	4.10	W23
3.60-3.99	4.50	W24
4.00-4.39	5.00	W25
4.40-4.79	5.50	W26
4.80-5.26	6.00	W27
5.27-5.83	6.60	W28
5.84-6.39	7.30	W29
6.40-7.03	8.00	W30
7.07-7.74	8.80	W31
7.75-8.46	9.70	W32
8.47-9.35	10.60	W33
9.36-10.30	11.70	W34
10.31-11.35	12.90	W35
11.36-12.47	14.20	W36
12.48-13.67	15.60	W37
13.68-15.12	17.10	W38
15.13-16.00	18.60	W39

† Cutler-Hammer is a registered trademark of Eaton Corporation.
 ◀ Allen-Bradley is a registered trademark of Rockwell Automation.

Contender™ Series Factory Sealed Manual Motor Starter Mounting Bodies

Explosionproof, Dust-Ignitionproof

NEC/CEC:
 Class I, Division 1, Groups C, D
 Class I, Division 2, Groups B, C, D
 Class II, Division 1 and 2, Groups E, F, G
 Class III

	Type	Hub Size (Inches)	Catalog Number	
			Malleable Iron	Aluminum
1-Gang				
	Dead-End	1/2	EDS171	EDS171-SA
		3/4	EDS271	EDS271-SA
		1	EDS371	EDS371-SA
	Feed-Thru	1/2	EDSC171	EDSC171-SA
		3/4	EDSC271	EDSC271-SA
		1	EDSC371	EDSC371-SA
2-Gang				
	Dead-End	1/2	EDS172	EDS172-SA
		3/4	EDS272	EDS272-SA
		1	EDS372	EDS372-SA
	Feed-Thru	1/2	EDSC172	EDSC172-SA
		3/4	EDSC272	EDSC272-SA
		1	EDSC372	EDSC372-SA
Tandem ①				
	Dead-End	1/2	EDS177	EDS177-SA
		3/4	EDS277	EDS277-SA
		1	EDS377	EDS377-SA
	Feed-Thru	1/2	EDSC177	EDSC177-SA
		3/4	EDSC277	EDSC277-SA
		1	EDSC377	EDSC377-SA

CONTROLS: NEC/CEC EXPLOSIONPROOF MOTOR STARTERS



① For tandem bodies, external seals must be installed within 1.5 meters (5 feet) of each conduit entrance for Class I, Groups C and D.

Contender™ Series Factory Sealed Manual Motor Starter and Contactor

Explosionproof, Dust-Ignitionproof

NEC/CEC:
 Class I, Division 1 and 2, Groups C, D
 Class II, Division 1 and 2, Groups E, F, G
 Class III
 NEMA 3, 7CD, 9EFG

Dimensions in Millimeters (Inches)

1-Gang and 2-Gang

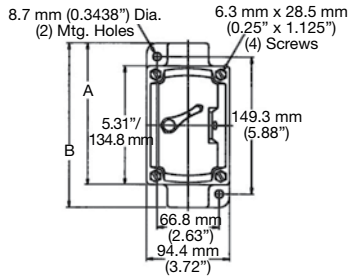

1-Gang Front

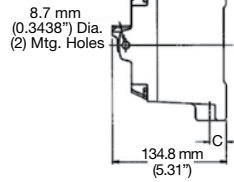

1- 2- Gang Side

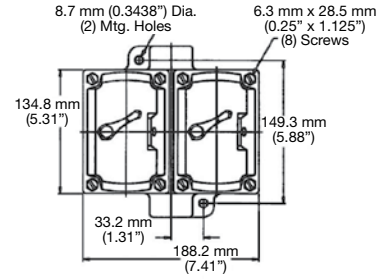

2-Gang Front

Hub Size (Inches)	Dimensions in Millimeters (Inches)		
	A	B	C
1/2	153.9 (6.06)	172.9 (6.81)	19.0 (0.75)
3/4	153.9 (6.06)	172.9 (6.81)	22.3 (0.88)
1	156.7 (6.17)	178.5 (7.03)	25.4 (1.00)

CONTROLS: NEC/CEC EXPLOSIONPROOF MOTOR STARTERS

Appleton®

Intraground™ N1 Series Nonmetallic Manual Motor Starters

Explosionproof

UNILETS™ for Use with Threaded Metal Conduit.

NEC:

Class I, Division 1 and 2, Groups C, D
NEMA 3, 4X, 7CD ①, 12

Applications

- Listed for use in Class I, Groups C and D, Division 1 and 2 atmospheres, such as:
 - Diethyl ether
 - Methyl ethyl ketone
 - Acetone
 - Toluene
 - No. 3 fuel oil
 - Ammonium hydroxide (20%)
 - Benzene
 - Regular unleaded gas
 - Ethyl acetate
 - Hexane
 - Methanol
- Not suitable for ethylene dichloride and partially halogenated hydrocarbons. Sealing fittings must be field installed adjacent to enclosure on all conduit runs.
- Explosionproof. With sealing fittings installed at each conduit entrance, the N1 Series enclosures withstood a hydrostatic test of four times the maximum internal explosion pressure that could be developed from a gas or vapor explosion.

Features

- Nonmetallic construction with metal imbedded grounding grid. No need to install special wires and parts for grounding. Feed-thru and dead-end styles are grounded through 1/2" or 3/4" threaded conduit openings.
- Special grounding wire furnished with each box provides safe grounding when cover is removed.
- Ideal for use in corrosive environments. Nonmetallic enclosures with corrosion resistant parts coated with epoxy. Teflon® ② or Mylar® ② these motor starters offer unsurpassed resistance to chemicals.
- Unique labyrinth-path construction assures flame-tight joint between body and cover.
- Silicone gasket, specially designed for the labyrinth-path joint, prevents entrance of moisture without interfering with the venting of cooled hazardous gases and vapors.
- Typical mechanical properties of 24,500 psi tensile strength, 3% elongation at break, 33,000 psi flexural strength, and 1,200,000 psi flexural modulus.
- Electrical properties of sample specimens: dielectric strength (in air) of 769 at 1/16".
- High strength thermoplastic polyetherimide, together with thick wall (5/16") and sound structural design (rounded corners) provides superior resistance to impact and crushing.
- Excellent resistance to ultraviolet light and water. After 336 hours of immersion in water at +82 °C (+180 °F) and 720 hours of exposure to ultraviolet radiation, there was no appreciable change in tensile strength.
- Excellent conduit connection strength. UL pull-out and bending resistance tests resulted in no effect on conduit connections.
- Excellent resistance to attack by fungi and mold.
- UL Temperature Index (continuous use temperature): +170 °C (+338 °F) electrical properties, +170 °C (+338 °F) mechanical properties with impact.
- Superior flammability resistance.



Standard Materials

- Body and cover: 30% glass-reinforced thermoplastic polyetherimide
- Handle: Nylon 6/6
- Cover bolts: stainless steel
- Gasket: silicone
- Nameplates: aluminum

Standard Finishes

- Cover bolts: Teflon® ②
- Nameplates: Mylar® ②

NEC Certifications and Compliances

- UL Standards: UL 508, UL 698, UL 1203
- UL Listed: E76550

Product Cross Reference

- For classified-location push button, pilot light and selector switch control stations, see *Controls Section*.
- Sealing fittings not furnished. See *Hazardous Location Fittings Section*.

① Sealing fittings must be field installed adjacent to enclosure on all conduit runs.

② Teflon and Mylar are registered trademarks of E. I. du Pont de Nemours and Company.

Intraground™ N1 Series Nonmetallic Manual Motor Starters

Explosionproof

Enclosures and Covers Have Neutral Color. Non-Factory Sealed.

NEC:
Class I, Division 1 and 2, Groups C, D
NEMA 3, 4X, 7CD ①, 12



Dead-End



Feed-Thru

N1 Series Manual Motor Starters — Order Heaters From Following Page ③

Poles	Hub Size (Inches) ②	Starter	Catalog Number	
			Dead-End	Feed-Thru
1	1/2 or 3/4	Allen-Bradley	N1D75-1MSAB	N1DC75-1MSAB
1	1/2 or 3/4	Cutler-Hammer	N1D75-1MSW	N1DC75-1MSW
2	1/2 or 3/4	Allen-Bradley	N1D75-2MSAB	N1DC75-2MSAB
2	1/2 or 3/4	Cutler-Hammer	N1D75-2MSW	N1DC75-2MSW

N1 Series Manual Motor Starters without Overload Protection — No Heater Required

Poles	Hub Size (Inches) ②	Starter Furnished	Catalog Number	
			Dead-End	Feed-Thru
2	1/2 or 3/4	Square D	N1D75-2MS	N1DC75-2MS
3	1/2 or 3/4	Bryant	N1D75-3MS	N1DC75-3MS

N1 Series Manual Motor Starters Horsepower Ratings

Allen-Bradley ◀ Catalog Number	Poles	Voltage				Heaters
		115-230 Vac	32 Vdc	115 Vdc	230 Vdc	
Bulletin 600	1	1 HP	—	—	—	(See Following Page)
Bulletin 600	2	1 HP	—	3/4 HP	3/4 HP	(See Following Page)

Cutler-Hammer ⇄ Catalog Number	Poles	Voltage				Heaters
		120-240 Vac	32 Vdc	120 Vdc	240 Vdc	
MST01	1	1 HP	1/4 HP	—	1/4 HP	(See Following Page)
MST02	2	1 HP	1/4 HP	1 HP	1 HP	(See Following Page)

N1 Series Manual Motor Starters without Overload Protection Horsepower Ratings

2-Poles	Rating	3-Poles	Rating
	30 Amp, 250 Vac/Vdc		30 Amp, 600 Vac
Square D	20 Amp, 600 Vac		3HP 120 Vac
Class 2510	1HP 115 Vac	Bryant	7-1/2HP 240 Vac
Type KO-1	2HP 230 Vac	7810-UD	15HP 480 Vac
	3HP 460-575 Vac		15HP 600 Vac

⇄ Cutler-Hammer is a registered trademark of Eaton Corporation.

◀ Allen-Bradley is a registered trademark of Rockwell Automation.

① Sealing fittings must be field installed adjacent to enclosure on all conduit runs.

② Furnished with 3/4" to 1/2" reducer.

③ Starters are furnished with one interchangeable heater. See following page for Heaters. Select heater number from heater selection table and add appropriate suffix to catalog number. For example, a complete catalog number with Allen-Bradley heater: **N1D75-1MSAB-AB1**.

Intraground™ N1 Series Nonmetallic Manual Motor Starter Heaters

Allen-Bradley ◀ and Cutler-Hammer ⚡ heaters and starters are not interchangeable with each other.

NEC:
Class I, Division 1 and 2, Groups C, D
NEMA 3, 4X, 7CD ①, 12

The "Full Load Motor Current" listed in the tables below are ratings which determine the proper heat element that should be used with the EDS Series starters. Refer to motor nameplate for its full load motor current. It is our recommendation that for normal conditions the heater element selected should have a capacity of 20 to 25% greater than the full load current of the motor. This applies to standard +40 °C (+104 °F) temperature rise motors. For +50 °C (+122 °F) rise motors, a heater not greater than 115% full load current should be selected.

However, due to the difference between full load motor currents of various motor manufacturers of the same size motors, the above information is approximate.

If selection of heater element is uncertain as might be in the case of a motor subject to frequent starting and intermittent load, it is advisable to contact the starter manufacturer or his local representative giving full particulars, such as motor horsepower, voltage, phase cycles, name or manufacturer or pertinent data that may aid in the selection of the proper heater element.

Allen-Bradley ◀

Full Load Motor Current (Amp)	Add Suffix N1
0.17	-AB1
0.21	-AB2
0.25	-AB3
0.32	-AB4
0.39	-AB5
0.46	-AB6
0.57	-AB7
0.71	-AB8
0.79	-AB9
0.87	-AB10
0.98	-AB11
1.08	-AB12
1.19	-AB13
1.30	-AB14
1.43	-AB15
1.58	-AB16
1.75	-AB17
1.88	-AB18
2.13	-AB19
2.40	-AB20
2.58	-AB21
2.92	-AB22
3.09	-AB23
3.32	-AB24
3.77	-AB25
4.16	-AB26
4.51	-AB27
4.93	-AB28
5.43	-AB29
6.03	-AB30
6.83	-AB31
7.72	-AB32
8.24	-AB33
8.90	-AB34
9.60	-AB35
10.80	-AB36
12.00	-AB37
13.50	-AB38
15.20	-AB39

Cutler-Hammer ⚡

Full Load Motor Current (Amp)	Heater Rating (Amp)	Add Suffix N1
0.40-0.43	0.50	-WH1
0.44-0.48	0.55	-WH2
0.49-0.53	0.61	-WH3
0.54-0.58	0.67	-WH4
0.59-0.64	0.74	-WH5
0.65-0.71	0.81	-WH6
0.72-0.78	0.89	-WH7
0.79-0.87	0.98	-WH8
0.88-0.95	1.10	-WH9
0.96-1.03	1.20	-WH10
1.04-1.15	1.30	-WH11
1.16-1.27	1.45	-WH12
1.28-1.35	1.60	-WH13
1.36-1.51	1.70	-WH14
1.52-1.67	1.90	-WH15
1.68-1.83	2.10	-WH16
1.84-1.99	2.30	-WH17
2.00-2.23	2.50	-WH18
2.24-2.47	2.80	-WH19
2.48-2.71	3.10	-WH20
2.72-2.95	3.40	-WH21
2.96-3.27	3.70	-WH22
3.28-3.59	4.10	-WH23
3.60-3.99	4.50	-WH24
4.00-4.39	5.00	-WH25
4.40-4.79	5.50	-WH26
4.80-5.26	6.00	-WH27
5.27-5.83	6.60	-WH28
5.84-6.39	7.30	-WH29
6.40-7.03	8.00	-WH30
7.07-7.74	8.80	-WH31
7.75-8.46	9.70	-WH32
8.47-9.35	10.60	-WH33
9.36-10.30	11.70	-WH34
10.31-11.35	12.90	-WH35
11.36-12.47	14.20	-WH36
12.48-13.67	15.60	-WH37
13.68-15.12	17.10	-WH38
15.13-16.00	18.60	-WH39

⚡ Cutler-Hammer is a registered trademark of Eaton Corporation.

◀ Allen-Bradley is a registered trademark of Rockwell Automation.

① Sealing fittings must be field installed adjacent to enclosure on all conduit runs.

CONTROLS: NEC/CEC EXPLOSIONPROOF MOTOR STARTERS

Appleton®

Intraground™ N1 Series Nonmetallic Manual Motor Starter

Explosionproof

UNILETS™ for Use with Threaded Metal Conduit.

NEC:
Class I, Division 1 and 2, Groups C, D
NEMA 3, 4X, 7CD ①, 12

Dimensions in Millimeters (Inches)

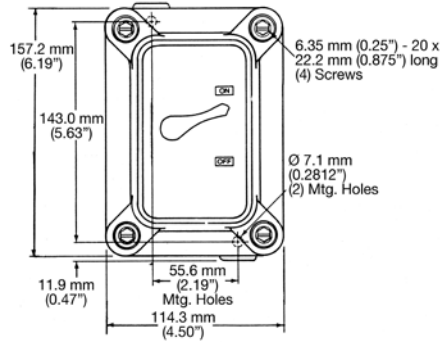

Front

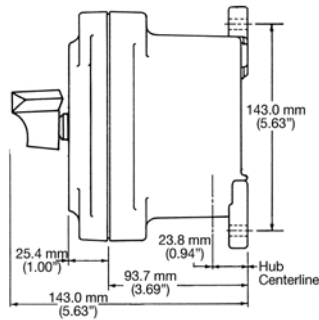

Side

① Sealing fittings must be field installed adjacent to enclosure on all conduit runs.

EBC Bolt-On Series Combination Line Starters with Breakers

Explosionproof, Dust-Ignitionproof

EBC, ERC, and ESC Series.

CEC:

Class I, Groups B, C, D

Class II, Groups E, F, G

Class III

NEMA 7CD, 9EFG

Applications

- Enclosures combine thermal magnetic circuit breakers and magnetic motor starters to provide across the line starting and stopping of polyphase AC motors, branch circuit protection, disconnect means, and motor running overcurrent protection.

Features

- Bolt-On Series incorporates compact, ruggedly built enclosures with hinged, removable covers secured by stainless steel bolts.
- Mating surfaces are precision-ground to explosionproof specifications.
- All starters are 3-pole and equipped with overload protection.
- Optional accessories provide for start-stop control, either remotely or on the enclosure.
- Removable hinged cover with captive, hex head bolts allow fast, easy release of cover with a few turns on each.
- Covers are hinged on left side and are removable. Provides easy access to interior for installation and maintenance. The hinged cover may be left in place to help protect the explosionproof machined surface during routine maintenance.
- Breaker handles are rugged and positive operating. The breaker actuator is designed to self-locate on the breaker handle. This unique feature prevents damage to the breaker toggle if the door is closed without aligning handle with breaker toggle position.
- Enclosures have two tapped and plugged openings in the cover (3/4" N.P.S.M.) for installation of push buttons, pilot lights, selector switches and other accessories.
- Accessories may be factory installed or added later in the field.
- Enclosures feature compact design. Four removable mounting lugs have pear shaped holes, permitting easy installation for rack or individual mounting.
- Standard conduit openings are located top and bottom
- Openings for drain and breather or control circuit are also provided, with close-up plugs.
- Interior components are mounted on easily removable pan. Complete removal of this assembly gives full access to enclosure interior for wire pulling. Room for a control transformer is provided in all EBC series enclosures.

Standard Materials

- Bodies and covers: copperfree (4/10 of 1%) aluminum
- Operating shafts, bushings, cover bolts and hinges: stainless steel
- Breaker actuator: spring steel
- O-ring: neoprene

Standard Finish

- Corrosion resistant gray powder coat epoxy

CEC Certifications and Compliances

- CSA Standards: C22.2 No. 14M, 25, 30
- CSA Certified: 052308

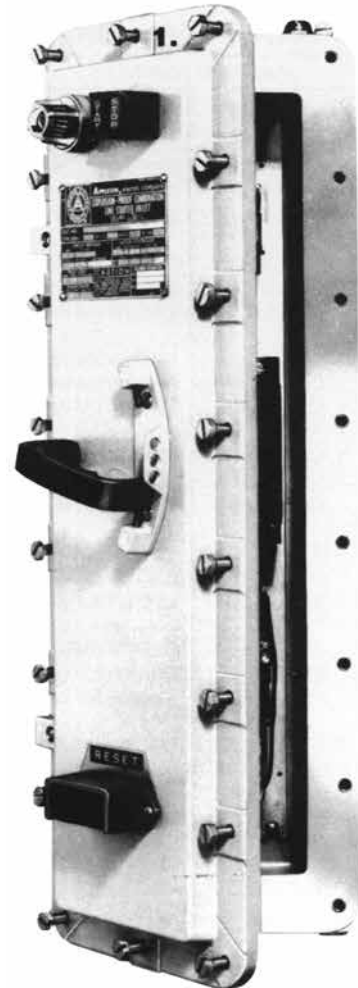

CONTROLS: NEC/CEC EXPLOSIONPROOF MOTOR STARTERS

Appleton

EBC Bolt-On Series Combination Line Starters with Breakers

Explosionproof, Dust-Ignitionproof

EBC, ERC, and ESC Series.

CEC:
 Class I, Groups C, D
 Class II, Groups E, F, G
 Class III
 NEMA 3R ①, 7CD, 9EFG, 12 ①

Catalog Number Logic

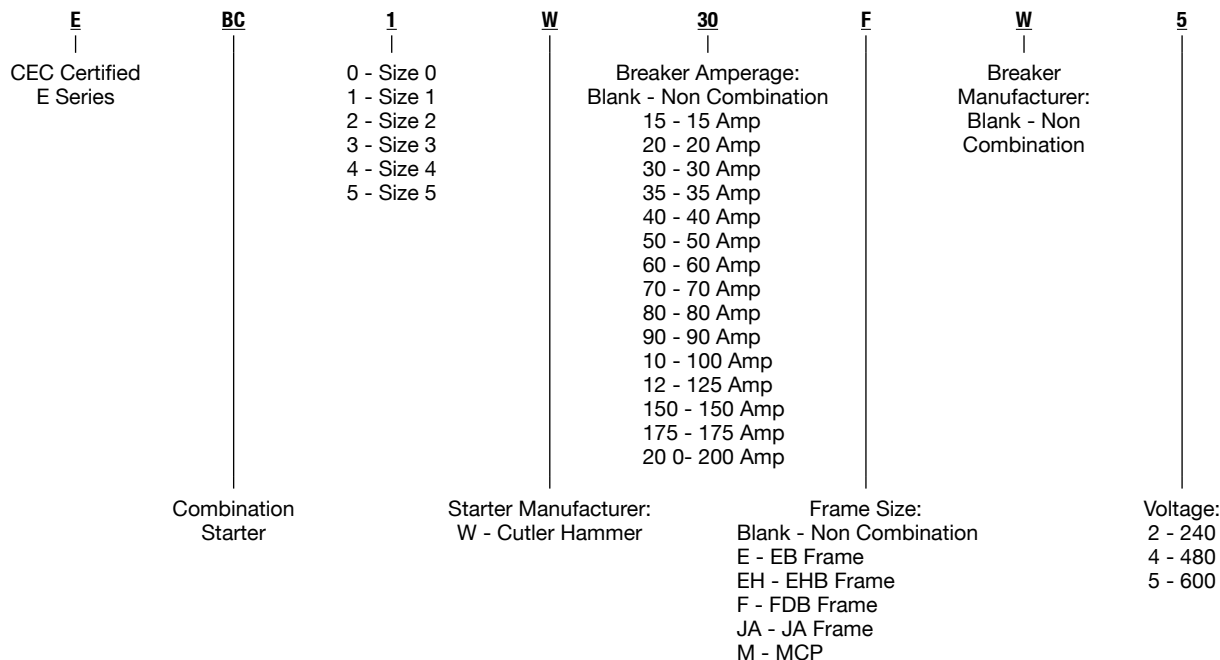

CONTROLS: NEC/CEC EXPLOSIONPROOF MOTOR STARTERS

Appleton®

Coil Voltage: If separate control or control transformer is required, add suffix **-120** immediately following the basic catalog number, preceding any accessory suffixes to be added.

Heater Selection: Select heater number from Heater Selection Table, based on motor full-load amperes. Add heater suffix to enclosure catalog number.

Starters and Breakers: Catalog listings for EBC enclosure have Cutler-Hammer + starters and breakers as standard.

Factory Installed Accessories: Add suffix to catalog number for accessories, if any.

Factory Installed Accessories

Description	Bolt-On Suffix	Description	Bolt-On Suffix
START-STOP push button	-GR	Additional NO or NC interlock — one (add prefix 2, 3 or 4 as needed)	-XLK
START-STOP push button (one barrel)	-DGR	Time delay low-voltage release for 3-wire control with 2 or 4-second adjustment.	
Universal push button (one)	—	For single-speed, nonreversing starters only.	
Dust-cap push button, Universal (one)	-DKU	Control circuit voltage:	
HAND-OFF-AUTO selector switch	-HOA	120 Vac, 60 Hz	-LVR1
ON-OFF selector switch	-BOF	240 Vac, 60 Hz	-LVR2
Pilot light — Red	-RPL	480 Vac, 60 Hz	-LVR4
Pilot light — Green	-GPL	Forward—Off— Reverse (Reversing Starters)	-FOR
Pilot light transformer, 240/120 Vac	-PLT2	High—Off—Low (2-speed starter)	-HOL
Pilot light transformer, 480/120 Vac	-PLT4	Drain and breather set	-DV
Pilot light transformer, 600/120 Vac	-PLT5		
Control transformer ③			
50 Vac non-fused, for size 0 and 1 starter	-CT50		
100 Vac non-fused, for size 2 starter	-CT100		
200 Vac non-fused, for size 3 and 4 starter	-CT200		
300 Vac non-fused, for size 5 starter	-CT300		

① Available upon request.

† Not available on ES1 and ES2 enclosures.

③ Control transformers have 480/240 Vac primary; 120 Vac secondary. Fused control transformers available on special order.

+ Cutler-Hammer is a registered trademark of Eaton Corporation.

ES Bolt-On Series Line Starter Enclosures

Explosionproof, Dust-Ignitionproof

ES, ERS, and ESS Series.

CEC:

Class I, Groups B, C, D

Class II, Groups E, F, G

Class III

NEMA 3R ①, 7CD, 9EFG, 12 ①

Applications

- Enclosures combine thermal magnetic circuit breakers and magnetic motor starters to provide across the line starting and stopping of polyphase AC motors, branch circuit protection, disconnect means, and motor running overcurrent protection.

Features

- Bolt-On Series incorporates compact, ruggedly built enclosures with hinged, removable covers secured by stainless steel bolts.
- Mating surfaces are precision-ground to explosionproof specifications.
- All starters are 3-pole and equipped with overload protection.
- Optional accessories provide for start-stop control, either remotely or on the enclosure.
- Removable hinged cover with captive, hex head bolts allow fast, easy release of cover with a few turns on each.
- Covers are hinged on left side and are removable. Provides easy access to interior for installation and maintenance. The hinged cover may be left in place to help protect the explosionproof machined surface during routine maintenance.
- Breaker handles are rugged and positive operating. The breaker actuator is designed to self-locate on the breaker handle. This unique feature prevents damage to the breaker toggle if the door is closed without aligning handle with breaker toggle position.
- Enclosures have two tapped and plugged openings in the cover (3/4" N.P.S.M.) for installation of push buttons, pilot lights, selector switches and other accessories.
- Accessories may be factory installed or added later in the field.
- Enclosures feature compact design. Four removable mounting lugs have pear shaped holes, permitting easy installation for rack or individual mounting.
- Standard conduit openings are located top and bottom
- Openings for drain and breather or control circuit are also provided, with close-up plugs.
- Interior components are mounted on easily removable pan. Complete removal of this assembly gives full access to enclosure interior for wire pulling. Room for a control transformer is provided in all EBC series enclosures.

Standard Materials

- Bodies and covers: copperfree (4/10 of 1%) aluminum
- Operating shafts, bushings, cover bolts and hinges: stainless steel
- O-ring: neoprene

Standard Finish

- Corrosion resistant gray powder coat epoxy

CEC Certifications and Compliances

- CSA Standards: C22.2 No. 14M, C22.2 No. 25, C22.2 No. 30
- CSA Certified: 035831



CONTROLS: NEC/CEC EXPLOSIONPROOF MOTOR STARTERS

Appleton®

① Available upon request. CSA 4X is also available on request.

ES Bolt-On Series Line Starter Enclosures

Explosionproof, Dust-Ignitionproof

ES, ERS, and ESS Series.

CEC:
 Class I, Groups B, C, D
 Class II, Groups E, F, G
 Class III
 NEMA 3R ①, 7CD, 9EFG, 12 ①

CONTROLS: NEC/CEC EXPLOSIONPROOF MOTOR STARTERS

Appleton®



Max. H.P.	Line Starter Volts, 60 Hz	NEMA Size	Tap Size ②	Catalog Number	
				Enclosure Only	With Starter
ES Series 2 thru 220 Horsepower — Single Speed, Non-Reversing					
2	120	0	1-1/2	ES2	ES0W1
2	240	0	1-1/2	ES2	ES0W2
2	480	0	1-1/2	ES2	ES0W4
2	600	0	1-1/2	ES2	ES0W5
3	120	1	1-1/2	ES2	ES1W1
3	240	0	1-1/2	ES2	ES0W2
3	480	0	1-1/2	ES2	ES0W4
3	600	0	1-1/2	ES2	ES0W5
5	240	1	1-1/2	ES2	ES1W2
5	480	0	1-1/2	ES2	ES0W4
5	600	0	1-1/2	ES2	ES0W5
7-1/2	120	2	2	ES2	ES2W1
7-1/2	240	1	1-1/2	ES2	ES1W2
7-1/2	480	1	1-1/2	ES2	ES1W4
7-1/2	600	1	1-1/2	ES2	ES1W5
10	240	2	2	ES2	ES2W2
10	480	1	1-1/2	ES2	ES1W4
10	600	1	1-1/2	ES2	ES1W5
15	120	3	2-1/2	ES3	ES3W1
15	240	2	2	ES2	ES2W2
15	480	2	2	ES2	ES2W4
15	600	2	2	ES2	ES2W5
20	240	3	2-1/2	ES3	ES3W2
20	480	2	2	ES2	ES2W4
20	600	2	2	ES2	ES2W5
25	240	3	2-1/2	ES3	ES3W2
25	480	2	2	ES2	ES2W4
25	600	2	2	ES2	ES2W5
30	240	3	2-1/2	ES3	ES3W2
30	480	3	2-1/2	ES3	ES3W4
30	600	3	2-1/2	ES3	ES3W5
40	240	4	3	ES4	ES4W2
40	480	3	2-1/2	ES3	ES3W4
40	600	3	2-1/2	ES3	ES3W5
50	240	4	3	ES4	ES4W2
50	480	3	2-1/2	ES3	ES3W4
50	600	3	2-1/2	ES3	ES3W5
60	480	4	3	ES4	ES4W4
60	600	4	3	ES4	ES4W5
75	480	4	3	ES4	ES4W4
75	600	4	3	ES4	ES4W5
100	480	4	3	ES4	ES4W4
100	600	4	3	ES4	ES4W5
125	480	5	4	ES5	ES5W4
125	600	5	4	ES5	ES5W5
150	480	5	4	ES5	ES5W4
150	600	5	4	ES5	ES5W5
220	600	5	4	ES5	ES5W5

① Available upon request. CSA 4X is also available on request.

② Conduit openings are tapped to size shown. A removable reducer bushing is furnished for each opening which, when installed, makes the conduit opening one size smaller.

ES Bolt-On Series Line Starter Enclosures

Explosionproof, Dust-Ignitionproof

ES, ERS, and ESS Series.



CEC:

Class I, Groups B, C, D

Class II, Groups E, F, G

Class III

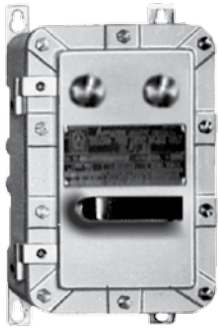
NEMA 3R ①, 7CD, 9EFG, 12 ①

	Max. H.P.	Line Starter Volts, 60 Hz	NEMA Size	Tap Size ②	Catalog Number Enclosure Only
ERS Series 3 thru 50 Horsepower — 3-Phase, Single Speed, Non-Reversing					
	3	240	0	2	ERS2
	5	480	0	2	ERS2
	5	600	0	2	ERS2
	7-1/2	240	1	2	ERS2
	10	480	1	2	ERS2
	10	600	1	2	ERS2
	15	240	2	2	ERS2
	25	480	2	2	ERS2
	25	600	2	2	ERS2
	30	240	3	2-1/2	ERS3
	50	480	3	2-1/2	ERS3
	50	600	3	2-1/2	ERS3
ESS Series 3 thru 50 Horsepower — 3-Phase Two-Speed, Single-Winding (Consequent-Pole, Constant or Variable-Torque) Motors					
	3	240	0	2	ESS2
	5	480	0	2	ESS2
	5	600	0	2	ESS2
	7-1/2	240	1	2	ESS2
	10	480	1	2	ESS2
	10	600	1	2	ESS2
	15	240	2	2	ESS2
	25	480	2	2	ESS2
	25	600	2	2	ESS2
	30	240	3	3	ESS3
	50	480	3	3	ESS3
	50	600	3	3	ESS3

CONTROLS: NEC/CEC EXPLOSIONPROOF MOTOR STARTERS

Appleton

① Available upon request. CSA 4X is also available on request.

② Conduit openings are tapped to size shown. A removable reducer bushing is furnished for each opening which, when installed, makes the conduit opening one size smaller

ES Bolt-On Series Line Starter Enclosure

Explosionproof, Dust-Ignitionproof

ES, ERS, and ESS Series.

CEC:
 Class I, Groups B, C, D
 Class II, Groups E, F, G
 Class III
 NEMA 3R ①, 7CD, 9EFG, 12 ①

CONTROLS: NEC/CEC EXPLOSIONPROOF MOTOR STARTERS

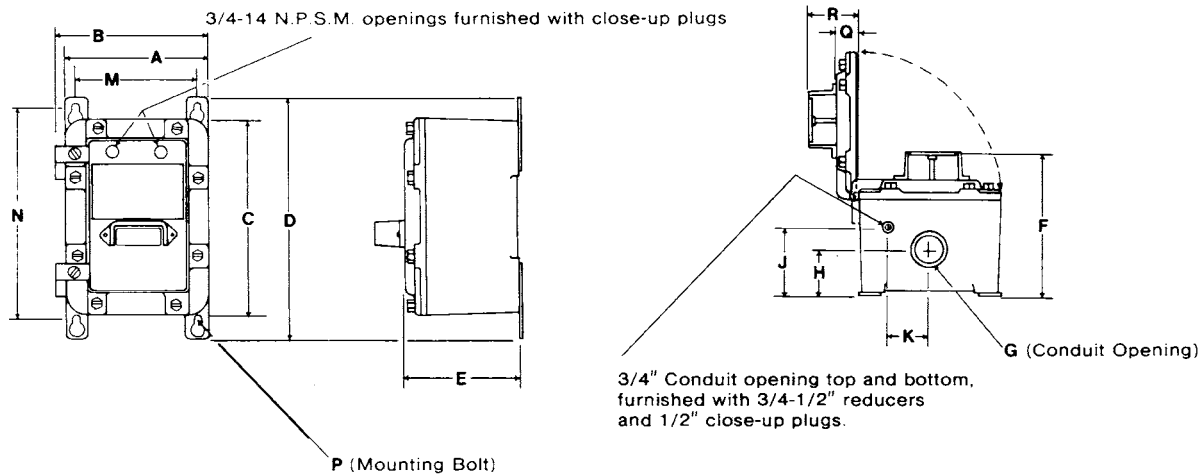

Dimensions in Millimeters (Inches) — Dimensions are approximate, not for construction

	ES2	ERS2	ERS3	ES3/ESS2	ES4/ESS4	ESS5
A	231.8 (9.13)	231.8 (9.13)	314.4 (12.38)	393.7 (15.50)	393.7 (15.50)	393.7 (15.50)
B	244.5 (9.23)	244.5 (9.23)	336.6 (13.25)	406.4 (16.00)	406.4 (16.00)	406.4 (16.00)
C ②	358.8 (14.13)	714.4 (28.13)	816.0 (32.13)	596.9 (23.50)	800.1 (31.50)	1028.7 (40.50)
D	425.45 (16.75)	781.1 (30.75)	936.6 (36.88)	614.4 (24.19)	817.6 (32.19)	1058.9 (41.69)
E	184.2 (7.25)	184.2 (7.25)	269.9 (10.63)	289.6 (11.40)	289.6 (11.40)	289.6 (11.40)
F	222.3 (8.75)	222.3 (8.75)	308.0 (12.13)	323.9 (12.75)	323.9 (12.75)	323.9 (12.75)
G ③	50.8 (2.00)	50.8 (2.00)	76.2 (3.00)	50.8 (2.00)	76.2 (3.00)	101.6 (4.00)
H	69.9 (2.75)	69.9 (2.75)	117.5 (4.63)	100.1 (3.94)	100.1 (3.94)	100.1 (3.94)
J	95.3 (3.75)	95.3 (3.75)	171.5 (6.75)	115.8 (4.56)	115.8 (4.56)	115.8 (4.56)
K	69.9 (2.75)	69.9 (2.75)	79.4 (3.13)	—	—	—
M	190.5 (7.50)	190.5 (7.50)	254.0 (10.00)	298.5 (11.75)	298.5 (11.75)	298.5 (11.75)
N	384.2 (15.13)	739.8 (29.13)	892.2 (35.13)	576.3 (22.69)	779.5 (30.69)	1008.1 (39.69)
P	9.5 (0.38)	9.5 (0.38)	9.5 (0.38)	—	—	—
Q	44.5 (1.75)	44.5 (1.75)	57.2 (2.25)	—	—	—
R	85.7 (3.38)	85.7 (3.38)	101.6 (4.00)	—	—	—

Approximate Weight in Kilograms (Pounds)

Enclosure Only	6.4 (14)	13.2 (29)	18.6 (41)	36.7 (81)	45.8 (101)	57.2 (126)	61.2 (135)
With Interior ④	10.9 (24)	18.6 (41)	29.5 (65)	49.9 (110)	38.6 (85)	63.5 (140)	142.4 (314)

① Available upon request. CSA 4X is also available on request.

② For Drain and Breather set, add 2" to Dimension C. Close-up plugs furnished when enclosures are ordered without drains and breathers.

③ Conduit openings are tapped to size shown. A removable reducer bushing is furnished for each opening which, when installed, makes the conduit opening one size smaller.

④ Approximate weights shown reflect largest size component that will fit in each respective enclosure.

ATX™ DM Series Motor Starters

Flameproof

ATEX/IECEX:
 Zone 1 and 2 - 21 and 22
 Ⓢ II 2 G
 IP66 - IK10

Applications

- DM Series motor starters are used in areas where hazardous materials are handled or stored.
- These units provide disconnecting means and thermal overload protection.

Features

- Three pole contactor.
- Thermal overload relay with stop/reset push button.
- Start push button.
- Rated voltage 400/415 Vac, 50/60 Hz AC-3 category.
- Yellow laminated plastic legend plate with black lettering.
- Internal earth terminal: 2 x 4 mm² (0.003 x 0.006 in²).
- External ground terminal: M5 for Ex d IIB version.
- Earth crossing terminal: M8 for Ex d IIC version.
- 1 x M20 entry on top.
- 2 x M20 entries at bottom with one blanking plug.

Standard Materials

- Housing: gray painted marine grade aluminum alloy (RAL7038)
- Cover bolts: stainless steel

ATEX/IECEX Certifications and Compliances

- Certification Type CF2D
 - Gas: Zone 1 and 2
 - Conforming to ATEX 94/9/CE: Ⓢ II 2 G
 - Type of Protection: Ex d IIB
 - Temperature Class: T4 [ta +40 °C (-40 °F)] or T3 [ta +55 °C (+131 °F)]
 - Dust: Zone 21 and 22
 - Conforming to ATEX 94/9/CE: Ⓢ II 2 D
 - Type of Protection: Ex tD A21
 - Surface Temperature: T195 °C (T383 °F)
 - Ambient Temperature: -20 °C to +55 °C (-4 °F to +131 °F)
 - CE Declaration of Conformity: 50254
 - ATEX Certificate: LCIE 03 ATEX 6061X
- Certification Type CF1B
 - Gas: Zone 1 and 2
 - Conforming to ATEX 94/9/CE: Ⓢ II 2 G
 - Type of Protection: Ex d IIC
 - Temperature Class: T4 (ta +40 °C) or T3 (ta +55 °C)



Ex d IIB Version



Ex d IIC Version

- Dust: Zone 21 and 22
 - Conforming to ATEX 94/9/CE: Ⓢ II 2 D
 - Type of Protection: Ex tD A21
 - Surface Temperature: T195 °C (T383 °F)
- Ambient Temperature: -20 °C to +55 °C (-4 °F to +131 °F)
- CE Declaration of Conformity: 50257
- ATEX Certificate: LCIE 03 ATEX 6044X
- Index of Protection according EN/IEC 60529: IP66
- Impact Resistance (shock): IK10
- Internal Volume: > 2 dm³ (122 in³) - 2 liters

EURASEC Certification

- Certification Type CF2D
 - EURASEC RU C-FR.Г505.В.0091
- Certification Type CF1B
 - EURASEC RU C-FR.Г505.В.00911

Related Products

- Cable glands must be ordered separately. See *Hazardous Location Fittings Section*.

Dimensions in Millimeters (Inches)

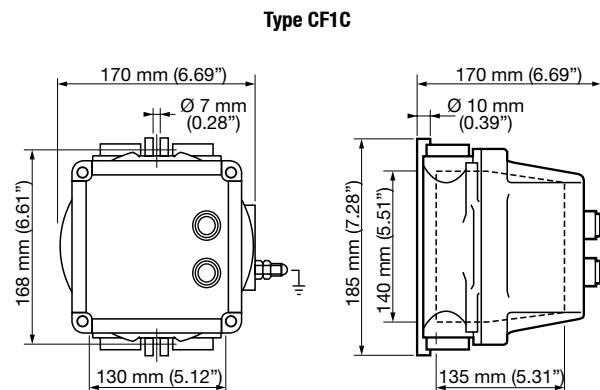
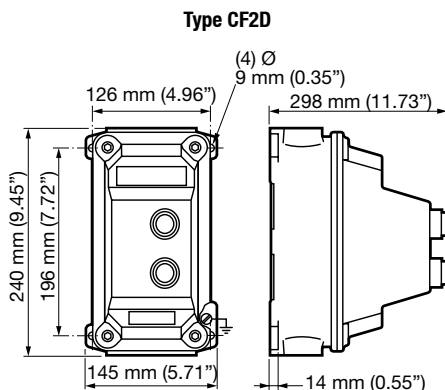

ATX™ MS Series Motor Starters

Flameproof

ATEX/IECEX:
 Zone 1 and 2 - 21 and 22
 Ⓢ II 2 GD
 IP66 - IK10

Applications

- These motor starters are used in areas where hazardous material are handled or stored. These units provide:
 - Disconnecting means
 - Undervoltage protection
 - Circuit protection
 - Motor running protection
 - Thermal time delay overload protection

Features

- Magnetic circuit breaker protects equipment and personnel and eliminates replacement of fuses.
- Three pole contactor.
- Thermal overload relay with manual reset push button.
- Green pilot light "Running/ON".
- Rated voltage 400/415 Vac 50/60 Hz AC-3 category.
- Control circuit supplied via a transformer fed between phases.
- Direct entries or indirect entries with Ex e box allows use of cable gland with elastomer seal.
- Type 2 coordinated protection (IEC 60947-4-1) has the following benefits:
 - Safety - limiting the energy delivered to the short circuit ensures the safest applications for personnel, facilities and equipment.
 - Reduced costs - preventing short circuit damage to components minimizes labor and replacement costs.
 - Increased productivity - as component replacement due to short circuits is minimized, so are interruptions to production.
- Direct ammeter for 0.37 kW to 2.2 kW versions. Ammeter with current transformer for 3 kW to 75 kW versions.

Standard Materials

- Body and cover:
 - Gray painted marine grade aluminum alloy (RAL 7038)
 - Cover bolts: stainless steel
 - Hinges: stainless steel
- Ex e box for indirect entries:
 - Gray (RAL 7038) painted aluminum alloy (size 2 and 6) or stainless steel (size 8 and 11)
 - Cover bolts: stainless steel

Standard Finish

- Corrosion resistant gray powder coat epoxy

Options

- Available up to 300 kW - contact your local representative.

ATEX/IECEX Certifications and Compliances

- Certification Type CF
 - Gas: Zone 1 and 2
 - Conforming to ATEX 94/9/CE: Ⓢ II 2 G
 - Type of Protection: Ex d IIB
 - Temperature Class: T6
 - Dust: Zone 21 and 22
 - Conforming to ATEX 94/9/CE: Ⓢ II 2 D
 - Type of Protection: Ex tD A21
 - Surface Temperature: T80 °C (T176)
 - Ambient Temperature: CF 60: -50 °C to +55 °C (-58 °F to +131 °F); CF 20, 40, 50: -40 °C to +55 °C (-40 °F to +131 °F); CF 30: -20 °C to +55 °C (-4 °F to +131 °F)

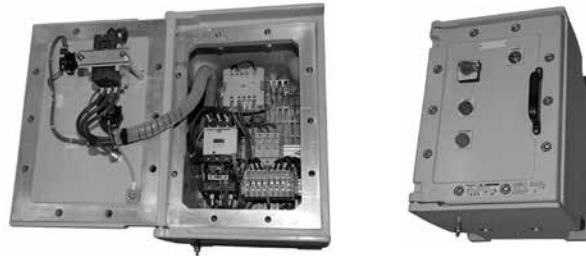

Ex d Version

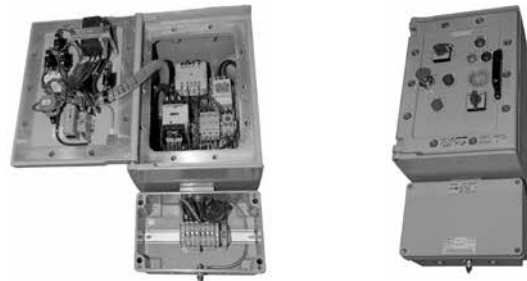

Ex de Version

- CE Declaration of Conformity: 50229
- ATEX Certificate: LCIE 02 ATEX 6057X
- IECEx Certificate: IECEx LCI 08.0023X
- Index of Protection according EN/IEC 60529: IP66
- Impact Resistance (shock): IK10
- Internal Volume: > 2 dm³ (122 in³) - 2 liters

EURASEC Certification

- EURASEC RU C-FR. Г505.В.00911

ATX™ MS Series Motor Starters

Flameproof

ATEX/IECEX:
 Zone 1 and 2 - 21 and 22
 II 2 GD
 IP66 - IK10

Catalog Numbering Guide

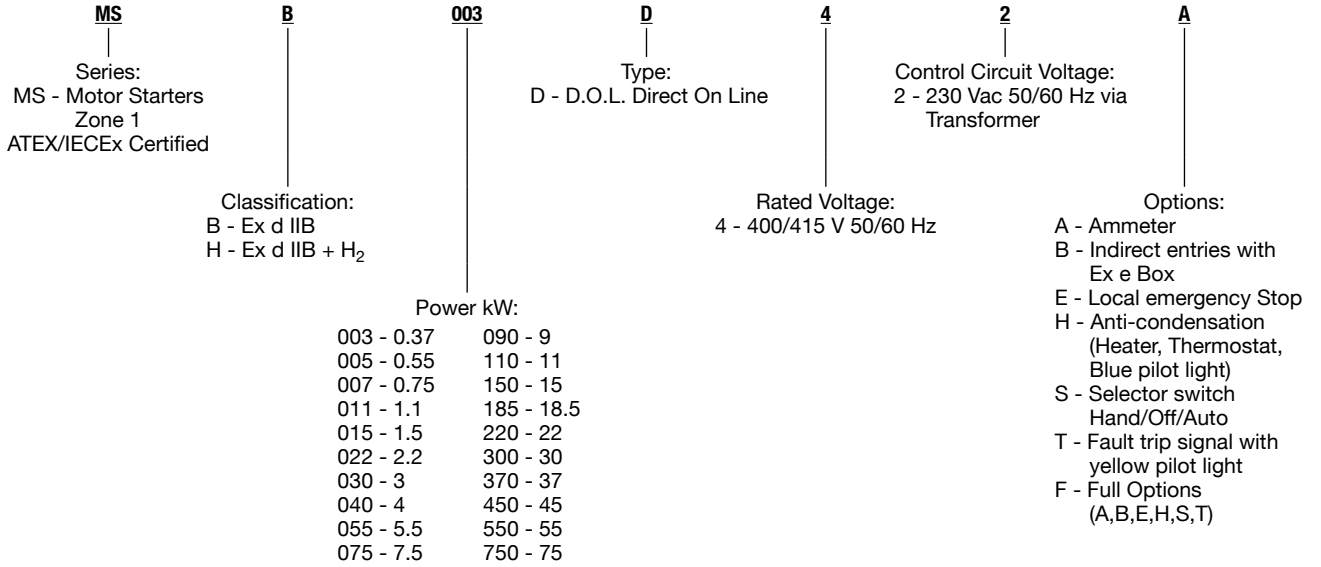

CONTROLS: ATEX/IECEX FLAMEPROOF MOTOR STARTERS



ATX™ MS Series Motor Starters

Flameproof

ATEX/IECEX:
Zone 1 and 2 - 21 and 22
II 2 GD
IP66 - IK10

Motor Capacity AC-3 to 415 Vac	Size	Terminals Cross Section mm ² (in ²)	Cable Entries at Bottom	Weight kg (lb)	Volume dm ³ (in ³)	Catalog Number
Standard Version						
<i>Fitted with magnetic circuit breaker, contactor with overload relay, Start/Stop buttons and green pilot light. (1 x M20 plugged).</i>						
0.37 kW	1	2.5 (0.004)	2 x M20 + 1 M20	16 (35)	25 (1525.59)	MSB003D42
0.55 kW	1	2.5 (0.004)	2 x M20 + 1 M20	16 (35)	25 (1525.59)	MSB005D42
0.75 kW	1	2.5 (0.004)	2 x M20 + 1 M20	16 (35)	25 (1525.59)	MSB007D42
1.1 kW	1	2.5 (0.004)	2 x M20 + 1 M20	16 (35)	25 (1525.59)	MSB011D42
1.5 kW	1	2.5 (0.004)	2 x M20 + 1 M20	16 (35)	25 (1525.59)	MSB015D42
2.2 kW	1	2.5 (0.004)	2 x M20 + 1 M20	16 (35)	25 (1525.59)	MSB022D42
3 kW	1	2.5 (0.004)	2 x M20 + 1 M20	16 (35)	25 (1525.59)	MSB030D42
4 kW	1	2.5 (0.004)	2 x M20 + 1 M20	16 (35)	25 (1525.59)	MSB040D42
5.5 kW	5	4.0 (0.006)	2 x M25 + 1 M20	56 (123)	126 (7688.99)	MSB055D42
7.5 kW	5	6.0 (0.009)	2 x M25 + 1 M20	56 (123)	126 (7688.99)	MSB075D42
9 kW	5	10.0 (0.016)	2 x M25 + 1 M20	56 (123)	126 (7688.99)	MSB090D42
11 kW	5	10.0 (0.016)	2 x M25 + 1 M20	56 (123)	126 (7688.99)	MSB110D42
15 kW	5	16.0 (0.025)	2 x M32 + 1 M20	56 (123)	126 (7688.99)	MSB150D42
18.5 kW	7	25.0 (0.039)	2 x M32 + 1 M20	72 (159)	236 (14401.60)	MSB185D42
22 kW	7	25.0 (0.039)	2 x M32 + 1 M20	72 (159)	236 (14401.60)	MSB220D42
30 kW	7	35.0 (0.054)	2 x M40 + 1 M20	72 (159)	236 (14401.60)	MSB300D42
37 kW	9	50.0 (0.078)	2 x M40 + 1 M20	132 (291)	370 (22578.79)	MSB370D42
45 kW	9	70.0 (0.109)	2 x M50 + 1 M20	132 (291)	370 (22578.79)	MSB450D42
55 kW	9	95.0 (0.147)	2 x M50 + 1 M20	132 (291)	370 (22578.79)	MSB550D42
75 kW	9	120.0 (0.189)	2 x M63 + 1 M20	132 (291)	370 (22578.79)	MSB750D42
Full Options Version						
<i>Standard version + HOA selector switch, local emergency stop, fault trip signal, ammeter, anti-condensation and indirect entries. (1 x M20 plugged).</i>						
0.37 kW	4	2.5 (0.004)	2 x M20 + 1 x M20	51 (112)	700 (42716.62)	MSB003D42F
0.55 kW	4	2.5 (0.004)	2 x M20 + 1 x M20	51 (112)	700 (42716.62)	MSB005D42F
0.75 kW	4	2.5 (0.004)	2 x M20 + 1 x M20	51 (112)	700 (42716.62)	MSB007D42F
1.1 kW	4	2.5 (0.004)	2 x M20 + 1 x M20	51 (112)	700 (42716.62)	MSB011D42F
1.5 kW	4	2.5 (0.004)	2 x M20 + 1 x M20	51 (112)	700 (42716.62)	MSB015D42F
2.2 kW	4	2.5 (0.004)	2 x M20 + 1 x M20	51 (112)	700 (42716.62)	MSB022D42F
3 kW	4	2.5 (0.004)	2 x M20 + 1 x M20	51 (112)	700 (42716.62)	MSB030D42F
4 kW	4	2.5 (0.004)	2 x M20 + 1 x M20	51 (112)	700 (42716.62)	MSB040D42F
5.5 kW	6	4.0 (0.006)	2 x M25 + 1 x M20	62 (137)	700 (42716.62)	MSB055D42F
7.5 kW	6	6.0 (0.009)	2 x M25 + 1 x M20	62 (137)	700 (42716.62)	MSB075D42F
9 kW	6	10.0 (0.016)	2 x M25 + 1 x M20	62 (137)	700 (42716.62)	MSB090D42F
11 kW	6	10.0 (0.016)	2 x M25 + 1 x M20	62 (137)	700 (42716.62)	MSB110D42F
15 kW	6	16.0 (0.025)	2 x M32 + 1 x M20	62 (137)	700 (42716.62)	MSB150D42F
18.5 kW	8	25.0 (0.039)	2 x M32 + 1 x M20	81 (179)	700 (42716.62)	MSB185D42F
22 kW	8	25.0 (0.039)	2 x M32 + 1 x M20	81 (179)	700 (42716.62)	MSB220D42F
30 kW	8	35.0 (0.054)	2 x M40 + 1 x M20	81 (179)	700 (42716.62)	MSB300D42F
37 kW	10	50.0 (0.078)	2 x M40 + 1 x M20	145 (320)	700 (42716.62)	MSB370D42F
45 kW	10	70.0 (0.109)	2 x M50 + 1 x M20	145 (320)	700 (42716.62)	MSB450D42F
55 kW	10	95.0 (0.147)	2 x M50 + 1 x M20	145 (320)	700 (42716.62)	MSB550D42F
75 kW	10	120.0 (0.189)	2 x M63 + 1 x M20	145 (320)	700 (42716.62)	MSB750D42F

CONTROLS: ATEX/IECEX FLAMEPROOF MOTOR STARTERS



ATX™ MS Series Motor Starters

Flameproof

ATEX/IECEX:
 Zone 1 and 2 - 21 and 22
 II 2 GD
 IP66 - IK10

Wiring Diagram

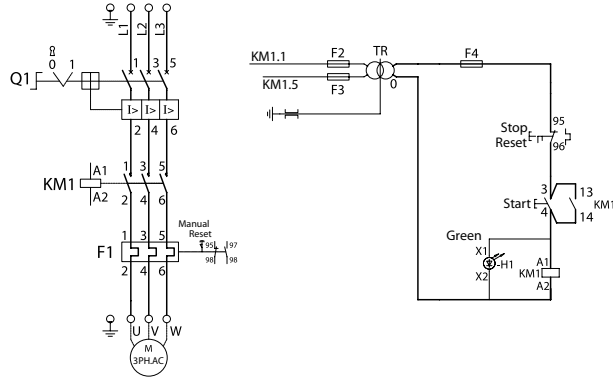

Dimensions in Millimeters (Inches)

Size 1: CF20B

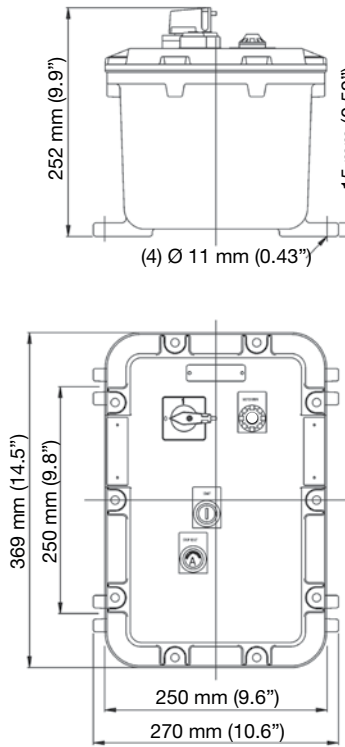

Size 2: CF20B + CAe1

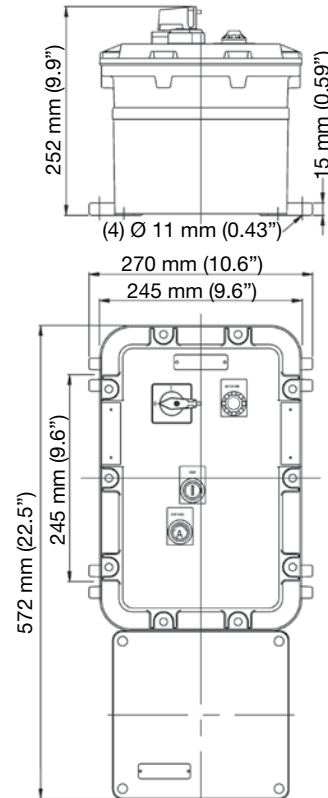

CONTROLS: ATEX/IECEX FLAMEPROOF MOTOR STARTERS

Appleton®

ATX™ MS Series Motor Starters

Flameproof

ATEX/IECEX:
 Zone 1 and 2 - 21 and 22
 II 2 GD
 IP66 - IK10

Dimensions in Millimeters (Inches)

Size 3: CF30B

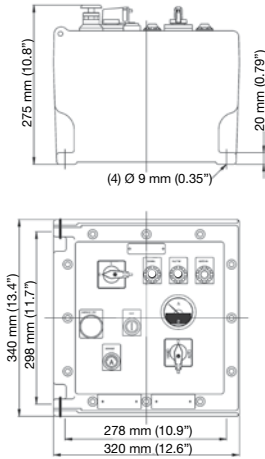

Size 4: CF30B + CAe2

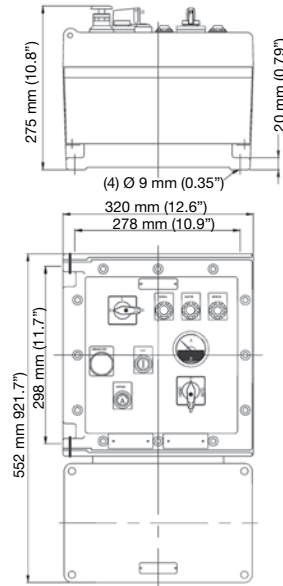

Size 5: CF40B

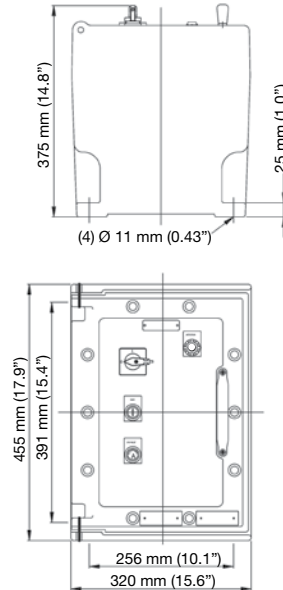

Size 6: CF40B + CAe2

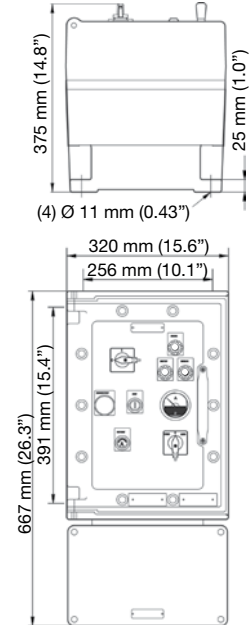

Size 7: CF50B

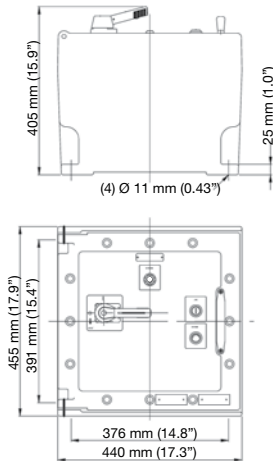

Size 8: CF50B + JBe47

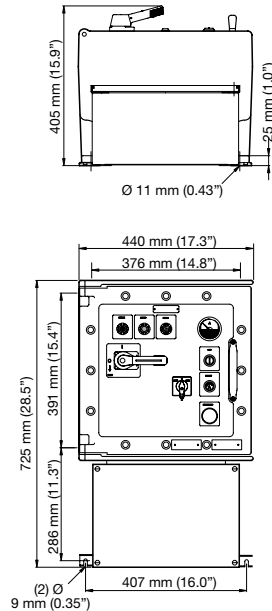

Size 9: CF60B

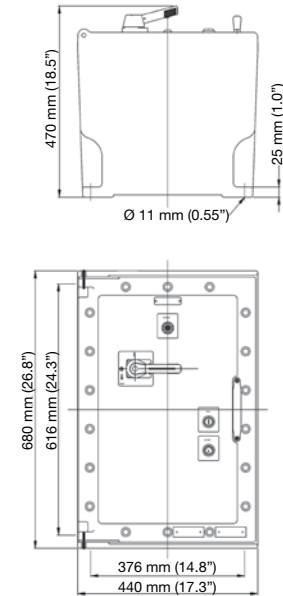

Size 10: CF60B + JBe55

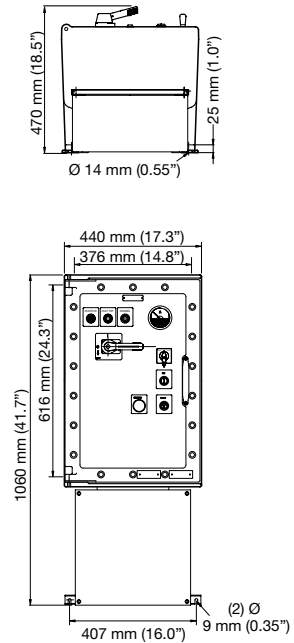

CONTROLS: ATEX/IECEX FLAMEPROOF MOTOR STARTERS



SD Series Static Discharge Grounding Reelites™

NEC/CEC:
Rated for (Unclassified) Locations

Applications

- SD Static Discharge Reelites are used for grounding portable machines or equipment operating in hazardous atmospheres. These Reelites safely dissipate static electrical buildup and reduce the chance of a spark and resulting explosion.
- SD Series Reelites are spring-driven and carry various lengths of wire cable with grounding clamps. They are applied to:
 - Fuel-transfer trucks
 - Barges
 - Dock side loading facilities
 - Grain elevators
 - Hazardous maintenance areas
 - Wherever flammable liquids or combustible dust is present
- Maximum Vdc resistance through Reelite and cable is approximately one ohm for each 15.2 meters (50 feet) of 2.38 mm (3/32") steel aviation control cable. On Reelites carrying 14 gauge, stranded, rubber-covered, copper cable, maximum Vdc resistance is approximately 0.15 ohms per 15.2 meters (50 feet) of cable.
- SD11 Series
 - Lightweight, compact, enclosed, all-steel construction.
 - 15.2 meter (50 foot) single or Y-type cable lengths in 3/32" galvanized steel aviation control cable with or without nylon jacket.
 - 100 Amp universal jaw type grounding clamp.
 - Gravity type ratchet.
 - Mounts on ceiling, wall or with base down to a clean, unpainted conductive surface to assure positive electrical continuity through frame.
- SD50A thru SD100A Series
 - Lightweight and compact. Rugged open drum design with all steel construction.
 - Available with cable lengths from 15.2 meters (50 feet) to 30.5 meters (100 feet), single and Y-type construction.

Standard Materials

- SD11, SD50A thru SD100A: all steel construction

Standard Finishes

- SD11 series: red epoxy powder coat
- SD50A thru SD100A Series: yellow epoxy/polyester powder coat

Options

- Stainless steel cable, nylon jacketed steel cable, or rubber-covered copper cable #14.
- An SDG grounding stud and SDP grounding plug, required by some state regulations, provides positive grounding and prevents accidental cable severing.
- Stainless steel cable is available, add suffix **-SS**
- Without ratchet, add suffix **-LR**



SD11 Series



SD50A thru SD100A Series



SDG

Permanent grounding stud
for 2.38 mm (13/32") hole.
Thread 3/8 – 16 UNC-2B.



SDP





Positive grounding plug.
Without cord.

SD Series Static Discharge Grounding Reelites™

NEC/CEC:
Rated for (Unclassified) Locations

Appleton®

CONTROLS: NEC/CEC HAZARDOUS INDICATORS AND GROUNDING DEVICES

	Description	Catalog Number
	15.2 meters (50 feet) of 2.38 mm (3/32") galvanized steel aviation control cable. 1 ohm D.C. resistance.	SD11
	15.2 meters (50 feet) of 2.38 mm (3/32") nylon covered galvanized steel aviation control cable. 1 ohm D.C. resistance.	SD11N
	15.2 meters (50 feet) total cable length consisting of 10.7 meters (35 feet) of 2.38 mm (3/32") galvanized steel aviation control cable branching out to two 4.6 meters (15 feet) lengths with grounding clamps. 1 ohm D.C. resistance.	SD11Y
	15.2 meters (50 feet) of 2.38 mm (3/32") galvanized steel aviation control cable. 1 ohm D.C. resistance.	SD50A
	15.2 meters (50 feet) of 2.38 mm (3/32") galvanized-steel cable with 1/64" nylon jacket. 1 ohm D.C. resistance.	SD50AN
	15.2 meters (50 feet) of rubber covered 14 gauge stranded copper cable. 0.3 ohm D.C. resistance.	SD50AR
	30.5 meters (100 feet) of 2.38 mm (3/32") galvanized steel cable with 0.40 mm (1/64") nylon jacket. 1.5 ohm D.C. resistance.	SD100AN
	30.5 meters (100 feet) of 2.38 mm (3/32") galvanized steel aviation control cable. 2 ohms D.C. resistance.	SD100A
	22.9 meters (75 feet) total cable length consisting of 15.2 meters (50 feet) of 2.38 mm (3/32") galvanized steel aviation control cable branching out to two 7.6 meters (25 feet) lengths with grounding clamps. 1.5 ohms D.C. resistance.	SD75AY
	30.5 meters (100 feet) total cable length consisting of 22.9 meters (75 feet) of 2.38 mm (3/32") galvanized steel aviation control cable branching out to two 7.6 meters (25 feet) lengths with grounding clamps. 2.0 ohms D.C. resistance.	SD100AY
	Permanent Grounding Stud for 2.38 mm (3/32") hole. Thread 3/8-16 UNC-2B.	SDG
	Positive Grounding Plug. Without cord. #14 Type "S" 0.265 max.	SDP

SD Series Static Discharge Reelites™

NEC/CEC:
Rated for (Unclassified) Locations

Dimensions in Millimeters (Inches)

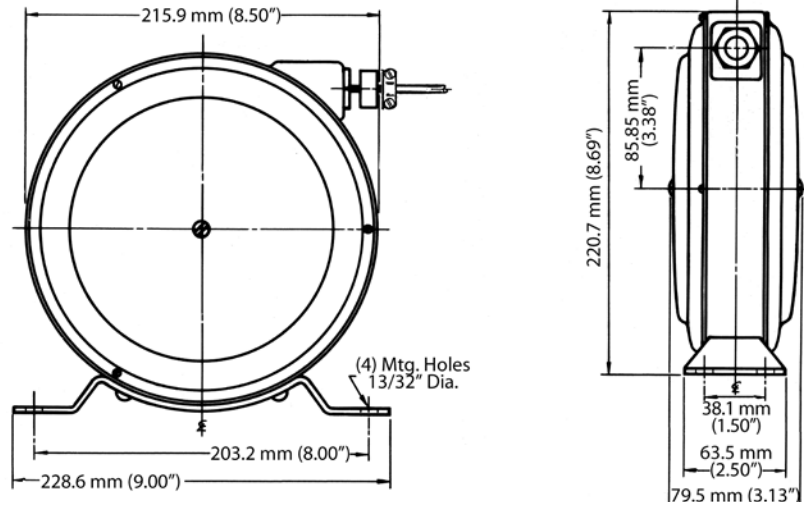

SD11 Series

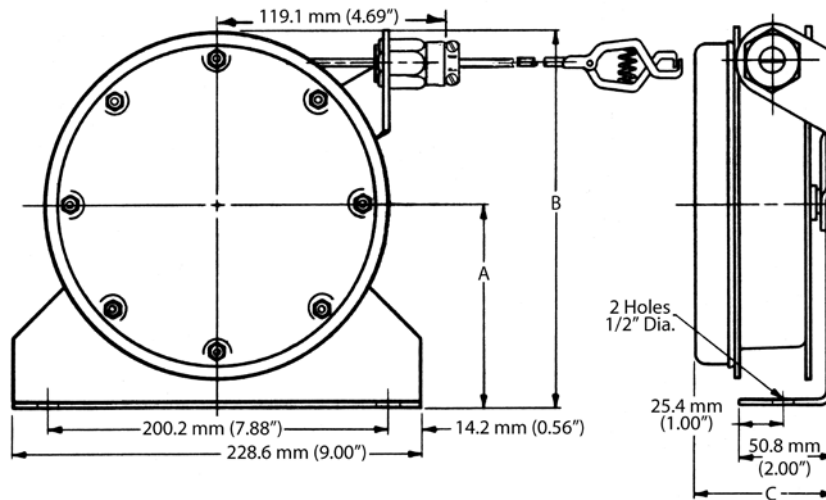

SD50A thru SD100A Series

Catalog Number	Dimensions in Millimeters (Inches)		
	A	B	C
SD50A	112.8 (4.44)	215.9 (8.50)	76.2 (3.00)
SD100A	127.0 (5.00)	244.6 (9.63)	95.3 (3.75)
SD75AY	127.0 (5.00)	244.6 (9.63)	95.3 (3.75)
SD100AY	127.0 (5.00)	244.6 (9.63)	95.3 (3.75)
SD50AR	127.0 (5.00)	244.6 (9.63)	95.3 (3.75)

AEPGI Series Ground Indicators

Explosionproof, Dust-Ignitionproof

NEC:
 Class I, Division 1 and 2, Groups B♦, C♦, D
 Class II, Division 1 and 2, Groups E, F, G
 Class III
 NEMA 4,7,9

Applications

- The grounding device is used to logically indicate the presence of grounding of tank cars or tank trucks before and during transfer of combustible materials.
- When connected to a truck prior to loading or unloading, the presence of a safe ground is indicated by a green light and the absence of ground is indicated by a red light.
- Interlocking circuitry will prevent pumps from starting until a ground is established or shut pumps down if a ground is lost at any time during loading or unloading.
- This intrinsically safe circuit and explosionproof enclosure enables the ground device to be used in hazardous location areas.

Features

- Clamp and Cable - The coiled cable provided: 2 conductor #14 SJEOO-WA terminated with an alligator ground clamp.
- Operating temperature: -46 °C to +105 °C (-51 °F to +221 °F).
- Power requirements: — 115/240 Vac.
- Control contacts: 250 Vac — 10 amp continuous.
- Indicators: one green light for "Satisfactory Ground", one red light for "No Ground".
- Compact design.
- Hinges supplied.
- External ground lug and internal ground lug supplied; accommodates #14 through #2 AWG.

Standard Materials

- Enclosure: copperfree (4/10 of 1% max.) aluminum

Standard Finishes

- Epoxy powder coat on enclosure

NEC Compliances

- UL Standards: UL 508, UL 698, UL 1203
- UL Classified: E84577

Dimensions in Millimeters (Inches)

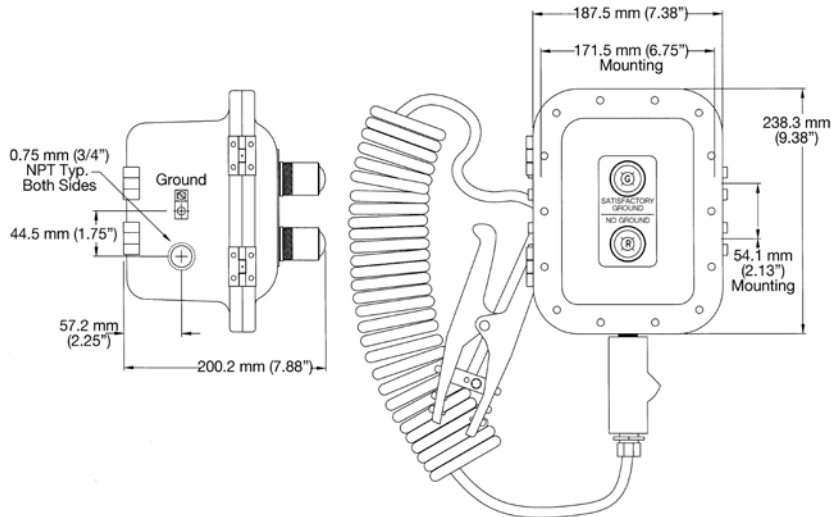

Coiled Cable Length in Meters (Feet)	Conduit Entries (Inches)	Catalog Number
7.6 (25)	3/4 NPT	AEPGI
15.2 (50)	3/4 NPT	AEPGI-50

♦ For Groups B and C, all conduit entries must be sealed adjacent to enclosure.

EGC Static Ground Indicators

Indicates safe static ground in hazardous locations.

CEC:
Class I Division 1 and 2, Groups C, D
Class II Division 1, Groups E, F, G
Class II Division 2, Groups F, G
Class III

CEC:
CSA Enclosure Type 3R
Exia

Applications

- Static grounding indicator is connected to tanker trucks, providing a positive ground prior to the dispensing of flammable materials.
- A positive ground safeguards trucks, railcars and loading racks from the accumulation of static charge during transfer operations.
- For use in tank vehicle transfer stations classified by CEC as Class I Division 1, Groups C, D; Class II, Division 1, Groups E, F, G; Class II, Groups F, G and Class III.

Features

- Two wire positive ground indicator system renders the pumping system inoperable without a positive ground.
- Intrinsically safe ground detecting circuitry.
- Supplied standard with two LED indicator lights. Red indicates unit is on but without a positive ground. Green indicates positive ground.
- Supplied with a 7.6 meter (25 foot) cord and heavy duty self release clamp.
- Release of the ground clamp opens the contacts, stops the product flow and is indicated by the red LED pilot light.
- Circuitry will control a pump, valve or indicating device such as light or audible warning device.
- Provided with internal ground lug.
- If any electrical connections fail (either in the enclosure or at the ground rod) the red indicator light will be on and the unit will not operate and switch to green; until the problem is solved.
- An optional retractable reel is available to raise and lower static ground cable. Allows cable and clamp to hang free when not in use. The clamp should not be in contact with ground when not in use. The retractable reel is supplied with 7.6 meter (25 foot) of nylon covered steel cable and cable securing clamp.

Electrical Characteristics

- Line Voltage: 120 Vac. Control transformers for 240, 480 or 600 volt available. Contact your local representative.
- Control relay rating interlocking contact: 15 Amp at 277 Vac, 10 Amp at 600 Vac.
- Temperature limitations: +100 °C to -25 °C (+212 °F to -13 °F).

Standard Materials

- Enclosure, cover and clamp: copperfree (4/10 of 1%) aluminum
- Indicator lights: red and green LED
- All hardware (except clamp): stainless steel

Standard Finish

- Gray baked epoxy

Options

- 7.6 meter (25 foot) retractable reel.
- Breather and drain, add suffix **-BD**.
- Heater and thermostat, add suffix **-HTR**.

CEC Certifications and Compliances

- CSA Standards: C22.2 No. 14M, C22.2 No. 25, C22.2 No. 30
- CSA Certified: 038339



**Appleton**

CONTROLS: NEC/CEC HAZARDOUS INDICATORS AND GROUNDING DEVICES

EGC Static Ground Indicators

Indicates safe static ground in hazardous locations.

CEC:
 Class I Division 1 and 2, Groups C, D
 Class II Division 1, Groups E, F, G
 Class II Division 2, Groups F, G
 Class III

CEC:
 GSA Enclosure Type 3R
 Exia

Description	Catalog Number
Ground Indicator with 2 LED Indicator lights, Ground Clamp, 7.62 meters (25 feet) of cord and connector accessories (order separately)	EGC210
7.62 meter (25 foot) retractable reel	SD11N25C
Ground Clamp	EGCK1P
Ground Clamp, 7.62 meters (25 feet) of cord and connector	EGCKECC

Dimensions in Millimeters (Inches)

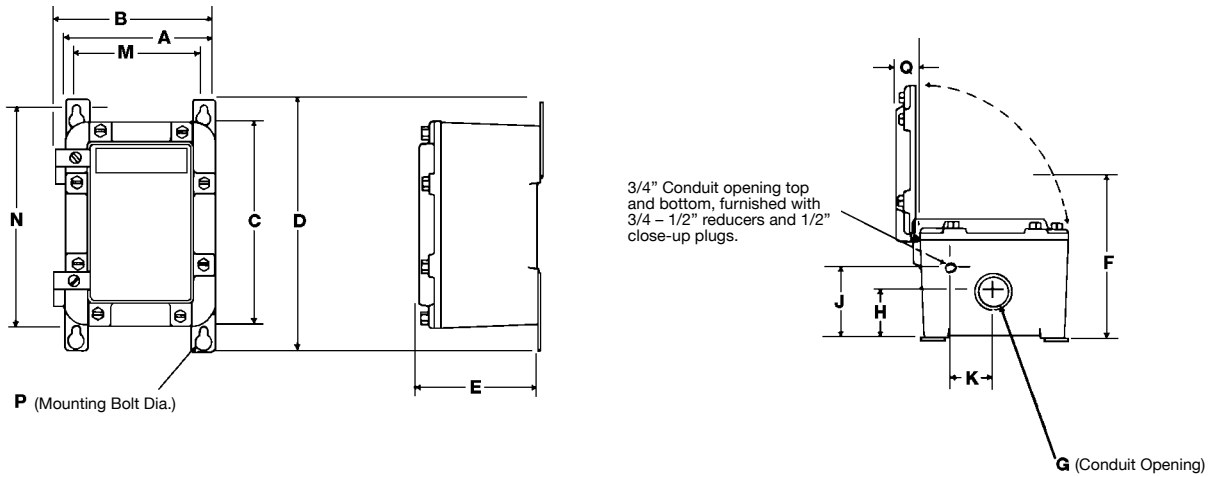

A	B	C	D	E	F	G	H	J	K	M	N	P	Q
232	244	359	425	184	184	51	70	95	70	191	384	10	44
(9.13)	(9.63)	(14.13)	(16.75)	(7.25)	(7.25)	(2.00)	(2.75)	(3.75)	(2.75)	(7.50)	(15.13)	(0.38)	(1.75)

Appleton®

CONTROLS: NEC/CEC HAZARDOUS INDICATORS AND GROUNDING DEVICES

AFA and AFAX Conveyor Belt Alignment Switches

Post Style or Large Roller Style.

NEC/CEC — AFAX Series:
Class I, Division 1 and 2, Groups C, D
Class II, Division 1 and 2, Groups E, F, G
Class III
NEMA 7CD, 9EFG

NEC/CEC — AFA Series:
NEMA 3, 4, 4X, 12

Applications

- Emergency stop switch for conveyer or lines and bulk handling systems which become misaligned or run off their tracks due to excessive speed, uneven load, leveling, breakage or other problems.
- Used where alarm or computer interface capabilities are needed.
- Used in the control circuit of magnetic motor starters to shut down motor driven conveyors in case of abnormal belt misalignment or run-off.
- For installation in:
 - Steel mills
 - Mining (ore and coal) handling operations
 - Automotive and other assembly lines
 - Warehouses
 - Loading docks
 - Other industrial processes.
- AFAX Series is used in Class I and II areas where flammable vapors or highly combustible dusts are present.
- AFA Series has a gasketed cover rated for NEMA 3, 3R, 4, 4X.
- Unit is used in pairs with one switch placed on each side of the conveyor belt. Recommended installation locates switches near the tail and head pulleys on conveyors 91.44 meters (300 feet) and longer.

Features

- AFA10, AFA20, AFAX10, AFAX20:
 - Each unit can be equipped with two micro switches to produce signals indicating belt misalignment at two deviation points.
 - The first signal point could indicate small belt deviations by sounding an alarm.
 - The second signal point could guard against extreme belt runoff by shutting down the conveyor.
 - Operating arm has 247.65 mm (9.75") high and 31.75 mm (1.25") diameter roller and moves 90 degrees in both directions.
 - 3/4" NPT standard conduit opening.
 - Spring loaded arm returns to original position when belt is realigned.
- AFA1, AFA2, AFAX1, AFAX2:
 - Roller is 3.5" high and actuates with 0.25" travel.
 - Unit should be mounted about 1" from belt to eliminate false signals.
 - Operating temperatures are -40 °C to +65 °C (-40 °F to +149 °F).
 - One 1/2" NPT standard, conduit opening.

Standard Materials

- AFA10, AFA20, AFAX10, AFAX20:
 - Housing: cast aluminum
 - Actuating arm contains: red epoxy coated steel roller with stainless steel shaft
 - Hardware: stainless steel
- AFA1, AFA2, AFAX1, AFAX2:
 - Steel coated with enamel paint

Standard Finishes

- Standard enclosure: peened



AFA1, AFA2, AFAX1, AFAX2
Large Roller Style



AFA10, AFA20, AFAX10, AFAX20
Post Style (No Accessories)

Options

- Epoxy powder coated switches for AFA10, AFA20, AFAX10 and AFAX20 add suffix **-G1**.
- AFA1, AFA2, AFAX1, AFAX2:
 - Breakaway mounting bracket: **AFABMB**.
 - Breakaway mounting bracket with switch: **AFABMBS**.
 - Breakaway mounting bracket with explosionproof switch: **AFABMSX**.

NEC/CEC Certifications and Compliances

- UL Standards: UL 508, UL 698
- UL Listed: E10449
- CSA Standards: C22.2 No. 14M, C22.2 No. 25, C22.2 No. 30
- CSA Certified: 700921

CONTROLS: NEC/CEC EXPLOSIONPROOF CONVEYOR SWITCHES

Appleton®



AFA and AFAX Conveyor Belt Alignment Switches

Post Style or Large Roller Style.



NEC/CEC — AFAX Series:
 Class I, Division 1 and 2, Groups C, D
 Class II, Division 1 and 2, Groups E, F, G
 Class III
 NEMA 7CD, 9EFG

NEC/CEC — AFA Series:
 NEMA 3, 4, 4X, 12

CONTROLS: NEC/CEC EXPLOSIONPROOF CONVEYOR SWITCHES

	Classification	Switch Quantity/Description	Switch Rating	Catalog Number
 Post Style	NEMA 3, 4X	1 – sp/dt	1	AFA10
	NEMA 3, 4X	2 – sp/dt	1	AFA20
	NEMA 7: Class I; Groups C, D	1 – sp/dt	1	AFAX10
	NEMA 9: Class II; Groups E, F, G	2 – sp/dt	1	AFAX20
 Large Roller Style	NEMA 3, 4X	1 – sp/dt	1	AFA1
	NEMA 3, 4X	1 – dp/dt	2	AFA2
	NEMA 7: Class I; Groups C, D	1 – sp/dt	3	AFAX1
	NEMA 9: Class II; Groups E, F, G	1 – dp/dt	2	AFAX2

Breakaway Mounting - AFA1, AFA2, AFAX1, AFAX2 Accessories

	Classification	Switch Description	Description	Catalog Number
	—	—	Designed especially for high speed conveyors. This new feature allows the switch to perform its job of shutting down the system, but automatically moves it out of the way if a high speed belt does run off before stopping. Automatically returns to unactuated position when belt is realigned.	AFABMB
	NEMA 1, 3, 4X, 13	1 – sp/dt 10 Amp	Dust and weathertight	AFABMBS
	NEMA 7: Class I; Groups C, D NEMA 9: Class II; Groups E, F, G	1 – sp/dt 10 Amp	Explosionproof	AFABMBSX

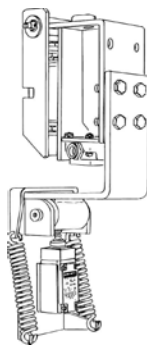

Switch Mounting with Breakaway Mount

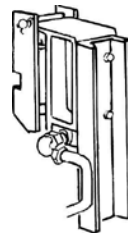

Typical Application

Switch Electrical Ratings:

- 20 Amp at 125, 250 or 480 Vac; 1 HP at 125 Vac; 2 HP at 250 Vac; 1/2 Amp at 125 Vdc; 1/4 Amp at 250 Vdc.
- 10 Amp at 125 or 250 Vac; 0.3 Amp at 125 Vac; 0.15 Amp 250 Vdc.
- 10 Amp at 125, 250 or 480 Vac; 1/2 Amp at 125 Vdc; 0.15 Amp 250 Vdc.

AFA and AFAX Conveyor Belt Alignment Switch

Post Style or Large Roller Style.

NEC/CEC — AFAX Series:
 Class I, Division 1 and 2, Groups C, D
 Class II, Division 1 and 2, Groups E, F, G
 Class III
 NEMA 7CD, 9EFG

NEC/CEC — AFA Series:
 NEMA 3, 4, 4X, 12

Dimensions in Millimeters (Inches)

Post Style Roller arm moves 90° in both directions

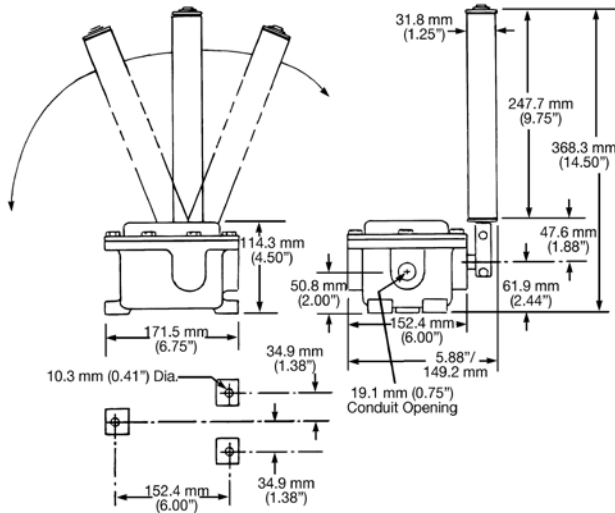

Roller Style

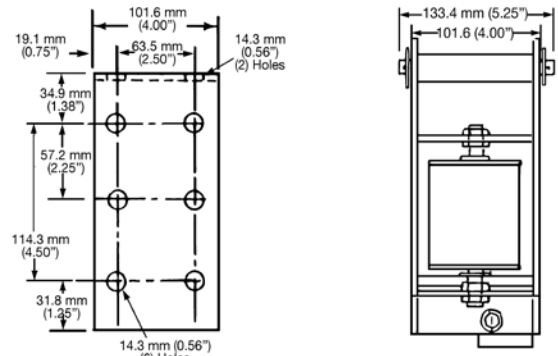

Mounting Pan

Front View

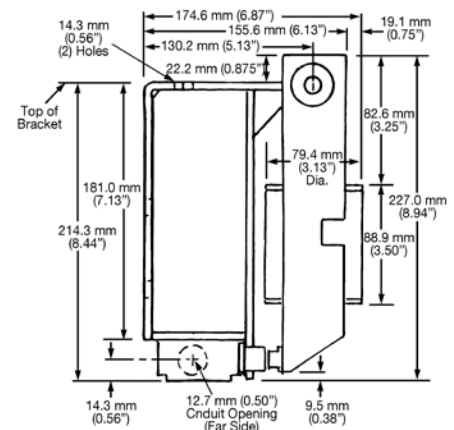

Side View

Breakaway Mounting

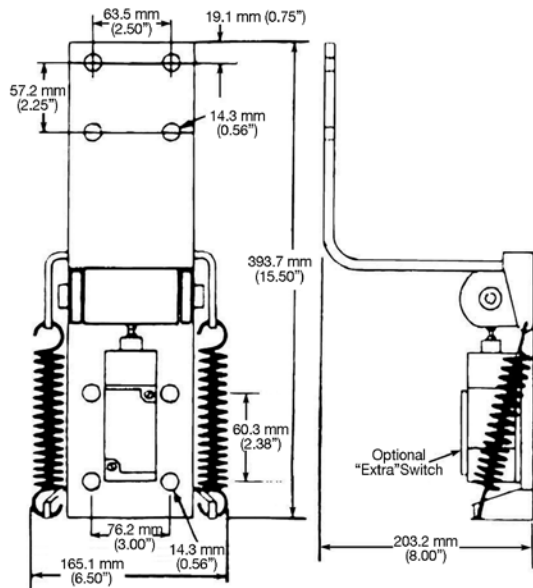

Support Bracket

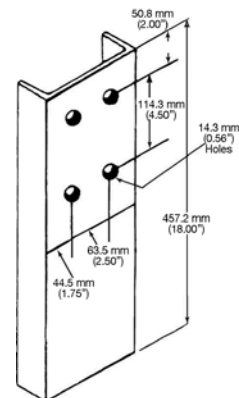

CONTROLS: NEC/CEC EXPLOSION-PROOF CONVEYOR SWITCHES

Appleton

AFSX Speed Responsive Switch

0.1–1000 RPM.

NEC/CEC — Rated for:
Class I, Division 1 and 2, Groups C, D
Class II, Division 1 and 2, Groups E, F, G
Class III
NEMA 7CD, 9EFG

Applications

- For use in bulk material handling/processing systems to monitor speeds of:
 - Belt conveyors
 - Screw conveyors
 - Bucket elevators
 - Rotating machinery
- Used where alarm or computer interface capabilities are needed.
- For installation in:
 - Steel mills
 - Mining (ore and coal) operations
 - Grain handling
 - Chemical and plastic industries to protect elevators, feeders, and conveyors from speed related damage resulting from broken belts, overloads or belt slippage.
- For installation in mining and industrial areas where rugged control enclosures are needed for protection from falling ores, other heavy aggregates and from dripping water or hoses.
- Used in Class I and II areas where flammable vapors or highly combustible dusts are present.
- Designed to monitor material flow by sequencing the operation of multiple conveyors feeding a common bin or conveyor.
- Used as overspeed switches to detect motor overrun conditions. Pickup speed should be set above normal operating speeds. The output relay will energize if operating speed exceeds the set point.
- Used as underspeed switches to detect slipping belts, jammed conveyors or equipment and stalled motors: Pickup speed setting should be below normal operating speeds. The output relay will de-energize if operating speed falls below the set point.
- Used as zero speed switch: When speed approaches zero (0.1 RPM), the output relay will de-energize.

Features

- Signal range: three settings available (0.1-10 RPM; 1-100 RPM; 10-1000 RPM).
- Adjustable time delay (up to 45 seconds).
- Input power is applied to the speed responsive switch at all times. The switch then senses input shaft speed in either direction.
- When input shaft speed exceeds the pickup set point, the output relay is energized.
- If shaft speed falls below 80-85% of the pickup speed the relay will de-energize.
- Clockwise or counterclockwise rotation.
- Senses speed changes as slight as 1%.
- Operating temperatures are -45 °C to +65 °C (-49 °F to +149 °F).
- 3/4" NPT standard, two conduit openings.
- Radial load is 57 kilogram (125 pound) maximum at center of the key.
- Axial thrust load is 45 kilogram (100 pound) maximum.
- Driving torque required is one inch-pound maximum.
- Flexible coupling accessory allows up to 7.5° misalignment, high shock resistance and eliminates transmission of thrust loads.



Front

Back

Electrical Specifications

- Input voltage is 105-135 Vac, 50-60 Hz
- Output is a double pole, double throw relay rated 5 Amp resistive at 120 Vac, 5 Amp at 240 Vac, 5 Amp at 30 Vdc.
- Repeatability is +/-2% maximum at constant voltage and temperature.
- Power consumption is 3 watts maximum.
- Pulse sensor (solid state opto-electric infrared device) operating life is 25 years if constant operation is at maximum speed.
- Pickup speed is adjustable by set point potentiometer.
- Drop-out RPM will be 10-15% lower than pickup speed to account for normal fluctuations in actual operating RPM.
- If a signal is required within 1-15% of the normal operating speed, contact your local representative for presetting.

Standard Materials

- Housing: cast copperfree (4/10 of 1% max.) aluminum
- Shaft: stainless steel, 5/8" diameter
- #11 Woodruff key and hardware: stainless steel
- Flexible coupling: cast zinc
- Sleeve: neoprene with textile reinforcement

Standard Finishes

- Standard enclosure: shot peened

Optional Materials

- Housing: corrosion resistant epoxy powder coat

Options

- Epoxy powder coated switches, add suffix **-G1**.
- Mounting Bracket: **AFSA1, AFSB1, AFSB2, AFSB3**.
- Coupling guard: **AFSG1**.

AFSX Speed Responsive Switch

0.1–1000 RPM.

NEC/CEC — Rated for:
 Class I, Division 1 and 2, Groups C, D
 Class II, Division 1 and 2, Groups E, F, G
 Class III
 NEMA 7CD, 9EFG

	Catalog Number
	AFSX300

Optional Accessories

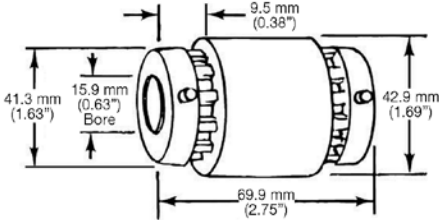
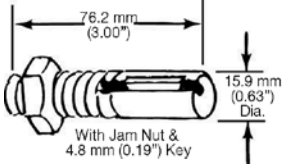
	Description	Catalog Number
	<p>Flexible Coupling</p> <p>This coupling will operate at up to a 7-1/2° axial misalignment with no significant life reduction. This unit features high shock resistance and eliminates transmission of lateral thrust from one shaft to the other (no end thrust).</p> <p>Sleeve: With axially molded internal teeth. Made of neoprene with textile reinforcement. Two end fittings grooved to mate with sleeve teeth. One fitting attached to each shaft.</p>	AFSC1
	<p>Stub Shaft</p> <p>76.2 mm (3") threaded one end, keyed other end. With jam nut and 3/16" key.</p>	AFSS1

CONTROLS: NEC/CEC EXPLOSION-PROOF CONVEYOR SWITCHES

Appleton

AFSX Speed Responsive Switch Mounting

0.1–1000 RPM.

NEC/CEC — Rated for:
 Class I, Division 1 and 2, Groups C, D
 Class II, Division 1 and 2, Groups E, F, G
 Class III
 NEMA 7CD, 9EFG

Dimensions in Millimeters (Inches) and Suggested Mounting Arrangement

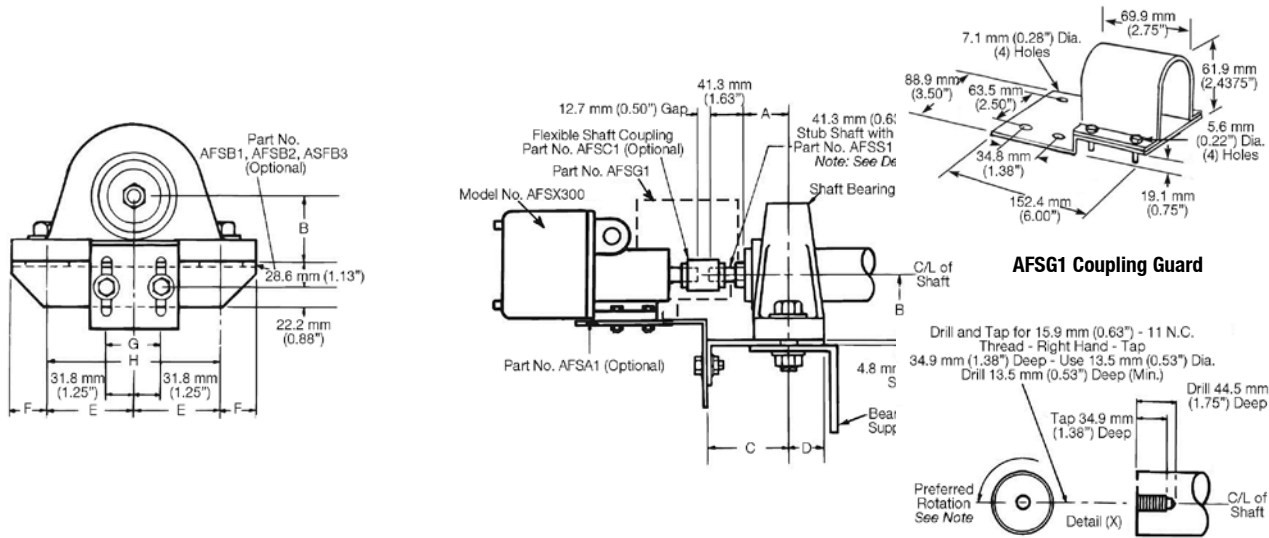

Bearing Bracket and Shim Plate Part #	Shaft Diameter	Dimensions in Millimeters (Inches)						Width x Length	
		A	B	C	D	E	F	G	H
AFSB1	36.6 (1.44)	31.8 - 50.8 (1.25 - 2.00)	47.8 - 54.1 (1.88 - 2.13)	79.5 (3.13)	28.7 (1.13)	68.3 (2.69)	46.0 (1.81)	49.2 x 25.4 (0.194 x 1.00)	14.3 x 33.3 (0.56 x 1.31)
AFSB2	49.3 - 62.0 (1.94 - 2.44)	38.1 - 65.0 (1.50 - 2.56)	57.2 - 76.2 (2.25 - 3.00)	95.3 (3.75)	41.4 (1.63)	93.7 (3.69)	49.3 (1.94)	49.2 x 25.4 (0.194 x 1.00)	20.6 x 50.8 (0.81 x 2.00)
AFSB3	74.7 - 100.1 (2.94 - 3.94)	76.2 - 95.3 (3.00 - 3.75)	79.5 - 104.9 (3.13 - 4.13)	114.3 (4.50)	55.6 (2.19)	122.2 (4.81)	68.3 (2.69)	49.2 x 25.4 (0.194 x 1.00)	27.0 x 65.1 (1.06 x 2.56)

Mounting Dimensions in Millimeters (inches)

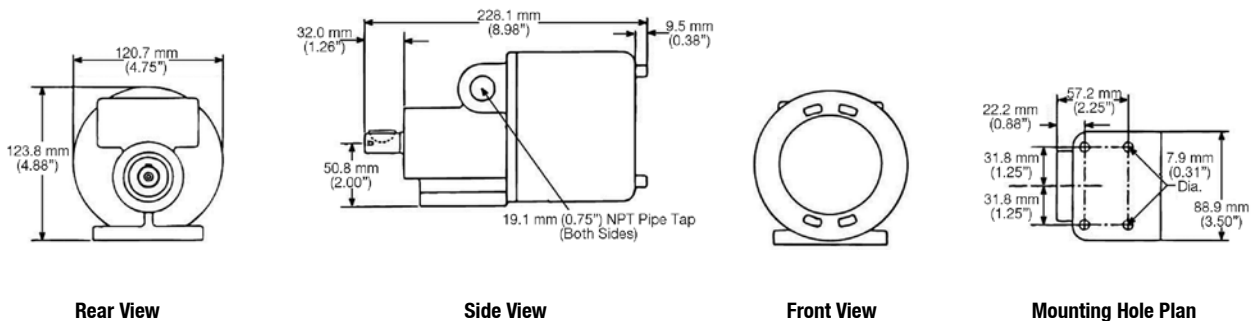

AFU and AFUX Conveyor Control Switches

Pull Cord Type, Left or Right Hand, Single or Double End.

NEC – AFUX Series:
Class I, Division 1 and 2, Groups C, D
Class II, Division 1 and 2, Groups E, F, G
Class III
NEMA 7CD, 9EFG

NEC – AFU Series:
NEMA 3, 4, 4X, 12

Applications

- Emergency stop or normal stop switch for:
 - Conveyor lines
 - Cranes
 - Unloaders
 - Bulk handling systems
- Where alarm or computer interface capabilities are needed.
- Used in the control circuit of magnetic motor starters to shut down motor driven conveyors or other machinery.
- For use in:
 - Steel mills
 - Mining ore and coal handling operations
 - Automotive and other assembly lines
 - Warehouses
 - Loading docks
 - Other industrial processes
- AFUX Series is used in Class I and II areas where flammable vapors or highly combustible dusts are present.
- AFU Series has a gasketed cover rated for NEMA 3, 3R, 4, 4X.

Features

- Rugged torsion spring for positive actuation of flag arm.
- Stainless steel bushing may be easily reversed to increase or decrease actuation force — 6.8 or 11.3 kgs (15 or 25 lbs).
- Maximum distance between switches should not exceed 61 meters (200 feet).
- Available with two switch types:
 - A) Two circuit double break switch is rated 15 Amp, 120, 240, 480, 600 Vac, 0.5 HP 120 Vac, 1 HP 240 Vac, 0.8 Amp 115 Vdc, 0.4 Amp 230 Vdc.
 - B) Single pole/double throw switch is rated 20 Amp, 125, 250, 480 Vac, 10 Amp 125 Vac “L” tungsten lamp load, 1 HP 125 Vac, 2 HP 250 Vac, 0.5 Amp 125 Vdc, 0.25 Amp 250 Vdc.
- Switch temperature range -40 °C to +66 °C (-40 °C to +151 °F).
- Two 1” conduit openings (top and bottom).

Standard Materials

- Housing: cast aluminum
- Flag arm: steel with red epoxy paint
- Actuator shaft, retaining ring, clevis loop and torsion springs: stainless steel

Standard Finishes

- Standard enclosure: peened

Options

- When using in dimly lit applications, add suffix **-L** for red warning light (uses top conduit opening).
- To order epoxy powder coated switches add suffix **-S752**.

NEC Certifications and Compliances

- UL Standards: UL 508, UL 698, UL 1203
- UL Listed: E164877, E10449

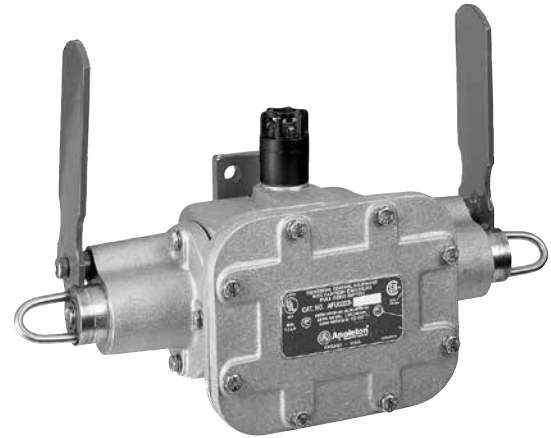

Double End Unit Right and Left Handed with Option Warning Light AFU or AFUX

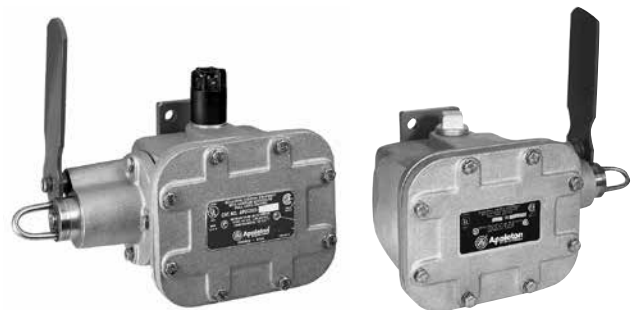

Left Hand Single Unit

Right Hand Single Unit

CONTROLS: NEC/CEC EXPLOSION-PROOF CONVEYOR SWITCHES

Appleton







AFU and AFUX Conveyor Control Switches

Pull Cord Type, Left or Right Hand, Single or Double End.

NEC — AFUX Series:
Class I, Division 1 and 2, Groups C, D
Class II, Division 1 and 2, Groups E, F, G
Class III
NEMA 7CD, 9EFG

NEC — AFU Series:
NEMA 3, 4, 4X, 12

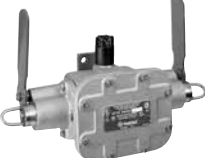
CONTROLS: NEC/CEC EXPLOSIONPROOF CONVEYOR SWITCHES

	Left or Right	No. of Two Circuit Double Break Micro Switches	Location Type	
			Ordinary	Hazardous
 Left Hand Single	15 Pound Pull Force — Single End			
	Left	1	AFU0333-10	AFUX0333-10
	Right	1	AFU0333-01	AFUX0333-01
	Left	2	AFU0333-50	AFUX0333-50
	Right	2	AFU0333-05	AFUX0333-05
 Double End	15 Pound Pull Force — Double End			
	Double End	1, each end	AFU0333-11	AFUX0333-11
 Right Hand Single	25 Pound Pull Force — Single End			
	Left	1	AFU0333-20	AFUX0333-20
	Right	1	AFU0333-02	AFUX0333-02
	Left	2	AFU0333-60	AFUX0333-60
	Right	2	AFU0333-06	AFUX0333-06
	25 Pound Pull Force — Double End			
Double End	1, each end	AFU0333-22	AFUX0333-22	
Double End	2, each end	AFU0333-66	AFUX0333-66	
	Left or Right	No. of Single Pole, Double Throw Micro Switches	Location Type	
			Ordinary	Hazardous
 Left Hand Single	15 Pound Pull Force — Single End			
	Left	1	AFU0333-30	AFUX0333-30
	Right	1	AFU0333-03	AFUX0333-03
	Left	2	AFU0333-70	AFUX0333-70
	Right	2	AFU0333-07	AFUX0333-07
 Double End	15 Pound Pull Force — Double End			
	Double End	1, each end	AFU0333-33	AFUX0333-33
 Right Hand Single	25 Pound Pull Force — Single End			
	Left	1	AFU0333-40	AFUX0333-40
	Right	1	AFU0333-04	AFUX0333-04
	Left	2	AFU0333-80	AFUX0333-80
	Right	2	AFU0333-08	AFUX0333-08
	25 Pound Pull Force — Double End			
Double End	1, each end	AFU0333-44	AFUX0333-44	
Double End	2, each end	AFU0333-88	AFUX0333-88	



AFU and AFUX Conveyor Control Switch Accessories and Application

Pull Cord Type, Left or Right Hand, Single or Double End. Pull Cord Type, Left or Right Hand, Single or Double End.

NEC — AFUX Series:
Class I, Division 1 and 2, Groups C, D
Class II, Division 1 and 2, Groups E, F, G
Class III
NEMA 7CD, 9EFG

NEC — AFU Series:
NEMA 3, 4, 4X, 12

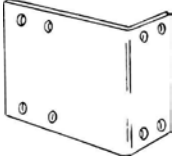
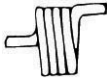
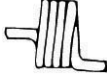
Accessories

	Description	Catalog Number
	Mounting Bracket	AFUMB
	Replacement Torsion Spring — Left	AFUTSL
	Replacement Torsion Spring — Right	AFUTSR
	Conduit Plug 1"—11-1/2 NPT	PLG100-S

Typical Application

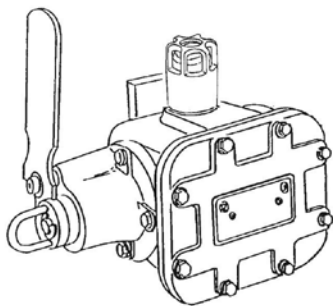
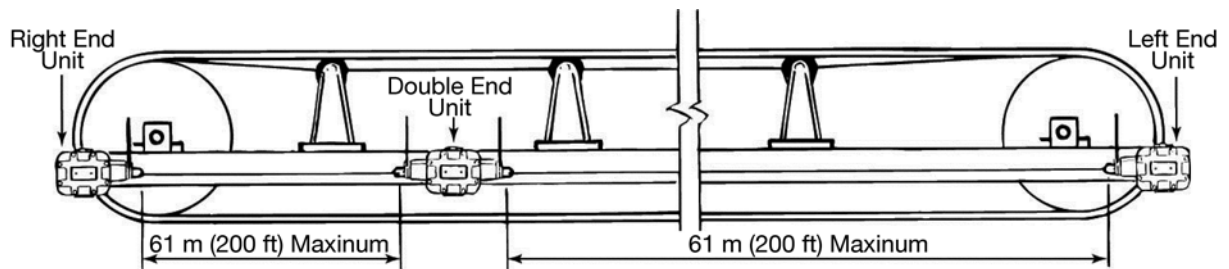

Left Hand Single Unit
(with option Warning Lamp)

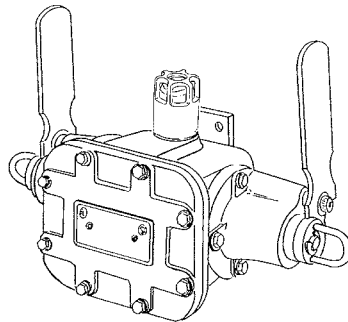

Double End Unit Right and Left Handed
(with option Warning Lamp)

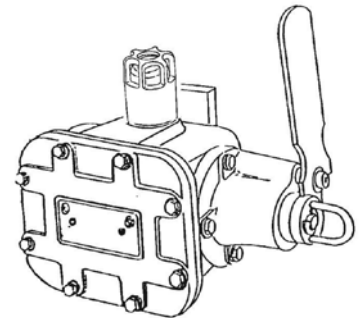

Right Hand Single Unit
(with option Warning Lamp)

CONTROLS: NEC/CEC EXPLOSIONPROOF CONVEYOR SWITCHES

Appleton

AFU and AFUX Conveyor Control Switch

Pull Cord Type, Left or Right Hand, Single or Double End.

NEC – AFUX Series:
 Class I, Division 1 and 2, Groups C, D
 Class II, Division 1 and 2, Groups E, F, G
 Class III
 NEMA 7CD, 9EFG

NEC – AFU Series:
 NEMA 3, 4, 4X, 12

Wiring Information

Description	Diagram
-------------	---------

Single Pole Double Throw Circuit

Single Pole, Double Throw Micro Switch Rating

- 20 Amps, 125, 250 or 480 Vac
- 10 Amps, 125 Vac "L" (tungsten lamp load)
- 1 HP, 125 Vac
- 2 HP, 250 Vac
- 1/2 Amp, 125 Vdc
- 1/4 Amp, 250 Vdc

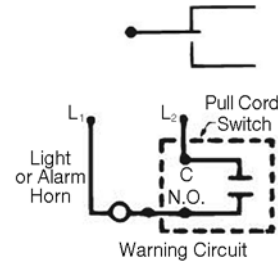
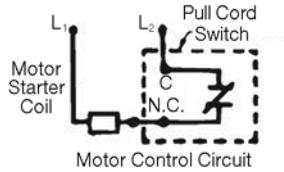

Two Circuit, Double Break Micro Switch Rating

- 15 Amps, 120, 240, 480 or 600 Vac
- 1/2 HP, 120 Vac
- 1 HP, 240 Vac
- 0.8 Amp, 115 Vdc
- 0.4 Amp, 230 Vdc 0.8, 250 Vac
- 1/2 Amp, 125 Vdc
- 1/4 Amp, 250 Vdc

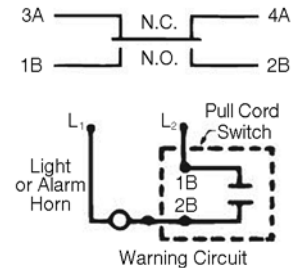
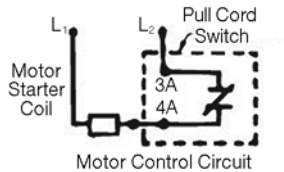

Two circuit double break switches must be wired to equal voltage sources and the same polarity. Loads should be on the same side of the lines. 1B has the same polarity as 3A.

Dimensions in Millimeters (Inches)

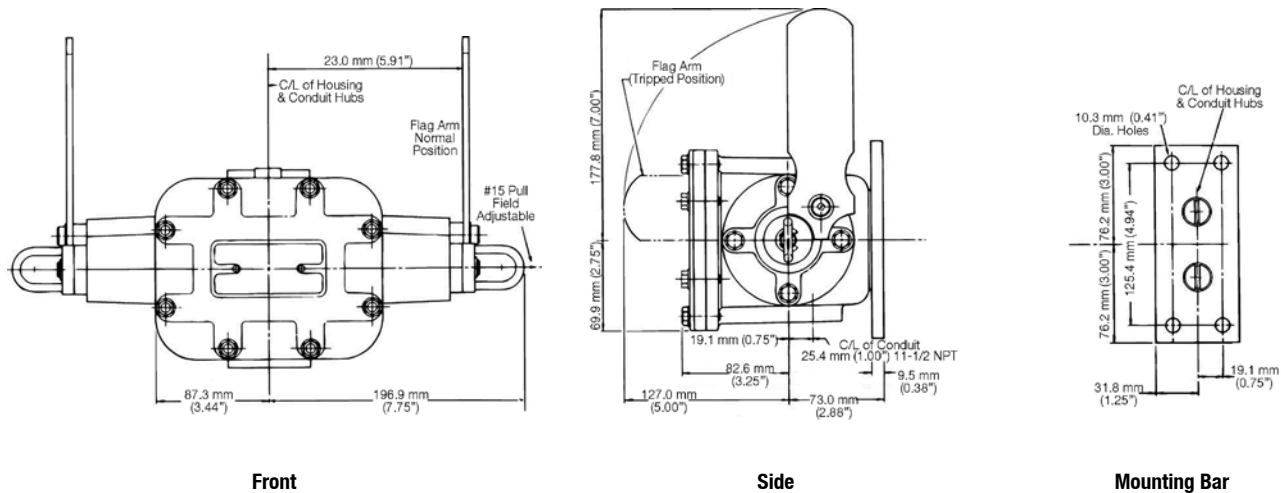

ATX™ FAS Series “Break Glass” Call Points

Increased Safety and Flameproof

ATEX:
Zone 1 and 2
⊕ II 2 GD
IP66 - IK10

Applications

- Located on exit routes, in particular on the floor landings of staircases and at all exits to the open air.
- For use in hazardous areas where ignitable vapors, gases or highly combustible dusts are present.
- For installation in chemical and petrochemical plants, refineries and other process industries.

Features

- Type PCe (increased safety version):
 - Hammer and stainless steel chain.
 - NO+NC contacts with 2.5 mm² (0.004 in²) terminals.
 - Earth termination: 2 x 4 mm² (0.003 x 0.006 in²) – internal and external.
 - 2 x M20 bottom entries supplied with polyamide cable gland – 6.5 to 14.5 mm (0.26 to 0.57 in) diameter and polyamide blanking plug.
- Type BR1d (flameproof version):
 - Hammer and stainless steel chain.
 - NO+NC contacts with 2.5 mm² (0.004 in²) terminals.
 - Earth termination: 2 x 4 mm² (0.003 x 0.006 in²) – internal and external.
 - 2 x M20 entries (1 top and 1 bottom) supplied with one aluminum blanking plug.

Standard Materials

- Type PCe
 - Box: red painted aluminum alloy
 - Cover: red painted steel
 - Chain: stainless steel
- Type BR1d
 - Box: painted marine grade aluminum alloy (gray painted body and red painted cover)
 - Chain: stainless steel

Options

- Special options available - consult factory for details.

ATEX Certifications and Compliances

- Certification Type: PCe
 - Gas: Zone 1 and 2
 - Conforming to ATEX 94/9/CE: ⊕ II 2 G
 - Type of Protection: Ex de IIC
 - Temperature Class: T6
 - Dust: Zone 21 and 22
 - Conforming to ATEX 94/9/CE: ⊕ II 2 D
 - Type of Protection: Ex td A21
 - Surface Temperature: T80 °C (T167 °F)
 - Ambient Temperature: -55 °C to +60 °C (-67 °F to +140 °F)
 - CE Declaration of Conformity: 50221
 - ATEX Certificate: LCIE 00 ATEX 6047
- Certification Type: BR1d
 - Gas: Zone 1 and 2
 - Conforming to ATEX 94/9/CE: ⊕ II 2 G
 - Type of Protection: Ex d IIC
 - Temperature Class: T6 for Ta = +40 °C (+104 °F); T5 for Ta = +55 °C (+131 °F)



Ex de IIC Version
(PCe Type)

Ex d IIC Version
(BR1d Type)

- Dust: Zone 21 and 22
- Conforming to ATEX 94/9/CE: ⊕ II 2 D
- Type of Protection: Ex td A21
- Surface Temperature: T95 °C (T203 °F)
- Ambient Temperature: -40 °C to +55 °C (-40 °F to + 131 °F)
- CE Declaration of Conformity: 50230
- ATEX Certificate: LCIE 02 ATEX 605
- Impact Resistance: IK10
- Index of Protection according EN/IEC 60529: IP66

Other Certification ①

- Certification Type: PCe
 - EURASEC RU C-FR. Г505.B.00911
- Certification Type: BR1d
 - EURASEC RU C-FR. Г505.B.00911

① INMETRO certification available on special request only. Contact your local sales representative for more information.

ATX™ FAS Series “Break Glass” Call Points

Increased Safety and Flameproof

ATEX:
 Zone 1 and 2
 II 2 GD
 IP66 - IK10

Catalog Numbering Guide

FAS
 |
 Series:
 ATEX Certified

D
 |
 D - Ex d
 E - Ex e

A
 |
 A - Automatic
 M - Manual

Description	Weight kg (lb)	Volume dm ³ (in ³)	Catalog Number	Pack
Increased Safety Ex de IIC Version - Type PCe:				
Manual breaking of the circuit after breaking the glass. Momentary NO+NC contacts	1.2 (2.6)	5 (305.1)	FASEM	1
Automatic breaking of the circuit as soon as glass is broken. Momentary NO+NC contacts	1.2 (2.6)	5 (305.1)	FASEA	1
Flameproof Ex d IIC Version - Type BR1d:				
Automatic breaking of the circuit as soon as glass is broken. Momentary NO+NC contacts	1.2 (2.6)	3.8 (231.9)	FASDA ①	1

Dimensions in Millimeters (Inches)

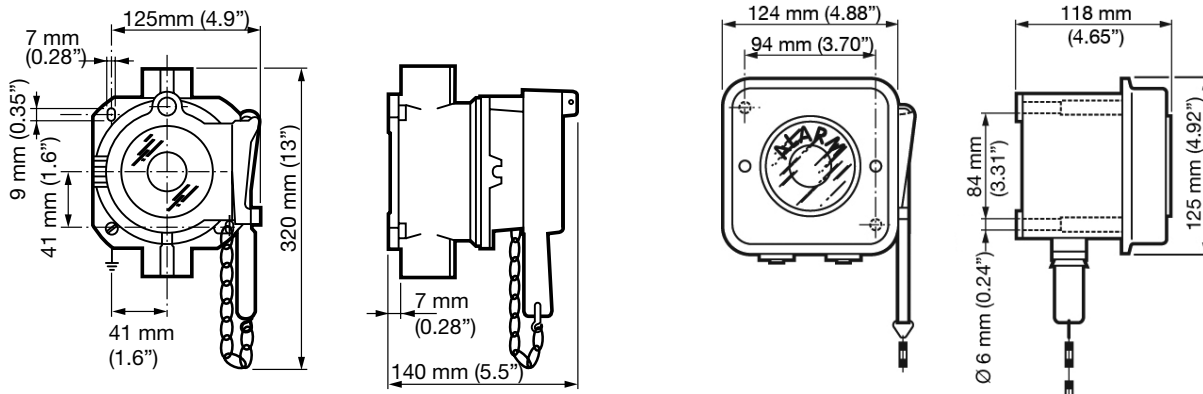

① Cable entry is M25. Old PN 093818 had M20 entry. Please confirm cable entry size.

ATX™ SWD Series 16 and 32 Amp Switches, Circuit Breakers and “Break Glass”

Call Points

Flameproof

ATEX/IECEX:
Zone 1 and 2 - 21 and 22
II 2 GD
IP66 - IK10

Applications

- Designed to prevent operation in explosive atmospheres during connect and disconnect operation of lighting and light power loads.
- For use in hazardous areas where ignitable vapors, gases or highly combustible dusts are present.
- For installation in chemical and petrochemical plants, refineries and other process industries.

Features

- Available up to 690 Volts, and up to 32 Amps.
- Two threaded entries (one top and one bottom) M20 or M25.
- Switch mechanism fixed at the bottom of the box.
- Padlockable handle.
- Termination:
 - 16 Amp 4 mm² (0.006 in²) terminals
 - 32 Amp 6 mm² (0.009 in²) terminals
- Internal earth:
 - 2 x 4 mm² (0.006 in²) terminals
- External earth:
 - M5 for 16 Amps
 - M6 for 32 Amps

Standard Materials

- Box: marine grade aluminum alloy
- Captive screws: A2 stainless steel

ATEX/IECEX Certifications and Compliances

- 16 Amp Version. Certification Type: BR1d (16A)
 - Gas: Zone 1 and 2
 - Conforming to ATEX 94/9/CE: II 2 G
 - Type of Protection: Ex d IIC
 - Temperature Class: T6 for Ta = +40 °C (+104 °F), T5 for Ta = +55 °C (+131 °F)
 - Dust: Zone 21 and 22
 - Conforming to ATEX 94/9/CE: II 2 D
 - Type of Protection: Ex tD A21
 - Surface Temperature: T95 °C (+203 °F)
 - Ambient Temperature: -40 °C to +55 °C (-40 °F to +131 °F)
 - CE Declaration of Conformity: 50230
 - ATEX Certificate: LCIE 02 ATEX 6056
- 32 Amp Version. Certification Type: CF1E (32A)
 - Gas: Zone 1 and 2
 - Conforming to ATEX 94/9/CE: II 2 G
 - Type of Protection: Ex d IIC
 - Temperature Class: T6 for Ta ≤ +40 °C (+104 °F), T5 for +40 °C (+104 °F) < Ta ≤ +55 °C (+131 °F)
 - Dust: Zone 21 and 22
 - Conforming to ATEX 94/9/CE: II 2 D
 - Type of Protection: Ex tD A21
 - Surface Temperature: T95 °C (+203 °F)
 - Ambient Temperature: -40 °C to +55 °C (-40 °F to +131 °F)
 - CE Declaration of Conformity: 50257
 - ATEX Certificate: LCIE 03 ATEX 6044X
- Index of Protection according EN/IEC 60529: IP66
- Impact Resistance (shock): IK10

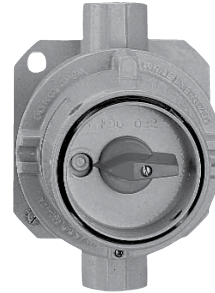

16 Amp Version



32 Amp Version

EURASEC Certification

- 16 Amp Version. Certification Type: BR1d (16A)
 - EURASEC RU C-FR. Г505.B.00911
- 32 Amp Version. Certification Type: CF1E (32A)
 - EURASEC RU C-FR. Г505.B.00911

CONTROL S: ATEX/IECEX INCREASED SAFETY CALL POINTS STATIONS AND AUDIO SIGNALING DEVICES

ATX™ SWD Series 16 and 32 Amp Switches, Circuit Breakers and “Break Glass”

Call Points

Flameproof

ATEX/IECEX:
Zone 1 and 2 - 21 and 22
II 2 GD
IP66 - IK10

Catalog Numbering Guide

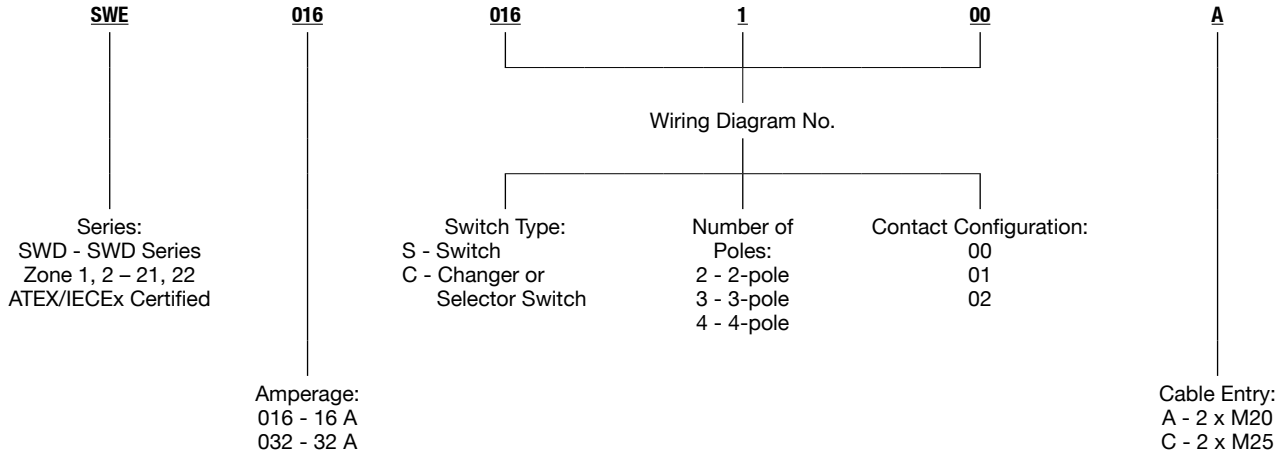

Switch Type	Wiring Diagram No.	Entries	Weight kg (lb)	Volume dm ³ (in ³)	Catalog Number
16 Amp Switch					
1-pole changeover	C100	2 x M20	1.1 (2.43)	3.8 (231.89)	SWD016C100A
		2 x M25			SWD016C100C
2-pole switch	S200	2 x M20	1.1 (2.43)	3.8 (231.89)	SWD016S200A
		2 x M25			SWD016S200C
3-pole switch	S300	2 x M20	1.1 (2.43)	3.8 (231.89)	SWD016S300A
		2 x M25			SWD016S300C
4-pole switch	S400	2 x M20	1.1 (2.43)	3.8 (231.89)	SWD016S400A
		2 x M25			SWD016S400C
32 Amp Switch					
2-pole switch	S200	2 x M20	2.7 (5.95)	8.0 (488.19)	SWD032S200A
		2 x M25			SWD032S200C
3-pole switch	S300	2 x M20	2.7 (5.95)	8.0 (488.19)	SWD032S300A
		2 x M25			SWD032S300C
4-pole switch	S400	2 x M20	2.7 (5.95)	8.0 (488.19)	SWD032S400A
		2 x M25			SWD032S400C

Switching Arrangement — X Denotes “Closed Contact”

C100			C200			S300				S400				
Positions	Contacts		Positions	Contacts		Positions	Contacts			Positions	Contacts			
	1-2	3-4		1-2	3-4		1-2	3-4	5-6		1-2	3-4	5-6	7-8
0	X		0			0				0				
1		X	1	X	X	1	X	X	X	1	X	X	X	X

ATX™ SWD Series 16 and 32 Amp Switches, Circuit Breakers and “Break Glass”

Call Points

Flameproof

ATEX/IECEX:
 Zone 1 and 2 - 21 and 22
 II 2 GD
 IP66 - IK10

Main Contacts	16 Amps	32 Amps
Rated insulation voltage (Ui)	690 V	690 V
Thermal rating	20 A	40 A
AC 21 A	16 A	32 A
AC 15	6 A	12 A
AC 23 A	3 x 230 V	4 KW
	3 x 400 V	7.5 KW
	3 x 500 V	5.5 KW
	3 x 690 V	4 KW
AC 3 A	3 x 230 V	3 KW
	3 x 400 V	4 KW
	3 x 500 V	5.5 KW
	3 x 690 V	3 KW
Flexible Termination	2.5 mm ² (0.004 in ²)	6 mm ² (0.009 in ²)
Solid Termination	4 mm ² (0.006 in ²)	6 mm ² (0.009 in ²)

Dimensions in Millimeters (Inches)

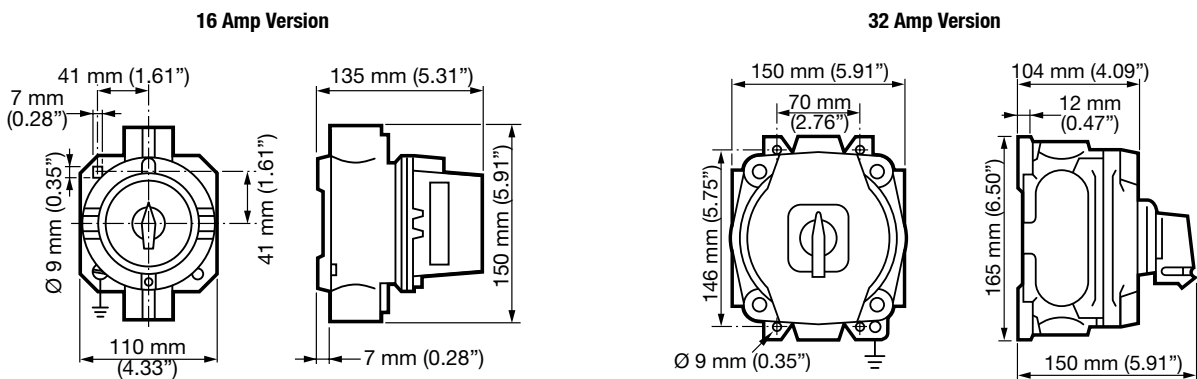

CONTROL S: ATEX/IECEX INCREASED SAFETY CALL POINTS STATIONS AND AUDIO SIGNALING DEVICES



ATX™ SWD Series 20, 32, 63, 100, 125, 160 and 250 Amp Isolator Switches, Circuit Breakers and “Break Glass” Call Points

Flameproof

ATEX/IECEX:
Zone 1 and 2 - 21 and 22
⊕ II 2 GD
IP66 - IK10

Applications

- Designed to prevent operation in explosive atmospheres during connect and disconnect operation of power loads.
- For use in hazardous areas where ignitable vapors, gases or highly combustible dusts are present.
- For installation in chemical and petrochemical plants, refineries and other process industries.

Features

- Available up to 690 Volts, and up to 250 Amps.
- Padlockable handle in position “O”.
- 3 or 4-pole switch mechanism.
- “NO-NC” early break auxiliary contact.
- Main contact termination: Up to 85 mm² (0.2868 in²).
- Auxiliary contact termination: 2.5 mm² (0.004 in²).
- Threaded cable entries:
two at bottom and one at top – M20 to M63
- Supplied with:
1 x M20 blanking plug
1 x M8 earth stud

Standard Materials

- Box: marine grade aluminum alloy
- Captive screws: A2 stainless steel

Standard Finishes

- Box: gray paint

Options

- Visible break assembly including a window to view power connection (only for 100 A to 160 A versions).

ATEX/IECEX Certifications and Compliances

- Certification Type: CF2D
 - Gas: Zone 1 and 2
 - Conforming to ATEX 94/9/CE: ⊕ II 2 G
 - Type of Protection: Ex d IIB
 - Temperature Class: T6 for Ta ≤ +40 °C (+104 °F);
T5 for +40 °C (+104 °F) < Ta ≤ +55 °C (+131 °F)
 - Dust: Zone 21 and 22
 - Conforming to ATEX 94/9/CE: ⊕ II 2 D
 - Type of Protection: Ex tD A21
 - Surface Temperature: T95 °C (T203 °F)
 - Ambient Temperature: -40 °C to +55 °C (-40 °F to +131 °F)
 - CE Declaration of Conformity: 50254
 - ATEX Certificate: LCIE 02 ATEX 6061X
- Certification Type: CF
 - Gas: Zone 1 and 2
 - Conforming to ATEX 94/9/CE: ⊕ II 2 G
 - ATEX/IEC Protection: Ex d IIB
 - Temperature Class: T6
 - Dust: Zone 21 and 22
 - Conforming to ATEX 94/9/CE: ⊕ II 2 D
 - Type of Protection: Ex tD A21
 - Surface Temperature: T80 °C (T176 °F)
 - Ambient Temperature: -40 °C to +55 °C (-40 °F to +131 °F);
CF10B is -20 °C to +55 °C (-4 °F to +131 °F)
 - CE Declaration of Conformity: 50229
 - ATEX Certificate: LCIE 02 ATEX 6057X
 - IECEx Certificate: LCI.08 0023X
- Index of Protection according EN/IEC 60529: IP66
- Impact Resistance (shock): IK10
- Internal Volume: >2 dm³ (122 in³) - 2 liters

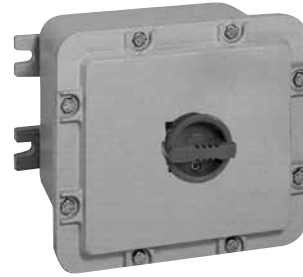

63 Amp Version

EURASEC Certification

- Certification Type: CF2D
 - EURASEC RU C-FR.Г505.B.00911
- Certification Type: CF
 - EURASEC RU C-FR.Г505.B.00911

ATX™ SWD Series 20, 32, 63, 100, 125, 160 and 250 Amp Isolator Switches, Circuit Breakers and “Break Glass” Call Points

Flameproof

ATEX/IECEX:
Zone 1 and 2 - 21 and 22
II 2 GD
IP66 - IK10

Catalog Numbering Guide

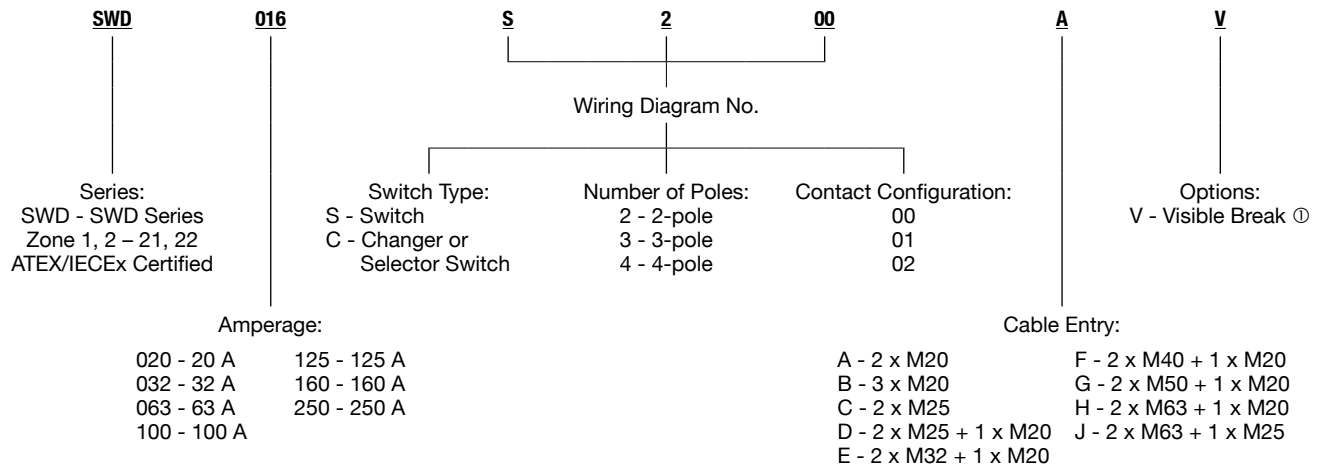

Switch Type	Wiring Diagram No.	Certified Type	Weight kg (lb)	Volume dm ³ (in ³)	Catalog Number
20 A – 3 x M20 threaded entries (1 Top and 2 Bottom)					
3-pole switch	S300	CF2D	3.8 (0.15)	11 (671.3)	SWD020S300B
4-pole switch	S400	CF2D	3.8 (0.15)	11 (671.3)	SWD020S400B
32 A – Bottom entries: 1 x M25 + 1 x M20 – Top entries: 1 x M25					
3-pole switch	S300	CF2D	3.8 (0.15)	11 (671.3)	SWD032S300D
4-pole switch	S400	CF10B	11 (0.43)	19.6 (1196.1)	SWD032S400D
63 A – Bottom entries: 1 x M32 + 1 x M20 – Top entries: 1 x M32					
3-pole switch	S300	CF10B	11 (0.43)	19.6 (1196.1)	SWD063S300E
4-pole switch	S400	CF10B	11 (0.43)	19.6 (1196.1)	SWD063S400E
100 A – Bottom entries: 1 x M40 + 1 x M20 – Top entries: 1 x M40					
3-pole switch	S300	CF20B	13 (0.51)	24.5 (1495.1)	SWD100S300F
4-pole switch	S400	CF20B	13 (0.51)	24.5 (1495.1)	SWD100S400F
125 A – Bottom entries: 1 x M50 + 1 x M20 – Top entries: 1 x M50					
3-pole switch	S300	CF20B	13 (0.51)	24.5 (1495.1)	SWD125S300G
4-pole switch	S400	CF20B	13 (0.51)	24.5 (1495.1)	SWD125S400G
160 A – Bottom entries: 1 x M50 + 1 x M20 – Top entries: 1 x M50					
3-pole switch	S300	CF40B	50.5 (1.99)	235.2 (14352.8)	SWD160S300G
4-pole switch	S400	CF40B	50.5 (1.99)	235.2 (14352.8)	SWD160S400G
250 A – Bottom entries: 1 x M63 + 1 x M20 – Top entries: 1 x M63					
3-pole switch	S300	CF60B	112 (4.41)	646.6 (39458.0)	SWD250S300H
4-pole switch	S400	CF60B	112 (4.41)	646.6 (39458.0)	SWD250S400H

Switching Arrangement – X Denotes “Closed Contact”

S300

Positions	Contacts		
	1–2	3–4	5–6
0			
1	X	X	X

S400

Positions	Contacts			
	1–2	3–4	5–6	7–8
0				
1	X	X	X	X

① For 100, 125 and 160 Amp versions only.

ATX™ SWD Series 20, 32, 63, 100, 125, 160 and 250 Amp Isolator Switches, Circuit Breakers and “Break Glass” Call Points

Flameproof

ATEX/IECEX:
Zone 1 and 2 - 21 and 22
II 2 GD
IP66 - IK10

CONTROLS: ATEX/IECEX INCREASED SAFETY CALL POINTS STATIONS AND AUDIO SIGNALING DEVICES

Technical Data

Main Contacts	20 Amps	32 Amps	63 Amps	100 Amps	125 Amps	160 Amps	250 Amps
Rated Insulation Voltage (Ui)	800 V	800 V	800 V	800 V	800 V	800 V	800 V
Rated Operating Voltage (Ue)	415 V/500 V/ 690 V	415 V/500 V/ 690 V	415 V/500 V/ 690 V	415 V/500 V/ 690 V	415 V/500 V/ 690 V	415 V/500 V/ 690 V	415 V/500 V/ 690 V
Rated Operating Current (Ie)	25 A	32 A/32 A/ 25 A	63 A/63 A/ 40 A	100 A	125 A	160 A/160 A/ 125 A	250 A/250 A/ 200 A
Rated Surge Voltage (Uimp)	8 kV	8 kV	8 kV	8 kV	8 kV	8 kV	8 kV
Short Circuit Resistance	50 kA (with fuse)	50 kA (with fuse)	50 kA (with fuse)	100 kA (with fuse)	63 kA (with fuse)	80 kA (with fuse)	50 kA (with fuse)
Switching Capacity							
AC 21 A	415 V	25 A	32 A	63 A	100 A	125 A	250 A
	500 V	25 A	32 A	63 A	100 A	125 A	250 A
	690 V	25 A	32 A	63 A	100 A	125 A	200 A
AC 22 A	415 V	25 A	32 A	63 A	100 A	125 A	250 A
	500 V	25 A	32 A	63 A	100 A	125 A	250 A
	690 V	25 A	32 A	63 A	63 A	80 A	100 A
AC 23 A	230 V	25 A	-	-	-	-	-
	415 V	25 A	32 A	63 A	100 A	125 A	250 A
	500 V	25 A	25 A	63 A	80 A	100 A	200 A
	690 V	25 A	25 A	40 A	63 A	80 A	100 A
AC 23 A Motor Power (kW)	230 V	-	-	-	-	-	-
	415 V	11 kW	15 kW	30 kW	45 kW	55 kW	75 kW
	500 V	11 kW	15 kW	30 kW	45 kW	55 kW	75 kW
	690 V	15 kW	18.5 kW	30 kW	45 kW	75 kW	90 kW
DC 21	24/48 V, 25 A ①	-	-	-	-	-	220 V, 250 A ①
	-	-	-	-	800 V, 125 A ①	800 V, 125 A ①	440 V, 200 A ①
	-	-	-	-	-	-	500 V, 200 A ①
DC 22	-	-	-	-	-	-	220 V, 250 A ①
	-	-	-	-	-	-	440 V, 200 A ①
	-	-	-	-	-	-	500 V, 200 A ①
DC 23	-	-	-	-	-	-	220 V, 250 A ①
	-	-	-	-	-	-	440 V, 200 A ①
	-	-	-	-	-	-	500 V, 200 A ①
Flexible Termination	0.75 to 6 mm ² (0.001 to 0.009 in ²)	16 mm ² (0.025 in ²)	4 to 35 mm ² (0.006 to 0.054 in ²)	4 to 50 mm ² (0.006 to 0.078 in ²)	4 to 50 mm ² (0.006 to 0.078 in ²)	4 to 50 mm ² (0.006 to 0.078 in ²)	95 mm ² (0.147 in ²)
Solid Termination	10 mm ² (0.016 in ²)	16 mm ² (0.025 in ²)	50 mm ² (0.076 in ²)	70 mm ² (0.109 in ²)	70 mm ² (0.109 in ²)	70 mm ² (0.109 in ²)	150 mm ² (0.233 in ²)
Auxiliary Contacts							
Rated Operating Voltage (Ue)	230 V/400 V	250 V	250 V	250 V	250 V	250 V	230 V/400 V
Rated Operating Current (Ie)	6 A/4 A	5 A	5 A	5 A	5 A	5 A	4 A/3 A
Switching Capacity							
AC 15	6 A/230 V	5 A/250 V	5 A/250 V	5 A/250 V	5 A/250 V	5 A/250 V	4 A/230 V - 3 A/400 V
DC 14	-	-	-	-	-	-	1 A/24 V - 0.2 A/48 V
Flexible Termination	2.5 mm ² (0.004 in ²)	2.5 mm ² (0.004 in ²)	2.5 mm ² (0.004 in ²)	2.5 mm ² (0.004 in ²)	2.5 mm ² (0.004 in ²)	2.5 mm ² (0.004 in ²)	2.5 mm ² (0.004 in ²)

① Two contacts connected in series.

ATX™ SWD Series 20, 32, 63, 100, 125, 160 and 250 Amp Isolator Switches, Circuit Breakers and “Break Glass” Call Points

Flameproof

Dimensions in Millimeters (Inches)

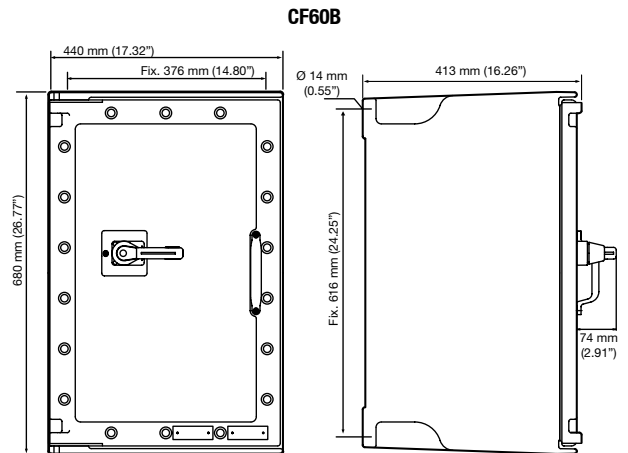
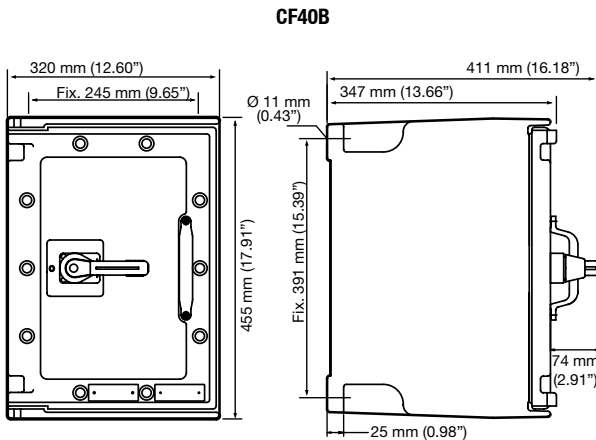
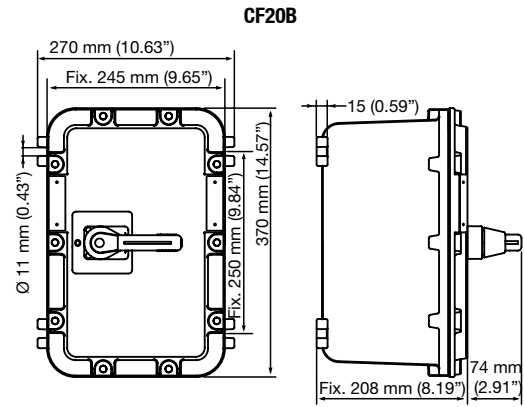
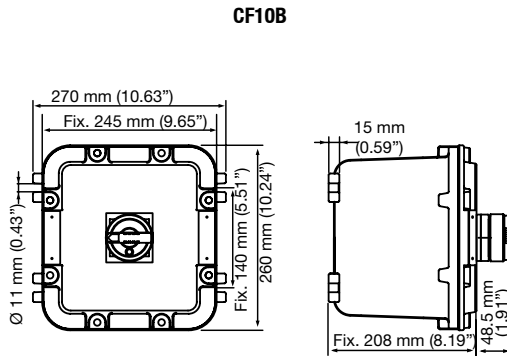
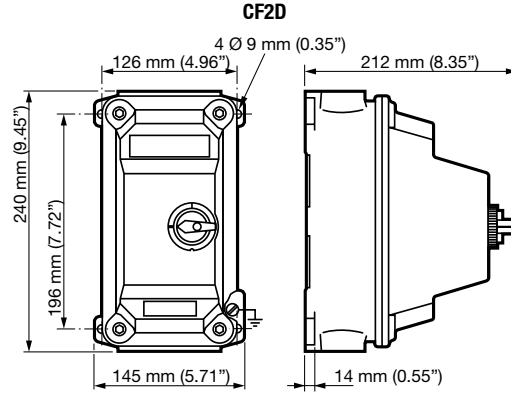

CONTROLS: ATEX/IECEx INCREASED SAFETY CALL POINTS STATIONS AND AUDIO SIGNALING DEVICES



ATX™ SWE Series 16 and 20 Amp Switches, Circuit Breakers, and “Break Glass”

Call Points

Increased Safety

ATEX:
Zone 1 and 2 - 21 and 22
II 2 GD
IP66 - IK09 or IK10

Applications

- Designed to prevent operation in explosive atmospheres during connect and disconnect operation of lighting and light power loads.
- For use in hazardous areas where ignitable vapors, gases or highly combustible dusts are present.
- For installation in chemical and petrochemical plants, refineries and other process industries.

Features

- Available up to 690 Volts, and up to 20 Amps
- 16 Amp version:
 - Two bottom M20 clearance holes.
 - Switch mechanism fixed at the bottom of the box.
 - Termination:
 - Type 1: 2.5 mm² (0.004 in²)
 - Type 2: 2.5 mm² (0.004 in²) flexible, 4 mm² (0.006 in²) solid
 - Internal earth:
 - 2 x 2.5 mm² (0.004 in²) terminals
 - Supplied with:
 - 1 x white self-adhesive laminated plastic label with black lettering – 58 mm x 18 mm (2.28” x 0.71”)
- 20 Amp version:
 - Two M20 threaded entries on the bottom of the box.
 - Switch mechanism fixed on the bottom of the box.
 - Padlockable handle in position 0 using maximum 4 padlocks
 - maximum handle diameter 8 mm (0.315”) and minimum 15 mm (0.59”) length.
 - Termination:
 - 2.5 mm² (0.004 in²) flexible/4 mm² (0.006 in²) solid
 - Internal earth:
 - 2 x 4 mm² (0.006 in²) terminals
 - Supplied with:
 - 1 x yellow self-adhesive laminated plastic label with black lettering – 65 mm x 18 mm (2.56” x 0.71”)

Standard Materials

- 16 Amp version
 - Box: polyamide
 - Screws: A2 stainless steel
 - Cable glands: polyamide
 - Locknuts: nickel plated brass
- 20 Amp version
 - Box: polyamide
 - Screws: A2 stainless steel
 - Cable glands: polyamide

ATEX Certifications and Compliances

- Certification Type PCe
 - Gas: Zone 1 and 2
 - Conforming to ATEX 94/9/CE: II 2 G
 - Type of Protection: Ex de IIC
 - Temperature Class: T6
 - Dust: Zone 21 and 22
 - Conforming to ATEX 94/9/CE: II 2 D
 - Type of Protection: Ex tD A21
 - Surface Temperature: T80 °C (T176 °F)
 - Ambient Temperature: -20 °C to +40 °C (-4 °F to +104 °F)
- CE Declaration of Conformity: 50221
- ATEX Certificate: LCIE 00 ATEX 60472
- Index of Protection according EN/IEC 60529: IP66



16 A Version – Type 1



16 A Version – Type 2



20 A Version

EURASEC Certification

- Certification Type PCe
 - EURASEC RU C-FR. Г505.B.00911

Other Certification ①

- Certification Type PCe
 - INMETRO Certificate: BVC 11.0640-X

① INMETRO certification available on special request only. Contact your local sales representative for more information.

ATX™ SWE Series 16 and 20 Amp Switches, Circuit Breakers, and “Break Glass”

Call Points

Increased Safety

ATEX:
 Zone 1 and 2 - 21 and 22
 II 2 GD
 IP66 - IK09 or IK10

Catalog Numbering Guide

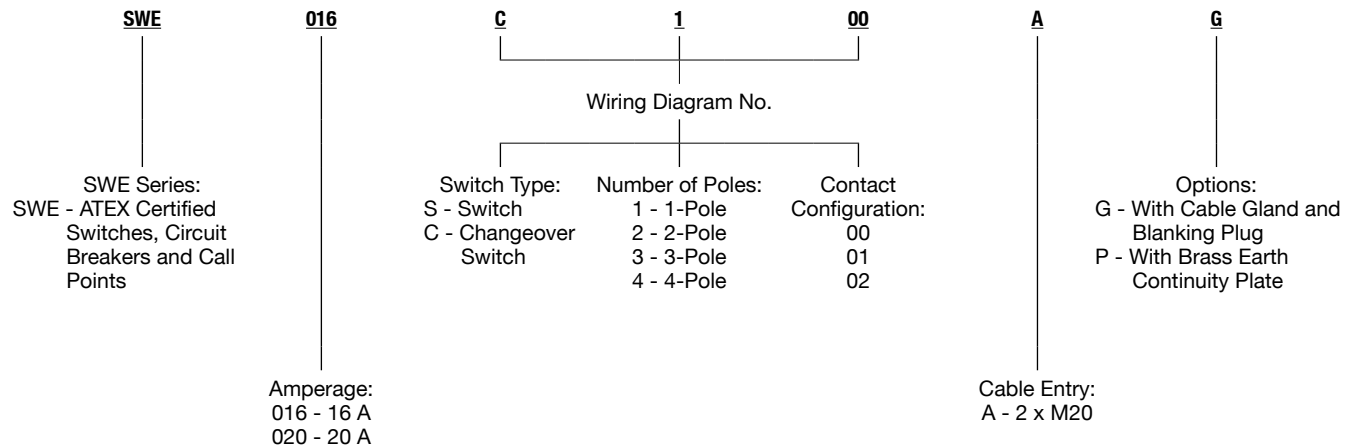

Switch Type	Wiring Diagram No.	Type	Weight kg (lb)	Volume dm ³ (in ³)	Catalog Number
16 Amp Switch – Type 1 – Padlockable handle – Two M20 polyamide cable glands (cable dia. 6.5 to 14.5 mm) on the bottom					
Changeover switch	C101	1	0.53 (1.17)	2 (122.05)	SWE016C101AG
2-pole	S201	1	0.53 (1.17)	2 (122.05)	SWE016S201AG
16 Amp Twist Button - Type 2 – Non-padlockable handle – Two M20 clearance holes on the bottom					
Changeover switch	C100	2	0.50 (1.10)	2 (122.05)	SWE016C100A
2-pole	S200	2	0.50 (1.10)	2 (122.05)	SWE016S200A
20 Amp Switch – Padlockable handle – Two M20 polyamide cable glands (cable dia. 6.5 to 14.5 mm) on the bottom					
Changeover switch	C100	—	1 (2.20)	2 (122.05)	SWE020C100AG
2-pole	S202	—	1 (2.20)	2 (122.05)	SWE020S202AG
3-pole	S301	—	1 (2.20)	2 (122.05)	SWE020S301AG
4-pole	S401	—	1 (2.20)	2 (122.05)	SWE020S401AG

CONTROL S: ATEX/IECEX INCREASED SAFETY CALL POINTS STATIONS AND AUDIO SIGNALING DEVICES



ATX™ SWE Series 16 and 20 Amp Switches, Circuit Breakers, and “Break Glass”

Call Points

Increased Safety

ATEX:
 Zone 1 and 2 - 21 and 22
 II 2 GD
 IP66 - IK09 or IK10

CONTROLS: ATEX/IECEx INCREASED SAFETY CALL POINTS STATIONS AND AUDIO SIGNALING DEVICES

Main Contacts	16 Amps Type 1	16 Amps Type 2	20 Amps
Rated Insulation Voltage	750 V	500 V	500 V
Rated Operating Voltage	690 Vac/110 Vdc	500 V	500 V
Rated Operating Current	16 Amp	16 Amp	20 Amp
Switching Capacity			
AC 1	16 Amp, 690 V	16 Amp, 500 V	—
AC 12	—	16 Amp, 400 V	—
AC 14	—	10 Amp, 400 V	—
AC 15	16 Amp, 415 V	6 Amp, 500 V	—
AC 21	—	—	16 Amp, 500 V
AC 23	—	—	16 Amp, 400 V
AC 3	08 Amp, 500 V	—	—
AC 3	04 Amp, 690 V	—	—
DC 1	10 Amp, 24 V	—	—
DC 1	06 Amp, 60 V	—	—
DC 1	06 Amp, 110 V ①	—	—
DC 13	—	1 Amp, 110 V	—
DC 13	—	2 Amp, 24 V	—
Termination (flexible/solid)	2.5 mm ² /4 mm ² (0.004 in ² /0.006 in ²)	2.5 mm ² (0.004 in ²)	2.5 mm ² /4 mm ² (0.004 in ² /0.006 in ²)

Dimensions in Millimeters (Inches)

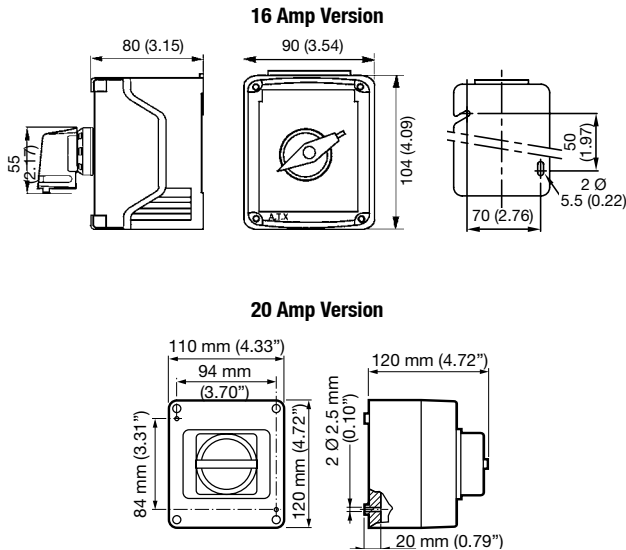

Switching Arrangement X Denotes “Closed Contact”

16 Amp Switch C101

Positions	Contacts	
	11–12	23–24
0	X	
1		X

S201

Positions	Contacts	
	13–14	23–24
0		
1	X	X

16 Amp Twist Button C100

Positions	Contacts	
	1–2	3–4
0	X	
1		X

S200

Positions	Contacts	
	3–4	3–4
0		
1	X	X

20 Amp Switch C100

Positions	Contacts	
	1–2	3–4
0	X	
1		X

S202

Positions	Contacts	
	1–2	3–4
0		
1	X	X

S301

Positions	Contacts		
	1–2	3–4	5–6
0			
1	X	X	X

S401

Positions	Contacts			
	1–2	3–4	5–6	7–8
0				
1	X	X	X	X

① 2 contacts connected in series.

ATX™ SWE Series 40, 63 and 160 Amp Switches, Circuit Breakers, and “Break Glass” Call Points

Increased Safety

ATEX/IECEX:
Zone 1 and 2 - 21 and 22
Ⓢ II 2 GD
IP66 - IK10

Applications

- Designed to prevent operation in explosive atmospheres during connect and disconnect operation of power loads.
- For use in hazardous areas where ignitable vapors, gases or highly combustible dusts are present.
- For installation in chemical and petrochemical plants, refineries and other process industries.

Features

- Available up to 690 Volts, and up to 160 Amps
- 63 Amp version:
 - Padlockable handle in position “O” using maximum 4 padlocks [maximum handle diameter 8 mm (0.315 in) and minimum 15 mm (0.59 in) length].
 - 3 or 4-pole switch mechanism with one ‘NO’ early break auxiliary contact.
 - Main contact termination: 35 mm² (0.054 in²).
 - Auxiliary contact termination: 2.5 mm² (0.004 in²).
 - Supplied with:
 - Cable entries:
 - 1 x M32 clearance on top
 - 1 x M32 and 1 x M20 clearance on bottom
 - Supplied with:
 - 2 x M32 polyamide cable glands – cable 10 mm to 25 mm (0.39” to 0.98”)
 - 1 x M20 blanking plug
 - 1 x yellow self-adhesive laminated plastic label with black lettering – 65 mm to 18 mm (2.56” x 0.71”)
- 160 Amp version:
 - Hinged door.
 - Closed with plastic double bar locks (key supplied).
 - Supplied with 4 fixing lugs.
 - Padlockable handle in position “O”.
 - 3 or 4-pole switch mechanism with one ‘NO’ early break auxiliary contact.
 - Main contact termination: 120 mm² (0.1860 in²).
 - Auxiliary contact termination: 2.5 mm² (0.004 in²).
 - Supplied with:
 - Cable entries:
 - 1 x M63 clearance on top
 - 1 x M63 and 1 x M25 clearance on bottom
 - Supplied with:
 - 2 x M63 polyamide cable glands – cable 36 mm to 44 mm (1.42” to 1.73”)
 - 1 x M25 blanking plug

Standard Materials

- Box: polyester (GRP) or 316L stainless steel
- Captive screws: A2 stainless steel
- Cable glands: polyamide cable glands and blanking plugs
- Locknut: nickel plated brass.

ATEX/IECEX Certifications and Compliances

- Certification Type: CAe (Polyester box)
 - Gas: Zone 1 and 2
 - Conforming to ATEX 94/9/CE: Ⓢ II 2 G
 - Type of Protection: Ex de IIC
 - Temperature Class: T5 at +40 °C (+104 °F), T4 at +55 °C (+131 °F)



40 A/63 Amp Version



160 Amp Version

- Dust: Zone 21 and 22
- Conforming to ATEX 94/9/CE: Ⓢ II 2 D
- Type of Protection: Ex tD A21
- Surface Temperature: T95 °C (T 203 °F) at +40 °C (+104 °F), T130 °C (T266 °F) at +55 °C (+131 °F)
- Ambient Temperature: 20 °C to +55 °C (68 °F to +131 °F) [40 A and 63 A]; -30 °C to +55 °C (-22 °F to +131 °F) [160 A]
- CE Declaration of Conformity: 50235
- ATEX Certificate: LCIE 02 ATEX 6248X
- IECEx Certificate: IECEx LCI 04.0016X
- Certification Type: JBe (Stainless steel box)
 - Gas: Zone 1 and 2
 - Conforming to ATEX 94/9/CE: Ⓢ II 2 G
 - Type of Protection: Ex de IIC
 - Temperature Class: T5 at +40 °C (+104 °F), T4 at +55 °C (+131 °F)
- Dust: Zone 21 and 22
- Conforming to ATEX 94/9/CE: Ⓢ II 2 D
- Type of Protection: Ex tD A21
- Surface Temperature: T95 °C (T 203 °F) at +40 °C (+104 °F), T130 °C (T266 °F) at +55 °C (+131 °F)
- Ambient Temperature: 20 °C to +55 °C (68 °F to +131 °F) [40 A and 63 A]; -30 °C to +55 °C (-22 °F to +131 °F) [160 A]
- CE Declaration of Conformity: 50232
- ATEX Certificate: LCIE 02 ATEX 6118X
- IECEx Certificate: IECEx LCI 11.0008X
- Index of Protection according EN/IEC 60529: IP66
- Impact Resistance (shock): IK10

EURASEC Certification

- Certification Type: CAe (Polyester box)
 - EURASEC RU C-FR. Γ505.B.00911
- Certification Type: JBe (Stainless steel box)
 - EURASEC RU C-FR.Γ505.B.00911

Other Certification ①

- Certification Type: CAe (Polyester box)
 - INMETRO Certificate: BVC 12.0421-X

① INMETRO certification available on special request only. Contact your local sales representative for more information.

ATX™ SWE Series 40, 63 and 160 Amp Switches, Circuit Breakers, and “Break Glass”

Call Points

Increased Safety

ATEX/IECEX:
 Zone 1 and 2 - 21 and 22
 II 2 GD
 IP66 - IK10

Catalog Numbering Guide

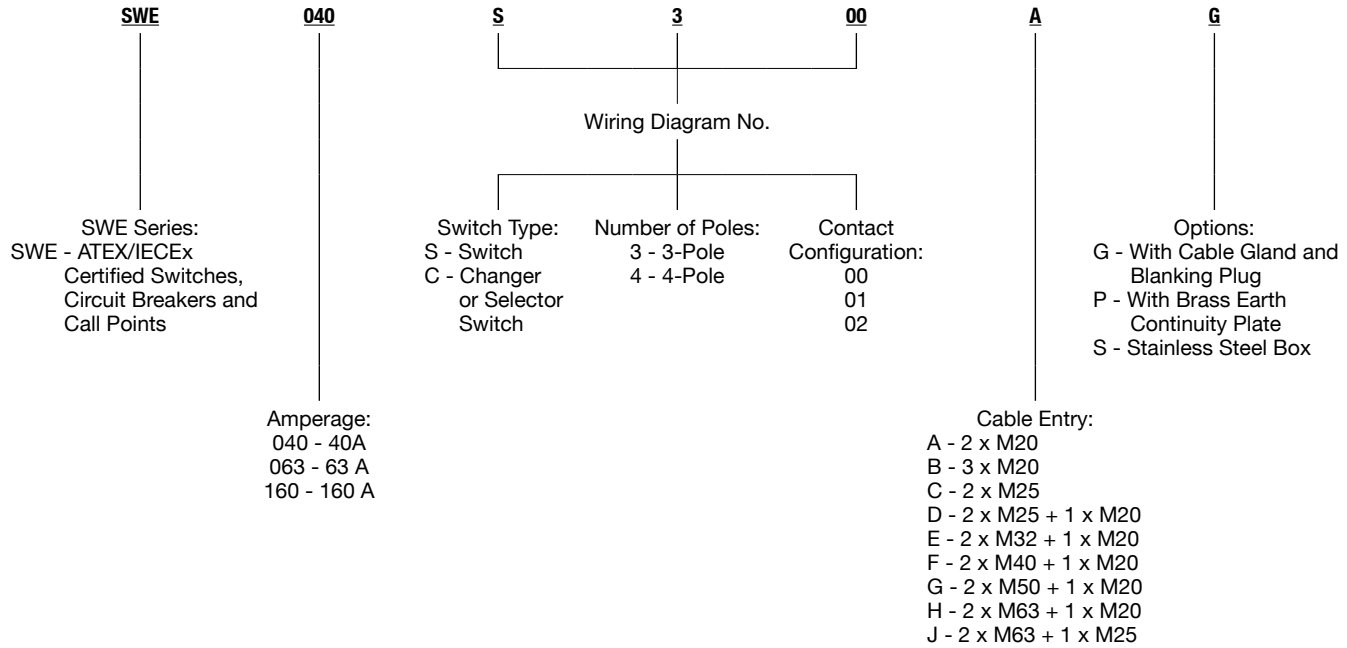

CONTROLS: ATEX/IECEX INCREASED SAFETY CALL POINTS STATIONS AND AUDIO SIGNALING DEVICES

Switch Type	Wiring Diagram No.	Weight kg (lb)	Volume dm ³ (in ³)	Catalog Number
63 A Switch – 2 x M32 + 1 x M20 – Polyester Box				
3-pole switch	S302	8 (17.64)	14.5 (884.8)	SWE063S302EG
4 Pole Switch	S402	8 (17.64)	14.5 (884.8)	SWE063S402EG
160 A Switch – 2 x M63 + 1 x M25 – Polyester Box				
3-pole switch	S302	16 (35.27)	75 (4576.8)	SWE160S302JG
4 Pole Switch	S402	16 (35.27)	75 (4576.8)	SWE160S402JG
160 A Switch – 2 x M63 + 1 x M25 – Stainless Steel Box				
4-pole switch	S402	25 (55.12)	75 (4576.8)	SWE160S402JS

Switching Arrangement – X Denotes “Closed Contact”

S302

Positions	Aux	Contacts		
		1	2	3
0				
1	X	X	X	X

S402

Positions	Aux	Contacts			
		1	2	3	4
0					
1	X	X	X	X	X

ATX™ SWE Series 40, 63 and 160 Amp Switches, Circuit Breakers, and “Break Glass” Call Points

Increased Safety

ATEX/IECEX:
 Zone 1 and 2 - 21 and 22
 II 2 GD
 IP66 - IK10

Main Contacts	63 Amps	160 Amps
Rated Insulation Voltage	690 Vac	690 Vac
Rated Operating Voltage	690 Vac	690 Vac
Rated Operating Current	63 Amp	160 Amp
Rated Surge Voltage	6 kV	8 kV
Switching Capacity		
AC 21 A/AC 22 A	63 Amp, 230 V to 690 V	160 Amp, 400 V to 690 V
	15 kW, 230 V	
AC 23 A	22 kW, 400 V	80 kW, 400 V
	30 kW, 500 V	110 kW, 500 V
	18.5 kW, 690 V	55 kW, 690 V
AC 3	11 kW, 230 V	
	18.5 kW, 400 V	90 kW, 400 V
	22 kW, 500 V	70 kW, 500 V
	15 kW, 690 V	
DC 21	—	160 Amp, 220 V ①
		160 Amp, 440 V ①
DC 22	—	160 Amp, 220 V ①
		100 Amp, 440 V ①
DC 23	—	160 Amp, 220 V ①
		63 Amp, 440 V ①
Auxiliary Contacts		
Rated Insulation Voltage	400 V	230 V
Rated Operating Voltage	400 V	230 V
Rated Operating Current	10 Amp	10 Amp
Switching Capacity		
AC 15	6 Amp, 230 V	6 Amp, 230 V
	4 Amp, 400 V	
Others		
Termination (flexible/solid)	35 mm ² (0.054 in ²)	120 mm ² (0.186 in ²)

① 2 contacts connected in series per pole.

ATX™ SWE Series 40, 63 and 160 Amp Switches, Circuit Breakers, and “Break Glass”

Call Points

Increased Safety

CONTROLS: ATEX/IECEx INCREASED SAFETY CALL POINTS STATIONS AND AUDIO SIGNALING DEVICES

Dimensions in Millimeters (Inches)

40 Amp/63 Amp Polyester Version

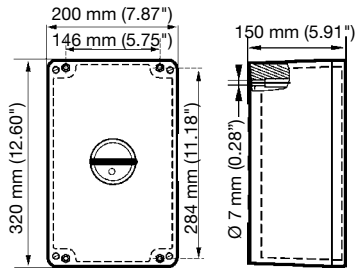

160 Amp Polyester Version

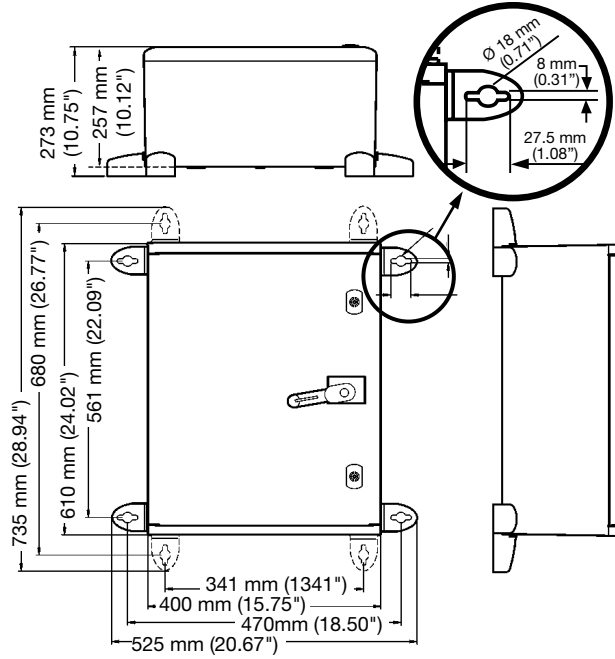

160 Amp Stainless Steel Version

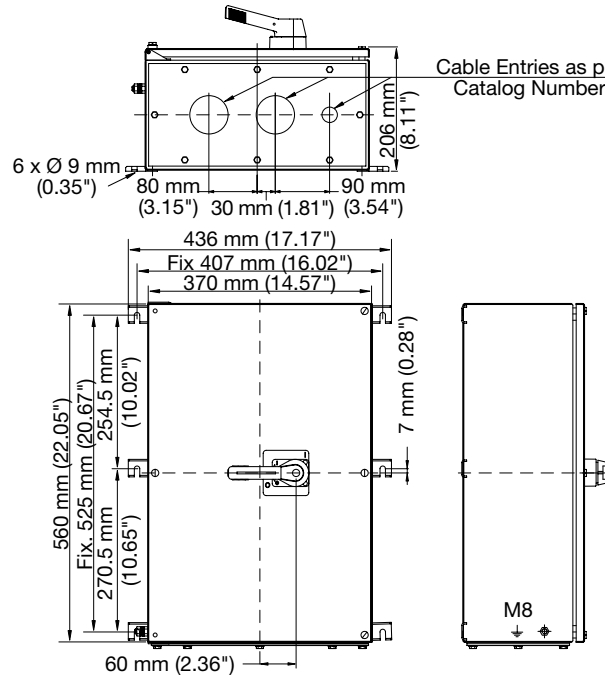

ATX™ KL Series Audio Signaling Devices

Flameproof

ATEX:
Zone 1 and 2
Ex d IIB
II 2 G
IP55 - IK10

Applications

- Audio alarm to signal an evacuation due to fire, gas or other dangers.

Features

- Klaxon type warning horn.
- Flameproof enclosure.
- Operation:
 - Operating cycle: 5 minutes maximum
 - Pause cycle: 15 minutes minimum
 - Maximum 5 consecutive cycles
 - Predicts temporary pause cycles
- One M20 bottom cable entry.
- M6 earth stud.

Standard Materials

- Enclosure: marine grade aluminum

Standard Finishes

- Enclosure: gray paint

ATEX Certifications and Compliances

- Certification Type: KL1X
 - Gas: Zones 1 and 2
 - Conforming to ATEX 94/9/CE: II 2 G
 - Type of Protection: Ex d IIB
 - Temperature Class: T6
 - Ambient Temperature: -20 °C to +40 °C (-4 °F to +104 °F)
- CE Declaration of Conformity: 50216
- ATEX Certificate: LCIE 00 ATEX 6018
- Index of Protection according EN/IEC 60529: IP55
- Impact Resistance (shock): IK10
- Internal Volume: $\leq 2 \text{ dm}^3$ (122 in³) - 2 liters



Horn

Dimensions in Millimeters (Inches)

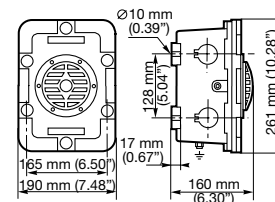

CONTROL S: ATEX/IECX INCREASED SAFETY CALL POINTS STATIONS AND AUDIO SIGNALING DEVICES

Appleton®

ATX™ KL Series Audio Signaling Devices

Flameproof

ATEX:
 Zone 1 and 2
 Ex d IIB
 II 2 G
 IP55 - IK10

Catalog Numbering Guide

KL
 Series:
 KL - KL Series
 ATEX Certified Horn

C02D
 Voltage:
 02D - 24 Vdc
 02A - 24 Vac
 04D - 48 Vdc
 04A - 48 Vac
 11A - 110 Vac
 23A - 220-230 Vac

E
 Option:
 E - Electronic

Series	Voltage	Frequency	Sound Volume at 2m	Sound Frequency (Hz)	Amp Rating	Weight kg (lb)	Volume dm ³ (in ³)	Catalog Number
KL	24 Vdc	0 Hz	80 dB mini	420	0.75	5.2 (11.46)	13 (793.3)	KL02D
KL	24 Vac	50/60 Hz	80 dB mini	420	0.75	5.2 (11.46)	13 (793.3)	KL02A
KL	48 Vdc	0 Hz	80 dB mini	420	0.75	5.2 (11.46)	13 (793.3)	KL04D
KL	48 Vac	50 Hz	80 dB mini	420	0.75	5.2 (11.46)	13 (793.3)	KL04A
KL	110 Vac	50/60 Hz	80 dB mini	420	0.13	5.2 (11.46)	13 (793.3)	KL11A
KL	220/230 Vac	50/60 Hz	80 dB mini	420	0.13	5.2 (11.46)	13 (793.3)	KL23A

CONTROLS: ATEX/IECEx INCREASED SAFETY CALL POINTS STATIONS AND AUDIO SIGNALING DEVICES



Plugs and Receptacles

Description	Page	NEC	CEC	ATEX/ IEC(Ex)
NEC/CEC Hazardous Location				
U-Line™ 20 Amp Plugs and Receptacles	381	X	X	
• EFSR—GFI Ground Fault Circuit Interrupter	388	X		
• U-Line™ 20 Amp Portable Receptacle with GFCI	390	X	X	
U-Line™ 15 and 20 Amp Plugs and Receptacles	393		X	
• ECKS—GFI Ground Fault Circuit Interrupter	397		X	
U-Line™ Contender™ 20 Amp Plugs and Receptacles	399	X		
• GFS—1 Ground Fault Circuit Interrupter	403	X		
U-Line™ N1 Series 20 Amp Plugs and Receptacles	405	X		
U-Line™ 20 Amp ECH/ECHT Panel Mounting Plugs and Receptacles	408	X	X	
U-Line™ ECCL Factory Sealed 20 Amp Cable Connectors	410		X	
CPS 20 Amp Factory Sealed Pin and Sleeve Receptacles	411	X	X	
Contender™ CPS Factory Sealed 20 Amp Pin and Sleeve Receptacles	415	X		
FSQX 30 Amp Receptacles with Interlocked Switch and Cover	420	X		
CES and CESD Factory Sealed 30 and 60 Amp Pin and Sleeve Receptacles	422	X	X	
FSQC 30, 60 and 100 Amp Series Receptacles	425	X	X	
JBR Series 30 and 60 Amp Switched Receptacles	428	X		
EBR 30, 60, 100 and 150 Amp Series Receptacles	432	X		
DBR 30, 60, 100 and 150 Amp Series Receptacles	438	X		
EBR Interlocked Circuit Breaker Receptacle for Portable Electrical Equipment	444		X	
MD2SR Interlocked Switched Receptacles	448	X		
ID2SR Factory Sealed Interlocked Switched Receptacles	451		X	
ECC Factory Sealed 20 Amp Portable Cord Connector	454	X	X	
NEC/CEC Ordinary Location				
Powertite™ Series Pin and Sleeve Plugs, Connectors and Receptacles	455	X	X	
ASR Nonmetallic Interlocked Receptacle with Enclosed Disconnect Switch	484	X	X	
WSR Interlocked Receptacle	487	X	X	
WSRD Interlocked Receptacle	490	X	X	
IDSR Interlocked Switched Receptacles	494		X	
AE Series Pin and Sleeve Plugs, Connectors and Receptacles	496	X		
M-Line Series MN Multi-Pin Plugs and Receptacles	503	X	X	

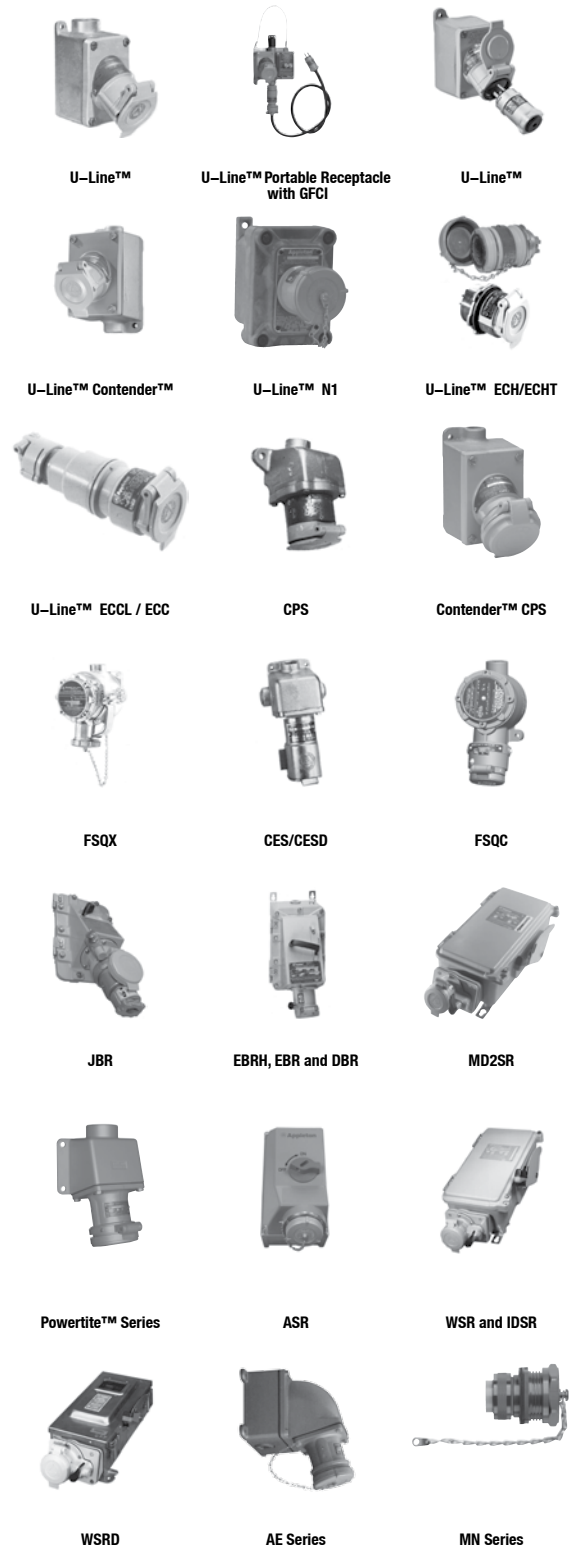

Plugs and Receptacles

Description	Page	NEC	CEC	ATEX/IEC(Ex)
ATEX/IECEx Increased Safety				
ATX™ PRE Series Plugs and Receptacles	528			X
ATX™ MRE Series 16 and 32 Amp Multiple Socket Outlets	547			X
ATEX/IECEx Flameproof				
ATX™ PRD Series 16, 32, 80 and 125 Amp Plugs and Sockets	555			X
ATX™ UPR Series Plugs and Sockets	561			X
M-Line Series MEP Explosionproof Multi-Pin Plugs and Receptacles	570			X



PRE Series



MRE Series



PRD Series



UPR Series



MEP Series

U-Line™ Factory Sealed 20 Amp Plugs and Receptacles

Explosionproof, Dust-Ignitionproof

Dead-Front Safety Construction. Choice of Aluminum or Thermoplastic Polyester Plug.

NEC/CEC:

Class I, Division 1 and 2 Groups B+, C, D

Class II, Division 1 and 2 Groups F, G

Class III

NEMA 3, 3R, 7BCD, 9FG

Applications

- Locations where receptacles are used with stationary or portable electrically operated devices such as:
 - Lighting systems
 - Conveyors
 - Heaters
 - Motor-generator sets
 - Air conditioners
 - Compressors
 - Pumps
- Locations with damp or corrosive conditions.
- Class I: classified locations where ignitable vapors or gases are present such as:
 - Petrochemical plants
 - Petroleum refineries
 - Paint and chemical plants
- Class II: classified locations such as:
 - Process industries where there are dust hazards from handling such products as flour, grain and starch or any location where ignitable amounts of dust are present or amounts which would adversely affect performance.

Features

- Intermateable with competitor's plugs of like configurations.
- Factory sealed, external seals not required in most areas. Arcing is safely confined to receptacle interior.
- Choice of aluminum receptacle with malleable iron mounting box or all malleable iron receptacle and box.
- Energized receptacle contacts deeply recessed to reduce danger of accidental touching.
- Unique blade-type, brass contacts exert constant pressure along entire contact surface and provide superior electrical contact.
- Insulators provide superior dielectric and mechanical strength and lowest arc tracking.
- ECP plug fits any standard non-explosionproof receptacle (NEMA 5-20R, or 6-20R) as well as U-Line™ explosionproof receptacles.



Standard Materials

- U-Line™ receptacle and cover: copperfree (4/10 of 1% max.) aluminum
- U-Line™ mounting box: malleable iron
- U-Line™ M Series receptacle and mounting box: malleable iron
- ECP plugs: copperfree (4/10 of 1% max.) aluminum housings
- Insulating blocks: glass-filled reinforced polyester

Standard Finishes

- Malleable iron mounting boxes: triple-coat—(1) zinc electroplate, (2) chromate and (3) epoxy powder coat
- U-Line™ receptacles: epoxy powder coat
- Cord connector housings and caps: epoxy powder coat

Options

- U-Line™ all-aluminum receptacle cover and box. Add suffix **-A**.

NEC/CEC Certifications and Compliances

- UL Listed: E10784, E81751
- UL Standard: 1203, 1010, 894
- CSA Standard: C22.2 No. 25, C22.2 No. 30, C22.2 No. 42, C22 No. 159
- CSA Certified: 038644

Illustrated Features

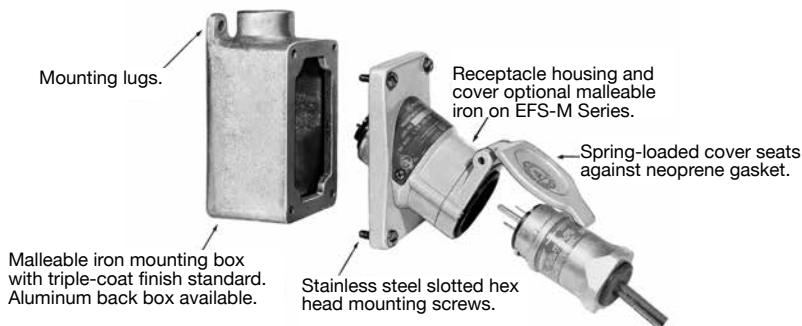

U-Line™ NEMA 4X corrosion resistance screw cover kit available: **ULINEREC4XKIT**.



♦ Select items suitable for Class I, Group B, C and D; Class II, Groups F, G; and Class III. See product selection pages for suitable items.
Note: Special U-Line™ receptacles are UL Classified to mount on Killark SWB boxes. Killark is a registered trademark of Hubbell Incorporated.

U-Line™ Factory Sealed 20 Amp Plugs and Receptacles

Explosionproof, Dust-Ignitionproof

Dead-Front Safety Construction. Choice of Aluminum or Thermoplastic Polyester Plug.

NEC/CEC:

Class I, Division 1 and 2 Groups B+, C, D

Class II, Division 1 and 2 Groups F, G

Class III

NEMA 3, 3R, 7BCD, 9FG

Illustrated Features

Spring door cover keeps dust out of receptacle when plug is not in use, which may be rotated 180° or completely removed. Stainless steel cover spring-completely enclosed for protection from corrosive environments.

With plug in use, neoprene gasket in throat of receptacle "seals" around plug keeping out dirt, water, dust and other foreign matter.

With plug not in use, spring-loaded door seats against neoprene gasket to seal receptacle from corrosive atmospheres.



Factory sealed receptacle/switch interior. Switch is an integral part of receptacle interior, contained in an aluminum sleeve. Protective xylan coating on inside of sleeve provides smooth "rotating" action of internal switch, which is activated by rotating plug in receptacle. Entire aluminum sleeve is sealed at both ends with neoprene O-rings to protect receptacle/switch interior against moisture.

For safety... Ordinary location plug will NOT activate explosionproof U-Line™ receptacle.

Plug mechanical cable clamps on the plug prevent strain on cables and meet or exceed UL 150 lb. strain relief pull-out test for classified locations.

ECP Interchanger plug fits ordinary location receptacles (NEMA 5-20R and NEMA 6-20R) and explosionproof U-Line™ receptacle as well competitors comparable NEMA blade configured receptacles.



A twist of the plug produces audible "click" to indicate fast make and break of built-in switch contacts. Twisting plug locks it in place—cannot be accidentally pulled out.

Special neoprene watertight plug bushing accommodates flexible cord ranging from .538" to .639" in diameter.



Solderless lugs—all terminals are pressure type to facilitate wiring.

Longer plug housing for better gripping and easier plug insertion and withdrawal.

♦ Select items suitable for Class I, Group B, C and D; Class II, Groups F, G; and Class III. See product selection pages for suitable items.

U-Line™ Factory Sealed 20 Amp Aluminum Receptacles

Explosionproof, Dust-Ignitionproof

125 Vac, 20 Amp, 1 HP; 250 Vac, 20 Amp, 2 HP. Dead-Front Safety Construction.

NEC/CEC:

Class I, Division 1 Groups B⁺, C, D
 Class I, Division 2 Groups B, C, D
 Class II, Division 1 and 2 Groups F, G
 Class III
 NEMA 3, 3R

Aluminum Receptacle and Malleable Iron Mounting Box ①

Type	Wire/Pole	Hub Size (Inches)	Catalog Number	
			125 Vac, 1 HP 	250 Vac, 2 HP 

Single Gang

Class I, Division 1 and 2 Groups B⁺, C, D; Class II, Division 1 and 2 Groups F, G; Class III.

Suitable for use in Class I, Division 1, Group B when used with external seals. ②



Dead-End



Feed-Thru

Dead-End	2W, 3P	1/2	3/4	1
		1		
Feed-Thru	2W, 3P	1/2	3/4	1
		1		

EFS150-2023	EFS150-20232
EFS175-2023	EFS175-20232
EFS110-2023	EFS110-20232
EFSC150-2023	EFSC150-20232
EFSC175-2023	EFSC175-20232
EFSC110-2023	EFSC110-20232

Two Gang

Class I, Division 1 and 2 Groups C, D; Class I, Division 2, Groups B, C, D; Class II, Division 1 and 2 Groups F, G; Class III.



Dead-End



Feed-Thru

Dead-End	2W, 3P	1/2	3/4	1
		3/4		
		1		
Feed-Thru	2W, 3P	1/2	3/4	1
		3/4		
		1		

EFS250-2023	EFS250-20232
EFS275-2023	EFS275-20232
EFS210-2023	EFS210-20232
EFSC250-2023	EFSC250-20232
EFSC275-2023	EFSC275-20232
EFSC210-2023	EFSC210-20232

Replacement Receptacles



2W, 3P
 Spring Door Replacement Assembly (aluminum)
 Receptacle for use on Killark [✦] SWB Boxes.

EFSR-2023	EFSR-20232
ULSCA	
EFSR-2023K	EFSR-20232K



NEMA 4X Corrosion Resistance Kit [▼]

ULINEREC4XKIT

① Standard back box malleable iron. For aluminum back box, add suffix **-A** to catalog number.

② Seals (not furnished—see Hazardous Location Fittings Section) must be placed within 2 inches from each conduit opening. Seals are not required in Class I, Division 2 locations.

▼ NEMA Type 4X when the screw cover is installed and the cover is fully engaged.

◆ Shaded area indicates items suitable for Class I, Group B, C and D; Class II, Groups F, G; and Class III.

✦ Killark is a registered trademark of Hubbell Incorporated.

U-Line™ Factory Sealed 20 Amp Malleable Iron Receptacles

Explosionproof, Dust-Ignitionproof

125 Vac, 20 Amp, 1 HP; 250 Vac, 20 Amp, 2 HP. Dead-Front Safety Construction.

NEC/CEC:

Class I, Division 1 Groups B♦, C, D
 Class I, Division 2 Groups B, C, D
 Class II, Division 1 and 2 Groups F, G
 Class III
 NEMA 3, 3R

Malleable Iron Receptacle and Malleable Iron Mounting Box

Type	Wire/Pole	Hub Size (Inches)	Catalog Number	
			125 Vac, 1 HP 	250 Vac, 2 HP 

Single Gang — Class I, Group B

Class I, Division 1 and 2 Groups B, C, D; Class II, Division 1 and 2 Groups F, G; Class III

These models have separate factory sealed chamber— suitable for Class I, Group B as well as Class I, Groups C and D, Class II, Groups F ①, G and Class III. No external seals required.



Dead-End

Feed-Thru

Dead-End	2W, 3P	1/2	EFSB150-2023M	EFSB150-20232M
		3/4	EFSB175-2023M	EFSB175-20232M
Feed-Thru	2W, 3P	1/2	EFSCB150-2023M	EFSCB150-20232M
		3/4	EFSCB175-2023M	EFSCB175-20232M



Separate Sealing Chamber
Factory Sealed

Single Gang

Class I, Division 1 and 2 Groups B♦, C, D; Class II, Division 1 and 2 Groups F, G; Class III

Suitable for use in Class I, Division 1, Group B when used with external seals. ①



Dead-End

Feed-Thru

Dead-End	2W, 3P	1/2	EFS150-2023M	EFS150-20232M
		3/4	EFS175-2023M	EFS175-20232M
		1	EFS110-2023M	EFS110-20232M
Feed-Thru	2W, 3P	1/2	EFSC150-2023M	EFSC150-20232M
		3/4	EFSC175-2023M	EFSC175-20232M
		1	EFSC110-2023M	EFSC110-20232M

① Seals (not furnished—see Hazardous Location Fittings Section) must be placed within 2 inches from each conduit opening. Seals are not required in Class I, Division 2 locations.

♦ Shaded area indicates items suitable for Class I, Group B, C and D; Class II, Groups F, G; and Class III.

U-Line™ Factory Sealed 20 Amp Malleable Iron Receptacles





Explosionproof, Dust-Ignitionproof

125 Vac, 20 Amp, 1 HP; 250 Vac, 20 Amp, 2 HP. Dead-Front Safety Construction.

NEC/CEC:

Class I, Division 1 Groups B⁺, C, D
 Class I, Division 2 Groups B, C, D
 Class II, Division 1 and 2 Groups F, G
 Class III
 NEMA 3, 3R

Malleable Iron Receptacle and Malleable Iron Mounting Box

Type	Wire/Pole	Hub Size (Inches)	Catalog Number		
			125 Vac, 1 HP 	250 Vac, 2 HP 	
Two Gang					
<i>Class I, Division 1 and 2 Groups C, D; Class I, Division 2, Groups B, C, D; Class II, Division 1 and 2 Groups F, G; Class III.</i>					
 	Dead-End	2W, 3P	1/2	EFS250-2023M	EFS250-20232M
			3/4	EFS275-2023M	EFS275-20232M
			1	EFS210-2023M	EFS210-20232M
	Feed-Thru	2W, 3P	1/2	EFSC250-2023M	EFSC250-20232M
			3/4	EFSC275-2023M	EFSC275-20232M
			1	EFSC210-2023M	EFSC210-20232M
Dead-End	Feed-Thru				

Malleable Iron Replacement Receptacle Only

	2W, 3P	EFSR-2023M	EFSR-20232M
	Spring door replacement assembly (iron)	ULSCM	

Appleton

PLUGS AND RECEPTACLES: NEC/CEC HAZARDOUS LOCATION

◆ Select items suitable for Class I, Group B, C and D; Class II, Groups F, G; and Class III. See product selection pages for suitable items.

U-Line™ Factory Sealed 20 Amp Receptacles

Explosionproof, Dust-Ignitionproof

125 Vac, 20 Amp, 1 HP; 250 Vac, 20 Amp, 2 HP. Dead-Front Safety Construction.

NEC/CEC:

- Class I, Division 1 Groups B+, C, D
- Class I, Division 2 Groups B, C, D
- Class II, Division 1 and 2 Groups F, G
- Class III
- NEMA 3, 3R

Dimensions in Millimeters (Inches)

Single Gang Box

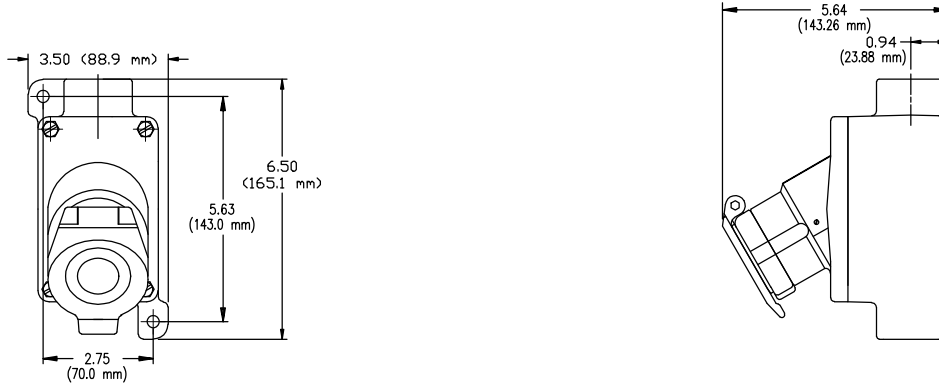

Two Gang Box

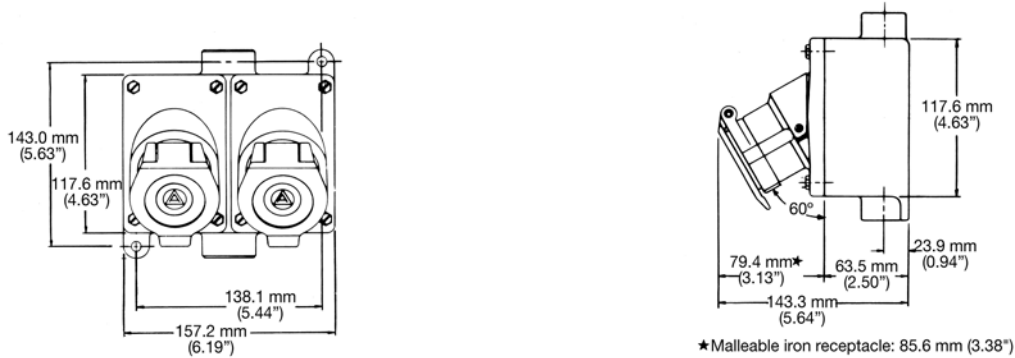

Receptacle Cover



♦ Select items suitable for Class I, Group B, C and D; Class II, Groups F, G; and Class III. See product selection pages for suitable items.

U-Line™ Interchanger Sealed 15 and 20 Amp Plugs

For U-Line™ 20 Amp Receptacles. Explosionproof, Dust-Ignitionproof

These raintight ① plugs also fit NEMA 5-20R or 6-20R receptacles in nonclassified areas. Choice of Aluminum or Thermoplastic Polyester Plug.

NEC/CEC:

Class I, Division 1 and 2 Groups B, C, D
 Class II, Division 1 and 2 Groups F, G
 Class III
 NEMA 3, 3R, 7BCD, 9FG

Applications

- U-Line™ Interchanger ECP plug: suitable for use in such areas as refineries, petrochemical plants, and other areas subject to where ignitable gases are present.
- NCP Plug: ideal where moisture or corrosion is a constant problem, such as production facilities on marine platforms, and pipeline transportation facilities.











Features

- Unique blade-type, brass contacts exert constant pressure along entire contact surface and provide superior electrical contact.
- Insulators provide superior dielectric and mechanical strength and lowest arc tracking.
- Longer plug housing for better gripping and easier plug insertion and withdrawal.

- Plugs fits any standard non-explosionproof receptacle (NEMA 5-15R, 5-20R, or 6-20R) as well as U-Line™ explosionproof receptacles.
- ECP plug: a twist of the plug produces audible "click" to indicate fast make and break of built-in switch contacts. Twisting plug locks it in place and cannot be accidentally pulled out.
- NCP plug: special neoprene watertight plug bushing accommodates flexible cord ranging from .538" to .639" diameter.

Standard Materials

- ECP plug: copperfree (less than 4/10ths of 1%) aluminum
- NCP plug: 30% glass-reinforced thermoplastic polyester

	Amp	Diagram	Wire/ Pole	Cable Dia., (Inches)	Catalog Number	
					125 Vac 	250 Vac 
U-Line™ Interchanger ECP Standard Plug						
	15		2W, 3P	0.538 to 0.639	ECP-1523	—
	20		2W, 3P	0.538 to 0.639	ECP-2023	—
	20		2W, 3P	0.538 to 0.639	—	ECP-20232
NCP Plug						
	15		2W, 3P	0.538 to 0.639	NCP-1523	—
	20		2W, 3P	0.538 to 0.639	NCP-2023	—
	20		2W, 3P	0.538 to 0.639	—	NCP-20232

Dimensions in Millimeters (Inches)

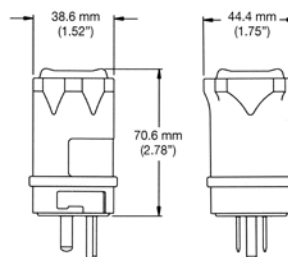

① Raintight when mated with receptacle.

EFSR–GFI Factory Sealed Ground Fault Circuit Interrupter

For U-Line™ 20 Amp Receptacles. Explosionproof, Dust-Ignitionproof

125 Vac branch circuits. Installs in standard EFD Mounting Box.

NEC:

Class I, Division 1 Groups B+, C, D
Class I, Division 2 Groups B, C, D
Class II, Division 1 and 2 Groups E, F, G
Class III
NEMA 3, 3R, 7BCD, 9EFG

CEC – EFSR-GFI:

Class I, Division 1 and 2 Groups B, C, D
Class II, Division 1 and 2 Groups E, F, G
Class III

Applications

- Provides required ground fault protection for portable electrically-operated devices. Meets all UL and CSA requirements for ground fault protection in hazardous locations.
- Well suited for use in highly corrosive atmospheres and wet locations.
- Can be used in conjunction with U-Line™ factory sealed receptacle on 20 Amp, 125 Vac 50/60 Hz branch circuits.

Features

- Factory sealed construction; **no external seals are required.** Arcing is confined within the device's interior sealed chamber.
- Rated 20 Amp, 125 Vac, 5 mA trip setting.
- Smooth-operating test and reset buttons.
- Can be installed in standard EFD Series mounting boxes. Choice of malleable iron or aluminum, dead-end or feed-thru styles.

Standard Materials

- Cover and sealing chamber: cast copperfree (less than 4/10ths of 1%) aluminum
- Cover bolts, test and reset buttons and shafts: stainless steel

Standard Finish

- Cover and sealing chamber: baked gray epoxy clad finish

NEC Certifications and Compliances

- UL/cUL Listed: E81751
- UL Standard: 943, 1203



EFSR–GFI cover mounted on single–gang EFD box. The GFI cover has separate factory sealed sealing chamber and is suitable for Class I, Group B as well as Class I, Groups C and D; Class II, Groups E, F, G and Class III.

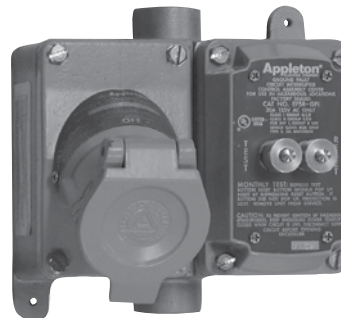

EFSR–GFI cover installed on two–gang EFD box together with U–Line™ 20 Amp, 125 Vac factory sealed receptacle. Receptacle listed for Class I, Groups C and D, Class II, Groups F and G, and Class III.

EFSR-GFI Factory Sealed Ground Fault Circuit Interrupter

For U-Line™ 20 Amp Receptacles. Explosionproof, Dust-Ignitionproof

125 Vac branch circuits. Installs in standard EFD Mounting Box.

NEC:

Class I, Division 1 Groups B⁺, C, D
 Class I, Division 2 Groups B, C, D
 Class II, Division 1 and 2 Groups E, F, G
 Class III
 NEMA 3, 3R, 7BCD, 9EFG

CEC – EFSR-GFI:

Class I, Division 1 and 2 Groups B, C, D
 Class II, Division 1 and 2 Groups E, F, G
 Class III

Description	Hub Size (Inches)	Catalog Number	
		Malleable Iron	Aluminum
GFI Cover and Box – Single Gang			
Dead-End	1/2	EFS150-GFI	EFS150A-GFI
	3/4	EFS175-GFI	EFS175A-GFI
	1	EFS110-GFI	EFS110A-GFI
Feed-Thru	1/2	EFSC150-GFI	EFSC150A-GFI
	3/4	EFSC175-GFI	EFSC175A-GFI
	1	EFSC110-GFI	EFSC110A-GFI
GFI Cover, U-Line™ Receptacle and Box – Two Gang			
Dead-End	1/2	EFS250-2023GFI	EFS250A-2023GFI
	3/4	EFS275-2023GFI	EFS275A-2023GFI
	1	EFS210-2023GFI	EFS210A-2023GFI
Feed-Thru	1/2	EFSC250-2023GFI	EFSC250A-2023GFI
	3/4	EFSC275-2023GFI	EFSC275A-2023GFI
	1	EFSC210-2023GFI	EFSC210A-2023GFI
Aluminum Ground Fault Interrupter Cover/Device		EFSR-GFI	
Cover may be used with other EFD boxes and U-Line™ receptacles in this section.			

◆ Shaded area indicated items suitable for Class I, Group B.

Appleton®

PLUGS AND RECEPTACLES: NEC/CEC HAZARDOUS LOCATION

U-Line™ 20 Amp Portable Receptacle with GFCI

Explosionproof, Dust-Ignitionproof

125 Vac. For use on Hazardous or Non-Hazardous Receptacles.

NEC/CEC:

Class I, Division 1 and 2 Groups C, D
 Class II, Division 1 and 2 Groups F, G
 Class III
 NEMA 3, 3R, 7CD, 9FG

Applications

- Provides required portable ground fault protection for electrically-operated devices. Meets all UL and CSA requirements for ground fault protection in hazardous locations.
- Well suited for use in highly corrosive atmospheres and wet locations.

Features

- Arcing is confined within the device's interior.
- Rated 20 Amp, 125 Vac, 5 mA trip setting.
- Provides open neutral protection to maximize safety.
- High intensity LED pilot light rated at 100,000 hours
- Smooth operating test and reset buttons.
- Heavy duty 0.91 meter (3 foot) SO power cord with U-Line™ 20 Amp NEMA 5-20R plug.
- Lightweight design.
- Convenient carry/hanging handle.
- Plug mates with competitors comparable receptacles. The receptacle also accepts their respective plugs.

Standard Materials

- Covers and back box: cast copperfree (less than 4/10ths of 1%) aluminum
- Cover bolts, test and reset buttons and shafts: stainless steel
- Carry/hanging handle: nylon covered galvanized steel

Standard Finish

- Covers and back box: baked gray epoxy clad finish

Options

- Incandescent pilot light available, contact local sales representative.

NEC/CEC Compliances and Certifications

- UL Standard: 943, 1203
- CSA Standard: C22.2 No. 30

Dimensions in Millimeters (Inches)

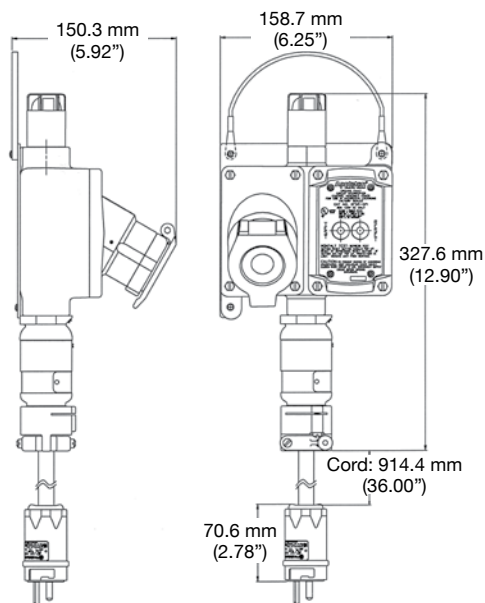

Amp	Pilot Light	Class I, Division 1 and 2
20	Green LED	U2023PGFID1G3
	Red LED	U2023PGFID1R3

U-Line™ 20 Amp Portable Receptacle with GFCI





Mounting Boxes

Single, Two, Tandem, and One through Five Gang Boxes.

NEC/CEC:

Class I, Division 1, Groups C, D
 Class I, Division 2, Groups B, C, D
 Class II, Division 1 and 2, Groups E, F, G
 Class III
 NEMA 3, 3R, 7CD, 9EFG

EFD Cast Device Mounting Boxes

	Type	Hub Size (Inches)	Catalog Number	
			Malleable Iron	Aluminum
Single Gang				
	Dead-End	1/2	EFD150NLQ	EFD150ANLQ
		3/4	EFD175NLQ	EFD175ANLQ
		1	EFD110NLQ	EFD110ANLQ
	Feed-Thru	1/2	EFDC150NLQ	EFDC150ANLQ
		3/4	EFDC175NLQ	EFDC175ANLQ
		1	EFDC110NLQ	EFDC110ANLQ
Two Gang				
	Dead-End	1/2	EFD250NLQ	EFD250ANLQ
		3/4	EFD275NLQ	EFD275ANLQ
		1	EFD210NLQ	EFD210ANLQ
	Feed-Thru	1/2	EFDC250NLQ	EFDC250ANLQ
		3/4	EFDC275NLQ	EFDC275ANLQ
		1	EFDC210NLQ	EFDC210ANLQ
Tandem ①				
	Dead-End	1/2	EFDT50NLQ	—
		3/4	EFDT75NLQ	—
		1	EFDT10NLQ	—
	Feed-Thru	1/2	EFDC250NLQ	—
		3/4	EFDC275NLQ	—
		1	EFDC210NLQ	—
Blank Bodies for Brazed Hubs				
<i>Construct complete catalog number per following page. Hubs will be located in center of walls and evenly spaced unless otherwise specified. Where spacings are critical, submit sketch showing spacing requirements.</i>				
	1 Gang		EFD1NL	—
	2 Gang		EFD2NL	—
	3 Gang		EFD3NL	—
	4 Gang		EFD4NL	—
	5 Gang		EFD5NL	—

① For tandem bodies, eternal seals must be installed within 1.52 meters (5 feet) of each conduit entrance or Class I, Group C and D.

U-Line™ 20 Amp Portable Receptacle with GFCI

EFD Blank Cast Device Boxes. Drilling Information for Brazed Threaded and Union Hubs

Single, Two, Three, Four and Five Gang Boxes.

NEC/CEC:

Class I, Division 1, Groups C, D
 Class I, Division 2, Groups B, C, D
 Class II, Division 1 and 2, Groups E, F, G
 Class III
 NEMA 3, 3R, 7CD, 9EFG

Determine catalog number as follows:

- (1) Select EFD device box catalog number.
- (2) Select "Standard Hub Arrangement Diagram" number.
- (3) Select symbols that represent hub sizes from "Symbol Table." (Use "0" where no hub is required, and separate the various divisions of the complete catalog number by dashes.)

Example

The blank body device box selected is EFD3NL and the hub arrangement is diagram #8. Hub "a" is to be 3/4" brazed threaded; hub "b", 1" brazed threaded; hub "c", 3/4" brazed threaded; hub "d", no hub is required; and hub "e", 1" brazed union.

The complete catalog number will be:
EFD-3NL-8-23203E

If a "Standard Hub Arrangement" is not suitable for the application, or when hubs are to be more accurately spaced, submit sketch locating hubs (1) from centerlines of walls and (2) from outside back of box (or from mounting lug surface if lugs are supplied).

All hubs will be located in centerlines of walls and evenly spaced unless otherwise specified.

Symbol Table

Hub Size (Inches)	Brazed Threaded Hub Symbol	Brazed Union Hub Symbol
Blank	0	0
1/2	1	1E
3/4	2	2E
1	3	3E

Standard Hub Arrangement Diagrams

Hub "a" is always TOP of box

Two, Three, Four and Five Gang (Front View)

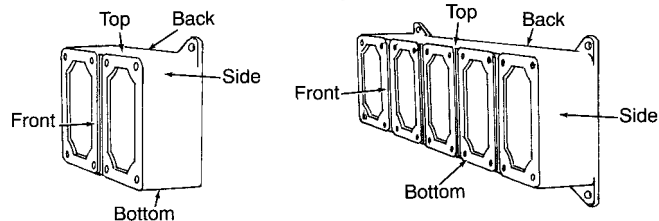
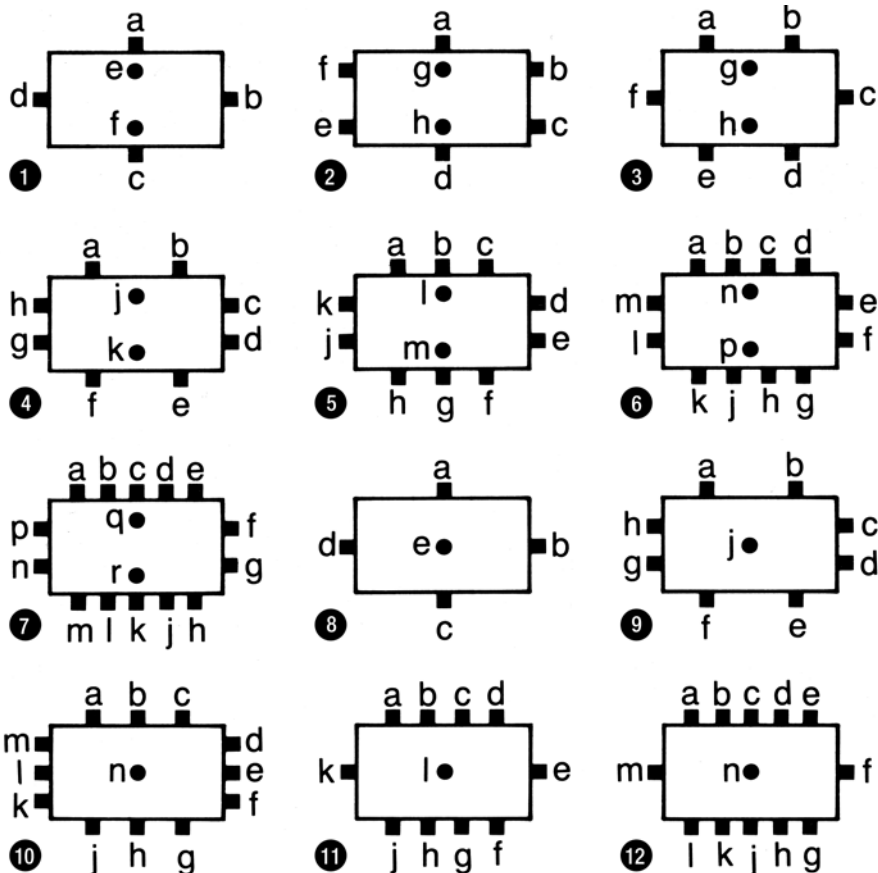

One Gang (Front View)

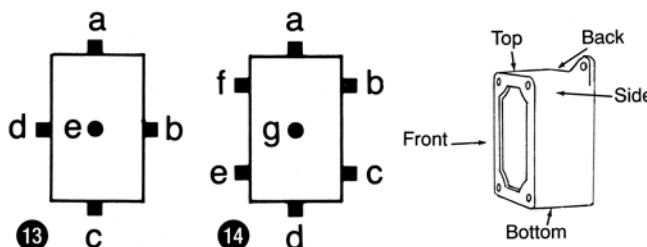

U-Line™ Factory Sealed 15 and 20 Amp Plugs and Receptacles

Explosionproof, Dust-Ignitionproof

Dead-Front Safety Construction – Grounding through Extra Pole and Shell.

CEC:

Class I, Division 1 and 2 Groups B, C, D
Class II, Division 1 and 2 Group G – Coal Dust
Class III
CSA Type 7BCD, 9G

Applications

- Locations where receptacles are used with stationary or portable electrically operated devices such as:
 - Lighting systems
 - Conveyors
 - Heaters
 - Motor-generator sets
 - Air conditioners
 - Compressors
 - Pumps
- Locations with damp or corrosive conditions.
- Class I: classified locations where ignitable vapors or gases are present such as:
 - Petrochemical plants
 - Petroleum refineries
 - Paint and chemical plants
- Class II: classified locations such as:
 - Process industries where there are dust hazards from handling such products as flour, grain and starch or any location where ignitable amounts of dust are present or amounts which would adversely affect performance.

Features

- Intermateable with competitor's plugs of like configurations.
- Factory sealed, external seals not required. Arcing is safely confined to receptacle interior.
- Energized receptacle contacts deeply recessed to reduce danger of accidental touching.
- Unique blade-type, brass contacts exert constant pressure along entire contact surface and provide superior electrical contact.
- Insulators provide superior dielectric and mechanical strength and lowest arc tracking.
- ECP plug fits any standard non-explosionproof receptacle (NEMA 5-15R, 5-20R, or 6-20R) as well as U-Line™ explosionproof receptacles.



Standard Materials

- Receptacle, cover and mounting box: copperfree (4/10 of 1% max.) aluminum
- ECP plugs: copperfree (4/10 of 1% max.) aluminum housings
- Insulating blocks: glass-filled reinforced polyester

Standard Finishes

- Receptacles: epoxy powder coat
- Cord connector housings and caps: epoxy powder coat

CEC Certifications and Compliances

- CSA Standard: C22.2 No. 25, C22.2 No. 30, C22.2 No 42, C22.2 No. 159
- CSA Certified: 038644

Illustrated Features



CSA Approved when used with Killark® "UGR" Series and Crouse-Hinds® "ENR" Series receptacles. Crouse-Hinds and ENP are registered trademarks of Cooper Crouse-Hinds. Killark and UGR are registered trademarks of Hubbell Incorporated

U-Line™ Factory Sealed 15 and 20 Amp Plugs and Receptacles

Explosionproof, Dust-Ignitionproof

Dead-Front Safety Construction – Grounding through Extra Pole and Shell.

CEC:
Class I, Division 1 and 2 Groups B, C, D
Class II, Division 1 and 2 Group G – Coal Dust
Class III
CSA Type 7BCD, 9G

Illustrated Features

Spring door cover keeps dust out of receptacle when plug is not in use, which may be rotated 180° or completely removed. Stainless steel cover spring-completely enclosed for protection from corrosive environments. Cover may be used with hinge at top (standard) or rotated 180° to put hinge at bottom.

Factory sealed receptacle/switch interior. Switch is an integral part of receptacle interior, contained in an aluminum sleeve. Protective xylan coating on inside of sleeve provides smooth "rotating" action of internal switch, which is activated by rotating plug in receptacle. Entire aluminum sleeve is sealed at both ends with neoprene O-rings to protect receptacle/switch interior against moisture.

ECP Interchanger plug fits ordinary location receptacles (NEMA 5-20R or 15R and NEMA 6-20R) and explosionproof U-Line™ receptacle as well competitors comparable NEMA blade configured receptacles.

Solderless lugs—all terminals are pressure type to facilitate wiring.

Longer plug housing for better gripping and easier plug insertion and withdrawal.

Knock-out in plug insulator permits "potting" of terminations for positive protection in severe environments.

A twist of the plug produces audible "click" to indicate fast make and break of built-in switch contacts. Twisting plug locks it in place—cannot be accidentally pulled out.

With plug in use, neoprene gasket in throat of receptacle "seals" around plug keeping out dirt, water, dust and other foreign matter.

With plug not in use, spring-loaded door seats against neoprene gasket to seal receptacle from corrosive atmospheres.



For safety... Ordinary location plug will NOT activate explosionproof U-Line™ receptacle.

Plug mechanical cable clamps on the plug prevent strain on cables and meet or exceed UL 150 lb. strain relief pull-out test for classified locations.



Special neoprene watertight plug bushing accommodates flexible cord ranging from .538" to .639" in diameter.



U-Line™ Factory Sealed 15 and 20 Amp Plugs and Receptacles



Explosionproof, Dust-Ignitionproof

Dead-Front Safety Construction – Grounding through Extra Pole and Shell.



CEC:

Class I, Division 1 and 2 Groups B, C, D
 Class II, Division 1 and 2 Group G – Coal Dust
 Class III
 CSA Type 7BCD, 9G

Receptacle and Cover Assembly

Description	Catalog Number	
	125 Vac, 1 HP 	250 Vac, 2 HP 
 20 Amp	ECSK-2023	ECSK-20232

Mounting Box – Complete with 1 Close-Up Plug

	Hub Size	Catalog Number
Single Gang		
	3/4"	ECS175
	1"	ECS110
Two Gang		
	3/4"	ECS275
	1"	ECS210

Dimensions in Millimeters (Inches)

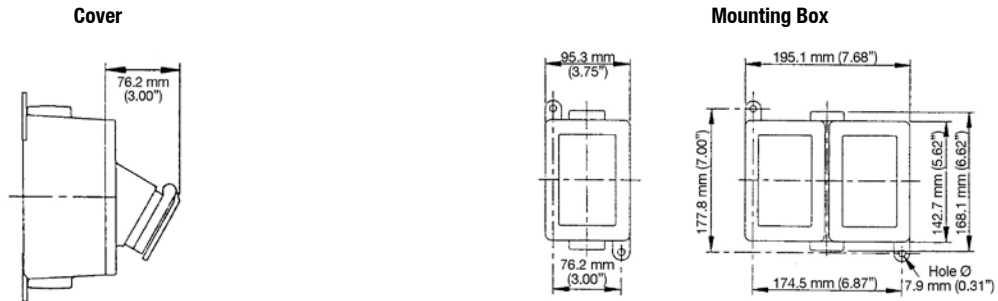

U-Line™ Interchanger 15 and 20 Amp Plugs

For U-Line™ 15 and 20 Amp Receptacles. Explosionproof, Dust-Ignitionproof

These raintight ① plugs also fit NEMA 5-15R, 5-20R or 6-20R receptacles in nonclassified areas. Choice of Aluminum or Thermoplastic Polyester Plug.

NEC/CEC:

Class I, Division 1 and 2 Groups B, C, D

Class II, Division 1 and 2 Groups F, G

Class III

NEMA 3, 3R, 7BCD, 9FG

Applications

- U-Line™ Interchanger ECP plug: suitable for use in such areas as refineries, petrochemical plants, and other areas subject to where ignitable gases are present.
- NCP Plug: ideal where moisture or corrosion is a constant problem, such as production facilities on marine platforms, and pipeline transportation facilities.

Features

- Unique blade-type, brass contacts exert constant pressure along entire contact surface and provide superior electrical contact.
- Insulators provide superior dielectric and mechanical strength and lowest arc tracking.
- Longer plug housing for better gripping and easier plug insertion and withdrawal.

- Plugs fits any standard non-explosionproof receptacle (NEMA 5-15R, 5-20R, or 6-20R) as well as U-Line™ explosionproof receptacles.
- 15 Amp ECP1523 125 Vac and 20 Amp ECP2023 125 Vac U-Line™ plugs are for use in the T-slot configured 20 Amp U-Line™ receptacle. ie ECSK-2023.
- ECP plug: a twist of the plug produces audible "click" to indicate fast make and break of built-in switch contacts. Twisting plug locks it in place and cannot be accidentally pulled out.
- NCP plug: special neoprene watertight plug bushing accommodates flexible cord ranging from .538" to .639" diameter.

Standard Materials

- ECP plug: copperfree (less than 4/10ths of 1%) aluminum
- NCP plug: 30% glass-reinforced thermoplastic polyester

Amp	Diagram	Wire/ Pole	Cable Dia., (Inches)	Catalog Number	
				125 Vac 	250 Vac 

U-Line™ Interchanger ECP Standard Plug

	15		2W, 3P	0.538 to 0.639	ECP-1523	—
	20		2W, 3P	0.538 to 0.639	ECP-2023	—
	20		2W, 3P	0.538 to 0.639	—	ECP-20232

NCP Plug

	15		2W, 3P	0.538 to 0.639	NCP-1523	—
	20		2W, 3P	0.538 to 0.639	NCP-2023	—
	20		2W, 3P	0.538 to 0.639	—	NCP-20232

Dimensions in Millimeters (Inches)

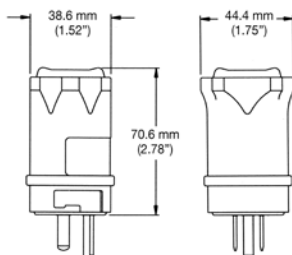

① Raintight when mated with receptacle.

U-Line™ ECK-GFI Ground Fault Circuit Interrupter

Explosionproof, Dust-Ignitionproof

For U-Line™ 20 Amp Receptacles. Dead-Front Safety Construction – Grounding through Extra Pole and Shell.

CEC:

Class I, Division 1 and 2, Groups B, C, D
Class I Zone 1 and 2, IIB + H₂ T6
Class II, Division 1 and 2, Groups E, F, G
Class III, Encl. 3R, raintight
CSA Type 3R, 7BCD, 9EFG

CEC:

CSA Approved
Class I, Division 1 and 2 Groups B, C, D
Class II, Division 1 and 2 Group G – Coal Dust
Class III
CSA Type 7BCD, 9G

Applications

- Provides required ground fault protection for portable electrically-operated devices. Meets all CSA requirements for ground fault protection in hazardous locations.
- Well suited for use in highly corrosive atmospheres and wet locations.
- Can be used in conjunction with U-Line™ factory sealed receptacle on 20 Amp, 125 Vac branch circuits.

Features

- Rated 20 Amp, 125 Vac, 5 mA trip setting. 0.075 second trip time.
- Smooth-operating test and reset buttons.
- Can be installed in standard ECS Series mounting boxes.

Standard Materials

- Cover: cast copperfree (less than 4/10ths of 1%) aluminum
- Push Buttons: Aluminum Upper Barrel and phelonic lower barrel (Dust cap models have neoprene buttons)

Standard Finish

- Cover: baked gray epoxy clad finish

Options

- Securing rod for push button factory sealed units. Add suffix **-S153**.
- CSA Type 4X enclosure and cover. Add suffix **-4X**.
- Flush mounted single LED trip indicator light. Add suffix **-LED**.

CEC Certifications and Compliances

- CSA Standard: C22.2 No. 25, C22.2 No. 30, C22.2 No.42, C22.2 No. 159
- CSA Certified: 038644



Ground Fault Circuit Interrupter Cover Assembly



2-Gang — GFCI and Receptacle

Appleton®

PLUGS AND RECEPTACLES: NEC/CEC HAZARDOUS LOCATION

U-Line™ ECSK-GFI Ground Fault Circuit Interrupter

Explosionproof, Dust-Ignitionproof



For U-Line™ 20 Amp Receptacles. Dead-Front Safety Construction – Grounding through Extra Pole and Shell.

CEC:
 Class I, Division 1 and 2, Groups B, C, D
 Class I Zone 1 and 2, IIB + H₂ T6
 Class II, Division 1 and 2, Groups E, F, G
 Class III, Encl. 3R, raintight
 CSA Type 3R, 7BCD, 9EFG

CEC:
 CSA Approved
 Class I, Division 1 and 2 Groups B, C, D
 Class II, Division 1 and 2 Group G – Coal Dust
 Class III
 CSA Type 7BCD, 9G

	Hub Size (Inches)	Electrical Rating	Catalog Number
Ground Fault Circuit Interrupter – 1-Gang – Non-Factory Sealed Devices			
	1/2 – 3/4	20 Amp 120 Vac, 5 mA Trip 0.075 Sec. Trip Time	ECS2GFI
	1	20 Amp 120 Vac, 5 mA Trip 0.075 Sec. Trip Time	ECS4GFI



U-Line™ Receptacles – Factory Sealed Device. Not approved for Group E ①

	Hub Size (Inches)	Electrical Rating	Catalog Number
1-Gang			
	1/2 – 3/4	20 Amp 125 Vac, 1 HP	ECS32023
	1	20 Amp 125 Vac, 1 HP	ECS52023
	1/2 – 3/4	20 Amp 250 Vac, 2 HP	ECS320232
	1	20 Amp 250 Vac, 2 HP	ECS520232
2-Gang with two, single receptacle covers			
	1/2 – 3/4	15/20 Amp 125 Vac, 1 HP	ECS72023
	1	15/20 Amp 125 Vac, 1 HP	ECS92023
	1/2 – 3/4	15/20 Amp 250 Vac, 2 HP	ECS720232
	1	15/20 Amp 250 Vac, 2 HP	ECS920232

U-Line™ Plugs and Receptacles with Ground Fault Protection – 2-Gang – Non-Factory Sealed Devices

	Hub Size (Inches)	Electrical Rating	Catalog Number
	1/2 – 3/4	20 Amp 125 Vac, 1 HP	ECS6GFI2023
	1	20 Amp 125 Vac, 1 HP	ECS8GFI2023

Cover Assemblies

	Description	Catalog Number Single Gang
	Ground Fault Circuit Interrupter (Cover Assembly)	ECSK-GFI
	Receptacle and Cover Assembly	ECSK-2023

① Approved for Group F with non-electrically conductive dusts.

U-Line™ Contender™ Factory Sealed 20 Amp Plugs and Receptacles

Explosionproof, Dust-Ignitionproof

NEC:
 Class I, Groups C, D
 Class I, Division 2, Group B
 Class I, Zone 1, Group IIB
 Class I, Zone 2, Group IIB + H₂
 Class II, Groups F, G

NEC:
 Class III
 NEMA 3R*

Applications

- Locations where receptacles are used with stationary or portable electrically operated devices such as:
 - Lighting systems
 - Conveyors
 - Heaters
 - Motor-generator sets
 - Air conditioners
 - Compressors
 - Pumps
- Locations where damp or corrosive conditions exist.

Features

- Covers are UL Listed when used with Contender™ Series back boxes.
- ECP plug fits any standard non-explosionproof receptacle (NEMA 5-20R, or 6-20R) as well as U-Line™ explosionproof receptacles.
- Insulators provide superior dielectric and mechanical strength and lowest arc tracking.
- Dead front design: receptacle is not energized until plug is fully inserted and switch is engaged.

Standard Materials

- Cover: copperfree (4/10 of 1% max.) aluminum
- Back box: malleable iron
- Insulating blocks: fiberglass reinforced thermoset polyester

Standard Finishes

- Malleable iron mounting boxes: triple-coat– (1) zinc electroplate, (2) chromate and (3) epoxy powder coat
- Covers and aluminum back boxes: epoxy powder coat

Options

- Copperfree (4/10 of 1% max.) aluminum receptacle cover and box. Add suffix **–SA**.

NEC Certifications and Compliances

- UL Listed: E10784
- UL Standard: UL 1203, UL 1010, UL 894

Illustrated Features

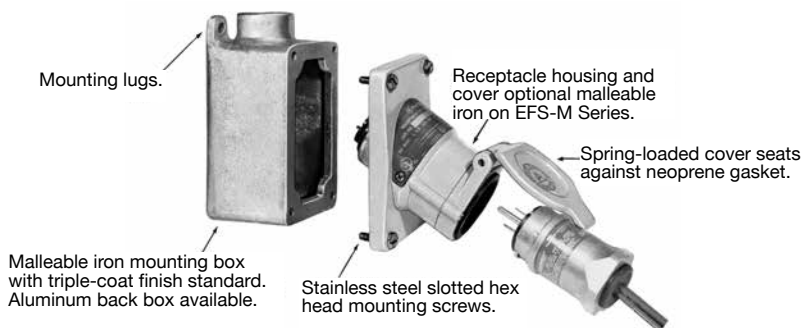

Related Products

- U-Line™ Contender™ receptacles only available for use in combination with 1- and 2-gang EDS boxes incorporating such devices as pilot lights, switches and push buttons. See *Controls Section*.

U-Line NEMA 4X corrosion resistance screw cover kit available: **ULINEREC4XKIT**.



• NEMA Type 4X when the screw cover kit is installed and the cover is fully engaged.
 Covers are UL Classified to mount on Crouse-Hinds® EDS back boxes. Appleton "ENR" Series receptacles are UL Classified for use with Crouse-Hinds® ENP Series plugs. Crouse-Hinds, EDS and ENP are registered trademarks of Cooper Crouse-Hinds.

U-Line™ Contender™ Factory Sealed 20 Amp Plugs and Receptacles

Explosionproof, Dust-Ignitionproof

NEC:
 Class I, Groups C, D
 Class I, Division 2, Group B
 Class I, Zone 1, Group IIB
 Class I, Zone 2, Group IIB + H₂
 Class II, Groups F, G

NEC:
 Class III
 NEMA 3RX*

Illustrated Features

Spring door cover keeps dust out of receptacle when plug is not in use, which may be rotated 180° or completely removed. Stainless steel cover spring-completely enclosed for protection from corrosive environments.

With plug in use, neoprene gasket in throat of receptacle "seals" around plug keeping out dirt, water, dust and other foreign matter.

With plug not in use, spring-loaded door seats against neoprene gasket to seal receptacle from corrosive atmospheres.

Factory sealed receptacle/switch interior. Switch is an integral part of receptacle interior, contained in an aluminum sleeve. Protective xylan coating on inside of sleeve provides smooth "rotating" action of internal switch, which is activated by rotating plug in receptacle. Entire aluminum sleeve is sealed at both ends with neoprene O-rings to protect receptacle/switch interior against moisture.



ECP Interchanger plug fits ordinary location receptacles (NEMA 5-20R and NEMA 6-20R) and explosionproof U-Line™ receptacle as well competitors comparable NEMA blade configured receptacles.

For safety... Ordinary location plug will NOT activate explosionproof U-Line™ receptacle.

Plug mechanical cable clamps on the plug prevent strain on cables and meet or exceed UL 150 lb. strain relief pull-out test for classified locations.

A twist of the plug produces audible "click" to indicate fast make and break of built-in switch contacts. Twisting plug locks it in place—cannot be accidentally pulled out.



Special neoprene watertight plug bushing accommodates flexible cord ranging from .538" to .639" in diameter.



Solderless lugs—all terminals are pressure type to facilitate wiring.

Longer plug housing for better gripping and easier plug insertion and withdrawal.







* NEMA Type 3RX when the screw cover kit is installed and the cover is fully engaged.

U-Line™ Contender™ Factory Sealed 20 Amp Receptacles

Explosionproof, Dust-Ignitionproof

NEC:
 Class I, Groups C, D
 Class I, Division 2, Group B
 Class I, Zone 1, Group IIB
 Class I, Zone 2, Group IIB + H₂
 Class II, Groups F, G

NEC:
 Class III
 NEMA 3RX*

		Catalog Numbers ①		
		125 Vac	250 Vac	
Type	Hub Size			
Single Gang				
	Dead-End	1/2	ENR11201	ENR11202
		3/4	ENR21201	ENR21202
	Feed-Thru	1	ENR31201	ENR31202
		1/2	ENRC11201	ENRC11202
		3/4	ENRC21201	ENRC21202
		1	ENRC31201	ENRC31202
Two Gang				
	Dead-End	1/2	ENR12201	ENR12202
		3/4	ENR22201	ENR22202
		1	ENR32201	ENR32202
	Feed-Thru	1/2	ENRC12201	ENRC12202
		3/4	ENRC22201	ENRC22202
		1	ENRC32201	ENRC32202
Replacement Receptacles				
	Receptacle Cover Assembly	ENR5201	ENR6202	
	Spring Cover Replacement Kit (Aluminum)	ULSCA		
	NEMA 4X Corrosion Resistance Kit ▼	ULINEREC4XKIT		

① Standard back box malleable iron. For aluminum back box, add suffix **-SA** to catalog number.
 ▼ NEMA Type 4X when the screw cover is installed and the cover is fully engaged.
 • NEMA Type 3RX when the screw cover kit is installed and the cover is fully engaged.

U-Line™ Interchanger 20 Amp Plugs

For U-Line™ Contender™ 20 Amp Receptacles. Explosionproof, Dust-Ignitionproof

These raintight ① plugs also fit NEMA 5-20R or 6-20R receptacles in nonclassified areas. Choice of Aluminum or Thermoplastic Polyester Plug.

NEC/CEC:

Class I, Division 1 and 2 Groups B, C, D
 Class II, Division 1 and 2 Groups F, G
 Class III
 NEMA 3, 3R, 7BCD, 9FG

Applications

- U-Line™ Interchanger ECP plug: suitable for use in such areas as refineries, petrochemical plants, and other areas subject to where ignitable gases are present.
- NCP Plug: ideal where moisture or corrosion is a constant problem, such as production facilities on marine platforms, and pipeline transportation facilities.

Features

- Unique blade-type, brass contacts exert constant pressure along entire contact surface and provide superior electrical contact.
- Insulators provide superior dielectric and mechanical strength and lowest arc tracking.
- Longer plug housing for better gripping and easier plug insertion and withdrawal.









- Plugs fits any standard non-explosionproof receptacle (NEMA 5-20R, or 6-20R) as well as U-Line™ explosionproof receptacles.
- ECP plug: a twist of the plug produces audible "click" to indicate fast make and break of built-in switch contacts. Twisting plug locks it in place and cannot be accidentally pulled out.
- NCP plug: special neoprene watertight plug bushing accommodates flexible cord ranging from .538" to .639" diameter.

Standard Materials

- ECP plug: copperfree (less than 4/10ths of 1%) aluminum.
- NCP plug: 30% glass-reinforced thermoplastic polyester.

Appleton

PLUGS AND RECEPTACLES: NEC/CEC HAZARDOUS LOCATION

	Amp	Diagram	Wire/ Pole	Cable Dia., (Inches)	Catalog Number	
					125 Vac 	250 Vac 
U-Line™ Interchanger ECP Standard Plug						
	20		2W, 3P	0.538 to 0.639	ECP-2023	—
	20		2W, 3P	0.538 to 0.639	—	ECP-20232
NCP Plug						
	20		2W, 3P	0.538 to 0.639	NCP-2023	—
	20		2W, 3P	0.538 to 0.639	—	NCP-20232

Dimensions in Millimeters (Inches)

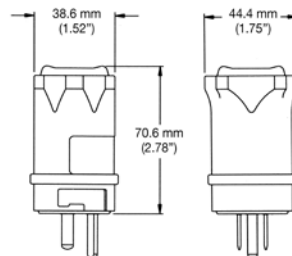

① Raintight when mated with receptacle.

GFS-1 Factory Sealed Ground Fault Circuit Interrupter

For U-Line™ Contender™ 20 Amp Receptacles. Explosionproof, Dust-Ignitionproof

125 Vac Branch Circuits. Installs in Standard Contender Series Mounting Box.

NEC:

- Class I, Division 1 and 2, Groups C, D
- Class II, Division 1 and 2, Groups E, F, G
- Class III
- NEMA 3RX, 7CD, 9EFG

Applications

- Provides required ground fault protection for portable electrically-operated devices. Meets all UL and CSA requirements for ground fault protection in hazardous locations.
- Well suited for use in highly corrosive atmospheres and wet locations.
- Can be used in conjunction with U-Line™ factory sealed Contender receptacle on 20 Amp, 125 Vac branch circuits.

Features

- Covers are UL Listed when used with Contender™ Series back boxes.
- Factory sealed construction; no external seals are required. Arcing is confined within the device's interior sealed chamber.
- Rated 20 Amp, 125 Vac, 5 mA trip setting.
- Smooth-operating test and reset buttons.

Standard Materials

- Cover and sealing chamber cast copperfree (less than 4/10 of 1%) aluminum
- Cover bolts, test and reset buttons and shafts: stainless steel

NEC Certifications and Compliances

- UL Listed: E81751
- UL Standard: UL 943, UL 1203



Appleton

Description	Catalog Number
Aluminum Ground Fault Interrupter Cover/Device	GFS1

Dimensions in Millimeters (Inches)

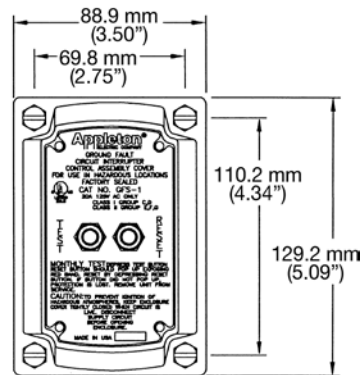
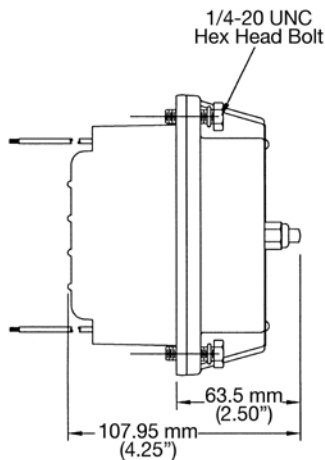

PLUGS AND RECEPTACLES: NEC/CEC HAZARDOUS LOCATION



Covers are UL Classified to mount on Crouse-Hinds® EDS back boxes. Crouse-Hinds, EDS and ENP are registered trademarks of Cooper Crouse-Hinds.

GFS-1 Factory Sealed Ground Fault Circuit Interrupter

For U-Line™ Contender™ 20 Amp Receptacles. Mounting Boxes

NEC/CEC:
 Class I, Division 1 and 2, Groups C, D
 Class II, Division 1 and 2, Groups E, F, G
 Class III
 NEMA 3, 7CD, 9EFG

EDS Cast Device Mounting Boxes

Type	Hub Size (Inches)	Dimensions in Millimeters (Inches)			Catalog Number		
		A	B	C	Malleable Iron	Aluminum	
Single Gang							
	Dead-End	1/2	153.9 (6.06)	172.9 (6.81)	19.0 (0.75)	EDS171	EDS171-SA
		3/4	153.9 (6.06)	172.9 (6.81)	22.3 (0.88)	EDS271	EDS271-SA
		1	156.7 (6.17)	178.5 (7.03)	25.4 (1.00)	EDS371	EDS371-SA
	Feed-Thru	1/2	153.9 (6.06)	172.9 (6.81)	19.0 (0.75)	EDSC171	EDSC171-SA
		3/4	153.9 (6.06)	172.9 (6.81)	22.3 (0.88)	EDSC271	EDSC271-SA
		1	156.7 (6.17)	178.5 (7.03)	25.4 (1.00)	EDSC371	EDSC371-SA
Two Gang							
	Dead-End	1/2	153.9 (6.06)	172.9 (6.81)	22.3 (0.88)	EDS172	EDS172-SA
		3/4	153.9 (6.06)	172.9 (6.81)	22.3 (0.88)	EDS272	EDS272-SA
		1	156.7 (6.17)	178.5 (7.03)	25.4 (1.00)	EDS372	EDS372-SA
	Feed-Thru	1/2	153.9 (6.06)	172.9 (6.81)	22.3 (0.88)	EDSC172	EDSC172-SA
		3/4	153.9 (6.06)	172.9 (6.81)	22.3 (0.88)	EDSC272	EDSC272-SA
		1	156.7 (6.17)	178.5 (7.03)	25.4 (1.00)	EDSC372	EDSC372-SA
Tandem ①							
	Dead-End	1/2	287.2 (11.31)	307.0 (12.09)	22.3 (0.88)	EDS147	EDS147-SA
		3/4	287.2 (11.31)	307.0 (12.09)	22.3 (0.88)	EDS247	EDS247-SA
		1	290.5 (11.44)	312.6 (12.31)	25.4 (1.00)	EDS347	EDS347-SA
	Feed-Thru	1/2	287.2 (11.31)	307.0 (12.09)	22.3 (0.88)	EDSC147	EDSC147-SA
		3/4	287.2 (11.31)	307.0 (12.09)	22.3 (0.88)	EDSC247	EDSC247-SA
		1	290.5 (11.44)	312.6 (12.31)	25.4 (1.00)	EDSC347	EDSC347-SA

Dimensions in Millimeters (Inches)

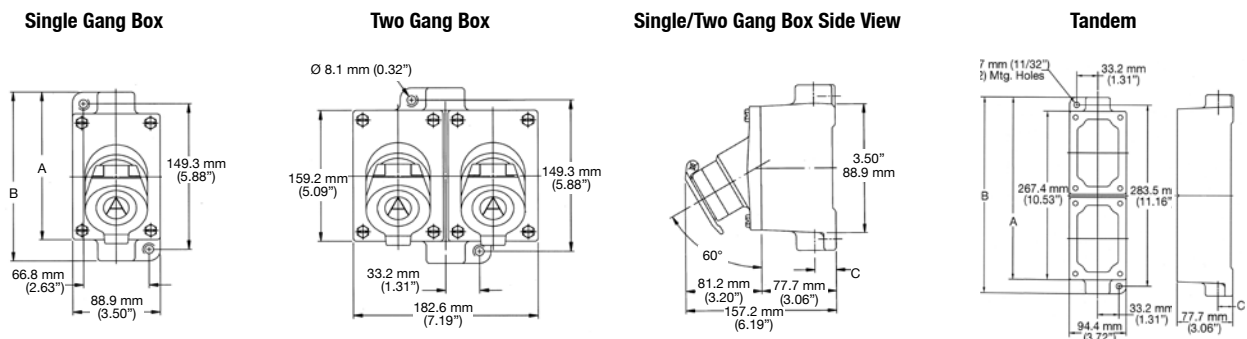

① For tandem bodies, external seals must be installed within 1.52 meters (5 feet) of each conduit entrance for Class I, Groups C and D.

U-Line™ N1 Series 20 Amp Plugs and Receptacles

With Nonmetallic Intraground™ Enclosure. Explosionproof

125 Vac, 20 Amp, 1 HP; 250 Vac, 20 Amp, 2 HP. Dead-Front Safety Construction.

NEC:

Class I, Division 1, Groups C, D
Class I, Division 2, Groups B, C, D
NEMA 3, 3R, 3RX, 4X, 7CD, 12

Applications

- Locations where receptacles are used with stationary or portable electrically operated devices such as:
 - Lighting systems
 - Conveyors
 - Heaters
 - Motor-generator sets
 - Air conditioners
 - Compressors
 - Pumps
- Locations where damp or corrosive conditions exist.

Features

- Nonmetallic construction with metal imbedded grounding grid.
- Feed-thru or dead-end grounded 1/2" or 3/4" conduit openings for threaded conduit.
- Special grounding wire provides safe grounding when cover is removed.
- Excellent resistance to ultraviolet light and water.
- Excellent conduit connection strength.
- Superior flammability resistance.
- Enclosure walls are 5/16" thick.
- Silicone gasket, specially designed for the labyrinth-path joint, prevents entrance of moisture without interfering with the venting of cooled hazardous gases and vapors.
- Explosionproof when sealing fittings (sold separately) are installed at each conduit entrance.
- Excellent resistance to fungi, mold.

Materials

- Mounting box: natural color, high strength thermoplastic polyetherimide
- Gasket: silicone

NEC Certifications and Compliances

- UL Standard: UL 1010 (UL 1203)
- UL Listed: E10784

Related Products

- Sealing fitting must be installed at each conduit entrance of the N1 enclosure to be explosionproof. See *Hazardous Fittings Section*.



Illustrated Features

Unique labyrinth-path construction assures flame-tight joint between body and cover.



Aluminium grounding grid, imbedded into the nonmetallic enclosure during molding, provides complete grounding system. No field work. No extra grounding wires or parts required.



Appleton®

PLUGS AND RECEPTACLES: NEC/CEC HAZARDOUS LOCATION





U-Line™ N1 Series 20 Amp Receptacles

With Nonmetallic Intraground™ Enclosure. Explosionproof

125 Vac, 20 Amp, 1 HP; 250 Vac, 20 Amp, 2 HP. Dead-Front Safety Construction.

NEC:
 Class I, Division 1, Groups C, D
 Class I, Division 2, Groups B, C, D
 NEMA 3, 3R, 3RX, 4X, 7CD, 12

Nonmetallic Mounting Box with Aluminum Epoxy Coated Receptacle

Catalog Number	Hub Size (Inches) ①	Wire/Pole	Volts	Catalog Number ②
	1/2 or 3/4	2W, 3P	125 	N1D75-2023
	1/2 or 3/4	2W, 3P	250 	N1D75-20232
	1/2 or 3/4	2W, 3P	125 	N1DC75-2023
	1/2 or 3/4	2W, 3P	250 	N1DC75-20232

Dimensions in Millimeters (Inches)

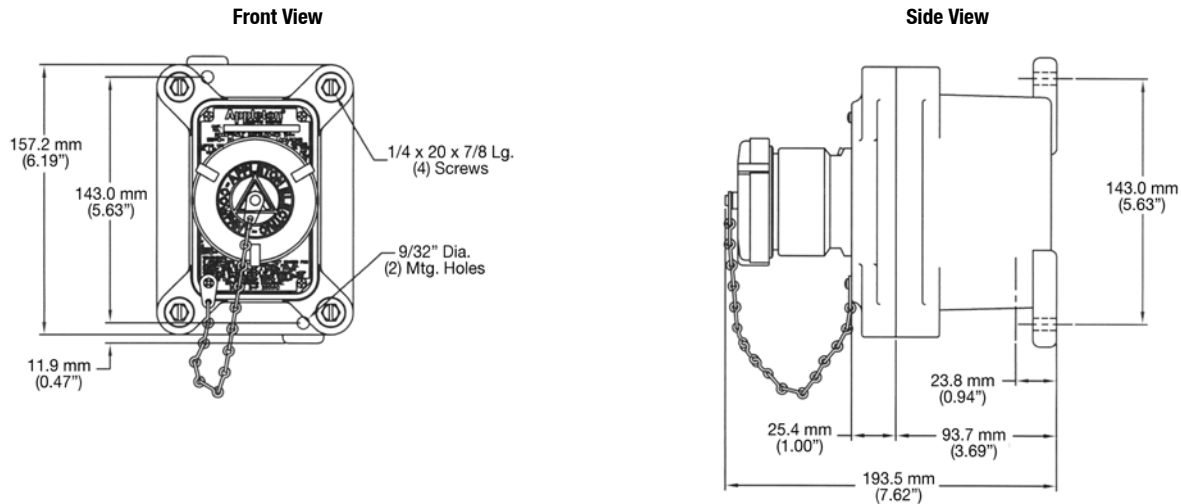

① Furnished with a 3/4" to 1/2" reducer for each hub.
 ② Sealing fittings must be field installed adjacent to enclosure on all conduit runs.

U-Line™ Interchanger 20 Amp Plugs

For U-Line™ Intraground™ N1 Series 20 Amp Receptacles. Explosionproof, Dust-Ignitionproof

These raintight ① plugs also fit NEMA 5-20R or 6-20R receptacles in nonclassified areas. Choice of Aluminum or Thermoplastic Polyester Plug.

NEC/CEC:

Class I, Division 1 and 2 Groups B, C, D

Class II, Division 1 and 2 Groups F, G

Class III

NEMA 3, 3R, 7BCD, 9FG

Applications

- U-Line™ Interchanger ECP plug: suitable for use in such areas as refineries, petrochemical plants, and other areas subject to where ignitable gases are present.
- NCP Plug: ideal where moisture or corrosion is a constant problem, such as production facilities on marine platforms, and pipeline transportation facilities.









Features

- Unique blade-type, brass contacts exert constant pressure along entire contact surface and provide superior electrical contact.
- Insulators provide superior dielectric and mechanical strength and lowest arc tracking.
- Longer plug housing for better gripping and easier plug insertion and withdrawal.

- Plugs fits any standard non-explosionproof receptacle (NEMA 5-20R, or 6-20R) as well as U-Line™ explosionproof receptacles.
- ECP plug: a twist of the plug produces audible "click" to indicate fast make and break of built-in switch contacts. Twisting plug locks it in place and cannot be accidentally pulled out.
- NCP plug: special neoprene watertight plug bushing accommodates flexible cord ranging from .538" to .639" diameter.

Standard Materials

- ECP plug: copperfree (less than 4/10ths of 1%) aluminum
- NCP plug: 30% glass-reinforced thermoplastic polyester

	Amp	Diagram	Wire/ Pole	Cable Dia., (Inches)	Catalog Number	
					125 Vac 	250 Vac 
U-Line™ Interchanger ECP Standard Plug						
	20		2W, 3P	.538 to .639	ECP-2023	—
	20		2W, 3P	.538 to .639	—	ECP-20232
NCP Plug						
	20		2W, 3P	.538 to .639	NCP-2023	—
	20		2W, 3P	.538 to .639	—	NCP-20232

Dimensions in Millimeters (Inches)

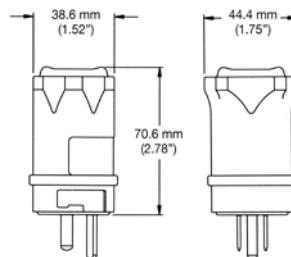

① Raintight when mated with receptacle.

U-Line™ Factory Sealed 20 Amp Panel Mounting Plugs and Receptacles

Explosionproof, Dust-Ignitionproof, Watertight

125 Vac, 20 Amp, 1 HP; 250 Vac, 20 Amp, 2HP. Dead-Front Safety Construction.

NEC/CEC:

Class I, Division 1 and 2, Groups B, C, D

Class II, Division, 1 and 2, Groups F ①, G

Class III

NEMA ② 3, 3R, 3RX*, 4X*, 7BCD, 9F ①G, 12

Applications

- Class I, Division 1 applications require a minimum of five full threads of engagement (seven for Group B).
 - ECHT is designed to be used where unit is threaded into 1-1/2" NPT (tapered) threads, such as in panelboards.
 - ECH is designed to be used where the unit is threaded into 2" NPSM (straight) threads.
- In Class I, Division 2 applications no thread engagement is required unless non-factory sealed devices are also installed in the enclosure.
 - ECHT and ECH are suitable for use with approved enclosures having threaded or non-threaded openings for these receptacles.
 - Where threaded enclosures are used, they must have 1-1/2" NPT or NPSM threads to fit the ECHT and 2" NPSM (straight) threads to fit the ECH.



Features

- Furnished with steel locknut and neoprene sealing gasket assembly.
- Gasketed construction protects receptacle against moisture and dirt with plug in or out.
- Interior switch cylinder has neoprene O-ring at each end to seal out dust and moisture.
- Style 2 (shell and extra pole) grounding.

Standard Materials

- Copperfree (less than 4/10ths of 1%) aluminum

Standard Finishes

- Epoxy clad-two-coat baked finish

NEC/CEC Certifications and Compliances

- UL Standard: UL 1010 (UL 1203)
- UL Listed: E10784
- CSA Standard: C22.2 No. 25, C22.2 No. 30, C22.2 No. 159
- CSA Certified: 038644

Recommended Enclosure Types



Typical Class I, Division 1 Application



Typical Class I, Division 2 Application

Hazardous (Classified) Location	Suitable Enclosure Type
Class I, Division 1	NEMA 7BCD with 1-1/2" (1-1/2 – 11-1/2 NPT) or 2" (2 – 11 1/2 NPSM) thread opening. Minimum 7 full threads of engagement required for Group B; minimum 5 threads for Groups C and D.
Class I, Division 2	NEMA 3, 3R, 3S,12 or any suitable enclosed and gasketed enclosure that prevents the escape of sparks or burning materials.
Class II, Division 1	NEMA 9F †, G with 1-1/2" (1-1/2 – 11-1/2 NPT) or 2" (2 – 11-1/2 NPSM) thread opening. Minimum 3 full threads of engagement required.
Class II, Division 2	NEMA 3, 3S,12 or any suitable enclosed and gasketed enclosure that minimizes entrance of dust and prevents escape of sparks or burning materials.

① Do not use where electrically conductive dusts are present (most coal dusts are not electrically conductive).

② Suitable for these types with a suitable NEMA enclosure.

▼ Meets NEMA 4X when plug is installed or screw cover is fully engaged and mounted in a suitable enclosure.

• NEMA 3X when spring cover is used and mounted in a suitable enclosure.

U-Line™ Factory Sealed 20 Amp Panel Mounting Plugs and Receptacles

Explosionproof, Dust-Ignitionproof, Watertight

125 Vac, 20 Amp, 1 HP; 250 Vac, 20 Amp, 2HP. Dead-Front Safety Construction.

NEC/CEC:



Class I, Division 1 and 2, Groups B, C, D

Class II, Division, 1 and 2, Groups F, G

Class III

NEMA 3, 3R, 3RX*, 4X†, 7BCD, 9FG, 12

20 Amp Aluminum Receptacle

		Catalog Number	
		125 Vac, 1 HP	250 Vac, 2 HP
			
Thread Size and Type ①		Wire/Pole	
 <p>Spring and Screw Cap Included with Assembly</p>	1-1/2" (1-1/2–11-1/2 NPT)	ECHT2023	ECHT20232
	2" (2–11-1/2 NPSM)	ECH2023	ECH20232

Dimensions in Millimeters (Inches)

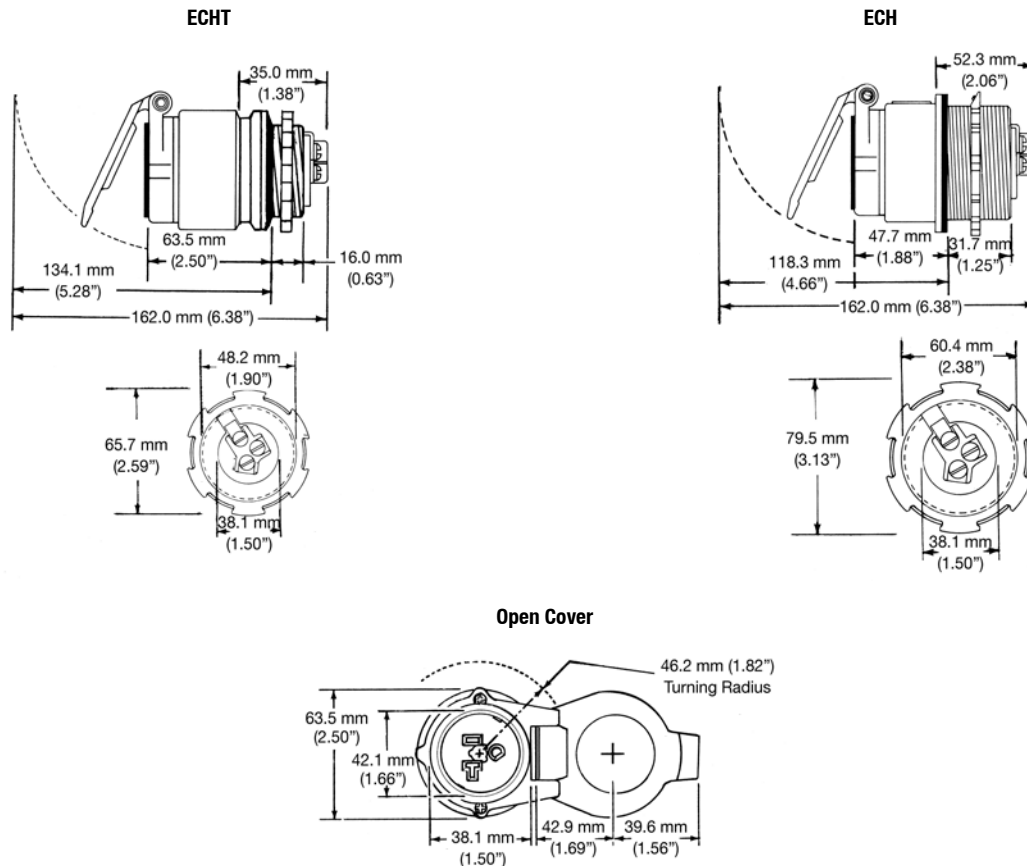

① ECHT has 1-1/2" tapered threads (1-1/2-11-1/2 NPT); ECH has 2" straight threads (2–11-1/2 NPSM).

② Suitable for these types with a suitable NEMA enclosure.

▼ Meets NEMA 4X when plug is installed or screw cover is fully engaged and mounted in a suitable enclosure.

• NEMA 3X when spring cover is used and mounted in a suitable enclosure.

U-Line™ ECCL/ECC Factory Sealed 20 Amp Cable Connectors

125 Vac, 20 Amp, 1 HP; 250 Vac, 20 Amp, 2HP. Dead-Front Safety Construction.

CEC:
 Class I, Division 1 and 2 Groups B, C, D
 Class II, Division, 1 and 2 Groups F, G
 Class III
 NEMA 3, 3R, 7BCD, 9FG

Applications

- Adapter sets for connecting portable devices having ECP U-Line™ Plugs to existing receptacles in non-hazardous areas. Completed adapter set consists of ECCL (or ECC), short flexible cord and plug to fit existing receptacle.



Features

- Gasketed spring cover snaps shut to protect against moisture and combustible dust.
- Gasket in receptacle throat "seals" around plug for protection against environment.
- Interior switch cylinder.
- O-ring at each end to seals combustible dust and moisture.
- 2 bushings to accommodate various cable sizes.

Standard Materials

- Housing: copperfree (4/10ths of 1% max.) aluminum
- O-ring: neoprene



Standard Finishes

- Epoxy powder coat

CEC Certifications and Compliances

- CSA Standard: C22.2 No.25, C22.2 No. 30, C22.2 No. 159
- CSA Certified: 038644

20 Amp Cable Connectors

	Wire/Pole	Cable Diameter (Inches)	Amps	Catalog Number	
				125 Vac, 1 HP	250 Vac, 2 HP
	2W, 3P	0.538 to 0.639	20	ECCL2023	
	2W, 3P	0.538 to 0.639	20	ECC2023	ECC20232
	NEMA 4X Corrosion Resistance Kit ▼			ULINEREC4XKIT	

Dimensions in Millimeters (Inches)

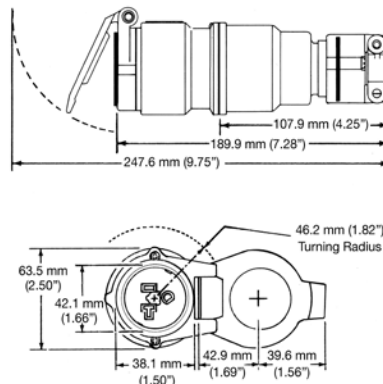

▼ NEMA Type 4X when screw cover kit is used and screw cover is fully engaged.

CPS Factory Sealed 20 Amp Pin and Sleeve Receptacles

Explosionproof

120-240 Vac, 20 Amp at 1 HP; 20 Amp at 24 Vdc. Dead-Front Safety Construction.

NEC/CEC:

Class I, Division 1 and 2 Groups B*, C, D
Class II, Division 1 and 2 Groups F, G
NEMA 3RX*, 7BCD

**Does not intermate with
Contender™ CPS 20 Amp
Pin and Sleeve Receptacles**

Applications

- Locations where receptacles are used with stationary or portable electrically operated devices such as:
 - Lighting systems
 - Conveyors
 - Heaters
 - Motor-generator sets
 - Air conditioners
 - Compressors
 - Pumps
- Locations where damp or corrosive conditions exist.

Features

- Captive stainless steel hex head slotted screws.
- Plug mechanical cable clamps prevent strain on cables; they meet or exceed UL strain relief pull-out requirements.
- Insulators provide superior dielectric and mechanical strength and lowest arc tracking.
- Delayed action construction. Insert plug partially rotate slide on front of receptacle and insert plug fully.
- Factory sealed: external seals not required.
- CPS Series plug and receptacles are supplied with pressure terminal connectors.
- Energizes receptacle terminals deeply recessed to prevent accidental touching.

Standard Materials

- Cover: copperfree (less than 4/10ths of 1%) aluminum
- Mounting bodies: malleable iron
- Insulating blocks: fiberglass reinforced thermoset polyester
- Cover gasket and plug grommet: neoprene

Standard Finishes

- Malleable iron mounting bodies: triple-coat (1) zinc electroplate, (2) chromate and (3) epoxy powder coat
- Aluminum covers: epoxy powder coat

NEC/CEC Certifications and Compliances

- UL Standard: UL 1010 (UL 1203)
- UL Listed: E10784, E81751
- CSA Standard: C22.2 No. 25, C22.2 No. 30, C22.2 No. 159
- CSA Certified: 038644

Related Products

- For a EFSR-GFI Ground Fault Circuit Interrupter refer to the U-Line™ 20 Amp Receptacles within the *Plugs and Receptacles: Hazardous Location Section*.



CPS Receptacle
15° Angle Type



CPS Receptacles
with EFD Mounting Boxes

Appleton®

PLUGS AND RECEPTACLES: NEC/CEC HAZARDOUS LOCATION

- ♦ Select items suitable for Class I, Group B in addition to Class I, Groups C and D. See product selection pages for suitable items.
- NEMA 3X with Screw Cover Kit installed and cover full engaged.









CPS Factory Sealed 20 Amp Pin and Sleeve Receptacles

Explosionproof

120-240 Vac, 20 Amp at 1 HP; 20 Amp at 24 Vdc. Dead-Front Safety Construction.

NEC/CEC:
Class I, Division 1 and 2 Groups B+, C, D
Class II, Division 1 and 2 Groups F, G
NEMA 3RX*, 7BCD

*Does not intermate with
Contender™ CPS 20 Amp
Pin and Sleeve Receptacles*

	Type	Number of Gangs	Wire/Pole	Hub Size (Inches)	Catalog Number
CPS Receptacle 15° Angle Type					
	Dead-End	—	2W, 3P	1/2	CPSA-2350
				3/4	CPSA-2375
CPS Receptacles with EFD Mounting Boxes					
 CPC1	Dead-End	Single	2W, 3P	1/2	CPE1-2350
				3/4	CPE1-2375
				1	CPE1-23100
 CPC2 ①	Feed-Thru	Single	2W, 3P	1/2	CPC1-2350
				3/4	CPC1-2375
				1	CPC1-23100
 CPC2 ①	Dead-End	Two	2W, 3P	1/2	CPE2-2350
				3/4	CPE2-2375
				1	CPE2-23100
 CPC2 ①	Feed-Thru	Two	2W, 3P	1/2	CPC2-2350
				1	CPC2-23100
				3/4	CPC2-2375
CPS Replacement Receptacle and Cover Assembly					
	CPSR		2W, 3P		CPSR-23
	Replacement Spring Cover				CPSCA
CPR Replacement Receptacle Cover Assembly Only					
	CPR		2W, 3P		CPR23
	Spring Cover Kit				CPRCA
	NEMA 3X Corrosion Resistance Kit •				CPS233RXKIT
CPP Plugs for use with CPS Receptacles					
	Pressure Terminals				
	Plug amperes match receptacle ratings		2W, 3P	.536 to .639	CPP2023

• NEMA 3X with Screw Cover Kit installed and cover full engaged.

① Suitable for Class 1, Group C, D; Class I, Division 2, Group B, C, D; Class II, Groups F, G

♦ Shaded area indicates items suitable for Class I, Group B in addition to Class I, Groups C and D. Applies to UL only.

CPS Factory Sealed 20 Amp Pin and Sleeve Receptacles



For use with CPS 20 Amp Receptacles. Explosionproof. Mounting Bodies

120-240 Vac, 20 Amp at 1 HP; 20 Amp at 24 Vdc. Dead-Front Safety Construction.

NEC/CEC:

Class I, Division 1, Groups C, D
 Class I, Division 2, Groups B, C, D
 Class II, Division 1 and 2, Groups E, F, G
 Class III
 NEMA 3, 3R, 7CD, 9EFG

EFD Cast Device Single, Two, and Tandem Mounting Boxes

	Type	Hub Size (Inches)	Catalog Number	
			Malleable Iron	Aluminum
Single Gang				
	Dead-End	1/2	EFD150NLQ	EFD150ANLQ
		3/4	EFD175NLQ	EFD175ANLQ
		1	EFD110NLQ	EFD110ANLQ
	Feed-Thru	1/2	EFDC150NLQ	EFDC150ANLQ
		3/4	EFDC175NLQ	EFDC175ANLQ
		1	EFDC110NLQ	EFDC110ANLQ
Two Gang				
	Dead-End	1/2	EFD250NLQ	EFD250ANLQ
		3/4	EFD275NLQ	EFD275ANLQ
		1	EFD210NLQ	EFD210ANLQ
	Feed-Thru	1/2	EFDC250NLQ	EFDC250ANLQ
		3/4	EFDC275NLQ	EFDC275ANLQ
		1	EFDC210NLQ	EFDC210ANLQ
Tandem ①				
	Dead-End	1/2	EFDT50NLQ	—
		3/4	EFDT75NLQ	—
		1	EFDT10NLQ	—
	Feed-Thru	1/2	EFDCT50NLQ	—
		3/4	EFDCT75NLQ	—
		1	EFDCT10NLQ	—

Appleton®

PLUGS AND RECEPTACLES: NEC/CEC HAZARDOUS LOCATION

① For tandem bodies, eternal seals must be installed within 1.52 meters (5 feet) of each conduit entrance or Class I, Group C and D.

CPS 20 Amp Factory Sealed Receptacles and CPP Plugs

NEC/CEC:
 Class I, Division 1 and 2 Groups B+, C, D
 Class II, Division 1 and 2 Groups F, G
 NEMA 3RX+, 7BCD

**Does not intermate with
 Contender™ CPS 20 Amp
 Pin and Sleeve Receptacles**

Dimensions in Millimeters (Inches)

CPSA 45° Angle Type Receptacle

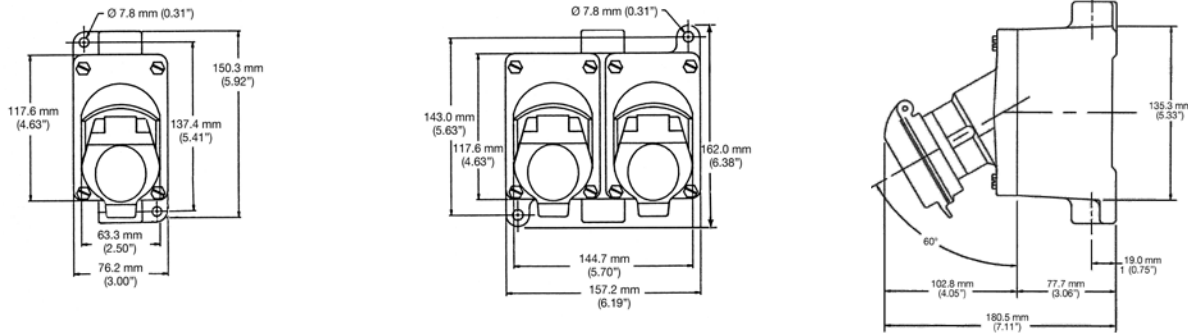

CPSA 15° Angle Type Receptacle

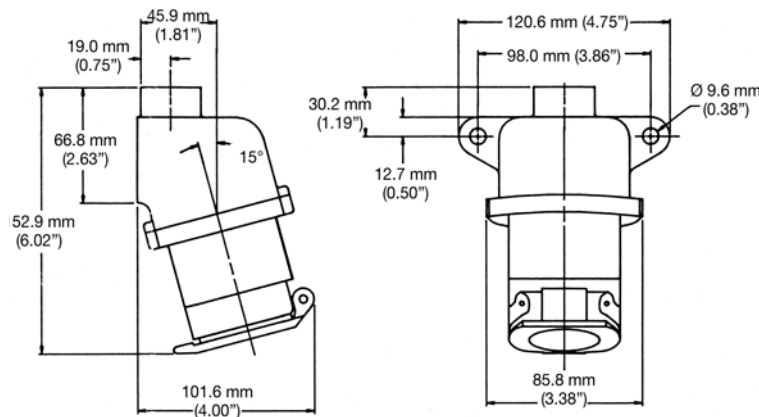

CPP Plug

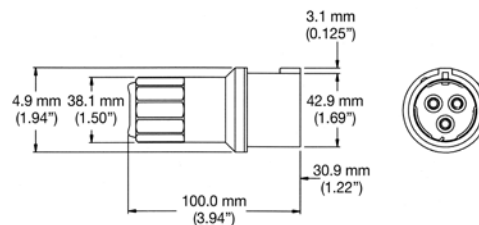

- ◆ Select items suitable for Class I, Group B in addition to Class I, Groups C and D. See product selection pages for suitable items.
- NEMA 3X with Screw Cover Kit installed and cover full engaged.

Contender™ CPS Factory Sealed 20 Amp Pin and Sleeve Receptacles

Explosionproof, Delayed Action

NEC/CEC:
Class I, Division 1 and 2, Groups C, D

**Does not intermate with
CPS 20 Amp Factory Sealed Pin
and Sleeve Receptacles**

Applications

- Locations where receptacles are used with stationary or portable electrically operated devices such as:
 - Lighting systems
 - Conveyors
 - Heaters
 - Motor-generator sets
 - Air conditioners
 - Compressors
 - Pumps
- Locations where damp or corrosive conditions exist.
- Meets all UL and CSA requirements for ground fault protection in hazardous locations when GFCI cover is used.

Features

- Covers are UL Listed when used with Contender™ Series mounting bodies.
- Plug mechanical cable clamps prevent strain on cables – they meet or exceed UL strain relief pull-out requirements.
- Insulators provide superior dielectric and mechanical strength and lowest arc tracking.
- Delayed action construction: insert plug partially rotate slide on front of receptacle and insert plug fully.
- Factory sealed: external seals not required.
- Plug and receptacles are supplied with pressure terminal connectors.

Standard Materials

- Cover: copperfree (4/10 of 1% max.) aluminum
- Mounting bodies: malleable iron
- Screws: captive hex head slotted, stainless steel
- Insulating blocks: fiberglass reinforced thermoset polyester
- Plug grommet: neoprene

Standard Finishes

- Malleable iron mounting bodies: triple-coat– (1) zinc electroplate, (2) chromate and (3) epoxy powder coat
- Covers and aluminum mounting bodies: epoxy powder coat

Options

- Copperfree (4/10 of 1% max.) aluminum receptacle cover and box. Add suffix **-SA**.
- U-Line™ Corrosion Resistance kit. Order **ULINE3RXKIT**.

NEC/CEC Certifications and Compliances

- UL Standard: UL 1010 (UL 1203), UL 894
- UL Listed: E10784
- CSA Standard: C22.2 No. 25, C22.2 No. 30, C22.2 No. 159
- CSA Certified: 038644



Appleton®

PLUGS AND RECEPTACLES: NEC/CEC HAZARDOUS LOCATION



Covers are UL Classified to mount on Crouse-Hinds EDS mounting bodies. Crouse-Hinds and ENP are registered trademarks of Cooper Crouse-Hinds.

Contender™ CPS Factory Sealed 20 Amp Pin and Sleeve Receptacles

Explosionproof, Delayed Action

NEC/CEC:
Class I, Division 1 and 2, Groups C, D

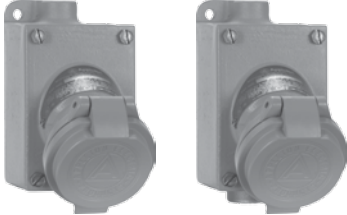
*Does not intermate with
CPS 20 Amp Factory Sealed Pin
and Sleeve Receptacles*

		Type	Wire/Pole	Hub Size (Inches)	Catalog Numbers ① 20 Amp 125–250 Vac 1HP, 20 Amp @ 18 Vdc
Single Gang					
 <p>Dead-End Feed-Thru</p>	Dead-End	2W, 3P	1/2	CPS152-101	
			3/4	CPS152-201	
			1	CPS152-301	
	Feed-Thru	2W, 3P	1/2	CPS152-111	
			3/4	CPS152-211	
			1	CPS152-311	
Two Gang					
	Dead-End	2W, 3P	1/2	CPS152-102	
			3/4	CPS152-202	
			1	CPS152-302	
	Feed-Thru	2W, 3P	1/2	CPS152-112	
			3/4	CPS152-212	
			1	CPS152-312	
Receptacle with GFI ②					
	Dead-End	2W, 3P	1/2	CPS152-102GFI	
			3/4	CPS152-202GFI	
			1	CPS152-302GFI	
	Feed-Thru	2W, 3P	1/2	CPS152-112GFI	
			3/4	CPS152-212GFI	
			1	CPS152-312GFI	

① Aluminum receptacle cover and malleable iron EDS box. For aluminum box and receptacle cover, add suffix **-SA**.

② GFI units rated 20 Amp, 125 Vac.





Appleton Contender CPS Receptacles UL Classified for use with Crouse-Hinds CPS plugs. Appleton covers are UL Classified to mount on Crouse-Hinds EDS mounting bodies. Crouse-Hinds and ENP are registered trademarks of Cooper Crouse-Hinds.

Contender™ CPS Factory Sealed 20 Amp Pin and Sleeve Receptacles

Explosionproof, Delayed Action

NEC/CEC:
Class I, Division 1 and 2, Groups C, D

*Does not intermate with
CPS 20 Amp Factory Sealed Pin
and Sleeve Receptacles*

		Type	Wire/Pole	Catalog Numbers ①
Cover Assemblies				
		Receptacle with Spring Cover Only		CPS152R
		GFCI Cover, 5 mA Trip Setting ②		GFS1
CPS152R	GFS1			
<hr/>				
		Spring Cover Replacement Kit (Aluminum)		CPSCA
CPSCA				
<hr/>				
Plug			Plug Cable Diameter (Inches)	
		Pressure Terminals Plug amperes match receptacle ratings	2W, 3P 0.538 to 0.639	CPP516

① Aluminum receptacle cover and malleable iron EDS box. For aluminum box and receptacle cover, add suffix **-SA**.

② GFI units rated 20 Amp, 125 Vac.



Appleton CPP516 plug is UL Classified for use on Crouse-Hinds CPS receptacles. Appleton covers are UL Classified to mount on Crouse-Hinds EDS mounting bodies. Crouse-Hinds and ENP are registered trademarks of Cooper Crouse-Hinds.

Contender™ CPS Factory Sealed 20 Amp Pin and Sleeve Receptacles

For Contender™ CPS 20 Amp Factory Sealed Receptacles and CPP Plugs. Mounting Boxes

NEC/CEC:
 Class I, Division 1 and 2, Groups C, D
 Class II, Division 1 and 2, Groups E, F, G
 Class III
 NEMA 3, 7CD, 9EFG

EDS Cast Device Mounting Boxes

Type	Hub Size (Inches)	Dimensions in Millimeters (Inches)			Catalog Number		
		A	B	C	Malleable Iron	Aluminum	
Single Gang							
	Dead-End	1/2	153.9 (6.06)	172.9 (6.81)	19.0 (0.75)	EDS171	EDS171-SA
		3/4	153.9 (6.06)	172.9 (6.81)	22.3 (0.88)	EDS271	EDS271-SA
		1	156.7 (6.17)	178.5 (7.03)	25.4 (1.00)	EDS371	EDS371-SA
Feed-Thru		1/2	153.9 (6.06)	172.9 (6.81)	19.0 (0.75)	EDSC171	EDSC171-SA
		3/4	153.9 (6.06)	172.9 (6.81)	22.3 (0.88)	EDSC271	EDSC271-SA
		1	156.7 (6.17)	178.5 (7.03)	25.4 (1.00)	EDSC371	EDSC371-SA
Two Gang							
	Dead-End	1/2	153.9 (6.06)	172.9 (6.81)	22.3 (0.88)	EDS172	EDS172-SA
		3/4	153.9 (6.06)	172.9 (6.81)	22.3 (0.88)	EDS272	EDS272-SA
		1	156.7 (6.17)	178.5 (7.03)	25.4 (1.00)	EDS372	EDS372-SA
Feed-Thru		1/2	153.9 (6.06)	172.9 (6.81)	22.3 (0.88)	EDSC172	EDSC172-SA
		3/4	153.9 (6.06)	172.9 (6.81)	22.3 (0.88)	EDSC272	EDSC272-SA
		1	156.7 (6.17)	178.5 (7.03)	25.4 (1.00)	EDSC372	EDSC372-SA
Tandem ①							
	Dead-End	1/2	287.2 (11.31)	307.0 (12.09)	22.3 (0.88)	EDS147	EDS147-SA
		3/4	287.2 (11.31)	307.0 (12.09)	22.3 (0.88)	EDS247	EDS247-SA
		1	290.5 (11.44)	312.6 (12.31)	25.4 (1.00)	EDS347	EDS347-SA
Feed-Thru		1/2	287.2 (11.31)	307.0 (12.09)	22.3 (0.88)	EDSC147	EDSC147-SA
		3/4	287.2 (11.31)	307.0 (12.09)	22.3 (0.88)	EDSC247	EDSC247-SA
		1	290.5 (11.44)	312.6 (12.31)	25.4 (1.00)	EDSC347	EDSC347-SA

Dimensions in Millimeters (Inches)

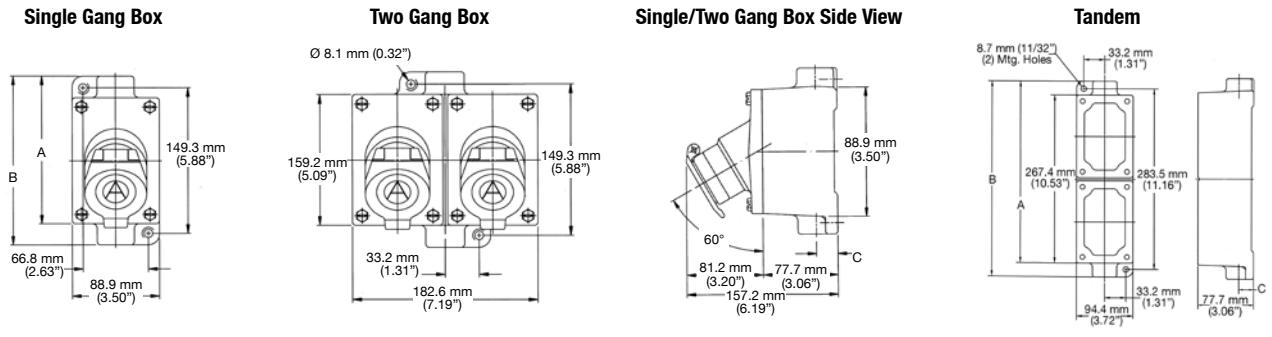

① For tandem bodies, external seals must be installed within 1.52 meters (5 feet) of each conduit entrance for Class I, Groups C and D.

Contender™ CPS Factory Sealed 20 Amp Pin and Sleeve Receptacles

Explosionproof, Delayed Action

NEC/CEC:
Class I, Division 1 and 2, Groups C, D

**Does not intermate with
CPS 20 Amp Factory Sealed Pin
and Sleeve Receptacles**

Dimensions in Millimeters (Inches)

GFS-1

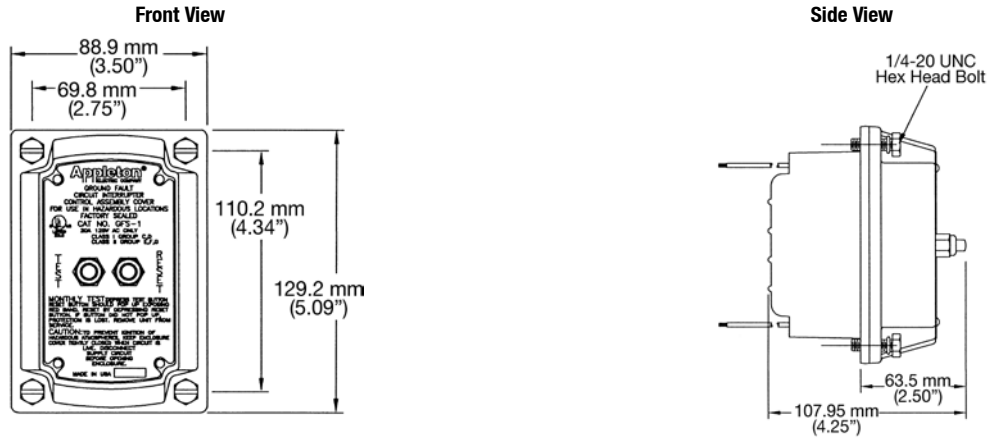

CPP Plug

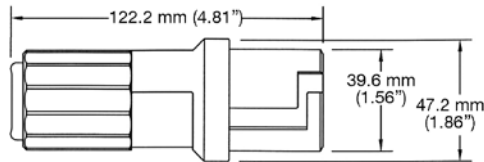

Appleton

PLUGS AND RECEPTACLES: NEC/CEC HAZARDOUS LOCATION

FSQX 30 Amp Receptacles with Interlocked Switch and Cover

Explosionproof, Dust-Ignitionproof

Raintight Screw Cap Receptacle Cover—Interlocked Switch and Cover Safety Construction.

NEC:

Class I, Division 1 and 2, Groups B, C, D

Class II, Division 1 and 2, Groups F, G

Class III

NEMA 7BCD, 9FG

Applications

- Locations where receptacles are used with stationary or portable electrically operated devices such as:
 - Lighting systems
 - Conveyors
 - Heaters
 - Motor-generator sets
 - Air conditioners
 - Compressors
 - Pumps
- Locations with damp or corrosive conditions.
- Class I: locations where ignitable vapors or gases are present such as:
 - Petrochemical plants
 - Petroleum refineries
 - Paint and chemical plants
- Class II: locations such as process industries where there are dust hazards from handling such products as flour, grain and starch or any location where ignitable amounts of dust are present or amounts which would adversely affect performance.



Features

- Energized receptacle contacts deeply recessed to reduce danger of accidental touching.
- Screw cap fastened to chain.
- Unique design brass contacts exert constant pressure along entire contact surface and provide superior electrical contact.
- Plug mechanical cable clamps prevent strain on cables — they meet or exceed UL strain relief pull-out requirements.
- Neoprene bushing compressed by cable collar prevents entrance of water.
- Insulators provide superior dielectric and mechanical strength and lowest arc tracking.
- Smooth, rounded integral bushing in each hub protects conductor insulation.
- "Interlocked Switch and Cover" offers double protection—plug cannot be inserted or removed unless switch is in "OFF" position. Interlock device in the cover breaks circuit when locking screw is backed down for cover removal. To operate, insert plug and turn switch to "ON" position.

Standard Materials

- Body: malleable iron
- Screw covers: copperfree (4/10 of 1% max.) aluminum
- Insulating blocks: phenolic

Standard Finishes

- Malleable iron receptacles: triple-coat-(1) zinc electroplate, (2) chromate and (3) epoxy powder coat
- Cord connector housings and caps: epoxy powder coat

NEC Certifications and Compliances

- UL Standard: UL 1010 (UL1203), UL 894
- UL Listed: E10784

FSQX 30 Amp Receptacles with Interlocked Switch and Cover

Explosionproof, Dust-Ignitionproof

Raintight Screw Cap Receptacle Cover—Interlocked Switch and Cover Safety Construction.

NEC:

Class I, Division 1 and 2, Groups B, C, D

Class II, Division 1 and 2, Groups F, G

Class III

NEMA 7BCD, 9FG

Type	Wire/Pole	Hub Size (Inches)	Catalog Number
------	-----------	-------------------	----------------

FSQX Receptacles

Furnished with four hubs and three close-up plugs. Supplied with 1" to 3/4" reducers.



2-Pole Switch rated at 30 Amp 2 HP, 120 Vac 5 HP, 240 Vac 10 HP, 480 Vac 15 HP, 600 Vac	2W, 3P	1	FSQX3023-100
3-Pole Switch rated at 30 Amp 3 HP, 120 Vac 7.5 HP, 240 Vac 15 HP, 480 Vac 20 HP, 600 Vac	3W, 4P	1	FSQX3034-100

Type	Wire/Pole	Cable Dia., Inches Min. — Max.	Catalog Number
------	-----------	-----------------------------------	----------------

FP Plugs for Use with Receptacles Above

Furnished with cable grip and rubber bushing. Solder well wire terminals. Pressure terminal for grounding.



Plug amperes match receptacle ratings	2W, 3P	.75 to .875	FP-3023
	3W, 4P	.75 to .875	FP-3034

Dimensions in Millimeters (Inches)

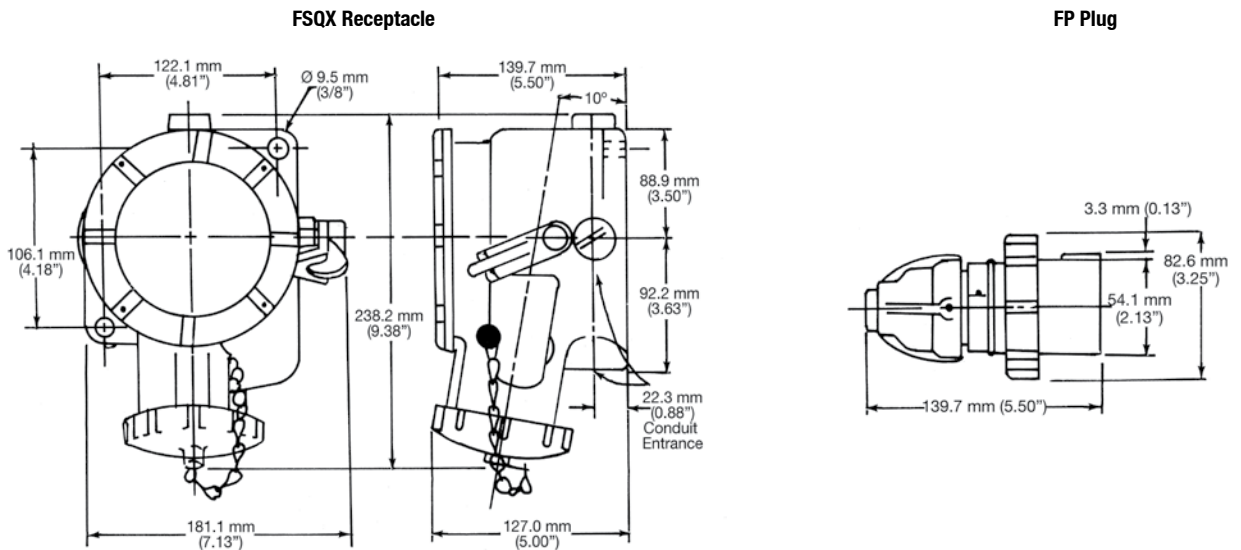

GES and CESD Factory Sealed Receptacles

30 and 60 Amp Pin and Sleeve. Explosionproof.

Delayed-Action Safety Construction with Slide-Lok® Design. Pressure Wire Terminals.

NEC/CEC — 30 Amp CES and CESD:
Class I, Division 1 and 2, Groups C, D

NEC/CEC — 60 Amp CESD:
Class I, Division 1 and 2, Groups D

Applications

- Locations where receptacles are used with stationary or portable electrically operated devices such as:
 - Lighting systems
 - Conveyors
 - Heaters
 - Motor-generator sets
 - Air conditioners
 - Compressors
 - Pumps
- Class I: classified locations such as:
 - Petrochemical plants
 - Petroleum refineries
 - Paint and chemical plants
 - Any location where ignitable vapors or gases are present

Features

- Factory sealed. No external seals required. Arcing is safely confined to receptacle interior.
- Energized receptacle contacts deeply recessed to reduce danger of accidental touching.
- Style 2 (shell and extra pole) grounding.
- Spring door keeps dust out of receptacle when plug is not in use.
- Unique design brass contacts exert constant pressure along entire contact surface and provide superior electrical contact.
- Contacts have beryllium copper wire springs.
- Plug mechanical cable clamps prevent strain on cables; they meet or exceed UL strain relief pull-out requirements.
- Neoprene bushing compressed by cable collar prevents entrance of water.
- Insulators provide superior dielectric and mechanical strength and lowest arc tracking.
- Smooth, rounded integral bushing in each hub protects conductor insulation.
- Delayed action construction. To operate, insert plug to first stop, move Slide-Lok® slide to right and push plug fully forward.
- CPH plug fits Powertite™ Series hazardous location receptacles.

Standard Materials

- Receptacle and cover: copperfree (4/10 of 1% max.) aluminum
- Mounting box: malleable iron
- Insulating blocks: fiber glass reinforced polyester

Standard Finishes

- Malleable iron mounting bodies: triple-coat (1) zinc electroplate, (2) chromate and (3) epoxy powder coat
- Aluminum receptacles: ceramic burnished
- Cord connector housings and caps: epoxy powder coat

NEC/CEC Certifications and Compliances

- UL Standard: UL 1010 (UL 1203), UL 894, UL 1682, UL 1686
- UL Listed: E10784
- CSA Standard: C22. No 30, C22.2 No. 159, C22.2 No 182.1



CES and CESD Factory Sealed Receptacles

30 and 60 Amp Pin and Sleeve. Explosionproof

Delayed-Action Safety Construction with Slide-Lok® Design. Pressure Wire Terminals.

NEC/CEC — 30 Amp CES and CESD:
Class I, Division 1 and 2, Groups C, D

NEC/CEC — 60 Amp CESD:
Class I, Division 1 and 2, Groups D

Amp	Wire/Pole	Hub Size (Inches)	Complete With Box ①	Catalog Number			Replacement Interior
				Back Box Only	Receptacle Only ②		

CES Receptacles — 30 Amp and 60 Amp, 125-250 Vac (See HP ratings below.)

Furnished with one vertical and two horizontal feed-thru hubs.



CES



CESR

30	2W, 3P	3/4	CES-3023	CES-30B	CESR-3023	CERI-3023
	3W, 4P	3/4	CES-3034	CES-30B	CESR-3034	CERI-3034
60	2W, 3P	1-1/4	CES-6023	CES-60B	CESR-6023	CERI-6023
	3W, 4P	1-1/4	CES-6034	CES-60B	CESR-6034	CERI-6034

CESD Receptacles — 30 Amp and 60 Amp, 125-250 Vac (See HP ratings below.)

Furnished with vertical feed-thru hubs.



CESD



CESR

30	2W, 3P	3/4	CESD-3023	CESD-30B	CESR-3023	CERI-3023
	3W, 4P	3/4	CESD-3034	CESD-30B	CESR-3034	CERI-3034
60	2W, 3P	1-1/4	CESD-6023	CESD-60B	CESR-6023	CERI-6023
	3W, 4P	1-1/4	CESD-6034	CESD-60B	CESR-6034	CERI-6034

CPH Plugs and Plug Interiors for Use with Receptacles Above

Type	Wire/Pole	Cable Dia. (Inches)	Complete Plug	Replacement Interior
30	2W, 3P	.390-1.375	CPH3023BC	CEPI-3023B
	3W, 4P	.390-1.375	CPH3034BC	CEPI-3034B
60	2W, 3P	.390-1.375	CPH6023BC	CEPI-6023BC
	3W, 4P	.390-1.375	CPH6034BC	CEPI-6034BC

CES/CESD Maximum Horsepower Ratings

125-250 Vac					480 Vac				
Wire/Pole	Phase	Max. HP	Max. Amp	Catalog Number	Wire/Pole	Phase	Max. HP	Max. Amp	Catalog Number
2W, 3P	1	1-1/2	30	CES/CESD-3023	2W, 3P	1	1/2	7	CES/CESD-3023
3W, 4P	3	3	30	CES/CESD-3034	3W, 4P	3	1	7	CES/CESD-3034
2W, 3P	1	1-1/2	60	CES/CESD-6023	2W, 3P	1	1-1/2	30	CES/CESD-6023
3W, 4P	3	5	60	CES/CESD-6034	3W, 4P	3	5	30	CES/CESD-6034

① UL Listed with Mounting Box.

② NOT UL Listed. Only UL Listed when Receptacle is provided with Mounting Box.

CES and CESD Factory Sealed Receptacles

30 and 60 Amp Pin and Sleeve. Explosionproof

Delayed-Action Safety Construction with Slide-Lok® Design. Pressure Wire Terminals.

NEC/CEC — 30 Amp CES and CESD:
Class I, Division 1 and 2, Groups C, D

NEC/CEC — 60 Amp CESD:
Class I, Division 1 and 2, Groups D

Dimensions in Millimeters (Inches)

CES Receptacles

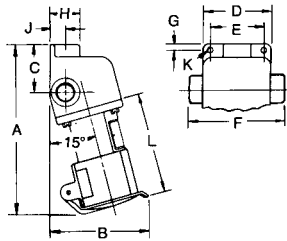

Hub Size (Inches)	Max. Amp	Dimensions in Millimeters (Inches)										
		A	B	C	D	E	F	G	H	J	K	L
3/4	30	211.0 (8.31)	125.4 (4.94)	60.4 (2.38)	85.8 (3.38)	66.8 (2.63)	119.1 (4.69)	7.8 (0.31)	38.1 (1.50)	19.8 (0.78)	4/1 ϕ	128.7 (5.07)
1-1/4	60	301.7 (11.88)	174.7 (6.88)	73.1 (2.88)	133.3 (5.25)	111.2 (4.38)	185.6 (7.31)	11.1 (0.44)	65.0 (2.56)	35.0 (1.38)	32/13 ϕ	180.3 (7.10)

CESD Receptacles

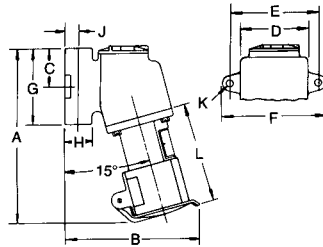

Hub Size (Inches)	Max. Amp	Dimensions in Millimeters (Inches)										
		A	B	C	D	E	F	G	H	J	K	L
3/4	30	220.7 (8.69)	171.4 (6.75)	47.7 (1.88)	85.8 (3.38)	111.2 (4.38)	130.3 (5.13)	95.2 (3.75)	35.0 (1.38)	17.5 (0.69)	32/11 ϕ	128.7 (5.07)
1-1/4	60	323.8 (12.75)	236.4 (9.31)	81.0 (3.19)	133.3 (5.25)	158.7 (6.25)	184.1 (7.25)	160.2 (6.31)	65.0 (2.56)	35.0 (1.38)	32/11 ϕ	180.3 (7.10)

CPH Plugs

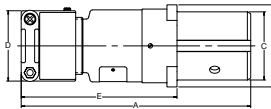

Max. Amp	Wire/Pole	Dimensions in Millimeters (Inches)				
		A	B	C	D	E
30	2W, 3P; 3W, 4P	155.7 (6.13)	60.4 (2.38)	47.2 (1.86)	6.68 (2.63)	113.7 (4.44)
60	2W, 3P	123.9 (8.44)	77.7 (3.06)	56.6 (2.23)	6.68 (2.63)	144.5 (5.69)
60	3W, 4P	123.9 (8.44)	77.7 (3.06)	64.7 (2.55)	6.68 (2.63)	144.5 (5.69)

FSQC 30, 60 and 100 Amp Series Receptacles and ACP Plugs

Disconnect Switch. Explosionproof, Dust-Ignitionproof

600 Vac Max. 250 Vdc Max.

NEC/CEC:

Class I, Division 1 and 2, Groups B, C, D

Class II, Division 1 and 2, Groups F, G

Class III

NEMA 3*, 3R*, 4*, 4X*, 7CD, 9FG

Applications

- Locations where receptacles are used with stationary or portable electrically operated devices such as:
 - Lighting systems
 - Conveyors
 - Heaters
 - Motor-generator sets
 - Air conditioners
 - Compressors
 - Pumps
- Locations where damp or corrosive conditions exist
- Class I: classified locations such as:
 - Petrochemical plants
 - Petroleum refineries
 - Paint and chemical plants
 - Any location where ignitable vapors or gases are present
- Class II: classified locations such as:
 - Process industries where there are dust hazards from handling such products as flour, grain and starch or any location where ignitable amounts of dust are present or amounts which would adversely affect performance

Features

- Large housing provides ample wiring room.
- Style 2 (shell and extra pole) grounding.
- Spring door keeps dust out of receptacle when plug is not in use. Screw cover also supplied.
- Brass contacts exert constant pressure along entire contact surface and provide superior electrical contact.
- Contacts have beryllium copper wire springs.
- Insulators provide superior dielectric and mechanical strength and lowest arc tracking.
- Tapped NPT conduit openings at top and bottom: 30 Amp 3/4", 60 Amp 1-1/2", 100 Amp 2".
- "Interlocked Disconnect Switch" provides safe connect and disconnect operation at 30, 60 or 100 Amp, 600 Vac maximum, three pole, non-fused motor circuit switch. FSQC permits safe operation in Class I, Group B as well as Class I, Groups C and D, Class II, Groups F, G, and Class III.
- To operate, insert plug and turn receptacle face to "ON" position. To remove plug, turn to OFF position and pull plug out.
- ACP plug fits Powertite™ Series hazardous location receptacles.

Standard Materials

- Receptacle and mounting box: copperfree (4/10 of 1% max.) aluminum
- ACP plugs: copperfree (4/10 of 1% max.) aluminum housings
- Insulating blocks: fiber glass reinforced polyester

Standard Finishes

- Receptacles, mounting boxes, cord connector housings and caps: epoxy powder coat



30 Amp
Shown with Flip Lid
Cover



60 Amp
Shown with Screw
Cap Cover



100 Amp
Shown with Flip Lid
Cover

Options

- Special Polarization: Prevents plug insertion in a receptacle or connector wired for a different voltage. In installations where there are different line voltages, the special polarization option is desirable. This allows only plugs and receptacles wired for the same line voltage to be mated together. The receptacle or connector interior is positioned 22-1/2°, relative to the polarization rivet, to the right (as specified) of standard, and plug is polarized to correspond. This option can be added to receptacles using the Powertite™ Plug. Add suffix **-P4** to receptacle or plug.
- Auxiliary contacts 1NO + 1NC. Add suffix **-AUX** to receptacle.

NEC/CEC Certifications and Compliances

- UL Standard: UL 1010 (UL 1203), UL 894, UL 1682, UL 1686
- UL Listed: E10784
- CSA Standard: C22.2 No. 25, C22.2 No. 30, C22.2 No. 159
- CSA Certified: 025875

• Flip cover suitable for NEMA 3, 3R only.

▼ NEMA 4 rating maintained with Appleton NEMA 4 plug installed. Install screw cover for 4, 4X. Both covers are included with product.

Classified by UL and Certified by CSA for use in specific combinations with Crouse-Hinds Arktite. Arktite is a registered trademark of Cooper Crouse-Hinds.

Visit our website at www.emerson.com or contact us at (800) 621-1506.

© November 2016

Appleton®

PLUGS AND RECEPTACLES: NEC/CEC HAZARDOUS LOCATION

425

EMERSON

FSQC 30, 60 and 100 Amp Series Receptacles and ACP Plugs

Disconnect Switch. Explosionproof, Dust-Ignitionproof

600 Vac Max. 250 Vdc Max.

NEC/CEC:

Class I, Division 1 and 2, Groups B, C, D

Class II, Division 1 and 2, Groups F, G

Class III

NEMA 3*, 3R*, 4*, 4X*, 7CD, 9FG

	Amp	Hub Size (Inches) †	Wire/Poles	Terminal Block Wire Range	Receptacle Catalog Number ①	Mating Plug Powertite™
	30	3/4 or 1	3W, 4P	#10 - #8	FSQC3430	ACP3034BC
	60	1-1/2	3W, 4P	#6 - #4	FSQC5640	ACP6034BC
	100	2	3W, 4P	#2 - 1/0	FSQC61040	ACP1034CD

ACP Plugs

	Wire/Poles	Cable Dia. (Inches)	30 Amp	60 Amp	100 Amp
	3W, 4P	.390 to 1.375	ACP3034BC	ACP6034BC	—
		.875 to 1.906	—	—	ACP1034CD

Maximum Horsepower Ratings of Switch

Phase	Amps	120 Vac	240 Vac	480 Vac	600 Vac
Three	30	3	7.5	15	20
	60	—	10	25	30
	100	10	30	60	75

ACP Plug Dimensions in Millimeters (Inches)

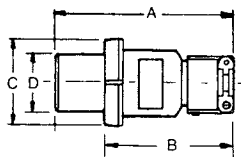

Max. Amp	A	B	C	D
30	152.4 (6.00)	120.6 (4.75)	79.5 (3.13)	47.2 (1.86)
60	198.3 (7.81)	125.4 (4.94)	88.9 (3.50)	56.6 (2.23)
100	267 (10.50)	168.4 (6.63)	101.6 (4.00)	62.7 (2.47)

① Receptacle insulator and contacts are not serviceable.

• Flip cover suitable for NEMA 3, 3R only.

▼ NEMA 4 rating maintained with Appleton NEMA 4 plug installed. Install screw cover for 4, 4X. Both covers are included with product.

FSQC 30, 60 and 100 Amp Series Receptacles and ACP Plugs

Disconnect Switch. Explosionproof, Dust-Ignitionproof

600 Vac Max. 250 Vdc Max.

NEC/CEC:

Class I, Division 1 and 2, Groups B, C, D

Class II, Division 1 and 2, Groups F, G

Class III

NEMA 3⁺, 3R⁺, 4⁺, 4X⁺, 7CD, 9FG

FSQC Receptacles — Shown with Flip Lid Cover — Dimensions in Millimeters (Inches)

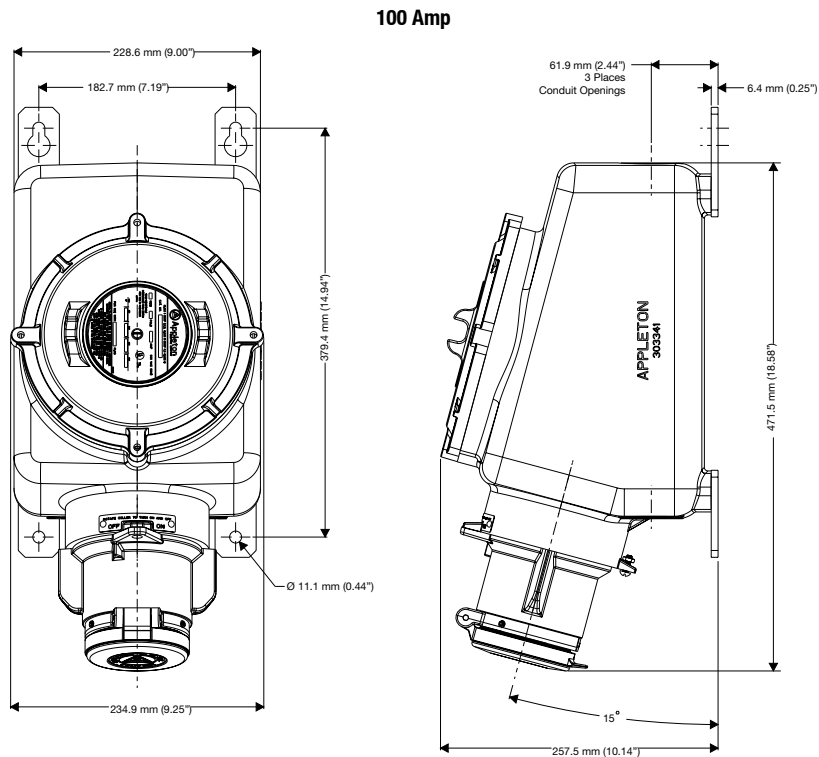
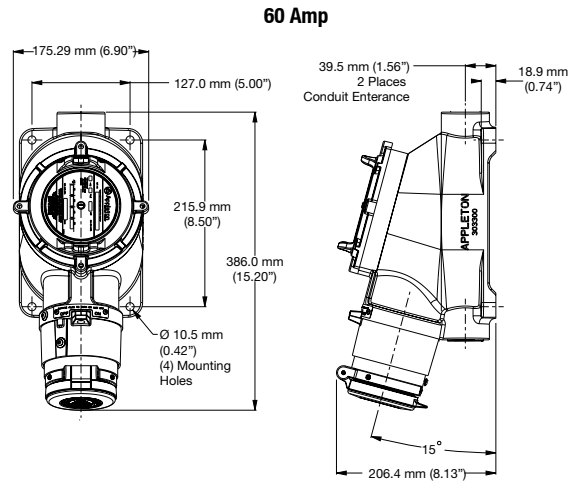
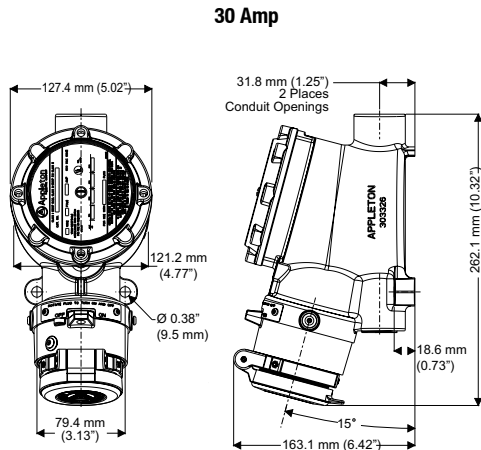

• Flip cover suitable for NEMA 3, 3R only.

▼ NEMA 4 rating maintained with Appleton NEMA 4 plug installed. Install screw cover for 4, 4X. Both covers are included with product.

JBR Series 30 and 60 Amp Switched Receptacles

Dead Front Interlocked Construction; 600 Volts AC, 50-400 Hertz; Pressure Wire Terminals

NEC:

Class I, Division 1 and 2, Groups B, C, D
Class II, Division 1 and 2, Groups F, G
Class III
NEMA 3^o, 3R^o, 4^x, 4X^y, 7BCD, 9FG

Applications

- Locations where receptacles are used with stationary or portable electrically operated devices such as:
 - Lighting systems
 - Conveyors
 - Heaters
 - Motor-generator sets
 - Air conditioners
 - Compressors
 - Pumps

Features

- Plug must be inserted into receptacle before the switch is in the on position.
- JBR is UL Listed for use with ACP Powertite™ and CPH plugs.
- Receptacle supplied with flip cover and screw cover.
- Positive polarization: only plugs of the same style, number of poles and amperage rating may be used with these receptacles.
- Terminal block provided in mounting box for ease of wiring. Factory wired between the receptacle and terminal block.
- Style 2 (shell and extra pole) grounding.
- Receptacles may be locked in the "OFF" position.
- Mounting box provided 1-1/2" vertical feed-thru conduit openings. Reducer bushings provided for 1-1/4" conduit opening. All conduit openings have NPT threads.
- O-ring gasket provided between the mounting box and receptacle cover.
- Internal switch provides safe and quick disconnect means. No need for separate disconnect switch.
- UL Classified for use with competitors like plugs ①.

Standard Materials

- Receptacle housing and mounting box: copperfree (4/10 of 1% max.) aluminum
- Captive cover bolts, mounting feet and hinges: stainless steel

Standard Finishes

- Receptacle and mounting box: epoxy powder coat

Options

- For field installed drain and breather set, order one **ECD50B4X** drain and one **BRTB4X** breather. Both are NEMA 4X rated for Group B.
- Special Polarization: Prevents plug insertion in a receptacle or connector wired for a different voltage. In installations where there are different line voltages, the special polarization option is desirable. This allows only plugs and receptacles wired for the same line voltage to be mated together. The receptacle or connector interior is positioned 22-1/2°, relative to the polarization rivet, to the right (as specified) of standard, and plug is polarized to correspond. Suffix **-P4** to receptacle or plug.

NEC Certifications and Compliances

- UL Standard: UL 1010 (UL 1203), UL 894, UL 1682, UL 1686
- UL Listed: E10784

• Flip cover suitable for NEMA 3, 3R only.

▼ NEMA 4 rating maintained with Appleton NEMA 4 plug installed. Install screw cover for 4, 4X. Both covers are included with product.

① UL Classified for use with Crouse-Hinds APJ series plug. Crouse-Hinds is a registered trademark of Cooper Crouse-Hinds.



Illustrated Features

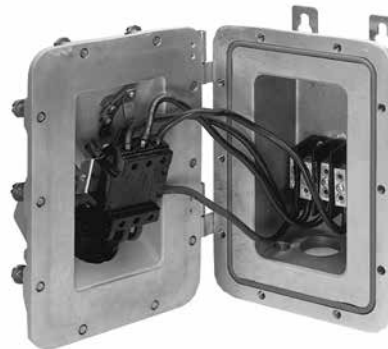

- **Terminal block** provided for line connections.
- **Terminal** provided for grounding connection.
- **Receptacle** is prewired to the terminal block.
- **Disconnect switch** mounted on the cover assembly.

JBR Series 30 and 60 Amp Series Switched Receptacles

Dead Front Interlocked Construction

30 and 60 Amp, 600 Vac, 50-400 Hz

NEC:

Class I, Division 1 and 2, Groups B, C, D

Class II, Division 1 and 2, Groups F, G

Class III

NEMA 3*, 3R*, 4*, 4X*, 7BCD, 9FG

Amp	Hub Size (Inches) ①	Wire/Poles	Terminal Block Wire Range	Receptacle Catalog Number	Mating Plug Powertite™	Complete Plug
30	1-1/2	2W, 3P	#10 - #4	JBR3023-150	ACP3023BC	CPH3023B
	1-1/2	3W, 4P	CU-AL	JBR3034-150	ACP3034BC	CPH3034B
60	1-1/2	2W, 3P	#4 - #6	JBR6023-150	ACP6023BC	CPH6023BC
	1-1/2	3W, 4P	CU-AL	JBR6034-150	ACP6034BC	CPH6034BC



Accessories

Description	Catalog Number
Type 4X Drain (field installed)	ECD50B4X
Type 4X Breather (field installed)	BRTB4X

Replacement Parts

Description	Catalog Number
30 Amp, 2W, 3P Interlock Rod Assembly	DEJS30
30 Amp, 3W, 4P Interlock Rod Assembly	DEJS30
60 Amp, 2W, 3P Interlock Rod Assembly	DEJS60A
60 Amp, 3W, 4P Interlock Rod Assembly	DEJS60B
100 Amp, 2W, 3P Interlock Rod Assembly	DEJS100A
100 Amp, 3W, 4P Interlock Rod Assembly	DEJS100B
30 Amp, 2W, 3P Receptacle Interior	EBRI3023
30 Amp, 3W, 4P Receptacle Interior	EBRI3034
60 Amp, 2W, 3P Receptacle Interior	EBRI6023
60 Amp, 3W, 4P Receptacle Interior	EBRI6034
100 Amp, 2W, 3P Receptacle Interior	EBRI1023
100 Amp, 3W, 4P Receptacle Interior	EBRI1034
150 Amp, 3W, 4P Receptacle Interior	EBRI15034
30 Amp Plug Clamping Ring (standard with 30 Amp models)	30CRING
30 Amp Screw Cover (for receptacle)	30SCAP

Maximum Horsepower Ratings of Switch

Phase Motor	Amp	Motor Horsepower		
		240 Vac	480 Vac	600 Vac
1-Phase, 2W, 3P	30	7.5	15	20
	60	10	15	20
3-Phase, 3W, 4P	30	7.5	15	20
	60	10	25	30

• Flip cover suitable for NEMA 3, 3R only.

▼ NEMA 4 rating maintained with Appleton NEMA 4 plug installed. Install screw cover for 4, 4X. Both covers are included with product.

① Supplied with (2) 1-1/2" to 1-1/4" reducing bushings.

JBR Series 30 and 60 Amp Switched Receptacles

NEC:
 Class I, Division 1 and 2, Groups B, C, D
 Class II, Division 1 and 2, Groups F, G
 Class III
 NEMA 3*, 3R*, 4*, 4X*, 7BCD, 9FG

ACP Plugs for JBR Receptacles

Cable Dia. (Inches)	30 Amp		60 Amp	
	2W, 3P	3W, 4P	2W, 3P	3W, 4P
 .390 to 1.375	ACP3023BC	ACP3034BC	ACP6023BC	ACP6034BC

CPH Plugs for JBR Receptacles

Cable Dia. (Inches)	30 Amp		60 Amp	
	2W, 3P	3W, 4P	2W, 3P	3W, 4P
 .390 to 1.375	CPH3023BC	CPH3034BC	CPH6023BC	CPH6034BC

Dimensions in Millimeters (Inches)

ACP Plugs

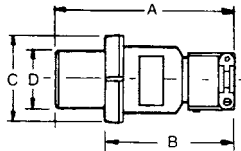

Max. Amp	No. Poles	Dimensions in Millimeters (Inches)			
		A	B	C	D
30	2,3,4	152.4 (6.00)	120.6 (4.75)	79.5 (3.13)	47.2 (1.86)
60	2,3	198.3 (7.81)	125.4 (4.94)	88.9 (3.50)	56.6 (2.23)
60	4	198.3 (7.81)	125.4 (4.94)	96.7 (3.81)	64.7 (2.55)

CPH Plugs

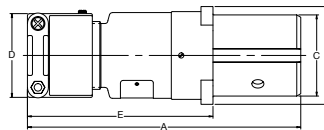

Max. Amp	Wire/Pole	Dimensions in Millimeters (Inches)				
		A	B	C	D	E
30	2W, 3P; 3W, 4P	155.7 (6.13)	60.4 (2.38)	47.2 (1.86)	6.68 (2.63)	112.7 (4.44)
60	2W, 3P	214.3 (8.44)	77.7 (3.06)	77.7 (3.06)	6.68 (2.63)	144.5 (5.69)
60	3W, 4P	214.3 (8.44)	77.7 (3.06)	64.7 (2.55)	6.68 (2.63)	144.5 (5.69)

• Flip cover suitable for NEMA 3, 3R only.

▼ NEMA 4 rating maintained with Appleton NEMA 4 plug installed. Install screw cover for 4, 4X. Both covers are included with product.

JBR Series 30 and 60 Amp Switched Receptacles

NEC:

Class I, Division 1 and 2, Groups B, C, D
 Class II, Division 1 and 2, Groups F, G
 Class III
 NEMA 3*, 3R*, 4*, 4X*, 7BCD, 9FG

Dimensions in Millimeters (Inches)

Shown with Flip Cover

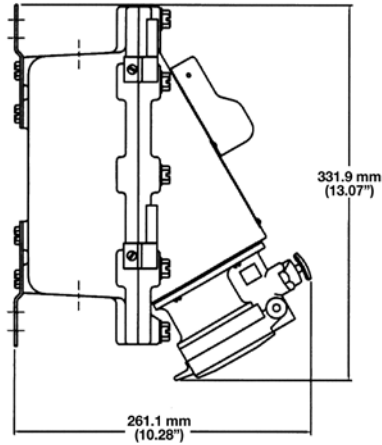

Drilling Plans for Mounting Bolts

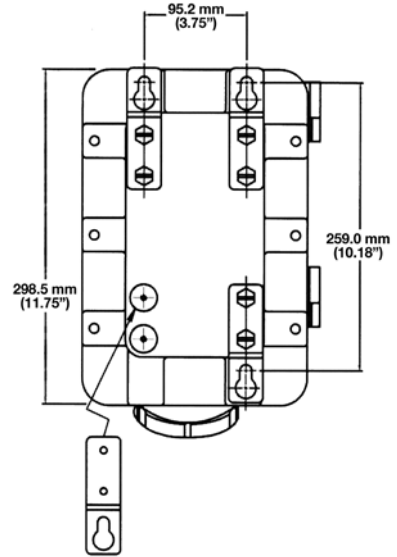

Top View

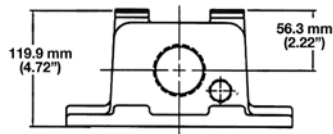

Bottom View

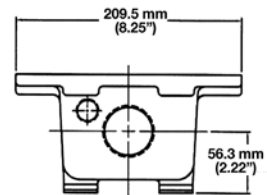

• Flip cover suitable for NEMA 3, 3R only.

▼ NEMA 4 rating maintained with Appleton NEMA 4 plug installed. Install screw cover for 4, 4X. Both covers are included with product.

EBR 30, 60, 100 and 150 Amp Series Receptacles

Explosionproof, Dust-Ignitionproof

With Disconnect Switch or Circuit Breaker. Weatherproof Spring Cover. 600 Vac Max. 250 Vdc Max.

NEC:

Class I, Division 1 and 2, Groups B*, C, D

Class II, Division 1 and 2, Groups F, G

Class III

NEMA 3*, 3R*, 4*, 4X*, 7CD, 9FG

Applications

- Locations where receptacles are used with stationary or portable electrically operated devices such as:
 - Lighting systems
 - Conveyors
 - Heaters
 - Motor-generator sets
 - Air conditioners
 - Compressors
 - Pumps
- Locations where damp or corrosive conditions exist
- Class I: classified locations such as:
 - Petrochemical plants
 - Petroleum refineries
 - Paint and chemical plants
 - Any location where ignitable vapors or gases are present
- Class II: classified locations such as:
 - Process industries where there are dust hazards from handling such products as flour, grain and starch or any location where ignitable amounts of dust are present or amounts which would adversely affect performance

Features

- Energized receptacle contacts deeply recessed to reduce danger of accidental touching.
- Style 2 (shell and extra pole) grounding.
- Spring door keeps dust out of receptacle when plug is not in use. Screw cap also supplied.
- Brass contacts exert constant pressure along entire contact surface and provide superior electrical contact.
- Contacts have beryllium copper wire springs.
- Plug mechanical cable clamps prevent strain on cables—they meet or exceed UL strain relief pull-out requirements.
- Neoprene bushing compressed by cable collar prevents entrance of water.
- Insulators provide superior dielectric and mechanical strength and lowest arc tracking.
- 1-1/2 NPT tapped conduit openings; one top two bottom.
- EBRH: interlocked disconnect switch provides safe connect and disconnect operation at 30, 60 or 100 Amp, 600 Vac maximum. Two or three pole, non-fused motor circuit switch. EBRH permits safe operation in Class I, Group B as well as Class I, Groups C and D, Class II, Groups F, G, and Class III.
- EBR: interlocked circuit breaker provides interlocked connect and disconnect operation as well as short circuit and thermal time delay overload protection.
- To operate, insert plug (which automatically locks into receptacle) and turn Breaker Handle to "ON" position. To remove plug, turn Handle to "OFF" position, lift Plug Release Knob and pull plug out.
- ACP and CPH plug fits Powertite™ Series hazardous location EBR and EBRH receptacles.



Standard Materials

- EBR and EBRH receptacles: copperfree (4/10 of 1% max.) aluminum receptacle and mounting box
- CPH and ACP plugs: copperfree (4/10 of 1% max.) aluminum housings
- Insulating blocks: fiber glass reinforced polyester

Standard Finishes

- Receptacles, mounting boxes, cord connector housings and caps: epoxy powder coat

Options

- For Group B version add suffix **-GB** to receptacle (Group B version not suitable for NEMA 4, 4X).
- For GE ⤴ breaker, add **-GE** to receptacle. Contact your local representative for availability and price.
- Molded case switch available on the 150 Amp versions, add suffix **-K** to receptacle.
- Special Polarization: Prevents plug insertion in a receptacle or connector wired for a different voltage. In installations where there are different line voltages, the special polarization option is desirable. This allows only plugs and receptacles wired for the same line voltage to be mated together. The receptacle or connector interior is positioned 22-1/2°, relative to the polarization rivet, to the right (as specified) of standard, and plug is polarized to correspond. This option can be added to receptacles using the Powertite™ Plug. Add suffix **-P4** to receptacle or plug.
- For 2" feed-thru openings (one top, one bottom) add suffix **-22** to receptacle.
- 1 N/O and 1 N/C Auxiliary Contacts. Add suffix **-AUX**.

NEC Certifications and Compliances

- UL Standard: UL 1010 (UL 1203), UL 894, UL 1682, UL 1686
- UL Listed: E79132, E10784, E313360(EBR)

• Flip cover suitable for NEMA 3, 3R only.

▼ NEMA 4 rating maintained with Appleton NEMA 4 plug installed. Install screw cover for 4, 4X. Both covers are included with product.

◆ Add suffix **-GB** to Cat. No. for Group B. (Group B version not suitable for NEMA 4, 4X).

▶ GE is a registered trademark of General Electric Company.

EBR 30, 60, 100 and 150 Amp Series Receptacles

Explosionproof, Dust-Ignitionproof

With Disconnect Switch or Circuit Breaker. Weatherproof Spring Cover. 600 Vac Max. Pressure Wire Terminals.

NEC:

Class I, Division 1 and 2, Groups B*, C, D

Class II, Division 1 and 2, Groups F, G

Class III

NEMA 3*, 3R*, 4*, 4X*, 7CD, 9FG

EBRH Receptacles with Disconnect Switch

Receptacle	Wires/Poles	Catalog Number
30 Amp	2W, 3P	EBRH3023DS
	3W, 4P	EBRH3034DS
60 Amp	2W, 3P	EBRH6023DS
	3W, 4P	EBRH6034DS
100 Amp	2W, 3P	EBRH1023DS
	3W, 4P	EBRH1034DS



EBRH with Switch

EBR Receptacles with Circuit Breaker ◀

Receptacle	Circuit Breaker Amp	Pole	Catalog Number		
			with 480 Vac EHD Breaker	with 600 Vac FDB Breaker	with 600 Vac FD Breaker
30 Amp 2W, 3P	20	2	EBR3023EH20	EBR3023FB20	EBR3023HFB20
	30	2	EBR3023EH30	EBR3023FB30	EBR3023HFB30
	40	2	EBR3023EH40	EBR3023FB40	EBR3023HFB40
	50	2	EBR3023EH50	EBR3023FB50	EBR3023HFB50
30 Amp 3W, 4P	20	3	EBR3034EH20	EBR3034FB20	EBR3034HFB20
	30	3	EBR3034EH30	EBR3034FB30	EBR3034HFB30
	40	3	EBR3034EH40	EBR3034FB40	EBR3034HFB40
	50	3	EBR3034EH50	EBR3034FB50	EBR3034HFB50
60 Amp 2W, 3P	50	2	EBR6023EH50	EBR6023FB50	EBR6023HFB50
	60	2	EBR6023EH60	EBR6023FB60	EBR6023HFB60
	70	2	EBR6023EH70	EBR6023FB70	EBR6023HFB70
	90	2	EBR6023EH90	EBR6023FB90	EBR6023HFB90
60 Amp 3W, 4P	100	2	EBR6023EH100	EBR6023FB100	EBR6023HFB100
	50	3	EBR6034EH50	EBR6034FB50	EBR6034HFB50
	60	3	EBR6034EH60	EBR6034FB60	EBR6034HFB60
	70	3	EBR6034EH70	EBR6034FB70	EBR6034HFB70
100 Amp 2W, 3P	90	3	EBR6034EH90	EBR6034FB90	EBR6034HFB90
	100	3	EBR6034EH100	EBR6034FB100	EBR6034HFB100
	50	2	EBR1023EH50	EBR1023FB50	EBR1023HFB50
	70	2	EBR1023EH70	EBR1023FB70	EBR1023HFB70
100 Amp 3W, 4P	90	2	EBR1023EH90	EBR1023FB90	EBR1023HFB90
	100	2	EBR1023EH100	EBR1023FB100	EBR1023HFB100
	50	3	EBR1034EH50	EBR1034FB50	EBR1034HFB50
	70	3	EBR1034EH70	EBR1034FB70	EBR1034HFB70
150 Amp 3W, 4P	90	3	EBR1034EH90	EBR1034FB90	EBR1034HFB90
	100	3	EBR1034EH100	EBR1034FB100	EBR1034HFB100
	100	3	N/A	N/A	EBR15034FD100 ①
	125	3	N/A	N/A	EBR15034FD125 ①
	150	3	N/A	N/A	EBR15034FD150 ①



EBR with Breaker

1-1/2" threaded conduit openings – one in top and two in bottom

◀ Circuit Breakers are Cutler-Hammer. Cutler-Hammer F-Frame breakers available up to 175 Amps. Add **GE** after EH, FB, or HFB for GE Circuit Breakers. Contact your local representative for availability and price. Cutler-Hammer is a registered trademark of Eaton Corporation. GE is a registered trademark of General Electric Company.

• Flip cover suitable for NEMA 3, 3R only.

▼ NEMA 4 rating maintained with Appleton NEMA 4 plug installed. Install screw cover for 4, 4X. Both covers are included with product.

◆ Add suffix **-GB** to Cat. No. for Group B. (Group B version not suitable for NEMA 4, 4X)

① Molded Case Switch available. Add suffix **-K**.

EBR Receptacles 30, 60, 100 and 150 Amp

Circuit Breaker and Disconnect Switch Data

600 Vac Max.

NEC:
 Class I, Division 1 and 2, Groups B*, C, D
 Class II, Division 1 and 2, Groups F, G
 Class III
 NEMA 3*, 3R*, 4*, 4X*, 7CD, 9FG



EBR Shown

Solderless lugs are provided for line connections, and receptacle is prewired to the load side of breaker. Cover-mounted components leave entire enclosure space free for pulling of line conductors and wiring.

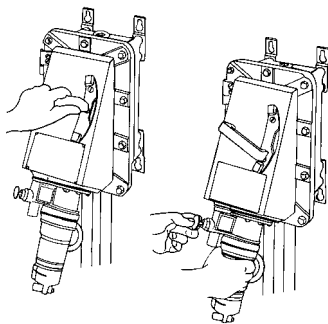

EBR Shown

Plug is mechanically locked in receptacle when circuit breaker is ON. Design provides interlocked connect and disconnect operation as well as short circuit and thermal time delay overload protection.

Breaker operating handle can be padlocked in either ON or OFF position and is trip-free.

Enclosure has additional 3/4" threaded openings top and bottom for installation of optional drain and breather; reducers furnished.

- Flip cover suitable for NEMA 3, 3R only.
- ▼ NEMA 4 rating maintained with Appleton NEMA 4 plug installed. Install screw cover for 4, 4X. Both covers are included with product.
- ◀ Cutler-Hammer is a registered trademark of Eaton Corporation.

EBR Horsepower Tables

These Cutler-Hammer * circuit breaker recommendations are for induction motors running with usual speed and torque characteristics. Ambient temperature, and frequency of starting could require different protective characteristics.

	HP	120 Vac	240 Vac	480 Vac	600 Vac
EBR3023 (2W, 3P, 1-Phase, 30 Amp 2-Pole)	1	40EHD	20EHD	15EHD	15FDB
	1-1/2	40EHD	30EHD	15EHD	15FDB
	2	50EHD	30EHD	20EHD	15FDB
	3	—	40EHD	30EHD	20FDB
	5	—	—	40EHD	30FDB
EBR6023 (2W, 3P, 1-Phase, 60 Amp 2-Pole)	7-1/2	—	—	40EHD	40FDB
	3	50EHD	—	—	—
	5	100EHD	50EHD	—	—
	7-1/2	—	70EHD	—	—
EBR3034 (3W, 4P, 3-Phase, 30 Amp 3-Pole)	10	—	—	50EHD	40FDB
	1	—	15EHD	15EHD	15FDB
	1-1/2	—	15EHD	15EHD	15FDB
	2	—	20EHD	15EHD	15FDB
	3	—	30EHD	15EHD	15FDB
	5	—	40EHD	20EHD	20FDB
	7-1/2	—	50EHD	30EHD	30FDB
	10	—	—	40EHD	30FDB
	15	—	—	40EHD	40FDB
	20	—	—	—	50FDB
EBR6034 (3W, 4P, 3-Phase, 60 Amp 3-Pole)	10	—	50EHD	—	—
	15	—	70EHD	—	—
	20	—	—	50EHD	—
	25	—	—	50EHD	50FDB
	30	—	—	70EHD	50FDB
	40	—	—	—	70FDB
EBR1034 (3W, 4P, 3-Phase, 100A and 150 Amp 3-Pole)	20	—	100EHD	—	—
	25	—	100EHD	—	—
	30	—	150FD	—	—
	40	—	—	100EHD	—
	50	—	—	100EHD	100FDB
	60	—	—	125FD	125FDB
	75	—	—	—	125FDB

EBR Circuit Breaker Data — Cutler-Hammer *

Frame	Continuous		Interrupting Ratings (RMS SYM Amp)		
	Amp	Max Volts	240 Vac	480 Vac	600 Vac
EHD	20-100	480	18,000	14,000	—
FDB	20-125	600	18,000	14,000	14,000
FD	20-150	600	65,000	25,000	18,000

EBR Horsepower Rating Table — Disconnect Switch

Max. Amp	Max. Horsepower Rating				
	120 Vac	240 Vac	480 Vac	600 Vac	250 Vdc
30	5	10	20	25	7-1/2
60	10	20	40	60	15
100	15	30	75	75	25
150	—	50	100	150	—

Plugs for EBR and EBRH Receptacles

NEC:

Class I, Division 1 and 2, Groups B*, C, D
 Class II, Division 1 and 2, Groups F, G
 Class III
 NEMA 3*, 3R*, 4*, 4X*, 7CD, 9FG

ACP Plugs for EBR and EBRH Receptacles

Cable Dia. (Inches)	30 Amp		60 Amp		100 Amp		150 Amp
	2W, 3P	3W, 4P	2W, 3P	3W, 4P	2W, 3P	3W, 4P	3W, 4P
.500 to 1.250	ACP3023BC	ACP3034BC	—	—	—	—	—
.500 to 1.375	—	—	ACP6023BC	ACP6034BC	—	—	—
.875 to 1.906	—	—	—	—	ACP1023CD	ACP1034CD	ACP15034CD
1.09 to 2.187	—	—	—	—	—	—	ACP15034DE



CPH Plugs for EBR and EBRH Receptacles

Cable Dia. (Inches)	30 Amp		60 Amp		100 Amp		150 Amp
	2W, 3P	3W, 4P	2W, 3P	3W, 4P	2W, 3P	3W, 4P	3W, 4P
.390 to 1.375	CPH3023BC	CPH3034BC	CPH6023BC	CPH6034BC	—	—	—



Dimensions of ACP Plugs

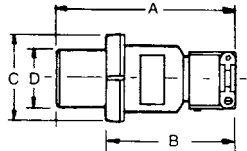

Max. Amp	No. Poles	Dimensions in Millimeters (Inches)			
		A	B	C	D
30	2,3,4	152.4 (6.00)	120.6 (4.75)	79.5 (3.13)	47.2 (1.86)
60	2,3	198.3 (7.81)	125.4 (4.94)	88.9 (3.50)	56.6 (2.23)
60	4	198.3 (7.81)	125.4 (4.94)	96.7 (3.81)	64.7 (2.55)
100	2,3	266.7 (10.50)	168.4 (6.63)	101.6 (4.00)	62.7 (2.47)
100	4	266.7 (10.50)	168.4 (6.63)	107.9 (4.25)	69.0 (2.72)
150 (CD & DE)	4	266.7 (10.50)	168.4 (6.63)	107.9 (4.25)	69.0 (2.72)

Dimensions of CPH Plugs

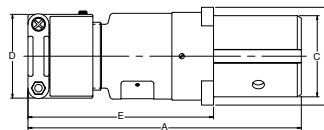

Max. Amp	Wire/Pole	Dimensions in Millimeters (Inches)				
		A	B	C	D	E
30	2W, 3P; 3W, 4P	155.7 (6.13)	60.4 (2.38)	47.2 (1.86)	6.68 (2.63)	112.7 (4.44)
60	2W, 3P	214.3 (8.44)	77.7 (3.06)	77.7 (3.06)	6.68 (2.63)	144.5 (5.69)
60	3W, 4P	214.3 (8.44)	77.7 (3.06)	64.7 (2.55)	6.68 (2.63)	144.5 (5.69)

• Flip cover suitable for NEMA 3, 3R only.

▼ NEMA 4 rating maintained with Appleton NEMA 4 plug installed. Install screw cover for 4, 4X. Both covers are included with product.

EBR 30, 60, 100 and 150 Amp Series Receptacles

Explosionproof, Dust-Ignitionproof

With Disconnect Switch or Circuit Breaker. Weatherproof Spring Cover. 600 Vac Max. 250 Vdc Max.

NEC:

Class I, Division 1 and 2, Groups B*, C, D

Class II, Division 1 and 2, Groups F, G

Class III

NEMA 3*, 3R*, 4*, 4X*, 7CD, 9FG

Replacement Parts

Description	Catalog Number
30 Amp, 2W, 3P Receptacle Interior	EBRI3023
30 Amp, 3W, 4P Receptacle Interior	EBRI3034
60 Amp, 2W, 3P Receptacle Interior	EBRI6023
60 Amp, 3W, 4P Receptacle Interior	EBRI6034
100 Amp, 2W, 3P Receptacle Interior	EBRI1023
100 Amp, 3W, 4P Receptacle Interior	EBRI1034
150 Amp, 3W, 4P Receptacle Interior	EBRI15034
30 Amp, 2W, 3P Disconnect Interlock Rod Assembly	DEJS30
30 Amp, 3W, 4P Disconnect Interlock Rod Assembly	DEJS30
60 Amp, 2W, 3P Disconnect Interlock Rod Assembly	DEJS60A
60 Amp, 3W, 4P Disconnect Interlock Rod Assembly	DEJS60B
100 Amp, 2W, 3P Disconnect Interlock Rod Assembly	DEJS100A
100 Amp, 3W, 4P Disconnect Interlock Rod Assembly	DEJS100B
30 Amp, 2W, 3P Breaker Interlock Rod Assembly	DEJS30
30 Amp, 3W, 4P Breaker Interlock Rod Assembly	DEJS30
60 Amp, 2W, 3P Breaker Interlock Rod Assembly	DEJS60A
60 Amp, 3W, 4P Breaker Interlock Rod Assembly	DEJS60B
100 Amp, 2W, 3P Breaker Interlock Rod Assembly	DEJS100A
100 Amp, 3W, 4P Breaker Interlock Rod Assembly	DEJS100B
150 Amp, 3W, 4P Breaker Interlock Rod Assembly	DEJS100B

Appleton®

PLUGS AND RECEPTACLES: NEC/CEC HAZARDOUS LOCATION

• Flip cover suitable for NEMA 3, 3R only.

▼ NEMA 4 rating maintained with Appleton NEMA 4 plug installed. Install screw cover for 4, 4X. Both covers are included with product.

EBR 30, 60, 100 and 150 Amp Series Receptacles

NEC:

Class I, Division 1 and 2, Groups B*, C, D
 Class II, Division 1 and 2, Groups F, G
 Class III
 NEMA 3*, 3R*, 4*, 4X*, 7CD, 9FG

Dimensions in Millimeters (Inches)

Shown with Flip Cover

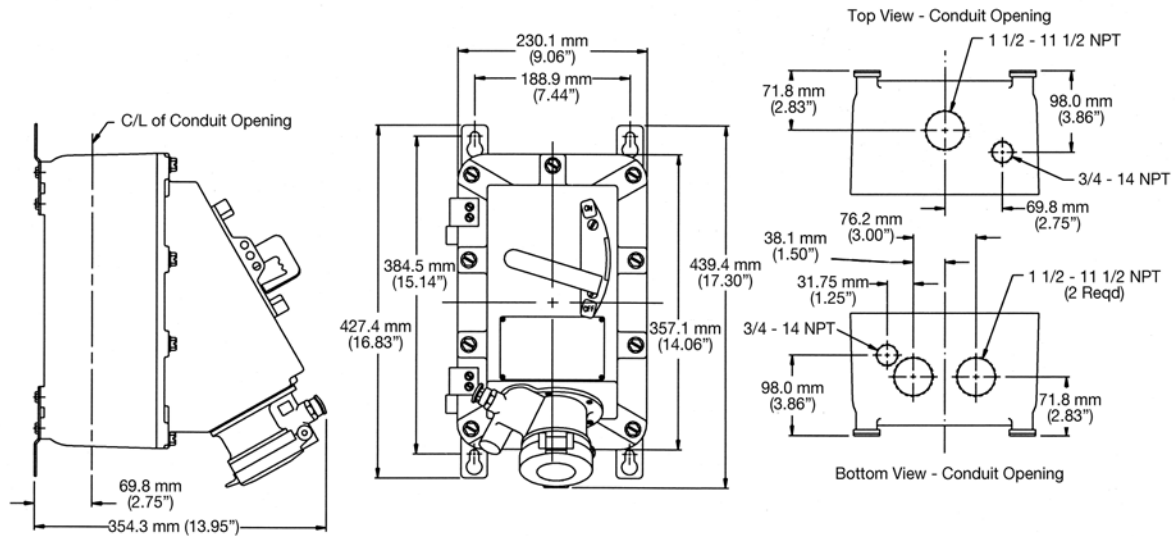

Shown with Screw Cover

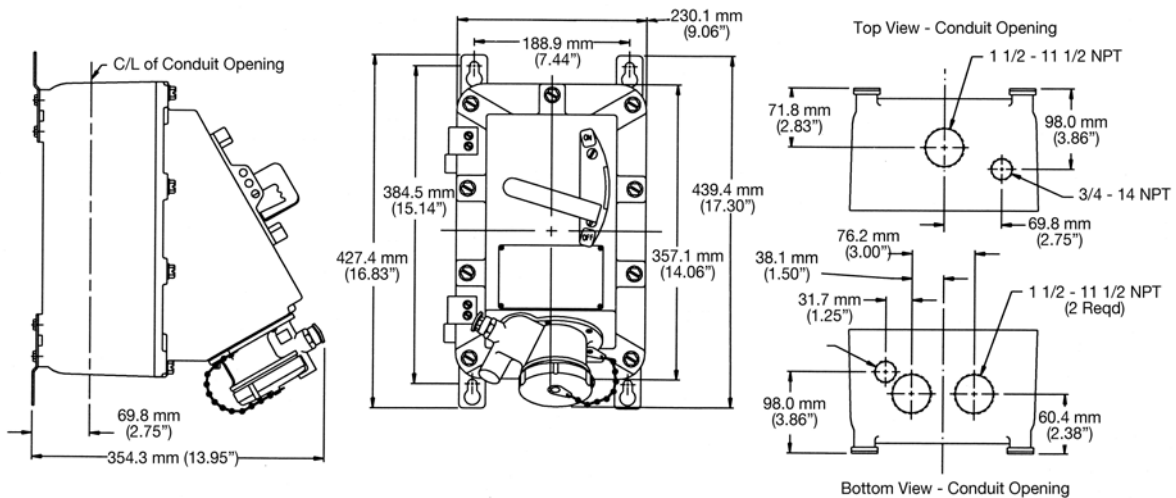

- Flip cover suitable for NEMA 3, 3R only.
- ▼ NEMA 4 rating maintained with Appleton NEMA 4 plug installed. Install screw cover for 4, 4X. Both covers are included with product.

DBR 30, 60, 100 and 150 Amp Series Receptacles

Explosionproof, Dust-Ignitionproof

With Disconnect Switch or Circuit Breaker. Weatherproof Spring Cover. 600 Vac Max. 250 Vdc Max.

NEC:

Class II, Division 1 and 2, Groups F, G

Class III

NEMA 3, 3R, 4⁺, 4X⁺, 9FG

Applications

- Locations where receptacles are used with stationary or portable electrically operated devices such as:
 - Lighting systems
 - Conveyors
 - Heaters
 - Motor-generator sets
 - Air conditioners
 - Compressors
 - Pumps
 - Locations where damp or corrosive conditions exist
- Class I: classified locations such as:
 - Petrochemical plants
 - Petroleum refineries
 - Paint and chemical plants
 - Any location where ignitable vapors or gases are present
- Class II: classified locations such as:
 - Process industries where there are dust hazards from handling such products as flour, grain and starch or any location where ignitable amounts of dust are present or amounts which would adversely affect performance

Features

- Energized receptacle contacts deeply recessed to reduce danger of accidental touching.
- Style 2 (shell and extra pole) grounding.
- Spring door keeps dust out of receptacle when plug is not in use. Screw cap also supplied.
- Brass contacts exert constant pressure along entire contact surface and provide superior electrical contact.
- Contacts have beryllium copper wire springs.
- Plug mechanical cable clamps prevent strain on cables— they meet or exceed UL strain relief pull-out requirements.
- Neoprene bushing compressed by cable collar prevents entrance of water.
- Insulators provide superior dielectric and mechanical strength and lowest arc tracking.
- 1-1/2 NPT tapped conduit openings; one top two bottom.
- Interlocked disconnect switch provides safe connect and disconnect operation at 30, 60 or 100 Amp, 600 Vac maximum. Two or three pole, non-fused motor circuit switch.
- Interlocked circuit breaker provides interlocked connect and disconnect operation as well as short circuit and thermal time delay overload protection. DBR permits safe operation in Class II and III only.
- To operate, insert plug (which automatically locks into receptacle) and turn Breaker Handle to "ON" position. To remove plug, turn Handle to "OFF" position, lift Plug Release Knob and pull plug out.
- ACP and CPH plug fits Powertite™ Series hazardous location and DBR receptacles.



Standard Materials

- DBR receptacles: copperfree (4/10 of 1% max.) aluminum receptacle and mounting box
- CPH and ACP plugs: copperfree (4/10 of 1% max.) aluminum housings
- Insulating blocks: fiber glass reinforced polyester

Standard Finishes

- Receptacles, mounting boxes, cord connector housings and caps: epoxy powder coat

Options

- For Group B version add suffix **-GB** to receptacle (Group B version not suitable for NEMA 4, 4X).
- For GE ⁺ breaker, add **-GE** to receptacle. Contact your local representative for availability and price.
- Molded case switch available on the 150 Amp versions, add suffix **-K** to receptacle.
- Special Polarization: Prevents plug insertion in a receptacle or connector wired for a different voltage. In installations where there are different line voltages, the special polarization option is desirable. This allows only plugs and receptacles wired for the same line voltage to be mated together. The receptacle or connector interior is positioned 22-1/2°, relative to the polarization rivet, to the right (as specified) of standard, and plug is polarized to correspond. This option can be added to receptacles using the Powertite™ Plug. Add suffix **-P4** to receptacle or plug.
- For 2" feed-thru openings (one top, one bottom) add suffix **-22** to receptacle.
- 1 N/O and 1 N/C Auxiliary Contacts. Add suffix **-AUX**.

NEC Certifications and Compliances

- UL Standard: UL 1010 (UL 1203), UL 894, UL 1682, UL 1686

• Flip cover suitable for NEMA 3, 3R only.

▼ NEMA 4 rating maintained with Appleton NEMA 4 plug installed. Install screw cover for 4, 4X. Both covers are included with product.

◆ Add suffix **-GB** to Cat. No. for Group B. (Group B version not suitable for NEMA 4, 4X).

▶ GE is a registered trademark of General Electric Company.

DBR 30, 60 and 100 Amp Series Receptacles

Dust-Ignitionproof

With Disconnect Switch or Circuit Breaker. Weatherproof Spring Cover. 600 Vac Max.

NEC:

Class II, Division 1 and 2, Groups F, G

Class III

NEMA 3, 3R, 4⁺, 4X⁺, 9FG

DBR Receptacles with Disconnect Switch

	Receptacle	Wires/Poles	Catalog Number
 <p>DBR with Switch</p>	30 Amp	2W, 3P	DBR3023DS
		3W, 4P	DBR3034DS
	60 Amp	2W, 3P	DBR6023DS
		3W, 4P	DBR6034DS
	100 Amp	2W, 3P	DBR1023DS
		3W, 4P	DBR1034DS

DBR Receptacles with Circuit Breaker *

	Receptacle	Circuit Breaker Amp	Pole	with 480 Vac EHD Breaker	Catalog Number with 600 Vac FDB Breaker	with 600 Vac FD Breaker
 <p>DBR with Breaker</p>	30 Amp 2W, 3P	20	2	DBR3023EH20	DBR3023FB20	DBR3023HFB20
		30	2	DBR3023EH30	DBR3023FB30	DBR3023HFB30
		40	2	DBR3023EH40	DBR3023FB40	DBR3023HFB40
		50	2	DBR3023EH50	DBR3023FB50	DBR3023HFB50
	30 Amp 3W, 4P	20	3	DBR3034EH20	DBR3034FB20	DBR3034HFB20
		30	3	DBR3034EH30	DBR3034FB30	DBR3034HFB30
		40	3	DBR3034EH40	DBR3034FB40	DBR3034HFB40
		50	3	DBR3034EH50	DBR3034FB50	DBR3034HFB50
	60 Amp 2W, 3P	50	2	DBR6023EH50	DBR6023FB50	DBR6023HFB50
		60	2	DBR6023EH60	DBR6023FB60	DBR6023HFB60
		70	2	DBR6023EH70	DBR6023FB70	DBR6023HFB70
		90	2	DBR6023EH90	DBR6023FB90	DBR6023HFB90
	60 Amp 3W, 4P	100	2	DBR6023EH100	DBR6023FB100	DBR6023HFB100
		50	3	DBR6034EH50	DBR6034FB50	DBR6034HFB50
		60	3	DBR6034EH60	DBR6034FB60	DBR6034HFB60
		70	3	DBR6034EH70	DBR6034FB70	DBR6034HFB70
	100 Amp 2W, 3P	90	3	DBR6034EH90	DBR6034FB90	DBR6034HFB90
		100	3	DBR6034EH100	DBR6034FB100	DBR6034HFB100
		50	2	DBR1023EH50	DBR1023FB50	DBR1023HFB50
		70	2	DBR1023EH70	DBR1023FB70	DBR1023HFB70
	100 Amp 3W, 4P	90	2	DBR1023EH90	DBR1023FB90	DBR1023HFB90
		100	2	DBR1023EH100	DBR1023FB100	DBR1023HFB100
		50	3	DBR1034EH50	DBR1034FB50	DBR1034HFB50
		70	3	DBR1034EH70	DBR1034FB70	DBR1034HFB70
		90	3	DBR1034EH90	DBR1034FB90	DBR1034HFB90
		100	3	DBR1034EH100	DBR1034FB100	DBR1034HFB100

* Circuit Breakers are Cutler-Hammer. Cutler-Hammer F-Frame breakers available up to 175 Amps. Add GE after EH, FB, or HFB for GE Circuit Breakers. Contact your local representative for availability and price. Cutler-Hammer is a registered trademark of Eaton Corporation. GE is a registered trademark of General Electric Company.

▼ NEMA 4 rating maintained with Appleton NEMA 4 plug installed. Install screw cover for 4, 4X. Both covers are included with product.

DBR Receptacles 30, 60, 100 and 150 Amp

Circuit Breaker and Disconnect Switch Data

600 Vac Max.

NEC:
Class II, Division 1 and 2, Groups F, G
Class III
NEMA 3, 3R, 4[†], 4X[†], 9FG

DBR Horsepower Tables

These Cutler-Hammer * circuit breaker recommendations are for induction motors running with usual speed and torque characteristics. Ambient temperature, and frequency of starting could require different protective characteristics.

	HP	120 Vac	240 Vac	480 Vac	600 Vac
DBR3023 (2W, 3P, 1-Phase, 30 Amp 2-Pole)	1	40EHD	20EHD	15EHD	15FDB
	1-1/2	40EHD	30EHD	15EHD	15FDB
	2	50EHD	30EHD	20EHD	15FDB
	3	—	40EHD	30EHD	20FDB
	5	—	—	40EHD	30FDB
	7-1/2	—	—	40EHD	40FDB
DBR6023 (2W, 3P, 1-Phase, 60 Amp 2-Pole)	3	50EHD	—	—	—
	5	100EHD	50EHD	—	—
	7-1/2	—	70EHD	—	—
	10	—	—	50EHD	40FDB
DBR3034 (3W, 4P, 3-Phase, 30 Amp 3-Pole)	1	—	15EHD	15EHD	15FDB
	1-1/2	—	15EHD	15EHD	15FDB
	2	—	20EHD	15EHD	15FDB
	3	—	30EHD	15EHD	15FDB
	5	—	40EHD	20EHD	20FDB
	7-1/2	—	50EHD	30EHD	30FDB
	10	—	—	40EHD	30FDB
	15	—	—	40EHD	40FDB
	20	—	—	—	50FDB
	DBR6034 (3W, 4P, 3-Phase, 60 Amp 3-Pole)	10	—	50EHD	—
15		—	70EHD	—	—
20		—	—	50EHD	—
25		—	—	50EHD	50FDB
30		—	—	70EHD	50FDB
40		—	—	—	70FDB
DBR1034 (3W, 4P, 3-Phase, 100A and 150 Amp 3-Pole)	20	—	100EHD	—	—
	25	—	100EHD	—	—
	30	—	150FD	—	—
	40	—	—	100EHD	—
	50	—	—	100EHD	100FDB
	60	—	—	125FD	125FDB
	75	—	—	—	125FDB

DBR Circuit Breaker Data — Cutler-Hammer *

Frame	Continuous Amp	Max Volts	Interrupting Ratings (RMS SYM Amp)		
			240 Vac	480 Vac	600 Vac
EHD	20-100	480	18,000	14,000	—
FDB	20-125	600	18,000	14,000	14,000
FD	20-150	600	65,000	25,000	18,000

DBR Horsepower Rating Table — Disconnect Switch

Max. Amp	Max. Horsepower Rating				
	120 Vac	240 Vac	480 Vac	600 Vac	250 Vdc
30	5	10	20	25	7-1/2
60	10	20	40	60	15
100	15	30	75	75	25
150	—	50	100	150	—

* Flip cover suitable for NEMA 3, 3R only.

▼ NEMA 4 rating maintained with Appleton NEMA 4 plug installed. Install screw cover for 4, 4X. Both covers are included with product.

◀ Cutler-Hammer is a registered trademark of Eaton Corporation.

Plugs for DBR Receptacles

NEC:
 Class II, Division 1 and 2, Groups F, G
 Class III
 NEMA 3, 3R, 4[†], 4X[†], 9FG

ACP Plugs for DBR Receptacles

Cable Dia. (Inches)	30 Amp		60 Amp		100 Amp		150 Amp
	2W, 3P	3W, 4P	2W, 3P	3W, 4P	2W, 3P	3W, 4P	3W, 4P
.500 to 1.250	ACP3023BC	ACP3034BC	—	—	—	—	—
.500 to 1.375	—	—	ACP6023BC	ACP6034BC	—	—	—
.875 to 1.906	—	—	—	—	ACP1023CD	ACP1034CD	ACP15034CD
1.09 to 2.187	—	—	—	—	—	—	ACP15034DE



CPH Plugs for DBR Receptacles

Cable Dia. (Inches)	30 Amp		60 Amp		100 Amp		150 Amp
	2W, 3P	3W, 4P	2W, 3P	3W, 4P	2W, 3P	3W, 4P	3W, 4P
.390 to 1.375	CPH3023BC	CPH3034BC	CPH6023BC	CPH6034BC	—	—	—



Dimensions of ACP Plugs

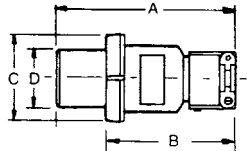

Max. Amp	No. Poles	Dimensions in Millimeters (Inches)			
		A	B	C	D
30	2,3,4	152.4 (6.00)	120.6 (4.75)	79.5 (3.13)	47.2 (1.86)
60	2,3	198.3 (7.81)	125.4 (4.94)	88.9 (3.50)	56.6 (2.23)
60	4	198.3 (7.81)	125.4 (4.94)	96.7 (3.81)	64.7 (2.55)
100	2,3	266.7 (10.50)	168.4 (6.63)	101.6 (4.00)	62.7 (2.47)
100	4	266.7 (10.50)	168.4 (6.63)	107.9 (4.25)	69.0 (2.72)
150 (CD & DE)	4	266.7 (10.50)	168.4 (6.63)	107.9 (4.25)	69.0 (2.72)

Dimensions of CPH Plugs

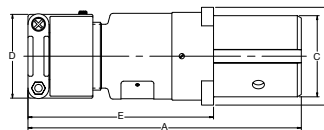

Max. Amp	Wire/Pole	Dimensions in Millimeters (Inches)				
		A	B	C	D	E
30	2W, 3P; 3W, 4P	155.7 (6.13)	60.4 (2.38)	47.2 (1.86)	6.68 (2.63)	112.7 (4.44)
60	2W, 3P	214.3 (8.44)	77.7 (3.06)	77.7 (3.06)	6.68 (2.63)	144.5 (5.69)
60	3W, 4P	214.3 (8.44)	77.7 (3.06)	64.7 (2.55)	6.68 (2.63)	144.5 (5.69)

• Flip cover suitable for NEMA 3, 3R only.
 ▼ NEMA 4 rating maintained with Appleton NEMA 4 plug installed. Install screw cover for 4, 4X. Both covers are included with product.

DBR 30, 60, 100 and 150 Amp Series Receptacles

Explosionproof, Dust-Ignitionproof

With Disconnect Switch or Circuit Breaker. Weatherproof Spring Cover. 600 Vac Max. 250 Vdc Max.

NEC:

Class II, Division 1 and 2, Groups F, G

Class III

NEMA 3, 3R, 4[†], 4X[†], 9FG

Replacement Parts

Description	Catalog Number
30 Amp, 2W, 3P Receptacle Interior	EBRI3023
30 Amp, 3W, 4P Receptacle Interior	EBRI3034
60 Amp, 2W, 3P Receptacle Interior	EBRI6023
60 Amp, 3W, 4P Receptacle Interior	EBRI6034
100 Amp, 2W, 3P Receptacle Interior	EBRI1023
100 Amp, 3W, 4P Receptacle Interior	EBRI1034
150 Amp, 3W, 4P Receptacle Interior	EBRI15034
30 Amp, 2W, 3P Disconnect Interlock Rod Assembly	DEJS30
30 Amp, 3W, 4P Disconnect Interlock Rod Assembly	DEJS30
60 Amp, 2W, 3P Disconnect Interlock Rod Assembly	DEJS60A
60 Amp, 3W, 4P Disconnect Interlock Rod Assembly	DEJS60B
100 Amp, 2W, 3P Disconnect Interlock Rod Assembly	DEJS100A
100 Amp, 3W, 4P Disconnect Interlock Rod Assembly	DEJS100B
30 Amp, 2W, 3P Breaker Interlock Rod Assembly	DEJS30
30 Amp, 3W, 4P Breaker Interlock Rod Assembly	DEJS30
60 Amp, 2W, 3P Breaker Interlock Rod Assembly	DEJS60A
60 Amp, 3W, 4P Breaker Interlock Rod Assembly	DEJS60B
100 Amp, 2W, 3P Breaker Interlock Rod Assembly	DEJS100A
100 Amp, 3W, 4P Breaker Interlock Rod Assembly	DEJS100B
150 Amp, 3W, 4P Breaker Interlock Rod Assembly	DEJS100B

• Flip cover suitable for NEMA 3, 3R only.

▼ NEMA 4 rating maintained with Appleton NEMA 4 plug installed. Install screw cover for 4, 4X. Both covers are included with product.

DBR 30, 60, 100 and 150 Amp Series Receptacles

NEC:
 Class II, Division 1 and 2, Groups F, G
 Class III
 NEMA 3, 3R, 4*, 4X*, 9FG

Dimensions in Millimeters (Inches)

Shown with Flip Cover

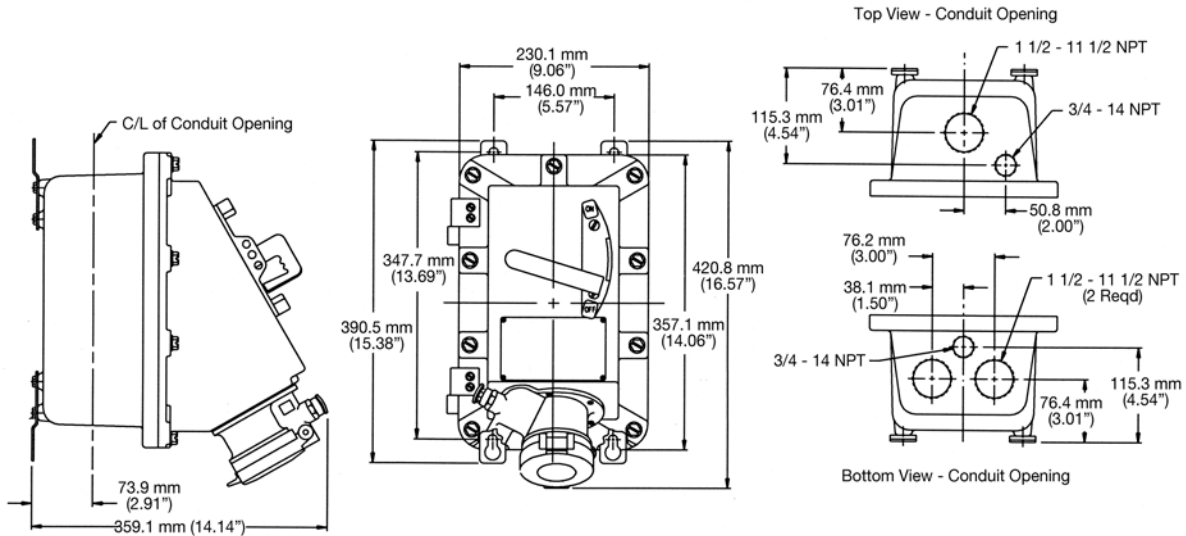

Shown with Screw Cover

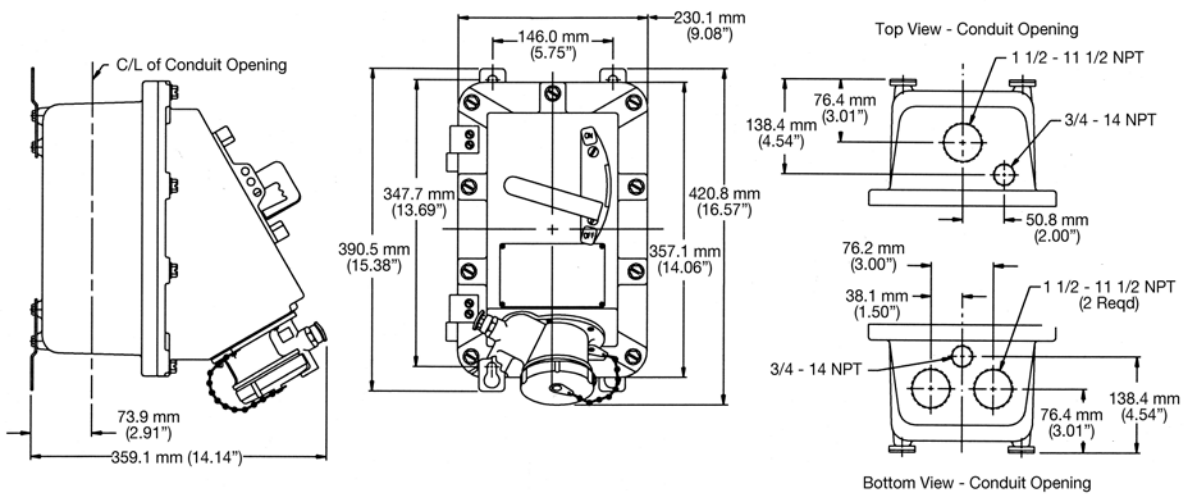

▼ NEMA 4 rating maintained with Appleton NEMA 4 plug installed. Install screw cover for 4, 4X. Both covers are included with product.

Visit our website at www.emerson.com or contact us at (800) 621-1506.
 © November 2016

EBR Interlocked Circuit Breaker Receptacle

Explosionproof, Dust-Ignitionproof, Weather Resistant

30, 60, 100 and 150 Amp, 600 Vac

CEC:

Class I, Groups B, C, D

Class II, Group G and Coal Dust

Class III

CSA Type 3*, 3R*, 4*, 4X*, 7CD, 9G, 12

Applications

- The EBR is designed to connect portable electrical equipment for use in hazardous areas such as:
 - Compressors
 - Conveyors
 - Motor generators
 - Air conditioners
 - Heaters
- Its construction and features provide short circuit protection and is ideally suited for use in:
 - Damp, wet locations
 - Corrosive areas
 - Indoor or outdoor
 - Hazardous or non-hazardous locations
- Class I: classified locations such as:
 - Refineries
 - Petrochemical plants
 - Petroleum refineries
 - Paint and chemical plants
 - Any location where ignitable vapors or gases are present
- Class II: classified locations such as:
 - Process industries where there are dust hazards from handling such products as flour, grain and starch
 - Any location where ignitable amounts of dust are present or amounts which would adversely affect performance

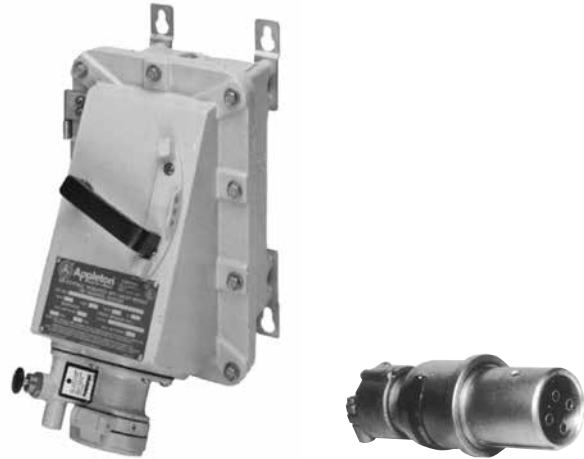

- 1 N/O and 1 N/C Auxiliary Contacts – Suffix **-XLK**.
- 2 N/O and 2 N/C Auxiliary Contacts – Suffix **-2XLK**.
- CSA 4X ▼ Versions available. Add suffix **-4X**.

Features

- Plug is mechanically locked in receptacle when circuit breaker is "ON". Design provides interlocked connect and disconnect operation as well as short circuit and thermal time delay overload protection.
- Plug and receptacle contacts cannot be made or broken under load. Breaker operating handle can be padlocked in either "ON" or "OFF" position and is trip free.
- Body is easily installed with 4 mounting brackets provided, each having keyhole slots. Body has three 1 1/2" taper tapped conduit openings – (1) top and (2) bottom. Also provided are 3/4" threaded openings (3/4" -1/2" reducer furnished) top and bottom for installation of optional drain and breathers.
- Appleton's EBR explosion-proof receptacle with interlocked circuit breakers utilize either ACP or CPH series plugs.
- The cover is secured with captive quick-bolts for easy installation or removal.
- Receptacle ratings available are 30, 60, and 150 Amp.
- Circuit Breakers are thermal-magnetic type – 150 Amp frame size, 20 to 100 Amp trip.

Standard Materials and Finishes

- Receptacle and mounting box: copperfree (4/10 of 1% max.) aluminum with gray epoxy coated inside and out
- Quick-bolts and hinge pins: stainless steel

CEC Certifications and Compliances

- CSA Standard: C22.2 No. 25, C22.2 No. 30, C22.2 No. 159, C22.2 No.182.1
- CSA Certified: 038644

Options

- Special Polarization: Prevents plug insertion in a receptacle or connector wired for a different voltage. In installations where there are different line voltages, the special polarization option is desirable. This allows only plugs and receptacles wired for the same line voltage to be mated together. The receptacle or connector interior is positioned 22-1/2°, relative to the polarization rivet, to the right (as specified) of standard, and plug is polarized to correspond. This option can be added to receptacles using the Powertite™ Plug. Suffix **-PR** to receptacle or plug.

• Flip cover suitable for NEMA 3, 3R only.

▼ NEMA 4 rating maintained with Appleton NEMA 4 plug installed. Install screw cover for 4, 4X. Both covers are included with product. The EBR will also accept Crouse-Hinds APJ series plugs. Crouse-Hinds and APJ are registered trademarks of Cooper Crouse-Hinds.

EBR Interlocked Circuit Breaker Receptacle

Explosionproof, Dust-Ignitionproof, Weather Resistant

30, 60, 100 and 150 Amp, 600 Vac

CEC:

Class I, Groups B, C, D

Class II, Group G and Coal Dust

Class III

CSA Type 3*, 3R*, 4*, 4X*, 7CD, 9G, 12



Solderless lugs are provided for line connections, and receptacle is prewired to the load side of breaker. Cover-mounted components leave entire enclosure space free for pulling of line conductors and wiring.

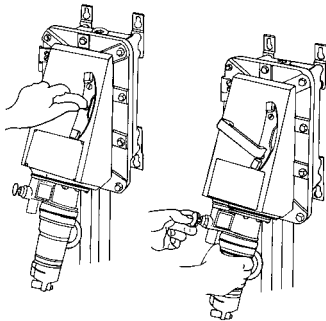

Plug is mechanically locked in receptacle when circuit breaker is ON. Design provides interlocked connect and disconnect operation as well as short circuit and thermal time delay overload protection.

Breaker operating handle can be padlocked in either ON or OFF position and is trip-free.

Enclosure has additional 3/4" threaded openings top and bottom for installation of optional drain and breather; reducers furnished.

- Flip cover suitable for NEMA 3, 3R only.
- ▼ NEMA 4 rating maintained with Appleton NEMA 4 plug installed. Install screw cover for 4, 4X. Both covers are included with product.
- ◀ Cutler-Hammer is a registered trademark of Eaton Corporation.

Horsepower Tables

These Cutler-Hammer * circuit breaker recommendations are for induction motors running with usual speed and torque characteristics. Ambient temperature, and frequency of starting could require different protective characteristics.

	HP	120 Vac	240 Vac	480 Vac	600 Vac
2W, 3P, 1-Phase, 30 Amp 2-Pole	1	40EHD	20EHD	15EHD	15FDB
	1-1/2	40EHD	30EHD	15EHD	15FDB
	2	50EHD	30EHD	20EHD	15FDB
	3	—	40EHD	30EHD	20FDB
	5	—	—	40EHD	30FDB
	7-1/2	—	—	40EHD	40FDB
2W, 3P, 1-Phase, 60 Amp 2-Pole	3	50EHD	—	—	—
	5	100EHD	50EHD	—	—
	7-1/2	—	70EHD	—	—
	10	—	—	50EHD	40FDB
3W, 4P, 3-Phase, 30 Amp 3-Pole	1	—	15EHD	15EHD	15FDB
	1-1/2	—	15EHD	15EHD	15FDB
	2	—	20EHD	15EHD	15FDB
	3	—	30EHD	15EHD	15FDB
	5	—	40EHD	20EHD	20FDB
	7-1/2	—	50EHD	30EHD	30FDB
	10	—	—	40EHD	30FDB
	15	—	—	40EHD	40FDB
	20	—	—	—	50FDB
	3W, 4P, 3-Phase, 60 Amp 3-Pole	10	—	50EHD	—
15		—	70EHD	—	—
20		—	—	50EHD	—
25		—	—	50EHD	50FDB
30		—	—	70EHD	50FDB
40		—	—	—	70FDB
20		—	100EHD	—	—
25		—	100EHD	—	—
3W, 4P, 3-Phase, 100A and 150 Amp 3-Pole	30	—	150FD	—	—
	40	—	—	100EHD	—
	50	—	—	100EHD	100FDB
	60	—	—	125FD	125FDB
	75	—	—	—	125FDB

Circuit Breaker Data — Cutler-Hammer *

Frame	Continuous		Interrupting Ratings (RMS SYM Amp)		
	Amp	Max Volts	240 Vac	480 Vac	600 Vac
EHD	20-100	480	18,000	14,000	—
FDB	20-125	600	18,000	14,000	14,000
FD	20-150	600	65,000	25,000	18,000
HFD	20-100	600	100,000	65,000	25,000

Horsepower Rating Table — Disconnect Switch

Max. Amp	Max. Horsepower Rating				
	120 Vac	240 Vac	480 Vac	600 Vac	250 Vdc
30	5	10	20	25	7-1/2
60	10	20	40	60	15
100	15	30	75	75	25
150	—	50	100	150	—

EBR Interlocked Circuit Breaker Receptacle

Explosionproof, Dust-Ignitionproof, Weather Resistant

30, 60, 100 and 150 Amp, 600 Vac

CEC:
 Class I, Groups B, C, D
 Class II, Group G and Coal Dust
 Class III
 CSA Type 3*, 3R*, 4*, 4X*, 7CD, 9G, 12

Receptacle Description	Circuit Breaker		With 480 Vac		With 600 Vac	
	Amp	Pole	EHD Breaker	FDB Breaker	FD Breaker	HFD Breaker
30 Amp 2W 3P	20	2	EBR3023EHD20W	EBR3023FDB20W	EBR3023FD20W	EBR3023HFD20W
	30		EBR3023EHD30W	EBR3023FDB30W	EBR3023FD30W	EBR3023HFD30W
	40		EBR3023EHD40W	EBR3023FDB40W	EBR3023FD40W	EBR3023HFD40W
	50		EBR3023EHD50W	EBR3023FDB50W	EBR3023FD50W	EBR3023HFD50W
30 Amp 3W 4P	20	3	EBR3034EHD20W	EBR3034FDB20W	EBR3034FD20W	EBR3034HFD20W
	30		EBR3034EHD30W	EBR3034FDB30W	EBR3034FD30W	EBR3034HFD30W
	40		EBR3034EHD40W	EBR3034FDB40W	EBR3034FD40W	EBR3034HFD40W
	50		EBR3034EHD50W	EBR3034FDB50W	EBR3034FD50W	EBR3034HFD50W
60 Amp 2W 3P One Threaded (1-1/2") Conduit Opening in Top	50	2	EBR6023EHD50W	EBR6023FDB50W	EBR6023FD50W	EBR6023HFD50W
	60		EBR6023EHD60W	EBR6023FDB60W	EBR6023FD60W	EBR6023HFD60W
	70		EBR6023EHD70W	EBR6023FDB70W	EBR6023FD70W	EBR6023HFD70W
	90		EBR6023EHD90W	EBR6023FDB90W	EBR6023FD90W	EBR6023HFD90W
	100		EBR6023EHD100W	EBR6023FDB100W	EBR6023FD100W	EBR6023HFD100W
60 Amp 3W 4P	50	3	EBR6034EHD50W	EBR6034FDB50W	EBR6034FD50W	EBR6034HFD50W
	60		EBR6034EHD60W	EBR6034FDB60W	EBR6034FD60W	EBR6034HFD60W
	70		EBR6034EHD70W	EBR6034FDB70W	EBR6034FD70W	EBR6034HFD70W
	90		EBR6034EHD90W	EBR6034FDB90W	EBR6034FD90W	EBR6034HFD90W
	100		EBR6034EHD100W	EBR6034FDB100W	EBR6034FD100W	EBR6034HFD100W
100 Amp 2W 3P	50	2	EBR1023EHD50W	EBR1023FDB50W	EBR1023FD50W	EBR1023HFD50W
	70		EBR1023EHD70W	EBR1023FDB70W	EBR1023FD70W	EBR1023HFD70W
	90		EBR1023EHD90W	EBR1023FDB90W	EBR1023FD90W	EBR1023HFD90W
	100		EBR1023EHD100W	EBR1023FDB100W	EBR1023FD100W	EBR1023HFD100W
100 Amp 3W 4P	50	3	EBR1034EHD50W	EBR1034FDB50W	EBR1034FD50W	EBR1034HFD50W
	70		EBR1034EHD70W	EBR1034FDB70W	EBR1034FD70W	EBR1034HFD70W
	90		EBR1034EHD90W	EBR1034FDB90W	EBR1034FD90W	EBR1034HFD90W
	100		EBR1034EHD100W	EBR1034FDB100W	EBR1034FD100W	EBR1034HFD100W
150 Amp 3W, 4P	100	3	N/A	N/A	EBR15034FD100W ①	N/A
	125		N/A	N/A	EBR15034FD125W ①	N/A
	150		N/A	N/A	EBR15034FD150W ①	N/A



Two Threaded
(1-1/2")
Conduit Openings
in Bottom

ACP Plugs for EBR Receptacles

Cable Dia. (Inches)	30 Amp		60 Amp		100 Amp		150 Amp
	2W, 3P	3W, 4P	2W, 3P	3W, 4P	2W, 3P	3W, 4P	3W, 4P
.500 to 1.250	ACP3023BC	ACP3034BC	—	—	—	—	—
.500 to 1.375	—	—	ACP6023BC	ACP6034BC	—	—	—
.875 to 1.375	—	—	—	—	ACP1023CD	ACP1034CD	—
1.09 to 2.187	—	—	—	—	—	—	ACP15034CD
	—	—	—	—	—	—	ACP15034DE

• Flip cover suitable for NEMA 3, 3R only.
 ▼ NEMA 4 rating maintained with Appleton NEMA 4 plug installed. Install screw cover for 4, 4X. Both covers are included with product.
 ① Molded Case Switch available. Add suffix -K.

EBR Interlocked Circuit Breaker Receptacle

Explosionproof, Dust-Ignitionproof, Weather Resistant

30, 60, 100 and 150 Amp, 600 Vac

CEC:

Class I, Groups B, C, D

Class II, Group G and Coal Dust

Class III

CSA Type 3*, 3R*, 4*, 4X*, 7CD, 9G, 12

Dimensions in Millimeters (Inches)

Shown with Flip Cover

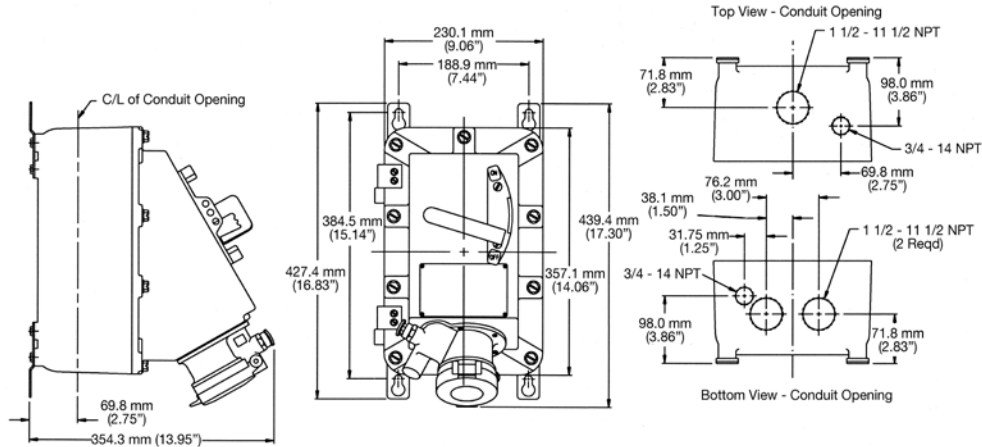

Shown with Screw Cover

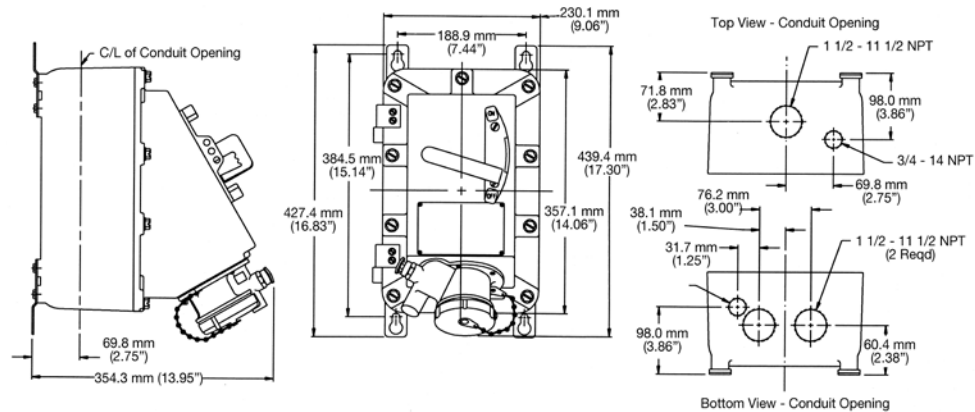

ACP Plugs

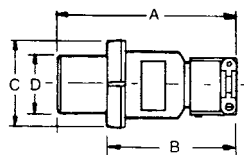

Max. Amp	No. Poles	Dimensions in Millimeters (Inches)			
		A	B	C	D
30	2,3,4	152.4 (6.00)	120.6 (4.75)	79.5 (3.13)	47.2 (1.86)
60	2,3	198.3 (7.81)	125.4 (4.94)	88.9 (3.50)	56.6 (2.23)
60	4	198.3 (7.81)	125.4 (4.94)	96.7 (3.81)	64.7 (2.55)
100	2,3	266.7 (10.50)	168.4 (6.63)	101.6 (4.00)	62.7 (2.47)
100	4	266.7 (10.50)	168.4 (6.63)	107.9 (4.25)	69.0 (2.72)

• Flip cover suitable for NEMA 3, 3R only.

▼ NEMA 4 rating maintained with Appleton NEMA 4 plug installed. Install screw cover for 4, 4X. Both covers are included with product.

MD2SR Factory Sealed Interlocked Switched Receptacles

Dead Front Interlocked Construction; No External Seals Required.

NEC:

Class I, Division 2, Groups B, C, D
Class II, Division 1 and 2, Groups F, G
Class III
Class I, Zone 2, Group IIC T3
NEMA 3*, 3R*, 4*, 4X*, 9FG, 12

Applications

- Locations where receptacles are used with stationary or portable electrically operated devices such as:
 - Lighting systems
 - Conveyors
 - Heaters
 - Motor generator sets
 - Air conditioners
 - Compressors
 - Pumps

Features

- Factory sealed; no external seals required.
- Available in fused and unfused versions.
- UL Listed for use with Appleton ACP plugs.
- UL Classified for use with competitors like plugs.
- Positive polarization; only plugs of the same style, number of poles, and Amperage rating may be used with these receptacles.
- Plug must be inserted into the receptacle before the switch can be turned on. Plug cannot be withdrawn unless the switch is in the off position.
- Cover bolts are stainless steel and captive.
- Insulated, dual-color polymer operating handle clearly indicates the switch being energized. Ergonomically designed handle is made of high-impact polymer material for exceptional ruggedness, durability and corrosion resistance.
- Style 2 (shell and extra pole) grounding.
- Removable hinged cover allows for ease of installation and maintenance.
- Short circuit withstand rated to 200,000 RMS symmetrical amperes (Class J fusing).
- Short circuit withstand rated to 10,000 RMS symmetrical amperes (unfused).
- Conduit entry is drilled and tapped to 1-1/2". Reducer bushings 1-1/2"-1-1/4" and 1-1/2"-1" provided at no additional cost.
- Stainless steel key-hole mounting feet for easy installation.
- Accommodates #8 – #4/0 AWG copper wire.
- Unit is equipped with defeatable door interlock which allows emergency access when switch is energized.
- Cover can be padlocked closed.
- Operating handle can be locked in the "OFF" position with provision to lock in the "ON" position.

Standard Materials

- Enclosure: copperfree (4/10 of 1% max.) aluminum
- Operating handle: high impact polymer
- Hardware: stainless steel

Standard Finish

- Enclosure: epoxy powder coating inside and outside

Options

- One normally opened, one normally closed auxiliary switch, add suffix **-AUX**.
- Two normally opened, two normally closed auxiliary switch, add suffix **-2AUX**.



- Special Polarization: Prevents plug insertion in a receptacle or connector wired for a different voltage. In installations where there are different line voltages, the special polarization option is desirable. This allows only plugs and receptacles wired for the same line voltage to be mated together. The receptacle or connector interior is positioned 22-1/2°, relative to the polarization rivet, to the right (as specified) of standard, and plug is polarized to correspond. Add Suffix **-P4** to receptacle.
- Reverse Service is useful where a "hot" plug feeds a dead receptacle. Reverse service is often used for generator applications where the receptacle houses a dead plug interior. Plug houses an energized receptacle interior, which has recessed male contacts to reduce danger of accidental touching. 30 and 60 Amp units can be easily converted to reverse service in the field when matching plug and receptacle are ordered. Add suffix **-RS** to receptacle or connector.

NEC Certifications and Compliances

- UL Standard: UL 894, UL 1203, UL 1604, UL 1682, UL 1686
- UL Listed: E10784

• Flip cover suitable for NEMA 3, 3R only.

▼ NEMA 4 rating maintained with Appleton NEMA 4 plug installed. Install screw cover for 4, 4X. Both covers are included with product.

MD2SR Factory Sealed Interlocked Switched Receptacles

Dead Front Interlocked Construction; No External Seals Required.

NEC:

Class I, Division 2, Groups B, C, D
 Class II, Division 1 and 2, Groups F, G
 Class III
 Class I, Zone 2, Group IIC T3
 NEMA 3*, 3R*, 4*, 4X*, 9FG, 12

Amp	Wires/Poles	Max HP	Fusing *	Catalog Number ①+	Mating Plug
30	2W, 3P	3 HP @ 240 Vac	Non-Fused	MD2SR3023U	ACP3023BC
			Fused	MD2SR3023F	
	3W, 4P	20 HP @ 600 Vac 30 HP @ 600 Vac	Non-Fused	MD2SR3034U	ACP3034BC
			Fused	MD2SR3034F	
60	2W, 3P	7.5 HP @ 240 Vac 10 HP @ 240 Vac	Non-Fused	MD2SR6023U	ACP6023BC
			Fused	MD2SR6023F	
	3W, 4P	50 HP @ 600 Vac	Non-Fused	MD2SR6034U	ACP6034BC
			Fused	MD2SR6034F	
100	2W, 3P	10 HP @ 240 Vac	Non-Fused	MD2SR1023U	ACP1023CD
			Fused	MD2SR1023F	
	3W, 4P	50 HP @ 600 Vac	Non-Fused	MD2SR1034U	ACP1034CD
			Fused	MD2SR1034F	

ACP Plugs for MD2SR Receptacles

Cable Dia. (Inches)	30 Amp		60 Amp		100 Amp	
	2W, 3P	3W, 4P	2W, 3P	3W, 4P	2W, 3P	3W, 4P
.390 to 1.375	ACP3023BC	ACP3034BC	ACP6023BC	ACP6034BC	—	—
.875 to 1.906	—	—	—	—	ACP1023CD	ACP1034CD



CPH Plugs for MD2SR Receptacles

Cable Dia. (Inches)	30 Amp		60 Amp		100 Amp	
	2W, 3P	3W, 4P	2W, 3P	3W, 4P	2W, 3P	3W, 4P
.390 to 1.375	CPH3023BC	CPH3034BC	CPH6023BC	CPH6034BC	—	—



- Flip cover suitable for NEMA 3, 3R only.
- ▼ NEMA 4 rating maintained with Appleton NEMA 4 plug installed. Install screw cover for 4, 4X. Both covers are included with product.
- * Fused units contain fuse holders; fuses not included.
- ① For auxiliary switch: one normally opened, one normally closed, add suffix **-AUX**.
- † For special polarization add **-P4**.

MD2SR Factory Sealed Interlocked Switched Receptacle

Dead Front Interlocked Construction; No External Seals Required.

NEC:
 Class I, Division 2, Groups B, C, D
 Class II, Division 1 and 2, Groups F, G
 Class III
 Class I, Zone 2, Group IIC T3
 NEMA 3*, 3R*, 4*, 4X*, 9FG, 12

Dimensions in Millimeters (Inches)

MD2SR

Catalog No.	Dimensions in Millimeters (Inches)	
	A	B
MD2SR3023U	488.9 (19.25)	617.9 (24.33)
MD2SR3023F	488.9 (19.25)	617.9 (24.33)
MD2SR3034U	488.9 (19.25)	617.9 (24.33)
MD2SR3034F	488.9 (19.25)	617.9 (24.33)
MD2SR6023U	488.9 (19.25)	617.9 (24.33)
MD2SR6023F	488.9 (19.25)	617.9 (24.33)
MD2SR6034U	488.9 (19.25)	617.9 (24.33)
MD2SR6034F	488.9 (19.25)	617.9 (24.33)
MD2SR1023U	488.9 (19.25)	617.9 (24.33)
MD2SR1023F	581.1 (22.88)	710.1 (27.96)
MD2SR1034U	488.9 (19.25)	617.9 (24.33)
MD2SR1034F	581.1 (22.88)	710.1 (27.96)

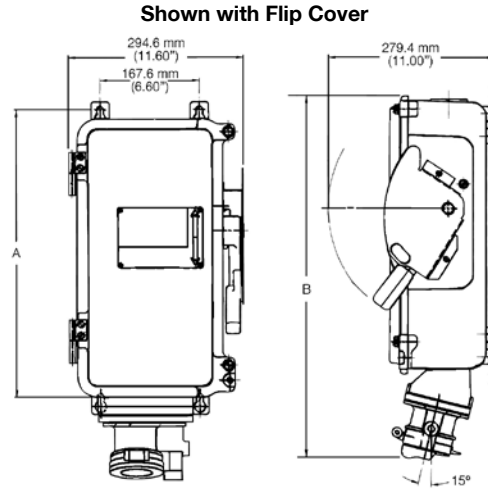

ACP Plugs

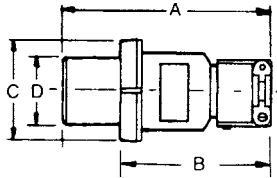

Max. Amp	No. Poles	Dimensions in Millimeters (Inches)			
		A	B	C	D
30	2,3,4	152.4 (6.00)	120.6 (4.75)	79.5 (3.13)	47.2 (1.86)
60	2,3	198.3 (7.81)	125.4 (4.94)	88.9 (3.50)	56.6 (2.23)
60	4	198.3 (7.81)	125.4 (4.94)	96.7 (3.81)	64.7 (2.55)
100	2,3	266.7 (10.50)	168.4 (6.63)	101.6 (4.00)	62.7 (2.47)
100	4	266.7 (10.50)	168.4 (6.63)	107.9 (4.25)	69.0 (2.72)

CPH Plugs

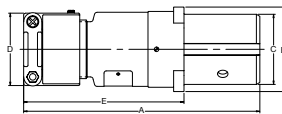

Max. Amp	Wire/Pole	Dimensions in Millimeters (Inches)				
		A	B	C	D	E
30	2W, 3P; 3W, 4P	155.7 (6.13)	60.4 (2.38)	47.2 (1.86)	6.68 (2.63)	112.7 (4.44)
60	2W, 3P	214.3 (8.44)	77.7 (3.06)	77.7 (3.06)	6.68 (2.63)	144.5 (5.69)
60	3W, 4P	214.3 (8.44)	77.7 (3.06)	64.7 (2.55)	6.68 (2.63)	144.5 (5.69)

• Flip cover suitable for NEMA 3, 3R only.

▼ NEMA 4 rating maintained with Appleton NEMA 4 plug installed. Install screw cover for 4, 4X. Both covers are included with product.

ID2SR Factory Sealed Interlocked Switched Receptacles

Dead Front Interlocked Construction; No External Seals Required.

CEC:

Class I, Division 2, Groups B, C and D
Class II, Division 1 and 2, Groups F¹ and G
Class III
CSA Type 3, 3R, 4², 4X², 9F²G, 12

Applications

- Locations where receptacles are used with stationary or portable electrically operated devices such as:
 - Lighting systems
 - Conveyors
 - Heaters
 - Motor generator sets
 - Air conditioners
 - Compressors
 - Pumps

Features

- Factory sealed; No external seals required.
- Available in unfused versions only.
- Certified for use with Appleton ACP plugs ⁺.
- Positive polarization; only plugs of the same style, number of poles, and amperage rating may be used with these receptacles.
- Safety Interlock mechanism. Plug must be inserted into the receptacle before the switch can be turned on. Plug cannot be withdrawn unless the switch is in the "OFF" position.
- Cover latches are stainless steel.
- Standard epoxy powder coating delivers exceptional corrosion resistance.
- Ergonomically designed.
- Rugged cast aluminum handle for exceptional durability and corrosion resistance.
- Style 2 (shell and extra pole) grounding.
- Removable hinged cover allows for ease of installation and maintenance.
- Short circuit withstand rated to 10,000 RMS Symmetrical Amperes (Unfused).
- Stainless steel key-hole mounting feet for easy installation.
- Accommodates #8 – #4/0 AWG copper wire.
- Unit is equipped with defeatable door interlock which allows emergency access when switch is energized.
- Cover can be padlocked closed.
- Operating handle can be locked in the "OFF" position with provision to lock in the "ON" position.

Standard Materials

- Enclosure: copper-free aluminum with epoxy powder coating
- Operating handle: durable cast aluminum
- Hardware: stainless steel

Options

- One normally opened, one normally closed auxiliary switch, add suffix **-AUX**.
- LED indicator lights: one light indicates power to unit and other indicates switch is in "ON" position add suffix **-IL**.
- Can be supplied with viewing window; add suffix **-W**.



Enclosure cover can be padlocked closed

- Special Polarization: Prevents plug insertion in a receptacle or connector wired for a different voltage. In installations where there are different line voltages, the special polarization option is desirable. This allows only plugs and receptacles wired for the same line voltage to be mated together. The receptacle or connector interior is positioned 22-1/2°, relative to the polarization rivet, to the right (as specified) of standard, and plug is polarized to correspond. Suffix **-P4** to receptacle.
- Reverse Service application available – Consult with local representative on use and application prior to ordering.

CEC Certifications and Compliances

- CSA Standard: C22.2 No.4, C22.2 No. 25, C22.2 No. 159, C22.2 No. 182.1
- CSA Certified: 038644

¹ Do not use where electrically conductive dusts are present (most coal dusts are not electrically conductive).

² Flip cover suitable for CSA Type 3, 3R only. Select screw cover for 4, 4X. Both covers are included with product. NEMA 4 rating maintained with Appleton NEMA 4 plug installed. (Screw cover not available on 30 Amp).

³ Do not use where electrically conductive dusts are present (most coal dusts are not electrically conductive).

+ The ID2SR will also accept Crouse-Hinds Arkrite plugs. Crouse-Hinds and Arkrite are registered trademarks of Cooper Crouse-Hinds.

ID2SR Factory Sealed Interlocked Switched Receptacles

Dead Front Interlocked Construction; No External Seals Required.

CEC:
 Class I, Division 2, Groups B, C and D
 Class II, Division 1 and 2, Groups F^① and G
 Class III
 CSA Type 3, 3R, 4^②, 4X^②, 9F^③G, 12

ID2SR Receptacles

	Amps	Wires/Poles	Max HP	Catalog Number		Mating Plug
				Non-Fused	Fused	
	30	2W, 3P	3 HP @ 240 Vac	ID2SR3023	ID2SR3023F	ACP3023BC
		3W, 4P	20 HP @ 600 Vac	ID2SR3034	ID2SR3034F	ACP3034BC
	60	2W, 3P	7.5 HP @ 240 Vac	ID2SR6023	ID2SR6023F	ACP6023BC
		3W, 4P	50 HP @ 600 Vac	ID2SR6034	ID2SR6034F	ACP6034BC
	100	2W, 3P	10 HP @ 240 Vac	ID2SR1023	ID2SR1023F	ACP1023CD
		3W, 4P	50 HP @ 600 Vac	ID2SR1034	ID2SR1034F	ACP1034CD

ACP Plugs for ID2SR Receptacles

Cable Dia. (Inches)	30 Amp		60 Amp		100 Amp	
	2W, 3P	3W, 4P	2W, 3P	3W, 4P	2W, 3P	3W, 4P
.500 to 1.250	ACP3023BC	ACP3034BC	—	—	—	—
.500 to 1.375	—	—	ACP6023BC	ACP6034BC	—	—
.875 to 1.906	—	—	—	—	ACP1023CD	ACP1034CD

① Do not use where electrically conductive dusts are present (most coal dusts are not electrically conductive).
 ② Flip cover suitable for CSA Type 3, 3R only. Select screw cover for 4, 4X. Both covers are included with product. NEMA 4 rating maintained with Appleton NEMA 4 plug installed. (Screw cover not available on 30 Amp).
 ③ Do not use where electrically conductive dusts are present (most coal dusts are not electrically conductive).

ID2SR Factory Sealed Interlocked Switched Receptacle

Dead Front Interlocked Construction; No External Seals Required.

CEC:

Class I, Division 2, Groups B, C and D
 Class II, Division 1 and 2, Groups F^① and G
 Class III
 CSA Type 3, 3R, 4^②, 4X^②, 9F^③G, 12

Dimensions in Millimeters (Inches)

ID2SR Receptacles

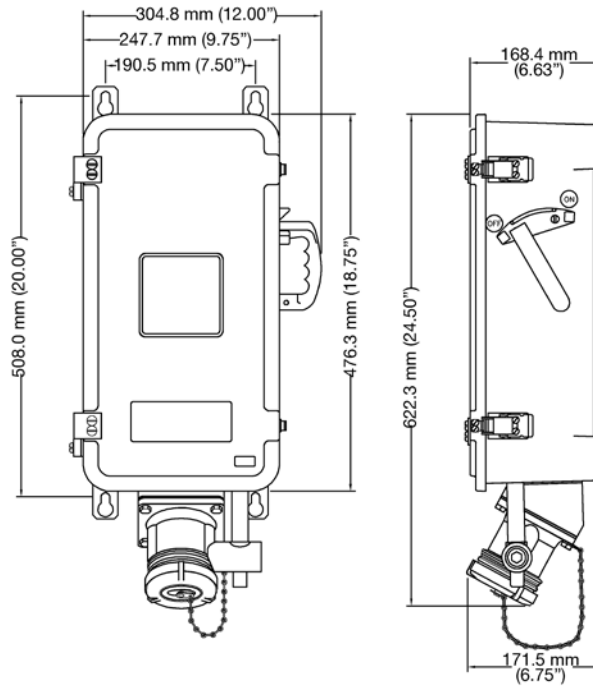

ACP Plugs

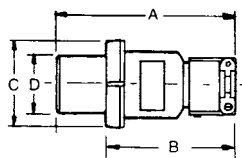

Max. Amp	No. Poles	Dimensions in Millimeters (Inches)			
		A	B	C	D
30	2,3,4	152.4 (6.00)	120.6 (4.75)	79.5 (3.13)	47.2 (1.86)
60	2,3	198.3 (7.81)	125.4 (4.94)	88.9 (3.50)	56.6 (2.23)
60	4	198.3 (7.81)	125.4 (4.94)	96.7 (3.81)	64.7 (2.55)
100	2,3	266.7 (10.50)	168.4 (6.63)	101.6 (4.00)	62.7 (2.47)
100	4	266.7 (10.50)	168.4 (6.63)	107.9 (4.25)	69.0 (2.72)

- ① Do not use where electrically conductive dusts are present (most coal dusts are not electrically conductive).
- ② Flip cover suitable for CSA Type 3, 3R only. Select screw cover for 4, 4X. Both covers are included with product. NEMA 4 rating maintained with Appleton NEMA 4 plug installed. (Screw cover not available on 30 Amp).
- ③ Do not use where electrically conductive dusts are present (most coal dusts are not electrically conductive).

ECC Factory Sealed 20 Amp Portable Cord Connector

Explosionproof, Dust-Ignitionproof

ECC Connects Portable Cord to Explosionproof Fixed Enclosure.

NEC/CEC:

Class I, Division 1 and 2, Groups B ϕ , C, D

Class II, Division 1 and 2, Group G

Class III

NEMA 7BCD, 9G

Watertight

Applications

- Connects portable cord to explosionproof fixed enclosure.

Features

- For use with No. 18 thru 12 AWG 3-Conductor Type S or SO cord.
- Furnished with 90 °C wire leads.
- 12" leads of #12 stranded wire are furnished for connection to wiring or equipment within the explosion-proof housing.



Standard Materials

- Copperfree (4/10 of 1% max.) aluminum.

Standard Finishes

- Epoxy powder coat.

NEC/CEC Certifications and Compliances

- UL Standard: UL1203
- UL Listed: E10444
- CSA Standard: C22.2 No. 25, C22.2 No. 30, C22.2 No. 182.1
- CSA Certified: 038644, 087428

20 Amp, 480 Vac or Vdc

Nipple Size	Cord Dia.	Catalog Number	
		NEC	CEC
1/2	.250 to .375	ECC503RH	ECC503RH-C
1/2	.375 to .500	ECC505RH	ECC505RH-C
1/2	.500 to .625	ECC506RH	ECC506RH-C
3/4	.250 to .375	ECC753RH	ECC753RH-C
3/4	.375 to .500	ECC755RH	ECC755RH-C
3/4	.500 to .625	ECC756RH	ECC756RH-C

Dimensions in Millimeters (Inches)

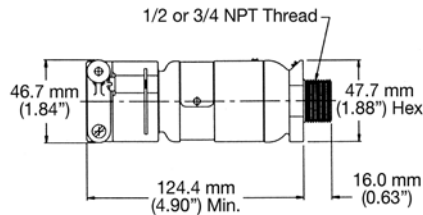

◆ Shaded area indicated items suitable for Class I, Group B and Class II, Group E in addition to Class I, Groups C and D and Class II, Groups F,G.

Powertite™ Series Pin and Sleeve Plugs, Connectors and Receptacles

NEC/CEC:

Listed for Ordinary (Unclassified) Locations
NEMA 3, 3R, 4, 4X

Applications

- Designed to supply power to portable or fixed electrical equipment such as motor generator units, welders, pumps, compressors, cellular relay stations, and similar apparatus.
- Ideal for use on shipping docks, ports, and other "ship to shore" applications.
- Suitable for use in locations where a weatherproof enclosure is required.
- Rough usage construction.

Features

- Available in 30, 60, 100, 150, 200, and 400 Amp units.
- Available in two grounding styles: Style 1 (shell only) and Style 2 (shell and extra pole).
- Neoprene bushing compressed by cable collar prevents entrance of water. Bushing is highly resistant to hydrocarbon deterioration and is self-extinguishing.
- Locking screw and slot prevents plug cable collar from "backing off."
- Contacts exert constant pressure along entire contact surface and provide electrical continuity.
- Suitable for use from -40 °C to 107 °C (-40 °F to 225 °F).
- Insulating blocks provide greatest dielectric and mechanical strength and lowest arc tracking.
- Positive polarization: only plugs and receptacles of same style, number of poles and ampere rating can be used together.
- Circuit breaking: in 30, 60, 100, 150 and 200 Amp units, any arcing created as line and load terminals disengage is safely confined deep within terminal cavities. Plugs may be withdrawn in an emergency under full rated loads without separate disconnect switches (400 Amp plug is for disconnecting use only; not for current rupturing).
- 30, 60, 100, and 150 Amp Powertite™ plugs also suitable for classified locations when used with Appleton EBR, EBRH, JBR, MD2SR, or DBR explosionproof interlocking receptacles.
- Controlled length contacts ensure that ground makes first and breaks last for added safety.

Standard Materials

- Plug, receptacle, connector and mounting box housings: copperfree (4/10 of 1% max.) aluminum
- Insulating blocks: glass filled polyester

Standard Finishes

- Aluminum plug, receptacle, connector and mounting box housings: epoxy powder coat
- Insulating blocks and contacts: natural finish

Options

- See Illustrated Options

NEC/CEC Certifications and Compliances

- UL Standard: UL 1682, UL 1686 ①, UL 50E
- UL Listed: E145916, E145917
- CSA Standard: C22.2 No. 182.1
- CSA Certified: 065179
- NEMA 4X (30, 60, 100, 150, and 200 Amp)
- NEMA Configuration: FB11

Related Products

- For classified location plugs and receptacles, see *Plugs and Receptacles: Hazardous Location*.

① UL 1686 does not apply to 150, 200 or 500 Amp units.

Classified by UL and Certified by CSA for use in specific combinations with Crouse-Hinds Arkrite. Arkrite is a registered trademark of Cooper Crouse-Hinds.



30 and 60 Amp



100 and 150 Amp



200 Amp

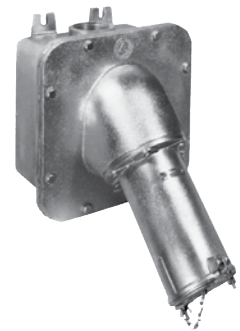

400 Amp

PLUGS AND RECEPTACLES: NEC/CEC ORDINARY LOCATION

Appleton®

Powertite™ Series Pin and Sleeve Plugs, Connectors and Receptacles

NEC/CEC:
Listed for Ordinary (Unclassified) Locations
NEMA 3, 3R, 4, 4X

Illustrated Features

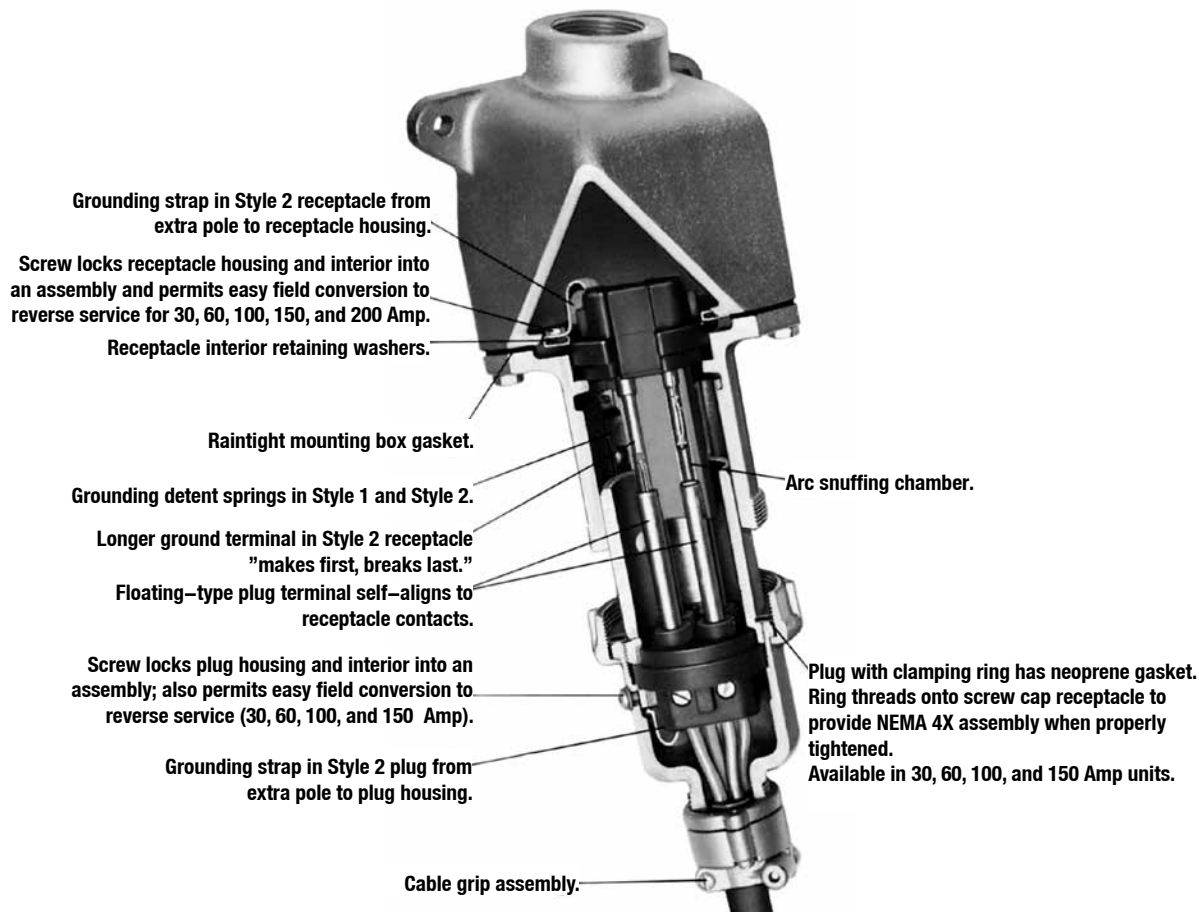

PLUGS AND RECEPTACLES: NEC/CEC ORDINARY LOCATION

Appleton

Powertite™ Series Pin and Sleeve Plugs, Connectors and Receptacles

NEC/CEC:
Listed for Ordinary (Unclassified) Locations
NEMA 3, 3R, 4, 4X

Illustrated Features

Grounding Styles

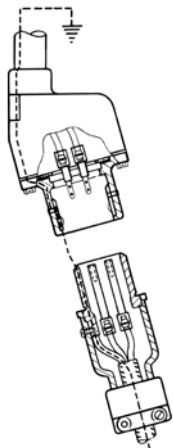

**Style 1
(Shell Only)**

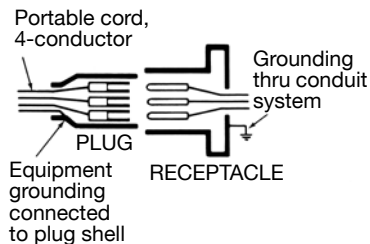

Plug—Equipment grounding conductor is wired directly to solderless lug which is connected to the plug housing with a pressure connector. All terminals are "current carrying."

Receptacle—Two detent spring clips engage the grounded plug housing on plug insertion—grounded plug shell makes contact with receptacle ground spring before line and load poles are engaged. Grounding path is maintained until after current-carrying contacts disengage. All terminals are "current carrying."

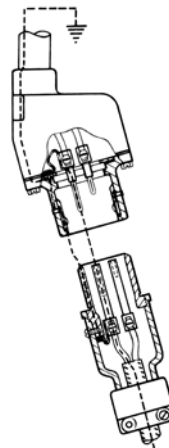

**Style 2
(Shell and Extra Pole)**

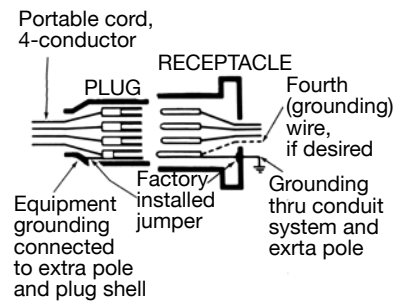

Plug—Equipment grounding conductor is not only connected to the solderless lug in the plug housing, but also to an extra grounding pole. Grounding pole has copper alloy grounding jumper strap that connects to plug housing.

Receptacle—Two detent spring clips engage grounded plug housing on plug insertion. Jumper from extra grounding pole is electrically connected to a screw on receptacle housing. Longer grounding pole "makes first and breaks last."

Pin and Sleeve Design ①



30, 60, and 100 Amp Pressure Wire Terminals.
Solid Brass Contacts with Beryllium Copper Springs.

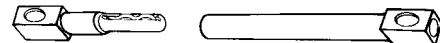

150 Amp Pressure Wire Terminals.
Solid Copper Contacts with Beryllium Copper Springs.



200 Amp Pressure Wire Terminals. Solid Copper Split-Type Contact.



400 Amp 0.84" Solder Well Wire Terminals. Solid Copper Contacts with Four Spring-Loaded Borosilicate Bearings.



400 Amp 1.25" Solder Wire Well Terminals. Solid Copper Contacts with Four Spring-Loaded Borosilicate Bearings.

① Pins and sleeves are not sold separately. Must be purchased as entire interior replacement. Available on the Replacement Interiors pages.

Powertite™ Series Pin and Sleeve Plugs, Connectors and Receptacles

NEC/CEC:

Listed for Ordinary (Unclassified) Locations
NEMA 3, 3R, 4, 4X

PLUGS AND RECEPTACLES: NEC/CEC ORDINARY LOCATION

Illustrated Features

Spring Door and Screw Cap

30, 60, 100, and 150 Amp spring door and screw cap receptacles are threaded to accept clamping ring ACP plug. The ring threads onto the receptacle to form a raintight assembly with plug in use-and also to prevent plug fallout. When the plug is withdrawn, the gasketed spring door cover closes tightly against receptacle opening automatically, providing weatherproof protection. Spring door has stainless steel spring and shaft.



Spring Door Cover

30, 60, 100, and 150 Amp units may be located at any position in a 360° circle by adjusting a setscrew. Set screw also allows complete removal of cover. Spring door available on 200 Amp units.

NOTE: Spring Door cover in open positions for illustration only.



ACP Plugs

Supplied with bushings to accommodate a wide variety of cable diameters. 30 Amp plug clamp used in first position with smallest inside diameter bushing provides positive grip on cables as small as 0.390 inches, such as those that are used in oil rig installations.



Reversible Cable Clamps

Permits wide cable range (just loosen screws and flip over). Each position accommodates one of two bushings. Convenient in installations having different cable sizes.



Illustrated Options

Standard Service

Energized receptacle has recessed male contacts to reduce danger of accidental touching. Plug has female contacts that are energized only upon insertion in receptacle.

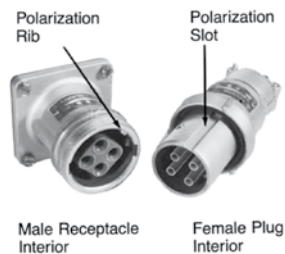

Reverse Service (Generator Application)

Useful where a "hot" plug feeds a dead receptacle. Reverse service is often used for generator applications where the receptacle houses a dead plug interior. Plug houses an energized receptacle interior, which has recessed male contacts to reduce danger of accidental touching. 30, 60, 100, 150, and 200 Amp units can be easily converted to reverse service in the field when matching plug and receptacle are ordered. 400 Amp unit is only available as a factory assembled item at extra cost. Add suffix **-RS** to receptacle or connector.

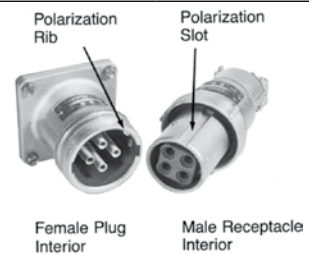

Special Polarization

Special polarization is available on 30, 60, 100, 200, and 400 Amp units. Prevents plug insertion in a receptacle or connector wired for a different voltage. In installations where there are different line voltages, the special polarization option is desirable. This allows only plugs and receptacles wired for the same line voltage to be mated together. The receptacle or connector interior is positioned 22-1/2°, relative to the polarization rivet, to the right (as specified) of standard, and plug is polarized to correspond. Add suffix **-P4** to the standard or reverse service plug, receptacle or connector.

Powertite™ Series Pin and Sleeve Plugs, Connectors and Receptacles

NEC/CEC:
Listed for Ordinary (Unclassified) Locations
NEMA 3, 3R, 4, 4X

Features at a Glance

Amp	Receptacle Types				Brass with Beryllium Copper Springs	Copper with Borosilicate Bearings	Contacts Split-type Copper Contacts	Brass Ground Contacts	Reverse Service	
	Grounding Styles	Weatherproof Spring Door	NEMA 4X Screw Cap	Raintight Clamp Cover					In Field	Factory Only
30	1 and 2	X	X		X			Style 2	X	
60	1 and 2	X	X		X			Style 2	X	
100	1 and 2	X	X		X			Style 2	X	
150	2	X	X		X ②			Style 2	X	
200	1 and 2	X ▼		X ▼			X	Style 2	X ①	
400	1 and 2					X		Style 2		X

Application Chart

Grounding Style	Wire/Pole	Single Phase		Grounding Style	Wire/Pole	Three Phase	
		With Neutral	Without Neutral			With Neutral	Without Neutral
Style 1 (Shell Only)	2W, 2P	L1+N+G	L1+L2+G	Style 1 (Shell Only)	2W, 2P		
	3W, 3P	L1+L2+N+G			3W, 3P		L1+L2+L3+G
	4W, 4P				4W, 4P	L1+L2+L3+N+G	
Style 2 (Shell and Extra Pole)	2W, 3P	L1+N+G	L1+L2+G	Style 2 (Shell and Extra Pole)	2W, 3P		
	3W, 4P	L1+L2+N+G			3W, 4P		L1+L2+L3+G

Powertite™ Horsepower Ratings Plug may be withdrawn in an emergency if within these maximum HP ratings. Not for normal starting/stopping.

Phase Motor	Amps	Motor Horsepower				Phase Motor	Amps	Motor Horsepower			
		115 Vac	230 Vac	480 Vac	600 Vac			115 Vac	230 Vac	480 Vac	600 Vac
For Emergency Disconnect Only											
3-Phase 3W, 3P; 3W, 4P; or 4W, 4P	30	3	7-1/2	15	20	1-Phase 2W, 2P or 2W, 3P	30	2	3	10	10
	60	7-1/2	15	30	30		60	3	10	20	20
	100	10	20	40	40		100	7-1/2	15	30	30
	150	Do Not Disconnect Under Load					200	15	30	40	40
	200	20	40	50	50						

Range of Wire Sizes Accommodated in Powertite™ Plug and Receptacle Terminals

60 °C (140 °F) minimum wire ratings.

30, 60, 100, and 150 Amp				200 Amp			400 Amp		
Amps	Wire Recess Dia. (Inches)	Wire Range		Wire Recess Dia. (Inches)	Conductor Size	Type Conductor	Solder Recess Dia. (Inches)	Conductor Size	Type Conductor
		Building	Extra Flex.						
30	.281	#10 – #6	#10 – #8	0.687	250	General Wire	0.84	500 MCM	General Wire
60	.312	#6 – #2	#6 – #4		4/0	General Wire		400 MCM	Flex. Cable
100	.391	#4 – #1	#4 – #2		4/0	Flex. Cable		400 MCM	Extra Flex.
150	.525	#2 – 2/0	#2 – 2/0		3/0	Flex. Cable	1.25	1000 MCM	General wire
					3/0	Extra Flex.		900 MCM	General Wire
					2/0	Flex. Cable		800 MCM	Extra Flex.

▼ NEMA 4X.

① For receptacle only.

② Copper with beryllium copper springs.

Powertite™ 30 Amp Pin and Sleeve Plugs and Receptacles

600 Vac, 250 Vdc, 50-400 Hz

Pressure Wire Terminals – Wire Recess Diameter: .281". Wire Size Range: #10—#6 Building; #10—#8 Extra Flex.

NEC/CEC:

Listed for Ordinary (Unclassified) Locations
NEMA 3, 3R, 4, 4X



PLUGS AND RECEPTACLES: NEC/CEC ORDINARY LOCATION

Grounding Style	Wire/Pole	Receptacle with AEE Mounting Box ①	Hub Size (Inches)	Receptacle Only ③	Metallic Clamping Ring Plug ②	Nonmetallic Clamping Ring Plug ②	Plug Cable Dia. (Inches)
Style 1 (Shell Only)	2W, 2P	ADRE3022-50	1/2	ADR3022	ACP3022BC	—	.500 to 1.250
		ADRE3022-75	3/4				
	3W, 3P	ADRE3033-75	3/4	ADR3033	ACP3033BC	—	.500 to 1.250
		ADRE3033-100	1				
		4W, 4P	ADRE3044-75				
ADRE3044-100	1						
Style 2 (Shell and Extra Pole)	2W, 3P	ADRE3023-75	3/4	ADR3023	ACP3023BC	—	.500 to 1.250
		ADRE3023-100	1				
	3W, 4P	ADRE3034-75	3/4	ADR3034	ACP3034BC	NMACP3034BC	.500 to 1.250
		ADRE3034-100	1				

Receptacles are provided with spring door and screw cover.
For Reverse Service, add suffix **-RS** to Catalog Number.
For Special Polarization, add suffix **-P4** to Catalog Number.

Horsepower Ratings for Emergency Disconnect Under Load

Plug may be withdrawn in an emergency if within these maximum HP ratings. Not for normal starting and stopping.

Phase Motor	Wire/Pole	Motor Horsepower			
		120 Vac	240 Vac	480 Vac	600 Vac
1-Phase	2W, 2P or 2W, 3P	2HP	3HP	10HP	10HP
3-Phase	3W, 3P; 3W, 4P; or 4W, 4P	3HP	7-1/2HP	15HP	20HP

① For additional mounting boxes, see Aluminum Mounting Boxes.

② Plug and receptacle combination is NEMA 4X rated when clamping ring is fully tightened on receptacle.

③ Receptacle is NEMA 4X rated when screw cover is fully engaged when the receptacle is not in use.

Powerlite™ 30 Amp Pin and Sleeve Connectors and Plugs

600 Vac, 250 Vdc, 50-400 Hz

Pressure Wire Terminals – Wire Recess Diameter: .281". Wire Size Range: #10—#6 Building; #10—#8 Extra Flex.

NEC/CEC:

Listed for Ordinary (Unclassified) Locations
NEMA 3, 3R, 4, 4X

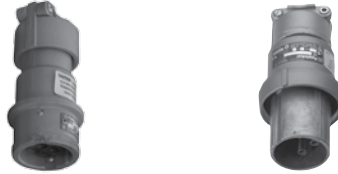

Grounding Style	Wire/Pole	Connector Body Only	Metallic Clamping Ring Plug ①	Connector/Plug Cable Dia. (Inches)
Style 1 (Shell Only)	2W, 2P	ARC3022BC	ACP3022BC	.500 to 1.250
	3W, 3P	ARC3033BC	ACP3033BC	.500 to 1.250
	4W, 4P	ARC3044BC	ACP3044BC	.500 to 1.250
Style 2 (Shell and Extra Pole)	2W, 3P	ARC3023BC	ACP3023BC	.500 to 1.250
	3W, 4P	ARC3034BC	ACP3034BC	.500 to 1.250

For Reverse Service, add suffix **-RS** to Catalog Number.
For Special Polarization, add suffix **-P4** to Catalog Number.

PLUGS AND RECEPTACLES: NEC/CEC ORDINARY LOCATION

Pin and Sleeve Design

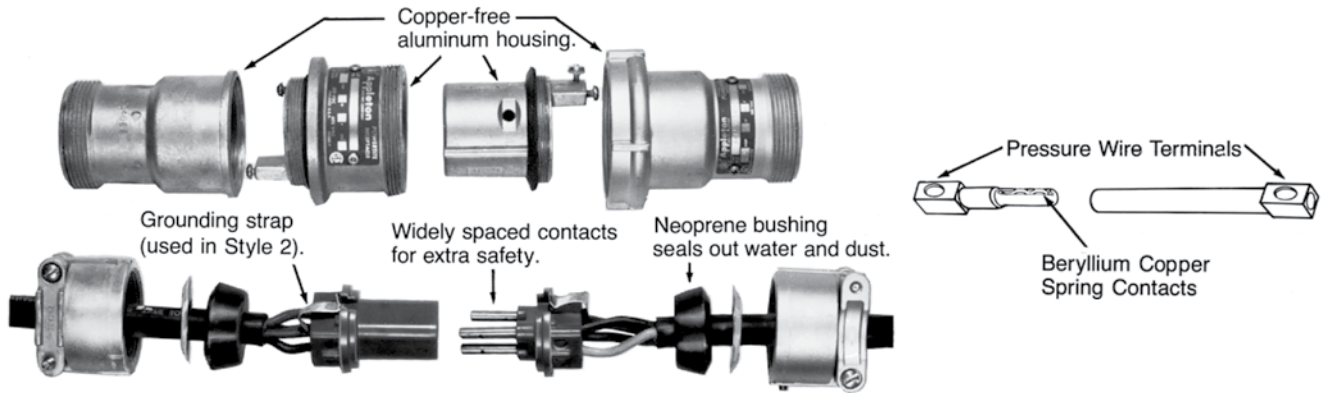

Energized contacts deeply recessed to reduce danger of accidental touching, minimize possibility of exposed arcs. Insulator quenches arcing, and is resistant to abnormal heat and to fire.

Plug mechanical cable clamps provide strain relief conductor connections, allow easy cable replacement.

Pressure wire terminals allow cable to be readily replaced when necessary. Terminal screws grip conductors firmly. Spring contacts provide constant pressure.

① Plug and connector body combination is NEMA 4X rated when clamping ring is fully tightened on connector body.

Powerlite™ 60 Amp Pin and Sleeve Plugs and Receptacles

600 Vac, 250 Vdc, 50-400 Hz

Pressure Wire Terminals – Wire Recess Diameter: .312". Wire Size Range: #6—#2 Building; #6—#4 Extra Flex.

NEC/CEC:

Listed for Ordinary (Unclassified) Locations
NEMA 3, 3R, 4, 4X

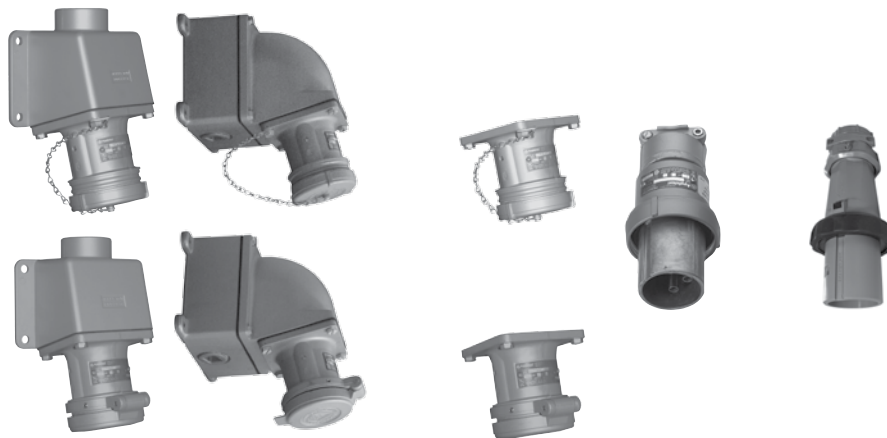

PLUGS AND RECEPTACLES: NEC/CEC ORDINARY LOCATION

Grounding Style	Wire/Pole	Receptacle with AEE Mounting Box ①	Receptacle with AJA Mounting Box ①	Hub Size (Inches)	Receptacle Only ③	Metallic Clamping Ring Plug ②	Nonmetallic Clamping Ring Plug ②	Plug Cable Dia. (Inches)
Style 1 (Shell Only)	2W, 2P	ADRE6022-100	ADJA6022-100	1	ADR6022	ACP6022BC	—	.500 to 1.250
		ADRE6022-125	ADJA6022-125	1-1/4				
	3W, 3P	ADRE6033-100	ADJA6033-100	1	ADR6033	ACP6033BC	—	.500 to 1.250
		ADRE6033-125	ADJA6033-125	1-1/4				
4W, 4P		ADRE6044-125	ADJA6044-125	1-1/4	ADR6044	ACP6044BC	—	.500 to 1.250
		ADRE6044-150	ADJA6044-150	1-1/2				
Style 2 (Shell and Extra Pole)	2W, 3P	ADRE6023-100	ADJA6023-100	1	ADR6023	ACP6023BC	—	.500 to 1.250
		ADRE6023-125	ADJA6023-125	1-1/4				
	3W, 4P	ADRE6034-125	ADJA6034-125	1-1/4	ADR6034	ACP6034BC	NMACP6034BC	.500 to 1.250
		ADRE6034-150	ADJA6034-150	1-1/2				

Receptacles are provided with spring door and screw cover.
For Reverse Service, add suffix **-RS** to Catalog Number.
For Special Polarization, add suffix **-P4** to Catalog Number.

Horsepower Ratings for Emergency Disconnect Under Load

Plug may be withdrawn in an emergency if within these maximum HP ratings. Not for normal starting and stopping.

Phase Motor	Wire/Pole	120 Vac	240 Vac	480 Vac	600 Vac
1-Phase	2W, 2P or 2W, 3P	3HP	10HP	20HP	20HP
3-Phase	3W, 3P; 3W, 4P; or 4W, 4P	7-1/2HP	15HP	30HP	30HP

① For additional mounting boxes, see Aluminum Mounting Boxes.

② Plug and receptacle combination is NEMA 4X rated when clamping ring is fully tightened on receptacle.

③ Receptacle is NEMA 4X rated when screw cover is fully engaged when the receptacle is not in use.

Powerlite™ 60 Amp Pin and Sleeve Connectors and Plugs

600 Vac, 250 Vdc, 50-400 Hz

Pressure Wire Terminals – Wire Recess Diameter: .312". Wire Size Range: #6—#2 Building; #6—#4 Extra Flex.

NEC/CEC:

Listed for Ordinary (Unclassified) Locations
NEMA 3, 3R, 4, 4X



Grounding Style	Wire/Pole	Connector Body Only	Metallic Clamping Ring Plug ①	Connector/Plug Cable Dia. (Inches)
Style 1 (Shell Only)	2W, 2P	ARC6022BC	ACP6022BC	.500 to 1.250
	3W, 3P	ARC6033BC	ACP6033BC	.500 to 1.250
	4W, 4P	ARC6044BC	ACP6044BC	.500 to 1.250
Style 2 (Shell and Extra Pole)	2W, 3P	ARC6023BC	ACP6023BC	.500 to 1.250
	3W, 4P	ARC6034BC	ACP6034BC	.500 to 1.250

For Reverse Service, add suffix **-RS** to Catalog Number.
For Special Polarization, add suffix **-P4** to Catalog Number.

Pin and Sleeve Design

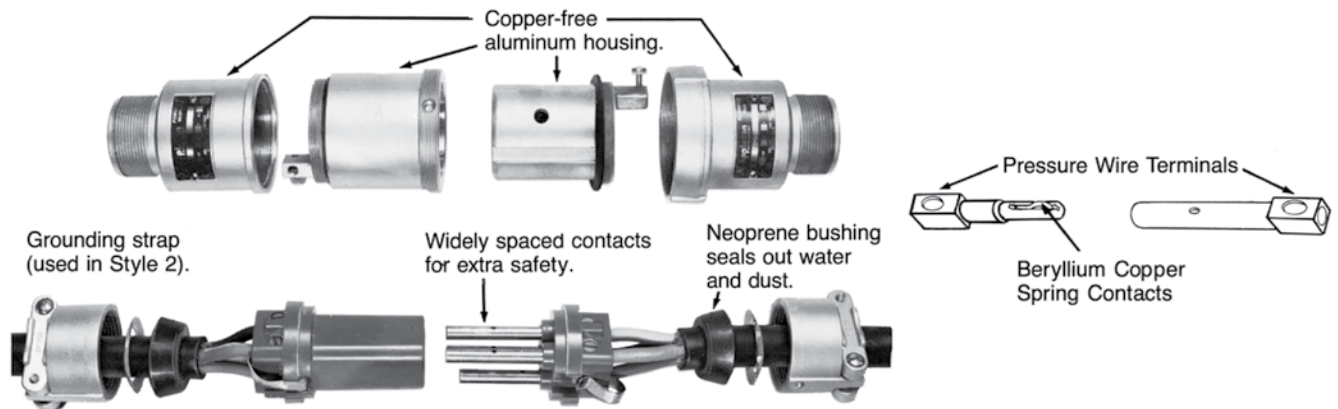

Energized contacts deeply recessed to reduce danger of accidental touching, minimize possibility of exposed arcs. Insulator quenches arcing, and is resistant to abnormal heat and to fire.

Plug mechanical cable clamps provide strain relief at conductor connections, allow easy cable replacement.

Pressure wire terminals allow cable to be readily replaced when necessary. Terminal screws grip conductors firmly. Spring contacts provide constant pressure.

① Plug and connector body combination is NEMA 4X rated when clamping ring is fully tightened on connector body.

Powerlite™ 100 and 150 Amp Pin and Sleeve Plugs and Receptacles

600 Vac, 250 Vdc, 50-400 Hz

Pressure Wire Terminals – 100 Amp: Wire Recess Diameter: .391". Wire Size Range: #4—#1 Building; #4—#2 Extra Flex.

150 Amp: Wire Recess Diameter: .525". Wire Size Range: #2—2/0 Building; #2—#2/0 Extra Flex.

NEC/CEC:

Listed for Ordinary (Unclassified) Locations
NEMA 3, 3R, 4, 4X

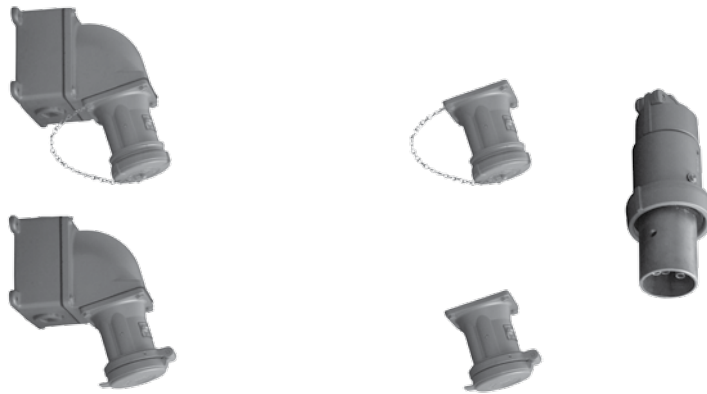

PLUGS AND RECEPTACLES: NEC/CEC ORDINARY LOCATION

Grounding Style	Wire/Pole	Receptacle with AJA Mounting Box ①	Hub Size (Inches)	Receptacle Only ③	Clamping Ring Plug ②	Plug Cable Dia. (Inches)
100 Amp Style 1 (Shell Only)	2W, 2P	ADJA1022-125	1-1/4	ADR1022	ACP1022CD	.875 to 1.906
		ADJA1022-150	1-1/2			
	3W, 3P	ADJA1033-125	1-1/4	ADR1033	ACP1033CD	.875 to 1.906
		ADJA1033-150	1-1/2			
	4W, 4P	ADJA1044-150	1-1/2	ADR1044	ACP1044CD	.875 to 1.906
		ADJA1044-200	2			
100 Amp Style 2 (Shell and Extra Pole)	2W, 3P	ADJA1023-125	1-1/4	ADR1023	ACP1023CD	.875 to 1.906
		ADJA1023-150	1-1/2			
	3W, 4P	ADJA1034-150	1-1/2	ADR1034	ACP1034CD	.875 to 1.906
		ADJA1034-200	2			
150 Amp Style 2 (Shell and Extra Pole)	3W, 4P	ADJA15034-150	1-1/2	ADR15034	ACP15034CD	.875 to 1.906
		ADJA15034-200	2			

Receptacles are provided with spring door and screw cover.

For Reverse Service, add suffix **-RS** to Catalog Number.

For Special Polarization for 100 Amp units, add suffix **-P4** to Catalog Number. (Not available for 150 Amp units.)

Horsepower Ratings for Emergency Disconnect Under Load

Not for normal starting and stopping, but plug may be withdrawn in an emergency if within these maximum HP ratings.

Amp	Motor Phase	Wire/Pole	Motor Horsepower			
			120 Vac	240 Vac	480 Vac	600 Vac
100	1-Phase	2W, 2P or 2W, 3P	7-1/2HP	15HP	30HP	30HP
	3-Phase	3W, 3P; 3W, 4P; or 4W, 4P	10HP	20HP	40HP	40HP
150	3-Phase	3W, 4P	Do Not Disconnect Under Load			

① For additional mounting boxes, see Aluminum Mounting Boxes.

② Plug and receptacle combination is NEMA 4X rated when clamping ring is fully tightened on receptacle.

③ Receptacle is NEMA 4X rated when screw cover is fully engaged when the receptacle is not in use.

Powertite™ 100 and 150 Amp Pin and Sleeve Connectors and Plugs

600 Vac, 250 Vdc, 50-400 Hz

Pressure Wire Terminals – 100 Amp: Wire Recess Diameter: .391". Wire Size Range: #4—#1 Building; #4—#2 Extra Flex.

150 Amp: Wire Recess Diameter: .525". Wire Size Range: #2—2/0 Building; #2—#2/0 Extra Flex.

NEC/CEC:

Listed for Ordinary (Unclassified) Locations
NEMA 3, 3R, 4, 4X



Grounding Style	Wire/Pole	Connector Body Only	Clamping Ring Plug ①	Connector/Plug Cable Dia. (Inches)
100 Amp Style 1 (Shell Only)	2W, 2P	ARC1022CD	ACP1022CD	.875 to 1.906
	3W, 3P	ARC1033CD	ACP1033CD	.875 to 1.906
	4W, 4P	ARC1044CD	ACP1044CD	.875 to 1.906
100 Amp Style 2 (Shell and Extra Pole)	2W, 3P	ARC1023CD	ACP1023CD	.875 to 1.906
	3W, 4P	ARC1034CD	ACP1034CD	.875 to 1.906
150 Amp Style 2 (Shell and Extra Pole)	3W, 4P	ARC15034CD	ACP15034CD	.875 to 1.906
	3W, 4P	ARC15034DE	ACP15034DE	1.250 to 2.187

For Reverse Service, add suffix **-RS** to Catalog Number.

For Special Polarization for 100 Amp units, add suffix **-P4** to Catalog Number. (Not available for 150 Amp units.)

Pin and Sleeve Design

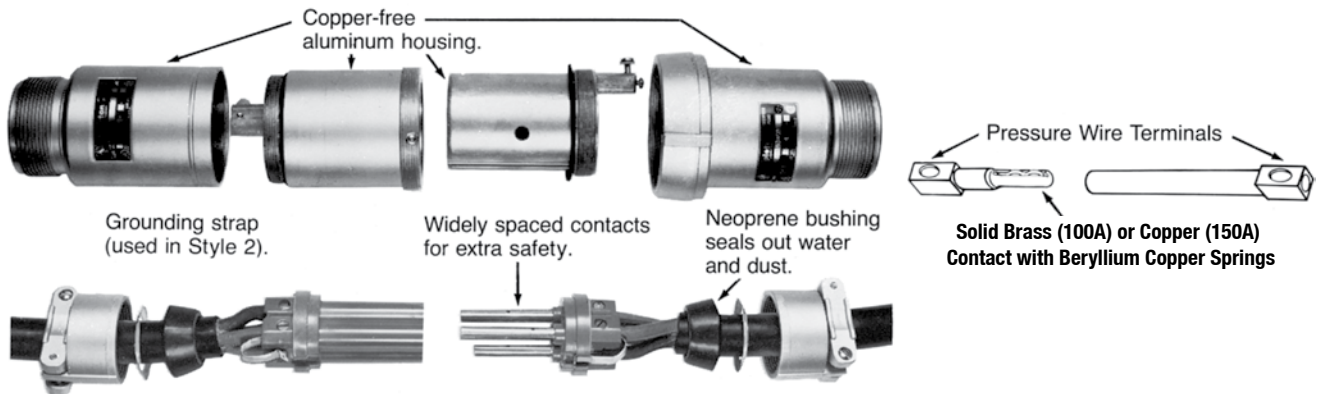

Energized contacts deeply recessed to reduce danger of accidental touching, minimize possibility of exposed arcs. Insulator quenches arcing, and is resistant to abnormal heat and to fire.

Plug mechanical cable clamps provide strain relief at conductor connections, allow easy cable replacement.

Pressure wire terminals allow cable to be readily replaced when necessary. Terminal screws grip conductors firmly. Spring contacts provide constant pressure.

① Plug and receptacle combination is NEMA 4X rated when clamping ring is fully tightened on receptacle.

Powertite™ 30, 60, 100, and 150 Amp Caps For Plug

NEC/CEC:
Listed for Ordinary (Unclassified) Locations
NEMA 3, 3R, 4, 4X

Applications

- Protects insulation and plug contacts from excessive moisture, dirt, dust, and corrosion when portable equipment is not in use.
- For use with 30 Amp 3-Pole and 4-Pole, 60 Amp 4-Pole and 100 and 150 Amp 4-Pole plugs.
- Cap is secured to plug by aviation cable. When in use the cap is held in place with standard plug clamping ring.

Standard Materials

- Cap: ABS plastic

Ordering Information

Catalog Number	Amp	For Use With
ACPCAP3034	30	ACP3023BC
		ACP3033BC
		ACP3034BC
		ACP3044BC
ACPCAP6004	60	ACP6034BC
		ACP6044BC
ACPCAP1004	100	ACP1034CD
		ACP1044CD
	150	ACP15034CD
		ACP15034DE



PLUGS AND RECEPTACLES: NEC/CEC ORDINARY LOCATION

Appleton®

Aluminum Mounting Boxes

For Powertite™ 30, 60, 100, and 150 Amp Receptacles

NEC/CEC:
Listed for Ordinary (Unclassified) Locations
NEMA 3, 3R, 4, 4X

30 Amp



Hub Size (Inches)	AEE	AERH	AERC	AERA
1/2	AEE13	AERH13	AERC13	AERA13
3/4	AEE23	AERH23	AERC23	AERA23
1	AEE33	AERH33	AERC33	AERA33

60 and 100 Amp



Hub Size (Inches)	AEE	AERH	AERC	AERA
1	AEE36	AERH36	AERC36	AERA36
1-1/4	AEE46	AERH46	AERC46	AERA46
1-1/2	AEE56	AERH56	AERC56	AERA56

60, 100, and 150 Amp



Hub Size (Inches)	AJA Back Box and Adapter ①	Angle Adapter Only
1	AJA310	
1-1/4	AJA410	
1-1/2	AJA510	AJA100
2	AJA610	

Replacement Receptacle Mounting Gasket

Amp	Back Box Type	Part Number
30	AEE, AERH, AERC, AERA	69060871000
60, 100	AEE, AERH, AERC, AERA	69060567000
60, 100, 150	AJA	69009497000

① Feed-Thru box furnished with one close-up plug in bottom recessed hub.

Powertite™ 30, 60, 100, and 150 Amp Replacement Interiors

600 Vac, 250 Vdc, 50-400 Hz

NEC/CEC:
Listed for Ordinary (Unclassified) Locations
NEMA 3, 3R, 4, 4X

PLUGS AND RECEPTACLES: NEC/CEC ORDINARY LOCATION

30 Amp ①



Grounding Style	Wire/Pole	Receptacle	Plug	Receptacle	Plug
Style 1 (Shell Only)	2W, 2P	ARI-3022	API-3022	—	—
	3W, 3P	ARI-3033	API-3033	—	—
	4W, 4P	ARI-3044	API-3044	—	—
Style 2 (Shell and Extra Pole)	2W, 3P	—	—	ARI-3023	API-3023
	3W, 4P	—	—	ARI-3034	API-3034

60 Amp ①



Grounding Style	Wire/Pole	Receptacle	Plug	Receptacle	Plug
Style 1 (Shell Only)	2W, 2P	ARI-6022	API-6022	—	—
	3W, 3P	ARI-6033	API-6033	—	—
	4W, 4P	ARI-6044	API-6044	—	—
Style 2 (Shell and Extra Pole)	2W, 3P	—	—	ARI-6023	API-6023
	3W, 4P	—	—	ARI-6034	API-6034

100 and 150 Amp ①



Grounding Style	Wire/Pole	Receptacle	Plug	Receptacle	Plug
Style 1 (Shell Only)	2W, 2P	ARI-1022	API-1022	—	—
	3W, 3P	ARI-1033	API-1033	—	—
	4W, 4P	ARI-1044	API-1044	—	—
Style 2 (Shell and Extra Pole)	2W, 3P	—	—	ARI-1023	API-1023
	3W, 4P	—	—	ARI-1034	API-1034
150 Amp Style 2 (Shell and Extra Pole)	3W, 4P	—	—	ARI-15034	API-15034







① Pins and sleeves are not sold separately.

Powertite™ 30, 60, 100, and 150 Amp Replacement Parts

600 Vac, 250 Vdc, 50-400 Hz

NEC/CEC:

Listed for Ordinary (Unclassified) Locations
NEMA 3, 3R, 4, 4X

	Description	Catalog Number
ACP Plug Clamping Ring — Includes Gasket		
	30 Amp — 2-, 3- and 4-Pole	CLMPR30
	30 Amp — 3-Wire, 4-Pole	30CRING ①
	60 Amp — 2- and 3-Pole	CLMPR23P60
	60 Amp — 4-Pole	CLMPR4P60
	100 Amp — 2- and 3-Pole	CLMPR23P100
	100 and 150 Amp — 4-Pole	CLMPR4P100
Receptacle Spring Cover — Includes Gasket and Chain		
	30 Amp — 2-, 3- and 4-Pole	PTSC30
	60 Amp — 2- and 3-Pole	PTSC60A
	60 Amp — 4-Pole	PTSC60B
	100 Amp — 2- and 3-Pole	PTSC100A
	100 and 150 Amp — 4-Pole	PTSC100B
Receptacle Threaded Cover — Includes Gasket and Chain		
	30 Amp — 2, 3, and 4-Pole	PTTC30
	30 Amp — 3 Wire, 4-Pole	30SCAP ①
	60 Amp — 2- and 3-Pole	PTTC60A
	60 Amp — 4-Pole	PTTC60B
	100 Amp — 2- and 3-Pole	PTTC100A
	100 and 150 Amp — 4-Pole	PTTC100B
Bushing Bags and Crown Bushings for Plugs and Cable Connectors		
	30 Amp	PTGB30
	60 Amp	PTGB60
	100 Amp and 150 Amp (CD)	PTGBCD
	150 Amp (DE)	PTGBDE
Universal Plug Bushing		
	30 and 60 Amp Cable Range 0.300" – 9.00" Package of 10	PTGBUBC
Receptacle Ground Lug Kit		
	30 Amp Receptacle Ground Lug Kit. Wire Well ID 0.272"	PTRGL30
	60 Amp Receptacle Ground Lug Kit. Wire Well ID 0.312"	PTRGL60
	100 Amp Receptacle Ground Lug Kit. Wire Well ID 0.389" ②	PTRGL100

① For use with 30 Amp Powertite™ plugs and WSR/WSRD/JBR/EBR/DBR receptacles.

② Ground lug is cast into the housing after 09/2008.

Powertite™ 30, 60, 100, and 150 Amp Mounted Receptacle

600 Vac, 250 Vdc, 50-400 Hz

NEC/CEC:

Listed for Ordinary (Unclassified) Locations
NEMA 3, 3R, 4, 4X

Dimensions in Millimeters (Inches)

Receptacle Mounted on AEE Box

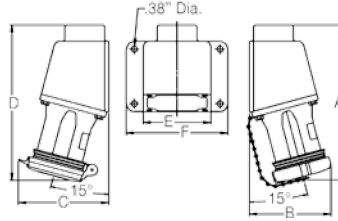

Amp	Dimensions in Millimeters (Inches)					
	A	B	C	D	E	F
30	174.7 (6.88)	89.6 (3.45)	100.3 (3.95)	181.1 (7.13)	107.9 (4.25)	127.0 (5.00)
60	247.6 (9.75)	120.1 (4.73)	126.4 (4.98)	254.0 (10.00)	136.6 (5.38)	162.0 (6.38)

Receptacle Mounted on AJA Box

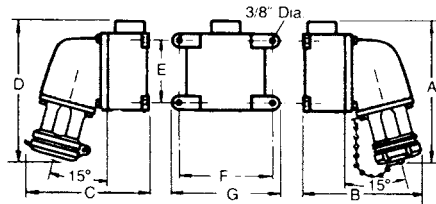

Amp	Dimensions in Millimeters (Inches)						
	A	B	C	D	E	F	G
60	244.6 (9.63)	203.2 (8.00)	223.7 (8.81)	271.5 (10.69)	123.9 (4.88)	174.7 (6.88)	200.15 (7.88)
100 and 150	290.5 (11.44)	228.6 (9.00)	233.4 (9.19)	300.2 (11.82)	123.9 (4.88)	174.7 (6.88)	200.15 (7.88)

ADR Receptacle

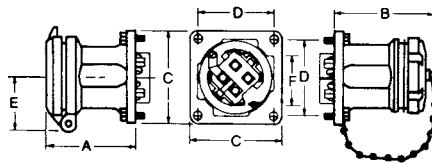

Amp	No. Poles	Dimensions in Millimeters (Inches)					
		A	B	C	D	E	F
30	2,3,4	71.1 (2.80)	81.0 (3.19)	85.8 (3.38)	69.0 (2.72)	52.3 (2.06)	69.8 (2.75)
60	2,3	123.9 (4.88)	117.6 (4.63)	107.9 (4.25)	88.9 (3.50)	58.6 (2.31)	78.7 (3.10)
60	4	123.9 (4.88)	117.6 (4.63)	107.9 (4.25)	88.9 (3.50)	61.9 (2.44)	85.0 (3.35)
100	2,3	129.5 (5.10)	139.7 (5.50)	107.9 (4.25)	88.9 (3.50)	61.9 (2.44)	86.3 (3.40)
100 and 150	4	129.5 (5.10)	139.7 (5.50)	107.9 (4.25)	88.9 (3.50)	65.0 (2.56)	91.4 (3.60)

PLUGS AND RECEPTACLES: NEC/CEC ORDINARY LOCATION

Appleton®

Powertite™ 30, 60, 100, and 150 Amp Connector and Plug

600 Vac, 250 Vdc, 50-400 Hz

NEC/CEC:

Listed for Ordinary (Unclassified) Locations
NEMA 3, 3R, 4, 4X

Dimensions in Millimeters (Inches)

ARC Cable Connector

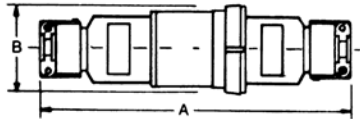

Amp	Dimensions in Millimeters (Inches)	
	A	B
30	266.7 (10.50)	79.5 (3.13)
60	336.5 (13.25)	96.7 (3.81)
100	406.4 (16.00)	107.9 (4.25)
150	406.4 (16.00)	107.9 (4.25)

ACP Plug

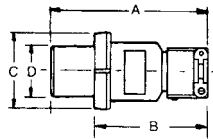

Amp	No. Poles	Dimensions in Millimeters (Inches)			
		A	B	C	D
30	2,3,4	152.4 (6.00)	120.6 (4.75)	79.5 (3.13)	47.2 (1.86)
60	2,3	198.3 (7.81)	125.4 (4.94)	88.9 (3.50)	56.6 (2.23)
60	4	198.3 (7.81)	125.4 (4.94)	96.7 (3.81)	64.7 (2.55)
100	2,3	266.7 (10.50)	168.4 (6.63)	101.6 (4.00)	62.7 (2.47)
100	4	266.7 (10.50)	168.4 (6.63)	107.9 (4.25)	69.0 (2.72)
150 (CD)	4	266.7 (10.50)	168.4 (6.63)	107.9 (4.25)	69.0 (2.72)
150 (DE)	4	340.3 (13.40)	247.1 (9.73)	107.9 (4.25)	69.0 (2.72)

NMACP Plug

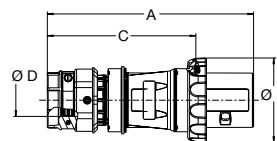

Amp	No. Poles	Dimensions in Millimeters (Inches)			
		A	B	C	D Min — Max
30	4	187.0 (7.36)	63.0 (2.48)	145.0 (5.71)	11.0 - 24.5 (0.43 - 0.97)
60	4	245.0 (9.65)	100.0 (3.94)	174.0 (6.85)	14.5 - 36.0 (0.57 - 1.42)

PLUGS AND RECEPTACLES: NEC/CEC ORDINARY LOCATION



Powertite™ 30, 60, 100, and 150 Amp Mounting Box

600 Vac, 250 Vdc, 50-400 Hz

NEC/CEC:

Listed for Ordinary (Unclassified) Locations
NEMA 3, 3R, 4, 4X

Dimensions in Millimeters (Inches)

AJA Mounting Boxes

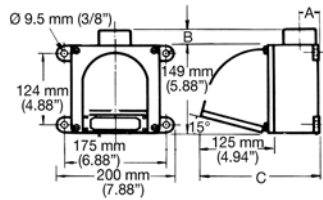

Amp	Hub Size (Inches)	Dimensions in Millimeters (Inches)		
		A	B ①	C
60, 100 and 150	1	28.7 (1.13)	14.2 (0.56)	203.2 (8.0)
	1-1/4	28.7 (1.13)	14.2 (0.56)	203.2 (8.0)
	1-1/2	38.1 (1.50)	14.2 (0.56)	203.2 (8.0)
	2	38.1 (1.50)	14.2 (0.56)	203.2 (8.0)

AJA100 Angle Adapter

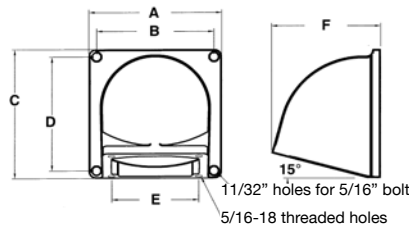

Dimensions in Millimeters (Inches)					
A	B	C	D	E	F
149.0 (5.87)	131.5 (5.18)	149.0 (5.87)	131.5 (5.18)	88.9 (3.50)	122.1 (4.81)

① AJA has two hubs. Close-up plug furnished in bottom recessed hub.

Powertite™ 30, 60, 100, and 150 Amp Mounting Box

600 Vac, 250 Vdc, 50-400 Hz

NEC/CEC:

Listed for Ordinary (Unclassified) Locations
NEMA 3, 3R, 4, 4X

Dimensions in Millimeters (Inches)

AERA ①, AERC ② and AERH Mounting Boxes

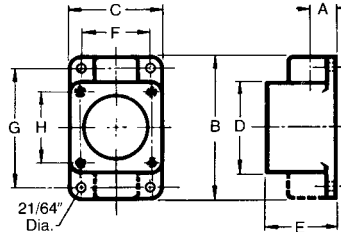

Amp	Hub Size (Inches)	Dimensions in Millimeters (Inches)								
		A ①	B ②	C	D	E	F	G	H	J
30	1/2	17.5 (0.69)	134.8 (5.31)	85.8 (3.38)	85.8 (3.38)	63.5 (2.50)	66.8 (2.63)	115.8 (4.56)	69.0 (2.72)	23.8 (0.94)
30	3/4	19.0 (0.75)	134.8 (5.31)	85.8 (3.38)	85.8 (3.38)	63.5 (2.50)	66.8 (2.63)	115.8 (4.56)	69.0 (2.72)	23.8 (0.94)
30	1	20.5 (0.81)	134.8 (5.31)	85.8 (3.38)	85.8 (3.38)	63.5 (2.50)	66.8 (2.63)	115.8 (4.56)	69.0 (2.72)	23.8 (0.94)
60	1	20.5 (0.81)	165.1 (6.50)	107.9 (4.25)	107.9 (4.25)	79.5 (3.13)	88.9 (3.50)	149.3 (5.88)	88.9 (3.50)	35.0 (1.38)
60	1-1/4	23.8 (0.94)	165.1 (6.50)	107.9 (4.25)	107.9 (4.25)	79.5 (3.13)	88.9 (3.50)	149.3 (5.88)	88.9 (3.50)	35.0 (1.38)
60	1-1/2	25.4 (1.00)	165.1 (6.50)	107.9 (4.25)	107.9 (4.25)	79.5 (3.13)	88.9 (3.50)	149.3 (5.88)	88.9 (3.50)	35.0 (1.38)

AEE Mounting Box

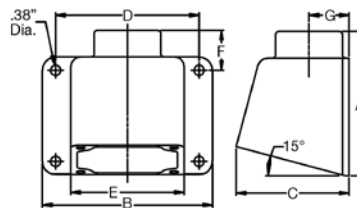

Amp	Hub Size (Inches)	Dimensions in Millimeters (Inches)						
		A	B	C	D	E	F	G
30	1/2, 3/4, 1	104.6 (4.12)	127.0 (5.00)	84.5 (3.33)	107.9 (4.25)	85.8 (3.38)	29.9 (1.18)	27.9 (1.10)
60	1, 1-1/4, 1-1/2	137.4 (5.41)	162.0 (6.38)	107.4 (4.23)	136.6 (5.38)	107.9 (4.25)	38.1 (1.50)	38.1 (1.50)

① Dimension "A" for AERA only.
② Dimension "B" for AERC only.

Powertite™ 200 Amp Pin and Plugs and Receptacles

600 Vac, 250 Vdc, 50-400 Hz. Sleeve Spring Door. Wire Recess Diameter: .687". Wire Size Range: 250 MCM-#2/0. Pressure Wire Terminals ①.

NEC/CEC:
Listed for Ordinary (Unclassified) Locations
NEMA 3, 3R, 4, 4X



Grounding Style	Wire/Pole	Receptacle with AJA Mounting Box ②	Hub Size (Inches)	Receptacle Only ③	Plug Only	Cable Dia. (Inches)
Style 1 (Shell Only)	3W, 3P	ADJA20033-150	1-1/2	ADR20033	AP20033CD	.875 to 1.906
		ADJA20033-200	2		AP20033E	1.875 to 2.500
	4W, 4P	ADJA20044-200	2	ADR20044	AP20044CD	.875 to 1.906
		ADJA20044-250	2-1/2		AP20044E	1.875 to 2.500
Style 2 (Shell and Extra Pole)	2W, 3P	ADJA20023-150	1-1/2	ADR20023	AP20023CD	.875 to 1.906
		ADJA20023-200	2		AP20023E	1.875 to 2.500
		ADJA20023-250	2-1/2			
	3W, 4P	ADJA20034-150	1-1/2	ADR20034	AP20034CD	.875 to 1.906
		ADJA20034-200	2		AP20034E	1.875 to 2.500
		ADJA20034-250	2-1/2			

For Reverse Service add suffix **-RS** to Catalog Number.
For Special Polarization, add suffix **-P4** to Catalog Number.

Maximum Conductor Size

Wire Recess Dia. (Inches)	Conductor Size	Max. Strand	Type Conductor
0.687	250 MCM	37	General Wire
	4/0	19	General Wire
	4/0	259	Flexible Cable
	3/0	427	Extra Flexible Cable
	2/0	259	Flexible Cable
	2/0	259	Flexible Cable

Horsepower Ratings for Emergency Disconnect Under Load

Plug may be withdrawn in an emergency if within these maximum HP ratings. Not for normal starting and stopping.

Motor Phase	Wire/Pole	Motor Horsepower			
		120 Vac	240 Vac	480 Vac	600 Vac
1-Phase	2W, 3P	15HP	30HP	40HP	40HP
3-Phase	3W, 3P; 3W, 4P; or 4W, 4P	20HP	40HP	50HP	50HP

① Adapters for #4-#1 wire available, see Powertite™ 200 and 400 Amp Replacement Parts.

② For additional mounting boxes, see Aluminum Mounting Boxes.

③ Receptacle meets NEMA 3R with spring door closed and NEMA 3, 3R, 4, 4X with plug fully inserted and wing nuts fully tightened or cover closed with wing nuts fully tightened.

Powertite™ 200 Amp Pin and Sleeve Plugs, Connectors and Receptacles

600 Vac, 250 Vdc, 50-400 Hz. Clamp Cover. Wire Recess Diameter: .687". Wire Size Range: 250 MCM-#2/0. Pressure Wire Terminals ①.

NEC/CEC:
Listed for Ordinary (Unclassified) Locations
NEMA 3, 3R, 4, 4X



Grounding Style	Wire/Pole	Receptacle with AJA Mounting Box ①	Hub Size (Inches)	Receptacle Only ②	Connector Body Only	Plug Only ③	Cable Dia. (Inches)	
Style 1 (Shell Only)	3W, 3P	AJA20033-150	1-1/2	AR20033	ARC20033CD	AP20033CD	.875 to 1.906	
		AJA20033-200	2		ARC20033E	AP20033E	1.875 to 2.500	
	4W, 4P	AJA20044-200	2	AR20044	ARC20044CD	AP20044CD	.875 to 1.906	
		AJA20044-250	2-1/2		ARC20044E	AP20044E	1.875 to 2.500	
Style 2 (Shell and Extra Pole)	2W, 3P	AJA20023-150	1-1/2	AR20023	ARC20023CD	AP20023CD	.875 to 1.906	
		AJA20023-200	2		ARC20023E	AP20023E	1.875 to 2.500	
	3W, 4P	AJA20034-150	1-1/2	AR20034	ARC20034CD	AP20034CD	.875 to 1.906	
		AJA20034-200	2		ARC20034E	AP20034E	1.875 to 2.500	
			AJA20034-250	2-1/2			ARC20034E	1.875 to 2.500

For Reverse Service add suffix **-RS** to Catalog Number.
For Special Polarization, add suffix **-P4** to Catalog Number.

Pin and Sleeve Design

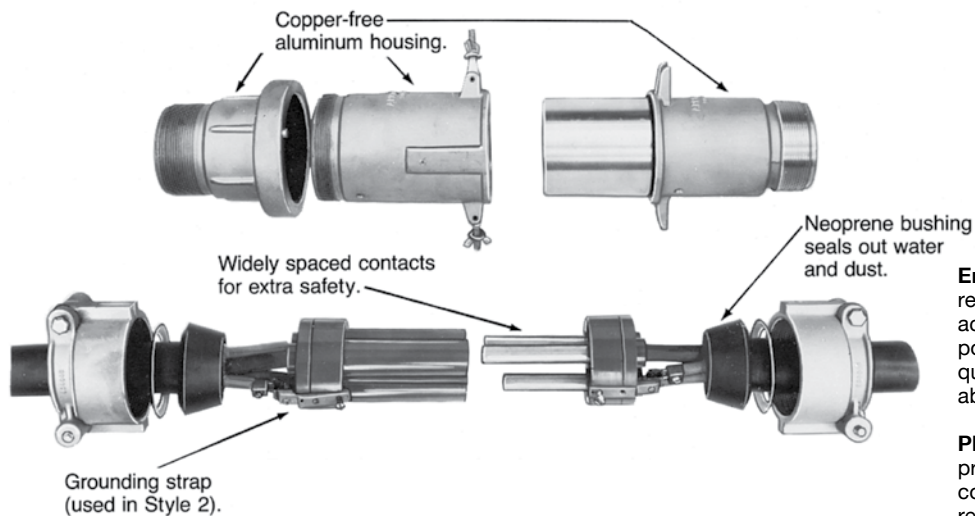

Energized contacts deeply recessed to reduce danger of accidental touching, minimize possibility of exposed arcs. Insulator quenches arcing, and is resistant to abnormal heat and to fire.

Plug mechanical cable clamps provide strain relief at conductor connections, allow easy cable replacement.

Note: Adapters for #4-#1 wire available, see Powertite™ 200 and 400 Amp Replacement Parts.

① For additional mounting boxes, see Aluminum Mounting Boxes.

② Receptacle meets NEMA 3, 3R, 4, 4X with plug fully inserted and wing nuts fully tightened or clamp cover installed with wing nuts fully tightened.

③ Plug and connector body combination is NEMA 4X rated when wing nuts are fully tightened on connector body.

Powertite™ 400 Amp Pin and Sleeve Plugs and Receptacles

Weatherproof

600 Vac, 250 Vdc, 50-400 Hz. Clamp Cover. Wire Recess Diameter: .84" or 1.25". Wire Size Range: 400MCM—1000MCM. Solder Wire Terminals.

NEC/CEC:

Listed for Ordinary (Unclassified) Locations
NEMA 4 – Optional

PLUGS AND RECEPTACLES: NEC/CEC ORDINARY LOCATION

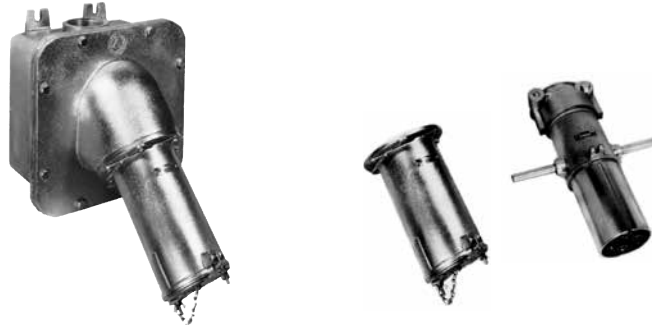

Wire Recess Dia. (Inches)	Grounding Style	Wire/Pole	Receptacle with AJA Mounting Box ②	Hub Size (Inches) ③	Receptacle Only ②	Plug Only	Cable Dia. (Inches)
0.84 ①	Style 1 (Shell Only)	3W, 3P	AJA40033-400	4	AR40033	AP40033E	1.875 to 2.500
		4W, 4P	AJA40044-400		AR40044	AP40044E	1.875 to 2.500
		4W, 4P	AJA40044-400N4		AR40044N4	AP40044E	1.875 to 2.500
	Style 2 (Shell and Extra Pole)	2W, 3P	AJA40023-400	4	AR40023	AP40023E	1.875 to 2.500
		3W, 4P	AJA40034-400		AR40034	AP40034E	1.875 to 2.500
		3W, 4P	AJA40034-400N4		AR40034N4	AP40034E	1.875 to 2.500
1.25	Style 1 (Shell Only)	3W, 3P	AJA40133-400	4	AR40133	AP40133F	2.500 to 3.000
		4W, 4P	AJA40144-400		AR40144	AP40144F	2.500 to 3.000
		4W, 4P	AJA40144-400N4		AR40144N4	AP40144G	3.000 to 3.500
	Style 2 (Shell and Extra Pole)	2W, 3P	AJA40123-400	4	AR40123	AP40123F	2.500 to 3.000
		3W, 4P	AJA40134-400		AR40134	AP40134F	2.500 to 3.000
		3W, 4P	AJA40134-400N4		AR40134N4	AP40134G	3.000 to 3.500
		3W, 4P	AJA40134-400N4		AR40134N4	AP40134G	3.000 to 3.500
		3W, 4P	AJA40134-400N4		AR40134N4	AP40134G	3.000 to 3.500
		3W, 4P	AJA40134-400N4		AR40134N4	AP40134G	3.000 to 3.500

Solder wire terminals standard on all models.

For Reverse Service add suffix **-RS** to Catalog Number.

For Special Polarization add suffix **-P4** to Catalog Number.

Note: Box can be turned for vertical or horizontal mountin=g.

Maximum Conductor Size

400 Amp not horsepower rated. Plug is for disconnecting use only — not for current rupturing.

Solder Recess Dia. (Inches)	Conductor Size	Max. Strand	Type Conductor
0.84	500 MCM	37	General Wire
	400 MCM	259	Flexible Cable
	400 MCM	427	Extra Flexible Cable
1.25	1000 MCM	61	General Wire
	900 MCM	427	Flexible Cable
	800 MCM	703	Extra Flexible Cable

① Pressure terminal kits available for .84 wire recess size only to convert solder terminal to pressure terminal. See Replacement Parts page.

② 400 Amp versions with the **-N4** suffix are NEMA 4 rated.

③ Has feed-thru 4" tapped openings. Supplied with one 4" to 3" reducer and one 4" close-up plug.

Powertite™ 400 Amp Pin and Sleeve Connectors and Plugs

Weatherproof

600 Vac, 250 Vdc, 50-400 Hz. Wire Recess Diameter: .84" or 1.25". Wire Size Range: 400MCM—1000MCM. Solder Wire Terminals.

NEC/CEC:
Listed for Ordinary (Unclassified) Locations
NEMA 4 – Optional



PLUGS AND RECEPTACLES: NEC/CEC ORDINARY LOCATION

Wire Recess Dia. (Inches)	Grounding Style	Wire/Pole	Connector Body Only	Plug Only	Cable Dia. (Inches)
0.84 ②	Style 1 (Shell Only)	3W, 3P	ARC40033E	AP40033E	1.875 to 2.500
		4W, 4P	ARC40044E	AP40044E	1.875 to 2.500
	Style 2 (Shell and Extra Pole)	2W, 3P	ARC40023E	AP40023E	1.875 to 2.500
		3W, 4P	ARC40034E	AP40034E	1.875 to 2.500
1.25	Style 1 (Shell Only)	3W, 3P	ARC40133F	AP40133F	2.500 to 3.000
			ARC40133G	AP40133G	3.000 to 3.500
		4W, 4P	ARC40144F	AP40144F	2.500 to 3.000
	Style 2 (Shell and Extra Pole)		ARC40144G	AP40144G	3.000 to 3.500
		2W, 3P	ARC40123F	AP40123F	2.500 to 3.000
			ARC40123G	AP40123G	3.000 to 3.500
		3W, 4P	ARC40134F	AP40134F	2.500 to 3.000
			ARC40134G	AP40134G	3.000 to 3.500

Solder wire terminals standard on all models.
For Reverse Service add suffix **-RS** to Catalog Number.
For Special Polarization add suffix **-P4** to Catalog Number.

Pin and Sleeve Design

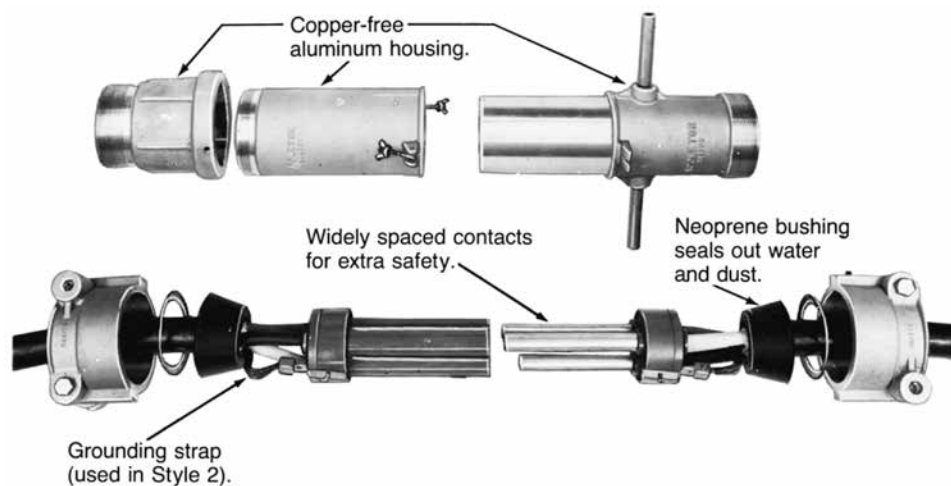

Energized contacts deeply recessed to reduce danger of accidental touching, minimize possibility of exposed arcs. Insulator quenches arcing, and is resistant to abnormal heat and to fire.

Plug mechanical cable clamps provide strain relief at conductor connections, allow easy cable replacement.

② Pressure terminal kits available for .84 wire recess size only to convert solder terminal to pressure terminal. See Replacement Parts page.

Powertite™ 200 and 400 Amp Pin and Sleeve Connectors and Plugs

Mounting Boxes and Replacement Interiors. 600 Vac, 250 Vdc, 50-400 Hz.

NEC/CEC — 200 Amp:
Listed for Ordinary (Unclassified) Locations
NEMA 3, 3R, 4, 4X

NEC/CEC — 400 Amp:
Listed for Ordinary (Unclassified) Locations
NEMA 4 — Optional

200 Amp Mounting Boxes and Angle Adapter



Hub Size (Inches)	AJB	AJA	AJAC (Feed-Thru)	AJA200 (Angle Adapter Only)
1-1/2 NPT	—	AJA520	—	AJA200
2 NPT	AJB620	AJA620	—	AJA200
2-1/2 NPT	—	AJA720	AJAC720	AJA200
2-3/8 (Slip Hole)	AJB238	—	—	—

400 Amp Mounting Box and Angle Adapter



Hub Size (Inches)	AJAC ①	AJA400 (Angle Adapter Only)
4	AJAC400	AJA400

200 Amp Interiors ②



Grounding Style	Wire/Pole	Receptacle	Plug	Receptacle	Plug
Style 1 (Shell Only)	3W, 3P	ARI20033	API20033	—	—
	4W, 4P	ARI20044	API20044	—	—
Style 2 (Shell and Extra Pole)	2W, 3P	—	—	ARI20023	API20023
	3W, 4P	—	—	ARI20034	API20034

400 Amp Interiors ②



Wire Recess Dia. (Inches)	Grounding Style	Wire/Pole	Receptacle	Plug	Receptacle	Plug
.84	Style 1 (Shell Only)	3W, 3P	ARI40033	API40033	—	—
		4W, 4P	ARI40044	API40044	—	—
	Style 2 (Shell and Extra Pole)	2W, 3P	—	—	ARI40023	API40023
		3W, 4P	—	—	ARI40034	API40034
1.25	Style 1 (Shell Only)	3W, 3P	ARI40133	API40133	—	—
		4W, 4P	ARI40144	API40144	—	—
	Style 2 (Shell and Extra Pole)	2W, 3P	—	—	ARI40123	API40123
		3W, 4P	—	—	ARI40134	API40134

② Has feed-thru 4" tapped openings. Supplied with one 4" to 3" reducer and one 4" close-up plug.

③ Pins and sleeves are not sold separately.

PLUGS AND RECEPTACLES: NEC/CEC ORDINARY LOCATION







Appleton®

Powerlite™ 200 and 400 Amp Replacement Parts

600 Vac, 250 Vdc, 50-400 Hz.

NEC/CEC — 200 Amp:
Listed for Ordinary (Unclassified) Locations
NEMA 3, 3R, 4, 4X

NEC/CEC — 400 Amp:
Listed for Ordinary (Unclassified) Locations
NEMA 4 — Optional

	Description	Catalog Number
Receptacle Covers		
	Spring Cover — Includes Gasket	
	200 Amp — 2- and 3-Pole	PTLC200A
	200 Amp — 4-Pole	PTLC200B
Clamping Cover — Includes Gasket and Chain		
	200 Amp — 2- and 3-Pole	PTBC200A
	200 Amp — 4-Pole	PTBC200B
	400 Amp — 2- and 3-Pole	PTBC400A
	400 Amp — 4-Pole	PTBC400B
Bushing Bags for Plugs and Cable Connectors		
	200 Amp - Suffix CD	PTGBCD
	200 Amp - Suffix E	PTGB200E
	400 Amp - Suffix E	PTGB400E
	400 Amp - Suffix F	PTGB400F
	400 Amp - Suffix G	PTGB400G
Receptacle Lockout Device		
	Lockout, 200 Amp 3- and 4-Pole Models	PTLOCK2004
	Lockout, 400 Amp 4-Pole Models	PTLOCK4004
Optional Accessory for Wire Size #1 to #4		
<i>Check National Electrical Code for proper wire size and application.</i>		
	200 Amp, 3-Pole Wire Adapter Kit	PTK200WA3
	200 Amp, 4-Pole Wire Adapter Kit	PTK200WA4
400 Amp Pressure Terminal Kits		
	Use with 400-500 MCM Wire 0.84" I.D. Wire Recess	
	3 Adapters	PTK84-3P
	4 Adapters	PTK84-4P
	Use With 750 MCM General Wire or 500-777 MCM Flexible Wire 1.18" I.D. Wire Recess	
	3 Adapters	PTK750-3P
	4 Adapters	PTK750-4P

PLUGS AND RECEPTACLES: NEC/CEC ORDINARY LOCATION



Powertite™ 200 Amp Mounted Receptacle

600 Vac, 250 Vdc, 50-400 Hz.

NEC/CEC:

Listed for Ordinary (Unclassified) Locations
NEMA 3, 3R, 4, 4X

Dimensions in Millimeters (Inches)

Receptacle Mounted on AJA and AJAC Boxes

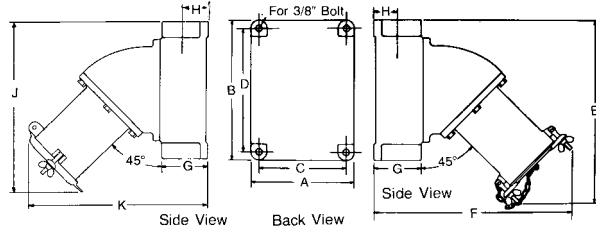

Dimensions in Millimeters (Inches)

A	B	C	D	E	F	G	H	J	K
203.2 (8.00)	273.0 (10.75)	171.4 (6.75)	241.3 (9.50)	355.6 (14.00)	387.3 (15.25)	95.2 (3.75)	47.7 (1.88)	342.9 (13.50)	361.9 (14.25)

Receptacle

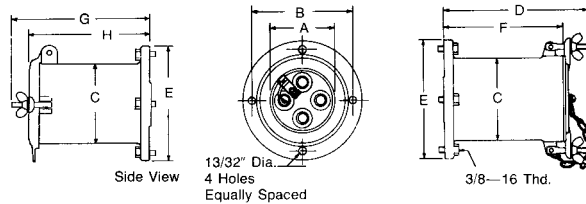

Dimensions in Millimeters (Inches)

No. Poles	A	B	C	D	E	F	G	H
3	82.5 (3.25)	143.0 (5.63)	10.46 (4.19)	203.2 (8.00)	168.4 (6.63)	166.6 (6.56)	170.1 (6.70)	179.0 (7.05)
4	92.2 (3.63)	143.0 (5.63)	115.8 (4.56)	203.2 (8.00)	168.4 (6.63)	166.6 (6.56)	170.1 (6.70)	179.0 (7.05)

PLUGS AND RECEPTACLES: NEC/CEC ORDINARY LOCATION

Appleton

Powertite™ 200 Amp Connector, Plug and Adapter

600 Vac, 250 Vdc, 50-400 Hz.

NEC/CEC:

Listed for Ordinary (Unclassified) Locations
NEMA 3, 3R, 4, 4X

Dimensions in Millimeters (Inches)

Connector Body

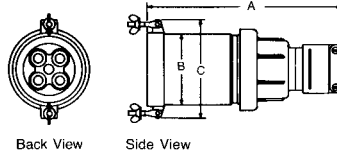

No. Poles	Dimensions in Millimeters (Inches)		
	A	B	C
3	330.2 (13.00)	106.4 (4.19)	136.6 (5.38)
4	330.2 (13.00)	115.8 (4.56)	146.0 (5.75)

Plug

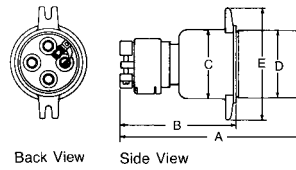

No. Poles	Dimensions in Millimeters (Inches)				
	A	B	C	D	E
3	303.2 (11.94)	198.3 (7.81)	96.7 (3.81)	95.2 (3.75)	163.5 (6.44)
4	303.2 (11.94)	198.3 (7.81)	106.4 (4.19)	104.95 (4.13)	172.9 (6.81)

AJA200 Angle Adapter

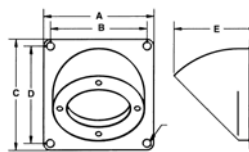

Dimensions in Millimeters (Inches)				
A	B	C	D	E
203.2 (8.0)	177.8 (7.0)	203.2 (8.0)	177.8 (7.0)	152.4 (6.0)

PLUGS AND RECEPTACLES: NEC/CEC ORDINARY LOCATION



Powertite™ 400 Amp Mounted Receptacle and Receptacle

600 Vac, 250 Vdc, 50-400 Hz.

NEC/CEC:
Listed for Ordinary (Unclassified) Locations
NEMA 4 – Optional

Dimensions in Millimeters (Inches)

Receptacle Mounted on AJAC Box

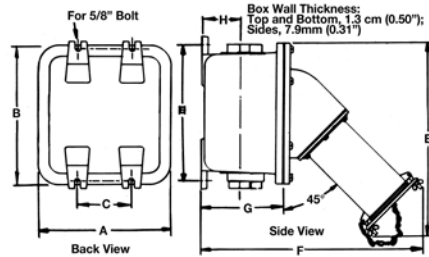

Hub Size ①	Dimensions in Millimeters (Inches)							
	A	B	C	D	E	F	G	H
4.00/10.16	403.3 (15.88)	403.3 (15.88)	165.1 (6.50)	384.3 (15.13)	558.8 (22.00)	615.9 (24.25)	215.9 (8.50)	98.5 (3.88)

Receptacle

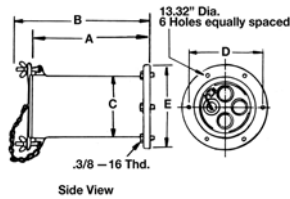

No. Poles	Dimensions in Millimeters (Inches)					
	A	B	C	D	E	F
3	285.7 (11.25)	311.1 (12.25)	130.3 (5.13)	171.4 (6.75)	196.8 (7.75)	106.4 (4.19)
4	285.7 (11.25)	311.1 (12.25)	143.0 (5.63)	171.4 (6.75)	196.8 (7.75)	119.1 (4.69)

① AJAC box has feed-thru 101.6 mm (4") openings. Supplied with one 101.6 mm (4") to 76.2 mm (3") reducer, and one 101.6 mm (4") close-up plug.

Powertite™ 400 Amp Connector and Plug

600 Vac, 250 Vdc, 50-400 Hz.

NEC/CEC:

Listed for Ordinary (Unclassified) Locations
NEMA 4 – Optional

Dimensions in Millimeters (Inches)

Plug

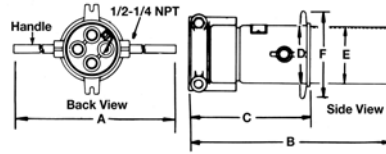

No. Poles	Dimensions in Millimeters (Inches)					
	A	B	C	D	E	F
3	381.0 (15.00)	482.6 (19.00)	285.7 (11.25)	119.3 (4.70)	118.3 (4.66)	190.5 (7.50)
4	393.7 (15.50)	482.6 (19.00)	285.7 (11.25)	131.8 (5.19)	131.0 (5.16)	203.2 (8.00)

Connector Body

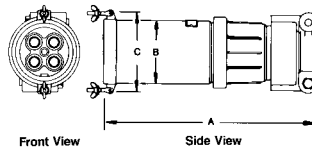

No. Poles	Dimensions in Millimeters (Inches)		
	A	B	C
3	482.6 (19.00)	130.3 (5.13)	184.1 (7.25)
4	482.6 (19.00)	143.0 (5.63)	196.8 (7.75)

PLUGS AND RECEPTACLES: NEC/CEC ORDINARY LOCATION



ASR Nonmetallic Interlocked Receptacles

With Enclosed Disconnect Switch

600 Vac, 30 and 60 Amp, Fused and Non-Fused

NEC/CEC:
NEMA 4X, 12

Applications

- For use where an interlocked disconnect switch is desired to control a Powertite™ receptacle and removal of the plug. Interlock prohibits plug insertion or removal under load. Plug is secured in place by interlock and cannot be withdrawn unless interlock switch is actuated.
- Designed for use in hose-down areas, damp or corrosive locations, raintight or watertight non-hazardous applications.
- For heavy duty applications where a service outlet is required for portable or fixed electrical equipment such as:
 - Welders
 - Generators
 - Compressors
 - Infrared ovens
 - Batch feeders
 - Conveyors
 - Truck terminals
 - Marine docks
- Ideally suited for use in industrial plant applications such as:
 - Automotive and steel processing plants
 - Pulp and paper processing plants
 - Milk processing plants and creameries
 - Fabrication yards and shipyards
 - Refrigerated truck terminals
- Suitable for use as a motor disconnect.



NEC/CEC Certifications and Compliances

- UL Standard: UL 98, UL 1682, and UL 1686
- UL Listed: E304212
- CSA Standard: CSA 22.2 No. 4, C22.2 No. 182.1
- cUL Listed: E160652

Related Products

- Uses standard Powertite™ ACP and NACP plugs for wide acceptability.

Features

- Moveable mounting feet allow for installation on irregular surfaces for easy installation.
- Internal mounting tubes where mounting area is limited.
- Hidden hinge system eliminates sanitation concerns.
- The switch is the latest in technology utilizing self-cleaning contacts and driven by a solid bridge bar to prevent single phasing of motors. The quick make/break action provides long electrical life.
- Meets OSHA requirements for lockout/tagout (Reg. 1910.147). Switch can be locked in the "OFF" position.
- Utilizes Style 2 (shell and extra pole) grounding and 3-wire, 4-pole receptacle wiring.
- Available in fused or non-fused using the same compact enclosure.
- Class J fusing standard on fusible units (100 kAIC short circuit protection at the load source).
- Removable fuse holders allow for installation and replacement of fuse away from interior of unit (fuses not supplied).
- Supplied conduit hub can be installed on top or bottom of the enclosure. Hub sizes: 1.0" 30 Amp, 1.25" 60 Amp.
- Dead front design: Receptacle is not energized until plug is fully inserted and switch is engaged.
- IP66 Suitable.
- UL04 – 5V Flame Rating.

Standard Materials

- Enclosure: VALOX® ① thermoplastic polyester with seamless form in place gasket
- Screws: stainless steel screws for outstanding corrosion resistance
- Materials are UV stabilized

① Valox is a registered trademark of General Electric Co.

Classified by UL for use in specific combinations with Crouse-Hinds. Arkite is a registered trademark of Cooper Crouse-Hinds.

ASR Nonmetallic Interlocked Receptacles



With Enclosed Disconnect Switch

600 Vac, 30 and 60 Amp, Fused and Non-Fused

NEC/CEC:
NEMA 4X, 12

	Amp	Type	Config.	Catalog Number
	30	Non-Fused	3W 4P	ASR3034
		Fused		ASR3034F
	60	Non-Fused	3W 4P	ASR6034
		Fused		ASR6034F

Mating Powertite™ Plug

	Type	Amp	AWG	Cable Range (inches)	Style of Cable	Config.	Mating Plug
	Non-Metallic	30	12-6	.45-1.12 O.D.	G,W,S, SO and STO	3W 4P	NMACP3034BC
		60	8-4	.50-1.45 O.D.			NMACP6034BC
	Metallic	30	12-6	.45-1.12 O.D.	G,W,S, SO and STO	3W 4P	ACP3034BC
		60	8-4	.50-1.45 O.D.			ACP6034BC

Optional Auxiliary Contacts

Amps	Interlock Type	Fusible Catalog Number	Non-Fusible Catalog Number
30	1 N/O, 1 N/C	ASR30FDAUX	ASR30AUX
60	1 N/O	ASR60FDAUX-O	ASR60AUX
60	1 N/C	ASR60FDAUX-C	N/A

Replacement Parts

	Description	Catalog Number
	30 Amp Cover	PTTC30
	60 Amp Cover	PTTC60B

Horsepower Ratings

Amp		Fusible — Single Phase				Non-Fused — Single Phase			
		208 Vac	240 Vac	480 Vac	600 Vac	208 Vac	240 Vac	480 Vac	600 Vac
30	Standard	—	1.5	3	—	5	5	10	10
	Maximum	5	5	7.5	—	—	—	—	—
60	Standard	—	3	5	—	10	10	20	30
	Maximum	7.5	7.5	15	—	—	—	—	—

Amp		Fusible — Three Phase				Non-Fused — Three Phase			
		208 Vac	240 Vac	480 Vac	600 Vac	208 Vac	240 Vac	480 Vac	600 Vac
30	Standard	—	3	5	7.5	10	10	20	20
	Maximum	7.5	7.5	15	20	—	—	—	—
60	Standard	7.5	7.5	15	15	20	20	40	50
	Maximum	15	15	30	50	—	—	—	—

ASR Nonmetallic Interlocked Receptacles

With Enclosed Disconnect Switch

600 Vac, 30 and 60 Amp, Fused and Non-Fused

NEC/CEC:
NEMA 4X, 12

ASR Receptacle Dimensions in Millimeters (Inches)

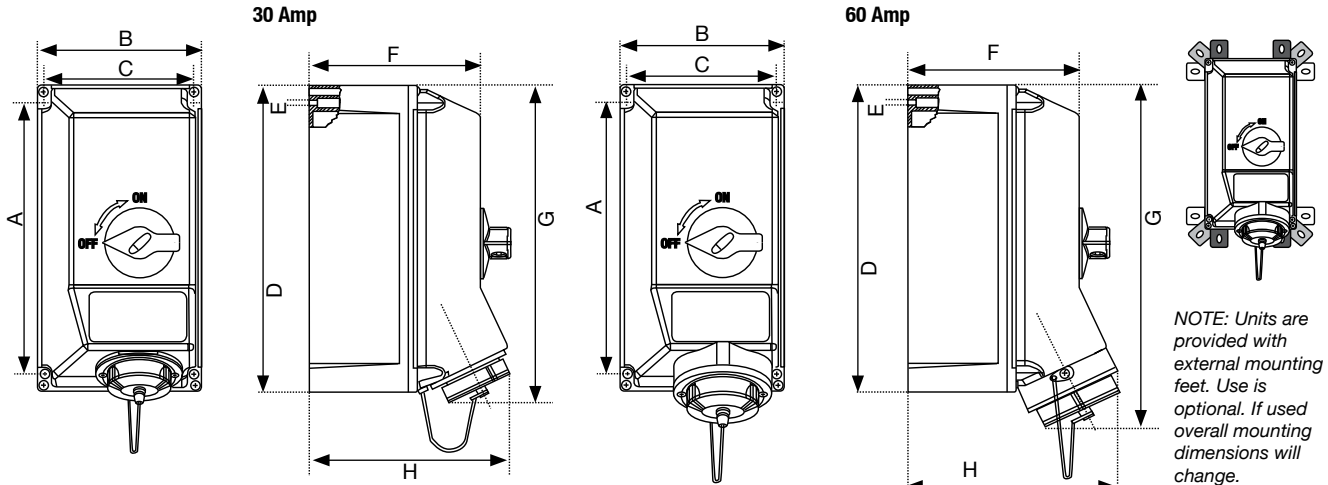

Amp	A	B	C	D	E	F	G	H
30	292.1 (11.50)	177.8 (7.0)	161.0 (6.34)	330.2 (13.00)	4.57 (0.18)	183.6 (7.23)	341.8 (13.46)	214.6 (8.45)
60	292.1 (11.50)	177.8 (7.0)	161.0 (6.34)	330.2 (13.00)	4.57 (0.18)	183.6 (7.23)	367.0 (14.45)	226.8 (8.93)

NMACP Plug Dimensions in Millimeters (Inches)

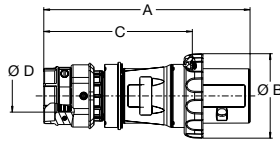

Amp	No. Poles	A	B	C	D Minimum	D Maximum
30	4	187.0 (7.36)	63.0 (2.48)	145.0 (5.71)	11.0 (0.43)	24.5 (0.97)
60	4	245.0 (9.65)	3.94 (100.0)	174.0 (6.85)	14.5 (0.57)	36.0 (1.42)

ACP Plug Dimensions in Millimeters (Inches)

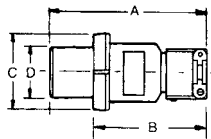

Amp	No. Poles	A	B	C	D
30	2,3,4	152.4 (6.00)	120.6 (4.75)	79.5 (3.13)	47.2 (1.86)
60	2,3	198.3 (7.81)	125.4 (4.94)	88.9 (3.50)	56.6 (2.23)
60	4	198.3 (7.81)	125.4 (4.94)	96.7 (3.81)	64.7 (2.55)

PLUGS AND RECEPTACLES: NEC/CEC ORDINARY LOCATION

Appleton®

WSR Interlocked Receptacle

With Enclosed Disconnect Switch

600 Vac, 250 Vdc, 30, 60, 100 Amp, 50/60 Hz, Fused and Non-fused for use with Powertite™ ACP and CPH plugs.

NEC/CEC :
NEMA 3, 3R, 4, 4X, 12

Applications

- Designed for use in raintight or watertight, non-hazardous, heavy duty applications where a service outlet is required for portable or fixed electrical equipment such as:
 - Welders
 - Generators
 - Compressors
 - Infrared ovens
 - Batch feeders
 - Conveyors
 - Truck terminals
 - Marine docks
- Ideally suited for use in industrial plant applications such as:
 - Automotive and steel processing plants
 - Pulp and paper processing plants
 - Milk processing plants and creameries
 - Fabrication yards and shipyards
 - Refrigerated truck terminals

Features

- For use where an interlocked disconnect switch is desired to control a Powertite™ receptacle and insertion or removal of plug. Interlock prohibits plug insertion or removal under load. Plug is secured in place by interlock and cannot be withdrawn unless interlock release lever is actuated.
- Spring door standard and screw cap provided at no additional cost to meet NEMA 3, 3R, 4, 4X applications.
- The Square D ■ F-Series offers the latest in switch technology: An operating mechanism designed to endure at least three times the number of operations required by NEMA and UL standards; modular componentry designed for quick and easy maintenance; and visible blades for an extra measure of safety while the low mass cam allows greater blade operating speed and reduced mechanical wear.
- Insulated, dual-color polymer operating handle clearly indicates the switch being energized. Ergonomically designed handle is made of high-impact polymer material for exceptional ruggedness, durability and corrosion resistance ◀.
- Utilizes Style 2 (shell and extra pole) grounding and 3-wire, 4-pole receptacle wiring.
- Removable hinged cover allows for ease of installation and maintenance.
- Class J fusing standard on WSR. Product can be retrofitted with Class J, K, or S fusing.
- Short circuit withstand rated to 200,000 RMS symmetrical Amps (Class R and J Fusing).
- Stainless Steel captive spring out quad lead cover bolts for easy access and corrosion resistance.
- Conduit entry is drilled and tapped to 1-1/2". Reducer bushings 1-1/2" – 1-1/4" and 1-1/2" – 1" provided at no additional cost.
- Stainless steel key-hole mounting feet for easy installation.
- Unit is equipped with defeatable door interlock which allows emergency access when switch is energized.
- Cover can be padlocked closed.
- Operating handle can be locked in the "OFF" or "ON" position.
- Dead front design: receptacle is not energized until plug is fully inserted and switch is engaged.
- Wire size for 30 and 60 Amp models is #14 to #2 AWG. For 100 Amp models it is #14 to #1/0 AWG.

■ Square D is a registered trademark of Schneider Electric.

◀ Cutler Hammer models have metallic handles. Cutler Hammer is a registered trademark of Eaton Corporation.
UL Classified for use with Crouse-Hinds Arktite® plugs. Arktite is a registered trademark of Cooper Crouse-Hinds.



WSR Cast Aluminum Enclosure

Standard Materials and Finishes

- Receptacle assembly: copperfree (4/10 of 1% max.) aluminum with epoxy powder coating inside and outside
- WSR enclosure: copperfree aluminum with epoxy powder coating inside and outside
- Operating handle ◀: high impact polymer
- WSR hardware: stainless steel

Options

- Special polarization prevents plug insertion in a receptacle wired for a different voltage. In installations where there are different line voltages, the special polarization option is desirable. This allows only plugs and receptacles wired for the same line voltage to be mated together. The receptacle interior is positioned 22-1/2°, relative to the polarization rivet, to the right (as specified) of standard, and plug is polarized to correspond. Add suffix -P4 to the standard receptacle.
- Reverse Service: useful where a "hot" plug feeds a dead receptacle. Reverse service is often used for generator applications where the receptacle houses a dead plug interior. Plug houses an energized receptacle interior, which has recessed male contacts to reduce danger of accidental touching. Add suffix -RS to receptacle or connector.

NEC/CEC Certifications and Compliances

- UL Standard: UL 98, UL 50E, UL 1682, UL 1686
- UL Listed: E145917, E160652
- CSA Standard: C22.2 No.4, C22.2 No. 182.1
- CSA Certified: 025875

Related Products

- Uses standard Powertite™ ACP or CPH plugs for wide acceptability.

WSR Interlocked Receptacle

With Enclosed Disconnect Switch

600 Vac, 250 Vdc, 30, 60, 100 Amp, 50/60 Hz, Fused and Non-fused for use with Powertite™ ACP and CPH plugs.

NEC/CEC :
NEMA 3, 3R, 4, 4X, 12

PLUGS AND RECEPTACLES: NEC/CEC ORDINARY LOCATION

Amp	Wire Size AWG	Fusing ①	HP at 600 Vac Std/Max 3-Phase	Without Viewing Window	With Viewing Window	Aux. Contacts ② 1 or 2 NO/NC		Mating Plug
Cast Aluminum Enclosure — NEMA 3, 3R, 4, 4X, 12 *								
30	#14 to #2	Fused	7.5/20	WSR3352	N/A	WSAUX1	WSAUX2	ACP3034BC
		Non-Fused	30	WSR33542	N/A	WSAUX1	WSAUX2	ACP3034BC
60	#6 to #2	Fused	15/50	WSR6352	N/A	WSAUX1	WSAUX2	ACP6034BC
		Non-Fused	60	WSR63542	N/A	WSAUX1	WSAUX2	ACP6034BC
100	#4 to #1/0	Fused	30/75	WSR10352	N/A	WSAUX1	WSAUX2	ACP1034CD
		Non-Fused	75	WSR103542	N/A	WSAUX1	WSAUX2	ACP1034CD

Square D Auxiliary Contacts for WSR Disconnect Switch †

Interlock Type	50 or 60 Hz Vac	Make	Break	Cont.	Vdc	Make and Break	Cont.	Catalog Number
1 NO/1 NC CONTACT	120	40A	15A	15A	115	0.50A	15A	WSAUX1
	240	20A	10A	15A	230	0.25A	15A	
	480	10A	6A	15A	—	—	—	
	600	8A	5A	15A	600	0.05A	15A	
2 NO/2 NC CONTACTS	120	30A	3.0A	10A	115	1.0A	10A	WSAUX2
	240	15A	1.5A	10A	230	0.30A	10A	
	480	7.5A	.75A	10A	—	—	—	
	600	6.0A	.60A	10A	600	0.10A	10A	

① Fuses not included in fused products. Class J Type on WSR. Product can be retrofitted with Class J, K, or S fusing.

② To order with auxiliary contacts installed, add suffix from this column to end of Catalog Number.

■ Standard Square D F-Series Disconnect Switch, except where noted.

♦ Cutler Hammer Disconnect Switch. Cutler Hammer auxiliary switch is 1 NO/1 NC or 2 NO/2 NC.

† Single pole single throw interlock kits are rated 1/2 HP @ 110 and 220 Vac. WSAUX1 utilizes a 9007A01 limit switch. WSAUX2 utilizes a 9007C03 limit switch.

WSR Interlocked Receptacle

With Enclosed Disconnect Switch

600 Vac, 250 Vdc, 30, 60, 100 Amp, 50/60 Hz, Fused and Non-fused for use with Powertite™ ACP and CPH plugs.

NEC/CEC:
NEMA 3, 3R, 4, 4X, 12

Dimensions in Millimeters (Inches)

WSR Interlocked Receptacle – with Enclosed Switch

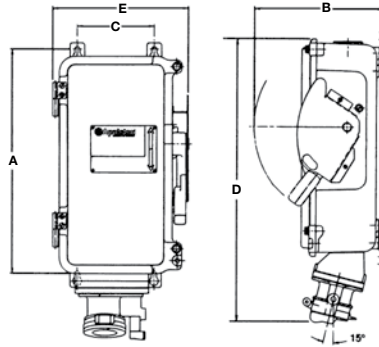

Catalog Number	Dimensions in Millimeters (Inches)				
	A	B	C	D	E
WSR3352, WSR33542, WSR6352 WSR63542, WSR103542	488.9 (19.25)	279.4 (11.00)	166.6 (6.56)	617.9 (24.33)	293.6 (11.56)
WSR10352	581.1 (22.88)	279.4 (11.00)	166.6 (6.56)	617.9 (24.33)	293.6 (11.56)

ACP Plug

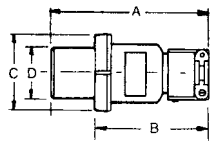

Amp	No. Poles	Dimensions in Millimeters (Inches)			
		A	B	C	D
30	2,3,4	152.4 (6.00)	120.6 (4.75)	79.5 (3.13)	47.2 (1.86)
60	4	198.3 (7.81)	125.4 (4.94)	96.7 (3.81)	64.7 (2.55)
100	4	266.7 (10.50)	168.4 (6.63)	107.9 (4.25)	69.0 (2.72)

PLUGS AND RECEPTACLES: NEC/CEC ORDINARY LOCATION

Appleton

WSRD Interlocked Receptacle

With Enclosed Disconnect Switch

600 Vac, 250 Vdc, 30, 60, 100 Amp, 50/60 Hz, Fused and Non-fused for use with Powertite™ ACP and CPH plugs.

NEC/CEC:

Rated for Ordinary (Unclassified) Locations

Applications

- Designed for use in raintight or watertight, non-hazardous, heavy duty applications where a service outlet is required for portable or fixed electrical equipment such as:
 - Welders
 - Generators
 - Compressors
 - Infrared ovens
 - Batch feeders
 - Conveyors
 - Truck terminals
 - Marine docks
- Ideally suited for use in industrial plant applications such as:
 - Automotive and steel processing plants
 - Pulp and paper processing plants
 - Milk processing plants and creameries
 - Fabrication yards and shipyards
 - Refrigerated truck terminals

Features

- For use where an interlocked disconnect switch is desired to control a Powertite™ receptacle and insertion or removal of plug. Interlock prohibits plug insertion or removal under load. Plug is secured in place by interlock and cannot be withdrawn unless interlock release lever is actuated.
- Spring door standard and screw cap provided at no additional cost to meet NEMA 3, 3R, 4, 4X applications.
- The Square D® F-Series offers the latest in switch technology: An operating mechanism designed to endure at least three times the number of operations required by NEMA and UL standards; modular componentry designed for quick and easy maintenance; and visible blades for an extra measure of safety while the low mass cam allows greater blade operating speed and reduced mechanical wear.
- Insulated, dual-color polymer operating handle clearly indicates the switch being energized. Ergonomically designed handle is made of high-impact polymer material for exceptional ruggedness, durability and corrosion resistance ◀.
- Utilizes Style 2 (shell and extra pole) grounding and 3-wire, 4-pole receptacle wiring.
- Class R fusing standard on WSRD units. Product can be retrofitted with Class J, K, or S fusing.
- Short circuit withstand rated to 200,000 RMS symmetrical Amps (Class R and J Fusing).
- Unit is equipped with defeatable door interlock which allows emergency access when switch is energized.
- Cover can be padlocked closed.
- Operating handle can be locked in the "OFF" or "ON" position.
- Dead front design: receptacle is not energized until plug is fully inserted and switch is engaged.
- Wire size for 30 and 60 Amp models is #14 to #2 AWG. For 100 Amp models it is #14 to #1/0 AWG.



WSRD (Cutler Hammer)
Sheet Metal Enclosure

WSRD (Square D)
Sheet Metal Enclosure

WSRD
Stainless Steel Enclosure

Standard Materials and Finishes

- Receptacle assembly: copperfree (4/10 of 1% max.) aluminum with epoxy powder coating inside and outside
- WSRD enclosure: enamel coated sheet metal
- WSRD-N4 enclosure: stainless steel
- Operating handle ◀: high impact polymer
- WSRD-N4 hardware: stainless steel

NEC/CEC Certifications and Compliances

- UL Standard: UL 98, UL 50E, UL 1682, UL 1686
- CSA Standard: C22.2 No.4, C22.2 No. 182.1

Related Products

- Uses standard Powertite™ ACP or CPH plugs for wide acceptability.

■ Square D is a registered trademark of Schneider Electric.

◀ Cutler Hammer models have metallic handles. Cutler Hammer is a registered trademark of Eaton Corporation.

UL Classified for use with Crouse-Hinds Arktite® plugs. Arktite is a registered trademark of Cooper Crouse-Hinds.

WSRD Interlocked Receptacle

With Enclosed Disconnect Switch

600 Vac, 250 Vdc, 30, 60, 100 Amp, 50/60 Hz, Fused and Non-fused for use with Powertite™ ACP and CPH plugs.

NEC/CEC :
Rated for Ordinary (Unclassified) Locations

Amp	Wire Size AWG	Fusing ①	HP at 600 Vac Std/Max 3-Phase	Without Viewing Window	With Viewing Window	Aux. Contacts ② 1 or 2 NO/NC		Mating Plug
Sheet Metal Enclosure — NEMA 3R, 12 *								
30	#14 to #2	Fused	7.5/20	WSRD3352SQ	WSRD3352WSQ	WSAUX1	WSAUX2	ACP3034BC
		Non-Fused	30	WSRD33542SQ	WSRD33542WSQ	WSAUX1	WSAUX2	ACP3034BC
60	#6 to #2	Fused	15/50	WSRD6352 *	N/A	WSRDAUX1	WSRDAUX2	ACP6034BC
		Non-Fused	60	WSRD63542 *	N/A	WSRDAUX1	WSRDAUX2	ACP6034BC
		Fused	15/50	WSRD6352SQ	WSRD6352WSQ	WSAUX1	WSAUX2	ACP6034BC
		Non-Fused	60	WSRD63542SQ	WSRD63542WSQ	WSAUX1	WSAUX2	ACP6034BC
100	#4 to #1/0	Fused	30/75	WSRD10352SQ	WSRD10352WSQ	WSAUX1	WSAUX2	ACP1034CD
		Non-Fused	75	WSRD103542SQ	WSRD103542WSQ	WSAUX1	WSAUX2	ACP1034CD
Stainless Steel Enclosure — NEMA 3, 3R, 4, 4X, 12 *								
30	#14 to #2	Fused	7.5/20	WSRD3352N4SD	WSRD3352N4WSD	WSAUX1	WSAUX2	ACP3034BC
		Non-Fused	20	WSRD33542N4SD	WSRD33542N4WSD	WSAUX1	WSAUX2	ACP3034BC
60	#6 to #2	Fused	15/50	WSRD6352N4SD	WSRD6352N4WSD	WSAUX1	WSAUX2	ACP6034BC
		Non-Fused	50	WSRD63542N4SD	WSRD63542N4WSD	WSAUX1	WSAUX2	ACP6034BC
100	#4 to #1/0	Fused	30/75	WSRD10352N4SD	WSRD10352N4WSD	WSAUX1	WSAUX2	ACP1034CD
		Non-Fused	75	WSRD103542N4SD	WSRD103542N4WSD	WSAUX1	WSAUX2	ACP1034CD

Square D Auxiliary Contacts for WSRD Disconnect Switch †

Interlock Type	50 or 60 Hz Vac	Make	Break	Cont.	Vdc	Make and Break	Cont.	Catalog Number
1 NO/1 NC CONTACT	120	40A	15A	15A	115	0.50A	15A	WSAUX1
	240	20A	10A	15A	230	0.25A	15A	
	480	10A	6A	15A	—	—	—	
	600	8A	5A	15A	600	0.05A	15A	
2 NO/2 NC CONTACTS	120	30A	3.0A	10A	115	1.0A	10A	WSAUX2
	240	15A	1.5A	10A	230	0.30A	10A	
	480	7.5A	.75A	10A	—	—	—	
	600	6.0A	.60A	10A	600	0.10A	10A	

① Fuses not included in fused products. Class R fusing standard on WSRD fusible units. Product can be retrofitted with Class J, K, or S fusing.

② To order with auxiliary contacts installed, add suffix from this column to end of Catalog Number.

■ Standard Square D F-Series Disconnect Switch, except where noted.

♦ Cutler Hammer Disconnect Switch. Cutler Hammer auxiliary switch is 1 NO/1 NC or 2 NO/2 NC.

† Single pole single throw interlock kits are rated 1/2 HP @ 110 and 220 Vac. WSAUX1 utilizes a 9007A01 limit switch. WSAUX2 utilizes a 9007C03 limit switch.

WSRD Interlocked Receptacle

With Enclosed Disconnect Switch

600 Vac, 250 Vdc, 30, 60, 100 Amp, 50/60 Hz, Fused and Non-fused for use with Powertite™ ACP and CPH plugs.

NEC/CEC:
Rated for Ordinary (Unclassified) Locations

Dimensions in Millimeters (Inches)

WSRD Interlocked Receptacle with Enclosed Switch – Square D – NEMA 12

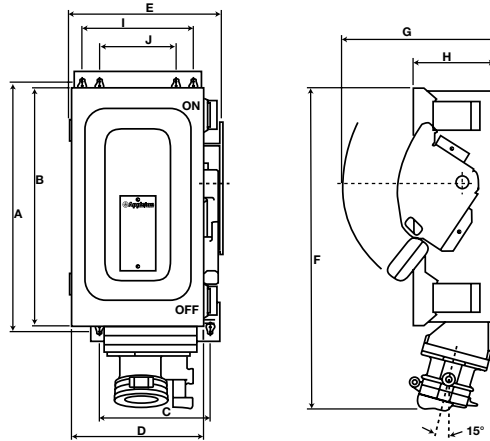

Dimensions in Millimeters (Inches)										
Amp	A	B	C	D	E	F	G	H	I	J
30 and 60	425.4 (16.75)	419.1 (16.50)	190.5 (7.50)	228.6 (9.0)	266.7 (10.50)	565.1 (22.25)	261.8 (10.31)	140.4 (5.53)	190.5 (7.50)	130.0 (5.12)
100	527.0 (20.75)	520.7 (20.50)	190.5 (7.50)	228.6 (9.0)	266.7 (10.50)	666.7 (26.25)	261.8 (10.31)	140.4 (5.53)	190.5 (7.50)	130.0 (5.12)

WSRD Interlocked Receptacle with Enclosed Switch – Square D – NEMA 4

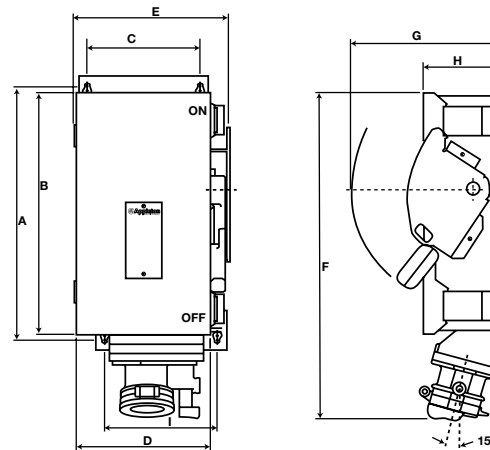

Dimensions in Millimeters (Inches)									
Amp	A	B	C	D	E	F	G	H	I
30 and 60	443.4 (17.46)	428.4 (16.87)	190.5 (7.50)	226.5 (8.92)	274.5 (10.81)	584.2 (23.0)	25.4 (10.00)	129.7 (5.11)	190.5 (7.50)
100	543.8 (21.41)	528.8 (20.82)	190.5 (7.50)	237.4 (9.36)	285.7 (11.25)	711.2 (28.0)	25.7 (10.13)	177.0 (6.97)	190.5 (7.50)

PLUGS AND RECEPTACLES: NEC/CEC ORDINARY LOCATION

Appleton®

WSRD Interlocked Receptacle

With Enclosed Disconnect Switch

600 Vac, 250 Vdc, 30, 60, 100 Amp, 50/60 Hz, Fused and Non-fused for use with Powertite™ ACP and CPH plugs.

NEC/CEC:
Rated for Ordinary (Unclassified) Locations

Dimensions in Millimeters (Inches)

WSRD Interlocked Receptacle – Cutler Hammer – NEMA 12

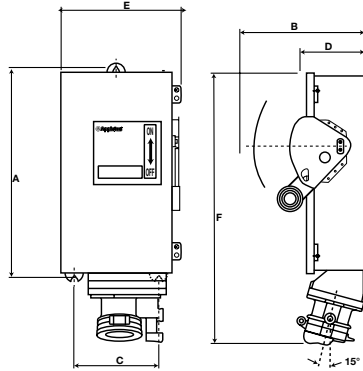

ACP Plug

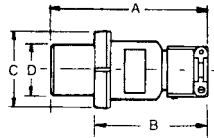

Amp	No. Poles	Dimensions in Millimeters (Inches)			
		A	B	C	D
30	2,3,4	152.4 (6.00)	120.6 (4.75)	79.5 (3.13)	47.2 (1.86)
60	4	198.3 (7.81)	125.4 (4.94)	96.7 (3.81)	64.7 (2.55)
100	4	266.7 (10.50)	168.4 (6.63)	107.9 (4.25)	69.0 (2.72)

PLUGS AND RECEPTACLES: NEC/CEC ORDINARY LOCATION

Appleton®

IDSR Interlocked Switched Receptacles

Weatherproof. Watertight.

With Breaker or Disconnect Switch, Fusible or Non-fusible. For use with Powertite™ ACP plugs.

CEC:

Listed for Ordinary (Unclassified) Locations
NEMA 3, 5 or 3, 4X, 5

Applications

- Used to supply power to portable and mobile electrical equipment in all indoor and outdoor non-hazardous locations.
- Used to provide short circuit protection to portable equipment when supplied with a circuit breaker or fused disconnect.
- Provides a convenient ON-OFF mechanism.
- Ideal for use in areas where dust, dirt or moisture is a problem.
- Suitable for use in:
 - Chemical plants
 - Process facilities
 - Meat packing plants
 - Other manufacturing industries
- Provides high amperage power to heavy equipment such as:
 - Motor-generator sets
 - Compressors
 - Heating and cooling units
 - Welders
 - Conveyors

Features

- Receptacles are provided with a safety-interlock system. Plugs cannot be inserted or removed unless the power switch is in the "OFF" position.
- The Safety-Interlock is designed to free both hands for insertion and removal of the plug.
- A cover interlock is provided to prevent entry to the enclosure while the operator is in the "ON" position.
- Uses standard Powertite™ ACP or CPH plugs for wide acceptability.
- Furnished with rugged cast aluminum housings.
- Receptacle with standard spring door cover is NEMA 3 and 5, when used with supplied screw cover it is NEMA 3, 4x and 5.
- Receptacles with 3 phase 4 wire grounded receptacles are pre-wired to the breaker or disconnect switch.
- Patented brass receptacle contacts exert constant pressure for good electrical continuity.
- Appleton's insulating blocks provide the greatest dielectric and mechanical strength.
- Ergonomically designed yet rugged cast aluminum handle for exceptional durability and corrosion resistance.
- 600 Vac FB Circuit Breakers.
- Provision is made for locking the operating mechanism in the "OFF" position.

Standard Materials

- Enclosure and Receptacle: cast copperfree (4/10 of 1% max.) aluminum

Standard Finish

- Epoxy powder coat.

Options

- One normally opened, one normally closed auxiliary switch, add suffix **-AUX**.
- Lockable cover latch add suffix **-DL**.
- LED Indicator Lights: one light indicates power unit and other indicates switch is in "ON" position add suffix **-IL**.
- Supplied with viewing window add suffix **-W**.

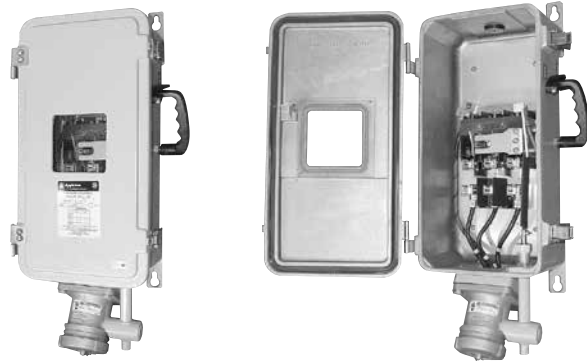

CEC Certifications and Compliances

- CSA Standard: C22.2 No. 4, C22.2 No. 5, C22.2 No. 182.1
- CSA Certified: 048391

Related Products

- Uses standard Powertite™ ACP or CPH plugs for wide acceptability.

IDSR Interlocked Switched Receptacles

Weatherproof. Watertight.

With Breaker or Disconnect Switch, Fusible or Non-fusible. For use with Powertite™ ACP plugs.

CEC:

Listed for Ordinary (Unclassified) Locations
NEMA 3, 5 or 3, 4X, 5

	Amp.	Fusing •	HP at 600 Vac 3-Phase ①	Without Viewing Window	With Viewing Window	Aux. Contacts ② 1 or 2 NO/NC		Mating Plug
	30	Fused	7.5/20	IDSR3034	IDSR3034-W	WS30AUX1	WS30AUX2	ACP3034BC
	60	Fused	15/50	IDSR6034	IDSR6034-W	WS60AUX1	WS60AUX2	ACP6034BC
	100	Fused	30/70	IDSR1034	IDSR1034-W	WS100AUX1	WS100AUX2	ACP1034CD
	30	Non-Fused	25	IDSR3034-NF	IDSR3034-NF-W	WS30AUX1	WS30AUX2	ACP3034BC
	60	Non-Fused	60	IDSR6034-NF	IDSR6034-NF-W	WS60AUX1	WS60AUX2	ACP6034BC
	100	Non-Fused	75	IDSR1034-NF	IDSR1034-NF-W	WS100AUX1	WS100AUX2	ACP1034CD

Dimensions in Millimeters (Inches)

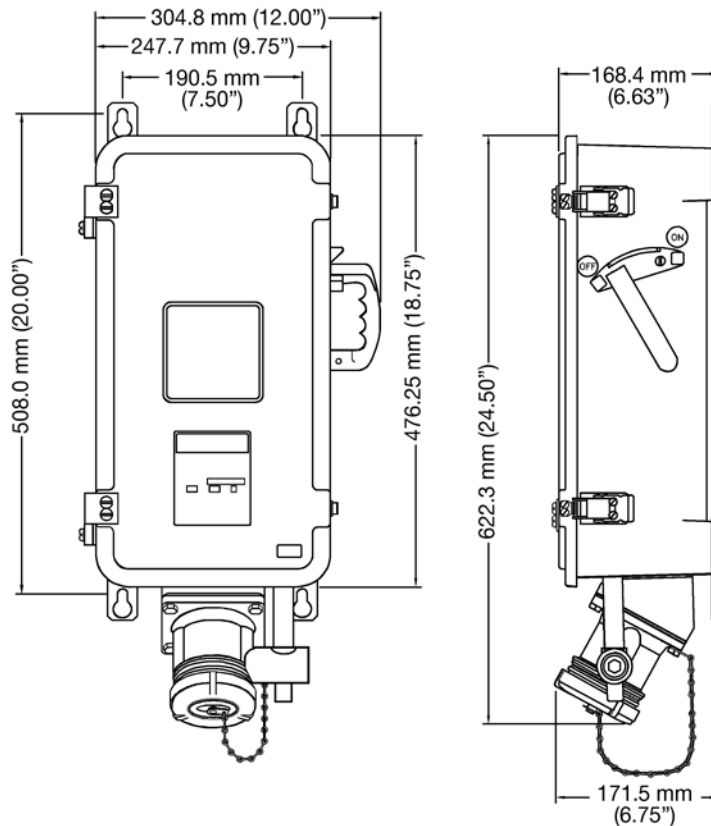

• Fuses not included.

① STD/MAX ratings based on type of fuse used eg. For IDSR 3034 – rated at 7.5 HP with standard fuse or rated at 20 HP with time delay fuse.

② Auxiliary contacts ordered separately for field installation.

AE Series Pin and Sleeve Plugs, Connectors and Receptacles

Weatherproof

600 Vac, 250 Vdc. Pressure Wire Terminals.

NEC:

Rated for Ordinary (Unclassified) Locations

Applications

- Designed to supply power to portable or fixed electrical equipment such as:
 - Welders
 - Generators
 - Compressors
 - Pumps
 - Similar apparatus
- Suitable for use in locations where a weatherproof enclosure is required such as:
 - Shipping docks
 - Ports
 - Ship to shore applications

Features

- Available in 30, 60, and 100 Amp units.
- Contacts exert constant pressure along the entire contact surface, providing electrical continuity. Solid brass contacts with beryllium copper springs.
- Choice of receptacle types: weatherproof spring door or raintight screw cap.
- Plug with clamp ring has neoprene gasket. Ring threads onto screw cap receptacle to provide raintight assembly when properly tightened.
- Cable clamps prevent strain on cables and allow easy cable replacement.
- Mounting box gasket protects receptacle from moisture.
- Insulating blocks provide high degree of dielectric and mechanical strength and lowest moisture absorption, lowest arc tracking.
- Choice of several mounting boxes permits different types of installations.
- Floating-type plug contacts self-align to receptacle contacts.
- Available in two grounding styles: Style 1 (shell only) and Style 2 (shell and extra pole).
- Grounding detent springs in Style 1 and Style 2.
- Grounding strap provided in Style 2 permits extra pole grounding.
- Longer ground contact in Style 2 "makes first and breaks last."

Standard Materials

- Plug, connector, receptacle and mounting box housings: copperfree (4/10 of 1% max.) aluminum
- Insulating blocks: fiber glass reinforced phenolic
- Contacts: brass

Standard Finishes

- Aluminum plug, receptacle, connector, and mounting box housings: epoxy powder coat
- Insulating blocks and contacts: natural finish

Options

- Reverse Service: useful where a "hot" plug feeds a dead receptacle. Reverse service is often used for generator applications where the receptacle houses a dead plug interior. Plug houses an energized receptacle interior, which has recessed male contacts to reduce danger of accidental touching. Suffix **-RS** to receptacle or connector.

NEC Compliances

- UL Standard: UL 1682, UL 1686



AE Series 30 Amp Pin and Sleeve Receptacles Connectors and Plugs

Weatherproof

600 Vac, 250 Vdc. Pressure Wire Terminals. Wire Size Range: #14—#8

NEC:

Rated for Ordinary (Unclassified) Locations



Grounding Style	Wire/Pole	Spring Door Receptacle Only	Screw Cap Receptacle Only	Connector Body Only	Clamping Ring Plug	Plug Cable Dia. (Inches)
Style 1 (Shell Only)	2W, 2P	AE321	AE327	APR3251	AEP3251	.625 to .750
	3W, 3P	AE331	AE337	APR3351	AEP3351	.625 to .750
	4W, 4P	AE341	AE347	APR3451	AEP3451	.625 to .750
Style 2 (Shell and Extra Pole)	2W, 3P	AE332	AE338	APR3361	AEP3361	.625 to .750
	3W, 4P	AE342	AE348	APR3461	AEP3461	.625 to .750

AE Series Mounting Boxes



Hub Size (Inches)	AEE	AERH	AERC	AERA
1/2	AEE13	AERH13	AERC13	AERA13
3/4	AEE23	AERH23	AERC23	AERA23
1	AEE33	AERH33	AERC33	AERA33

30 Amp Interiors ①



Grounding Style	Wire/Pole	Interior Style 1		Interior Style 2	
		Receptacle	Plug	Receptacle	Plug
Style 1 (Shell Only)	2W, 2P	AEI-321	AEPI-321	—	—
	3W, 3P	AEI-331	AEPI-331	—	—
	4W, 4P	AEI-341	AEPI-341	—	—
Style 2 (Shell and Extra Pole)	2W, 3P	—	—	AEI-332	AEPI-332
	3W, 4P	—	—	AEI-342	AEPI-342

① Pins and sleeves are not sold separately. Must purchase as a replacement interior.

AE Series 60 Amp Pin and Sleeve Receptacles Connectors and Plugs

Weatherproof

600 Vac, 250 Vdc. Pressure Wire Terminals. Wire Size Range: #8—#4

NEC:
Rated for Ordinary (Unclassified) Locations

PLUGS AND RECEPTACLES: NEC/CEC ORDINARY LOCATION



Grounding Style	Wire/Pole	Spring Door Receptacle Only	Screw Cap Receptacle Only	Connector Body Only	Clamping Ring Plug	Plug Cable Dia. (Inches)
Style 1 (Shell Only)	2W, 2P	AE621	AE627	APR6252	AEP6252	1.000 to 1.312
	3W, 3P	AE631	AE637	APR6352	AEP6352	1.000 to 1.312
	4W, 4P	AE641	AE647	APR6452	AEP6452	1.000 to 1.312
Style 2 (Shell and Extra Pole)	2W, 3P	AE632	AE638	APR6362	AEP6362	1.000 to 1.312
	3W, 4P	AE642	AE648	APR6462	AEP6462	1.000 to 1.312

AE Series Mounting Boxes



Hub Size (Inches)	AEE	AERH	AERC	AERA	AJA ①	AJA Adapter
1	AEE36	AERH36	AERC36	AERA36	AJA310	AJA100
1-1/4	AEE46	AERH46	AERC46	AERA46	AJA410	AJA100
1-1/2	AEE56	AERH56	AERC56	AERA56	AJA510	AJA100
2	—	—	—	—	AJA610	AJA100

60 Amp Interiors ②



Grounding Style	Wire/Pole	Interior Style 1		Interior Style 2	
		Receptacle	Plug	Receptacle	Plug
Style 1 (Shell Only)	2W, 2P	AEI-621	AEPI-621	—	—
	3W, 3P	AEI-631	AEPI-631	—	—
	4W, 4P	AEI-641	AEPI-641	—	—
Style 2 (Shell and Extra Pole)	2W, 3P	—	—	AEI-632	AEPI-632
	3W, 4P	—	—	AEI-642	AEPI-642

① AJA Feed Thru box furnished with one close-up plug in bottom recessed hub.
② Pins and sleeves are not sold separately. Must purchase as a replacement interior.

AE Series 100 Amp Pin and Sleeve Receptacles Connectors and Plugs

Weatherproof

600 Vac, 250 Vdc. Pressure Wire Terminals. Wire Size Range: #3—#1

NEC:

Rated for Ordinary (Unclassified) Locations



Grounding Style	Wire/Pole	Spring Door Receptacle Only	Screw Cap Receptacle Only	Connector Body Only	Clamping Ring Plug	Plug Cable Dia. (Inches)
Style 1 (Shell Only)	2W, 2P	AE1021	AE1027	APR10253	AEP10253	.875, 1.437 to 1.750
	3W, 3P	AE1031	AE1037	APR10353	AEP10353	.875, 1.437 to 1.750
	4W, 4P	AE1041	AE1047	APR10453	AEP10453	.875, 1.437 to 1.750
Style 2 (Shell and Extra Pole)	2W, 3P	AE1032	AE1038	APR10363	AEP10363	.875, 1.437 to 1.750
	3W, 4P	AE1042	AE1048	APR10463	AEP10463	.875, 1.437 to 1.750

AE Series Mounting Boxes

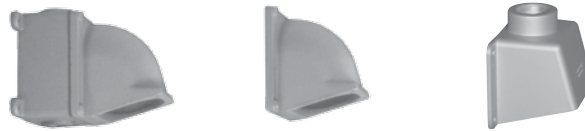

Hub Size (Inches)	AJA ①	AJA Adapter	AEE
1	AJA310	AJA100	AEE36
1-1/4	AJA410	AJA100	AEE46
1-1/2	AJA510	AJA100	AEE56
2	AJA610	AJA100	—

100 Amp Interiors ②



Grounding Style	Wire/Pole	Interiors Style 1		Interiors Style 2	
		Receptacle	Plug	Receptacle	Plug
Style 1 (Shell Only)	2W, 2P	AEI-1021	AEPI-1021	—	—
	3W, 3P	AEI-1031	AEPI-1031	—	—
	4W, 4P	AEI-1041	AEPI-1041	—	—
Style 2 (Shell and Extra Pole)	2W, 3P	—	—	AEI-1032	AEPI-1032
	3W, 4P	—	—	AEI-1042	AEPI-1042

① AJA Feed Thru box furnished with one close-up plug in bottom recessed hub.

② Pins and sleeves are not sold separately. Must purchase as a replacement interior.

AE Series 30, 60, and 100 Amp Receptacle

Pin and Sleeve Plugs, Connectors and Receptacles

NEC:
Rated for Ordinary (Unclassified) Locations

Dimensions in Millimeters (Inches)

Receptacle Mounted on AEE Box

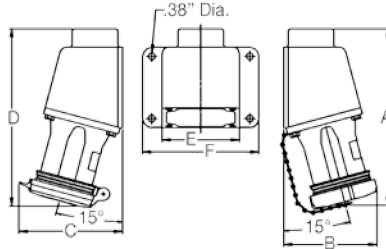

Dimensions in Millimeters (Inches)						
Amp	A	B	C	D	E	F
30	174.7 (6.88)	87.6 (3.45)	100.3 (3.95)	181.1 (7.13)	107.9 (4.25)	127.0 (5.00)
60	247.6 (9.75)	120.1 (4.73)	126.4 (4.98)	254.0 (10.00)	136.6 (5.38)	162.0 (6.38)

Receptacle Mounted on AJA-AJAC Box

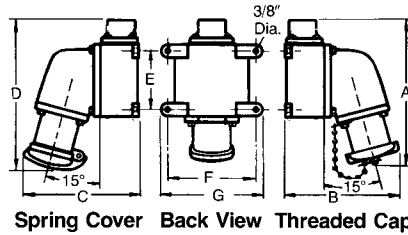

Spring Cover Back View Threaded Cap

Dimensions in Millimeters (Inches)							
Amp	A	B	C	D	E	F	G
60	225.5 (8.88)	215.9 (8.50)	215.9 (8.50)	273.0 (10.75)	123.9 (4.88)	174.7 (6.88)	200.1 (7.88)
100	241.3 (9.50)	231.9 (9.13)	238.2 (9.38)	290.5 (11.44)	123.9 (4.88)	174.7 (6.88)	200.1 (7.88)

AE Receptacle

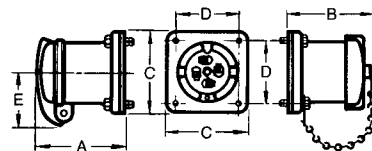

Spring Cover Back View Threaded Cap

Dimensions in Millimeters (Inches)					
Amp	A	B	C	D	E
30	90.4 (3.56)	87.3 (3.44)	85.9 (3.38)	69.0 (2.72)	55.6 (2.19)
60	115.8 (4.56)	111.2 (4.38)	114.3 (4.50)	88.9 (3.50)	68.3 (2.69)
100	136.6 (5.38)	131.8 (5.19)	114.3 (4.50)	88.9 (3.50)	71.3 (2.81)

PLUGS AND RECEPTACLES: NEC/CEC ORDINARY LOCATION

Appleton®

AE Series 30, 60, and 100 Amp Connector, Plug and Mounting Box

Pin and Sleeve Plugs, Connectors and Receptacles

NEC:
Rated for Ordinary (Unclassified) Locations

Dimensions in Millimeters (Inches)

APC Cable Connector

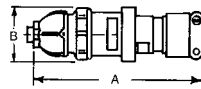

Amp	Dimensions in Millimeters (Inches)	
	A	B
30	234.9 (9.25)	74.6 (2.94)
60	304.8 (12.00)	93.7 (3.69)
100	355.6 (14.00)	104.9 (4.13)

AEP Plug

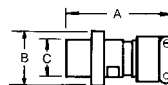

Clamping Ring

Amp	Dimensions in Millimeters (Inches)		
	A	B	C
30	152.4 (6.00)	81.0 (3.19)	54.8 (2.16)
60	152.4 (6.00)	81.0 (3.19)	54.8 (2.16)
100	227.0 (8.94)	107.9 (4.25)	79.5 (3.13)

AJAC and AJA Mounting Boxes ①

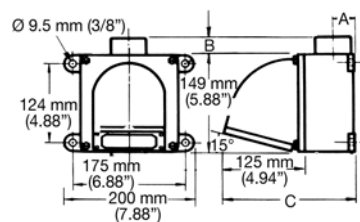

Amp	Hub Size (Inches)	Dimensions in Millimeters (Inches)		
		A	B ①	C
60 and 100	1	28.7 (1.13)	14.2 (0.56)	203.2 (8.0)
	1-1 (4)	28.7 (1.13)	14.2 (0.56)	203.2 (8.0)
	1-1 (2)	38.1 (1.50)	14.2 (0.56)	203.2 (8.0)
	2	38.1 (1.50)	14.2 (0.56)	203.2 (8.0)

① AJA has two hubs. Close-up plug furnished in bottom recessed hub.

AE Series Mounting Box

For AE Series 30, 60, and 100 Amp Receptacles

NEC:
Rated for Ordinary (Unclassified) Locations

Dimensions in Millimeters (Inches)

AERA ①, AERC and AERH Mounting Boxes

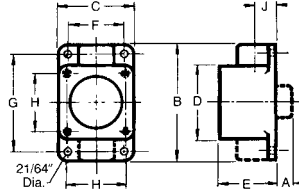

Amp	Hub Size (Inches)	Dimensions in Millimeters (Inches)								
		A ①	B	C	D	E	F	G	H	J
30	1/2	17.5 (0.69)	134.8 (5.31)	85.8 (3.38)	85.8 (3.38)	63.5 (2.50)	66.8 (2.63)	115.8 (4.56)	69.0 (2.72)	23.8 (0.94)
30	3/4	19.0 (0.75)	134.8 (5.31)	85.8 (3.38)	85.8 (3.38)	63.5 (2.50)	66.8 (2.63)	115.8 (4.56)	69.0 (2.72)	23.8 (0.94)
30	1	20.5 (0.81)	134.8 (5.31)	85.8 (3.38)	85.8 (3.38)	63.5 (2.50)	66.8 (2.63)	115.8 (4.56)	69.0 (2.72)	23.8 (0.94)
60	1	20.5 (0.81)	165.1 (6.50)	107.9 (4.25)	107.9 (4.25)	79.5 (3.13)	88.9 (3.50)	149.3 (5.88)	88.9 (3.50)	35.0 (1.38)
60	1-1/4	23.8 (0.94)	165.1 (6.50)	107.9 (4.25)	107.9 (4.25)	79.5 (3.13)	88.9 (3.50)	149.3 (5.88)	88.9 (3.50)	35.0 (1.38)
60	1-1/2	25.4 (1.00)	165.1 (6.50)	107.9 (4.25)	107.9 (4.25)	79.5 (3.13)	88.9 (3.50)	149.3 (5.88)	88.9 (3.50)	35.0 (1.38)

AEE Mounting Box

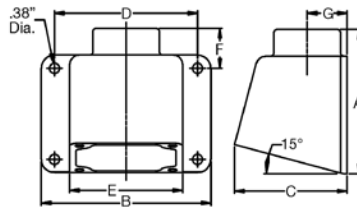

Amp	Hub Size (Inches)	Dimensions in Millimeters (Inches)						
		A	B	C	D	E	F	G
30	1/2, 3/4, 1	104.6 (4.12)	127.0 (5.00)	84.5 (3.33)	107.9 (4.25)	85.8 (3.38)	29.9 (1.18)	27.9 (1.10)
60 and 100	1, 1-1/4, 1-1/2	137.4 (5.41)	162.0 (6.38)	107.4 (4.23)	136.6 (5.38)	107.9 (4.25)	38.1 (1.50)	38.1 (1.50)

① Dimension "A" for AERA only.

M-Line Series MN Multi-Pin Plugs and Receptacles

240 - 600 Vac, 250 - 600 Vdc

NEC/CEC:
IP68

Applications

- Designed for the roughest industrial applications, providing reliable, rugged service for power, control and instrumentation.
- For use in the roughest industrial applications, ranging from:
 - Process and control
 - Marine
 - Oil and gas
 - Machine tool
 - Industrial
 - Power distribution systems
 - Transportation

Features

- Environmental connector rated IP68.
- Designed to meet or exceed the electrical performance requirements of Mil-C-5015.
- Large coupling sleeve, secured with captive set screws.
- Quick coupling, double-lead thread resists cross-mating problems and provides positive mating.
- Durable, scratch resistant hardcoat plating.
- All hardware is machined using 6061T aluminum bar stock.
- Vast family of reversible inserts.
- Power, signal and mixed applications.
- From 1 to 68 contact positions.
- Connector designs offer crimp style terminals as standard:
 - Crimp insert arrangements allow the contacts to be inserted or removed from the rear through use of insertion/extraction tools without removing the insert from the connector body.
 - Solder/pressure insert contacts cannot be removed without first pushing out the insert from the shell body. However the contacts can be serviced while the insert is locked in the shell hardware by simply repairing each individual wire termination.
- Inserts provide water, vapor, moisture and dust resistance and fit into standard hardware components
- Contact sizes for 18, 16, 12, 10, 8, 4, 1/0, 4/0, 313 to 777 MCM AWG.
- Shell sizes 6, 8, 10, 12, 14. Contact your local sales representative for other shell sizes.
- Extensive array of hardware and strain relief options.
- Custom cable assembly manufactured to support customer application specific designs.
- Silver plated contacts standard. Gold contacts optional.
- Stainless steel and brass components available. Contact your local sales representative for details.
- Intermateable and interchangeable with other connector brands available in the market.

Standard Materials

- Body construction: machined 6061T aluminum bar stock
- Insulating blocks: fiber glass reinforced polyester

Standard Finishes

- Body: scratch resistant natural hardcoat plating

Options

- Black hardcoat plating
- 316L stainless steel, or brass components.
- Gold plated contacts.
- Solder or pressure contacts.
- Additional key locking options available.



MNPEM — Plug with Environmental Cover and Mechanical Clamp Nut



MNREK — In-Line Receptacle with Environmental Cover and Basket Weave Grip/Gland Nut



MNREP — Panel Mount Receptacle with Environmental Cover

NEC/CEC Certifications and Compliances

- UL Standard: 1977
- CSA Standard: C22.2, No. 182.3
- ETL Listed

Related Products

- Additional configurations are available, please contact your local sales representative.
- Classified location M-Line Series plugs and receptacles are available, see M-Line Series Explosionproof Multi-Pin Plugs and Receptacles.

PLUGS AND RECEPTACLES: NEC/CEC ORDINARY LOCATION

Appleton

M-Line Series MN Multi-Pin Plugs and Receptacles

240 - 600 Vac, 250 - 600 Vdc

NEC/CEC:
IP68

PLUGS AND RECEPTACLES: NEC/CEC ORDINARY LOCATION

Illustrated Features

Connector Component Overview

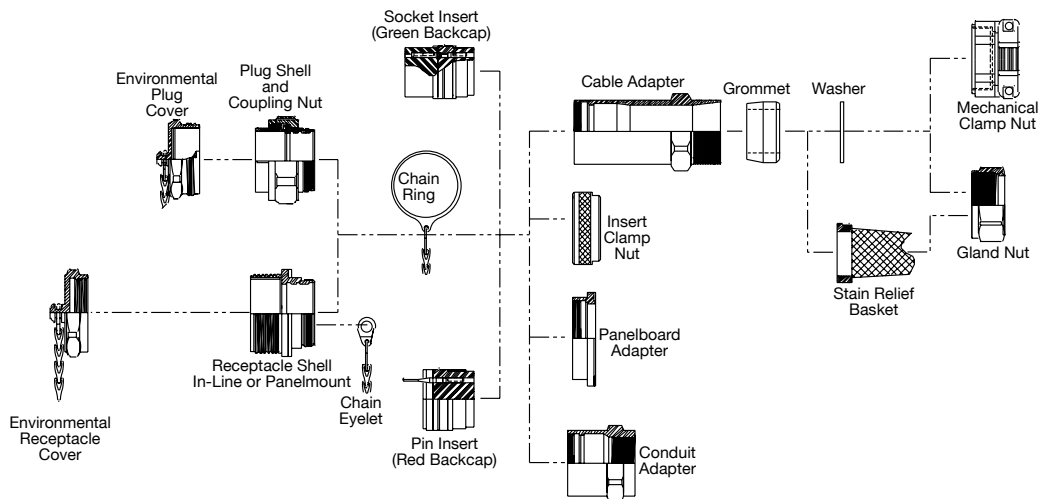

Crimp Inserts

The crimp style inserts utilize a 2 piece insert design comprised of a rigid front insulator and a resilient backcap. Each of the rear backcaps are color coded to indicate use for pin contacts - red, or socket contacts - green. The contacts are crimp terminated outside the insert utilizing the correct wire size and ready for insertion into the contact cavity. The insert should be positioned into the shell hardware prior to insertion. When the insert is positioned into the shell hardware each individual contact can then be easily inserted into each cavity using the proper insertion tool. To ease the assembly of the contacts into the insert cavities, the inserts provide number markings on the front and rear of the insert. When all contacts are assembled into the insert, each contact shoulder is securely positioned into the front rigid insulator body providing a stabilized and positive alignment of the contacts. The inserts are locked or pressurized into place when the clamp nut (receptacle) or cable adapter (plug/in-line receptacle) is threaded and tightened against the plastic pressure seal shoulder. The crimp inserts allows each contact to be individually serviced/repaired by removal from the insert. In order to relieve the locked or pressured contacts, the rear retaining nut (receptacle) or the cable adapter (plug/in-line receptacle) must be backed off the rear of the shell hardware. Once removed each contact can be easily removed by use of the proper sized removal tool. Contacts will be released at the rear of the connector.

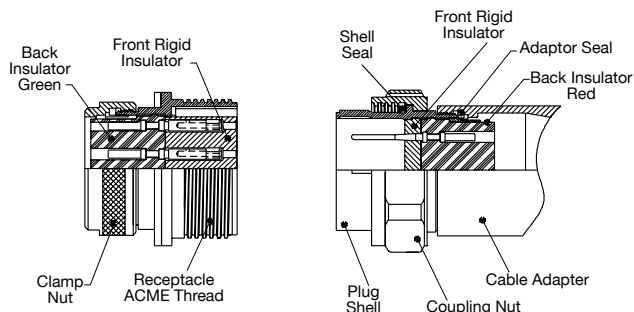

M-Line Series MN Multi-Pin Plugs and Receptacles

240 - 600 Vac, 250 - 600 Vdc

NEC/CEC:
IP68

Contact Ratings – Wire Well Dimensions – All Minimum in Millimeters (Inches)

- Mil Spec Ampere Ratings: (MIL-C-39029). Based on the combination of the following:
 - The amount of current which an individual pin and socket contact may carry is a function of contact material and design efficiency of the pin and socket system as well as the ability of the primary conductor insulation to resist temperature rises due to inherent copper losses and bundling factors.
 - Total current carrying capacity of the connector is a function of the insert temperature which is rated at 100 °C (212 °F) for continuous operation. The total operating temperature is the summation of the ambient temperature plus the temperature rise resulting from the thermal losses of each contact.
 - NEC specifications may be used as a general reference on the subject in as much as pertinent cable de-rating data is included.
- NEC Non-Circuit Breaking Ampere Ratings
 - The non-interrupting current ratings, shown in the table below are based on the temperature of the contacts being within the range specified by Underwriter's Laboratories, Inc. when wire sizes are selected in accordance with the National Electrical Code.
 - When multiple conductors are used, the load factor and temperature rise based on ambient and total insert temperature must be taken into consideration.

Contact Size AWG/MM	NEC Ampere Rating ①	Solder Diameter	Solder Depth	Crimp Diameter ②	Crimp Depth ②	Crimp Pullout Newton (Pound) ③	Pressure Contact Torque Newtons per Meter (Inches per Pound)
#16 (1.5)	16	2.00 (.078)	5.15 (.203)	2.00 (.078)	12.70 (.500)	222.4 (50)	—
#12 (4.0)	30	2.80 (.110)	6.45 (.250)	2.80 (.110)	12.70 (.500)	489.3 (110)	—
#10 (6.0)	40	3.60 (.142)	10.00 (.394)	3.60 (.142)	15.00 (.591)	800.7 (180)	1.7 (15)
#8 (10.0)	50	5.30 (.209)	9.12 (.516)	4.80 (.189)	19.00 (.748)	1000 (225)	2.8 (25)
#4 (25.0)	90	8.35 (.329)	14.70 (.580)	7.24 (.285)	22.20 (.875)	1779 (400)	2.3 (20)
#1/0 (50.0)	155	11.50 (.470)	16.30 (.641)	11.40 (.450)	19.70 (.775)	2447 (550)	5.7 (50)
#4/0 (120.0)	225	16.50 (.650)	22.50 (.885)	15.70 (.620)	25.40 (1.00)	3892 (875)	11.3 (100)
500MCM	750	—	—	25.40 (1.000)	34.90 (1.375)	11120 (2500)	—

Electrical Performance – Service Voltage Ratings (for various specifications)

NEC voltage rating is designated by a service voltage rating letter which is shown listed in the table below corresponds to the insert configurations listings on the following pages. The voltage to which contact inserts are limited is a function of the dielectric separation between adjacent contacts and between contacts and shell.

Service Voltage	Inches Nominal		Mil-C-5015 Rating Non-Circuit Breaking Volts RMS		NEC Rating Non-Circuit Breaking Volts RMS		Circuit Breaking
	Over Surface Distance	Thru-Air Spacing	DC	AC	DC	AC	AC
Instrument	1/16	—	250	200	—	—	—
A	1/8	1/16	700	500	250	240	240
D	3/16	1/8	1250	900	600	600	600
E	1/4	3/16	1750	1250	600	600	600
B	5/16	1/4	2450	1750	600	600	600
C	1	5/16	4200	3000	600	600	600

① Non-circuit breaking rating, based on Arcing Control (National Electrical Code).

② Includes wire inspection hole.

③ Values vary per wire strand count, consult factory.

M-Line Series MN Multi-Pin Plugs and Receptacles

240 - 600 Vac, 250 - 600 Vdc

NEC/CEC:
IP68

Standard Product Configurations ①

Catalog Description	Number of Contacts	Wire AWG	Wire (mm ²)	Shell Size	Service Voltage Rating	Part Number
Plug Male w/ Basket Weave 3 Pin	3	12	4	6	D	MNPEKL-06-06-327PN
Plug Male w/ Basket Weave 7 Pin	7	12	4	6	A	MNPEKL-10-06-354PN
Plug Male w/ Basket Weave 10 Pin	10	16	2	6	A	MNPEKL-10-06-355PN
Plug Male w/ Basket Weave 16 Pin	16	16	2	8	D	MNPEKL-12-08-325PN
Plug Male w/ Basket Weave 37 Pin	37	16	2	10	A	MNPEKLJ-18-10-386PN ②
Plug Male w/ Basket Weave 37 Pin	37	16	2	12	D	MNPEKLJ-22-12-371PN ③
In-Line Receptacle w/ Basket Weave Female 3 Pin	3	12	4	6	D	MNREKL-06-06-327SN
In-Line Receptacle w/ Basket Weave Female 4 Pin	4	10	6	6	D	MNREKL-06-06-314SN
In-Line Receptacle w/ Basket Weave Female 7 Pin	7	12	4	6	A	MNREKL-10-06-354SN
In-Line Receptacle w/ Basket Weave Female 10 Pin	10	16	2	6	A	MNREKL-10-06-355SN
In-Line Receptacle w/ Basket Weave Male 10 Pin	10	16	2	6	A	MNREKL-10-06-355PN
In-Line Receptacle w/ Basket Weave Female 16 Pin	16	16	2	8	D	MNREKL-12-08-325SN
In-Line Receptacle w/ Basket Weave Female 20 Pin	20	12	4	10	A	MNREKL-18-10-332SN
In-Line Receptacle w/ Basket Weave Female 37 Pin	37	16	2	12	D	MNREKL-22-12-371SN
In-Line Receptacle Female w/ Basket Weave 68 Pin	68	16	2	10	A	MNREKL-22-10-313SN
In-Line Receptacle Male 68 Pin	68	16	2	10	A	MNREP-00-10-313PN
Panel Mount Receptacle Male 3 Pin	3	12	4	6	D	MNREP-00-06-327PN
Panel Mount Receptacle Male 4 Pin	4	10	6	6	D	MNREP-00-06-314PN
Panel Mount Receptacle Female 7 Pin	7	12	4	6	A	MNREP-00-06-354SN
Panel Mount Receptacle Male 7 Pin	7	12	4	6	A	MNREP-00-06-354PN
Panel Mount Receptacle Female 10 Pin	10	16	2	6	A	MNREP-00-06-355SN
Panel Mount Receptacle Female 16 Pin	16	16	2	8	D	MNREP-00-08-325SN
Panel Mount Receptacle Female 20 Pin	20	12	4	10	A	MNREP-00-10-332SN
Panel Mount Receptacle Male 20 Pin	20	12	4	10	A	MNREP-00-10-332PN
Panel Mount Receptacle Female 37 Pin	37	16	2	10	A	MNREP-00-10-386SN
Panel Mount Receptacle Female 37 Pin	37	16	2	12	D	MNREP-00-12-371SN
Panel Mount Receptacle Male 37 Pin	37	16	2	12	D	MNREP-00-12-371PN

① Additional configurations are available, please contact your local sales representative for details.

② Order as P/N MPIN00000001.

③ Order as P/N MPIN00000002.

M-Line Series MN Multi-Pin Plugs and Receptacles

240 - 600 Vac, 250 - 600 Vdc

NEC/CEC:
IP68

How to Select a Multi-Pin Connector

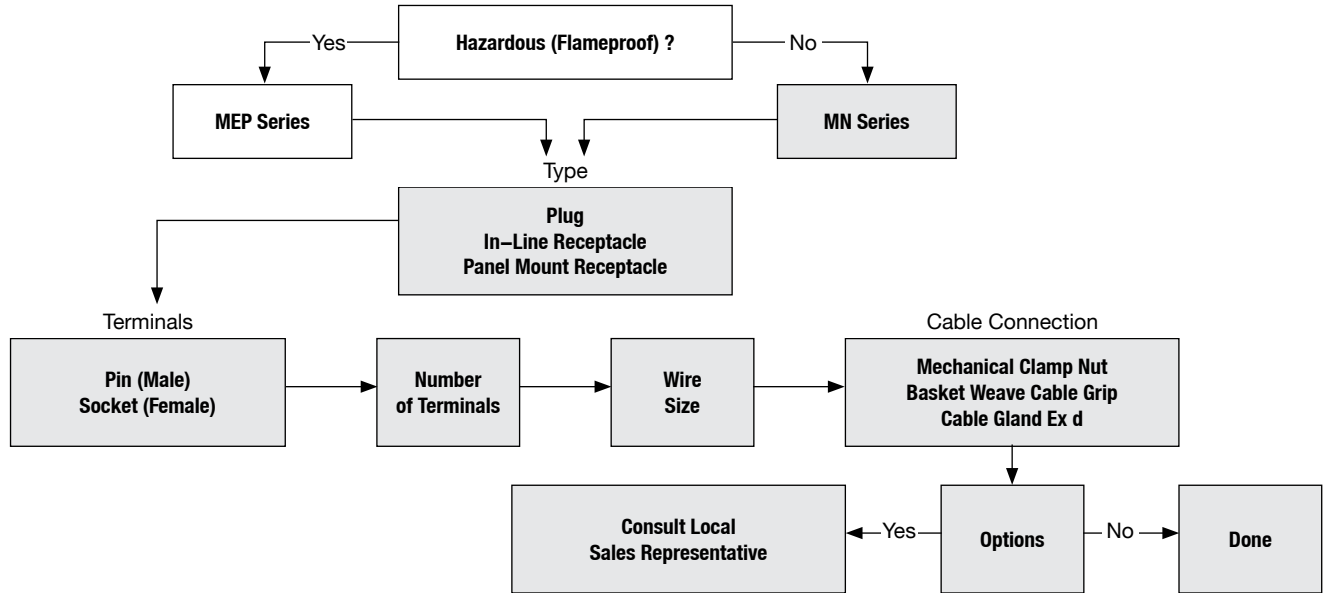

PLUGS AND RECEPTACLES: NEC/CEC ORDINARY LOCATION

Appleton

M-Line Series MN Multi-Pin Plugs and Receptacles

240 - 600 Vac, 250 - 600 Vdc

NEC/CEC:
IP68

PLUGS AND RECEPTACLES: NEC/CEC ORDINARY LOCATION

Appleton®

Catalog Numbering Guide – Plug Assembly

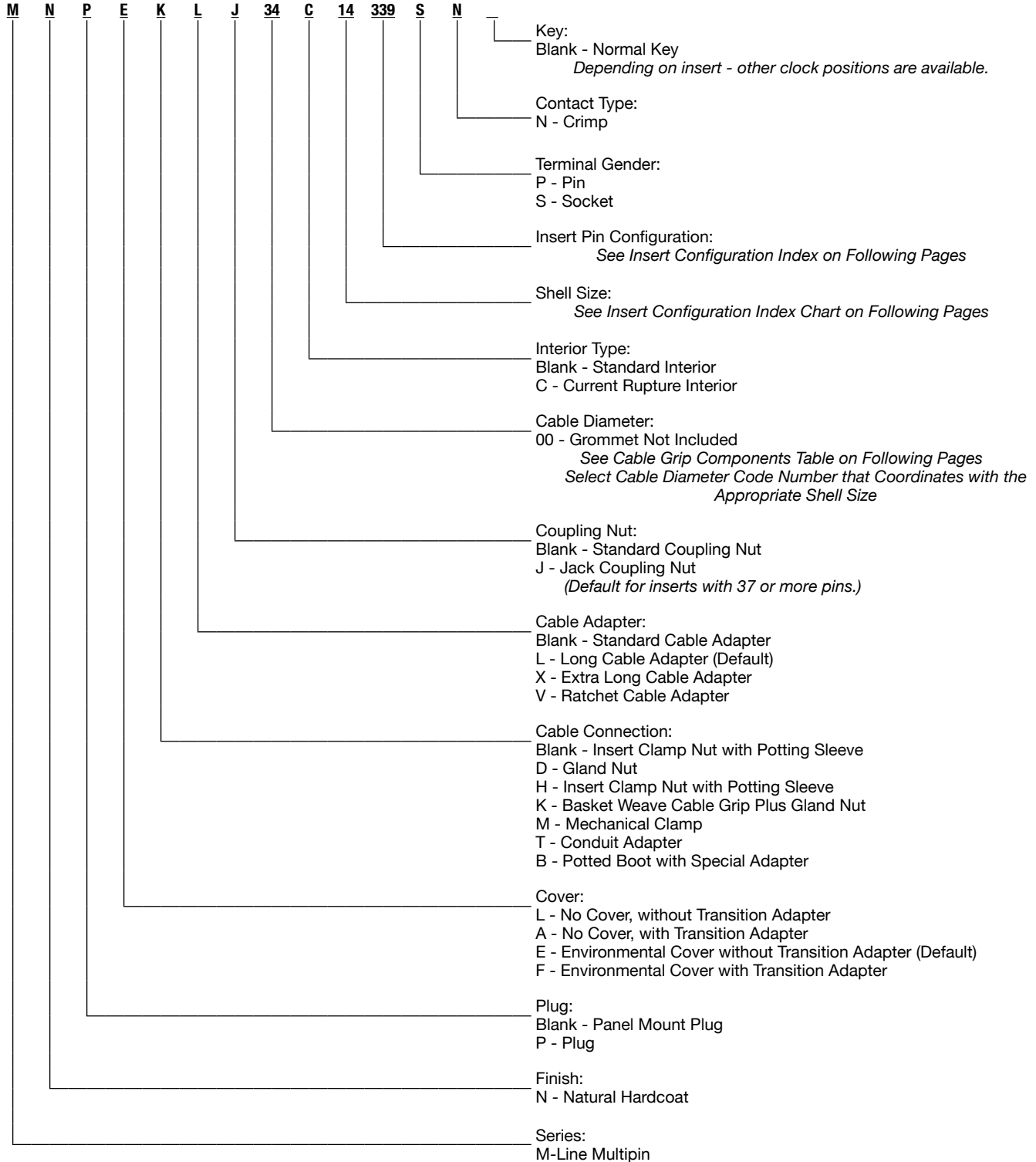

M-Line Series MN Multi-Pin Plugs and Receptacles

240 - 600 Vac, 250 - 600 Vdc

NEC/CEC:
IP68

Catalog Numbering Guide – Receptacle Assembly

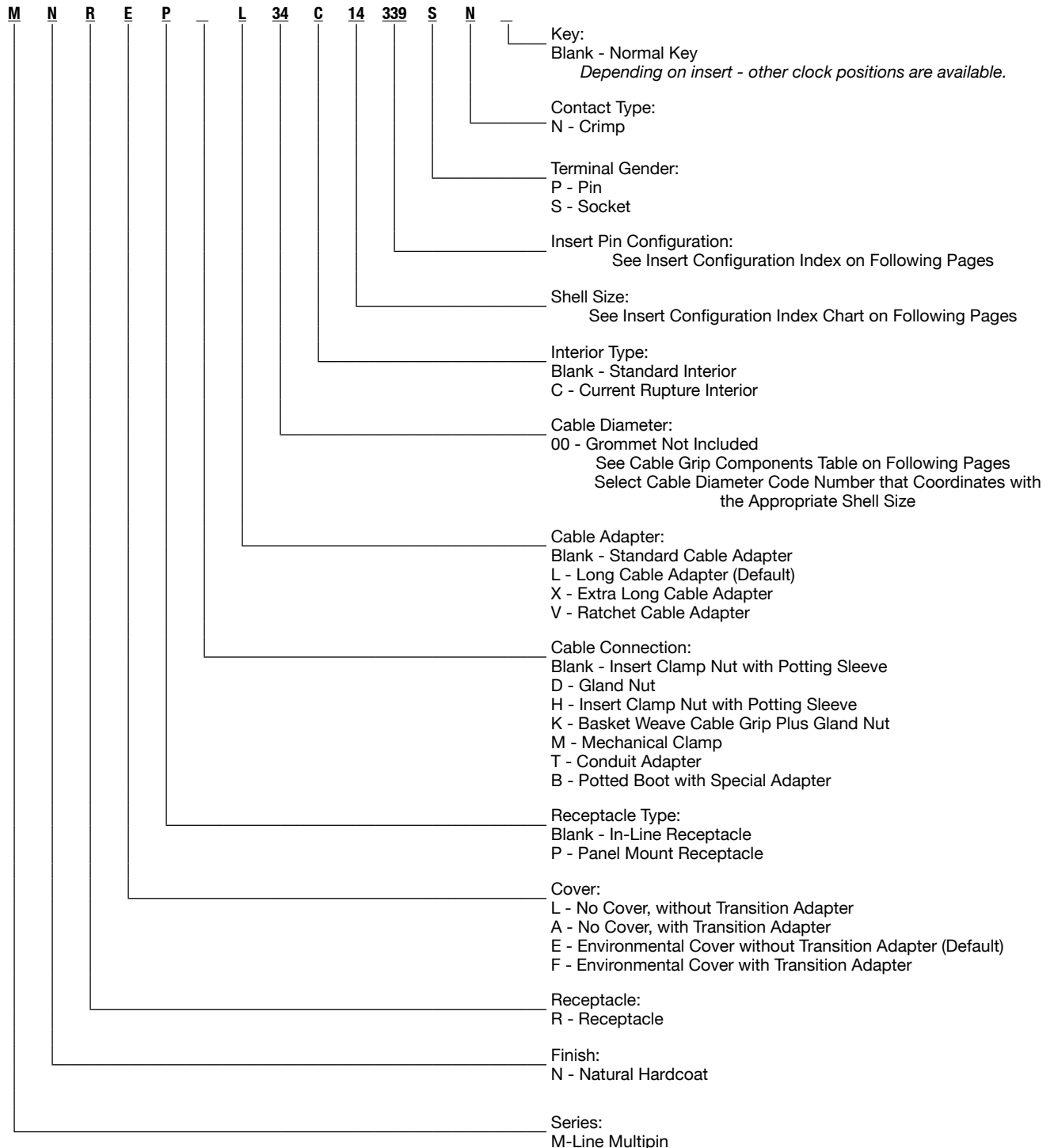

PLUGS AND RECEPTACLES: NEC/CEC ORDINARY LOCATION



M-Line Series MN Multi-Pin Plugs and Receptacles

240 - 600 Vac, 250 - 600 Vdc

NEC/CEC:
IP68

Types MNPEM

Straight Plug with Mechanical Clamp and Environmental Cover

To specify a complete plug substitute the Dash number of the contact insert for the Asterisk (*) in the catalog number listed below.

PLUGS AND RECEPTACLES: NEC/CEC ORDINARY LOCATION

Size Cable	Shell Size	Catalog Number with Standard Coupling Nut	Dimensions — mm (in)					Catalog Number with Jack Coupling Nut
			L1	L2	D	S1	S2	
With Long Cable Adapter								
Select Cable Size from the Cable Grip Components Table then, substitute the Cable Diameter Code Number for XX in the Catalog Number.	6	MNPEMLXX06-*	213 (8.37)	228 (8.96)	46.0 (1.81)	60.2 (2.37)	44.4 (1.75)	MNPEMLXX06-*
	8	MNPEMLXX08-*	220 (8.68)	236 (9.28)	58.7 (2.31)	76.2 (3.00)	57.1 (2.25)	MNPEMLXX08-*
	10	MNPEMLXX10-*	235 (9.25)	250 (9.84)	71.4 (2.81)	95.3 (3.75)	69.8 (2.75)	MNPEMLXX10-*
	C10	MNPEMLXXC10-*	248 (9.75)	263 (10.34)	71.4 (2.81)	95.3 (3.75)	69.8 (2.75)	MNPEMLXXC10-*
	12	MNPEMLXX12-*	249 (9.81)	264 (10.40)	84.1 (3.31)	114.0 (4.50)	82.5 (3.25)	MNPEMLXX12-*
	C12	MNPEMLXXC12-*	262 (10.31)	277 (10.90)	84.1 (3.31)	114.0 (4.50)	82.5 (3.25)	MNPEMLXXC12-*
	14	MNPEMLXX14-*	257 (10.12)	272 (10.71)	96.8 (3.81)	130.0 (5.12)	95.3 (3.75)	MNPEMLXX14-*
	C14	MNPEMLXXC14-*	270 (10.62)	285 (11.21)	96.8 (3.81)	130.0 (5.12)	95.3 (3.75)	MNPEMLXXC14-*

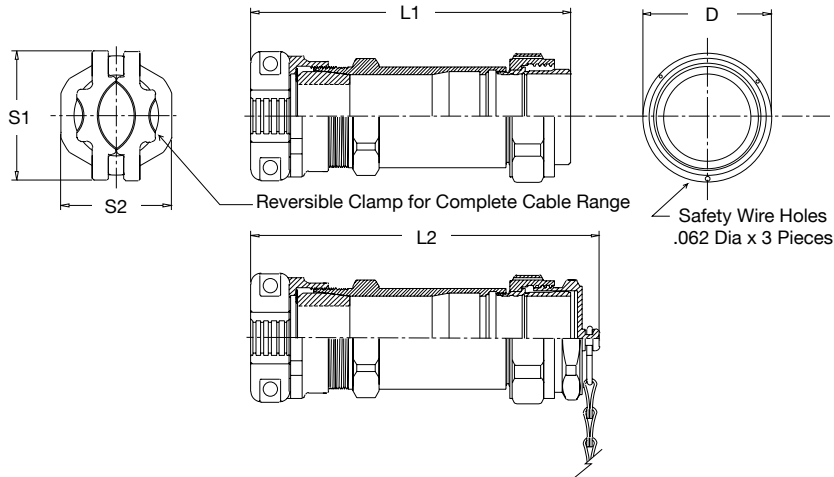

M-Line Series MN Multi-Pin Plugs and Receptacles

240 - 600 Vac, 250 - 600 Vdc

NEC/CEC:
IP68

Types MNPEK

Straight Plug with Basket Weave Grip, Gland Nut and Environmental Cover

To specify a complete plug substitute the Dash number of the contact insert for the Asterisk (*) in the catalog number listed below.

Size Cable	Shell Size	Catalog Number with Standard Coupling Nut	Dimensions — mm (in)			Catalog Number with Jack Coupling Nut
			L1	L2	D	
With Long Cable Adapter						
Select Cable Size from the Cable Grip Components Table then, substitute the Cable Diameter Code Number for XX in the Catalog Number.	6	MNPEKLXX06-*	194 (7.62)	209 (8.21)	46.0 (1.81)	MNPEKLJXX06-*
	8	MNPEKLXX08-*	200 (7.87)	215 (8.46)	58.7 (2.31)	MNPEKLJXX08-*
	10	MNPEKLXX10-*	213 (8.37)	228 (8.96)	71.4 (2.81)	MNPEKLJXX10-*
	C10	MNPEKLXXC10-*	225 (8.87)	240 (9.46)	71.4 (2.81)	MNPEKLJXXC10-*
	12	MNPEKLXX12-*	225 (8.87)	240 (9.46)	58.7 (3.31)	MNPEKLJXX12-*
	C12	MNPEKLXXC12-*	238 (9.37)	253 (9.96)	58.7 (3.31)	MNPEKLJXXC12-*
	14	MNPEKLXX14-*	232 (9.12)	247 (9.71)	71.4 (3.81)	MNPEKLJXX14-*
	C14	MNPEKLXXC14-*	244 (9.62)	259 (10.21)	71.4 (3.81)	MNPEKLJXXC14-*

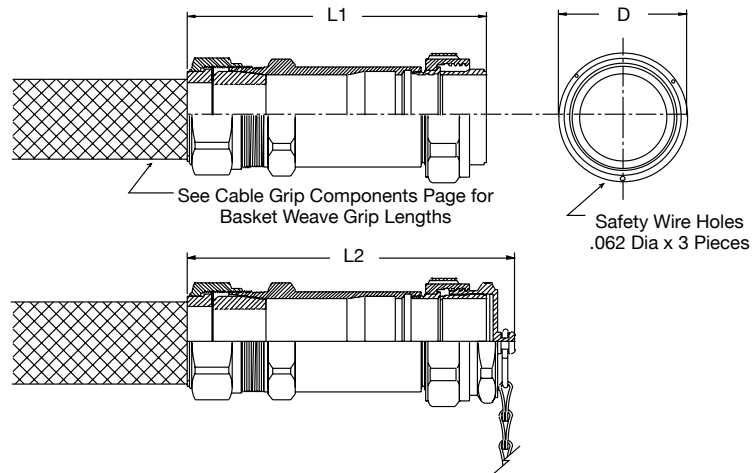

PLUGS AND RECEPTACLES: NEC/CEC ORDINARY LOCATION

Appleton

M-Line Series MN Multi-Pin Plugs and Receptacles

240 - 600 Vac, 250 - 600 Vdc

NEC/CEC:
IP68

Types MNPED

Straight Plug with Standard Coupling Nut and Environmental Cover

To specify a complete plug substitute the Dash number of the contact insert for the Asterisk (*) in the catalog number listed below.

Size Cable	Shell Size	Catalog Number with Standard Coupling Nut	Dimensions — mm (in)			Catalog Number with Jack Coupling Nut
			L1	L2	D	
With Long Cable Adapter						
Select Cable Size from the Cable Grip Components Table then, substitute the Cable Diameter Code Number for XX in the Catalog Number.	6	MNPEDLXX06-*	194 (7.62)	209 (8.21)	46.0 (1.81)	MNPEDLJXX06-*
	8	MNPEDLXX08-*	200 (7.87)	215 (8.46)	58.7 (2.31)	MNPEDLJXX08-*
	10	MNPEDLXX10-*	213 (8.37)	228 (8.96)	71.4(2.81)	MNPEDLJXX10-*
	C10	MNPEDLXXC10-*	213 (8.87)	252 (9.93)	71.4(2.81)	MNPEDLJXXC10-*
	12	MNPEDLXX12-*	213 (8.87)	252 (9.93)	84.1(3.31)	MNPEDLJXX12-*
	C12	MNPEDLXXC12-*	238 (9.37)	253 (9.96)	84.1(3.31)	MNPEDLJXXC12-*
	14	MNPEDLXX14-*	232 (9.12)	247 (9.71)	96.8(3.81)	MNPEDLJXX14-*
	C14	MNPEDLXXC14-*	244 (9.62)	259 (10.21)	96.8(3.81)	MNPEDLJXXC14-*

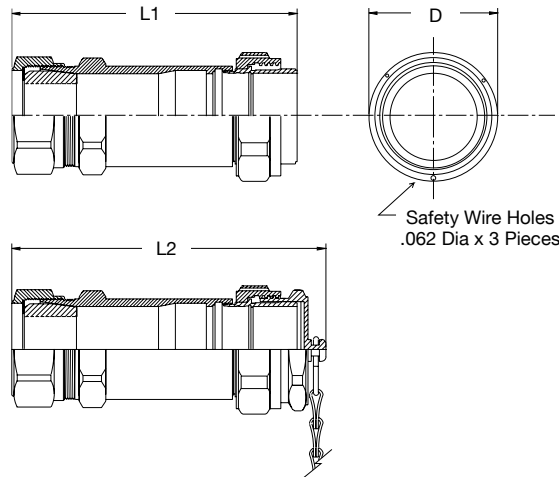

PLUGS AND RECEPTACLES: NEC/CEC ORDINARY LOCATION

Appleton®

M-Line Series MN Multi-Pin Plugs and Receptacles

240 - 600 Vac, 250 - 600 Vdc

NEC/CEC:
IP68

Types MNREM

In-Line Receptacle with Mechanical Clamp Nut and Environmental Cover

To specify a complete plug substitute the Dash number of the contact insert for the Asterisk (*) in the catalog number listed below.

Size Cable	Shell Size	Catalog Number with Standard Coupling Nut	Dimensions — mm (in)					
			L1	L2	S1	S2	S3	S4
With Long Cable Adapter								
Select Cable Size from the Cable Grip Components Table then, substitute the Cable Diameter Code Number for XX in the Catalog Number.	6	MNREMLXX06-*	213 (8.37)	229 (9.00)	44.4(1.75)	49.5 (1.95)	44.4 (1.75)	60.2 (2.37)
	8	MNREMLXX08-*	220(8.68)	236 (9.31)	57.1(2.25)	63.0 (2.48)	57.1 (2.25)	76.2 (3.00)
	10	MNREMLXX10-*	235 (9.25)	251 (9.87)	69.8(2.75)	77.0 (3.03)	69.8 (2.75)	95.3 (3.75)
	C10	MNREMLXXC10-*	248 (9.75)	263 (10.37)	69.8(2.75)	77.0 (3.03)	69.8 (2.75)	95.3 (3.75)
	12	MNREMLXX12-*	249 (9.81)	265 (10.43)	82.5(3.25)	90.4(3.56)	82.5 (3.25)	114.0 (4.50)
	C12	MNREMLXXC12-*	262 (10.31)	278 (10.93)	82.5(3.25)	90.4(3.56)	82.5 (3.25)	114.0 (4.50)
	14	MNREMLXX14-*	257 (10.12)	273 (10.75)	95.3(3.75)	103.0 (4.06)	95.3 (3.75)	130.0 (5.12)
	C14	MNREMLXXC14-*	270 (10.62)	286 (11.25)	95.3(3.75)	103.0 (4.06)	95.3 (3.75)	130.0 (5.12)

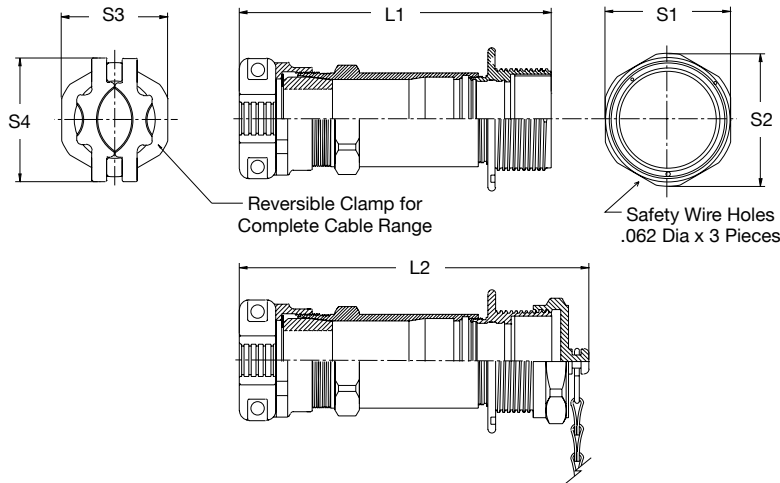

PLUGS AND RECEPTACLES: NEC/CEC ORDINARY LOCATION

Appleton

M-Line Series MN Multi-Pin Plugs and Receptacles

240 - 600 Vac, 250 - 600 Vdc

NEC/CEC:
IP68

Types MNREK & MNREK

In-Line Receptacle with Basket Weave Grip and Environmental Cover

To specify a complete plug substitute the Dash number of the contact insert for the Asterisk (*) in the catalog number listed below.

PLUGS AND RECEPTACLES: NEC/CEC ORDINARY LOCATION

Size Cable	Shell Size	Catalog Number with Standard Coupling Nut	Dimensions — mm (in)			
			L1	L2	S1	S2
With Long Cable Adapter						
Select Cable Size from the Cable Grip Components Table then, substitute the Cable Diameter Code Number for XX in the Catalog Number.	6	MNREKLXX06-*	194 (7.62)	210 (8.25)	44.4 (1.75)	49.5 (1.95)
	8	MNREKLXX08-*	200 (7.87)	216 (8.50)	57.1 (2.25)	63 (2.48)
	10	MNREKLXX10-*	213 (8.37)	229 (9.00)	69.8 (2.75)	77.0 (3.03)
	C10	MNREKLXXC10-*	225 (8.87)	241 (9.50)	69.8 (2.75)	77.0 (3.03)
	12	MNREKLXX12-*	225 (8.87)	241 (9.50)	82.5 (3.25)	90.4 (3.56)
	C12	MNREKLXXC12-*	238 (9.37)	254 (10.00)	82.5 (3.25)	90.4 (3.56)
	14	MNREKLXX14-*	232 (9.12)	248 (9.75)	95.3 (3.75)	103.0 (4.06)
	C14	MNREKLXXC14-*	244 (9.62)	260 (10.25)	95.3 (3.75)	103.0 (4.06)

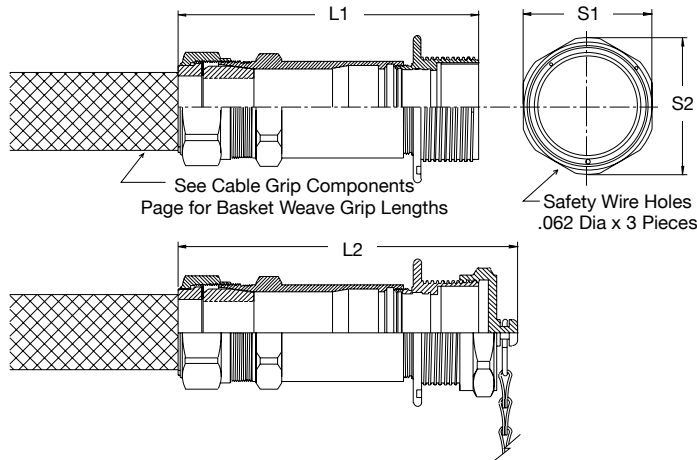

M-Line Series MN Multi-Pin Plugs and Receptacles

240 - 600 Vac, 250 - 600 Vdc

NEC/CEC:
IP68

Types MNRED

In-Line Receptacle with Standard Coupling Nut and Environmental Cover

To specify a complete plug substitute the Dash number of the contact insert for the Asterisk (*) in the catalog number listed below.

Size Cable	Shell Size	Catalog Number with Standard Coupling Nut	Dimensions — mm (in)			
			L1	L2	S1	S2
With Long Cable Adapter						
Select Cable Size from the Cable Grip Components Table then, substitute the Cable Diameter Code Number for XX in the Catalog Number.	6	MNREDLXX06-*	194 (7.62)	210 (8.25)	44.4 (1.75)	49.5 (1.95)
	8	MNREDLXX08-*	200 (7.87)	216 (8.50)	57.1 (2.25)	63.0 (2.48)
	10	MNREDLXX10-*	213 (8.37)	229 (9.00)	69.8 (2.75)	77.0 (3.03)
	C10	MNREDLXXC10-*	225 (8.87)	241 (9.50)	69.8 (2.75)	77.0 (3.03)
	12	MNREDLXX12-*	225 (8.87)	241 (9.50)	82.5 (3.25)	90.4 (3.56)
	C12	MNREDLXXC12-*	238 (9.37)	254 (10.00)	82.5 (3.25)	90.4 (3.56)
	14	MNREDLXX14-*	232 (9.12)	248 (9.75)	95.3 (3.75)	103.0 (4.06)
	C14	MNREDLXXC14-*	244 (9.62)	260 (10.25)	95.3 (3.75)	103.0 (4.06)

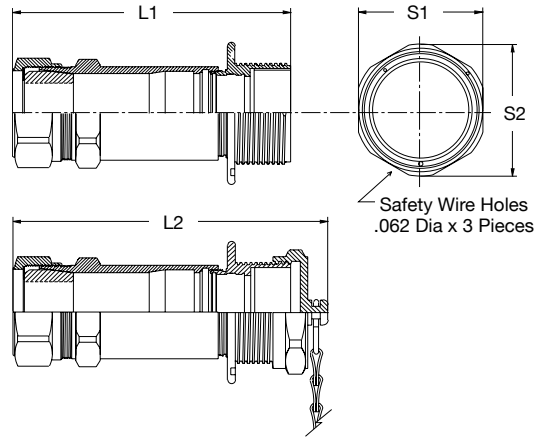

PLUGS AND RECEPTACLES: NEC/CEC ORDINARY LOCATION

Appleton

M-Line Series MN Multi-Pin Plugs and Receptacles

240 - 600 Vac, 250 - 600 Vdc

NEC/CEC:
IP68

Types MNREP

Square Flange Panel Mount Receptacle with Environmental Cover

To specify a complete plug substitute the Dash number of the contact insert for the Asterisk (*) in the catalog number listed below.

PLUGS AND RECEPTACLES: NEC/CEC ORDINARY LOCATION

Shell Size	Catalog Number with Standard Coupling Nut	Dimensions — mm (in)										
		L1	L2	L3	L4	L5	D1	D2	D3	S1	S2	
6	MNREP0006-*	74.4 (2.93)	25.4 (1.00)	74.4 (2.93)	61.7 (0.25)	53.8 (2.12)	38.1 (1.50)	34.0 (1.34)	4.32 (0.17)	44.4 (1.75)	34.8 (1.37)	
8	MNREP0008-*	58.9 (2.32)	25.4 (1.00)	74.4 (2.93)	61.7 (0.25)	53.8 (2.12)	50.8 (2.00)	46.7 (1.84)	5.08 (0.20)	57.1 (2.25)	42.7 (1.68)	
10	MNREP0010-*	58.9 (2.32)	25.4 (1.00)	74.4 (2.93)	61.7 (0.25)	55.4 (2.18)	63.5 (2.50)	59.4 (2.34)	5.33 (0.21)	69.8 (2.75)	53.1 (2.09)	
C10	MNREP00C10-*	71.6 (2.82)	38.1 (1.50)	61.7 (2.43)	19.0 (0.75)	68.1 (2.68)	63.5 (2.50)	59.4 (2.34)	5.33 (0.21)	69.8 (2.75)	53.1 (2.09)	
12	MNREP0012-*	58.9 (2.32)	25.4 (1.00)	74.4 (2.93)	61.7 (0.25)	55.4 (2.18)	76.2 (3.00)	72.1 (2.84)	7.11 (0.28)	82.5 (3.25)	64.3 (2.53)	
C12	MNREP00C12-*	71.6 (2.82)	38.1 (1.50)	61.7 (2.43)	19.0 (0.75)	68.1 (2.68)	76.2 (3.00)	72.1 (2.84)	7.11 (0.28)	82.5 (3.25)	64.3 (2.53)	
14	MNREP0014-*	58.9 (2.32)	25.4 (1.00)	74.4 (2.93)	61.7 (0.25)	55.4 (2.18)	88.9 (3.50)	84.8 (3.34)	8.64 (0.34)	95.3 (3.75)	77.0 (3.03)	
C14	MNREP00C14-*	71.6 (2.82)	38.1 (1.50)	61.7 (2.43)	19.0 (0.75)	68.1 (2.68)	88.9 (3.50)	84.8 (3.34)	8.64 (0.34)	95.3 (3.75)	77.0 (3.03)	

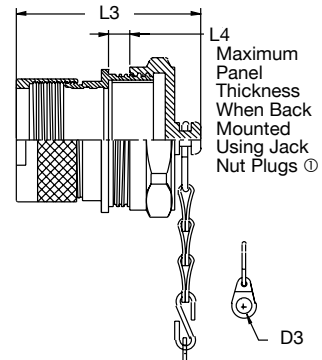
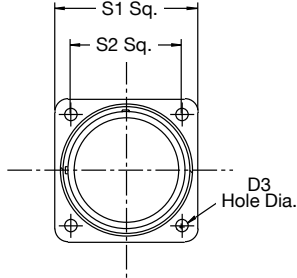
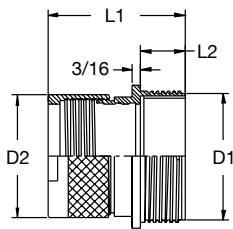

① Maximum panel thickness may be increased 1/8" when using standard coupling nut plugs.

M-Line Series MN Multi-Pin Plugs and Receptacles

240 - 600 Vac, 250 - 600 Vdc

NEC/CEC:
IP68

Insert Configuration Index

Insert Arrangement	Total Contacts	Crimp	Service Rating	Contact Size										
				18	16	12	10	8	4	1/0	4/0	350 MCM	500 MCM	
CN-06-327	3	X	D			3								
CN-06-314	4	X	D				4							
CN-06-316	4	X	D				4							
CN-06-322	4	X	D				4							
CN-06-333	4	X	D		4									
CN-08-328	4	X	D					4						
CN-06-324	5	X	D			5								
CN-06-353	5	X	D			5								
CN-08-316	5	X	D					5						
CN-08-375	5	X	D					5						
CN-06-310	7	X	A			7								
CN-06-354	7	X	A			7								
CN-06-348	7	X	A		7									
CN-10-359	7	X	D					7						
CN-C12-353	8	X	A/B			4				4				
CN-12-355	8	X	D						4	4				
CN-06-355	10	X	A		10									
CN-06-334	10	X	A		10									
CN-08-376	10	X	D			6	4							
CN-08-381	10	X	D			6	4							
CN-12-375	10	X	D			6				4				

PLUGS AND RECEPTACLES: NEC/CEC ORDINARY LOCATION

Appleton®

Electrical Performance — Service Voltage Ratings (for various specifications)

NEC voltage rating is designated by a service voltage rating letter which is shown listed in the table below corresponds to the insert configurations listings on the following pages. The voltage to which contact inserts are limited is a function of the dielectric separation between adjacent contacts and between contacts and shell.

Service Voltage	Inches Nominal		Mil-C-5015 Rating — Volts RMS		NEC Rating — Volts RMS	
			Non-Circuit Breaking		Non-Circuit Breaking	Circuit Breaking
	Over Surface	Distance Thru-Air Spacing	DC	AC	DC	AC
Instrument	1/16	—	250	200	—	—
A	1/8	1/16	700	500	250	240
D	3/16	1/8	1250	900	600	600
E	1/4	3/16	1750	1250	600	600
B	5/16	1/4	2450	1750	600	600
C	1	5/16	4200	3000	600	600

M-Line Series MN Multi-Pin Plugs and Receptacles

240 - 600 Vac, 250 - 600 Vdc

NEC/CEC:
IP68

Insert Configuration Index

Insert Arrangement	Total Contacts	Crimp	Service Rating	Contact Size										
				18	16	12	10	8	4	1/0	4/0	350 MCM	500 MCM	
CN-10-375	12	X	D				12							
CN-08-325	16	X	D		16									
CN-08-312	19	X	A			19								
CN-08-377	19	X	A			19								
CN-08-355	19	X	A		19									
CN-10-376	19	X	D			19								
CN-10-388	19	X	D			19								
CN-10-332	20	X	A			20								
CN-10-387	20	X	A			20								
CN-08-335	27	X	A		24	3								
CN-10-374	27	X	D/A			25			2					
CN-08-321	37	X	A		37									
CN-10-350	37	X	A			37								
CN-10-386	37	X	A			37								
CN-12-371	37	X	D		37									
CN-14-339	42	X	D			42								
CN-12-352	58	X	A			58								
CN-12-384	58	X	A			58								
CN-10-313	68	X	A		68									

PLUGS AND RECEPTACLES: NEC/CEC ORDINARY LOCATION

Appleton®

Electrical Performance — Service Voltage Ratings (for various specifications)

NEC voltage rating is designated by a service voltage rating letter which is shown listed in the table below corresponds to the insert configurations listings on the following pages. The voltage to which contact inserts are limited is a function of the dielectric separation between adjacent contacts and between contacts and shell.

Service Voltage	Inches Nominal		Mil-C-5015 Rating — Volts RMS		NEC Rating — Volts RMS	
			Non-Circuit Breaking		Non-Circuit Breaking	Circuit Breaking
	Over Surface Distance	Thru-Air Spacing	DC	AC	DC	AC
Instrument	1/16	—	250	200	—	—
A	1/8	1/16	700	500	250	240
D	3/16	1/8	1250	900	600	600
E	1/4	3/16	1750	1250	600	600
B	5/16	1/4	2450	1750	600	600
C	1	5/16	4200	3000	600	600

M-Line Series MN Multi-Pin Plugs and Receptacles

240 - 600 Vac, 250 - 600 Vdc

NEC/CEC:
IP68

Insert Configurations

Special insert configurations may be available upon request. Contact your local sales representative for more information.

	Shell Size	Insert Type	Number of Contacts	AWG Size	Wire Terminal Type	Service Voltage Rating	Catalog Number
3 Contacts							
	06	Pin	3	12	Crimp	D	CN-06-327PN
	06	Socket	3	12	Crimp	D	CN-06-327SN
4 Contacts							
	06	Pin	4	10	Crimp	D	CN-06-314PN
	06	Socket	4	10	Crimp	D	CN-06-314SN
	06	Pin	4	10	Crimp	D	CN-06-316PN
	06	Socket	4	10	Crimp	D	CN-06-316SN
	06	Pin	4	10	Crimp	D	CN-06-322PN
	06	Socket	4	10	Crimp	D	CN-06-322SN
	06	Pin	4	16	Crimp	D	CN-06-333PN
	06	Socket	4	16	Crimp	D	CN-06-333SN
	08	Pin	4	8	Crimp	D	CN-08-328PN
	08	Socket	4	8	Crimp	D	CN-08-328SN
5 Contacts							
	06	Pin	5	12	Crimp	D	CN-06-324PN
	06	Socket	5	12	Crimp	D	CN-06-324SN

Contacts Symbols	○	●	⊕	○	⊙	⦿	⊕	△	□	○	⊕	⊕	⊕
AWG	18	16	12	10	8	4	1/0	4/0	350 MCM	500 MCM	Ground Crimp	Contact Solder	Termination Pressure

Service Voltage Rating: A = 240V, B, D, E = 600V

M-Line Series MN Multi-Pin Plugs and Receptacles

240 - 600 Vac, 250 - 600 Vdc

NEC/CEC:
IP68

PLUGS AND RECEPTACLES: NEC/CEC ORDINARY LOCATION

Appleton®

Insert Configurations

Special insert configurations may be available upon request. Contact your local sales representative for more information.

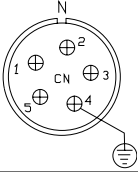
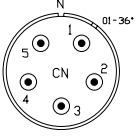
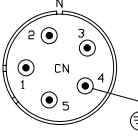
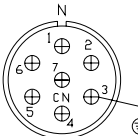
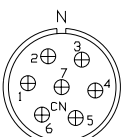
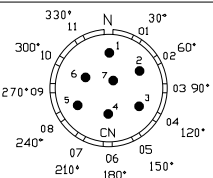
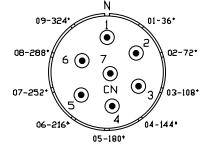
	Shell Size	Insert Type	Number of Contacts	AWG Size	Wire Terminal Type	Service Voltage Rating	Catalog Number
5 Contacts (continued)							
	06	Pin	5	12	Crimp	D	CN-06-353PN
	06	Socket	5	12	Crimp	D	CN-06-353SN
	08	Pin	5	8	Crimp	D	CN-08-316PN
	08	Socket	5	8	Crimp	D	CN-08-316SN
	08	Pin	5	8	Crimp	D	CN-08-375PN
	08	Socket	5	8	Crimp	D	CN-08-375SN
7 Contacts							
	06	Pin	7	12	Crimp	A	CN-06-310PN
	06	Socket	7	12	Crimp	A	CN-06-310SN
	06	Pin	7	12	Crimp	A	CN-06-354PN
	06	Socket	7	12	Crimp	A	CN-06-354SN
	06	Pin	7	16	Crimp	A	CN-06-348PN
	06	Socket	7	16	Crimp	A	CN-06-348SN
	10	Pin	7	8	Crimp	D	CN-10-359PN
	10	Socket	7	8	Crimp	D	CN-10-359SN

Contacts Symbols													
AWG	18	16	12	10	8	4	1/0	4/0	350 MCM	500 MCM	Ground Crimp	Contact Solder	Termination Pressure

Service Voltage Rating: A = 240V, B, D, E = 600V

M-Line Series MN Multi-Pin Plugs and Receptacles

240 - 600 Vac, 250 - 600 Vdc

NEC/CEC:
IP68

Insert Configurations

Special insert configurations may be available upon request. Contact your local sales representative for more information.

	Shell Size	Insert Type	Number of Contacts	AWG Size	Wire Terminal Type	Service Voltage Rating	Catalog Number
8 Contacts							
	C12	Pin	4	12 1/0	Crimp	A B	CN-C12-353PN
	C12	Socket	4	12 1/0	Crimp	A B	CN-C12-353SN
	12	Pin	4	4 1/0	Crimp	D	CN-12-355PN
	12	Socket	4	4 1/0	Crimp	D	CN-12-355SN
10 Contacts							
	06	Pin	10	16	Crimp	A	CN-06-355PN
	06	Socket	10	16	Crimp	A	CN-06-355SN
	06	Pin	10	16	Crimp	A	CN-06-334PN
	06	Socket	10	16	Crimp	A	CN-06-334SN
	08	Pin	4 6	10 12	Crimp	D	CN-08-376PN
	08	Socket	4 6	10 12	Crimp	D	CN-08-376SN
	08	Pin	4 6	10 12	Crimp	D	CN-08-381PN
	08	Socket	4 6	10 12	Crimp	D	CN-08-381SN
	C12	Pin	4 6	1/0 12	Crimp	D	CN-C12-375PN
	C12	Socket	4 6	1/0 12	Crimp	D	CN-C12-375SN

Contacts Symbols													
AWG	18	16	12	10	8	4	1/0	4/0	350 MCM	500 MCM	Ground Crimp	Contact Solder	Termination Pressure

Service Voltage Rating: A = 240V, B, D, E = 600V

M-Line Series MN Multi-Pin Plugs and Receptacles

240 - 600 Vac, 250 - 600 Vdc

NEC/CEC:
IP68

Insert Configurations

Special insert configurations may be available upon request. Contact your local sales representative for more information.

	Shell Size	Insert Type	Number of Contacts	AWG Size	Wire Terminal Type	Service Voltage Rating	Catalog Number
12 Contacts							
	10	Pin	12	10	Crimp	D	CN-10-375PN
	10	Socket	12	10	Crimp	D	CN-10-375SN
16 Contacts							
	08	Pin	16	16	Crimp	D	CN-08-325PN
	08	Socket	16	16	Crimp	D	CN-08-325SN
19 Contacts							
	08	Pin	19	12	Crimp	A	CN-08-312PN
	08	Socket	19	12	Crimp	A	CN-08-312SN
	08	Pin	19	12	Crimp	A	CN-08-377PN
	08	Socket	19	12	Crimp	A	CN-08-377SN
	08	Pin	19	16	Crimp	A	CN-08-355PN
	08	Socket	19	16	Crimp	A	CN-08-355SN
	10	Pin	19	12	Crimp	D	CN-10-376PN
	10	Socket	19	12	Crimp	D	CN-10-376SN
	10	Pin	19	12	Crimp	D	CN-10-388PN
	10	Socket	19	12	Crimp	D	CN-10-388SN

Contacts Symbols													
AWG	18	16	12	10	8	4	1/0	4/0	350 MCM	500 MCM	Ground Crimp	Contact Solder	Termination Pressure

Service Voltage Rating: A = 240V, B, D, E = 600V

PLUGS AND RECEPTACLES: NEC/CEC ORDINARY LOCATION

Appleton®

M-Line Series MN Multi-Pin Plugs and Receptacles

240 - 600 Vac, 250 - 600 Vdc

NEC/CEC:
IP68

Insert Configurations

Special insert configurations may be available upon request. Contact your local sales representative for more information.

	Shell Size	Insert Type	Number of Contacts	AWG Size	Wire Terminal Type	Service Voltage Rating	Catalog Number
20 Contacts							
	10	Pin	20	12	Crimp	A	CN-10-332PN
	10	Socket	20	12	Crimp	A	CN-10-332SN
	10	Pin	20	12	Crimp	A	CN-10-387PN
	10	Socket	20	12	Crimp	A	CN-10-387SN
27 Contacts							
	08	Pin	3 24	12 16	Crimp	A A	CN-08-335PN
	08	Socket	3 24	12 16	Crimp	A A	CN-08-335SN
	10	Pin	2 25	4 12	Crimp	D A	CN-10-374PN
	10	Socket	2 25	4 12	Crimp	D A	CN-10-374SN
37 Contacts							
	08	Pin	37	16	Crimp	A	CN-08-321PN
	08	Socket	37	16	Crimp	A	CN-08-321SN
	10	Pin	37	12	Crimp	A	CN-10-350PN
	10	Socket	37	12	Crimp	A	CN-10-350SN
	10	Pin	37	12	Crimp	A	CN-10-386PN
	10	Socket	37	12	Crimp	A	CN-10-386SN

Contacts Symbols													
AWG	18	16	12	10	8	4	1/0	4/0	350 MCM	500 MCM	Ground Crimp	Contact Solder	Termination Pressure

Service Voltage Rating: A = 240V, B, D, E = 600V

M-Line Series MN Multi-Pin Plugs and Receptacles

240 - 600 Vac, 250 - 600 Vdc

NEC/CEC:
IP68

Insert Configurations

Special insert configurations may be available upon request. Contact your local sales representative for more information.

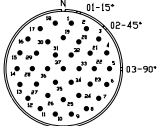
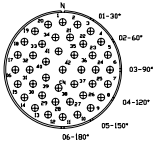
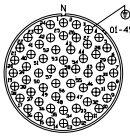
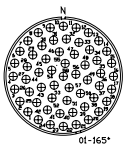
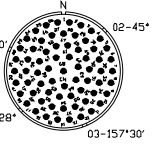
	Shell Size	Insert Type	Number of Contacts	AWG Size	Wire Terminal Type	Service Voltage Rating	Catalog Number
37 Contacts (continued)							
	12	Pin	37	16	Crimp	D	CN-12-371PN
	12	Socket	37	16	Crimp	D	CN-12-371SN
42 Contacts							
	14	Pin	42	12	Crimp	D	CN-14-339PN
	14	Socket	42	12	Crimp	D	CN-14-339SN
58 Contacts							
	12	Pin	58	12	Crimp	A	CN-12-352PN
	12	Socket	58	12	Crimp	A	CN-12-352SN
	12	Pin	58	12	Crimp	A	CN-12-384PN
	12	Socket	58	12	Crimp	A	CN-12-384SN
68 Contacts							
	10	Pin	68	16	Crimp	A	CN-10-313PN
	10	Socket	68	16	Crimp	A	CN-10-313SN

PLUGS AND RECEPTACLES: NEC/CEC ORDINARY LOCATION

Appleton

Contacts Symbols													
AWG	18	16	12	10	8	4	1/0	4/0	350 MCM	500 MCM	Ground Crimp	Contact Solder	Termination Pressure

Service Voltage Rating: A = 240V, B, D, E = 600V

M-Line Series MN Multi-Pin Plugs and Receptacles

240 - 600 Vac, 250 - 600 Vdc

NEC/CEC:
IP68

Cable Grip Components

Shell Size	Cable Diameter Dimension mm (in)		Cable Diameter Code Number	Catalog Number Oil Resistant Rubber Grommets	Catalog Number Steel Gland Washers ①	Catalog Number Stainless Steel Basket Weave Grips	Basket Weave Nominal Length mm (in)
	Minimum	Maximum					
06	1.57 (0.062)	3.18 (0.125)	02	CN-6306-02C	CN-8006-15E	CN-5006-4E	76.2 (3.0)
	3.18 (0.125)	6.35 (0.250)	04	CN-6306-04C		CN-5006-4E	76.2 (3.0)
	6.35 (0.250)	9.53 (0.375)	06	CN-6306-06C		CN-5006-6E	101.6 (4.0)
	9.53 (0.375)	12.70 (0.500)	08	CN-6306-08C		CN-5006-8E	127.0 (5.0)
	12.70 (0.500)	15.88 (0.625)	10	CN-6306-10C		CN-5006-10E	152.4 (6.0)
	15.88 (0.625)	19.05 (0.750)	12	CN-6306-12C		CN-5006-12E	177.8 (7.0)
	19.05 (0.750)	22.23 (0.875)	14	CN-6306-14C		CN-5006-14E	190.5 (7.5)
08	22.23 (0.875)	23.80 (0.937)	15	CN-6306-15C	CN-8008-23E	CN-5006-15E	203.2 (8.0)
	6.35 (0.250)	9.53 (0.375)	06	CN-6308-06C		CN-5008-6E	101.6 (4.0)
	9.53 (0.375)	12.70 (0.500)	08	CN-6308-08C		CN-5008-8E	127.0 (5.0)
	12.70 (0.500)	15.88 (0.625)	10	CN-6308-10C		CN-5008-10E	152.4 (6.0)
	15.88 (0.625)	19.05 (0.750)	12	CN-6308-12C		CN-5008-12E	177.8 (7.0)
	19.05 (0.750)	22.23 (0.875)	14	CN-6308-14C		CN-5008-14E	190.5 (7.5)
	22.23 (0.875)	25.40 (1.000)	16	CN-6308-16C		CN-5008-16E	215.9 (8.5)
	25.40 (1.000)	28.58 (1.125)	18	CN-6308-18C		CN-5008-18E	228.6 (9.0)
	28.58 (1.125)	31.75 (1.250)	20	CN-6308-20C		CN-5008-20E	254.0 (10.0)
	31.75 (1.250)	34.93 (1.375)	22	CN-6308-22C		CN-5008-22E	266.7 (10.5)
10 & C10	34.93 (1.375)	36.50 (1.437)	23	CN-6308-23C	CN-8010-31E	CN-5008-23E	266.7 (10.5)
	12.70 (0.500)	15.88 (0.625)	10	CN-6310-10C		CN-5010-10E	152.4 (6.0)
	15.88 (0.625)	19.05 (0.750)	12	CN-6310-12C		CN-5010-14E	190.5 (7.5)
	19.05 (0.750)	22.23 (0.875)	14	CN-6310-14C		CN-5010-14E	190.5 (7.5)
	22.23 (0.875)	25.40 (1.000)	16	CN-6310-16C		CN-5010-18E	228.6 (9.0)
	25.40 (1.000)	28.58 (1.125)	18	CN-6310-18C		CN-5010-18E	228.6 (9.0)
	28.58 (1.125)	31.75 (1.250)	20	CN-6310-20C		CN-5010-20E	254.0 (10.0)
	31.75 (1.250)	34.93 (1.375)	22	CN-6310-22C		CN-5010-24E	279.4 (11.0)
	34.93 (1.375)	38.10 (1.500)	24	CN-6310-24C		CN-5010-24E	279.4 (11.0)
	38.10 (1.500)	41.28 (1.625)	26	CN-6310-26C		CN-5010-28E	330.2 (13.0)
	41.28 (1.625)	44.45 (1.750)	28	CN-6310-28C		CN-5010-28E	330.2 (13.0)
	44.45 (1.750)	47.63 (1.875)	30	CN-6310-30C		CN-5010-31E	368.3 (14.5)
	47.63 (1.875)	49.20 (1.937)	31	CN-6310-31C		CN-5010-31E	368.3 (14.5)
12 & C12	22.23 (0.875)	25.40 (1.000)	16	CN-6312-16C	CN-8012-39E	CN-5012-16E	215.9 (8.5)
	25.40 (1.000)	28.58 (1.125)	18	CN-6312-18C		CN-5012-20E	254.0 (10.0)
	28.58 (1.125)	31.75 (1.250)	20	CN-6312-20C		CN-5012-20E	254.0 (10.0)
	31.75 (1.250)	34.93 (1.375)	22	CN-6312-22C		CN-5012-24E	279.4 (11.0)
	34.93 (1.375)	38.10 (1.500)	24	CN-6312-24C		CN-5012-24E	279.4 (11.0)
	38.10 (1.500)	41.28 (1.625)	26	CN-6312-26C		CN-5012-28E	330.2 (13.0)
	41.28 (1.625)	44.45 (1.750)	28	CN-6312-28C		CN-5012-28E	330.2 (13.0)
	44.45 (1.750)	47.63 (1.875)	30	CN-6312-30C		CN-5012-32E	381.0 (15.0)
	47.63 (1.875)	50.80 (2.000)	32	CN-6312-32C		CN-5012-32E	381.0 (15.0)
	50.80 (2.000)	53.98 (2.125)	34	CN-6312-34C		CN-5012-36E	406.4 (16.0)
14 & C14	53.98 (2.125)	57.15 (2.250)	36	CN-6312-36C	CN-8014-46E	CN-5012-36E	406.4 (16.0)
	57.15 (2.250)	60.33 (2.375)	38	CN-6312-38C		CN-5012-39E	444.5 (17.0)
	60.33 (2.375)	61.90 (2.437)	39	CN-6312-39C		CN-5012-39E	444.5 (17.0)
	34.93 (1.375)	38.10 (1.500)	24	CN-6314-24C		CN-5014-24E	330.2 (13.0)
	38.10 (1.500)	41.28 (1.625)	26	CN-6314-26C		CN-5014-28E	330.2 (13.0)
	41.28 (1.625)	44.45 (1.750)	28	CN-6314-28C		CN-5014-28E	330.2 (13.0)
	44.45 (1.750)	47.63 (1.875)	30	CN-6314-30C		CN-5014-32E	381.0 (15.0)
	47.63 (1.875)	50.80 (2.000)	32	CN-6314-32C		CN-5014-32E	381.0 (15.0)
	50.80 (2.000)	53.98 (2.125)	34	CN-6314-34C		CN-5014-36E	406.4 (16.0)
	53.98 (2.125)	57.15 (2.250)	36	CN-6314-36C		CN-5014-36E	406.4 (16.0)
Gland Washers	57.15 (2.250)	60.33 (2.375)	38	CN-6314-38C	CN-8014-46E	CN-5014-40E	444.5 (17.0)
	60.33 (2.375)	63.50 (2.500)	40	CN-6314-40C		CN-5014-40E	444.5 (17.0)
	63.50 (2.500)	59.06 (2.625)	42	CN-6314-42C		CN-5014-44E	482.6 (19.0)
	59.06 (2.625)	69.85 (2.750)	44	CN-6314-44C		CN-5014-44E	482.6 (19.0)
	69.85 (2.750)	73.03 (2.875)	46	CN-6314-46C		CN-5014-46E	482.6 (19.0)

① One steel gland washer size is used for each shell size available.

M-Line Series MN Multi-Pin Plugs and Receptacles

240 - 600 Vac, 250 - 600 Vdc

NEC/CEC:
IP68

PLUGS AND RECEPTACLES: NEC/CEC ORDINARY LOCATION

Mechanical Clamp Nut

Shell Size	L1	Dimensions mm (in)				Catalog Number
		L2	L3	L4		
	06	50.8 (2.00)	25.4 (1.00)	52.1 (2.05)	46.5 (1.83)	CN-W-5306N
	08	50.8 (2.00)	25.4 (1.00)	64.8 (2.55)	57.1 (2.25)	CN-W-5308N
	10/C10	51.6 (2.03)	25.4 (1.00)	77.5 (3.05)	77.5 (3.05)	CN-W-5310N
	12/C12	53.3 (2.10)	25.4 (1.00)	92.7 (3.65)	92.7 (3.65)	CN-W-5312N
	14/C14	57.1 (2.25)	28.7 (1.13)	113.0 (4.45)	113.0 (4.45)	CN-W-5314N

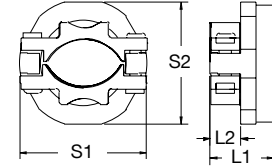





Contact Data

Contact Terminal (Crimp)	Size	Catalog Number
Pin	4 AWG	CN400420L
Socket	4 AWG	CN410420L
Pin	8 AWG	CN400820L
Socket	8 AWG	CN410820L
Pin	10 AWG	CN401020L
Socket	10 AWG	CN411020L
Pin	12 AWG	CN401220L
Pin Ground	12 AWG	CN401221L
Socket	12 AWG	CN411220L
Pin	16 AWG	CN401620L
Socket	16 AWG	CN411620L

M-Line Series MN Multi-Pin Plugs and Receptacles

240 - 600 Vac, 250 - 600 Vdc

NEC/CEC:
IP68

Contact Crimping and Insertion/Removal Tools		
	Description	Catalog Number
Full Cycle Crimp Tool		
	This tool is a full cycle crimp tool for crimping Appleton crimp contact sizes #10 AWG through #16 AWG — To be used with TC-CN-XX-20L locator dies	TC-CN-M309
Locator Dies for TC-CN_M309 Crimp Tool		
	Locator die for #10 AWG pin/socket crimp contacts	TC-CN-10-20L
	Locator die for #12 AWG pin/socket crimp contacts	TC-CN-12-20L
	Locator die for #16 AWG pin/socket crimp contacts	TC-CN-16-20L
Insertion Tool for Pin/Socket Crimp Contacts		
	Locator tool for #10 AWG pin/socket crimp contact	TI-10H
	Locator tool for #12 AWG pin/socket crimp contact	TI-12H
	Locator tool for #16 AWG pin/socket crimp contact	TI-16H
Removal Tool for Pin Crimp Contacts		
	Removal tool for #8, #10 and #12 AWG pin crimp contact	TEP-LGH
	Removal tool for #16 AWG pin crimp contact	TEP-SMH
Removal Tool for Crimp Socket Contacts		
	Removal tool for #10 AWG socket crimp contact	TES-10H
	Removal tool for #12 AWG socket crimp contact	TES-12H
	Removal tool for #16 AWG socket crimp contact	TES-16H

PLUGS AND RECEPTACLES: NEC/CEC ORDINARY LOCATION

 Appleton

ATX™ PRE Series 16 Amp Plugs and Sockets

Increased Safety

ATEX/IECEX:
 Zone 1 and 2 - 21 and 22
 Ⓢ II 2 GD
 IP66 - IK09/10

Applications

- Plugs and receptacles are used with portable or stationery electrical equipment such as:
 - Lighting systems
 - Conveyors
 - Heaters
 - Motor generators
 - Air conditioning equipment
 - Compressors
 - Pumps
- For use in corrosive atmospheres and installations in Zone 1 and 2 and 21 and 22 of the oil and gas industry; such as:
 - Refineries
 - Chemical and petrochemical plants
 - Pipelines
 - Loading docks
 - Onshore and offshore drilling platforms

Features

- Plug and socket system is designed with a safe disconnect mechanism to insure maximum hazardous location protection:
 - The contact separation is in a flameproof chamber
 - The automatic electrical disconnection of each phase is contained in a second flameproof chamber
- Short circuit protection is 20 kA, while normal reference is 10 kA.
- Different voltages are color coded for easy identification.
- The receptacles are keyed to accept only ATX plugs (other plugs can not be inserted).
- ATX plugs can be used in non-hazardous IEC 309 sockets.
- Operating temperature of -40 °C to +55 °C (-40 °F to +131 °F)

Standard Materials

- Wall Socket for 2P - 2P+E - 3P: high impact resistance polycarbonate
- Wall Socket for 3P+E - 3P+N+E: high impact resistance fiberglass reinforced polyester
- Plug, mobile socket and flush socket: polyamide

ATEX/IECEX Certifications and Compliances

- Certification Type PCX (Plug, socket and mobile socket)
 - Gas: Zones 1 and 2
 - Conforming to ATEX 94/9/CE: Ⓢ II 2 G
 - Type of Protection: Ex de IIC
 - Temperature Class: T6 for Ta ≤ +40 °C (-40 °F) and T5 for +55 °C (+131 °F)
 - Dust: Zones 21 and 22
 - Conforming to ATEX 94/9/CE: Ⓢ II 2 D
 - Type of Protection: Ex tD A21
 - Surface Temperature: T68 °C (T154 °F)
 - Impact Resistance (shock): IK10 (Polyester) and IK09 (Polyamide)
 - CE Declaration of Conformity: 50228
 - ATEX Certificate: LCIE 02 ATEX 6068
 - IECEX Certificate: IECEX LCI 04.0014
- Certification Type PCX/EN (Flush socket)
 - Gas: Zones 1 and 2
 - Conforming to ATEX 94/9/CE: Ⓢ II 2 G
 - Type of Protection: Ex de IIC
 - Temperature Class: T6 for Ta ≤ +40 °C (-40 °F) and T5 for +55 °C (+131 °F)



Technical Data

Breaking Capacity	
AC 3	4 kW – 220 V
	4.3 kW – 240 V
	7.5 kW – 380 V
	8.2 kW – 415 V
ICC	20 kA

- Dust: Zones 21 and 22
 - Conforming to ATEX 94/9/CE: Ⓢ II 2 D
 - Type of Protection: Ex tD A21
 - Surface Temperature: T68 °C (T154 °F)
- Impact Resistance (shock): IK09 (Polyamide)
- CE Declaration of Conformity: 5C214
- ATEX Certificate: LCIE 02 ATEX 0001U
- IECEX Certificate: IECEX LCI 07.0012U
- Ambient Temperature: -40 °C ≤ Ta ≤ +55 °C (-40 °F ≤ Ta ≤ +131 °F)
- Index of Protection according EN/IEC 60529: IP66

EURASEC Certification

- Certification Type PCX (Plug, socket and mobile socket)
 - EURASEC N° TC RU C-FR.Г505.В.00910
- Certification Type PCX/EN (Flush socket)
 - EURASEC N° TC RU C-FR.Г505.В.00910

Other Certification

- Certification Type PCX (Plug, socket and mobile socket)
 - INMETRO Certificate: BVC11.0639 ①
- Certification Type PCX/EN (Flush socket)
 - INMETRO Certificate: BVC11.0598-U ①

① INMETRO certification available on special request only. Contact your local sales representative for more information.

ATX™ PRE Series 16 Amp Plugs and Sockets

Increased Safety

ATEX/IECEX:
 Zone 1 and 2 - 21 and 22
 II 2 GD
 IP66 - IK09/10



Wall Mounting Socket

- Three M20 threaded entries (one on the top and two on the bottom).
- Supplied with one M20 cable gland – Ø 6.5 to Ø 14.5 mm (Ø 0.26 to Ø 0.57”) and two M20 blanking plugs.
- Terminal capacity 2 x 4 mm² (0.003 x 0.006 in²). Can be through-wired.
- Fitted with three linked earth terminals.



Plug

- One PG16 integrated cable gland – Ø 6.5 to Ø 14.5 mm (Ø 0.26 to Ø 0.57”).
- Terminal capacity 2.5 mm² (0.004 in²).



Mobile Socket

- One PG16 integrated cable gland – Ø 6.5 to Ø 14.5 mm (Ø 0.26 to Ø 0.57”).
- Terminal capacity 2 x 4 mm² (0.003 x 0.006 in²).



Flush Socket

- Terminal capacity 2 x 4 mm² (0.003 x 0.006 in²).

Catalog Numbering Guide - IECEx Internationally Certified Plugs and Receptacles

PRE
 IECEx Series:
 PRE - PRE Series
 Zone 1, 2, 21 and 22
 ATEX / IECEx

2
 Pin Configuration:
 2 - 2P
 3 - 2P+E
 4 - 3P+E
 5 - 3P+N+E
 6 - 3P

16
 Amps:
 16 - 16A

R
 Equipment:
 P - Plug
 R - Receptacle
 (Wall Mounting)
 M - Mobile Socket
 F - Flush Socket

P
 Voltage:
 P - 20 - 25 Vac 50/60 Hz
 W1 - 20 - 50 Vdc
 W - 40 - 50 Vac 50/60 Hz
 Y - 100 - 130 Vac 50/60 Hz
 B - 200 - 250 Vac 50/60 Hz
 R - 380 - 415 Vac 50/60 Hz
 N - 480 - 500 Vac 50/60 Hz
 G - 50 - 500 Vac 300 to 500 Hz

ELV: Extra Low Voltage

Purple	White	White
20/25 Vac	20/50 Vdc	40/50 Vac

LV: Low Voltage

Yellow	Blue	Red	Black	Green
100/130 Vac	200/250 Vac	380/415 Vac	480/500 Vac	50/500 Vac (300 to 500 Hz)

















PLUGS AND RECEPTACLES: ATEX/IECEX INCREASED SAFETY



ATX™ PRE Series 16 Amp Plugs and Sockets

Increased Safety

ATEX/IECEX:
Zone 1 and 2 - 21 and 22
II 2 GD
IP66 - IK09/10

Description	Pin Configuration	Weight kg (lb)	Volume dm ³ (in ³)	Catalog Number
Extra Low Voltage: ELV				
20/25 Vac 50/60 Hz – Purple				
Wall Socket		0.6 (1.3)	3.8 (231.89)	PRE216RP
Plug		0.2 (0.4)	0.6 (361.6)	PRE216PP
Mobile Socket		0.4 (0.9)	1.3 (79.33)	PRE216MP
Flush Socket	2P polarization tab	0.2 (0.4)	1.3 (79.33)	PRE216FP
Wall Socket		0.6 (1.3)	3.8 (231.89)	PRE316RP
Plug		0.2 (0.4)	0.6 (36.61)	PRE316PP
Mobile Socket		0.4 (0.9)	1.3 (79.33)	PRE316MP
Flush Socket	10h 2P+E	0.2 (0.4)	1.3 (79.33)	PRE316FP
Wall Socket		0.6 (1.3)	3.8 (231.89)	PRE616RP
Plug		0.2 (0.4)	0.6 (36.61)	PRE616PP
Mobile Socket		0.4 (0.9)	1.3 (79.33)	PRE616MP
Flush Socket	3P polarization tab	0.2 (0.4)	1.3 (79.33)	PRE616FP
20/50 Vdc – White				
Wall Socket		0.6 (1.3)	3.8 (231.89)	PRE216RW1
Plug		0.2 (0.4)	0.6 (36.61)	PRE216PW1
Mobile Socket		0.4 (0.9)	1.3 (79.33)	PRE216MW1
Flush Socket	2P polarization tab auxiliary tab 10h	0.2 (0.4)	1.3 (79.33)	PRE216FW1
40/50 Vac 50/60 Hz – White				
Wall Socket		0.6 (1.3)	3.8 (231.89)	PRE216RW
Plug		0.2 (0.4)	0.6 (36.61)	PRE216PW
Mobile Socket		0.4 (0.9)	1.3 (79.33)	PRE216MW
Flush Socket	2P polarization tab	0.2 (0.4)	1.3 (79.33)	PRE216FW
Wall Socket		0.6 (1.3)	3.8 (231.89)	PRE616RW
Plug		0.2 (0.4)	0.6 (36.61)	PRE616PW
Mobile Socket		0.4 (0.9)	1.3 (79.33)	PRE616MW
Flush Socket	3P polarization tab auxiliary pin 12h	0.2 (0.4)	1.3 (79.33)	PRE616FW
Low Voltage: LV				
100/130 Vac 50/60 Hz – Yellow				
Wall Socket		0.6 (1.3)	3.8 (231.89)	PRE316RY
Plug		0.2 (0.4)	0.6 (36.61)	PRE316PY
Mobile Socket		0.4 (0.9)	1.3 (79.33)	PRE316MY
Flush Socket	2P+E	0.2 (0.4)	1.3 (79.33)	PRE316FY
200/250 Vac 50/60 Hz – Blue				
Wall Socket		0.6 (1.3)	3.8 (231.89)	PRE316RB
Plug		0.2 (0.4)	0.6 (36.61)	PRE316PB
Mobile Socket		0.4 (0.9)	1.3 (79.33)	PRE316MB
Flush Socket	2P+E	0.2 (0.4)	1.3 (79.33)	PRE316FB

PLUGS AND RECEPTACLES: ATEX/IECEX INCREASED SAFETY

Appleton®

ATX™ PRE Series 16 Amp Low Voltage Plugs and Sockets

Increased Safety

ATEX/IECEX:
Zone 1 and 2 - 21 and 22
II 2 GD
IP66 - IK09/10

Description	Pin Configuration	Weight kg (lb)	Volume dm ³ (in ³)	Catalog Number
Low Voltage: LV				
200/250 Vac 50/60 Hz — Blue				
Wall Socket		1.5 (3.3)	4.7 (286.81)	PRE416RB
Plug		0.6 (1.3)	0.6 (361.6)	PRE416PB
Mobile Socket		0.6 (1.3)	4.0 (244.09)	PRE416MB
Flush Socket		0.2 (0.4)	1.3 (79.33)	PRE416FB
Wall Socket		1.6 (3.5)	4.7 (286.81)	PRE516RB
Plug		0.3 (0.7)	1.3 (79.33)	PRE516PB
Mobile Socket		0.6 (1.3)	4.0 (244.09)	PRE516MB
Flush Socket		(1) 120/208 V - 144/250 Vac 50/60 Hz	0.2 (0.4)	1.3 (79.33)
380/415 Vac 50/60 Hz — Red				
Wall Socket		1.5 (3.3)	4.7 (286.81)	PRE416RR
Plug		0.2 (0.4)	0.6 (361.6)	PRE416PR
Mobile Socket		0.6 (1.3)	4.0 (244.09)	PRE416MR
Flush Socket		0.3 (0.7)	1.3 (79.33)	PRE416FR
Wall Socket		1.6 (3.5)	4.7 (286.81)	PRE516RR
Plug		0.3 (0.7)	1.3 (79.33)	PRE516PR
Mobile Socket		0.6 (1.3)	4.0 (244.09)	PRE516MR
Flush Socket		(2) 200/346 V - 240/415 Vac 50/60 Hz	0.3 (0.7)	1.3 (79.33)
480/500 Vac 50/60 Hz — Black				
Wall Socket		1.5 (3.3)	4.7 (286.81)	PRE416RN
Plug		0.2 (0.4)	0.6 (361.6)	PRE416PN
Mobile Socket		0.6 (1.3)	4.0 (244.09)	PRE416MN
Flush Socket		0.3 (0.7)	1.3 (79.33)	PRE416FN
50/500 Vac 300/500 Hz — Green				
Wall Socket		1.6 (3.5)	4.7 (286.81)	PRE516RG
Plug		0.2 (0.4)	0.6 (361.6)	PRE516PG
Mobile Socket		0.6 (1.3)	4.0 (244.09)	PRE516MG
Flush Socket		0.3 (0.7)	1.3 (79.33)	PRE516FG
Accessories				
Description				
	M5 earth stud with black neoprene sealing washer and green/yellow earth conductor, length 300 mm (11.8")			PREESTM20
	M20 earth continuity adaptor with black neoprene sealing washer and green/yellow earth conductor, length 300 mm (11.8")			PREECAM20

PLUGS AND RECEPTACLES: ATEX/IECEX INCREASED SAFETY

Appleton

ATX™ PRE Series 16 Amp Plug and Socket

Increased Safety

ATEX/IECEX:
 Zone 1 and 2 - 21 and 22
 II 2 GD
 IP66 - IK09/10

Dimensions in Millimeters (Inches)

16A – 2P – 2P+E – 3P Versions

Wall Mounting Sockets

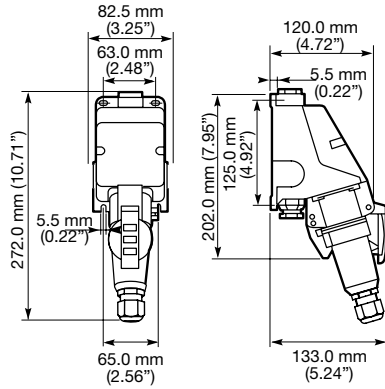

Plugs

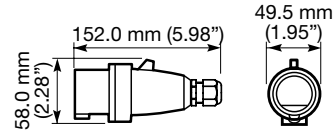

Mobile Sockets

Can be mounted on panel - 3.0 mm (0.12") thickness maximum

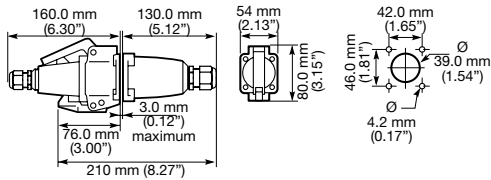

Flush Sockets

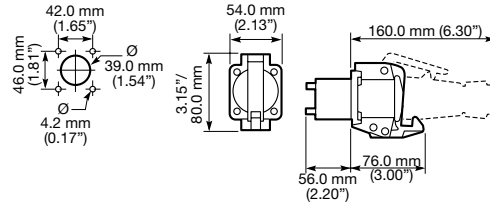

16A – 3P+E – 3P+N+E Versions

Wall Mounting Sockets

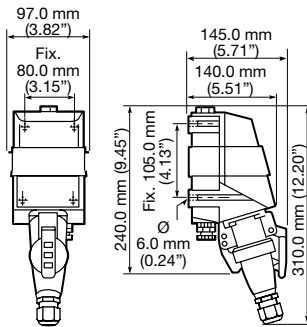

Plugs

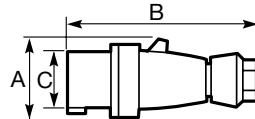

Dimensions in Millimeters (Inches)			
	A	B	C
3 P + E	66.0 (2.60)	154.0 (6.06)	55.5 (2.19)
3 P + N + E	73.0 (2.87)	166.0 (6.54)	62.0 (2.44)

Mobile Sockets

Can be mounted on panel - 3.0 mm (0.12") thickness maximum

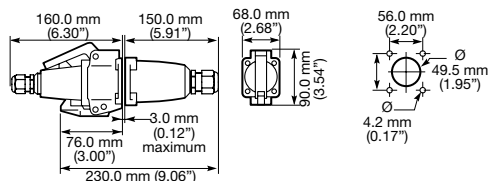

Flush Sockets

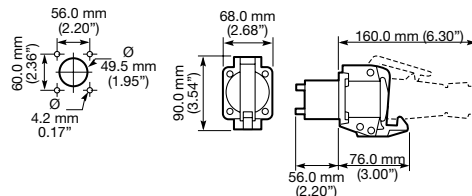

PLUGS AND RECEPTACLES: ATEX/IECEX INCREASED SAFETY

Appleton

ATX™ PRE Series 32 Amp Plugs and Sockets

Increased Safety

ATEX/IECEX:
 Zone 1 and 2 - 21 and 22
 Ⓢ II 2 GD
 IP66 - IK10

Applications

- Plugs and sockets are used with portable or stationary electrical equipment such as:
 - Lighting systems
 - Conveyors
 - Heaters
 - Motor generators
 - Air conditioning equipment
 - Compressors
 - Pumps
- For use in corrosive atmospheres and installations in Zone 1 and 2 and 21 and 22 of the oil and gas industry, such as:
 - Refineries
 - Chemical and petrochemical plants
 - Pipelines
 - Loading docks
 - Onshore and offshore drilling platforms

Features

- Plug and socket system is designed with a safe disconnect mechanism to insure maximum hazardous location protection:
 - The contact separation is in a flameproof chamber
 - The automatic electrical disconnection of each phase is contained in a second flameproof chamber
- Short circuit protection is 20 kA, while normal reference is 10 kA.
- Different voltages are color coded for easy identification.
- The sockets are keyed to accept only ATX plugs (other plugs can not be inserted).
- ATX plugs can be used in non-hazardous sockets.

Standard Materials

- Wall Socket: high impact resistance fiberglass reinforced polyester
- Plug, mobile socket and flush socket: polyamide

ATEX/IECEX Certifications and Compliances

- Certification Type PCX (Plug, socket and mobile socket)
 - Gas: Zones 1 and 2
 - Conforming to ATEX 94/9/CE: Ⓢ II 2 G
 - Type of Protection: Ex de IIC
 - Temperature Class: T6 for Ta ≤ +40 °C (-40 °F) and T5 for +55 °C (+131 °F)
- Dust: Zones 21 and 22
 - Conforming to ATEX 94/9/CE: Ⓢ II 2 D
 - Type of Protection: Ex tD A21
 - Surface Temperature: T68 °C (T154 °F)
- Index of Protection according EN/IEC 60529: IP66
- Impact Resistance (shock): IK10 (Polyester) and IK09 (Polyamide)
- CE Declaration of Conformity: 50228
- ATEX Certificate: LCIE 02 ATEX 6068
- IECEx Certificate: IECEx LCI 04.0014
- Certification Type PCX/EN (Flush socket)
 - Gas: Zones 1 and 2
 - Conforming to ATEX 94/9/CE: Ⓢ II 2 G
 - Type of Protection: Ex de IIC
 - Temperature Class: T6 for Ta ≤ +40 °C (-40 °F) and T5 for +55 °C (+131 °F)

LV: Low Voltage



Plug



Wall Mounting Socket



Mobile Socket



Flush Socket

Technical Data

Breaking Capacity	
AC 1	32 A – 500 V
	11 kW – 220 V
	12 kW – 240 V
AC 22	19 kW – 380 V
	20.7 kW – 415 V
ICC	20 kA

- Dust: Zones 21 and 22
- Conforming to ATEX 94/9/CE: Ⓢ II 2 D
- Type of Protection: Ex tD A21
- Surface Temperature: T68 °C (T154 °F)
- Impact Resistance (shock): IK09 (Polyamide)
- CE Declaration of Conformity: 5C214
- ATEX Certificate: LCIE 02 ATEX 0001U
- IECEx Certificate: IECEx LCI 07.0012U
- Ambient Temperature: -40 °C ≤ Ta ≤ +55 °C (-40 °F ≤ Ta ≤ +131 °F)
- Index of Protection according EN/IEC 60529: IP66

EURASEC Certification

- Certification Type PCX (Plug, socket and mobile socket)
 - EURASEC N° TC RU C-FR.Г505.В.00910
- Certification Type PCX/EN (Flush socket)
 - EURASEC N° TC RU C-FR.Г505.В.00910

Other Certification

- Certification Type PCX (Plug, socket and mobile socket)
 - INMETRO Certificate: BVC11.0639 ①
- Certification Type PCX/EN (Flush socket)
 - INMETRO Certificate: BVC11.0598-U ①

① INMETRO certification available on special request only. Contact your local sales representative for more information.

ATX™ PRE Series 32 Amp Plugs and Sockets

Increased Safety

ATEX/IECEX:
 Zone 1 and 2 - 21 and 22
 II 2 GD
 IP66 - IK10



Wall Mounting Socket

- Three M25 threaded entries (one on the top and two on the bottom).
- Supplied with one M25 cable gland – Ø 8 to Ø 18.5 mm (Ø 0.31 to Ø 0.73”) and two M25 blanking plugs.
- Terminal capacity 2 x 6 mm² (0.003 x 0.009 in²).
- Fitted with three linked earth terminals.



Plug

- One PG21 integrated cable gland – Ø 8 to Ø 18.5 mm (Ø 0.31 to Ø 0.73”) for 3P+N+E versions.
- Terminal capacity 6 mm² (0.009 in²).



Mobile Socket

- One PG21 integrated cable gland – Ø 8 to Ø 18.5 mm (Ø 0.31 to Ø 0.73”) for 2P+E and 3P+E versions.
- One PG29 integrated cable gland – Ø 18 to Ø 25 mm (Ø 0.70 to Ø 0.98”) for 3P+N+E versions.
- Terminal capacity 2 x 6 mm² (0.003 x 0.009 in²).



Flush Socket

- Terminal capacity 2 x 6 mm² (0.003 x 0.009 in²)

PLUGS AND RECEPTACLES: ATEX/IECEX INCREASED SAFETY

Catalog Numbering Guide – IECEx Internationally Certified Plugs and Receptacles

PRE
 |
 IECEx Series:
 PRE - PRE Series
 Zone 1, 2, 21 and 22
 ATEX / IECEx Certified

3
 |
 Pin Configuration:
 3 - 2P+E
 4 - 3P+E
 5 - 3P+N+E

32
 |
 Amps:
 32 - 32A

R
 |
 Equipment:
 P - Plug
 R - Receptacle
 (Wall Mounting)
 M - Mobile Socket
 F - Flush Socket

P
 |
 Voltage:
 Y - 100 - 130 Vac
 50/60 Hz
 B - 200 - 250 Vac
 50/60 Hz
 R - 380 - 415 Vac
 50/60 Hz
 N - 480 - 500 Vac
 50/60 Hz

LV: Low Voltage

Yellow	Blue	Red	Black
100/130 Vac	200/250 Vac	380/415 Vac	480/500 Vac

ATX™ PRE Series 32 Amp Low Voltage Plugs and Sockets

Increased Safety

ATEX/IECEX:
 Zone 1 and 2 - 21 and 22
 II 2 GD
 IP66 - IK10

Description	Pin Configuration	Weight kg (lb)	Volume dm ³ (in ³)	Catalog Number
100/130 Vac 50/60 Hz — Yellow				
Wall Socket		1.9 (4.19)	7.0 (427.17)	PRE332RY
Plug		0.5 (1.10)	4.0 (244.09)	PRE332PY
Mobile Socket		0.8 (1.76)	3.2 (195.28)	PRE332MY
Flush Socket		0.6 (1.32)	2.7 (164.76)	PRE332FY
200/250 Vac 50/60 Hz — Blue				
Wall Socket		1.9 (4.19)	7.0 (427.17)	PRE332RB
Plug		0.5 (1.10)	4.0 (244.09)	PRE332PB
Mobile Socket		0.8 (1.76)	3.2 (195.28)	PRE332MB
Flush Socket		0.6 (1.32)	2.7 (164.76)	PRE332FB
Wall Socket		1.9 (4.19)	7.0 (427.17)	PRE432RB
Plug		0.5 (1.10)	4.0 (244.09)	PRE432PB
Mobile Socket		0.8 (1.76)	3.2 (195.28)	PRE432MB
Flush Socket		0.6 (1.32)	2.7 (164.76)	PRE432FB
Wall Socket		1.9 (4.19)	7.0 (427.17)	PRE532RB
Plug		0.5 (1.10)	4.0 (244.09)	PRE532PB
Mobile Socket		1.0 (2.20)	4.0 (244.09)	PRE532MB
Flush Socket	(1) 120/208 V - 144/250 Vac 50/60 Hz	0.6 (1.32)	2.7 (164.76)	PRE532FB
380/415 Vac 50/60 Hz — Red				
Wall Socket		2.0 (4.41)	7.0 (427.17)	PRE432RR
Plug		0.4 (0.88)	4.0 (244.09)	PRE432PR
Mobile Socket		0.8 (1.76)	3.2 (195.28)	PRE432MR
Flush Socket		0.6 (1.32)	2.7 (164.76)	PRE432FR
Wall Socket		2.0 (4.41)	7.0 (427.17)	PRE532RR
Plug		0.5 (1.10)	4.0 (244.09)	PRE532PR
Mobile Socket		1.0 (2.20)	4.0 (244.09)	PRE532MR
Flush Socket	(2) 200/346 V - 240/415 Vac 50/60 Hz	0.6 (1.32)	2.7 (164.76)	PRE532FR
480/500 Vac 50/60 Hz — Black				
Wall Socket		2.0 (4.41)	7.0 (427.17)	PRE432RN
Plug		0.4 (0.88)	4.0 (244.09)	PRE432PN
Mobile Socket		1.0 (2.20)	4.0 (244.09)	PRE432MN
Flush Socket		0.6 (1.32)	2.7 (164.76)	PRE432FN

PLUGS AND RECEPTACLES: ATEX/IECEX INCREASED SAFETY



ATX™ PRE Series 32 Amp Low Voltage Plug and Socket Accessories

Increased Safety

ATEX/IECEX:
 Zone 1 and 2 - 21 and 22
 II 2 GD
 IP66 - IK10

Accessories

	Description	Catalog Number
	M5 earth stud with black neoprene sealing washer and green/yellow earth conductor, length 300 mm (11.8")	PREESTM25
	M20 earth continuity adaptor with black neoprene sealing washer and green/yellow earth conductor, length 300 mm (11.8")	PREECAM25

Dimensions in Millimeters (Inches)

32A – 2P+E – 3P+E – 3P+N+E Versions

Wall Mounting Sockets

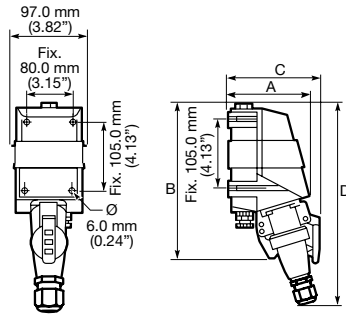

Plugs

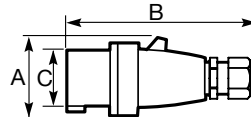

Dimensions in Millimeters (Inches)

	A	B	C	D
2 P + E	140.0 (5.51)	275.0 (10.83)	155.0 (6.10)	370.0 (14.67)
3 P + E	140.0 (5.51)	275.0 (10.83)	155.0 (6.10)	370.0 (14.67)
3 P + N + E	140.0 (5.51)	275.0 (10.83)	165.0 (6.50)	375.0 (14.76)

Dimensions in Millimeters (Inches)

	A	B	C
2 P + T	80.0 (3.15)	170.0 (6.69)	67.0 (2.64)
3 P + T	80.0 (3.15)	170.0 (6.69)	67.0 (2.64)
3 P + N + T	80.0 (3.15)	195.0 (7.68)	74.0 (2.91)

Mobile Sockets

Can be mounted on panel - 3.0 mm (0.12") thickness maximum

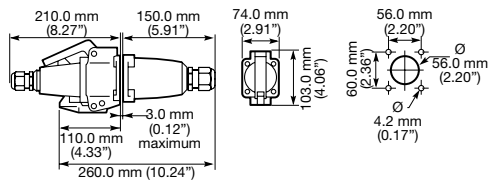

Flush Sockets

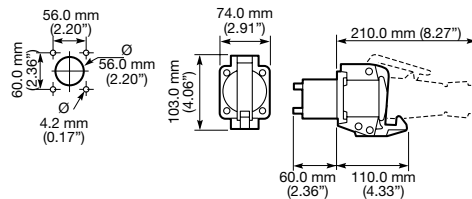

PLUGS AND RECEPTACLES: ATEX/IECEX INCREASED SAFETY

Appleton

ATX™ PRE Series 63 Amp Plugs and Sockets

Increased Safety

ATEX/IECEX:
Zone 1 and 2 - 21 and 22
Ⓢ II 2 GD
IP66 - IK10

Applications

- Plugs and sockets are used with stationary or portable electrically operated devices such as:
 - Welding devices
 - Lighting systems
 - Conveyors
 - Heaters
 - Motor generator sets
 - Air conditionings
 - Compressors
 - Pumps
- For use in corrosive atmospheres and installations in Zones 1, and 2 and 21 and 22 of oil and gas industry, such as
 - Refineries
 - Chemical and petrochemical plants
 - Pipelines
 - Onshore and offshore drilling platforms

Features

- Positive polarization: only ATX plugs of same style, number of poles and ampere rating may be used with these sockets.
- Interlocked 3-pole or 4-pole Ex de disconnecting on-load switch, with auxiliary early break contact capacity 2.5 mm² (0.004 in²) max .
- Plug is mechanically locked in socket when switch is "ON".
- Switch operating handle can be padlocked in "OFF" position (max 4 padlocks).
- Plug cannot be inserted or removed unless switch is in "OFF" position.

Standard Materials

- Socket: high impact resistance fiberglass reinforced polyester
- Flap cover and plug: polyamide

ATEX/IECEX Certifications and Compliances

- Certification Type PC63X
 - Gas: Zones 1 and 2
 - Conforming to ATEX 94/9/CE: Ⓢ II 2 G
 - Type of Protection: Ex de IIC
 - Temperature Class: T6 for Ta ≤ +40 °C (+104 °F) and T5 for +55 °C (+131 °F)
 - Dust: Zones 21 and 22
 - Conforming to ATEX 94/9/CE: Ⓢ II 2 D
 - Type of Protection: Ex tD A21
 - Surface Temperature: T90 °C (T194 °F)
- Ambient Temperature: -30 °C to +55 °C (-22 °F to +131 °F)
- Index of Protection according EN/IEC 60529: IP66
- Impact Resistance (shock): IK10
- CE Declaration of Conformity: 50208
- ATEX Certificate: LCIE 99 ATEX 6004
- IECEx Certificate: IECEx LCIE 13.0010

EURASEC Certification

- EURASEC N° TC RU C-FR.Г505.B.00910

Other Certification

- INMETRO Certificate: BVC11.0595 ①



Plug

Wall Mounting Socket



Wall Mounting Socket Through-Wired

PLUGS AND RECEPTACLES: ATEX/IECEX INCREASED SAFETY

Appleton®

① INMETRO certification available on special request only. Contact your local sales representative for more information.

ATX™ PRE Series 63 Amp Plugs and Sockets

Increased Safety

ATEX/IECEX:
 Zone 1 and 2 - 21 and 22
 II 2 GD
 IP66 - IK10



Wall Mounting Socket



Plug

- Standard versions:
 - Supplied with one M50 cable gland for unarmored cable – Ø 28 to Ø 42 mm (Ø 1.10 to Ø 1.65”) and one M25 blanking plug.
 - Terminal capacity 1 x 35 mm² (0.002 x 0.054 in²).
- Through-wired versions:
 - Supplied with two M50 cable glands for unarmored cable – Ø 28 to Ø 42 mm (Ø 1.10 to Ø 1.65”) and one M25 blanking plug.
 - Terminal capacity 2 x 35 mm² (0.003 x 0.054 in²).
- One integrated cable entry for unarmored flexible cable – Ø 17.5 to Ø 29 mm (Ø 0.69 to Ø 1.14”) for 3P + E versions; Ø 17.5 to Ø 32 mm (Ø 0.69 to Ø 1.26”) for 3P + N + E versions.
- Terminals capacity 16 mm² (0.025 in²).

63 Amps

Main Contacts

Rated Insulation Voltage	690 Vac
Rated Operating Voltage	690 Vac
Rated Operating Current	63 Amp
Rated Surge Voltage	6 KV

Switching Capacity

AC 21 A / AC 22 A	63 Amp	230 Volt to 690 Volt
	15 kW	230 Volt
AC 23 A	22 kW	400 Volt
	30 kW	500 Volt
	18.5 kW	690 Volt
	11 kW	230 Volt
AC 3	18.5 kW	400 Volt
	22 kW	500 Volt
	15 KW	690 Volt

DC 21

–

DC 22

–

DC 23

–

Auxiliary Contacts

Rated Insulation Voltage	400 Volt
Rated Operating Voltage	400 Volt
Rated Operating Current	10 Amp
Switching Capacity: AC 15	6 Amp
	4 Amp

230 Volt

400 Volt

Others

Termination (flexible/solid)	35 mm ² (0.002 in ²)
------------------------------	---

ATX™ PRE Series 63 Amp Plugs and Sockets

Increased Safety

ATEX/IECEX:
 Zone 1 and 2 - 21 and 22
 II 2 GD
 IP66 - IK10

Catalog Numbering Guide – IECEx Internationally Certified Plugs and Receptacles

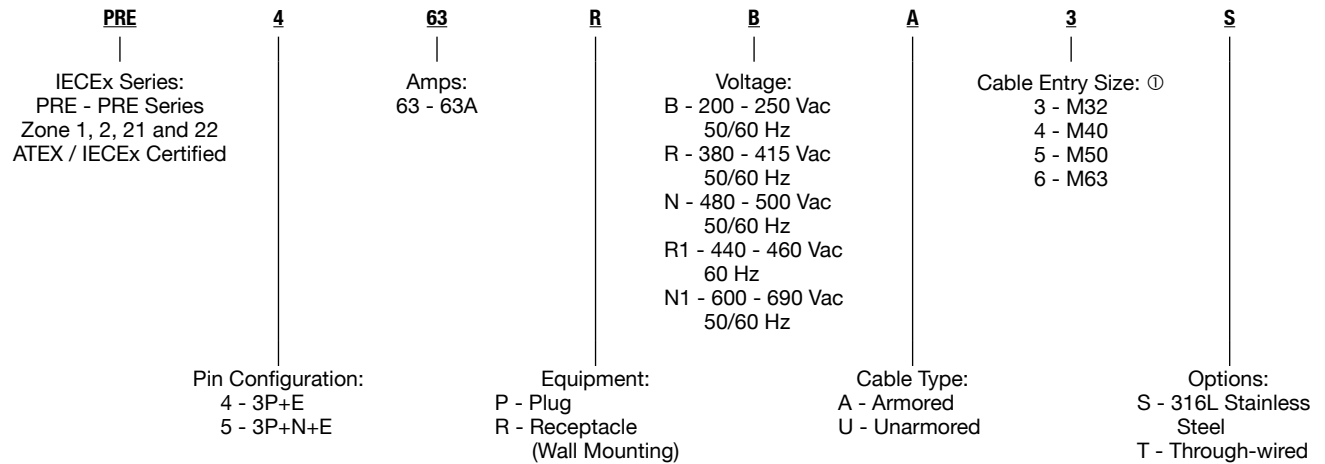

LV: Low Voltage

Blue	Red	Black	Red 1	Black 1
200/250 Vac	380/415 Vac	480/500 Vac	440/460 Vac	600/690 Vac

PLUGS AND RECEPTACLES: ATEX/IECEX INCREASED SAFETY









① With one M25 plugged entry.

ATX™ PRE Series 63 Amp Plugs and Sockets

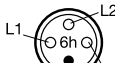
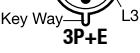
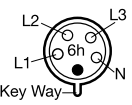
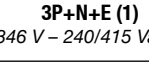
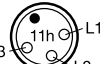
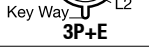
Increased Safety

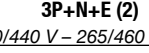
ATEX/IECEX:
 Zone 1 and 2 - 21 and 22
 II 2 GD
 IP66 - IK10

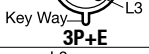
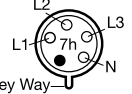
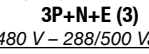
Standard Versions

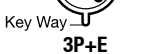
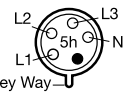
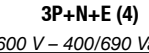
Description	Pin Configuration	Weight kg (lb)	Volume dm ³ (in ³)	Catalog Number
200/250 Vac 50/60 Hz — Blue				
Wall Socket		8.0 (17.64)	26.0 (1586.62)	PRE463RBU5
Plug	 3P+E	1.0 (2.20)	7.0 (427.17)	PRE463PB
380/415 Vac 50/60 Hz — Red				
Wall Socket		8.0 (17.64)	26.0 (1586.62)	PRE463RRU5
Plug	 3P+E	1.0 (2.20)	7.0 (427.17)	PRE463PR
Wall Socket		8.0 (17.64)	26.0 (1586.62)	PRE563RRU5
Plug	 3P+N+E (1) <i>(1) 200/346 V – 240/415 Vac 50/60 Hz</i>	1.0 (2.20)	7.0 (427.17)	PRE563PR
440/460 Vac 60 Hz — Red				
Wall Socket		8.0 (17.64)	26.0 (1586.62)	PRE463RR1U5
Plug	 3P+E	1.0 (2.20)	7.0 (427.17)	PRE463PR1
Wall Socket		8.0 (17.64)	26.0 (1586.62)	PRE563RR1U5
Plug	 3P+N+E (2) <i>(2) 250/440 V – 265/460 Vac 60 Hz</i>	1.0 (2.20)	7.0 (427.17)	PRE563PR1
480/500 Vac 50/60 Hz — Black				
Wall Socket		8.0 (17.64)	26.0 (1586.62)	PRE463RNU5
Plug	 3P+E	1.0 (2.20)	7.0 (427.17)	PRE463PN
Wall Socket		8.0 (17.64)	26.0 (1586.62)	PRE563RNU5
Plug	 3P+N+E (3) <i>(3) 277/480 V – 288/500 Vac 50/60 Hz</i>	1.0 (2.20)	7.0 (427.17)	PRE563PN
600/690 Vac 50/60 Hz — Black				
Wall Socket		8.0 (17.64)	26.0 (1586.62)	PRE463RN1U5
Plug	 3P+E	1.0 (2.20)	7.0 (427.17)	PRE463PN1
Wall Socket		8.0 (17.64)	26.0 (1586.62)	PRE563RN1U5
Plug	 3P+N+E (4) <i>(4) 347/600 V – 400/690 Vac 50/60 Hz</i>	1.0 (2.20)	7.0 (427.17)	PRE563PN1

PLUGS AND RECEPTACLES: ATEX/IECEX INCREASED SAFETY

Appleton®

ATX™ PRE Series 63 Amp Plugs and Sockets

Increased Safety

ATEX/IECEX:
 Zone 1 and 2 - 21 and 22
 II 2 GD
 IP66 - IK10

Through-Wired Versions

Description	Pin Configuration	Weight kg (lb)	Volume dm ³ (in ³)	Catalog Number
380/415 Vac 50/60 Hz — Red				
Wall Socket		16.0 (35.27)	110.0 (6712.61)	PRE463RRU5T
Wall Socket		16.0 (35.27)	110.0 (6712.61)	PRE563RRU5T
(1) 200/346 V – 240/415 Vac 50/60 Hz				

Dimensions in Millimeters (Inches)

Standard Version

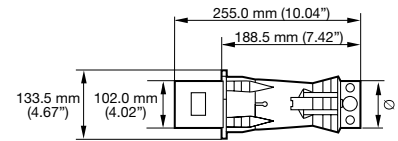
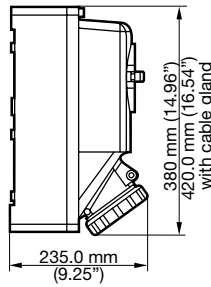
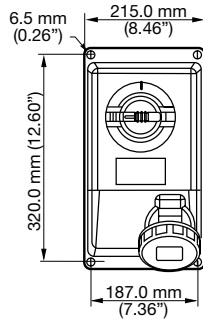

Through-Wired Version

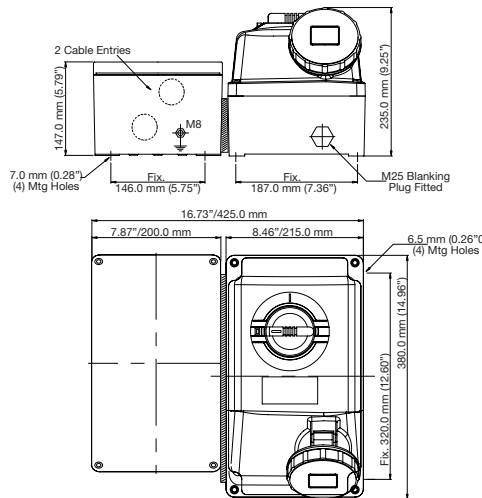

PLUGS AND RECEPTACLES: ATEX/IECEX INCREASED SAFETY



ATX™ PRE Series 125 Amp Plugs and Sockets

Increased Safety

ATEX:
Zone 1 and 2 - 21 and 22
II 2 GD
IP66 - IK10

Applications

- Plugs and sockets are used with stationary or portable electrically operated devices such as:
 - Welding devices
 - Lighting systems
 - Conveyors
 - Heaters
 - Motor generator sets
 - Air conditioning
 - Compressors
 - Pumps
- For use in corrosive atmospheres and installations in Zones 1, and 2 and 21 and 22 of oil and gas industry, such as
 - Refineries
 - Chemical and petrochemical plants
 - Pipelines
 - Onshore and offshore drilling platforms



Plug



Wall Mounting Socket

Features

- Positive polarization: only ATX plugs of same style, number of poles and ampere rating may be used with these sockets.
- Interlocked 3-pole or 4-pole Ex de disconnecting on-load switch, with auxiliary early break contact – capacity 2.5 mm² (0.004 in²) maximum.
- Plug is mechanically locked in socket when switch is "ON".
- Switch operating handle can be padlocked in "OFF" position (max 4 padlocks).
- Plug cannot be inserted or removed unless switch is in "OFF" position.

Standard Materials

- Socket: 316L stainless steel
- Flap cover and plug: polyamide

ATEX Certifications and Compliances

- Certification Type PC125X
 - Gas: Zones 1 and 2
 - Conforming to ATEX 94/9/CE: II 2 G
 - Type of Protection: Ex de IIC
 - Temperature Class: T6 for Ta ≤ +40 °C (+104 °F) and T5 for +55 °C (+131 °F)
 - Dust: Zones 21 and 22
 - Conforming to ATEX 94/9/CE: II 2 D
 - Type of Protection: Ex td A21
 - Surface Temperature: T90 °C (T194 °F)
- Ambient Temperature: -30 °C to +55 °C (-22 °F to +131 °F)
- Index of Protection according EN/IEC 60529: IP66
- Impact Resistance (shock): IK10
- CE Declaration of Conformity: 50218
- ATEX Certificate: LCIE 99 ATEX 6031

EURASEC Certification

- EURASEC N° TC RU C-FR.Г505.В.00910

Other Certification

- INMETRO Certificate: BVC11.0596 ①

PLUGS AND RECEPTACLES: ATEX/IECEx INCREASED SAFETY

Appleton

① INMETRO certification available on special request only. Contact your local sales representative for more information.

ATX™ PRE Series 125 Amp Plugs and Sockets

Increased Safety

ATEX:
 Zone 1 and 2 - 21 and 22
 II 2 GD
 IP66 - IK10



Wall Mounting Socket

- One M63 cable gland for unarmored cable – Ø 36 to Ø 44 mm (Ø 1.42 to Ø 1.73") and one M25 blanking plug.
- Terminal capacity 120 mm² (0.186in²).



Plug

- One integrated cable entry for unarmored flexible cable – Ø 30 to Ø 48 mm (Ø 1.18 to Ø 1.89").
- Terminals capacity 50 mm² (0.078in²).

160 Amps		
Main Contacts		
Rated Insulation Voltage	690 Vac	
Rated Operating Voltage	690 Vac	
Rated Operating Current	125 Amp	
Rated Surge Voltage	8 KV	
Switching Capacity		
AC 21 A / AC 22 A	125 Amp	400 Volt to 690 Volt
AC 23 A	80 kW	400 Volt
	110 kW	500 Volt
	55 kW	690 Volt
AC 3	90 kW	400 Volt
	70 kW	500 Volt
DC 21	125 Amp	220 Volt ①
	125 Amp	440 Volt ①
DC 22	125 Amp	220 Volt ①
	100 Amp	440 Volt ①
DC 23	125 Amp	220 Volt ①
	63 Amp	440 Volt ①
Auxiliary Contacts		
Rated Insulation Voltage	230 Volt	
Rated Operating Voltage	230 Volt	
Rated Operating Current	10 Amp	
Switching Capacity: AC 15	6 Amp	230 Volt
Others		
Termination (flexible/solid)	120 mm ² (0.007 in ²)	

① 2 contacts connected in series per pole.

ATX™ PRE Series 125 Amp Plugs and Sockets

Increased Safety

ATEX:
 Zone 1 and 2 - 21 and 22
 II 2 GD
 IP66 - IK10

Catalog Numbering Guide – IECEx Internationally Certified Plugs and Receptacles

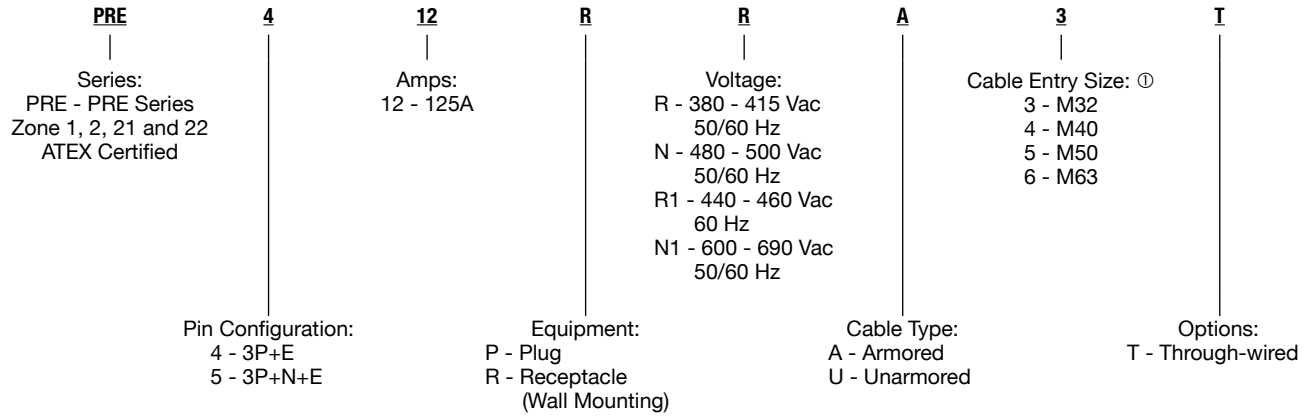

LV: Low Voltage

Red	Black	Red 1	Black 1
380/415 Vac	480/500 Vac	440/460 Vac	600/690 Vac

PLUGS AND RECEPTACLES: ATEX/IECEx INCREASED SAFETY



① With one M25 plugged entry.

ATX™ PRE Series 125 Amp Plugs and Sockets

Increased Safety

ATEX:
 Zone 1 and 2 - 21 and 22
 II 2 GD
 IP66 - IK10

Description	Pin Configuration	Weight kg (lb)	Volume dm ³ (in ³)	Catalog Number
380/415 Vac 50/60Hz — Red				
Wall Socket		16.0 (0.63)	70.0 (4271.66)	PRE412RRU6
Plug		1.1 (0.04)	13.0 (793.31)	PRE412PR
Wall Socket		16.0 (0.63)	70.0 (4271.66)	PRE512RRU6
Plug		1.1 (0.04)	13.0 (793.31)	PRE512PR
3P+N+E (1) (1) 200/346 V – 240/415 Vac 50/60 Hz				
440/460 Vac 60 Hz — Red				
Wall Socket		16.0 (0.63)	70.0 (4271.66)	PRE412RR1U6
Plug		1.1 (0.04)	13.0 (793.31)	PRE412PR1
Wall Socket		16.0 (0.63)	70.0 (4271.66)	PRE512RR1U6
Plug		1.1 (0.04)	13.0 (793.31)	PRE512PR1
3P+N+E (2) (2) 250/440 V – 265/460 Vac 60 Hz				
480/500 Vac 50/60 Hz — Black				
Wall Socket		16.0 (0.63)	70.0 (4271.66)	PRE412RNU6
Plug		1.1 (0.04)	13.0 (793.31)	PRE412PN
Wall Socket		16.0 (0.63)	70.0 (4271.66)	PRE512RNU6
Plug		1.1 (0.04)	13.0 (793.31)	PRE512PN
3P+N+E (3) (3) 277/480 V – 288/500 Vac 50/60 Hz				
600/690 Vac 50/60 Hz — Black				
Wall Socket		16.0 (0.63)	70.0 (4271.66)	PRE412RN1U6
Plug		1.1 (0.04)	13.0 (793.31)	PRE412PN1
Wall Socket		16.0 (0.63)	70.0 (4271.66)	PRE512RN1U6
Plug		1.1 (0.04)	13.0 (793.31)	PRE512PN1
3P+N+E (4) (4) 347/600 V – 400/690 Vac 50/60 Hz				

PLUGS AND RECEPTACLES: ATEX/IECEX INCREASED SAFETY



ATX™ PRE Series 125 Amp Plug and Socket

Increased Safety

ATEX:
Zone 1 and 2 - 21 and 22
II 2 GD
IP66 - IK10

Dimensions in Millimeters (Inches)

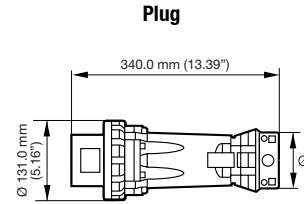
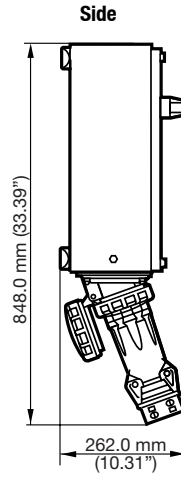
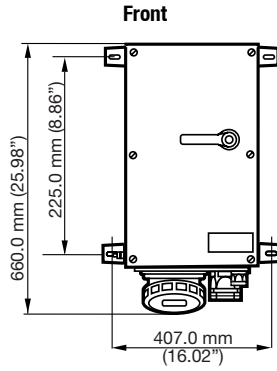

PLUGS AND RECEPTACLES: ATEX/IECEx INCREASED SAFETY

 **Appleton**

ATX™ MRE Series 16 and 32 Amp Multiple Socket Outlets

Stationary and Portable. Increased Safety

ATEX/IECEX:
 Zone 1 and 2 - 21 and 22
 Ⓢ II 2 GD
 IP66 - IK10

Applications

- Plugs and sockets are used with portable or stationary electrical equipment such as:
 - Lighting systems
 - Conveyors
 - Heaters
 - Motor generators
 - Air conditioning equipment
 - Compressors
 - Pumps
- For use in corrosive atmospheres and installations in Zone 1 and 2 and 21 and 22 of the oil and gas industry such as:
 - Refineries
 - Chemical plants
 - Petrochemical plants
 - Pipelines
 - Loading docks
 - Onshore and offshore drilling platforms

Features

- Plug and socket assembly is equipped with a patented silver plated linear switch which allows a total disconnection of power when plug is removed.
- The high voltage contact separation is in a flameproof chamber.
- The automatic electrical disconnection of each phase is contained in a second flameproof chamber.
- Short circuit protection is 20 kA, while normal reference is 10 kA.
- Different voltages are color coded for easy identification.
- The sockets are keyed to accept only ATX plugs (other plugs can not be inserted).
- ATX plugs can be used in non-hazardous sockets.

Standard Materials

- Housing: high impact resistance fiberglass reinforced polyester or 316L stainless steel
- Flush sockets: polyamide

Options

- Customized multiple socket outlets.

ATEX/IECEX Certifications and Compliances

- Certification Type PCX/EN (Flush Socket)
 - Gas: Zones 1 and 2
 - Conforming to ATEX 94/9/CE: Ⓢ II 2 G
 - Type of Protection: Ex de IIC
 - Temperature Class: T6 for Ta ≤ +40 °C (+104 °F) and T5 for +55 °C (+131 °F)
 - Dust: Zones 21 and 22
 - Conforming to ATEX 94/9/CE: Ⓢ II 2 D
 - Type of Protection: Ex tD A21
 - Surface Temperature: T68 °C (T154 °F)
 - Service Temperature: -40 °C to +55 °C (+104 °F to +131 °F)
 - Impact Resistance (shock): IK09
 - Index of Protection according EN/IEC 60529: IP66
 - CE Declaration of Conformity: 5C214
 - ATEX Certificate: LCIE 02 ATEX 0001U
 - IECEX Certificate: IECEX LCI 07.0012U



Customized Version



Two Socket Outlet Version



Four Socket Outlet Version



Cable Reel

- Certification Type CSPe (Housing)
 - Gas: Zones 1 and 2
 - Conforming to ATEX 94/9/CE: Ⓢ II 2 G
 - Type of Protection: Ex e II
 - Temperature Class: T6
 - Dust: Zones 21 and 22
 - Conforming to ATEX 94/9/CE: Ⓢ II 2 D
 - Type of Protection: Ex tD A21
 - Surface Temperature: T75 °C (T167 °F)
 - Ambient Temperature: -55 °C to +60 °C (empty house)
 - Impact Resistance (shock): IK10
 - Index of Protection according EN/IEC 60529: IP66
 - CE Declaration of Conformity: 50284
 - ATEX Certificate: LCIE 09 ATEX 3032X
 - IECEX Certificate: IECEX LCI 09.0016X
- Certification Type CAe (Housing)
 - Gas: Zones 1 and 2
 - Conforming to ATEX 94/9/CE: Ⓢ II 2 G
 - Type of Protection: Ex e II
 - Temperature Class: T6 to T3
 - Dust: Zones 21 and 22
 - Conforming to ATEX 94/9/CE: Ⓢ II 2 D
 - Type of Protection: Ex tD A21
 - Surface Temperature: T80 °C to T95 °C (T176 °F to T203 °F)
 - Ambient Temperature: -40 °C to +55 °C (+104 °F to +131 °F) (empty house)
 - Impact Resistance (shock): IK10
 - Index of Protection according EN/IEC 60529: IP66
 - CE Declaration of Conformity: 50235
 - ATEX Certificate: LCIE 02 ATEX 6248X
 - IECEX Certificate: IECEX LCI 04.0016

Note: The ambient temperature for complete assembly is determined by all of the components used.

ATX™ MRE Series 16 and 32 Amp Multiple Socket Outlets

Stationary and Portable. Increased Safety

ATEX/IECEX:
Zone 1 and 2 - 21 and 22
Ⓢ II 2 GD
IP66 - IK10

- Certification Type JBe (Housing)
 - Gas: Zones 1 and 2
 - Conforming to ATEX 94/9/CE: Ⓢ II 2 G
 - Type of Protection: Ex e II
 - Temperature Class: T6 to T2
- Dust Zones 21 and 22
 - Conforming to ATEX 94/9/CE: Ⓢ II 2 D
 - Type of Protection: Ex tD A21
 - Surface Temperature: T80 °C to T290 °C (T176 °F to T554 °F)
- Ambient Temperature: -50 °C to +70 °C (-58 °F to +158 °F) (empty house)
- Impact Resistance (shock): IK10
- Index of Protection according EN/IEC 60529: IP66
- CE Declaration of Conformity: 50232
- ATEX Certificate: LCIE 02 ATEX 6118X
- IECEX Certificate: IECEX LCI 11.0008X

EURASEC Certification

- Certification Type (Flush Socket) PCX/EN
 - EURASEC N° TC RU C-FR.Г505.B.00910
- Certification Type (Housing) CSPe
 - EURASEC N° TC RU C-FR.Г505.B.00911
- Certification Type (Housing) CAe
 - EURASEC N° TC RU C-FR.Г505.B.00911
- Certification Type (Housing) JBe
 - EURASEC N° TC RU C-FR.Г505.B.00911

Other Certification

- Certification Type (Flush Socket) PCX/EN
 - INMETRO Certificate: BR230598-U ①
- Certification Type (Housing) CSPe
 - INMETRO Certificate: BR230637-X ①
- Certification Type (Housing) CAe
 - INMETRO Certificate: BR230421-X ①
- Certification Type (Housing) JBe
 - INMETRO Certificate: BR230418-X ①

PLUGS AND RECEPTACLES: ATEX/IECEX INCREASED SAFETY

Appleton®

Note: The ambient temperature for complete assembly is determined by all of the components used.

① INMETRO certification available on special request only. Contact your local sales representative for more information.

ATX™ MRE Series 16 and 32 Amp Multiple Socket Outlets

Stationary and Portable. Increased Safety

ATEX/IECEX:
 Zone 1 and 2 - 21 and 22
 II 2 GD
 IP66 - IK10

Catalog Numbering Guide – IECEx Internationally Certified Plugs and Receptacles

MRE	P	1	2	16	P	TO	K	#
IECEX Series: MRE - MRE Series Zone 1, 2, 21 and 22 ATEX / IECEx Certified	Enclosure Material: P - Polyester S - 316L Stainless Steel	Socket Outlets Quantity: 0 1 2 3 4 5 6 7 8	Pin Configuration: 2 - 2P 3 - 2P+E 6 - 3P 4 - 3P+E 5 - 3P+N+E F - Drilling for Socket 2P-3P-2P+E 16A G - Drilling for Socket 3P+E - 3P+N+E 16A J - Drilling for Socket 3P+E - 3P+N+E 32A	Amps: 16 - 16 A 32 - 32 A	Voltage: P - 20-25 Vac 50/60 Hz Y - 100-130 Vac 50/60 Hz B - 200-250 Vac 50/60 Hz R - 380-415 Vac 50/60 Hz	Transformer Power: T0 - None T1 - 100 VA T2 - 160 VA T3 - 250 VA T4 - 400 VA	Primary/ Secondary Voltage: K - 230-400 V / 24 V L - 240-415 V / 24 V M - 230-400 V / 110 V	Options: <i>Options must be listed alphabetically</i> H - Portable Unit with Handle: Only available with SS 316L enclosure # - Customized Multiple Socket 6 digit number will be assigned at time of order placement.

PLUGS AND RECEPTACLES: ATEX/IECEX INCREASED SAFETY

Description	Type	Weight kg (lb)	Volume dm ³ (in ³)	Catalog Number	Pack
-------------	------	-------------------	--	----------------	------

Pre-drilled Multiple Sockets in Polyester for 2 Flush Sockets 16 A – Ex de IIC T5 -40 °C to +55 °C (-40 °F to +131 °F)

Supplied with: 1 x Terminal block 2P+E 6 mm² (0,009 in²); 1 x M20 plastic cable gland for unarmored cable – sealing diameter 6.5 to 14.5 mm (0.26 to 0.57 in).

Layout 1

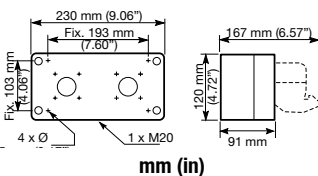

Pre-drilled enclosure for 2 flush sockets (not supplied)
 PRE Series 2P or 2P+E – 16A

CSPe3
 PCX/EN

1.3 (2.87) 7 (427)

MREP2F 1

ATX™ MRE Series 16 and 32 Amp Multiple Socket Outlets

Stationary and Portable. Increased Safety

ATEX/IECEX:
 Zone 1 and 2 - 21 and 22
 II 2 GD
 IP66 - IK10

Description	Type	Weight kg (lb)	Volume dm ³ (in ³)	Catalog Number
-------------	------	-------------------	--	----------------

Pre-drilled Multiple Sockets in Polyester for 4 Flush Sockets 16A — Ex de IIC T5 -40 °C to +55 °C (-40 °F to +131 °F)

Supplied with: 1 x Distribution block 4 poles 12 x 4 mm (0.47 x 0.16 in) with cable clamps – 2 x 10 mm² (0.003 x 0.016 in²) max.; 1 x M20 plastic cable gland for unarmored cable – sealing diameter 6.5 to 14.5 mm (0.26 to 0.57 in); 1 x M20 plastic blanking plug.

Layout 2

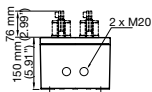

Pre-drilled enclosure for 4 flush sockets (not supplied)
 PRE Series 2P or 2P+E – 16A

CAe2
 PCX/EN

4 (8.82)

15 (915)

MREP4F

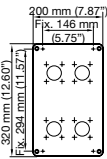

Pre-drilled enclosure for 4 flush sockets (not supplied)
 PRE Series 3P+E or 3P+N+E – 16A

CAe2
 PCX/EN

4 (8.82)

15 (915)

MREP4G



Mounting adaptor to install 2P or 2P+E – 16A flush sockets with pre-drilled enclosure MREP4G

—

0.1 (0.22)

0.7 (43)

096496



Blanking plate to install Unicode2 Series component diameter 30 mm (Push button, Pilot light or blanking plug) on 096496

—

0.1 (0.22)

0.7 (43)

097494



Blanking plug diameter 30 mm

—

0.1 (0.22)

0.18 (11)

UBP

Combined Units in Polyester with 4 Flush Sockets 16A — Ex de IIC T5 -40 °C to +55 °C (-40 °F to +131 °F)

Supplied with: 1 x Distribution block 4 poles 12 x 4 mm (0.47 x 0.16 in) with cable clamps – 2 x 10 mm² (0.003 x 0.016 in²) max.; 1 x M20 plastic cable gland for unarmored cable – sealing diameter 6.5 to 14.5 mm (0.26 to 0.57 in); 1 x M20 plastic blanking plug.

Layout 3

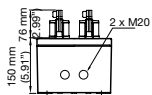

4 flush sockets 2P+E 16 A 20/25 Vac

CAe2
 PCX/EN

5 (11.02)

25 (1526)

MREP4316P

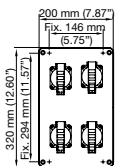

4 flush sockets 2P+E 16 A 200/250 Vac

CAe2
 PCX/EN

5 (11.02)

25 (1526)

MREP4316B

PLUGS AND RECEPTACLES: ATEX/IECEX INCREASED SAFETY

Appleton

ATX™ MRE Series 16 and 32 Amp Multiple Socket Outlets

Stationary and Portable. Increased Safety

ATEX/IECEX:
 Zone 1 and 2 - 21 and 22
 II 2 GD
 IP66 - IK10

Description	Type	Weight kg (lb)	Volume dm ³ (in ³)	Catalog Number
-------------	------	-------------------	--	----------------

Combined Units in Polyester with 1 Flush Socket 16 A – Ex de IIC T3 -40 °C to +55 °C (-40 °F to +131 °F)

Supplied with: 1 x Transformer 230-400 V / 24 V 250 VA; 2 x Fuse carriers 14 x 51 for primary protection; 2 x Fuse carriers 14 x 51 for secondary protection; 1 x Flush socket 2P+E 16 A 24 Vac (PRE316FP); 1 x M20 plastic cable gland for unarmored cable – sealing diameter 6.5 to 14.5 mm (0.26 to 0.57 in).

Layout 4

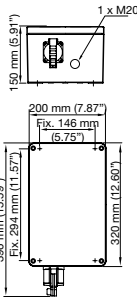

1 flush socket 2P+E 16 A 20/25
 Vac and transformer 230-400 V/24
 V 250 VA

CAe2
 PCX/EN

12 (26.46)

25 (1526)

MREP1316PT3K

Combined Units in Polyester with 4 Flush Sockets 16 A – Ex de IIC T3 -40 °C to +55 °C (-40 °F to +131 °F)

Supplied with: 1 x Transformer 230-400 V / 24 V 400 VA ;2 x Fuse carriers 14 x 51 for primary protection; 2 x Fuse carriers 14 x 51 for secondary protection; 4 x Flush sockets 2P+E 16 A 24 Vac (PRE316FP); 1 x M20 plastic cable gland for unarmored cable – sealing diameter 6.5 to 14.5 mm (0.26 to 0.57 in); 1 x M20 plastic blanking plug.

Layout 5

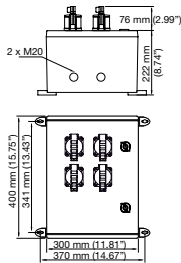

4 flush sockets 2P+E 16 A 20/25
 Vac and transformer 230-400 V/24
 V 400 VA

CAe6
 PCX/EN

15 (33.07)

36 (2197)

MREP4316PT4K

PLUGS AND RECEPTACLES: ATEX/IECEX INCREASED SAFETY



ATX™ MRE Series 16 and 32 Amp Multiple Socket Outlets

Stationary and Portable. Increased Safety

ATEX/IECEX:
 Zone 1 and 2 - 21 and 22
 II 2 GD
 IP66 - IK10

Description	Type	Weight kg (lb)	Volume dm ³ (in ³)	Catalog Number
-------------	------	-------------------	--	----------------

Portable Combined Units in 316L Stainless Steel with 4 Flush Sockets 16 A – Ex de IIC T3 -40 °C to +55 °C (-40 °F to +131 °F)

Supplied with: 1 x Transformer; 2 x Fuse carriers 14 x 51 for primary protection; 2 x Fuse carriers 14 x 51 for secondary protection; 4 x Flush sockets 2P+E 16 A 24 V (PRE316FP); 1 x M20 cable gland for unarmored cable – sealing diameter 6.5 to 14.5 mm (0.26 to 0.57 in).

Layout 6 mm (in)

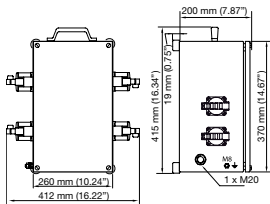

250 VA Portable Unit:

Ex de IIC T3 -40 °C to +55 °C
 (-40 °F to +131 °F)
 4 flush sockets 2P+E 16 A
 20/25 Vac and transformer
 230-400 V / 24 V 250 VA

JBe47

PCX/EN

19 (41.89)

30 (1831)

MRES4316PT3KH

Layout 7 mm (in)

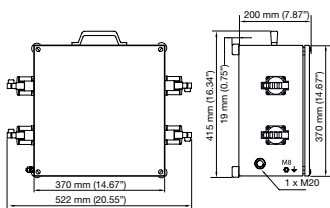

400 VA Portable Unit:

Ex de IIC T2 -40 °C to +55 °C
 (-40 °F to +131 °F) or
 Ex de IIC T3 -40 °C to +40
 °C (-40 °F to +104 °F) 4 flush
 sockets 2P+E 16 A 20/25
 Vac and transformer 230-400
 V/24 V 400 VA

JBe55

PCX/EN

23 (50.71)

42 (2563)

MRES4316PT4KH

Cable Reel

Polyamide reel: Reel capacity: 40 meters (131 ft) of 3 x 2.5 mm² (0.005 x 0.004 in²) flexible cable; Handle with drum brake

Layout 8 mm (in)

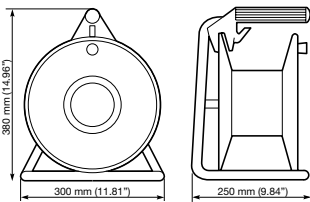

Cable reel

2.5 (5.51)

32 (1953)

097499

Cable reel is used for carrying and storing of the electrical lead.
 The electrical lead must be completely removed from the cable reel before use.

Cable Reel

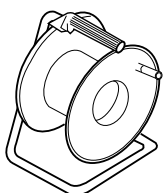

Electrical lead — not supplied



Mobile Socket

Plug

PLUGS AND RECEPTACLES: ATEX/IECEX INCREASED SAFETY

Appleton®

ATX™ MRE Series 16 and 32 Amp Multiple Socket Outlet

Stationary and Portable. Increased Safety

ATEX/IECEX:
 Zone 1 and 2 - 21 and 22
 II 2 GD
 IP66 - IK10

Polyester Enclosure Dimensions in Millimeters (Inches)

Layout 1

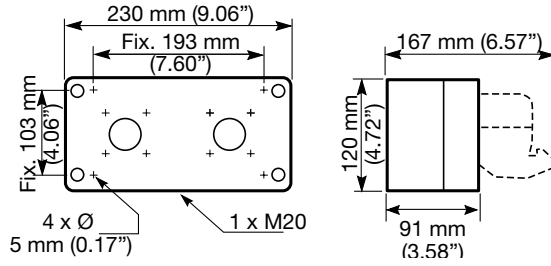

Layout 2

(Flush Sockets Not Supplied)

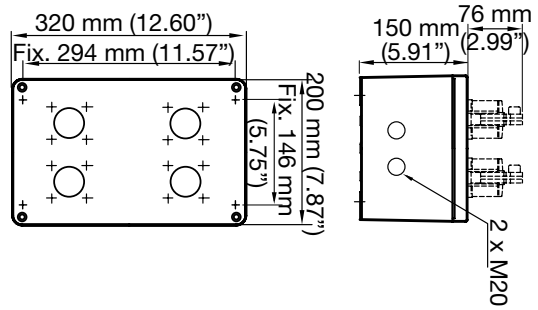

Layout 3

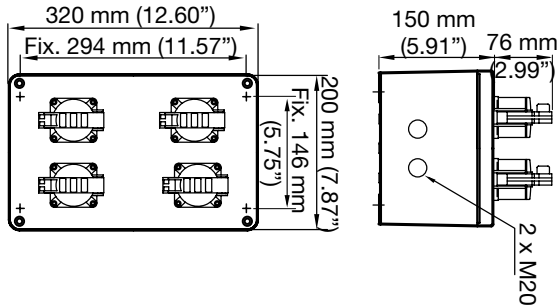

Layout 4

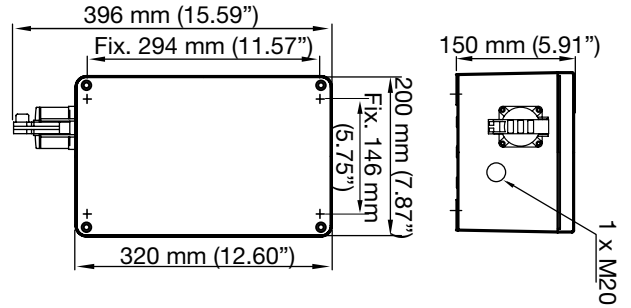

Layout 5

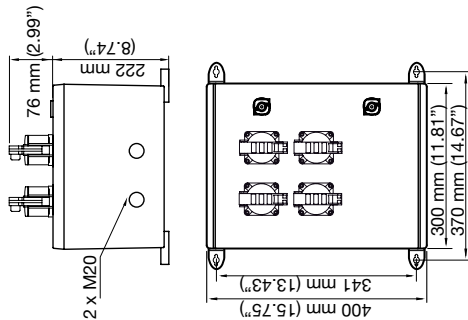

PLUGS AND RECEPTACLES: ATEX/IECEX INCREASED SAFETY

Appleton

ATX™ MRE Series 16 and 32 Amp Multiple Socket Outlet

Stationary and Portable. Increased Safety

ATEX/IECEX:
 Zone 1 and 2 - 21 and 22
 II 2 GD
 IP66 - IK10

316L Stainless Steel Enclosure Dimensions in Millimeters (Inches)

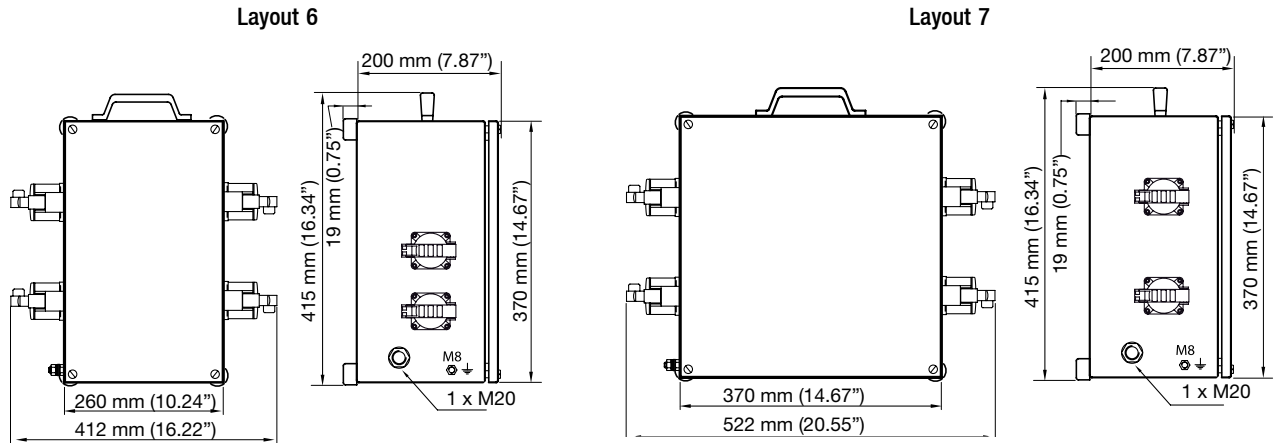

Position for Transportation

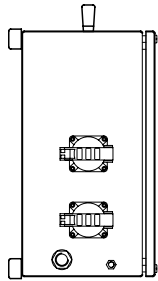

Position for Use

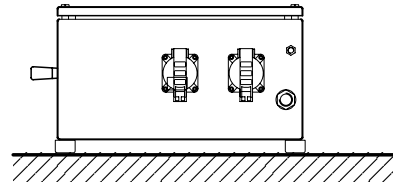

Cable Reel Dimensions in Millimeters (Inches)

Layout 8

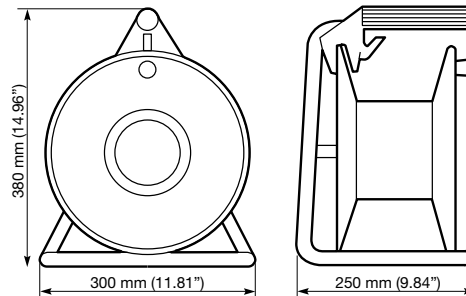

PLUGS AND RECEPTACLES: ATEX/IECEX INCREASED SAFETY

Appleton®

ATX™ PRD Series 16, 32, 80 and 125 Amp Plugs and Sockets

Flameproof

ATEX:
 Zone 1 and 2 – 21 and 22
 II 2 GD or II 2 G
 IP66 or IP55 – IK10

Applications

- Hazardous areas where plugs and sockets are used with portable or stationary electrical equipment such as lighting and heating systems, conveyors, motor starters, air-conditioning appliances, compressors and pumps.
- Ideal for hazardous areas where weatherproof and robust equipment is required.
- Ideal for hazardous areas Zones 1, 2, 21 and 22 in the oil and gas industry; such as refineries, pipelines and offshore sea-rigs.

Features

- General — 16 A:
 - Flameproof seal with cylindrical spigot joint.
 - Automatic disconnection of the poles by patented dual-safety device, which ensures the following once the plug is removed from the socket outlet:
 - Automatic and simultaneous disconnection of each phase in a flameproof chamber
 - Disconnection, once power is off, of the pins in the second flameproof chamber
 - Cover can be padlocked – 1 padlock diameter 5 mm (0.20 in), length 45 mm (1.77 in).
 - Wall sockets and flush sockets incorporate a safety device that only accepts plugging of ATX plugs which are certified for use in hazardous areas.
 - Plugs can be used with IEC 60309-2 compliant industrial pin socket outlets in non-hazardous areas.
- General — 32 A:
 - Flameproof seal with cylindrical spigot joint.
 - Mechanical interlocking device ensures:
 - Disconnection takes place within the flameproof chamber before the plug is removed from the socket outlet
 - The plug cannot be removed when energized
 - Straight handle placed on the plug for use with IEC 60309-2 compliant industrial pin socket outlets in non-hazardous areas.
- General — 80 A and 125 A:
 - Interlocking mechanical device which prevents:
 - The switch from closing until the plug is fully inserted into the wall socket
 - The plug from being removed until the switch is off
 - Socket outlet supplied with a load break isolating switch ensuring disconnection with power on.
 - Switch handle can be padlocked in the "off" position (3 padlocks).
- Wall Sockets — 16 A:
 - 2 x M20 threaded cable entries (1 at the top, 1 at bottom).
 - Supplied with one M20 plug.
 - Connection on 2 x 4 mm² (0.003 x 0.006 in²) terminals.
 - Earth terminals: internal and external, with 4 mm diameter screws.
- Wall Sockets — 32 A:
 - 2 x M25 threaded cable entries (1 at the top, 1 at bottom).
 - Supplied with one M25 plug.
 - Connection on 10 mm² (0.016 in²) terminals.
 - Earth terminals: internal and external with 6 mm diameter screws.
- Wall Sockets — 80 A:
 - 1 x M32 threaded cable entry (on the top side).
 - Connection via 8 mm (0.32 in) diameter lug terminals (not supplied).
 - Internal earth through 35 mm² (0.054 in²) connection and external earth through 6 mm (0.24 in) diameter screws.



16 Amp Plug and Socket

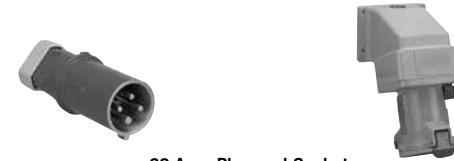

32 Amp Plug and Socket



80 Amp and 125 Amp Plug and Socket

- Wall Sockets — 125 A:
 - 1 x M50 threaded entry (on the top side).
 - Connection via 8 mm (0.32 in) diameter lug terminals (not supplied).
 - Internal earth through 35 mm² (0.054 in²) connection and external earth through 6 mm (0.24 in) diameter screws.
- Plugs — 16 A:
 - 1 cable entry through integrated M25 cable gland
 - 9 to 12 mm (9 to 12 in) diameter for the 2P+E plug
 - 12 to 15 mm (0.47 to 15 in) diameter for the 3P+E plug
 - 15 to 17 mm (0.59 to 0.70 in) diameter for the 3P+N+E plug
 - Connection on 2.5 mm² (0.004 in²) maximum terminals.
- Plugs — 32 A:
 - 1 cable entry via integrated cable gland diameter 17 to 22 mm (0.70 to 0.87 in).
 - Connection on 6 mm² (0.009 in²) maximum terminals.
- Plugs — 80 A:
 - 1 cable entry via supplied cable gland diameter 18 to 28 mm (0.71 to 1.1 in).
 - Connection on 16 mm² (0.025 in²) maximum terminals.
- Plugs — 125 A:
 - 1 cable entry via supplied cable gland diameter 30 to 36 mm (1.18 to 1.42 in).
 - Connection on 35 mm² (0.054 in²) maximum terminals.

Standard Materials

- 16 A socket outlet body and socket: gray painted marine grade aluminum alloy
- 32 A socket outlet body: gray painted marine grade aluminum alloy body
- 32 A socket outlet flush socket: cast iron
- 80 and 125 A socket outlet body and socket: painted cast iron with marine anti-corrosion treatment
- Plugs: gray painted marine grade aluminum alloy

ATX™ PRD Series 16, 32, 80 and 125 Amp Plugs and Sockets

Flameproof

ATEX:
Zone 1 and 2 – 21 and 22
⊕ II 2 GD or II 2 G
IP66 or IP55 – IK10

ATEX Certifications and Compliances

- Certification Type (16 A Plugs and Wall Sockets) PCX 16d
 - Gas: Zones 1 and 2
 - Conforming to ATEX 94/9/CE: ⊕ II 2 G
 - Type of Protection: Ex d IIC
 - Temperature Class: T6 for $T_a \leq +40$ °C (-40 °F) and T5 for +55 °C (+131 °F)
 - Dust: Zones 21 and 22
 - Conforming to ATEX 94/9/CE: ⊕ II 2 D
 - Type of Protection: Ex tD A21
 - Surface Temperature: T95 °C (T203 °F)
 - CE Declaration of Conformity: 50243
 - ATEX Certificate: LCIE 02 ATEX 6234
- Certification Type (16 A Flush Sockets) PCXd/EN
 - Gas: Zones 1 and 2
 - Conforming to ATEX 94/9/CE: ⊕ II 2 G
 - Type of Protection: Ex d IIC
 - Dust, Zones 21 and 22
 - Conforming to ATEX 94/9/CE: ⊕ II 2 D
 - Type of Protection: Ex tD A21
 - Ambient Temperature: -40 °C to +55 °C (-40 °F to +131 °F)
 - CE Declaration of Conformity: 5C227
 - ATEX Certificate: LCIE 03 ATEX 0022U
- Certification Type (32 A Plugs and Wall Sockets) PCX 32d
 - Gas: Zones 1 and 2
 - Conforming to ATEX 94/9/CE: ⊕ II 2 G
 - Type of Protection: Ex d IIC
 - Temperature Class: T6 for $T_a \leq +40$ °C (-40 °F) and T5 for +55 °C (+131 °F)
 - Dust, Zones 21 and 22
 - Conforming to ATEX 94/9/CE: ⊕ II 2 D
 - Type of Protection: Ex tD A21
 - Surface Temperature: T95 °C (T203 °F)
 - CE Declaration of Conformity: 50258
 - ATEX Certificate: LCIE 03 ATEX 6134X
- Certification Type (80 A Plugs and Wall Sockets) PCX 80d
 - Gas: Zones 1 and 2
 - Conforming to ATEX 94/9/CE: ⊕ II 2 G
 - Type of Protection: Ex d IIB
 - Temperature Class: T6 for $T_a \leq 40$ °C (-40 °F) and T5 for +55 °C (+131 °F)
 - CE Declaration of Conformity: 50262
 - ATEX Certificate: LCIE 03 ATEX 6149X
 - Internal Volume: < 2 dm³ (122 in³) - 2 liters
 - Index of Protection according EN/IEC 60529: IP66
- Certification Type (125 A Plugs and Wall Sockets) PCX 125d
 - Gas: Zones 1 and 2
 - Conforming to ATEX 94/9/CE: ⊕ II 2 G
 - Type of Protection: Ex d IIB
 - Temperature Class: T5
 - CE Declaration of Conformity: 50263
 - ATEX Certificate: LCIE 03 ATEX 6148X
 - Internal Volume: < 2 dm³ (122 in³) - 2 liters
 - Ambient Temperature: -40 °C to 55 °C (-40 °F to +131 °F)
 - Index of Protection according EN/IEC 60529: IP66

EURASEC Certification

- EURASEC N° TC RU C-FR.Г505.B.00910

ATX™ PRD Series 16, 32, 80 and 125 Amp Plugs and Sockets

Flameproof

ATEX:
 Zone 1 and 2 – 21 and 22
 II 2 GD or II 2 G
 IP66 or IP55 – IK10

Equipment	Pin Configuration	Weight kg (lb)	Volume dm ³ (in ³)	Catalog Number
Extra Low Voltage				
16 A – 20/25 Vac 50/60 Hz – Purple				
Wall Socket		1.7 (3.75)	5 (305)	PRD316RP
Plug		0.5 (1.10)	4 (244)	PRD316PP
Low Voltage				
16 A – 100/130 Vac 50/60 Hz – Yellow				
Wall Socket		1.7 (3.75)	5 (305)	PRD316RY
Plug		0.5 (1.10)	4 (244)	PRD316PY
16 A – 200/250 Vac 50/60 Hz – Blue				
Wall Socket		1.7 (3.75)	5 (305)	PRD316RB
Plug		0.5 (1.10)	4 (244)	PRD316PB
16 A – 380/415 Vac 50/60 Hz – Red				
Wall Socket		1.8 (3.97)	5 (305)	PRD416RR
Plug		0.5 (1.10)	4 (244)	PRD416PR
Wall Socket		1.9 (4.19)	5 (305)	PRD516RR
Plug		0.5 (1.10)	4 (244)	PRD516PR
32 A – 380/415 Vac 50/60 Hz – Red				
Wall Socket		10.4 (22.93)	17 (1037)	PRD432RR
Plug		1.5 (3.31)	4 (244)	PRD432PR
80 A – 380/415 Vac 50/60 Hz – Red				
Wall Socket		44.6 (98.33)	69 (4211)	PRD480RR
Plug		3.4 (7.50)	6 (366)	PRD480PR
125 A – 380/415 Vac 50/60 Hz – Red				
Wall Socket		47 (103.62)	69 (4211)	PRD412RR
Plug		5.9 (13.01)	7 (427)	PRD412PR

Ⓢ 200/346 V – 240/415 Vac 50/60 Hz.







ATX™ PRD Series 16, 32, 80 and 125 Amp Plugs and Sockets

Flameproof

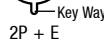
ATEX:
 Zone 1 and 2 – 21 and 22
 II 2 GD or II 2 G
 IP66 or IP55 – IK10

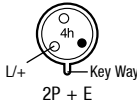
Appleton

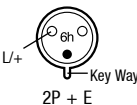
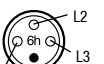
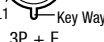
PLUGS AND RECEPTACLES: ATEX/IECEx FLAMEPROOF

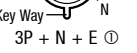
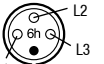
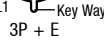
Gas Group	Pin Configuration	Weight kg (lb)	Volume dm ³ (in ³)	Catalog Number
Flush Sockets for Mounting on Ex d IIB or Ex d IIC Enclosures				
16 A – 20/25 Vac 50/60 Hz – Purple				
Ex d IIC		1.7 (3.75)	5.0 (305)	PRD316FPC
Ex d IIB		1.5 (3.31)	5.0 (305)	PRD316FPB
16 A – 100/130 Vac 50/60 Hz – Yellow				
Ex d IIC		1.7 (3.75)	5.0 (305)	PRD316FYC
Ex d IIB		1.5 (3.31)	5.0 (305)	PRD316FYB
16 A – 200/250 Vac 50/60 Hz – Blue				
Ex d IIC		1.7 (3.75)	5.0 (305)	PRD316FBC
Ex d IIB		1.7 (3.75)	5.0 (305)	PRD316FBB
16 A – 380/415 Vac 50/60 Hz – Red				
Ex d IIC		1.8 (3.97)	5.0 (305)	PRD416FRC
Ex d IIB		1.6 (3.53)	5.0 (305)	PRD416FRB
Ex d IIC		1.9 (4.19)	5.0 (305)	PRD516FRC
Ex d IIB		1.7 (3.75)	5.0 (305)	PRD516FRB
32 A – 380/415 Vac 50/60 Hz – Red				
Ex d IIC		9.5 (20.94)	17.0 (1037)	PRD432FRC
Ex d IIB		9.2 (10.28)	17.0 (1037)	PRD432FRB

Ⓢ 200/346 V – 240/415 Vac 50/60 Hz.

ATX™ PRD Series 16, 32, 80 and 125 Amp Plug and Socket Flameproof

ATEX:
Zone 1 and 2 – 21 and 22
II 2 GD or II 2 G
IP66 or IP55 – IK10

16 Amp Plug and Wall Socket Dimensions in Millimeters (Inches)

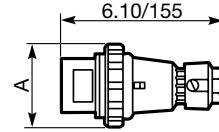
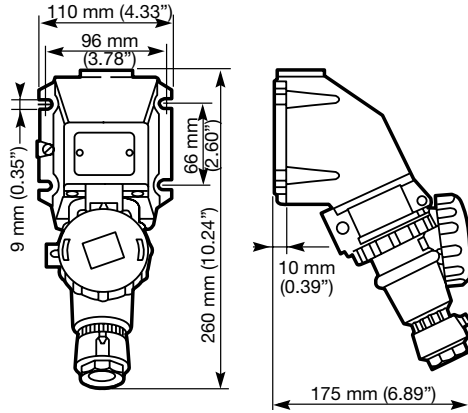

	A
2 P + E	70 (2.76)
3 P + E	78 (3.07)
3 P + N + E	85 (3.35)

32 Amp Plug and Wall Socket Dimensions in Millimeters (Inches)

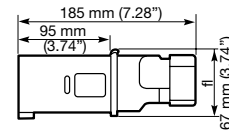
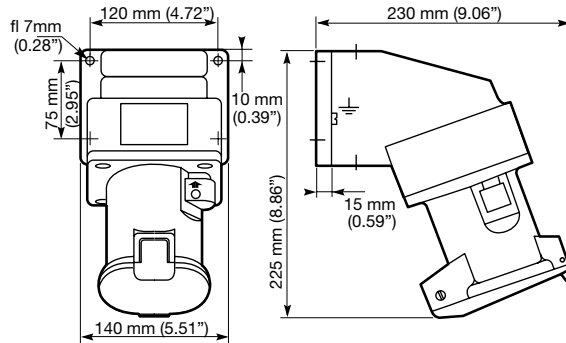

80 and 125 Amp Plug and Wall Socket Dimensions in Millimeters (Inches)

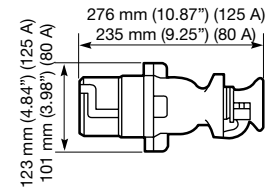
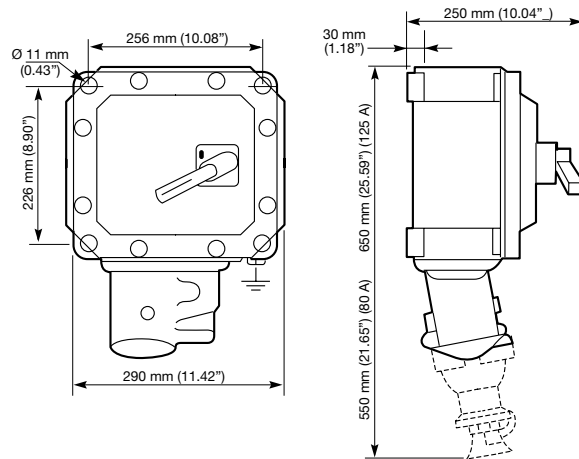

ATX™ PRD Series 16, 32, 80 and 125 Amp Plug and Socket Flameproof

ATEX:
Zone 1 and 2 – 21 and 22
II 2 GD or II 2 G
IP66 or IP55 – IK10

16 and 32 Amp Flush Socket Dimensions in Millimeters (Inches)

16 A – Ex d IIB

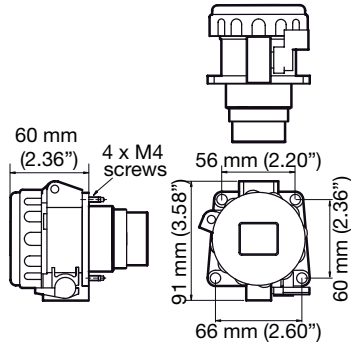

32 A – Ex d IIB

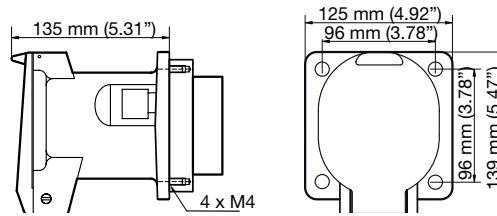

16 A – Ex d IIC

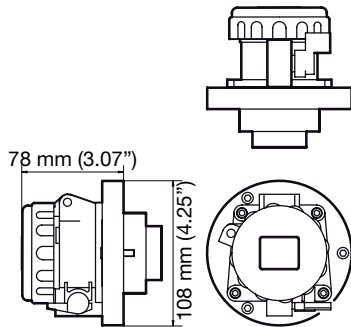

32 A – Ex d IIC

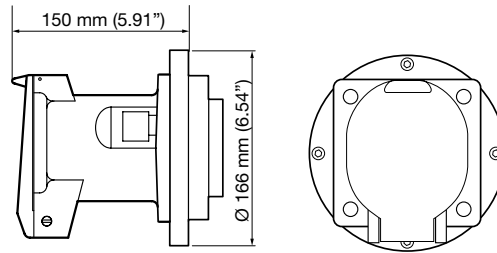

PLUGS AND RECEPTACLES: ATEX/IECEx FLAMEPROOF

ATX™ UPR Series 16 Amp Plugs and Sockets

Increased Safety

ATEX/IECEX:
 Zone 1 and 2 - 21 and 22
 Ⓢ II 2 GD
 IP66 - IK09

Applications

- Plugs and receptacles are used with portable or stationery electrical equipment such as:
 - Lighting systems
 - Conveyors
 - Heaters
 - Motor generators
 - Air conditioning equipment
 - Compressors
 - Pumps
- For use in corrosive atmospheres and installations in Zone 1 and 2 and 21 and 22 of the oil and gas industry; such as:
 - Refineries
 - Chemical and petrochemical plants
 - Pipelines
 - Loading docks
 - Onshore and offshore drilling platforms

Features

- Plug and socket system is designed with a mechanical interlock to insure disengagement cannot occur while energized.
- Large ON/OFF actuator on the receptacle gives clear, visible indication of the receptacle status for maximum hazardous location protection.
- Low Voltage receptacle can be locked in 0 (Off) and 1 (On) positions.
- Different voltages are color coded for easy identification.
- The receptacles are keyed to accept UPR plugs of the proper voltage.
- Receptacle explosionproof switch.
- UPR plugs can be used in non-hazardous IEC 60309-2 sockets.
- Operating temperature of -20 °C to +55 °C (-4 °F to +131 °F)

Standard Materials

- Wall Socket: polyamide
- Plug: polyamide

ATEX/IECEX Certifications and Compliances

- Certification Type UPR
 - Gas: Zones 1 and 2
 - Conforming to ATEX 94/9/CE: Ⓢ II 2 G
 - Type of Protection: Ex db eb IIB
 - Temperature Class: T6 for Ta ≤ +40 °C (+104 °F) and T5 for +55 °C (+131 °F)
 - Dust: Zones 21 and 22
 - Conforming to ATEX 94/9/CE: Ⓢ II 2 D
 - Type of Protection: Ex tb IIIB
 - Surface Temperature: T79 °C [Ta +40 °C (+104 °F)]; T94 °C [(Ta +55 °C (+131 °F))]
- Ambient Temperature: -20 °C ≤ Ta ≤ +55 °C (-4 °F ≤ Ta ≤ +131 °F)
- Index of Protection according EN/IEC 60529: IP66
- Impact Resistance (shock): IK09
- CE Declaration of Conformity: 50311
- ATEX Certificate: LCIE 15 ATEX 3054X
- IECEx Certificate: IECEx LCIE 15.0044X



Wall Mounting Socket



Plug

Technical Data

	Breaking Capacity	
	Amp	Vac
AC1	16 Amp	690 Vac
	8 Amp	500 Vac
AC3	4 Amp	690 Vac
	16 Amp	690 Vac
AC15	16 Amp	415 Vac
DC1	10 Amp	24 Vdc
	6 Amp	50 vdc

Short Circuit Withstand (ICC) : 10kA

ATX™ UPR Series 16 Amp Plugs and Sockets

Increased Safety

ATEX/IECEX:
Zone 1 and 2 - 21 and 22
II 2 GD
IP66 - IK09

Appleton



Wall Mounting Socket (LV)

- Two M25 threaded entries on the bottom. Available on top upon request.
- Supplied with one M25 cable gland – Ø 8 to Ø 18.5 mm (0.31 to 0.73 in) and one M25 blanking plug.
- Terminal capacity 2 x 2.5 to 4 mm² (#14 to #12 AWG). Can be through-wired up to 4 mm² (#12 AWG).
- Fitted with two linked earth terminals.



Plug (LV)

- Integrated cable clamp – Ø 9.2 to Ø 17 mm (0.36 to 0.67 in).
- Terminal capacity 2.5 to 4 mm² (#14 to #12 AWG).

LV: Low Voltage

Yellow	Blue	Red	Black
100/130 Vac	200/250 Vac	380/415 Vac	480/500 Vac
			600/690 Vac

PLUGS AND RECEPTACLES: ATEX/IECEX FLAMEPROOF

ATX™ UPR Series 16 Amp Plugs and Sockets

Increased Safety

ATEX/IECEX:
 Zone 1 and 2 - 21 and 22
 II 2 GD
 IP66 - IK09

Description	Pin Configuration	Weight kg (lb)	Volume dm ³ (in ³)	Color	Catalog Number
Low Voltage: LV					
100/130 Vac 50/60 Hz - Yellow					
Wall Socket		1.29 (2.84)	11.30 (689.57)	Yellow	UPR316RY4
Plug		0.31 (0.68)	2.40 (146.46)	Yellow	UPR316PY4
200/250 Vac 50/60 Hz - Blue					
Wall Socket		1.29 (2.84)	11.30 (689.57)	Blue	UPR316RB6
Plug		0.31 (0.68)	2.40 (146.46)	Blue	UPR316PB6
Wall Socket		1.39 (3.06)	11.30 (689.57)	Blue	UPR416RB9
Plug		0.38 (0.84)	2.40 (146.46)	Blue	UPR416PB9
Wall Socket		1.43 (3.15)	11.30 (689.57)	Blue	UPR516RB9
Plug		0.41 (0.90)	2.40 (146.46)	Blue	UPR516PB9
	(1) 120/208 V - 144/250 Vac 50/60 Hz				
380/415 Vac 50/60 Hz - Red					
Wall Socket		1.39 (3.06)	11.30 (689.57)	Red	UPR416RR6
Plug		0.38 (0.84)	2.40 (146.46)	Red	UPR416PR6
Wall Socket		1.43 (3.15)	11.30 (689.57)	Red	UPR516RR6
Plug		0.41 (0.90)	2.40 (146.46)	Red	UPR516PR6
	(2) 200/346 V - 240/415 Vac 50/60 Hz				
480/500 Vac 50/60 Hz - Black					
Wall Socket		1.39 (3.06)	11.30 (689.57)	Black	UPR416RN7
Plug		0.38 (0.84)	2.40 (146.46)	Black	UPR416PN7
Wall Socket		1.43 (3.15)	11.30 (689.57)	Black	UPR516RN7
Plug		0.41 (0.90)	2.40 (146.46)	Black	UPR516PN7
	(3) 277/480-288/500 Vac 50/60Hz				

ATX™ UPR Series 16 Amp Plugs and Sockets

Increased Safety

ATEX/IECEX:
 Zone 1 and 2 - 21 and 22
 II 2 GD
 IP66 - IK09

Appleton®

PLUGS AND RECEPTACLES: ATEX/IECEX FLAMEPROOF

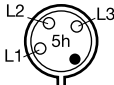
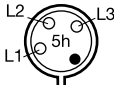
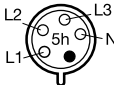
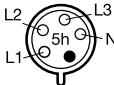
Description	Pin Configuration	Weight kg (lb)	Volume dm ³ (in ³)	Color	Catalog Number
Low Voltage: LV					
600/690 Vac 50/60 Hz - Black					
Wall Socket		1.39 (3.06)	11.30 (689.57)	Black	UPR416RN5
Plug		0.38 (0.84)	2.40 (146.46)	Black	UPR416PN5
Wall Socket		1.43 (3.15)	11.30 (689.57)	Black	UPR516RN5
Plug		0.41 (0.90)	2.40 (146.46)	Black	UPR516PN5

ATX™ UPR Series 16 Amp Plugs and Sockets

Increased Safety

ATEX/IECEX:
 Zone 1 and 2 - 21 and 22
 II 2 GD
 IP66 - IK09

Dimensions in Millimeters (Inches)

16A — 2P+E — 3P+E — 3P+N+E Versions

Wall Mounting Sockets

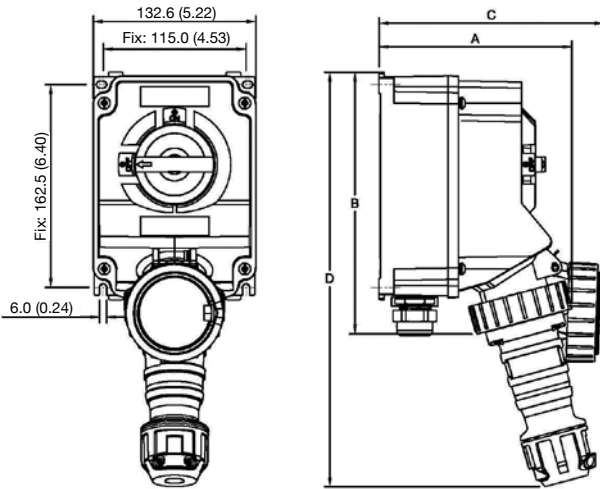

Plugs

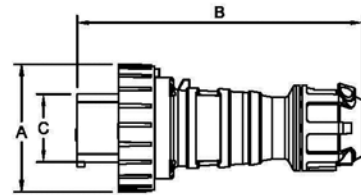

	Dimensions in Millimeters (Inches)			
	A	B	C	D
2 P + E	157.0 (6.18)	211.0 (8.31)	183.5 (7.22)	335.0 (13.19)
3 P + E	161.0 (6.34)	215.0 (8.47)	193.0 (7.60)	335.0 (13.19)
3 P + N + E	163.0 (6.42)	215.0 (8.47)	193.0 (7.60)	335.0 (13.19)

	Dimensions in Millimeters (Inches)		
	A	B	C
2 P + E	81.0 (3.19)	183.0 (7.20)	44.0 (1.73)
3 P + E	89.0 (3.50)	183.0 (7.20)	49.0 (1.93)
3 P + N + E	93.5 (3.68)	183.0 (7.20)	56.0 (2.20)

ATX™ UPR Series 32 Amp Plugs and Sockets

Increased Safety

ATEX/IECEX:
Zone 1 and 2 - 21 and 22
II 2 GD
IP66 - IK09

Applications

- Plugs and sockets are used with portable or stationery electrical equipment such as:
 - Lighting systems
 - Conveyors
 - Heaters
 - Motor generators
 - Air conditioning equipment
 - Compressors
 - Pumps
- For use in corrosive atmospheres and installations in Zone 1 and 2 and 21 and 22 of the oil and gas industry, such as:
 - Refineries
 - Chemical and petrochemical plants
 - Pipelines
 - Loading docks
 - Onshore and offshore drilling platforms

Features

- Plug and socket system is designed with a mechanical interlock to insure disengagement cannot occur while energized.
- Large ON/OFF actuator on the receptacle gives clear, visible indication of the receptacle status for maximum hazardous location protection.
- Low Voltage receptacle can be locked in 0 (Off) and 1 (On) positions.
- Different voltages are color coded for easy identification.
- The receptacles are keyed to accept UPR plugs of the proper voltage.
- Receptacle explosionproof switch.
- UPR plugs can be used in non-hazardous IEC 60309-2 sockets.
- Operating temperature of -20 °C to +55 °C (-4 °F to +131 °F)

Standard Materials

- Wall Socket: polyamide
- Plug: polyamide

ATEX/IECEX Certifications and Compliances

- Certification Type UPR
 - Gas: Zones 1 and 2
 - Conforming to ATEX 94/9/CE: II 2 G
 - Type of Protection: Ex db eb IIB
 - Temperature Class: T6 for $T_a \leq +40$ °C (+104 °F) and T5 for +55 °C (+131 °F)
 - Dust: Zones 21 and 22
 - Conforming to ATEX 94/9/CE: II 2 D
 - Type of Protection: Ex tb IIIB
 - Surface Temperature: T79 °C [$T_a + 40$ °C (+104 °F)]; T94 °C [$(T_a + 55$ °C (+131 °F))]
- Ambient Temperature: -20 °C $\leq T_a \leq +55$ °C (-4 °F $\leq T_a \leq +131$ °F)
- Index of Protection according EN/IEC 60529: IP66
- Impact Resistance (shock): IK09
- CE Declaration of Conformity: 50311
- ATEX Certificate: LCIE 15 ATEX 3054X
- IECEx Certificate: IECEx LCIE 15.0044X



Plug



Wall Mounting Socket

Technical Data

Breaking Capacity		
AC3	32 Amp	690 Vac
AC22	32 Amp	690 Vac

Short Circuit Withstand (ICC) : 10kA

ATX™ UPR Series 32 Amp Plugs and Sockets

Increased Safety

ATEX/IECEX:
 Zone 1 and 2 - 21 and 22
 II 2 GD
 IP66 - IK09



Wall Mounting Socket

- Two M32 threaded entries on the bottom or top upon request.
- Supplied with one M32 cable gland – Ø 10 to Ø 25 mm (0.39 to 0.98 in) and one M32 blanking plugs.
- Terminal capacity 2 x 6 to 10 mm² (#10 to #8 AWG). Can be through-wired up to 6mm² (#10 AWG).
- Fitted with two linked earth terminals.



Plug

- One integrated cable clamp – Ø 14.1 to Ø 29.1 mm (0.55 to 0.98 in) for 3P+N+E versions.
- Terminal capacity 6 to 10 mm² (#10 to #8 AWG).

LV - Low Voltage

Yellow	Blue	Red	Black
100/130 Vac	200/250 Vac	380/415 Vac	480/500 Vac
			600/690 Vac











ATX™ UPR Series 32 Amp Plugs and Sockets

Increased Safety

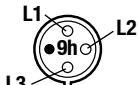
ATEX/IECEX:
Zone 1 and 2 - 21 and 22
II 2 GD
IP66 - IK09

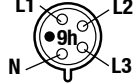
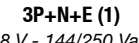
Appleton®

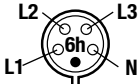
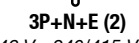
PLUGS AND RECEPTACLES: ATEX/IECEX FLAMEPROOF

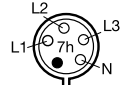
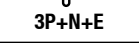
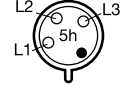
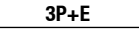
Description	Pin Configuration	Weight kg (lb)	Volume dm ³ (in ³)	Color	Catalog Number
100/130 Vac 50/60 Hz - Yellow					
Wall Socket		1.71 (3.77)	11.30 (689.57)	Yellow	UPR332RY4
Plug		0.46 (1.01)	2.40 (146.46)	Yellow	UPR332PY4
200/250 Vac 50/60 Hz - Blue					
Wall Socket		1.71 (3.77)	11.30 (689.57)	Blue	UPR332RB6
Plug		0.46 (1.01)	2.40 (146.46)	Blue	UPR332PB6
Wall Socket		1.85 (4.08)	11.30 (689.57)	Blue	UPR432RB9
Plug		0.49 (1.08)	2.40 (146.46)	Blue	UPR432PB9
Wall Socket		1.91 (4.21)	11.30 (689.57)	Blue	UPR532RB9
Plug		0.54 (1.19)	2.40 (146.46)	Blue	UPR532PB9
	<i>(1) 120/208 V - 144/250 Vac 50/60 Hz</i>				
380/415 Vac 50/60 Hz - Red					
Wall Socket		1.85 (4.08)	11.30 (689.57)	Red	UPR432RR6
Plug		0.49 (1.08)	2.40 (146.46)	Red	UPR432PR6
Wall Socket		1.91 (4.21)	11.30 (689.57)	Red	UPR532RR6
Plug		0.54 (1.19)	2.40 (146.46)	Red	UPR532PR6
	<i>(2) 200/346 V - 240/415 Vac 50/60 Hz</i>				
480/500 Vac 50/60 Hz - Black					
Wall Socket		1.85 (4.08)	11.30 (689.57)	Black	UPR432RN7
Plug		0.49 (1.08)	2.40 (146.46)	Black	UPR432PN7
Wall Socket		1.91 (4.21)	11.30 (689.57)	Black	UPR532RN7
Plug		0.54 (1.19)	2.40 (146.46)	Black	UPR532PN7
600/690 Vac 50/60 Hz -Black					
Wall Socket		1.85 (4.08)	11.30 (689.57)	Black	UPR432RN5
Plug		0.49 (1.08)	2.40 (146.46)	Black	UPR432PN5

ATX™ UPR Series 32 Amp Plugs and Sockets

Increased Safety

ATEX/IECEX:
 Zone 1 and 2 - 21 and 22
 II 2 GD
 IP66 - IK09

Dimensions in Millimeters (Inches)

32A — 2P+E — 3P+E — 3P+N+E Versions

Wall Mounting Sockets

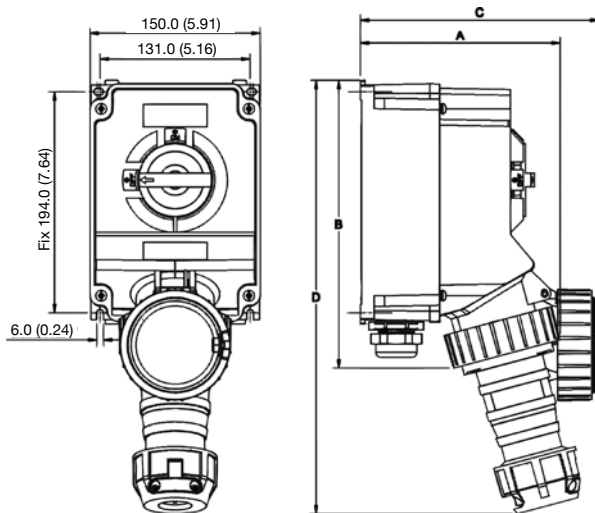

Plugs

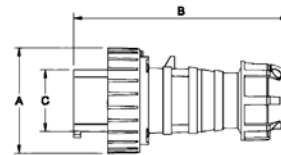

	Dimensions in Millimeters (Inches)			
	A	B	C	D
2 P + E	175.0 (6.89)	250.0 (9.84)	210.0 (8.27)	380.0 (14.96)
3 P + E	175.0 (6.89)	250.0 (9.84)	210.0 (8.27)	380.0 (14.96)
3 P + N + E	177.0 (6.97)	250.0 (9.84)	210.0 (8.27)	380.0 (14.96)

	Dimensions in Millimeters (Inches)		
	A	B	C
2 P + E	98.0 (3.86)	200.0 (7.87)	57.0 (2.24)
3 P + E	98.0 (3.86)	200.0 (7.87)	57.0 (2.24)
3 P + N + E	102.0 (4.02)	200.0 (7.87)	63.0 (2.48)

M-Line Series MEP Multi-Pin Plugs and Receptacles

Explosionproof. Flameproof

Up to 600 Vac/Vdc

ATEX/IECEX Cable Mount Plug and Receptacle:

- II 2GD Ex d IIC T6 Gb
- II 2GD Ex tb IIIC T85C Db
- Tamb -20 °C to +40 °C
- IP68

ATEX/IECEX Panel Mount Plug and Receptacle:

- II 2GD Ex de IIC T6 Gb
- II 2GD Ex tb IIIC T85C Db
- Tamb -20 °C to +40 °C
- IP68

Applications

- Offshore oil rigs
- Offshore production platforms
- Pharmaceutical manufacturing equipment
- Fuel storage areas
- Airport fueling pits
- Paint spray booths
- Paint storage areas

Features

- Hazardous area, environmental connector rated IP68.
- For use in Zone 1 IIC environment.
- Designed for the roughest industrial applications.
- Large coupling sleeve, secured with captive set screws.
- Secure single lead threaded coupling system.
- Durable, scratch resistant hardcoat plating.
- Vast family of reversible inserts.
- Power, signal and mixed applications.
- From 1 to 68 contact positions.
- Crimp type contacts. Solder or pressure also available.
- Contact sizes for 18, 16, 12, 10, 8, 4, 1/0, 4/0, 313 to 777 MCM AWG.
- Shell sizes 6, 8, 10, 12. Contact your local sales representative for other shell sizes.
- Extensive array of hardware and strain relief options.
- Custom cable assembly manufacture to support customer application specific designs.
- Silver plated contacts standard. Gold contacts optional.
- Stainless steel and brass components available upon request.

Standard Materials

- Body construction: machined 6061T aluminum bar stock
- Insulating blocks: fiber glass reinforced polyester
- Cable gland: nickel plated brass

Standard Finishes

- Body: scratch resistant black hardcoat plating

Options

- 316L stainless steel, or brass components.
- Gold plated contacts.
- Solder or pressure contacts.
- Additional key clocking options available.

ATEX/IECEX Certifications and Compliances

- ATEX Certificate: ITS13ATEX17884X
- IECEX Certificate: IECEX ITS 13.0041X
- IEC Standards: IEC 60079-7:2001; IEC 60079-1:2003
- EN/IEC Standards: EN 60079-0:2009; 60079-1:2007; 60079-7:2007; 61241-1:2004; 61241-0:2006

Related Products

- Additional configurations are available, please contact your local sales representative.
- Ordinary location M-Line Series plugs and receptacles are available, see M-Line Series Multi-Pin Plugs and Receptacles.



MEP13-3 — Plug with Environmental Cover and ATEX Gland Nut



MEP17-1 — Panel Mount Receptacle with Environmental Cover



MEP15-4 — In-Line Receptacle with Environmental Cover and Basket Weave Grip/Gland Nut



MEP13-2 — Plug with Environmental Cover and Mechanical Clamp Nut

M-Line Series MEP Multi-Pin Plugs and Receptacles

Explosionproof. Flameproof

Up to 600 Vac/Vdc

ATEX/IECEX Cable Mount Plug and Receptacle:

- Ⓜ II 2GD Ex d IIC T6 Gb
- Ⓜ II 2GD Ex tb IIIC T85C Db
- Tamb -20 °C to +40 °C
- IP68

ATEX/IECEX Panel Mount Plug and Receptacle:

- Ⓜ II 2GD Ex de IIC T6 Gb
- Ⓜ II 2GD Ex tb IIIC T85C Db
- Tamb -20 °C to +40 °C
- IP68

Illustrated Features

Connector Component Overview

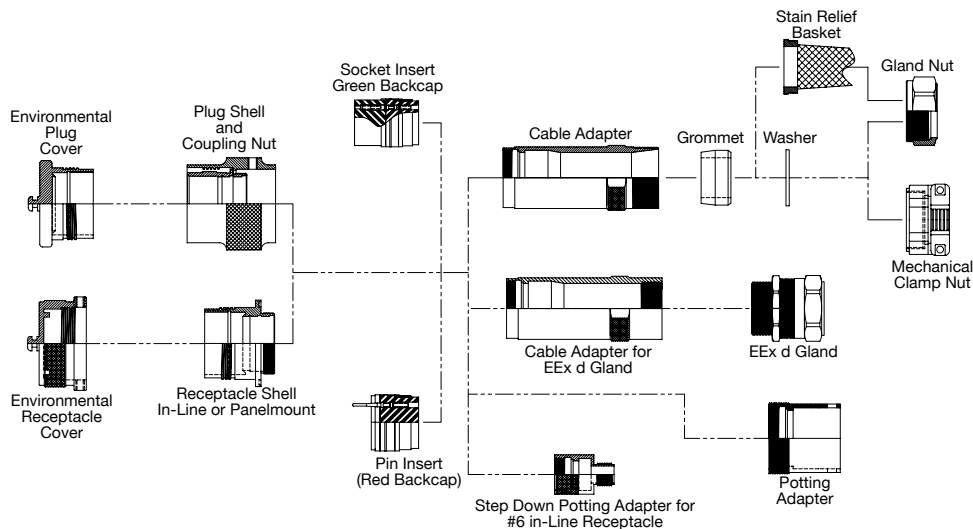

Explosionproof Connector Major Components

The Appleton MEP Series is derived from the MN Series, a UL and CSA Certified ruggedized general purpose connector that is earning a reputation for performance and quality in the Industrial and Marine, Oil and Gas Markets. As an outgrowth and variant of Mil-C-5015 threaded connectors the MN Series provides a flexible design for the toughest connector applications. In keeping with the same performance as the MN Series, Appleton offers the MEP Series for increased performance and explosion protection in hazardous environments. This connector series is ATEX/IECEX certified for use in a Zone 1, Gas IIC and Dust 21 environments with IP68 environmental sealing characteristics and T6 Temperature Class.

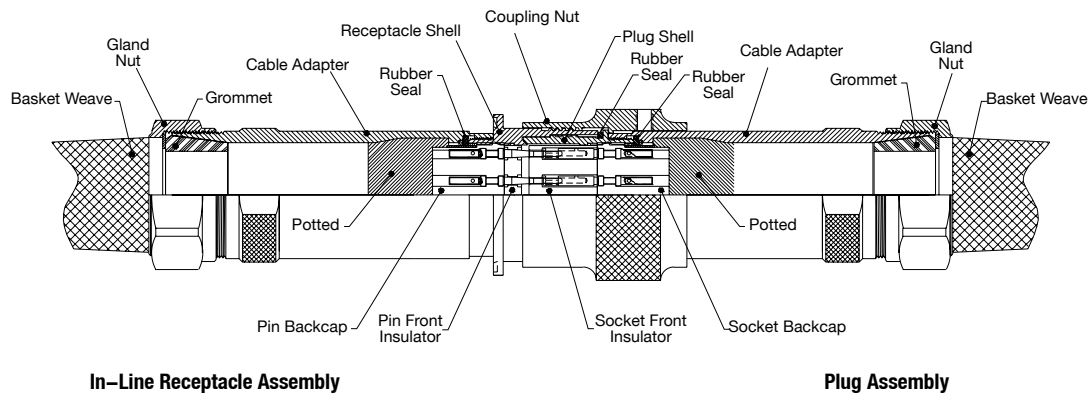

In-Line Receptacle Assembly

Plug Assembly

M-Line Series MEP Multi-Pin Plugs and Receptacles

Explosionproof. Flameproof

Up to 600 Vac/Vdc

ATEX/IECEX Cable Mount Plug and Receptacle:

- Ⓢ II 2GD Ex d IIC T6 Gb
- Ⓢ II 2GD Ex tb IIIC T85C Db
- Tamb -20 °C to +40 °C
- IP68

ATEX/IECEX Panel Mount Plug and Receptacle:

- Ⓢ II 2GD Ex de IIC T6 Gb
- Ⓢ II 2GD Ex tb IIIC T85C Db
- Tamb -20 °C to +40 °C
- IP68

Contact Ratings — Wire Well Dimensions — All Minimum in Millimeters (Inches)

Contact Size AWG/MM	NEC Ampere Rating ①	Solder Diameter	Solder Depth	Crimp Diameter ②	Crimp Depth ②	Crimp Pullout Newton (Pound) ③	Pressure Contact Torque Newtons per Meter (Inches per Pound)
#16 (1.5)	16	2.00 (.078)	5.15 (.203)	2.00 (.078)	12.70 (.500)	222.4 (50)	—
#12 (4.0)	30	2.80 (.110)	6.45 (.250)	2.80 (.110)	12.70 (.500)	489.3 (110)	—
#10 (6.0)	40	3.60 (.142)	10.00 (.394)	3.60 (.142)	15.00 (.591)	800.7 (180)	1.7 (15)
#8 (10.0)	50	5.30 (.209)	9.12 (.516)	4.80 (.189)	19.00 (.748)	1000 (225)	2.8 (25)
#4 (25.0)	90	8.35 (.329)	14.70 (.580)	7.24 (.285)	22.20 (.875)	1779 (400)	2.3 (20)
#1/0 (50.0)	155	11.50 (.470)	16.30 (.641)	11.40 (.450)	19.70 (.775)	2447 (550)	5.7 (50)
#4/0 (120.0)	225	16.50 (.650)	22.50 (.885)	15.70 (.620)	25.40 (1.00)	3892 (875)	11.3 (100)
500MCM	750	—	—	25.40 (1.000)	34.90 (1.375)	11120 (2500)	—

Electrical Performance — Service Voltage Ratings (for various specifications)

Voltage rating is designated by a service voltage rating letter which is shown listed in the table below corresponds to the insert configurations listings on the following pages. The voltage to which contact inserts are limited is a function of the dielectric separation between adjacent contacts and between contacts and shell.

Service Voltage	Millimeters (Inches) Nominal		Mil-C-5015 Rating — Volts RMS		Volts RMS	
	Over Surface Distance	Thru-Air Spacing	Non-Circuit Breaking		Non-Circuit Breaking	Circuit Breaking
			DC	AC		
Instrument	1.59 (0.0625)	—	250	200	—	—
A	3.18 (0.215)	1.59 (0.0625)	700	500	250	240
D	4.76 (0.1875)	3.18 (0.215)	1250	900	600	600
E	6.35 (0.25)	4.76 (0.1875)	1750	1250	600	600
B	7.94 (0.3125)	6.35 (0.25)	2450	1750	600	600
C	25.40 (1.00)	7.94 (0.3125)	4200	3000	600	600

① Non-circuit breaking rating, based on Arcing Control (National Electrical Code).

② Includes wire inspection hole.

③ Values vary per wire stand count, consult factory.

M-Line Series MEP Multi-Pin Plugs and Receptacles

Explosionproof. Flameproof

Up to 600 Vac/Vdc

ATEX/IECEX Cable Mount Plug and Receptacle:

- Ⓜ II 2GD Ex d IIC T6 Gb
- Ⓜ II 2GD Ex tb IIIC T85C Db
- Tamb -20 °C to +40 °C
- IP68

ATEX/IECEX Panel Mount Plug and Receptacle:

- Ⓜ II 2GD Ex de IIC T6 Gb
- Ⓜ II 2GD Ex tb IIIC T85C Db
- Tamb -20 °C to +40 °C
- IP68

Standard Product Configurations ①②

Catalog Description	Number of Contacts	Wire AWG	Wire (mm ²)	Shell Size	Service Voltage Rating	Part Number
Plug Male w/ Cable Gland 10 Pin	10	16	2	06	A	MEP13-3-B206-355PN
Plug Male w/ Cable Gland 19 Pin	19	12	4	10	D	MEP13-3-D210-376PN
Plug Male w/ Cable Gland 37 Pin	37	16	2	08	A	MEP13-3-C208-321PN
Plug Female w/ Cable Gland 4 Pin	4	16	2	06	D	MEP13-3-B206-333SN
Plug Female w/ Cable Gland 10 Pin	10	16	2	06	A	MEP13-3-B206-334SN
Plug Female w/ Cable Gland 19 Pin	19	16	2	08	A	MEP13-3-C208-355SN
Plug Female w/ Cable Gland 37 Pin	37	16	2	08	A	MEP13-3-C208-321SN
Plug Female w/ Cable Gland 37 Pin	37	12	4	10	A	MEP13-3-D210-386SN
Plug Female w/ Basket Weave 10 Pin	10	16	2	06	A	MEP13-4-1006-355SN
Panel Mount Receptacle Male w/ Cable Gland 4 Pin	4	16	2	06	D	MEP17-3-B206-333PN
Panel Mount Receptacle Male w/ Cable Gland 10 Pin	10	16	2	06	A	MEP17-3-B206-334PN
Panel Mount Receptacle Male w/ Cable Gland 19 Pin	19	16	2	08	A	MEP17-3-C208-355PN
In-Line Receptacle Male w/ Cable Gland 37 Pin	37	16	2	08	A	MEP15-3-C208-321PN
In-Line Receptacle Male w/ Basket Weave 10 Pin	10	16	2	06	A	MEP15-4-1006-355PN
In-Line Receptacle Female w/ Cable Gland 10 Pin	10	16	2	06	A	MEP15-3-B206-355SN
In-Line Receptacle Female w/ Cable Gland 19 Pin	19	12	4	10	D	MEP15-3-D210-376SN

How to Select a Multi-Pin Connector

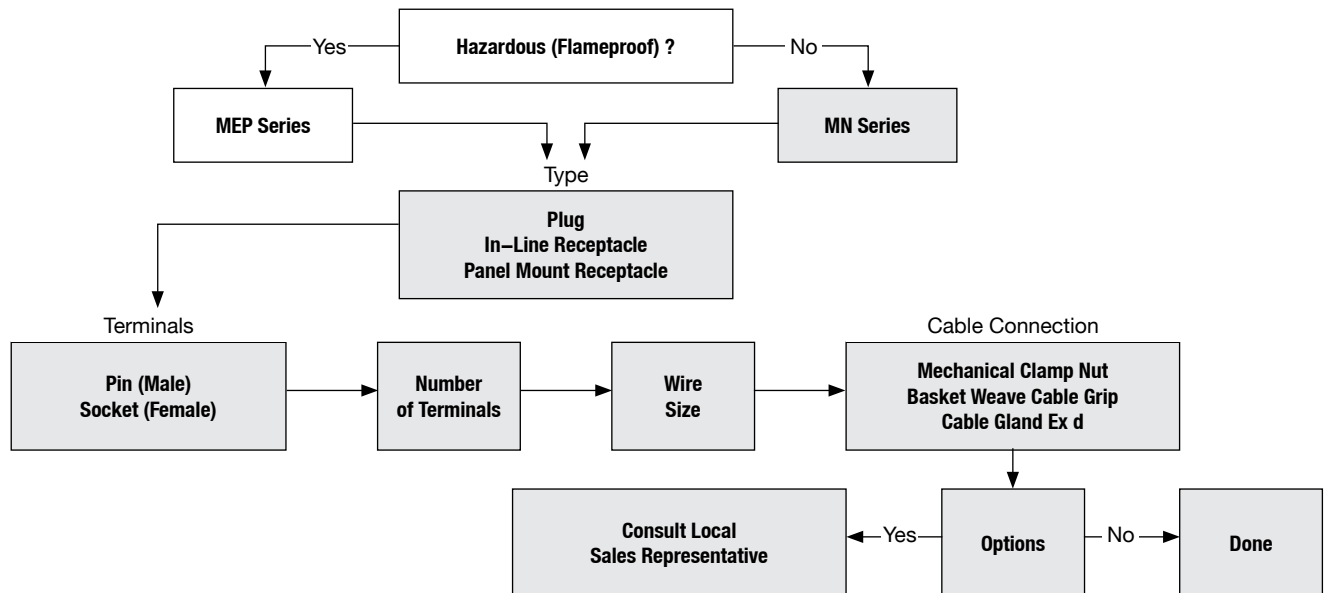

① Additional configurations are available, please contact your local sales representative for details.

② Cable glands supplied are for Armored Cable only.

M-Line Series MEP Multi-Pin Plugs and Receptacles

Explosionproof. Flameproof

Up to 600 Vac/Vdc

ATEX/IECEX Cable Mount Plug and Receptacle:

- ⊕ II 2GD Ex d IIC T6 Gb
- ⊕ II 2GD Ex tb IIIC T85C Db
- Tamb -20 °C to +40 °C
- IP68

ATEX/IECEX Panel Mount Plug and Receptacle:

- ⊕ II 2GD Ex de IIC T6 Gb
- ⊕ II 2GD Ex tb IIIC T85C Db
- Tamb -20 °C to +40 °C
- IP68

Catalog Numbering Guide

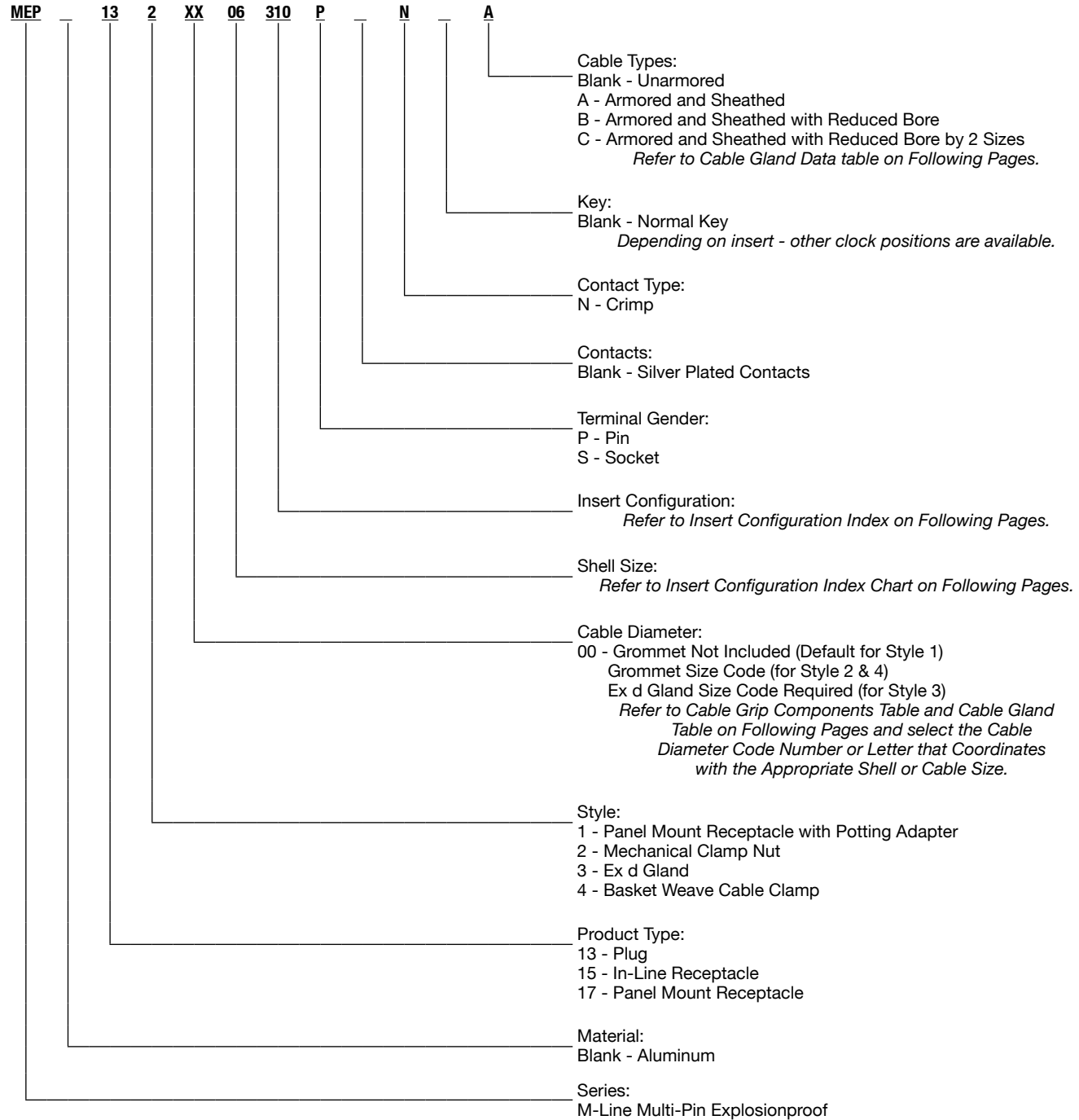

M-Line Series MEP Multi-Pin Plugs and Receptacles

Explosionproof. Flameproof

Up to 600 Vac/Vdc

ATEX/IECEX Cable Mount Plug and Receptacle:

- ⊕ II 2GD Ex d IIC T6 Gb
- ⊕ II 2GD Ex tb IIIC T85C Db
- Tamb -20 °C to +40 °C
- IP68

ATEX/IECEX Panel Mount Plug and Receptacle:

- ⊕ II 2GD Ex de IIC T6 Gb
- ⊕ II 2GD Ex tb IIIC T85C Db
- Tamb -20 °C to +40 °C
- IP68

Insert Configuration Index

Insert Arrangement	Total Contacts	Crimp	Service Rating	Contact Size											
				18	16	12	10	8	4	1/0	4/0	350 MCM			
CN-C10-379	1	X	1 kV	Consult Factory for 313 to 777 MCM											
MOG-C12-535	1	X	1 kV	Consult Factory for 313 to 777 MCM											
MOG-C12-777	1	X	1 kV	Consult Factory for 313 to 777 MCM											
CN-06-327	3	X	D			3									
CN-06-349	3	X	D				3								
CN-06-314	4	X	D				4								
CN-06-316	4	X	D				4								
CN-06-322	4	X	D				4								
CN-06-333	4	X	D		4										
CN-08-328	4	X	D					4							
CN-06-324	5	X	D			5									
CN-06-353	5	X	D			5									
CN-08-316	5	X	D					5							
CN-08-375	5	X	D					5							
CN-06-310	7	X	A			7									
CN-06-354	7	X	A			7									
CN-06-348	7	X	A		7										
CN-10-359	7	X	D					7							
CN-C12-353	8	X	A/B			4					4				
CN-12-355	8	X	D							4	4				
CN-06-355	10	X	A		10										
CN-06-334	10	X	A		10										
CN-08-376	10	X	D			6	4								
CN-08-381	10	X	D			6	4								

Electrical Performance — Service Voltage Ratings (for various specifications)

Voltage rating is designated by a service voltage rating letter which is shown listed in the table below corresponds to the insert configurations listings on the following pages. The voltage to which contact inserts are limited is a function of the dielectric separation between adjacent contacts and between contacts and shell.

Service Voltage	Millimeters (Inches) Nominal		Mil-C-5015 Rating — Volts RMS		Volts RMS	
			Non-Circuit Breaking		Non-Circuit Breaking	Circuit Breaking
	Over Surface Distance	Thru-Air Spacing	DC	AC	DC	AC
Instrument	1.59 (0.0625)	—	250	200	—	—
A	3.18 (0.215)	1.59 (0.0625)	700	500	250	240
D	4.76 (0.1875)	3.18 (0.215)	1250	900	600	600
E	6.35 (0.25)	4.76 (0.1875)	1750	1250	600	600
B	7.94 (0.3125)	6.35 (0.25)	2450	1750	600	600
C	25.40 (1.00)	7.94 (0.3125)	4200	3000	600	600

M-Line Series MEP Multi-Pin Plugs and Receptacles

Explosionproof. Flameproof

Up to 600 Vac/Vdc

ATEX/IECEX Cable Mount Plug and Receptacle:

- Ⓜ II 2GD Ex d IIC T6 Gb
- Ⓜ II 2GD Ex tb IIC T85C Db
- Tamb -20 °C to +40 °C
- IP68

ATEX/IECEX Panel Mount Plug and Receptacle:

- Ⓜ II 2GD Ex de IIC T6 Gb
- Ⓜ II 2GD Ex tb IIC T85C Db
- Tamb -20 °C to +40 °C
- IP68

Insert Configuration Index

Insert Arrangement	Total Contacts	Crimp	Service Rating	Contact Size									
				18	16	12	10	8	4	1/0	4/0	350 MCM	
CN-10-380	10	X	D			6			4				
CN-C12-375	10	X	D			6				4			
CN-10-375	12	X	D				12						
CN-08-325	16	X	D		16								
CN-06-323	17	X	A	17									
CN-08-312	19	X	A			19							
CN-08-377	19	X	A			19							
CN-08-355	19	X	A		19								
CN-10-376	19	X	D			19							
CN-10-388	19	X	D			19							
CN-10-332	20	X	A			20							
CN-10-387	20	X	A			20							
CN-08-335	27	X	A		24	3							
CN-10-374	27	X	D/A			25			2				
CN-08-321	37	X	A		37								
CN-10-350	37	X	A			37							
CN-10-386	37	X	A			37							
CN-12-371	37	X	D		37								
CN-14-339	42	X	D			42							
CN-12-352	58	X	A			58							
CN-12-384	58	X	A			58							
CN-08-333	61	X	Inst.	61									
CN-10-313	68	X	A		68								

Electrical Performance — Service Voltage Ratings (for various specifications)

Voltage rating is designated by a service voltage rating letter which is shown listed in the table below corresponds to the insert configurations listings on the following pages. The voltage to which contact inserts are limited is a function of the dielectric separation between adjacent contacts and between contacts and shell.

Service Voltage	Millimeters (Inches) Nominal		Mil-C-5015 Rating — Volts RMS			
			Non-Circuit Breaking		Volts RMS	
	Over Surface Distance	Thru-Air Spacing	DC	AC	Non-Circuit Breaking DC	Circuit Breaking AC
Instrument	1.59 (0.0625)	—	250	200	—	—
A	3.18 (0.215)	1.59 (0.0625)	700	500	250	240
D	4.76 (0.1875)	3.18 (0.215)	1250	900	600	600
E	6.35 (0.25)	4.76 (0.1875)	1750	1250	600	600
B	7.94 (0.3125)	6.35 (0.25)	2450	1750	600	600
C	25.40 (1.00)	7.94 (0.3125)	4200	3000	600	600

M-Line Series MEP Multi-Pin Plugs and Receptacles

Explosionproof. Flameproof

Up to 600 Vac/Vdc

ATEX/IECEX Cable Mount Plug and Receptacle:

- ⊕ II 2GD Ex d IIC T6 Gb
- ⊕ II 2GD Ex tb IIIC T85C Db
- Tamb -20 °C to +40 °C
- IP68

ATEX/IECEX Panel Mount Plug and Receptacle:

- ⊕ II 2GD Ex de IIC T6 Gb
- ⊕ II 2GD Ex tb IIIC T85C Db
- Tamb -20 °C to +40 °C
- IP68

Insert Configurations

Special insert configurations may be available upon request. Contact your local sales representative for more information.

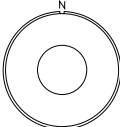
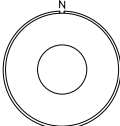
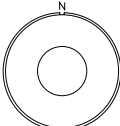
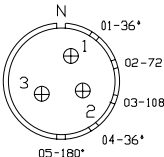
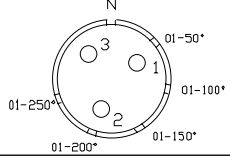
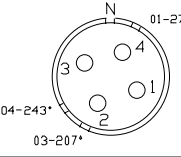
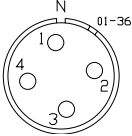
	Shell Size	Insert Type	Number of Contacts	AWG Size	Wire Terminal Type	Service Voltage Rating	Catalog Number
1 Contact							
	10	Pin	1	#500 MCM	Crimp	D	CN-C10-379PN
	10	Socket	1	#500 MCM	Crimp	D	CN-C10-379SN
	12	Pin	1	#535 MCM	Crimp	D	MOG-C12-535PN
	12	Socket	1	#535 MCM	Crimp	D	MOG-C12-535SN
	12	Pin	1	#777 MCM	Crimp	D	MOG-C12-777PN
	12	Socket	1	#777 MCM	Crimp	D	MOG-C12-777SN
3 Contacts							
	06	Pin	3	12	Crimp	D	CN-06-327PN
	06	Socket	3	12	Crimp	D	CN-06-327SN
	06	Pin	3	10	Crimp	D	CN-06-349PN
	06	Socket	3	10	Crimp	D	CN-06-349SN
4 Contacts							
	06	Pin	4	10	Crimp	D	CN-06-314PN
	06	Socket	4	10	Crimp	D	CN-06-314SN
	06	Pin	4	10	Crimp	D	CN-06-316PN
	06	Socket	4	10	Crimp	D	CN-06-316SN

Contacts Symbols	○	●	⊕	○	⊙	⦿	⊕	△	⊠	○	⊕	⊕	⏏
AWG	18	16	12	10	8	4	1/0	4/0	350 MCM	500 MCM	Ground Crimp	Contact Solder	Termination Pressure

Service Voltage Rating: A = 240V, B, D, E = 600V

M-Line Series MEP Multi-Pin Plugs and Receptacles

Explosionproof. Flameproof

Up to 600 Vac/Vdc

ATEX/IECEX Cable Mount Plug and Receptacle:

- ⊕ II 2GD Ex d IIC T6 Gb
- ⊕ II 2GD Ex tb IIIC T85C Db
- Tamb -20 °C to +40 °C
- IP68

ATEX/IECEX Panel Mount Plug and Receptacle:

- ⊕ II 2GD Ex de IIC T6 Gb
- ⊕ II 2GD Ex tb IIIC T85C Db
- Tamb -20 °C to +40 °C
- IP68

Insert Configurations

Special insert configurations may be available upon request. Contact your local sales representative for more information.

	Shell Size	Insert Type	Number of Contacts	AWG Size	Wire Terminal Type	Service Voltage Rating	Catalog Number
4 Contacts (continued)							
	06	Pin	4	10	Crimp	D	CN-06-322PN
	06	Socket	4	10	Crimp	D	CN-06-322SN
	06	Pin	4	16	Crimp	D	CN-06-333PN
	06	Socket	4	16	Crimp	D	CN-06-333SN
	08	Pin	4	8	Crimp	D	CN-08-328PN
	08	Socket	4	8	Crimp	D	CN-08-328SN
5 Contacts							
	06	Pin	5	12	Crimp	D	CN-06-324PN
	06	Socket	5	12	Crimp	D	CN-06-324SN
	06	Pin	5	12	Crimp	D	CN-06-353PN
	06	Socket	5	12	Crimp	D	CN-06-353SN
	08	Pin	5	8	Crimp	D	CN-08-316PN
	08	Socket	5	8	Crimp	D	CN-08-316SN
	08	Pin	5	8	Crimp	D	CN-08-375PN
	08	Socket	5	8	Crimp	D	CN-08-375SN

Contacts Symbols	○	●	⊕	○	⊙	⦿	⊕	△	⊠	○	⊕	⊕	⏏
AWG	18	16	12	10	8	4	1/0	4/0	350 MCM	500 MCM	Ground Crimp	Contact Solder	Termination Pressure

Service Voltage Rating: A = 240V, B, D, E = 600V

M-Line Series MEP Multi-Pin Plugs and Receptacles

Explosionproof. Flameproof

Up to 600 Vac/Vdc

ATEX/IECEX Cable Mount Plug and Receptacle:

- ⊕ II 2GD Ex d IIC T6 Gb
- ⊕ II 2GD Ex tb IIIC T85C Db
- Tamb -20 °C to +40 °C
- IP68

ATEX/IECEX Panel Mount Plug and Receptacle:

- ⊕ II 2GD Ex de IIC T6 Gb
- ⊕ II 2GD Ex tb IIIC T85C Db
- Tamb -20 °C to +40 °C
- IP68

Insert Configurations

Special insert configurations may be available upon request. Contact your local sales representative for more information.

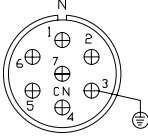
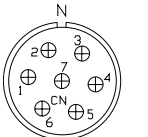
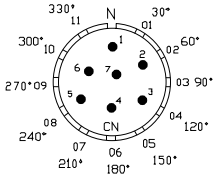
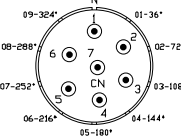
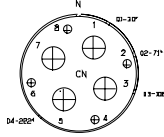
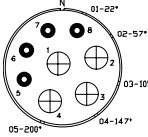
	Shell Size	Insert Type	Number of Contacts	AWG Size	Wire Terminal Type	Service Voltage Rating	Catalog Number
7 Contacts							
	06	Pin	7	12	Crimp	A	CN-06-310PN
	06	Socket	7	12	Crimp	A	CN-06-310SN
	06	Pin	7	12	Crimp	A	CN-06-354PN
	06	Socket	7	12	Crimp	A	CN-06-354SN
	06	Pin	7	16	Crimp	A	CN-06-348PN
	06	Socket	7	16	Crimp	A	CN-06-348SN
	10	Pin	7	8	Crimp	D	CN-10-359PN
	10	Socket	7	8	Crimp	D	CN-10-359SN
8 Contacts							
	C12	Pin	4	12 1/0	Crimp	A B	CN-C12-353PN
	C12	Socket	4	12 1/0	Crimp	A B	CN-C12-353SN
	12	Pin	4	4 1/0	Crimp	D	CN-12-355PN
	12	Socket	4	4 1/0	Crimp	D	CN-12-355SN

Contacts Symbols	○	●	⊕	○	⊙	⦿	⊕	⊖	⊖	⊖	⊖	⊖	⊖
AWG	18	16	12	10	8	4	1/0	4/0	350 MCM	500 MCM	Ground Crimp	Contact Solder	Termination Pressure

Service Voltage Rating: A = 240V, B, D, E = 600V

M-Line Series MEP Multi-Pin Plugs and Receptacles

Explosionproof. Flameproof

Up to 600 Vac/Vdc

ATEX/IECEX Cable Mount Plug and Receptacle:

- ⊕ II 2GD Ex d IIC T6 Gb
- ⊕ II 2GD Ex tb IIIC T85C Db
- Tamb -20 °C to +40 °C
- IP68

ATEX/IECEX Panel Mount Plug and Receptacle:

- ⊕ II 2GD Ex de IIC T6 Gb
- ⊕ II 2GD Ex tb IIIC T85C Db
- Tamb -20 °C to +40 °C
- IP68

Insert Configurations

Special insert configurations may be available upon request. Contact your local sales representative for more information.

	Shell Size	Insert Type	Number of Contacts	AWG Size	Wire Terminal Type	Service Voltage Rating	Catalog Number
10 Contacts							
	06	Pin	10	16	Crimp	A	CN-06-355PN
	06	Socket	10	16	Crimp	A	CN-06-355SN
	06	Pin	10	16	Crimp	A	CN-06-334PN
	06	Socket	10	16	Crimp	A	CN-06-334SN
	08	Pin	4 6	10 12	Crimp	D	CN-08-376PN
	08	Socket	4 6	10 12	Crimp	D	CN-08-376SN
	08	Pin	4 6	10 12	Crimp	D	CN-08-381PN
	08	Socket	4 6	10 12	Crimp	D	CN-08-381SN
	10	Pin	4 6	4 12	Crimp	D	CN-10-380PN
	10	Socket	4 6	4 12	Crimp	D	CN-10-380SN
	C12	Pin	4 6	1/0 12	Crimp	D	CN-C12-375PN
	C12	Socket	4 6	1/0 12	Crimp	D	CN-C12-375SN
12 Contacts							
	10	Pin	12	10	Crimp	D	CN-10-375PN
	10	Socket	12	10	Crimp	D	CN-10-375SN

Contacts Symbols	○	●	⊕	○	⊙	⦿	⊕	⊖	○	○	⊖	⊖	⏏
AWG	18	16	12	10	8	4	1/0	4/0	350 MCM	500 MCM	Ground Crimp	Contact Solder	Termination Pressure

Service Voltage Rating: A = 240V, B, D, E = 600V

M-Line Series MEP Multi-Pin Plugs and Receptacles

Explosionproof. Flameproof

Up to 600 Vac/Vdc

ATEX/IECEX Cable Mount Plug and Receptacle:

- ⊕ II 2GD Ex d IIC T6 Gb
- ⊕ II 2GD Ex tb IIIC T85C Db
- Tamb -20 °C to +40 °C
- IP68

ATEX/IECEX Panel Mount Plug and Receptacle:

- ⊕ II 2GD Ex de IIC T6 Gb
- ⊕ II 2GD Ex tb IIIC T85C Db
- Tamb -20 °C to +40 °C
- IP68

Insert Configurations

Special insert configurations may be available upon request. Contact your local sales representative for more information.

	Shell Size	Insert Type	Number of Contacts	AWG Size	Wire Terminal Type	Service Voltage Rating	Catalog Number
16 Contacts							
	08	Pin	16	16	Crimp	D	CN-08-325PN
	08	Socket	16	16	Crimp	D	CN-08-325SN
19 Contacts							
	08	Pin	19	12	Crimp	A	CN-08-312PN
	08	Socket	19	12	Crimp	A	CN-08-312SN
	08	Pin	19	12	Crimp	A	CN-08-377PN
	08	Socket	19	12	Crimp	A	CN-08-377SN
	08	Pin	19	16	Crimp	A	CN-08-355PN
	08	Socket	19	16	Crimp	A	CN-08-355SN
	10	Pin	19	12	Crimp	D	CN-10-376PN
	10	Socket	19	12	Crimp	D	CN-10-376SN
	10	Pin	19	12	Crimp	D	CN-10-388PN
	10	Socket	19	12	Crimp	D	CN-10-388SN
20 Contacts							
	10	Pin	20	12	Crimp	A	CN-10-332PN
	10	Socket	20	12	Crimp	A	CN-10-332SN

Contacts Symbols													
AWG	18	16	12	10	8	4	1/0	4/0	350 MCM	500 MCM	Ground Crimp	Contact Solder	Termination Pressure

Service Voltage Rating: A = 240V, B, D, E = 600V

M-Line Series MEP Multi-Pin Plugs and Receptacles

Explosionproof. Flameproof

Up to 600 Vac/Vdc

ATEX/IECEX Cable Mount Plug and Receptacle:

- ⊕ II 2GD Ex d IIC T6 Gb
- ⊕ II 2GD Ex tb IIIC T85C Db
- Tamb -20 °C to +40 °C
- IP68

ATEX/IECEX Panel Mount Plug and Receptacle:

- ⊕ II 2GD Ex de IIC T6 Gb
- ⊕ II 2GD Ex tb IIIC T85C Db
- Tamb -20 °C to +40 °C
- IP68

Insert Configurations

Special insert configurations may be available upon request. Contact your local sales representative for more information.

	Shell Size	Insert Type	Number of Contacts	AWG Size	Wire Terminal Type	Service Voltage Rating	Catalog Number
20 Contacts (continued)							
	10	Pin	20	12	Crimp	A	CN-10-387PN
	10	Socket	20	12	Crimp	A	CN-10-387SN
27 Contacts							
	08	Pin	3 24	12 16	Crimp	A A	CN-08-335PN
	08	Socket	3 24	12 16	Crimp	A A	CN-08-335SN
	10	Pin	2 25	4 12	Crimp	D A	CN-10-374PN
	10	Socket	2 25	4 12	Crimp	D A	CN-10-374SN
37 Contacts							
	08	Pin	37	16	Crimp	A	CN-08-321PN
	08	Socket	37	16	Crimp	A	CN-08-321SN
	10	Pin	37	12	Crimp	A	CN-10-350PN
	10	Socket	37	12	Crimp	A	CN-10-350SN
	10	Pin	37	12	Crimp	A	CN-10-386PN
	10	Socket	37	12	Crimp	A	CN-10-386SN
	12	Pin	37	16	Crimp	D	CN-12-371PN
	12	Socket	37	16	Crimp	D	CN-12-371SN

Contacts Symbols	○	●	⊕	○	⊙	⦿	⊕	△	⊖	○	⊕	⊖	⏏
AWG	18	16	12	10	8	4	1/0	4/0	350 MCM	500 MCM	Ground Crimp	Contact Solder	Termination Pressure

Service Voltage Rating: A = 240V, B, D, E = 600V

M-Line Series MEP Multi-Pin Plugs and Receptacles

Explosionproof. Flameproof

Up to 600 Vac/Vdc

ATEX/IECEX Cable Mount Plug and Receptacle:



- ⊕ II 2GD Ex d IIC T6 Gb
- ⊕ II 2GD Ex tb IIIC T85C Db
- Tamb -20 °C to +40 °C
- IP68

ATEX/IECEX Panel Mount Plug and Receptacle:

- ⊕ II 2GD Ex de IIC T6 Gb
- ⊕ II 2GD Ex tb IIIC T85C Db
- Tamb -20 °C to +40 °C
- IP68

Insert Configurations

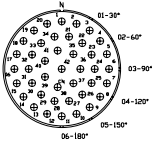
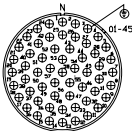
Special insert configurations may be available upon request. Contact your local sales representative for more information.

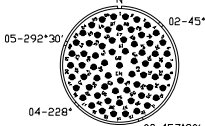
	Shell Size	Insert Type	Number of Contacts	AWG Size	Wire Terminal Type	Service Voltage Rating	Catalog Number
42 Contacts							
	14	Pin	42	12	Crimp	D	CN-14-339PN
	14	Socket	42	12	Crimp	D	CN-14-339SN
58 Contacts							
	12	Pin	58	12	Crimp	A	CN-12-352PN
	12	Socket	58	12	Crimp	A	CN-12-352SN
	12	Pin	58	12	Crimp	A	CN-12-384PN
	12	Socket	58	12	Crimp	A	CN-12-384SN
68 Contacts							
	10	Pin	68	16	Crimp	A	CN-10-313PN
	10	Socket	68	16	Crimp	A	CN-10-313SN

Contacts Symbols	○	●	⊕	○	⊙	⦿	⊕	△	⊖	○	⊖	⊖	⏏
AWG	18	16	12	10	8	4	1/0	4/0	350 MCM	500 MCM	Ground Crimp	Contact Solder	Termination Pressure

Service Voltage Rating: A = 240V, B, D, E = 600V

M-Line Series MEP Multi-Pin Plugs and Receptacles

Explosionproof. Flameproof

Up to 600 Vac/Vdc

ATEX/IECEx Cable Mount Plug and Receptacle:

Ⓢ II 2GD Ex d IIC T6 Gb
 Ⓢ II 2GD Ex tb IIIC T85C Db
 Tamb -20 °C to +40 °C
 IP68

ATEX/IECEx Panel Mount Plug and Receptacle:

Ⓢ II 2GD Ex de IIC T6 Gb
 Ⓢ II 2GD Ex tb IIIC T85C Db
 Tamb -20 °C to +40 °C
 IP68

Contact Data

Contact Terminal (Crimp)	Size	Catalog Number
Pin	4 AWG	CN400420L
Socket	4 AWG	CN410420L
Pin	8 AWG	CN400820L
Socket	8 AWG	CN410820L
Pin	10 AWG	CN401020L
Socket	10 AWG	CN411020L
Pin	12 AWG	CN401220L
Pin Ground	12 AWG	CN401221L
Socket	12 AWG	CN411220L
Pin	16 AWG	CN401620L
Socket	16 AWG	CN411620L

Cable Gland Data

For additional cable gland information, see Appleton T3 Series in the Hazardous Location Fittings Section.



Catalog Value	Shell Size	C Shell Size	Standard Cable Gland	Standard Cable OD mm (in)	Reduced Bore Size	Reduced Bore Cable	Reduced Bore	Reduced Bore Cable
						OD mm (in)	Size	OD mm (in)
STANDARD SIZE					REDUCED BY ONE SIZE – Suffix B		REDUCED BY TWO SIZES – Suffix C	
B1	6	—	M25	0.55 - 0.87 (14.0 - 22.0)	M20	0.37 - 0.63 (9.5 - 15.9)	N/A	N/A
B2	6	—	M25	0.72 - 1.03 (18.2 - 26.2)	M20	0.49 - 0.82 (12.5 - 20.9)	N/A	N/A
C2	8	—	M40	1.10 - 1.59 (27.9 - 40.4)	M32	0.93 - 1.33 (23.7 - 33.9)	M25	0.72 - 1.03 (18.2 - 26.0)
D	10	C10	M50	1.39 - 1.84 (35.2 - 46.7)	M40	1.10 - 1.59 (27.9 - 40.4)	M32	0.93 - 1.33 (23.7 - 33.9)
D2	10	C10	M50	1.59 - 2.09 (40.4 - 53.1)	—	—	—	—
E	12	C12	M63	1.80 - 2.34 (45.6 - 59.4)	M50	1.39 - 1.84 (35.2 - 46.7)	M40	1.10 - 1.59 (27.9 - 40.4)
E2	12	C12	M63	2.15 - 2.59 (54.6 - 65.9)	M50	1.59 - 2.09 (40.4 - 53.1)	—	—
F	14	—	M75	2.32 - 2.84 (59.0 - 72.1)	M63	1.80 - 2.34 (45.6 - 59.4)	M50	1.39 - 1.84 (35.2 - 46.7)
F2	14	—	M75	2.63 - 3.09 (66.7 - 78.5)	M63	2.15 - 2.59 (54.6 - 65.9)	M50	1.59 - 2.09 (40.4 - 53.1)

M-Line Series MEP Multi-Pin Plugs and Receptacles

Explosionproof. Flameproof

Up to 600 Vac/Vdc

ATEX/IECEX Cable Mount Plug and Receptacle:

Ⓜ II 2GD Ex d IIC T6 Gb
 Ⓜ II 2GD Ex tb IIIC T85C Db
 Tamb -20 °C to +40 °C
 IP68

ATEX/IECEX Panel Mount Plug and Receptacle:

Ⓜ II 2GD Ex de IIC T6 Gb
 Ⓜ II 2GD Ex tb IIIC T85C Db
 Tamb -20 °C to +40 °C
 IP68

Cable Grip Components

Shell Size	Cable Diameter Dimension mm (in)		Cable Diameter Code Number	Catalog Number Oil Resistant Rubber Grommets	Catalog Number Steel Gland Washers ①	Catalog Number Stainless Steel Basket Weave Grips	Basket Weave Nominal Length mm (in)
	Minimum	Maximum					
06	1.57 (0.062)	3.18 (0.125)	02	CN-6306-02C	CN-8006-15E	CN-5006-4E	76.2 (3.0)
	3.18 (0.125)	6.35 (0.250)	04	CN-6306-04C		CN-5006-4E	76.2 (3.0)
	6.35 (0.250)	9.53 (0.375)	06	CN-6306-06C		CN-5006-6E	101.6 (4.0)
	9.53 (0.375)	12.70 (0.500)	08	CN-6306-08C		CN-5006-8E	127.0 (5.0)
	12.70 (0.500)	15.88 (0.625)	10	CN-6306-10C		CN-5006-10E	152.4 (6.0)
	15.88 (0.625)	19.05 (0.750)	12	CN-6306-12C		CN-5006-12E	177.8 (7.0)
	19.05 (0.750)	22.23 (0.875)	14	CN-6306-14C		CN-5006-14E	190.5 (7.5)
	22.23 (0.875)	23.80 (0.937)	15	CN-6306-15C		CN-5006-15E	203.2 (8.0)
08	6.35 (0.250)	9.53 (0.375)	06	CN-6308-06C	CN-8008-23E	CN-5008-6E	101.6 (4.0)
	9.53 (0.375)	12.70 (0.500)	08	CN-6308-08C		CN-5008-8E	127.0 (5.0)
	12.70 (0.500)	15.88 (0.625)	10	CN-6308-10C		CN-5008-10E	152.4 (6.0)
	15.88 (0.625)	19.05 (0.750)	12	CN-6308-12C		CN-5008-12E	177.8 (7.0)
	19.05 (0.750)	22.23 (0.875)	14	CN-6308-14C		CN-5008-14E	190.5 (7.5)
	22.23 (0.875)	25.40 (1.000)	16	CN-6308-16C		CN-5008-16E	215.9 (8.5)
	25.40 (1.000)	28.58 (1.125)	18	CN-6308-18C		CN-5008-18E	228.6 (9.0)
	28.58 (1.125)	31.75 (1.250)	20	CN-6308-20C		CN-5008-20E	254.0 (10.0)
10 & C10	31.75 (1.250)	34.93 (1.375)	22	CN-6308-22C	CN-8010-31E	CN-5008-22E	266.7 (10.5)
	34.93 (1.375)	36.50 (1.437)	23	CN-6308-23C		CN-5008-23E	266.7 (10.5)
	12.70 (0.500)	15.88 (0.625)	10	CN-6310-10C		CN-5010-10E	152.4 (6.0)
	15.88 (0.625)	19.05 (0.750)	12	CN-6310-12C		CN-5010-14E	190.5 (7.5)
	19.05 (0.750)	22.23 (0.875)	14	CN-6310-14C		CN-5010-14E	190.5 (7.5)
	22.23 (0.875)	25.40 (1.000)	16	CN-6310-16C		CN-5010-18E	228.6 (9.0)
	25.40 (1.000)	28.58 (1.125)	18	CN-6310-18C		CN-5010-18E	228.6 (9.0)
	28.58 (1.125)	31.75 (1.250)	20	CN-6310-20C		CN-5010-20E	254.0 (10.0)
12 & C12	31.75 (1.250)	34.93 (1.375)	22	CN-6310-22C	CN-8012-39E	CN-5010-24E	279.4 (11.0)
	34.93 (1.375)	38.10 (1.500)	24	CN-6310-24C		CN-5010-24E	279.4 (11.0)
	38.10 (1.500)	41.28 (1.625)	26	CN-6310-26C		CN-5010-28E	330.2 (13.0)
	41.28 (1.625)	44.45 (1.750)	28	CN-6310-28C		CN-5010-28E	330.2 (13.0)
	44.45 (1.750)	47.63 (1.875)	30	CN-6310-30C		CN-5010-31E	368.3 (14.5)
	47.63 (1.875)	49.20 (1.937)	31	CN-6310-31C		CN-5010-31E	368.3 (14.5)
	22.23 (0.875)	25.40 (1.000)	16	CN-6312-16C		CN-5012-16E	215.9 (8.5)
	25.40 (1.000)	28.58 (1.125)	18	CN-6312-18C		CN-5012-20E	254.0 (10.0)
28.58 (1.125)	31.75 (1.250)	20	CN-6312-20C	CN-5012-20E	254.0 (10.0)		
31.75 (1.250)	34.93 (1.375)	22	CN-6312-22C	CN-5012-24E	279.4 (11.0)		
34.93 (1.375)	38.10 (1.500)	24	CN-6312-24C	CN-5012-24E	279.4 (11.0)		
38.10 (1.500)	41.28 (1.625)	26	CN-6312-26C	CN-5012-28E	330.2 (13.0)		
41.28 (1.625)	44.45 (1.750)	28	CN-6312-28C	CN-5012-28E	330.2 (13.0)		
44.45 (1.750)	47.63 (1.875)	30	CN-6312-30C	CN-5012-32E	381.0 (15.0)		
47.63 (1.875)	50.80 (2.000)	32	CN-6312-32C	CN-5012-32E	381.0 (15.0)		
50.80 (2.000)	53.98 (2.125)	34	CN-6312-34C	CN-5012-36E	406.4 (16.0)		
53.98 (2.125)	57.15 (2.250)	36	CN-6312-36C	CN-5012-36E	406.4 (16.0)		
57.15 (2.250)	60.33 (2.375)	38	CN-6312-38C	CN-5012-39E	444.5 (17.0)		
60.33 (2.375)	61.90 (2.437)	39	CN-6312-39C	CN-5012-39E	444.5 (17.0)		



Rubber Grommet



Basket Weave Grip



Gland Washers

① One steel gland washer size is used for each shell size available.

M-Line Series MEP Multi-Pin Plugs and Receptacles

Explosionproof. Flameproof

Up to 600 Vac/Vdc

ATEX/IECEX Cable Mount Plug and Receptacle:

- Ⓜ II 2GD Ex d IIC T6 Gb
- Ⓜ II 2GD Ex tb IIIC T85C Db
- Tamb -20 °C to +40 °C
- IP68



ATEX/IECEX Panel Mount Plug and Receptacle:

- Ⓜ II 2GD Ex de IIC T6 Gb
- Ⓜ II 2GD Ex tb IIIC T85C Db
- Tamb -20 °C to +40 °C
- IP68



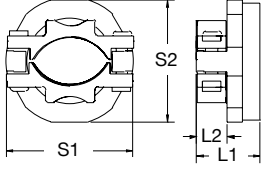

Appleton

PLUGS AND RECEPTACLES: ATEX/IECEX FLAMEPROOF

Mechanical Clamp Nut

Shell Size	L1	Dimensions mm (in)				Catalog Number	
		L2	L3	L4			
 06	50.8 (2.00)	25.4 (1.00)	52.1 (2.05)	46.5 (1.83)	CN-W-5306N		
08	50.8 (2.00)	25.4 (1.00)	64.8 (2.55)	57.1 (2.25)	CN-W-5308N		
10/C10	51.6 (2.03)	25.4 (1.00)	77.5 (3.05)	77.5 (3.05)	CN-W-5310N		
12/C12	53.3 (2.10)	25.4 (1.00)	92.7 (3.65)	92.7 (3.65)	CN-W-5312N		
14/C14	57.1 (2.25)	28.7 (1.13)	113.0 (4.45)	113.0 (4.45)	CN-W-5314N		

Contact Crimping and Insertion/Removal Tools

	Description	Catalog Number
Full Cycle Crimp Tool		
	This tool is a full cycle crimp tool for crimping Appleton crimp contact sizes #10 AWG through #16 AWG — To be used with TC-CN-XX-20L locator dies	TC-CN-M309
Locator Dies for TC-CN_M309 Crimp Tool		
	Locator die for #10 AWG pin/socket crimp contacts	TC-CN-10-20L
	Locator die for #12 AWG pin/socket crimp contacts	TC-CN-12-20L
	Locator die for #16 AWG pin/socket crimp contacts	TC-CN-16-20L
Insertion Tool for Pin/Socket Crimp Contacts		
	Locator tool for #10 AWG pin/socket crimp contact	TI-10H
	Locator tool for #12 AWG pin/socket crimp contact	TI-12H
	Locator tool for #16 AWG pin/socket crimp contact	TI-16H
Removal Tool for Pin Crimp Contacts		
	Removal tool for #8, #10 and #12 AWG pin crimp contact	TEP-LGH
	Removal tool for #16 AWG pin crimp contact	TEP-SMH
Removal Tool for Crimp Socket Contacts		
	Removal tool for #10 AWG socket crimp contact	TES-10H
	Removal tool for #12 AWG socket crimp contact	TES-12H
	Removal tool for #16 AWG socket crimp contact	TES-16H

M-Line Series MEP Multi-Pin Plugs and Receptacles

Explosionproof. Flameproof

Up to 600 Vac/Vdc

ATEX/IECEX Cable Mount Plug and Receptacle:

Ⓢ II 2GD Ex d IIC T6 Gb
 Ⓢ II 2GD Ex tb IIIC T85C Db
 Tamb -20 °C to +40 °C
 IP68

ATEX/IECEX Panel Mount Plug and Receptacle:

Ⓢ II 2GD Ex de IIC T6 Gb
 Ⓢ II 2GD Ex tb IIIC T85C Db
 Tamb -20 °C to +40 °C
 IP68

Mixing/Potting Information

- Not for use with cable gland version.
 - All cable adapters, other than ones suited for mating with an EX-certified gland, must be filled with encapsulate (potting material).
- The user or installer shall consider the performance of these materials with regard to attack by aggressive substances that may be present in the hazardous area.
- Shell sizes #06 and #08 require Appleton P/N EPX4A30Z 95 cc (3.2 oz) burst pack potting material
- Shell size 10 requires Appleton P/N EPX4B70Z 219 cc (7.4 oz) burst pack potting material
 - Both materials are a two-component casting system with a 1:1 volumetric mix ratio.
 - Typical cure times at 21 °C (70 °F) are 1-2 hours and at 10 °C (50 °F) 4-8 hours.
- For shell size #12 the potting material is available in pre-measured cartridges and utilizes a dispenser and mixing tube to "mix and dispense". These must be ordered separately from the connector.
 - This material is a two-component casting system with a 1:2 volumetric mix ratio.
 - Typical complete cure time is three to five days at room temperature
 - Parts can typically be handled after the first 12 to 16 hours.
- Potting material should be kept at a room temperature of 16 °C to 25 °C (60 °F to 77 °F).
- Follow the instructions on the package for mixing and pouring.
- For additional information, please contact your local sales representative.

Potting Material Ordering Information — Required when Cable Gland is not used.

Shell Size	Description	Note	Catalog Number
06	95 cc (3.2 oz) 2-Part Burst Pack Potting Resin	One Time Use	EPX4A30Z
08	95 cc (3.2 oz) 2-Part Burst Pack Potting Resin	One Time Use	EPX4A30Z
10	219 cc (7.4 oz) 2-Part Burst Pack Potting Resin	One Time Use	EPX4B70Z
12	TS-22 Potting Resin Cartridge 50 cc (1.7 oz)	Pots 1-3 Connectors	MAT-6051A
	Static Mixer for 50 cc (1.7 oz) Cartridge	One Time Use	MAT-6051B
	Manual Dispenser 2:1 for 50 cc (1.7 oz) Cartridge	Reusable	MAT-6051C
12	TS-22 Potting Resin Cartridge 200 cc (6.8 oz)	Pots 3 or more Connectors	MAT-6050A
	Static Mixer for 200 cc (6.8 oz) Cartridge	One Time Use	MAT-6050B
	Manual Dispenser 2:1 for 200 cc (6.8 oz) Cartridge	Reusable	MAT-6050C

M-Line Series MEP Multi-Pin Plugs and Receptacles

Explosionproof. Flameproof

Up to 600 Vac/Vdc

ATEX/IECEX Cable Mount Plug and Receptacle:

- ⊕ II 2GD Ex d IIC T6 Gb
- ⊕ II 2GD Ex tb IIIC T85C Db
- Tamb -20 °C to +40 °C
- IP68

ATEX/IECEX Panel Mount Plug and Receptacle:

- ⊕ II 2GD Ex de IIC T6 Gb
- ⊕ II 2GD Ex tb IIIC T85C Db
- Tamb -20 °C to +40 °C
- IP68

Plug Assemblies Dimensional Data — mm (in) — Add 12.7 mm (1/2") to both L & L1 dimensions for C length inserts.

Plug with Mechanical Clamp — Must be Potted

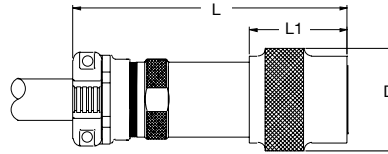

Shell Size	L	L1	D	Gland Size
06	172.7 (6.80)	78.0 (3.07)	55.9 (2.20)	M25
08	223.5 (8.80)	78.0 (3.07)	68.6 (2.70)	M40
10	223.5 (8.80)	78.0 (3.07)	81.3 (3.20)	M50
12	223.5 (8.80)	78.0 (3.07)	94.0 (3.70)	M63
14	247.7 (9.75)	78.0 (3.07)	106.7 (4.20)	M75

Plug with Cable Gland

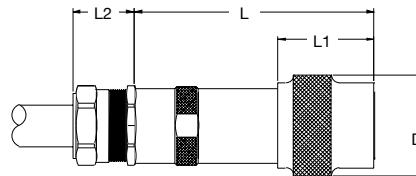

Shell Size	L	L1	L2	D	Gland Size
06	142.2 (5.60)	78.0 (3.07)		55.9 (2.20)	M25
08	193.0 (7.60)	78.0 (3.07)	Not Available	68.6 (2.70)	M40
10	193.0 (7.60)	78.0 (3.07)	Determined by ATEX Gland Selected	81.3 (3.20)	M50
12	193.0 (7.60)	78.0 (3.07)		94.0 (3.70)	M63
14	193.0 (7.60)	78.0 (3.07)		106.7 (4.20)	M75

Plug with Basket Weave — Must be Potted

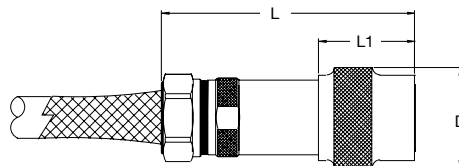

Shell Size	L	L1	D	Gland Size
06	158.8 (6.25)	78.0 (3.07)	55.9 (2.20)	M25
08	209.6 (8.25)	78.0 (3.07)	68.6 (2.70)	M40
10	209.6 (8.25)	78.0 (3.07)	81.3 (3.20)	M50
12	209.6 (8.25)	78.0 (3.07)	94.0 (3.70)	M63
14	209.6 (8.25)	78.0 (3.07)	106.7 (4.20)	M75

M-Line Series MEP Multi-Pin Plugs and Receptacles

Explosionproof. Flameproof

Up to 600 Vac/Vdc

ATEX/IECEX Cable Mount Plug and Receptacle:

- Ⓜ II 2GD Ex d IIC T6 Gb
- Ⓜ II 2GD Ex tb IIC T85C Db
- Tamb -20 °C to +40 °C
- IP68

ATEX/IECEX Panel Mount Plug and Receptacle:

- Ⓜ II 2GD Ex de IIC T6 Gb
- Ⓜ II 2GD Ex tb IIC T85C Db
- Tamb -20 °C to +40 °C
- IP68

Receptacle Assemblies Dimensional Data — mm (in) — Add 12.7 mm (1/2") to both L & L1 dimensions for C length inserts.

In-Line Receptacle with Mechanical Clamp — Must be Potted

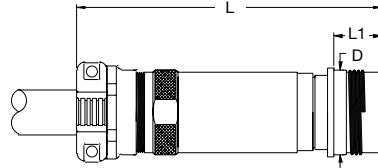

Shell Size	L	L1	D	Gland Size
06	177.8 (7.00)	35.6 (1.40)	38.1 (1.50)	M25
08	228.6 (9.00)	35.6 (1.40)	50.8 (2.00)	M40
10	228.6 (9.00)	35.6 (1.40)	63.5 (2.50)	M50
12	228.6 (9.00)	35.6 (1.40)	76.2 (3.00)	M63
14	241.3 (9.50)	35.6 (1.40)	88.9 (3.50)	M75

In-Line Receptacle with Cable Gland

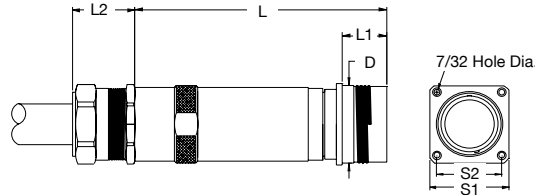

Shell Size	L	L1	L2	D	Gland Size
06	152.4 (6.00)	35.6 (1.40)		38.1 (1.50)	M25
08	203.2 (8.00)	35.6 (1.40)	Not Available	50.8 (2.00)	M40
10	203.2 (8.00)	35.6 (1.40)	Determined by ATEX Gland Selected	63.5 (2.50)	M50
12	203.2 (8.00)	35.6 (1.40)		76.2 (3.00)	M63
14	203.2 (8.00)	35.6 (1.40)		88.9 (3.50)	M75

In-Line Receptacle with Basket Weave — Must be Potted

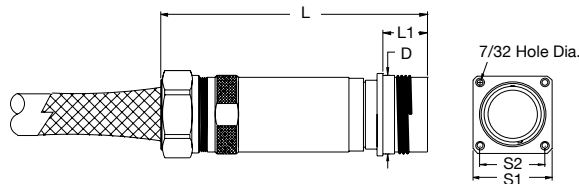

Shell Size	L	L1	D
06	165.1 (6.50)	35.6 (1.40)	38.1 (1.50)
08	215.9 (8.50)	35.6 (1.40)	50.8 (2.00)
10	215.9 (8.50)	35.6 (1.40)	63.5 (2.50)
12	215.9 (8.50)	35.6 (1.40)	76.2 (3.00)
14	215.9 (8.50)	35.6 (1.40)	88.9 (3.50)

M-Line Series MEP Multi-Pin Plugs and Receptacles

Explosionproof. Flameproof

Up to 600 Vac/Vdc

ATEX/IECEX Cable Mount Plug and Receptacle:

- Ⓜ II 2GD Ex d IIC T6 Gb
- Ⓜ II 2GD Ex tb IIC T85C Db
- Tamb -20 °C to +40 °C
- IP68

ATEX/IECEX Panel Mount Plug and Receptacle:

- Ⓜ II 2GD Ex de IIC T6 Gb
- Ⓜ II 2GD Ex tb IIC T85C Db
- Tamb -20 °C to +40 °C
- IP68

Panel Mount Receptacle Assemblies Dimensional Data — mm (in) — Add 12.7 mm (1/2") to both L & L1 dimensions for C length inserts.

Panel Mount Receptacle for Ex d and Ex e Enclosures — Must be Potted

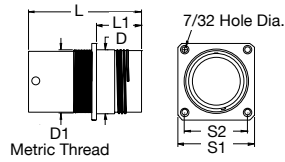

Shell Size	L	L1	D	D1	S1	S1
06	116.8 (4.60)	44.4 (1.75)	38.1 (1.50)	M25	58.4 (2.30)	41.9 (1.65)
08	116.8 (4.60)	44.4 (1.75)	50.8 (2.00)	M40	66.0 (2.60)	51.9 (2.04)
10	116.8 (4.60)	44.4 (1.75)	63.5 (2.50)	M50	76.2 (3.00)	62.0 (2.44)
12	116.8 (4.60)	44.4 (1.75)	76.2 (3.00)	M63	88.9 (3.50)	71.9 (2.83)
14	116.8 (4.60)	44.4 (1.75)	88.9 (3.50)	M75	102.0 (4.00)	82.0 (3.23)

PLUGS AND RECEPTACLES: ATEX/IECEX FLAMEPROOF

Appleton

Hazardous Location Fittings

Description	Page	NEC	CEC	ATEX/ IEC
Ordinary Location Cable Glands				
Cable Gland Selection Guide	594			
A2 Industrial Cable Gland	596		X	
NEC/CEC Explosionproof and ATEX/IECEx Flameproof Cable Glands				
C2KX Marine Cable Connectors	598	X	X	X
TC Cable Connector: Tray Cable	600	X	X	X
T3 Series Nickel Plated Brass Cable Gland	602	X	X	X
PXSS2K Series Compound Barrier Type Cable Connector	604	X	X	X
PXSS2K-REX Series Liquid Resin Barrier Type Cable Connector	606	X	X	X
PX2K Series Nickel Plated Brass Cable Glands	608	X	X	X
PX2K-REX Series Liquid Resin Barrier Type Cable Glands	610	X	X	X
A2F Series Nickel Plated Brass Cable Glands	612		X	X
TE1FU Series Stainless Steel Cable Glands	614	X	X	X
ATEX/IECEx Increased Safety Cable Glands				
Ex e Series Polyamide Cable Glands	616			X
ATEX/IECEx Flameproof Cable Glands				
E1FW Series Nickel Plated Brass Cable Gland	618	X	X	X
E1FX Series Nickel Plated Brass Cable Gland	620	X	X	X
A2FRC Series Nickel Plated Brass Cable Glands	622	X	X	X
E1FU Triple Certified Cable Glands	624	X	X	X
NEC/CEC ATEX/IECEx Explosionproof Connectors				
PX2KX Compound Barrier Type Cable Connector	626	X	X	X
PX2KX-REX Liquid Resin Barrier Type Cable Connector	628	X	X	X
NEC/CEC MC Connectors				
TMC2X Connectors For Jacketed Metal Clad Cable	630	X	X	X
TMC2 Connectors For Jacketed Metal Clad Cable	632	X	X	X
TMCX Connectors For Jacketed Metal Clad Cable	634	X	X	X



A2 Cable Gland



C2KX Cable Connector



TC Cable Connector



T3 Cable Glands



PXSS2K Cable Glands



PX2K Cable Glands



PX2K-REX Cable Glands



A2F Cable Glands



TE1FU Cable Glands



Ex e Cable Glands



E1FX/E1FW Cable Gland



A2FRC Cable Glands



E1FU Cable Glands



PX2KX Cable Connector



TMC2X Connectors



TMC2 Connectors



TMCX Connectors

Hazardous Location Fittings

Description	Page	NEC	CEC	ATEX/IEC
-------------	------	-----	-----	----------

Cable Gland Accessories and Tools				
Cable Gland Accessories: 737 Series Adaptors and Reducers	636	X	X	X
Cable Gland Accessories: 747 Series Stopper Plugs	639	X	X	X
Cable Gland Accessories: 757 Series Blanking Plugs	640	X	X	X
Cable Gland Accessories: 757 BVE Series Blanking Plugs	642	X	X	X
Cable Gland Accessories: 767 Series Stopper Plugs	643	X	X	X
Cable Gland Accessories and Tools	644			

NEC/CEC Explosionproof Conduit Fittings				
360° Swivel Conduit Unions	648	X	X	
360° Swivel Conduit Unions	649	X	X	
45° and 90° Elbows	650	X	X	
45° and 90° Elbows	651	X	X	
EXGJH and EXLK Flexible Couplings	652	X	X	
ECGJH and ECLK Flexible Couplings	655	X	X	
ECHF Flexible Couplings	658	X	X	
PLG Close-Up Plugs and BR Reducers	659	X	X	
PLG Close-Up Plugs	661	X	X	
REC Reducing Couplings	662	X	X	
UNY, UNF, UNL Unions and UNY, UNF Expansion Unions	663	X	X	
UNY and UNF Conduit Unions	666	X	X	
ME-S Male Enlargers	668	X	X	
RB Series Threaded Rigid Conduit and IMC Reducers	669	X	X	
RB Reducing Bushings	670	X	X	

ATEX/IECEx Flameproof, Increased Safety Conduit Fittings				
ATX™ DB Series IIB Unions	671			X
ATX™ DB Series IIC Elbows	672			X
ATX™ DB Series IIC Flexible Couplings	673			X

NEC/CEC Explosionproof Drain and Breathers				
Drain, Breather, Universal Drain and Breather	674		X	
Drain, Breather, Universal Drain or Breather	676	X	X	



Hazardous Location Fittings

Description	Page	NEC	CEC	ATEX/ IEC
ATEX/IEC Flameproof, Increased Safety Drain and Breathers				
ATX™ DB Series Drain and Breather Valves	677			X
NEC/CEC Explosionproof Sealing Fittings				
Sealing Fittings	678			
• EYS 25% Fill	679	X	X	
• ESU 25% Fill	682	X	X	
• EY 25% Fill	683	X	X	
• EY 40% Fill	684	X	X	
• EYD 25% Fill	685	X	X	
• EYDM 25% Fill	686	X	X	
ES 25% Sealing Hubs	687	X	X	
Kwiko™ A Sealing Cement and Filler	688	X	X	
Sealing Fittings	690			
• EYA 25% Fill	691	X	X	
• EYAX 40% Fill	692	X	X	
• EYD 25% Fill	693	X	X	
• EYDX 40% Fill	694	X	X	
• EY 25% Fill	695	X	X	
Kwiko™ A Sealing Cement and Filler	696	X	X	
ALESKO Epoxy Sealing Putty	698		X	
ATEX/IECex Flameproof Seals				
ATX™ DB Series Fire Retardant Seal	699		X	
NEC/CEC Explosionproof Outlet Bodies and Boxes				
ELBY Pulling Elbows	700	X	X	
LBY Capped Elbows	701	X	X	
ELBD 90° Pulling Elbows	702	X	X	
LBH 90° Aluminum Pulling Elbows	704	X	X	
ER Conduit Outlet Boxes	706	X	X	
OER Conduit Outlet Boxes	708	X	X	



Cable Gland Selection Guide

Selection Chart – Certifications

Type	Series	NEC/ CEC	ATEX/ IECEX	Material	Non- Armored Cables	Armored Cables				
						Wire	Braid	Tape		
Neoprene Seal	"e" or "i"	Ex e	X	Polyamide	Yes ②		Yes	Yes		
Elastomer Seal	Non-Hazardous	A2	X	X	Brass, fully nickel plated	Yes		Yes ②		
		A2F	X	X	Brass, fully nickel plated	Yes		Yes ②		
		A2FRC		X	Brass, fully nickel plated	Yes ③				
		T3	X	X	Brass, fully nickel plated	Yes ②	Yes	Yes	Yes	
	"d" and "e"	E1FX		X	Brass, fully nickel plated	Yes ②		Yes	Yes	
		E1FW		X	Brass, fully nickel plated	Yes ②	Yes			
		E1FU	X	X	Brass, fully nickel plated	Yes ②	Yes	Yes	Yes	
		TE1FU	X	X	Stainless Steel	Yes ②	Yes	Yes	Yes	
	Compound Seal	UL	PXSS2K PXSS2K-REX	X	X	Brass, fully nickel plated	Yes ④			
			PX2K	X	X	Brass, fully nickel plated	Yes ②⑤	Yes	Yes	Yes
PX2K-REX			X	X	Brass, fully nickel plated	Yes ②	Yes	Yes	Yes	
PX2KX ① PX2KX-REX ①			X	X	Brass, fully nickel plated	Yes ②		Yes		
Marine	C2KX	X	X	Brass, fully nickel plated			Yes	Yes		

Note: Cable must be substantially compact and circular with an extruding bedding, and if any filters are used they are Non-Hygroscopic.

① Also ATEX and Marine rated.

② Applicable to ATEX/IECEX applications only.

③ Non-armored cables – through rigid conduit.

④ Non-armored cables – tray and extra hard usage cord.

⑤ Non-armored cables – SWA armored tray.

⑥ dm³: 1 cubic decimeter equals approximately 61 cubic inches.

Cable Gland Selection Guide

Selection Guide

Selection of cable entry for Ex d flameproof enclosure according to electrical installations IEC 60079-14.

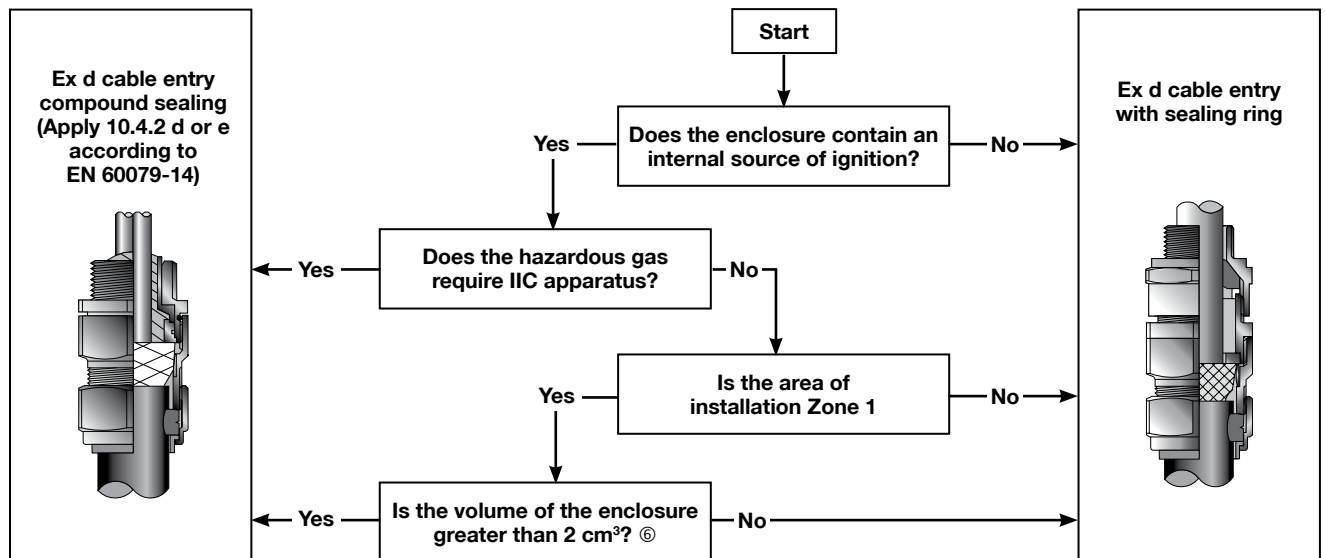

Note: Cable must be substantially compact and circular with an extruding bedding, and if any filters are used they are Non-Hygroscopic.

- ① Also ATEX and Marine rated.
- ② Applicable to ATEX/IECEx applications only.
- ③ Non-armored cables — through rigid conduit.
- ④ Non-armored cables — tray and extra hard usage cord.
- ⑤ Non-armored cables — SWA armored tray.
- ⑥ dm³: 1 cubic decimeter equals approximately 61 cubic inches.

A2 Industrial Cable Gland

Unarmored and Exterior Braid Armor With Protective Sheath Cable.

CEC:
 Rated for Non - Hazardous Locations
 Type 4x

Applications

- A2 type brass indoor and outdoor cable gland for use with all types of unarmored and exterior braid armor with protective sheath cable providing mechanical cable retention and an environmental seal on the cable outer sheath.

Features

- Designed and tested to BS 6121: Part 1: 1989, meets and surpasses the requirements of EN 50262:1999.
- Brass grade CuZn39Pb3 (CW614N) to EN12168.
- Continuous operating temperature range: -60 °C to +130 °C (-76 °F to +266 °F).
- Cable type: unarmored.
- Sealing technique - Displacement seal concept.
- Sealing area(s) - outer sheath.

Standard Materials

- Gland: brass, fully nickel plated
- Seal: SOLO LSF (low smoke fumes) thermoplastic elastomer

Options

- Aluminum: replace last digit 5 with 1
- 316L stainless steel: replace last digit 5 with 4
- Shroud, locknut, earth tag, entry thread seal, serrated washers, adaptors and reducers: see *Cable Gland Accessories* pages

CEC Certifications and Compliances

- cCSAus Certified: 101909
- CSA Standard: C22.2 No. 174
- Ingress Protection IP66, IP67 and IP68
- Deluge Protection - To DTS01: 91
- CEPEL/INMENRD: EX-023
- SAQAS: AUSEX764

Cable Gland Size	Metric Thread C	Standard Metric ①	Standard NPT Thread C	Catalog Numbers		
				Standard NPT ①	Optional NPT Thread C	Optional NPT Thread ①
20S/16	M20	2016A25	1/2	2016A20505	3/4	2016A20755
20S	M20	20SA25	1/2	20SA20505	3/4	20SA20755
20	M20	20A25	1/2	20A20505	3/4	20A20755
25	M25	25A25	3/4	25A20755	1	25A21005
32	M32	32A25	1	32A21005	1-1/4	32A21255
40	M40	40A25	1-1/4	40A21255	1-1/2	40A21505
50S	M50	50SA25	1-1/2	50SA21505	2	50SA22005
50	M50	50A25	2	50A22005	2-1/2	50A22505
63S	M63	63SA25	2	63SA22005	2-1/2	63SA22505
63	M63	63A25	2-1/2	63A22505	3	63A23005
75S	M75	75SA25	2-1/2	75SA22505	3	75SA23005
75	M75	75A25	3	75A23005	3-1/2	75A23505
90	M90	90A25	3	90A23005	4	90A2X3505
100	M100	100A25	4	100A24005	5	100A25005
115	M115	115A25	4	115A24005	5	115A25005
130	M130	130A25	5	130A25005	6	130A26005

① Entry thread seal not supplied, see *Cable Gland Accessories and Tools*.

A2 Industrial Cable Gland

Unarmored and Exterior Braid Armor With Protective Sheath Cable.

CEC:
Rated for Non - Hazardous Locations
Type 4x



Dimensions in Millimeters (Inches)

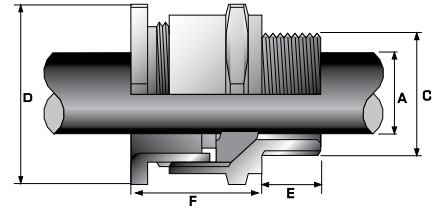

Cable Gland Size	Overall Cable Diameter mm (in) A		Across Flats mm (in) D	Across Corners mm (in) D	Maximum Thread Length mm (in) E	Nominal Protrusion Length mm (in) F	Optional PVC Shroud	Weight kg (oz)
	Min	Max						
20S/16	3.20 (0.13)	8.70 (0.34)	24.00 (0.94)	26.40 (1.04)	10.00 (0.39)	21.00 (0.83)	PVC04	0.07 (2.47)
20S	6.10 (0.24)	11.70 (0.46)	24.00 (0.94)	26.40 (1.04)	10.00 (0.39)	21.00 (0.83)	PVC04	0.06 (2.12)
20	6.50 (0.26)	14.00 (0.55)	27.00 (1.06)	29.70 (1.17)	10.00 (0.39)	24.00 (0.94)	PVC05	0.07 (2.47)
25	11.10 (0.44)	20.00 (0.79)	36.00 (1.42)	39.60 (1.56)	10.00 (0.39)	26.00 (1.02)	PVC09	0.13 (4.59)
32	17.00 (0.67)	26.30 (1.04)	41.00 (1.61)	45.10 (1.78)	10.00 (0.39)	27.00 (1.06)	PVC10	0.15 (5.29)
40	23.50 (0.93)	32.20 (1.27)	50.00 (1.97)	55.00 (2.17)	15.00 (0.59)	28.00 (1.10)	PVC13	0.20 (7.05)
50S	31.00 (1.22)	38.20 (1.50)	55.00 (2.17)	60.50 (2.38)	15.00 (0.59)	29.00 (1.14)	PVC14	0.26 (9.17)
50	35.60 (1.40)	44.10 (1.74)	60.00 (2.36)	66.00 (2.60)	15.00 (0.59)	30.00 (1.18)	PVC17	0.27 (9.52)
63S	41.50 (1.63)	50.00 (1.97)	70.00 (2.76)	77.00 (3.03)	15.00 (0.59)	30.00 (1.18)	PVC20	0.43 (15.17)
63	47.20 (1.86)	56.00 (2.20)	75.00 (2.95)	82.50 (3.25)	15.00 (0.59)	30.00 (1.18)	PVC22	0.46 (16.23)
75S	54.00 (2.13)	62.00 (2.44)	80.00 (3.15)	88.00 (3.46)	15.00 (0.59)	32.00 (1.26)	PVC24	0.52 (18.34)
75	61.10 (2.41)	68.00 (2.68)	85.00 (3.35)	93.50 (3.68)	15.00 (0.59)	32.00 (1.26)	PVC26	0.50 (17.64)
90	66.60 (2.62)	80.00 (3.15)	108.00 (4.25)	118.80 (4.68)	24.00 (0.94)	44.00 (1.73)	PVC31	1.60 (56.44)
100	76.00 (2.99)	91.00 (3.58)	123.00 (4.84)	135.30 (5.33)	24.00 (0.94)	48.00 (1.89)	LSF32	1.78 (62.79)
115	86.00 (3.39)	98.00 (3.86)	133.40 (5.25)	146.70 (5.78)	24.00 (0.94)	55.00 (2.17)	LSF34	2.67 (94.18)
130	97.00 (3.82)	115.00 (4.53)	152.40 (6.00)	167.60 (6.6)	24.00 (0.94)	62.00 (2.44)	LSF35	3.80 (134.04)

C2KX Marine Cable Connector

Wire Braid Armor and Jacketed Cables.

HAZARDOUS LOCATION FITTINGS: NEC/CEC, ATEX/IECEx WEATHERPROOF CABLE GLANDS

NEC/CEC:

Class I, Division 2 ①, Groups A, B, C, D
 Class I, Zone 1, AEx e II, AEx nR II
 Class I, Zone 2, AEx e II
 NEMA 4X
 IP66, IP67, IP68

ATEX/IECEx:

Ex II 2 GD
 Ex e II
 Ex tD A21 IP66
 Ex II 3 G Ex nR II

Applications

- Cable connector for armor braid shipboard cable and all IEC braid cables is suitable for ordinary and wet locations and provides mechanical retention and electrical continuity via a removable armor termination.

Features

- Connector provides an environmental seal on the cable outer jacket and is UL Listed for NPT or Metric entry threads.
- The C2KX forms part of a comprehensive range of deluge proof connectors for marine shipboard and IEE45 armor jacketed cables.
- Permitted for use in Division 2 areas on equipment without internal source of ignition (i.e. no arcing or sparking devices).
- Armor termination — removable armor cone and ring.
- Sealing technique — Displacement seal concept. Sealing area — Outer sheath.

Standard Materials

- Connector: brass fully nickel plated
- Seal: SOLO LSF (low smoke fumes) thermoplastic elastomer

Options

- Brass with nickel plated threaded entry: replace last digit **5** with **7**
- Aluminum: replace last digit **5** with **1**
- 316L stainless steel: replace last digit **5** with **4**
- Shroud, locknut, earth tag, entry thread seal, serrated washers, adaptors and reducers: see *Cable Gland Accessories* pages.

NEC/CEC Certifications and Compliances

- UL Standard: 514B
- UL Listed: E200163, E256367
- CSA Standard: C22.2 No. 0.18.3,94.1,94.2, CAN/CSA E60079-0,7, CAN/CSA C22.2 No. 60529:05
- CSA Certified: 101909

Cable Connector Size	Metric Thread C	Standard Metric ②	Standard NPT Thread C	Catalog Numbers			Minimum Thread Length mm (in) E	
				Standard NPT ②	Optional NPT Thread C	Optional NPT Thread ②	NPT	Metric
20S/16	M20	2016C2KX5	1/2	2016C2KX0505	3/4	2016C2KX0755	20.19 (0.79)	15.01 (0.59)
20S	M20	20SC2KX5	1/2	20SC2KX0505	3/4	20SC2KX0755	20.19 (0.79)	15.01 (0.59)
20	M20	20C2KX5	1/2	20C2KX0505	3/4	20C2KX0755	20.19 (0.79)	15.01 (0.59)
25	M25	25C2KX5	3/4	25C2KX0755	1	25C2KX1005	20.50 (0.81)	15.01 (0.59)
32	M32	32C2KX5	1	32C2KX1005	1-1/4	32C2KX1255	24.54 (0.97)	15.01 (0.59)
40	M40	40C2KX5	1-1/4	40C2KX1255	1-1/2	40C2KX1505	25.91 (1.02)	15.01 (0.59)
50S	M50	50SC2KX5	1-1/2	50SC2KX1505	2	50SC2KX2005	26.39 (1.04)	15.01 (0.59)
50	M50	50C2KX5	2	50C2KX2005	2-1/2	50C2KX2505	27.20 (1.07)	15.01 (0.59)
63S	M63	63SC2KX5	2	63SC2KX2005	2-1/2	63SC2KX2505	27.20 (1.07)	15.01 (0.59)
63	M63	63C2KX5	2-1/2	63C2KX2505	3	63C2KX3005	40.21 (1.58)	15.01 (0.59)
75S	M75	75SC2KX5	2-1/2	75SC2KX2505	3	75SC2KX3005	40.21 (1.58)	15.01 (0.59)
75	M75	75C2KX5	3	75C2KX3005	3-1/2	75C2KX3505	41.81 (1.65)	15.01 (0.59)
90	M90	90C2KX5	3-1/2	90C2KX3505	4	90C2KX4005	41.81 (1.65)	24.13 (0.95)
100 ③	M100	100C2KX5	4	100C2KX4005	5	100C2KX5005	44.30 (1.74)	24.13 (0.95)

① When installed in accordance with the National Electrical Code.

② Entry thread seal not supplied, see *Cable Gland Accessories and Tools*.

③ Not UL Listed or CSA Certified.

C2KX Marine Cable Connector

Wire Braid Armor and Jacketed Cables.

NEC/CEC:

Class I, Division 2 ①, Groups A, B, C, D
 Class I, Zone 1, AEx e II, AEx nR II
 Class I, Zone 2, AEx e II
 NEMA 4X
 IP66, IP67, IP68

ATEX/IECEx:

Ex II 2 GD
 Ex e II
 Ex tD A21 IP66
 Ex II 3 G Ex nR II

ATEX/IECEx Certifications and Compliances

- EN/IEC Standards: 60079-0; 60079-1; 60079-7; 60079-15; 60079-31
- Oil Resistant II
- Marine: LLOYDS, DNV, ABS
- Shell / ERA deluge test DTS 01:1991 (after 20 years simulated accelerated aging)



Dimensions in Millimeters (Inches)

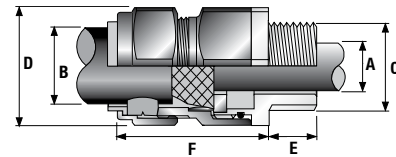

Cable Connector Size	Maximum Cable Bedding Diameter mm (in) A	Overall Cable Diameter mm (in) B		Across Flats mm (in) D	Across Corners mm (in) D	Nominal Protrusion Length mm (in) F	Optional PVC Shroud	Cable Connector Weight kgs (oz)
		Min	Max					
20S/16	8.71 (0.34)	6.10 (0.24)	13.21 (0.52)	24.00 (0.94)	26.42 (1.04)	48.01 (1.89)	PVC06	0.13 (4.66)
20S	11.71 (0.46)	9.50 (0.37)	15.90 (0.63)	24.00 (0.94)	26.42 (1.04)	48.01 (1.89)	PVC06	0.13 (4.66)
20	14.00 (0.55)	12.50 (0.49)	20.90 (0.82)	30.51 (1.20)	33.58 (1.32)	48.01 (1.89)	PVC06	0.19 (6.84)
25	19.99 (0.79)	18.21 (0.72)	26.19 (1.03)	37.49 (1.48)	41.25 (1.62)	56.13 (2.21)	PVC09	0.31 (10.79)
32	26.29 (1.04)	23.70 (0.93)	33.91 (1.34)	46.00 (1.81)	50.62 (1.99)	54.10 (2.13)	PVC09	0.31 (10.79)
40	32.21 (1.27)	27.89 (1.10)	40.41 (1.59)	54.99 (2.16)	60.50 (2.38)	57.91 (2.28)	PVC11	0.47 (16.51)
50S	38.20 (1.50)	35.20 (1.39)	46.71 (1.84)	59.99 (2.36)	66.01 (2.60)	60.96 (2.40)	PVC15	0.68 (23.92)
50	44.09 (1.74)	40.41 (1.59)	53.11 (2.09)	70.00 (2.76)	77.01 (3.03)	59.94 (2.36)	PVC18	0.75 (26.46)
63S	50.01 (1.97)	45.59 (1.79)	59.41 (2.34)	75.01 (2.95)	82.52 (3.25)	73.91 (2.91)	PVC21	1.04 (36.83)
63	56.01 (2.21)	54.61 (2.15)	65.89 (2.59)	80.01 (3.15)	88.01 (3.46)	71.12 (2.80)	PVC23	1.07 (37.88)
75S	62.00 (2.44)	59.00 (2.32)	72.11 (2.84)	89.00 (3.50)	97.92 (3.86)	86.11 (3.39)	PVC25	1.28 (45.15)
75	68.00 (2.68)	66.70 (2.63)	78.51 (3.09)	99.01 (3.90)	108.92 (4.29)	82.04 (3.23)	PVC28	1.86 (65.61)
90	80.01 (3.15)	76.20 (3.00)	90.40 (3.56)	114.0 (4.49)	125.40 (4.94)	95.00 (3.74)	PVC30	2.55 (89.95)
100 ②	91.01 (3.58)	86.11 (3.39)	101.50 (4.00)	123.01 (4.84)	135.31 (5.33)	95.00 (3.74)	PVC32	3.65 (128.75)

① When installed in accordance with the National Electrical Code.
 ② Not UL Listed or CSA Certified.

TC Cable Connector

Tray Cable

HAZARDOUS LOCATION FITTINGS: NEC/CEC, ATEX/IECEx WEATHERPROOF CABLE GLANDS

NEC/CEC
 Class I, Division 2, Groups A, B, C, D
 Class II, Division 2, Groups E, F, G
 Class III, Division 2
 NEMA Type 4X

ATEX/IECEx:

Applications

- Type TC cable connector is suitable for use with type (TC) tray cable and flex cord in ordinary, wet and hazardous locations including:
 - Class I, Division 2, where permitted by code
 - Class I, Zone 1 AEx e and Ex e, where permitted by code
 - Ingress protection to NEMA 4X and IP66/67/68

Features

- Guarantees code compliance by satisfying the requirements of NEC article 501.10(B)(1)
- The unique use of the seal insert, enables each gland size to terminate the widest range available in a single hub size.
- Continuous operating temperature: -60 °C to 110 °C (-76 °F to 230 °F).
- Jacket sealing technique: compensating displacement seal
- Sealing area(s) — cable outer jacket

Standard Material/Finish

- Connector: copperfree (4/10 of 1% max) aluminium, stainless steel or electroless nickel plated brass in NPT (standard) and metric thread forms

Options

- Adaptor/reducer, earth tag

NEC/CEC Certifications and Compliances

- UL Standard: 514B, 2225
- CSA Standard: CSA 22.2 No. 30, CAN/CSA E60079-0, CAN/CSA E60079-7
- cCSAus Certified: 184585

Entry Thread C		Cable Range Insert mm (in) A		Cable Range No Insert mm (in) B		Catalog Number		
NPT	NPT Option	Min	Max	Min	Max	Aluminium	NP Brass	Stainless Steel
1/2	—	—	—	3.3 (0.13)	7.1 (0.28)	TC050028	TC050028NB	TC050028SS
—	3/4	—	—	—	—	TC075028	TC075028NB	TC075028SS
1/2	—	6.6 (0.26)	10.4 (0.41)	10.4 (0.41)	13.9 (0.55)	TC050055	TC050055NB	TC050055SS
—	3/4	—	—	—	—	TC075055	TC075055NB	TC075055SS
3/4	—	11.9 (0.47)	15.5 (0.61)	15.5 (0.61)	20.1 (0.79)	TC075079	TC075079NB	TC075079SS
—	1	—	—	—	—	TC100079	TC100079NB	TC100079SS
1	—	17.0 (0.67)	21.6 (0.85)	21.6 (0.85)	26.4 (1.04)	TC100104	TC100104NB	TC100104SS
—	1-1/4	—	—	—	—	TC125104	TC125104NB	TC125104SS
1-1/4	—	23.4 (0.92)	27.9 (1.10)	27.9 (1.10)	32.3 (1.27)	TC125127	TC125127NB	TC125127SS
—	1-1/2	—	—	—	—	TC150127	TC150127NB	TC150127SS
1-1/2	—	30.9 (1.22)	34.8 (1.37)	34.8 (1.37)	38.1 (1.50)	TC150150	TC150150NB	TC150150SS
—	2	—	—	—	—	TC200150	TC200150NB	TC200150SS
2	—	—	—	35.6 (1.40)	44.2 (1.74)	TC200174	TC200174NB	TC200174SS
—	2-1/2	—	—	—	—	TC250174	TC250174NB	TC250174SS
2	—	—	—	41.4 (1.63)	50.0 (1.97)	TC200197	TC200197NB	TC200197SS
—	2-1/2	—	—	—	—	TC250197	TC250197NB	TC250197SS
2-1/2	—	—	—	47.2 (1.86)	55.9 (2.20)	TC250220	TC250220NB	TC250220SS
—	3	—	—	—	—	TC300220	TC300220NB	TC300220SS
2-1/2	—	—	—	54.1 (2.13)	61.9 (2.44)	TC250244	TC250244NB	TC250244SS
—	3	—	—	—	—	TC300244	TC300244NB	TC300244SS
3	—	—	—	60.9 (2.40)	68.1 (2.68)	TC300268	TC300268NB	TC300268SS
—	3-1/2	—	—	—	—	TC350268	TC350268NB	TC350268SS
3-1/2	—	—	—	66.5 (2.62)	80.0 (3.15)	TC350315	TC350315NB	TC350315SS
—	4	—	—	—	—	TC400315	TC400315NB	TC400315SS
4	—	—	—	75.9 (2.99)	89.9 (3.54)	TC400354	TC400354NB	TC400354SS

TC Cable Connector Tray Cable

NEC/CEC
Class I, Division 2, Groups A, B, C, D
Class II, Division 2, Groups E, F, G
Class III, Division 2
NEMA Type 4X

ATEX/IECEx:
II 2 GD
d IIC Gb
e IIC Gb
ta IIIC Da

ATEX/IECEx Certifications and Compliances

- ATEX Certification/Code of Protection Category:
SIRA09ATEX1092X ATEX II 2 GD, Ex d IIC Gb, Ex e IIC Gb,
Ex ta IIIC Da
- IECEx Approval Number/Code of Protection Category:
IECEx SIR 09.0042X



Dimensions in Millimeters (Inches)

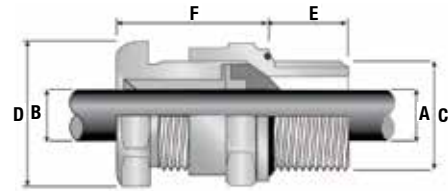

Across Flats mm (in) D	Across Corners mm (in) D	Min. Thread Length mm (in) E	Nominal Assembly Length mm (in) F	Approx. Weight Aluminum kg (oz)
30.5 (1.20)	33.0 (1.30)	19.8 (0.78)	20.1 (0.79)	0.06 (1.94)
		20.3 (0.80)		
30.5 (1.20)	33.0 (1.30)	19.8 (0.78)	20.1 (0.79)	0.05 (1.69)
		20.3 (0.80)		
37.6 (1.48)	40.6 (1.60)	20.3 (0.80)	24.9 (0.98)	0.09 (3.17)
		24.9 (0.98)		
45.9 (1.81)	49.5 (1.95)	24.9 (0.98)	24.9 (0.98)	0.11 (3.88)
		25.4 (1.00)		
52.1 (2.05)	56.1 (2.21)	25.4 (1.00)	29.9 (1.18)	0.14 (4.94)
		26.2 (1.03)		
59.9 (2.36)	64.8 (2.55)	26.2 (1.03)	32.0 (1.26)	0.17 (6.00)
		26.9 (1.06)		
74.9 (2.95)	81.0 (3.19)	26.9 (1.06)	32.0 (1.26)	0.25 (8.64)
		39.9 (1.57)		
74.9 (2.95)	81.0 (3.19)	26.9 (1.06)	41.9 (1.65)	0.24 (8.29)
		39.9 (1.57)		
89.9 (3.54)	97.0 (3.82)	39.9 (1.57)	41.9 (1.65)	0.39 (13.58)
		41.4 (1.63)		
89.9 (3.54)	97.0 (3.82)	39.9 (1.57)	42.9 (1.69)	0.39 (13.58)
		41.4 (1.63)		
109.9 (4.33)	118.9 (4.68)	41.4 (1.63)	42.9 (1.69)	0.76 (26.63)
		42.7 (1.68)		
122.9 (4.84)	132.8 (5.23)	42.7 (1.68)	57.9 (2.28)	0.97 (34.22)
		43.9 (1.73)		
133.4 (5.25)	144.0 (5.67)	43.9 (1.73)	57.9 (2.28)	1.08 (38.80)

T3 Series Nickel Plated Brass Cable Glands

Increased Safety and Flameproof. Ex d ①.

With Elastomer Seal for Armored Cables.

NEC/CEC:
Class I, Division 2, Groups A, B, C, D
Class II, Division 2, Groups E, F, G
Class III
NEMA 3, 4, 4X

NEC/CEC:
Class I, Zone 1, AEx e II / Ex d IIC
Class I, Zone 2, AEx e II / Ex e II
IP66, IP67 ①, IP68 ①

ATEX/IECEX:
Zone 1 and 2 – 21 and 22
② II 2 GD
IP66 / 68 (10 m)

Applications

- Cable gland for all types of armored cable certified for enclosures with the following protection modes:
 - Ex d flameproof IIB or IIC (as per §10.4.2 of IEC 60079-14) (Refer to ATX Guide for Use of Electrical Products in Hazardous Locations)
 - Ex e increased safety.
 - Ex nR restricted breathing.
 - Ex d flameproof.
- Hazardous areas (gas and dust).
- Onshore and offshore.

Features

- Cable gland with elastomer seal for use in hazardous areas with all types of armored cable.
- This product utilizes a unique Compensating Displacement Seal (CDS) system which provides full compatibility with restricted breathing equipment.
- The CDS system is designed to alleviate any pressure on soft bedded cables.
- The cable gland allows mechanical cable retention and earth continuity via armor termination.

- A reversible armor cone and AnyWay universal clamping ring arrangement allows the cable to be easily disconnected from equipment.
- The cable gland is IP66/68 rated with deluge protection to DTS01: 91.
- Inspection of the armor can be carried out while still maintaining the protection mode of the enclosure.

Standard Materials

- Body: nickel plated brass
- Seal: LSF (Low Smoke Fume) thermoplastic elastomer
 - Inner CDS system and LRS (Load Retention Seal) outer seal

Options

- 316L stainless steel version: replace last digit **5** with **4**
- Lead sheath version: replace **T3** with **T3PB**
- Copper-free aluminum: replace last digit **5** with **1**
- Shroud, locknut, earth tag, entry thread seal, serrated washers, adaptors and reducers: see *Cable Gland Accessories* pages.

NEC/CEC Certifications and Compliances

- UL Standard: 2225
- CSA Standard: C22.2 No. 174
- cCSAus Certified: 101909

Cable Gland Size	Metric Thread C	Standard Metric ②	Standard NPT Thread C	Catalog Numbers			Minimum Thread Length mm (in) E
				Standard NPT ②	Optional NPT Thread C	Optional NPT Thread ②	
20S16	M20	2016T35	1/2	2016T30505	3/4	2016T30755	15.0 (0.59)
20S	M20	20ST35	1/2	20ST30505	3/4	20ST30755	15.0 (0.59)
20	M20	20T35	1/2	20T30505	3/4	20T30755	15.0 (0.59)
25S	M25	25ST35	3/4	25ST30755	1	25ST31005	15.0 (0.59)
25	M25	25T35	3/4	25T30755	1	25T31005	15.0 (0.59)
32	M32	32T35	1	32T31005	1-1/4	32T31255	15.0 (0.59)
40	M40	40T35	1-1/4	40T31255	1-1/2	40T31505	15.0 (0.59)
50S	M50	50ST35	1-1/2	50ST31505	2	50ST32005	15.0 (0.59)
50	M50	50T35	2	50T32005	2-1/2	50T32505	15.0 (0.59)
63S	M63	63ST35	2	63ST32005	2-1/2	63ST32505	15.0 (0.59)
63	M63	63T35	2-1/2	63T32505	3	63T33005	15.0 (0.59)
75S	M75	75ST35	2-1/2	75ST32505	3	75ST33005	15.0 (0.59)
75	M75	75T35	3	75T33005	3-1/2	75T33505	24.0 (0.94)
90	M90	90T35	3	90T33005	3-1/2	90T33505	24.0 (0.94)
100	M100	100T35	4	100T34005	5	100T35005	24.0 (0.94)
115	M115	115T35	4	115T34005	5	115T35005	24.0 (0.94)
130	M130	130T35	5	130T35005	6	130T36005	24.0 (0.94)

① The T3 Cable Gland is suitable for use with all forms of equipment protection permitted in Zone 1, Zone 2, Zone 21 and Zone 22 provided always that the prevailing code of practice for selection and installation is observed, e.g. IEC 60079-14.

② Entry thread seal not supplied, see *Cable Gland Accessories* and *Tools*.

T3 Series Nickel Plated Brass Cable Glands

Increased Safety and Flameproof. Ex d ①.

With Elastomer Seal for Armored Cables.

NEC/CEC:
 Class I, Division 2, Groups A, B, C, D
 Class II, Division 2, Groups E, F, G
 Class III
 NEMA 3, 4, 4X

NEC/CEC:
 Class I, Zone I, AEx e II / Ex d IIC
 Class I, Zone 2, AEx e II / Ex e II
 IP66, IP67 ①, IP68 ①

ATEX/IECEX:
 Zone 1 and 2 – 21 and 22
 ② II 2 GD
 IP66 / 68 (10 mm)

ATEX/IECEX Certifications and Compliances

- Certification Type T3CDS
 - Gas: Zones 1 and 2
 - Type of Protection: Ex d IIC Gb, Ex e IIC Gb, Ex nR IIC Gc
 - Dust: Zone 20
 - Type of Protection: Ex ta IIIC Da
- Conforming to ATEX 94/9/CE: ② II 2G 3G 1D
- Ambient Temperature: -60 °C to +130 °C (-76 °F to +266 °F)
- CE Declaration of Conformity: DC07001
- ATEX Certificate: Sira 13ATEX1073X, Sira 13ATEX4079X
- IECEX Certificate: IECEX SIR 13.0028X, IECEX SIM 14.0007X
- Other Certifications: cCSAus, UL, CCOE/PESO (India)
- Marine Approval: LLOYDS, DNV, ABS
- Index of Protection according EN/IEC 60529: IP66, IP67, IP68
- Deluge Protection Compliance: DTS01:91

INMETRO Certification

- INMETRO Certificate: TÜV 11.0374X

EURASEC Certification

- TC RU C-GB. Г505.B.00138



Dimensions in Millimeters (Inches)

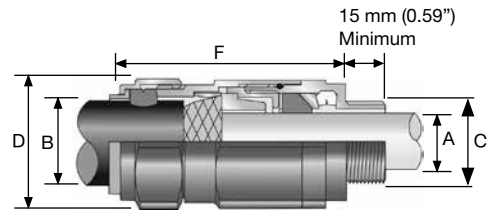

Cable Gland Size	Cable Bedding Diameter mm (in) A		Overall Cable Diameter mm (in) B		Across Corners mm (in) D	Across Flats mm (in) D	Nominal Protrusion Length mm (in) F	Optional PVC Shroud	Weight kg (oz)
	Min	Max	Min	Max					
20S16	3.2 (0.13)	8.7 (0.34)	6.1 (0.24)	13.2 (0.52)	26.4 (1.04)	24.0 (0.94)	70.0 (2.76)	PVC36	0.17 (6.00)
20S	6.1 (0.24)	11.7 (0.46)	9.5 (0.37)	15.9 (0.63)	26.4 (1.04)	24.0 (0.94)	70.0 (2.76)	PVC36	0.17 (6.00)
20	6.5 (0.26)	14.0 (0.55)	12.5 (0.49)	20.9 (0.82)	33.6 (1.32)	30.5 (1.20)	72.0 (2.83)	PVC06	0.26 (9.03)
25S	11.0 (0.43)	20.0 (0.79)	14.0 (0.55)	22.0 (0.87)	41.3 (1.63)	37.5 (1.48)	82.0 (3.23)	PVC09	0.38 (13.55)
25	11.0 (0.43)	20.0 (0.79)	18.2 (0.72)	26.2 (1.03)	41.3 (1.63)	37.5 (1.48)	82.0 (3.23)	PVC09	0.38 (13.37)
32	17.0 (0.67)	26.3 (1.04)	23.7 (0.93)	33.9 (1.33)	50.6 (1.99)	46.0 (1.81)	85.0 (3.35)	PVC11	0.56 (19.75)
40	22.0 (0.87)	32.2 (1.27)	27.9 (1.10)	40.4 (1.59)	60.5 (2.38)	55.0 (2.17)	86.0 (3.39)	PVC15	0.85 (29.91)
50S	29.5 (1.16)	38.2 (1.50)	35.2 (1.39)	46.7 (1.84)	66.0 (2.60)	60.0 (2.36)	98.0 (3.86)	PVC18	1.06 (37.21)
50	35.6 (1.40)	44.1 (1.74)	40.4 (1.59)	53.1 (2.09)	77.0 (3.03)	70.0 (2.76)	100.0 (3.94)	PVC21	1.52 (53.65)
63S	40.1 (1.58)	50.0 (1.97)	45.6 (1.80)	59.4 (2.34)	82.5 (3.25)	75.0 (2.95)	108.0 (4.25)	PVC23	1.75 (61.73)
63	47.2 (1.86)	56.0 (2.20)	54.6 (2.15)	65.9 (2.59)	88.0 (3.46)	80.0 (3.15)	103.0 (4.06)	PVC25	1.69 (59.44)
75S	52.8 (2.08)	62.0 (2.44)	59.0 (2.32)	72.1 (2.84)	97.9 (3.85)	89.0 (3.50)	105.0 (4.13)	PVC28	2.35 (82.72)
75	59.1 (2.33)	68.0 (2.68)	66.7 (2.63)	78.5 (3.09)	108.9 (4.29)	99.0 (3.90)	114.0 (4.49)	PVC30	3.2 (112.88)
90	66.6 (2.62)	80.0 (3.15)	76.2 (3.00)	90.4 (3.56)	125.4 (4.94)	114.0 (4.49)	140.0 (5.51)	PVC32	5.1 (179.90)
100	76.6 (3.02)	91.0 (3.58)	86.1 (3.39)	101.5 (4.00)	135.3 (5.33)	123.0 (4.84)	170.0 (6.69)	LSF33	6.5 (229.28)
115	86.0 (3.39)	98.0 (3.86)	101.5 (4.00)	110.3 (4.34)	146.1 (5.75)	133.4 (5.25)	210.0 (8.27)	LSF34	7.0 (246.92)
130	97.0 (3.82)	115.0 (4.53)	114.2 (4.50)	123.3 (4.85)	160.7 (6.33)	146.1 (5.75)	250.0 (9.84)	LSF35	7.8 (275.14)

① The T3 Cable Gland is suitable for use with all forms of equipment protection permitted in Zone 1, Zone 2, Zone 21 and Zone 22 provided always that the prevailing code of practice for selection and installation is observed, e.g. IEC 60079-14.

PXSS2K Series Compound Barrier Type Cable Connector

Flameproof

Unarmored, Tray, Shipboard and SO Type Cable.

NEC/CEC:

Class I, Division 1 ①, Groups C, D
Class I, Division 2, Groups A ②, B ②, C, D

NEC/CEC:

Class II, Division 2, Groups F, G
Class I, Zone 1
NEMA 4X
IP66, IP67, IP68

ATEX/IECEX:

Zone 1
Ex d IIC
Ex e II
Ex nR II, Ex tD
IP66, IP67, IP68

Applications

- Flame proof Class I cable connector suitable for unarmored, extra hard usage, tray (TC) and shipboard cables.

Features

- Connector provides an environmental seal on the cable jacket and an explosionproof compound barrier seal around the cable inner cores.
- The connector is UL Listed for NPT or Metric entry threads.
- Continuous operating temperature -60 °C to +85 °C (-76 °F to +185 °F).
- Sealing technique - displacement seal concept. Sealing area(s) - inner compound barrier and outer sheath.

Standard Materials

- Connector: brass fully nickel plated
- Seal: SOLO LSF (low smoke fumes) thermoplastic elastomer
- Epoxy putty.

Options

- Aluminum: replace last digit suffix 5 with 1
- 316L stainless steel: replace last digit suffix 5 with 4
- Shroud, locknut, earth tag, entry thread seal, serrated washers, adaptors and reducers: see *Cable Gland Accessories* pages.

NEC/CEC Certifications and Compliances

- UL Standard: 2225
- UL Listed: E161256
- CSA Standard: C22.2 No. 174
- cCSAus Certified: 101909

ATEX/IECEX Certifications and Compliances

- Certification Type PXSS2K
 - Gas: Zones 1 and 2
 - Type of Protection: Ex d IIC Gb, Ex e IIC Gb, Ex nR IIC Gc
 - Dust: Zone 20
 - Type of Protection: Ex ta IIIC Da
- Conforming to ATEX 94/9/CE: Ⓢ II 2G 3G 1D
- Ambient Temperature: -60 °C to +85 °C (-76 °F to +185 °F)

HAZARDOUS LOCATION FITTINGS: NEC/CEC EXPLOSIONPROOF AND ATEX/IECEX FLAMEPROOF CABLE GLANDS

Cable Gland Size	Metric Thread C	Thread Pitch (mm)	Catalog Numbers				Minimum Thread Length mm (in) E	Maximum Number of Cores	
			Standard Metric ③	Standard NPT Thread C	Standard NPT ③	Optional NPT Thread C			
20S16	M20	1.5	20S16PX5	1/2	20S16PX0505	3/4	20S16PX0755	15.0 (0.59)	11
20S	M20	1.5	20SPX5	1/2	20SPX0505	3/4	20SPX0755	15.0 (0.59)	11
20	M20	1.5	20PX5	1/2	20PX0505	3/4	20PX0755	15.0 (0.59)	11
20L	M20	1.5	20LPX5	1/2	20LPX0505	3/4	20LPX0755	15.0 (0.59)	11
25	M25	1.5	25PX5	3/4	25PX0755	1	25PX1005	15.0 (0.59)	21
32	M32	1.5	32PX5	1	32PX1005	1-1/4	32PX1255	15.0 (0.59)	38
32L	M32	1.5	32LPX5	1	32LPX1005	1-1/4	32LPX1255	15 (0.591)	38
40	M40	1.5	40PX5	1-1/4	40PX1255	1-1/2	40PX1505	15.0 (0.59)	59
50S	M50	1.5	50SPX5	1-1/2	50SPX1505	2	50SPX2005	15.0 (0.59)	89
50	M50	1.5	50PX5	2	50PX2005	2-1/2	50PX2505	15.0 (0.59)	89
63S	M63	1.5	63SPX5	2	63SPX2005	2-1/2	63SPX2505	15.0 (0.59)	115
63	M63	1.5	63PX5	2-1/2	63PX2505	3	63PX3005	15.0 (0.59)	115
75S	M75	1.5	75SPX5	2-1/2	75SPX2505	3	75SPX3005	15.0 (0.59)	140
75	M75	1.5	75PX5	3	75PX3005	3-1/2	75PX3505	15.0 (0.59)	140
90	M90	1.5	90PX5	3	90PX3505	4	90PX4005	20.0 (0.79)	200
100	M100	2.0	100PX5	4	100PX4005	5	100PX5005	20.0 (0.79)	200

① Extra hard usage cable cord only

② Increased thread engagement is required for gas groups A and B. Please specify gas group, thread form and size when ordering.

③ Entry thread seal not supplied, see *Cable Gland Accessories and Tools*.

PXSS2K Series Compound Barrier Type Cable Connector

Flameproof

Unarmored, Tray, Shipboard and SO Type Cable.

NEC/CEC:

Class I, Division 1 ①, Groups C, D
Class I, Division 2, Groups A ②, B ②, C, D

NEC/CEC:

Class II, Division 2, Groups F, G
Class I, Zone 1
NEMA 4X
IP66, IP67, IP68

ATEX/IECEX:

Zone 1
Ex d IIC
Ex e II
Ex nR II, Ex tD
IP66, IP67, IP68

- CE Declaration of Conformity: DC07001
- ATEX Certificate: Sira 13ATEX10712X, Sira 13ATEX4078X
- IECEX Certificate: IECEX SIR 13.0027X
- Other Certifications: cCSAus, UL, KCC, CCOE/PESO (India)
- Marine Approval: LLOYDS, DNV, ABS
- Index of Protection according EN/IEC 60529: IP66, IP67, IP68
- Deluge Protection Compliance: DTS01:91

INMETRO Certification

- INMETRO Certificate: TUV 12.2073X

EURASEC Certification

- TC RU C-GB.Г505.B.00138



Dimensions in Millimeters (Inches)

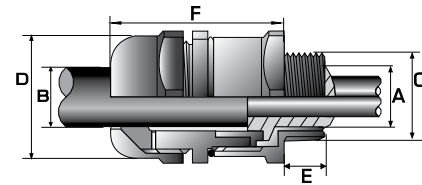

Cable Gland Size	Maximum Diameter Over Conductors mm (in) A	Overall Cable Diameter mm (in) B		Across Flats mm (in) D	Across Corners mm (in) D	Nominal Protrusion Length mm (in) F	Optional PVC Shroud	Cable Connector Weight kgs (oz)
		Min	Max					
20S16	12.6 (0.50)	3.1 (0.12)	8.7 (0.34)	30.5 (1.20)	33.6 (1.32)	58.5 (2.30)	PVC04	0.20 (7.05)
20S	12.6 (0.50)	6.1 (0.24)	11.7 (0.46)	30.5 (1.20)	33.6 (1.32)	58.5 (2.30)	PVC04	0.20 (7.05)
20	12.6 (0.50)	6.5 (0.26)	14.0 (0.55)	30.5 (1.20)	33.6 (1.32)	60.5 (2.38)	PVC05	0.25 (8.82)
20L	12.6 (0.50)	6.5 (0.26)	14.0 (0.55)	30.5 (1.20)	33.6 (1.32)	60.5 (2.38)	PVC05	0.25 (8.82)
25	17.5 (0.69)	11.1 (0.44)	20.0 (0.79)	37.5 (1.48)	41.3 (1.63)	67.5 (2.66)	PVC09	0.40 (14.22)
32	23.6 (0.93)	17.0 (0.67)	26.3 (1.04)	46.0 (1.81)	45.5 (1.79)	69.5 (2.74)	PVC10	0.56 (19.58)
32L	23.6 (0.93)	17.0 (0.67)	26.3 (1.04)	46.0 (1.81)	50.6 (1.99)	69.5 (2.74)	PVC10	0.56 (19.58)
40	30.0 (1.18)	22.0 (0.87)	32.1 (1.26)	55.0 (2.17)	60.5 (2.38)	78.0 (3.07)	PVC13	0.60 (21.16)
50S	36.6 (1.44)	29.5 (1.16)	38.2 (1.5)	60.0 (2.36)	66.0 (2.60)	75.5 (2.97)	PVC15	0.61 (21.34)
50	41.0 (1.61)	35.6 (1.40)	44.1 (1.74)	70.0 (2.76)	77.0 (3.03)	80.5 (3.17)	PVC18	0.62 (21.87)
63S	47.9 (1.89)	40.1 (1.58)	50.1 (1.97)	75.0 (2.95)	82.5 (3.25)	91.5 (3.60)	PVC21	0.71 (24.87)
63	53.7 (2.11)	47.2 (1.86)	56.0 (2.20)	80.0 (3.15)	88.0 (3.46)	92.0 (3.62)	PVC23	0.73 (25.75)
75S	59.9 (2.36)	52.8 (2.08)	62.0 (2.44)	89.0 (3.50)	97.9 (3.85)	99.0 (3.90)	PVC24	1.15 (40.57)
75	64.3 (2.53)	59.1 (2.33)	68.0 (2.68)	99.0 (3.90)	108.9 (4.29)	102.0 (4.02)	PVC26	1.15 (40.57)
90	75.3 (2.96)	66.6 (2.62)	79.4 (3.13)	114.0 (4.49)	125.4 (4.94)	120.0 (4.72)	PVC31	2.70 (95.24)
100	85.6 (3.37)	80.0 (3.15)	90.9 (3.58)	133.0 (5.24)	146.3 (5.76)	135.0 (5.31)	LSF33	3.40 (119.93)

① Extra hard usage cable cord only

② Increased thread engagement is required for gas groups A and B. Please specify gas group, thread form and size when ordering.

PXSS2K-REX Series Liquid Resin Barrier Type Cable Connector

Flameproof

Unarmored, Tray, Shipboard and SO Type Cable.

NEC/CEC:
Class I, Division 1, Groups C, D
Class I, Division 2, Groups A ①, B ①, C, D
Class II, Division 2, Groups F, G

NEC/CEC:
Class I, Zone 1 and 2
NEMA 4X
IP66, IP67, IP68

ATEX/IECEX:
Zone 1
Ex d IIC
Ex e II
Ex nR II, Ex tD
IP66, IP67, IP68

Applications

- Flame proof Class I cable connector suitable for unarmored, extra hard usage, tray (TC) and shipboard cables.

Features

- Utilizes RapidEx high speed liquid resin sealing compound included with each gland.
- The gland utilizes a liquid pour resin seal that vastly reduces installation time and associated costs. This solution is particularly effective on multicore cables where traditional compound is difficult and time consuming to apply.
- Connector provides an environmental seal on the cable jacket and an explosionproof liquid resin barrier seal around the cable inner cores.
- Continuous operating temperature -60 °C to +100 °C (-76 °F to +212 °F).
- Sealing technique - displacement seal concept. Sealing area(s) - inner liquid resin barrier and outer sheath.

Standard Materials

- Connector: brass fully nickel plated
- Seal: SOLO LSF (low smoke fumes) thermoplastic elastomer
- High speed liquid resin sealing compound.

Options

- Aluminum: replace last digit 5 with 1
- 316L stainless steel: replace last digit 5 with 4 (available by quote only)
- Shroud, locknut, earth tag, entry thread seal, serrated washers, adaptors and reducers: see *Cable Gland Accessories* pages

NEC/CEC Certifications and Compliances

- UL Standard: 2225
- CSA Standard: C22.2 No. 174
- cCSAus Certified: 101909

HAZARDOUS LOCATION FITTINGS: NEC/CEC EXPLOSIONPROOF AND ATEX/IECEX FLAMEPROOF CABLE GLANDS

Cable Gland Size	Metric Thread C	Thread Pitch (mm)	Standard Metric ②	Standard NPT Thread C	Standard NPT ②	Optional NPT Thread C	Optional NPT ②	Replacement Sealing Resin	Maximum Diameter Over Conductors mm (in) A
20S/16	M20	1.5	2016SPXREX5X	1/2	20S16PXREX0505X	3/4	20S16PXREX0755X	RAPIDEX30	12.6 (0.50)
20S	M20	1.5	20SPXREX5X	1/2	20SPXREX0505X	3/4	20SPXREX0755X	RAPIDEX30	12.6 (0.50)
20	M20	1.5	20PXREX5X	1/2	20PXREX0505X	3/4	20PXREX0755X	RAPIDEX30	12.6 (0.50)
20L	M20	1.5	20LPXREX5X	1/2	20LPXREX0505X	3/4	20LPXREX0755X	RAPIDEX30	12.6 (0.50)
25	M25	1.5	25PXREX5X	3/4	25PXREX0755X	1	25PXREX1005X	RAPIDEX30	17.5 (0.69)
32	M32	1.5	32PXREX5X	1	32PXREX1005X	1-1/4	32PXREX1255X	RAPIDEX30	23.6 (0.93)
32L	M32	1.5	32LPXREX5X	1	32LPXREX1005X	1-1/4	32LPXREX1255X	RAPIDEX30	23.6 (0.93)
40	M40	1.5	40PXREX5X	1-1/4	40PXREX1255X	1-1/2	40PXREX1505X	RAPIDEX30	30.0 (1.18)
50S	M50	1.5	50SPXREX5X	1-1/2	50SPXREX1505X	2	50SPXREX2005X	RAPIDEX80	36.6 (1.44)
50	M50	1.5	50PXREX5X	2	50PXREX2005X	2-1/2	50PXREX2505X	RAPIDEX80	41.0 (1.61)
63S	M63	1.5	63SPXREX5X	2	63SPXREX2005X	2-1/2	63SPXREX2505X	2RAPIDEX80	47.9 (1.89)
63	M63	1.5	63PXREX5X	2	63PXREX2005X	2-1/2	63PXREX2505X	2RAPIDEX80	53.7 (2.11)
75S	M75	1.5	75SPXREX5X	2-1/2	75SPXREX2505X	3	75SPXREX3005X	3RAPIDEX80	59.9 (2.36)
75	M75	1.5	75PXREX5X	3	75PXREX3005X	3-1/2	75PXREX3505X	3RAPIDEX80	64.3 (2.53)
90	M90	2.0	90PXREX5X	3-1/2	90PXREX3505X	4	90PXREX4005X	3RAPIDEX80	75.3 (2.96)

① Increased thread engagement is required for gas groups A and B. Please specify gas group, thread form and size when ordering.

② Entry thread seal not supplied, see *Cable Gland Accessories and Tools*.

PXSS2K-REX Series Liquid Resin Barrier Type Cable Connector

Flameproof

Unarmored, Tray, Shipboard and SO Type Cable.

NEC/CEC:

Class I, Division 1, Groups C, D
Class I, Division 2, Groups A ①, B ①, C, D
Class II, Division 2, Groups F, G

NEC/CEC:

Class I, Zone 1
NEMA 4X
IP66, IP67, IP68

ATEX/IECEX:

Zone 1
Ex d IIC
Ex e II
Ex nR II, Ex tD
IP66, IP67, IP68

ATEX/IECEX Certifications and Compliances

- Certification Type PXSS2K-REX
 - Gas: Zones 1 and 2
 - Type of Protection: Ex d IIC Gb, Ex e IIC Gb, Ex nR IIC Gc
 - Dust: Zone 20
 - Type of Protection: Ex ta IIIC Da
- Conforming to ATEX 94/9/CE: Ⓢ II 2G 3G 1D
- Ambient Temperature: -60 °C to +85 °C (-76 °F to +185 °F)
- CE Declaration of Conformity: DC07001
- ATEX Certificate: Sira 13ATEX1072X, Sira 13ATEX4078X
- IECEX Certificate: IECEX SIR 13.0027X, IECEX SIM 14.0008X
- Other Certifications: cCSAus, CCOE/PESO (India)
- Marine Approval: LLOYDS, DNV, ABS
- Index of Protection according EN/IEC 60529: IP66, IP67, IP68
- Deluge Protection Compliance: DTS01:91

INMETRO Certification

- INMETRO Certificate: TUV 12.2073X

EURASEC Certification

- TC RU C-GB.Г505.B.00138



Dimensions in Millimeters (Inches)

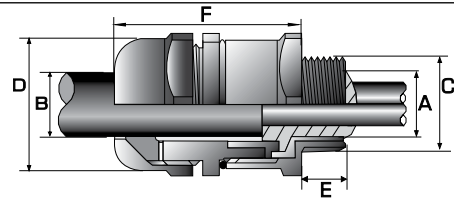

Cable Gland Size	Maximum Cable Bedding Diameter mm (in) G	Minimum Thread Length mm (in) E	Cable Bedding Diameter mm (in) B		Across Flats mm (in) D	Across Corners mm (in) D	Protrusion Length mm (in) F	Optional PVC Shroud	Weight kg (oz)
			Min	Max					
20S/16	13.0 (0.51)	15.0 (0.59)	3.2 (0.13)	8.7 (0.34)	30.5 (1.20)	30.5 (1.20)	58.5 (2.30)	PVC04	0.20 (7.05)
20S	13.0 (0.51)	15.0 (0.59)	6.1 (0.24)	11.7 (0.46)	30.5 (1.20)	30.5 (1.20)	58.5 (2.30)	PVC04	0.20 (7.05)
20	13.0 (0.51)	15.0 (0.59)	6.5 (0.26)	14.0 (0.55)	30.5 (1.20)	30.5 (1.20)	60.5 (2.38)	PVC05	0.25 (8.82)
20L	14.1 (0.56)	15 (0.59)	9.9 (0.39)	16.0 (0.63)	30.5 (1.20)	33.6 (1.30)	60.5 (2.38)	PVC05	0.20 (7.09)
25	18.0 (0.71)	15.0 (0.59)	11.1 (0.44)	20.0 (0.79)	37.5 (1.48)	37.5 (1.48)	67.5 (2.66)	PVC09	0.40 (14.22)
32	24.0 (0.94)	15.0 (0.59)	17.0 (0.67)	26.3 (1.04)	45.5 (1.79)	45.5 (1.79)	69.5 (2.74)	PVC10	0.56 (19.58)
32L	26.4 (1.04)	15 (0.59)	20.0 (0.79)	27.4 (1.08)	46.0 (1.81)	50.6 (1.99)	69.5 (2.74)	PVC10	0.45 (15.75)
40	30.4 (1.2)	15.0 (0.59)	22.0 (0.87)	32.1 (1.26)	55.0 (2.17)	55.0 (2.17)	78.0 (3.07)	PVC13	0.60 (21.16)
50S	37.0 (1.46)	15.0 (0.59)	29.5 (1.16)	38.2 (1.50)	60.0 (2.36)	60.0 (2.36)	60.0 (2.36)	PVC15	0.61 (21.34)
50	41.4 (1.63)	15 (0.59)	35.6 (1.40)	44.1 (1.74)	70.0 (2.76)	70.0 (2.76)	80.5 (3.17)	PVC18	0.62 (21.87)
63S	48.5 (1.91)	15.0 (0.59)	40.1 (1.58)	50.1 (1.97)	75.0 (2.95)	75.0 (2.95)	91.5 (3.60)	PVC21	0.71 (24.87)
63	54.2 (2.13)	15.0 (0.59)	47.2 (1.86)	56.0 (2.2)	80.0 (3.15)	80.0 (3.15)	92.0 (3.62)	PVC23	0.73 (25.75)
75S	60.3 (2.37)	15 (0.59)	52.8 (2.08)	62.0 (2.44)	89.0 (3.50)	89.0 (3.50)	99.0 (3.90)	PVC24	1.15 (40.57)
75	64.7 (2.55)	20.0 (0.79)	59.1 (2.33)	68.0 (2.68)	99.0 (3.90)	99.0 (3.90)	102.0 (4.02)	PVC26	1.15 (40.57)
90	75.7 (2.98)	20.0 (0.79)	66.6 (2.62)	80.0 (3.15)	114.0 (4.49)	114.0 (4.49)	120.0 (4.72)	PVC31	2.70 (95.24)

① Increased thread engagement is required for gas groups A and B. Please specify gas group, thread form and size when ordering.

PX2K Series Nickel Plated Brass Cable Glands

Increased Safety and Flameproof

(Braids, Tape and Wire with Lead Sheath Version) with Compound Barrier Seal.

NEC/CEC (Braid-Armor Cable, Armored Jacketed Marine Shipboard Cable):
Class I, Division 1 and 2, Groups A, B, C, D
Class II, Division 1 and 2, Groups E, F, G
Class III
NEMA 4X

ATEX/IECEx:
Zone 1 and 2 – 21 and 22
II 2 GD
IP66/68 (10 m)

Applications:

- Cable gland for all types of armored cables (braid, tape, wire and lead sheath version) certified for enclosures with the following protection modes:
 - Ex d flameproof IIB or IIC (as per §10.4.2 of IEC 60079-14) (Refer to the ATX Guide for Use of Electrical Products in Hazardous Locations)
 - Ex e increased safety.
 - Ex nR restricted breathing.
 - D dust environment.
- Hazardous areas (gas and dust).
- Onshore and offshore.

Features

- Cable gland with compound barrier seal for use in hazardous areas with all types of armored cables (braid, tape and wire).
- The cable gland provides mechanical cable retention and earth continuity via cable armor termination.
- A combined detachable armor cone and compound tube, together with AnyWay universal clamping ring arrangement allows the cable to be easily disconnected from the equipment.
- The cable gland is IP66/68 and complies with deluge protection tests.
- The cable gland is supplied with epoxy resin and two detachable armor cones.

Standard Materials

- Body: nickel plated brass
- Epoxy resin barrier compound
- Seal: LSF (Low Smoke Fume) thermoplastic elastomer displacement outer seal

Options

- 316L stainless steel version: replace last digit 5 with 4
- Lead sheath version: Replace **PX2K** with **PX2KPB**
- Copper-free aluminum: replace last digit 5 with 1
- Shroud, locknut, earth tag, entry thread seal, serrated washers, adaptors and reducers: see *Cable Gland Accessories* pages.

NEC/CEC Certifications and Compliances

- UL Standard: 2225
- UL Listed: E161256, E201187
- CSA Standard: C22.2 No. 174
- cCSAus Certified: 101909

HAZARDOUS LOCATION FITTINGS: NEC/CEC EXPLOSIONPROOF AND ATEX/IECEx FLAMEPROOF CABLE GLANDS

Cable Gland Size	Metric Thread C	Catalog Numbers					Maximum Cable Bedding Diameter mm (in) G	Minimum Thread Length mm (in) E
		Standard Metric ①	Standard NPT Thread C	Standard NPT ①	Optional NPT Thread C	Optional NPT Thread ①		
20S16	M20	2016PX2K5	1/2	2016PX2K0505	3/4	2016PX2K0755	11.8 (0.46)	15.0 (0.59)
20S	M20	20SPX2K5	1/2	20SPX2K0505	3/4	20SPX2K0755	11.8 (0.46)	15.0 (0.59)
20	M20	20PX2K5	1/2	20PX2K0505	3/4	20PX2K0755	13.5 (0.53)	15.0 (0.59)
25S	M25	25SPX2K5	3/4	25SPX2K0755	1	25SPX2K1005	19.5 (0.77)	15.0 (0.59)
25	M25	25PX2K5	3/4	25PX2K0755	1	25PX2K1005	19.5 (0.77)	15.0 (0.59)
32	M32	32PX2K5	1	32PX2K1005	1-1/4	32PX2K1255	25.8 (1.02)	15.0 (0.59)
40	M40	40PX2K5	1-1/4	40PX2K1255	1-1/2	40PX2K1505	32.3 (1.27)	15.0 (0.59)
50S	M50	50SPX2K5	1-1/2	50SPX2K1505	2	50SPX2K2005	38.3 (1.51)	15.0 (0.59)
50	M50	50PX2K5	2	50PX2K2005	2-1/2	50PX2K2505	44.2 (1.74)	15.0 (0.59)
63S	M63	63SPX2K5	2	63SPX2K2005	2-1/2	63SPX2K2505	50.1 (1.97)	15.0 (0.59)
63	M63	63PX2K5	2-1/2	63PX2K2505	3	63PX2K 3005	56.1 (2.21)	15.0 (0.59)
75S	M75	75SPX2K5	2-1/2	75SPX2K2505	3	75SPX2K3005	62.1 (2.44)	15.0 (0.59)
75	M75	75PX2K5	3	75PX2K3005	3-1/2	75PX2K3505	68.1 (2.68)	15.0 (0.59)
90	M90	90PX2K5	3	90PX2K3005	3-1/2	90PX2K3505	78.4 (3.09)	24.0 (0.94)
100	M100	100PX2K5	4	100PX2K4005	4	100PX2K5005	91.1 (3.59)	24.0 (0.94)

① Entry thread seal not supplied, see *Cable Gland Accessories and Tools*.

PX2K Series Nickel Plated Brass Cable Glands

Increased Safety and Flameproof

(Braids, Tape and Wire with Lead Sheath Version) with Compound Barrier Seal.

NEC/CEC (Braid-Armor Cable, Armored Jacketed Marine Shipboard Cable):
Class I, Division 1 and 2, Groups A, B, C, D
Class II, Division 1 and 2, Groups E, F, G
Class III
NEMA 4X

ATEX/IECEX:
Zone 1 and 2 – 21 and 22
II 2 GD
IP66/68 (10 m)

ATEX/IECEX Certifications and Compliances

- Certification Type PX2K
 - Gas: Zones 1 and 2
 - Type of Protection: Ex d IIC Gb, Ex e IIC Gb, Ex nR IIC Gc
 - Dust: Zone 20
 - Type of Protection: Ex ta IIC Da
- Conforming to ATEX 94/9/CE: II 2G 3G 1D
- Ambient Temperature: -60 °C to +85 °C (-76 °F to +185 °F)
- CE Declaration of Conformity: DC07001
- ATEX Certificate: Sira 13ATEX1072X, Sira 13ATEX4078X
- IECEX Certificate: IECEX SIR 13.0027X, IECEX SIM 14.0008X
- Other Certifications: cCSAus, UL, KCC, CCOE/PESO (India)
- Marine Approval: LLOYDS, DNV, ABS
- Index of Protection according EN/IEC 60529: IP66, IP67, IP68
- Deluge Protection Compliance: DTS01:91

INMETRO Certification

- INMETRO Certificate: TUV 12.2073X

EURASEC Certification

- TC RU C-GB.Г505.В.00138



Dimensions in Millimeters (Inches)

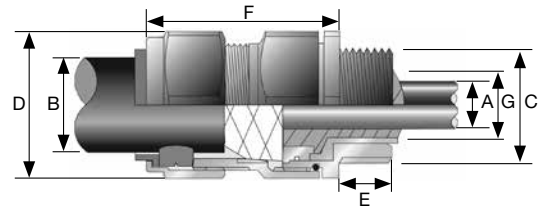

Cable Gland Size	Maximum Diameter Over Conductors mm (in) A	Maximum Number of Cores mm (in)	Overall Cable Diameter mm (in) B		Across Flats mm (in) D	Across Corners mm (in) D	Protrusion Length mm (in) F	Optional PVC Shroud	Weight kg (oz)
			Min	Max					
20S16	12.6 (0.50)	11.0 (0.43)	6.1 (0.24)	11.5 (0.45)	30.5 (1.20)	33.6 (1.32)	58.5 (2.30)	PVC06	0.20 (7.05)
20S	12.6 (0.50)	11.0 (0.43)	9.5 (0.37)	15.9 (0.63)	30.5 (1.20)	33.6 (1.32)	58.5 (2.30)	PVC06	0.20 (7.05)
20	12.6 (0.50)	11.0 (0.43)	12.5 (0.49)	20.9 (0.82)	30.5 (1.20)	33.6 (1.32)	60.5 (2.38)	PVC06	0.23 (8.11)
25S	17.5 (0.69)	11.0 (0.43)	14.0 (0.55)	22.0 (0.87)	37.5 (1.48)	41.3 (1.63)	67.5 (2.66)	PVC09	0.33 (11.64)
25	17.5 (0.69)	21.0 (0.83)	18.2 (0.72)	26.2 (1.03)	37.5 (1.48)	41.3 (1.63)	67.5 (2.66)	PVC09	0.33 (11.64)
32	23.6 (0.93)	38.0 (1.50)	23.7 (0.93)	33.9 (1.33)	46.0 (1.81)	50.6 (1.99)	69.5 (2.74)	PVC11	0.51 (17.99)
40	30.0 (1.18)	38.0 (1.50)	27.9 (1.10)	40.4 (1.59)	55.0 (2.17)	60.5 (2.38)	78.0 (3.07)	PVC15	0.72 (25.40)
50S	36.6 (1.44)	59.0 (2.32)	35.2 (1.39)	46.7 (1.84)	60.0 (2.36)	66.0 (2.60)	75.5 (2.97)	PVC18	0.83 (29.10)
50	41.0 (1.61)	89.0 (3.50)	40.4 (1.59)	53.1 (2.09)	70.0 (2.76)	77.0 (3.03)	80.5 (3.17)	PVC21	0.86 (30.34)
63S	47.9 (1.89)	89.0 (3.50)	45.6 (1.80)	59.4 (2.34)	75.0 (2.95)	82.5 (3.25)	91.5 (3.6)	PVC23	1.45 (51.15)
63	53.7 (2.11)	115.0 (4.53)	54.6 (2.15)	65.9 (2.59)	80.0 (3.15)	88.0 (3.46)	92.0 (3.62)	PVC25	1.60 (56.44)
75S	59.8 (2.35)	115.0 (4.53)	59.0 (2.32)	72.1 (2.84)	89.0 (3.50)	97.9 (3.85)	99.0 (3.90)	PVC28	2.30 (81.13)
75	64.3 (2.53)	140.0 (5.51)	66.7 (2.63)	78.5 (3.09)	99.0 (3.90)	108.9 (4.29)	102.0 (4.02)	PVC30	3.05 (107.59)
90	75.3 (2.96)	140.0 (5.51)	76.2 (3.00)	90.4 (3.56)	114.0 (4.49)	125.4 (4.94)	120.0 (4.72)	PVC32	5.00 (176.37)
100	86.1 (3.39)	200.0 (7.87)	86.1 (3.39)	101.5 (4.00)	133.0 (5.24)	146.3 (5.76)	135.0 (5.31)	LSF33	6.00 (211.64)

HAZARDOUS LOCATION FITTINGS: NEC/CEC EXPLOSIONPROOF AND ATEX/IECEX FLAMEPROOF CABLE GLANDS



PX2K-REX Series Liquid Resin Barrier Type Cable Glands

Increased Safety, Flameproof, Restricted Breathing and Dust Environment

NEC/CEC:

Class I, Division 1 and 2, Groups A, B, C, D
Class II, Division 1 and 2, Groups E, F, G,
Class III, Division 1 and 2

NEC/CEC:

Class I, Zone 1 and 2 – 21 and 22
NEMA 4X
IP66, IP67, IP68

ATEX/IECEX:

Zone 1 and 2, Zone 20
Ex d IIC
Ex e IIC
Ex nR II, Ex ta IIIC
IP66, IP67, IP68

Applications

- Cable gland for all types of armored cables (braid, tape, wire and lead sheath version) certified for enclosures with the following protection modes:
 - Ex d flameproof IIB or IIC.
 - Ex e increased safety.
 - Ex nR restricted breathing.
 - D dust environment.
- Hazardous areas (gas and dust).
- Onshore and offshore.

Features

- Utilizes RapidEx high speed liquid resin sealing compound included with each gland.
- The gland utilizes a liquid pour resin seal, that vastly reduces installation time and associated costs. This solution is particularly effective on multicore cables where traditional compound is difficult and time consuming to apply.
- Connector provides an environmental seal on the cable outer jacket and an explosionproof liquid resin barrier seal around the cable inner cores.
- Connector provides mechanical cable retention and electrical continuity via armor termination.
- PX2K forms part of a comprehensive connector range for marine shipboard and IEE45 armored and jacketed cables.
- Sealing technique: LRS outer seal (load retention seal).

Standard Materials

- Connector: brass fully nickel plated.
- Seal: LSF (Low Smoke Fume) Halogen Free thermoplastic elastomer
- High speed liquid resin sealing compound.

Options

- Aluminum: replace last digit 5 with 1
- 316L stainless steel: replace last digit 5 with 4 (available by quote only)
- Shroud, locknut, earth tag, entry thread seal, serrated washers, adaptors and reducers: see *Cable Gland Accessories* pages.

NEC/CEC Certifications and Compliances

- UL Standard: 2225
- CSA Standard: C22.2 No. 174
- cCSAus Certified: 101909

HAZARDOUS LOCATION FITTINGS: NEC/CEC EXPLOSIONPROOF AND ATEX/IECEX FLAMEPROOF CABLE GLANDS

Appleton®

Cable Gland Size	Metric Thread C	Minimum Thread Length mm (in) E	Catalog Numbers						Replacement Sealing Resin
			Standard Metric ①	Standard NPT Thread C	Standard NPT ①	Optional NPT Thread C	Optional NPT ①		
20S/16	M20	15.0 (0.59)	2016PX2KREX5	1/2	2016PX2KRX505	3/4	2016PX2KRX755	RAPIDEX30	
20S	M20	15.0 (0.59)	20SPX2KREX5	1/2	20SPX2KRX0505	3/4	20SPX2KRX0755	RAPIDEX30	
20	M20	15.0 (0.59)	20PX2KREX5	1/2	20PX2KREX0505	3/4	20PX2KREX0755	RAPIDEX30	
25S	M25	15.0 (0.59)	25SPX2KREX5	3/4	25SPX2KRX0755	1	25SPX2KRX1005	RAPIDEX30	
25	M25	15.0 (0.59)	25PX2KREX5	3/4	25PX2KREX0755	1	25PX2KREX1005	RAPIDEX30	
32	M32	15.0 (0.59)	32PX2KREX5	1	32PX2KREX1005	1-1/4	32PX2KREX1255	RAPIDEX30	
40	M40	15.0 (0.59)	40PX2KREX5	1-1/4	40PX2KREX1255	1-1/2	40PX2KREX1505	RAPIDEX30	
50S	M50	15.0 (0.59)	50SPX2KREX5	1-1/2	50SPX2KRX1505	2	50SPX2KRX2005	RAPIDEX80	
50	M50	15.0 (0.59)	50PX2KREX5	2	50PX2KREX2005	2-1/2	50PX2KREX2505	RAPIDEX80	
63S	M63	15.0 (0.59)	63SPX2KREX5	2	63SPX2KRX2005	2-1/2	63SPX2KRX2505	2RAPIDEX80	
63	M63	15.0 (0.59)	63PX2KREX5	2-1/2	63PX2KREX2505	3	63PX2KREX3005	2RAPIDEX80	
75S	M75	15.0 (0.59)	75SPX2KREX5	2-1/2	75SPX2KRX2505	3	75SPX2KRX3005	2RAPIDEX80	
75	M75	15.0 (0.59)	75PX2KREX5	3	75PX2KREX3005	3-1/2	75PX2KREX3505	3RAPIDEX80	
90	M90	20.0 (0.79)	90PX2KREX5	3-1/2	90PX2KREX3505	4	90PX2KREX4005	3RAPIDEX80	

① Entry thread seal not supplied, see *Cable Gland Accessories and Tools*.

PX2K-REX Series Liquid Resin Barrier Type Cable Glands

Increased Safety, Flameproof, Restricted Breathing and Dust Environment

NEC/CEC:

Class I, Division 1 and 2, Groups A, B, C, D
Class II, Division 1 and 2, Groups E, F, G,
Class III, Division 1 and 2

NEC/CEC:

Class I, Zone 1 and 2 – 21 and 22
NEMA 4X
IP66, IP67, IP68

ATEX/IECEX:

Zone 1 and 2, Zone 20
Ex d IIC
Ex e IIC
Ex nR II, Ex ta IIIC
IP66, IP67, IP68

ATEX/IECEX Certifications and Compliances

- Certification Type PX2K REX
 - Gas: Zones 1 and 2
 - Type of Protection: Ex d IIC Gb, Ex e IIC Gb, Ex nR IIC Gc
 - Dust: Zone 20
 - Type of Protection: Ex ta IIIC Da
- Conforming to ATEX 94/9/CE: Ⓢ II 2G 3G 1D
- Ambient Temperature: -60 °C to +85 °C (-76 °F to +185 °F)
- CE Declaration of Conformity: DC07001
- ATEX Certificate: Sira 13ATEX1072X, Sira 13ATEX4078X
- IECEX Certificate: IECEX SIR 13.0027X, IECEX SIM 14.0008X
- Other Certifications: cCSAus, CCOE/PESO (india)
- Marine Approval: LLOYDS, DNV, ABS
- Index of Protection according EN/IEC 60529: IP66, IP67, IP68
- Deluge Protection Compliance: DTS01:91

INMETRO Certification

- INMETRO Certificate: TUV 12.2073X

EURASEC Certification

- TC RU C-GB.ГБ.05.B.00138



Dimensions in Millimeters

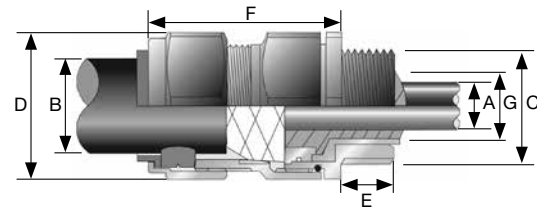

Cable Gland Size	Maximum Diameter Over Conductors mm (in) A	Overall Cable Diameter mm (in) B		Maximum Cable Bedding Diameter mm (in) G	Across Flats mm (in) D	Across Corners mm (in) D	Protrusion Length mm (in) F	Optional PVC Shroud	Cable Gland Weight kg (lb)
		Min	Max						
20S/16	11.7 (0.46)	6.1 (0.24)	13.1 (0.52)	11.7 (0.46)	30.5 (1.20)	33.6 (1.32)	62.0 (2.44)	PVC06	0.24 (0.53)
20S	11.7 (0.46)	9.5 (0.37)	15.9 (0.63)	11.7 (0.46)	30.5 (1.20)	33.6 (1.32)	62.0 (2.44)	PVC06	0.23 (0.51)
20	12.6 (0.50)	12.5 (0.49)	20.9 (0.82)	12.9 (0.51)	30.5 (1.20)	33.6 (1.32)	63.0 (2.48)	PVC06	0.24 (0.53)
25S	17.5 (0.69)	14.0 (0.55)	22.0 (0.87)	17.9 (0.70)	37.5 (1.48)	41.3 (1.63)	69.5 (2.74)	PVC09	0.37 (0.82)
25	17.5 (0.69)	18.2 (0.72)	26.2 (1.03)	17.9 (0.70)	37.5 (1.48)	41.3 (1.63)	69.5 (2.74)	PVC09	0.37 (0.82)
32	23.6 (0.93)	23.7 (0.93)	33.9 (1.33)	23.9 (0.94)	46.0 (1.81)	50.6 (1.99)	75.0 (2.95)	PVC11	0.57 (1.26)
40	30.0 (1.18)	27.9 (1.10)	40.4 (1.59)	30.3 (1.19)	55.0 (2.17)	60.5 (2.38)	75.0 (2.95)	PVC15	0.80 (1.76)
50S	36.6 (1.44)	35.2 (1.39)	46.7 (1.84)	36.9 (1.45)	60.0 (2.36)	66.0 (2.60)	77.0 (3.03)	PVC18	0.90 (1.98)
50	41.0 (1.61)	40.4 (1.59)	53.0 (2.09)	41.3 (1.63)	70.0 (2.76)	77.0 (3.03)	77.0 (3.03)	PVC21	1.19 (2.62)
63S	47.9 (1.89)	45.6 (1.80)	59.4 (2.34)	48.4 (1.91)	75.0 (2.95)	82.5 (3.25)	79.7 (3.14)	PVC23	1.39 (3.06)
63	53.7 (2.11)	54.6 (2.15)	65.8 (2.59)	54.0 (2.13)	80.0 (3.15)	88.0 (3.46)	80.3 (3.16)	PVC25	1.41 (3.11)
75S	59.9 (2.36)	59.0 (2.32)	72.0 (2.83)	60.2 (2.37)	90.0 (3.54)	99.0 (3.90)	86.8 (3.42)	PVC28	2.09 (4.61)
75	64.2 (2.53)	66.7 (2.63)	78.4 (3.09)	64.2 (2.53)	100.0 (3.94)	110.0 (4.33)	88.3 (3.48)	PVC30	2.54 (5.60)
90	75.3 (2.96)	76.2 (3.00)	90.3 (3.56)	75.6 (2.98)	115.0 (4.53)	126.5 (4.98)	102.2 (4.02)	PVC32	3.71 (8.18)

HAZARDOUS LOCATION FITTINGS: NEC/CEC EXPLOSIONPROOF AND ATEX/IECEX FLAMEPROOF CABLE GLANDS



A2F Series Nickel Plated Brass Cable Glands

Increased Safety and Flameproof

With Elastomer Seal for Unarmored and Exterior Braid Armor With Protective Sheath Cables.

CEC:
Class I, Division 1 and 2, Groups B, C, D

ATEX/IECEX:
II 2 GD
Ex d ① ② IIC
Ex e II
Ex nR II
Ex tD A21

ATEX/IECEX:
Zone 1 and 2 – 21 and 22
Gas Groups IIA, IIB and IIC
Ex d ② I
Ex e I

Applications

- Cable glands for unarmored and exterior braid armor with protective sheath cable certified for enclosures with the following protection modes:
 - Ex d ① flameproof IIB or IIC (as per §10.4.2 of IEC 60079-14)
 - Ex e increased safety
 - Ex nR restricted breathing
 - D dust environment
- Hazardous areas (gas and dust)
- Onshore and offshore

Features

- Elastomer displacement seal for unarmored cable provides a combined flameproof and weatherproof seal on the outer sheath of the cable.

Standard Materials

- Body: nickel plated brass (suffix 5)
- Seal: LSF (Low Smoke Fume) thermoplastic elastomer

Options

- 316L stainless steel version: replace last digit 5 with 4
- Copper-free aluminum: replace last digit 5 with 1
- Shroud, locknut, earth tag, entry thread seal, serrated washers, adaptors and reducers: see *Cable Gland Accessories* pages

CEC Certifications and Compliances

- CSA Standard: C22.2 No. 174
- cCSAus Certified: 101909

HAZARDOUS LOCATION FITTINGS: NEC/CEC EXPLOSIONPROOF AND ATEX/IECEX FLAMEPROOF CABLE GLANDS

Appleton®

Cable Gland Size	Metric Thread C	Catalog Numbers				
		Standard Metric ②	Standard NPT Thread C	Standard NPT ②	Optional NPT Thread C	Optional NPT Thread ②
20S/16	M20	2016A2F5	1/2	2016A2F0505	3/4	2016A2F0755
20S	M20	20SA2F5	1/2	20SA2F0505	3/4	20SA2F0755
20	M20	20A2F5	1/2	20A2F0505	3/4	20A2F0755
25	M25	25A2F5	3/4	25A2F0755	1	25A2F1005
32	M32	32A2F5	1	32A2F1005	1-1/4	32A2F1255
40	M40	40A2F5	1-1/4	40A2F1255	1-1/2	40A2F1505
50S	M50	50SA2F5	1-1/2	50SA2F1505	2	50SA2F2005
50	M50	50A2F5	2	50A2F2005	2-1/2	50A2F2505
63S	M63	63SA2F5	2	63SA2F2005	2-1/2	63SA2F2505
63	M63	63A2F5	2-1/2	63A2F2505	3	63A2F3005
75S	M75	75SA2F5	2-1/2	75SA2F2505	3	75SA2F3005
75	M75	75A2F5	3	75A2F3005	3-1/2	75A2F3505
90	M90	90A2F5	3	90A2F3005	4	90A2F3505
100	M100	100A2F5	4	100A2F4005	5	100A2F5005
115	M115	115A2F5	4	115A2F4005	5	115A2F5005
130	M130	130A2F5	5	130A2F5005	6	130A2F6005

① The A2F Cable Gland is suitable for use with all forms of equipment protection permitted in Zone 1, Zone 2, Zone 21 and Zone 22 provided always that the prevailing code of practice for selection and installation is observed, e.g. IEC 60079-14.

② Applies to unarmored cable only.

③ Entry thread seal not supplied, see *Cable Gland Accessories and Tools*.

A2F Series Nickel Plated Brass Cable Glands

Increased Safety and Flameproof

With Elastomer Seal for Unarmored and Exterior Braid Armor With Protective Sheath Cables.

CEC:
Class I, Division 1 and 2, Groups B, C, D

ATEX/IECEX:
Ⓢ II 2 GD
Ex d ① ② IIC
Ex e II
Ex nR II
Ex tD A21

ATEX/IECEX:
Zone 1 and 2 – 21 and 22
Gas Groups IIA, IIB and IIC
Ex d ② I
Ex e I

ATEX/IECEX Certifications and Compliances

- Certification Type A2F
 - Gas: Zones 1 and 2
 - Type of Protection: Ex d IIC Gb, Ex e IIC Gb, Ex nR IIC Gc
 - Dust: Zone 20
 - Type of Protection: Ex ta IIIC Da
- Conforming to ATEX 94/9/CE: Ⓢ II 2G 3G 1D
- Ambient Temperature: -60 °C to +130 °C (-76 °F to +266 °F)
- CE Declaration of Conformity: DC07001
- ATEX Certificate: Sira 13ATEX1068X, Sira 13ATEX4074X
- IECEX Certificate: IECEX SIR 13.0023X, IECEX SIM 14.0006
- Other Certifications: CSA, KCC, CCOE/PESO (India)
- Marine Approval: LLOYDS, DNV, ABS
- Index of Protection according EN/IEC 60529: IP66, IP67, IP68
- Deluge Protection Compliance: DTS01:91

INMETRO Certification

- INMETRO Certificate: TÜV 12.0619X

EURASEC Certification

- TC RU C-GB.Г505.B.00138



Dimensions in Millimeters (Inches)

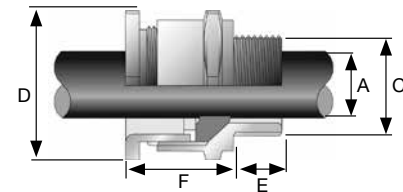

Cable Gland Size	Minimum Thread Length mm (in) E	Overall Cable Diameter mm (in) A		Across Flats mm (in) D	Across Corners mm (in) D	Nominal Protrusion Length mm (in) F	Optional PVC Shroud	Weight kg (oz)
		Min	Max					
20S/16	15.00 (0.59)	3.30 (0.13)	8.64 (0.34)	22.10 (0.87)	24.13 (0.95)	21.08 (0.83)	PVC04	0.05 (1.90)
20S	15.00 (0.59)	6.10 (0.24)	11.68 (0.46)	22.10 (0.87)	24.13 (0.95)	21.08 (0.83)	PVC04	0.06 (2.08)
20	15.00 (0.59)	6.60 (0.26)	13.97 (0.55)	26.92 (1.06)	29.72 (1.17)	23.88 (0.94)	PVC05	0.11 (3.95)
25	15.00 (0.59)	11.18 (0.44)	20.07 (0.79)	36.07 (1.42)	39.62 (1.56)	25.91 (1.02)	PVC09	0.13 (4.52)
32	15.00 (0.59)	17.02 (0.67)	26.42 (1.04)	40.89 (1.61)	45.21 (1.78)	26.92 (1.06)	PVC10	0.17 (5.93)
40	15.00 (0.59)	23.62 (0.93)	32.26 (1.27)	45.97 (1.81)	50.55 (1.99)	27.94 (1.10)	PVC13	0.22 (7.90)
50S	15.00 (0.59)	30.99 (1.22)	38.10 (1.50)	55.12 (2.17)	60.45 (2.38)	28.96 (1.14)	PVC14	0.23 (8.15)
50	15.00 (0.59)	35.56 (1.40)	44.20 (1.74)	59.94 (2.36)	66.04 (2.60)	29.97 (1.18)	PVC17	0.36 (12.7)
63S	15.00 (0.59)	41.40 (1.63)	50.04 (1.97)	65.02 (2.56)	71.37 (2.81)	29.97 (1.18)	PVC20	0.34 (12.13)
63	15.00 (0.59)	47.24 (1.86)	55.88 (2.20)	70.10 (2.76)	76.96 (3.03)	29.97 (1.18)	PVC22	0.47 (16.44)
75S	15.00 (0.59)	54.10 (2.13)	61.98 (2.44)	80.01 (3.15)	88.65 (3.49)	32.00 (1.26)	PVC24	0.40 (13.93)
75	15.00 (0.59)	61.21 (2.41)	68.07 (2.68)	84.07 (3.31)	92.46 (3.64)	32.00 (1.26)	PVC26	1.35 (47.48)
90	24.00 (0.94)	66.55 (2.62)	80.01 (3.15)	107.95 (4.25)	120.65 (4.75)	43.94 (1.73)	PVC31	1.58 (55.56)
100	24.00 (0.94)	75.95 (2.99)	90.93 (3.58)	114.30 (4.5)	128.52 (5.06)	48.01 (1.89)	LSF32	2.32 (81.91)
115	24.00 (0.94)	86.11 (3.39)	98.04 (3.86)	131.57 (5.18)	146.05 (5.75)	55.12 (2.17)	LSF34	3.40 (119.93)
130	24.00 (0.94)	97.03 (3.82)	115.06 (4.53)	152.40 (6.00)	167.64 (6.60)	61.98 (2.44)	LSF35	2.44 (86.07)

① The A2F Cable Gland is suitable for use with all forms of equipment protection permitted in Zone 1, Zone 2, Zone 21 and Zone 22 provided always that the prevailing code of practice for selection and installation is observed, e.g. IEC 60079-14.

② Applies to unarmored cable only.

TE1FU Series Stainless Steel Cable Glands

Increased Safety, Flameproof, Restricted Breathing and Dust Environment

For All Types of IEC Armored Cables

NEC/CEC:
Class I, Division 1 and 2, Groups A, B, C, D
Class II, Division 1 and 2, Groups E, F, G,
Class III

NEC/CEC:
Zone 1
AEx e II, AEx nR II

ATEX/IECEx:
Zone 1 and 2, Zone 20
Ex d IIC
Ex e IIC
Ex nR II, Ex ta IIIC
IP66, IP67, IP68

Applications

- Cable gland certified for enclosures with the following protection modes:
 - Ex d flameproof IIB or IIC.
 - Ex e increased safety
 - Ex nR restricted breathing
 - D dust environment
- Hazardous areas (gas and dust).
- Onshore and offshore.

Features

- Provides a flameproof (Type "d") seal on the cable inner bedding.
- Provides a gas tight seal permitting the compatibility of use with restricted breathing (Type "nR") equipment.
- Allows mechanical cable retention and earth continuity via the cable armor termination.
- Separate tightening actions for the inner
- The inner displacement seal and armor terminations are separate tightening actions providing maximum control over the pressure applied to the cable bedding.

- Reversible armor cone and AnyWay clamping ring arrangement facilitates remote make off and enables the cable to be disconnected from the equipment.
- Environmental/load retention seal is provided on the cable outer sheath.
- Stepped cone is suitable for SWA cables. Grooved cone is suitable for all other approved armored cables.
- Sealing Technique : Inner Displacement Seal and LRS (load retention seal) outer seal.

Standard Materials

- Body: Stainless Steel.
- Seal: LSF (Low Smoke Fume) Halogen Free thermoset elastomer.

Options

- Aluminum: replace last digit 5 with 1
- Shroud, locknut, earth tag, entry thread seal, serrated washers, adaptors and reducers: see *Cable Gland Accessories* pages.

NEC/CEC Certifications and Compliances

- UL Standard: 2225
- CSA Standard: C22.2 No. 174
- cCSAus Certified: 101909

HAZARDOUS LOCATION FITTINGS: NEC/CEC EXPLOSIONPROOF AND ATEX/IECEx FLAMEPROOF CABLE GLANDS

Appleton®

Cable Gland Size	Metric Thread C	Thread Length (Metric) mm E	Catalog Numbers				
			Standard Metric ①	Standard NPT Thread C	Standard NPT ①	Optional NPT Thread C	Optional NPT Thread ①
20S/16	M20	15.0 (0.59)	2016TE1FU4	1/2	2016TE1FU0504	3/4	2016TE1FU0754
20S	M20	15.0 (0.59)	20STE1FU4	1/2	20STE1FU0504	3/4	20STE1FU0754
20	M20	15.0 (0.59)	20TE1FU4	1/2	20TE1FU0504	3/4	20TE1FU0754
25S	M25	15.0 (0.59)	25STE1FU4	3/4	25STE1FU0754	1	25STE1FU1004
25	M25	15.0 (0.59)	25TE1FU4	3/4	25TE1FU0754	1	25TE1FU1004
32	M32	15.0 (0.59)	32TE1FU4	1	32TE1FU1004	1-1/4	32TE1FU1254
40	M40	15.0 (0.59)	40TE1FU4	1-1/4	40TE1FU1254	1-1/2	40TE1FU1504
50S	M50	15.0 (0.59)	50STE1FU4	1-1/2	50STE1FU1504	2	50STE1FU2004
50	M50	15.0 (0.59)	50TE1FU4	2	50TE1FU2004	2-1/2	50TE1FU2504
63S	M63	15.0 (0.59)	63STE1FU4	2	63STE1FU2004	2-1/2	63STE1FU2504
63	M63	15.0 (0.59)	63TE1FU4	2-1/2	63TE1FU2504	3	63TE1FU3004
75S	M75	15.0 (0.59)	75STE1FU4	2-1/2	75STE1FU2504	3	75STE1FU3004
75	M75	15.0 (0.59)	75TE1FU4	3	75TE1FU3004	3-1/2	75TE1FU3504
90	M90	24.0 (0.94)	90TE1FU4	3-1/2	90TE1FU3504	4	90TE1FU4004
100	M100	24.0 (0.94)	100TE1FU4	4	100TE1FU4004	5	100TE1FU5004
115	M115	24.0 (0.94)	115TE1FU4	4	115TE1FU4004	5	115TE1FU5004
130	M130	24.0 (0.94)	130TE1FU4	5	130TE1FU5004	6	130TE1FU6004

① Entry thread seal not supplied, see *Cable Gland Accessories and Tools*.

TE1FU Series Stainless Steel Cable Glands

Increased Safety, Flameproof, Restricted Breathing and Dust Environment

For All Types of IEC Armored Cables

NEC/CEC:
Class I, Division 1 and 2, Groups A, B, C, D
Class II, Division 1 and 2, Groups E, F, G,
Class III

NEC/CEC:
Zone 1
AEx e II, AEx nR II

ATEX/IECEX:
Zone 1 and 2, Zone 20
Ex d IIC
Ex e IIC
Ex nR II, Ex ta IIIC
IP66, IP67, IP68

ATEX/IECEX Certifications and Compliances

- Certification Type TE1FU
 - Gas: Zones 1 and 2
 - Type of Protection: Ex d IIC Gb, Ex e IIC Gb, Ex nR IIC Gc
 - Dust: Zone 20
 - Type of Protection: Ex ta IIIC Da
- Conforming to ATEX 94/9/CE: Ⓢ II 2G 3G 1D
- Ambient Temperature: -60 °C to +130 °C (-76 °F to +266 °F)
- CE Declaration of Conformity: DC07001
- ATEX Certificate: Sira 13ATEX1073X, Sira 13ATEX4079X
- IECEX Certificate: IECEX SIR 13.0028X, IECEX SIM 14.0007X
- Other Certifications: LLOYDS, DNV, ABS
- Index of Protection according EN/IEC 60529: IP66, IP67, IP68
- Deluge Protection Compliance: DTS01:91

INMETRO Certification

- INMETRO Certificate: TÜV 11.0374-X

EURASEC Certification

- EURASEC TC RU C-GB.Г505.B.00138



Dimensions in Millimeters

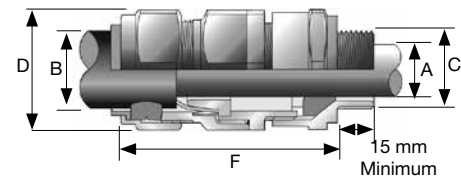

Cable Gland Size	Cable Bedding Diameter mm (in) A		Overall Cable Diameter mm (in) B		Across Flats mm (in) D	Across Corners mm (in) D	Protrusion Length mm (in) F	Optional PVC Shroud	Cable Gland Weight kgs (lb)
	Min	Max	Min	Max					
20S/16	3.1 (0.12)	8.6 (0.34)	6.1 (0.24)	13.1 (0.52)	24.0 (0.94)	26.4 (1.04)	57.3 (2.26)	PVC04	0.15 (0.33)
20S	6.1 (0.24)	11.6 (0.46)	9.5 (0.37)	15.9 (0.63)	24.0 (0.94)	26.4 (1.04)	57.3 (2.26)	PVC04	0.15 (0.33)
20	6.5 (0.26)	13.9 (0.55)	12.5 (0.49)	20.9 (0.82)	30.5 (1.2)	33.6 (1.32)	61.2 (2.41)	PVC06	0.23 (0.51)
25S	11.1 (0.44)	19.9 (0.78)	14.0 (0.55)	22.0 (0.87)	37.5 (1.48)	41.3 (1.63)	74.0 (2.91)	PVC09	0.34 (0.75)
25	11.1 (0.44)	19.9 (0.78)	18.2 (0.72)	26.2 (1.03)	37.5 (1.48)	41.3 (1.63)	74.0 (2.91)	PVC09	0.34 (0.75)
32	17.0 (0.67)	26.2 (1.03)	23.7 (0.93)	33.9 (1.33)	46.0 (1.81)	50.6 (1.99)	78.2 (3.08)	PVC11	0.55 (1.21)
40	22.0 (0.87)	32.1 (1.26)	27.9 (1.10)	40.4 (1.59)	55.0 (2.17)	60.5 (2.38)	81.6 (3.21)	PVC15	0.79 (1.74)
50S	29.5 (1.16)	38.1 (1.50)	35.2 (1.39)	46.7 (1.84)	60.0 (2.36)	66.0 (2.60)	88.1 (3.47)	PVC18	1.00 (2.20)
50	35.6 (1.40)	44.0 (1.73)	40.4 (1.59)	53.0 (2.09)	70.1 (2.76)	77.1 (3.04)	91.2 (3.59)	PVC21	1.37 (3.02)
63S	40.1 (1.58)	49.9 (1.96)	45.6 (1.80)	59.4 (2.34)	75.0 (2.95)	82.4 (3.24)	90.5 (3.56)	PVC23	1.50 (3.31)
63	47.2 (1.86)	55.9 (2.20)	54.6 (2.15)	65.8 (2.59)	80.0 (3.15)	88.0 (3.46)	90.3 (3.56)	PVC25	1.56 (3.44)
75S	52.8 (2.08)	61.9 (2.44)	59.0 (2.32)	72.0 (2.83)	90.0 (3.54)	99.0 (3.90)	104.7 (4.12)	PVC28	2.45 (5.40)
75	59.1 (2.33)	67.9 (2.67)	66.7 (2.63)	78.4 (3.09)	100.0 (3.94)	110.0 (4.33)	110.8 (4.36)	PVC30	3.15 (6.94)
90	66.6 (2.62)	78.6 (3.09)	76.2 (3.00)	90.3 (3.56)	115.0 (4.53)	126.5 (4.98)	135.5 (5.33)	PVC32	4.62 (10.19)
100	76.0 (2.99)	90.9 (3.58)	86.1 (3.39)	101.4 (3.99)	127.0 (5.00)	139.7 (5.50)	126.8 (4.99)	LSF33	4.95 (10.91)
115	86.0 (3.39)	97.9 (3.85)	101.5 (4.00)	110.2 (4.34)	138.0 (5.43)	151.8 (5.98)	157.5 (6.20)	LSF34	7.60 (16.76)
130	97.0 (3.82)	114.9 (4.52)	110.2 (4.34)	123.2 (4.85)	157.0 (6.18)	172.7 (6.80)	164.5 (6.48)	LSF35	8.73 (19.25)

HAZARDOUS LOCATION FITTINGS: NEC/CEC EXPLOSIONPROOF AND ATEX/IECEX FLAMEPROOF CABLE GLANDS



Ex e Series Polyamide Cable Glands

Increased Safety for Hazardous Areas

For Non-Armored Cable.

ATEX:

Zone 1 and 2 – 21 and 22

⊕ II 2 GD

IP66 / 68

Applications

- Ex e Certified
 - For non-armored cables certified for enclosures with the following protection modes:
 - Ex e Increased safety
 - Ex nR Restricted breathing
 - D Dust environment
 - Hazardous areas (gas and dust)
 - On-shore and off-shore
- Weatherproof IP68 or Ex i
 - For non-armored cables for intrinsic safety Ex i applications in hazardous areas (Gas and Dust).

Features

- Ex e Certified
 - Black polyamide body
 - Weatherproof elastomer gasket
 - Supplied with sealing gasket
- Weatherproof IP68 or Ex i
 - Blue polyamide body Ral 5012
 - Supplied with polyamide clamping ring
 - Weatherproof elastomer gasket
 - Supplied with sealing gasket

Materials

- Ex e Certified
 - Body: polyamide
 - Weatherproof gasket: thermoplastic elastomer
 - Entry thread seal: neoprene
- Weatherproof IP68 or Ex i
 - Body: polyamide
 - Weatherproof gasket: thermoplastic elastomer
 - Entry thread seal: neoprene

ATEX Certifications and Compliances

- Certification Type EEx e
 - Gas, Zones 1 et 2
 - Type of Protection: Ex eb IIC
 - Dust, Zones 21 and 22
 - Type of Protection: Ex tb IIIC
- Conforming to ATEX 94/9/CE: ⊕ II 2 GD
- Ambient Temperature: -20 °C to +55 °C (-4 °F to +131 °F)
- CE Declaration of Conformity: 50233
- ATEX Certificate: LCIE 99 ATEX 6030X
- Index of Protection according EN/IEC 60529: IP66 (Ex e version), IP68 (Weatherproof)

INMETRO Certification

- INMETRO Certificate: BR 230662-X



Ex e Certified



Weatherproof IP68

Dimensions in Millimeters (Inches)

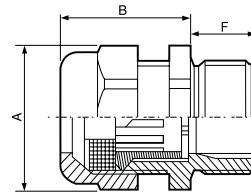

Ex e Series Polyamide Cable Glands

Increased Safety for Hazardous Areas

For Non-Armored Cable.

ATEX:

Zone 1 and 2 – 21 and 22

II 2 GD

IP66 / 68

Metric Thread	Thread Pitch (mm)	Cable Capacity mm (in)		Across Flats mm (in) A	Gland Length mm (in) B	Thread Length mm (in) F	Weight kg (lb)	Volume dm ³ (in ³)	Catalog Number ①	Pack
		Min.	Max.							
Ex e Certified										
M16	1.5	3.0 (0.12)	8.5 (0.33)	19.0 (0.75)	24.0 (0.94)	15.0 (0.59)	0.015 (0.03)	0.160 (9.76)	095756	10
M20	1.5	6.5 (0.26)	14.5 (0.57)	27.0 (1.06)	30.0 (1.18)	15.0 (0.59)	0.021 (0.05)	0.160 (9.76)	095605	10
M25	1.5	8.0 (0.31)	18.5 (0.73)	33.0 (1.30)	33.0 (1.30)	15.0 (0.59)	0.032 (0.07)	0.160 (9.76)	095606	10
M32	1.5	10.0 (0.39)	25.0 (0.98)	42.0 (1.65)	43.0 (1.69)	15.0 (0.59)	0.061 (0.13)	0.440 (26.85)	095757	10
M40	1.5	24.0 (0.94)	34.0 (1.34)	55.0 (2.17)	47.0 (1.85)	15.0 (0.59)	0.072 (0.16)	0.072 (4.39)	095758	1
M50	1.5	28.0 (1.10)	42.0 (1.65)	65.0 (2.56)	49.0 (1.93)	15.0 (0.59)	0.124 (0.27)	0.072 (4.39)	095759	1
Weatherproof IP68										
M16	1.5	2.5 (0.10)	8.0 (0.31)	19.0 (0.75)	27.0 (1.06)	15.0 (0.59)	0.013 (0.03)	0.160 (9.76)	095800	10
M20	1.5	5.0 (0.20)	12.0 (0.47)	24.0 (0.94)	30.0 (1.18)	15.0 (0.59)	0.017 (0.04)	0.160 (9.76)	095801	10
M25	1.5	7.0 (0.28)	14.0 (0.55)	27.0 (1.06)	35.0 (1.38)	15.0 (0.59)	0.020 (0.04)	0.160 (9.76)	095802	10
M32	1.5	14.0 (0.55)	25.0 (0.98)	42.0 (1.65)	42.0 (1.65)	15.0 (0.59)	0.051 (0.11)	0.440 (26.85)	095803	10
M40	1.5	18.0 (0.71)	32.0 (1.26)	53.0 (2.09)	52.0 (2.05)	15.0 (0.59)	0.072 (0.16)	0.072 (4.39)	095804	1
M50	1.5	24.0 (0.94)	38.5 (1.52)	60.0 (2.36)	55.0 (2.17)	15.0 (0.59)	0.100 (0.22)	0.072 (4.39)	095805	1

① For Locknut, see Cable Gland Accessories section.

E1FW Nickel Plated Brass Cable Glands

Increased Safety and Flameproof

With Elastomer Seal for Armored Cables.

NEC/CEC:
Class I, Division 2, Groups A, B, C, D

ATEX/IECEX:
Class 1, Zone 1 and 2 – 21 and 22
II 2 GD
IP66

Applications

- Cable gland for Single Wire Armored cables (SWA with wire and lead sheath) certified for enclosures with the following protection modes:
 - Ex d flameproof IIB or IIC (as per §10.4.2 of IEC 60079-14) (Refer to the ATX Guide for Use of Electrical Products in Hazardous Locations)
 - Ex e increased safety
 - Ex nR restricted breathing
 - D dust environment
- Hazardous areas (gas and dust).
- Onshore and offshore.

Features

- Cable gland with elastomer seal for use in hazardous areas with Single Wire Armor (SWA) cable.
- The cable gland allows mechanical cable retention and earth continuity via cable armor termination.
- A detachable armor cone and AnyWay clamping ring arrangement facilitates remote make off and enables cable to be disconnected from the equipment.

- Inspection of the armor can be carried out while still maintaining the protection mode of the enclosure.

Standard Materials

- Body: nickel plated brass
- Seal: LSF (Low Smoke Fume) thermoplastic elastomer
 - Inner displacement seal and LRS (Load Retention seal) outer seal

Options

- Lead sheath version – Replace digit E1 with E2; Example: 32E1FW5 - 32E2FW5
- Copper-free aluminum: replace last digit 5 with 1
- Shroud, locknut, earth tag, entry thread seal, serrated washers, adaptors and reducers: see *Cable Gland Accessories* pages.

NEC/CEC Certifications and Compliances

- cCSAus Certified: 101909

Cable Gland Size	Metric Thread C	Standard Metric ①	Standard PT C	Catalog Numbers		
				Standard NPT ①	Optional NPT C	Optional NPT Thread ①
20S16	M20	2016E1FW5	1/2	2016E1FW0505	3/4	2016E1FW0755
20S	M20	20SE1FW5	1/2	20SE1FW0505	3/4	20SE1FW0755
20	M20	20E1FW5	1/2	20E1FW0505	3/4	20E1FW0755
25S	M25	25SE1FW5	3/4	25SE1FW0755	1	25SE1FW1005
25	M25	25E1FW5	3/4	25E1FW0755	1	25E1FW1005
32	M32	32E1FW5	1	32E1FW1005	1-1/4	32E1FW1255
40	M40	40E1FW5	1-1/4	40E1FW1255	1-1/2	40E1FW1505
50S	M50	50SE1FW5	1-1/2	50SE1FW1505	2	50SE1FW2005
50	M50	50E1FW5	2	50E1FW2005	2-1/2	50E1FW2505
63S	M63	63SE1FW5	2	63SE1FW2005	2-1/2	63SE1FW2505
63	M63	63E1FW5	2-1/2	63E1FW2505	3	63E1FW3005
75S	M75	75SE1FW5	2-1/2	75SE1FW2505	3	75SE1FW3005
75	M75	75E1FW5	3	75E1FW3005	3-1/2	75E1FW3505
90	M90	90E1FW5	3	90E1FW3005	3-1/2	90E1FW3505
100	M100	100E1FW5	4	100E1FW4005	5	100E1FW5005
115	M115	115E1FW5	4	115E1FW4005	5	115E1FW5005
130	M130	130E1FW5	5	130E1FW5005	6	130E1FW6005

① Entry thread seal not supplied, see *Cable Gland Accessories and Tools*.

E1FW Nickel Plated Brass Cable Glands

Increased Safety and Flameproof

With Elastomer Seal for Armored Cables.

NEC/CEC:
Class I, Division 2, Groups A, B, C, D

ATEX/IECEX:
Class 1, Zone 1 and 2 – 21 and 22
II 2 GD
IP66

ATEX/IECEX Certifications and Compliances

- Certification Type E1FX/Z - E2FX/Z
 - Gas: Zones 1 and 2
 - Type of Protection: Ex d IIC Gb, Ex e IIC Gb, Ex nR IIC Gc
 - Dust: Zone 20
 - Type of Protection: Ex ta IIIC Da
- Conforming to ATEX 94/9/CE: II 2G 3G 1D
- Ambient Temperature: -60 °C to +130 °C (-76 °F to +266 °F)
- CE Declaration of Conformity: DC07001
- ATEX Certificate: Sira 13ATEX1071X, Sira 13ATEX4077X
- IECEx Certificate: IECEx SIR 13.0026X, IECEx SIM 14.0007X
- Other Certifications: KCC, CCOE/PESO (India)
- Marine Approval: LLOYDS, DNV, ABS
- Index of Protection according EN/IEC 60529: IP66
- Deluge Protection Compliance: DTS01:91 (option available on request only)

INMETRO Certification

- INMETRO Certificate: TUV 12.0618X

EURASEC Certification

- TC RU C-GB.Г505.В.00138



Dimensions in Millimeters (Inches)

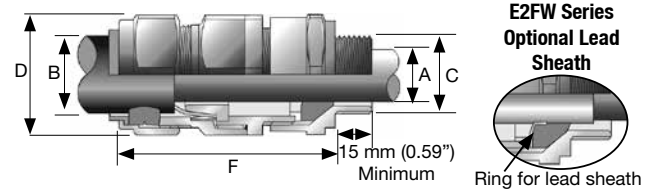

Cable Gland Size	Cable Bedding Diameter mm (in) A		Outer Cable Capacity mm (in) B		Across Corners mm (in) D	Across Flats mm (in) D	Nominal Protrusion Length mm (in) F	Optional PVC Shroud	Weight kg (oz)
	Min	Max	Min	Max					
20S16	3.1 (0.12)	8.6 (0.34)	6.1 (0.24)	13.2 (0.52)	26.4 (1.04)	24.0 (0.94)	58.5 (2.30)	PVC04	0.16 (5.64)
20S	6.1 (0.24)	11.6 (0.46)	9.5 (0.37)	15.9 (0.63)	26.4 (1.04)	24.0 (0.94)	58.5 (2.30)	PVC04	0.16 (5.64)
20	6.5 (0.26)	13.9 (0.55)	12.5 (0.49)	20.9 (0.82)	33.6 (1.32)	30.5 (1.20)	60.5 (2.38)	PVC06	0.21 (7.41)
25S	11.1 (0.44)	19.9 (0.78)	14.0 (0.55)	22.0 (0.87)	41.3 (1.63)	37.5 (1.48)	67.5 (2.66)	PVC09	0.33 (11.64)
25	11.1 (0.44)	19.9 (0.78)	18.2 (0.72)	26.2 (1.03)	41.3 (1.63)	37.5 (1.48)	67.5 (2.66)	PVC09	0.33 (11.64)
32	17.0 (0.67)	26.2 (1.03)	23.7 (0.93)	33.9 (1.33)	50.6 (1.99)	46.0 (1.81)	69.5 (2.74)	PVC11	0.45 (15.87)
40	22.0 (0.87)	32.1 (1.26)	27.9 (1.10)	40.4 (1.59)	60.5 (2.38)	55.0 (2.17)	78.0 (3.07)	PVC15	0.66 (23.28)
50S	29.5 (1.16)	38.1 (1.50)	35.2 (1.39)	46.7 (1.84)	66.0 (2.60)	60.0 (2.36)	75.5 (2.97)	PVC18	0.73 (25.75)
50	35.6 (1.40)	44.0 (1.73)	40.4 (1.59)	53.1 (2.09)	77.0 (3.03)	70.0 (2.76)	80.5 (3.17)	PVC21	0.75 (26.45)
63S	40.1 (1.58)	49.9 (1.96)	45.6 (1.80)	59.4 (2.34)	82.5 (3.25)	75.0 (2.95)	91.5 (3.60)	PVC23	1.34 (47.27)
63	47.2 (1.86)	55.9 (2.20)	54.6 (2.15)	65.9 (2.59)	88.0 (3.46)	80.0 (3.15)	92.0 (3.62)	PVC25	1.44 (50.44)
75S	52.8 (2.08)	61.9 (2.44)	59.0 (2.32)	72.1 (2.84)	97.9 (3.85)	89.0 (3.50)	99.0 (3.90)	PVC28	2.07 (73.02)
75	59.1 (2.33)	67.9 (2.67)	66.7 (2.63)	78.5 (3.09)	108.9 (4.29)	99.0 (3.90)	102.0 (4.02)	PVC30	2.62 (92.42)
90	66.6 (2.62)	79.9 (3.15)	76.2 (3.00)	90.4 (3.56)	125.4 (4.94)	114.0 (4.49)	120.0 (4.72)	PVC32	4.17 (147.09)
100	76.0 (2.99)	90.9 (3.58)	86.1 (3.39)	101.5 (4.00)	135.3 (5.33)	123.0 (4.84)	148.0 (5.83)	LSF33	4.52 (159.44)
115	86.0 (3.39)	97.9 (3.85)	101.5 (4.00)	110.3 (4.34)	146.7 (5.78)	133.4 (5.25)	169.0 (6.65)	LSF34	6.86 (241.98)
130	97.0 (3.82)	114.9 (4.52)	114.2 (4.50)	123.3 (4.85)	160.7 (6.33)	146.1 (5.75)	183.0 (7.20)	LSF35	8.12 (286.42)

E1FX Series Nickel Plated Brass Cable Gland

Increased Safety and Flameproof

For Armored Cables.

NEC/CEC:
Class I, Division 2, Groups A, B, C, D

ATEX/IECEX:
Zone 1 and 2 – 21 and 22
II 2 GD
IP66

Applications

- Cable gland for armored cables (braid, tape, tape with lead sheath) certified for enclosures with the following protection modes:
 - Ex d flameproof IIB or IIC (as per §10.4.2 of IEC 60079-14) (Refer to the ATX Guide for Use of Electrical Products in Hazardous Locations)
 - Ex e increased safety
 - Ex nR restricted breathing
 - D dust environment
- Hazardous areas (gas and dust)
- Onshore and offshore

Features

- Cable gland with elastomer seal for use in hazardous areas with braided and tape armor cable.
- The cable gland allows mechanical cable retention and earth continuity via cable armor termination.
- A detachable armor cone and AnyWay clamping ring arrangement facilitates remote make off and enables cable to be disconnected from the equipment.
- Inspection of the armor can be carried out while still maintaining the explosionproof protection mode of the enclosure.

Standard Materials

- Body: nickel plated brass
- Seal: LSF (Low Smoke Fume) thermoplastic elastomer
 - Inner displacement seal and LRS (Load Retention seal) outer seal

Options

- Lead sheath version – Replace digit 1 with 2; Example: 32E1FX5 - 32E2FX5
- Copper-free aluminum: replace last digit 5 with 1
- Shroud, locknut, earth tag, entry thread seal, serrated washers, adaptors and reducers: see *Cable Gland Accessories* pages.

NEC/CEC Certifications and Compliances

- cCSAus Certified: 101909

Cable Gland Size	Metric Thread C	Standard Metric ①	Standard NPT C	Catalog Numbers		
				Standard NPT ①	Optional NPT C	Optional NPT Thread ①
20S16	M20	2016E1FX5	1/2	2016E1FX0505	3/4	2016E1FX0755
20S	M20	20SE1FX5	1/2	20SE1FX0505	3/4	20SE1FX0755
20	M20	20E1FX5	1/2	20E1FX0505	3/4	20E1FX0755
25S	M25	25SE1FX5	3/4	25SE1FX0755	1	25SE1FX1005
25	M25	25E1FX5	3/4	25E1FX0755	1	25E1FX1005
32	M32	32E1FX5	1	32E1FX1005	1-1/4	32E1FX1255
40	M40	40E1FX5	1-1/4	40E1FX1255	1-1/2	40E1FX1505
50S	M50	50SE1FX5	1-1/2	50SE1FX1505	2	50SE1FX2005
50	M50	50E1FX5	2	50E1FX2005	2-1/2	50E1FX2505
63S	M63	63SE1FX5	2	63SE1FX2005	2-1/2	63SE1FX2505
63	M63	63E1FX5	2-1/2	63E1FX2505	3	63E1FX3005
75S	M75	75SE1FX5	2-1/2	75SE1FX2505	3	75SE1FX3005
75	M75	75E1FX5	3	75E1FX3005	3-1/2	75E1FX3505
90	M90	90E1FX5	3	90E1FX3005	3-1/2	90E1FX3505
100	M100	100E1FX5	4	100E1FX4005	5	100E1FX5005
115	M115	115E1FX5	4	115E1FX4005	5	115E1FX5005
130	M130	130E1FX5	5	130E1FX5005	6	130E1FX6005

① Entry thread seal not supplied, see *Cable Gland Accessories and Tools*.

E1FX Series Nickel Plated Brass Cable Gland

Increased Safety and Flameproof

For Armored Cables.

NEC/CEC:
Class I, Division 2, Groups A, B, C, D

ATEX/IECEX:
Zone 1 and 2 – 21 and 22
II 2 GD
IP66

ATEX/IECEX Certifications and Compliances

- Certification Type E1FX/Z - E2FX/Z
 - Gas: Zones 1 and 2
 - Type of Protection: Ex d IIC Gb, Ex e IIC Gb, Ex nR IIC Gc
 - Dust: Zone 20
 - Type of Protection: Ex ta IIC Da
- Conforming to ATEX 94/9/CE: II 2G 3G 1D
- Ambient Temperature: -60 °C to +130 °C (-76 °F to +266 °F)
- CE Declaration of Conformity: DC07001
- ATEX Certificate: Sira 13ATEX1071X, Sira 13ATEX4077X
- IECEX Certificate: IECEX SIR 13.0026X, IECEX SIM 14.0007X
- Other Certifications: KCC, CCOE/PESO (India)
- Marine Approval: LLOYDS, DNV, ABS
- Index of Protection according EN/IEC 60529: IP66
- Deluge Protection Compliance: DTS01:91 (option available on request only)

INMETRO Certification

- INMETRO Certificate: TUV 12.0618X

EURASEC Certification

- TC RU C-GB.Г505.B.00138



Dimensions in Millimeters (Inches)

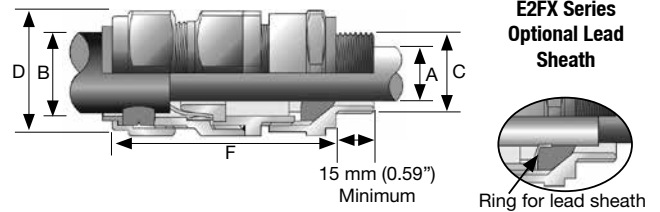

Cable Gland Size	Cable Bedding Diameter mm (in) A		Overall Cable Diameter mm (in) B		Across Corners mm (in) D	Across Flats mm (in) D	Nominal Protrusion Length mm (in) F	Optional PVC Shroud	Weight kg (oz)
	Min	Max	Min	Max					
20S16	3.1 (0.12)	8.6 (0.34)	6.1 (0.24)	13.2 (0.52)	26.4 (1.04)	24.0 (0.94)	58.5 (2.30)	PVC04	0.16 (5.64)
20S	6.1 (0.24)	11.6 (0.46)	9.5 (0.37)	15.9 (0.63)	26.4 (1.04)	24.0 (0.94)	58.5 (2.30)	PVC04	0.16 (5.64)
20	6.5 (0.26)	13.9 (0.55)	12.5 (0.49)	20.9 (0.82)	33.6 (1.32)	30.5 (1.20)	60.5 (2.38)	PVC06	0.21 (7.41)
25S	11.1 (0.44)	19.9 (0.78)	14.0 (0.55)	22.0 (0.87)	41.3 (1.63)	37.5 (1.48)	67.5 (2.66)	PVC09	0.33 (11.64)
25	11.1 (0.44)	19.9 (0.78)	18.2 (0.72)	26.2 (1.03)	41.3 (1.63)	37.5 (1.48)	67.5 (2.66)	PVC09	0.33 (11.64)
32	17.0 (0.67)	26.2 (1.03)	23.7 (0.93)	33.9 (1.33)	50.6 (1.99)	46.0 (1.81)	69.5 (2.74)	PVC11	0.46 (16.23)
40	22.0 (0.87)	32.1 (1.26)	27.9 (1.10)	40.4 (1.59)	60.5 (2.38)	55.0 (2.17)	78.0 (3.07)	PVC15	0.67 (23.63)
50S	29.5 (1.16)	38.1 (1.50)	35.2 (1.39)	46.7 (1.84)	66.0 (2.60)	60.0 (2.36)	75.5 (2.97)	PVC18	0.76 (26.81)
50	35.6 (1.40)	44.0 (1.73)	40.4 (1.59)	53.1 (2.09)	77.0 (3.03)	70.0 (2.76)	80.5 (3.17)	PVC21	0.78 (27.51)
63S	40.1 (1.58)	49.9 (1.96)	45.6 (1.80)	59.4 (2.34)	82.5 (3.25)	75.0 (2.95)	91.5 (3.60)	PVC23	1.37 (48.33)
63	47.2 (1.86)	55.9 (2.20)	54.6 (2.15)	65.9 (2.59)	88.0 (3.46)	80.0 (3.15)	92.0 (3.62)	PVC25	1.47 (51.85)
75S	52.8 (2.08)	61.9 (2.44)	59.0 (2.32)	72.1 (2.84)	97.9 (3.85)	89.0 (3.50)	99.0 (3.90)	PVC28	2.12 (74.78)
75	59.1 (2.33)	67.9 (2.67)	66.7 (2.63)	78.5 (3.09)	108.9 (4.29)	99.0 (3.90)	102.0 (4.02)	PVC30	2.69 (94.89)
90	66.6 (2.62)	79.9 (3.15)	76.2 (3.00)	90.4 (3.56)	125.4 (4.94)	114.0 (4.49)	120.0 (4.72)	PVC32	4.28 (150.97)
100	76.0 (2.99)	90.9 (3.58)	86.1 (3.39)	101.5 (4.00)	135.3 (5.33)	123.0 (4.84)	148.0 (5.83)	LSF33	4.67 (164.73)
115	86.0 (3.39)	97.9 (3.85)	101.5 (4.00)	110.3 (4.34)	146.7 (5.78)	133.4 (5.25)	169.0 (6.65)	LSF34	7.09 (250.09)
130	97.0 (3.82)	114.9 (4.52)	114.2 (4.5)	123.3 (4.85)	160.7 (6.33)	146.1 (5.75)	183.0 (7.20)	LSF35	8.38 (295.6)

Appleton

HAZARDOUS LOCATION FITTINGS: ATEX/IECEX FLAMEPROOF CABLE GLANDS

A2FRC Series Nickel Plated Brass Cable Glands

Increased Safety and Flameproof

With Elastomer Seal for Unarmored Cables. For Conduit Connection ①

CEC:
Ex d IIC
Ex e II
Ex nR II
Type 4x

ATEX/IECEx:
Ex d IIC
Ex e IIC Gb
Ex nR IIC Gc
Ex ta IIc Da

Applications

- Cable glands for unarmored cable certified for enclosures with the following protection modes:
 - Ex d flameproof IIB or IIC (as per §10.4.2 of IEC 60079-14)
 - Ex e increased safety
 - Ex nR restricted breathing
 - D dust environment
- Hazardous areas (gas and dust)
- Onshore and offshore

Features

- Elastomer displacement seal for unarmored cable provides a combined flameproof and weatherproof seal on the outer sheath of the cable.

Standard Materials

- Gland: brass, fully nickel plated
- Seal: LSF (low smoke fumes) thermoplastic elastomer

Options

- Aluminum: replace last digit 5 with 1
- 316L stainless steel: replace last digit 5 with 4
- Shroud, locknut, earth tag, entry thread seal, serrated washers, adaptors and reducers: see *Cable Gland Accessories* pages

CEC Certifications and Compliances

- CSA Standard: CSA Standard: C22.2 No. 174, CAN/CSA E60079-0, CAN/CSA E60079-1, CAN/CSA E60079-7
- CSA Certified: 1211841

Appleton®

HAZARDOUS LOCATION FITTINGS: ATEX/IECEx FLAMEPROOF CABLE GLANDS

Cable Gland Size	Metric Thread C	Catalog Numbers ②				
		Standard Metric	Standard NPT Thread C	Catalog Numbers Standard NPT	Optional NPT Thread C	Optional NPT Thread
20S16	M20	2016A2FRC5	1/2	2016A2FRC0505	3/4	2016A2FRC0755
20S	M20	20SA2FRC5	1/2	20SA2FRC0505	3/4	20SA2FRC0755
20	M20	20A2FRC5	1/2	20A2FRC0505	3/4	20A2FRC0755
25	M25	25A2FRC5	3/4	25A2FRC0755	1	25A2FRC1005
32	M32	32A2FRC5	1	32A2FRC1005	1-1/4	32A2FRC1255
40	M40	40A2FRC5	1-1/4	40A2FRC1255	1-1/2	40A2FRC1505
50S	M50	50SA2FRC5	1-1/2	50SA2FRC1505	2	50SA2FRC2005
50	M50	50A2FRC5	2	50A2FRC2005	2-1/2	50A2FRC2505
63S	M63	63SA2FRC5	2	63SA2FRC2005	2-1/2	63SA2FRC2505
63	M63	63A2FRC5	2-1/2	63A2FRC2505	3	63A2FRC3005
75S	M75	75SA2FRC5	2-1/2	75SA2FRC2505	3	75SA2FRC3005
75	M75	75A2FRC5	3	75A2FRC3005	3-1/2	75A2FRC3505
90	M90	90A2FRC5	3	90A2FRC3005	3-1/2	90A2FRC3505
100	M100	100A2FRC5	4	100A2FRC4005	5	100A2FRC5005
115	M115	115A2FRC5	4	115A2FRC4005	5	115A2FRC5005
130	M130	130A2FRC5	5	130A2FRC5005	6	130A2FRC6005

① The A2FRC Cable Gland is suitable for use with all forms of equipment protection permitted in Zone 1, Zone 2, Zone 21 and Zone 22 provided always that the prevailing code of practice for selection and installation is observed, e.g. IEC 60079-14.

② Entry thread seal not supplied, see *Cable Gland Accessories and Tools*.

A2FRC Series Nickel Plated Brass Cable Glands

Increased Safety and Flameproof

With Elastomer Seal for Unarmored Cables. For Conduit Connection ①

CEC:
Ex d IIC
Ex e II
Ex nR II
Type 4x

ATEX/IECEX:
Ex d IIC
Ex e IIC Gb
Ex nR IIC Gc
Ex ta IIc Da

ATEX/IECEX Certifications and Compliances

- Certification Type A2F
 - Gas: Zones 1 and 2
 - Type of Protection: Ex d IIC, Ex e II, Ex nR II
 - Dust: Zones 21 and 22
 - Type of Protection: Ex tD A21
- Conforming to ATEX 94/9/CE: Ⓢ II 2 GD
- Ambient Temperature: -60 °C to +130 °C (-76 °F to +266 °F)
- CE Declaration of Conformity: DC07001
- ATEX Certificate: SIR A 1 3ATEX1 068X, SIR A 1 3ATEX4074X
- IECEX Certificate: IECEX SIR 1 3.0023X
- Other Certifications: LLOYDS, DNV, ABS
- Ingress Protection (solid and liquid): IP66, IP67, IP68
- EN/IEC Standards: 60079-0; 60079-1; 60079-7; 60079-15

INMETRO Certification

- INMETRO Certificate: TÜV 12.0878X

EURASEC Certification

- TC RU C-GB.Г505.B.00138



Dimensions in Millimeters (Inches)

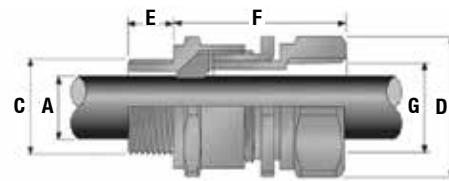

Cable Gland Size	Standard Female Connection Thread G	Minimum Thread Length mm (in) E	Overall Cable Diameter mm (in) A		Across Corners mm (in) D	Across Flats mm (in) D	Nominal Protrusion Length mm (in) F	Optional PVC Shroud	Weight kg (oz)
			Min	Max					
20S16	1/2	15.0 (0.59)	3.2 (0.13)	8.7 (0.34)	26.4 (1.04)	24.0 (0.94)	37.0 (1.46)	PVC04	0.11 (3.88)
20S	1/2	15.0 (0.59)	6.1 (0.24)	11.7 (0.46)	26.4 (1.04)	24.0 (0.94)	37.0 (1.46)	PVC04	0.11 (3.88)
20	1/2	15.0 (0.59)	6.5 (0.26)	14.0 (0.55)	29.7 (1.17)	27.0 (1.06)	37.0 (1.46)	PVC05	0.11 (3.88)
25	3/4	15.0 (0.59)	11.1 (0.44)	20.0 (0.79)	39.6 (1.56)	36.0 (1.42)	39.0 (1.54)	PVC09	0.20 (7.05)
32	1	15.0 (0.59)	17.0 (0.67)	26.3 (1.04)	39.6 (1.56)	36.0 (1.42)	41.0 (1.61)	PVC10	0.24 (8.47)
40	1-1/4	15.0 (0.59)	23.5 (0.93)	32.2 (1.27)	50.6 (1.99)	46.0 (1.81)	42.0 (1.65)	PVC13	0.33 (11.64)
50S	1-1/2	15.0 (0.59)	31.0 (1.22)	38.2 (1.50)	55.0 (2.17)	50.0 (1.97)	48.0 (1.89)	PVC15	0.43 (15.17)
50	2	15.0 (0.59)	35.6 (1.40)	44.1 (1.74)	71.5 (2.81)	65.0 (2.56)	51.0 (2.01)	PVC18	0.44 (15.52)
63S	2	15.0 (0.59)	41.5 (1.63)	50.0 (1.97)	71.5 (2.81)	65.0 (2.56)	50.0 (1.97)	PVC21	0.72 (25.40)
63	2-1/2	15.0 (0.59)	47.2 (1.86)	56.0 (2.20)	88.0 (3.46)	80.0 (3.15)	50.0 (1.97)	PVC23	0.64 (22.58)
75S	2-1/2	15.0 (0.59)	54.0 (2.13)	62.0 (2.44)	88.0 (3.46)	80.0 (3.15)	60.0 (2.36)	PVC26	0.96 (33.86)
75	3	15.0 (0.59)	61.1 (2.41)	68.0 (2.68)	110.0 (4.33)	100.0 (3.94)	60.0 (2.36)	PVC26	0.86 (30.34)
90	3	24.0 (0.94)	66.6 (2.62)	80.0 (3.15)	110.0 (4.33)	100.0 (3.94)	79.0 (3.11)	PVC31	2.25 (79.37)
100	4	24.0 (0.94)	76.0 (2.99)	91.0 (3.58)	135.3 (5.33)	123.0 (4.84)	110.0 (4.33)	—	3.86 (136.16)
115	4	24.0 (0.94)	86.0 (3.39)	98.0 (3.86)	146.4 (5.76)	133.0 (5.24)	110.0 (4.33)	—	4.50 (158.73)
130	5	24.0 (0.94)	97.0 (3.82)	115.0 (4.53)	165.0 (6.50)	152.0 (5.98)	120.0 (4.72)	—	4.77 (168.26)

① The A2FRC Cable Gland is suitable for use with all forms of equipment protection permitted in Zone 1, Zone 2, Zone 21 and Zone 22 provided always that the prevailing code of practice for selection and installation is observed, e.g. IEC 60079-14.

E1FU Triple Certified Cable Glands

Increased Safety, Flameproof and Restricted Breathing

For All Types of IEC Armored Cables.

NEC/CEC:
Class I, Division 2, Groups A, B, C, D

ATEX/IECEX:
Ex d IIC
Ex e II
Ex nR II

ATEX/IECEX:
Zone 1 and 2 – 21 and 22
II 2 GD
IP66

Applications

- Cable gland certified for enclosures with the following protection modes:
 - Ex d flameproof IIB or IIC (as per §10.4.2 of IEC 60079-14) (Refer to the ATX Guide for Use of Electrical Products in Hazardous Locations)
 - Ex e increased safety
 - Ex nR restricted breathing
 - D dust environment
- Hazardous areas (gas and dust).
- Onshore and offshore.

Features

- Provides a flameproof (Type "d") seal on the cable inner bedding.
- Provides a gas tight seal permitting the compatibility of use with restricted breathing (Type "nR") equipment.
- Allows mechanical cable retention and earth continuity via the cable armor termination.
- Separate tightening actions for the inner
- The inner displacement seal and armor terminations are separate tightening actions providing maximum control over the pressure applied to the cable bedding.

- Reversible armor cone and AnyWay clamping ring arrangement facilitates remote make off and enables the cable to be disconnected from the equipment.
- Environmental/load retention seal is provided on the cable outer sheath.
- Stepped cone is suitable for SWA cables. Grooved cone is suitable for all other approved armored cables.

Standard Materials

- Body: nickel plated brass
- Seal: LSF (Low Smoke Fume) thermoplastic elastomer
 - Inner CDS system and LRS (Load Retention Seal) outer seal

Options

- Lead sheath version – Replace digit E1 with E2;
Example: 32E1FW5 - 32E2FW5
- Aluminum: replace last digit 5 with 1
- Shroud, locknut, earth tag, entry thread seal, serrated washers, adaptors and reducers: see *Cable Gland Accessories* pages.

NEC/CEC Certifications and Compliances

- cCSAus Certified: 1310517

Cable Gland Size	Metric Thread C	Catalog Numbers					Minimum Thread Length mm (in) E
		Standard Metric ①	Standard NPT Thread C	Standard NPT ①	Optional NPT Thread C	Optional NPT Thread ①	
20S/16	M20	20S16E1FU5	1/2	20S16E1FU0505	3/4	20S16E1FU0755	15.0 (0.59)
20S	M20	20SE1FU5	1/2	20SE1FU0505	3/4	20SE1FU0755	15.0 (0.59)
20	M20	20E1FU5	1/2	20E1FU0505	3/4	20E1FU0755	15.0 (0.59)
25S	M25	25SE1FU5	3/4	25SE1FU0755	1	25SE1FU1005	15.0 (0.59)
25	M25	25E1FU5	3/4	25E1FU0755	1	25E1FU1005	15.0 (0.59)
32	M32	32E1FU5	1	32E1FU1005	1-1/4	32E1FU1255	15.0 (0.59)
40	M40	40E1FU5	1-1/4	40E1FU1255	1-1/2	40E1FU1505	15.0 (0.59)
50S	M50	50SE1FU5	1-1/2	50SE1FU1505	2	50SE1FU2005	15.0 (0.59)
50	M50	50E1FU5	2	50E1FU2005	2-1/2	50E1FU2505	15.0 (0.59)
63S	M63	63SE1FU5	2	63SE1FU2005	2-1/2	63SE1FU2505	15.0 (0.59)
63	M63	63E1FU5	2-1/2	63E1FU2505	3	63E1FU3005	15.0 (0.59)
75S	M75	75SE1FU5	2-1/2	75SE1FU2505	3	75SE1FU3005	15.0 (0.59)
75	M75	75E1FU5	3	75E1FU3005	3-1/2	75E1FU3505	15.0 (0.59)
90	M90	90E1FU5	3-1/2	90E1FU3505	4	90E1FU4005	24.0 (0.94)
100	M100	100E1FU5	4	100E1FU4005	5	100E1FU5005	24.0 (0.94)
115	M115	115E1FU5	4	115E1FU4005	5	115E1FU5005	24.0 (0.94)
130	M130	130E1FU5	5	130E1FU5005	6	130E1FU6005	24.0 (0.94)

① Entry thread seal not supplied, see *Cable Gland Accessories and Tools*.

E1FU Triple Certified Cable Glands

Increased Safety, Flameproof and Restricted Breathing

For All Types of IEC Armored Cables.

NEC/CEC:
Class I, Division 2, Groups A, B, C, D

ATEX/IECEX:
Ex d IIC
Ex e II
Ex nR II

ATEX/IECEX:
Zone 1 and 2 – 21 and 22
II 2 GD
IP66

ATEX/IECEX Certifications and Compliances

- Certification Type E1FU
 - Gas: Zones 1 and 2
 - Type of Protection: Ex d IIC Gb, Ex e IIC Gb, Ex nR IIC Gc
 - Dust: Zone 20
 - Type of Protection: Ex ta IIIC Da
- Conforming to ATEX 94/9/CE: II 2G 3G 1D
- Ambient Temperature: -60 °C to +130 °C (-76 °F to +266 °F)
- CE Declaration of Conformity: DC07001
- ATEX Certificate: Sira 13ATEX1071X, Sira 13ATEX4077X
- IECEx Certificate: IECEx SIR 13.0026X, IECEx SIM 14.0007X
- Other Certifications: cCSAus, KCC, CCOE/PESO (India)
- Marine Approval: LLOYDS, DNV, ABS
- Index of Protection according EN/IEC 60529: IP66
- Deluge Protection Compliance: DTS01:91 (option available on request only)

IINMETRO Certification

- INMETRO Certificate: TUV 12.0618X

EURASEC Certification

- TC RU C-GB.Г505.В.00138



Dimensions in Millimeters (Inches)

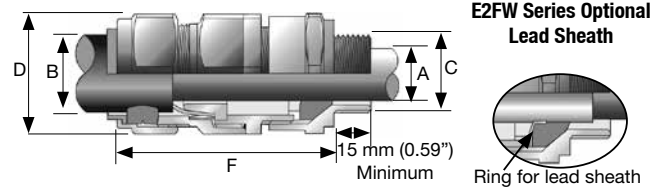

Cable Gland Size	Cable Bedding Diameter mm (in) A		Overall Cable Diameter mm (in) B		Across Flats mm (in) D	Across Corners mm (in) D	Nominal Protrusion Length mm (in) F	Optional PVC Shroud	Cable Gland Weight kgs (oz)
	Min	Max	Min	Max					
20S/16	3.1 (0.12)	8.6 (0.34)	6.1 (0.24)	13.2 (0.52)	24.0 (0.94)	26.4 (1.04)	58.5 (2.30)	PVC04	0.16 (5.64)
20S	6.1 (0.24)	11.6 (0.46)	9.5 (0.37)	15.9 (0.63)	24.0 (0.94)	26.4 (1.04)	58.5 (2.30)	PVC04	0.16 (5.64)
20	6.5 (0.26)	13.9 (0.55)	12.5 (0.49)	20.9 (0.82)	30.5 (1.20)	33.6 (1.32)	60.5 (2.38)	PVC06	0.22 (7.76)
25S	11.1 (0.44)	19.9 (0.78)	14.0 (0.55)	22.0 (0.87)	37.5 (1.48)	41.3 (1.63)	67.5 (2.66)	PVC09	0.35 (12.35)
25	11.1 (0.44)	19.9 (0.78)	18.2 (0.72)	26.2 (1.03)	37.5 (1.48)	41.3 (1.63)	67.5 (2.66)	PVC09	0.35 (12.35)
32	17.0 (0.67)	26.2 (1.03)	23.7 (0.93)	33.9 (1.33)	46.0 (1.81)	50.6 (1.99)	69.5 (2.74)	PVC11	0.48 (16.93)
40	22.0 (0.87)	32.1 (1.26)	27.9 (1.10)	40.4 (1.59)	55.0 (2.17)	60.5 (2.38)	78.0 (3.07)	PVC15	0.70 (24.69)
50S	29.5 (1.16)	38.1 (1.50)	35.2 (1.39)	46.7 (1.84)	60.0 (2.36)	66.0 (2.60)	75.5 (2.97)	PVC18	0.80 (28.22)
50	35.6 (1.40)	44.0 (1.73)	40.4 (1.59)	53.1 (2.09)	70.0 (2.76)	77.0 (3.03)	80.5 (3.17)	PVC21	0.83 (29.28)
63S	40.1 (1.58)	49.9 (1.96)	45.6 (1.80)	59.4 (2.34)	75.0 (2.95)	82.5 (3.25)	91.5 (3.60)	PVC23	1.42 (50.09)
63	47.2 (1.86)	55.9 (2.20)	54.6 (2.15)	65.9 (2.59)	80.0 (3.15)	88.0 (3.46)	92.0 (3.62)	PVC25	1.51 (53.26)
75S	52.8 (2.08)	61.9 (2.44)	59.0 (2.32)	72.1 (2.84)	89.0 (3.50)	97.9 (3.85)	99.0 (3.90)	PVC28	2.20 (77.60)
75	59.1 (2.33)	67.9 (2.67)	66.7 (2.63)	78.5 (3.09)	99.0 (3.90)	108.9 (4.29)	102.0 (4.02)	PVC30	2.77 (97.71)
90	66.6 (2.62)	79.9 (3.15)	76.2 (3.00)	90.4 (3.56)	114.0 (4.49)	125.4 (4.94)	120.0 (4.72)	PVC32	4.35 (153.44)
100	76.0 (2.99)	90.9 (3.58)	86.1 (3.39)	101.5 (4.00)	123.0 (4.84)	135.3 (5.33)	148.0 (5.83)	LSF33	4.75 (167.55)
115	86.0 (3.39)	97.9 (3.85)	101.5 (4.00)	110.3 (4.34)	133.4 (5.25)	146.7 (5.78)	169.0 (6.65)	LSF34	7.30 (257.5)
130	97.0 (3.82)	114.9 (4.52)	110.2 (4.34)	123.3 (4.85)	146.1 (5.75)	160.7 (6.33)	183.0 (7.20)	LSF35	8.60 (303.36)

Appleton

HAZARDOUS LOCATION FITTINGS: ATEX/IECEX FLAMEPROOF CABLE GLANDS

PX2KX Compound Barrier Type Cable Connector

Explosionproof

Wire Braid Armor and Jacketed Cables.

NEC/CEC:

Class I, Division 1 and 2, Groups A, B, C, D
Class II, Division 1 and 2, Groups E, F, G
Class III
NEMA 4X
IP66, IP67, IP68

ATEX/IECEX:

Class I, Zone 1, Ex d IIC
IP66, IP67, IP68

Applications

- Explosionproof Class I Division 1 brass cable connector suitable for wire braid armor or tape.

Features

- Connector provides an environmental seal on the cable outer jacket and an explosionproof compound barrier seal around the cable inner cores.
- Connector provides mechanical cable retention and electrical continuity via armor termination.
- The connector is UL Listed for NPT and metric threads.
- PX2KX forms part of a comprehensive connector range for marine shipboard and IEE45 armored cables.
- Armor termination — removable armor cone and ring. Sealing area(s) — displacement seal concept.

Standard Materials

- Connector: brass fully nickel plated
- Seal: SOLO LSF (low smoke fumes) thermoplastic elastomer
- Epoxy putty

Options

- Aluminum: replace last digit 5 with 1
- 316L stainless steel: replace last digit 5 with 4
- Shroud, locknut, earth tag, entry thread seal, serrated washers, adaptors and reducers: see *Cable Gland Accessories* pages.

NEC/CEC Certifications and Compliances

- UL Standard: 2225
- CSA Standard: C22.2 No. 174
- CSA Certified: 101909

ATEX/IECEX Certifications and Compliances

- Third Party Approvals: IP66, IP67 and IP68
- ATEX: SIRA13ATEX1072X, SIRA13ATEX4078X
- Marine: LLOYDS, DNV, ABS
- Ingress Protection: NEMA 4X, Oil Resistant II
- IEC Standards: 60079-0; 60079-1; 60079-7; 60079-15; 60079-31
- Shell / ERA deluge test DTS 01:1991 (after 20 years simulated accelerated ageing)

Cable Connector Size	Metric Thread C	Standard Metric ①	Standard NPT Thread C	Catalog Numbers			Maximum Diameter Over Conductors mm (in) A	Maximum Cable Bedding Diameter mm (in) G
				Standard NPT ①	Optional NPT Thread C	Optional NPT Thread ①		
20S16	M20	2016PX2KX5	1/2	2016PX2KX0505	3/4	2016PX2KX0755	12.6 (0.5)	6.1 (0.24)
20S	M20	20SPX2KX5	1/2	20SPX2KX0505	3/4	20SPX2KX0755	12.6 (0.5)	9.5 (0.37)
20	M20	20PX2KX5	1/2	20PX2KX0505	3/4	20PX2KX0755	12.6 (0.5)	12.5 (0.49)
25S	M25	25SPX2KX5	3/4	25SPX2KX0755	1	25SPX2KX1005	17.5 (0.69)	14.0 (0.55)
25	M25	25PX2KX5	3/4	25PX2KX0755	1	25PX2KX1005	17.5 (0.69)	18.2 (0.72)
32	M32	32PX2KX5	1	32PX2KX1005	1-1/4	32PX2KX1255	23.6 (0.93)	23.7 (0.93)
40	M40	40PX2KX5	1-1/4	40PX2KX1255	1-1/2	40PX2KX1505	30.0 (1.18)	27.9 (1.10)
50S	M50	50SPX2KX5	1-1/2	50SPX2KX1505	2	50SPX2KX2005	36.6 (1.44)	35.2 (1.39)
50	M50	50PX2KX5	2	50PX2KX2005	2-1/2	50PX2KX2505	41.0 (1.61)	40.4 (1.59)
63S	M63	63SPX2KX5	2	63SPX2KX2005	2-1/2	63SPX2KX2505	47.9 (1.89)	45.6 (1.80)
63	M63	63PX2KX5	2-1/2	63PX2KX2505	3	63PX2KX3005	53.0 (2.09)	54.6 (2.15)
75S	M75	75SPX2KX5	2-1/2	75SPX2KX3005	3	75SPX2KX3005	59.9 (2.36)	59.0 (2.32)
75	M75	75PX2KX5	3	75PX2KX3005	3-1/2	75PX2KX3505	64.3 (2.53)	66.7 (2.63)
90	M90	90PX2KX5	3-1/2	90PX2KX3505	4	90PX2KX4005	75.3 (2.96)	76.2 (3.00)
100	M100	100PX2KX5	4	100PX2KX4005	5	100PX2KX5005	85.6 (3.37)	86.1 (3.39)

① Entry thread seal not supplied, see *Cable Gland Accessories and Tools*.

PX2KX Compound Barrier Type Cable Connector

Explosionproof

Wire Braid Armor and Jacketed Cables.

NEC/CEC:

Class I, Division 1 and 2, Groups A, B, C, D
Class II, Division 1 and 2, Groups E, F, G

Class III

NEMA 4X

IP66, IP67, IP68

ATEX/IECEX:

Class I, Zone 1, Ex d IIC
IP66, IP67, IP68



Dimensions in Millimeters (Inches)

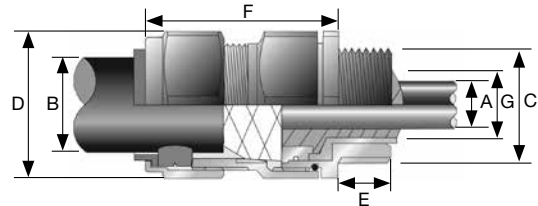

Cable Connector Size	Overall Cable Diameter mm (in) B		Across Flats mm (in) D	Across Corners mm (in) D	Minimum Thread Length mm (in) E	Nominal Protrusion Length mm (in) F	Maximum Number of Cores mm (in)	Optional PVC Shroud	Cable Connector Weight kg (oz)
	Min	Max							
20S16	6.1 (0.24)	11.5 (0.45)	30.5 (1.20)	33.6 (1.32)	15.0 (0.59)	58.5 (2.30)	11.0 (0.43)	PVC04	0.20 (7.05)
20S	9.5 (0.37)	15.9 (0.63)	30.5 (1.20)	33.6 (1.32)	15.0 (0.59)	58.5 (2.30)	11.0 (0.43)	PVC04	0.20 (7.05)
20	12.5 (0.49)	20.9 (0.82)	30.5 (1.20)	33.6 (1.32)	15.0 (0.59)	60.5 (2.38)	11.0 (0.43)	PVC06	0.23 (8.11)
25S	14.0 (0.55)	22.0 (0.87)	37.5 (1.48)	41.3 (1.63)	15.0 (0.59)	67.5 (2.66)	21.0 (0.83)	PVC09	0.33 (11.64)
25	18.2 (0.72)	26.2 (1.03)	37.5 (1.48)	41.3 (1.63)	15.0 (0.59)	67.5 (2.66)	21.0 (0.83)	PVC09	0.33 (11.64)
32	23.7 (0.93)	33.9 (1.33)	46.0 (1.81)	50.6 (1.99)	15.0 (0.59)	69.5 (2.74)	38.0 (1.50)	PVC11	0.51 (17.99)
40	27.9 (1.10)	40.4 (1.59)	55.0 (2.17)	60.5 (2.38)	15.0 (0.59)	78.0 (3.07)	59.0 (2.32)	PVC15	0.72 (25.40)
50S	35.2 (1.39)	46.7 (1.84)	60.0 (2.36)	66.0 (2.6)	15.0 (0.59)	75.5 (2.97)	89.0 (3.50)	PVC18	0.83 (29.28)
50	40.4 (1.59)	53.1 (2.09)	70.0 (2.76)	77.0 (3.03)	15.0 (0.59)	80.5 (3.17)	89.0 (3.50)	PVC21	0.86 (30.34)
63S	45.6 (1.80)	59.4 (2.34)	75.0 (2.95)	82.5 (3.25)	15.0 (0.59)	91.5 (3.60)	115.0 (4.53)	PVC23	1.45 (51.15)
63	54.6 (2.15)	65.9 (2.59)	80.0 (3.15)	88.0 (3.46)	15.0 (0.59)	92.0 (3.62)	115.0 (4.53)	PVC25	1.60 (56.44)
75S	59.0 (2.32)	72.1 (2.84)	89.0 (3.50)	97.9 (3.85)	15.0 (0.59)	99.0 (3.90)	140.0 (5.51)	PVC28	2.30 (81.13)
75	66.7 (2.63)	78.5 (3.09)	99.0 (3.90)	108.9 (4.29)	15.0 (0.59)	102.0 (4.02)	140.0 (5.51)	PVC30	3.05 (107.59)
90	76.2 (3.00)	90.4 (3.56)	114.0 (4.49)	125.4 (4.94)	20.0 (0.79)	120.0 (4.72)	200.0 (7.87)	PVC32	5.00 (176.37)
100	86.1 (3.39)	101.5 (4.00)	133.0 (5.24)	146.3 (5.76)	20.0 (0.79)	135.5 (5.33)	200.0 (7.87)	LSF33	6.00 (211.64)

PX2KX-REX Liquid Resin Barrier Type Cable Connector

Explosionproof

Wire Braid Armor and Jacketed Cables.

NEC/CEC:

Class I, Division 1 and 2, Groups A, B, C, D
Class II, Division 1 and 2, Groups E, F, G
Class III
NEMA 4X
IP66, IP67, IP68

ATEX/IECEX:

Class I, Zone 1, Ex d IIC
IP66, IP67, IP68

Applications

- Explosionproof Class I Division 1 and 2 brass cable connector suitable for wire braid armor and jacketed cables.

Features

- Utilizes RapidEx high speed liquid resin sealing compound included with each gland.
- The gland utilizes a liquid pour resin seal, that vastly reduces installation time and associated costs. This solution is particularly effective on multicore cables where traditional compound is difficult and time consuming to apply.
- Connector provides an environmental seal on the cable outer jacket and an explosionproof liquid resin barrier seal around the cable inner cores.
- Connector provides mechanical cable retention and electrical continuity via armor termination.
- PX2KX forms part of a comprehensive connector range for marine shipboard and IEE45 armored and jacketed cables.
- Armor termination — removable armor cone and ring. Sealing area(s) — displacement seal concept.

Standard Materials

- Connector: brass fully nickel plated
- Seal: SOLO LSF (low smoke fumes) thermoplastic elastomer
- High speed liquid resin sealing compound

Options

- Aluminum: replace last digit 5 with 1
- 316L stainless steel: replace last digit 5 with 4 (available by quote only)
- Shroud, locknut, earth tag, entry thread seal, serrated washers, adaptors and reducers: see *Cable Gland Accessories* pages.

NEC/CEC Certifications and Compliances

- UL Standard: 2225
- CSA Standard: C22.2 No. 174
- CSA Certified: 101909

Cable Gland Size	Metric Thread C	Thread Length (Metric) E mm (in)	Catalog Numbers					
			Standard Metric ①	Standard NPT Thread C	Standard NPT ①	Optional NPT Thread C	Optional NPT ①	Replacement Sealing Resin
20S/16	M20	15.0 (0.59)	2016PX2KXREX5X	1/2	2016PX2KXRX505X	3/4	2016PX2KXRX755X	RAPIDEX30
20S	M20	15.0 (0.59)	20SPX2KXREX5X	1/2	20SPX2KXRX0505X	3/4	20SPX2KXRX0755X	RAPIDEX30
20	M20	15.0 (0.59)	20PX2KXREX5X	1/2	20PX2KXRX0505X	3/4	20PX2KXRX0755X	RAPIDEX30
25S	M25	15.0 (0.59)	25SPX2KXREX5X	3/4	25SPX2KXRX0755X	1	25SPX2KXRX1005X	RAPIDEX30
25	M25	15.0 (0.59)	25PX2KXREX5X	3/4	25PX2KXRX0755X	1	25PX2KXRX1005X	RAPIDEX30
32	M32	15.0 (0.59)	32PX2KXREX5X	1	32PX2KXRX1005X	1-1/4	32PX2KXRX1255X	RAPIDEX30
40	M40	15.0 (0.59)	40PX2KXREX5X	1-1/4	40PX2KXRX1255X	1-1/2	40PX2KXRX1505X	RAPIDEX30
50S	M50	15.0 (0.59)	50SPX2KXREX5X	1-1/2	50SPX2KXRX1505X	2	50SPX2KXRX2005X	RAPIDEX80
50	M50	15.0 (0.59)	50PX2KXREX5X	2	50PX2KXRX2005X	2-1/2	50PX2KXRX2005X	RAPIDEX80
63S	M63	15.0 (0.59)	63SPX2KXREX5X	2	63SPX2KXRX2005X	2-1/2	63SPX2KXRX2505X	2RAPIDEX80
63	M63	15.0 (0.59)	63PX2KXREX5X	2-1/2	63PX2KXRX2505X	3	63PX2KXRX3005X	2RAPIDEX80
75S	M75	15.0 (0.59)	75SPX2KXREX5X	2-1/2	75SPX2KXRX2505X	3	75SPX2KXRX3005X	2RAPIDEX80
75	M75	15.0 (0.59)	75PX2KXREX5X	3	75PX2KXRX3005X	3-1/2	75PX2KXRX3505X	3RAPIDEX80
90	M90	20.0 (0.79)	90PX2KXREX5X	3	90PX2KXRX3005X	4	90PX2KXRX4005X	3RAPIDEX80

① Entry thread seal not supplied, see *Cable Gland Accessories and Tools*.

PX2KX-REX Liquid Resin Barrier Type Cable Connector

Explosionproof

Wire Braid Armor and Jacketed Cables.

NEC/CEC:

Class I, Division 1 and 2, Groups A, B, C, D
Class II, Division 1 and 2, Groups E, F, G
Class III
NEMA 4X
IP66, IP67, IP68

ATEX/IECEX:

Class I, Zone 1, Ex d IIC
IP66, IP67, IP68

ATEX/IECEX Certifications and Compliances

- ATEX: SIRA13ATEX1072X, SIRA13ATEX4078X
- Marine: LLOYDS, DNV, ABS
- Ingress Protection: NEMA 4X, Oil Resistant II
- Third Party Approvals: IP66, IP67 and IP68
- Shell / ERA deluge test DTS 01:1991 (after 20 years simulated accelerated ageing)



Dimensions in Millimeters (Inches)

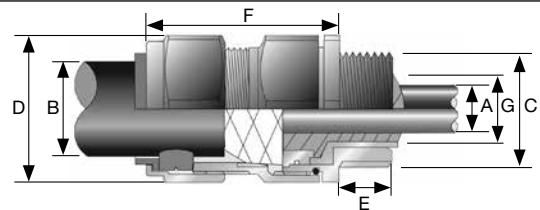

Cable Gland Size	Maximum Diameter Over Conductors mm (in) A	Overall Cable Diameter mm (in) B		Maximum Cable Bedding Diameter mm (in) G	Across Flats mm (in) D	Across Corners mm (in) D	Nominal Protrusion Length mm (in) F	Optional PVC Shroud	Cable Gland Weight kg (oz)
		Min	Max						
20S/16	12.6 (0.5)	6.1 (0.24)	13.2 (0.52)	11.8 (0.47)	30.5 (1.20)	33.6 (1.32)	58.5 (2.30)	PVC06	0.20 (7.05)
20S	12.6 (0.5)	9.5 (0.37)	15.9 (0.63)	11.8 (0.47)	30.5 (1.20)	33.6 (1.32)	58.5 (2.30)	PVC06	0.20 (7.05)
20	12.6 (0.5)	12.5 (0.49)	20.9 (0.82)	14.1 (0.56)	30.5 (1.20)	33.6 (1.32)	60.5 (2.38)	PVC06	0.23 (8.11)
25S	17.5 (0.69)	14.0 (0.55)	22.0 (0.87)	20.1 (0.79)	37.5 (1.48)	41.3 (1.63)	67.5 (2.66)	PVC09	0.33 (11.64)
25	17.5 (0.69)	18.2 (0.72)	26.2 (1.03)	20.1 (0.79)	37.5 (1.48)	41.3 (1.63)	67.5 (2.66)	PVC09	0.33 (11.64)
32	23.6 (0.93)	23.7 (0.93)	33.9 (1.33)	26.4 (1.04)	46.0 (1.81)	50.6 (1.99)	69.5 (2.74)	PVC11	0.51 (17.99)
40	30.0 (1.18)	27.9 (1.10)	40.4 (1.59)	32.3 (1.27)	55.0 (2.17)	60.5 (2.38)	78.0 (3.07)	PVC15	0.72 (25.40)
50S	36.6 (1.44)	35.2 (1.39)	46.7 (1.84)	38.3 (1.51)	60.0 (2.36)	66.0 (2.60)	75.5 (2.97)	PVC18	0.83 (29.10)
50	41.0 (1.61)	40.4 (1.59)	53.1 (2.09)	44.2 (1.74)	70.0 (2.76)	77.0 (3.03)	80.5 (3.17)	PVC21	0.86 (30.34)
63S	47.9 (1.89)	45.6 (1.80)	59.4 (2.34)	50.1 (1.97)	75.0 (2.95)	82.5 (3.25)	91.5 (3.60)	PVC23	1.45 (51.15)
63	53.7 (2.11)	54.6 (2.15)	65.9 (2.59)	56.1 (2.21)	80.0 (3.15)	88.0 (3.46)	92.0 (3.62)	PVC25	1.60 (56.44)
75S	59.9 (2.36)	59.0 (2.32)	72.1 (2.84)	62.1 (2.44)	89.0 (3.50)	97.9 (3.85)	99.0 (3.90)	PVC28	2.30 (91.71)
75	64.3 (2.53)	66.7 (2.63)	78.5 (3.09)	64.3 (2.53)	99.0 (3.90)	108.9 (4.29)	102.0 (4.02)	PVC30	3.05 (107.59)
90	75.3 (2.96)	76.2 (3.00)	90.4 (3.56)	78.4 (3.09)	114.0 (4.49)	125.4 (4.94)	120.0 (4.72)	PVC32	5.00 (176.37)

HAZARDOUS LOCATION FITTINGS: NEC, ATEX/IECEX EXPLOSIONPROOF CONNECTORS



TMC2X Connectors For Jacketed Metal Clad Cable

Explosionproof, Dust-Ignitionproof

For Hazardous Locations.

NEC/CEC:

Class I, Divisions 1 and 2, Groups A, B, C, D
Class I, Zone 1, AEx d IIC, AEx e II, AEx tA IIC
Class I, Zone 1, EX e II, Ex tA IIC
Class II, Division 1 and 2, Groups E, F, G

NEC/CEC:

Class III, Divisions 1 and 2
NEMA 4X
IP66

Applications

- TMC2X connectors are designed for use with the following cables:
 - MC/MC-HL
 - Corrugated Interlocked Aluminium/Steel Armor
 - Continuously Welded Armor Cables or TECK
- Provide a means for terminating jacketed type MC cable, forming a mechanical watertight connection and providing ground continuity for cable armor.
- For use on horizontal or vertical runs.

Features

- Simplified two piece design.
- Utilizes RapidEx high speed liquid resin sealing compound included with each gland.
- Independent sealing and armor clamping/ grounding.

- True 360° grounding.
- Removable cable armor end stop accommodates larger insulated conductors.
- Superior pull out prevention.
- Compact slim profile.
- Widest cable acceptance range.
- Disconnectable design.
- Additional integral deluge proof seal for protection in extreme offshore and onshore environments.
- Continuous operating temperature: -60 °C to +85 °C (-76 °F to +185 °F).

Size Ranges

- Trade sizes: 1/2" thru 4".
- Cable Jacket Diameter Range: 0.50" thru 4.25"
- Cable Armor Diameter Range: 0.42" thru 3.94"

Cable Gland Size	Entry Thread C		Cable Armor Diameter mm (in) A		Cable Jacket Diameter mm (in) B		Catalog Number		
	NPT	NPT Option	Min	Max	Min	Max	Aluminum	Nickel Plated Brass	Stainless Steel
20S	1/2	-	10.70 (0.42)	16.00 (0.63)	12.70 (0.50)	19.10 (0.75)	TMC2X-050075AX	TMC2X-050075NBX	TMC2X-050075SSX
20S	-	3/4					TMC2X-075075AX	TMC2X-075075NBX	TMC2X-075075SSX
20	3/4	-	15.20 (0.60)	22.60 (0.89)	17.50 (0.69)	25.10 (0.99)	TMC2X-075099AX	TMC2X-075099NBX	TMC2X-075099SSX
20	-	1/2					TMC2X-050099AX	TMC2X-050099NBX	TMC2X-050099SSX
25	1	-	20.10 (0.79)	27.90 (1.10)	22.10 (0.87)	30.00 (1.18)	TMC2X-100118AX	TMC2X-100118NBX	TMC2X-100118SSX
25	-	3/4					TMC2X-075118AX	TMC2X-075118NBX	TMC2X-075118SSX
32	1-1/4	-	23.90 (0.94)	32.50 (1.28)	25.90 (1.02)	34.80 (1.37)	TMC2X-125137AX	TMC2X-125137NBX	TMC2X-125137SSX
32	-	1					TMC2X-100137AX	TMC2X-100137NBX	TMC2X-100137SSX
40S	1-1/2	-	31.00 (1.22)	38.10 (1.50)	33.00 (1.30)	41.10 (1.62)	TMC2X-150162AX	TMC2X-150162NBX	TMC2X-150162SSX
40S	-	1-1/4					TMC2X-125162AX	TMC2X-125162NBX	TMC2X-125162SSX
40	1-1/2	-	37.80 (1.49)	43.70 (1.72)	39.90 (1.57)	48.30 (1.90)	TMC2X-150190AX	TMC2X-150190NBX	TMC2X-150190SSX
40	-	1-1/4					TMC2X-125190AX	TMC2X-125190NBX	TMC2X-125190SSX
50S	2	-	39.90 (1.57)	47.80 (1.88)	41.90 (1.65)	50.80 (2.00)	TMC2X-200200AX	TMC2X-200200NBX	TMC2X-200200SSX
50S	-	1-1/2					TMC2X-150200AX	TMC2X-150200NBX	TMC2X-150200SSX
63S	2-1/2	-	45.50 (1.79)	56.10 (2.21)	48.50 (1.91)	59.20 (2.33)	TMC2X-250233AX	TMC2X-250233NBX	TMC2X-250233SSX
63S	-	2					TMC2X-200233AX	TMC2X-200233NBX	TMC2X-200233SSX
75	3	-	54.40 (2.14)	66.30 (2.61)	57.70 (2.27)	69.10 (2.72)	TMC2X-300272AX	TMC2X-300272NBX	TMC2X-300272SSX
75	-	2-1/2					TMC2X-250272AX	TMC2X-250272NBX	TMC2X-250272SSX
90	3-1/2	-	63.20 (2.49)	75.40 (2.97)	66.50 (2.62)	82.60 (3.25)	TMC2X-350325AX	TMC2X-350325NBX	TMC2X-350325SSX
90	-	3					TMC2X-300325AX	TMC2X-300325NBX	TMC2X-300325SSX
100	4	-	74.90 (2.95)	89.90 (3.54)	80.30 (3.16)	95.50 (3.76)	TMC2X-400376AX	TMC2X-400376NBX	TMC2X-400376SSX
100	-	3-1/2					TMC2X-350376AX	TMC2X-350376NBX	TMC2X-350376SSX
115	4	-	89.40 (3.52)	100.10 (3.94)	94.00 (3.70)	108.00 (4.25)	TMC2X-400425AX	TMC2X-400425NBX	TMC2X-400425SSX

HAZARDOUS LOCATION FITTINGS: NEC/CEC MC CONNECTORS

Appleton

TMC2X Connectors For Jacketed Metal Clad Cable

Explosionproof, Dust-Ignitionproof

For Hazardous Locations.

NEC/CEC:

Class I, Divisions 1 and 2, Groups A, B, C, D
Class I, Zone 1, AEx d IIC, AEx e II, AEx tA IIC
Class I, Zone 1, EX e II, Ex tA IIC
Class II, Division 1 and 2, Groups E, F, G

NEC/CEC:

Class III, Divisions 1 and 2
NEMA 4X
IP66

Standard Materials

- Bodies, sleeve and gland nut: copperfree (4/10 of 1% max.) aluminum, nickel plated brass, or stainless steel
- Grounding spring: stainless steel
- Bushing: LSF-TPE (halogen free)
- End stop washer: nylon

Options

- Metric threads available. Add metric thread size to the end of catalog number, i.e. TMC2X-050075A-M20.

NEC/CEC Certifications and Compliances

- UL Standards: UL 514B, UL 2225
- CSA Standard: C22.2 No. 174
- cCSAus Certified: 184585



Dimensions in Millimeters (Inches)

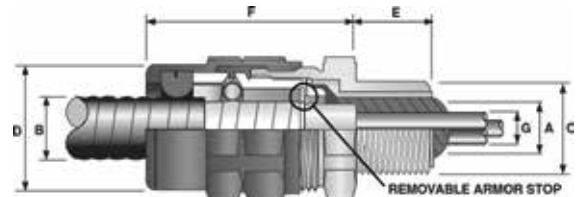

Cable Gland Size	Entry Thread C		Minimum Thread Length mm (in) E	Cable Bedding Diameter mm (in) G	Across Flats mm (in) D	Across Corners mm (in) D	Nominal Assembly Length mm (in) F	Replacement High Speed Sealing Resin ①
	NPT	NPT Option						
20S	1/2	-	19.81 (0.78)	12.95 (0.51)	30.48 (1.20)	33.53 (1.32)	62.10 (2.45)	RAPIDEX30
20S	-	3/4	20.32 (0.8)	12.95 (0.51)	37.59 (1.48)	41.35 (1.63)	75.11 (2.96)	RAPIDEX30
20	3/4	-	20.32 (0.8)	12.95 (0.51)	37.59 (1.48)	41.35 (1.63)	75.11 (2.96)	RAPIDEX30
20	-	1/2	19.81 (0.78)	12.95 (0.51)	30.48 (1.20)	33.53 (1.32)	62.10 (2.45)	RAPIDEX30
25	1	-	24.89 (0.98)	18.03 (0.71)	45.97 (1.81)	50.57 (1.99)	80.11 (3.15)	RAPIDEX30
25	-	3/4	20.32 (0.8)	12.95 (0.51)	37.59 (1.48)	41.35 (1.63)	75.11 (2.96)	RAPIDEX30
32	1-1/4	-	25.4 (1.00)	24.13 (0.95)	52.07 (2.05)	57.28 (2.26)	90.09 (3.55)	RAPIDEX30
32	-	1	24.89 (0.98)	18.03 (0.71)	45.97 (1.81)	50.57 (1.99)	80.11 (3.15)	RAPIDEX30
40S	1-1/2	-	26.16 (1.03)	30.48 (1.20)	59.94 (2.36)	65.94 (2.60)	91.21 (3.59)	RAPIDEX80
40S	-	1-1/4	25.4 (1.00)	24.13 (0.95)	52.07 (2.05)	57.28 (2.26)	90.09 (3.55)	RAPIDEX30
40	1-1/2	-	26.16 (1.03)	30.48 (1.20)	65.02 (2.56)	71.53 (2.82)	91.11 (3.59)	RAPIDEX80
40	-	1-1/4	25.4 (1.00)	24.13 (0.95)	52.07 (2.05)	57.28 (2.26)	90.09 (3.55)	RAPIDEX30
50S	2	-	26.92 (1.06)	37.08 (1.46)	69.85 (2.75)	76.84 (3.03)	95.4 (3.76)	RAPIDEX80
50S	-	1-1/2	26.16 (1.03)	30.48 (1.20)	59.94 (2.36)	65.94 (2.60)	91.21 (3.59)	2RAPIDEX80
63S	2-1/2	-	39.88 (1.57)	48.51 (1.91)	74.93 (2.95)	82.42 (3.25)	100.89 (3.97)	2RAPIDEX80
63S	-	2	26.92 (1.06)	37.08 (1.46)	69.85 (2.75)	76.84 (3.03)	95.4 (3.76)	2RAPIDEX80
75	3	-	41.4 (1.63)	64.77 (2.55)	89.92 (3.54)	98.91 (3.894)	104.09 (4.10)	3RAPIDEX80
75	-	2-1/2	39.88 (1.57)	48.51 (1.91)	74.93 (2.95)	82.42 (3.25)	100.89 (3.97)	2RAPIDEX80
90	3-1/2	-	42.67 (1.68)	75.69 (2.98)	109.98 (4.33)	120.98 (4.763)	118.49 (4.67)	3RAPIDEX80
90	-	3	41.4 (1.63)	64.77 (2.55)	89.92 (3.54)	98.91 (3.894)	104.09 (4.10)	3RAPIDEX80
100	4	-	43.94 (1.73)	86.11 (3.39)	122.94 (4.84)	135.23 (5.32)	125.81 (4.95)	4RAPIDEX80
100	-	3-1/2	42.67 (1.68)	75.69 (2.98)	109.98 (4.33)	120.98 (4.763)	118.49 (4.67)	3RAPIDEX80
115	4	-	43.94 (1.73)	43.94 (1.73)	132.84 (5.23)	146.13 (5.75)	131.09 (5.16)	4RAPIDEX80

① Included with cable gland

TMC2 Connectors For Jacketed Metal Clad Cable

NEC/CEC:
 Class I, Division 2, Groups A, B, C, D ②
 Class I, Zones 1 and 2, AExe II AEx tA IIC
 Class I, Zones 1 and 2, Exe II Ex tA IIC
 Class II, Divisions 1 and 2, Groups E, F, G
 Class III, Divisions 1 and 2

NEC/CEC:
 NEMA 4X
 IP66

Applications

- TMC2 connectors are designed for use with the following cables:
 - MC/MC-HL
 - Corrugated Interlocked Aluminium/Steel Armor
 - Continuously Welded Armor Cables, e.g. TECK or CLX
- TMC2 connectors provide a means for terminating jacketed type MC cable, forming a mechanical watertight connection and providing ground continuity for cable armor.

Features

- Simplified two piece design.
- Integral 'O' ring face seal providing – 4X and IP66.
- Independent sealing and armor clamping.
- True 360° grounding.
- Removable cable armor end stop accommodates larger insulated conductors.

- Superior pull out prevention.
- Compact slim profile
- Reduced installation time (no disassembly required).
- Widest cable acceptance range.
- Re-usable design.
- Additional integral deluge proof seal for protection in extreme offshore and onshore environments.
- Continuous operating temperature -60 °C to +110 °C (-76 °F to +230°F).

Standard Materials

- Bodies, sleeve and gland nut: copperfree (4/10 of 1% max.) aluminum, nickel plated brass, or stainless steel
- Grounding spring: stainless steel
- Bushing: LSF-TPE (halogen free)
- End stop washer: nylon
- O-Ring: Viton

HAZARDOUS LOCATION FITTINGS: NEC/CEC MC CONNECTORS

Entry Thread C	Cable Armor Diameter mm (in) A		Cable Jacket Diameter mm (in) B		Catalog Number			
	NPT Option	Min	Max	Min	Max	Aluminum	Nickel Plated Brass	Stainless Steel ①
1/2"	-	10.7 (0.42)	16.0 (0.63)	12.7 (0.50)	19.1 (0.75)	TMC2-050075A	TMC2-050075NB	TMC2-050075SS
-	3/4"					TMC2-075075A	TMC2-075075NB	TMC2-075075SS
1/2"	-	15.2 (0.60)	22.6 (0.89)	17.5 (0.69)	25.1 (0.99)	TMC2-050099A	TMC2-050099NB	TMC2-050099SS
-	3/4"					TMC2-075099A	TMC2-075099NB	TMC2-075099SS
3/4"	-	20.1 (0.79)	27.9 (1.10)	22.1 (0.87)	30.0 (1.18)	TMC2-075118A	TMC2-075118NB	TMC2-075118SS
-	1"					TMC2-100118A	TMC2-100118NB	TMC2-100118SS
1"	-	23.9 (0.94)	32.5 (1.28)	25.9 (1.02)	34.8 (1.37)	TMC2-100137A	TMC2-100137NB	TMC2-100137SS
-	1-1/4"					TMC2-125137A	TMC2-125137NB	TMC2-125137SS
1-1/4"	-	31.0 (1.22)	38.1 (1.50)	33.0 (1.30)	41.1 (1.62)	TMC2-125162A	TMC2-125162NB	TMC2-125162SS
-	1-1/2"					TMC2-150162A	TMC2-150162NB	TMC2-150162SS
1-1/4"	-	37.8 (1.49)	43.7 (1.72)	39.9 (1.57)	48.3 (1.90)	TMC2-125190A	TMC2-125190NB	TMC2-125190SS
-	1-1/2"					TMC2-150190A	TMC2-150190NB	TMC2-150190SS
1-1/2"	-	39.9 (1.57)	47.8 (1.88)	41.9 (1.65)	50.8 (2.00)	TMC2-150200A	TMC2-150200NB	TMC2-150200SS
-	2"					TMC2-200200A	TMC2-200200NB	TMC2-200200SS
1-1/2"	-	45.5 (1.79)	56.1 (2.21)	48.5 (1.91)	59.2 (2.33)	TMC2-150233A	TMC2-150233NB	TMC2-150233SS
-	2"					TMC2-200233A	TMC2-200233NB	TMC2-200233SS
2"	-	54.4 (2.14)	66.3 (2.61)	57.7 (2.27)	69.1 (2.72)	TMC2-200272A	TMC2-200272NB	TMC2-200272SS
-	2-1/2"					TMC2-250272A	TMC2-250272NB	TMC2-250272SS
3"	-	63.2 (2.49)	75.4 (2.97)	66.5 (2.62)	82.6 (3.25)	TMC2-300325A	TMC2-300325NB	TMC2-300325SS
-	3-1/2"					TMC2-350325A	TMC2-350325NB	TMC2-350325SS
3-1/2"	-	74.9 (2.95)	89.9 (3.54)	80.3 (3.16)	95.5 (3.76)	TMC2-350376A	TMC2-350376NB	TMC2-350376SS
-	4"					TMC2-400376A	TMC2-400376NB	TMC2-400376SS
4"	-	89.4 (3.52)	100.1 (3.94)	94.0 (3.70)	108.0 (4.25)	TMC2-400425A	TMC2-400425NB	TMC2-400425SS

① Stainless steel is priced by quote only. Contact your factory representative for assistance.

② Where explosionproof enclosures are being used the TMC2 must be installed in conjunction with an approved pouring or compound sealing fitting. In Division 2 areas the TMC2 can be fitted directly to an enclosure which has no source of ignition in accordance with NEC/CEC requirements.

TMC2 Connectors For Jacketed Metal Clad Cable

NEC/CEC:

Class I, Division 2, Groups A, B, C, D ②
 Class I, Zones 1 and 2, AExe II AEx tA IIC
 Class I, Zones 1 and 2, Exe II Ex tA IIC
 Class II, Divisions 1 and 2, Groups E, F, G
 Class III, Divisions 1 and 2

NEC/CEC:

NEMA 4X
 IP66

Size Ranges

- Trade sizes 1/2" thru 4"
- Cable Jacket Diameter Range: 0.50" thru 4.25"
- Cable Armor Diameter Range: 0.42 thru 3.94"

NEC/CEC Certifications and Compliances

- UL Standards: UL 514B, UL 2225
- CSA Standard: C22.2 No. 174
- cCSAus Certified: 184585

Options

- Metric threads available. Add metric thread size to catalog number, i.e. TMC2-050075A-M20



Dimensions in Millimeters (Inches)

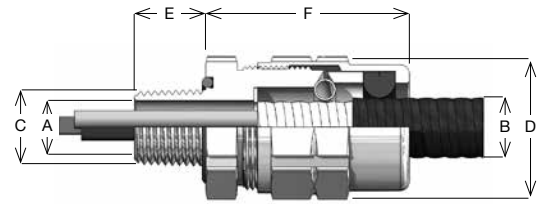

Entry Thread C		Minimum Thread Length mm (in) E	Across Flats mm (in) D	Across Corners mm (in) D	Nominal Assembly Length mm (in) F	Optional PVC Shroud	Cable Gland Weight kg (oz)
NPT	NPT Option						
1/2"	-	20.3 (0.80)	30.5 (1.20)	33.0 (1.30)	41.9 (1.65)	PVC06	0.06 (2.29)
-	3/4"	19.8 (0.78)					
1/2"	-	20.3 (0.80)	37.6 (1.48)	40.6 (1.60)	50.0 (1.97)	PVC09	0.09 (3.00)
-	3/4"	20.1 (0.79)					
3/4"	-	24.9 (0.98)	46.0 (1.81)	49.5 (1.95)	54.1 (2.13)	PVC11	0.14 (5.11)
-	1"	24.9 (0.98)					
1"	-	25.4 (1.00)	52.1 (2.05)	56.1 (2.21)	59.4 (2.34)	PVC15	0.19 (6.70)
-	1-1/4"	25.4 (1.00)					
1-1/4"	-	26.9 (1.06)	59.9 (2.36)	64.8 (2.55)	62.0 (2.44)	PVC18	0.25 (8.82)
-	1-1/2"	26.2 (1.03)					
1-1/4"	-	26.9 (1.06)	65.0 (2.56)	70.1 (2.76)	62.0 (2.44)	PVC37	0.27 (9.45)
-	1-1/2"	26.9 (1.06)					
1-1/2"	-	39.9 (1.57)	69.9 (2.75)	75.4 (2.97)	66.0 (2.60)	PVC21	0.31 (11.06)
-	2"	26.9 (1.06)					
1-1/2"	-	39.9 (1.57)	74.9 (2.95)	81.0 (3.19)	67.1 (2.64)	PVC23	0.36 (12.77)
-	2"	39.9 (1.57)					
2"	-	39.9 (1.57)	89.9 (3.54)	97.0 (3.82)	70.1 (2.76)	PVC28	0.70 (24.69)
-	2-1/2"	41.4 (1.63)					
3"	-	42.7 (1.68)	110.0 (4.33)	118.9 (4.68)	87.9 (3.46)	PVC32	1.21 (42.68)
-	3-1/2"	42.7 (1.68)					
3-1/2"	-	43.9 (1.73)	122.9 (4.84)	132.8 (5.23)	93.5 (3.68)	LSF33	1.51 (53.44)
-	4"	43.9 (1.73)					
4"	-	43.9 (1.73)	132.8 (5.23)	143.5 (5.65)	98.8 (3.89)	LSF34	1.68 (59.19)

② Where explosionproof enclosures are being used the TMC2 must be installed in conjunction with an approved pouring or compound sealing fitting. In Division 2 areas the TMC2 can be fitted directly to an enclosure which has no source of ignition in accordance with NEC/CEC requirements.

TMCX Connectors For Jacketed Metal Clad Cable

Explosionproof, Dust-Ignitionproof

TMCX For Hazardous Locations.

NEC/CEC:

Class I, Division 1 and 2, Groups A, B, C, D
 Class I, Zone 1, AExd IIC
 Class II, Division 1 and 2, Groups E, F, G
 Class III
 NEMA 4X

NEC/CEC:

IP66

Applications

- TMC connectors are designed for use with the following cables:
 - MC/MCHL
 - Corrugated Interlocked Aluminium/Steel Armor
 - Continuously Welded Armor Cables
 - E.g. TECK or CLX
- Provide a means for terminating jacketed type MC cable, forming a mechanical watertight connection and providing ground continuity for cable armor.
- For use on horizontal or vertical runs.

Features

- Independent sealing and armor clamping.
- True 360° grounding.
- Superior pull out prevention.
- Compact slim profile.
- Widest cable acceptance range.
- Supplied complete with epoxy sealing compound.
- Disconnectable design.
- Additional integral deluge proof seal for protection in extreme offshore and onshore environments.

Size Ranges

- Trade sizes: 1/2" thru 4".
- Cable Jacket Diameter Range: 0.354" thru 4.220"
- Cable Armor Diameter Range: 0.342" thru 4.020"

Standard Materials

- Bodies, sleeve and gland nut: copperfree (4/10 of 1% max.) aluminum, nickel plated brass, stainless steel
- Grounding spring: stainless steel
- Bushing: LSF-TPE (halogen-free)
- Stop and slip washers: nylon
- O-ring: Viton

Options

- Metric threads available. Add metric thread size to the end of the catalog number, i.e. TMCX-050A-**M20**.
- Stainless steel available. Contact your local representative for price and availability.

NEC/CEC Certifications and Compliances

- UL Standard: 2225, 514B
- UL Listed: 83827
- CSA Standard: C22.2 No. 174
- cCSAus Certified: 025875, 249506

HAZARDOUS LOCATION FITTINGS: NEC/CEC MC CONNECTORS

Entry Thread A		Cable Armor Diameter mm (in) C				Cable Jacket Diameter mm (in) D			Catalog Number	
NPT	Metric	End Stop In		End Stop Out		Min	Max	Aluminum	NP Brass	
		Min	Max	Min	Max					
1/2S	M20	—	—	8.6 (0.34)	12.7 (0.50)	8.70 (0.35)	13.8 (0.55)	TMCX050SA	TMCX050SNB	
1/2	M20	—	—	12.9 (0.51)	16.9 (0.67)	13.9 (0.55)	19.9 (0.79)	TMCX050A	TMCX050NB	
3/4	M25	15.0 (0.59)	19.3 (0.76)	19.3 (0.76)	23.2 (0.92)	19.9 (0.67)	26.2 (1.04)	TMCX075A	TMCX075NB	
1	M32	20.9 (0.83)	24.6 (0.97)	24.6 (0.97)	29.2 (1.15)	23.1 (0.91)	32.2 (1.27)	TMCX100A	TMCX100NB	
1-1/4	M40	27.5 (1.08)	31.1 (1.23)	31.1 (1.23)	35.2 (1.39)	29.4 (1.16)	38.2 (1.50)	TMCX125A	TMCX125NB	
1-1/2	M50	33.5 (1.32)	37.1 (1.46)	37.1 (1.46)	41.0 (1.62)	35.6 (1.40)	44.0 (1.74)	TMCX150A	TMCX150NB	
2S	M50	38.3 (1.51)	42.5 (1.68)	42.5 (1.68)	47.0 (1.85)	40.1 (1.58)	51.0 (2.07)	TMCX200SA	TMCX200SNB	
2	M63	45.0 (1.77)	49.0 (1.93)	49.0 (1.93)	53.0 (2.09)	47.1 (1.86)	56.0 (2.21)	TMCX200A	TMCX200NB	
2-1/2S	M63	52.1 (2.05)	54.8 (2.16)	54.8 (2.16)	58.9 (2.32)	52.8 (2.08)	26.0 (2.44)	TMCX250SA	TMCX250SNB	
2-1/2	M75	57.0 (2.25)	61.1 (2.41)	61.1 (2.41)	64.6 (2.55)	59.1 (2.33)	67.9 (2.68)	TMCX250A	TMCX250NB	
3	M90	64.5 (2.54)	70.5 (2.78)	70.5 (2.78)	75.3 (2.97)	66.5 (2.62)	79.4 (3.13)	TMCX300A	TMCX300NB	
3-1/2	M100	73.9 (2.91)	83.5 (3.29)	83.5 (3.29)	88.5 (3.49)	75.9 (2.99)	97.2 (3.83)	TMCX350A	TMCX350NB	

TMCX Connectors For Jacketed Metal Clad Cable

Explosionproof, Dust-Ignitionproof

TMCX For Hazardous Locations.

NEC/CEC:

Class I, Division 1 and 2, Groups A, B, C, D
 Class I, Zone 1, AExd IIC
 Class II, Division 1 and 2, Groups E, F, G
 Class III
 NEMA 4X

NEC/CEC:

IP66



Dimensions in Millimeters (Inches)

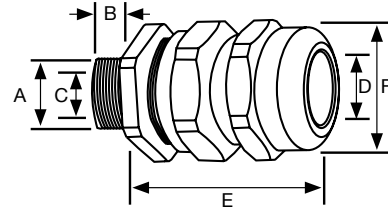

Entry Thread A		Minimum Thread Length mm (in) B	Nominal Assembly Length mm (in) E	Envelope Diameter mm (in) F	Compound Weight (Ounces)	Compound Supplied (Grams)	PVC Shroud Reference	Replacement Compound	Quantity Each	Cable Gland Weight kg (oz)
NPT (Inches)	Metric									
1/2S	M20	15.0 (0.59)	55.8 (2.20)	33.2 (1.31)	0.5	15	PVC09	LTCOMP15	1	0.22 (7.90)
1/2	M20	15.0 (0.59)	55.8 (2.20)	39.8 (1.57)	0.5	15	PVC09		1	0.28 (9.91)
3/4	M25	15.0 (0.59)	55.8 (2.20)	45.4 (1.79)	1.2	35	PVC10	LTCOMP35	1	0.33 (11.61)
1	M32	16.0 (0.63)	56.8 (2.24)	55.3 (2.18)	1.2	35	PVC13	LTCOMP35	1	0.50 (17.53)
1-1/4	M40	16.0 (0.63)	56.8 (2.24)	60.9 (2.40)	2	55	PVC16	LTCOMP55	1	0.59 (20.92)
1-1/2	M50	16.0 (0.63)	60.1 (2.37)	66.5 (2.62)	3.2	90	PVC18	LTCOMP90	1	0.69 (24.45)
2S	M50	16.0 (0.63)	66.0 (2.60)	77.7 (3.06)	3.2	90	PVC21	LTCOMP90	1	1.20 (42.33)
2	M63	16.0 (0.63)	71.3 (2.81)	83.3 (3.28)	4.8	135	PVC24	LTCOMP135	1	1.10 (38.80)
2-1/2S	M63	22.8 (0.90)	73.1 (2.88)	88.6 (3.49)	9.5	270	PVC25	LTCOMP270	1	1.70 (59.97)
2-1/2	M75	22.8 (0.90)	73.1 (2.88)	94.2 (3.71)	9.5	270	PVC27	LTCOMP270	1	1.60 (56.48)
3	M90	24.8 (0.98)	99.6 (3.92)	121.9 (4.80)	14.3	405	PVC32	LTCOMP135 LTCOMP270	1	3.50 (123.46)
3-1/2	M100	36.4 (1.44)	117.0 (4.61)	147.8 (5.82)	19	540	-	LTCOMP270	2	6.70 (236.34)

HAZARDOUS LOCATION FITTINGS: NEC/CEC MC CONNECTORS



737 Series Adaptors and Reducers

Increased Safety and Flameproof

Cable Gland Accessories.

NEC/CEC:
Class 1, Group A, B, C, D
Zone 1, AEx de II
IP66/68 ①

ATEX/IECEX:
Zone 1 and 2 – 21 and 22
II 2 GD
IP66/68 ①

Applications

- A wide range of thread conversion adaptors and reducers for hazardous area applications. Used to connect cable entry devices and equipment having dissimilar threads.
- Care should be taken to ensure that a suitable sealing gasket is also selected and installed, where applicable, to ensure that an effective seal is made at the entry, thereby maintaining the integrity of the enclosure or equipment IP rating.



Features

- Triple Certification Ex d/Ex e/Ex nR.

Standard Materials

- Nickel plated brass

Options

- Copper-free aluminum: replace last digit 5 with 1
- Brass version: remove last digit 5
- 316L stainless steel version: replace last digit 5 with 4
- Shroud, locknut, earth tag, entry thread seal, serrated washers, adaptors and reducers: see *Cable Gland Accessories* pages.

NEC/CEC Certifications and Compliances

- UL Standard: 886 (1203), E60079-0, E60079-1, E60079-7
- CSA Standard: C22.2 No. 30, CAN/CSA E60079-0, CAN/CSA E60079-1, CAN/CSA E60079-7
- cCSAus Certified: 113642

ATEX/IECEX Certifications and Compliances

- Certification Type 737
 - Gas: Zones 1
 - Type of Protection: Ex d IIC Gb, Ex e IIC Gb
 - Dust: Zone 20
 - Type of Protection: Ex ta IIC Da
- Conforming to ATEX 94/9/CE: II 2G 1D
- Operating Temperature: -60 °C to +200 °C (-76 °F to +392 °F) (Metallic)
- CE Declaration of Conformity: DC07001
- ATEX Certificate: Sira 13ATEX1265X
- IECEX Certificate: IECEX SIR 13.0094X
- Other Certifications: UL, cCSAus
- Marine Approval: LLOYDS, DNV, ABS
- Index of Protection according EN/IEC 60529: IP66, IP67, IP68 (when fitted with seal)

EURASEC Certification

- TC RU C-GB.Г505.B.00138

Catalog Numbering Guide

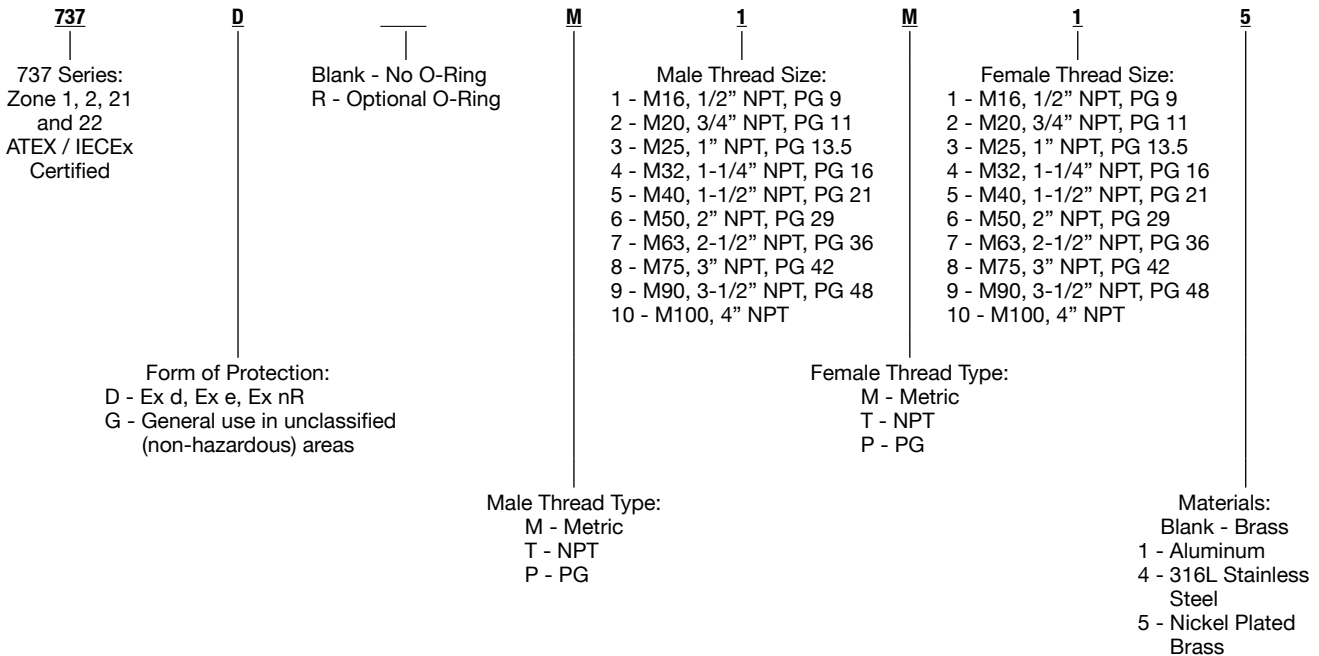

① IP68 with entry thread seal or O-Ring not supplied, see *Cable Gland Accessories and Tools*.

737 Series Adaptors and Reducers

Increased Safety and Flameproof

Cable Gland Accessories.

NEC/CEC:
Class 1, Group A, B, C, D
Zone 1, AEx de II
IP66/68 ①

ATEX/IECEx:
Zone 1 and 2 – 21 and 22
Ⓜ II 2 GD
IP66/68 ①

Size	Male Thread										Female Thread																			
	M16	M20	M25	M32	M40	M50	M63	M75	PG7	PG9	PG11	PG13.5	PG16	PG21	PG29	PG36	PG42	PG48	1/2" NPT/NPS (M)	3/4" NPT/NPS (M)	1" NPT/NPS (M)	1-1/4" NPT/NPS (M)	1-1/2" NPT/NPS (M)	2" NPT/NPS (M)	2-1/2" NPT/NPS (M)	3" NPT/NPS (M)	3-1/2" NPT/NPS (M)	4" NPT/NPS (M)		
M16	█	█																	█											
M20		█	█																											
M25			█	█																										
M32				█	█																									
M40					█	█																								
M50						█	█																							
M63							█	█																						
M75								█	█																					
PG7	█								█	█																				
PG9		█								█	█																			
PG11			█								█	█																		
PG13.5				█								█	█																	
PG16					█								█	█																
PG21						█								█	█															
PG29							█								█	█														
PG36								█								█	█													
PG42									█								█	█												
PG48										█								█	█											
1/2" NPT/NPS (M)																			█	█										
3/4" NPT/NPS (M)																					█	█								
1" NPT/NPS (M)																						█	█							
1-1/4" NPT/NPS (M)																							█	█						
1-1/2" NPT/NPS (M)																								█	█					
2" NPT/NPS (M)																									█	█				
2-1/2" NPT/NPS (M)																										█	█			
3" NPT/NPS (M)																												█	█	
3-1/2" NPT/NPS (M)																													█	█
4" NPT/NPS (M)																														█

█ Ex d/Ex e reducer █ Ex d/Ex e adaptor □ Non-certified adaptor

Thread Table

	Metric ①	NPT	PG
1	M16	1/2"	PG9
2	M20	3/4"	PG11
3	M25	1"	PG13.5
4	M32	1-1/4"	PG16
5	M40	1-1/2"	PG21
6	M50	2"	PG29
7	M63	2-1/2"	PG36
8	M75	3"	PG42
9	M90	3-1/2"	PG48
10	M100	4"	-

① IP68 with entry thread seal or O-Ring (not supplied), see Cable Gland Accessories and Tools.

737 Series Adaptors and Reducers

Increased Safety and Flameproof

Cable Gland Accessories.

NEC/CEC:
Class 1, Group A, B, C, D
Zone 1, AEx de II
IP66/68 ①

ATEX/IECEX:
Zone 1 and 2 – 21 and 22
II 2 GD
IP66/68 ①

Appleton

HAZARDOUS LOCATION FITTINGS: CABLE GLAND ACCESSORIES AND TOOLS

Reducers (Nickel Plated Brass)

Male Thread	Female Thread	Catalog Number
M20	M16	737DM2M15
M25	M16	737DM3M15
M25	M20	737DM3M25
M32	M20	737DM4M25
M32	M25	737DM4M35
M40	M25	737DM5M35
M40	M32	737DM5M45
M50	M32	737DM6M45
M50	M40	737DM6M55
M63	M40	737DM7M55
M63	M50	737DM7M65
M75	M50	737DM8M65
M75	M63	737DM8M75
1/2	3/4	737DT1T25
3/4	1/2	737DT2T15
1	1/2	737DT3T15
1	3/4	737DT3T25
1-1/4	3/4	737DT4T25
1-1/4	1	737DT4T35
1-1/2	1	737DT5T35
1-1/2	1-1/4	737DT5T45
2	1-1/4	737DT6T45
2	1-1/2	737DT6T55
2-1/2	1-1/2	737DT7T55
2-1/2	2	737DT7T65
3	2	737DT8T65
3	2-1/2	737DT8T75
3-1/2	2-1/2	737DT9T75
3-1/2	3	737DT9T85
4	3	737DT10T85
4	3-1/2	737DT10T95

Adapters (Nickel Plated Brass)

Male Thread	Female Thread	Catalog Number
M16	M20	737DM1M25
M20	M25	737DM2M35
M25	M32	737DM3M45
M32	M40	737DM4M55
M40	M50	737DM5M65
M50	M63	737DM6M75
M63	M75	737DM7M85
M75	M90	737DM8M95
M90	M100	737DM9M105
M16	1/2	737DM1T15
M20	1/2	737DM2T15
M20	3/4	737DM2T25
M25	3/4	737DM3T25
M25	1	737DM3T35
M32	1	737DM4T35
M32	1-1/4	737DM4T45
M40	1-1/4	737DM5T45
M40	1-1/2	737DM5T55
M50	1-1/2	737DM6T55
M50	2	737DM6T65
M63	2	737DM7T65
M63	2-1/2	737DM7T75
M75	2-1/2	737DM8T75
M75	3	737DM8T85
1/2	M20	737DT1M25
3/4	M20	737DT2M25
3/4	M25	737DT2M35
1	M25	737DT3M35
1	M32	737DT3M45
1-1/4	M32	737DT4M45
1-1/4	M40	737DT4M55
1-1/2	M40	737DT5M55
1-1/2	M50	737DT5M65
2	M50	737DT6M65
2	M63	737DT6M75
2-1/2	M63	737DT7M75
2-1/2	M75	737DT7M85
3	M75	737DT8M85

① IP68 with entry thread seal or O-Ring not supplied, see Cable Gland Accessories and Tools.

747 Series Stopper Plugs

Flameproof

Cable Gland Accessories.

NEC/CEC:
 Class I, Groups A, B, C, D
 Class II, Groups E, F, G
 Class III
 Type 4X; Ex d II
 IP68

ATEX/IECEx:
 Ⓢ II 2 GD Ex d IIC and Ex e II
 Zone 1, Zone 2, Zone 21 and Zone 22 - Gas
 Groups IIA, IIB, IIC
 Ⓢ IM 2 Ex d I and Ex e I
 IP66/68

Applications

- Stopper plug is designed for use from the outside of the enclosure to permanently or temporarily close any unused entries.
- Idea for use on flameproof electrical equipment in hazardous areas.
- In general, care should be taken to ensure that a suitable entry thread sealing washer is also selected and installed, where applicable, to ensure that an effective seal is made at the entry, thereby maintaining the integrity of the enclosure or equipment I.P. rating.

Features

- Catering to both Industrial and Hazardous Area applications the range covers a number of different metallic and non-metallic (e.g. Nylon) forms.
- Compensating Displacement Seal (CDS) system allows for use with Restricted Breathing equipment.
- Available with both external (Type A) or internal (Type B) Allen Key design.
- Internal Allen Key design is considered tamper proof. Once the equipment has been de-energized and the terminal chamber cover removed it can be removed from the inside.

Standard Materials

- Brass fully nickel plated

Options

- Copper-free aluminum: replace suffix -5 with 1
- 316L stainless steel: replace suffix -5 with 4
- Nylon: replace suffix -5 with 2

NEC/CEC Certifications and Compliances

- UL Standard: 886 (1203), E60079-0, E60079-1, E60079-7



- CSA Standard: C22.2 No. 30, CAN/CSA E60079-0, CAN/CSA E60079-1, CAN/CSA E60079-7
- cCSAus Certified: 113642

ATEX/IECEx Certifications and Compliances

- Certification Type 747
 - Gas: Zones 1
 - Type of Protection: Ex d IIC Gb (except Nylon), Ex e IIC Gb
 - Dust: Zone 20
 - Type of Protection: Ex ta IIC Da
- Conforming to ATEX 94/9/CE: Ⓢ II 2G 1D
- Operating Temperature: -60 °C to +200 °C (-76 °F to +392 °F) (Metallic) and -20 °C to +60 °C (-4 °F to +140 °F) (Nylon)
- CE Declaration of Conformity: DC07001
- ATEX Certificate: Sira 13ATEX1265X
- IECEx Certificate: IECEx SIR 13.0094X
- Other Certifications: UL, cCSAus
- Marine Approval: LLOYDS, DNV, ABS
- Index of Protection according EN/IEC 60529: IP66

INMETRO Certification

- INMETRO Certificate: TÜV 12.1333X

EURASEC Certification

- TC RU C-GB.Г505.В.00138

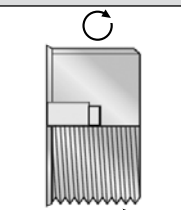
	A/F Socket in mm	Male Thread Size	Thread Length mm (in)	Nickel Plated Brass Catalog Number
 Ex 'd' Recessed Stopper Plug Type 'A'	8	M16	10.0 (0.394)	747DAM15
		M20	10.0 (0.394)	747DAM25
	10	M25	10.0 (0.394)	747DAM35
		M32	10.0 (0.394)	747DAM45
	10	M40	10.0 (0.394)	747DAM55
		M50	10.0 (0.394)	747DAM65
	10	M63	10.0 (0.394)	747DAM75
		M75	10.0 (0.394)	747DAM85
	10	M90	10.0 (0.394)	747DAM95
		1/2 NPT	10.0 (0.394)	747DAT15
	10	3/4 NPT	10.0 (0.394)	747DAT25
		1 NPT	10.0 (0.394)	747DAT35
	14	1-1/4 NPT	10.0 (0.394)	747DAT45
		1-1/2 NPT	10.0 (0.394)	747DAT55
	14	2 NPT	10.0 (0.394)	747DAT65
		2-1/2 NPT	10.0 (0.394)	747DAT75
		3 NPT	10.0 (0.394)	747DAT85

757 Series Blanking Plugs

Increased Safety and Flameproof

Cable Gland Accessories.

NEC/CEC:
Class I, Groups A, B, C, D
Class II, Groups E, F, G
Class III
Zone 1 AEx de II
Type 4X, Ex e II
IP68

ATEX/IECEx:
Ⓢ II 2 GD Ex d IIC and Ex e II
Zone 1, Zone 2, Zone 21 and Zone 22 - Gas
Groups IIA, IIB, IIC
Ⓢ IM 2 Ex d I and Ex e I
IP66/68

Applications

- Blanking plugs are designed for use from the outside of the enclosure to permanently or temporarily close any unused entries.
- Idea for use on flameproof, increased safety electrical equipment in hazardous areas.
- In general, care should be taken to ensure that a suitable entry thread sealing washer is also selected and installed, where applicable, to ensure that an effective seal is made at the entry, thereby maintaining the integrity of the enclosure or equipment I.P. rating.



Features

- Catering to hazardous area applications, the range of products covers a number of different design types which are supplied in both metal and plastic (Exe only).
- Triple certification Ex d/Ex e/Ex nR.
- Hexagon head allows for the installation or remove of the plug with either an open ended or ring type spanner or wrench.

Standard Materials

- Nickel plated brass

Options

- Copper-free aluminum: replace suffix -5 with 1
- Brass version: remove last digit 5
- 316L stainless steel version: replace last digit 5 with 4
- Plastic (see BVE series)

Optional Accessories

- Shroud, locknut, earth tag, entry thread seal, serrated washers, adaptors and reducers: see *Cable Gland Accessories* pages.

NEC/CEC Certifications and Compliances

- UL Standard: E60079-0, E60079-1, E60079-7
- CSA Standard: CAN/CSA E60079-0, CAN/CSA E60079-1, CAN/CSA E60079-7
- cCSAus Certified: 113642

ATEX/IECEx Certifications and Compliances

- Certification Type 757
 - Gas: Zones 1
 - Type of Protection: Ex d IIC Gb, Ex e IIC Gb
 - Dust: Zone 20
 - Type of Protection: Ex ta IIIC Da
- Conforming to ATEX 94/9/CE: Ⓢ II 2G 1D
- Operating Temperature: -60 °C to +200 °C (-76 °F to +392 °F) (Metallic)
- CE Declaration of Conformity: DC07001
- ATEX Certificate: Sira 13ATEX1265X
- IECEx Certificate: IECEx SIR 13.0094X
- Other Certifications: UL, cCSAus
- Marine Approval: LLOYDS, DNV, ABS
- Index of Protection according EN/IEC 60529: IP66 or IP68 with seal

INMETRO Certification

- INMETRO Certificate: TÜV 12.1333X

EURASEC Certification

- TC RU C-GB.Г505.B.00138

Dimensions in Millimeters (Inches)

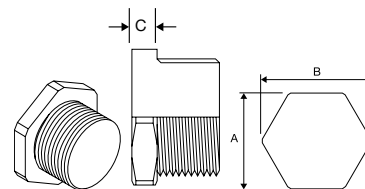

① IP68 with entry thread seal or O-Ring not supplied, see *Cable Gland Accessories and Tools*.

757 Series Blanking Plugs

Increased Safety and Flameproof

Cable Gland Accessories.

NEC/CEC:
 Class I, Groups A, B, C, D
 Class II, Groups E, F, G
 Class III
 Zone 1 AEx de II,
 Type 4X, Ex e II
 IP68

ATEX/IECEX:
 ATEX [Ⓢ] II 2 GD Ex d IIC and Ex e II
 Zone 1, Zone 2, Zone 21 and Zone 22 - Gas
 Groups IIA, IIB, IIC
[Ⓢ] IM 2 Ex d I and Ex e I
 IP66/68

Catalog Numbering Guide

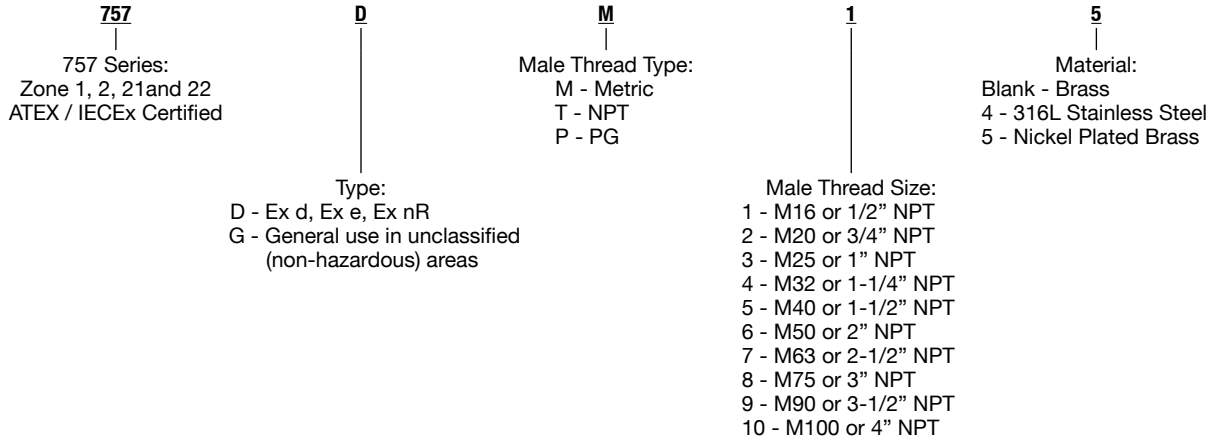

Dimensions in Millimeters (Inches)

Flats A	Corners B	C	Catalog Numbers (Nickel Plated Brass)		Weight kg (lb)		
			Metric [Ⓢ]	NPT			
24.0 (0.94)	26.0 (1.02)	5.0 (0.20)	M16 x 1.5	757DM15	1/2	757DT15	0.05 (0.11)
24.0 (0.94)	26.0 (1.02)	5.0 (0.20)	M20 x 1.5	757DM25	3/4	757DT25	0.07 (0.15)
30.0 (1.18)	33.0 (1.30)	5.0 (0.20)	M25 x 1.5	757DM35	1	757DT35	0.10 (0.22)
36.0 (1.42)	40.0 (1.57)	5.0 (0.20)	M32 x 1.5	757DM45	1-1/4	757DT45	0.16 (0.35)
46.0 (1.81)	51.0 (2.01)	6.0 (0.24)	M40 x 1.5	757DM55	1-1/2	757DT55	0.32 (0.71)
55.0 (2.17)	61.0 (2.40)	6.0 (0.24)	M50 x 1.5	757DM65	2	757DT65	0.42 (0.93)
70.0 (2.76)	78.0 (3.07)	6.0 (0.24)	M63 x 1.5	757DM75	2-1/2	757DT75	0.63 (1.39)
80.0 (3.15)	89.0 (3.50)	6.0 (0.24)	M75 x 1.5	757DM85	3	757DT85	0.98 (2.16)
95.0 (3.74)	106.0 (4.17)	6.0 (0.24)	M90 x 2	757DM95	3-1/2	757DT95	1.35 (2.98)
110.0 (4.33)	123.0 (4.84)	6.0 (0.24)	M100 x 2	757DM105	4	757DT105	1.60 (3.53)

Thread Table

	Metric	NPT	PG
1	M16	1/2	PG9
2	M20	3/4	PG11
3	M25	1	PG13.5
4	M32	1-1/4	PG16
5	M40	1-1/2	PG21
6	M50	2	PG29
7	M63	2-1/2	PG36
8	M75	3	PG42
9	M90	3-1/2	PG48
10	M100	-	-

[Ⓢ] IP68 with entry thread seal or O-Ring not supplied, see Cable Gland Accessories and Tools.

[Ⓢ] Entry thread seal not supplied, see Cable Gland Accessories and Tools.

757 BVE Series Blanking Plugs

Increased Safety

Cable Gland Accessories.

NEC/CEC:
 Class I, Groups A, B, C, D
 Class II, Groups E, F, G
 Class III
 Ex e II, Class I, Zone 1
 AEx e II; IP66, 67, 68

ATEX/IECEx:
 Zone 1 and 2 – 21 and 22
 Ⓜ II 2 GD
 IP66

Applications

- A comprehensive range of plastic blanking plugs designed to close any unused entries in electrical equipment.
- Entry thread sealing washer supplied.

Features

- Catering to hazardous areas, the range covers all metric threads from M16 to M50.
- Certification Ex e.

Standard Materials

- Nylon

NEC/CEC Certifications and Compliances

- UL Standard: 886 (1203), E60079-0, E60079-1, E60079-7
- CSA Standard: C22.2 No. 30, CAN/CSA E60079-0, CAN/CSA E60079-1, CAN/CSA E60079-7
- cCSAus Certified: 113642

ATEX/IECEx Certifications and Compliances

- Certification Type BVe
 - Gas: Zones 1 and 2
 - Type of Protection: Ex e II
 - Dust: Zone 21 and 22
 - Type of Protection: Ex tD
- Conforming to ATEX 94/9/CE: Ⓜ II 2GD
- Ambient Temperature: -40 °C to +55 °C (-40 °F to +131 °F)
- CE Declaration of Conformity: 5C218
- ATEX Certificate: LCIE 03 ATEX 0011U
- IECEx Certificate: IECEx LCI 04.0027U
- Index of Protection according EN/IEC 60529: IP66

INMETRO Certification

- INMETRO Certificate: BVC 11.0600-U



Dimensions in Millimeters (Inches)

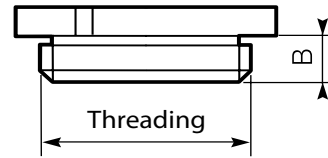

Dimensions mm (in)	Metric	Weight kg (lbs)	Volume dm ³ (in ³)	Catalog Number
B				
–	M16	0.10 (0.22)	0.03 (1.83)	095485
12.0 (0.47)	M20	0.10 (0.22)	0.03 (1.83)	095714
12.0 (0.47)	M25	0.10 (0.22)	0.03 (1.83)	095715
12.0 (0.47)	M32	0.10 (0.22)	0.03 (1.83)	095486
12.0 (0.47)	M40	0.10 (0.22)	0.07 (4.27)	095487
–	M50	0.20 (0.44)	0.07 (4.27)	095488

767 Series Stopper Plugs

Increased Safety and Flameproof

Cable Gland Accessories.

NEC/CEC:
 Class I, Groups A, B, C, D
 Class II, Groups E, F, G
 Class III
 Ex d/Ex e IIC
 Type 4X
 IP68

ATEX/IECEX:
 ATEX II 2 GD Ex d IIC and Ex e II
 Zone 1, Zone 2, Zone 21 and Zone 22 - Gas
 Groups IIA, IIB, IIC
 ATEX IM 2 Ex d I and Ex e I
 IP66/68

Applications

- Stopper plug is designed for use from the outside of the enclosure to permanently or temporarily close any unused entries.
- Idea for use on flameproof, increased safety electrical equipment in hazardous areas.
- In general, care should be taken to ensure that a suitable entry thread sealing washer is also selected and installed, where applicable, to ensure that an effective seal is made at the entry, thereby maintaining the integrity of the enclosure or equipment I.P. rating.

Features

- Catering to both Industrial and Hazardous Area applications the range covers a number of different metallic and non-metallic (e.g. Nylon) forms.
- Features a dome head with an Allen Key.

Standard Materials

- Brass fully nickel plated

Options

- Copper-free aluminum: replace suffix -5 with 1
- 316L stainless steel: replace suffix -5 with 4
- Nylon: replace suffix -5 with 2

NEC/CEC Certifications and Compliances

- UL Standard: 886 (1203), E60079-0, E60079-1, E60079-7
- CSA Standard: C22.2 No. 30, CAN/CSA E60079-0, CAN/CSA E60079-1, CAN/CSA E60079-7
- cCSAus Certified: 113642



ATEX/IECEX Certifications and Compliances

- Certification Type 767
 - Gas: Zones 1
 - Type of Protection: Ex d IIC Gb (except Nylon), Ex e IIC Gb
 - Dust: Zone 20
 - Type of Protection: Ex ta IIIC Da
- Conforming to ATEX 94/9/CE: II 2G 1D
- Operating Temperature: -60 °C to +200 °C (-76 °F to +392 °F) (Metallic) and -20 °C to +60 °C (-4 °F to +140 °F) (Nylon)
- CE Declaration of Conformity: DC07001
- ATEX Certificate: Sira 13ATEX1265X
- IECEx Certificate: IECEx SIR 13.0094X
- Marine Approval: LLOYDS, DNV, ABS
- Index of Protection according EN/IEC 60529: IP66 or IP68 with seal

INMETRO Certification

- INMETRO Certificate: TÜV 12.1333X

EURASEC Certification

- TC RU C-GB.Г505.B.00138

Plug Size	A/F Socket in mm	767 Series Male Thread Size	Catalog Number	
			Nickel Plated Brass	Nylon
—	8	M16	767DM15	N767ERM12
		M20	767DM25	N767ERM22
M16	10	M25	767DM35	N767ERM32
		M32	767DM45	N767ERM42
M20	10	M40	767DM55	N767ERM52
		M50	767DM65	N767ERM62
M25	10	M63	767DM75	N767ERM72
		M75	767DM85	N767ERM82
M32	10	M90	767DM95	N767ERM92
		1/2"NPT	767DT15	N767ERT12
M50	10	3/4"NPT	767DT25	N767ERT22
		1"NPT	767DT35	N767ERT32
M63	14	1-1/4"NPT	767DT45	N767ERT42
		1-1/2"NPT	767DT55	N767ERT52
M75	14	2"NPT	767DT65	N767ERT62
		2-1/2"NPT	767DT75	N767ERT72
		3"NPT	767DT85	N767ERT82

Optional 'O' Ring ①

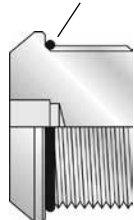

Mushroom Head Stopper Plug

① For optional O-Ring, change **D** to **DR** in catalog number. Contact your factory representative for price and availability.

Cable Gland Accessories and Tools

Description	Box Quantity	Metric Catalog Number	Description	Box Quantity	NPT Catalog Number
-------------	--------------	-----------------------	-------------	--------------	--------------------

Locknuts – Nickel Plated Brass

- Brass locknuts are recommended for use in securing brass cable glands to a gland plate or into equipment.



M16	100	16LN5	050NPT	100	050NPTLN5
M20	100	20LN5	075NPT	100	075NPTLN5
M25	100	25LN5	100NPT	50	100NPTLN5
M32	50	32LN5	125NPT	50	125NPTLN5
M40	50	40LN5	150NPT	10	150NPTLN5
M50	10	50LN5	200NPT	5	200NPTLN5
M63	5	63LN5	250NPT	5	250NPTLN5
M75	5	75LN5	300NPT	1	300NPTLN5
M90	1	90LN5	350NPT	1	350NPTLN5
M100	1	100LN5	—	—	—

Earth Tags – Pear (Nickel Plated Brass)

- Installed between the cable gland and equipment. Provide an earth bond connection as specified in BS 6121 : Part 5 : 1993.



M16	100	16ET5	050NPT	100	050NPTET5
M20	100	20ET5	075NPT	100	075NPTET5
M25	100	25ET5	100NPT	50	100NPTET5
M32	50	32ET5	125NPT	50	125NPTET5
M40	50	40ET5	150NPT	10	150NPTET5
M50	10	50ET5	200NPT	5	200NPTET5
M63	5	63ET5	250NPT	5	250NPTET5
M75	5	75ET5	300NPT	1	300NPTET5
M90	1	90ET5	350NPT	1	350NPTET5
M100	1	100ET5	—	—	—

Cable Gland Accessories and Tools

Serrated Washers – Stainless Steel

- Available in plated steel or stainless steel as standard, these "shake-proof" serrated washers fitted internally to the equipment and before a locknut act as an anti-vibration device to prevent the gland and locknut arrangement from inadvertently loosening in service.

	Metric Thread	Metric Catalog Number	Box Quantity	NPT	NPT Catalog Number	Box Quantity
		M16	16SW4	500	—	—
	M20	20SW4	500	1/2	050NPTSW4	100
	M25	25SW4	500	3/4	075NPTSW4	100
	M32	32SW4	200	1	100NPTSW4	50
	M40	40SW4	100	1-1/4	125NPTSW4	50
	M50	50SW4	100	1-1/2	150SPTNW4	10
	M63	63SW4	50	2	200NPTSW4	5
	M75	75SW4	50	2-1/2	250NPTSW4	5
	M90	90SW4	10	3	300NPTSW4	1
	M100	100SW4	10	3-1/2	350NPTSW4	1

	Metric Thread	NPT	Dimensions mm (in)		Weight kg (lbs)
			B	C	
	M16	—	19 (0.75)	25.4 (10)	0.01 (0.02)
	M20	1/2	24 (0.94)	32 (1.26)	0.01 (0.02)
	M25	3/4	33 (1.30)	40 (1.57)	0.01 (0.02)
	M32	1	42 (1.65)	44 (1.73)	0.01 (0.02)
	M40	1-1/4	55 (2.17)	59 (2.32)	0.02 (0.04)
	M50	1-1/2	65 (2.56)	80 (3.15)	0.02 (0.04)
	M63	2	70 (2.76)	100 (3.94)	0.06 (0.13)
	M75	2-1/2	85 (3.35)	112 (4.41)	0.09 (0.20)
	M90	3	100 (3.94)	120 (4.72)	0.11 (0.24)
	M100	3-1/2	110 (4.33)	150 (5.91)	0.16 (0.35)



Cable Gland Accessories and Tools

For Cable Entries

Entry Thread Seals – Sealing (IP) Washers

- It is essential to maintain the integrity of the degree of IP protection for which explosionproof equipment have been rated. The need for a sealing washer will depend on the IP rating, code of protection and the type of entry holes available within that equipment (e.g. for Ex e apparatus or terminal boxes which are permitted to have untapped through clearance holes it is necessary to fit a sealing washer to ensure that the minimum IP54 requirement is met). Other equipment with tapped entry holes may not require a sealing washer to maintain the rated integrity of the installation.
- Entry thread sealing washers are produced in 2mm thick white nylon as standard which are recommended and meet the specified requirements of Shell's Offshore operations.
- To verify the effectiveness of the nylon entry sealing washers, independent 3rd party tests to BS EN 60529:1992 have been conducted on certain cable gland types at IP66, IP67 and IP68 levels of protection. Documentation of these high standard tests is available upon request.



Description	Box Quantity	Metric Catalog Number (White)	Description	Box Quantity	NPT Catalog Number (Green)
M16	1000	16ETS2	050NPT	100	050NPTETS
M20	1000	20ETS2	075NPT	100	075NPTETS
M25	1000	25ETS2	100NPT	50	100NPTETS
M32	500	32ETS2	125NPT	50	125NPTETS
M40	200	40ETS2	150NPT	10	150NPTETS
M50	200	50ETS2	200NPT	5	200NPTETS
M63	100	63ETS2	250NPT	5	250NPTETS
M75	100	75ETS2	300NPT	1	300NPTETS
M90	10	90ETS2	350NPT	1	350NPTETS
M100	10	100ETS2	—	—	—

Cable Gland Accessories and Tools

For Cable Entries

Cable Gland Size	Catalog Number
Lead Star Clamp for E2FX and E2FW Cable Glands Lead Sheath Continuity	
2016	2016LSW
20S	20SLSW
20	20LSW
25S and 25	25LSW
32	32LSW
40	40LSW
50S	50SLSW
50	50LSW
63S	63SLSW
63	63LSW
75S	75SLSW
75	75LSW
90	90LSW
100	100LSW



360° Swivel Conduit Unions

Explosionproof, Dust-Ignitionproof

UNILETS™ for Use with Threaded Rigid Metal Conduit and IMC.

NEC/CEC:

Class I, Division 1 and 2, Groups C, D
 Class I, Zone 1 and 2, Groups IIA, IIB
 Class II, Division 1 and 2, Groups E, F, G
 Class III

Application

- Allows conduit to be joined at any angle.

Features

- Explosionproof, dust-ignitionproof.
- Smooth, rounded integral bushing in each hub protects conductor insulation.
- Accurately tapped, tapered NPT threads for tight, rigid joints and ground continuity.
- Threaded for rigid conduit or IMC.



Standard Materials

- Gray iron

Standard Finishes

- Zinc electroplate

NEC/CEC Compliances and Certifications

- UL Standard: 886 (500-503 and 505)
- UL Listed: E34997
- CSA Standard: C22.2 No. 30
- CSA Certified: 009795

Size (Inches)	Dimensions in Millimeters (Inches)		Catalog Number
	Overall Length	Maximum Diameter	
Flexible/Swivel Elbows — Full 360°			
1/2	101.6 (4.00)	47.6 (1.88)	UNAF50
3/4	114.3 (4.50)	50.8 (2.00)	UNAF75
1	133.4 (5.25)	63.5 (5.50)	UNAF100



Dimensions in Millimeters (Inches)

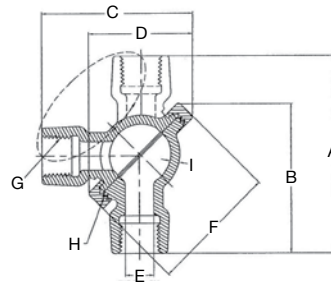

Size (Inches)	A	B	C	D	E Throat Ø	F Ø	G NPT	H UN Thread	I
1/2	101.60 (4.00)	76.20 (3.00)	76.20 (3.00)	47.63 (1.88)	15.08 (0.59)	66.68 (2.63)	12.70 — 355.60 (0.50 — 14.00)	50.80 — 6.35 (2.00 — 0.25)	3.97 (0.16)
3/4	114.30 (4.50)	84.37 (3.32)	84.37 (3.32)	52.39 (2.06)	19.84 (0.78)	74.61 (2.94)	19.05 — 355.60 (0.75 — 14.00)	63.5 — 304.80 (2.50 — 12.00)	3.97 (0.16)
1	133.35 (5.25)	88.90 (3.50)	88.90 (3.50)	63.50 (2.50)	25.40 (1.00)	88.90 (3.50)	25.40 — 292.10 (1.00 — 11.50)	79.38 — 304.80 (3.13 — 12.00)	4.76 (0.19)

360° Swivel Conduit Unions

Explosionproof, Dust-Ignitionproof

For Use with Threaded Rigid Metal Conduit and IMC.

NEC/CEC:

Class I, Division 1 and 2, Groups C, D
 Class I, Zone 1 and 2, Groups IIA, IIB
 Class II, Division 1 and 2, Groups E, F, G
 Class III

Application

- Allows conduit to be joined at any angle.

Features

- Explosionproof, dust-ignitionproof.
- Smooth, rounded integral bushing in each hub protects conductor insulation.
- Accurately tapped, tapered NPT threads for tight, rigid joints and ground continuity.
- Threaded for rigid conduit or IMC.

Standard Materials

- Gray iron



Standard Finishes

- Zinc electroplate



NEC/CEC Compliances and Certifications

- UL Standard: 886
- UL Listed: E-34997
- CSA Standard: C22.2 No. 30
- CSA Certified: 009795
- NEC Articles 500-503 and 505

	Size (Inches)	Dimensions in Millimeters (Inches)		Catalog Number
		Overall Length	Maximum Diameter	
Flexible/Swivel Elbows — Full 360°				
	1/2	101.6 (4.00)	47.6 (1.88)	UNA50
	3/4	114.3 (4.50)	50.8 (2.00)	UNA75
	1	133.4 (5.25)	63.5 (5.50)	UNA100
Flexible/Swivel Elbows — Full 360° (Removable Nipple)				
	1/2	114.3 (4.50)	47.75 (1.88)	UNAM50
	3/4	2.27 (5.00)	52.32 (2.06)	UNAM75
	1	2.61 (5.75)	63.5 (2.50)	UNAM100

Dimensions in Millimeters (Inches)

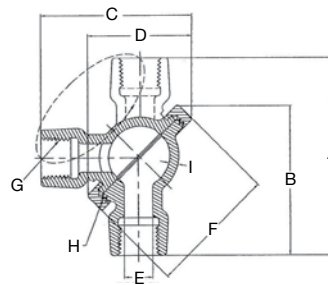

Size (Inches)	A	B	C	D	E Throat Ø	F Ø	G NPT	H UN Thread	I
1/2	101.60 (4.00)	76.20 (3.00)	76.20 (3.00)	47.63 (1.88)	15.08 (0.59)	66.68 (2.63)	12.70 — 355.60 (0.50 — 14.00)	50.80 — 6.35 (2.00 — 0.25)	3.97 (0.16)
3/4	114.30 (4.50)	84.37 (3.32)	84.37 (3.32)	52.39 (2.06)	19.84 (0.78)	74.61 (2.94)	19.05 — 355.60 (0.75 — 14.00)	63.5 — 304.80 (2.50 — 12.00)	3.97 (0.16)
1	133.35 (5.25)	88.90 (3.50)	88.90 (3.50)	63.50 (2.50)	25.40 (1.00)	88.90 (3.50)	25.40 — 292.10 (1.00 — 11.50)	79.38 — 304.80 (3.13 — 12.00)	4.76 (0.19)

45° and 90° Elbows

Explosionproof, Dust-Ignitionproof

UNILETS™ for Use with Threaded Rigid Metal Conduit and IMC.

NEC/CEC:

Class I, Division 1 and 2, Groups A◇, B◇, C, D
Class II, Division 1 and 2, Groups E, F, G
Class III

Features

- Explosionproof, dust-ignitionproof.
- Smooth, rounded integral bushing in each hub protects conductor insulation.
- Accurately tapped, tapered NPT threads for tight, rigid joints and ground continuity.



Standard Materials

- Malleable iron or copperfree (4/10 of 1% max.) aluminum

Standard Finishes





- EL malleable iron: zinc electroplate
- EL aluminum: natural

NEC/CEC Compliances and Certifications

- UL Standard: 886 (1203)
- UL Listed: E10444
- CSA Standard: C22.2 No. 25, C22.2 No. 30
- CSA Certified: 065181

Appleton®

HAZARDOUS LOCATION FITTINGS: NEC/CEC EXPLOSIONPROOF CONDUIT FITTINGS

	Size (Inches)	Millimeters (Inches) Dimensions (A)	Catalog Number	
			Malleable Iron	Aluminium
45° Female Elbows				
	1/2	30.2 (1.19)	ELF45-50 ◇	ELF45-50-A ◇
	3/4	33.3 (1.31)	ELF45-75 ◇	ELF45-75-A ◇
	1	39.7 (1.56)	ELF45-100	—
	1-1/4	42.9 (1.69)	ELF45-125	—
	1-1/2	50.8 (2.00)	ELF45-150	ELF45-150-A
	2	57.2 (2.25)	ELF45-200	—
90° Female Elbows				
	1/2	38.1 (1.50)	ELF90-50 ◇	ELF90-50-A ◇
	3/4	42.9 (1.69)	ELF90-75 ◇	ELF90-75-A ◇
	1	46.0 (1.81)	ELF90-100 ◇	ELF90-100-A ◇
	1-1/4	52.4 (2.06)	ELF90-125	ELF90-125-A
90° Male and Female Elbows				
	1/2	43.6 (1.72)	ELMF90-50 ◇	ELMF90-50-A ◇
	3/4	42.9 (1.69)	ELMF90-75 ◇	ELMF90-75-A ◇
	1	55.6 (2.19)	ELMF90-100	ELMF90-100-A
	1-1/4	52.4 (2.06)	ELMF90-125	—
90° Male Elbows				
	1/2	42.9 (1.69)	ELM90-50 ◇	ELM90-50-A ◇
	3/4	46.7 (1.84)	ELM90-75 ◇	ELM90-75-A ◇
	1	47.6 (1.88)	ELM90-100	—
	1/2	45.2 (1.78)	ELMFL90-50 ◇	ELMFL90-50-A ◇
	3/4	57.9 (2.28)	ELMFL90-75 ◇	ELMFL90-75-A ◇
	1	67.6 (2.66)	ELMFL90-100 ◇	ELMFL90-100-A ◇
	1-1/4	84.1 (3.31)	ELMFL90-125	—
	1-1/2	100.1 (3.94)	ELMFL90-150	—
	2	101.6 (4.00)	ELMFL90-200	—

◇ Indicates items in the shaded area which are UL Listed for Class I, Groups A, B, C, D; Class II, Groups E, F, G; and Class III.

45° and 90° Elbows

Explosionproof, Dust-Ignitionproof

NEC/CEC— EL 90° Elbows 1/2" thru 1-1/4" Sizes, ELFF 45° Short Elbow, 90° Conduit Elbows:
Class I, Division 1 and 2, Groups A◇, B◇, C, D
Class II, Division 1 and 2, Groups E, F, G
Class III

NEC/CEC— EL 90° Elbows 1-1/2" thru 2" Sizes:
Class I, Division 1 and 2, Groups C, D
Class I, Zone 1 and 2, Groups IIA, IIB
Class II, Div. 1, 2, Groups E, F, G
Class III

Features

- Explosionproof, dust-ignitionproof.
- Smooth, rounded integral bushing in each hub protects conductor insulation.
- Accurately tapped, tapered NPT threads for tight, rigid joints and ground continuity.

Standard Materials

- Malleable iron

Standard Finishes



- Zinc electroplated

Options

- Mechanical galvanize. Add suffix **-G** to standard catalog number. Contact your local representative for pricing and availability.

NEC/CEC Certifications and Compliances

- UL Standard: ANSI/UL 514B and 886
- UL Listed:
 - ELFF 45° Short Elbow and EL 90° Elbow: E10444
 - 90° Conduit Elbow: E34997
- CSA Standard: C22.2 No. 30
- CSA Certified:
 - ELFF 45° Short Elbow and EL 90° Elbow: 065181
 - 90° Conduit Elbow: 009795
- Suitable for wet locations
- NEC Articles 500-503 and 505

	Size (Inches)	Millimeters (Inches)		Catalog Number Aluminium
		Dimensions (A)	Dimensions (B)	
ELFF 45° Short Elbow	1/2	30.2 (1.19)	—	ELFF-450
				
EL 90° Elbows				
	1/2	38.10 (1.50)	19.05 (0.75)	EL-950 ◇
	3/4	44.45 (1.75)	22.23 (0.88)	EL-975 ◇
	1	50.80 (2.00)	26.92 (1.06)	EL-9100 ◇
	1-1/4	57.15 (2.25)	34.93 (1.38)	EL-9125
	1-1/2	101.60 (4.00)	76.20 (3.00)	EL-9150
	2	127.00 (5.00)	101.60 (4.00)	EL-9200
90° Conduit Elbows				
	1/2	43.6 (1.72)	—	8-50 ◇
	3/4	42.9 (1.69)	—	8-75 ◇
	1	55.6 (2.19)	—	8-100

◇ Indicates items in the shaded area which are UL Listed for Class I, Groups A, B, C, D; Class II, Groups E, F, G; and Class III.

EXGJH and EXLK Flexible Couplings

Explosionproof, Dust-Ignitionproof

UNILETS™ for Use with Threaded Rigid Metal Conduit and IMC.

NEC/CEC — 1/2" and 3/4" Sizes:
Class I, Groups A, B, C, D
Class II, Groups E, F, G
Class III

NEC/CEC — 1" Size:
Class I, Groups C, D
Class II, Groups E, F, G
Class III

NEC/CEC — 1-1/4" thru 4" Sizes:
Class I, Group D
Class II, Groups E, F, G
Class III

ATEX: — stainless steel 1/2" thru
2" Sizes:
⊕ II 2 GD
Ex d IIC Gb
Ex t IIIC Db
IP66

Applications

- Used in areas where vibration and/or movement is a problem. Also used in place of rigid conduit in difficult-bend situations.

Features

- Explosionproof, dust-ignitionproof, watertight
- Smooth, rounded integral bushing in each hub protects conductor insulation.
- Accurately tapped, tapered threads for tight, rigid joints and ground continuity.
- Heavy duty design resists mechanical abuse.
- Electrical conductivity equal to rigid conduit on a similar length basis—no bonding jumper required.
- Interior insulating liner protects conductors from abrasion under vibrating conditions.
- EXGJH: both end fittings are female, each furnished with a removable male nipple.
- EXLK: female end fitting with union at one end and a female end fitting with a removable male nipple at the other end.

Standard Materials

- 1/2" thru 2": outer bronze braid, inner brass core with insulating liner
- 2-1/2" thru 4": outer stainless steel braid, inner stainless steel core with insulating liner
- End Fittings: 1/2" thru 2" — brass; 2-1/2" thru 4" — stainless steel
- Unions: 1/2" thru 1" zinc plated steel; 1-1/4" thru 2" ductile iron

Standard Finishes

- Natural finish

Options

- 1/2" through 2" available in stainless steel. Add suffix **-SS**. EXLK Union is zinc plated steel. Stainless steel union available in 1/2" through 1". Add suffix **-SU**.
- 1/2" through 1" stainless steel nipple. Add suffix **-NS**
- Custom lengths available—consult factory

NEC/CEC Certifications and Compliances

- UL Standard: 886 (1203)
- UL Listed: E10444
- CSA Standard: C22.2 No. 25, C22.2 No. 30
- CSA Certified: 065181

ATEX Certifications and Compliances

- Certification Type FLEXCO (Excludes Nipples and Unions)
 - Gas, Zones 1 and 2:
 - Conforming to ATEX 94/9/EC: ⊕ II 2G
 - Type of Protection: Ex d IIC Gb
 - Dusts, Zones 21 and 22:
 - Conforming to ATEX: ⊕ II 2D
 - Type of Protection: Ex t IIIC Db
- Ambient Temperatures: -40 °C ≤ to ≤ + 150 °C (-40 °F ≤ to ≤ + 302 °F)
- Ex Standards: EN 60079-0, 60079-1, EN 60079-31
- ATEX Certificate : LCIE 11 ATEX 3006U
- Index of Protection according EN/IEC 60529: IP66



EXGJH

Suitable for Wet Locations – Two Removal Male Nipples



EXLK

One Removal Male Nipple, One Removable Union

EXGJH and EXLK Flexible Couplings

Explosionproof, Dust-Ignitionproof

UNILETS™ for Use with Threaded Rigid Metal Conduit and IMC.

NEC/CEC — 1/2" and 3/4" Sizes:
Class I, Groups A, B, C, D
Class II, Groups E, F, G
Class III

NEC/CEC — 1" Size:
Class I, Groups C, D
Class II, Groups E, F, G
Class III

NEC/CEC — 1-1/4" thru 4" Sizes:
Class I, Group D
Class II, Groups E, F, G
Class III

ATEX: — stainless steel 1/2" thru
2" Sizes:
Ex d IIC Gb
Ex t IIC Db
IP66

Size (Inches)		Catalog Number	
Flex Length	Diameter Size	EXGJH	EXLK
4	1/2	EXGJH-14 ◊	EXLK-14 ◊
4	3/4	EXGJH-24 ◊	EXLK-24 ◊
6	1/2	EXGJH-16 ◊	EXLK-16 ◊
6	3/4	EXGJH-26 ◊	EXLK-26 ◊
6	1	EXGJH-36	EXLK-36
8	1/2	EXGJH-18 ◊	EXLK-18 ◊
8	3/4	EXGJH-28 ◊	EXLK-28 ◊
8	1	EXGJH-38	EXLK-38
10	1/2	EXGJH-110 ◊	EXLK-110 ◊
10	3/4	EXGJH-210 ◊	EXLK-210 ◊
10	1	EXGJH-310	EXLK-310
12	1/2	EXGJH-112 ◊	EXLK-112 ◊
12	3/4	EXGJH-212 ◊	EXLK-212 ◊
12	1	EXGJH-312	EXLK-312
12	1-1/4	EXGJH-412	EXLK-412
12	1-1/2	EXGJH-512	EXLK-512
12	2	EXGJH-612	EXLK-612
12	2-1/2	EXGJH-712	
12	3	EXGJH-812	
12	4	EXGJH-1012	
15	1/2	EXGJH-115 ◊	EXLK-115 ◊
15	3/4	EXGJH-215 ◊	EXLK-215 ◊
15	1	EXGJH-315	EXLK-315
15	1-1/4	EXGJH-415	EXLK-415
15	1-1/2	EXGJH-515	EXLK-515
15	2	EXGJH-615	EXLK-615
15	2-1/2	EXGJH-715	
15	3	EXGJH-815	
15	4	EXGJH-1015	
18	1/2	EXGJH-118 ◊	EXLK-118 ◊
18	3/4	EXGJH-218 ◊	EXLK-218 ◊
18	1	EXGJH-318	EXLK-318
18	1-1/4	EXGJH-418	EXLK-418
18	1-1/2	EXGJH-518	EXLK-518
18	2	EXGJH-618	EXLK-618
18	2-1/2	EXGJH-718	
18	3	EXGJH-818	
18	4	EXGJH-1018	
21	1/2	EXGJH-121 ◊	EXLK-121 ◊
21	3/4	EXGJH-221 ◊	EXLK-221 ◊
21	1	EXGJH-321	EXLK-321
21	1-1/4	EXGJH-421	EXLK-421
21	1-1/2	EXGJH-521	EXLK-521
21	2	EXGJH-621	EXLK-621
21	2-1/2	EXGJH-721	
21	3	EXGJH-821	
21	4	EXGJH-1021	

Size (Inches)		Catalog Number	
Flex Length	Diameter Size	EXGJH	EXLK
24	1/2	EXGJH-124 ◊	EXLK-124 ◊
24	3/4	EXGJH-224 ◊	EXLK-224 ◊
24	1	EXGJH-324	EXLK-324
24	1-1/4	EXGJH-424	EXLK-424
24	1-1/2	EXGJH-524	EXLK-524
24	2	EXGJH-624	EXLK-624
24	2-1/2	EXGJH-724	—
24	3	EXGJH-824	—
24	4	EXGJH-1024	—
27	1/2	EXGJH-127 ◊	EXLK-127 ◊
27	3/4	EXGJH-227 ◊	EXLK-227 ◊
27	1	EXGJH-327	EXLK-327
27	1-1/4	EXGJH-427	EXLK-427
27	1-1/2	EXGJH-527	EXLK-527
27	2	EXGJH-627	EXLK-627
27	2-1/2	EXGJH-727	
27	3	EXGJH-827	
27	4	EXGJH-1027	
30	1/2	EXGJH-130 ◊	EXLK-130 ◊
30	3/4	EXGJH-230 ◊	EXLK-230 ◊
30	1	EXGJH-330	EXLK-330
30	1-1/4	EXGJH-430	EXLK-430
30	1-1/2	EXGJH-530	EXLK-530
30	2	EXGJH-630	EXLK-630
30	2-1/2	EXGJH-730	
30	3	EXGJH-830	
30	4	EXGJH-1030	
33	1/2	EXGJH-133 ◊	EXLK-133 ◊
33	3/4	EXGJH-233 ◊	EXLK-233 ◊
33	1	EXGJH-333	EXLK-333
33	1-1/4	EXGJH-433	EXLK-433
33	1-1/2	EXGJH-533	EXLK-533
33	2	EXGJH-633	EXLK-633
33	2-1/2	EXGJH-733	
33	3	EXGJH-833	
33	4	EXGJH-1033	
36	1/2	EXGJH-136 ◊	EXLK-136 ◊
36	3/4	EXGJH-236 ◊	EXLK-236 ◊
36	1	EXGJH-336	EXLK-336
36	1-1/4	EXGJH-436	EXLK-436
36	1-1/2	EXGJH-536	EXLK-536
36	2	EXGJH-636	EXLK-636
36	2-1/2	EXGJH-736	
36	3	EXGJH-836	
36	4	EXGJH-1036	

NOTE: Unions are not available in stainless steel.

◊ Indicates items in the shaded area which are UL Listed for Class I, Groups A, B, C, D; Class II, Groups E, F, G; Class III.

EXGJH and EXLK Flexible Couplings

Explosionproof, Dust-Ignitionproof, Watertight

UNILETS™ for Use with Threaded Rigid Metal Conduit and IMC.

NEC/CEC — 1/2" and 3/4" Sizes:
Class I, Groups A, B, C, D
Class II, Groups E, F, G
Class III

NEC/CEC — 1" Size:
Class I, Groups C, D
Class II, Groups E, F, G
Class III

NEC/CEC — 1-1/4" thru 4" Sizes:
Class I, Group D
Class II, Groups E, F, G
Class III

ATEX: — stainless steel 1/2" thru
2" Sizes:
Ex d IIC Gb
Ex t IIIC Db
IP66

EXGJH and EXLK Dimensions in Millimeters (Inches)

Coupling Size	A	B	C	D	E	Bending Radius ①
1/2	52.4 (2.06)	34.9 (1.38)	76.2 (3.00)	35.7 (1.41)	37.3 (1.47)	254.0 (10.00)
3/4	57.2 (2.25)	34.9 (1.38)	82.6 (3.25)	44.5 (1.75)	44.5 (1.75)	304.8 (12.00)
1	68.3 (1.69)	44.5 (1.75)	92.1 (3.63)	52.4 (2.06)	50.8 (2.00)	355.6 (14.00)
1-1/4	76.2 (3.00)	51.6 (2.03)	111.1 (4.38)	66.7 (2.63)	71.4 (2.81)	406.4 (16.00)
1-1/2	85.7 (3.38)	55.6 (2.19)	115.9 (4.56)	79.4 (3.13)	77.8 (3.06)	406.4 (16.00)
2	100.0 (3.94)	61.9 (2.44)	125.4 (4.94)	98.4 (3.88)	94.5 (3.72)	457.2 (18.00)
2-1/2	101.6 (4.00)	66.7 (2.63)	158.8 (6.25)	114.3 (4.50)	123.8 (4.88)	381.0 (15.00)
3	102.4 (4.03)	66.7 (2.63)	158.8 (6.25)	127.8 (5.03)	136.5 (5.38)	584.2 (23.00)
4	104.0 (4.09)	66.7 (2.63)	161.9 (6.38)	168.3 (6.63)	163.5 (6.44)	1219.2 (48.00)

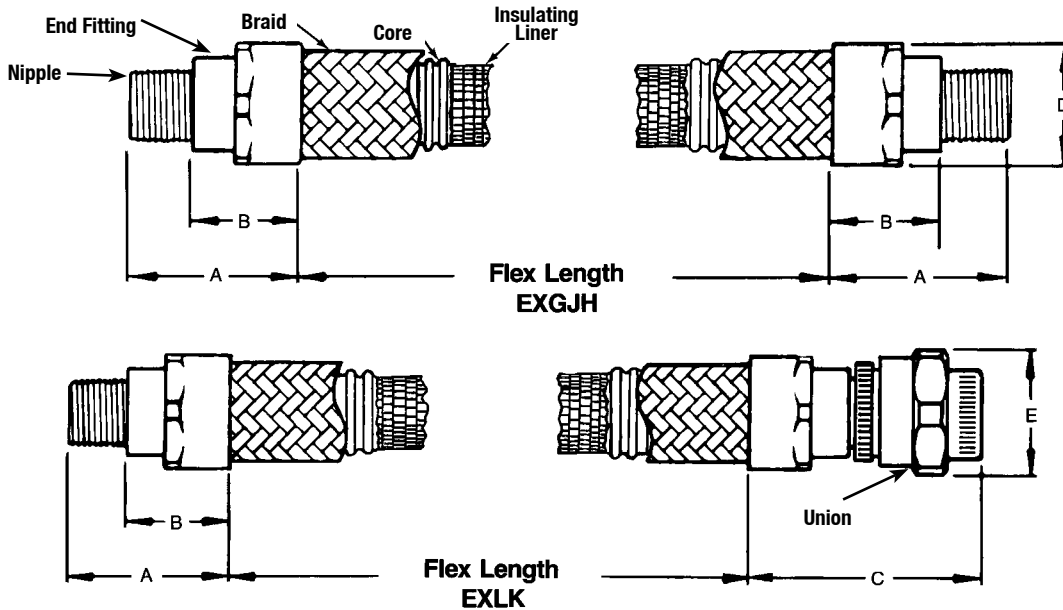

① Bending Radius shown is minimum recommended.

ECGJH and ECLK Flexible Couplings

Explosionproof, Dust-Ignitionproof

For Use with Threaded Rigid Metal Conduit and IMC.

NEC/CEC – 1/2" and 3/4" Sizes:
Class I, Division 1 and 2, Groups A, B, C, D
Class I, Zone 1 and 2, Groups IIA, IIB, IIC
Class II, Division 1 and 2, Groups E, F, G
Class III

NEC/CEC – 1" Size:
Class I, Division 1 and 2, Groups C, D
Class I, Zone 1 and 2, Groups IIA, IIB
Class II, Division 1 and 2, Groups E, F, G
Class III

NEC/CEC – 1-1/4" thru 4" Sizes:
Class I, Division 1 and 2, Group D
Class I, Zone 1 and 2, Group IIA
Class II, Division 1 and 2, Groups E, F, G
Class III

Applications

- Used in areas where vibration and/or movement is a problem. Also used in place of rigid conduit in difficult-bend situations.

Features

- Explosionproof, dust-ignitionproof, watertight
- Smooth, rounded integral bushing in each hub protects conductor insulation.
- Accurately tapped, tapered threads for tight, rigid joints and ground continuity.
- Heavy duty design resists mechanical abuse.
- Electrical conductivity equal to rigid conduit on a similar length basis—no bonding jumper required.
- Interior insulating liner protects conductors from abrasion under vibrating conditions.
- ECGJH: both end fittings are female, each furnished with a removable male nipple.
- ECLK: female end fitting with union at one end and a female end fitting with a removable male nipple at the other end.

Standard Materials

- Flexible coupling is constructed from brass tubing and bronze outer braid, with insulating liner
- 1/2" - 1" trade size
Bronze end fittings with zinc plated steel UNF female union on one end and steel close nipple on the other
- 1-1/4" - 2" trade size
Bronze end fittings with malleable iron UNF female union on one end and steel close nipple on other end
- Unions: 1/2" thru 1" zinc plated steel; 1-1/4" thru 2" ductile iron

Standard Finishes

- Natural finish

Options

- 1/2" through 2" available in stainless steel. Add suffix **-SS**. ECLK Union is zinc plated steel. Stainless steel union available in 1/2" through 1". Add suffix **-SU**.
- 1/2" through 1" stainless steel nipple. Add suffix **-NS**
- Custom lengths available—consult factory

NEC/CEC Certifications and Compliances

- UL Standard: 886
- UL Listed: E-34997 ①
- CSA Standard: C22.2 No. 30
- CSA Certified: 009795 ①
- NEC Articles 500-503 and 505
- Suitable for wet locations



ECGJH
Suitable for Wet Locations – Two Removal Male Nipples



ECLK
One Removal Male Nipple, One Removable Union

OSG EDNEY

HAZARDOUS LOCATION FITTINGS: NEC/CEC EXPLOSIONPROOF CONDUIT FITTINGS

① UL Listing and CSA Certification not applicable over 2" Trade Size.

ECGJH and ECLK Flexible Couplings

Explosionproof, Dust-Ignitionproof

For Use with Threaded Rigid Metal Conduit and IMC.

NEC/CEC — 1/2" and 3/4" Sizes:
Class I, Division 1 and 2, Groups A, B, C, D
Class I, Zone 1 and 2, Groups IIA, IIB, IIC
Class II, Division 1 and 2, Groups E, F, G
Class III

NEC/CEC — 1" Size:
Class I, Division 1 and 2, Groups C, D
Class I, Zone 1 and 2, Groups IIA, IIB
Class II, Division 1 and 2, Groups E, F, G
Class III

NEC/CEC — 1-1/4" thru 4" Sizes:
Class I, Division 1 and 2, Group D
Class I, Zone 1 and 2, Group IIA
Class II, Division 1 and 2, Groups E, F, G
Class III

Size (Inches)		Catalog Number	
Flex Length	Diameter Size	ECGJH	ECLK
4	1/2	ECGJH-50-4	ECLK-50-4
4	3/4	ECGJH-75-4	ECLK-75-4
6	1/2	ECGJH-50-6	ECLK-50-6
6	3/4	ECGJH-75-6	ECLK-75-6
6	1	ECGJH-100-6	ECLK-100-6
8	1/2	ECGJH-50-8	ECLK-50-8
8	3/4	ECGJH-75-8	ECLK-75-8
8	1	ECGJH-100-8	ECLK-100-8
10	1/2	ECGJH-50-10	ECLK-50-10
10	3/4	ECGJH-75-10	ECLK-75-10
10	1	ECGJH-100-10	ECLK-100-10
12	1/2	ECGJH-50-12	ECLK-50-12
12	3/4	ECGJH-75-12	ECLK-75-12
12	1	ECGJH-100-12	ECLK-100-12
12	1-1/4	ECGJH-125-12	ECLK-125-12
12	1-1/2	ECGJH-150-12	ECLK-150-12
12	2	ECGJH-200-12	ECLK-200-12
12	2-1/2	ECGJH-250-12	
12	3	ECGJH-300-12	
12	4	ECGJH-400-12	
15	1/2	ECGJH-50-15	ECLK-50-15
15	3/4	ECGJH-75-15	ECLK-75-15
15	1	ECGJH-100-15	ECLK-100-15
15	1-1/4	ECGJH-125-15	ECLK-125-15
15	1-1/2	ECGJH-150-15	ECLK-150-15
15	2	ECGJH-200-15	ECLK-200-15
15	2-1/2	ECGJH-250-15	
15	3	ECGJH-300-15	
15	4	ECGJH-400-15	
18	1/2	ECGJH-50-18	ECLK-50-18
18	3/4	ECGJH-75-18	ECLK-75-18
18	1	ECGJH-100-18	ECLK-100-18
18	1-1/4	ECGJH-125-18	ECLK-125-18
18	1-1/2	ECGJH-150-18	ECLK-150-18
18	2	ECGJH-200-18	ECLK-200-18
18	2-1/2	ECGJH-250-18	
18	3	ECGJH-300-18	
18	4	ECGJH-400-18	
21	1/2	ECGJH-50-21	ECLK-50-21
21	3/4	ECGJH-75-21	ECLK-75-21
21	1	ECGJH-100-21	ECLK-100-21
21	1-1/4	ECGJH-125-21	ECLK-125-21
21	1-1/2	ECGJH-150-21	ECLK-150-21
21	2	ECGJH-200-21	ECLK-200-21
21	2-1/2	ECGJH-250-21	
21	3	ECGJH-300-21	
21	4	ECGJH-400-21	

Size (Inches)		Catalog Number	
Flex Length	Diameter Size	ECGJH	ECLK
24	1/2	ECGJH-50-24	ECLK-50-24
24	3/4	ECGJH-75-24	ECLK-75-24
24	1	ECGJH-100-24	ECLK-100-24
24	1-1/4	ECGJH-125-24	ECLK-125-24
24	1-1/2	ECGJH-150-24	ECLK-150-24
24	2	ECGJH-200-24	ECLK-200-24
24	2-1/2	ECGJH-250-24	—
24	3	ECGJH-300-24	—
24	4	ECGJH-400-24	—
27	1/2	ECGJH-50-27	ECLK-50-27
27	3/4	ECGJH-75-27	ECLK-75-27
27	1	ECGJH-100-27	ECLK-100-27
27	1-1/4	ECGJH-125-27	ECLK-125-27
27	1-1/2	ECGJH-150-27	ECLK-150-27
27	2	ECGJH-200-27	ECLK-200-27
27	2-1/2	ECGJH-250-27	
27	3	ECGJH-300-27	
27	4	ECGJH-400-27	
30	1/2	ECGJH-50-30	ECLK-50-30
30	3/4	ECGJH-75-30	ECLK-75-30
30	1	ECGJH-100-30	ECLK-100-30
30	1-1/4	ECGJH-125-30	ECLK-125-30
30	1-1/2	ECGJH-150-30	ECLK-150-30
30	2	ECGJH-200-30	ECLK-200-30
30	2-1/2	ECGJH-250-30	
30	3	ECGJH-300-30	
30	4	ECGJH-400-30	
33	1/2	ECGJH-50-33	ECLK-50-33
33	3/4	ECGJH-75-33	ECLK-75-33
33	1	ECGJH-100-33	ECLK-100-33
33	1-1/4	ECGJH-125-33	ECLK-125-33
33	1-1/2	ECGJH-150-33	ECLK-150-33
33	2	ECGJH-200-33	ECLK-200-33
33	2-1/2	ECGJH-250-33	
33	3	ECGJH-300-33	
33	4	ECGJH-400-33	
36	1/2	ECGJH-50-36	ECLK-50-36
36	3/4	ECGJH-75-36	ECLK-75-36
36	1	ECGJH-100-36	ECLK-100-36
36	1-1/4	ECGJH-125-36	ECLK-125-36
36	1-1/2	ECGJH-150-36	ECLK-150-36
36	2	ECGJH-200-36	ECLK-200-36
36	2-1/2	ECGJH-250-36	
36	3	ECGJH-300-36	
36	4	ECGJH-400-36	

NOTE: Unions are not available in stainless steel.

◇ Indicates items in the shaded area which are UL Listed for Class I, Groups A, B, C, D; Class II, Groups E, F, G; Class III.

ECGJH and ECLK Flexible Couplings

Explosionproof, Dust-Ignitionproof, Watertight

For Use with Threaded Rigid Metal Conduit and IMC.

NEC/CEC — 1/2" and 3/4" Sizes:
 Class I, Division 1 and 2, Groups A, B, C, D
 Class I, Zone 1 and 2, Groups IIA, IIB, IIC
 Class II, Division 1 and 2, Groups E, F, G
 Class III

NEC/CEC — 1" Size:
 Class I, Division 1 and 2, Groups C, D
 Class I, Zone 1 and 2, Groups IIA, IIB
 Class II, Division 1 and 2, Groups E, F, G
 Class III

NEC/CEC — 1-1/4" thru 4" Sizes:
 Class I, Division 1 and 2, Group D
 Class I, Zone 1 and 2, Group IIA
 Class II, Division 1 and 2, Groups E, F, G
 Class III

ECGJH and ECLK Dimensions in Millimeters (Inches)

Coupling Size (Inches)	A	B	C	D	E	Bending Radius ①
1/2	52.4 (2.06)	34.9 (1.38)	76.2 (3.00)	35.7 (1.41)	37.3 (1.47)	254.0 (10.00)
3/4	57.2 (2.25)	34.9 (1.38)	82.6 (3.25)	44.5 (1.75)	44.5 (1.75)	304.8 (12.00)
1	68.3 (1.69)	44.5 (1.75)	92.1 (3.63)	52.4 (2.06)	50.8 (2.00)	355.6 (14.00)
1-1/4	76.2 (3.00)	51.6 (2.03)	111.1 (4.38)	66.7 (2.63)	71.4 (2.81)	406.4 (16.00)
1-1/2	85.7 (3.38)	55.6 (2.19)	115.9 (4.56)	79.4 (3.13)	77.8 (3.06)	406.4 (16.00)
2	100.0 (3.94)	61.9 (2.44)	125.4 (4.94)	98.4 (3.88)	94.5 (3.72)	457.2 (18.00)
2-1/2	101.6 (4.00)	66.7 (2.63)	158.8 (6.25)	114.3 (4.50)	123.8 (4.88)	381.0 (15.00)
3	102.4 (4.03)	66.7 (2.63)	158.8 (6.25)	127.8 (5.03)	136.5 (5.38)	584.2 (23.00)
4	104.0 (4.09)	66.7 (2.63)	161.9 (6.38)	168.3 (6.63)	163.5 (6.44)	1219.2 (48.00)

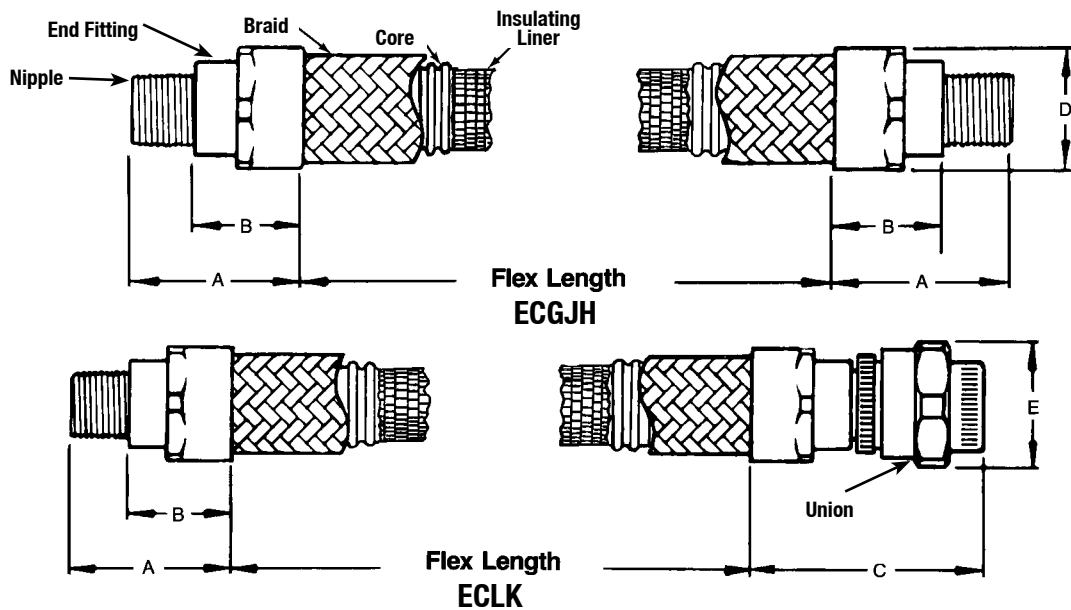

① Bending Radius shown is minimum recommended.

ECHF Flexible Couplings

Explosionproof, Dust-Ignitionproof

NEC/CEC:

Class I, Division 1 and 2, Groups A, B, C, D
 Class I, Zone 1 and 2, Groups IIA, IIB, IIC
 Class II, Division 1 and 2, Groups E, F, G
 Class III

Applications

- To suspend pendant mount hazardous location lighting fixtures in accordance with Article 501 of the National Electrical Code to assure the fixtures will swing freely if struck accidentally.

Features

- Female end fittings
- Supplied with two removable steel close nipples threaded into the female ends.
- Set screws prevent nipples and fixtures from rotating during relamping.
- Suitable for ground path.
- Maximum weight capacity: 50 lbs. per NEC Section 314-27(B).

Standard Materials

- Flexible coupling is constructed from brass tubing and bronze outer braid, with insulating liner.
- Bronze female end fittings are supplied with removable steel close nipples.

Options

- Stainless Steel - add suffix "SS" to standard catalog number. Contact your local representative for pricing and availability.

NEC/CEC Certifications and Compliances

- UL Standard: 844 and 886
- UL Listed: E-74593
- CSA Standard: C22.2 No. 30
- CSA Certified: 053390
- NEC Articles 500-503 and 505
- Suitable for wet locations when used with gasketed covers.



ECHF
 Suitable for Ground Path – Two Removable Steel Close Nipples
 1/2" – 3/4" Trade Size (Inches)

Dimensions in Millimeters (Inches)

Trade Size (Inches)	Flexible Length	A	B	Max. Dia. C	Min. Bending Radius	Catalog Number
1/2	101.60 (4.00)	85.85 (3.38)	47.75 (1.88)	36.58 (1.44)	254.00 (10.00)	ECHF-50-4
1/2	152.40 (6.00)	85.85 (3.38)	47.75 (1.88)	36.58 (1.44)	254.00 (10.00)	ECHF-50-6
1/2	203.20 (8.00)	85.85 (3.38)	47.75 (1.88)	36.58 (1.44)	254.00 (10.00)	ECHF-50-8
1/2	254.00 (10.00)	85.85 (3.38)	47.75 (1.88)	36.58 (1.44)	254.00 (10.00)	ECHF-50-10
1/2	304.80 (12.00)	85.85 (3.38)	47.75 (1.88)	36.58 (1.44)	254.00 (10.00)	ECHF-50-12
1/2	381.00 (15.00)	85.85 (3.38)	47.75 (1.88)	36.58 (1.44)	254.00 (10.00)	ECHF-50-15
1/2	457.20 (18.00)	85.85 (3.38)	47.75 (1.88)	36.58 (1.44)	254.00 (10.00)	ECHF-50-18
3/4	101.60 (4.00)	85.85 (3.38)	47.75 (1.88)	44.45 (1.75)	304.80 (12.00)	ECHF-75-4
3/4	152.40 (6.00)	85.85 (3.38)	47.75 (1.88)	44.45 (1.75)	304.80 (12.00)	ECHF-75-6
3/4	203.20 (8.00)	85.85 (3.38)	47.75 (1.88)	44.45 (1.75)	304.80 (12.00)	ECHF-75-8
3/4	254.00 (10.00)	85.85 (3.38)	47.75 (1.88)	44.45 (1.75)	304.80 (12.00)	ECHF-75-10
3/4	304.80 (12.00)	85.85 (3.38)	47.75 (1.88)	44.45 (1.75)	304.80 (12.00)	ECHF-75-12
3/4	381.00 (15.00)	85.85 (3.38)	47.75 (1.88)	44.45 (1.75)	304.80 (12.00)	ECHF-75-15
3/4	457.20 (18.00)	85.85 (3.38)	47.75 (1.88)	44.45 (1.75)	304.80 (12.00)	ECHF-75-18

NOTE: Unions are not available in stainless steel.

PLG Close-Up Plugs and BR Reducers

Explosionproof, Dust-Ignitionproof

UNILETS™ for Use with Threaded Rigid Metal Conduit and IMC.

NEC/CEC:

Class I, Division 1 and 2, Groups A, B, C,
Class II, Division 1 and 2, Groups E, F, G
Class III

Features

- Explosionproof, dust-ignitionproof.
- Smooth, rounded integral bushing in each hub protects conductor insulation.
- Accurately tapped, tapered threads for tight, rigid joints and ground continuity.

Standard Materials

- PLG Plugs: malleable iron, steel (1/2" - 1") or copperfree (4/10 of 1% max.) aluminum.
- BR Reducers: malleable iron or copperfree (4/10 of 1% max.) aluminum.

Standard Finishes

- Close-up Plugs:
 - Malleable iron: zinc electroplate
 - Steel: zinc electroplate
 - Aluminum: natural finish
- Bell Reducers:
 - Malleable iron: triple-coat — (1) zinc electroplate, (2) chromate, and (3) epoxy powder coat
 - Aluminum: epoxy powder coat

Options

- Urethane paint available on select items. Add suffix **-UP** to catalog number.

NEC/CEC Certifications and Compliances

- UL Standard: 886 (1203)
- UL Listed: E10444
- CSA Standard: C22.2 No. 25, C22.2 No. 30
- CSA Certified: 065181



Recessed Head Close-Up Plug



Square Head Close-Up Plug

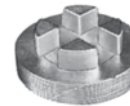

Bar Head Close-Up Plug



Bell Reducing Coupling

PLG Close-Up Plugs and BR Reducers

Explosionproof, Dust-Ignitionproof

UNILETS™ for Use with Threaded Rigid Metal Conduit and IMC.

NEC/CEC:

Class I, Division 1 and 2, Groups A◇, B◆, C, D
 Class II, Division 1 and 2, Groups E, F, G
 Class III

NPT Threads Size (Inches)	Catalog Number		
	Steel (1/2" to 1")	Malleable (1-1/4" to 6")	Aluminium (1/2" to 4")

PLG — Close-Up Plugs

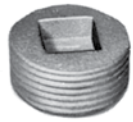

Recessed Head

Recessed Head				
1/2	PLG-50R ①◇	—	—	PLG-50RA ①◇
3/4	PLG-75R ①◇	—	—	PLG-75RA ①◇
1	PLG-100R ①◇	—	—	PLG-100RA ①◇
1-1/4	—	PLG-125 ①◆	—	PLG-125A ①◆
1-1/2	—	PLG-150 ①◆	—	PLG-150A ①◆
2	—	PLG-200 ①◆	—	PLG-200A ①◆
2-1/2	—	PLG-250 ①◆	—	PLG-250A ①◆
3	—	PLG-300 ①◆	—	PLG-300A ①◆
4	—	PLG-400 ①◆	—	PLG-400A ①◆



Square Head

Square Head				
1/2	PLG-50S ◇	—	—	—
3/4	PLG-75S ◇	—	—	—
1	PLG-100S ◇	—	—	—
1-1/4	—	PLG-125S ◆	—	—
1-1/2	—	PLG-150S ◆	—	—
2	—	PLG-200S ◆	—	—
2-1/2	—	PLG-250S ◆	—	—
3	—	PLG-300S ◆	—	—
3-1/2	—	PLG-350S ◆	—	—
4	—	PLG-400S ◆	—	—



Bar Head

Bar Head (Cast Iron)				
5	—	PLG-500B	—	—
6	—	PLG-600B	—	—

Large Hub Size (Inches)	Small Hub Size (Inches)	Catalog Number	
		Malleable	Aluminium

BR — Threaded Bell Reducing Couplings



3/4	1/2	BR75-50 ◆	BR75-50A ◆
1	1/2	BR100-50 ◇	BR100-50A ◆
1	3/4	BR100-75 ◇	BR100-75A ◆
1	1	BR125-100 ◆	BR125-100A
1-1/4	3/4	BR125-75 ◆	BR125-75A
1-1/2	1	BR150-100 ◆	BR150-100A
1-1/2	3/4	BR150-75 ◆	BR150-75A
1-1/2	1-1/4	BR150-125 ◆	BR150-125A
2	3/4	BR200-75 ◆	BR200-75A
2	1	BR200-100 ◆	BR200-100A
2	1-1/4	BR200-125 ◆	BR200-125A
2	1-1/2	BR200-150 ◆	BR200-150A
2-1/2	1-1/2	BR250-150 ◆	BR250-150A
3	2	BR300-200 ◆	BR300-200A
3-1/2	2-1/2	BR350-250 ◆	BR350-250A
4	3	BR400-300 ◆	BR400-300A
5	4	BR500-400	BR500-400A

① Urethane paint available on select items. Add suffix **-UP** to catalog number.

◇ Indicates items in the shaded area which are UL Listed for Class I, Groups A, B, C, D; Class II, Groups E, F, G; and Class III.

◆ Indicates items are UL Listed for Class I, Groups B, C, D; Class II, Groups E, F, G; and Class III.

PLG Close-Up Plugs

Explosionproof, Dust-Ignitionproof

For Outlet Boxes and Hubs

NEC/CEC:

Class I, Division 1 and 2, Groups A◇, B◆, C, D
Class II, Division 1 and 2, Groups E, F, G
Class III

NEC/CEC — PLG500C and PLG600C:

Class I, Division 1 and 2, Group C, D
Class II, Division 1 and 2, Groups E, F, G

Features

- Smooth, rounded integral bushing in each hub protects conductor insulation.
- Accurately tapped, tapered threads for tight, rigid joints and ground continuity.

Standard Materials

- Malleable iron, steel or copperfree (4/10 of 1% max.) aluminum

Standard Finishes

- Malleable iron: zinc electroplate
- Steel: zinc electroplate
- Aluminum: natural finish

NEC/CEC Certifications and Compliances

- UL Standard: 886
- UL Listed: E34997
- CSA Standard: C22.2 No. 30
- CSA Certified: 009795
- NEC Articles 500-503 and 505

Options

- Mechanical Galvanize. Add suffix **-G** to standard catalog number. Contact your local representative for pricing and availability.

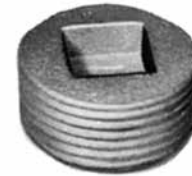

Recessed Head Close-Up Plug

Trade Size (Inches)	Dimensions in Millimeters (Inches)		Catalog Number		
	Body Thickness	Socket	Steel (1/2" to 1")	Malleable (1-1/4" to 6")	Aluminium (1/2" to 4")
1/2	12.70 (0.50)	9.53 (0.38)	PLG-50R◇	—	PLG-50RA◇
3/4	12.70 (0.50)	12.70 (0.50)	PLG-75R◇	—	PLG-75RA◇
1	19.05 (0.75)	12.70 (0.50)	PLG-100R◇	—	PLG-100RA◇
1-1/4	19.05 (0.75)	19.05 (0.75)	—	PLG-125R◆	PLG-125RA◆
1-1/2	19.05 (0.75)	19.05 (0.75)	—	PLG-150R◆	PLG-150RA◆
2	19.05 (0.75)	25.40 (1.00)	—	PLG-200R◆	PLG-200RA◆
2-1/2	28.58 (1.13)	—	—	PLG-250C◆	PLG-250CA◆
3	31.75 (1.25)	—	—	PLG-300C◆	PLG-300CA◆
3-1/2	31.75 (1.25)	—	—	PLG-350C◆	PLG-350CA◆
4	31.75 (1.25)	—	—	PLG-400C◆	PLG-400CA◆
5	34.93 (1.38)	—	—	PLG-500C	—
6	38.10 (1.50)	—	—	PLG-600C	—

◇ Indicates items in the shaded area which are UL Listed for Class I, Groups A, B, C, D; Class II, Groups E, F, G; and Class III.

◆ Indicates items are UL Listed for Class I, Groups B, C, D; Class II, Groups E, F, G; and Class III.

REC Reducing Couplings

Explosionproof, Dust-Ignitionproof

NEC/CEC:
 Class I, Division 1 and 2 Groups A \diamond , B \blacklozenge , C, D
 Class II, Division 1 and 2 Groups E, F, G
 Class III

Applications

- To connect two different sizes of conduit together or to replace a coupling and reducer in an installation.

Features

- Tapered threads (NPT).

Standard Materials

- Malleable Iron

Standard Finishes

- Zinc electroplated

NEC/CEC Certifications and Compliances

- CSA Standard: C22.2 No. 30
- CSA Certified: LR-9795
- NEC Articles 500-503 and 505



OZGEDNEY

HAZARDOUS LOCATION FITTINGS: NEC/CEC EXPLOSIONPROOF CONDUIT FITTINGS

	Large Hub Size (Inches)	Small Hub Size (Inches)	Catalog Number
REC – Threaded Bell Reducing Couplings			
	3/4	1/2	REC-0705S \blacklozenge
	1	1/2	REC-1005S \diamond
	1	3/4	REC-1007S \diamond
	1-1/4	3/4	REC-1207 \blacklozenge
	1-1/4	1	REC-1210 \blacklozenge
	1-1/2	3/4	REC-1507 \blacklozenge
	1-1/2	1	REC-1510 \blacklozenge
	2	3/4	REC-2007 \blacklozenge
	2	1	REC-2010 \blacklozenge
	2	1-1/4	REC-2012 \blacklozenge
	2	1-1/2	REC-2015 \blacklozenge
	2-1/2	1-1/2	REC-2515 \blacklozenge
	3	2	REC-3020 \blacklozenge
	4	3	REC-4030 \blacklozenge
	5	4	REC-5040 \blacklozenge

\diamond Indicates items in the shaded area which are UL Listed for Class I, Groups A, B, C, D; Class II, Groups E, F, G; and Class III.

\blacklozenge Indicates items are UL Listed for Class I, Groups B, C, D; Class II, Groups E, F, G; and Class III.

UNY, UNF, and UNL Unions

Explosionproof, Dust-Ignitionproof

For Use with Threaded Rigid Metal Conduit and IMC.

NEC/CEC:

Class I, Division 1 and 2, Groups A, B, C, D

Class II, Division 1 and 2, Groups E, F, G

Class III

Applications

- UNY and UNF unions are used for joining conduit and connecting conduit to enclosures. Facilitates modifications, permits removal of enclosures without turning or removal of conduit.
- Expansion unions compensate for expansion and contraction of conduit.

Features

- Explosionproof, dust-ignitionproof.
- Smooth, rounded integral bushing in each hub protects conductor insulation.
- Accurately tapped, tapered threads for tight, rigid joints and ground continuity.
- Non-expansion unions
 - Concentric ring interlocked design of 1/2", 3/4" and 1" sizes makes possible smaller diameter, allowing use in tighter spaces. 1-1/4" and larger UNY sizes have removable male nipple.
 - Concretetight
- Expansion unions
 - One-piece design eliminates need for disassembly during installation.
 - Telescoping cylinder within cylinder design permits expansion or contraction.
 - Standard or long types available.
 - Small external diameters—excellent in restricted areas in wiring of pumps, motors, and other equipment.
 - Internal phosphor bronze "bonding jumper" ring assures positive ground between telescoping cylinders.

Standard Materials

- UNY and UNF (non-expansion) unions:
 - 1/2" thru 1": steel or aluminum
 - 1-1/4" thru 6": malleable iron or copperfree (4/10 of 1% max.) aluminum
- UNY and UNF expansion unions: steel
- UNL unions: malleable iron and steel

Standard Finishes

- Malleable iron products: triplecoat — (1) zinc electroplate, (2) chromate and (3) epoxy powder coat
- Steel products: zinc electroplate
- Aluminum products 1/2" thru 4": natural

Options

- Stainless steel UNF/UNY available 1/2", 3/4", and 1". Add suffix **-SS** to catalog number.

NEC/CEC Certifications and Compliances

- UL Standard: 886 (1203)
- UL Listed: E10444
- CSA Standard: C22.2 No. 25, C22.2 No. 30
- CSA Certified: 065181



Appleton®

HAZARDOUS LOCATION FITTINGS: NEC/CEC EXPLOSIONPROOF CONDUIT FITTINGS

UNY, UNF, and UNL Unions

Explosionproof, Dust-Ignitionproof

UNILETS™ for Use with Threaded Rigid Metal Conduit and IMC.

NEC/CEC:

Class I, Division 1 and 2, Groups A, B, C, D

Class II, Division 1 and 2, Groups E, F, G

Class III

Size (Inches)	Millimeters (Inches)		Steel (1/2" to 1")	Catalog Number Malleable (1-1/4" to 6")	Aluminum (1/2" to 4")
	A	B			

UNY Unions — For connecting conduit to enclosure



Male/Female (Nipple Not Removable)

	1/2	54.4 (2.15)	37.3 (1.47)	UNY50NR ◊	—	UNY50NR-A ◊
	3/4-1/2	54.8 (2.16)	37.3 (1.47)	UNY75-50NR ◊	—	UNY75-50NR-A ◊
	3/4	54.8 (2.16)	44.5 (1.75)	UNY75NR ◊	—	UNY75NR-A ◊
1/2" — 1"	1	66.7 (2.62)	50.8 (2.00)	UNY100NR ◊	—	UNY100NR-A ◊

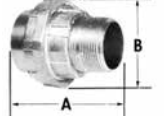
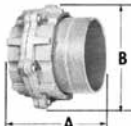
Male/Female (Removable Male Nipple)

	1-1/4	79.4 (3.13)	71.4 (2.81)	—	UNY125NR ♦	UNY125NR-A ♦
	1-1/2	82.6 (3.25)	77.8 (3.06)	—	UNY150NR ♦	UNY150NR-A ♦
1-1/4" — 4"	2	92.1 (3.63)	94.5 (3.72)	—	UNY200NR ♦	UNY200NR-A ♦
	2-1/2	122.2 (4.81)	123.8 (4.88)	—	UNY250R ♦	UNY250R-A ♦
	3	122.2 (4.81)	136.5 (5.38)	—	UNY300R ♦	UNY300R-A ♦
	3-1/2	125.4 (4.94)	149.2 (5.88)	—	UNY350R ♦	UNY350R-A ♦
5" — 6"	4	130.2 (5.13)	163.5 (6.44)	—	UNY400R ♦	UNY400R-A ♦
	5	142.9 (5.63)	212.7 (8.33)	—	UNY500R	—
	6	146.1 (5.75)	244.5 (9.63)	—	UNY600R	—

UNF Female Unions — For connecting conduit to conduit

	1/2	37.3 (1.47)	37.3 (1.47)	UNF50NR ◊	—	UNF50NR-A ◊
	3/4-1/2 ①	37.3 (1.47)	37.3 (1.47)	UNF75-50NR ◊	—	UNF75-50NR-A ◊
	3/4	37.3 (1.47)	44.5 (1.75)	UNF75NR ◊	—	UNF75NR-A ◊
1/2" — 1"	1	43.7 (1.72)	50.8 (2.00)	UNF100NR ◊	—	UNF100NR-A ◊
	1-1/4	55.6 (2.19)	71.4 (2.81)	—	UNF125NR ♦	UNF125NR-A ♦
	1-1/2	55.6 (2.19)	77.8 (3.06)	—	UNF150NR ♦	UNF150NR-A ♦
1-1/4" — 4"	2	58.7 (2.31)	94.5 (3.72)	—	UNF200NR ♦	UNF200NR-A ♦
	2-1/2	85.7 (3.38)	123.8 (4.88)	—	UNF250R ♦	UNF250R-A ♦
	3	85.7 (3.38)	136.5 (5.38)	—	UNF300R ♦	UNF300R-A ♦
	3-1/2	85.7 (3.38)	149.2 (5.88)	—	UNF350R ♦	UNF350R-A ♦
5" — 6"	4	88.9 (3.50)	163.5 (6.44)	—	UNF400R ♦	UNF400R-A ♦
	5	98.4 (3.88)	212.7 (8.33)	—	UNF500R	—
	6	101.6 (4.00)	244.5 (9.63)	—	UNF600R	—

Dimensions in Millimeters (Inches)

Size (Inches)	Millimeters (Inches)		Catalog Number Malleable
	Male	Female	

UNL 90° Elbow Unions — For connecting conduit to enclosure

	1/2	1/2	62.7 (2.47)	35.1 (1.38)	52.3 (2.06)	UNL50N ◊
	1/2	3/4 ①	62.7 (2.47)	41.4 (1.63)	52.3 (2.06)	UNL50-75N ◊
	3/4	1/2 ①	50.8 (2.00)	35.1 (1.38)	47.6 (1.88)	UNL75-50N ◊
	3/4	3/4	50.8 (2.00)	41.4 (1.63)	47.6 (1.88)	UNL75N ◊

① Male end given first

◊ Indicates items in the shaded area which are UL Listed for Class I, Groups A, B, C, D; Class II, Groups E, F, G; and Class III.

♦ Indicates items are UL Listed for Class I, Groups B, C, D; Class II, Groups E, F, G; and Class III.

UNY and UNF Expansion Unions

Explosionproof, Dust-Ignitionproof

UNILETS™ for Use with Threaded Rigid Metal Conduit and IMC.

NEC/CEC:

Class I, Division 1 and 2, Groups C, D
 Class II, Division 1 and 2, Groups E, F, G
 Class III

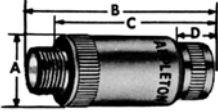
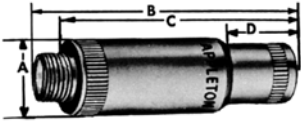
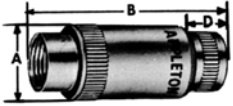
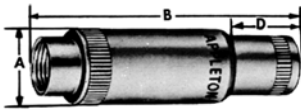
	Size (Inches)	Catalog Number Steel
	UNY Male Unions— Standard — For connecting conduit to enclosure	
	1/2	UNY50
	3/4	UNY75
	1	UNY100
	UNYL Male Unions— Long — For connecting conduit to enclosure	
	1/2	UNYL50
	3/4	UNYL75
	1	UNYL100
	UNF Female Unions— Standard — For connecting conduit to conduit	
	1/2	UNF50
	3/4	UNF75
	1	UNF100
	UNFL Female Unions— Long — For connecting conduit to conduit	
	1/2	UNFL50
	3/4	UNFL75
	1	UNFL100

Dimensions in Millimeters (Inches)

Catalog Number	Size (Inches)	A	B (Overall Length at Max. Expansion)	C	D (Maximum Expansion)
UNY50	1/2	30.2 (1.19)	78.9 (3.88)	58.7 (2.31)	12.7 (0.50)
UNY75	3/4	36.5 (1.44)	83.3 (3.28)	61.9 (2.44)	13.5 (0.53)
UNY100	1	44.5 (1.75)	93.2 (3.67)	68.3 (2.69)	16.7 (0.66)
UNYL50	1/2	30.2 (1.19)	104.4 (4.11)	84.1 (3.31)	25.4 (1.00)
UNYL75	3/4	36.5 (1.44)	108.7 (4.28)	87.3 (3.44)	27.8 (1.09)
UNYL100	1	44.5 (1.75)	126.5 (4.98)	101.6 (4.00)	34.1 (1.34)
UNF50	1/2	30.2 (1.19)	74.6 (2.94)	—	12.7 (0.50)
UNF75	3/4	36.5 (1.44)	77.8 (3.06)	—	13.5 (0.53)
UNF100	1	44.5 (1.75)	85.7 (3.38)	—	16.7 (0.66)
UNFL50	1/2	30.2 (1.19)	100.0 (3.94)	—	25.4 (1.00)
UNFL75	3/4	36.5 (1.44)	104.8 (4.13)	—	27.8 (1.09)
UNFL100	1	44.5 (1.75)	120.7 (4.75)	—	34.1 (1.34)

UNY and UNF Unions

Explosionproof, Dust-Ignitionproof

NEC/CEC:

Class I, Division 1 and 2, Groups A◇, B◆, C, D
Class II, Division 1 and 2, Groups E, F, G
Class III

Applications

- UNY and UNF unions are used for joining conduit and connecting conduit to enclosures. Facilitates modifications, permits removal of enclosures without turning or removal of conduit.
- Expansion unions compensate for expansion and contraction of conduit.

Features

- Smooth, rounded integral bushing in each hub protects conductor insulation.
- Accurately tapped, tapered threads for tight, rigid joints and ground continuity.
- Non-expansion unions
 - Concentric ring interlocked design of 1/2", 3/4" and 1" sizes makes possible smaller diameter, allowing use in tighter spaces. 1-1/4" and larger UNY sizes have removable male nipple.
 - Concretetight
- Expansion unions
 - One-piece design eliminates need for disassembly during installation.
 - Telescoping cylinder within cylinder design permits expansion or contraction.
 - Standard or long types available.
 - Small external diameters—excellent in restricted areas in wiring of pumps, motors, and other equipment.
 - Internal phosphor bronze "bonding jumper" ring assures positive ground between telescoping cylinders.

Standard Materials

- UNY and UNF (non-expansion) unions:
 - 1/2" thru 1": steel or aluminum
 - 1-1/4" thru 6": malleable iron or copperfree (4/10 of 1% max.) aluminum
- UNY and UNF expansion unions: steel
- Concretetight

Standard Finishes

- Malleable iron products: triplecoat — (1) zinc electroplate, (2) chromate and (3) epoxy powder coat
- Steel products: zinc electroplate
- Aluminum products 1/2" thru 4": natural

Options

- Stainless steel UNF/UNY available 1/2", 3/4", and 1". Add suffix **-SS** to catalog number.

NEC/CEC Certifications and Compliances





- UL Standard: 886
- UL Listed: E-34997
- CSA Standard: C22.2 No. 30
- CSA Certified: 065181
- NEC Articles 500-503 and 505
- Mil. Spec: Mil-F28675

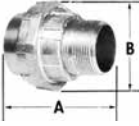

UNY and UNF Unions

Explosionproof, Dust-Ignitionproof

NEC/CEC:
 Class I, Division 1 and 2, Groups A ◊, B ♦, C, D
 Class II, Division 1 and 2, Groups E, F, G
 Class III

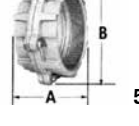
	Millimeters (Inches)		Catalog Number			
	Size (Inches)	A	B	Steel (1/2" to 1")	Malleable (1-1/4" to 6")	Aluminium (1/2" to 4")
UNY Unions – For connecting conduit to enclosure						
<i>Male/Female (Nipple Not Removable)</i>						
 1/2" — 1"	1/2	54.4 (2.15)	37.3 (1.47)	UNY50S ◊	—	UNY50A ◊
	3/4-1/2	54.8 (2.16)	37.3 (1.47)	UNY7550S ◊	—	UNY7550A ◊
	3/4	54.8 (2.16)	44.5 (1.75)	UNY75S ◊	—	UNY75A ◊
	1	66.7 (2.62)	50.8 (2.00)	UNY100S ◊	—	UNY100A ◊
<i>Male/Female (Removable Male Nipple)</i>						
 1-1/4" — 4"	1-1/4	79.4 (3.13)	71.4 (2.81)	—	UNY125 ♦	UNY125NA ♦
	1-1/2	82.6 (3.25)	77.8 (3.06)	—	UNY150 ♦	UNY150NA ♦
 5" — 6"	2	92.1 (3.63)	94.5 (3.72)	—	UNY200 ♦	UNY200NA ♦
	2-1/2	122.2 (4.81)	123.8 (4.88)	—	UNY250 ♦	UNY250A ♦
	3	122.2 (4.81)	136.5 (5.38)	—	UNY300 ♦	UNY300A ♦
	3-1/2	125.4 (4.94)	149.2 (5.88)	—	UNY350 ♦	UNY350A ♦
	4	130.2 (5.13)	163.5 (6.44)	—	UNY400 ♦	UNY400A ♦
	5	142.9 (5.63)	212.7 (8.33)	—	UNY500	UNY500A
6	146.1 (5.75)	244.5 (9.63)	—	UNY600	UNY600A	
UNF Female Unions – For connecting conduit to conduit						
 1/2" — 1"	1/2	37.3 (1.47)	37.3 (1.47)	UNF50S ◊	—	UNF50A ◊
	3/4-1/2 ①	37.3 (1.47)	37.3 (1.47)	UNF7550S ◊	—	UNF7550A ◊
	3/4	37.3 (1.47)	44.5 (1.75)	UNF75S ◊	—	UNF75A ◊
	1	43.7 (1.72)	50.8 (2.00)	UNF100S ◊	—	UNF100A ◊
 1-1/4" — 4"	1-1/4	55.6 (2.19)	71.4 (2.81)	—	UNF125NR ♦	UNF125A ♦
	1-1/2	55.6 (2.19)	77.8 (3.06)	—	UNF150NR ♦	UNF150A ♦
	2	58.7 (2.31)	94.5 (3.72)	—	UNF200NR ♦	UNF200A ♦
	2-1/2	85.7 (3.38)	123.8 (4.88)	—	UNF250R ♦	UNF250A ♦
	3	85.7 (3.38)	136.5 (5.38)	—	UNF300R ♦	UNF300A ♦
	3-1/2	85.7 (3.38)	149.2 (5.88)	—	UNF350R ♦	UNF350A ♦
 5" — 6"	4	88.9 (3.50)	163.5 (6.44)	—	UNF400R ♦	UNF400A ♦
	5	98.4 (3.88)	212.7 (8.38)	—	UNF500R	UNF500A
	6	101.6 (4.00)	244.5 (9.63)	—	UNF600R	UNF600A

① Male end given first

◊ Indicates items in the shaded area which are UL Listed for Class I, Groups A, B, C, D; Class II, Groups E, F, G; and Class III.

♦ Indicates items are UL Listed for Class I, Groups B, C, D; Class II, Groups E, F, G; and Class III.

ME-S Male Enlargers

Explosionproof, Dust-Ignitionproof

NEC/CEC:
 Class I, Division 1 and 2, Groups A, B, C, D
 Class II, Division 1 and 2, Groups E, F, G
 Class III

Applications

- Enlarges a threaded hub in an enclosure or fitting. Example: A 3/4" conduit may connect to a 1/2" female hub by using an ME-323S. See illustration below.

Features

- Knurled female hub.
- Tapered threaded hubs (NPT) for Rigid Conduit and IMC.

Standard Materials

- Turned steel

Standard Finishes

- Zinc electroplated

NEC/CEC Certifications and Compliances

- UL Standards: ANSI/UL 514B and 886
- UL Listed: E-34997
- CSA Standard: C22.2 No. 30
- CSA Certified: 009795
- Suitable for wet locations
- NEC Articles 500-503 and 505



OZGEDNEY

HAZARDOUS LOCATION FITTINGS: NEC/CEC EXPLOSIONPROOF CONDUIT FITTINGS

	Trade Size (Inches)	Dimensions in Millimeters (Inches)			Weight per 100 kg (lb)	Catalog Number
		A	B	C		
Male Enlargers – Turned Steel						
	3/4F x 1/2M	14.20 (0.56)	19.80 (0.78)	35.10 (1.38)	7.26 (16.00)	ME-323S
	1F x 3/4M	12.70 (0.50)	23.90 (0.94)	44.50 (1.75)	1.80 (26.00)	ME-324S
	1-1/4F x 1M	14.20 (0.56)	26.90 (1.06)	57.20 (2.25)	21.32 (47.00)	ME-325S

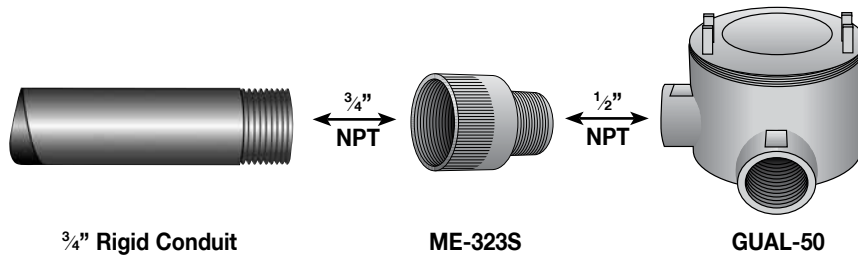
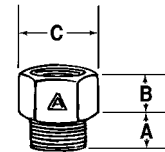

RB Series Threaded Rigid Conduit and IMC Reducers

Explosionproof, Dust-Ignitionproof

NEC/CEC:
RB75-50 thru RB200-150 all materials:
 Class I, Division 1 and 2, Groups A, B, C, D
 Class I, Zone 1 and 2, Groups IIA, IIB, IIC
 Class II, Division 1 and 2, Groups E, F, G
 Class III

NEC/CEC:
RB-200-100 thru RB400-350:
 Class I, Division 1 and 2, Groups B, C, D
 Class I, Zone 1 and 2, Groups IIA, IIB + H₂
 Class II, Division 1 and 2, Groups E, F, G
 Class III

Applications

- RB reducing bushings are designed to reduce conduit entriesto a smaller size and are used in threaded rigid and IMC conduit systems.

Features

- Smooth rounded integral bushing protects conductor insulation
- Full machine tapered threads (NPT)

Standard Materials

- Steel, malleable iron or copperfree (4/10 of 1% max.) aluminum

Standard Finish

- Steel: zinc electroplate
- Malleable iron: zinc electroplate, chromate and epoxy powder coat
- Aluminum: natural



NEC/CEC Compliances and Certifications

- UL Standard: 886 (1203)
- UL Listed: E10444
- CSA Standard: C22.2 No. 25, C22.2 No. 30
- CSA Certified: 065181

Options

- Urethane paint available. Add suffix **-UP** to catalog number.

Size (Inches)	Weight Per 100 kg (lb)	Catalog Number
Reducing Bushings – Steel		
1/2 – 1/8	0.7 (1.50)	RB50-13 ①②
1/2 – 1/4	0.9 (2.00)	RB50-25 ①②
1/2 – 3/8	1.2 (2.70)	RB50-38 ①②
3/4 – 1/2	2.7 (6.00)	RB75-50 ②
1 – 1/2	6.3 (13.80)	RB100-50 ②
1 – 3/4	3.6 (8.00)	RB100-75 ②
1-1/4 – 1/2	13.2 (29.00)	RB125-50
1-1/4 – 3/4	10.4 (23.00)	RB125-75
1-1/4 – 1	7.7 (17.00)	RB125-100
1-1/2 – 1/2	17.7 (39.00)	RB150-50
1-1/2 – 3/4	15.9 (35.00)	RB150-75
1-1/2 – 1	14.1 (31.00)	RB150-100
1-1/2 – 1-1/4	17.5 (16.50)	RB150-125
2 – 1/2	30.8 (68.00)	RB200-50
2 – 3/4	29.0 (64.00)	RB200-75
2 – 1	25.9 (57.00)	RB200-100
2 – 1-1/4	20.4 (45.00)	RB200-125
2 – 1-1/2	17.2 (38.00)	RB200-150
Reducing Bushings – Malleable Iron		
2-1/2 – 1	34.0 (75.00)	RB250-100
2-1/2 – 1-1/4	35.4 (78.00)	RB250-125
2-1/2 – 1-1/2	37.2 (82.00)	RB250-150
2-1/2 – 2	25.4 (56.00)	RB250-200
3 – 1	59.0 (130.00)	RB300-100
3 – 1-1/4	61.2 (135.00)	RB300-125
3 – 1-1/2	64.4 (142.00)	RB300-150
3 – 2	57.2 (126.00)	RB300-200
3 – 2-1/2	37.6 (83.00)	RB300-250
3-1/2 – 2	70.3 (155.00)	RB350-200
3-1/2 – 2-1/2	74.4 (164.00)	RB350-250
3-1/2 – 3	41.7 (92.00)	RB350-300
4 – 2	74.8 (165.00)	RB400-200
4 – 2-1/2	65.8 (245.00)	RB400-250
4 – 3	78.9 (174.00)	RB400-300
4 – 3-1/2	48.1 (106.00)	RB400-350
5 – 3-1/2	81.6 (180.00)	RB500-350 ③
5 – 4	86.2 (190.00)	RB500-400 ③
6 – 4	87.1 (192.00)	RB600-400 ③
6 – 5	88.5 (195.00)	RB600-500 ③

Size (Inches)	Weight Per 100 kg (lb)	Catalog Number
Reducing Bushings – Aluminum		
1/2 – 1/8	0.20 (0.50)	RB50-13A ①③
1/2 – 1/4	0.30 (0.70)	RB50-25A ①③
1/2 – 3/8	0.40 (0.90)	RB50-38A ①③
3/4 – 1/2	1.00 (2.30)	RB75-50A ③
1 – 1/2	3.10 (6.80)	RB100-50A ③
1 – 3/4	1.60 (3.50)	RB100-75A ③
1-1/4 – 1/2	4.20 (9.20)	RB125-50A
1-1/4 – 3/4	3.30 (7.30)	RB125-75A
1-1/4 – 1	2.70 (6.00)	RB125-100A
1-1/2 – 1/2	6.40 (14.20)	RB150-50A
1-1/2 – 3/4	5.80 (12.80)	RB150-75A
1-1/2 – 1	5.40 (12.00)	RB150-100A
1-1/2 – 1-1/4	2.90 (6.50)	RB150-125A
2 – 1/2	13.20 (29.00)	RB200-50A
2 – 3/4	12.00 (26.50)	RB200-75A
2 – 1	10.70 (23.60)	RB200-100A
2 – 1-1/4	8.50 (18.70)	RB200-125A
2 – 1-1/2	7.30 (16.00)	RB200-150A
2-1/2 – 1	12.20 (27.00)	RB250-100A
2-1/2 – 1-1/4	12.7 (28.10)	RB250-125A
2-1/2 – 1-1/2	37.2 (82.00)	RB250-150A
2-1/2 – 2	9.1 (20.00)	RB250-200A
3 – 1	21.2 (46.80)	RB300-100A
3 – 1-1/4	22.0 (48.60)	RB300-125A
3 – 1-1/2	23.2 (51.10)	RB300-150A
3 – 2	23.1 (51.00)	RB300-200A
3 – 2-1/2	15.9 (35.00)	RB300-250A
3-1/2 – 2	25.3 (55.80)	RB350-200A
3-1/2 – 2-1/2	26.0 (57.40)	RB350-250A
3-1/2 – 3	19.1 (42.00)	RB350-300A
4 – 2	26.9 (59.40)	RB400-200A
4 – 2-1/2	27.6 (60.90)	RB400-250A
4 – 3	35.2 (77.50)	RB400-300A
4 – 3-1/2	22.7 (50.00)	RB400-350A
5 – 3-1/2	29.4 (64.80)	RB500-350A ③
5 – 4	31.0 (68.40)	RB500-400A ③
6 – 4	31.3 (69.10)	RB600-400A ③
6 – 5	31.8 (70.20)	RB600-500A ③

① UL Recognized.

② Suitable for Class I, Group A, B, C, D, Class II Groups E, F, G, and Class III.

③ Class I, Groups C,D; Class II, Groups E,F,G; Class III.

RB Reducing Bushings

Explosionproof, Dust-Ignitionproof

NEC/CEC:

RB-321 thru RB-330 all materials:
 Class I, Division 1 and 2, Groups A, B, C, D
 Class I, Zone 1 and 2, Groups IIA, IIB, IIC
 Class II, Division 1 and 2, Groups E, F, G
 Class III

NEC/CEC:

RB-331-100 thru RB-357:
 Class I, Division 1 and 2, Groups B, C, D
 Class I, Zone 1 and 2, Groups IIA, IIB + H₂
 Class II, Division 1 and 2, Groups E, F, G
 Class III

Applications

- To reduce the trade size of a tapped hole or hub

Features

- Tapered threads (NPT)
- Smooth internal bushing protects conductors.
- Threaded for Rigid Conduit or IMC.

Standard Materials

- Malleable iron

Standard Finishes

- Malleable iron: zinc electroplate, chromate and epoxy powder coat

NEC/CEC Certifications and Compliances

- UL Standard: 886
- UL Listed: E10444
- CSA Standard: C22.2 No. 30
- CSA Certified: 009795
- NEC Articles 500-503 and 505



OZGEDNEY

HAZARDOUS LOCATION FITTINGS: NEC/CEC EXPLOSIONPROOF CONDUIT FITTINGS

Size (Inches)	Catalog Number
Reducing Bushings – Steel	
1/2 – 3/8	RB-320S
3/4 – 1/2	RB-321S
1 – 1/2	RB-323S
1 – 3/4	RB-322S
1-1/4 – 1/2	RB-324S
1-1/4 – 3/4	RB-325S
1-1/4 – 1	RB-326S
1-1/2 – 1/2	RB-330S
1-1/2 – 3/4	RB-329S
1-1/2 – 1	RB-328S
1-1/2 – 1-1/4	RB-327S
Reducing Bushings – Malleable Iron	
2 – 1/2	RB-335
2 – 3/4	RB-334
2 – 1	RB-333
2 – 1-1/4	RB-332
2 – 1 1/2	RB-331
2-1/2 – 1	RB-339
2-1/2 – 1-1/2	RB-337
2-1/2 – 2	RB-336
3 – 1-1/2	RB-340
3 – 2	RB-341
3 – 2-1/2	RB-342
3-1/2 – 2-1/2	RB-350
3 1/2 – 3	RB-349
4 – 2	RB-351
4 – 2-1/2	RB-355
4 – 3	RB-356
4 – 3-1/2	RB-357

Size (Inches)	Catalog Number
Reducing Bushings – Aluminum	
3/4 – 1/2	RB-321A
1 – 1/2	RB-323A
1 – 3/4	RB-322A
1-1/4 – 1/2	RB-324A
1-1/4 – 3/4	RB-325A
1-1/4 – 1	RB-326A
1-1/2 – 1/2	RB-330A
1-1/2 – 3/4	RB-329A
1-1/2 – 1	RB-328A
1-1/2 – 1-1/4	RB-327A
2 – 1/2	RB-335A
2 – 3/4	RB-334A
2 – 1	RB-333A
2 – 1-1/4	RB-332A
2 – 1-1/2	RB-331A
2-1/2 – 1	RB-339A
2-1/2 – 1-1/2	RB-337A
2-1/2 – 2	RB-336A
3 – 1-1/2	RB-340A
3 – 2	RB-341A
3 – 2-1/2	RB-342A
3-1/2 – 2-1/2	RB-350A
3-1/2 – 3	RB-349A
4 – 2	RB-351A
4 – 2-1/2	RB-355A
4 – 3	RB-356A
4 – 3-1/2	RB-357A

ATX™ DB Series IIB Unions

Flameproof

ATEX/IECEX:
 Zone 1 and 2 – 21 and 22
 Ⓢ II 2 GD Ex d IIB
 IP66/67

Applications

- To be used with a fire retardant seal fitted directly at the entry to the flameproof housing. Enables connection via rigid or flexible union.
- Used for joining conduit and connecting conduit to enclosures.
- Facilitates modifications, permits the removal of enclosures without turning or removal of conduit.

Features

- Accurately tapped, tapered threads for tight, rigid joints and ground continuity.

Standard Materials

- Nickel plated steel

ATEX/IECEX Certifications and Compliances

- Certification Type BMF - BFF
 - Gas: Zone 1
 - Type of Protection: Ex d IIB
 - Dust: Zone 21
 - Type of Protection: Ex tD A21
- Conforming to ATEX 94/9/CE: Ⓢ II 2GD
- Operating Temperatures: -20 °C to +60 °C (-4 °F to +140 °C)
- CE Declaration of Conformity: 5C232
- ATEX Certificate: CESI 99 ATEX 034U
- Index of Protection according EN/IEC 60529: IP66/67



500044



500049

Tapered Thread (NPT)	Weight kg (lb)	Volume dm ³ (in ³)	Pack	Catalog Number
Male/Female				
1/2"	0.17 (0.37)	0.12 (7.32)	1	500044
3/4"	0.19 (0.42)	0.12 (7.32)	1	500045
1"	0.30 (0.66)	0.23 (0.87)	1	500046
1-1/4"	0.80 (1.76)	0.50 (30.51)	1	500047
1-1/2"	1.00 (2.20)	0.50 (30.51)	1	500048
Female/Female				
1/2"	0.15 (0.33)	0.12 (7.32)	1	500049
3/4"	0.15 (0.33)	0.12 (7.32)	1	500050
1"	0.23 (0.51)	0.23 (14.04)	1	500051
1-1/4"	0.70 (1.54)	0.50 (30.51)	1	500052
1-1/2"	0.37 (0.82)	0.50 (30.51)	1	500053
3"	0.90 (1.98)	2.00 (122.03)	1	500158

ATX™ DB Series IIC Elbows

Increased Safety

ATEX/IECEX:
Zone 1 and 2 – 21 and 22
⊕ II 2 GD
Ex d IIC

Applications

- Used to connect two lengths of conduit.
- Used to make 90° bends in conduit runs.

Features

- Accurately tapped, tapered threads for tight, rigid joints and ground continuity.

Standard Materials

- Aluminum

Features

- Female to female thread.

ATEX/IECEX Certifications and Compliances

- Certification Type ELF
 - Gas: Zone 1
 - Type of Protection: Ex d IIC Gb; Ex e IIC Gb
 - Dust: Zone 21
 - Type of Protection: Ex tb IIIC Db
- Conforming to ATEX 94/9/CE: ⊕ II 2GD
- Operating Temperatures: -55 °C to +150 °C (-67 °F to +302 °F)
- CE Declaration of Conformity: 5C223
- ATEX Certificate: CESI 01 ATEX 104U
- IECEx Certificate: IECEx CES 15.0005U
- Index of Protection according EN/IEC 60529: IP66/67

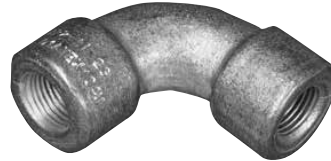

Tapered Thread (NPT)	Dimensions mm (in)		Weight kg (lb)	Volume dm ³ (in ³)	Catalog Number
	A	B			
1/2"	73 (2.87)	57 (2.24)	0.12 (0.28)	0.12 (7.32)	500054
3/4"	73 (2.87)	67 (2.64)	0.10 (0.22)	0.12 (7.32)	500055
1"	92 (3.62)	83 (3.27)	0.20 (0.44)	0.23 (14.04)	500056
1-1/4"	115 (4.53)	84 (3.31)	0.40 (0.88)	0.50 (30.51)	500057
1-1/2"	115 (4.53)	84 (3.31)	0.60 (1.32)	0.50 (30.51)	500058
3"	185 (7.28)	95 (3.74)	0.50 (1.10)	2.00 (122.03)	500059

ATX™ DB Series IIC Flexible Couplings

Increased Safety. Flameproof.

ATEX/IECEX:
 Zone 1 and 2 - 21 and 22
 II 2 GD Ex d IIC
 IP66/67

Applications

- Used in areas where vibration and/or movement are a problem.
- Used in place of rigid conduit in where it would be difficult to bend conduit.

Standard Materials

- Stainless steel

ATEX/IECEX Certifications and Compliances

- Certification Type FLEXCO
 - Gas: Zones 1
 - Type of Protection: Ex d IIC Gb
 - Dust: Zone 21
 - Type of Protection: Ex t IIIIC Db
- Conforming to ATEX 94/9/CE: II 2G 2D



- Operating Temperatures: -40 °C to +150 °C (-40 °F to +302 °F)
- CE Declaration of Conformity: 5C247
- ATEX Certificate: LCIE 11 ATEX 3006U
- IECEx Certificate: IECEx LCIE 12.0011U
- Index of Protection according EN/IEC 60529: IP66

Male/Male — To be used with fire-retardant seals or unions,

Tapered Thread (NPT)	Length mm (in)	Weight kg (lb)	Volume dm ³ (in ³)	Catalog Number	Pack
1/2"	100 (3.94)	0.65 (1.43)	1 (61)	500060	1
1/2"	170 (6.69)	0.7 (1.54)	1.75 (107)	500061	1
1/2"	250 (9.84)	0.7 (1.54)	2.5 (153)	500106	1
1/2"	300 (11.81)	0.75 (1.65)	3 (183)	500062	1
1/2"	400 (15.75)	0.8 (1.76)	4 (244)	500063	1
1/2"	500 (19.68)	0.85 (1.87)	5 (305)	500064	1
1/2"	600 (23.62)	0.9 (1.98)	6 (366)	500065	1
1/2"	700 (27.56)	0.95 (2.09)	7 (427)	500066	1
1/2"	800 (31.50)	1.0 (2.20)	8 (488)	500067	1
1/2"	900 (35.43)	1.05 (2.31)	9 (549)	500068	1
1/2"	1000 (39.37)	1.1 (2.43)	10 (610)	500069	1
3/4"	300 (11.81)	0.75 (1.65)	3 (183)	500070	1
3/4"	400 (15.75)	0.8 (1.76)	1 (61)	500071	1
3/4"	500 (19.68)	0.85 (1.87)	5 (305)	500072	1
3/4"	600 (23.62)	0.9 (1.98)	6 (366)	500073	1
3/4"	700 (27.56)	0.95 (2.09)	7 (427)	500074	1
3/4"	800 (31.50)	1.0 (2.20)	8 (488)	500075	1
3/4"	900 (35.43)	1.05 (2.31)	9 (549)	500076	1
3/4"	1000 (39.37)	1.1 (2.43)	10 (610)	500077	1
1"	300 (11.81)	0.75 (1.65)	3 (183)	500078	1
1"	400 (15.75)	0.8 (1.76)	1 (61)	500079	1
1"	500 (19.68)	0.85 (1.87)	5 (305)	500080	1
1"	600 (23.62)	0.9 (1.98)	6 (366)	500081	1
1"	700 (27.56)	0.95 (2.09)	7 (427)	500082	1
1"	800 (31.50)	1.0 (2.20)	8 (488)	500083	1
1"	900 (35.43)	1.05 (2.31)	9 (549)	500084	1
1"	1000 (39.37)	1.1 (2.43)	3 (183)	500085	1
1-1/4"	300 (11.81)	0.75 (1.65)	3 (183)	500086	1
1-1/4"	400 (15.75)	0.8 (1.76)	3 (183)	500087	1
1-1/4"	500 (19.68)	0.85 (1.87)	5 (305)	500088	1
1-1/4"	600 (23.62)	0.9 (1.98)	6 (366)	500089	1
1-1/4"	700 (27.56)	0.95 (2.09)	7 (427)	500090	1
1-1/4"	800 (31.50)	1.0 (2.20)	8 (488)	500091	1
1-1/4"	900 (35.43)	1.05 (2.31)	9 (549)	500092	1
1-1/4"	1000 (39.37)	1.1 (2.43)	10 (610)	500093	1
1-1/2"	300 (11.81)	0.75 (1.65)	3 (183)	500094	1
1-1/2"	400 (15.75)	0.8 (1.76)	1 (61)	500095	1
1-1/2"	500 (19.68)	0.85 (1.87)	5 (305)	500096	1
1-1/2"	600 (23.62)	0.9 (1.98)	6 (366)	500097	1
1-1/2"	700 (27.56)	0.95 (2.09)	7 (427)	500098	1

Drain, Breather, Universal Drain or Breather

Explosionproof, Dust-Ignitionproof

NEC/CEC:
 Class I, Division 1 and 2, Groups B♦, C, D
 Class II, Division 1 and 2, Groups E, F, G
 Class III

Applications

- To provide a means for the prevention and/or release of condensation when properly installed in the appropriate location.

Features

- Accurately tapped, tapered threads for tight, rigid joints and ground continuity.

Standard Materials

- Hazardous location combination drain/breathers: stainless steel
- Non-hazardous CRN drains: copperfree (4/10 of 1% max.) aluminum

Standard Finishes

- Stainless steel: natural finish
- Aluminum: natural finish

Options

- CRN: steel/zinc electroplate add suffix -S.

NEC/CEC Certifications and Compliances

- UL Standard: 886 (1203)
- UL Listed: E10444
- CSA Standard: C22.2 No. 30
- CSA Certified: 065181



ECD50B4X



ECDB38



CRN38

HAZARDOUS LOCATION FITTINGS: NEC/CEC EXPLOSIONPROOF DRAIN AND BREATHERS

Illustrated Features

Drain Fittings:

Generally installed at bottom of enclosure housing to drain moisture caused by condensation.

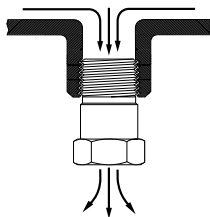

Breather Fittings:

Generally installed at top of enclosure housing to minimize condensation.

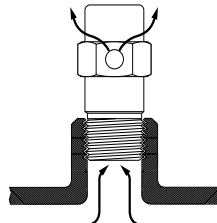

Universal Drain-Breather Fittings:

Generally installed at top and/or bottom of enclosure housing. The features of a drain fitting and a breather fitting are combined into one fitting.

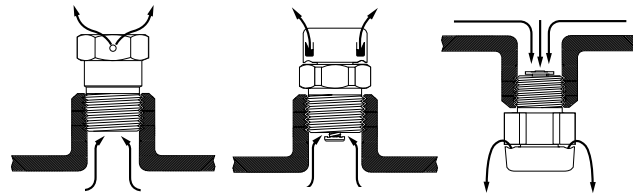







♦ Items in the shaded area on the following page are UL Listed for Class I, Groups B, C, D; Class II, Groups E, F, G; Class III.

Drain, Breather, Universal Drain or Breather

Explosionproof, Dust-Ignitionproof

NEC/CEC:
 Class I, Division 1 and 2, Groups B♦, C, D
 Class II, Division 1 and 2, Groups E, F, G
 Class III

		Type	Trade Size (Inches)	Catalog Number
		NEMA 3R Universal Drain or Breather For high performance water drainage or continuous ventilation.	1/2	ECDB50HP
		NEMA 4X Breather For continuous ventilation.	1/2	BRTB4X ♦
		NEMA 4X Drain For automatic water drainage.	1/2	ECD50B4X ♦
		NEMA 3R Group B Universal Drain or Breather Raintight. For automatic water drainage or continuous ventilation.	3/8 1/2	ECDB38B ♦ ECDB50B ♦
		Groups C and D Universal Drain or Breather For automatic water drainage or continuous ventilation.	3/8	ECDB38
		Non-Hazardous Location Drain ①	3/8 1/2 3/4	CRN38 CRN50 CRN75

HAZARDOUS LOCATION FITTINGS: NEC/CEC EXPLOSIONPROOF DRAIN AND BREATHERS

① Also suitable for Class I, Division 2. Not UL Listed.

♦ Indicates items in the shaded area which are UL Listed for Class I, Groups B, C, D; Class II, Groups E, F, G; Class III.

Drain, Breather, Universal Drain or Breather

Explosionproof, Dust-Ignitionproof

NEC/CEC Type DB:

Class I, Division 1 and 2, Groups C, D
 Class I, Zone 1 and 2, Groups IIA, IIB
 Class II, Division 1 and 2, Groups F, G
 Class III

NEC/CEC Type DBB:

Class I, Division 1 and 2, Groups B, C, D
 Class I, Zone 1 and 2, Groups IIA, IIB + H2
 Class II, Division 1 and 2, Groups E, F, G
 Class III

Applications

- May be used as a combination drain or breather.
- When installed at the top of an enclosure it acts as a breather.
- When Installed in the bottom of an enclosure it acts as a drain for moisture inside the enclosure.

Features

- Tapered threads (NPT).

Standard Materials

- Stainless steel

NEC/CEC Certifications and Compliances

- UL Standard: 886
- UL Listed: E-34997
- CSA Standard: C22.2 No. 30
- CSA Certified: 009795
- NEC Articles 500-503 and 505



Type DB

HAZARDOUS LOCATION FITTINGS: NEC/CEC EXPLOSIONPROOF DRAIN AND BREATHERS

Trade Size (Inches)	Dimensions in Millimeters (Inches)			Catalog Number
	Length	Max Dia	A	
1/2	33.33 (1.31)	26.99 (1.06)	33.34 (1.31)	DB-38 ①
3/4	38.10 (1.50)	25.40 (1.00)	38.10 (1.50)	DB-50
1	42.86 (1.69)	33.34 (1.31)	61.91 (2.44)	DBB-50SS

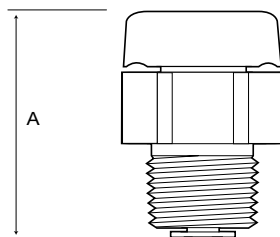

① UL component recognized.

ATX™ DB Series Drain and Breather Valves

Increased Safety

ATEX/IECEX:
 Zone 1 and 2 – 21 and 22
 Ⓢ II 2 GD Ex e II
 IP66

Applications



- Flameproof Bleed Valve
 - Used to drain condensation from inside enclosures and boxes.
- Increased Safety Breather Drain
 - Ensures that the condensation is evacuated from the lower section of the enclosures and limits the “pumping” effect in the upper section.

Standard Materials

- Bleed valve: nickel plated brass
- Breather/drain: polyamide, brass or stainless steel

ATEX/IECEX Certifications and Compliances

- Certification Type DP-E
 - Gas: Zones 1
 - Type of Protection: Ex e IIC Gb
 - Dust: Zone 21
 - Type of Protection: Ex tb IIIC Db
- Conforming to ATEX 94/9/CE: Ⓢ II 2G 2D
- Ambient Temperature: -50 °C to +85 °C (-58 °F to +185 °F)
- CE Declaration of Conformity: 5C225
- ATEX Certificate: Sira 99ATEX3050X
- IECEX Certificate: IECEX SIR 08.0024X
- Index of Protection according EN/IEC 60529: IP66

	Metric Thread	Material	Weight kgs (lbs)	Volume dm ³ (in ³)	Pack	Catalog Number
Flameproof Bleed Valve						
<i>To be used only with our range of flameproof enclosure. The ATEX certification is included in our Exd enclosure's certification.</i>						
	M20	Nickel plated brass	0.10 (0.22)	0.01 (0.60)	1	DBD20NB
Increased Safety Combination Drain and Breather						
	M20	Polyamide	0.20 (0.44)	0.01 (0.60)	1	DBE20P
	M20	Brass	0.20 (0.44)	0.01 (0.60)	1	DBE20B
	M20	Stainless steel	0.20 (0.44)	0.01 (0.60)	1	DBE20S

Dimensions in Millimeters (Inches)

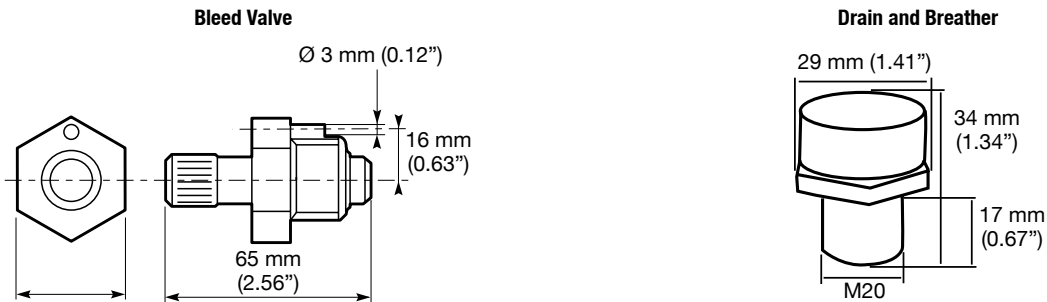

Sealing Fittings

Explosionproof, Dust-Ignitionproof

UNILETS™ for Use with Threaded Rigid Metal Conduit and IMC.

Applications

- Prevent passage of gases, vapors or flames from one portion of conduit system to another. Restrict any explosion to the sealed off enclosure. Prevent pressure piling within conduit system.
- Required in Class I, Division 1 and 2 locations within 18" of enclosures containing apparatus that may cause arcs, sparks or high temperatures.
- Required in Class I, Division 1 and 2 locations where 2" or larger conduit enters enclosure, fitting housing terminals, splices or taps.
- Required in Class I, Division 1 and 2 locations at the boundary where conduit leaves classified location.
- Required in Class I, Division 1 and 2 locations where two or more enclosures are connected by 36" or less conduit. Seal must be located within 18" of either enclosure.
- Required where cables (which exceed rate of gas or vapor transmission permitted for seals) are used in Class I, Division 2 locations.

Features

- Explosionproof, dust-ignitionproof, raintight.
- Smooth, rounded integral bushing in each hub protects conductor insulation.
- Accurately tapped, tapered threads for tight, rigid joints and ground continuity.
- Removable nipple in male sealing fitting may be used interchangeably in top or bottom hub.
- EYS—for sealing vertical conduit. Large opening for damming and filling.
- Expanded fill EYSEF/EYDEF—allow up to 40% conduit fill in compliance with the National Electrical Code.
- EYSF/EYSM—for sealing vertical conduit. Large opening for damming and filling.

Illustrated Features

Sealing fittings prevent passage of gases, vapors or flames from one portion of a conduit system to another. They also restrict large amounts of ignitable gases or vapors from accumulating to confine explosive pressure.

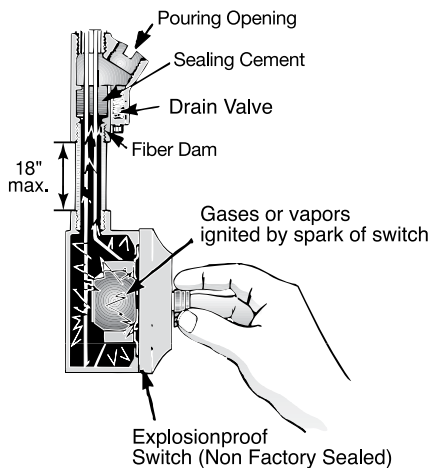

- ESUF/ESUM—for sealing vertical or horizontal conduit. Pouring spout rotates 90°. Removable cover provides full access for damming 1/2" thru 1" sizes have threaded cover openings for damming.
- EYF/EYM—close radius type for sealing vertical or horizontal conduit runs.
- EYDM Drain Sealing Fittings—close radius type for sealing vertical conduit runs. Access cover has drain valve for automatic draining of water accumulation above the seal.
- UL Listed for use with Kwiko™ A Sealing Compound. Also listed with certain competitors sealing cement, contact factory for details.

Standard Materials

- EYSF/EYSM, EYF/EYM and EYDM seals: malleable iron or copperfree Almag 35 aluminum
- EYS, EYSEF/EYDEF, and ESUF/ESUM seals: malleable iron
- EYD and EYS seals: Grayloy®-iron

Standard Finishes

- Malleable iron and Grayloy®-iron products have triple-coat — (1) zinc electroplate, (2) chromate, and (3) epoxy powder coat,
- Almag 35 aluminum products have epoxy powder coat

NEC/CEC Certifications and Compliances

- UL Standard: 886 (1203)
- UL Listed: E10444
- CSA Standard: C22.2 No. 30
- CSA Certified: 065181

Related Products

- Kwiko™ A sealing cement and fiber filler

Appleton sealing fittings are suitable for Class I and II locations. EYS, EYSF and EYD are for sealing vertical conduit. EY and ESU are for sealing vertical and horizontal conduit. EYDM and EYD also have drain valves.

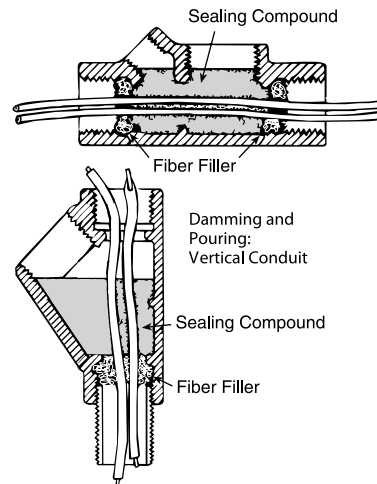

EYS 25% * Fill Vertical Conduit Sealing Fittings

Explosionproof, Dust-Ignitionproof, Raintight





UNILETS™ for Use with Threaded Rigid Metal Conduit and IMC.

NEC/CEC:

Class I, Division 1 and 2, Groups A, B♦, C, D

Class II, Division 1 and 2, Groups E, F, G

Class III

	Trade Size (Inches)	Millimeters (Inches)			Kwiko™ A Cement Required Grams (Ounces)	Catalog Number	
		A (Length)	B (Width)	Turning Radius ①		Malleable Iron	Almag 35 Aluminum
Female							
	1/2	82.5 (3.25)	28.7 (1.13)	45.9 (1.81)	56.7 (2.00)	EYSF-50	EYSF-50AL
	3/4	92.2 (3.63)	35.0 (1.38)	57.1 (2.25)	85.1 (3.00)	EYSF-75	EYSF-75AL
	1	107.9 (4.25)	44.5 (1.75)	60.4 (2.38)	141.7 (5.00)	EYSF-100	EYSF-100AL
	1-1/4	128.5 (5.06)	50.8 (2.00)	74.6 (2.94)	311.8 (11.00)	EYSF-125	—
	1-1/2	139.7 (5.50)	63.5 (2.50)	89.9 (3.50)	538.6 (19.00)	EYSF-150	—
	2	158.7 (6.25)	74.6 (2.94)	104.9 (4.13)	878.8 (31.00)	EYSF-200	—
	2-1/2	188.9 (7.44)	85.8 (3.38)	120.6 (4.75)	1304.1 (46.00)	EYSF-250	—
	3	215.9 (8.50)	104.9 (4.13)	143.0 (5.63)	2324.7 (82.00)	EYSF-300	—
	4	219.2 (8.63)	130.3 (5.13)	165.1 (6.50)	2608.2 (92.00)	EYSF-400	—
	Male/Female (Removable Male Nipple)						
	1/2	82.5 (3.25)	28.7 (1.13)	45.9 (1.81)	56.7 (2.00)	EYSM-50	EYSM-50AL
	3/4	92.2 (3.63)	35.5 (1.38)	57.1 (2.25)	85.1 (3.00)	EYSM-75	EYSM-75AL
	1	107.9 (4.25)	44.5 (1.75)	60.4 (2.38)	141.7 (5.00)	EYSM-100	EYSM-100AL

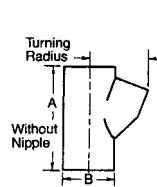

EYSF
1/2" — 3"
EYSM
1/2" — 1"

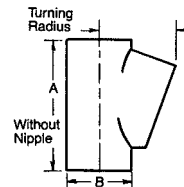

EYSF
4"

* Per NEC 501.15(C)(6) seals in Class I, Division 1 and 2 must be limited to conductor fill of 25% of cross sectional area of a rigid metal conduit of the same trade size unless approved for higher percentage fill. See 40% fill sealing fittings.

① Turning radius with cover or plug removed.

♦ Indicates items in the shaded area which are UL Listed for Class I, Groups A, B, C, D; Class II, Groups E, F, G; and Class III.

EYS 25% * Fill Vertical and Horizontal Sealing Fittings

For Close Turning Radius. Explosionproof, Dust-Ignitionproof, Raintight.

UNILETS™ for Use with Threaded Rigid Metal Conduit and IMC.

NEC/CEC:

Class I, Division 1 and 2, Groups A, B, C, D







Class II, Division 1 and 2, Groups E, F, G

Class III







Trade Size (Inches)	Millimeters (Inches)			Kwiko™ A Cement Required Grams (Ounces)	Catalog Number Grayloy™-Iron
	A (Length)	B (Width)	Turning Radius ①		

EYS Vertical and Horizontal Conduit Seals for Close Turning Radius (25% fill)

Female

	1/2	93.7 (3.69)	31.7 (1.25)	29.4 (1.16)	28.0 (1.00)	EYS-11 ◇
	3/4	93.7 (3.69)	38.1 (1.50)	31.7 (1.25)	57.0 (2.00)	EYS-21 ◇
	1	109.4 (4.31)	44.4 (1.75)	35.5 (1.38)	113.0 (4.00)	EYS-31 ◇
	1-1/4	128.5 (5.06)	55.6 (2.19)	44.4 (1.75)	255.0 (9.00)	EYS-4
	1-1/2	139.7 (5.50)	61.9 (2.44)	52.3 (2.06)	340.0 (12.00)	EYS-5
	2	158.7 (6.25)	76.2 (3.00)	58.6 (2.31)	595.0 (21.00)	EYS-6
	2-1/2	190.5 (7.50)	88.9 (3.50)	68.3 (2.69)	1049.0 (37.00)	EYS-7
	3	215.9 (8.50)	107.9 (4.25)	79.5 (3.13)	1729.0 (61.00)	EYS-8
	3-1/2	233.4 (9.19)	120.6 (4.75)	87.3 (3.44)	2268.0 (80.00)	EYS-9
	4	247.6 (9.75)	133.3 (5.25)	93.7 (3.69)	3175.0 (112.00)	EYS-10
	5	294.6 (11.06)	165.1 (6.50)	119.1 (4.69)	5613.0 (198.00)	EYS-012
	6	308.1 (12.13)	193.8 (7.63)	136.6 (5.38)	9667.0 (230.00)	EYS-014

Male/Female (Removable Male Nipple)

	1/2	93.7 (3.69)	31.7 (1.25)	29.4 (1.16)	28.0 (1.00)	EYS-116 ◇
	3/4	93.7 (3.69)	38.1 (1.50)	31.7 (1.25)	57.0 (2.00)	EYS-216 ◇
	1	109.4 (4.31)	44.4 (1.75)	35.5 (1.38)	113.0 (4.00)	EYS-316 ◇
	1-1/4	128.5 (5.06)	55.6 (2.19)	44.4 (1.75)	255.0 (9.00)	EYS-46
	1-1/2	139.7 (5.50)	61.9 (2.44)	52.3 (2.06)	340.0 (12.00)	EYS-56
	2	158.7 (6.25)	76.2 (3.00)	58.6 (2.31)	595.0 (21.00)	EYS-66
	2-1/2	190.5 (7.50)	88.9 (3.50)	68.3 (2.69)	1,049.0 (37.00)	EYS-76
	3	215.9 (8.50)	107.9 (4.25)	79.5 (3.13)	1,729.0 (61.00)	EYS-86
	3-1/2	233.4 (9.19)	120.6 (4.75)	87.3 (3.44)	2,268.0 (80.00)	EYS-96
	4	247.6 (9.75)	133.3 (5.25)	93.7 (3.69)	3,175.0 (112.00)	EYS-106
	5	294.6 (11.06)	165.1 (6.50)	119.1 (4.69)	5,613.0 (198.00)	EYS-0126
	6	308.1 (12.13)	193.8 (7.63)	136.6 (5.38)	9,667.0 (230.00)	EYS-0146

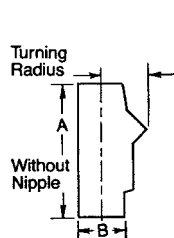

EYS
1/2" — 1"

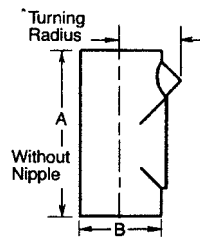

EYS
1-1/4" — 6"

* Per NEC 501.15(C)(6), seals in Class I, Division 1 and 2 must be limited to conductor fill of 25% of cross sectional area of a rigid metal conduit of the same trade size unless approved for higher percentage fill. See 40% fill sealing fittings.

① Turning radius with cover or plug removed.

◇ Indicates items in the shaded area which are UL Listed for Class I, Groups A, B, C, D; Class II, Groups E, F, G; and Class III.



EYS 25% * Fill Vertical Sealing Fittings for Close Turning Radius

Explosionproof, Dust-Ignitionproof, Raintight

UNILETS™ for Use with Threaded Rigid Metal Conduit and IMC.

NEC/CEC:

Class I, Division 1 and 2, Groups A◇, B, C, D
 Class II, Division 1 and 2, Groups E, F, G
 Class III

	Trade Size (Inches)	Millimeters (Inches)			Kwiko™ A Cement Required Grams (Ounces)	Catalog Number Grayloy™-Iron
		A (Length)	B (Width)	Turning Radius ①		
EYS Vertical Sealing Fittings (25% fill)						
Female						
	1/2	83.3 (3.28)	31.7 (1.25)	41.4 (1.63)	28.4 (1.00)	EYS-1 ◇
	3/4	93.7 (3.69)	38.1 (1.50)	48.5 (1.91)	56.8 (2.00)	EYS-2 ◇
	1	109.4 (4.31)	44.4 (1.75)	60.4 (2.38)	85.1 (3.00)	EYS-3 ◇
Male/Female (Removable Male Nipple)						
	1/2	83.3 (3.28)	31.7 (1.25)	41.4 (1.63)	28.4 (1.00)	EYS-16 ◇
	3/4	93.7 (3.69)	38.1 (1.50)	48.5 (1.91)	56.8 (2.00)	EYS-26 ◇
	1	109.4 (4.31)	44.4 (1.75)	60.4 (2.38)	85.1 (3.00)	EYS-36 ◇

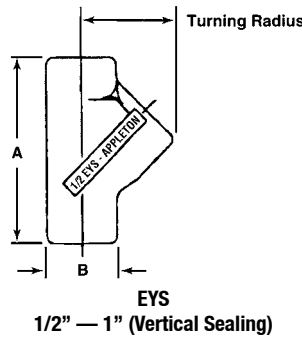

Appleton

HAZARDOUS LOCATION FITTINGS: NEC/CEC EXPLOSIONPROOF SEALING FITTINGS

* Per NEC 501.15(C)(6), seals in Class I, Division 1 and 2 must be limited to conductor fill of 25% of cross sectional area of a rigid metal conduit of the same trade size unless approved for higher percentage fill. See 40% fill sealing fittings.

① Turning radius with cover or plug removed.

◇ Indicates items in the shaded area which are UL Listed for Class I, Groups A, B, C, D; Class II, Groups E, F, G; and Class III.



ESU 25% * Fill Vertical and Horizontal Conduit Sealing Fittings

Explosionproof, Dust-Ignitionproof, Raintight

UNILETS™ for Use with Threaded Rigid Metal Conduit and IMC.

NEC/CEC:

Class I, Division 1 and 2, Groups C, D
 Class II, Division 1 and 2, Groups E, F, G
 Class III

	Trade Size (Inches)	Millimeters (Inches)			Turning Radius ①	Kwiko™ A Cement Required Grams (Ounces)	Catalog Number Malleable Iron
		A (Length)	B (Width)	C (Hub CL)			
Female							
	1/2	76.2 (3.00)	79.4 (2.94)	17.5 (0.69)	31.7 (1.25)	113.4 (4.00)	ESUF-50
	3/4	79.5 (3.13)	79.4 (2.94)	17.5 (0.69)	31.7 (1.25)	113.4 (4.00)	ESUF-75
	1	85.8 (3.38)	82.5 (3.25)	22.3 (0.88)	35.0 (1.38)	141.7 (5.00)	ESUF-100
Male/Female (Removable Male Nipple)							
	1/2	76.0 (3.00)	79.4 (2.94)	17.5 (0.69)	31.7 (1.25)	113.4 (4.00)	ESUM-50
	3/4	79.5 (3.13)	79.4 (2.94)	17.5 (0.69)	31.7 (1.25)	113.4 (4.00)	ESUM-75
	1	85.8 (3.38)	82.5 (3.25)	22.3 (0.88)	35.0 (1.38)	141.7 (5.00)	ESUM-100

1/2" — 1"

1/2" — 1"

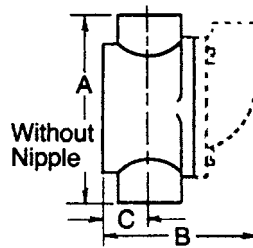

ESUF/ESUM
 1/2" — 1"

HAZARDOUS LOCATION FITTINGS: NEC/CEC EXPLOSIONPROOF SEALING FITTINGS

* Per NEC 501.15(C)(6) seals in Class I, Division 1 and 2 must be limited to conductor fill of 25% of cross sectional area of a rigid metal conduit of the same trade size unless approved for higher percentage fill. See 40% fill sealing fittings.

① Turning radius with cover or plug removed.

EY 25% * Fill Vertical and Horizontal Conduit Sealing Fittings

For Close Turning Radius. Explosionproof, Dust-Ignitionproof, Raintight.











UNILETS™ for Use with Threaded Rigid Metal Conduit and IMC.

NEC/CEC:

Class I, Division 1 and 2, Groups A ◊, B ♦, C, D

Class II, Division 1 and 2, Groups E, F, G

Class III

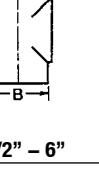
	Trade Size (Inches)	Millimeters (Inches)			Kwiko™ A Cement Required Grams (Ounces)	Catalog Number	
		A (Length)	B (Width)	Turning Radius ①		Malleable Iron	Almag 35 Aluminum
Female							
	1/2	88.9 (3.50)	30.2 (1.19)	26.9 (1.06)	28.4 (1.00)	EYF-50 ◊	EYF-50AL ◊
	3/4	88.9 (3.50)	35.0 (1.38)	30.2 (1.19)	56.7 (2.00)	EYF-75 ◊	EYF-75AL ◊
	1	107.9 (4.25)	44.4 (1.75)	35.0 (1.38)	113.4 (4.00)	EYF-100 ◊	EYF-100AL ◊
	1-1/4	125.4 (4.94)	50.8 (2.00)	44.4 (1.75)	198.4 (7.00)	EYF-125 ♦	EYF-125AL
	1-1/2	139.7 (5.50)	60.4 (2.38)	52.3 (2.06)	368.5 (13.00)	EYF-150 ♦	EYF-150AL
	2	155.7 (6.13)	73.1 (2.88)	58.6 (2.31)	623.7 (22.00)	EYF-200 ♦	EYF-200AL
	2-1/2	190.5 (7.50)	85.8 (3.38)	68.3 (2.69)	1020.6 (36.00)	EYF-250 ♦	EYF-250AL
	3	206.5 (8.13)	104.9 (4.13)	79.5 (3.13)	1729.3 (61.00)	EYF-300 ♦	EYF-300AL
	3-1/2	227.0 (8.94)	120.6 (4.75)	87.3 (3.44)	2523.1 (89.00)	EYF-350 ♦	EYF-350AL
	4	238.2 (9.38)	130.3 (5.13)	93.7 (3.69)	3231.8 (114.00)	EYF-400 ♦	EYF-400AL
	5	274.5 (10.81)	158.7 (6.25)	119.1 (4.69)	5726.6 (202.00)	EYF-500 ②	—
	6	299.9 (11.81)	185.6 (7.31)	136.6 (5.38)	6520.4 (230.00)	EYF-600 ②	—
Male/Female (Removable Male Nipple)							
	1/2	119.9 (4.72)	30.2 (1.19)	26.9 (1.06)	28.4 (1.00)	EYM-50 ◊	EYM-50AL ◊
	3/4	119.6 (4.71)	35.0 (1.38)	30.2 (1.19)	56.7 (2.00)	EYM-75 ◊	EYM-75AL ◊
	1	137.7 (5.42)	44.4 (1.75)	35.0 (1.38)	113.4 (4.00)	EYM-100 ◊	EYM-100AL ◊
	1-1/4	160.3 (6.31)	50.8 (2.00)	44.4 (1.75)	198.4 (7.00)	EYM-125 ♦	EYM-125AL
	1-1/2	177.3 (6.98)	60.4 (2.38)	52.3 (2.06)	368.5 (13.00)	EYM-150 ♦	EYM-150AL
	2	195.3 (7.69)	73.1 (2.88)	58.6 (2.31)	623.7 (22.00)	EYM-200 ♦	EYM-200AL
	2-1/2	236.2 (9.30)	85.8 (3.38)	68.3 (2.69)	1020.6 (36.00)	EYM-250 ♦	EYM-250AL
	3	263.4 (10.37)	104.9 (4.13)	79.5 (3.13)	1729.3 (61.00)	EYM-300 ♦	EYM-300AL
	3-1/2	282.7 (11.13)	120.6 (4.75)	87.3 (3.44)	2523.1 (89.00)	EYM-350 ♦	EYM-350AL
	4	299.0 (11.77)	130.3 (5.13)	93.7 (3.69)	3231.8 (114.00)	EYM-400 ♦	EYM-400AL
	5	329.4 (12.97)	158.7 (6.25)	119.1 (4.69)	5726.6 (202.00)	EYM-500 ②	—
	6	358.6 (14.12)	185.6 (7.31)	136.6 (5.38)	6520.4 (230.00)	EYM-600 ②	—

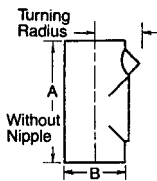

EYF 1/2" – 6"

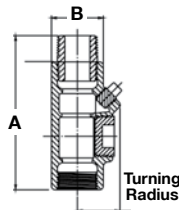

EYM 1/2" – 1"

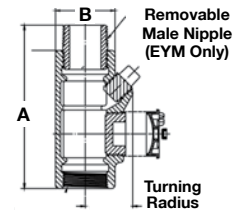

EYM 1-1/4" – 6"

* Per NEC 501.15(C)(6), seals in Class I, Division 1 and 2 must be limited to conductor fill of 25% of cross sectional area of a rigid metal conduit of the same trade size unless approved for higher percentage fill. See 40% fill sealing fittings.

① Turning radius with cover or plug removed.

② Not UL Listed. CSA Certified only.

◊ Indicates items in the shaded area which are UL Listed for Class I, Groups A, B, C, D; Class II, Groups E, F, G; and Class III.

♦ Indicated items in the shaded area which are UL Listed for Class I, Groups B, C, D; Class II, Groups E, F, G; and Class III.

Appleton

HAZARDOUS LOCATION FITTINGS: NEC/CEC EXPLOSIONPROOF SEALING FITTINGS

EY 40% Fill Expanded Fill Sealing Fittings for Close Turning Radius

Explosionproof, Dust-Ignitionproof, Raintight

UNILETS™ for Use with Threaded Rigid Metal Conduit and IMC.

NEC/CEC:





Class I, Division 1 and 2, Groups A◇, B◆, C, D

Class II, Division 1 and 2, Groups E, F, G





Class III

Trade Size (Inches)	Millimeters (Inches)		Turning Radius ①	Kwiko™ A Cement Required Grams (Ounces)	Catalog Number	
	A (Length)	B (Width)			Malleable Iron	Almag 35 Aluminum

EYSEF Female 1/2"-4" Vertical and Horizontal Conduit Seals for Close Turning Radius

	1/2	93.7 (3.69)	38.1 (1.50)	31.7 (1.25)	56.8 (2.00)	EYSEF50 ◇	EYSEF50AL ◇
	3/4	109.4 (4.31)	44.4 (1.75)	35.0 (1.38)	113.5 (4.00)	EYSEF75 ◇	EYSEF75AL ◇
	1	128.5 (5.06)	55.6 (2.19)	44.4 (1.75)	198.6 (7.00)	EYSEF100 ◆	EYSEF100AL ◆
	1-1/4	139.7 (5.50)	61.9 (2.44)	52.3 (2.06)	368.9 (13.00)	EYSEF125 ◆	EYSEF125AL ◆
	1-1/2	158.7 (6.25)	76.2 (3.00)	58.6 (2.31)	624.3 (22.00)	EYSEF150 ◆	EYSEF150AL
	2	190.5 (7.50)	88.9 (3.50)	66.8 (2.63)	1,021.5 (36.00)	EYSEF200 ◆	EYSEF200AL
	2-1/2	215.9 (8.50)	107.9 (4.25)	76.2 (3.00)	1,730.9 (61.00)	EYSEF250 ◆	EYSEF250AL
	3	233.4 (9.19)	120.6 (4.75)	84.0 (3.31)	2,525.4 (89.00)	EYSEF300 ◆	EYSEF300AL
	3-1/2	247.6 (9.75)	133.3 (5.25)	91.1 (3.59)	3,234.8 (114.00)	EYSEF350 ◆	EYSEF350AL
	4	280.9 (11.06)	165.1 (6.50)	107.1 (4.22)	5,726.6 (202.00)	EYSEF400	EYSEF400AL

EYDEF Female 1/2"-4" Vertical Drain Seals for Close Turning Radius

	1/2	93.7 (3.69)	38.1 (1.50)	31.7 (1.25)	113.5 (4.00)	EYDEF50 ◆	EYDEF50AL ◆
	3/4	109.4 (4.31)	44.4 (1.75)	35.0 (1.38)	170.3 (6.00)	EYDEF75 ◆	EYDEF75AL ◆
	1	128.5 (5.06)	55.6 (2.19)	44.4 (1.75)	198.6 (7.00)	EYDEF100 ◆	EYDEF100AL ◆
	1-1/4	139.7 (5.50)	61.9 (2.44)	52.3 (2.06)	368.9 (13.00)	EYDEF125 ◆	EYDEF125AL ◆
	1-1/2	158.7 (6.25)	76.2 (3.00)	58.6 (2.31)	624.3 (22.00)	EYDEF150 ◆	EYDEF150AL
	2	190.5 (7.50)	88.9 (3.50)	66.8 (2.63)	1,021.5 (36.00)	EYDEF200 ◆	EYDEF200AL
	2-1/2	215.9 (8.50)	107.9 (4.25)	76.2 (3.00)	1,730.9 (61.00)	EYDEF250 ◆	EYDEF250AL
	3	233.4 (9.19)	120.6 (4.75)	84.0 (3.31)	2,525.4 (89.00)	EYDEF300 ◆	EYDEF300AL
	3-1/2	247.6 (9.75)	133.3 (5.25)	91.1 (3.59)	3,234.8 (114.00)	EYDEF350 ◆	EYDEF350AL
	4	280.9 (11.06)	165.1 (6.50)	107.1 (4.22)	5,726.6 (202.00)	EYDEF400	EYDEF400AL

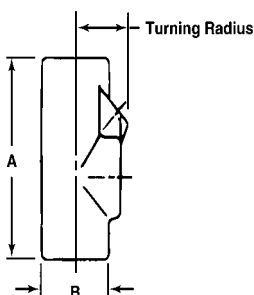

① Turning radius with cover or plug removed.

◇ Indicates items in the shaded area which are UL Listed for Class I, Groups A, B, C, D; Class II, Groups E, F, G; and Class III.

◆ Indicated items in the shaded area which are UL Listed for Class I, Groups B, C, D; Class II, Groups E, F, G; and Class III.

EYD 25% * Fill Vertical Conduit Drain Sealing Fittings

For Close Turning Radius. Explosionproof, Dust-Ignitionproof, Raintight.

UNILETS™ for Use with Threaded Rigid Metal Conduit and IMC.

NEC/CEC:

Class I, Division 1 and 2, Groups C, D
Class II, Division 1 and 2, Groups E, F, G
Class III

	Trade Size (Inches)	Millimeters (Inches)			Kwiko™ A Cement Required Grams (Ounces)	Catalog Number Grayloy™-Iron
		A (Length)	B (Width)	Turning Radius ①		
EYD Vertical Conduit Drain Seals for Close Turning Radius (25% fill)						
Female						
	1/2	83.3 (3.28)	38.1 (1.50)	26.9 (1.06)	28.0 (1.00)	EYD-1
	3/4	93.7 (3.69)	44.4 (1.75)	30.2 (1.19)	57.0 (2.00)	EYD-2
	1	109.4 (4.31)	55.6 (2.19)	35.0 (1.38)	113.0 (4.00)	EYD-3
	1-1/4	128.5 (5.06)	55.6 (2.19)	44.4 (1.75)	255.0 (9.00)	EYD-4
	1-1/2	139.7 (5.50)	61.9 (2.44)	52.3 (2.06)	340.0 (12.00)	EYD-5
	2	158.7 (6.25)	76.2 (3.00)	58.9 (2.31)	595.0 (21.00)	EYD-6
	2-1/2	190.5 (7.50)	88.9 (3.50)	68.8 (2.69)	1049.0 (37.00)	EYD-7
	3	215.9 (8.50)	107.9 (4.25)	79.5 (3.13)	1729.0 (61.00)	EYD-8
	3-1/2	233.4 (9.19)	120.6 (4.75)	87.3 (3.44)	2268.0 (80.00)	EYD-9
	4	247.6 (9.75)	13.33 (5.25)	93.7 (3.69)	3175.0 (112.00)	EYD-10
Male/Female (Removable Male Nipple)						
	1/2	83.3 (3.28)	38.1 (1.50)	26.9 (1.06)	28.0 (1.00)	EYD-16
	3/4	93.7 (3.69)	44.4 (1.75)	30.2 (1.19)	57.0 (2.00)	EYD-26
	1	109.4 (4.31)	55.6 (2.19)	35.0 (1.38)	113.0 (4.00)	EYD-36
	1-1/4	128.5 (5.06)	55.6 (2.19)	44.4 (1.75)	255.0 (9.00)	EYD-46
	1-1/2	139.7 (5.50)	61.9 (2.44)	52.3 (2.06)	340.0 (12.00)	EYD-56
	2	158.7 (6.25)	76.2 (3.00)	58.9 (2.31)	595.0 (21.00)	EYD-66
	2-1/2	190.5 (7.50)	88.9 (3.50)	68.8 (2.69)	1049.0 (37.00)	EYD-76
	3	215.9 (8.50)	107.9 (4.25)	79.5 (3.13)	1729.0 (61.00)	EYD-86
	3-1/2	233.4 (9.19)	120.6 (4.75)	87.3 (3.44)	2268.0 (80.00)	EYD-96
	4	247.6 (9.75)	13.33 (5.25)	93.7 (3.69)	3175.0 (112.00)	EYD-106

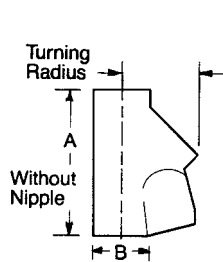

EYD
1/2" — 1"

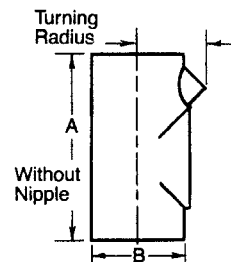

EYD
1-1/4" — 4"

* Per NEC 501.15(C)(6), seals in Class I, Division 1 and 2 must be limited to conductor fill of 25% of cross sectional area of a rigid metal conduit of the same trade size unless approved for higher percentage fill. See 40% fill sealing fittings.

① Turning radius with cover or plug removed.





EYDM 25% * Fill Vertical Conduit Drain Sealing Fittings

For Close Turning Radius. Explosionproof, Dust-Ignitionproof, Raintight.

UNILETS™ for Use with Threaded Rigid Metal Conduit and IMC.

NEC/CEC:

Class I, Division 1 and 2, Groups B♦, C, D
 Class II, Division 1 and 2, Groups E, F, G
 Class III

Trade Size (Inches)	Centimeters (Inches)			Turning Radius ①	Kwiko™ A Cement Required Grams (Ounces)	Catalog Number	
	A (Length)	B (Width)				Malleable Iron	Almag 35 Aluminum
EYDM Vertical Conduit Drain Seals for Close Turning Radius (25% fill) †							
Male/Female (Removable Male Nipple)							
 1/2" — 1"	1/2	9.2 (3.63)	3.5 (1.38)	4.9 (1.94)	56.7 (2.00)	EYDM-50 ♦	EYDM-50AL
	3/4	9.2 (3.63)	3.5 (1.38)	4.9 (1.94)	56.7 (2.00)	EYDM-75 ♦	EYDM-75AL
	1	10.3 (4.06)	4.0 (1.56)	5.2 (2.06)	85.1 (3.00)	EYDM-100 ♦	EYDM-100AL
 1-1/4" — 3"	1-1/4	12.5 (4.94)	5.1 (2.00)	4.5 (1.75)	198.4 (7.00)	EYDM-125 ♦	EYDM-125AL
	1-1/2	14.0 (5.50)	6.0 (2.38)	5.2 (2.06)	368.5 (13.00)	EYDM-150 ♦	EYDM-150AL
 2" — 3"	2	15.6 (6.13)	7.3 (2.88)	5.9 (2.31)	623.7 (22.00)	EYDM-200 ♦	EYDM-200AL
	2-1/2	19.1 (7.50)	8.6 (3.38)	6.8 (2.69)	1020.6 (36.00)	EYDM-250 ♦	EYDM-250AL
	3	20.7 (8.13)	10.5 (4.13)	7.9 (3.13)	1729.3 (61.00)	EYDM-300 ♦	EYDM-300AL
	3-1/2	22.7 (8.94)	12.1 (4.75)	8.7 (3.44)	2523.1 (89.00)	EYDM-350 ♦	EYDM-350AL
 3-1/2" — 4"	4	23.8 (9.38)	13.0 (5.13)	9.4 (3.69)	3231.8 (114.00)	EYDM-400 ♦	EYDM-400AL

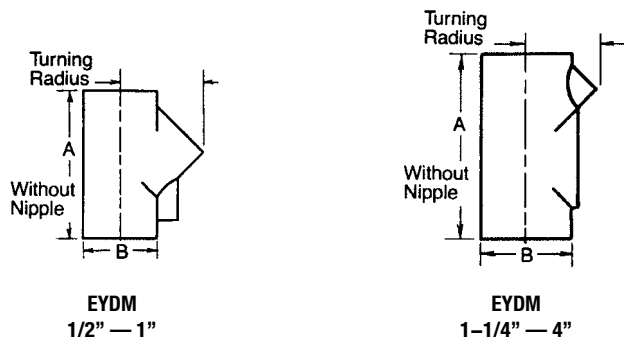

* Per NEC 501.15(C)(6), seals in Class I, Division 1 and 2 must be limited to conductor fill of 25% of cross sectional area of a rigid metal conduit of the same trade size unless approved for higher percentage fill. See 40% fill sealing fittings.

① Turning radius with cover or plug removed.

♦ Indicated items in the shaded area which are UL Listed for Class I, Groups B, C, D; Class II, Groups E, F, G; and Class III.

ES 25% Sealing Hubs

Explosionproof, Dust-Ignitionproof

UNILETS™ for Use with Threaded Rigid Metal Conduit and IMC.

NEC/CEC:

Class I, Division 1 and 2, Groups A◇, B◆, C, D
Class II, Division 1 and 2, Groups E, F, G
Class III

Applications

- Used to seal vertical conduit risers at switch gear and motor control centers, sheet metal structures, or cast boxes and enclosures.
- Can be used as a male thread enlarger or conduit hub in an ordinary location.

Features

- Explosionproof, dust-ignitionproof.
- Smooth, rounded integral bushing in each hub protects conductor insulation.
- Accurately tapped, tapered threads for tight, rigid joints and ground continuity.
- Allows up to 25% conduit fill in compliance with the National Electrical Code.
- UL Listed for use with Kwiko™ A Sealing Compound. Also listed with certain competitors sealing cement, contact factory for details.

Standard Materials

- Malleable iron

Standard Finishes

- Triple-coat — (1) zinc electroplate, (2) chromate, and (3) epoxy powder coat

Options

- Sealing gaskets and locknuts (to provide a water and oil-tight connection), add suffix **-BLSG** to catalog number



Standard Hub



Standard Hub with Locknut and Sealing Gasket Option (Suffix – BLSG)

NEC/CEC Certifications and Compliances

- UL Standard: 886 (1203)
- UL Listed: E10444
- CSA Standard: C22.2 No. 30
- CSA Certified: 065181

Related Products

- Kwiko™ A Sealing Cement and Filler

Male Hub Size (Inches)	Female Hub Size (Inches)	Approximate Internal Volume dm ³ (in ³)	Kwiko™ A Cement Required Grams (Ounces)	Catalog Number
1	1/2	0.01 (0.74)	25.2 (1.00)	ES10050 ◇
1	3/4	0.01 (0.76)	25.9 (1.00)	ES10075 ◇
1-1/2	1	0.05 (3.10)	105.6 (4.00)	ES150100 ◇
2	1-1/4	0.08 (4.69)	159.7 (6.00)	ES200125 ◆
2	1-1/2	0.08 (4.69)	159.7 (6.00)	ES200150 ◆
2-1/2	2	0.15 (9.38)	319.4 (11.00)	ES250200 ◆
4	3	0.55 (33.70)	1,147.5 (40.00)	ES400300 ◆
5	4	1.50 (91.23)	3106.4 (109.00)	ES500400 ◆
6	5	2.36 (143.73)	4894.0 (172.00)	ES600500

Dimensions in Millimeters (Inches)

Catalog Number	Millimeters (Inches)				
	A	B	C	D	E
ES10050	41.4 (1.63)	22.3 (0.88)	57.2 (2.25)	26.9 (1.06)	31.7 (1.25)
ES10075	45.9 (1.81)	22.3 (0.88)	57.2 (2.25)	26.9 (1.06)	38.1 (1.50)
ES150100	57.1 (2.25)	35.0 (1.38)	79.5 (3.13)	30.2 (1.19)	44.4 (1.75)
ES200125	71.3 (2.81)	44.4 (1.75)	79.5 (3.13)	30.2 (1.19)	55.6 (2.19)
ES200150	71.3 (2.81)	44.4 (1.75)	79.5 (3.13)	30.2 (1.19)	61.9 (2.44)
ES250200	88.9 (3.50)	52.3 (2.06)	96.7 (3.81)	44.4 (1.75)	76.2 (3.00)
ES400300	133.3 (5.25)	92.2 (3.63)	127.0 (5.00)	50.8 (2.00)	107.9 (4.25)
ES500400	168.4 (6.63)	117.6 (4.63)	177.8 (7.00)	54.1 (2.13)	133.3 (5.25)
ES600500	193.8 (7.63)	146.0 (5.75)	190.5 (7.50)	55.6 (2.19)	165.1 (6.50)

◇ Indicates items in the shaded area which are UL Listed for Class I, Groups A, B, C, D; Class II, Groups E, F, G; and Class III.

◆ Indicated items in the shaded area which are UL Listed for Class I, Groups B, C, D; Class II, Groups E, F, G; and Class III.

Kwiko™ A Sealing Cement and Filler

For use in Sealing Fittings and Sealing Hubs

See specific sealing fitting and sealing hubs for quantities required.

NEC/CEC:

Rated for Ordinary (Unclassified) Locations

Applications

- Fiber filler-makes dams around and between all conductors to prevent sealing compound from leaking while being poured in its liquid state.

Features

- Kwiko™ A sealing cement is a specially formulated water soluble powder. Mixed to the proper proportions, it is poured in sealing fittings and hardens to contain and restrict the passage of gases and explosions in classified areas.

Options

- For larger quantities of Twin Pack® Sealing Cement, contact your local sales representative.



AC5A



F02



ACK12F-A

Kwiko™ A Sealing Cement and Filler

For use in Sealing Fittings and Sealing Hubs

See specific sealing fitting and sealing hubs for quantities required.

NEC/CEC:

Rated for Ordinary (Unclassified) Locations

	Weight Grams (Ounces)	Volume When Set dm ³ (in ³)	Catalog Number
--	--------------------------	---	-------------------

Kwiko™ A Sealing Cement Mixing Ratio: 2 parts cement to 1 part water



	453.6 (16.00)	0.38 (23.00)	AC1-A
	2268.0 (80.00)	1.89 (115.00)	AC5-A

Kwiko™ A TwinPak® Sealing Cements



Each plastic pouch contains pre-measured Kwiko™ A cement and pre-measured water (in an inner bag). Squeeze pouch to break inner water bag and knead mixture thoroughly, then pour. Kwiko™ A TwinPak® also includes adequate amount of fiber filler packed separately.

Cement	460.1 (16.25)	635.0 (25.00)	ACK6F-A ①
Fiber	28.4 (1.00)		
Cement	1027.7 (36.25)	1397.0 (55.00)	ACK12F-A ②
Fiber	56.7 (2.00)		

Fiber Filler



Filler is used to make dams to prevent cement from leaking while in fluid state.

10.8 (0.38)	—	F038
21.3 (0.75)	—	F075
28.4 (1.00)	—	F01
56.7 (2.00)	—	F02
113.4 (4.00)	—	F04
226.8 (8.00)	—	F08
453.6 (16.00)	—	F1

Kwiko™ A Sealing Cement and Fiber Filler Kits



Cement	453.6 (16.00)	377.0 (23.00)	AC1F01-A
Fiber	28.4 (1.00)		

Approximate amount of fiber filler required per hub — For 25% fill ③

Hub Size (Inches)	Weight Grams (Ounces)	Hub Size (Inches)	Weight Grams (Ounces)	Hub Size (Inches)	Weight Grams (Ounces)
1/2	0.9 (0.03)	1-1/2	14.2 (0.50)	3-1/2	85.1 (3.00)
3/4	1.7 (0.06)	2	28.4 (1.00)	4	127.6 (4.50)
1	3.7 (0.13)	2-1/2	42.5 (1.50)	5	198.5 (7.00)
1-1/4	7.1 (0.25)	3	56.9 (2.00)	6	284.1 (10.00)

① Product No. ACK6F-A includes five 3-1/4-ounce cement pouches.

② Product No. ACK12F-A includes five 7-1/4-ounce cement pouches.

③ For 40% expanded fill seal fittings, double the amount of fiber filler shown.

Sealing Fittings

Explosionproof, Dust-Ignitionproof

For Use with Threaded Rigid Metal Conduit and IMC.

Applications

- Prevent passage of gases, vapors or flames from one portion of conduit system to another. Restrict any explosion to the sealed off enclosure. Prevent pressure piling within conduit system.
- Required in Class I, Division 1 and 2 locations within 18" of enclosures containing apparatus that may cause arcs, sparks or high temperatures.
- Required in Class I, Division 1 and 2 locations where 2" or larger conduit enters enclosure, fitting housing terminals, splices or taps.
- Required in Class I, Division 1 and 2 locations at the boundary where conduit leaves classified location.
- Required in Class I, Division 1 and 2 locations where two or more enclosures are connected by 36" or less conduit. Seal must be located within 18" of either enclosure.
- Required where cables (which exceed rate of gas or vapor transmission permitted for seals) are used in Class I, Division 2 locations.

Features

- Explosionproof, dust-ignitionproof, raintight.
- Smooth, rounded integral bushing in each hub protects conductor insulation.
- Accurately tapped, tapered threads for tight, rigid joints and ground continuity.
- Removable nipple in male sealing fitting may be used interchangeably in top or bottom hub.
- EYA/EYAM—for sealing vertical conduit. Large opening for damming and filling.
- Expanded fill EYAX/EYDX— allow up to 40% conduit fill in compliance with the National Electrical Code.
- EY/EYM—for sealing vertical conduit. Large opening for damming and filling.

Illustrated Features

Sealing fittings prevent passage of gases, vapors or flames from one portion of a conduit system to another. They also restrict large amounts of ignitable gases or vapors from accumulating to confine explosive pressure.

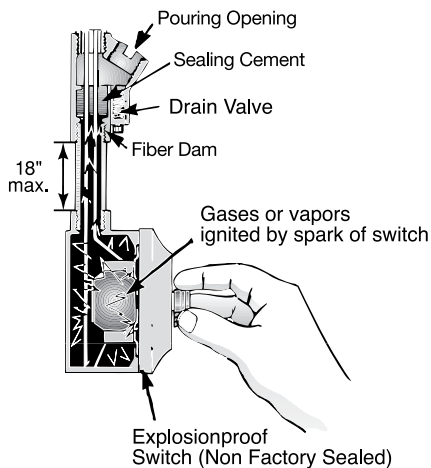

- EYD/EYDM Drain Sealing Fittings—close radius type for sealing vertical conduit runs. Access cover has drain valve for automatic draining of water accumulation above the seal.
- UL Listed for use with Kwiko™ A Sealing Compound. Also listed with certain competitors sealing cement, contact factory for details.

Standard Materials

- EYA/EYAM: malleable iron or Almag 35 aluminum
- EYAX/EYDX and EYD/EYDM seals: malleable iron
- EY/EYM: Grayloy®-iron

Standard Finishes

- Malleable iron and Grayloy®-iron products have triple-coat — (1) zinc electroplate, (2) chromate, and (3) epoxy powder coat,
- Almag 35 aluminum products have epoxy powder coat

NEC/CEC Certifications and Compliances

- UL Standard: 886
- UL Listed: E-34997
- CSA Standard: C22.2 No. 30
- CSA Certified: 009795
- NEC Articles 500-503 and 505
- Mil. Spec: Mil-F-28675

Related Products

- Kwiko™ A sealing cement and fiber filler

OZ-Gedney sealing fittings are suitable for Class I and II locations. EYA/EYAM, EYAX/EYDX and EY/EYM are for sealing vertical conduit. EYD/EYDM also have drain valves.

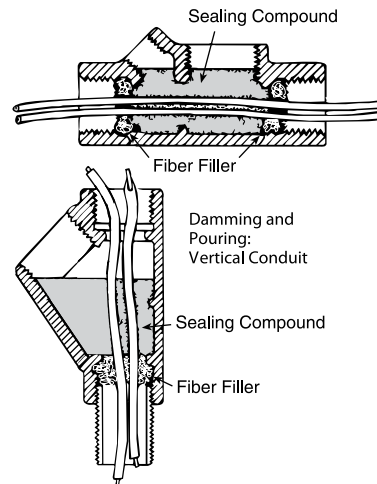



EYA 25% * Fill Vertical and Horizontal Conduit Sealing Fittings

For Close Turning Radius. Explosionproof, Dust-Ignitionproof, Raintight.

For Use with Threaded Rigid Metal Conduit and IMC.

NEC/CEC:

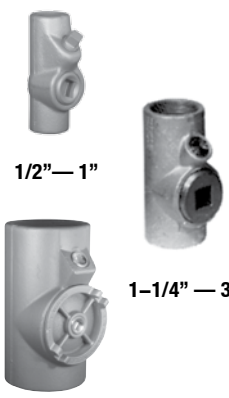
Class I, Division 1 and 2, Groups A \diamond , B \blacklozenge , C, D
 Class II, Division 1 and 2, Groups E, F, G
 Class III

	Trade Size (Inches)	Millimeters (Inches)			Kwiko™ A Cement Required Grams (Ounces)	Catalog Number	
		A (Length)	B (Width)	Turning Radius		Malleable Iron	Almag 35 Aluminum
Female							
 <p>1/2" — 1" 1-1/4" — 3" 3-1/2" — 6"</p>	1/2	88.9 (3.50)	30.2 (1.19)	26.9 (1.06)	28.4 (1.00)	EYA-50 \diamond	EYA-50A \diamond
	3/4	88.9 (3.50)	35.0 (1.38)	30.2 (1.19)	56.7 (2.00)	EYA-75 \diamond	EYA-75A \diamond
	1	107.9 (4.25)	44.4 (1.75)	35.0 (1.38)	113.4 (4.00)	EYA-100 \diamond	EYA-100A \diamond
	1-1/4	125.4 (4.94)	50.8 (2.00)	44.4 (1.75)	198.4 (7.00)	EYA-125 \blacklozenge	EYA-125A
	1-1/2	139.7 (5.50)	60.4 (2.38)	52.3 (2.06)	368.5 (13.00)	EYA-150 \blacklozenge	EYA-150A
	2	155.7 (6.13)	73.1 (2.88)	58.6 (2.31)	623.7 (22.00)	EYA-200 \blacklozenge	EYA-200A
	2-1/2	190.5 (7.50)	85.8 (3.38)	68.3 (2.69)	1020.6 (36.00)	EYA-250 \blacklozenge	EYA-250A
	3	206.5 (8.13)	104.9 (4.13)	79.5 (3.13)	1729.3 (61.00)	EYA-300 \blacklozenge	EYA-300A
	3-1/2	227.0 (8.94)	120.6 (4.75)	87.3 (3.44)	2523.1 (89.00)	EYA-350 \blacklozenge	EYA-350A
	4	238.2 (9.38)	130.3 (5.13)	93.7 (3.69)	3231.8 (114.00)	EYA-400 \blacklozenge	EYA-400A
	5	274.5 (10.81)	158.7 (6.25)	119.1 (4.69)	5726.6 (202.00)	EYA-500 $\textcircled{1}$	—
	6	299.9 (11.81)	185.6 (7.31)	136.6 (5.38)	6520.4 (230.00)	EYA-600 $\textcircled{1}$	—
Male/Female (Removable Male Nipple)							
 <p>1/2" — 1" 1-1/4" — 3" 3-1/2" — 6"</p>	1/2	119.9 (4.72)	30.2 (1.19)	26.9 (1.06)	28.4 (1.00)	EYAM-50 \diamond	EYAM-50A \diamond
	3/4	119.6 (4.71)	35.0 (1.38)	30.2 (1.19)	56.7 (2.00)	EYAM-75 \diamond	EYAM-75A \diamond
	1	137.7 (5.42)	44.4 (1.75)	35.0 (1.38)	113.4 (4.00)	EYAM-100 \diamond	EYAM-100A \diamond
	1-1/4	160.3 (6.31)	50.8 (2.00)	44.4 (1.75)	198.4 (7.00)	EYAM-125 \blacklozenge	EYAM-125A
	1-1/2	177.3 (6.98)	60.4 (2.38)	52.3 (2.06)	368.5 (13.00)	EYAM-150 \blacklozenge	EYAM-150A
	2	195.3 (7.69)	73.1 (2.88)	58.6 (2.31)	623.7 (22.00)	EYAM-200 \blacklozenge	EYAM-200A
	2-1/2	236.2 (9.30)	85.8 (3.38)	68.3 (2.69)	1020.6 (36.00)	EYAM-250 \blacklozenge	EYAM-250A
	3	263.4 (10.37)	104.9 (4.13)	79.5 (3.13)	1729.3 (61.00)	EYAM-300 \blacklozenge	EYAM-300A
	3-1/2	282.7 (11.13)	120.6 (4.75)	87.3 (3.44)	2523.1 (89.00)	EYAM-350 \blacklozenge	EYAM-350A
	4	299.0 (11.77)	130.3 (5.13)	93.7 (3.69)	3231.8 (114.00)	EYAM-400 \blacklozenge	EYAM-400A
	5	329.4 (12.97)	158.7 (6.25)	119.1 (4.69)	5726.6 (202.00)	EYAM-500 $\textcircled{1}$	—
	6	358.6 (14.12)	185.6 (7.31)	136.6 (5.38)	6520.4 (230.00)	EYAM-600 $\textcircled{1}$	—

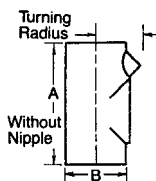

EYA 1/2" - 6"

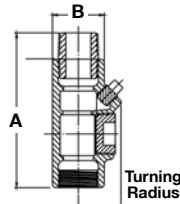

EYAM 1/2" - 1"

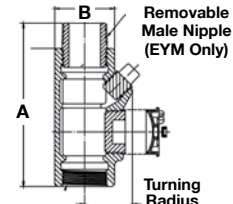

EYAM 1-1/4" - 6"

* Per NEC 501.15(C)(6), seals in Class I, Division 1 and 2 must be limited to conductor fill of 25% of cross sectional area of a rigid metal conduit of the same trade size unless approved for higher percentage fill. See 40% fill sealing fittings.

$\textcircled{1}$ Not UL Listed. CSA Certified only.

\diamond Indicates items in the shaded area which are UL Listed for Class I, Groups A, B, C, D; Class II, Groups E, F, G; and Class III.

\blacklozenge Indicated items in the shaded area which are UL Listed for Class I, Groups B, C, D; Class II, Groups E, F, G; and Class III.

OZGEDNEY

HAZARDOUS LOCATION FITTINGS: NEC/CEC EXPLOSIONPROOF SEALING FITTINGS

EYAX 40% Fill Expanded Fill Sealing Fittings for Close Turning Radius

Explosionproof, Dust-Ignitionproof, Raintight





For Use with Threaded Rigid Metal Conduit and IMC.

NEC/CEC:

Class I, Division 1 and 2, Groups A◇, B◆, C, D

Class II, Division 1 and 2, Groups E, F, G

Class III

	Trade Size (Inches)	Millimeters (Inches)		Turning Radius ①	Kwiko™ A Cement Required Grams (Ounces)	Catalog Number
		A (Length)	B (Width)			Malleable Iron
EYAX Female 1/2"-4" Vertical and Horizontal Conduit Seals for Close Turning Radius						
	1/2	93.7 (3.69)	38.1 (1.50)	31.7 (1.25)	56.8 (2.00)	EYAX-50
	3/4	109.4 (4.31)	44.4 (1.75)	35.0 (1.38)	113.5 (4.00)	EYAX-75
	1	128.5 (5.06)	55.6 (2.19)	44.4 (1.75)	198.6 (7.00)	EYAX-100
	1-1/4	139.7 (5.50)	61.9 (2.44)	52.3 (2.06)	368.9 (13.00)	EYAX-125
	1-1/2	158.7 (6.25)	76.2 (3.00)	58.6 (2.31)	624.3 (22.00)	EYAX-150
	2	190.5 (7.50)	88.9 (3.50)	66.8 (2.63)	1,021.5 (36.00)	EYAX-200
	2-1/2	215.9 (8.50)	107.9 (4.25)	76.2 (3.00)	1,730.9 (61.00)	EYAX-250
	3	233.4 (9.19)	120.6 (4.75)	84.0 (3.31)	2,525.4 (89.00)	EYAX-300
	3-1/2	247.6 (9.75)	133.3 (5.25)	91.1 (3.59)	3,234.8 (114.00)	EYAX-350
	4	280.9 (11.06)	165.1 (6.50)	107.1 (4.22)	5,726.6 (202.00)	EYAX-400 ①

OZGEDNEY

HAZARDOUS LOCATION FITTINGS: NEC/CEC EXPLOSIONPROOF SEALING FITTINGS

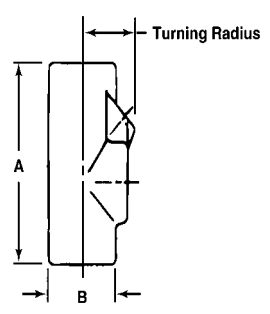
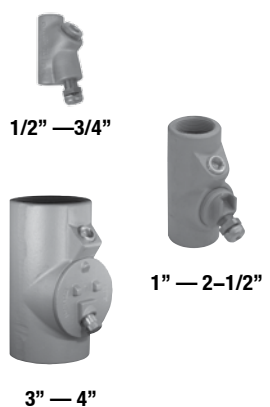

① Turning radius with cover or plug removed.
 ◇ Indicates items in the shaded area which are UL Listed for Class I, Groups A, B, C, D; Class II, Groups E, F, G; and Class III.
 ◆ Indicated items in the shaded area which are UL Listed for Class I, Groups B, C, D; Class II, Groups E, F, G; and Class III.









EYD 25% * Fill Vertical Conduit Drain Sealing Fittings

For Close Turning Radius. Explosionproof, Dust-Ignitionproof, Raintight

For Use with Threaded Rigid Metal Conduit and IMC.

NEC/CEC:

Class I, Division 1 and 2, Groups C, D
Class II, Division 1 and 2, Groups E, F, G
Class III

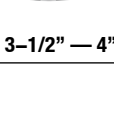
	Trade Size (Inches)	Millimeters (Inches)			Kwiko™ A Cement Required Grams (Ounces)	Catalog Number Ductile/Malleable Iron
		A (Length)	B (Width)	Turning Radius ①		
EYD Vertical Conduit Drain Seals for Close Turning Radius (25% fill)						
Female						
	1/2" — 1"	83.3 (3.28)	38.1 (1.50)	26.9 (1.06)	28.0 (1.00)	EYD-50
	3/4	93.7 (3.69)	44.4 (1.75)	30.2 (1.19)	57.0 (2.00)	EYD-75
	1	109.4 (4.31)	55.6 (2.19)	35.0 (1.38)	113.0 (4.00)	EYD-100
	1-1/4	128.5 (5.06)	55.6 (2.19)	44.4 (1.75)	255.0 (9.00)	EYD-125
	1-1/2	139.7 (5.50)	61.9 (2.44)	52.3 (2.06)	340.0 (12.00)	EYD-150
	2	158.7 (6.25)	76.2 (3.00)	58.9 (2.31)	595.0 (21.00)	EYD-200
	2-1/2	190.5 (7.50)	88.9 (3.50)	68.8 (2.69)	1049.0 (37.00)	EYD-250
	3	215.9 (8.50)	107.9 (4.25)	79.5 (3.13)	1729.0 (61.00)	EYD-300
	3-1/2	233.4 (9.19)	120.6 (4.75)	87.3 (3.44)	2268.0 (80.00)	EYD-350
	4	247.6 (9.75)	133.3 (5.25)	93.7 (3.69)	3175.0 (112.00)	EYD-400
Male/Female (Removable Male Nipple)						
	1/2" — 1"	83.3 (3.28)	38.1 (1.50)	26.9 (1.06)	28.0 (1.00)	EYDM-50
	3/4	93.7 (3.69)	44.4 (1.75)	30.2 (1.19)	57.0 (2.00)	EYDM-75
	1	109.4 (4.31)	55.6 (2.19)	35.0 (1.38)	113.0 (4.00)	EYDM-100
	1-1/4	128.5 (5.06)	55.6 (2.19)	44.4 (1.75)	255.0 (9.00)	EYDM-125
	1-1/2	139.7 (5.50)	61.9 (2.44)	52.3 (2.06)	340.0 (12.00)	EYDM-150
	2	158.7 (6.25)	76.2 (3.00)	58.9 (2.31)	595.0 (21.00)	EYDM-200
	2-1/2	190.5 (7.50)	88.9 (3.50)	68.8 (2.69)	1049.0 (37.00)	EYDM-250
	3	215.9 (8.50)	107.9 (4.25)	79.5 (3.13)	1729.0 (61.00)	EYDM-300
	3-1/2	233.4 (9.19)	120.6 (4.75)	87.3 (3.44)	2268.0 (80.00)	EYDM-350
	4	247.6 (9.75)	133.3 (5.25)	93.7 (3.69)	3175.0 (112.00)	EYDM-400

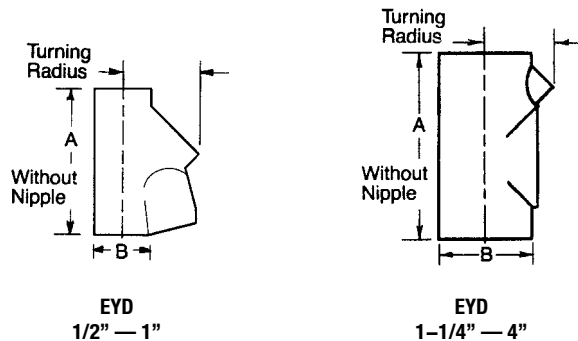

* Per NEC 501.15(C)(6), seals in Class I, Division 1 and 2 must be limited to conductor fill of 25% of cross sectional area of a rigid metal conduit of the same trade size unless approved for higher percentage fill. See 40% fill sealing fittings.

① Turning radius with cover or plug removed.

EYDX 40% Fill Expanded Fill Sealing Fittings for Close Turning Radius

Explosionproof, Dust-Ignitionproof, Raintight

For Use with Threaded Rigid Metal Conduit and IMC.

NEC/CEC:

Class I, Division 1 and 2, Groups A◇, B◆, C, D
 Class II, Division 1 and 2, Groups E, F, G
 Class III

Trade Size (Inches)	Millimeters (Inches)			Kwiko™ A Cement Required Grams (Ounces)	Catalog Number Ductile/Malleable Iron
	A (Length)	B (Width)	Turning Radius ①		

EYDX Female 1/2"-4" Vertical Drain Seals for Close Turning Radius

	1/2	3-11/16	1-1/4	1-1/2	114 (4.00)	EYDX-50
	3/4	4-5/16	1-3/8	1-3/4	170 (6.00)	EYDX-75
1/2" — 3/4"	1	5-1/16	1-3/4	2-3/16	198 (7.00)	EYDX-100
	1-1/4	5-1/2	2-1/16	2-7/16	369 (13.00)	EYDX-125
	1-1/2	6-1/4	2-5/16	3	624 (22.00)	EYDX-150
	2	7-1/2	2-5/8	3-1/2	1021 (36.00)	EYDX-200
	2-1/2	8-1/2	3	4-1/4	1729 (61.00)	EYDX-250
1" — 2-1/2"	3	9-3/16	3-5/16	4-3/4	2523 (89.00)	EYDX-300
4"						

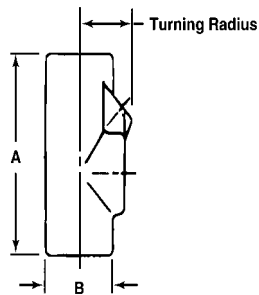

* Per NEC 501.15(C)(6), seals in Class I, Division 1 and 2 must be limited to conductor fill of 25% of cross sectional area of a rigid metal conduit of the same trade size unless approved for higher percentage fill. See 40% fill sealing fittings.

① Turning radius with cover or plug removed.

EY 25% * Fill Vertical Sealing Fittings for Close Turning Radius

Explosionproof, Dust-Ignitionproof, Raintight

For Use with Threaded Rigid Metal Conduit and IMC.

NEC/CEC:

Class I, Division 1 and 2, Groups A◇, B, C, D
 Class II, Division 1 and 2, Groups E, F, G
 Class III

Trade Size (Inches)	Millimeters (Inches)			Kwiko™ A Cement Required Grams (Ounces)	Catalog Number Grayloy™ Iron
	A (Length)	B (Width)	Turning Radius ①		
EY Vertical Sealing Fittings (25% fill)					
Female					
1/2	3-1/4	1-3/16	1-1/8	2	EY-50
3/4	3-5/8	1-1/4	2-3/8	3	EY-75
1	4-1/4	1-3/8	2-3/4	5	EY-100
1-1/4	5-1/16	2-15/16	2	11	EY-125
1-1/2	5-1/2	2-1/2	3-1/2	19	EY-150
2	6-1/4	2-1/8	3-15/16	31	EY-200
Male/Female (Removable Male Nipple)					
1/2	4-15/16	1-3/16	1-1/8	2	EYM-50
3/4	5-19/64	2-1/4	1-3/8	3	EYM-75
1	6-1/32	2-3/8	1-3/4	5	EYM-100
1-1/4	5-13/16	2	2-5/8	6	EYM-125
1-1/2	6-1/4	2-1/4	3	9	EYM-150
2	7	2-3/4	3-5/8	15	EYM-200

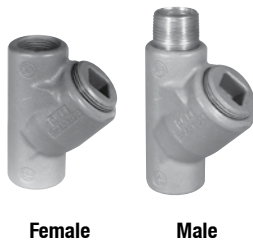

Female

Male



Type EY

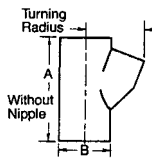

Type EYM

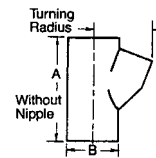

* Per NEC 501.15(C)(6), seals in Class I, Division 1 and 2 must be limited to conductor fill of 25% of cross sectional area of a rigid metal conduit of the same trade size unless approved for higher percentage fill. See 40% fill sealing fittings.

① Turning radius with cover or plug removed.

◇ Indicates items in the shaded area which are UL Listed for Class I, Groups A, B, C, D; Class II, Groups E, F, G; and Class III.

Kwiko™ A Sealing Cement and Filler

For use in Sealing Fittings and Sealing Hubs

See specific sealing fitting and sealing hubs for quantities required.

NEC/CEC:

Class I, Division 1 and 2, Groups A, B, C, D

Class II, Division 1 and 2, Groups E, F, G

Class III

Applications

- Fiber filler-makes dams around and between all conductors to prevent sealing compound from leaking while being poured in its liquid state.

Features

- Kwiko™ A sealing cement is a specially formulated water soluble powder. Mixed to the proper proportions, it is poured in sealing fittings and hardens to contain and restrict the passage of gases and explosions in classified areas.

Options

- For larger quantities of Twin Pack® Sealing Cement, contact your local sales representative.



EYCK5LB



EYFK4



AC1F01-A0Z

Kwiko™ A Sealing Cement and Filler

For use in Sealing Fittings and Sealing Hubs

See specific sealing fitting and sealing hubs for quantities required.

NEC/CEC:

Class I, Division 1 and 2, Groups A◇, B, C, D

Class II, Division 1 and 2, Groups E, F, G

Class III

	Weight Grams (Ounces)	Volume When Set dm ³ (in ³)	Catalog Number
--	--------------------------	---	-------------------

Kwiko™ A Sealing Cement Mixing Ratio: 2 parts cement to 1 part water



453.6 (16.00)

0.38 (23.00)

EYCK160Z

2268.0 (80.00)

1.89 (115.00)

EYCK5LB

Fiber Filler

Filler is used to make dams to prevent cement from leaking while in fluid state.



113.4 (4.00)

—

EYFK4

226.8 (8.00)

—

EYFK8

453.6 (16.00)

—

EYFK16

Kwiko™ A Sealing Cement and Fiber Filler Kits



Cement 453.6 (16.00)

Fiber 28.4 (1.00)

377.0 (23.00)

AC1F01-A0Z

Approximate amount of fiber filler required per hub — For 25% fill ①

Hub Size (Inches)	Weight Grams (Ounces)	Hub Size (Inches)	Weight Grams (Ounces)	Hub Size (Inches)	Weight Grams (Ounces)
1/2	0.9 (0.03)	1-1/2	14.2 (0.50)	3-1/2	85.1 (3.00)
3/4	1.7 (0.06)	2	28.4 (1.00)	4	127.6 (4.50)
1	3.7 (0.13)	2-1/2	42.5 (1.50)	5	198.5 (7.00)
1-1/4	7.1 (0.25)	3	56.9 (2.00)	6	284.1 (10.00)

① For 40% expanded fill seal fittings, double the amount of fiber filler shown.

ALESKO Epoxy Sealing Putty

Liquid Epoxy Sealing Compound

For use in Sealing Fittings in Hazardous Locations

CEC:
Rated for Ordinary (Unclassified) Locations

Applications ①

- Prevents passages of gases, vapors or flames from one portion of conduit to another, restricts any explosion to the sealed off enclosure.
- Required in Class I, Zone 1 and 2 (Division 1 and 2) locations within 18" of enclosures containing apparatus that may arc, spark or have high temperatures.

Features: ALESKO

- Each tube will seal over 20 1/2" seals.
- Appleton Liquid Epoxy Seal Compound is a two-part epoxy supplied in a double barrel dispensing tube.
- Automatic mixing: the two-part epoxy is automatically mixed as the epoxy resin and hardener travel through the static-mixing nozzle. Environmentally and User friendly mixing process, as it is totally contained in the dispensing tools, therefor no personal contact.
- Reduce waste: unused epoxy resin and hardener in two part tube can be used as needed with remainder stored for later use by replacing used mixing nozzle with dispensing tube plug.
- Reduce labor cost due to quick, accurate and efficient mixing of epoxy and filling of seal fitting.
- Operating temperature: -40 °C to +121 °C (-40 °F to +250 °F).

Features: Dispensing Gun

- Robust high thrust drive system will deliver up to 499 kg (1100 lb) of propulsion.



- Two speed drive system:
 1. High thrust/low displacement for high viscosity materials
 2. Low thrust/high displacement for low to moderate viscosity materials
- Dent resistant rod.

CEC Certifications and Compliances

- ALESKO: Approved as a compound to seal CSA certified explosionproof sealing fittings
- CSA Standard: C22.2 No. 30

Description	Catalog Number
ALESKO liquid epoxy seal (225 ml. tube) (Supplied with 3 nozzles)	ALE250
Dispensing gun	DM200-04
Spare Nozzle	ALENOZZLE

Fiber Filler — Prevents epoxy from leaking while in fluid state

Ounces	Quantity	Grams	Catalog Number
0.38		10.8	F038
0.75		21.3	F075
1.00		28.4	F01
2.00		56.7	F02
4.00		113.4	F04
8.00		226.8	F08
16.00		453.6	F1

① Not suitable for use in acetic acid atmospheres.

ATX™ DB Series Fire Retardant Seal

Increased Safety. Flameproof.

ATEX/IECEX:
 Zone 1 and 2 - 21 and 22
 II 2 GD
 Ex d IIC
 IP66

Applications

- Used to prevent passage of gasses, vapors or flames from one portion of a conduit system to another.

Features

- Female to female threads.

Standard Materials

- Aluminum

ATEX/IECEX Certifications and Compliances

- Certification Type EYS
 - Gas: Zones 1
 - Type of Protection: Ex d IIC
 - Dust: Zone 21
 - Type of Protection: Ex tD A21
- Conforming to ATEX 94/9/CE: II 2GD
- Ambient Temperature: -60 °C to +130 °C (-76 °F to +266 °F)
- CE Declaration of Conformity: 50268
- ATEX Certificate: CESI 03 ATEX 085
- Index of Protection according EN/IEC 60529: IP66



HAZARDOUS LOCATION FITTINGS: ATEX/IECEX FLAMEPROOF SEALS

Tapered Thread (NPT)	Dimensions mm (in)				Weight kg (lb)	Volume dm ³ (in ³)	Pack	Catalog Number
	A	B	B1	R				
Aluminum Fire-Retardant Seal — Female/Female								
1/2"	77 (3.03)	57 (2.24)	—	0.13 (0.29)	2.3 (140)	2.3 (140.35)	1	500146
3/4"	87 (3.43)	67 (2.64)	—	0.19 (0.42)	3.2 (195)	3.2 (195.28)	1	500147
1"	105 (4.13)	83 (3.27)	—	0.32 (0.71)	3.2 (195)	3.2 (195.28)	1	500148
1-1/4"	130 (5.12)	84 (3.31)	—	0.60 (1.32)	3.2 (195)	3.2 (195.28)	1	500149
1-1/2"	130 (5.12)	84 (3.31)	—	0.60 (1.32)	4.0 (244)	4.0 (244.09)	1	500150
2"	140 (5.51)	95 (3.74)	—	0.65 (1.43)	7.6 (464)	7.6 (463.78)	1	500151
2-1/2"	175 (6.89)	113 (4.45)	—	1.26 (2.78)	7.6 (464)	7.6 (463.78)	1	500152
3"	190 (7.48)	—	135 (5.31)	1.33 (2.93)	7.6 (464)	7.6 (463.78)	1	500153
Fire Retardant Resin								
	1 kg (2.2 lb) pot + 250 g (0.55 lb) of catalyst				1.5 (3.31)	3.2 (195)	1	500154
	Fire retardant fiber — 1 kg (2.2 lb) bag				1.5 (3.31)	8.0 (488)	1	500155

Appleton

ELBY Capped Elbows

Explosionproof, Dust-Ignitionproof

UNILETS™ for use with Threaded Metal Conduit.

NEC/CEC — Aluminum and Malleable Iron:
Class I, Division 1 and 2, Groups B ♦, C, D
Class II, Division 1 and 2, Groups E, F, G
Class III

NEC/CEC — Malleable Iron Only:
Class I, Zone 1 and 2, Groups IIA, IIB +H₂

Applications

- Serves as pulling fitting.
- Makes 90° bend in conduit runs.

Features

- Screw-on Cover for ease of installation and removal.
- Cover opens on an angle permitting conductors to be pulled straight through either hub.
- Can make 90° turns in conduit where a compact turn is desired.
- Female tapered threaded hubs (NPT) for rigid conduit and IMC.



Standard Materials

- Malleable iron or aluminum

Standard Finishes

- Aluminum: epoxy powder coat
- Malleable iron: triplecoat— (1) zinc electroplate, (2) chromate, and (3) epoxy powder coat

NEC/CEC Certifications and Compliances

- UL Standard: 886 (1203)
- UL Listed: E10444
- CSA Standard: C22.2 No. 30
- CSA Certified: 065181

HAZARDOUS LOCATION FITTINGS: NEC/CEC EXPLOSIONPROOF OUTLET BODIES AND BOXES

Type and Size (Inches)	Catalog Number	
	Malleable Iron	Aluminum
1/2	ELBY-50 ♦	ELBY-50A
3/4	ELBY-75 ♦	ELBY-75A
1	ELBY-100 ♦	ELBY-100A
1-1/4	ELBY-125 ♦	ELBY-125A

♦ Suitable for Class 1, Group B in addition to Class I, Groups C, D; Class II, Groups E, F, G and Class III.

LBY Capped Elbows

Explosionproof, Dust-Ignitionproof

For use with Threaded Metal Conduit.

NEC/CEC:

Class I, Division 1 and 2, Groups B, C, D
Class I, Zone 1 and 2, Groups IIA, IIB +H₂
Class II, Division 1 and 2, Groups E, F, G
Class III

Applications

- Serves as pulling fitting.
- Makes 90° bend in conduit runs.

Features

- Screw-on Cover for ease of installation and removal.
- Cover opens on an angle permitting conductors to be pulled straight through either hub.
- Can make 90° turns in conduit where a compact turn is desired.
- Female tapered threaded hubs (NPT) for rigid conduit and IMC.

Standard Materials

- Malleable iron

Standard Finishes

- Malleable iron: triplecoat— (1) zinc electroplate, (2) chromate, and (3) epoxy powder coat

NEC/CEC Certifications and Compliances

- UL Standard: ANSI/UL 514B and 886 (1203)
- UL Listed: E34997, E10444
- CSA Standard: C22.2 No. 30
- CSA Certified: 009795/065181

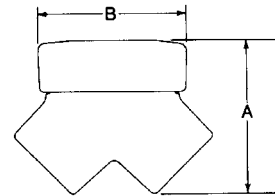

Trade Size (Inches)	Dimensions in Millimeters (Inches)		Catalog Number
	A	B	
1/2	57.15 (2.25)	18.29 (0.72)	LBY-50
3/4	63.50 (2.50)	60.33 (2.38)	LBY-75
1	71.37 (2.81)	71.44 (2.81)	LBY-10
1-1/4	79.50 (3.13)	84.14 (3.31)	LBY-125
1-1/2	84.07 (3.31)	96.84 (3.81)	LBY-150

HAZARDOUS LOCATION FITTINGS: NEC/CEC EXPLOSIONPROOF OUTLET BODIES AND BOXES

OZGEDNEY

ELBD 90° Aluminum Pulling Elbows

Explosionproof, Dust-Ignitionproof

UNILETS™ for use with Threaded Metal Conduit.

NEC/CEC — 1/2" thru 3/4":
 Class I, Division 1 and 2, Groups C, D
 Class I, Zone 1 and 2, Groups IIA, IIB
 Class II, Division 1 and 2, Groups E, F, G
 Class III
 NEMA 4, 7CD, 9EFG

NEC/CEC — 1" thru 4":
 Class I, Division 1 and 2, Group D
 Class I, Zone 1 and 2, Group IIA
 Class II, Division 1 and 2, Groups E, F, G
 Class III
 NEMA 4, 7CD, 9EFG

NEC/CEC — 1-1/2" thru 4":
 Class I, Division 1 and 2, Group D
 Class II, Division 1 and 2, Groups E, F, G
 Class III

Applications

- To provide access to conductors for pulling, splicing and maintenance in Hazardous Locations.

Features

- Tapered Threaded Hubs (NPT) for Rigid Conduit and IMC.
- Angled cover opening allows conductors to be pulled straight through hubs.
- Smooth cover opening and pulling surfaces prevents abrasion of conductors.
- Neoprene gasket cemented into groove in cover for NEMA 4 application.
- Provided with reducing bushings to adapt to the next smaller trade size.

Standard Materials

- Copper-free aluminum
- Cover screws are steel zinc electroplated

Standard Finishes

- Epoxy powder coat

NEC/CEC Certifications and Compliances

- UL Standard: 886
- UL Listed: E85310
- CSA Standard: C22.2 No. 30
- CSA Certified: 009
- NEC Articles 500-503 and 505
- Fed. Spec: A-A-50563

HAZARDOUS LOCATION FITTINGS: NEC/CEC EXPLOSIONPROOF OUTLET BODIES AND BOXES



Type and Size (Inches)	Catalog Number
1/2	ELBD-50A ①
3/4	ELBD-75A ①
1	ELBD-100A ①
1-1/4	ELBD-125A ①
1-1/2	ELBD-150A
2	ELBD-200A ①
2-1/2	ELBD-250A ①
3	ELBD-300A ①
3-1/2	ELBD-350A ①
4	ELBD-400A

Trade Size (Inches)	Dimensions in Millimeters (Inches)						Volume dm ³ (in ³)	Reducing Bushing Size	Reducing Bushing Quantity Provided
	A	B	C	D	E	F			
1/2 to 3/4	127.00 (5.00)	67.00 (2.63)	102.00 (4.00)	25.00 (1.00)	108.00 (4.25)	70.00 (2.75)	0.14 (8.50)	3/4 to 1/2	2
1 to 1-1/4	200.00 (7.88)	86.00 (3.38)	133.00 (5.25)	45.00 (1.75)	184.00 (7.25)	102.00 (4.00)	0.54 (33.20)	1-1/4 to 1	2
1-1/2 to 2	270.00 (10.63)	121.00 (4.75)	181.00 (7.13)	60.00 (2.38)	260.00 (10.25)	127.00 (5.00)	1.36 (83.00)	2 to 1-1/2	2
2-1/2 to 3	397.00 (15.63)	140.00 (5.50)	235.00 (9.25)	86.00 (3.38)	394.00 (15.50)	162.00 (6.38)	4.06 (248.00)	3 to 2-1/2	2
4	597.00 (23.50)	168.00 (6.63)	298.00 (11.75)	108.00 (4.25)	597.00 (23.50)	197.00 (7.75)	11.68 (713.00)	4 to 3-1/2	0 ②
1/2 to 3/4	127.00 (5.00)	67.00 (2.63)	102.00 (4.00)	25.00 (1.00)	108.00 (4.25)	70.00 (2.75)	0.14 (8.50)	3/4 to 1/2	2
1 to 1-1/4	200.00 (7.88)	86.00 (3.38)	133.00 (5.25)	45.00 (1.75)	184.00 (7.25)	102.00 (4.00)	0.54 (33.20)	1-1/4 to 1	2
1-1/2 to 2	270.00 (10.63)	121.00 (4.75)	181.00 (7.13)	60.00 (2.38)	260.00 (10.25)	127.00 (5.00)	1.36 (83.00)	2 to 1-1/2	2
2-1/2 to 3	397.00 (15.63)	140.00 (5.50)	235.00 (9.25)	86.00 (3.38)	394.00 (15.50)	162.00 (6.38)	4.06 (248.00)	3 to 2-1/2	2
4	597.00 (23.50)	168.00 (6.63)	298.00 (11.75)	108.00 (4.25)	597.00 (23.50)	197.00 (7.75)	11.68 (713.00)	4 to 3-1/2	0 ②

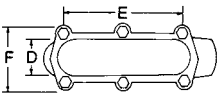
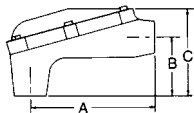

① Aluminum reducing bushings furnished.

② Reducing bushings are available for adaptation to 31/2" conduit, contact your local representative for pricing and availability.

ELBD 90° Malleable Iron Pulling Elbows

Explosionproof, Dust-Ignitionproof

UNILETS™ for use with Threaded Metal Conduit.

NEC/CEC:

Class I, Division 1 and 2, Group D
Class II, Division 1 and 2, Groups E, F, G
Class III

Applications

- Serves as pulling fitting.
- Makes 90° bend in conduit runs.

Features

- 2-1/2 thru 4" — ELBD Pulling Elbows feature built-in rollers to facilitate cable pulling.
- Permits easy access to pulling conductors.
- Easily removeable covers
- 1" - 4" raintight

Standard Materials

- Malleable iron

Standard Finishes

- Triplecoat— (1) zinc electroplate, (2) chromate, and (3) epoxy powder coat

NEC/CEC Certifications and Compliances

- UL Standard: 886 (1203)
- UL Listed: E85310
- CSA Standard: C22.2 No. 30
- CSA Certified: 065181



Type and Size (Inches)	Catalog Number
1/2	ELBD-50
3/4	ELBD-75
1	ELBD-100
1-1/4	ELBD-125
1-1/2	ELBD-150
2	ELBD-200
2-1/2	ELBD-250
3	ELBD-300
3-1/2	ELBD-350
4	ELBD-400

Hub Size (Inches)	Dimensions in Millimeters (Inches)					
	A	B	C	D	E	F
1/2	128.5 (5.06)	66.8 (2.63)	114.3 (4.50)	26.9 (1.06)	119.1 (4.69)	68.3 (2.69)
3/4	128.5 (5.06)	66.8 (2.63)	114.3 (4.50)	26.9 (1.06)	119.1 (4.69)	68.3 (2.69)
1	200.2 (7.88)	87.3 (3.44)	127.0 (5.00)	44.5 (1.75)	190.5 (7.50)	100.1 (3.94)
1-1/4	200.2 (7.88)	87.3 (3.44)	127.0 (5.00)	44.5 (1.75)	190.5 (7.50)	100.1 (3.94)
1-1/2	270.0 (10.63)	122.2 (4.81)	171.5 (6.75)	65.0 (2.56)	271.5 (10.69)	125.5 (4.94)
2	270.0 (10.63)	122.2 (4.81)	171.5 (6.75)	65.0 (2.56)	271.5 (10.69)	125.5 (4.94)
2-1/2	373.1 (14.69)	168.4 (6.63)	235.0 (9.25)	95.3 (3.75)	350.8 (13.81)	169.9 (6.69)
3	373.1 (14.69)	168.4 (6.63)	235.0 (9.25)	95.3 (3.75)	350.8 (13.81)	169.9 (6.69)
3-1/2	717.6 (28.25)	190.5 (7.50)	323.9 (12.75)	117.6 (4.63)	700.0 (27.56)	187.5 (7.38)
4	717.6 (28.25)	190.5 (7.50)	323.9 (12.75)	117.6 (4.63)	700.0 (27.56)	187.5 (7.38)

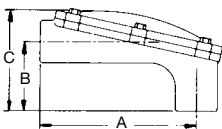
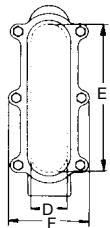

HAZARDOUS LOCATION FITTINGS: NEC/CEC EXPLOSIONPROOF OUTLET BODIES AND BOXES



LBH 90° Aluminum Pulling Elbows

Explosionproof, Dust-Ignitionproof

For use with Threaded Metal Conduit.

NEC/CEC — 1/2" thru 3/4":
 Class I, Division 1 and 2, Groups C, D
 Class I, Zone 1 and 2, Groups IIA, IIB
 Class II, Division 1 and 2, Groups E, F, G
 Class III
 NEMA 4, 7CD, 9EFG

NEC/CEC — 1" thru 4":
 Class I, Division 1 and 2, Group D
 Class I, Zone 1 and 2, Group IIA
 Class II, Division 1 and 2, Groups E, F, G
 Class III
 NEMA 4, 7CD, 9EFG

NEC/CEC — 1-1/2" thru 4":
 Class I, Division 1 and 2, Group D
 Class II, Division 1 and 2, Groups E, F, G
 Class III

Applications

- To provide access to conductors for pulling, splicing and maintenance in Hazardous Locations.

Features

- Tapered Threaded Hubs (NPT) for Rigid Conduit and IMC.
- Angled cover opening allows conductors to be pulled straight through hubs.
- Smooth cover opening and pulling surfaces prevents abrasion of conductors.
- Neoprene gasket cemented into groove in cover for NEMA 4 application.
- Provided with reducing bushings to adapt to the next smaller trade size.

Standard Materials

- Copper-free aluminum
- Cover screws are steel zinc electroplated

Standard Finishes

- Epoxy powder coat

NEC/CEC Certifications and Compliances

- UL Standard: 886
- UL Listed: E85310
- CSA Standard: C22.2 No. 30
- CSA Certified: 009
- NEC Articles 500-503 and 505
- Fed. Spec: A-A-50563

HAZARDOUS LOCATION FITTINGS: NEC/CEC EXPLOSIONPROOF OUTLET BODIES AND BOXES



Trade Size (Inches)	Catalog Number
1/2 - 3/4	LBH-0507A ①
1 - 1-1/4	LBH-1012A ①
1-1/2 - 2	LBH-1520A ①
2-1/2 - 3	LBH-2530A ①
4	LBH-400A
1/2 - 3/4	LBH-0507AN4 ①
1 - 1-1/4	LBH-1012AN4 ①
1-1/2 - 2	LBH-1520AN4 ①
2-1/2 - 3	LBH-2530AN4 ①
4	LBH-400AN4

Trade Size (Inches)	Dimensions in Millimeters (Inches)						Volume dm ³ (in ³)	Reducing Bushing Size	Reducing Bushing Quantity Provided
	A	B	C	D	E	F			
1/2 to 3/4	127.00 (5.00)	67.00 (2.63)	102.00 (4.00)	25.00 (1.00)	108.00 (4.25)	70.00 (2.75)	0.14 (8.50)	3/4 to 1/2	2
1 to 1-1/4	200.00 (7.88)	86.00 (3.38)	133.00 (5.25)	45.00 (1.75)	184.00 (7.25)	102.00 (4.00)	0.54 (33.20)	1-1/4 to 1	2
1-1/2 to 2	270.00 (10.63)	121.00 (4.75)	181.00 (7.13)	60.00 (2.38)	260.00 (10.25)	127.00 (5.00)	1.36 (83.00)	2 to 1-1/2	2
2-1/2 to 3	397.00 (15.63)	140.00 (5.50)	235.00 (9.25)	86.00 (3.38)	394.00 (15.50)	162.00 (6.38)	4.06 (248.00)	3 to 2-1/2	2
4	597.00 (23.50)	168.00 (6.63)	298.00 (11.75)	108.00 (4.25)	597.00 (23.50)	197.00 (7.75)	11.68 (713.00)	4 to 3-1/2	0 ②
1/2 to 3/4	127.00 (5.00)	67.00 (2.63)	102.00 (4.00)	25.00 (1.00)	108.00 (4.25)	70.00 (2.75)	0.14 (8.50)	3/4 to 1/2	2
1 to 1-1/4	200.00 (7.88)	86.00 (3.38)	133.00 (5.25)	45.00 (1.75)	184.00 (7.25)	102.00 (4.00)	0.54 (33.20)	1-1/4 to 1	2
1-1/2 to 2	270.00 (10.63)	121.00 (4.75)	181.00 (7.13)	60.00 (2.38)	260.00 (10.25)	127.00 (5.00)	1.36 (83.00)	2 to 1-1/2	2
2-1/2 to 3	397.00 (15.63)	140.00 (5.50)	235.00 (9.25)	86.00 (3.38)	394.00 (15.50)	162.00 (6.38)	4.06 (248.00)	3 to 2-1/2	2
4	597.00 (23.50)	168.00 (6.63)	298.00 (11.75)	108.00 (4.25)	597.00 (23.50)	197.00 (7.75)	11.68 (713.00)	4 to 3-1/2	0 ②

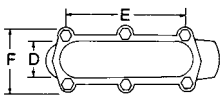
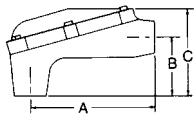

① Aluminum reducing bushings furnished.

② Reducing bushings are available for adaptation to 3-1/2" conduit, contact your local representative for pricing and availability.

LBH 90° Malleable Iron Pulling Elbows

Explosionproof, Dust-Ignitionproof

For use with Threaded Metal Conduit.

NEC/CEC:

Class I, Division 1 and 2, Group D
Class II, Division 1 and 2, Groups E, F, G
Class III

Applications

- Serves as pulling fitting.
- Makes 90° bend in conduit runs.

Features

- 2-1/2 thru 4" — LBD Pulling Elbows feature built-in rollers to facilitate cable pulling.
- Permits easy access to pulling conductors.
- Easily removeable covers
- 1" - 4" raintight

Standard Materials

- Malleable iron

Standard Finishes

- Triplecoat — (1) zinc electroplate, (2) chromate, and (3) epoxy powder coat

NEC/CEC Certifications and Compliances

- UL Standard: 886 (1203)
- UL Listed: E85310
- CSA Standard: C22.2 No. 30
- CSA Certified: 065181

	Trade Size (Inches)	Catalog Number
	1/2 - 3/4	LBH-0507 ①
	1 - 1-1/4	LBH-1012 ①
	1-1/2 - 2	LBH-1520 ①
	2-1/2 - 3	LBH-2530 ①
	4	LBH-400

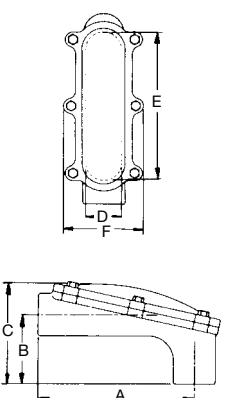
	Hub Size (Inches)	Dimensions in Millimeters (Inches)					
		A	B	C	D	E	F
	1/2	128.5 (5.06)	66.8 (2.63)	114.3 (4.50)	26.9 (1.06)	119.1 (4.69)	68.3 (2.69)
	3/4	128.5 (5.06)	66.8 (2.63)	114.3 (4.50)	26.9 (1.06)	119.1 (4.69)	68.3 (2.69)
	1	200.2 (7.88)	87.3 (3.44)	127.0 (5.00)	44.5 (1.75)	190.5 (7.50)	100.1 (3.94)
	1-1/4	200.2 (7.88)	87.3 (3.44)	127.0 (5.00)	44.5 (1.75)	190.5 (7.50)	100.1 (3.94)
	1-1/2	270.0 (10.63)	122.2 (4.81)	171.5 (6.75)	65.0 (2.56)	271.5 (10.69)	125.5 (4.94)
	2	270.0 (10.63)	122.2 (4.81)	171.5 (6.75)	65.0 (2.56)	271.5 (10.69)	125.5 (4.94)
	2-1/2	373.1 (14.69)	168.4 (6.63)	235.0 (9.25)	95.3 (3.75)	350.8 (13.81)	169.9 (6.69)
	3	373.1 (14.69)	168.4 (6.63)	235.0 (9.25)	95.3 (3.75)	350.8 (13.81)	169.9 (6.69)
	3-1/2	717.6 (28.25)	190.5 (7.50)	323.9 (12.75)	117.6 (4.63)	700.0 (27.56)	187.5 (7.38)
	4	717.6 (28.25)	190.5 (7.50)	323.9 (12.75)	117.6 (4.63)	700.0 (27.56)	187.5 (7.38)

① Ferrous reducing bushings furnished.

ER Conduit Outlet Boxes

Explosionproof, Dust-Ignitionproof

UNILETS™ for use with Threaded Rigid Metal Conduit.

NEC/CEC:

Class I, Division 1 and 2, Group C, D
Class II, Division 1 and 2, Groups E, F, G
Class III

Applications

- Meet a wide range of classified area requirements.
- Corrosion-resistant — ideal indoors or out.
- For pulling of wires.
- Connect conduit lengths and change direction of conduit.
- Provide access for maintenance.

Features

- Malleable iron bodies have high tensile strength and ductility. Provides great resistance to corrosion, impact, and shock.
- Accurately tapped, tapered hub threads for tight, rigid joints and ground continuity.
- Furnished with covers.
- General purpose wiring.
- Compact, rectangular conduit outlet boxes are ideal in classified locations where space is limited.
- Six different hub arrangements.
- Ground surface contact between body and cover assures a flame-tight joint.
- Smooth, rounded integral bushing in each hub type box protects conductor insulation.

Standard Materials

- Bodies and covers: malleable iron

Standard Finishes

- Bodies and covers: malleable iron triple-coat — (1) zinc electroplate, (2) chromate, and (3) epoxy powder coat

NEC Certifications and Compliances

- UL Standard: 886 (1203)
- UL Listed: E85310
- CSA Standard: C22.2 No. 30
- CSA Certified: 013017



ERC



ERLB



ERLL



ERLR



ERT



ERTB







ER Raintight Conduit Outlet Boxes

Explosionproof, Dust-Ignitionproof

UNILETS™ for use with Rigid Metal Conduit.

NEC/CEC:

Class I, Division 1 and 2, Groups C, D
 Class II, Division 1 and 2, Groups E, F, G
 Class III

	Size	Weight in kgs (lbs)	Catalog Number
Furnished with blank cover			
	1/2	0.68 (1.50)	ERC50
	3/4	1.32 (2.90)	ERC75
	1/2	0.68 (1.50)	ERLB50
	3/4	1.25 (2.75)	ERLB75
	1/2	0.91 (2.00)	ERLL50
	3/4	1.25 (2.75)	ERLL75
	1/2	0.85 (1.88)	ERLR50
	3/4	1.25 (2.75)	ERLR75
	1/2 ①	0.93 (2.05)	ERT50
	3/4 ①	1.25 (2.75)	ERT75
	1/2 ①	0.73 (1.62)	ERTB50
	3/4 ①	0.99 (2.20)	ERTB75

Trade Size (Inches)	Dimensions in Millimeters (Inches)					
	A	B	C	D	E	G
1/2	93.7 (3.69)	38.1 (1.50)	46.0 (1.81)	127.0 (5.00)	54.1 (2.13)	14.2 (0.56)
3/4	25.4 (1.00)	44.5 (1.75)	50.8 (2.00)	138.2 (5.44)	68.3 (2.69)	17.5 (0.69)

① Suitable for use Class 1 Division 1 and 2, Group D only.

OE Conduit Outlet Boxes

Explosionproof, Dust-Ignitionproof

For use with Threaded Rigid Metal Conduit.

NEC/CEC:

Class I, Division 1 and 2, Group C, D
Class II, Division 1 and 2, Groups E, F, G
Class III

Applications

- Meet a wide range of classified area requirements.
- Corrosion-resistant — ideal indoors or out.
- For pulling of wires.
- Connect conduit lengths and change direction of conduit.
- Provide access for maintenance.

Features

- Malleable iron bodies have high tensile strength and ductility. Provides great resistance to corrosion, impact, and shock.
- Accurately tapped, tapered hub threads for tight, rigid joints and ground continuity.
- Furnished with covers.
- General purpose wiring.
- Compact, rectangular conduit outlet boxes are ideal in classified locations where space is limited.
- Six different hub arrangements.
- Ground surface contact between body and cover assures a flame-tight joint.
- Smooth, rounded integral bushing in each hub type box protects conductor insulation.

Standard Materials

- Bodies and covers: malleable iron

Standard Finishes

- Bodies and covers: malleable iron triple-coat — (1) zinc electroplate, (2) chromate, and (3) epoxy powder coat

NEC Certifications and Compliances

- UL Standard: 886
- UL Listed: E85310
- CSA Standard: C22.2 No. 30
- CSA Certified: 009795
- Mil. Spec: Mil-F-28675
- Fed. Spec: A-A-50563



0EC



0ELB



0ELL



0ELR



0ET





OE Raintight Conduit Outlet Boxes

Explosionproof, Dust-Ignitionproof

For use with Rigid Metal Conduit.

NEC/CEC:

Class I, Division 1 and 2, Group C, D
 Class II, Division 1 and 2, Groups E, F, G
 Class III

	Size	Weight in kgs (lbs)	Catalog Number
Furnished with blank cover			
	1/2	0.68 (1.50)	0EC-50
	3/4	1.32 (2.90)	0EC-75
	1/2	0.68 (1.50)	0ELB-50
	3/4	1.25 (2.75)	0ELB-75
	1/2	0.91 (2.00)	0ELL-50
	3/4	1.25 (2.75)	0ELL-75
	1/2 ①	0.85 (1.88)	0ELR-50
	3/4 ①	1.25 (2.75)	0ELR-75
	1/2 ①	0.93 (2.05)	0ET-50
	3/4 ①	1.25 (2.75)	0ET-75

Trade Size (Inches)	Dimensions in Millimeters (Inches)					
	A	B	C	D	E	G
1/2	93.7 (3.69)	38.1 (1.50)	46.0 (1.81)	127.0 (5.00)	54.1 (2.13)	14.2 (0.56)
3/4	25.4 (1.00)	44.5 (1.75)	50.8 (2.00)	138.2 (5.44)	68.3 (2.69)	17.5 (0.69)

① Suitable for use Class 1 Division 1 and 2, Group D only.

Notes

Notes

Notes

Notes

Notes

Notes

Notes

Notes

Notes

Notes

Notes

Notes

Notes

Safety and productivity in industrial facilities demand reliable connectivity and control to protect people and equipment.



Appleton and O-Z/Gedney are the cornerstone brands of Emerson's Electrical Apparatus and Lighting business; trusted worldwide to make electrical installations safer, more productive and more reliable.

**United States
(Headquarters)**

Appleton Grp LLC
9377 W. Higgins Road
Rosemont, IL 60018
United States
T +1 800 621 1506

Europe

ATX SAS
Espace Industriel Nord
35, rue André Durouchez,
CS 98017
80084 Amiens Cedex 2, France
T +33 3 2254 1390

Canada

EGS Electrical Group Canada Ltd.
99 Union Street
Elmira ON, N3B 3L7
Canada
T +1 888 765 2226

Asia Pacific

EGS Private Ltd.
Block 4008, Ang Mo Kio Ave 10,
#04-16 TechPlace 1,
Singapore 569625
T +65 6556 1100

Latin America

EGS Comercializadora Mexico S
de RL de CV
Calle 10 N°145 Piso 3
Col. San Pedro de los Pinos
Del. Álvaro Obregon
Ciudad de México. 01180
T +52 55 5809 5049

Australia Sales Office

Bayswater, Victoria
T +61 3 9721 0348

China Sales Office

Shanghai
T +86 21 3338 7000

Middle East Sales Office

Dammam, Saudi Arabia
T +966 13 510 3702

Chile Sales Office

Las Condes
T +56 2928 4819

India Sales Office

Chennai
T +91 44 3919 7300

Korea Sales Office

Seoul
T +82 2 3483 1555



Emerson.com



LinkedIn.com/company/emerson

The Emerson logo is a trademark and service mark of Emerson Electric Co. © 2016 Emerson Electric Co. Appleton and O-Z/Gedney brand logos are registered trademarks of Appleton Grp LLC. All other marks are the property of their respective owners. © 2016 Emerson Automation Solutions. All rights reserved.



EMERSON. CONSIDER IT SOLVED.™