

# Radiometry and reflectance

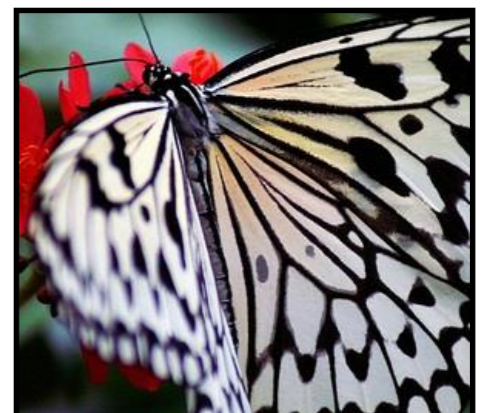

# Course announcements

- Programming assignments 1 and 2 have been graded.
- Programming assignment 3 has been posted and is due on March 4<sup>th</sup>.
  - Any questions about the homework?
  - How many of you have looked at/started/finished programming assignment 3?
- Take-home quiz 6 will be posted tonight and will be due Sunday March 15<sup>th</sup>.
- Programming assignment 4 will be posted on Wednesday.

# Overview of today's lecture

- Appearance phenomena.
- Measuring light and radiometry.
- Reflectance and BRDF.
- Light sources.

# Slide credits

Most of these slides were adapted from:

- Srinivasa Narasimhan (16-385, Spring 2014).
- Todd Zickler (Harvard University).
- Steven Gortler (Harvard University).

Appearance

# Appearance

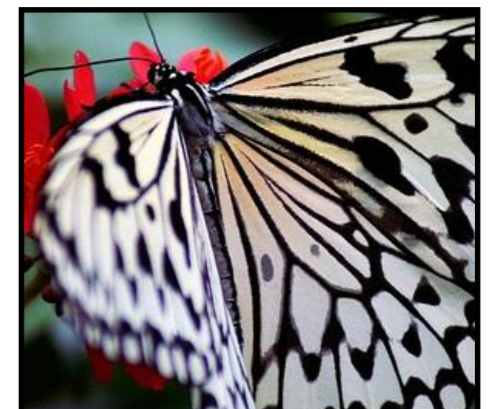

# “Physics-based” computer vision (a.k.a “inverse optics”)

Our challenge: Invent computational representations of shape, lighting, and reflectance that are *efficient*: simple enough to make inference tractable, yet general enough to capture the world’s most important phenomena

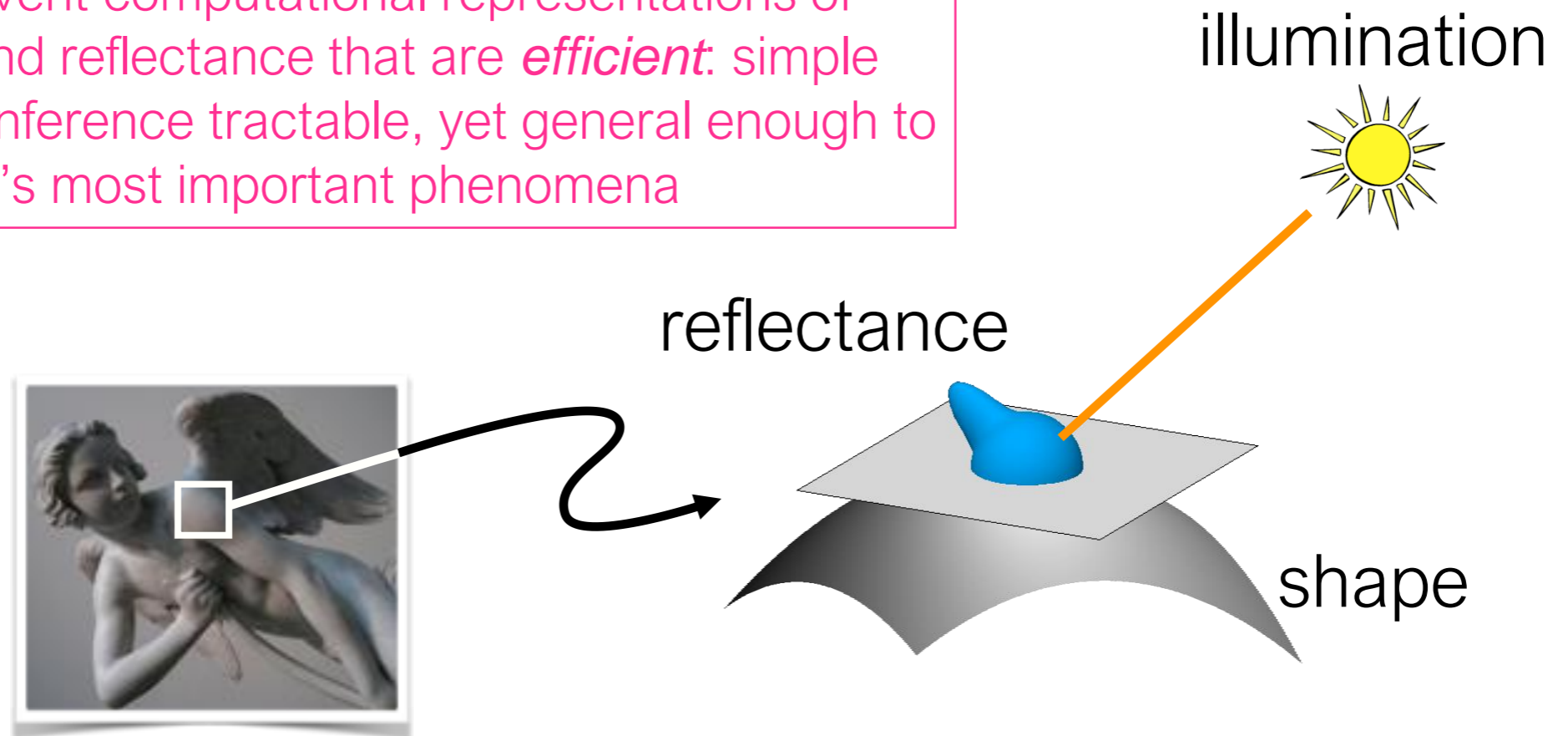

**I**  $\longrightarrow$  shape, illumination, reflectance

# Example application: Photometric Stereo

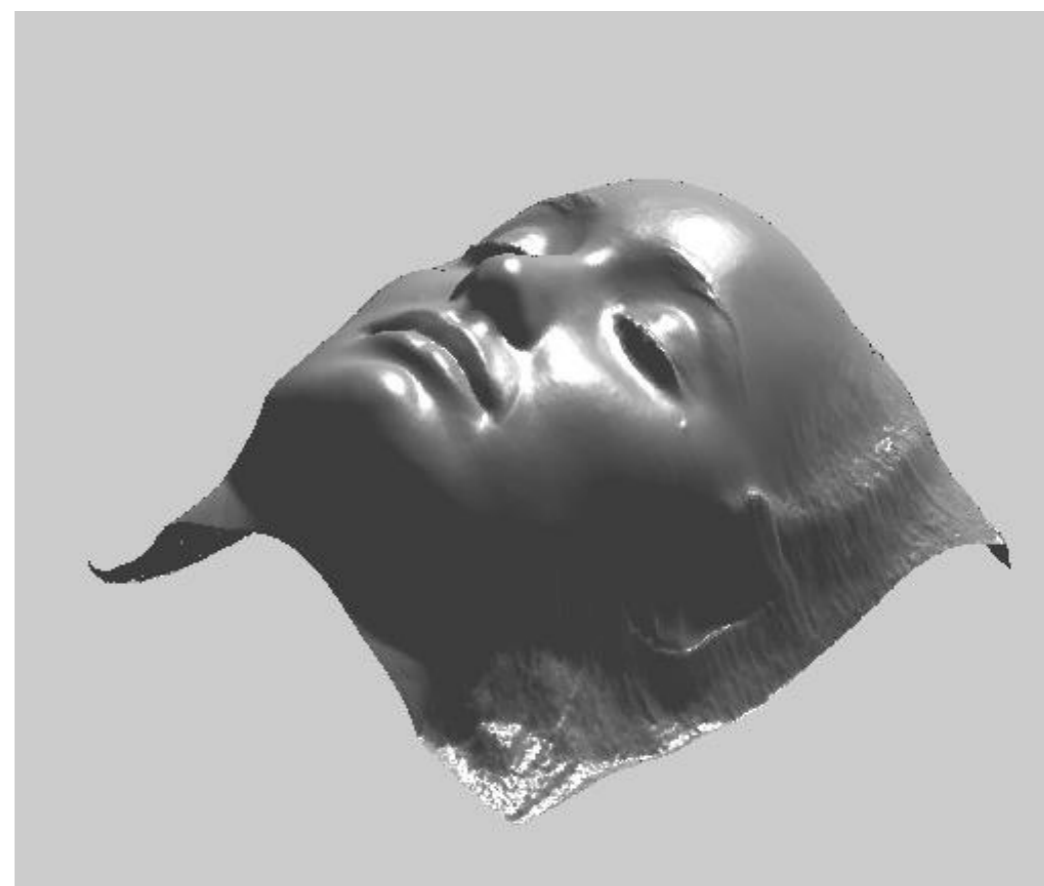
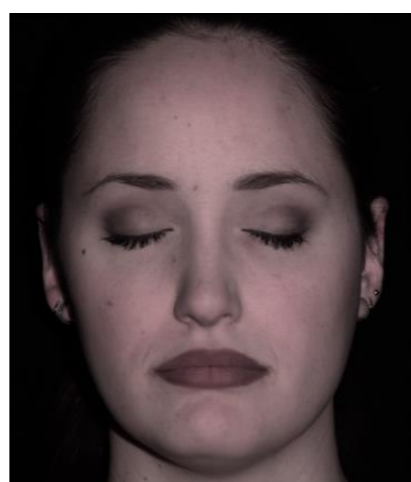
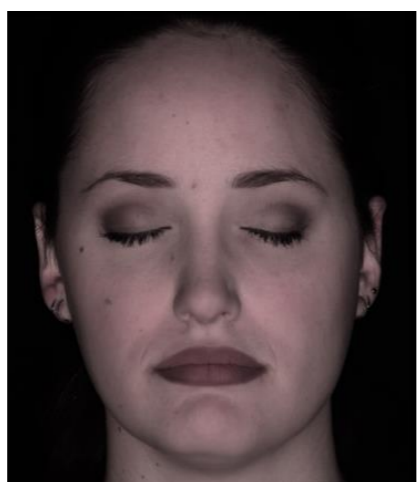
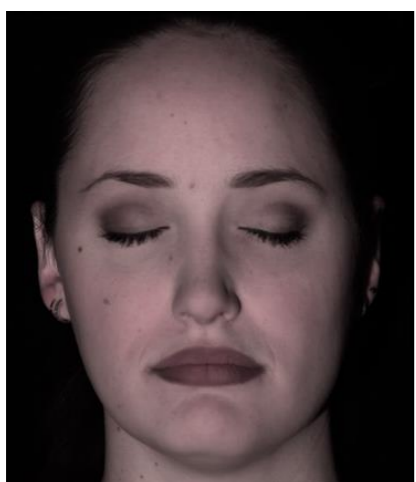
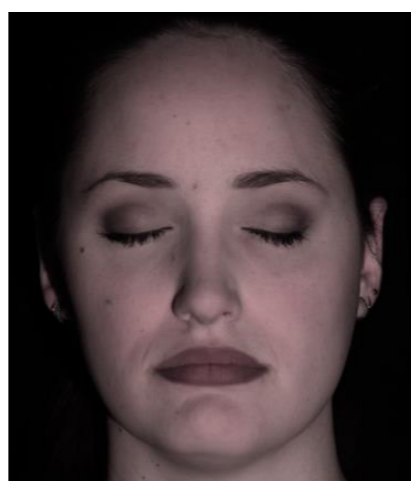
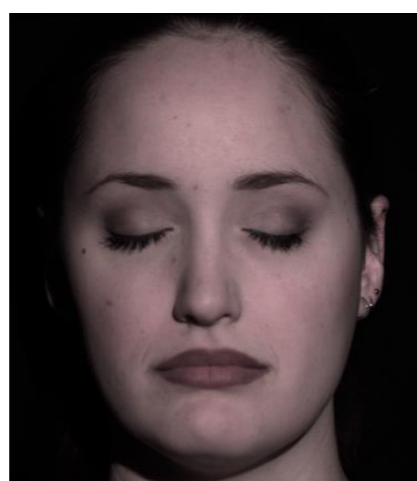
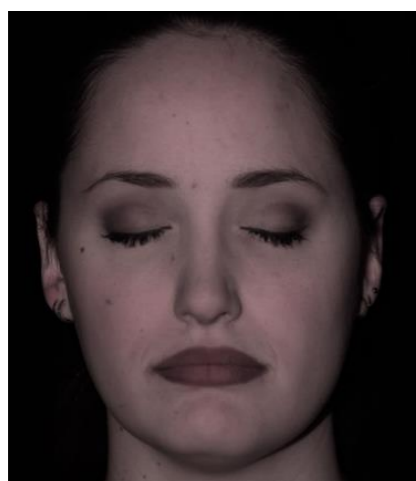
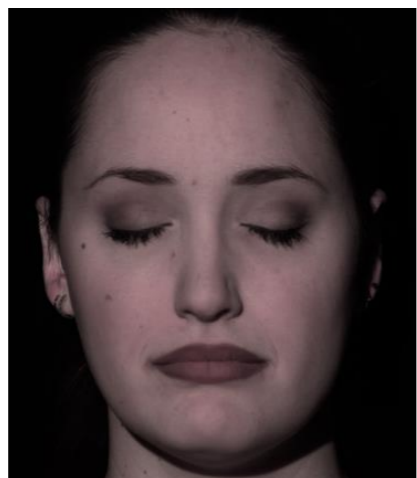



Why study the physics (optics) of the  
world?

Lets see some pictures!

# Light and Shadows





# Reflections









# Refractions

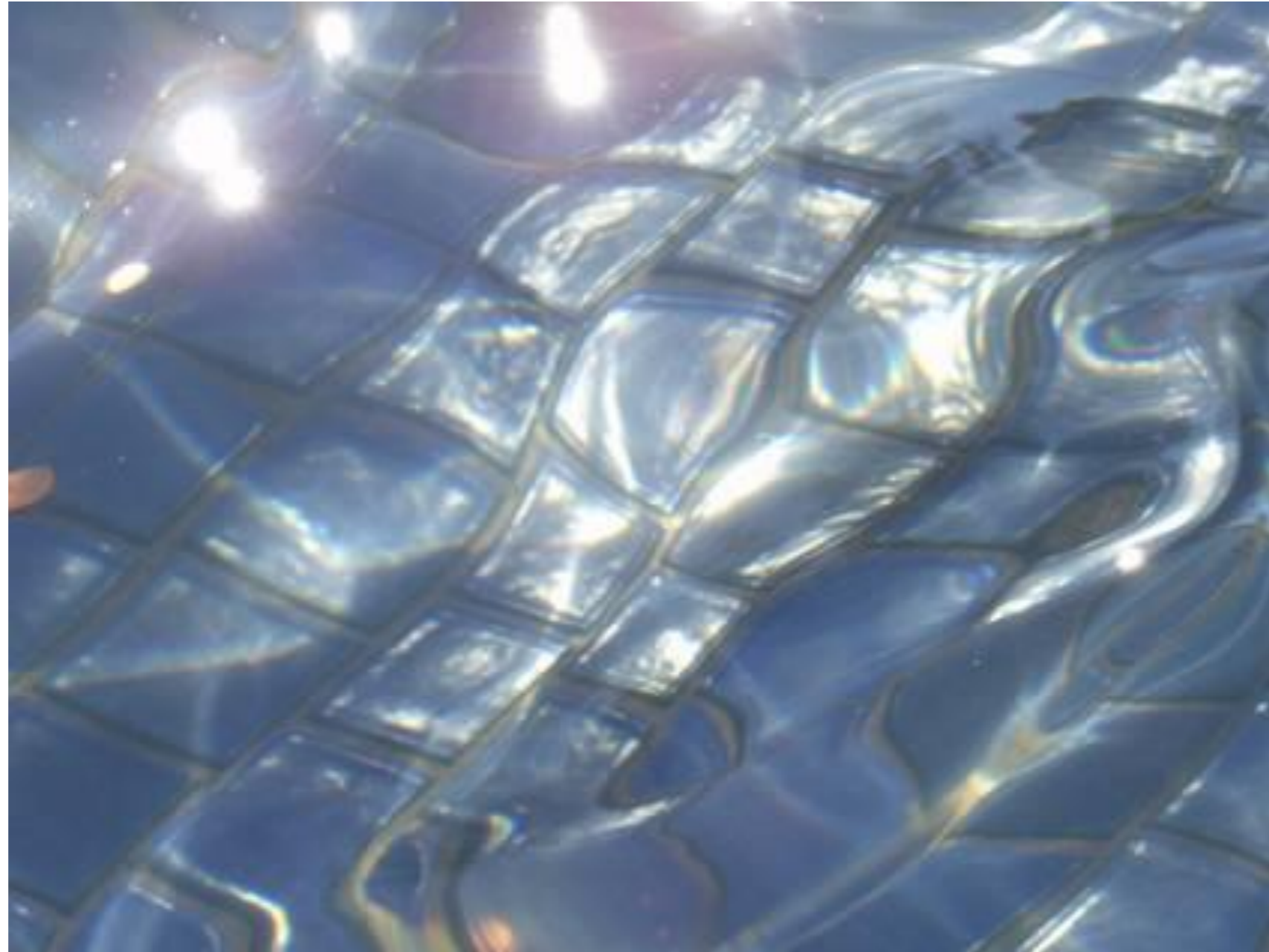

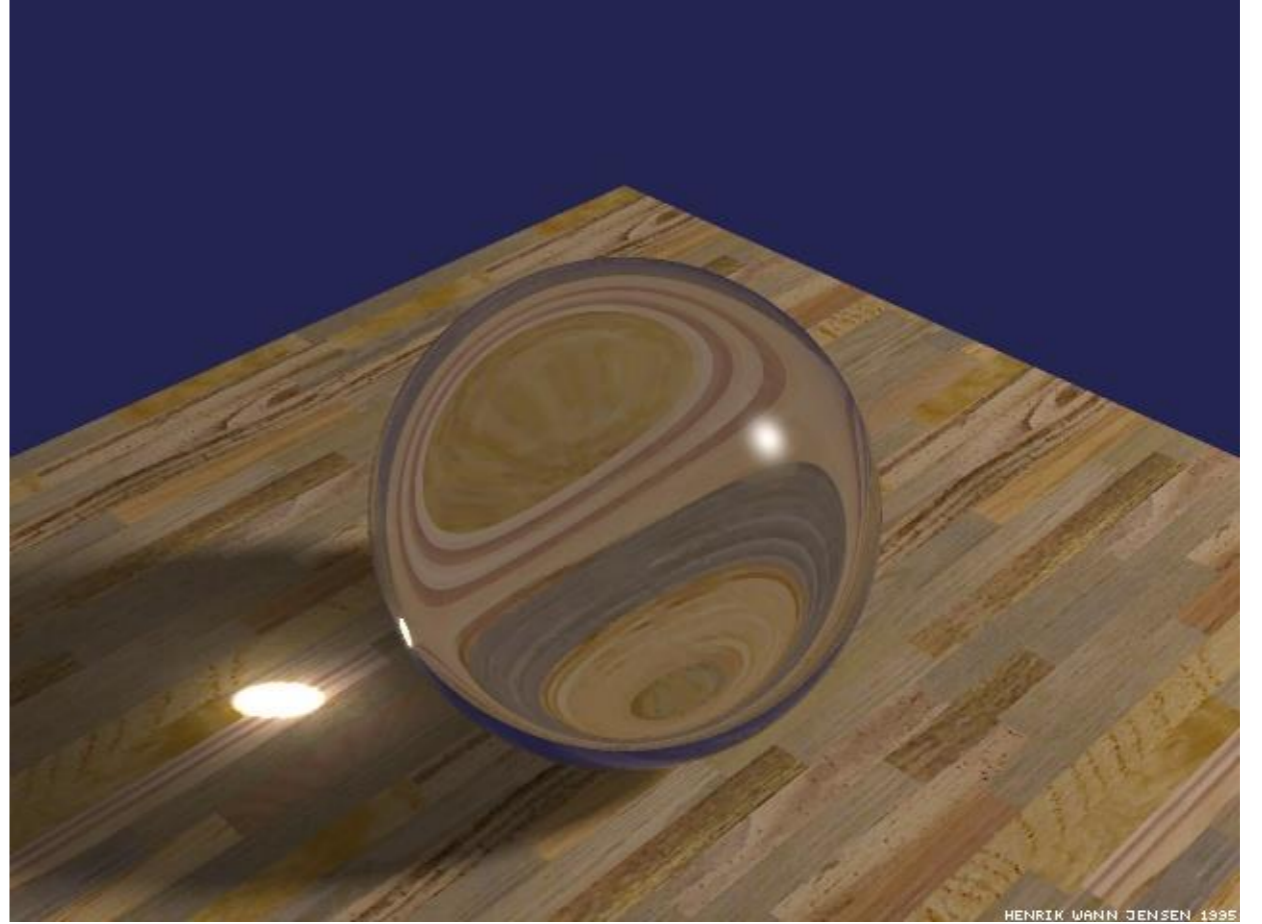



# Interreflections

Mies Courtyard House with Curved Elements



Scattering

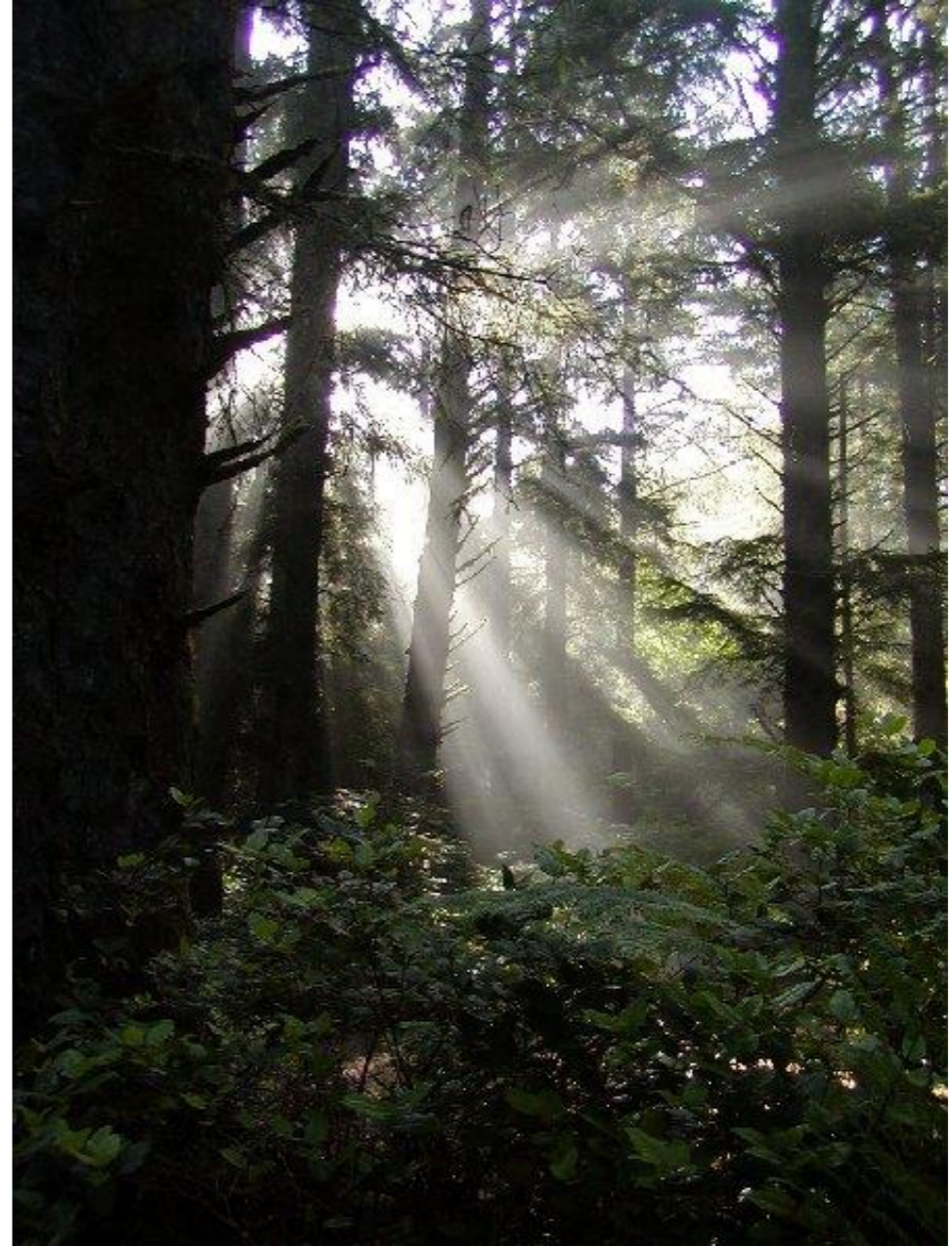







More Complex Appearances













# Measuring light and radiometry

# Solid angle

- The *solid angle* subtended by a small surface patch with respect to point  $O$  is the area of its central projection onto the unit sphere about  $O$

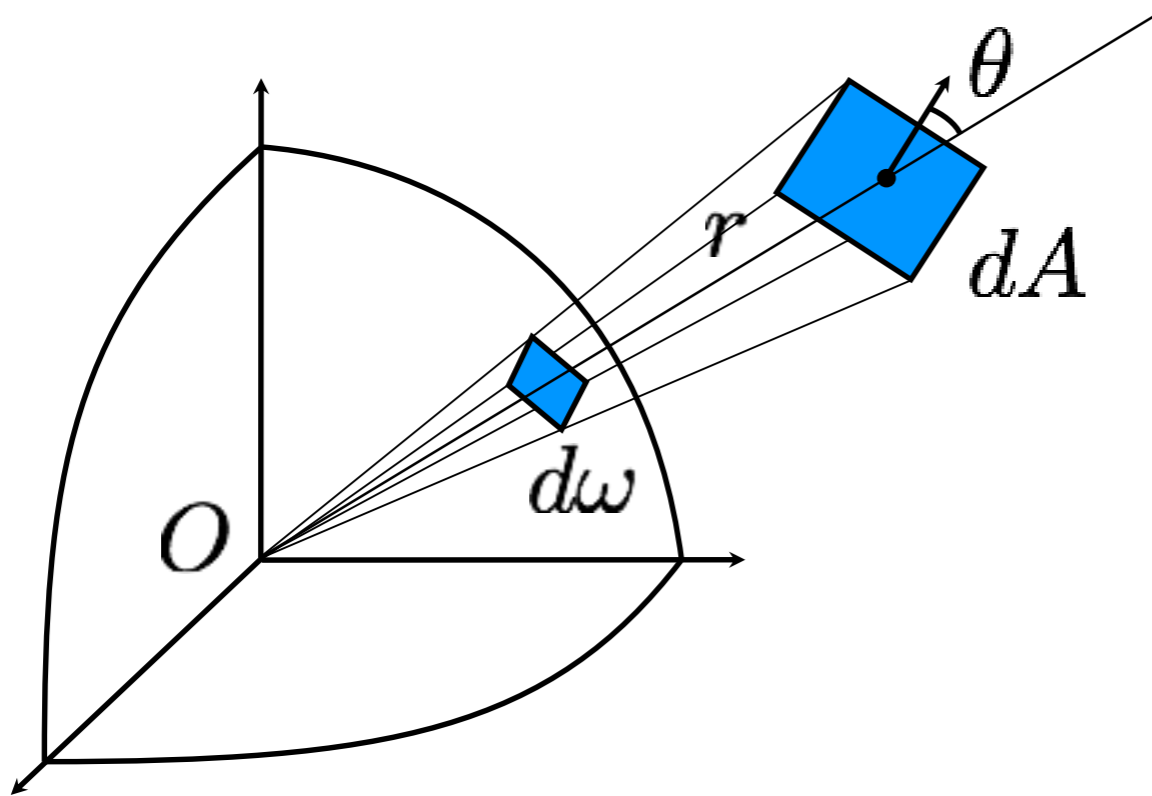

Depends on:

- orientation of patch
- distance of patch

# Solid angle

- The *solid angle* subtended by a small surface patch with respect to point O is the area of its central projection onto the unit sphere about O

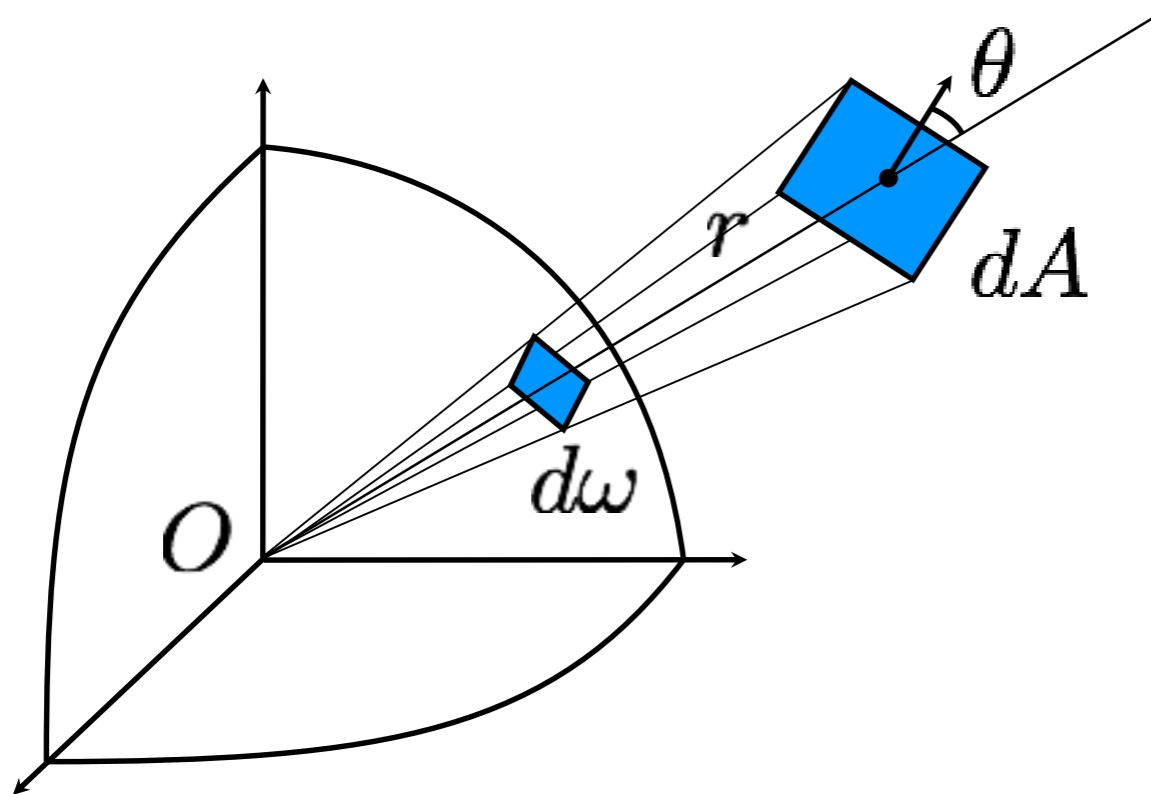

Depends on:

- orientation of patch
- distance of patch

One can show:

$$d\omega = \frac{dA \cos \theta}{r^2}$$

Units: steradians [sr]

# Solid angle

- The *solid angle* subtended by a small surface patch with respect to point  $O$  is the area of its central projection onto the unit sphere about  $O$

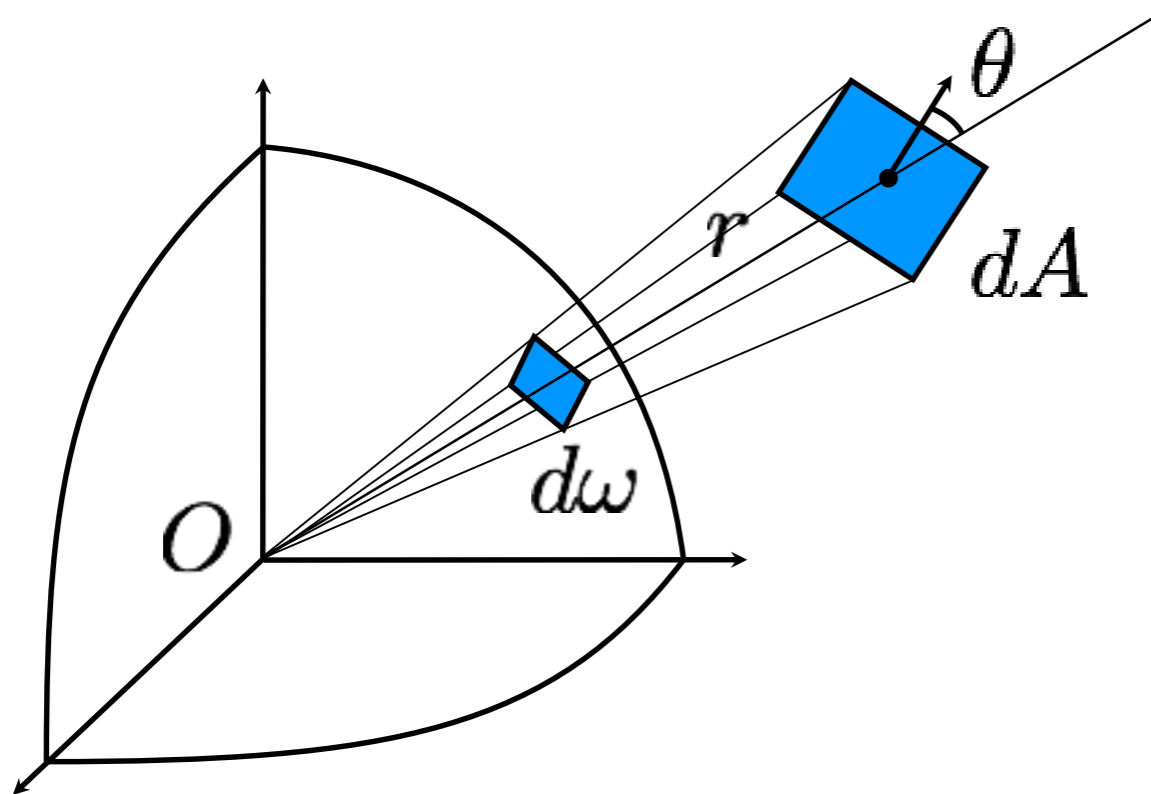

Depends on:

- orientation of patch
- distance of patch

One can show:

“surface foreshortening”

$$d\omega = \frac{dA \cos \theta}{r^2}$$

Units: steradians [sr]

# Solid angle

- To calculate solid angle subtended by a surface  $S$  relative to  $O$  you must add up (integrate) contributions from all tiny patches (nasty integral)

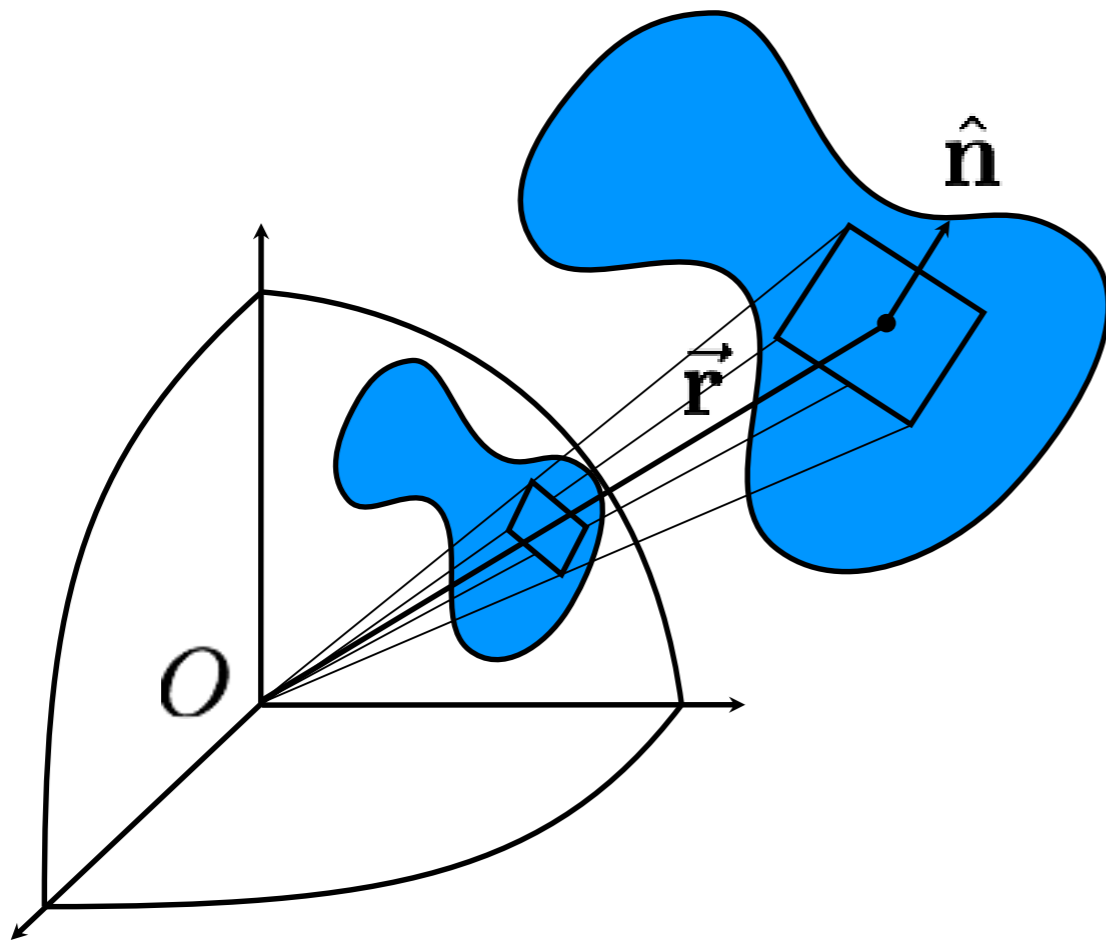

$$\Omega = \iint_S \frac{\vec{r} \cdot \hat{n} dS}{|\vec{r}|^3}$$

One can show:

“surface foreshortening”

$$d\omega = \frac{dA \cos \theta}{r^2}$$

Units: steradians [sr]

# Question

- Suppose surface  $S$  is a hemisphere centered at  $O$ . What is the solid angle it subtends?

# Question

- Suppose surface  $S$  is a hemisphere centered at  $O$ . What is the solid angle it subtends?
- Answer:  $2\pi$  (area of sphere is  $4\pi r^2$ ; area of unit sphere is  $4\pi$ ; half of that is  $2\pi$ )

# Quantifying light: flux, irradiance, and radiance

- Imagine a sensor that counts photons passing through planar patch  $X$  in directions within angular wedge  $W$
- It measures *radiant flux* [watts = joules/sec]: rate of photons hitting sensor area
- Measurement depends on sensor area  $|X|$

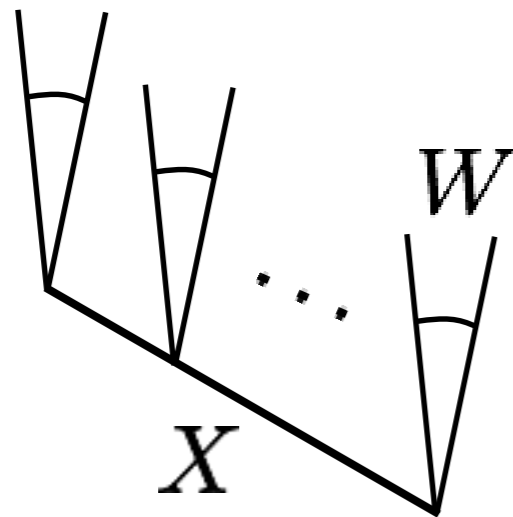

\* shown in 2D for clarity; imagine three dimensions

radiant flux  $\Phi(W, X)$



# Quantifying light: flux, irradiance, and radiance

- *Irradiance:*  
A measure of incoming light that is independent of sensor area  $|X|$
- Units: watts per square meter  $[\text{W}/\text{m}^2]$

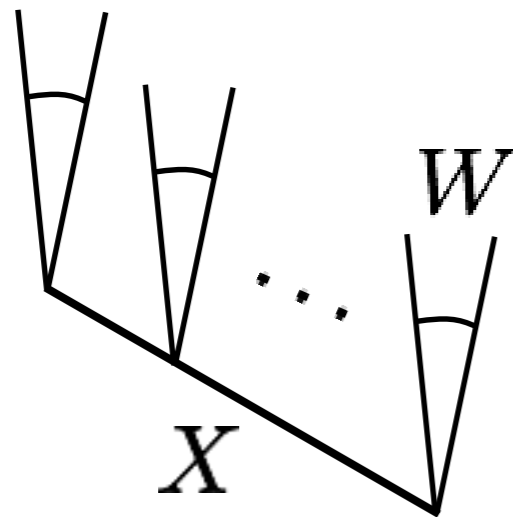

$$\frac{\Phi(W, X)}{|X|}$$

# Quantifying light: flux, irradiance, and radiance

- *Irradiance*:  
A measure of incoming light that is independent of sensor area  $|X|$
- Units: watts per square meter  $[\text{W}/\text{m}^2]$

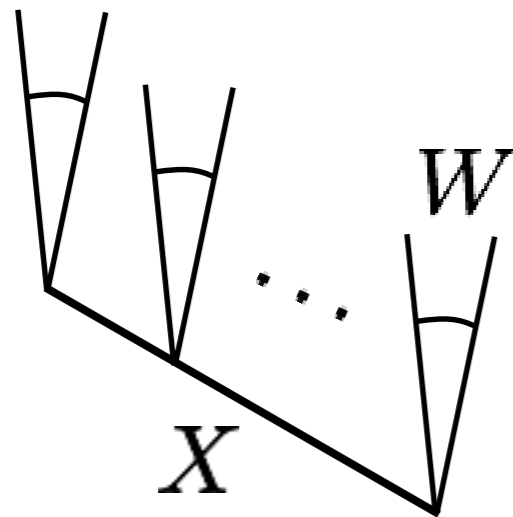

$$\lim_{X \rightarrow x}$$

$$\frac{\Phi(W, X)}{|X|}$$

# Quantifying light: flux, irradiance, and radiance

- *Irradiance*:  
A measure of incoming light that is independent of sensor area  $|X|$
- Units: watts per square meter  $[W/m^2]$
- Depends on sensor direction normal.

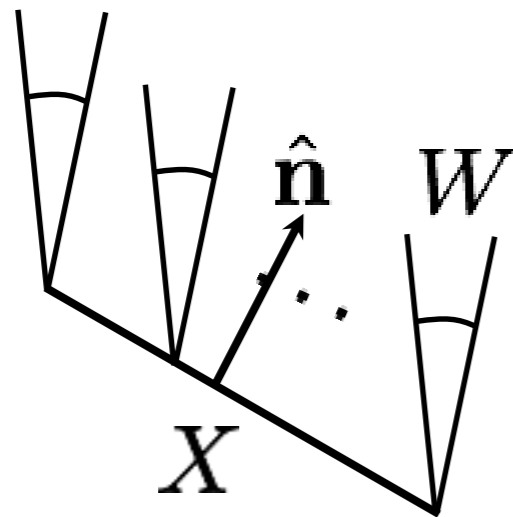

$$\frac{\Phi(W, X)}{|X|}$$

$$\lim_{X \rightarrow x}$$

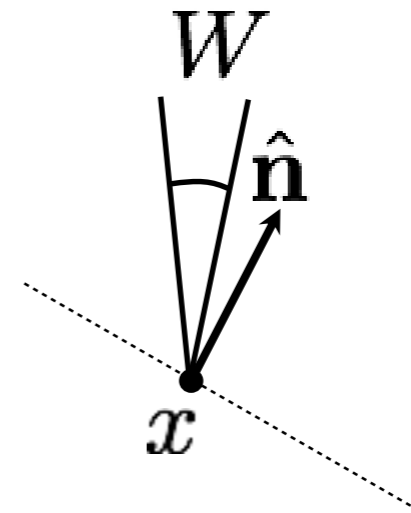

$$E_{\hat{n}}(W, x)$$

- We keep track of the normal because a planar sensor with distinct orientation would converge to a different limit
- In the literature, notations  $n$  and  $W$  are often omitted, and values are implied by context

# Quantifying light: flux, irradiance, and radiance

- *Radiance*:  
A measure of incoming light that is independent of sensor area  $|X|$ , orientation  $\hat{n}$ , and wedge size (solid angle)  $|W|$
- Units: watts per steradian per square meter  $[W/(m^2 \cdot sr)]$

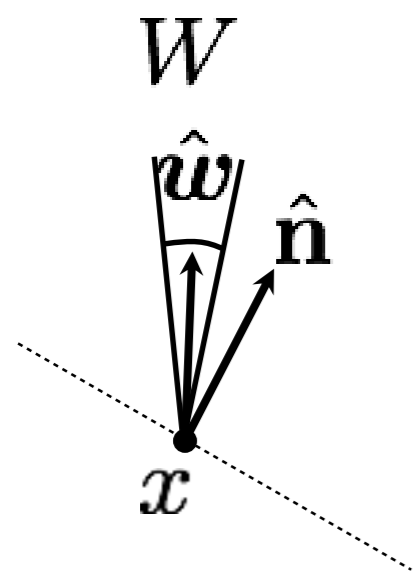

$$\frac{E_{\hat{n}}(W, x)}{|W|}$$

$$\lim_{W \rightarrow \hat{\omega}}$$

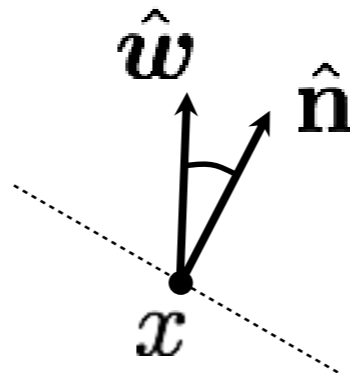

$$L_{\hat{n}}(\hat{\omega}, x)$$

- Has correct units, but still depends on sensor orientation
- To correct this, convert to measurement that would have been made if sensor was perpendicular to direction  $\omega$

# Quantifying light: flux, irradiance, and radiance

- *Radiance*:  
A measure of incoming light that is independent of sensor area  $|X|$ , orientation  $\hat{n}$ , and wedge size (solid angle)  $|W|$
- Units: watts per steradian per square meter  $[W/(m^2 \cdot sr)]$

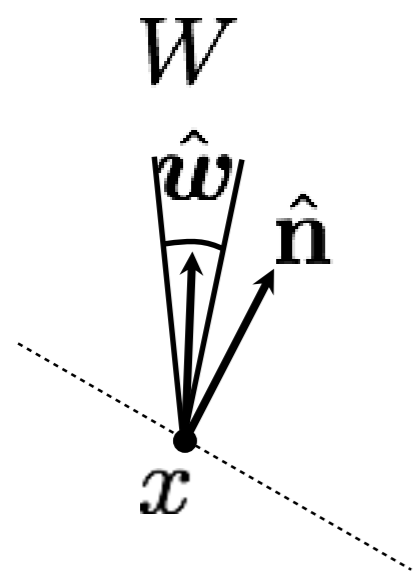

$$\frac{E_{\hat{n}}(W, x)}{|W|}$$

$\lim_{W \rightarrow \hat{\omega}}$

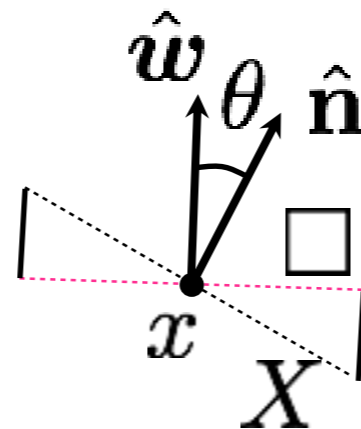

$$L_{\hat{n}}(\hat{\omega}, x)$$

$$\cos \theta = \frac{\square/2}{|X|/2}$$

$$\rightarrow \square = |X| \cos \theta$$

“foreshortened area”

- Has correct units, but still depends on sensor orientation
- To correct this, convert to measurement that would have been made if sensor was perpendicular to direction  $\omega$

# Quantifying light: flux, irradiance, and radiance

- *Radiance*:  
A measure of incoming light that is independent of sensor area  $|X|$ , orientation  $\hat{n}$ , and wedge size (solid angle)  $|W|$
- Units: watts per steradian per square meter  $[W/(m^2 \cdot sr)]$

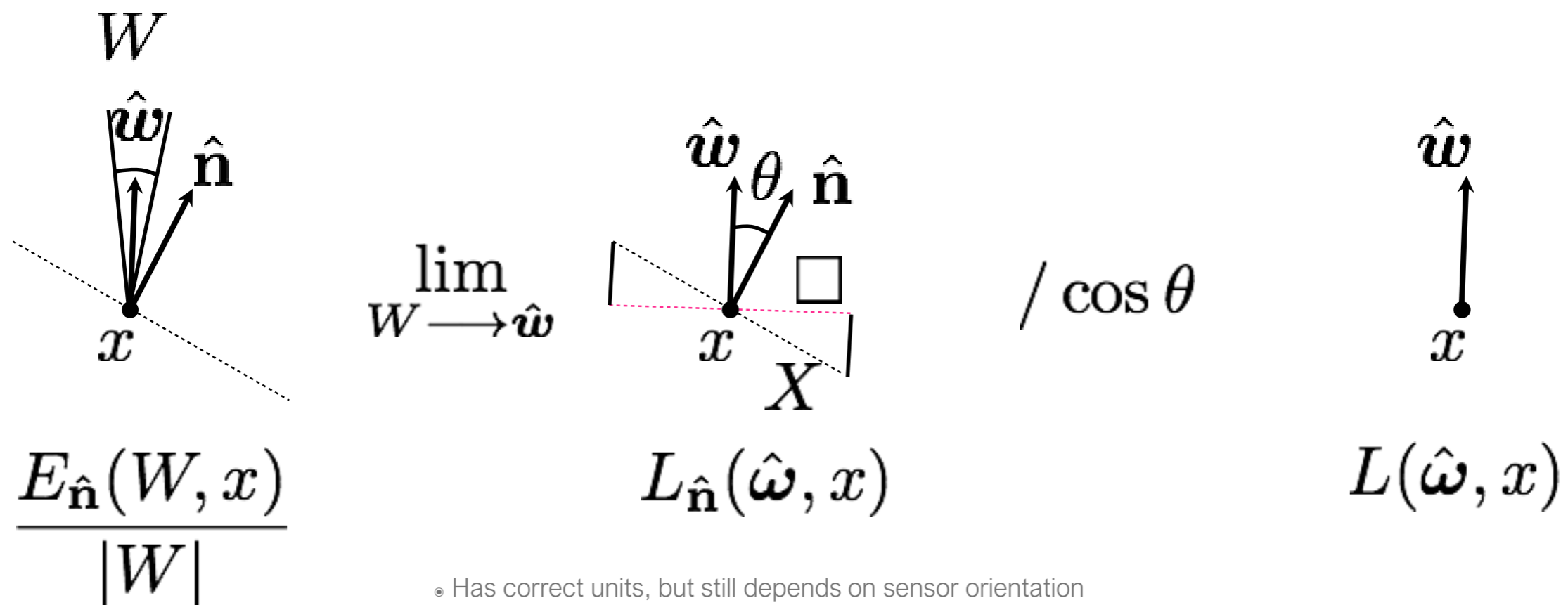

- Has correct units, but still depends on sensor orientation
- To correct this, convert to measurement that would have been made if sensor was perpendicular to direction  $\omega$

# Quantifying light: flux, irradiance, and radiance

- *Radiance*:

A measure of incoming light that is independent of sensor area  $|X|$ , orientation  $\hat{n}$ , and wedge size (solid angle)  $|W|$

- Units: watts per steradian per square meter  $[W/(m^2 \cdot sr)]$

^  
"foreshortened in the direction of travel"

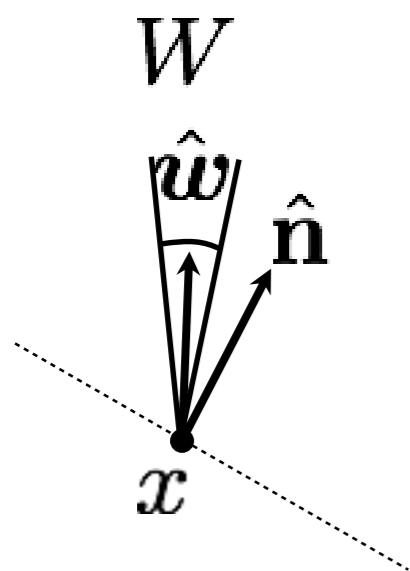

$$\frac{E_{\hat{n}}(W, x)}{|W|}$$

$$\lim_{W \rightarrow \hat{\omega}} W$$

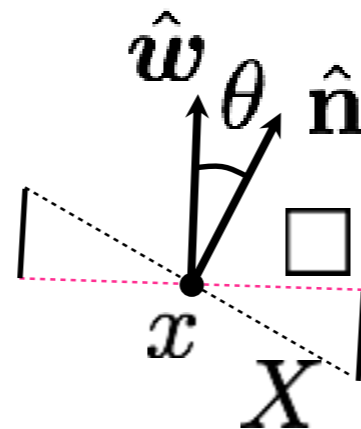

$$L_{\hat{n}}(\hat{\omega}, x)$$

$$/ \cos \theta$$



$$L(\hat{\omega}, x)$$

- Has correct units, but still depends on sensor orientation
- To correct this, convert to measurement that would have been made if sensor was perpendicular to direction  $\omega$

# Quantifying light: flux, irradiance, and radiance

- Attractive properties of radiance:
  - Allows computing the radiant flux measured by *any* finite sensor

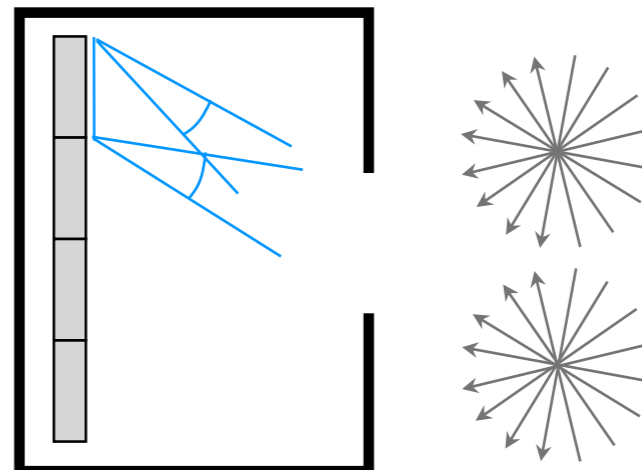



# Quantifying light: flux, irradiance, and radiance

- Attractive properties of radiance:
  - Allows computing the radiant flux measured by *any* finite sensor

$$\Phi(W, X) = \int_X \int_W L(\hat{\omega}, x) \cos \theta d\omega dA$$

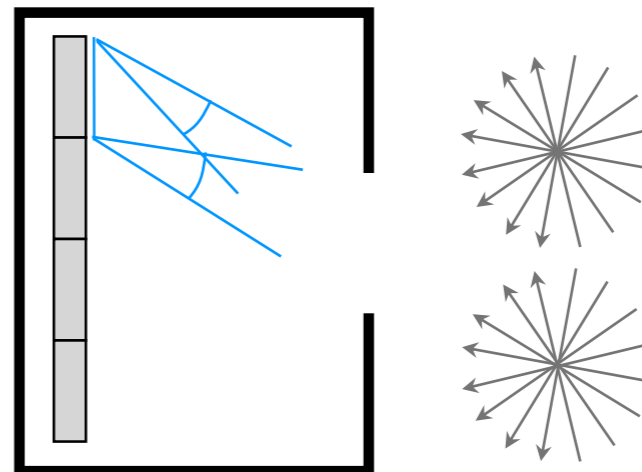

# Quantifying light: flux, irradiance, and radiance

- Attractive properties of radiance:
  - Allows computing the radiant flux measured by *any* finite sensor

$$\Phi(W, X) = \int_X \int_W L(\hat{\omega}, x) \cos \theta d\omega dA$$

- Constant along a ray in free space

$$L(\hat{\omega}, x) = L(\hat{\omega}, x + \hat{\omega})$$

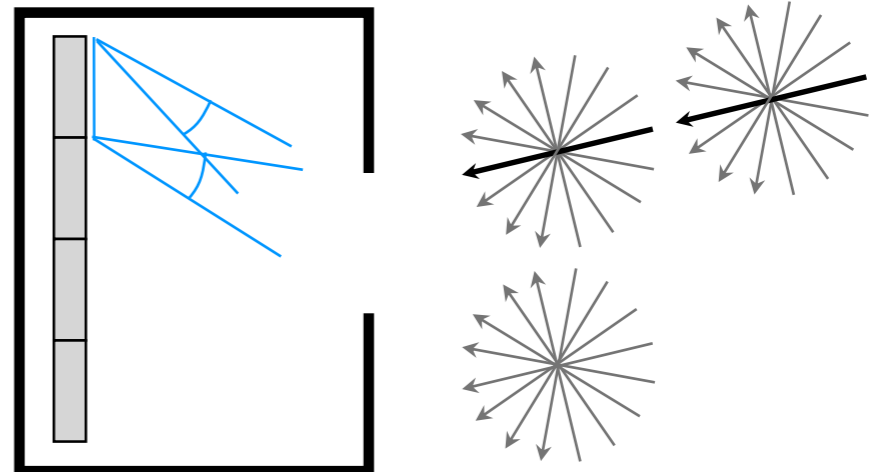

# Quantifying light: flux, irradiance, and radiance

- Attractive properties of radiance:

- Allows computing the radiant flux measured by *any* finite sensor

$$\Phi(W, X) = \int_X \int_W L(\hat{\omega}, x) \cos \theta d\omega dA$$

- Constant along a ray in free space

$$L(\hat{\omega}, x) = L(\hat{\omega}, x + \hat{\omega})$$

- A camera measures radiance (after a one-time radiometric calibration).  
So RAW pixel values are proportional to radiance.
  - “Processed” images (like PNG and JPEG) are not linear radiance measurements!!

# Question

- Most light sources, like a heated metal sheet, follow Lambert's Law

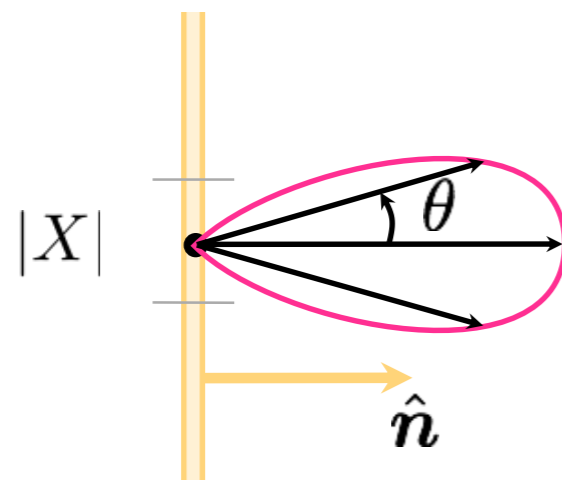

$$J(\hat{\omega}) = J_o \langle \hat{\omega}, \hat{n} \rangle = J_o \cos \theta$$

↑  
radiant intensity [W/sr]

“Lambertian  
area source”

- What is the radiance  $L(\hat{\omega}, \mathbf{x})$  of an infinitesimal patch [W/sr·m<sup>2</sup>]?

# Question

- Most light sources, like a heated metal sheet, follow Lambert's Law

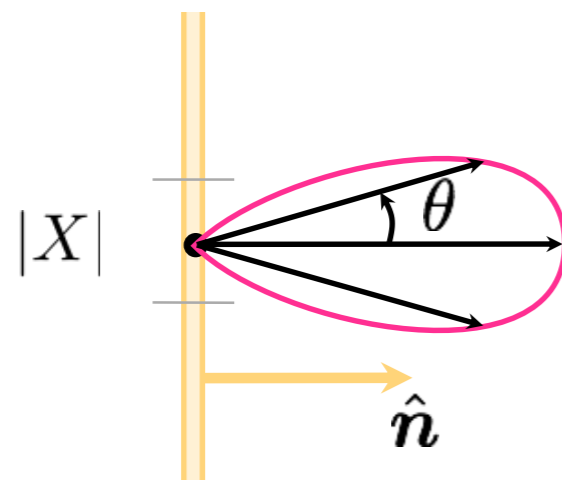

$$J(\hat{\omega}) = J_o \langle \hat{\omega}, \hat{n} \rangle = J_o \cos \theta$$

↑  
radiant intensity [W/sr]

“Lambertian  
area source”

- What is the radiance  $L(\hat{\omega}, \mathbf{x})$  of an infinitesimal patch [W/sr · m<sup>2</sup>]?

Answer:  $L(\hat{\omega}, \mathbf{x}) = J_o/|X|$  (independent of direction)

# Question

- Most light sources, like a heated metal sheet, follow Lambert's Law

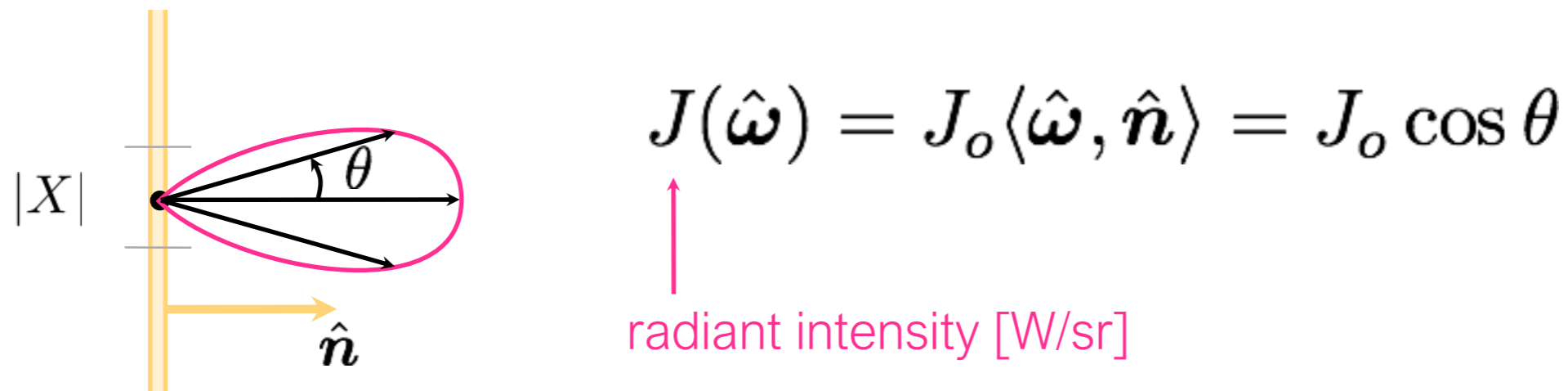

“Lambertian  
area source”

- What is the radiance  $L(\hat{\omega}, \mathbf{x})$  of an infinitesimal patch [W/sr · m<sup>2</sup>]?

Answer:  $L(\hat{\omega}, \mathbf{x}) = J_o/|X|$  (independent of direction)

“Looks equally bright when viewed from any direction”

# Appearance

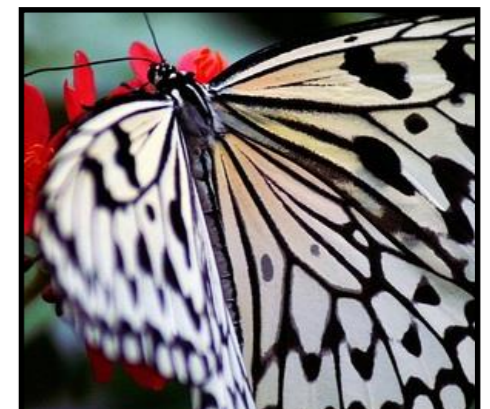

# “Physics-based” computer vision (a.k.a “inverse optics”)

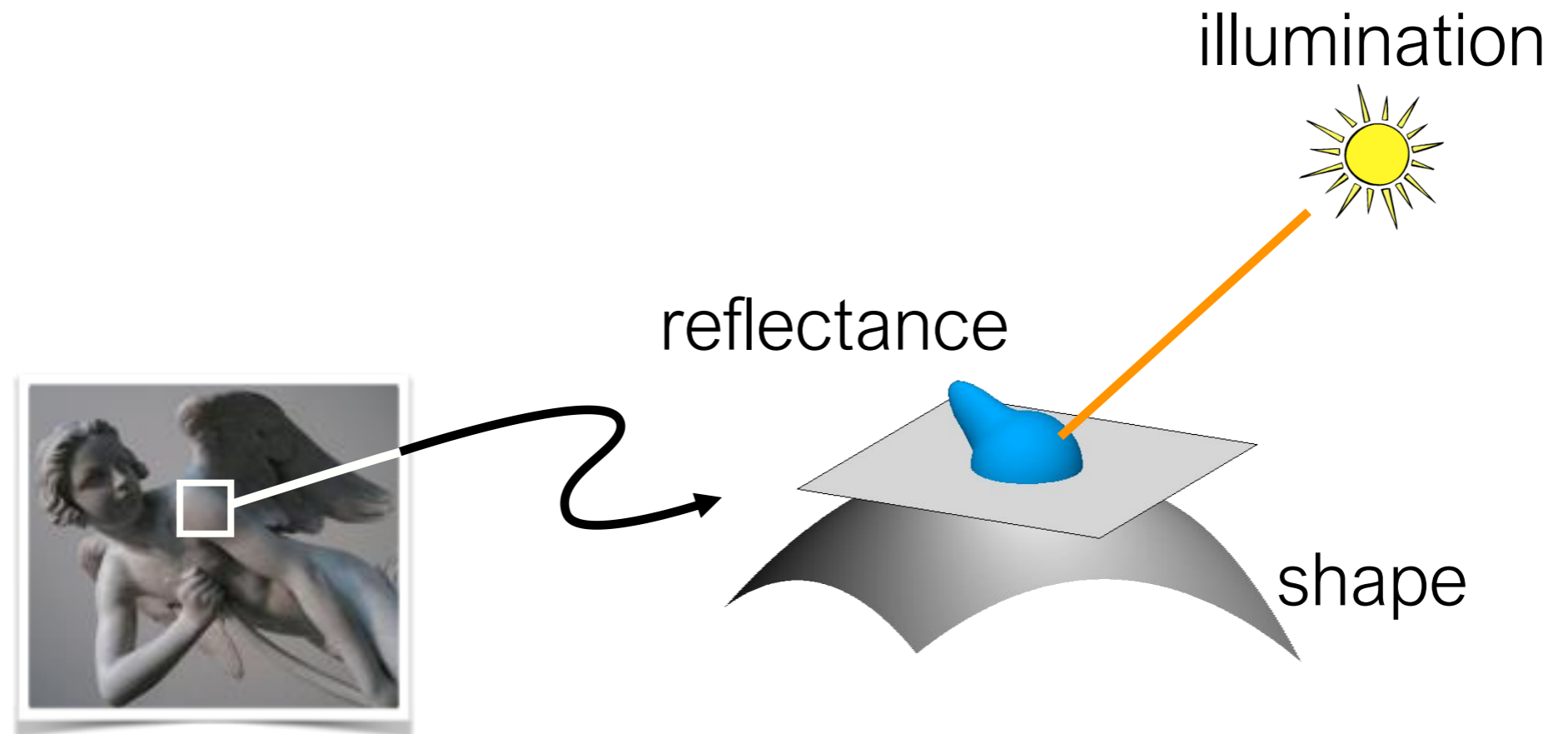

**I**  $\longrightarrow$  shape, illumination, reflectance



# Reflectance and BRDF

# Reflectance

- Ratio of outgoing energy to incoming energy at a single point
- Want to define a ratio such that it:
  - converges as we use smaller and smaller incoming and outgoing wedges
  - does not depend on the size of the wedges (i.e. is intrinsic to the material)

# Reflectance

- Ratio of outgoing energy to incoming energy at a single point
- Want to define a ratio such that it:
  - converges as we use smaller and smaller incoming and outgoing wedges
  - does not depend on the size of the wedges (i.e. is intrinsic to the material)

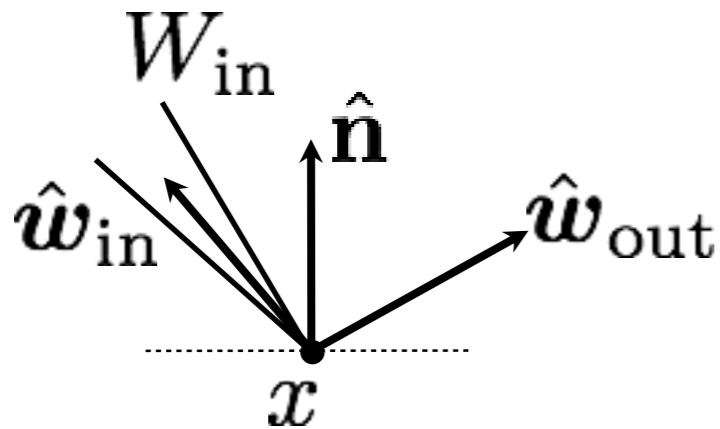

$$\lim_{W_{\text{in}} \rightarrow \hat{\omega}_{\text{in}}} f_{x, \hat{\mathbf{n}}}(\hat{\omega}_{\text{in}}, \hat{\omega}_{\text{out}})$$

$$f_{x, \hat{\mathbf{n}}}(W_{\text{in}}, \hat{\omega}_{\text{out}}) = \frac{L^{\text{out}}(x, \hat{\omega}_{\text{out}})}{E_{\hat{\mathbf{n}}}^{\text{in}}(W_{\text{in}}, x)}$$

- Notations  $x$  and  $n$  often implied by context and omitted; directions  $\omega$  are expressed in local coordinate system defined by normal  $n$  (and some chosen tangent vector)
- Units:  $\text{sr}^{-1}$
- Called Bidirectional Reflectance Distribution Function (BRDF)

# BRDF: Bidirectional Reflectance Distribution Function

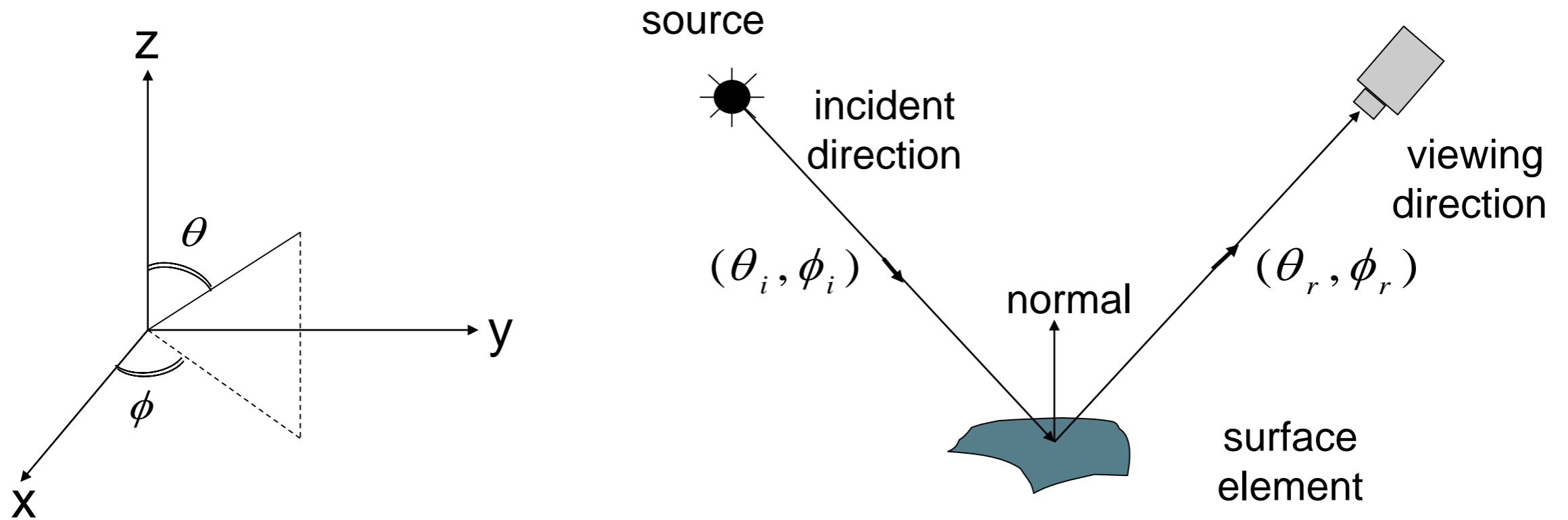

$E^{surface}(\theta_i, \phi_i)$  Irradiance at Surface in direction  $(\theta_i, \phi_i)$

$L^{surface}(\theta_r, \phi_r)$  Radiance of Surface in direction  $(\theta_r, \phi_r)$

$$\text{BRDF} : f(\theta_i, \phi_i; \theta_r, \phi_r) = \frac{L^{surface}(\theta_r, \phi_r)}{E^{surface}(\theta_i, \phi_i)}$$

# Reflectance: BRDF

- Units:  $\text{sr}^{-1}$
- Real-valued function defined on the double-hemisphere
- Has many useful properties

# Important Properties of BRDFs

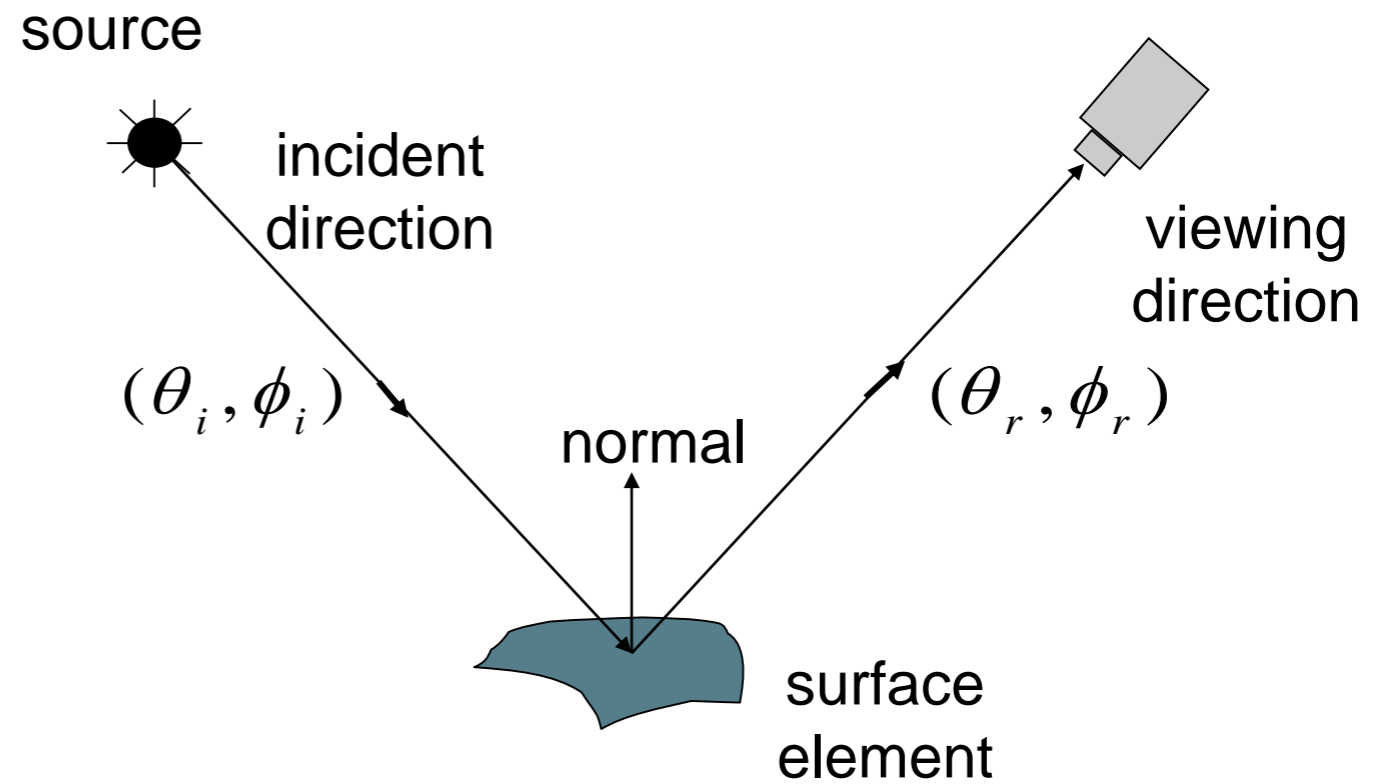
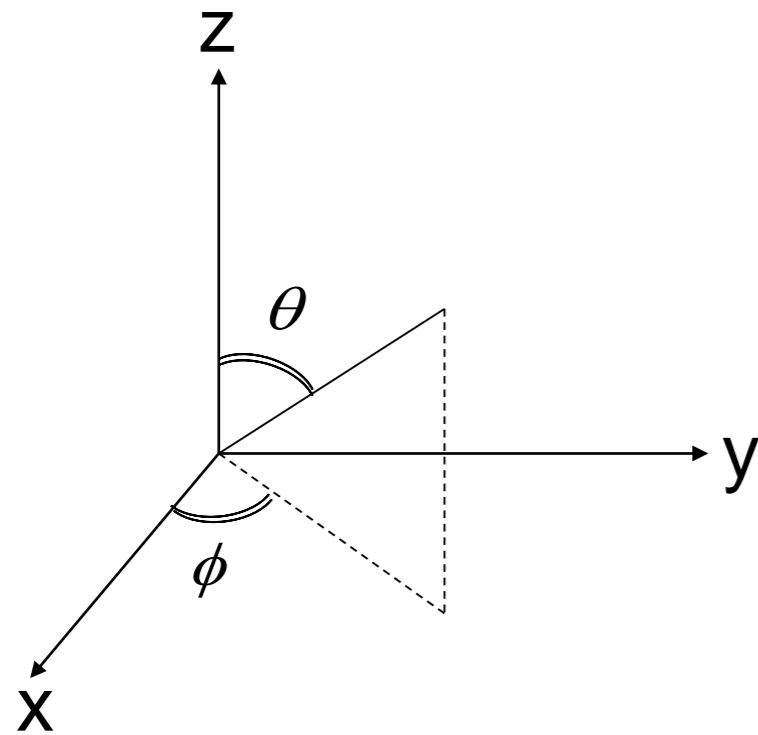

- Conservation of Energy:

$$\forall \hat{\omega}_{\text{in}}, \int_{\Omega_{\text{out}}} f(\hat{\omega}_{\text{in}}, \hat{\omega}_{\text{out}}) \cos \theta_{\text{out}} d\hat{\omega}_{\text{out}} \leq 1$$

Why smaller than or equal?

Property: “Helmholtz reciprocity”

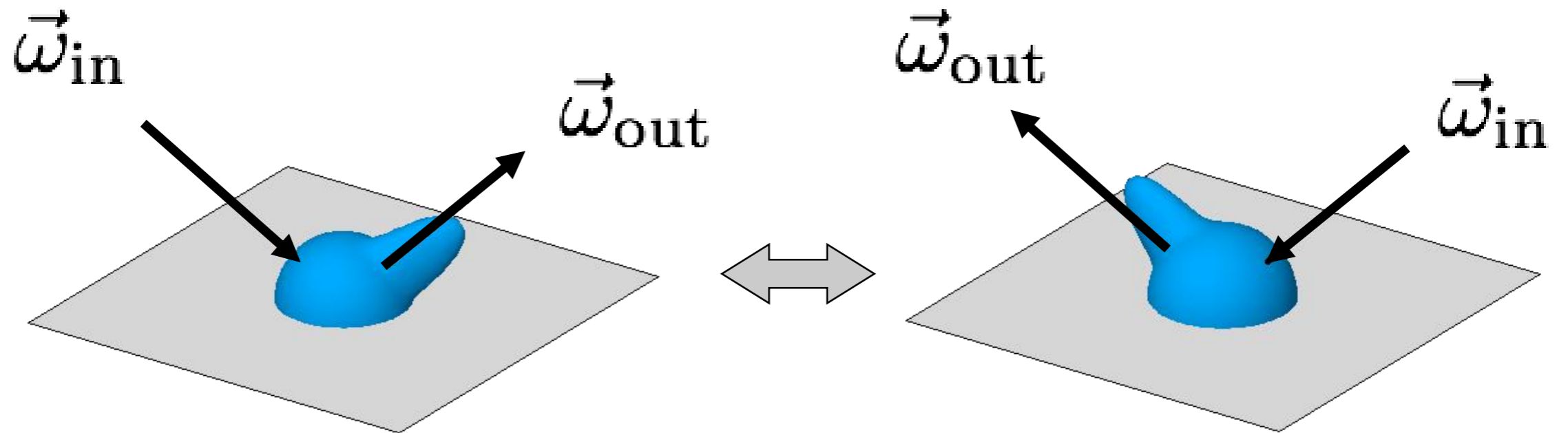

- **Helmholtz Reciprocity:** (follows from 2<sup>nd</sup> Law of Thermodynamics)  
BRDF does not change when source and viewing directions are swapped.

$$f_r(\vec{\omega}_{\text{in}}, \vec{\omega}_{\text{out}}) = f_r(\vec{\omega}_{\text{out}}, \vec{\omega}_{\text{in}})$$

# Common assumption: Isotropy

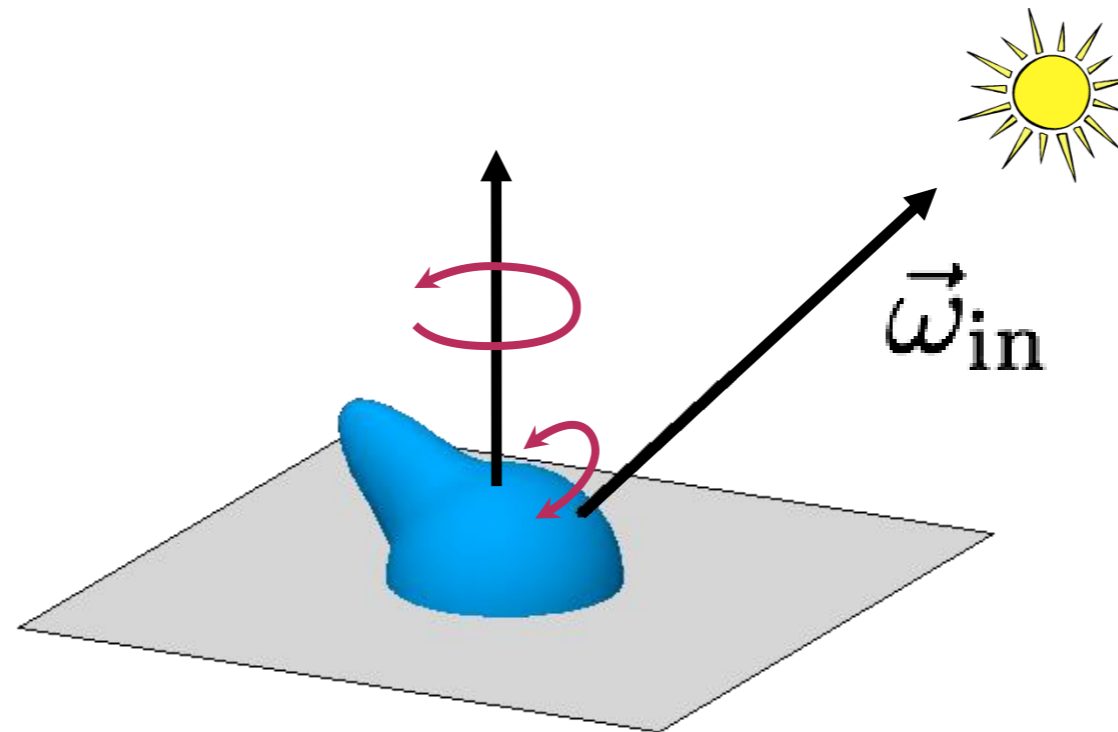
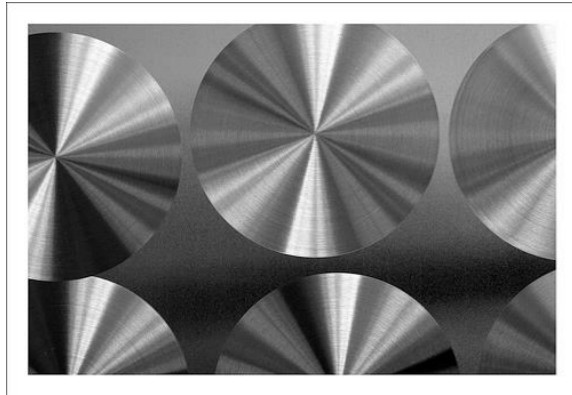

BRDF does not change when surface is rotated about the normal.

$$f_r(\vec{\omega}_{in}, \cdot)$$

4D  $\rightarrow$  3D

$$f_r(\vec{\omega}_{in}, \vec{\omega}_{out})$$

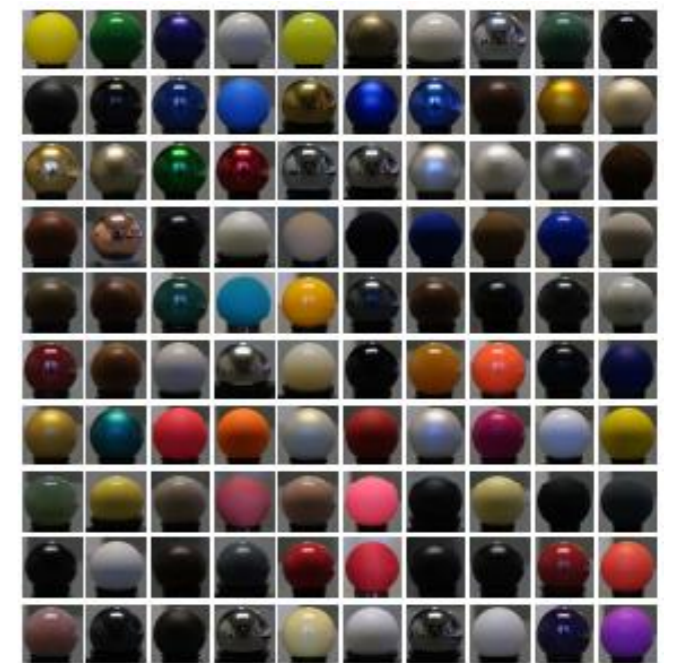

[Matusik et al., 2003]

Bi-directional Reflectance Distribution Function (BRDF)

Can be written as a function of 3 variables :  $f(\theta_i, \theta_r, \phi_i - \phi_r)$



# Reflectance: BRDF

- Units:  $\text{sr}^{-1}$
- Real-valued function defined on the double-hemisphere
- Has many useful properties
- Allows computing output radiance (and thus pixel value) for *any* configuration of lights and viewpoint

$$L^{\text{out}}(\hat{\omega}) = \int_{\Omega_{\text{in}}} f(\hat{\omega}_{\text{in}}, \hat{\omega}_{\text{out}}) L^{\text{in}}(\hat{\omega}_{\text{in}}) \cos \theta_{\text{in}} d\hat{\omega}_{\text{in}}$$

reflectance equation

Why is there a cosine in the reflectance equation?

# Derivation of the Reflectance Equation

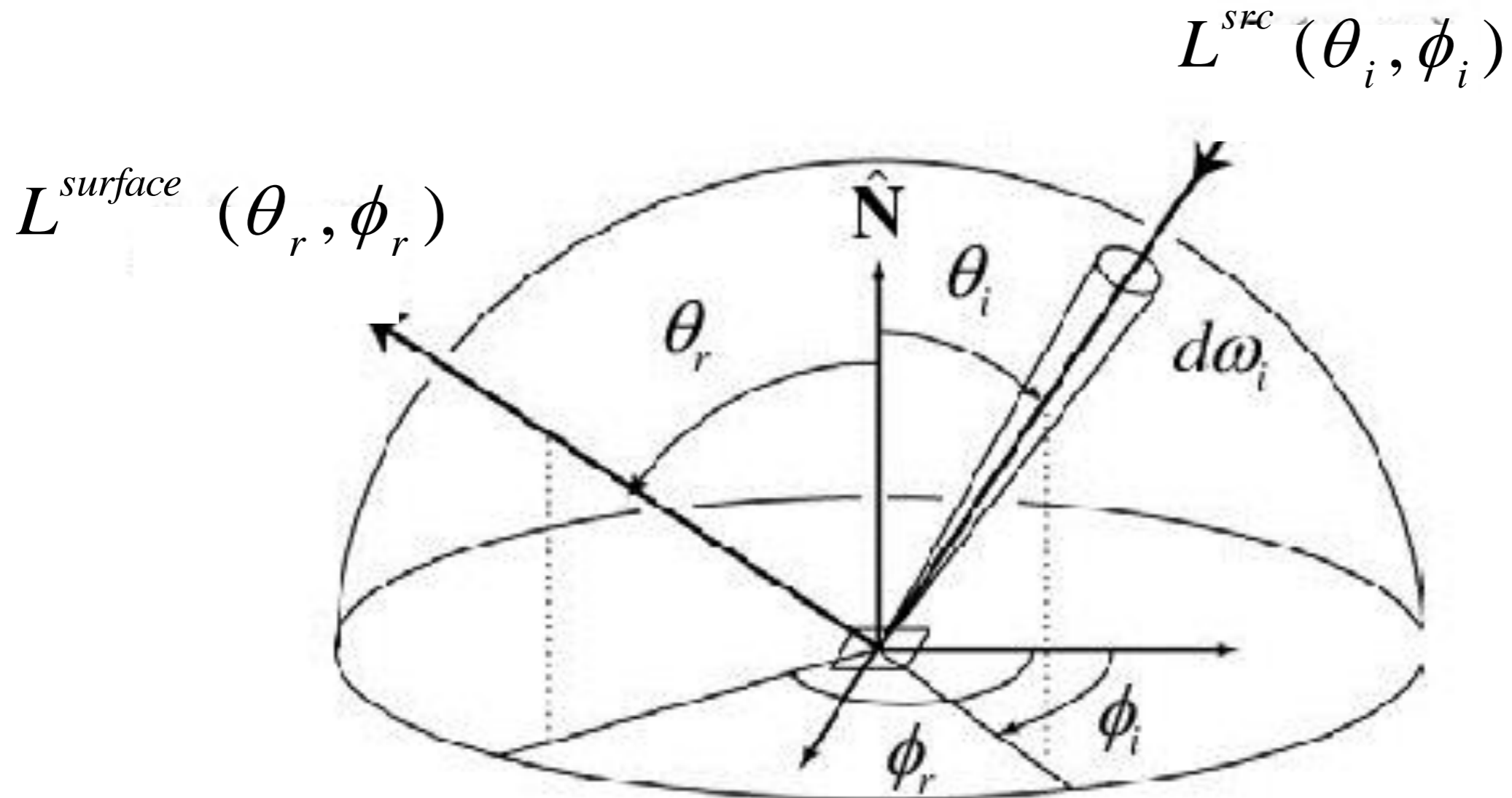

From the definition of BRDF:

$$L^{surface}(\theta_r, \phi_r) = E^{surface}(\theta_i, \phi_i) f(\theta_i, \phi_i; \theta_r, \phi_r)$$

# Derivation of the Scene Radiance Equation

From the definition of BRDF:

$$L^{surface}(\theta_r, \phi_r) = \frac{E^{surface}(\theta_i, \phi_i) f(\theta_i, \phi_i; \theta_r, \phi_r)}{}$$

Write Surface Irradiance in terms of Source Radiance:

$$L^{surface}(\theta_r, \phi_r) = \frac{L^{src}(\theta_i, \phi_i) f(\theta_i, \phi_i; \theta_r, \phi_r) \cos \theta_i d\omega_i}{}$$

Integrate over entire hemisphere of possible source directions:

$$L^{surface}(\theta_r, \phi_r) = \int_{2\pi} L^{src}(\theta_i, \phi_i) f(\theta_i, \phi_i; \theta_r, \phi_r) \cos \theta_i \underline{d\omega_i}$$

Convert from solid angle to theta-phi representation:

$$L^{surface}(\theta_r, \phi_r) = \int_{-\pi}^{\pi} \int_0^{\pi/2} L^{src}(\theta_i, \phi_i) f(\theta_i, \phi_i; \theta_r, \phi_r) \cos \theta_i \underline{\sin \theta_i d\theta_i d\phi_i}$$

# Differential Solid Angles

---

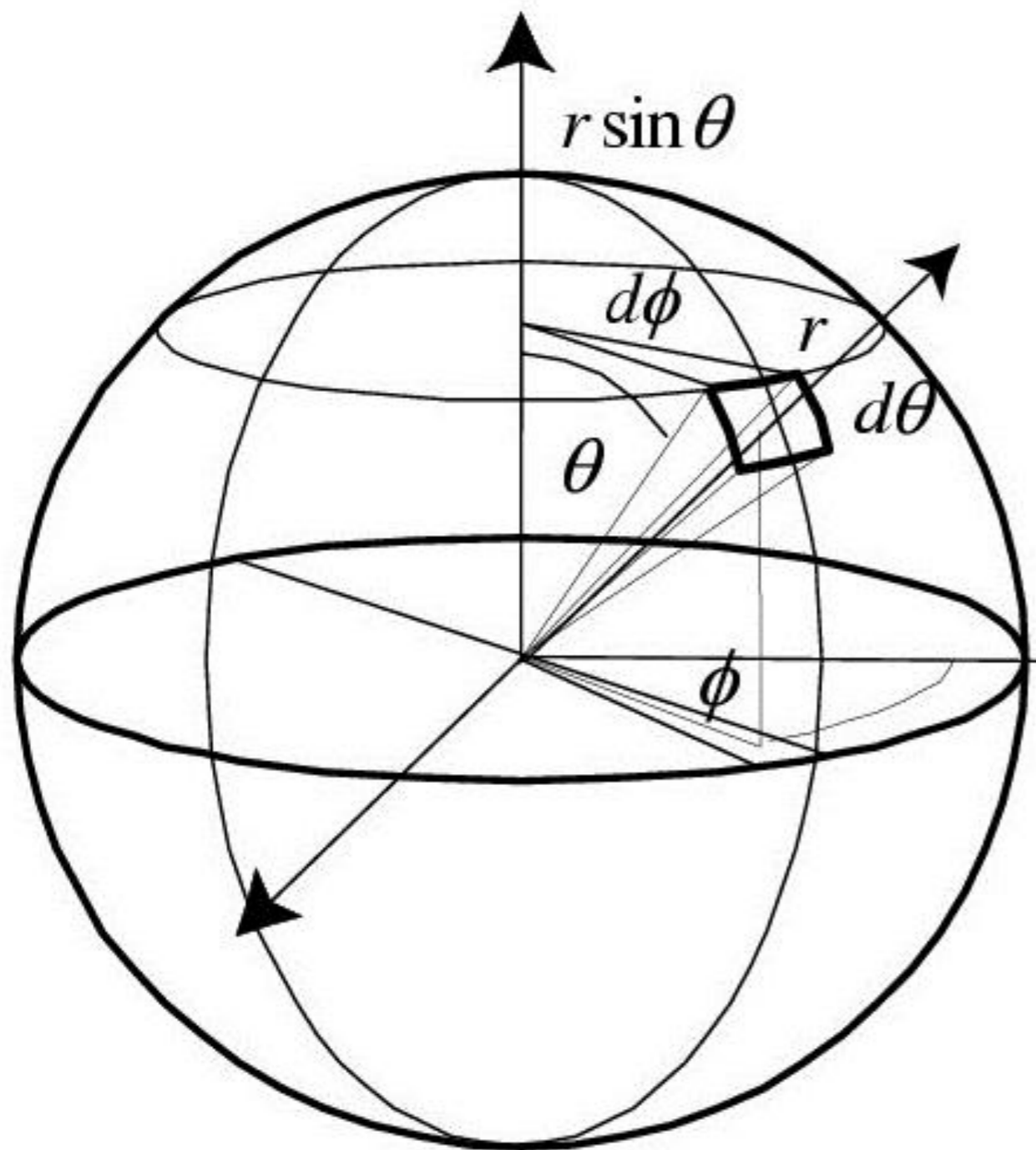

$$\begin{aligned}dA &= (r d\theta)(r \sin \theta d\phi) \\ &= r^2 \sin \theta d\theta d\phi\end{aligned}$$

$$d\omega = \frac{dA}{r^2} = \sin \theta d\theta d\phi$$

$$S = \int_0^{\pi} \int_0^{2\pi} \sin \theta d\theta d\phi = 4\pi$$

# BRDF

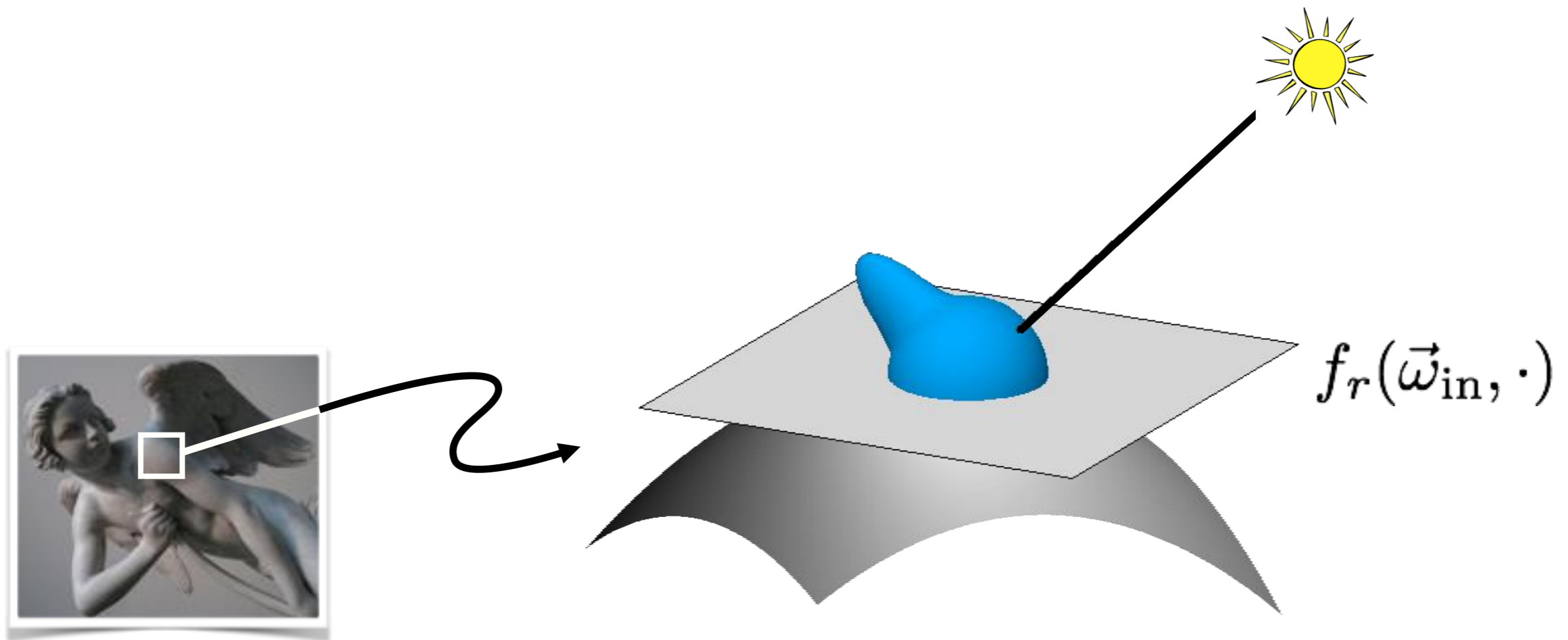

$$f_r(\vec{\omega}_{in}, \vec{\omega}_{out})$$

Bi-directional Reflectance Distribution Function (BRDF)

# BRDF

Lambertian (diffuse) BRDF: energy equally distributed in all directions

What does the BRDF equal in this case?

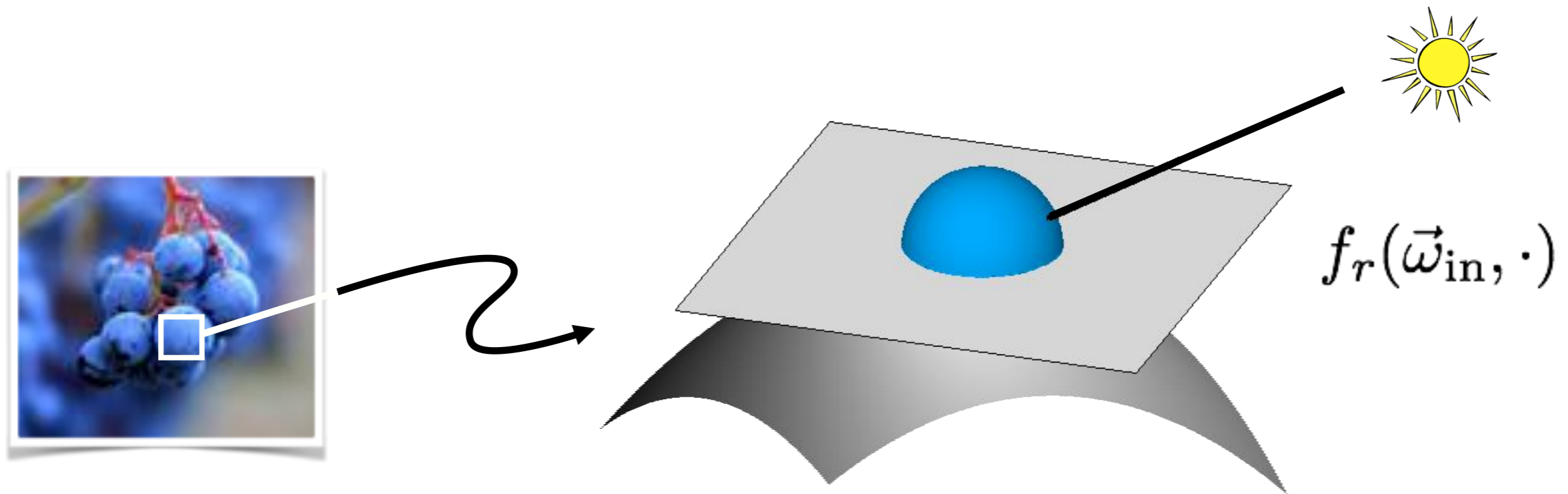

$$f_r(\vec{\omega}_{in}, \vec{\omega}_{out})$$

Bi-directional Reflectance Distribution Function (BRDF)

# Diffuse Reflection and Lambertian BRDF

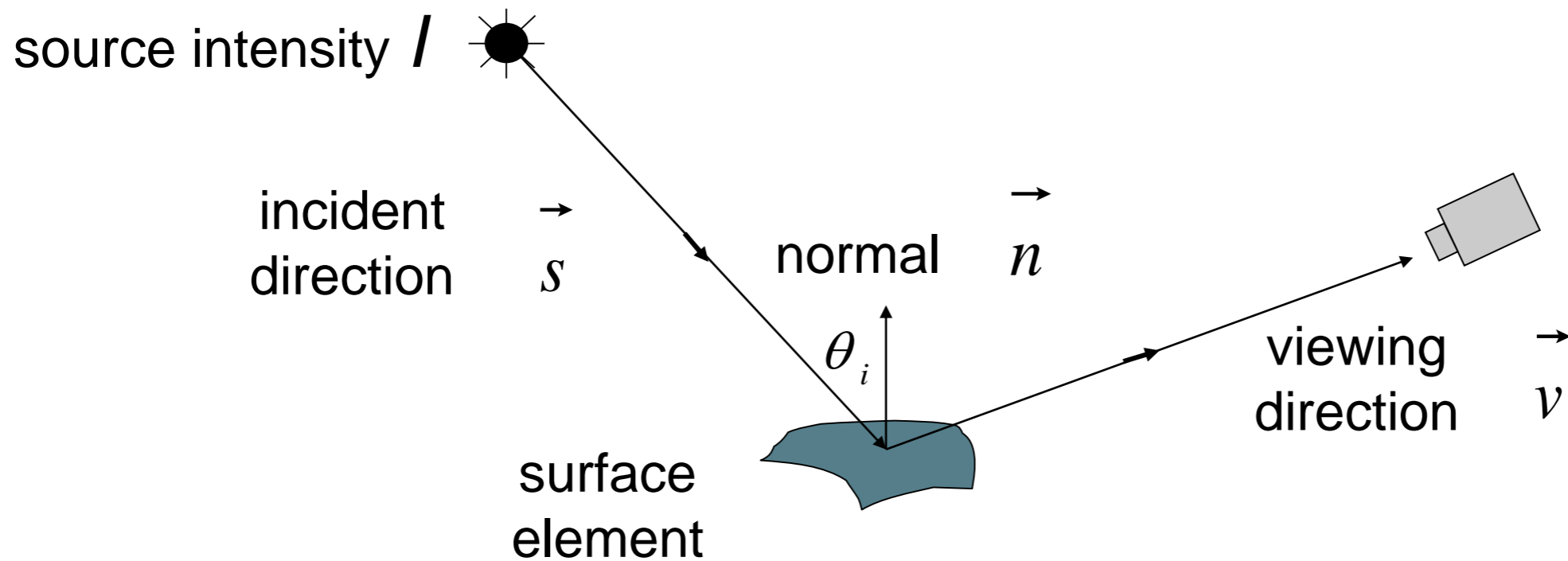

- Surface appears equally bright from ALL directions! (independent of  $\vec{v}$ )
- Lambertian BRDF is simply a constant :  $f(\theta_i, \phi_i; \theta_r, \phi_r) = \frac{\rho_d}{\pi}$  ↗ albedo
- Most commonly used BRDF in Vision and Graphics!

# BRDF

Specular BRDF: all energy concentrated in mirror direction

What does the BRDF equal in this case?

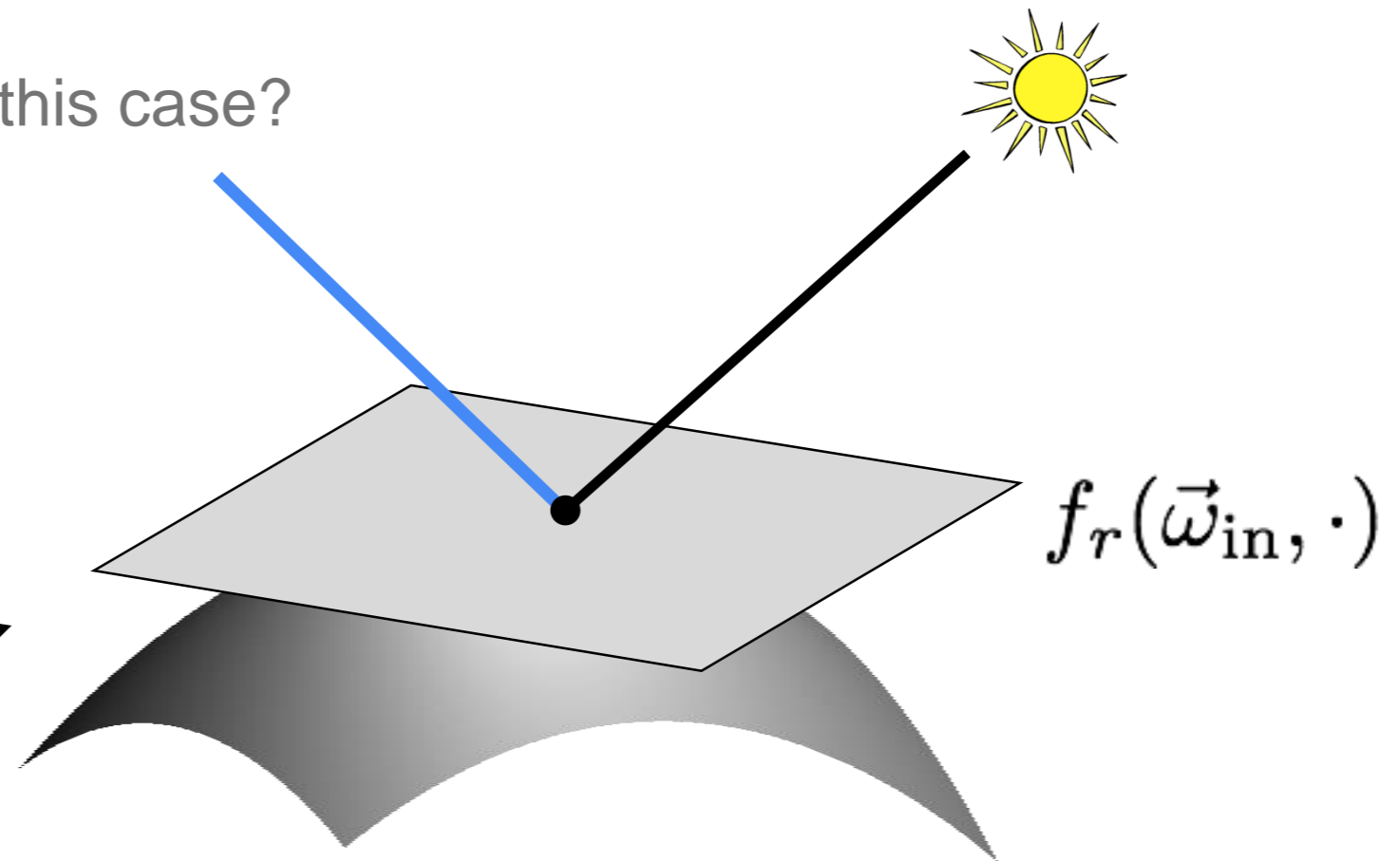

$$f_r(\vec{\omega}_{in}, \vec{\omega}_{out})$$

Bi-directional Reflectance Distribution Function (BRDF)



# Specular Reflection and Mirror BRDF

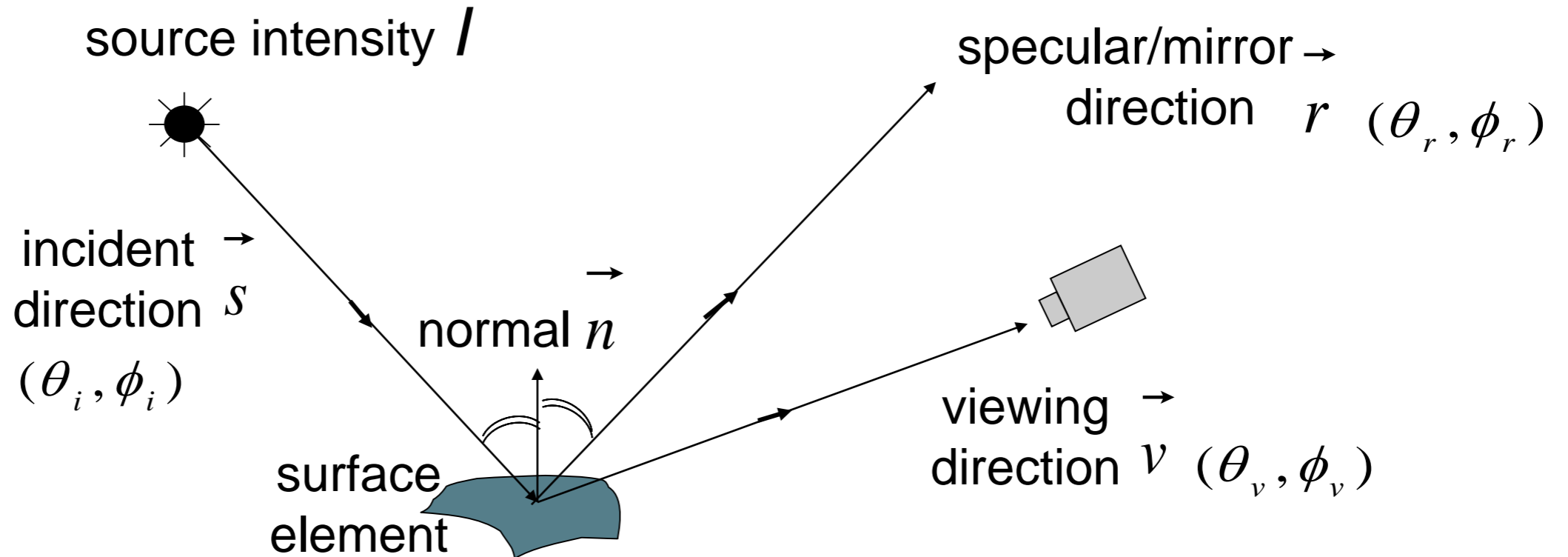

- Valid for very smooth surfaces.
- All incident light energy reflected in a SINGLE direction (only when  $\vec{v} = \vec{r}$ ).
- Mirror BRDF is simply a double-delta function :

$$f(\theta_i, \phi_i; \theta_v, \phi_v) = \rho_s \delta(\theta_i - \theta_v) \delta(\phi_i + \pi - \phi_v)$$

specular albedo

# Example Surfaces

Body Reflection:

Diffuse Reflection  
Matte Appearance  
Non-Homogeneous Medium  
Clay, paper, etc



Surface Reflection:

Specular Reflection  
Glossy Appearance  
Highlights  
Dominant for Metals



Many materials exhibit  
both Reflections:



# BRDF

Glossy BRDF: more energy concentrated in mirror direction than elsewhere

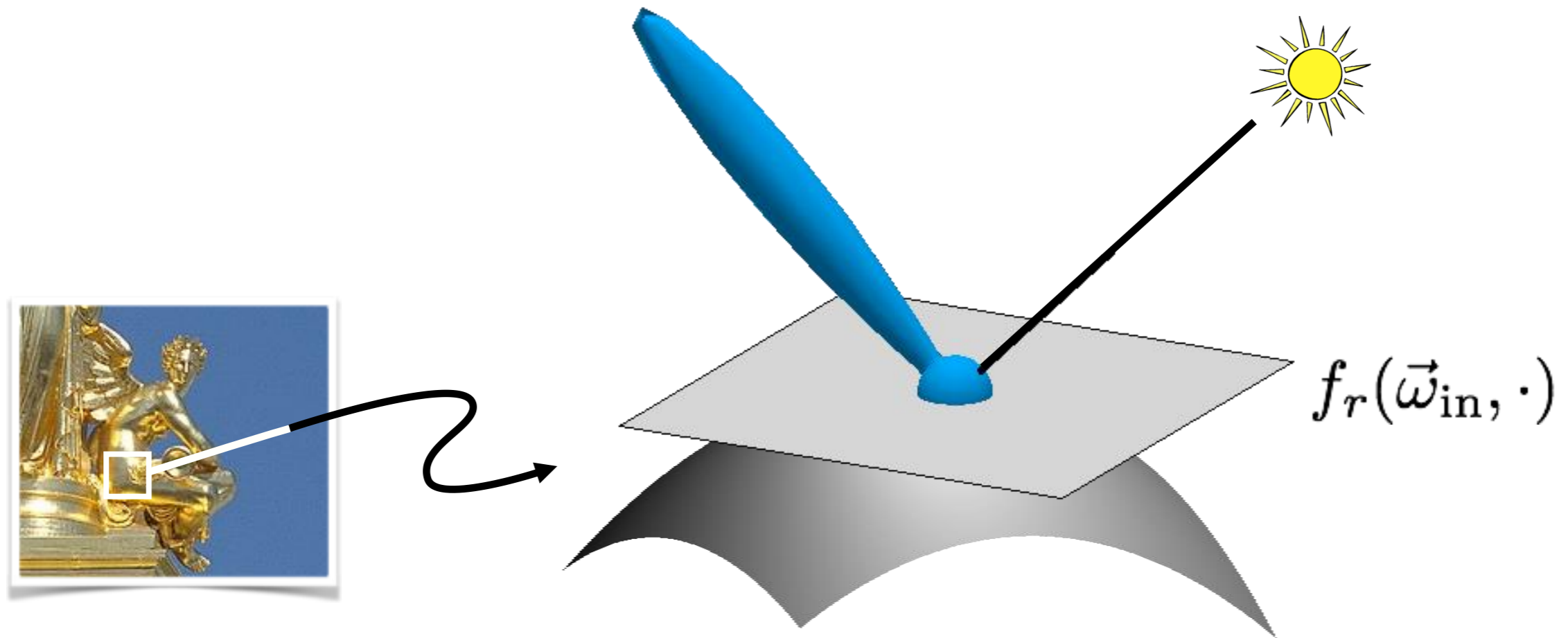

$$f_r(\vec{\omega}_{in}, \vec{\omega}_{out})$$

Bi-directional Reflectance Distribution Function (BRDF)

# Trick for dielectrics (non-metals)

- BRDF is a sum of a Lambertian diffuse component and non-Lambertian specular components
- The two components differ in terms of color and polarization, and under certain conditions, this can be exploited to separate them.

$$f(\vec{\omega}_i, \vec{\omega}_o) = f_d + f_s(\vec{\omega}_i, \vec{\omega}_o)$$

# Trick for dielectrics (non-metals)

- BRDF is a sum of a Lambertian diffuse component and non-Lambertian specular components
- The two components differ in terms of color and polarization, and under certain conditions, this can be exploited to separate them.

$$f(\vec{\omega}_i, \vec{\omega}_o) = f_d + f_s(\vec{\omega}_i, \vec{\omega}_o)$$

Often called the *dichromatic BRDF*:

- Diffuse term varies with wavelength, constant with polarization
- Specular term constant with wavelength, varies with polarization

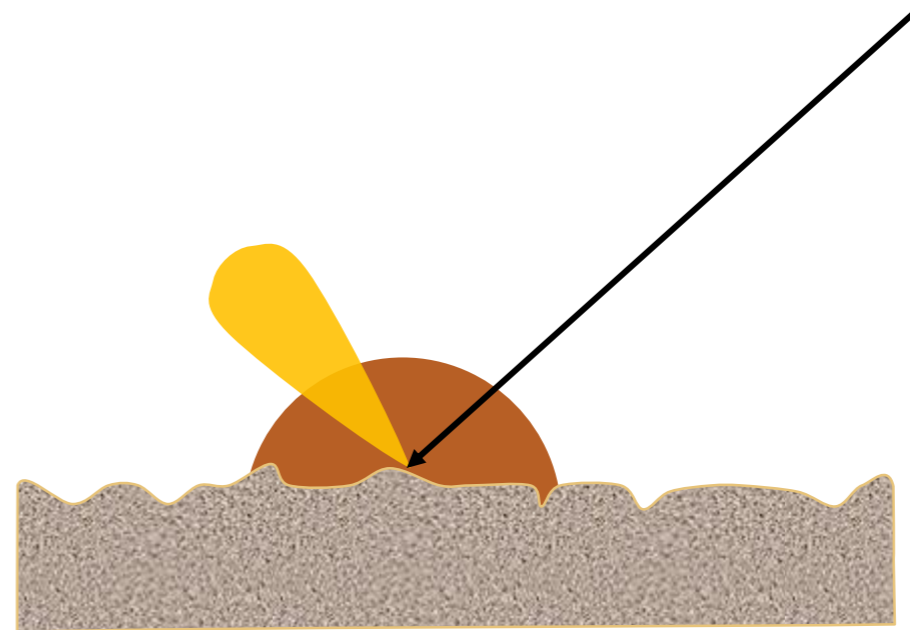

# Trick for dielectrics (non-metals)

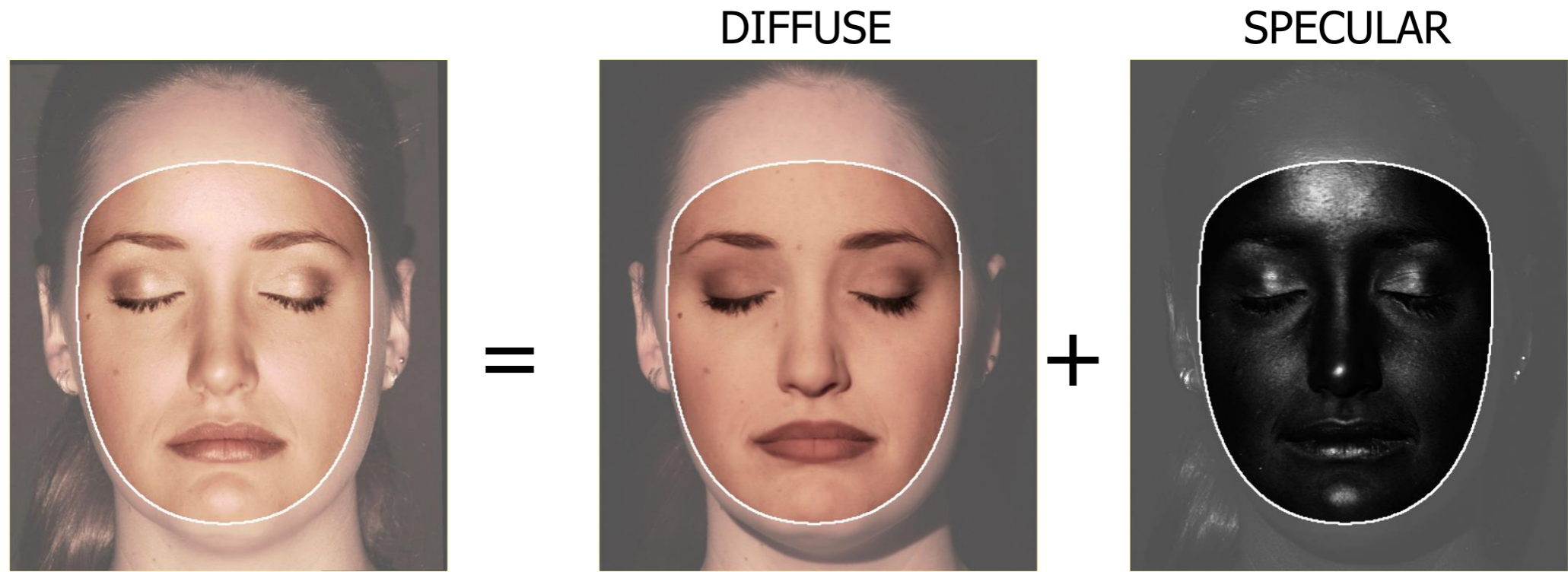

- In this example, the two components were separated using linear polarizing filters on the camera and light source.

# Trick for dielectrics (non-metals)

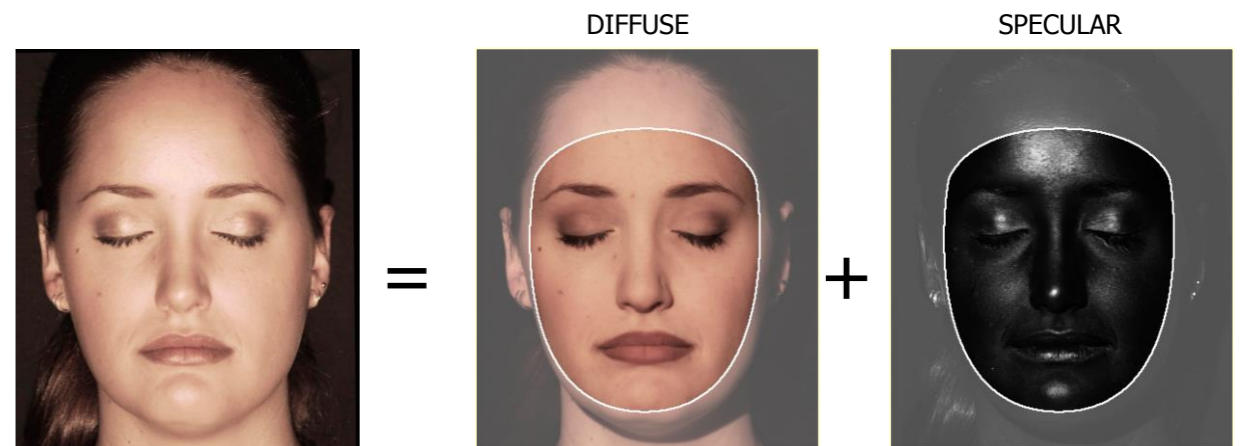
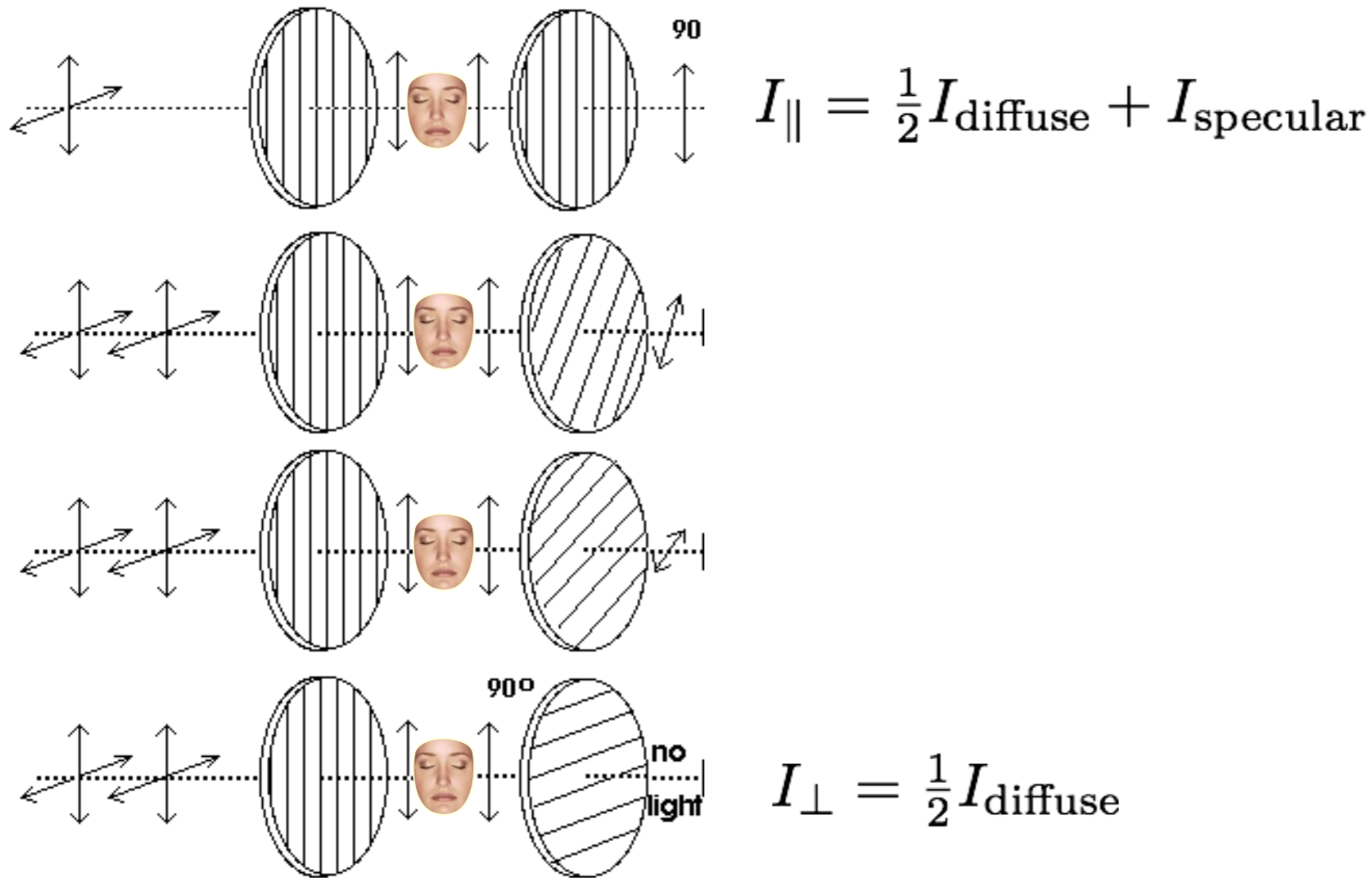

# Tabulated 4D BRDFs (hard to measure)

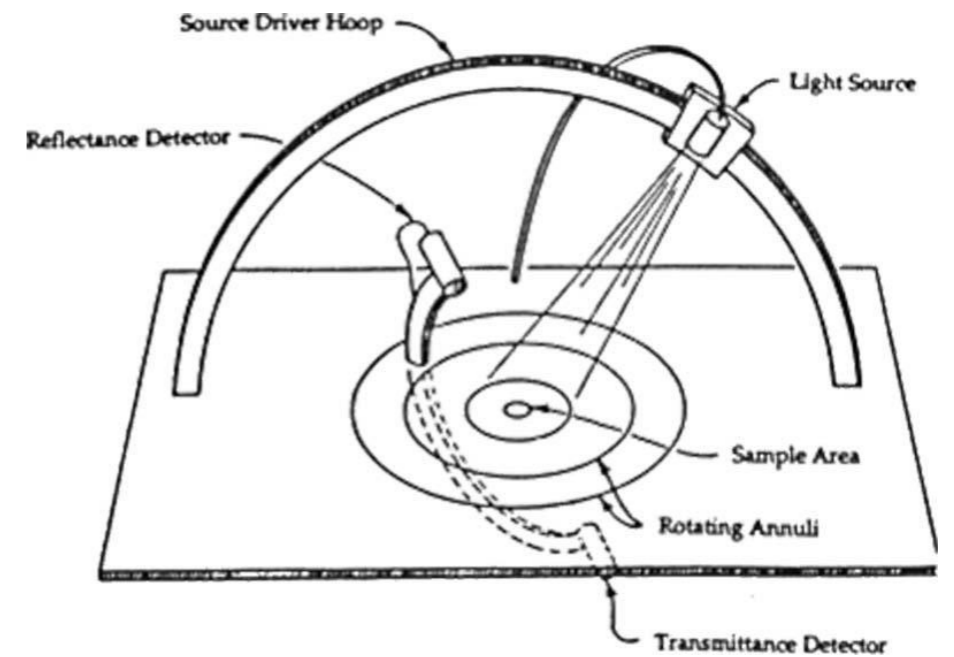
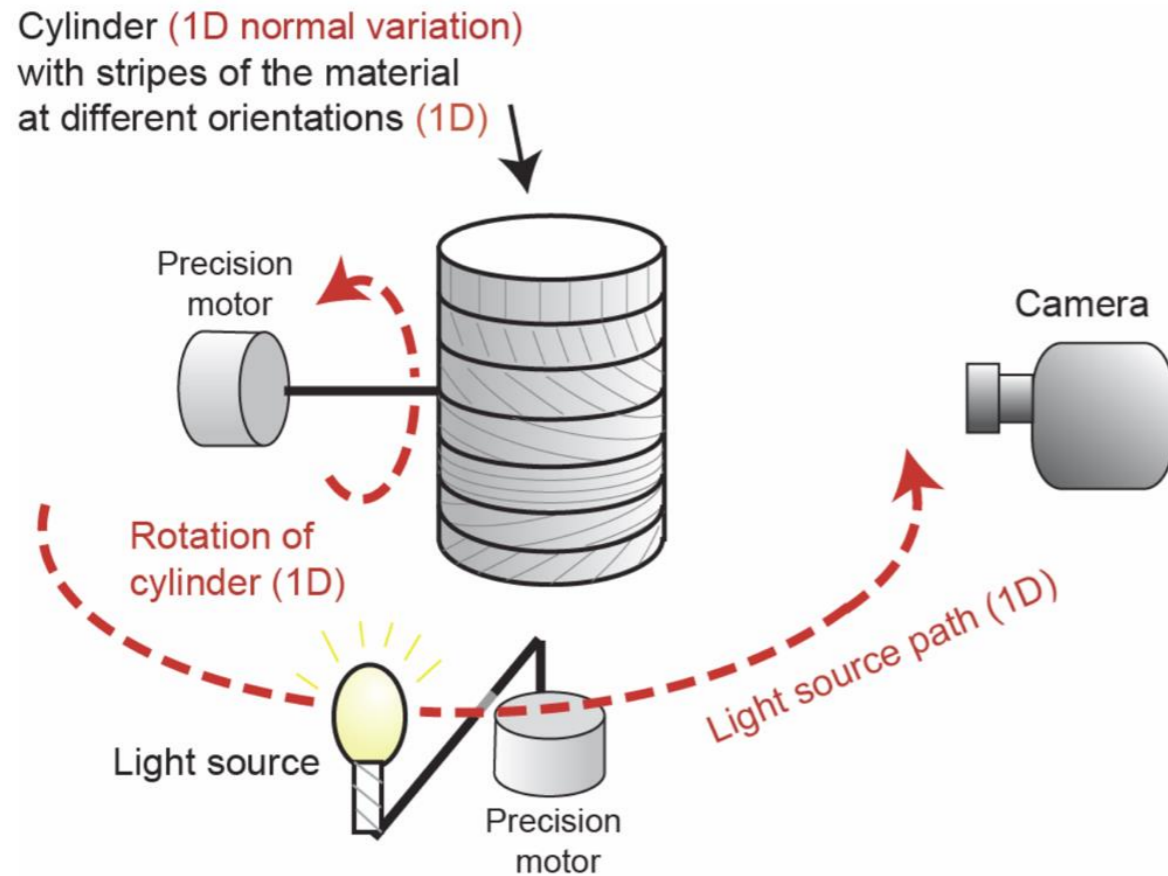

Gonioreflectometer

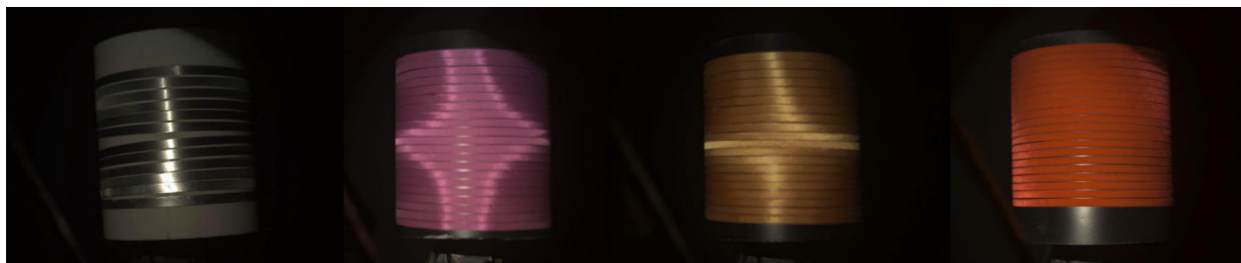

[Ngan et al., 2005]



# Low-parameter (non-linear) BRDF models

- A small number of parameters define the (2D,3D, or 4D) function
- Except for Lambertian, the BRDF is non-linear in these parameters
- Examples:

Lambertian:  $f(\omega_i, \omega_o) = \frac{a}{\pi}$  ← Where do these constants come from?

Phong:  $f(\omega_i, \omega_o) = \frac{a}{\pi} + b \cos^c (2\langle \omega_i, n \rangle \langle \omega_o, n \rangle - \langle \omega_i, \omega_o \rangle)$

Blinn:  $f(\omega_i, \omega_o) = \frac{a}{\pi} + b \cos^c b(\omega_i, \omega_o)$

Lafortune:  $f(\omega_i, \omega_o) = \frac{a}{\pi} + b(-\omega_i^\top A \omega_o)^k$

Ward:  $f(\omega_i, \omega_o) = \frac{a}{\pi} + \frac{b}{4\pi c^2 \sqrt{\langle n, \omega_i \rangle \langle n, \omega_o \rangle}} \exp\left(\frac{-\tan^2 b(\omega_i, \omega_o)}{c^2}\right)$

$\alpha$  is called the *albedo*

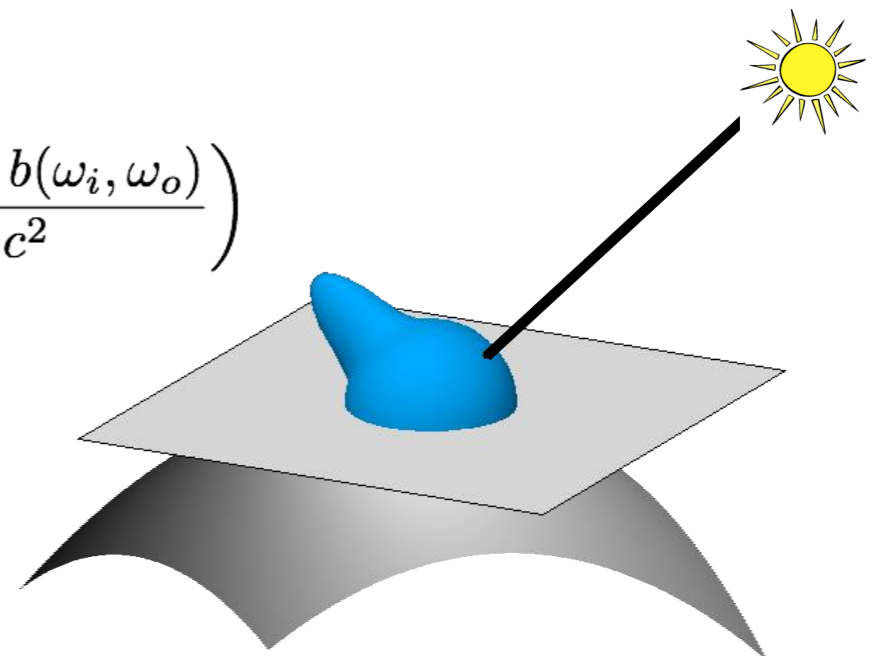

# Reflectance Models

## Reflection: An Electromagnetic Phenomenon

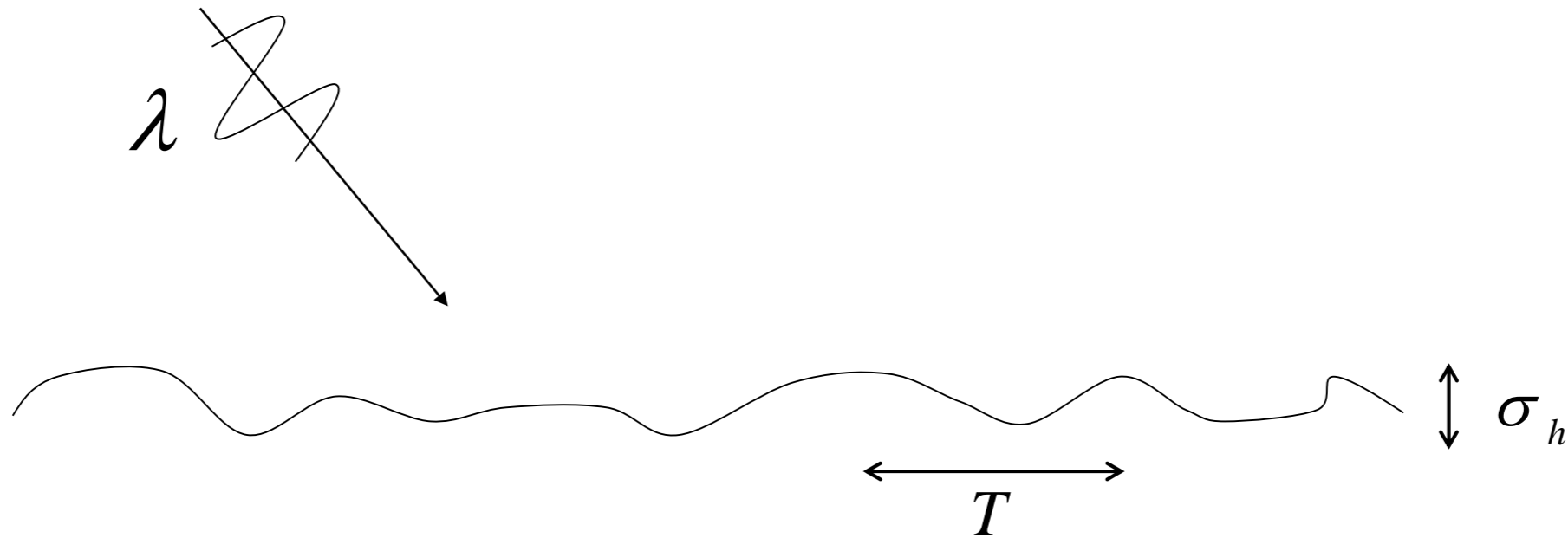

## Two approaches to derive Reflectance Models:

- Physical Optics (Wave Optics)
- Geometrical Optics (Ray Optics)

Geometrical models are approximations to physical models

But they are easier to use!

# Reflectance that Require Wave Optics

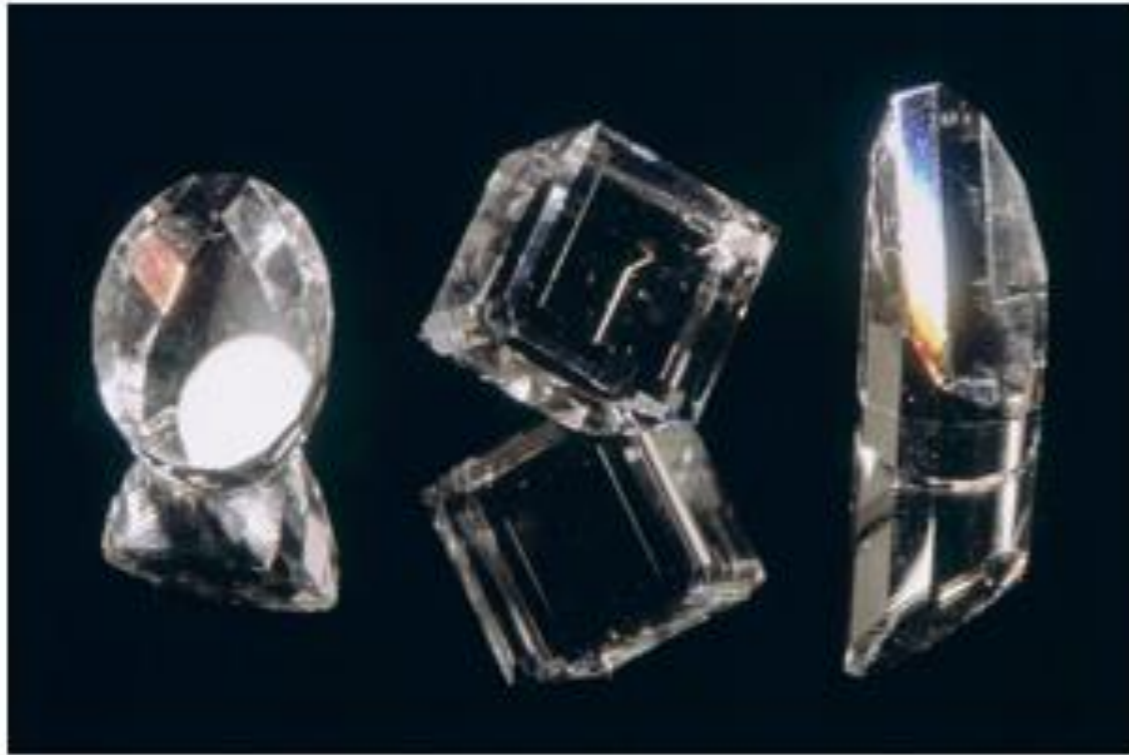

# Summary of some useful lighting models

- plenoptic function (function on 5D domain)
- far-field illumination (function on 2D domain)
- low-frequency far-field illumination (nine numbers)
- directional lighting (three numbers = direction and strength)
- point source (four numbers = location and strength)

# References

## Basic reading:

- Szeliski, Section 2.2.
- Gortler, Chapter 21.

This book by Steven Gortler has a great *introduction* to radiometry, reflectance, and their use for image formation.

## Additional reading:

- Arvo, “Analytic Methods for Simulated Light Transport,” Yale 1995.
- Veach, “Robust Monte Carlo Methods for Light Transport Simulation,” Stanford 1997.  
These two thesis are foundational for modern computer graphics. Among other things, they include a thorough derivation (starting from wave optics and measure theory) of all radiometric quantities and associated integro-differentialequations. You can also look at them if you are interested in physics-based rendering.
- Dutre et al., “Advanced Global Illumination,” 2006.  
A book discussing modeling and simulation of other appearance effects beyond single-bounce reflectance.
- Weyrich et al., “Principles of Appearance Acquisition and Representation,” FTCEG 2009.  
A very thorough review of everything that has to do with modeling and measuring BRDFs.
- Walter et al., “Microfacet models for refraction through rough surfaces,” EGSR 2007.  
This paper has a great review of physics-based models for reflectance and refraction.
- Matusik, “A data-driven reflectance model,” MIT 2003.  
This thesis introduced the largest measured dataset of 4D reflectances. It also provides detailed discussion of many topics relating to modelling reflectance.
- Rusinkiewicz, “A New Change of Variables for Efficient BRDF Representation,” 1998.
- Romeiro and Zickler, “Inferring reflectance under real-world illumination,” Harvard TR 2010.  
These two papers discuss the isotropy and other properties of common BRDFs, and how one can take advantage of them using alternative parameterizations.
- Shafer, “Using color to separate reflection components,” 1984.  
The paper introducing the dichromatic reflectance model.
- Stam, “Diffraction Shaders,” SIGGRAPH 1999.
- Levin et al., “Fabricating BRDFs at high spatial resolution using wave optics,” SIGGRAPH 2013.
- Cuypers et al., “Reflectance model for diffraction,” TOG 2013.  
These three papers describe reflectance effects that can only be modeled using wave optics (and in particular diffraction).