



REPORT

# My data are mine

Why we should have ownership rights on our personal data



---

## MY DATA ARE MINE

**By**

**Isabelle LANDREAU**

Attorney at the Paris Bar,  
Doctor of Law in Intellectual Property  
and Law of New Technologies

**G rard PELIKS**

Cyber-security engineer,  
expert in information security  
and President of CyberEdu

**Nicolas BINCTIN**

Professor of Law Schools,  
Senior Lecturer at the University of Poitiers

**Virginie PEZ-P RARD**

Teacher-researcher, Lecturer at the  
University of Paris II Panth on-Assas,  
specializing in issues of "privacy"  
in commercial practices

**Under the direction of**

**Lucas L GER**

Doctoral student at the CNAM,  
Research Director of the  
GenerationLibre Think Tank

**Statement of responsibility.** This report is organized in three parts. Each author has contributed to a specific part, in their specialist field. Their name is indicated at the beginning of each part, thereby distinguishing the work of each of them. GenerationLibre has overseen all these contributions and edited the final text. The authors are not deemed to approve all the parts.

---

## SUMMARY

# 01

## Executive summary

---

p.6

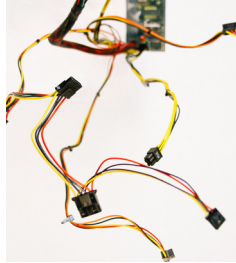

# 02

## Introduction

---

p.10

# 03

## Part 1

---

p.18

## The socio-economic and ethical aspects of personal data

### 1. The information society and data explosion

- 1.1. In the beginning, was the digital revolution
- 1.2. Monitoring by states: "business as usual"?
- 1.3. The hunting down of personal data held up as a business model
- 1.4. The collection and use of personal data in practice

### 2. Give control back to the consumer?

- 2.1. The resistance of "citizen-consumers" is taking shape
- 2.2. Towards payment for personal data?
- 2.3. The respect of individual choice, an ethical challenge

# 04

## Part 2

---

p.44

## Creating ownership of data under existing law

### 1. Another look at a complex, evolving legal framework

- 1.1. The legal status of data
- 1.2. Appropriation of personal data under ordinary property law
- 1.3. The power of collecting information

### 2. The GDPR, a step in the right direction?

### 3. Overview of privacy and data protection in the USA

- 3.1. Privacy and data
- 3.2. Ownership and data

### 4. Towards ownership of personal data: legal solutions

- 4.1. Distinguishing data from information
- 4.2. Sharing the data utilization value chain





# 05

## Part 3

p.92

## Technology to the rescue of your privacy?

### 1. Proving a person's online identity?

- 1.1. The limits of the IP address
- 1.2. Proving authenticity through an electronic signature

### 2. Blockchains to guarantee data authenticity

### 3. Marketing personal data thanks to technology?

### 4. The socio-economic questions posed by a technological solution

# 06

## Conclusion

p.116



# 07

## Annexes

p.122

### Annex 1. Analysis and evaluation of the data

### Annex 2. The case of decentralized "Data Market places"

# 08

## Main references

p. 130

# 09

## Acknowledgments

p. 134

# 10

## Think tank

p. 136



---

**EXECUTIVE SUMMARY**

**E**very day, we accept dozens of cookies on our computers and agree to one-sided terms of use that dispossess us of **our personal data**, including the most intimate. The GAFA and other platforms, to a large extent, obtain their income by **monetising these aggregated data**, in particular through **advertising**.

However, users get no direct payment for the raw materials they provide, while the value of their personal data is expected to reach 8% of European GDP by 2020. The free of charge nature of the services hides a lawful **plundering** of our data, i.e. of our person.

**As far as our data are concerned, we still live in the age of serfdom**, giving up our production against "free" services. We need to enter into the stage of market economy.

**In this paper, the Think tank GenerationLibre studies how to establish a system of ownership on personal data. Just as the industrial revolution made intellectual property rights necessary, the digital revolution should create an ownership right on personal data. If data represent the oil of the 21<sup>st</sup> century, is it not time to ask who owns the oilfields ?**

This legal innovation would change the way the digital ecosystem works, by giving user-producers:

- **The possibility for e-citizens to negotiate and conclude contracts** with the platforms (possibly via intermediaries) regarding the use of their personal data, so that they can decide for themselves which use they wish to make of them.
- **The ability to monetise these data (or not)** according to the terms of the contract (which could include licensing, leasing, etc.).
- **The ability, conversely, to pay the price of the service** provided by the platforms without giving away our data (the price of privacy?).

This paper sets out the principles of the paradigm shift that GenerationLibre advocates, giving back to the individual data producer the legitimate ownership over personal data. This echoes the reasoning developed by **Jaron Lanier**, author of *Who Owns The Future?* and co-signatory, together with scholars from Stanford and Columbia universities, of a recent research paper entitled "*Should We Treat Data As Labor? Moving Beyond 'Free'*". However, GenerationLibre argues that data should be treated as capital rather than labor, as they effortlessly emanate from self-owned individuals.

**Only a proprietary approach will ensure real control on our data by granting the classical rights of *usus*, *abusus* and *fructus*. Only the creation of a data market will be able to rebalance the power relationship** between the platforms and their users by providing each one of us with a **real asset**. Although some form of contractual agreements are already possible in the US, a proper ownership right does not currently exist in any legal system in the world.

**GenerationLibre worked with a team of experts (law professors, engineers, data scientists and economists) to analyze the entire range of socio-economic and ethical issues relating to personal data (I) and to envisage how to introduce ownership of personal data into the law (II).**

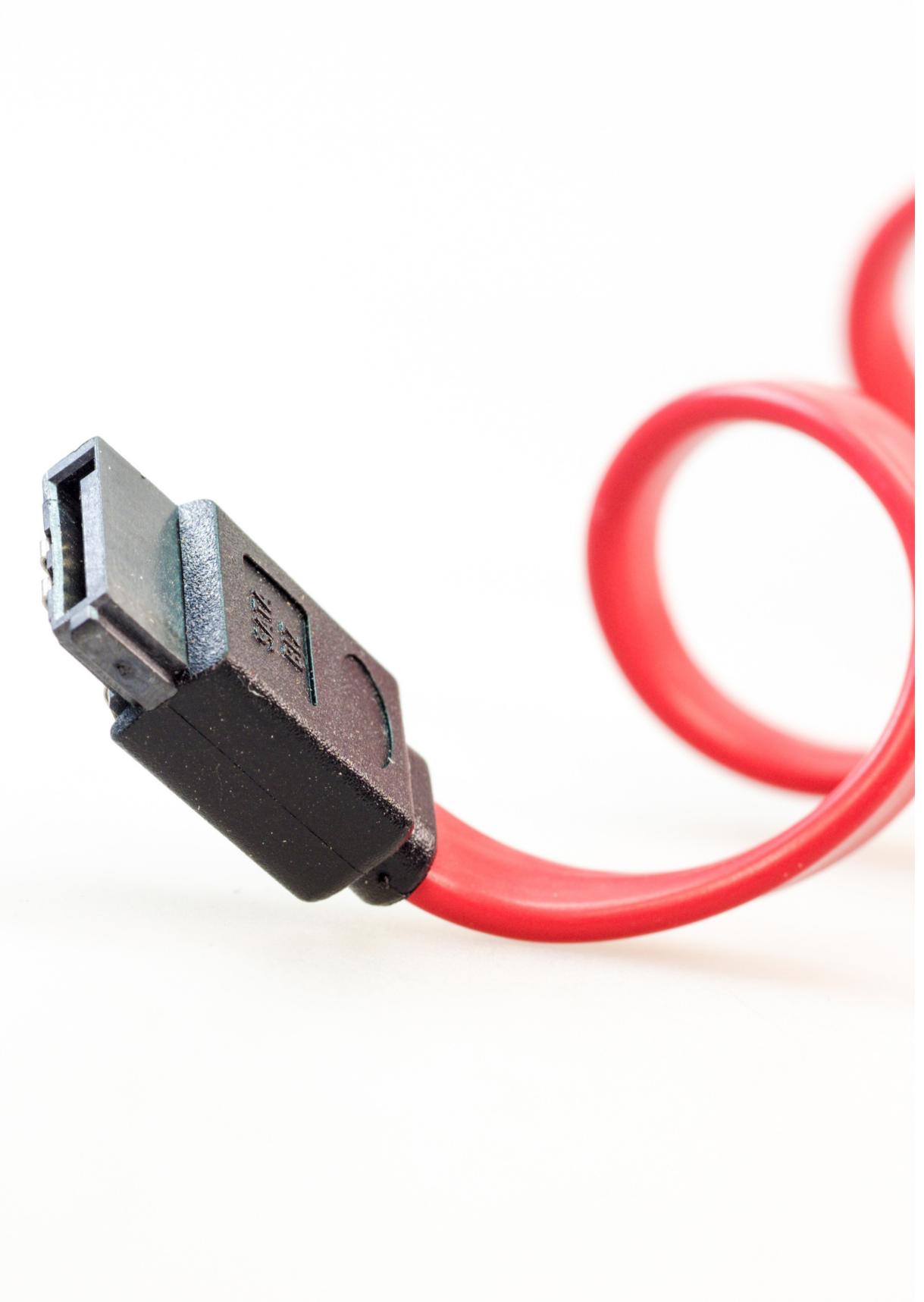



At the European level, the **General Regulation on the Protection of Personal Data** (GDPR), which will enter into force on 25 May 2018, takes a step in the right direction by treating companies as data “guardians” and not owners, as well as guaranteeing the **portability** of personal data. The establishment of a **property** right would be the logical conclusion of this regulatory progress.

**Finally, we explore how technology can now be used to implement this new property right (III).** We analyse several possible methods for authenticating users and making their data available. We propose a model based on a **“blockchain”** managing **“smart contracts”** which would allow everyone to gather and possibly to **commercialize** their data.

**In order to assess the value of such a “data market”, this study will be completed by econometric modelling** that is being carried out in partnership with researchers at the *Toulouse School of Economics - TSE*. This modelling will provide a better idea of the income that e-citizens could receive from a near-continuous flow of nano-payments.

We believe in a decentralised Internet where **individual identity** is preserved. This is the opportunity for **Europe** to innovate and to propose a **new model in the age of dataism**.

---

INTRODUCTION

# The softian bargain

By **GASPARD KOENIG**

**W**eb users are like travellers in past ages, held up by highwaymen. The thieves are the GAFA<sup>1</sup> and other Internet companies.  
**The booty: our data.**

But unlike our predecessors, we seem to take a certain amount of pleasure in being ripped off. Every day, we allow dozens of *cookies* onto our computers and click "OK" on the "Terms and Conditions" that rob us of our personal data. According to a study by Carnegie Mellon University, the average American signs nearly 1500 of them per year which would take 76 days to read. PayPal's terms and conditions are longer than Hamlet. It is simply impossible that under these conditions the web user gives their "informed consent", as the law requires? We cannot read these contracts, still less negotiate them. If we were to scrutinize them a little more closely, we would have good reasons to be wary. A LinkedIn user thus entrusts the social media with an irrevocable right, worldwide, perpetual, unrestricted and unremunerated, to copy, use and resell all the information it receives. When Facebook undertook, for internal research purposes, to manipulate the emotions of 700,000 users by altering the posts which were displayed to them, the company was able to avail itself of contractual terms allowing it to carry out "research and analysis" on collected data<sup>2</sup>. Mischievously, GameStation had included between the lines of its contracts "the eternal surrender of the user's soul"; unsurprisingly, 700 users signed up to this Faustian bargain in one day...

**Naturally, in exchange for these data, we receive free-of-charge services.** As Jean Tirole emphasizes: *"We often hear that the platforms should pay for the data that we provide them with. In practice, however, some actually do, but not in the form of a financial transfer but in the form*

---

1 Common acronym for Google, Amazon, Facebook, Apple.

2 Source: <http://www.wired.com/2014/06/everything-you-need-to-know-about-facebooks-manipulative-experiment/>.

of free services.”<sup>3</sup> The platforms are in fact paid through the use and/or the resale of these data, primarily to advertising companies that can thereby more accurately identify consumers<sup>4</sup>. Almost all of Facebook’s income is thus generated by targeted advertising (increasingly via the application rather than the site)<sup>5</sup>, which explains its fierce resistance to ad-blocker software. And this is only a beginning: in a letter dated May 2014 to the *Securities and Exchange Commission*, the American financial regulator, Google explained that advertising would soon appear on fridges, car windscreens, glasses and watches...

The worst dystopias are possible: In a famous scene of the film *Minority Report*, the hero is offered personalized advertisements while walking in the street (by iris recognition): “John Anderton! You could use a Guinness right about now”; “Get away, John Anderton, forget your troubles.” The deal is quite simple: in return for free access to sites, social media, search engines or pieces of music, we agree to entrust our data to algorithms which offer us in return bespoke products. Let us call this **the Softian bargain** (as in software and Faust). A contractual arrangement between willing parties, but for a mutual benefit? That remains to be seen. The Softian bargain includes at least five very one-sided clauses.

**A cultural clause:** far from being offered an infinite number of possible choices, everyone ends up seeing what they want to see, hearing what they want to hear and reading what they want to read. Based on our past searches, Google delivers first and foremost the information that we want to see, at the risk of increasing our subjective bias<sup>6</sup>. Instead of opening us up to the world, the Internet imprisons us in our bubble<sup>7</sup>.

**A social clause:** we become dependent on “siren servers” which, after having attracted us by the song of simplicity, impose little by little their own system of norms up on us. The banishment of any naked image by Facebook, even if it is a painting by Courbet, is a famous example.

---

3 TIROLE Jean, *Économie du bien commun*, PUF, 2016.

4 Some, like Criteo, have made a fortune by using “behavioral retargeting” methods.

5 Source: <https://investor.fb.com/investor-news/press-release-details/2017/facebook-Reports-Fourth-Quarter-and-Full-Year-2016-Results/default.aspx>.

6 It was thus observed, after the Charlie Hebdo attacks, that the dissemination of conspiracy theories was accelerated by Google algorithms (more explicitly, a regular visitor of pro-Palestinian sites will be automatically referred to contents presenting anti-Semitic tendencies).

7 What the online activist Eli Pariser calls the “filter bubble”.



As Jaron Lanier, one of the pioneers of virtual reality explains: “‘Free’ inevitably means that someone else will be deciding how you live.”<sup>8</sup>

**An economic clause:** free is based on the fiction according to which we all have the same value in relation to platforms (namely, zero), even though some users produce large masses of data, and others behave like stowaways, leaving behind only the slightest of digital tracks.

**A political clause:** If currently we are free to disconnect, there is nothing to ensure that this will be the case tomorrow. The authorities will be tempted to impose *Big Data* on us in the name of the public good. To reduce our electricity consumption, make smart meters compulsory; to prevent traffic jams and accidents, make the interconnection of GPS systems compulsory; to improve public health, make connected bracelets compulsory; etc.

**A legal clause,** that is fundamental: what privacy am I entitled to in a world where the merest start-up can buy files containing my tastes, my travel, my love-life? It is noteworthy that a champion of the “end of privacy” like Mark Zuckerberg has had a 2-meter high wall built around his Hawaiian residence and is buying up all the houses adjacent to his Palo Alto property. Does the end of privacy only apply to others?

**In fact, the Softian bargain  
is flawed by a basic anomaly:  
today, we no longer control  
our data.**

They are scattered around the wilderness of the web, owned by nobody, *res nullius*, but which someone can appropriate and then convert into databases which, by contrast, are then protected by intellectual

---

8 LANIER Jaron, *Who Owns the Future?*, Simon & Schuster, 2013.

property rights<sup>9</sup>. This appropriation has a phenomenal value: according to the Boston Consulting Group, the value of personal data in Europe could reach 1,000 billion euros by 2020, or 8% of European GDP. It is the contemporary version of the tragedy of the commons, when the coexistence of several herds on public grazing lands lead to overexploitation of a scarce resource (grass, in this case): digital actors graze the same data pasture without worrying about the consequences.

Given this widely accepted observation<sup>10</sup>, three kinds of logic can be applied, reflecting three conventional options of political philosophy.

**The first is nationalization.** The State acquires the pasture and distributes the plots. The data are then considered as a *res communis*, in the same way as air or water in the sea. There would need to be a kind of national data agency, bringing together, pooling and encrypting all the data of the population, to then make them available, under certain conditions, to companies which are in the best position to use them. This form of digital communism has quite a lot of support in France<sup>11</sup>. Such a takeover by the State of our data would create a bureaucracy that is diametrically opposed to the culture of the Internet and would give the central power an inordinate means of control.

**The second option is based on fundamental rights.**

The State regulates the use of the pasture land and creates obligations for the shepherds. This so-called “personalist” logic, because it is attached to the rights of the person, has been embraced by the European Commission and the various national regulators (such as the CNIL data protection agency in France). It is based on the concept, defined by the German Federal Constitutional Court of “informational self-determination”: everyone should be able to decide autonomously about the use made of their own data. In the same vein as the right to be forgotten, the user would be granted additional rights: the right to allow data to be circulated and to know what use is made of them, (including for example via annual reports), the portability of data from

---

9 BENABOU Valérie-Laure, ROCHFELD Judith, *À qui profite le clic ? : Le partage de valeur à l'ère numérique*, Odile Jacob, 2015.

10 Conseil d'État, 2014 *Annual Study: Fundamental rights in the Digital Age*, La documentation française, Paris.

11 Particularly under the authorship of Pierre Bellanger, who has put forward the idea of “digital sovereignty”.

one tool to another, the strengthening of consent procedures, etc. As for the platforms, they would be subject to new obligations: revealing the parameters of the algorithms, offering alternative, non-personalized, services, revealing the processes used to process the information obtained, etc. The risk of this logic is that it would lead to an exponential judicialization of the digital world and hampering innovation without offering users any real guarantees (and still less payment).

**That is why it is urgent to explore a third option, which supplements and in a sense, creates the foundation of the second one: that of assigning ownership to data.** In other words, making the people the legal owners of their personal data, which is not currently the case anywhere in the world. The State guarantees the shepherds ownership of their plot of pasture — they are free to exchange them to find the best balance. If data are, according to the agreed formula, the oil of the 21<sup>st</sup> century, it is time to ask the question: who owns the oil? In the case of oil, the primary producer, who resells it to others for refining. Similarly, you and me, the data producers, should be paid for the raw material that we supply to the algorithms of *Big Data*. Just as the industrial revolution made intellectual property rights necessary, the digital revolution should create an ownership right to the data.<sup>12</sup>

This option was explicitly rejected by the French *Conseil d'État* in its 2014 report on digital technology and fundamental rights, on the grounds that it would imply “*relinquishing the logic of protection*” (of the individual by the State). Implicitly, the *Conseil d'État* mentions an argument that is familiar to jurists, namely, that personal data could not be monetized in the name of the protection of fundamental freedoms: since a person is deemed to be unavailable and cannot be traded, the data which stem from them should also be excluded from the market. They would be part of what “*money can't buy*”, to use the phrase of the American philosopher Michael Sandel.

---

12 REES Christopher, “Who owns our data?”, *Computer Law & Security Review*, 30, 2015.

This moral and philosophical argument calls for at least four points in the rebuttal list :

- The first, **empirical**, notes the existence today of huge profits made by data aggregators: would not the most basic justice distribute the value chain more fairly?

In the name of what “human dignity” should the consumer-citizen be refused their legitimate share of economic production?

- The second, **legal**, recalls that ownership rights are designed primarily as a control tool: each person can then dispose of it as they see fit, including rejecting the mechanisms of the market. We can only truly choose to give what we own.
- The third, **moral**, justifies abandoning the logic of protection and replacing it with a logic of responsibility: in a mature society, the State must abandon its supervision of the citizen-consumer, and trust them to use their data in an intelligent way.
- The fourth, **philosophical**, asserts the Lockean idea of “self-property”<sup>13</sup> as the ideal of modernity, freeing the individual from the hold of any transcendence.

However, we don't believe that it is necessary to open this sensitive debate. Indeed, data can be considered under the law of property as something that can be appropriated and controlled. In this sense, they remain separate from the person – just as “ideas”, which also are very closely linked to the individual who has produced them, can be intellectual property.

We also need to highlight the concern expressed by the Conseil d'État that *“the recognition of an individual's ownership right to his data creates serious legal issues for the public authorities”*<sup>14</sup> if that was the case, these authorities would have to justify the collection and processing of citizens'

---

13 LOCKE John, *Second Treatise of Government*, Chapter 5: Property, 1690: *“Though men as a whole own the earth and all inferior creatures, every individual man has a property in his own person ; this is something that nobody else has any right to.”* Locke in fact uses the idea of “self-property” already expounded by Richard Overton a few years earlier.

14 Conseil d'État, *Op. cit.*



data for a public interest purpose. For us, this concern represents rather a hope : is it not desirable that the State should explain, if necessary before a judge, how its agencies (including the intelligence services) gather our data? Would this not strengthen the trust needed between the State and its citizens in the digital age?

**French and European law is particularly well suited to the inclusion of such an ownership right, the logical next stage in the new regulations regarding data protection. This is the opportunity for Europe to innovate and to impose its model. So that, tomorrow, it will be Facebook that is paying us.**

---

---

PART 1

# The socio- economic and ethical aspects of personal data

By VIRGINIE PEZ-PÉRARD, ISABELLE LANDREAU & LUCAS LÉGER

**T**echnological change has often been the source of major economic transformations. The emergence of the IT industry has allowed access to and effective processing of increasingly larger data sets. The companies that have been able to set themselves up as intermediaries in this new market are now extremely powerful companies, not only in financial terms, but also in terms of information. In those societies where the latter has become a commodity and is traded at a premium prices, we think it is essential to ask questions about this new economic order. This introductory section is used to place our analysis within a historical, legal, economic and ethical context.

The goal of this section is to firstly and foremost to inform the reader. Consumers can only make choices if they have enough information to be able to measure the impact they have, at least in broad terms. For we spend a significant amount of time on most of the platforms we visit. On average, we spend 2.5 hours per day in 2017 on social media, against 45 minutes in 2012<sup>1</sup>. And the longer we spend on these platforms, the more data they gather.

**These data-gathering capabilities are now very important.** One positive aspect of the Snowden case was to reveal the magnitude of the phenomenon: the PRISM program launched by the NSA could, already in 2010, intercept up to 1.7 billion e-mails, telephone calls and other telecommunications<sup>2</sup>. It also showed that the technical capabilities for gathering and processing data are now a reality.

Once the data are analyzed, internet platforms and governments extract information that goes well beyond simple commercial interaction. Is this

---

1 Source: <http://blog.globalwebindex.net/chart-of-the-day/social-media-captures-30-of-online-time/>

2 HARCOURT B.E., Exposed, Harvard University Press, 2015.

a problem? By reading these few pages, you will be able to make up your own mind.

# 1. The information society and data explosion

## 1.1 IN THE BEGINNING WAS THE DIGITAL REVOLUTION

**Just like the Industrial Revolution, the Digital Revolution, and more generally the radical innovations that stem from it, are not only changing the way we consume and produce, but in turn it is transforming our entire economic and institutional landscape.** Much more than simply in a crisis, our economies are undergoing profound change, characterized by the advent of a society that could be described as one of knowledge<sup>3</sup>, where new technologies are helping us overcome our cognitive limitations. These successive technological revolutions have profoundly affected mankind. *“Technological change is in large part responsible for the improvement in the human condition, whether by the size of its population, the lengthening of life expectancy, the level of education, living standards, changes to work, telecommunications, health care, as well as the effects of human activities on our environment.”*<sup>4</sup>

After the Industrial Revolution, we are now witnessing a real break with the past driven by technological change, in which **information has become the value-creating variable**<sup>5</sup>. The networks are the instruments used to transmit and exchange this new form of knowledge,

---

3 BELL Daniel, *The coming of post industrial society*, Basic Books, 1973 ; DRUCKER Peter, *Age of discontinuity*, Harper & Row, 1969 ; TOFFLER Alvin, *The third wave*, Bantam Books, 1980.

4 BOSTROM Nick, *Technological revolutions: Ethics and policy in the dark*, Published in *Nanoscale : Issues and Perspectives for the Nano Century*, eds. Nigel M. de S. Cameron and M. Ellen Mitchell, John Wiley, 2007, pp. 129–152. Although we are moving away from our subject, it should be noted that there is on consensus on this vision. Indeed, the relationship of mankind to technology was strongly criticized by Jacques Ellul, in *Le bluff technologique*, Hachette, 1988.

5 HIDALGO Cesar, *Why information grows: The evolution of order, from atoms to economies*, Basic Books, 2015.

and more widely innovation<sup>6</sup>. Information<sup>7</sup> is transmitted and spreads through the development of software.

In a written statement, the investor and co-founder of Napster, Marc Andreessen<sup>8</sup>, put forward the argument that, increasingly, **software** was going to “conquer the world” and that all sectors of the economy would be more or less affected by the arrival of new actors able to reduce fixed costs and provide cheaper and more efficient service. When one takes the time to think about it, the new knowledge economy has indeed allowed these software programs to emerge, which allows their users to access an efficient service in just a few clicks: Amazon in the retail trade, Google in marketing and advertising, drones in the defense sector, the super computer Watson developed by IBM to assist many physicians with their diagnoses, music with Spotify, iTunes and Deezer, payment via PayPal, MOOCs (Massive Open Online Courses) in education, photography, animated films, etc.

Software development is affecting all sectors of the economy and is contributing to automation in industry and services. All these innovations use an ever-increasing quantity of data which most often includes monetizable behaviors. In order to provide such an efficient service, **these new platforms must gather and reprocess personal data** from users who make a purchase on the Internet or simply browse the Web.

## 1.2 MONITORING BY STATES: “BUSINESS AS USUAL”?

Conventionally, States monitor people, and *Big Data* is the opportunity to monitor them even more, on the pretext of protecting their citizens.

---

6 VALENTE, T.W., “Social network thresholds in the diffusion of innovations”, *Social Networks*, 18 (1), 1996, pp. 69-89; DEROIAN, F., “Formation of social networks and diffusion of innovations”, *Research policy*, 31 (5), 2002, pp. 835-846.

7 Knowledge and know-how are the two fundamental components of the emergence of information.

8 ANDREESSEN Marc, “Why software is eating the world”, *World Street Journal*, August 20, 2011.

**Each second, a flood of personal and other data flow into “data centers”<sup>9</sup>**, most of which are located on American territory. Even though we are fully aware of it, we are to a certain extent **dispossessed of our identity**. The previously obvious dividing line between the private sphere and our public identity (our name, address, etc.) no longer exists. Although Google knows you better than your close family<sup>10</sup>, the use of mass data is not confined to the GAFA alone. On the contrary, a certain laxity with regard to the ownership of personal data also allows the State to increase its monitoring and to improve its methods. Moreover, this reversal of the situation has not been brought about coercively.

China is still pioneering in terms of surveillance and restriction of freedom of expression. Already in 2009, this country put forward the implementation of the “Green Dam project”. The purpose of this project was to install a parental control software on all new computers produced in China. Although the intention was commendable, a few tests were enough to show however, that the program went well beyond simple control<sup>11</sup>. Besides the security risks that it posed, this software was entirely intrusive and allowed China to carry out intensive espionage of its citizens.

More recently, on 14 June 2014, the Chinese Council of State unveiled its Master Plan for the construction of a social credit system (2014-2020)<sup>12</sup>. The aim would be to build a national reputation system, allowing Chinese citizens to be assessed based on their personal digital data. The goal of such a tool, for the Chinese leadership, would be, eventually, to strengthen integrity and *“honesty in public affairs, trade, social issues and the construction of judicial credibility”*<sup>13</sup>. The means? The analysis and compilation of the digital behavior of its citizens in the form of individual scores. This control tool, based on a system of incentives to act properly, could currently take the form of a smartphone application, that

---

9 Source: <http://www.iflscience.com/technology/how-much-data-does-the-world-generate-every-minute/>. On American territory, 2,657,700 of gigabits of Internet data are generated each minute.

10 Source: <http://www.journals.uchicago.edu/doi/abs/10.1086/680084>. See also: STEPHENS-DAVIDOWITZ S., *Everybody Lies: Big Data, New Data, and What the Internet Can Tell Us About Who We Really Are*, Dey Street Books, 2017.

11 Source: <https://opennet.net/chinas-green-dam-the-implications-government-control-encroaching-home-pc>.

12 Source: <http://www.wired.co.uk/article/chinese-government-social-credit-score-privacy-invasion>.

13 Source: <https://chinacopyrightandmedia.wordpress.com/2014/06/14/planning-outline-for-the-construction-of-a-social-credit-system-2014-2020/>.

could be deployed in a synchronized version over our various screens, our connected watches, and the part of the *cloud* reserved to us. The establishment of an entire system based on Pavlovian reflexes could encourage us to carry out our affairs with complete integrity, rewarded for acting properly and punished for any wrongdoing. Because it is about us and our behaviors that we are talking about here, translated into data shared in the *cloud* during our digital travels. It is on the basis of our own data that such systems are established. Without them, they are nothing.

According to a video published by *The Economist*<sup>14</sup>, the Chinese Government has developed **a powerful facial recognition software**, particularly through the growing effectiveness of “machine learning” tools. China has thus compiled a database of approximately 700 million different profiles, i.e. half of its population. Companies which manage sensitive content, such as banks or even States could do likewise in the medium to long term. In this way, we could improve the security of individuals. Facial recognition is an effective tool to limit identity theft and hunt down criminals and terrorists. Currently, the start-up *Face-six* boasts a success rate of 99%. It is still not good enough for security applications, which would potentially return too many false positives to manage administratively, but this rate is growing.

People may argue that we are not talking about a democratic country here since these few examples illustrate the trend in China. However, the Snowden case revealed that mass surveillance was not a monopoly of governments with questionable democratic principles.

### **1.3 THE HUNTING DOWN OF PERSONAL DATA HELD UP AS A BUSINESS MODEL**

We are also seeing commercial facial recognition applications appearing. One of the potential benefits for individuals would be the end of passwords. The iPhone X has deleted them making access to the device easier. Again, in China, this technology is used for access to amusement

---

<sup>14</sup> Source: [https://www.youtube.com/watch?v=nT\\_PXjLol\\_8](https://www.youtube.com/watch?v=nT_PXjLol_8).



parks or as a means of payment in fast food outlets<sup>15</sup>. Behavioural data are thus stored and processed with the aim of improving the “customer experience” we are told. Indeed, advertising targeted according to our gender and our purchasing characteristics is carried out without us even needing to fill in any form or having a loyalty card.

**Does this mean, however, that we control our personal data?** Our digital tracks, even if they are not yet used to compile a citizens’ social credit score, are definitely used to produce value to those who know how to utilize them. The University of North Carolina estimates<sup>16</sup> the 2012 turnover of the nine, largest personal data brokers at \$426 million. We, the primary producers of these data, however take no part in this market. We share our data **voluntarily** – at least on the surface – most often because it is a **condition of use** of the services that we use on the Internet. However, some research is reported to show that we would even be willing to pay for our data not to be used by others during our interactions on the Internet<sup>17</sup>. Is this possible? To find out, let us go over why our data are currently at the heart of companies’ business models.

**In the traditional model, companies fund the digital services they offer to consumers through advertising.** That is why most web sites or free applications (if not all) include pop-ups or advertising banners that allow them to generate advertising revenue. But in the face of resistance of consumers (reactions of rejection given these forms of advertising; an increase +20% of *adblocs* in 2016<sup>18</sup>), advertising audiences are falling. It is becoming essential to better target advertising campaigns to increase the profitability of the advertising for advertisers. In addition, it is essential to maintain the attention of the targets by limiting the commercial pressure put on them. To do so, companies are betting everything on data. These are collected and used both to develop a detailed profile of the customer but also to resell them to “partners” (which are in fact customers of course!).

Last names, first names, email addresses, phone numbers, but also products viewed, purchased, interests, habits, etc. All these data are

---

15 Again according to the report of The Economist, *ibid*.

16 Source: <https://onlinemba.unc.edu/blog/data-brokers-infographic/>

17 *idem*.

18 Baromètre Adblocks IAB France/ Ipsos – November 2016, <http://www.iabfrance.com/content/presentation-de-la-v2-de-letude-ipsos-realisee-pour-liab-france-sur-les-adblocks>.

currently one of the major value sources for companies replacing or supplementing reduced advertising revenue.

**But what does the customer get in exchange?** The gathering of data by companies is above all part of a mercantile logic. The data are a source of considerable income, via the increase in the value of the advertising spaces sold (due to the better targeting made possible), and resale to “partners”. But basically, they are indispensable for ensuring that the digital technologies operate intelligently and relevantly. Thanks to them, businesses can customize the service, such as keeping the products placed in the shopping cart during a previous visit for example, or recommending products based on the consumer’s profile or their previous purchases. They can thus provide users with fluid, simple and practical experiences. In fact, even if they are not always aware of it, consumers derive **functional benefits** from the use of their personal information (time-saving, comfort, convenience). Sometimes, they may also derive **monetary benefits**. This is particularly the case with loyalty cards. By scanning their card when making their purchases, customers get reductions or benefits, directly or indirectly, in exchange for points that they earn in proportion to how much they spend. Offering these benefits to customers is necessary, because they ensure that the customer “will play the game” and scan their card for each purchase. This is essential for them to obtain a complete and faithful view of the customer. But the **question of the fairness** of such practices arises. Even if the data provide improved services to the citizen-consumers and even if this improvement is a form of value which meets real expectations, **the share of the value returned to customers** in the form of these benefits is probably **relatively low** compared to **the total value that the distributors derive from them** through the resale of the information.

Restoring **the balance** seems essential from an ethical stance, but also to preserve growth and not to reach a point of no return that would result in citizen-consumers being put off from using these services. To make progress on this issue, it is necessary to understand when and how the data are collected, in practice.

## 1.4 THE COLLECTION AND USE OF PERSONAL DATA IN PRACTICE

The companies take advantage of every opportunity of contact to collect data about their customers, and continuously enrich them through multiple approaches.

- **In the physical store, the loyalty card or the “customer file”**

In the physical store, the check-out is now always accompanied by the perennial question from the assistant “Do you have the store’s loyalty card?” or “Are you registered in our customer file?” Even if this information is not useful for finalizing the purchase, consumers are asked for their identity, address or post code, their email address, their telephone contact details, their date of birth, or even the composition of their household or the first names of their children! Each purchase is carefully recorded: products, date, time, store. **These data are then cross-referenced to develop a profile that is as complete as possible of the customer.** If a childcare company wanted, for example, to target expectant mothers, it could therefore buy data about consumers who, over the same period, have bought ovulation or pregnancy tests in the store and whose consumption of alcohol has fallen in the past few months. The brand would thus have a good chance of attaining its target using criteria of this kind and at the same time, maximizing its return on investment.

These practices raise questions: besides the income generated by their data unbeknown to them, these methods can encourage consumers into over-consuming and buying products that they do not really need, enticing them with a pseudo-promotion which gives them the illusion of getting a “good deal”. In a context where the rate of indebtedness of households continues to grow (+1.1 point between 2015 and 2016 in France<sup>19</sup>), is subjecting consumers and citizens to such temptations reasonable? The issue deserves investigating especially as recent research has shown that certain marketing practices targeting

---

<sup>19</sup> Figures communicated by the Bank of France, viewable via the following link <https://www.banque-france.fr/statistiques/credit/endettement-et-titres/endettement-des-agents-non-financiers>.

consumers based on their personal data could encourage them to make purchases that they later regret. This can lead to a malaise in their relationship with the company and ultimately, become a source of malaise for the consumer<sup>20</sup>.

- **In the physical store, “beacons” and other connected technologies**

“Beacons” are terminals installed in the stores (in the surrounding area or in the aisles) which use Bluetooth technology. They capture which shoppers are close to the beacons, because the company is able to link a shopper with their phone, thanks to its customer file. Once the individual is identified near the store or within a specific aisle, **the company can then in real time push them into making purchases with personalized promotional offers**. According to the Business Insider website, in 2018 there will be 4.5 million beacons in service in the United States, 3.5 million for the Retail sector (see graph)<sup>21</sup>. 50% of major North American retailers have already launched experimental phases since 2014, and it is estimated that by the end of 2016 85% of their points of sale were equipped. For retailers, this is the fastest technological adaptation since they were equipped with mobile credit card readers! As is often the case, the French market should logically follow the pattern of adoption by the American market by speeding up equipping its points of sale over the next few years.

---

20 BUTORI R., MIMOUNI A., PEZ V., « Le côté sombre de la pression exercée sur les consommateurs par les programmes de fidélité : enjeux éthiques et pratiques », *Recherche et Applications en Marketing*, Vol. 32, No. 3, 2017, pp. 76-89.

21 Source: <http://www.businessinsider.fr/us/beacons-are-the-most-important-new-retail-tech-2014-7/>.

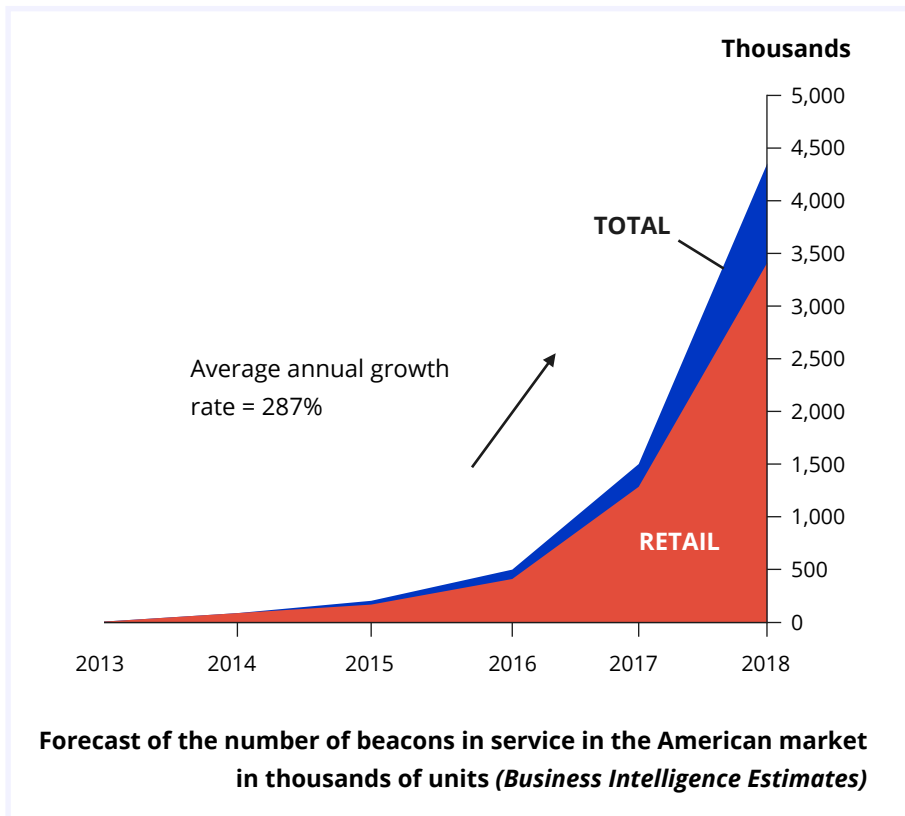

Physical stores are also capitalizing on digital technologies to provide value-added services to consumers... while at the same time taking advantage of these technologies to gather personal information of course. In 2017, Facebook for example tested a new loyalty feature in its mobile application ("Rewards"). This gave users the option of scanning QR codes deployed in physical stores to benefit from targeted promotions<sup>22</sup>. This technology is a useful sales promotion tool for the retailer, which can generate additional footfall in the store. **But especially for Facebook it is the opportunity to collect new data about its users and to generate additional advertising income.** The same thing is true for connected loyalty cards, which will in the future, propose personalized shopping experiences, based around product recommendations and discounts, which will be the occasion for the retail

<sup>22</sup> Source: <https://techcrunch.com/2017/05/01/facebook-rewards/>.

chains to increasingly expand knowledge of their customers (e.g. the Kiabi clothing chain tested a connected in-store loyalty card in January 2017<sup>23</sup>).

- **The collection of data on the digital customer pathways**

When browsing the web, **each connection is logged**. The pages visited, the pathway followed, the time spent per page, the information read, the products viewed, placed in the shopping cart, and actually purchased, etc. are tracked through *cookies* installed on the devices. On smartphones, positions and uses can be tracked. Smartphones collect the geographical position of their user several times per minute<sup>24</sup>, often via background applications (i.e. without the user being aware of it) which is fed into the databases of the giants of the Internet.

- **The scanning of private conversations**

Free email services, such as Gmail, are financed through advertising and operate just like dedicated media advertising companies. The purpose of these email services is to **offer targeting that is as pinpointed and accurate as possible, to allow advertisers to optimize their advertising investments** by maximizing the transformation rate (i.e. the ratio between the number of individuals who have indeed adopted the desired behavior, such as buying the product, for example, compared to the number of ads played/paid for by the advertiser). To offer the most accurate targeting and optimize this rate, the messaging services analyse the private conversations of their web users to extract key words, and thus find out whether they are interested in a particular product, if they intend to go on holiday or make a trip in the near future and where, whether they are taking part in an event that would require particular equipment, etc. In short, they generally identify needs or potential desires.

---

23 Source: <http://www.e-marketing.fr/Thematique/general-1080/Breves/Kiabi-teste-carte-fidelite-connectee-magasin-313408.htm#EABi3g3hu0PSfy8d.97>.

24 LEFILLIÂTRE J., "Où étiez-vous hier ? Google peut vous le montrer et c'est effrayant", 19/12/2013 [http://www.challenges.fr/high-tech/big-data-comment-la-geolocalisation-de-google-traque-tous-vos-deplacements\\_10453](http://www.challenges.fr/high-tech/big-data-comment-la-geolocalisation-de-google-traque-tous-vos-deplacements_10453).

- **Information gathering in exchange for a free service**

Many sites which are free-of-charge for the consumer (insurance comparison engines, hotel or plane fare comparison engines, sites for providing property guide prices, used-car guide price sites, etc.) have a business model based on data. To benefit from the service offered by the site, the consumer must provide a number of pieces of information. For flight comparison sites for example, the user must enter their travel dates, their destination and the number and age of the travellers... For the property guide price site, the user must indicate whether they are a tenant or owner, the condition of the shared parts of the building, or even information which in principle is irrelevant and unconnected with performing the service, such as marital situation and the range of household income. It is easier to understand **why this highly personal information is requested once we know that these sites are largely financed by the resale of this information**. That is why shortly after using these services the user will receive promotional offers for hotels for their next holiday destination or untimely calls from estate agents looking for new customers. Did they say a free service?

- **Intelligence watch on social media**

This information may be supplemented by data from social media, in a more or less automated way depending on the relational maturity of the companies. Even if this practice is not wide-spread today (60% of companies do not incorporate data from social media in their analyses<sup>25</sup>), it is very likely that this information will be more widely used in the future as increasing numbers of firms adopt CRM tools (customer relationship management tools) of the latest generation. **This information is very rich: it comes from the individuals themselves who share it believing they are talking with their close circle of family and friends**. They are not aware that this information can be bought by brands. This gold mine of information, sometimes very intimate, is still currently little exploited due to the lack of know-how in industrializing its processing. But its use should intensify in the future.

---

<sup>25</sup> Oracle study, "Can virtual experiences Replace reality?", 2016, <http://business.lesechos.fr/directions-marketing/marketing/marketing-digital/0211586548032-en-2020-un-marketing-en-realite-virtuelle-303621.php>.



- **Prize contests**

Prize contests are a simple, fast, and very profitable way of gathering data about individuals by companies. On the pretext of being able to identify you clearly and handing over your prize if you win, taking part in prize contests often requires you to provide a host of personal information, top of the list of which are last names, first names, full address, telephone number (to inform you that you have won, of course!) and date of birth. **Sometimes, other information is requested with a promise of offering you a personalized prize, such as the composition of the household or information about your personal preferences, tastes and habits.** And finally and nearly systematically you will be given the opportunity to increase your chances of winning by communicating the email addresses of family and friends who may be interested in the offer. By referring them in this way, they themselves will become the target of the contest and provide all this information in turn. Through a “snowball effect”, a prize contest campaign can thus pay off very handsomely in terms of personal information. The information gathered is deemed to be of good quality, because the individuals communicate the information honestly in the event they will be contacted to receive their personalized prize.

- **The purchase of incremental data through customer files**

To even better characterize the individuals present in companies’ databases, they may buy files to enrich them with the missing information (or to create new files, as part of canvassing policies). **These files, whose quality and freshness cannot always be taken as a given, can be bought very easily from service providers whose number has literally exploded in the past few years.** These files are used to increase the value of the information that is already available to the company, based on the principle that a lone piece of information has no meaning. It is, rich, aggregated data, which have value. By offering a profile of the individual that is as complete as possible, the company exponentially increases the value of its data.

- ... and at each contact

Finally, let us not forget that each contact with the company is an opportunity to collect data about individuals. The letters, telephone conversations and conversations with sales assistants in the store, are scanned, recorded, annotated and “logged” to best complete the customers’ profiles.

Thus, by combining all these sources of information, companies are able to obtain **a very detailed and complete view of individuals**. They attain a real “360° view” of individual-consumers, and data specialists predict an intensification of these practices. Although most in fact collect a lot of data, there are very few which are currently able to give them meaning. According to an Oracle study<sup>26</sup>, 42% of companies are currently unable to extract usable analyses of the data collected. There is thus significant room for improvement in the future. With the new tools and occupations of the *Big Data* era, personalization practices will necessarily intensify.



©CommScope on VisualHunt / CC BY-NC-ND

---

<sup>26</sup> Oracle study, *ibid.*

## 2. Giving control back to the consumer?

In this picture, citizen-consumers are becoming increasingly worried as they are gradually becoming more familiar with these practices. Some fear the intensification of the “Big Brother” effect and the generation of income at their expense. They are beginning to organize the resistance.

**What can our citizens do in this 2.0 world? Are they recognized legal persons or coveted objects?** It is obvious that the two visions oppose each other: the European vision directed towards the protection of personal data and the American vision directed towards the enormous business potential.

The future of *Big Data* involves not only security but also the establishment of a new business model which places **citizens back at the center of the exploitation of their data**, supported by a simple, practical and existing legal model whose mechanisms and opportunities we are going to set out.

### 2.1 THE RESISTANCE OF “CITIZEN-CONSUMERS” IS TAKING SHAPE

Consumers have never been so seasoned and aware of business practices. They are familiar with the tools, techniques and business models. At the same time, they are showing themselves to be increasingly suspicious vis-a-vis the consumer system and commercial practices. Resistance is gaining ground, taking the form of avoiding certain companies, giving up certain products as well as more active forms of rebellion such as complaining and boycotts. These movements have always existed, but with the advent of digital technology, they can be easily organized, be quickly visible on a large scale or go viral in just a few clicks. Tools such as the brands’ Facebook pages, web forums, consumer opinion sites and even petition sites or appeals for

coordinated boycott are some of the weapons used to take back power. This is why brands such as Petit Navire, Starbucks, Marineland, H&M or LU for example are now having to deal with the anger of consumers acting as real counterbalance.

**On a theoretical level, these behaviors result “from a state of motivational resistance”, i.e. an internal tension that consumers feel when they perceive a situation as being oppressive<sup>27</sup>.** More specifically, these actions are the response by individuals to foil an attempt to pressurize or influence them that is deemed unacceptable because of the dissonant representations and negative emotions that they create. In other words, putting too much pressure on consumers could result in the brands obtaining the opposite effect to what they want.

Additionally, we are reaching a stage where consumers are perfectly familiar with the practices of digital economy companies. This familiarity is such as to create “marketplace metacognition”<sup>28</sup>, a kind of preconceived ideas that consumers develop about companies and their tools. That means that they tend to associate their preconceived ideas with all the practices, regardless of their actual characteristics. In fact, individuals form a body of knowledge about the influencing techniques used by companies, from their direct observations or their interactions with people who have faced them. This knowledge is then used to interpret the commercial approaches of companies. When dealing with these companies, consumers seek to maintain their conventional decision-making power, regardless of what the company attempts to obtain through its approach.

**With regard to personal data, that is why an individual could systematically consider that their data are appropriated or “stolen” in an unjustified and illegitimate way** (for example, to resell them), **even when they may simply be essential for providing the service.** To reduce the risks of such inferences, companies eagerly publish ethical charters on the respect of their customers’ privacy. By providing

---

27 ROUX D., “La résistance du consommateur : proposition d’un cadre d’analyse”, *Recherche et Applications en Marketing*, 22, 4, 2007, pp. 59-80.

28 WRIGHT P., “Marketplace Metacognition and Social Intelligence”, *Journal of Consumer Research*, 28, 4, 2002, pp. 677-83.

information about the kind of data collected and the use that is made of them, they hope to avoid being accused of having dishonest or self-serving intentions.

**Thus, digital citizen-consumers create a real paradox: they want the services offered to be as personalized as possible, tailored to their specific needs and the processes to be fluid and “seamless”, all without paying a penny. But at the same time, they want relative anonymity and absolute control over their personal data. Are these expectations reconcilable?**

## **2.2 TOWARDS PAYMENT FOR PERSONAL DATA?**

Given the heightened collective awareness of the practices of companies about personal data and the potential danger that this represents, consumers want to take back control. **88% say they are troubled by the utilization of their personal data**; 88% also say they are worried that their navigation is recorded by private companies<sup>29</sup>. Independent initiatives intended to raise the awareness of citizen-consumers of the advertising income that they generate for the benefit of the Internet giants are flourishing. Such is the Facebook *Data Valuation Tool*<sup>30</sup>, a little extension developed by three Spanish researchers which is used to view in real time the total profits generated by Facebook using the user's personal data.

---

29 Baromètre Adblocks IAB France/ Ipsos – November 2016, <http://www.iabfrance.com/content/presentation-de-la-v2-de-letude-ipsos-realisee-pour-liab-france-sur-les-adblocks>.

30 Source: <http://www.fdvt.org/>.



**The Facebook Data Valuation Tool extension allows you to view in real time the income generated by Facebook using the users' personal data (<http://www.fdvt.org/>)**

A study published by the Ponemon Institute in 2015<sup>31</sup>, shows that **individuals would be willing to share their personal information in exchange for payment**. Their survey, carried out on a panel of consumers, asked respondents from what amount they would be willing to share specific information about themselves. Using this method, the analysts showed that on average individuals valued an item of personal information at \$19.60. The most expensive information is passwords at \$75.80, health data at \$59.80, payment information at \$36, credit situation at \$29.20 and consumption habits at \$20.60. The least expensive are gender \$2.90, name \$3.90 and phone number \$5.90. Of course the methodology is incomplete since it is based only on individual perceptions, but the report demonstrates growing awareness by citizen-consumers of the value of the assets that they are squandering.

In 2016, **“adblocks”** experienced an unprecedented increase in use (+20%), which shows the desire of consumers to equip themselves with real “shields” intended to block practices which, from their point of view, impede their principles or their freedom. The feeling of intrusiveness is more and more strongly felt by citizens but paradoxically they understand that these practices are needed to provide the services

31 Source: <https://www.trendmicro.com/vinfo/us/security/news/internet-of-things/internet-of-things-connected-life-security/>.

they want. How can this paradox be addressed? Two potential solutions present themselves: the first is to **compensate for the psychological and social costs** of data gathering by offering useful or functional benefits; the second is to **pay for the data**.

On the first point, academic research has already looked into the question. It has attempted to identify ways of **reducing the feelings of intrusion** into the private lives of citizen-consumers. Their conclusion is that individual-consumers are willing to share their personal data, and to agree to them being used and processed in different ways if they are given an incentive. Obtaining certain benefits, and particularly utilitarian benefits or ease of use, legitimizes even the most personal use of data. Recent research<sup>32</sup> stresses that companies thus have two levers in this regard: on the one hand, they can offer more benefits to customers to “compensate” for the intrusion, such as an improved interface, greater fluidity, usability, and better personalization; on the other hand, they can better manage the problems of privacy through digital education both for the companies and for the users (ethical charters on the use of personal information, trust commitments, education, information and awareness-raising by citizen-consumers in a concern for transparency). On the second point, thinking is under way, reflecting this collaborative work, to come up with **a payment model for citizens** of their personal data.

**Future technologies will most probably be even more intrusive.** In 2017, specialists forecast increased use of artificial intelligence tools, virtual reality and “**chatbots**”, a kind of software-robot that can join in private conversations to chat with an individual and offer a personalized service (such as booking their train tickets for example, if they are talking about a future trip with a friend). An Oracle study<sup>33</sup> even reveals that more than three-quarters of brands will rely on “chatbots” to manage the customer experience by 2020! These prospects should remind us of the urgency of providing answers to the questions surrounding the value of citizens’ data. Given all the services which plan to generate profits by the mass exploitation of citizen-consumers data, it is high time we share

---

32 BELVAUX B., HERAULT S., “*Privacy paradox et adoption de technologies intrusives. Le cas de la géolocalisation mobile*”, *Décisions Marketing*, 74, 2014.

33 Oracle study, *Op. cit.*



out the wealth fairly and give back to citizen-consumers what belongs to them.

**Although it provides responses to deal with such commercial and societal challenges, a model where data is rewarded also raising new questions.** Rewarding citizen-consumers for their data could in fact result in opportunistic behaviors, where false digital identities (false Facebook profiles, multiple "faxe" email addresses, etc.) could be created, motivated by profit, for the sole purpose of receiving remuneration. This kind of "sabotage" behavior could then devalue the data by making their exploitation less efficient (because based on fake information). Given such a scenario, the model will probably regulate itself: the data provider is paid based on the effectiveness of the campaigns set up on the basis of their data; it will be adjusted according to the remuneration paid to the citizen-consumer who has transferred their data. The models take a while to settle down, but quickly regulate themselves, adjust and find a balance. After all, this system pursues a common interest: protecting the business models. Rewarding data in a fair way means preserving growth and laying down the basis of sound, ethical and therefore long-lasting relationships.

## **2.3 THE RESPECT OF INDIVIDUAL CHOICES, AN ETHICAL CHALLENGE**

Personal data are, as we have just seen, central to governmental and commercial challenges. Practical use of them ranges from the proliferation of military drones<sup>34</sup> to the increasingly accurate targeting of online advertising. For this purpose, Facebook, for example, has continuously increased the visibility of the data available in its default mode, as shown in the graph below.

Besides these aspects, an ethical question therefore arises. What is the place of privacy in the world of *Big Data*<sup>35</sup>? The American General Michael Hayden recalled in an interview that the U.S. State "kills on the basis of

---

<sup>34</sup> Science, *The End of Privacy*, 30 January 2015, p. 497.

<sup>35</sup> To better understand the debate from a philosophical point of view, reference may be made to:  
<https://plato.stanford.edu/entries/it-privacy/#ImpInfTecPri>.

## Default visibility settings in social media over time

■ Visible (default setting)    □ Not visible

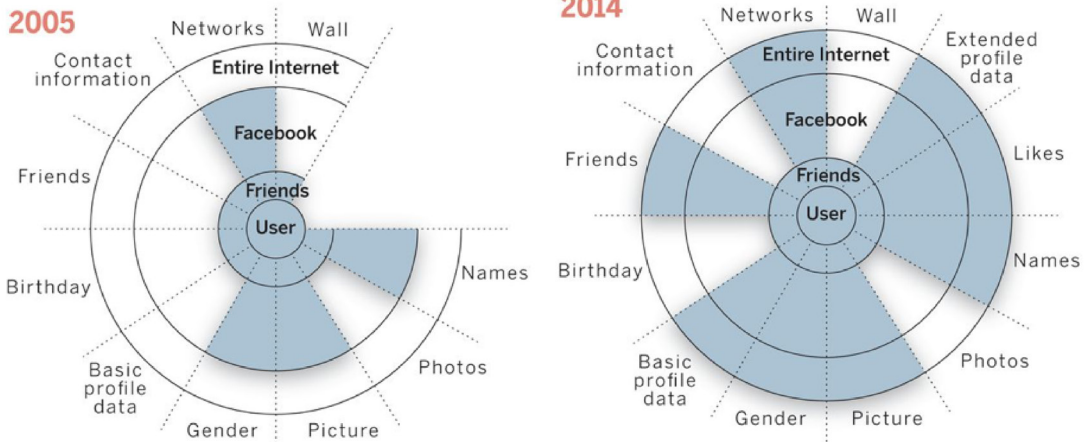

Source: Acquisti, Brandimarte, Loewenstein, "Privacy and human behaviour in the age of information", *Science*, vol. 347 (6221), 2015.

meta-data". For its part, the data collected by Google are used to deduce a certain number of things about your individual preferences<sup>36</sup>.

This volume of information is in no way comparable, especially as it is sold, with a simple social interaction within a group. It is true that each of us has a public identity on the web. But the scale of the "knowledge" of the GAFA about our behaviors and preferences is disproportionate. They are not a small group of individuals, that we are acquainted with, who know our address, last name, first name and a few additional details that they might want to tell their direct contact about.

### To what extent is private life a universal concept?

Must it be reduced under the pretext of the internal security of a country, or the free-of-charge service provided to a user?

36 Stephens-Davidowitz S., *Op. cit.*

## Beyond the utilitarian vision which would consist of measuring the pros and cons, can we still hope to be able to protect our privacy?

A strong argument is to say that we should simply not use the services of the giants of the Internet. Is that the only alternative when the Internet was born out of a promise to decentralize and disseminate information?

These ethical issues are important and are also the source of the thinking that has motivated this text to be written, drawing directly from the work of **Jaron Lanier**, an American activist and developer. We believe that another, more ethical model is possible, namely one that best respects choices and individual freedom.

### • Details of the approach used and definitions

**In this context, our proposal is to shift responsibility for the data from the platform or the company to its owner.** Rights ensue from this responsibility, allowing owners to better protect their personal data, or at the very least, tip the economic power back in favor of the consumer of the services, thus facilitating their protection.

**Our approach is essentially a legal one. The main question is to what extent can we associate personal data with an ownership right?** This question cannot be dissociated from three other aspects: i) being able to characterize personal data within our legal framework, ii) establishing the value of the data and a way to assess it, and finally, iii) how to transfer these data securely from one actor of the value chain to another.

**This seems particularly important since *Big Data* affects all business sectors:** industry, health, transport, the city, education, services, local authorities and even the State. An enormous issue is at stake that is not only economic but strategic as well: the mass storage of data and their operational use as a central part of the new economy.

In France *Big Data* could account for between 3.6 and 7% of GDP. The true problem, as emphasized by Ms. Antoinette Rouvroy, is not so much the *“inappropriate processing of personal data but rather the proliferation and very availability of digital data”*<sup>37</sup>.

The first challenge is to properly characterize these data, and therefore give them a sufficiently flexible definition to ensure that they can be included in an analytical framework which is able to cover all their characteristics.

- **What data should be considered ?**

We give a broad definition of data:

> **Primary data** are produced by citizens and include their **identity data** (last name, first name, date and place of birth, home, status) and their **sensitive data** (sexual orientation, health, religious affiliation, membership of political groups).

They can be defined as follows: any stored information, recorded on a digital medium, connected to a person and allowing this person to be identified, stemming from the person or from connected objects or humanoid over which the person has control (author’s definition). These data are at the heart of the data economy.

> **Generated data** are those which are collected by various entities (websites, internet access providers, platforms, e-commerce companies, institutions, associations, NGOs) for a lucrative purposes or not. They are collected by trackers, cookies, etc. using primary data include **consumption data** (buying habits) and **financial data** (payment means, status of loans and financing).

---

<sup>37</sup> ROUVROY A., *“Big Data : l’enjeu est moins la donnée personnelle que la disparition de la personne”*, Le Monde/The Conversation, 22 January 2016.

**Aggregated data** are those which are analyzed according to a precise objective and for Mega Data purposes, using generated data. Since a private citizen cannot perform this task, it is left to private companies and large, sometimes monopolistic groups. It is the speed and calculation capacity of multiple sources of data that create the richness of the result.

**The source is always primary data.** But it is the citizen who produces them. The citizen has become the primary free supplier of the 21<sup>st</sup> century's wealth.

• **Data and information: are there any differences nowadays?**

The laws, regulations and European directives since 1978 have frenetically included all information and have made a multi-shaped magma of it called data (Mega Data). These data in fact cover a range of information such as manufacturing secrets, business information, financial information, patents, trademarks, designs and models, images, writings, lyrics, personal information, family ties, beliefs, consumption habits, etc.

However, the law distinguishes different regimes for this information. What will characterize the data? Scientifically, a distinction is made between:

- qualitative data
- quantitative data
- categorical data
- countable data
- structured data
- unstructured data

Data are any information that is stored and read by a computer in a digital format, CSV for example. The computer language is not yet as complex as the human language. However, computers are superior in terms of storage capacity and calculation ability. Consequently, what makes economic sense is structured aggregate data.



```
Child(o.createElement("div"), r, s, t, u, v, w, x, y, z, aa, ab, ac, ad, ae, af, ag, ah, ai, aj, ak, al, am, an, ao, ap, aq, ar, as, at, au, av, aw, ax, ay, az, ba, bb, bc, bd, be, bf, bg, bh, bi, bj, bk, bl, bm, bn, bo, bp, bq, br, bs, bt, bu, bv, bw, bx, by, bz, ca, cb, cc, cd, ce, cf, cg, ch, ci, cj, ck, cl, cm, cn, co, cp, cq, cr, cs, ct, cu, cv, cw, cx, cy, cz, da, db, dc, dd, de, df, dg, dh, di, dj, dk, dl, dm, dn, do, dp, dq, dr, ds, dt, du, dv, dw, dx, dy, dz, ea, eb, ec, ed, ee, ef, eg, eh, ei, ej, ek, el, em, en, eo, ep, eq, er, es, et, eu, ev, ew, ex, ey, ez, fa, fb, fc, fd, fe, ff, fg, fh, fi, fj, fk, fl, fm, fn, fo, fp, fq, fr, fs, ft, fu, fv, fw, fx, fy, fz, ga, gb, gc, gd, ge, gf, gg, gh, gi, gj, gk, gl, gm, gn, go, gp, gq, gr, gs, gt, gu, gv, gw, gx, gy, gz, ha, hb, hc, hd, he, hf, hg, hh, hi, hj, hk, hl, hm, hn, ho, hp, hq, hr, hs, ht, hu, hv, hw, hx, hy, hz, ia, ib, ic, id, ie, if, ig, ih, ii, ij, ik, il, im, in, io, ip, iq, ir, is, it, iu, iv, iw, ix, iy, iz, ja, jb, jc, jd, je, jf, jg, jh, ji, jj, jk, jl, jm, jn, jo, jp, jq, jr, js, jt, ju, jv, jw, jx, jy, jz, ka, kb, kc, kd, ke, kf, kg, kh, ki, kj, kk, kl, km, kn, ko, kp, kq, kr, ks, kt, ku, kv, kw, kx, ky, kz, la, lb, lc, ld, le, lf, lg, lh, li, lj, lk, ll, lm, ln, lo, lp, lq, lr, ls, lt, lu, lv, lw, lx, ly, lz, ma, mb, mc, md, me, mf, mg, mh, mi, mj, mk, ml, mm, mn, mo, mp, mq, mr, ms, mt, mu, mv, mw, mx, my, mz, na, nb, nc, nd, ne, nf, ng, nh, ni, nj, nk, nl, nm, nn, no, np, nq, nr, ns, nt, nu, nv, nw, nx, ny, nz, oa, ob, oc, od, oe, of, og, oh, oi, oj, ok, ol, om, on, oo, op, oq, or, os, ot, ou, ov, ow, ox, oy, oz, pa, pb, pc, pd, pe, pf, pg, ph, pi, pj, pk, pl, pm, pn, po, pp, pq, pr, ps, pt, pu, pv, pw, px, py, pz, qa, qb, qc, qd, qe, qf, qg, qh, qi, qj, qk, ql, qm, qn, qo, qp, qq, qr, qs, qt, qu, qv, qw, qx, qy, qz, ra, rb, rc, rd, re, rf, rg, rh, ri, rj, rk, rl, rm, rn, ro, rp, rq, rr, rs, rt, ru, rv, rw, rx, ry, rz, sa, sb, sc, sd, se, sf, sg, sh, si, sj, sk, sl, sm, sn, so, sp, sq, sr, ss, st, su, sv, sw, sx, sy, sz, ta, tb, tc, td, te, tf, tg, th, ti, tj, tk, tl, tm, tn, to, tp, tq, tr, ts, tt, tu, tv, tw, tx, ty, tz, ua, ub, uc, ud, ue, uf, ug, uh, ui, uj, uk, ul, um, un, uo, up, uq, ur, us, ut, uu, uv, uw, ux, uy, uz, va, vb, vc, vd, ve, vf, vg, vh, vi, vj, vk, vl, vm, vn, vo, vp, vq, vr, vs, vt, vu, vv, vw, vx, vy, vz, wa, wb, wc, wd, we, wf, wg, wh, wi, wj, wk, wl, wm, wn, wo, wp, wq, wr, ws, wt, wu, wv, ww, wx, wy, wz, xa, xb, xc, xd, xe, xf, xg, xh, xi, xj, xk, xl, xm, xn, xo, xp, xq, xr, xs, xt, xu, xv, xw, xx, xy, xz, ya, yb, yc, yd, ye, yf, yg, yh, yi, yj, yk, yl, ym, yn, yo, yp, yq, yr, ys, yt, yu, yv, yw, yx, yy, yz, za, zb, zc, zd, ze, zf, zg, zh, zi, zj, zk, zl, zm, zn, zo, zp, zq, zr, zs, zt, zu, zv, zw, zx, zy, zz
```

---

PART 2

# Creating ownership of data under existing law

**O**wnership and regulation should not be set against each other<sup>1</sup>. The law provides a legal framework that will legitimize a real market of personal data. This framework will ensure the good faith in the transaction. We review here the legal framework in which this new market will operate and ensure the protection of the consumer.

Our line of argument aligns itself with the GDPR, since Article 17 of it guarantees data portability.

## 1. Another look at a complex, evolving legal framework

By **NICOLAS BINCTIN**

It has now been over thirty years since the legal status of information, or data according to the current terminology - although the two concepts are similar - and their inclusion in the ordinary system or a special system of property law have been discussed. The founding article by Catala<sup>2</sup> which emerged after several initial drafts<sup>3</sup> has since

---

1 ACQUISTI A., TAYLOR C., and WAGMAN L., "The Economics of Privacy", *Journal of Economic Literature*, 54(2), 442-492, 2016.

2 CATALA P. "Ébauche d'une théorie juridique de l'information", *Rev. de droit prospectif* 1983, No. 1, p. 185; *D.* 1984, chron p. 975; *Le droit à l'épreuve du numérique*, Puf 1998, p. 224 (only this last version is used for the following points); same author, "La propriété de l'information", *Mélanges Raynaud*, Dalloz-Sirey 1985, p. 97.

3 In particular, LECLERCQ P., "Essai sur le statut juridique des informations", Ministry of Justice, 1980; *L'information sans frontière*, (1980), la Doc. Française, Paris ; CHAMOIX J.-P., *Impacts économiques et juridiques de l'informatisation*, Paradoxes 1982, p. 116.



been the source of intense doctrinal debate<sup>4</sup>. It no longer appears necessary to re-examine and discuss these various contributions<sup>5</sup>. Noting the elusive nature of this concept, as well as its central role in the information society, we can simply concur with Catala and remember that *“information is first an expression, a formulation designed to make a message communicable (and) is then communicated, or may be”, a “message of some kind”, “intelligible” and “communicable”*<sup>6</sup>. The information recorded and communicated takes the form of a thing<sup>7</sup> which is legally interesting through its ability to circulate and to be utilized in a variety of ways<sup>8</sup>. The underlying heterogeneity has no bearing on the analysis that this information may undergo, whether this is sports or stock market results, consumer behavioral data, or of all human populations or otherwise, studied scientifically, medically or sociologically, such the data collected through consumers’ loyalty cards.

**Data, organized, in particular from the angle of their source or as part of mass processing within a *Big Data* logic, are given meaning to the receiving party and are of interest,** in the broadest possible sense, echoing the concept of interest developed by the European Court

---

4 HILTY R., “La privatisation de l’information par la propriété intellectuelle : problèmes et perspectives. Introduction”, *Revue Internationale de droit économique*, 2006/4, p. 353; VIVANT M., “La privatisation de l’information par la propriété intellectuelle”, *Revue Internationale de droit économique*, 2006/4, p. 361; same author, “À propos des biens informationnels”, *JCP ed. G* 1984, I, No.3132; LUCAS DE LEYSSAC C., “Une information seule est-elle susceptible de vol ou d’une autre atteinte juridique aux biens?”, *D.* 1985, p. 43; DEVÈZE J., “Le vol de “biens informatiques”, *JCP G* 1985, I, 3210; A. Piédelièvre “Le matériel et l’immatériel. Essai d’une approche de la notion de bien”, *Les aspects du droit privé en fin du XX<sup>e</sup> siècle, Mélanges Michel de Juglart, Montchrestien* 1986, p. 55; GEIGER C., “La privatisation de l’information par la propriété intellectuelle. Quels remèdes pour la propriété littéraire et artistique”, *Revue Internationale de droit économique*, 2006/4, p. 389; LECLERCQ P., “L’information est-elle un bien?”, *Droit et informatique. L’hermine et la puce*, Masson, 1992 p 91; GALLOUX J.-C., “Ébauche d’une définition juridique de l’information”, *D.*, 1994, chr., p. 229; MALLET-PUJOL N., “Appropriation de l’information : l’éternelle chimère”, *D.* 1997, *Chron.* 330 ; E. Daragon, “*Etude sur le statut de l’information*”, *D.* 1998, *chron.* p. 63; J. Passa, “La propriété de l’information : un malentendu?”, *Droit & Patrimoine*, March 2001, p. 64.

5 See VIVANT M., “La privatisation de l’information par la propriété intellectuelle”, *op. cit.*

6 CATALA P., “Ébauche d’une théorie juridique de l’information”, *op. cit.*

7 GALLOUX J.-C., “Ébauche d’une définition juridique.”, *op. cit.*; contra, W. Dross, *Droit civil – Les choses*, LGDJ 2012, No. 483-1.

8 PASSA J., “La propriété de l’information”, *op. cit.*, l’information comme “*action* consistant à communiquer à un public des faits ou des opinions”.

of Human Rights for analyzing the right to property laid down in the 1<sup>st</sup> additional protocol. Finally, the full force of the criminal law, utilizes it<sup>9</sup>.

The legal approach to data is all the trickier since the interest of this thing, viewed from the perspective of value theory applied to the appropriated thing, is evolving. Knowing that an anonymous person likes to eat chocolate is a data item that is of no interest. However, knowing that, in a given population, X people like to eat chocolate is useful information.

**Data agglomeration creates new data – or information – which is of significant interest, but we see no accompanying change in its legal characterization.** The legal hold over this thing, discounting the special regimes applicable to property rights, including intellectual property, is tricky to implement, even if we follow in this regard, Catala's analysis and apply ordinary property law, both civil and criminal.

**Thus, data appropriation mainly comes about through their processing,** which begins when they are collected and enhanced, particularly through their sorting within databases and through algorithmic analyses. The “collection-formulation”<sup>10</sup> concept remains relevant. It has even been clearly laid down through the emergence of the neighboring right of the database producer in the 1995 directive<sup>11</sup>. Freely accessible data are *res communis*, open to being viewed by everyone, but not all data are of this nature, specifically those collected from individuals.

The legal status of data means that they can no longer be regarded simply as facts, but they must now be treated within a legal framework. Whether or not they can be appropriated as such, data can be controlled by the party that collects them. Although their collection is free and open, the use of the information collected is, however, subject, in whole or in part, to what the collector wishes. The status of the data stays the

---

9 See in particular, Cass. crim., 16 Nov. 2011, No. 10-87.866, to be published, D. 2012. 137, obs. M. Léna; *AJ pénal* 2012. 163, obs. J. Lasserre Capdeville; RSC 2012. 169, obs. J. Francillon; *RTD com.* 2012. 203, obs. B. Bouloc; *JCP G* 2012. II. 322; see also, P. Berlioz, “Quelle protection pour les informations économiques secrètes de l'entreprise ?”, *RTD com.* 2012.263.

10 CATALA P., Ébauche d'une théorie juridique de l'information, *op. cit.*, in particular p. 234.

11 Directive 96/9/EC of 11 March 1996 regarding the legal protection of databases, *OJEU No. L 077, 27 March 1996 p. 20.*

same and it is the treatment stage of them which changes. The same data, at different stages, can legally be dealt with differently, possibly to the disadvantage of their initial source: for example, when access to data is not public and free but is attached to a person. Thus, we can distinguish data flows, taken as a whole (such as road traffic, water or electricity consumption, the frequency of means of public transport), from personal data, directly connected to the activity of a given person.

**In this second category, collection of the data assumes access to the person and their agreement for collection of the data.** The collection is thus made on a contractual basis. It must also be carried out in compliance with the protection of people, and in particular the regulation on the protection of individuals with regard to the processing of personal data and the free movement of these data<sup>12</sup>.

**After having considered the nature of data (i), we will come back to their appropriation (ii) and the influence of the power of the collector on their status (iii).**

## **1.1 THE LEGAL STATUS OF DATA**

The legal framework governing data can be used to attribute a status to them depending on the nature of the data in question. Two broad categories of data emerge to determine their regime according to their nature. Firstly, data whose importance will vary over time, i.e. the long-lasting or short-lived aspect of the data (A); and secondly, the sensitive nature of the data (B), mainly with regard to the situation of the person.

These two categories of data mean we can identify important elements of the regime, both regarding the conditions for collection and the conditions for communication of these data.

---

<sup>12</sup> Regulation (EU) 2016/679 of the European Parliament and of the Council of 27 April 2016 on the protection of natural persons with regard to the processing of personal data and on the free movement of such data, and repealing Directive 95/46/EC (General Data Protection Regulation).

## A / Short-lived or long-lasting data

P. Catala had discussed it widely, and every day the 21<sup>st</sup> century confirms the truth that the issue of data appropriation is the corollary of the economic importance that these data represent. The value of the data leads to a questioning of their commodification. Not all data have the same characteristics or undergo the same change in their value over time and this influences their legal statuses. With regard to the temporal consideration of data, certain data only have an economic interest at the time they are issued and potentially collected and disseminated, whereas others may have a much more long-lasting interest, even if the idea of perpetuity of the interest is largely absent.

**Short-lived data are characterized by an instantaneous aspect and by a necessary control of their disclosure.** Collection is controlled, and disclosure curbed, mainly through the use of systems of responsibility, but also through the emergence of quasi-appropriation. Two sectors illustrate this first category: the betting and gambling sector and that of information about the financial markets. In both cases, the data are not appropriated as such, but laws regulate the conditions of their collection and dissemination.

**There is currently a movement towards commodifying data in order to ensure control over them.** Data have no characteristics allowing them to be appropriated as such but major economic issues are attached to them. The tools of ownership are used to establish a legal framework. Data on bets have only a short-lived interest, until the outcome of the bet is known and so therefore, it is only during this time that the law oversees the taking of bets and the dissemination of data about the result.

**When the data have no instantaneous pecuniary interest (and a high risk of fraud), collection of the data is free, as well as their dissemination, subject to people's rights.**

These data are more long-lasting, and their interest is not dependent on the fate of an instantaneous aspect. Dissemination of these data will be free and open in equal measure. This is the ideal ground for setting up databases whose value is based not on the scarcity of the data but on

their collection, accumulation and their analysis. The greater the volume of the data, the more the result of their processing is useful, where value is not derived from a single data item but from an analytical overview of the data. The data economy, in particular that of search engines and social media is situated in this area. This data category includes collected personal and sometimes anonymized data which allow behavioral profiles to be created. This is information obtained through loyalty cards or collected through *cookies* on computers or telephones.

**These profiles result from the analysis of a host of data, often anonymous, with no individual value in most cases.** Their interest lies in finding out the behavior of a social profile which market operators then exploit to tailor their offerings and their communications in line with these categories. No specific outcome influences the value of these data, unlike sports betting or stock market information. The reform of<sup>13</sup> *Google* or *Facebook's* privacy policies appears to go in this direction, offering this company an increased profiling capacity. The information society and its ecosystem mean that people are increasingly aware of the economic importance that these data, which on the face of it are banal, may represent. Social media are on the front line of this mechanism of collecting anonymous information, through use in strata of data voluntarily provided by members of the media.

## **B / Sensitive data**

**The specific status of sensitive data<sup>14</sup> – in the sense that they refer to the intimacy of a natural person – is no longer a revolution.** The 1995 Directive organized a broad protection and cooperation mechanism within the European Union, before being replaced by Regulation 2016/679. However, since 1995, the technical capacity to collect sensitive data has increased and new categories of sensitive information have emerged, such as tracking by GPS or the geolocation of mobile phones.

---

<sup>13</sup> <http://www.google.fr/intl/fr/policies/privacy/>

<sup>14</sup> Other sensitive information, not directly referring to a particular person can be added, in particular information collected during clinical trials to obtain marketing authorisation, which are collected according to the mechanism of Article R 5121-26 of the Public Health Code.

**In this case, the data regime is guided, not by its short-lived or long-lasting aspect, but by the actual content of the data.** The outcome of an operation does not change the characterization of the data unlike for the first category mentioned. It can be seen in fact, with the question of the right to be forgotten on the Internet, that the temporal approach to these sensitive data is a new sticking point.

**These personal data are of significant economic sensitivity and economic models are emerging for their use.** The case of online social media is significant. Facebook has had to change its practice in the United States and it is likely that it will have to do likewise in Europe. Personal data circulate on social media shrouded in uncertainty: firstly, with regard to the perception of the consequence of the action of the person who puts them online; and secondly, with regard to the ability of the operator who offers this service to derive a source of income from these personal data. The economic model of most social media and search engines relies, for an important part, on the provision of a free service in return for the collection of the user's data for commercial use.

**It is not a free use of services but an exchange of value:** searches and media in return for personal data. The economic sensitivity of personal data should mark a change in their legal regime. The 1978 model established by the Data Protection Act, adapted to rapid and transnational circulation in 1995, primarily targeted the control of private data by the States, to combat the excesses of public authorities. The second or even third change to this legal framework must allow control of the commercial exploitation of personal data by online non-state operators. The nature of the data remains the same as it was over thirty years ago, but the risks associated with using them is of a completely different nature.

**From a mistrust of the hegemony and arbitrariness of the State, we must now deal with a mistrust of the online economic operators.**

This economic sensitivity of personal data does not eliminate the risk to freedom. A judgment of the ECHR of July 2012<sup>15</sup> reminded us of this context. The Court clarified the nature of personal data that can be collected during a search ordered by an investigating judge in the

---

15 CECHR, 3 July 2012, *Robathin v. Austria*, application No. 30457/06.

premises of a law firm. On the basis of Article 8<sup>16</sup> of the European Convention of Human Rights, the seizure of data must not violate the principle of the seizure being proportional to the purpose of the investigations.

## 1.2 APPROPRIATION OF PERSONAL DATA UNDER ORDINARY PROPERTY LAW

The value of personal data not only presupposes having means of reservation and appropriation, but also means of defense. Therefore, beside the protection of personal data by the GDPR, which uses a mainly static logic, it is necessary to review the solutions provided by property law, and possibly related subjects, to apply them to personal data within a dynamic, ownership approach.

We will consider personal data as an object of property (A) and then the consequences on their utilization and defense (B).

### A / Personal data, an object of property

**Data appropriation under the ordinary law of property requires consideration of the concept of “personal data” before invoking the mechanisms of ordinary property law which allow this appropriation.** It is the possession conferred by secrecy or keeping them within the privacy of the person – the control of the data by their initial issuer – which allows one to deduce that an ownership right exists. For the appropriation of property, the relation between ordinary law and special law imposes an appropriate method resulting from the traditional adage, *specialia generalibus derogant* (the specific derogates from the general<sup>17</sup>).

---

16 Article 8: 1. Everyone has the right to respect for his private and family life, his home and his correspondence. 2. 11 There shall be no interference by a public authority with the exercise of this right except such as is in accordance with the law and is necessary in a democratic society in the interests of national security, public safety or the economic well-being of the country, for the prevention of disorder or crime, for the protection of health or morals, or for the protection of the rights and freedoms of others.

17 See in particular CARBONNIER, *Droit civil – Introduction*, 27<sup>th</sup> ed. Puf 2002, No. 107, p. 208; CORNU, *Droit civil – Introduction au droit*, 13<sup>th</sup> ed. Montchrestien 2007, No. 329.

**Firstly, it is necessary to check whether the thing can be appropriated by special law.** If this solution is possible, it rules out the application of ordinary property law unless the special law offers an option to the owner of the thing. Indeed, appropriation made possible by special law applies, but special law may give the owner of the intellectual property the option to fall back on the ordinary property law.

**A distinction needs to be made between the possessor who abandons their claim to ownership and a person who seeks to obtain appropriation through the ordinary law.** In the first case, the thing will not be appropriated but can be freely used by any interested party: it is a *res communes*. For example, for an invention, the special patent law regime allows appropriation of the intellectual property if substantive criteria are met. However, even if these criteria are met, the inventor does not have to use patent law to appropriate their property. Depending on the option available to them, they can also do so using another avenue: that of secrecy. The invention will then be appropriated under ordinary property law, subject to them retaining the possession of it offered by secrecy. Lastly, they can simply disclose their invention before making any patent application and it will become a *res communes*. Conversely, copyright does not offer such an option: if the intellectual property meets the substantive criterion imposed by this ownership regime, it is necessarily appropriated through this means. Exclusion from it is very uncertain.

**Where special law does not allow appropriation or if an option is available, and a desire for appropriation exists, use of the ordinary property law is possible for the appropriation of intellectual property and, more generally, for data, including personal data.**

Possession must then be exercised over the personal data, an intangible thing, effectively enabling ownership to be exercised.

**A personal data item can only be possessed if the person who claims to be the possessor holds these two elements: the *corpus* and the *animus*.** The *corpus* of possession consists in material acts carried out by the possessor on the thing<sup>18</sup>. These material acts are, according specifically to, within the meaning of Article 2228 of the Civil Code, acts

---

<sup>18</sup> In this sense, CARBONNIER, *Droit civil - Les biens*, 19th ed. PUF 2000, No. 119 p. 203.



of holding – the thing must be subject to the power and control of the possessor – and acts of possession – i.e. the economic use of the thing. Secrecy like control enable the thing to be held like possession. These two types of acts can be carried out on a data item, which proves the existence of its *corpus*.

**Factual power lies in the capacity to maintain it under the seal of secrecy or to control access to it.** The *animus* is independent of the possessed object. This element must be assumed to be the case because it relates only to the behavior of the possessor and there can be no possessory relationship without will<sup>19</sup>. For personal data, the desire to keep them does not require a discussion, so the *animus* is therefore assumed to be established. *“As regards moveable property, it is through possession that the owner materially asserts his sovereignty to the thing by precluding others from taking hold of it”*<sup>20</sup>.

Thus, if personal data do not result in appropriation under special property law and they are subject to possession, then the possessor is able to retain appropriation of the property under the ordinary law, provided they maintain the possessory elements in force. The data are then treated as property appropriated under ordinary law.

**Therefore, and this is the last step in allowing the application of the ordinary property law to apply to an intangible thing, possession is ownership. This allows us to assert that the possession of data thanks to secrecy or control, gives the possessor ownership of these data, in accordance with ordinary property law**<sup>21</sup>.

Secrecy, control or intimacy allows possessory hold over intangible property, including data, voluntarily controlled by a person. This possession means that the acquisitive mechanism of Article 2276 of the Civil Code applies and hence the conclusion that personal data are appropriated under ordinary property law.

19 In this sense, JHERING, *Études complémentaires de l'esprit du droit romain – Du rôle de la volonté dans la possession*, tome III, 2nd ed. A. Marescq senior, Paris 1891, p. 17 et sq.

20 ZENATI-CASTAING F. and REVET Th., *Les biens*, *op. cit.*, No. 194

21 Application of the mechanism of Article 2276 of the Civil Code to intangible property is the source of a doctrinal debate, but must be allowed. We follow the proposals of William Dross in this area. Since possession is only the factual exercise of a right, it can be applied to intangible property. See DROSS W., *Droit des biens*, 2<sup>nd</sup> ed. LGDJ 2014, No. 473.

## B / Exercising ordinary law ownership over personal data

**Ownership is characterised by its exclusive mechanism. Personal data meet the criteria of this central phenomenon of ordinary law ownership, since possession allowed by secrecy or control is “a form of expression of the will of the owner to exclude”<sup>22</sup>.**

The exclusivity of ownership ensures that its owner can enjoy their property and prevent others from doing so<sup>23</sup>. Exclusivity does not mean that the owner is the only person to have the property in question. Through their behavior, the owner intends to reserve the use of the thing. This exclusivity is protected by the means of defense which the owner has against infringements of their property. Exclusive power can be used to withdraw all the benefits of the property. *“It is because he enjoys the sovereign power to prohibit his thing from others that the beneficiary benefits from all the uses that it may provide, and not by virtue of special prerogatives which are inherent in property law”<sup>24</sup>.*

**Exclusivity is defended under property law in particular by the ability to claim property from a third party.** For personal data, case-law has accepted, on several occasions, the application of a claim for restitution of moveable property against a third party having unlawfully appropriated another person’s property<sup>25</sup>. One must allow, by analogy, the same solutions for personal data. The noting of an ordinary law ownership right results in implications for using and defending the property.

---

22 ZENATI-CASTAING F. and REVET Th., *op. cit.*, No. 194.

23 DANOS V. F., *Propriété, possession et opposabilité*, Economica 2007.

24 ZENATI-CASTAING and Th. REVET, *op. cit.*, No. 208.

25 See CA Versailles, 19 May 2006, No. 04/08720, *“the misappropriation of an invention that constitutes one of the cases of the initiation of [claim] proceedings may be successful, with regard to an intangible property claim, even without dispossession of the property, due to an infringement of the enjoyment of the thing over which possession of the property is exercised”.*

- Usage

**Having concluded that ordinary property law applies to personal data, all the conclusions of this must be drawn about the legal situation.** All legal provisions apply *mutatis mutandis* with respect to the specificities of this property, in particular the co-ownership regime<sup>26</sup>. Only ordinary law will govern the situation of this property unless the co-owners have intentionally opted for an application of special law to their property. Joint ownership of know-how and secret data is therefore not governed by the patent joint ownership system but by that of ordinary law.

Ordinary law ownership, unlike special ownership for intellectual property, lasts for as long as the possession subsists. It may even be forever, but at the very least, it is effective for as long as the secrecy or the control is maintained.

**Following the logic of ordinary property law, personal data may be sold, rented or leased like any property for which the owner has a *usus*, a *fructus* and an *abusus*.** The courts have also applied other mechanisms of ordinary property law to data whose ownership is appropriated by secrecy, such as claims for the restitution of moveable property<sup>27</sup>. The Court of Appeal of Paris also rightly imposes the application of legal guarantees for peaceful possession when personal data is transferred<sup>28</sup>, confirming that the contract includes the transfer of an ownership right, ownership under ordinary and not special law.

In France, the Data Protection Commission (CNIL) is the independent administrative authority responsible for regulating personal data. Currently the competences of the CNIL for the protection of personal data are broad and its power of sanction wide-ranging; the maximum amount of the sanctions it can impose have been increased from 150,000 to 3 million euros. These acts are acts disposing of property belonging to a person who is entitled to exercise prerogatives and imposing choices on the use or circulation of their data.

---

<sup>26</sup> Cass. com., 7 Dec. 2010, No. 10-30034.

<sup>27</sup> CA Versailles, 19 May 2006, Rep. 04/08720, *op. cit.*

<sup>28</sup> CA Paris, 11 April 2013, No. 12/21643, see *contra*, J. Passa, *RDC* Dec. 2014, p. 739.

- **Defense**

**Defense is a central aspect of appropriated data.** The Business Secrecy directive moves in this direction: the bulk of its provisions relate to lawsuits and sanctions, to make sanctions for the infringement of secrecy effective and therefore allow the control of appropriated data. One could also add the solutions of Regulation 2016/679.

**Special law has several provisions that can be used to envisage penalizing the infringement of control over data.**

**Still in relation to special law, data are protected depending on where they are stored.** if data are included in a database, the law governing the database producer applies to preserve this data. Substantial qualitative or quantitative extraction opens the way to mobilizing the legal arsenal attached to this property regime and obtaining both interlocutory measures and civil or criminal sanctions. Proceedings similar to an action for infringement are available. In the same spirit, if access to a data item results from the violation of an information system, it is possible to act against the perpetrator of this wrongdoing under criminal law<sup>29</sup>. It is no longer the data as such which are at issue but the way in which they have been obtained. Accessing or staying, fraudulently, in all or part of an automated data processing system is punishable by up to two years' imprisonment and a 30,000-euro fine. Thus, criminal law can be applied to data and strengthens the image of a regime for their appropriation through the tools of defense that it provides.

**Even more than these special measures, application of the ordinary criminal law is adopted for infringement of property subject to ordinary law.** Indeed, although infringement of a data item does not mean that the owner loses possession of it, which precludes them initiating proceedings for theft, the owner of a data item can bring proceedings for breach of trust, an accusation relating to property infringements.

---

<sup>29</sup> Art 323-1 CP.

## 1.3 THE POWER OF COLLECTING INFORMATION

**The third series of elements that influence the data regime relates to the nature and power of the person who collects the data.** Case-law specifically shows that important consideration is given to these elements in assessing the power to collect/disseminate information, in particular on the ability to benefit from data collected by a third party. In the first place, we can cite the case-law relating to essential infrastructure. In the case of *IMS Health*<sup>30</sup>, although the database was covered by copyright (and today it could also be covered by the right of the database producer), the data collected and used did appear, in themselves, eligible for this appropriation. The solution adopted by the Court of Justice is not very far removed from this classification, which has led several authors to identify a specific category of property or work, informational property, or a data item.

**The power of collection is a key element of the legal regime of data.**

In principle, data that are not secret or not controlled may be collected freely by anyone, provided it is possible to have free access to them. Collection which infringes a person's privacy, control that they wish to have over their data, or a secret is wrongful and should be sanctioned. However, some people have a power of collection that enable them to impose communication of data, in general through the exercise of the prerogatives of public power or thanks to de facto monopolies.

**The status of collected data can be influenced by the power or the legal nature of the collector (A).** This movement has a voluntary correcting system; without calling into question the power of collection and its privilege, the data will then be circulated widely, even freely, which will allow their reuse by third parties, which will also have an influence on the economic analysis of the data in question (B).

---

<sup>30</sup> ECJ, 29 Apr. 2004, C-418/01, *Rec. I-5039*.

## A / The influence of the legal prerogative justifying the collection

### **The status of the data is influenced by the power of the collector.**

It entails determining whether the status of the data is different according to whether it is a free collection or the result of the use of the prerogatives of public power. In the latter case, what would be the impact on the status of the data? Consideration is not given to the legal framework allowing or controlling the collection, in accordance with the procedures introduced since 1978, but the status of the data thus collected.

**Thus, the activity of a public authority consisting of:** storing, in a database, data that companies are required to communicate due to their legal obligations; allowing interested persons to view these data; and/or to provide them with copies on a paper medium of them; **is not an economic activity.** This public authority must not, therefore, be considered, for this activity, as an undertaking, within the meaning of Article 102 TFEU.

The fact that this viewing and/or this supply of copies are made in return for remuneration laid down by the law and not determined, directly or indirectly, by the entity concerned is not such as to change the legal characterization of the said activity. To the extent that such a public authority prohibits any other use of the data collected and made available to the public, by availing itself of the *sui generis* protection which is granted to it as a producer of the database in question under Article 7 of Directive 96/9, or any other intellectual property right, neither does it exercise an economic activity and therefore should not be considered, with regard to this activity, as an undertaking, within the meaning of Article 102 TFEU.

**The power, arising from the collection and the corresponding capacity to become a database producer and exercise a right over the extraction and reuse of these data, does not constitute a change in the analysis of the ECJ.** The Court puts an end by this decision to the ambition of the company *Compass-Datenbank* to obtain from the Austrian State a massive transfer of recent data collected via the commercial register in return for reasonable remuneration, accompanied by the right to reuse these raw data to enable it to offer

a service developed because of data already accessible to everyone through intermediate agencies. Since the ECJ concluded that the Austrian State was not acting as an undertaking in the market, it did not have to respond to the final preliminary question submitted to it, namely the application of the essential facilities doctrine to the case. The question however was relevant, since the facts at issue appear to be very close to those observed in the *IMS* case.

**Thus, the prohibition on the reuse of data contained in the commercial register falls within the exercise of the prerogatives of public powers and,** and cannot be separated from the other activities of public powers of the State in question. A public authority may legitimately consider that it is necessary, even obligatory given the provisions of its national law, to prohibit the reuse of data contained in a database such as that in question, in order that the interest that companies and other subjects of law, who make declarations imposed by the law have in ensuring that information will not be reused outside of this database is respected. The Court appears to refer to the necessary protection, if not of trade secrets, at least of the data specific to the businesses, against systematic and organized disclosure.

**In these different cases, the legal characterization of the data does not change. They are not appropriated as such, but the power of the collector, or the cause of collection<sup>31</sup>, influences their re-utilisation regime.**

---

<sup>31</sup> See *supra* the status of information included in marketing authorisations.

## B / Correcting mechanisms

Correcting mechanisms find their source in the *Open Data* movement. This includes many countries and organizations, including Saudi Arabia, Australia, Austria, Belgium, Canada, South Korea, the United States, the European Union, Hong Kong, Kenya, Mexico, Morocco, the Netherlands, the United Kingdom, Singapore and Tunisia.

In general, the objective of the public authorities is to ensure that **the creativity of developers and entrepreneurs does not come up against legal barriers perceived as obstacles to the development of innovation**. The collective interest prevails over the control by the State of the data that it collects. The State retains the principle of use of a free license applicable to public data put online on the public portal, without totally excluding the possibility of paid licenses. The words used are essential here. With regard to a license, the State affirms that we are considering a right of enjoyment that may, legally, be granted only to property. Assigning ownership of the data thus appears to be required.

The reuse of data disseminated under this license requires the producer, *i.e.* the entity that produces the data and opens it up to reuse in accordance with the freedoms and the conditions laid down by the license, guarantees to the re-user a personal, non-exclusive and free of charge right, of reuse worldwide and for an unlimited duration, according to the freedoms and the terms and conditions of the contract. It is thus possible to reproduce, copy, publish and transmit the data, disseminate and redistribute, adapt, modify, extract and transform them, in particular to create derived data. It is also possible to use the data commercially, for example by combining them with other data, or by including them in a product or an application.

**These huge possibilities are conditional on stating the source of the data** (at the very least, the name of the "Producer") and the date of their last update. The regime here is constructed analogously with copyright and can only strengthen the idea of an ownership approach to data.



## 2. The GDPR, a step in the right direction?

By ISABELLE LANDREAU

Adopted by the European Union on 27 April 2016, the **General Regulation** 2016/679 on the protection of personal data (GDPR) will enter into force on 25 May 2018 and will repeal Directive 95/46/EC on the protection of personal data, in force for the past twenty years. It will also replace the French Data Protection Act.

**It is with the twofold objective of reaffirming the fundamental principle of the free movement of data** – it had become difficult for businesses to determine which national law to apply to their processing of personal data – and **to provide a uniform level of protection within the Union** (while avoiding ethical *dumping*, since the level of protection varied depending on the Member State) that the Parliament and the European Commission adopted the GDPR.

From a declarative system, in France based on the famous “CNIL declarations” that businesses must submit prior to any file processing, **the GDPR pushes personal data rights into the era of compliance** by requiring organizations, both private and public, to be able to demonstrate at any time both to the regulator and to the people whose data they process that their practices, their processing and their systems comply with a certain number of guiding principles.

**Therefore, to each *right* conferred on natural persons there is, facing it, an *obligation* for the organization.** This paradigm shift is accompanied by a new, far-reaching obligation, since the GDPR requires the establishment of a “*strengthened*” level of security which is “*appropriate to the risk*” which falls within the protection of privacy and which considers not only the nature, scope, context and purpose of the processing of personal data, but also the risks for the rights and freedoms of persons, the implementation costs and the state of

knowledge (Article 32). It therefore means for the organizations that they have **an obligation to specifically secure personal data** according to the risks involved, not only by the organization, but by the person themselves.

**Our project in favor of the ownership of personal data is in line with the provisions of the Act for a Digital Republic and those of the new General Data Protection Regulation (GDPR)** in that it consecrates, at least implicitly, the *usus* and henceforth the *abusus* of personal data, in particular in Articles 26 of the Act and sections 1, 17 and 20 of the Regulation.

**Our project in favor of ownership of personal data goes further because it organizes a real *fructus* mechanism of personal data.** It sets out that a citizen who has freely and explicitly consented (Article 7 of the GDPR) to the utilization of their personal data, must be able to obtain the fruit of them (income) that others make on their back...

Articles 17 and 20 of the GDPR consecrate the fact that personal data are intangible property since the cyber citizen can request to have their data erased (Article 17) and to receive and transmit their data (Article 20: data portability).

### **The first principle: the free movement of data within the Union.**

The circulation of data is neither restricted nor prohibited. In accordance with the founding principle when the Common Market was created, the data becomes a good through its free movement (Article 1). This Regulation applies to any establishment located within the Union. Therefore, French subsidiaries of large American groups are subject to the GDPR (Article 3). It applies to natural persons. It is regrettable that this Regulation does not consider the connected object of the natural person because the connected object is linked to the use of a citizen and will generate personal data. They must be the property of the citizen user, "*the cyber citizen*"<sup>32</sup>, the new man in the digital city (Article 4.1).

**Consent must be the linchpin of the categorial utilization of the digital citizen's data.** In its Article 7, it sets out that the responsibility for consent lies with the controller. Currently, **this consent is given by**

---

<sup>32</sup> Ibid. 11.

**default.** Personal data are siphoned off by the game of acceptance of the General Terms and Conditions of Sale that the digital citizen does not read. It must therefore be a positive act (written declaration Article 7.2). However, any inclination to influence the utilization of your data is wiped out because if you do not agree, the processing remains lawful even if you subsequently withdraw your consent (Article 7.3). It also seems possible to attack when a significant imbalance arises (Article 7.4).

**Article 17 is interesting because it established a right to erasure also called a “right to be forgotten”** which the Court of Justice of the European Union had begun to recognize. The digital citizen may request an end to the dissemination of their data when these data are no longer necessary for the purpose for which they were collected or processed, or because the digital citizen withdraws their consent because the purpose has changed (cf. Article 6-1 a). The withdrawal reason refers to the specific purposes of the data. The system of consent by categorical utilization presented here fits into the scheme of Article 17 1 a) combined with Article 6-1 a). They can also simply oppose this use. In this case, the controller must erase the data without delay. There are also cases of restriction of the use of the data.

**Article 20 provides for data portability:** receiving and transmitting personal data to another system (an operator in practice) and the controller may not oppose it. Concretely what the arrangements for the transmission and the technical standards are remain to be defined. Data portability is not, in practice, very effective today. Issues of interoperability of data and processing arise. What about the processing performed by an internet access provider that is useful for my administrative and tax declarations ? Would this information still be accessible if I switch provider ? There is technical locking by the operator.

**Therefore, portability confirms the *abusus* by the cyber-citizen of their personal data.** A confusion must not be made between portability and transfer. In fact, portability does not imply the erasure of the data. The data may still be retained by the operator in line with its processing purpose.

**In the GDPR system, there is the obligation to carry out a data protection impact assessment** (Articles 33 and 34). There is therefore a case for ensuring utilization of personal data to be able to transform the asymmetric model into a symmetric model of mutual gains in respect of personal data. In addition, the future Data Protection Officer (DPO) simply needs to check that the consent of the cyber-citizen has been expressly given in their missions of Article 39 of the GDPR. The DPO naturally becomes the guarantor of the categorial utilization granted to the cyber-citizen's data.

In addition, the GDPR tightens the obligations between the *"controller"* (the organization on whose behalf the data are processed, and which sets out the purposes of the processing) and *"sub-contractors"* (the service providers responsible for carrying out the processing according to the instructions of their clients). Whereas, up to now, responsibilities could in large part be apportioned contractually between these two key players in processing data, the GDPR requires that controllers ensure that their service providers offer a level of security in line with the requirements seen above, and that sub-contractors assist their clients in fulfilling their obligations.

**In addition, Articles 73 to 77 provide for actions against the regulatory authorities and the controllers** through the traditional channel of legal remedy before the national courts. Up to now, legal action by a citizen on use that is non-compliant with the data protection provisions in France has never been taken before a national court. It is possible to consider class actions or joint actions through associations.

**Finally, the entry into force of the GDPR is accompanied by a considerable increase in the applicable fines:** in the event of loss, leak or compromise of personal data, or failure to guarantee the rights set out in the Regulation, the sanctions will, in effect, total **EUR 20 million or 4% of the group's annual turnover** (the higher of the two amounts).

**Taken together, it is true that these new elements do not create a real personal data ownership regime for the benefit of natural persons, but nevertheless they encourage businesses and institutions to establish a genuine “governance of data”.**

Without allowing the citizen to receive payment for processing of their personal data, **the GDPR thus shifts the role played by businesses, which are now the *guardians* and no longer the *owners* of these data.** Individuals are again the center of attention **but although the value of their information is recognized, that of their personal data is still out of their hands.**

There nevertheless remains the question **of aggregated data.** The citizen should receive payment on the mass of raw data from those entities which are going to produce aggregated data. Companies in France and abroad are beginning to create *ad hoc* systems to allow this payment on data transactions. Several experiments are being carried out in Europe on monetizing personal data, such as MiData in the United Kingdom or MesInfos by the Fondation Internet Nouvelle Génération (Fing) in France.

**In the USA, *databrokers* are already a reality.** Databrokers, such as ACXIOM<sup>33</sup> or BLUEKAI generate income on the personal data they sell to businesses. Acxiom is reported to have already amassed 600 data items per household from 6 million French households. In principle, Acxiom does not trade in sensitive data (e.g. health data). However, the company collects social media data and can create your consumer profile. The

---

33 [www.zdnet.fr/actualites/data-brokers-aux-etats-unis](http://www.zdnet.fr/actualites/data-brokers-aux-etats-unis).

Federal Trade Commission (FTC) is investigating the collection made by this company.

As far as rebalancing the income stream derived from data, it must be recognized that the American system of *databrokers* is biased in favor of the GAFA, since for example Facebook has signed partnerships with 4 of the biggest databrokers. The current system suffers from a lack of transparency about the customers to which the data are resold and the cyber-citizens whose data are sucked up, receiving payment in return. In addition, there are few access rights for American cyber-citizens.



## 3. Overview of privacy and data protection in the USA

Private data covers a different conception than in Europe as the US system focuses on allowing citizens to bring legal action for unfair or deceptive business practices, whereas in Europe we would focus on privacy protection and control of Data.

In the USA, we have two levels of law requirements: Federal Law and State Law. Some State laws may be more restrictive than federal law.

### 3.1 PRIVACY AND DATA

#### A / The concept of privacy

The concept of privacy arose in 1890 in an article from professors Samuel D. Warren and Louis D. Brandeis. It is defined as **a right “to be let alone”**. In 1974 the Federal Privacy Act was passed to regulate government databases and the concept of privacy is recognised as a personal and fundamental right protected by the US Constitution. Since the Clinton Administration, the US Policy towards Privacy Laws is to let the private sector to lead the activity. It is in the American approach of « laissez-faire » in economics as well as in the legal tradition.

**The Constitution does not have an explicit right to privacy, on a federal level. Although, many States have an explicit right of privacy in their constitutions. That is why there is not a single data privacy act.**

There are as many State Privacy Laws as States, and there is not one single data Authority in the US. The Federal Trade Commission (FTC) plays the role of the referral authority for consumers privacy. There are specific privacy laws for what we call sensitive Data as financial, insurance, medical information, information on children and students, credit and consumer reports.

Privacy is also protected by tort law as invasion of privacy, public disclosure of private facts, appropriation or infringement of the right of publicity or personal likeness and remedies against general misappropriation or negligence.

Then adding Federal Law, states laws and sectoral laws, the US regulation covers a wide range of data privacy and use of private data.

## **B / Classification of data**

**The FTC considers as personal data any information that can reasonably be used to contact or distinguished an individual.**

This definition is broader than the European one, as it considers any information to identify directly or indirectly an individual.

Sensitive data includes personal health data, credit reports, personal information collected on line from children under 13, precise location data and information that can be used for identity theft or fraud.

## **C / The rules of protection by the Federal laws**

The first act is the Privacy Act of 1974, enacted in December 31, 1974. It is called Code of Fair Information Practice, established to govern the collection, maintenance, use and dissemination of personally identifiable information on individuals when their data is maintained in systems of records by federal agencies. The federal agencies have to keep a system of records where they collect individual data and each agency must give public notice of their records in the federal register. There is an absolute prohibition of disclosure of information of an individual from this system of records without a written consent of the subject individual.

The Privacy Act states that each agency maintaining a system of records shall :

- i) upon request by an individual permit him to review the record and to have a copy made of all or any portion thereof in a form comprehensible to him and
- ii) permit the individual to request amendment of the record on him.



**For european citizens, similar rights are stated in articles 15 and 16 of GDPR.**

The Privacy Act applies only with the data collected or maintained by agencies. Therefore, the data collected in records of courts, non-agency government entities are not subject to this Act. President Trump signed on January 25th, 2017 an executive order that eliminates the benefit of the Privacy Act for foreigners... for the cause of public safety.

There are many federal privacy laws as to protect Children: Children Online Privacy Protection Act 1998 (COPPA), financial information with the Fair Credit Reporting Act and the Dood-Frank legislation, healthcare private information with the Health Insurance Portability and Accountability Act (HIPPA), personal information in the areas of education, cable television, driver's and motor vehicle records, telecommunications customer information, marketing activities...

**D / The Example of the Electronic Communications Privacy Act (ECPA) of 1986**

**The Act was passed to promote the privacy of citizens on wiretapping and electronic communication.** The ECPA includes the Wiretap Act and the Stores communication Act. It protects citizens against interception of electronic and wire communications, including any oral communication. Any oral communication is defined as "any oral communication uttered by a person exhibiting an expectation that such communication is not subject to interception under circumstances justifying such expectation". Anyone who violates the ECPA faces 5 years in prison and fines up to 250.000 USD. Victims are also entitled to bring civil suits and recover actual damages, in addition to punitive damages and attorneys' fees.

The fourth Amendment of the Constitution of the United States provides that:

"The right of the people to be secure in their persons, houses, papers, and effects, against unreasonable searches and seizures, shall not be violated, and no Warrants shall issue, but upon probable cause,

supported by Oath or affirmation, and particularly describing the place to be searched, and the persons or things to be seized.”

The Supreme Court considered that individuals have a reasonable expectation of privacy in stored messages (cf *Quon v. City of Ontario, CA*, 560 U.S. 746, 748 2010). The court also decided that individuals have a legitimate expectation of privacy in their private communications (*Nixon v. Administrator of General Services*, 433 U.S. 425, 463- 1977). It was extended to e-mails in 2010 : “a reasonable expectation of privacy in e-mails stored by their internet providers” (*United States v. Warshack*, 632 F.3d 266- 6th Cir. 2010).

The judges recognize a right to Privacy and in *United States v. Comprehensive Drug Testing*, 621 F.3d 1162, 1180 (9th Cir.), Judge Alex KOZINSKI encourages data minimization by proposing guidelines as:

1. Magistrates should insist that the government waive reliance upon the plain view doctrine in digital evidence cases.
2. Segregation and redaction must be either done by specialized personnel or an independent third party. If the segregation is to be done by government computer personnel, it must agree in the warrant application that the computer personnel will not disclose to the investigators any information other than that which is the target of the warrant.
3. Warrants and subpoenas must disclose the actual risks of destruction of information as well as prior efforts to seize that information in other judicial fora.
4. The government’s search protocol must be designed to uncover only the information for which it has probable cause, and only that information may be examined by the case agents.
5. The government must destroy or, if the recipient may lawfully possess it, return non-responsive data, keeping the issuing magistrate informed about when it has done so and what it has kept.

In 2016, Email Privacy Act was passed in April to include i) an extension of the warrant requirement to communications stored for more than 180 days and ii) a requirement of notice before email searchers (see [www.epic.org](http://www.epic.org))

## 3.2 OWNERSHIP AND DATA

### A / What is ownership under US laws ?

We share with Americans the same definition. Ownership is the right of possession, use, control, and to exclude others of the same, by having a monopole of use on the thing possessed. They recognize at least three forms of property, and thus three things that can be owned:

- **Real Property.** Real property ownership includes ownership of land, or "real property," material things as in feudal times. It is also a right to grant, to lease, to sell, to exclude others from using its property.

- **Personal Property.** Personal property is generally movable while real property is not and attached to the movable items.

- **Intellectual Property.** It is the property of intangible objects—so called "intellectual property". IP law is statutory and protects inventions (patents), creative works (copyrights), and trademarks. IP law also protects trade secrets, such as the formula for Coca-Cola, or the recipe of Chocolate cake Ispahan from Pierre Hermé.

Data may be an object protected by trade secrets. Data is all the information stored on an electronic device. Personal Data is any information on an individual stored on an electronic format.

### B / Who owns the data in the USA ?

**There is an easy step to say that each citizen owns its data as he generates it. But with all the channels of communications, platforms, devices, combinations thereof, ownership of data becomes more complex.**

One option is to divide by channel of communications as today it is more often cross-channel communications (Josh MANION, *The power of data ownership: getting it right in 2017*, December 20, 2016). Then we will recognise the first party data, data generator: **the citizen** ; then the second party data, data **collectors** and analyzers ; then the third party data, the **marketers**, who will work on cross data and big data.

**In this vision, there is no doubt that data in the USA is considered as an intangible asset, as a good in the market. It is treated as a product with a life cycle.**

The sharp question will be the accuracy of the data.

Another proposal comes from David LOSHIN (*Business-Oriented Data Governance for effective Master data Management*, 2015), where he establishes ten possible data owners (I quote):

- **Creator** – The party that creates or generates data ;
- **Consumer** – The party that uses the data owns the data ;
- **Compiler** - This is the entity that selects and compiles information from different information sources ;
- **Enterprise** - All data that enters the enterprise or is created within the enterprise is completely owned by the enterprise ;
- **Funder** - The user that commissions the data creation claims ownership ;
- **Decoder** - In environments where information is “locked” inside particular encoded formats, the party that can unlock the information becomes an owner of that information ;
- **Packager** - The party that collects information for a particular use and adds value through formatting the information for a particular market or set of consumers ;
- **Reader as owner** - The value of any data that can be read is subsumed by the reader and, therefore, the reader gains value through adding that information to an information repository ;
- **Subject as owner** - The subject of the data claims ownership of that data, mostly in reaction to another party claiming ownership of the same data ;
- **Purchaser/Licenser as Owner** – The individual or organization that buys or licenses data may stake a claim to ownership.

**Now in the USA, there is a market place for Data and various startups work on collecting data, processing and selling data as Gnip, Infochimps, Windows Azure DataMarket, Factual...** They seldom create new data but they clean it up to provide usable data and to connect buyers and suppliers.

The value of the data comes from making the data usable and accessible. What we call Personal Data Economy (PDE) is emerging in the USA, where companies can purchase data directly from individuals, like Datacoup.

**So US citizens have two options: either they pay extra fee to have their personal data protected (the Pay for privacy “PFP” approach) ; or they accept with no opt in consent to be paid for the personal data they disclose (the PDE approach).**

The Federal Communications Commission (FCC) adopted various rules where the consumer has the tools to decide whether or not to share and sell their own data. But these rules have been challenged by the Congress and the Industry trade association.

**PDE is close to what GenerationLibre think tank claims as each cyber citizen shall have a right to choose whether or not to sell its own personal data. It is what they call in the USA, the “API of Me” of the “Internet of Me”.**

**The US approach is a business approach and the question of the ownership of data is now rising as there is no property per se on the personal data.**

The business is done by **Data brokers** using the digital tools to mine the data, without any form of consent. The main restriction will be the protection of privacy coming afterwards. Data brokers compile data from various sources and sign contracts with other businesses. They have servers to scrutinize consumers data, without asking any consent and then transfer and sell them to third parties. Acxiom (Natasha Singer, Mapping and sharing the customer Genome, NY Times, June 16, 2012) is the biggest one and has 23 000 servers collecting data of millions of citizens. The former Federal Trade Commission (FTC) Commissioner Julie BRILL underlined that consumers lost “control over (their) private and sensitive information”.

After the scandal of Facebook with Cambridge Analytica revealing that 87 millions of facebook users had their profiles disclosed and their data robbed, we should reasonably think of not only the control of our

personal data but **also the entire property of our personal data, as to be able to withdraw, delete, refuse, sell to someone else.** A true right of property where you can decide by yourself of the destiny of your patrimony.

**We are at a turning point where we have two options either more citizen privacy or state security.**

President Trump chose as he signed the so-called « Cloud Act », a law that gives US authorities easier access to data stored abroad. US authorities will be able to demand that internet companies and cloud providers hand over e-mails and other personal information stored beyond the US borders... It will affect Google, Microsoft, Facebook which have data centers in Europe and especially in Paris. It has also an impact of the said Privacy shield for data transfer. It completely reduces the need for new negotiations to comply with the European standards of citizen protection and privacy.

**To conclude, it is necessary to stick to the guidelines edited by OECD on personal data in 1980:**

- 1. Notice:** data subjects should be given notice when their data is being collected ;
- 2. Purpose:** data should only be used for the purpose stated and not for any other purposes ;
- 3. Consent:** data should not be disclosed without the data subject's consent ;
- 4. Security:** collected data should be kept secure from any potential abuses ;
- 5. Disclosure:** data subjects should be informed as to who is collecting their data ;
- 6. Access:** data subjects should be allowed to access their data and make corrections to any inaccurate data ;
- 7. Accountability:** data subjects should have a method available to them to hold data collectors accountable for following the above principles.

## 4. Towards ownership of personal data: legal solutions

After having established that data are covered by the ordinary property system, we come to the concrete proposals which will ensure an ownership right.

### 4.1 DISTINGUISH DATA FROM INFORMATION

- **Data is an ownership right of the thing and rights**

**Considering a data item as property like any other property means applying property rights to data.** To be property according to the law, it must be:

- an object of **desire**, an object which has a value resulting from its usefulness or rarity;
- an **appropriable** object: the person establishes a relationship of exclusivity with the property, a private situation in relation to third parties;
- an object that can be **transferred**: the object is passed on lawfully between individuals, the object can be transmitted and is transferable.

**Currently, data are monetized but they have been unilaterally appropriated**, without a genuine circulation to the benefit of the primary provider of the data: the citizen.

Natural and legal persons have assets. Here we will attach the data ownership of connected objects and humanoids to the natural person who **uses** the connected object and the humanoid and these will be the only assets of *homo numericus*<sup>34</sup>.

---

<sup>34</sup> The phrase of Professor Solange Ghernaoui.

**Therefore, the citizen has data assets.** We will use here the broad concept of property, dear to Professor Ginossar<sup>35</sup>, which can be used to include the rights and obligations of a legal person in personal assets. It thus includes animate or inanimate, moveable or immovable, tangible or **intangible**, present or **future** things from a natural or legal person.

As mentioned, personal assets include: tangible and intangible things, and the object of the realization of rights, real and personal rights.

**The citizen is therefore the owner of the primary data and data generated and aggregated as the provider of the raw material, which are things included in their personal assets.** He becomes the creator/generator of data, the raw material about himself and his their activities.

**He must therefore be able to control them: sell, rent, transfer or even pledge them.** It is an enormous opportunity that is being made available to citizens. Let us make sure we do not waste it. It would be conceivable to build separate asset funds and to place some of the citizen's data in a trust.

- **A new paradigm: the citizen at the center of the business model for the utilization of data**

The *business model* of the GAFA which makes the citizen a good "sleeping" provider of data with enormous potential can be shaken up by taking into account in France and in Europe, the rights of the *homo numericus*<sup>36</sup> and the establishment of a new economic model based on payment of the income generated back to the citizen, the price of their consent to categorial utilization or according to the purpose pursued by their data.

**We will therefore switch from a free model to a payment model which will not only be a factor of growth but also create security.**

---

35 GINOSSAR S., *Pour une meilleure définition du droit réel et du droit personnel*, RTD civ. 1960, P37

36 Ibid.



If we stick to the definition of aggregate as given in the 2015 Larousse dictionary, an aggregate is a “*set of elements constituting a whole but not having a defined form, organization, real unity or purpose*”.

**Data belong to the person who provides them (classic concept) and the *business model* must be based on the primary data provider: the citizen, who will be paid on the added value produced by the data, whether it is primary, generated or aggregated.**

#### **A / The actors of the data utilization chain**

We sketch out the different actors of the data utilization chain with possible business lines:

- **The citizen or the legal person with data assets:** primary data provider: either their personal data, or their entity's data.
- **The data collector** (data centers, ISPS).
- **The data aggregator:** will be the private entity (commercial or associative) or public entity (possibly a State API which would collect the categorial data from publicly-owned industrial/commercial establishments) which will have the technical and financial capacity to manage and analyze these data. The citizen must receive income from this collection based on the volume of data and the relevance of the data. The aggregator can sell these data to platforms.
- **The platform:** the status of the platforms must also be reformed. The Conseil d'État in its annual report<sup>37</sup> suggests reserving a particular status to platforms that *offer their classification or referencing services for content, goods or services put online by third parties*.

---

<sup>37</sup> Conseil d'État, Annual Report 2014,

- **The data retailer**<sup>38</sup> (or analyzer): the retailer or broker is the party that will sell a service linked to the utilization of the data.
- **The Data Privacy Officer** (DPO): the person responsible for personal data in the business according to the new GDPR. The DPO will become the person responsible for defining the content of usable data and could assist with the sale of categorial data according to a strategy defined with the company, in collaboration with the controller.

## **B / A data utilization business model regulated by the law**

Payment by the actors of the data utilization chain may be carried out on the basis of various existing legal mechanisms: in the form of a trademark license agreement, the resale right used by copyright, or even a fee for each utilization granted (pay per loyal use, PPLU<sup>39</sup>) included in the data collection system.

### **• First model: the trademark and license agreement**

**According to this mechanism, the citizen registers their data assets in the form of a trademark.** It is a distinctive sign, a name, a pseudonym, a number (IP address, identity card, health card), which is enclosed within an ownership monopoly.

Utilization of this trademark can only be made under **a trademark license agreement** that they grant to a third party (e.g. their insurer) and the citizen is paid by a **fee**, on the volume of the data and the use.

The advantage here is that **an upstream ownership monopoly** is created and that the operators must go through the citizen. The downside is that access to the property in this way is not free of charge and creates discrimination between citizens. In addition, the data that are used are not static data. Also, the trademark freezes part of their data at a specific time.

---

<sup>38</sup> Term used by Gérard Peliks.

<sup>39</sup> Terminology of the author.

- **Second model: the resale right of copyright**

The data can be included in **Article L.111-1** of the Intellectual Property Code by considering that it is **a work of the mind** with intellectual, moral and economic attributes.

**Article 111-2** allows the work to be deemed to have been created independently of any disclosure, by the sole fact of the realization, even incomplete of the author's concept.

Thus, the citizen web user whose data are absorbed by computer mechanisms such as cookies or others, would be allowed to consider *de facto* that **data stemming from them by their activities on the Internet**, are a work of the mind, whose content can be utilized on other media.

**It will be the responsibility of the data collecting company to inform the web user about the data collected** (which is currently often done via an *opt out system*; We should make sure that explicit consent via an *opt in system* would not boil down to a blank cheque by the web user for utilization whose exact content or scope is unknown), the type of utilization of their data (still to be defined), and to pay a percentage or a fixed amount on the valuation of the database or of the results of the utilised data to the web user (still to be defined).

**Article L 111-3** allows this utilization since intangible ownership is distinct from ownership of the material object. This therefore allows data to be used on many media (TV, laptops, tablets, watches, etc.). It will be sufficient to add to Article L 122-1 of the Intellectual Property Code the words: right of collection (of data) as follows: *"The utilization right belonging to the author includes the right of representation and the right of reproduction and the right of digital collection".*

**Article L. 122-3** on the right of reproduction could also be amended by adding a third paragraph: *"For personal data, reproduction is the implicit or explicit collection of data of the web user and his connected objects for a for-profit purpose".*

**Whenever a company utilizes a user's data, it will have to pay a percentage or a fixed amount to the web user producing the raw material.**

This might be a controversial measure<sup>40</sup> because it is indeed difficult to find any original feature connected to data or numerical data such as a telephone number, a health card or a credit card. The system here is only attractive for the organization of data usage, with for example, a collective management company of personal data.

**• Third model: the citizen, a creator of a database and the declarative system – Declaration of limited use and *pay per loyal use* governed by contract law**

Citizens become database creators because they consent to the human and material investment of which they are the subject-object. **They are the owners of the primary and the generated data.**

An amendment would need to be introduced into the definition of database producer in order to include as the database creator (recognized by the ECJ in its 2015 ruling), that is the citizen who agrees that his activities generate usable data.

**Two conditions need to be met to be recognized as a database producer:** a natural person or a company whose registered office/ central administration/main establishment is in Europe and who has made a substantial financial, human and material investment (Article L. 341-1 and L. 341-2 of the Intellectual Property Code). The investment here is human. We would therefore change from the database producer to the database creator (citizen).

---

40 MATATIA Fabrice and YAÏCHE Morgane, "Etre propriétaire de ses données personnelles: peut-on recourir au régime traditionnel de propriété ?", Revue Lamy de droit immatériel, 2015/114, pp60-63.

**The declarative system works quite well and has proved itself.**

The only drawback is that the mass of data that we will have with connected objects will become unmanageable. The mechanism would be as follows:

**1.** The database citizen creator declares to the French Data Regulator (CNIL) that he wishes to have his data utilized by a platform data manager and to derive income from them either via connected objects or via platforms or ISPs, for a specific data category and a specific purpose.

**2.** The database citizen creator consents in writing, in a license agreement to the platform data manager, to the **categorial utilization** of his data according to a **specific purpose**.

**This utilization is subject to the consent of the citizen from which the data are derived, for a categorial utilization, limited in time and quantitatively.** The declarative system of the data protection regulator (CNIL) is used and makes the citizen the decision-maker of such categorial utilization of the database. This must be valid for any citizen but also open to any company which uses Mega Data<sup>41</sup>. This is a DWYU system standing for *Declare what you use*<sup>42</sup>. This required consent must be explicit. It can be envisaged that the citizen goes onto a CNIL platform or on a data management API or on a platform of a data managing company platform, where he registers with his personal data. This platform would be a center for managing the utilization of personal data. The citizen would receive a categorial utilization request for his data on this platform, and they would reply to the alert and actively select the checkbox to accept fair and monetized use of his data.

---

<sup>41</sup> INPI study, PI et Économie numérique, 2014.

<sup>42</sup> Terminology of the author.

**3. The platform manager resells the use of this database to platforms or to ISPs or GAFA through a “smart contract”** in the blockchain. Therefore, through the blockchain, the purpose and category of data are enclosed and encrypted.

**4.** The ISP and GAFA platforms pay a percentage to the retailer for the utilization of the data category according to the declared purpose.

**5. The data retailer pays an income through micro-payments according to the value of the use of the data category.**

**6.** This utilization is subject to a payment by the manager of the data platform to the citizen providing the raw material. The payment is made on the platform, which complies with the exceptions of Article L 342-2 of the Intellectual Property Code. The data are stored on the platform which becomes the databroker.

**7.** A pay per loyal use for what you say you use, or PPLU, is introduced. Control of the utilization of the data is therefore the CNIL’s responsibility. Any unlawful and unfair use, about which the citizen would be notified by a system of intelligent alerts, would result in the suspension or withdrawal by the citizen of the selective utilization of their data from the platform or the API.

There would need to be an equal correspondence between the DWYU and PPLU lists and strong oversight by the CNIL, to ensure the respect the rights of the citizen-data creator. The CNIL would remain the authority empowered to impose sanctions in the event of categorial usage that is not in line with the declared purpose.

**This latter system is also easy to set up because it is based on an existing administrative authority, the CNIL, and current mechanisms. It can be included in the data production chain while respecting all the actors.**

It becomes part of the new General Data Protection Regulation by the use of express consent and endorses the *usus* and the *abusus* of personal data set out in Articles 17 and 20 in particular, it goes further because it provides for income (*fructus*) for the cyber-citizen.

**People may argue in reply that personal data should not be included in assets and that they must remain non-pecuniary and non-assignable rights, to prevent data utilization misuses and the multiplication of personal data theft<sup>43</sup>.**

But in the light of the current situation, does excluding data from being considered as assets that can be owned prevent any abusive utilization of a person's data? Are we seeing a fall in the number of identity thefts? Obviously, this is not the case. On the contrary, we notice that cyber-citizens have seen their right of *abusus* taken away from them.

The idea put forward here is to create an economic balance in an unprofitable game for the cyber-citizen. Furthermore, reducing this asymmetry is one of the aims of the 2016 GDPR. In the proposed system, we see the CNIL as the major control actor - that it already is - to ensure the fair and lawful utilization of data.

---

<sup>43</sup> MATATIA Fabrice and YAÏCHE Morgane, "Être propriétaire de ses données personnelles : peut-on recourir au régime traditionnel de propriété ?", *Revue Lamy de droit immatériel*, 2015/114, p62.

## 4.2 SHARING THE DATA UTILISATION VALUE CHAIN

By **NICOLAS BINCTIN**

**The data status has an important influence on sharing the value chain.** Public data, that can be freely used, hardly seem to allow the initial data collector or issuer of the data to be included in the value chain. Without excluding an ownership approach to data, the State has ruled out participating in the value chain attached to the use of these data.

**This is not the case with secret data or personal data collected by software solutions when terminals are used.** In both cases, the data are not public. They are central to **the transaction**: either they are the direct object of the contract (this is the case regarding a transfer of secret data), or they are granted as one of the conditions of the contract (this is the case of the use of personal data by search engines or social media). The false free-of-charge use of these services is found here: they are based on an exchange of value, content in exchange for personal data instead of monetary consideration. Under these circumstances, we need to find out under what conditions the data issuer will be able to participate in their value chain.

The question is complex and may, in certain ways, suggest that it is possible to **directly monetize data**. For example, for each data item collected, a micro-payment is made for the data issuer and thus a balance is re-established. This idea would be tantamount to saying that the data have value that is greater than the service provided by the online operator because the latter would not only provide the service but also pay the data issuer using the service. Although this situation is not impossible, it would appear to be complex to identify and implement. We shall therefore set it aside from the proposals set out below.

**At the present stage of development of the online barter of services in return for data, we consider that sharing the value chain must**



**not be viewed from an individual approach but from a collective approach**, more in line with the issue of the mass collection of data. In both cases, the question of data ownership remains an issue because it is a legal tool for the analysis.

In the data economy, it is not a single data item that has value but a mass of data. Under these conditions, the relevant value is collective and not individual, and part of the value attached to these operations must be collectivized to allow public action to be funded. Therefore, given a barter transaction, services in return for data, between a professional, the search engine or social media, and a consumer, the web user, it is necessary to search for the conditions under which it would be possible to **subject the operation to VAT**. The VAT collected would provide funds to the budgets of the Member States of the European Union and would ensure a sharing of the value chain linked to the general interest.

#### **A / A value-added transaction**

Barter is an age-old transaction which has found new life in the online economy and the collection of data. Barter between companies, according to the *International reciprocal trade association (IRTA)*, totals between \$12 billion and \$14 billion per year. It would be necessary today to review this study to include in it the value of trading in the context of the online data economy. Given such exchanges, tax law provides that, if the person is a tax payer, the exchange is regarded as a double sale and so each transfer is subject to VAT. If the exchange is made between two tax payers, the VAT is due only in principle on the profit margin.

Barter is also known to characterize the collaborative economy and local, solidarity currency projects such as the LETS<sup>44</sup>. How these initiatives are considered by the tax authorities is a recurring source of tension, particularly because they are not designed to exclude social contributions and VAT from the payment.

---

44 MAGNEN J.-Ph. and FOUREL Ch., Study mission about local supplementary currencies and local trading systems, *D'AUTRES MONNAIES POUR UNE NOUVELLE PROSPÉRITÉ*, A report delivered to the Secretary of State responsible for trade, artisanal trades, consumption and the social and solidarity economy, 8 April 2015.

**In the digital world, exchanges must be thought of not in terms of the relationships between professionals, or between individuals, but between professionals and consumer-web users.** It is therefore the professional's responsibility to establish the value of the transaction and to declare the appropriate VAT. Indeed, according to the General Tax Code, VAT is due on all "*deliveries of goods and provision of services for an economic activity carried out for a fee*". This **provision of services** applies to all operations other than supplies of tangible goods, i.e. all intangible services, including the use of a search engine, a social medium, an online films platform, etc.

**VAT is due for an economic activity carried out for a fee.** This must be understood as covering market activities, economic operations in return for consideration and exchanges. This consideration is most often represented by a pecuniary element but it can also be in the form of a payment in kind, such as data collection. VAT is thus required for bartering, to deter companies from preferring bartering to dealing in cash. The intervention on the market must be for a fee, i.e. for fair consideration, which is not limited solely to the search for commercial gain which presupposes, in addition, the search for profit. Even Internet operators which do not have a profit-making objective could still have an action on the market in return for a fee, which could be the case for *Firefox* for example.

**In the light of these elements, there is no doubt that the collection of data when using online tools, in return for the use of these tools, is a form of barter, which must be described, from a tax point of view, as an economic activity carried out for a fee.**

Therefore, the operators which collect data must declare a value for the transaction and pay the corresponding VAT. If for the web user, the

exchange is commutative and reciprocal because it allows access to a search service, and provided that he is aware that the operation is not free but simply provided in return for consideration in kind, i.e. their data, it is imperative that States can collect the value added tax attached to each of these transactions. At a time when the OECD is seeking to implement coordinated tax policies to combat the erosion of the tax base, there is a need to include in the analysis of the value chain, this essential point of the online economy.

To implement such a tax solution, allowing the integration into the local economy of operations conducted online and allowing the States to link their tax revenues with changes to the practices of economic operators, it would be necessary to define a base, a rate and the liable operator.

**For such VAT to be applied efficiently, all these points must find a response at the level of the European Union and not locally for such VAT to be applied effectively, because not only is VAT subject to European harmonization but, in addition, the digital economy is transnational by nature.** It is not necessary here to move forward on the details of these elements. We believe that VAT should be considered taking into account the mass of personal data collected by the online operators and not simply the data unit collected. We could take into consideration data categories, the presence of cookies, the presence of behavioral analysis tools, etc. For example, geolocation data would have a higher value than those relating to the web user's age.

Furthermore, the implementation of VAT on false free transactions, in the form of bartering services in return for data, would partially offset the effects of the economic models based on this false free service. The cost of the VAT would reduce a little the amazing margins of certain operators. It would restore more face-to-face and less unfair competition between different online service solutions. It would thus be possible to open up spaces for other economic models for trading and online services and provide a choice for consumers between bartering and purchasing the services they need.

## B / Payment of VAT in the country of collection

**The growth of the digital economy creates challenges related to international taxation.** An OECD analyses these challenges in detail<sup>45</sup>. It shows that the digital economy is increasingly becoming the economy, meaning that it would be difficult, if not impossible, to ring-fence it from the rest of the economy for tax purposes. It adds however that certain economic models and the essential attributes of the digital economy can exacerbate the risks of erosion of the tax base of the economic operators and describes the expected effects of the measures stemming from all the actions included in the BEPS project. In particular, it presents the rules and enforcement mechanisms that have been defined to facilitate the collection of VAT from the country in which the consumer is located during cross-border transactions between companies and consumers, and which could be used to establish a fair level playing field between domestic and foreign suppliers.

**The report explores and analyses possible solutions to the fiscal challenges of a wider scope posed by the digital economy** and highlights the need to follow the developments of the digital economy over time. The idea of VAT on collecting and mass processing of data, in specifically personal data, does not appear to conflict with the solutions advocated by this report.

**For online commerce, the Commission proposes to improve the VAT environment in the EU**, to allow consumers and companies, particularly start-ups and SMEs, to buy and sell goods and services online more easily. Freeing-up the potential of electronic commerce in Europe and creating a digital single market form part of the Juncker Commission main priorities. The establishment of a pan-European portal for online VAT online payments (the “one-stop shop”) should significantly reduce the costs related to compliance with the rules attached to VAT within the EU, estimated at EUR 9,000 per company and per country of declaration, thus enabling companies throughout the EU to save approximately €2.3 billion per year.

---

<sup>45</sup> OECD, *Addressing the Tax Challenges of the Digital Economy, Action 1 - 2015 Final Report*, OECD Publications, Paris.

**The new rules will ensure that VAT is paid in the Member State of the end consumer, which will result in a fairer distribution of tax revenues between the countries of the EU.** These proposals should enable Member States to recover the VAT not collected on online sales every year, which is currently estimated at €5 billion. According to the estimates, revenue losses will reach EUR 7 billion by 2020 if no action is taken. The proposal of imposing VAT on collecting and mass processing of data attached to an online service offer is fully in line with these perspectives.







---

PART 3

# Technology to the rescue of your privacy?

By GÉRARD PELIKS & LUCAS LÉGER

**A**s we have just seen, users may want to derive financial benefits from their personal digital data which are collected in order to be cross-referenced and used by the *Big Data* technologies. Tools are offered to them free of charge, such as search engines, but users are not explicitly informed that their data collected are resold to various organizations such as advertising agencies or companies trying to better target their customers. Users should be able to reject this economic model, even if it means they will have to pay to use tools that up to now have been free of charge, and also be paid for supplying their personal data.

**But it also means that the creator of digital data has to be able prove their authenticity and establish that these data and metadata belong to him when his good faith is not sufficient.** It is also important that these data are easily accessible to potential buyers and remain integral. Here, we analyze several possible methods for users to authenticate themselves and make their data available, and we propose a model based on a blockchain which manages “smart contracts”.

We will first demonstrate that an **IP address** cannot establish for certain a user’s authenticity, even though it is recognized by the law as personal data. Then we will explain how **an electronic signature** authenticates a user and proves the integrity of a document. Trust is based on the authority which has signed the digital certificate held by this user. Finally, we discuss how **a blockchain** can be used to collect the data of a user who wants to get something out of them. Trust is therefore based on multiple duplication of data and how many people validate the transactions. Finally, we discuss how **smart contracts** in this blockchain can establish the conditions for the transfer of property between the people who provide their data and the entities which use them, for



example to cross-reference the elements collected with other external data, using the algorithms of *Big Data*.

The model that we propose here assumes significant changes in the tools and methods used and can only be achieved through an adversarial relationship where the users impose them on the companies developing the tools and those exploiting their data.

# 1. Proving a person's online identity

## 1.1 THE LIMITS OF THE IP ADDRESS

**Is an IP address (Internet Protocol) personal data? The law currently states that it is. But if we analyse this issue at a technical level, we can see that in reality, it is complicated if not impossible to establish a credible correspondence between the IP address of a device and the user who is using it.**

Each physical element connected to the Internet has an IP address. This address is a series of four bytes separated by a dot, in the case of IPv4 (e.g. 192.23.34.1) and 16 bytes in IPv6. To make the handling of these addresses simpler to remember, each IP address is associated with a computer name followed by a domain name, for example: node.domain.fr, or even for email: name@domaine.fr. DNS servers (Domain Name Servers) are responsible for establishing the relationship between the representation in IP addresses and the representation in domain names. It is easier for a user to use addresses with domain names which are easy to remember rather than remembering a number. Machines on the Internet only handle IP addresses. In the text that follows, we characterize an element connected by its IP address alone rather than

by the domain names because these add nothing to the relationship between a user and the internet terminal that he uses.

**Can an IP address be used to authenticate a user? Not really.** It only designates a terminal (PC, tablet, smartphone, etc.) with which the user connects to the Internet. An IP address does not authenticate the user. One might think that if a smartphone belongs to a person, the IP address of this smartphone is associated with this person. But this assertion is risky because the smartphone may have been borrowed or stolen by another person.

## Can an IP address alone be used to ascertain the identity of an internet user behind a terminal ?

In IPv4, the shortage of IP addresses available today means that an individual who is connected is assigned a dynamic IP address for the duration of their session (using the DHCP protocol) by their Internet service provider. This address will then be assigned by this provider to another of its customers. Knowing the time of the connection of a user, the provider can, at all times find out to which customer it has assigned a particular address. Indeed, the provider is required to retain, at least for a certain amount of time, the connection logs of its customers. **But this additional level increases the difficulty of linking a particular person to a particular IP address.** To find out who is behind a particular IP address, in addition to the precise time of the connection, you must also know who the service provider is and whether this provider agrees to make the connection between its customer and the IP address that it has assigned for the duration of their session.

Moreover, in the servers or desktop PCs connected to a company intranet and protected from the Internet by a firewall, an employee will generally access the Internet using the IP address of the outside network controller (the person seeing the Internet) of the firewall. Here, it is their company that assigns, internally, to each server or PC connected to its Intranet, a fixed so-called "RFC1918" IP address, non-routable that begins with a 10 (e.g. 10.20.3.41), by 172 or by 192. The company knows to which computer it has assigned a particular IP address, but again, outside of the company, on the Internet, there is an added layer which increases the difficulty of attributing a particular transaction to a particular user since all external transactions appear to come from the external IP address of the firewall that protects the organization.

**So we see that an IP address cannot identify a person for certain.**

It can only identify a person's way of accessing the Internet, but without having authenticated him. Between them, software layers blur the confirmation of a relationship between a particular person and a particular IP address. **In conclusion, if a person wishes to benefit from their data, they will have to be authenticated by something other than by their IP address.**

## **1.2 PROVING AUTHENTICITY THROUGH AN ELECTRONIC SIGNATURE**

**An electronic signature, based on cryptographic mechanisms, can be used to establish a person's strong authentication, regardless of his means of access to digital data, and even that person not connected.**

**We are going to give here some simple explanations about the cryptographic mechanisms used by electronic signatures. We will explain how an electronic signature establishes a relationship between a person and a digital document in a way that is at least as valid, under certain conditions, as a handwritten signature between a person and a paper document can be.**

We should understand first what is a hash, and then what is **public key cryptography**, also known as asymmetric cryptography. We will not go into the technical details, particularly regarding the algorithms that are used and make the complexity and beauty of cryptography. We will give just a brief outline, sufficient to understand this vast and complex area. In the next few paragraphs, the main idea is to understand how a document can be electronically signed and how this electronic signature establishes to whom the document belongs.

- **Hashing using hash functions**

A **hash** function, also called a mathematical one-way function, matches a document of variable length with a hash that is a string of characters of fixed length. For example, if this text is put through the hash function SHA256, its hash will be a 256-bit character string, regardless of the length of the text. Let us take another example to illustrate this. If all the works of Emile Zola are processed with the SHA256 function, its hash will also be a 256-bit character string, of course different from the hash of the text that you are currently reading, but which, if put through this hash function, would also be a 256-bit character string. If just a comma or any other character were added to one of the texts of Zola, the new hash of the whole of his work will be different from the hash of his initial work.

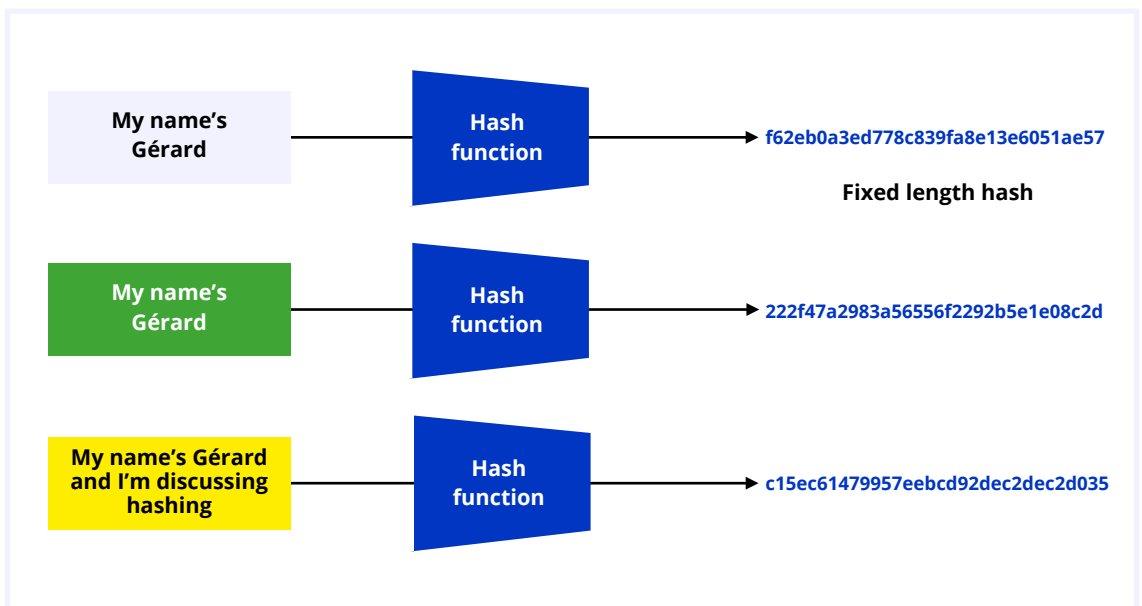

Does the hash of an original document, attached to this document, establish **the integrity of the document**? Yes, but only for as long as it is not altered and its hash subsequently recalculated and attached to this amended document. **Therefore, to establish a document's integrity,**

**this document needs to be linked to its hash. The document is said to be sealed. However, although the integrity of the document begins to be established, it doesn't provide an indication about who the author is.** To establish this, we will now explain how public key cryptography works.

- **Public key cryptography for encrypting the hash**

**Public key cryptography involves two mathematically related keys: a private key and a public key. If we encrypt using one of the two keys, we can only decrypt using the other. The encryption key and the decryption key are therefore different, and that is why this encryption is called "asymmetric". But the two keys are mathematically related to each other so that by encrypting using one of them, we can decrypt by using the other.** The private key must be kept secret by its owner and he must not disclose it to anyone. By contrast, the public key mathematically linked to the private key, as its name indicates, is public and can be disseminated to everyone. Of course, with a public key, it is not possible, or in any case very costly in terms of calculations, and therefore takes a very long time, to reconstitute the corresponding private key.

But what establishes that a public key, which can be widely distributed to anyone who asks, really is that of a particular person who holds the corresponding private key? The answer is that a public key is not provided alone and is included in **a digital certificate** that contains, in addition to the public key, several other elements that identify its owner such as the last name, first name and possibly an organisation. It also contains the start and end dates of the validity period of this certificate. And above all, it is electronically signed by a trusted authority which proves that the contents of the certificate have not been tampered with. We will see how this is possible when we have finished explaining what the electronic signature is. Remember here that the certificate has been signed electronically by an authority trusted by all those people who will check the electronic signature.

- **The electronic signature to guarantee who a digital data belongs to**

***NB: This paragraph is more technical but the reader can refer directly to the diagram below for an illustration of what follows.***

The author of a document calculates the hash of their document using a **hash function**. He encrypts this hash using his private key, that only he has, using an asymmetric encryption algorithm such as the RSA or elliptic curves. He attaches this hash to the document. The document is then sealed.

People who wants to establish the authenticity of the owner and at the same time the integrity of the document go about getting **the certificate containing the owner's public key** by requesting it from him or retrieving it from a directory of certificates. They look at who the authority is which has signed the certificate. If they trust this authority and if the certificate is within the validity dates, they know that the public key that they extract from the certificate is the one mathematically linked to the owner's private key and whose details are found in the certificate. They decrypt the document hash thanks to the public key of the person who has signed the document, using the same asymmetric encryption algorithm. They obtain a decrypted hash. Of course, it is not a user who makes all these calculations, but the application of the electronic signature that he uses, such as an email system or the web browser in the case of a secure HTTPS connection.

The recipient of the signed document then calculates **the document hash** using the same hash function and obtains the hash. If the recalculated hash is the same as the decrypted hash, only the author, whose details have been found in the certificate from which the public key has been extracted and certified by the trusted authority that has signed it, can have encrypted the document hash. This is because they alone have the private key which mathematically matches the public key found in the certificate of the person who has signed the document. The recipient is also assured of the integrity of the document because he is sure that the document has not been changed since its signature, which

would have been the case had the recalculated hash not have matched the decrypted hash.

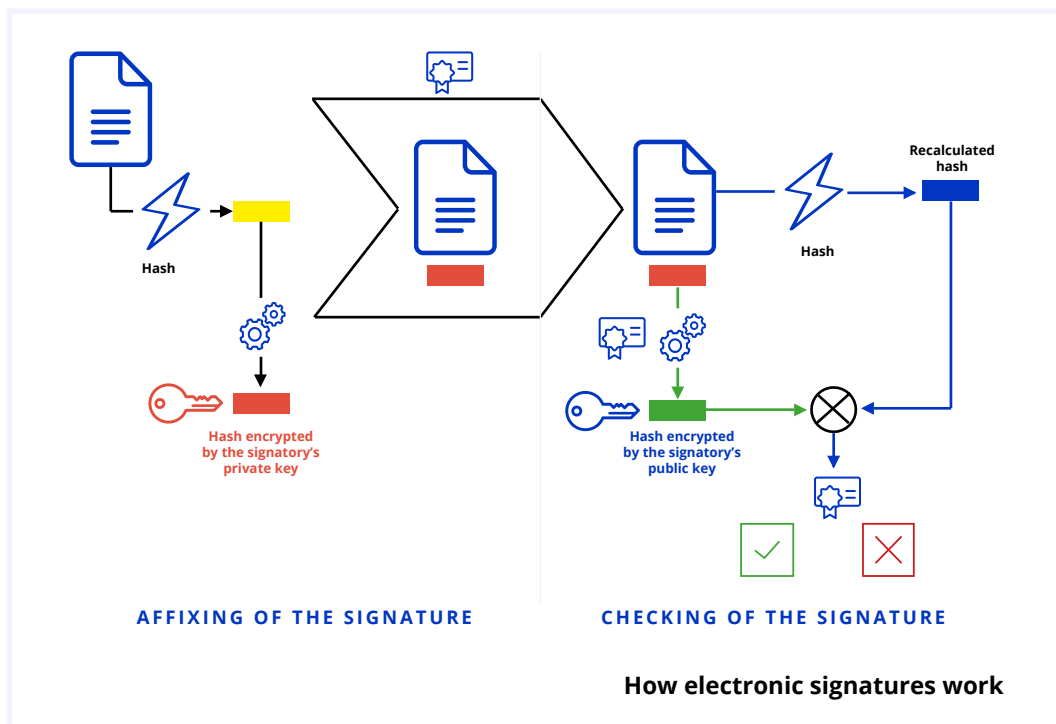

In this way, the authenticity of the author and the integrity of his document are established. The trusted authority has signed the digital certificate of the person who signed the document using the same mechanism as we have described. When a user wants to sign a document, they must therefore have a private key and a certificate containing the public key that matches the private key, since the certificate is signed by a trusted authority.

But not all digital certificates have the same value depending on how they have been obtained. Similarly, trusted authorities do not have the same weight, especially in a country which is different from where this trusted authority resides.



**An electronic signature is therefore a good way for a user to prove that he is the owner of digital data and that these data have not been altered since they were signed, thus proving their integrity.**

The document has been signed by its owner regardless of the device that he has used. Trust is based on the authority which has signed the digital certificate, because it also has a private key that it keeps secret, and a certificate containing its public key that it distributes widely, and which, for a web browser, is often included in the certificate store that the browser has.

**No-one can therefore modify a certificate signed by a trusted authority without it being noticed, because the result of the hash of this certificate would not match the hash of the decrypted certificate with the public key of the trusted authority.**

---

## 2. Blockchains to guarantee data authenticity

A blockchain is a “distributed autonomously decentralised database”<sup>1</sup>. The most well-known of blockchains is the Bitcoin<sup>2</sup>, a computer protocol that, in particular, has resulted in the emergence of distributed applications without trusted third parties, such as cryptocurrencies.

Far from being a flash in the pan, some see it as a disruptive technology just as revolutionary as the advent of the Internet and then that of the Web. In the area which concerns us, we will see that **blockchains can provide original solutions** for the economic model that we are discussing here.

**Where in cyberspace, should you place the data that you want to market? The simplest thing is to put them in an easily accessible place, that everyone can view, but that nobody can change.** Additional security about the availability of these data can be guaranteed if these data are automatically duplicated on many servers, widely distributed in cyberspace. Blockchain technology provides this possibility, but the limited sizes of the current blocks of the blockchains do not allow large data volumes to be stored. Therefore, we recommend that the blocks are used to store the transferred data hashes only and these will be kept by their owner in a special dedicated portfolio. By using an application such as Zcash, these transfers can even be anonymized.

**A blockchain can be viewed as a large registry open to everyone, duplicated, automatically and constantly on many servers, whose digital data are located in tamper-proof blocks.** Indeed, these blocks are chained; each block is time-stamped and depends on the previous ones using cryptographic mechanisms. Once included in the blockchain,

---

1 Source: [https://www.youtube.com/watch?v=wKu\\_nZcgy3w](https://www.youtube.com/watch?v=wKu_nZcgy3w).

2 Source: <https://bitcoin.org/bitcoin.pdf>.

a block cannot be changed because of other blocks in front of them and if one of them is changed, you would also have to change all the blocks that precede it. Checks on the **integrity of the blocks of the blockchain** will be carried out, on each inclusion of new blocks, by many people called miners. Technically, all the duplications would have to be changed, because they are highly secure against this kind of attack. **The blockchain mechanism can be considered as reasonably secure.**

The digital data of the blocks are electrically signed by their owner. They could be encrypted but generally are not because everyone must be able to view them. Note also that the owner can identify himself using a pseudonym; if he wants to remain anonymous, only his private key used to include their data in the blockchain will allow him to be authenticated and prove that the data entered are in fact his.

**Therefore, if the digital data of a person who wishes to market them are in a blockchain, the owner of these data can certify that they belong to them until a transaction certifies that the owner has sold them, in which case the digital data sold no longer belong to them but belong to the person who has bought them. The blockchain allows everyone to ensure that this is the case.**

With the current blockchains standards, the size of each block is limited. The blocks simply contain the hash of the data and their timestamp.

### 3. Marketing personal data thanks to technology?

- **The self-performing contract to establish the conditions of data sale**

Ethereum, one of the blockchains which manages so-called *smart contracts* seems currently to be a solution to manage identities and the digital data that we agree to market.

**In the contracts entered in this type blockchain, which are tamper proof and non-erasable as soon as the miners have validated them, it is possible to define the conditions under which the data can be acquired and how payments must be made.** In the case of Ethereum, **payments are made in *ethers*.** The *ether* is the unit of one of the many cryptocurrencies found in blockchains. The owners of *ethers* can then convert this cryptocurrency into euros or other currencies via an exchange platform.

In the Ethereum blockchain, the smart contracts are written in a computer language called *Solidity*, that obviously needs to be mastered. It is also essential to predict all cases of application of the contracts because here, *code is law*. But it must be said that after the collapse of *TheDao* following a vulnerability in the smart contract code using recursion, *code is law* is called into question. Other public or private blockchains will no doubt be created<sup>3</sup> on the Ethereum model, with smart contract description languages that are simpler to use, and with better performance, using verification and validation processes by miners that are more suited to our economic model.

---

<sup>3</sup> We can cite *Cardano*, *EOS*, *Dfinity* or *Tezos* as a few potential competitors.

- **Possible use of these tools to manage personal data**

The use of the foregoing implies large changes compared to what is done today. **With this economic model, the data used by the GAFA or by advertising firms will not be directly deducted at source, as is currently done, with or without their owner's consent. They will be available on dedicated servers where the owner will make them available subject to certain payment conditions that they will specify in a smart contract.**

The user or the programs they use must supply this blockchain. This is only possible if the process is automated. The tools familiar to us: browsers, office tools, etc. will need to be modified to allow users to place their data directly in a blockchain that each user can choose. **If, in the future, this method were to become universal, the current mechanisms of blockchains will need to be improved to offer the performances required by the avalanche of transactions that will need to be dealt with.**

Of course, we are only discussing here about processing the personal data that a person wants to market. It is better to keep them at home and not to disclose and encrypt data that you want to keep confidential. **And it will then be better to use tools able to address a blockchain to provide data, rather than using tools that directly provide developers with the data that you want to market.** If your data appear in the Internet ecosystem, although the blockchain managing them makes no reference to this transaction, (for example transfer to a third party of your data without your prior agreement), this will prove that your digital data have not been taken from this place, and have therefore been acquired illegally. We can then talk about theft or plagiarism.

- **New services for a new profession**

It is obvious that we cannot ask each user to implement this model. We cannot ask them to find the buyer to whom the data can be offered for sale, and which are of interest to advertising firms and all organizations eager to process these data to get to know their customers better. **In the**

**chain for making data available, an intermediary is needed between those who produce the data and those who can benefit from them by cross-referencing them with other data and processing them using algorithms to obtain results that they themselves will sell. This intermediary is the “digital data retailer”.**

**Just like performers use the services of communication managers, users will be able to use the services of digital data retailers who will provide several services.** That of providing them with the tools so that the data that come out of their terminals, sometimes without their knowledge, no longer go directly to the GAFA, for example, but are transferred to digital data retailers. These new service providers will gather data of all types in a *data lake* and be responsible for duplicating and saving the data if they are deemed valuable, with the quality of Veracity and Value in *Big Data*<sup>4</sup>.

**It is obvious that an isolated data item has little value and that the producer cannot obtain much from it, but a data item cross-referenced with many others may produce information of great value. The cross-referencing of data which requires algorithms and software processing will be made by the digital data retailer.**

Another service which will be very popular, will be help with writing, or turnkey design of smart contracts, in the *Solidity* language in the case of Ethereum blockchains, or in other languages on other blockchains managing smart contracts. These contracts will set out the conditions for marketing data.

An additional service will be to render data anonymous or to allow his owner to use an alias. Another service of the digital data retailer could be to offer its data providers everything that is necessary for them to sign, in particular the private key and the certificate containing the public key which the user will use to sign their data. The digital data retailer may also be a trusted authority who signs the certificates that it issues.

The retailer also knows where to find customers who will agree to pay a percentage of the sum due to the data producers. The rest is carried out under the terms of the smart contract which will link the producer's

---

4 This refers to the famous 5V of Big Data.

obligations and the user of the data. If the idea becomes reality, pushed by users who wish to take advantage of their digital data, a tremendous amount of work will need to be accomplished. Currently, these data are often taken and used unbeknown to the users under the pretext that the tool they use (browser, virus protection, etc.) is free.

**When a software is free, it is customary to say that the product is the user. With this model, the user takes back control of the value of their data and can then agree to pay for the software that they previously used for free. This is another business model, and perhaps a model for the future.**

- **The conditions for success and a few concrete examples**

First, our proposal is firstly, part of a much broader debate on the use of different technologies to ensure better protection of the privacy of individuals when they go on the Internet. We can distinguish two approaches, which are not exclusive<sup>5</sup>. The first solution is to use technical means to limit the dissemination of personal data. The second tends to set up rights directly related to the use and/or the dissemination of these same data. This short presentation of our solution is based on these two aspects.

Secondly, we note that solutions already exist for monetizing the content of an online site. The concern for protecting privacy or fair reward for producers of content are central to these solutions. With its *Smart*

---

<sup>5</sup> We refer the reader directly to the work of: LE METAYER D., "Whom to Trust? Using Technology to Enforce Privacy", Chapter 17, in Wright D., De Hert P. 2016. *Enforcing Privacy Regulatory, Legal and Technological Approaches. Law, Governance and Technology Series*, Volume 25.

*Media Token*, the start-up *Steem* proposes to reward and encourage the creation of web content using its blockchain<sup>6</sup>.

Moreover, it is not necessary to use this kind of technology to log and monetize data<sup>7</sup>.

In our solution, the *smart contract* here is used as a bridge between personal data, whether situated in a database or directly held by their owner.

**The blockchain here is only the register of the transactions and is not used for storing data.** Indeed, a transaction on a blockchain provides proof of publication<sup>8</sup>, which avoids the duplication of expenditure<sup>9</sup>, or in our case, the duplication of a data item without the consent of its holder. In this context, transfer of responsibility is total. The data belongs to you<sup>10</sup> and the law guarantees ownership of them. If Bitcoin allows you to be your own bank, our solution is relatively comparable, to the extent that you are now responsible for retaining and protecting your data. You decide or not to share them. But, unlike Bitcoin, you have an ownership right guaranteed by the State.

---

6 <https://smt.steem.io/smt-whitepaper.pdf>. On a fairly similar principle, see also the Akasha project on Ethereum: <https://akasha.world/>. This is concerned with protecting users' privacy via a content publication platform (on the model of Medium), but with no data storage on a dedicated server. See also BAT (*Basic attention token*): <https://basicattentiontoken.org/>.

7 Without necessarily monetizing data, researchers at MIT have developed the protocol HTTPa (standing for Accountable Hypertext Transfer Protocol), which logs the use of data from one server to another. Certain restrictions can be included upstream. See O. Seneviratne and L. Kagal, HTTPa: Accountable HTTP, November 2010, [https://www.iab.org/wp-content/IAB-uploads/2011/03/oshani\\_seneviratne.pdf](https://www.iab.org/wp-content/IAB-uploads/2011/03/oshani_seneviratne.pdf). Sweeney et al. propose for their part to associate with each transferred file, a system of '*datatags*'. This concept introduces in sharing a file, a '*tag*' which controls access depending on the degree of sensitivity of the data transferred. See: <https://techscience.org/a/2015101601/>. A more radical solution would be to move towards decentralized platforms, where all user data are stored on servers of their choice. See: <https://www.w3.org/2008/09/msnws/papers/decentralization.pdf>.

8 This term needs of course to be distinguished from the 'proof of work', which, in the Bitcoin and Ethereum protocols, is used to reach a consensus on the legitimacy of all the transactions.

9 Source: <https://petertodd.org/2014/setting-the-record-proof-of-publication#what-is-timestamping>.

10 We can already see this kind of solution emerging with distributed applications which work with Ethereum blockchains, such as for example IPFS (<https://github.com/ipfs/ipfs>).



**Although it is now clear that blockchains provide proof of transfer and assignment of an individual's personal data to a third party, our "techno-legal" solution has at the present time certain limits that should nevertheless be mentioned here.**

The first is linked to the territoriality of the law, which may conflict with the fact that data are geographically agnostic. The second has to do with the problem of identity on a blockchain that could cause certain legal complications. We will see next that decentralized market places make monetizing data problematic (cf. Annex 2).

## 4. The socio-economic questions posed by a technological solution

### • Non-territoriality of data

Beside the technical limits<sup>11</sup> of scaling-up the solution, the complexity of human interactions introduces specific problems relating to social sciences, even if they are not insurmountable over the long term.

In addition, the nature of the data, which can be easily copied, does sometimes render the maintenance of exclusive and non-rival property rights complex. We could go even further in this theoretical discussion: the location of a server and a database necessarily has an impact on the efficiency of an ownership right. Let us take a very real example to illustrate our point. The publication of academic journals is not made directly by universities, but by recognized publishers such as *Springer* or *Elsevier*. Researchers submit their articles to these publishers, who are responsible for what is called “peer review”. The articles are sent anonymously to other researchers for comments. This process is organized by the publishers who, once this work is completed, publish the article. It is then sold by the publisher either per copy, or in the form of a subscription. Very expensive for the universities, access to academic research is therefore limited to a few journals or platforms.

Challenging this monopoly of publishers, a Kazakh neuroscientist, Alexandra Elbakyan, founded Sci-hub in 2011. The site today houses more than 64 million articles<sup>12</sup>. It has become the largest virtual library of academic articles. The site bypasses the journals’ payment systems using existing identifiers and directly downloads to a dedicated server the article thus unlocked. Most often, the content is retrieved illegally.

---

11 Scaled up, high transaction costs for nano-payments using protocols still under construction or that need refining. Scaling up public blockchains (<https://blockgeeks.com/guides/blockchain-scalability/>) is, currently, the greatest obstacle to implementing our solution, to the extent that we know in advance that a vast number of smart contracts will be triggered for the remuneration of personal data in the form of micro-payments. On Ethereum, work is in progress: <https://plasma.io/plasma.pdf>.

12 Source: <https://en.wikipedia.org/wiki/Sci-Hub>.

However, the site is so simple to handle that most researchers use it even if they have credentials provided by their own university<sup>13</sup>!

The founder of the site is being sued by many publishers for violation of intellectual property rights<sup>14</sup>. Although several U.S. courts have already ruled that the site is illegal and have convicted its founder in absentia to substantial fines, Sci-hub continues to be used and to copy content originally protected by intellectual property. Elbakyan uses several domain names and the site is also accessible via *Tor*, a computer network which can be used to make the origin of connections disappear. Finally, the servers are not located on American territory and the illegal database cannot therefore be seized or destroyed.

How does that concern our data? **This example shows two limits to our solution. First, that data can be easily copied and stored without the consent of the counterparty. Secondly, that the law has territorial limits. If a malicious person decides to plunder personal data and is located geographically in a place where the rule of law is different, it will be very difficult to enforce it.**

The question is: would the States that do not wish to apply this solution be able to enter into this kind of balance of forces. Currently, there is no technical solution to restrict data duplication.

- **Digital identity and physical identity**

A second limitation comes from the blockchains themselves. **The transaction system is, due to the way it is built, fully pseudonymous**, if not anonymous. Let us take again the example of a current transaction. If I sell a property, the solicitor has the role of a trusted third party. The latter disappears if the transaction is now done through a self-performing contract. This poses no problem from the point of view of the exchange, provided the two parties have agreed on its terms. However, the solicitor also has the role of guarantor that

---

13 Source: <http://www.sciencemag.org/news/2016/04/whos-downloading-pirated-papers-everyone>.

14 Source: [http://www.sciencemag.org/news/2017/11/court-demands-search-engines-and-internet-service-providers-block-sci-hub?utm\\_source=sciencemagazine&utm\\_medium=facebook-text&utm\\_campaign=scihibblock-16248](http://www.sciencemag.org/news/2017/11/court-demands-search-engines-and-internet-service-providers-block-sci-hub?utm_source=sciencemagazine&utm_medium=facebook-text&utm_campaign=scihibblock-16248).

the co-contractors are in full possession of their faculties at the time of the transaction. The same transaction via a self-performing contract on a blockchain therefore has two limitations. First, it is difficult to check that the private key has not been misappropriated and that the transaction is legitimate. Second, even if there has been no theft of this private key, nothing guarantees that I am not under guardianship for example, and that therefore I am in full possession of my faculties at the time of the exchange.

**These difficulties related to identity are real and have a potential impact in legal terms.** This directly relates to a problem of **repudiation of the contract**, where a dissatisfied co-contractor will have a greater interest in not honoring their commitments. Since the identity is not formally verifiable, a person can always argue that someone has robbed them or that they have lost their private key. In addition, we have already shown in these pages the propensity of individuals to neglect their security on the Internet. The intermediary will probably be encouraged to facilitate the task of its customer by offering them to keep the private key and protect their access with a password. These two aspects have the effect of increasing instability and uncertainty related to the “contract”.

Certain technological safeguards exist but currently remain imperfect and still need further research and development. **It may be possible to circumvent this problem in part thanks to the multi-signature. A transaction, to be valid, must be signed by several parties, which reduces the risks mentioned above.**

More generally, individuals should be able to self-manage their digital identity<sup>15</sup>. This is not the case today, to the extent that it has become a product used by platforms to maximize their advertising income. That's why defenders of self-sovereignty intend to give the control of his digital identity to the individual<sup>16</sup>. Applications exist or are being developed, that allow users to better protect their data related to their identity<sup>17</sup>. These applications also provide part of the response to the limitations related

---

15 Source: <https://arxiv.org/pdf/1712.01767.pdf>.

16 Vitalik Buterin briefly decries these points in a recent interview: <http://unchainedpodcast.co/>.

17 We are thinking here of uPort: [https://whitepaper.uport.me/uPort\\_whitepaper\\_DRAFT20170221.pdf](https://whitepaper.uport.me/uPort_whitepaper_DRAFT20170221.pdf), or CIVIC: <https://www.civic.com/products/how-it-works>.

to the identity theft mentioned above. These techniques are used to formally identify each user.

- **Granting of rights v. control**

One of the aspects developed in our analysis relies particularly on the concept of control of data. In the current environment, this is a central theme, because the consumer-citizen needs to be put back at the heart of our solution, giving them back, at least in part, a certain amount of control over the use or non-use of their data by a third party. The very concept of control, from a twofold technical and legal aspect can sometimes be ambiguous, depending on whether you place yourself on the side of the technical or legal point of view<sup>18</sup>. Although we have seen the legal outlines of the concept of control of personal data, we need to say a few words about its technical aspects.

As a solution for the decentralized production of proof, blockchains could be a reference registry, registering not the transactions of the data themselves, but the granting of rights to use these personal data. **One could imagine a market of rights relating to the use of the data. A kind of on-air broadcasting market applied to the use of personal data.** The duration and the scope of the use of these data could take the form of metadata embedded in the transactions. The transactions recorded in the blockchains could constitute proof of granting of use of the data and their terms of use. This could constitute legal proof of the use of personal data. The citizen could invoke this transaction in the event of a dispute. It is this reference, this proof that a right has been granted, which may increase in value and therefore take the form of a traded asset, rather than the data themselves.

---

18 The difficulty of control over personal data, from a technical point of view anyway, is particularly true in the era of Big Data, see for example: <https://scripted.org/article/control-over-personal-data-true-remedy-or-fairy-tale/>. It is specifically for this reason that a technological solution must be associated with a legal guarantee, see WERBACH K., "Trust purpose verify: Why the Blockchain Needs the Law?" Berkeley Technology Law Journal, 2018.

**The challenge could therefore reside in constructing a market of data use rights prior to any attempt to create a data market.**



---

**CONCLUSION**

**We believe in a decentralized Internet, where individual identity still has meaning. The individual is not simply reduced to a flow of data. It is in this spirit that we have come up with our proposals.**

**T**he advent of the digital age in the early 2000s brought about the hope of a certain degree of decentralization of power as well as free flow of information. We have seen, on the contrary, a concentration of power in the hands of those who have unlimited access to the information that we produce every day through our data.

**We believe in a decentralized Internet, where individual identity still has meaning. The individual is not simply reduced to a flow of data. It is in this spirit that we have come up with our proposals which are structured around two focus areas: one is technical and the other legal, so that each person can regain control of his digital identity.**

Advancing the public debate on these issues is the ambition of these few lines, which unfortunately cannot cover all aspects of such huge and complex questions. If the analysis set out here is mainly a legal one, a second publication will focus on the economic aspect and the value given to personal data.

For now, and as a conclusion, the technicality of some of our proposals may be reflected through a few possible future scenarios.

**9 September 2019.** Gérard only drives on Sundays to visit his daughter and grandchildren. Dozens of kilometers separate them and Gérard is very familiar with the road. He nevertheless uses a real-time traffic application to avoid congestion on the Paris ring-road. For her part, Camille, drives her truck all over France for a transport company and also uses the same application.

In both cases, access to the application “costs” the same thing (i.e. nothing) to a truck driver who drives every day or to a retiree who only drives his car on Sundays. In exchange, they both have to share their geolocation, to inform the application about the status of the traffic: Camille therefore contributes much more than Gérard to the value of the application.



If data ownership came about, Camille could demand to be paid, since the value that she produces for the application is much greater than what she receives from it. In contrast, Gérard could choose to pay for access to the application without transferring his data, thus compensating it for his 'stowaway' behavior. In this way, everyone, depending on their life style and uses of the Internet, everyone could build the economic model which best suits them<sup>1</sup>.

**21 June 2021.** Karim struggles to wake up. Summer light floods into the room as the blinds in his apartment rise automatically. A radio program is activated on his smartphone. Karim is hungry. But he ignored the warning from his refrigerator about the shortage of food needed for breakfast and makes do with coffee already prepared by his machine connected to the alarm on his phone. In his home, everything is programmed remotely and interconnected to make sure he wakes up in the best possible way. Everything is calculated based on his sleeping pattern and the time he needs before going to work.

The constant interconnection between different devices generates a significant amount of data about his daily comings and goings, his health, and consumption habits<sup>2</sup>. These devices are also a source of IT risks. Karim is aware of it and wants to protect this intimacy, while limiting any potential piracy of this home automation.

In this case, two options are available. The first is to select each of the devices that include in their design a mechanism for data protection, in specifically using encryption code<sup>3</sup>. However, the transfer of data between the different devices is not always guaranteed. Karim opts for a distributed solution. Each of the devices is connected to the same API. The data are transferred via a dedicated blockchain<sup>4</sup> which protects Karim's home automation system from potential attacks while at the same time guaranteeing the confidentiality of his private life.

---

1 The Steamr application takes a step in this direction: <https://www.streamr.com/#howItWorks>.

2 About the risks of the Internet of Things and the end of confidentiality, see for example: <https://dl.acm.org/citation.cfm?id=3105843&dl=ACM&coll=DL&CFID=850514586&CFTOKEN=59441772>.

3 This is what the English-speaking world calls *privacy by design*.

4 We are thinking here of IOTA: [https://iota.org/IOTA\\_Whitepaper.pdf](https://iota.org/IOTA_Whitepaper.pdf). Although this blockchain is criticized (<https://hackernoon.com/why-i-find-iota-deeply-alarming-934f1908194b>), the idea of a blockchain dedicated to the Internet of Things remains of interest.

**22 January 2022.** Alice is 19 and, for the first time in her life, wants to open an account on a social media platform. Instead of electronically signing a “user agreement” that she will not read, a home page opens, listing all the data the platform will offer to pay in exchange for their use by the company.

For each type of data (age, ethnicity, city, analysis of photos, political preferences, etc.), two prices are displayed<sup>5</sup>. The first is the purchase price by the platform of Alice’s data, the second is the price for the protection of her personal data. These prices have been calculated based on how she previously replied to a few questions about her browsing habits.

Now an adult, she has been proactive and has already transferred the data that she agrees to share on the social media to her data broker. The broker keeps them on protected servers, set up in Alice’s country of origin. The only thing she had to do was to provide the name of her broker and her contract number<sup>6</sup> on the dedicated page of her new social media account. This contract is triggered automatically every time all the pre-established conditions are met. For example, if Alice has agreed to share her age and gender with the platform, she will be paid annually for their use via a smart contract. Validation by Alice via her contract number is what triggers the *smart contract*.

Each year, her broker will send a statement of what she owes the platform to protect her data. If the platform owes her money, it will pay her the corresponding amount in euros. Alternatively, Alice could choose to manage her data alone and to protect them on a dedicated IT medium. In this case, she will have to inform the social media of the data she agrees to make public and of the ones she doesn't. A contract will then be directly created with the social media platform.

---

5 This reflects the latest work on behavioral economics, where the price that a person is willing to pay to protect their data is often different from the price that they are prepared to receive to transfer them. See ACQUISTI A., BRANDIMARTE, L., LOEXENSTEIN G., *Op. cit.* And <https://www.cmu.edu/dietrich/sds/docs/loewenstein/WhatPrivacyWorth.pdf>. This price strategy could possibly be taken into account by the platforms to reflect this cognitive bias.

6 When the conditions of use change, the *smart contract* then becomes obsolete. This has a twofold effect. First, it encourages the supplier of a service not to change them too regularly, otherwise it risks seeing access to its service reduced during a transition phase. Second, we see here a certain limitation to the *smart contract*, which is fairly rigid and does not change in line with the updates of a non-paying site.

Alice now pays for her service with her personal information. In both cases, validation of the transaction via a blockchain is used to authenticate a transfer of rights to these data, and to be paid accordingly.



ANNEXES

---

# Technical details

## Annex 1. Analysis and evaluation of the data

Whether it is from the point of view of the government or large Internet companies, personal data play an increasingly important role in the analysis of behaviors. Most often, it is not your individual data items in themselves that are of interest and are monetized, but their aggregation<sup>1</sup>.

**Consequently, a change in the *business model* implies a change in the value chain.** We leave this issue pending in this report, which focuses primarily on the legal aspect of the data and tries to answer the following question: how can the consumer being given power over his data ? Although the economic approach is of real interest to initiate a debate, this overall technical issue is too broad for this publication and will be addressed subsequently. The question is already thorny, to the extent that it involves issues of public policy that are only now being dealt with by lawmakers.

**The objective is therefore to paint a broad outline of the economic issues and give the reader a brief overview of the literature<sup>2</sup>.**

**At the macroeconomic level, allocating an intellectual property right can be used to eliminate Arrow's information paradox set out in his 1962 paper.** Let's suppose that I want to sell the data linked to my identity to a third party. During this transaction, the buyer will

---

1 It should be noted that economies of scale cannot always be made. The increase in the number of observations does not necessarily improve the return on investment. This is the case for example in advertising. Lewis, R. and Rao J., *The unfavorable economics of measuring the returns to advertising*, Quarterly Journal of Economics, 130(4), 2015.

2 Literature reviews are available, see in particular: ACQUISTI A., TAYLOR C., and WAGMAN L., *Op. cit.* or: <https://ec.europa.eu/jrc/sites/jrcsh/files/jrc104756.pdf>.



how much he is prepared to pay for this information. This is called in microeconomics terms "his propensity to pay". However, to make this assessment, the buyer can ask the seller to reveal the information so he can determine the right price. But as opposed to a good or service, the data that have been disclosed that way no longer have any value. In this context, intellectual property appears to be a natural candidate for the protection of personal data.

**Although it seems that the Arrow paradox can be overcome, there is another problem related to the marketing of data: they are non-rivalrous and non-excludable<sup>3</sup>.** First, this means that the information can be copied without it affecting its use by another consumer. Second, it is difficult to exclude access to this information by the user, even via the intermediary of a price system. Indeed, a buyer may choose to resell the data that it has just acquired, if the law is not specific on this point.

An approach in terms of property rights can be used to regulate the exchange of data rather strictly<sup>4</sup>, as illustrated in the following graph:

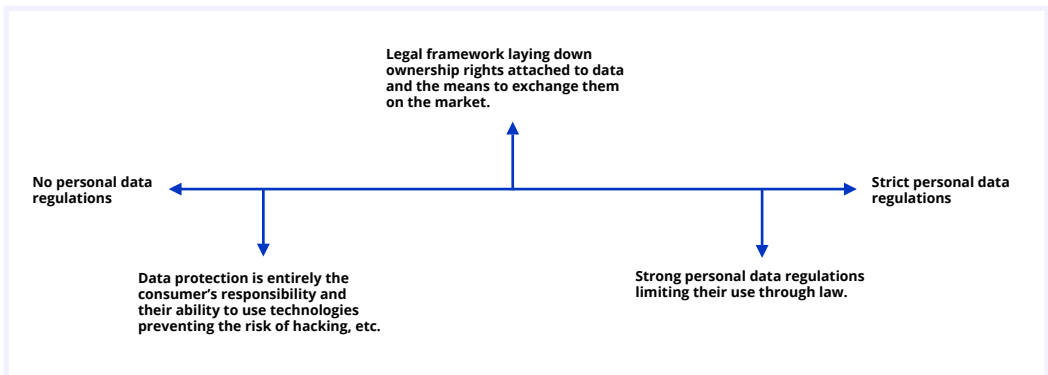

<sup>3</sup> Source: [https://papers.ssrn.com/sol3/papers.cfm?abstract\\_id=2858171](https://papers.ssrn.com/sol3/papers.cfm?abstract_id=2858171).

<sup>4</sup> In relation to this, Europe and the United States have different approaches. As we have seen, the GDPR opens the door to assigning ownership to data. Whereas the United States defends a position which facilitates the appropriation of personal data by *databrokers*. This market is little known to consumers, to such an extent that the *Federal Trade Commission* is calling for greater transparency and improved oversight. Source: <https://www.ftc.gov/system/files/documents/reports/data-brokers-call-transparency-accountability-report-federal-trade-commission-may-2014/140527databrokerreport.pdf>.

On the other hand, this kind of model would lead to reducing the consumer's surplus<sup>5</sup>. There is therefore a cost/benefit to the excludability that must be assessed. But before being able to calculate this cost, it is necessary to establish a market price for the data.

What's more, collection and reprocessing of the data represent a cost for the organizations, which they must assess<sup>6</sup>. This assessment is necessary because it is central to our knowledge economies, where value is derived from information.

First, the new information and telecommunications technologies have economic models that work based on these data<sup>7</sup>. They become the raw material of the new digital economy. The dematerialization of our relations gave a way to a new kind of benevolent "surveillance". If information has an economic value, we can be sure that it implies a new balance of power.

Second, the analysis of the data is itself part of a value chain, which can have a positive impact on growth. The graph below illustrates this cycle of the value chain:

---

5 ACQUISTI A., TAYLOR C., and WAGMAN L., *Op. cit.*

6 We refer the reader directly to the work of the OECD on this subject, which provide a better understanding of the difficulties that are met in this complex exercise. Source: [https://www.oecd.org/officialdocuments/publicdisplaydocumentpdf/?cote=DSTI/ICCP/IE/REG\(2011\)2/FINAL&docLanguage=EN](https://www.oecd.org/officialdocuments/publicdisplaydocumentpdf/?cote=DSTI/ICCP/IE/REG(2011)2/FINAL&docLanguage=EN) and [http://predipubcn.sistemaip.net:8096/intranet-tmpl/prog/img/local\\_repository/koha\\_upload/DSTI-CDEP\(2016\)4-ENG.pdf](http://predipubcn.sistemaip.net:8096/intranet-tmpl/prog/img/local_repository/koha_upload/DSTI-CDEP(2016)4-ENG.pdf).

7 Varian H., Farrell J., and Shapiro C., *The economics of Information Technology: An Introduction*, Cambridge University Press, 2004.



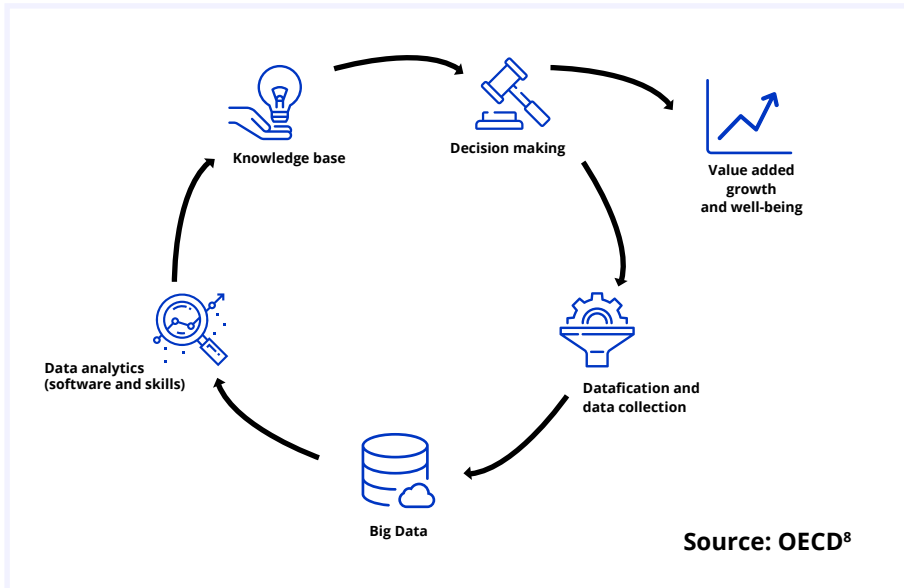

Third, the platforms are a market mechanism rather unique. Since the work of Rochet and Tirole<sup>9</sup>, we know that these two sided markets must satisfy customers with heterogeneous profiles. On the one hand, the users, and on the other, the advertisers. In the first models, the price mechanisms were based on a network effect, and not on the collection and data use. These models today are evolving to better integrate the effects on well-being. The platforms would indeed reduce transaction and information costs<sup>10</sup>.

Finally, there is an obvious behavioral component that influences individual choices and highlights the difficulty of establishing a price for data, which depends mainly on the context<sup>11</sup>.

<sup>8</sup> Source: *Ibid.*

<sup>9</sup> Rochet J. C., and Tirole J., *Two-sided markets: a progress report*, Rand Journal of Economics, 37(3), 2006.

<sup>10</sup> Source: <https://ec.europa.eu/jrc/sites/jrcsh/files/jrc104756.pdf>.

<sup>11</sup> ACQUISTI A., BRANDIMARTE, L., LOEXENSTEIN G., *Op. cit.*



## Annex 2. The case of decentralized “Data Market places”

A data market is **an information market**. Would allocating **property rights** to the latter help correct some **shortcomings in the market**? One of the particularities of the information economy was set out in 1962 by the economist Arrow<sup>12</sup>. Sharing of information in fact introduces this paradox.

**Let's consider for a few moments this very simplified ownership structure**; in general, large groups have tens or even hundreds of subsidiaries that they control more or less directly. A holding company A has a majority shareholding in several companies. Let's suppose that all these companies are recognized as “establishments” by the new European regulations and that they are all located within the EU. This hypothesis removes certain difficulties and provisions specific to the GDPR and related to the transfer of data from the EU to third countries. In this case, such a cascading structure would allow a holding company to share its customers databases with several subsidiaries, without the customers having necessarily given their consent, in this case with firms 1 and 2 and their subsidiaries A1, and A2. This is due to the ownership structure in our example. In this context, the data partly escape from the control of their holder. This results in an additional difficulty of control for the regulator. In this case the regulations should provide for the establishment of a sufficiently transparent system to enable the user to easily know where their data are.

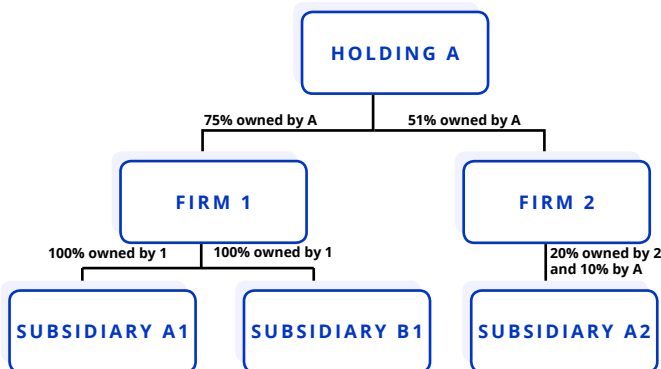

12 Source: <http://www.nber.org/chapters/c2144.pdf>.

Although a legal contract can specify in detail what entity holds what data, this also generates **monitoring** costs that are difficult to dissociate from the said contract. Indeed, it would be much too expensive to store each data item related to each transaction on a blockchain. This new architecture is not designed for this. In this context, monitoring of compliance with the law will have to be done on a case by case basis, where data are indeed exchanged, within each company. The information needed by the court to apply the law should therefore be easily verifiable by this third party. However, the court is itself subject to two constraints, well known to economists: moral hazard and adverse selection. The first assumes that the judge has not made the effort necessary (perhaps due to time constraints or resources) to understand the ins and outs of the case. The second stipulates that the judge does not have the necessary knowledge and/or the information to deal with this case in all fairness or that (s)he has his or her own preferences in terms of case-law. These information asymmetries are reinforced by the fact that the technologies used here are new and not yet mastered by law professionals. On this last point, some jurists talk about the “ossification of the law”<sup>13</sup>. These inherent uncertainties in the judicial decision result in an additional risk for the stakeholders, namely that neither the letter nor the spirit of the contract are implemented<sup>14</sup>.

Let's imagine an exchange of digital personal data platform, on which we could put up for sale the data of our choice and find an interested buyer. The data transactions would be recorded on the register of a public blockchain in return for remuneration in crypto-currency. The only problem is that once the data are exchanged, nothing can prevent them from being duplicated. A single exchange is enough, in theory, to destroy your own market. And although it contains proof of the transaction, a blockchain seems here powerless in addressing the risk of “infringement”.

---

13 MC GARITY, Thomas O. 1992. Some thoughts on deossifying the rulemaking process. *Duke Law Journal* 41: 1385, 1385-1462 ; Pierce, Richard J. Jr., 1995. Seven ways to deossify agency rulemaking. *Administrative Law Review* 47: 59, 60.

14 Source: [https://www.jstor.org/stable/2999457?seq=1#page\\_scan\\_tab\\_contents](https://www.jstor.org/stable/2999457?seq=1#page_scan_tab_contents).

---

# Main references.

## Books.

- BENYAYER L-D., CHIGNARD S., *Datanomics, les nouveaux business models des données*, FYP Editions, 2015.
- MANION Josh, *The power of data ownership : getting it right in 2017*, December 20, 2016.
- LOSHIN David, *Business-Oriented Data Governance for effective Master data Management*, 2015.
- LANIER J., *Who owns the future ?*, Simon and Schuster, 2013.
- LUCAS André et LUCAS Henri-Jacques, *Traité de la propriété littéraire et artistique*, Litec, 2012.
- SIMLER C., *Droit d'auteur et droit commun des biens*, Litec, 2008.
- WRIGHT D., DE HERT P., « Enforcing Privacy Regulatory, Legal and Technological Approaches. Law », *Governance and Technology Series*, Volume 25, 2016.
- SFADJ Rubin et GRANGER Elodie, *Réussir votre mise en conformité GDPR : Guide pratique*, Broché, 2017

## Reports.

- ARROW K., *Economic Welfare and the Allocation of Resources for Invention*, The Rand Corporation, 1962.
- Organization for Economic Co-operation and Development (OECD), *Thirty years after the OECD Privacy Guidelines*, 2011.
- OECD, *Exploring the economics of personal data : a survey of methodologies for measuring monetary value*, 2013.
- SEN A., STIGLITZ J., FITOUSSI J-P, *Rapport de la Commission sur la mesure des performances économiques et du progrès social*, La Documentation française, sept. 2009.

## Articles.

- DASKAL Jennifer, "Beware of the Emergency Exception Loophole in the Email Privacy Act", Just Security, June 7, 2016.
- NAKASHIMA Ellen, "FBI Wants Access to Internet Browser History without a Warrant in Terrorism and Spy Cases", Wash. Post, June 6, 2016.
- GREENE Robyn, "FBI's Push to "Fix a Typo" Would Really Expand Its Surveillance Authority", Just Security, February 17, 2016.
- TRUJILLO Mario, "California Puts Email Privacy Law on the Books", The Hill, October 9, 2015.
- TRUJILLO Mario and McCABE David, "Overnight Tech: Senate Gets Late Start on Email Privacy", The Hill, Sept. 15, 2015.
- Sen. LEAHY Patrick & Sen. LEE Mike, "Update Privacy Laws for the Digital Age", Real Clear Policy, Jan. 28, 2015.
- FARIVAR Cyrus, "Unprecedented E-mail Privacy Bill Sent to Texas Governor's Desk", ArsTechnica, May 28, 2013.
- Editorial, "Upgrade Protections of Digital Records", Seattle Times, May 16, 2013.
- McGREEVY Patrick, "California Senate Backs Requiring Warrants When Police Want E-mails", L.A. Times, May 13, 2013.
- ACQUISTI A., TAYLOR C., WAGMAN L., « The Economics of Privacy », *Journal of Economic Literature*, 54(2), 442-492, 2016.
- CANTERO Isabelle, « En attendant le règlement européen sur les données personnelles... 'l'essentiel fait vertu' », *L'Usine Digitale*, 19 février 2016.
- LECHENET Alexandre, « Données de santé : une base saine mais peut mieux faire », *Libération*, 5 mai 2016.
- HERAULT S., BELVAUX B., « Privacy paradox et adoption de technologies intrusives. Le cas de la géolocalisation mobile », *Décisions Marketing*, 74, 2014.
- MATTATIA F., YAÏCHE M., « Etre propriétaire de ses données personnelles : peut-on recourir au régime traditionnel de propriété ? », *Revue Lamy de droit immatériel*, 114, 2015, p.62.

- NAKAMOTO S., Bitcoin : « A Peer-to-Peer Electronic Cash System », 2008 : <https://bitcoin.org/bitcoin.pdf>
- ROCHET J. C., TIROLE J., « Two-sided markets: a progress report », *Rand Journal of Economics*, 37(3), 2006.
- ROUX D., « La résistance du consommateur : proposition d'un cadre d'analyse », *Recherche et Applications en Marketing*, 22, 4, 2007, pp.59-80.
- Science, *The End of Privacy*, vol . 347 (6221), 2015.
- WRIGHT P., « Marketplace Metacognition and Social Intelligence », *Journal of Consumer Research*, 28, 4, 2002, pp. 677-83.

## Websites.

- Une carte interactive de la CNIL pour savoir où vos données vont être exportées : <https://www.cnil.fr/fr/la-protection-des-donnees-dans-le-monde>
- Ethereum White Paper : <https://github.com/ethereum/wiki/wiki/White-Paper>

## Conferences.

- #Dataday, Conférence débat sur la stratégie d'open Data pour le développement de l'économie de la donnée , 12 janvier 2016.



ACKNOWLEDGMENTS

---

# Authors

## **Nicolas BINCTIN**

Professor of Law Schools, Nicolas Binctin teaches the various components of business law and intellectual property law at the Universities of Poitiers and Paris XII, and the School of Law and Management of the University of Paris II.

## **Isabelle LANDREAU**

Attorney at the Bar of Paris and Doctor of Law, Isabelle Landreau specializes in intellectual property law and new technologies law. She assists her clients in protecting and enhancing their immaterial creations and practices as a lawyer-mediator in intellectual property.

## **G rard PELIKS**

An engineer in cyber security, G rard Peliks has worked in the information security field for over 20 years. President of CyberEdu, he is also Deputy Director of the MBA Management of the security of Digital Data at the "Institut L onard de Vinci".

## **Virginie PEZ-PERARD**

Teacher-researcher, Lecturer at the University of Paris II Panth on-Assas, Virginia PEZ is a specialist in consumer behavior, the psychology of consumption and issues of privacy and intrusiveness in commercial practices.

# The Think tank's Purpose

Tocqueville already deplored in *The Old Regime and the Revolution*, “the frightening spectacle” of French philosophers, cut off from their peers, unaware of the life of society and blind to the rest of the world. “The same attraction for general theories, comprehensive systems of legislation and exact symmetry in the laws; the same contempt for existing facts; the same confidence in theory.”

Conversely, politicians are too often detached from any philosophical reflection, relying too much on the civil service to come up with reform projects.

**“It is therefore for the purpose of better combining theory with practice, and philosophical principles with political action, that Think tanks must work”**

On the basis of a clear doctrine, they bring together the skills of experts to shape sometimes unusual ideas into specific and quantified public policies. With regard to basic Income for example, GenerationLibre took hold of a powerful but very abstract concept and developed an economically viable proposition in the form of a negative tax.

It is good that Think tanks are playing an increasingly large role in the French public arena. Beyond the convictions of each person, this is the guarantee of a rich and informed debate on the major issues of our age.

---

**ACTIONS**

# Our daily challenge

## Our objectives

**1.** **Live and let live**, to allow everyone to define their own values in an open society.

**2.** **Liberalize economy**, because the free trade of goods and services like ideas is the best way to challenge the established order.

**3.** **Apprehend progress**, so that technological innovation continues to benefit individuals.

## Our latest publications

- “Redesigning employment contracts: from subordination to cooperation”, January 2017;
- “LIBER, a realistic proposal, tome II”, January 2017;
- “Gender and the State: from the status of non-disposal to free determination”, June 2017;
- “Refounding Europe, for a minimal European State”, Chapter I, April 2017;
- “Schumpeter and robots, the case of France”, November 2017.

---

SUPPORT US

# Support new ideas

founded in 2013 by the French philosopher Gaspard Koenig, GenerationLibre is a liberal think tank. It is financed exclusively by the generosity of its members, the only guarantee of its freedom to be outspoken and its independence. It refuses any public subsidy and is not involved in any consulting activity. GenerationLibre pursues 3 objectives which are: to live and let live, to liberalize economy, and to apprehend progress.

## Write to us, come and see us

GenerationLibre  
24, rue Saint-Lazare  
75009 Paris  
[contact@generationlibre.eu](mailto:contact@generationlibre.eu)

[www.generationlibre.eu](http://www.generationlibre.eu)