

A11100 990108

NBS  
PUBLICATIONS

NAT'L INST OF STANDARDS & TECH R.I.C.  
A11100990108  
/NBS monograph  
QC100 .U556 V160;1977 C.1 NBS-PUB-C 1959



# NBS MONOGRAPH 160

## Geometrical Considerations and Nonmenclature for Reflectance

U.S. DEPARTMENT OF COMMERCE / National Bureau of Standards

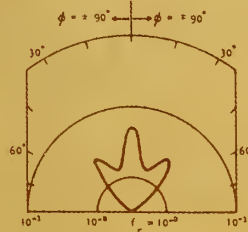
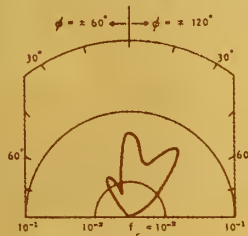
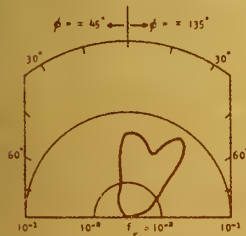
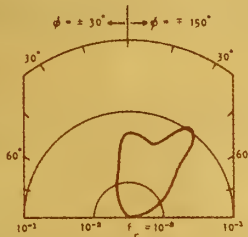
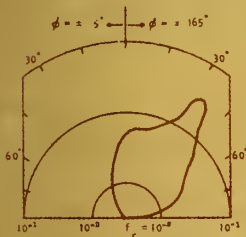
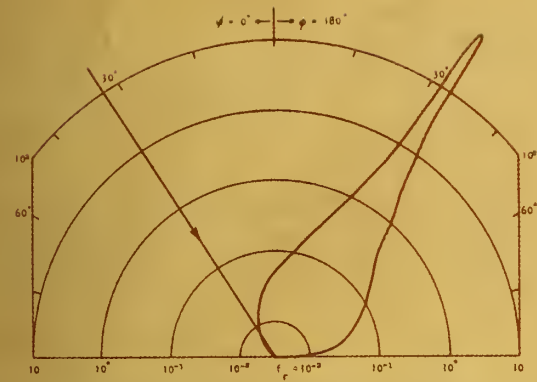

QC  
100  
U556  
No 160  
1977  
6 2

## NATIONAL BUREAU OF STANDARDS

The National Bureau of Standards<sup>1</sup> was established by an act of Congress March 3, 1901. The Bureau's overall goal is to strengthen and advance the Nation's science and technology and facilitate their effective application for public benefit. To this end, the Bureau conducts research and provides: (1) a basis for the Nation's physical measurement system, (2) scientific and technological services for industry and government, (3) a technical basis for equity in trade, and (4) technical services to promote public safety. The Bureau consists of the Institute for Basic Standards, the Institute for Materials Research, the Institute for Applied Technology, the Institute for Computer Sciences and Technology, the Office for Information Programs, and the Office of Experimental Technology Incentives Program.

**THE INSTITUTE FOR BASIC STANDARDS** provides the central basis within the United States of a complete and consistent system of physical measurement; coordinates that system with measurement systems of other nations; and furnishes essential services leading to accurate and uniform physical measurements throughout the Nation's scientific community, industry, and commerce. The Institute consists of the Office of Measurement Services, and the following center and divisions:

Applied Mathematics — Electricity — Mechanics — Heat — Optical Physics — Center for Radiation Research — Laboratory Astrophysics<sup>2</sup> — Cryogenics<sup>2</sup> — Electromagnetics<sup>2</sup> — Time and Frequency<sup>2</sup>.

**THE INSTITUTE FOR MATERIALS RESEARCH** conducts materials research leading to improved methods of measurement, standards, and data on the properties of well-characterized materials needed by industry, commerce, educational institutions, and Government; provides advisory and research services to other Government agencies; and develops, produces, and distributes standard reference materials. The Institute consists of the Office of Standard Reference Materials, the Office of Air and Water Measurement, and the following divisions:

Analytical Chemistry — Polymers — Metallurgy — Inorganic Materials — Reactor Radiation — Physical Chemistry.

**THE INSTITUTE FOR APPLIED TECHNOLOGY** provides technical services developing and promoting the use of available technology; cooperates with public and private organizations in developing technological standards, codes, and test methods; and provides technical advice services, and information to Government agencies and the public. The Institute consists of the following divisions and centers:

Standards Application and Analysis — Electronic Technology — Center for Consumer Product Technology: Product Systems Analysis; Product Engineering — Center for Building Technology: Structures, Materials, and Safety; Building Environment; Technical Evaluation and Application — Center for Fire Research: Fire Science; Fire Safety Engineering.

**THE INSTITUTE FOR COMPUTER SCIENCES AND TECHNOLOGY** conducts research and provides technical services designed to aid Government agencies in improving cost effectiveness in the conduct of their programs through the selection, acquisition, and effective utilization of automatic data processing equipment; and serves as the principal focus within the executive branch for the development of Federal standards for automatic data processing equipment, techniques, and computer languages. The Institute consist of the following divisions:

Computer Services — Systems and Software — Computer Systems Engineering — Information Technology.

**THE OFFICE OF EXPERIMENTAL TECHNOLOGY INCENTIVES PROGRAM** seeks to affect public policy and process to facilitate technological change in the private sector by examining and experimenting with Government policies and practices in order to identify and remove Government-related barriers and to correct inherent market imperfections that impede the innovation process.

**THE OFFICE FOR INFORMATION PROGRAMS** promotes optimum dissemination and accessibility of scientific information generated within NBS; promotes the development of the National Standard Reference Data System and a system of information analysis centers dealing with the broader aspects of the National Measurement System; provides appropriate services to ensure that the NBS staff has optimum accessibility to the scientific information of the world. The Office consists of the following organizational units:

Office of Standard Reference Data — Office of Information Activities — Office of Technical Publications — Library — Office of International Standards — Office of International Relations.

<sup>1</sup> Headquarters and Laboratories at Gaithersburg, Maryland, unless otherwise noted; mailing address Washington, D.C. 20234.

<sup>2</sup> Located at Boulder, Colorado 80302.

NOV 8 1977

not acc

# Geometrical Considerations and Nomenclature for Reflectance

2C100  
USS6  
no. 160  
1977  
C. 2

→ Monograph, no 160

F.E. Nicodemus, J.C. Richmond,  
and J.J. Hsia

Institute for Basic Standards  
National Bureau of Standards  
Washington, D.C. 20234

and

I.W. Ginsberg

EG&G, Inc.  
Las Vegas, Nevada 89101

and

T. Limperis

Agro Sciences, Inc.  
Ann Arbor, Michigan 48103



---

U.S. DEPARTMENT OF COMMERCE, Juanita M. Kreps, Secretary

Dr. Sidney Harman, Under Secretary  
Jordan J. Baruch, Assistant Secretary for Science and Technology

NATIONAL BUREAU OF STANDARDS, Ernest Ambler, Acting Director

Issued October 1977

For sale by the Superintendent of Documents, U.S. Government Printing Office  
Washington, D.C. 20402 - Price \$2.10  
Stock No. 003-003-01793

## Contents

	Page
I. Introduction .....	1
II. Reflectance Concepts and Nomenclature .....	3
A. Bidirectional Reflectance-Distribution Function (BRDF) .....	3
B. Definitions of Reflectance and Reflectance Factor .....	7
C. Reflectances and Reflectance Factors for Nine Geometries .....	9
III. Some Additional Reflectance-Nomenclature Possibilities .....	12
A. McCamy's Notation for Right Circular Cones .....	12
B. Multivariate Reflectance-Distribution Functions (MRDF's) .....	14
C. Other Special Types (BRIDF and BRPDF) .....	19
IV. Practical Considerations for Measurement of Reflectance .....	20
A. Effects of Finite Intervals .....	21
B. Definition of Reflecting-Surface Area .....	24
C. Sub-Surface Scattering (Edge Effects) .....	28
D. Extrapolation to Different Geometries .....	30
E. Other Radiation Parameters and Fluorescence (or Phosphorescence) ..	30
F. Use of Reference Standards .....	32
V. Summary, Conclusions, and Recommendations .....	33
 Appendices	
VI. A. Background and Basis for Recommendations .....	34
VII. B. Details of Reflectance Derivations (A Thought Experiment) .....	37
VIII. C. Perfectly Diffuse and Perfectly Specular Reflectances .....	43
IX. D. Details for Derivations of McCamy's Notation .....	46
X. Acknowledgments .....	50
XII. References .....	51

## Illustrations

### Figure

1. Geometry of incident and reflected beams (for general cases where sub-surface scattering is involved) .....	4
2. Geometry of incident and reflected elementary beams ( $Z$ axis is chosen along the normal to the surface element $dA$ at $O$ .) (Adapted from [10]) .....	6
3. Designations for denoting incident- and reflected- (collected-) beam geometry ..	10
4. McCamy's notation for right circular cones .....	13
5. Three-dimensional graph of <i>bidirectional reflectance-distribution function</i> (BRDF) $f_r(33.2^\circ, 0^\circ; \theta, \phi)$ (from [10]) .....	22
6. Three configurations for physically defining the reflecting area. (See sec. IV.C concerning important limitations arising from sub-surface scattering or "edge effects".) .....	25

	Page
7. Simplified configuration when source (or receiver) is located in focal plane (or just behind field stop in focal plane) of primary optics .....	26
8. Simplified configuration with source (or receiver) and sample (reflecting surface) in conjugate image planes of primary optics.....	27
9. "Thought-experiment" configuration for bidirectional reflectance .....	38
10. "Thought-experiment" configuration for directional-conical reflectance .....	40
11. "Thought-experiment" configuration for conical-directional reflectance .....	41
12. Construction for deriving relationships between spherical coordinates and McCamy's notation for right-circular cones .....	47
13. Details of the construction of figure 12 .....	48

## Tables

### Table

1. Proposed nomenclature for nine kinds of reflectance .....	11
2. Proposed nomenclature for nine reflectance factors .....	12
3. The multivariate reflectance-distribution functions .....	15
4. Comparison between recommended reflectance nomenclature and that of [10]	35

List of Abbreviations

<u>Abbreviation</u>	<u>Term</u>	<u>Defined or used in sec., eq, table, etc.</u>
BRDF	bidirectional reflectance-distribution function	II.A [eq (7)].
BRIDF	bidirectional reflected-intensity-distribution function	III.C [eq (26)].
BRRDF	bidirectional reflected-radiance-distribution function	III.C [eq (25)].
BSSRDF	bidirectional scattering-surface reflectance-distribution function	II.A [eqs (1) & (2)].
MRDF	multivariate reflectance-distribution function	III.B [table 3].
RDF	reflectance-distribution function	III.C.
SI	Système International d'Unités (the International System of Units)	List of Unit-Dimensions.
ORDF	avariate reflectance-distribution function	III.B [table 3].
1RDF	univariate reflectance-distribution function	III.B [table 3].
2RDF	bivariate reflectance-distribution function	III.B [table 3].
3RDF	trivariate reflectance-distribution function	III.B [table 3].
4RDF	quadrivariate reflectance-distribution function	III.B [table 3].

List of Symbols

<u>Symbol</u>	<u>Term</u>	<u>Explanation</u>	<u>Unit-Dimension</u>	<u>Defined or used in sec., eq, table, fig., etc.</u>
$A$	area	of a surface; $= \iint dx \cdot dy$	$[m^2]$	II.A [eq (4)].
$a$	area	of a band of diminishing reflected radiance; $a(r_m)$	$[m^2]$	IV.C [eq (34)].
$C$	constant	with respect to wavelength	$[X]$	IV.E.
$c$	speed of light	electromagnetic radiation— in empty space; $= (2.997$ $924\ 58 \pm 0.000\ 000$ $012) \times 10^8 [m \cdot s^{-1}]$	$[m \cdot s^{-1}]$	I (footnote).
$E$	irradiance	incident flux (surface) density; $\equiv d\Phi/dA$	$[W \cdot m^{-2}]$	II.A [eq (4)].
$f$	frequency	of modulation or fluctuation; $f \ll \nu$	$[Hz]$	I (footnote).
$f( )$	function	of the quantities or parameters in the parentheses	...	II.A [eq (9)].
$f_r(\theta_i, \phi_i; \theta_r, \phi_r)$	BRDF	bidirectional reflectance-distribution function	$[sr^{-1}]$	II.A [eq (6)].
$f_r(\theta_i, \phi_i; \theta_r, \phi_r; \lambda)$	spectral BRDF	spectral bidirectional reflectance-distribution function	$[sr^{-1}]$	IV.E [eq (38)].
$f_r(\lambda)$	relative spectral BRDF	separable relative spectral reflectance-distribution function	[dimensionless]	IV.E [eq (40)].

List of Symbols (continued)

<u>Symbol</u>	<u>Term</u>	<u>Explanation</u>	<u>Unit-Dimension</u>	<u>Defined or used in sec., eq, table, fig., etc.</u>
$\bar{f}_r(\dots; \dots)$	average RDF for indicated beam geometry	[see note at end of table 3, and accompanying text, concerning special rules for designating parameter intervals for such averaging in the MRDF scheme]	[sr <sup>-1</sup> ]	III.B [table 3].
$f_{rI}(\theta_i, \phi_i; \theta_r, \phi_r)$	BRIDF	bidirectional reflected-intensity-distribution function	[sr <sup>-1</sup> ]	III.C [eq (26)].
$f_{rL}(\theta_i, \phi_i; \theta_r, \phi_r)$	BRRDF	bidirectional reflected-radiance-distribution function	[sr <sup>-1</sup> ]	III.C [eq (25)].
$H$ (obs.)	irradiance	[obsolete—replaced by $E$ ] (now used for exposure—in [J · m <sup>-2</sup> ])	[W · m <sup>-2</sup> ]	App. A [table 4].
$I$	radiant intensity (of a source)	existent flux per unit solid angle; $\equiv d\Phi/d\omega$	[W · sr <sup>-1</sup> ]	III.C [eq (26)].
$J$ (obs.)	radiant intensity	[obsolete—replaced by $I$ ]	[W · sr <sup>-1</sup> ]	App. A [table 4].
$L$	radiance	$\equiv d^2\Phi/(dA \cdot \cos\theta \cdot d\omega)$	[W · m <sup>-2</sup> · sr <sup>-1</sup> ]	II.A [eq (1)].
$l$	direction cosine	of cone axis with respect to $X$ -axis; $= x_0/\rho_0$ ; used in App. D only.	[dimensionless]	App. D [eq (D3)].
$M$	radiant exitance	existent flux (surface) density; $\equiv d\Phi/dA$	[W · m <sup>-2</sup> ]	App. B [eq (B3)].
$m$	direction cosine	of cone axis with respect to $Y$ -axis; $= y_0/\rho_0$ ; used in App. D only	[dimensionless]	App. D [eq (D3)].
$N$ (obs.)	radiance	[obsolete—replaced by $L$ ]	[W · m <sup>-2</sup> · sr <sup>-1</sup> ]	App. A [table 4].
$n$	direction cosine	of cone axis with respect to $Z$ -axis; $= z_0/\rho_0$ ; used in App. D only	[dimensionless]	App. D [eq (D3)].
$P$ (obs.)	radiant flux (power)	[obsolete—replaced by $\Phi$ ]	[W]	App. A [table 4].
$R$	reflectance factor	$\equiv d\Phi_r/d\Phi_{rid}$	[dimensionless]	II.B.2 [eq (18)].
$R$	receiver	[designation used in figs. 9, 10, and 11, and accompanying text only]		App. B [figs. 9, 10, and 11].



List of Symbols (continued)

<u>Symbol</u>	<u>Term</u>	<u>Explanation</u>	<u>Unit-Dimension</u>	<u>Defined or used in sec., eq., table, fig., etc.</u>
$r$	width of reflected beam	width of reflected (and collected) beam in fig. 6 and accompanying text only	[m]	IV.B [fig. 6].
$r$	radial polar coordinate in $X$ - $Y$ plane	related to spherical coordinates by $r = \rho \cdot \sin \theta$ ; and to rectangular coordinates by $x = r \cdot \cos \phi$ , $y = r \cdot \sin \phi$	[m]	IV.C [eq (32)].
$r$	radius of base of right circular cone	$= \rho \cdot \sin \kappa$ in fig. 12 and related text only	[m]	App. D [fig. 12].
$r$	sub-surface-scattering distance	separation between point of incidence and point of significant reflection (exitance) on reference surface with sub-surface scattering; $= [(x_r - x_i)^2 + (y_r - y_i)^2]^{\frac{1}{2}}$ .	[m]	II.A [eqs (7) and (8)].
$r^{ir}$	partial reflectance	used by De Vos [19] for the BRIDF $f_{r,l}$ of eq (26)	[sr <sup>-1</sup> ]	III.C [following eq (26)] only.
$r_m$	maximum sub-surface-scattering dist.	maximum distance (across reference surface or nominal reflecting surface) for significant sub-surface-scattering	[m]	IV.C [eq (32)].
$S$	BSSRDF	bidirectional scattering-surface reflectance-distribution function; $= S(\theta_i, \phi_i, x_i, y_i; \theta_r, \phi_r, x_r, y_r)$	[m <sup>-2</sup> · sr <sup>-1</sup> ]	II.A [eq (2)].
$s$	width of exposed sample surface	used in fig. 6 and accompanying text only	[m]	IV.B [fig. 6].
$u$	parameter; variable quantity	[may also be a function of other variables]	...	App. C [following eq (C10)].
$X$	radiometric quantity	includes: $Q$ [J], $\Phi$ [W], $I$ [W · sr <sup>-1</sup> ], $E$ or $M$ [W · m <sup>-2</sup> ], or $L$ [W · m <sup>-2</sup> · sr <sup>-1</sup> ]	[X]	IV.E [following eq (40)].

List of Symbols (continued)

<u>Symbol</u>	<u>Term</u>	<u>Explanation</u>	<u>Unit-Dimension</u>	<u>Defined or used in sec., eq, table, fig., etc.</u>
$X, Y, Z$	rectangular-coordinate axes	usually oriented with $Z$ -axis normal to element $dA$ of reference surface and $X$ - $Y$ axes in tangent plane containing $dA$ ; $Z$ -axis is also polar axis ( $\theta = 0$ ) for spherical coordinates $\rho, \theta, \phi$ .	...	II.A [fig. 2].
$X', Y', Z'$	"tilted" axes	[used in App. D only]	...	App. D [fig. 12].
$X'', Y'', Z''$	"rotated" axes	[used in App. D only]	...	App. D [fig. 12].
$x_\lambda$	relative spectroradiometric quantity	$= X_\lambda / C$ ; relative spectral distribution of radiation	[nm <sup>-1</sup> ]	IV.E [eq (40)].
$x, y, z$	rectangular position coordinates	$x$ = distance from $Y$ - $Z$ plane, etc.	[m]	II.A [eq (2)].
$\alpha$	off-specular angle	$\theta_r = \theta_i \pm \alpha$ —direction in which off-specular glints are observed	[rad]	App. C [eq (C14)].
$\alpha(\theta)$	limit function	used to designate integration limits for $\phi$ when expressing reflectance quantities in terms of the BRDF in McCamy's notation for rt.-circular cones; $= \cos^{-1}[(\cos \kappa - \cos \theta_0 \cdot \cos \theta) / (\sin \theta_0 \cdot \sin \theta)]$	[rad]	III.A [eq (21)].
$\beta$	radiance factor	CIE symbol for a radiance factor or ...-directional reflectance factor $R(\dots; \theta_r, \phi_r)$ ; also luminance factor	[dimensionless]	II.C.2.
$\beta$	off-specular angle	$\phi_r = \phi_i \pm \beta$ —direction in which off-specular glints are observed	[rad]	App. C [eq (C14)].
$\beta$	angle	angle between $OP$ and $OP_0$ , where $P$ is any point on a plane through $P_0$ , perpendicular to $OP_0$ ; $= \angle POP_0$	[rad]	App. D [eq (D3)].
$\delta(\ )$	Dirac delta-function	defined by eqs (C11)	...	App. C [eq (C10)].

List of Symbols (continued)

<u>Symbol</u>	<u>Term</u>	<u>Explanation</u>	<u>Unit-Dimension</u>	<u>Defined or used in sec., eq, table, fig., etc.</u>
$\theta$	polar angle; * colatitude	spherical direction coordinate; axes usually oriented so $\theta$ is the angle from the Z-axis, which is normal to a surface element $dA$	[rad]	II.A [fig. 2].
$\theta_0, \phi_0, \kappa$	McCamy's notation	for a right-circular cone; axis direction is $\theta_0, \phi_0$ , half-vertex angle is $\kappa$	[rad]	III.A [fig. 4].
$\kappa$	half-vertex angle	of right-circular cone (McCamy's notation)	[rad]	III.A [fig. 4].
$\lambda_0$	vacuum wavelength	$= c/\nu$	[m], [nm] or [ $\mu\text{m}$ ]	I (footnote).
$\mu$	obliquity factor	$\equiv \cos \theta$ ; $d\mu = -\sin \theta \cdot d\theta$ ; widely used, but not in this monograph	[dimensionless]	II.B.1 (footnote).
$\nu$	frequency	spectral or "carrier" frequency; $\nu = c/\lambda_0 \gg f$	[Hz] or [THz]	I (footnote).
$\pi$	pi	ratio of circumference to diameter of a circle ( $= 3.141\ 592\ 65$ ; solid angle of 1[hemisphere] = $2\pi$ [sr]; projected solid angle of 1[hemisphere] = $\pi$ [sr])	[dimensionless]	II.C.1 [eq (19)].
$\rho$	reflectance	$\equiv \Phi_r/\Phi_i$	[dimensionless]	II.B.1 [eq (15)].
$\rho$	radial coordinate	distance from origin, in three-dimensional spherical coordinates $\rho, \theta, \phi$ .	[m]	App. D <i>only</i> .
$\rho'$ (obs.)	BRDF	mistakenly called "bidirectional reflectance" or "partial reflectance" in [10]	[ $\text{sr}^{-1}$ ]	App. A [table 4].
$\rho', \theta', \phi'$	"tilted" coordinates	[used in App. D only]	[m], [rad], [rad]	App. D.
$\rho'', \theta'', \phi''$	"rotated" coordinates	[used in App. D only]	[m], [rad], [rad]	App. D.
$\rho_{di}(\theta_i, \phi_i)$	(obs.)	mistakenly termed "directional reflectance" in [10]; should be directional-hemispherical reflectance, $\rho(\theta_i, \phi_i; 2\pi)$	[dimensionless]	App. A [table 4].

List of Symbols (continued)

<u>Symbol</u>	<u>Term</u>	<u>Explanation</u>	<u>Unit-Dimension</u>	<u>Defined or used in sec., eq, table, fig., etc.</u>
$\rho_{dr}(\theta_r, \phi_r)$	(obs.)	mistakenly termed "directional reflectance" in [10]; should be hemispherical-directional reflectance factor $R(2\pi; \theta_r, \phi_r)$ or, by [12], hemispherical radiance factor $\beta(2\pi; \theta_r, \phi_r)$	[dimensionless]	App. A [table 4].
$\Phi$	radiant flux	power propagated as optical electromagnetic radiation	[W]	II.A [eq (1)].
$\phi$	azimuth angle; longitude	spherical direction coordinate; axes usually oriented so that $\phi$ is the angle from the $X$ -axis in the $X-Y$ plane, tangent to reference surface at common surface element $dA$	[rad]	II.A [fig. 2].
$\Omega$	projected solid angle	$\equiv \int \cos \theta \cdot d\omega \equiv \iint \cos \theta \cdot \sin \theta \cdot d\theta \cdot d\phi$ , as distinguished from solid angle $\omega$	[sr]	II.B.1 [eq (10)]; II.C.1 [eq (19)].
$\Omega$	solid angle	<i>elsewhere</i> , often used interchangeably with $\omega$	[sr]	App. A [table 4].
$\Omega'$	projected solid angle	used in [10], but we <i>now</i> recommend $\omega = \iint \sin \theta \cdot d\theta \cdot d\phi$ and $\Omega = \int \cos \theta \cdot d\omega$	[sr]	App. A [table 4].
$\omega$	solid angle	$\equiv \iint \sin \theta \cdot d\theta \cdot d\phi$	[sr]	II.B.1 [eq (10)].

## List of Subscripts

<u>Subscript</u>	<u>Significance</u>	<u>Defined or used in sec., eq, table, etc.</u>
<i>d</i>	perfectly diffuse (isotropic; lambertian)	App. C [eq (C1)].
<i>i</i>	intensity; e.g., the BRIDF $f_{rI}$	III.C [eq (26)].
<i>i</i>	incident	II.A.
<i>id</i>	<i>i</i> deal (lossless) and <i>d</i> iffuse (isotropic or lambertian); e.g., $\rho_{id} = 1$ .	App. C [eq (C7)].
<i>isp</i>	<i>i</i> deal (lossless) and <i>s</i> pecular (mirror-like); e.g., $\rho_{isp} = 1$ .	App. C [eq (C12)].
<i>L</i>	radiance; e.g., the BRRDF $f_{rL}$	III.C [eq (25)].
<i>m</i>	maximum; e.g., $r_m$	IV.C [eq (32)].
<i>0</i>	direction coordinate of axis of right-circular cone in Mc-Camy's notation	III.A [fig. 4].
<i>0</i>	fixed coordinates (with respect to fixed axes)	App. D [fig. 12].
<i>r</i>	reflected	II.A.
<i>rI</i>	reflected-intensity	III.C [eq (26)].
<i>rL</i>	reflected-radiance	III.C [eq (25)].
<i>sp</i>	specular, regular (mirror-like)	App. C [eq (C9)].
$\lambda$	denotes a derivative with respect to wavelength; e.g., $X_\lambda \equiv dX/d\lambda$ [ $X \cdot \text{nm}^{-1}$ ]	IV.E [eq (40)].

## List of Unit-Dimension Symbols

<u>Symbol</u>	<u>Name of unit</u>	<u>Dimension or quantity</u>	<u>Status in SI [38]</u>
[g]	gram	mass	base unit
[Hz]	hertz	frequency	derived unit with special name; = $[\text{s}^{-1}]$ .
[J]	joule	energy	derived unit with special name; = $[\text{m}^2 \cdot \text{kg} \cdot \text{s}^{-2}]$
[m]	meter	length	base unit
[rad]	radian	plane angle {1[ $\circ$ ] = $2\pi$ [rad]}	supplementary unit
[s]	second	time	base unit
[sr]	steradian	solid angle {1[sphere] = $4\pi$ [sr]}	supplementary unit
[W]	watt	power, radiant flux	derived unit with special name; = $[\text{m}^2 \cdot \text{kg} \cdot \text{s}^{-3}]$
[X]	-----	unspecified (those of radiometric quantity X)	-----

NOTE: the symbols are enclosed in square brackets to emphasize the dimensionality of the units and the usefulness of that dimensionality in routine unit-dimension-consistency checks and analyses to cope with the great diversity of nomenclature in the literature on optical radiation measurements.

List of Unit-Prefix Symbols [38]

<u>SYMBOL</u>	<u>PREFIX</u>	<u>FACTOR</u>	<u>SYMBOL</u>	<u>PREFIX</u>	<u>FACTOR</u>	NOTE: The symbols and prefix names listed in this table are used, in combination with the symbols and names, respectively, of the SI units (see above) to form decimal multiples and sub-multiples of those units. For example, one terrahertz [THz] is equal to $10^{12}$ hertz [Hz] or $10^{12}$ [s <sup>-1</sup> ]. Similarly, one kilogram [kg] is equal to $10^3$ grams [g].
a	atto	$10^{-18}$	k	kilo	$10^3$	
c	centi	$10^{-2}$	M	mega	$10^6$	
d	deci	$10^{-1}$	m	milli	$10^{-3}$	
da	deka	$10^1$	n	nano	$10^{-9}$	
E	exa	$10^{18}$	P	peta	$10^{15}$	
f	femto	$10^{-15}$	p	pico	$10^{-12}$	
G	giga	$10^9$	T	tera	$10^{12}$	
h	hecto	$10^2$	$\mu$	micro	$10^{-6}$	

# Geometrical Considerations and Nomenclature for Reflectance

F. E. Nicodemus, J. C. Richmond, and J. J. Hsia

National Bureau of Standards,  
Washington, D.C. 20234

and

I. W. Ginsberg

EG&G, Inc., Las Vegas, Nev. 89101

and

T. Limperis

Agro Sciences, Inc., Ann Arbor, Mich. 48103

A unified approach to the specification of reflectance, in terms of both incident- and reflected-beam geometry, is presented. Nomenclature to facilitate this approach is proposed.

Under specified conditions—including uniform irradiance, a uniform, isotropic, plane surface, and allowance for edge effects due to sub-surface scattering—the geometrical reflecting properties of a reflecting surface are readily characterized or specified in terms of the *bidirectional reflectance-distribution function* (BRDF). The BRDF is denoted symbolically as  $f_r$ :

$$f_r(\theta_i, \phi_i; \theta_r, \phi_r) \equiv dL_r(\theta_i, \phi_i; \theta_r, \phi_r; E_i) / dE_i(\theta_i, \phi_i) \quad [sr^{-1}]$$

where

$\theta$  and  $\phi$  together indicate a direction, the subscript  $i$  indicates quantities associated with incident radiant flux, the subscript  $r$  indicates quantities associated with reflected radiant flux,  $E_i$  is incident irradiance,  $L_r$  is reflected radiance, and  $d$  indicates a differential quantity.

The BRDF is a derivative, a distribution function, relating the irradiance incident from one given direction to its contribution to the reflected radiance in another direction. Nomenclature (concepts, terms, symbols, and units) for categorizing and specifying reflectance quantities for a variety of different beam configurations (both incident and reflected beams) is described, and all are defined and interrelated in terms of the BRDF. The conditions under which the formalism can be applied, including situations involving considerable sub-surface scattering, are carefully established. The entire treatment is limited to the domain of classical geometrical-optics radiometry and does not take into account interference and diffraction phenomena, such as are frequently encountered with highly coherent radiant flux. The other radiation parameters such as wavelength, (temporal) modulation, and polarization and the effects of fluorescence (or phosphorescence) are discussed briefly.

Key words: Bidirectional reflectance-distribution function; diffuse reflectance; directional reflectance; nomenclature of reflectance; reflectance; reflectance factor; reflectance geometry; reflectance nomenclature; specular reflectance; sub-surface scattering; reflection; optical reflection.

## I. Introduction

This monograph presents a unified approach to the specification of reflectance in relation to the beam geometry of both the incident and the reflected flux in any reflectometer or in any application of measured reflectance data. Nomenclature to facilitate this approach is proposed.

Traditionally, optical propagation has been treated as consisting of two distinct phenomena—regular (specular) propagation and diffuse propagation. However, while purely regular (specular) or purely diffuse propagation can be very closely approximated, neither is ever completely and independently achieved in practice. Furthermore, when directional propagation [1]<sup>1</sup> (transmittance

<sup>1</sup> Figures in brackets indicate the literature references at the end of this Monograph.

and/or reflectance) curves are plotted for actual measurement results, they not only exhibit a continuous distribution, from the pure delta-function spikes of highly specular propagation through gradually broader and flatter peaks to the smooth flat curves of isotropically diffuse propagation, but also show a wide variety of distorted shapes that do not fall directly between the two extremes. An example of this is presented in our cover illustration that is repeated later in figure 5. The usual practice in reflectometry has been to express the reflectance properties of a real surface as the sum of a specular component and a diffuse component (with the possibly misleading implication of being isotropically diffuse), and this is mathematically feasible. However, we feel that to do this is to make an unnecessarily artificial distinction, since the choice of what is included as specular and what as diffuse turns out to depend in many situations on the interests and objectives of the investigator or user and on the resolution capability of his instrumentation. Accordingly, we propose to achieve greater generality and flexibility through the use of a single bidirectional scattering-surface reflectance-distribution function (BSSRDF) to specify the geometrical reflectance properties of any surface. This approach is developed in this monograph where it is also the basis for a proposed nomenclature for more adequately describing and specifying the (geometrical) reflecting properties of most surfaces in terms of the simpler bidirectional reflectance-distribution function (BRDF).

Note that the use of this nomenclature and approach does not preclude the use of quantities associated with the concepts of specular and diffuse propagation, when appropriate. Whenever attention is focused on a single ray (or the associated element of throughput) that retains its identity, for any purposes, along a given propagation path [2], its interactions with matter along the path are usually most usefully described in terms of the propagation [1] (transmittance and/or reflectance) or the attenuation [3] (absorptance and/or scatterance [3], the fractional scattering or reflection loss) of the optical ray path. For example, this might be the path along each ray through an image-forming optical system between a pair of conjugate points on an object and its image. Values of the BRDF at a point of reflection along a ray path in such a system with reflecting optical elements can then be related to the "regular" or "specular" reflectance and/or the reflection or scattering loss by "diffuse" reflectance in terms of the angular resolution capability of the system. Values for directions within that angular resolution contribute to the "specular" reflectance; those outside the angular resolution contribute to the loss or attenuation by "diffuse" reflection or scattering. Of course the BRDF must be measured with angular resolution superior to that to which the data are applied. But that is a measurement problem that is not limited to this particular situation but applies to the measurement of many distributed quantities; and it does not detract from the usefulness of the underlying concept, even in situations where only coarser measurement data are available.

*Reflection* is the process by which electromagnetic flux<sup>2</sup> (power), incident on a stationary<sup>3</sup> surface or medium, leaves that surface or medium from the incident side without change in frequency;<sup>4</sup> *reflectance* is the fraction of the incident flux that is reflected. There exists a large volume of data on the reflectance, for optical electromagnetic flux, of a wide variety of reflecting surfaces. Most of these data are for the visible region, where the primary concern has been with the visual appearance of reflecting surfaces, their color, texture, gloss, etc. More recently, a substantial body of reflectance data for broader spectral regions, extending particularly into the infrared, has also been collected, much of it in connection with heat-transfer analyses. And, very recently, an interest in the possibilities for spectral analysis by reflected flux has arisen, principally in connection with remote sensing of earth and other planetary and satellite surfaces. However, attempts to apply these data to particular situations frequently lead to difficulties and inconsistencies. One very large source of difficulty is the lack of attention to geometrical

<sup>2</sup> Radiant flux, luminous flux, photon flux, etc., can be substituted in the expression to be derived. Nomenclature (terminology, symbols, and units) used here, unless specially defined or self-explanatory, is that of ANSI Z7.1-1967 [4].

<sup>3</sup> There would be a frequency shift in the flux from a moving reflector due to the Doppler effect.

<sup>4</sup> Radiation frequency  $\nu = c/\lambda_0$  [Hz], where  $c$  [m·s<sup>-1</sup>] is the vacuum velocity of light and  $\lambda_0$  [m] is the vacuum wavelength, as well as the fluctuation or modulation frequency  $f \ll \nu$  [Hz].



parameters, both for beams of incident flux and for beams in which reflected flux is collected and detected. In fact, most optics texts fail to provide adequate nomenclature (terms and/or symbols) for clearly designating and discussing these geometrical considerations. A unified approach to geometrical-reflectance and related nomenclature is proposed in this monograph.

Transmission, absorption, spectral and polarization effects, and fluorescence, essential considerations for any complete treatment of reflectance [5], are not treated here. It should also be emphasized that we are concerned only with geometrical (ray) optics; it is assumed that there is no significant interference or diffraction. With the explosive increase in the use of coherent laser flux, situations involving these phenomena of physical (wave) optics are becoming increasingly important. Accordingly, it should be emphasized that the quantities and relationships developed in this paper should not be blindly applied to situations involving lasers. They may only be used when it has been verified that, in fact, the basic assumptions of geometrical optics do apply to an adequate degree of approximation. Those assumptions are discussed in [6] and [7].

The remainder of this monograph is organized into four sections, in order to present first the principal approach and then some variations on that approach and some related details. The main ideas proposed by the authors are presented in section II. The bidirectional reflectance-distribution function (BRDF) and reflectance concepts as well as the basic set of reflectance nomenclature are formalized. Section III deals with some possibilities for additional reflectance quantities and nomenclature. Practical considerations for measurement of reflectance quantities and nomenclature are discussed in section IV. Section V concludes with a summary and recommendations. In addition, there are four appendices. Appendix A is a brief historical review of how we came to write this monograph and what transpired while it took so long to complete and publish it. It also gives the reasons for some of our choices of nomenclature. Appendix B describes a thought experiment that some may find helpful in trying to understand the concept of the BRDF. The expressions for perfectly diffuse and perfectly specular (regular) reflection are derived and discussed in appendix C and the latter is also extended to off-specular peaks or "glints." The last appendix, appendix D, presents the detailed derivations of some important relations in McCamy's notation.

## II. Reflectance Concepts and Nomenclature

In order to simplify the development of concepts and formalization of nomenclature, we first study a model in which a relatively large area of reflecting surface is irradiated by a well-collimated beam of incident radiation, examining the radiation reflected from a point well within the irradiated area. Here, we confine our attention to geometrical considerations, to the effects of just the spatial parameters of position and direction of all rays. Important effects of the other radiation parameters—the spectral parameter (wavelength, frequency  $\nu$ , or wave number), the temporal parameter (time, or fluctuation or modulation frequency  $f \ll \nu$ ), and the polarization parameter(s)—and of fluorescence (or phosphorescence) are briefly discussed in section IV.E.

### A. Bidirectional Reflectance-Distribution Function (BRDF)

Consider the radiation flux incident on a surface from the direction  $(\theta_i, \phi_i)$ , within the element of solid angle  $d\omega_i$  [sr], as shown in figure 1.  $A_i$  denotes the total irradiated surface area. That portion of the incident flux which strikes an element of area  $dA_i$  [ $m^2$ ] centered at the point  $(x_i, y_i)$  will be denoted by  $d\Phi_i$  [W]. The reflected radiance in the direction  $(\theta_r, \phi_r)$  at the point  $(x_r, y_r)$  which comes from  $d\Phi_i$  will be called  $dL_r$ . In general,  $dL_r$  is directly proportional to  $d\Phi_i$ , or

$$dL_r = S \cdot d\Phi_i \quad [W \cdot m^{-2} \cdot sr^{-1}]. \quad (1)$$

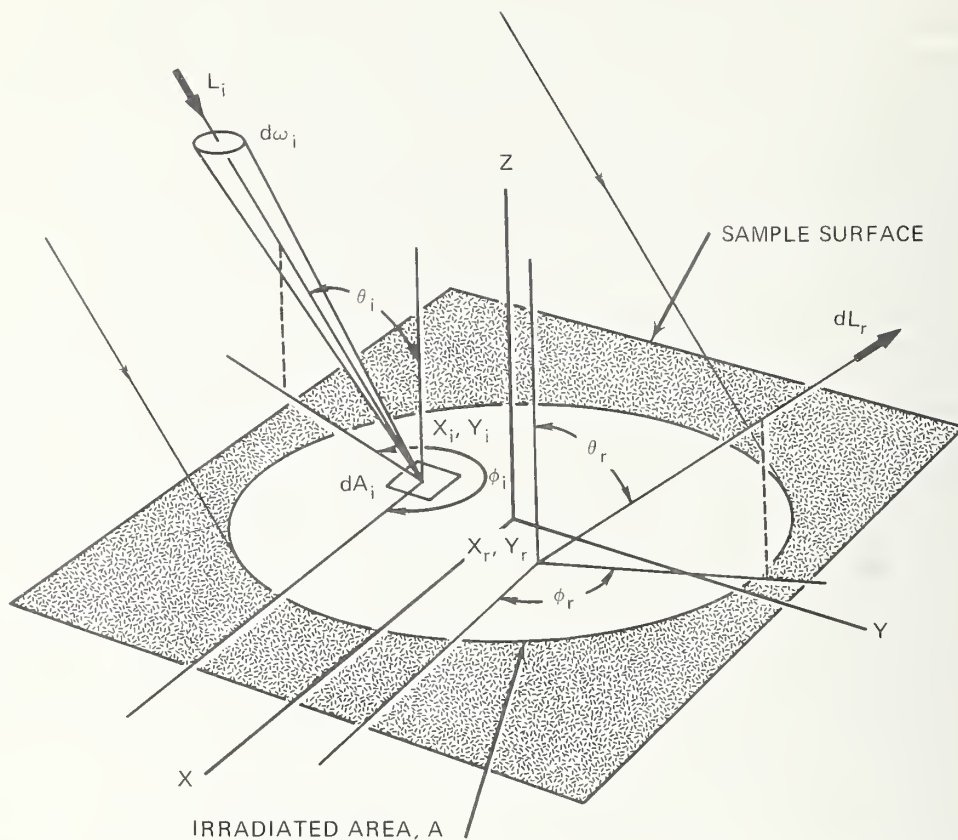

FIGURE 1. Geometry of incident and reflected beams (for general cases where sub-surface scattering is involved).

The factor of proportionality  $S$  will, in general, depend upon the location of the point at which the incident flux strikes, upon the location of the point at which the ray of radiance  $dL_r$  emerges, and upon the directions involved, i.e.,

$$S = S(\theta_i, \phi_i, x_i, y_i; \theta_r, \phi_r, x_r, y_r) \quad [\text{m}^{-2} \cdot \text{sr}^{-1}]. \quad (2)$$

This basic proportionality function  $S$  is called the bidirectional scattering-surface reflectance-distribution function, or BSSRDF, and it is a property of the reflecting surface. It is a particular example of the more general scattering function  $S$  of [8].<sup>5</sup>

The treatment, so far, is completely general, with no simplifying assumptions other than those of geometrical (ray) optics and the ignoring of other than spatial parameters. The function  $S$  merely provides a way of quantitatively expressing or designating the connection between reflected flux leaving  $(x_r, y_r)$  in a given direction and the flux incident at  $(x_i, y_i)$  from another given direction (including, in the case of retroreflection, the same direction) which produces it. No assumption is made about the mechanism involved other than that there is some form of interaction between radiation and matter by which some of the flux incident at  $(x_i, y_i)$  emerges as reflected flux from  $(x_r, y_r)$ . However, to obtain more tractable expressions, we will make some simplifying assumptions that will still cover a very wide group of the cases of interest, at least to a useful degree of approximation.

<sup>5</sup> For more details about this important function and its significance, see below, section IV.C.

A convenient flat surface is chosen as a reference plane to represent the reflecting surface, instead of attempting to describe and deal with its surface contours in microscopic detail. Then the polar angles  $\theta$  are angles from the reference-plane normal, and azimuth angles  $\phi$  are angles from an arbitrary reference direction in the reference plane. It is also assumed that the surface is uniformly irradiated over the entire part of the area  $A_i$  from which there is a significant contribution to the reflected radiance at  $(x_r, y_r)$ , i.e., the incident radiance depends only on direction:

$$L_i = L_i(\theta_i, \phi_i) \quad [\text{W} \cdot \text{m}^{-2} \cdot \text{sr}^{-1}]. \quad (3)$$

The incident flux  $d\Phi_i$  on the element of area  $dA_i$  [from just the solid-angle element  $d\omega_i$  in the direction  $(\theta_i, \phi_i)$ ] is

$$\begin{aligned} d\Phi_i &= L_i \cdot \cos \theta_i \cdot d\omega_i \cdot dA_i \\ &= dE_i \cdot dA_i \quad [\text{W}], \end{aligned} \quad (4)$$

where  $dE_i$  [=  $L_i \cdot \cos \theta_i \cdot d\omega_i$ ] is the incident irradiance and  $d\omega_i$  is the solid-angle element within which the incident radiance is confined. We can add up the contributions to the reflected radiance at  $(x_r, y_r)$  from the entire incident flux in the direction  $(\theta_i, \phi_i)$  and within the solid-angle element  $d\omega_i$  by integrating  $dL_r$  [eq (1)] over the entire irradiated area:

$$\begin{aligned} dL_r(\theta_i, \phi_i; \theta_r, \phi_r, x_r, y_r) &= \int_{A_i} dL_r(\theta_i, \phi_i, x_i, y_i; \theta_r, \phi_r, x_r, y_r) \\ &= \int_{A_i} S \cdot d\Phi_i = dE_i \cdot \int_{A_i} S \cdot dA_i \\ &= dE_i \cdot \int_{A_i} S(\theta_i, \phi_i, x_i, y_i; \theta_r, \phi_r, x_r, y_r) \cdot dA_i \quad [\text{W} \cdot \text{m}^{-2} \cdot \text{sr}^{-1}]. \end{aligned} \quad (5)$$

If we further assume that the scattering properties of the sample are uniform and isotropic across the reference plane, the scattering function  $S$  does not depend on the location of the point of observation  $(x_r, y_r)$ , but it still depends on the distance  $r$  between  $(x_i, y_i)$  and  $(x_r, y_r)$ . Equation (5) can now be written as

$$dL_r = dE_i \cdot f_r(\theta_i, \phi_i; \theta_r, \phi_r) \quad [\text{W} \cdot \text{m}^{-2} \cdot \text{sr}^{-1}] \quad (6)$$

where

$$f_r = \int_{A_i} S(\theta_i, \phi_i; \theta_r, \phi_r; r) \cdot dA_i \quad [\text{sr}^{-1}] \quad (7)$$

and

$$r = [(x_r - x_i)^2 + (y_r - y_i)^2]^{\frac{1}{2}}. \quad (8)$$

Thus, for uniform irradiance over a large enough area of a uniform and isotropic surface, the basic quantity that characterizes (geometrically) the reflecting properties of that surface is the function  $f_r$ :

$$\begin{aligned} f_r(\theta_i, \phi_i; \theta_r, \phi_r) &\equiv dL_r(\theta_i, \phi_i; \theta_r, \phi_r; E_i) / dE_i(\theta_i, \phi_i) \\ &\equiv dL_r(\theta_i, \phi_i; \theta_r, \phi_r; E_i) / [L_i(\theta_i, \phi_i) \cdot \cos \theta_i \cdot d\omega_i] \quad [\text{sr}^{-1}]. \end{aligned} \quad (9)$$

The name that we propose for this function  $f_r$  is the bidirectional reflectance-distribution function, abbreviated as BRDF [9]. Since for a given pair of directions, the BRDF  $f_r$  is a concentration of reflectance (per steradian) it may take on any value from zero to infinity. Also, since  $f_r$  depends only upon directions, we can represent the geometry of the incident and exitent radiation by a simple polar diagram as in figure 2.

Nomenclature for categorizing and specifying reflectance quantities for a variety of different beam configurations is defined and all such quantities are interrelated in terms of the BRDF in the following sections.

The use of infinitesimals in radiometric analysis, as in the above definition of the BRDF, is discussed and explained in detail in [2] and by Jones [7].<sup>6</sup> The BRDF itself, as a ratio of infinitesimals, is a derivative with "instantaneous" values that can never be measured directly.

<sup>6</sup> See, also, section IV.A.

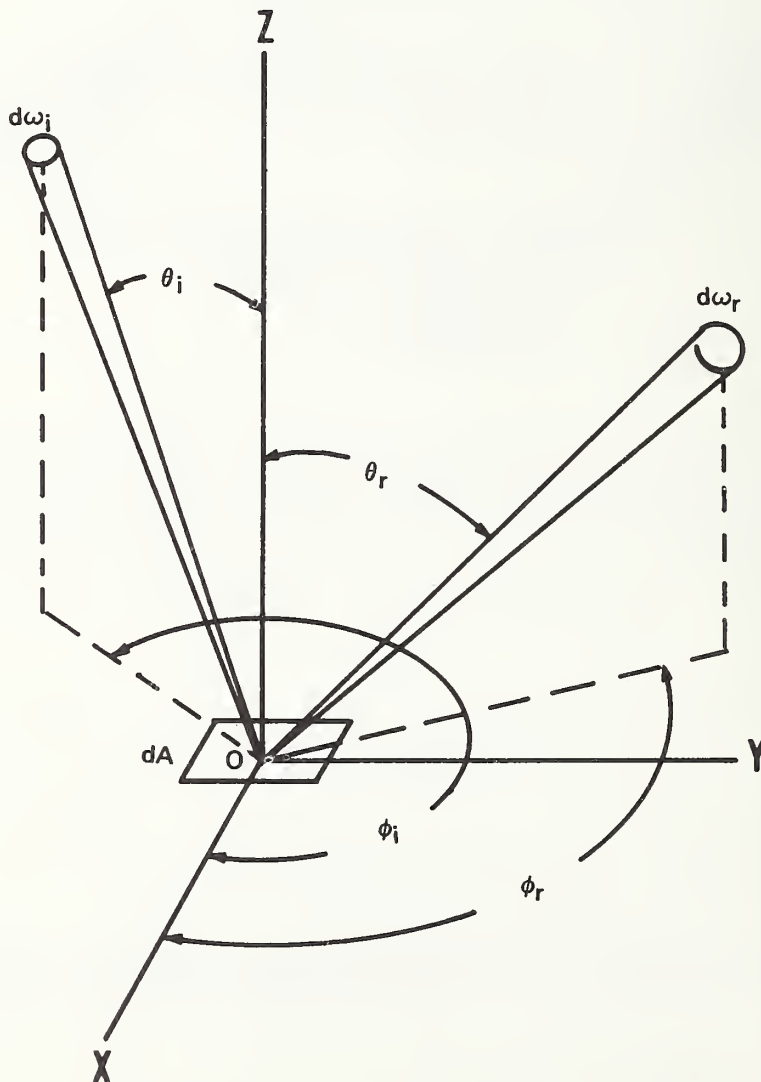

FIGURE 2. Geometry of incident and reflected elementary beams.  
(Z-Axis is chosen along the normal to the surface element  $dA$  at 0.) (adapted from [10]).

Real measurements involve non-zero intervals of the parameters, e.g.,  $\Delta\omega$  or  $\Delta\lambda$  rather than  $d\omega$  or  $d\lambda$ , and, hence, can yield only average values  $f_r$  over those parameter intervals. But this is true of many basic physical quantities. A speedometer never truly shows instantaneous speed, only an average over a period of the order of its time constant, but that does not invalidate the usefulness of the underlying concept of instantaneous speed.

## B. Definitions of Reflectance and Reflectance Factor

### 1. Reflectance

Reflectance is the ratio of reflected to incident flux. From conservation of energy, it follows that reflectance may have values only in the interval 0 to 1, inclusive. As previously mentioned, a derivative quantity, such as the BRDF  $f_r$  defined in eq (9), is useful primarily as an underlying concept, but it can never be measured directly because truly infinitesimal elements of solid angle do not include measurable amounts of radiant flux. Actual measurements of reflectance quantities always involve non-zero intervals of the governing parameters (in this case, the spatial parameters of position and direction). We need, then, a general expression for reflectance for cases where the geometry of the incident and reflected beams can be specified arbitrarily, and this can be written readily in terms of the BRDF  $f_r(\theta_i, \phi_i; \theta_r, \phi_r)$ .

In order to economize on writing we will represent the product of an element of solid angle  $d\omega$  with the cosine of the angle  $\theta$  between the normal to the surface and the direction associated with  $d\omega$  by  $d\Omega$  ( $d\Omega \equiv \cos\theta \cdot d\omega$ ). The quantity  $d\Omega$  is commonly called an element of projected solid angle. {See appendix 2 in [2].}<sup>7</sup>

In general, the radiant flux incident through a solid angle  $\omega_i$  onto a surface element  $dA$  is

$$d\Phi_i = dA \cdot \int_{\omega_i} L_i(\theta_i, \phi_i) \cdot d\Omega_i \quad [\text{W}]. \quad (10)$$

Similarly, the flux reflected by the surface element  $dA$  into a solid angle  $\omega_r$  is

$$d\Phi_r = dA \cdot \int_{\omega_r} L_r(\theta_r, \phi_r) \cdot d\Omega_r \quad [\text{W}], \quad (11)$$

which can be written as

$$d\Phi_r = dA \cdot \int_{\omega_r} \int_{\omega_i} f_r(\theta_i, \phi_i; \theta_r, \phi_r) \cdot L_i(\theta_i, \phi_i) \cdot d\Omega_i \cdot d\Omega_r \quad [\text{W}] \quad (12)$$

since

$$L_r(\theta_r, \phi_r) = \int_{\omega_i} dL_r(\theta_i, \phi_i; \theta_r, \phi_r; E_i) \quad (13)$$

and, from expression (9),

$$dL_r(\theta_i, \phi_i; \theta_r, \phi_r; E_i) = f_r(\theta_i, \phi_i; \theta_r, \phi_r) \cdot L_i(\theta_i, \phi_i) \cdot d\Omega_i. \quad (14)$$

A general expression for the reflectance of a surface with an arbitrary configuration of beam geometry with regards to direction is obtained from the ratio of eq (12) to eq (10):

<sup>7</sup> Another approach is to use the notation  $\mu = \cos\theta$ ,  $d\mu = -\sin\theta \cdot d\theta$ . Then  $d\omega = -\sin\theta \cdot d\theta \cdot d\phi = -d\mu \cdot d\phi$ , etc. [11]; but it is not adopted here.

$$\rho(\omega_i; \omega_r; L_i) = d\Phi_r / d\Phi_i \quad (15)$$

$$= \frac{\int_{\omega_r} \int_{\omega_i} f_r(\theta_i, \phi_i; \theta_r, \phi_r) \cdot L_i(\theta_i, \phi_i) \cdot d\Omega_i \cdot d\Omega_r}{\int_{\omega_i} L_i(\theta_i, \phi_i) \cdot d\Omega_i} \quad [\text{dimensionless}]. \quad (15a)$$

Up to this point, we have only placed the condition upon  $L_i$  that it be uniform over a sufficiently large area, and have not placed any conditions on its variation with direction. If we now specify that the incident radiation be uniform *and isotropic* within the incident beam, the constant value of  $L_i$  can be brought outside the integrals in both numerator and denominator so that it cancels, leaving the *biconical reflectance*.

$$\rho(\omega_i; \omega_r) = (1/\Omega_i) \cdot \int_{\omega_r} \int_{\omega_i} f_r(\theta_i, \phi_i; \theta_r, \phi_r) \cdot d\Omega_i \cdot d\Omega_r \quad [\text{dimensionless}], \quad (16)$$

where

$$\Omega_i = \int_{\omega_i} d\Omega_i.$$

The assumed condition, that  $L_i$  is the same at all points and in all directions within the incident beam, is fairly well approximated in any well-designed reflectometer, so this expression, given in eq (16), is very useful for describing the observed reflectance of a surface under various configurations of beam geometry. Note, however, that it is important, always, to specify the geometry of both the incident and reflected beams associated with a given value of reflectance.

## 2. Reflectance Factor

A reflectance factor is defined as the ratio of the radiant flux actually reflected by a sample surface to that which would be reflected into the same reflected-beam geometry by an ideal (lossless) perfectly diffuse (Lambertian) standard surface irradiated in exactly the same way as the sample. In eq (12), we already have a general expression for the reflected flux  $d\Phi_r$  of any sample surface element, characterized by its BRDF  $f_r(\theta_i, \phi_i; \theta_r, \phi_r)$ . This same equation will also give the reflected flux  $d\Phi_{r,id}$  of an element of the ideal standard surface for  $f_{r,id} = 1/\pi$  [eq (C8), app. C].

Then the ratio is

$$d\Phi_r / d\Phi_{r,id} = \frac{dA \cdot \int_{\omega_r} \int_{\omega_i} f_r(\theta_i, \phi_i; \theta_r, \phi_r) \cdot L_i(\theta_i, \phi_i) \cdot d\Omega_i \cdot d\Omega_r}{(dA/\pi) \cdot \int_{\omega_r} \int_{\omega_i} L_i(\theta_i, \phi_i) \cdot d\Omega_i \cdot d\Omega_r} \quad (17)$$

If, as before, we make the assumption that  $L_i$  is constant (isotropic within the full solid angle of incidence  $\omega_i$ ),  $L_i$  can again be brought out from the integral sign in both numerator and denominator where it cancels along with  $dA$ , leaving as the general expression for a *biconical reflectance factor*

$$R(\omega_i; \omega_r) = [\pi / (\Omega_i \Omega_r)] \cdot \int_{\omega_r} \int_{\omega_i} f_r(\theta_i, \phi_i; \theta_r, \phi_r) \cdot d\Omega_i \cdot d\Omega_r \quad [\text{dimensionless}]. \quad (18)$$

In some cases, the use of the reflectance factor is preferred over the use of reflectance. For example, in the case of almost lambertian reflectors, the reflectance factor  $R$  is nearly independent of beam orientations, thereby making the reflectance factor a particularly attractive quantity to use in describing such reflectors.

## C. Reflectances and Reflectance Factors for Nine Geometries

### 1. Reflectances for Nine Geometries

The proposed nomenclature for nine kinds of reflectance is presented in table 1. Listed there are the proposed term, the proposed symbol, and the definition in terms of the bidirectional reflectance-distribution function (BRDF)  $f_r(\theta_i, \phi_i; \theta_r, \phi_r)$  for each kind of reflectance, following, with some modifications, a scheme presented in [12]. The geometry for the designations used in the terms of table 1 is illustrated in figure 3. Directional denotes an element of solid angle  $d\omega$  about a single direction  $(\theta, \phi)$ ; conical denotes a solid angle  $\omega$  of *any* configuration (the common special case where  $\omega$  is a right circular cone will be discussed in section III.A); and hemispherical denotes a full hemispherical solid angle  $\omega = 2\pi$  [sr], for which the corresponding projected solid angle

$$\Omega = \int_{2\pi} \cos \theta \cdot d\omega = \int_0^{2\pi} \int_0^{\pi/2} \cos \theta \cdot \sin \theta \cdot d\theta \cdot d\phi = \pi \quad [\text{sr}]. \quad (19)$$

If we permit the solid angle  $\omega$  to include the extreme values, so that  $d\omega \leq \omega \leq 2\pi$  [sr], then eq (16) (relation 5 in table 1) contains all of table 1. The corresponding expressions for all nine reflectances listed in table 1 are formed merely by substituting the appropriate values for  $\omega_i$  and  $\omega_r$  in eq (16). Note that each reflectance is formed simply by integrating the BRDF  $f_r(\theta_i, \phi_i; \theta_r, \phi_r)$  with respect to the projected solid angle  $\Omega_r$  over the appropriate  $\omega_r$  and averaging it with respect to the projected solid angle  $\Omega_i$  over the appropriate  $\omega_i$ .

It should also be emphasized that the foregoing reflectances are applicable only to situations with uniform and isotropic radiation throughout the incident beam of radiation; i.e., where the incident radiance  $L_i(\theta_i, \phi_i) = L_i$  is a constant, with the same value at all locations and for all directions  $(\theta_i, \phi_i)$  included in the incident solid angle  $\omega_i$ . If this is not true, then one must refer to the more general expressions, such as eq (15) for non-isotropic uniform incident radiation. In the same way, note that these quantities are given only for a uniform reflecting surface. They are applicable to extended areas of non-uniform surfaces when it is adequate to obtain just the average properties over such areas. In this case, it is important that there be uniform irradiation of all parts of the surface, from which is produced the flux reflected from the designated area. Otherwise, the result will be a weighted average, according to the distribution of incident irradiance as a function of position, for each direction involved. The considerations discussed in these last two paragraphs with respect to reflectances are equally applicable to reflectance factors, multivariate reflectance-distribution functions (MRDF's), and other reflectance quantities described and discussed throughout this monograph.

### 2. Reflectance Factors for Nine Geometries

The proposed nomenclature for nine kinds of reflectance factor is presented in table 2, which follows the same format as table 1.

Here we have departed from ANSI Z7.1-1967 [4], and from the CIE-IEC International Lighting Vocabulary [14] on which most of [4] is based, in recommending that the term "reflectance factor" and symbol  $R$  be used for all nine of these quantities, including three for which the term "radiance factor" (or "luminance factor") and symbol  $\beta$  are now the accepted standards. We make this recommendation because we feel that the proposed scheme is adequately

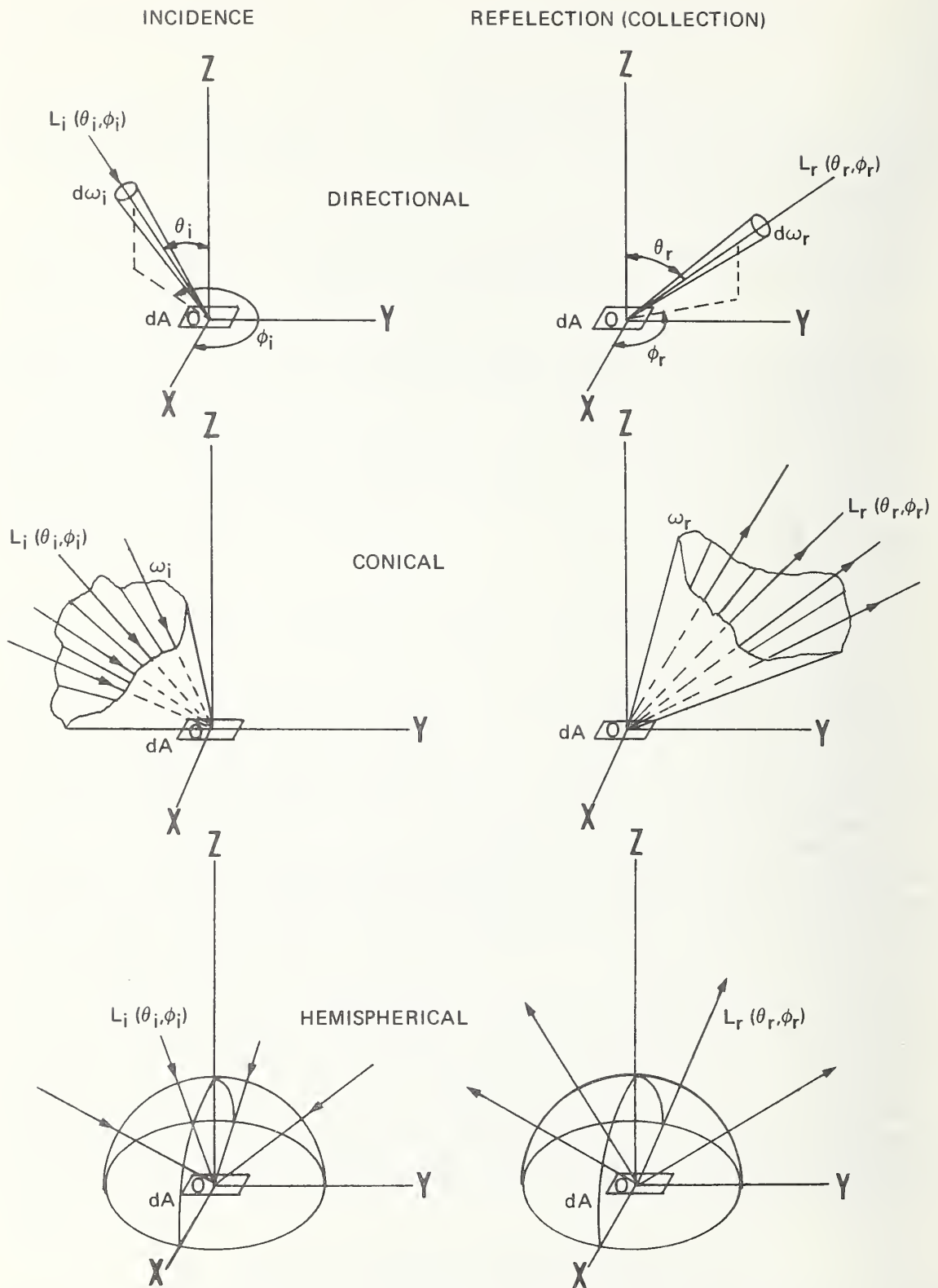

FIGURE 3. Designations for denoting incident and reflected (collected) beam geometry.



TABLE 1. Proposed nomenclature for nine kinds of reflectance\*

1. Bidirectional reflectance	$d\rho(\theta_i, \phi_i; \theta_r, \phi_r)$	$= f_r(\theta_i, \phi_i; \theta_r, \phi_r) \cdot d\Omega_r$
2. Directional-conical reflectance <sup>a</sup>	$\rho(\theta_i, \phi_i; \omega_r)$	$= \int_{\omega_r} f_r(\theta_i, \phi_i; \theta_r, \phi_r) \cdot d\Omega_r$
3. Directional-hemispherical reflectance	$\rho(\theta_i, \phi_i; 2\pi)$	$= \int_{2\pi} f_r(\theta_i, \phi_i; \theta_r, \phi_r) \cdot d\Omega_r$
4. Conical-directional reflectance <sup>a</sup>	$d\rho(\omega_i; \theta_r, \phi_r)$	$= (d\Omega_r/\Omega_i) \cdot \int_{\omega_i} f_r(\theta_i, \phi_i; \theta_r, \phi_r) \cdot d\Omega_i$
5. Biconical reflectance <sup>a</sup>	$\rho(\omega_i; \omega_r)$	$= (1/\Omega_i) \cdot \int_{\omega_i} \int_{\omega_r} f_r(\theta_i, \phi_i; \theta_r, \phi_r) \cdot d\Omega_r \cdot d\Omega_i$
6. Conical-hemispherical reflectance <sup>a</sup>	$\rho(\omega_i; 2\pi)$	$= (1/\Omega_i) \cdot \int_{\omega_i} \int_{2\pi} f_r(\theta_i, \phi_i; \theta_r, \phi_r) \cdot d\Omega_r \cdot d\Omega_i$
7. Hemispherical-directional reflectance	$d\rho(2\pi; \theta_r, \phi_r)$	$= (d\Omega_r/\pi) \cdot \int_{2\pi} f_r(\theta_i, \phi_i; \theta_r, \phi_r) \cdot d\Omega_i$
8. Hemispherical-conical reflectance <sup>a</sup>	$\rho(2\pi; \omega_r)$	$= (1/\pi) \cdot \int_{2\pi} \int_{\omega_r} f_r(\theta_i, \phi_i; \theta_r, \phi_r) \cdot d\Omega_r \cdot d\Omega_i$
9. Bihemispherical reflectance	$\rho(2\pi; 2\pi)$	$= (1/\pi) \cdot \int_{2\pi} \int_{2\pi} f_r(\theta_i, \phi_i; \theta_r, \phi_r) \cdot d\Omega_r \cdot d\Omega_i$

\*adapted [9] from [12].

<sup>a</sup> When, as happens most frequently, a "conical" solid angle  $\omega$ , lying between the extremes of an element  $d\omega$  and a full hemisphere, is in the form of a right circular cone of half-vertex angle  $\kappa$ , with its axis in the direction  $(\theta_0, \phi_0)$ , this can be specified more explicitly with a notation suggested by McCamy [13]  $(\theta_0, \phi_0, \kappa)$ . For example, if this is true of both the solid angles of incidence and reflection, the biconical reflectance  $\rho(\omega_i; \omega_r)$  could be written more explicitly as (see section III.A)

$$\rho(\theta_{0i}, \phi_{0i}, \kappa_i; \theta_{0r}, \phi_{0r}, \kappa_r)$$

Note:

The symbol  $\omega$  is used here to designate solid angle, and  $\Omega$  to designate projected solid angle:

$$\omega = \int d\omega = \iint \sin\theta \cdot d\theta \cdot d\phi; \quad \Omega = \int d\Omega = \int \cos\theta \cdot d\omega = \iint \cos\theta \cdot \sin\theta \cdot d\theta \cdot d\phi$$

clear and explicit and because it is more consistent with the close interrelationship between all nine quantities. On the other hand, we also favor retention of the present terms as acceptable alternates to the proposed basic scheme. There are times when it is convenient to be able to refer to items 1, 4, and 7, of table 2, collectively, as the "radiance factors"  $R(\omega_i; \theta_r, \phi_r)$  or  $R(\omega_i; d\omega_r)$ , an expression that becomes quite awkward as the "...-directional reflectance factors."

Again, as in table 1, the biconical quantity [eq (18)] can be considered as the basic one. The (biconical) reflectance factor is just  $\pi$  [sr] times the average value of the BRDF  $f_r$ , averaged over the designated solid angles of both incidence and reflectance (collection) with respect to projected solid angle. (The reflectance factor is a pure dimensionless ratio while the BRDF has the dimension [sr<sup>-1</sup>], which is cancelled when its average value is divided by  $1/\pi$  [sr<sup>-1</sup>], the BRDF of a perfect lambertian reflector {equivalent to multiplying by  $\pi$  [sr]}.) And again, all eight of the remaining reflectance factors can be formed by substituting  $(\theta, \phi)$  or  $d\omega$ , as appropriate, for a directional quantity, or the other extreme value  $2\pi$  [sr] solid angle for a hemispherical quantity, for either one or both of the solid angles  $\omega_i$  and  $\omega_r$  in eq (18).

TABLE 2. Proposed nomenclature for nine reflectance factors\*

1. Bidirectional reflectance factor <sup>b</sup>	$R(\theta_i, \phi_i; \theta_r, \phi_r)$	$= \pi f_r(\theta_i, \phi_i; \theta_r, \phi_r)$
2. Directional-conical reflectance factor <sup>a</sup>	$R(\theta_i, \phi_i; \omega_r)$	$= (\pi/\Omega_r) \cdot \int_{\omega_r} f_r(\theta_i, \phi_i; \theta_r, \phi_r) \cdot d\Omega_r$
3. Directional-hemispherical reflectance factor	$R(\theta_i, \phi_i; 2\pi)$	$= \int_{2\pi} f_r(\theta_i, \phi_i; \theta_r, \phi_r) d\Omega_r$
4. Conical-directional reflectance factor <sup>a,b</sup>	$R(\omega_i; \theta_r, \phi_r)$	$= (\pi/\Omega_i) \cdot \int_{\omega_i} f_r(\theta_i, \phi_i; \theta_r, \phi_r) d\Omega_i$
5. Biconical reflectance factor <sup>a</sup>	$R(\omega_i; \omega_r)$	$= [\pi / (\Omega_i \cdot \Omega_r)] \cdot \int_{\omega_i} \int_{\omega_r} f_r(\theta_i, \phi_i; \theta_r, \phi_r) \cdot d\Omega_r \cdot d\Omega_i$
6. Conical-hemispherical reflectance factor <sup>a</sup>	$R(\omega_i; 2\pi)$	$= (1/\Omega_i) \cdot \int_{\omega_i} \int_{2\pi} f_r(\theta_i, \phi_i; \theta_r, \phi_r) \cdot d\Omega_r \cdot d\Omega_i$
7. Hemispherical-directional reflectance factor <sup>b</sup>	$R(2\pi; \theta_r, \phi_r)$	$= \int_{2\pi} f_r(\theta_i, \phi_i; \theta_r, \phi_r) \cdot d\Omega_i$
8. Hemispherical-conical reflectance factor <sup>a</sup>	$R(2\pi; \omega_r)$	$= (1/\Omega_r) \cdot \int_{2\pi} \int_{\omega_r} f_r(\theta_i, \phi_i; \theta_r, \phi_r) \cdot d\Omega_r \cdot d\Omega_i$
9. Bihemispherical reflectance factor	$R(2\pi; 2\pi)$	$= (1/\pi) \cdot \int_{2\pi} \int_{2\pi} f_r(\theta_i, \phi_i; \theta_r, \phi_r) \cdot d\Omega_r \cdot d\Omega_i$

\*adapted [9] from [12].

<sup>a</sup> (See footnote "a" of table 1.)

<sup>b</sup> Judd [12] calls these three quantities "radiance factors" (in accordance with [14]) and uses the symbol  $\beta$  (instead of  $R$ ). The recommended change to "reflectance factor" and the symbol  $R$  for all nine quantities is discussed briefly in the text. Note: (See note following table 1).

### III. Some Additional Reflectance-Nomenclature Possibilities

We have presented the BSSRDF and BRDF, the basic quantities for characterizing and specifying the (geometrical) reflecting properties of a surface, and have related them to the widely used reflectances and reflectance factors (including radiance or luminance factors). Now we want to present some other modifications and extensions to this scheme of nomenclature that, although they may not be so essential or of such wide application, nevertheless may have substantial usefulness for filling more limited needs.

#### A. McCamy's Notation for Right Circular Cones

As illustrated in figure 3, the solid angle  $\omega$  denoted by the term conical, as used here, may have any configuration and is not limited to a right circular cone. On the other hand, with cylindrically symmetric optical systems, the commonest form of beam for either  $\omega_i$  or  $\omega_r$  is a right circular cone. Accordingly, for this common special case, McCamy has proposed [13] that such a cone be specified by its half-vertex angle  $\kappa$  and the angles, in spherical coordinates, for the direction of its axis (through the origin)  $\theta_0, \phi_0$  (see fig. 4). Thus, a biconical reflectance where *both* beams are right circular cones would become (see appendix D)

$$\rho(\theta_{0i}, \phi_{0i}, \kappa_i; \theta_{0r}, \phi_{0r}, \kappa_r) = (\pi \cdot \sin^2 \kappa_i \cdot \cos \theta_{0i})^{-1} \cdot$$

$$\int_{\theta_{0i}-\kappa_i}^{\theta_{0i}+\kappa_i} \int_{\phi_{0i}-\alpha(\theta_i)}^{\phi_{0i}+\alpha(\theta_i)} \int_{\theta_{0r}-\kappa_r}^{\theta_{0r}+\kappa_r} \int_{\phi_{0r}-\alpha(\theta_r)}^{\phi_{0r}+\alpha(\theta_r)} f_r(\theta_i, \phi_i; \theta_r, \phi_r) \cdot$$

$$d\phi_r \cdot \cos \theta_r \cdot \sin \theta_r \cdot d\theta_r \cdot d\phi_i \cdot \cos \theta_i \cdot \sin \theta_i \cdot d\theta_i, \quad (20)$$

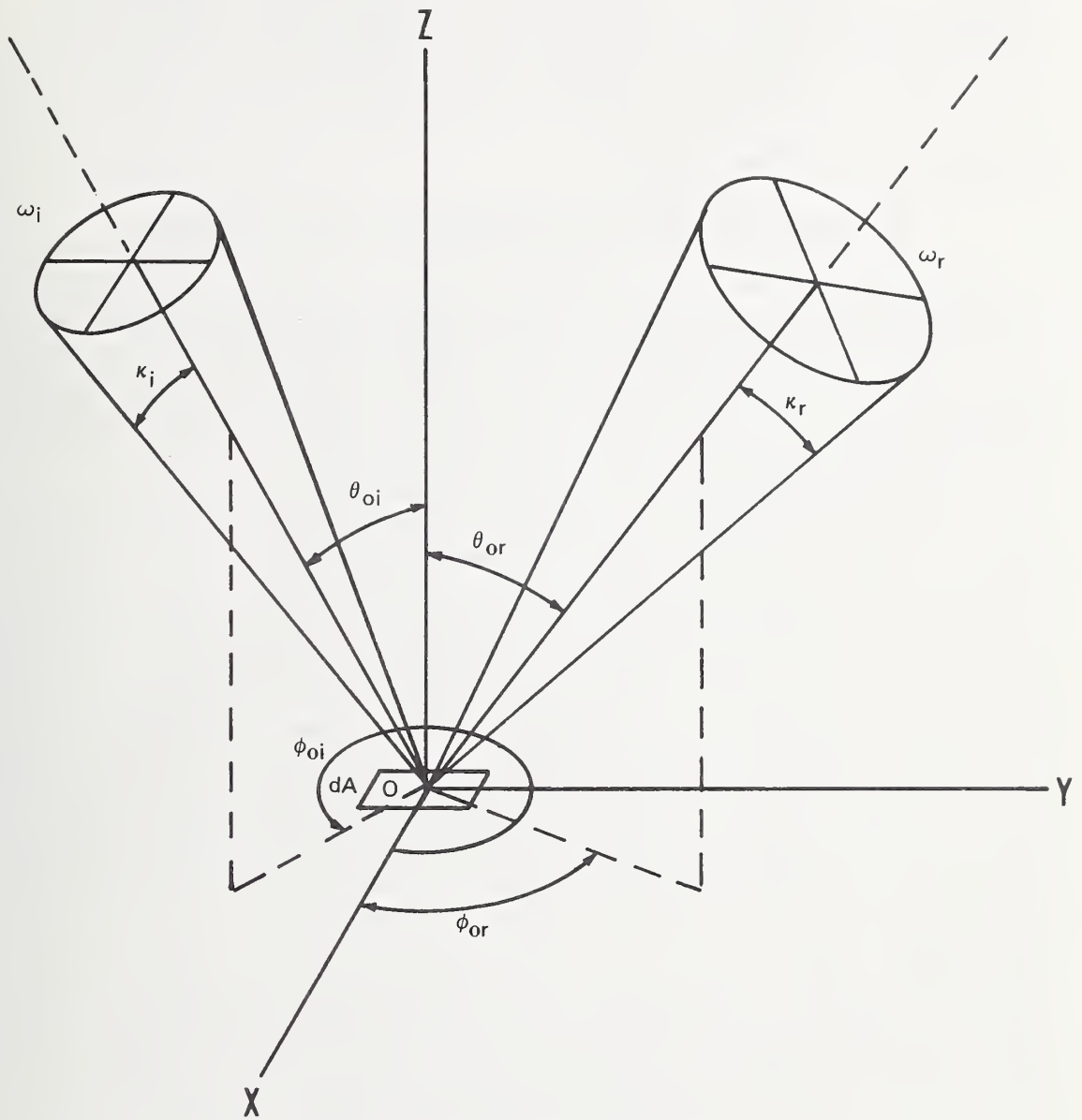

FIGURE 4. *McCamy's notation for right-circular cones.*

where

$$\alpha(\theta) = \cos^{-1}[(\cos\kappa - \cos\theta_0 \cdot \cos\theta)/(\sin\theta_0 \cdot \sin\theta)]. \quad (21)$$

A similar expression can be written for the biconical reflectance factor, or for any conical reflectance quantity, where the beam is a right circular cone.

$$R(\theta_{0i}, \phi_{0i}, \kappa_i; \theta_{0r}, \phi_{0r}, \kappa_r) = (\pi \cdot \sin^2 \kappa_i \cdot \cos \theta_{0i} \cdot \sin^2 \kappa_r \cdot \cos \theta_{0r})^{-1} \cdot$$

$$\int_{\theta_{0i}-\kappa_i}^{\theta_{0i}+\kappa_i} \int_{\phi_{0i}-\alpha(\theta_i)}^{\phi_{0i}+\alpha(\theta_i)} \int_{\theta_{0r}-\kappa_r}^{\theta_{0r}+\kappa_r} \int_{\phi_{0r}-\alpha(\theta_r)}^{\phi_{0r}+\alpha(\theta_r)} f_r(\theta_i, \phi_i; \theta_r, \phi_r) \cdot \cos \theta_r \cdot \sin \theta_r \cdot d\phi_r \cdot d\theta_r \cdot \cos \theta_i \cdot \sin \theta_i \cdot d\phi_i \cdot d\theta_i, \quad (22)$$

where, as before,  $\alpha(\theta)$  is given by eq (21).

## B. Multivariate Reflectance-Distribution Functions (MRDF's)

Two of us, (Ginsberg and Limperis), feeling a need for more explicit subdivision of the broad biconical category, proposed the multivariate scheme of reflectance-distribution functions shown in table 3. Reflectances and reflectance factors can also be categorized in the same manner. However, the most useful quantity for extrapolation to different beam geometries is the average reflectance-distribution function, so it is that quantity that is tabulated here. In table 3, in addition to listing the proposed term, symbol, and defining relation (in terms of the BRDF or 4RDF), there are also small pictorial diagrams to aid in visualizing the beam geometry for each case.

The multivariate reflectance-distribution functions (MRDF's) are grouped according to the number of independent variables as: (1) quadrivariate—all four independent variables ( $\theta_i, \phi_i; \theta_r, \phi_r$ ) govern the bidirectional reflectance-distribution function BRDF or quadrivariate reflectance-distribution function 4RDF (these designations are completely synonymous); (2) trivariate—any three of those four variables are still independent variables for the trivariate reflectance-distribution functions 3RDF's that have been averaged, with respect to the corresponding component of the projected solid angle, over the full range of the remaining variable; (3) bivariate—any two of the four variables are independent for the bivariate reflectance-distribution functions 2RDF's that have been averaged, with respect to the corresponding components of the projected solid angle, over the full range of each of the remaining two variables; (4) univariate—any one of the four variables is still an independent variable for the univariate reflectance-distribution functions 1RDF's that have been averaged, with respect to the corresponding components of the projected solid angle, over the full range of each of the remaining three variables; (5) avariate—the avariate reflectance-distribution function 0RDF is single valued, with no independent variables, having been averaged over the full range of each of all four variables (the bihemispherical case), with respect to projected solid angle.

There is an explanatory note at the end of the table concerning the functional notation for designating directionality for the MRDF's. The situations where an independent variable is assigned its maximum value ( $\theta = \pi/2$  [rad] or  $\phi = 2\pi$  [rad]) are explicitly distinguished from those where the function is averaged over the full range of that variable ( $\theta$  from 0 to  $\pi/2$  [rad] or  $\phi$  from 0 to  $2\pi$  [rad]) as well as from those where the function is averaged over the full solid angle of a hemisphere ( $\omega_h = 2\pi$  [sr]). For example,  $f_r(\pi/2, 2\pi; \pi/2, 2\pi)$  denotes a particular value of the bivariate reflectance-distribution function 2RDF  $f_r(\theta_i, 2\pi; \pi/2, \phi_r)$  that has been averaged (with respect to projected solid angle) over the full ranges 0 to  $2\pi$  [rad] for  $\phi_i$  and 0 to  $\pi/2$  [rad] for  $\theta_r$  [(3.4) table 3], evaluated at  $\theta_i = \pi/2$  [rad] and  $\phi_r = 2\pi$  [rad]. Another example is the conical-hemispherical reflectance-distribution function CHRDF  $f_r(\omega_i; 2\pi)$ , which denotes a reflectance-distribution function where the BRDF has been averaged (with respect to projected solid angle) over an unspecified (conical) configuration of incident beam and over a reflected (collected) beam filling a full hemisphere of  $\omega_r = 2\pi$  [sr]. Each MRDF is an average of the quadrivariate (bidirectional) reflectance-distribution function (4RDF or BRDF), with respect to the corresponding component of projected solid angle, over the full range of each of the angles *not* shown as independent variables. For example, the bivariate reflectance-distribution function (2RDF)  $f_r(\theta_i, 2\pi; \pi/2, \phi_r)$  is the average of the 4RDF or BRDF taken over the full range of each of the remaining angles  $\phi_i$  (0 to  $2\pi$ ) and  $\theta_r$  (0 to  $\pi/2$ ) with respect to  $\cos \theta_r \cdot \sin \theta_r \cdot d\theta_r \cdot d\phi_i$ . Thus:

TABLE 3. The multivariate reflectance-distribution functions (MRDF's)

1. Quadrivariate (or bidirectional) reflectance-distribution function (4RDF):

$$(1.1) \quad f_r(\theta_i, \phi_i; \theta_r, \phi_r) \equiv dL_r(\theta_r, \phi_r) \mathcal{X}(L_i(\theta_i, \phi_i), d\Omega_i) = d\rho(\theta_i, \phi_i; \theta_r, \phi_r) / d\Omega_r \quad [\text{sr}^{-1}]$$



2. Trivariate reflectance-distribution functions (3RDF's):

$$(2.1) \quad \bar{f}_r(\theta_i, \phi_i; \theta_r, \overline{2\pi}) = (1/2\pi) \cdot \int_0^{2\pi} f_r(\theta_i, \phi_i; \theta_r, \phi_r) \cdot d\phi_r \quad [\text{sr}^{-1}]$$



$$(2.2) \quad \bar{f}_r(\theta_i, \phi_i; \overline{\pi/2}, \phi_r) = 2 \cdot \int_0^{\pi/2} f_r(\theta_i, \phi_i; \theta_r, \phi_r) \cdot \cos \theta_r \cdot \sin \theta_r \cdot d\theta_r \quad [\text{sr}^{-1}]$$



$$(2.3) \quad \bar{f}_r(\theta_i, \overline{2\pi}; \theta_r, \phi_r) = (1/2\pi) \cdot \int_0^{2\pi} f_r(\theta_i, \phi_i; \theta_r, \phi_r) \cdot d\phi_i \quad [\text{sr}^{-1}]$$



$$(2.4) \quad \bar{f}_r(\overline{\pi/2}, \phi_i; \theta_r, \phi_r) = 2 \cdot \int_0^{\pi/2} f_r(\theta_i, \phi_i; \theta_r, \phi_r) \cdot \cos \theta_i \cdot \sin \theta_i \cdot d\theta_i \quad [\text{sr}^{-1}]$$

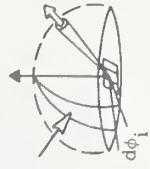

3. Bivariate reflectance-distribution functions (2RDFs):

$$(3.1) \quad \bar{f}_r(\theta_i, \phi_i; 2\pi) = (1/\pi) \int_0^{2\pi} \int_0^{\pi/2} f_r(\theta_i, \phi_i; \theta_r, \phi_r) \cdot \cos \theta_r \cdot \sin \theta_r \cdot d\theta_r \cdot d\phi_r \quad [\text{sr}^{-1}]$$

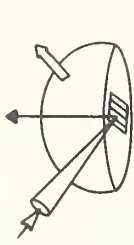

$$(3.2) \quad \bar{f}_r(\theta_i, \overline{2\pi}; \theta_r, \overline{2\pi}) = (1/4\pi^2) \cdot \int_0^{2\pi} \int_0^{2\pi} f_r(\theta_i, \phi_i; \theta_r, \phi_r) \cdot d\phi_i \cdot d\phi_r \quad [\text{sr}^{-1}]$$

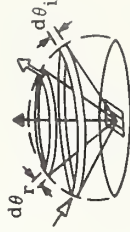

$$(3.3) \quad \bar{f}_r(\overline{\pi/2}, \phi_i; \theta_r, \overline{2\pi}) = (1/\pi) \cdot \int_0^{2\pi} \int_0^{\pi/2} f_r(\theta_i, \phi_i; \theta_r, \phi_r) \cdot \cos \theta_i \cdot \sin \theta_i \cdot d\theta_i \cdot d\phi_r \quad [\text{sr}^{-1}]$$

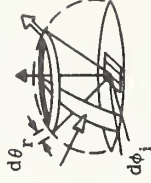

$$(3.4) \quad \bar{f}_r(\theta_i, \overline{2\pi}; \overline{\pi/2}, \phi_r) = (1/\pi) \cdot \int_0^{2\pi} \int_0^{\pi/2} f_r(\theta_i, \phi_i; \theta_r, \phi_r) \cdot \cos \theta_r \cdot \sin \theta_r \cdot d\theta_r \cdot d\phi_i \quad [\text{sr}^{-1}]$$

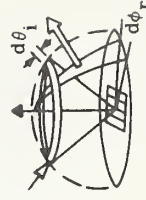

$$(3.5) \quad \bar{f}_r(\overline{\pi/2}, \phi_i; \overline{\pi/2}, \phi_r) = 4 \cdot \int_0^{\pi/2} \int_0^{\pi/2} f_r(\theta_i, \phi_i; \theta_r, \phi_r) \cdot \cos \theta_r \cdot \sin \theta_r \cdot \cos \theta_i \cdot \sin \theta_i \cdot d\theta_r \cdot d\theta_i \quad [\text{sr}^{-1}]$$

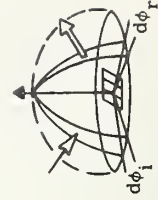

$$(3.6) \quad \bar{f}_r(2\pi; \theta_r, \phi_r) = (1/\pi) \cdot \int_0^{2\pi} \int_0^{\pi/2} f_r(\theta_i, \phi_i; \theta_r, \phi_r) \cdot \cos \theta_i \cdot \sin \theta_i \cdot d\theta_i \cdot d\phi_i \quad [sr^{-1}]$$



#### 4. Univariate reflectance-distribution functions (IRDF's):

$$(4.1) \quad \bar{f}_r(\theta_i, \overline{2\pi}; 2\pi) = (1/2\pi^2) \cdot \int_0^{2\pi} \int_0^{\pi/2} f_r(\theta_i, \phi_i; \theta_r, \phi_r) \cdot \cos \theta_r \cdot \sin \theta_r \cdot d\theta_r \cdot d\phi_r \cdot d\phi_i \quad [sr^{-1}]$$



$$(4.2) \quad \bar{f}_r(\overline{\pi/2}, \phi_i; 2\pi) = (2/\pi) \cdot \int_0^{2\pi} \int_0^{\pi/2} f_r(\theta_i, \phi_i; \theta_r, \phi_r) \cdot \cos \theta_r \cdot \sin \theta_r \cdot \cos \theta_i \cdot \sin \theta_i \cdot d\theta_r \cdot d\theta_i \cdot d\phi_r \quad [sr^{-1}]$$

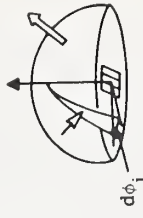

$$(4.3) \quad \bar{f}_r(2\pi; \theta_r, \overline{2\pi}) = (1/2\pi^2) \cdot \int_0^{2\pi} \int_0^{\pi/2} f_r(\theta_i, \phi_i; \theta_r, \phi_r) \cdot \cos \theta_i \cdot \sin \theta_i \cdot d\theta_i \cdot d\phi_r \cdot d\phi_i \quad [sr^{-1}]$$

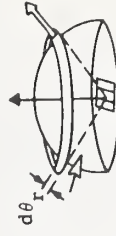

$$(4.4) \quad \bar{f}_r(2\pi; \overline{\pi/2}, \phi_r) = (2/\pi) \cdot \int_0^{2\pi} \int_0^{\pi/2} f_r(\theta_i, \phi_i; \theta_r, \phi_r) \cdot \cos \theta_r \cdot \sin \theta_r \cdot \cos \theta_i \cdot \sin \theta_i \cdot d\theta_r \cdot d\theta_i \cdot d\phi_i \quad [sr^{-1}]$$

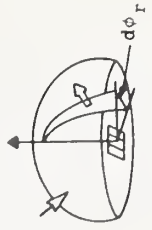

5. Avariate reflectance-distribution function (ORDF):

$$(5.1) \quad \bar{f}_r(2\pi; 2\pi) = (1/\pi^2) \cdot \int_0^{2\pi} \int_0^{2\pi} \int_0^{\pi/2} \int_0^{\pi/2} f_r(\theta_i, \phi_i; \theta_r, \phi_r) \cdot \cos \theta_r \cdot \sin \theta_r \cdot \cos \theta_i \cdot \sin \theta_i \cdot d\theta_r \cdot d\theta_i \cdot d\phi_r \cdot d\phi_i \quad [\text{sr}^{-1}]$$

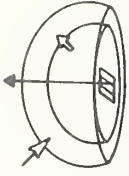

Note:

$$(1) \quad \int_0^{2\pi} d\phi = 2\pi \quad (2) \quad \int_0^{\pi/2} \cos \theta \cdot \sin \theta \cdot d\theta = 1/2 \quad (3) \quad \int_{-2\pi}^{2\pi} \int_0^{\pi/2} \cos \theta \cdot \sin \theta \cdot d\theta \cdot d\phi = \pi$$

The functional notation for designating beam geometry— $f(\omega; \omega_r)$ ,  $f(\theta_i, \phi_i; \theta_r, \phi_r)$ , etc.—has been extended here. When the value  $2\pi$  appears alone on either side of the semicolon within the parentheses for  $f_r(\cdot; \cdot)$ , this indicates that the 4RDF has been averaged (a weighted average with respect to projected solid angle) over the corresponding full hemisphere of  $2\pi$  [sr] of either the incident or reflected beam. When  $2\pi$  appears along with a variable  $\theta$ , it indicates averaging over a full circle of the corresponding  $\phi$  and, similarly,  $\pi/2$  appearing along with a variable  $\phi$  indicates averaging over a full quadrant of the corresponding  $\theta$ . The bar over  $2\pi$  or  $\pi/2$  is required to distinguish these cases of averaging over the full range of the variable from those where the variable is assigned just the single value  $\phi = 2\pi$  or  $\theta = \pi/2$ , respectively. Thus, each MRDF is an average  $\bar{f}_r$  of  $f_r$  over the full range of all parameters except those still shown as independent variables. In every case, the average is a weighted average with respect to the appropriate component of the projected solid angle  $\Omega = \int \cos \theta \cdot d\omega = \iint \cos \theta \cdot \sin \theta \cdot d\theta \cdot d\phi$ .



$$\begin{aligned} \overline{f_r}(\theta_i, 2\pi; \pi/2, \phi_r) &= \langle f_r(\theta_i, \phi_i; \theta_r, \phi_r) \rangle_{\phi_i, \theta_r} \\ &= \frac{\int_0^{2\pi} \int_0^{\pi/2} f_r(\theta_i, \phi_i; \theta_r, \phi_r) \cdot \cos\theta_r \cdot \sin\theta_r \cdot d\theta_r \cdot d\phi_i}{\int_0^{2\pi} \int_0^{\pi/2} \cos\theta_r \cdot \sin\theta_r \cdot d\theta_r \cdot d\phi_i} \quad [\text{sr}^{-1}]. \end{aligned} \quad (23)$$

But

$$\begin{aligned} \int_0^{2\pi} d\phi &= 2\pi \text{ [rad]} \text{ and } \int_0^{\pi/2} \cos\theta \cdot \sin\theta \cdot d\theta = 1/2 \text{ [rad]}, \text{ so} \\ \overline{f_r}(\theta_i; \phi_r) &= (1/\pi) \int_0^{2\pi} \int_0^{\pi/2} f_r(\theta_i, \phi_i; \theta_r, \phi_r) \cdot \cos\theta_r \cdot \sin\theta_r \cdot d\theta_r \cdot d\phi_i \quad [\text{sr}^{-1}]. \end{aligned} \quad (24)$$

As was previously mentioned, the reflectance factor for uniform isotropic irradiation is equal to the BRDF averaged with respect to the projected solid angle over the specific solid angles of incidence and reflectance involved and divided by  $(1/\pi)[\text{sr}^{-1}]$ . Since the MRDF's are similar averages over specific solid angles, one may simply multiply an MRDF by  $\pi$  [sr] to obtain the value of the reflectance factor for the corresponding geometry.<sup>8</sup>

### C. Other Special Types (BRIDF and BRRDF)

The McCamy notation (section III.A) is specific to the choice of right-circular-cone solid angles, and the MRDF's (section III.B), as given, are specific to the polar coordinate system by which they are defined. Other specific solid angles are also sometimes used. As an example, consider the measurement of gloss, in which the geometry involves specified rectangular-conical solid angles in a special case of biconical reflectance.

In glossimetry, the measurement of luminous specularity, the value of  $f_r$  varies significantly with angles of reflection making it a very sensitive measure of gloss. Specifications have been established for the measurement configuration [15, 16, 17] including the orientation and magnitude of the rectangular-conical solid angles of irradiation and reflection, and the characteristics of the light source and the detector. Since gloss is defined in terms of rectangular-conical solid angles, it may be more convenient to express the BRDF in terms of a coordinate system in which the integrals over these solid angles can be more easily evaluated. However, the meaning and usefulness of the concepts of BRDF and projected solid angle are retained even when they are expressed in other coordinate systems.

Occasionally, situations arise where a reflecting surface is viewed from a great distance where it appears to be, for all practical purposes, a point source. This occurs, for example, in imaging systems when an object cannot be resolved because it subtends an angle less than the resolution limit of the system. In such circumstances, it is not the radiance  $L$ , but rather the radiant intensity  $I = \int L \cdot \cos\theta \cdot dA$ , of the object that is of significance, and, in dealing with reflected radiation from the object, the significant distribution function is one giving the directional distribution of reflected intensity.

This has been ignored up to this point and emphasis has been placed on the directional distribution of reflected radiance, because the reflected-intensity distribution is too often used when we believe the reflected-radiance distribution is more appropriate. The latter is the more basic,

<sup>8</sup> See last paragraph of section II.B.2.

because, when the radiance is known, the intensity can always be obtained from it as  $I = \int_A L \cdot \cos\theta \cdot dA$  [ $\text{W} \cdot \text{sr}^{-1}$ ], while the reverse is not true. Given only the intensity  $I$ , this integral equation cannot be solved for the radiance  $L$  without more information about its distribution over the radiating (emitting and/or reflecting) surface in question.

When it is necessary to distinguish between these two reflectance-distribution functions (RDF's), the following terminology and notation may be used. The *bidirectional reflected-radiance-distribution function* (BRRDF), which we have been calling just the BRDF up to this point,<sup>9</sup>

$$f_{rL}(\theta_i, \phi_i; \theta_r, \phi_r) \equiv dL_r(\theta_i, \phi_i; \theta_r, \phi_r; \mathbf{E}_i) / d\mathbf{E}_i(\theta_i, \phi_i) \quad [\text{sr}^{-1}] \quad (25)$$

while the *bidirectional reflected-intensity-distribution function* (BRIDF) is

$$f_{rI}(\theta_i, \phi_i; \theta_r, \phi_r) \equiv dI_r(\theta_i, \phi_i; \theta_r, \phi_r; \Phi_i) / d\Phi_i(\theta_i, \phi_i) \quad [\text{sr}^{-1}]. \quad (26)$$

DeVos calls this quantity the "partial reflectance"  $r^{ir}$  [19]. For a surface *element*  $dA$ , small enough so that there is no significant variation of radiance  $L$  across its surface, it is easily shown that

$$f_{rI}(\theta_i, \phi_i; \theta_r, \phi_r) = f_{rL}(\theta_i, \phi_i; \theta_r, \phi_r) \cdot \cos\theta_r \quad [\text{sr}^{-1}]. \quad (27)$$

It may also be useful to express reflectances and reflectance factors in terms of the BRIDF  $f_{rI}$ . As we have seen, it is adequate to have just the expression for the biconical quantity, since the other eight follow readily from it, in each case. The *biconical reflectance*, then, is

$$\rho(\omega_i, \omega_r) = [1/\Omega_i] \cdot \int_{\omega_i} \int_{\omega_r} f_{rI}(\theta_i, \phi_i; \theta_r, \phi_r) \cdot d\omega_r \cdot d\Omega_i; \quad (28)$$

and the corresponding *biconical reflectance factor* is

$$R(\omega_i, \omega_r) = [\pi/(\Omega_i \cdot \Omega_r)] \cdot \int_{\omega_i} \int_{\omega_r} f_{rI}(\theta_i, \phi_i; \theta_r, \phi_r) \cdot d\omega_r \cdot d\Omega_i. \quad (29)$$

The BRIDF also figures prominently in an ingenious approach to modelling the reflectance of any rough surface in terms of an equivalent, single, optically smooth, curved surface of revolution, by Trowbridge and Reitz [20].

In the balance of this monograph, and elsewhere, we will continue the practice of using the simpler nomenclature *bidirectional reflectance-distribution function* (BRDF)  $f_r(\theta_i, \phi_i; \theta_r, \phi_r)$  in lieu of the longer *bidirectional reflected-radiance-distribution function* (BRRDF) unless otherwise explicitly stated.

#### IV. Practical Considerations for Measurement of Reflectance

So far, the proposed scheme of reflectance nomenclature is described primarily in relation to an idealized abstraction, reflection by a surface element. Concerning the application of this proposed reflectance nomenclature to real situations, we are going to point out several areas where caution is needed: effects of finite intervals of area, angle, solid angle, and distribution function; definition of reflecting surface area; effect of sub-surface scattering; effects of other radiation parameters such as wavelength and polarization and of fluorescence (or phosphorescence); and the advantage of using reference standards of reflectance.

<sup>9</sup> The term "relative radiance" and symbol  $I_r(\theta, \phi; \theta', \phi')$  have also been used for this quantity [18].

## A. Effects of Finite Intervals

There are some very general considerations, of wide application to many types of physical measurements, that are involved here when we speak of a differential quantity, such as an (infinitesimal) element of area, of angle, or of solid angle, and of the closely related concept of a derivative, an instantaneous rate, or a distribution (function), such as irradiance or exitance [ $\text{W}\cdot\text{m}^{-2}$ ], radiance [ $\text{W}\cdot\text{m}^{-2}\cdot\text{sr}^{-1}$ ], or reflectance-distribution function [ $\text{sr}^{-1}$ ]. It must always be recognized that none of the latter can ever be measured exactly, just because any real measurement must be made over a finite interval (neither infinite nor infinitesimal) of each independent variable or parameter governing the quantity or its distribution, so that the result, necessarily, is an average value over each such interval. This is true even in situations where, at first glance, it may seem that instantaneous rates are being measured quite directly. For example, an automobile speedometer is actually fairly sluggish and, when speed is changing, responds rather slowly to those changes, so that its indication is always the average value over some small time interval, of the order of its time constant or response time. Similarly, for a doppler-effect measurement of velocity, a certain number of cycles, possibly only a fraction of a cycle in highly sophisticated instrumentation, must be received in order to establish a value for the frequency shift in hertz, placing a limit on the speed of response. And there is always a resolution limit, related to a noise level or a frequency-response characteristic, that establishes an interval over which averaging or integration takes place, so that a truly "instantaneous" measurement, though a highly useful concept, is never actually possible.

For slowly varying distribution functions, where it is possible to measure over parameter intervals small enough so that significant variations do not occur within the interval, this is not a problem. However, when a distribution fluctuates more rapidly or, in the limit, becomes discontinuous, problems arise. For example, we have seen that, in specular or near-specular reflection, the bidirectional reflectance-distribution function (BRDF) rapidly grows very large, approaching infinity in the ideal case, in the specular direction. This is illustrated in figure 5. Note that a logarithmic scale was used in order to portray both the very high peak value and the interesting structure in the very low values in other directions at the same time. Such measurements of the BRDF with a gonireflectometer may be so sensitive to the angular-resolution capability of the instrument as to make the resulting values, averaged over that resolution interval, of little significance. This is analogous to trying to measure absolute spectral line profiles with a spectroradiometer of inadequate spectral resolving power. In such cases, while the concept of a BRDF that approximates a delta function is still useful for understanding and relating one situation to another, values of *reflectance* or *reflectance factor* that are proportional to the integral or average of the BRDF over the projected solid angle of reflection, for appropriate sizes and configurations of that solid angle, are probably more useful.

Although we will not go into the details, it should be noted that the methods of Fourier analysis [21], developed to a large degree in connection with electrical communications, and the broader related developments of information and communication theory and statistical analysis, can be very helpful in understanding and dealing with interactions between distributions and measuring instruments. By treating an incident distribution as an input signal, and expressing the characteristics of a measuring instrument in the appropriate way as a response function (mathematically relating the resulting output to the input signal), it is theoretically possible to reconstruct the input, from the output, to any desired degree of resolution, depending on the extent to which the output and the system response function are known. However, in reality, there is always some noise level that places a limit on the specification of these quantities and hence limits the achievable reconstruction of the input, causing an irretrievable loss of information. The degree of this loss and the extent to which degradation of resolution by instrument characteristics is recoverable can be evaluated.

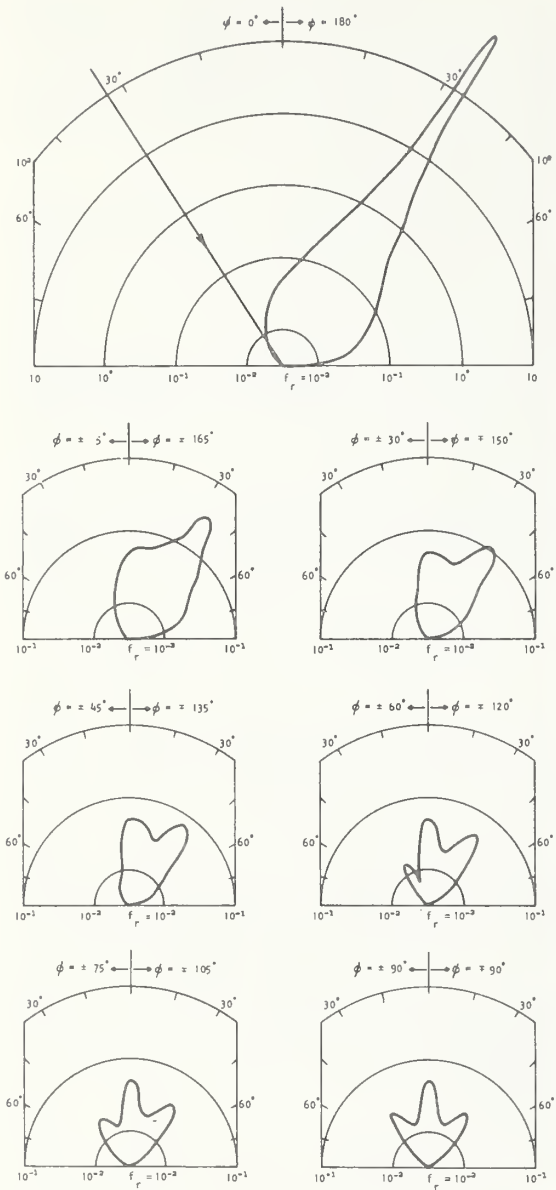

FIGURE 5. Three-dimensional graph of bidirectional reflectance-distribution function  $(BRDF)_f(33.2^\circ, 0^\circ; \theta, \phi)$  (from [10]).

### Explanation of Figure 5<sup>10</sup>

This represents a three-dimensional graph (surface) of the *bidirectional reflectance-distribution function*  $f_r(33.2^\circ, 0^\circ; \theta, \phi)$  of a sample of aluminum. It shows the directional distribution of reflected radiance [ $\text{W} \cdot \text{cm}^{-2} \cdot \text{sr}^{-1}$ ] per unit incident irradiance [ $\text{W} \cdot \text{cm}^{-2}$ ] in a well-collimated beam from the direction  $\theta_i = 33.2^\circ$  (angle from normal to reflecting surface)  $\phi_i = 0^\circ$  (azimuth angle in plane of surface). It was prepared by Nicodemus as a cover illustration for Applied Optics to go with [10]. Data reported by Gerald M. Keating and James A. Mullins in "Vectorial Reflectance of the Explorer IX Satellite Material," NASA Technical Note NASA TN D-2388 (Aug. 1964), in the form of a contour plot of bidirectional reflected-intensity-distribution function (BRIDF; see sec. III.C)  $f_{rI}(33.2^\circ, 0^\circ; \theta, \phi) = f_{rL}(33.2^\circ, 0^\circ; \theta, \phi) \cdot \cos\theta$ , were transformed into polar plots of  $f_r = f_{rL}$  in vertical planes at different azimuth angles  $\phi$ . Artist James Cutter at Sylvania Electronic Defense Laboratories fabricated aluminum fins cut to the shapes of these polar graphs and assembled them to produce the modernistic sculpture which was photographed. The graph is the surface which forms the envelope of the curved sections. Examples of individual vertical-plane sections are also shown. The logarithmic scale for  $f_r$  exaggerates the variations in the low values of  $f_r$  in directions away from the strong specular reflection at  $(33.2^\circ, 180^\circ)$  to bring out the fact that any description as a combination of specular reflection ( $\delta$ -function) and perfectly diffuse (lambertian) reflection (constant in all directions) cannot tell the whole story. In commenting on the peculiar ridges observed in this pattern, Keating and Mullins state that "It was suggested . . . that this effect was probably due to the cross grain of the [aluminum] material."

<sup>10</sup>Figure 5 also appears on the cover.

In addition to the problems of achievable resolution in measuring rates or derivative quantities, there is also the problem (still geometrical) of interaction between position and direction parameters, known as vignetting. Ostensibly, we should be able to extend the relations stated for a surface element to a larger portion of a plane reflecting surface merely by arranging for uniform isotropic irradiation and for reflection (collection or viewing) through the same solid angles or directions, respectively, for all elements of the more extended surface. However, with practical laboratory-size instrumentation, sources and receivers are not at infinity, although they can be optically at infinity if they are each positioned in the focal surface of a collimating or collecting optical system. But this, in turn, introduces still other problems.

The imperfect reflectance and/or transmittance of the optical elements of a collimator, and its aberrations, which may produce significant departures from perfect collimation or focusing, are not easy to control or to evaluate for their effects on a reflectance measurement. Similar considerations apply to the receiver and its associated collecting optics, if any. Even with ideally perfect optics, directional variations in the collimated beam will be produced by any variations in radiance across the surface of a source located in the focal plane; and the size of the solid angle filled by the collimated beam will depend on the size of the source (the solid angle that it subtends at the primary optics). Similarly, uniformity of radiance across the collimated beam (across the exit pupil or aperture of the collimator) depends on the radiation being isotropic (lambertian) at each point of the source. Since extended sources of uniform radiance that are isotropic over large solid angles are difficult to obtain, the problems involved in using a collimator become even greater for the larger solid angles of irradiance when "fast" optics (of low  $f$  number) are used. Similar considerations apply to the receiver and its associated collecting optics for the larger solid angles of collection (of reflected radiation).

It is particularly hard to achieve uniform, isotropic irradiation and/or collection of reflected flux from a full hemisphere above an extended flat reflecting surface, even without considering the unavoidable problem of spatial overlapping of the two beams when one (or both) of them fills the full hemisphere. The integrating sphere probably offers the most satisfactory approach from the standpoint of geometry alone, but it introduces problems of achieving adequate power levels for detection and even more serious difficulties due to spectral variations in the reflectance of available wall materials. Again, we do not go into details but merely call attention to the possible difficulties in extending the nomenclature and concepts to real situations involving extended reflecting surfaces.

## B. Definition of Reflecting-Surface Area

Another geometrical problem is that of physically defining the exact portion of reflecting surface entering into a measurement. This can be done in three ways, deferring until the next section the major problem of sub-surface scattering effects: (1) by a sharply focused irradiating beam; (2) by a sharply focused collecting beam; or (3) by the extent of the (exposed) reflecting-material surface itself for non-sub-surface scattering conditions (see fig. 6). In (1) both the reflecting-material surface and the area from which reflected radiation may be collected by the receiver must, of course, be greater than the area defined by the focused irradiating beam at the largest obliquity (maximum value of  $\theta_i$ ) that is used. Similarly, in (2) the area irradiated and the extent of the sample-material surface must be clearly greater than the maximum area from which the focused collecting beam receives reflected radiation at the largest obliquity (maximum value of  $\theta_r$ ). In both of these cases, sharp focusing also implies adequate stops and baffles to insure against transmitting or receiving any rays outside of the defined beams. For the moment, we ignore the added problems of aberrations and adequate depth of focus. Finally, in (3) both beams extend beyond the limits of the (exposed) reflecting-material surface and extreme ingenuity must be exercised to devise arrangements where the measurement is not falsified by additional stray reflections from supports, housings, and other unwanted sources. Alas, the convenient cold black non-emitting and non-reflecting material of our thought experiment, described in appendix B, is not available in practice.

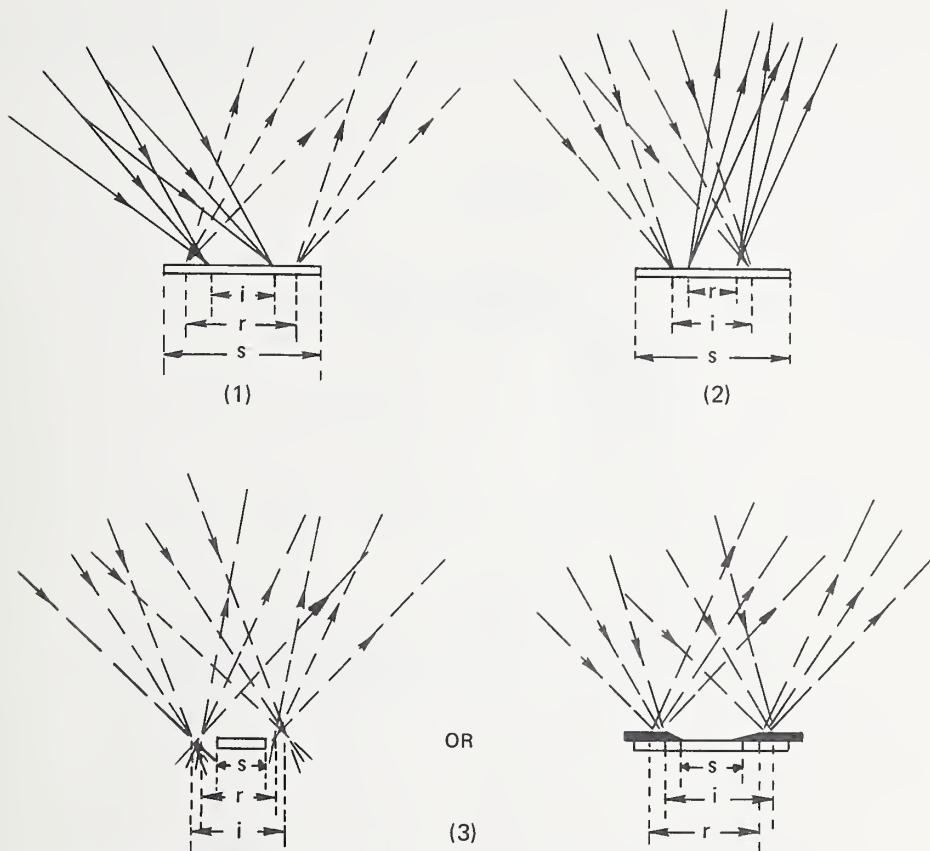

$i$  - WIDTH OF INCIDENT BEAM [DEFINES REFLECTING AREA IN (1) ].  
 $r$  - WIDTH OF REFLECTED BEAM (THAT CAN BE ACCEPTED AND MEASURED) [DEFINES AREA IN (2) ].  
 $s$  - WIDTH OF EXPOSED SAMPLE SURFACE [DEFINES REFLECTING AREA IN (3) ].

ONLY THE EXTREME RAYS OF EACH BEAM ARE SHOWN.  
 SOLID RAYS MUST BE SHARPLY FOCUSED TO DEFINE THE REFLECTING AREA.  
 DASHED RAYS NEED NOT BE SO SHARPLY FOCUSED.  
 IN CONFIGURATION (3) IT IS IMMATERIAL WHETHER  $i > r$  OR  $i < r$  OR  $i \approx r$ .

FIGURE 6. *Three configurations for physically defining the reflecting area.*  
 (See section IV.C concerning important limitations arising from sub-surface scattering or "edge effects".)

Unfortunately, there are unavoidable conflicts between some of the foregoing considerations concerning the collimating and collecting optics. In order to avoid vignetting and have the beam occupy the same solid angle (with the same orientation) at each point of the reflecting surface, the source or detector should be placed in the focal surface (or immediately behind a field stop in the focal surface) of the primary optics, as shown in figure 7. Then the rays passing through each point of the field stop form a parallel beam (focused at infinity) at the reflecting surface. But, if that beam is wide enough to intercept the entire reflecting surface at all angles, it must extend beyond it in all cases, as shown. This means that the supports, housing, or whatever is adjacent to the defined reflecting-surface area will also be irradiated by the source and may contribute erroneous reflected radiation to the collected beam reaching the detector, to the extent that they are not perfectly black or nonreflecting (configuration (3) of fig. 6). On the other hand, if the field stop is in the image plane rather than the focal plane, so that it is sharply imaged at the reflecting surface, then rays will reach each point of that surface from the entire entrance pupil or aperture

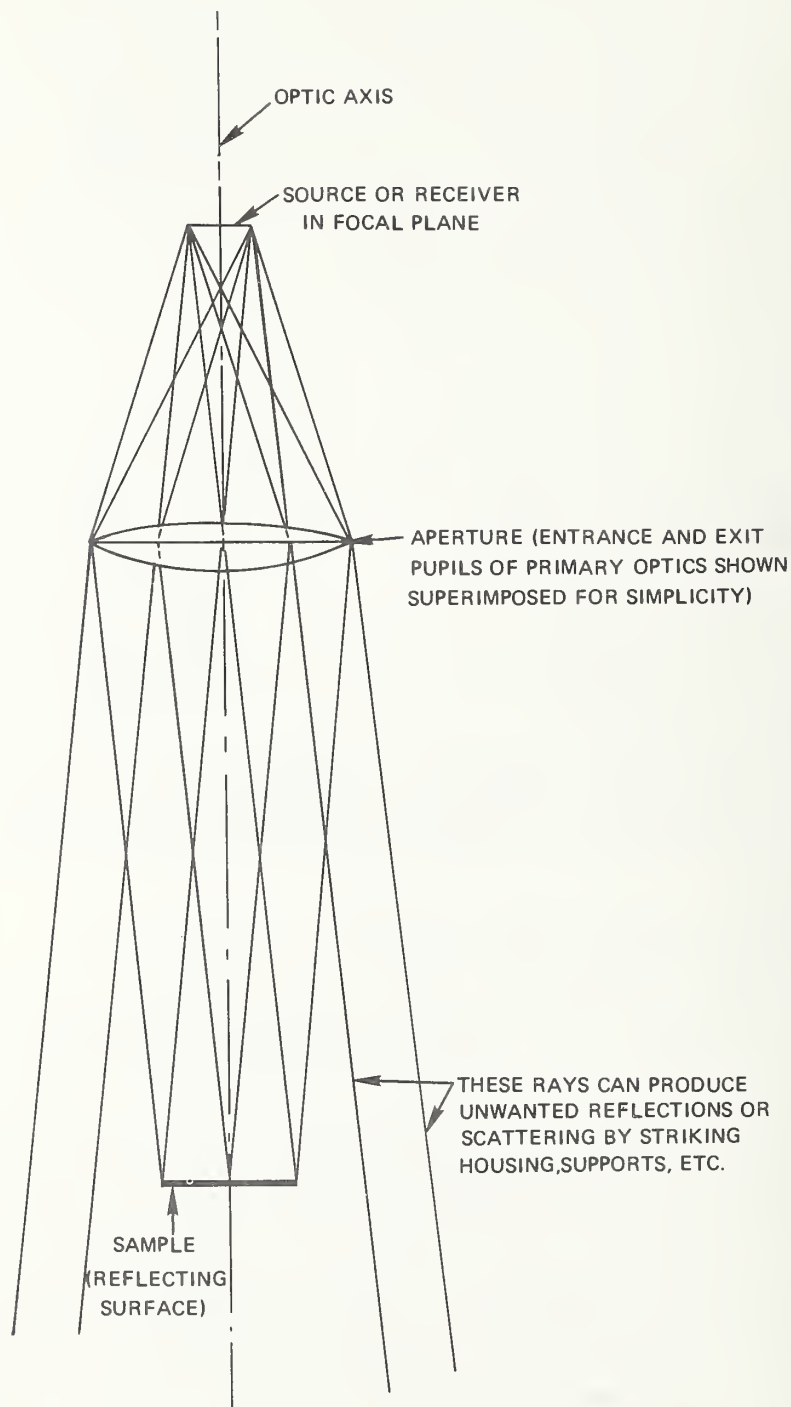

FIGURE 7. Simplified configuration when source (or receiver) is located in focal plane (or just behind field stop in focal plane) of primary optics.



of the primary optics and the solid angle of the beam will vary from point to point across the reflecting surface, as shown for the extreme edges in figure 8 (this would be the case in configurations (1) and (2) of fig. 6).

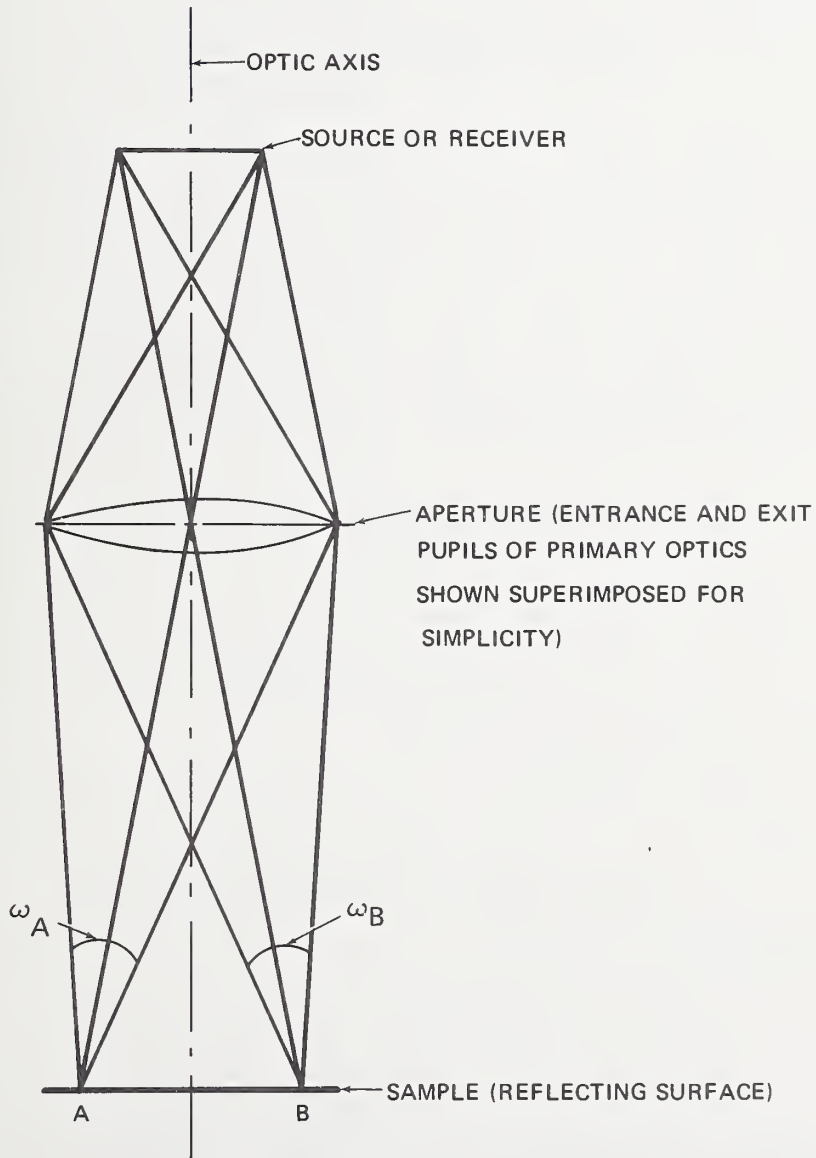

FIGURE 8. *Simplified configuration with source (or receiver) and sample (reflecting surface) in conjugate image planes of primary optics.*

### C. Sub-Surface Scattering (Edge Effects)

Earlier (sec. II.A), we treated sub-surface scattering in terms of the BSSRDF (eqs (1) and (2)) without making any assumptions about the mechanism(s) involved. However, it may be helpful to look briefly at a few considerations, without examining possible mechanisms in any great detail. For example, for very rough surfaces we may choose a reference plane lying just above the highest points. Then microscopic analysis would reveal many interreflections between the surface irregularities by which an incident ray would be returned as reflected radiation through a point of the reference plane different from the point through which the incident ray entered the space beneath. An example might be a roughened metal surface, or again, the surface of the moon, with large hills and valleys, viewed from the great distance of the earth. Probably the most common situation, however, is the body scattering within the material of most diffuse reflectors.

For body scattering materials, besides the Fresnel reflection, there are diffuse reflections produced by internal scattering [22–25], usually multiple scattering, in the material below the nominal reflecting surface (usually the boundary between that material and the air above it). This occurs with diffuse reflectors, which include, in varying degrees, nearly all natural reflecting-surface materials, depending to a great extent on their opacity, i.e., on the degree to which the incident beam penetrates into the material before being absorbed or scattered back through the surface again, each ray emerging at a point which, in most cases, is different from the point of incidence (for that ray). The reflected rays each include radiation which is incident at adjacent points as well, and for the more translucent materials, the separation between the points involved in such interaction can be quite substantial [26]. In such cases, it is necessary to either irradiate a large area and view a smaller area (or vice versa), as indicated in section II.A.

In order to take such interaction into account, we should refer back to eqs (1) and (2) where the BSSRDF represents the basic property of the material. For uniform irradiance and a uniform and isotropic sample surface, the expression for the reflected radiance is simplified to the relation expressed by eq (6) which is rewritten as:

$$dL_r = dE_i(\theta_i, \phi_i; \lambda) \cdot \int_{A_i} S(\theta_i, \phi_i; \theta_r, \phi_r; r) \cdot dA_i \quad (30)$$

where

$$r = [(x_i - x_r)^2 + (y_i - y_r)^2]^{\frac{1}{2}}. \quad (8)$$

The reflected radiant flux can be expressed as:

$$\begin{aligned} d\Phi_r &= \int_{A_r} dL_r \cdot d\Omega_r \cdot dA_r \\ &= dE_i(\theta_i, \phi_i; \lambda) \cdot d\Omega_r \cdot \int_{A_r} \int_{A_i} S(\theta_i, \phi_i; \theta_r, \phi_r; r) \cdot dA_i \cdot dA_r. \end{aligned} \quad (31)$$

The inner integration can be written as

$$\int_{A_i} S(\theta_i, \phi_i; \theta_r, \phi_r; r) \cdot dA_i = 2\pi \int_0^{r_m} S(\theta_i, \phi_i; \theta_r, \phi_r; r) \cdot r \cdot dr \quad (32)$$

where  $r_m$  is the radius of the circle about  $(x_r, y_r)$  beyond which increasing the size of the irradiated sample has no further effect on  $L_r$ , i.e., beyond which there is no significant interaction between  $dA_r$  and  $dA_i$ . In other words,  $S$  diminishes rapidly enough so that

$$2\pi \int_{r_m}^{\infty} S(\theta_i, \phi_i; \theta_r, \phi_r; r) \cdot r \cdot dr \approx 0. \quad (33)$$

This means that, when the two areas  $A_i$  and  $A_r$  are unequal, with one completely contained within the other and with a band of width greater than  $r_m$  between their margins all around, the integral over the larger area is effectively limited to just the area covered by the smaller plus a band of width  $r_m$  surrounding it. If we denote the area of such a band, of width  $r_m$ , surrounding the smaller area as  $a(r_m)$ , then, if  $[A_i + a(r_m)]$  lies wholly within  $A_r$ , the double integral of eq (31) becomes

$$\int_{A_i + a(r_m)} \int_{A_i} S(\theta_i, \phi_i; \theta_r, \phi_r; r) \cdot dA_i \cdot dA_r \quad [\text{m}^2 \cdot \text{sr}^{-1}] \quad (34)$$

but if we reverse the directions of all rays so that incident and reflected beams are exactly interchanged, then  $A_r + a(r_m)$  lies wholly within  $A_i$  and the double integral becomes, instead,

$$\int_{A_r} \int_{A_r + a(r_m)} S(\theta_i, \phi_i; \theta_r, \phi_r; r) \cdot dA_i \cdot dA_r \quad [\text{m}^2 \cdot \text{sr}^{-1}]. \quad (35)$$

Since, in this case  $S(\theta_i, \phi_i; \theta_r, \phi_r; r)$  involves the coordinates  $(x_i, y_i)$  and  $(x_r, y_r)$  only symmetrically through  $r$ , it follows that the integrals (34) and (35) are equal. Hence, it is immaterial which of the areas is the smaller, the irradiated area  $A_i$  or the defined area  $A_r$  from which reflected radiation is collected and measured. For a given magnitude of that smaller area, as long as it is contained in the larger area and separated from the boundary of the larger area by a band of width equal to or greater than  $r_m$  in all directions, the reflected radiant power collected and measured will be the same. Furthermore, if  $A_i$  and  $A_r$  are concentric circular areas that can be adjusted in size,  $r_m$  can be estimated or measured (*with respect to the noise level or resolution limit of the reflectometer*) by starting with them nearly the same size and gradually increasing the larger one until there is no longer any observable increase in the signal from the radiation detector. At this point the radial separation between their boundaries is equal to  $r_m$ .

It is assumed throughout the foregoing discussion that the sample size  $A_s \gg A_i$  or  $A_r$  and that the distance from the boundary of the larger area  $A_i$  or  $A_r$  to the sample edges is much greater than  $r_m$ . Otherwise, there may be disturbing internal reflections and/or scattering from the margins of the sample. It should also be reiterated that this analysis applies only to samples that have uniform isotropic scattering properties parallel to the nominal reflecting surface, and it should be noted that it is essential that the uniformly-irradiated sample area extend in all directions beyond the edges of the observed reflecting area, or vice versa, by more than the distance  $r_m$ , i.e., that  $r > r_m$  for each pair of incident and exitent points lying, respectively, on the margins of  $A_i$  and  $A_r$ .

It should be emphasized that this quantity  $r_m$  is not a fixed distance for a given material; it is a function also of the desired degree of accuracy or approximation accepted in eq (33). An example, which provides a method for directly estimating  $r_m$ , is to visually (with suitable precautions for eye protection) observe the reflection from a point intensely irradiated by a sharply focused beam, such as that from a laser source. The radius of the visible band of diminishing radiance or brightness surrounding the intense central spot is  $r_m$ , to the degree of approximation established by the strength of the source and the threshold of visibility for the particular circumstances. For larger ( $>2r_m$  across in any direction), sharply focused, uniformly illuminated areas, the width of the *band* of gradually diminishing brightness surrounding the central region of uniform brightness will be approximately  $2r_m$ . Note also that  $r_m$  is usually spectrally dependent, having different values for different wavelengths.

From the equality of integrals (34) and (35) it follows that the measurement configurations (1) and (2) of figure 6 are equivalent. In the case of configuration (1), the choice of  $r_m$  may be described as being large enough to collect all of the reflected light due to the irradiation of  $A_i$ , while in the case of configuration (2), the choice of  $r_m$  may be described, as before, as being large enough to include all of the irradiated area which contributes significantly to the radiance from  $A_r$ .

Of the two, configuration (1) of figure 6 is the one that is more likely to be used in a reflectometer that measures reflectance, rather than a reflectance factor, by measuring, separately, the radiant flux in both the incident and reflected beams. On the other hand, configuration (3) of figure 6 should not be used for materials for which sub-surface scattering is appreciable, but rather should be restricted to cases in which surface (Fresnel) reflectance of highly opaque material, such as metal, is to be measured. In this configuration, as well as in configurations (1) and (2) for which  $r_m$  is not chosen large enough, scattered radiation passes laterally beyond the edges of the defined area with no opportunity for any of it to be returned into the reflected beam, or there is not enough (if any) compensating scattered radiation coming back through those edges from irradiated surface elements outside the defined area. These "edge losses" may account for otherwise unexplained differences in reported values of reflectance or reflectance factor for a given sample measured with different instruments, since the exact configurations employed in the different instruments vary considerably.

For materials that are uniform, but are non-isotropic, the illustrative situation of an intensely illuminated point would no longer produce a circular region of gradually diminishing brightness. Instead, it would be elliptical or perhaps even more irregular and  $2r_m$  would correspond to its greatest width (diameter) in any direction. Furthermore, the requirement for uniformity, that  $S$  be independent of the location of the temporarily fixed point, can also be relaxed to a requirement for only statistical macroscopic uniformity, with variations only over small enough distances so that they are not significant.

#### D. Extrapolation to Different Geometries

It is easily shown that, for any beam geometry, the reflectance is given by

$$\rho(\omega_i; \omega_r) = \overline{f_r}(\omega_i; \omega_r) \cdot \Omega_r \quad [\text{dimensionless}], \quad (36)$$

where

$$\overline{f_r}(\omega_i; \omega_r) = [1/(\Omega_i \cdot \Omega_r)] \cdot \int_{\omega_i} \int_{\omega_r} f_r(\theta_i, \phi_i; \theta_r, \phi_r) \cdot d\Omega_r \cdot d\Omega_i \quad [\text{sr}^{-1}] \quad (37)$$

is the averaged BRDF, with respect to projected solid angle, over both the solid angle of incidence and the solid angle of reflection (collection). In fact, this is readily apparent upon comparing eqs (36) and (37) with eq (16). Thus, as the beam geometry changes, as long as the *average* value of the BRDF  $f_r$  is not significantly changed, it is only necessary to multiply it by the new value of  $\Omega_r$ , if any, to obtain the reflectance  $\rho$  for the new beam geometry. If no measurements are available that were taken with the beam geometry for which a reflectance value is required, the best estimate is obtained by using the value of  $\overline{f_r}$  (based on a measured value of reflectance factor) for the beam geometry that most nearly approximates the desired one, and multiplying it by the appropriate value of  $\Omega_r$ . If possible, also try to take into account any supplemental data that might indicate how the value of  $f_r$  may vary with the directions involved in the differences between the two geometries. Some practical problems and some measurement results are reported by Hsia and Richmond [27]. Part II of their paper [27] is a useful bibliography on diffuse reflectance.

#### E. Other Radiation Parameters and Fluorescence (or Phosphorescence)

Reflectance, like absorptance and transmittance, may be highly dependent on the wavelength or frequency  $\nu$  [THz] (as distinguished from modulation or fluctuation frequency  $f \ll \nu$ ) of the radiation. Accordingly, selective reflection may frequently alter the spectral distribution in a beam of radiation, so that the spectral-total reflectance (all wavelengths), even of identical surfaces, may change as a beam, which includes an extended distribution of wavelengths, undergoes successive

reflections. If there is interaction between spectral and geometrical parameters, as just noted as a possibility in materials with significant internal scattering, the geometrical distribution may also be affected. In so-called linear situations, where propagation effects, such as reflection, are independent of the strength of the beam, mathematical treatment is simplified by dealing with relative factors and distributions, usually normalized to a maximum of one. We will not consider non-linear situations where radiation effects are intensity-dependent except to remind the reader that, with high-powered lasers becoming available, such non-linear optical effects are being encountered more frequently as time passes.

The bidirectional reflectance-distribution function to be used in evaluating all of the reflectances, reflectance factors, and MRDF's can be expressed by the weighted average of the BRDF with respect to wavelength, with the spectral distribution of the incident radiation beam as the weighting function. If, however, there is no interaction between the wavelength or frequency dependence and the geometrical dependence of reflection, the functions are separable. Then

$$f_r(\theta_i, \phi_i; \theta_r, \phi_r; \lambda) = f_r(\theta_i, \phi_i; \theta_r, \phi_r) \cdot f_r(\lambda) \quad [\text{sr}^{-1}], \quad (38)$$

where  $f_r(\lambda)$  is normalized to have a maximum value of one by choosing

$$f_r(\theta_i, \phi_i; \theta_r, \phi_r) = f_r(\theta_i, \phi_i; \theta_r, \phi_i; \lambda_p) \quad [\text{sr}^{-1}], \quad (39)$$

where  $\lambda_p$  is the wavelength at which the value of the right side of eq (39) is a peak or maximum; hence  $f_r(\lambda_p) = 1$ . Then it is only necessary to multiply any reflectance, reflectance factor, or MRDF, computed from the BRDF given by eq (39) by the weighted average of  $f_r(\lambda)$ , with the spectral distribution (relative is sufficient) of the incident beam as the weighting function  $x_\lambda(\lambda)$ , i.e., by

$$f_r[x_\lambda(\lambda)] = \int_0^\infty x_\lambda(\lambda) \cdot f_r(\lambda) \cdot d\lambda / \int_0^\infty x_\lambda(\lambda) \cdot d\lambda \quad [\text{dimensionless}], \quad (40)$$

where  $x_\lambda(\lambda) = X_\lambda(\lambda)/C$  is the relative spectral distribution of the incident beam;  $X_\lambda(\lambda)$  is the spectral radiometric quantity characterizing the beam;  $X$  may be any one of the radiometric quantities  $Q$ ,  $\Phi$ ,  $I$ ,  $E$ ,  $M$ , or  $L$ ;  $C$  is a constant with respect to wavelength.

Unfortunately, we are not aware of any data that will establish the extent to which there may be interaction between geometrical dependence and spectral dependence, except for the knowledge that it is a significant factor in some internal-scattering situations, as pointed out earlier, in addition to the obvious case of a diffraction grating where there is clearly substantial interaction. Certainly, there will be some wavelength bands over which the interaction is so slight that this last procedure will yield a good approximation, and it will probably hold more widely. But until more complete bidirectional reflectance-distribution data are gathered to establish such dependencies, we can only speculate and caution against the possibility of interaction effects.

Of the radiation parameters [5,28], the modulation or fluctuation frequency  $f$  ( $\ll \nu$ ) appears to be unique in that, up to the limit of the frequency-response capability of available radiation detectors, there ordinarily appears to be no frequency- $f$  dependence on the part of the propagation properties of matter-radiation interaction, the transmittance and the reflectance (or scatterance). This means that coding of an incident beam by time-modulation or chopping can be used, and is widely used, to distinguish between its effects and those due to other ambient radiation that is difficult to control and/or measure accurately and comprehensively. For example, in many reflectometers, the incident beam is chopped, and synchronous amplifiers are used to insure that the receiver-amplifier is responding only to reflected radiation produced by that incident beam and not to reflected radiation from other ambient incident rays and/or emitted thermal radiation from the sample surface and from other ambient objects, including the collecting optics, if any, of the receiver.

Finally, the last of the radiation parameters, polarization, is often neglected or ignored, and we know of no published treatment that adequately deals with its implications for radiometry, although it can strongly affect the propagation, particularly the reflectance, in many situations. Chapter 6 on polarization has been prepared for the "Self-Study Manual on Optical Radiation Measurements" [28] and has been published in June 1977 as NBS Technical Note 910-3, and we hope that it will help to clear up some of the problems in this area. Meanwhile, we note that a full description of the polarization of a beam can be given in terms of the four Stokes parameters [29], each of which can be regarded as representing a component of that beam. Then, with four such components for the incident beam, each possibly contributing to four such components in the reflected beam, the most general description of the possible interactions would require a matrix of sixteen (four  $\times$  four) BRDF's. This matrix approach, but with fewer components (not the most general case), is used in [30].

This topic will not be developed further here except to re-emphasize the fact that polarization can have a very large effect on reflectance, particularly in the case of specular reflectance. This may not be particularly significant when measuring a single reflection of unpolarized incident radiation with an unpolarized detector (one insensitive to polarization). Too often, however, it is assumed that an incident beam is unpolarized when, in fact, it is not, and/or that a detector is unpolarized when it is not. Actually, any off-normal emission [31], or off-normal reflection or refraction of an unpolarized incident beam, will produce some polarization. The latter, however, is often obscured because the cylindrical symmetry of refraction by circular lenses produces no net polarization. Similarly, there is usually no net polarization from circular focusing mirrors used on-axis, as in a Cassegrain configuration, but off-axis or asymmetrical systems, such as a Newtonian configuration or an off-axis paraboloid, may exhibit substantial polarization characteristics.

Fluorescence (or phosphorescence), if present, greatly complicates the measurement of reflectance. The phenomenon of fluorescence involves the absorption of photons within one frequency (photon-energy) range to produce emission of photons within a second, lower frequency (photon-energy) range after a time interval governed by an exponential decay, characteristic of the half-life of the excited atoms. If such re-emission persists noticeably (sometimes even for hours) it is called phosphorescence.<sup>11</sup> Reflection, on the other hand, is the process by which radiant flux incident on a surface or medium leaves that surface or medium on the incident side *without change in frequency* (spectral frequency  $\nu = c/\lambda_0$ ). Thus, the flux produced by fluorescence (or phosphorescence) is, by definition, *not* reflected flux. But both will be present in any real measurements of fluorescent (or phosphorescent) materials so that spectral dispersion of both incident and observed radiation is required to distinguish between them. If the incident beam is restricted to a narrow spectral range by a monochromator, radiation of that same spectral frequency, observed to be leaving the surface only when it is irradiated, is reflected radiation. Similar observations of a lower exitent spectral frequency establish the presence of fluorescent (or phosphorescent) emission. Further, if the incident beam is modulated, the fluorescent (or phosphorescent) emission will be found to be modulation-frequency dependent because of the time constant associated with the exponential decay characteristic of the excited atoms. The details of such measurements are a separate problem that will not be discussed further here.

## F. Use of Reference Standards

The absolute value of reflectance is usually very difficult to measure. The main problems are to measure the solid angle of viewing and to measure the flux in the incident beam accurately. This usually requires removal of the sample of reflecting surface as well as shifting of the detector (collector) and it is hard to be sure that the geometry (throughput) of the measured beam is exactly the same as that of the beam incident on the sample (when it is replaced) that produces the

<sup>11</sup>Fluorescence is characterized by a time delay of less than about 10 [ns]. Re-emission after 10 [ns], sometimes much later than 10 [ns], is called phosphorescence.

reflected beam. For precise and accurate measurements, the flux in the incident beam and its distribution in position and direction, as it impinges on the sample surface, must be completely known. (We ignore the equally important spectral and polarization parameters for this discussion.) However, once the absolute reflectances of a set of reference standards are carefully measured, the reflectance measurement of an unknown sample can be more easily done by the comparison method. The BRDF of the chosen reference standard should resemble that of the sample as closely as possible to minimize the sensitivity to instrument-alignment errors.

On the other hand, the measurement of a reflectance factor being inherently a comparison measurement, the beam-defining apertures for both source and detector (receiver) beams can be left undisturbed while a sample and a comparison-standard surface are interchanged. Accordingly, with identical beam geometry thus insured, it is much easier to achieve high precision (repeatability) in the measurement of reflectance factors. The main limitation on measurement accuracy is then the fact that there is no ideal (100%) perfectly diffusing (lambertian) comparison-standard surface. When the departure of the actual standard from 100 percent reflectance, and from a perfectly isotropic (lambertian) diffusing characteristic, are accurately known, appropriate allowance can be made for them. For the highest accuracy, however, this also involves the exact beam configuration and throughput for both the incident and reflected beams and the BRDF of the comparison-standard surface (in order to know exactly how much it differs from the ideal perfectly diffusing standard in the particular measurement configuration). Finally, a knowledge of at least the relative BRDF of the unknown surface being measured is also needed for any estimate of the accuracy and significance of the final measurement result. Only with this information can the sensitivity of the measurement result to small changes in beam geometry be assessed. The final result, of course, is valid only for the particular beam geometry of the measurement. The BRDF information is needed to determine how restrictive that limitation may be in the particular case.

Incidentally, it turns out that one of the comparison standards which can be most accurately characterized in terms of its BRDF for such use in the measurement of reflectance factors is a specular reflector. For convenience, to keep the total incident flux on the detector (receiver) more nearly at the same level for all of the measurements, one of low reflectance, such as a polished flat black glass of known specular reflectance  $\rho_{sp}$ , is used. Its BRDF is then closely approximated by eq (C10).

## V. Summary, Conclusions, and Recommendations

Within the domain of geometrical (ray) optics, the description and specification of the geometrical reflecting properties of any surface are given by the bidirectional scattering-surface reflectance-distribution function (BSSRDF)  $S$ . In most cases, however (see sec. II.A for the necessary conditions), they can be adequately specified by the simpler bidirectional reflectance-distribution function (BRDF)  $f_r$ . Other useful geometrical reflectance quantities, including reflectances and reflectance factors, are expressed and interrelated in terms of the BRDF. The effects of radiation parameters, other than geometrical, including polarization, and of fluorescence, are briefly discussed and their importance in the measurement and specification of reflectance quantities is indicated.

Within the limited scope we impose on ourselves for this monograph, our principal recommendations for the approach to the geometrical description and specification of reflecting properties of surfaces, and for nomenclature to facilitate that approach, are:

1. The term "bidirectional reflectance-distribution function" (BRDF) and symbol  $f_r(\theta_i, \phi_i; \theta_r, \phi_r)$  should be adopted and this quantity, under appropriate conditions (see sec. II.A), should be recognized as the basic quantity to be used in defining all other reflectance quantities or measures of reflectance, except in some situations involving substantial sub-surface scattering.
2. The beam geometry should always be completely specified (including uncertainties) in any quantitative statement about reflectance.

3. The nomenclature of tables 1 and 2, including McCamy's notation for right-circular-conical beams, should be adopted.
4. Other schemes of concepts and nomenclature to cover special beam geometries should be considered acceptable as long as they are clearly defined in terms of bidirectional reflectance-distribution function (BDRF) or the bidirectional scattering-surface reflectance-distribution function (BSSRDF) (including adequate consideration of any special conditions).

With the foregoing as a point of departure, we hope that, in time, our approach can be extended to also take into account the effects of the other radiation parameters, particularly polarization.

While we strongly urge the appropriate organizations concerned with establishing nomenclature standards to consider the foregoing recommendations, we should, at the same time, clarify our position with respect to all such standards. Standardization is an important requirement for efficient communication. Standards should be adopted as rapidly as a workable consensus in support of them can be established. On the other hand, they should never be permitted to become a strait jacket that stifles innovation and progress. An author who feels that he needs new and different nomenclature to adequately express his ideas should always be free to adopt and use such nomenclature. However, he should always do so explicitly, defining his nomenclature or usage clearly and, as far as possible, showing how it is related to, or differs from, any pertinent standard nomenclature. In fact, we fully expect that we, ourselves, may not infrequently find occasion to depart from the detailed nomenclature proposed in this monograph. But we also accept the obligation, when doing so, to define any such nomenclature and to relate it, where appropriate, to existing standards and/or to our recommended standards.

In conclusion, we want to emphasize that this monograph is not primarily intended to propose or advocate any particular nomenclature. Far more important than the nomenclature are the underlying concepts which we believe are essential to full understanding and effective treatment of reflectances and related quantities. We introduce nomenclature only in order to be able to talk about the concepts. The essential point is the recognition that complete specification of the reflecting properties of a highly opaque material<sup>12</sup> must take into account the directional distribution (in terms of radiance) of radiation in both the incident and reflected beams. Finally, when there is significant internal scattering, which is true in some degree for all diffusely reflecting materials, it must also be recognized that rays incident at one point contribute to the exitent "reflected" radiation from adjacent points. We have shown how these considerations can be treated and have proposed nomenclature to facilitate that treatment.

## VI. Appendix A. Background and Basis for Recommendations

In this appendix we present, briefly, the basis for our recommendations, particularly where they represent changes from earlier proposals and practices.

Reflectance nomenclature, primarily from the standpoint of beam geometry, including concepts, terms, and symbols, was discussed by Nicodemus [10] in an analysis of the interrelationship between directional reflectance and directional emissivity or emittance (Kirchhoff's law), and by Judd [12] from the standpoint of reflectometry. Subsequent experience revealed inadequacies in and inconsistencies between the two approaches, as well as useful interrelationships. Within a year following the publication of Judd's paper [12], four of the authors of this monograph (Nicodemus, Richmond, Ginsberg and Limperis) had met and outlined most of what is presented here. We have tried to eliminate the inadequacies and inconsistencies of the two earlier papers, recommending nomenclature that incorporates the best from both of them. This is supplemented by the multivariate approach (see table 3), devised by two of us (Ginsberg and Limperis) and by

---

<sup>12</sup> Material in which there is negligible separation (for a particular application) between the point of incidence of a ray and the points of exitence of all resulting internally scattered rays leaving the "reflecting" surface.



the approach of McCamy [13] who was concerned with transmittance and reflectance in connection with photographic imagery. Preparation of this paper for publication was repeatedly delayed for a variety of reasons. Meanwhile, Nicodemus became aware that a number of his earlier recommendations for terminology and symbols, that we had agreed were undesirable and in need of revision, were being rather extensively used. Accordingly, he published a letter to the editor of Applied Optics [9] to set the record straight on those points.

The changes from Nicodemus' earlier nomenclature [10] included in our recommendations are summarized in table 4, from [9]. The reasons for them are also essentially those given in [9].

TABLE 4. Comparison between recommended reflectance nomenclature and that of [10]\*

Item No.	Quantity, Recommended terminology	Quantity, Ref-[10] terminology	Recommended symbol	Ref-[10] symbol
1	Radiant power	...	$\Phi$	$P$
2	Radiant intensity	...	$I$	$J$
3	Radiant exitance	(radiant emittance)	$M$	$W$
4	Irradiance	...	$E$	$H$
5	Radiance	...	$L$	$N$
6	Solid angle	...	$\omega$	$\Omega$
7	Projected solid angle	...	$\Omega$	$\Omega'$
8	Bidirectional reflectance-distribution function	(Partial reflectance, or bidirectional reflectance)	$f_r$	$\rho'$
9	Directional-hemispherical reflectance	(Directional reflectance)	$\rho(\theta_i, \phi_i; 2\pi)$	$\rho_{di}(\theta_i, \phi_i)$
10	Hemispherical-directional reflectance factor	(Directional reflectance)	$R(2\pi; \theta_r, \phi_r)$	$\rho_{dr}(\theta_r, \phi_r)$

\*from [9].

Items 1 through 5 merely establish conformity with the radiometric nomenclature of [4]. Items 6 and 7 follow a practice suggested by R. Clark Jones [32], leaving the prime notation available for other purposes. Solid angle and projected solid angle are explicitly defined and discussed in [2].

Item 8, the bidirectional reflectance-distribution function (BRDF)  $f_r$ , is the most important entry in table 4. Except for considerations of sub-surface scattering (see the last paragraph of this section), it is the basic quantity, underlying all of the reflectance nomenclature recommended in this paper. It has [2] unit-dimension [ $\text{sr}^{-1}$ ] and its value may range from zero to extremely high values, even going to infinity in the delta-function form for ideally specular reflectance in eq (C10). It is, therefore, important to distinguish it clearly from reflectance, the dimensionless ratio  $0 \leq \rho \leq 1$  of eq (15a). However, both the terms "partial reflectance" and "bidirectional reflectance" (especially the latter) and the symbol  $\rho'$ , to denote the BRDF, have caused much confusion by failing to emphasize this distinction adequately. The poor choice of terms is probably most to blame, since the prime notation is widely used for derivatives elsewhere in other connections. However, in line with our desire to free the prime for other purposes and because the confusion with  $\rho$  has occurred, even though the terminology rather than the notation may have been primarily responsible, we are recommending the notation  $f_r$ . Furthermore, both the new term and new symbol help to emphasize the nature of this quantity as a distribution function, encouraging appropriate utilization of existing mathematical treatments of distribution functions in general. Finally, the fact that two directions are involved is clearly denoted by the physically descriptive modifier "bidirectional" and by the explicit statement of functional dependence in the full notation  $f_r(\theta_i, \phi_i; \theta_r, \phi_r)$ .

Items 9 and 10 clarify the nature of two quantities (both called reflectances in [10]) by the application of Judd's (modified) terminology and symbols, which show that while one is a reflectance, the other is actually a reflectance (radiance) factor. As shown in [10], and recognized in [12], these two quantities for a given direction are always equal (i.e.,  $\rho(\theta, \phi; 2\pi) = R(2\pi; \theta, \phi)$ ) as a direct consequence of Kirchhoff's law (as originally stated in directional form), regardless of Helmholtz reciprocity [9].

Judd's [12] scheme of functional notation for designating the beam geometry for any reflectance quantity has been adopted with certain modifications. We prefer the semicolon used in an earlier draft of Judd's paper [12], rather than the colon that appeared in the published paper, for separating the parameters designating the incident-beam geometry from those designating the geometry of the reflected (collected) beam. This avoids possible confusion with similar use of a colon in other notations. We also prefer the more explicit  $\omega$  rather than Judd's  $g$  as the symbol for the conical beam geometry, and have extended it to include, also, the extremes of an element of solid angle  $d\omega$  (which we use interchangeably with  $(\theta, \phi)$  to denote a well-collimated beam in a given direction) or a full hemisphere of  $2\pi$  [sr]. The use of  $\omega$  is also more consistent with the other symbols; this way, all three— $d\omega$ ,  $\omega$ , and  $2\pi$ —represent solid angles. The nine permutations of three incident and three reflected (collected) beam geometries (see fig. 3) used by Judd have been followed in tables 1 and 2, except that the order has been reversed. We start with the bidirectional quantity and end with the bihemispherical quantity. This seems more consistent with the approach of building up all of the quantities by integration and/or averaging of the BRDF, as shown in the last column of each table.

In table 1, note that three quantities—bidirectional reflectance  $d\rho(\theta_i, \phi_i; \theta_r, \phi_r)$ , conical-directional reflectance  $d\rho(\omega_i; \theta_r, \phi_r)$ , and hemispherical-directional reflectance  $d\rho(2\pi; \theta_r, \phi_r)$ —are all designated as differentials by the notation used, the reason being clear from the last expression on the same line, giving each quantity in terms of the BRDF. Judd [12] speaks of integrating the bidirectional reflectance to obtain other forms of reflectance but, unfortunately, used the notation  $\rho$  rather than the differential notation  $d\rho$  for all three of these quantities. All of Judd's [12] rather involved sets of interrelationships between the various quantities in both tables 1 and 2 are readily apparent and derivable from the consistent set of expressions for each quantity in terms of the BRDF  $f_r(\theta_i, \phi_i; \theta_r, \phi_r)$  in the last column of each table.

In table 2, we propose a clear departure from the terms and symbols of Judd [12] and of ANSI [4] and its source, the CIE [14], by abandoning the term radiance factor and the symbol  $\beta$  for the three quantities: bidirectional-reflectance factor  $R(\theta_i, \phi_i; \theta_r, \phi_r)$ , conical-directional reflectance factor  $R(\omega_i; \theta_r, \phi_r)$ , and hemispherical-directional reflectance factor  $R(2\pi; \theta_r, \phi_r)$ . In this way, the close interrelationship of all nine quantities in table 2, all of which are contained in the expression for the biconical reflectance factor  $R(\omega_i; \omega_r)$ , if the range for the solid angles  $\omega_i$  and  $\omega_r$  is extended to include the extremes of an element of solid angle  $d\omega$  and a full hemisphere of  $2\pi$  [sr], is more clearly apparent. On the other hand, since first deciding on this recommendation, we have realized that there are occasions when one may wish to make a general statement about a radiance factor  $\beta$  which applies equally to any one of the three, or about the radiance factors  $\beta$  generally, which applies to all three, but in neither case to any of the other reflectance factors. In the newly proposed nomenclature, it is very awkward to make such a distinction between these three quantities and the other reflectance factors. Accordingly, we also favor retention of the older nomenclature as an acceptable alternate form.

From the outset, we were aware, also, of the phenomenon of sub-surface scattering and so-called "edge effects" in diffuse reflectors, particularly in obviously translucent materials. Accordingly, the discussion of the "edge effects" (sec. IV.C) was developed. However, since it justified wide continued use of the formalism already established on the basis of the BRDF, we left it there and made relatively little mention of it earlier. Later, during reviews at NBS, in order to improve clarity and continuity, Venable and Hsia proposed a new approach in which the more general BSSRDF was introduced first and the BRDF was then developed as the important special case. Meanwhile, their publication [8] established the even more general scattering function  $S$ , of which the BSSRDF is a special case. The main body of this monograph was, accordingly, rewritten using this approach.

## VII. Appendix B. Details of Reflectance Derivations (A Thought Experiment)

Consider a large, opaque hemisphere with walls and base of cold, rough, black material that does not transmit, emit, or reflect any radiation. Of course there is no real material that can fully meet these conditions; but it is useful, conceptually, to postulate them in order to isolate and clarify the concepts involved in the reflectance relations to be analyzed.

An element of completely opaque reflecting surface  $dA$  is positioned at the center of the base and lies in the plane of the base. Here, too, we postulate a material so opaque that there is no penetration at all, a condition only approximated by real materials (e.g., metals).<sup>13</sup> Outside the hemisphere, there exists a field of radiation (radiant energy) flowing in all directions. However, the hemisphere is so large (relative to  $dA$ ) that, when holes are cut in the spherical surface to admit this radiation from outside, only radially-directed rays of radiance  $L_i(\theta_i, \phi_i)$  [ $\text{W} \cdot \text{cm}^{-2} \cdot \text{sr}^{-1}$ ] can reach  $dA$ ; all others strike the cold black walls and base and are absorbed. (This use of differentials, such as the area element  $dA$ , and the relations of the calculus, based on assumptions of continuity in the domain of geometrical optics, is well explained by Jones [7] and is also discussed in [2].)

A small hole in the spherical wall, which subtends an elementary solid angle  $d\omega_i$  at  $dA$ , admits an elementary beam which strikes  $dA$  with an irradiance (see chapter 4 of [28], still in preparation)

$$dE_i(\theta_i, \phi_i) = L_i(\theta_i, \phi_i) \cdot \cos\theta_i \cdot d\omega_i = L_i(\theta_i, \phi_i) \cdot d\Omega_i \quad [\text{W} \cdot \text{m}^{-2}]. \quad (\text{B1})$$

In radiometry, irradiance  $E$  [ $\text{W} \cdot \text{m}^{-2}$ ] is not ordinarily treated as a directional quantity, except in a vectorial method for lighting calculations in illumination engineering [33,34]. However, the differential element  $dE$  is clearly a directional quantity as it is used here in eq (B1). The incident radiant flux or power reaching  $dA$  is then

$$d\Phi_i = dE_i(\theta_i, \phi_i) \cdot dA \quad [\text{W}]. \quad (\text{B2})$$

Note that, for generality, no restriction is placed on the incident radiance  $L_i$  which may vary with direction as  $L_i(\theta_i, \phi_i)$ , a possibility that must be recognized in dealing with real situations. However, as soon as we consider the effects of increasing the angular size  $\omega_i$  of the incident beam, it becomes apparent that the reflected radiant flux may depend not only on the amount contained in the incident beam but also on the way in which it is distributed with respect to incident direction within that beam. Only in the case of a perfectly uniform and isotropic diffusing surface, with the same reflecting properties in all directions, will the reflected flux depend only on the amount of incident flux and not on its directional distribution.

For useful reflectance quantities, to characterize the reflecting properties of a surface for different beam geometries, the possibilities become prohibitively complex if we also try to take into account different directional distributions of flux within the incident beam. The situation is greatly simplified, and the results are still of substantial utility, by assuming isotropic incident radiance  $L_i$  (isotropic for all directions *within the defined solid angle*  $\omega_i$ ); hence  $L_i$  is shown as having everywhere the same value outside the hemisphere in figure 9. Wherever feasible, however, we retain the variable  $L_i(\theta_i, \phi_i)$  for greater generality.

In general, the incident radiant flux is either absorbed or is reflected into all directions within the hemisphere by the surface element, as indicated by the arrows of varying lengths  $dL_r(\theta_r, \phi_r)$  diverging from  $dA$  in figure 9. As noted in [5] and [10], even when the reflecting surface is highly specular, there is always *some*, perhaps very small, scattering or diffuse reflection in directions other than the specular angle. (Special considerations concerning such glossy or highly specular

<sup>13</sup>The conditions underlying the definition of BRDF and the discussion of section IV.C should be noted, particularly for materials in which a substantial part of the reflection is due to sub surface-scattering.

surfaces are discussed in appendix C.) Often, however, we are not interested in all of this reflected radiation but only in that reflected into some specified solid angle  $\omega_r$ , occupying only a portion of the full hemisphere. In the present case, it is only into an elementary solid angle  $d\omega_r$ , in a single direction  $(\theta_r, \phi_r)$ , defined by cutting another small hole in the hemispherical wall and placing a receiver R just outside to respond to the reflected radiation reaching it from  $dA$  through the hole and to block any outside radiation from entering, as illustrated in figure 9.

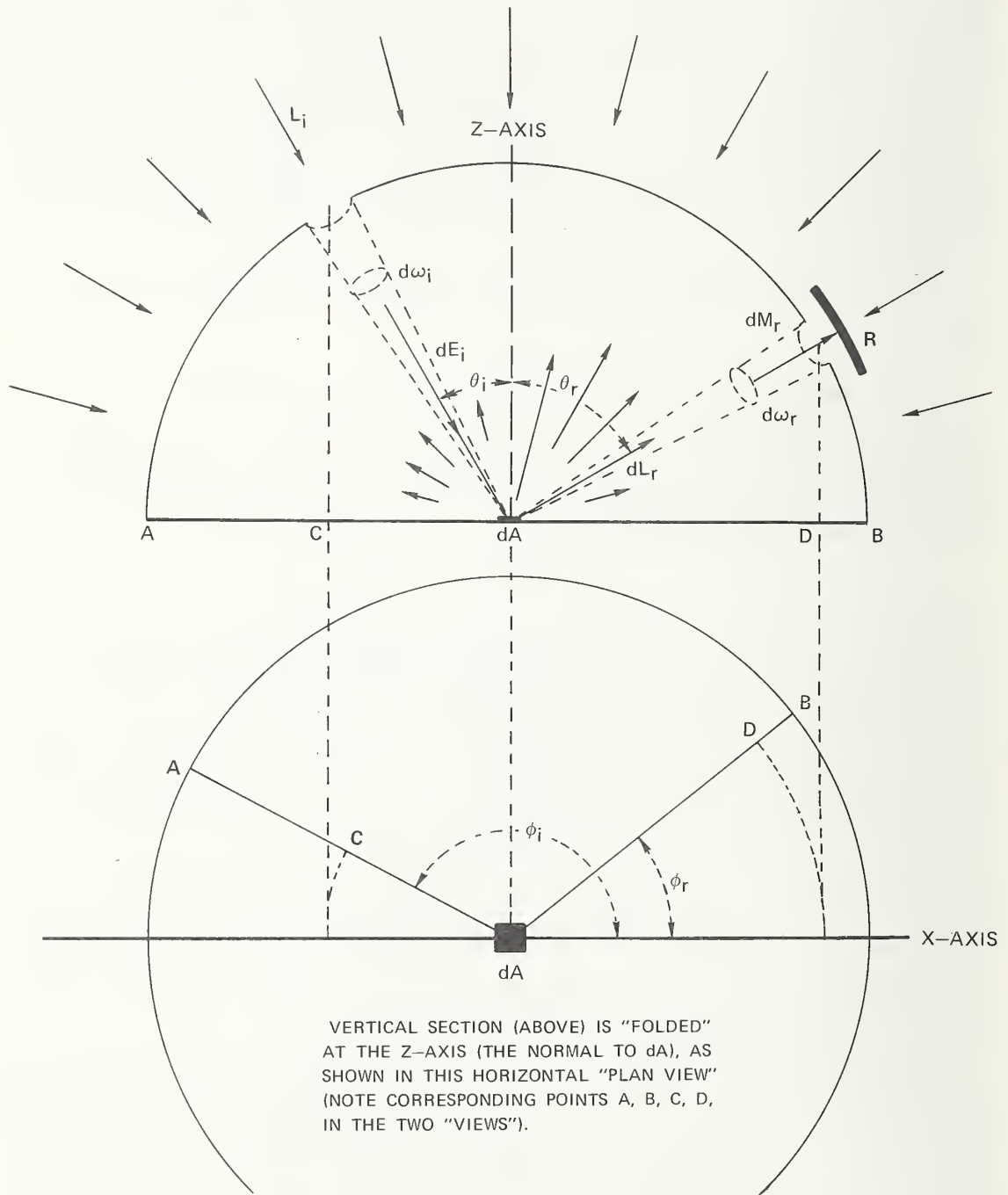

FIGURE 9. "Thought-experiment" configuration for bidirectional reflectance.

The reflected radiant flux reaching the receiver through the element of solid angle  $d\omega_r$  is

$$\begin{aligned} d\Phi_r &= dL_r(\theta_r, \phi_r) \cdot d\Omega_r \cdot dA = dL_r(\theta_r, \phi_r) \cdot \cos\theta_r \cdot d\omega_r \cdot dA \\ &= dM_r(\theta_r, \phi_r) \cdot dA \quad [\text{W}], \end{aligned} \quad (\text{B3})$$

where  $dM_r(\theta_r, \phi_r)$ , like  $dE_i(\theta_i, \phi_i)$  in eq (B1), is a directional quantity, defined by (see chapter 4 of [28], still in preparation):

$$dM_r(\theta_r, \phi_r) = dL_r(\theta_r, \phi_r) \cdot d\Omega_r = dL_r(\theta_r, \phi_r) \cdot \cos\theta_r \cdot d\omega_r \quad [\text{W} \cdot \text{m}^{-2}]; \quad (\text{B4})$$

Then, combining the basic definition of reflectance with eq (B1), (B2), (B3), and (B4), the bidirectional reflectance is

$$\begin{aligned} d\rho(\theta_i, \phi_i; \theta_r, \phi_r) &= d\Phi_r / d\Phi_i = dM_r(\theta_r, \phi_r) / dE_i(\theta_i, \phi_i) \\ &= dL_r(\theta_r, \phi_r) \cdot d\Omega_r / dE_i(\theta_i, \phi_i) \\ &= dL_r(\theta_r, \phi_r) \cdot d\Omega_r / L_i(\theta_i, \phi_i) \cdot d\Omega_i \quad [\text{dimensionless}]. \end{aligned} \quad (\text{B5})$$

Now consider what will happen to the reflected radiance  $dL_r$  and the bidirectional reflectance  $d\rho$  as we change conditions to produce small changes in each of the factors on the right-hand side of eq (B5). First, changes in the magnitude of the incident radiance  $L_i(\theta_i, \phi_i)$  will be seen to produce corresponding proportionate changes in the reflected radiance  $dL_r$ , leaving the ratio  $d\rho$  unchanged. (We are not concerned, here, with the non-linear effects that may occur at extremely high values of  $L_i$ , found only in the radiation beams from the highest-powered lasers.) Similarly, small variations in the incident projected solid angle element  $d\Omega_i$  (changing the size of the small hole through which  $L_i$  enters) will also produce proportionate changes in  $dL_r$ , again leaving  $d\rho$  unchanged. (At small values of  $\theta$ , where  $\cos\theta \approx 1$ , the difference between  $d\Omega$  and  $d\omega$  may not be perceptible, but as  $\theta$  approaches  $\pi/2$  [rad], where  $\cos\theta$  changes more rapidly with changing  $\theta$ , it will be clear that the direct proportionality is between  $dL_r$  and  $d\Omega_i = \cos\theta \cdot d\omega_i$ , not just  $d\omega_i$ .) Thus,  $dL_r$  is seen to be a function of incident irradiance  $dE_i = L_i(\theta_i, \phi_i) \cdot d\Omega_i$  and, for a given value of  $dE_i$ , it will depend both on the direction  $(\theta_i, \phi_i)$  from which that radiation is incident on  $dA$  and on the direction  $(\theta_r, \phi_r)$  in which it is reflected (and collected), as can be established by shifting the locations of the holes in the hemispherical shell. Hence, we will write  $dL_r(\theta_i, \phi_i; \theta_r, \phi_r; E_i)$ , as in eq (9), and we recognize that this quantity, since it is produced by the incident radiation interacting with the reflecting surface  $dA$ , is a dependent variable that cannot be independently varied. It changes in direct proportion to changes in the denominator on the right-hand side of eq (B5), leaving the ratio  $d\rho$  unchanged. However,  $d\Omega_r$  can be varied arbitrarily to produce directly proportionate changes in  $d\Phi_r$ , the reflected flux that is collected and measured, and hence in  $d\rho$ . Thus,  $d\rho$  is not a measure of just the reflecting properties of the surface for the given pair of directions but is also directly proportional to the size of the element of projected solid angle of reflection (and collection)  $d\Omega_r$ . The invariant quantity for a particular element of reflecting surface  $dA$ , the one that characterizes its (geometrical) reflecting properties, is the bidirectional reflectance-distribution function (BRDF) of eq (7):

$$\begin{aligned} f_r(\theta_i, \phi_i; \theta_r, \phi_r) &= d\rho(\theta_i, \phi_i; \theta_r, \phi_r; \Omega_r) / d\Omega_r \\ &= dL_r(\theta_i, \phi_i; \theta_r, \phi_r; E_i) / dE_i(\theta_i, \phi_i) \quad [\text{sr}^{-1}]. \end{aligned} \quad (\text{B6})$$

This quantity, given by eq (B6), is unaffected by small changes in the geometry of the incident or the reflected elementary beams, as long as they are still elements in essentially the single directions indicated, or by changes in the strength of the incident radiation. In other words, it characterizes the reflecting property of the surface element  $dA$  for the given pair of directions. Furthermore, by Helmholtz reciprocity, which holds in the absence of polarization and magnetic fields, it is immaterial which direction, of the pair, is that of the incident radiation:

$$f_r(\theta_1, \phi_1; \theta_2, \phi_2) = f_r(\theta_2, \phi_2; \theta_1, \phi_1) \quad [\text{sr}^{-1}]. \quad (\text{B7})$$

Consider, next, what will happen to the reflectance as the projected solid angle of the reflected beam is made much larger, so that  $d\Omega_r$  in eq (B6) increases to become  $\Omega_r$ , with correspondingly finite  $\omega_r$ , as illustrated in figure 10. The incident radiant flux is still given by eq (B2). The reflected flux, however, is now given by

$$d\Phi_r = dA \cdot \int_{\omega_r} dL_r(\theta_i, \phi_i; \theta_r, \phi_r; E_i) \cdot d\Omega_r \quad [\text{W}]. \quad (\text{B8})$$

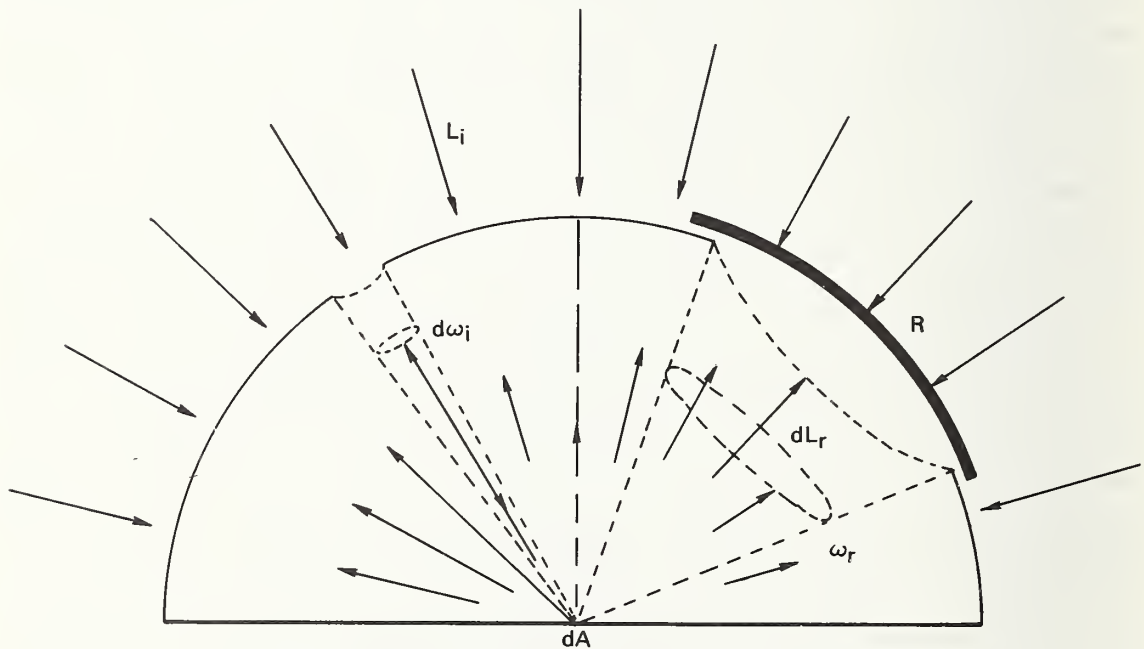

FIGURE 10. "Thought-experiment" configuration for directional-conical reflectance.

In order to relate this to the incident radiation, note that eq (B6) provides the relationship between the incident radiation and the reflected radiance  $dL_r$  in every element of solid angle  $d\omega_r$  within the solid angle  $\omega_r$ . Accordingly, combining eqs (B6) and (B8),

$$d\Phi_r = dA \cdot dE_i(\theta_i, \phi_i) \cdot \int_{\omega_r} f_r(\theta_i, \phi_i; \theta_r, \phi_r) \cdot d\Omega_r \quad [\text{W}]. \quad (\text{B9})$$

The directional-conical reflectance is then obtained by combining eqs (15), (B2), and (B9):

$$\begin{aligned} \rho(\theta_i, \phi_i; \omega_r) &= d\Phi_r / d\Phi_i \\ &= \int_{\omega_r} f_r(\theta_i, \phi_i; \theta_r, \phi_r) \cdot d\Omega_r \quad [\text{dimensionless}], \end{aligned} \quad (\text{B10})$$

in agreement with table 1. The same result can be obtained quite directly by rearranging and integrating the first line of eq (B6):

$$\begin{aligned} \rho(\theta_i, \phi_i; \omega_r) &= \int_{\omega_r} d\rho(\theta_i, \phi_i; \theta_r, \phi_r) \\ &= \int_{\omega_r} f_r(\theta_i, \phi_i; \theta_r, \phi_r) \cdot d\Omega_r \quad [\text{dimensionless}]. \end{aligned} \quad (\text{B10a})$$

However, we presented the first derivation because this second approach, although mathematically simpler, may leave some doubt whether the mathematics adequately represents the physics of the situation.

Now, returning to the original configuration with two small holes, consider, instead, what happens if the hole for the incident beam is enlarged substantially, so that  $d\Omega_i$  in eqs (B1) and (B5) is increased to  $\Omega_i$ , with corresponding finite  $\omega_i$ . As depicted in figure 11, the resulting reflected radiance  $L_r(\theta_r, \phi_r)$  is made up of contributions (see eq. (B6))

$$dL_r(\theta_i, \phi_i; \theta_r, \phi_r; E_i) = f_r(\theta_i, \phi_i; \theta_r, \phi_r) \cdot dE_i(\theta_i, \phi_i) \quad [\text{W} \cdot \text{m}^{-2} \cdot \text{sr}^{-1}] \quad (\text{B11})$$

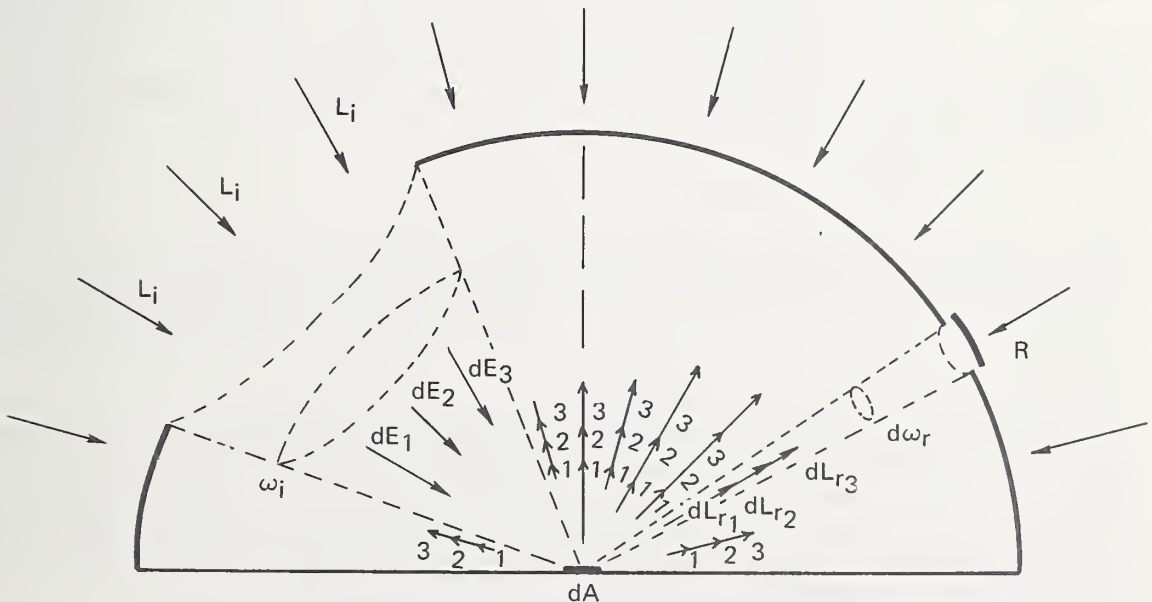

FIGURE 11. "Thought-experiment" configuration for conical-directional reflectance.

for each

$$dE_i(\theta_i, \phi_i) = L_i(\theta_i, \phi_i) \cdot d\Omega_i = L_i(\theta_i, \phi_i) \cdot \cos\theta_i \cdot d\omega_i \quad [\text{W} \cdot \text{m}^{-2}] \quad (\text{B1})$$

for every element of solid angle  $d\omega_i$  in a direction  $(\theta_i, \phi_i)$  throughout the entire solid angle  $\omega_i$ , corresponding to the projected solid angle

$$\Omega_i \equiv \int_{\omega_i} \cos\theta_i \cdot d\omega_i = \int_{\omega_i} \int \cos\theta_i \cdot \sin\theta_i \cdot d\theta_i \cdot d\phi_i \quad [\text{sr}]. \quad (\text{B12})$$

The total reflected radiance is then obtained by integrating eq (B11) over the solid angle of incidence  $\omega_i$ :

$$\begin{aligned} L_r(\theta_r, \phi_r) &= \int_{\omega_i} dL_r(\theta_i, \phi_i; \theta_r, \phi_r; E_i) \\ &= \int_{\omega_i} f_r(\theta_i, \phi_i; \theta_r, \phi_r) \cdot dE_i(\theta_i, \phi_i) \\ &= \int_{\omega_i} L_i(\theta_i, \phi_i) \cdot f_r(\theta_i, \phi_i; \theta_r, \phi_r) \cdot d\Omega_i \quad [\text{W} \cdot \text{m}^{-2} \cdot \text{sr}^{-1}]. \end{aligned} \quad (\text{B13})$$

Accordingly, the reflected flux is given by

$$\begin{aligned} d\Phi_r &= L_r(\theta_r; \phi_r) \cdot d\Omega_r \cdot dA \\ &= d\Omega_r \cdot dA \int_{\omega_i} L_i(\theta_i, \phi_i) \cdot f_r(\theta_i, \phi_i; \theta_r, \phi_r) \cdot d\Omega_i \quad [\text{W}]. \end{aligned} \quad (\text{B14})$$

The incident flux is obtained by integrating eq (B1) over the solid angle of incidence  $\omega_i$  and multiplying by  $dA$ :

$$d\Phi_i = dA \cdot \int_{\omega_i} dE_i(\theta_i, \phi_i) = dA \cdot \int_{\omega_i} L_i(\theta_i, \phi_i) \cdot d\Omega_i \quad [\text{W}]. \quad (\text{B15})$$

The conical-directional reflectance, for the geometry depicted in figure 11, is the ratio of eq (B14) to eq (B15):

$$\begin{aligned} d\rho(\omega_i; \theta_r, \phi_r) &= d\Phi_r / d\Phi_i \\ &= d\Omega_r \cdot \int_{\omega_i} L_i(\theta_i, \phi_i) \cdot f_r(\theta_i, \phi_i; \theta_r, \phi_r) \cdot d\Omega_i / \int_{\omega_i} L_i(\theta_i, \phi_i) \cdot d\Omega_i \\ &\quad [\text{dimensionless}]. \end{aligned} \quad (\text{B16})$$

The expression in eq (B16) is the general expression, where no restriction has been placed on  $L_i(\theta_i, \phi_i)$ . Strictly, then, this should be termed the *conical-directional reflectance for non-isotropic incident radiation*. When the term *conical-directional reflectance* is used alone as in table 1, it refers to the simpler situation where the incident radiant is isotropic, i.e.,  $L_i$  is constant, within the solid angle of incidence  $\omega_i$ . With this assumption, the constant term  $L_i$  can be brought outside the integral sign in both numerator and denominator in eq (B16), where it will cancel out, leaving the *conical-directional reflectance*



$$d\rho(\omega_i; \theta_r, \phi_r) = (d\Omega_r/\Omega_i) \cdot \int_{\omega_i} f_r(\theta_i, \phi_i; \theta_r, \phi_r) \cdot d\Omega_i \quad [\text{dimensionless}], \quad (\text{B17})$$

again in agreement with table 1.

From eqs (B10) and (B17) it can be seen that, over a finite solid angle of reflection  $\omega_r$ , the value of reflectance is obtained by integrating the bidirectional reflectance-distribution function  $f_r(\theta_i, \phi_i; \theta_r, \phi_r)$  with respect to projected solid angle  $d\Omega_r$  over that solid angle  $\omega_r$  and, over a finite solid angle of incidence  $\omega_i$ , it is obtained by averaging  $f_r(\theta_i, \phi_i; \theta_r, \phi_r)$  with respect to projected solid angle  $d\Omega_i$  over that solid angle  $\omega_i$ . We can, then, combine these two operations to obtain the general expression for the *biconical reflectance*

$$\rho(\omega_i; \omega_r) = (1/\Omega_i) \int_{\omega_i} \int_{\omega_r} f_r(\theta_i, \phi_i; \theta_r, \phi_r) \cdot d\Omega_r \cdot d\Omega_i \quad [\text{dimensionless}]. \quad (\text{B18})$$

As previously pointed out, this is the completely general expression for all geometries if we assume that the solid angle  $d\omega \leq \omega \leq 2\pi$  [sr] for both  $\omega_i$  and  $\omega_r$ . Hence, all of the expressions in table 1 may be derived from eq (B18) by substituting the corresponding values for these solid angles. Note, however, this is not completely general, in the sense that it is based on the assumption of isotropic irradiance within the solid angle of incidence  $\omega_i$ . The more general expression, for non-isotropic incidence, is that given earlier in eq (15a).

## VIII. Appendix C. Perfectly Diffuse and Perfectly Specular Reflectances

### *Perfectly Diffuse Reflectance*

A perfectly diffuse or "lambertian" surface element  $dA$  is one for which the reflected radiance is isotropic so that  $L_r$  is a constant, with the same value for all directions  $(\theta_r, \phi_r)$ , regardless of how it is irradiated. From eq (B13) it is apparent that this is possible only when  $f_r = f_{r,d}$  a constant, so that

$$L_{r,d} = f_{r,d} \int_{\omega_i} L_i(\theta_i, \phi_i) \cdot d\Omega_i = f_{r,d} \cdot E_i \quad [\text{W} \cdot \text{m}^{-2} \cdot \text{sr}^{-1}]; \quad (\text{C1})$$

hence

$$f_{r,d} = L_{r,d}/E_i \quad [\text{sr}^{-1}]. \quad (\text{C2})$$

In terms of the perfectly diffuse reflectance  $\rho_d$ , which is the fraction of the total incident flux that is reflected isotropically (iso-radiance rays) in all directions (into the full hemisphere above the element  $dA$  of the reflecting surface), we have

$$\begin{aligned} \rho_d(\omega_i; 2\pi) &= d\Phi_r/d\Phi_i = (L_{r,d} \cdot dA \cdot \int_{2\pi} d\Omega_r) / (E_i \cdot dA) \\ &= f_{r,d}(\theta_i, \phi_i; \theta_r, \phi_r) \cdot \pi \quad [\text{dimensionless}]; \end{aligned} \quad (\text{C3})$$

hence

$$f_{r,d}(\theta_i, \phi_i; \theta_r, \phi_r) = \rho_d(\omega_i; 2\pi)/\pi \quad [\text{sr}^{-1}] \quad (\text{C4})$$

and

$$L_{r,d}(\theta_i, \phi_i; \theta_r, \phi_r) = \rho_d(\omega_i; 2\pi) \cdot E_i / \pi \quad [\text{W} \cdot \text{m}^{-2} \cdot \text{sr}^{-1}], \quad (\text{C5})$$

where

$$\rho_d(d\omega_i; 2\pi) = \rho_d(\omega_i; 2\pi) = \rho_d(2\pi; 2\pi) = \text{a constant}. \quad (\text{C6})$$

An *ideal* (lossless) diffuse standard reflector returns all of the incident flux so that

$$\rho_d = \rho_{id} = 1 \quad (\text{C7})$$

and

$$f_{r,id}(\theta_i, \phi_i; \theta_r, \phi_r) = 1/\pi \quad [\text{sr}^{-1}]. \quad (\text{C8})$$

### *Perfectly Specular (Mirror-Like) Reflectance*

A perfectly specular (mirror-like) or regular reflecting element  $dA$  is one for which each ray of incident flux produces only a corresponding reflected ray in the specular direction ( $\theta_r = \theta_i$ ;  $\phi_r = \phi_i \pm \pi$ ) [rad], so that

$$L_{r,sp}(\theta_r, \phi_r) = \rho_{sp} \cdot L_i(\theta_r, \phi_r \pm \pi) \quad [\text{W} \cdot \text{m}^{-2} \cdot \text{sr}^{-1}]. \quad (\text{C9})$$

If the general expression for reflected radiance in eq (B13) is to include specular reflection, we must find an expression for  $f_{r,sp}$  which, when substituted into eq (B13) reduces it to eq (C9). This means that the integral must vanish ( $=0$ ) for all values of  $\theta_r \neq \theta_i$  and of  $\phi_r \neq \phi_i \pm \pi$  [rad] and must have a finite singularity when  $\theta_r = \theta_i$  and  $\phi_r = \phi_i \pm \pi$  [rad]. This is not possible with any normal functional form of BRDF  $f_r$  but these conditions are satisfied by the Dirac delta-function form

$$f_{r,sp}(\theta_i, \phi_i; \theta_r, \phi_r) = 2\rho_{sp} \cdot \delta(\sin^2 \theta_r - \sin^2 \theta_i) \cdot \delta(\phi_r - \phi_i \pm \pi) \quad [\text{sr}^{-1}], \quad (\text{C10})$$

where the Dirac delta-functions are defined by

$$\begin{aligned} \delta(u) &= 0 \text{ for } u \neq 0, \\ \int \delta(u) \cdot du &= 1, \text{ and} \\ \int f(u) \cdot \delta(u-a) \cdot du &= f(a), \end{aligned} \quad (\text{C11})$$

when the integration is carried out over any range of the variable that includes the zero of the argument of the  $\delta$ -function [21]. This is readily verified by making the substitution and carrying out the integrations in accordance with the defining relations for the Dirac delta-function, eq (C11).

An *ideal* (lossless) specular reflector is one which also reflects all of the incident flux without attenuation so that  $\rho_{isp} = 1$  and

$$f_{r,isp}(\theta_i, \phi_i; \theta_r, \phi_r) = 2 \cdot \delta(\sin^2 \theta_r - \sin^2 \theta_i) \cdot \delta(\phi_r - \phi_i \pm \pi) \quad [\text{sr}^{-1}]. \quad (\text{C12})$$

### *Specular Reflection*

Traditionally, specular reflection and diffuse reflection have been treated quite separately in ways that do not adequately recognize the broad spectrum of intermediate conditions filling, in

reality, the entire region between the two conceptual extremes of perfectly specular and perfectly diffuse reflectance as well as a much broader region not on a direct line between (not just a mixture of perfectly specular and perfectly diffuse reflectance—see fig. 5). The distribution-function approach presented here provides a much better means for modeling that reality and, in our zeal to emphasize this, we have so far neglected some very real problems that arise in dealing with practical cases of specular reflection.

We have defined perfect specular reflectance as the condition where the reflected radiance in any direction  $L_r(\theta_r, \phi_r)$  is directly proportional only to the incident radiance from the specular direction  $L_i(\theta_r, \phi_r \pm \pi)$ , so that  $L_r(\theta_r, \phi_r) = \rho_{sp} \cdot L_i(\theta_r, \phi_r \pm \pi)$ . That is a perfectly good definition of the ideal concept, but it is not a convenient form for dealing with practical specular reflectors that only approximate the ideal condition. For that purpose, it is more useful to consider that a specular reflector is one where the directional-hemispherical reflectance for a given direction of incidence is equal to the directional-conical reflectance for the same direction of incidence where the solid angle of reflection (collection) is a right circular cone of arbitrarily small vertex angle with its axis oriented in the specular direction. In the ideal case, the vertex angle approaches zero as a limit so that, using McCamy's notation [sec. III.A] for  $\omega_r$ .

$$\rho_{sp}(\theta_i, \phi_i; 2\pi) = \lim_{\kappa_r \rightarrow 0} \rho_{sp}(\theta_i, \phi_i; \theta_{or} = \theta_i, \phi_{or} = \phi_i \pm \pi, \kappa_r) \quad [\text{dimensionless}]. \quad (\text{C13})$$

For real specular reflectors (see fig. 5), the equality is only approximate, since there is always some, perhaps extremely little, scattering into other directions. The value of  $\kappa_r$  for which the closest approximation holds true may become very small but will never actually reach the zero limit for obvious reasons. Some of those reasons are mentioned briefly in commenting on figure 5 and in discussing glossimetry practices in section III.C.

In any case of specular reflection, the value of  $\rho_{sp}$  in eq (C10) is that which satisfies eq (C13). Hence, it should probably be written as  $\rho_{sp}(\theta_i, \phi_i)$  in eq (C10), since it may vary with the direction of incidence.

Often, a reflectance-factor measurement is not only the simplest but is also the most useful measurement of the reflecting properties of a sample. It can readily be extrapolated to estimate the reflectance for beam geometries other than that used in the measurement, as long as the average value of  $f_r$  remains roughly the same over all of the directions involved. Clearly, however, this comment applies only to fairly diffuse reflectors and does not deal with glints and specularities, where  $f_r$  changes very rapidly with direction. As a matter of fact, in the ideal case, the directional-conical reflectance factor corresponding to eq (C13) becomes infinitely large as  $\kappa$  approaches zero.

With specular reflectors, the need for extrapolation to different beam geometries is not so likely to arise. When used as specular reflectors, e.g., for imaging, the significant reflected flux is mainly that reflected in the specular direction; when measurements are made it is only in that direction that there is likely to be enough reflected flux to make a measurement; and from eq (C13), it is apparent that a measurement of  $\rho_{sp}$  will not be very sensitive to the size of  $\omega_r$  (as long as  $\omega_r > \omega_i$ ). Nevertheless, in evaluating the imaging quality of good specularly-reflecting optical components, it is just the small inequality in the approximation of eq (C13) that is significant. It is the difference between the directional-hemispherical reflectance and the specular reflectance, the fraction of the incident radiation that is scattered into directions other than the specular direction, that produces veiling glare to degrade image contrast.

### *Off-Specular Peaks or "Glints"*

One further complication that can arise in connection with specular reflection concerns the occurrence of off-specular peaks or "glints" [35]. However, our approach can accommodate them quite easily [36].

First, the delta-function form of the BRDF for perfectly specular reflectance can be adjusted for such off-specular peaks. If, for example, a specular peak or glint is observed, for an unusual reflecting surface, at  $\theta_r = \theta_i \pm \alpha$  and  $\phi_r = \phi_i \pm \beta$ , that condition can be represented by a delta-function component of the BRDF  $f_r$  as follows:

$$f_r = 2 \cdot \rho_{sp} \cdot \delta[\sin^2 \theta_r - \sin^2(\theta_i \pm \alpha)] \cdot \delta[\phi_r - (\phi_i \pm \beta)] \quad [\text{sr}^{-1}] \quad (\text{C14})$$

and, again, the value of  $\rho_{sp}$  may vary with  $\theta_i, \phi_i$  and, possibly, with  $\theta_r, \phi_r$  as well, since we have shown two possibilities for each incident direction angle with the plus-or-minus signs, so, for complete generality, we probably should write  $\rho_{sp} = \rho_{sp}(\theta_i, \phi_i; \theta_r, \phi_r)$  in eq (C14).

A similar adjustment of the expression in McCamy's notation in eq (C13) is quite straightforward.

For real reflecting surfaces, since no limitations have been placed on the form of the BRDF  $f_r(\theta_i, \phi_i; \theta_r, \phi_r)$ , it is obviously possible to express it in any way that will serve a useful purpose. Measurement results can be just a table of values at appropriate parameter intervals, with, possibly, smaller intervals in the vicinity of sharp peaks or other rapid changes in value, to facilitate interpolation where required. For some purposes it may be useful to approximate these values by a curve for an analytic function, if one can be found to serve. Such a function may turn out to be the sum of two or more functions, one function for a continuous diffuse distribution and one or more functions (possibly, delta functions, if the peaks are sharp enough) for the specular peak(s) or glint(s). There is no limit to the possibilities.

## IX. Appendix D. Details for Derivation of McCamy's Notation

Quite frequently, an element of reflecting surface  $dA$  is located at the focus of circular optics, so that the beam is a right circular cone with its vertex at  $dA$ . This may be true for either, or both, the incident and/or the reflected beam, as depicted in figure 4. The solid angle formed by and containing such a beam can be specified completely by giving the angular-direction coordinates  $(\theta_0, \phi_0)$  of the axis along with the half-vertex angle  $\kappa$ , as in figure 4. However, in order to use this notation, as proposed by McCamy [13], we need to be able to write the expressions for biconical reflectance  $\rho(\theta_{0i}, \phi_{0i}, \kappa_i; \theta_{0r}, \phi_{0r}, \kappa_r)$  and for biconical reflectance factor  $R(\theta_{0i}, \phi_{0i}, \kappa_i; \theta_{0r}, \phi_{0r}, \kappa_r)$  in terms of the BRDF  $f_r(\theta_i, \phi_i; \theta_r, \phi_r)$  corresponding, respectively, to eqs (16) and (18).

Consider a right circular cone, of half-vertex angle  $\kappa$ , with its vertex at the origin  $O$  and its axis tilted in the direction  $(\theta_0, \phi_0)$  as in figure 12. A point  $P_0$  on its axis then has the coordinates<sup>14</sup>  $(\rho_0, \theta_0, \phi_0)$  in the fixed system of spherical coordinates with the  $X$ - $Y$  plane tangent to the surface element  $dA$  at  $O$  and the  $Z$ -axis along the normal to  $dA$ . A plane through  $P_0$  perpendicular to the axis of the cone, cuts the cone in a circle of radius  $r = \rho_0 \cdot \tan \kappa$ . A point  $P$  on this circle has the coordinates  $(\rho, \theta, \phi)$ , as depicted in figure 12.

Consider, also, a second, tilted set of spherical coordinates, with the same origin  $O$ , and with the new polar axis (the  $Z'$ -axis) along the axis of the cone. The new polar angle  $\theta'$  is the angle from that axis and, for any point  $P$  on the surface of the cone,  $\theta' = \kappa$ . The  $X'$ -axis may be arbitrarily chosen—e.g., to lie as shown along the line of intersection between the  $X$ - $Y$  plane and the tilted  $X'$ - $Y'$  plane. Then, in the new tilted (primed) spherical coordinates, the point  $P$  on the circle bounding the base of the right circular cone of half-vertex angle  $\kappa$ , has the coordinates  $(\rho', \theta', \phi') = (\rho, \kappa, \phi')$ . (See fig. 12.)

The solid angle  $\omega$  enclosed by the cone at its vertex  $O$  is easily evaluated by eq (A2-10), p. 70, of [2] since  $\theta_h = \kappa$ :

$$\omega = 2\pi(1 - \cos \kappa) = 4\pi \cdot \sin^2(\kappa/2) \quad [\text{sr}]. \quad (\text{D1})$$

<sup>14</sup> This use of  $\rho$  as a spherical coordinate is confined just to appendix D. Since, when so used,  $\rho$  is always explicitly designated as a spherical coordinate or is enclosed in parentheses along with one or both of the other spherical coordinates  $(\theta, \phi)$ , there should be no confusion with the use of  $\rho$  for reflectance.

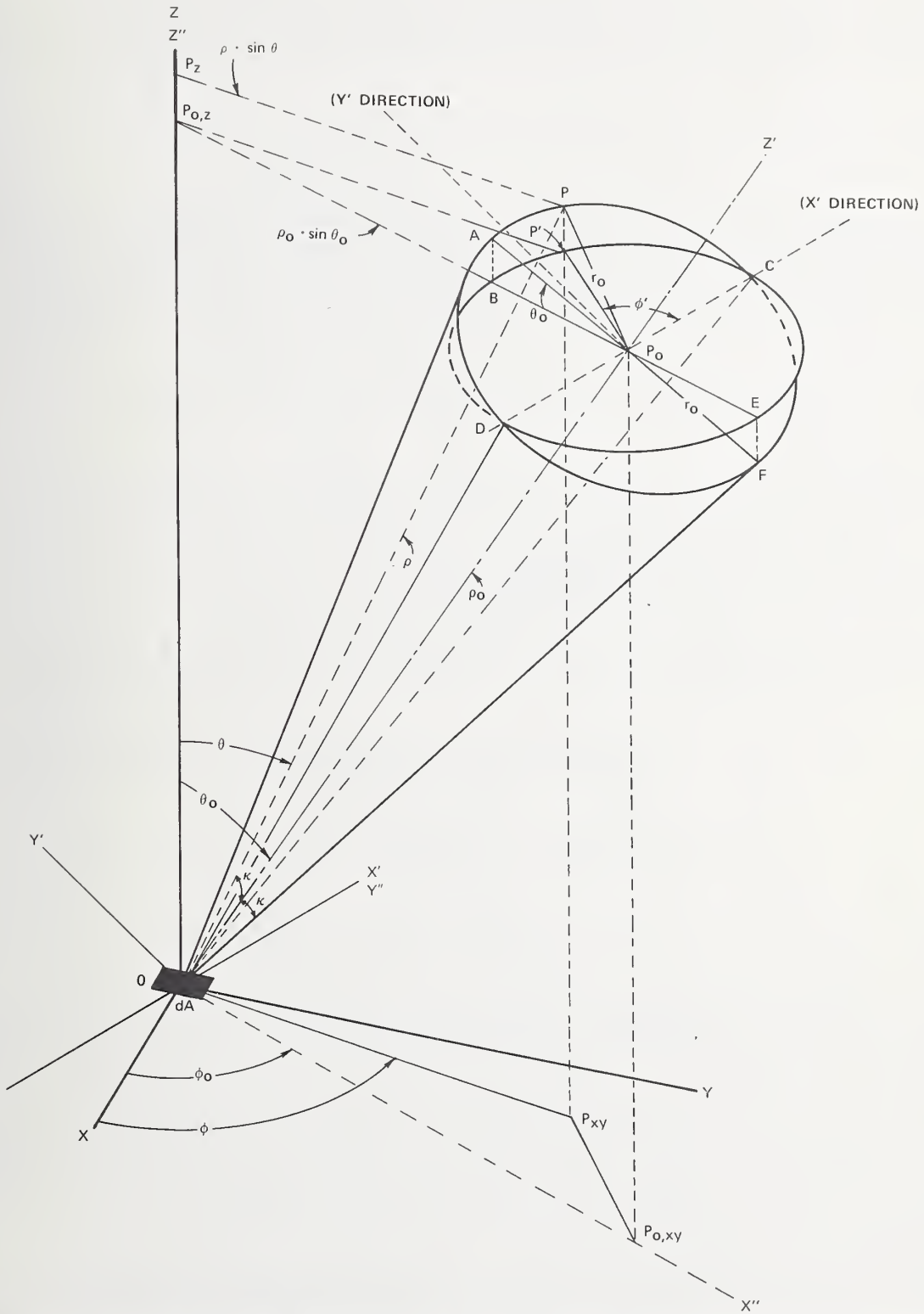

FIGURE 12. Construction for deriving relationships between spherical coordinates and McCamy's notation for right-circular cones.

(See figure 13 for additional details.)

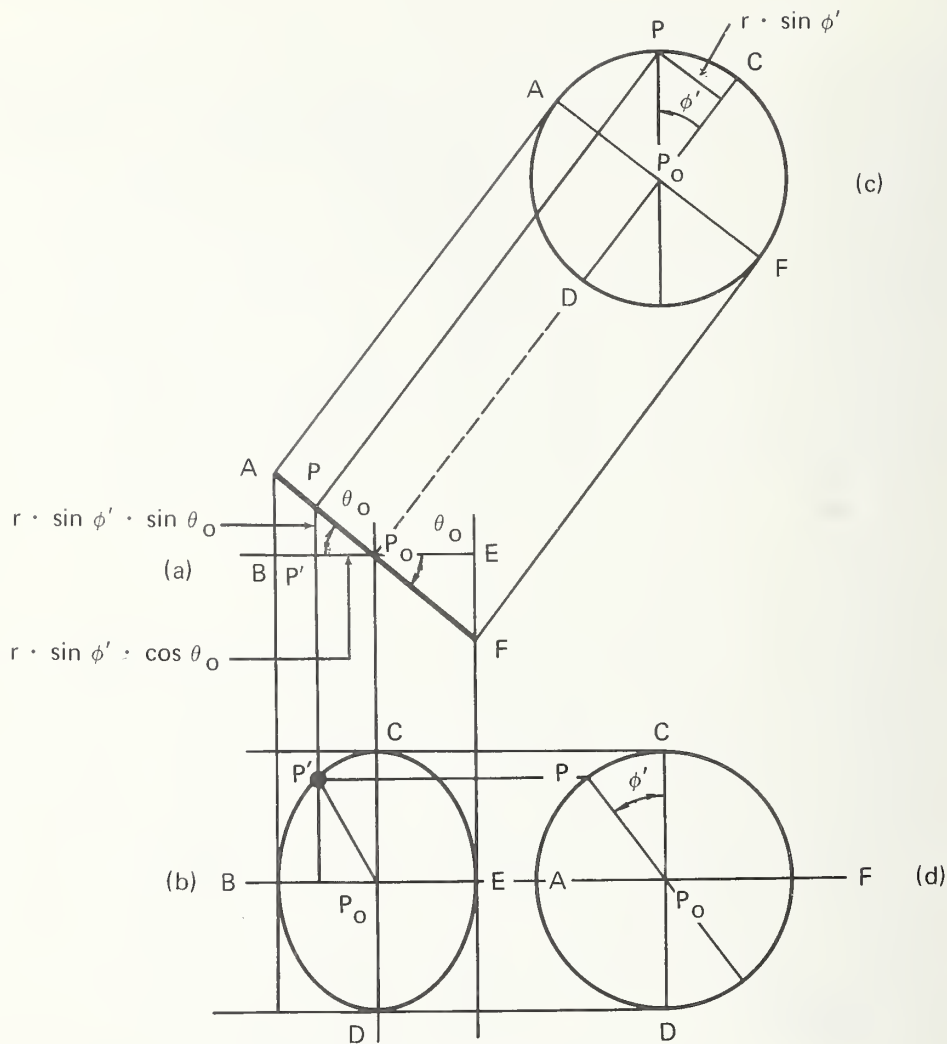

FIGURE 13. Details of construction of figure 12.

However, the projected solid angle  $\Omega$  is not quite so readily obtained by a similar approach, except in the special situation where the axis of symmetry coincides with the normal to the surface element  $dA$ , so that  $\theta_0 = 0$  and  $\theta' = \theta$ , i.e., only when the cone is not tilted. However,  $\Omega$  can be obtained quite directly in all cases by the application of Wiener's construction (see fig. A2-9, p. 76, of [2]).

In figure 12, if we set the spherical radius  $\rho = OP$  equal to unity, then the solid angle  $\omega$  [eq (D1)] is measured by the area on the unit-radius sphere enclosed by the circle ADFCP where it intersects the cone. The radius of that circle is clearly  $r = \rho \cdot \sin \kappa$  in general, and in this case, for  $\rho = 1$ , it is just  $r = \sin \kappa$ . Then, by Wiener's construction, the projected solid angle  $\Omega = \int \cos \theta \cdot d\omega$  (note that this is  $\cos \theta$  not  $\cos \theta'$  or  $\cos \kappa$ , so we cannot use eq A2-14, p 74, of [2]) is given by the area of the projection of this intercepted portion of the sphere onto the plane

containing the element  $dA$ , i.e., by the area of the projection of the circle  $ADFCP$  onto that plane (The  $X-Y$  plane). It is readily seen in figure 12 that this will be the same as the area of the ellipse  $BDECP'$ , the projection of the circle  $ADFCP$  onto a horizontal plane parallel to the  $X-Y$  plane. The area of the ellipse is clearly just  $\cos\theta_0$  times the area of the circle, which, in turn, is given by  $\pi \cdot r^2$  so that we can write

$$\Omega = \pi \cdot \cos\theta_0 \cdot \sin^2\kappa \quad [\text{sr}] \quad (\text{D2})$$

for the projected solid angle subtended at  $dA$  by a right circular cone of half-vertex-angle  $\kappa$  with its vertex at  $dA$  and its axis tilted at an angle  $\theta_0$  from the normal to  $dA$ .

With these preliminary statements for  $\omega$  and  $\Omega$ , we are now ready to attack the main problem of expressing and evaluating biconical reflectance in McCamy's notation. We start with the general relation

$$\rho(\omega_i; \omega_r) = (1/\Omega_i) \cdot \int_{\omega_i} \int_{\omega_r} f_r(\theta_i, \phi_i; \theta_r, \phi_r) \cdot d\Omega_r \cdot d\Omega_i \quad [\text{dimensionless}]. \quad (16)$$

First, from eq (D2), we can write  $\Omega_i = \pi \cdot \cos\theta_{0i} \cdot \sin^2\kappa_i$ . Next, if the usual order of integration is reversed, the extreme limits for the full range of  $\theta$  (both  $\theta_i$  and  $\theta_r$ ) are clearly  $\theta_0 + \kappa$  and  $\theta_0 - \kappa$ . Finally, the limits of integration for  $\phi$  (both  $\phi_i$  and  $\phi_r$ ) will be a function of (the corresponding)  $\theta$ . In each case, the first integration, with respect to  $\phi$ , will be along lines of constant  $\theta$  (parallels of "latitude," parallel to the  $X-Y$  plane) between the limits where they cut the circle  $ADFCP$  (see fig. 12). These limits, then, are clearly symmetrical about the value  $\phi_0$ , so that they can be written as  $\phi_0 + \alpha(\theta)$  and  $\phi_0 - \alpha(\theta)$ . Before deriving an expression for the function  $\alpha(\theta)$ , we can now summarize the foregoing by writing the biconical reflectance, in terms of McCamy's notation and the function  $\alpha(\theta)$ , as

$$\rho(\theta_{0i}, \phi_{0i}, \kappa_i; \theta_{0r}, \phi_{0r}, \kappa_r) = (\pi \cdot \sin^2\kappa_i \cdot \cos\theta_{0i})^{-1} \cdot$$

$$\int_{\theta_{0i}-\kappa_i}^{\theta_{0i}+\kappa_i} \int_{\phi_{0i}-\alpha(\theta_i)}^{\phi_{0i}+\alpha(\theta_i)} \int_{\theta_{0r}-\kappa_r}^{\theta_{0r}+\kappa_r} \int_{\phi_{0r}-\alpha(\theta_r)}^{\phi_{0r}+\alpha(\theta_r)} f_r(\theta_i, \phi_i; \theta_r, \phi_r) \cdot$$

$$d\phi_r \cdot \cos\theta_r \cdot \sin\theta_r \cdot d\theta_r \cdot d\phi_i \cdot \cos\theta_i \cdot \sin\theta_i \cdot d\theta_i. \quad (20)$$

In order to evaluate the function  $\alpha(\theta)$ , we need to determine the equation of the circle  $ADFCP$  (fig. 12). This task can be simplified considerably by eliminating  $\phi_0$ . We set  $\phi_0'' = 0$ , which is equivalent to rotating the fixed  $X-Y$  axes about the  $Z$ -axis to bring the  $X$ -axis into the same "vertical" plane as the axis of the tilted cone (so that the  $X-Y$  axis now lies in the "vertical"  $X-Z$  plane). Quantities given in the new rotated coordinates will be distinguished by a double prime; thus, the rotated coordinates of the point  $P_0$  on the axis of the cone are

$$\rho_0'' = \rho_0; \quad \theta_0'' = \theta_0; \quad \phi_0'' = 0; \quad \text{etc.}$$

In general, the equation of a plane through a point  $P_0$  and perpendicular to the line  $OP_0$  [ $=\rho_0 = (x_0^2 + y_0^2 + z_0^2)^{1/2}$ ], with direction cosines

$$l = x_0/\rho_0, \quad m = y_0/\rho_0, \quad n = z_0/\rho_0$$

is

$$lx + my + nz = \rho_0 = \rho \cdot \cos \beta, \quad (D3)$$

where  $\beta$  is the angle between the line  $OP_0$  and the line  $OP$ , and  $P$  is any point  $(x, y, z)$  in the plane. If  $\beta = \kappa$  and the value of  $\rho$  are both fixed, we have the equation of the circle  $ADFCP$  (fig. 12) as

$$l''x'' + n''z'' = \rho \cdot \cos \kappa, \quad x'' = \rho \cdot \sin \theta'' \cdot \cos \phi'', \quad z'' = \rho \cdot \cos \theta'', \quad (D4)$$

because, with  $\phi_0'' = 0$ ,  $y_0'' = \rho_0'' \cdot \sin \theta_0 \cdot \sin \phi_0'' = 0$  so that  $m'' = 0$ . Then  $l'' = \sin \theta_0''$  and  $n'' = \cos \theta_0''$ , and the values of  $\phi''$  for points on the circle that satisfy these relations are the desired expressions for the function  $\alpha(\theta)$ . From eq (D4)

$$l'' \cdot \sin \theta'' \cdot \cos \phi'' = \cos \kappa - n'' \cdot \cos \theta'' \quad (D5)$$

and

$$\begin{aligned} \cos \phi'' &= (\cos \kappa - n'' \cdot \cos \theta'') / (l'' \cdot \sin \theta'') \\ &= (\cos \kappa - \cos \theta_0'' \cdot \cos \theta'') / (\sin \theta_0'' \cdot \sin \theta'') \end{aligned} \quad (D6)$$

hence the desired limits are, recalling that  $\theta'' = \theta$ ,

$$\alpha(\theta) = \phi'' = \cos^{-1} [(\cos \kappa - \cos \theta_0 \cdot \cos \theta) / (\sin \theta_0 \cdot \sin \theta)]. \quad (21)$$

When this expression for  $\alpha(\theta)$  is inserted in eq (20), we have the desired expression for biconical reflectance in terms of the BRDF, all in McCamy's notation for right-circular-conical beams.

In the same way we can obtain, from eq (18), the expression for a biconical reflectance factor, as in eq (22).

## X. Acknowledgments

The authors wish to express their sincere thanks for their support from a variety of sources since this effort started in 1967: Infrared Information and Analysis Center<sup>15</sup> under ONR contract and Target Signature Analysis Center under USAF Avionics Lab. contract (Limperis, Ginsberg, and Nicodemus); Sylvania Electronics Systems Western Division under U.S. Army Electronics Command contract, Cintra, and U.S. Naval Weapons Center (Nicodemus); National Bureau of Standards (Nicodemus, Richmond and Hsia).

In all of this time, portions of this material have been presented or circulated, with resulting comments and criticisms from a great many helpful individuals to whom we are very much indebted. Our efforts were first announced and discussed at the meeting of the Optical Society of America, Technical Group on Radiometry and Photometry, in Detroit, Michigan, in October 1967. Acknowledgment is due to Applied Optics for publishing the letter to the editor by Nicodemus [9] to clarify some urgent matters when it was apparent in 1970 that the full paper would still be substantially delayed. He also informally circulated rather widely a summary of much of this material in a draft intended as part of a Cintra report (that was never published). More recently, in January 1973, he reported on our efforts to the IRIS Specialty Group on Infrared Standards, at Huntsville, Alabama. We are deeply grateful for all of the suggestions, criticisms, and comments

<sup>15</sup> Willow Run Laboratories, University of Michigan (now Environmental Research Institute of Michigan).



that have resulted from these and other individual exchanges and we regret our inability to make individual acknowledgments in so very many instances.

We are particularly grateful to Dr. G. J. Zissis and his staff at the IRIA Center, Environmental Research Institute of Michigan (ERIM), for making available the small figures used to illustrate table 3. And finally, we acknowledge the very extensive review and criticism by W. H. Venable, who made substantial contributions to our efforts.

## XI. References

- [1] The term "propagance" for this useful concept, the ratio of received radiance at a receiver to the emitted radiance along the same ray at the source, was suggested by C. S. McCamy [13]. It is also defined and discussed in [2]; see esp. eqs (2.37) and (2.38) and accompanying discussion.
- [2] Part I. Concepts, Chapters 1-3, of [28], Nat. Bur. Stand. (U.S.), Tech. Note 910-1, 93 pages (March 1976).
- [3] The terms "attenuance" and "scatterance" for these useful ratio concepts, which we prefer to define, like propagance, in terms of single rays or elements of throughput by taking the ratios of radiances, are widely used by oceanographers; see N. G. Jerlov, *Optical Oceanography* (Elsevier Publishing Co., New York, 1968), esp. pp. 6 & 7.
- [4] ANSI Standard Nomenclature and Definitions for Illuminating Engineering, ANSI Z7.1-1967 (Revision of Z7.1-1942), RP-16, approved August 16, 1967, by American National Standards Institute, sponsored and published by Illuminating Engineering Society, 345 East 47th Street, New York, N.Y. 10017. See also Appendix 1 of [2].
- [5] Nicodemus, Fred E., Radiometry, Chapter 8 in Volume IV of *Applied Optics and Optical Engineering*, R. Kingslake, Ed. (Academic Press, New York, 1967); also included in [37].
- [6] Planck, Max, *The Theory of Heat Radiation*, trans. by Morton Masius (Dover Publications, Inc., New York, 1959), Part I, Chapter I, pp. 1-21.
- [7] Jones, R. Clark, Appendix [on Radiometry] in: I. F. Spiro, R. Clark Jones, and D. Q. Wark, *Atmospheric Transmission: Concepts, Symbols, Units and Nomenclature*, *Infrared Physics*, **5**, No. 1, March 1965, pp. 11-36. (With the help of Dr. Jones, a number of unfortunate typographical errors were corrected for its reproduction in [37].)
- [8] Venable, William H., Jr., and Hsia, Jack J., Describing Spectrophotometric Measurements, Nat. Bur. Stand. (U.S.), Tech. Note 594-9, November 1974.
- [9] Nicodemus, Fred E., Reflectance Nomenclature and Directional Reflectance and Emissivity, *Appl. Optics* **9**, No. 6, June 1970, pp. 1474-1475; also included in [37].
- [10] Nicodemus, Fred E., Directional Reflectance and Emissivity of an Opaque Surface, *Appl. Optics* **4**, No. 7, July 1965, pp. 767-773; Erratum, *Appl. Optics* **5**, No. 5, May 1966, p. 715.
- [11] Chandrasekhar, S., *Radiative Transfer* (Dover Publications, Inc., New York, 1960).
- [12] Judd, Deane B., Terms, Definitions, and Symbols in Reflectometry, *J. Opt. Soc. Am.* **57**, No. 4, April 1967, pp. 445-452.
- [13] McCamy, C. S., Concepts, Terminology, and Notation for Optical Modulation, *Photographic Science and Engineering* **10**, No. 6, November-December, 1966, pp. 314-325.
- [14] *International Lighting Vocabulary—3rd Edition* (common to the CIE and IEC), International Commission on Illumination (Commission Internationale de l'Éclairage—CIE), Bureau Central de la CIE, 4 Av. du Recteur Poincaré, 75-Paris 16<sup>e</sup>, France; Publication CIE No. 17 (E-1.1) 1970. (The IEC is the International Electrotechnical Commission.)
- [15] Tentative Method of Test for Specular Gloss, Federation of Societies for Paint Technology Standard No. Le-5-64; ASTM Designation: D523-62T, Issued 1953, Revised 1962, American Society for Testing and Materials (1965 Book of ASTM Standards, Part 21, pp. 109-112).
- [16] Hammond, Harry K., III, and Nimeroff, Isadore, Measurement of Sixty-Degree Specular Gloss, *J. Res. Nat. Bur. Stand. (U.S.)*, **44**, June 1950, pp. 585-598; Research Paper RP2105.
- [17] Nimeroff, Isadore, Analysis of Goniophotometric Reflection Curves, *J. Res. Nat. Bur. Stand. (U.S.)*, **48**, No. 6, June 1952, pp. 441-448; Research Paper RP2335; also a less extended treatment in *J. Opt. Soc. Am.* **42**, No. 8, August 1952, pp. 579-583.
- [18] Kneissl, Gerhart J., and Richmond, Joseph C., A Laser-Source Integrating Sphere Reflectometer, Nat. Bur. Stand. (U.S.), Tech. Note 439 (February 1968).
- [19] DeVos, J. C., Evaluation of the Quality of a Blackbody, *Physica*, **20**, No. 10 (October 1954) pp. 669-689.
- [20] Trowbridge T. S., and Reitz, K. P., Average irregularity representation of a rough surface for ray reflection, *J. Opt. Soc. Am.* **69**, No. 5 (May 1975) pp. 531-536.
- [21] Bracewell, Ron, *The Fourier Transform and Its Applications* (McGraw-Hill Book Co., New York, 1965) Chapter 5, The Impulse Symbol.
- [22] Kubelka, Paul, New Contributions to the Optics of Intensely Light-Scattering Materials. Part I, *J. Opt. Soc. Am.* **38**, No. 5, (May 1948) pp. 448-457; ERRATA, **38**, No. 12 (Dec. 1948) p. 1067.

- [23] Hamaker, H. C., Radiation and Heat Conduction in Light-Scattering Material, Philips Res. Rep. **2** (1947): I. Reflection and Transmission, pp. 55-67; II. General Equations Including Heat Conduction, pp. 103-111; III. Application of the Theory, pp. 112-125; IV. Various Extensions and a Generalized Theory, pp. 420-425.
- [24] Richmond, Joseph C., Thermal Radiation Properties of Ceramic Materials, Proc. Symposium on Mechanical and Thermal Properties of Ceramics, Gaithersburg, Md., April 1-2, 1968, Nat. Bur. Stand. (U.S.), Spec. Pub. 303 (May 1969) pp. 125-137; also in Nat. Bur. Stand. (U.S.) Spec. Pub. 300, Precision Measurement and Calibration, **7**, Radiometry and Photometry, H. K. Hammond, III, and H. L. Mason, Eds. (November 1971) pp. 223-235.
- [25] Nelson, Richard W., On the Significance of a Simplified Theory of Radiative Transfer, J. Opt. Soc. Am. **62**, No. 11 (November 1972) p. 1368, Abstract ThC17 (paper presented at 1972 Annual Meeting of Optical Society of America, San Francisco, Calif., October 1972).
- [26] Hsia, Jack J., Optical Radiation Measurements.—The Translucent Blurring Effect—Method of Evaluation and Estimation, Nat. Bur. Stand. (U.S.), Tech. Note 594-12 (October 1976).
- [27] Hsia, Jack J., and Richmond, Joseph C., Bidirectional Reflectometry, Part I. A high resolution laser bidirectional reflectometer with results on several optical coatings, J. Res. Nat. Bur. Stand. (U.S.), **80A** (Phys. & Chem.), No. 2, (March-April 1976) pp. 189-205; Part II. Bibliography on Scattering by Reflection from Surfaces, *ibid.*, pp. 207-220.
- [28] Self-Study Manual on Optical Radiation Measurements, Fred E. Nicodemus, Ed., in preparation by the Optical Radiation Section, National Bureau of Standards (U.S.). Chapters are being published first, as completed, as NBS Technical Notes, Series 910-.
- [29] Šurcliff, William A., Polarized Light (Harvard University Press, Cambridge, Mass., 1962).
- [30] Edwards, D. K., and Bevans, J. T., Effect of Polarization on Spacecraft Radiation Heat Transfer, AIAA J. **3**, No. 7 (July 1965) pp. 1323-1329.
- [31] Sandus, Oscar, A Review of Emission Polarization, Appl. Optics **4**, No. 12 (December 1965) pp. 1634-1642.
- [32] Jones, R. Clark, Immersed Radiation Detectors, Appl. Optics **1**, No. 5 (September 1962) pp. 607-613.
- [33] Gershun, A., The Light Field, Moscow, 1936 (eng. Transl. by Moon and Timoshenko, J. Math. Physics, **18**, May 1939, pp. 51-151).
- [34] Moon, Parry, The Scientific Basis of Illuminating Engineering (Dover, New York, 1957).
- [35] Torrance, K. E., Sparrow, E. M., and Birkebak, R. C., Polarization, Directional Distribution, and Off-Specular Peak Phenomena in Light Reflected from Roughened Surfaces, J. Opt. Soc. Am. **56**, No. 7 (July 1966) pp. 916-925.
- [36] Nicodemus, Fred E., Comment on 'Current definitions of reflectance', J. Opt. Soc. Am. **66**, No. 3 (March 1976) pp. 283-285.
- [37] Nicodemus, Fred E., Ed., Radiometry—Selected Reprints, American Association of Physics Teachers (AAPT), Stony Brook, New York, July 1971, (Includes reprints of [5], [7], and [9]).
- [38] Page, Chester H., and Vigoureux, Paul, Eds., The International System of Units (SI), Nat. Bur. Stand. (U.S.), Spec. Publ. 330, 1974 edition, 49 pages (July 1974).

U.S. DEPT. OF COMM. BIBLIOGRAPHIC DATA SHEET	1. PUBLICATION OR REPORT NO.  NBS MN -160	2. Gov't Accession No.	3. Recipient's Accession No.
----------------------------------------------------	-------------------------------------------------	---------------------------	------------------------------

TITLE AND SUBTITLE  GEOMETRICAL CONSIDERATIONS AND NOMENCLATURE FOR REFLECTANCE	5. Publication Date  October 1977
	6. Performing Organization Code

AUTHOR(S) F.E. Nicodemus, J.C. Richmond, J.J. Hsia, I.W. Ginsberg* and T. Limperis**	8. Performing Organ. Report No.
-----------------------------------------------------------------------------------------	---------------------------------

PERFORMING ORGANIZATION NAME AND ADDRESS  NATIONAL BUREAU OF STANDARDS DEPARTMENT OF COMMERCE WASHINGTON, D.C. 20234	10. Project/Task/Work Unit No.
	11. Contract/Grant No.

Sponsoring Organization Name and Complete Address (Street, City, State, ZIP)  Same as 9.  Library of Congress Catalog Number: 77-22966	13. Type of Report & Period Covered  Final
	14. Sponsoring Agency Code

SUPPLEMENTARY NOTES  
 \* EG&G, Inc., Las Vegas, Nevada 89101  
 \*\*Agro Sciences, Inc., Ann Arbor, Michigan 48103

ABSTRACT (A 200-word or less factual summary of most significant information. If document includes a significant bibliography or literature survey, mention it here.)

A unified approach to the specification of reflectance, in terms of both incident- and reflected-beam geometry, is presented. Nomenclature to facilitate this approach is proposed.

Under specified conditions—including uniform irradiance, a uniform, isotropic, plane surface, and allowance for edge effects due to sub-surface scattering—the geometrical reflecting properties of a reflecting surface are readily characterized or specified in terms of the *bidirectional reflectance-distribution function* (BRDF). The BRDF is denoted symbolically as  $f_r$ :

$$f_r(\theta_i, \phi_i; \theta_r, \phi_r) = dL_r(\theta_i, \phi_i; \theta_r, \phi_r; E_i) / dE_i(\theta_i, \phi_i) \quad [sr^{-1}]$$

where

$\theta$  and  $\phi$  together indicate a direction, the subscript  $i$  indicates quantities associated with incident radiant flux, the subscript  $r$  indicates quantities associated with reflected radiant flux,  $E_i$  is incident irradiance,  $L_r$  is reflected radiance, and  $d$  indicates a differential quantity.

The BRDF is a derivative, a distribution function, relating the irradiance incident from one given direction to its contribution to the reflected radiance in another direction. Nomenclature (concepts, terms, symbols, and units) for categorizing and specifying reflectance quantities for a variety of different beam configurations (both incident and reflected beams) is described, and all are defined and interrelated in terms of the BRDF. The conditions under which the formalism can be applied, including situations involving considerable sub-surface scattering, are carefully established. The entire treatment is limited to the domain of classical geometrical-optics radiometry and does not take into account interference and diffraction phenomena, such as are frequently encountered with highly coherent radiant flux. The other radiation parameters such as wavelength, (temporal) modulation, and polarization and the effects of fluorescence (or phosphorescence) are discussed briefly.

Key words: Bidirectional reflectance-distribution function; diffuse reflectance; directional reflectance; nomenclature of reflectance; reflectance; reflectance factor; reflectance geometry; reflectance nomenclature; specular reflectance; sub-surface scattering; reflection; optical reflection.

7. KEY WORDS (six to twelve entries; alphabetical order; capitalize only the first letter of the first key word unless a proper name; separated by semicolons) Bidirectional reflectance-distribution function; diffuse reflectance; directional reflectance; nomenclature of reflectance; reflectance; reflectance factor; reflectance geometry; reflectance nomenclature; reflection; specular reflectance; sub-surface scattering; optical reflection.

8. AVAILABILITY  <input type="checkbox"/> For Official Distribution. Do Not Release to NTIS  <input checked="" type="checkbox"/> Order From Sup. of Doc., U.S. Government Printing Office Washington, D.C. 20402, SD Cat. No. C13. 44:160  <input type="checkbox"/> Order From National Technical Information Service (NTIS) Springfield, Virginia 22151	<input checked="" type="checkbox"/> Unlimited	19. SECURITY CLASS (THIS REPORT)  UNCLASSIFIED	21. NO. OF PAGES
		20. SECURITY CLASS (THIS PAGE)  UNCLASSIFIED	22. Price  \$2.10

There's  
a new  
look  
to...

# DIMENSIONS



... the monthly magazine of the National Bureau of Standards. Still featured are special articles of general interest on current topics such as consumer product safety and building technology. In addition, new sections are designed to . . . PROVIDE SCIENTISTS with illustrated discussions of recent technical developments and work in progress . . . INFORM INDUSTRIAL MANAGERS of technology transfer activities in Federal and private labs. . . DESCRIBE TO MANUFACTURERS advances in the field of voluntary and mandatory standards. The new DIMENSIONS/NBS also carries complete listings of upcoming conferences to be held at NBS and reports on all the latest NBS publications, with information on how to order. Finally, each issue carries a page of News Briefs, aimed at keeping scientist and consumer alike up to date on major developments at the Nation's physical sciences and measurement laboratory.

(please detach here)

**SUBSCRIPTION ORDER FORM**

Enter my Subscription To DIMENSIONS/NBS at \$12.50. Add \$3.15 for foreign mailing. No additional postage is required for mailing within the United States or its possessions. Domestic remittances should be made either by postal money order, express money order, or check. Foreign remittances should be made either by international money order, draft on an American bank, or by UNESCO coupons.

- Remittance Enclosed (Make checks payable to Superintendent of Documents)
- Charge to my Deposit Account No.

Send Subscription to:

NAME-FIRST, LAST		
COMPANY NAME OR ADDITIONAL ADDRESS LINE		
STREET ADDRESS		
CITY	STATE	ZIP CODE

**MAIL ORDER FORM TO:**  
 Superintendent of Documents  
 Government Printing Office  
 Washington, D.C. 20402

PLEASE PRINT

**Where can you find  
all the reference data  
you need?**

**Right in the  
Journal of Physical  
and Chemical  
Reference Data!**

Now in its sixth year, this valuable publication has proved that it fills the important gaps for you in the literature of the physical sciences.

Published by the American Institute of Physics and the American Chemical Society for the National Bureau of Standards, this quarterly gives you quantitative numerical data, with recommended values and uncertainty limits chosen by experts in the field.

Critical commentary on methods of measurement and sources of error, as well as full references to the original literature, is an integral part of each of your four issues a year.

Can you afford to be without this prime source of reliable data on physical and chemical properties? To start receiving your copies, just fill in the order form and drop into the mail. If you do use a purchase order, please attach the printed form as this will help us to expedite your order.

Send for complete list of reprints!

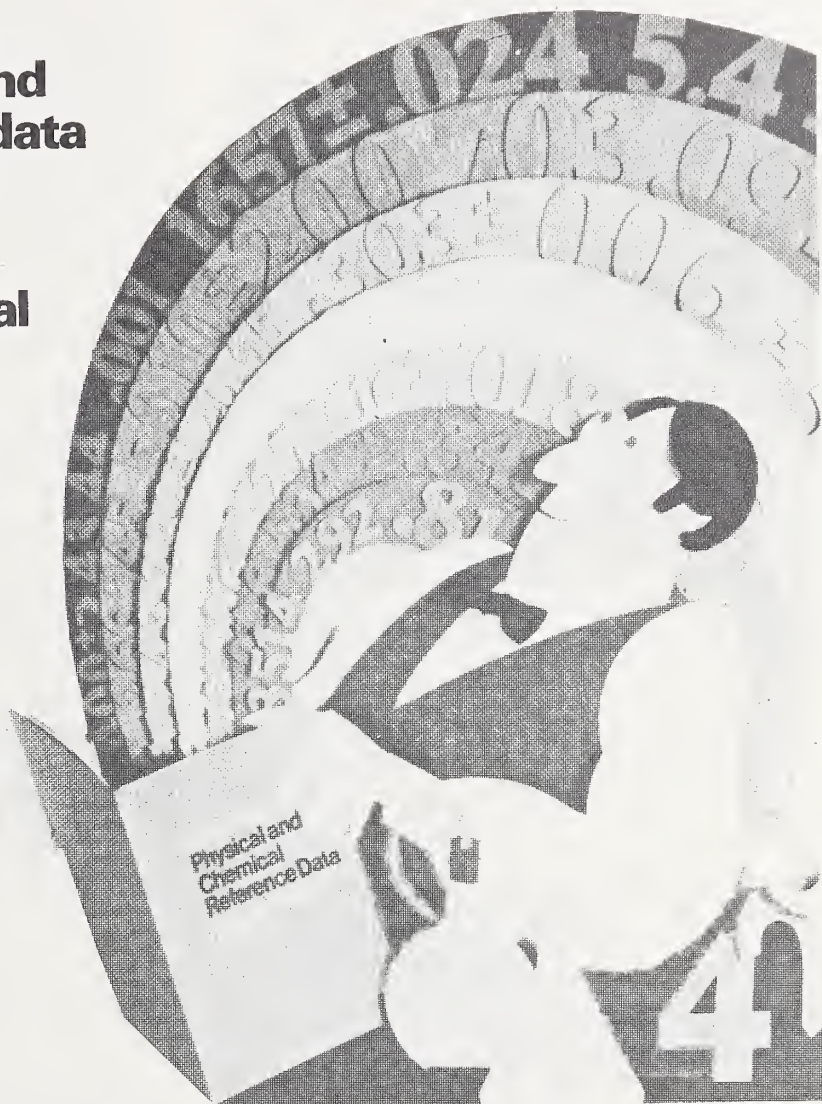

**Journal of Physical and Chemical Reference Data**  
**American Chemical Society**  
 1155 Sixteenth Street, N.W., Washington, D.C. 20036

Yes, I would like to receive the JOURNAL OF PHYSICAL AND CHEMICAL REFERENCE DATA at the one-year rate checked below:

Name \_\_\_\_\_  
 \_\_\_\_\_  
 Home  
 Business  
 Street \_\_\_\_\_  
 City \_\_\_\_\_ State \_\_\_\_\_ Zip \_\_\_\_\_

	Members	Nonmembers
<i>U.S., Canada, Mexico</i>	<input type="checkbox"/> \$25.00	<input type="checkbox"/> \$90.00
<i>Other Countries</i>	<input type="checkbox"/> \$29.00	<input type="checkbox"/> \$94.00

Bill me       Bill company or school       Payment enclosed

Please Attach This Order Form To Purchase Order.



## PERIODICALS

**JOURNAL OF RESEARCH**—The Journal of Research of the National Bureau of Standards reports NBS research and development in those disciplines of the physical and engineering sciences in which the Bureau is active. These include physics, chemistry, engineering, mathematics, and computer sciences. Papers cover a broad range of subjects, with major emphasis on measurement methodology, and the basic technology underlying standardization. Also included from time to time are survey articles on topics closely related to the Bureau's technical and scientific programs. As a special service to subscribers each issue contains complete citations to all recent NBS publications in NBS and non-NBS media. Issued six times a year. Annual subscription: domestic \$17.00; foreign \$21.25. Single copy, \$3.00 domestic; \$3.75 foreign.

Note: The Journal was formerly published in two sections: Section A "Physics and Chemistry" and Section B "Mathematical Sciences."

**DIMENSIONS/NBS (formerly Technical News Bulletin)**—This monthly magazine is published to inform scientists, engineers, businessmen, industry, teachers, students, and consumers of the latest advances in science and technology, with primary emphasis on the work at NBS. The magazine highlights and reviews such issues as energy research, fire protection, building technology, metric conversion, pollution abatement, health and safety, and consumer product performance. In addition, it reports the results of Bureau programs in measurement standards and techniques, properties of matter and materials, engineering standards and services, instrumentation, and automatic data processing.

Annual subscription: Domestic, \$12.50; Foreign \$15.65.

## NONPERIODICALS

**Monographs**—Major contributions to the technical literature on various subjects related to the Bureau's scientific and technical activities.

**Handbooks**—Recommended codes of engineering and industrial practice (including safety codes) developed in cooperation with interested industries, professional organizations, and regulatory bodies.

**Special Publications**—Include proceedings of conferences sponsored by NBS, NBS annual reports, and other special publications appropriate to this grouping such as wall charts, pocket cards, and bibliographies.

**Applied Mathematics Series**—Mathematical tables, manuals, and studies of special interest to physicists, engineers, chemists, biologists, mathematicians, computer programmers, and others engaged in scientific and technical work.

**National Standard Reference Data Series**—Provides quantitative data on the physical and chemical properties of materials, compiled from the world's literature and critically evaluated. Developed under a world-wide program coordinated by NBS. Program under authority of National Standard Data Act (Public Law 90-396).

NOTE: At present the principal publication outlet for these data is the Journal of Physical and Chemical Reference Data (JPCRD) published quarterly for NBS by the American Chemical Society (ACS) and the American Institute of Physics (AIP). Subscriptions, reprints, and supplements available from ACS, 1155 Sixteenth St. N.W., Wash., D.C. 20056.

**Building Science Series**—Disseminates technical information developed at the Bureau on building materials, components, systems, and whole structures. The series presents research results, test methods, and performance criteria related to the structural and environmental functions and the durability and safety characteristics of building elements and systems.

**Technical Notes**—Studies or reports which are complete in themselves but restrictive in their treatment of a subject. Analogous to monographs but not so comprehensive in scope or definitive in treatment of the subject area. Often serve as a vehicle for final reports of work performed at NBS under the sponsorship of other government agencies.

**Voluntary Product Standards**—Developed under procedures published by the Department of Commerce in Part 10, Title 15, of the Code of Federal Regulations. The purpose of the standards is to establish nationally recognized requirements for products, and to provide all concerned interests with a basis for common understanding of the characteristics of the products. NBS administers this program as a supplement to the activities of the private sector standardizing organizations.

**Consumer Information Series**—Practical information, based on NBS research and experience, covering areas of interest to the consumer. Easily understandable language and illustrations provide useful background knowledge for shopping in today's technological marketplace.

Order above NBS publications from: Superintendent of Documents, Government Printing Office, Washington, D.C. 20402.

Order following NBS publications—NBSIR's and FIPS from the National Technical Information Services, Springfield, Va. 22161.

**Federal Information Processing Standards Publications (FIPS PUB)**—Publications in this series collectively constitute the Federal Information Processing Standards Register. Register serves as the official source of information in the Federal Government regarding standards issued by NBS pursuant to the Federal Property and Administrative Services Act of 1949 as amended, Public Law 89-306 (79 Stat. 1127), and as implemented by Executive Order 11717 (38 FR 12315, dated May 11, 1973) and Part 6 of Title 15 CFR (Code of Federal Regulations).

**NBS Interagency Reports (NBSIR)**—A special series of interim or final reports on work performed by NBS for outside sponsors (both government and non-government). In general, initial distribution is handled by the sponsor; public distribution is by the National Technical Information Services (Springfield, Va. 22161) in paper copy or microfiche form.

## BIBLIOGRAPHIC SUBSCRIPTION SERVICES

The following current-awareness and literature-survey bibliographies are issued periodically by the Bureau:

**Cryogenic Data Center Current Awareness Service.** A literature survey issued biweekly. Annual subscription: Domestic, \$25.00; Foreign, \$30.00.

**Liquified Natural Gas.** A literature survey issued quarterly. Annual subscription: \$20.00.

**Superconducting Devices and Materials.** A literature survey issued quarterly. Annual subscription: \$30.00. Send subscription orders and remittances for the preceding bibliographic services to National Bureau of Standards, Cryogenic Data Center (275.02) Boulder, Colorado 80302.

**U.S. DEPARTMENT OF COMMERCE**  
**National Bureau of Standards**  
Washington, D.C. 20234

OFFICIAL BUSINESS

Penalty for Private Use, \$300

POSTAGE AND FEES PAID  
U.S. DEPARTMENT OF COMMERCE  
COM-215



SPECIAL FOURTH-CLASS RATE  
BOOK

---