

# **Asteroid explorer, Hayabusa2, reporter briefing**

**December 24, 2020**

**JAXA Hayabusa2 Project**

---



# Topics



Regarding Hayabusa2,

- Curation work
- Capsule collection group return report
- Extended Mission target astronomical observations
- Other



# Contents



0. Overview of Hayabusa2
1. Current status and overall schedule of the project
2. Curation work
3. Capsule collection group return reports
4. Observations of the Extended Mission target
5. Public relations / outreach
6. Future plans



# Overview of Hayabusa2



## Objective

We will explore and sample the C-type asteroid Ryugu, which is a more primitive type than the S-type asteroid Itokawa that Hayabusa explored, and elucidate interactions between minerals, water, and organic matter in the primitive solar system. By doing so, we will learn about the origin and evolution of Earth, the oceans, and life, and maintain and develop the technologies for deep-space return exploration (as demonstrated with Hayabusa), a field in which Japan leads the world.

## Expected results and effects

- By exploring a C-type asteroid, which is rich in water and organic materials, we will clarify interactions between the building blocks of Earth and the evolution of its oceans and life, thereby developing solar system science.
- Japan will further its worldwide lead in this field by taking on the new challenge of obtaining samples from a crater produced by an impacting device.
- We will establish stable technologies for return exploration of solar-system bodies.

## Features:

- World's first sample return mission to a C-type asteroid.
- World's first attempt at a rendezvous with an asteroid and performance of observation before and after projectile impact from an impactor.
- Comparison with results from Hayabusa will allow deeper understanding of the distribution, origins, and evolution of materials in the solar system.

## International positioning:

- Japan is a leader in the field of primitive body exploration, and visiting a type-C asteroid marks a new accomplishment.
- This mission builds on the originality and successes of the Hayabusa mission. In addition to developing planetary science and solar system exploration technologies in Japan, this mission develops new frontiers in exploration of primitive heavenly bodies.
- NASA too is conducting an asteroid sample return mission, OSIRIS-REx (launch: 2016; asteroid arrival: 2018; Earth return: 2023). We will exchange samples and otherwise promote scientific exchange, and expect further scientific findings through comparison and investigation of the results from both missions.

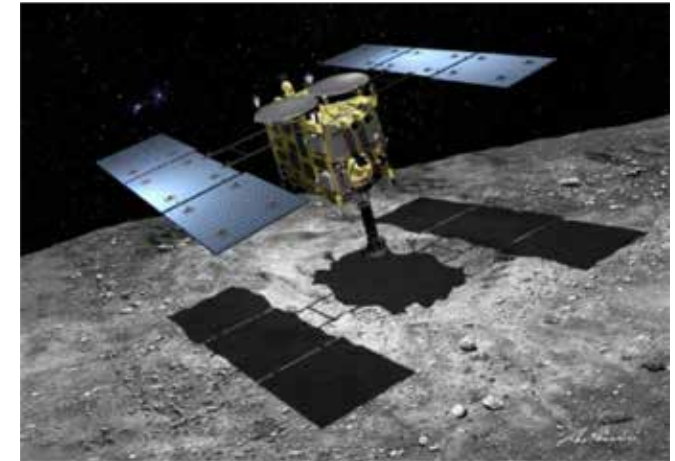

(Illustration: Akihiro Ikeshita)

## Hayabusa 2 primary specifications

Mass	Approx. 609 kg
Launch	3 Dec 2014
Mission	Asteroid return
Arrival	27 June 2018
Departure	13 Nov 2019
Earth return	6 Dec 2020 (plan)
Stay at asteroid	Approx. 18 months
Target body	Near-Earth asteroid Ryugu

## Primary instruments

Sampling mechanism, re-entry capsule, optical cameras, laser range-finder, scientific observation equipment (near-infrared, thermal infrared), impactor, miniature rovers.



# Mission flow



**Launch**  
Dec 3, 2014



**Earth swing-by**  
Dec 3, 2015



**Ryugu arrival**  
June 27, 2018

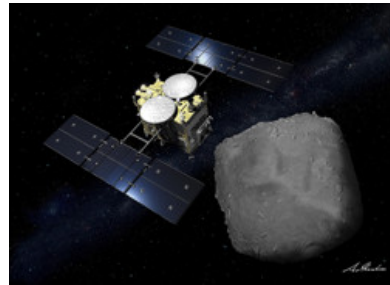

**MINERVA-III1 separation**  
Sep 21, 2018

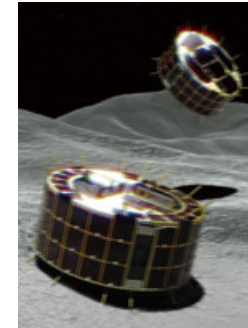

**MASCOT separation**  
Oct 3, 2018



**Earth return**  
Dec. 6, 2020  
**Complete!**

(image credit: illustrations including spacecraft by Akihiro Ikeshita, others by JAXA)

**Ryugu departure**  
Nov 13, 2019



**MINERVA-II2 separation**  
Oct. 3, 2019



**Target marker separation**  
Sept. 17, 2019

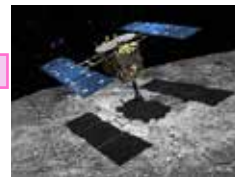

**Second touchdown**  
July 11, 2019

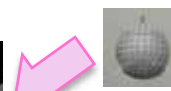

**Target marker separation**  
May 30, 2019

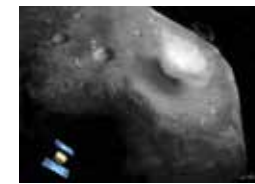

**Impactor (SCI)**  
5 April, 2019

**Target marker separation**  
Oct 25, 2018

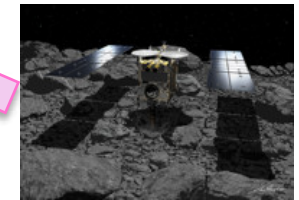

**First touchdown**  
Feb 22, 2019

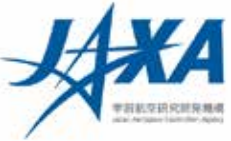

# 1. Current project status & schedule overview

## Current status :

- During the curation work, chambers B & C, in addition to chamber A, have been opened.
- The collection teams have all returned to Japan and are currently in quarantine (participating via telework).
- The spacecraft is operating smoothly. Earth/Moon observations are almost complete. As of today, the distance from Earth is over 7 million km.
- Observations of the target of the Extended Mission, celestial body 1998 KY26, were carried out and successful observations made at three locations.

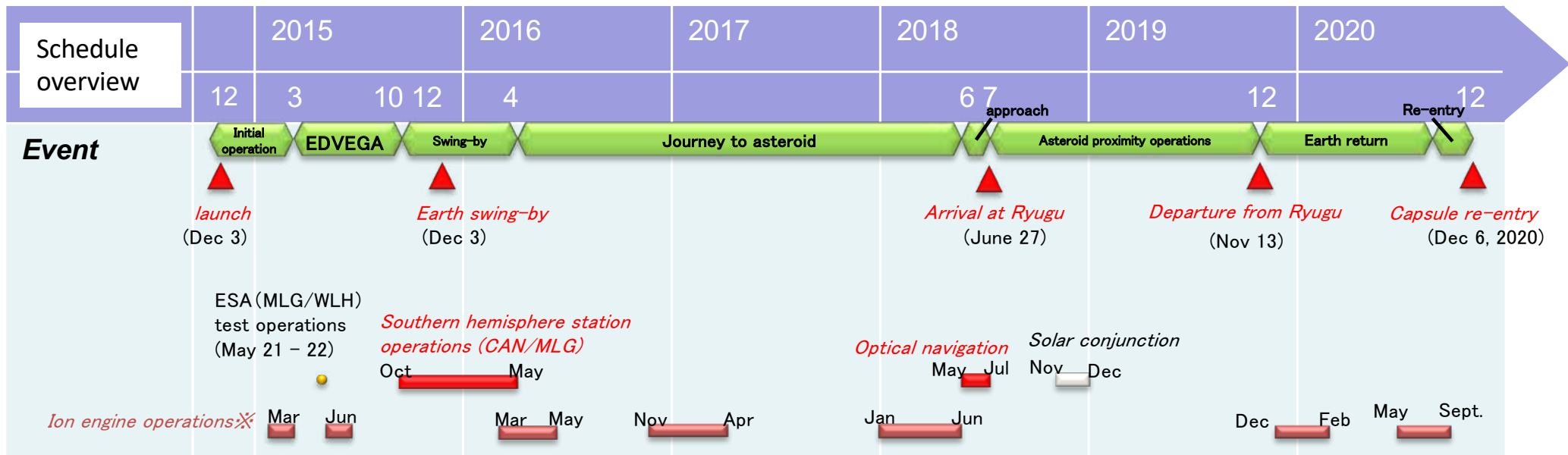

(image credit: JAXA)





## 2. Curation work



- Catcher chamber A (below), chamber B and chamber C are opened, and after moving to the the collection container (right), microscopic observation has begun.



Image after opening chamber A

(image credit: JAXA)

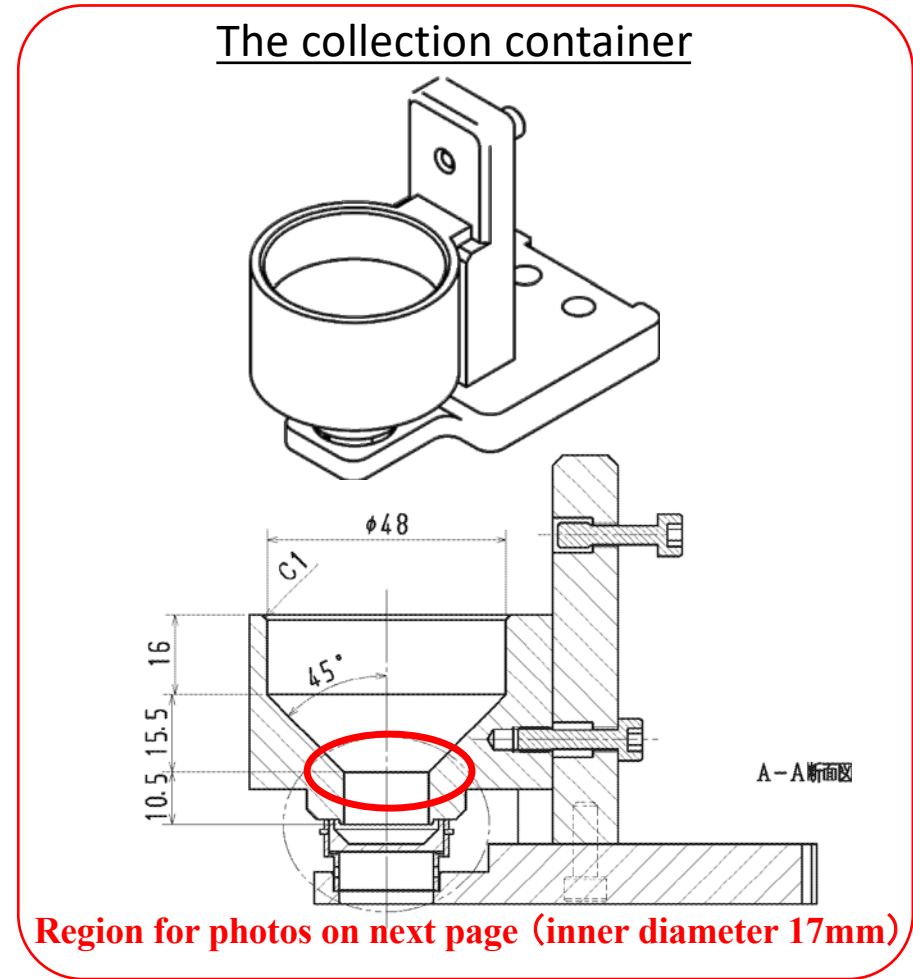



## 2. Curation work

- The presence of many particles larger than 1 mm in both chambers A and C has been verified.
- Particles in chamber C are clearly larger in size than those in chamber A.
- A substance that appears to have an artificial origin has been confirmed in chamber C (currently under investigation)

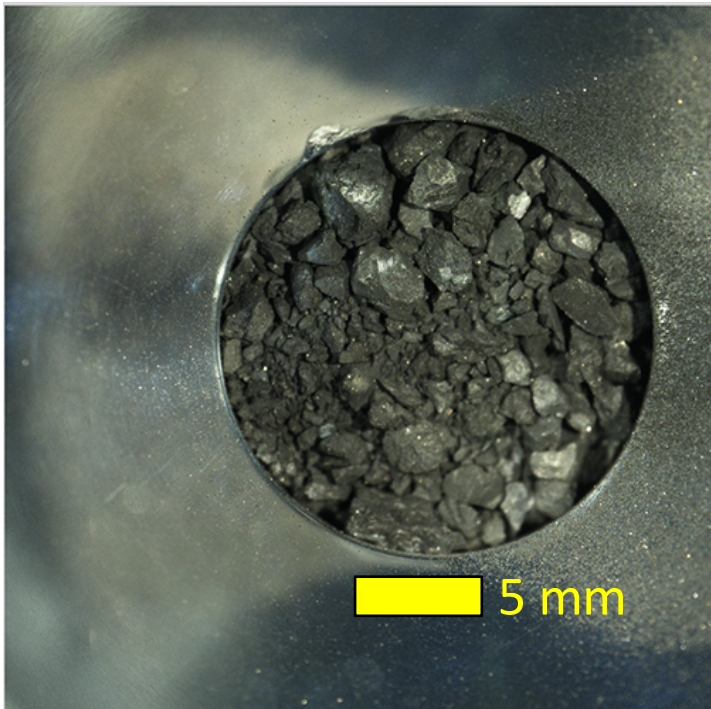

Optical microscope image of chamber A  
(inside the collection container)

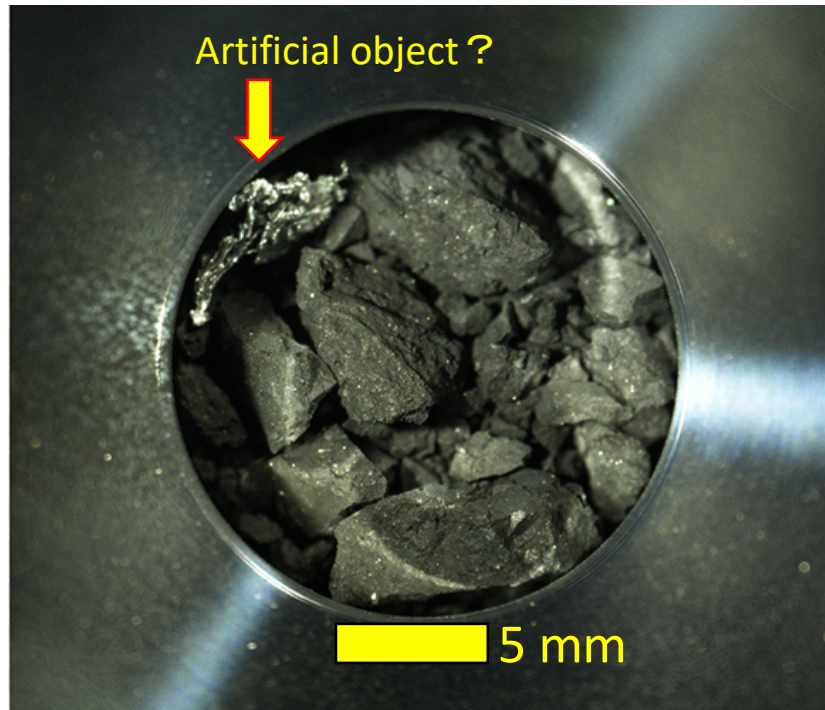

Optical microscope image of chamber C  
(inside the collection container)

Right figure  
(View from above the  
collection container)

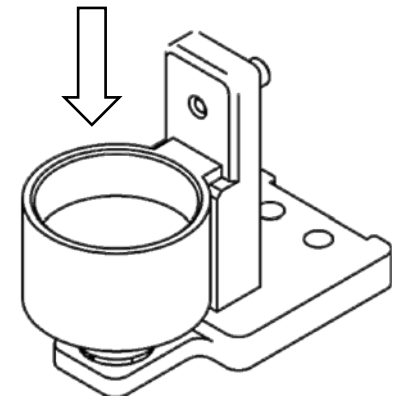

The collection container

(image credit: JAXA)





### 3. Capsule collection team return report

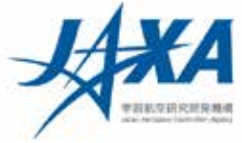

- Although the results of the capsule collection have been explained, here each of the people in charge will introduce their specific work and the site situation.
- Introduced in the order following the flow of the collection work:
  1. Ground Optical Observation System (GOS)
  2. Direction Finding System (DFS)
  3. Marine Rader System (MRS)
  4. Drone search (DRONE)
  5. RHQ (Recovery Headquarters) & Helicopter
  6. Capsule



### 3. Capsule collection team return report

# Ground Optical Observation System (GOS)



## 1) Equipment development and training in Japan

- Based on knowledge from Hayabusa, we developed a Mobile Optical Orbit Determination System using a star-alignment camera and tracking camera that can perform automatic observations with high accuracy (right figure).
- However, there were concerns that sufficient practice would not be possible, as there was no appropriate fast moving light source to simulate the capsule.

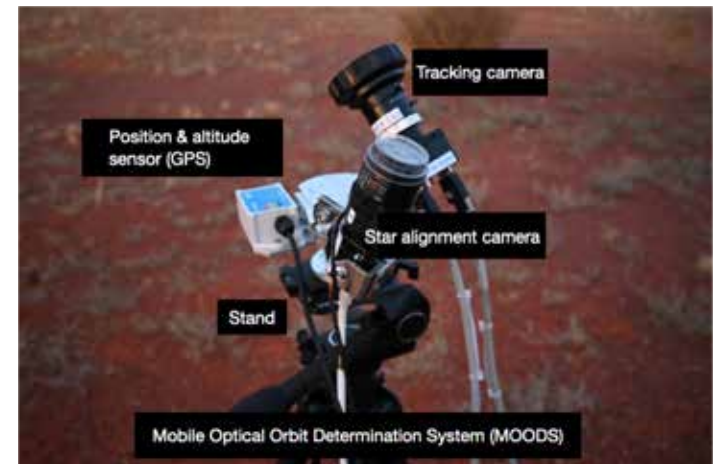

## 2) Preparation work at Woomera

- The preparation work suffered from the intense heat during the day and cold at dawn, invasion of flies during the day and moths at night. There was also the appearance of terrifying insects!
- As we had introduced airborne observations for this mission, a big concern was the weather. During the on-site rehearsals, there were many days when the stars were not visible, so preparations for the optical orbit determination system and telephoto tracking had to be completed at the last minute.



(image credit: JAXA)



### 3. Capsule collection team return report

# Ground Optical Observation System (GOS)



## 3) Capsule return day

- Strong winds the previous day led to concerns about observation of the capsule, but the wind suddenly weakened and sky to the northwest cleared to give perfect conditions.
- The ground station's optical orbit determination system worked perfectly and the trajectory and predicted landing site were successfully determined. The telephoto tracking system also captured the capsule and succeeded in tracking until just before the fireball disappeared (right image).
- We would like to thank the local DOD staff and NASA for their cooperation!

(animation)



N3局



Coober Pedy 局と COS3 局



航空機チーム (NASA 観測者とともに)

(image credit: JAXA)



### 3. Capsule collection team return report

# Direction Finding System (DFS)



#### ■ Overview

- Five beacon directional search stations were placed to surround the expected landing area of 150 km × 100 km to predict the capsule landing point based on the principal of triangulation and wind data [slide: “Direction Finding System Team”]

#### ■ Preparation

##### 1. Life in isolation and in the scorching heat

- Immediately after 3 weeks of isolation in Japan & Australia, assembly and adjustment work began in the desert with 47°C temperatures and 5% humidity with wind speeds of 10m/s.
- Physical strength and condition needed to be maintained.
- Also a healthy mind and motivation.
- ※ “DFS gymnastics” at lunchtime every day during the isolation in Australia. This helped some team members with back pain.

##### 2. Operation on the reentry day was backed up by a lot of practice

- Practice sessions more than 10 times in Japan
  - Hot climate simulation in August (support of Sagami City)
  - Balloon tracking practice in Uchinoura (support from Kushima City and Cape Toi)
  - Tracking practice assuming a variety of events with the DFS simulator.
- ※ Real operation went easier than in practice. Operation timings were no difference between practice to real one.

##### 3. Activities in Woomera

- Challenges coordinating between 6 bases scattered over 100 square km and Japan base in a poor communication environment [slide: “DFS station members”]
- Moving over 500 km / day. [Reinforcement signal via Michibiki’s MADOCA assisted efficiency] [Slide: “Position measurement with Michibiki /MADOCA”]
- Cooperation with the DoD escort (directions, animal avoidance, generators, water, cars).
- Activities rescheduled / re-think due to delayed cargo arrival
- One of the 5 receiving stations collapsed due to strong wind, damaging the antenna. A practice day was reallocated to repair and the antenna was safely revived [slide: “Receiving station collapse and recovery”]

- ※ A flexible response allows handling of diverse predicaments.

##### 4. “Chanko” team

- A team consists from members from all over JAXA, including researchers, engineers (electricity, battery, radio waves, geology, aircraft, materials, computers, crewed space), procurement & business promotion departments etc.
- Challenges include securing a schedule for practice, sharing goals among members with different specialties and establish the integrated operation needed by a team.
- As a step for the next project: in addition to information collection by telephone (voice), we also tried using data communication (network) and succeeded in predicting the landing point.
- ※ Meeting people is the real thrill of the project.

(map from the Royal Australia Air Force website, see p34)



(image credit: JAXA)





### 3. Capsule collection team return report

# Direction Finding System (DFS)



#### ■ Directional search results

- While the system requirement was 3 km, the capsule landing point was predicted with an error of about 200 m.

#### ■ Reasons for DFS high-precision landing point prediction

- Operation on the reentry day was based on practice and calibration.

- Receiver assembly know-how affects accuracy: the parts are for amateur radio specifications. The aim is to combine these into a system that allows highly accurate directional exploration.
- High precision antenna operation assisted through abundant practice: how to move the antenna considering gear backlash, and secure beacon lock-on.
- 4 hour calibration for 20 minute beacon reception: Measurement system characteristics change over time. Calibration was performed multiple times to understand the characteristics of the measurement system when the beacon was actually received.
- Measure accuracy: For every location, it was necessary to measure the location of 3 places: the receiving station, the collimation station and check antenna station.

The determination of longitude, latitude and altitude greatly contributes to the accuracy of directional exploration.

- Continuously improving accuracy from practice in Japan to just before actual event

- Improvement of calibration formula
- Improvement of triangulation intersection determination map for higher accuracy
- Success utilizes the knowledge of JAXA as a whole, such as from balloon tracking practice at Uchinoura Space Center and wind prediction from the atmospheric balloon experiment group.

※ In the helicopter test on November 30, the results of practice were apparent and we could begin production with confidence.

#### ■ Looking back on the work

- Experience of conveying the location from the middle of the desert to the I/B coverage team and ISAS spacecraft control team. Despite the enthusiasm in each place, events cannot be rushed.
- When the visual fireball to confirm the capsule entry to the atmosphere appeared in the expected location, and the light got steadily brighter followed by the white tail, time stood still! You're here! Next is the beacon!
- Sending the location. Great landing point prediction – thank you! Due to cooperation between system and people. [Slide: “DFS (Voice): ILPP Accuracy  $\approx$ 200m]
- The spacecraft heads to the next celestial target. Thank you for delivering the capsule!
- Reference slides: “Information transmission by DFS phone (voice)”, “Operation in the DFS (voice) caravan”, “capsule fireball seen from northernmost DFS station”.

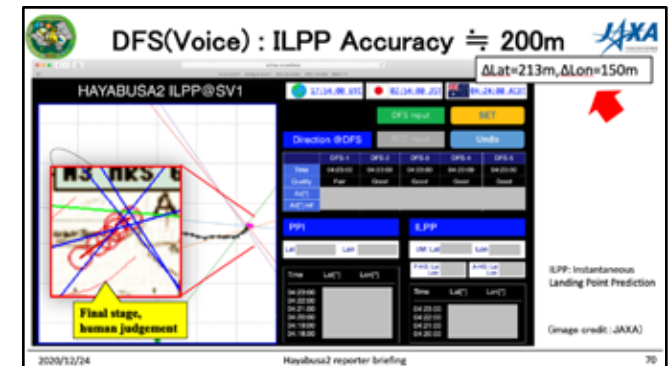

(image credit: JAXA)





### 3. Capsule collection team return report



# Atmospheric flight trajectory

5,000 case analysis / condition  
3 degrees of freedom : 1 hr  
6 degrees of freedom : ~8 hrs

TCM-4 OD result  
+ landing point analysis using day's  
predicted wind

Strong and expected jet stream at  
an altitude of 10 – 15 km, and  
moved trajectory significantly to  
the east.

#### ■ 12/3(R-2d) 17:30 :

TCM-4 OD1 + predicted wind  
sent to DFS team at dawn on 12/4

- **Capsule parameters confirmed**  
(parachute trigger, anchor separation,  
REMM etc)
- **for TCM-5 permission**

#### ■ 12/5(R-1d) night :

Flight analysis based on TCM-4 OD2 +  
predicted wind → DFS server

- **To prepare search with latest data**

#### ■ 12/6(R) after 02:30 : DFS AOS

#### Reliable data :

- **5 stations form a beautiful intersection**
- **Expected flight, with sufficient time for signal  
reception (~25 minutes)**

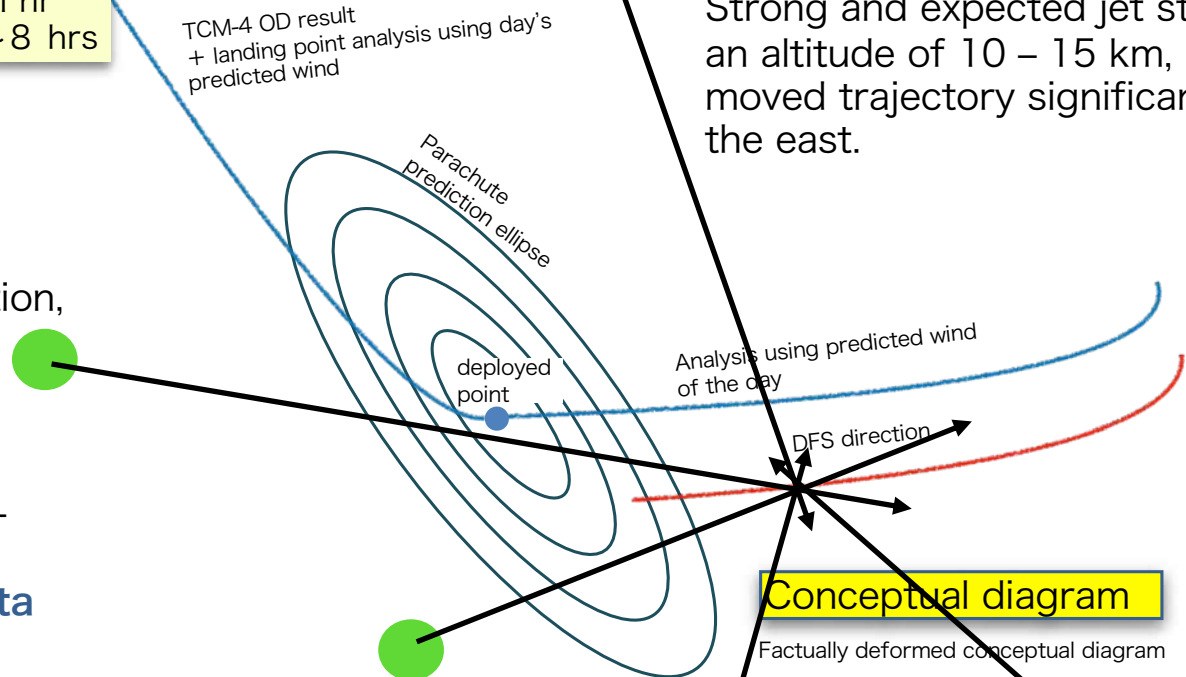

Conceptual diagram

Factually deformed conceptual diagram



### 3. Capsule collection team return report

# Marine Rader System (MRS)



## Overview

- ❑ Search using marine radar
  - Search without requiring a beacon as a back-up for DFS.
- ❑ Private sector-based team
  - Led by Kodan Electronics Co., Ltd.
  - (mixed team of 3 x JAXA, 6 x Kodan)

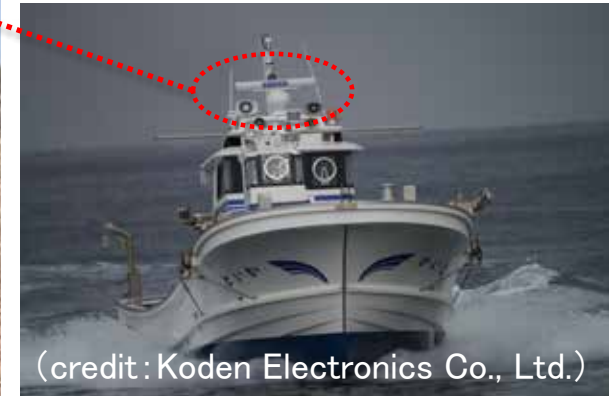

Marine radar jointly developed by Kodan Electronics and JAXA Space Exploration Hub.

## Preparation

Repeated multiple tests and training lowered concern about preparations

### 【Activities】

- 2018: Joined to collection team
- 2019: Tracking test at Uchinoura (Feb.) and Woomera (Dec.), domestic training (Sept. ~ Nov.)
- 2020: Domestic training (Jul. ~ Oct.), collection operation (Dec.)





### 3. Capsule collection team return report

# Marine Rader System (MRS)



## On-site work

Deploy marine radar at 4 sites

- Extreme heat (high of 47°C)  
The 2 days for equipment installation were particularly hot...
- Dirt driving (4 hour round trip, 160 km commute)

## Equipment layout

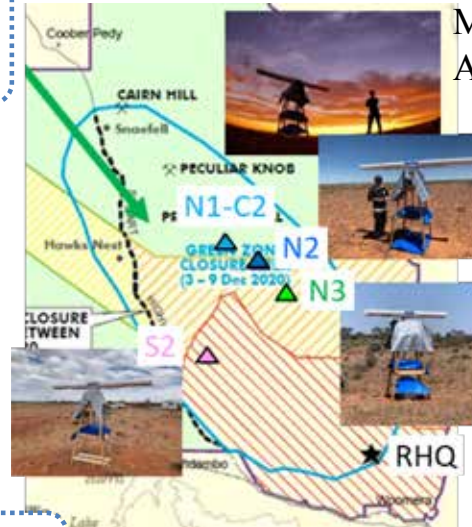

Map from Royal Australian Airforce website. See p. 34

## Operation on the reentry day

Each site searched individually. Results were aggregated and then the final result was reported to headquarters (RHQ)

- Required quick aggregation and reporting.  
The ringing tone of the satellite phone still reverberates in our ears...

## Search results

- ✓ 3 stations successfully tracked (up to 30 km or more)
- ✓ Detected to a range of ~200m near the landing point

## Search results summary

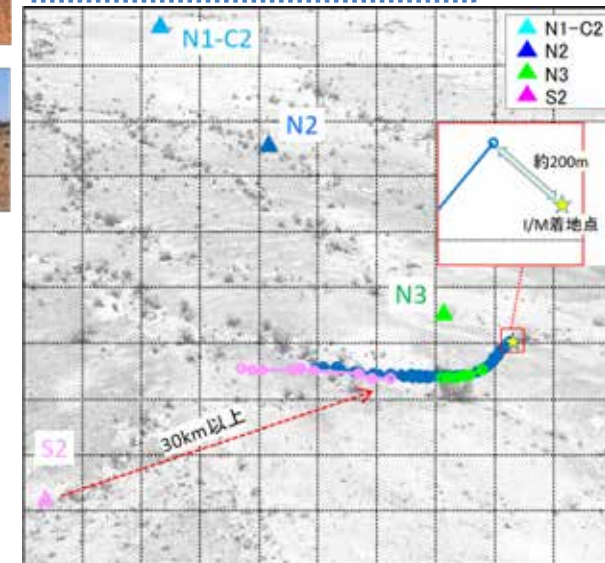

## Contact system

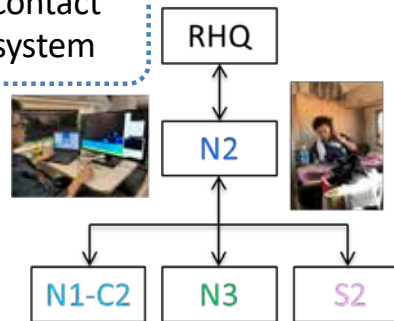

(credit: JAXA)







### 3. Capsule collection team return report

# DRONE



- Aerial photograph by uncrewed flight + high speed image recognition technology -> capsule detection  
→ High-precision position determination + capsule status confirmation via aerial images  
→ Last resort for capsule discovery
- Results: The front heat shield was detected during the sample capsule collection operations, and location and status reported. Contributed to the subsequent quick recovery of the heat shield.
- Realized with cooperation from Fuji Imvac (uncrewed aerial vehicle), Aero Asahi, Skymatics (aerial photography, onboard image analysis) and JAXA (image analysis).

(animation)



(image credit: JAXA)

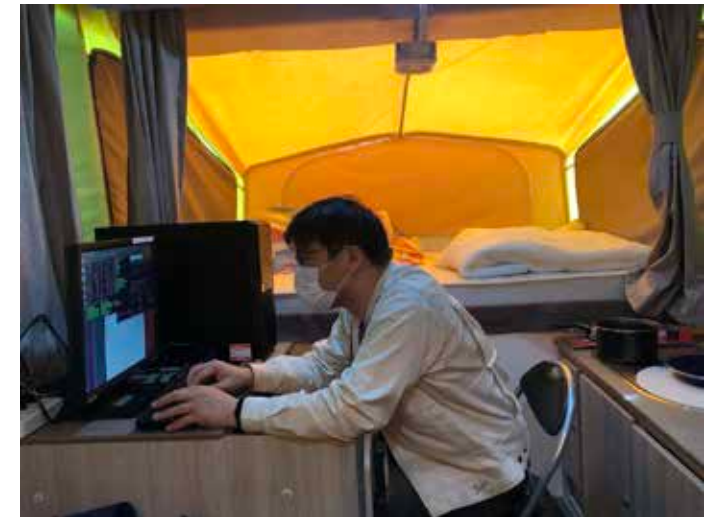



### 3. Capsule collection team return report

# DRONE



- Headquarters informed of the expected landing point at around 06:30. (times listed are local times)
- Take off was at around 07:20 with the front heat shield as the search target.
- Aerial view of an area approximately 2 km x 2 km → around 2500 photographs taken.
- Landed at around 08:50 and began analysis.
- Before 09:00, the capsule was recognized and location and status reported.

Front heat shield



(image credit: JAXA)





### 3. Capsule collection team return report

# DRONE

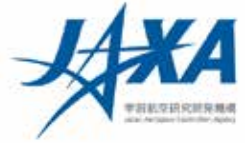

- Successful practical use by a hybrid combination of uncrewed aerial vehicles and AI technology  
→ Value in achieving results in limited time and conditions.
- Suggests future applications for cost-efficiency and rapid sample collection  
→ The experience provided insights for more efficient detection
- Although the arrival of the equipment was late, and it was not possible to participate in rehearsals, the rapid recovery was able to proceed as scheduled.  
→ Careful training for this situation
- To achieve results in this operation, it was necessary to overcome problems through flexibly responding to situations in the field such as non-ideal runway conditions or unexpected wind.  
→ Skilled technology operator for image recognition, repeated improvements



### 3. Capsule collection team return report



# RHQ - helicopter

RHQ: Planning, execution and work support for the overall recovery operation from the re-entry of the sample return capsule (SRC) through to the delivery of the collected material to the curation chamber on the Sagami-hara Campus in Japan.

Helicopter: Search for the SRC components (I/M. parachute, front H/S, back H/S) and transport them.

Search helicopter: AW139, Transport helicopter: Bell412

#### (1) Preparation until the reentry

Test day	Test	Details
8/6	Domestic helicopter test (assistant from Aero Asahi Co., Ltd)	Confirm visibility at search altitude (~100 m), measure vibration environment within helicopter
11/30 AM	Exploration helicopter function test	Performance test of directional field probe (DF) mounted on exploration helicopter using a test beacon transmitter
11/30 PM	Evaluation test of ground systems (DFS ,MRS) using the helicopter	Tracking test conducted using a helicopter with a test beacon transmitter to act as the capsule.
12/1, 2	Rehearsal	Confirmation of operation procedures, night exploration training with the exploration helicopter

Domestic helicopter test



(image credit: JAXA)



### 3. Capsule collection team return report

# RHQ - helicopter



#### (2) Episode

- A confirmation test with the exploration helicopter was scheduled to be conducted in Australia in September, but restrictions on international movement meant that prior verification in Australia had to be abandoned. Actual production was therefore completed with one previous test conducted a week before the collection operation.
- During the Hayabusa mission, the search-only flight and recovery flight were completed separately. However, to reduce the time until recovery, this time the flight encompassed both exploration and transportation of the recovered units. As a result, we were able to recover the SRC in a very short time but the helicopter cruising time was prolonged.

#### (3) Actual operation and results

- The helicopter advanced test and rehearsal were worthwhile, and the actual operation could be performed calmly.
- Approximately 20 mins after the take-off of the search helicopter, the beacon signal emitted from the I/M was received. After that, it took some times, but the I/M was visually confirmed from the air at around 06:00 am, at around sunrise.
- As a result, the recovery helicopter took-off and the work at the I/M landing point began.
- DFS, MRS and the Australian radar were used as radio wave sensors for directional exploration. Although the wind was strong during the operation, we were able to identify the position of the landing point to extremely high accuracy. This was established as a result of the direction exploration method.
- The heat shield did not have a radio wave source, so an optical search using UAV (winged aircraft) was attempting for the first time. The error from the actual landing point was 50m or less, so we were able to demonstrate the technology as a powerful search method.
- We were able to collect all SRC components and deliver them to the QLF in just 11 hours after re-entry.



(image credit: JAXA)



### 3. Capsule collection team return report

# Capsule

## Capsule collection and safety processing

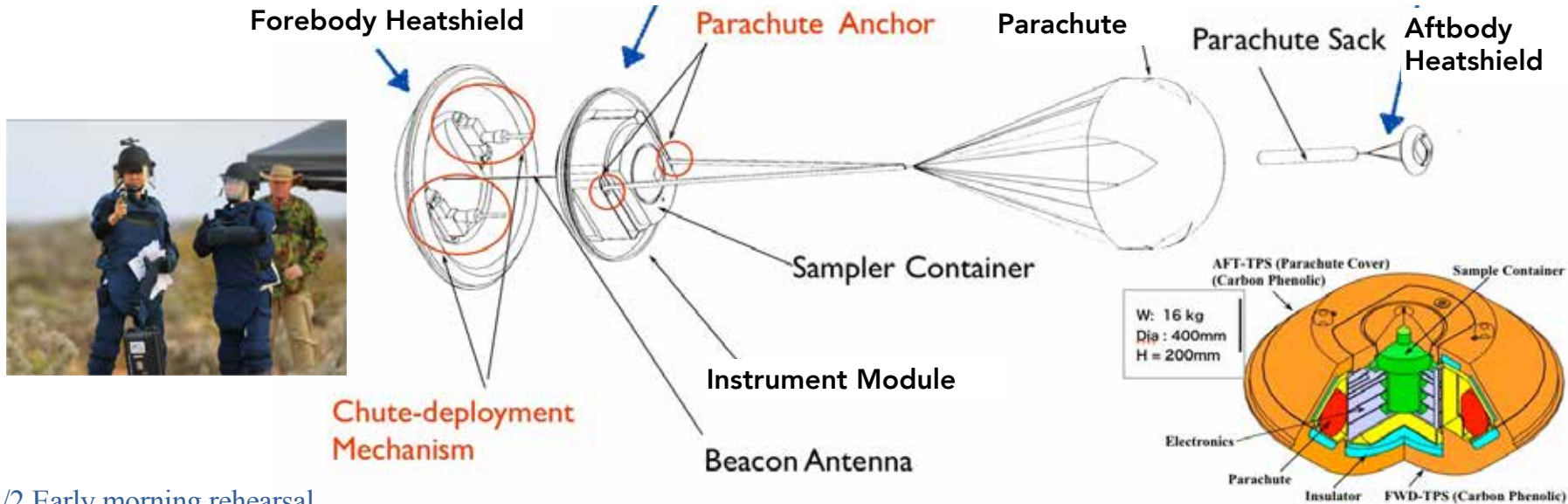

#### ■ 12/2 Early morning rehearsal

- Practice for an unexpected situation where the anchor had not separated (ad lib)
- Identify many safety issues and reflect them in actual operation (manual, work clothes, work)
- ✂ Discussion with DoD in Australia was particularly productive in overcoming issues and the success of the actual operation.

#### ■ 12/6 Early morning actual operation

- Rehearsal return? I/M with parachute remaining, anchor normal operation (no wind on ground).
- Perfect collection and safety work





### 3. Capsule collection team return report

## Confirmation of sound within the sample container at the QLF

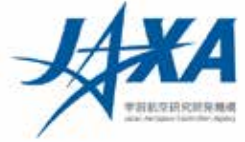

### ~QLF inside story~

- ❑ The process of processing the capsule safely, disassembling the instrument module and connecting the sample container to the gas sampling device requires several steps in order to turn the sample container upside down.
- ❑ If you measure the internal sound (vibrations) while turning the capsule over, it is possible you may hear something to indicate a sample is inside. Therefore, a high-performance microphone was attached to the flange surface of the sample container to measure noise.
- ❑ As the inside of the sample container is close to a vacuum, sound is transmitted only via the conducting metal parts and is very small, so cannot be heard directly by ear.
- ❑ Listening to the recorded sound revealed the noise of small, hard particles moving (personal impression: like the sound of glass beads)
- ❑ Based on general C-type meteorite analysis, a hard sound was not expected, we decided to analyze again at a later date (QLF work is carried out on a very tight timeframe, so we could not discuss it further at the time)
- ❑ After directly observing the particles in the catcher in the curation chamber, it was found that hard particles were included based on the feel of picking up the particles for vacuum storage. It is therefore probably that the sound heard at the QLF was the sound of the Ryugu sample.
- ❑ We decided to share the sound so everyone can hear the Ryugu sample!

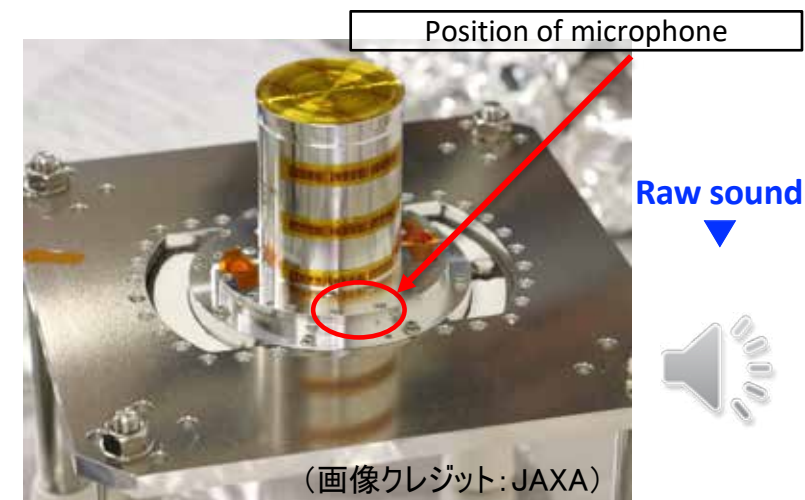





## 4. Observations of the Extended Mission target

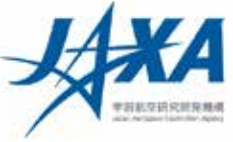

- At the end of 2020, there was an opportunity to observe asteroid 1998 KY26, which is the destination of the Extended Mission. The brightness was only about 25 mag, so a large telescope was required for the observation. The purpose of the observation was to improve the accuracy of the known orbit.
- Successful observations were completed with the Subaru Telescope of the National Astronomical Observatory of Japan (Hawaii, aperture 8.2m), the VLT and GTC.
- These observations will improve the accuracy of the known orbit of 1998 KY26 and allow a more reliable trajectory plan to be performed.

### **VLT (Very Large Telescope)**

4 x 8.2m caliber telescopes built by the European Southern Observatory (ESO) at the Paranal Observatory in Chile.

### **GTC (Gran Telescopio Canarias)**

A 10.4m telescope on the island of La Palma in the Spanish Canary Islands, led by the Canary Institute of Astrophysics (Instituto de Astrofísica de Canarias).



# 4. Observations of the Extended Mission target



Observation of 1998 KY26

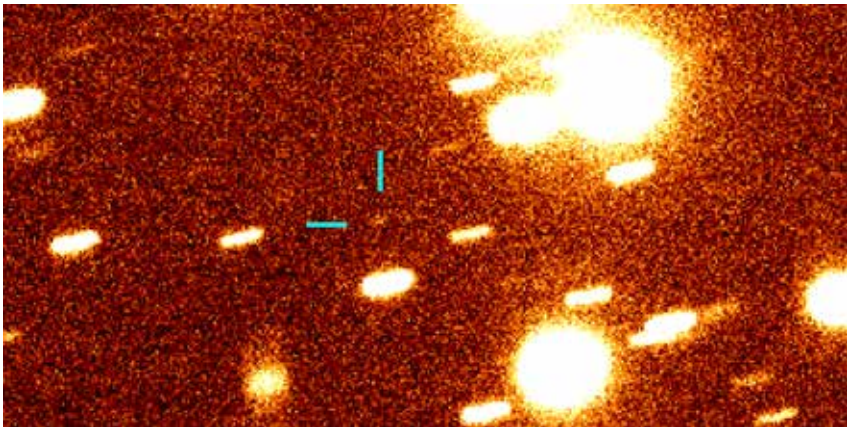

### Observations with the Subaru Telescope

Observation time: 2020/12/10 at 12:04-12:16 UTC

25.4 mag  
(image credit: NAOJ)

<https://www.nao.ac.jp/news/topics/2020/20201218-subaru.html>

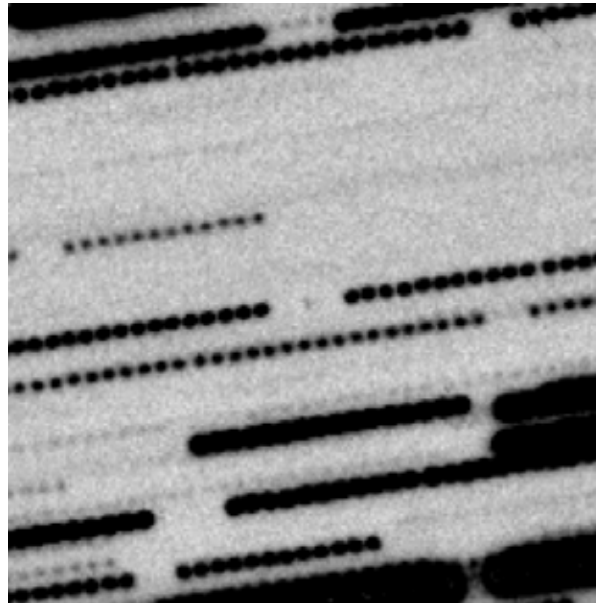

### Observations with the VLT

Observation time: 2020/12/10  
26.1 mag

(image credit: ESO / ESA NEOCC)  
<http://neo.ssa.esa.int>

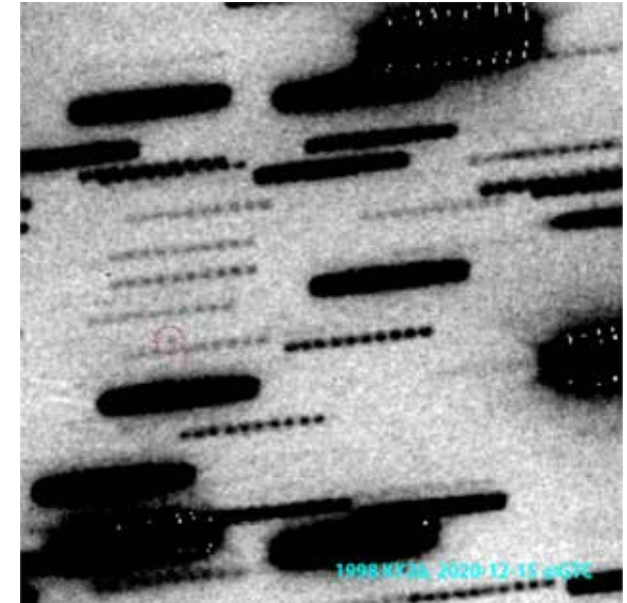

### Observations with the GTC

Observation time: 2020/12/15  
1:00-3:08 UTC

45s observations x 70 images  
(image credit: M. Popescu  
(Astronomical Institute of the  
Romanian Academy) /GTC/IAC)



## 5. Public relations / outreach



### Photographing the capsule fireball

- Time of fireball appearance:  
2:28:48 ~ 2:29:22 (JST)
- The track next to the capsule fireball track is likely Starlink-1190.



(image credit: JAXA)

Captured at Coober Pedy



## 5. Public relations / outreach



### 「Good-bye, Earth」 observation campaign

- Our planet Earth, seen from the receding Hayabusa2. Captured with the ONC-T.
- Photo: Japan time: 12/6~12 (distance approx. 200,000km ~ 2.5 million km)
- Data reveals the existence of abundant water and life (plants). The Earth image is useful as a check for the accuracy of the onboard sensors.

Left: Color composition

Right: Vegetation-weighted image

(image credit: JAXA, AIST, University of Tokyo, Kochi University, Rikkyo University, Nagoya University, Chiba Institute of Technology, Meiji University, University of Aizu.

(animation)



(animation)

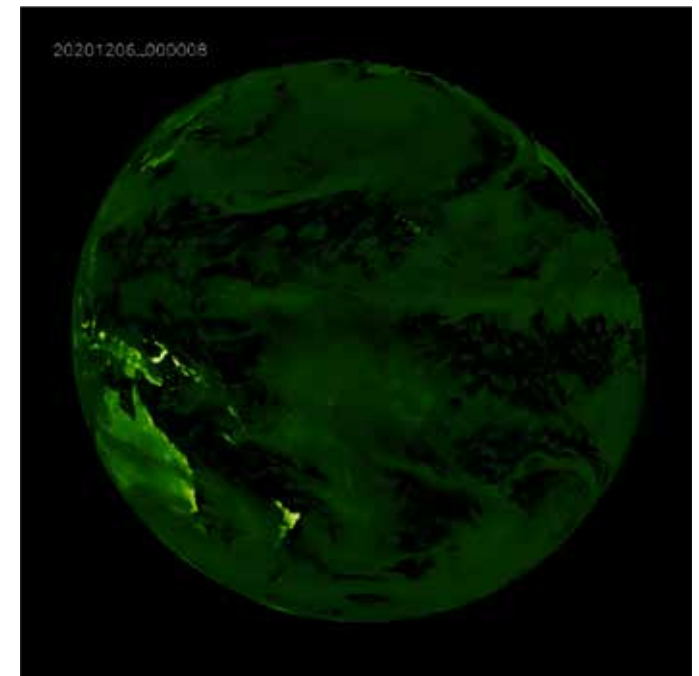





# 5. Public relations / outreach



## Ryugu & Hayabusa2 Return Observation Campaign Report

- Number of registrants : 135
- 77 successful observations of the Hayabusa2 spacecraft  
(10 additionally succeeded in observing the re-entry capsule)

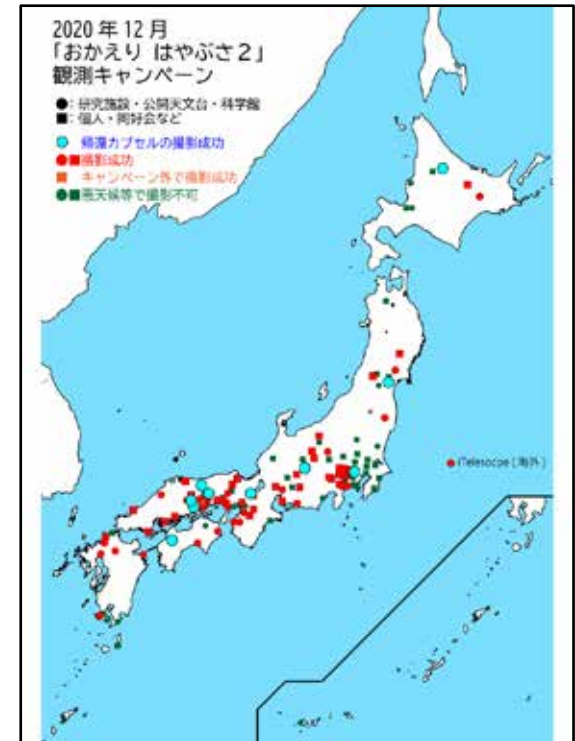

### Institutes that successfully observed the re-entry capsule

- Okayama: Kyoto U Okayama Observatory Seimei Telescope
- Nagano: Kiso Observatory, U. of Tokyo
- Hyogo: Nishiharima Observatory, Hyogo Prefectural U.
- Tottori: Tottori City Saji Observatory
- Tokyo: NAOJ Information Center
- Hokkaido: Nayoro Observatory, Hokkaido University Observatory
- Ehime: Kuma Kogen Astronomical Observatory
- Miyagi: Sendai Astronomical Observatory
- Okayama: Bisei Observatory
- Kyoto: Kayama Astronomical Obs. Kyoto Sangyo U.

(credit : JAXA, JAPOS, TPSJ)

Organizer : Hayabusa2 Project, Japan Public Observatory Society (JAPOS), The Planetary Society of Japan (TPSJ)

Campaign URL

JAPOS <https://www.city.himeji.lg.jp/atom/planet/info/campaign/haya2return/index.html>

TPSJ <http://planetary.jp/Haya2-Special/projects/hayabusa2-serv.html>



## 6. Future Plans

### ■ Operation schedule

Early 2021/1      ion engine operation begins

### ■ Press and media briefings

2021/1 TBD      Press briefing @ online

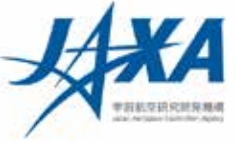

# Reference material



# Clean chamber overview

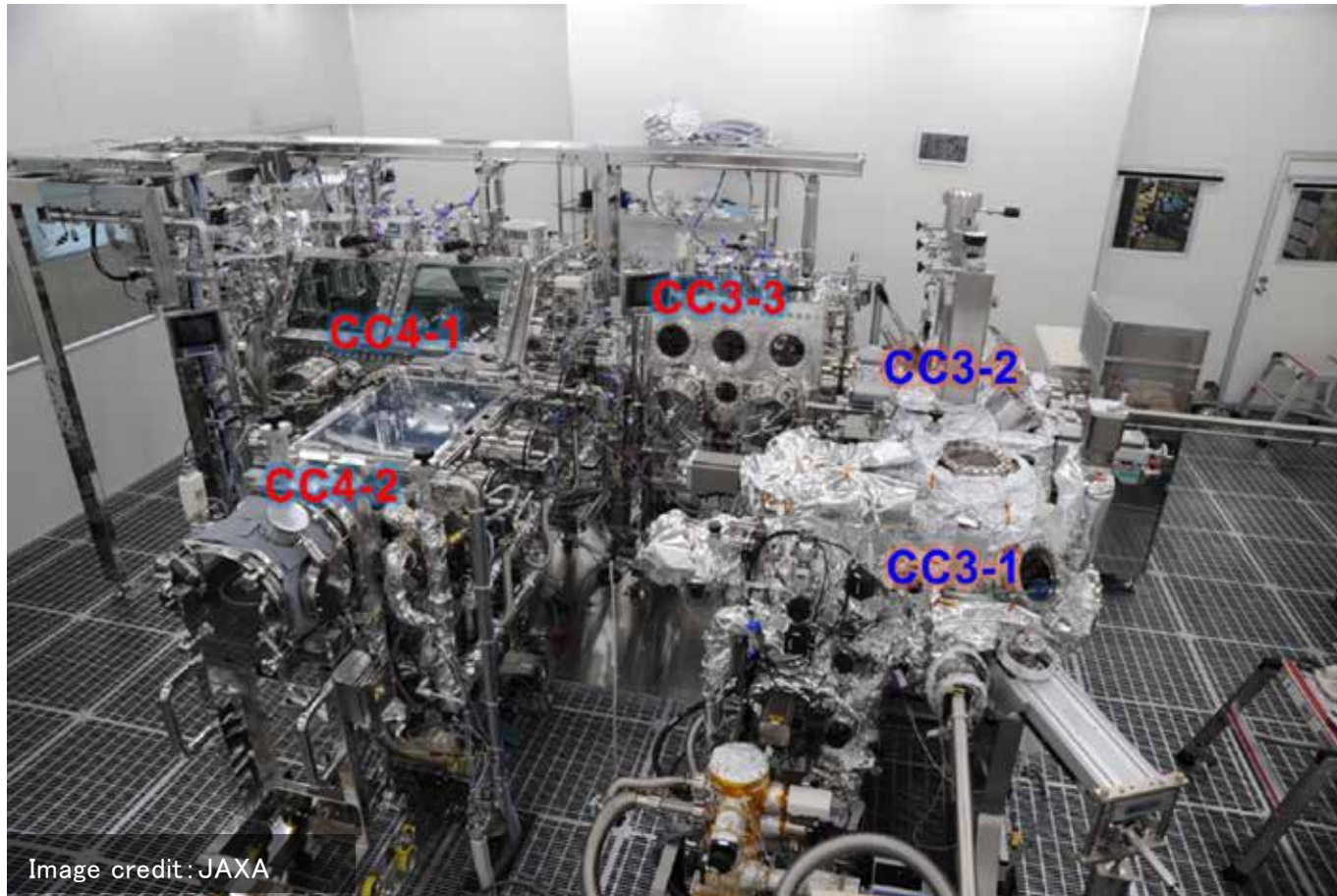

Image credit: JAXA

**CC3-1 :**  
**Opening the sample container under vacuum environment**

**CC3-2 :**  
**Sample collection under vacuum**

**CC3-3 :**  
**Transition from vacuum to nitrogen environment**

**CC4-1 :**  
**Handling of submillimeter-sized particles**

**CC4-2 :**  
**Handling / observation / sorting of relatively large particles (> mm)**





# Reference: Catcher opening operation

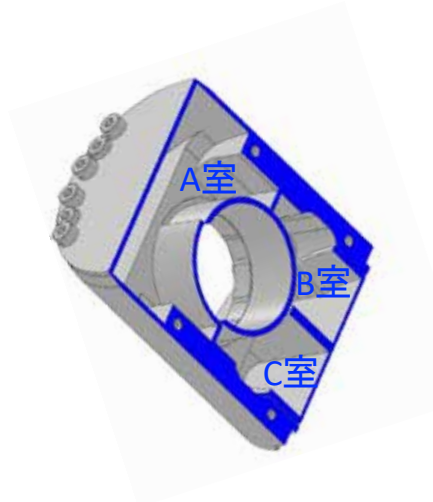
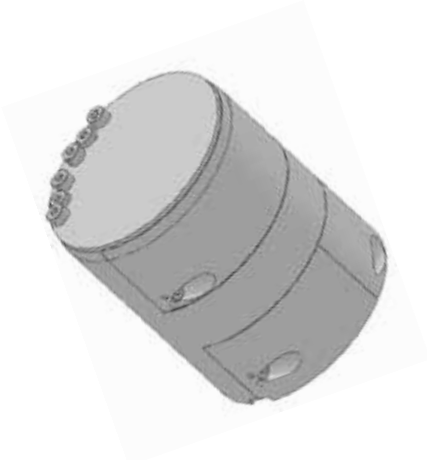

Particles are confirmed from above chamber A

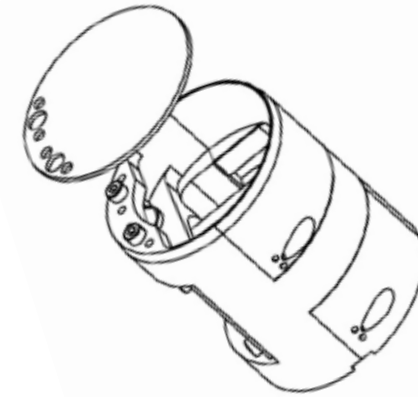

- ❑ The sample catcher was moved to clean chamber CC3-2, and the lid of sample catcher chamber A was opened in vacuum conditions.
- ❑ Many particles are confirmed to be in chamber A. This is thought to be the sample collected during Touchdown #1 on Ryugu.
- ❑ Part of the sample was picked up in Chamber A to be stored in vacuum in its present condition.
- ❑ From here, we will move to chamber CC3-3, remove the samples from chamber A in a nitrogen environment, and open chambers B and C.

(image credit: JAXA)

# Direction Finding System Team

- Tracking system after parachute deployment.
- 5 stations in the field track the capsule beacon using antenna, the azimuths are aggregated at headquarters, then identify coordinates of the capsule.

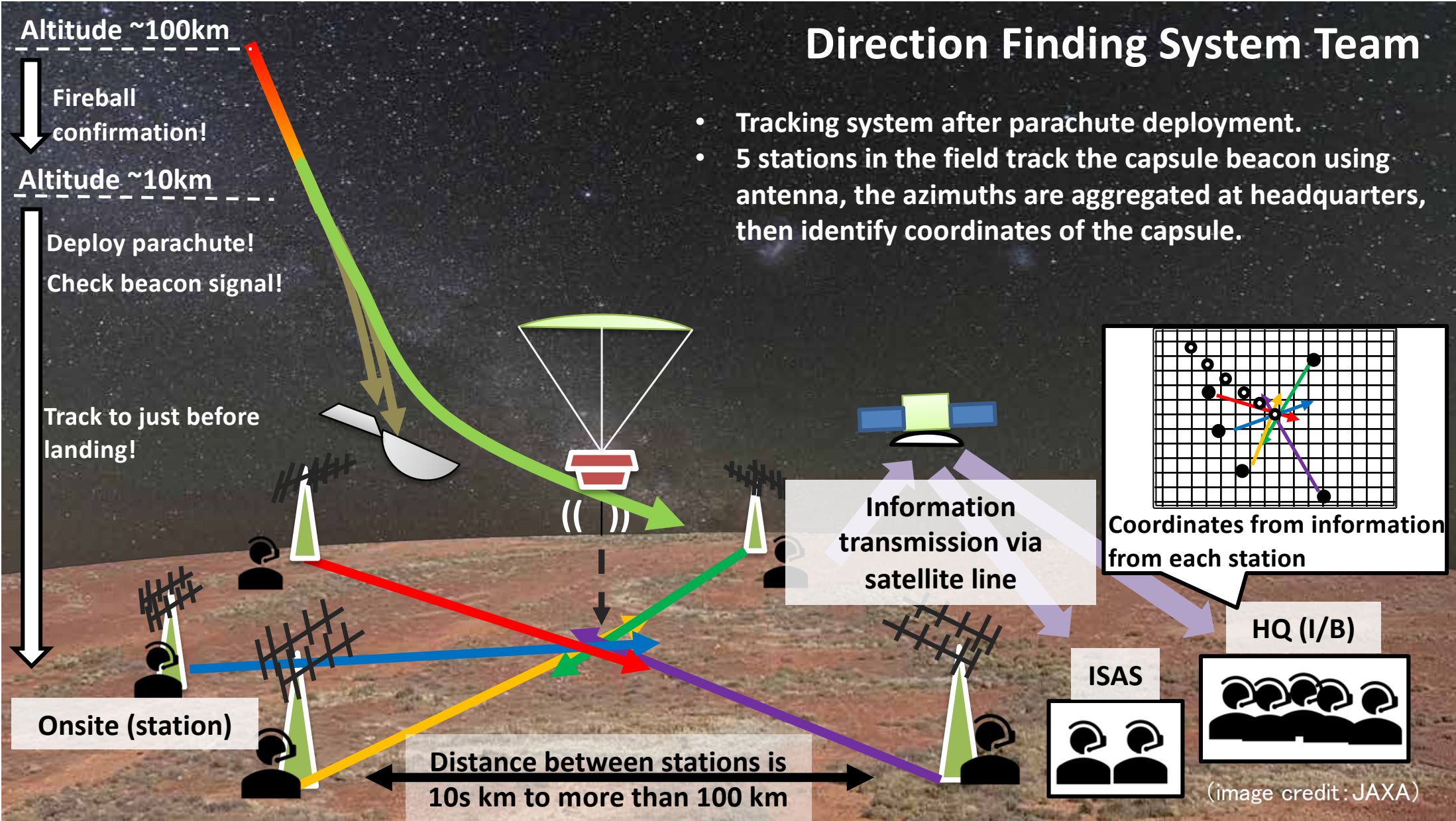





# DFS station members

(image credit: JAXA)

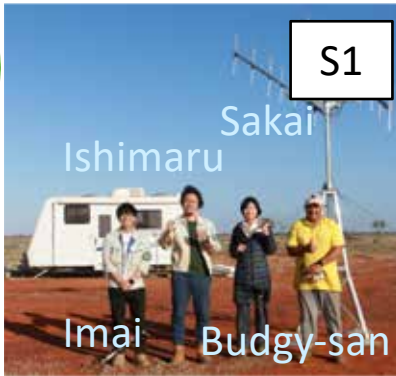

S1

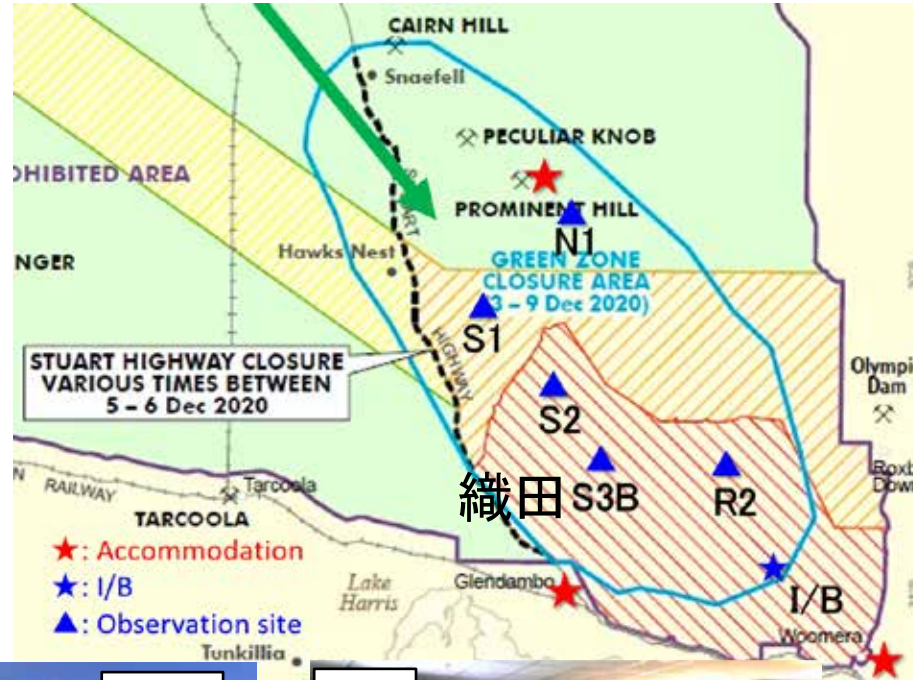

N1



S2

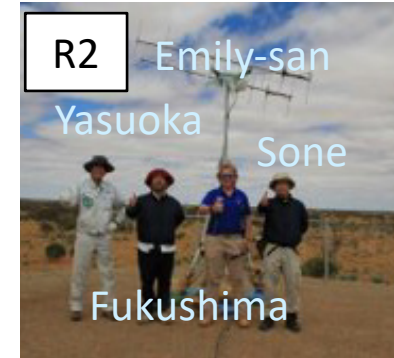

R2



S3B



I/B



ISAS@Japan



# Position measurement with Michibiki /MADOCA

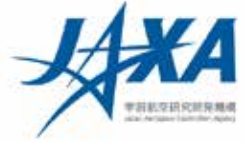





# Receiving station collapse & recovery



(image credit: JAXA)

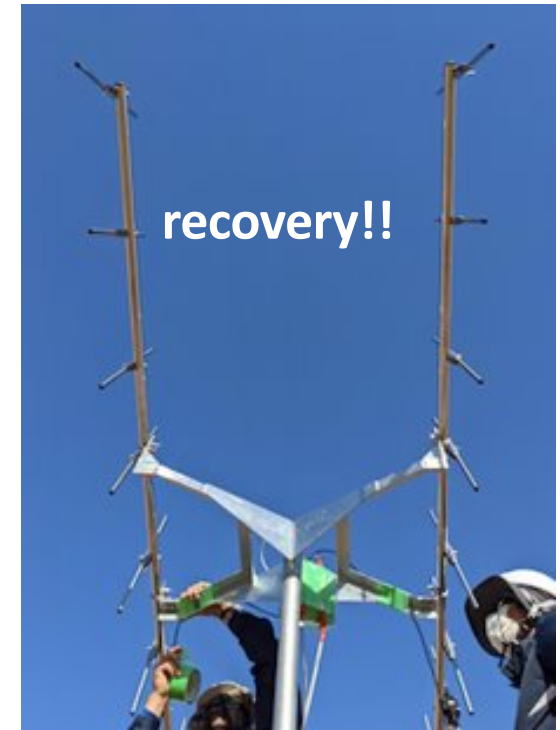

- The strong wind in the desert caused the gantry to fall and the antenna to bend.
- But repair was completed the next day with help by members of R2 onsite and headquarters. It worked without problems on the day of the return, and we were able to track the capsule with high accuracy.



# DFS(Voice) : ILPP Accuracy $\approx$ 200m

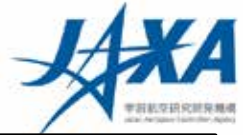

$\Delta\text{Lat}=213\text{m}, \Delta\text{Lon}=150\text{m}$



hy2rop-server1.local

roc @ server1 setting @ server1 HALD @ server1 WRC-1167052 衛星A-9

## HAYABUSA2 ILPP@SV1

17:54:00 UTC | 02:54:00 JST | 04:24:00 ACDT

DFS Input SET

Direction @DFS RCC Input Undo

	DFS-1	DFS-2	DFS-3	DFS-4	DFS-5
Time	04:23:00	04:23:00	04:23:00	04:23:00	04:23:00
Quality	Fair	Good	Good	Good	Good
Az[°]					
Az[°] ref					

PPI ILPP

Lat Lon I/M: Lat Lon

F-HS: Lat Lon A-HS: Lat Lon

Time	Lat[°]	Lon[°]
04:23:00		
04:22:00		
04:21:00		
04:20:00		
04:19:00		
04:18:00		

Time	Lat[°]	Lon[°]
04:23:00		
04:22:00		
04:21:00		
04:20:00		

Final stage, human judgement

ILPP: Instantaneous Landing Point Prediction

(image credit: JAXA)



# Information transmission by DFS phone (voice)

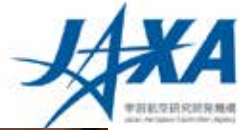





# Operation in the DFS (voice) caravan



Collimation station

Receiving station



(image credit: JAXA)





# Capsule fireball seen from the northernmost DFS station

(image credit: JAXA)