

PBB-TE Segment Protection Requirements for Consideration

Bob Sultan, Ben Mack-Crane, Deng
Zhusheng: *Huawei Technologies*

Purpose of this Presentation

- **The purpose of this presentation is to identify requirements for PBB-TE Segment Protection proposed by various parties for purposes of discussion;**
- **Support for this proposal does not imply support for any or all of the listed requirements;**
- **It simply implies agreement that the list accurately represents the set of requirements that are under consideration.**

Motivation for Segment Protection

- **Address the relatively high failure rate of particular links or bridges within a network.**
- **Address the likelihood of concurrent failures occurring in different segments of a network.**
- **Allow maintenance activities to be performed independently in different segments of the network.**
- **Allow maintenance activities to be performed in one segment of a network without disabling protection in another segment.**
- **Localize changes in traffic distribution due to failure or maintenance actions.**
- **Provide an efficient means of protecting portions of a PtMP TESI.**

Segment

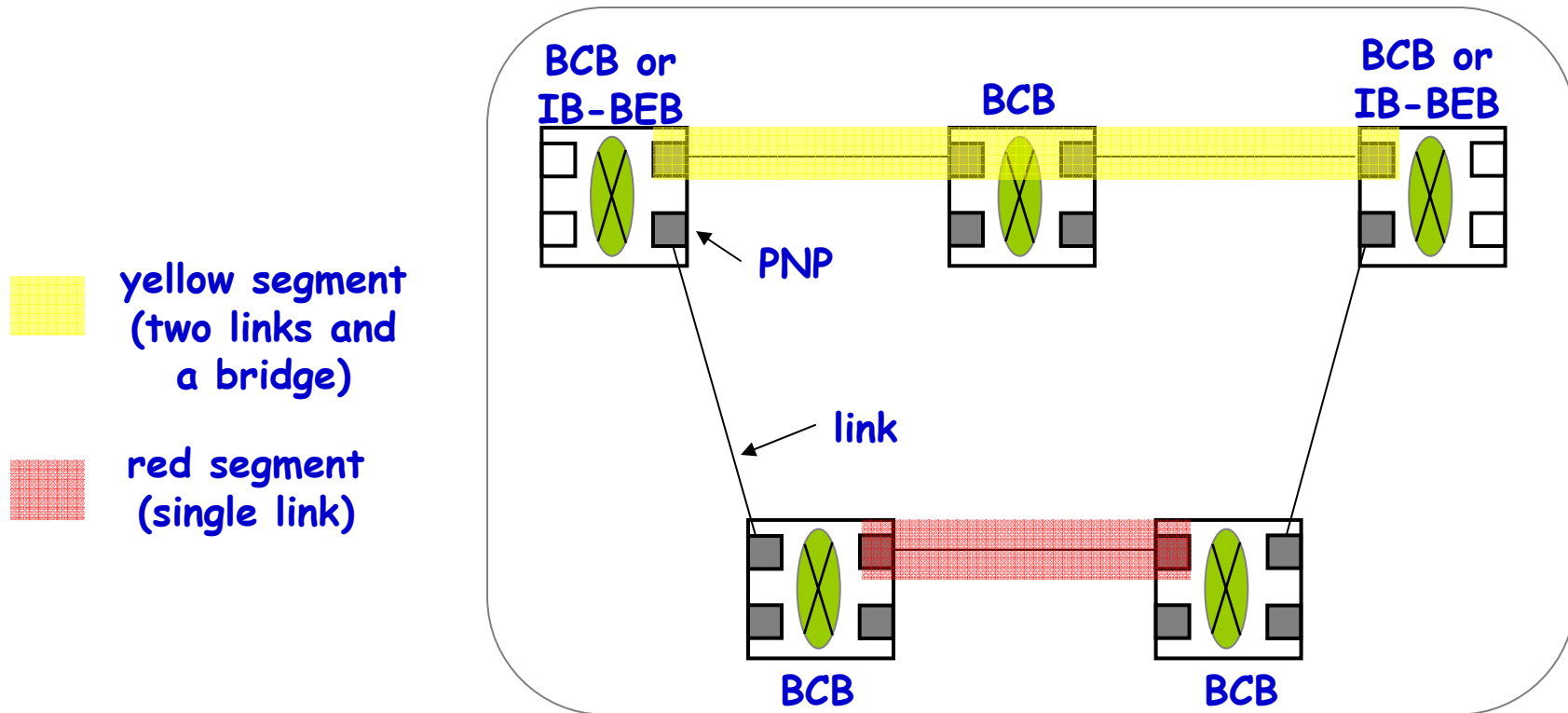

A *segment* is a single link, or a sequence of links and bridges, providing connectivity between two bridges. The segment is bounded at each end by a Provider Network Port (PNP). A bridge lying within the segment is a BCB. A segment endpoint bridge is a BCB or an IB-BEB. A segment is said to have failed when any component (link or bridge) of that segment has failed.

Primary and Backup Segments

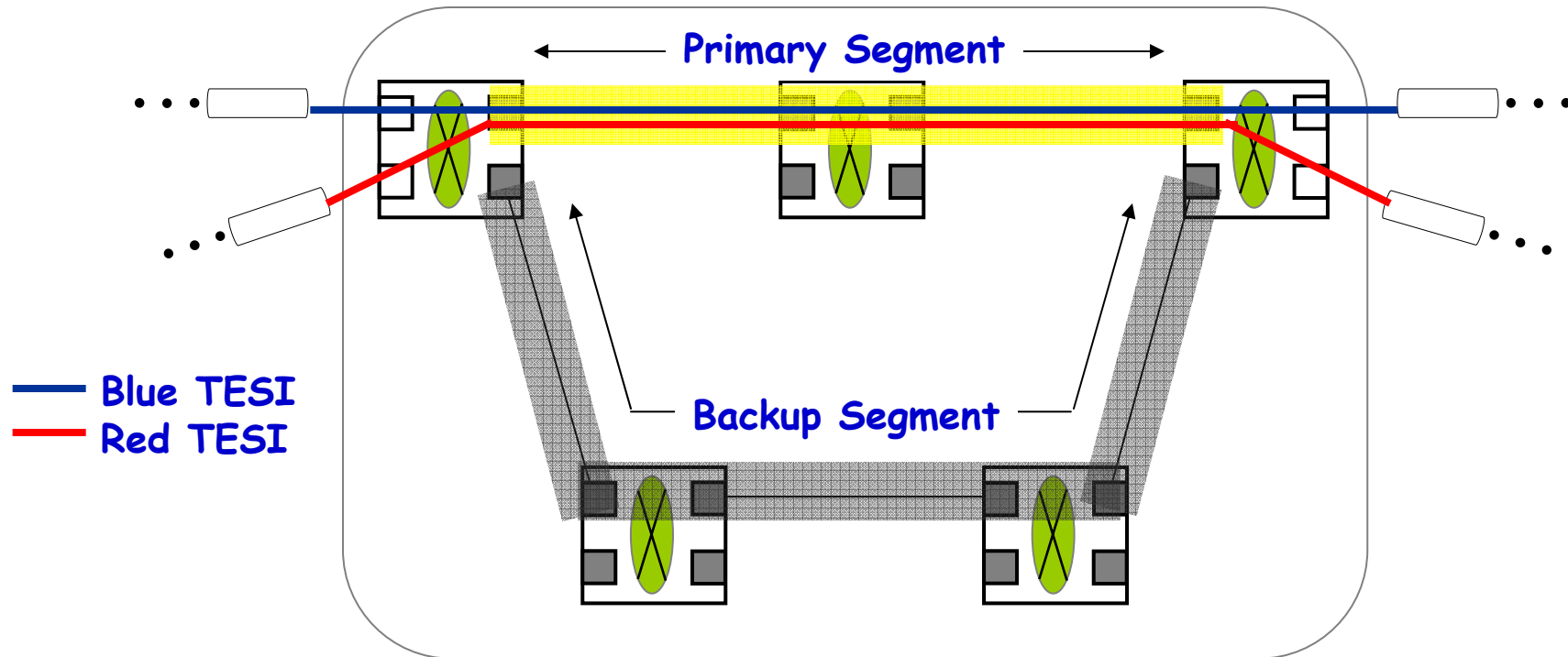

A *primary segment* is a segment along whose path one or more TESIS have been provisioned.

A *backup segment* is a segment having the same endpoint bridges as the primary segment but whose path is otherwise disjoint from the primary segment.

Active Segment

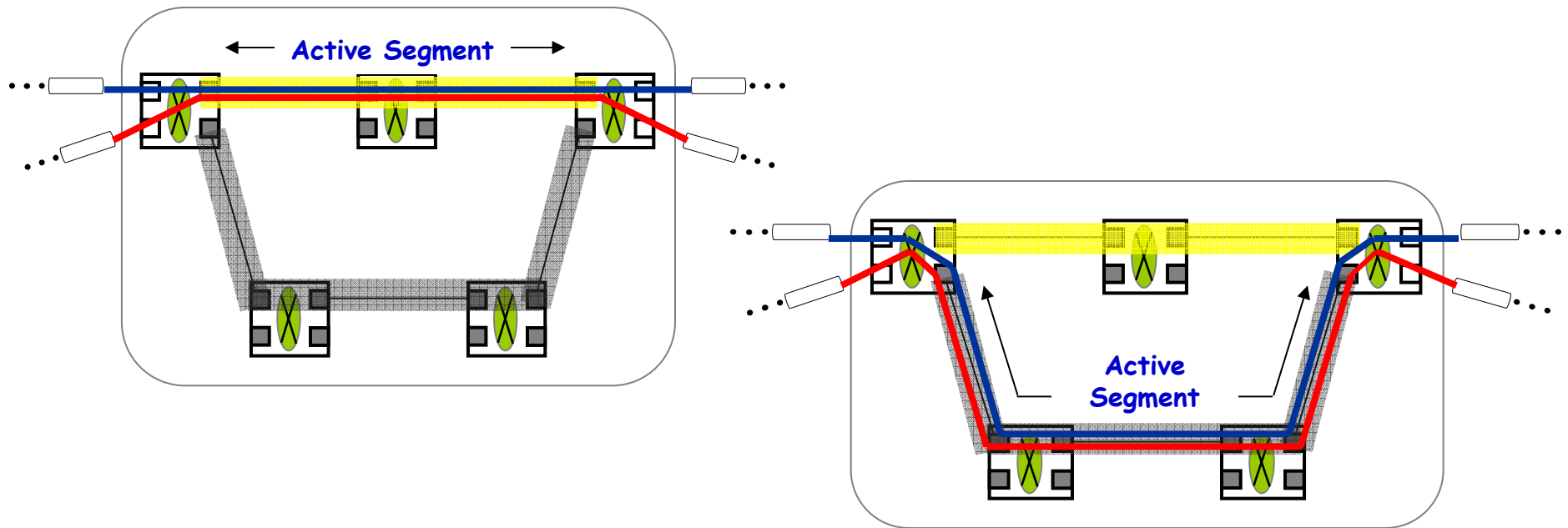

TESI traffic can be exchanged between the endpoint bridges via the primary segment or the backup segment.

The segment on which the traffic is exchanged is called the *active* segment.

Segment Protection Switching

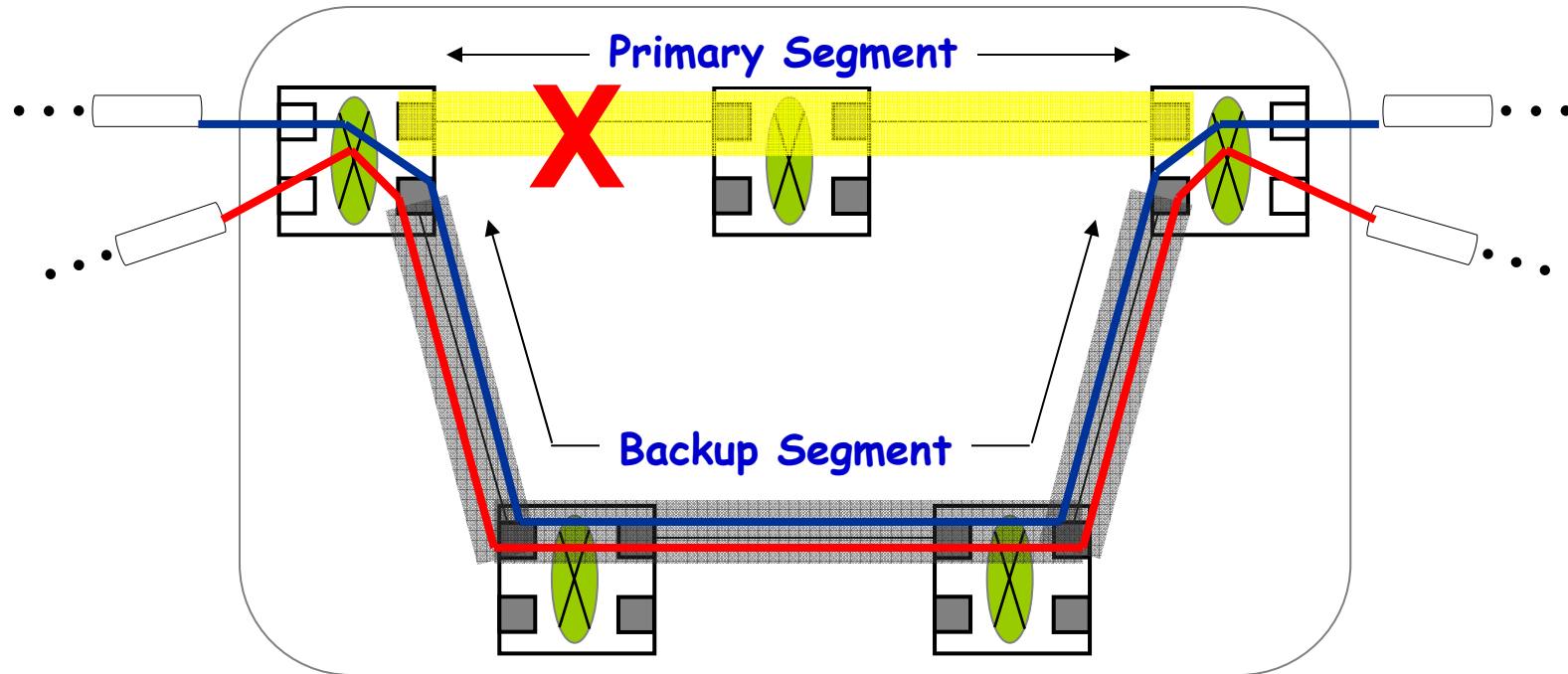

Segment protection switching is the redirection of TESI traffic from the primary segment to the backup segment or from the backup segment to the primary segment. Segment protection switching occurs as a result of a failure of the primary or backup segment and/or the issuance operator requests.

Segment Protection Domain

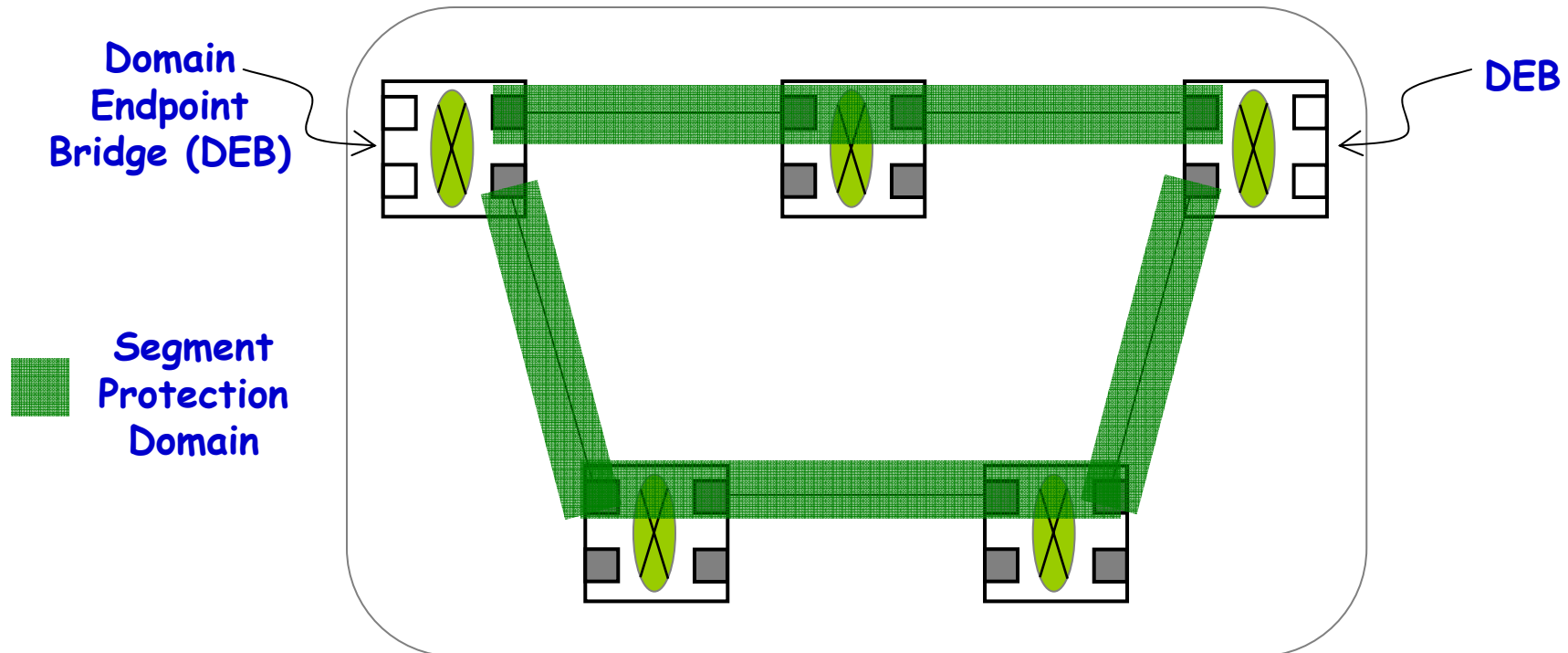

A segment protection domain consists of a primary segment and its associated backup segment.

The bridge at an endpoint of the primary segment (and of the backup segment) is called a *Domain Endpoint Bridge (DEB)*.

Shared Segment

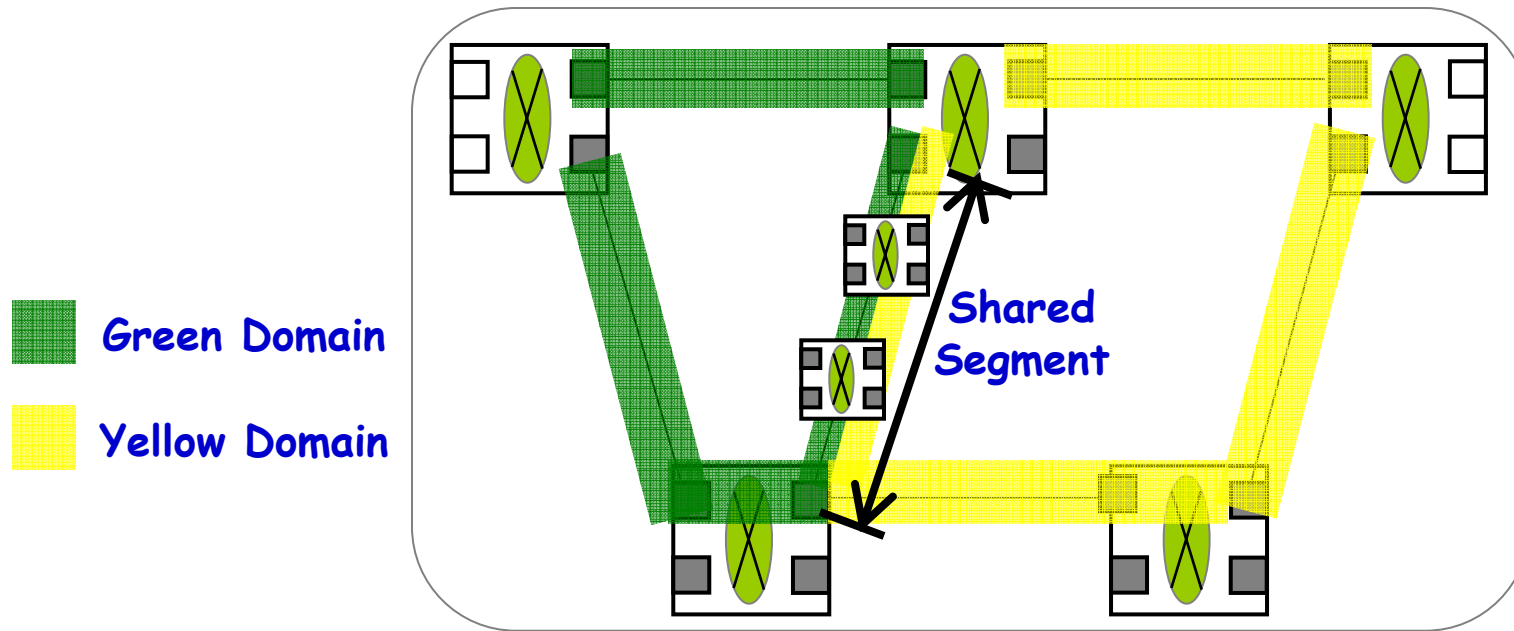

Two domains can share a sequence of links and intervening bridges (ie., a segment). Such a segment is called a *shared segment*.

The failure of a shared segment is considered to be a failure within *both* domains.

Primary and Alternate Bridges

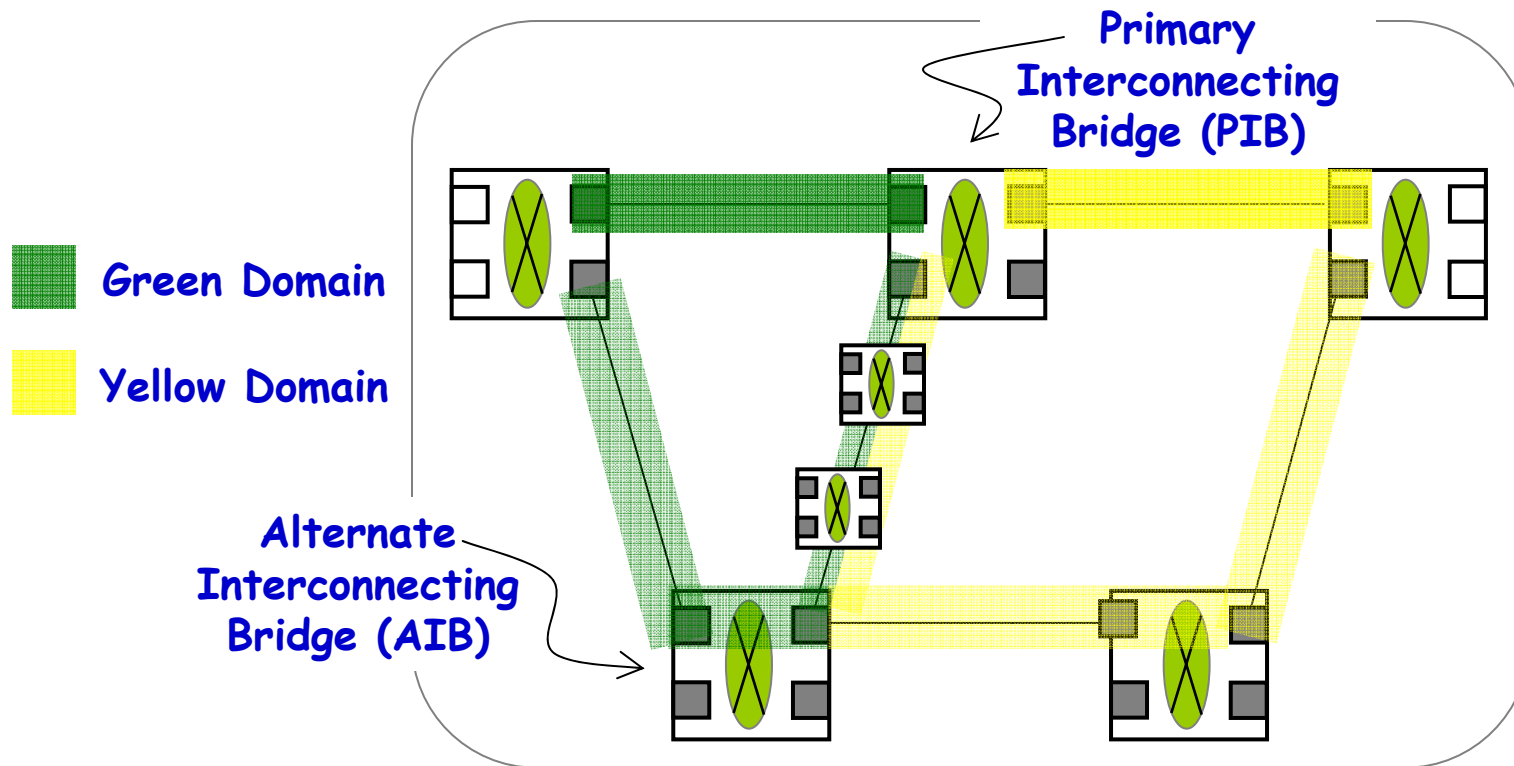

The bridge at the intersection of the primary segments is the *Primary Interconnecting Bridge (PIB)*. The bridge at the other end of the shared segment is the *Alternate Interconnecting Bridge (AIB)*.

M:1 Segment Protection

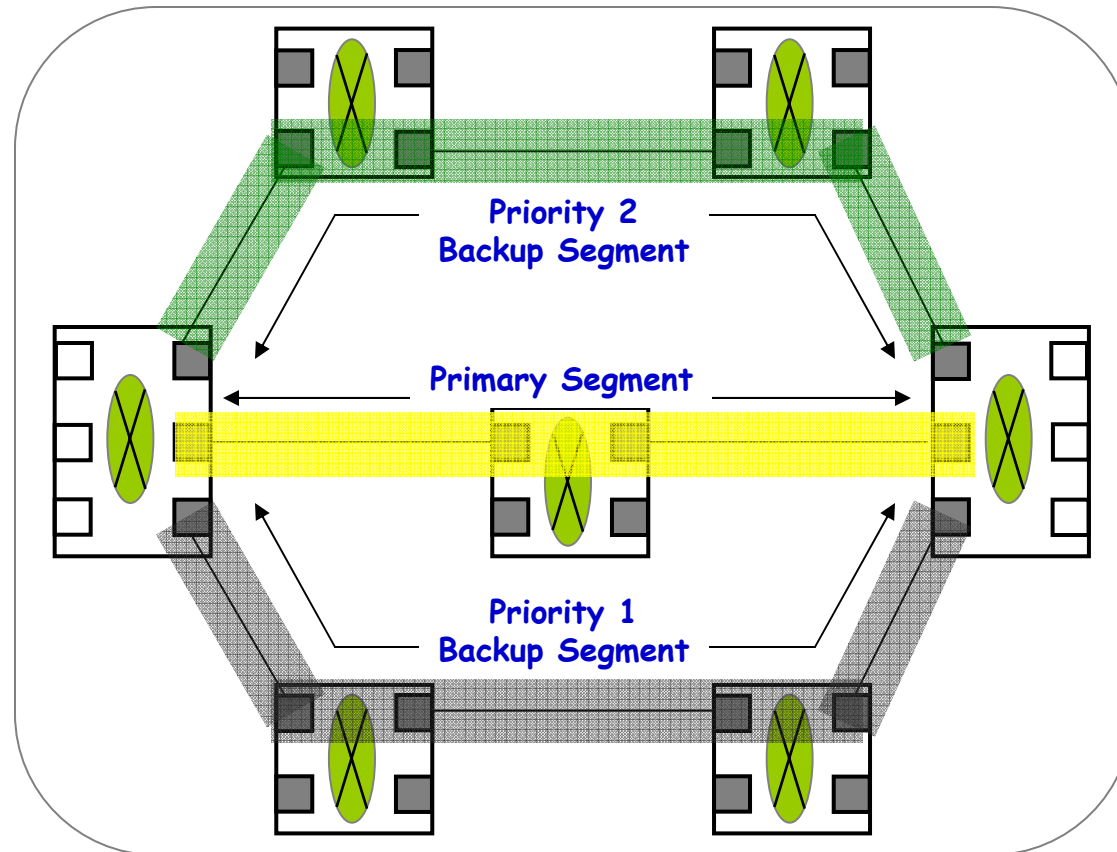

M backup segments ($M \geq 1$) may be associated with a primary segment. Backup segments become active in priority order.

Segment Protection *per* Domain



In both cases shown above a TESI survives a failure in *each* domain through which it passes.

Segment Protection Operator Requests

- **Clear** - An indication to clear all other administrative commands;
- **Lockout of Protection (LoP)** – An administrative command to prohibit the use of the backup segment;
- **Forced Switch** – An administrative command to switch to the backup segment;
- **Manual Switch to Backup** – An administrative command to switch to the backup segment if that segment is operational;
- **Manual Switch to Primary** – An administrative command to switch to the primary segment if that segment is operational;

NOTE: The above wording changes if M:1 protection is supported in order to account for cases of multiple backup segments.

Segment Protection Requirements for Consideration

- **Segment Protection** - Preserve connectivity of *all* TESI transiting a domain in the event of a single failure within that domain (see slide 8);
- **Domain Independence** – Preserve connectivity of a TESI in the presence of a failure in *each* domain through which that TESI passes (see slide 12);
- **Shared Segment** – Domains may be provisioned such that they share a segment (see slide 12);
- **M:1 Protection / prioritized backup segments** – (see slide 11);
- **Operator Requests** – FS, MS, LoP (see slides 13);
- **Operational Modes** – Revertive / non-revertive.

Guidelines

- **BCB-based** – Segment protection can be implemented by a BCB (possibly with minor modifications).