

EVS25

Shenzhen, China, Nov 5-9, 2010

Crashworthiness of Electric Vehicles

Toshiaki Sakurai¹, Takanobu Suzuki²

¹Mechanical engineering and system Course, Iwaki Meisei University, 5-5-1 Iino Chuodai, Iwaki, Fukushima 970-8551, Japan. E-mail: sakurait@iwakimu.ac.jp

²Graduate Student, Iwaki Meisei, University

Abstract

This paper describes the crashworthiness of electric vehicles when the vehicle has alterations from a gasoline engine to an electric motor. The crashworthiness is dependent on the crushable length of the frame and the center of gravity. It is presumed that the transfer of the center of gravity has the disadvantage in a crash.

Keywords: Electric Vehicle, Crashworthiness, Compatibility, Safety Regulation

1 Introduction

1.1 Regulation of Electric Vehicle (EV) for safety in Japan

The regulations regarding EV's have been issued [1]: 1) General rules of the electricity for the vehicle are the protection of the electric shock as follows: /to equip the direct covering with conductivity and/or non-conductivity, /to equip the indirect covering with conductivity and/or to condition equivalent voltages. 2) Rules for the occupant protection in general usages and accidents are as follows: /Parts must be distributed having high voltage at the place easily untouched from outside, /Harnesses having high voltage are colored orange, /Not to remove the connectors from the terminals by hand, /There is no damage of battery after accidents, /There is no damage of harnesses after accidents, /To fix firmly battery package after accidents, /Liquid does not leak from the vessel of batteries, As seen from these explanations, we have the regulations regarding EV's but we have not yet established the regulations regarding crashworthiness.

1.2 EV developed by using the used cars

We have developed an advance study on EV equipped with solar panels to commute in a local town [2]. The vehicle was given the license to operate in town in 2007.

Main specifications are as follows: /Direct motor, /Lead batteries, /Electric charger (100), /Electric plug-in charges.

In requirements of getting license in Japan, some conditions are not over the power than that having characteristic of power of the used-car. And also the safety regulations of the electric vehicle are enacted as shown in the former paragraph. Furthermore, by fundamentally studying solar cars in the solar car championship in Ogata Village in Akita Prefecture, Japan every year [3] ~ [5]. On the background pertaining to the electric vehicle, the social demand of the emission reduction of CO₂ for the prevention of global warming. The importance of the research and development of alternative energy has increased due to the depletion of fossil fuels. Therefore, development and popularization of low emission vehicles is an important issue for the well-being of the earth.

2 Results

2.1 Under-floor of EV produced by automakers

Recently, some electric vehicles are being produced all over the world for economic reasons. Many automakers have produced electric vehicles. Here, we research the structure of the under-floor of electric vehicles.

Mitsubishi i-Mive’s under-floor is shown in Figure 1[6]. Nissan Leaf’s under-floor is shown in Figure 2 [7]. As shown in these Figures, heavier batteries are installed under-floors.

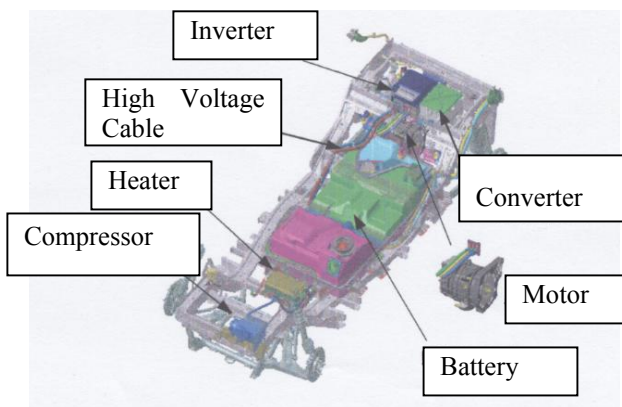

Figure 1: Under-floor of the Mitsubishi i-Mive [6]

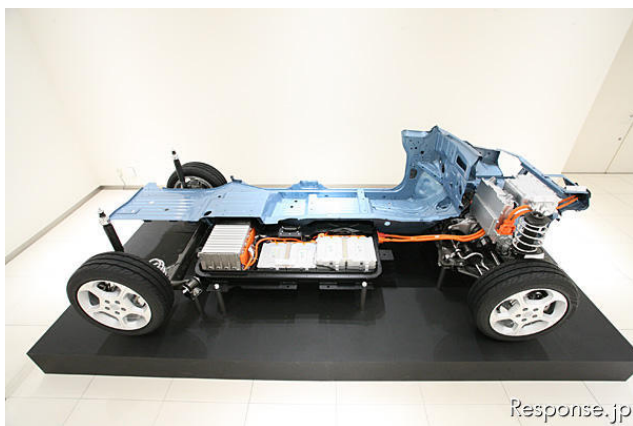

Figure 2: Under-floor of the Nissan Leaf [7]

Therefore, the centers of gravity transfer to the underneath positions compared to the current vehicles. And also the crashworthiness of electric vehicles is presumed to change as the point view of crushable length. As the electric motors are not

installed into the engine compartments, crashworthiness is changed dramatically in the case of the frontal crash.

2.2 Modification to the EV

Two types of vehicles in the Japanese market have been selected. First, the ordinary vehicle from the used-car in Japan is selected. The engine is installed in the engine compartment in the ordinary vehicle. Main specifications are indicated in Table 1.

Table 1: Main specifications of the ordinary vehicle

Category	Ordinary vehicle
Length (mm)	3,950
Width (mm)	1,670
Height (mm)	1,230
Vehicle weight (kg)	990

Schematic drawing of the ordinary vehicle is shown in Figure 3.

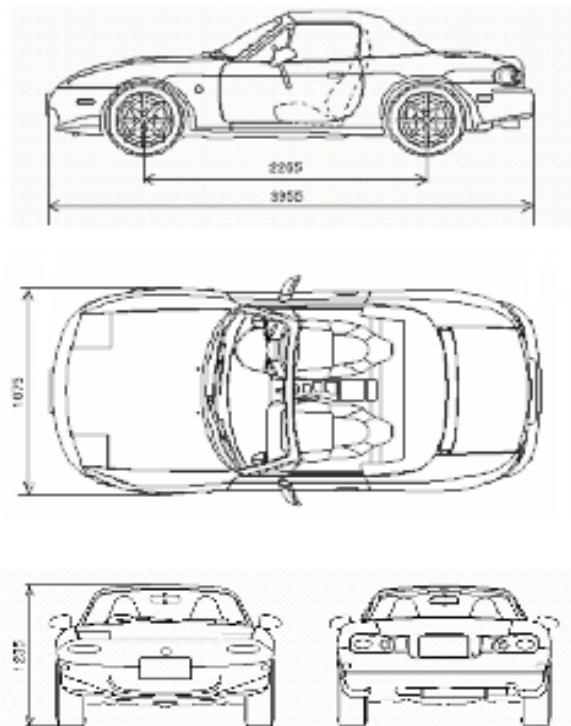

Figure 3: Schematic drawing of the ordinary vehicle

Second, the small vehicle from the used-car in Japanese market is selected. The engine is installed under the front passenger's seats. Main specifications are indicated in Table 2. Schematic drawing of the ordinary vehicle is shown in Figure 4.

Table 2: Main specifications of the small vehicle

Category	Small vehicle
Length (mm)	3,295
Width (mm)	1,395
Height (mm)	1,920
Vehicle weight (kg)	830

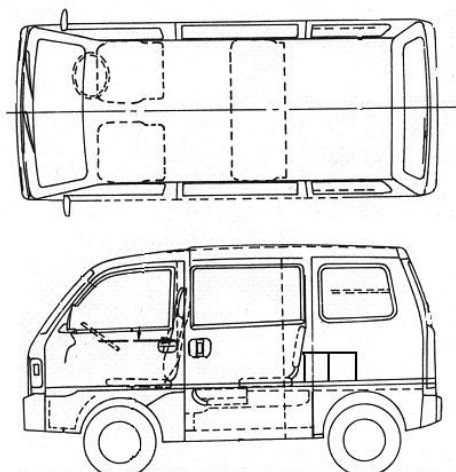

Figure 4: Schematic drawing of the small vehicle.

These vehicles are modified to the electric vehicle from the vehicle equipped with an engine. Parts related to the fuel systems such as gasoline engine, fuel tank and etc. are removed and parts related to electricity such as motor, some batteries and etc. are installed.

2.3 Crashworthiness of modified EV

2.3.1 Changing of the distribution of the center of gravity

In order to research the crashworthiness of the modified electric vehicles, the distribution of the center of gravity is studied and the affect the crashworthiness of vehicle. The crashworthiness is affected by the mass and distribution of the center of gravities of vehicles. When the gravity of mass is located straight to the frames, an axial load is applied to the frames. If the eccentricity to the frame is changed by the location of the gravity of mass, the bending moment occurs to the frame. In the case of electric vehicles modified from the used-cars, the center of gravity of electric vehicles has a tendency to a lower position because the size of the motor is smaller than that of the engine and also the batteries are located underneath compared to the current vehicles. Table 3 shows the comparison of changing the distribution of the center of gravity calculating the height from the engine mount equipped with the front frame. As shown in Table 3, the gravity of the EV transfers to the engine mount and the center of gravity of the vehicle transit to the underneath area.

Table 3: Center of gravity

Vehicle	Height from the engine mount (mm)
O-Car	210
EV	100

The mass such as the engine and the motor affects the buckling load and buckling mode through the mount equipped with the front frame.

Here, the effect of deviation as the input load is considered. The differential equation of the deflection is

$$EI_z \frac{d^2 y}{dx^2} = P(\delta + e - v) \quad (1)$$

The equation (1) shows the effect of deviations. By considering the initial conditions, the equation (2) is obtained [8].

$$P = \frac{2EI_z \delta}{el^2} \tag{2}$$

Here, P : Concentrated load, E : Modulus of elasticity, I_z : Moment of inertia of a plane area with respect to the z -axis, l : Length, e : Eccentricity, δ : Deflection.

The equation (2) shows that the load is in inverse proportion to the eccentricity e . To make the center of gravity transfers to the underside direction means the buckling load changes. By using this equation, the effect of the eccentricity is calculated under certain conditions as shown in Figure 5. Figure shows the relationship between the maximum stress and the eccentricity of the impact loads. As shown in Figure, the maximum stress has tendency to increase, as the eccentricity is larger.

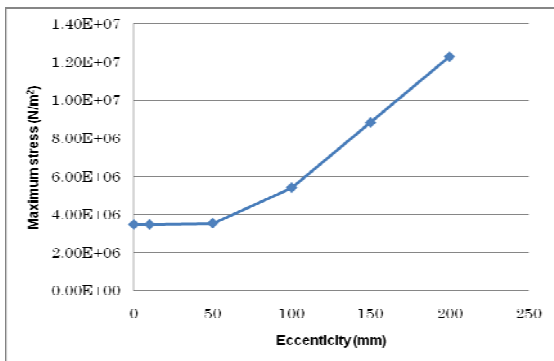

Figure 5: Relation between the effect of eccentricity and maximum stresses

2.3.2 Crushable length

In order to research the crashworthiness of the modified electric vehicles, the crushable length of the frame in the vehicle is introduced. The frontal crushes are noticeable in this case.

Definition of the crushable length [9]

There are frontal tests such as a full-lap rigid barrier test, an offset deformable barrier test, a pole test and an oblique rigid barrier test. The full-lap rigid test is objective in this case. In order to secure

survival spaces for passengers, deformation of the frontal frames distributed in the engine compartment absorbs the impact energy. The crushable length of the frame in the vehicle is defined as shown in Figure 6.

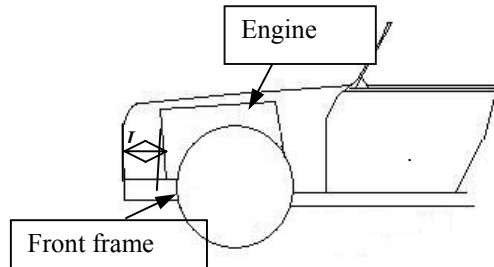

Figure 6: Definition of crushable length

As shown in the Figure, it is calculated by formula (3).

$$L_c = L_f - L_e \tag{3}$$

Here, L_c : Crushable length, L_f : Length of the front frame, L_e : length of the engine

According to the definition of the crushable length (3), these crushable lengths are calculated as shown in Table 4.

Table 4: Crushable lengths L_c

	L_c	L_f	L_e
O-Car	630	1170	540
S-Car	650	1120	470

In the case of the motors installed in the engine rooms, calculated results are shown in Table 5 included the differential quantity $\Delta L = L'_c - L_c$.

Table 5: Crushable lengths in the case of motors

	L'_c	$\Delta L = L'_c - L_c$
O-Car	720	90
S-Car	750	100

Therefore, the maximum buckling loads are calculated by using the load-displacement curves of actual vehicles. The load-displacement curves are shown in Figure 7. The load-displacement curve of a current vehicle is shown in a solid line. To simplify the discussion, complex curve of the current vehicle is assumed to be a straight line in the Figure.

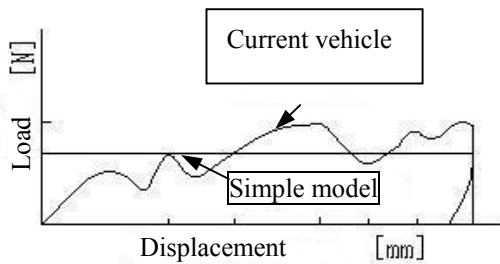

Figure 7: The Load-Displacement curves

By utilizing the Figure 7, the crushable lengths are discussed to the comparison of current vehicles with engine and electric vehicles with motor as shown in Figure 8. Here, areas of the load-displacement curve equal to the motive energy, called impact energy.

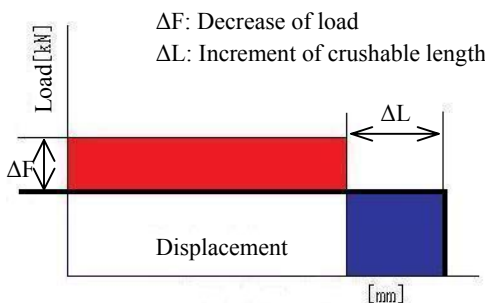

Figure 8: Consideration of load and crushable length

On the basis of the crushable length in Table 5, so

to speak, impact energy is equal to each vehicle and the load-displacement curve is shown in Table 6. The decrease of loads is calculated with relation to the increment of crushable lengths. Calculated results are shown in Table 6.

Table 6: Extension of crushable length

Name	ΔL (mm)	ΔF (kN)	Ratio of loading
S-CAR	100	9	14%
A-CAR	90	17	13%

Next, we will look at the stress from buckling loads. The configuration of the front frame of current vehicles is a hat-shaped frame as shown in Figure 9.

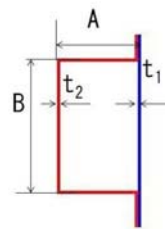

Figure 9: Hat-shaped frame

By using the equation (4), we can calculate the thickness of the frames of each vehicle.

$$P = A \sigma \tag{4}$$

Here, A : sectional areas. The yield stress is presumed to be equivalent to SPC material in calculations. Calculated results are shown in Table 7.

Table 7: Thickness of frames

Name	S-CAR		A-CAR	
	Current	Thickness	Current	Thickness
t_1 (mm)	1.1	More than 0.38	1.2	More than 0.40
t_2 (mm)	1.4	More than 0.25	1.8	More than 0.36

FEM Model

In order to confirm the calculated results, we use the Finite Element Method (FEM). Figure 10 shows the calculated results of stress distributions of pipes with rectangular shape. The square pipe measures 80 mm wide by 500mm long by 1.5mm thick. As shown in the Figure, stress contribution range is concentrated into the center of pipe as the eccentricity is increase. Here, the upper level displayed in the Figure shows the higher stress level. Figure 11 shows the relationship between the maximum stress and the eccentricity of the impact loads. As shown in the Figure, the maximum stress has tendency to increase, as the eccentricity is larger.

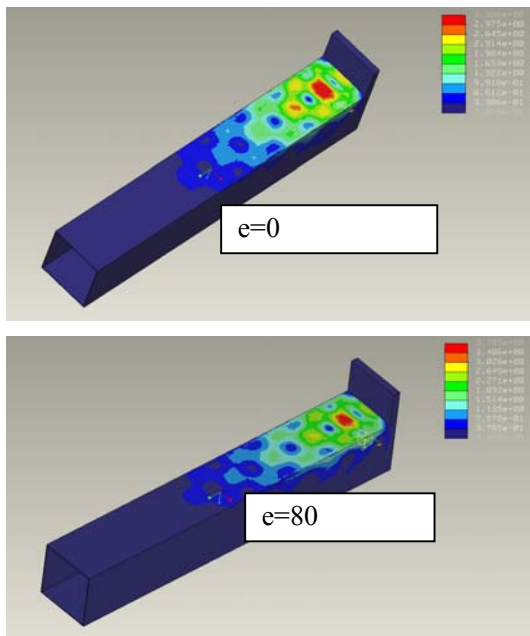

Figure 10: Calculated results of stress distributions

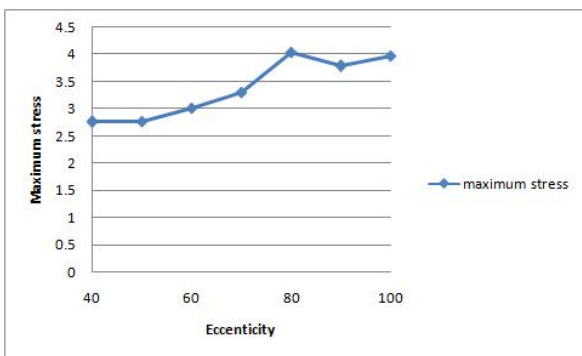
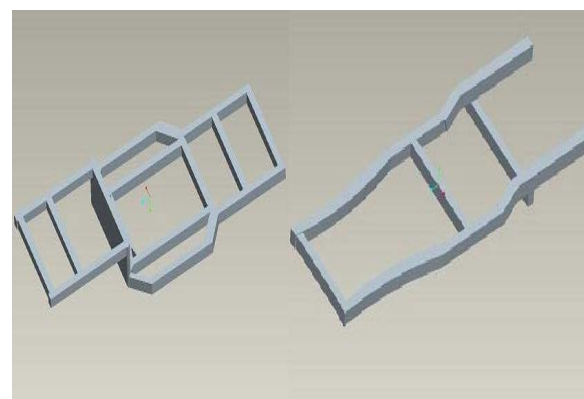

Figure 11: Relation between eccentricity and stress

We calculate the stress distribution of the front frames of the actual vehicles by utilizing the Finite Element Method (FEM). First, we make the models of frames by the Computer Aided Design (CAD) as shown in Figure 12.

Next, frontal body structures separated from the whole body of the ordinary vehicle are an available use for calculation by FEM as shown in Figure 13. Main calculated conditions are as follows: Load: Compression, Support: Fixed support, Model: Shell.



(a) Ordinary vehicle (b) Small vehicle

Figure 12: Whole body structures by CAD models

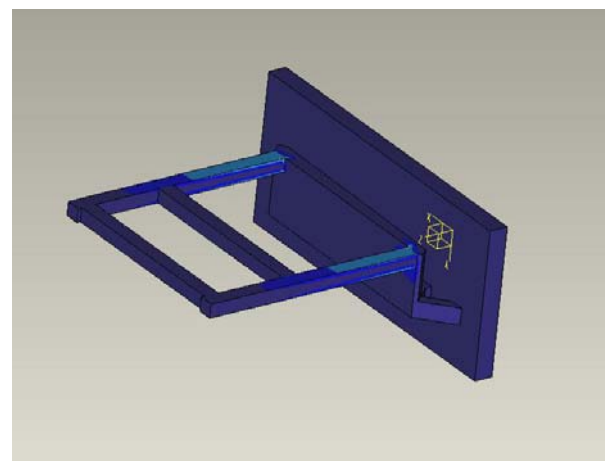

Figure 13: Calculation of frame by FEM

2.4 Compatibility

The compatibility is defined as the capability of existing together in harmony [10]. In case of the usability of vehicles, users can drive any electric

vehicle without confusion. Also, if some equipment have similar operating functions, then it is easier for driving. In the case of post-accident, rescue workers do well to cut the body of the car without electric shock to rescue passengers from the inner compartment. In the final case of impact, the compatibility of crash of vehicles is discussed as the aggressiveness and the defensiveness. The concepts of these words are completely different. The concept of aggressiveness used in the discussion of compatibility is widely known and the center of force (COF) and the average height of force (AHOF) are measured [11]. Here, frontal forces of front frames are considered under impact conditions such as vehicle weight, and impact speed being equivalent to each vehicle. From these points, the electric vehicle made from the used-car has the advantage of crushable length; on the other hand, it has the disadvantage of transferring the center of gravity.

3 Conclusions

From environmental standpoint, we hope to see more electric vehicles in consideration of the circumstances. Electric vehicles will operate in urban areas as a commuter car and its characteristics will be recognized. The electric vehicles are modified from used-cars. It is important for the electric vehicle to establish the standardization regarding the operations, rescue of passenger from the compartment and the crashworthiness. In discussion the crashworthiness of the electric vehicle, it is found that crashworthiness is affected from the center of gravity and the crushable length of the front frame. Also, the compatibility of each electric vehicle is discussed. Some results are summarized as follows:

3.1 Crashworthiness

1. Displacing the engine to the electric motor in the vehicle is to change the center of gravity.
2. Changing the center of gravity means to change the crashworthiness of vehicle.
3. It is important to notice the crushable length of the frame to inspect the crashworthiness.

4. Improving the crushable length means to design the reasonable body structure.
5. That technology might develop the weight reduction.
6. In the near future, some requirements of crashworthiness of the electric vehicle will be necessary to establish.

3.2 Compatibility

Frontal forces of front frames are considered under impact conditions such as vehicle weight, and impact speed being equivalent to each vehicle.

1. The electric vehicle made from the used-car has the advantage of crushable length; on the other hand, it has the disadvantage of transferring the center of gravity.
2. It will be related to establish the standardization thought the world.

References

- [1] Ministry of Land, Infrastructure, Transport and Tourism in Japan, <http://www.mlit.go.jp/report/press/>, 2010.3.11.
- [2] T. Sakurai, An advance study on electric vehicle equipping solar panel transferring to commute to office in local downtown, Proceedings of the EVS 22, 2034-2039, October, 2006.
- [3] T. Kobayashi and T. Sakurai, The development of electric vehicles equipped with solar cells in local downtowns, Proceedings of the 2008 Annual Meeting of JSAE Tohoku Regional Student Division, 208, March 2008 (Japanese).
- [4] Y. Sawamura, T. Suzuki and T. Sakurai, Study on crashworthiness and compatibility of electric vehicle, Proceedings of the 2010 Annual Meeting of JSAE Tohoku Regional Student Division, 908, March 2010 (Japanese).
- [5] S. Ebata and T. Sakurai, The development of popularized electric vehicle equipped with solar cells to commute to work in local down towns, Proceedings of the 2007 Annual Meeting of JSAE Tohoku Regional Student Division, 411, March 2007 (Japanese).
- [6] H. Yoshida, The Advance of Electric Vehicles in the New Energy Age, MITSUBISHI

MOTORS Technical Review 2010 No.22
(Japanese).

- [7] <http://autos.yahoo.co.jp>.
- [8] S. Timoshenko, Strength of Materials, 1955.
- [9] T. Sakurai and T. Aoki, On the Safety Body Structure of Finite Element Method Analysis, 12 International Technical Conference of Experimental Safety Vehicle (ESV), 89-2A-O-015, 1989.
- [10] Webster's New Encyclopedic Dictionary.
- [11] Y. Sekine, et al., Compatibility between sports-utility vehicles and sedan-type vehicles, International Journal of crashworthiness, Vol.13, No.5, October 2008, 551-55.

Authors



**Professor, Dr. Eng.
Toshiaki SAKURAI**
Iwaki Meisei University
5-5-1 Iino Chuodai, Iwaki,
Fukushima 970-8551, Japan,

Tel: +81-246-29-7180

Fax: +81-246-29-0577

E-mail: sakurait@iwakimu.ac.jp



**Graduate Student
Takanobu SUZUKI**
Iwaki Meisei University
5-5-1 Iino Chuodai, Iwaki,
Fukushima 970-8551, Japan,
Tel: +81-246-29-7180

Fax: +81-246-29-0577

E-mail: mk0902@iwakimu.ac.jp